

Network Infrastructure
Enterprise Data Center Industrial



EMEA

Panduit Network Infrastructure

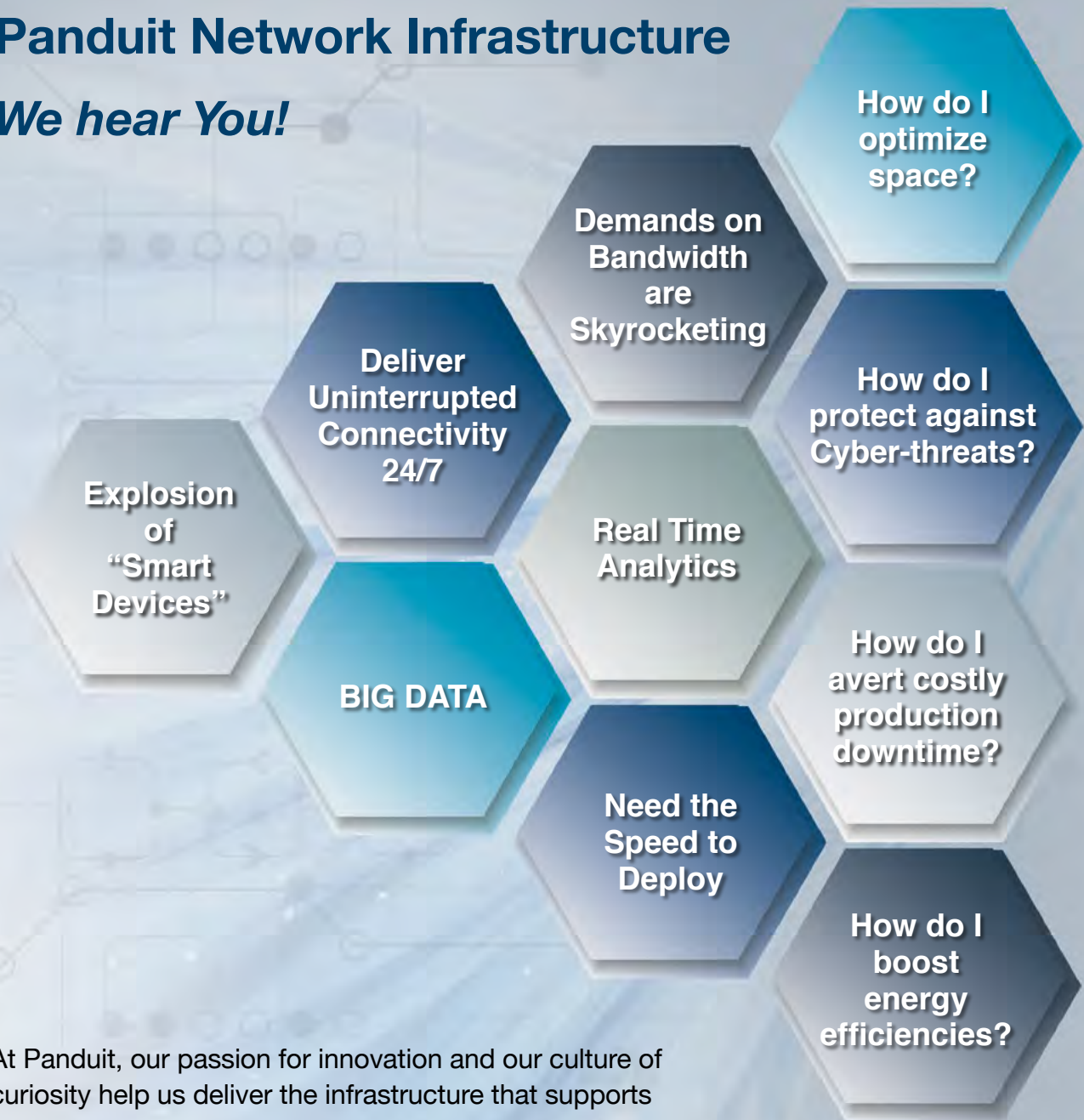

We hear You!



At Panduit, our passion for innovation and our culture of curiosity help us deliver the infrastructure that supports future-focused technology.

Customers trust and rely on the strength of the Panduit Ecosystem. From our Alliance partners Cisco, Rockwell Automation and General Cable to our global Contractor/Installer partners, System Integrators, Consultants, and Distributor channels, we help customers assess, plan, deploy and manage their mission-critical networks.

Our determination to deliver enterprise, data center, and industrial network solutions ensures every customer enjoys reliable, agile, scalable, secure, high-performance physical layer infrastructure; meeting their IT and OT challenges today and tomorrow.

	A. Featured Products
	B. Copper Systems
	C. Fiber Systems
	D. Faceplates, Frames and Surface Mount Boxes
	E. Industrial Networks
	F. Audio Video Systems
	G. Keystone Cabling Systems
	H. Zone Cabling
	J. Cable Routing Systems
	K. Cable Cleats
	L. Cabinets and Rack Systems
	M. Power and Connectivity Management
	N. Grounding and Bonding
	O. Identification Products
	P. Cable Management Accessories
	Q. Part Number Index

A. Featured Products
B. Copper Systems
C. Fiber Systems
D. Faceplates, Frames & Surface Mount Boxes
E. Industrial Networks
F. Audio Video Systems
G. Keystone Cabling Systems
H. Zone Cabling
J. Cable Routing Systems
K. Cable Cleats
L. Cabinets & Rack Systems
M. Power & Connectivity Management
N. Grounding & Bonding
O. Identification Products
P. Cable Management Accessories
Q. Part Number Index

- A. Featured Products
- B. Copper Systems
- C. Fiber Systems
- D. Faceplates, Frames & Surface Mount Boxes
- E. Industrial Networks
- F. Audio Video Systems
- G. Keystone Cabling Systems
- H. Zone Cabling
- J. Cable Routing Systems
- K. Cable Cleats
- L. Cabinets & Rack Systems
- M. Power & Connectivity Management
- N. Grounding & Bonding
- O. Identification Products
- P. Cable Management Accessories
- Q. Part Number Index

Panduit Research and Development: Driving Innovation



The Jack E. Caveney Innovation Center in Tinley Park, IL, accommodates more than 200 members of the Panduit Research and Development team. Named for one of the most prolific inventors in the industry and the founder of Panduit, the Innovation Center carries on the legacy that began more than 60 years ago. Throughout this period, Panduit has introduced thousands of problem-solving new products, achieved 2,000 patents globally and remains demonstrably committed to advancing state-of-the-art solutions.



As a 250,000-square-foot R&D facility, the Center contains 18 labs including a copper transmission lab, an anechoic chamber and a hands-on industrial automation lab to visualize, test, and architect converged solutions designed to benefit IT migration onto the factory floor. A world-class data center thermal laboratory is equipped with a 320kW capacity air handler for testing and validation of real-world scenarios.

The Innovation Center enables collaboration with partners, academia, industry consortiums, and standards bodies to investigate how Panduit technologies are best integrated into applications, helping to build superior products.

The World's Smallest Cat 6A Cable

Fit up to 40% more cable in your pathways with Vari-MaTriX Copper Cable, the industry's leading Cat 6A cabling system.

B.3



Designed with the M.I.C.E Environment in Mind

The NEMA Type 12 Rated MDC connects enterprise to the plant floor while turning standards to solutions.

E.8

Best-In-Class Form and Function

The SmartZone™ G5 Intelligent PDU provides comprehensive, accurate monitoring of data center power, environment and security to increase uptime and save energy costs.

M.3 – M.6



A. Featured Products

B. Copper Systems

C. Fiber Systems

D. Faceplates, Frames & Surface Mount Boxes

E. Industrial Networks

F. Audio Video Systems

G. Keystone Cabling Systems

H. Zone Cabling

J. Cable Routing Systems

K. Cable Cleats

L. Cabinets & Rack Systems

M. Power & Connectivity Management

N. Grounding & Bonding

O. Identification Products

P. Cable Management Accessories

Q. Part Number Index

A. Featured Products
B. Copper Systems
C. Fiber Systems
D. Faceplates, Frames & Surface Mount Boxes
E. Industrial Networks
F. Audio Video Systems
G. Keystone Cabling Systems
H. Zone Cabling
J. Cable Routing Systems
K. Cable Cleats
L. Cabinets & Rack Systems
M. Power & Connectivity Management
N. Grounding & Bonding
O. Identification Products
P. Cable Management Accessories
Q. Part Number Index



The Newest Angle in Field Term Plugs Actually is an Angle

Panduit's Field Term Plugs easily connect networked devices such as wireless access points, LED lighting, IP cameras and more.

B.9



Remove Barriers!

- The HD Flex™ Fiber Cabling System solves:
- Time consuming deployments
 - Disrupting adjacent circuits during moves, adds, and changes
 - Density challenges with 4, 6 and 12-port capabilities

C.13 – C.18



Deploy Network Infrastructure Faster

The Pre-Configured Industrial Distribution Frame delivers:

- 25% faster installation
- 3X the typical cooling capacity
- 12 or 26 rack unit availability

E.11 – E.12

Big Benefits in a Small Cord

At half the size of standard cords, 28 AWG Patch Cords are the key to maximizing space in the telco room while ensuring optimal performance.

B.8



Versatility Made Simple

The Net-Verse™ Cabinets are ideal for network or server deployments requiring efficiency and cost savings.

L.5

Up to 75% Quicker Deployment Time!

- Network Zone Systems
- Universal NZS
 - Pre-Configured NZS

E.9 – E.10



A. Featured Products

B. Copper Systems

C. Fiber Systems

D. Faceplates, Frames & Surface Mount Boxes

E. Industrial Networks

F. Audio Video Systems

G. Keystone Cabling Systems

H. Zone Cabling

J. Cable Routing Systems

K. Cable Cleats

L. Cabinets & Rack Systems

M. Power & Connectivity Management

N. Grounding & Bonding

O. Identification Products

P. Cable Management Accessories

Q. Part Number Index

- A. Featured Products
- B. Copper Systems
- C. Fiber Systems
- D. Faceplates, Frames & Surface Mount Boxes
- E. Industrial Networks
- F. Audio Video Systems
- G. Keystone Cabling Systems
- H. Zone Cabling
- J. Cable Routing Systems
- K. Cable Cleats
- L. Cabinets & Rack Systems
- M. Power & Connectivity Management
- N. Grounding & Bonding
- O. Identification Products
- P. Cable Management Accessories
- Q. Part Number Index



Angled Wire Caps = Easy Connectivity

The 45° Angled Wire Cap maintains the bend radius of bulky cable to protect network performance in tight configurations, such as cubicle walls or raceway.

B.8

IntraVUE™ Software

- Documents the industrial network to the edge
- Quicker network troubleshooting
- Real-time monitoring

E.13

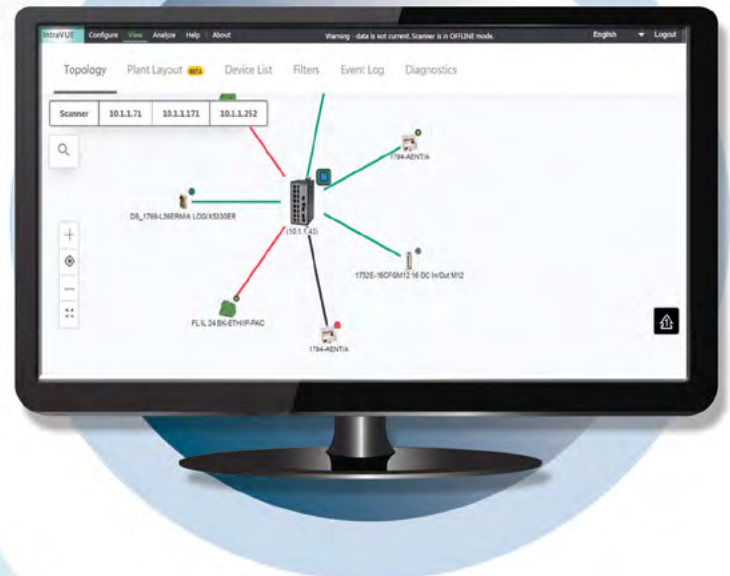

A Universal System

The Fiber Optic Cassettes with Universal Polarity eliminate deploying different cassettes or patch cords to maintain transmit-to-receiver continuity:

“... we recognize the customer base that uses universal systems and will also support them.”

- Marc Naese, SVP

- Network Infrastructure Business Unit

C.14 – C.15, C.20 – C.21, C.27

Cable Management Never Looked this Good

The PatchRunner™ 2 Vertical Cable Manager offers easy installation and operation with high density cable capacity – all in a clean, sleek design.

L.27



Achieve Up to 27% Savings

The Universal Aisle Containment Systems are configurable to cold or hot aisle, help reclaim underutilized cooling capacity, and deliver up to 27% savings on operational expenses.

L.12 – L.16



Reliable, Fast Connections from Control Cabinet to Machine

The IndustrialNet™ Overmolded Cordsets perform in harsh plant floor conditions and offer quicker installation compared to traditional hard wiring.

E.5



A.
Featured
Products

B.
Copper
Systems

C.
Fiber
Systems

D.
Faceplates,
Frames &
Surface
Mount Boxes

E.
Industrial
Networks

F.
Audio
Video
Systems

G.
Keystone
Cabling
Systems

H.
Zone
Cabling

J.
Cable
Routing
Systems

K.
Cable
Cleats

L.
Cabinets
& Rack
Systems

M.
Power &
Connectivity
Management

N.
Grounding
& Bonding

O.
Identification
Products

P.
Cable
Management
Accessories

Q.
Part
Number
Index

A. Featured Products
B. Copper Systems
C. Fiber Systems
D. Faceplates, Frames & Surface Mount Boxes
E. Industrial Networks
F. Audio Video Systems
G. Keystone Cabling Systems
H. Zone Cabling
J. Cable Routing Systems
K. Cable Cleats
L. Cabinets & Rack Systems
M. Power & Connectivity Management
N. Grounding & Bonding
O. Identification Products
P. Cable Management Accessories
Q. Part Number Index



Today's Connectivity Enables Tomorrow's A/V Applications

From the classroom to the conference room, our A/V solutions pair with structured cabling to deliver enhanced audio and video capabilities.

F.2 – F.6

Bridge the Gap Between IT and OT: Now Legacy MCCs can Communicate via Ethernet Networks

E.6

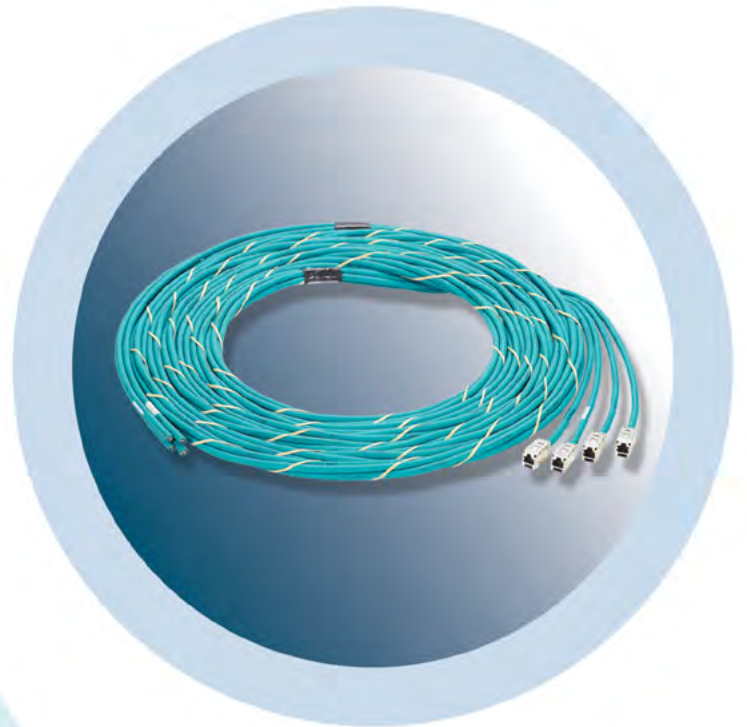

Optimize Your Space

The Net-Access™ S-Type Cabinets are designed to manage space requirements and provide a complete solution for all server and Top of Rack switch architectures.

L.3 – L.4

The Smartest Termination Tool on the Planet

The OptiCam™ 2 Fiber Termination Tool delivers immediate calculated insertion loss for “right the first time” termination of OptiCam™ Connectors.

C.4



Push the Limits

The OM5 Signature Core™ Fiber Optic Cabling System delivers the ultimate in reach and performance.

C.30, C.34, C.39

Table 1 - 40G/100G SWDM Link Distance

PMD	OM5	OM5 SC
40GBASE-SWDM4	440m	485m
100GBASE-SWDM4	150m	185m

Keep it Clean!

The Shutter Jack blocks dust and debris to protect critical connections – ideal for applications with open ports.

B.7



A. Featured Products

B. Copper Systems

C. Fiber Systems

D. Faceplates, Frames & Surface Mount Boxes

E. Industrial Networks

F. Audio Video Systems

G. Keystone Cabling Systems

H. Zone Cabling

J. Cable Routing Systems

K. Cable Cleats

L. Cabinets & Rack Systems

M. Power & Connectivity Management

N. Grounding & Bonding

O. Identification Products

P. Cable Management Accessories

Q. Part Number Index

A. Featured Products
B. Copper Systems
C. Fiber Systems
D. Faceplates, Frames & Surface Mount Boxes
E. Industrial Networks
F. Audio Video Systems
G. Keystone Cabling Systems
H. Zone Cabling
J. Cable Routing Systems
K. Cable Cleats
L. Cabinets & Rack Systems
M. Power & Connectivity Management
N. Grounding & Bonding
O. Identification Products
P. Cable Management Accessories
Q. Part Number Index



In-Ceiling Connections Made Simple and Safe

Easily connect in-ceiling devices with a Surface Mount Box.

D.6

Exceeds Industry Requirements

Interconnect active equipment in the same or adjacent rack with the Panduit Direct Attach Copper (DAC) Cable

- High speed 25GbE switches and servers
- 100% production tested

B.16



Long-Reach PoE Goes the Distance

The PoE Extender Series simplifies PoE delivery to distant devices.

- 610 meters of uninterrupted PoE connectivity

B.11

Table of Contents

Panduit Copper Cabling System Standards Compliance Guide B.2

Panduit Copper Cabling System Selection Guide B.2

Copper Cable B.3 – B.7

Copper Patch Cords B.8

Modules and Plugs. B.9 – B.12

The PoE Extender Series. B.13

QuickNet™ Copper Cabling System B.14 – B.17

Direct Attach Cable Assemblies. B.18 – B.19

Patch Panels. B.20 – B.23

110 Punchdown Systems B.24 – B.26

RJ45 Lock-In and Blockout Devices B.27

SmartKeeper Blockout Devices B.28

Patch Cord Color Bands B.29

Tools B.29

A.
Featured
Products

B.
Copper
Systems

C.
Fiber
Systems

D.
Faceplates,
Frames &
Surface
Mount Boxes

E.
Industrial
Networks

F.
Audio
Video
Systems

G.
Keystone
Cabling
Systems

H.
Zone
Cabling

J.
Cable
Routing
Systems

K.
Cable
Cleats

L.
Cabinets
& Rack
Systems

M.
Power &
Connectivity
Management

N.
Grounding
& Bonding

O.
Identification
Products

P.
Cable
Management
Accessories

Q.
Part
Number
Index

A. Featured Products
B. Copper Systems
C. Fiber Systems
D. Faceplates, Frames & Surface Mount Boxes
E. Industrial Networks
F. Audio Video Systems
G. Keystone Cabling Systems
H. Zone Cabling
J. Cable Routing Systems
K. Cable Cleats
L. Cabinets & Rack Systems
M. Power & Connectivity Management
N. Grounding & Bonding
O. Identification Products
P. Cable Management Accessories
Q. Part Number Index

Panduit Copper Cabling System Standards Compliance Guide

Performance Level	ANSI/TIA	ISO/IEC	Supported Applications	Specified Bandwidth
Category 6A Unshielded	ANSI/TIA.568.2-D	ISO11801 Class Ea	10GBASE-T	500 MHz
Category 6A Shielded			5GBASE-T 2.5GBASE-T 1000BASE-T 100BASE-T 802.3 Power over Ethernet (PoE, PoE+, PoE++) HDBASE-T	
Category 6 Unshielded	ANSI/TIA.568.2-D	ISO11801 Class E	10GBASE-T (limited distances per TSB-155-A)	250 MHz
			5GBASE-T (Low risk with bundled cables per TSB-5021) 2.5GBASE-T (Low risk with bundled cables per TSB-5021) 1000BASE-T 100BASE-T 802.3 Power over Ethernet (PoE, PoE+, PoE++) HDBASE-T	
Category 5e Unshielded	ANSI/TIA.568.2-D	ISO11801 Class D	5GBASE-T (High risk with bundled cables per TSB-5021)	100 MHz
Category 5e Shielded			2.5GBASE-T (High risk with bundled cables per TSB-5021) 1000BASE-T 100BASE-T 802.3 Power over Ethernet (PoE, PoE+, PoE++) HDBASE-T	

Panduit Copper Cabling System Selection Guide

System	Cable	Jack Modules	Field Term Plugs	Patch Cords	Populated Patch Panels	Zone Cords	Punchdown Systems
Category 6A Unshielded	PUL6AV04** PUZ6AV04** PUY6AV04** PUW6AV04** PUL6X04** PUY6X04**	CJ6X88TG** CJLR6X88TG** CJUD6X88TG**	FP6X88MTG FPUD6X88MTG	UTP6A^** UTP28X^*	DP246X88TGY DP486X88TGY	UZPP**^ UZPR**^	—
Category 6A Shielded	PUFL6X04** PUFY6X04** PFL6X04** PFY6X04** PFFL6X04** PFFY6X04**	CJS6X88TGY CJSLR6X88TGY CJSUD6X88TGY	FPS6X88MTG	STP6X^** STP28X^**	—	SAPP**^ SAPR**^	—
Category 6 Unshielded	PUL6004** PUZ6004** PUY6004** PUW6C04**	CJ688TG** CJLR688TG** CJUD688TG**	FP6X88MTG FPUD6X88MTG	UTPSP^**Y UTP28SP^**	DP24688TGY DP48688TGY	UPP**^ UPR**^	GP6™ PLUS
Category 6 Unshielded 28 AWG	—	CJT688TG**	—	UTPSP^**Y UTP28SP^**	DP24688TGY DP48688TGY	UPP**^ UPR**^	—
Category 6 Shielded	PFL6004** PSY6C04** PSFL6004**	CJS688TG** CJSLR688TG** CJSUD688TG**	FPS6X88MTG FPSUD6X88MTG	STPSP^**Y STP28SP^**	—	SAPP**^ SAPR**^	—
Category 5e Unshielded	PUL5504** PUY5504**	CJ5E88TG**	FP6X88MTG FPUD6X88MTG	UTPCH^**Y UTP28CH^**	DP24688TGY DP48688TGY	—	Pan-Punch™
Category 5e Shielded	PFL5504**	CJS5E88TGY	FPS6X88MTG	STPCH^B**	—	—	—

**Contact Customer Service for color options.
^Contact Customer Service for available lengths.

TX6A™ Copper Cable

- UTP cables feature a small cable diameter; improves cable fill and simplifies upgrades from Category 6
- Lighter weight cables, smaller bend radius and increased flexibility ease installation
- Best-in-class alien crosstalk mitigation
- Vari-MaTriX cables offer the best EMI immunity in a UTP cable
- Exceptional performance for PoE++ applications

Vari-MaTriX Category 6A Copper Cable



Part Number	Flame Rating	EuroClass	Barrier Tape	Cable Diameter, mm	UL Temperature Range °C	Length, m.
Category 6A Copper Cable TX6A™ U/UTP						
PUL6AV04WH-EG	LSZH-3	Dca-s2,d2,a1	Vari-MaTriX	6.6	-20° to 75°	305
PUL6AV04WH-ED						500
PUY6AV04WH-EG		Cca-s1b,d1,a1		6.7		305
PUY6AV04WH-ED						500
PUW6AV04WH-EG		B2ca-s1a,d1,a1		305		
PUL6X04WH-HEG	LSZH-1	Dca-s2-d2-a1	U/MTP	7.2	-20° to 60°	305
PUY6X04WH-HEG						Cca-s1a-d1-a1
PUY6X04WH-HED		500				

Part number reflects White cable. For other color options, please contact Customer Service.



Panduit™ Copper Cabling Systems utilizing Mini-Com™ Connectivity Components are designed for optimum network performance, design flexibility and reliability to protect network investments well into the future. Each system denoted provides users with headroom assurance that will exceed the applicable category of ANSI/TIA-568.2-D and ISO 11801 standards. Headroom values are based on “real world” conditions through the use of industry recognized hand-held testers. No test analyzers or computer models were used.

Channel Headroom

Electrical Value	Category 6A Shielded	Vari-MaTriX UTP
Insertion Loss	3%	3%
NEXT	3.5	3.5
PSNEXT	5	5
PSACR-F	10	10
Return Loss	3	3
PSACR-N	6.5	6.5
PSANEXT	20	4
PSAACR-F	20	10

- A. Featured Products
- B. Copper Systems
- C. Fiber Systems
- D. Faceplates, Frames & Surface Mount Boxes
- E. Industrial Networks
- F. Audio Video Systems
- G. Keystone Cabling Systems
- H. Zone Cabling
- J. Cable Routing Systems
- K. Cable Cleats
- L. Cabinets & Rack Systems
- M. Power & Connectivity Management
- N. Grounding & Bonding
- O. Identification Products
- P. Cable Management Accessories
- Q. Part Number Index

Category 6A Shielded Copper Cable

- Superior performance which exceeds requirements of ANSI/TIA-568.2-D Category 6A, IEEE 802.3an-2006, and ISO 11801 Class E_A channel standards
- Conductors are 23 AWG with polyethylene (PE) insulation



PUFL6X04WH-HED

Part Number	Flame Rating	EuroClass	Packaging	Color	AWG	Length, m
Category 6A U/FTP Copper Cable						
PUFL6X04WH-HED	LSZH-1	Dca-s2,d2,a1	Reel	White	23	500
PUFY6X04WH-HED	-	Cca-s1,d1,a1				

Part Number	Flame Rating	EuroClass	Packaging	Color	AWG	Length, m
Category 6A F/UTP and F/FTP Copper Cable						
PFL6X04WH-CEG	LSZH-1	Dca-s2,d2,a1	Reel	White	23	305
PFY6X04WH-CED	-	Cca-s1a,d1,a1				500
PFFL6X04WH-HED	LSZH-1	Dca-s2,d2,a1				
PFFY6X04WH-HED		Cca-s1,d1,a1				

For other color options, please contact Customer Service.

Category 7 and 7A Shielded Copper Cable

- Certified component performance up to 100 meters and meets or exceeds the component requirement of the IEC 61156-5 Category 7 or 7A standard
- Descending length cable markings enable easy identification of remaining cable which reduces installation time and cable scrap



PSL7004WH-KD

Part Number	Flame Rating	EuroClass	Packaging	Color	AWG	Length, m
Category 7A S/FTP Copper Cable						
PSL7A04WH-HED	LSZH-1	Dca-s1a,d1,a1	Reel	White	23	500
PSL7A2204WH-HED					22	
PSL27A2204WH-HD						
PSW7A04WH-HED		B2ca-s1a,d1,a1				

Part Number	Flame Rating	EuroClass	Packaging	Color	AWG	Length, m
Category 7 S/FTP Copper Cable						
PSL7004WH-HED	LSZH-1	Dca-s1a,d1,a1	Reel	White	23	500
PSW7004WH-HED		B2ca-s1a,d1,a1				

For other color options, please contact Customer Service.

Category 6 U/UTP Copper Cable

- Reduced diameter and weight for improved cable fill and increased flexibility for ease during installation
- Superior channel headroom performance provides margin above the Industry Standard



PUL6004BU-FE



PUW6C04BU-CE

Part Number	Flame Rating	EuroClass	Packaging	Color	AWG	Length, m
-------------	--------------	-----------	-----------	-------	-----	-----------

Category 6 U/UTP Copper Cable, Enhanced Performance

PUL6004WH-FE	LSZH-1 and LSZH-3-22	Dca-s2,d2,a1	Easy Payout Carton	White	23	305
PUZ6004WH-CEG	LSZH-3-25	Dca-s1a,d2,a1	Reel			305
PUY6004WH-HE	LSZH-1	Cca-s1a,d1,a1	Easy Payout Carton			305
PUY6004WH-HED			Reel			500

Category 6 U/UTP Copper Cable, Standard Performance

PUW6C04WH-CE	LSZH-1	B2ca-s1a,d1,a1	Easy Payout Carton	White	24	305
PUW6C04WH-CED			Reel			500

For standard colors other than White, please contact Customer Service.

Category 6 Shielded Copper Cable

- Exceeds ANSI/TIA-568.2-D Category 6 and ISO 11801 Class E channel requirements; Meets ANSI/TIA-568.2-D and ISO 11801 Category 6 component requirements
- Descending length cable markings enable easy identification of remaining cable which reduces installation time and cable scrap



PSY6C04WH-CED

Part Number	Flame Rating	EuroClass	Shield Type	Packaging	Color	AWG	Length, m
-------------	--------------	-----------	-------------	-----------	-------	-----	-----------

Category 6 Shielded Copper Cable

PFL6004WH-KD	LSZH-1	Eca	F/UTP	Reel	White	23	500
PSY6C04WH-CED		Cca-s1a,d1,a1	S/FTP				
PSFL6004WH-KD		Eca	SF/UTP				

For standard colors other than White, please contact Customer Service.

Panduit™ Copper Cabling Systems utilizing Mini-Com™ Connectivity Components are designed for optimum network performance, design flexibility and reliability to protect network investments well into the future. Each system denoted provides users with headroom assurance that will exceed the applicable category of ANSI/TIA-568.2-D and ISO 11801 standards. Headroom values are based on “real world” conditions through the use of industry recognized hand-held testers. No test analyzers or computer models were used.

Channel Headroom for Category 6 U/UTP Copper Cable

Electrical Value	Category 6 Enhanced
Insertion Loss	5%
NEXT	4.0 dB
PSNEXT	5.0 dB
PSACR-F	9.0 dB
Return Loss	2.0 dB
ACR-N	5.0 dB
PSACR-N	5.0 dB
ACR-F	7.0 dB

- A. Featured Products
- B. Copper Systems**
- C. Fiber Systems
- D. Faceplates, Frames & Surface Mount Boxes
- E. Industrial Networks
- F. Audio Video Systems
- G. Keystone Cabling Systems
- H. Zone Cabling
- J. Cable Routing Systems
- K. Cable Cleats
- L. Cabinets & Rack Systems
- M. Power & Connectivity Management
- N. Grounding & Bonding
- O. Identification Products
- P. Cable Management Accessories
- Q. Part Number Index

Category 5e Copper Cable

- Superior channel headroom performance provides margins above the Industry Standard



PUL5504WH-EY



PFL5504WH-KG

Part Number	Flame Rating	EuroClass	Packaging	AWG	Length, m
-------------	--------------	-----------	-----------	-----	-----------

Category 5e U/UTP Copper Cable

PUL5504WH-EY	LSZH-1 and LSZH-3-22	Dca-s2,d2,a1	Easy Payout Carton	24	305
PUZ5504WH-CEG	LSZH-3-25	Dca-s1a,d2,a1			

Category 5e Shielded F/UTP Copper Cable

PFL5504WH-KG	LSZH-1	Eca	Reel	24	305
--------------	--------	-----	------	----	-----

For standard colors other than White, please contact Customer Service.

Panduit™ Copper Cabling Systems utilizing Mini-Com™ Connectivity Components are designed for optimum network performance, design flexibility and reliability to protect network investments well into the future. Each system denoted provides users with headroom assurance that will exceed the applicable category of ANSI/TIA-568.2-D and ISO 11801 standards. Headroom values are based on “real world” conditions through the use of industry recognized hand-held testers. No test analyzers or computer models were used.

Channel Headroom for Category 5e U/UTP Copper Cable

Electrical Value	Category 5e
Insertion Loss	5%
NEXT	3.0 dB
PSNEXT	6.5 dB
PSACR-F	4.5 dB
Return Loss	2.0 dB
ACR-N	4.5 dB
PSACR-N	8.0 dB
ACR-F	4.0 dB

Outdoor (OSP) Copper Cable

- Protects against environmental elements that can cause electrical performance failures
- Gel-filled construction prevents moisture migration in underground and wet applications
- Black in color

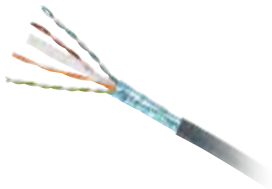

PFO6X04BL-CEG

Part Number	Performance Level	Flame Rating	EuroClass	Construction, AWG	Packaging	Length, m
PFO6X04BL-CEG	6A	OSP	Fca	F/UTP, 23	Reel	305
PUO6X04BL-CEG	6A			U/UTP, 23		305
PSO7004BL-KED	7		Eca	S/FTP, 23		500

Part numbers reflect Black cable. For other color options, please contact Customer Service.

Multi-Pair Copper Cable



PUL3025WH-A

Part Number	Flame Rating	EuroClass	AWG	Packaging	Length, m
PUL3025WH-A	LSZH-1	Dca-s2,d2,a1	24	Reel	305

Part number reflects White cable. For other color options, please contact Customer Service.

A. Featured Products

B. Copper Systems

C. Fiber Systems

D. Faceplates, Frames & Surface Mount Boxes

E. Industrial Networks

F. Audio Video Systems

G. Keystone Cabling Systems

H. Zone Cabling

J. Cable Routing Systems

K. Cable Cleats

L. Cabinets & Rack Systems

M. Power & Connectivity Management

N. Grounding & Bonding

O. Identification Products

P. Cable Management Accessories

Q. Part Number Index

- A. Featured Products
- B. Copper Systems
- C. Fiber Systems
- D. Faceplates, Frames & Surface Mount Boxes
- E. Industrial Networks
- F. Audio Video Systems
- G. Keystone Cabling Systems
- H. Zone Cabling
- J. Cable Routing Systems
- K. Cable Cleats
- L. Cabinets & Rack Systems
- M. Power & Connectivity Management
- N. Grounding & Bonding
- O. Identification Products
- P. Cable Management Accessories
- Q. Part Number Index

Copper Patch Cords

- Each patch cord is 100% performance tested to component limits
- Patented tangle-free latch on all plugs
- Supports IEEE 802.3af, 802.3at, and 802.3bt type 3 and 4 for PoE applications up to 100 W
- 28 AWG patch cords support up to 96 meters of channel length when using 6m of patch cord; De-rating factor:1.9
- 26 AWG patch cords support full 100 meter channel length; De-rating factor:1.5
- 24 AWG patch cords support full 100 meter channel length; De-rating factor:1.2



UTP6ASD*
UTP28X*



STP28X*



UTP28SP*



UTP28SP8INBU

Part Number	Cable Type	Conductor Gauge AWG	Cable Diameter In. (mm)	Flammability Rating	Std. Pkg. Qty.
-------------	------------	---------------------	-------------------------	---------------------	----------------

TX6A™ 10 Gig Patch Cords

UTP28X*MBU	Unshielded	28	0.185 (4.7)	CM; LSZH	1	
UTP28X*MBU-Q					25	
UTP6ASD*MBU		26	0.240 (6.1)		CM	1
UTP6ASD*MBU-Q						25
UTP6A*MBU		24	0.275 (7.0)			1
UTP6A*MBU-Q						25
STP28X*MBU	Shielded	28	0.185 (4.7)	CM; LSZH		1
STP28X*MBU-Q						25
STP6X*MIG		26	0.240 (6.1)		1	
STP6X*MIG-Q					25	
STP6C*MBU		0.252 (6.4)	1			
STP6C*MBU-Q			25			

TX6™ Patch Cords

UTP28SP*MBU	Unshielded	28	0.150 (3.8)	CM; LSZH	1
UTP28SP*MBU-Q					25
UTPSP*MBUY	24	0.235 (6.0)	CM	1	
UTPSP*MBUY-Q				25	

TX5e™ Patch Cords

UTP28CH*MBU	Unshielded	28	0.149 (3.8)	CM; LSZH	1
UTP28CH*MBU-Q					25
UTPCH*MBUY	24	0.215 (5.5)	CM	1	
UTPCH*MBUY-Q				25	

**For lengths 0.5 to 10 meters (increments of 0.5 meter) and 1.5, 2.5, 15, 20, 25, 30, 35, 40 meters, change the length designation in the part number to the desired length.
For standard cable colors other than IG (International Gray) substitute IG suffix with BL (Black), BU (Blue), GR (Green), RD (Red), YL (Yellow), OR (Orange), or VL (Violet) to the end of the part number. For example, the part number for a blue 15-meter patch cord is STP6X15MBU.

Break-Away Adapter

- Enables any standard patch cord to “breakaway” upon a sudden pulling force, minimizing tripping hazards to people and potential damage to connected equipment or ports
- Meets all Category 6A requirements (including alien crosstalk) and is acceptable for use with Category 5e, 6 and 6A UTP patch cords



BKA6ASD8INBL

Part Number	Cable Type	AWG	Length In. (Cm)	Flammability Rating	Color	Std. Pkg. Qty.
BKA6ASD8INBL	Category 6A UTP	26	8.0 (20.3)	CM	Black	1

Mini-Com™ TX6A™, TX6™ PLUS and TX5e™ UTP and Shielded Jack Modules

- All jacks 100% tested to ensure NEXT and RL performance and individually serialized for traceability
- Mini-Com™ TG-style Jack Modules have EPDs and HPDs to help earn LEED points
- Utilize patented Giga-TX™ Technology for jack terminations which maintain cable pair geometry and minimize conductor untwist

UTP Jack Modules



Standard



Angled



Spring Shutter



28/30

Part Number	Jack Type	Performance Level	Termination Style	Std. Pkg. Qty.	
CJ6X88TG**	Standard	Category 6A	TG-Style	1	
CJ688TG**		Category 6			
CJ5E88TG**		Category 5e			
CJ6X88TG**-24		Category 6A		24	
CJ688TG**-24		Category 6			
CJ5E88TG**-24		Category 5e			
CJ6X88TG**-C	Angled Left/Right	Category 6A		100	
CJ688TG**-C		Category 6			
CJLR6X88TG**		Category 6A			1
CJLR688TG**	Category 6				
CJLR6X88TG**-24	Category 6A	24			
CJLR688TG**-24	Category 6				
CJUD6X88TG**	Angled Up/Down			Category 6A	1
CJUD688TG**		Category 6			
CJH6X88TG**	Spring Shutter	Category 6A		1	
CJH688TG**		Category 6			
CJH5E88TG**		Category 5e			
CJT6X88TG**	28/30 AWG	Category 6A		1	
CJT688TG**		Category 6			
CJT5E88TG**		Category 5e			

**Colors available: IW (Off White), EI (Electric Ivory), IG (International Gray), AW (Arctic White), BL (Black), BU (Blue), GR (Green), RD (Red), OR (Orange), VL (Violet), YL (Yellow), WH (White).
 Must be installed as part of complete TX6A™ UTP Copper Cabling System in order to achieve 10BASE-T certified performance.
 For labeling and identification, see pages O.1 through O.18.

A. Featured Products

B. Copper Systems

C. Fiber Systems

D. Faceplates, Frames & Surface Mount Boxes

E. Industrial Networks

F. Audio Video Systems

G. Keystone Cabling Systems

H. Zone Cabling

J. Cable Routing Systems

K. Cable Cleats

L. Cabinets & Rack Systems

M. Power & Connectivity Management

N. Grounding & Bonding

O. Identification Products

P. Cable Management Accessories

Q. Part Number Index

Continued on next page

A. Featured Products

B. Copper Systems

C. Fiber Systems

D. Faceplates, Frames & Surface Mount Boxes

E. Industrial Networks

F. Audio Video Systems

G. Keystone Cabling Systems

H. Zone Cabling

J. Cable Routing Systems

K. Cable Cleats

L. Cabinets & Rack Systems

M. Power & Connectivity Management

N. Grounding & Bonding

O. Identification Products

P. Cable Management Accessories

Q. Part Number Index

Mini-Com™ TX6A™, TX6™ PLUS and TX5e™ UTP and Shielded Jack Modules (continued)



Angled Wire Cap (UTP)



Left/Right Shielded Angled Wire Cap



Up/Down Shielded Angled Wire Cap

Wire Caps

Part Number	Part Type	Performance Level	Color	Termination Style	Std. Pkg. Qty.
CJLRCAPBU-X	Left/Right Angled Wire Cap	Category 6A	Blue	TG-Style	10
CJLRCAPIW-X		Category 6	Off White		
CJUDCAPBU-X	Up/Down Angled Wire Cap	Category 6A	Blue		
CJUDCAPIW-X		Category 6	Off White		
CJSLRCAPBU-X	Left/Right Shielded Angled Wire Cap	Category 6A	Blue		
CJSLRCAPIW-X		Category 6	Off White		
CJSUDCAPBU-X	Up/Down Shielded Angled Wire Cap	Category 6A	Blue		
CJSUDCAPIW-X		Category 6	Off White		

45° Angled Wire Caps available in packs of 100. Change -X to -C.

Mini-Com™ TX6A™, TX6™ PLUS and TX5e™ Shielded Jack Modules

- All jacks 100% tested to ensure NEXT and RL performance and individually serialized for traceability
- Mini-Com™ TG-Style Jack Modules have EPDs and HPDs to help earn LEED points
- Utilize patented Giga-TX™ Technology for jack terminations which maintain cable pair geometry and minimize conductor untwist



CJS6X88TGY-24



CJSH6X88TGY



CJST6X88TGY

Part Number	Jack Type	Performance Level	Color	Termination Style	Std. Pkg. Qty.
CJS6X88TGY	Standard	Category 6A	Black	TG-Style	1
CJS688TGY		Category 6			
CJS5E88TGY		Category 5e			
CJS6X88TGY-24		Category 6A			24
CJS688TGY-24		Category 6			
CJS5E88TGY-24		Category 5e			
CJSLR6X88TGY	Angled Left/Right	Category 6A	Blue		1
CJSLR688TGY		Category 6	Off White		
CJSUD6X88TGY	Angled Up/Down	Category 6A	Blue		
CJSUD688TGY		Category 6	Off White		
CJSH6X88TGY	Spring Shutter	Category 6A	Black		
CJSH688TGY		Category 6			
CJSH5E88TGY		Category 5e			
CJST6X88TGY	28/30 AWG	Category 6A			

Other colors available, add color suffix after "TG" and before "Y". BU (Blue), GR (Green), RD (Red), VL (Violet), YL (Yellow). Standard parts also available in WH (White). Shield grounding requires proper installation of shielded jack module, the use of shielded patch cords, and cable. All Metal Modular Patch Panels available on page B.18. Must be installed as part of a complete TX6A™ Copper Cabling System in order to achieve in 10GBASE-T certified performance. For labeling and identification, see pages O.1 through O.18.

Mini-Com™ TX6A™, TX6™ PLUS and TX5e™ UTP Coupler Modules

- RJ45 8-position female to RJ45 8-position female pass-through module for easy connection of 6 and 8-position RJ45 patch cords
- 100% tested to ensure NEXT and RL performance
- Compatible with Mini-Com™ Module Patch Panels and Faceplates; not compatible with surface mount box applications
- Also available as 24-port coupler patch panels, see page B.19



Coupler

Part Number	Performance Level	Color	Termination Style	Std. Pkg. Qty.
CC6X88BL	Category 6A	Black	RJ45	1
CC688BL	Category 6	Black		
CC5E88BL	Category 5e	Black		

Other colors available, replace BL with: BU (Blue), GR (Green), IG (International Gray), IW (Off White), OR (Orange), RD (Red), YL (Yellow).TX6™, TX6A™, TX5e™ UTP Patch Cords available on page B.6.

TX6A™ UTP and Shielded Field Term Plugs

- Simple-to-attach field terminable plugs in straight and angled versions
- Category 6A performance, also compatible with Category 6 and 5e systems
- 22-26 AWG compatible and re-terminable up to 20 times
- Utilizes patented Giga-TX™ Technology for cable terminations which maintain cable pair geometry and minimize conductor untwist



UTP Straight Field Term Plug



UTP Angled Field Term Plug



Shielded Straight Field Term Plug

Field Term Plugs

Part Number	Plug Type	Performance Level	Color	Termination Style	Std. Pkg. Qty.
FP6X88MTG	UTP Straight Field Term	Category 6A	Black	TG-Style	1
FP6X88MTG-X					10
FPUD6X88MTG	UTP Angled Field Term				1
FPUD6X88MTG-X					10
FPS6X88MTG	Shielded Straight Field Term		Silver		1
FPS6X88MTG-S					10

Module Termination Tools and Accessories



EGPT



Termination Tools

Part Number	Part Type	Performance Level	Color	Termination Style	Std. Pkg. Qty.
EGJT-1	Tool for Straight TG Jacks	All	Green	TG-Style	1
EGPT	Tool for Non-Straight or Angled Field Term Plug		Violet		
TGSJT	Tool for Angled TG Jacks		Ruby Red		
TGJT	High Volume Tool for Straight TG Jacks		Black		
FP6X88TC	Optional Field Test Cord	Category 6A	Red	RJ45	

A. Featured Products

B. Copper Systems

C. Fiber Systems

D. Faceplates, Frames & Surface Mount Boxes

E. Industrial Networks

F. Audio Video Systems

G. Keystone Cabling Systems

H. Zone Cabling

J. Cable Routing Systems

K. Cable Cleats

L. Cabinets & Rack Systems

M. Power & Connectivity Management

N. Grounding & Bonding

O. Identification Products

P. Cable Management Accessories

Q. Part Number Index

TX6A™, TX6™ PLUS and Category 5e Modular Plugs

- Exceed respective ANSI/TIA-568.2-D Category and ISO 11801 Class performance levels when properly terminated
- Patented tangle free latch prevents snags and provides easy release



SP6X88



SP688



SP628



MP588



SPS6X88



MPS588



Modular Plug Tools

UTP Modular Plugs

Part Number	Performance Level	Wire Gauge AWG	Cable Diameter Range In. (mm)	Insulation Diameter Range In. (mm)	Std. Pkg. Qty.
SP6X88-C	Category 6A	23-24	0.275–0.315 (6.99–8.00)	0.040–0.048 (1.02–1.22)	100
SP6X88P-C		24	0.260–0.300 (6.60–7.62)	0.036–0.042 (0.91–1.07)	
SP6X88SD-C		26	0.220–0.250 (5.59–6.35)	0.025–0.030 (0.64–0.76)	
SP628-C	Category 6/6A	28	0.138–0.189 (3.50–4.80)	Max 0.027 (0.686)	
SP630-C		30	0.122–0.130 (3.10–3.30)	Max 0.021 (0.533)	
SP688-C	Category 6	23-24	0.225–0.250 (5.72–6.35)	0.036–0.042 (0.91–1.07)	
MP588-L	Category 5e	24	0.208–0.259 (5.28–6.58)	0.037–0.042 (0.94–1.07)	50
MP588-C					100
MP588-M					1000
MP528-C		28	0.138–0.162 (3.51–4.11)	0.023–0.027 (0.58–0.69)	100
MP528-M					1000
MP530-C					30

Shielded Modular Plugs

Part Number	Performance Level	Wire Gauge AWG	Cable Diameter Range In. (mm)	Insulation Diameter Range In. (mm)	Std. Pkg. Qty.
SPS6X88-C	Category 6A	23-24	0.275–0.300 (6.99–7.62)	0.042–0.047 (1.07–1.19)	100
SPS688-C	Category 6	24	0.230–0.265 (5.84–6.73)	0.036–0.040 (0.91–1.02)	
MPS588-C	Category 5e	24-26	0.210–0.250 (5.33–6.35)	Max. 0.040 (1.02)	

For labeling and identification, see pages O.1 through O.18.

Modular Plug Accessories

Part Number	Performance Level	Part Type	Color	Std. Pkg. Qty.
WPT-8	All	Wire Prep Tool for Modular Plugs	Black	1
MPT5-8AS		Crimp Tool for Modular Plugs		
CSPT		Assembly Tool for 23-26 AWG Modular Plugs	Blue	
SGPT		Assembly Tool for 28/30 AWG Modular Plugs		

The PoE Extender Series

- Extend your power and data up to 2000 feet (610 m)*
- One-port extender boxes are IEEE-compliant and negotiates power requirements with an IP device, delivers 50 W of power over 4-pairs, and can be locally powered
- Four-port extender boxes are IEEE-compliant and negotiates power requirements with up to 4 IP devices, delivers 30 W of power over 2-pairs, and can be locally powered
- Bandwidth availability: 100 Mbps full duplex, symmetrical on 4-pair UTP
- Connected End IP devices must be IEEE 802.3 af/at compliant
- Operating temperature from -40°C to +70°C
- Power consumption: 1.5 W or less
- Most cost-effective way to increase the reach of PoE beyond 100 meters



POEXKIT1



POEXTX1



POEXRX1



POEXRX4

Part Number	Part Description
-------------	------------------

PoE Extender Kits

POEXKIT1	1-port transmitter box, 1-port receiver box, with 60 W, 55 V power supply.
POEXKIT4	1-port transmitter box, 4-port receiver box, with 110 W, 55 V power supply.

PoE Extender Transmitter

POEXTX1	1 RJ45 to 1 RJ45 port, power from standard PoE switch or external power supply (48 V-56 VDC).
----------------	---

PoE Extender Receivers

POEXRX1	1 RJ45 port to 1 RJ45 port, power from standard PoE switch or external power supply (48 V-56 VDC).
POEXRX4	1 RJ45 port to 4 RJ45 ports, power from standard PoE switch or external power supply (48 V-56 VDC).

Refer to page B.3-B.5 for cable details.
*Distance of power varies based on power supply options.

A.
Featured
Products

B.
Copper
Systems

C.
Fiber
Systems

D.
Faceplates,
Frames &
Surface
Mount Boxes

E.
Industrial
Networks

F.
Audio
Video
Systems

G.
Keystone
Cabling
Systems

H.
Zone
Cabling

J.
Cable
Routing
Systems

K.
Cable
Cleats

L.
Cabinets
& Rack
Systems

M.
Power &
Connectivity
Management

N.
Grounding
& Bonding

O.
Identification
Products

P.
Cable
Management
Accessories

Q.
Part
Number
Index

- A. Featured Products
- B. Copper Systems
- C. Fiber Systems
- D. Faceplates, Frames & Surface Mount Boxes
- E. Industrial Networks
- F. Audio Video Systems
- G. Keystone Cabling Systems
- H. Zone Cabling
- J. Cable Routing Systems
- K. Cable Cleats
- L. Cabinets & Rack Systems
- M. Power & Connectivity Management
- N. Grounding & Bonding
- O. Identification Products
- P. Cable Management Accessories
- Q. Part Number Index

QuickNet™ Category 6 Switch Harnesses with 28 AWG Cabling

- Bring unprecedented levels of installation speed, consistency, and clean aesthetics to the cabling in network racks and IDFs/MDFs
- Plug meets all applicable FCC part 68 Sub part F requirements and exceeds IEC 60603-7 specifications
- Each patch cord is 100% performance tested
- Integrated finger latch enables quick, one-handed installation and removal from switch



12-Cable Switch Patching Harness
(Plugs at Panel End)



12-Cable Switch Port Harness
(Jacks at Panel End)

Performance Level	6-Cable with Plug Pack	6-Cable with Recessed Plug Pack	8-Cable with Plug Pack	12-Cable with Plug Pack
-------------------	------------------------	---------------------------------	------------------------	-------------------------

Standard Parts - Switch Patching Harnesses (Plug-to-Plug Type)

 Plug Pack to Loose Plug				
Category 6A	QPPUDBAB**	QPPUDBRS**	QPPUDBDB**	QPPUDBBB**
Category 6	QPPSDBAB**	QPPSDBRS**	QPPSDBDB**	

**Length in feet. Lengths of 3, 5, 7, 10, and 14 (indicated as 03, 05, 07, 10, 14).

Performance Level	6-Cable with Plug Pack	6-Cable with Recessed Plug Pack	12-Cable with Plug Pack
-------------------	------------------------	---------------------------------	-------------------------

Standard Parts - Switch Port Harnesses (Plug-to-Jack Type)

 Plug Pack to Cassette			
Category 6A	QPCUDBABB**	QPCUDBRSB**	QPCUDBBBB**
Category 6	QPCSDBABB**	QPCSDBRSB**	QPCSDBBBB**

**Length in feet. Lengths of 5, 7, 10, 14, and 20 feet (indicated as 05, 07, 10, 14, and 20).

Performance Level	6-Cable with Plug Pack	12-Cable with Plug Pack
-------------------	------------------------	-------------------------

Standard Parts - Switch Port Harnesses (Plug-to-Jack Type)

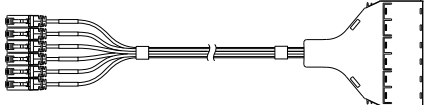
 Loose Plug to Cassette		
Category 6A	QPPUDBAB**	QPPUDBDB**
Category 6	QPPSDBAB**	QPPSDBBB**

**Length in feet. Lengths of 5, 7, 10, 14, and 20 feet (indicated as 05, 07, 10, 14, and 20).

For Labeling and Identification (Section O), see pages O.1 through O.18.
Other cable color and end configurations may be available, contact Panduit Customer Service for details.

QuickNet™ Plug Pack Housings

- Facilitate quick and easy connection and disconnection of multiple patch cords, simultaneously to a variety of switches, reducing time and cost associated when installing and maintaining structured cabling links
- Available in 6, 8, or 12-pack configurations for optimal switch compatibility
- Recessed version available when additional clearance is required at the switch port
- Integrated finger latch enables quick, one-handed installation and removal from switch
- Low profile design allows assemblies to be installed side by side or stacked on top of each other providing maximum port density in high-density installations



QPPN6BU



QPPNR6S

Part Number	Part Description	Std. Pkg. Qty.	Std. Ctn. Qty.
QPPN6BU‡	QuickNet™ Plug Pack accepts six Panduit RJ45 modular plugs.	1	10
QPPN8BU‡	QuickNet™ Plug Pack accepts eight Panduit RJ45 modular plugs.		
QPPN12BU‡	QuickNet™ Plug Pack accepts twelve Panduit RJ45 modular plugs.		
QPPNR6S	QuickNet™ Recessed Plug Pack accepts six Panduit RJ45 modular plugs.		

‡Plug Pack housing shown in BU (Blue). Other colors available: BL (Black), RD (Red), or WH (White). Recessed plug pack available in silver only. For Labeling and Identification (Section O), see pages O.1 through O.18.

QuickNet™ Plug Pack Removal Tool

- Allows individual patch cords to be removed from a plug pack without disruption of other network connections
- Compatible with 6, 8, and 12-pack QuickNet™ Plug Pack Assemblies



Part Number	Part Description	Std. Pkg. Qty.
QPPRT	Removal tool allows individual patch cords to be removed from a plug pack without disruption of other network connections.	1

QuickNet™ Plug Pack Lock-In Device

- Prevents unintentional removal of QuickNet™ Plug Pack Assembly from the switch
- Marker tie (included with assembly) can be used to connect plug pack and lock-in device for additional level of security
- Two recommended per plug pack



QPPLD6-X

Part Number	Part Description	Std. Pkg. Qty.	Std. Ctn. Qty.
QPPLD6-X	Lock-in device prevents unauthorized removal of patch cords from 6 and 12-pack plug pack.	10	100
QPPLD8-X	Lock-in device prevents unauthorized removal of patch cords from 8-pack plug pack. Recommended quantity two per 8-pack.		

Recommended quantity two QPPLD6 per 6-pack plug pack, four QPPLD6 per 12-pack plug pack, and two QPPLD8 per 8-pack plug pack. For Labeling and Identification (Section O), see pages O.1 through O.18.

A. Featured Products

B. Copper Systems

C. Fiber Systems

D. Faceplates, Frames & Surface Mount Boxes

E. Industrial Networks

F. Audio Video Systems

G. Keystone Cabling Systems

H. Zone Cabling

J. Cable Routing Systems

K. Cable Cleats

L. Cabinets & Rack Systems

M. Power & Connectivity Management

N. Grounding & Bonding

O. Identification Products

P. Cable Management Accessories

Q. Part Number Index

- A. Featured Products
- B. Copper Systems
- C. Fiber Systems
- D. Faceplates, Frames & Surface Mount Boxes
- E. Industrial Networks
- F. Audio Video Systems
- G. Keystone Cabling Systems
- H. Zone Cabling
- J. Cable Routing Systems
- K. Cable Cleats
- L. Cabinets & Rack Systems
- M. Power & Connectivity Management
- N. Grounding & Bonding
- O. Identification Products
- P. Cable Management Accessories
- Q. Part Number Index

QuickNet™ Cable Assembly Components

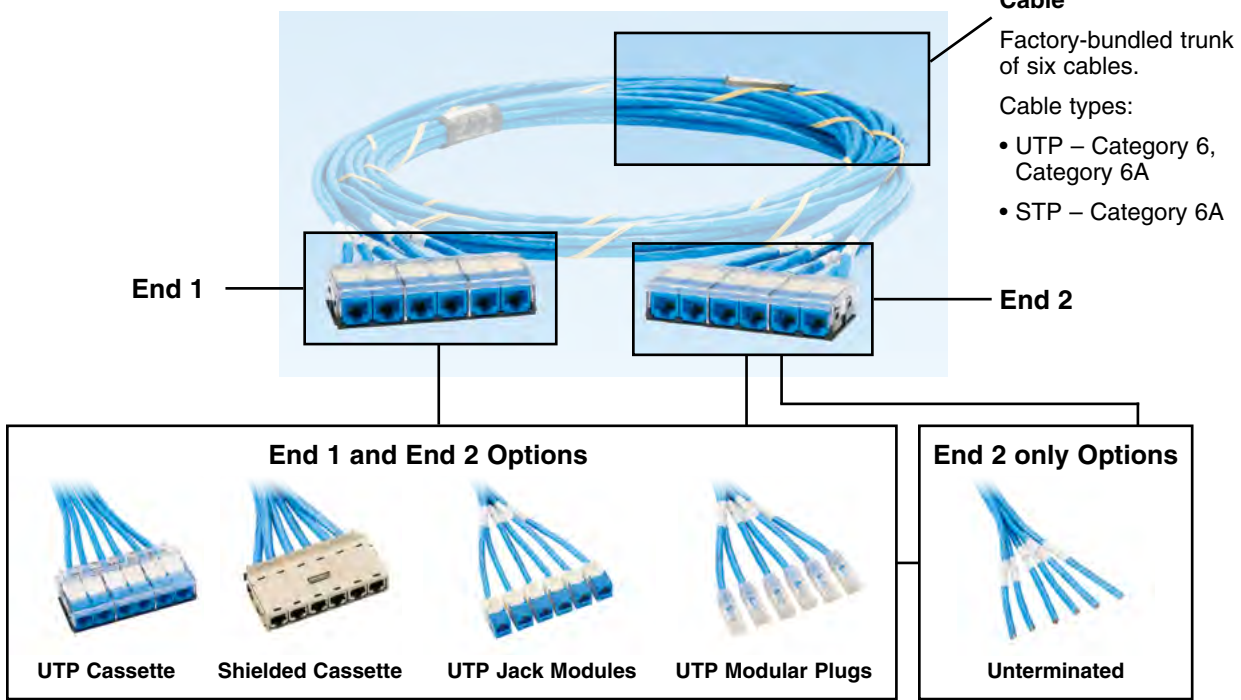

Common QuickNet™ Cable Assembly Configurations

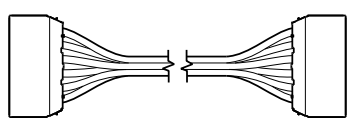

Cassette to Cassette

- Cassette of six jack modules on both ends of assembly
- Typically used in cabinet-to-cabinet permanent link trunks
- Installs into QuickNet™ Patch Panels on both ends in common interconnect and cross connect architectures, with cassette enabling quick installation into panels
- The most common QuickNet™ Configuration for permanent link trunks
- QuickNet™ Standard Parts for the Americas: UTP cassette-cassette, blue cable, blue jack modules

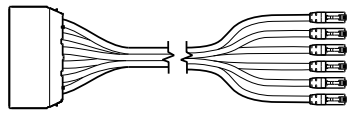

Cassette to Plug

- Similar configuration as above, but with six modular plugs on one end
- Typically used for in-cabinet or cabinet-to-cabinet equipment cord harnesses
- Installs into QuickNet™ Patch Panels on one end and switch ports on the other for switch port replication applications

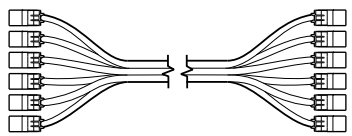

Jack to Jack

- Six loose jack modules on both ends of assembly
- Typically used in cabinet-to-cabinet permanent link trunks
- Installs into Mini-Com™ Modular Patch Panels (or QuickNet™ Patch Panels with panel adapters) on both ends in common interconnect and cross connect architectures
- Compatible with PViQ™ and PanView™ Intelligent Modular Patching Systems

QuickNet™ Configure to Order Cable Assemblies

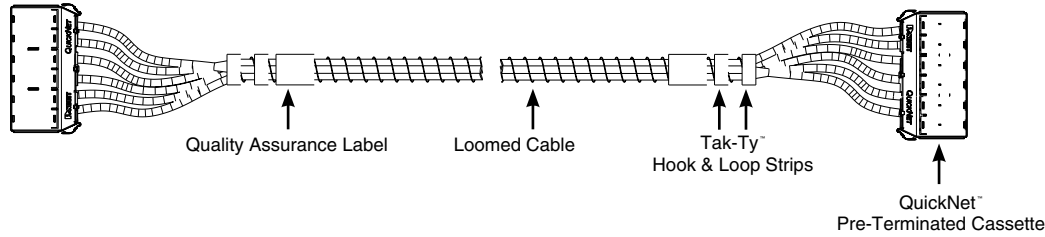

Ordering Information

Part Number Example	Q	Z	L	W	C	C	L	0	0	0	1	M	0	1	0
	1	2	3	4	5	6	7	8	9	10	11	12	13	14	15

Copper QN Trunk, Cat6A, UTP VariMaTriX, LSZH, White Cable, End 1 Cassette, End 2 Cassette, Black Jacks, Standard Pkg, 10 Meters

1 – Q = QuickNet™

2 – Performance Level

- C = Category 6 UTP
- H = Category 6A U/FTP Shielded
- Z = Category 6A UTP Vari-MaTriX

3 – Flame Rating

- L = Dca-s2-d2-a1
- Y = Cca-s1a-d1-a1
- W = B2ca-s1a-d1-a1

4 – Cable Color

- W = White

5 – Termination End 1

- C = Cassette
- J = Jack modules
- P = Modular plugs

6 – Termination End 2

- C = Cassette
- J = Jack modules
- P = Modular plugs
- U = Unterminated

7 – Termination Color Options

Jack Module Color Options

- B = Blue, L = Black, R = Red, W = White, Shielded Jack Modules, choose option L (all Shielded Jack Modules are Black).

Modular Plug and Unterminated Color Options

- X = No color option available, End1 and End2 are plug and/or unterminated

8-11 – Serial Code

12 – Unit of Measure

- M = Meters

13,14,15 – Assembly Length**

- Meters = 003 to 090

A. Featured Products

B. Copper Systems

C. Fiber Systems

D. Faceplates, Frames & Surface Mount Boxes

E. Industrial Networks

F. Audio Video Systems

G. Keystone Cabling Systems

H. Zone Cabling

J. Cable Routing Systems

K. Cable Cleats

L. Cabinets & Rack Systems

M. Power & Connectivity Management

N. Grounding & Bonding

O. Identification Products

P. Cable Management Accessories

Q. Part Number Index

A. Featured Products

B. Copper Systems

C. Fiber Systems

D. Faceplates, Frames & Surface Mount Boxes

E. Industrial Networks

F. Audio Video Systems

G. Keystone Cabling Systems

H. Zone Cabling

J. Cable Routing Systems

K. Cable Cleats

L. Cabinets & Rack Systems

M. Power & Connectivity Management

N. Grounding & Bonding

O. Identification Products

P. Cable Management Accessories

Q. Part Number Index

SFP+ 10 Gb/s Direct Attach Passive Cable Assemblies

- Ideal for Top of Rack (ToR) switch to server applications
- Small diameter cable design enables superior cable management and improved air flow
- Passive connection provides a low cost, short reach interconnect option without additional power requirements
- Robust strain relief boot provides proper bend radius control for consistent reliability
- Constructed with high-speed, 2-pair, twinaxial cable, factory terminated to SFP+ 10 Gb/s hot pluggable modular connectors
- Variety of standard lengths allow more precise deployment, improved cable management and cost efficiencies
- 100% performance tested
- Low profile latching mechanism in connector allows assemblies to be installed side by side or stacked on top of each other providing maximum port density in high-density installations



PSF1PZA1MBL

Part Number	Length m	Length Ft.	Cable Gauge	Nominal Cable O.D.		Cable Jacket	Std. Pkg. Qty.	Std. Ctn. Qty.
				mm	In.			
PSF1PZA0.5MBL‡	0.5	1.6	30 AWG	4.1	0.161	PVC	1	10
PSF1PZA1MBL‡	1	3.3						
PSF1PZA1.5MBL‡	1.5	4.9						
PSF1PZA2MBL‡	2	6.6						
PSF1PZA2.5MBL‡	2.5	8.2						
PSF1PZA3MBL‡	3	9.8						
PSF1PZA3.5MBL‡	3.5	11.5						
PSF1PZD4MBL‡	4	13.1	24 AWG	6.0	0.236			
PSF1PZD4.5MBL‡	4.5	14.4						
PSF1PZD5MBL‡	5	16.4						
PSF1PZD5.5MBL‡	5.5	17.6						
PSF1PZD6MBL‡	6	19.7						
PSF1PZD6.5MBL‡	6.5	21.3						
PSF1PZD7MBL‡	7	23.0						

All parts listed are in black; other options are white, red, and blue. For Labeling and Identification (Section O), see pages O.1 through O.18.

SFP28 25 Gb/s Direct Attach Active Cable Assemblies

- Ideal for Top of Rack (ToR) and End of Row (EoR) switch to server applications
- Fibre Channel over Ethernet (FCoE) capable
- Connector contains low power circuitry to extend beyond passive cable assemblies
- Constructed with high-speed, 2-pair, twinaxial cable, factory terminated to SFP28 25Gbps hot pluggable modular connectors
- 100% performance tested
- Low profile latching mechanism in connector allows assemblies to be installed side by side or stacked on top of each other providing maximum port density in high-density installations
- Small diameter cable design enables superior cable management and improved air flow
- Robust strain relief boot provides proper bend radius control for consistent reliability
- Variety of standard lengths allow more precise deployment, improved cable management, and cost efficiencies



PSF2PZA1MBL

Part Number	Length m	Cable Gauge	Nominal Cable O.D.		Cable Jacket	Std. Pkg. Qty.	Std. Ctn. Qty.
			mm	In.			
PSF2PZA1MBL‡	1	30 AWG	4.1	1.61	PVC	1	10
PSF2PZA2MBL‡‡	2						
PSF2PZA3MBL‡	3						
PSF2PZC4MBL‡	4	26 AWG	4.9	0.193			
PSF2PZC5MBL‡	5						

‡Direct attach active cable assemblies shown in BL (Black). Other colors available: WH (White), BU (Blue), RD (Red).
For Labeling and Identification (Section O), see pages O.1 through O.18.

QSFP28 100Gig Direct Attach Copper Cable Assemblies

- EEPROM compliant to SFF-8436 ensures interoperability with 100 Gigabit Ethernet equipment
- Low latency is ideal for use in high-performance computer clustering, financial trading, and other latency sensitive applications
- Low profile latching allows high-density belly-to-belly installation
- Constructed with 8-pair twinaxial cable factory terminated to QSFP28 100 Gb/s hot pluggable modular connectors
- 100% tested for assured system performance
- Advanced proprietary connector paddle card design reduces crosstalk



PQSF2PXA1MBL

Part Number	Length m	Cable Gauge	Color	Std. Pkg. Qty.	Std. Ctn. Qty.
PQSF2PXA1MBL	1	30 AWG	Black	1	10
PQSF2PXA2MBL	2				
PQSF2PXA3MBL	3				
PQSF2PXC4MBL	4	26 AWG			
PQSF2PXC5MBL	5				

For Labeling and Identification (Section O), see pages O.1 through O.18.

A. Featured Products

B. Copper Systems

C. Fiber Systems

D. Faceplates, Frames & Surface Mount Boxes

E. Industrial Networks

F. Audio Video Systems

G. Keystone Cabling Systems

H. Zone Cabling

J. Cable Routing Systems

K. Cable Cleats

L. Cabinets & Rack Systems

M. Power & Connectivity Management

N. Grounding & Bonding

O. Identification Products

P. Cable Management Accessories

Q. Part Number Index

- A. Featured Products
- B. Copper Systems
- C. Fiber Systems
- D. Faceplates, Frames & Surface Mount Boxes
- E. Industrial Networks
- F. Audio Video Systems
- G. Keystone Cabling Systems
- H. Zone Cabling
- J. Cable Routing Systems
- K. Cable Cleats
- L. Cabinets & Rack Systems
- M. Power & Connectivity Management
- N. Grounding & Bonding
- O. Identification Products
- P. Cable Management Accessories
- Q. Part Number Index

QuickNet™ Patch Panels and Accessories

- Accept QuickNet™ Copper Cable Assemblies and QuickNet™ SFQ Series MTP* Fiber Optic Cassettes which snap in and out with one hand
- High-density patch panels conserve valuable rack space
- Angled patch panels facilitate proper bend radius control and minimize the need for horizontal cable managers
- All metal patch panels accept shielded cassettes, no additional grounding kit required
- Pre-printed numbers above each port for easy identification
- Mount to standard EIA 19" racks or 23" racks with optional extender brackets



QPP24**



QPP48HD**



QAPP24**



QAPP48HD**



QSP24**



QASP24**



QASP48HD**



QPPABL



QPPBBL



QPPLC24

Part Number	Ports	No. of Rack Spaces ^	Style
QuickNet™ Unshielded Patch Panels			
QPP24**	24	1	Flat
QPP48HD**	48		
QPP48HDVNS**	48		Angled
QAPP24**	24		
QAPP48HD**	48		
QAPP48HDVNS**	48		

Part Number	Ports	No. of Rack Spaces ^	Style
QuickNet™ Shielded Patch Panels			
QSP24**	24	1	Flat
QSP48HD**	48		
QASP24**	24		Angled
QASP48HD**	48		

**Colors available: BL (Black), WH (White).
 ^One rack space = 1.75" (44.45mm). M6 and #12-24 mounting screws included. QuickNet™ Pre-Terminated.

Part Number	Part Description
QPPABL	QuickNet™ Patch Panel Adapter which accepts Mini-Com™ Modules for UTP, fiber optic, and audio/visual applications.
QPPBBL	QuickNet™ Patch Panel Blank reserves space for future use and promotes proper airflow and cooling.
QPPLC24	Label/label cover kit for 24-port QuickNet™ Patch Panels. Each kit contains four labels and four clear label covers per bag.

*MTP is a registered trademark of US Conec Ltd.
 For Labeling and Identification (Section O), see pages O.1 through O.18.



Mini-Com™ Modular Patch Panels

- Accept Mini-Com™ Modules, which snap in and out for easy moves, adds and changes
- Angled style facilitate proper bend radius control and minimizes the need for horizontal cable managers
- Front access design includes faceplate with easy snap release feature
- Select panels available in White
- Shielded panels limited to shielded jacks



CPP24FMWBLY



CPP24FMWWH



CPPA24FMWBLY



CPPA24FMWWH



CPPL24WBLY



CPPLA24WBLY



CPPL48WBLY



CPP12WBL



CPP12WBL



CPP48HDWBLY



CPP48HDWWH



CPPA48HDWBLY



CPPA48HDWWH



CP48BLY



CPA24BLY

Part Number	Ports	RU	Style	Identification	Color
Flush Mount					
CPP24FMWBLY	24	1	Flat	Adhesive	Black
CPP24FMWWH					White
CPPA24FMWBLY			Angled*		Black
CPPA24FMWWH					White
CPP48FMWBLY	48	2	Flat		Black
CPP48FMWWH					White
CPPA48FMWBLY			Angled*		Black
CPPA48FMWWH					White

Part Number	Ports	RU	Style	Identification	Color
Front Access					
CPPL24WBLY	24	1	Flat	Label pocket	Black
CPP24WBLY				Adhesive	
CPPLA24WBLY			Angled*	Label pocket	
CPPL48WBLY				Adhesive	
CPP48WBLY	48	2	Flat	Label pocket	
CPPLA48WBLY				Adhesive	
CWPP12WBL	12	-	Wall mount	Adhesive	
CPP12WBL			89D mount		

Part Number	Ports	RU	Style	Identification	Color
High Density					
CPP48HDWBLY	48	1	Flat	-	Black
CPP48HDWWH				White	
CPP48HDEWBL				Adhesive	Black
CPPA48HDWBLY			Angled*	-	Black
CPPA48HDWWH				White	
CPPA48HDEWBL				Adhesive	Black

Part Number	Ports	RU	Style	Identification	Color
All Metal Shielded					
CP24BLY	24	1	Flat	Adhesive	Black
CP48BLY	48	2			
CPA24BLY	24	1	Angled*		
CPA48BLY	48	2			

*Patented design.

A. Featured Products

B. Copper Systems

C. Fiber Systems

D. Faceplates, Frames & Surface Mount Boxes

E. Industrial Networks

F. Audio Video Systems

G. Keystone Cabling Systems

H. Zone Cabling

J. Cable Routing Systems

K. Cable Cleats

L. Cabinets & Rack Systems

M. Power & Connectivity Management

N. Grounding & Bonding

O. Identification Products

P. Cable Management Accessories

Q. Part Number Index

A. Featured Products

UL LISTED **Populated UTP Patch Panels**

- Includes DP6A™, DP6™, DP5e™ Panels with 110 punchdown termination and Category 6A, 6, and 5e coupler-based panels

- Coupler-based panels provide fast and easy connection of 6 and 8-position RJ45 patch cords

B. Copper Systems

C. Fiber Systems



DP246X88TGY



DPA246X88TGY



DPA486X88TGY



DP246X88TGWH



DPA246X88TGWH



DP486X88TGWH



DPA486X88TGWH



CP246X88BL



DP24688TGY



DPA24688TGY



DP48688TGY



DPA48688TGY



DP24688TGWH

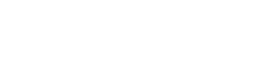

DPA24688TGWH



DP48688TGWH



DPA48688TGWH

Part Number	Performance Level	Ports	RU	Style	Identification	Color	Termination Type	Std. Pkg. Qty.		
DP246X88TGY	Category 6A	24	1	Flat	Adhesive	Black	110	1		
DPA246X88TGY				Angled*						
DP486X88TGY		48	2	Flat						
DPA486X88TGY				Angled*						
DP246X88TGWH		24	1	Flat					White	
DPA246X88TGWH				Angled*						
DP486X88TGWH		48	2	Flat						
DPA486X88TGWH				Angled*						
CP246X88BL		24	1	Flat		Adhesive	Black	Coupler		1
DP24688TGY				48			2	Flat		
DPA24688TGY		24	1					Angled*		
DP48688TGY				48			2	Flat		
DPA48688TGY	24	1	Angled*		White					
DP24688TGWH			48	2			Flat			
DPA24688TGWH	24	1				Angled*				
DP48688TGWH			48	2		Flat	Adhesive	Black	110	1
DPA48688TGWH	24	1				Angled*				
CP24688BL			24	1		Flat				
DP245E88TGY	48	2			Flat					
DPA245E88TGY			24	1	Angled*					
DP485E88TGY	48	2			Flat	Adhesive				
DPA485E88TGY			24	1	Angled*					
DP245E88TGWH	48	2			Flat					
DPA245E88TGWH			24	1	Angled*					
DP485E88TGWH	48	2			Flat		Adhesive	Black	Coupler	
DPA485E88TGWH			24	1	Angled*					
CP245E88BLY	24	1			Flat					

*Patented design.
M6 and #12-24 mounting screws included.
Termination tool (PDT110) available on page B.24.
For labeling and identification, see pages O.1 through O.18.



Voice Patch Panel

- Single female telco 50-pin/25-pair connector with hook and loop fasteners wired for common active voice equipment
- 24 RJ45 ports with pins 4 and 5 active in each port



Part Number	Performance Level	Ports	RU	Style	Identification	Color	Termination Type	Std. Pkg. Qty.
VP24382TV25Y	Category 3	24	1	Flat	Adhesive	Black	RJ21	1



Patch Panel Accessories

- Strain relief bars help support cable exiting the back of the panel
- Filler panels cover unused rack space
- Transitional cover for angled panels to help promote proper airflow and cooling
- Select product available in White



SRB19D5BL



CPAF2WH



CPATCWH



CPAF1WH



CPATCBL



SRBBRKT



WB89D

Part Number	Type	Style	Color
SRB19D5BL	Strain Relief Bar	Deep	Black
SRB19BLY		Extended	
SRB19D7BL		Deep	
SRBWYCY		With Clips	
CPAF2BLY	Filler Panel	Angled	White
CPAF2WH			Black
CPAF1BLY			White
CPAF1WH			Black
CPATCBL	Transitional Cover		Black
CPATCWH			White
SRBBRKT	Mounting Bracket	Quick Release	Black
WB89D	Bracket	89D	White

A. Featured Products

B. Copper Systems

C. Fiber Systems

D. Faceplates, Frames & Surface Mount Boxes

E. Industrial Networks

F. Audio Video Systems

G. Keystone Cabling Systems

H. Zone Cabling

J. Cable Routing Systems

K. Cable Cleats

L. Cabinets & Rack Systems

M. Power & Connectivity Management

N. Grounding & Bonding

O. Identification Products

P. Cable Management Accessories

Q. Part Number Index

- A. Featured Products
- B. Copper Systems
- C. Fiber Systems
- D. Faceplates, Frames & Surface Mount Boxes
- E. Industrial Networks
- F. Audio Video Systems
- G. Keystone Cabling Systems
- H. Zone Cabling
- J. Cable Routing Systems
- K. Cable Cleats
- L. Cabinets & Rack Systems
- M. Power & Connectivity Management
- N. Grounding & Bonding
- O. Identification Products
- P. Cable Management Accessories
- Q. Part Number Index

110 Punchdown Systems

- Includes GP6™ (Category 6) and Pan-Punch™ (Category 5e) Punchdown Systems
- Kits provide all prepackaged components necessary for system
- Rack mount kits mount to standard 19" racks
- Patch cords are factory assembled with 110-to-110 or 110-to-RJ45 (A or B) configurations
- Wall mount tower systems available in 300 and 900 pair configurations



Punchdown Base Kits with Legs

Part Number	Performance Level	Pairs	Density	4-Pair Connector	5-Pair Connector	Label and Holder
GPKBW144Y	Category 6	144	High	36	-	2
GPKBW432Y		432				
GPKBW24Y		96				
GPKBW72Y		288				
P110KB1004Y	Category 5e	100	Standard	20	4	6
P110KB1005Y				-	20	
P110KB3004Y		300	-	60	12	
P110KB3005Y				-	60	

Termination tool available on page B.9.
 Cable requirement: terminates most 22-26 AWG solid or stranded IWC wire with a 0.050" (1.27mm) o.d., either PVC or LSZH rated.
 To ensure optimal performance, Panduit recommends use with other Panduit Category 6 PLUS components.
 For labeling and identification, see pages O.1 through O.18.

Rack Mount 110 Punchdown Panel Kits



Part Number	Performance Level	Pairs	Density	4-Pair Connector	5-Pair Connector	Label and Holder	Jumper Troughs	RU	
GPB2884R2Y	Category 6	Two 144	High	48	-	4	-	2	
GPB484R2Y		Two 96							
P110B1004R2Y	Category 5e	Two 100	Standard	40	8	4	-	2	
P110B1005R2Y				-	40				
P110B1004R4WJY				40	8	2	4		
P110B1005R4WJY				-	40				
P110B100R2Y				-	-	-	-	2	4
P110B100R4WJY				-	-	-	-	2	4

Termination tool available on page B.9.
 Cable requirement: terminates most 22-26 AWG solid or stranded IWC wire with a 0.050" (1.27mm) o.d., either PVC or LSZH rated.
 To ensure optimal performance, Panduit recommends use with other Panduit Category 6 PLUS components.
 For labeling and identification, see pages O.1 through O.18.

110 Punchdown Systems (continued)

Connecting Blocks



P110CB4-XY

Part Number	Performance Level	Pairs	Std. Pkg. Qty.
GPCB4-X	Category 6	4	10
GPCB5-X		5	
P110CB4-XY	Category 5e	4	100
P110CB4-CY			10
P110CB5-XY		5	100
P110CB5-CY			100

Termination tool available on page B.9.

Cable requirement: terminates most 22-26 AWG solid or stranded IWC wire with a 0.050" (1.27mm) o.d., either PVC or LSZH rated.

To ensure optimal performance, Panduit recommends use with other Panduit Category 6 PLUS components.

For labeling and identification, see pages O.1 through O.18.



P110BW100-X



P110B100-X



P110BW300-X



P110B300-X

Bases

Part Number	Performance Level	Pairs	Density	With Legs	Std. Pkg. Qty.
GPBW24-X	Category 6	96	Standard	Yes	10
GPB24-X				No	
P110BW100-X	Category 5e	100		Yes	
P110B100-X				No	
P110BW300-X		300		Yes	
P110B300-X				No	

Termination tool available on page B.9.

Cable requirement: terminates most 22-26 AWG solid or stranded IWC wire with a 0.050" (1.27mm) o.d., either PVC or LSZH rated.

To ensure optimal performance, Panduit recommends use with other Panduit Category 6 components.

For labeling and identification, see pages O.1 through O.18.

Patch Cord Assemblies



P110PC1IG2Y



P110PC4IG2AY

Part Number	Performance Level	Connector 1	Connector 2
GPPC4IG#Y	Category 6	110 - 4-pair	110 - 4-pair
GPPC4IG#AY			RJ45 A
GPPC4IG#BY			RJ45 B
P110PC1IG#Y	Category 3	110 - 1-pair	110 - 1-pair
P110PC2IG#Y	Category 5	110 - 2-pair	110 - 2-pair
P110PC4IG#Y	Category 5e	110 - 4-pair	110 - 4-pair
P110PC4IG#AY			RJ45 A
P110PC4IG#BY			RJ45 B

For available lengths replace # with 3, 5, 7, 9, 14, 20 feet.

A. Featured Products

B. Copper Systems

C. Fiber Systems

D. Faceplates, Frames & Surface Mount Boxes

E. Industrial Networks

F. Audio Video Systems

G. Keystone Cabling Systems

H. Zone Cabling

J. Cable Routing Systems

K. Cable Cleats

L. Cabinets & Rack Systems

M. Power & Connectivity Management

N. Grounding & Bonding

O. Identification Products

P. Cable Management Accessories

Q. Part Number Index

Continued on next page

A.
Featured
Products

110 Punchdown Systems (continued)

B.
Copper
Systems

C.
Fiber
Systems

D.
Faceplates,
Frames &
Surface
Mount Boxes

E.
Industrial
Networks

F.
Audio
Video
Systems

G.
Keystone
Cabling
Systems

H.
Zone
Cabling

J.
Cable
Routing
Systems

K.
Cable
Cleats

L.
Cabinets
& Rack
Systems

M.
Power &
Connectivity
Management

N.
Grounding
& Bonding

O.
Identification
Products

P.
Cable
Management
Accessories

Q.
Part
Number
Index

110 Category 5e Tower System



P110KT3004Y

Part Number	Pairs	4-Pair Connector	5-Pair Connector	Label and Holder	110 Base	Jumper Troughs
P110KT3004Y	300	60	12	6	3	3
P110KT3005Y		12	60			
P110KT9004Y	900	180	36	18	9	9
P110KT9005Y		–	180			

Each tower system contains adequate connecting blocks to complete each 25-pair wiring strip. Example: P110KT3004Y includes five 4-pair and one 5-pair connecting block per 25-pair wiring strip for a total of sixty 4-pair and twelve 5-pair connecting blocks. Cable requirement: terminates most 22-26 AWG solid or stranded IWC wire with a 0.050" (1.27mm) max o.d., either PVC or LSZH rated. For labeling and identification, see pages O.1 through O.18.

110 Tools and Accessories



GPDTM

GPST



PDT110M

PDT110



P110B100R2BY

Part Number	Part Description
GPDTM	4-pair punchdown tool, for use with GP6 system.
GPST	Single wire punchdown tool, for use with GP6 system.
PDT110M	5-pair punchdown tool.
PDT110	Single pair punchdown tool.
P110PC4-XY	Pan-Punch 110 patch connector, 4-pair.
P110LH	110 label holder, compatible with 110 and GP6 bases.
P110JT-X	Jumper troughs without legs.
P110JTW-X	Jumper troughs with legs.
P110B100R2BY	19" punchdown rack mount panel, 2 RU.

RJ45 Plug Lock-In Device

- Blocks unauthorized removal of patch cord, VoIP phone, other networking equipment or critical connection
- Compact design does not interfere with adjacent jack modules, including high density applications
- Requires key to lock and unlock
- Locking mechanism is white for Flush and clear for Recessed



PSL-DCPLRX-BL



Part Number	Color	Type	Number of Keys	Std. Pkg. Qty.
PSL-DCPLX	Red	Flush	1	10
PSL-DCPLX-C			5	100
PSL-DCPLX-*	*See below		1	10
PSL-DCPLX-*-C			5	100
PSL-DCPLRX	Red	Recessed	1	10
PSL-DCPLRX-C			5	100
PSL-DCPLRX-*	*See below		1	10
PSL-DCPLRX-*-C			5	100

*For other colors replace asterisk with: IW (Off White), EI (Electric Ivory), WH (White), BU (Blue), BL (Black), YL (Yellow), OR (Orange).

RJ45 Jack Blockout Device

- Saves time and money by blocking unauthorized access and protecting jacks from foreign objects
- Compatible with most RJ45 jacks and does not interfere with jack contacts
- Does not interfere with adjacent jacks or hardware
- Requires key to remove



PSL-DCJB



Part Number	Color	Type	Number of Keys	Std. Pkg. Qty.	
PSL-DCJB	Red	RJ45	1	10	
PSL-DCJB-C			5	100	
PSL-DCJB-*	*See below		1	10	
PSL-DCJB-*-C			5	100	
PSL-USBA	Red		USB	1	5
PSL-USBA-L				5	50

*For other colors replace asterisk with: IW (Off White), EI (Electric Ivory), WH (White), BU (Blue), BL (Black), YL (Yellow), OR (Orange).

A. Featured Products

B. Copper Systems

C. Fiber Systems

D. Faceplates, Frames & Surface Mount Boxes

E. Industrial Networks

F. Audio Video Systems

G. Keystone Cabling Systems

H. Zone Cabling

J. Cable Routing Systems

K. Cable Cleats

L. Cabinets & Rack Systems

M. Power & Connectivity Management

N. Grounding & Bonding

O. Identification Products

P. Cable Management Accessories

Q. Part Number Index

A.
Featured
Products

SmartKeeper Blockout Devices

B.
Copper
Systems

- Panduit SmartKeeper Blockout Devices protect connections from unauthorized access, dust and debris or damage caused by foreign objects
- Accommodate a variety of applications where RJ45 connections are present
- Mount flush with the opening and do not interfere with adjoining connections
- Unique mechanism can only be unlocked with the special master key

C.
Fiber
Systems

D.
Faceplates,
Frames &
Surface
Mount Boxes



SKRJ45RD-X

E.
Industrial
Networks



SKUSBA-V

F.
Audio
Video
Systems

G.
Keystone
Cabling
Systems



SKUSBC

H.
Zone
Cabling

J.
Cable
Routing
Systems



SKMKEY

K.
Cable
Cleats

L.
Cabinets
& Rack
Systems

M.
Power &
Connectivity
Management

N.
Grounding
& Bonding

O.
Identification
Products

P.
Cable
Management
Accessories

Q.
Part
Number
Index

Part Number	Description	Color	Type	Std. Pkg. Qty.	Std. Ctn. Qty.
SKRJ45RD-X	SmartKeeper RJ45 Blockout Device	Red	Flush	1	10
SKUSBA-V	SmartKeeper USB Type A Blockout Device			1	5
SKUSBC	Smartkeeper USB Type C blockout device			1	1
SKMKEY	SmartKeeper Master Key	—		1	1

Patch Cord Color Bands

- Removable band snaps on and off individual cables allowing the same patch cord to be used for different applications
- Can be installed next to each other allowing multiple color bands to be used on one cable, offering endless color coding options
- Internal grooves secure color bands in place on cable

- providing easy identification at the connection
- Available in ten standard colors that match Panduit connectivity and provide an aesthetically pleasing solution
- Compatible with all Panduit patch cords including 28 AWG patch cords
- Existing and new installations can be color-coded as networks change



PCBANDBU-Q



PCBANDRD-Q



PCBANDIG-Q

Part Number	Part Description	Color	Std. Pkg. Qty.
PCBANDBL-Q	Snaps onto individual patch cable for additional color-coding.	Black	25
PCBANDBU-Q		Blue	
PCBANDWH-Q		White	
PCBANDEI-Q		Electric Ivory	
PCBANDIG-Q		International Gray	
PCBANDOR-Q		Orange	
PCBANDRD-Q		Red	
PCBANDGR-Q		Green	
PCBANDYL-Q		Yellow	
PCBANDVL-Q		Violet	

Patch cords available on page B.6.

Cable Prep Tools

- Copper Wire Snipping Tool (CWST) cuts conductors flush for improved performance
- Adjustable Cable Jacket Stripping Tool (CJAST) strips outer jacket of 4-pair UTP and shielded copper cable



CJAST

CWST

Part Number	Part Description	Std. Pkg. Qty.
CWST	Copper conductor snipping tool.	1
CJAST	Cable jacket stripping tool.	
CJASTB	Replacement blade for cable stripping tool CJAST.	

Patch Cord Removal Tool

- Tool arms allow the installer to pass over cabling which interferes with accessibility
- Compatible with copper and fiber patch cords
- Optional flashlight kit (KPCRT1-FL) attaches to top of tool



PCRT1



KPCRT1-FL

Part Number	Part Description	Std. Pkg. Qty.
PCRT1	Easily removes copper and fiber patch cords in dense rack installations.	1
KPCRT1-FL	Flashlight kit for patch cord removal tool (PCRT1).	

**A.
Featured
Products**

**B.
Copper
Systems**

**C.
Fiber
Systems**

**D.
Faceplates,
Frames &
Surface
Mount Boxes**

**E.
Industrial
Networks**

**F.
Audio
Video
Systems**

**G.
Keystone
Cabling
Systems**

**H.
Zone
Cabling**

**J.
Cable
Routing
Systems**

**K.
Cable
Cleats**

**L.
Cabinets
& Rack
Systems**

**M.
Power &
Connectivity
Management**

**N.
Grounding
& Bonding**

**O.
Identification
Products**

**P.
Cable
Management
Accessories**

**Q.
Part
Number
Index**

Notes

Table of Contents

Panduit Fiber Cabling System Standards Compliance Guide . C.2 – C.3

OptiCam™ 2 Termination Tool C.4

OptiCam™ Fiber Optic Connectors C.5 – C.6

Opti-Core™ Fiber Optic Cable C.6 – C.9

Fiber Optic Adapters and Modules C.10

HD Flex™ Enclosures, Panels and Accessories C.11

HD Flex™ Fiber Optic Cassettes C.12 – C.14

HD Flex™ Adapter Panel and Accessories C.15

HD Fusion Splicing Enclosure and Accessories C.16

Opticom™ QuickNet™ Enclosures C.16 – C.17

Opticom™ Rack Mount Fiber Trays C.17

Opticom™ Fiber Adapter Patch Panels C.18

Opticom™ QuickNet™ MPO Fiber Optic Cassettes C.18 – C.20

Opticom™ MPO Fiber Optic Adapter Panels (FAPs) C.20

Opticom™ LC Fiber Adapter Panels (FAPs) C.21

Opticom™ Accessories and Splice Solutions C.22

QuickNet™ Zone Distribution C.23

QuickNet™ HDQ High Density Fiber Optic Cassettes C.23

QuickNet™ Patch Panels C.24

QuickNet™ SFQ MPO Fiber Optic Cassettes C.25

QuickNet™ MPO Fiber Adapter Panels (FAPs) C.23

Fiber Optic Interconnect Assemblies C.27 – C.29

Fiber Optic Trunk Cable Assemblies C.30 – C.32

Fiber Optic Harness Assemblies C.33 – C.35

Fiber Optic Patch Cord and Pigtail Assemblies C.36 – C.39

QuickNet™ High Density SFQ Small Form Factor Cable Assemblies C.40 – C.41

**A.
Featured
Products**

**B.
Copper
Systems**

**C.
Fiber
Systems**

**D.
Faceplates,
Frames &
Surface
Mount Boxes**

**E.
Industrial
Networks**

**F.
Audio
Video
Systems**

**G.
Keystone
Cabling
Systems**

**H.
Zone
Cabling**

**J.
Cable
Routing
Systems**

**K.
Cable
Cleats**

**L.
Cabinets
& Rack
Systems**

**M.
Power &
Connectivity
Management**

**N.
Grounding
& Bonding**

**O.
Identification
Products**

**P.
Cable
Management
Accessories**

**Q.
Part
Number
Index**

- A. Featured Products
- B. Copper Systems
- C. Fiber Systems
- D. Faceplates, Frames & Surface Mount Boxes
- E. Industrial Networks
- F. Audio Video Systems
- G. Keystone Cabling Systems
- H. Zone Cabling
- J. Cable Routing Systems
- K. Cable Cleats
- L. Cabinets & Rack Systems
- M. Power & Connectivity Management
- N. Grounding & Bonding
- O. Identification Products
- P. Cable Management Accessories
- Q. Part Number Index

Panduit Fiber Cabling System Standards Compliance Guide

	Panduit Multimode Systems		Panduit Singlemode Systems
	OM3/OM4 50/125µm	Signature Core™ OM4+/OM5+ 50/125µm	OS2 9/125µm
Technical Information	<ul style="list-style-type: none"> Exceed domestic and international standards for optical fiber, including TIA-492AAAB, TIA-492AAAC, TIA-492AAAD and IEC 60793-2-10 Support a diverse set of legacy and contemporary applications including Ethernet, Fiber Channel, Infiniband™, Fiber Distributed Data Interface (FDDI), Token Ring, Asynchronous Transfer Mode (ATM) and FICON (Fiber Connection) among others 		<ul style="list-style-type: none"> Meet or exceed numerous standards for optical fiber, including ITU-TG.652 (Categories A, B, C and D), IEC 60793-2-50, ISO 11801 OS2, and TIA-492-CAAB and Telcordia GR-20 Ensure performance over the entire 1250nm to 1625nm spectrum and are compatible with legacy fiber and the geometric properties contributing to minimizing splice loss and increasing splice yield

	Panduit Multimode Systems		Panduit Singlemode Systems
	OM3/OM4 50/125µm	Signature Core™ OM4+/OM5+ 50/125µm	OS2 9/125µm
Geometry			
Dimension			
Core Diameter	50.0µm ± 2.5µm	50.0µm ± 2.5µm	8.2µm typical
Cladding Diameter	125µm ± 1.0µm	125µm ± 1.0µm	125µm ± 0.7µm
Attenuation			
Wavelength			
850 nm	≤2.4dB/km	≤2.4dB/km	–
1300 nm	≤0.6dB/km	≤0.6dB/km	–
1310 nm	–	–	≤0.34dB/km
1550 nm	–	–	≤0.22dB/km
Environmental Properties			
Test			
Operating Temperature	-60°C to 85°C	-60°C to 85°C	-60°C to 85°C
Temperature Dependence (850 nm & 1300 nm from -60°C to +85°C)	≤0.1 dB/km	≤0.1 dB/km	≤0.1 dB/km

Panduit Fiber Cabling System Standards Compliance Guide

	Panduit Multimode Systems		Panduit Singlemode Systems
	OM3/OM4 50/125µm	Signature Core™ OM4+/OM5+ 50/125µm	OS2 9/125µm
Standards	IEEE 802.3z 1GBASE-SX - 850nm	IEEE 802.3z 1GBASE-SX - 850nm	1GBASE-LX-1310nm
	IEEE 802.3ae 10GBASE-SR/SW - 850nm 10GBASE-LX4 - CWDM, 1310nm	IEEE 802.3ae 10GBASE-SR/SW - 850nm 10GBASE-LX4 - CWDM	IEEE 802.3ae: 10GBASE-LX4 – CWDM, 1310nm 10GBASE-LX - 1310nm 10GBASE-EX - 1550nm
	IEEE 802.3ba 40GBASE-SR4 - 850nm 100GBASE-SR10 - 850nm	IEEE 802.3ba 40GBASE-SR4 - 850nm 100GBASE-SR10 - 850nm	IEEE 802.3ba 40GBASE-LR4 - CWDM, 1310nm 100GBASE-LR4 - CWDM, 1310nm 100GBASE-ER4 - CWDM, 1550nm
	IEEE 802.3bm 100GBASE-SR4 - 850nm	IEEE 802.3bm 100GBASE-SR4 - 850nm	IEEE 802.3by 25GBASE-LR - 1310nm 25GBASE-ER - 1550nm
	IEEE 802.3by 25GBASE-SR - 850nm	IEEE 802.3by 25GBASE-SR - 850nm	
	1G thru 128G Fibre Channel SWDM4 MSA InfiniBand	1G thru 128G Fibre Channel SWDM4 MSA InfiniBand	1G thru 128G Fibre Channel 40G PSM4 & 100G PSM4 MSAs CWDM4 & CWDM4-OC P MSAs InfiniBand SONET OC-192 and OC-768
Bandwidth (EMBc in Mz.km)	OM3>2000 OM4>4700	Both meet OM4 EMBc requirements and are wavelength dispersion compensated OM5 Sig. Core meets Modal Bandwidth requirements of OM4 at the 4 operating wavelengths of the SWDM MSA	-
Reach (Based on applicable standard listed above)	OM3 fiber: 300m (10GBASE-SR/SW) 300m (10GBASE-LX4) 100m (40GBASE-SR4 and 100GBASE-SR10) 70m (25GBASE-SR) 150m (FC-800-M5E-SN-I) 100m (FC-1600-M5E-SN-I) 70m (FC-3200-M5E-SN-I)	OM4 Sig Core fiber: 550m (10GBASE-SR/SW) 300m (10GBASE-LX4) 200m (40GBASE-SR4 and 100GBASE-SR10) 100m (25GBASE-SR) 125m (100GBASE-SR4) 250m (FC-800-M5F-SN-I) 200m (FC-1600-M5F-SN-I) 150m (FC-3200-M5F-SN-I)	5km (1GBASE-LX) 10km (10GBASE-LX4) 10km (10GBASE-LX4) 40km (10GBASE-EX) 10km (25GBASE-LX) 40km (25GBASE-EX) 10km (40GBASE-LR4) 10km (100GBASE-LR4) 40km (100GBASE-ER4)
	OM4 fiber: 400m (10GBASE-SR/SW) 300m (10GBASE-LX4) 150m (40GBASE-SR4 and 100GBASE-SR10) 190m (FC-800-M5F-SN-I) 125m (FC-1600-M5F-SN-I) 100m (FC-3200-M5F-SN-I) 75m (100G-SWDM4) 240m (40G-SWDM4)	OM5 Sig Core fiber: 465m (10GBASE-SR/SW) 300m (10GBASE-LX4) 145m (40GBASE-SR4 and 100GBASE-SR10) 115m (25GBASE-SR) 115m (100GBASE-SR4) 215m (FC-800-M5F-SN-I) 160m (FC-1600-M5F-SN-I) 115m (FC-3200-M5F-SN-I) 90m (FC-12800-M5F-SN-I) 100m (100G-SWDM4) 350m (40G-SWDM4)	1.4km (FC-800-SM-LC-I) 10km (FC-1600-SM-LC-L) 2km (FC-1600-SM-LZ-I) 10km (FC-3200-SM-LC-L)

Multimode-based Fibre Channel (FC-x00-My-SN-I); x = 1, 2, 8, 16, 32, 128; y = 5E(OM3), 5F(OM4)
 Singlemode-based Fibre Channel (FC-x00-SM-Ly-I); x = 1, 2, 4, 8, 16, 32, 128; y = I, C, Z, A
 InfiniBand (18-xX-yDR-SX); x = 1, 4, 8, 12 lanes; y = S, D, Q (Single, Double, Quadruple data rates)

- A. Featured Products
- B. Copper Systems
- C. Fiber Systems
- D. Faceplates, Frames & Surface Mount Boxes
- E. Industrial Networks
- F. Audio Video Systems
- G. Keystone Cabling Systems
- H. Zone Cabling
- J. Cable Routing Systems
- K. Cable Cleats
- L. Cabinets & Rack Systems
- M. Power & Connectivity Management
- N. Grounding & Bonding
- O. Identification Products
- P. Cable Management Accessories
- Q. Part Number Index

- A. Featured Products
- B. Copper Systems
- C. Fiber Systems
- D. Faceplates, Frames & Surface Mount Boxes
- E. Industrial Networks
- F. Audio Video Systems
- G. Keystone Cabling Systems
- H. Zone Cabling
- J. Cable Routing Systems
- K. Cable Cleats
- L. Cabinets & Rack Systems
- M. Power & Connectivity Management
- N. Grounding & Bonding
- O. Identification Products
- P. Cable Management Accessories
- Q. Part Number Index

OptiCam™ 2 Termination Tool

- Provides accurate calculated connector insertion loss with pass/fail thresholds in accordance with ANSI/TIA-568.3-D
- LCD Display with on-screen directions for three step termination process
- Wireless enabled for synchronization with Connect-It mobile app, allowing rich data analytics and project documentation
- Works with all current Panduit OptiCam™ LC, Keyed LC, SC, and ST Connectors



Part Number	Part Description
FOCTT2-KIT	Entry level kit including OptiCam™ 2 Tool, cradles for LC, SC, and ST OptiCam™ Connectors; launch cords for singlemode and multimode terminations, cover, and strip/cleave templates; all in an ultra-compact carrying case.
FOCTT2-BKIT	Basics kit including the OptiCam™ 2 Tool, cradles for LC, SC, and ST OptiCam™ Connectors; launch cords for singlemode and multimode terminations, cover, and strip/cleave templates, plus a jacket stripper, buffer stripper, Kevlar shears, cleaning solution, lint-free wipes, marker, and FJQCVR leaf-spring style fiber cleaver; all in a compact and organized carrying case.
FOCTT2-PKIT	Pro kit includes all components of the FOCTT2-BKIT, replacing the leaf-spring style FJQCVR cleaver with the FSPCVR precision cleaver.
FOLPC-1.25SM	Replacement 1.25mm ferrule launch cord for singlemode LC terminations (Singlemode).
FOLPC-1.25MM	Replacement 1.25mm ferrule launch cord for multimode LC terminations (OM1, OM2, OM3/4 Multimode).
FOLPC-2.5SM	Replacement 2.5mm ferrule launch cord for singlemode SC and ST terminations (Singlemode).
FOLPC-2.5MM	Replacement 2.5mm ferrule launch cord for multimode SC and ST terminations (OM1, OM2, OM3/4 Multimode).
FSPCVR	Precision fiber cleaver with rotary blade, receptacle for scrap stubs, cleave counter.

OptiCam™ LC Fiber Optic Connectors- Pre-Polished Cam Termination

- TIA/EIA-604 FOCIS-10 compliant connectors
- Exceed ANSI/TIA-568.3-D requirements
- Connector backbone and boot colors follow ANSI/TIA-568.3-D suggested color identification scheme
- Insertion loss: 0.3dB average (multimode and singlemode)
- Return loss: >26dB (multimode), >20dB (multimode), >50dB (singlemode)
- Quick installation; provide field termination in less than half the time of the field polish connectors
- Patented re-termination capability provide yield rates approaching 100%
- Factory pre-polished fiber end face eliminates time-consuming field polishing to reduce installation costs, labor, scrap and the number of tools required
- Cam activated fiber and buffer clamp mechanisms provide superior fiber and buffer retention- less sensitivity to fiber tensile loading
- OptiCam™ 2 Termination Tool simplifies tooling and termination, and virtually eliminates operator error by providing calculated insertion loss after the cam step has been completed
- Cable retention boot assembly's consistency provide higher than industry standard cable retention
- Fiber cable size: accept 900µm tight buffered fiber with included boot (s); accept 1.6mm-2.0mm and 3.0mm jacketed cable with available OptiCam™ Cable Retention Boot Assemblies
- Ferrule type: 2.5mm zirconia ceramic (highest durability for repeated mating's) to meet a variety of application requirements
- Use OptiCam™ Termination Kit (FOCTT2-KIT; FOCTT2-BKIT; FOCTT2-PKIT)



FLCDMCXAQY



FLCDMC5BLY



FLCDMC6EIY



FLCSSCBUY

	OS2	OM1	OM2	OM3/OM4	
	Part Number				Part Type
FLCSSCBUY	FLCSMC6EIY	FLCSMC5BLY	FLCSMCXAQY		LC Simplex
FLCDSCBUY	FLCDMC6EIY	FLCDMC5BLY	FLCDMCXAQY		LC Duplex
FLCSSC***	FLCSMC6***	FLCSMC5***	FLCSMCX***		Keyed LC Simplex

Part Number Example	F	L	C	D	M	C	X	A	Q	Y	-	C
	1	2	3	4	5	6	7	8	9	10	11	12

1-Fiber

F = Fiber

2 & 3-Connector Type

LC = LC Opticam

4-Cable Type

D = Duplex

S = Simplex

5-Connector Variant

M = Multimode

S = Singlemode

6-Termination Style

C = Cam Style Termination

7-Fiber Type

X = OM3/OM4

9 = OS1/OS2

6 = OM1

5 = OM2

8 & 9-Cable Color

AQ = Aqua (OM3/OM4)

BU = Blue (OS1/OS2)

EI = Electric Ivory (OM1)

BL = Black (OM2)

10-Compliance

Y = RoHS Compliant

11 & 12- Package Quantity

-C = Pack of 100 Simplex Connectors

For 1.6/2.0mm jacketed cable, use boot FMCBT2**-X (where ** is the color). For 3.0mm jacketed cable, use boot FMCBT3**-X (where ** is the color). Duplexing clip is part number FLCCLIPBL-L.

***Keyed LC

A. Featured Products

B. Copper Systems

C. Fiber Systems

D. Faceplates, Frames & Surface Mount Boxes

E. Industrial Networks

F. Audio Video Systems

G. Keystone Cabling Systems

H. Zone Cabling

J. Cable Routing Systems

K. Cable Cleats

L. Cabinets & Rack Systems

M. Power & Connectivity Management

N. Grounding & Bonding

O. Identification Products



P. Cable Management Accessories

Q. Part Number Index

- A. Featured Products
- B. Copper Systems
- C. Fiber Systems
- D. Faceplates, Frames & Surface Mount Boxes
- E. Industrial Networks
- F. Audio Video Systems
- G. Keystone Cabling Systems
- H. Zone Cabling
- J. Cable Routing Systems
- K. Cable Cleats
- L. Cabinets & Rack Systems
- M. Power & Connectivity Management
- N. Grounding & Bonding
- O. Identification Products
- P. Cable Management Accessories
- Q. Part Number Index

OptiCam™ SC/ST Fiber Optic Connectors – Pre-Polished Cam Termination

- TIA/EIA-604 FOCIS-3 (SC) and FOCIS-2 (ST) compliant connectors
- Exceed ANSI/TIA-568.3-D requirements
- Connector boot colors follow ANSI/TIA-568.3-D suggested color identification scheme
- Insertion loss: 0.3dB average (multimode and singlemode)
- Return loss: >26dB (multimode), >20dB (multimode), >50dB (singlemode)
- Quick installation; provide field termination in less than half the time of the field polish connectors
- Patented re-termination capability provide yield rates approaching 100%
- Factory pre-polished fiber end face eliminates time-consuming field polishing to reduce installation costs, labor, scrap and the number of tools required
- Cam activated fiber and buffer clamp mechanisms provide superior fiber and buffer retention- less sensitivity to fiber tensile loading
- OptiCam™ Termination Tool simplifies tooling and termination, and virtually eliminates operator error by providing visual indication of proper termination after the cam step has been completed
- Cable retention boot assembly's consistency provide higher than industry standard cable retention
- Fiber cable size: accept 900µm tight buffered fiber with included boot (s); accept 1.6mm-2.0mm and 3.0mm jacketed cable with available OptiCam™ Cable Retention Boot Assemblies
- Ferrule type: 2.5mm zirconia ceramic (highest durability for repeated mating) or composite to meet a variety of application requirements
- Use OptiCam™ Termination Kit (FOCTT2-KIT; FOCTT2-BKIT; FOCTT2-PKIT)

 FSC2MC5BL	OS2	OM1	OM2	OM3/OM4	
 FST2MC6EI	Part Number				Part Type
	FSC2SCBU	FSC2MC6EI	FSC2MC5BL	FSC2MCXAQ	SC Simplex
	FSC2DSCBU	FSC2DMC6EI	FSC2DMC5BL	FSC2DMCXAQ	SC Duplex
	FST2SCBU	FST2MC6EI	FST2MC5BL	FST2MCXAQ	ST Simplex

For 1.6/2.0mm jacketed cable, use boot FMCBT2**-X (where ** is the color). For 3.0mm jacketed cable, use boot FMCBT3**-X (where ** is the color). Duplexing clip is part number FSCCLIP-L.

Opti-Core™ Fiber Optic Indoor Distribution Cable

- Used in intrabuilding backbone, building backbone, and horizontal installations
- Available in 4, 6, 8, 12 and 24-fiber counts in a "single jacket" design, and in 36, 48, 72 and 96-fiber counts in a sub-unit design
- Sheath markings provide positive identification, quality, traceability, and length verification
- Cable design and flexible buffer tubes allow for quick breakout and ease of routing
- 900mm standards-based color-coded buffer coating protects fibers during handling and allows for easy identification and stripping

Part Number Example	F	A	D	C	Z	0	4	-	3	7
	1	2	3	4	5	6	7	8	9	10



- 1,2 - Fiber Type**
FA = Fiber EuroClass
- 3 - Construction**
D = Indoor Distribution Single Jacket (up to 24 fiber)
E = Indoor Distribution Sub-Unitized (36 fiber and up)
- 4 - Flame Rating**
C = EuroClass Rated
- 5 - Fiber Mode Type**
9 = 9µm Singlemode OS2
- X = 50µm Multimode OM3
Z = 50µm Multimode OM4
- 6,7 - Fiber Count**
04
06
08
12
24
36
48
72
- 96
- 8 - Dash**
- 9,10 - EuroClass Code**
24 = Cca-s1a,d1,a1 (single jacket only)
37 = Dca-s2,d2,a1 (single jacket only)
40 = Eca (sub-unitized only)

Opti-Core™ Fiber Optic Interconnect Cable

- Used in interconnect and horizontal installations for general purpose environments
- Sheath markings provide positive identification, quality, traceability, and length verification
- Colored buffered for ease of identification
- High quality buffering offers ease of stripping while maintaining optical performance
- Small diameter and flexible jackets allow for routing in tight spaces such as panels, cable trays, and fiber to the desk (FTTD) applications

Part Number Example	F	A	I	C	Z	0	2	-	4	0
	1	2	3	4	5	6	7	8	9	10



FAICZ02-40

1,2 - Fiber Type

FA = Fiber EuroClass

3 - Construction

I = Interconnect 2.9mm (Zipcord)

4 - Flame Rating

C = EuroClass Rated

5 - Fiber Mode Type

9 = 9µm Singlemode OS2

X = 50µm Multimode OM3

Z = 50µm Multimode OM4

6,7 - Fiber Count

02

8 - Dash

9,10 – EuroClass Code

40 = Eca

Opti-Core™ Fiber Optic Indoor/Outdoor Loose Tube Cable (Gel-Filled)

- Allows installation using loose tube cable methods within building and outdoor environments for duct applications and in entrance facilities
- Eliminates the need for building entrance transition point
- All-dielectric cable construction requires no grounding or bonding
- UV resistant cable sheathing for harsh outdoor environments
- Loose tubes are gel-filled for superior water-blocking
- Central tube design available with 4, 6, 8, 12 or 24 fibers. Stranded tube design available with 36, 48, 72, 96 or 144 fibers
- Sheath markings provide positive identification, quality, traceability, and length verification
- 250µm coating protects fibers during handling and allows for ease of stripping

Part Number Example	F	A	N	C	Z	4	8	-	4	0
	1	2	3	4	5	6	7	8	9	10



FANCZ36-40

1,2 - Fiber Type

FA = Fiber EuroClass

3 - Construction

C = Indoor/Outdoor Central Tube (up to 24 fibers)

N = Indoor/Outdoor Stranded Tube (36 fibers or more)

4 - Flame Rating

C = EuroClass rated

5 - Fiber Mode Type

9 = 9µm Singlemode OS2

X = 50µm Multimode OM3

Z = 50µm Multimode OM4

W = 50µm Multimode OM5 (only for Cca with 12 or 24 fibers)

6,7 - Fiber Count

04

06

08

12

24

36

48

72

96

1A = 144

8 - Dash

9,10 - EuroClass Code

14 = B2ca-s1a,d1,a1

24 = Cca-s1a,d1,a1

40 = Eca

- A. Featured Products
- B. Copper Systems
- C. Fiber Systems
- D. Faceplates, Frames & Surface Mount Boxes
- E. Industrial Networks
- F. Audio Video Systems
- G. Keystone Cabling Systems
- H. Zone Cabling
- J. Cable Routing Systems
- K. Cable Cleats
- L. Cabinets & Rack Systems
- M. Power & Connectivity Management
- N. Grounding & Bonding
- O. Identification Products
- P. Cable Management Accessories
- Q. Part Number Index

Opti-Core™ Fiber Optic Indoor/Outdoor Steel Armour Cable

- Corrugated steel tape armour eliminates the need for inner duct or conduit to provide a smaller crush resistant pathway, improved design flexibility, and lower installed cost
- UV resistant cable sheathing for harsh outdoor environments
- Loose tubes are gel-filled for superior water-blocking
- Central tube design available with 4, 6, 8, 12 or 24 fibers; Stranded tube design available with 36, 48, 72, 96 or 144 fibers
- High density design can be used indoors or outdoors; suitable for duct applications and entrance facilities

Part Number Example	F	A	G	C	9	1	2	-	4	0
	1	2	3	4	5	6	7	8	9	10



FAGC912-40

- 1,2 - Fiber Type**
FA = Fiber EuroClass
- 3 - Construction**
G = Indoor-Outdoor Central Tube Armoured (up to 24 fibres)
M = Indoor-Outdoor Stranded Tube Armoured (36 fibres or more)
- 4 - Flame Rating**
C = EuroClass Rated
- 5 - Fiber Mode Type**
9 = 9um Singlemode OS2
X = 50um Multimode OM3
Z = 50um Multimode OM4
- 6,7 - Fiber Count**
04
- 06
08
12
24
36
48
72
96
1A = 144
- 8 - Dash**
- 9,10 - EuroClass Code**
14 = B2ca-s1a-d1-a1
24 = Cca-s1a-d1-a1 (Stranded Tube only)
40 = Eca

Opti-Core™ Fiber Optic Gel-Free Indoor/Outdoor Tight Buffered

- For indoor and outdoor applications including data centers and routing between telecommunications rooms; can be installed in ducts and on trays
- Dry water-blocking technology allows rapid cable preparation and termination for lower termination costs and time (no messy gel)
- Eliminates the need for building entrance transition point
- Sheath markings provide positive identification, quality, traceability, and length verification
- All-dielectric cable construction requires no grounding or bonding
- 900µm buffer coating protects fibers during handling and allows for ease of stripping
- UV resistant cable sheathing for harsh outdoor environments

Part Number Example	F	A	K	C	9	1	2	-	4	0
	1	2	3	4	5	6	7	8	9	10



FAKC912-40

- 1,2 - Fiber Type**
FA = Fiber EuroClass
- 3 - Construction**
K = Indoor/Outdoor Tight Buffered Unarmored
- 4 - Flame Rating**
C = EuroClass Rated
- 5 - Fiber Mode Type**
9 = 9um Singlemode OS2
X = 50um Multimode OM3
Z = 50um Multimode OM4
W = 50um Multimode OM5 (only for Cca with 12 or 24 fibers)
- 6,7 - Fiber Count**
02
04
06
08
12
24
- 8 - Dash**
- 9,10 - EuroClass Code**
14 = B2ca-s1a,d1,a1
24 = Cca-s1a,d1,a1
40 = Eca

Opti-Core™ Fiber Optic Outside Plant Cable (Gel-Filled)

- Allows installation using loose tube cable methods in harsh outdoor environments
- Loose tubes are gel-filled for superior water-locking
- Central tube design has LLDPE sheath for direct burial with sand back filling and is available with 2, 4, 6, 8, 12 or 24 fibers
- Stranded tube design has MDPE sheath for low friction installation and is available with 6, 8, 12, 24, 36, 48, 72, 96 or 144 fibers
- All-dielectric cable construction requires no grounding or bonding
- UV resistant cable sheathing resists degradation due to sunlight exposure
- Sheath markings provide positive identification, quality, traceability, and length verification
- 250µm coating protects fibers during handling and allows for ease of stripping

Part Number Example	FQ	T	N	Z	3	6
	1	2	3	4	5	6



FQTNZ36

- 1 - Fiber Type**
FP = Fiber EMEA - OS2
FQ = Fiber EMEA - OM3, OM4
- 2 - Construction**
T = Outside plant, gel-filled, all-dielectric stranded tube (6 to 144 fibers)
U = Outside plant, gel-filled, all-dielectric central tube (2 to 24 fibres)
- 3 - Flame Rating**
N = Non Rated
- 4 - Fiber Mode Type**
9 = 9µm Singlemode OS2
X = 50µm Multimode OM3
- Z = 50µm Multimode OM4
- 5,6 - Fiber Count**
02
04
06
08
12
24
36
48
72
96
1A = 144

Opti-Core™ Fiber Optic Outside Plant Armored Cable (Gel-Filled)

- Allows installation using loose tube cable methods in harsh outdoor environments
- Loose tubes are gel-filled for superior water-blocking
- Corrugated steel armor provides superior crush resistance and rodent protection for extended durability
- UV resistant cable sheathing resists degradation due to sunlight exposure
- Complies with ISO/IEC 11801, IEC 60794 and EN 50173
- Single armor single jacket version available with central tube design and 4 to 24 fibers
- Single armor double jacket version available with stranded tube design and 2 to 144 fibers
- Medium density polyethylene jacket provides low friction installation
- Sheath markings provide positive identification, quality, traceability, and length verification
- 250µm coating protects fibers during handling and allows for ease of stripping

Part Number Example	FP	S	N	9	1	2	
	FQ	Q	N	X	9	6	B
	1	2	3	4	5	6	7



FPQN948B

- 1 - Fiber Type**
FP = Fiber EMEA - OS2
FQ = Fiber EMEA - OM3, OM4
- 2 - Construction**
S = OSP Single Armor Single Jacket Central Tube (4 to 24 fibers)
Q = OSP Single Armor Double Jacket Stranded Tube (2 to 144 fibers)
- 3 - Flame Rating**
N = Non Rated
- 4 - Fiber Mode Type**
9 = 9µm Singlemode OS2
X = 50µm Multimode OM3
Z = 50µm Multimode OM4
- 5,6 - Fiber Count**
2
4
6
8
12
24
36
48
72
96
1A = 144
- 7 - Double Jacket**
B = OSP Single Armor Double Jacket Stranded Tube
Leave blank for OSP Single Armor Single Jacket Central Tube

- A. Featured Products
- B. Copper Systems
- C. Fiber Systems
- D. Faceplates, Frames & Surface Mount Boxes
- E. Industrial Networks
- F. Audio Video Systems
- G. Keystone Cabling Systems
- H. Zone Cabling
- J. Cable Routing Systems
- K. Cable Cleats
- L. Cabinets & Rack Systems
- M. Power & Connectivity Management
- N. Grounding & Bonding
- O. Identification Products
- P. Cable Management Accessories
- Q. Part Number Index

- A. Featured Products
- B. Copper Systems
- C. Fiber Systems
- D. Faceplates, Frames & Surface Mount Boxes
- E. Industrial Networks
- F. Audio Video Systems
- G. Keystone Cabling Systems
- H. Zone Cabling
- J. Cable Routing Systems
- K. Cable Cleats
- L. Cabinets & Rack Systems
- M. Power & Connectivity Management
- N. Grounding & Bonding
- O. Identification Products
- P. Cable Management Accessories
- Q. Part Number Index

Fiber Optic Adapters

- TIA/EIA-604 FOCIS-10, FOCIS-3, and FOCIS-2 compatible adapters
- Exceed ANSI/TIA-568.3-D requirements
- Adapter housing colors follow ANSI/TIA-568.3-D suggested color identification scheme
- Adapters have a FOCIS-10, FOCIS-3, and FOCIS-2 adapter interface at each end
- Accept FOCIS-10 compatible LC connectors, FOCIS-3 compatible SC connectors and FOCIS-2 compatible ST connectors

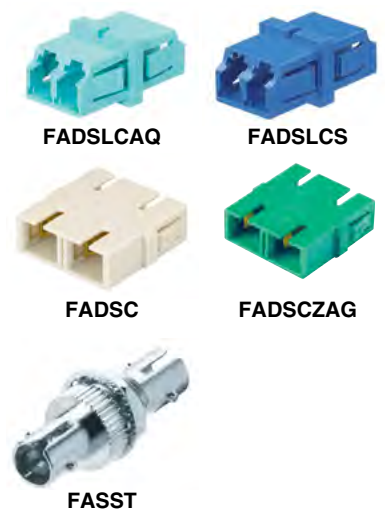

Part Number	Adapter Type	Color	Split Sleeve	Std. Pkg. Qty
FADSLCZAQ-L	Duplex LC	Aqua	Zirconia	50
FADSLCEI-L		Electric Ivory	Phos. Bronze	
FADSLCZBU-L		Blue	Zirconia	
FADSLCZAG-L	Duplex LC APC	Green	Zirconia	
FADSCZAQ-L	Duplex SC	Aqua	Zirconia	
FADSCEI-L		Electric Ivory	Phos. Bronze	
FADSCZBU-L		Blue	Zirconia	
FADSCZAG-L	SC APC	Green	Zirconia	
FASSTZ-L	ST	–	Zirconia	

Mini-Com™ Fiber Optic Adapter Modules

- TIA/EIA-604 FOCIS-10, FOCIS-3, and FOCIS-2 compatible adapters
- Exceed ANSI/TIA-568.3-D requirements
- Adapter housing colors follow ANSI/TIA-568.3-D suggested color identification scheme
- Small form factor (SFF) duplex adapter design fits into single module space
- Compatible with Mini-Com™ Products for complete modularity
- Provide a FOCIS-10, FOCIS-3, and FOCIS-2 senior adapter interface at each end
- Accept FOCIS-10, FOCIS-3, and FOCIS-2 compatible senior LC connectors



Part Number	Adapter Type	Adapter Color	Split Sleeve	Module Color‡
CMDSAQLCZBL	Duplex LC	Aqua	Zirconia	Black
CMDSLCEI		Electric Ivory	Phos. Bronze	Electric Ivory
CMDSLCZBU		Blue	Zirconia	Blue
CMDAGLCZBL	Duplex LC APC	Green	Zirconia	Black
CMDAQSCZBL	Duplex SC	Aqua	Zirconia	Black
CMDEISCEI		Electric Ivory	Phos. Bronze	Electric Ivory
CMDBUSCZBU		Blue	Zirconia	Blue
CMDAGSCZBL	Duplex SC APC	Green	Zirconia	Black
CMSTZBU	ST	–	Zirconia	Blue

‡For other module colors, replace suffix BL (Black), EI (Electric Ivory), or BU (Blue) with EI (Electric Ivory), IW (Off White) or AW (Arctic White).

HD Flex™ Enclosures, Panels and Accessories

- Enclosures and panels support 144-fibers with LC connectors and 864-fiber with MPO-12 connectors per RU
- Enclosure drawers slide to two locked positions for easy moves, adds, and changes from the front or rear of the enclosure
- Enclosure split tray design allows half of the tray to operate independently, eliminating unnecessary fiber movement on the other half of the tray
- Panels are fixed tray design, light weight, and shallow depth - ideal for high density cabinets or overhead installation
- 4-, 6-, and 12-port enclosures and panels ship pre-configured to house 4-, 6-, and 12-port cassettes, respectively
- Enclosures and panels can be configured in the field to support 4-port, 6-port, and/or 12-port cassettes by adding/removing divider rails
- Zero RU brackets secure HD Flex™ Cassettes and/or FAPs to vertical rails, saving valuable RU space

Part Number	Part Description	Cassette/ FAP Openings
HD Flex™ 4 Port Fiber Enclosures, Panels and Zero RU Bracket		
FLEX1U04	1 RU HD Flex™ 4-Port Enclosure	18
FLEX2U04	2 RU HD Flex™ 4-Port Enclosure	36
FLEX4U04	4 RU HD Flex™ 4-Port Enclosure	72
FLEX1UPN04	1 RU HD Flex™ 4-Port Panel	18
FLEX2UPN04	2 RU HD Flex™ 4-Port Panel	36
FLEX4UPN04	4 RU HD Flex™ 4-Port Panel	72
FLEX-0RUBR04	HD Flex™ 0 RU 4-Port Bracket and Cassette Holder	3
FLEX-0RUCH04	HD Flex™ 0 RU 4-Port Cassette Holder	–

HD Flex™ 6 Port Fiber Enclosures, Panels and Zero RU Bracket		
FLEX1U06**	1 RU HD Flex™ 6-Port Enclosure	12
FLEX2U06**	2 RU HD Flex™ 6-Port Enclosure	24
FLEX4U06**	4 RU HD Flex™ 6-Port Enclosure	48
FLEX1UPN06**	1 RU HD Flex™ 6-Port Panel	12
FLEX2UPN06**	2 RU HD Flex™ 6-Port Panel	24
FLEX4UPN06**	4 RU HD Flex™ 6-Port Panel	48
FLEX-0RUBR06**	HD Flex™ 0 RU 6-Port Bracket and Cassette Holder	2
FLEX-0RUCH06	HD Flex™ 0 RU 6-Port Cassette Holder	–

HD Flex™ 12 Port Fiber Enclosures, Panels and Zero RU Bracket		
FLEX1U12	1 RU HD Flex™ 12-Port Enclosure	6
FLEX2U12	2 RU HD Flex™ 12-Port Enclosure	12
FLEX4U12	4 RU HD Flex™ 12-Port Enclosure	24
FLEX1UPN12	1 RU HD Flex™ 12-Port Panel	6
FLEX2UPN12	2 RU HD Flex™ 12-Port Panel	12
FLEX4UPN12	4 RU HD Flex™ 12-Port Panel	24
FLEX-0RUBR12	HD Flex™ 0 RU 12-Port Bracket and Cassette Holder	1
FLEX-0RUCH12	HD Flex™ 0 RU 12-Port Cassette Holder	–

**Offered in White (add WH to part number for White).

A. Featured Products

B. Copper Systems

C. Fiber Systems

D. Faceplates, Frames & Surface Mount Boxes

E. Industrial Networks

F. Audio Video Systems

G. Keystone Cabling Systems

H. Zone Cabling

J. Cable Routing Systems

K. Cable Cleats

L. Cabinets & Rack Systems

M. Power & Connectivity Management

N. Grounding & Bonding

O. Identification Products

P. Cable Management Accessories

Q. Part Number Index



FLEX4U04



FLEX1UPN04



FLEX1U06



FLEX1UPN06



FLEX-0RUBR06



FLEX1U12



FLEX1UPN12

- A. Featured Products
- B. Copper Systems
- C. Fiber Systems
- D. Faceplates, Frames & Surface Mount Boxes
- E. Industrial Networks
- F. Audio Video Systems
- G. Keystone Cabling Systems
- H. Zone Cabling
- J. Cable Routing Systems
- K. Cable Cleats
- L. Cabinets & Rack Systems
- M. Power & Connectivity Management
- N. Grounding & Bonding
- O. Identification Products
- P. Cable Management Accessories
- Q. Part Number Index

HD Flex™ Fiber Optic Cassettes

- Compatible with HD Flex™ Rack Mount Enclosures, Panels, and Zero RU Brackets
- LC adapters include integral shutters for dust protection and VFL light identification
- Low insertion loss of 0.5dB per optimized cassette, 0.35dB for ultra cassette, and 0.75dB for standard singlemode cassette
- Return loss >26dB (multimode) and >55dB (singlemode). Contact your Panduit representative for details of low loss OS2 options
- Adapter housing colors follow ANSI/TIA-568.3-D suggested color identification scheme
- Cassettes accessible from the front or back to streamline installation and migration from 10G to 40G/100G and beyond
- Performance test data provided with each cassette
- Lifetime traceability of test data to a QC numbers on each fiber cassette



FHCZO-12-10AS



FHCXO-24-10AS

Part Number	Fiber Type	Fiber Count	Port Count	No. of MPOs	No. of Duplex LCs	Performance
HD Flex™ LC/MPO Cassettes						
FHCXO-12-10**	OM3	12	6	1x12f	6	Optimized
FHCXA-12-10**						Ultra
FHCZO-12-10**	OM4					Optimized
FHCZA-12-10**						Ultra
FHCSA-12-10**	OM4+					
FHCWA-12-10**	OM5+					
FHC9N-12-10**	OS2	Standard				
FHCXO-24-10**	OM3	24	12	2x12f	12	Optimized
FHCXA-24-10**						Ultra
FHCZO-24-10**	OM4					Optimized
FHCZA-24-10**						Ultra
FHCSA-24-10**	OM4+					
FHCWA-24-10**	OM5+					
FHC9N-24-10**	OS2	Standard				

**AS for Method A, AF for Modified Method A (pair flipped), BN for Method B, U for Universal.

HD Flex™ Fiber Optic Cassettes (continued)



FHC39N-08-10AN



FHC3ZO-08H-10B



FHC3ZO-24H-10A



FHCXO-24F-10A

Part Number	Fiber Type	Fiber Count	Port Count	No. of Rear MPOs	No. of Front Duplex LCs	Performance
-------------	------------	-------------	------------	------------------	-------------------------	-------------

HD Flex 4-to-1 Conversion Cassettes

FHC3XO-08H-10^	OM3	8	4	1x8f	4	Optimized
FHC3ZA-08H-10^	OM4					Ultra
FHC3ZO-08H-10^						Optimized
FHC39N-08H-10^	OS2					Standard
FHC3XO-08-10^	OM3	8	4	1x8f	4	Optimized
FHC3ZA-08-10^	OM4					Ultra
FHC3ZO-08-10^						Optimized
FHC39N-08-10^	OS2					Standard
FHC3XO-24H-10^	OM3	24	12	3x8f	12	Optimized
FHC3ZA-24H-10^	OM4					Ultra
FHC3ZO-24H-10^						Optimized
FHC39N-24H-10^	OS2					Standard

1xMPO24 (20F) to 10 x LC and 1xMPO24 (24F) to 12 x LC

FHCXO-20F-10A	OM3	20	10	1x20f	10	Optimized
FHCZO-20F-10A	OM4					Standard
FHC9N-20F-10A	OS2					
FHCXO-24F-10A	OM3	24	12	1x24f	12	Optimized
FHCZO-24F-10A	OM4					Standard
FHC9N-24F-10A	OS2					

^A for Method A, B for Method B/Universal.

A. Featured Products

B. Copper Systems

C. Fiber Systems

D. Faceplates, Frames & Surface Mount Boxes

E. Industrial Networks

F. Audio Video Systems

G. Keystone Cabling Systems

H. Zone Cabling

J. Cable Routing Systems

K. Cable Cleats

L. Cabinets & Rack Systems

M. Power & Connectivity Management

N. Grounding & Bonding

O. Identification Products

P. Cable Management Accessories

Q. Part Number Index

Continued on next page

- A. Featured Products
- B. Copper Systems
- C. Fiber Systems
- D. Faceplates, Frames & Surface Mount Boxes
- E. Industrial Networks
- F. Audio Video Systems
- G. Keystone Cabling Systems
- H. Zone Cabling
- J. Cable Routing Systems
- K. Cable Cleats
- L. Cabinets & Rack Systems
- M. Power & Connectivity Management
- N. Grounding & Bonding
- O. Identification Products
- P. Cable Management Accessories
- Q. Part Number Index

HD Flex™ Fiber Optic Cassettes (continued)

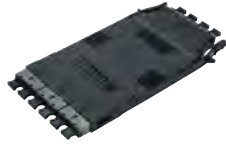

FH4ZU-48-NMNM

HD Flex™ Dark Fiber Conversion Cassette

Part Number	Fiber Type	Fiber Count	Port Count	No. of Rear MPOs	No. of Front MPOs	Performance
FH4ZU-24-NMNM*	OM4	24	12	2x12f	3x8f	Ultra
FH4ZU-48-NMNM*		48		4x12f	6x8f	

*A for Method A, B for Method B.



FHSXO-12-10R

HD Flex™ Splice Cassettes

Part Number	Fiber Type	Fiber Count	Port Count	No. of Duplex LCs	Performance
FHSXN-12-10*	OM3	12	6	6	Standard
FHSXO-12-10*					Optimized
FHSZO-12-10*	OM4				
FHS9N-12-10*	OS2				Standard

**P for 250µm pigtails, R for Ribbon Pigtails.



FHCT-7ZUB

HD Flex™ TAP Cassettes

Part Number	Fiber Type	Live (In) Ports	Live (Out) Ports	TAP Ports	Split Ratio
FHCT-5ZUB	OM4	1 MPO (Rear)	6 Duplex LC (Front)	1 MPO (Rear)	50/50
FHCT-7ZUB					70/30
FHCT-5ZUC		2 Duplex LC (Front)	2 Duplex LC (Front)	2 Duplex LC (Front)	50/50
FHCT-7ZUC					70/30
FHCT-5ZUFB		OM4 (BiDi TAP)	1 Duplex LC (Front)	1 Duplex LC (Front)	

Extended range available including OS2 TAP cassettes. Please contact your Panduit representative for details.



FHCT-5ZUC



FHCT-5ZUFB

HD Flex™ Adapter Panel and Accessories

A. Featured Products

B. Copper Systems

C. Fiber Systems

D. Faceplates, Frames & Surface Mount Boxes

E. Industrial Networks

F. Audio Video Systems

G. Keystone Cabling Systems

H. Zone Cabling

J. Cable Routing Systems

K. Cable Cleats

L. Cabinets & Rack Systems

M. Power & Connectivity Management

N. Grounding & Bonding

O. Identification Products

P. Cable Management Accessories

Q. Part Number Index



FHSXN-12-10N



FHMP-6-ABL



FHSBBL06W



FLEX-RCM1U



FLEX-FCM1UA



FLEX-PLATE1U



FLEX-CLIP12

FLEX-CLIP18



FLEX-CM12S

FLEX-CM18S



FLEX-CM-1UB

FLEX-OPTI-1RU

Part Number	Part Description
FHSXN-12-10N	6 LC duplex multimode adapters in aqua with zirconia sleeves.
FHS9N-12-10N	6 LC duplex singlemode adapters in blue with zirconia sleeves.
FHMP-6-ABL	6 MPO type A adapters (key-up to key-down) in black.
FHMP-6-BCG	6 MPO type B adapters (key-up to key-up) in charcoal gray.
FHMP-6-ARD	6 MPO type A adapters (key-up to key-down) in red.
FHSBBL06W	HD Flex™ Blanking Panel for 6-port enclosures and panels.
FLEX-RAIL04EN	HD Flex™ 4 Port Enclosure Rail Kit, 1RU, 12 rails, 36 labels.
FLEX-RAIL06EN	HD Flex™ 6 Port Enclosure Rail Kit, 1RU, 6 rails, 12 labels.
FLEX-RAIL04PN	HD Flex™ 4-Port Panel Rail Kit, 1RU, 12 rails.
FLEX-RAIL06PN	HD Flex™ 6-Port Panel Rail Kit, 1RU, 6 rails.
FLEX-RCM1U**	1 RU HD Flex™ Rear Cable Manager.
FLEX-RCM4U**	4 RU HD Flex™ Rear Cable Manager.
FLEX-FCM1UA**	1 RU HD Flex™ Front Cable Manager.
FLEX-FCM2UA**	2 RU HD Flex™ Front Cable Manager.
FLEX-FCM4UA**	4 RU HD Flex™ Front Cable Manager.
FLEX-PLATE1U**	HD Flex™ Enclosure Trunk Slack Plate 1 RU.
FLEX-PLATE2U**	HD Flex™ Enclosure Trunk Slack Plate 2 RU.
FLEX-PLATE4U**	HD Flex™ Enclosure Trunk Slack Plate 4 RU.
FLEX-PLATE1UR	HD Flex™ Enclosure Trunk Slack Plate with Rear Cover – 1RU.
FLEX-PLATE2UR	HD Flex™ Enclosure Trunk Slack Plate with Rear Cover – 2RU.
FLEX-PLATE4UR	HD Flex™ Enclosure Trunk Slack Plate with Rear Cover – 4RU.
FLEX-PLATE1UPR	HD Flex™ Patch Panel Trunk Slack Plate with Rear Cover – 1RU.
FLEX-PLATE2UPR	HD Flex™ Patch Panel Trunk Slack Plate with Rear Cover – 2RU.
FLEX-PLATE4UPR	HD Flex™ Patch Panel Trunk Slack Plate with Rear Cover – 4RU.
FLEX-CLIP12	HD Flex™ Trunk Transition Clip (quantity 2); 12 position.
FLEX-CLIP18	HD Flex™ Trunk Transition Clip (quantity 2); 18 position.
FLEX-CM12S	HD Flex™ Universal Rear Cable Manager includes (2) FLEX-CLIP12.
FLEX-CM18S	HD Flex™ Universal Rear Cable Manager includes (4) FLEX-CLIP18.
FLEX-CM12C	HD Flex™ Universal Rear Cable Manager for PEV12, includes 2 FLEX-CLIP12.
FLEX-CM18C	HD Flex™ Universal Rear Cable Manager for PEV12, includes 2 FLEX-CLIP18.
FLEX-CM-1UB	HD Flex™ Universal Expandable Cable Management Bracket (front to back of cabinet or 4 post rack).
FLEX-CM-1UBKIT	HD Flex™ Cable Management 1RU Universal Bracket 19" Kit (2 FLEX-CM-1UB and horizontal strain relief bar).
FLEX-OPTI-1RU	HD Flex™ Bracket Adapter for Opticom™ Panels, houses 2 HD Flex cassettes.

**Offered in White (add WH to part number for White).

A. Featured Products
 B. Copper Systems
 C. Fiber Systems
 D. Faceplates, Frames & Surface Mount Boxes
 E. Industrial Networks
 F. Audio Video Systems
 G. Keystone Cabling Systems
 H. Zone Cabling
 J. Cable Routing Systems
 K. Cable Cleats
 L. Cabinets & Rack Systems
 M. Power & Connectivity Management
 N. Grounding & Bonding
 O. Identification Products
 P. Cable Management Accessories
 Q. Part Number Index

HD Fusion Splicing Enclosure and Accessories



FRMHSS-4RU

Part Number	Part Description
FRMHSS-4RU	HD fusion - fiber rack mount hyperscale splicing solution 4RU that can splice up to 576 single fibers and 864 ribbon fibers.
FST48	Fiber splice tray kit for up to 48 mechanical or fusion splices for use in Panduit FRMHSS-4RU.
FST144R	Fiber splice tray kit for up to 144 ribbon fusion splices for use in Panduit FRMHSS-4RU.

Opticom™ QuickNet™ Enclosures

Opticom™ QuickNet™ Rack Mount Fiber Cassette Enclosures

- Support up to 96 LC fiber connections per RU
- Mount to standard 19" rack rails
- Hold QuickNet™ Fiber Optic Cassettes for Opticom™ Fiber Adapter Panels
- Suitable for all pre-terminated, field-terminated, or field-splice applications
- Slide-out, tilt-down drawer provides full front access to all fibers and cables
- Integral bend radius control and cable management for fiber patch cords
- Innovative rear cable management for proper slacking/spooling
- Multiple cable entry locations



FCE1U



FCE2U



FCE4U

Part Number	Part Description	Cassette/FAP/FOSM Openings
FCE1U**	Rack mount fiber enclosure 1RU, with sliding/tilt drawers.	4
FCE1UA**	Rack mount fiber enclosure 1RU, open access.	
FCE1US	Rack mount fiber enclosure 1RU, with screws instead of rivets for ease of cover removal.	8
FCE2U**	Rack mount fiber enclosure 2RU, with sliding/tilt drawers.	
FCE4U**	Rack mount fiber enclosure 4RU, with sliding/tilt drawers.	12

**Offered in White (add WH to part number for White).

Opticom™ QuickNet™ Rack Mount Fiber Enclosures

- Supports up to 96 LC fiber connections per RU
- Mount to standard 19" or 23" EIA rack or cabinet
- Hold QuickNet™ or Opticom™ Fiber Adapter Panels (FAPs)
- Front and rear access on all models via durable molded-hinge doors
- Integral bend radius control and cable management for fiber patch cords
- Multiple trunk cable entry locations
- Include fiber optic cable routing kit (grommets, cable ties, saddle clips, strain relief bracket, and ID/caution labels) for various cable management solutions
- Extends 4.9" from Rack



FRME1U

FRME3

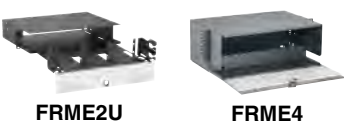

FRME2U

FRME4

Part Number	Part Description	Cassette/FAP/FOSM Openings
FRME1U**	Rack mount fiber enclosure 1RU.	3
FRME2U**	Rack mount fiber enclosure 2RU.	6
FRME3**	Rack mount fiber enclosure 3RU.	9
FRME4**	Rack mount fiber enclosure 4RU.	12

**Offered in White (add WH to part number for White).

Opticom™ QuickNet™ Wall Mount Enclosures

- Holds Opticom™ Fiber Adapter Panels (FAP's)
- Rugged all metal construction for fiber protection and secure mounting
- Compact design allows installation in tight areas
- Separate doors for service side and user side with optional keyed locks for added security includes fiber optic routing kit (grommets, cable ties, spools, strain relief bracket and ID/caution labels) for various cable management solutions



FWME2

Part Number	Part Description	FAP/FMP Openings
FWME2	Wall mount enclosure 2 openings.	2
FWME4	Wall mount enclosure 4 openings.	4
FWME8	Wall mount enclosure 8 openings.	8

Opticom™ Rack Mount Fiber Trays

- Supports up to 96 LC fiber connections per RU
- Mount to standard EIA 19" rack rails
- Standard front or angled front options
- Use with Opticom™ Fiber Adapter Patch Panels (below) to protect fibers and terminations
- Can be used as a back box for select Mini-Com™ Patch Panels
- Removable top cover provides access to connections, fibers, and slack storage in rear of tray
- Multiple trunk cable entry locations provided on rear and sides of enclosure
- Include fiber optic cable routing kit (grommets, cable ties, spools, strain relief bracket and ID/caution labels) for various cable management solutions
- Utilizes accessory kit, FMTDKIT



FMT1



FMT2



FMT1A



FMT2A

Part Number	Part Description	Cassette/FAP/FMP Openings
Standard Fiber Mount Trays		
FMT1**	Mount with 1 CFAPPBL1 fiber adapter patch panel.	4
FMT2	Mount with 2 CFAPPBL1 fiber adapter patch panels.	8
Angled Fiber Mount Trays		
FMT1A**	Mount with 1 CFAPPBL1 fiber adapter patch panel.	4
FMT2A	Mount with 2 CFAPPBL1 fiber adapter patch panels.	8

**Offered in White (add WH to part number for White).

A. Featured Products

B. Copper Systems

C. Fiber Systems

D. Faceplates, Frames & Surface Mount Boxes

E. Industrial Networks

F. Audio Video Systems

G. Keystone Cabling Systems

H. Zone Cabling

J. Cable Routing Systems

K. Cable Cleats

L. Cabinets & Rack Systems

M. Power & Connectivity Management

N. Grounding & Bonding

O. Identification Products

P. Cable Management Accessories

Q. Part Number Index

Opticom™ Fiber Adapter Patch Panels

- Mount to standard EIA 19" rack rails
- Standard version holds both QuickNet™ Fiber Optic Cassettes and Opticom™ Fiber Adapter Panels
- Angled version holds Opticom™ Fiber Adapter Panels and matches Mini-Com™ Angled Patch Panel profile
- Use with Opticom™ Rack Mount Fiber Trays (above) to protect fibers and terminations



CFAPPBL1



CFAPPBL2



CFAPPBL1A



CFAPPBL2A

Part Number	Part Description	Cassette/FAP/FMP Openings
-------------	------------------	---------------------------

Standard Fiber Adapter Patch Panels

CFAPPBL1	Flat fiber patch panel. Holds up to four FAP or FMP adapter panels. 1RU.	4
CFAPPBL2	Flat fiber patch panel. Holds up to eight FAP or FMP adapter panels. 2RU.	8

Angled Fiber Adapter Patch Panels

CFAPPBL1A	Angled fiber patch panel. Holds up to four FAP or FMP adapter panels. 1RU.	4
CFAPPBL2A	Angled fiber patch panel. Holds up to eight FAP or FMP adapter panels. 2RU.	8

Opticom™ QuickNet™ MPO Fiber Optic Cassettes

- Compatible with Opticom™ Rack Mount Cassette Enclosures, Wall Mount Enclosure, Fiber Trays, and Adapter Patch Panels
- Supports up to 96 LC fiber connections per RU
- Low insertion loss of 0.75dB for standard cassette, 0.5dB for optimized cassette, and 0.35dB for ultra cassette
- Return loss >26dB (multimode) and >55dB (singlemode)
- Adapter housing colors follow ANSI/TIA-568.3-D suggested color scheme
- Factory terminated, assembled, and 100% tested
- Performance test data provided with each cassette
- Lifetime traceability of test data to a QC number on each fiber cassette
- 4-to-1 conversion cassettes split MPO parallel optics signals into 4 discrete channels on duplex LCs - 40G MPO to (4)10G LC, and 100G MPO to (4) 25G LC

12 Fiber LC Cassettes



FC2XN-12-10AS



FC2WA-12-10AS

Part Number	Fiber Type	Fiber Count	Port Count	No. of MPOs	No. of Duplex LCs	Performance
FC26N-12-10**	OM1	12	6	1x12f	6	Standard
FC2XN-12-10**	OM3					
FC2XO-12-10**						OM4
FC2ZN-12-10**	OM4					
FC2ZO-12-10**						OM4+
FC2SA-12-10**	OM5+					
FC2WA-12-10**						OS2
FC29N-12-10**						

**AS for Method A, AF for Modified Method A (pair flipped), B1 for Method B end 1 and B2 for Method B end 2, U for Universal.

Opticom™ QuickNet™ MPO Fiber Optic Cassettes (continued)



FC2XN-24-10AS



FC29N-24-10AS



FC2XN-12-03AS



FC3ZO-16-10A



FC4ZU-24-NMNMA

Part Number	Fiber Type	Fiber Count	Port Count	No. of MPOs	No. of Duplex LCs	Performance
24 Fiber LC Cassettes						
FC26N-24-10**	OM1	24	12	2x12f	12	Standard
FC2XN-24-10**	OM3					Optimized
FC2XO-24-10**						Standard
FC2ZN-24-10**	OM4					Standard
FC2ZO-24-10**						Optimized
FC2SA-24-10**	OM4+					Ultra
FC2WA-24-10**	OM5+					
FC29N-24-10**	OS2					

**AS for Method A, AF for Modified Method A (pair flipped), B1 for Method B end 1 and B2 for Method B end 2, U for Universal.

Part Number	Fiber Type	Fiber Count	Port Count	No. of Rear MPOs	No. of Front MPOs	Performance
12 Fiber SC Cassettes						
FC26N-12-03**	OM1	12	6	1x12f	6	Standard
FC2XN-12-03**	OM3					Optimized
FC2XO-12-03**						Standard
FC2ZN-12-03**	OM4					Optimized
FC2ZO-12-03**						Standard
FC29N-12-03**	OS2					Standard

**AS for Method A, AF for Modified Method A (pair flipped).

Part Number	Fiber Type	Fiber Count	Port Count	No. of Rear MPOs	No. of Front MPOs	Performance
Opticom™ 4-to-1 Conversion Cassettes						
FC3XN-16-10*	OM3	16	8	2x8f	8	Standard
FC3XO-16-10*						Optimized
FC3ZN-16-10*	OM4					Standard
FC3ZO-16-10*						Optimized
FC39N-16-10A	OS2					Standard

*A for Method A, B for Method B/Universal.

Part Number	Fiber Type	Fiber Count	Port Count	No. of Rear MPOs	No. of Front MPOs	Performance
Opticom™ Dark Fiber Conversion Cassettes						
FC4ZU-24-NMNM*	OM4	24	3	2x12f	3x8f	Ultra
FC4ZU-48-NMNM*		48	6	4x12f	6x8f	

*A for Method A, B for Method B.

A. Featured Products

B. Copper Systems

C. Fiber Systems

D. Faceplates, Frames & Surface Mount Boxes

E. Industrial Networks

F. Audio Video Systems

G. Keystone Cabling Systems

H. Zone Cabling

J. Cable Routing Systems

K. Cable Cleats

L. Cabinets & Rack Systems

M. Power & Connectivity Management

N. Grounding & Bonding

O. Identification Products

P. Cable Management Accessories

Q. Part Number Index

A. Featured Products

B. Copper Systems

C. Fiber Systems

D. Faceplates, Frames & Surface Mount Boxes

E. Industrial Networks

F. Audio Video Systems

G. Keystone Cabling Systems

H. Zone Cabling

J. Cable Routing Systems

K. Cable Cleats

L. Cabinets & Rack Systems

M. Power & Connectivity Management

N. Grounding & Bonding

O. Identification Products

P. Cable Management Accessories

Q. Part Number Index

Opticom™ QuickNet™ MPO Fiber Optic Cassettes (continued)



FCT-7ZB

Part Number	Fiber Type	Live (In) Ports	Live (Out) Ports	TAP Ports	Split Ratio
Opticom™ Tap Cassettes					
FCT-7ZA	OM4	6 Duplex LC (Rear)	6 Duplex LC (Front)	6 Duplex LC (Front)	70/30
FCT-7ZB		1 MPO (Rear)	6 Duplex LC (Front)	6 Duplex LC (Front)	
FCT-7ZC		4 Duplex LC (Front)	4 Duplex LC (Front)	4 Duplex LC (Front)	
FCT-7ZD		2 MPO (Rear)	12 Duplex LC (Front)	2 MPO (Rear)	

Opticom™ MPO Fiber Optic Adapter Panels (FAPs)

- Loaded with TIA/EIA-604 FOCIS-5 compliant adapters
- Exceed ANSI/TIA-568.3-D requirements
- Screen printed for horizontal or vertical orientation
- Designed for multimode or singlemode MPO connectors, patch cords, or cable assemblies
- Snap quickly into the front of all Opticom™ QuickNet™ Components
- Can be used with Opticom™ Zero RU Cable Management Solutions and QuickNet™ Harness Cable Assemblies to facilitate connection to the active equipment



FAPH0412BLMPO



FAPV0612BLMPO



FAPH1612BLMPO



FAPV0812BLMPO



FAPH1224RDMPO

Part Number	No. of Adapters	Adapter Type	Polarity	Color	Orientation
MPO Opticom™ Fiber Adapter Panels (FAPs)					
FAPH0412BLMPO	4	12f MPO	Method A, Key-Up/Key-Down	Black	Horizontal
FAPH0612BLMPO	6				
FAPH0812BLMPO	8				
FAPH1212BLMPO	12				
FAPH1612BLMPO	16				
FAPH1812BLMPO	8				
FAPV0412BLMPO	4				
FAPV0612BLMPO	6				
FAPV0812BLMPO	8		Method B, Key-Up/Key-Up	Charcoal Gray	Vertical
FAPH0412CGMPO	4				
FAPH0612CGMPO	6				
FAPH0812CGMPO	8				
FAPH1212CGMPO	12				
FAPH1612CGMPO	16				
FAPH1812CGMPO	8				
FAPV0412CGMPO	4				
FAPV0612CGMPO	6	24f MPO	Method A, Key-Up/Key-Down	Red	Horizontal
FAPV0812CGMPO	8				
FAPH0424RDMPO	4				
FAPH0624RDMPO	6				
FAPH0824RDMPO	8				
FAPH1224RDMPO	12				
FAPH1624RDMPO	16				
FAPH1824RDMPO	8				
FAPV0424RDMPO	4	Vertical			
FAPV0624RDMPO	6				
FAPV0824RDMPO	8				

Opticom™ LC Fiber Adapter Panels (FAPs)

- Loaded with TIA/EIA-604 FOCIS-10, TIA/EIA-604 FOCIS-3, or FOCIS-2 compatible adapters
- Exceed ANSI/TIA-568.3-D requirements
- Adapter housing colors follow ANSI/TIA-568.3-D suggested color identification scheme
- Snap quickly into the front of all Opticom™ Components

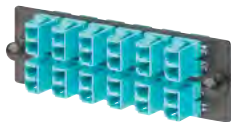

FAP12WAQDLCZ



FAP6WEIDLK

Part Number	No. of Ports	Adapter Type	Color	Split Sleeve	Fibers					
LC Fiber Adapter Panels										
FAP6WAQDLCZ	6	LC	Aqua	Zirconia	12					
FAP12WAQDLCZ	12				24					
FAP6WBUDLCZ	6				Blue	Zirconia	12			
FAP12WBUDLCZ	12						24			
FAP6WWDLCZ	6						Lime Green	Zirconia	12	
FAP12WWDLCZ	12								24	
FAP6WEIDLK	6		Electric Ivory	Phos. Bronze					12	
FAP12WEIDLK	12								24	
FAP6WAGDLCZ	6				LC/APC	Green			Zirconia	12
FAP12WAGDLCZ	12									24



FAP6WAQDSCZ

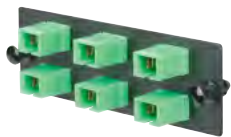

FAP6WAGSCZ

Part Number	No. of Ports	Adapter Type	Color	Split Sleeve	Fibers				
SC Fiber Adapter Panels									
FAP3WAQDSCZ	3	SC	Aqua	Zirconia	6				
FAP6WAQDSCZ	6				12				
FAP3WBUDSCZ	3				Blue	Zirconia	6		
FAP6WBUDSCZ	6						12		
FAP3WEIDSC	3						Electric Ivory	Phos. Bronze	6
FAP6WEIDSC	6								12
FAP3WAGDSCZ	3	SC/APC	Green	Zirconia					6
FAP6WAGDSCZ	6								12



FAP6WSTZ

Part Number	No. of Ports	Adapter Type	Color	Split Sleeve	Fibers
ST Fiber Adapter Panels					
FAP6WSTZ	6	ST	-	Zirconia	6
FAP8WSTZ	8				8

12 Fiber Splice Cassettes

Part Number	Number of Fibers	Fiber Type	Connector	Port Count	Performance
FCS9N-12-10P^	12	OS2	LC	6	Standard (0.35dB + Splice loss)
FCS9N-12-LAP^	12	OS2	LC/APC	6	Standard (0.35dB + Splice loss)
FCSZO-12-10P^	12	OM3/OM4	LC	6	Optimized (0.15dB + Splice loss)
FCS9N-12-03P	12	OS2	SC	6	Standard (0.35dB + Splice loss)
FCS9N-12-SAP	12	OS2	SC/APC	6	Standard (0.35dB + Splice loss)
FCSZO-12-03P	12	OM3/OM4	SC	6	Optimized (0.15dB + Splice loss)

^ Also available in ribbon fiber, change the "P" in the part number to a "R"

A. Featured Products
B. Copper Systems
C. Fiber Systems
D. Faceplates, Frames & Surface Mount Boxes
E. Industrial Networks
F. Audio Video Systems
G. Keystone Cabling Systems
H. Zone Cabling
J. Cable Routing Systems
K. Cable Cleats
L. Cabinets & Rack Systems
M. Power & Connectivity Management
N. Grounding & Bonding
O. Identification Products
P. Cable Management Accessories
Q. Part Number Index

Opticom™ Accessories and Splice Solutions



Part Number	Part Description
FEABRUA	Zero RU adhesive or magnetic mount 90° fiber enclosure adapter panel bracket can be used with cassettes or FAP's.
FEABRU	Zero RU Opticom™ Adapter Bracket mounts cassettes or FAPs directly to vertical rails, saving valuable rack space.
FPFPC1	1RU fiber patch field protection cover.
FMP6	Unloaded panel accepts up to six Mini-Com™ Modules - enables copper and fiber to populate the same Opticom™ Enclosure or Panel.
FAPB	Blank fiber adapter panel.
FELS	Fiber enclosure lock for service side.
FELU	Fiber enclosure lock for user side.
FLEX-OPTI-1RU	HD Flex™ Bracket Adapter for Opticom Enclosures houses 2 HD flex cassettes.
FOSMF	Splice module holds and protects up to 24 fusion splices for use with Panduit Opticom™ FCE*U, FRME*U and FMT* Enclosures.
FOSMM	Splice module holds and protects up to 12 mechanical splices for use with Panduit Opticom™ FCE*U, FRME*U and FMT* Enclosures.
FOSMH1U	Splice module holder 1 RU holds up to 4 FOSM splice modules for use with Panduit FCE1U or FCE1UA.
FOSMH2U	Splice module holder 2 RU holds up to 8 FOSM splice modules for use with Panduit FCE2U.
FOSMH4U	Splice module holder 4 RU holds up to 12 FOSM splice modules for use with Panduit FCE4U.
FST24	Fiber splice tray kit for up to 24 mechanical or fusion splices or 144 ribbon fusion splices for use in Panduit FRME3 and FRME4.
FST24H3	Stacking holder for FST24, stacks and secures up to 3 FST24.
FST6	Fiber splice tray kit for up to 12 mechanical or fusion splices for use in Panduit FMT, FWME4 and FWME8.
FSTHE	Stacking holder for FST6 holds and secures up to 4 FST6.
FSTK	Fiber splice tray kit for up to 6 mechanical or fusion splices for use in Panduit FWME2.
FTHS	Stacking holder for FSTK holds and secures up to 2 FSTK.
FSC24	Fiber splice chip holder accommodates and protects up to 24 fusion splices for use with any Panduit Opticom Enclosure.
FRME144SBL	Opticom™ (144) fiber optic splice enclosure; holds up to (12) splice trays (FST6).

QuickNet™ Zone Distribution



Part Number	Part Description
FLRME	Fiber ladder rack mount enclosure, compatible with all Opticom FAPs and cassettes. Holds 2 Opticom cassettes, FAPs, or copper adapters.

QuickNet™ HDQ High Density Fiber Optic Cassettes

- Mounts to standard 19" rack rails
- Low insertion loss of 0.5dB max, per optimized cassette and 0.75dB max. per standard cassette
- Adapter housing colors follow ANSI/TIA-568.3-D suggested color identification scheme
- Connect together with high-density female MPO cable assemblies/trunks to quickly deploy DC network segments
- Significantly reduce installation time and labor by eliminating field connector termination
- Factory terminated, assembled, and 100% tested
- Insertion loss data provided on every fiber cassette
- Lifetime traceability of test data to a QC number

Standard/Generic Port Mapping



Part Number	Fiber Type	Fiber Count	Port Count	No. of MPOs	No. of Duplex LCs	Performance	Style
F1RS9N-1A12-10*	OS2	144	72	12	72	Standard	Flat
F1RSZN-9612-10*	OM4	96	48	8	48		
F1RSZO-9612-10*						Standard	
F1RSZN-1A12-10*		Optimized					
F1RSZO-1A12-10*	OS2	144	72	12	72	Standard	Angled
F1AS9N-1A12-10*	OM4	96	48	8	48	Optimized	
F1ASZN-9612-10*						Standard	
F1ASZO-9612-10*		Optimized					
F1ASZN-1A12-10*	OS2	144	72	12	72	Standard	Angled
F1ASZO-1A12-10*	Optimized						

*S for Method A and F for Modified Method A.

A. Featured Products

B. Copper Systems

C. Fiber Systems

D. Faceplates, Frames & Surface Mount Boxes

E. Industrial Networks

F. Audio Video Systems

G. Keystone Cabling Systems

H. Zone Cabling

J. Cable Routing Systems

K. Cable Cleats

L. Cabinets & Rack Systems

M. Power & Connectivity Management

N. Grounding & Bonding

O. Identification Products

P. Cable Management Accessories

Q. Part Number Index

- A. Featured Products
- B. Copper Systems
- C. Fiber Systems
- D. Faceplates, Frames & Surface Mount Boxes
- E. Industrial Networks
- F. Audio Video Systems
- G. Keystone Cabling Systems
- H. Zone Cabling
- J. Cable Routing Systems
- K. Cable Cleats
- L. Cabinets & Rack Systems
- M. Power & Connectivity Management
- N. Grounding & Bonding
- O. Identification Products
- P. Cable Management Accessories
- Q. Part Number Index

QuickNet™ Patch Panels

- Accept QuickNet™ Copper Cable Assemblies and QuickNet™ SFQ Series MTP Fiber Optic Cassettes which snap in and out with one hand
- Supports up to 96 LC fiber connections per RU
- High-density patch panels conserve valuable rack space
- Angled patch panels facilitate proper bend radius control and minimize the need for horizontal cable managers
- Pre-printed numbers above each port for easy identification
- Mount to standard EIA 19" racks or 23" racks with optional extender brackets
- Optional patch panel adapter (QPPABL) accepts all Mini-Com™ Modules for shared copper, fiber, and A/V applications in a single rack space
- Optional patch panel blank (QPPBBL) promotes proper airflow and cooling
- Label/label cover kit (QPPLC24) provides port and panel identification for 24-port patch panels
- Optional retrofit grounding kit (QNSMRRT) required to ground shielded cassettes to QuickNet™ Modular Patch Panels
- QuickNet™ All Metal Modular Patch Panels accept shielded cassettes with no additional grounding kit required

Part Number	Ports	No. of Rack Spaces	Style
-------------	-------	--------------------	-------

QuickNet™ Unshielded Patch Panels

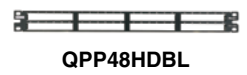

QPP48HDBL



QAPP48HDBL

QPP24**	24	1	Flat
QPP48HD**	48		
QPP48HDVNS**^			Angled
QAPP24**	24		
QAPP48HD**	48		
QAPP48HDVNS**^			

QuickNet™ Shielded Patch Panels



QSP24



QASP48HDBL

QSP24**	24	1	Flat
QSP48HD**	48		
QASP24**	24		Angled
QASP48HD**	48		

**BL (Black), WH (White).
^Vertical port numbering.

QuickNet™ SFQ MPO Fiber Optic Cassettes

- Compatible with QuickNet™ patch panels for up to 96 LC fiber connections in a single RU
- Low insertion loss of 0.75dB for standard cassettes, 0.50dB for optimized cassettes, and 0.35dB for ultra cassettes
- Significantly reduce installation time and labor by eliminating field connector terminations
- Connect together with high-density female MPO cable assemblies/trunks to quickly deploy DC network segments
- Factory terminated, assembled and 100% tested
- Performance test data provided with each cassette
- Lifetime traceability of test data to a QC number on each fiber cassette



FQXN-12-10AS

Part Number	Fiber Type	Fiber Count	Port Count	No. of MPOs	No. of Duplex Connectors	Performance
FQ6N-12-10**	OM1	12	6	1x12f	6	Standard
FQXN-12-10**	OM3					Optimized
FQXO-12-10**						Standard
FQZN-12-10**	OM4					Optimized
FQZO-12-10**						Ultra
FQSA-12-10**	OM4+					Standard
FQWA-12-10**	OM5+					
FQ9N-12-10**	OS2					Standard

**AS for Method A, AF for Modified Method A (pair flipped), B1 for Method B end 1 and B2 for Method B end 2, U for Universal.

QuickNet™ SFQ MPO Fiber Optic Cassettes



FQ3XN-08-10B



FQ39N-08-10A

Part Number	Fiber Type	Fiber Count	Port Count	Number of MPO's	Number of Duplex Connectors	Performance
FQ3XN-08-10B	OM3	8	4	1x12f	4	Standard
FQ3ZN-08-10B	OM4					Optimized
FQ3ZO-08-10B						Standard
FQ39N-08-10A	OS2					Standard

A. Featured Products

B. Copper Systems

C. Fiber Systems

D. Faceplates, Frames & Surface Mount Boxes

E. Industrial Networks

F. Audio Video Systems

G. Keystone Cabling Systems

H. Zone Cabling

J. Cable Routing Systems

K. Cable Cleats

L. Cabinets & Rack Systems

M. Power & Connectivity Management

N. Grounding & Bonding

O. Identification Products

P. Cable Management Accessories

Q. Part Number Index

- A. Featured Products
- B. Copper Systems
- C. Fiber Systems
- D. Faceplates, Frames & Surface Mount Boxes
- E. Industrial Networks
- F. Audio Video Systems
- G. Keystone Cabling Systems
- H. Zone Cabling
- J. Cable Routing Systems
- K. Cable Cleats
- L. Cabinets & Rack Systems
- M. Power & Connectivity Management
- N. Grounding & Bonding
- O. Identification Products
- P. Cable Management Accessories
- Q. Part Number Index

QuickNet™ MPO Fiber Adapter Panels (FAPs)

- Factory assembled, and 100% tested
- Significantly reduce installation time and labor by eliminating field connector terminations
- Compatible with QuickNet™ Patch Panels
- Adapter housing colors follow ANSI/TIA-568.3-D suggested color identification scheme



FQMAP45BL



FQMAP65BL



FQMAP85RD



QPPABL



QPPBBL



FQCRBUA



FQCRCM

Part Number	No. of Adapters	Adapter Type	Polarity	Color	
QuickNet™ MPO Fiber Adapter Panels (FAPs)					
FQMAP45BL	4	12f MPO	Method A, Key-Up/ Key-Down	Black	
FQMAP65BL	6			Lime Green	
FQMAP65W				Black	
FQMAP85BL				8	Black
FQMAP46CG	4			Method B, Key-Up/ Key-Up	Charcoal Gray
FQMAP66CG	6				Lime Green
FQMAP66W			Charcoal Gray		
FQMAP86CG	8		Charcoal Gray		
FQMAP45RD	4		24f MPO	Method A, Key-Up/ Key-Down	Red
FQMAP65RD	6				
FQMAP85RD	8				

Part Number	Part Description
QuickNet Accessories	
QPPABL	QuickNet™ Patch Panel Adapter which accepts Mini-Com™ Modules facilitating the use of fiber, copper, and A/V in a single RU.
QPPBBL	QuickNet™ Patch Panel Blank reserves space for future use and promotes proper airflow and cooling.
QPPLC24	Label/label cover kit for 24-port QuickNet™ Patch Panels. Each kit contains four labels and four clear label covers per bag.
FQCRBUA	QuickNet™ SFQ Cassette Zero RU Bracket
FQCRCM	QuickNet™ Cassette Rear Cable Manager

^One rack space = 1.75" (44.45mm). M6 and #12-24 mounting screws included. QuickNet™ Pre-Terminated. For Labeling and Identification (Section O), see pages O.1 through O.18.

Fiber Optic Interconnect Assemblies

- PanMPO™ Multimode and MPO Singlemode Interconnect Cable Assemblies are pre-terminated and 100% factory tested
- Test results are provided with each assembly
- The 3.0mm round interconnect cable provides high flexibility and tight bend radius for easy installation and cable management
- The PanMPO™ Connector allows rapid gender and polarity change in the field
- Meets or exceeds ANSI/TIA-568.3-D and TIA/EIA-604 (FOCIS-5)
- Maximum connector insertion loss: Multimode MPO, Standard IL = 0.50dB; Optimised IL = 0.35dB; Ultra IL = 0.25dB
- Minimum connector return loss: Multimode LC: 26dB; Multimode MPO: 26dB
- RoHS Compliant

Multimode Interconnects

8 and 12 Fiber Multimode Interconnects

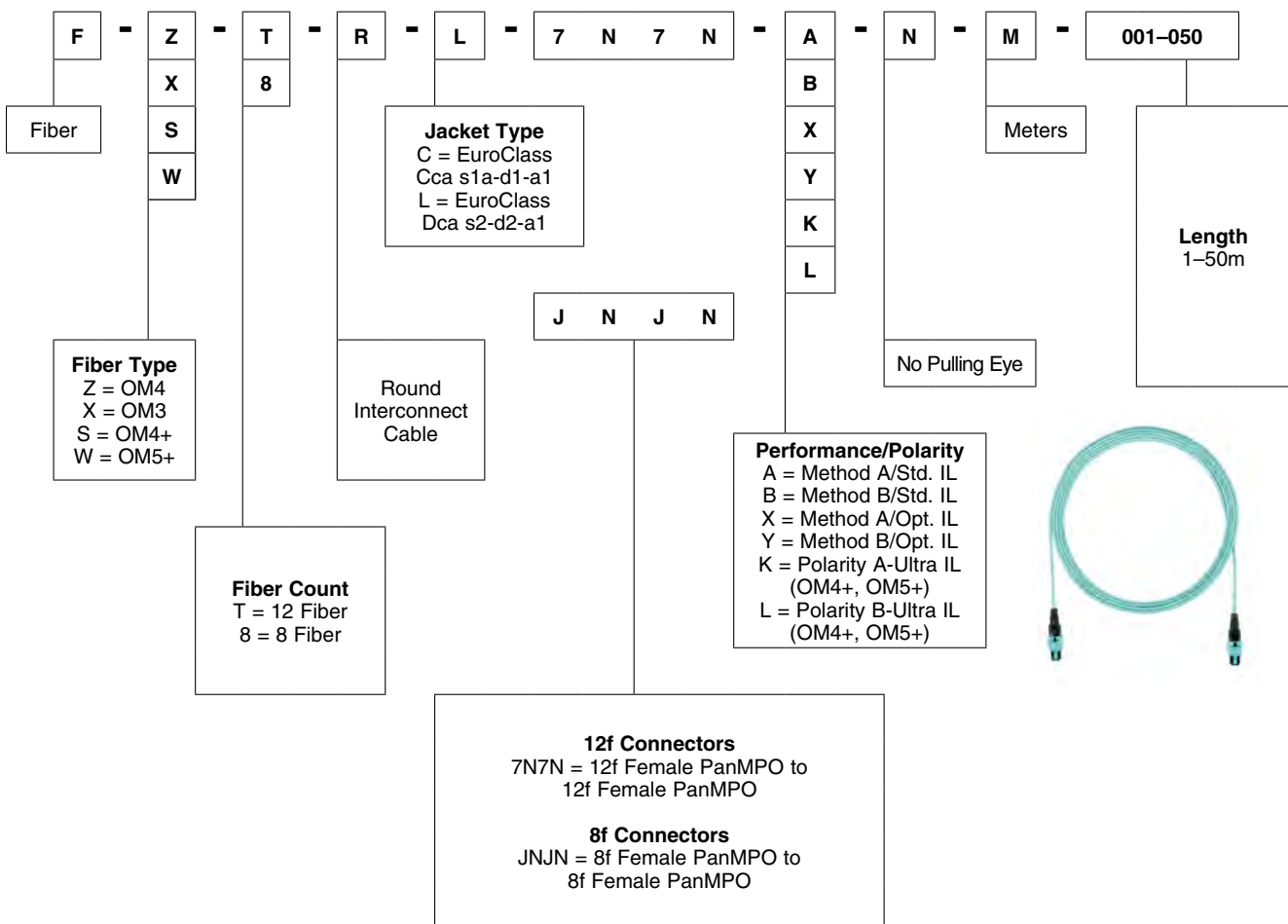

A. Featured Products

B. Copper Systems

C. Fiber Systems

D. Faceplates, Frames & Surface Mount Boxes

E. Industrial Networks

F. Audio Video Systems

G. Keystone Cabling Systems

H. Zone Cabling

J. Cable Routing Systems

K. Cable Cleats

L. Cabinets & Rack Systems

M. Power & Connectivity Management

N. Grounding & Bonding

O. Identification Products

P. Cable Management Accessories

Q. Part Number Index

Continued on next page

- A. Featured Products
- B. Copper Systems
- C. Fiber Systems
- D. Faceplates, Frames & Surface Mount Boxes
- E. Industrial Networks
- F. Audio Video Systems
- G. Keystone Cabling Systems
- H. Zone Cabling
- J. Cable Routing Systems
- K. Cable Cleats
- L. Cabinets & Rack Systems
- M. Power & Connectivity Management
- N. Grounding & Bonding
- O. Identification Products
- P. Cable Management Accessories
- Q. Part Number Index

Fiber Optic Interconnect Assemblies (continued)

24 Fiber Multimode Interconnects (MPO24)

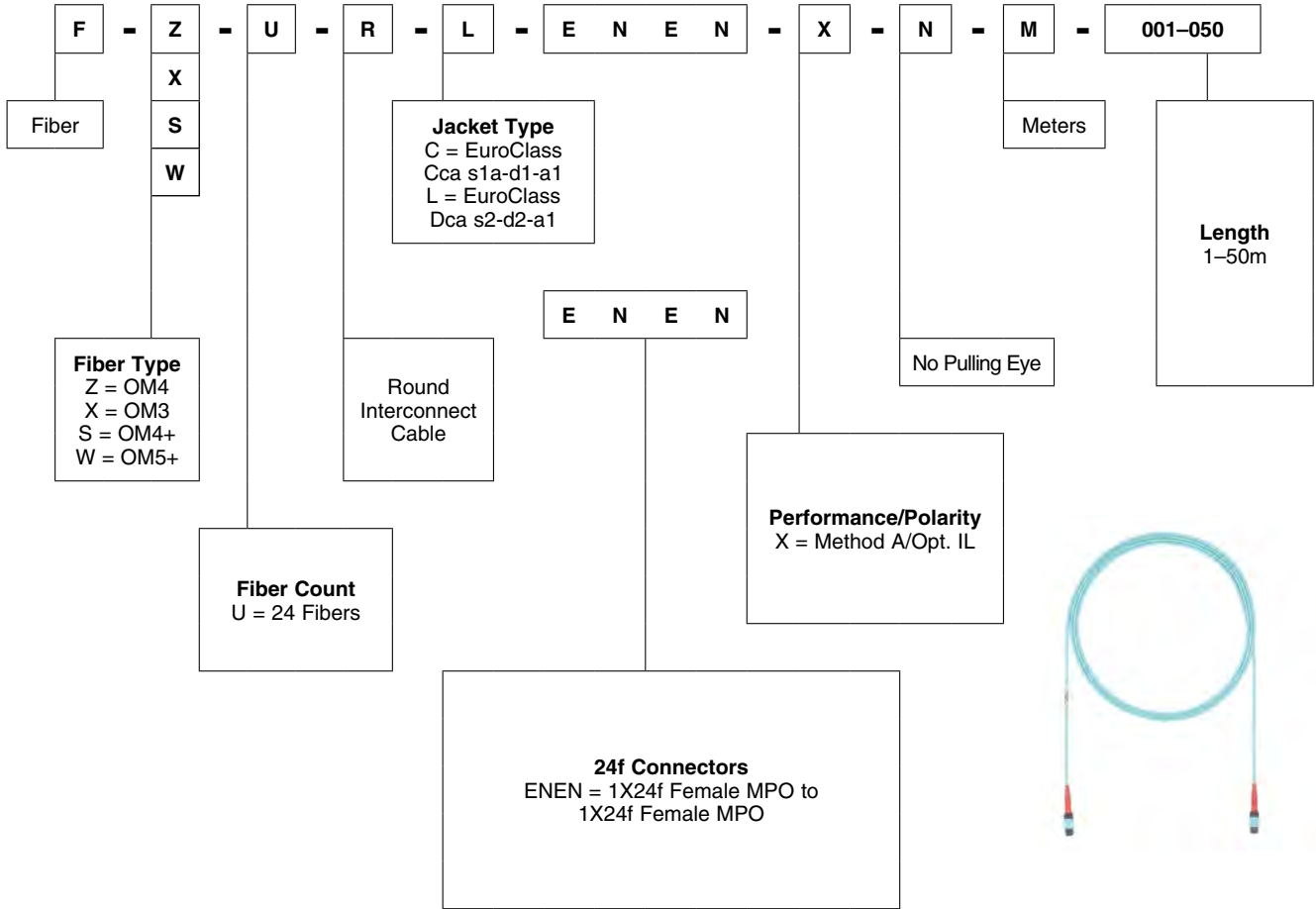

Continued on next page

Fiber Optic Interconnect Assemblies (continued)

Singlemode Interconnects

8 and 12 Fiber Singlemode Interconnects

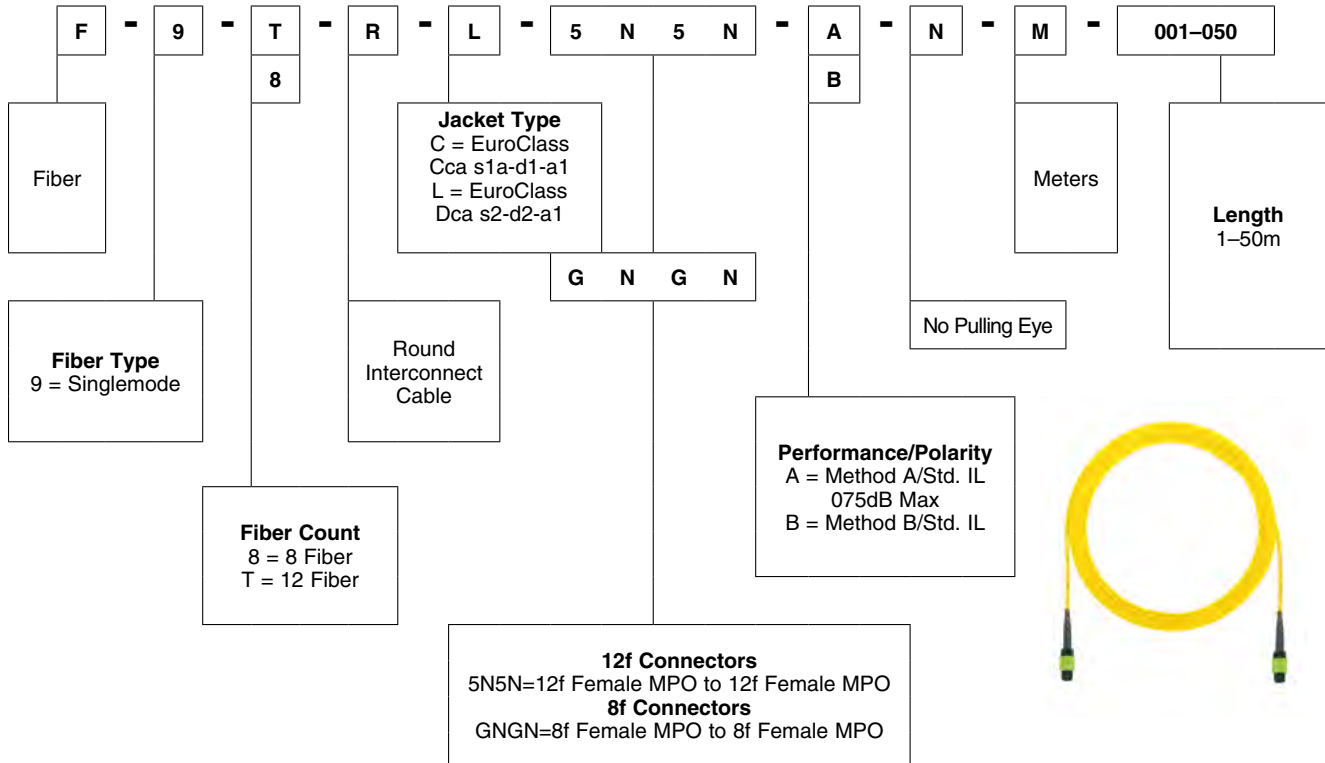

Please contact your Panduit representative for low loss single mode options.

24 Fiber Singlemode Interconnects

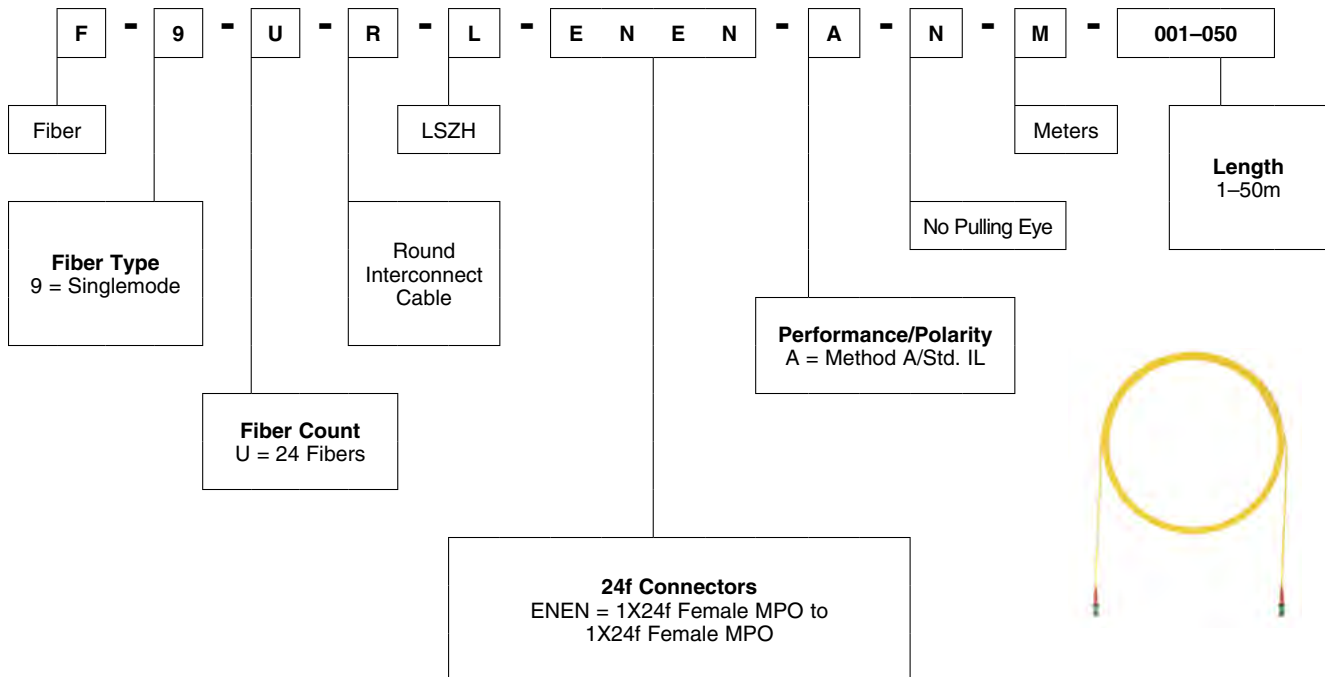

A. Featured Products

B. Copper Systems

C. Fiber Systems

D. Faceplates, Frames & Surface Mount Boxes

E. Industrial Networks

F. Audio Video Systems

G. Keystone Cabling Systems

H. Zone Cabling

J. Cable Routing Systems

K. Cable Cleats

L. Cabinets & Rack Systems

M. Power & Connectivity Management

N. Grounding & Bonding

O. Identification Products

P. Cable Management Accessories

Q. Part Number Index

Continued on next page

- A. Featured Products
- B. Copper Systems
- C. Fiber Systems
- D. Faceplates, Frames & Surface Mount Boxes
- E. Industrial Networks
- F. Audio Video Systems
- G. Keystone Cabling Systems
- H. Zone Cabling
- J. Cable Routing Systems
- K. Cable Cleats
- L. Cabinets & Rack Systems
- M. Power & Connectivity Management
- N. Grounding & Bonding
- O. Identification Products
- P. Cable Management Accessories
- Q. Part Number Index

Fiber Optic Trunk Cable Assemblies

- Small Diameter Trunk Cable Assemblies allow for rapid deployment of high-density permanent links
- Optimize cable routing requirements to ensure efficient use of pathway space
- Significantly reduce installation time and cost
- 100% factory tested
- Test results are provided with each trunk
- PanMPO™ allows for rapid gender and polarity change in the field
- ISO/IEC 11801, TIA/EIA-568-C.3, TIA-604-5 (FOCIS-5), TIC/EIA-568-C.1, GR-409-CORE, ICEA S-83-596
- RoHS Compliant
- Standard 1 meter breakout length

Low Smoke Zero Halogen Trunks

12, 24, 48, 72, 96 & 144 fiber LSZH Trunks

F	-	T	-	9	-	T	-	L	-	5	-	5	-	A	-	0	-	0	-	1	-	M	-	005-999															
Fiber		Y		X		Z		W		LSZH		6		7		8		U		K		L		0		0		2		3		5		6		7		Meters	Length 15 - 999 Meters in 1 meter increments

Cable Type T= Indoor Trunk Cable (72 - 144 fibers) Y = Indoor Small Diameter Trunk Cable (12 - 48 fibers)	Fiber Count T = 12 Fiber U = 24 Fiber W = 48 Fiber X = 72 Fiber Y = 96 Fiber A = 144 Fiber	Connector type 5 = 12f MPO Female 6 = 12f MPO Male 7 = 12f PanMPO Female 8 = 12f PanMPO Male U = Pigtail
--	---	--

Cable Type 9 = OS2 9/125um X = OM3 Z = OM4	Connector type 5 = 12f MPO Female 6 = 12f MPO Male 7 = 12f PanMPO Female 8 = 12f PanMPO Male U = Pigtail	Performance/Polarity A = Method A/Std. IL Singlmode B = Method B/Std. IL Singlmode X = Method A/Opt. IL Multlmode Y = Method B/Opt. IL Multlmode K = Method A/Ultra IL Multlmode L = Method B/Ultra IL Multlmode
---	--	---



Singlemode Trunk



Multimode Trunk

Fiber Optic Trunk Cable Assemblies (continued)

Low Smoke Zero Halogen Signature Core Trunks

12, 24, 48 fiber LSZH Trunks

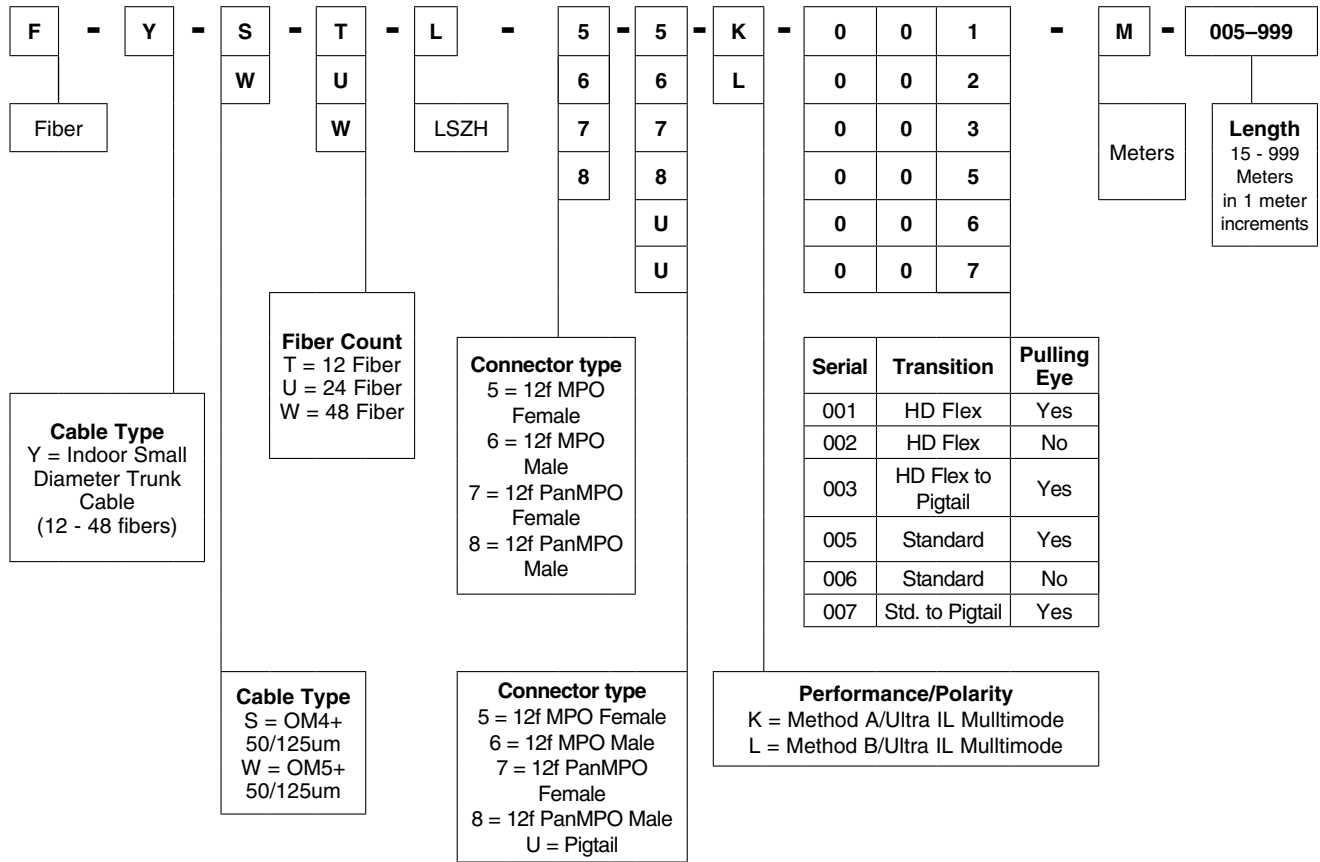

Singlemode Trunk



Multimode Trunk

A. Featured Products

B. Copper Systems

C. Fiber Systems

D. Faceplates, Frames & Surface Mount Boxes

E. Industrial Networks

F. Audio Video Systems

G. Keystone Cabling Systems

H. Zone Cabling

J. Cable Routing Systems

K. Cable Cleats

L. Cabinets & Rack Systems

M. Power & Connectivity Management

N. Grounding & Bonding

O. Identification Products

P. Cable Management Accessories

Q. Part Number Index

Fiber Optic Trunk Cable Assemblies (continued)

Euroclass B2ca Trunks

12, 24, 48, 72, 96 & 144 fiber B2ca Trunks

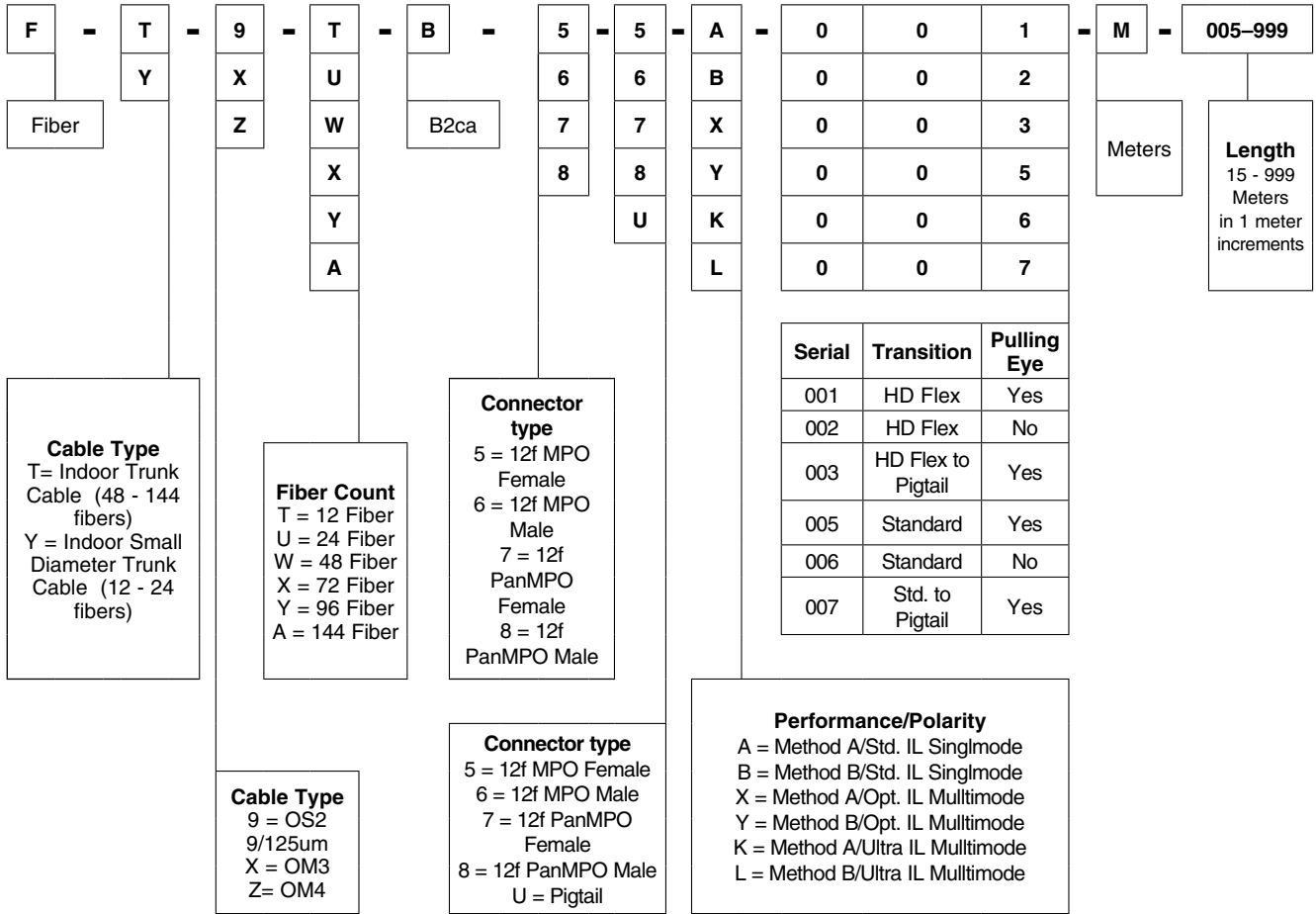

Singlemode Trunk



Multimode Trunk

A. Featured Products

B. Copper Systems

C. Fiber Systems

D. Faceplates, Frames & Surface Mount Boxes

E. Industrial Networks

F. Audio Video Systems

G. Keystone Cabling Systems

H. Zone Cabling

J. Cable Routing Systems

K. Cable Cleats

L. Cabinets & Rack Systems

M. Power & Connectivity Management

N. Grounding & Bonding

O. Identification Products

P. Cable Management Accessories

Q. Part Number Index

Fiber Optic Trunk Cable Assemblies (continued)

Euroclass B2ca Signature Core Trunks

12, 24 Fiber B2ca Trunks

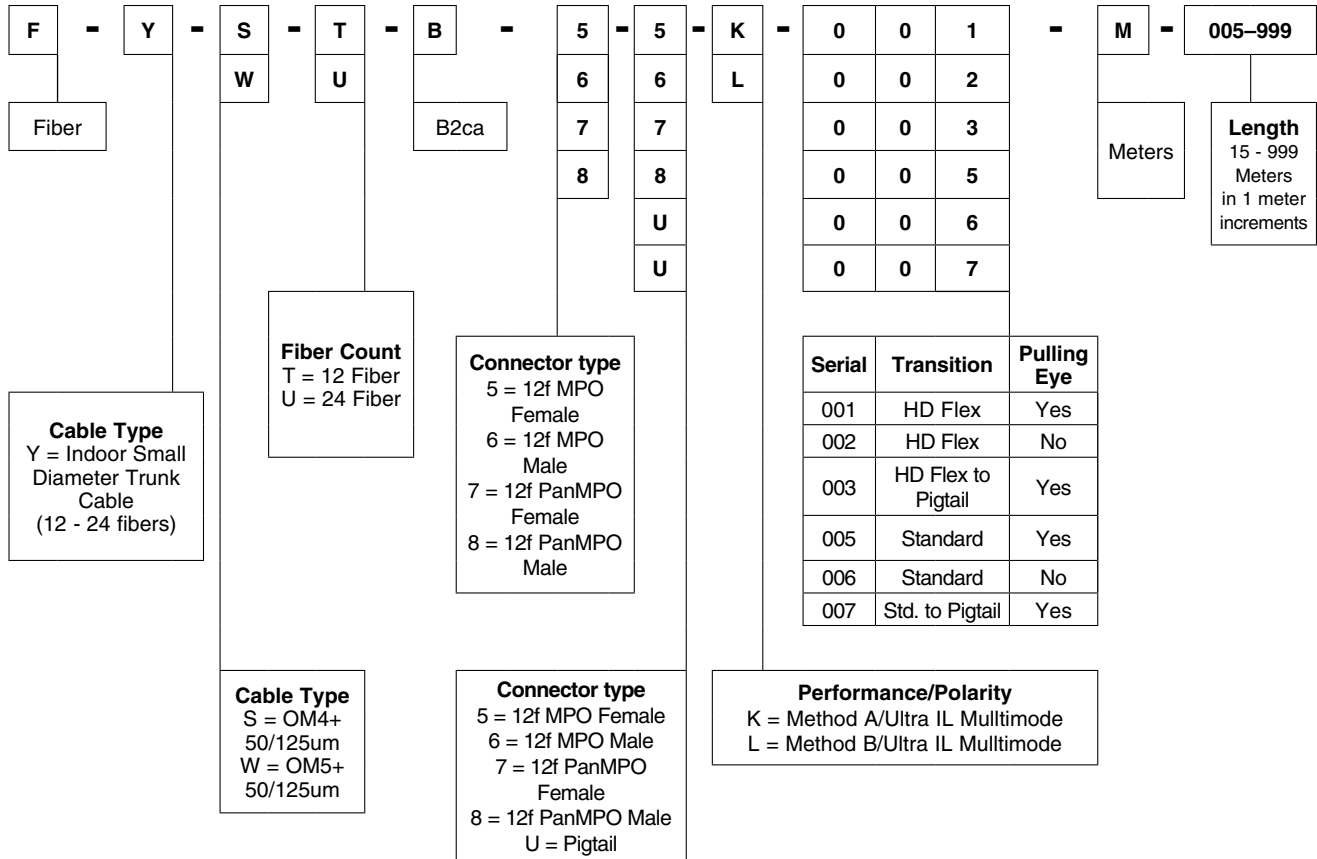

Singlemode Trunk



Multimode Trunk

A. Featured Products

B. Copper Systems

C. Fiber Systems

D. Faceplates, Frames & Surface Mount Boxes

E. Industrial Networks

F. Audio Video Systems

G. Keystone Cabling Systems

H. Zone Cabling

J. Cable Routing Systems

K. Cable Cleats

L. Cabinets & Rack Systems

M. Power & Connectivity Management

N. Grounding & Bonding

O. Identification Products

P. Cable Management Accessories

Q. Part Number Index

- A. Featured Products
- B. Copper Systems
- C. Fiber Systems
- D. Faceplates, Frames & Surface Mount Boxes
- E. Industrial Networks
- F. Audio Video Systems
- G. Keystone Cabling Systems
- H. Zone Cabling
- J. Cable Routing Systems
- K. Cable Cleats
- L. Cabinets & Rack Systems
- M. Power & Connectivity Management
- N. Grounding & Bonding
- O. Identification Products
- P. Cable Management Accessories
- Q. Part Number Index

Fiber Optic Harness Assemblies

- PanMPO™ Multimode and MPO Singlemode Round Harness Cable Assemblies are pre-terminated and 100% factory tested
- The PanMPO™ Connector allows for rapid gender and polarity change in the field
- Push-Pull LC allow easy removal in high density applications
- LC uniboot connectors reduce cable density on the switch up to 40% and allow easy change of polarity
- Meets or exceeds ISO/IEC 11801, ANSI/TIA-568.3-D, TIA-604-5, TIA/EIA-604 (FOCIS-5 and FOCIS-10)
- RoHS compliant
- 4-to-1 conversion harness convert one 8-fiber MTP (Parallel optics for 40/100GBASE-SR4) to (4) Duplex LC connectors

Multimode Harnesses

12 Fiber Multimode Harnesses

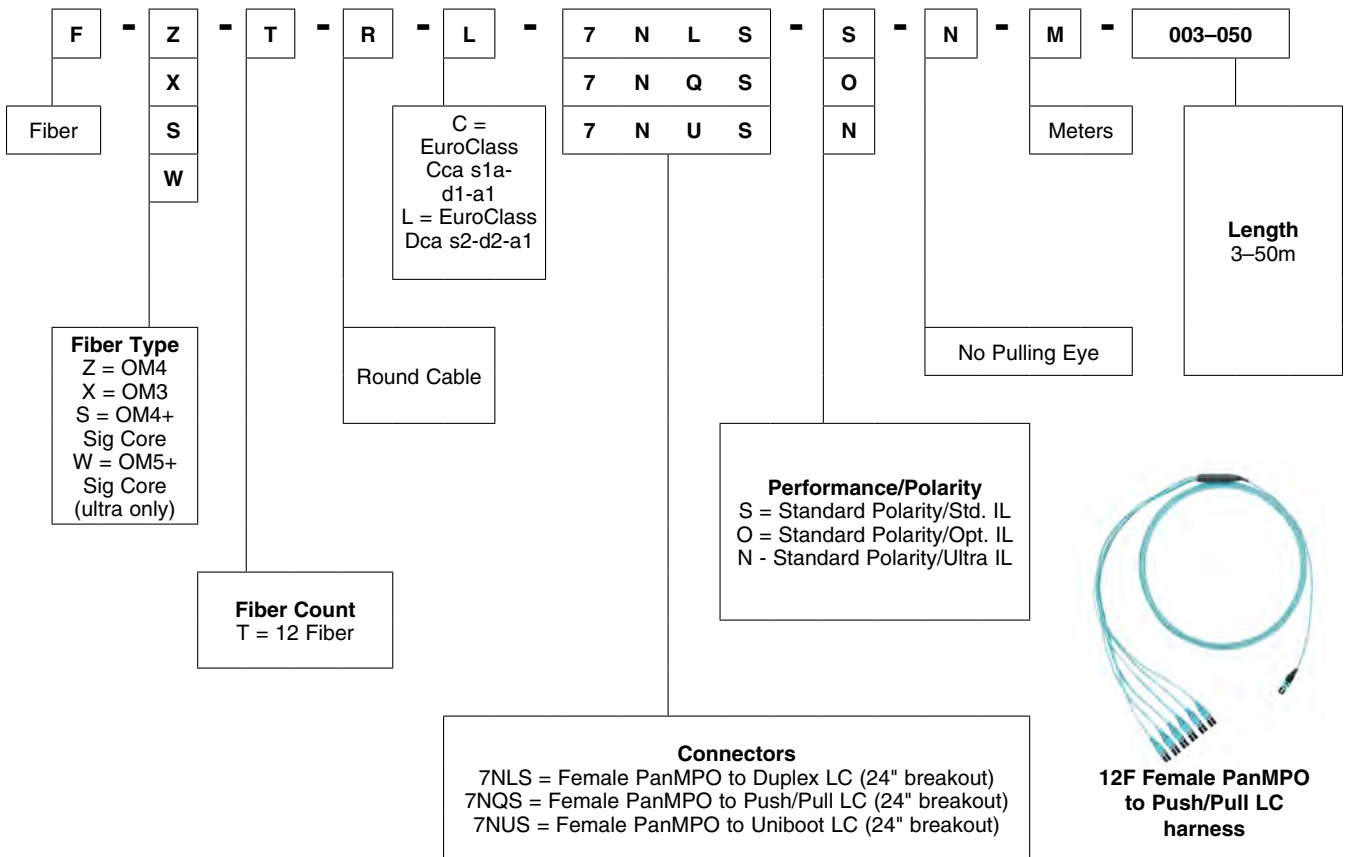

12F Female PanMPO to Push/Pull LC harness

Fiber Optic Harness Assemblies (continued)

12 Fiber Singlemode Harnesses

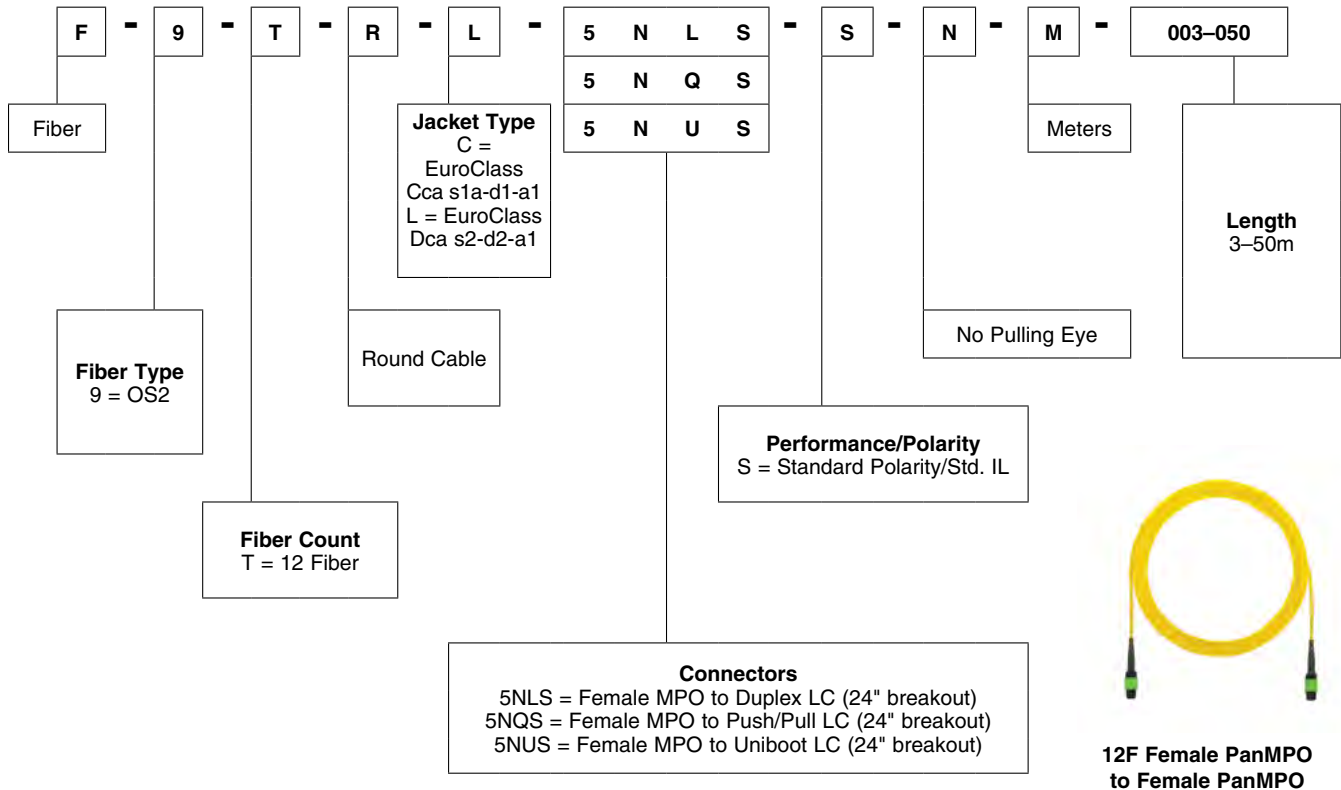

8 Fiber Multimode 4-to-1 Conversion Harnesses

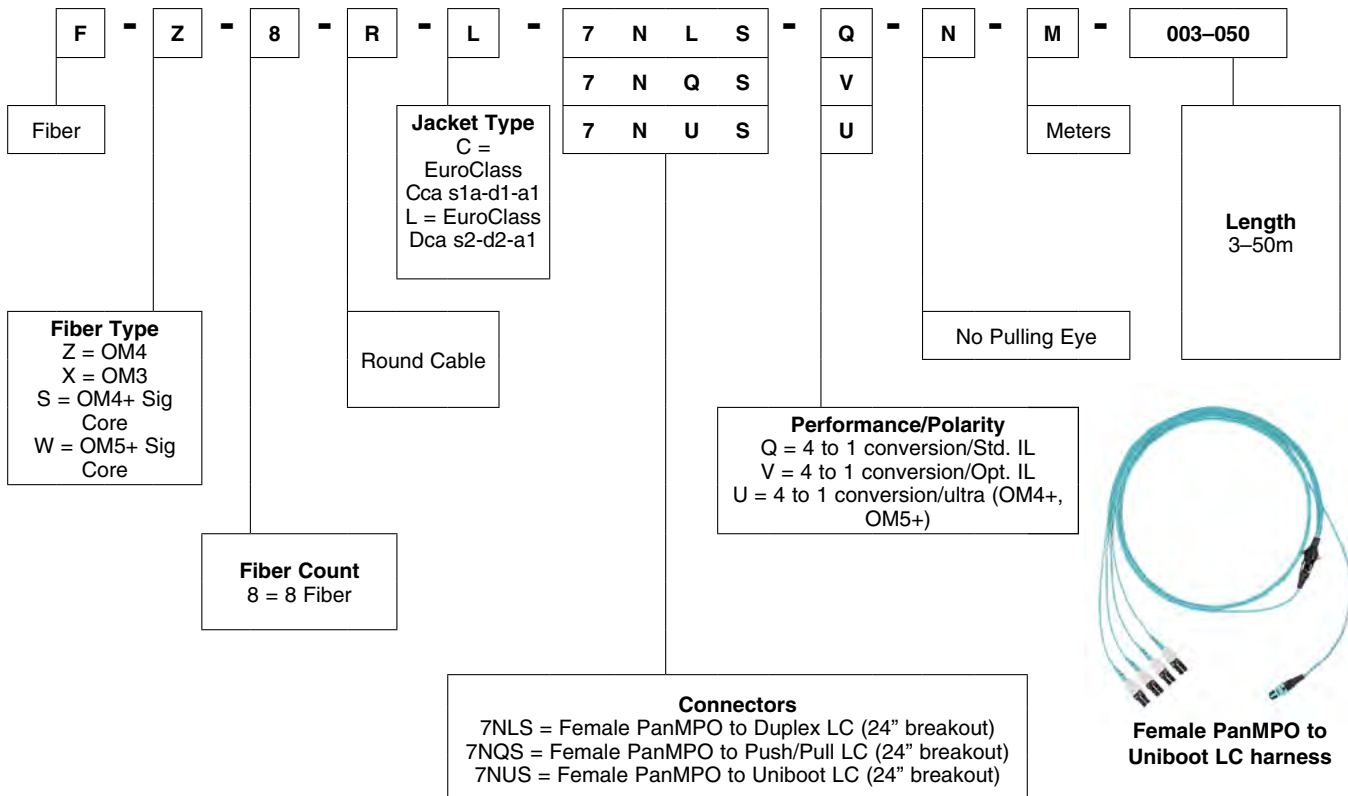

Continued on next page

A. Featured Products

B. Copper Systems

C. Fiber Systems

D. Faceplates, Frames & Surface Mount Boxes

E. Industrial Networks

F. Audio Video Systems

G. Keystone Cabling Systems

H. Zone Cabling

J. Cable Routing Systems

K. Cable Cleats

L. Cabinets & Rack Systems

M. Power & Connectivity Management

N. Grounding & Bonding

O. Identification Products

P. Cable Management Accessories

Q. Part Number Index

- A. Featured Products
- B. Copper Systems
- C. Fiber Systems
- D. Faceplates, Frames & Surface Mount Boxes
- E. Industrial Networks
- F. Audio Video Systems
- G. Keystone Cabling Systems
- H. Zone Cabling
- J. Cable Routing Systems
- K. Cable Cleats
- L. Cabinets & Rack Systems
- M. Power & Connectivity Management
- N. Grounding & Bonding
- O. Identification Products
- P. Cable Management Accessories
- Q. Part Number Index

Fiber Optic Harness Assemblies (continued)

8 Fiber Singlemode 4-to-1 Conversion Harnesses

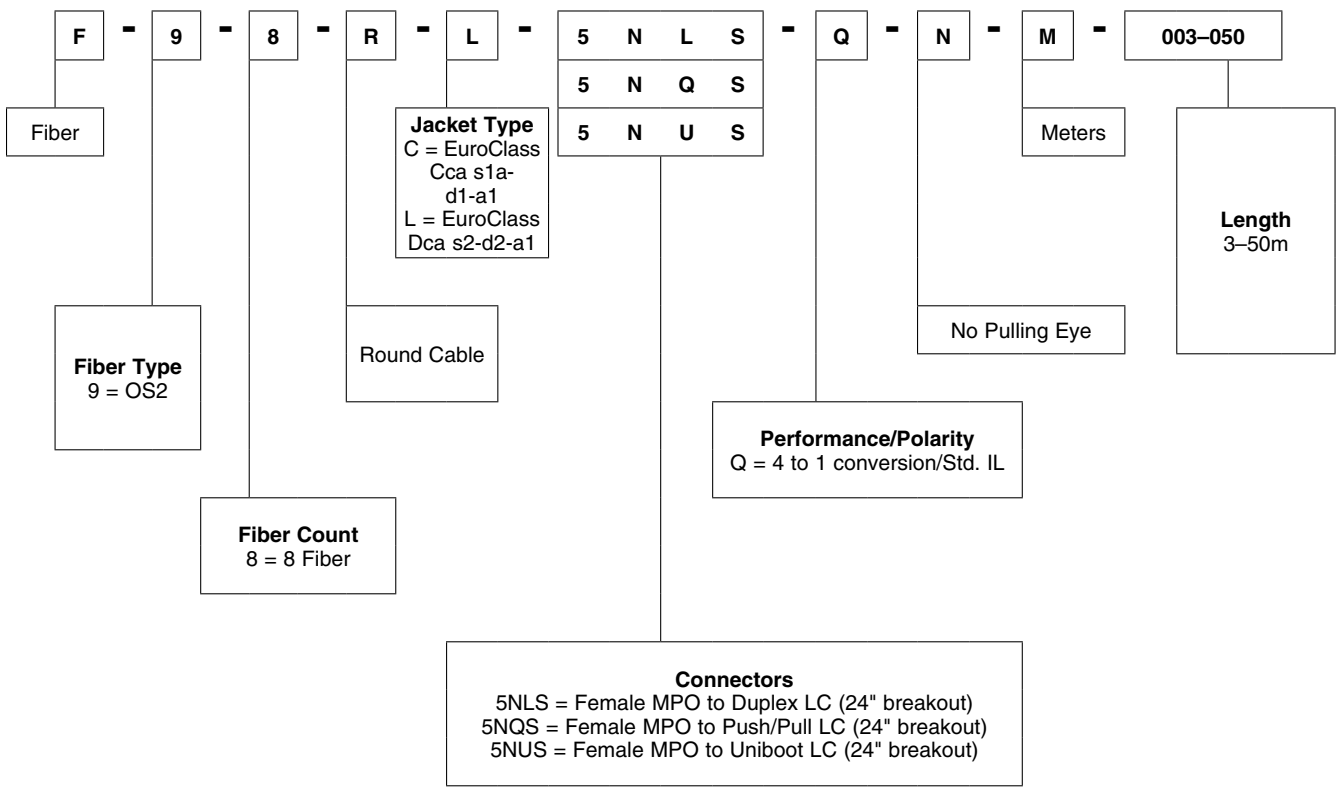

Fiber Optic Patch Cord and Pigtail Assemblies

- Fiber optic patch cords and pigtails provide interconnect and cross-connect of applications over installations in entrance facilities, telecommunications rooms, data centers and at the desk
- Patch cords support network applications in main, horizontal and equipment distribution areas and are available in riser (OFNR)
- Pre-terminated fiber optic pigtails support fusion splice field termination applications. Fiber optic patch cords and pigtails are available in OM5+, OM4+, OM4, OM3 OM1, or OS2 fiber types
- Meets or exceeds ISO/IEC 11801, ANSI/TIA-568.3-D, TIA/EIA-604 (FOCIS-3 and FOCIS-10)
- Restriction of Hazardous Substances (RoHS) Compliance: All patch cord components meet the requirements of Directive 2002/95/EC

Multimode Duplex Patch Cords

LC Duplex Patch Cords

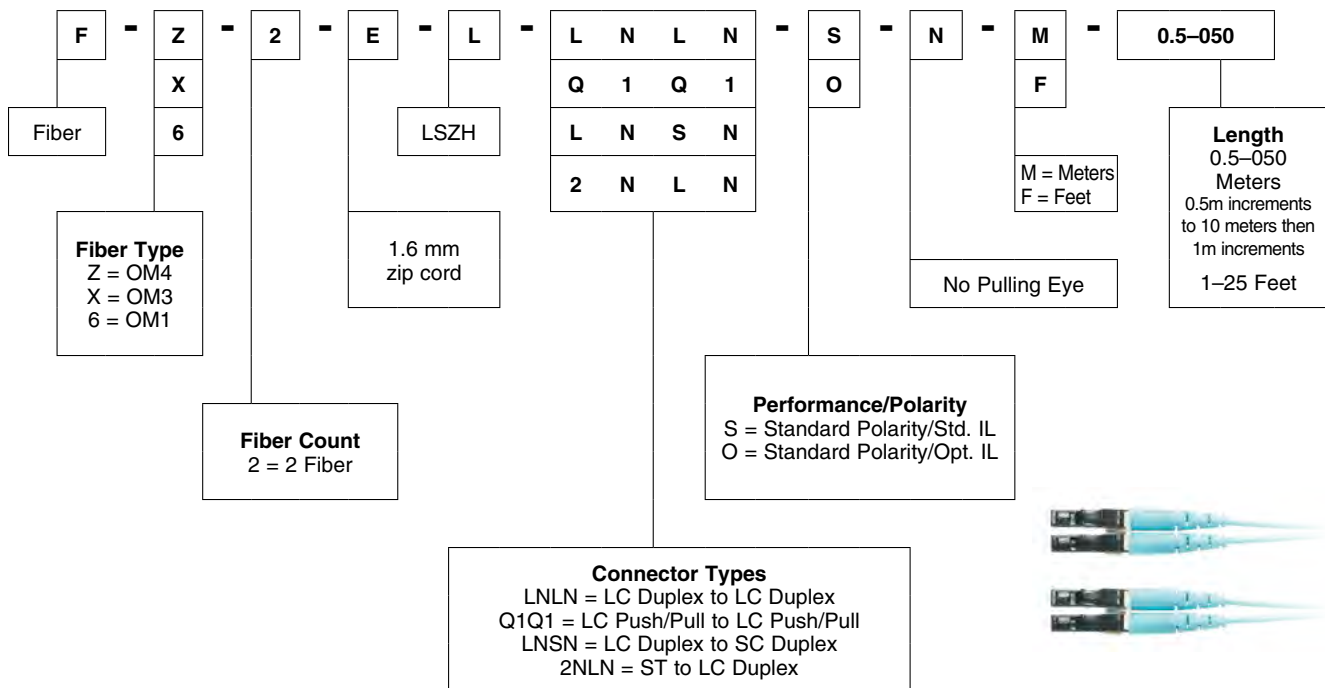

A. Featured Products

B. Copper Systems

C. Fiber Systems

D. Faceplates, Frames & Surface Mount Boxes

E. Industrial Networks

F. Audio Video Systems

G. Keystone Cabling Systems

H. Zone Cabling

J. Cable Routing Systems

K. Cable Cleats

L. Cabinets & Rack Systems

M. Power & Connectivity Management

N. Grounding & Bonding

O. Identification Products

P. Cable Management Accessories

Q. Part Number Index

Continued on next page

- A. Featured Products
- B. Copper Systems
- C. Fiber Systems
- D. Faceplates, Frames & Surface Mount Boxes
- E. Industrial Networks
- F. Audio Video Systems
- G. Keystone Cabling Systems
- H. Zone Cabling
- J. Cable Routing Systems
- K. Cable Cleats
- L. Cabinets & Rack Systems
- M. Power & Connectivity Management
- N. Grounding & Bonding
- O. Identification Products
- P. Cable Management Accessories
- Q. Part Number Index

Fiber Optic Patch Cord and Pigtail Assemblies (continued)

SC & ST Duplex Patch Cords

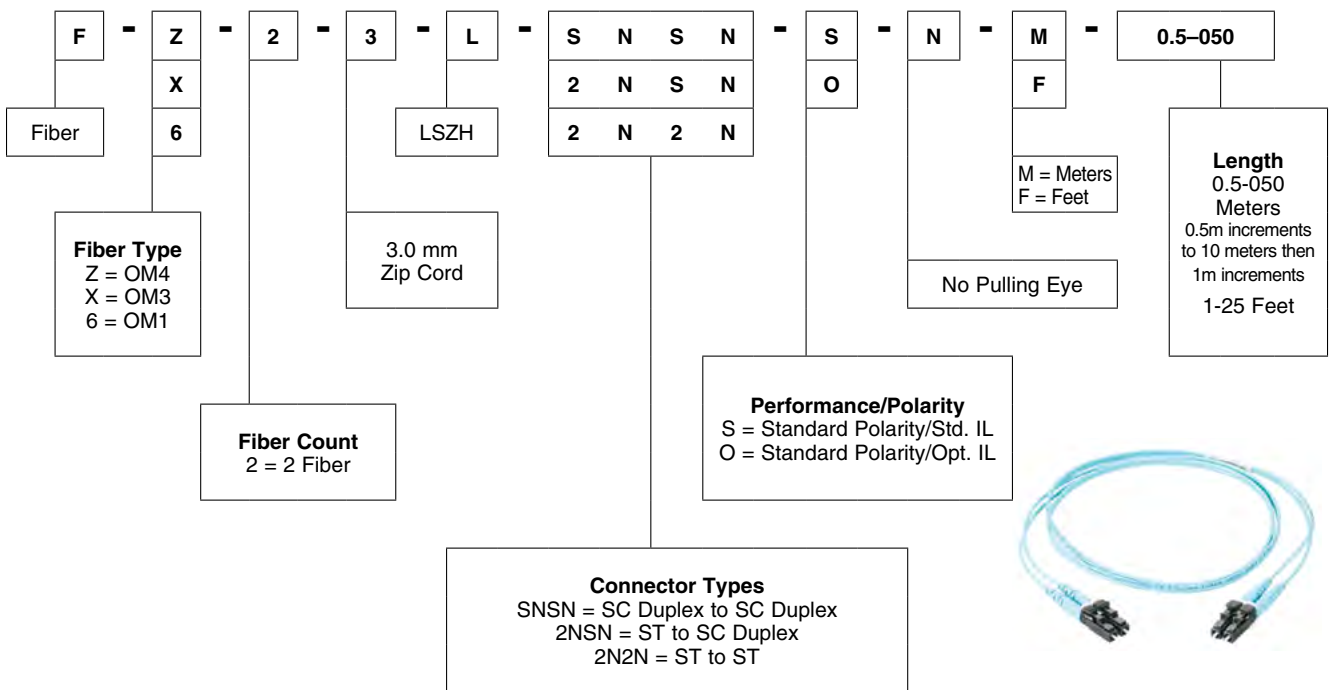

Signature Core™ Duplex Patch Cords

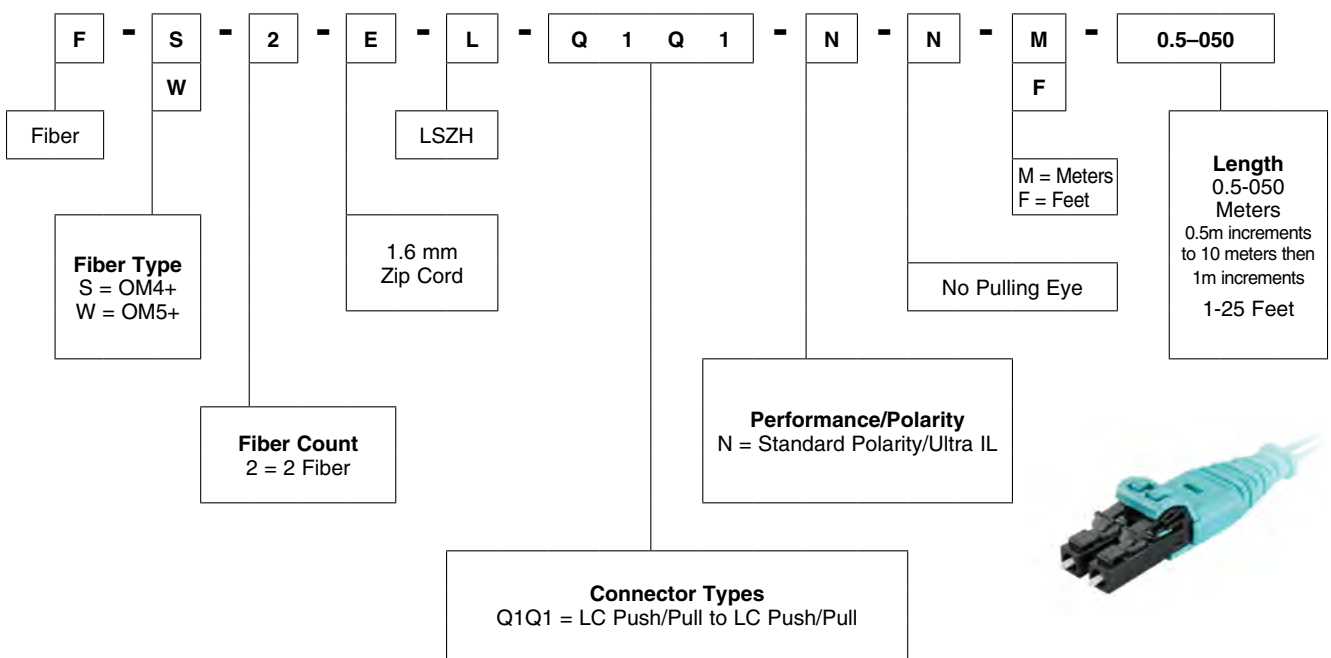

Continued on next page

Fiber Optic Patch Cord and Pigtail Assemblies (continued)

Singlemode Duplex Patch Cords

LC Duplex Patch Cords

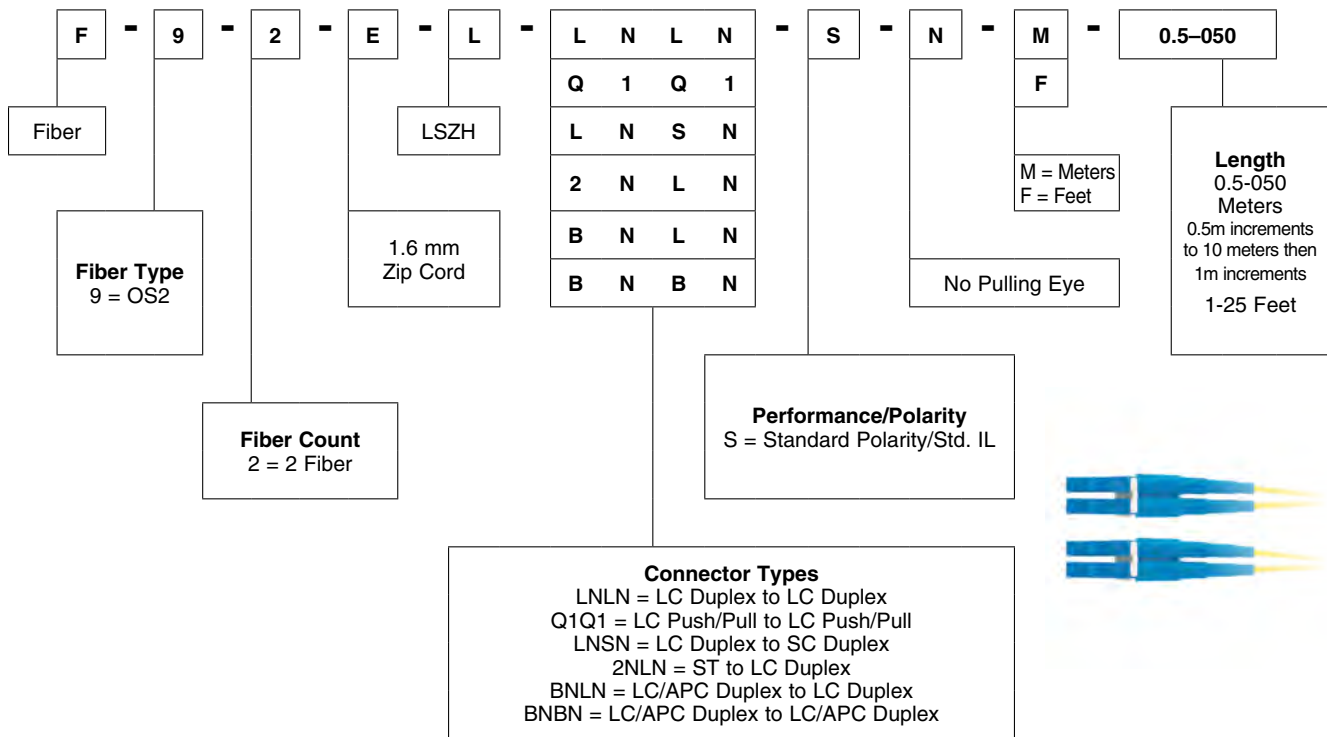

SC & ST Duplex Patch Cords

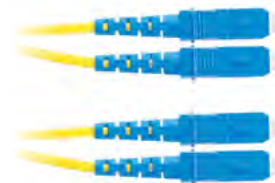
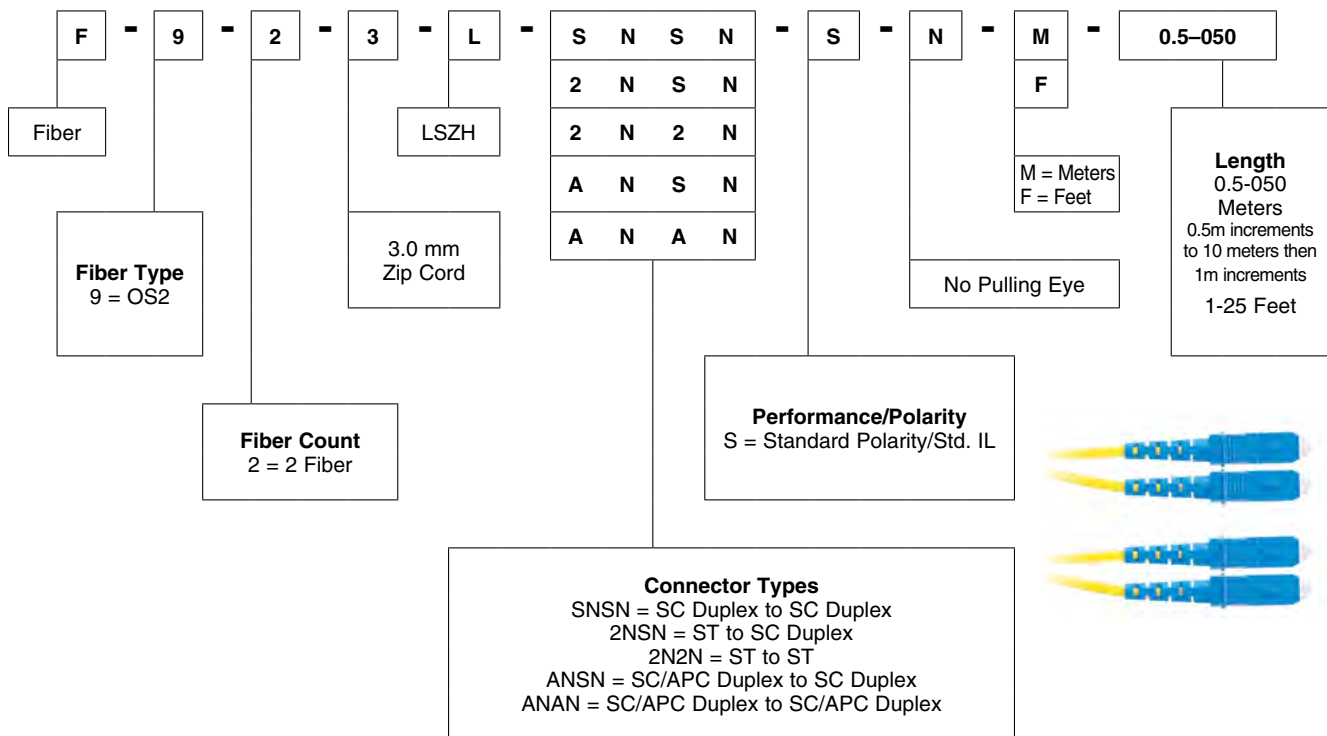

A. Featured Products

B. Copper Systems

C. Fiber Systems

D. Faceplates, Frames & Surface Mount Boxes

E. Industrial Networks

F. Audio Video Systems

G. Keystone Cabling Systems

H. Zone Cabling

J. Cable Routing Systems

K. Cable Cleats

L. Cabinets & Rack Systems

M. Power & Connectivity Management

N. Grounding & Bonding

O. Identification Products

P. Cable Management Accessories

Q. Part Number Index

Continued on next page

- A. Featured Products
- B. Copper Systems
- C. Fiber Systems
- D. Faceplates, Frames & Surface Mount Boxes
- E. Industrial Networks
- F. Audio Video Systems
- G. Keystone Cabling Systems
- H. Zone Cabling
- J. Cable Routing Systems
- K. Cable Cleats
- L. Cabinets & Rack Systems
- M. Power & Connectivity Management
- N. Grounding & Bonding
- O. Identification Products
- P. Cable Management Accessories
- Q. Part Number Index

Fiber Optic Patch Cord and Pigtail Assemblies (continued)

Multimode Pigtails

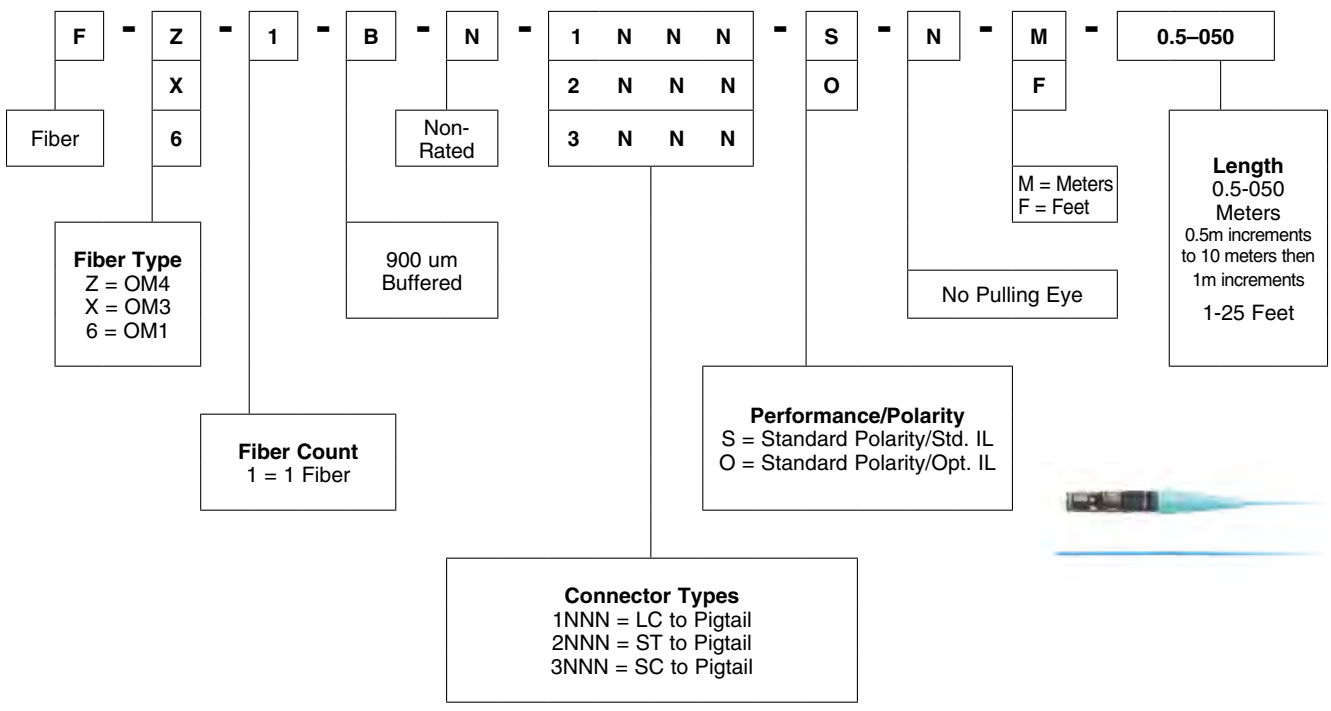

Singlemode Pigtails

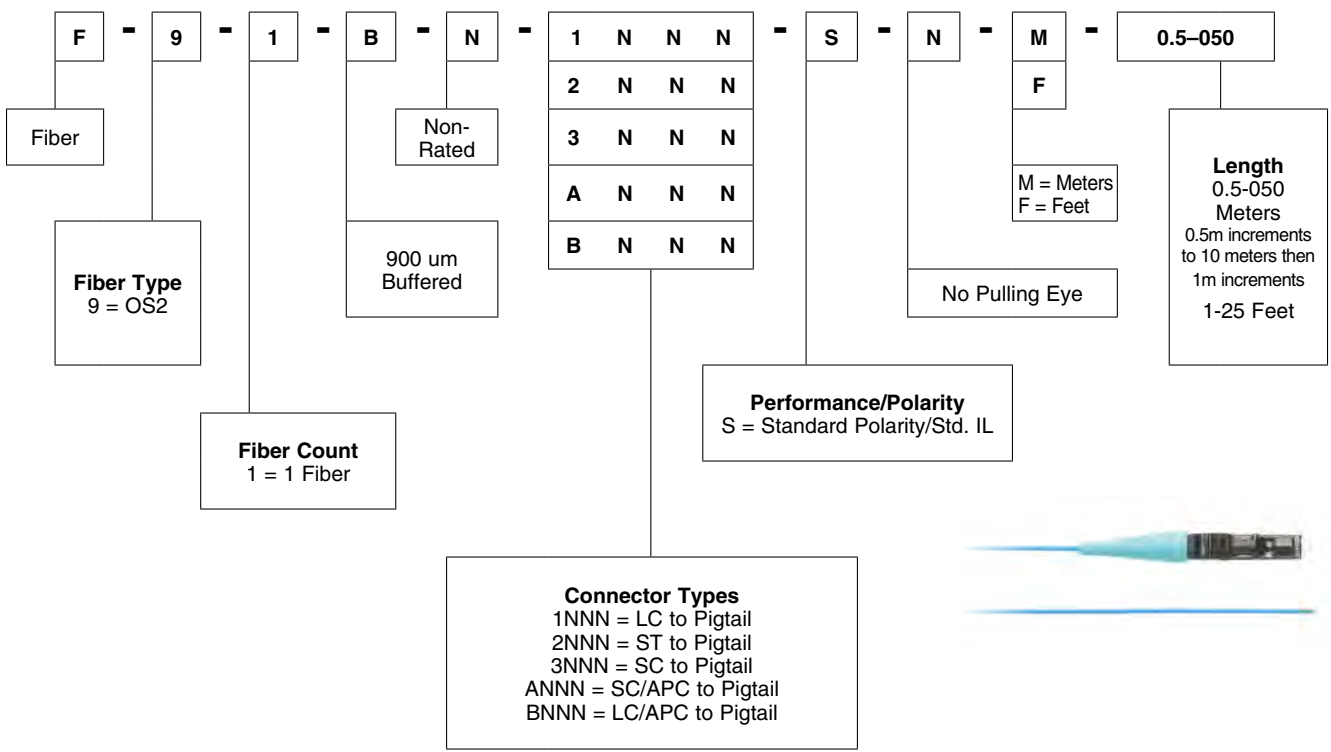

QuickNet™ High Density SFQ Small Form Factor Cable Assemblies

- Identical copper and fiber cassette form factor offers design flexibility, easy maintenance and upgrade enabling a unified, highly scalable pre-terminated solution
- MPO 12-fiber connector provides reduced overall insertion loss with low channel to channel variability
- 100% tested with test data provided for each product
- Factory verified optical performance provides channel to channel consistency and reliability for improved network integrity
- Pre-terminated modular cassette system provides quick deployment that reduces installation time and cost
- Product is compatible with QuickNet™ Patch Panels and uses the same cassette form factor as Copper QuickNet™ Patch Panels (or cable assemblies)
- Product identification with data labels and QC numbers which are supplied with each product for quick port identification and 100% traceability

12 Fiber Multimode LC Tethered Trunks

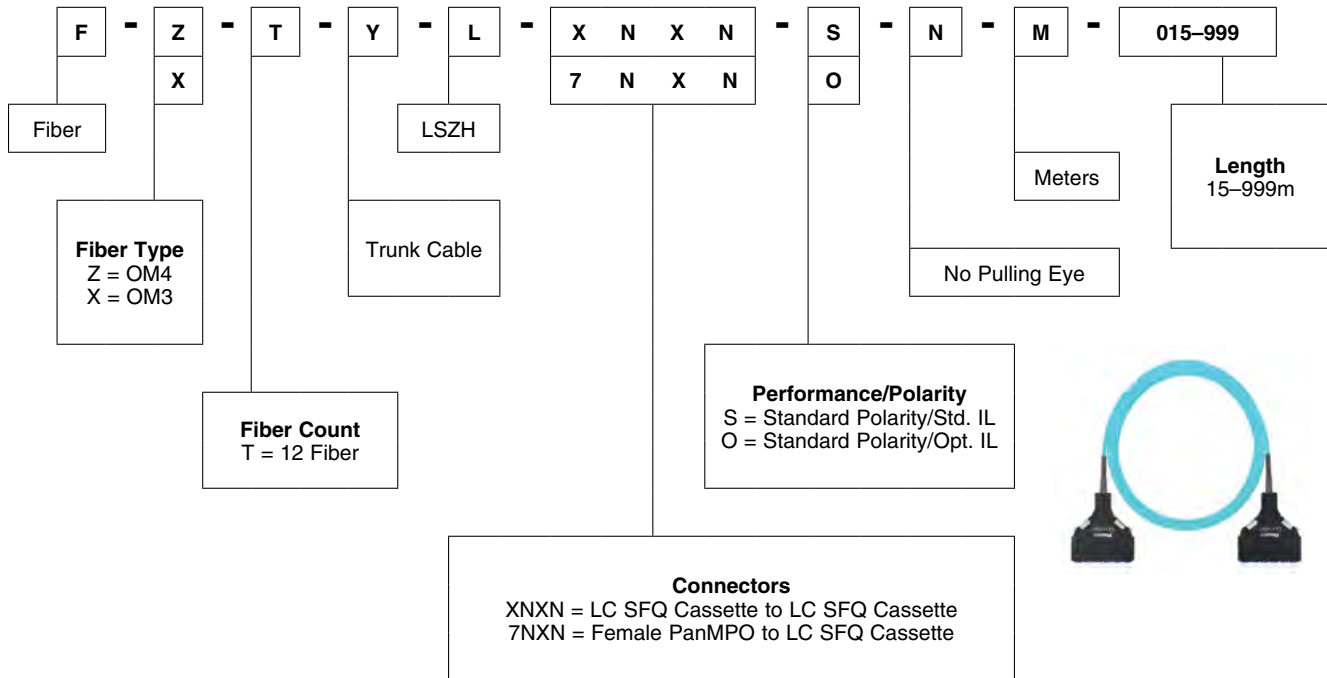

A. Featured Products

B. Copper Systems

C. Fiber Systems

D. Faceplates, Frames & Surface Mount Boxes

E. Industrial Networks

F. Audio Video Systems

G. Keystone Cabling Systems

H. Zone Cabling

J. Cable Routing Systems

K. Cable Cleats

L. Cabinets & Rack Systems

M. Power & Connectivity Management

N. Grounding & Bonding

O. Identification Products

P. Cable Management Accessories

Q. Part Number Index

- A. Featured Products
- B. Copper Systems
- C. Fiber Systems
- D. Faceplates, Frames & Surface Mount Boxes
- E. Industrial Networks
- F. Audio Video Systems
- G. Keystone Cabling Systems
- H. Zone Cabling
- J. Cable Routing Systems
- K. Cable Cleats
- L. Cabinets & Rack Systems
- M. Power & Connectivity Management
- N. Grounding & Bonding
- O. Identification Products
- P. Cable Management Accessories
- Q. Part Number Index

QuickNet™ High Density SFQ Small Form Factor Cable Assemblies (continued)

12 Fiber Singlemode LC Tethered Trunks

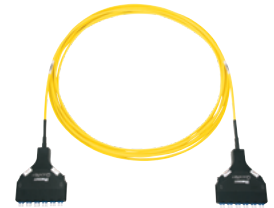
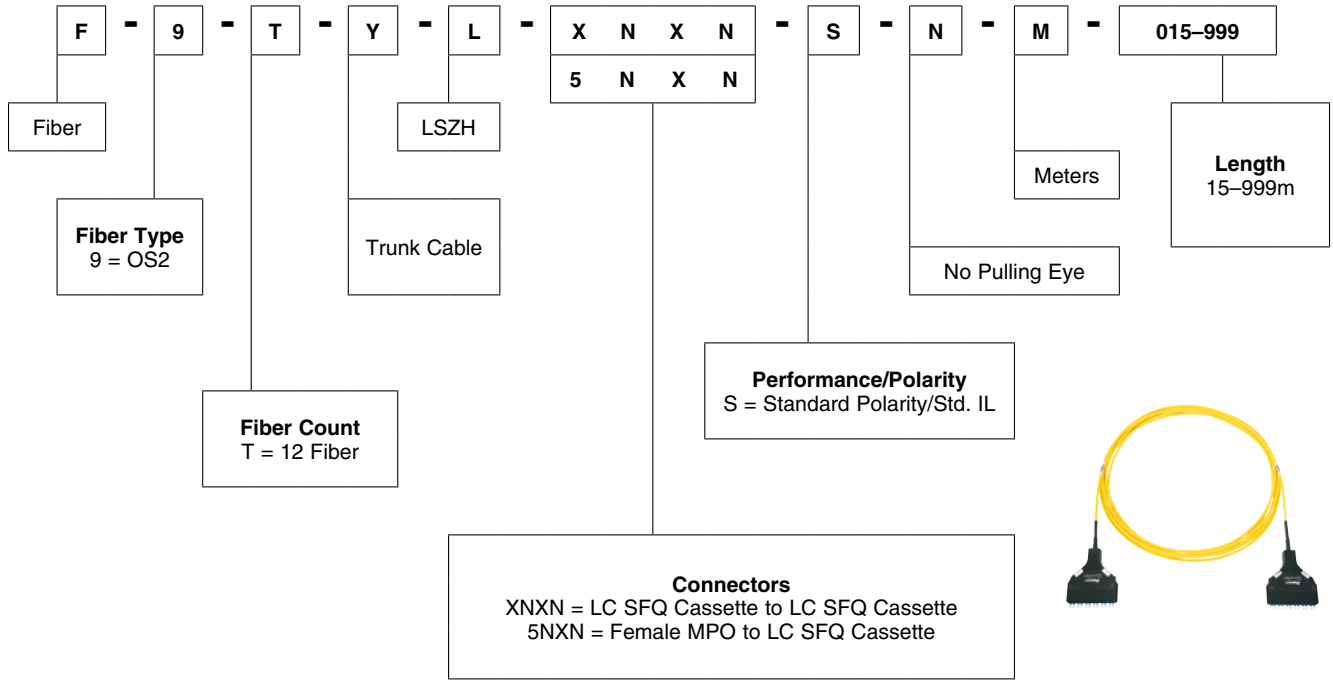

Table of Contents

Mini-Com™ Faceplates	D.2 – D.4
Mini-Com™ Furniture Faceplates	D.5
Mini-Com™ Surface Mount Boxes	D.6
Mini-Com™ Water Resistant Faceplates	D.6
Mini-Com™ GFCI Decora Module Frames	D.7
Mini-Com™ 106 Duplex Module Frames	D.7
Phone Plates	D.7
Wall Board Adapter	D.7
Mini-Com™ Blank Modules	D.8
Mini-Com™ Adapter for WIREMOLD* Frames	D.8
Mini-Com™ One Position Adapters	D.8
Replacement Label and Label Covers	D.8

A.
Featured
Products

B.
Copper
Systems

C.
Fiber
Systems

D.
Faceplates,
Frames &
Surface
Mount Boxes

E.
Industrial
Networks

F.
Audio
Video
Systems

G.
Keystone
Cabling
Systems

H.
Zone
Cabling

J.
Cable
Routing
Systems

K.
Cable
Cleats

L.
Cabinets
& Rack
Systems

M.
Power &
Connectivity
Management

N.
Grounding
& Bonding

O.
Identification
Products

P.
Cable
Management
Accessories

Q.
Part
Number
Index



*WIREMOLD is a registered trademark of Legrand in the United States.

A. Featured Products
B. Copper Systems
C. Fiber Systems
D. Faceplates, Frames & Surface Mount Boxes
E. Industrial Networks
F. Audio Video Systems
G. Keystone Cabling Systems
H. Zone Cabling
J. Cable Routing Systems
K. Cable Cleats
L. Cabinets & Rack Systems
M. Power & Connectivity Management
N. Grounding & Bonding
O. Identification Products
P. Cable Management Accessories
Q. Part Number Index

Mini-Com™ Faceplates

- Accept Mini-Com™ Modules for STP and UTP, fiber optic, and audio/video
- Replacement label/label covers available where applicable
- Sloped design includes icon slots
- Non-label faceplates include screws with matching color head screws



CFPUKS2SAWY



CFPUKS3AWY



CM6CSSAW-X



CM6CESSAW-X



CFPE3AWY

Part Number	Description	Std. Pkg. Qty.	Std. Ctn. Qty.
-------------	-------------	----------------	----------------

UK Faceplates

CFPUKS2SAWY	86mm x 86mm single gang faceplate frame and one 1/2-size sloped shuttered module insert.	1	10
CFPUKS4SAW-2GY	86mm x 146mm double gang faceplate frame and two 1/2-sized sloped shuttered module inserts.	1	10
CFPLUKF2SAW	86mm x 86mm single gang shuttered faceplate with label and icon slots. Accepts up to two Mini-Com™ Modules. Includes two M3.5-0.5x30mm panhead mounting screws.	1	10
CFPLUKF4SAW	86mm x 86mm single gang shuttered faceplate with label and icon slots. Accepts up to four Mini-Com™ Modules. Includes two M3.5-0.5x30mm panhead mounting screws	1	10
CFPUKS2BAWY	86mm x 86mm single gang faceplate holds up to two Mini-Com™ Modules. Supplied with CMB blank module.	1	10
CFPUKS3AWY	86mm x 86mm single gang faceplate hold up to three Mini-Com™ Modules.	1	10
CFP86S2AWY	86mm x 86mm single gang sloped faceplate with screw cover. Accepts two Mini-Com™ Modules.	1	10

UK Adapters

CM6CSAW-X	Shuttered module snaps into standard UK LJU6C floor box mounting plates, faceplates and patch panels. Holds one Mini-Com™ Module. Compatible with standard UK LJU6C openings with 22.3mm x 36.9mm dimensions.	10	50
CM6CSSAW-X	Sloped shuttered module snaps into standard UK LJU6C floor box mounting plates, faceplates and patch panels. Holds one Mini-Com™ Module. Compatible with standard UK LJU6C openings with 22.3mm x 36.9mm dimensions.	10	50
CM6CESAW-X	Shuttered Euro-mod adapter accepts one Mini-Com™ Module (25mm x 50mm).	10	50
CM6CESSAW-X	Sloped shuttered Euro-mod adapter accepts one Mini-Com™ Module (25mm x 50mm).	10	50

German Faceplates

CFPE3AWY	80mm x 80mm faceplate frame and one 55mm x 55mm sloped faceplate accepts up to three Mini-Com™ Modules. Supplied with mounting screws, metal mounting plate, label and label cover.	1	10
CFPAGS2AWY	50mm x 50mm adapter and one 1/2-size sloped module insert accepts up to two Mini-Com™ Modules. Supplied with mounting screws and metal mounting plate.	1	10
CFPAGS2SAWY	50mm x 50mm adapter and one 1/2-size sloped shuttered module insert accepts up to two Mini-Com™ Modules. Supplied with mounting screws and metal mounting plate.	1	10
CHES3AWY	55mm x 55mm sloped faceplate holds up to three Mini-Com™ Modules. Supplied with mounting screws, metal mounting plate, label and label cover.	1	10
FCFPAW	80mm x 80mm faceplate frame accepts all Panduit 50mm x 50mm adapters and the CHES3AWY adapter.	1	10

Continued on next page

Mini-Com™ Faceplates (continued)



CFPFF2AW



CFPFS1SAW



CFPFLS1SAW



CFPH4IW



CBTAL1WH-X



CFPDPS2SEW



CFPCH3AW

Part Number	Description	Std. Pkg. Qty.	Std. Ctn. Qty.
French Faceplates			
CFPFF2AW	45mm x 45mm adapter with one 1/2-size flat module insert accepts two Mini-Com™ Modules.	1	10
CFPFS2AW	45mm x 45mm adapter with one 1/2-size sloped module insert accepts two Mini-Com™ Modules.	1	10
CFPFS1SAW	45mm x 45mm adapter with one 1/2-size sloped shuttered insert. Accepts one Mini-Com™ Module.	1	10
CFPFS2SAW	45mm x 45mm adapter with one 1/2-size sloped shuttered module insert accepts up to two Mini-Com™ Modules.	1	10
CFPFLS1SAW	45mm x 45mm adapter with one-port sloped shuttered module with labels and icon slots. Accepts a single Mini-Com™ Module.	1	10
CFPFLS2SAW	45mm x 45mm adapter with two-port sloped shuttered module with labels and icon slots. Accepts up to two Mini-Com™ Modules.	1	10
CFP45LS2SAW	45mm x 45mm adapter with one 1/2-size sloped shuttered module insert with label and label cover. Accepts up to two Mini-Com™ Modules.	1	10
French Adapter			
CFA1SAW-X	Accepts a single Mini-Com™ Module, 22.5mm x 45mm shuttered adapter.	10	50
Italian Faceplates			
CFPH2IW	Single gang horizontal faceplate accepts two Mini-Com™ Modules.	1	10
CFPHS2IW	Single gang, sloped horizontal faceplate accepts two Mini-Com™ Modules.	1	10
CFPH4IW	Single gang horizontal faceplate accepts four Mini-Com™ Modules.	1	10
CFPHSL4IW	Single gang sloped horizontal faceplate accepts four Mini-Com™ Modules. Includes label and label cover.	1	10
Italian Adapters			
CGAGY-X	Adapter holds one Mini-Com™ Module in a Gewiss Playbus* Series Faceplate.	10	50
CBTAL1BL-X	Adapter label pocket accepts one Mini-Com™ Module for Bticino** Living International series faceplates.	10	50
CBTA1BL-X	Adapter accepts one Mini-Com™ Module for Bticino** Living International series faceplates.	10	50
CBTAL1WH-X	Adapter with label pocket accepts one Mini-Com™ Module for Bticino** Light series faceplates.	10	50
CBTA1WH-X	Adapter accepts one Mini-Com™ Module for Bticino** Light series faceplates.	10	50
Denmark Faceplates			
CFPDS2SEWY	Danish 77.1mm x 50.4mm faceplate with one 1/2-size sloped shuttered module insert holds up to two Mini-Com™ Modules. Supplied with label and label cover.	1	10
CFPDPS2SEW	Denmark faceplate with one 1/2-size sloped shuttered insert holds up to two Mini-Com™ Modules. Supplied with label and label cover.	1	10
CHLKCLS2SEW	Mini-Com™ Faceplate for use with LK Clic'Line^ Series faceplate snaps to LK back box. Includes one 1/2-size sloped shuttered insert that hold up to two Mini-Com™ Modules.	1	10
CFD66S2SEW	Mini-Com™ 2-position Sloped Shuttered OPUS 66^^ Adapter holds up to two Mini-Com™ Modules. Compatible with in-wall and surface mount installations.	1	10
Switzerland Faceplate			
CFPCH3AW	Mini-Com™ Faceplate, accepts three Mini-Com™ Modules.	1	10

*Playbus is a trademark of Gewiss S.p.

**Living International and Light are trademarks of Bticino S.p.A.

^Clic'Line is a trademark of Schneider Electric.

^^OPUS 66 is a trademark of Schneider Electric.

A. Featured Products

B. Copper Systems

C. Fiber Systems

D. Faceplates, Frames & Surface Mount Boxes

E. Industrial Networks

F. Audio Video Systems

G. Keystone Cabling Systems

H. Zone Cabling

J. Cable Routing Systems

K. Cable Cleats

L. Cabinets & Rack Systems

M. Power & Connectivity Management

N. Grounding & Bonding

O. Identification Products

P. Cable Management Accessories

Q. Part Number Index

A. Featured Products



Faceplate Frames and Mini-Com™ Inserts

- Single and double gang faceplate frames
- Inserts accept Mini-Com™ Modules and are front releasable
- Allows custom installations

B. Copper Systems

C. Fiber Systems



CBIW **CBEIWY**

Faceplate Frames

Part Number	Size	Style	Identification
CBIW	Single Gang	Classic	Adhesive
CBIW-2G	Double Gang		
CBEIWY	Single Gang	Executive	Label Pocket
CBEIW-2GY	Double Gang		



CBIW-2G **CBEIW-2GY**

D. Faceplates, Frames & Surface Mount Boxes

F. Audio Video Systems

G. Keystone Cabling Systems

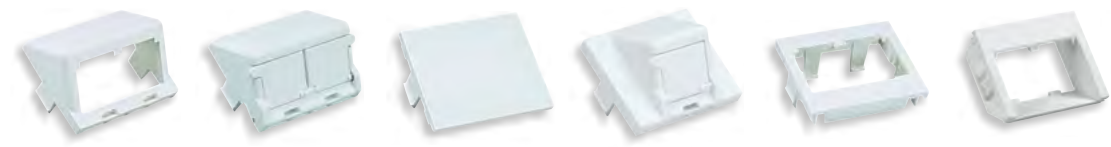

CHS2IW-X **CHS2SIW-X** **CHB2IW-X** **CHS1SIW-X** **CHF2IW-X** **CHSRE2IW-X**

H. Zone Cabling

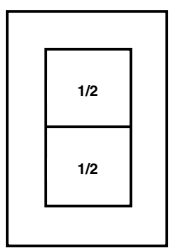

Accepts two 1/2 inserts in a single gang frame.
Accepts four 1/2 inserts in a double gang frame.

1/2 Size Inserts

Part Number	Ports	Style	Identification
CHS2IW-X	2	Sloped	Adhesive
CHF2IW-X		Flat	
CHS2SIW-X		Sloped Shuttered	
CHB2IW-X	-	Blank	Adhesive
CHSRE2IW-X	2	Sloped Recessed	

J. Cable Routing Systems

K. Cable Cleats

L. Cabinets & Rack Systems



CHF2MIW-X



CHB2MIW-X



CHR3WYRIW



CHD15HDCIWY



CHD15HDSCIWY

M. Power & Connectivity Management

N. Grounding & Bonding

1/3 Size Inserts

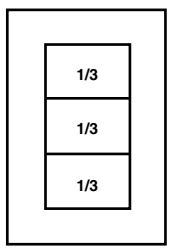

Accepts three 1/3 inserts in a single gang frame.
Accepts three 1/3 inserts in a double gang frame.

Part Number	Ports	Style
CHF2MIW-X	2	Flat
CHF1MIW-X	1	
CHB2MIW-X	-	Blank
CHR3WYRIW		RCA Coupler
CHD15HDCIWY		VGA 15 Pin HD Coupler
CHD15HDSCIWY		VGA 15 Pin HD Screw Down

For other colors, replace IW (Off White) with EI(Electric Ivory,) or WH (White).

O. Identification Products

P. Cable Management Accessories

Q. Part Number Index



Mini-Com™ Furniture Faceplates

- Accept Mini-Com™ Modules for STP and UTP, fiber optic, and audio/video
- Replacement label/label covers available where applicable
- Optional adhesive labels available

Standard Opening



CFFPL4BL



CFFP4BL



UICFFP4BL
(Labels not included)



CFFPE3BL



MFFPEBL

Extender frame

Adds approximately 1/2" in depth (12.7mm)



CFFPA2BL

Not compatible with MFFPE**

Panel Cutout Requirements for Standard Opening

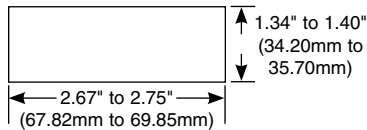

Maximum Panel Thickness: 0.09" (2.29mm)

Custom Opening

Herman Miller



CFFPHM4BL

Not compatible with MFFPE**

Panel Cutout Requirements for CFFPHM4:

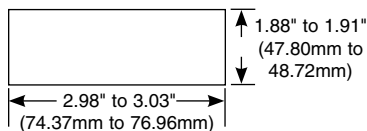

Maximum Panel Thickness: 0.09" (2.29mm)

Part Number	Part Description	Ports	Identification	Furniture Opening
CFFPL4BL	Furniture faceplate, compatible with extender frame MFFPE**.	4	Label Pocket	Standard
CFFP4BL			Adhesive	
UICFFP4BL			Label Pocket	
CFFPE3BL			Adhesive	
CFFPL2BL		2	Label Pocket	
MFFPEBL	Extender frame	—	—	
CFFPA2BL	Furniture faceplate, not compatible with extender frame MFFPE**.	2	Adhesive	Herman Miller
CFFPHM4BL		4		

For other colors, replace BL (Black) with IW (Off White), WH (White) or IG (International Gray).

A. Featured Products

B. Copper Systems

C. Fiber Systems

D. Faceplates, Frames & Surface Mount Boxes

E. Industrial Networks

F. Audio Video Systems

G. Keystone Cabling Systems

H. Zone Cabling

J. Cable Routing Systems

K. Cable Cleats

L. Cabinets & Rack Systems

M. Power & Connectivity Management

N. Grounding & Bonding

O. Identification Products

P. Cable Management Accessories

Q. Part Number Index

*HERMAN MILLER is a trademark of Herman Miller, Inc., Zeeland, MI.

- A. Featured Products
- B. Copper Systems
- C. Fiber Systems
- D. Faceplates, Frames & Surface Mount Boxes
- E. Industrial Networks
- F. Audio Video Systems
- G. Keystone Cabling Systems
- H. Zone Cabling
- J. Cable Routing Systems
- K. Cable Cleats
- L. Cabinets & Rack Systems
- M. Power & Connectivity Management
- N. Grounding & Bonding
- O. Identification Products
- P. Cable Management Accessories
- Q. Part Number Index



Mini-Com™ Surface Mount Boxes

- Accept Mini-Com™ Modules for STP and UTP, fiber optic, and audio/video
- Replacement label/label covers available where applicable
- Mount easily with supplied mounting screws, adhesive tape or optional magnet
- Multimedia boxes include built-in fiber spool
- For shuttered applications use shuttered jacks with quick release style



CBXQ1IW-A CBXQ2IW-A



CBXQ4IW-A CBXQ6IW-A



CBXF12IW-AY

Part Number	Ports	Style	Identification	Magnet	Raceway Compatibility	
Standard						
CBX1IW-A	1	Elongated	Adhesive	-	LD3/LDPH3	
CBX2IW-AY	2				Label Pocket	CBM-X
CBX4IW-AY	4		Quick Release	Adhesive		
CBXQ1IW-A	1	Label Pocket		-	LD3/LDPH3 LD5/LDPH5	
CBXQ2IW-A	2				Label Pocket	-
CBXQ4IW-A	4	LD3/LDPH3 LD5/LDPH5 LD10/LDPH10				
CBXQ6IW-A	6					

Multimedia

CBXF6IW-AY	6	Multimedia	Label Pocket	-	LD3/LDPH3 LD5/LDPH5
CBXF12IW-AY	12				LD3/LDPH3 LD5/LDPH5 LD10/LDPH10

For other colors, replace IW (Off White) with EI (Electric Ivory), WH (White), IG (International Gray), or BL (Black).



Mini-Com™ Water Resistant Faceplates



CFPWR4CIG

Part Number	Part Description
CFPWR4CIG	Meets a level of protection of IP56, made of impact resistant material, single gang, two-piece hinged design, includes combo head and tamper resistant screws to secure cover to base.

For other colors, replace CIG with BL (Black), IW (Off White), or WH (White).



Mini-Com™ GFCI Decora Module Frames

• Mount behind standard GFCI electrical faceplates



CFG1IW



CFG2IW



CFG4IW

Part Number	Ports	Style	Identification	Std. Pkg. Qty.
CFG1IW	1	GFCI	Adhesive	1
CFG2IW	2			
CFG4IW	4			

For other colors, replace IW (Off White) with BL (Black) or WH (White).



Mini-Com™ 106 Duplex Module Frames

• Mount behind standard duplex electrical faceplates



CF1062IWY



CF1064IWY

Part Number	Ports	Style	Identification	Std. Pkg. Qty.
CF1062IWY	2	Duplex	-	1
CF1064IWY	4			

For other colors, replace IW (Off White) with BL (Black) or WH (White).



Phone Plates



KWP6PY
KWP5EY



KWPY

Part Number	Part Description
KWPY	Empty faceplate, accepts one keystone module.
KWP6PY	Includes Category 6 keystone module.
KWP5EY	Includes Category 5e keystone module.



Wall Board Adapter



MWBA1

Part Number	Part Description
MWBA1	Provides mounting surface for single gang faceplates.

A. Featured Products

B. Copper Systems

C. Fiber Systems

D. Faceplates, Frames & Surface Mount Boxes

E. Industrial Networks

F. Audio Video Systems

G. Keystone Cabling Systems

H. Zone Cabling

J. Cable Routing Systems

K. Cable Cleats

L. Cabinets & Rack Systems

M. Power & Connectivity Management

N. Grounding & Bonding

O. Identification Products

P. Cable Management Accessories

Q. Part Number Index

- A. Featured Products
- B. Copper Systems
- C. Fiber Systems
- D. Faceplates, Frames & Surface Mount Boxes
- E. Industrial Networks
- F. Audio Video Systems
- G. Keystone Cabling Systems
- H. Zone Cabling
- J. Cable Routing Systems
- K. Cable Cleats
- L. Cabinets & Rack Systems
- M. Power & Connectivity Management
- N. Grounding & Bonding
- O. Identification Products
- P. Cable Management Accessories
- Q. Part Number Index



Mini-Com™ Blank Modules

- Occupies unused ports for future use



CMBBL

Part Number	Std. Pkg. Qty.
CMBBL-X	10
CMBBL-L	50
CMBBL-C	100

For other colors, replace BL (Black) with IW (Off White), WH (White), or EI (Electric Ivory).

Mini-Com™ Adapter for WIREMOLD* Frames



CHI2MBL-X

Part Number	Part Description
CHI2MBL-X	Snaps into most open communication frames from WIREMOLD*.

For other colors, replace BL (Black) with WI (Walker Ivory) or WG (Walker Gray).
*WIREMOLD is a registered trademark of Legrand in the United States.

Mini-Com™ One Position Adapters



CMNZABL-X



CMAA1IW

Part Number	Part Description
CMNZABL-X	Snaps into 0.827" x 0.827" (21mm x 21mm) opening.

For other colors, replace BL (Black) with WH (White).

Part Number	Part Description
CMAA1IW-X	Snaps into 1" x 1" (25mm x 25mm) opening.

For other colors, replace IW with BL (Black), WH (White).

Icons



CIDBU-C
CIPBU-C

Part Number	Part Description
CIDBU-C	Data icon.
CIPBU-C	Phone icon.

For other colors, replace BU (Blue) with YL (Yellow), OR (Orange), VL (Violet), RD (Red), IW (Off White), GR (Green).

Replacement Label and Label Covers



CSGLLC-L



EFPK-X

Part Number	Part Description
C4PPLK	Label and cover kit for furniture faceplate and CPPL type panels (six labels and covers).
CSGLLC-L	Label and cover kit for single gang faceplates (50 labels and covers).
EFPK-XY	Label and cover kit with screws for single gang faceplates. Includes two labels, covers and screws.
EFPK102G-XY	Label and cover kit with screws for double gang faceplates. Includes two labels, covers and screws.

Table of Contents

IndustrialNet™ Copper Cable for Category 5e, Category 6 and Category 6A Ethernet E.2

IndustrialNet™ RJ45 Copper Patch Cords for Category 5e and Category 6 Ethernet E.3

IndustrialNet™ Copper Connectors. E.4

IndustrialNet™ Overmolded Cordsets. E.5

IndustrialNet™ Motor Control Connectivity E.6

Fiber Adapter and Patch Cords E.6

Industrial Accessories E.7

IndustrialNet™ Data Access Port E.7

Pre-Configured Micro Data Center (MDC) E.8

Industrial Network Uninterruptible Power Supply (UPS) E.8

Network Zone Systems E.9 – E.10

Universal Distribution Frames. E.11

Pre-Configured Industrial Distribution Frames. E.12

Wireless Enclosures. E.12

IntraVUE™ Industrial Ethernet Visualization and Monitoring Software E.13

A. Featured Products

B. Copper Systems

C. Fiber Systems

D. Faceplates, Frames & Surface Mount Boxes

E. Industrial Networks

F. Audio Video Systems

G. Keystone Cabling Systems

H. Zone Cabling

J. Cable Routing Systems

K. Cable Cleats

L. Cabinets & Rack Systems

M. Power & Connectivity Management

N. Grounding & Bonding

O. Identification Products

P. Cable Management Accessories

Q. Part Number Index

- A. Featured Products
- B. Copper Systems
- C. Fiber Systems
- D. Faceplates, Frames & Surface Mount Boxes
- E. Industrial Networks**
- F. Audio Video Systems
- G. Keystone Cabling Systems
- H. Zone Cabling
- J. Cable Routing Systems
- K. Cable Cleats
- L. Cabinets & Rack Systems
- M. Power & Connectivity Management
- N. Grounding & Bonding
- O. Identification Products
- P. Cable Management Accessories
- Q. Part Number Index

IndustrialNet™ Copper Cable for Category 5e, Category 6 and Category 6A Ethernet

- Cable has been tested by an independent laboratory and complies with the electrical standard requirements of ISO11801 and ANSI/TIA-568.2-D
- UL Approved
- Industrial rated cable for reliable performance in harsh environments
- Descending length cable markings enable easy identification of remaining cable which reduces installation time and cable scrap
- Packaged on a reel



Part Number	Part Description	Min. Order Qty. (MOQ)^	Min. Order Increment (MOI)^	UOM
ISFCH6X04ATL-UG	Category 6A, 4-pair, 24 AWG stranded, SF/UTP, industrial 600V, (CMX), Teal.	10000	1000	Ft.
ISFCH6X04BTL-UG	Category 6A, 4-pair, 26 AWG stranded, SF/UTP, industrial 600V, (CMX), Teal.			
IUC6C04ABL-CEG	Category 6, 4-pair, 24 AWG stranded, U/UTP, flame-retardant (CM) Black.	6	1	Reel
ISX6004AYL-LED	Category 6, 4-pair, 24 AWG stranded, S/FTP, industrial high flex, flame retardant, Yellow.	12	12	
ISX6X04AYL-LED	Category 6A, 4-pair, 24 AWG stranded, S/FTP, industrial high flex, flame retardant, Yellow.			
ISFCH5C04ATL-XG	Category 5e, 4-pair, 24 AWG stranded, SF/UTP, 600V high flex, flame-retardant (CM/CMX), Teal.	9000	1000	Ft.
ISFCH5C02ATL-XG	Category 5e, 2-pair, 24 AWG stranded, SF/UTP, 600V high flex, flame-retardant (CM/CMX), Teal.			
ISFX5502ATL-LED	Category 5e, 2-pair, 24 AWG stranded, SF/UTP, industrial high flex, flame-retardant (CM/CMX), Teal.	6	1	Reel
ESFLHT5C02FGR-X	Category 5e, 2-pair, 22 AWG stranded, SF/UTP, PROFINET 600V, (CPR), Green.	9000	1000	Ft.
ESFLHT5C02GR-X	Category 5e, 2-pair, 22 AWG solid, SF/UTP, PROFINET 600V, (CPR), Green.			
IFRH6C04** - UG	Category 6, 4-pair, 23 AWG solid, F/UTP, industrial 600V, (CMR), Black/Red.			
IFRH5C04** - UG	Category 5e, 4-pair, 24 AWG solid, F/UTP, industrial 600V, (CMR), Black/Red.			
IFRH5C02** - UG	Category 5e, 4-pair, 24 AWG solid, F/UTP, industrial 600V, (CMR), Black/Red.			

^MOQ needs to be met prior to MOI. Contact Customer Service for additional information.
 **Colors available: BL (Black) or RD (Red).
 Additional colors available, refer to www.panduit.com.

IndustrialNet™ RJ45 Copper Patch Cords for Category 5e and Category 6 Ethernet

- Patch cords have been tested by an independent laboratory and comply with the electrical standard requirements of IEC 60603-7 and ANSI/TIA-568.2-D
- Variant 1 bulkhead patch cords meet IP67 when mated to IP67 IndustrialNet™ Connectors
- UL Approved
- Industrial rated patch cord for reliable performance in harsh environments
- Category 5e 600V rated patch cords provide reliable performance for panel or on-machine applications when space is shared with 600V high voltage power cables



ISTPHCH1MTL



ISTPCH1MBLY, ISTPSP1MBL, IUTPCH3BLY, IUTPSP3BL

Part Number	Part Description	Std. Pkg. Qty.	Std. Ctn. Qty.
ISTPHCH1MTL	Category 5e 600V 24 AWG stranded SF/UTP patch cord, RJ45 plug to RJ45 plug, 1 meter, Teal.	1	10
ISTPH6X0.3MBL	Category 6A 600V 26 AWG stranded 4-pair SF/UTP patch cord, shielded RJ45 plug to RJ45 plug, TPE jacket, Black.		
ISTPCH1MBLY	Category 5e 26 AWG stranded F/UTP patch cord, RJ45 plug to RJ45 plug, 1 meter, Black. Includes dust caps.		
ISTPSP1MBL	Category 6 26 AWG stranded S/UTP patch cord, RJ45 plug with bulkhead to RJ45 plug with bulkhead, 1 meter, Black. Includes dust caps.		
IUTPCH3BLY	Category 5e 24 stranded U/UTP patch cord, RJ45 plug to RJ45 plug, 3 feet, Black. Includes dust caps.		
IUTPSP3BL	Category 6 24 AWG stranded U/UTP patch cord, RJ45 plug with bulkhead to RJ45 plug with bulkhead, 3 feet, Black. Includes dust caps.		

Additional colors and lengths available, refer to www.panduit.com.

A. Featured Products

B. Copper Systems

C. Fiber Systems

D. Faceplates, Frames & Surface Mount Boxes

E. Industrial Networks

F. Audio Video Systems

G. Keystone Cabling Systems

H. Zone Cabling

J. Cable Routing Systems

K. Cable Cleats

L. Cabinets & Rack Systems

M. Power & Connectivity Management

N. Grounding & Bonding

O. Identification Products

P. Cable Management Accessories

Q. Part Number Index

A. Featured Products
B. Copper Systems
C. Fiber Systems
D. Faceplates, Frames & Surface Mount Boxes
E. Industrial Networks
F. Audio Video Systems
G. Keystone Cabling Systems
H. Zone Cabling
J. Cable Routing Systems
K. Cable Cleats
L. Cabinets & Rack Systems
M. Power & Connectivity Management
N. Grounding & Bonding
O. Identification Products
P. Cable Management Accessories
Q. Part Number Index

IndustrialNet™ Copper Connectors

- IP/NEMA/UL/CE rated to ensure reliable performance in harsh factory environments
- Extended temperature range provides durable connections in extreme conditions
- Factory terminated design assures reliability and saves time
- Optional RJ45 connector speeds deployment



ISPS5E44MFA
ISPS6A88MFA



ICAM12X90RJS



ICAM12XRJS



ICAM12DRJS



IAEBHV56XS



IAEBH5*, IAEBH6*,
IAEBHC5*, IAEBHC6*



MPI588T, MPSI588T



ISPS688FA

Part Number	Part Description	Std. Pkg. Qty.	Std. Ctn. Qty.
-------------	------------------	----------------	----------------

Industrial M12 Connectors

ISPS5E44MFA	Category 5e M12 D-Code shielded field terminable connector, male.	1	25
ISPS6A88MFA	Category 6A M12 X-Code shielded field terminable connector, male.		10
ICAM12X90RJS	Category 6A M12 X-Code shielded to RJ45 industrial adapter, 90° angle, panel mount.	1	15
ICAM12XRJS	Category 6A M12 X-Code shielded to RJ45 industrial adapter, panel mount.		10
ICAM12DRJS	Category 5e, M12 D-code to RJ45 industrial adapter, panel mount.		

Industrial Bulkhead Connector with Protective Cover

IAEBHV56XS	Category 6A Variant 5 IP67 rated, NEMA 4/4X rated, RJ45 connector, shielded.	1	10
MPSIV56XT	RJ45 Category 6A plug set.		
IAEBH6X	Category 6A Variant 1 IP67 rated RJ45 connector.		
IAEBH6XS	Category 6A Variant 1 IP67 rated RJ45 connector, shielded.		
IAEBH6	Category 6 Variant 1 IP67 rated RJ45 connector.		
IAEBH6S	Category 6 Variant 1 IP67 rated RJ45 connector, shielded.		
IAEBH5E	Category 5e Variant 1 IP67 rated RJ45 connector.		
IAEBH5ES	Category 5e Variant 1 IP67 rated RJ45 connector, shielded.		
MPI588T	Category 5e Variant 1 IP67 rated modular plug.		
MPSI588T	Category 5e Variant 1 IP67 rated modular plug, shielded.		

Industrial Bulkhead Coupler with Protective Cover

IAEBHC6	Category 6 Variant 1 IP67 rated RJ45 coupler.	1	10
IAEBHC5E	Category 5e Variant 1 IP67 rated RJ45 coupler.		

Industrial Mini-Com™ Coupler Module

IAEBHUSBAA	USB 2.0 Variant 1 IP67 rated female A to female A coupler.	1	10
------------	--	---	----

Industrial RJ45 Plugs

ISPS688FA	Category 6A RJ45 plug for 24-22 AWG solid, 1.0-1.6mm conductor diameter, shielded.	1	10
ISPS688FAS	Category 6A RJ45 plug for 24-22 AWG stranded, 0.85-1.00mm conductor diameter, shielded.		

IndustrialNet™ Overmolded Cordsets

- IP/NEMA/UL/CE rated to ensure reliable performance in harsh factory environments
- Factory terminated design assures reliability and saves time
- TPE/TPU jackets protect cable, providing increased reliability in high-flex applications
- Extended temperature range provides durable connections in extreme conditions
- Rated to 10 million flex cycles
- Optional RJ45 connector speeds deployment



Part Number	Termination End 1	Termination End 2	Std. Pkg. Qty.	Std. Ctn. Qty.
-------------	-------------------	-------------------	----------------	----------------

Category 5e STP Cable, 600V rated, TL

D-Code	ICD11T1NTL*M	M12, Male Straight Connector	M12, Male Straight Connector	1	10
	ICD12T1NTL*M	M12, Male Straight Connector	M12, Male Angled Connector		
	ICD13T1NTL*M	M12, Male Straight Connector	M12, Female Straight Connector		
	ICD14T1NTL*M	M12, Male Straight Connector	RJ45 Modular Plug		
	ICD15T1NTL*M	M12, Male Straight Connector	Unterminated		
	ICD22T1NTL*M	M12, Male Angled Connector	M12, Male Angled Connector		
	ICD25T1NTL*M	M12, Male Angled Connector	Unterminated		
	ICD26T1NTL*M	M12, Male Angled Connector	M12, Female Angled Connector		
	ICD35T1NTL*M	M12, Female Straight Connector	Unterminated		
	ICD44T1NTL*M	M12, Female Bulkhead Connector	RJ45 Modular Plug		
	ICD45T1NTL*M	M12, Female Bulkhead Connector	Unterminated		

Category 5e UTP Cable, TL

D-Code	ICD11T2NTL*M	M12, Male Straight Connector	M12, Male Straight Connector	1	10
--------	--------------	------------------------------	------------------------------	---	----

Category 6A STP Cable, 600V rated, TL

X-Code	ICX11T1NTL*M	M12, Male Straight Connector	M12, Male Straight Connector	1	10
	ICX14T1NTL*M	M12, Male Straight Connector	RJ45 Modular Plug		
	ICX15T1NTL*M	M12, Male Straight Connector	Unterminated		
	ICX44T1NTL*M	M12, Female Bulkhead Connector	RJ45 Modular Plug		
	ICX45T1NTL*M	M12, Female Bulkhead Connector	Unterminated		

*A variety of standard lengths and configurations are available, contact Customer Service.

A. Featured Products

B. Copper Systems

C. Fiber Systems

D. Faceplates, Frames & Surface Mount Boxes

E. Industrial Networks

F. Audio Video Systems

G. Keystone Cabling Systems

H. Zone Cabling

J. Cable Routing Systems

K. Cable Cleats

L. Cabinets & Rack Systems

M. Power & Connectivity Management

N. Grounding & Bonding

O. Identification Products

P. Cable Management Accessories

Q. Part Number Index

A.
Featured
Products

B.
Copper
Systems

C.
Fiber
Systems

D.
Faceplates,
Frames &
Surface
Mount Boxes

E.
Industrial
Networks

F.
Audio
Video
Systems

G.
Keystone
Cabling
Systems

H.
Zone
Cabling

J.
Cable
Routing
Systems

K.
Cable
Cleats

L.
Cabinets
& Rack
Systems

M.
Power &
Connectivity
Management

N.
Grounding
& Bonding

O.
Identification
Products

P.
Cable
Management
Accessories

Q.
Part
Number
Index

IndustrialNet™ Motor Control Connectivity (MCC)

- Used to upgrade legacy MCCs to intelligent MCCs or to quickly connect Micro Data Centers with Industrial Distribution Frames and Network Zone Systems for holistic network connectivity
- Factory terminated design assures reliability and saves time
- 100% factory tested ensures performance
- Snaps in and out of DIN rail patch panels and other Mini-Com™ Products
- Each bundle is wrapped with a Kevlar^ band
- Cables are bundled to prevent alien cross-talk within the bundle
- Each bundle includes cable assembly identification for future traceability



I4JPBJLUXX

Part Number	Part Description	Std. Pkg. Qty.	Std. Ctn. Qty.
I4JPBJLUXX*	Category 6A LSZH; jack no stagger to jack no stagger, Blue.	1	—
I4KOTJLUXX*	Category 6A outdoor; jack no stagger to jack no stagger, Teal.		

*A variety of connections and lengths in loomed and non-loomed versions available, contact Customer Service.
^Kevlar is a registered trademark of E.I. du Pont de Nemours and Company or its affiliates.

Fiber Adapter and Patch Cords

- NEC 770 Compliant
- UL Approved
- LSZH cable jacket rating
- Industrial rated cable for reliable performance in harsh environments



IAEF617P-7PM1



IAEF617P-NM1 IAEF7JMA

Part Number	Part Description	Std. Pkg. Qty.	Std. Ctn. Qty.
IAEF617P-7PM1	Industrial LC to LC multimode duplex patch cord – 62.5/125µm.	1	10
IAEF617P-NM1	Industrial LC to pigtail multimode duplex pigtail – 62.5/125µm.		
IAEF7JMA	Industrial LC fiber optic bulkhead adapter.		

Industrial Accessories

- Modular design for easy DIN rail mounting
- Compact size and low profile saves valuable DIN rail space
- Include labels for easy moves, adds and changes
- Easy installation - no special tools required



CADIN1IG



CMDJAQLCZBL



CJ688TGBL



CDPP8RG



FDME8RG



IAEFP1



IAEFP2-2G

Part Number	Part Description	Std. Pkg. Qty.	Std. Ctn. Qty.
Mini-Com™ DIN Rail Mount Adapter			
CADIN1IG	Single-port DIN rail mount adapter, International Gray.	1	10
CADIN1BL	Single-port DIN rail mount adapter, Black.		
CADIN1IW	Single-port DIN rail mount adapter, International White.		
CMDJAQLCZBL	Adapter module supplied with one LC Sr./Jr. OM3/OM4 duplex multimode fiber optic adapter (AQ) with zirconia ceramic split sleeves.		50
CJ688TGBL	Category 6, RJ45, UTP Mini-Com™ Universal Jack Module, TG-style termination, Black.		

IndustrialNet™ DIN Rail Mount Copper Patch Panel			
CDPP8RG	8-port patch panel, DIN rail mount.	1	10

IndustrialNet™ DIN Rail Mount Fiber Enclosure			
FDME8RG	8-port fiber optic enclosure, DIN rail mount.	1	10

IndustrialNet™ Stainless Steel Faceplate			
IAEFP1	Vertical faceplate accepts one IndustrialNet™ Bulkhead Connector or Adapter.	1	10
IAEFP2-2G	Double gang, vertical faceplate accepts two IndustrialNet™ Bulkhead Connectors or Adapters.		

IndustrialNet™ Data Access Port

- NEMA/UL Type 4X and Type 12, IP65 Rated
- Removable mounting plate accepts a variety of power supplies providing flexibility to meet regional electrical requirements
- Modular design provides design flexibility; accepts select Mini-Com™ Modules including copper, fiber, USB ports, serial ports and HMI memory components
- Meets TIA/EIA-606-A labeling standards allowing identification of data and power, reducing downtime during maintenance and trouble shooting
- Integrated GFCI receptacle outlet provides power to external monitoring devices preventing downtime associated with overloading critical system components
- Covered screw holes prevent unintentional disruption of service by unauthorized personnel and protection against arc flash improving security, safety and network uptime
- Locking hasp accepts Panduit lockout/tagout products or padlock to prevent unauthorized access for improved security
- Pre-configured mounting template quickly and easily identifies mounting hole locations and cutouts



Part Number	Part Description	Std. Pkg. Qty.	Std. Ctn. Qty.
IAPNG5EWH	GFCI data access port, Category 5e coupler and blank, White.	1	—

A. Featured Products

B. Copper Systems

C. Fiber Systems

D. Faceplates, Frames & Surface Mount Boxes

E. Industrial Networks

F. Audio Video Systems

G. Keystone Cabling Systems

H. Zone Cabling

J. Cable Routing Systems

K. Cable Cleats

L. Cabinets & Rack Systems

M. Power & Connectivity Management

N. Grounding & Bonding

O. Identification Products

P. Cable Management Accessories

Q. Part Number Index

A. Featured Products
B. Copper Systems
C. Fiber Systems
D. Faceplates, Frames & Surface Mount Boxes
E. Industrial Networks
F. Audio Video Systems
G. Keystone Cabling Systems
H. Zone Cabling
J. Cable Routing Systems
K. Cable Cleats
L. Cabinets & Rack Systems
M. Power & Connectivity Management
N. Grounding & Bonding
O. Identification Products
P. Cable Management Accessories
Q. Part Number Index

Pre-Configured Micro Data Center (MDC)

- Pre-configured solution enables fast deployment of servers, storage, and switches for an industrial network
- Dynamic rated version ensures safe transport of IT equipment under typical shipping conditions
- Includes space for future expansion of server, storage, and related patching to allow for increased network capacity without requiring addition to control room footprint
- Bonded structure helps ensure network reliability and prevent equipment failure
- Integrated cable management with bend radius control maintains bandwidth through the network for increased uptime
- Reference architecture provides a physical map of the logical network layer following recommended installation practices to increase reliability



MDC79D and MDC79



MDC82NN

Part Number	Part Description	Std. Pkg. Qty.	Std. Ctn. Qty.
MDC79D	Dynamic, single hinge perforated front door, split perforated rear doors, split side panels (2), 42 RU, network cabling, patch panels, cable management, grounding, casters, shock pallet and ramp. Color Black. Dimensions: 79.8" H x 27.6" W x 48.0" D (2026mm x 700mm x 1200mm).	1	—
MDC79	Single hinge perforated front door, split perforated rear doors, split side panels (2), 42 RU, network cabling, patch panels, cable management, grounding and casters. Color Black. Dimensions: 79.8" H x 27.6" W x 48.0" D (2026mm x 700mm x 1200mm).		
MDC82NN	NEMA Type 12, IP55, single hinge front door with windowed glass, single hinge rear door, solid side panels (2), 42 RU, network cabling, patch panels, cable management, grounding, and casters. Color Light Gray. Dimensions: 78.7" H x 27.6" W x 47.2" D (2000mm x 700mm x 1200mm).		
MDC82NS	NEMA Type 12, IP55, single hinge front door with windowed glass, single hinge rear door, solid side panel (1), side panel with cutout for 12k BTU AC (1), 42 RU, network cabling, patch panels, cable management, grounding, and casters. Color Light Gray. Dimensions: 78.7" H x 27.6" W x 47.2" D (2000mm x 700mm x 1200mm).		
MDC82NL	NEMA Type 12, IP55, single hinge front door with windowed glass, single hinge rear door, solid side panel (1), side panel with cutout for 20k BTU AC (1), 42 RU, network cabling, patch panels, cable management, grounding, and casters. Color Light Gray. Dimensions: 78.7" H x 27.6" W x 47.2" D (2000mm x 700mm x 1200mm).		

Industrial Network Uninterruptible Power Supply (UPS)

- Supports industrial switches during power outages
- Ultracapacitor technology decreases downtime risk by up to 40%*
- Maintenance-free operation contributes to 50–70% reduced cost of ownership*
- Non-HazMat
- Remote management with auto alerts works with standard web browsers and EtherNet/IP**
- Easy device monitoring through SNMP v1/V2c/V3
- Wide operating temperature range -40°C to +60°C
- Compact, one-piece design saves 50% or more DIN Rail space compared to similar UPS devices



UPS00100DC



UPS003LSM

Part Number	Part Description	Std. Pkg. Qty.	Std. Ctn. Qty.
UPS00100DC	Uninterruptible power supply (UPS), 100W; no-battery, maintenance-free with remote management; 24-28 VDC in/out; DIN rail mount.	1	—
UPS003LSM	UPS load sense module; optional accessory for use in dual, redundant power supply configurations to monitor load on primary supply.		

*Compared to battery-based UPS devices.

**EtherNet/IP is a trademark of ODVA.

Network Zone Systems

- Universal design works with most DIN mount industrial Ethernet switches, providing design flexibility
- Pre-configured solution delivers up to 75% faster implementation
- Designed to accept customer supplied switches
- Copper/fiber patch fields and connectivity enable troubleshooting of network connections
- Isolation barrier segregates higher line voltage from lower voltage switch for increased safety
- Bonding provisions and grounding bar ensure path to ground to protect personnel and equipment
- Gland plate allows quick and easy access to machine ingress points into enclosure
- Detailed installation guide provides easy, repeatable design instructions assuring consistency and saving time on the job-site
- UL Type 4/12 or 4X, UL 508A Listed, CE Approved, IP66 Rated



Z23U

Part Number	Enclosure Material	Downlink Port Connectivity	Included Accessories	Power Infrastructure	Std. Pkg. Qty.	Std. Ctn. Qty.
24" x 36" Universal Network Zone; for Two Industrial Switches						
Z23U-S25	Mild Steel	Category 6 UTP	Sixteen Copper Patch Cords and Jacks, Six LC Adapters, Four LC OM3 Patch Cords	Redundant Power Supplies with One Maintenance-Free UPS	1	—
Z23U-S25S		Category 6A STP				
Z23U-S24		Category 6 UTP		Redundant Power Supplies		
Z23U-S24S		Category 6A STP				
Z23U-S26		Category 6 UTP		Redundant Power Supplies with Battery UPS and PoE		
Z23U-S26S		Category 6A STP				
Z23U-625	316 Stainless Steel	Category 6 UTP		Redundant Power Supplies with 2 Maintenance-Free UPSs		
Z23U-625S		Category 6A STP				
Z23U-624		Category 6 UTP		Redundant Power Supplies		
Z23U-624S		Category 6A STP				
Z23U-626		Category 6 UTP		Redundant Power Supplies with Battery UPS and PoE		
Z23U-626S		Category 6A STP				



Z22U

24" x 24" Universal Network Zone; for One Industrial Switch						
Z22U-S15	Mild Steel	Category 6 UTP	Eight Copper Patch Cords and Jacks, Six LC Adapters, Two LC OM3 Patch Cords	Redundant Power Supplies with One Maintenance-Free UPS	1	—
Z22U-S15S		Category 6A STP				
Z22U-S14		Category 6 UTP		Redundant Power Supplies		
Z22U-S14S		Category 6A STP				
Z22U-S16		Category 6 UTP		Redundant Power Supplies with Battery UPS and PoE		
Z22U-S16S		Category 6A STP				
Z22U-615	316 Stainless Steel	Category 6 UTP		Redundant Power Supplies with One Maintenance-Free UPS		
Z22U-615S		Category 6A STP				
Z22U-614		Category 6 UTP		Redundant Power Supplies		
Z22U-614S		Category 6A STP				
Z22U-616		Category 6 UTP		Redundant Power Supplies with Battery UPS and PoE		
Z22U-616S		Category 6A STP				

A. Featured Products

B. Copper Systems

C. Fiber Systems

D. Faceplates, Frames & Surface Mount Boxes

E. Industrial Networks

F. Audio Video Systems

G. Keystone Cabling Systems

H. Zone Cabling

J. Cable Routing Systems

K. Cable Cleats

L. Cabinets & Rack Systems

M. Power & Connectivity Management

N. Grounding & Bonding

O. Identification Products

P. Cable Management Accessories

Q. Part Number Index

Continued on next page

A. Featured Products
B. Copper Systems
C. Fiber Systems
D. Faceplates, Frames & Surface Mount Boxes
E. Industrial Networks
F. Audio Video Systems
G. Keystone Cabling Systems
H. Zone Cabling
J. Cable Routing Systems
K. Cable Cleats
L. Cabinets & Rack Systems
M. Power & Connectivity Management
N. Grounding & Bonding
O. Identification Products
P. Cable Management Accessories
Q. Part Number Index

Network Zone Systems (continued)



Z23C-S

Part Number	Enclosure Material	Downlink Port Connectivity	Included Accessories	Power Infrastructure	Std. Pkg. Qty.	Std. Ctn. Qty.
24" x 36" Pre-Configured Network Zone; for Two Industrial Switches						
Z23C-S	Mild Steel	Category 6 UTP	Sixteen Copper Patch Cords and Jacks, Six LC adapters, Four LC OM3 Patch Cords	—	1	—
Z23C-SS		Category 6A STP				
Z23C-6	316 Stainless Steel	Category 6 UTP				
Z23C-6S		Category 6A STP				



Z22C-S

Part Number	Enclosure Material	Downlink Port Connectivity	Included Accessories	Power Infrastructure	Std. Pkg. Qty.	Std. Ctn. Qty.
24" x 24" Pre-Configured Network Zone; for Two Industrial Switches						
Z22C-S	Mild Steel	Category 6 UTP	Eight Copper Patch Cords and Jacks, Six LC Adapters, Two LC OM3 Patch Cords	—	1	—
Z22C-SS		Category 6A STP				
Z22C-6	316 Stainless Steel	Category 6 UTP				
Z22C-6S		Category 6A STP				



Z11C-S

Part Number	Enclosure Material	Downlink Port Connectivity	Included Accessories	Power Infrastructure	Std. Pkg. Qty.	Std. Ctn. Qty.
12" x 14" Pre-Configured Network Zone; for One Industrial Switch						
Z11C-S	Mild Steel	—	—	—	1	—
Z11C-6	316 Stainless Steel	—	—	—	1	—



ZFLEX1

HD Flex Cassette Accessories for Network Zone Systems						
Part Number	Part Description				Std. Pkg. Qty.	Std. Ctn. Qty.
ZFLEX1	Mounting bracket for one 6-port fiber cassette in network zone systems Z22X-X and Z23X-X.				1	—
ZFLEX2	Mounting bracket for two 6-port fiber cassettes in network zone systems Z22X-X and Z23X-X.					



ZFLEX2

Enclosure Accessories						
Part Number	Part Description				Std. Pkg. Qty.	Std. Ctn. Qty.
PZNDVK	NEMA 4X drain and vent kit.				1	—
PZNF1	NEMA 4X rated compression fitting, ideal for cable diameters of .115 to .250 (2.82mm to 6.35mm).					
PZNF2	NEMA 4X rated compression fitting, ideal for cable diameters of .230 to .395 (5.84mm to 10.03mm).					
PZNF3	NEMA 4X rated compression fitting, ideal for cable diameters of .170 to .450 (4.32mm to 11.43mm).					



PZNDVK



PZNF2

Universal Distribution Frames

- Engineered to deploy and protect Industrial Ethernet DIN mount switches in industrial applications
- Pre-configured, wall mount design delivers up to 75% faster implementation
- Pre-engineered power infrastructure, with redundant power supplies, optional UPS, wiring, labels, terminal blocks, and disconnects
- Defined cable routings incorporate Panduit best practices in connectivity, cable management, wiring and grounding
- Additional back-end space allows for 3X the cooling capacity over typical deployments
- Key-locking handle limits access to authorized personnel for a secure network
- Detailed installation guide provides easy instructions assuring consistency and saving time on the job-site
- UL Type 4/12 or 4X, UL 508A Listed, CE Approved, IP66 Rated

Pre-installed with: front and rear rack angles, fiber tray, 48-port patch panel(s), DIN mount brackets with power infrastructure, cable management, grounding, fiber spools, back panel(s), (2) ESD ports, cage nuts, labeling for cable routing, strain relief bars; includes ESD wrist strap, (1) hook and loop, (1) grounding cable, mounting hardware, conduit schedule and ingress template.



ZDF48-S65

Part Number	Enclosure Material	Included Accessories	Power Infrastructure	Std. Pkg. Qty.	Std. Ctn. Qty.
26U Universal Distribution Frame for Industrial DIN Mount Switches					
ZDF48-S64	Mild Steel	Three 48-Port Patch Panels, Three 4U DIN Mount Brackets to Support Six Switches	Redundant Power Supplies AC to DC, Terminal Blocks and Wiring for 120V AC Input	1	—
ZDF48-S65			Three Maintenance-Free UPS, Redundant Power Supplies AC to DC, Terminal Blocks and Wiring for 120V AC Input		
ZDF48-S85			Four 48-Port Patch Panels, Four 4U DIN Mount Brackets to Support Eight Switches		
ZDF48-664	316 Stainless Steel	Three 48-Port Patch Panels, Three 4U DIN Mount Brackets to Support Six Switches	Redundant Power Supplies AC to DC, Terminal Blocks and Wiring for 120V AC Input		
ZDF48-665			Three Maintenance Free UPS, Redundant Power Supplies AC to DC, Terminal Blocks and Wiring for 120V AC Input		



ZDF24-S25

12U Universal Distribution Frame for Industrial DIN Mount Switches					
ZDF24-S24	Mild Steel	One 48-Port Patch Panel and One 4U DIN Mount Bracket to Support Two Switches	Redundant Power Supplies AC to DC, Terminal Blocks and Wiring for 120V AC Input	1	—
ZDF24-S25			One Maintenance Free UPS, Redundant Power Supplies AC to DC, Terminal Blocks and Wiring for 120V AC Input		
ZDF24-S45			Two 48-Port Patch Panels and Two 4U DIN Mount Brackets to Support Four Switches		
ZDF24-624	316 Stainless Steel	One 48-Port Patch Panel and One 4U DIN Mount Bracket to Support Two Switches	Redundant Power Supplies AC to DC, Terminal Blocks and Wiring for 120V AC Input		
ZDF24-625			One Maintenance Free UPS, Redundant Power Supplies AC to DC, Terminal Blocks and Wiring for 120V AC Input		

Universal Distribution Frame Tiers



ZDINS25

Part Number	Part Description
ZDINS24	Tier for 2 industrial switches, one 48-port patch panel, one 4U DIN bracket, two power supplies AC to DC, terminal blocks, wiring for 120 V AC input to support two industrial DIN mount switches.
ZDINS25	Tier for 2 industrial switches, one 48-port patch panel, one 4U DIN bracket, one maintenance-free UPS, two power supplies AC to DC, terminal blocks, wiring for 120 V AC input to support two industrial DIN mount switches.

A. Featured Products
B. Copper Systems
C. Fiber Systems
D. Faceplates, Frames & Surface Mount Boxes
E. Industrial Networks
F. Audio Video Systems
G. Keystone Cabling Systems
H. Zone Cabling
J. Cable Routing Systems
K. Cable Cleats
L. Cabinets & Rack Systems
M. Power & Connectivity Management
N. Grounding & Bonding
O. Identification Products
P. Cable Management Accessories
Q. Part Number Index

Pre-Configured Industrial Distribution Frames

- Engineered to deploy and protect 19" rack mount Ethernet switches in industrial applications
- Pre-configured, wall mount design delivers up to 25% faster implementation
- Defined equipment locations and cable routings incorporate Panduit best practices in connectivity, cable management, wiring and grounding
- Additional back-end space allows for 3X the cooling capacity over typical deployments
- Key-locking handle limits access to authorized personnel for a secure network
- Detailed installation guide provides easy instructions assuring consistency and saving time on the job-site
- UL Type 4/12 or 4X, UL 508A Listed, IP66 Rated

Pre-installed with: front and rear rack angles, fiber tray, 48-port patch panel(s), cable management, grounding, fiber spools, back panel(s), (2) ESD ports, cage nuts, labeling for cable routing, strain relief bars; includes ESD wrist strap, (1) hook and loop, (1) grounding cable, mounting hardware, conduit schedule and ingress template, installation guide.



ZDF48-**

Part Number	Enclosure Material	Included Accessories	Power Infrastructure	Std. Pkg. Qty.	Std. Ctn. Qty.
26U Industrial Distribution Frame for Two Access and Two Distribution Switches					
ZDF48-RA	Mild Steel	Two 48-Port Patch Panels, Fiber Tray, Fiber Spools, Back Panels, 10" DIN Rail, 30" Length of Duct	Two Duplex Power Receptacles and Four Power Cables	1	—
ZDF48-EA			—		
ZDF48-6RA	316 Stainless Steel		Two Duplex Power Receptacles and Four Power Cables		
ZDF48-6EA			—		



ZDF242430

Part Number	Enclosure Material	Included Accessories	Power Infrastructure	Std. Pkg. Qty.	Std. Ctn. Qty.
12U Industrial Distribution Frame for Two Access or Two Distribution Switches					
ZDF242430	Mild Steel	Two 48-Port Patch Panels, Fiber Tray, Fiber Spools, Back Panels, 10" DIN Rail, 30" Length of Duct	—	1	—
ZDF242430-6	316 Stainless Steel				

Wireless Enclosures

- Accommodates the most popular Wireless Access Points
- Fiberglass construction and aluminum mounting plate allows quick and easy access point installation
- Provisions for padlocks to protect against tampering and theft
- Include pre-configured mounting template and connectivity kit with 2-position outlet box, Mini-Com™ TX6™ PLUS Jack Module, TX6™ PLUS Patch Cord, silicone sealant and grounding cable
- UL 508A Listed, NEMA 4X and IP66 Rated



PZNWE12

Part Number	Connectivity Kit	External Dimensions	Internal Dimensions	Std. Pkg. Qty.	Std. Ctn. Qty.
Power over Ethernet Applications					
PZNWE12	UTP	13.56"H x 13.47"W x 6.56"D (344.4mm x 342.1mm x 166.6mm)	11.70"H x 11.70"W x 6.29"D (297.2mm x 297.2mm x 159.8mm)	1	—
PZNWE12S	Shielded				



PZNWE14

Part Number	Connectivity Kit	External Dimensions	Internal Dimensions	Std. Pkg. Qty.	Std. Ctn. Qty.
Traditional AC Power Applications					
PZNWE14	UTP	15.50"H x 13.50"W x 6.25"D (393.7mm x 342.9mm x 158.8mm)	13.53"H x 11.55"W x 5.94"D (343.7mm x 293.4mm x 150.9mm)	1	—
PZNWE14S	Shielded				

Shielded connectivity kit, NEMA 4X rated fittings, and NEMA 4X drain and vent kit available, refer to www.panduit.com.

IntraVUE™ Industrial Ethernet Visualization and Monitoring Software

- Automatic discovery and monitoring of connected devices
- Plant layout documentation with export to Microsoft* Visio*
- Export of device asset inventory and event log
- Simple Network Visualization built for industrial and SCADA controls
- Historical event logs and trend graphs
- Detects common Industrial Ethernet connectivity issues
- Built for Automation Systems using EtherNet/IP**, Modbus TCP/IP and PROFINET

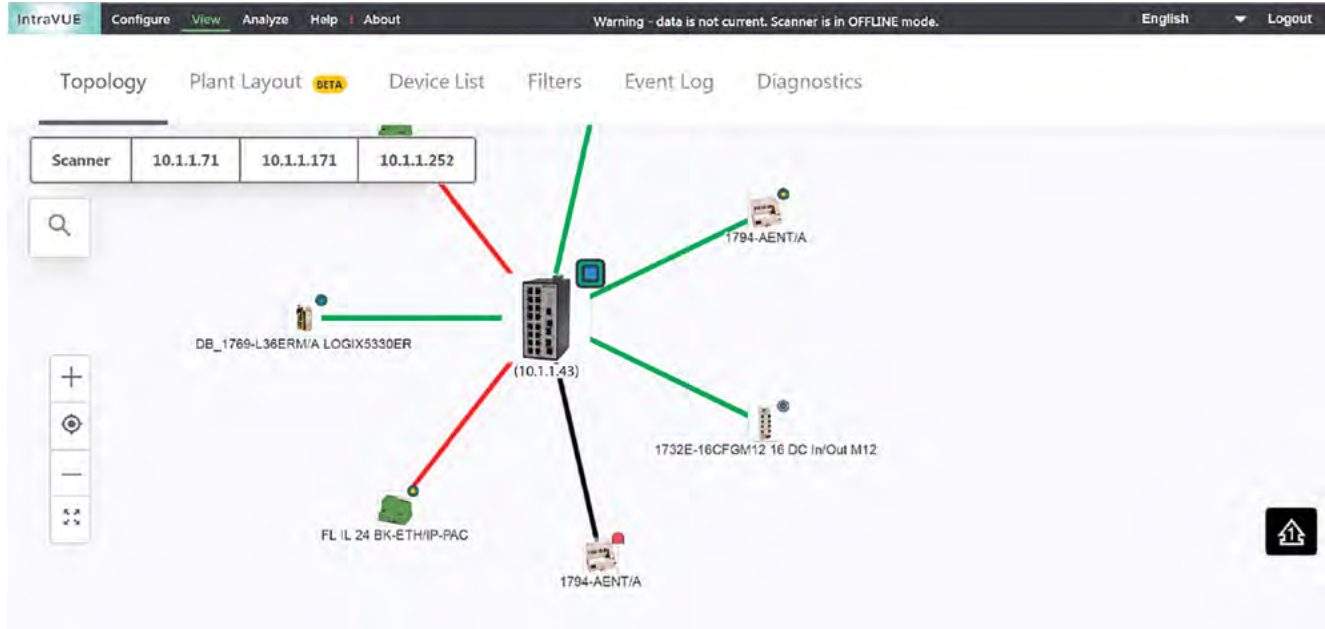

IntraVUE™ Edge is a permanent Industrial Network Documentation and Monitoring Solution. By simply connecting the device to the network that needs to be scanned, IntraVUE™ Edge is capable of continuously monitoring the status of all devices and switches within the network. It is physically hardened with a fan-less design and has been designed for compliance with the Center for Internet Security (CIS) benchmarks.

Part Number	Part Description	Size of Network
IntraVUE™ Edge		
PNPIV	IntraVUE™ Edge permanently licensed appliance. Includes accessories to support shelf mount, VESA Mount, Wall Mount, and DIN Rail Mount. Packaged Accessories: 12V 3 AMP Converter with American and European Power Cord, USB flash drive loaded with configuration support, CAT 6A UTP patch cable, printed Getting Started guide. Dimensions: 4.33 x 4.57 x 1.93 in (110mm x 116mm x 49mm).	1,204 IP Devices
IntraVUE™ Hardware		
WNMS-APPL	Appliance package to scan remote or isolated industrial networks.	1 IntraVUE Appliance

*Microsoft and Visio are registered trademarks of Microsoft Corp. in the United States and/or other countries.
 **EtherNet/IP is a trademark of ODVA.

A. Featured Products

B. Copper Systems

C. Fiber Systems

D. Faceplates, Frames & Surface Mount Boxes

E. Industrial Networks

F. Audio Video Systems

G. Keystone Cabling Systems

H. Zone Cabling

J. Cable Routing Systems

K. Cable Cleats

L. Cabinets & Rack Systems

M. Power & Connectivity Management

N. Grounding & Bonding

O. Identification Products

P. Cable Management Accessories

Q. Part Number Index

A. Featured Products
B. Copper Systems
C. Fiber Systems
D. Faceplates, Frames & Surface Mount Boxes
E. Industrial Networks
F. Audio Video Systems
G. Keystone Cabling Systems
H. Zone Cabling
J. Cable Routing Systems
K. Cable Cleats
L. Cabinets & Rack Systems
M. Power & Connectivity Management
N. Grounding & Bonding
O. Identification Products
P. Cable Management Accessories
Q. Part Number Index

Notes

Table of Contents

Above Floor Raceway F.2
HDMI Patch Cords F.2
In Wall Boxes and Accessories. F.3
Table Boxes and Accessories. F.3
Faceplate Frames and Inserts F.4
GFCI Faceplates and Inserts. F.4
AV Modules. F.5
HDBaseT Extenders F.6

**A.
Featured
Products**

**B.
Copper
Systems**

**C.
Fiber
Systems**

**D.
Faceplates,
Frames &
Surface
Mount Boxes**

**E.
Industrial
Networks**

**F.
Audio
Video
Systems**

**G.
Keystone
Cabling
Systems**

**H.
Zone
Cabling**

**J.
Cable
Routing
Systems**

**K.
Cable
Cleats**

**L.
Cabinets
& Rack
Systems**

**M.
Power &
Connectivity
Management**

**N.
Grounding
& Bonding**

**O.
Identification
Products**

**P.
Cable
Management
Accessories**

**Q.
Part
Number
Index**

A. Featured Products



Above Floor Raceway

B. Copper Systems

- ADA Compliant over floor raceway system
- Fast snap, tamper resistant base and cover
- Power rated 4-channel design

C. Fiber Systems



AFR4BCBL6

AFR4JB2SBL

D. Faceplates, Frames & Surface Mount Boxes



AFR4TRT70BL

AFR4RABL

E. Industrial Networks

F. Audio Video Systems

G. Keystone Cabling Systems



AFR4CCBL

AFR4ECBL

H. Zone Cabling

J. Cable Routing Systems

K. Cable Cleats

L. Cabinets & Rack Systems

M. Power & Connectivity Management

N. Grounding & Bonding

O. Identification Products

P. Cable Management Accessories

Q. Part Number Index

Part Number	Part Description
AFR4BCBL6	Above floor raceway base and cover, 6-foot, Black.
AFR4JB2SBL	Above floor raceway, power rated two-piece snap together junction box, Black.
AFR4TRT70BL	Above floor raceway transition fitting from above floor raceway to T70, Black.
AFR4RABL	Above floor raceway, right angle fitting, Black.
AFR4CCBL	Above floor raceway, coupler fitting, Black.
AFR4ECBL	Above floor raceway, end cap fitting, Black.

For other colors, replace BL (Black) with OS (Office Slate) or IW (Off White).

HDMI Patch Cords

- Certified premium HDMI 2.0 patch cords
- Great for 4K video transmission



HDMI1MWH

Part Number	Part Description
HDMI1MWH	HDMI 2.0 1M patch cord, White.
HDMI2MWH	HDMI 2.0 2M patch cord, White.
HDMI4MWH	HDMI 2.0 4M patch cord, White.

For Black, replace WH (White) with BL (Black).

In Wall Boxes and Accessories

- Full grid pattern for customized equipment placement and cable management
- Each box includes push-mount cable ties for cable management
- Power receptacle knockout



CMBBLWH

Part Number	Part Description	Height In.	Width In.
CMBBSWH	Small in-wall box for 16 inch stud installation.	8.65	17.41
CMBBLWH	Large in-wall box for 16 inch stud installation.	15.4	
CMBBCMR	Cable management D-ring.	–	–
CMBBRKT	Equipment bracket.	–	–

Table Boxes and Accessories

- Table boxes come pre-populated with power outlets
- Each table box includes both a Mini-Com™ and NetKey™ (Keystone) Faceplate
- Faceplates can be filled with any connectivity or blank modules
- Once installed, faceplates can be removed at a later date for future moves, adds, and changes



PND100



PND110



PND400

Part Number	Part Description	Module Spaces	Power
PND100	Cable nook box.	8	UL-cUL Listed Power Module with 2 Type A USB 2.0 Ports
PND110	Tilt up table box.	4	UL-cUL Listed Power Module
PND400	Retractable HDMI cable for cable nook box with mounting bracket.	–	–

A. Featured Products

B. Copper Systems

C. Fiber Systems

D. Faceplates, Frames & Surface Mount Boxes

E. Industrial Networks

F. Audio Video Systems

G. Keystone Cabling Systems

H. Zone Cabling

J. Cable Routing Systems

K. Cable Cleats

L. Cabinets & Rack Systems

M. Power & Connectivity Management

N. Grounding & Bonding

O. Identification Products

P. Cable Management Accessories

Q. Part Number Index

A.
Featured
Products

Faceplate Frames and Inserts

- Faceplate frames allow customizable solutions
- Combine Mini-Com™ and NetKey™ Modules in a single faceplate through frame inserts

B.
Copper
Systems

C.
Fiber
Systems



CBIW



CBIW-2G



CHF2MIW-X



NKHF2MIW-X



CHBHIW

D.
Faceplates,
Frames &
Surface
Mount Boxes

E.
Industrial
Networks

F.
Audio
Video
Systems

G.
Keystone
Cabling
Systems

H.
Zone
Cabling

J.
Cable
Routing
Systems

K.
Cable
Cleats

L.
Cabinets
& Rack
Systems

M.
Power &
Connectivity
Management

N.
Grounding
& Bonding

O.
Identification
Products

P.
Cable
Management
Accessories

Q.
Part
Number
Index

Part Number	Part Description
CBIW	Single gang faceplate frame.
CBIW-2G	Double gang faceplate frame.
CHF2MIW-X	Two module 1/3 insert for Mini-Com™ Modules.
NKHF2MIW-X	Two module 1/3 insert for NetKey™ Modules.
CHBHIW	Hooded insert.

For other colors, replace IW (Off White) with BL (Black), IG (International Gray), EI (Electric Ivory), or WH (White).

GFCI Faceplates and Inserts



CFGBIW
Faceplate not included.



CPGIW



CPGIW-2G



CFG4IW



CFG2IW



NK2RMFIW



NK4RMFIW

Part Number	Part Description
CFGBIW	Brush insert, off white.
CPGIW	Single gang rectangular faceplate.
CPGIW-2G	Double gang rectangular faceplate.
CFG4IW	Mini-Com™ Four Module Rectangular Adapter.
CFG2IW	Mini-Com™ Two Module Rectangular Adapter.
NK4RMFIW	NetKey™ Four Module Rectangular Adapter.
NK2RMFIW	NetKey™ Two Module Rectangular Adapter.

For other colors, replace IW (Off White) with BL (Black), IG (International Gray), EI (Electric Ivory) or WH (White).

AV Modules



Part Number	Part Description	Footprint	Specification
CMBIW-X	Blank module.	Mini-Com™	–
CMHDMIW	2-position HDMI module.		HDMI 2.0
CMUSBAAIW	USB module.		USB 2.0
CM35MSCIWY	3.5 stereo coupler.		–
CM35MSSIW	Solder Type 3.5 stereo connector.		–
CMFIW	F Type coupler.		3 GHz
CMFSRIWY	Self-terminating F Type module.		2 GHz
CMD15HDIWAY	2-position VGA module, 15 pin with circuit board to be terminated on site.	Insert	–
CHD15HDCIWY	1/3 insert 15 pin VGA connector module.		–
NKBIW-X	Blank module.	Keystone	–
NKHDMIW	1-position HDMI module.		HDMI 2.0
NKUSBAAIW	USB module.		USB 2.0
NK35MSCIW	3.5 stereo coupler.		–
NKFIW	F Type coupler.		3 GHz

For other colors, replace IW (Off White) with BL (Black), WH (White), EI (Electric Ivory), IG (International Gray), or AW (Arctic White).

A. Featured Products

B. Copper Systems

C. Fiber Systems

D. Faceplates, Frames & Surface Mount Boxes

E. Industrial Networks

F. Audio Video Systems

G. Keystone Cabling Systems

H. Zone Cabling

J. Cable Routing Systems

K. Cable Cleats

L. Cabinets & Rack Systems

M. Power & Connectivity Management

N. Grounding & Bonding

O. Identification Products

P. Cable Management Accessories

Q. Part Number Index

- A. Featured Products
- B. Copper Systems
- C. Fiber Systems
- D. Faceplates, Frames & Surface Mount Boxes
- E. Industrial Networks
- F. Audio Video Systems
- G. Keystone Cabling Systems
- H. Zone Cabling
- J. Cable Routing Systems
- K. Cable Cleats
- L. Cabinets & Rack Systems
- M. Power & Connectivity Management
- N. Grounding & Bonding
- O. Identification Products
- P. Cable Management Accessories
- Q. Part Number Index

HDBaseT Extenders

- HDBaseT transmitters and receivers can be mixed and matched
- Transmits a 4K video signal up to 40 meters and a 1080p video signal up to 70 meters
- Ideal for small conference rooms and classrooms
- Can be used with Category 6 or Category 6A cable



Part Number	Part Description
CMHDBTBTX	HDBaseT slim line transmitter box.
CMHDBTBRX	HDBaseT slim line receiver box.
CMHDBTWPTX	HDBaseT wallplate transmitter with 2 HDMI inputs, 1 VGA input and autoswitching feature.
CMHDBTWRX	HDBaseT slim line receiver box with audio de-embedding.

Table of Contents

NetKey™ Copper Cable G.2

NetKey™ Jack Modules G.2

NetKey™ Patch Cords..... G.2

NetKey™ Modular Patch Panels G.3

Accessories G.4

NetKey™ Fiber Enclosures..... G.4

NetKey™ Fiber Optic Adapters G.4

NetKey™ Fiber Patch Cords and Pigtails G.5

NetKey™ Faceplates..... G.6

NetKey™ Stainless Steel Faceplates..... G.7

Faceplate Frames and Inserts G.7

NetKey™ Furniture Faceplates G.8

NetKey™ Surface Mount Boxes..... G.8

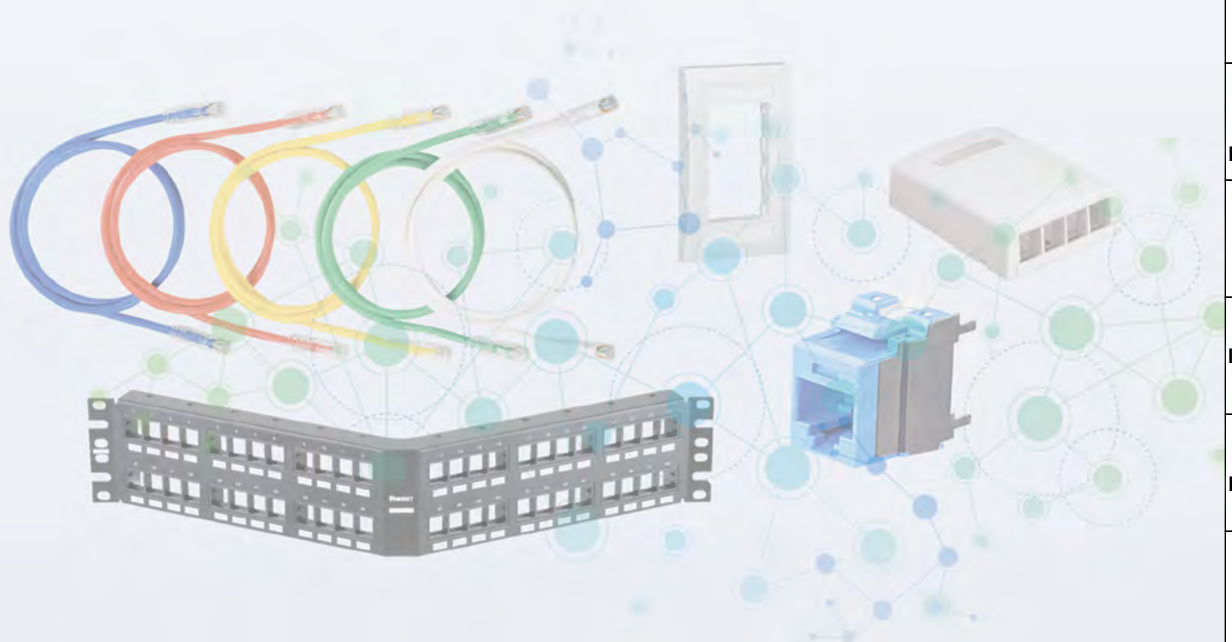

**A.
Featured
Products**

**B.
Copper
Systems**

**C.
Fiber
Systems**

**D.
Faceplates,
Frames &
Surface
Mount Boxes**

**E.
Industrial
Networks**

**F.
Audio
Video
Systems**

**G.
Keystone
Cabling
Systems**

**H.
Zone
Cabling**

**J.
Cable
Routing
Systems**

**K.
Cable
Cleats**

**L.
Cabinets
& Rack
Systems**

**M.
Power &
Connectivity
Management**

**N.
Grounding
& Bonding**

**O.
Identification
Products**

**P.
Cable
Management
Accessories**

**Q.
Part
Number
Index**

- A. Featured Products
- B. Copper Systems
- C. Fiber Systems
- D. Faceplates, Frames & Surface Mount Boxes
- E. Industrial Networks
- F. Audio Video Systems
- G. Keystone Cabling Systems
- H. Zone Cabling
- J. Cable Routing Systems
- K. Cable Cleats
- L. Cabinets & Rack Systems
- M. Power & Connectivity Management
- N. Grounding & Bonding
- O. Identification Products
- P. Cable Management Accessories
- Q. Part Number Index

NetKey™ Copper Cable

- Exceeds ANSI/TIA-568.2-D and ISO 11801 channel requirements.



NUY6C04BU-CE

Part Number	Performance Level	Flame Rating	EuroClass	Packaging	Construction, AWG	Color	Length, m
NUL6X04BU-HEG	Category 6A	LSZH-1	Dca-s2,d2,a1	Reel	U/UTP, 23	Blue	305
NUY6X04BU-HEG			Cca-s1a,d1,a1				
NFFY6X04BU-HED			Cca-s1a,d1,a1		F/FTP, 23		500
NUC6C04BU-FE	CM	Easy Payout Carton	U/UTP, 24	305			
NUZ6C04BU-KE	LSZH-1 and LSZH-3-22				Dca-s2,d2,a1		
NUY6C04BU-CE	LSZH-1				Cca-s1,d1,a1		
NUL5C04BU-CE	Category 5e				LSZH-1	Eca	

For standard colors other than Blue, please contact Customer Service.

NetKey™ Jack Modules

- Meet all industry performance standards for Category 6A, 6 and 5e
- Punchdown jack modules are 100% performance tested and individually serialized for future traceability
- Keystone punchdown jacks meet ANSI/TIA-568.2-D and ISO 11801 component requirements
- Snap in and out of keystone openings for easy moves, adds and changes
- Universal label includes T568A and T568B wiring schemes
- Shielded Jack Module terminates 4-pair, 22-24 AWG, 100ohm shielded twisted pair cable; does not require Punch down tool



NK6X88MBU
NK688MBU
NKP5E88MBU



KJS6X88TC

Part Number	Performance Level	Termination Style	Color	Std. Pkg. Qty.
Unshielded jack modules				
NK6X88MBU	Category 6A	Punchdown	Blue	1
NK6X88MBU-Q				25
NK688MBU	Category 6			1
NK688MBU-Q				25
NKP5E88MBU	Category 5e			1
NKP5E88MBU-Q				25
Shielded jack modules				
KJS6X88TC	Category 6A	TG Style	Silver	1

For other colors, replace BU (Blue) with IW (Off White), BL (Black), EI (Electric Ivory), or WH (White).

NetKey™ Patch Cords

- Meet all industry performance standards for Category 6A, 6 and 5e
- 100% performance tested
- Available in a variety of colors and lengths for design flexibility



NK6APC3BU
NK6PC3BUY



NK5EPC3BUY

Part Number	Performance Level	Length Ft.
NK6APC3BU	Category 6A	1-20, 25, 30, 35, 40, 45, 50
NK6PC3BUY	Category 6	
NK5EPC3BUY	Category 5e	

For other lengths, replace "3" in the part number with the desired patch cord length.
For other colors, replace BU (Blue) with IW (off White) or RD (Red).

NetKey™ Modular Patch Panels

- Accept NetKey™ Modules, which snap in and out for easy moves, adds and changes
- Angled style facilitates proper bend radius control and minimizes the need for horizontal cable managers
- Front access design includes faceplate with easy snap release feature

Unshielded Patch Panels



NKFP24Y



NKFP48Y



NKPP24FMY



NKPPA24FMY

Part Number	Ports	RU	Style	Identification	Color	Design	Std. Pkg. Qty.			
NKFP24Y	24	1	Flat	Adhesive	Black	Front Access	1			
NKFP48Y	48	2								
NKPP24FMY	24	1								
NKPP48FMY	48	2								
NKFP24Y	24	1	Angled			Adhesive		Black	Front Access	1
NKFP48Y	48	2								
NKPPA24FMY	24	1								
NKPPA48FMY	48	2								

Shielded Patch Panels



NKA6XPPG24Y
NKA6PPG24Y
NKA5EPPG24Y



NK6XPPG24Y
NK6PPG24Y
NK5EPPG24Y



NKA6XPPG48Y
NKA6PPG48Y
NKA5EPPG48Y



NK6PPG12WY

Part Number	Ports	RU	Style	Identification	Color	Design	Std. Pkg. Qty.
KP24WSBL	24	1	Flat	Label pocket	Black	Front Access	1
KPS24BL	24	1					
KPA24WSBL	24	1	Angled	Adhesive			
KPA48WSBL	48	2					

Punchdown Panels

Part Number	Ports	RU	Style	Identification	Color	Category	Std. Pkg. Qty.
NKA6XPPG24Y	24	1	Angled	Adhesive	Black	6A	1
NKA6XPPG48Y	48	2					
NK6XPPG24Y	24	1	Flat				
NK6XPPG48Y	48	2					
NKA6PPG24Y	24	1	Angled				
NKA6PPG48Y	48	2					
NK6PPG24Y	24	1	Flat				
NK6PPG48Y	48	2					
NK6PPG12WY	12	–	Angled				
NKA5EPPG24Y	24	1					
NKA5EPPG48Y	48	2					
NK5EPPG24Y	24	1				Flat	
NK5EPPG48Y	48	2					
NK5EPPG12WY	12	–					

- A. Featured Products
- B. Copper Systems
- C. Fiber Systems
- D. Faceplates, Frames & Surface Mount Boxes
- E. Industrial Networks
- F. Audio Video Systems
- G. Keystone Cabling Systems
- H. Zone Cabling
- J. Cable Routing Systems
- K. Cable Cleats
- L. Cabinets & Rack Systems
- M. Power & Connectivity Management
- N. Grounding & Bonding
- O. Identification Products
- P. Cable Management Accessories
- Q. Part Number Index

A. Featured Products

B. Copper Systems

C. Fiber Systems

D. Faceplates, Frames & Surface Mount Boxes

E. Industrial Networks

F. Audio Video Systems

G. Keystone Cabling Systems

H. Zone Cabling

J. Cable Routing Systems

K. Cable Cleats

L. Cabinets & Rack Systems

M. Power & Connectivity Management

N. Grounding & Bonding

O. Identification Products

P. Cable Management Accessories

Q. Part Number Index

Accessories

- Strain relief bars help support cable exiting the back of the panel
- Filler panels cover unused rack space
- Transitional cover for angled panels to help promote proper airflow and cooling
- Select product available in White

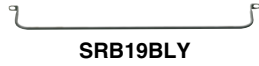

SRB19BLY



WB89D

Part Number	Type	Style	Color	Std. Pkg. Qty.
SRB19D5BL	Strain Relief Bar	Deep	Black	1
SRB19BLY		Extended		
SRB19D7BL		Deep		
CPAF2BLY	Filler Panel	Angled	Black	
CPAF1BLY				
CPATCBL	Transitional Cover	Quick Release		
SRBBRKT	Mounting Bracket			
WB89D	Bracket	89D	White	

NetKey™ Fiber Enclosures

- Factory configured with 6, 12 or 24 duplex LC or SC adapters for fast and easy installation
- Slide-out drawer slides forward a full 300mm for service access to all fiber terminations, connections, and/or splices
- Supports both field termination or fusion splicing with appropriate slack storage and cable management provisions
- Simple two-piece, all-metal body construction for easy and economical installation with no loose components to misplace; improved protection over plastic fiber drawers

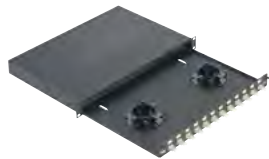

NKFD1W12BUDSCZ

Part Number	Adapter Type	Fiber Type	Adapter Color	Number of Adapters*
NKFD1W6BUDSCZ	SC	Multimode	Blue	6
		Singlemode		
NKFD1W12BUDSCZ	SC	Multimode		12
		Singlemode		
NKFD1W12BUDLCZ	LC	Multimode		12
		Singlemode		
NKFD1W24BUDLCZ	LC	Multimode	24	
		Singlemode		

NetKey™ Fiber Optic Adapters



NKDLCMZIW



NKDSCMZIW

Part Number	Adapter Type	Fiber Type
NKDLCMZIW	LC	Multimode
		Singlemode
NKDSCMZIW	SC	Multimode
		Singlemode

For other colors, replace IW (Off White) with BL (Black), EI (Electric Ivory), IG (International Gray), or WH (White).

NetKey™ Fiber Patch Cords and Pigtails

- Compliant with ANSI/TIA 568-C.3-1 and ISO/IEC 11801, TIA-604-5 (FOCIS-5), and UL 1666 (OFNR) flame rating
- Patch cords and pigtails include OM1, OM3, OM4 or OS2 fiber in 900µm tight-buffered fiber, 1.6mm, 2.0mm or 3.0mm duplex zipcord jacketed cable
- 100% performance tested assures that patch cords and pigtails are standard compliant, Riser rated jacket meets UL 1666 (OFNR) flame rating for standard compliant safety
- Q.C. identification label quality control reference provides lifetime traceability of test data



ST to ST Patch Cord **SC to SC Patch Cord** **LC to LC Patch Cord** **SC to LC Patch Cord** **LC to Pigtail** **SC to Pigtail** **ST to Pigtail**

Part Number Example	NK	FP	X	2	E	R	L	L	S	M	001
	1	2	3	4	5	6	7	8	9	10	11

- NK**
NetKey
- FP**
Fiber Patch Cord
- X**
X = OM3
Z = OM4
9 = OS2
- 2**
2 = Duplex
- E**
E = 1.6mm
2 = 2.0mm
3 = 3.0mm
- R**
R = Riser
L = LSZH
- L**
L = LC
S = SC
2 = ST
- L**
L = LC
S = SC
2 = ST
- S**
S = Standard
- M**
M = Meter
- 001**
Length

OM3, OM4, and OS2 pigtails available in 1m and 2m lengths. All other only available in 1m.

Part Number Example	NK	FP	X	1	B	N	1	N	S	N	001
	1	2	3	4	5	6	7	8	9	10	11

- NK**
NetKey
- FP**
Fiber Patch Cord
- X**
X = OM3
Z = OM4
9 = OS2
- 1**
1 = Simplex
- B**
B = 900µm
- N**
N = N/A
- 1**
1 = LC
2 = ST
3 = SC
- N**
N = N/A
- N**
N = N/A
K = 12pc kit
- 001**
Length

OM3, OM4, and OS2 pigtails available in 1m and 2m lengths. All others only available in 1m.

- A. Featured Products
- B. Copper Systems
- C. Fiber Systems
- D. Faceplates, Frames & Surface Mount Boxes
- E. Industrial Networks
- F. Audio Video Systems
- G. Keystone Cabling Systems
- H. Zone Cabling
- J. Cable Routing Systems
- K. Cable Cleats
- L. Cabinets & Rack Systems
- M. Power & Connectivity Management
- N. Grounding & Bonding
- O. Identification Products
- P. Cable Management Accessories
- Q. Part Number Index

NetKey™ Faceplates

- Accept NetKey™ Modules for UTP, fiber optic, and audio/video
- Replacement label/label covers available for select products
- Non-label faceplates include screws with matching color head screws



NK1FIWY NK2FIWY NK4FIWY



NK6FIWY NK1FNIW NK2FNIW



NK3FNIW NK4FNIW NK4VSIWY

Part Number	Ports	Style	Identification	Std. Pkg. Qty.
NK1FIWY	1	Flat	Label Pocket	1
NK2FIWY	2			
NK4FIWY	4			
NK6FIWY	6		Adhesive	
NK1FNIW	1			
NK2FNIW	2			
NK3FNIW	3	Sloped	Label Pocket	
NK4FNIW	4			
NK6FNIW	6			
NK4VSIWY	4			

For other colors, replace IW (Off White) with EI (Electric Ivory), WH (White), or IG (International Gray).

NetKey™ Shielded Faceplates

- Keystone sloped shuttered faceplates
- Two piece design includes a metal mounting plate concealed by the outer frame for added security and aesthetic look.
- Faceplates accept two standard Keystone modules for copper, fiber and audio/video installations
- Supplied with mounting screws, metal mounting plate, label/label holder



KFPL80S2SWH KFPL86S2SWH

Part Number	Ports	Style	Identification	Std. Pkg. Qty.
KFPL80S2SWH	2	Sloped	Label Pocket	1
KFPL86S2SWH	2			

NetKey™ Stainless Steel Faceplates

- Accept NetKey™ Modules for UTP, fiber optic, and audio/video
- Replacement label/label covers available where applicable
- Impact-resistant 304 stainless steel for light industrial environments



Part Number	Ports	Style	Identification	Size	Std. Pkg. Qty.
NKF2S	2	Flat	Label Pocket	Single	1
NKF4S	4				
NKF6S	6				

Faceplate Frames and Inserts

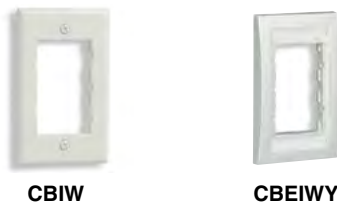

Faceplate Frames

Part Number	Size	Style	Identification	Std. Pkg. Qty.
CBIW	Single	Classic	Adhesive	1
CBIW-2G	Double			
CBEIWY	Single	Executive	Label Pocket	
CBEIW-2GY	Double			



1/2 Size Inserts

Part Number	Ports	Style	Identification	Std. Pkg. Qty.
NKHS2IW-X	2	Sloped	Adhesive	10
NKHS2SIW-X		Sloped Shuttered		

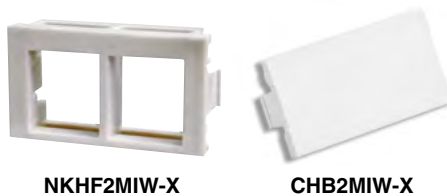

1/3 Size Inserts

Part Number	Ports	Style	Identification	Std. Pkg. Qty.
NKHF2MIW-X	2	Flat	-	10
CHB2MIW-X	-	Blank		

For other colors, replace IW (Off White) with EI (Electric Ivory) or WH (White).

- A. Featured Products
- B. Copper Systems
- C. Fiber Systems
- D. Faceplates, Frames & Surface Mount Boxes
- E. Industrial Networks
- F. Audio Video Systems
- G. Keystone Cabling Systems
- H. Zone Cabling
- J. Cable Routing Systems
- K. Cable Cleats
- L. Cabinets & Rack Systems
- M. Power & Connectivity Management
- N. Grounding & Bonding
- O. Identification Products
- P. Cable Management Accessories
- Q. Part Number Index

A. Featured Products

NetKey™ Furniture Faceplates

- Accept NetKey™ Modules for UTP, fiber optic, and audio/video
- Optional adhesive labels available
- Compatible with standard furniture opening

B. Copper Systems

C. Fiber Systems

Panel Cutout Requirements

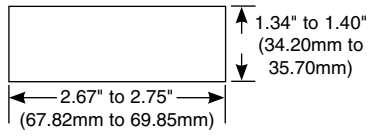

Maximum Panel Thickness: 0.09" (2.29mm)

Part Number	Ports	Style	Std. Pkg. Qty.
NK4MFBL	4	Flat	1
NK4MFABL		Sloped	

For other colors, replace BL (Black) with IW (Off White), WH (White), IG (International Gray).

D. Faceplates, Frames & Surface Mount Boxes

E. Industrial Networks



F. Audio Video Systems

G. Keystone Cabling Systems

H. Zone Cabling

NetKey™ Surface Mount Boxes

- Accept all NetKey™ Modules
- Replacement label/label covers available where applicable
- Mount easily with supplied mounting screws, adhesive tape or optional magnet
- Cable entry from side knockouts

J. Cable Routing Systems

K. Cable Cleats



L. Cabinets & Rack Systems

M. Power & Connectivity Management

N. Grounding & Bonding

Part Number	Ports	Style	Identification	Magnet	Raceway Compatibility
NK2BXIW-A	2	Elongated	Adhesive	CBM-X	LD3/LDPH3 LD5/LDPH5
NK4BXIW-AY	4		Label Pocket		
NK6BXIW-AY	6			-	

For other colors, replace IW (Off White) with EI (Electric Ivory), WH (White), or IG (International Gray).

O. Identification Products

P. Cable Management Accessories

Q. Part Number Index

Table of Contents

PanZone™ Wall Mount Cabinets H.2

PanZone™ In-Ceiling Enclosures H.3

PanZone™ Basic In-Ceiling Enclosures H.3

PanZone™ Raised Floor Enclosures H.4

**PanZone™ Work Area Raised Floor Consolidation
Point Enclosure H.4**

Consolidation Point Boxes H.5

PanZone™ Overhead Distribution Racks H.5

Zone Accessories H.6

PanZone™ Cable Assemblies H.6

**A.
Featured
Products**

**B.
Copper
Systems**

**C.
Fiber
Systems**

**D.
Faceplates,
Frames &
Surface
Mount Boxes**

**E.
Industrial
Networks**

**F.
Audio
Video
Systems**

**G.
Keystone
Cabling
Systems**

**H.
Zone
Cabling**

**J.
Cable
Routing
Systems**

**K.
Cable
Cleats**

**L.
Cabinets
& Rack
Systems**

**M.
Power &
Connectivity
Management**

**N.
Grounding
& Bonding**

**O.
Identification
Products**

**P.
Cable
Management
Accessories**

**Q.
Part
Number
Index**

- A. Featured Products
- B. Copper Systems
- C. Fiber Systems
- D. Faceplates, Frames & Surface Mount Boxes
- E. Industrial Networks
- F. Audio Video Systems
- G. Keystone Cabling Systems
- H. Zone Cabling
- J. Cable Routing Systems
- K. Cable Cleats
- L. Cabinets & Rack Systems
- M. Power & Connectivity Management
- N. Grounding & Bonding
- O. Identification Products
- P. Cable Management Accessories
- Q. Part Number Index

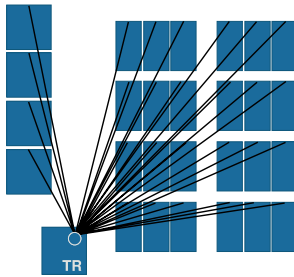

Traditional Cable Deployment

Traditional cable deployment is difficult to manage. Moves, adds and changes can be challenging in this typical cable environment. Longer cable lengths are needed which add to additional cost.

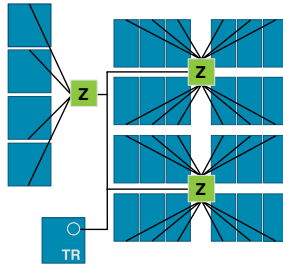

Panduit Zone Cabling System

Panduit Zone Cabling Systems are TIA-568, 569, and 942 compliant and provide accessibility and flexibility to reconfigure office space to meet frequent organizational requirements, easily and quickly. They solve telecommunication room congestion and reduce network downtime. Each zone enclosure product serves as a main distribution point for a particular zone.

PanZone™ Wall Mount Cabinets

- Holds 12 RU of active and passive network equipment plus two additional RU for power strips and small electronic devices (modems, routers and power strips, etc.)
- Thermal management design (vents, perforated doors, and optional fan) optimizes air flow for improved heat dissipation
- Installed as hinged right or hinged left
- Conduit and wireless access point antenna knockouts provided
- Rear hinging access manages the back of the cabinet
- Accessories include horizontal slack manager, bend radius holders, rear equipment rail kit and exhaust fan
- Working load rating of 250 lbs.
- Adjustable rails mount at 1" increments to accommodate various depths of network equipment including PoE switches
- Individual rack spaces are identified for ease of equipment mounting
- Keys to secure front and rear doors and side panels



PZWMC12W



PZWMC12P



Part Number	RU	Depth In.	Door Type	Load Rating Lbs.
-------------	----	-----------	-----------	------------------

PanZone™ Wall Mount Cabinets

PZWMC12W	12	25	Window	250	
PZWMC12P			Perforated		
PZWMC1230W	30	30	Window		
PZWMC1230P			Perforated		
PZWMC18W	18	25	Window	300	
PZWMC18P			Perforated		
PZWMC1830W	30	30	Window		
PZWMC1830P			Perforated		
PZWMC26W	26	25	Window	350	
PZWMC26P			Perforated		
PZWMC2630W		30	30		Window
PZWMC2630P					Perforated

Part Number	Part Description	No. of Rack Units [^]	Std. Pkg. Qty.
-------------	------------------	--------------------------------	----------------

PanZone™ Active Wall Mount Enclosure

PZAEWM3	Active wall mount enclosure includes mounting template for quick installation; gray finish. Dimensions: 38.50"H x 27.92"W x 8.61"D (977.9mm x 709.2mm x 218.7mm).	6	1
---------	---	---	---

[^]One rack unit = 1.75" (44.45mm).
Accessories available; refer to www.panduit.com for additional information.

PanZone™ In-Ceiling Enclosures

- Hinged door with integrated 110V exhaust fan and gas assist air cylinders for restraining the load on the ceiling door when opening
- Ceiling tile brackets and cutout template for inserting ceiling tile on the enclosure door
- Thermal management design optimizes air flow for improved heat dissipation; ideal for high heat load network equipment
- Two-tier mounting bracket accommodates two rack spaces of active equipment up to 17.5" deep and three additional rack spaces up to 13.5" deep for improved network design flexibility
- 50 lb. door weight capacity
- Include door plate, equipment mounting bracket, integrated horizontal cable slack manager
- AC power ready – receptacle not included (PZICEA only)
- Includes low decibel 60 CFM fan (PZICEA only)
- Keys for locking latch to secure the ceiling door
- UL 2043 rated and UL 1863 rated



Part Number	Part Description	No. of Rack Units [^]	Std. Pkg. Qty.
PanZone™ In-Ceiling Enclosures			
PZICEA	Fully assembled in-ceiling active enclosure. Accepts up to 2 RU of active network equipment and up to 6 RU of passive product. Includes mounting brackets, integrated horizontal slack manager, AC power provisions, fan assembly, air dam, electrical junction box and 20 Hook & Loop Cable Ties for bundling cables. External dimensions: 13.43"H x 23.50"W x 27.23"D (341.1mm x 596.9mm x 691.6mm). Internal dimensions: 12.24"H x 22.28"W x 22.46"D (310.9mm x 565.8mm x 570.5mm).	8	1
PZICE	Fully assembled in-ceiling passive enclosure. Accepts up to 8 RU of standard 19" patch panels. Includes mounting brackets, integrated horizontal slack manager and 20 Hook & Loop Cable Ties for bundling cables. External dimensions: 13.43"H x 23.50"W x 23.50"D (341.1mm x 596.9mm x 596.9mm). Internal dimensions: 12.24"H x 22.28"W x 22.46"D (310.9mm x 565.8mm x 570.5mm).		

[^]One rack unit = 1.75" (44.45mm).
Accessories available; refer to www.panduit.com for additional information.

PanZone™ Basic In-Ceiling Enclosures

- Holds 2 RU of active equipment and up to 6 RU of patch panels (PZICEAE) or up to 8 RU of patch panels (PZICEE) by minimizing floor space required in telecommunications rooms to relieve congestion
- Hinged door with integrated 110V exhaust fan and folding lid supports
- Thermal management system (PZICEAE) optimizes airflow for improved heat dissipation of higher heat load network equipment
- Two-tier mounting bracket accommodates two rack spaces of active equipment up to 17.5" deep and three additional rack spaces up to 13.5" deep for improved network design flexibility
- 35 lb. door weight capacity
- Four snap bushings that fit around side wall knockouts to protect cables from sharp edges
- UL 2043 rated and UL 1863 rated



PZICEAE

Part Number	Part Description	No. of Rack Units [^]	Std. Pkg. Qty.
PanZone™ Basic In-Ceiling Enclosures			
PZICEAE	Fully assembled in-ceiling active enclosure. Accepts up to 2 RU of active network equipment and up to 6 RU of passive product. Includes mounting brackets, integrated horizontal slack manager, AC power provisions and 20 Hook & Loop Cable Ties for bundling cables. External dimensions: 12.63"H x 23.50"W x 23.50"D (320.9mm x 596.9mm x 596.9mm). Internal dimensions: 11.63"H x 22.36"W x 22.55"D (295.5mm x 568.0mm x 572.7mm).	8	1
PZICEE	Fully assembled in-ceiling passive enclosure. Accepts up to 8 RU of standard 19" patch panels. Includes mounting brackets, integrated horizontal slack manager and 20 Hook & Loop Cable Ties for bundling cables. External dimensions: 12.63"H x 23.50"W x 23.50"D (320.9mm x 596.9mm x 596.9mm). Internal dimensions: 11.63"H x 22.36"W x 22.55"D (295.5mm x 568.0mm x 572.7mm).		

[^]One rack unit = 1.75" (44.45mm).
Accessories available; refer to www.panduit.com for additional information.

A. Featured Products

B. Copper Systems

C. Fiber Systems

D. Faceplates, Frames & Surface Mount Boxes

E. Industrial Networks

F. Audio Video Systems

G. Keystone Cabling Systems

H. Zone Cabling

J. Cable Routing Systems

K. Cable Cleats

L. Cabinets & Rack Systems

M. Power & Connectivity Management

N. Grounding & Bonding

O. Identification Products

P. Cable Management Accessories

Q. Part Number Index



PanZone™ Raised Floor Enclosures

- Work with standard office raised floor tiles; saves valuable real estate in the data center by allowing cable terminations below raised floors, relieves congestion in racks and cabinets
- Include Cool Boot™ Raised Floor Air Sealing Grommet for quick moves, adds, and changes
- Adjustable TIA/EIA 19" mounting brackets can be rotated and/or adjusted for greater network design flexibility and improve access to patch panels
- Secure lockable cover
- Compatible with 7/8" square, 1" diameter, 1 1/2" diameter, and 2" diameter raised floor pedestals
- UL 2043 for use in "PSL7A04WH-HED" on page B.4 spaces
- Single tile drop-in design significantly reduces installation time
- Enclosure installation creates a mechanical electrical bond to raised floor pedestals without the need for extra components; protects network equipment and personnel
- Accepts standard patch panels or QuickNet™ Pre-Terminated Assemblies or Cassettes



PZRFE4U



PZRFE8U



PZRFE12U



PZRFC

Part Number	Part Description	No. of Rack Units [^]	Std. Pkg. Qty.
PZRFE4U	Fully assembled raised floor enclosure requires 6" minimum raised floor depth; black finish. Dimensions: 22.62"H x 22.62"W x 5.0"D (575mm x 575mm x 127mm).	4	1
PZRFE8U	Fully assembled raised floor enclosure requires 9.5" minimum raised floor depth; black finish. Dimensions: 22.62"H x 22.62"W x 8.5"D (575mm x 575mm x 216mm).	8	
PZRFE12U	Fully assembled raised floor enclosure requires 13" minimum raised floor depth; black finish. Dimensions: 22.6"H x 22.6"W x 12.0"D (575mm x 575mm x 305mm).	12	
PZRFC	Lockable cover for raised floor enclosures, includes two keys. Dimensions: 24.0"H x 24.0"W x .75"D (610mm x 610mm x 19.05mm).	—	

[^]One rack unit = 1.75" (44.45mm).



PanZone™ Work Area Raised Floor Consolidation Point Enclosure

- Mount in 10.5" x 10.5" cutout in one raised floor tile; tested to 2000 lbs. per square inch to support furniture
- Include Cool Boot™ Raised Floor Air Sealing Grommet
- Include built-in 48-port Mini-Com™ Modular Panel; accept all Mini-Com™ Modules for quick moves, adds, and changes
- Accept field terminated or pre-terminated connectivity solutions
- Secure lockable cover
- UL 2043 rated for use in ceiling spaces
- In-floor design allows access to the patch field within the local work area without removing floor tiles



Part Number	Part Description	Std. Pkg. Qty.
ACE48	Fully assembled office raised floor consolidation point enclosure; black finish. Support 48 copper cables or up to 96 fiber cables. Dimensions: 12.37"H x 12.45"W x 7.88"D (314mm x 316mm x 200mm).	1



Consolidation Point Boxes

- Suitable for wall mount and underfloor applications
- UL 2043 approved for use in air-handling spaces for copper applications

- Accept Mini-Com™ Modules for STP and UTP, fiber optic, and audio/video, which snap in and out for easy moves, adds, and changes

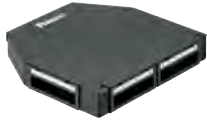

CUFMB24BL



CUFB48BL

Part Number	Part Description	Std. Pkg. Qty.
CUFMB24BL	24-port underfloor consolidation point box includes pre-printed numbered labels with writable surface on back when pre-numbered labels are not applicable. Dimensions: 1.69"H x 10.85"W x 10.67"L (42.9mm x 275.6mm x 271.0mm).	1
CUFB48BL	48-port underfloor consolidation point box. Dimensions: 1.63"H x 10.00"W x 14.88"L (41.4mm x 254.0mm x 378.0mm).	
CUFMB12D4PBL	Under floor consolidation point box with 12 data and 4 power ports, accepts Mini-Com™ Modules, with removable grommet plate. Dimensions: 1.63"H x 10.66"W x 10.18"L (41.5mm x 270.8mm x 258.6mm).	

Optional fiber conversion kit available; refer to www.panduit.com for additional information.

PanZone™ Overhead Distribution Racks

- Ideal solution for adding more rack spaces above racks or cabinets in data centers or telecommunication rooms
- Universal mounting bracket can be mounted to most industry ladder racks, wire basket, or suspended by threaded rod from ceiling

- 40/60/80 lbs. load rating
- Cable management accessories available



PZLRB6U



PZLRB4P4

Part Number	Part Description	No. of Rack Units [^]	Std. Pkg. Qty.
PZLRB2U	2 RU ladder rack bracket. Bracket fits Wyr-Grid™ Overhead Cable Tray. Dimensions: 8.75"H x 20.26"W x 3.26"D (222.3mm x 514.6mm x 82.8mm).	2	1
PZLRB4U	4 RU ladder rack bracket. Bracket fits Wyr-Grid™ Overhead Cable Tray. Dimensions: 12.25"H x 20.26"W x 3.26"D (311.2mm x 514.6mm x 82.8mm).	4	
PZLRB6U	6 RU ladder rack bracket. Bracket fits Wyr-Grid™ Overhead Cable Tray. Dimensions: 15.75"H x 20.26"W x 3.26"D (400.1mm x 514.6mm x 82.8mm).	6	

4 Post Overhead Distribution Racks

PZLRB4P4	4 RU overhead 4-post rack. Dimensions: 10.8"H x 20.3"W x 34.0"D (274mm x 515mm x 864mm).	4	1
PZLRB4P6	6 RU overhead 4-post rack. Dimensions: 14.3"H x 20.3"W x 34.0"D (363mm x 515mm x 864mm).	6	

[^]One rack unit = 1.75" (44.45mm).

A.
Featured
Products

Zone Accessories

B.
Copper
Systems



PZWMC12RR

C.
Fiber
Systems



PZWMC26RR

D.
Faceplates,
Frames &
Surface
Mount Boxes

E.
Industrial
Networks



PZWMCGK

F.
Audio
Video
Systems

G.
Keystone
Cabling
Systems



PZCHSM2

H.
Zone
Cabling

J.
Cable
Routing
Systems

K.
Cable
Cleats

L.
Cabinets
& Rack
Systems

M.
Power &
Connectivity
Management

N.
Grounding
& Bonding

O.
Identification
Products

P.
Cable
Management
Accessories

Q.
Part
Number
Index

Part Number	Part Description
PZWMC12RR	12 RU wall mount cabinet rear rail kit, Black.
PZWMC18RR	18 RU wall mount cabinet rear rail kit, Black.
PZWMC26RR	26 RU wall mount cabinet rear rail kit, Black.
PZCFK	Wall mount cabinet fan kit, 60 CFM.
PZWMCFKHF	Wall mount cabinet fan kit, 120 CFM.
PZWMC-CL	Wall mount cabinet combination lock kit.
PZWMCGK	Jumper grounding kit, includes two 6" jumpers, one 16" jumper, and one 18" jumper with 1/4" stud hole LCB lugs.
PZCHSM2	Horizontal slack manager, 2 RU.

For use with PanZone™ Wall Mount Cabinets.

PanZone™ Cable Assemblies

- Exceeds requirements of ANSI/TIA-568.2-D and ISO 11801 standards for permanent link performance
- Each cord is 100% performance tested to permanent link limits
- Supports IEEE 802.3af, 802.3at, and 802.3bt type 3 and 4 for PoE applications up to 100 W

Part Number	Cable Type	Flammability Rating	Std. Pkg. Qty.
Category 6A Plug to Plug Assemblies			
UZPLWH25M	Unshielded	LSZH	1
SAPLWH25M	Shielded		
Category 6A Jack to Plug Assemblies			
UZJLWH25M	Unshielded	LSZH	1
SAJLWH25MBL	Shielded		

Part number reflects White patch cords; 25 m length. For additional lengths refer to www.panduit.com.



Plug to Plug Shielded Cable Assembly



Jack to Plug UTP Cable Assembly

Table of Contents

24x4 FiberRunner™ Routing System J.2 – J.7

12x4 FiberRunner™ Routing System J.8 – J.17

6x4 FiberRunner™ Routing System J.18 – J.24

4x4 and 6x4 FiberRunner™ Mounting Brackets J.25 – J.27

Adapters to Other Systems J.27

4x4 FiberRunner™ Routing System J.28 – J.34

FiberRunner™ Accessories J.35 – J.36

2x2 FiberRunner™ Routing System J.38 – J.48

Wyr-Grid™ Overhead Cable Tray Routing System J.49 – J.56

**A.
Featured
Products**

**B.
Copper
Systems**

**C.
Fiber
Systems**

**D.
Faceplates,
Frames &
Surface
Mount Boxes**

**E.
Industrial
Networks**

**F.
Audio
Video
Systems**

**G.
Keystone
Cabling
Systems**

**H.
Zone
Cabling**

**J.
Cable
Routing
Systems**

**K.
Cable
Cleats**

**L.
Cabinets
& Rack
Systems**

**M.
Power &
Connectivity
Management**

**N.
Grounding
& Bonding**

**O.
Identification
Products**

**P.
Cable
Management
Accessories**

**Q.
Part
Number
Index**



A.
Featured
Products

24x4 Routing System Roadmap

B.
Copper
Systems

C.
Fiber
Systems

D.
Faceplates,
Frames &
Surface
Mount Boxes

E.
Industrial
Networks

F.
Audio
Video
Systems

G.
Keystone
Cabling
Systems

H.
Zone
Cabling

J.
Cable
Routing
Systems

K.
Cable
Cleats

L.
Cabinets
& Rack
Systems

M.
Power &
Connectivity
Management

N.
Grounding
& Bonding

O.
Identification
Products

P.
Cable
Management
Accessories

Q.
Part
Number
Index

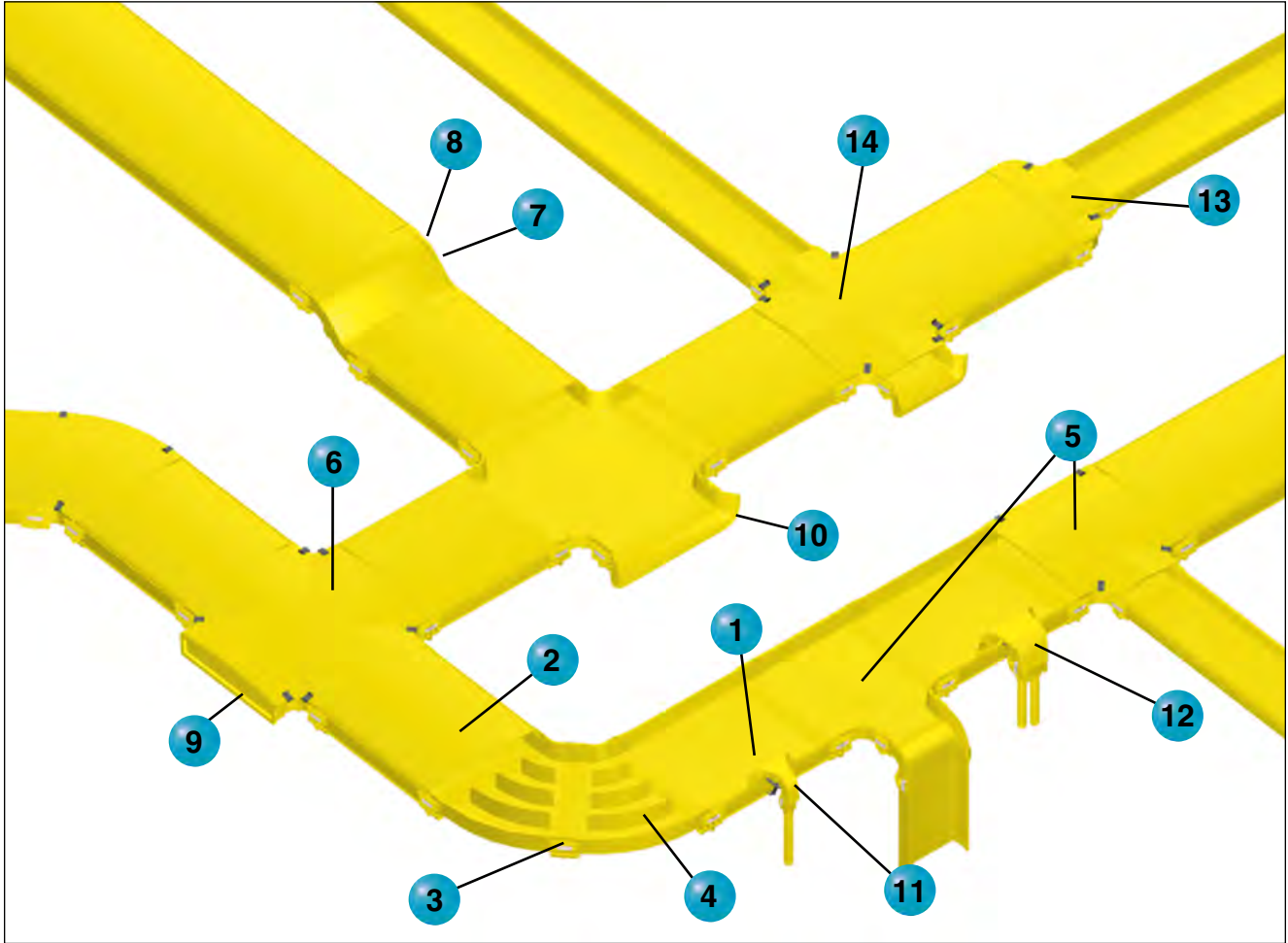

24x4 FiberRunner™ Mounting Brackets

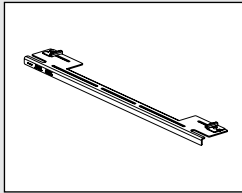

FR24TBE12 – Existing Threaded Rod QuikLock™ Bracket (page J.7)

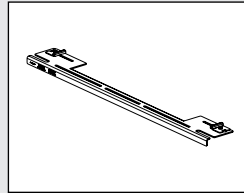

FR24TBN12 - New Threaded Rod QuikLock™ Bracket (page J.7)

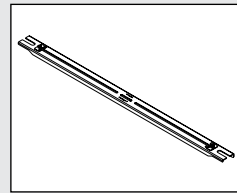

FRTBWG30BL - Wyr-Grid™ Mounting Bracket for FiberRunner™ System (page J.7)

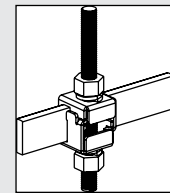

F2PCLB12 - Two-Piece Ladder Rack Bracket for Attaching Threaded Rod to 1 1/2" - 2" Ladder Rack (page J.7)

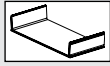

1 FR24X4**10 – 24x4 FiberRunner™ Channel (page J.4)

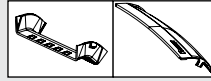

8 FROV4524X4** – 24x4 Outside Vertical 45° Angle Fitting and FROV45CV24** – Cover (page J.5)



2 FRCV24**10 – 24x4 Snap-On Cover (page J.4)



9 FREC24X4** – 24x4 End Cap Fitting (page J.5)

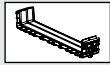

3 FRBC24X4** – 24x4 QuikLock™ Coupler (page J.4)

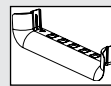

10 FRTR24X4** – 3-Sided BRC Trumpet Spillout for 24x4 Exit (page J.6)

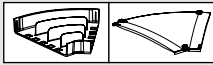

4 FRH4524X4** – 24x4 Horizontal 45° Angle Fitting and FRH45CV24** – Cover (page J.5)

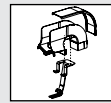

11 FRSPJ2X2** – Spill-Over Junction with 2x2 Exit (page J.6)

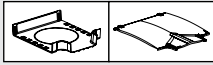

5 FRT24X4W12** – 24x4 Horizontal Tee with 12x4 Exit and FRTCVCV24W12** – Cover (page J.5)

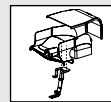

12 FRSPJ4X4** – Spill-Over Junction with 4x4 Exit (page J.6)

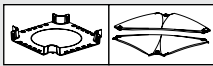

6 FRFWC24X4** – 24x4 4-Way Cross Fitting and FRFWCCV24** – Cover (page J.5)

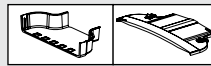

13 FRRF2412** – 24x4 to 12x4 FiberRunner™ Reducer Fitting and FRRF2412CV** – Cover (page J.6)

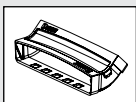

7 FRIV4524X4** – 24x4 Inside Vertical 45° Angle Fitting (page J.5)



14 FRFWC24X4W12** – 24x4 4-Way Cross Fitting with 12x4 Exits and FRFWCCV24W12** – Cover (page J.5)

A. Featured Products

B. Copper Systems

C. Fiber Systems

D. Faceplates, Frames & Surface Mount Boxes

E. Industrial Networks

F. Audio Video Systems

G. Keystone Cabling Systems

H. Zone Cabling

J. Cable Routing Systems

K. Cable Cleats

L. Cabinets & Rack Systems

M. Power & Connectivity Management

N. Grounding & Bonding

O. Identification Products

P. Cable Management Accessories

Q. Part Number Index

**Available colors: YL (Yellow), OR (Orange), and BL (Black).

A. Featured Products

24x4 FiberRunner™ Routing System

Cable Fills for 24x4 FiberRunner™ Routing System

The maximum amounts may vary according to the cable fill installation methods, straightness of cables, etc.

24x4 FiberRunner™ Cable Routing System								
Fill/Pile Up	Internal Area (in ²)	Diameter 1.6mm 0.063"	Diameter 2.0mm 0.079"	Diameter 3.0mm 0.118"	Fiber Optic Ribbon Interconnect Cable Diameter 5.20mm 0.205"	Category 6A (SD) Diameter 6.1mm 0.240"	Category 6A Diameter 7.6mm 0.300"	Category 6 Diameter 6.1mm 0.240"
40% Fill								
2" Pile Up	48.1	6174	3951	1756	583	425	272	425
3" Pile Up	72.4	9293	5947	2643	877	640	410	640
4" Pile Up	98.6	12656	8099	3600	1195	872	558	872
50% Fill								
2" Pile Up	48.1	7718	4939	2195	729	532	340	532
3" Pile Up	72.4	11616	7434	3304	1097	800	512	800
4" Pile Up	98.6	15820	10124	4500	1494	1090	697	1090
60% Fill								
2" Pile Up	48.1	9261	5927	2634	874	638	408	638
3" Pile Up	72.4	13940	8921	3965	1316	960	615	960
4" Pile Up	98.6	18984	12149	6400	1792	1308	837	1308

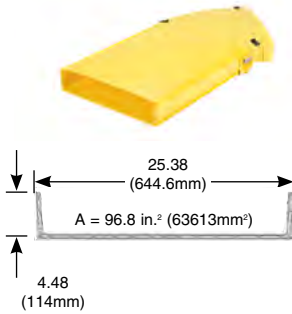

Channel cutting instructions: For optimum results, use a miter box and saw. For larger quantities use a plastic cutting saw blade for clean, burr-free cuts. Recommend: Carbide 80T and 100T; .090" thickness, .125" kerf. The above cable diameters represent the nominal Panduit cable diameter per performance level. For specific cable fill information based on specific part numbers, contact Panduit Customer Service.

B. Copper Systems

C. Fiber Systems

D. Faceplates, Frames & Surface Mount Boxes

E. Industrial Networks

F. Audio Video Systems

G. Keystone Cabling Systems

H. Zone Cabling

24x4 FiberRunner™ Routing System – Channel and Cover

- Robust, large capacity 24x4 system ideal for use with large cable counts
- Channel, covers, fittings and other non-metallic system components made from V-0 flame class rated material
- QuikLock™ Couplers and Brackets reduce system installation time dramatically
- Compatible with all sizes of Panduit™ FiberRunner™ Routing Systems, cable management, and racks

J. Cable Routing Systems

K. Cable Cleats

L. Cabinets & Rack Systems

M. Power & Connectivity Management

N. Grounding & Bonding

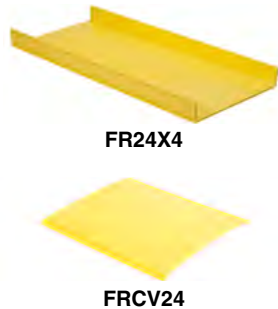

Part Number	Part Description	Std. Pkg. Qty.	Std. Ctn. Qty.
FR24X4YL10	Used to carry cables horizontally throughout the system. Use QuikLock™ Coupler FRBC24X4YL to attach channel and/or fittings.	10	20

24x4 Snap-On Cover

FRCV24YL10	Snap-on cover for channel FR24X4YL10. Supplied in four 30" long pieces.	10	—
------------	---	----	---

For other colors replace YL (Yellow) with OR (Orange) or BL (Black). Order number of feet required, in multiples of standard 10' length increments.

24x4 FiberRunner™ QuikLock™ Coupler

- Pre-assembled to provide fast mechanical assembly of components
- No tools required for installation; bolts loosen for component disassembly

Part Number	Part Description	Std. Pkg. Qty.	Std. Ctn. Qty.
FRBC24X4YL	Coupler quickly joins two sections of channel and/or fittings.	1	5

For other colors replace YL (Yellow) with OR (Orange) or BL (Black).

O. Identification Products

P. Cable Management Accessories

Q. Part Number Index



24x4 FiberRunner™ System Fittings

- Minimum 3" (76.2mm) bend radius control fittings
- Assemble using FRBC QuikLock™ Couplers
- Protect against signal loss and performance degradation



Part Number	Part Description	Couplers Required	Std. Pkg. Qty.	Std. Ctn. Qty.
24x4 Horizontal 45° Angle Fitting				
FRH4524X4YL	Attaches to 24x4 channel and/or fittings to create a 45° horizontal turn from a straight horizontal run.	(2 pcs.) FRBC24X4YL	1	—
Cover for 24x4 Horizontal 45° Angle Fitting				
FRH45CV24YL	Cover for the horizontal 45° angle fitting FRH4524X4YL.	—	1	—
24x4 Horizontal Tee with 12x4 Exit				
FRT24X4W12YL	Attaches to 24x4 channel and/or fittings to create a 90° horizontal branch with a 12x4 exit from straight horizontal run. Accepts split cover FRTCV24W12YL.	(2 pcs.) FRBC24X4YL (1 pc.) FRBC12X4YL	1	—
Cover for 24x4 Horizontal Tee with 12x4 Exit				
FRTCV24W12YL	Cover for the horizontal tee fitting FRT24X4W12YL.	—	1	—
24x4 Four-Way Cross Fitting				
FRFWC24X4YL	Attaches to 24x4 channel and/or fittings to create a horizontal four-way cross intersection with two 24x4 exits. Accepts split cover FRFWCCV24YL.	(4 pcs.) FRBC24X4YL	1	—
24x4 FiberRunner™ Four-Way Cross Cover				
FRFWCCV24YL	Cover for the four-way cross fitting FRFWC24X4YL.	—	1	—
24x4 Four-Way Cross Fitting with 12x4 Exits				
FRFWC24X4W12YL	Attaches to a 24x4 channel and/or fittings to create a horizontal four-way cross intersection with two 12x4 exits. Accepts split cover FRFWCCV24W12YL.	(2 pcs.) FRBC24X4YL (2 pcs.) FRBC12X4YL	1	—
Cover for 24x4 Four-Way Cross Fitting with 12x4 Exits				
FRFWCCV24W12YL	Cover for the four-way cross fitting FRFWC24X4W12YL.	—	1	—
24x4 End Cap Fitting				
FREC24X4YL	Used for closing off open ends of the channel or fittings.	—	1	5
24x4 Inside Vertical 45° Fitting and Cover				
FRIV4524X4YL	Attaches to 24x4 channel and/or fittings to create a 45° upward angle from a straight horizontal run. Used with outside vertical 45° angle fitting FROV4524X4YL to change level of a straight horizontal run. Includes cover.	(2 pcs.) FRBC24X4YL	1	—
24x4 Outside Vertical 45° Fitting				
FROV4524X4YL	Attaches to 24x4 channel and/or fittings to create a 45° downward angle from a straight horizontal run. Used with inside vertical 45° angle fitting FRIV4524X4YL to change level of a horizontal run.	(2 pcs.) FRBC24X4YL	1	—
Cover for 24x4 Outside Vertical 45° Angle Fitting				
FROV45CV24YL	Cover for the outside vertical 45° angle fitting FROV4524X4YL.	—	1	—

For other colors replace YL (Yellow) with OR (Orange) or BL (Black).

Continued on next page

A.
Featured
Products

B.
Copper
Systems

C.
Fiber
Systems

D.
Faceplates,
Frames &
Surface
Mount Boxes

E.
Industrial
Networks

F.
Audio
Video
Systems

G.
Keystone
Cabling
Systems

H.
Zone
Cabling

J.
Cable
Routing
Systems

K.
Cable
Cleats

L.
Cabinets
& Rack
Systems

M.
Power &
Connectivity
Management

N.
Grounding
& Bonding

O.
Identification
Products

P.
Cable
Management
Accessories

Q.
Part
Number
Index

A.
Featured
Products

24x4 FiberRunner™ System Fittings (continued)

B.
Copper
Systems



FRRF2412

C.
Fiber
Systems



FRRF2412CVL

D.
Faceplates,
Frames &
Surface
Mount Boxes

E.
Industrial
Networks

F.
Audio
Video
Systems

G.
Keystone
Cabling
Systems

H.
Zone
Cabling

J.
Cable
Routing
Systems

K.
Cable
Cleats

L.
Cabinets
& Rack
Systems

M.
Power &
Connectivity
Management

N.
Grounding
& Bonding

O.
Identification
Products

P.
Cable
Management
Accessories

Q.
Part
Number
Index

Part Number	Part Description	Couplers Required	Std. Pkg. Qty.	Std. Ctn. Qty.
Reducer from 24x4 to 12x4 FiberRunner™ Fitting or Channel				
FRRF2412YL	Attaches any 24x4 FiberRunner™ Fitting or Channel to any 12x4 FiberRunner™ Fitting or Channel.	(1 pc.) FRBC24X4YL (1 pc.) FRBC12X4YL	1	—
Cover for 24x4 to 12x4 FiberRunner™ Reducer Fitting				
FRRF2412CVYL	Cover for the reducer fitting FRRF2412YL.	—	1	—

For other colors replace YL (Yellow) with OR (Orange) or BL (Black).

24x4 FiberRunner™ System Spillouts

- Spill-overs allow safe transition from horizontal to vertical runs
- 2" (50.8mm) bend radius control
- Transition to channel, slotted channel, and corrugated loom tubing
- Spill-over junction fittings can be retro-fitted to existing horizontal runs



FRSPJ2X2



FTR2X2



FRSPJ4X4



FRTR4X4

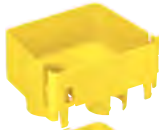

FRIDT4X4



FRTR24X4

Part Number	Part Description	Couplers Required	Std. Pkg. Qty.	Std. Ctn. Qty.
Spill-Over Junction with 2x2 Exit				
FRSPJ2X2YL	Assembles onto 4x4, 6x4, 12x4, or 24x4 FiberRunner™ Channel, spilling over the side into a 2x2 vertical exit. Requires coupler to attach 2x2 FiberRunner™ Channel and Fittings to the vertical exit.	(1 pc.) FBC2X2YL	1	—
3-Sided BRC Trumpet Spillout for 2x2 Exit				
FTR2X2YL	Used to limit the bend radius of the cable to 2" (50.8mm) when exiting from a spill-over junction with a 2x2 exit or from 2x2 channel.	(1 pc.) FBC2X2YL	1	5
Spill-Over Junction with 4x4 Exit				
FRSPJ4X4YL	Assembles onto 4x4, 6x4, 12x4, or 24x4 FiberRunner™ Channel, spilling over the side into a 4x4 vertical exit. Requires coupler to attach 4x4 FiberRunner™ Channel and fittings to the vertical exit.	(1 pc.) FRBC4X4YL	1	—
3-Sided BRC Trumpet Spillout for 4x4 FiberRunner™ Exit				
FRTR4X4YL	Used to limit the bend radius of the cable to 2" (50.8mm) when exiting from 4x4 FiberRunner™ Channel or a 4x4 FiberRunner™ Horizontal Tee.	(1 pc.) FRBC4X4YL	1	5
2-Port Spillout to 1.5" (38mm) Inside Diameter Corrugated Tubing				
FRIDT4X4YL	Used to route cable into one or two pieces of 1.5" (38mm) diameter split corrugated tubing. Requires coupler to be used with 4x4 FiberRunner™ Fitting. Used with any 4x4 FiberRunner™ Fitting.	(1 pc.) FRBC4X4YL	1	—
3-Sided BRC Trumpet Spillout for 24x4 Exit				
FRTR24X4YL	Used to limit the bend radius of the cable to 3" (76.2mm) when exiting from the 24x4 channel or a 24x4 horizontal tee.	(1 pc.) FRBC24X4YL	1	5

For other colors replace YL (Yellow) with OR (Orange), BL (Black), or LG (Light Gray).

24x4 FiberRunner™ Mounting Brackets



FR24TBE12
FR24TBE12M



FR24TBN12
FR24TBN12M



FRTBWG30BL



F2PCLB12

Part Number	Part Description	For Threaded Rod Size	Std. Pkg. Qty.	Std. Ctn. Qty.
Existing Threaded Rod QuikLock™ Mounting Bracket for 24x4 System				
FR24TBE12	Used to support the 24x4 system by spanning two 1/2" existing threaded rod drops.	1/2"	1	—
FR24TBE12M		12mm		
New Threaded Rod QuikLock™ Mounting Bracket for 24x4 System				
FR24TBN12	Used to support the 24x4 system from new threaded rod installations.	1/2"	1	—
FR24TBN12M		12mm		
Wyr-Grid™ Mounting Bracket for FiberRunner™ System				
FRTBWG30BL	FiberRunner™ QuikLock™ Threaded Rod Trapeze Bracket for Wyr-Grid™ Pathway 30" (762mm) width. Used to support FiberRunner™ 4x4, 6x4, 12x4, and 24x4 Channel above or below the Wyr-Grid™ 30" Pathway using the same 1/2" or 12mm threaded rod used to support the WGTB30BL bracket. Quick mount clips, FRQMC24-X are not included for installing the 24x4 channel.	1/2" 12mm	1	10
FiberRunner™ Quick Mount Clips				
FRQMC24-X	Used whenever a FiberRunner™ 24x4 Channel is installed on the FiberRunner™ Trapeze Bracket, FRTBWG30BL for 30" Wyr-Grid™ Pathway. For use with FiberRunner™ 24x4 Channel only.	—	10	50
Two-Piece Ladder Rack Bracket for Attaching Threaded Rod to 1 1/2" – 2" Ladder Rack				
F2PCLB12	Two-piece bracket attaches to 3/8" (9.5mm) wide x 1 1/2" (38.1mm) or 3/8" (9.5mm) wide x 2" (50.8mm) ladder rack rail.	1/2"	1	10

A. Featured Products

B. Copper Systems

C. Fiber Systems

D. Faceplates, Frames & Surface Mount Boxes

E. Industrial Networks

F. Audio Video Systems

G. Keystone Cabling Systems

H. Zone Cabling

J. Cable Routing Systems

K. Cable Cleats

L. Cabinets & Rack Systems

M. Power & Connectivity Management

N. Grounding & Bonding

O. Identification Products

P. Cable Management Accessories

Q. Part Number Index

A.
Featured
Products

12x4 Routing System Roadmap

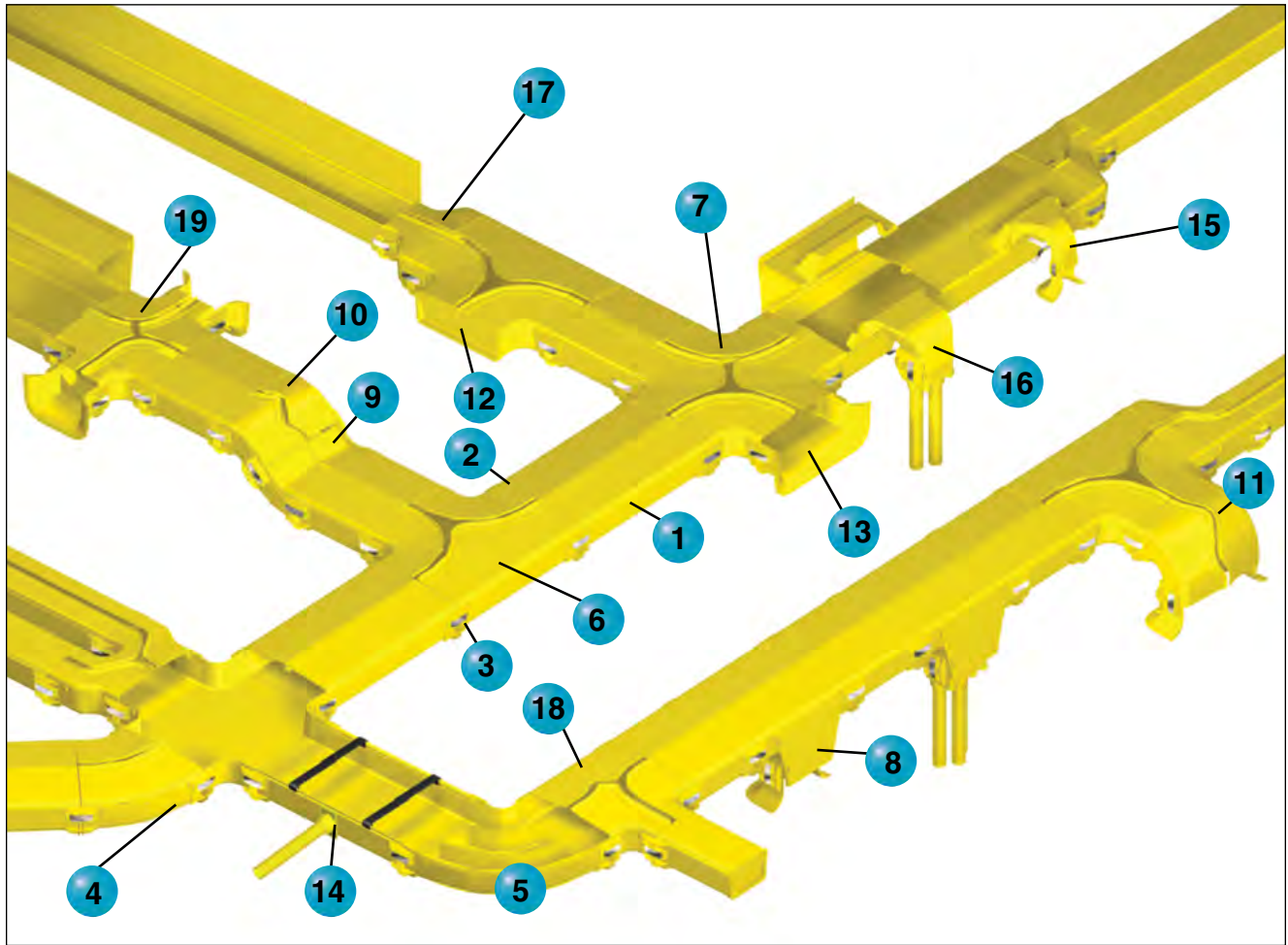

B.
Copper
Systems

C.
Fiber
Systems

D.
Faceplates,
Frames &
Surface
Mount Boxes

E.
Industrial
Networks

F.
Audio
Video
Systems

G.
Keystone
Cabling
Systems

H.
Zone
Cabling

J.
Cable
Routing
Systems

K.
Cable
Cleats

12x4 FiberRunner™ Mounting Brackets

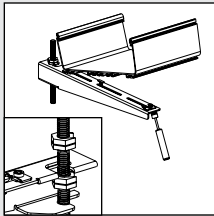

FR12TRBE58 – Existing Threaded Rod QuikLock™ Bracket (page J.15)

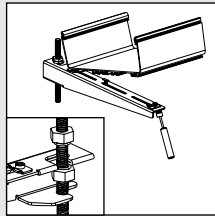

FR12TRBN58 – New Threaded Rod QuikLock™ Bracket (page J.15)

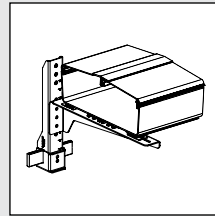

FR12ALB – Adjustable Ladder QuikLock™ Bracket (page J.15)

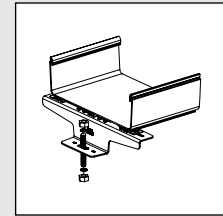

FR12CS58 – Center Support QuikLock™ Bracket (page J.15)

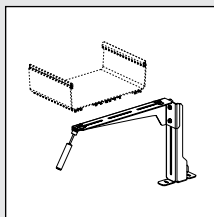

FR12ACAB – Adjustable Cabinet QuikLock™ Bracket (page J.17)

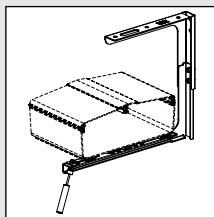

FR12ACB58 – Top Support Adjustable “C” QuikLock™ Bracket (page J.16)

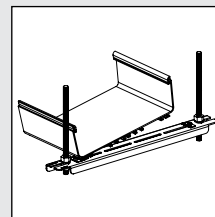

FR12TB58 – Trapeze QuikLock™ Bracket (page J.16)

L.
Cabinets
& Rack
Systems











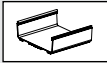

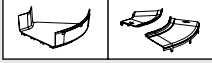
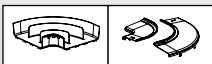
M.
Power &
Connectivity
Management

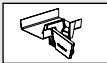
N.
Grounding
& Bonding

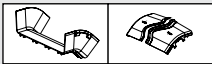
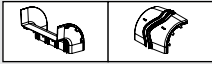
O.
Identification
Products

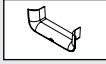
P.
Cable
Management
Accessories

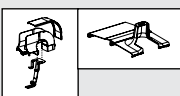
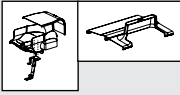
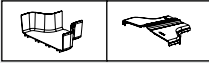
Q.
Part
Number
Index

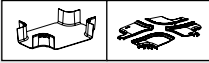
- | | |
|--|---|
| <p> 1 FR12X4**6 – 12x4 FiberRunner™ Channel (page J.10)</p> <p> 2 FRHC12**6 – 12x4 Snap-On Hinged Cover (page J.10)</p> <p> 3 FRBC12X4** – 12x4 QuikLock™ Coupler (page J.11)</p> <p> 4 FRH4512X4** – 12x4 Horizontal 45° Angle Fitting and FRH45SC12** – Split Cover (page J.11)</p> <p> 5 FRRA12X4** – 12x4 Horizontal Right Angle Fitting and FRRASC12** – Split Cover (page J.11)</p> <p> 6 FRT12X4** – 12x4 Horizontal Tee Fitting and FRTSC12** – Split Cover (page J.11 and J.12)</p> <p> 7 FRFWC12X4** – 12x4 4-Way Cross Fitting and FRFWCSC12** – Split Cover (page J.12)</p> <p> 8 FRVT12X4** – 12x4 Vertical Tee (page J.14)</p> <p> 9 FRIV4512X4** – 12x4 Inside Vertical 45° Angle Fitting (page J.13)</p> <p> 10 FROV4512X4** – 12x4 Outside Vertical 45° Angle Fitting and FROV45SC12** – Split Cover (page J.13)</p> <p> 11 FROVRA12X4** – 12x4 Outside Vertical Right Angle Fitting and FROVRASC12** – Split Cover (page J.13)</p> | <p> 12 FREC12X4** – 12x4 End Cap Fitting (page J.13)</p> <p> 13 FRTR12X4** – 3-Sided BRC Trumpet Spillover for 12x4 Exit (page J.15)</p> <p> 14 FR1.5IDE** – 1-Port Spillover Side Exit to 1.5" (38mm) Inside Diameter Corrugated Tubing (page J.35)</p> <p> 15 FRSPJ2X2** – Spill-Over Junction with 2x2 Exit and FRSPJC212** – Cover for 12x4 System (page J.14)</p> <p> 16 FRSPJ4X4** – Spill-Over Junction with 4x4 Exit and FRSPJC412** – Cover for 12x4 System (page J.24)</p> <p> 17 FRRF126** – 12x4 to 6x4 FiberRunner™ Reducer Fitting and FRRF126SC** – Split Cover (page J.13)</p> <p> 18 FRT12X4W6** – 12x4 Horizontal Tee with 6x4 Exit and FRTSC12W6** – Split Cover (page J.12)</p> <p> 19 FRFWC12X4W6** – 12x4 4-Way Cross Fitting with 6x4 Exits and FRFWCSC12W6** – Split Cover (page J.12)</p> |
|--|---|

**Available colors: YL (Yellow), OR (Orange), and BL (Black).

A.
Featured
Products

B.
Copper
Systems

C.
Fiber
Systems

D.
Faceplates,
Frames &
Surface
Mount Boxes

E.
Industrial
Networks

F.
Audio
Video
Systems

G.
Keystone
Cabling
Systems

H.
Zone
Cabling

J.
Cable
Routing
Systems

K.
Cable
Cleats

L.
Cabinets
& Rack
Systems

M.
Power &
Connectivity
Management

N.
Grounding
& Bonding

O.
Identification
Products

P.
Cable
Management
Accessories

Q.
Part
Number
Index

- A. Featured Products
- B. Copper Systems
- C. Fiber Systems
- D. Faceplates, Frames & Surface Mount Boxes
- E. Industrial Networks
- F. Audio Video Systems
- G. Keystone Cabling Systems
- H. Zone Cabling
- J. Cable Routing Systems
- K. Cable Cleats
- L. Cabinets & Rack Systems
- M. Power & Connectivity Management
- N. Grounding & Bonding
- O. Identification Products
- P. Cable Management Accessories
- Q. Part Number Index



12x4 FiberRunner™ Routing System

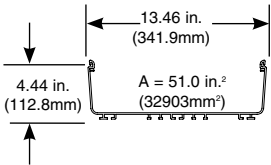

Cable Fills for 12x4 FiberRunner™ Routing System

The maximum amounts may vary according to the cable fill installation methods, straightness of cables, etc.

12x4 FiberRunner™ Cable Routing System								
Fill/Pile Up	Internal Area (in ²)	Diameter 1.6mm 0.063"	Diameter 2.0mm 0.079"	Diameter 3.0mm 0.118"	Fiber Optic Ribbon Interconnect Cable Diameter 5.20mm 0.205"	Category 6A (SD) Diameter 6.1mm 0.240"	Category 6A Diameter 7.6mm 0.300"	Category 6 Diameter 6.1mm 0.240"
40% Fill								
2" Pile Up	25.7	3299	2111	938	311	227	147	209
3" Pile Up	38.8	4980	3187	1417	470	343	223	316
4" Pile Up	51	6546	4189	1862	618	451	292	416
50% Fill								
2" Pile Up	25.7	4124	2639	1173	389	284	184	262
3" Pile Up	38.8	6225	3984	1771	588	429	278	395
4" Pile Up	51	8183	5237	2327	773	564	366	519
60% Fill								
2" Pile Up	25.7	4948	3167	1407	467	341	221	314
3" Pile Up	38.8	7470	4781	2125	705	515	334	474
4" Pile Up	51	9819	6284	2793	927	676	439	623

Channel cutting instructions: For optimum results, use a miter box and saw. For larger quantities use a plastic cutting saw blade for clean, burr-free cuts. Recommend: Carbide 80T and 100T; .090" thickness, .125" kerf.

The above cable diameters represent the nominal Panduit cable diameter per performance level. For specific cable fill information based on specific part numbers, contact Panduit Customer Service.

12x4 FiberRunner™ Routing System – Channel and Cover

- Robust, large capacity 12x4 system ideal for use with large cable counts
- Multiple spillover options provide versatility to mate to various equipment and rack configurations
- QuikLock™ Couplers and Brackets reduce system installation time dramatically
- Channel, covers, fittings and other non-metallic system components made from V-0 flame class rated material
- Compatible with all sizes of Panduit™ FiberRunner™ Routing Systems, cable management, and racks
- Compliant with the applicable tests in Telcordia GR-63-CORE Network Equipment Building Systems (NEBS) Level 3



FR12X4



FRHC12

Part Number	Part Description	Std. Pkg. Qty.	Std. Ctn. Qty.
12x4 FiberRunner™ Channel			
FR12X4YL6	Used to carry the cables horizontally throughout the system. Accepts cable retainers FRCR12BL-X or hinged cover FRHC12YL6. Use QuikLock™ Coupler FRBC12X4YL to attach channel and/or fittings.	6	12
12x4 Snap-On Hinged Cover			
FRHC12YL6	Snap-on hinged cover for channel FR12X4YL6.	6	12

For other colors replace YL (Yellow) with OR (Orange) or BL (Black). Order number of feet required, in multiples of standard 6' length increments.

12x4 FiberRunner™ QuikLock™ Coupler

- Pre-assembled to provide fast mechanical assembly of components
- No tools required for installation; bolts loosen for component disassembly



Part Number	Part Description	Std. Pkg. Qty.	Std. Ctn. Qty.
FRBC12X4YL	Coupler quickly joins two sections of channel and/or fittings.	1	5

For a bulk package of 10 couplers, order FRBC12X4YL-X.
For other colors replace YL (Yellow) with OR (Orange) or BL (Black).

12x4 FiberRunner™ System Fittings

- Minimum 2" (50.8mm) bend radius control fittings
- Protect against signal loss and performance degradation
- Assemble using FRBC QuikLock™ Couplers
- Split covers snap onto each fitting
- Covers feature 3/4" (19mm) gap to allow cable to be laid in



FRRA12X4



FRRASC12



FRH4512X4



FRH45SC12

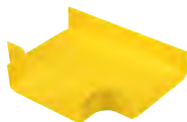

FRT12X4

Part Number	Part Description	Couplers Required	Std. Pkg. Qty.	Std. Ctn. Qty.
12x4 Horizontal Right Angle Fitting				
FRRA12X4YL	Attaches to 12x4 channel and/or fitting to create a 90° horizontal turn from a straight horizontal run. Accepts split cover FRRASC12YL.	(2 pcs.) FRBC12X4YL	1	—
Split Cover for 12x4 Horizontal Right Angle Fitting				
FRRASC12YL	Split cover for the horizontal right angle fitting FRRA12X4YL.	—	1	5
12x4 Horizontal 45° Angle Fitting				
FRH4512X4YL	Attaches to 12x4 channel and/or fitting to create a 45° horizontal turn from a straight horizontal run. Accepts split cover FRH45SC12YL.	—	1	—
Split Cover for 12x4 Horizontal 45° Angle Fitting				
FRH45SC12YL	Split cover for the horizontal 45° angle fitting FRH4512X4YL.	—	1	5
12x4 Horizontal Tee Fitting				
FRT12X4YL	Attaches to 12x4 channel and/or fittings to create a 90° horizontal branch with a 12x4 exit from straight horizontal run. Accepts split cover FRTSC12YL.	(3 pcs.) FRBC12X4YL	1	—

For other colors replace YL (Yellow) with OR (Orange) or BL (Black).

A. Featured Products

B. Copper Systems

C. Fiber Systems

D. Faceplates, Frames & Surface Mount Boxes

E. Industrial Networks

F. Audio Video Systems

G. Keystone Cabling Systems

H. Zone Cabling

J. Cable Routing Systems

K. Cable Cleats

L. Cabinets & Rack Systems

M. Power & Connectivity Management

N. Grounding & Bonding

O. Identification Products

P. Cable Management Accessories

Q. Part Number Index

Continued on next page

A. Featured Products
B. Copper Systems
C. Fiber Systems
D. Faceplates, Frames & Surface Mount Boxes
E. Industrial Networks
F. Audio Video Systems
G. Keystone Cabling Systems
H. Zone Cabling
J. Cable Routing Systems
K. Cable Cleats
L. Cabinets & Rack Systems
M. Power & Connectivity Management
N. Grounding & Bonding
O. Identification Products
P. Cable Management Accessories
Q. Part Number Index

12x4 FiberRunner™ System Fittings (continued)



Part Number	Part Description	Couplers Required	Std. Pkg. Qty.	Std. Ctn. Qty.
Split Cover for 12x4 Horizontal Tee Fitting				
FRTSC12YL	Split cover for the horizontal tee fitting FRT12X4YL. Snap-on feature allows cover to be installed and removed with no tools required. Creates radiused 3/4" (19mm) opening for easy access to add or remove cables.	—	1	5
12x4 Horizontal Tee with 6x4 Exit				
FRT12X4W6YL	Attaches to 12x4 channel and/or fittings to create a 90° horizontal branch with a 6x4 exit from straight horizontal run. Accepts split cover FRTSC12W6YL.	(2 pcs.) FRBC12X4YL (1 pc.) FRBC6X4YL	1	—
Split Cover for 12x4 Horizontal Tee with 6x4 Exit				
FRTSC12W6YL	Split cover for the horizontal tee with 6x4 exit fitting FRT12X4W6YL. Snap-on feature allows cover to be installed and removed without tools. Creates radiused 3/4" (19mm) opening for easy access to add or remove cables.	—	1	5
12x4 Horizontal Tee with 4x4 Exit				
FRT12X4W4YL	Attaches to 12x4 channel and/or fittings to create a 90° horizontal branch with a 4x4 exit from straight horizontal run. Accepts split cover FRTSC12W4YL.	(2 pcs.) FRBC12X4YL (1 pc.) FRBC4X4YL	1	—
Split Cover for 12x4 Horizontal Tee with 4x4 Exit				
FRTSC12W4YL	Split Cover, Horizontal Tee with 4x4 exit.	—	1	5
12x4 Four-Way Cross Fitting				
FRFWC12X4YL	Attaches to 12x4 channel and/or fitting to create a horizontal four-way cross intersection with two 12x4 exits.	—	1	—
Split Cover for 12x4 Four-Way Cross				
FRFWCSC12YL	Split cover for the four-way cross fitting FRFWC12X4YL.	—	1	—
12x4 Four-Way Cross Fitting with 6x4 Exits				
FRFWC12X4W6YL	Attaches to 12x4 channel and/or fittings to create a horizontal four-way cross intersection with two 6x4 exits. Accepts split cover FRFWCSC12W6YL.	(2 pcs.) FRBC12X4YL (2 pcs.) FRBC6X4YL	1	—
Split Cover for 12x4 Four-Way Cross Fitting with 6x4 Exits				
FRFWCSC12W6YL	Split cover for the four-way cross fitting FRFWC12X4W6YL. Snap-on feature allows cover to be installed and removed with no tools required. Creates radiused 3/4" (19mm) opening for easy access to add or remove cables.	—	1	5
12x4 Four-Way Cross Fitting with 4x4 Exits				
FRFWC12X4W4YL	Attaches to 12x4 channel and/or fittings to create a horizontal four-way cross intersection with two 4x4 exits.	(2 pcs.) FRBC12X4YL (2 pcs.) FRBC4X4YL	1	—
Split Cover for 12x4 Four-Way Cross with 4x4 Exit				
FRFWCSC12W4YL	Split cover for the four-way cross fitting FRFWC12X4W4YL.	—	1	5

For other colors replace YL (Yellow) with OR (Orange) or BL (Black).

Continued on next page

12x4 FiberRunner™ System Fittings (continued)



FRFWCSC12W4



FREC12X4



FRIV4512X4



FROV4512X4



FROV45SC12



FROVRA12X4



FROVRASC12



FRRF126



FRRF126SC

Part Number	Part Description	Couplers Required	Std. Pkg. Qty.	Std. Ctn. Qty.
Split Cover for 12x4 Four Way Cross Fitting with 6x4 Exits				
FRFWCSC12W4YL	Split cover for the four-way cross fitting FRFWC12X4W4YL.	—	1	5
12x4 End Cap Fitting				
FREC12X4YL	Used for closing off open ends of the channel or fittings.	—	1	5
12x4 Inside Vertical 45° Angle Fitting				
FRIV4512X4YL	Attaches to 12x4 channel and/or fitting to create a 45° upward angle from a straight horizontal run. Used with outside vertical 45° angle fitting FROV4512X4YL to change level of a straight horizontal run. Includes split cover.	(2 pcs.) FRBC12X4YL	1	—
12x4 Outside Vertical 45° Angle Fitting				
FROV4512X4YL	Attaches to 12x4 channel and/or fitting to create a 45° downward angle from a straight horizontal run. Used with inside vertical 45° angle fitting FRIV4512X4YL to change level of a horizontal run. Accepts split cover FROV45SC12YL.	(2 pcs.) FRBC12X4YL	1	—
Split Cover for 12x4 Outside Vertical 45° Angle Fitting				
FROV45SC12YL	Split cover for the outside vertical 45° angle fitting FROV4512X4YL.	—	1	5
12x4 Outside Vertical Right Angle Fitting				
FROVRA12X4YL	Attaches to 12x4 channel and/or fitting to create a 90° vertical turn down from a straight horizontal run. Accepts split cover FROVRASC12YL.	(2 pcs.) FRBC12X4YL	1	—
12x4 Outside Vertical Right Angle Cover				
FROVRASC12YL	Split cover for the outside vertical right angle fitting FROVRA12X4YL.	—	1	5
12x4 to 6x4 FiberRunner™ Reducer Fitting				
FRRF126YL	Attaches any 12x4 FiberRunner™ Fitting or Channel to any 6x4 FiberRunner™ Fitting or Channel. Accepts split cover FRRF126SCYL.	(1 pc.) FRBC12X4YL (1 pc.) FRBC6X4YL	1	—
Split Cover for 12x4 to 6x4 FiberRunner™ Reducer Fitting				
FRRF126SCYL	Split cover for the reducer fitting FRRF126YL.	—	1	5

For other colors replace YL (Yellow) with OR (Orange) or BL (Black).

A. Featured Products

B. Copper Systems

C. Fiber Systems

D. Faceplates, Frames & Surface Mount Boxes

E. Industrial Networks

F. Audio Video Systems

G. Keystone Cabling Systems

H. Zone Cabling

J. Cable Routing Systems

K. Cable Cleats

L. Cabinets & Rack Systems

M. Power & Connectivity Management

N. Grounding & Bonding

O. Identification Products

P. Cable Management Accessories

Q. Part Number Index

A. Featured Products

B. Copper Systems

C. Fiber Systems

D. Faceplates, Frames & Surface Mount Boxes

E. Industrial Networks

F. Audio Video Systems

G. Keystone Cabling Systems

H. Zone Cabling

J. Cable Routing Systems

K. Cable Cleats

L. Cabinets & Rack Systems

M. Power & Connectivity Management

N. Grounding & Bonding

O. Identification Products

P. Cable Management Accessories

Q. Part Number Index

12x4 FiberRunner™ System Spillouts

- Spill-overs allow safe transition from horizontal to vertical runs
- 2" (50.8mm) bend radius control
- Transition to channel, slotted channel, and corrugated loom tubing
- Spill-over junction fittings can be retro-fitted to existing horizontal runs



FRVT12X4



FRTR6X4



FRIDT6X4



FRSPJ2X2



FRSPJC212



FTR2X2



FRSPJ4X4



FRSPJC412

Part Number	Part Description	Couplers Required	Std. Pkg. Qty.	Std. Ctn. Qty.
-------------	------------------	-------------------	----------------	----------------

12x4 Vertical Tee

FRVT12X4YL	Attaches to 12x4 channel and/or fittings to create a 90° vertical drop from a horizontal run. Hinged door included. Accepts snap-on cover FRHC12YL6 in conjunction with channel.	(2 pcs.) FRBC12X4YL (1 pc.) FRBC6X4YL	1	—
------------	--	--	---	---

3-Sided BRC Trumpet Spillout for 6x4 Exit

FRTR6X4YL	Used to limit the bend radius of the cable to 2" (50.8mm) when exiting from 6x4 channel, 6x4 horizontal tee fitting, or 6x4 exit on 12x4 vertical tee.	(1 pc.) FRBC6X4YL	1	5
-----------	--	----------------------	---	---

3-Port Spillout to 1.5" (38mm) Inside Diameter Corrugated Tubing

FRIDT6X4YL	Used to route cable into three separate pieces of 1.5" (38mm) diameter split corrugated tubing. Used with FRVT12X4YL or any 6x4 fitting.	(1 pc.) FRBC6X4YL	1	5
------------	--	----------------------	---	---

Spill-Over Junction with 2x2 Exit

FRSPJ2X2YL	Assembles onto 4x4, 6x4, 12x4, or 24x4 FiberRunner™ Channel, spilling over the side into a 2x2 vertical exit. Requires coupler to attach 2x2 FiberRunner™ Channel and Fittings to the vertical exit.	(1 pc.) FBC2X2YL	1	—
------------	--	---------------------	---	---

Cover for Spill-Over Junction with 2x2 Exit for 12x4 Channel

FRSPJC212YL	Used to fully enclose 12x4 channel in conjunction with the spill-over junction FRSPJ2X2YL.	—	1	5
-------------	--	---	---	---

3-Sided BRC Trumpet Spillout for 2x2 Exit

FTR2X2YL	Used to limit the bend radius of the cable to 2" (50.8mm) when exiting from a spill-over junction with a 2x2 exit or from 2x2 channel.	(1 pc.) FBC2X2YL	1	5
----------	--	---------------------	---	---

Spill-Over Junction with 4x4 Exit

FRSPJ4X4YL	Assembles onto 4x4, 6x4, 12x4, or 24x4 FiberRunner™ Channel, spilling over the side into a 4x4 vertical exit. Requires coupler to attach 4x4 FiberRunner™ Channel and fittings to the vertical exit.	(1 pc.) FRBC4X4YL	1	—
------------	--	----------------------	---	---

Cover for Spill-Over Junction with 4x4 Exit for 12x4 Channel

FRSPJC412YL	Used to fully enclose 12x4 channel in conjunction with the spill-over junction FRSPJ4X4YL.	—	1	5
-------------	--	---	---	---

For other colors replace YL (Yellow) with OR (Orange) or BL (Black).

Continued on next page

12x4 FiberRunner™ System Spillouts (continued)



FRTR4X4



FRIDT4X4



FRIDT4X4



FRTR12X4

Part Number	Part Description	Couplers Required	Std. Pkg. Qty.	Std. Ctn. Qty.
3-Sided BRC Trumpet Spillout for 4x4 FiberRunner™ Exit				
FRTR4X4YL	Used to limit the bend radius of the cable to 2" (50.8mm) when exiting from 4x4 FiberRunner™ Channel or a 4x4 FiberRunner™ Horizontal Tee.	(1 pc.) FRBC4X4YL	1	5
2-Port Spillout to 1.5" (38mm) Inside Diameter Corrugated Tubing				
FRIDT4X4YL	Used to route cable into one or two pieces of 1.5" (38mm) diameter split corrugated tubing.	(1 pc.) FRBC4X4YL	1	5
3-Sided BRC Trumpet Spillout for 12x4 Exit				
FRTR12X4YL	Used to limit the bend radius of the cable to 2" (50.8mm) when exiting from the 12x4 channel or a 12x4 horizontal tee.	(1 pc.) FRBC12X4YL	1	5

For other colors replace YL (Yellow) with OR (Orange) or BL (Black).

12x4 FiberRunner™ Mounting Brackets



FR12TRBE58
FR12TRBE58M



FR12TRBN58
FR12TRBN58M



FR12ALB



FR12CS12
FR12CS58
FR12CS12M
FR12CS58M

Part Number	Part Description	For Threaded Rod Size	Std. Pkg. Qty.	Std. Ctn. Qty.
Existing Threaded Rod QuikLock™ Bracket for 12x4 System				
FR12TRBE58	Used to support the 12x4 system from existing threaded rod installations.	5/8"	1	—
FR12TRBE58M		16mm		
New Threaded Rod QuikLock™ Bracket for 12x4 System				
FR12TRBN58	Used to support the 12x4 system from new threaded rod installations. Bracket is secured to threaded rod with two nuts. The pre-assembled slide clamps enable fast assembly to channel. Use 7/16" nut driver on slide clamps.	5/8"	1	—
FR12TRBN58M		16mm		
Ladder Rack Bracket for 12x4 System				
FR12ALB	Used to support the 12x4 system by attaching to any 3/8" (9.5mm) x 1 1/2" (38.1mm) or 3/8" (9.5mm) x 2" (50.8mm) ladder rack rail. Adjustable to nine incremental positions from 4" (101mm) to 12" (305mm) above or below the ladder rack. No threaded rod required.	—	1	—
Center Support QuikLock™ Bracket for 12x4 System				
FR12CS12	Used to support the 12x4 system from below with new threaded rod.	1/2"	1	—
FR12CS58		5/8"		
FR12CS12M		12mm		
FR12CS58M		16mm		

Continued on next page

A. Featured Products

12x4 FiberRunner™ Mounting Brackets (continued)

B. Copper Systems



FR12ACB12
FR12ACB58
FR12ACB12M
FR12ACB58M

C. Fiber Systems

D. Faceplates, Frames & Surface Mount Boxes

E. Industrial Networks



FR12TB12
FR12TB58
FR12TB12M
FR12TB58M

F. Audio Video Systems

G. Keystone Cabling Systems



FRTBWG18BL

H. Zone Cabling

J. Cable Routing Systems



FRTBWG24BL

K. Cable Cleats

L. Cabinets & Rack Systems



FRTBWG30BL

M. Power & Connectivity Management



FR12TB2412
FR12TB2412M

N. Grounding & Bonding

O. Identification Products

P. Cable Management Accessories

Q. Part Number Index

Part Number	Part Description	For Threaded Rod Size	Std. Pkg. Qty.	Std. Ctn. Qty.
-------------	------------------	-----------------------	----------------	----------------

Top Support Adjustable "C" QuikLock™ Bracket for 12x4 System

FR12ACB12	Used to support the 12x4 system from any new threaded rod extending down directly from the ceiling, grid, or ladder rack system. Two position height adjustments to accommodate system with or without hinged cover. Bracket is secured to threaded rod with two nuts. The pre-assembled slide clamps enable fast assembly to channel. Use 7/16" nut driver on slide clamps.	1/2"	1	—
FR12ACB58		5/8"		
FR12ACB12M		12mm		
FR12ACB58M		16mm		

Trapeze QuikLock™ Bracket for 12x4 System

FR12TB12	Used to support the 12x4 system by spanning two threaded rod drops that are 18" apart. Can be installed from above or below. Bracket is secured to each threaded rod with two nuts. The pre-assembled slide clamps enable fast assembly to channel. Use 7/16" nut driver on slide clamps.	1/2"	1	—
FR12TB58		5/8"		
FR12TB12M		12mm		
FR12TB58M		16mm		

Wyr-Grid™ Mounting Brackets for FiberRunner™ System

FRTBWG18BL	FiberRunner™ QuikLock™ Threaded Rod Trapeze Bracket for Wyr-Grid™ 18" (457mm) width. Used to support FiberRunner™ 4x4, 6x4, and 12x4 Channel above or below the Wyr-Grid™ 18" Pathway using the same 1/2" or 12mm threaded rod used to support the WGTB18BL bracket. Hardware for attaching to threaded rod sold separately.	1/2" 12mm	1	10	
FRTBWG24BL					FiberRunner™ QuikLock™ Threaded Rod Trapeze Bracket for Wyr-Grid™ 24" (610mm) width. Used to support FiberRunner™ 4x4, 6x4, and 12x4 Channel above or below the Wyr-Grid™ 24" Pathway using the same 1/2" or 12mm threaded rod used to support the WGTB24BL bracket. Hardware for attaching to threaded rod sold separately.
FRTBWG30BL					FiberRunner™ QuikLock™ Threaded Rod Trapeze Bracket for Wyr-Grid™ Pathway 30" (762mm) width. Used to support FiberRunner™ 4x4, 6x4, 12x4, and 24x4 Channel above or below the Wyr-Grid™ 30" Pathway using the same 1/2" or 12mm threaded rod used to support the WGTB30BL bracket. Quick mount clips, FRQMC24-X are not included for installing the 24x4 channel. Hardware for attaching to threaded rod sold separately.

Trapeze QuikLock™ Bracket for 12x4 System

FR12TB2412	Used to support the 12x4 system by spanning two threaded rod drops that are 24" apart. Ideal for supporting trapeze bracket from 24" wide ladder rack or 24" wide cable tray. Can be installed from above or below. Bracket is secured to each threaded rod with two nuts. The pre-assembled slide clamps enable fast assembly to channel. Use 7/16" nut driver on slide clamps.	1/2"	1	—
FR12TB2412M		12mm		

Continued on next page

12x4 FiberRunner™ Mounting Brackets (continued)



Part Number	Part Description	For Threaded Rod Size	Std. Pkg. Qty.	Std. Ctn. Qty.
Adjustable Cabinet QuikLock™ Bracket for 12x4 System				
FR12ACAB	Used to support the 12x4 system, dual 6x4, or dual 4x4 systems attaching to the top of cabinets. Adjustable from 4 1/4" (108mm) to 12" (305mm) allowing runs to be leveled over uneven cabinet heights.	—	1	—
4-Post Rack Bracket				
FR4PRB58	Used to support 12x4, 6x4, and 4x4 systems attaching to the top of the 19" wide version of the Panduit R4P 4-post rack.	5/8"	1	—
Two-Piece Ladder Rack Bracket for Attaching Threaded Rod to 1 1/2" — 2" Ladder Rack				
F2PCLB12	Two-piece bracket attaches to 3/8" (9.5mm) wide x 1 1/2" (38.1mm) or 3/8" (9.5mm) wide x 2" (50.8mm) ladder rack rail.	1/2"	1	10
F2PCLB58		5/8"		

A. Featured Products

B. Copper Systems

C. Fiber Systems

D. Faceplates, Frames & Surface Mount Boxes

E. Industrial Networks

F. Audio Video Systems

G. Keystone Cabling Systems

H. Zone Cabling

J. Cable Routing Systems

K. Cable Cleats

L. Cabinets & Rack Systems

M. Power & Connectivity Management

N. Grounding & Bonding

O. Identification Products

P. Cable Management Accessories

Q. Part Number Index

- A. Featured Products
- B. Copper Systems
- C. Fiber Systems
- D. Faceplates, Frames & Surface Mount Boxes
- E. Industrial Networks
- F. Audio Video Systems
- G. Keystone Cabling Systems
- H. Zone Cabling
- J. Cable Routing Systems
- K. Cable Cleats
- L. Cabinets & Rack Systems
- M. Power & Connectivity Management
- N. Grounding & Bonding
- O. Identification Products
- P. Cable Management Accessories
- Q. Part Number Index

6x4 Routing System Roadmap

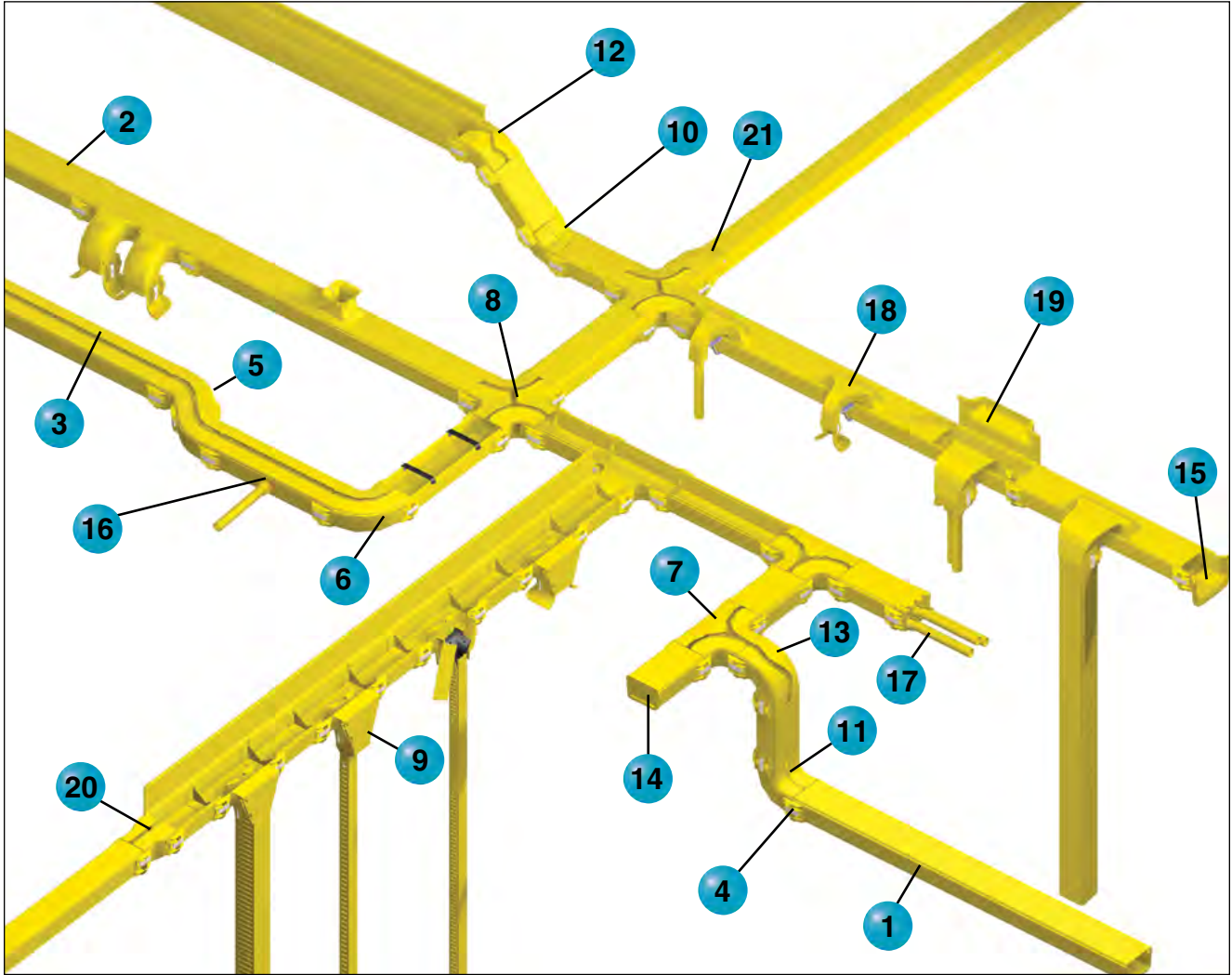

4x4 and 6x4 FiberRunner™ Mounting Brackets

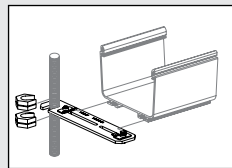

FR6TRBE58 – Existing Threaded Rod QuikLock™ Bracket (page J.25)

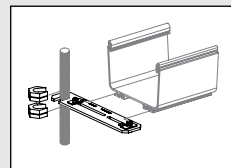

FR6TRBN58 – New Threaded Rod QuikLock™ Bracket (page J.25)

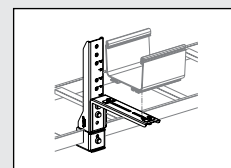



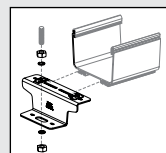



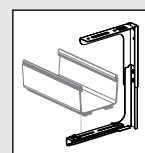



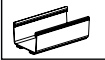





FR6ALB – Adjustable Ladder QuikLock™ Bracket (page J.25)

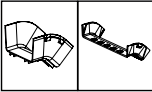
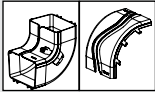

FR6CS58 – Center Support QuikLock™ Bracket (page J.25)

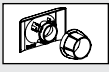

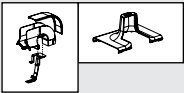
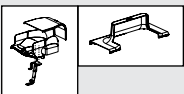
FR6ACB58 – Top Support Adjustable “C” QuikLock™ Bracket (page J.25)

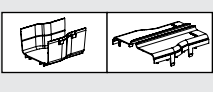
- | | | |
|--|--|---|
| <p> 1 FR6X4**6 – 6x4 FiberRunner™ Channel (page J.20)</p> <p> 2 FRHC6**6 – 6x4 Snap-On Hinged Cover (page J.20)</p> <p> 3 FRSHC6**6 – 6x4 Split Hinged Cover (page J.20)</p> <p> 4 FRBC6X4** – 6x4 QuikLock™ Coupler (page J.21)</p> | <p> 5 FRH456X4** – 6x4 Horizontal 45° Angle Fitting and FRH45SC6** – Split Cover (page J.21)</p> <p> 6 FRRA6X4** – 6x4 Horizontal Right Angle Fitting and FRRASC6** – Split Cover (page J.21)</p> <p> 7 FRT6X4** – 6x4 Horizontal Tee Fitting and FRTSC6** – Split Cover (page J.21)</p> <p> 8 FRFWC6X4** – 6x4 4-Way Cross Fitting and FRFWCSC6** – Split Cover (page J.22)</p> <p> 9 FRVT6X4** – 6x4 QuikLock™ Vertical Tee (page J.23)</p> <p> 10 FRIV456X4** – 6x4 Inside Vertical 45° Angle Fitting (page J.22)</p> <p> 11 FRIVRA6X4** – 6x4 Inside Vertical 90° Angle Fitting (page J.22)</p> <p> 12 FROV456X4** – 6x4 Outside Vertical 45° Angle Fitting and FROV45SC6** – Split Cover (page J.22)</p> | <p> 13 FROVRA6X4** – 6x4 Outside Vertical Right Angle Fitting and FROVRASC6** – Split Cover (page J.22)</p> <p> 14 FREC6X4** – 6x4 End Cap Fitting (page J.22)</p> <p> 15 FRTR6X4** – 3-Sided BRC Trumpet Spillout for 6x4 Exit (page J.24)</p> <p> 16 FR1.5IDE** – 1-Port Spillout Side Exit to 1.5" (38mm) Inside Diameter Corrugated Tubing (page J.35)</p> <p> 17 FRIDT6X4** – 3-Port Spillout to 1.5" (38mm) Inside Diameter Corrugated Tubing (page J.24)</p> <p> 18 FRSPJ2X2** – Spill-Over Junction with 2x2 Exit and FRSPJC26** – Cover for 6x4 System (page J.23)</p> <p> 19 FRSPJ4X4** – Spill-Over Junction with 4x4 Exit and FRSPJC46** – Cover for 6x4 System (page J.24)</p> <p> 20 FRRF64** – 6x4 FiberRunner™ Fitting to 4x4 Channel Reducer Fitting (page J.24)</p> <p> 21 FRRF6FR4** – 6x4 to 4x4 FiberRunner™ Reducer Fitting and FRRF6FR4SC** – Split Cover (page J.23)</p> |
|--|--|---|

**Available Colors: YL (Yellow), OR (Orange), and BL (Black).
Note: Additional 6x4 and 4x4 bracket applications, see page J.28.

A.
Featured
Products

B.
Copper
Systems

C.
Fiber
Systems

D.
Faceplates,
Frames &
Surface
Mount Boxes

E.
Industrial
Networks

F.
Audio
Video
Systems

G.
Keystone
Cabling
Systems

H.
Zone
Cabling

J.
Cable
Routing
Systems

K.
Cable
Cleats

L.
Cabinets
& Rack
Systems

M.
Power &
Connectivity
Management

N.
Grounding
& Bonding

O.
Identification
Products

P.
Cable
Management
Accessories

Q.
Part
Number
Index

- A. Featured Products
- B. Copper Systems
- C. Fiber Systems
- D. Faceplates, Frames & Surface Mount Boxes
- E. Industrial Networks
- F. Audio Video Systems
- G. Keystone Cabling Systems
- H. Zone Cabling
- J. Cable Routing Systems
- K. Cable Cleats
- L. Cabinets & Rack Systems
- M. Power & Connectivity Management
- N. Grounding & Bonding
- O. Identification Products
- P. Cable Management Accessories
- Q. Part Number Index

6x4 FiberRunner™ Routing System

Cable Fills for 6x4 FiberRunner™ Cable Routing System

The maximum amounts may vary according to the cable fill installation methods, straightness of cables, etc.

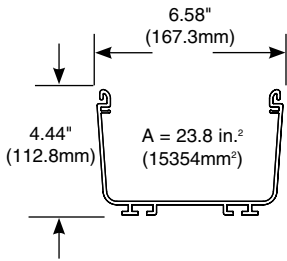

6x4 FiberRunner™ Cable Routing System								
Fill/Pile Up	Internal Area (in²)	Diameter 1.6mm 0.063"	Diameter 2.0mm 0.079"	Diameter 3.0mm 0.118"	Fiber Optic Ribbon Interconnect Cable Diameter 5.20mm 0.205"	Category 6A (SD) Diameter 6.1mm 0.240"	Category 6A Diameter 7.6mm 0.300"	Category 6 Diameter 6.1mm 0.240"
40% Fill								
2" Pile Up	11.95	1534	982	436	145	106	69	97
3" Pile Up	18.16	2331	1492	663	220	161	104	148
4" Pile Up	23.80	3055	1955	869	288	210	136	194
50% Fill								
2" Pile Up	11.95	1917	1227	545	181	132	86	122
3" Pile Up	18.16	2914	1865	829	275	201	130	185
4" Pile Up	23.80	2444	1086	361	263	171	242	519
60% Fill								
2" Pile Up	11.95	22301	1472	654	217	158	103	146
3" Pile Up	18.16	3496	2238	994	330	241	156	222
4" Pile Up	23.80	4582	2933	1303	433	316	205	291

Channel cutting instructions: For optimum results, use a miter box and saw. For larger quantities use a plastic cutting saw blade for clean, burr-free cuts. Recommend: Carbide 80T and 100T; .090" thickness, .125" kerf.

The above cable diameters represent the nominal Panduit cable diameter per performance level. For specific cable fill information based on specific part numbers, contact Panduit Customer Service.

6x4 FiberRunner™ Routing System – Channel and Covers

- Robust, large capacity 6x4 system ideal for use with large cable counts
- Multiple spillout options provide versatility to mate to various equipment and rack configurations
- QuikLock™ Couplers and Brackets reduce system installation time dramatically
- Channel, covers, fittings and other non-metallic system components made from V-0 flame class rated material
- Compatible with all sizes of Panduit™ FiberRunner™ Routing Systems, cable management, and racks
- Compliant with the applicable tests in Telcordia GR-63-CORE Network Equipment Building Systems (NEBS)a Level 3



Part Number	Part Description	Std. Pkg. Qty.	Std. Ctn. Qty.
6x4 FiberRunner™ Channel			
FR6X4YL6	Used to carry the cables horizontally throughout the system. Accepts hinged cable retainers FRCR6BL-X, hinged cover FRHC6YL6 or split hinged cover FRSHC6YL6. Use QuikLock™ Coupler FRBC6X4YL to attach channel and/or fittings.	6	36
6x4 Snap-On Hinged Cover			
FRHC6YL6	Snap-on hinged cover for channel FR6X4YL6. Hinge feature enables positioning of cover at angles between 30° and 90°.	6	36
6x4 Split Hinged Cover			
FRSHC6YL6	Split hinged cover for the channel FR6X4YL6. Creates radiused 3/4" (19mm) opening for easy access to add or remove cables. Snap-on hinge feature enables positioning of cover at angles between 30° and 90°.	6	36

For other colors replace YL (Yellow) with OR (Orange) or BL (Black). Order number of feet required, in multiples of standard 6' length increments.

6x4 FiberRunner™ QuikLock™ Coupler

- Pre-assembled to provide fast mechanical assembly of components
- No tools required for installation; bolts loosen for component disassembly



Part Number	Part Description	Std. Pkg. Qty.	Std. Ctn. Qty.
FRBC6X4YL	Coupler quickly joins two sections of channel and/or fittings.	1	5

For a bulk package of 20 couplers, order FRBC6X4YL-E.
For other colors replace YL (Yellow) with OR (Orange) or BL (Black).

6x4 FiberRunner™ System Fittings

- Minimum 2" (50.8mm) bend radius control fittings
- Protect against signal loss and performance degradation
- Assemble using FRBC QuikLock™ Couplers
- Split covers snap onto each fitting
- Covers feature 3/4" (19mm) gap to allow cable to be laid in



FRRA6X4



FRRASC6



FRH456X4



FRH45SC6



FRT6X4



FRTSC6

Part Number	Part Description	Couplers Required	Std. Pkg. Qty.	Std. Ctn. Qty.
6x4 Horizontal Right Angle Fitting				
FRRA6X4YL	Attaches to 6x4 channel and/or fittings to create a 90° horizontal turn from a straight horizontal run. Accepts split cover FRRASC6YL.	(2 pcs.) FRBC6X4YL	1	5
Split Cover for 6x4 Horizontal Right Angle Fitting				
FRRASC6YL	Split cover for the horizontal right angle fitting FRRA6X4YL.	—	1	5
6x4 Horizontal 45° Angle Fitting				
FRH456X4YL	Attaches to 6x4 channel and/or fittings to create a 45° horizontal turn from a straight horizontal run. Accepts split cover FRH45SC6YL.	(2 pcs.) FRBC6X4YL	1	5
Split Cover for 6x4 Horizontal 45° Angle Fitting				
FRH45SC6YL	Split cover for the horizontal 45° angle fitting FRH456X4YL.	—	1	5
6x4 Horizontal Tee Fitting				
FRT6X4YL	Attaches to 6x4 channel and/or fittings to create a 90° horizontal branch from a straight horizontal run. Accepts split cover FRTSC6YL.	(3 pcs.) FRBC6X4YL	1	5
Split Cover for 6x4 Horizontal Tee Fitting				
FRTSC6YL	Split cover for the horizontal tee fitting FRT6X4YL.	—	1	5

For other colors replace YL (Yellow) with OR (Orange) or BL (Black).

Continued on next page

A. Featured Products
B. Copper Systems
C. Fiber Systems
D. Faceplates, Frames & Surface Mount Boxes
E. Industrial Networks
F. Audio Video Systems
G. Keystone Cabling Systems
H. Zone Cabling
J. Cable Routing Systems
K. Cable Cleats
L. Cabinets & Rack Systems
M. Power & Connectivity Management
N. Grounding & Bonding
O. Identification Products
P. Cable Management Accessories
Q. Part Number Index

6x4 FiberRunner™ System Fittings (continued)



FRFWC6X4



FRFWCSC6



FREC6X4



FRIVRA6X4



FRIV456X4



FROV456X4



FROV45SC6



FROVRA6X4



FROVRASC6

Part Number	Part Description	Couplers Required	Std. Pkg. Qty.	Std. Ctn. Qty.
6x4 Four-Way Cross Fitting				
FRFWC6X4YL	Attaches to 6x4 channel and/or fittings to create a horizontal four-way cross intersection. Accepts split cover FRFWCSC6YL.	(4 pcs.) FRBC6X4YL	1	5
Split Cover for 6x4 Four-Way Cross Fitting				
FRFWCSC6YL	Split cover for the four-way cross fitting FRFWC6X4YL.	—	1	5
6x4 End Cap Fitting				
FREC6X4YL	Used for closing off open ends of the channel or fittings.	—	1	5
6x4 Inside Vertical 90° Angle Fitting				
FRIVRA6X4YL	Attaches to 6x4 channel and/or fittings to create a 90° upward angle from a straight horizontal run. Used with outside vertical 90° angle fitting FROVRA6X4YL to change level of a straight horizontal run. Includes split cover.	(2 pcs.) FRBC6X4YL	1	5
6x4 Inside Vertical 45° Angle Fitting				
FRIV456X4YL	Attaches to 6x4 channel and/or fittings to create a 45° upward angle from a straight horizontal run. Used with outside vertical 45° angle fitting FROV456X4YL to change level of a straight horizontal run. Includes split cover.	(2 pcs.) FRBC6X4YL	1	5
6x4 Outside Vertical 45° Angle Fitting				
FROV456X4YL	Attaches to 6x4 channel and/or fittings to create a 45° downward angle from a straight horizontal run. Used with inside vertical 45° angle fitting FRIV456X4YL to change level of a straight horizontal run. Accepts split cover FROV45SC6YL.	(2 pcs.) FRBC6X4YL	1	5
Split Cover for 6x4 Outside Vertical 45° Angle Fitting				
FROV45SC6YL	Split cover for the outside vertical 45° angle fitting FROV456X4YL.	—	1	5
6x4 Outside Vertical Right Angle Fitting				
FROVRA6X4YL	Attaches to 6x4 channel and/or fittings to create a 90° vertical turn down from a straight horizontal run. Accepts split cover FROVRASC6YL.	(2 pcs.) FRBC6X4YL	1	5
Split Cover for 6x4 Outside Vertical Right Angle Fitting				
FROVRASC6YL	Split cover for the outside vertical right angle fitting FROVRA6X4YL.	—	1	5

For other colors replace YL (Yellow) with OR (Orange) or BL (Black).

Continued on next page

6x4 FiberRunner™ System Fittings (continued)

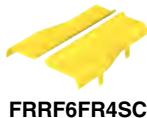

Part Number	Part Description	Couplers Required	Std. Pkg. Qty.	Std. Ctn. Qty.
6x4 to 4x4 FiberRunner™ Reducer Fitting				
FRRF6FR4YL	Attaches any 6x4 FiberRunner™ Fitting or Channel to any 4x4 FiberRunner™ Fitting or Channel. Accepts split cover FRRF6FR4SCYL.	(1 pc.) FRBC6X4YL (1 pc.) FRBC4X4YL	1	5
Split Cover for 6x4 to 4x4 FiberRunner™ Reducer Fitting				
FRRF6FR4SCYL	Split cover for the 6x4 FiberRunner™ to 4x4 FiberRunner™ Reducer Fitting FRRF6FR4YL.	—	1	5
6x4 FiberRunner™ System to 4x4 Reducer Fitting				
FRRF64YL	Attaches any 6x4 FiberRunner™ Fitting or Channel to the 4x4 Channel S4X4YL6 or E4X4YL6. Includes solid cover.	(1 pc.) FRBC6X4YL	1	5

For other colors replace YL (Yellow) with OR (Orange) or BL (Black).

6x4 FiberRunner™ System Spillouts

- Spill-overs allow safe transition from horizontal to vertical runs
- 2" (50.8mm) bend radius control
- Transition to channel, slotted channel, and corrugated loom tubing
- Spill-over junction fittings can be retro-fitted to existing horizontal runs



Part Number	Part Description	Couplers Required	Std. Pkg. Qty.	Std. Ctn. Qty.
6x4 QuikLock™ Vertical Tee				
FRVT6X4YL	Attaches to 6x4 channel and/or fittings to create 90° vertical drop from a straight horizontal run. Hinged door included. Accepts FTR4X4YL, FIDT4X4BL, S4X4YL6 or E4X4YL6 directly. Accepts snap-on cover FRHC6YL6 in conjunction with channel.	(2 pcs.) FRBC6X4YL	1	5
3-Sided Vertical Tee Trumpet Spillout				
FTR4X4YL	Used to limit the bend radius of the cable to 2" (50.8mm) when exiting from a 4x4 or 6x4 FiberRunner™ Vertical Tee and 4x4 Fittings.	—	1	5
2-Port Spillout to 1.5" (38mm) Inside Diameter Corrugated Tubing				
FIDT4X4BL	Used to route cable into one or two pieces of 1.5" (38mm) diameter split corrugated tubing. Used with FRVT6X4YL, FTR4X4YL, or FVT4X4YL. Black color only.	—	1	5
Spill-Over Junction with 2x2 Exit				
FRSPJ2X2YL	Assembles onto 4x4, 6x4, 12x4, or 24x4 FiberRunner™ Channel, spilling over the side into a 2x2 vertical exit. Requires coupler to attach 2x2 FiberRunner™ Channel and Fittings to the vertical exit. Mounts directly to existing installation with no alteration required.	(1 pc.) FBC2X2YL	1	5
Cover for Spill-Over Junction with 2x2 Exit for 6x4 Channel				
FRSPJC26YL	Used to fully enclose 6x4 channel in conjunction with the spill-over junction FRSPJ2X2YL.	—	1	5

For other colors replace YL (Yellow) with OR (Orange) or BL (Black).

Continued on next page

A.
Featured
Products

6x4 FiberRunner™ System Spillovers (continued)

B.
Copper
Systems



FTR2X2

C.
Fiber
Systems



FRSPJ2X2

D.
Faceplates,
Frames &
Surface
Mount Boxes



FRSPJ4X4

E.
Industrial
Networks

F.
Audio
Video
Systems

G.
Keystone
Cabling
Systems



FRSPJC46

H.
Zone
Cabling



FRTR4X4

J.
Cable
Routing
Systems

K.
Cable
Cleats



FRTR6X4

L.
Cabinets
& Rack
Systems



M.
Power &
Connectivity
Management

N.
Grounding
& Bonding



FRIDT6X4

O.
Identification
Products

P.
Cable
Management
Accessories

Q.
Part
Number
Index

Part Number	Part Description	Couplers Required	Std. Pkg. Qty.	Std. Ctn. Qty.
-------------	------------------	----------------------	----------------------	----------------------

3-Sided BRC Trumpet Spillover for 2x2 Exit

FTR2X2YL	Used to limit the bend radius of the cable to 2" (50.8mm) when exiting from a spill-over junction with a 2x2 exit or from a 2x2 Channel.	(1 pc.) FBC2X2YL	1	5
----------	--	---------------------	---	---

Spill-Over Junction with 2x2 Exit

FRSPJ2X2YL	Assembles onto 4x4, 6x4, 12x4, or 24x4 FiberRunner™ Channel, spilling over the side into a 2x2 vertical exit. Requires coupler to attach 2x2 FiberRunner™ and fittings to the vertical exit.	(1 pc.) FBC2X2YL	1	5
------------	--	---------------------	---	---

Spill-Over Junction with 4x4 Exit

FRSPJ4X4YL	Assembles onto 4x4, 6x4, 12x4, or 24x4 FiberRunner™ Channel, spilling over the side into a 4x4 vertical exit. Requires coupler to attach 4x4 FiberRunner™ Channel and fittings to the vertical exit.	(1 pc.) FRBC4X4YL	1	5
------------	--	----------------------	---	---

Cover for Spill-Over Junction with 4x4 Exit for 6x4 Channel

FRSPJC46YL	Used to fully enclose 6x4 channel in conjunction with the spill-over junction FRSPJ4X4YL.	—	1	5
------------	---	---	---	---

3-Sided BRC Trumpet Spillover for 4x4 FiberRunner™ Exit

FRTR4X4YL	Used to limit the bend radius of the cable to 2" (50.8mm) when exiting from 4x4 FiberRunner™ Channel or a 4x4 FiberRunner™ Horizontal Tee.	(1 pc.) FRBC4X4YL	1	5
-----------	--	----------------------	---	---

2-Port Spillover to 1.5" (38mm) Inside Diameter Corrugated Tubing

FRIDT4X4YL	Used to route cable into one or two pieces of 1.5" (38mm) diameter split corrugated tubing. Requires coupler to be used with 4x4 FiberRunner™ Fitting. Used with any 4x4 FiberRunner™ Fitting.	(1 pc.) FRBC4X4YL	1	5
------------	--	----------------------	---	---

3-Sided BRC Trumpet Spillover for 6x4 Exit

FRTR6X4YL	Used to limit the bend radius of the cable to 2" (50.8mm) when exiting from 6x4 channel, 6x4 horizontal tee fitting, or 6x4 exit on 12x4 vertical tee.	(1 pc.) FRBC6X4YL	1	5
-----------	--	----------------------	---	---

3-Port Spillover to 1.5" (38mm) Inside Diameter Corrugated Tubing

FRIDT6X4YL	Used to route cable into three separate pieces of 1.5" (38mm) diameter split corrugated tubing. Used with FRVT12X4YL or any 6x4 fitting.	(1 pc.) FRBC6X4YL	1	5
------------	--	----------------------	---	---

For other colors replace YL (Yellow) with OR (Orange) or BL (Black).

4x4 and 6x4 FiberRunner™ Mounting Brackets



FR6TRBE12
FR6TRBE58
FR6TRBE12M
FR6TRBE58M



FR6TRBN12
FR6TRBN58
FR6TRBN12M
FR6TRBN58M



FR6ALB



FR6CS12
FR6CS58
FR6CS12M
FR6CS58M



FR6ACB12
FR6ACB58
FR6ACB12M
FR6ACB58M



FR6TB38
FR6TB12
FR6TB38M
FR6TB12M

Part Number	Part Description	For Threaded Rod Size	Std. Pkg. Qty.	Std. Ctn. Qty.
-------------	------------------	-----------------------	----------------	----------------

Existing Threaded Rod QuikLock™ Bracket for 6x4 and 4x4 Systems

FR6TRBE12	Used to support the 6x4 and 4x4 systems from existing threaded rod installations.	1/2"	1	10
FR6TRBE58		5/8"		
FR6TRBE12M		12mm		
FR6TRBE58M		16mm		

New Threaded Rod QuikLock™ Bracket for 6x4 and 4x4 Systems

FR6TRBN12	Used to support the 6x4 and 4x4 systems from any new threaded rod installations.	1/2"	1	10
FR6TRBN58		5/8"		
FR6TRBN12M		12mm		
FR6TRBN58M		16mm		

Adjustable Ladder QuikLock™ Bracket for 6x4 and 4x4 Systems

FR6ALB	Used to support the 6x4 and 4x4 systems attaching to any 3/8" (9.5mm) x 1 1/2" (38.1mm) or 3/8" (9.5mm) x 2" (50.8mm) ladder rack rail. Adjustable to nine incremental positions from 4" (101mm) to 12" (305mm) above or below the ladder rack.	—	1	10
--------	---	---	---	----

Center Support QuikLock™ Bracket for 6x4 and 4x4 Systems

FR6CS12	Used to support the 6x4 and 4x4 systems from below with new threaded rod.	1/2"	1	10
FR6CS58		5/8"		
FR6CS12M		12mm		
FR6CS58M		16mm		

Top Support Adjustable “C” QuikLock™ Bracket for 6x4 and 4x4 Systems

FR6ACB12	Used to support the 6x4 and 4x4 systems from any new threaded rod extending down directly from the ceiling, grid, or ladder rack system. Two position height adjustments to accommodate system with or without hinged cover.	1/2"	1	10
FR6ACB58		5/8"		
FR6ACB12M		12mm		
FR6ACB58M		16mm		

Trapeze QuikLock™ Bracket for 6x4 and 4x4 Systems

FR6TB38	Used to support the 6x4 and 4x4 systems by spanning two threaded rod drops. Can be installed from above or below.	3/8"	1	10
FR6TB12		1/2"		
FR6TB38M		10mm		
FR6TB12M		12mm		

A. Featured Products

B. Copper Systems

C. Fiber Systems

D. Faceplates, Frames & Surface Mount Boxes

E. Industrial Networks

F. Audio Video Systems

G. Keystone Cabling Systems

H. Zone Cabling

J. Cable Routing Systems

K. Cable Cleats

L. Cabinets & Rack Systems

M. Power & Connectivity Management

N. Grounding & Bonding

O. Identification Products





P. Cable Management Accessories

Q. Part Number Index

Continued on next page

A. Featured Products
B. Copper Systems
C. Fiber Systems
D. Faceplates, Frames & Surface Mount Boxes
E. Industrial Networks
F. Audio Video Systems
G. Keystone Cabling Systems
H. Zone Cabling
J. Cable Routing Systems
K. Cable Cleats
L. Cabinets & Rack Systems
M. Power & Connectivity Management
N. Grounding & Bonding
O. Identification Products
P. Cable Management Accessories
Q. Part Number Index

4x4 and 6x4 FiberRunner™ Mounting Brackets (continued)

Part Number	Part Description	For Threaded Rod Size	Std. Pkg. Qty.	Std. Ctn. Qty.
 FRTBWG12BL	FiberRunner™ QuikLock™ Threaded Rod Trapeze Bracket for Wyr-Grid™ 12" (305mm) width. Used to support FiberRunner™ 4x4 and 6x4 Channel above or below the Wyr-Grid™ 12" Pathway using the same 1/2" or 12mm threaded rod used to support the WGTB12BL bracket. Hardware for attaching to threaded rod sold separately.	1/2" 12mm	1	10
 FRTBWG18BL	FiberRunner™ QuikLock™ Threaded Rod Trapeze Bracket for Wyr-Grid™ Pathway 18" (457mm) width. Used to support FiberRunner™ 4x4, 6x4, and 12x4 Channel above or below the Wyr-Grid™ 18" Pathway using the same 1/2" or 12mm threaded rod used to support the WGTB18BL bracket. Hardware for attaching to threaded rod sold separately.			
 FRTBWG24BL	FiberRunner™ QuikLock™ Threaded Rod Trapeze Bracket for Wyr-Grid™ Pathway 24" (610mm) width. Used to support FiberRunner™ 4x4, 6x4, and 12x4 Channel above or below the Wyr-Grid™ 24" Pathway using the same 1/2" or 12mm threaded rod used to support the WGTB24BL bracket. Hardware for attaching to threaded rod sold separately.			
 FRTBWG30BL	FiberRunner™ QuikLock™ Threaded Rod Trapeze Bracket for Wyr-Grid™ Pathway 30" (762mm) width. Used to support FiberRunner™ 4x4, 6x4, 12x4, and 24x4 Channel above or below the Wyr-Grid™ 30" Pathway using the same 1/2" or 12mm threaded rod used to support the WGTB30BL bracket. Quick mount clips, FRQMC24-X are not included for installing the 24x4 channel. Hardware for attaching to threaded rod sold separately.			

Adjustable Cabinet QuikLock™ Bracket for 6x4 and 4x4 Systems

FR6ACAB	Used to support the 6x4 and 4x4 systems attaching to the top of cabinets. Adjustable from 4 1/4" (108mm) to 9" (229mm) allowing runs to be leveled over uneven cabinet heights.	—	1	—
---------	---	---	---	---

Two-Piece Ladder Rack Bracket for Attaching Threaded Rod to 1 1/2" — 2" Ladder Rack

F2PCLB12	Two-piece bracket attaches to 3/8" (9.5mm) wide x 1 1/2" (38.1mm) or 3/8" (9.5mm) wide x 2" (50.8mm) ladder rack rail.	1/2"	1	10
F2PCLB58		5/8"		

Ladder Rack QuikLock™ Bracket for 6x4 and 4x4 Systems

FR6LRB	Used to support the 6x4 and 4x4 systems attaching directly to any 3/8 (9.5mm) x 1 1/2" (38.1mm) or 3/8" (9.5mm) x 2" (50.8mm) ladder rack rail. No threaded rod required.	—	1	10
--------	---	---	---	----



FR6ACAB



F2PCLB12
F2PCLB58



FR6LRB

Continued on next page

4x4 and 6x4 FiberRunner™ Mounting Brackets (continued)



Part Number	Part Description	For Threaded Rod Size In.	Std. Pkg. Qty.	Std. Ctn. Qty.
“L” Wall Mount QuikLock™ Bracket for 6x4 and 4x4 Systems				
FR6LB	Used to support the 6x4 and 4x4 systems attaching to a wall or the front or back of an equipment rack.	—	1	10
4 Post Rack Bracket				
FR4PRB58	Used to support 12x4, 6x4, and 4x4 systems attaching to the top of the 19" wide version of the Panduit R4P 4 post rack.	5/8	1	—

Adapters to Other Systems



Part Number	Part Description	Couplers Required	Std. Pkg. Qty.	Std. Ctn. Qty.
Adapter from 12x4 FiberRunner™ System to CommScope's 12x4 FiberGuide*				
FRADC12X4BL	Fitting that transitions from CommScope's 12x4 FiberGuide* System to 12x4 FiberRunner™ System.	(1 pc.) FRBC12X4YL	1	5
Adapter from 6x4 FiberRunner™ System to CommScope's 6x4 FiberGuide*				
FRADC6X4YL	Fitting that transitions from CommScope's 6x4 FiberGuide* System to 6x4 FiberRunner™ System.	—	1	5
Adapter from 4x4 FiberRunner™ System to CommScope's 4x4 FiberGuide*				
FRADC4X4BL	Fitting that transitions from CommScope's 4x4 FiberGuide* System to 4x4 FiberRunner™ System.	(1 pc.) FRBC4X4YL	1	5
Adapter from 4x4 Fiber-Duct™ System to CommScope's 4x4 FiberGuide*				
FADC4X4	Fitting that transitions from CommScope's 4x4 FiberGuide* Fiber Cable Management System to 4x4 Fiber-Duct™ System.	—	1	5
Adapter from 4x4 Fiber-Duct™ System to Various 4x4 Systems				
FTDNS4X4YL	Fitting that transitions from various 4x4 systems to 4x4 Fiber-Duct™ System.	—	1	5

*FiberGuide is a registered trademark of CommScope.

- A. Featured Products
- B. Copper Systems
- C. Fiber Systems
- D. Faceplates, Frames & Surface Mount Boxes
- E. Industrial Networks
- F. Audio Video Systems
- G. Keystone Cabling Systems
- H. Zone Cabling
- J. Cable Routing Systems
- K. Cable Cleats
- L. Cabinets & Rack Systems
- M. Power & Connectivity Management
- N. Grounding & Bonding
- O. Identification Products
- P. Cable Management Accessories
- Q. Part Number Index

A. Featured Products

4x4 Routing System Roadmap

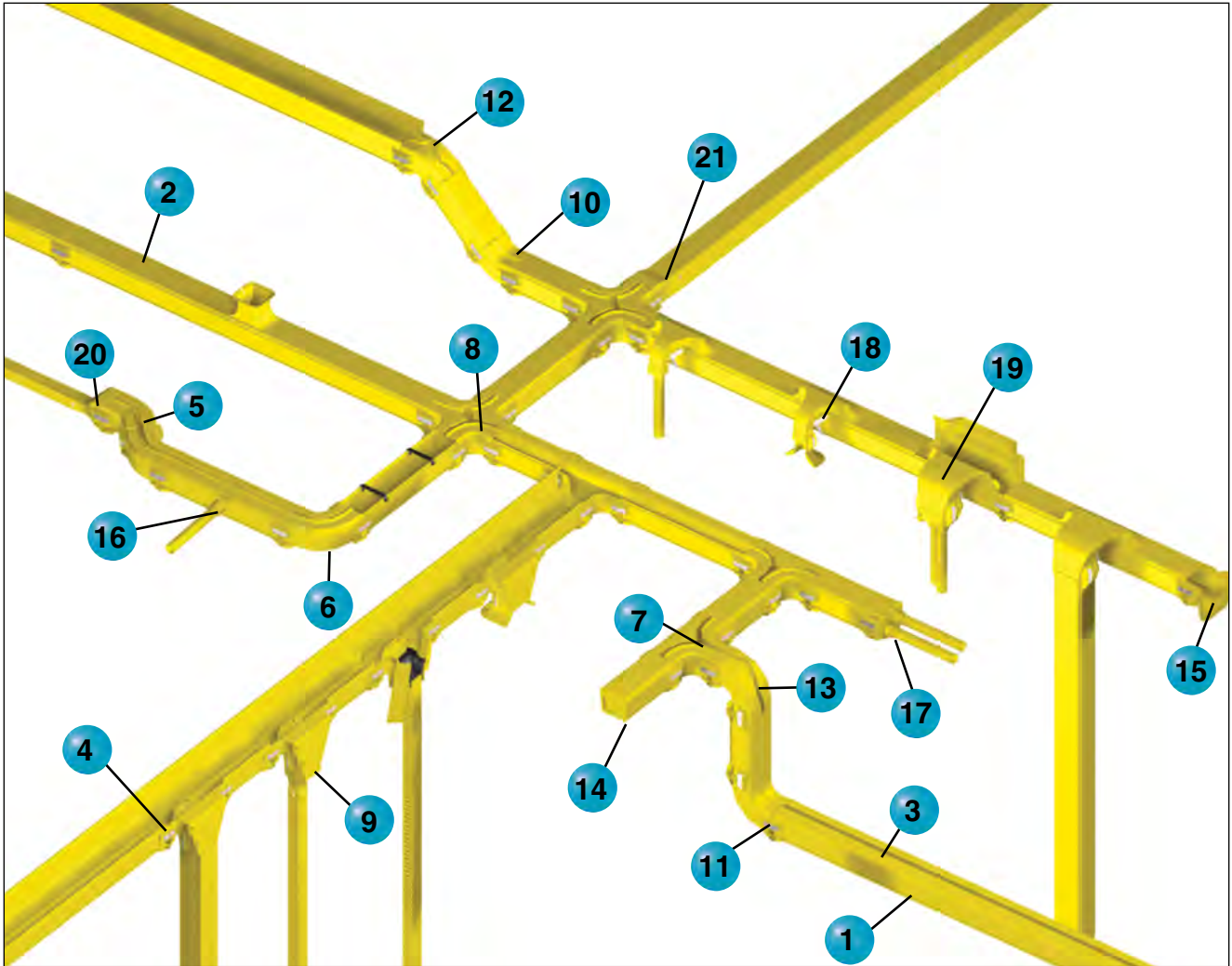

B. Copper Systems

C. Fiber Systems

D. Faceplates, Frames & Surface Mount Boxes

E. Industrial Networks

F. Audio Video Systems

G. Keystone Cabling Systems

H. Zone Cabling

J. Cable Routing Systems

K. Cable Cleats

L. Cabinets & Rack Systems

4x4 and 6x4 FiberRunner™ Mounting Brackets

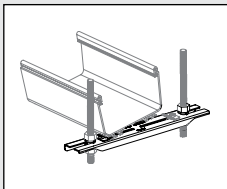

FR6TB38 – Trapeze QuikLock™ Bracket
(page J.25)

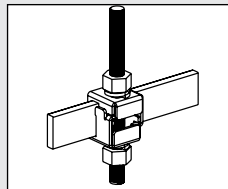

F2PCLB – Two-Piece Ladder Rack Bracket
for Attaching Threaded Rod to 1 1/2" – 2" Ladder Rack
(page J.26)

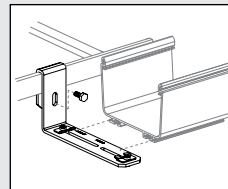

FR6LRB – Ladder Rack QuikLock™ Bracket
(page J.26)

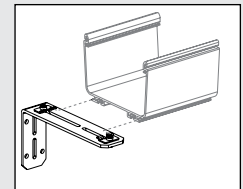

FR6LB – "L" Wall Mount QuikLock™ Bracket
(page J.27)











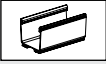

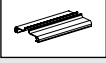



M. Power & Connectivity Management

N. Grounding & Bonding

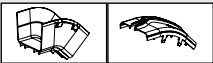
O. Identification Products

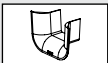
P. Cable Management Accessories

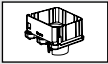
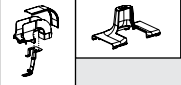
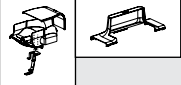
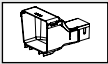
Q. Part Number Index

- | | |
|---|---|
| <p> 1 FR4X4**6 – 4x4 FiberRunner™ Channel (page J.30)</p> <p> 2 FRHC4**6 – 4x4 Snap-On Hinged Cover (page J.30)</p> <p> 3 FRSHC4**6 – 4x4 Split Hinged Cover (page J.30)</p> <p> 4 FRBC4X4** – 4x4 QuikLock™ Coupler (page J.31)</p> <p> 5 FRH454X4** – 4x4 Horizontal 45° Angle Fitting and FRH45SC4** – Split Cover (page J.31)</p> <p> 6 FRRA4X4** – 4x4 Horizontal Right Angle Fitting and FRRASC4** – Split Cover (page J.31)</p> <p> 7 FRT4X4** – 4x4 Horizontal Tee Fitting and FRTSC4** – Split Cover (page J.31)</p> <p> 8 FRFWC4X4** – 4x4 4-Way Cross Fitting and FRFWCSC4** – Split Cover (page J.32)</p> <p> 9 FRVT4X4** – 4x4 QuikLock™ Vertical Tee (page J.33)</p> <p> 10 FRIV454X4** – 4x4 Inside Vertical 45° Angle Fitting (page J.32)</p> <p> 11 FRIVRA4X4** – 4x4 Inside Vertical 90° Angle Fitting (page J.32)</p> <p> 12 FROV454X4** – 4x4 Outside Vertical 45° Angle Fitting and FROV45SC4** – Split Cover (page J.32)</p> | <p> 13 FROVRA4X4** – 4x4 Outside Vertical Right Angle Fitting and FROVRASC4** – Split Cover (page J.32 and J.33)</p> <p> 14 FREC4X4** – 4x4 End Cap Fitting (page J.32)</p> <p> 15 FRTR4X4** – 3-Sided BRC Trumpet Spillover for 4x4 FiberRunner™ Exit (page J.34)</p> <p> 16 FR1.5IDE** – 1-Port Spillover Side Exit to 1.5" (38mm) Inside Diameter Corrugated Tubing (page J.35)</p> <p> 17 FRIDT4X4** – 2-Port Spillover to 1.5" (38mm) inside diameter Corrugated Tubing (page J.34)</p> <p> 18 FRSPJ2X2** – Spill-Over Junction with 2x2 Exit and FRSPJC24** – Cover for 4x4 System (page J.34)</p> <p> 19 FRSPJ4X4** – Spill-Over Junction with 4x4 Exit and FRSPJC44** – Cover for 4x4 System (page J.34)</p> <p> 20 FRRF4FD2** – 4x4 FiberRunner™ System to 2x2 Reducer Fitting with Cover (page J.33)</p> <p> 21 FRRF4FD4** – 4x4 FiberRunner™ System to 4x4 Reducer Fitting with Cover (page J.33)</p> <p> 22 FRLPR42BL – Low Profile Reducer 4x4 to 2x2 for Vertical Tee (page J.35)</p> |
|---|---|

**Available colors: YL (Yellow), OR (Orange), and BL (Black).
Note: Additional 6x4 and 4x4 bracket applications, see page J.18.

A.
Featured
Products

B.
Copper
Systems

C.
Fiber
Systems

D.
Faceplates,
Frames &
Surface
Mount Boxes

E.
Industrial
Networks

F.
Audio
Video
Systems

G.
Keystone
Cabling
Systems

H.
Zone
Cabling

J.
Cable
Routing
Systems

K.
Cable
Cleats

L.
Cabinets
& Rack
Systems

M.
Power &
Connectivity
Management

N.
Grounding
& Bonding

O.
Identification
Products

P.
Cable
Management
Accessories

Q.
Part
Number
Index

A. Featured Products



4x4 FiberRunner™ Routing System

B. Copper Systems

Cable Fills for 4x4 FiberRunner™ Cable Routing System

The maximum amounts may vary according to the cable fill installation methods, straightness of cables, etc.

C. Fiber Systems



4x4 FiberRunner™ Cable Routing System								
Fill/Pile Up	Internal Area (in ²)	Diameter 1.6mm 0.063"	Diameter 2.0mm 0.079"	Diameter 3.0mm 0.118"	Fiber Optic Ribbon Interconnect Cable Diameter 5.20mm 0.205"	Category 6A (SD) Diameter 6.1mm 0.240"	Category 6A Diameter 7.6mm 0.300"	Category 6 Diameter 6.1mm 0.240"
40% Fill								
2" Pile Up	8.90	1142	731	325	108	79	50	79
3" Pile Up	13.58	1743	1116	496	165	120	77	120
4" Pile Up	17.60	2259	1446	643	213	156	100	156
50% Fill								
2" Pile Up	8.90	1428	914	406	135	98	63	98
3" Pile Up	13.58	2179	1394	620	206	150	96	150
4" Pile Up	17.60	2824	1807	803	267	195	124	195
60% Fill								
2" Pile Up	8.90	1714	1097	487	162	118	76	118
3" Pile Up	13.58	2615	1673	744	247	180	115	180
4" Pile Up	17.60	3389	2169	964	320	233	149	233

Channel cutting instructions: For optimum results, use a miter box and saw. For larger quantities use a plastic cutting saw blade for clean, burr-free cuts. Recommend: Carbide 80T and 100T; .090" thickness, .125" kerf.

The above cable diameters represent the nominal Panduit cable diameter per performance level. For specific cable fill information based on specific part numbers, contact Panduit Customer Service.

D. Faceplates, Frames & Surface Mount Boxes

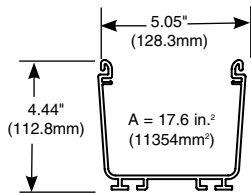

E. Industrial Networks

F. Audio Video Systems

G. Keystone Cabling Systems

H. Zone Cabling

J. Cable Routing Systems

4x4 FiberRunner™ Routing System – Channel and Covers

- Robust 4x4 system ideal for use with smaller cable counts
- Multiple spillout options provide versatility to mate to various equipment and rack configurations
- QuikLock™ Couplers and Brackets reduce system installation time dramatically
- Channel, covers, fittings and other non-metallic system components made from V-0 flame class rated material
- Compatible with all sizes of Panduit™ FiberRunner™ Routing Systems, cable management, and racks
- Compliant with the applicable tests in Telcordia GR-63-CORE Network Equipment Building Systems (NEBS) Level 3

K. Cable Cleats

L. Cabinets & Rack Systems

M. Power & Connectivity Management

N. Grounding & Bonding

O. Identification Products

P. Cable Management Accessories

Q. Part Number Index



Part Number	Part Description	Std. Pkg. Qty.	Std. Ctn. Qty.
4x4 FiberRunner™ Channel			
FR4X4YL6	Used to carry the cables horizontally throughout the system. Accepts hinged cable retainers FRCR4BL-X, hinged cover FRHC4YL6, or split hinged cover FRSHC4YL6. Use QuikLock™ Coupler FRBC4X4YL to attach channel and/or fittings.	6	36
4x4 Snap-On Hinged Cover			
FRHC4YL6	Snap-on hinged cover for channel FR4X4YL6. Hinge feature enables positioning of cover at angles between 30° to 90°.	6	36
4x4 Split Hinged Cover			
FRSHC4YL6	Split hinged cover for the channel FR4X4YL6. Creates radiused 3/4" (19mm) opening for easy access to add or remove cables. Snap-on hinge feature enables positioning of cover at angles between 30° and 90°.	6	36

For other colors replace YL (Yellow) with OR (Orange) or BL (Black). Order number of feet required, in multiples of standard 6' length increments.

4x4 FiberRunner™ QuikLock™ Coupler

- Pre-assembled to provide fast mechanical assembly of components
- No tools required for installation; bolts loosen for component disassembly



Part Number	Part Description	Std. Pkg. Qty.	Std. Ctn. Qty.
FRBC4X4YL	Pre-assembled coupler quickly joins two sections of channel and/or fittings.	1	5

For a bulk package of 20 couplers, order FRBC4X4YL-E.
For other colors replace YL (Yellow) with OR (Orange) or BL (Black).

4x4 FiberRunner™ System Fittings

- Minimum 2" (50.8mm) bend radius control fittings
- Protects against signal loss and performance degradation
- Assemble using FRBC QuikLock™ Couplers
- Split covers snap onto each fitting
- Covers feature 3/4" (19mm) gap to allow cable to be laid in



FRRA4X4



FRRASC4



FRH454X4



FRH45SC4



FRT4X4



FRTSC4

Part Number	Part Description	Couplers Required	Std. Pkg. Qty.	Std. Ctn. Qty.
-------------	------------------	-------------------	----------------	----------------

4x4 Horizontal Right Angle Fitting

FRRA4X4YL	Attaches to 4x4 channel and/or fitting to create a 90° horizontal turn from a straight horizontal run. Accepts split cover FRRASC4YL.	(2 pcs.) FRBC4X4YL	1	5
-----------	---	-----------------------	---	---

Split Cover for 4x4 Horizontal Right Angle Fitting

FRRASC4YL	Split cover for the horizontal right angle fitting FRRA4X4YL.	—	1	5
-----------	---	---	---	---

4x4 Horizontal 45° Angle Fitting

FRH454X4YL	Attaches to 4x4 channel and/or fittings to create a 45° horizontal turn from a straight horizontal run. Accepts split cover FRH45SC4YL.	(2 pcs.) FRBC4X4YL	1	5
------------	---	-----------------------	---	---

Split Cover for 4x4 Horizontal 45° Angle Fitting

FRH45SC4YL	Split cover for the horizontal 45° angle fitting FRH454X4YL.	—	1	5
------------	--	---	---	---

4x4 Horizontal Tee Fitting

FRT4X4YL	Attaches to 4x4 channel and/or fittings to create a 90° horizontal branch from straight horizontal runs. Accepts split cover FRTSC4YL.	(3 pcs.) FRBC4X4YL	1	5
----------	--	-----------------------	---	---

Split Cover for 4x4 Horizontal Tee Fitting

FRTSC4YL	Split cover for the horizontal tee fitting FRT4X4YL.	—	1	5
----------	--	---	---	---

For other colors replace YL (Yellow) with OR (Orange) or BL (Black).

A. Featured Products

B. Copper Systems

C. Fiber Systems

D. Faceplates, Frames & Surface Mount Boxes

E. Industrial Networks

F. Audio Video Systems

G. Keystone Cabling Systems

H. Zone Cabling

J. Cable Routing Systems

K. Cable Cleats

L. Cabinets & Rack Systems

M. Power & Connectivity Management

N. Grounding & Bonding

O. Identification Products

P. Cable Management Accessories

Q. Part Number Index

Continued on next page

A.
Featured
Products

4x4 FiberRunner™ System Fittings (continued)

B.
Copper
Systems

C.
Fiber
Systems



FRFWC4X4

D.
Faceplates,
Frames &
Surface
Mount Boxes



FRFWCSC4

E.
Industrial
Networks



FREC4X4

F.
Audio
Video
Systems



FRIVRA4X4

G.
Keystone
Cabling
Systems



FRIV454X4

H.
Zone
Cabling



FROV454X4

J.
Cable
Routing
Systems



FROV45SC4

K.
Cable
Cleats



FROVRA4X4

L.
Cabinets
& Rack
Systems



FROVRASC4

M.
Power &
Connectivity
Management

N.
Grounding
& Bonding

O.
Identification
Products

P.
Cable
Management
Accessories

Q.
Part
Number
Index

Part Number	Part Description	Couplers Required	Std. Pkg. Qty.	Std. Ctn. Qty.
-------------	------------------	----------------------	----------------------	----------------------

4x4 Four Way Cross Fitting

FRFWC4X4YL	Attaches to 4x4 channel and/or fittings to create a horizontal four way cross intersection. Accepts split cover FRFWCSC4YL.	(4 pcs.) FRBC4X4YL	1	5
------------	---	-----------------------	---	---

Split Cover for 4x4 Four Way Cross Fitting

FRFWCSC4YL	Split cover for the four way cross fitting FRFWC4X4YL.	—	1	5
------------	--	---	---	---

4x4 End Cap Fitting

FREC4X4YL	Used for closing off open ends of the channel or fittings.	—	1	5
-----------	--	---	---	---

4x4 Inside Vertical 90° Angle Fitting

FRIVRA4X4YL	Attaches to 4x4 channel and/or fittings to create a 90° upward angle from a straight horizontal run. Used with outside vertical 90° angle fitting FROVRA4X4YL to change level of a straight horizontal run. Includes split cover.	(2 pcs.) FRBC4X4YL	1	5
-------------	---	-----------------------	---	---

4x4 Inside Vertical 45° Angle Fitting

FRIV454X4YL	Attaches to 4x4 channel and/or fittings to create a 45° upward angle from a horizontal run. Used with outside vertical 45° angle fitting FROV454X4YL to change level of a straight horizontal run. Includes split cover.	(2 pcs.) FRBC4X4YL	1	5
-------------	--	-----------------------	---	---

4x4 Outside Vertical 45° Angle Fitting

FROV454X4YL	Attaches to 4x4 channel and/or fittings to create a 45° downward angle from a horizontal run. Used with inside vertical 45° angle fitting FRIV454X4YL to change level of a straight horizontal run. Accepts split cover FROV45SC4YL.	(2 pcs.) FRBC4X4YL	1	5
-------------	--	-----------------------	---	---

Split Cover for 4x4 Outside Vertical 45° Angle Fitting

FROV45SC4YL	Split cover for the outside vertical 45° angle fitting FROV454X4YL.	—	1	5
-------------	---	---	---	---

4x4 Outside Vertical Right Angle Fitting

FROVRA4X4YL	Attaches to 4x4 channel and/or fittings to create a 90° vertical turn down from a straight horizontal run. Accepts split cover FROVRASC4YL.	(2 pcs.) FRBC4X4YL	1	5
-------------	---	-----------------------	---	---

Split Cover for 4x4 Outside Vertical Right Angle Fitting

FROVRASC4YL	Split cover for the outside vertical right angle fitting FROVRA4X4YL.	—	1	5
-------------	---	---	---	---

For other colors replace YL (Yellow) with OR (Orange) or BL (Black).

Continued on next page

4x4 FiberRunner™ System Fittings (continued)



FRRF6FR4



FRRF6FR4SCYL



FRRF4FD2



FRRF4FD4

Part Number	Part Description	Couplers Required	Std. Pkg. Qty.	Std. Ctn. Qty.
6x4 to 4x4 FiberRunner™ Reducer Fitting				
FRRF6FR4YL	Attaches any 6x4 FiberRunner™ Fitting or Channel to any 4x4 FiberRunner™ Fitting or Channel. Accepts split cover FRRF6FR4SCYL.	(1 pc.) FRBC6X4YL (1 pc.) FRBC4X4YL	1	5
Split Cover for 6x4 to 4x4 FiberRunner™ Reducer Fitting				
FRRF6FR4SCYL	Split cover for the 6x4 FiberRunner™ to 4x4 FiberRunner™ Reducer Fitting FRRF6FR4YL.	—	1	5
4x4 FiberRunner™ to 2x2 Reducer Fitting with Cover				
FRRF4FD2YL	Attaches any 4x4 FiberRunner™ Fitting or Channel to the 2x2 Channel, S2X2YL6 or E2X2YL6 or 2x2 FiberRunner™ Channel, HS2X2YL6 or H2X2YL6. Note: Attachment to 2x2 FiberRunner™ Channel requires a QuikLock™ Coupler FBC2X2YL.	(1 pc.) FRBC4X4YL	1	5
4x4 FiberRunner™ to 4x4 Reducer Fitting with Cover				
FRRF4FD4YL	Attaches any 4x4 FiberRunner™ Fitting or Channel to the 4x4 Channel, S4X4YL6 or E4X4YL6. Includes solid cover.	(1 pc.) FRBC4X4YL	1	5

For other colors replace YL (Yellow) with OR (Orange) or BL (Black).

A. Featured Products

B. Copper Systems

C. Fiber Systems

D. Faceplates, Frames & Surface Mount Boxes

E. Industrial Networks

F. Audio Video Systems

G. Keystone Cabling Systems

H. Zone Cabling

J. Cable Routing Systems

K. Cable Cleats

L. Cabinets & Rack Systems

M. Power & Connectivity Management

N. Grounding & Bonding

O. Identification Products

P. Cable Management Accessories

Q. Part Number Index

A. Featured Products
B. Copper Systems
C. Fiber Systems
D. Faceplates, Frames & Surface Mount Boxes
E. Industrial Networks
F. Audio Video Systems
G. Keystone Cabling Systems
H. Zone Cabling
J. Cable Routing Systems
K. Cable Cleats
L. Cabinets & Rack Systems
M. Power & Connectivity Management
N. Grounding & Bonding
O. Identification Products
P. Cable Management Accessories
Q. Part Number Index

4x4 FiberRunner™ System Spillouts

- Spill-overs allow safe transition from horizontal to vertical runs
- 2" (50.8mm) bend radius control
- Transition to channel, slotted channel, and corrugated loom tubing
- Spill-over junction fittings can be retro-fitted to existing horizontal runs



FRVT4X4



FTR4X4



FIDT4X4BL



FRSPJ2X2YL



FRSPJC24

Part Number	Part Description	Couplers Required	Std. Pkg. Qty.	Std. Ctn. Qty.
-------------	------------------	-------------------	----------------	----------------

4x4 QuikLock™ Vertical Tee Spillout

FRVT4X4YL	Attaches to 4x4 channel and/or fittings to create a 90° vertical drop from a horizontal run. Hinged door included. Accepts FTR4X4YL, FIDT4X4BL, S4X4YL6 or E4X4YL6 directly. Accepts snap-on cover FRHC4YL6 in conjunction with channel.	(2 pcs.) FRBC4X4YL	1	5
-----------	--	-----------------------	---	---

3-Sided Vertical Tee Trumpet Spillout

FTR4X4YL	Used to limit the bend radius of the cable to 2" (50.8mm) when exiting from a 4x4 or 6x4 FiberRunner™ Vertical Tee and 4x4 Fittings.	—	1	5
----------	--	---	---	---

2-Port Spillout to 1.5" (38mm) Inside Diameter Corrugated Tubing

FIDT4X4BL	Used to route cable into one or two pieces of 1.5" (38mm) diameter split corrugated tubing. Used with FRVT6X4YL, FRVT4X4YL, or FVT4X4YL. Black color only.	—	1	5
-----------	--	---	---	---

Spill-Over Junction with 2x2 Exit

FRSPJ2X2YL	Assembles onto 4x4, 6x4, 12x4, or 24x4 FiberRunner™ Channel, spilling over the side into a 2x2 vertical exit. Requires coupler to attach 2x2 FiberRunner™ and fittings to the vertical exit.	(1 pc.) FBC2X2YL	1	—
------------	--	---------------------	---	---

Cover for Spill-Over Junction with 2x2 Exit for 4x4 Channel

FRSPJC24YL	Used to fully enclose 4x4 channel in conjunction with the spill-over junction FRSPJ2X2YL.	—	1	5
------------	---	---	---	---

Continued on next page

4x4 FiberRunner™ System Spillouts (continued)

- Spill-overs allow safe transition from horizontal to vertical runs
- 2" (50.8mm) bend radius control
- Transition to channel, slotted channel, and corrugated loom tubing
- Spill-over junction fittings can be retro-fitted to existing horizontal runs



FTR2X2



FRSPJ4X4YL



FRSPJC44



FRTR4X4



FRIDT4X4

Part Number	Part Description	Couplers Required	Std. Pkg. Qty.	Std. Ctn. Qty.
3-Sided BRC Trumpet Spillout for 2x2 Exit				
FTR2X2YL	Used to limit the bend radius of the cable to 2" (50.8mm) when exiting from a spill-over junction with a 2x2 exit or from 2x2 Channel.	(1 pc.) FBC2X2YL	1	5
Spill-Over Junction with 4x4 Exit				
FRSPJ4X4YL	Assembles onto 4x4, 6x4, 12x4, or 24x4 FiberRunner™ Channel, spilling over the side into a 4x4 vertical exit. Requires coupler to attach 4x4 FiberRunner™ Channel and fittings to the vertical exit.	(1 pc.) FRBC4X4YL	1	—
Cover for Spill-Over Junction with 4x4 Exit for 4x4 Channel				
FRSPJC44YL	Used to fully enclose 4x4 channel in conjunction with the spill-over junction FRSPJ4X4YL.	—	1	5
3-Sided BRC Trumpet Spillout for 4x4 FiberRunner™ Exit				
FRTR4X4YL	Used to limit the bend radius of the cable to 2" (50.8mm) when exiting from 4x4 FiberRunner™ Channel or a 4x4 FiberRunner™ Horizontal Tee.	(1 pc.) FRBC4X4YL	1	5
2-Port Spillout to 1.5" (38mm) Inside Diameter Corrugated Tubing				
FRIDT4X4YL	Used to route cable into one or two pieces of 1.5" (38mm) diameter split corrugated tubing. Requires coupler to be used with 4x4 FiberRunner™ Fitting. Used with any 4x4 FiberRunner™ Fitting.	(1 pc.) FRBC4X4YL	1	5

For other colors replace YL (Yellow) with OR (Orange) or BL (Black).

A.
Featured
Products

B.
Copper
Systems

C.
Fiber
Systems

D.
Faceplates,
Frames &
Surface
Mount Boxes

E.
Industrial
Networks

F.
Audio
Video
Systems

G.
Keystone
Cabling
Systems

H.
Zone
Cabling

J.
Cable
Routing
Systems

K.
Cable
Cleats

L.
Cabinets
& Rack
Systems

M.
Power &
Connectivity
Management

N.
Grounding
& Bonding

O.
Identification
Products

P.
Cable
Management
Accessories

Q.
Part
Number
Index

A. Featured Products
B. Copper Systems
C. Fiber Systems
D. Faceplates, Frames & Surface Mount Boxes
E. Industrial Networks
F. Audio Video Systems
G. Keystone Cabling Systems
H. Zone Cabling
J. Cable Routing Systems
K. Cable Cleats
L. Cabinets & Rack Systems
M. Power & Connectivity Management
N. Grounding & Bonding
O. Identification Products
P. Cable Management Accessories
Q. Part Number Index

2x2 Routing System Roadmap

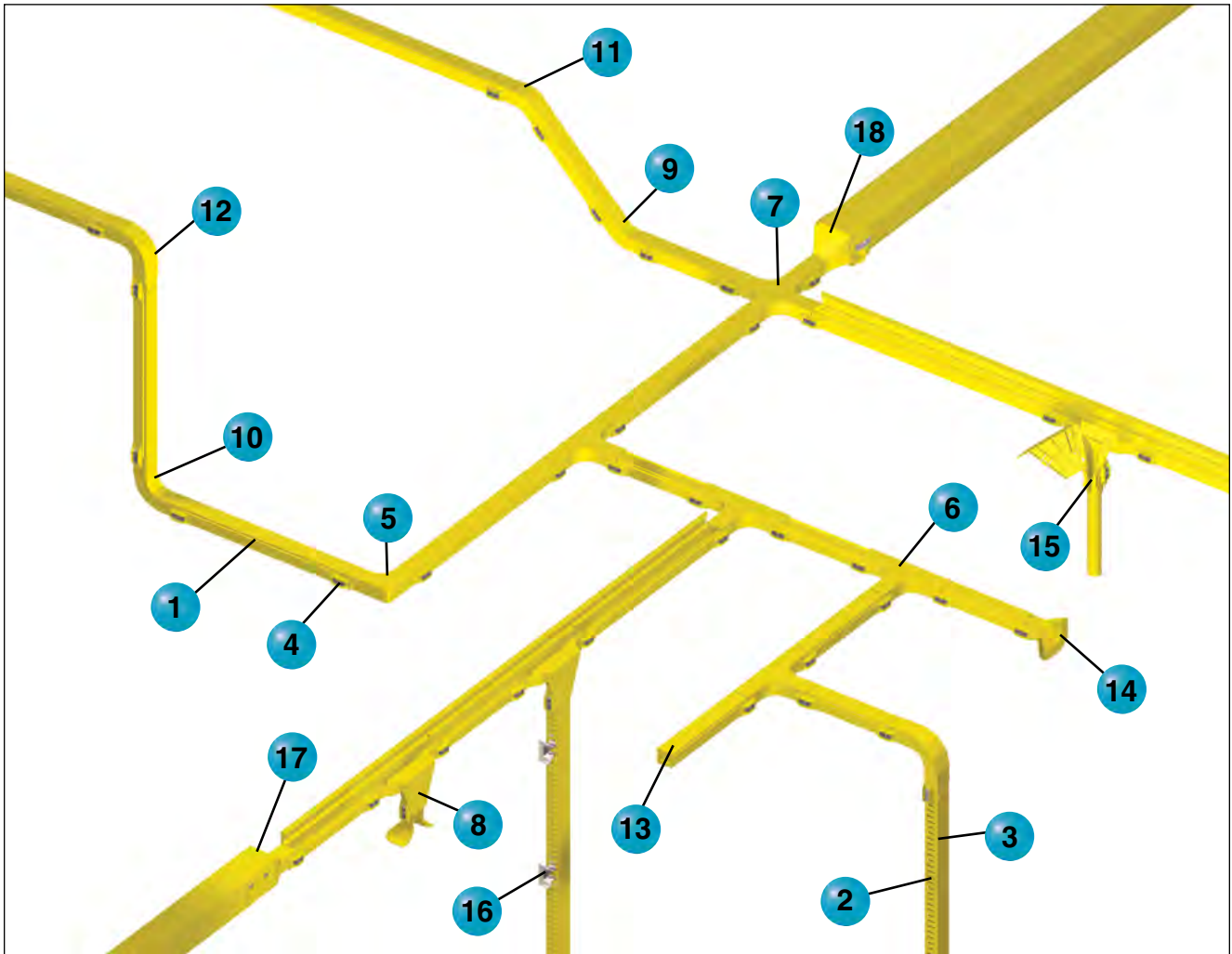

FiberRunner™ Mounting Brackets

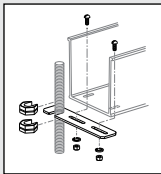

FTRBE12 – Existing Threaded Rod Bracket (page J.48)

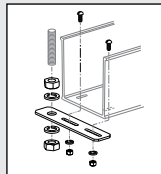

FTRBN12 – New Threaded Rod Bracket (page J.48)

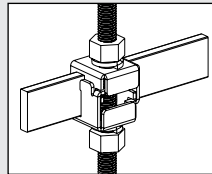

F2PCLB12 – Two-Piece Ladder Rack Bracket for Attaching Threaded Rod to 1 1/2" – 2" Ladder Rack (page J.48)

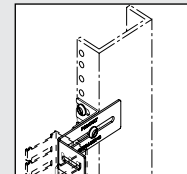

FZBA1.5X4 – Adjustable "Z" Bracket (page J.48)

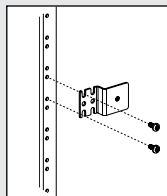

FZBLP – Low Profile "Z" Bracket (page J.48)

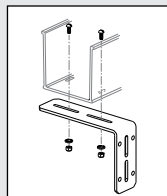

FLB – "L" Wall Mount Bracket (page J.48)

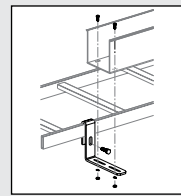

FLRB – Ladder Rack Bracket (page J.48)

- | | | |
|---|-----------|---|
|  | 1 | HS2X2** – 2x2 FiberRunner™ Hinged Channel (page J.40) |
|  | 2 | H2X2** – 2x2 FiberRunner™ Hinged Slotted Channel (page J.40) |
|  | 3 | HC2**6 – 2x2 FiberRunner™ Snap-On Hinged Cover (page J.40) |
|  | 4 | FBC2X2** – 2x2 QuikLock™ Coupler (page J.41) |
|  | 5 | FRA2X2** – 2x2 Horizontal Right Angle Fitting (page J.45) |
|  | 6 | FT2X2** – 2x2 Horizontal Tee Fitting (page J.45) |
|  | 7 | FFWC2X2** – 2x2 4-Way Cross Fitting (page J.46) |
|  | 8 | FVTHD2X2** – 2x2 Vertical Tee (page J.41) |
|  | 9 | FIV452X2** – 2x2 Inside Vertical 45° Angle Fitting (page J.46) |
|  | 10 | FIVRA2X2** – 2x2 Inside Vertical Right Angle Fitting (page J.46) |
|  | 11 | FOV452X2** – 2x2 Outside 45° Angle Fitting (page J.46) |
|  | 12 | FOVRA2X2** – 2x2 Outside Vertical Right Angle Fitting (page J.46) |
|  | 13 | FHDEC2X2** – 2x2 End Cap Fitting (page J.41) |
|  | 14 | FTR2X2** – 3-Sided BRC Trumpet Spillover for 2x2 Exit (page J.41) |
|  | 15 | FIDT2X2** – 1-Port Spillover to 1.5" (38mm) Inside Diameter Corrugated Tubing (page J.47) |
|  | 16 | FTRC2HDBL – 2x2 Hinged Channel 1" Bend Radius Control Trumpet (page J.35) |
|  | 17 | FRF42** – 4x4 to 2x2 FiberRunner™ Reducer Fitting (page J.46) |
|  | 18 | FRRF4FD2** – 4x4 FiberRunner™ to 2x2 Reducer Fitting (page J.33) |

**Available colors: YL (Yellow), OR (Orange), BL (Black), and LG (Light Gray).

A.
Featured
Products

B.
Copper
Systems

C.
Fiber
Systems

D.
Faceplates,
Frames &
Surface
Mount Boxes

E.
Industrial
Networks

F.
Audio
Video
Systems

G.
Keystone
Cabling
Systems

H.
Zone
Cabling

J.
Cable
Routing
Systems

K.
Cable
Cleats

L.
Cabinets
& Rack
Systems

M.
Power &
Connectivity
Management

N.
Grounding
& Bonding

O.
Identification
Products

P.
Cable
Management
Accessories

Q.
Part
Number
Index

A. Featured Products

2x2 FiberRunner™ Routing System

Cable Fills for 2x2 FiberRunner™ Cable Routing System

The maximum amounts may vary according to the cable fill installation methods, straightness of cables, etc.

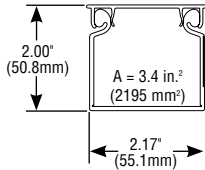

2x2 FiberRunner™ Routing System								
Fill/Pile Up	Internal Area (in²)	Diameter 1.6mm 0.063"	Diameter 2.0mm 0.079"	Diameter 3.0mm 0.118"	Fiber Optic Ribbon Interconnect Cable Diameter 5.20mm 0.205"	Category 6A (SD) Diameter 6.1mm 0.240"	Category 6A Diameter 7.6mm 0.300"	Category 6 Diameter 6.1mm 0.240"
40% Fill								
2" Pile Up	3.40	436	279	124	41	30	19	30
50% Fill								
2" Pile Up	3.40	546	349	155	52	38	24	38
60% Fill								
2" Pile Up	3.40	655	419	186	62	45	29	45

Channel cutting instructions: For optimum results, use a miter box and saw. For larger quantities use a plastic cutting saw blade for clean, burr-free cuts. Recommend: Carbide 80T and 100T; .090" thickness, .125" kerf.

The above cable diameters represent the nominal Panduit cable diameter per performance level. For specific cable fill information based on specific part numbers, contact Panduit Customer Service.

2x2 FiberRunner™ Routing System – Channels and Cover

- 2x2 system ideal for use with smaller cable counts
- Multiple spillout options provide versatility to mate to various equipment and rack configurations
- QuikLock™ Couplers reduce system installation time dramatically
- Channel, covers, fittings and other non-metallic system components made from V-0 flame class rated material
- Compatible with all sizes of Panduit™ FiberRunner™ Routing Systems, cable management, and racks
- 2x2 FiberRunner™ Hinged and Slotted Channels can be used with 2x2 fittings (see pages J.45 and J.46) and brackets (see page J.48)
- Compliant with the applicable tests in Telcordia GR-63-CORE Network Equipment Building Systems (NEBS) Level 3

Part Number	Part Description	Std. Pkg. Qty.	Std. Ctn. Qty.
2x2 FiberRunner™ Hinged Channel			
HS2X2YL6NM	Used to carry the cables throughout the system. Accepts hinged cover HC2YL6. Use QuikLock™ Coupler FBC2X2YL to attach channel and/or fittings.	6	120
2x2 FiberRunner™ Hinged Slotted Channel			
H2X2YL6	Used to carry the cables vertically to the front or the back of equipment racks throughout the system. Accepts hinged cover HC2YL6. Extra supports required when used in horizontal applications. Use QuikLock™ Coupler FBC2X2YL to attach channel and/or fittings.	6	120
2x2 Snap-On Hinged Cover			
HC2YL6	Snap-on cover for hinged channel HS2X2YL6 or H2X2YL6. Cover can hinge open to 90° from either side of the channel and be removed completely if desired.	6	120

NOTE: Available with mounting holes. To order, delete NM from the part number. For other colors replace YL (Yellow) with OR (Orange), BL (Black), or LG (Light Gray). Order number of feet required, in multiples of standard 6' length increments.

B. Copper Systems

C. Fiber Systems

D. Faceplates, Frames & Surface Mount Boxes

E. Industrial Networks

F. Audio Video Systems

G. Keystone Cabling Systems

H. Zone Cabling

J. Cable Routing Systems

K. Cable Cleats

L. Cabinets & Rack Systems

M. Power & Connectivity Management

N. Grounding & Bonding

O. Identification Products

P. Cable Management Accessories

Q. Part Number Index

2x2 FiberRunner™ QuikLock™ Coupler

- Pre-assembled to provide fast mechanical assembly of components
- No tools required for installation; bolts loosen for component disassembly



Part Number	Part Description	Std. Pkg. Qty.	Std. Ctn. Qty.
FBC2X2YL	Coupler quickly joins two sections of hinged channel and/or fittings.	1	5

For other colors replace YL (Yellow) with OR (Orange), BL (Black), or LG (Light Gray).

2x2 FiberRunner™ System Fitting



Part Number	Part Description	Std. Pkg. Qty.	Std. Ctn. Qty.
FHDEC2X2YL	Used for closing off open ends of the hinged channel or fittings.	1	5

For other colors replace YL (Yellow) with OR (Orange), BL (Black), or LG (Light Gray).

2x2 FiberRunner™ System Spillouts

- Spill-overs allow safe transition from horizontal to vertical runs
- 2" bend radius control
- Transition to channel, slotted channel, and corrugated loom tubing



FVTHD2X2

Part Number	Part Description	Couplers Required	Std. Pkg. Qty.	Std. Ctn. Qty.
2x2 Vertical Tee				
FVTHD2X2YL	Attaches to 2x2 channel to create a 90° vertical drop from a horizontal run. Hinged door included. Accepts channel cover in conjunction with channel. Use QuikLock™ Coupler FBC2X2YL with HS2X2YL6 or H2X2YL6 channels. Use snap rivets NR2WH-L or bolts F14PN-L with S2X2YL6 or E2X2YL6 channels. Also accepts FIDT2X2YL.	(2 pcs.) FBC2X2YL	1	5



FTR2X2

3-Sided BRC Trumpet Spillout for 2x2 Exit

FTR2X2YL	Used to limit the bend radius of the cable to 2" (50.8mm) when exiting from a FiberRunner™ Spill-Over FRSPYL or from 2x2 FiberRunner™ Channel.	(1 pc.) FBC2X2YL	1	5
----------	--	---------------------	---	---



FIDT2X2

1-Port Spillout to 1.5" (38mm) Inside Diameter Corrugated Tubing

FIDT2X2YL	Used to route cable into one piece of 1.5" (38mm) diameter split corrugated tubing. Used with FiberRunner™ Spill-Over FRSPYL, 2x2 FiberRunner™ Fittings, and the 2x2 FiberRunner™ Hinged Channel.	2x2	1	5
-----------	---	-----	---	---

For other colors replace YL (Yellow) with OR (Orange) or BL (Black).

A. Featured Products

B. Copper Systems

C. Fiber Systems

D. Faceplates, Frames & Surface Mount Boxes

E. Industrial Networks

F. Audio Video Systems

G. Keystone Cabling Systems

H. Zone Cabling

J. Cable Routing Systems

K. Cable Cleats

L. Cabinets & Rack Systems

M. Power & Connectivity Management

N. Grounding & Bonding

O. Identification Products

P. Cable Management Accessories

Q. Part Number Index

A. Featured Products
B. Copper Systems
C. Fiber Systems
D. Faceplates, Frames & Surface Mount Boxes
E. Industrial Networks
F. Audio Video Systems
G. Keystone Cabling Systems
H. Zone Cabling
J. Cable Routing Systems
K. Cable Cleats
L. Cabinets & Rack Systems
M. Power & Connectivity Management
N. Grounding & Bonding
O. Identification Products
P. Cable Management Accessories
Q. Part Number Index

FiberRunner™ System Fittings



FRA2X2



FT2X2



FFWC2X2



FEC2X2



FIV452X2



FOV452X2



FIVRA2X2



FOVRA2X2

Part Number	Part Description	System Size	Std. Pkg. Qty.	Std. Ctn. Qty.
-------------	------------------	-------------	----------------	----------------

Horizontal Right Angle Fitting

FRA2X2YL	Attaches to channel to create a 90° horizontal turn from a straight horizontal run. Cover included.	2x2	1	5
----------	---	-----	---	---

Horizontal Tee Fitting

FT2X2YL	Attaches to channel to create a 90° horizontal branch from a straight horizontal run. Cover included.	2x2	1	5
---------	---	-----	---	---

Four Way Cross Fitting

FFWC2X2YL	Attaches to channel to create a horizontal four way cross intersection. Cover included.	2x2	1	5
-----------	---	-----	---	---

End Cap Fitting

FEC2X2YL	Used for closing off open ends of the channel.	2x2	1	5
----------	--	-----	---	---

Inside Vertical 45° Angle Fitting

FIV452X2YL	Attaches to channel to create a 45° upward angle from a straight horizontal run. Used with outside vertical 45° angle fitting FOV452X2YL or FOV454X4YL to change level of straight horizontal runs. Cover included.	2x2	1	5
------------	---	-----	---	---

Outside Vertical 45° Angle Fitting

FOV452X2YL	Attaches to channel to create a 45° downward angle from a straight horizontal run. Used with inside vertical 45° angle fitting FIV452X2YL or FIV454X4YL to change level of straight horizontal runs. Cover included.	2x2	1	5
------------	--	-----	---	---

Inside Vertical Right Angle Fitting

FIVRA2X2YL	Attaches to channel to create a 90° upward angle from a straight horizontal run. Used with outside vertical 90° angle fitting FOVRA2X2YL or FOVRA4X4YL to change level of straight horizontal runs. Cover included.	2x2	1	5
------------	---	-----	---	---

Outside Vertical Right Angle Fitting

FOVRA2X2YL	Attaches to channel to create a 90° downward angle from a straight horizontal run. Used with inside vertical 90° angle fitting FIVRA2X2YL or FIVRA4X4YL to change level of straight horizontal runs. Cover included.	2x2	1	5
------------	--	-----	---	---

For other colors replace YL (Yellow) with OR (Orange), BL (Black), or LG (Light Gray).
Fittings include 5/16" assembly holes for fast mechanical fastening.

FiberRunner™ Mounting Brackets



FTRBE12
FTRBE12M
FTRBE58



FTRBN12
FTRBN12M
FTRBN58



FLRB



FLB



FZBA1.5X4



FZBLP



F2PCLB12
F2PCLB58

Part Number	Part Description	System Size	Std. Pkg. Qty.	Std. Ctn. Qty.
-------------	------------------	-------------	----------------	----------------

Existing Threaded Rod Brackets

FTRBE12	Used for supporting the 2x2 Systems from existing threaded rod installations.	1/2"	1	10
FTRBE12M		12mm		
FTRBE58		5/8"		

New Threaded Rod Brackets for 2x2 System

FTRBN12	Used for supporting the 2x2 Systems from new threaded rod installations.	1/2"	1	10
FTRBN12M		12mm		
FTRBN58		5/8"		

Ladder Rack Bracket for 2x2 System

FLRB	Used to support the 2x2 Systems attaching directly to any 3/8" (9.5mm) x 1 1/2" (38.1mm) or 3/8" (9.5mm) x 2" (50.8mm) ladder rack rail. No threaded rod required.	—	1	10
------	--	---	---	----

"L" Wall Mount Bracket for 2x2 System

FLB	Used to support 2x2 Systems by attaching to a wall or the front or back of an equipment rack.	—	1	10
-----	---	---	---	----

Adjustable "Z" Bracket

FZBA1.5X4	Bracket used to offset FiberRunner™ System from mounting surface, adjustable from 1.5" (38mm) to 4" (101mm).	—	1	10
-----------	--	---	---	----

Part Number	Part Description	For Threaded Rod Size In.	Std. Pkg. Qty.	Std. Ctn. Qty.
-------------	------------------	---------------------------	----------------	----------------

Low Profile "Z" Bracket

FZBLP	Bracket used to offset 2x2 System and hinged duct from the front face of an equipment rack. Bracket provides a secure mounting surface .67" (17mm) from the front of an equipment rack.	—	1	10
-------	---	---	---	----

Two-Piece Ladder Rack Bracket for Attaching Threaded Rod to 1 1/2" – 2" Ladder Rack

F2PCLB12	Two-piece bracket attaches to 3/8" (9.5mm) wide x 1 1/2" (38.1mm) or 3/8" (9.5mm) wide x 2" (50.8mm) ladder rack rail.	1/2"	1	10
F2PCLB58		5/8"		

A. Featured Products

B. Copper Systems

C. Fiber Systems

D. Faceplates, Frames & Surface Mount Boxes

E. Industrial Networks

F. Audio Video Systems

G. Keystone Cabling Systems

H. Zone Cabling

J. Cable Routing Systems

K. Cable Cleats

L. Cabinets & Rack Systems

M. Power & Connectivity Management

N. Grounding & Bonding

O. Identification Products

P. Cable Management Accessories

Q. Part Number Index

A. Featured Products
B. Copper Systems
C. Fiber Systems
D. Faceplates, Frames & Surface Mount Boxes
E. Industrial Networks
F. Audio Video Systems
G. Keystone Cabling Systems
H. Zone Cabling
J. Cable Routing Systems
K. Cable Cleats
L. Cabinets & Rack Systems
M. Power & Connectivity Management
N. Grounding & Bonding
O. Identification Products
P. Cable Management Accessories
Q. Part Number Index

FiberRunner™ Accessories



FRHD4KT



TRC4HD



FRLPR64



FRLPR42

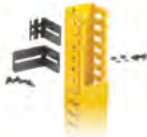

FRHD2KT



FTRC2HDBL



FIDT2X2



FR1.5IDE

Part Number	Part Description	Couplers Required	Std. Pkg. Qty.	Std. Ctn. Qty.
4x4 Hinged Duct Vertical Cable Manager Kit				
FRHD4KTYL	Provides secure, accessible route for cables spilling out from vertical tee to rack mounted equipment. Kit includes 6' length of 4x4 capacity hinged duct, 6' length of 4x4 hinged duct cover, one end cap for 4x4 hinged duct, three FZBA1.5X4 adjustable "Z" brackets, an adapter fitting, six WR4-C wire retainers and all required mounting hardware. Attaches directly to 6x4 and 4x4 vertical tee exit or FRLPR64 low profile reducer.	—	1	—
4x4 Hinged Duct Bend Radius Control Trumpet				
TRC4HDBL	Bend radius control trumpet for exiting at the sidewall of 4" wall heights of type H hinged cover wiring duct channels. Maintains 1" (25.4mm) bend radius control. Black color only.	—	1	10
Low Profile Reducer 6x4 to 4x4 for Vertical Tee				
FRLPR64BL	Assembled into the 12x4 vertical tee FRVT12X4YL. FRLPR64BL allows for the transition to the 4x4 Channel. Black color only.	—	1	5
Low Profile Reducer 4x4 to 2x2 for Vertical Tee				
FRLPR42BL	Assembled into the 6x4 vertical tee FRVT6X4YL or 4x4 vertical tee FRVT4X4YL. FRLPR42BL allows for the transition to 2x2 FiberRunner™ or 2x2 Channel. Black color only.	—	1	5
2x2 Hinged Duct Vertical Cable Manager Kit				
FRHD2KTYL	Provides secure, accessible route for cables spilling out from a vertical tee or spill-over junction to rack mounted equipment. Kit includes 6' length of 2x2 FiberRunner™ Hinged Channel H2X2YL6, 6' length of 2x2 snap-on hinged cover HC2YL6, four adjustable "Z" brackets FZBA1.5X4, one FiberRunner™ 2x2 End Cap FHDEC2X2YL, six hinged duct 2" wire retainers WR2H-C and all required mounting hardware. Attaches to 2x2 vertical tee exit or spill-over junction with a 2x2 exit with a 2x2 QuikLock™ Coupler FBC2X2YL. Also attaches directly to 4x4 or 6x4 vertical tee exits with low profile reducer FRLPR42BL.	—	1	—
2x2 FiberRunner™ Bend Radius Control Trumpet				
FTRC2HDBL	Bend radius control trumpet for exiting at the sidewall of 2" wall heights of type H hinged cover wiring duct channels. Maintains 1" (25.4mm) bend radius control. Black color only.	—	1	5
1-Port Spillover to 1.5" (38mm) Inside Diameter Corrugated Tubing				
FIDT2X2YL	Used to route cable into one piece of 1.5" (38mm) diameter split corrugated tubing. Used with a spill-over junction with a 2x2 exit, 2x2 Fittings, and the 2x2 FiberRunner™ Hinged Channel.	—	1	5
1-Port Spillover Side Exit to 1.5" (38mm) Inside Diameter Corrugated Tubing				
FR1.5IDEYL	Used to route cable into 1.5" (38mm) diameter split corrugated tubing directly through a hole cut in the side wall of the 4x4, 6x4, and 12x4 FiberRunner™ or 4x4 Channel.	—	1	5

Continued on next page

FiberRunner™ Accessories (continued)

Part Number	Part Description	For Threaded Rod Size In.	Std. Pkg. Qty.	Std. Ctn. Qty.
3/8" Nut Driver				
FR38DR	Used to disassemble 4x4, 6x4, and 12x4 FiberRunner™ QuikLock™ Couplers when required.	—	1	10
7/16" Nut Driver				
FR716DR	7/16" nut driver for use with the FiberRunner™, GridRunner™, and Wyr-Grid™ Systems.	—	1	10
5/16" Nut Driver				
FR516DR	Used to disassemble 2x2 FiberRunner™ QuikLock™ Couplers when required.	—	1	10
Strut Clip Kit				
FRSTRCBL	Strut mounting clip assembly allows FiberRunner™ Channel to be attached directly to standard 1 5/8" wide strut structures. Contains two clips and all hardware for assembly. Bolts release with 7/16" nut driver.	—	1	10
1/4" T-Bolt Kit				
FRTBKT-X	T-bolts can be used for additional attachment when securing FiberRunner™ Channel to mounting brackets. For example, a T-bolt can be inserted thru a 12x4 mounting bracket and positioned within the center rib structure on the underside of 12x4 channel. By tightening the nut, the 12x4 channel is more securely fastened to the mounting bracket.	—	10	100
FiberRunner™ Quick Mount Clips				
FRQMC-X	Bracket mounting clips to accommodate runs for various FiberRunner™ Channels. Use on 12x4 FiberRunner™ QuikLock™ Brackets to accommodate dual runs of 6x4 or 4x4 FiberRunner™ Channel.	1/2	10	—
Threaded Rod in One Foot Lengths				
TR1-12-X	Threaded rod can be used with various mounting brackets. Length = 12" (305mm).	1/2	10	—
TR1-58-X	Threaded rod can be used with various mounting brackets. Length = 12" (305mm).	5/8		
Threaded Rod Cover				
TRC18FR-X8Y	Used to protect cabling from threaded rod. Vertical slit allows easy installation. For indoor use only. Gray.	1/2 – 5/8	10	100
TRC18FR-X20Y	Used to protect cabling from threaded rod. Vertical slit allows easy installation. Black.			
Slit Corrugated Loom Tubing				
CLT150F-X4*	Slit corrugated loom tubing provides a vertical pathway as cables transfer from the FiberRunner™ Fitting to the equipment below. Inside diameter is 1.48" (37.6mm) and outside diameter 1.73" (43.9mm). Sold in 10' rolls.	—	1	—

*For other colors replace X4 (Yellow) with X3 (Orange) or X20 (Black).



FR716DR



FR716DR



FRSTRCBL



FRTBKT-X



FRQMC-X



TR1-12-X
TR1-58-X



TRC18FR-X8Y



CLT150F-X4

A. Featured Products

B. Copper Systems

C. Fiber Systems

D. Faceplates, Frames & Surface Mount Boxes

E. Industrial Networks

F. Audio Video Systems

G. Keystone Cabling Systems

H. Zone Cabling

J. Cable Routing Systems

K. Cable Cleats

L. Cabinets & Rack Systems

M. Power & Connectivity Management

N. Grounding & Bonding

O. Identification Products

P. Cable Management Accessories

Q. Part Number Index

A. Featured Products
B. Copper Systems
C. Fiber Systems
D. Faceplates, Frames & Surface Mount Boxes
E. Industrial Networks
F. Audio Video Systems
G. Keystone Cabling Systems
H. Zone Cabling
J. Cable Routing Systems
K. Cable Cleats
L. Cabinets & Rack Systems
M. Power & Connectivity Management
N. Grounding & Bonding
O. Identification Products
P. Cable Management Accessories
Q. Part Number Index

Wyr-Grid™ Overhead Cable Tray Routing System

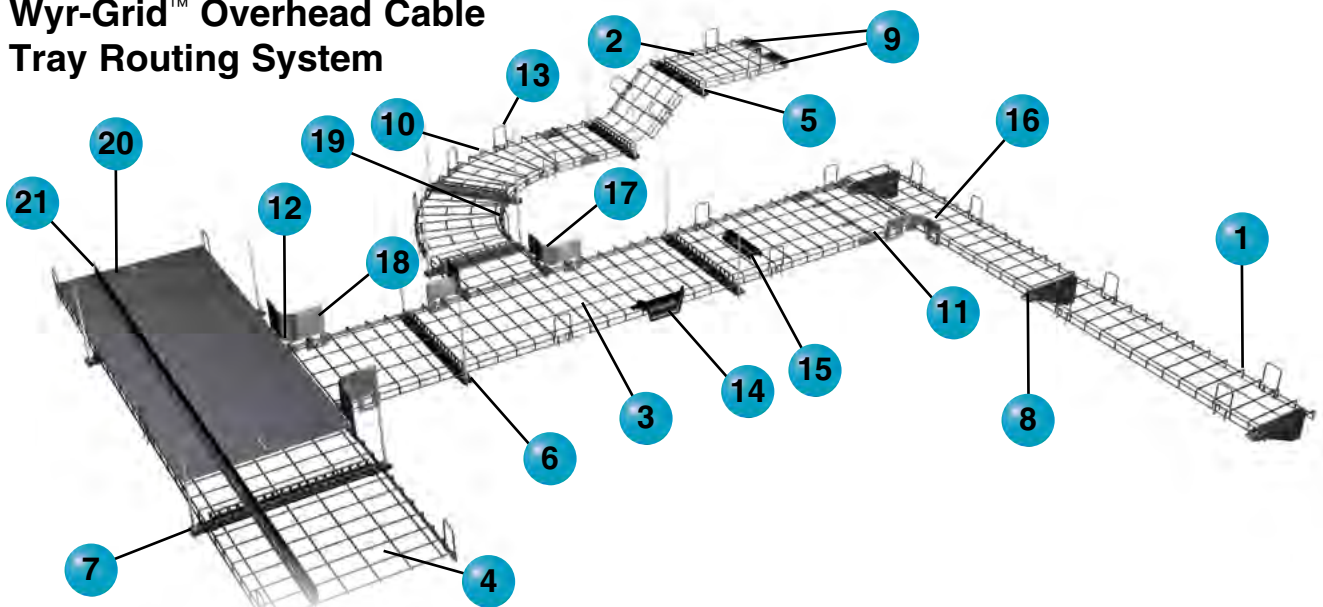

Pathway Sections

8" Width: WG8BL10 (not shown)

- 1 12" Width: WG12BL10
- 2 18" Width: WG18BL10
- 3 24" Width: WG24BL10
- 4 30" Width: WG30BL10

Snap-On Sidewalls

2" Sidewall: WGSW2BL (not shown)



- 13 4" Sidewall: WGSW4BL
- 6" Sidewall: WGSW6BL

Waterfalls



- 14 4" Side Waterfall: WGSWF4BL
- 15 Bottom Waterfall: WGBTMWFBL

Mounting Brackets

Trapeze Brackets

8" Wide: WGTBS8BL (not shown)
12" Wide: WGTBS12BL (not shown)

- 5 18" Wide: WGTBS18BL
- 6 24" Wide: WGTBS24BL
- 7 30" Wide: WGTBS30BL

Cantilever Brackets

- 8 12" Wide: WGCB12BL
- 18" Wide: WGCB18BL (not shown)
- 24" Wide: WGCB24BL (not shown)

Wall Mount Termination Brackets

8" Wide: WGWMTB8BL (not shown)
12" Wide: WGWMTB12BL (not shown)

- 9 18" – 30" Wide: WGWMTB1830BL

Splice Connectors

- 10 For 8", 12", and 18" Widths: WGSPL1218BL
- 11 For 24" and 30" Widths: WGSPL2430BL
- 12 Intersection Splice: WGINTSPLBL

Intersection Bend Radius Control



- 16 2" High Sidewall: WGIBRC2BL
- 17 4" High Sidewall: WGIBRC4BL
- 18 6" High Sidewall: WGIBRC6BL

Accessories

- 19 Hardware Kit: WGHWDWKTBL

Tray Liner



- 8" Tray Liner: WGTL8PG (not shown)
- 12" Tray Liner: WGTL12PG (not shown)
- 18" Tray Liner: WGTL18PG (not shown)
- 24" Tray Liner: WGTL24PG (not shown)
- 20 30" Tray Liner: WGTL30PG

Divider Wall



- 2" Divider Wall: WGDW2PG (not shown)
- 4" Divider Wall: WGDW4PG
- 6" Divider Wall: WGDW6PG (not shown)

Additional splice connectors are available. Refer to page J.51.

Wyr-Grid™ Overhead Cable Tray Routing System

Wire Fill for Wyr-Grid™ Overhead Cable Tray Routing System

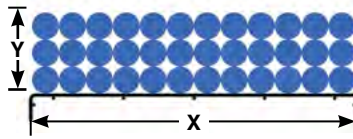

X In.	Y In.	Internal Area In ²	Category 6A (SD) Diameter 6.1mm 0.240"	Category 6A Diameter 7.6mm 0.300"	Category 6 Diameter 6.1mm 0.240"	X In.	Y In.	Internal Area In ²	Category 6A (SD) Diameter 6.1mm 0.240"	Category 6A Diameter 7.6mm 0.300"	Category 6 Diameter 6.1mm 0.240"
12.2	2	24.3	269	172	269	24.2	2	48.3	534	342	534
	4	48.7	538	344	538		4	96.7	1069	684	1069
	6	73.0	807	516	807		6	145.0	1603	1026	1603
18.2	2	36.3	401	257	401	30.2	2	60.3	666	427	666
	4	72.7	804	514	804		4	120.7	1334	854	1334
	6	109.0	1205	771	1205		6	181.0	2000	1280	2000

"Y" equates to the height of the Wyr-Grid™ Sidewalls. The internal area defines the allowable fill capacity based on the Wyr-Grid™ Pathway width and sidewall height. The Wyr-Grid™ Pathway cable fill is based on NEC allowable fill of 50%. The above cable diameters represent the nominal Panduit cable diameter per performance level.

Wyr-Grid™ Pathway Sections

- Pathways are provided in five widths: 8" (203mm), 12" (305mm), 18" (457mm), 24" (610mm), and 30" (762mm)
- Standard finishes are black powder coat and electro zinc plated
- Non-integral sidewalls minimize specification requirements



WG8BL10



WG12BL10



WG18BL10

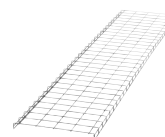

WG24BL10

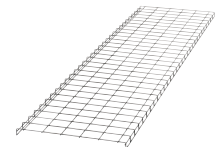

WG30BL10

Part Number	Part Description	Std. Pkg. Qty.
-------------	------------------	----------------

Low Profile "Z" Bracket

WG8BL10	8" Wide x 118.35" long pathway section used to carry cables horizontally throughout the system. Available in black only. Uses splice connector WGSP1218BL to connect straight sections and intersection splice WGINTSPLBL to connect pathways at intersection.	10
WG12BL10	12" Wide x 118.35" long pathway section used to carry cables horizontally throughout the system. Uses splice connector WGSP1218BL to connect straight sections and intersection splice WGINTSPLBL to connect pathways at intersection.	
WG18BL10	18" Wide x 118.35" long pathway section used to carry cables horizontally throughout the system. Available in black only. Uses splice connector WGSP1218BL to connect straight sections and intersection splice WGINTSPLBL to connect pathways at intersection.	
WG24BL10	24" Wide x 118.35" long pathway section used to carry cables horizontally throughout the system. Uses splice connector WGSP2430BL to connect straight sections and intersection splice WGINTSPLBL to connect pathways at intersection.	
WG30BL10	30" Wide x 118.35" long pathway section used to carry cables horizontally throughout the system. Uses splice connector WGSP2430BL to connect straight sections and intersection splice WGINTSPLBL to connect pathways at intersection.	

Order number of feet required, in multiples of standard 10' length increments.

*For electro zinc finish replace BL (Black) with EZ.

A. Featured Products
B. Copper Systems
C. Fiber Systems
D. Faceplates, Frames & Surface Mount Boxes
E. Industrial Networks
F. Audio Video Systems
G. Keystone Cabling Systems
H. Zone Cabling
J. Cable Routing Systems
K. Cable Cleats
L. Cabinets & Rack Systems
M. Power & Connectivity Management
N. Grounding & Bonding
O. Identification Products
P. Cable Management Accessories
Q. Part Number Index

Wyr-Grid™ Splice Connectors

- Integral bonding screw creates a mechanical electrical bond between cable tray pathway sections
- Standard finishes are black powder coat and electro zinc plated
- Sold in pairs



Part Number	Part Description	Std. Pkg. Qty.	Std. Ctn. Qty.
WGSP1218BL	Straight Splice connector quickly joins two (305mm) or 18" (457mm) wide Pathways together. Packaging contains 2 components needed to join two pathway sections.	1	10
WGSP2430BL	Straight Splice connector quickly joins two 24" (610mm) or 30" (762mm) wide Pathways together. Packaging contains 4 components needed to join two pathway sections.		
WGINTSPLBL	Intersection splice connector quickly joins Pathways at all intersections. Package contains 2 components needed to create one tee or right angle intersection.		
WGESPLBL	Straight splice connector with clips join two 8" (203mm), 12" (30mm) or 18" (457mm) wide Pathways together. Package contains 2 components needed to join two pathway sections.		
WGESPL2430BL	Straight splice connector with clips join two 24" (610mm) or 30" (762mm) wide Pathways together. Package contains 4 components needed to join two pathway sections.		

Wyr-Grid™ Waterfalls

- Offered in two different configurations that attach to all pathway sections 8" (203mm), 18" (457mm), 24" (610mm) and 30" (762mm)
- Standard finishes are black powder coat and electro zinc plated



Part Number	Part Description	Std. Pkg. Qty.	Std. Ctn. Qty.
WGBTMWFBL*	The bottom waterfall provides 1.38" (35mm) bend radius control for cables transitioning down into the racks or cabinets from within the Wyr-Grid™ Pathway. Standard finish is black powder coat.	1	10
WGSWF4BL	The side waterfall provides 3" (76mm) bend radius control for cables transitioning down into the racks or cabinets from the side of the Wyr-Grid™ Pathway. Waterfall only offered in black color.		—

*For electro zinc finish replace BL (Black) with EZ.

Wyr-Grid™ Support Brackets

- Offered in various widths to accommodate pathways: 8" (203mm), 12" (305mm), 18" (457mm), 24" (610mm), and 30" (762mm)
- Standard finishes are black powder coat and electro zinc plated
- Integral quick-clip retention
- Accommodates 1/2" or 12mm threaded rod



WGTBS8BL WGTBS12BL



WGTBS18BL WGTBS24BL



WGTBS30BL WGTBS30BL



WGTBS30BL WGTBS30BL



WGWTB8BL WGWTB12BL



WGWTB1830BL WGVWMBEZ

Part Number	Part Description	Std. Pkg. Qty.	Std. Ctn. Qty.
-------------	------------------	----------------	----------------

Wyr-Grid™ Trapeze Brackets

WGTBS8BL	Used to support 8" (203mm) wide Wyr-Grid™ Pathway from the ceiling using a pair of 1/2" or 12mm threaded rod drops. Hardware for attaching to threaded rod sold separately.	1	5
WGTBS12BL	Used to support 12" (305mm) wide Wyr-Grid™ Pathway from the ceiling using a pair of 1/2" or 12mm threaded rod drops. Hardware for attaching to threaded rod sold separately.		
WGTBS18BL	Used to support 18" (457mm) wide Wyr-Grid™ Pathway from the ceiling using a pair of 1/2" or 12mm threaded rod drops. Hardware for attaching to threaded rod sold separately.		
WGTBS24BL	Used to support 24" (610mm) wide Wyr-Grid™ Pathway from the ceiling using a pair of 1/2" or 12mm threaded rod drops. Hardware for attaching to threaded rod sold separately.		
WGTBS30BL	Used to support 30" (762mm) wide Wyr-Grid™ Pathway from the ceiling using a pair of 1/2" or 12mm threaded rod drops. Hardware for attaching to threaded rod sold separately.		

Wyr-Grid™ Cantilever Brackets

WGCB12BL	Used to support the 12" (305mm) wide Wyr-Grid™ Pathway along a wall. Mounting hardware for attaching to wall not included.	1	5
WGCB18BL	Used to support the 18" (457mm) wide Wyr-Grid™ Pathway along a wall. Mounting hardware for attaching to wall not included.		
WGCB24BL	Used to support the 24" (610mm) wide Wyr-Grid™ Pathway along a wall. Mounting hardware for attaching to wall not included.		

Wyr-Grid™ Wall Mount Termination Brackets

WGWTB8BL	Used to support the end of the 8" (203mm) Wyr-Grid™ Pathway against the wall. Mounting hardware for attaching to wall not included.	1	5
WGWTB12BL	Used to support the end of the 12" (305mm) Wyr-Grid™ Pathway against the wall. Mounting hardware for attaching to wall not included.		
WGWTB1830BL	Used to support the 24" (610mm) wide Wyr-Grid™ Pathway along a wall. Integral retaining clip secures the pathway to the bracket. Mounting hardware for attaching to wall not included.		
WGVWMBEZ	Electro Zinc plated vertical wall mount bracket.		

For electro zinc finish replace BL (Black) with EZ.

A. Featured Products

B. Copper Systems

C. Fiber Systems

D. Faceplates, Frames & Surface Mount Boxes

E. Industrial Networks

F. Audio Video Systems

G. Keystone Cabling Systems

H. Zone Cabling

J. Cable Routing Systems

K. Cable Cleats

L. Cabinets & Rack Systems

M. Power & Connectivity Management

N. Grounding & Bonding

O. Identification Products

P. Cable Management Accessories

Q. Part Number Index

Continued on next page

A. Featured Products
B. Copper Systems
C. Fiber Systems
D. Faceplates, Frames & Surface Mount Boxes
E. Industrial Networks
F. Audio Video Systems
G. Keystone Cabling Systems
H. Zone Cabling
J. Cable Routing Systems
K. Cable Cleats
L. Cabinets & Rack Systems
M. Power & Connectivity Management
N. Grounding & Bonding
O. Identification Products
P. Cable Management Accessories
Q. Part Number Index

Wyr-Grid™ Support Brackets (continued)

- Offered in various widths to accommodate pathways: 12" (305mm), 18" (457mm), 24" (610mm), and 30" (762mm)
- Integral quick-clip retention
- Accommodates 1/2" or 12mm threaded rod
- Standard finish is black powder coat



WG2PRB12BL



WG2PRB18BL



WG2PRB24BL



WGR4PK30BL



WGCMB1200BL



WGCMB1070BL



WGCMK1200BL

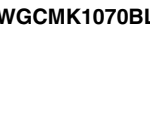

WGCMK1070BL

Part Number	Part Description	Std. Pkg. Qty.	Std. Ctn. Qty.
-------------	------------------	----------------	----------------

Wyr-Grid™ 2-Post Channel Trapeze Rack Mount Brackets

WG2PRB12BL	Used to support the 12" (305mm) wide Wyr-Grid™ Pathway directly to standard 3" or 6" EIA channel racks. Brackets can be installed parallel or perpendicular.	1	5
WG2PRB18BL	Used to support the 18" (457mm) wide Wyr-Grid™ Pathway directly to standard 3" or 6" EIA channel racks. Brackets can be installed parallel or perpendicular.		
WG2PRB24BL	Used to support the 24" (610mm) wide Wyr-Grid™ Pathway directly to standard 3" or 6" EIA channel racks. Brackets can be installed parallel or perpendicular.		

Wyr-Grid™ 4-Post Channel Trapeze Rack Mount Bracket

WGR4PK30BL	Direct mounted strut bracket for use on a 4-post rack.	1	5
------------	--	---	---

Wyr-Grid™ Cabinet Direct Mounting Brackets

WGCMB1200BL	Direct mounted strut bracket for use on a Net-Access™ N-Type or S-Type 1200mm Cabinet (not elevated).	1	5
WGCMB1070BL	Direct mounted strut bracket for use on a Net-Access™ N-Type or S-Type 1070mm Cabinet (not elevated).		

Wyr-Grid™ Cabinet Mounting Brackets

WGCMK1200BL	Elevated trapeze bracket for use on a Net-Access™ N-Type or S-Type 1200mm Cabinet (elevated).	1	5
WGCMK1070BL	Elevated trapeze bracket for use on a Net-Access™ N-Type or S-Type 1070mm Cabinet (elevated).		

For electro zinc finish replace BL (Black) with EZ.

Wyr-Grid™ Mounting Brackets for FiberRunner™ System

- Offered in various widths to accommodate pathways: 12" (305mm), 18" (457mm), 24" (610mm), and 30" (762mm)
- Standard finish is black powder coat
- Integral quick-clip retention
- Accommodates 1/2" or 12mm threaded rod



Part Number	Part Description	Std. Pkg. Qty.	Std. Ctn. Qty.
Wyr-Grid™ Mounting Brackets for FiberRunner™ System			
FRTBWG12BL	FiberRunner™ QuikLock™ Threaded Rod Trapeze Bracket for Wyr-Grid™ Pathway 12" (305mm) width. Used to support FiberRunner™ 4x4 and 6x4 Channel above or below the Wyr-Grid™ 12" Pathway using the same 1/2" or 12mm threaded rod used to support the WGTB12BL bracket. Hardware for attaching to threaded rod sold separately.	10	1
FRTBWG18BL	FiberRunner™ QuikLock™ Threaded Rod Trapeze Bracket for Wyr-Grid™ Pathway 18" (457mm) width. Used to support FiberRunner™ 4x4, 6x4, and 12x4 Channel above or below the Wyr-Grid™ 18" Pathway using the same 1/2" or 12mm threaded rod used to support the WGTB18BL bracket. Hardware for attaching to threaded rod sold separately.	10	1
FRTBWG24BL	FiberRunner™ QuikLock™ Threaded Rod Trapeze Bracket for Wyr-Grid™ Pathway 24" (610mm) width. Used to support FiberRunner™ 4x4, 6x4, and 12x4 Channel above or below the Wyr-Grid™ 24" Pathway using the same 1/2" or 12mm threaded rod used to support the WGTB24BL bracket. Hardware for attaching to threaded rod sold separately.	10	1
FRTBWG30BL	FiberRunner™ QuikLock™ Threaded Rod Trapeze Bracket for Wyr-Grid™ Pathway 30" (762mm) width. Used to support FiberRunner™ 4x4, 6x4, 12x4, and 24x4 Channel above or below the Wyr-Grid™ 30" Pathway using the same 1/2" or 12mm threaded rod used to support the WGTB30BL bracket. Quick mount clips, FRQMC24-X are not included for installing the 24x4 Channel. These must be purchased separately. This bracket is on the same pitch as the Wyr-Grid™ Bracket. Hardware for attaching to threaded rod sold separately.	10	1
WG12FRTBBL	Wyr-Grid™ Pathway 12" (305mm) width FiberRunner™ QuikLock™ Trapeze Bracket. Attaches to the Wyr-Grid™ 12" (305mm) wide Pathway to support a secondary FiberRunner™ 4x4 or 6x4 Channel above the Wyr-Grid™ Pathway. Adjustable 6 9/16" to 9 7/8" over the top surface of the Wyr-Grid™ Pathway.	—	—
WG18FRTBBL	Wyr-Grid™ Pathway 18" (457mm) width FiberRunner™ QuikLock™ Trapeze Bracket. Attaches to the Wyr-Grid™ 18" (457mm) wide Pathway to support a secondary FiberRunner™ 4x4 or 6x4 Channel above the Wyr-Grid™ Pathway. Adjustable 6 9/16" to 9 7/8" over the top surface of the Wyr-Grid™ Pathway.	—	—
WG24FRTBBL	Wyr-Grid™ Pathway 24" (610mm) width FiberRunner™ QuikLock™ Trapeze Bracket. Attaches to the Wyr-Grid™ 24" (610mm) wide Pathway to support a secondary FiberRunner™ 4x4 or 6x4 Channel above the Wyr-Grid™ Pathway. Adjustable 6 9/16" to 9 7/8" over the top surface of the Wyr-Grid™ Pathway.	—	—
WG30FRTBBL	Wyr-Grid™ Pathway 30" (762mm) width FiberRunner™ QuikLock™ Trapeze Bracket. Attaches to the Wyr-Grid™ 30" (762mm) wide Pathway to support a secondary FiberRunner™ 4x4 or 6x4 Channel above the Wyr-Grid™ Pathway. Adjustable 6 9/16" to 9 7/8" over the top surface of the Wyr-Grid™ Pathway.	—	—
Wyr-Grid™ Mounting Bracket for Strut			
WGSKBL*	Black powder coated bracket strut mounting clip assembly allows Wyr-Grid™ Pathway to be attached directly to standard 1 5/8" wide strut structures. Contains support member, two clips and all hardware for assembly.	1	5

*For electro zinc finish replace BL (Black) with EZ.

- A. Featured Products
- B. Copper Systems
- C. Fiber Systems
- D. Faceplates, Frames & Surface Mount Boxes
- E. Industrial Networks
- F. Audio Video Systems
- G. Keystone Cabling Systems
- H. Zone Cabling
- J. Cable Routing Systems
- K. Cable Cleats
- L. Cabinets & Rack Systems
- M. Power & Connectivity Management
- N. Grounding & Bonding
- O. Identification Products
- P. Cable Management Accessories
- Q. Part Number Index

A. Featured Products

Wyr-Grid™ Accessories

- Offered in three different heights: 2" (50mm), 4" (102mm), and 6" (152mm)
- Standard finishes are black powder coat and electro zinc plated

B. Copper Systems

C. Fiber Systems



WGSW4BL

D. Faceplates, Frames & Surface Mount Boxes

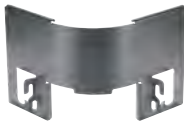

WGBRC2BL

E. Industrial Networks

F. Audio Video Systems

G. Keystone Cabling Systems

H. Zone Cabling

J. Cable Routing Systems

K. Cable Cleats

L. Cabinets & Rack Systems

M. Power & Connectivity Management

N. Grounding & Bonding

O. Identification Products

P. Cable Management Accessories

Q. Part Number Index

Part Number	Part Description	Std. Pkg. Qty.	Std. Ctn. Qty.
-------------	------------------	----------------	----------------

Wyr-Grid™ Pathway Snap-On Sidewalls

Part Number	Part Description	Std. Pkg. Qty.	Std. Ctn. Qty.
WGSW2BL	Wyr-Grid™ 2" (50mm) high Snap-On Sidewalls can be attached anywhere along the pathway where needed to retain cables.	1	40
WGSW4BL	Wyr-Grid™ 4" (102mm) high Snap-On Sidewalls can be attached anywhere along the pathway where needed to retain cables.		
WGSW6BL	Wyr-Grid™ 6" (152mm) high Snap-On Sidewalls can be attached anywhere along the pathway where needed to retain cables.		

Wyr-Grid™ Pathway Intersection Bend Radius Controls

Part Number	Part Description	Std. Pkg. Qty.
WGBIRC2BL	Wyr-Grid™ Intersection Bend Radius 2", Black.	1
WGBIRC4BL	Wyr-Grid™ Intersection Bend Radius 4", Black.	
WGBIRC6BL	Wyr-Grid™ Intersection Bend Radius 6", Black.	

For electro zinc finish replace BL (Black) with EZ.

Wyr-Grid™ Tray Liners



WGTL18PG

Part Number	Part Description	Std. Pkg. Qty.
WGTL8PG	8" Tray Liner	1
WGTL12PG	12" Tray Liner	
WGTL18PG	18" Tray Liner	
WGTL24PG	24" Tray Liner	
WGTL30PG	30" Tray Liner	

Available in BL (Black) only.

Divider Wall

- Provides the capability to have lane separations in the pathway
- Comes in pairs to fill the length of the pathway



WGDW2PG

Part Number	Part Description
WGDW2PG	Pre-galvanized metal divider wall in gray is 2.0" high with a 63" length.
WGDW4PG	Pre-galvanized metal divider wall in gray is 4.0" high with a 63" length.
WGDW6PG	Pre-galvanized metal divider wall in gray is 6.0" high with a 63" length.

Wyr-Grid™ Hardware



WGHRDWKTBL

Part Number	Part Description	Std. Pkg. Qty.	Std. Ctn. Qty.
WGHRDWKTBL	The hardware kit is used when field fabricating a right angle, allowing large radii to be created by cutting the pathway, bending it, and securing it into a right angle. 12" (305mm) width requires 6 pieces to create a 15.8" radius. 18" (457mm) width requires 9 pieces to create a 24.4" radius. 24" (610mm) width requires 12 pieces to create a 33.4" radius. 30" (762mm) width requires 15 pieces to create a 41.5" radius.	1	10

Available in BL (Black) only.

StructuredGround™ Grounding System for Wyr-Grid™ System



GACB brackets provide a convenient location to attach ground wire for grounding Wyr-Grid™ System to the ground bar.

GACB brackets provide the flexibility to install grounding conductors above or below the Wyr-Grid™ System.



Part Number	Part Description	Std. Pkg. Qty.	Std. Ctn. Qty.
Grounding Cable Hanger Brackets			
GACB-2	Supports grounding conductors positioned below Wyr-Grid™ Pathways and automatically makes bonding connection. Used with ladder rack and wire basket.	1	40
GACB-3	Supports grounding conductors positioned above Wyr-Grid™ Pathways and automatically makes bonding connection. Used with ladder rack and wire basket.		
GACBJ68U*	Auxiliary cable bracket jumper for bonding pathway sections; #6 AWG (16mm ²); 8.0" (203mm) length; factory terminated on both ends with straight, two-hole, long barrel compression lugs; provided with .16 oz. (5cc) of antioxidant and four mounting screws.		

*Length in inches. Available in 8", 12", and 18" lengths.

A. Featured Products

B. Copper Systems

C. Fiber Systems

D. Faceplates, Frames & Surface Mount Boxes

E. Industrial Networks

F. Audio Video Systems

G. Keystone Cabling Systems

H. Zone Cabling

J. Cable Routing Systems

K. Cable Cleats

L. Cabinets & Rack Systems

M. Power & Connectivity Management

N. Grounding & Bonding

O. Identification Products

P. Cable Management Accessories

Q. Part Number Index

A. Featured Products
B. Copper Systems
C. Fiber Systems
D. Faceplates, Frames & Surface Mount Boxes
E. Industrial Networks
F. Audio Video Systems
G. Keystone Cabling Systems
H. Zone Cabling
J. Cable Routing Systems
K. Cable Cleats
L. Cabinets & Rack Systems
M. Power & Connectivity Management
N. Grounding & Bonding
O. Identification Products
P. Cable Management Accessories
Q. Part Number Index

Wyr-Grid™ Tools



Part Number	Part Description	Std. Pkg. Qty.	Std. Ctn. Qty.
Tools			
FR716DR	7/16" nut driver for use with the FiberRunner™, GridRunner™, and Wyr-Grid™ Systems.	1	10
WGCT-A	Battery powered cutting tool for cutting Wyr-Grid™ Cable Trays, 2 – 18 volt lithium-ion batteries, and 115 volt, 60 Hz charger included.		—
WGCT-M	Manual cutting tool for cutting Wyr-Grid™ Cable Trays. Weight: 5.4 lbs. (2.45 kg).		—

Table of Contents

Cable Cleat Products for Short Circuit Protection K.2 – K.5
Installation Tools K.6
Cleat kAlculator™ App K.7

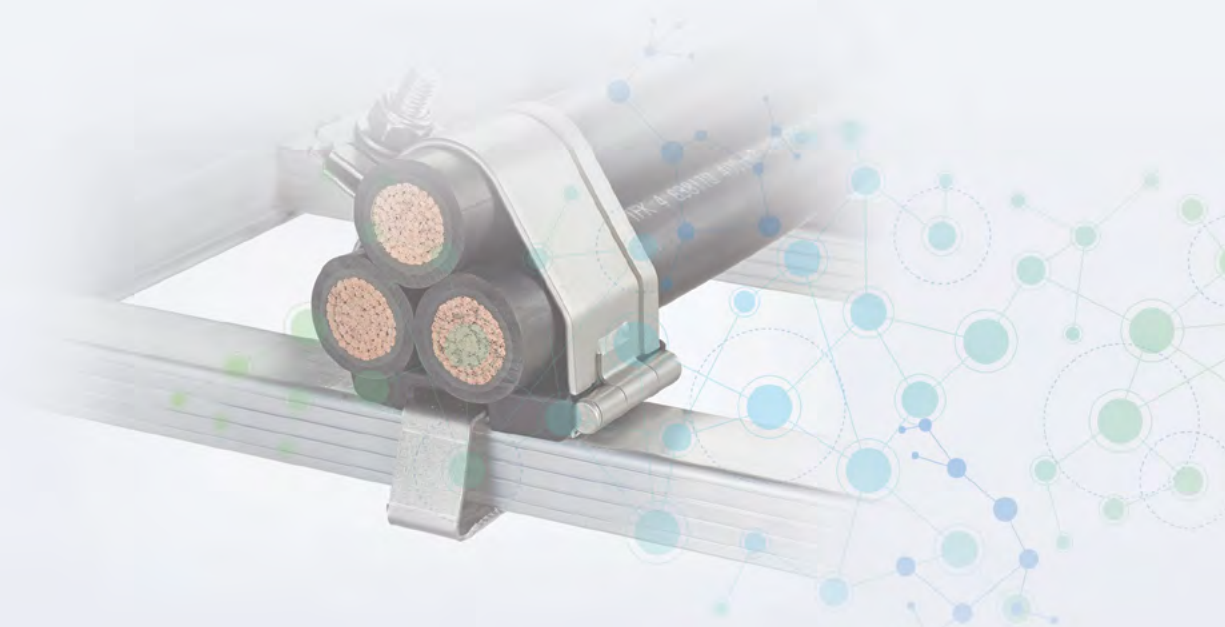

A. Featured Products
B. Copper Systems
C. Fiber Systems
D. Faceplates, Frames & Surface Mount Boxes
E. Industrial Networks
F. Audio Video Systems
G. Keystone Cabling Systems
H. Zone Cabling
J. Cable Routing Systems
K. Cable Cleats
L. Cabinets & Rack Systems
M. Power & Connectivity Management
N. Grounding & Bonding
O. Identification Products
P. Cable Management Accessories
Q. Part Number Index

- A. Featured Products
- B. Copper Systems
- C. Fiber Systems
- D. Faceplates, Frames & Surface Mount Boxes
- E. Industrial Networks
- F. Audio Video Systems
- G. Keystone Cabling Systems
- H. Zone Cabling
- J. Cable Routing Systems
- K. Cable Cleats**
- L. Cabinets & Rack Systems
- M. Power & Connectivity Management
- N. Grounding & Bonding
- O. Identification Products
- P. Cable Management Accessories
- Q. Part Number Index

Cable Cleat Products for Short Circuit Protection

Panduit Cable Cleat Self-Locking Cable Ties and the MS75 Metal Strapping System represent Panduit’s cable cleat offering for robust cable management and short circuit protection up to 156kA. Available in a variety of sizes, these solutions ensure cables remain contained in the event of a short circuit occurrence, minimizing disruption and damage to personnel and property. Panduit’s Cable Cleat Products for short circuit protection are designed to perform in a wide range of harsh environments, including industries such as Oil and Gas, Power Generation, Mining, and Shipbuilding.

- Up to 2X faster installation versus competitive cable cleats
- Simple and intuitive design leads to increased productivity
- Up to 50% reduction in material cost
- Compatible with a variety of ladder racks and cables



MS75 Technical Specifications and Testing Results

Design Specification	IEC 61914:2015
Classification	6.1.3 Composite SDSS – Standard Duty Stainless Steel
Temperature for permanent application	-60°C to +60°C IEC 61914:2015 clause 6.2
Needle Flame Test	PASS IEC 61914:2015 clause 10.1
Lateral Load Test	PASS IEC 61914:2015 clause 9.3
Axial Load Test	PASS IEC 61914:2015 clause 9.4
Impact Resistance	PASS – Very Heavy IEC 61914:2015 clause 6.3, 6.3.5, 9.2
Material	316/316L Stainless Steel Cushion sleeve is Low Smoke Halogen Free (LSHF) TPE



MLT Technical Specifications and Testing Results

Design Specification	IEC 61914:2015
Classification	6.1.3 Composite SDSS – Standard Duty Stainless Steel
Temperature for permanent application	-60°C to +60°C IEC 61914:2015 clause 6.2
Needle Flame Test	PASS IEC 61914:2015 clause 10.1
Lateral Load Test	PASS IEC 61914:2015 clause 9.3
Axial Load Test	PASS IEC 61914:2015 clause 9.4
Impact Resistance	PASS – Very Heavy IEC 61914:2015 clause 6.3, 6.3.5, 9.2
Material	316/316L Stainless Steel Cushion sleeve is Low Smoke Halogen Free (LSHF) TPE

Continued on next page

Cable Cleat Products for Short Circuit Protection

To provide optimum performance, the use of cushion sleeve is recommended, and may be required in some applications.

Type 316, Self-Locking Cable Ties — MLT and MS75 Strapping Series



Part Number	Width (mm)	Max Peak Current (kA)	Cable Tie Spacing (mm)	Tested Cable Outer Diameter (mm)
MLT#DEH15-Q316	12.7	45	300	27
MLT#DSH-Q316	15.9	70		39
MS#W75T30-Q6 (single loop)	19.1	85		40
MS#W75T30-Q6 (double loop)		156		43
MS#W75T30-Q6* (double loop)		142		38

represents maximum bundle diameter in inches
 • MLT#DEH15-Q316 and MLT#DSH-Q316: 4.0, 6.0 and 8.0
 • MS#W75T30-Q6 (single loop): 4.0, 6.0, 8.0, 10.0 and 12.0
 • MS#W75T30-Q6 (double loop): 2.0, 3.0, 4.0, 5.0 and 6.0
 When double looped, same part numbers are used as for single loop, but maximum bundle diameter is reduced in half.
 *MS75 is compliant with IEC 61914:2015 Section 6.4.5 (Resistant to electromechanical forces, withstanding more than one short circuit event).

Metal Uniclip Brackets

- Allows Panduit stainless steel ties and straps to be installed on any style or design of cable tray; slotted or un-slotted
- Eliminate consideration of diagonal installations
- High resistance to lateral and axial movement



Part Number	Material	Used with Pan-Steel™ Ties	Description
UCSQ1-VC	Galvanized Steel	MLTS/LH/H/EH/EH15/SH, MLTC/H, MLTFC/S/LH/H/EH/SH, or MSW75	Metal Rung Bracket – Strut Type
UCRND1-VC			Metal Rung Bracket – Round
UCIB1-VC			Metal Rung Bracket – I-Beam
UCTH1-VC			Metal Rung Bracket – Top Hat
UCSQ1-V316	Stainless Steel Type 316		Metal Rung Bracket – Strut Type
UCRND1-V316			Metal Rung Bracket – Round
UCIB1-V316			Metal Rung Bracket – I-Beam
UCTH1-V316			Metal Rung Bracket – Top Hat

PCS Cushion Sleeve



Part Number	Material	Used with Pan-Steel™ Ties	Description
PCSLSH-B-CR	TPE Low Smoke, Halogen-Free, and Flame-Resistant	MLTEH/SH Ties/Banding/Strapping	Cushion Sleeving, Extra-Heavy or Super-Heavy, 100' (30.5m) Long x 1.05" (26.8 mm) Wide

A. Featured Products

Cable Cleat Products for Short Circuit Protection

B. Copper Systems

Stainless Steel Trefoil Cleats

CCSSTR series is the newest addition to Panduit's cable cleat offering for robust cable management and short circuit protection. Available in a variety of sizes, these solutions ensure cables remain contained in the event of a short circuit occurrence, minimizing disruption and damage to personnel and property. Panduit's Cable Cleat Products for short circuit protection are designed to perform in a wide range of harsh environments, including industries such as Oil and Gas, Power Generation, Mining, and Shipbuilding.

C. Fiber Systems

- Easy Installation (Intuitive design for single tool tightening)
- Removeable Spacer (Range taking up to 7mm)
- Bracket Slot (Providing options for installer)
- 316L Stainless Steel (Suitable for harsh environments)
- IEC 61914:2015 Tested (Independent 3rd Party Lab)

D. Faceplates, Frames & Surface Mount Boxes

E. Industrial Networks

F. Audio Video Systems

G. Keystone Cabling Systems

H. Zone Cabling

J. Cable Routing Systems

K. Cable Cleats

L. Cabinets & Rack Systems

M. Power & Connectivity Management

N. Grounding & Bonding

O. Identification Products

P. Cable Management Accessories

Q. Part Number Index



Technical Specifications and Testing Results

Design Specification	IEC 61914:2015
Classification	Composite SDSS - Standard Duty Stainless Steel IEC 61914:2015 Clause 6.1.3
Temperature for permanent application	-40°C to +60°C IEC 61914:2015 clause 6.2
Needle Flame Test	PASS IEC 61914:2015 clause 10.1
Lateral Load Test	PASS IEC 61914:2015 clause 9.3
Axial Load Test	PASS IEC 61914:2015 clause 9.4
Impact Resistance	PASS – Very Heavy IEC 61914:2015 clause 6.3, 6.3.5, 9.2
Material	316/316L Stainless steel Spacer is Low Smoke Halogen Free (LSHF)

Short Circuit Testing Summary¹

Trefoil Formation 38 mm Cable Diameter	Trefoil Formation 38 mm Cable Diameter	Trefoil Formation 35 mm Cable Diameter	Trefoil Formation 38 mm Cable Diameter
One Short Circuit Event (Clause 6.4.4) 300 mm spacing	Two Short Circuit Events (Clause 6.4.5) 300 mm spacing	One Short Circuit Event (Clause 6.4.4) 600 mm spacing	Two Short Circuit Events (Clause 6.4.5) 600 mm spacing
0.1 sec	0.1 sec	0.1 sec	0.1 sec
172 kA Peak	162 kA Peak	143 kA Peak	125 kA Peak
8926 lbs force (39.77 kN)	7919 lbs force (37.4 kN)	13398 lbs force (59.5 kN)	9429 lbs force (41.9 kN)

¹Test compliance to IEC 61914:2015 utilizing KEMA facility; Independent, ISO 17025 accredited testing, inspection, and certification services (IEEE, IEC, UL, and ANSI) for electric power equipment.

Continued on next page

Cable Cleat Products for Short Circuit Protection

Stainless Steel Trefoil Cleats

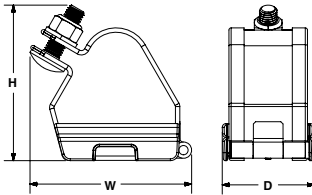

Part Number	Cable Range (mm)		Dimensions (mm)				
	Min Dia.	Max Dia.	H	W	D	Mounting Holes	Weight (g)
CCSSTR1822	18	22	83	79	63	1 x M8	392
CCSSTR2025	20	25	87	86	63		417
CCSSTR2328	23	28	91	90	63		439
CCSSTR2632	26	32	95	97	63		480
CCSSTR3036	30	36	100	105	63		518
CCSSTR3440	34	40	108	111	63		547
CCSSTR3844	38	44	108	119	63		581
CCSSTR4248	42	48	112	126	63		613
CCSSTR4652	46	52	117	133	63		647
CCSSTR5057	50	57	123	143	63		686
CCSSTR5461	54	61	130	150	63		720
CCSSTR5865	58	65	138	157	63		754
CCSSTR6269	62	69	145	165	63		782
CCSSTR6673	66	73	153	173	63		822
CCSSTR7077	70	77	161	178	63		856

Note: Alternative fault levels, fixing spacings, and custom alternatives can be offered. Please contact our Sales Team for further information.

Cable Cleat Bracket

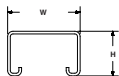
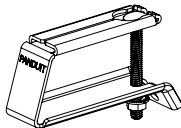

Part Number	Description	Height	Length
CBH15L50-V6	Metal Rung Bracket (with closure bolt).	15 mm	50 mm
CBH20L50-V6	Metal Rung Bracket (with closure bolt).	20 mm	
CBH25L50-V6	Metal Rung Bracket (with closure bolt).	25 mm	
CBH30L50-V6	Metal Rung Bracket (with closure bolt).	30 mm	

Note: Alternative sizes available upon request. Please contact our Sales Team for further information.

- A. Featured Products
- B. Copper Systems
- C. Fiber Systems
- D. Faceplates, Frames & Surface Mount Boxes
- E. Industrial Networks
- F. Audio Video Systems
- G. Keystone Cabling Systems
- H. Zone Cabling
- J. Cable Routing Systems
- K. Cable Cleats
- L. Cabinets & Rack Systems
- M. Power & Connectivity Management
- N. Grounding & Bonding
- O. Identification Products
- P. Cable Management Accessories
- Q. Part Number Index

A.
Featured
Products

Installation Tools

B.
Copper
Systems

C.
Fiber
Systems

D.
Faceplates,
Frames &
Surface
Mount Boxes

E.
Industrial
Networks

F.
Audio
Video
Systems

G.
Keystone
Cabling
Systems

H.
Zone
Cabling

J.
Cable
Routing
Systems

K.
Cable
Cleats

L.
Cabinets
& Rack
Systems

M.
Power &
Connectivity
Management

N.
Grounding
& Bonding

O.
Identification
Products

P.
Cable
Management
Accessories

Q.
Part
Number
Index

- The manually-operated BT2HTI and BT75SDT tools are used to install Panduit's Buckle Strap Cleats
- The BT2HTI is a ratchet-style installation tool, allowing for high tension with minimal effort
- The BT75SDT tensions the strap using a screw drive mechanism, providing high tension while reducing operator fatigue
- Both tools use a lever to cut the strap so there is an appropriate length remaining to fold over and secure with the buckle tab.
- The BT2HTI is more suitable for higher volume installations, and the BT75SDT for lower volume
- The battery-operated PBTMT and manually-operated, ratchet-style RT2HT tools are used to install Panduit's Locking Strap Cleats.
- Both tools tension the strap through its locking head using a gripping tooth mechanism and then cut the end flush, eliminating any sharp edges.
- The PBTMT is more suitable for higher volume installations, and the RT2HT for lower volume
- A side entry slot allows for easy strap insertion, streamlining installation



BT2HTI



BT75SDT



PBTMT/E



RT2HT

Part Number	Description	Length		Width		Used With	Std Pkg. Qty.
		In.	mm	In.	mm		
BT2HTI	Installation tool for use with MS75 buckles.	6.94	176	7.64	194	Stainless Steel Buckle Strap Cleat	1
BT75SDT	Screw drive tension mechanism provides high tension with minimal effort, reducing operator fatigue; Heavy duty construction offers a longer service life; Strapping side entry allows quick side entry of the strap into tool to speed installation.	15	381	8	203		1
PBTMT/E	Battery powered installation tool, for use with Pan-Steel™ Heavy, Extra-heavy, and Super-Heavy, Cross Section MLT Style Ties, and MLTD Double Wrapped Style Ties, 2 –12 volt lithium-ion batteries and 115 volt, 60 Hz charger included.	10.33	262.4	3.17	80.5	Stainless Steel Locking Strap Cleat	1
RT2HT	Hand Operated Tool for use with Extra-Heavy and Super-Heavy Cross Section Pan-Steel™ Type MLT Ties.	7.1	180	4.05	103		1

Cleat kAlculator™ App

- Helps engineers in specifying the correct cleat and spacing
- Users can input information such as cable layout, cable diameter and peak fault level
- Based upon the results of independent laboratory short circuit testing the Cleat kAlculator™ app will suggest a cleat type and recommend the correct cleat spacing
- If there is more than one option to match the enquiry the app will offer a choice and the user can assess the benefits of each option.
- Results can also be saved on the device and emailed
- Available in the iOS and Android



- A. Featured Products
- B. Copper Systems
- C. Fiber Systems
- D. Faceplates, Frames & Surface Mount Boxes
- E. Industrial Networks
- F. Audio Video Systems
- G. Keystone Cabling Systems
- H. Zone Cabling
- J. Cable Routing Systems
- K. Cable Cleats
- L. Cabinets & Rack Systems
- M. Power & Connectivity Management
- N. Grounding & Bonding
- O. Identification Products
- P. Cable Management Accessories
- Q. Part Number Index

A. Featured Products
B. Copper Systems
C. Fiber Systems
D. Faceplates, Frames & Surface Mount Boxes
E. Industrial Networks
F. Audio Video Systems
G. Keystone Cabling Systems
H. Zone Cabling
J. Cable Routing Systems
K. Cable Cleats
L. Cabinets & Rack Systems
M. Power & Connectivity Management
N. Grounding & Bonding
O. Identification Products
P. Cable Management Accessories
Q. Part Number Index

Notes

Table of Contents

Net-Access™ N-Type Cabinets L.2

Net-Access™ S-Type Cabinets L.3

Net-Access™ S-Type Universal Cabinets..... L.4

Net-Verse™ Cabinets L.5

Net-Access™ Enterprise Cabinets L.6

Net-Access™ Dynamic Cabinets..... L.7

Net-Contain™ Vertical Exhaust Ducts (VEDs) L.8

Net-Access™ Cabinet Top Cable Routing System L.8

Net-Access™ Cabinet Accessories..... L.9 – L.11

Net-Access™ Cabinet Thermal Management Accessories L.11

Net-Contain™ Universal Containment System..... L.12 – L.16

Net-Contain™ Cabinet Supported Cold Aisle/Hot Aisle Containment..... L.17 – L.23

4 Post Cable Management Rack System and Accessories. . L.24 – L.25

2 Post Cable Management Rack System and Accessories..... L.26

PatchRunner™ 2 Vertical Cable Management Systems L.27 – L.29

NetRunner™ Vertical Cable Management L.30

PatchLink™ Horizontal Cable Managers L.31

NetManager™ High Capacity Horizontal Cable Managers..... L.32

Open-Access™ Horizontal Cable Managers L.33

Cable Routing Troughs L.33

Rack Mount Shelves L.34

Panel Extender Brackets..... L.34

Rack Mount Cable Management Accessories L.35

Hinged Wall Brackets L.35

Rack Filler Panels..... L.36

Angled Panel Accessories..... L.36

IN-Cabinet Vertical Cable Managers L.36

**A.
Featured
Products**

**B.
Copper
Systems**

**C.
Fiber
Systems**

**D.
Faceplates,
Frames &
Surface
Mount Boxes**

**E.
Industrial
Networks**

**F.
Audio
Video
Systems**

**G.
Keystone
Cabling
Systems**

**H.
Zone
Cabling**

**J.
Cable
Routing
Systems**

**K.
Cable
Cleats**

**L.
Cabinets
& Rack
Systems**

**M.
Power &
Connectivity
Management**

**N.
Grounding
& Bonding**

**O.
Identification
Products**

**P.
Cable
Management
Accessories**

**Q.
Part
Number
Index**

- A. Featured Products
- B. Copper Systems
- C. Fiber Systems
- D. Faceplates, Frames & Surface Mount Boxes
- E. Industrial Networks
- F. Audio Video Systems
- G. Keystone Cabling Systems
- H. Zone Cabling
- J. Cable Routing Systems
- K. Cable Cleats
- L. Cabinets & Rack Systems
- M. Power & Connectivity Management
- N. Grounding & Bonding
- O. Identification Products
- P. Cable Management Accessories
- Q. Part Number Index

Net-Access™ N-Type Cabinets

Net-Access™ N-Type Cabinets are ideal for network applications that requires optimal thermal management and the capacity to manage high cable densities of switch applications.



- Front dual or single hinge doors with 69% open perforation
- Dual hinge front door allows door to open to the left or right
- Rear perforated split doors with 69% opening
- Inset frame for improved cable management
- Single point bonding at top and bottom of cabinet
- Static load rating - 3000 lbs. and rolling load rating - 2500 lbs.
- Fully integral bonded without the use of grounding wires - equipment rails, door and side panels

Net-Access™ N-Type Standard Configured Cabinets

Series	Width	Height	Depth	Side Panels	Colors	Standards Options (Select Only One)
N	8 = 800mm	2 = 42RU 5 = 45RU 8 = 48RU	1 = 1070mm 2 = 1200mm	2 = 2 side panels* 9 = No side panel	B = Black W = White	C = Cage Nut Rails E = Single Hinge Front Door and Cage Nut Rails S = No Doors** T = Integral Cabinet Top Cable Routing System** TC = Integral Cabinet Top Cable Routing System and Cage Nut Rails U = Vertical Blanking and Cage Nut Rails V = VED Ready ** Y = VED Ready and Cage Nut Rails YT = VED Ready, Cage Nut Rails, and Integral Cabinet Top Cable Routing System

*Standard side panel.
**Includes #12-24 tapped equipment rails. V, Y and YT - only available for 1200mm deep cabinets.

Standard Configurations have 6 characters with only one standard option suffix.

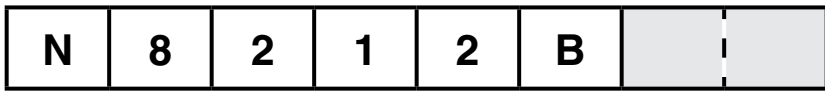

Net-Access™ S-Type Cabinets

Net-Access™ S-Type Cabinets are ideal for server applications where high density RU utilization and cable management are required.



- Front single hinge door and split perforated rear door with 69% open perforation
- Vertically split hinged side panels (if applicable)
- Vertical blanking panel
- Heavy-duty leveling legs
- Ganging brackets
- Rear equipment rails accommodate cable management fingers (finger sold separately)
- Fully integral bonded without the use of grounding wires - equipment rails, door and side panels
- Static load rating - 3000 lbs. and rolling load rating - 2500 lbs.
- Casters

Net-Access™ S-Type Standard Configured Cabinets

Series	Width	Height	Depth	Side Panels	Colors	Standards Options (Select Only One)
S	6 = 600mm 7 = 700mm 8 = 800mm	2 = 42RU 5 = 45RU 8 = 48RU	1 = 1070mm 2 = 1200mm	2 = 2 side panels* 9 = No side panel	B = Black W = White	F = Vertical Cable Management Fingers P = Vertical Patching Equipment Rails S = No Doors T = Integral Cabinet Top Cable Routing System T9 = Integral Cabinet Top Cable Routing System and No Casters V = VED Ready V9 = VED Ready and No Casters 9 = No Casters

*Standard side panel P - only available for 600mm wide S-Type Cabinets. V and V9 - only available for 1200mm deep cabinets.

Standard Configurations have 6 characters with only one standard option suffix.

S	6	2	1	2	B		
---	---	---	---	---	---	--	--

A. Featured Products

B. Copper Systems

C. Fiber Systems

D. Faceplates, Frames & Surface Mount Boxes

E. Industrial Networks

F. Audio Video Systems

G. Keystone Cabling Systems

H. Zone Cabling

J. Cable Routing Systems

K. Cable Cleats

L. Cabinets & Rack Systems

M. Power & Connectivity Management

N. Grounding & Bonding

O. Identification Products

P. Cable Management Accessories

Q. Part Number Index

- A. Featured Products
- B. Copper Systems
- C. Fiber Systems
- D. Faceplates, Frames & Surface Mount Boxes
- E. Industrial Networks
- F. Audio Video Systems
- G. Keystone Cabling Systems
- H. Zone Cabling
- J. Cable Routing Systems
- K. Cable Cleats
- L. Cabinets & Rack Systems
- M. Power & Connectivity Management
- N. Grounding & Bonding
- O. Identification Products
- P. Cable Management Accessories
- Q. Part Number Index

Net-Access™ S-Type Universal Cabinets

Net-Access™ S-Type Universal Cabinets are ideal for network or server application that provides effective thermal management, high density cable management and RU utilization.



- Front single hinge door and split perforated rear door with 69% open perforation accommodate cable management fingers (includes 1 set of fingers)
- Vertically split hinged side panels (if applicable) • Fully integral bonded without the use of grounding wires - equipment rails, door and side panels
- Ganging brackets included
- Heavy-duty leveling legs
- Adjustable front and rear equipment rails
- Top and bottom rail position markings
- Front and rear equipment rails

Net-Access™ S-Type Universal Standard Configured Cabinets

Series	Width	Height	Depth	Side Panels	Colors	Standards Options (Select Only One)
S	6 = 600mm 7 = 700mm 8 = 800mm	2 = 42RU 5 = 45RU 8 = 48RU	1 = 1070mm 2 = 1200mm	2 = 2 side panels* 9 = No side panel	B = Black W = White	U = Universal Frame

*Standard side panel.

Standard Universal Configurations have 7 characters



Net-Verse™ Cabinets

Net-Verse™ Cabinets are the preferred choice for network or server applications that provides a versatile and cost effective solution for data center, enterprise or colocation deployment.



- Fully adjustable e-rail offer application flexibility
- Optional in-cabinet blanking panels are fully compatible with Panduit Universal Aisle Containment System maximizing airflow and thermal efficiency
- Multi-point locking doors and locking side panels provides enhanced security
- Two full height multi-purpose PDU/cable management brackets for mounting PDUs or lashing cables
- Adjustable front and rear equipment rails
- Top and bottom rail position markings
- Front and rear equipment rails accommodate cable management fingers (includes 1 set of fingers)
- Static load rating - 3000 lbs. and rolling load rating - 2500 lbs.
- Casters
- Fully electrically bonded - equipment rails, door and side panels

Net-Verse™ Configured Cabinets

Series	Width	Height	Depth	Side Panels	Colors
DN	6 = 600mm 8 = 800mm	2 = 42RU 5 = 45RU 8 = 48RU	1 = 1070mm 2 = 1200mm	2 = 2 side panels 9 = No side panel	B = Black W = White

Standard Universal Configurations have 6 characters

DN	6	2	1	2	B
-----------	----------	----------	----------	----------	----------

Net-Verse™ Cabinet Accessories

Part Number	RU	Width of Cabinet mm	Description
Doors			
D6*FDB	42,45,48	600	Front, Black
D8*FDB		800	
D6*RDB		600	Rear Split, Black
D8*RDB		800	

Part Number	RU	Depth of Cabinet mm	Description
Side Panels			
D*1SPB	42	1070	Side Panel
D*2SPB		1200	
D*1SPB	45	1070	
D*2SPB		1200	
D*1SPB	48	1070	
D*2SPB		1200	

Part Number	RU	Depth of Cabinet mm	Description
Equipment Rails			
D*ERB	42,45,48	-	Cage Nut Rail Set (1 Right and 1 Left Rail)
D*ERTB			12-24 Tapped Rail Set (1 Right and 1 Left Rail)

Part Number	RU	Depth of Cabinet mm	Description
Cable Management Fingers with Mounting Brackets			
D1*FBB	42,45,48	800	Fingers Kit With Mounting Brackets

Part Number	RU	Depth of Cabinet mm	Description
Bottom Cover Plate			
D61BCPB	-	600	For Use In 1000mm D Cabinets
D62BCPB			For Use In 1200mm D Cabinets
D81BCPB			For Use In 1000mm D Cabinets
D82BCPB			For Use In 1200mm D Cabinets

*2 = 42RU, 5 = 45RU, 8 = 48RU, 1 = 51RU.
Also available in White, replace the "B" with "W".

- A. Featured Products
- B. Copper Systems
- C. Fiber Systems
- D. Faceplates, Frames & Surface Mount Boxes
- E. Industrial Networks
- F. Audio Video Systems
- G. Keystone Cabling Systems
- H. Zone Cabling
- J. Cable Routing Systems
- K. Cable Cleats
- L. Cabinets & Rack Systems
- M. Power & Connectivity Management
- N. Grounding & Bonding
- O. Identification Products
- P. Cable Management Accessories
- Q. Part Number Index

Net-Access™ Enterprise Cabinets

The 12 and 24 RU Net-Access™ Enterprise Cabinets store switches, patching, and servers used in office and small business areas. They are easy to roll away under a desk or in a closet. The ability of the cabinet is to easily move where needed, enables fast setups and quick changes of network capabilities. Perforated doors encourage airflow to help cool equipment in tight spaces.

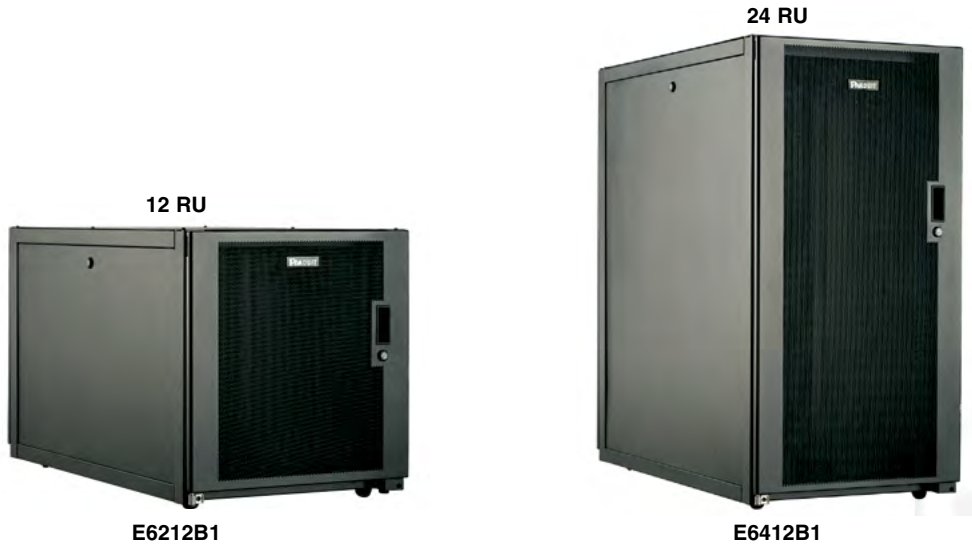

- Outset post design
- Welded and assembled steel frame construction
- Easy maintenance powder coat finish
- Adjustable rear equipment rails
- Fixed front equipment rails
- Integral vertical airdams
- Dual cut outs (1.5" x 5") in the rear cap of the cabinet for cable entry/cable access
- Single hinge perforated doors on front and rear with locks
- Side panels on both sides with ¼ turn locks
- Static load of 567kg (1,250 lbs.)
- Rolling load of 227kg (500 lbs.)
- EIA-310-E compliant
- Cabinet ships either fully assembled one per pallet, flat packed one per pallet, or flat packed 5 per pallet
- Hardware kit: M6 screws and cage nuts
- Swivel casters
- Adjustable leveling legs
- Single point grounding locations at bottom of cabinet

Part Number	Nominal Width mm	Height	Nominal Depth mm	Side Panels	Color	Packaging
E6212B1	600	12 RU	1070	2	Black	Assembled on Pallet
E6212B1FP						Flat Packed on Pallet
E6412B2		24 RU				Assembled on Pallet
E6412B2FP						Flat Packed on Pallet

Net-Access™ Dynamic Cabinets

The Net-Access™ Dynamic Cabinet is designed to allow the cabinet to be installed with equipment at one facility and safely shipped to another location. This is the ideal cabinet for System Integrators or Value Added Resellers as it allows the equipment to be pre-installed, cabled and ready for quick deployment. The heavy duty reinforced frame has been tested and approved to support the additional weight of equipment. A heavy duty shock pallet allows the cabinet to be shipped with equipment. The optional reusable ramp allows the cabinet to be easily unloaded from the pallet.



- Outset post design
- Welded and assembled steel frame construction
- Easy maintenance powder coat finish
- Adjustable rear equipment rails with continuous positioning
- Fixed front equipment rails
- Integral vertical airdams with covered cable pass-through openings
- Large cable entry/cable access
- Single hinge perforated front door with keyed swing handle
- Split hinge perforated rear door with keyed swing handle
- Optional split side panels on both sides with dual latches and keyed lock
- Two sets of PDU mounting brackets

- High density cable management fingers (SN25F)
- Select cable entry holes are equipped with plastic sealing plugs, others have cutouts
- Static load of 1,361kg (3,000 lbs.)
- Rolling load of 1,136kg (2,500 lbs.)
- Dynamic shipping load of 907kg (2,000 lbs.)
- EIA-310-E compliant
- Fully integral bonded without the use of grounding wires - equipment rails, door and side panels
- Hardware kit: M6 screws and cage nuts
- Factory installed casters, swivel in the rear and fixed in the front
- Adjustable leveling legs
- Single point grounding locations at bottom of cabinet

Part Number	Nominal Width mm	Height	Nominal Depth mm	Side Panels	Color	Ramp
S7222BDHRSP	700	42 RU	1200	2	Black	Yes
S7222BDHSP						No
S7229BDHRSP				Yes		
S7229BDHSP				No		

A. Featured Products

B. Copper Systems

C. Fiber Systems

D. Faceplates, Frames & Surface Mount Boxes

E. Industrial Networks

F. Audio Video Systems

G. Keystone Cabling Systems

H. Zone Cabling

J. Cable Routing Systems

K. Cable Cleats

L. Cabinets & Rack Systems

M. Power & Connectivity Management

N. Grounding & Bonding

O. Identification Products

P. Cable Management Accessories

Q. Part Number Index

- A. Featured Products
- B. Copper Systems
- C. Fiber Systems
- D. Faceplates, Frames & Surface Mount Boxes
- E. Industrial Networks
- F. Audio Video Systems
- G. Keystone Cabling Systems
- H. Zone Cabling
- J. Cable Routing Systems
- K. Cable Cleats
- L. Cabinets & Rack Systems
- M. Power & Connectivity Management
- N. Grounding & Bonding
- O. Identification Products
- P. Cable Management Accessories
- Q. Part Number Index

Net-Contain™ Vertical Exhaust Ducts (VEDs)



Part Number	N-Type Compatibility	S-Type Compatibility	Description
C2VED**I1626B1	X	X	VED - Adjustable from 406mm (16") up to 660mm (26") Height
C2VED**I2638B1			VED - Adjustable from 660mm (26") up to 965mm (38") Height
C2VED**I3866B1			VED - Adjustable from 965mm (38") up to 1676mm (66") Height

Replace** with 06 (600mm), 07 (700mm), 08 (800mm).
Also available in white, replace the "B1" with "W1".

Net-Access™ Cabinet Top Cable Routing System

- Protects, routes, and manages large quantities of twisted pair data cables into and out of any Net-Access™ Cabinet
- Available as an integral design with the cabinet or as a stand-alone accessory
- When ordered integrated into the cabinet, the cabinet top cable routing system provides up to a 30% reduction in installation costs



SN7TCDW
SN8TCDW



SN1070CREC
SN1200CREC
SN1200VCREC

Part Number	N- Type Compatibility	S-Type Compatibility	Width of Cabinet mm	Depth of Cabinet mm	Description
Integral Top Hat					
STH61B	—	X	600	1070	Top Cap
STH62B				1200	
STH71B			700	1070	
STH72B				1200	
SNTH81B	X	X	800	1070	Divider Wall
SNTH82B				1200	
SN7TCDW	—	X	600/700	—	End of Row Cap
SN8TCDW	X		800		
SN1070CREC			X	—	
SN1200CREC	End of Row Cap (VED)				
SN1200VCREC		1200			

For other colors replace suffix B (Black) with W (White).

Net-Access™ Cabinet Accessories

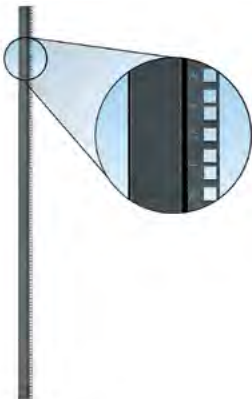

SN5RC

Part Number	N-Type Compatibility	S-Type Compatibility	RU	Width of Cabinet mm	Description
Doors					
N8*DHDB	X	—	42,45,48,51	800	Dual Hinge Front, Black
N8*SHDB					Single Hinge Front, Black
S6*SHDB	600				
S7*SHDB	700				
S8*SHDB	800				
S6*SDB	—	600		Split Perforated Rear, Black	
SN8*SDB		800			
S6*SSHDB	X	600		Solid Rear, Black	
S75SSHDB		—			
S78SSHDB	X				
SN8*SSHDB		—			

Part Number	N-Type Compatibility	S-Type Compatibility	RU	Depth of Cabinet mm	Description
Cabinet Side Panels					
N*1SPS	X	—	42,45,48,51	1070	Split, Black
N*2SPS				1200	
S*1SPSE	—	X		1070	Split Hinged, Black
S*2SPSE				1200	
S*1SPD2B	—	X		1070	Day 2, Post Cabinet Installation, Black
S*2SPD2B				1200	
SPSPNL	—	—		1070 or 1200	Partial Side Panel, Black

Part Number	N-Type Compatibility	S-Type Compatibility	RU	Description
Equipment Rail Sets				
SN*RC	X	X	42,45,48,51	1 Set of REAR Rails - Cage Nut

*2 = 42RU, 5 = 45RU, 8 = 48RU, 1 = 51RU.
Parts reflect Black; may also be available in White.

A. Featured Products

B. Copper Systems

C. Fiber Systems

D. Faceplates, Frames & Surface Mount Boxes

E. Industrial Networks

F. Audio Video Systems

G. Keystone Cabling Systems

H. Zone Cabling

J. Cable Routing Systems

K. Cable Cleats

L. Cabinets & Rack Systems

M. Power & Connectivity Management

N. Grounding & Bonding

O. Identification Products

P. Cable Management Accessories

Q. Part Number Index

Continued on next page

Net-Access™ Cabinet Accessories (continued)



Part Number	N-Type Compatibility	S-Type Compatibility	Description
PDU Brackets and Cable Management			
SN15F	X	X	Finger Kit (100mm Deep) 42-45 RU Cabinets
SN25F			Finger Kit (150mm Deep) 42-45 RU Cabinets
SN18F			Finger Kit (100mm Deep) 48 RU Cabinets
SN28F			Finger Kit (150mm Deep) 48 RU Cabinets
SN11F			Finger Kit (100mm Deep) 51 RU Cabinets
SN21F			Finger Kit (150mm Deep) 51 RU Cabinets
NVPDUBE		—	PDU Bracket - Sold in Pairs
SPDUBRK			
S2BRK6	—		Combination PDU/Cable Management Bracket - 6" Wide
S2BRK12			Combination PDU/Cable Management Bracket - 12" Wide
SN7VCM			Vertical Cable Management Bracket - 700mm Wide Cabinets
SN8VCM	X	X	Vertical Cable Management Bracket - 800mm Wide Cabinets
SN8FBB			Front to Back Cable Management Bracket
S1DR	—		1 RU D-Ring Kit to be used with S2BRK6, S2BRK12, SN7VCM and SN8VCM
S2DR			2 RU D-Ring Kit to be used with S2BRK6, S2BRK12, SN7VCM and SN8VCM
S1LR			1 RU L-Ring Kit to be used with S2BRK6, S2BRK12, SN7VCM and SN8VCM
S2LR			2 RU L-Ring Kit to be used with S2BRK6, S2BRK12, SN7VCM and SN8VCM
Slack Spools			
NERSS	X	—	End of Row Slack Spool
NACSS			Adjustable Center Slack Spools 210mm (8.3") to 267mm (10.5")
Vertical Patch			
S7VPPB	—	X	Vertical Patch Bracket for 700mm Wide Cabinets
SN8VPPB	X		Vertical Patch Bracket for 800mm Wide Cabinets

- A. Featured Products
- B. Copper Systems
- C. Fiber Systems
- D. Faceplates, Frames & Surface Mount Boxes
- E. Industrial Networks
- F. Audio Video Systems
- G. Keystone Cabling Systems
- H. Zone Cabling
- J. Cable Routing Systems
- K. Cable Cleats
- L. Cabinets & Rack Systems
- M. Power & Connectivity Management
- N. Grounding & Bonding
- O. Identification Products
- P. Cable Management Accessories
- Q. Part Number Index

Continued on next page

Net-Access™ Cabinet Accessories (continued)



Part Number	N-Type Compatibility	S-Type Compatibility	Description
Casters			
NCSTR4	X	—	2 Fixed Casters for Front - 2 Swivel Casters for Rear
SCSTR4	—	X	
OSHPD Brackets			
NAKOSHPD	X	—	Oshpod Bracket for N-Type Cabinet
SAKOSHPD	—	X	Oshpod Bracket for S-Type Cabinet
Locks			
CCL3	X	X	3-digit Combination Locks with Key Over-ride for Single Hinge or Split Doors
Shelves			
RSHLF23	X	X	Shelf Kit - 44mm H x 483mm W x 584mm D Load Rating 275 lbs.
RSHLF			Shelf Kit - 44mm H x 483mm W x 762mm D Load Rating 275 lbs.

NetAccess™ Cabinet Thermal Management Accessories



Part Number	N-Type Compatibility	S-Type Compatibility	Description
Vertical Blanking Panels			
NVBP	X	—	Vertical Blanking Panels with Pass Thru Openings for 42-48 RU
S6VBPN	—	X*	Vertical Blanking Panels (No Pass Thru Openings)
S7VBPN			
S8VBPN			Vertical Blanking Panels with 1x5 Knockouts
S8VPBNE			Vertical Blanking Panels with 19" 1 RU Pass Thru Openings
Floor Seals			
N2EOR1BA1070B1	X	—	End of Row Floor Seal for 1070mm Deep Cabinets
N2EOR1CA1200B1			
S2EOR1BA1070B1	X	—	End of Row Floor Seal for 1200mm Deep Cabinets
S2EOR1CA1200B1			
C2FAB06A1200B1	X	X	Front or Back Floor Seal
C2FAB07A1200B1			
C2FAB08A1200B1			

*S-Type Universal Cabinets only.

A. Featured Products

B. Copper Systems

C. Fiber Systems

D. Faceplates, Frames & Surface Mount Boxes

E. Industrial Networks

F. Audio Video Systems

G. Keystone Cabling Systems

H. Zone Cabling

J. Cable Routing Systems

K. Cable Cleats

L. Cabinets & Rack Systems

M. Power & Connectivity Management

N. Grounding & Bonding

O. Identification Products

P. Cable Management Accessories

Q. Part Number Index

- A. Featured Products
- B. Copper Systems
- C. Fiber Systems
- D. Faceplates, Frames & Surface Mount Boxes
- E. Industrial Networks
- F. Audio Video Systems
- G. Keystone Cabling Systems
- H. Zone Cabling
- J. Cable Routing Systems
- K. Cable Cleats
- L. Cabinets & Rack Systems
- M. Power & Connectivity Management
- N. Grounding & Bonding
- O. Identification Products
- P. Cable Management Accessories
- Q. Part Number Index

Net-Contain™ Universal Containment System

The Universal Containment System allows user to go back and reclaim underutilized cooling capacity, reduce energy expense and reduce OpEx by retrofitting the existing data center with an innovative containment system. The system includes independent support structure, sliding doors, vertical blanking panels, and roof structure.

This offering can be configured in Vertical Wall (Hot Aisle Containment) and Roof Containment (Cold Aisle Containment) and allows the addition of cabinets (Panduit or non-Panduit) of varying sizes and design as needs dictate, reducing deployment time and capital investment.

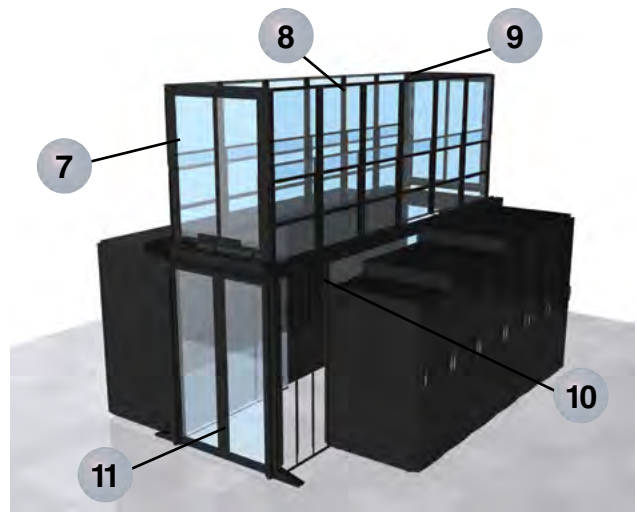
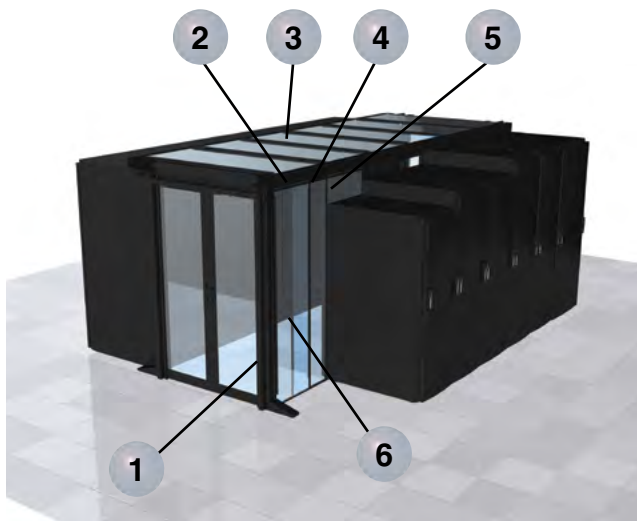
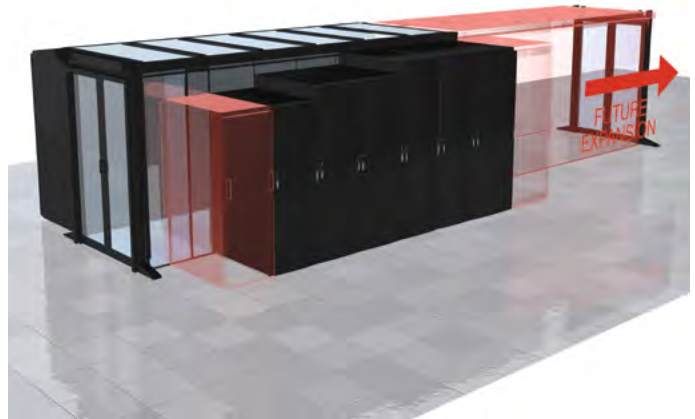

Roof Containment

Typically used for Passive Cold Aisle Containment; deployed either on raised floor or within-row cooling.

Vertical Wall Containment

Typically used for Passive Hot Aisle Containment or Ceiling Discharge Cold Aisle Containment.

Part Number	Description
1 CUEFRT**^^	End of row frames form the Universal Aisle Containment structure at each end of a containment pod.
2 CUWBSS**ST^^	Wall beam used to help create the UAC frame; configurations of 4 available wall beams will allow all aisle lengths to be contained.
3 CUSMPR52ST01NC	Mid-span post that provides structural support to the UAC frame; required for every 2400 mm on partially populated row.
4 CURFS06F**HB^^	Integral ceiling structure used for aisle containment and mounted onto the top of the UAC frame.
5 CUTBPR0610HBN1	Top of cabinet blanking panel used to fill gaps above cabinets; needed when cabinet height is less than UAC frame size.
6 CUFBPR**06HB^^	Full blanking panel used to fill gap in containment where cabinets have not been deployed; mount directly under UAC frame.
7 C2HACER11626^^	End of row adjustable vertical wall used to seal at the end of the UAC and mounted above end of row frame for aisle containment.
8 C2HAC**11626^^	Adjustable vertical wall mounted onto UAC frame to seal gap up to ceiling in aisle containment.
9 CUVWB12S12ST^^	Vertical wall brace is mounted across the aisle between wall beams to provide extra stability in aisle containment.
10 CUVWA06S**ST^^	Vertical wall adapter used to mount Vertical Walls to UAC frame in aisle containment.
11 CUD*SD^1	Dual sliding doors provide thermal seal at the end of the row and attach to the end of row frames.

^^B1 = Black, W1 = White.

**Please reference www.panduit.com for information on the Net-Contain Universal Containment System.

Net-Contain™ Universal Aisle Containment and Single Aisle Containment

End of Row Frames



CUEFRT8F06STB1

Part Number	Roof Containment	Vertical Wall Containment	Aisle Width mm	RU	UAC/USRC
CUSREFRT8B1*	X	X	900	42 RU to 45 RU	USRC
CUSREFRT9B1*				48 RU to 52 RU	
CUEFRT8W04B1			42 RU to 45 RU	UAC	
CUEFRT9W04B1		48 RU to 52 RU			
CUEFRT8W06B1		42 RU to 45 RU			
CUEFRT9W06B1		—	1800	48 RU to 52 RU	

*Used with CUEFRCKITB1 conversion kit for applications with 2 rows of cabinets.
USRC represents Universal Single Row Containment.
UAC represents Universal Aisle Containment.

USRC to UAC Conversion Kit



CUEFRCKITB1

Part Number	Roof Containment	Vertical Wall Containment	Aisle Width mm	RU	UAC/USRC
CUEFRCKITB1	X	X	900	—	UAC

Attaches to end of row frames.

Full Height Blanking Panels



CUFBPR4506HBB1

Part Number	Roof Containment	Vertical Wall Containment	Panel Width mm	RU	UAC/USRC
CUFBPR4206HBB1	X	X	600	42	UAC/USRC
CUFBPR4506HBB1				45	
CUFBPR4806HBB1				48	
CUFBPR5206HBB1				52	

Top of Cabinet Blanking Panel

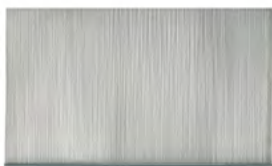

CUTBPR0610HBB1

Part Number	Roof Containment	Vertical Wall Containment	Width mm	Height mm	UAC/USRC
CUTBPR0610HBB1	X	X	1000	600	UAC/USRC

Roof Sections



CURFS08F06

Part Number	Roof Containment	Vertical Wall Containment	Aisle Width mm	Cabinet Width mm	UAC/USRC		
CUSRRF0S06B1	X	—	900	600	USRC		
CUSRRF0S07B1				700			
CUSRRF0S08B1				800			
CURFS06F04HBB1			X	—	1200	600	UAC
CURFS07F04HBB1						700	
CURFS08F04HBB1						800	
CURFS06F06HBB1					1800	600	
CURFS07F06HBB1						700	
CURFS08F06HBB1						800	

Continued on next page

A. Featured Products

B. Copper Systems

C. Fiber Systems

D. Faceplates, Frames & Surface Mount Boxes

E. Industrial Networks

F. Audio Video Systems

G. Keystone Cabling Systems

H. Zone Cabling

J. Cable Routing Systems

K. Cable Cleats

L. Cabinets & Rack Systems

M. Power & Connectivity Management

N. Grounding & Bonding

O. Identification Products

P. Cable Management Accessories

Q. Part Number Index

- A. Featured Products
- B. Copper Systems
- C. Fiber Systems
- D. Faceplates, Frames & Surface Mount Boxes
- E. Industrial Networks
- F. Audio Video Systems
- G. Keystone Cabling Systems
- H. Zone Cabling
- J. Cable Routing Systems
- K. Cable Cleats
- L. Cabinets & Rack Systems
- M. Power & Connectivity Management
- N. Grounding & Bonding
- O. Identification Products
- P. Cable Management Accessories
- Q. Part Number Index

Net-Contain™ Universal Aisle Containment and Single Aisle Containment (continued)

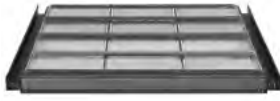

CUCGF06DBP1

Drop Away Panels

Part Number	Roof Containment	Vertical Wall Containment	Aisle Width mm	Cabinet Width mm	UAC/USRC
CUCGF03DPB1	X	—	900	—	UAC
CUCGF04DBP1			1200		
CUCGF06DBP1			1800		



CUEORF03DPB1

End of Row Kits for Drop Away Panels

Part Number	Roof Containment	Vertical Wall Containment	Aisle Width mm	Cabinet Width mm	UAC/USRC
CUEORF03DPB1	X	—	900	—	UAC
CUEORF04DPB1			1200		
CUEORF06DPB1			1800		



CUVWA08S08STB1

Vertical Wall Adapters

Part Number	Roof Containment	Vertical Wall Containment	Aisle Width mm	Cabinet Width mm	UAC/USRC
CUSRVA06B1	—	X	—	600	UAC/USRC
CUSRVA07B1				700	
CUSRVA08B1				800	
CUVWA06S06STB1				600	UAC
CUVWA07S07STB1				700	
CUVWA08S08STB1				800	



CUSRWB1

Vertical Wall Brace

Part Number	Roof Containment	Vertical Wall Containment	Aisle Width mm	Cabinet Width mm	UAC/USRC
CUSRWB1	—	X	900	—	USRC
CUVWB12S12STB1			1200		UAC



C2HAC0*13866B1

Vertical Wall

Part Number	Roof Containment	Vertical Wall Containment	Adjustability In.	Cabinet Width mm	UAC/USRC
C2HAC0*11626B1	—	X	16-26	600/700/800	UAC/USRC
C2HAC0*12638B1			26-38		
C2HAC0*13866B1			38-66		

*For width size, use 06 (600mm), 07 (700mm) or 08 (800mm).

Net-Contain™ Universal Aisle Containment and Single Aisle Containment (continued)

End of Row Vertical Wall



C2HAC0*13866B1

Part Number	Roof Containment	Vertical Wall Containment	Adjustability In.	Aisle Width mm	UAC/USRC
CUSRVWERI1626B1	—	X	16-26	—	USRC
CUSRVWER2638B1			26-38		
CUSRVWER3866B1			38-66		
C2HACERI1626B1			16-26		UAC
C2HACERI2638B1			26-38		
C2HACERI3866B1			38-66		

Sliding Doors



CUSR1SDHLB1



CUD1SDB1



CUEOR12CPB1

Part Number	Roof Containment	Vertical Wall Containment	Aisle Width mm	Description	UAC/USRC
CUSR1SDLHB1	X	X	900	Single Sliding, Left Hand Opening	USRC
CUSR1SDRHB1				Single Sliding, Right Hand Opening	
CUD1SDB1			1200/1800	Double Sliding Door	UAC
CUD2SDB1				Double Sliding Door, Packaged as a Pair	

For other colors, replace B1 (Black) with S1 (Silver).

End Of Row Caps

Part Number	Roof Containment	Vertical Wall Containment	Aisle Width mm	UAC/USRC
CUSREORCPB1	X	X	900	UAC/USRC
CUEOR12CPB1			1200	UAC
CUEOR18CPB1			1800	

Wall Beams



CUWBPS08ST02B1

Part Number	Roof Containment	Vertical Wall Containment	Length mm	Description	UAC/USRC
CUWBPS06ST02B1	X	X	600	2 Piece	UAC/USRC
CUWBPS07ST02B1			700		
CUWBPS08ST02B1			800		
CUWBPS24ST02B1			2400		
CUWBPS06ST01B1			1 Piece	600	
CUWBPS07ST01B1				700	
CUWBPS08ST01B1				800	
CUWBPS24ST01B1				2400	

Continued on next page

A. Featured Products

B. Copper Systems

C. Fiber Systems

D. Faceplates, Frames & Surface Mount Boxes

E. Industrial Networks

F. Audio Video Systems

G. Keystone Cabling Systems

H. Zone Cabling

J. Cable Routing Systems

K. Cable Cleats

L. Cabinets & Rack Systems

M. Power & Connectivity Management

N. Grounding & Bonding

O. Identification Products

P. Cable Management Accessories

Q. Part Number Index

- A. Featured Products
- B. Copper Systems
- C. Fiber Systems
- D. Faceplates, Frames & Surface Mount Boxes
- E. Industrial Networks
- F. Audio Video Systems
- G. Keystone Cabling Systems
- H. Zone Cabling
- J. Cable Routing Systems
- K. Cable Cleats
- L. Cabinets & Rack Systems
- M. Power & Connectivity Management
- N. Grounding & Bonding
- O. Identification Products
- P. Cable Management Accessories
- Q. Part Number Index

Net-Contain™ Universal Aisle Containment and Single Aisle Containment (continued)



CUCMSS03ST01NC

Mid-Span Cabinet Support

Part Number	Roof Containment	Vertical Wall Containment	Height mm	UAC/USRC
CUCMSS03ST01NC	X	X	300	UAC/USRC
CUCMSS06ST01NC			600	



CUSMPR52ST01B1

Mid-Span Post

Part Number	Roof Containment	Vertical Wall Containment	RU	UAC/USRC
CUSMPR52ST01B1	X	X	42-52	UAC/USRC



CUCFS06B1, CUCFS07B1, CUCFS08B1, CUCFS10B1

Cabinet to Floor Seal

Part Number	Roof Containment	Vertical Wall Containment	Cabinet Width mm	UAC/USRC
CUCFS06B1	X	X	600	UAC/USRC
CUCFS07B1			700	
CUCFS08B1			800	
CUCFS10B1			1000	

Building Column Adapter

Part Number	Roof Containment	Vertical Wall Containment	UAC/USRC
CUCAKITB1	X	X	UAC/USRC

For other colors, replace B1 (Black) with W1 (White).

Net-Contain™ Cabinet Supported Cold Aisle/Hot Aisle Containment

The Net-Contain™ Cabinet Supported Cold Aisle Containment (CAC) System provides a physical separation between the cold air and the hot exhaust air by enclosing the cold aisle. The goal of a CAC system is to supply cold air to the cold aisle where the equipment air intakes are located to optimize airflow distribution and improve cooling system thermal performance. As a result, a cold aisle system is typically used in high-density data centers because it is more efficient to direct cold air onto densely populated racks than to cool the entire room.

The Net-Contain™ Cabinet Supported Hot Aisle Containment (HAC) System provides a physical separation between the cold air and the hot exhaust air by enclosing the hot aisle. The goal of a HAC system is to capture all of the cabinet exhaust air and return it to the cooling units. HAC optimizes airflow distribution and cooling system performance. The remaining area outside of the HAC becomes a cold room with ambient air temperature close to the supply air temperature.

This integrated system is compatible with numerous Panduit product lines including; Net-Access™ N-Type and S-Type Cabinets, FiberRunner™, and Wyr-Grid™ Overhead Cable Routing Systems.

Benefits

Energy Efficiency: Prevents hot spots and allows installation of high-density server cabinets close together in new builds or existing data centers, reducing the need for extra real estate and CRAH units lowering operating costs.

Optimized Airflow Distribution: Prevents mixing of cold and hot air streams; eliminates recirculation of hot air to cabinet inlets; provides uniform temperature at the inlets of IT equipment; prevents cold air bypass optimizing cool air delivery.

Improves Thermal Performance: Allows raising supply air set point temperature; higher return air temperature increases the thermal efficiency of cooling units, reducing cooling energy cost up to 30%.

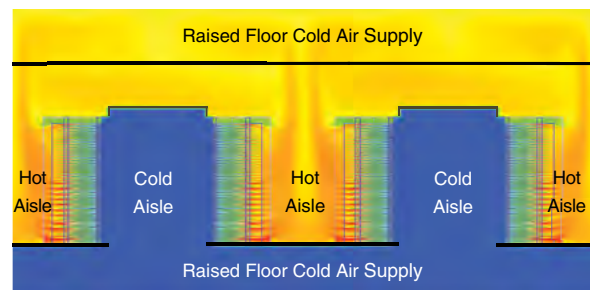
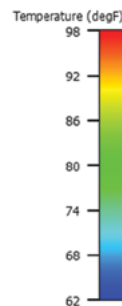
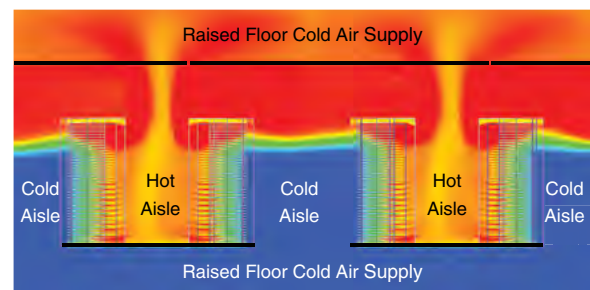
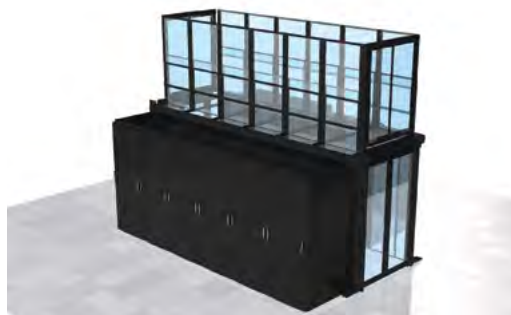

A. Featured Products

B. Copper Systems

C. Fiber Systems

D. Faceplates, Frames & Surface Mount Boxes

E. Industrial Networks

F. Audio Video Systems

G. Keystone Cabling Systems

H. Zone Cabling

J. Cable Routing Systems

K. Cable Cleats

L. Cabinets & Rack Systems

M. Power & Connectivity Management

N. Grounding & Bonding

O. Identification Products

P. Cable Management Accessories

Q. Part Number Index

A. Featured Products
B. Copper Systems
C. Fiber Systems
D. Faceplates, Frames & Surface Mount Boxes
E. Industrial Networks
F. Audio Video Systems
G. Keystone Cabling Systems
H. Zone Cabling
J. Cable Routing Systems
K. Cable Cleats
L. Cabinets & Rack Systems
M. Power & Connectivity Management
N. Grounding & Bonding
O. Identification Products
P. Cable Management Accessories
Q. Part Number Index

Net-Contain™ Aisle Containment Systems

Panduit's Passive Cold Aisle Containment (CAC) and Hot Aisle Containment (HAC) Systems provide a physical separation between the cold air and the hot exhaust air. This integrated system is compatible with numerous Panduit product lines including; Net-Access™ N-Type and S-Type Cabinets, FiberRunner™, and Wyr-Grid™ Overhead Cable Routing Systems.



C2CAC08F04IRB1B1



C2CAC06F08WPB1



C2HAC08I1626B1



C2HACERI1626B1

Part Number	Aisle Width mm	Cabinet Width mm	Adjustability In.	RU	Compatible With CAC/HAC
-------------	----------------	------------------	-------------------	----	-------------------------

Low Profile Ceiling Structures

C2CAC06F04IRB1B1	1200	600	—	—	CAC
C2CAC07F04IRB1B1		700			
C2CAC08F04IRB1B1		800			
C2CAC06F06IRB1B1	1800	600			
C2CAC07F06IRB1B1		700			
C2CAC08F06IRB1B1		800			

Integral Roof Wall Panels

C2CAC06F08WPB1	—	600	—	—	CAC
C2CAC07F08WPB1		700			
C2CAC08F08WPB1		800			

Row Base Cooling Blanking Panels

C2CAC06ABWPAB1	—	600	—	—	CAC
C2CAC06ABWPAB1		700			
C2CAC06ABWPAB1		800			

Adjustable Vertical Walls

C2HAC**I1626B1	—	600/700/800	16-26	—	HAC
C2HAC**I2638B1			26-38		
C2HAC**I3866B1			38-66		

Adjustable EOR Vertical Walls

C2HACERI1626B1	—	600/700/800	16-26	—	HAC
C2HACERI2638B1			26-38		
C2HACERI3866B1			38-66		

Net-Contain™ Aisle Containment Systems (continued)



End of Row Caps

Part Number	Aisle Width mm	Width of Cabinet mm	Adjustability In.	RU	Compatible With CAC/HAC			
C2CEOR04CP2B1	1200	—	—	42	CAC/HAC			
C2CEOR04CP5B1				45				
C2CEOR04CP8B1				48				
C2CEOR04CP1B1				51				
C2CEOR06CP2B1	1800			—		—	42	CAC/HAC
C2CEOR06CP5B1							45	
C2CEOR06CP8B1							48	
C2CEOR06CP1B1							51	



Sliding Doors

Part Number	Roof Containment	Vertical Wall Containment	Aisle Width mm	Description	Compatible With CAC/HAC
CUSR1SDLHB1	X	X	900	Single Sliding, Left Hand Opening	CAC/HAC
CUSR1SDRHB1				Single Sliding, Right Hand Opening	
CUD1SDB1			1200/1800	Double Sliding Door	CAC/HAC
CUD2SDB1				Double Sliding Door, Packaged as a Pair	

For other colors, replace B1 (Black) with S1 (Silver).

Sliding Door Adapter Frames

Part Number	Aisle Width mm	Width of Cabinet mm	Adjustability In.	RU	Compatible With CAC/HAC		
C2SDT8W04DAB1	1200	—	—	42-45	CAC/HAC		
C2SDT9W04DAB1				48-51			
C2SDT8W06DAB1	1800			—		—	42-45
C2SDT9W06DAB1							48-51

For other colors, replace B1 (Black) with W1 (White).
 Single sliding doors are also available in Silver. Replace B1 (Black) with S1 (Silver).
 Replace ** with 06 (600mm), 07 (700mm) or 08 (800mm).

- A. Featured Products
- B. Copper Systems
- C. Fiber Systems
- D. Faceplates, Frames & Surface Mount Boxes
- E. Industrial Networks
- F. Audio Video Systems
- G. Keystone Cabling Systems
- H. Zone Cabling
- J. Cable Routing Systems
- K. Cable Cleats
- L. Cabinets & Rack Systems
- M. Power & Connectivity Management
- N. Grounding & Bonding
- O. Identification Products
- P. Cable Management Accessories
- Q. Part Number Index

A. Featured Products
B. Copper Systems
C. Fiber Systems
D. Faceplates, Frames & Surface Mount Boxes
E. Industrial Networks
F. Audio Video Systems
G. Keystone Cabling Systems
H. Zone Cabling
J. Cable Routing Systems
K. Cable Cleats
L. Cabinets & Rack Systems
M. Power & Connectivity Management
N. Grounding & Bonding
O. Identification Products
P. Cable Management Accessories
Q. Part Number Index

Direct Cold Air To Where It Is Needed



Net-Direct™ Inlet Ducts enable optimized containment by effectively directing airflow to improve network reliability

- Inlet duct solutions deliver cooling air directly from the cold aisle into the intake fans of switches
- Inlet ducts are completely passive, requiring no energy to operate and eliminating a point of failure
- Ensures front to back cooling airflow which enables an effective deployment of network switches with a Net-Contain™ Cold Aisle Containment deployment
- Inlet ducts enable reduced fan power energy consumption by allowing lower fan speeds, improving the reliability of the switch

Available for: Cisco^ Nexus, Catalyst and MDS Switches and Juniper Networks^^ EX Series Switches.

Direct Hot Air To Where It Needs To Exhaust



Net-Direct™ Exhaust Ducts direct hot exhaust air out of a cabinet away from adjacent devices within non-contained environments

- Exhaust duct solutions channel hot exhaust air directly to the hot aisle, away from the cold air inlet of adjacent switches
- Exhaust ducts are completely passive, requiring no energy to operate and eliminating a point of failure
- Ensures switch exhaust airflow is directed to the hot aisle enabling effective deployment of network switches with a standard hot aisle/ cold aisle configuration
- Exhaust ducts enable reduced fan power energy consumption by allowing lower fan speeds, improving the reliability of the switch

Available for: Cisco^ Nexus and Catalyst Switches.

Patented* In-Cabinet Ducting optimizes cooling system efficiency by establishing front-to-back airflow patterns through the cabinet.

^Cisco, Catalyst, and Cisco Nexus are registered trademarks of Cisco Systems, Inc. and/or its affiliates in the United States and certain other countries.
 ^^Juniper Networks is a registered trademark of Juniper Networks, Inc.
 *Patents #8,035,965, #7,855,885 and #7,595,985 - Network Cabinet with Thermal Airflow Management System.

In-Cabinet Ducting

Net-Direct™ In-Cabinet Ducting

- Net-Direct™ Passive Cabinet Inlet Ducting directs cooling air from the cold aisle into the intake fans of switches

- Net-Direct™ Passive Cabinet Exhaust Ducting directs exhaust air from the side exhaust of the switch into the hot aisle



CDE1



CDE2

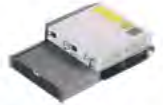

CNLTD21B2



CNLTD52A2



CNLTD142A3



CNLTD72A3



DIBBC2314S21W



DIRLC2214M21W



DIRBB2007S21W



Exhaust Ducts

Part Number	Part Description	Std. Pkg. Qty.
Air Inlet Ducting		
CDE1	Air inlet duct, 1 RU that resides below the switch provides cold aisle airflow to Cisco® Catalyst® 4948, 4928, and 4924. Optimized for use in server cabinet applications.	1
CDE2	Air inlet duct, 1 RU that resides in-line and below switch provides cold aisle airflow to Cisco Nexus® N2K-C2148T-1GE, N2K-C2248TP-1GE, and N2K-C2232PP-10GE fabric extenders and Cisco® WS-C4948E-F, WS-C4948E-F-S, and WS-C4948E-F-E. Optimized for use in server cabinet applications.	
CNLTD21B2	Air inlet duct designed for Cisco® Catalyst® 4900M switch. Consists of one 2 RU inlet duct and a side duct. Compatible with Net-Access™ N-Type Network Cabinets.	
CNLTD52A2	Air inlet duct designed for Cisco® Catalyst® 6504-E switch. Consists of 2 RU top and 2 RU bottom inlet ducts and a side duct. Compatible with Net-Access™ N-Type Network Cabinets.	
DIRLC2214M21W	Air inlet duct designed for Cisco® Catalyst® 6509-E switch. Consists of 2 RU top and 2 RU bottom inlet ducts and a side duct. Compatible with Net-Access™ N-Type Network Cabinets.	
DIRBB2007S21W	Air inlet duct designed for Cisco® Nexus® 7004 switch. Consists of one 2 RU inlet duct and a side duct. Compatible with Net-Access™ N-Type Network Cabinets.	
CNLTD142A3	Air inlet duct designed for Cisco® Nexus® 7009 switch. Consists of 3 RU top and 3 RU bottom inlet ducts and a side duct. Compatible with Net-Access™ N-Type Network Cabinets.	
CNLTD72A3	Air inlet duct designed for Cisco® MDS 9506 switch. Consists of 3 RU top and 3 RU bottom inlet ducts and a side duct. Compatible with Net-Access™ N-Type Network Cabinets.	
DIBBC2314S21W	Air inlet duct designed for Cisco® MDS 9513 switch. Consists of 2 RU top and 3 RU bottom inlet ducts and a side duct. Compatible with Net-Access™ N-Type Network Cabinets.	
CID1RU22-23DB1	Air inlet 1RU duct for Cisco® Nexus® 9372 switch, compatible with 21.5" – 23.5" switch depth.	
CID2RU16-20DB1	Air inlet duct for Cisco® TOR switches, 2RU, depth compatible with 16" – 20" switch depth.	
DIFBA2002S00S	Air inlet duct for Cisco® Nexus® 9396 switch.	
DIFBA3003S00S	Air inlet duct for Cisco® Nexus® 93128 switch.	
DIRLC3210S17W	Air inlet duct for Cisco® Catalyst® 6807XL switch.	
DIRLC25S23W	Air inlet duct for Cisco® Catalyst® 6880X switch.	
Exhaust Ducting		
DERLCC6509A	Air exhaust duct for Net-Access™ N-Type 1070mm depth cabinets. Designed for Cisco® Catalyst® 6509 switch.	1
DERLCC9513A	Air exhaust duct for Net-Access™ N-Type 1070mm depth cabinets. Designed for Cisco® MDS 9513 switch.	
DERLCC7009A	Air exhaust duct for Net-Access™ N-Type 1070mm depth cabinets. Designed for Cisco® Nexus® 7009 switch.	
DERLCC6513A	Air exhaust duct for Net-Access™ N-Type 1070mm depth cabinets. Designed for Cisco® Catalyst® 6513 switch.	

^Cisco, Catalyst, and Cisco Nexus are registered trademarks of Cisco Systems, Inc. and/or its affiliates in the United States and certain other countries.

A. Featured Products

B. Copper Systems

C. Fiber Systems

D. Faceplates, Frames & Surface Mount Boxes

E. Industrial Networks

F. Audio Video Systems

G. Keystone Cabling Systems

H. Zone Cabling

J. Cable Routing Systems

K. Cable Cleats

L. Cabinets & Rack Systems

M. Power & Connectivity Management

N. Grounding & Bonding

O. Identification Products

P. Cable Management Accessories

Q. Part Number Index

A. Featured Products

Thermal Sealing Accessories

B. Copper Systems



FLBSIM-51

Part Number	Part Description	Color	Std. Pkg. Qty.	Std. Ctn. Qty.
-------------	------------------	-------	----------------	----------------

Blanking Shades

FLBSIM-51	Full-length blanking shade blanks out 1-51 consecutive rack units on standard 19" (482.6mm) wide vertical mounting rails.	Black	1	–
-----------	---	-------	---	---

Cabinet Blanking Foam Strip

BFS100X2000	Adhesive-backed foam strips, 1/16" (1.6mm) closed-cell vinyl foam, perforated to create multiples of 1.00" x 20.00" strips.	Black	1	10
-------------	---	-------	---	----

Tool-Less Blanking Panels

TLBP1R-V10	1 RU tool-less blanking panel, round hole 19" (483mm) width for tapped rails.	White	5	–
TLBP1S-V	1 RU tool-less blanking panel, square hole 19" (483mm) width for 3/8" cage nut holes (may be used with or without cage nuts installed).	Black		
TLBP1S-V10	1 RU tool-less blanking panel, square hole 19" (483mm) width for 3/8" cage nut holes (may be used with or without cage nuts installed).	White		
TLBP2S-V	2 RU tool-less blanking panel, square hole 19" (483mm) width for 3/8" cage nut holes (may be used with or without cage nuts installed).	Black		
TLBP2S-V10	2 RU tool-less blanking panel, square hole 19" (483mm) width for 3/8" cage nut holes (may be used with or without cage nuts installed).	White		
TLBP1S-L	1 RU tool-less blanking panel, square hole 19" (483mm) width for 3/8" cage nut holes (may be used with or without cage nuts installed).	Black	50	

19" Mount Brush Seal Kit

BR1B	1 RU 19" mount brush seal kit with cable pass thru.	Black	1	1
BR2B	2 RU 19" mount brush seal kit with cable pass thru.			

CoolBoot™ Raised Floor Air Sealing Grommet - Integral Mount

RFG10X8Y	Overall size of 10" x 8" (254.0mm x 203.2mm) allows for 8.2" x 6.2" (208.3mm x 157.5mm) capacity.	Navy Blue	1	10
RFG12X4Y	Overall size of 12" x 4" (304.8mm x 101.6mm) allows for 10.2" x 2.2" (259.1mm x 55.9mm) capacity.			
RFG12X8Y	Overall size of 12" x 8" (304.8mm x 203.3mm) allows for 10.2" x 6.2" (259.1mm x 157.5mm) capacity.			
RFG3DY	Overall size of 4.8" (121.9mm) diameter allows for 2.7" (68.6mm) diameter capacity.			
RFG5DY	Overall size of 6.8" (172.7mm) diameter allows for 4.7" (119.4mm) diameter capacity.			
RFG6X8Y	Overall size of 6" x 8" (152.4mm x 203.2mm) allows for 4.2" x 6.2" (106.7mm x 157.5mm) capacity.			
RFG8X8Y	Overall size of 8" x 8" (203.2mm x 203.2mm) allows for 6.2" x 6.2" (157.5mm x 157.5mm) capacity.			

C. Fiber Systems

D. Faceplates, Frames & Surface Mount Boxes



BFS100X2000

E. Industrial Networks

F. Audio Video Systems



TLBP1R-V

G. Keystone Cabling Systems



TLBP1S-V

H. Zone Cabling



TLBP2R-V

J. Cable Routing Systems

K. Cable Cleats



BR1B

L. Cabinets & Rack Systems

M. Power & Connectivity Management



RFG*X*Y

N. Grounding & Bonding

O. Identification Products

P. Cable Management Accessories

Q. Part Number Index

Continued on next page

Thermal Sealing Accessories (continued)



Part Number	Part Description	Color	Std. Pkg. Qty.	Std. Ctn. Qty.
CoolBoot™ Raised Floor Air Sealing Grommet - Surface Mount				
RFG10X8SMY	Overall size of 10" x 8" (254.0mm x 203.2mm) allows for 8.2" x 6.2" (208.3mm x 157.5mm) capacity.	Navy Blue	1	10
RFG12X4SMY	Overall size of 12" x 4" (304.8mm x 101.6mm) allows for 10.2" x 2.2" (259.1mm x 55.9mm) capacity.			
RFG12X8SMY	Overall size of 12" x 8" (304.8mm x 203.2mm) allows for 10.2" x 6.2" (259.1mm x 157.5mm) capacity.			
RFG3DSMY	Overall size of 4.8" (121.9mm) diameter allows for 2.7" (68.6mm) diameter capacity.			
RFG5DSMY	Overall size of 6.8" (172.7mm) diameter allows for 4.7" (119.4mm) diameter capacity.			
RFG6X8SMY	Overall size of 6" x 8" (152.4mm x 203.2mm) allows for 4.2" x 6.2" (106.7mm x 157.5mm) capacity.			
RFG8X8SMY	Overall size of 8" x 8" (203.2mm x 203.2mm) allows for 6.2" x 6.2" (157.5mm x 157.5mm) capacity.			

Also designed for retrofit application.



Part Number	Part Description	Std. Pkg. Qty.	Std. Ctn. Qty.
CoolBoot™ Cabinet Top Air Sealing Fitting			
CTGN1X5	Used to seal off 1" x 5" cabinet top openings when cables are routed through the top of a cabinet. Airtight fabric and Ultra-Cinch™ Tie close top of fabric, minimizing hot air bypass around cables to improve cooling of network equipment and reduce energy costs. For use with 600mm wide Net-Access™ Cabinets.	1	10
CTGN3X5	Used to seal off 3" x 5" cabinet top openings when cables are routed through the top of a cabinet. Airtight fabric and Ultra-Cinch™ Tie close top of fabric, minimizing hot air bypass around cables to improve cooling of network equipment and reduce energy costs. For use with 700mm, 800mm, and 1000mm wide Net-Access™ Cabinets.		
CTGN6X6	Used to seal off 6.5" x 6.5" cabinet top openings when cables are routed through the top of a cabinet. Airtight fabric and Ultra-Cinch™ Tie close top of fabric, minimizing hot air bypass around cables to improve cooling of network equipment and reduce energy costs. For use with 600mm, 700mm, 800mm, and 1000mm wide Net-Access™ Cabinets.		



Part Number	Part Description	Std. Pkg. Qty.	Std. Ctn. Qty.
Cabinet Top Cover and Cable Protection Bezel			
CTCN1X5	Used to seal off 1.5" x 5" cabinet top openings. Can also be used to add the CTGN1X5 to openings where the snap-on cover has been removed. For use with Net-Access™ Cabinets.	1	10
CTCN3X5	Used to seal off 3.5" x 5" cabinet top openings. Can also be used to add the CTGN3X5 to openings where the snap-on cover has been removed. For use with Net-Access™ Cabinets.		
CTCN6X6	Used to seal off 6" x 6" cabinet top openings. Can also be used to add the CTGN6X6 to openings where the snap-on cover has been removed. For use with Net-Access™ Cabinets.		1
CTNBZL6X6	Used to provide a protective edge for cables routed through the 6.5" x 6.5" cabinet top openings after knock-outs are removed. Can also be used to add the CTGN6X6 to openings where knock-out has been removed. For use with Net-Access™ Cabinets.		10

- A. Featured Products
- B. Copper Systems
- C. Fiber Systems
- D. Faceplates, Frames & Surface Mount Boxes
- E. Industrial Networks
- F. Audio Video Systems
- G. Keystone Cabling Systems
- H. Zone Cabling
- J. Cable Routing Systems
- K. Cable Cleats
- L. Cabinets & Rack Systems
- M. Power & Connectivity Management
- N. Grounding & Bonding
- O. Identification Products
- P. Cable Management Accessories
- Q. Part Number Index

A. Featured Products
B. Copper Systems
C. Fiber Systems
D. Faceplates, Frames & Surface Mount Boxes
E. Industrial Networks
F. Audio Video Systems
G. Keystone Cabling Systems
H. Zone Cabling
J. Cable Routing Systems
K. Cable Cleats
L. Cabinets & Rack Systems
M. Power & Connectivity Management
N. Grounding & Bonding
O. Identification Products
P. Cable Management Accessories
Q. Part Number Index

4 Post Cable Management Rack System and Accessories

- Independent adjustable front and rear mounting rails can be adjusted while the rack is secured to the floor
- Printed rack space identification on all equipment rails allows for quick location of rack spaces (shipped numbers up per TIA606 specifications; can be set to number down by flipping the rails)
- Multiple mounting holes in top flanges for securing overhead pathways
- Weld nut construction eliminates the need for a second wrench increasing speed and ease of assembly
- Panduit vertical cable managers mount directly to the 4 post rack at any of the four corners
- Paint piercing washers included to electrically bond rack for simplified grounding



R4P



R4PWH

4 Post Racks

Part Number	Height In. (mm)	Width In. (mm)	Depth In. (mm)	No. of Rack Units	Equipment Rails	Load Capacity (Lbs.)	Color	Std. Pkg. Qty.	
R4P79	79.0 (2006)	23.3 (591)	30.0 (762)	42	#12-24 Threaded	2500	Black	1	
R4PCN79	79.0 (2006)	23.3 (591)	30.0 (762)		Cage Nut				
R4P23	84.0 (2134)	23.3 (591)	23.0 (584)	45	#12-24 Threaded				Black
R4P	84.0 (2134)	23.3 (591)	30.0 (762)						
R4P36	84.0 (2134)	23.3 (591)	36.0 (914)						
R4P42	84.0 (2134)	23.3 (591)	42.0 (1054)						White
R4PWH	84.0 (2134)	23.3 (591)	30.0 (762)						
R4P36WH	84.0 (2134)	23.3 (591)	36.0 (914)						
R4P23CN	84.0 (2134)	23.3 (591)	23.0 (584)	52	Cage Nut		Black		
R4PCN	84.0 (2134)	23.3 (591)	30.0 (762)						
R4P36CN	84.0 (2134)	23.3 (591)	36.0 (914)						
R4P42CN	84.0 (2134)	23.3 (591)	42.0 (1054)				White		
R4PCNWH	84.0 (2134)	23.3 (591)	30.0 (762)						
R4P36CNWH	84.0 (2134)	23.3 (591)	36.0 (914)						
R4P2396	96.0 (2441)	23.3 (591)	23.0 (584)	52	#12-24 Threaded	Black			
R4P96	96.0 (2441)	23.3 (591)	30.0 (762)						
R4P3696	96.0 (2441)	23.3 (591)	36.0 (914)						
R4P4296	96.0 (2441)	23.3 (591)	42.0 (1054)			White			
R4P3696WH	96.0 (2441)	23.3 (591)	36.0 (914)						
R4P23CN96	96.0 (2441)	23.3 (591)	23.0 (584)						
R4PCN96	96.0 (2441)	23.3 (591)	30.0 (762)	Black					
R4P36CN96	96.0 (2441)	23.3 (591)	36.0 (914)						
R4P42CN96	96.0 (2441)	23.3 (591)	42.0 (1054)						
R4P36CN96WH	96.0 (2441)	23.3 (591)	36.0 (914)		White				

Continued on next page

4 Post Cable Management Rack System and Accessories (continued)

4 Post Rack Accessories

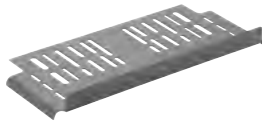

R4PWF



RSHLF

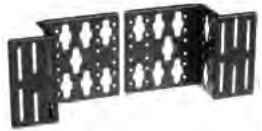

CVPDUB

Part Number	Description	Height In. (mm)	Width In. (mm)	Depth In. (mm)	Length In. (mm)	No. of Rack Units	Load Capacity (Lbs.)	Color	Std. Pkg. Qty.
R4PWF	Top of Rack Waterfall Trough	1.9 (50)	26.1 (662)	8.5 (216)		—	—		
RSHLF23	4-Post Rack Mount Shelf	1.7 (44)	19.0 (483)	23.0 (584)	—	1	275	Black	1
RSHLF				30.0 (762)				White	
RSHLF36				36.0 (914)					
RSHLF36WH									
CVPDUB	4-Post Rack PDU Bracket, Set of Two	6.0 (152)	3.6 (91)	8.5 (216)					
S1224-C	#12-24 Mounting Screws, Box of 100								100
CNWS1224-C	#12-24 Mounting Screws with Cage Nuts, Box of 100	—	—	—	0.5 (12.7)	—	—	Black	
CNWSM6-C	M6 Mounting Screws with Cage Nuts, Box of 100				0.6 (15.0)				

Additional accessories available please see www.panduit.com.

A. Featured Products

B. Copper Systems

C. Fiber Systems

D. Faceplates, Frames & Surface Mount Boxes

E. Industrial Networks

F. Audio Video Systems

G. Keystone Cabling Systems

H. Zone Cabling

J. Cable Routing Systems

K. Cable Cleats

L. Cabinets & Rack Systems

M. Power & Connectivity Management

N. Grounding & Bonding

O. Identification Products

P. Cable Management Accessories

Q. Part Number Index

A.
Featured
Products

B.
Copper
Systems

C.
Fiber
Systems

D.
Faceplates,
Frames &
Surface
Mount Boxes

E.
Industrial
Networks

F.
Audio
Video
Systems

G.
Keystone
Cabling
Systems

H.
Zone
Cabling

J.
Cable
Routing
Systems

K.
Cable
Cleats

L.
Cabinets
& Rack
Systems

M.
Power &
Connectivity
Management

N.
Grounding
& Bonding

O.
Identification
Products

P.
Cable
Management
Accessories

Q.
Part
Number
Index

2 Post Cable Management Rack System and Accessories

- Printed rack space identification on all equipment rails allows for quick location of rack spaces; numbers up per TIA606 specifications
- Double-sided #12-24 EIA universal mounting hole spacing
- 24 #12-24 mounting screws included
- Multiple mounting hole locations in each base angle
- Can be used with all Panduit cable management and patch panel products in addition to any industry standard 19" components
- Paint piercing washers included to electrically bond rack for simplified grounding; for the complete grounding solution, StructuredGround™ Kits for Racks see Section N.1–N.25 For Grounding and Bonding
- When mounting NetRunner managers to 6" channel rack, R2P6S, utilize side mount kit WMPVSMK



R2P



R2PWH



R2P6S



RFAKIT



R2PPDUB

2 Post Racks

Part Number	Height In. (mm)	Width In. (mm)	Depth In. (mm)	No. of Rack Units	Equipment Rails	Load Capacity (Lbs.)	Color	Std. Pkg. Qty.
R2P48	48.0 (1219)	20.3 (516)	3.0 (76)	24	#12-24 Threaded	300	Black	1
R2P79	79.0 (2006)			42		1,000		
R2P	84.0 (2134)			45			White	
R2PWH		24.3 (618)	52	Black				
R2PW	20.3 (516)					45	1,500	
R2P96		96.0 (2441)	52					
R2P6S	84.0 (2134)	6.0 (152)		52				
R2P6S96	96.0 (2441)							

2 Post Rack Accessories

Part Number	Description	Height In. (mm)	Width In. (mm)	Depth In. (mm)	Length In. (mm)	Color	Std. Pkg. Qty.
RFAKIT	Rack Anchor Kit for Concrete Floor, Set of Four Anchors	—	—	—	3.7 (95)	Silver	1
S1224-C	#12-24 Mounting Screws, Box of 100				0.5 (12.7)		100
R2PPDUB	2-Post Rack PDU Brackets, Set of Two Brackets	6.2 (157)	1.1 (27)	Adjustable 12.4 (315) Minimum 20.4 (518) Maximum	—	Black	1

Additional accessories available, please see www.panduit.com.

PatchRunner™ 2 Vertical Cable Management System

- A "push-to-close" door design allows for easy operation
- The doors ship with managers which simplifies the ordering process with less packaging waste
- There are no brackets to install, providing faster installation while reducing labor costs
- Managers and doors are available in black and white
- Up to 17% more usable capacity over existing PRV Vertical Managers
- The curved fingers support cables as they transition to vertical pathway eliminated need for horizontal managers
- Individual fingers aligns with rack spaces to simplify cable routing changes
- The integral bend radius control ensures network performance and system reliability
- An optional snap on vertical retainers can be placed on the fingers to help retain cables in channel for improved cable management and appearance
- An optional slack management spool helps organize and manage patch cord slack allowing for standardization of patch cord lengths



Black Part Number	White Part Number	Height In. (mm)	Width In. (mm)	Depth In. (mm)	No. of Rack Units	Single or Double Sided	No. of Doors Included	Std. Pkg. Qty.	
PR2VD0679	PR2VD0679WH	79.0 (2003)	6.0 (152)	20.6 (523)	42	Double-Sided	Two	1	
PR2VD1279	PR2VD1279WH	79.0 (2003)	12.0 (305)	20.6 (523)					
PR2VFD0679	PR2VFD0679WH	79.0 (2003)	6.0 (152)	12.0 (305)		Single-Sided	One		
PR2VFD1279	PR2VFD1279WH	79.0 (2003)	12.0 (305)	12.0 (305)					
PR2VD06	PR2VD06WH	84.0 (2130)	6.0 (152)	20.6 (523)	45	Double-Sided	Two		
PR2VD08	PR2VD08WH	84.0 (2130)	8.0 (203)	20.6 (523)					
PR2VD10	PR2VD10WH	84.0 (2130)	10.0 (254)	20.6 (523)					
PR2VD12	PR2VD12WH	84.0 (2130)	12.0 (305)	20.6 (523)					
PR2VFD06	PR2VFD06WH	84.0 (2130)	6.0 (152)	12.0 (305)	45	Single-Sided	One		
PR2VFD08	PR2VFD08WH	84.0 (2130)	8.0 (203)	12.0 (305)					
PR2VFD10	PR2VFD10WH	84.0 (2130)	10.0 (254)	12.0 (305)					
PR2VFD12	PR2VFD12WH	84.0 (2130)	12.0 (305)	12.0 (305)					
PR2VSD06	PR2VSD06WH	84.0 (2130)	6.0 (152)	20.6 (523)	45	Double-Sided	One		
PR2VSD08	PR2VSD08WH	84.0 (2130)	8.0 (203)	20.6 (523)					
PR2VSD10	PR2VSD10WH	84.0 (2130)	10.0 (254)	20.6 (523)					
PR2VSD12	PR2VSD12WH	84.0 (2130)	12.0 (305)	20.6 (523)					
PR2VD0696	PR2VD0696WH	96.0 (2435)	6.0 (152)	20.6 (523)	52	Double-Sided	Two		
PR2VD0896	PR2VD0896WH	96.0 (2435)	8.0 (203)	20.6 (523)					
PR2VD1096	PR2VD1096WH	96.0 (2435)	10.0 (254)	20.6 (523)					
PR2VD1296	PR2VD1296WH	96.0 (2435)	12.0 (305)	20.6 (523)					
PR2VFD0696	PR2VFD0696WH	96.0 (2435)	6.0 (152)	12.0 (305)				Single-Sided	One
PR2VFD0896	PR2VFD0896WH	96.0 (2435)	8.0 (203)	12.0 (305)					
PR2VFD1096	PR2VFD1096WH	96.0 (2435)	10.0 (254)	12.0 (305)					
PR2VFD1296	PR2VFD1296WH	96.0 (2435)	12.0 (305)	12.0 (305)					
PR2VSD0696	PR2VSD0696WH	96.0 (2435)	6.0 (152)	20.6 (523)		Double-Sided	One		
PR2VSD0896	PR2VSD0896WH	96.0 (2435)	8.0 (203)	20.6 (523)					
PR2VSD1096	PR2VSD1096WH	96.0 (2435)	10.0 (254)	20.6 (523)					
PR2VSD1296	PR2VSD1296WH	96.0 (2435)	12.0 (305)	20.6 (523)					

- A. Featured Products
- B. Copper Systems
- C. Fiber Systems
- D. Faceplates, Frames & Surface Mount Boxes
- E. Industrial Networks
- F. Audio Video Systems
- G. Keystone Cabling Systems
- H. Zone Cabling
- J. Cable Routing Systems
- K. Cable Cleats
- L. Cabinets & Rack Systems
- M. Power & Connectivity Management
- N. Grounding & Bonding
- O. Identification Products
- P. Cable Management Accessories
- Q. Part Number Index

PatchRunner™ 2 Enhanced Vertical Cable Manager with Vertical Patching



PE2VD12



PE2VFD12

Black Part Number	White Part Number	Height In. (mm)	Width In. (mm)	Depth In. (mm)	No. of Rack Units	Single or Double Sided	No. of Doors Included	Vertical RU Spacing	Std. Pkg. Qty.			
PE2VD06	PE2VD06WH	84.0 (2130)	6.0 (152)	26.8 (681)	45	Double-Sided	Two	6	1			
PE2VD08	PE2VD08WH	84.0 (2130)	8.0 (203)	26.8 (681)				9				
PE2VD10	PE2VD10WH	84.0 (2130)	10.0 (254)	26.8 (681)				12				
PE2VD12	PE2VD12WH	84.0 (2130)	12.0 (305)	26.8 (681)				15				
PE2VFD06	PE2VFD06WH	84.0 (2130)	6.0 (152)	16.3 (415)		52	Single-Sided	One		6		
PE2VFD08	PE2VFD08WH	84.0 (2130)	8.0 (203)	16.3 (415)						9		
PE2VFD10	PE2VFD10WH	84.0 (2130)	10.0 (254)	16.3 (415)						12		
PE2VFD12	PE2VFD12WH	84.0 (2130)	12.0 (305)	16.3 (415)						15		
PE2VSD06	PE2VSD06WH	84.0 (2130)	6.0 (152)	26.8 (681)						Double-Sided	Two	6
PE2VSD08	PE2VSD08WH	84.0 (2130)	8.0 (203)	26.8 (681)								9
PE2VSD10	PE2VSD10WH	84.0 (2130)	10.0 (254)	26.8 (681)			12					
PE2VSD12	PE2VSD12WH	84.0 (2130)	12.0 (305)	26.8 (681)			15					
PE2VD0696	PE2VD0696WH	96.0 (2435)	6.0 (152)	26.8 (681)	Single-Sided		One	6				
PE2VD0896	PE2VD0896WH	96.0 (2435)	8.0 (203)	26.8 (681)				9				
PE2VD1096	PE2VD1096WH	96.0 (2435)	10.0 (254)	26.8 (681)				12				
PE2VD1296	PE2VD1296WH	96.0 (2435)	12.0 (305)	26.8 (681)				15				
PE2VFD0696	PE2VFD0696WH	96.0 (2435)	6.0 (152)	16.3 (415)		Double-Sided		Two	6			
PE2VFD0896	PE2VFD0896WH	96.0 (2435)	8.0 (203)	16.3 (415)					9			
PE2VFD1096	PE2VFD1096WH	96.0 (2435)	10.0 (254)	16.3 (415)	12							
PE2VFD1296	PE2VFD1296WH	96.0 (2435)	12.0 (305)	16.3 (415)	15							
PE2VSD0696	PE2VSD0696WH	96.0 (2435)	6.0 (152)	26.8 (681)	Single-Sided		One		6			
PE2VSD0896	PE2VSD0896WH	96.0 (2435)	8.0 (203)	26.8 (681)					9			
PE2VSD1096	PE2VSD1096WH	96.0 (2435)	10.0 (254)	26.8 (681)		12						
PE2VSD1296	PE2VSD1296WH	96.0 (2435)	12.0 (305)	26.8 (681)		15						

- A. Featured Products
- B. Copper Systems
- C. Fiber Systems
- D. Faceplates, Frames & Surface Mount Boxes
- E. Industrial Networks
- F. Audio Video Systems
- G. Keystone Cabling Systems
- H. Zone Cabling
- J. Cable Routing Systems
- K. Cable Cleats
- L. Cabinets & Rack Systems
- M. Power & Connectivity Management
- N. Grounding & Bonding
- O. Identification Products
- P. Cable Management Accessories
- Q. Part Number Index

PatchRunner™ 2 Vertical Cable Manager Accessories



Part Number	Description	Color	Std. Pkg. Qty.	Std. Ctn. Qty.		
PR2VEP	PatchRunner™ 2 End Panel for use with 45RU Managers	Black	1	-		
PR2VEPWH		White				
PR2VEP96	PatchRunner™ 2 End Panel for use with 52RU Managers	Black				
PR2VEP96WH		White				
PE2VEP	PatchRunner™ 2 Enhanced End Panel for use with 45RU Managers	Black				
PE2VEPWH		White				
PE2VEP96	PatchRunner™ 2 Enhanced End Panel for use with 52RU Managers	Black				
PE2VEP96WH		White				
R2PPR2VWF	PatchRunner™ 2 Waterfall for use with 2-Post Racks	Black				
R2PPR2VWFWH		White				
R4PPR2VWF	PatchRunner™ 2 Waterfall for use with R4P-style 4-Post Racks	Black				
R4PPR2VWFWH		White				
PR2VBPK	PatchRunner™ 2 Pass-Through Hole Blanking Plugs, kit of five plugs	Black				10
PR2VGK	PatchRunner™ 2 Pass-Through Grommet Kit, kit of five grommets					
PRSP7	Molded Plastic Slack Spool, 7" depth					
PRSP5	Molded Plastic Slack Spool, 5" depth					
WR5E-X	Snap-on Finger Cable Retainers		10	100		

A. Featured Products

B. Copper Systems

C. Fiber Systems

D. Faceplates, Frames & Surface Mount Boxes

E. Industrial Networks

F. Audio Video Systems

G. Keystone Cabling Systems

H. Zone Cabling

J. Cable Routing Systems

K. Cable Cleats

L. Cabinets & Rack Systems

M. Power & Connectivity Management

N. Grounding & Bonding

O. Identification Products

P. Cable Management Accessories

Q. Part Number Index

A. Featured Products
B. Copper Systems
C. Fiber Systems
D. Faceplates, Frames & Surface Mount Boxes
E. Industrial Networks
F. Audio Video Systems
G. Keystone Cabling Systems
H. Zone Cabling
J. Cable Routing Systems
K. Cable Cleats
L. Cabinets & Rack Systems
M. Power & Connectivity Management
N. Grounding & Bonding
O. Identification Products
P. Cable Management Accessories
Q. Part Number Index

NetRunner™ Vertical Cable Management

- Integral cable retainers on the end of each finger provides easy access to route cables between fingers
- Bend radius fingers align with rack spaces to support cables as they transition to the vertical pathway
- Dual hinged covers can be opened 110° to the left or right to provide complete access to the cables inside the vertical pathway
- Vertical managers include hinged covers, mounting brackets and #12-24 screws



WMPV22E



WMPVF22E

NetRunner™ Vertical Cable Manager

Part Number	Height In. (mm)	Width In. (mm)	Depth In. (mm)	No. of Rack Units	Single or Double Sided	Color	Std. Pkg. Qty.
WMPV22E	41.5 (1054)	4.9 (125)	12.0 (306)	22	Double-Sided	Black	1
WMPV45E	83.0 (2108)			45			
WMPVHC45E		6.7 (170)	14.1 (357)				
WMPVF22E	41.5 (1054)	4.9 (125)	6.5 (165)	22	Single-Sided		
WMPVF45E	83.0 (2108)			45			
WMPVHCF45E		6.7 (170)	7.6 (192)				

NetRunner™ Accessories

Part Number	Description	No. of Rack Units	Color	Std. Pkg. Qty.	Std. Ctn. Qty.
WMPVCBE	NetRunner™ Standard Mount Bracket Kit allows mounting to adjacent racks, four brackets per kit.	—	Black	1	10
WMPVCMB	NetRunner™ Mounting Brackets for racks with a wider mounting face dimensions up to 1 5/8" (4.1mm) wide from the edge of the rack to the center of the mounting holes, four brackets per kit.				
WMPVSMK	NetRunner™ Side Mount Bracket Kit, for use with 6" channel 2 Post Racks.				
NREP1	End panel for use with WMPVHCF45E/WMPVHC45E, includes two panel sections to cover 45 RU on one side.	45			
WMPV45EPB1	End panel for use with WMPVF45E/WMPV45E, includes two panel sections to cover 45 RU on one side.				
WMPV45ERTW	Rack top trough with waterfall creates pathway above rack, for use with R2P rack and WMPV45E/WMPVHC45E managers.				
WR5E-X	Snap-on finger cable retainers.	—	10	100	

PatchLink™ Horizontal Cable Managers

- Lightweight plastic construction provides durability and easy installation
- Patented dual hinged cover allows cable access without removing cover
- Rounded edges on fingers protect cables from snags and damage to cable

- Flexible fingers allows easy installation and removal of cables
- Pass-through holes allow front to rear cabling
- Covers and #12-24 mounting screws included
- Recommended for use with NetRunner™ WMPVF45E and WMPV45E Vertical Managers found on page L.30



WMPSE



WMP1E



WMPH2E



WMPFSE



WMPF1E



WMPHF2E

Part Number	Height In. (mm)	Width In. (mm)	Depth In. (mm)	No. of Rack Units	Single or Double Sided	Color	Std. Pkg. Qty.
WMPSE	1.7 (44)	19.0 (483)	8.9 (226)	1	Double-Sided	Black	1
WMP1E			7.9 (200)				
WMPH2E*	3.5 (89)	20.2 (513)	8.9 (226)	2			
WMPFSE			3.7 (94)				
WMP1E	1.7 (44)	19.0 (483)	2.7 (69)	1	Single-Sided		
WMPF1E			3.7 (94)				
WMPHF2E*	3.5 (89)	20.2 (513)	3.7 (94)	2			

*Includes extended front cover and two bend radius clips.

A. Featured Products

B. Copper Systems

C. Fiber Systems

D. Faceplates, Frames & Surface Mount Boxes

E. Industrial Networks

F. Audio Video Systems

G. Keystone Cabling Systems

H. Zone Cabling

J. Cable Routing Systems

K. Cable Cleats

L. Cabinets & Rack Systems

M. Power & Connectivity Management

N. Grounding & Bonding

O. Identification Products

P. Cable Management Accessories

Q. Part Number Index

- A. Featured Products
- B. Copper Systems
- C. Fiber Systems
- D. Faceplates, Frames & Surface Mount Boxes
- E. Industrial Networks
- F. Audio Video Systems
- G. Keystone Cabling Systems
- H. Zone Cabling
- J. Cable Routing Systems
- K. Cable Cleats
- L. Cabinets & Rack Systems
- M. Power & Connectivity Management
- N. Grounding & Bonding
- O. Identification Products
- P. Cable Management Accessories
- Q. Part Number Index

NetManager™ High Capacity Horizontal Cable Managers

- Innovative inset fingers slope inward toward back of managers offering unobstructed access to network cabling for easier moves, adds, and changes
- Rear cable management finger spacing utilizes open D-rings for greater accessibility
- Can be used to create large capacity horizontal pathways for routing cable
- Patented front and rear dual hinged cover allows cable access without removing cover
- Pass-through holes allow for front to rear cabling
- Built in cable retainers hold cable in place for easy moves, adds, and changes
- Covers and #12-24 mounting screws included
- Recommended for use with NetRunner™ WMPVHC45E and WMPVHCF45E Vertical Managers or PatchRunner™ 2 Vertical Managers found on page L.27–L.28



NM2



NMF3



NMF4



NMF1WH



NMF2WH

Part Number	Height In. (mm)	Width In. (mm)	Depth In. (mm)	No. of Rack Units	Single or Double Sided	Color	Std. Pkg. Qty.	
NM1	1.7 (44)	19.0 (482)	13.1 (332)	1	Double-Sided	Black	1	
NM2	3.5 (88)			2				
NM3	5.2 (133)			3				
NM4	7.0 (177)			4				
NMF1	1.7 (44)	19.0 (482)	6.2 (157)	1	Single-Sided			White
NMF2	3.5 (88)			2				
NMF3	5.2 (133)			3				
NMF4	7.0 (177)			4				
NMF1WH	1.7 (44)			1				
NMF2WH	3.5 (88)			2				
NMF3WH	5.2 (133)			3				
NMF4WH	7.0 (177)			4				

Front to rear pass-through blanking panels are available. Refer to www.panduit.com for additional information.

Open-Access™ Horizontal Cable Managers

- D-ring managers provide an open and efficient way to manage cable
- Patented D-ring design provides flexibility for easy moves, adds, and changes
- Pass-through holes allow front to rear cabling
- Mount to 19" EIA racks and cabinets
- Hardware included
- Ideal when positioning managers above and below a 1RU patch panel or switch for better port access



CMPH1



CMPH2



CMPHF1



CMPH2



CMPHHF1



CMPHH2

Part Number	Height In. (mm)	Width In. (mm)	Depth In. (mm)	No. of Rack Units	Single or Double Sided	Color	Std. Pkg. Qty.
CMPH1	1.7 (44)	19.0 (483)	8.6 (218)	1	Double-Sided	Black	1
CMPH2	3.5 (88)		8.6 (228)	2			
CMPHF1	1.7 (44)		3.4 (87)	1	Single-Sided		
CMPHHF1			5.7 (144)				
CMPHF2	3.5 (88)		3.4 (87)	2			
CMPHH2			5.7 (144)				

Optional covers are available. Refer to www.panduit.com for additional information.

Cable Routing Troughs

- Provide pathways to route cables in a rack line-up
- Provides a gradual, controlled bend radius for both copper and fiber cable.
- Strong lightweight aluminum construction
- Mounts on 19" rack; may also be wall-mounted



CMLT19



CMUT19



CMT4

Part Number	Description	Height In. (mm)	Width In. (mm)	Depth In. (mm)	No. of Rack Units	Color	Std. Pkg. Qty.
CMLT19	Lower trough with 1.3" bend radius mounts to the bottom of a standard 19" EIA rack.	8.0 (203)	19.0 (483)	4.5 (114)	4	Black	1
CMUT19	Upper trough with 1.3" bend radius mounts to the top of a standard 19" EIA rack.	3.5 (89)			2		
CMT4	Cable routing trough for rack-to-rack cabling.	6.9 (176)			4		

- A. Featured Products
- B. Copper Systems
- C. Fiber Systems
- D. Faceplates, Frames & Surface Mount Boxes
- E. Industrial Networks
- F. Audio Video Systems
- G. Keystone Cabling Systems
- H. Zone Cabling
- J. Cable Routing Systems
- K. Cable Cleats
- L. Cabinets & Rack Systems
- M. Power & Connectivity Management
- N. Grounding & Bonding
- O. Identification Products
- P. Cable Management Accessories
- Q. Part Number Index

Rack Mount Shelves

- Compatible with all Panduit 2 post racks
- Mounting hardware included
- Vented shelves provide better heat distribution for active equipment

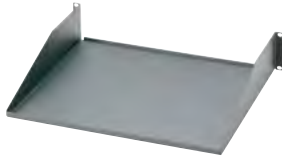

SRM19FM2

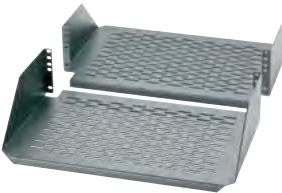

SRM19CMV3

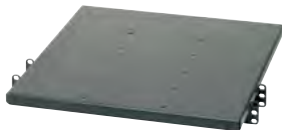

SRM19X18A1

Part Number	Height In. (mm)	Width In. (mm)	Depth In. (mm)	No. of Rack Units	Shelf Type	Material	Load Rating (Lbs.)	Color	Std. Pkg. Qty.
SRM19FM1	1.7 (44)	19.0 (483)	15.2 (385)	1	Front-Mount	Steel	30	Black	1
SRM19FM2	3.5 (88)			50					
SRM19CMV3	5.2 (133)	19.2 (489)	12.5 (316)	3	Cantilevered, Vented	Aluminum	200		
SRM19CM3	(133)				Cantilevered				
SRM19X18A1	1.7 (44)	19.0 (483)	18.0 (457)	1	Adjustable	Steel	250		
SRM19X25A1			25.0 (635)						

Additional shelves available. Refer to www.panduit.com for additional information.

Panel Extender Brackets

- Allow for mounting 19" product on 23" standard EIA racks or cabinets
- Offset bracket design maintains flush mounting of panels
- Mounting hardware included



PEB1



PEB2

Part Number	Description	No. of Rack Units	Color	Std. Pkg. Qty.	Std. Ctn. Qty.
PEB1	Set of two brackets, allows 19" rack mountable accessories to mount to 23" wide rack.	1	Black	1	10
PEB2	Set of two brackets, allows 19" rack mountable accessories to mount to 23" wide rack.	2			

Rack Mount Cable Management Accessories

- Bend radius control fingers support cables as they transition to the vertical pathway
- Finger spacing aligns with rack units
- Attach to patch panels or equipment mounting screws
- Lightweight plastic construction provides durability and easy installation



CMBRC1



CMBRC5E

Part Number	Description	Height In. (mm)	Width In. (mm)	Depth In. (mm)	No. of Rack Units	Color	Bend Radius In.	Std. Pkg. Qty.	Std. Ctn. Qty.
CMBRC1	Kit of two bend radius control fingers; for use with patch panels.	1.7 (44)	0.8 (19)	3.0 (77)	1	Black	0.5	1	10
CMBRC1E			1.0 (25)	5.1 (129)					
CMBRC5	One-piece unit with five bend radius control fingers; for use with active equipment.	8.7 (222)	1.0 (26)	3.3 (84)	5	Black	0.25	1	10
CMBRC5E				5.1 (129)					

Hinged Wall Brackets

- Mount to wall or standard EIA 19" rack
- Cable tie slots for securing cables
- Standard 19" EIA hole spacing
- L-Bracket can be removed from the main bracket to access the backside of the equipment for MAC's
- Panel rotates from one side for easy access to cabling; hinged bracket can be mounted on left or right side
- Include write-on labeling area
- Accept 19" patch panels, horizontal managers, and equipment



WBH1



WBH2



WBH3



WBH4



WBH4E

Part Number	Height In. (mm)	Width In. (mm)	Depth In. (mm)	No. of Rack Units	Load Rating (Lbs.)	Color	Std. Pkg. Qty.
WBH1	1.7 (44)	20.2 (513)	6.3 (159)	1	10	Black	1
WBH2	3.5 (88)			20.4 (519)	2		
WBH2E		20.4 (519)	15.8 (402)				
WBH3	5.2 (133)	20.2 (513)	6.3 (159)	3	30		
WBH4	7.0 (177)			20.4 (519)	15.8 (402)		
WBH4E		10.5 (267)	6				

A. Featured Products

Rack Filler Panels

- Reserve rack space for future use
- Direct airflow in cabinet applications
- Mount to standard EIA 19" racks or cabinets
- #12-24 and M6 mounting screws included

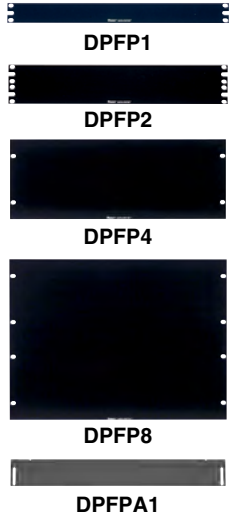

Part Number	Height In. (mm)	Width In. (mm)	No. of Rack Units	Color	Std. Pkg. Qty.	Std. Ctn. Qty.
DPFP1	1.7 (44)	19.0 (483)	1	Black	1	10
DPFP2	3.5 (88)		2			
DPFP4	7.0 (178)		4			
DPFP8	14.0 (355)		8			
DPFPA1	2.4 (60)		1	White		
DPFP1WH	1.7 (44)					
DPFP2WH	3.5 (88)					

B. Copper Systems

C. Fiber Systems

D. Faceplates, Frames & Surface Mount Boxes

E. Industrial Networks

F. Audio Video Systems

G. Keystone Cabling Systems



Angled Panel Accessories

- Aesthetic design provides a clean and consistent look when used with Panduit angled patch panels
- Support warm aisle/cold aisle methodology by sealing in cool air and not allowing it to escape, promoting proper airflow and cooling
- Protect exposed connectors from intrusion of debris or accidental disconnection

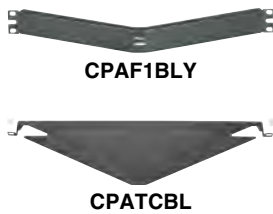

Part Number	Part Description	No. of Rack Units	Std. Pkg. Qty.	Std. Ctn. Qty.
CPAF1BLY	Covers one open rack space in standard EIA 19" rack.	1	1	10
CPATCBL	Transitional cover for angled patch panels that occupies zero rack space.	-		

Replace BL (Black) with WH (White).

H. Zone Cabling

J. Cable Routing Systems

K. Cable Cleats

L. Cabinets & Rack Systems

IN-Cabinet Vertical Cable Managers

- For managing cable within cabinets 27" or wider
- Attach to equipment mounting rails
- Two mounting bracket options to facilitate mounting to various cabinet configurations
- Snap-on covers included

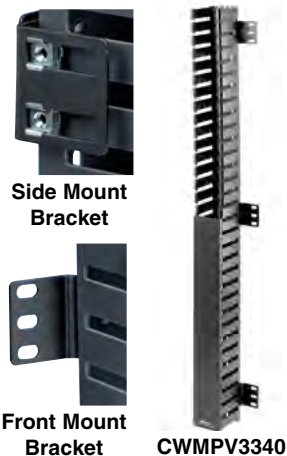

Part Number	Height In. (mm)	Width In. (mm)	Depth In. (mm)	No. of Rack Units	Orientation	Single or Double Sided	Color	Std. Pkg. Qty.
CWMPV3440	71.9 (1825)	3.5 (88)	4.3 (109)	40	Side Mount	Single-Sided	Black	1
CWMPV2440		2.5 (63)						
CWMPV2340	70.0 (1778)	3.7 (94)	3.3 (83)		Front Mount			
CWMPV3340		4.7 (119)						

Additional sizes available. Refer to www.panduit.com for additional information.

M. Power & Connectivity Management

N. Grounding & Bonding

O. Identification Products

P. Cable Management Accessories

Q. Part Number Index

Table of Contents

SmartZone™ G5 Power Distribution Units (PDUs).....M.2 – M.6

Monitored Input (MI Series).....M.3

Monitored Switched (MS Series)M.4

Monitored Per Outlet (MPO Series)M.4

Monitored and Switched Per Outlet (MSPO Series).....M.5

BasicM.6

SmartZone™ G5 Accessories.....M.7

Environmental.....M.7

SecurityM.7

SmartZone™ G5 Locking Power CordsM.8 – M.9

IEC C13 to IEC C14M.8

IEC C19 to IEC C20M.9

**A.
Featured
Products**

**B.
Copper
Systems**

**C.
Fiber
Systems**

**D.
Faceplates,
Frames &
Surface
Mount Boxes**

**E.
Industrial
Networks**

**F.
Audio
Video
Systems**

**G.
Keystone
Cabling
Systems**

**H.
Zone
Cabling**

**J.
Cable
Routing
Systems**

**K.
Cable
Cleats**

**L.
Cabinets
& Rack
Systems**

**M.
Power &
Connectivity
Management**

**N.
Grounding
& Bonding**

**O.
Identification
Products**

**P.
Cable
Management
Accessories**

**Q.
Part
Number
Index**



- A. Featured Products
- B. Copper Systems
- C. Fiber Systems
- D. Industrial Networks
- E. Audio Video Systems
- F. Keystone Cabling Systems
- G. Faceplates, Frames & Surface Mount Boxes
- H. Zone Cabling
- J. Cable Routing Systems
- K. Cable Cleats
- L. Cabinets & Rack Systems
- M. Power & Connectivity Management
- N. Grounding & Bonding
- O. Identification Products
- P. Cable Management Accessories
- Q. Part Number Index

SmartZone™ G5 Power Distribution Units (PDUs)

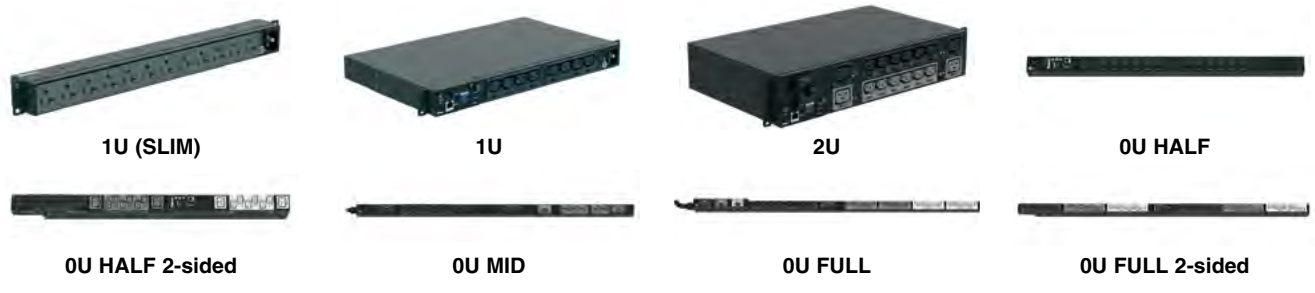

Dimensions

Form Factor	Height In. (mm)	Width In. (mm)	Depth In. (mm)
1U (SLIM)	1.6 (40.6)	17.5 (444.5)	2.0 (50.8)
1U	1.7 (43.2)		7.8 (198.1)
2U	3.4 (86.4)		
0U HALF	32.2 (817.9)	2.0 (50.8)	2.1 (53.3)
0U HALF (2 sided)	36 (914.4)		4.4 (111.8)
0U MID	58.7 (1491)		2.1 (53.3)
0U FULL	68.9 (1750.1)		
0U FULL (2 sided)	71.7 (1821.2)		

Mounting: Vertical units provide up to 48 outlets and do not occupy the EIA space. Horizontal units provide up to 16 outlets and mount in standard (1U or 2U) EIA rack space.

Monitored Input (MI Series)

- Provides aggregate PDU monitoring to quickly identify potential power issues and reclaim available or under-utilized power capacity
- Can also be used for environmental monitoring through sensors and electronic rack access control through electronic swing-handles (each sold separately)

Part Number	Input Current Per Phase	Form Factor	Input Plug Type	Apparent Power (kVA)	Outlet Count	Outlet Configuration	Length (mm)	Width (mm)	Depth (mm) at Outlet Position	Std. Pkg. Qty.	Std. Ctn. Qty.
100-240VAC, 1-Phase											
P12D36M	16	1U	IEC 60309 2P+E	3.7	12	(12)C13	43.51	443.51	269.75	1	—
P24D40M	16	0U MID	IEC 60309 2P+E	3.7	24	(20)C13 (4)C19	1489.99	51.99	53.01	1	—
200-240VAC, 1-Phase											
P24D03M	32	0U MID	IEC 60309 2P+E 6h	7.4	24	(20)C13, (4)C19	1489.99	51.99	53.01	1	—
P34D41M	32	0U FULL	IEC 60309 2P+E 6h	7.4	34	(28)C13 (6)C19	1750.01	51.99	53.01	1	—
P42D06M	32	0U FULL	IEC 60309 2P+E 6h	7.4	42	(36)C13, (6)C19	1750.01	51.99	53.01	1	—
200-240/346-415 VAC, 3-Phase											
P30D05M	16	0U MID	IEC 60309 3P+N+E 6h	11.0	30	(24)C13, (6)C19	1489.99	51.99	53.01	1	—
P42D42M	16	0U FULL	IEC 60309 3P+N+E 6h	11.0	42	(36)C13, (6)C19	1750.01	51.99	53.01	1	—
P24D43M	32	0U FULL	IEC 60309 3P+N+E 6h	22.0	24	(12)C13, (12)C19	1750.01	51.99	53.01	1	—
P42D04M	32	0U FULL	IEC 60309 3P+N+E 6h	22.0	42	(30)C13, (12)C19	1750.01	54.99	53.01	1	—

A. Featured Products

B. Copper Systems

C. Fiber Systems

D. Faceplates, Frames & Surface Mount Boxes

E. Industrial Networks

F. Audio Video Systems

G. Keystone Cabling Systems

H. Zone Cabling

J. Cable Routing Systems

K. Cable Cleats

L. Cabinets & Rack Systems

M. Power & Connectivity Management

N. Grounding & Bonding

O. Identification Products

P. Cable Management Accessories

Q. Part Number Index

Continued on next page

A. Featured Products
B. Copper Systems
C. Fiber Systems
D. Industrial Networks
E. Audio Video Systems
F. Keystone Cabling Systems
G. Faceplates, Frames & Surface Mount Boxes
H. Zone Cabling
J. Cable Routing Systems
K. Cable Cleats
L. Cabinets & Rack Systems
M. Power & Connectivity Management
N. Grounding & Bonding
O. Identification Products
P. Cable Management Accessories
Q. Part Number Index

Monitored Switched (MS Series)

- Provides aggregate power monitoring as well as outlet level switching capabilities for individual outlets or an outlet bank
- Can also be used for environmental monitoring through sensors and electronic rack access control through electronic swing-handles (each sold separately)

Part Number	Input Current Per Phase	Form Factor	Input Plug Type	Apparent Power (kVA)	Outlet Count	Outlet Configuration	Length (mm)	Width (mm)	Depth (mm) at Outlet Position	Std. Pkg. Qty.	Std. Ctn. Qty.
100-240VAC, 1-Phase											
P08E25M	16	1U	IEC 60309 2P+E 6h	3.7	8	(8)C13	43.5	443.5	269.7	1	—
P24E04M	16	0U MID	IEC 60309 2P+E 6h	3.7	24	(20)C13 (4)C19	1490.0	52.0	53.0	1	—
200-240VAC, 1-Phase											
P24E01M	32	0U FULL	IEC 60309 2P+E 6h	7.4	24	(20)C13 (4)C19	1750.0	52.0	53.0	1	—
P32E06M	32	0U FULL	IEC 60309 2P+E 6h	7.4	32	(24)C13 (8)C19	1750.0	52.0	53.0	1	—
200-240/346-415VAC, 3-Phase											
P24E02M	16	0U FULL	IEC 60309 3P+N+E	11.0	24	(18)C13 (6)C19	1750.0	52.0	53.0	1	—
P24E03M	32	0U FULL	IEC 60309 3P+N+E 6h	22.0	24	(12)C13 (12)C19	1750.0	52.0	53.0	1	—
P36E09M	32	0U FULL Wide	IEC 60309 3P+N+E 6h	22.0	36	(24)C13, (12)C19	1750.0	85.0	53.0	1	—

Monitored Per Outlet (MPO Series)

- Can provide outlet level and aggregate power monitoring to quickly identify potential power issues and reclaim available or under-utilized power capacity at the outlet level
- Can also be used for environmental monitoring through sensors and electronic rack access control through electronic swing-handles (each sold separately)

Part Number	Input Current Per Phase	Form Factor	Input Plug Type	Apparent Power (kVA)	Outlet Count	Outlet Configuration	Length (mm)	Width (mm)	Depth (mm) at Outlet Position	Std. Pkg. Qty.	Std. Ctn. Qty.
200-240VAC, 1-Phase											
P24F06M	32	0U FULL	IEC 60309 2P+E 6h	7.4	24	(20)C13, (4)C19	1750.01	51.99	53.01	1	—
P32F10M	32	0U FULL	IEC 60309 2P+E 6h	7.4	32	(24)C13 (8)C19	1750.01	51.99	53.01	1	—
200-240/346-415 VAC, 3-Phase											
P36F13M	32	0U FULL Wide	IEC 60309 3P+N+E 6h	22.0	36	(24)C13, (12)C19	1750.01	84.99	53.01	1	—

Continued on next page

Monitored and Switched Per Outlet (MSPO Series)

- Can provide outlet level and aggregate power monitoring and outlet level switching capabilities or individual or a group of outlets
- Can also be used for environmental monitoring through sensors and electronic rack access control through electronic swing-handles (each sold separately)

Part Number	Input Current Per Phase	Form Factor	Input Plug Type	Apparent Power (kVA)	Outlet Count	Outlet Configuration	Length (mm)	Width (mm)	Depth (mm) at Outlet Position	Std. Pkg. Qty.	Std. Ctn. Qty.
100-240VAC, 1-Phase											
P08G10M	16	1U	IEC 60309 2P+E 6h	3.7	8	(8)C13	43.51	443.51	269.75	1	—
P24G11M	16	0U MID	IEC 60309 2P+E 6h	3.7	24	(20)C13 (4)C19	1489.99	51.99	53.01	1	—
200-240VAC, 1-Phase											
P24G06M	32	0U FULL	IEC 60309 2P+E 6h	7.4	24	(20)C13 (4)C19	1750.01	51.99	53.01	1	—
P32G13M	32	0U FULL	IEC 60309 2P+E 6h	7.4	32	(24)C13 (8)C19	1750.01	51.99	53.01	1	—
200-240/346-415VAC, 3-Phase											
P24G08M	32	0U FULL	IEC 60309 3P+N+E 6h	22.0	24	(12)C13 (12)C19	1750.01	51.99	53.01	1	—
P36G16M	32	0U FULL Wide	IEC 60309 3P+N+E 6h	22.0	36	(24)C13, (12)C19	1750.01	84.99	53.01	1	—

A. Featured Products

B. Copper Systems

C. Fiber Systems

D. Faceplates, Frames & Surface Mount Boxes

E. Industrial Networks

F. Audio Video Systems

G. Keystone Cabling Systems

H. Zone Cabling

J. Cable Routing Systems

K. Cable Cleats

L. Cabinets & Rack Systems

M. Power & Connectivity Management

N. Grounding & Bonding

O. Identification Products

P. Cable Management Accessories

Q. Part Number Index

Continued on next page

A.
Featured
Products

Basic

- Basic PDUs have the capability to distribute highly reliable power to IT equipment in the rack or cabinet

B.
Copper
Systems

C.
Fiber
Systems

D.
Industrial
Networks

E.
Audio
Video
Systems

F.
Keystone
Cabling
Systems

G.
Faceplates,
Frames &
Surface
Mount Boxes

H.
Zone
Cabling

J.
Cable
Routing
Systems

K.
Cable
Cleats

L.
Cabinets
& Rack
Systems

M.
Power &
Connectivity
Management

N.
Grounding
& Bonding

O.
Identification
Products

P.
Cable
Management
Accessories

Q.
Part
Number
Index

Part Number	Input Current Per Phase	Form Factor	Input Plug Type	Apparent Power (kVA)	Outlet Count	Outlet Configuration	Length (mm)	Width (mm)	Depth (mm) at Outlet Position	Std. Pkg. Qty.	Std. Ctn. Qty.
100-240VAC, 1-Phase											
P12B34M	16	1U	IEC 60309 2P+E 6h	3.7	12	(12)C13	40.6	444.5	50.8	1	—
P22B39M	16	0U HALF	IEC 60309 2P+E 6h	3.7	22	(20)C13, (2)C19	817.9	50.8	53.3	1	—
P06B35M	32	1U	IEC 60309 2P+E 6h	7.4	6	(6)C19	43.2	444.5	198.1	1	—
P12B36M	32	1U	IEC 60309 2P+E 6h	7.4	12	(12)C13	43.2	444.5	198.1	1	—
P42B42M	32	0U MID	IEC 60309 2P+E 6h	7.4	42	(36)C13, (6)C19	1491	50.8	53.3	1	—
P30B06M	32	0U MID	IEC 60309 2P+E 6h	7.4	30	(24)C13, (6)C19	1491	50.8	53.3	1	—
240/415VAC, 3-Phase											
P06B38M	32	1U	IEC 60309 2P+E 6h	22.0	6	(6)C19	43.2	444.5	198.1	1	—
P42B44M	16	0U MID	IEC 60309 2P+E 6h	11.0	42	(36)C13, (6)C19	1491	50.8	53.3	1	—
P24B12M	32	0U FULL	IEC 60309 2P+E 6h	22.0	24	(12)C13, (12)C19	1750.1	50.8	53.3	1	—
P42B11M	32	0U FULL	IEC 60309 2P+E 6h	22.0	42	(30)C13, (12)C19	1750.1	55.88	53.3	1	—
P48B45M	32	0U FULL 2 Sided	IEC 60309 2P+E 6h	22.0	48	(36)C13, (12)C19	1821.2	50.8	111.8	1	—

SmartZone™ G5 Accessories Environmental



Part Number	Description	Dimensions L x W x H (mm)	Length (M)	Std. Pkg. Qty.	Std. Ctn. Qty.
EA001	Temperature Sensor	44 x 21 x 11	2	1	1
EB001	Temperature + Humidity Sensor	44 x 21 x 11	2	1	—
EC001	3 Temperature + Humidity Sensor	44 x 21 x 11	2	1	—
ED001	Water – Rope	60 x 60 x 22	2	1	—
EE001	Water – Spot	60 x 60 x 22	5	1	—
EF001	3 Sensor Hub	85 x 32 x 27	N/A	1	—
EG001	Water – Rope extension	N/A	2	1	—

Security

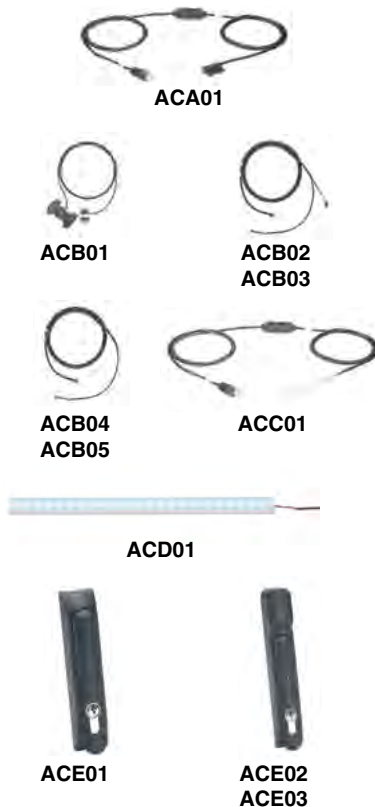

Part Number	Description	Dimensions L x W x H (mm)	Length (M)	Std. Pkg. Qty.	Std. Ctn. Qty.
ACA01	Door Switch (magnetic 2 piece)	44 x 21 x 11 (29 x 19 x 7 for magnet)	1	1	1
ACB01	Access hub for handle (cold & hot aisle selectable)	95 x 37 x 29	N/A	1	—
ACB02	Access hub harness cold aisle (ACE02)	N/A	3	1	—
ACB03	Access hub harness hot aisle (ACE02)	N/A	2.6	1	—
ACB04	Access hub harness cold aisle (ACE01)	N/A	3	1	—
ACB05	Access hub harness hot aisle (ACE01)	N/A	2.5	1	—
ACC01	Dry Contact Input	44 x 21 x 11	1.8	1	—
ACD01	USB Light Strip	382 x 17 x 12	N/A	1	—
ACE01	Swinghandle No Card Reader	N/A	N/A	1	—
ACE02	Swinghandle With Card Reader (125kHz)	N/A	N/A	1	—
ACE03	Swinghandle With Card Reader (13.5MHz)	N/A	N/A	1	—

A. Featured Products

B. Copper Systems

C. Fiber Systems

D. Faceplates, Frames & Surface Mount Boxes

E. Industrial Networks

F. Audio Video Systems

G. Keystone Cabling Systems

H. Zone Cabling

J. Cable Routing Systems

K. Cable Cleats

L. Cabinets & Rack Systems

M. Power & Connectivity Management

N. Grounding & Bonding

O. Identification Products

P. Cable Management Accessories

Q. Part Number Index

SmartZone™ G5 W-Lock and V-Lock Compatible Locking Power Cords IEC C14 to IEC C13



Part Number (1 pc)	Part Number (10 pk)	Description	Ratings	Gauge/ Cross Section Area	Jacket	Connector Angle	Length (M)	Color
Locking Cable Images C14 to C13								
LPCA01	LPCA01X	IEC C14 to IEC C13	10A/250V	17AWG/ 1.0mm ²	SJT/H05VV-F	Straight	0.6	Red
LPCA02	LPCA02X	IEC C14 to IEC C13	10A/250V	17AWG/ 1.0mm ²	SJT/H05VV-F	Straight	0.9	Red
LPCA03	LPCA03X	IEC C14 to IEC C13	10A/250V	17AWG/ 1.0mm ²	SJT/H05VV-F	Straight	1.2	Red
LPCA04	LPCA04X	IEC C14 to IEC C13	10A/250V	17AWG/ 1.0mm ²	SJT/H05VV-F	Straight	1.8	Red
LPCA06	LPCA06X	IEC C14 to IEC C13	10A/250V	17AWG/ 1.0mm ²	SJT/H05VV-F	Straight	0.6	Blue
LPCA07	LPCA07X	IEC C14 to IEC C136	10A/250V	17AWG/ 1.0mm ²	SJT/H05VV-F	Straight	0.9	Blue
LPCA08	LPCA08X	IEC C14 to IEC C13	10A/250V	17AWG/ 1.0mm ²	SJT/H05VV-F	Straight	1.2	Blue
LPCA09	LPCA09X	IEC C14 to IEC C13	10A/250V	17AWG/ 1.0mm ²	SJT/H05VV-F	Straight	1.8	Blue
LPCA11	LPCA11X	IEC C14 to IEC C13	10A/250V	17AWG/ 1.0mm ²	SJT/H05VV-F	Straight	0.6	Black
LPCA12	LPCA12X	IEC C14 to IEC C13	10A/250V	17AWG/ 1.0mm ²	SJT/H05VV-F	Straight	0.9	Black
LPCA13	LPCA13X	IEC C14 to IEC C13	10A/250V	17AWG/ 1.0mm ²	SJT/H05VV-F	Straight	1.2	Black
LPCA14	LPCA14X	EC C14 to IEC C13	10A/250V	17AWG/ 1.0mm ²	SJT/H05VV-F	Straight	1.8	Black

- A. Featured Products
- B. Copper Systems
- C. Fiber Systems
- D. Industrial Networks
- E. Audio Video Systems
- F. Keystone Cabling Systems
- G. Faceplates, Frames & Surface Mount Boxes
- H. Zone Cabling
- J. Cable Routing Systems
- K. Cable Cleats
- L. Cabinets & Rack Systems
- M. Power & Connectivity Management
- N. Grounding & Bonding
- O. Identification Products
- P. Cable Management Accessories
- Q. Part Number Index

Continued on next page

SmartZone™ G5 W-Lock and V-Lock Compatible Locking Power Cords IEC C20 to IEC C19



Part Number (1 pc)	Part Number (10 pk)	Description	Ratings	Gauge/ Cross Section Area	Jacket	Connector Angle	Length (M)	Color
Locking Cable Images IEC C20 to IEC C19								
LPCB01	LPCB01X	IEC C20 to IEC C19	16A/250V	15AWG/ 1.5mm ²	SJT/H05VV-F	Straight	0.6	Red
LPCB02	LPCB02X	IEC C20 to IEC C19	16A/250V	15AWG/ 1.5mm ²	SJT/H05VV-F	Straight	0.9	Red
LPCB03	LPCB03X	IEC C20 to IEC C19	16A/250V	15AWG/ 1.5mm ²	SJT/H05VV-F	Straight	1.2	Red
LPCB04	LPCB04X	IEC C20 to IEC C19	16A/250V	15AWG/ 1.5mm ²	SJT/H05VV-F	Straight	1.8	Red
LPCB06	LPCB06X	IEC C20 to IEC C19	16A/250V	15AWG/ 1.5mm ²	SJT/H05VV-F	Straight	0.6	Blue
LPCB07	LPCB07X	IEC C20 to IEC C19	16A/250V	15AWG/ 1.5mm ²	SJT/H05VV-F	Straight	0.9	Blue
LPCB08	LPCB08X	IEC C20 to IEC C19	16A/250V	15AWG/ 1.5mm ²	SJT/H05VV-F	Straight	1.2	Blue
LPCB09	LPCB09X	IEC C20 to IEC C19	16A/250V	15AWG/ 1.5mm ²	SJT/H05VV-F	Straight	1.8	Blue
LPCB11	LPCB11X	IEC C20 to IEC C19	16A/250V	15AWG/ 1.5mm ²	SJT/H05VV-F	Straight	0.6	Black
LPCB12	LPCB12X	IEC C20 to IEC C19	16A/250V	15AWG/ 1.5mm ²	SJT/H05VV-F	Straight	0.9	Black
LPCB13	LPCB13X	IEC C20 to IEC C19	16A/250V	15AWG/ 1.5mm ²	SJT/H05VV-F	Straight	1.2	Black
LPCB14	LPCB14X	IEC C20 to IEC C19	16A/250V	15AWG/ 1.5mm ²	SJT/H05VV-F	Straight	1.8	Black

A. Featured Products

B. Copper Systems

C. Fiber Systems

D. Faceplates, Frames & Surface Mount Boxes

E. Industrial Networks

F. Audio Video Systems

G. Keystone Cabling Systems

H. Zone Cabling

J. Cable Routing Systems

K. Cable Cleats

L. Cabinets & Rack Systems

M. Power & Connectivity Management

N. Grounding & Bonding

O. Identification Products

P. Cable Management Accessories

Q. Part Number Index

- A. Featured Products
- B. Copper Systems
- C. Fiber Systems
- D. Industrial Networks
- E. Audio Video Systems
- F. Keystone Cabling Systems
- G. Faceplates, Frames & Surface Mount Boxes
- H. Zone Cabling
- J. Cable Routing Systems
- K. Cable Cleats
- L. Cabinets & Rack Systems
- M. Power & Connectivity Management
- N. Grounding & Bonding
- O. Identification Products
- P. Cable Management Accessories
- Q. Part Number Index

SmartZone™ PViQ™ Connectivity

Research shows that half of all network problems arise from issues in the physical infrastructure. Yet the physical infrastructure is largely overlooked. Without real-time monitoring and visibility into dense physical layer connectivity and related data center infrastructure information, enterprises are vulnerable to a number of risks such as malicious disconnects or malicious tracing (to steal private information), and avoiding accidental disconnects creating unnecessary downtime.



Front View



Rear View



Panduit SmartZone™ Connectivity combines Panduit PViQ™ Connectivity Hardware and Panduit PViQ™ Connectivity Firmware to provide a secure connectivity solution.

Giving the user higher network visibility through intelligent monitoring devices and pre-defined WebGUI dashboards.

This solution will enhance security by monitoring for equipment disconnects in data centers as well as remote Edge Data Center & Colo Data Center for tenants.

This combined approach helps optimize data center operations as enterprises embark on server virtualization, private and cloud computing initiatives.

Part of Panduit's End-To-End Intelligent Data Center Solutions

Physical Infrastructure Management PanView iQ™ (PViQ™) System Hardware is a critical part of Panduit's Intelligent Data Center Solutions, which embody the next wave of systems integration and risk management by aligning and harmonizing critical systems to support the delivery of secure, energy-efficient, always-on, real-time data and services.

SmartZone™ PViQ™ Connectivity Firmware

The Firmware provides the user a simple interface with a connectivity dashboard page for visual network connectivity status, patch configuration page to enable port provisioning, alarm page to show descriptive active alarms, and log page to show historical events of patching activity plus many more features.

- Per port security policy setting, monitoring and alerting
- Real-time information on network connectivity status
- Monitor and alert of any patch field changes
- Monitor connectivity-based security risks
- Harden security with advanced encryption
- WebGUI-based management system
- Interconnect and cross-connect connections
- Cable presence detection assurance
- Cable mapping and visual tracing
- Copper and fiber options
- Field upgradeable panel



Set Port Security Policy for Interconnect and Cross-Connect
Cord Disconnect or Connect Security Alert:

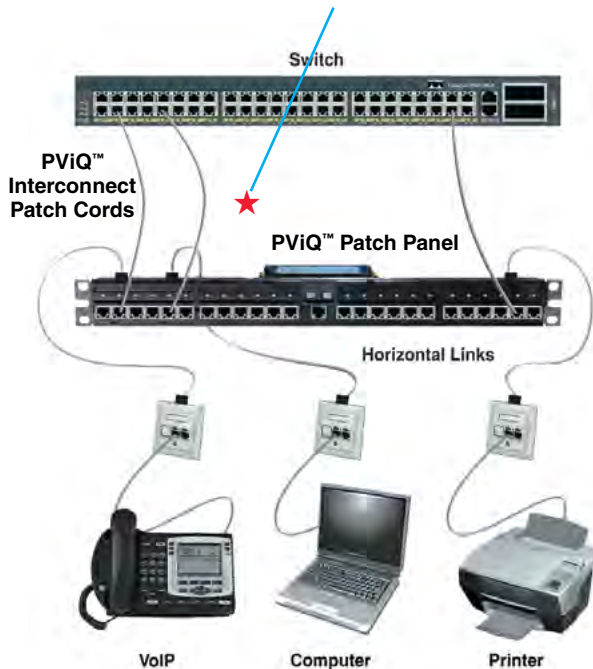

PViQ™ Standalone Solution

- Local visual alert
- Recovery instructions
- Audit trail completed
- Event alert sent



Real-Time Traps & Email (Disconnect, Connect, etc.)

WebGUI for remote access, configuration and upgrade

BYOD & Browser



Dashboards
Alarms
History

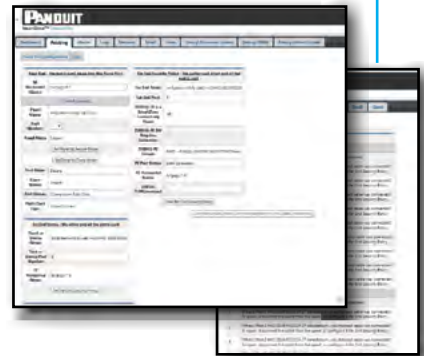

- A. Featured Products
- B. Copper Systems
- C. Fiber Systems
- D. Faceplates, Frames & Surface Mount Boxes
- E. Industrial Networks
- F. Audio Video Systems
- G. Keystone Cabling Systems
- H. Zone Cabling
- J. Cable Routing Systems
- K. Cable Cleats
- L. Cabinets & Rack Systems
- M. Power & Connectivity Management
- N. Grounding & Bonding
- O. Identification Products
- P. Cable Management Accessories
- Q. Part Number Index

- A. Featured Products
- B. Copper Systems
- C. Fiber Systems
- D. Industrial Networks
- E. Audio Video Systems
- F. Keystone Cabling Systems
- G. Faceplates, Frames & Surface Mount Boxes
- H. Zone Cabling
- J. Cable Routing Systems
- K. Cable Cleats
- L. Cabinets & Rack Systems
- M. Power & Connectivity Management
- N. Grounding & Bonding
- O. Identification Products
- P. Cable Management Accessories
- Q. Part Number Index

SmartZone™ PViQ™ Connectivity Hardware

As part of the SmartZone™ Solutions portfolio, Panduit's PViQ™ System Hardware combines industry-leading innovation of intelligent cabinet devices with complete system management. This combination of active patch panels, cabling, power distribution units, and environmental sensors provides you with a complete data center solution. Information about these devices can be accessed on site or remotely through a web-based interface to troubleshoot and execute on physical infrastructure changes for greater efficiency and cost savings.

PViQ™ Hardware for Connectivity Management includes intelligent patch panels, fiber trays, modules, and cabling to provide continuous real-time patch field monitoring and visibility of physical infrastructure connectivity for enhanced system reliability and security and capacity management.

PViQ™ Patch Panels

PViQ™ Patch Panels have been developed with functionality, scalability, and consideration for rack space efficiency. The innovative patch panel (copper or fiber) design gives IT Managers the option to phase installations (installing passive connectivity now and upgrading to a fully managed system at a later time) and to quickly swap out modules for upgrades or repairs without disrupting cabling or data traffic through the panels.

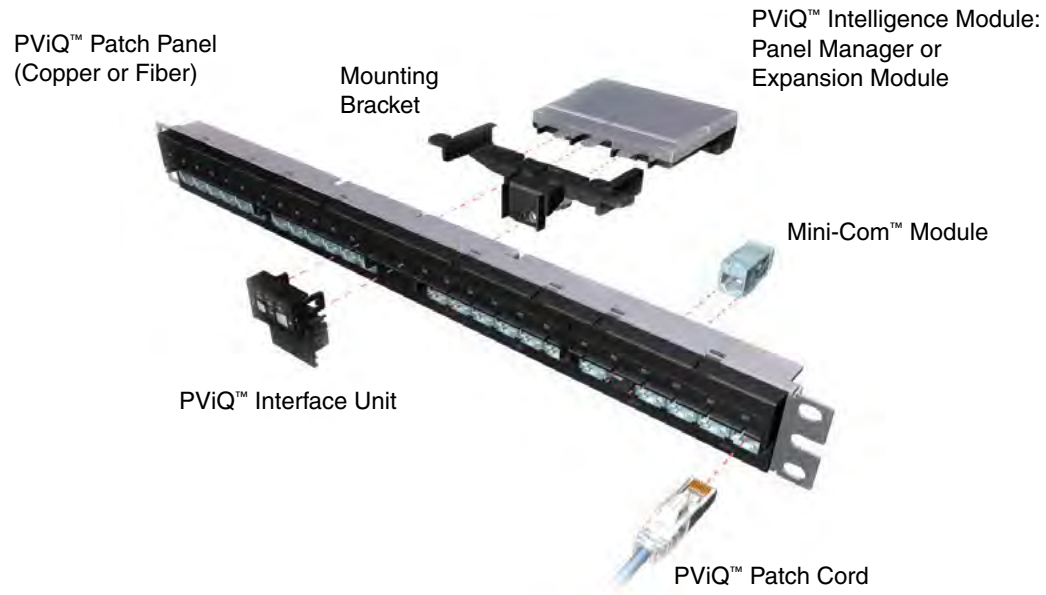

PViQ™ Fiber Trays

PViQ™ Fiber Trays provide real-time physical layer management to the fiber channels in the network. These fiber trays provide the capability to map and monitor the fiber channels to efficiently manage resources and substantially reduce network operations cost. They provide the capability to automate network documentation and maintenance procedures for the physical layer, which in turn supports improved reliability, security, and increased overall network management efficiency.



Interconnect Configurations

The interconnect configuration is ideal for data centers with limited space areas that have lower reconfiguration requirements and utilize higher density connections than other computing areas. The new PViQ™ System Hardware interconnect capability provides the assurance of accurate switch port provisioning and patch field documentation when monitored through the SmartZone™ Software Suite. This revolutionary design requires no additional cables, appliances, or obstructive overlays on network equipment which can interfere with port connections.



When network elements such as switches need to be reconfigured, the PViQ™ System provides LED guidance to ensure proper switch port allocation/de-allocation. Network elements such as servers can also be monitored at the physical layer to ensure proper connectivity. With the PViQ™ System Hardware, both ends of the switch-server relationship are monitored via the SmartZone™ Software Suite, which leads to quicker problem resolution and rapid service/application restoration.

Cross-Connect Configurations

A cross-connect configuration is warranted in data centers where frequent Moves, Adds, Changes and application reconfigurations necessitate flexible and easily accessible patching connectivity.

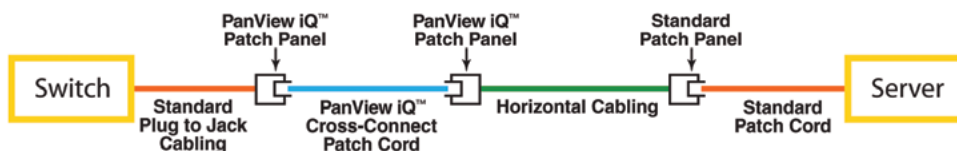

In cross-connect configurations, the highest density network element (such as the high-speed switch) is permanently cabled through the back of a PViQ™ Patch Panel with modular jacks. PViQ™ Patch Cords are then connected between the front of that panel and the remote PViQ™ Patch Panel cabled via horizontal runs to remote cabinets, typically containing other network elements (e.g., servers) or endpoint equipment (e.g., computers, IP phones, security equipment, etc.).

A. Featured Products

B. Copper Systems

C. Fiber Systems

D. Faceplates, Frames & Surface Mount Boxes

E. Industrial Networks

F. Audio Video Systems

G. Keystone Cabling Systems

H. Zone Cabling

J. Cable Routing Systems

K. Cable Cleats

L. Cabinets & Rack Systems

M. Power & Connectivity Management

N. Grounding & Bonding

O. Identification Products

P. Cable Management Accessories

Q. Part Number Index

- A. Featured Products
- B. Copper Systems
- C. Fiber Systems
- D. Industrial Networks
- E. Audio Video Systems
- F. Keystone Cabling Systems
- G. Faceplates, Frames & Surface Mount Boxes
- H. Zone Cabling
- J. Cable Routing Systems
- K. Cable Cleats
- L. Cabinets & Rack Systems
- M. Power & Connectivity Management
- N. Grounding & Bonding
- O. Identification Products
- P. Cable Management Accessories
- Q. Part Number Index

PViQ™ Intelligence Modules

Panel Manager (PM) – The PViQ™ Panel Manager is designed to consolidate patch field scanning and management functions into a single, removable module. It contains an embedded web interface for remote management and access to connectivity information.

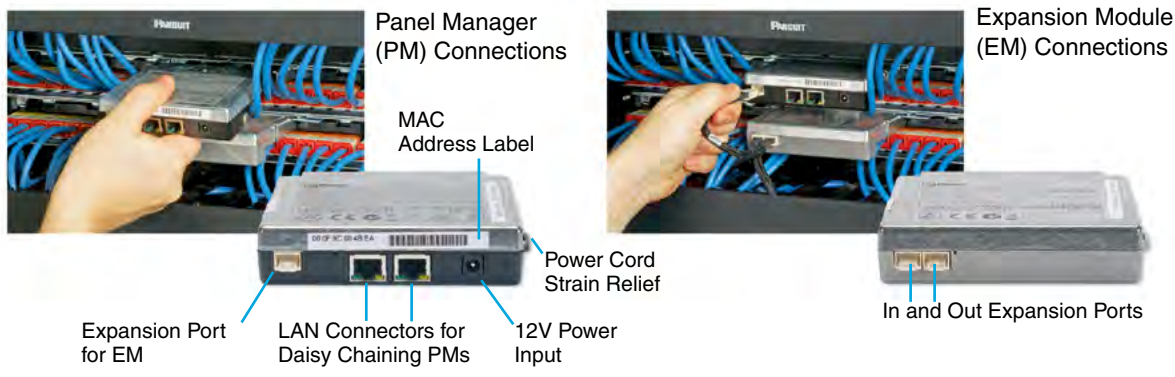

Expansion Manager (EM) – The PViQ™ Expansion Module cost effectively expands the scanning and management capabilities of the PViQ™ Panel Manager to additional patch panels.

PViQ™ Interface Units

- Secure Mode** – Visually and audibly alerts users when any changes are made
- Trace Mode** – Visually verifies patch field connectivity at both ends of the patch cord
- Maintenance Mode** – Enables locally and remotely performed diagnostic services
- Learn Mode** – Allows ad hoc patching changes to be automatically updated in the database

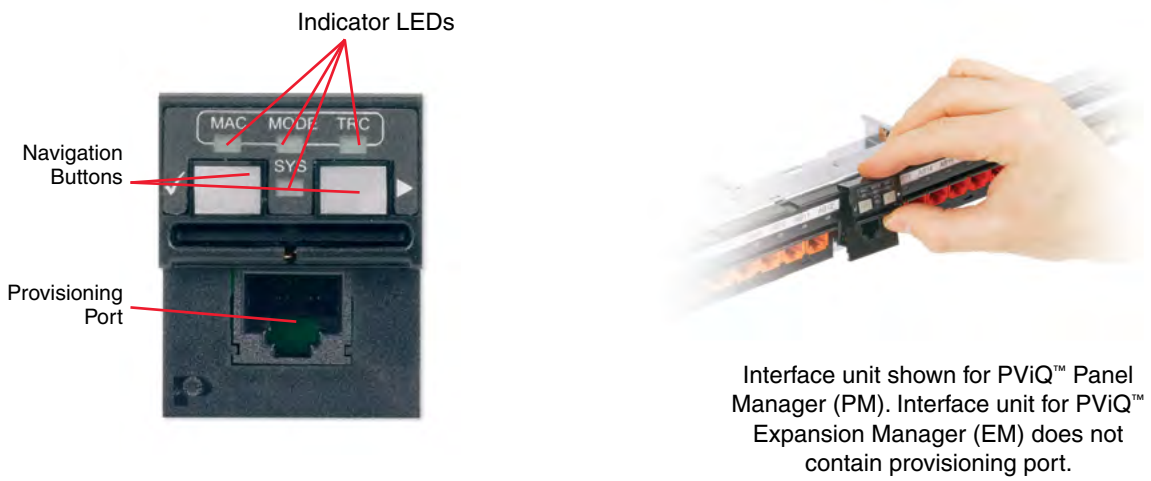

PViQ™ Patch Panels

PViQ™ Patch Panels revolutionize intelligent physical infrastructure management by providing a modular and scalable approach to meet the demands of enterprise and data center installations. Standard copper and fiber cabling is used for all (horizontal link) terminations onto the back of these panels while unique PViQ™ Patch Cords are used for cross-connect or interconnect installations. The innovative design of PViQ™ Patch Panels permit cabling and data connectivity to be installed immediately with “intelligence ready” connections that allow the incremental growth and provisioning of panel management capabilities.

- Accommodates intelligent modules that mount in the rear and utilize no additional rack space (zero RU)
- Accepts all Mini-Com™ UTP, STP, and LC Fiber Optic Modules
- Accepts a PViQ™ Interface Unit to provide patch cord tracing and provisioning of switch ports with PViQ™ Interconnect Patch Cords or patch field mapping with PViQ™ Cross-Connect Patch Cords
- Mount to standard EIA 19" rack or 23" racks with optional extender bracket

Part Number	Part Description	No. of Rack Spaces [^]	Std. Pkg. Qty.	Std. Ctn. Qty.
-------------	------------------	---------------------------------	----------------	----------------

Angled PViQ™ Patch Panels



PVQ-MIQAPU24



PVQ-MIQAPS24

PVQ-MIQAPU24	24-port unpopulated angled UTP modular intelligent module-ready patch panel. Accepts all Mini-Com™ UTP and LC Fiber Optic Modules.	1	1	10
PVQ-MIQAPS24	24-port unpopulated angled STP modular intelligent module-ready patch panel. Accepts all Mini-Com™ STP Modules. Accepts all Mini-Com™ STP Modules.			

Flat PViQ™ Patch Panels



PVQ-MIQPU24



PVQ-MIQPS24

PVQ-MIQPU24	24-port unpopulated modular intelligent module ready patch panel accepts all Mini-Com™ UTP and LC Fiber Optic Modules.	1	1	10
PVQ-MIQPS24	24-port unpopulated modular intelligent module ready patch panel accepts all Mini-Com™ STP Modules.			

PViQ™ Hardware Kits



PVQ-MIQPS96F



PVQ-MIQPS96A

PVQ-MIQPS96F	For standard configurations, this 96-port modular intelligent panel kit includes four flat PViQ™ Patch Panels (PVQ-MIQPU24), one PViQ™ Panel Manager with interface unit, and three PViQ™ Expansion Modules with expansion port cables and interface units. Also includes one 1.5' (0.5m) RJ45 patch cord for connection to network switch or additional daisy-chained PViQ™ Panel Managers. (Power supply, PViQ™ Patch Cords and Mini-Com™ Jack Modules are not included and must be purchased separately.)	4	1	—
PVQ-MIQPS96A	For standard configurations, this 96-port modular intelligent panel kit includes four angled PViQ™ Patch Panels (PVQ-MIQAPU24), one PViQ™ Panel Manager with interface unit, and three PViQ™ Expansion Modules with expansion port cables and interface units. Also includes one 1.5' (0.5m) RJ45 patch cord for connection to network switch or additional daisy-chained PViQ™ Panel Managers. (Power supply, PViQ™ Patch Cords and Mini-Com™ Jack Modules are not included and must be purchased separately.)			

PViQ™ Patch Panel Accessories

PVQ-MIQAPCVR	Transitional cover for angled PViQ patch panels that occupies zero rack space.	1	10	—
---------------------	--	---	----	---

[^]One rack space = 1.75" (44.45mm).

PViQ™ Panel Manager requires proper country-specific power supply (PVQ-PS12VDC-E for Europe or PVQ-PS12VDC-U for United Kingdom) which must be ordered separately.

A. Featured Products

B. Copper Systems

C. Fiber Systems

D. Faceplates, Frames & Surface Mount Boxes

E. Industrial Networks

F. Audio Video Systems

G. Keystone Cabling Systems

H. Zone Cabling

J. Cable Routing Systems

K. Cable Cleats

L. Cabinets & Rack Systems

M. Power & Connectivity Management

N. Grounding & Bonding

O. Identification Products

P. Cable Management Accessories

Q. Part Number Index

- A. Featured Products
- B. Copper Systems
- C. Fiber Systems
- D. Industrial Networks
- E. Audio Video Systems
- F. Keystone Cabling Systems
- G. Faceplates, Frames & Surface Mount Boxes
- H. Zone Cabling
- J. Cable Routing Systems
- K. Cable Cleats
- L. Cabinets & Rack Systems
- M. Power & Connectivity Management
- N. Grounding & Bonding
- O. Identification Products
- P. Cable Management Accessories
- Q. Part Number Index

PViQ™ Fiber Trays

- Provides real-time physical layer management to the fiber channels in the network
- Enhances usability and maintainability through an enclosure and drawer design that allows for easy access to the fiber connectivity
- An easily-accessible integrated mechanism for mounting a PM or EM module simplifies installation and maintenance
- Provides the capability to map and monitor the fiber channels to efficiently manage resources and substantially reduce network operations cost
- Provides the capability to automate network documentation and maintenance procedures for the physical layer, which in turn supports improved reliability, security, and increased overall network management efficiency
- Installable in a 19" standard TIA/EIA rack or cabinet utilizing 1RU of space



PVQ-FMT

Part Number	Part Description	No. of Rack Spaces [^]	Std. Pkg. Qty.	Std. Ctn. Qty.
PVQ-FMT	24-port PViQ™ Fiber Tray with no fiber adapters.	1	1	1
PVQ-FMTMTP-ZX	PViQ™ 24-Port OM3 MTP Fiber Tray including 24 (CMDQAQLCZBL) LC SR./SR. 10Gig™ SFF Duplex Multimode Aqua Adapters with Zirconia Ceramic Split Sleeves.			
PVQ-FMTMTP-ZZ	PViQ™ 24-Port OM4 MTP Fiber Tray including 24 (CMDQAQLCZBL) LC SR./SR. 10Gig™ SFF Duplex Multimode Aqua Adapters with Zirconia Ceramic Split Sleeves.			
PVQ-FMTMTP-9	PViQ™ 24-Port, Single-Mode Fiber Tray including 24 (CMDQLCZBU) LC SR./SR. SFF Duplex Singlemode Blue Adapters with Zirconia Ceramic Split Sleeves.			

[^]One rack space = 1.75" (44.45mm).

PViQ™ Intelligent Modules

PViQ™ Intelligent Modules enable the PViQ™ Patch Panels to sense connections and disconnections from each port and relay status information to the Software Database. The intelligent modules also accept trace mode and MAC commands to provide guidance via the PViQ™ Interface Unit and Patch Panel LEDs.

- Provides manageability for a PViQ™ Patch Panel
- Eliminates the need for additional rack space by attaching directly to the back of a PViQ™ Patch Panel
- Enables quick addition, removal, or replacement of intelligent modules to add management capabilities
- Supports both cross-connect and interconnect installations
- The intelligent panel manager (PM) module provides networking interface, power connection and expansion port connections
- The intelligent expansion module (EM) receives all power and data signals from the PM through the expansion port. Three EMs can be connected to one PM



PVQ-PM



PVQ-EM

Part Number	Part Description	Std. Pkg. Qty.
PVQ-PM	Panel manager (includes mounting bracket, 1.5' (0.5m) RJ45 patch cord, and interface unit).	1
PVQ-EM	Expansion module (includes mounting bracket, expansion port cable, and interface unit).	

PViQ™ Patch Cords

- PViQ™ Interconnect Patch Cords support connectivity between shielded non-PViQ™ enabled ports (e.g., switches with shielded jacks, servers with shielded jacks, etc.) and PViQ™ Panel Ports

- PViQ™ Cross-Connect Patch Cords manage and map the patch field between two PViQ™ Patch Panels
- All PViQ™ Patch Cords permit PViQ™ Panels to detect single-ended connections



PVQ-BIU6C3BU



PVQ-ES6X3BU



PVQXPE10LQM



PVUTPSPC*BBUY

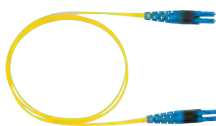

PVF9L10-10M*Y

Part Number	Part Description	Length		Cable Color	Std. Pkg. Qty.	Std. Ctn. Qty.
		Ft*	m^			

Copper Interconnect Patch Cords – Basic

PVQ-BIU6C3BU	Category 6 UTP interconnect patch cord for use with PViQ™ patch panel, Communications (CM) rated.	3	—	Blue	1	10
PVQ-BIU6C1MBU	Category 6 UTP interconnect patch cord for use with PViQ™ patch panel, Communications (CM) rated.	—	1			
PVQ-BIU6L1MBU	Category 6 UTP interconnect patch cord for use with PViQ™ patch panel, Low Smoke Zero Halogen (LSZH) rated.	—	1			

Copper Interconnect Patch Cords – Enhanced

PVQ-EU6AC3BU	10Gig™ UTP Enhanced Interconnect Patch Cord for use with PViQ™ Patch Panel, Communications (CM) rated.	3	—	Blue	1	10
PVQ-EU6AC1MBU	10Gig™ UTP Enhanced Interconnect Patch Cord for use with PViQ™ Patch Panel, Communications (CM) rated.	—	1			
PVQ-ES6X3BU	10Gig™ STP Enhanced Interconnect Patch Cord for use with PViQ™ Patch Panel, dual rated.	3	—			
PVQ-ES6X1MBU	10Gig™ STP Enhanced Interconnect Patch Cord for use with PViQ™ Patch Panel, dual rated.	—	1			

Fiber Interconnect Patch Cords

PVQXPE10LQM00.5	PViQ™ duplex LC to duplex standard LC, OM3, fiber interconnect patch cord, plenum rated, 1.6mm jacketed cable.	—	0.5	Aqua	1	10
PVQZPE10LQM00.5	PViQ™ duplex LC to duplex standard LC, OM4, fiber interconnect patch cord, plenum rated, 1.6mm jacketed cable.					
PVQ9PE10LQM00.5	PViQ™ duplex LC to duplex standard LC, OS1/OS2, fiber interconnect patch cord, plenum rated, 1.6mm jacketed cable.					

Cross-Connect Patch Cords

PVUTPSPC3BBUY	Category 6 UTP patch cord for use with modular patch panel.	3	—	Blue	1	10
PVUTPSPC1MBBUY	Category 6 UTP patch cord for use with modular patch panel.	—	1			
PVSTP6X1MBBU	Category 6A, STP modular 10Gig™ Patch Cord.					
PVUTP6X1MBBU	Category 6A, UTP modular 10Gig™ Patch Cord.					
PVF9L10-10M0.5Y	Singlemode LSZH LC-LC patch cord.			Yellow		
PVFXL10-10M0.5Y	Multimode LSZH OM3 LC-LC patch cord.			Yellow		

Additional lengths and colors available:

*For lengths of 5, 7, 10, 14, or 20 feet, change the length designation in the part number to the desired length. For standard cable color other than BU (Blue), replace BU in the part number with GR (Green). For example, the part number for a green, 5-foot patch cord is PVQ-BIU6C5GR.

^For lengths of 2, 3, 5, or 10 meters, change the length designation in the part number to the desired length. For standard cable color other than BU (Blue), replace BU with WH (White). For example, the part number for a white 2-meter patch cord is PVQ-BIU6L2MWH.

Contact Panduit Customer Service for lead times and for non-standard lengths and colors.

A. Featured Products

B. Copper Systems

C. Fiber Systems

D. Faceplates, Frames & Surface Mount Boxes

E. Industrial Networks

F. Audio Video Systems

G. Keystone Cabling Systems

H. Zone Cabling

J. Cable Routing Systems

K. Cable Cleats

L. Cabinets & Rack Systems

M. Power & Connectivity Management

N. Grounding & Bonding

O. Identification Products

P. Cable Management Accessories

Q. Part Number Index

A. Featured Products

PViQ™ Power Supply

- Provides 12 volts of regulated power
- Offers flexible placement inside of rack
- One power supply required per panel manager module
- 5 feet (1.5m) cord length

B. Copper Systems

C. Fiber Systems



PVQ-PS12VDC-E

D. Industrial Networks

Part Number	Part Description	Std. Pkg. Qty.
PVQ-PS12VDC-E	30W power supply for Europe.	1
PVQ-PS12VDC-U	30W power supply for UK.	

E. Audio Video Systems

Labels for PViQ™ Patch Cords



F. Keystone Cabling Systems

Suggested Label Solutions for TIA/EIA-606-A Compliance

Patch Cord Part Number	Laser/Ink Jet Desktop Printer Label	TDP43ME Thermal Transfer Desktop Printer Label	PanTher™ LS8E Hand-Held Printer Label	Cougar™ LS9 Hand-Held Printer Label
All Patch Cords on Page M.17	S100X150YAJ	S100X150VATY	S100X150VAC	T100X000CBC-BK

For complete labeling solutions and product information, see Section O.

G. Faceplates, Frames & Surface Mount Boxes

H. Zone Cabling

Component Labels for PViQ™ Patch Panels



J. Cable Routing Systems

Suggested Label Solutions for TIA/EIA-606-A Compliance

Patch Panel Part Number	Laser/Ink Jet Desktop Printer Label	PanTher™ LS8E Hand-Held Printer Label	Cougar™ LS9 Hand-Held Printer Label
All Patch Cords on Page M.15	UILJ6	UILS8BW	UILS8BW

For complete labeling solutions and product information, see Section O.

K. Cable Cleats

L. Cabinets & Rack Systems

M. Power & Connectivity Management

N. Grounding & Bonding

O. Identification Products

P. Cable Management Accessories

Q. Part Number Index

Table of Contents

Access Floor Grounding Clamps N.2
Split Bolt Quad Clamp, Bronze N.2
Common Bonding Network (CBN) Jumper Kits N.2
Grounding Strip Kits N.3
Grounding Busbar Kits N.3
Bonding Jumper Kits N.4 – N.7
Enclosure Grounding Kit N.7
Shielded Jack Module Grounding Kit N.8
Electrostatic Discharge (ESD) Port Kits and ESD Wrist Strap N.8
Bonding Hardware N.8 – N.9
Retrofit Cabinet and Rack Grounding Kits N.10 – N.11
Busbars N.12 – N.13
Beam Grounding Clamps N.13
Auxiliary Cable Brackets and Jumpers N.14
One-Hole Grounding Lay-In Lug N.15
Copper Compression Connectors N.16 – N.21
Grounding Clamp, U-Bolt, Bronze N.22
Split Bolt, Copper N.22
Crimping Tools and Dies N.23 – N.25

**A.
Featured
Products**

**B.
Copper
Systems**

**C.
Fiber
Systems**

**D.
Faceplates,
Frames &
Surface
Mount Boxes**

**E.
Industrial
Networks**

**F.
Audio
Video
Systems**

**G.
Keystone
Cabling
Systems**

**H.
Zone
Cabling**

**J.
Cable
Routing
Systems**

**K.
Cable
Cleats**

**L.
Cabinets
& Rack
Systems**

**M.
Power &
Connectivity
Management**

**N.
Grounding
& Bonding**

**O.
Identification
Products**

**P.
Cable
Management
Accessories**

**Q.
Part
Number
Index**

- A. Featured Products
- B. Copper Systems
- C. Fiber Systems
- D. Faceplates, Frames & Surface Mount Boxes
- E. Industrial Networks
- F. Audio Video Systems
- G. Keystone Cabling Systems
- H. Zone Cabling
- J. Cable Routing Systems
- K. Cable Cleats
- L. Cabinets & Rack Systems
- M. Power & Connectivity Management
- N. Grounding & Bonding
- O. Identification Products
- P. Cable Management Accessories
- Q. Part Number Index



Access Floor Grounding Clamps

- Bond mesh common bonding network (MCBN) conductors to each other and bond the access floor pedestals to the conductors
- Specifically designed to bond perpendicular MCBN conductors per TIA-942 and TIA-607-C
- Bond to the pedestal with a single bolt to simplify installation
- Accommodate conductors from #6 – 1/0 AWG, minimizes inventory requirements
- Bond round and square access floor pedestals for greater flexibility

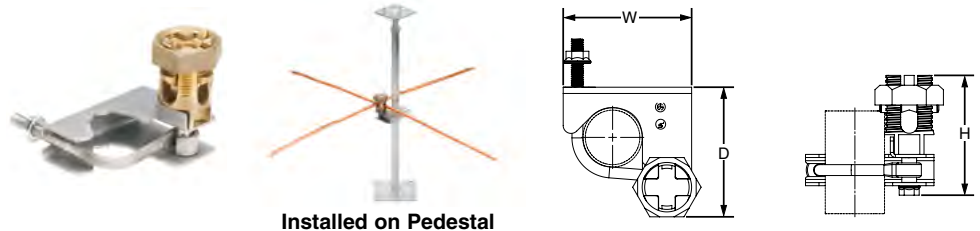

Installed on Pedestal

Part Number	Dimensions - In. (mm)				Pedestal Size and Type
	Width	Bracket Width	Depth	Height	
GPQC07-1/0	3.38 (85.9)	3.25 (82.6)	4.25 (108.0)	3.19 (81.0)	3/4" Round, 7/8" Round
GPQC10-1/0			4.19 (106.4)		7/8" Square, 1" Round, 1-1/8" Round
GPQC12-1/0	4.53 (115.1)		1-1/4" Round		
GPQC15-1/0	4.47 (113.5)	1-1/2" Round			
GPQC17-1/0	-	4.00 (101.6)	5.19 (131.8)		1-3/4" Round
GPQC20-1/0			5.06 (128.5)		2" Round

For use with copper wire range #6 AWG Solid to 1/0 Stranded (16 to 50mm²).



Split Bolt Quad Clamp, Bronze



- Split bolt design allows easy insertion of perpendicular conductors speeding installation
- UL 467 Listed and CSA Certified for direct burial in earth or concrete
- UL Listed and CSA Certified for use up to 600 V and temperature rated 90°C
- Each clamp accepts up to two conductors for a high performance bond with faster installation
- Wide wire range-taking capability minimizes inventory requirements
- Made from high strength, electrolytic bronze to provide reliable grounding connections

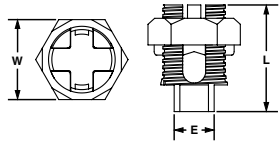

Part Number	Conductor Size Range	Figure Dimensions In.			Tightening Torque In. – Lbs.	Std. Ctn. Qty.
		E	W	L		
SBQC1/0-X	#6 – #10 AWG	0.75	1.50	2.00	#6 – #4 AWG – 165 #3 – #1 AWG – 275 #1/0 – #4 AWG – 385	10



Common Bonding Network (CBN) Jumper Kits

- Bond the rack or cabinet to the MCBN
- HTAPs, included in kits, require crimping tool and die; see the CT-920 and CT-920/CV crimping tools on page N.23, the CT-2931/ST and CT-2931/STCV crimping tools on page N.24 and the CD-930H-250 and CD-920H-2 crimping dies on page N.25
- HTAPs are UL Listed and CSA Certified for applications up to 600 V when crimped with Panduit and specified competitor crimping tools and Panduit crimping dies
- Engineered to comply with US and International grounding requirements

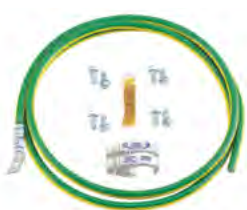

Part Number	MCBN Conductor Size AWG	Dimensions In.	Std. Pkg. Qty.	Std. Ctn. Qty.
RGCBNJ660P22	HTCT2-2-1 #6 – #2 AWG	#6 AWG (16mm ²) jumper; 60" (1.52m) length; 45° bent lug on grounding strip side; provided with .16 oz. (5cc) of antioxidant, two each #12-24 x 1/2", M6 x 12mm, #10-32 x 1/2" and M5 x 12mm thread-forming screws and a copper compression HTAP* for connecting to the MCBN.	1	10
RGCBNJ660PY	HTCT250-2-1 #6 AWG – 250 kcmil			

*HTAPs also sold separately, see pages N.19–N.20.



Grounding Strip Kits

- Bonds up to 45 RU per rack
- EIA Universal mounting hole pattern
- Engineered to comply with US and International grounding requirements

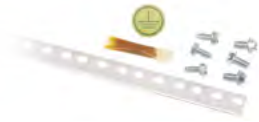

Threaded Rail Kit



Cage Nut Rail Kit

Part Number	Part Description	Std. Pkg. Qty.
Grounding Strip Kits for Threaded Rail Fasteners		
RGS134-1Y	Grounding strip; 78.65" (2m) length; .67" (17mm) width; .05" (1.27mm) thickness; provided with .16 oz. (5cc) of antioxidant, one grounding sticker and three each #12-24 x 1/2" and M6 x 12mm thread-forming screws.	1
RGS134-10-1Y	Ten grounding strips; 78.65" (2m) length; .67" (17mm) width; .05" (1.27mm) thickness; provided with .16 oz. (5cc) of antioxidant, ten grounding stickers and 30 each #12-24 x 1/2" and M6 x 12mm thread-forming screws.	
Grounding Strip Kits for Cage Nut Rail Fasteners		
RGS134B-1	Grounding strip; 78.70" (2m) length; .67" (17mm) width; .05" (1.27mm) thickness; provided with .16 oz. (5cc) of antioxidant, one grounding sticker, three cage nut bonding studs, eight #12-24 bonding nuts and three strip clips.	1
RGS134B-10-1	Ten grounding strips; 78.70" (2m) length; .67" (17mm) width; .05" (1.27mm) thickness; provided with .16 oz. (5cc) of antioxidant, ten grounding stickers, 30 cage nut bonding studs, 80 #12-24 bonding nuts and 30 strip clips.	



Grounding Busbar Kits

- Provide the common grounding point within the cabinet
- Optimized for installation on 19" racks or cabinets that meet EIA-310
- Can be positioned anywhere on the rack or cabinet
- Available pre-assembled with twenty mounting screws for quick and easy installation
- Engineered to comply with US and International grounding requirements



RGRB19U

Part Number	Part Description	Std. Pkg. Qty.
Grounding Busbar Kits for Threaded Rail Fasteners		
RGRB19Y	Grounding busbar; 19" (483mm) length; tin-plated copper; fourteen holes arranged for flexibility in mounting; provided with two each #12-24 x 1/2" and M6 x 12mm thread-forming screws.	1
RGRB19U	Grounding busbar; 19" (483mm) length; tin-plated copper; twenty holes arranged for flexibility in mounting with twenty #12-24 x 1/2" hex head screws installed; mounting hole sets have 5/8" (15.9mm) spacing; provided with two each #12-24 x 1/2", M6 x 12mm thread-forming screws, and two #12 flat washers for mounting.	
Grounding Busbar Kit for Cage Nut Rail Fasteners		
RGRB19CN	Grounding busbar; 19" (483mm) length; tin-plated copper; twenty holes arranged for flexibility in mounting with twenty #12-24 x 1/2" hex head screws installed; mounting hole sets have 5/8" (15.9mm) spacing; provided with two cage nut bonding studs and four #12-24 bonding nuts.	1

A. Featured Products

B. Copper Systems

C. Fiber Systems

D. Faceplates, Frames & Surface Mount Boxes

E. Industrial Networks

F. Audio Video Systems

G. Keystone Cabling Systems

H. Zone Cabling

J. Cable Routing Systems

K. Cable Cleats

L. Cabinets & Rack Systems

M. Power & Connectivity Management

N. Grounding & Bonding

O. Identification Products

P. Cable Management Accessories

Q. Part Number Index

A.
Featured
Products



Equipment Jumper Kits

B.
Copper
Systems

C.
Fiber
Systems

- Bond network equipment to grounding strip or grounding busbar
- Jumper kit available with both ends factory terminated to provide a bolt-on solution
- Jumper kit available with one end factory terminated to attach to the grounding strip or grounding busbar; free end accommodates unique equipment terminations

- Use jumpers with 90° bent lug, on grounding strip side, for high-density grounding requirements up to one ground point per RU
- Use jumpers with 45° bent lugs, on grounding strip side, for improved cable management
- Engineered to comply with US and International grounding requirements

D.
Faceplates,
Frames &
Surface
Mount Boxes

E.
Industrial
Networks

F.
Audio
Video
Systems

G.
Keystone
Cabling
Systems

H.
Zone
Cabling

J.
Cable
Routing
Systems

K.
Cable
Cleats

L.
Cabinets
& Rack
Systems

M.
Power &
Connectivity
Management

N.
Grounding
& Bonding

O.
Identification
Products

P.
Cable
Management
Accessories

Q.
Part
Number
Index



RGEJ1024PFY



RGEJ1057PFY

Part Number	Length In. (m)	Angle	Part Description	Std. Pkg. Qty.	Std. Ctn. Qty.
-------------	----------------	-------	------------------	----------------	----------------

#6 AWG (16mm²) Equipment Jumper Factory Terminated on One End for Switches, Cabinets, and 4-Post Racks

GJS660U	60 (1.52)	Straight	#6 AWG green wire with yellow horizontal stripe. Jumper is pre-terminated on one end with LCC6-14JAW-L.	1	10
GJS696U	96 (2.44)				

#10 AWG (6mm²) Equipment Jumpers Factory Terminated on Both Ends

RGEJ1024PHY	24 (0.61)	45°	#10 AWG (6mm ²) jumper; bent lug on grounding strip side to straight lug on equipment; provided with .16 oz. (5cc) of antioxidant and two each #12-24 x 1/2", M6 x 12mm, #10-32 x 1/2" and M5 x 12mm thread-forming screws.	1	10
RGEJ1024PFY	24 (0.61)	90°			
RGEJ1036PFY	36 (0.91)				
RGEJ1024URT	24 (0.61)	Straight	#10 AWG (6mm ²) jumper, 24 in. (609.6mm) L, pre-terminated with two #10 (5.3mm) stud hole ring terminals to provide a bolt-on solution for grounding network equipment.		

#6 AWG (16mm²) Equipment Jumpers Factory Terminated on Both Ends

RGEJ624PHY	24 (0.61)	45°	#6 AWG (16mm ²) jumper; bent lug on grounding strip side to straight lug on equipment; provided with .16 oz. (5cc) of antioxidant and two each #12-24 x 1/2", M6 x 12mm, #10-32 x 1/2" and M5 x 12mm thread-forming screws.	1	10
RGEJ624PFY	24 (0.61)	90°			
RGEJ636PFY	36 (0.91)				
RGEJ660PF	60 (1.52)	Straight	#6 AWG (16mm ²) jumper; bent lug on grounding strip side to straight lug on equipment.	1	10
RGEJ696PF	96 (2.44)				
RGEJ660U	60 (1.52)				
RGEJ696U	96 (2.44)		#6 AWG (16mm ²) jumper, 96 in. (2438.4mm) L, pre-terminated with two straight slotted lugs to provide a bolt-on solution for grounding network equipment.		

#10 AWG (6mm²) Equipment Jumper Factory Terminated on One End

RGEJ1057PFY	57 (1.45)	90°	#10 AWG (6mm ²) jumper; bent lug on grounding strip side; provided with .16 oz. (5cc) of antioxidant and two each #12-24 x 1/2", M6 x 12mm, #10-32 x 1/2" and M5 x 12mm thread-forming screws.	1	10
-------------	-----------	-----	--	---	----

#6 AWG (16mm²) Equipment Jumper Factory Terminated on One End

RGEJ657PFY	57 (1.45)	90°	#6 AWG (16mm ²) jumper; bent lug on grounding strip side; provided with .16 oz. (5cc) of antioxidant and two each #12-24 x 1/2", M6 x 12mm, #10-32 x 1/2" and M5 x 12mm thread-forming screws.	1	10
------------	-----------	-----	--	---	----



Surge Suppressor Jumper Kit

- Bonds power or data line surge suppressor to grounding strip or grounding busbar
- Engineered to comply with US and International grounding requirements
- Both ends factory terminated to provide a bolt-on solution



Part Number	Part Description	Std. Pkg. Qty.
SSGK-1	#10 AWG (6mm ²) jumper; 24" (61m) length; factory terminated on both ends; one-hole lug on surge suppressor to two-hole lug on grounding strip/busbar side; provided with .16 oz. (5cc) of antioxidant and two each #12-24 x 1/2", M6 x 12mm, #10-32 x 1/2" and M5 x 12mm thread-forming screws.	1

Armored Cable Grounding Kit

- Provides a secure bond to the armor sheath on indoor and indoor/outdoor fiber optic cables at both cassette and enclosure ends
- Worm-gear design evenly distributes forces across the armor
- Made from steel and tin-plated copper for chemical compatibility with common armor for long-term reliability
- Black insulating cover protects and hides the connection from incidental contact to prolong connection integrity
- Complies with industry requirements ensuring a high level of reliability and safety



Part Number	Part Description	Std. Pkg. Qty.
ACG24K	#6 AWG (16mm ²) jumper for armored cable diameter up to 0.84" (21.3mm); 24" (609.6mm) length; factory terminated on one end with LCC6 two-hole copper compression lug and the other end with grounding terminal; provided with two each #12-24 and M6 thread-forming screws and a black polypropylene terminal cover.	1
ACG24K-500	#6 AWG (16mm ²) jumper for armored cable diameter 0.85" (21.3mm) to 1.03" (26.2mm); 24" (609.6mm) length; factory terminated on one end with LCC6 two-hole copper compression lug and the other end with grounding terminal; provided with two each #12-24 and M6 thread-forming screws and a black polypropylene terminal cover.	
ACG24KX-500	#6 AWG (16mm ²) jumper for armored cable diameter 0.94" (23.9mm) to 1.5" (38.1mm); 24" (609.6mm) length; factory terminated on one end with LCC6 two-hole copper compression lug and the other end with grounding terminal; provided with two each #12-24 and M6 thread-forming screws and a black polypropylene terminal cover.	
ACGK	Armored cable grounding kit with one grounding terminal for #6 AWG and one #10 mechanical clamp, 9/16" – 1 1/16" diameter range.	
ACGKX	Armored cable grounding kit with one grounding terminal for #6 AWG and one #16 mechanical clamp, 15/16" – 1 1/2" diameter range.	

A. Featured Products

B. Copper Systems

C. Fiber Systems

D. Faceplates, Frames & Surface Mount Boxes

E. Industrial Networks

F. Audio Video Systems

G. Keystone Cabling Systems

H. Zone Cabling

J. Cable Routing Systems

K. Cable Cleats

L. Cabinets & Rack Systems

M. Power & Connectivity Management

N. Grounding & Bonding

O. Identification Products

P. Cable Management Accessories

Q. Part Number Index

A. Featured Products
B. Copper Systems
C. Fiber Systems
D. Faceplates, Frames & Surface Mount Boxes
E. Industrial Networks
F. Audio Video Systems
G. Keystone Cabling Systems
H. Zone Cabling
J. Cable Routing Systems
K. Cable Cleats
L. Cabinets & Rack Systems
M. Power & Connectivity Management
N. Grounding & Bonding
O. Identification Products
P. Cable Management Accessories
Q. Part Number Index

Telecommunication Equipment Bonding Conductor (TEBC) Kits

- Bonds the rack or cabinet to the telecommunications grounding busbar (SBB/TGB)
- Jumper kit available with both ends factory terminated to provide a bolt-on solution
- Jumper kit available with one end factory terminated to attach to the rack or cabinet; free end accommodates unique length requirements
- Engineered to comply with US and international grounding requirements



Pre-Terminated on Both Ends

Part Number	Length		Angle	Part Description	Std. Pkg. Qty.
	In.	m			

Jumpers Pre-Terminated on Both Ends

GJ672UH	72	1.83	Straight and 45°	One 72" length #6 AWG green wire with yellow horizontal stripe. Jumper is pre-terminated on one end with LCC6-14JAWH-L and the other end with LCC6-14JAW-L.	1
GJ696UH	96	2.44		One 96" length #6 AWG green wire with yellow horizontal stripe. Jumper is pre-terminated on one end with LCC6-14JAWH-L and the other end with LCC6-14JAW-L.	
GJ6120UH	120	3.05		One 120" length #6 AWG green wire with yellow horizontal stripe. Jumper is pre-terminated on one end with LCC6-14JAWH-L and the other end with LCC6-14JAW-L.	
GJ6144UH	144	3.66		One 144" length #6 AWG green wire with yellow horizontal stripe. Jumper is pre-terminated on one end with LCC6-14JAWH-L and the other end with LCC6-14JAW-L.	
GJ6168UH	168	4.27		One 168" length #6 AWG green wire with yellow horizontal stripe. Jumper is pre-terminated on one end with LCC6-14JAWH-L and the other end with LCC6-14JAW-L.	
GJ6192UH	192	4.88		One 192" length #6 AWG green wire with yellow horizontal stripe. Jumper is pre-terminated on one end with LCC6-14JAWH-L and the other end with LCC6-14JAW-L.	
GJ6216UH	216	5.49		One 216" length #6 AWG green wire with yellow horizontal stripe. Jumper is pre-terminated on one end with LCC6-14JAWH-L and the other end with LCC6-14JAW-L.	
GJ6240UH	240	6.10		One 240" length #6 AWG green wire with yellow horizontal stripe. Jumper is pre-terminated on one end with LCC6-14JAWH-L and the other end with LCC6-14JAW-L.	
GJ6264UH	264	6.71		One 264" length #6 AWG green wire with yellow horizontal stripe. Jumper is pre-terminated on one end with LCC6-14JAWH-L and the other end with LCC6-14JAW-L.	
GJ6288UH	288	7.32		One 288" length #6 AWG green wire with yellow horizontal stripe. Jumper is pre-terminated on one end with LCC6-14JAWH-L and the other end with LCC6-14JAW-L.	

Telecommunication Equipment Bonding Conductor (TEBC) Kits (continued)



Pre-Terminated on One End

Part Number	Length		Angle	Part Description	Std. Pkg. Qty.
	In.	m			
Jumpers Pre-Terminated on One End					
GJS6120U	120	3.05	Straight	One 120" length #6 AWG green wire with yellow horizontal stripe. Jumper is pre-terminated on one end with LCC6-14JAW-L.	1
GJS6180U	180	4.57	Straight	One 180" length #6 AWG green wire with yellow horizontal stripe. Jumper is pre-terminated on one end with LCC6-14JAW-L.	



Hardware for TEBC Kits

Part Number	Part Description	Std. Pkg. Qty.
Hardware for TEBC Kits		
HDW1/4-KT	Stainless steel mounting hardware for busbar; two 1/4-20 hex bolts, two 1/4-20 hex nuts, four 1/4 flat washers and two 1/4 Belleville compression washers. Mounting hardware for rack or cabinet; two #12-24 thread-forming screws and two M6 thread-forming screws.	1
HDW3/8-KT	Stainless steel mounting hardware for busbar; two 3/8-16 hex bolts, two 3/8-16 hex nuts, four 3/8 flat washers and two 3/8 Belleville compression washers. Mounting hardware for rack or cabinet; two #12-24 thread-forming screws and two M6 thread-forming screws.	
HDW1/4-A-KT	Stainless steel mounting hardware for busbar; two 1/4-20 hex bolts, two 1/4-20 hex nuts, four 1/4 flat washers and two 1/4 Belleville compression washers. Mounting hardware for rack or cabinet; two #10-32 thread-forming screws and two M5 thread-forming screws.	
HDW3/8-A-KT	Stainless steel mounting hardware for busbar; two 3/8-16 hex bolts, two 3/8-16 hex nuts, four 3/8 flat washers and two 3/8 Belleville compression washers. Mounting hardware for rack or cabinet; two #10-32 thread-forming screws and two M5 thread-forming screws.	



Enclosure Grounding Kit

- Patented bracket provides equipotential bonding and protection from static electricity for equipment housed in enclosures
- A discrete grounding point for each piece of equipment within the enclosure allows equipment to be easily added or moved without disturbing other grounding connections
- Anti-rotation design prevents one-hole lugs from loosening
- Grounding washer provides a high-performance electrical bond, eliminating the need to manually remove paint
- Built-in ESD port provides a convenient docking station for ESD wrist strap
- Provides proper bonding of PanZone™ Active Wall Mount Enclosure PZAEWM3, see page H.2



Part Number	Part Description	Std. Pkg. Qty.
PZAEWK	One tin-plated copper bracket; 3.92" L x .56" W x .79" H (99.6mm x 14.2mm x 20.1mm); provided with four #12-24 screws, one each #10-32 and #10-24 hex nut, #10 split lock washer, grounding washer and ESD protection sticker.	1

- A. Featured Products
- B. Copper Systems
- C. Fiber Systems
- D. Faceplates, Frames & Surface Mount Boxes
- E. Industrial Networks
- F. Audio Video Systems
- G. Keystone Cabling Systems
- H. Zone Cabling
- J. Cable Routing Systems
- K. Cable Cleats
- L. Cabinets & Rack Systems
- M. Power & Connectivity Management
- N. Grounding & Bonding
- O. Identification Products
- P. Cable Management Accessories
- Q. Part Number Index

A.
Featured
Products

Shielded Jack Module Grounding Kit

- Alternate method for grounding modules to another grounding wire in shielded applications



Part Number	Part Description	Std. Pkg. Qty.	Std. Ctn. Qty.
CJSGK-XY	Kit used to ground enhanced Giga-TX™ Shielded Jack Modules to another ground wire in shielded applications.	1	1

B.
Copper
Systems

C.
Fiber
Systems

D.
Faceplates,
Frames &
Surface
Mount Boxes

Electrostatic Discharge (ESD) Port Kits and ESD Wrist Strap

- Accommodate standard ESD wrist strap 4mm plug
- Wrist strap provides rapid and continuous drain of electrostatic charge between a person and the surface that the wrist strap is bonded to, preventing damaging static discharge into equipment
- Can be mounted to front or back of rack or cabinet for convenient access
- Bent 45°, acts as a hook to hold wrist strap
- Two-hole configuration provides anti-rotation and prevents loss of bond
- Barrel permanently marked with the protective earth (ground) symbol
- Engineered to comply with US and International grounding requirements

E.
Industrial
Networks

F.
Audio
Video
Systems

G.
Keystone
Cabling
Systems



Part Number	Part Description	Std. Pkg. Qty.	Std. Ctn. Qty.
ESD Port Kit for #12-24 or M6 Rail Fasteners			
RGESD2-1	Two-hole ESD port with 5/8" hole spacing; provided with an ESD protection sticker, .16 oz. (5cc) of antioxidant, and two each #12-24 x 1/2" and M6 x 12mm thread-forming screws.	1	20

H.
Zone
Cabling



Part Number	Part Description	Std. Pkg. Qty.	Std. Ctn. Qty.
ESD Port Kit for Cage Nut Rail Fasteners			
RGESD2B-1	Two-hole ESD port with 5/8" hole spacing; provided with an ESD protection sticker, .16 oz. (5cc) of antioxidant, two cage nut bonding studs and two #12-24 bonding nuts.	1	20

J.
Cable
Routing
Systems

K.
Cable
Cleats



Part Number	Part Description	Std. Pkg. Qty.	Std. Ctn. Qty.
ESD Wrist Strap			
RGESDWS	Adjustable fabric ESD wrist strap with 6' coil cord, banana plug, 1 megohm resistor and 4mm snap.	1	–

L.
Cabinets
& Rack
Systems

ESD port must be attached to a grounded member.
ESD wrist strap sold separately.



Bonding Screws

- Patented screws create an electrical bond between painted patch panels and racks or cabinets
- Serrations on bottom of screw remove paint from patch panel, providing metal-to-metal contact
- Available in two color options to meet different application needs
- Thread-forming, provides a bond to the rack or cabinet by removing paint from threaded holes and minimizing metal shavings
- Permanently marked with the protective earth (ground) symbol and Panduit logo
- Easily installed with Phillips screwdriver

M.
Power &
Connectivity
Management

N.
Grounding
& Bonding



Part Number	Part Description	Std. Pkg. Qty.
RGTBSG-C	Green thread-forming bonding screw, #12-24 x 1/2".	100
RGTBSM6G-C	Green thread-forming bonding screw, M6 x 15mm.	
RGTBS1032G-C	Green thread-forming bonding screw, #10-32 x 1/2".	
RGTBSM5G-C	Green thread-forming bonding screw, M5 x 15mm.	

O.
Identification
Products

P.
Cable
Management
Accessories

Q.
Part
Number
Index

PATENTED Bonding Cage Nuts

- Patented, creates an electrical bond between the mounting rails and equipment
- Conforms to EIA-310 specifications for racks and cabinets
- Made from high carbon steel
- Easily installed with a Phillips, flat blade, or nut screwdriver



Part Number	Part Description	Std. Pkg. Qty.
CNB4K	Green bonding cage nut, includes four #12-24 bonding cage nuts (.06 – .11 thick panel) and four #12-24 x 1/2" bonding screws with #2 Phillips/slotted combo hex head (use 5/16" or 8mm socket). Ideal for patch panel applications.	1
CNBK	Green bonding cage nut, includes 50 #12-24 bonding cage nuts (.06 – .11 thick panel) and 50 #12-24 x 1/2" bonding screws with #2 Phillips/slotted combo hex head (use 5/16" or 8mm socket).	

Thread-Forming Screws

- Thread-forming, provide a bond to the rack or cabinet by removing paint from threaded holes and minimizing metal shavings
- Easily installed with 5/16" (8mm) socket head wrench or flat blade screwdriver



Part Number	Part Description	Std. Pkg. Qty.
RGTS-CY	Thread-forming grounding screw, #12-24 x 1/2".	100
RGTSM6-C	Thread-forming grounding screw, M6 x 12mm.	
RGTS1032-C	Thread-forming grounding screw, #10-32 x 1/2".	
RGTSM5-C	Thread-forming grounding screw, M5 x 12mm.	

Paint Piercing Grounding Washer Kit

- Bonds frame members on bolt-together racks
- No paint scraping required
- Green color-coding to indicate bonding application
- Engineered to comply with US and International grounding requirements



Part Number	Part Description	Std. Pkg. Qty.
RGW-100-1Y	100 paint piercing bonding washers for 3/8" (M8) stud size; .875" (22.2mm) O.D.; provided with .16 oz. (5cc) of antioxidant.	1

A. Featured Products

B. Copper Systems

C. Fiber Systems

D. Faceplates, Frames & Surface Mount Boxes

E. Industrial Networks

F. Audio Video Systems

G. Keystone Cabling Systems

H. Zone Cabling

J. Cable Routing Systems

K. Cable Cleats

L. Cabinets & Rack Systems

M. Power & Connectivity Management

N. Grounding & Bonding

O. Identification Products

P. Cable Management Accessories

Q. Part Number Index

A. Featured Products

B. Copper Systems

C. Fiber Systems

D. Faceplates, Frames & Surface Mount Boxes

E. Industrial Networks

F. Audio Video Systems

G. Keystone Cabling Systems

H. Zone Cabling

J. Cable Routing Systems

K. Cable Cleats

L. Cabinets & Rack Systems

M. Power & Connectivity Management

N. Grounding & Bonding

O. Identification Products

P. Cable Management Accessories

Q. Part Number Index



PATENTED

Retrofit Cabinet Grounding Kits

- Provide a dedicated ground system to maintain system performance and protect network equipment when equipment is already installed
- Patented hardware incorporates paint piercing serrations to create a bond point between the cabinet rail, grounding busbar and lug; hardware never needs to be removed for new equipment installations
- Optimized for installation on 19" cabinets that meet EIA-310, with functioning equipment, and are deployed in the field
- Provides a complete system of matched components to save cost and labor
- Engineered to comply with US and International grounding requirements

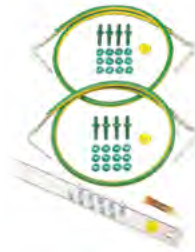
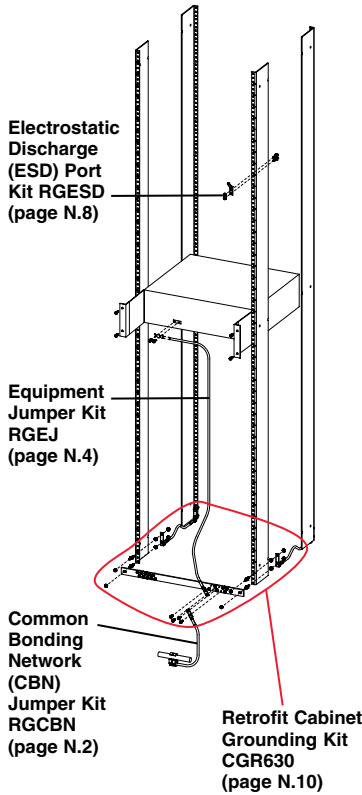

CGR630UB

Part Number	Part Description	Std. Pkg. Qty.
CGR630U	Retrofit grounding kit for installation on cabinets with threaded #12-24 or M6 rail fasteners and rail depth up to 30" (.75m); includes one RGRB19U grounding busbar kit and one CGJ630U front to back rail jumper kit.	1
CGR630UB	Retrofit grounding kit for installation on cabinets with cage nut rail fasteners and rail depth up to 30" (.75m); includes one RGRB19U grounding busbar kit and one CGJ630UB front to back rail jumper kit.	



Retrofit Rack Grounding Kits

- Provide a dedicated ground system to maintain system performance and protect network equipment when equipment is already installed
- Optimized for installation on 19" racks that meet EIA-310, with functioning equipment, and are deployed in the field
- Provide a complete system of matched components that can be easily selected to save cost and labor
- Thread-forming screws eliminate the need to manually remove paint from the rack
- Engineered to comply with US and International grounding requirements

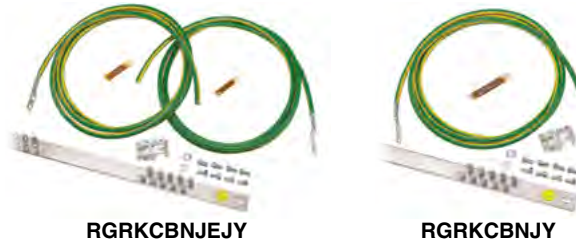
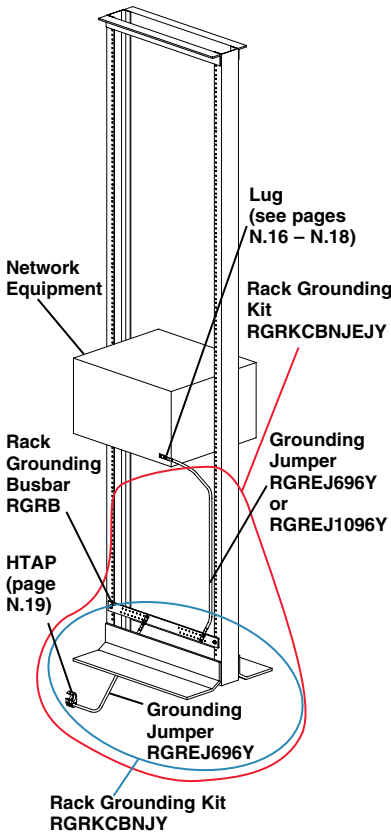

Part Number	Part Description	Std. Pkg. Qty.
-------------	------------------	----------------

Busbar and Jumper Kits

RGRKCBNJEJY	Rack grounding kit to ground the rack and one piece of equipment; includes one RGRB19U busbar, one HTCT250-2-1 HTAP, and two RGREJ696Y grounding jumpers.	1
RGRKCBNJJY	Rack grounding kit to ground the rack; includes one RGRB19U busbar, one HTCT250-2-1 HTAP, and one RGREJ696Y grounding jumper.	

Busbar Kits

RGRB19Y	Grounding busbar; 19" (483mm) length; tin-plated; fourteen holes arranged for flexibility in mounting; provided with two each #12-24 x 1/2" and M6 x 12mm thread-forming screws.	1
RGRB19U	Grounding busbar; 19" (483mm) length; tin-plated; twenty holes arranged for flexibility in mounting with twenty #12-24 x 1/2" hex head screws installed; mounting hole sets have 5/8" (15.9mm) spacing; provided with two each #12-24 x 1/2", M6 x 12mm thread-forming screws, and two #12 flat washers for mounting.	
RGRB19CN	Grounding busbar; 19" (483mm) length; tin-plated; twenty holes arranged for flexibility in mounting with twenty #12-24 x 1/2" hex head screws installed; mounting hole sets have 5/8" (15.9mm) spacing; provided with two bonding cage nuts and four #12-24 bonding screws.	

Equipment Jumper Kits

RGREJ696Y	Grounding jumper; #6 AWG (16mm ²); 96" (2.44m) length; one end factory terminated to lug; provided with .16 oz. (5cc) of antioxidant and two each #12-24 x 1/2", M6 x 12mm, #10-32 x 1/2" and M5 x 12mm thread-forming screws.	1
RGREJ1096Y	Grounding jumper; #10 AWG (6mm ²); 96" (2.44m) length; one end factory terminated to lug; provided with .16 oz. (5cc) of antioxidant and two each #12-24 x 1/2", M6 x 12mm, #10-32 x 1/2" and M5 x 12mm thread-forming screws.	

A. Featured Products

B. Copper Systems

C. Fiber Systems

D. Faceplates, Frames & Surface Mount Boxes

E. Industrial Networks

F. Audio Video Systems

G. Keystone Cabling Systems

H. Zone Cabling

J. Cable Routing Systems

K. Cable Cleats

L. Cabinets & Rack Systems

M. Power & Connectivity Management

N. Grounding & Bonding

O. Identification Products

P. Cable Management Accessories

Q. Part Number Index

- A. Featured Products
- B. Copper Systems
- C. Fiber Systems
- D. Faceplates, Frames & Surface Mount Boxes
- E. Industrial Networks
- F. Audio Video Systems
- G. Keystone Cabling Systems
- H. Zone Cabling
- J. Cable Routing Systems
- K. Cable Cleats
- L. Cabinets & Rack Systems
- M. Power & Connectivity Management
- N. Grounding & Bonding
- O. Identification Products
- P. Cable Management Accessories
- Q. Part Number Index

BICSI/TIA-607-C Telecommunications Grounding Busbars

- Meet BICSI and TIA-607-C requirements for network systems grounding applications
- Made of high conductivity copper and tin-plated to inhibit corrosion
- Come pre-assembled with brackets and insulators attached for quick installation
- Use Panduit component labels, sold separately, to identify busbars to meet TIA-607-C, see chart below



SBB/TGB



PBB/TMGB



LTYK



Part Number	Bar Size	No. of Mounting Positions		Std. Pkg. Qty.
		1/4" Stud Hole with 5/8" Hole Spacing	3/8" Stud Hole with 1" Hole Spacing	

Secondary Bonding Busbars (Telecommunications Grounding Busbars) (SBB/TGB)

GB2B0304TPI-1	1/4" x 2" x 10"	4	3	1
GB2B0306TPI-1	1/4" x 2" x 12"	6		
GB2B0312TPI-1	1/4" x 2" x 20"	12		
GB2B0514TPI-1	1/4" x 2" x 24"	14		

Primary Bonding Busbars (Telecommunications Main Grounding Busbars) (PPB/TMGB)

GB4B0612TPI-1	1/4" x 4" x 12"	12	6	1
GB4B0624TPI-1	1/4" x 4" x 20"	24		
GB4B1028TPI-1	1/4" x 4" x 24"	28		

Part Number	Part Description	Std. Pkg. Qty.
-------------	------------------	----------------

Telecommunications Grounding and Bonding Conductor Label Kit

LTYK	Label kit includes printed tag and one flame retardant cable tie.	1
------	---	---

For complete labeling solutions and product information, reference charts on pages O.1–O.18.

NEMA Hole Pattern Busbars

- Provided with standard NEMA hole pattern spacing
- Made of high conductivity copper and tin-plated to inhibit corrosion
- Come pre-assembled with brackets and insulators attached for quick installation
- Insulators provide 600 V of insulation



Part Number	Bar Size	No. of Mounting Positions	Std. Pkg. Qty.
		1/2" Stud Hole with 1 3/4" Hole Spacing	
GB4N0007TPI-1	1/4" x 4" x 12"	7	1
GB4N0016TPI-1	1/4" x 4" x 24"	16	
GB4N0024TPI-1	1/4" x 4" x 36"	24	
GB4N0026TPI-1	1/4" x 4" x 48"	26	
GB4N0034TPI-1	1/4" x 4" x 60"	34	

Busbar 1 Inch Hole Spacings

- Provided with 1 inch hole D pattern spacing
- Made of high conductivity copper and tin-plated to inhibit corrosion
- Come pre-assembled with brackets and insulators attached for quick installation
- Insulators provide 600 V of insulation



Part Number	Bar Size	No. of Mounting Positions	
		3/8" Stud Hole with 1" Hole Spacing	Std. Pkg. Qty.
GB2D0008TPI-1	1/4" x 2" x 12"	8	1
GB2D0021TPI-1	1/4" x 2" x 24"	21	
GB2D0033TPI-1	1/4" x 2" x 36"	33	
GB2D0044TPI-1	1/4" x 2" x 48"	44	
GB2D0056TPI-1	1/4" x 2" x 60"	56	

Busbar Type	Busbar Pattern
BICSI	B
GB2D...series	D
NEMA	N

See pages N.16–N.17 for Lug information.



IEEE Universal Beam Grounding Clamp



- Universal, fits on a wide range of standard (angled) and wide flange (parallel) structural steel beams
- Provide a mounting pad suitable for a two-hole compression lug
- Install quickly and easily with standard 1/4" key hex wrench tooling
- UL 467 Listed and CSA 22.2 Certified for grounding and bonding suitable for direct burial in earth or concrete
- Comply with vibration tests per MIL-STD-202G (METHOD 201A)

Part Number	Copper Conductor Size Range AWG (mm ²)	Flange Thickness In. (mm)	Stud Size In.	Hole Spacing In. (mm)	Thread Size	Length In. (mm)	Width In. (mm)	Height In. (mm)	Std. Pkg. Qty.
GUBC500-6	#6 AWG – 500 kcmil (16-240)	0.250 – 0.675 (6.3 – 17.1)	1/2	1.75 (44.4)	1/2 – 13	3.15 (80.0)	2.13 (54.0)	2.50 (63.5)	1

Part shown is copper. For tin-plated copper, order part number GUBC500-6TP. Stainless Steel mounting hardware kit sold separately; order part number GLMHK.

Stainless Steel Light Duty Beam Grounding Clamp



- Universal, fits on a wide range of standard (angled) and wide flange (parallel) structural steel beams
- Includes metal stays to position a 2-hole NEMA-spaced lug (requires no mounting hardware)
- Installs quickly by means of a single cone point screw, requires a standard 1/4" key hex wrench tool
- cULus 467 Listed for grounding and bonding and suitable for direct burial in earth or concrete

Part Number	Copper Conductor Size Range AWG (mm ²)	Flange Thickness In. (mm)	Stud Size In.	Hole Spacing In. (mm)	Length In. (mm)	Width In. (mm)	Height In. (mm)	Std. Pkg. Qty.
GUBC4/0-6	#6 AWG - 4/0 STR (16-95)	0.250 - 0.675 (6.3-17.1)	1/2	1.75 (44.4)	2.75 (69.8)	1.65 (41.9)	1.9 (48.3)	1



Auxiliary Cable Brackets and Jumpers

- Bonds ladder rack, wire basket and Panduit™ Wyr-Grid™ System sections together without drilling holes
- Supports grounding conductors in the telecommunications room, allows separation of grounding conductors from other cables
- Holds up to four conductors in sizes up to 750 kcmil
- Bonds to all 1" and 2" ladder rack rails
- Paint piercing teeth provide electrical continuity between cable pathway sections while minimizing debris
- Front and back mounting screw options allow easy installation and visual inspection
- GACB-2 and GACB-3 can be mounted above or below the cable pathway system for flexibility
- Brackets meet TIA-607-C

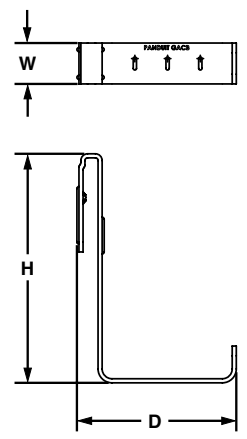

Part Number	Part Description	Std. Pkg. Qty.	Std. Ctn. Qty.
Auxiliary Cable Brackets			
GACB-1	Auxiliary cable bracket; 1.25" (31.8mm) W, 7.00" (177.8mm) H; 4.87" (123.7mm) D; provided with one mounting screw.	1	10
GACB-2	Auxiliary cable bracket; 1.63" (41.4mm) W, 3.95" (100.3mm) H; 5.22" (132.6mm) D; provided with one mounting screw.		
GACB-3	Auxiliary cable bracket; 1.63" (41.4mm) W, 4.58" (116.3mm) H; 5.29" (134.4mm) D; provided with one mounting screw.		

Bonding Jumper Kits			
GACBJ68U	Auxiliary cable bracket jumper for bonding pathway sections; #6 AWG (16mm ²); 8.0" (203mm) length; factory terminated on both ends with straight, two-hole, long barrel compression lugs; provided with .16 oz. (5cc) of antioxidant and four mounting screws.	1	—
GACBJ612U	Auxiliary cable bracket jumper for bonding pathway sections; #6 AWG (16mm ²); 12.0" (305mm) length; factory terminated on both ends with straight, two-hole, long barrel compression lugs; provided with .16 oz. (5cc) of antioxidant and four mounting screws.		
GACBJ618U	Auxiliary cable bracket jumper for bonding pathway sections; #6 AWG (16mm ²); 18.0" (457mm) length; factory terminated on both ends with straight, two-hole, long barrel compression lugs; provided with .16 oz. (5cc) of antioxidant and four mounting screws.		

GACBJ Jumper Kits do not include an auxiliary cable bracket. Sold separately.

- A. Featured Products
- B. Copper Systems
- C. Fiber Systems
- D. Faceplates, Frames & Surface Mount Boxes
- E. Industrial Networks
- F. Audio Video Systems
- G. Keystone Cabling Systems
- H. Zone Cabling
- J. Cable Routing Systems
- K. Cable Cleats
- L. Cabinets & Rack Systems
- M. Power & Connectivity Management
- N. Grounding & Bonding
- O. Identification Products
- P. Cable Management Accessories
- Q. Part Number Index



One-Hole Grounding Lay-In Lug

- Used for quick installation of a continuous grounding conductor
- UL 467 Listed for grounding and bonding, copper lugs
UL Listed for direct burial in earth or concrete

- UL Listed for use up to 600 V and temperature rated 90°C
- Wide wire range-taking capability minimizes inventory requirements



Copper



Tin-Plated Copper



Tin-Plated Aluminum

Part Number	Set Screw Material	Conductor Size Range	Stud Hole Size In.	Hex Key Size In.	Length In.	Width In.	Height In.	Std. Pkg. Qty.
-------------	--------------------	----------------------	--------------------	------------------	------------	-----------	------------	----------------

Copper Body

LICC4-22-C	Stainless Steel	#14 AWG – #4 AWG	0.22	**	1.09	0.39	0.75	100
------------	-----------------	------------------	------	----	------	------	------	-----

Tin-Plated Copper Body

LICC4-22TP-C	Stainless Steel	#14 AWG – #4 AWG	0.22	**	1.09	0.39	0.75	100
--------------	-----------------	------------------	------	----	------	------	------	-----

Tin-Plated Aluminum Body

LIAC4-22-C*	Stainless Steel	#14 AWG – #4 AWG	0.22	**	1.06	0.39	0.78	100
LIAS1/0-14-L*	Zinc Plated Steel	#14 AWG – 1/0 AWG	0.27	**	1.50	0.61	1.10	50
LIAS250-56-Q*		#6 AWG – 250 kcmil	0.33	1/4	2.20	0.80	1.70	25

*Not DB Rated.

**Uses slotted head set screw.

The use of Panduit oxide inhibiting joint compound (CMP) is recommended for pad to conductor connections. Refer to www.panduit.com for more information.

A. Featured Products

B. Copper Systems

C. Fiber Systems

D. Faceplates, Frames & Surface Mount Boxes

E. Industrial Networks

F. Audio Video Systems

G. Keystone Cabling Systems

H. Zone Cabling

J. Cable Routing Systems

K. Cable Cleats

L. Cabinets & Rack Systems

M. Power & Connectivity Management

N. Grounding & Bonding

O. Identification Products

P. Cable Management Accessories

Q. Part Number Index

A. Featured Products



Code Conductor, Two-Hole, Long Barrel with Window Lug

For Use with Stranded Copper Conductors



- Meets TIA-607-C requirements for network systems grounding applications
- Tested by Telcordia – meets NEBS Level 3 with AWG conductor
- UL Listed and CSA Certified with AWG conductor for use up to 35 kV** and temperature rated 90°C when crimped with Panduit and specified competitor crimping tools and dies
- Color-coded barrels marked with Panduit and specified competitor die index numbers for proper crimp die selection
- Long barrel maximizes number of crimps and provides premium wire pull-out strength and electrical performance
- Inspection window to visually assure full conductor insertion
- Tin-plated to inhibit corrosion

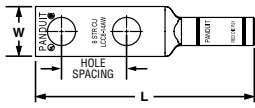

Figure 1: Straight

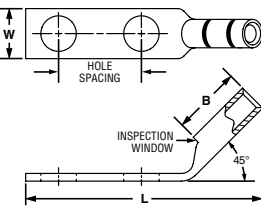

Figure 2: 45° Bent

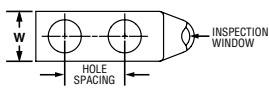

Figure 3: 90° Bent

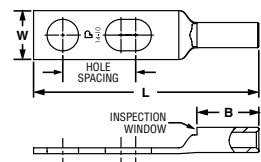

Figure 4: Slotted, Straight

Part Number	Figure No.	Copper Conductor Size	Stud Hole Size In.	Stud Hole Spacing In.	Figure Dimensions In.			Wire Strip Length In.	Busbar Pattern [^]	Std. Pkg. Qty.					
					W	B	L								
LCC10-14JAW-L*	4	#14 – #10 AWG STR, #12 – #10 AWG SOL	1/4	0.50 – 0.63	0.42	0.53	1.93	9/16	B	50					
LCC10-14JAWH-L*	5										1.78				
LCC10-14JAWF-L*	6										1.56				
LCC10-14AW-L*											1.93				
LCC8-10AW-L	1										#10	0.63	0.41	2.01	3/4
LCC8-14AWH-L	2										#8 AWG				
LCC8-14AWF-L	3	1.61													
LCC8-38DW-L	1		3/8	1.00	0.60	2.70		B,D							
LCC6-10ABW-L	4	#6 AWG	1/4	0.63 – 0.75	0.46	1.07	2.52	1 1/8	B	50					
LCC6-14JAW-L											2.49				
LCC6-14JAWH-L											2.08				
LCC6-14JAWF-L											1.66				
LCC6-14AW-L				0.63			2.49								
LCC6-38DW-L			3/8	1.00	0.62		3.08		B, D						
LCC6-12W-L			1/2	1.75	0.75		3.97		N						
LCC4-14AW-L	1	#4 – #3 AWG STR, #2 AWG SOL	1/4	0.63	0.55	1.05	2.50		B	50					
LCC4-38DW-L											3/8	1.00	0.62	3.09	
LCC4-12W-L											1/2	1.75	0.75	4.01	
LCC2-14AW-Q		#2 AWG	1/4	0.63	0.60	1.16	2.67	1 1/4	B	25					
LCC2-38DW-Q	3/8										1.00	0.66	3.24		
LCC2-12W-Q	1/2										1.75	0.75	4.41		

Refer to www.panduit.com for Panduit and competitor tool and die information.

*Not tested to NEBS Level 3 requirements.

**Consult cable manufacturer for voltage stress relief instructions with applications greater than 2000 V.

[^]See page N.13 for busbar patterns.

◆NEMA hole sizes and spacing.

Continued on next page



Code Conductor, Two-Hole, Long Barrel with Window Lug (continued)

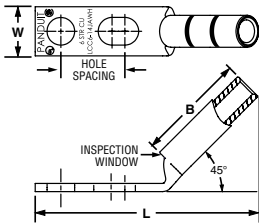

Figure 5: Slotted, 45° Bent

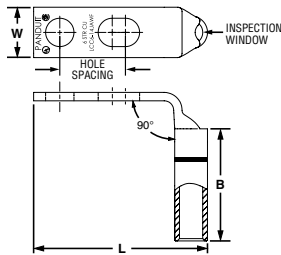

Figure 6: Slotted, 90° Bent

Part Number	Fig. No.	Copper Conductor Size	Stud Hole Size In.	Stud Hole Spacing In.	Figure Dimensions In.			Wire Strip Length In.	Busbar Pattern [^]	Std. Pkg. Qty.
					W	B	L			
LCC1/0-14AW-X	1	1/0 AWG	1/4	0.63	0.76	1.44	3.07	1 1/2	B	10
LCC1/0-38DW-X			3/8	1.00					B, D	
LCC1/0-12W-X			1/2	1.75					N	
LCC2/0-14AW-X		2/0 AWG	1/4	0.63	0.85	1.50	4.83	1 9/16	B	
LCC2/0-38DW-X			3/8	1.00					B, D	
LCC2/0-12W-X			1/2	1.75					N	
LCC3/0-38DW-X	3/0 AWG	3/8	1.00	0.96	1.56	3.81	1 5/8	B, D	6	
LCC3/0-12W-X		1/2	1.75					N		
LCC4/0-38DW-X	4/0 AWG	3/8	1.00	1.06	1.56	3.81	1 5/8	B, D	6	
LCC4/0-12W-X		1/2	1.75					N		
LCC250-38DW-X	250 kcmil	3/8	1.00	1.17	1.61	3.89	1 11/16	B, D	6	
LCC250-12W-X		1/2	1.75					N		
LCC350-38DW-X	350 kcmil	3/8	1.00	1.28	2.24	4.58	2 5/16	B, D	6	
LCC350-12W-X		1/2	1.75					N		
LCC400-38DW-6	400 kcmil	3/8	1.00	1.39	2.30	4.66	2 3/8	B, D	6	
LCC400-12W-6		1/2	1.75					N		
LCC500-38DW-6	500 kcmil	3/8	1.00	1.54	2.50	4.94	2 9/16	B, D	6	
LCC500-12W-6		1/2	1.75					N		
LCC600-38DW-6	600 kcmil	3/8	1.00	1.70	2.69	5.18	2 3/4	B, D	6	
LCC600-12W-6		1/2	1.75					N		
LCC750-38DW-6	750 kcmil	3/8	1.00	1.89	2.88	5.71	2 15/16	B, D	6	
LCC750-12W-6		1/2	1.75					N		

Refer to www.panduit.com for Panduit and competitor tool and die information.

*Not tested to NEBS Level 3 requirements.

**Consult cable manufacturer for voltage stress relief instructions with applications greater than 2000 V.

[^]See page N.13 for busbar patterns.

◆NEMA hole sizes and spacing.

A. Featured Products

B. Copper Systems

C. Fiber Systems

D. Faceplates, Frames & Surface Mount Boxes

E. Industrial Networks

F. Audio Video Systems

G. Keystone Cabling Systems

H. Zone Cabling

J. Cable Routing Systems

K. Cable Cleats

L. Cabinets & Rack Systems

M. Power & Connectivity Management

N. Grounding & Bonding

O. Identification Products

P. Cable Management Accessories

Q. Part Number Index

A. Featured Products



Flex Conductor, Two-Hole, Long Barrel with Window Lug

B. Copper Systems

For Use with Flexible, Extra-Flexible, and Code Stranded Copper Conductors

C. Fiber Systems



- Meets TIA-607-C requirements for network systems grounding applications
- UL Listed and CSA Certified with AWG conductor for use up to 35 kV** and temperature rated 90°C when crimped with Panduit and specified competitor crimping tools and dies
- Color-coded barrels marked with Panduit and specified competitor die index numbers for proper crimp die selection
- Can be used with code conductor and flex conductor class: G, H, I, K, M and Diesel Locomotive
- Long barrel maximizes number of crimps and provides premium wire pull-out strength and electrical performance
- Inspection window to visually assure full conductor insertion
- Generously beveled wire entry prevents bent back strands when inserting conductor into barrel
- Tin-plated to inhibit corrosion
- Available with NEMA hole sizes and spacing

D. Faceplates, Frames & Surface Mount Boxes

E. Industrial Networks

F. Audio Video Systems

G. Keystone Cabling Systems

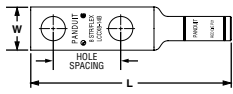

Figure 1: Straight

H. Zone Cabling



J. Cable Routing Systems

K. Cable Cleats

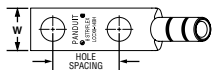
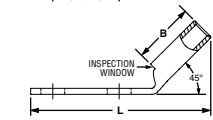

Figure 2: 45° Bent

L. Cabinets & Rack Systems



M. Power & Connectivity Management

N. Grounding & Bonding

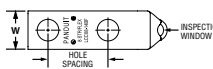

Figure 3: 90° Bent

O. Identification Products

P. Cable Management Accessories

Q. Part Number Index

Part Number	Fig. No.	Flex Conductor Size		Code Conductor Size	Stud Hole Size In.	Stud Hole Spacing In.	Figure Dimensions In.			Wire Strip Length In.	Busbar Pattern [^]	Std. Pkg. Qty.					
		Class G, H, I, K, M	Diesel Locomotive				W	B	L								
LCCX8-14A-L	1	#8 AWG	#8 AWG	#8 AWG	1/4	0.63	0.48	0.70	2.10	3/4	B	50					
LCCX8-14AH-L	2												1.91				
LCCX8-14AF-L	3												1.62				
LCCX8-38D-L	1	#6 AWG	#6 AWG	#6 AWG	3/8	1.00	0.60	1.07	2.70	1 1/8	B, D						
LCCX6-14A-L													2.49				
LCCX6-14AH-L													2	2.18			
LCCX6-14AF-L	3	1.66															
LCCX6-38D-L	1	#4 AWG	#5, #4, #3 AWG	#4 AWG	1/4	0.63	0.55	1.05	2.49	1 1/8	B						
LCCX4-14A-L													3.08				
LCCX4-38D-L													3/8	1.00	0.62	3.09	B, D
LCCX2-14A-E	1	#2 AWG	#2 AWG	#2 AWG	1/4	0.63	0.70	1.36	2.89	1 7/16	B	20					
LCCX2-38D-E													3/8	1.00	3.46	B, D	
LCCX2-12-E													1/2	1.75	0.75	4.63	N
LCCX1/0-14A-X	1	1/0 AWG	1/0 AWG	1/0 AWG	1/4	0.63	0.85	1.50	3.23	1 9/16	B	10					
LCCX1/0-38D-X													3/8	1.00	3.67	B, D	
LCCX1/0-12-X													1/2	1.75	4.83	N	
LCCX2/0-14A-X	1	2/0 AWG	2/0 AWG	2/0 AWG	1/4	0.63	0.96	1.50	3.27	1 9/16	B						
LCCX2/0-38D-X													3/8	1.00	3.70	B, D	
LCCX2/0-12-X													1/2	1.75	4.87	N	
LCCX3/0-38D-X	1	3/0 AWG	3/0 AWG	3/0 AWG	3/8	1.00	1.06	1.56	3.81	1 5/8	N						
LCCX4/0-38D-X													3/8	1.00	4.55	B, D	
LCCX4/0-12-X													1/2	1.75	2.24	5.73	2 5/16
LCCX250-38D-X	1	250 kcmil	262.6 kcmil	—	3/8	1.00	1.28	1.54	2.50	4.59	2 3/4		6				
LCCX350-38D-6												3/8		1.00	4.95	B, D	
LCCX350-12-6												1/2		1.75	1.54	2.50	6.13
LCCX450-38D-6	1	450 kcmil	444.4 kcmil	—	3/8	1.00	1.70	2.69	5.19	2 3/4	B, D						
LCCX450-12-6												1/2	1.75	1.70	2.69	6.37	N
LCCX500-38D-6												3/8	1.00	1.89	2.88	5.72	2 15/16
LCCX500-12-6	1	500 kcmil	535.3 kcmil	—	1/2	1.75	1.89	2.88	6.66	3.00	N						
LCCX650-12-6												1/2	1.75	1.95	2.94	6.75	3.00

Refer to www.panduit.com for Panduit and competitor tool and die information.

**Consult cable manufacturer for voltage stress relief instructions with applications greater than 2000 V.

[^]See page N.13 for busbar patterns.

◆NEMA hole sizes and spacing.



PATENTED

Code/Flex Conductor HTAP



- Used to tap into continuous conductors as a splice or pigtail
- Each HTAP terminates a wide range of conductor sizes and combinations of code and flex conductors Class G, H, I and Diesel Locomotive to suit a variety of applications
- Slotted design allows quick and easy assembly of conductor to HTAP using three Panduit 94V-0 cable ties included
- Tap grooves are separated from one another allowing them to function independently so HTAP can be used with a single or multiple taps providing maximum design and installation flexibility
- Color coded and marked with Panduit die index numbers for proper crimp die selection
- UL Listed and CSA Certified with AWG conductor for applications up to 600 V when crimped with Panduit and specified competitor crimping tools and Panduit crimping dies
- Tin plated to inhibit corrosion

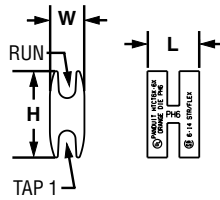
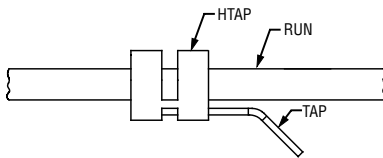

HTCT6X-6X

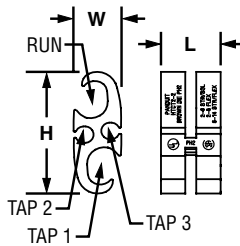

HTCT2-2

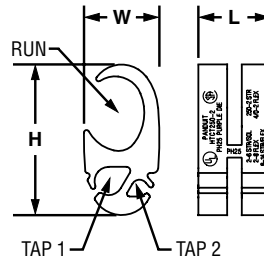

HTCT250-2

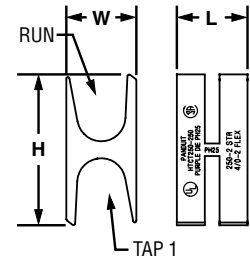

HTCT250-250

Part Number	Copper Conductor Size Range					Figure Dimensions In.			Wire Strip Length In.	Std. Pkg. Qty.
	Wire Strand Type	Run	Tap 1	Tap 2	Tap 3	L	W	H		
HTCT6X-6X-1	Code	#6 – #14 AWG	#6 – #14 AWG	—	—	0.60	0.40	1.00	11/16	
	Flex	#6 – #14 AWG								
HTCT2-2-1	Code	#2 – #6 AWG STR/SOL	#2 – #6 AWG STR/SOL	#8 – #14 AWG	0.76	0.61	1.55	13/16		
	Flex	#2 – #8 AWG	#2 – #8 AWG							
HTCT250-2-1	Code	250 kcmil – #2 AWG	#2 – #6 AWG STR/SOL	#8 – #14 AWG	0.92	0.96	1.92	1		
	Flex	4/0 – #2 AWG	#2 – #8 AWG							
HTCT250-250-1	Code	250 kcmil – #2 AWG	250 kcmil – #2 AWG	—	0.90	0.89	1.92	1		
	Flex	4/0 – #2 AWG	4/0 – #2 AWG							

Refer to www.panduit.com for Panduit and competitor tool and die information.

- A. Featured Products
- B. Copper Systems
- C. Fiber Systems
- D. Faceplates, Frames & Surface Mount Boxes
- E. Industrial Networks
- F. Audio Video Systems
- G. Keystone Cabling Systems
- H. Zone Cabling
- J. Cable Routing Systems
- K. Cable Cleats
- L. Cabinets & Rack Systems
- M. Power & Connectivity Management
- N. Grounding & Bonding
- O. Identification Products
- P. Cable Management Accessories
- Q. Part Number Index

A. Featured Products



PATENTED

Clear Covers for HTCT HTAPs

B. Copper Systems

C. Fiber Systems

D. Faceplates, Frames & Surface Mount Boxes

E. Industrial Networks

F. Audio Video Systems

G. Keystone Cabling Systems



H. Zone Cabling

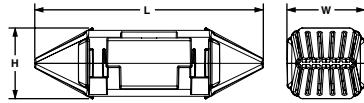

Shown Assembled

J. Cable Routing Systems

K. Cable Cleats



PATENTED

Code/Flex Conductor HTAP Kits

L. Cabinets & Rack Systems



M. Power & Connectivity Management

N. Grounding & Bonding

O. Identification Products

P. Cable Management Accessories

Q. Part Number Index

- Made of high-impact plastic to provide high-impact strength and 360° inspections of crimped connection to assure the crimp is complete and the correct die was used
- Incorporate dual self-latching spring loaded latches and supplied with two Panduit UL 94V-0 cable ties to allow for easy snap-on assembly and ensure covers are secured
- Low profile design minimizes space requirements
- Each cover half supports installation information labels inside plastic retainer strips to allow labels to be viewed on either side of cover and to protect labels from being removed
- Incorporate molded in flash barriers which encompass the HTAP installation providing protection against electrical flash over
- UL 94V-0 flame rating and oxygen index of 28 providing self-extinguishing, flame retardant properties
- Part number, voltage rating, temperature rating and HTCT part number molded into cover for easy identification
- Flexible fingers located at each end of cover prevent foreign objects from entering cover and are made from ductile plastic material that allows easy installation and will not damage conductor insulation

Part Number	Use with HTAP Part Number	Figure Dimensions			Std. Pkg. Qty.
		L	W	H	
CLRCVR1-1	HTCT6X-6X-1	4.48	1.41	1.20	1
CLRCVR2-1	HTCT2-2-1	5.10	1.66	1.40	
CLRCVR3-1	HTCT250-2-1, HTCT250-250-1	5.35	2.16	1.40	

Labels for clear covers are sold separately and are printed with the Panduit™ PanTher™ LS8E Hand-Held Thermal Transfer Printer, see pages O.1 – O.18.

Part Number	Components		Std. Pkg. Qty.
	HTAP Part Number	Clear Cover Part Number	
HTWC6X-6X-1	HTCT6X-6X-1	CLRCVR1-1	1
HTWC2-2-1	HTCT2-2-1	CLRCVR2-1	
HTWC250-2-1	HTCT250-2-1	CLRCVR3-1	
HTWC250-250-1	HTCT250-250-1		



Code Conductor, Thin Wall, Tin-Plated, CTAPF

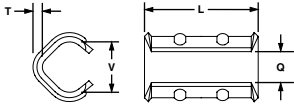

- For copper-to-copper tapping, splicing or pig-tailing
- Wide wire range-taking capability minimizes inventory requirements
- Color-coded for proper crimp die selection
- Ribbed design provides high strength
- Made from high-conductivity copper
- Tin-plated to inhibit corrosion and oxidation
- UL Listed and CSA Certified with AWG conductor to 600 V and temperature rated to 90°C when crimped with Panduit and specified competitor crimping tools and dies

Part Number	Copper Conductor Size		Number of Ribs	Figure Dimensions In.				Wire Strip Length In.	Std. Pkg. Qty.	
	Run AWG	Tap AWG		L	T	V	Q			
CTAPF4-12TP-C	#6 AWG	#8 – #6 AWG	1	1.82	0.07	0.40	0.28	1 5/16	100	
	#5, #4 AWG	#12 – #8 AWG								
CTAPF1/0-12TP-L	#2 AWG	#4 – #2 AWG	2		0.09	0.63	0.42		1 7/8	50
	#1 AWG	#4 – #3 AWG								
	1/0 AWG	#12 – #4 AWG								
CTAPF2/0-12TP-Q	#1 AWG	#2 – #1 AWG	2		0.09	0.71	0.48		1 7/8	25
	1/0 AWG	#3 – #2 AWG								
	2/0 AWG	#12 – #3 AWG								

Refer to www.panduit.com for Panduit and competitor tool and die information.

A. Featured Products

B. Copper Systems

C. Fiber Systems

D. Faceplates, Frames & Surface Mount Boxes

E. Industrial Networks

F. Audio Video Systems

G. Keystone Cabling Systems

H. Zone Cabling

J. Cable Routing Systems

K. Cable Cleats

L. Cabinets & Rack Systems

M. Power & Connectivity Management

N. Grounding & Bonding

O. Identification Products

P. Cable Management Accessories

Q. Part Number Index

A. Featured Products



DB
RATED

Grounding Clamp, U-Bolt, Bronze

B. Copper Systems

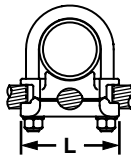
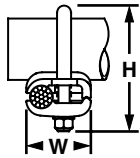

C. Fiber Systems

- Used to ground copper conductor parallel or at a right angle to a rod, tube, or pipe
- Made from high strength, electrolytic cast bronze
- High strength silicon bronze hardware provides long term reliable assembly
- Accommodates a wide range of pipe, tube, rod and conductor sizes – minimizes inventory
- UL Listed for grounding and bonding with AWG conductor and suitable for direct burial in earth or concrete

D. Faceplates, Frames & Surface Mount Boxes

Part Number	Ground Rod Size In.	Iron Pipe Size In.	Conductor Size Range AWG	Figure Dimensions In.			Bolt Dia. In.	Hex Size In.	Std. Pkg. Qty.
				L	W	H			
GPL-8-Q	7/8 or 1	1/2 or 3/4	#8 SOL – #4 STR	2.38	1.38	2.63	3/8	9/16	25
GPL-14-X	1	1		#4 SOL – 2/0 STR		2.63			
GPL-15-X			1.63						
GPL-16-X			3.25	10					
GPL-22-X	1 1/4	3.50							
GPL-28-X	1 1/2	4.00							
GPL-34-3	2	2/0 SOL – 250 kcmil	3.00	1.88	4.25	3			
			3.25		4.00				
			3.75		4.25				

Refer to www.panduit.com for additional sizes.

E. Industrial Networks

F. Audio Video Systems

G. Keystone Cabling Systems

H. Zone Cabling

J. Cable Routing Systems



Split Bolt, Copper

K. Cable Cleats



SBC3-C



SBCT3-C
Tin-Plated

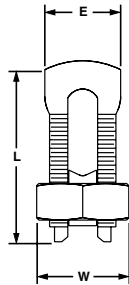

L. Cabinets & Rack Systems

M. Power & Connectivity Management

- Made from high-strength copper alloy to resist corrosion and provide premium electrical and mechanical performance
- Wire range-taking capability minimizes inventory requirements
- Nut hex provides correct fit with socket, box, or open end wrenches resulting in proper torquing of electrical connection
- Pressure bar provides secure connection on a full range of conductor combinations used with each connector assuring premium wire pull-out strength
- UL Listed and CSA Certified with AWG conductor for use up to 600 V and temperature rated 90°C
- SBCT3-C is Dual Rated for copper and aluminum code conductors

N. Grounding & Bonding

Part Number	Copper Conductor			Figure Dimensions In.			Std. Pkg. Qty.
	Range of Equal Run and Tap AWG		Min. Tap with One Max. Run AWG	E	W	L	
	Min.	Max.					
SBC3-C	#8 STR	#4 STR	#14 STR	0.58	0.81	1.16	100

UL Listed and CSA Certified with Copper Code Conductors

UL Listed and CSA Certified with Copper and Aluminum Code Conductors

SBCT3-C*	#8 STR	#4 STR	#10 STR	0.58	0.81	1.24	100
----------	--------	--------	---------	------	------	------	-----

*The use of Panduit oxide inhibiting joint compound (CMP-100) is recommended. Refer to www.panduit.com for more information.

O. Identification Products

P. Cable Management Accessories

Q. Part Number Index

Contour Crimp™ Controlled Cycle Tool

- Controlled cycle mechanism assures high quality, consistent terminations
- Ergonomic tool design assures operator comfort, safety, and performance
- Polypropylene, elastomeric handles provide chemical resistance and a cushioned, non-slip grip



CT- 1700

Part Number	Part Description	Std. Pkg. Qty.
CT-1700	Crimps Panduit #8 — 2 AWG non-insulated tubular terminals (S series), #8 — 1 AWG copper code conductor lugs and splices, #8 — 2 AWG copper flex conductor lugs, #6 — 4 AWG dual rated aluminum lugs and splices and CTAPF10-16 to CTAPF3-12 copper taps. Includes 5-position, color coded rotating die.	1

Die Type, Manual Hydraulic, 12 Ton, Crimping Tool

- High quality, durable tool construction provides long-term dependability
- Cushioned grip prevents hands from slipping on tool, reduces fatigue
- Uses Panduit CD-920 and CD-930 color-coded crimping dies to provide easy matching of crimping die to connector
- Audible “pop-off” valve indicates crimp completion
- Open “C” head, rotatable 350 degrees
- 2-stage hydraulic system: rapid advance, double action handle and power stroke
- Automatic retraction when operation is complete
- Manual retraction operation if needed
- Uses environmentally-friendly hydraulic oil, biodegradable
- CT-920/CV tool available with 2-layer PVC covered crimp head



CT-920



Part Number	Part Description	Std. Pkg. Qty.
CT-920 CT-920/CV	<p>Terminates Panduit™ Pan-Lug™ Compression Connectors:</p> <ul style="list-style-type: none"> Copper compression lugs and splices for #8 AWG – 750 kcmil code conductor Copper compression lugs and splices for #8 AWG – 535 kcmil flex conductor Copper compression lugs and splices for 10mm² - 400mm² Metric class 2r and 10mm² - 300mm² class 5f/6f StructuredGround™ Direct Burial Compression Grounding System connectors #6 AWG – 250 kcmil code conductor and select 500 kcmil conductor combinations Copper compression CTAPF taps for #10 – 3/0 AWG code conductor Copper compression CTAP taps for #8 – 4/0 AWG code conductor Copper compression HTCT taps for #14 AWG – 250 kcmil code conductor, #14 – 4/0 AWG flex conductor Aluminum compression lugs and splices for #6 AWG – 600 kcmil code conductor Panduit™ Tubular Terminals for #8 AWG – 250 kcmil code conductor <p>Specifications: Output: 12 tons (108 kN) Jaw opening: 1.65" (42mm) Weight: 13 lbs. (5.9 kg) Length: 22" (560mm) Handle span: 17 1/2" (open), 6" (closed) Length: 22.1" (560 mm), Height: 8.5" (217 mm), Width: 2.9" (74 mm) Ambient Temperature: -4°F to 104°F (-20°C to +40°C) Warranty: 2 years</p> <p>CT-920 includes:</p> <ul style="list-style-type: none"> Tool Steel tool case with die storage 	1

Uses Panduit CD-920 and CD-930 color-coded crimping dies. Dies must be purchased separately, see page N.25.

A. Featured Products

B. Copper Systems

C. Fiber Systems

D. Faceplates, Frames & Surface Mount Boxes

E. Industrial Networks

F. Audio Video Systems

G. Keystone Cabling Systems

H. Zone Cabling

J. Cable Routing Systems

K. Cable Cleats

L. Cabinets & Rack Systems

M. Power & Connectivity Management

N. Grounding & Bonding

O. Identification Products

P. Cable Management Accessories

Q. Part Number Index

- A. Featured Products
- B. Copper Systems
- C. Fiber Systems
- D. Faceplates, Frames & Surface Mount Boxes
- E. Industrial Networks
- F. Audio Video Systems
- G. Keystone Cabling Systems
- H. Zone Cabling
- J. Cable Routing Systems
- K. Cable Cleats
- L. Cabinets & Rack Systems
- M. Power & Connectivity Management
- N. Grounding & Bonding
- O. Identification Products
- P. Cable Management Accessories
- Q. Part Number Index



Die Type, Lithium-Ion Battery Powered Hydraulic, 12 Ton, Pistol Grip, Crimping Tool

- Meets OSHA mandated electrical and mechanical product safety requirements
- Meets requirements of safety for handheld, motor operated electric tools (UL 60745-1 and CSA No. 60745-1)
- Meets requirements of EU machinery directive and EMC directive
- Certified to SiQ to IEC/EN 62841-1, tested to ENV 61000 series
- Meets ISO 12100, Machinery Safety Risk Assessment, including ergonomics
- Electronic control and monitoring of crimping operation
- Integrated pressure measurement with visual and audible signals not meeting full crimp pressure
- Evaluation function via optical interface and optional CT-USB adapter accessory and FINS software downloadable from Panduit website
- Open “C” head design with 1.65” opening, rotates 350 degrees
- Ergonomic handle positioned at center of gravity for easy handling
- Ergonomic 2-component plastic housing with soft inlays for comfortable and safe one-hand operation
- One-button operating concept for controlling all tool functions
- LED worklight for workplace illumination
- 2-stage hydraulic system with rapid advance and power stroke, 8-9 second crimp cycle time
- Energy saving function with motor cut-out (autostop)
- Quick motor stop for user safety
- Automatic retraction when crimping is complete
- Manual retract operation if needed
- Automatic position control sets piston stop for multiple crimping operations
- Multi-function LED for maintenance display, battery charge status indicator and for data transmission via USB adapter and FINS software downloadable from Panduit website
- Uses environmentally-friendly hydraulic oil, biodegradable
- Includes two Makita* 18 V Li-ion, 3.0 Ah batteries with fast, 22 minute charge time and Makita* battery charger
- Approximately 115 crimps on 300 kcmil (150 mm²) copper lug per battery charge
- CT-2931/STCV tool available with 2-layer PVC covered crimp head
- Can be operated as a corded tool using Panduit A/C adapters sold separately



CT-2931/ST



CT-2931/STCV

Part Number	Charger Voltage	Part Description	Std. Pkg. Qty.
CT-2931/ST CT-2931/STCV	120 V	Terminates Panduit compression connectors: <ul style="list-style-type: none"> • Copper compression lugs and splices for #8 AWG – 750 kcmil code conductor • Copper compression lugs for #8 AWG – 535 kcmil flex conductor • Copper compression S Series, Tubular Terminals for #8 AWG – 250 kcmil code conductor • Copper compression lugs and splices for 10mm² – 400mm² class 2R conductor, 10mm² - 300mm² Class 5f/6f • StructuredGround™ Direct Burial Compression Grounding System connectors #6 AWG – 250 kcmil code conductor and select 500 kcmil conductor combinations • Copper compression CTAPF taps for #10 – 3/0 AWG code conductor • Copper compression CTAP taps for #8 – 4/0 AWG code conductor • Copper compression HTCT taps for #14 AWG – 250 kcmil code conductor, #14 - 4/0 AWG flex conductor • Aluminum compression lugs and splices for #6 AWG – 600 kcmil code conductor Specifications: Output: 12 tons (108 kN) Crimp Cycle: 8-9 seconds Number of crimps: Aprx. 115 on 300 kcmil (150mm ²) copper code lug Jaw opening: 1.65" (41.9mm) Weight: 15.9 lbs. (7.2 kg.) Length: 16.2" (412 mm), Height: 12.6" (319 mm), Width: 3.0" (75 mm) Ambient temperature 14°F - 104°F (-10°C to +40°C)	1
		Warranty: 2 years includes: <ul style="list-style-type: none"> • Two Makita* 3.0 Ah, high capacity, lithium-ion, 18 V rechargeable batteries • One Makita* battery charger • One shoulder strap • Heavy-duty plastic storage case with crimp die compartments 	

Uses Panduit CD-920 and CD-930 color-coded crimping dies. Dies must be purchased separately, see page N.25. *Makita is a registered trademark of Makita Corporation.
 For tool-only option order part number CT-2931/TO.

CD-920 Crimping Dies

- Crimping dies and connectors are color-coded for easy matching
- Emboss die index number on connector barrels for post crimp inspection
- Part number permanently marked on crimping die for easy identification
- Provide circumferential crimp results in terminations with premium electrical and mechanical performance
- Use in Panduit crimping tools: see the CT-920 and CT-920/CV crimping tools and the CT-2931/ST and CT-2931/CV located on pages N.23 and N.24

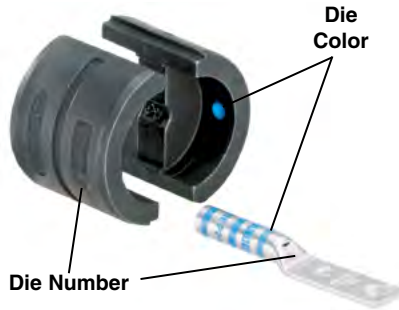

HTAP Die with Patented Locator



CD-920

Part Number	Used to Install Panduit Compression Lug and Splice Sizes	Std. Pkg. Qty.
	Copper Code Conductor Size and Die Color and Die Number	

Single Crimp Dies

CD-920-8	#8 AWG, Red P21	1
CD-920-6	#6 AWG, Blue P24	
CD-920-4	#4 AWG, Gray P29	
CD-920-2	#2 AWG, Brown P33	
CD-920-1	#1 AWG, Green P37	
CD-920-1/0	1/0 AWG, Pink P42	
CD-920-2/0	2/0 AWG, Black P45	
CD-920-3/0	3/0 AWG, Orange P50	
CD-920-4/0	4/0 AWG, Purple P54	
CD-920-250	250 kcmil, Yellow P62	
CD-920-350	350 kcmil, Red P71	
CD-920-400	400 kcmil, Blue P76	
CD-920-500	500 kcmil, Brown P87	
CD-920-500A	500 kcmil, Pink P99	
CD-920-600	600 kcmil, Green P94	
CD-920-750	750 kcmil, Black P106	



CD-920H

Part Number	Used to Install Panduit HTAP Part Numbers	Std. Pkg. Qty.
	Copper HTAP and Die Color and Die Number	

Single Crimp Dies with Patented Locator

CD-920H-6	HTCT6X-6X-1, Orange PH6	1
CD-920H-2	HTCT2-2-1, Brown PH2	
CD-930H-250	HTCT250-2-1, HTCT250-250-1, Purple PH25	

CD-930H

A. Featured Products
B. Copper Systems
C. Fiber Systems
D. Faceplates, Frames & Surface Mount Boxes
E. Industrial Networks
F. Audio Video Systems
G. Keystone Cabling Systems
H. Zone Cabling
J. Cable Routing Systems
K. Cable Cleats
L. Cabinets & Rack Systems
M. Power & Connectivity Management
N. Grounding & Bonding
O. Identification Products
P. Cable Management Accessories
Q. Part Number Index

Notes

Table of Contents

PanTher™ LS8E/LS8EQ Hand-Held Thermal Transfer Printers, Accessories and Labels 0.2 – 0.6

Labeling Software 0.7

TDP43ME Thermal Transfer Desktop Printer, Accessories and Ribbons 0.8 – 0.9

Thermal Transfer Labels 0.9 – 0.12

LabelCore™ Fiber Optic Cable Identification System 0.13

Thermal Transfer Marker Plates 0.13

Thermal Transfer Flag Labels 0.14

Super-Tack Polyester Continuous Tapes 0.14

Laser/Ink Jet Labels 0.15 – 0.17

Self-Laminating Fiber Optic Cable Marker Tags 0.18

Voltage and Fiber Optic Snap-On Markers (Non-Adhesive) 0.18



- A. Featured Products**
- B. Copper Systems**
- C. Fiber Systems**
- D. Faceplates, Frames & Surface Mount Boxes**
- E. Industrial Networks**
- F. Audio Video Systems**
- G. Keystone Cabling Systems**
- H. Zone Cabling**
- J. Cable Routing Systems**
- K. Cable Cleats**
- L. Cabinets & Rack Systems**
- M. Power & Connectivity Management**
- N. Grounding & Bonding**
- O. Identification Products**
- P. Cable Management Accessories**
- Q. Part Number Index**

A. Featured Products

B. Copper Systems

C. Fiber Systems

D. Faceplates, Frames & Surface Mount Boxes

E. Industrial Networks

F. Audio Video Systems

G. Keystone Cabling Systems

H. Zone Cabling

J. Cable Routing Systems

K. Cable Cleats

L. Cabinets & Rack Systems

M. Power & Connectivity Management

N. Grounding & Bonding

O. Identification Products

P. Cable Management Accessories

Q. Part Number Index

PanTher™ LS8E/LS8EQ Hand-Held Thermal Transfer Printers and Accessories

- Cut-to-length functionality eliminates label waste and label trimming labor
- Partial cut feature available to provide tear-apart strips of labels
- P1™ Label Cassette contains an integrated memory device for automatic formatting, recall of last legend used, and number of labels remaining in the cassette
- Market specific labeling tools simplify label creation for network components, panel building, and construction and maintenance
- USB interface for importing data, system upgrades, and printing from a wireless laptop or desktop computer
- Legends can be easily aligned with ports on patch panels and faceplates, eliminating the need for manual spacing and guesswork
- Prints self-laminating cable labels, continuous tapes, and die-cut labels for patch panels, faceplates, and other network applications
- Fast loading label cassette includes both label material and ribbon to make changing labels easy



LS8EQ



LS8E

Part Number	Part Description	Std. Pkg. Qty.
LS8EQ-KIT-ACS	Includes LS8EQ printer with QWERTY keypad, one cassette of S100X150VAC self-laminating labels, six AA alkaline batteries, LS8E-ACS adapter, LS8-CASE, LS8-PCKIT, LS8-IB, LS8-WS, quick reference card and operator's manual.	1
LS8EQ-KIT	Includes LS8EQ printer with QWERTY keypad, one cassette of S100X150VAC self-laminating labels, six AA alkaline batteries, LS8-CASE, LS8-PCKIT, LS8-IB, LS8-WS, quick reference card and operator's manual.	
LS8EQ	Includes LS8EQ printer with QWERTY keypad, one cassette of S100X150VAC self-laminating labels, six AA alkaline batteries and quick reference card.	
LS8E-KIT-ACS	Includes LS8E printer, one cassette of S100X150VAC self-laminating labels, six AA alkaline batteries, LS8E-ACS adapter, LS8-CASE, LS8-PCKIT, LS8-IB, LS8-WS, quick reference card and operator's manual.	
LS8E-KIT	Includes LS8E printer, one cassette of S100X150VAC self-laminating labels, six AA alkaline batteries, LS8-CASE, LS8-PCKIT, LS8-IB, LS8-WS, quick reference card and operator's manual.	
LS8E	Includes LS8E printer, one cassette of S100X150VAC self-laminating labels, six AA alkaline batteries and quick reference card.	
LS8E-ACS	120 VAC power adapter for North America. Cannot be used to charge batteries.	
LS8-CASE	Rigid carrying case.	
LS8-PCKIT	Includes USB cable and PC interface software for importing data, system upgrades, or printing from a wireless laptop or desktop computer.	
LS8-IB	Protective impact bumper.	
LS8-WS	Wrist strap.	
LS8-CLN	Cleaning kit.	

Reference chart of P1™ Label Cassettes for use with the LS8E Hand-Held Printer.

P1™ Network Component Label Cassettes for PanTher™ LS8E/LS8EQ Hand-Held Thermal Transfer Printers



- P1™ Label Cassette contains an integrated memory device for automatic formatting, recall of last legend used, and number of labels remaining in the cassette
- Fast loading label cassette includes both label material and ribbon to make changing labels easy
- Use for identifying patch panels, faceplates, punchdown blocks and other network systems hardware
- Die-cut labels designed to provide maximum aesthetic quality and appearance
- Available in adhesive polyolefin and non-adhesive polyester materials

Application Description	Typical Application Page	Code
Boxes – Surface Mount, Outlet, Hybrid	D.6	BX
Faceplates	D.1	FP
GP6™ PLUS Punchdown System	B.22 — B.24	GP
Jack Modules	B.7 — B.9	JM

Application Description	Typical Application Page	Code
110 Punchdown Blocks	B.22 — B.24	PB
Patch Panels	B.18 — B.21	PP
Racks and Cabinets	L.1	RK

Part Number	Part Description	Width		Height		Std. Pkg. Qty.	Std. Ctn. Qty.
		In.	mm	In.	mm		
C061X030FJC	White, adhesive polyolefin label, 500/cassette, 1-port identifier. Application codes: BX, FP, and PP.	0.61	15.5	0.30	7.6	1	10
C125X030FJC	White, adhesive polyolefin label, 200/cassette, 2-port identifier. Application codes: BX, FP, and PP.	1.25	31.8				
C138X019FJC	White, adhesive polyolefin label, 200/cassette, module identifier. Application code: JM.	1.38	35.1	0.19	4.8		
C150X030Y1C	White, non-adhesive polyester label, 75/cassette, 3-port identifier. Application code: FP.	1.50	38.1	0.30	7.6		
C188X030FJC	White, adhesive polyolefin label, 150/cassette, 3-port identifier. Application code: FP.	1.88	47.8				
C195X040Y1C	White, non-adhesive polyester label, 100/cassette, single-gang faceplate. Application code: FP.	1.95	49.5	0.40	10.2		
C200X100FJC	White, adhesive polyolefin label, 150/cassette, SLCT bundle marker identifier. Application codes: SL, RK.	2.00	50.8	1.00	25.4		
C252X030FJC	White, adhesive polyolefin label, 125/cassette, 4-port identifier. Application codes: BX, FP, and PP.	2.52	64.0	0.30	7.6		
C261X030FJC	White, adhesive polyolefin label, 125/cassette, 4-port identifier. Application codes: FP and PP.	2.61	66.3				
C261X035Y1C	White, non-adhesive polyester label, 75/cassette, 4-port identifier. Application codes: FP and PP.	2.82	71.6	0.35	8.9		
C282X030Y1C				0.30	7.6		
C288X040Y1C	White, non-adhesive polyester label, 75/cassette, double-gang faceplate. Application code: FP.	2.88	73.2	0.40	10.2		
C315X030FJC	White, adhesive polyolefin label, 100/cassette, 5-port identifier. Application code: FP.	3.15	80.0	0.30	7.6		
C379X030FJC	White, adhesive polyolefin label, 75/cassette, 6-port identifier. Application code: FP.	3.79	96.3				
C390X030Y1C	White, non-adhesive polyester label, 50/cassette, 6-port identifier. Application code: PP.	3.90	99.1				
C750X050Y1C	White, non-adhesive polyester label, 30/cassette, 110 block identifier. Application code: PB.	7.50	190.5	0.50	12.7		
C788X050Y1C	White, non-adhesive polyester label, 30/cassette, GP6™ Plus Punchdown System identifier. Application code: GP.	7.88	200.2				

- A. Featured Products
- B. Copper Systems
- C. Fiber Systems
- D. Faceplates, Frames & Surface Mount Boxes
- E. Industrial Networks
- F. Audio Video Systems
- G. Keystone Cabling Systems
- H. Zone Cabling
- J. Cable Routing Systems
- K. Cable Cleats
- L. Cabinets & Rack Systems
- M. Power & Connectivity Management
- N. Grounding & Bonding
- O. Identification Products
- P. Cable Management Accessories
- Q. Part Number Index

A. Featured Products

B. Copper Systems

C. Fiber Systems

D. Faceplates, Frames & Surface Mount Boxes

E. Industrial Networks

F. Audio Video Systems

G. Keystone Cabling Systems

H. Zone Cabling

J. Cable Routing Systems

K. Cable Cleats

L. Cabinets & Rack Systems

M. Power & Connectivity Management

N. Grounding & Bonding

O. Identification Products

P. Cable Management Accessories

Q. Part Number Index

P1™ Self-Laminating Label Cassettes for PanTher™ LS8E/LS8EQ Hand-Held Thermal Transfer Printers



- P1™ Label Cassette contains an integrated memory device for automatic formatting, recall of last legend used, and number of labels remaining in the cassette
- Temperature Range: -50°F to 225°F (-45.6°C to 107°C)
- Fast loading label cassette includes both label material and ribbon to make changing labels easy
- Self-laminating adhesive labels for wire/cable identification include a colored print-on area and clear overlamine

Part Number	Part Description	Width		Length		Print-On Height		Min. Cable O.D.		Max. Cable O.D.		Std. Pkg. Qty.	Std. Ctn. Qty.
		In.	mm	In.	mm	In.	mm	In.	mm	In.	mm		
S100X075VAC	White print-on area, vinyl label for 18 – 14 AWG wires, 350/cassette.	1.00	25.4	0.75	19.1	0.25	6.4	0.08	2.0	0.16	4.0	1	10
S100X125VAC	White print-on area, vinyl label for 12 – 10 AWG wire/cable Category 3 UTP cable, 225/cassette.			1.25	31.8	0.38	9.7	0.12	3.1	0.28	7.0		
S100X150VAC*	White print-on area, vinyl label for 10 - 6 AWG wire/cable Category 5e/6/6A UTP and Cat 5e FTP. 200 labels/cassette.			1.50	38.1	0.50	12.7	0.16	4.0	0.32	8.1		
S100X225VAC*	White print-on area, vinyl label for 8 - 4 AWG wire/cable Category 6 FTP and Category 6A 10Gig. 125 labels/cassette.			2.25	57.2	0.75	19.1	0.24	6.10	0.48	12.2		

*Other colors available, replace A with B (TIA Blue), D (TIA Green), H (TIA Red), and I (TIA Yellow).

P1™ Turn-Tell™ Label Cassettes for PanTher™ LS8E/LS8EQ Hand-Held Thermal Transfer Printers



- Fast loading P1™ Label Cassette includes both label material and ribbon to make changing labels easy
- Labels can be easily installed on existing terminated wires and assemblies without disconnecting the wires/cables
- Innovative label design allows labels to rotate for visibility from any angle, and for repositioning on the wire/cable to align legends and improve aesthetics
- Temperature range: -40°F to 150°F (-40°C to 65.6°C)

Part Number	Width		Length		Print-On Area Height		Min. Cable O.D.		Max. Cable O.D.		Std. Pkg. Qty.	Std. Ctn. Qty.
	In.	mm	In.	mm	In.	mm	In.	mm	In.	mm		
R100X075V1C	1.00	25.4	0.75	19.1	0.25	6.4	0.12	3.1	0.16	4.1	1	10
R100X125V1C			1.25	31.8	0.38	9.7	0.16	4.1	0.22	5.6		
R100X150V1C*			1.50	38.1	0.50	12.7	0.22	5.6	0.28	7.1		
R100X225V1C*			2.25	57.2	0.75	19.1	0.28	7.1	0.39	9.9		

*Other colors available, replace 1 with 2 (TIA Blue), 3 (TIA Green), 7 (TIA Red), and 8 (TIA Yellow).

P1™ Marker Plate Label Cassettes for PanTher™ LS8/LS8EQ Hand-Held Thermal Transfer Printers



- Fast loading P1™ Label Cassette includes both label material and ribbon to make changing labels easy
- Marker plates are designed for use on larger diameter wire/cables and may be applied after all terminations are complete
- Meets requirements for MIL-STD-202F, Notice 12 Method 215J
- Temperature range: -58°F to 221°F (-50°C to 105°C)

Part Number	Color	Width		Height		Print-On Area Width		Labels Per Cassette	Std. Pkg. Qty.	Std. Ctn. Qty.
		In.	mm	In.	mm	In.	mm			
M300X050Y6C	Yellow	3.00	76.2	0.50	12.7	1.80	45.7	50	1	10
M300X050Y7C	White									

P1™ Flag Label Cassettes for PanTher™ LS8E/LS8EQ Hand-Held Thermal Transfer Printers



- Fast loading P1™ Label Cassette includes both label material and ribbon to make changing labels easy
- Provides larger labeling area for small cables
- Innovative design allows flag labels to be applied in either adhesive or non-adhesive orientations
- Temperature range: -40°F to 302°F (-40°C to 150°C)

Part Number	Color	Width		Length		Min. Wire O.D.		Max. Wire O.D.		Wire Range	Labels Per Cassette	Std. Pkg. Qty.	Std. Ctn. Qty.
		In.	mm	In.	mm	In.	mm	In.	mm				
F100X150AJC	White	1.00	25.4	1.50	38.1	0.12	3.1	0.20	5.1	12-10 AWG	200	1	10

A. Featured Products

B. Copper Systems

C. Fiber Systems

D. Faceplates, Frames & Surface Mount Boxes

E. Industrial Networks

F. Audio Video Systems

G. Keystone Cabling Systems

H. Zone Cabling

J. Cable Routing Systems

K. Cable Cleats

L. Cabinets & Rack Systems

M. Power & Connectivity Management

N. Grounding & Bonding

O. Identification Products

P. Cable Management Accessories

Q. Part Number Index

- A. Featured Products
- B. Copper Systems
- C. Fiber Systems
- D. Faceplates, Frames & Surface Mount Boxes
- E. Industrial Networks
- F. Audio Video Systems
- G. Keystone Cabling Systems
- H. Zone Cabling
- J. Cable Routing Systems
- K. Cable Cleats
- L. Cabinets & Rack Systems
- M. Power & Connectivity Management
- N. Grounding & Bonding
- O. Identification Products
- P. Cable Management Accessories
- Q. Part Number Index

P1™ Continuous Tape Cassettes for PanTher™ LS8E/LS8EQ Hand-Held Thermal Transfer Printers

- P1™ Label Cassette contains an integrated memory device for automatic formatting, recall of last legend used, and number of labels remaining in the cassette
- Fast loading label cassette includes both label material and ribbon to make changing labels easy
- Labels for general network identification
- Available in a variety of colors, widths, and adhesive materials including continuous polyolefin, polyester, and vinyl
- For flat label applications only

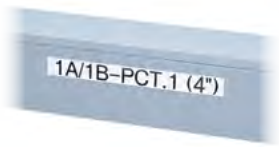

Part Number	Part Description	Height		Length		Std. Pkg. Qty.	Std. Ctn. Qty.
		In.	mm	In.	mm		
T050X000VPC-BK	Black on white, vinyl tape.	0.50	12.7	25.0	7.6	1	10
T050X000VQC-BK*	Black on blue, vinyl tape.						
T050X000VSC-BK*	Black on green, vinyl tape.						
T050X000VUC-BK	Black on orange, vinyl tape.						
T050X000VWC-BK*	Black on red, vinyl tape.						
T050X000VXC-BK	Black on yellow, vinyl tape.						
T050X000VYC-WH	White on black, vinyl tape.						
T050X000YKC-BK*	Black on clear, polyester tape.	1.00	25.4	25.0	7.6	1	10
T100X000VPC-BK	Black on white, vinyl tape.						
T100X000VQC-BK*	Black on blue, vinyl tape.						
T100X000VSC-BK*	Black on green, vinyl tape.						
T100X000VUC-BK	Black on orange, vinyl tape.						
T100X000VWC-BK*	Black on red, vinyl tape.						
T100X000VXC-BK	Black on yellow, vinyl tape.						
T100X000VYC-WH	White on black, vinyl tape.						
T100X000YKC-BK*	Black on clear, polyester tape.						

*Available with white ribbon, replace BK suffix with WH.

Easy-Mark Plus™ Labeling Software



- Powerful, easy-to-use, and affordable software that provides innovative features and functionality to address unique labeling needs
- Quickly create simple or complex labels with text boxes, lines, frames, or tables, and other useful tools
- Design detailed labels with multiple zones and objects for applications such as rating plates, arc flash labels, and fiber optic enclosures
- Simple user interface shows labels on the screen as they will be printed
- Create and print labels using QR codes, or any of the other 21 included barcode symbologies

- Upgrades available at <http://www.panduit.com/emp>

System Requirements:

- 300 MB hard drive space and 2 GB Memory
- Windows^ XP, Vista, 7, 8, 8.1 or 10
- 32 or 64 bit operating systems
- Microsoft.NET Framework 2.0 or higher
- Mouse or compatible pointing device
- Keyboard
- Optical Disc Drive or USB Port



Part Number	Part Description	Std Pkg. Qty.	Std. Ctn. Qty.
EMPLUS-CD	Easy-Mark Plus™ Labeling Software, CD-ROM.	1	10
EMPLUS-DL	Easy-Mark Plus™ Labeling Software, online download.		
EMPLUS-2GO	Easy-Mark Plus™ Portable Application, USB flash drive.		
EMPLUS-SERVER	Easy-Mark Plus™ Labeling Software, networkable server based version.		

^Windows is a registered trademark of Microsoft Corp. in the United States and/or other countries.

CAD-Connect™ Labeling Software

- Facilitates quick and easy organization of identifiers from CAD for printing within Easy-Mark Plus™ Labeling Software
- Easily captures and organizes CAD data for future use and documentation
- Saves time and reduces errors by utilizing identifiers previously created in CAD files to eliminate manual entry of data into labeling software
- Compatible with full versions of AutoCAD* 2002 to 2017 and Visio^ version 2002 or newer
- Exports to alternative formats such as Excel^ (XLS) or Text (CSV) files for future use and documentation

- Upgrades available at www.panduit.com

System Requirements:

- 64 MB hard drive space and 64 MB RAM (256 MB RAM recommended)
- Windows^ 2000, XP, Vista, 7, 8, 8.1
- 32 or 64 bit operating systems
- Microsoft.NET Framework 2.0 or higher
- Mouse or compatible pointing device
- Keyboard
- Optical Disc Drive



Part Number	Part Description	Std Pkg. Qty.	Std. Ctn. Qty.
PROG-CCCD	CAD-Connect™ Labeling Software, including Easy-Mark Plus™ Labeling Software, CD-ROM.	1	10

^Visio, Windows and EXCEL are registered trademarks of Microsoft Corp. in the United States and/or other countries.
*AutoCAD is a registered trademark of Autodesk, Inc.

A. Featured Products

B. Copper Systems

C. Fiber Systems

D. Faceplates, Frames & Surface Mount Boxes

E. Industrial Networks

F. Audio Video Systems

G. Keystone Cabling Systems

H. Zone Cabling

J. Cable Routing Systems

K. Cable Cleats

L. Cabinets & Rack Systems

M. Power & Connectivity Management

N. Grounding & Bonding

O. Identification Products

P. Cable Management Accessories

Q. Part Number Index

A.
Featured
Products

B.
Copper
Systems

C.
Fiber
Systems

D.
Faceplates,
Frames &
Surface
Mount Boxes

E.
Industrial
Networks

F.
Audio
Video
Systems

G.
Keystone
Cabling
Systems

H.
Zone
Cabling

J.
Cable
Routing
Systems

K.
Cable
Cleats

L.
Cabinets
& Rack
Systems

M.
Power &
Connectivity
Management

N.
Grounding
& Bonding

O.
Identification
Products

P.
Cable
Management
Accessories

Q.
Part
Number
Index

TDP43ME Thermal Transfer Desktop Printer and Accessories

- Creates durable, crisp, clear legends and graphics that offer superior legibility
- Prints durable legends for harsh industrial environments
- Fine resolution for small type characters and images
- Easy-Mark™ Labeling Software included with printer
- Up to 4 inches per second print speed
- Auto-sensing label gap and black mark sensors
- One-button operation and automatic self test
- Connects quickly and easily to PC, and offers connectivity flexibility to print by USB, parallel, serial or Ethernet
- Easy ribbon loading reduces printer downtime
- Able to connect to a network for sharing capability
- UL60950 listed, File #E165747



Part Number	Part Description	Std Pkg. Qty
TDP43ME	300 dpi printer; includes printer, Panduit™ Easy-Mark Plus™ Labeling Software, RMEH4BL black hybrid ribbon, AC power adapter with US power cord, USB cable, user manual, quick start card, and driver disk; for use in North America.	1
TDP43ME-KIT	TDP43ME printer kit. Includes: printer, Panduit™ Easy-Mark Plus™ Labeling Software, RMEH4BL black hybrid ribbon, AC power adapter with US power cord, USB cable, user manual, quick start card, TDP43ME-RS Roll Stand, TDP43ME-CASE, one roll of S100X150VATY labels, and driver disk; for use in North America.	
TDP43ME-AC	Replacement AC power adapter with power cord (US cord only).	
TDP43ME-CASE	Hardside carrying case accommodates printer, AC power adapter, ribbons, printer cable, external roll stand, labels, and tools.	
TDP43ME-CUTTER	Optional power/automatic cutter for TDP43ME thermal transfer desktop printer; easy to install for automatic cutting of labels.	
TDP43ME-RS	External label roll stand for TDP43ME printer; used to rear feed labels that are supplied on 3" cores.	
TDP43ME-SPINDLE	Replacement ribbon spindle for TDP43ME Thermal Transfer Desktop Printer, Package of Two Spools.	
TDP43ME-TB-KIT	Terminal block marker adapter kit.	
PTR-CLN	Printer cleaning kit – contains (1) cleaning pen, (8) cleaning solution soaked wipes, (8) foam swabs pre-saturated with cleaning solution, MSDS, and cleaning instructions.	

Ribbons for Use with the TDP43ME Thermal Transfer Desktop Printer

- Ribbons load easily into the TDP43ME printer



Part Number	Part Description	Width		Length		Std. Pkg. Qty.
		In.	mm	Ft.	m	
RMER1BL	Black resin thermal transfer ribbon. Use with terminal block markers.	1.1	27.9			
RMEH4BL*	Black hybrid thermal transfer ribbon. Use with heat shrink, self-laminating, Turn-Tell™, tan polyimide labels, and vinyl cloth labels.	4.25	108.0	300.0	91.4	1
RMER4BL*^A	Black resin thermal transfer ribbon. Use with polyester labels, continuous vinyl tape, marker plates, and raised panel labels.					
RMER4BL-A	Black resin thermal transfer ribbon. Use with high-temperature marker plates.					
RMER4BL-C	Black resin thermal transfer ribbon. Use with fluid-resistant heat shrink labels and white polyimide labels.					

*For 2.5" wide ribbons, replace 4 in part number with 2. For example, the part number of a 2.5" wide black hybrid thermal transfer ribbon is RMEH2BL.
 ^Other colors available, change "BL" to: BU for Blue, GR for Green, RD for Red, or WH for White (Example: RMER4BU = Blue Resin Ribbon).

Thermal Transfer Component Labels



- Use for identifying patch panels, faceplates, punchdown blocks and other network systems hardware
- Die-cut labels designed to provide maximum aesthetic quality and appearance
- Available in adhesive polyester and non-adhesive polyester materials
- Use with Panduit™ thermal transfer resin ribbons

Application Description	Typical Application Page	Code
Boxes – Surface Mount, Outlet, Hybrid	D.6	BX
Faceplates	D.1	FP
GP6™ PLUS Punchdown System	B.22 — B.24	GP
Jack Modules	B.7 — B.9	JM

Application Description	Typical Application Page	Code
110 Punchdown Blocks	B.22 — B.24	PB
Patch Panels	B.18 — B.21	PP
Racks and Cabinets	L.1	RK

Part Number	Part Description	Width		Height		Std. Pkg. Qty.	Std. Ctn. Qty.
		In.	mm	In.	mm		
C061X030YPT	White, adhesive polyester label, 1-port identifier. Application codes: BX, FP, and PP.	0.61	15.5	0.30	7.6	2500	10000
C125X030YPT	White, adhesive polyester label, 2-port identifier. Application codes: BX, FP, and PP.	1.25	31.8				
C138X019YPT	White, adhesive polyester label, module identifier. Application code: JM.	1.38	35.1	0.19	4.8		
C150X030Y1T	White, non-adhesive polyester label, 3-port identifier. Application code: FP.	1.50	38.1	0.30	7.6	1000	5000

*Label is perforated to be used in 1, 2, 3, or 4-position applications.
 Order number of pieces required in multiples of Standard Package Quantity.
 Labels roll mounted on 3.00" cores; when using the TDP43ME printer and 3.00" cores, the roll stand (TDP43ME-RS) is required.

Continued on next page

- A. Featured Products
- B. Copper Systems
- C. Fiber Systems
- D. Faceplates, Frames & Surface Mount Boxes
- E. Industrial Networks
- F. Audio Video Systems
- G. Keystone Cabling Systems
- H. Zone Cabling
- J. Cable Routing Systems
- K. Cable Cleats
- L. Cabinets & Rack Systems
- M. Power & Connectivity Management
- N. Grounding & Bonding
- O. Identification Products
- P. Cable Management Accessories
- Q. Part Number Index

A.
Featured
Products

B.
Copper
Systems

C.
Fiber
Systems

D.
Faceplates,
Frames &
Surface
Mount Boxes

E.
Industrial
Networks

F.
Audio
Video
Systems

G.
Keystone
Cabling
Systems

H.
Zone
Cabling

J.
Cable
Routing
Systems

K.
Cable
Cleats

L.
Cabinets
& Rack
Systems

M.
Power &
Connectivity
Management

N.
Grounding
& Bonding

O.
Identification
Products

P.
Cable
Management
Accessories

Q.
Part
Number
Index

Thermal Transfer Component Labels (continued)

Part Number	Part Description	Width		Height		Std. Pkg. Qty.	Std. Ctn. Qty.
		In.	mm	In.	mm		
C188X030YPT	White, adhesive polyester label, 3-port identifier. Application code: FP.	1.88	47.8	0.30	7.6	2500	10000
C195X040Y1T	White, non-adhesive polyester label, single gang faceplate. Application code: FP.	1.95	49.5	0.40	10.2	1000	5000
C200X100YPT	White, adhesive polyester label, SLCT bundle marker identifier. Application code: SL and RK.	2.00	50.8	1.00	25.4		
C252X030YPT	White, adhesive polyester label, 4-port identifier. Application codes: BX, FP, and PP.	2.52	64.0	0.30	7.6	2500	10000
C252X030YPT-P*	White, adhesive polyester label, perforated port identifier. Application codes: BX, FP, and PP.						
C261X030YPT	White, adhesive polyester label, 4-port identifier. Application codes: FP and PP.	2.61	66.3	0.35	8.9	1000	5000
C261X035Y1T	White, non-adhesive polyester label, 4-port identifier. Application codes: FP and PP.						
C275X125YPT	White, adhesive polyester label, general identifier. Application code: RK.	2.75	69.9	1.25	31.8	2500	10000
C288X030YPT	White, adhesive polyester label, double gang faceplate identifier. Application code: FP.	2.88	73.2	0.30	7.6		
C288X040Y1T	White, non-adhesive polyester label, double-gang faceplate. Application code: FP.			0.40	10.2	1000	5000
C379X030YPT	White, adhesive polyester label, 6-port identifier. Application code: FP.	3.79	96.3	0.30	7.6	2500	10000
C379X030YPT-P*	White, adhesive polyester label, perforated port identifier. Application codes: BX, FP, and PP.						
C390X030Y1T	White, non-adhesive polyester label, 6-port identifier. Application code: PP.	3.90	99.1			1000	5000
C750X050Y1T	White, non-adhesive polyester label, 110 block identifier. Application code: PB.	7.50	190.5	0.50	12.7		

*Label is perforated to be used in 1, 2, 3, or 4-position applications.
Order number of pieces required in multiples of Standard Package Quantity.
Labels roll mounted on 3.00" cores; when using the TDP43ME printer and 3.00" cores, the roll stand (TDP43ME-RS) is required.

Thermal Transfer Raised Panel Labels



- Raised thermal transfer printable surface with high-tack adhesive for strong holding power
- Variety of sizes and colors for a wide range of applications
- Thermal transfer print technology provides crisp, clear, and durable text
- Use with Panduit™ thermal transfer resin ribbons
- Temperature range: -40°F to 212°F (-40°C to 100°C)

Part Number	Part Description	Width		Height		Std. Pkg. Qty.	Std. Ctn. Qty.
		In.	mm	In.	mm		
C252X030APT	White, raised panel component label; for use on patch panels and faceplates.	2.52	64.0	0.30	7.6	500	2000
C252X030A0T	Black, raised panel component label; for use on patch panels and faceplates.						
C379X030APT	White, raised panel component label; for use on patch panels and faceplates.	3.79	96.3				
C379X030A0T	Black, raised panel component label; for use on patch panels and faceplates.						

Order number of labels required in multiples of Standard Package Quantity.

Thermal Transfer Self-Laminating Labels



- Self-laminating labels supplied on rolls, include a colored print-on area and clear overlaminates to protect the legend for clear and durable identification
- Use with Panduit™ Thermal Transfer Hybrid Ribbons
- Temperature Range: -40°F to 150°F (-40°C to 66°C)

Part Number	Part Description	Width		Length		Print-On Area Height		Min. Cable O.D.		Max Cable O.D.		Std. Pkg. Qty.	Std. Ctn. Qty.		
		In.	mm	In.	mm	In.	mm	In.	mm	In.	mm				
S100X075VATY*	White print-on area, vinyl label for 18 – 14 AWG and Category 6 28 AWG wires.	1.00	25.4	0.75	19.1	0.25	6.4	0.08	2.0	0.16	4.0	5000	10000		
S100X125VATY*	White print-on area, vinyl label for 12 – 10 AWG wires, Category 3 UTP cable.			1.25	31.8	0.38	9.7	0.12	3.1	0.28	7.0				
S100X150VATY**	White print-on area, vinyl label for Category 5e/Category 6/Category 6A UTP/Category 5e FTP cable.			1.50	38.1	0.50	12.7	0.16	4.0	0.32	8.1				
S100X225VATY**	White print-on area, vinyl label for 8 – 4 AWG wires, Category 6A UTP, FTP/ Category 6 FTP cable.			2.25	57.2	0.75	19.1	0.24	6.1	0.48	12.1				
S100X400VATY*	White print-on area, vinyl label for 2 – 1 AWG wires.			4.00	101.6	1.00	25.4	0.32	8.1	0.95	24.1			2500	12500
S100X650VATY*	White print-on area, vinyl label for 1/0 – 250 MCM wires.			6.50	165.1	1.50	38.1	0.48	12.1	1.59	40.4			1000	2000
S150X150VATY	White print-on area, vinyl label for Category 5e/6/6A UTP/ Category 5e FTP cable.	1.50	38.1	1.50	38.1	0.50	12.7	0.16	4.0	0.32	8.1	5000	20000		
S150X225VATY	White print-on area, vinyl label for 8 – 4 AWG wires, Category 6A UTP, FTP/ Category 6 FTP cable.			2.25	57.2	0.75	19.1	0.24	6.1	0.48	12.1				
S150X400VATY	White print-on area, vinyl label for 2 – 1 AWG wires.			4.00	101.6	1.00	25.4	0.32	8.1	0.95	24.1			2500	10000
S200X150VATY	White print-on area, vinyl label for Category 5e/ 6/ 6A UTP/Category 5e FTP cable.	2.00	50.8	1.50	38.1	0.50	12.7	0.16	4.0	0.32	8.1	5000	20000		
S200X225VATY*	White print-on area, vinyl label for 8 – 4 AWG wire, for Category 6A UTP, FTP/ Category 6 FTP cable.			2.25	57.2	0.75	19.1	0.24	6.1	0.48	12.1			4000	
S200X400VATY*	White print-on area, vinyl label for 2 – 1 AWG wires.			4.00	101.6	1.00	25.4	0.32	8.1	0.95	24.1			1000	3000
S200X650VATY*	White print-on area, vinyl label for 1/0 – 250 MCM wires.			6.50	165.1	1.50	38.1	0.48	12.1	1.59	40.4			2000	

Order number of labels required in multiples of Standard Package Quantity.

Labels are roll mounted on 3.00" cores; when using the TDP43ME printer and 3.00" cores, the roll stand (TDP43ME-RS) is required.

*For labels mounted on 1.00" cores, replace suffix TY with 1Y.

+ Other colors available, change VATY ending to: VBTY (TIA Blue), VCTY (TIA Brown), VDTY (TIA Green), VETY (TIA Gray), VFTY (TIA Orange), VGTY (TIA Purple), VHTY (TIA Red), VITY (TIA Yellow), VOTY (Black), V9TY (Gold).

A. Featured Products

B. Copper Systems

C. Fiber Systems

D. Faceplates, Frames & Surface Mount Boxes

E. Industrial Networks

F. Audio Video Systems

G. Keystone Cabling Systems

H. Zone Cabling

J. Cable Routing Systems

K. Cable Cleats

L. Cabinets & Rack Systems

M. Power & Connectivity Management

N. Grounding & Bonding

O. Identification Products

P. Cable Management Accessories

Q. Part Number Index

- A. Featured Products
- B. Copper Systems
- C. Fiber Systems
- D. Faceplates, Frames & Surface Mount Boxes
- E. Industrial Networks
- F. Audio Video Systems
- G. Keystone Cabling Systems
- H. Zone Cabling
- J. Cable Routing Systems
- K. Cable Cleats
- L. Cabinets & Rack Systems
- M. Power & Connectivity Management
- N. Grounding & Bonding
- O. Identification Products
- P. Cable Management Accessories
- Q. Part Number Index

Thermal Transfer Turn-Tell™ Labels



- Innovative label design allows labels to rotate for visibility from any angle and for repositioning on the wire/cable to align legends and improve aesthetics
- Labels can be easily installed on existing terminated wires and assemblies without disconnecting the wires/cables
- Available in P1™ Label Cassettes for the LS8E or LS8EQ printers and in computer printable rolls, for use with Easy-Mark™ Labeling Software and desktop thermal transfer printers
- Temperature range: -40°F to 150°F (-40°C to 65.6°C)

Part Number	Part Description	Width		Length		Print-On Area Height		Min. Cable O.D.		Max. Cable O.D.		Std. Pkg. Qty.	Std. Ctn. Qty.
		In.	mm	In.	mm	In.	mm	In.	mm	In.	mm		
R100X075V1T	Thermal Transfer, Vinyl, 1.00" W x 0.75" H, 0.25" POA, Clear/White, 3" Core, 18 – 14 AWG and Category 6 28 AWG wire/cable.	1.00	25.4	0.75	19.1	0.25	6.4	0.12	3.1	0.16	4.1	2500	10000
R100X125V1T	Thermal Transfer, Vinyl, 1.00" W x 1.25" H, 0.38" POA, Clear/White, 3" Core, 12 – 10 AWG wire/cable, Category 3 UTP cable.			1.25	31.8	0.38	9.7	0.16	4.1	0.22	5.6		
R100X150V1T*	Thermal Transfer, Vinyl, 1.00" W x 1.50" H, 0.50" POA, Clear/White, 3" Core, Category 5e/6/6A UTP/Category 5e FTP cable.			1.50	38.1	0.50	12.7	0.22	5.6	0.28	7.1		
R100X225V1T*	Thermal Transfer Vinyl, 1.00" W x 2.25" H, 0.75" POA, Clear/White, 3" Core, 8 – 4 AWG wire/cable, Category 6A UTP, FTP/Category 6 FTP cable.			2.25	57.2	0.75	19.1	0.28	7.1	0.39	9.9		
R100X400V1T	Thermal Transfer, Vinyl, 1.00" W x 4.00" H, 1.00" POA, Clear/White, 3" Core, 2 AWG – 250 MCM wire/cable.			4.00	101.6	1.00	25.4	0.39	9.9	0.95	24.1		
R200X150V1T	Thermal Transfer, Vinyl, 2.00" W x 1.50" H, 0.50" POA, Clear/White, 3" Core, Category 5e/6/6A UTP/Category 5e FTP cable. 5/5e/6 cable.	2.00	50.8	1.50	38.1	0.50	12.7	0.22	5.6	0.28	7.1	1000	4000
R200X225V1T	Thermal Transfer, Vinyl, 2.00" W x 2.25" H, 0.75" POA, Clear/White, 3" Core, 8 – 4 AWG wire/cable, Category 6A UTP, FTP/Category 6 FTP cable.			2.25	57.2	0.75	1.91	0.28	7.1	0.39	9.9		
R200X400V1T	Thermal Transfer, Vinyl, 2.00" W x 4.00" H, 1.00" POA, Clear/White, 3" Core, 2 AWG – 250 MCM wire/cable.			4.00	101.6	1.00	25.4	0.39	9.9	0.95	24.1		

Order number of labels required in multiples of Standard Package Quantity.
 *Other colors available, change V1T ending to: V2T (TIA Blue), V3T (TIA Green), V4T (TIA Gray), V7T (TIA Red), V8T (TIA Yellow).

LabelCore™ Fiber Optic Cable Identification System



- Provides a larger surface on small fiber cables and allows legends to be clearly seen
- Sleeves are made of flexible PVC material
- Locate sleeve on straight section of cable at least 2 inches from fiber boot

Part Number	Part Description	Std. Pkg. Qty.	Std. Ctn. Qty.
NWSLC-2Y	Yellow cable identification sleeve for 2mm simplex fiber cable, 1" long: S100X160YAJ or S100X150YAJ (Laser/Inkjet), S100X160VAC or S100X150VAC (LS8E Hand-Held Printer), S100X150VA1Y or S100X150VATY (Thermal Transfer Printer).	100	1000
NWSLC-2Y-AQ	Aqua cable identification sleeve for 2mm simplex cable, 1" long: S100X160YAJ or S100X150YAJ (Laser/Inkjet); S100X160VAC or S100X150VAC (LS8E Hand-Held Printer); S100X150VA1Y or S100X150VATY (Thermal Transfer Printer).		
NWSLC-3Y	Orange cable identification sleeve for 3mm simplex cable, 1" inch long: S100X160YAJ or S100X150YAJ (Laser/Inkjet); S100X160VAC or S100X150VAC (LS8E Hand-Held Printer); S100X150VA1Y or S100X150VATY (Thermal Transfer Printer).		
NWSLC-7Y	White cable identification sleeve for 3mm duplex fiber cable, 1" long: S100X225YAJ (Laser/Inkjet); S100X225VAC (LS8E Hand-Held Printer); S100X225VA1Y or S100X225VATY (Thermal Transfer Printer).		
NWSLC2-2Y	Yellow cable identification sleeve for 2mm simplex cable, 2" long: S200X150YAJ (Laser/Inkjet) or S200X150VATY (Thermal Transfer Printer).		
NWSLC2-2Y-AQ	Aqua cable identification sleeve for 2mm simplex cable, 2" long, use with labels: S200X150YAJ (Laser/Inkjet) or S200X150VATY (Thermal Transfer Printer).		
NWSLC2-3Y	Orange cable identification sleeve for 3mm simplex cable, 2" long, use with labels: S200X150YAJ (Laser/Inkjet) or S200X150VATY (Thermal Transfer Printer).		
NWSLC2-7Y	White cable identification sleeve for 3mm duplex fiber cable, 2" long, use with labels: S200X225YAJ (Laser/Inkjet); S200X225VATY (Thermal Transfer Printer).		

Order number of labels required in multiples of Standard Package Quantity.

Thermal Transfer Marker Plates



- Non-adhesive marker plates offer crisp, clear legends with superior legibility
- Attachable in a horizontal or vertical orientation
- Available in a variety of colors and sizes
- Use with Panduit™ RMER4BL resin thermal transfer ribbon, found on O.9
- Temperature range: -58°F to 221°F (-50°C to 105°C)

Part Number	Color (Code)							Width In. (mm)	Height In. (mm)	Print-On Area In. (mm)	Labels Per Roll	Std. Pkg. Qty.
	Yellow	White	Blue	Green	Gray	Orange	Red					
M200X050*	Y6T	Y7T	ACT	AET	AFT	AGT	AIT	2.00 (50.8)	0.50 (12.7)	1.07 (27.2)	500	1 Roll
M200X100*									1.00 (25.4)	0.80 (20.3)		
M300X050*									0.50 (12.7)	1.80 (45.7)		
M300X100*									1.00 (25.4)	1.80 (45.7)		

Replace the asterisk in part numbers above with the desired color code.
Order number of labels required in multiples of Standard Package Quantity.

- A. Featured Products
- B. Copper Systems
- C. Fiber Systems
- D. Faceplates, Frames & Surface Mount Boxes
- E. Industrial Networks
- F. Audio Video Systems
- G. Keystone Cabling Systems
- H. Zone Cabling
- J. Cable Routing Systems
- K. Cable Cleats
- L. Cabinets & Rack Systems
- M. Power & Connectivity Management
- N. Grounding & Bonding
- O. Identification Products
- P. Cable Management Accessories
- Q. Part Number Index

A.
Featured
Products

B.
Copper
Systems

C.
Fiber
Systems

D.
Faceplates,
Frames &
Surface
Mount Boxes

E.
Industrial
Networks

F.
Audio
Video
Systems

G.
Keystone
Cabling
Systems

H.
Zone
Cabling

J.
Cable
Routing
Systems

K.
Cable
Cleats

L.
Cabinets
& Rack
Systems

M.
Power &
Connectivity
Management

N.
Grounding
& Bonding

O.
Identification
Products

P.
Cable
Management
Accessories

Q.
Part
Number
Index

Thermal Transfer Flag Labels



- Improved legibility and more information on small wires and cables provide clearer, more complete identification
- Innovative design allows the product to be applied as a permanent adhesive label or as a repositionable non-adhesive label
- Use with Panduit™ RMER4BL resin thermal transfer ribbon, found on O.9
- Temperature range: -40°F to 302°F (-40°C to 150°C)

Part Number	Color	Width		Height		Min. Cable O.D.		Max. Cable O.D.		Wire Range	Std. Pkg. Qty.	Std. Ctn. Qty.
		In.	mm	In.	mm	In.	mm	In.	mm			
F100X150AJT	White	1.00	25.4	1.50	38.1	0.12	3.1	0.20	5.1	12 – 10 AWG	2500	10000
F100X213AJT				2.13	54.1	0.32	8.1	0.38	9.7	3 – 2 AWG		
F100X300AJT				3.00	76.2	0.90	2.3	0.28	7.1	18 – 6 AWG		
F100X363AJT				3.63	92.2	0.20	5.1	0.46	11.7	8 – 1 AWG		

Order number of labels required in multiples of Standard Package Quantity.

Super-Tack Polyester Continuous Tapes

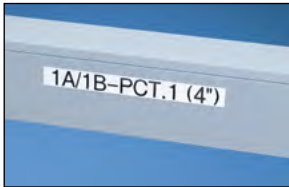

- Thermal transfer printable continuous tape format
- Super-tack polyester has ultra-aggressive adhesive
- Ideal for rough, textured, and coated surfaces
- Applications include rack unit labeling, cabinets, cable tray, pathways, control panels, enclosures, pipes, and much more
- Meets DIN 40050-9, IP69K for washdown applications
- Use thermal transfer resin ribbon
- Temperature range: -40°F to 302°F (-40°C to 150°C)
- UL969 recognized, File # MH14979, cUL recognized, C22.2 No. 0.15.01, File # MH14979

Part Number	Color	Material	Width		Length		Std. Pkg. Qty. (Roll)
			In.	mm	Ft.	m	
T038X000Y01	Black	Polyester	0.38	9.7	100.0	30.5	1
T038X000YP1	White						
T050X000Y01	Black						
T050X000YP1	White						
T100X000Y01	Black						
T100X000Y81	Yellow						
T100X000YP1	White						
T100X000YQ1	Blue						
T100X000YS1	Green						
T100X000YU1	Orange						
T100X000YW1	Red						
T200X000Y01	Black		2.00	50.8			
T200X000Y81	Yellow						
T200X000YP1	White						
T200X000YQ1	Blue						
T200X000YS1	Green		4.00	101.6			
T200X000YU1	Orange						
T200X000YW1	Red						
T400X000Y01	Black						
T400X000Y81	Yellow						
T400X000YP1	White						
T400X000YQ1	Blue						
T400X000YS1	Green						
T400X000YU1	Orange						
T400X000YW1	Red						

Laser/Ink Jet Component Labels



- Labels can be printed in both laser and ink jet printers
- Use for identifying patch panels, faceplates, punchdown blocks and other network systems hardware
- Die-cut labels designed to provide maximum aesthetic quality and appearance
- Available in adhesive polyolefin and non-adhesive polyester materials

Application Description	Typical Application Page	Code
Boxes – Surface Mount, Outlet, Hybrid	D.6	BX
Faceplates	D.1	FP
GP6™ PLUS Punchdown System	B.22 — B.24	GP
Jack Modules	B.7 — B.9	JM

Application Description	Typical Application Page	Code
110 Punchdown Blocks	B.22 — B.24	PB
Patch Panels	B.18 — B.21	PP
Racks and Cabinets	L.1	RK

Part Number	Part Description	Width		Height		Std. Pkg. Qty.	Std. Ctn. Qty.
		In.	mm	In.	mm		
C061X030FJJ	White, adhesive polyolefin label, 1-port identifier. Application codes: BX, FP, and PP.	0.61	15.5	0.30	7.6	5000	25000
C125X030FJJ	White, adhesive polyolefin label, 2-port identifier. Application codes: BX, FP, and PP.	1.25	31.8				
C138X019FJJ	White, adhesive polyolefin label, module identifier. Application code: JM.	1.38	35.1	0.19	4.8	2500	12500
C150X030Y1J	White, non-adhesive polyester label, 3-port identifier. Application code: FP.	1.50	38.1	0.30	7.6	1000	5000
C188X030FJJ	White, adhesive polyolefin label, 3-port identifier. Application code: FP.	1.88	47.8				
C195X040Y1J	White, non-adhesive polyester label, single-gang faceplate. Application code: FP.	1.95	49.5	0.40	10.2	1000	5000
C200X100FJJ	White, adhesive polyolefin label, SLCT bundle marker identifier. Application codes: SL and RK.	2.00	50.8	1.00	25.4		
C252X030FJJ	White, adhesive polyolefin label, 4-port identifier. Application codes: BX, FP, and PP.	2.52	64.0	0.30	7.6	1000	5000
C252X030FRJ	Brown, non-adhesive polyester label, 4-port identifier. Application codes: BX, FP, and PP.						
C252X030FTJ	Gray, non-adhesive polyester label, 4-port identifier. Application codes: BX, FP, and PP.	2.61	66.3	0.35	8.9	1000	5000
C261X030FJJ	White, adhesive polyolefin label, 4-port identifier. Application codes: FP and PP.						
C261X035Y1J	White, non-adhesive polyester label, 4-port identifier. Application codes: FP and PP.	2.82	71.6	0.30	7.6	1000	5000
C282X030Y1J	White, non-adhesive polyester label, 4-port identifier. Application codes: FP and PP.						
C288X040Y1J	White, non-adhesive polyester label, double-gang faceplate. Application code: FP.	2.88	73.2	0.40	10.2	1000	5000
C315X030FJJ	White, adhesive polyolefin label, 5-port identifier. Application code: FP.	3.15	80.0	0.30	7.6		
C379X030FJJ	White, adhesive polyolefin label, 6-port identifier. Application code: FP.	3.79	96.3				
C390X030Y1J	White, non-adhesive polyester label, 6-port identifier. Application code: PP.	3.90	99.1	0.50	12.7	500	2500
C750X050Y1J	White, non-adhesive polyester label, 110 block identifier. Application code: PB.	7.50	190.5				
C788X050Y1J	White, non-adhesive polyester label, GP6™ PLUS Punchdown System identifier. Application code: GP.	7.88	200.2	0.50	12.7	500	2500

Order number of labels required in multiples of Standard Package Quantity.

A. Featured Products

B. Copper Systems

C. Fiber Systems

D. Faceplates, Frames & Surface Mount Boxes

E. Industrial Networks

F. Audio Video Systems

G. Keystone Cabling Systems

H. Zone Cabling

J. Cable Routing Systems

K. Cable Cleats

L. Cabinets & Rack Systems

M. Power & Connectivity Management

N. Grounding & Bonding

O. Identification Products

P. Cable Management Accessories

Q. Part Number Index

A.
Featured
Products

B.
Copper
Systems

C.
Fiber
Systems

D.
Faceplates,
Frames &
Surface
Mount Boxes

E.
Industrial
Networks

F.
Audio
Video
Systems

G.
Keystone
Cabling
Systems

H.
Zone
Cabling

J.
Cable
Routing
Systems

K.
Cable
Cleats

L.
Cabinets
& Rack
Systems

M.
Power &
Connectivity
Management

N.
Grounding
& Bonding

O.
Identification
Products

P.
Cable
Management
Accessories

Q.
Part
Number
Index

Laser/Ink Jet Self-Laminating Labels



- Labels can be printed in both laser and ink jet printers
- Self-laminating adhesive labels include a colored print-on area and clear overlamine
- Temperature range: -65°F to 225°F (-54°C to 107°C)

Part Number	Part Description	Width		Length		Print-On Area Height		Min. Cable O.D.		Max. Cable O.D.		Std. Pkg. Qty.	Std. Ctn. Qty.
		In.	mm	In.	mm	In.	mm	In.	mm	In.	mm		
S100X075YAJ	White print-on area, polyester label for 18 – 14 AWG and Category 6 28 AWG wire.	1.00	25.4	0.75	19.1	0.25	6.4	0.08	2.0	0.16	4.1	2500	10000
S100X125YAJ	White print-on area, polyester label for 12 – 10 AWG wire, Category 3 UTP cable.			1.25	31.8	0.38	9.7	0.12	3.1	0.28	7.0		
S100X150YAJ+	White print-on area, polyester label for Category 5e/Category 6/Category 6A UTP/Category 5e FTP cable.			1.50	38.1	0.50	12.7	0.16	4.1	0.32	8.1		
S100X160YAJ	White print-on area, polyester label. For use with LabelCore™ Sleeves NWSLC-2Y and NWSLC-3Y.			1.60	40.6	0.80	20.3	0.25	6.4	0.25	6.4	1000	5000
S100X220YAJ	White print-on area, polyester label. For use with LabelCore™ Sleeves NWSLC-7Y.			2.20	55.9	1.10	27.9	0.35	8.9	0.35	8.9		
S100X225YAJ+	White print-on area, polyester label for 8 – 4 AWG wire, Category 6A UTP, FTP/Category 6 FTP cable.			2.25	57.2	0.75	19.1	0.24	6.1	0.48	12.1		
S100X400YAJ	White print-on area, polyester label for 2 – 1 AWG wire.			4.00	101.6	1.00	25.4	0.32	8.1	0.95	24.3		
S100X650YAJ	White print-on area, polyester label for 1/0 – 350 MCM wire.			6.50	165.1	1.50	38.1	0.48	12.1	1.59	40.4		

Order number of labels required in multiples of Standard Package Quantity.

+Other colors available, change VATY ending to: YBJ (TIA Blue), YCJ (TIA Brown), YDJ (TIA Green), YEJ (TIA Gray), YFJ (TIA Orange), YGJ (TIA Purple), YHJ (TIA Red), YIJ (TIA Yellow).

Laser Ink Jet Turn-Tell™ Labels

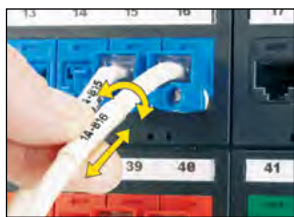

- Labels rotate and slide along cables after installation for visibility from any angle and allow repositioning on the wire/cable to align legends for improved aesthetics
- Ideal for use in high-density or space-constrained cable applications
- Eliminate the need to disconnect wire or replace label in the event of re-termination
- Temperature range: -0°F to 275°F (-18°C to 135°C)

Part Number	Print-On Area Color	Width		Length		Print-On Area Height		Min. Cable O.D.		Max. Cable O.D.		Wire/Cable Size Range	Labels Per Row	Labels Per Sheet	Std. Pkg. Qty.	
		In.	mm	In.	mm	In.	mm	In.	mm	In.	mm					
R050X075X1J	White	0.50	12.7	0.75	19.1	0.25	6.4	0.12	3.1	0.16	4.1	18 – 14 AWG and Category 6 28 AWG	12	84	5000	
R050X125X1J				1.25	31.8	0.38	9.7	0.16	4.1	0.22	5.6	Category 3 UTP/ 12 – 10 AWG		60		
R050X150X1J				12.5	1.50	38.1	0.50	12.7	0.22	5.6	0.28	7.1		Category 5e UTP/ Category 6 UTP/ Category 6A UTP/ Category 5e FTP/ 10 – 6 AWG		48
R100X075X1J		1.00	25.4	0.75	19.1	0.25	6.4	0.12	3.1	0.16	4.1	18 – 14 AWG and Category 6. 28 AWG	6	42		2500
R100X125X1J				1.25	31.8	0.38	9.7	0.16	4.1	0.22	5.6	Category 3 UTP/ 12 – 10 AWG		30		
R100X150X1J*				1.50	38.1	0.50	12.7	0.22	5.6	0.28	7.1	Category 5e UTP/ Category 6 UTP/ Category 6A UTP/ Category 5e FTP/ 10 – 6 AWG		24		
R100X225X1J*				2.25	57.2	0.75	19.1	0.28	7.1	0.39	9.9	Category 6 FTP/ Category 6A UTP/ Category 6A FTP/ 8 – 4 AWG		18		
R100X400X1J				4.00	101.6	1.00	25.4	0.39	9.9	0.95	24.1	2 – 1 AWG		12		
R150X150X1J				1.50	38.1					5.6				Category 5e UTP/ Category 6 UTP/ Category 6A UTP/ Category 5e FTP/ 10 – 6 AWG		
R200X150X1J		2.00	50.8	1.50	38.1	0.50	12.7	0.22	5.56	0.28	7.1	Category 5e UTP/ Category 6A UTP/ Category 5e FTP/ 10 – 6 AWG	3	12		500
R200X225X1J				2.25	57.2	0.75	19.1	0.28	7.1	0.39	9.9	Category 6 FTP/ Category 6A UTP/ Category 6A FTP/ 8 – 4 AWG		9		
R200X400X1J				4.00	101.6	1.00	25.4	0.39	9.9	0.95	24.1	2 – 1 AWG		6		

Order number of labels required in multiples of Standard Package Quantity.

*Other colors available, change X1J ending to: X2J (TIA Blue), X3J (TIA Green), X7J (TIA Red), X8J (TIA Yellow).

A. Featured Products

B. Copper Systems

C. Fiber Systems

D. Faceplates, Frames & Surface Mount Boxes

E. Industrial Networks

F. Audio Video Systems

G. Keystone Cabling Systems

H. Zone Cabling

J. Cable Routing Systems

K. Cable Cleats

L. Cabinets & Rack Systems

M. Power & Connectivity Management

N. Grounding & Bonding

O. Identification Products

P. Cable Management Accessories

Q. Part Number Index

A.
Featured
Products

Self-Laminating Fiber Optic Cable Marker Tags

B.
Copper
Systems



Material Chart

Material	Print Method	Temperature Range	Features
Rigid Vinyl, Self-Laminating	Pre-Printed	50°F to 200°F (-45.6°C to 93.3°C)	Indoor/outdoor rated; high quality, rugged material resistant to abrasion; legend is protected by overlamine; use where adhesives will not work.

C.
Fiber
Systems

D.
Faceplates,
Frames &
Surface
Mount Boxes

Part Number	Legend	Color (Legend/Background)	Width		Height		Tags Per Pkg.	Std. Pkg. Qty.	Std. Ctn. Qty.
			In.	mm	In.	mm			
PST-FO	CAUTION FIBER OPTIC CABLE TYPE _____ COUNT _____	Black/Yellow	3.50	88.9	2.00	50.8	5	1	40
PST-FOBLNK	BLANK	Yellow							

E.
Industrial
Networks

F.
Audio
Video
Systems

Voltage and Fiber Optic Snap-On Markers (Non-Adhesive)

G.
Keystone
Cabling
Systems



Style	Width		Height		Pipe/Conduit O.D. Range		Markers Per Card
	In.	mm	In.	mm	In.	mm	
M	14.00	355.6	23.00	584.2	2.25 – 6.00	57.2 – 152.4	1
R	8.00	203.2	8.00	230.2	0.75 – 2.25	19.1 – 57.2	

H.
Zone
Cabling

J.
Cable
Routing
Systems

Material Chart

Material	Print Method	Temperature Range	Features
Semi-Rigid Polyester	Pre-Printed	-20°F to 176°F (-29°C to 80°C)	Indoor/outdoor rated; pre-coiled material protects legend from abrasion and chemicals; resistant to UV light.

K.
Cable
Cleats

Part Number		Legend	Color (Legend/Background)	Std. Pkg. Qty.	Std. Ctn. Qty.
Style M	Style R				
—	PCV-480RY	480 Volts	Black/Orange	1	25
PCV-FOMY	PCV-FORY	Fiber Optic			

L.
Cabinets
& Rack
Systems

M.
Power &
Connectivity
Management

N.
Grounding
& Bonding

O.
Identification
Products

P.
Cable
Management
Accessories

Q.
Part
Number
Index

Table of Contents

Hook & Loop Cable Ties	P.2 – P.5
Elastomeric Cable Ties	P.6
Contour-Ty™ Cable Ties – Nylon 6.6.....	P.7
Cable Tie Mounts	P.8 – P.9
Adhesive Backed Cord Clips	P.10
Clincher™ Adjustable Releasable Clamp	P.10
Bevel Entry Clips	P.11
Wire Bundle Strap	P.11
Latching Wire Clips	P.12
Fixed Diameter Cable Clamps	P.13
Optical Fiber Network Saddles.....	P.14
J-Pro™ Cable Support System	P.15 – P.17



A.
Featured
Products

B.
Copper
Systems

C.
Fiber
Systems

D.
Faceplates,
Frames &
Surface
Mount Boxes

E.
Industrial
Networks

F.
Audio
Video
Systems

G.
Keystone
Cabling
Systems

H.
Zone
Cabling

J.
Cable
Routing
Systems

K.
Cable
Cleats

L.
Cabinets
& Rack
Systems

M.
Power &
Connectivity
Management

N.
Grounding
& Bonding

O.
Identification
Products

P.
Cable
Management
Accessories

Q.
Part
Number
Index

A. Featured Products

€ Tak-Ty™ Hook & Loop Cable Ties

B. Copper Systems

C. Fiber Systems

D. Faceplates, Frames & Surface Mount Boxes

E. Industrial Networks

F. Audio Video Systems

G. Keystone Cabling Systems

H. Zone Cabling

J. Cable Routing Systems

K. Cable Cleats

L. Cabinets & Rack Systems

M. Power & Connectivity Management

N. Grounding & Bonding

O. Identification Products

P. Cable Management Accessories

Q. Part Number Index

- Soft, premium material is safe to use on high performance network cables protecting against over-tensioning
- Broad selection of durable designs and sizes
- Adjustable, releasable, and re-usable hundreds of times – ideal for applications requiring frequent moves, adds, or changes
- Easy to use and operator safe with no sharp edges
- A full range of colors
- Operating temperature range: 0°F to 220°F (-18°C to 104°C)
- Complementary mounts available



HLT (Loop Ties)



HLB (Stacked Strips)



HLM/HLS (Rolls)

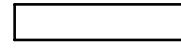
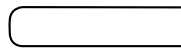

Part Number	Length		Width		Max. Bundle Dia.		Min. Loop Tensile Strength*		Std. Pkg. Qty.	Std. Ctn. Qty.
	In.	mm	In.	mm	In.	mm	Lbs.	N		

Loop Ties – Slot allows for pre-wrapping of bundles

HLT2I-X0	8.00	203.0	0.50	12.7	1.91	49.0	40	178	10	100
HLT3I-X0	12.00	305.0			3.18	81.0				
HLT2I-M0	8.00	203.0			1.91	49.0			1	1
HLT3I-M0	12.00	305.0			3.18	81.0				

Stacked Strip Ties – Eliminates cutting ties to length and staging them for each job Rounded edges for installer safety – 100 pieces

HLB2S-C0	7.00	178.0	0.75	19.1	1.60	41.0	50	222	1	10
----------	------	-------	------	------	------	------	----	-----	---	----

Part Number	Length		Width		Max. Bundle Dia.		Min. Loop Tensile Strength*		Std. Pkg. Qty.	Std. Ctn. Qty.
	Ft.	m	In.	mm	In.	mm	Lbs.	N		

15' and 75' Continuous Rolls – Can be cut to desired length, eliminating waste

HLM-15R0	15.0	4.6	0.33	8.4	Various	Various	18	80	1	10
HLS-15R0			0.75	19.1			50	222		
HLS-75R0			75.0	22.9						

For color options, reference hook and loop cable ties chart, see page P.5.
*Note: Minimum 2" overlap required to achieve loop tensile rating.



HLTP/HLSP Hook and Loop Cable Ties – Ceiling

- Soft, premium material is safe to use on high performance network cables protecting against over-tensioning
- UL Listed for use in ceiling or air handling spaces (such as ceiling voids and underfloor areas) per NEC, Section 300-22 (C) and (D)
- Material flammability rating: UL 94V-2
- Adjustable, releasable, and re-usable – ideal for applications requiring frequent moves, adds, or changes
- Operating temperature range: 0°F – 122°F (-18°C – 50°C)



Part Number	Length		Width		Max. Bundle Dia.		Min. Loop Tensile Str.*		Std. Pkg. Qty.	Std. Ctn. Qty.
	In.	m	In.	mm	In.	mm	Lbs.	N		

UL Listed Loop Ties (Maroon) – Slot allows for pre-wrapping of bundles

HLTP2I-X12	8.00	203.0	0.50	12.7	1.91	49.0	40	178	10	100
HLTP3I-X12	12.00	305.0			3.18	81.0				

UL Listed Loop Ties (Black) – Slot allows for pre-wrapping of bundles

HLTP2I-X0	8.00	203.0	0.50	12.7	1.91	49.0	40	178	10	100
HLTP3I-X0	12.00	305.0			3.18	81.0				

UL Listed Strip Ties (Maroon) – Perforated in convenient 6", 12", and 18" strips

HLSP1.5S-X12	6.00	152.0	0.75	19.1	1.50	38.0	50	222	10	100
HLSP3S-X12	12.00	305.0			3.20	81.0				
HLSP5S-X12	18.00	457.0			5.00	127.0				

UL Listed Strip Ties (Black) – Perforated in convenient 6", 12", and 18" strips

HLSP1.5S-X0	6.00	152.0	0.75	19.1	1.50	38.0	50	222	10	100
HLSP3S-X0	12.00	305.0			3.20	81.0				
HLSP5S-X0	18.00	457.0			5.00	127.0				

For color options, reference Hook & Loop cable ties chart, see page P.5.
*Note: Minimum 2" overlap required to achieve loop tensile rating.

CE Tak-Tape™ Hook & Loop Cable Tie Rolls

- Strong, low profile, flexible material is safe to use on high performance cabling protecting against over-tensioning
- Adjustable, releasable, and re-usable
- Cost-effective for general purpose bundling
- Continuous rolls can be easily cut to size – Panduit cutter included with TTR-35RX0
- Leaves no residue
- Available in black color
- Operating temperature range: 0°F – 220°F (-17°C – 104°C)
- Complementary mounts available, see page P.9



Part Number	Length		Width		Max. Bundle Dia.		Min. Loop Tensile Str.*		Std. Pkg. Qty.	Std. Ctn. Qty.
	Ft.	m	In.	mm	In.	mm	Lbs.	N		
TTR-20R0	20.0	6.1	0.75	19.1	Various	Various	40	178	1	10
TTR-35R3-0	35.0	10.7								8
TTR-35RX0										10

Standard Package Quantity for TTR-35R3-0 is 1 package of three 35' rolls, TTR-35RX0 is 1 package of ten 35' rolls.
For color options, reference Hook & Loop cable ties chart, see page P.5.
*Note: Minimum 2" overlap required to achieve loop tensile rating.

A. Featured Products

B. Copper Systems

C. Fiber Systems

D. Faceplates, Frames & Surface Mount Boxes

E. Industrial Networks

F. Audio Video Systems

G. Keystone Cabling Systems

H. Zone Cabling

J. Cable Routing Systems

K. Cable Cleats

L. Cabinets & Rack Systems

M. Power & Connectivity Management

N. Grounding & Bonding

O. Identification Products

P. Cable Management Accessories

Q. Part Number Index

A. Featured Products

B. Copper Systems

C. Fiber Systems

D. Faceplates, Frames & Surface Mount Boxes

E. Industrial Networks

F. Audio Video Systems

G. Keystone Cabling Systems

H. Zone Cabling

J. Cable Routing Systems

K. Cable Cleats

L. Cabinets & Rack Systems

M. Power & Connectivity Management

N. Grounding & Bonding

O. Identification Products

P. Cable Management Accessories

Q. Part Number Index

Ultra-Cinch™ Hook & Loop Cable Ties

- Unique material with hooks and loops on same side allows user to secure a greater range of bundle diameters, including smaller bundles
- Soft, premium material is safe to use on high performance cabling, protecting against over-tensioning
- Adjustable, releasable, and re-usable – ideal for applications requiring frequent moves, adds, or changes
- Low profile contoured cinch ring provides extra strength and bundle tightness while reducing overall bundle size
- Grommet (UGCTC and UGCTE styles) offers strength and assures reliable installations that resist pullout when bundling and mounting cables within cabinet applications
- Tapered tip facilitates easy, snag-free threading to speed installation
- Use flat head screws for grommet applications shown below
- A full range of colors
- Operating temperature range: 0°F – 140°F (-18°C – 60°C)



Part Number	Length		Width		Max. Bundle Dia.		Min. Loop Tensile Str.*		Std. Pkg. Qty.	Std. Ctn. Qty.
	In.	m	In.	mm	In.	mm	Lbs.	N		

Part Number	In.	m	In.	mm	In.	mm	Lbs.	N	Std. Pkg. Qty.	Std. Ctn. Qty.
UCT3S-X0	12.00	305.0	0.85	21.6	3.00	76.0	50	222	10	100
UCT5S-X0	18.00	457.0			5.00	127.0				

Part Number	In.	m	In.	mm	In.	mm	Lbs.	N	Std. Pkg. Qty.	Std. Ctn. Qty.
UGCTC3S-X0	12.00	305.0	0.85	21.6	3.00	76.0	50	222	10	100
UGCTE3S-X0	12.00	305.0			3.00	76.0				

Note: 1/4" (6mm) diameter mounting hole on grommet style cinch ties.
 For color options, reference Hook & Loop cable ties chart, see page P.5.
 *Note: Minimum 2" overlap required to achieve loop tensile rating.

Cable Bundle Organizing Tool

- Reduces cable installation time compared to traditional methods
- Arranges 24 cables prior to applying Panduit™ Tak-Ty™ Hook & Loop Cable Ties
- Optimizes bundle size and improves installed appearance
- Two inserts handle multiple network cable diameters
- Ergonomic fit and compact design
- Impact resistant material and low friction design to glide smoothly across cable bundle



Part Number	Description	Insert Color	Cable Diameter Range		Std. Pkg. Qty.	Std. Ctn. Qty.
			In.	mm		
CBOT24K	Kit contains jacket cover with hook and loop fastener and two inserts.	Fluorescent Green	0.18 – 0.25	4.6 – 6.3	1	10
		Fluorescent Yellow	0.23 – 0.31	5.8 – 7.9		



Part Number System for Tak-Ty™ Hook & Loop Cable Ties

HLT	2	I	—	X	0
Type	Size	Cross Section		Package Size	Color
HL = Hook and Loop HLB = Hook and Loop Stacked Strip HLM = HL Miniature HLT = HL Loop Tie HLTP = HL Loop Tie Ceiling-Rated HLS = HL Strip Tie HLSP = HL Strip Tie Ceiling-Rated TTR = Tak-Tape™ Roll HLTT = Hook and Loop with non-slip applicator	Approx. Maximum Bundle Dia. (In.)	M = Miniature I = Intermediate S = Standard		X = 10 Q = 25 C = 100 M = 1000 15R = 15' Roll 20R = 20' Roll 35R3 = 35' Rolls (3) 35RX = 35' Rolls (10) 75R = 75' Roll	See chart below

Part Number System for Ultra-Cinch™ Hook & Loop Cable Ties

UGCT	E	3	S	—	X	0
Type	Mount	Size	Cross Section		Package Size	Color
UCT = Cinch Tie UGCT = Grommet Cinch Tie	E = End Mount C = Center Mount	Approx. Maximum Bundle Dia. (In.)	I = Intermediate S = Standard		X = 10	See chart below

Color Chart

Color	Panduit Suffix	Color	Panduit Suffix
Black	0	White	10
Red	2	Maroon	12
Yellow	4	Lime Green	15
Blue	6	Aqua	16
Erika Violet	7	Black (indoor)	20

Part Number Availability List

Standard Packaging			
Part Number	Color	Part Number	Color
HLB2S-C	0,2,4,6,7,10,15,16	HLTP3I-X	0,12
HLM-15R		HLTT1.5S-C	20
HLS-15R		HLTT1.5S-Q	
HLS-75R		TTR-20R	0
HLSP1.5S-X	TTR-35RX		
HLSP3S-X	TTR-35R3		
HLSP5S-X	0,12	UCT3S-X	0
		UCT5S-X	
		UGCTC3S-X	
		UGCTC5S-X	
HLT2I-X	0,2,4,6,7,10,15,16	UGCTE3S-X	
HLT3I-X		UGCTE5S-X	
HLTP2I-X	0,12		

A. Featured Products

B. Copper Systems

C. Fiber Systems

D. Faceplates, Frames & Surface Mount Boxes

E. Industrial Networks

F. Audio Video Systems

G. Keystone Cabling Systems

H. Zone Cabling

J. Cable Routing Systems

K. Cable Cleats

L. Cabinets & Rack Systems

M. Power & Connectivity Management

N. Grounding & Bonding

O. Identification Products

P. Cable Management Accessories

Q. Part Number Index

- A. Featured Products
- B. Copper Systems
- C. Fiber Systems
- D. Faceplates, Frames & Surface Mount Boxes
- E. Industrial Networks
- F. Audio Video Systems
- G. Keystone Cabling Systems
- H. Zone Cabling
- J. Cable Routing Systems
- K. Cable Cleats
- L. Cabinets & Rack Systems
- M. Power & Connectivity Management
- N. Grounding & Bonding
- O. Identification Products
- P. Cable Management Accessories
- Q. Part Number Index

☞ Elastomeric Cable Ties

- Elastic material provides a flexible tie body that safely contours around cable bundle, preventing over-tensioning of data cables to maintain network integrity
- UL 94V-0 material provides greater flame resistance; meets stringent telecommunication flammability requirements (such as NEBS GR-63-CORE)
- Soft material has no sharp edges; protects the installer and the cable bundle
- High coefficient of friction grips and prevents lateral movement along cable bundle
- Releasable and re-usable to accommodate frequent moves, adds, and changes
- Halogen-free, non-toxic, and environmentally safe material will not release toxic or corrosive gases upon combustion
- Locking head design; the tapered tip threads into locking head to speed productivity; industry-accepted intuitive tie design



Part Number	Length		Width		Thickness		Max. Bundle Dia.		Min. Loop Tensile Str.		Recommended Installation Tool	Std. Pkg. Qty.	Std. Ctn. Qty.
	In.	mm	In.	mm	In.	mm	In.	mm	Lbs.	N			
ERT2M-C20	8.50	216.0	0.50	12.7	0.09	2.3	2.35	59.7	18	80	Hand install only	100	1000
ERT4.5M-C20	16.00	406.0					4.50	114					

Part Number System for Elastomeric Cable Ties

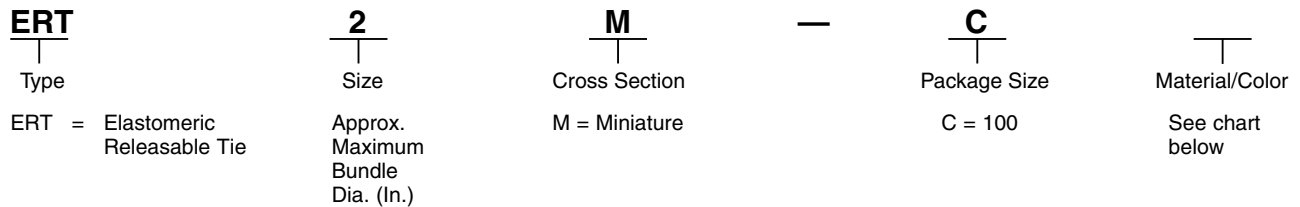

Material and Color Chart

Material	Color	Panduit Suffix
TPU	Black	20

UL LISTED CE SP US Contour-Ty™ Cable Ties – Nylon 6.6

- Unique design prevents wire and cable damage
- Low profile head avoids snags and reduces overall bundle size
- Outside teeth and smooth round edges protect cable jacket – ideal for high vibration applications

- Parallel-entry limits exposure to sharp edges and protects workers' arms/hands
- Fully enclosed head for consistent strength
- Curved tip is easy to pick up from flat surfaces and allows faster initial threading to speed installation
- UL Listed for use in ceiling or air handling spaces per NEC



Part Number	Length		Width		Thickness		Max. Bundle Dia.		Min. Loop Tensile Str.*		Recommended Installation Tool	Bulk Pkg. Qty.	Bulk Ctn. Qty.
	In.	mm	In.	mm	In.	mm	In.	mm	Lbs.	N			
Miniature Cross Section – Ceiling-Rated													
CBR1M-M	4.1	104	0.098	2.5	0.038	1.0	1.00	25	18	80	GTS-E, GS2B-E, PTS, PPTS, STS2	1000	50000
CBR1.5M-M	5.8	147			0.042	1.1	1.50	38					
CBR2M-M	7.3	185			2.00	51							
Intermediate Cross Section – Ceiling-Rated													
CBR1.5I-M	5.9	150	0.140	3.6	0.040	1.0	1.50	38	40	178	GTS-E, GS2B-E, PTS, PPTS, STS2	1000	25000
CBR3I-M	10.4	264			0.052	1.3	3.00	76					10000
CBR4I-M	13.6	345			3.60	102							
Standard Cross Section – Ceiling-Rated													
CBR2S-M	7.6	193	0.190	4.8	0.044	1.1	2.00	51	50	222	GTS-E, GTH-E, GS2B-E, GS4H-E, PTS, PTH, PPTS, STS2, STH2	1000	10000
CBR3S-M	10.8	274			0.052	1.3	3.00	76					5000
CBR4S-M	14.0	356			4.00	102							
Heavy-Standard Cross Section – Ceiling-Rated													
CBR2HS-D	8.0	203	0.250	6.4	0.058	1.4	2.00	51	85	378	GTH-E, GS4H-E, GS4EH-E, PTH, STH2, ST3EH	500	5000
Light-Heavy Cross Section – Ceiling-Rated													
CBR4LH-TL	14.6	371	0.300	7.6	0.070	1.8	7.60	102	120	534	GTH-E, GS4H-E, GS4EH-E, PTH, STH2, ST3EH	250	2500
CBR6LH-C	20.9	531					6.00	152				100	2000

A. Featured Products

B. Copper Systems

C. Fiber Systems

D. Faceplates, Frames & Surface Mount Boxes

E. Industrial Networks

F. Audio Video Systems

G. Keystone Cabling Systems

H. Zone Cabling

J. Cable Routing Systems

K. Cable Cleats

L. Cabinets & Rack Systems

M. Power & Connectivity Management

N. Grounding & Bonding

O. Identification Products

P. Cable Management Accessories

Q. Part Number Index

- A. Featured Products
- B. Copper Systems
- C. Fiber Systems
- D. Faceplates, Frames & Surface Mount Boxes
- E. Industrial Networks
- F. Audio Video Systems
- G. Keystone Cabling Systems
- H. Zone Cabling
- J. Cable Routing Systems
- K. Cable Cleats
- L. Cabinets & Rack Systems
- M. Power & Connectivity Management
- N. Grounding & Bonding
- O. Identification Products
- P. Cable Management Accessories
- Q. Part Number Index

Tak-Ty™ Hook & Loop Cable Tie Mounts

- For use with TTS Tak-Tape™ and HLT/HLS Tak-Ty™ Hook & Loop Cable Ties
- Unique cradle design provides maximum stability for cable bundle
- For indoor use only
- Dimensions: 1.12"L x 1.12"W x .34"H (28.4mm x 28.4mm x 8.6mm)



Part Number	Mounting Method	Material	Color	Std. Pkg. Qty.	Std. Ctn. Qty.
ABMT-A-C*	Pre-installed Rubber Adhesive	Nylon 6.6	Natural	100	1000
ABMT-A-C20*			Black		
ABMT-S6-C	#6 (M3) Screw		Natural		
ABMT-S6-C20			Black		
ABMT-S6-C69**		Flame Retardant Nylon 6.6	Natural		

*Maximum static load for adhesive backed mounts is .38 lbs. (174g).
 **Flame retardant products are manufactured from a material that is rated UL 94V-0.

4-Way Adhesive Backed Cable Tie Mounts

- Allow cable tie entry from all four sides
- Available in multiple sizes to match application load requirements
- Produced 2-up and with tear tabs for fast and easy liner removal to speed installation
- Rubber-based adhesive provides a strong and reliable bond
- For indoor use only



Part Number	Used With Cable Ties	Length		Width		Material	Color	Std. Pkg. Qty.	Std. Ctn. Qty.
		In.	mm	In.	mm				
ABM1M-A-C	M	.50	12.7	.50	12.7	Nylon 6.6	White	100	500
ABMM-A-C	M, I	.75	19.1	.75	19.1	ABS			
ABMM-A-C20									
ABM2S-A-C	M, I, S	1.00	25.4	1.00	25.4	White			
ABM2S-A-C14						Gray			
ABM2S-A-C15						Ivory			
ABM2S-A-C20						Black			
ABM100-A-C	M, I, S	1.12	28.6	1.12	28.6	Nylon 6.6	White	100	500
ABM100-A-C15						Ivory			
ABM100-A-D20	M, I, S, HS, LH, H, HLM	1.50	38.1	1.50	38.1	Nylon 6.6	Black	50	500
ABM112-A-C							White		
ABM112-A-D20							Black		
ABM3H-A-L	M, I, S, HS, LH, H, HLM	2.00	50.8	2.00	50.8	Nylon 6.6	White	50	500
ABM3H-A-L20							Black		
ABM4H-A-L							White		

Cable Tie Cross Sections: M = Miniature, I = Intermediate, S = Standard, HS = Heavy-Standard, LH = Light-Heavy, H = Heavy, HLM = Miniature Tak-Ty™ Hook & Loop Cable Ties.

Cable Tie Mounts



- Unique cradle design provides maximum stability for the cable bundle
- Low profile design keeps bundle close to mounting surface

- Material: Nylon 6.6 or as specified below

Part Number	Used With Cable Ties	Length		Width		Height		Color	Mounting Method	Std. Pkg. Qty.	Std. Ctn. Qty.
		In.	mm	In.	mm	In.	mm				
TM1S4-C	M	.51	13.0	.32	8.0	.23	5.8	Natural	#4 (M2.5) screw	100	500
TM1S4-C0*								Black			
TM1S6-C								Natural	#6 (M3) screw		
TM1S6-C0*								Black			
TM2S6-C	M, I, S	.63	16.0	.43	10.8	.28	7.0	Natural	#6 (M3) screw		
TM2S6-C0*								Black			
TM2S8-C								Natural	#8 (M4) screw		
TM2S8-C0*								Black			
TM3S8-C	M, I, S, LH	.86	21.9	.61	15.5	.37	9.4	Natural	#8 (M4) screw		
TM3S8-C0*								Black			
TM3S10-C								Natural	#10 (M5) screw		
TM3S10-C0*								Black			
TM3S25-C								Natural	1/4" (M6) screw		
TM3S25-C0*								Black			

*Material: Weather Resistant Nylon 6.6.

Cable Tie Cross Sections: M = Miniature, I = Intermediate, S = Standard, LH = Light-Heavy.

Extra-Heavy Cable Tie Mounts

- Unique cradle design provides maximum stability for cable bundle
- Route and support large diameter and heavy cable bundles

- Dimensions are 1.62"L x 0.72"W x .61"H (41.4mm x 18.8mm x 15.5mm)*
- Weather resistant material for indoor/outdoor use



Part Number	Used With Cable Ties	Material	Mounting Method	Std. Pkg. Qty.	Std. Ctn. Qty.
TMEH-S8-Q0	I, S, H, EH	Weather Resistant Nylon 6.6	#8 (M4) Screw	25	250
TMEH-S10-Q0					
TMEH-S10-C100		Weather Resistant Polypropylene	#10 (M5) Screw	100	500
TMEH-S10-C109					
TMEH-S25-Q0		Weather Resistant Nylon 6.6	1/4" (M6) Screw	25	250

All product color is Black.

*Polypropylene parts (TMEH-S10-C100, TMEH-S10-C109) have an overall length of 1.65" (41.9mm).

Cable Tie Cross Sections: I = Intermediate, S = Standard, H = Heavy, EH = Extra Heavy.

- A. Featured Products
- B. Copper Systems
- C. Fiber Systems
- D. Faceplates, Frames & Surface Mount Boxes
- E. Industrial Networks
- F. Audio Video Systems
- G. Keystone Cabling Systems
- H. Zone Cabling
- J. Cable Routing Systems
- K. Cable Cleats
- L. Cabinets & Rack Systems
- M. Power & Connectivity Management
- N. Grounding & Bonding
- O. Identification Products
- P. Cable Management Accessories
- Q. Part Number Index

Adhesive Backed Cord Clips

- Cables are easily snapped into or out of the clips
- Rubber-based adhesive (-A) provides a strong and reliable bond
- Acrylic-based adhesive (-AV) is VHB adhesive suitable for demanding applications
- For indoor use only
- Material: Nylon 6.6; Parts with suffix (M300) are Heat Stabilized Nylon 6.6



Part Number	Max. Bundle Diameter		Length		Width		Height		Color	Std. Pkg. Qty.	Std. Ctn. Qty.
	In.	mm	In.	mm	In.	mm	In.	mm			
ACC19-A-C	0.19	4.8	0.75	19.0	0.62	15.7	0.25	6.4	Natural	100	500
ACC19-A-C20									Black		
ACC19-AV-M300							0.38	9.7	1.00	25.4	1.00
ACC38-A-C	0.38	9.7	1.00	25.4	1.00	25.4	0.40	10.2	Black	1000	5000
ACC38-A-C20									Natural		
ACC38-AV-M300							0.62	15.7	1.24	31.5	1.12
ACC62-A-C	0.62	15.7	1.24	31.5	1.12	28.4	0.63	16.0	Natural	100	500
ACC62-A-C20									Black		
ACC62-AV-D300									Black	1000	5000

Clincher™ Adjustable Releasable Clamp

- Adjustable clamp designed to contain a range of cable bundle diameters
- Latch can be released to provide access to cable bundles
- Bundle range: .19" – .68" (4.8mm – 17.3mm) diameter
- Dimensions are 1.00"L x 1.00"W (25.4mm x 25.4mm)
- For indoor use only
- Material: Polypropylene

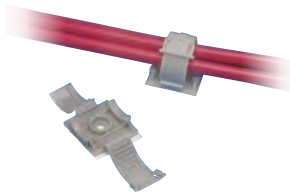

Part Number	Mounting Method	Color	Std. Pkg. Qty.	Std. Ctn. Qty.
ARC.68-A-Q14	Rubber Adhesive	Gray	25	250
ARC.68-S6-Q14	#6 (M3) Screw			
ARC.68-A-Q	Rubber Adhesive	White		
ARC.68-S6-Q	#6 (M3) Screw			

Bevel Entry Clips

- Beveled entry allows for easy insertion of cable bundle
- Rubber-based adhesive provides a strong and reliable bond

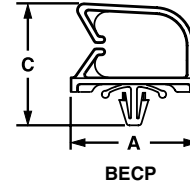
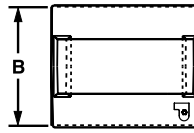
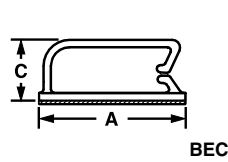

Part Number	Max. Bundle Diameter		Length A		Width B		Height C		Material	Color	Mounting Method	Std. Pkg. Qty.	Std. Ctn. Qty.
	In.	mm	In.	mm	In.	mm	In.	mm					

Adhesive Backed

BEC38-A-L	0.38	9.6	1.46	37.1	1.24	31.5	0.52	13.2	Nylon 6.6	Natural	Rubber Adhesive	50	500
BEC38-A-L20										Black			
BEC62-A-L	0.62	15.7			1.49	37.8	0.79	20.1		Natural			
BEC62-A-L20										Black			
BEC75-A-L	0.75	19.0			1.49	37.8	0.89	22.6		Natural			
BEC75-A-L20										Black			

Push Barb

BECP38H25-L	0.38	9.6	1.46	37.1	0.73	18.5	1.00	25.4	Nylon 6.6	Natural	Push Barb	50	500
BECP38H25-L20										Black			
BECP75H25-L	0.75	19.0	1.47	37.3	1.35	34.3	Natural						
BECP75H25-L20							Black						

Wire Bundle Strap

- Securely routes large cable bundles
- Rounded edges prevent damage to cable jackets
- Mounting method: two 1/4" (M6) screws
- Dimensions are 4.70"L x 1.00"W x 2.54"H (119.4mm x 25.4mm x 64.5mm)
- For indoor use only



Part Number	Material	Color	Std. Pkg. Qty.	Std. Ctn. Qty.
WBS6-Q	ABS	White	25	125
WBS6-Q60*	Flame Retardant Nylon 6.6	Black		

*Manufactured from a UL 94V-0 material.

A. Featured Products

Latching Wire Clips

- Route and secure cords and cables
- Convenient releasable latch
- Available in six sizes with releasable latch
- Push barb parts are for use with a max panel thickness of .11" (2.7mm) and a hole diameter of .22" (5.6mm)
- For indoor use only
- Material: Nylon 6.6

B. Copper Systems

C. Fiber Systems

D. Faceplates, Frames & Surface Mount Boxes



E. Industrial Networks

F. Audio Video Systems

G. Keystone Cabling Systems

H. Zone Cabling

J. Cable Routing Systems

K. Cable Cleats

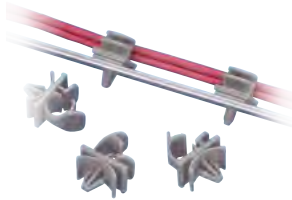

L. Cabinets & Rack Systems

M. Power & Connectivity Management

N. Grounding & Bonding

O. Identification Products

P. Cable Management Accessories

Q. Part Number Index

Part Number	Max. Bundle Diameter		Length		Width		Color	Std. Pkg. Qty.	Std. Ctn. Qty.
	In.	mm	In.	mm	In.	mm			

Adhesive Backed

LWC19-A-C							Natural		
LWC19-A-C14	.19	4.8	.85	21.6	.61	15.5	Gray		
LWC19-A-C20							Black		
LWC25-A-C							Natural	100	1000
LWC25-A-C20	.25	6.4	.88	22.4			Black		
LWC38-A-C							Natural		
LWC38-A-C20	.38	9.5	1.00	25.4	1.00	25.4	Black		
LWC50-A-L							Natural		
LWC50-A-L20	.50	12.7	1.26	32.0			Black		
LWC75-A-L							Natural		
LWC75-A-L20	.75	19.1	1.48	37.6	1.24	31.5	Black	50	500
LWC100-A-L							Natural		
LWC100-A-L20	1.00	25.4	2.21	56.1	1.97	50.0	Black		

Push Mount

LWC19-H25-C	0.19	4.8	.85	21.6	.51	12.8	Natural		
LWC25-H25-C							Natural		
LWC25-H25-C20	.25	6.4	.86	21.8			Black	100	1000
LWC38-H25-C					.58	14.7	Natural		
LWC38-H25-C20	.38	9.5	.94	23.9			Black		
LWC50-H25-L							Natural		
LWC50-H25-L20	.50	12.7	1.25	31.8	.76	19.3	Black		
LWC75-H25-L							Natural		
LWC75-H25-L20	.75	19.1	1.45	36.8	.87	22.1	Black	50	500
LWC100-H25-L							Natural		
LWC100-H25-L20	1.00	25.4	1.89	47.9	.99	25.2	Black		

Fixed Diameter Cable Clamps

• Durable Nylon 6.6 cable clamps

• Fully radiused edges



Part Number	Max. Bundle Diameter		Width		Bundle Offset		Mounting Method	Std. Pkg. Qty.	Std. Ctn. Qty.
	In.	mm	In.	mm	In.	mm			
CCS12-S8-C	.12	3.1	.37	9.4	.33	8.4	#8 (M4) Screw	100	500
CCS19-S8-C	.19	4.8			.43	10.9			
CCS25-S8-C	.25	6.3			.41	10.4	#10 (M5) Screw		
CCS25-S10-C	.25				.41	10.4			
CCS31-S8-C	.31	7.9			.49	12.4	#8 (M4) Screw		
CCS38-S8-C	.38	9.5			.59	15.0			
CCS44-S8-C	.44	11.1			.57	14.5			
CCS50-S8-C	.50	12.7			.60	15.2			
CCH12-S10-C	.12	3.1	.50	12.7	.36	9.1	#10 (M5) Screw		
CCH19-S10-C	.19	4.8			.42	10.7			
CCH25-S10-C	.25	6.3			.46	11.7			
CCH31-S10-C	.31	7.9			.50	12.7			
CCH38-S10-C	.38	9.5			.53	13.5			
CCH44-S10-C	.44	11.1			.56	14.2			
CCH50-S10-C	.50	12.7			.59	15.0			
CCH56-S10-C	.56	14.2			.61	15.5			
CCH62-S10-C	.62	15.7			.65	16.5			
CCH69-S10-C	.69	17.5			.75	19.1			
CCH75-S10-C	.75	19.1			.78	19.8			
CCH81-S10-C	.81	20.6			.81	20.6			
CCH87-S10-C	.87	22.1			.84	21.3			
CCH100-S10-C	1.00	25.4			.91	23.1			
CCH112-S10-C	1.12	28.4			.97	24.6			
CCH119-S10-C	1.19	30.2			1.00	25.4			
CCH125-S10-C	1.25	31.8	1.06	26.9					
CCH138-S10-C	1.37	34.8	1.12	28.4					
CCH150-S10-C	1.50	38.1	1.19	30.2					

All parts listed are also available in black weather resistant material (add suffix 0). Bulk package only.

A. Featured Products

B. Copper Systems

C. Fiber Systems

D. Faceplates, Frames & Surface Mount Boxes

E. Industrial Networks

F. Audio Video Systems

G. Keystone Cabling Systems

H. Zone Cabling

J. Cable Routing Systems

K. Cable Cleats

L. Cabinets & Rack Systems

M. Power & Connectivity Management

N. Grounding & Bonding

O. Identification Products

P. Cable Management Accessories

Q. Part Number Index

- A. Featured Products
- B. Copper Systems
- C. Fiber Systems
- D. Faceplates, Frames & Surface Mount Boxes
- E. Industrial Networks
- F. Audio Video Systems
- G. Keystone Cabling Systems
- H. Zone Cabling
- J. Cable Routing Systems
- K. Cable Cleats
- L. Cabinets & Rack Systems
- M. Power & Connectivity Management
- N. Grounding & Bonding
- O. Identification Products
- P. Cable Management Accessories
- Q. Part Number Index

Optical Fiber Network Saddles

- Use in pre-drilled .18 inch (4.0mm) holes in panels up to .09 inch (2.0mm) thick
- Smooth rounded edges eliminate potential for snagging and stress on cable

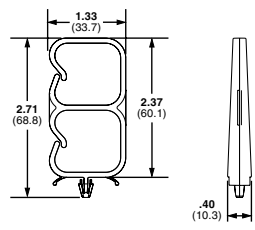

VWSDC

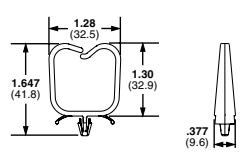

VWS106

Part Number	Max. Bundle Diameter		Material	Mounting Method	Color	Std. Pkg. Qty.	Std. Ctn. Qty.
	In.	mm					
VWSDC-C*	1.06	26.9	Nylon 6.6	Push Barb	Natural	100	500
VWSDC-C20*					Black		
VWS106-C					Natural		
VWS106-C20					Black		

*Accepts two bundles.



JP2W-L20

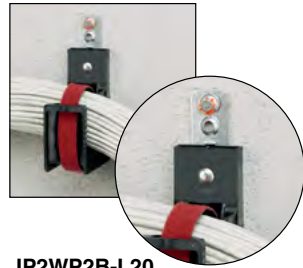

JP2WP2B-L20



JP2CMB-L20

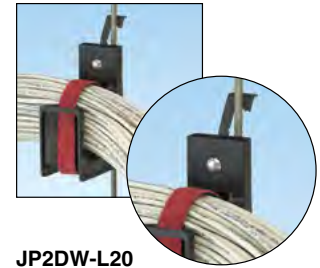

JP2DW-L20

J-Pro™ Cable Support System



Part Number	Part Description	Max. Bundle Capacity		Max. Cable Capacity*			Material**	Std. Pkg. Qty.
		In.	mm	Category 6A-SD/6A (0.30")	Category 6 (0.24")	Category 5e (0.23")		

Wall Mount



JP2W-L20

JP75W-L20	J Hook for wall mount applications. One 1/4" (M6) mounting hole for user supplied fastener. Not for use with powder actuated fasteners.	0.75	19.0	5	8	10	Nylon 6.6	50
JP131W-L20		1.31	33.3	15	25	29		
JP2W-L20		2.00	50.8	30	46	55		
JP4W-X20		4.00	101.6	115	180	200		10

Wall Mount with Bracket



JP2WP2B-L20

JP75WP2B-L20	J Hook for powder actuated installation on walls. One 5/32" (M4) mounting hole and one 1/4" (M6) mounting hole for user supplied fasteners.	0.75	19.0	5	8	10	Nylon 6.6 J Hook with Metal Attachments	50
JP131WP2B-L20		1.31	33.3	15	25	29		
JP2WP2B-L20		2.00	50.8	30	46	55		
JP4WP2B-X20		4.00	101.6	115	180	200		10

Ceiling Mount



JP2CMB-L20

JP75CMB-L20	J Hook with ceiling mount bracket that has one 3/16" (M5), 1/4" (M6), and 3/8" (M10) mounting hole.	0.75	19.0	5	8	10	Nylon 6.6 J Hook with Metal Attachments	50
JP131CMB-L20		1.31	33.3	15	25	29		
JP2CMB-L20		2.00	50.8	30	46	55		
JP4CMB-X20		4.00	101.6	115	180	200		10

Drop Wire and Threaded Rod Clip



JP2DW-L20

JP75DW-L20	J Hook with clip for use with #12 wire, threaded rod up to 3/8" (9.5mm) in diameter, or 1/8" - 1/4" (3.2mm - 6.4mm) thick flanges.	0.75	19.0	5	8	10	Nylon 6.6 J Hook with Metal Attachments	50
JP131DW-L20		1.31	33.3	15	25	29		
JP2DW-L20		2.00	50.8	30	46	55		
JP4DW-X20		4.00	101.6	115	180	200		10

*The above cable diameters represent the nominal Panduit cable diameter per performance level.

For specific cable fill information based on specific part numbers, please contact Customer Service.

**Suitable for use in air handling spaces in accordance with Sec. 300.22(C) and (D) of the National Electrical Code when mounted as single units or in pairs. JP4 family of parts suitable for use in single unit configurations only.

Listed in accordance with CAN/ULC S102.2 when mounted as single units or in pairs. Minimum spacing of 4' (1220mm) required between mount points. (Flame Spread Rating = 0, Smoke Developed Classification = 20).

Continued on next page

A. Featured Products

B. Copper Systems

C. Fiber Systems

D. Faceplates, Frames & Surface Mount Boxes

E. Industrial Networks

F. Audio Video Systems

G. Keystone Cabling Systems

H. Zone Cabling

J. Cable Routing Systems

K. Cable Cleats

L. Cabinets & Rack Systems

M. Power & Connectivity Management

N. Grounding & Bonding

O. Identification Products

P. Cable Management Accessories

Q. Part Number Index

A. Featured Products
B. Copper Systems
C. Fiber Systems
D. Faceplates, Frames & Surface Mount Boxes
E. Industrial Networks
F. Audio Video Systems
G. Keystone Cabling Systems
H. Zone Cabling
J. Cable Routing Systems
K. Cable Cleats
L. Cabinets & Rack Systems
M. Power & Connectivity Management
N. Grounding & Bonding
O. Identification Products
P. Cable Management Accessories
Q. Part Number Index

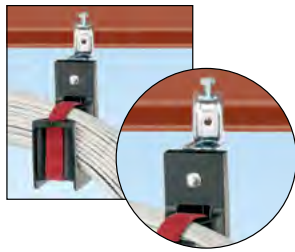

JP2SBC50RB-L20

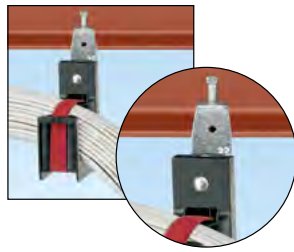

JP2SBC87RB-L20

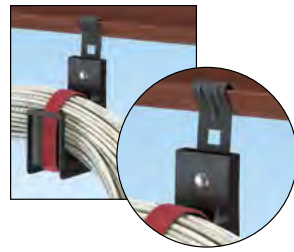

JP2ZP-L20

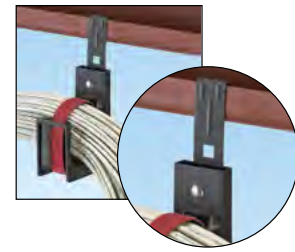

JP2CP-L20

J-Pro™ Cable Support System (continued)



JP2SBC50-L20



JP2SBC50RB-L20



JP2SBC87-L20



JP2SBC87RB-L20



JP2ZP-L20



JP2CP-L20

Part Number	Part Description	Max. Bundle Capacity		Max. Cable Capacity*			Material**	Std. Pkg. Qty.
		In.	mm	Category 6A-SD/6A (0.30")	Category 6 (0.24")	Category 5e (0.23")		

Screw-On Beam Clamps

JP75SBC50-L20	J Hook with screw-on beam clamp for use with flanges up to 1/2" (12.7mm) thick. Non-rotating mount.	0.75	19.0	5	8	10	Nylon 6.6 J Hook with Metal Attachments	50
JP131SBC50-L20	J Hook with screw-on beam clamp for use with flanges up to 1/2" (12.7mm) thick. Non-rotating mount.	1.31	33.3	15	25	29		
JP2SBC50-L20	J Hook with screw-on beam clamp for use with flanges up to 1/2" (12.7mm) thick. Non-rotating mount.	2.00	50.8	30	46	55		
JP4SBC50-X20	J Hook with screw-on beam clamp for use with flanges up to 1/2" (12.7mm) thick. Non-rotating mount.	4.00	101.6	115	180	200		10
JP75SBC50RB-L20	J Hook with screw-on beam clamp for use with flanges up to 1/2" (12.7mm) thick. Rotates 360 degrees.	0.75	19.0	5	8	10		50
JP131SBC50RBL20	J Hook with screw-on beam clamp for use with flanges up to 1/2" (12.7mm) thick. Rotates 360 degrees.	1.31	33.3	15	25	29		
JP2SBC50RB-L20	J Hook with screw-on beam clamp for use with flanges up to 1/2" (12.7mm) thick. Rotates 360 degrees.	2.00	50.8	30	46	55		
JP4SBC50RB-X20	J Hook with screw-on beam clamp for use with flanges up to 1/2" (12.7mm) thick. Rotates 360 degrees.	4.00	101.6	115	180	200		10
JP75SBC87-L20	J Hook with screw-on beam clamp for use with flanges up to 3/4" (19.1mm) thick. Non-rotating mount.	0.75	19.0	5	8	10		50
JP131SBC87-L20	J Hook with screw-on beam clamp for use with flanges up to 3/4" (19.1mm) thick. Non-rotating mount.	1.31	33.3	15	25	29		
JP2SBC87-L20	J Hook with screw-on beam clamp for use with flanges up to 3/4" (19.1mm) thick. Non-rotating mount.	2.00	50.8	30	46	55		
JP4SBC87-X20	J Hook with screw-on beam clamp for use with flanges up to 3/4" (19.1mm) thick. Non-rotating mount.	4.00	101.6	115	180	200		10
JP75SBC87RB-L20	J Hook with screw-on beam clamp for use with flanges up to 3/4" (19.1mm) thick. Rotates 360 degrees.	0.75	19.0	5	8	10	50	
JP131SBC87RBL20	J Hook with screw-on beam clamp for use with flanges up to 3/4" (19.1mm) thick. Rotates 360 degrees.	1.31	33.3	15	25	29		
JP2SBC87RB-L20	J Hook with screw-on beam clamp for use with flanges up to 3/4" (19.1mm) thick. Rotates 360 degrees.	2.00	50.8	30	46	55		
JP4SBC87RB-X20	J Hook with screw-on beam clamp for use with flanges up to 3/4" (19.1mm) thick. Rotates 360 degrees.	4.00	101.6	115	180	200	10	

Purlin Clips

JP75ZP-L20	J Hook with z-purlin clip for use with angled flanges up to 1/4" (6.4mm) thick.	0.75	19.0	5	8	10	Nylon 6.6 J Hook with Metal Attachments	50
JP131ZP-L20	J Hook with z-purlin clip for use with angled flanges up to 1/4" (6.4mm) thick.	1.31	33.3	15	25	29		
JP2ZP-L20	J Hook with z-purlin clip for use with angled flanges up to 1/4" (6.4mm) thick.	2.00	50.8	30	46	55		
JP4ZP-X20	J Hook with z-purlin clip for use with angled flanges up to 1/4" (6.4mm) thick.	4.00	101.6	115	180	200		10
JP75CP-L20	J Hook with c-purlin clip for use with vertical flanges up to 1/4" (6.4mm) thick.	0.75	19.0	5	8	10	Nylon 6.6 J Hook with Metal Attachments	50
JP131CP-L20	J Hook with c-purlin clip for use with vertical flanges up to 1/4" (6.4mm) thick.	1.31	33.3	15	25	29		
JP2CP-L20	J Hook with c-purlin clip for use with vertical flanges up to 1/4" (6.4mm) thick.	2.00	50.8	30	46	55		
JP4CP-X20	J Hook with c-purlin clip for use with vertical flanges up to 1/4" (6.4mm) thick.	4.00	101.6	115	180	200		10

*The above cable diameters represent the nominal Panduit cable diameter per performance level. For specific cable fill information based on specific part numbers, please contact Customer Service.
 **Suitable for use in air handling spaces in accordance with Sec. 300.22(C) and (D) of the National Electrical Code when mounted as single units or in pairs. JP4 family of parts suitable for use in single unit configurations only. Listed in accordance with CAN/ULC S102.2 when mounted as single units or in pairs. Minimum spacing of 4' (1220mm) required between mount points. (Flame Spread Rating = 0, Smoke Developed Classification = 20).

Continued on next page

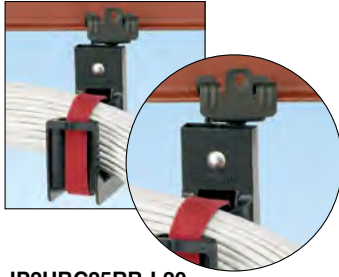

JP2HBC25RB-L20

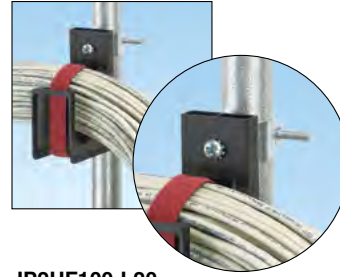

JP2UF100-L20

J-Pro™ Cable Support System (continued)



JP2HBC25RB-L20
JP2HBC50RB-L20
JP2HBC75RB-L20



JP2UF100-L20

Part Number	Part Description	Max. Bundle Capacity		Max. Cable Capacity*			Material**	Std. Pkg. Qty.
		In.	mm	Category 6A-SD/6A (0.30")	Category 6 (0.24")	Category 5e (0.23")		

Hammer-On Beam Clamps

JP75HBC25RB-L20	J Hook with hammer-on beam clamp for use with flanges 1/8" – 1/4" (3.2mm – 6.4mm) thick. Rotates 360 degrees.	0.75	19.0	5	8	10	Nylon 6.6 J Hook with Metal Attachments	50
JP131HBC25RBL20		1.31	33.3	15	25	29		
JP2HBC25RB-L20		2.00	50.8	30	46	55		
JP4HBC25RB-X20		4.00	101.6	115	180	200		
JP75HBC50RB-L20	J Hook with hammer-on beam clamp for use with flanges 5/16" – 1/2" (7.9mm – 12.7mm) thick. Rotates 360 degrees.	0.75	19.0	5	8	10	Nylon 6.6 J Hook with Metal Attachments	50
JP131HBC50RBL20		1.31	33.3	15	25	29		
JP2HBC50RB-L20		2.00	50.8	30	46	55		
JP4HBC50RB-X20		4.00	101.6	115	180	200		
JP75HBC75RB-L20	J Hook with hammer-on beam clamp for use with flanges 9/16" – 3/4" (14.3mm – 19.1mm) thick. Rotates 360 degrees.	0.75	19.0	5	8	10	Nylon 6.6 J Hook with Metal Attachments	50
JP131HBC75RBL20		1.31	33.3	15	25	29		
JP2HBC75RB-L20		2.00	50.8	30	46	55		
JP4HBC75RB-X20		4.00	101.6	115	180	200		

Underfloor Pedestal Clamps

JP75UF100-L20	J Hook with underfloor clamp for use with pedestal support 7/8" square or 1 1/8" – 1 3/8" in diameter.	0.75	19.0	5	8	10	Nylon 6.6 J Hook with Metal Attachments	50
JP131UF100-L20		1.31	33.3	15	25	29		
JP2UF100-L20		2.00	50.8	30	46	55		
JP4UF100-X20		4.00	101.6	115	180	200		

*The above cable diameters represent the nominal Panduit cable diameter per performance level. For specific cable fill information based on specific part numbers, please contact Customer Service.

**Suitable for use in air handling spaces in accordance with Sec. 300.22(C) and (D) of the National Electrical Code when mounted as single units or in pairs. JP4 family of parts suitable for use in single unit configurations only. Listed in accordance with CAN/ULC S102.2 when mounted as single units or in pairs. Minimum spacing of 4' (1220mm) required between mount points. (Flame Spread Rating = 0, Smoke Developed Classification = 20).

A. Featured Products

B. Copper Systems

C. Fiber Systems

D. Faceplates, Frames & Surface Mount Boxes

E. Industrial Networks

F. Audio Video Systems

G. Keystone Cabling Systems

H. Zone Cabling

J. Cable Routing Systems

K. Cable Cleats

L. Cabinets & Rack Systems

M. Power & Connectivity Management

N. Grounding & Bonding

O. Identification Products

P. Cable Management Accessories

Q. Part Number Index

A. Featured Products
B. Copper Systems
C. Fiber Systems
D. Faceplates, Frames & Surface Mount Boxes
E. Industrial Networks
F. Audio Video Systems
G. Keystone Cabling Systems
H. Zone Cabling
J. Cable Routing Systems
K. Cable Cleats
L. Cabinets & Rack Systems
M. Power & Connectivity Management
N. Grounding & Bonding
O. Identification Products
P. Cable Management Accessories
Q. Part Number Index

Notes

Index by Part Number

Part Number	Page Number
-------------	-------------

Part Number	Page Number
-------------	-------------

Part Number	Page Number
-------------	-------------

A

ABM100-A-C	P.8
ABM100-A-C15	P.8
ABM100-A-D20	P.8
ABM112-A-C	P.8
ABM112-A-D20	P.8
ABM1M-A-C	P.8
ABM2S-A-C	P.8
ABM2S-A-C14	P.8
ABM2S-A-C15	P.8
ABM2S-A-C20	P.8
ABM3H-A-L	P.8
ABM3H-A-L20	P.8
ABM4H-A-L	P.8
ABMM-A-C	P.8
ABMM-A-C20	P.8
ABMT-A-C*	P.8
ABMT-A-C20*	P.8
ABMT-S6-C	P.8
ABMT-S6-C20	P.8
ABMT-S6-C69**	P.8
ACA01	M.7
ACB01	M.7
ACB02	M.7
ACB03	M.7
ACB04	M.7
ACB05	M.7
ACC01	M.7
ACC19-A-C	P.10
ACC19-A-C20	P.10
ACC19-AV-M300	P.10
ACC38-A-C	P.10
ACC38-A-C20	P.10
ACC38-AV-M300	P.10
ACC62-A-C	P.10
ACC62-A-C20	P.10
ACC62-AV-D300	P.10
ACD01	M.7
ACE01	M.7
ACE02	M.7
ACE03	M.7
ACE48	H.4
ACR-F	B.5
ACR-F	B.6
ACR-N	B.5
ACR-N	B.6
AFR4BCBL6	F.2
AFR4CCBL	F.2
AFR4ECBL	F.2
AFR4JB2SBL	F.2
AFR4RABL	F.2
AFR4TRT70BL	F.2
ARC.68-A-Q	P.10
ARC.68-A-Q14	P.10
ARC.68-S6-Q	P.10
ARC.68-S6-Q14	P.10

B

BEC38-A-L	P.11
-----------	------

BEC38-A-L20	P.11
BEC62-A-L	P.11
BEC62-A-L20	P.11
BEC75-A-L	P.11
BEC75-A-L20	P.11
BECP38H25-L	P.11
BECP38H25-L20	P.11
BECP75H25-L	P.11
BECP75H25-L20	P.11
BFS100X2000	L.22
BKA6ASD8INBL	B.8
BR1B	L.22
BR2B	L.22
BT2HTI	K.6
BT75SDT	K.6

C

C061X030FJC	O.3
C061X030FJJ	O.15
C061X030YPT	O.9
C125X030FJC	O.3
C125X030FJJ	O.15
C125X030YPT	O.9
C138X019FJC	O.3
C138X019FJJ	O.15
C138X019YPT	O.9
C150X030Y1C	O.3
C150X030Y1J	O.15
C150X030Y1T	O.9
C188X030FJC	O.3
C188X030FJJ	O.15
C188X030YPT	O.10
C195X040Y1C	O.3
C195X040Y1J	O.15
C195X040Y1T	O.10
C200X100FJC	O.3
C200X100FJJ	O.15
C200X100YPT	O.10
C252X030FJC	O.3
C252X030FJJ	O.15
C252X030FRJ	O.15
C252X030FTJ	O.15
C252X030YPT	O.10
C252X030YPT-P*	O.10
C261X030FJC	O.3
C261X030FJJ	O.15
C261X030YPT	O.10
C261X035Y1C	O.3
C261X035Y1J	O.15
C261X035Y1T	O.10
C275X125YPT	O.10
C282X030Y1C	O.3
C282X030Y1J	O.15
C288X030YPT	O.10
C288X040Y1C	O.3
C288X040Y1J	O.15
C288X040Y1T	O.10
C2CAC06ABWPAB1	L.18
C2CAC06F04IRB1B1	L.18
C2CAC06F06IRB1B1	L.18

C2CAC06F08WPB1	L.18
C2CAC07F04IRB1B1	L.18
C2CAC07F06IRB1B1	L.18
C2CAC07F08WPB1	L.18
C2CAC08F04IRB1B1	L.18
C2CAC08F06IRB1B1	L.18
C2CAC08F08WPB1	L.18
C2CEOR04CP1B1	L.19
C2CEOR04CP2B1	L.19
C2CEOR04CP5B1	L.19
C2CEOR04CP8B1	L.19
C2CEOR06CP1B1	L.19
C2CEOR06CP2B1	L.19
C2CEOR06CP5B1	L.19
C2CEOR06CP8B1	L.19
C2FAB06A1200B1	L.11
C2FAB07A1200B1	L.11
C2FAB08A1200B1	L.11
C2HAC**11626^	L.12
C2HAC**11626B1	L.18
C2HAC**12638B1	L.18
C2HAC**13866B1	L.18
C2HAC0*13866B1	L.14
C2HAC0*13866B1	L.15
C2HAC0*11626B1	L.14
C2HAC0*12638B1	L.14
C2HAC0*13866B1	L.14
C2HACERI1626^	L.12
C2HACERI1626B1	L.15
C2HACERI1626B1	L.18
C2HACERI2638B1	L.15
C2HACERI2638B1	L.18
C2HACERI3866B1	L.15
C2HACERI3866B1	L.18
C2SDT8W04DAB1	L.19
C2SDT8W06DAB1	L.19
C2SDT9W04DAB1	L.19
C2SDT9W06DAB1	L.19
C2VED**11626B1	L.8
C2VED**12638B1	L.8
C2VED**13866B1	L.8
C315X030FJC	O.3
C315X030FJJ	O.15
C379X030FJC	O.3
C379X030FJJ	O.15
C379X030YPT	O.10
C379X030YPT-P*	O.10
C390X030Y1C	O.3
C390X030Y1J	O.15
C390X030Y1T	O.10
C4PPLK	D.8
C750X050Y1C	O.3
C750X050Y1J	O.15
C750X050Y1T	O.10
C788X050Y1C	O.3
C788X050Y1J	O.15
CADIN1BL	E.7
CADIN1IG	E.7
CADIN1IW	E.7
CBEIW-2GY	D.4
CBEIW-2GY	G.7

A. Featured Products

B. Copper Systems

C. Fiber Systems

D. Faceplates, Frames & Surface Mount Boxes

E. Industrial Networks

F. Audio Video Systems

G. Keystone Cabling Systems

H. Zone Cabling

J. Cable Routing Systems

K. Cable Cleats

L. Cabinets & Rack Systems

M. Power & Connectivity Management

N. Grounding & Bonding

O. Identification Products

P. Cable Management Accessories

Q. Part Number Index

Index by Part Number

Part Number	Page Number
CMPH1	L.33
CMPH2	L.33
CMPHF1	L.33
CMPHF2	L.33
CMPHH2	L.33
CMPHHF1	L.33
CMSTZBU	C.10
CMT4	L.33
CMUSBAAIW	F.5
CMUT19	L.33
CNLTD142A3	L.21
CNLTD21B2	L.21
CNLTD52A2	L.21
CNLTD72A3	L.21
CNWS1224-C	L.25
CNWSM6-C	L.25
CP245E88BLY	B.22
CP24688BL	B.22
CP246X88BL	B.22
CP24BLY	B.21
CP48BLY	B.21
CPA24BLY	B.21
CPA48BLY	B.21
CPAF1BLY	B.23
CPAF1BLY	G.4
CPAF1BLY	L.36
CPAF1WH	B.23
CPAF2BLY	B.23
CPAF2BLY	G.4
CPAF2WH	B.23
CPATCBL	B.23
CPATCBL	G.4
CPATCBL	L.36
CPATCWH	B.23
CPGIW	F.4
CPGIW-2G	F.4
CPP12WBL	B.21
CPP24FMWBLY	B.21
CPP24FMWWH	B.21
CPP24WBLY	B.21
CPP48FMWBLY	B.21
CPP48FMWWH	B.21
CPP48HDEWBL	B.21
CPP48HDWBLY	B.21
CPP48HDWWH	B.21
CPP48WBLY	B.21
CPPA24FMWBLY	B.21
CPPA24FMWWH	B.21
CPPA48FMWBLY	B.21
CPPA48FMWWH	B.21
CPPA48HDEWBL	B.21
CPPA48HDWBLY	B.21
CPPA48HDWWH	B.21
CPPL24WBLY	B.21
CPPL48WBLY	B.21
CPPLA24WBLY	B.21
CPPLA48WBLY	B.21
CSGLLC-L	D.8
CSPT	B.12
CT-2931/ST	
CT-2931/STCV	N.24

Part Number	Page Number
CT-920	
CT-920/CV	N.23
CTCN1X5	L.23
CTCN3X5	L.23
CTCN6X6	L.23
CTGN1X5	L.23
CTGN3X5	L.23
CTGN6X6	L.23
CTNBZL6X6	L.23
CUCAKITB1	L.16
CUCFS06B1	L.16
CUCFS07B1	L.16
CUCFS08B1	L.16
CUCFS10B1	L.16
CUCGF03DPB1	L.14
CUCGF04DBP1	L.14
CUCGF06DBP1	L.14
CUCMSS03ST01NC	L.16
CUCMSS06ST01NC	L.16
CUD*SD^1	L.12
CUD1SDB1	L.15
CUD1SDB1	L.19
CUD2SDB1	L.15
CUD2SDB1	L.19
CUEFRCKITB1	L.13
CUEFRT**^	L.12
CUEFRT8F06STB1	L.13
CUEFRT8W04B1	L.13
CUEFRT8W06B1	L.13
CUEFRT9W04B1	L.13
CUEFRT9W06B1	L.13
CUEOR12CPB1	L.15
CUEOR18CPB1	L.15
CUEORF03DPB1	L.14
CUEORF04DPB1	L.14
CUEORF06DPB1	L.14
CUFB48BL	H.5
CUFBPR**06HB^	L.12
CUFBPR4206HBB1	L.13
CUFBPR4506HBB1	L.13
CUFBPR4806HBB1	L.13
CUFBPR5206HBB1	L.13
CUFMB12D4PBL	H.5
CUFMB24BL	H.5
CURFS06F**HB^	L.12
CURFS06F04HBB1	L.13
CURFS06F06HBB1	L.13
CURFS07F04HBB1	L.13
CURFS07F06HBB1	L.13
CURFS08F04HBB1	L.13
CURFS08F06	L.13
CURFS08F06HBB1	L.13
CUSMPR52ST01B1	L.16
CUSMPR52ST01NC	L.12
CUSR1SDHLB1	L.15
CUSR1SDHLB1	L.19
CUSR1SDLHB1	L.15
CUSR1SDLHB1	L.19
CUSR1SDRHB1	L.15
CUSR1SDRHB1	L.19
CUSREFRT8B1*	L.13

Part Number	Page Number
CUSREFRT9B1*	L.13
CUSREORCPB1	L.15
CUSRRF0S06B1	L.13
CUSRRF0S07B1	L.13
CUSRRF0S08B1	L.13
CUSRVWA06B1	L.14
CUSRVWA07B1	L.14
CUSRVWA08B1	L.14
CUSRVWBB1	L.14
CUSRVWER2638B1	L.15
CUSRVWER3866B1	L.15
CUSRVWER1626B1	L.15
CUTBPR0610HBB1	L.13
CUTBPR0610HBN1	L.12
CUTBPR0610HBN1	L.13
CUVWA06S**ST^	L.12
CUVWA06S06STB1	L.14
CUVWA07S07STB1	L.14
CUVWA08S08STB1	L.14
CUVWB12S12ST^	L.12
CUVWB12S12STB1	L.14
CUWBPS06ST01B1	L.15
CUWBPS06ST02B1	L.15
CUWBPS07ST01B1	L.15
CUWBPS07ST02B1	L.15
CUWBPS08ST01B1	L.15
CUWBPS08ST02B1	L.15
CUWBPS24ST01B1	L.15
CUWBPS24ST02B1	L.15
CUWBSS**ST^	L.12
CVPDUB	L.25
CWMPV2340	L.36
CWMPV2440	L.36
CWMPV3340	L.36
CWMPV3440	L.36
CWPP12WBL	B.21
CWST	B.29

D

D*1SPB	L.5
D*2SPB	L.5
D*ERB	L.5
D*ERTB	L.5
D1*FBB	L.5
D6*FDB	L.5
D6*RDB	L.5
D61BCPB	L.5
D62BCPB	L.5
D8*FDB	L.5
D8*RDB	L.5
D81BCPB	L.5
D82BCPB	L.5
D-Code	E.5
DERLCC6509A	L.21
DERLCC6513A	L.21
DERLCC7009A	L.21
DERLCC9513A	L.21
DIBBC2314S21W	L.21
DIFBA2002S00S	L.21
DIFBA3003S00S	L.21

A. Featured Products

B. Copper Systems

C. Fiber Systems

D. Faceplates, Frames & Surface Mount Boxes

E. Industrial Networks

F. Audio Video Systems

G. Keystone Cabling Systems

H. Zone Cabling

J. Cable Routing Systems

K. Cable Cleats

L. Cabinets & Rack Systems

M. Power & Connectivity Management

N. Grounding & Bonding

O. Identification Products

P. Cable Management Accessories

Q. Part Number Index

Index by Part Number

A. Featured Products
B. Copper Systems
C. Fiber Systems
D. Faceplates, Frames & Surface Mount Boxes
E. Industrial Networks
F. Audio Video Systems
G. Keystone Cabling Systems
H. Zone Cabling
J. Cable Routing Systems
K. Cable Cleats
L. Cabinets & Rack Systems
M. Power & Connectivity Management
N. Grounding & Bonding
O. Identification Products
P. Cable Management Accessories
Q. Part Number Index

Part Number	Page Number
DIRBB2007S21W.....	L.21
DIRLC2214M21W.....	L.21
DIRLC25S23W.....	L.21
DIRLC3210S17W.....	L.21
DP245E88TGWH.....	B.22
DP245E88TGY.....	B.22
DP24688TGWH.....	B.22
DP24688TGY.....	B.22
DP246X88TGWH.....	B.22
DP246X88TGY.....	B.22
DP485E88TGWH.....	B.22
DP485E88TGY.....	B.22
DP48688TGWG.....	B.22
DP48688TGY.....	B.22
DP486X88TGWH.....	B.22
DP486X88TGY.....	B.22
DPA245E88TGWH.....	B.22
DPA245E88TGY.....	B.22
DPA24688TGWH.....	B.22
DPA24688TGY.....	B.22
DPA246X88TGWH.....	B.22
DPA246X88TGY.....	B.22
DPA485E88TGWH.....	B.22
DPA485E88TGY.....	B.22
DPA48688TGWH.....	B.22
DPA48688TGY.....	B.22
DPA486X88TGWH.....	B.22
DPA486X88TGY.....	B.22
DPFP1.....	L.36
DPFP1WH.....	L.36
DPFP2.....	L.36
DPFP2WH.....	L.36
DPFP4.....	L.36
DPFP8.....	L.36
DPFPA1.....	L.36
E	
E4X4YL6.....	J.42
E6212B1.....	L.6
E6212B1FP.....	L.6
E6412B2.....	L.6
E6412B2FP.....	L.6
EA001.....	M.7
EB001.....	M.7
EC001.....	M.7
ED001.....	M.7
EE001.....	M.7
EF001.....	M.7
EFPK102G-XY.....	D.8
EFPK-XY.....	D.8
EG001.....	M.7
EGJT-1.....	B.11
EGPT.....	B.11
EMPLUS-2GO.....	O.7
EMPLUS-CD.....	O.7
EMPLUS-DL.....	O.7
EMPLUS-SERVER.....	O.7
ERT2M-C20.....	P.6
ERT4.5M-C20.....	P.6
ESFLHT5C02FGR-X.....	E.2

Part Number	Page Number
ESFLHT5C02GR-X.....	E.2
F	
F100X150AJC.....	O.5
F100X150AJT.....	O.14
F100X213AJT.....	O.14
F100X300AJT.....	O.14
F100X363AJT.....	O.14
F1AS9N-1A12-10*.....	C.23
F1ASZN-1A12-10*.....	C.23
F1ASZN-9612-10*.....	C.23
F1ASZO-1A12-10*.....	C.23
F1ASZO-9612-10*.....	C.23
F1RS9N-1A12-10*.....	C.23
F1RSZN-1A12-10*.....	C.23
F1RSZN-9612-10*.....	C.23
F1RSZO-1A12-10*.....	C.23
F1RSZO-9612-10*.....	C.23
F2PCLB12.....	J.7
F2PCLB12.....	J.17
F2PCLB12.....	J.26
F2PCLB12.....	J.41
F2PCLB58.....	J.17
F2PCLB58.....	J.26
F2PCLB58.....	J.41
FADC4X4.....	J.27
FADSC-E-L.....	C.10
FADSCZAG-L.....	C.10
FADSCZAG-L.....	C.10
FADSCZBU-L.....	C.10
FADSLCEI-L.....	C.10
FADSLCZAG-L.....	C.10
FADSLCZAG-L.....	C.10
FADSLCZBU-L.....	C.10
FADSLCZBU-L.....	C.10
FAP12WAGDLCZ.....	C.21
FAP12WAQDLCZ.....	C.21
FAP12WBUDLCZ.....	C.21
FAP12WEIDLC.....	C.21
FAP12WWDLCZ.....	C.21
FAP3WAGDSCZ.....	C.21
FAP3WAGDSCZ.....	C.21
FAP3WAQDSCZ.....	C.21
FAP3WBUDSCZ.....	C.21
FAP3WEIDSC.....	C.21
FAP6WAGDLCZ.....	C.21
FAP6WAGDSCZ.....	C.21
FAP6WAQDLCZ.....	C.21
FAP6WAQDSCZ.....	C.21
FAP6WBUDLCZ.....	C.21
FAP6WBUDSCZ.....	C.21
FAP6WEIDLC.....	C.21
FAP6WEIDSC.....	C.21
FAP6WSTZ.....	C.21
FAP6WWDLCZ.....	C.21
FAP8WSTZ.....	C.21
FAPB.....	C.22
FAPH0412BLMPO.....	C.20
FAPH0412CGMPO.....	C.20
FAPH0424RDMPO.....	C.20
FAPH0612BLMPO.....	C.20
FAPH0612CGMPO.....	C.20

Part Number	Page Number
FAPH0624RDMPO.....	C.20
FAPH0812BLMPO.....	C.20
FAPH0812CGMPO.....	C.20
FAPH0824RDMPO.....	C.20
FAPH1212BLMPO.....	C.20
FAPH1212CGMPO.....	C.20
FAPH1224RDMPO.....	C.20
FAPH1612BLMPO.....	C.20
FAPH1612CGMPO.....	C.20
FAPH1624RDMPO.....	C.20
FAPH1812BLMPO.....	C.20
FAPH1812CGMPO.....	C.20
FAPH1824RDMPO.....	C.20
FAPV0412BLMPO.....	C.20
FAPV0412CGMPO.....	C.20
FAPV0424RDMPO.....	C.20
FAPV0612BLMPO.....	C.20
FAPV0612CGMPO.....	C.20
FAPV0624RDMPO.....	C.20
FAPV0812BLMPO.....	C.20
FAPV0812CGMPO.....	C.20
FAPV0824RDMPO.....	C.20
FASSTZ-L.....	C.10
FBC2X2YL.....	J.39
FC26N-12-03**.....	C.19
FC26N-12-10**.....	C.18
FC26N-24-10**.....	C.19
FC29N-12-03**.....	C.19
FC29N-12-10**.....	C.18
FC29N-24-10**.....	C.19
FC2SA-12-10**.....	C.18
FC2SA-24-10**.....	C.19
FC2WA-12-10**.....	C.18
FC2WA-24-10**.....	C.19
FC2XN-12-03**.....	C.19
FC2XN-12-10**.....	C.18
FC2XN-24-10**.....	C.19
FC2XO-12-03**.....	C.19
FC2XO-12-10**.....	C.18
FC2XO-24-10**.....	C.19
FC2ZN-12-03**.....	C.19
FC2ZN-12-10**.....	C.18
FC2ZN-24-10**.....	C.19
FC2ZO-12-03**.....	C.19
FC2ZO-12-10**.....	C.18
FC2ZO-24-10**.....	C.19
FC39N-16-10A.....	C.19
FC3XN-16-10*.....	C.19
FC3XO-16-10*.....	C.19
FC3ZN-16-10*.....	C.19
FC3ZO-16-10*.....	C.19
FC4ZU-24-NMNM*.....	C.19
FC4ZU-48-NMNM*.....	C.19
FCE1U**.....	C.16
FCE1UA**.....	C.16
FCE1US.....	C.16
FCE2U**.....	C.16
FCE4U**.....	C.16
FCT-7ZA.....	C.20
FCT-7ZB.....	C.20
FCT-7ZC.....	C.20

Index by Part Number

Part Number	Page Number
FCT-7ZD	C.20
FDME8RG	E.7
FEABRU	C.22
FEABRUA	C.22
FEC2X2YL	J.40
FELS	C.22
FELU	C.22
FFWC2X2YL	J.40
FH4ZU-24-NMNM*	C.14
FH4ZU-48-NMNM*	C.14
FHC39N-08-10^	C.13
FHC39N-08H-10^	C.13
FHC39N-24H-10^	C.13
FHC3XO-08-10^	C.13
FHC3XO-08H-10^	C.13
FHC3XO-24H-10^	C.13
FHC3ZA-08-10^	C.13
FHC3ZA-08H-10^	C.13
FHC3ZA-24H-10^	C.13
FHC3ZO-08-10^	C.13
FHC3ZO-08H-10^	C.13
FHC3ZO-24H-10^	C.13
FHC9N-12-10**	C.12
FHC9N-24-10**	C.12
FHCSA-12-10**	C.12
FHCSA-24-10**	C.12
FHCT-5ZUB	C.14
FHCT-5ZUC	C.14
FHCT-5ZUFB	C.14
FHCT-7ZUB	C.14
FHCT-7ZUC	C.14
FHCWA-12-10**	C.12
FHCWA-24-10**	C.12
FHCXA-12-10**	C.12
FHCXA-24-10**	C.12
FHCXO-12-10**	C.12
FHCXO-24-10**	C.12
FHCZA-12-10**	C.12
FHCZA-24-10**	C.12
FHCZO-12-10**	C.12
FHCZO-24-10**	C.12
FHDEC2X2YL	J.39
FHMP-6-ABL	C.15
FHMP-6-ARD	C.15
FHMP-6-BCG	C.15
FHS9N-12-10*	C.14
FHS9N-12-10N	C.15
FHSBBL06W	C.15
FHSXN-12-10*	C.14
FHSXN-12-10N	C.15
FHSXO-12-10*	C.14
FHSZO-12-10*	C.14
FIDT2X2YL	J.39
FIDT2X2YL	J.42
FIDT4X4BL	J.23
FIDT4X4BL	J.34
FIV452X2YL	J.40
FIVRA2X2YL	J.40
FLB	J.41
FLBSIM-51	L.22
FLCDMC5BLY	C.5

Part Number	Page Number
FLCDMC6EIY	C.5
FLCDMCXAQY	C.5
FLCDSCBUY	C.5
FLCSMC5***	C.5
FLCSMC5BLY	C.5
FLCSMC6***	C.5
FLCSMC6EIY	C.5
FLCSMCX***	C.5
FLCSMCXAQY	C.5
FLCSCC***	C.5
FLCSCCBUY	C.5
FLEX-0RUBR04	C.11
FLEX-0RUBR06**	C.11
FLEX-0RUBR12	C.11
FLEX-0RUCH04	C.11
FLEX-0RUCH06	C.11
FLEX-0RUCH12	C.11
FLEX1U04	C.11
FLEX1U06**	C.11
FLEX1U12	C.11
FLEX1UPN04	C.11
FLEX1UPN06**	C.11
FLEX1UPN12	C.11
FLEX2U04	C.11
FLEX2U06**	C.11
FLEX2U12	C.11
FLEX2UPN04	C.11
FLEX2UPN06**	C.11
FLEX2UPN12	C.11
FLEX4U04	C.11
FLEX4U06**	C.11
FLEX4U12	C.11
FLEX4UPN04	C.11
FLEX4UPN06**	C.11
FLEX4UPN12	C.11
FLEX-CLIP12	C.15
FLEX-CLIP18	C.15
FLEX-CM12C	C.15
FLEX-CM12S	C.15
FLEX-CM18C	C.15
FLEX-CM18S	C.15
FLEX-CM-1UB	C.15
FLEX-CM-1UBKIT	C.15
FLEX-FCM1UA**	C.15
FLEX-FCM2UA**	C.15
FLEX-FCM4UA**	C.15
FLEX-OPTI-1RU	C.15
FLEX-OPTI-1RU	C.22
FLEX-PLATE1U**	C.15
FLEX-PLATE1UPR	C.15
FLEX-PLATE1UR	C.15
FLEX-PLATE2U**	C.15
FLEX-PLATE2UPR	C.15
FLEX-PLATE2UR	C.15
FLEX-PLATE4U**	C.15
FLEX-PLATE4UPR	C.15
FLEX-PLATE4UR	C.15
FLEX-RAIL04EN	C.15
FLEX-RAIL04PN	C.15
FLEX-RAIL06EN	C.15
FLEX-RAIL06PN	C.15

Part Number	Page Number
FLEX-RCM1U**	C.15
FLEX-RCM4U**	C.15
FLRB	J.41
FLRME	C.23
FMP6	C.22
FMT1**	C.17
FMT1A**	C.17
FMT2	C.17
FMT2A	C.17
FOCTT2-BKIT	C.4
FOCTT2-KIT	C.4
FOCTT2-PKIT	C.4
FOLPC-1.25MM	C.4
FOLPC-1.25SM	C.4
FOLPC-2.5MM	C.4
FOLPC-2.5SM	C.4
FOSMF	C.22
FOSMH1U	C.22
FOSMH2U	C.22
FOSMH4U	C.22
FOSMM	C.22
FOV452X2YL	J.40
FOVRA2X2YL	J.40
FP6X88MTG	B.11
FP6X88MTG-X	B.11
FP6X88TC	B.11
FPFPC1	C.22
FPS6X88MTG	B.11
FPS6X88MTG-S	B.11
FPUD6X88MTG	B.11
FPUD6X88MTG-X	B.11
FQ39N-08-10A	C.25
FQ3XN-08-10B	C.25
FQ3ZN-08-10B	C.25
FQ3ZO-08-10B	C.25
FQ6N-12-10**	C.25
FQ9N-12-10**	C.25
FQCBRUA	C.26
FQCRCM	C.26
FQMAP45BL	C.26
FQMAP45RD	C.26
FQMAP46CG	C.26
FQMAP65BL	C.26
FQMAP65RD	C.26
FQMAP65W	C.26
FQMAP66CG	C.26
FQMAP66W	C.26
FQMAP85BL	C.26
FQMAP85RD	C.26
FQMAP86CG	C.26
FQSA-12-10**	C.25
FQWA-12-10**	C.25
FQXN-12-10**	C.25
FQXO-12-10**	C.25
FQZN-12-10**	C.25
FQZO-12-10**	C.25
FR1.5IDEYL	J.42
FR12ACAB	J.17
FR12ACB12	J.16
FR12ACB12M	J.16
FR12ACB58	J.16

A. Featured Products
B. Copper Systems
C. Fiber Systems
D. Faceplates, Frames & Surface Mount Boxes
E. Industrial Networks
F. Audio Video Systems
G. Keystone Cabling Systems
H. Zone Cabling
J. Cable Routing Systems
K. Cable Cleats
L. Cabinets & Rack Systems
M. Power & Connectivity Management
N. Grounding & Bonding
O. Identification Products
P. Cable Management Accessories
Q. Part Number Index

Index by Part Number

	A. Featured Products		B. Copper Systems		C. Fiber Systems		D. Faceplates, Frames & Surface Mount Boxes		E. Industrial Networks		F. Audio Video Systems		G. Keystone Cabling Systems		H. Zone Cabling		J. Cable Routing Systems		K. Cable Cleats		L. Cabinets & Rack Systems		M. Power & Connectivity Management		N. Grounding & Bonding		O. Identification Products		P. Cable Management Accessories		Q. Part Number Index																																																																																																																																																																																																																																																																																																																																															
	Part Number	Page Number	Part Number	Page Number	Part Number	Page Number	Part Number	Page Number	Part Number	Page Number	Part Number	Page Number	Part Number	Page Number	Part Number	Page Number	Part Number	Page Number	Part Number	Page Number	Part Number	Page Number	Part Number	Page Number	Part Number	Page Number	Part Number	Page Number	Part Number	Page Number	Part Number	Page Number																																																																																																																																																																																																																																																																																																																																														
	FR12ACB58M	J.16	FRBC6X4YL	J.21	FROVRA12X4YL	J.13	FR12ALB	J.15	FRCV24YL10	J.4	FROVRA4X4YL	J.32	FR12CS12	J.15	FREC12X4YL	J.13	FROVRA6X4YL	J.22	FR12CS12M	J.15	FREC24X4YL	J.5	FROVRASC12YL	J.13	FR12CS58	J.15	FREC4X4YL	J.32	FROVRASC4YL	J.32	FR12CS58M	J.15	FREC6X4YL	J.22	FROVRASC6YL	J.22	FR12TB12	J.16	FRFWC12X4W4YL	J.12	FRQMC24-X	J.7	FR12TB12M	J.16	FRFWC12X4W6YL	J.12	FRQMC-X	J.43	FR12TB2412	J.16	FRFWC12X4YL	J.12	FRRRA12X4YL	J.11	FR12TB2412M	J.16	FRFWC24X4W12YL	J.5	FRRRA4X4YL	J.31	FR12TB58	J.16	FRFWC24X4YL	J.5	FRRRA6X4YL	J.21	FR12TB58M	J.16	FRFWC4X4YL	J.32	FRRASC12YL	J.11	FR12TRBE58	J.15	FRFWC6X4YL	J.22	FRRASC4YL	J.31	FR12TRBE58M	J.15	FRFWCCV24W12YL	J.5	FRRASC6YL	J.21	FR12TRBN58	J.15	FRFWCCV24YL	J.5	FRRF126SCYL	J.13	FR12TRBN58M	J.15	FRFWCSC12W4YL	J.12	FRRF126YL	J.13	FR12X4YL6	J.10	FRFWCSC12W4YL	J.13	FRRF2412CVYL	J.6	FR24TBE12	J.7	FRFWCSC12W6YL	J.12	FRRF2412YL	J.6	FR24TBE12M	J.7	FRFWCSC4YL	J.32	FRRF4FD2YL	J.33	FR24TBN12	J.7	FRFWCSC6YL	J.22	FRRF4FD4YL	J.33	FR24TBN12M	J.7	FRH4512X4YL	J.11	FRRF64YL	J.23	FR24X4YL10	J.4	FRH4524X4YL	J.5	FRRF6FR4SCYL	J.23	FR38DR	J.43	FRH454X4YL	J.31	FRRF6FR4SCYL	J.33	FR4PRB58	J.17	FRH456X4YL	J.21	FRRF6FR4YL	J.23	FR4PRB58M	J.27	FRH45CV24YL	J.5	FRRF6FR4YL	J.33	FR4X4YL6	J.30	FRH45SC12YL	J.11	FRSHC4YL6	J.30	FR516DR	J.43	FRH45SC4YL	J.31	FRSHC6YL6	J.20	FR6ACAB	J.26	FRH45SC6YL	J.21	FRSPJ2X2YL	J.6	FR6ACB12	J.25	FRHC12YL6	J.10	FRSPJ2X2YL	J.14	FR6ACB12M	J.25	FRHC4YL6	J.30	FRSPJ2X2YL	J.23	FR6ACB58	J.25	FRHC6YL6	J.20	FRSPJ2X2YL	J.24	FR6ACB58M	J.25	FRHD2KTYL	J.42	FRSPJ2X2YL	J.34	FR6ALB	J.25	FRHD4KTYL	J.42	FRSPJ4X4YL	J.6	FR6CS12	J.25	FRIDT4X4YL	J.6	FRSPJ4X4YL	J.14	FR6CS12M	J.25	FRIDT4X4YL	J.15	FRSPJ4X4YL	J.24	FR6CS58	J.25	FRIDT4X4YL	J.24	FRSPJ4X4YL	J.35	FR6CS58M	J.25	FRIDT4X4YL	J.35	FRSPJC212YL	J.14	FR6LB	J.27	FRIDT6X4YL	J.14	FRSPJC24YL	J.34	FR6LRB	J.26	FRIDT6X4YL	J.24	FRSPJC26YL	J.23	FR6TB12	J.25	FRIV4512X4YL	J.13	FRSPJC412YL	J.14	FR6TB12M	J.25	FRIV4524X4YL	J.5	FRSPJC44YL	J.35	FR6TB38	J.25	FRIV454X4YL	J.32	FRSPJC46YL	J.24	FR6TB38M	J.25	FRIV456X4YL	J.22	FRSTRCBL	J.43	FR6TRBE12	J.25	FRIVRA4X4YL	J.32	FRT12X4W4YL	J.12	FR6TRBE12M	J.25	FRIVRA6X4YL	J.22	FRT12X4W6YL	J.12	FR6TRBE58	J.25	FRLPR42BL	J.42	FRT12X4YL	J.11	FR6TRBE58M	J.25	FRLPR64BL	J.42	FRT24X4W12YL	J.5	FR6TRBN12	J.25	FRME144SBL	C.22	FRT4X4YL	J.31	FR6TRBN12M	J.25	FRME1U**	C.16	FRT6X4YL	J.21	FR6TRBN58	J.25	FRME2U**	C.16	FRTBKT-X	J.43	FR6TRBN58M	J.25	FRME3**	C.16	FRTBWG12BL	J.26	FR6X4YL6	J.20	FRME4**	C.16	FRTBWG12BL	J.49	FR716DR	J.43	FRMHSS-4RU	C.16	FRTBWG18BL	J.16	FR716DR	J.52	FROV4512X4YL	J.13	FRTBWG18BL	J.26	FRA2X2YL	J.40	FROV4524X4YL	J.5	FRTBWG18BL	J.49	FRADC12X4BL	J.27	FROV454X4YL	J.32	FRTBWG24BL	J.26	FRADC4X4BL	J.27	FROV456X4YL	J.22	FRTBWG24BL	J.49	FRADC6X4YL	J.27	FROV45CV24YL	J.5	FRTBWG24BL	J.16	FRBC12X4YL	J.11	FROV45SC12YL	J.13	FRTBWG30BL	J.7	FRBC24X4YL	J.4	FROV45SC4YL	J.32	FRTBWG30BL	J.16	FRBC4X4YL	J.31	FROV45SC6YL	J.22	FRTBWG30BL	J.26

Index by Part Number

Part Number	Page Number
FRTBWG30BL	J.49
FRTC2V24W12YL	J.5
FRTR12X4YL	J.15
FRTR24X4YL	J.6
FRTR4X4YL	J.6
FRTR4X4YL	J.15
FRTR4X4YL	J.24
FRTR4X4YL	J.35
FRTR6X4YL	J.14
FRTR6X4YL	J.24
FRTSC12W4YL	J.12
FRTSC12W6YL	J.12
FRTSC12YL	J.12
FRTSC4YL	J.31
FRTSC6YL	J.21
FRVT12X4YL	J.14
FRVT4X4YL	J.34
FRVT6X4YL	J.23
FSC24	C.22
FSC2DMC5BL	C.6
FSC2DMC6EI	C.6
FSC2DMCXAQ	C.6
FSC2DSCBU	C.6
FSC2MC5BL	C.6
FSC2MC6EI	C.6
FSC2MCXAQ	C.6
FSC2SCBU	C.6
FSPCVR	C.4
FST144R	C.16
FST24	C.22
FST24H3	C.22
FST2MC5BL	C.6
FST2MC6EI	C.6
FST2MCXAQ	C.6
FST2SCBU	C.6
FST48	C.16
FST6	C.22
FSTHE	C.22
FSTK	C.22
FT2X2YL	J.40
FTDNS4X4YL	J.27
FTHS	C.22
FTR2X2YL	J.6
FTR2X2YL	J.14
FTR2X2YL	J.24
FTR2X2YL	J.35
FTR2X2YL	J.39
FTR4X4YL	J.23
FTR4X4YL	J.34
FTRBE12	J.41
FTRBE12M	J.41
FTRBE58	J.41
FTRBN12	J.41
FTRBN12M	J.41
FTRBN58	J.41
FTRC2HDBL	J.42
FVTHD2X2YL	J.39
FWME2	C.17
FWME4	C.17
FWME8	C.17
FZBA1.5X4	J.41

Part Number	Page Number
FZBLP	J.41
G	
GACB-2	J.51
GACB-3	J.51
GACBJ68U*	J.51
GPB24-X	B.25
GPB2884R2Y	B.24
GPB484R2Y	B.24
GPBW24-X	B.25
GPCB4-X	B.25
GPCB5-X	B.25
GPDTM	B.26
GPKBW144Y	B.24
GPKBW24Y	B.24
GPKBW432Y	B.24
GPKBW72Y	B.24
GPPC4IG#AY	B.25
GPPC4IG#BY	B.25
GPPC4IG#Y	B.25
GPST	B.26
H	
H2X2YL6	J.40
HC2YL6	J.40
HDMI1MWH	F.2
HDMI2MWH	F.2
HDMI4MWH	F.2
HDW1/4-A-KT	N.7
HDW1/4-KT	N.7
HDW3/8-A-KT	N.7
HDW3/8-KT	N.7
HLB2S-C	P.5
HLB2S-C0	P.2
HLM-15R	P.5
HLM-15R0	P.2
HLS-15R	P.5
HLS-15R0	P.2
HLS-75R	P.5
HLS-75R0	P.2
HLSP1.5S-X	P.5
HLSP1.5S-X0	P.3
HLSP1.5S-X12	P.3
HLSP3S-X	P.5
HLSP3S-X0	P.3
HLSP3S-X12	P.3
HLSP5S-X	P.5
HLSP5S-X0	P.3
HLSP5S-X12	P.3
HLT2I-M0	P.2
HLT2I-X	P.5
HLT2I-X0	P.2
HLT3I-M0	P.2
HLT3I-X	P.5
HLT3I-X0	P.2
HLTP2I-X	P.5
HLTP2I-X0	P.3
HLTP2I-X12	P.3
HLTP3I-X	P.5
HLTP3I-X0	P.3

Part Number	Page Number
HLTP3I-X12	P.3
HLTT1.5S-C	P.5
HLTT1.5S-Q	P.5
HS2X2YL6NM	J.40
HTCT2-2-1	N.19
HTCT250-2-1	N.19
HTCT250-250-1	N.19
HTCT6X-6X-1	N.19
I	
I4JPBJLUXX*	E.6
I4KOTJLUXX*	E.6
IAEBH5E	E.4
IAEBH5ES	E.4
IAEBH6	E.4
IAEBH6S	E.4
IAEBH6X	E.4
IAEBH6XS	E.4
IAEBHC5E	E.4
IAEBHC6	E.4
IAEBHUSBAA	E.4
IAEBHV56XS	E.4
IAEF617P-7PM1	E.6
IAEF617P-NM1	E.6
IAEF7JMA	E.6
IAEFP1	E.7
IAEFP2-2G	E.7
IAPNG5EWJ	E.7
ICAM12DRJS	E.4
ICAM12X90RJS	E.4
ICAM12XRJS	E.4
ICD11T1NTL*M	E.5
ICD11T2NTL*M	E.5
ICD12T1NTL*M	E.5
ICD13T1NTL*M	E.5
ICD14T1NTL*M	E.5
ICD15T1NTL*M	E.5
ICD22T1NTL*M	E.5
ICD25T1NTL*M	E.5
ICD26T1NTL*M	E.5
ICD35T1NTL*M	E.5
ICD44T1NTL*M	E.5
ICD45T1NTL*M	E.5
ICX11T1NTL*M	E.5
ICX14T1NTL*M	E.5
ICX15T1NTL*M	E.5
ICX44T1NTL*M	E.5
ICX45T1NTL*M	E.5
IFRH5C02** - UG	E.2
IFRH5C04** - UG	E.2
IFRH6C04** - UG	E.2
ISFCH5C02ATL-XG	E.2
ISFCH5C04ATL-XG	E.2
ISFCH6X04ATL-UG	E.2
ISFCH6X04BTL-UG	E.2
ISFX5502ATL-LED	E.2
ISPS5E44MFA	E.4
ISPS688FA	E.4
ISPS688FAS	E.4
ISPS6A88MFA	E.4
ISTPCH1MBLY	E.3

A. Featured Products

B. Copper Systems

C. Fiber Systems

D. Faceplates, Frames & Surface Mount Boxes

E. Industrial Networks

F. Audio Video Systems

G. Keystone Cabling Systems

H. Zone Cabling

J. Cable Routing Systems

K. Cable Cleats

L. Cabinets & Rack Systems

M. Power & Connectivity Management

N. Grounding & Bonding

O. Identification Products

P. Cable Management Accessories

Q. Part Number Index

Index by Part Number

A. Featured Products
B. Copper Systems
C. Fiber Systems
D. Faceplates, Frames & Surface Mount Boxes
E. Industrial Networks
F. Audio Video Systems
G. Keystone Cabling Systems
H. Zone Cabling
J. Cable Routing Systems
K. Cable Cleats
L. Cabinets & Rack Systems
M. Power & Connectivity Management
N. Grounding & Bonding
O. Identification Products
P. Cable Management Accessories
Q. Part Number Index

Part Number	Page Number
ISTPH6X0.3MBL	E.3
ISTPHCH1MTL	E.3
ISTPSP1MBL	E.3
ISX6004AYL-LED	E.2
ISX6X04AYL-LED	E.2
IUC6C04ABL-CEG	E.2
IUTPCH3BLY	E.3
IUTPSP3BL	E.3

J

JP131CMB-L20	P.15
JP131CP-L20	P.16
JP131DW-L20	P.15
JP131HBC25RBL20	P.17
JP131HBC50RBL20	P.17
JP131HBC75RBL20	P.17
JP131SBC50-L20	P.16
JP131SBC50RBL20	P.16
JP131SBC87-L20	P.16
JP131SBC87RBL20	P.16
JP131UF100-L20	P.17
JP131W-L20	P.15
JP131WP2B-L20	P.15
JP131ZP-L20	P.16
JP2CMB-L20	P.15
JP2CP-L20	P.16
JP2DW-L20	P.15
JP2HBC25RB-L20	P.17
JP2HBC50RB-L20	P.17
JP2HBC75RB-L20	P.17
JP2SBC50-L20	P.16
JP2SBC50RB-L20	P.16
JP2SBC87-L20	P.16
JP2SBC87RB-L20	P.16
JP2UF100-L20	P.17
JP2W-L20	P.15
JP2WP2B-L20	P.15
JP2ZP-L20	P.16
JP4CMB-X20	P.15
JP4CP-X20	P.16
JP4DW-X20	P.15
JP4HBC25RB-X20	P.17
JP4HBC50RB-X20	P.17
JP4HBC75RB-X20	P.17
JP4SBC50RB-X20	P.16
JP4SBC50-X20	P.16
JP4SBC87RB-X20	P.16
JP4SBC87-X20	P.16
JP4UF100-X20	P.17
JP4WP2B-X20	P.15
JP4W-X20	P.15
JP4ZP-X20	P.16
JP75CMB-L20	P.15
JP75CP-L20	P.16
JP75DW-L20	P.15
JP75HBC25RB-L20	P.17
JP75HBC50RB-L20	P.17
JP75HBC75RB-L20	P.17
JP75SBC50-L20	P.16
JP75SBC50RB-L20	P.16
JP75SBC87-L20	P.16

Part Number	Page Number
JP75SBC87RB-L20	P.16
JP75UF100-L20	P.17
JP75W-L20	P.15
JP75WP2B-L20	P.15
JP75ZP-L20	P.16

K

KFPL80S2SWH	G.6
KFPL86S2SWH	G.6
KJS6X88TC	G.2
KP24WSBL	G.3
KPA24WSBL	G.3
KPA48WSBL	G.3
KPCRT1-FL	B.29
KPS24BL	G.3
KWP5EY	D.7
KWP6PY	D.7
KWPY	D.7

L

LCC1/0-12W-X	N.17
LCC1/0-14AW-X	N.17
LCC1/0-38DW-X	N.17
LCC10-14AW-L*	N.16
LCC10-14JAWF-L*	N.16
LCC10-14JAWH-L*	N.16
LCC10-14JAW-L*	N.16
LCC2/0-12W-X	N.17
LCC2/0-14AW-X	N.17
LCC2/0-38DW-X	N.17
LCC2-12W-Q	N.16
LCC2-14AW-Q	N.16
LCC2-38DW-Q	N.16
LCC250-12W-X	N.17
LCC250-38DW-X	N.17
LCC3/0-12W-X	N.17
LCC3/0-38DW-X	N.17
LCC4/0-12W-X	N.17
LCC4/0-38DW-X	N.17
LCC4-12W-L	N.16
LCC4-14AW-L	N.16
LCC4-38DW-L	N.16
LCC6-10ABW-L	N.16
LCC6-12W-L	N.16
LCC6-14AW-L	N.16
LCC6-14JAWF-L	N.16
LCC6-14JAWH-L	N.16
LCC6-14JAW-L	N.16
LCC6-38DW-L	N.16
LCC8-10AW-L	N.16
LCC8-14AWF-L	N.16
LCC8-14AWH-L	N.16
LCC8-38DW-L	N.16
LCCX1/0-12-X	N.18
LCCX1/0-14A-X	N.18
LCCX1/0-38D-X	N.18
LCCX2/0-12-X	N.18
LCCX2/0-14A-X	N.18
LCCX2/0-38D-X	N.18
LCCX2-12-E	N.18

Part Number	Page Number
LCCX2-14A-E	N.18
LCCX2-38D-E	N.18
LCCX250-38D-X	N.18
LCCX3/0-38D-X	N.18
LCCX350-12-6	N.18
LCCX350-38D-6	N.18
LCCX4/0-12-X	N.18
LCCX4/0-38D-X	N.18
LCCX4-14A-L	N.18
LCCX4-38D-L	N.18
LCCX450-12-6	N.18
LCCX450-38D-6	N.18
LCCX500-12-6	N.18
LCCX500-38D-6	N.18
LCCX6-14AF-L	N.18
LCCX6-14AH-L	N.18
LCCX6-14A-L	N.18
LCCX6-38D-L	N.18
LCCX650-12-6	N.18
LCCX8-14AF-L	N.18
LCCX8-14AH-L	N.18
LCCX8-14A-L	N.18
LCCX8-38D-L	N.18
LPCA01	M.8
LPCA01X	M.8
LPCA02	M.8
LPCA02X	M.8
LPCA03	M.8
LPCA03X	M.8
LPCA04	M.8
LPCA04X	M.8
LPCA06	M.8
LPCA06X	M.8
LPCA07	M.8
LPCA07X	M.8
LPCA08	M.8
LPCA08X	M.8
LPCA09	M.8
LPCA09X	M.8
LPCA11	M.8
LPCA11X	M.8
LPCA12	M.8
LPCA12X	M.8
LPCA13	M.8
LPCA13X	M.8
LPCA14	M.8
LPCA14X	M.8
LPCB01	M.9
LPCB01X	M.9
LPCB02	M.9
LPCB02X	M.9
LPCB03	M.9
LPCB03X	M.9
LPCB04	M.9
LPCB04X	M.9
LPCB06	M.9
LPCB06X	M.9
LPCB07	M.9
LPCB07X	M.9
LPCB08	M.9
LPCB08X	M.9

Index by Part Number

Part Number	Page Number
LPCB09	M.9
LPCB09X	M.9
LPCB11	M.9
LPCB11X	M.9
LPCB12	M.9
LPCB12X	M.9
LPCB13	M.9
LPCB13X	M.9
LPCB14	M.9
LPCB14X	M.9
LS8-CASE	O.2
LS8-CLN	O.2
LS8E	O.2
LS8E-ACS	O.2
LS8E-KIT	O.2
LS8E-KIT-ACS	O.2
LS8EQ	O.2
LS8EQ-KIT	O.2
LS8EQ-KIT-ACS	O.2
LS8-IB	O.2
LS8-PCKIT	O.2
LS8-WS	O.2
LWC100-A-L	P.12
LWC100-A-L20	P.12
LWC100-H25-L	P.12
LWC100-H25-L20	P.12
LWC19-A-C	P.12
LWC19-A-C14	P.12
LWC19-A-C20	P.12
LWC19-H25-C	P.12
LWC25-A-C	P.12
LWC25-A-C20	P.12
LWC25-H25-C	P.12
LWC25-H25-C20	P.12
LWC38-A-C	P.12
LWC38-A-C20	P.12
LWC38-H25-C	P.12
LWC38-H25-C20	P.12
LWC50-A-L	P.12
LWC50-A-L20	P.12
LWC50-H25-L	P.12
LWC50-H25-L20	P.12
LWC75-A-L	P.12
LWC75-A-L20	P.12
LWC75-H25-L	P.12
LWC75-H25-L20	P.12
M	
M200X050*	O.13
M200X100*	O.13
M300X050*	O.13
M300X050Y6C	O.5
M300X050Y7C	O.5
M300X100*	O.13
MDC79	E.8
MDC79D	E.8
MDC82NL	E.8
MDC82NN	E.8
MDC82NS	E.8
MFFPEBL	D.5
MP528-C	B.12

Part Number	Page Number
MP528-M	B.12
MP530-C	B.12
MP588-C	B.12
MP588-L	B.12
MP588-M	B.12
MPI588T	E.4
MPS588-C	B.12
MPSI588T	E.4
MPSIV56XT	E.4
MPT5-8AS	B.12
MWBA1	D.7
N	
N*1SPS	L.9
N*2SPS	L.9
N2EOR1BA1070B1	L.11
N2EOR1CA1200B1	L.11
N8*DHDB	L.9
N8*SHDB	L.9
NACSS	L.10
NAKOSHDP	L.11
NCSTR4	L.11
NERSS	L.10
NFFY6X04BU-HED	G.2
NK1FIWY	G.6
NK1FNIW	G.6
NK2BXIW-A	G.8
NK2FIWY	G.6
NK2FNIW	G.6
NK2RMFIW	F.4
NK35MSCIW	F.5
NK3FNIW	G.6
NK4BXIW-AY	G.8
NK4FIWY	G.6
NK4FNIW	G.6
NK4MFABL	G.8
NK4MFBL	G.8
NK4RMFIW	F.4
NK4VSFIWY	G.6
NK5EPC3BUY	G.2
NK5EPPG12WY	G.3
NK5EPPG24Y	G.3
NK5EPPG48Y	G.3
NK688MBU	G.2
NK688MBU-Q	G.2
NK6APC3BU	G.2
NK6BXIW-AY	G.8
NK6FIWY	G.6
NK6FNIW	G.6
NK6PC3BUY	G.2
NK6PPG12WY	G.3
NK6PPG24Y	G.3
NK6PPG48Y	G.3
NK6X88MBU	G.2
NK6X88MBU-Q	G.2
NK6XPPG24Y	G.3
NK6XPPG48Y	G.3
NKA5EPPG24Y	G.3
NKA6PPG24Y	G.3
NKA6PPG48Y	G.3

Part Number	Page Number
NKA6XPPG24Y	G.3
NKA6XPPG48Y	G.3
NKBMIW-X	F.5
NKDLCMZIW	G.4
NKDSCMZIW	G.4
NKF2S	G.7
NKF4S	G.7
NKF6S	G.7
NKFD1W12BUDLCZ	G.4
NKFD1W12BUDSCZ	G.4
NKFD1W24BUDLCZ	G.4
NKFD1W6BUDSCZ	G.4
NKFIW	F.5
NKFP24Y	G.3
NKFP48Y	G.3
NKFP24	G.3
NKFP48	G.3
NKHDMIW	F.5
NKHF2MIW-X	F.4
NKHF2MIW-X	G.7
NKHS2IW-X	G.7
NKHS2SIW-X	G.7
NKP5E88MBU	G.2
NKP5E88MBU-Q	G.2
NKPP24FMY	G.3
NKPP48FMY	G.3
NKPPA24FMY	G.3
NKPPA48FMY	G.3
NKUSBAAIW	F.5
NM1	L.32
NM2	L.32
NM3	L.32
NM4	L.32
NMF1	L.32
NMF1WH	L.32
NMF2	L.32
NMF2WH	L.32
NMF3	L.32
NMF3WH	L.32
NMF4	L.32
NMF4WH	L.32
NREPBI	L.30
NUC6C04BU-FE	G.2
NUL5C04BU-CE	G.2
NUL6X04BU-HEG	G.2
NUY6C04BU-CE	G.2
NUY6X04BU-HEG	G.2
NUZ6C04BU-KE	G.2
NVBP	L.11
NVPDUBE	L.10
NWSLC2-2Y	O.13
NWSLC2-2Y-AQ	O.13
NWSLC2-3Y	O.13
NWSLC2-7Y	O.13
NWSLC-2Y	O.13
NWSLC-2Y-AQ	O.13
NWSLC-3Y	O.13
NWSLC-7Y	O.13
P	
P06B35M	M.6

A. Featured Products
B. Copper Systems
C. Fiber Systems
D. Faceplates, Frames & Surface Mount Boxes
E. Industrial Networks
F. Audio Video Systems
G. Keystone Cabling Systems
H. Zone Cabling
J. Cable Routing Systems
K. Cable Cleats
L. Cabinets & Rack Systems
M. Power & Connectivity Management
N. Grounding & Bonding
O. Identification Products
P. Cable Management Accessories
Q. Part Number Index

Index by Part Number

A. Featured Products	Part Number		Page Number		Part Number	Page Number		Part Number	Page Number	
	Part Number	Page Number	Part Number	Page Number		Part Number	Page Number		Part Number	Page Number
B. Copper Systems	P06B38M.....	M.6	P42B42M.....	M.6	PE2VSD0896	L.28	PE2VSD0896WH	L.28	PE2VSD08WH	L.28
	P08E25M.....	M.4	P42B44M.....	M.6	PE2VSD10	L.28	PE2VSD1096WH	L.28	PE2VSD10WH	L.28
C. Fiber Systems	P08G10M	M.5	P42D04M.....	M.3	PE2VSD1096	L.28	PE2VSD12	L.28	PE2VSD1296	L.28
	P110B1004R2Y.....	B.24	P42D06M.....	M.3	PE2VSD1296WH	L.28	PE2VSD12WH	L.28	PEB1	L.34
D. Faceplates, Frames & Surface Mount Boxes	P110B1004R4WJY.....	B.24	P42D42M.....	M.3	PEB2	L.34	PF6L6X04WH-HED.....	B.4	PFF6Y6X04WH-HED	B.4
	P110B1005R2Y.....	B.24	P48B45M.....	M.6	PFL5504**	B.2	PFL5504WH-KG.....	B.6	PFL6004WH-KD.....	B.5
E. Industrial Networks	P110B1005R4WJY.....	B.24	PBTMT/E.....	K.6	PFL6X04WH-CEG.....	B.4	PFO6X04BL-CEG	B.7	PFY6X04WH-CED	B.4
	P110B100R2BY	B.26	PCBANDBL-Q	B.29	PND100	F.3	PND110	F.3	PND400	F.3
F. Audio Video Systems	P110B100R2Y.....	B.24	PCBANDBU-Q	B.29	PNIPIV.....	E.13	POEXKIT1	B.13	POEXKIT4	B.13
	P110B100R4WJY.....	B.24	PCBANDEI-Q	B.29	POEXR1.....	B.13	POEXR4.....	B.13	POEXTX1	B.13
G. Keystone Cabling Systems	P110B100-X	B.25	PCBANDGR-Q	B.29	PR2VBPK	L.29	PR2VD06.....	L.27	PR2VD0679.....	L.27
	P110B300-X.....	B.25	PCBANDIG-Q	B.29	PR2VD0679WH.....	L.27	PR2VD0696.....	L.27	PR2VD0696WH.....	L.27
H. Zone Cabling	P110BW100-X.....	B.25	PCBANDOR-Q	B.29	PR2VD08.....	L.27	PR2VD0896.....	L.27	PR2VD0896WH.....	L.27
	P110BW300-X.....	B.25	PCBANDRD-Q	B.29	PR2VD08WH.....	L.27	PR2VD10.....	L.27	PR2VD1096.....	L.27
J. Cable Routing Systems	P110CB4-CY.....	B.25	PCBANDV-L-Q	B.29	PR2VD1096WH.....	L.27	PR2VD10WH.....	L.27	PR2VD12.....	L.27
	P110CB4-XY	B.25	PCBANDWH-Q	B.29	PR2VD1279.....	L.27	PR2VD1279WH.....	L.27	PR2VD1296.....	L.27
K. Cable Cleats	P110CB5-CY.....	B.25	PCBANDYL-Q	B.29	PR2VD1296WH.....	L.27	PR2VD1296WH.....	L.27	PR2VD1296WH.....	L.27
	P110CB5-XY	B.25	PCRT1.....	B.29	PR2VD1296WH.....	L.27	PR2VD1296WH.....	L.27	PR2VD1296WH.....	L.27
L. Cabinets & Rack Systems	P110JTW-X.....	B.26	PDT110	B.26	PR2VD1296WH.....	L.27	PR2VD1296WH.....	L.27	PR2VD1296WH.....	L.27
	P110JT-X.....	B.26	PDT110M.....	B.26	PR2VD1296WH.....	L.27	PR2VD1296WH.....	L.27	PR2VD1296WH.....	L.27
M. Power & Connectivity Management	P110KB1004Y.....	B.24	PE2VD06.....	L.28	PR2VD1296WH.....	L.27	PR2VD1296WH.....	L.27	PR2VD1296WH.....	L.27
	P110KB1005Y.....	B.24	PE2VD0696.....	L.28	PR2VD1296WH.....	L.27	PR2VD1296WH.....	L.27	PR2VD1296WH.....	L.27
N. Grounding & Bonding	P110KB3004Y.....	B.24	PE2VD0696WH.....	L.28	PR2VD1296WH.....	L.27	PR2VD1296WH.....	L.27	PR2VD1296WH.....	L.27
	P110KB3005Y.....	B.24	PE2VD06WH.....	L.28	PR2VD1296WH.....	L.27	PR2VD1296WH.....	L.27	PR2VD1296WH.....	L.27
O. Identification Products	P110KT3004Y.....	B.26	PE2VD08.....	L.28	PR2VD1296WH.....	L.27	PR2VD1296WH.....	L.27	PR2VD1296WH.....	L.27
	P110KT3005Y.....	B.26	PE2VD0896.....	L.28	PR2VD1296WH.....	L.27	PR2VD1296WH.....	L.27	PR2VD1296WH.....	L.27
P. Cable Management Accessories	P110KT9004Y.....	B.26	PE2VD0896WH.....	L.28	PR2VD1296WH.....	L.27	PR2VD1296WH.....	L.27	PR2VD1296WH.....	L.27
	P110KT9005Y.....	B.26	PE2VD08WH.....	L.28	PR2VD1296WH.....	L.27	PR2VD1296WH.....	L.27	PR2VD1296WH.....	L.27
Q. Part Number Index	P110LH.....	B.26	PE2VD10.....	L.28	PR2VD1296WH.....	L.27	PR2VD1296WH.....	L.27	PR2VD1296WH.....	L.27
	P110PC1IG#Y.....	B.25	PE2VD1096.....	L.28	PR2VD1296WH.....	L.27	PR2VD1296WH.....	L.27	PR2VD1296WH.....	L.27
	P110PC2IG#Y.....	B.25	PE2VD1096WH.....	L.28	PR2VD1296WH.....	L.27	PR2VD1296WH.....	L.27	PR2VD1296WH.....	L.27
	P110PC4IG#AY.....	B.25	PE2VD10WH.....	L.28	PR2VD1296WH.....	L.27	PR2VD1296WH.....	L.27	PR2VD1296WH.....	L.27
	P110PC4IG#BY.....	B.25	PE2VD12.....	L.28	PR2VD1296WH.....	L.27	PR2VD1296WH.....	L.27	PR2VD1296WH.....	L.27
	P110PC4IG#Y.....	B.25	PE2VD1296.....	L.28	PR2VD1296WH.....	L.27	PR2VD1296WH.....	L.27	PR2VD1296WH.....	L.27
	P110PC4-XY	B.26	PE2VD1296WH.....	L.28	PR2VD1296WH.....	L.27	PR2VD1296WH.....	L.27	PR2VD1296WH.....	L.27
	P12B34M.....	M.6	PE2VD12WH.....	L.28	PR2VD1296WH.....	L.27	PR2VD1296WH.....	L.27	PR2VD1296WH.....	L.27
	P12B36M.....	M.6	PE2VEP.....	L.29	PR2VD1296WH.....	L.27	PR2VD1296WH.....	L.27	PR2VD1296WH.....	L.27
	P12D36M.....	M.3	PE2VEP96.....	L.29	PR2VD1296WH.....	L.27	PR2VD1296WH.....	L.27	PR2VD1296WH.....	L.27
	P22B39M.....	M.6	PE2VEP96WH.....	L.29	PR2VD1296WH.....	L.27	PR2VD1296WH.....	L.27	PR2VD1296WH.....	L.27
	P24B12M.....	M.6	PE2VEPWH.....	L.29	PR2VD1296WH.....	L.27	PR2VD1296WH.....	L.27	PR2VD1296WH.....	L.27
	P24D03M.....	M.3	PE2VFD06.....	L.28	PR2VD1296WH.....	L.27	PR2VD1296WH.....	L.27	PR2VD1296WH.....	L.27
	P24D04M.....	M.3	PE2VFD0696.....	L.28	PR2VD1296WH.....	L.27	PR2VD1296WH.....	L.27	PR2VD1296WH.....	L.27
	P24D043M.....	M.3	PE2VFD0696WH.....	L.28	PR2VD1296WH.....	L.27	PR2VD1296WH.....	L.27	PR2VD1296WH.....	L.27
	P24E01M.....	M.4	PE2VFD06WH.....	L.28	PR2VD1296WH.....	L.27	PR2VD1296WH.....	L.27	PR2VD1296WH.....	L.27
	P24E02M.....	M.4	PE2VFD08.....	L.28	PR2VD1296WH.....	L.27	PR2VD1296WH.....	L.27	PR2VD1296WH.....	L.27
	P24E03M.....	M.4	PE2VFD0896.....	L.28	PR2VD1296WH.....	L.27	PR2VD1296WH.....	L.27	PR2VD1296WH.....	L.27
	P24E04M.....	M.4	PE2VFD0896WH.....	L.28	PR2VD1296WH.....	L.27	PR2VD1296WH.....	L.27	PR2VD1296WH.....	L.27
	P24F06M.....	M.4	PE2VFD08WH.....	L.28	PR2VD1296WH.....	L.27	PR2VD1296WH.....	L.27	PR2VD1296WH.....	L.27
	P24G06M.....	M.5	PE2VFD10.....	L.28	PR2VD1296WH.....	L.27	PR2VD1296WH.....	L.27	PR2VD1296WH.....	L.27
	P24G08M.....	M.5	PE2VFD1096.....	L.28	PR2VD1296WH.....	L.27	PR2VD1296WH.....	L.27	PR2VD1296WH.....	L.27
	P24G11M.....	M.5	PE2VFD1096WH.....	L.28	PR2VD1296WH.....	L.27	PR2VD1296WH.....	L.27	PR2VD1296WH.....	L.27
	P30B06M.....	M.6	PE2VFD10WH.....	L.28	PR2VD1296WH.....	L.27	PR2VD1296WH.....	L.27	PR2VD1296WH.....	L.27
	P30D05M.....	M.3	PE2VFD12.....	L.28	PR2VD1296WH.....	L.27	PR2VD1296WH.....	L.27	PR2VD1296WH.....	L.27
	P32E06M.....	M.4	PE2VFD1296.....	L.28	PR2VD1296WH.....	L.27	PR2VD1296WH.....	L.27	PR2VD1296WH.....	L.27
	P32F10M.....	M.4	PE2VFD1296WH.....	L.28	PR2VD1296WH.....	L.27	PR2VD1296WH.....	L.27	PR2VD1296WH.....	L.27
	P32G13M.....	M.5	PE2VFD12WH.....	L.28	PR2VD1296WH.....	L.27	PR2VD1296WH.....	L.27	PR2VD1296WH.....	L.27
	P34D41M.....	M.3	PE2VSD06.....	L.28	PR2VD1296WH.....	L.27	PR2VD1296WH.....	L.27	PR2VD1296WH.....	L.27
	P36E09M.....	M.4	PE2VSD0696.....	L.28	PR2VD1296WH.....	L.27	PR2VD1296WH.....	L.27	PR2VD1296WH.....	L.27
	P36F13M.....	M.4	PE2VSD0696WH.....	L.28	PR2VD1296WH.....	L.27	PR2VD1296WH.....	L.27	PR2VD1296WH.....	L.27
	P36G16M.....	M.5	PE2VSD06WH.....	L.28	PR2VD1296WH.....	L.27	PR2VD1296WH.....	L.27	PR2VD1296WH.....	L.27
	P42B11M.....	M.6	PE2VSD08.....	L.28	PR2VD1296WH.....	L.27	PR2VD1296WH.....	L.27	PR2VD1296WH.....	L.27

Index by Part Number

Part Number	Page Number
-------------	-------------

Part Number	Page Number
-------------	-------------

Part Number	Page Number
-------------	-------------

PR2VFD08	L.27
PR2VFD0896	L.27
PR2VFD0896WH	L.27
PR2VFD08WH	L.27
PR2VFD10	L.27
PR2VFD1096	L.27
PR2VFD1096WH	L.27
PR2VFD10WH	L.27
PR2VFD12	L.27
PR2VFD1279	L.27
PR2VFD1279WH	L.27
PR2VFD1296	L.27
PR2VFD1296WH	L.27
PR2VFD12WH	L.27
PR2VGD	L.29
PR2VSD06	L.27
PR2VSD0696	L.27
PR2VSD0696WH	L.27
PR2VSD06WH	L.27
PR2VSD08	L.27
PR2VSD0896	L.27
PR2VSD0896WH	L.27
PR2VSD08WH	L.27
PR2VSD10	L.27
PR2VSD1096	L.27
PR2VSD1096WH	L.27
PR2VSD10WH	L.27
PR2VSD12	L.27
PR2VSD1296	L.27
PR2VSD1296WH	L.27
PR2VSD12WH	L.27
PROG-CCCD	O.7
PRSP5	L.29
PRSP7	L.29
PSAACR-F	B.3
PSACR-F	B.3
PSACR-F	B.5
PSACR-F	B.6
PSACR-N	B.3
PSACR-N	B.5
PSACR-N	B.6
PSANEXT	B.3
PSF1PZA0.5MBL†	B.18
PSF1PZA1.5MBL†	B.18
PSF1PZA1MBL†	B.18
PSF1PZA2.5MBL†	B.18
PSF1PZA2MBL†	B.18
PSF1PZA3MBL†	B.18
PSF1PZD4.5MBL†	B.18
PSF1PZD4MBL†	B.18
PSF1PZD5.5MBL†	B.18
PSF1PZD5MBL†	B.18
PSF1PZD6MBL†	B.18
PSF1PZD7MBL†	B.18
PSFL6004WH-KD	B.5
PSL27A2204WH-HD	B.4
PSL7004WH-HED	B.4
PSL7004WH-KD	B.4
PSL7A04WH-HED	B.4
PSL7A2204WH-HED	B.4

PSL-DCJB	B.27
PSL-DCJB*	B.27
PSL-DCJB*-C	B.27
PSL-DCJB-C	B.27
PSL-DCPLRX	B.27
PSL-DCPLRX*	B.27
PSL-DCPLRX*-C	B.27
PSL-DCPLRX-C	B.27
PSL-DCPLX	B.27
PSL-DCPLX*	B.27
PSL-DCPLX*-C	B.27
PSL-DCPLX-C	B.27
PSL-USBA	B.27
PSL-USBA-L	B.27
PSNEXT	B.3
PSO7004BL-KED	B.7
PST-FO	O.18
PST-FOBLNK	O.18
PSW7004WH-HED	B.4
PSW7A04WH-HED	B.4
PSY6C04WH-CED	B.5
PTR-CLN	O.8
PUL6X04WH-HED	B.4
PUFY6X04WH-HED	B.4
PUL3025WH-A	B.7
PUL5504WH-EY	B.6
PUL6004BU-FE	B.5
PUL6004WH-FE	B.5
PUL6AV04WH-ED	B.3
PUL6AV04WH-EG	B.3
PUL6X04WH-HEG	B.3
PUO6X04BL-CEG	B.7
PUW6AV04**	B.2
PUW6AV04WH-EG	B.3
PUW6C04BU-CE	B.5
PUW6C04WH-CE	B.5
PUW6C04WH-CED	B.5
PUY6004WH-HE	B.5
PUY6004WH-HED	B.5
PUY6AV04**	B.2
PUY6AV04WH-ED	B.3
PUY6AV04WH-EG	B.3
PUY6X04WH-HED	B.3
PUY6X04WH-HEG	B.3
PUZ5504WH-CEG	B.6
PUZ6004WH-CEG	B.5
PVF9L10-10M0.5Y	M.17
PVFXL10-10M0.5Y	M.17
PVQ9PE10LQM00.5	M.17
PVQ-BIU6C1MBU	M.17
PVQ-BIU6C3BU	M.17
PVQ-BIU6L1MBU	M.17
PVQ-EM	M.16
PVQ-ES6X1MBU	M.17
PVQ-ES6X3BU	M.17
PVQ-EU6AC1MBU	M.17
PVQ-EU6AC3BU	M.17
PVQ-FMT	M.16
PVQ-FMTMTP-9	M.16
PVQ-FMTMTP-ZX	M.16
PVQ-FMTMTP-ZZ	M.16

PVQ-MIQAPCVR	M.15
PVQ-MIQAPS24	M.15
PVQ-MIQAPU24	M.15
PVQ-MIQPS24	M.15
PVQ-MIQPS96A	M.15
PVQ-MIQPS96F	M.15
PVQ-MIQPU24	M.15
PVQ-PM	M.16
PVQ-PS12VDC-E	M.18
PVQ-PS12VDC-U	M.18
PVQXPE10LQM00.5	M.17
PVQZPE10LQM00.5	M.17
PVSTP6X1MBBU	M.17
PVUTP6X1MBBU	M.17
PVUTPSPC1MBBUY	M.17
PVUTPSPC3BBUY	M.17
PZAEWM3	H.2
PZCFK	H.6
PZCHSM2	H.6
PZICE	H.3
PZICEA	H.3
PZICEAE	H.3
PZICEE	H.3
PZLRB2U	H.5
PZLRB4P4	H.5
PZLRB4P6	H.5
PZLRB4U	H.5
PZLRB6U	H.5
PZNDVK	E.10
PZNF1	E.10
PZNF2	E.10
PZNF3	E.10
PZNWE12	E.12
PZNWE12S	E.12
PZNWE14	E.12
PZNWE14S	E.12
PZRFC	H.4
PZRFE12U	H.4
PZRFE4U	H.4
PZRFE8U	H.4
PZWMC1230P	H.2
PZWMC1230W	H.2
PZWMC12P	H.2
PZWMC12RR	H.6
PZWMC12W	H.2
PZWMC1830P	H.2
PZWMC1830W	H.2
PZWMC18P	H.2
PZWMC18RR	H.6
PZWMC18W	H.2
PZWMC2630P	H.2
PZWMC2630W	H.2
PZWMC26P	H.2
PZWMC26RR	H.6
PZWMC26W	H.2
PZWMC-CL	H.6
PZWMCFKHF	H.6
PZWMCCKG	H.6

Q

QAPP24**	B.20
----------	------

A. Featured Products

B. Copper Systems

C. Fiber Systems

D. Faceplates, Frames & Surface Mount Boxes

E. Industrial Networks

F. Audio Video Systems

G. Keystone Cabling Systems

H. Zone Cabling

J. Cable Routing Systems

K. Cable Cleats

L. Cabinets & Rack Systems

M. Power & Connectivity Management

N. Grounding & Bonding

O. Identification Products

P. Cable Management Accessories

Q. Part Number Index

Index by Part Number

A. Featured Products
B. Copper Systems
C. Fiber Systems
D. Faceplates, Frames & Surface Mount Boxes
E. Industrial Networks
F. Audio Video Systems
G. Keystone Cabling Systems
H. Zone Cabling
J. Cable Routing Systems
K. Cable Cleats
L. Cabinets & Rack Systems
M. Power & Connectivity Management
N. Grounding & Bonding
O. Identification Products
P. Cable Management Accessories
Q. Part Number Index

Part Number	Page Number
QAPP24**	C.24
QAPP48HD**	B.20
QAPP48HD**	C.24
QAPP48HDVNS**	B.20
QAPP48HDVNS**^	C.24
QASP24**	B.20
QASP24**	C.24
QASP48HD**	B.20
QASP48HD**	C.24
QPP24**	B.20
QPP24**	C.24
QPP48HD**	B.20
QPP48HD**	C.24
QPP48HDVNS**	B.20
QPP48HDVNS**^	C.24
QPPABL	B.20
QPPABL	C.26
QPPBBL	C.26
QPPBBL	B.20
QPPLC24	B.20
QPPLC24	C.26
QPPLD6-X	B.15
QPPLD8-X	B.15
QPPN12BU‡	B.15
QPPN6BU‡	B.15
QPPN8BU‡	B.15
QPPNR6S	B.15
QPPRT	B.15
QSP24**	B.20
QSP24**	C.24
QSP48HD**	B.20
QSP48HD**	C.24
R	
R050X075X1J	O.17
R050X125X1J	O.17
R050X150X1J	O.17
R100X075V1C	O.4
R100X075V1T	O.12
R100X075X1J	O.17
R100X125V1C	O.4
R100X125V1T	O.12
R100X125X1J	O.17
R100X150V1C*	O.4
R100X150V1T*	O.12
R100X150X1J*	O.17
R100X225V1C*	O.4
R100X225X1J*	O.17
R100X400V1T	O.12
R100X400X1J	O.17
R150X150X1J	O.17
R200X150V1T	O.12
R200X150X1J	O.17
R200X225V1T	O.12
R200X225X1J	O.17
R200X400V1T	O.12
R200X400X1J	O.17
R2P	L.26
R2P48	L.26
R2P6S	L.26
R2P6S96	L.26

Part Number	Page Number
R2P79	L.26
R2P96	L.26
R2PPDUB	L.26
R2PPR2VWF	L.29
R2PPR2VWFWH	L.29
R2PW	L.26
R2PWH	L.26
R4P	L.24
R4P23	L.24
R4P2396	L.24
R4P23CN	L.24
R4P23CN96	L.24
R4P36	L.24
R4P3696	L.24
R4P3696WH	L.24
R4P36CN	L.24
R4P36CN96	L.24
R4P36CN96WH	L.24
R4P36CNWH	L.24
R4P36WH	L.24
R4P42	L.24
R4P4296	L.24
R4P42CN	L.24
R4P42CN96	L.24
R4P79	L.24
R4P96	L.24
R4PCN	L.24
R4PCN79	L.24
R4PCN96	L.24
R4PCNWH	L.24
R4PPR2VWF	L.29
R4PPR2VWFWH	L.29
R4PWF	L.25
R4PWH	L.24
RFAKIT	L.26
RFG10X8SMY	L.23
RFG10X8Y	L.22
RFG12X4SMY	L.23
RFG12X4Y	L.22
RFG12X8SMY	L.23
RFG12X8Y	L.22
RFG3DSMY	L.23
RFG3DY	L.22
RFG5DSMY	L.23
RFG5DY	L.22
RFG6X8SMY	L.23
RFG6X8Y	L.22
RFG8X8SMY	L.23
RFG8X8Y	L.22
RMEH4BL*	O.9
RMER1BL	O.9
RMER4BL*^	O.9
RMER4BL-A	O.9
RMER4BL-C	O.9
RSHLF	L.11
RSHLF	L.25
RSHLF23	L.11
RSHLF23	L.25
RSHLF36	L.25
RSHLF36WH	L.25
RT2HT	K.6

Part Number	Page Number
S	
S*1SPD2B	L.9
S*1SPSE	L.9
S*2SPD2B	L.9
S*2SPSE	L.9
S100X075VAC	O.4
S100X075VATY*	O.11
S100X075YAJ	O.16
S100X125VAC	O.4
S100X125VATY*	O.11
S100X125YAJ	O.16
S100X150VAC*	O.4
S100X150VATY*+	O.11
S100X150YAJ+	O.16
S100X160YAJ	O.16
S100X220YAJ	O.16
S100X225VAC*	O.4
S100X225YAJ+	O.16
S100X400YAJ	O.16
S100X650YAJ	O.16
S1224-C	L.25
S1224-C	L.26
S1DR	L.10
S1LR	L.10
S2BRK12	L.10
S2BRK6	L.10
S2DR	L.10
S2EOR1BA1070B1	L.11
S2EOR1CA1200B1	L.11
S2LR	L.10
S4X4YL6NM	J.42
S6*SDB	L.9
S6*SHDB	L.9
S6*SSHDB	L.9
S6VBPN	L.11
S7*SHDB	L.9
S7222BDHRSP	L.7
S7222BDHSP	L.7
S7229BDHRSP	L.7
S7229BDHSP	L.7
S75SSHDB	L.9
S78SSHDB	L.9
S7VBPN	L.11
S7VPPB	L.10
S8*SHDB	L.9
S8VBPN	L.11
S8VBPNE	L.11
SAJLWH25MBL	H.6
SAKOSHDP	L.11
SAPLWH25M	H.6
SCSTR4	L.11
SGPT	B.12
SKMKEY	B.28
SKRJ45RD-X	B.28
SKUSBA-V	B.28
SKUSBC	B.28
SN*RC	L.9
SN1070CREC	L.8
SN11F	L.10
SN1200CREC	L.8

Index by Part Number

Part Number	Page Number
-------------	-------------

Part Number	Page Number
-------------	-------------

Part Number	Page Number
-------------	-------------

SN1200VCREC.....	L.8
SN15F.....	L.10
SN18F.....	L.10
SN21F.....	L.10
SN25F.....	L.10
SN28F.....	L.10
SN7TCDW.....	L.8
SN7VCM.....	L.10
SN7VCM and SN8VCM.....	L.10
SN8*SDB.....	L.9
SN8*SSHDB.....	L.9
SN8FBB.....	L.10
SN8TCDW.....	L.8
SN8VCM.....	L.10
SN8VPPB.....	L.10
SNTH81B.....	L.8
SNTH82B.....	L.8
SP628-C.....	B.12
SP630-C.....	B.12
SP688-C.....	B.12
SP6X88-C.....	B.12
SP6X88P-C.....	B.12
SP6X88SD-C.....	B.12
SPDUBRK.....	L.10
SPS688-C.....	B.12
SPS6X88-C.....	B.12
SPSPNL.....	L.9
SRB19BLY.....	B.23
SRB19BLY.....	G.4
SRB19D5BL.....	B.23
SRB19D5BL.....	G.4
SRB19D7BL.....	B.23
SRB19D7BL.....	G.4
SRBBRKT.....	B.23
SRBBRKT.....	G.4
SRBWCV.....	B.23
SRM19CM3.....	L.34
SRM19CMV3.....	L.34
SRM19FM1.....	L.34
SRM19FM2.....	L.34
SRM19X18A1.....	L.34
SRM19X25A1.....	L.34
STH61B.....	L.8
STH62B.....	L.8
STH71B.....	L.8
STH72B.....	L.8
STP28X*MBU.....	B.8
STP28X*MBU-Q.....	B.8
STP6C*MBU.....	B.8
STP6C*MBU-Q.....	B.8
STP6X*MIG.....	B.8
STP6X*MIG-Q.....	B.8

T

T038X000Y01.....	O.14
T038X000YP1.....	O.14
T050X000VPC-BK.....	O.6
T050X000VQC-BK*.....	O.6
T050X000VSC-BK*.....	O.6
T050X000VUC-BK.....	O.6
T050X000VWC-BK*.....	O.6

T050X000VXC-BK.....	O.6
T050X000VYC-WH.....	O.6
T050X000Y01.....	O.14
T050X000YKC-BK*.....	O.6
T050X000YP1.....	O.14
T100X000VPC-BK.....	O.6
T100X000VQC-BK*.....	O.6
T100X000VSC-BK*.....	O.6
T100X000VUC-BK.....	O.6
T100X000VWC-BK*.....	O.6
T100X000VXC-BK.....	O.6
T100X000VYC-WH.....	O.6
T100X000Y01.....	O.14
T100X000Y81.....	O.14
T100X000Y81.....	O.14
T100X000YKC-BK*.....	O.6
T100X000YP1.....	O.14
T100X000YQ1.....	O.14
T100X000YS1.....	O.14
T100X000YU1.....	O.14
T100X000YW1.....	O.14
T200X000Y01.....	O.14
T200X000Y81.....	O.14
T200X000YP1.....	O.14
T200X000YQ1.....	O.14
T200X000YS1.....	O.14
T200X000YU1.....	O.14
T200X000YW1.....	O.14
T400X000Y01.....	O.14
T400X000Y81.....	O.14
T400X000YP1.....	O.14
T400X000YQ1.....	O.14
T400X000YS1.....	O.14
T400X000YU1.....	O.14
T400X000YW1.....	O.14
TDP43ME.....	O.8
TDP43ME-AC.....	O.8
TDP43ME-CASE.....	O.8
TDP43ME-CUTTER.....	O.8
TDP43ME-KIT.....	O.8
TDP43ME-RS.....	O.8
TDP43ME-SPINDLE.....	O.8
TDP43ME-TB-KIT.....	O.8
TGJT.....	B.11
TGSJT.....	B.11
TLBP1R-V.....	L.22
TLBP1R-V10.....	L.22
TLBP1S-L.....	L.22
TLBP1S-V.....	L.22
TLBP1S-V10.....	L.22
TLBP2R-V.....	L.22
TLBP2S-V.....	L.22
TLBP2S-V10.....	L.22
TM1S4-C.....	P.9
TM1S4-C0*.....	P.9
TM1S6-C.....	P.9
TM1S6-C0*.....	P.9
TM2S6-C.....	P.9
TM2S6-C0*.....	P.9
TM2S8-C.....	P.9
TM2S8-C0*.....	P.9
TM3S10-C.....	P.9

TM3S10-C0*.....	P.9
TM3S25-C.....	P.9
TM3S25-C0*.....	P.9
TM3S8-C.....	P.9
TM3S8-C0*.....	P.9
TMEH-S10-C100.....	P.9
TMEH-S10-C109.....	P.9
TMEH-S10-Q0.....	P.9
TMEH-S25-Q0.....	P.9
TMEH-S8-Q0.....	P.9
TR1-12-X.....	J.43
TR1-58-X.....	J.43
TRC18FR-X20Y.....	J.43
TRC18FR-X8Y.....	J.43
TRC4HDBL.....	J.42
TTR-20R.....	P.5
TTR-20R0.....	P.3
TTR-35R3.....	P.5
TTR-35R3-0.....	P.3
TTR-35RX.....	P.5
TTR-35RX0.....	P.3

U

UCT3S-X.....	P.5
UCT3S-X0.....	P.4
UCT5S-X.....	P.5
UCT5S-X0.....	P.4
UGCTC3S-X.....	P.5
UGCTC3S-X0.....	P.4
UGCTC5S-X.....	P.5
UGCTE3S-X.....	P.5
UGCTE3S-X0.....	P.4
UGCTE5S-X.....	P.5
UICFFP4BL.....	D.5
UPS00100DC.....	E.8
UPS003LSM.....	E.8
UTP28CH*MBU.....	B.8
UTP28CH*MBU-Q.....	B.8
UTP28SP*MBU.....	B.8
UTP28SP*MBU-Q.....	B.8
UTP28X*MBU.....	B.8
UTP28X*MBU-Q.....	B.8
UTP6A*MBU.....	B.8
UTP6A*MBU-Q.....	B.8
UTP6ASD*MBU.....	B.8
UTP6ASD*MBU-Q.....	B.8
UTPCH*MBUY.....	B.8
UTPCH*MBUY-Q.....	B.8
UTPSP*MBUY.....	B.8
UTPSP*MBUY-Q.....	B.8
UZJLWH25M.....	H.6
UZPLWH25M.....	H.6

V

VP24382TV25Y.....	B.23
VWS106-C.....	P.14
VWS106-C20.....	P.14
VWSDC-C*.....	P.14
VWSDC-C20*.....	P.14

A. Featured Products

B. Copper Systems

C. Fiber Systems

D. Faceplates, Frames & Surface Mount Boxes

E. Industrial Networks

F. Audio Video Systems

G. Keystone Cabling Systems

H. Zone Cabling

J. Cable Routing Systems

K. Cable Cleats

L. Cabinets & Rack Systems

M. Power & Connectivity Management

N. Grounding & Bonding

O. Identification Products

P. Cable Management Accessories

Q. Part Number Index

Index by Part Number

A. Featured Products
B. Copper Systems
C. Fiber Systems
D. Faceplates, Frames & Surface Mount Boxes
E. Industrial Networks
F. Audio Video Systems
G. Keystone Cabling Systems
H. Zone Cabling
J. Cable Routing Systems
K. Cable Cleats
L. Cabinets & Rack Systems
M. Power & Connectivity Management
N. Grounding & Bonding
O. Identification Products
P. Cable Management Accessories
Q. Part Number Index

Part Number	Page Number
-------------	-------------

Part Number	Page Number
-------------	-------------

Part Number	Page Number
-------------	-------------

W

WB89D	B.23
WB89D	G.4
WBH1	L.35
WBH2	L.35
WBH2E	L.35
WBH3	L.35
WBH4	L.35
WBH4E	L.35
WBH6E	L.35
WBS6-Q	P.11
WBS6-Q60*	P.11
WG12BL10	J.46
WG12FRTBBL	J.50
WG18BL10	J.46
WG18FRTBBL	J.50
WG24BL10	J.46
WG24FRTBBL	J.50
WG2PRB12BL	J.49
WG2PRB18BL	J.49
WG2PRB24BL	J.49
WG30BL10	J.46
WG30FRTBBL	J.50
WG8BL10	J.46
WGBTMWFBL*	J.47
WGCB12BL	J.48
WGCB18BL	J.48
WGCB24BL	J.48
WGCMB1070BL	J.49
WGCMB1200BL	J.49
WGCMB1070BL	J.49
WGCMB1200BL	J.49
WGCT-A	J.52
WGCT-M	J.52
WGDW2PG	J.51
WGDW4PG	J.51
WGDW6PG	J.51
WGESPL2430BL	J.47
WGESPLBL	J.47
WGHRDWKTBL	J.51
WGIBRC2BL	J.51
WGIBRC4BL	J.51
WGIBRC6BL	J.51
WGINTSPLBL	J.47
WGR4PK30BL	J.49
WGSKBL*	J.50
WGSPL1218BL	J.47
WGSPL2430BL	J.47
WGSW2BL	J.51
WGSW4BL	J.51
WGSW6BL	J.51
WGSWF4BL	J.47
WGTBS12BL	J.48
WGTBS18BL	J.48
WGTBS24BL	J.48
WGTBS30BL	J.48
WGTBS8BL	J.48
WGTL12PG	J.51
WGTL18PG	J.51
WGTL24PG	J.51

WGTL30PG	J.51
WGTL8PG	J.51
WGVWMBEZ	J.48
WGWMTB12BL	J.48
WGWMTB1830BL	J.48
WGWMTB8BL	J.48
WMP1E	L.31
WMPF1E	L.31
WMPFSE	L.31
WMPH2E*	L.31
WMPHF2E*	L.31
WMPHFSE	L.31
WMPLE	L.31
WMPSE	L.31
WMPV22E	L.30
WMPV45E	L.30
WMPV45EPB1	L.30
WMPV45ERTW	L.30
WMPVCBE	L.30
WMPVCMB	L.30
WMPVF22E	L.30
WMPVF45E	L.30
WMPVHC45E	L.30
WMPVHC45E	L.30
WMPVSMK	L.30
WNMS-APPL	E.13
WPT-8	B.12
WR5E-X	L.29
WR5E-X	L.30

Z

Z11C-6	E.10
Z11C-S	E.10
Z22C-6	E.10
Z22C-6S	E.10
Z22C-S	E.10
Z22C-SS	E.10
Z22U-614	E.9
Z22U-614S	E.9
Z22U-615	E.9
Z22U-615S	E.9
Z22U-616	E.9
Z22U-616S	E.9
Z22U-S14	E.9
Z22U-S14S	E.9
Z22U-S15	E.9
Z22U-S15S	E.9
Z22U-S16	E.9
Z22U-S16S	E.9
Z23C-6	E.10
Z23C-6S	E.10
Z23C-S	E.10
Z23C-SS	E.10
Z23U-624	E.9
Z23U-624S	E.9
Z23U-625	E.9
Z23U-625S	E.9
Z23U-626	E.9
Z23U-626S	E.9
Z23U-S24	E.9
Z23U-S24S	E.9

Z23U-S25	E.9
Z23U-S25S	E.9
Z23U-S26	E.9
Z23U-S26S	E.9
ZDF242430	E.12
ZDF242430-6	E.12
ZDF24-624	E.11
ZDF24-625	E.11
ZDF24-S24	E.11
ZDF24-S25	E.11
ZDF24-S45	E.11
ZDF48-664	E.11
ZDF48-665	E.11
ZDF48-6EA	E.12
ZDF48-6RA	E.12
ZDF48-EA	E.12
ZDF48-RA	E.12
ZDF48-S64	E.11
ZDF48-S65	E.11
ZDF48-S85	E.11
ZDINS24	E.11
ZDINS25	E.11
ZFLEX1	E.10
ZFLEX2	E.10

Notes

**A.
Featured
Products**

**B.
Copper
Systems**

**C.
Fiber
Systems**

**D.
Faceplates,
Frames &
Surface
Mount Boxes**

**E.
Industrial
Networks**

**F.
Audio
Video
Systems**

**G.
Keystone
Cabling
Systems**

**H.
Zone
Cabling**

**J.
Cable
Routing
Systems**

**K.
Cable
Cleats**

**L.
Cabinets
& Rack
Systems**

**M.
Power &
Connectivity
Management**

**N.
Grounding
& Bonding**

**O.
Identification
Products**

**P.
Cable
Management
Accessories**

**Q.
Part
Number
Index**

A. Featured Products
B. Copper Systems
C. Fiber Systems
D. Faceplates, Frames & Surface Mount Boxes
E. Industrial Networks
F. Audio Video Systems
G. Keystone Cabling Systems
H. Zone Cabling
J. Cable Routing Systems
K. Cable Cleats
L. Cabinets & Rack Systems
M. Power & Connectivity Management
N. Grounding & Bonding
O. Identification Products
P. Cable Management Accessories
Q. Part Number Index

Notes

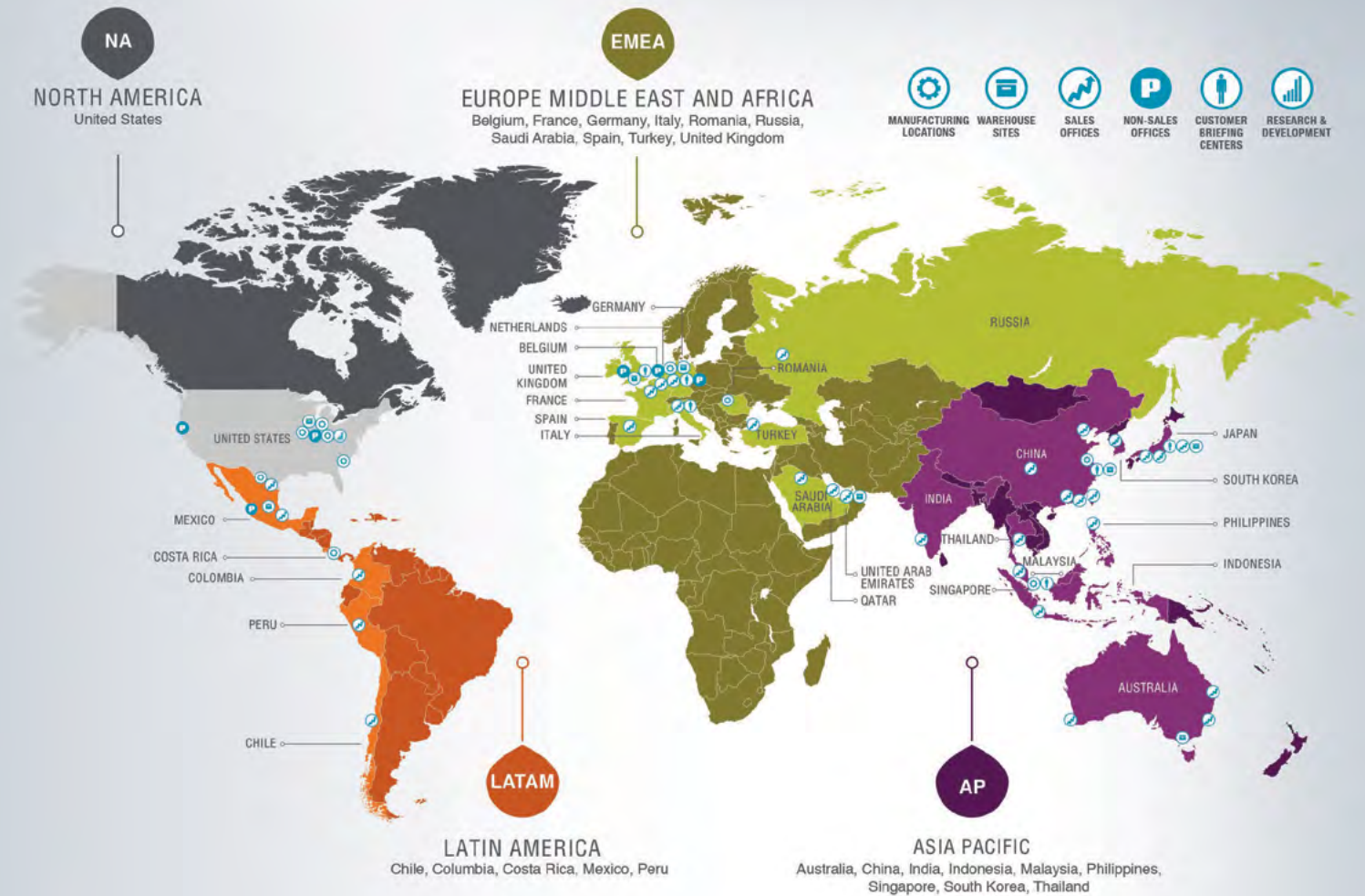

THE INFORMATION CONTAINED IN THIS CATALOG IS INTENDED AS A GUIDE FOR USE BY PERSONS HAVING TECHNICAL SKILL AT THEIR OWN DISCRETION AND RISK. BEFORE USING ANY PANDUIT PRODUCT, THE BUYER MUST DETERMINE THE SUITABILITY OF THE PRODUCT FOR HIS/HER INTENDED USE AND BUYER ASSUMES ALL RISK AND LIABILITY WHATSOEVER IN CONNECTION THEREWITH. PANDUIT DISCLAIMS ANY LIABILITY ARISING FROM ANY INFORMATION CONTAINED HEREIN OR FOR ABSENCE OF THE SAME.

All Panduit products are subject to the terms, conditions and limitation of its then current Limited Product Warranty, which can be found at www.panduit.com/warranty.



PANDUIT™

**Panduit Europe Ltd.
Westgate, Westworld
W5 1UD London
United Kingdom**

**phone +44 (0) 208 601 7200
EMEA-CustomerServices@panduit.com**

www.panduit.com