New VRF Systems ECOi EX.

A VRF system delivering energy-saving performance, powerful operation, reliability and comfort surpassing anything previously possible. It represents a true paradigm shift in air conditioning solutions.



New 8/10HP Mini ECOi.

The New Mini VRF compact system is the ideal solution for minimum outdoor space. Panasonic extends the Mini VRF range by 8 and 10HP units.

New ECO G GE3 series.

New "L" type heat exchanger and new inverter DC fan motor with a 3-blade propeller to reduce by 30% electrical energy consumption giving better energy efficiency.



New VRF Smart Connectivity.

Panasonic's VRF Smart Connectivity is a completely new, state-of-the-art solution providing energy saving and comfort as well as simple installation, operation and running.

Panasonic AC Smart Cloud.

Centralised control of your business premises, from wherever 24/7. Smartly control, maintain, optimise and save.



THE LAST GENERATION OF AIR CONDITIONING

NEW PANASONIC
TECHNOLOGY

'17



Panasonic is committed to creating a better life and a better world thanks to its breakthrough technology, continuously contributing to the evolution of society and to the happiness of people around the globe.

Constantly Improving

At Panasonic, we know that the best is always yet to come. This is why our air conditioning and heat pump solutions are constantly upgraded. We are always looking to improve our technology; finding the most efficient solutions that save our customers money. Our Technology & Design teams anticipate the needs of tomorrow. We look to produce smaller, quieter, efficient solutions - with better technological features - that can reduce energy consumption while providing suitable temperature conditions for the user.

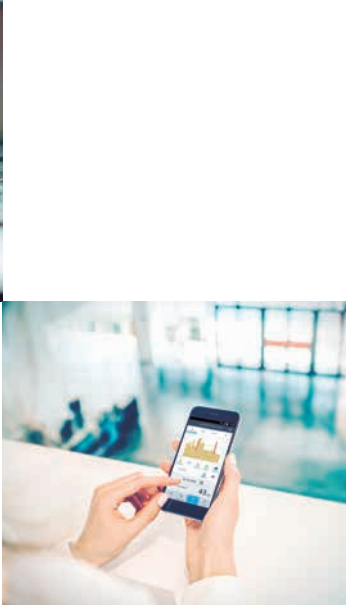
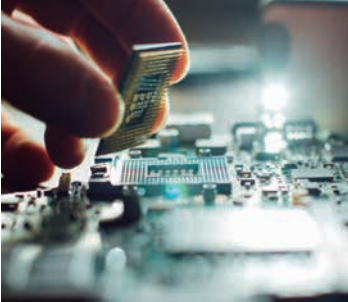

Look ahead to the “Future,” keep taking on challenges

Starting 1918, Panasonic has constantly added to its guarantee for innovation, taking tomorrow’s technologies and applying them to today’s needs. Always making “people” central to our activities, and thereby focusing on “people’s lives,” we will continue to provide better living for our customers. This is the unchanging commitment we at Panasonic have had over many years. We are aiming for now is to expand our contribution to “better living” everywhere. This means that in the variety of spaces where our customers go about their lives, ranging from inside the home, the office, the store, the automobile, and the airplane, as well as the town, we will provide not only single pieces of hardware,

but also total solutions including software and services. We will pursue the concept of “A Better Life, A Better World,” meeting the needs of each individual customer.

To that end, we will leverage the strengths that we at Panasonic have long developed in our consumer electronics business, the strengths of our business partners who have in-depth expertise in many areas, and will work to combine these strengths by pursuing “Cross-Value Innovation.” In this way, we will create new value. This is the new and challenging task we are now addressing.

A GLOBALLY TRUSTED AIR CONDITIONING BRAND



Panasonic – leading the way in Heating and Cooling. With more than 30 years of experience, selling to more than 120 countries around the world, Panasonic is unquestionably one of the leaders in the heating and cooling sector.

With a diverse network of production and R&D facilities, Panasonic delivers innovative products incorporating cutting-edge technologies that set the standard for air conditioners worldwide. Expanding globally, Panasonic provides superior international products transcending borders.



100% Panasonic: we control the process

The company is also a world leader in innovation as it has filed more than 91,539 patents to improve its customers' lives. Moreover, Panasonic is determined to remain at the forefront of its market. In all, the company has produced more than 200 million compressors and its products are manufactured in 294 plants which are located all over the world. You can be assured of the extremely high quality of Panasonic's heat pumps. This wish to excel has made Panasonic the international leader in heating and turn-key air conditioning solutions. These offer maximum effectiveness, comply with the strictest environmental standards and meet the most avant-garde construction requirements of our time.

History of Air Conditioning Group

Panasonic starts with a desire to create things of value. As hard work and dedication results in one innovative product after another, the new company took its first steps towards becoming the electronics giant of today.

Heating and Cooling Solutions designed and produced by Panasonic since 1958. See more information on www.aircon.panasonic.eu



1958

First room air conditioner launched for domestic installation.

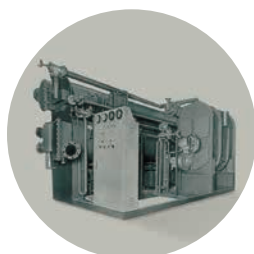

1971

Starts production of absorption chillers.



1973

Panasonic launches the first highly efficient air-to-water heat pump in Japan.



1975

Panasonic becomes the first Japanese air conditioner manufacturer in Europe.



1985

Introduces first GHP (gas heat pump) VRF air conditioner.



1989

Introduces world's first simultaneous 3-Pipe heating/cooling VRF system.



2008

Etherea new concept of air conditioning systems: high efficiency and high performances with a great design.



2010

New Aquarea. Panasonic has created Aquarea, an innovative new, low-energy system.



2012

New GHP units. Panasonic's gas-driven VRF systems are ideal for projects where power restrictions apply.



Looking ahead

New VRF Systems ECOi EX with Extraordinary Energy-Saving Performance and Powerful Operation EER 4.7.

Panasonic

100% PANASONIC, THE DNA OF
JAPANESE CRAFTSMANSHIP

JAPAN
QUALITY



Applying advanced technologies that truly make life better, we live by an unparalleled commitment to product quality. Panasonic is building on the Japanese tradition of uncompromising quality control worldwide, developing and manufacturing fine products and delivering them to customers everywhere.

At Panasonic, we believe that the best air conditioner is one that works quietly and effectively in the background whilst minimising its impact on the environment

People who use our products can look forward to long years of high-quality performance without the need for constant service. As part of our rigorous design and development process, Panasonic air conditioners undergo a variety of stringent tests to ensure their effectiveness and long-term reliability. Tests for durability, waterproofing, shock resistance, and noise are conducted on component parts or on the finished products themselves.

As a result of all of these time consuming efforts, Panasonic air conditioners meet even the most demanding industrial standards and regulations in every country where they are sold.

International Standard Quality

To uphold the company's reputation around the world, Panasonic strives continuously to offer the highest quality with the lowest possible environmental impact.

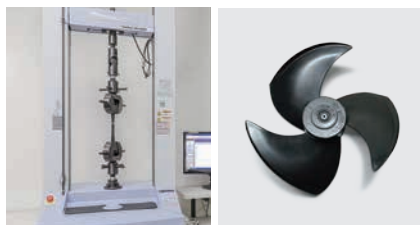

Reliable parts that meet or exceed industrial standards

In every country where they are sold, Panasonic air conditioners comply with all required industrial standards and regulations. In addition, Panasonic conducts stringent testing to ensure the reliability of parts and materials. The strength of the resin material used in a propeller fan is confirmed by a tension test.



RoHS / REACH compliant parts

All Panasonic parts and materials comply with Europe's strict RoHS/REACH environmental regulations. During the development and production of parts, stringent inspections are conducted on over 100 materials to ensure that no hazardous substances are included.



Sophisticated production process

Panasonic's air conditioner production lines employ state-of-the-art factory automation technologies to ensure products are manufactured efficiently and with uniformly high levels of quality and reliability.

Durability

At Panasonic we know the importance of a long service life with minimal maintenance. That's why we subject our air conditioners to a wide range of stringent durability tests.



Long-term durability test

To ensure durability and stable operation for many years, we conduct a long-term continuous operation test under conditions that are much more severe than actual operating conditions.



Compressor reliability test

After the continuous operation test, we remove the compressor from a selected outdoor unit, disassemble it, and examine the internal mechanisms and parts for potential failure. This helps ensure reliable long-term performance under harsh conditions.

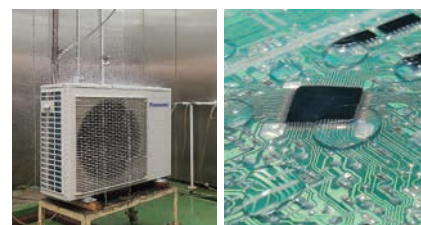

Waterproofing test

The unit - which is subject to rain and wind - complies with IPX4 waterproof specifications. Contact sections on printed circuit boards are resin-potted to prevent adverse effects caused by exposure to water (an unlikely occurrence).

PANASONIC: ECO & SMART IDEAS FOR A SUSTAINABLE LIFESTYLE



Panasonic Green Innovation Company.
 We will make the environment central to all our business activities and work to realise our vision with innovations for both every day life and business.

Exemplary sustainable projects

Fujisawa Sustainable Smart Town Goes Into Full-Scale Operation Near Tokyo.

Fujisawa SST Council is a consortium led by Panasonic Corporation spearheading the development of the Fujisawa Sustainable Smart Town (Fujisawa SST). With its core facility supporting sustainable development of the town and its community now coming into operation, the Fujisawa SST is moving from the construction stage into a new stage where the town is nurtured to grow in full-scale into an eco and smart town that puts a high priority on the residents' lifestyles.

The Fujisawa SST Management Company is the town management company located in the SQUARE. Together with partner companies, the company provides five essential services in the town: energy, security, mobility, healthcare and community. The company will also collect and manage information relating to the town's overall environment, energy, security and safety to support an eco and smart life in the town. As a fresh development in the town, the Fujisawa SST has set a detached housing zone for non car owners for the second phase of sales. By using the town's eco-car sharing and rent-a-car services, residents in the zone



can enjoy their lifestyles without the need to own a car while reducing economic burden and making effective use of the lot. Preparations are also underway for a new base to provide environmentally-friendly logistic services to the residents.

Solar Power Generator.

HIT solar cells achieve maximum output even on smaller roofs. These solar modules are 100% emission free, have no moving parts and produce no noise.

Home AV.

Panasonic offers a wide range of energy saving home equipment to fulfil a sustainable and comfortable lifestyle.

Heat Pump.

The Aquarea Heat Pump is part of a new generation of heating systems that use a renewable, free energy source: air, to heat or cool the home and to produce hot water.

Fuel Cell.

The Panasonic Fuel Cell is an energy-creating device, which generates electricity and heat at the same time with chemical reaction between hydrogen extracted from natural gas and oxygen.

Solar Power Generator.

Our mobility space can be connected to our HIT solar panels – with the help from our storage batteries.

LED Lamps.

Expertise gathered over years of research and development has enabled Panasonic to provide a renaissance in energy saving home LED lighting – with our LED Nostalgic Clear lamp.

Home Appliances.

Panasonic is globally committed to develop products which are environmentally friendly. Panasonic delivers home appliances such as refrigerators and washing machines that incorporate the latest energy-efficient technology.

Storage Battery.

The battery stores the energy generated by a combination of solar power and fuel cells to ensure a constant supply of electricity on demand.

PROJECTS & CASE STUDIES OF PANASONIC HEATING AND COOLING SOLUTIONS



New Hotel Monument 5*GL is located in an 1896 palace.
Barcelona, Spain. ECOi and E-Control

Panasonic, a partner with the knowledge and experience to achieve your objectives and green needs.

Integrated technology that permits better work, easy installation, high efficiency performance, and energy saving

Our main targets are the distributed services and B2B-integrated solutions.

Panasonic provides a single point of contact for the design and maintenance of your system, making things easy for you.

Given our experience in processes, technologies and complex business models, we can offer you effective solutions that reduce costs, whilst also being efficient, user-friendly, reliable and innovative.

Another advantage we offer to our clients is a support service for systems integration projects, which we provide through our wide range of services and solutions.

As a global company, we have at our disposal the financial, logistical and technical resources to develop complex and wide-ranging solutions, both at country and international level by implementing them both on-time and on-budget.



New Hotel OD Port Portals. Palma de Mallorca. Spain. **ECOi - ECO G**



Le Centurie Centro Commerciale. 40.000m² with 40 commercial spaces. Padua, Italy. **ECOi**



Europa-Park is the second most popular theme park resort. 300 rooms. Germany. **ECOi**



The new Hotel Vincci Gala with efficiency class A, up to 70% save energy. Barcelona, Spain. **ECOi - ECO G**

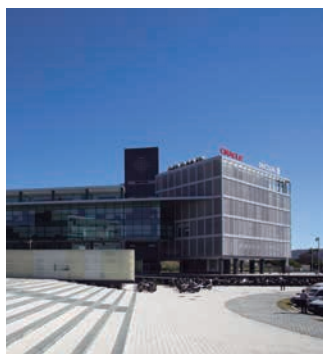

Andalucia Technology Park. Málaga, Spain. **ECOi**



Internet Search Giant. The best solution for this most demanding of applications. Dublin, Ireland. **ECOi**



Hotel refurbishment. The heat recovery system is ideal for a hotel of this category. Hotel Claris 5 *. Barcelona, Spain. **ECOi**



Lock Building, offices for media giant Viacom. Camden, London, UK. **ECOi**



Technopark of Nobosibirsk Academgorodok. Novosibirsk, Russia. **ECOi**



Shippensburg University. Pennsylvania, United States. **ECOi**



Restaurant Burger & Lobster. London, UK. **ECOi**



The K Club, the prestigious and internationally-renowned golf resort. Kildare, Ireland. **ECOi**

PRO CLUB. THE PROFESSIONAL WEBSITE OF PANASONIC



PRO Club 

Download on
www.panasonicproclub.com
or connect simply with your
smartphone to the PRO Club
using this QR

Panasonic has an impressive range of support services for designers, specifiers, engineers and distributors working in the heating and cooling markets.

Panasonic PRO Club (www.panasonicproclub.com) is the online tool which makes your life easier! You just have to register and a lot of functionalities are freely available to you, where ever you are, from your computer or smart phone!

- Print catalogues with your logo and your address
- Download the latest Aquarea designer to define your system and select the good Aquarea Heat pump.
- Calculate the specs of the Aquarea Air fan coil based on the parameters of your system
- Get Documents of Conformity and all other documents you may need
- Download all the service manuals, end user manuals and installation manuals
- Know what to do with error codes
- Find out about the latest news first
- Register for training

Highlighted Features:

- Extensive library of resources
- Tools & Apps for end users. Check availability in your country:
 - My Home: sizing wizard for domestic and A2W range
 - My Project: Contact form to Panasonic team
 - iFinder: Lists of installers displayed by postcode

- Special offers & promotions
- Training PRO Academy
- Catalogues (Commercial documentation)
- Marketing (Images in high resolution, advertisements, deco guidelines)
- Tools (Professional software, sizing tools...)
- Installers customise leaflets in PDF format with their logo & contact details
- Energy label generator. Download energy labels of any device in PDF format
- Heating calculator
- Noise calculator for outdoor unit
- Aquarea Radiator calculator
- Error Code Search by error code or unit ref. Compatible with smartphone and tablet computer
- Revit / CAD Images / Spec texts
- Access to Pananet, online library of technical documentation
- Download Documents of Conformity and other Certifications
- Commissioning online

Panasonic PRO Club is fully compatible with tablet computer and smartphone.



Easy download Panasonic service documentation and brochures



Customise leaflets with your logo & contact details. Save and print the PDF



Energy label generator. Download Energy labels of any device in PDF format



Error Code on your smartphone and your PC: Search by error code or model reference. Online version + downloadable version for offline use

The Panasonic PRO Academy

Panasonic takes its responsibility to its distributors, specifiers and installers seriously and has developed a comprehensive Training Programme. The Panasonic Pro-Academy encompasses the traditional hands-on approach to teaching.

New training courses cover three levels. Design, installation, and commissioning & trouble-shooting. Training courses include:

- Domestic applications Air to Air
- Aquarea air source heat pumps
- VRF ECOi

The courses are offered on site at Panasonic's premises across Europe. The Training Centres display Panasonic's latest product range and give delegates an opportunity to get a hands-on experience with the latest controllers, indoor and outdoor units from the VRF ECOi, Ethera, GHP and Aquarea ranges.



Panasonic

PANASONIC INDUSTRIAL VRF SYSTEMS

NEW VRF
TECHNOLOGY

'17



Professional solutions for all types of projects.

The new Panasonic VRF system is specifically designed for energy saving, easy installation and high efficiency performance, with a wide choice of outdoor and indoor unit models and unique features which are designed for the most demanding offices and big buildings.



VRF HIGHLIGHTED FEATURES



Panasonic provides an extensive range of solutions for mid and large buildings. Combining the best option to satisfy all needs and site restrictions.

The unique manufacturer that can combine both Electrical VRF and Gas powered VRF in same project, delivering best choice that makes the difference to our customers.

Providing large choice in indoor units, can connect also water heat exchangers, air handling unit and ventilation units with or without heat exchanger. All managed from simple and powerful stand alone remote control, new centralised controls or cloud connection with 3G embedded.

Controls that can be managed remotely by a simple.

The cutting edge control technology is called VRF Smart Connectivity, combining the expertise of VRF communication and BEMS leading company to maximise comfort, and efficiency while reducing installation and integration costs.

	ECOi. Electrical VRF			ECO G. Gas Powered VRF	
	Mini ECOi (LE)	ECOi EX (ME2)	ECOi 3-Pipe (MF2)	ECO G GE3	ECO G GF2 3-Pipe
Capacity range	4-10HP	8-80HP	8-48HP	16-60HP	16-25HP
Extreme temperatures operation	-25°C	-25°C	-20°C	-21°C	-21°C
Number of indoor units	15	64	52	64	24
Simultaneity ratio	50 ~ 130%	200%	150%	—	50 ~ 200%
Indoor units	All (check restrictions)				
Controls	All				
Other ranges integration	PACi full control integration + Domestic integration by accessory				

Energy saving



The Inverter range provides greater efficiency, more comfort, more precise temperature control, without highs and lows, and keeps the ambient temperature constant with lower energy consumption and a significant reduction in noise and vibration levels.



Multiple large-capacity all inverter compressors (more than 14HP). Two independently controlled inverter compressors achieve high efficiency. Redesigned components in the body provide performance improvement especially in the rated cooling condition and EER performance.



Intelligent Human Activity Sensor and new Sunlight Sensor technologies that can detect and reduce waste by optimising air conditioner operation according to room conditions. With just one touch of a button, you can save energy.



GHP technology offers the best in energy efficiency. ECO G gas VRF is specially designed for buildings where the electricity is restricted or CO₂ emissions must be reduced.

High performance



The ECOi EX system works in heating mode with performance data at outdoor temperature down to -25°C.

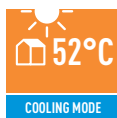

The ECOi EX system works in cooling mode with performance data at outdoor temperature up to 52°C.

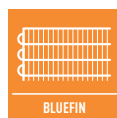

Panasonic has extended the life of its condensers with an original anti-rust coating.



Self-diagnosing function. By using electronic control valves past warnings are stored. This makes it easier to diagnose malfunctions, reducing service labour and therefore costs.



Automatic fan operation. Convenient microprocessor control automatically adjusts fan speed to High, Medium or Low, corresponding to room sensor and maintains comfortable airflow throughout the room.



By intermittent control of compressor and indoor unit's fan, "Mild Dry" gives you comfort. It realizes efficient dehumidification according to room temperature.



Comfortable auto-flap control. When the unit is first turned on, flap position is automatically adjusted in accordance with the cooling or heating operation.



Automatic restart function for power failure. Even when power failure occurs, preset programmed operation can be reactivated once power is resumed.



Air Sweep. The air sweep function moves the flap up and down in the air outlet, directing air in a "sweeping" motion around the room and providing comfort in every corner.



Built-in drain pump. Maximum head 50cm (or 75cm for U type) from the bottom of the unit.



The Panasonic renewal system allows good quality existing R22 pipe work to be re-used whilst installing new high efficiency R410A systems.



5 Years Warranty. We guarantee the outdoor unit compressors for five years.

High connectivity



The new AC Smart Cloud from Panasonic allows you to have complete control of all your installations. In a simple click, all your units from several locations, receive status updates in real-time of all your installations, preventing breakdowns and optimizing costs.



Internet Control is a next generation system providing a user-friendly remote control of air conditioning or heat pump units from everywhere, using a simple Android or iOS smartphone, tablet or PC via internet.



The communication port is integrated into the indoor unit and provides easy connection to, and control of, your Panasonic heat pump to your home or building management system.

PANASONIC IS DEFINITELY THE MOST EFFICIENT SYSTEM THROUGHOUT THE YEARS



And highly adapted to retail, hotels and offices applications

Super high efficiency at part load conditions:

Comparison with competitors: When many others do not declare performance data under 50% part load, Panasonic covers up to 30% part load with extremely high efficiency.

Load %	110%	100%	60%	50%	40%	30%
Other competitors	3,52	3,38	3,45	3,50		
Panasonic VRF 6N Series 32HP Standard	3,38	3,41	4,41	4,69	4,85	4,93
Panasonic VRF 6N Series 32HP HI COP	3,91	3,94	5,14	5,54	6,03	6,51

Conditions: Outdoor temperature 0°C DB, Room temperature 20°C DB.

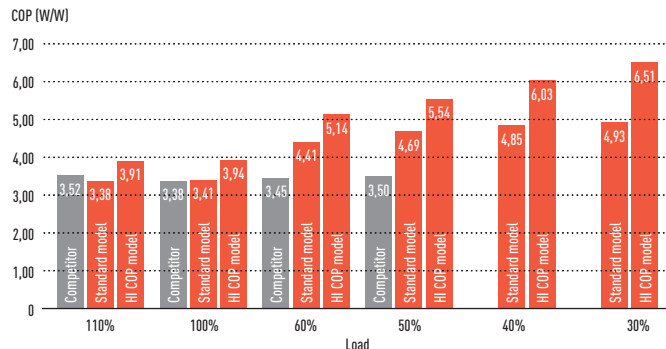

* Data extracted by Panasonic and competitor official technical data book.

Excellent SEER and SCOP values for 2 and 3-Pipe

Panasonic have a extremely high SEER and SCOP values following the SBEM method (some other manufacturers may use another non official calculation method).

Mini ECOi			2-Pipe			3-Pipe		
Model	SEER	SCOP	Model	SEER	SCOP	Model	SEER	SCOP
U-4LE1E5	5,77	5,43	U-8ME2E8	7,74	5,61	U-8MF2E8	5,89	5,74
U-4LE1E8	5,76	5,43	U-10ME2E8	7,66	5,71	U-10MF2E8	5,96	5,40
U-5LE1E5	5,88	5,12	U-12ME2E8	7,32	5,84	U-12MF2E8	6,15	5,25
U-5LE1E8	5,88	5,12	U-14ME2E8	6,97	5,72	U-14MF2E8	5,87	5,63
U-6LE1E5	5,20	4,86	U-16ME2E8	6,66	5,71	U-16MF2E8	6,04	4,88
U-6LE1E8	5,29	4,86	U-18ME2E8	6,56	5,65			
			U-20ME2E8	5,98	4,88			

Developed by BRE, SBEM (Simplified Building Energy Model) is the basis of non-domestic building energy calculations. Based on the National calculation method (NCM), it is used to determine compliance with Part L of the Building Regulations and is also used to provide Energy Performance Certification.

Non-Domestic Building Services Compliance Guide provides information on various aspects of the calculation method, including those of Heat Pumps (Section 3), and Comfort Cooling (Section 9).

	SCOP - Seasonal Coefficient of Performance ¹				SEER - Seasonal Energy Efficiency Rating ²			
	25%	50%	75%	100%	25%	50%	75%	100%
Part Load COP	25%	50%	75%	100%	25%	50%	75%	100%
Ambient conditions	15°C	7°C	1°C	-5°C	20°C	25°C	30°C	35°C
Weighting factor	0,20 (a)	0,36 (b)	0,32 (c)	0,12 (d)	0,20 (a)	0,36 (b)	0,32 (c)	0,12 (d)

1. UK winter -5°C DB (outdoor temperature), 20°C WB (indoor temperature). 2. UK summer 21°C DB (outdoor temperature), 16°C WB (indoor temperature).

ESEER calculation corresponds with below conditions and the input power of indoor units is not included.

- Indoor temperature: 27°C DB / 19°C WB
- Outdoor temperature conditions

Part load ratio	25%	50%	75%	100%
Outdoor air temperature (°C DB)	20	25	30	35
Weighting coefficients	0,23	0,41	0,33	0,03

• Formula : 0,23 x EER25% + 0,41 x EER50% + 0,33 x EER75% + 0,03 x EER100%.

Efficient defrost operation

Panasonic use the second unit to defrost the first unit. This makes the system more efficient during defrost and does not affect comfort.

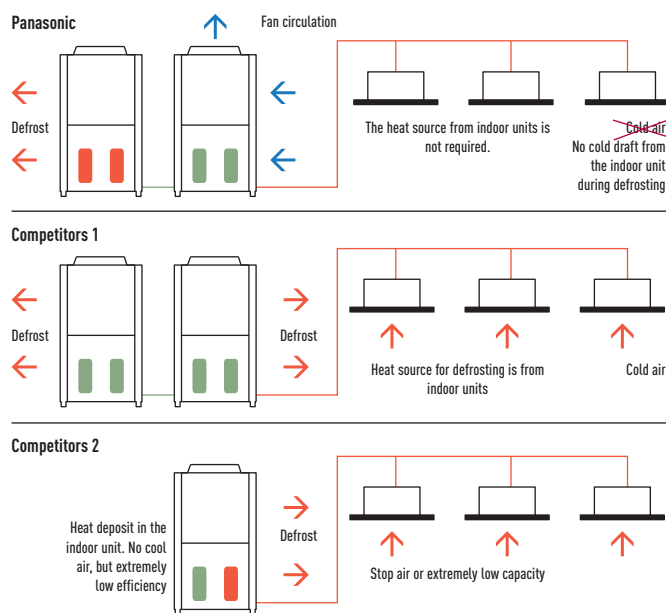

Panasonic ECOi operates at as low as -25°C

This unique feature demonstrate the supremacy of Panasonic ECOi 6N Series.

Panasonic use the second unit to defrost the first unit. This makes the system more efficient during defrost and does not affect the comfort.

Wide temperature setting range

Lowest operating outdoor temperature in the market
-25°C

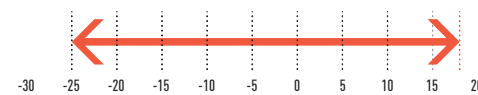

Outside air temperature (Upto 15 [°C WB])

PANASONIC VRF TOP COMFORT



Variable Evaporation Temperature (VET)

As a standard Panasonic includes VET in all ECOi series since 2006. This smart control logic is done every 30 minutes and depends directly on real demand and outdoor conditions giving the best performance and adapting really on time and on real needs. Panasonic also includes variable heating temperature function.

Cooling mode example (function also for heating is possible).

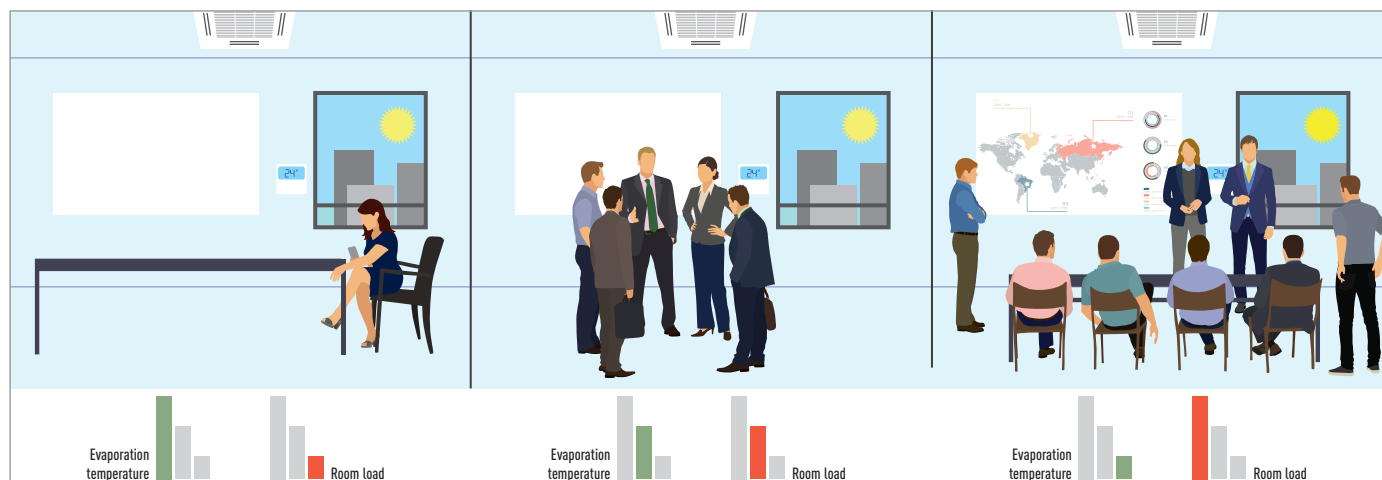
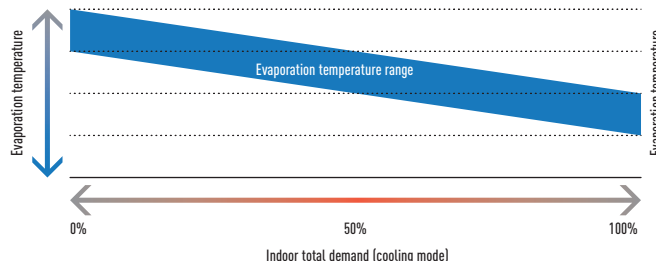

Air discharge temperature sensor advantages

Air discharge application.

This technology has been applied successfully in many applications since 2016.

- Hotels. This technology increases occupant comfort and decreases energy consumption
- AHU, thanks to the perfect temperature control AHU is one of the main applications of this sensor
- Industrial applications to keep constant temperature like warehouses

We have high experience on this advantage.

- Safety
- Healthy
- Comfort
- Energy Saving

The Panasonic air discharge temperature sensor was created for security purposes. To avoid condensation in metals ducts, grilles, and in some indoor units close to high humidity areas as restaurants, retail and residential applications close to the sea, lakes and so on. This technology prevents condensation inside ducts, increasing health, because without water in ducts there is no possibility to grow mold, bacteria or other pathogens, avoiding flu, cold, etc..

This temperature sensor can be set up for cooling also for heating for healthy purposes for several application; warehouses for seeds, pharmacist warehouses, hospital, kindergarden, etc..

Air discharge temperature control.

Available in all VRF indoor units, this control provides excellent comfort. Discharge air at below 10°C is uncomfortable and can cause draughts. With Panasonic air discharge temperature control, air off temperature can be controlled between 7°C - 22°C.

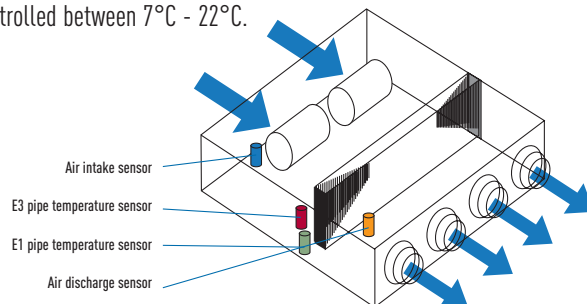

Big Pharmacist warehouse real case.

Big Pharmacist warehouse where total inside height were almost 10 meter and more than 2.000m². ECOi with high static pressure indoor units ME1 was used with this setting, because they need constant temperature 19°C all year, with a difference only 1°C between top sensor at 10m and 1m height. This was perfect, because we could reduce in winter time air discharge temperature to avoid a lot of stratification, where consumption was reduced by almost 45% because just with fan in on mode and discharge temperature at 40°C was more than enough to maintain this 19°C stable.

CONNECT TO THE FUTURE. VRF SMART CONNECTIVITY

Life Is On



Through thorough energy management, Panasonic's VRF Smart Connectivity is a completely new, state-of-the-art solution providing energy saving and comfort as well as simple installation, operation and running.

Panasonic, passionately pursuing the ultimate in energy saving through the application of cutting-edge technology, and Schneider Electric, an advanced global energy management specialist offering innovative control systems. This collaboration has set the new standard for creating the next generation of contemporary buildings.

VRF Smart Connectivity Advantages:

-  Easy Design and Plug and Play to Reduce CapEx
-  Dramatic Reduction of OpEx with Outstanding IAQ
-  Ultimate Customization
-  User-/Owner-friendly

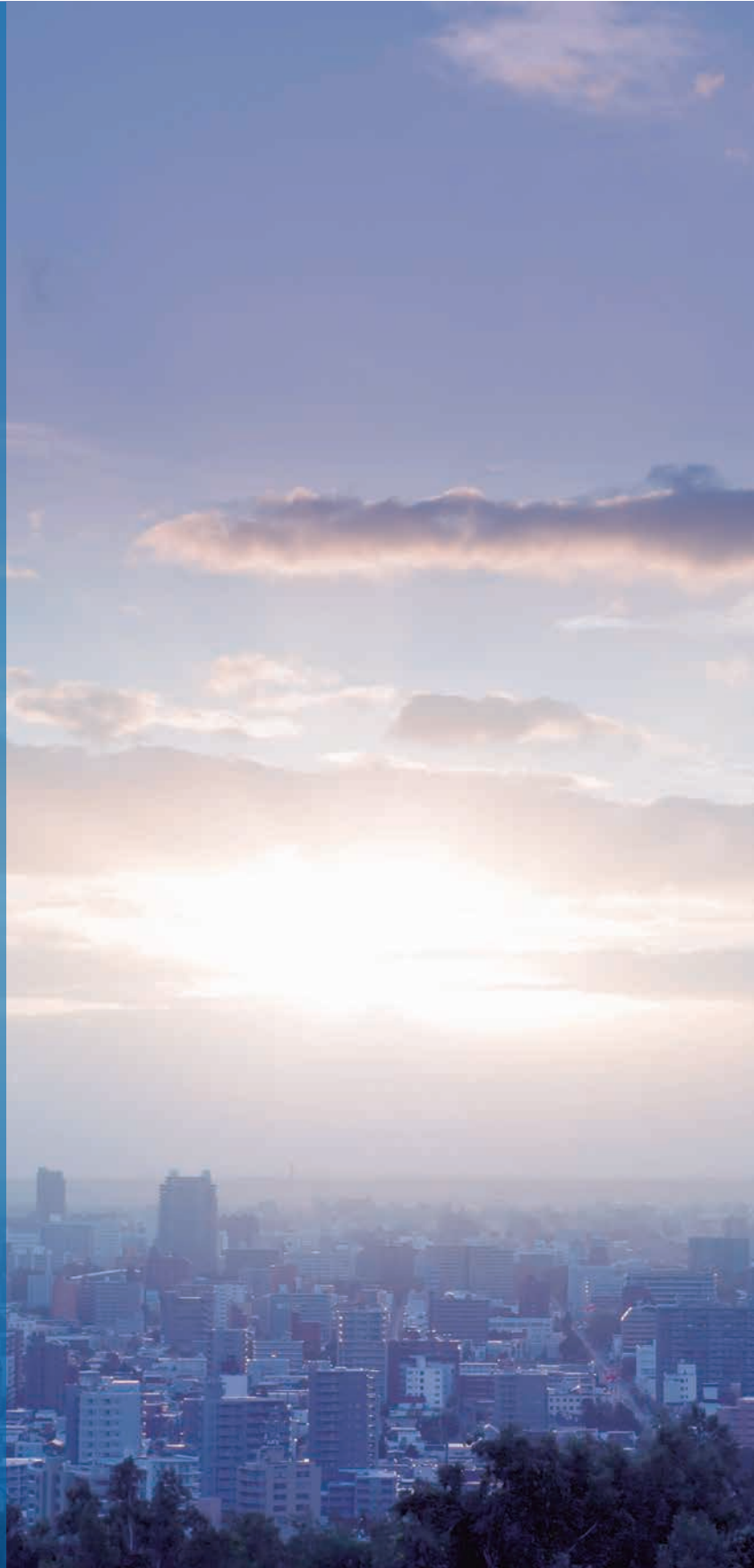

VRF Smart Connectivity.
The future of Control.

A remote controller is all that's required for occupancy control and optimum automatic indoor air quality (IAQ) control. Simple operation with a rented interface further contributes to increased energy efficiency and productivity for reduced capital expenditure (CapEx) and operating expense (OpEx).

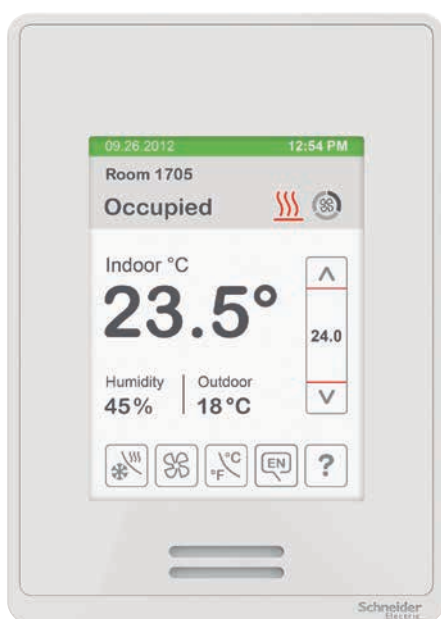
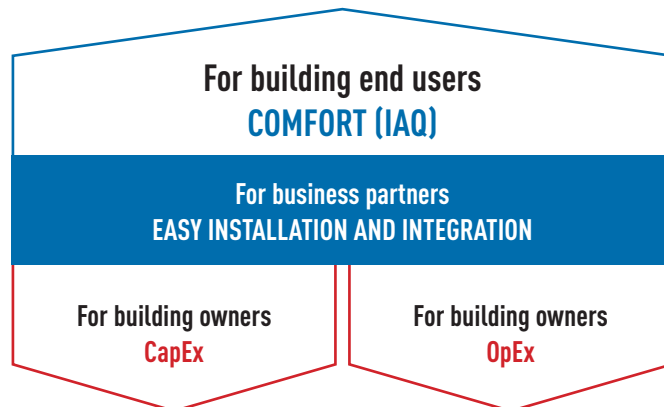

Extremely simple Plug and Play connection to a Building Energy Management System (BEMS) is possible. Compared to the current VRF systems and chillers of other companies, connection is smooth and stress-free, so there's considerably less burden on the system integrator.



Easy Design and Plug and Play to Reduce CapEx.

- Simple Plug & Play VRF connection to Building Energy Management System (BEMS)
- Stand alone or BEMS connected
- VRF indoor Wired or Wireless connection
- Plug and play additional ZigBee sensors



Dramatic Reduction of OpEx with Outstanding IAQ.

- 2 Built in sensors: Temperature and RH
- ZigBee wireless sensors: CO₂, window/door, human presence.



Ultimate Customization.

- Background colour customisable
- Custom display/icons, messages
- Set point boundaries
- Programmable logic (also stand alone)



User-/Owner-friendly.

- Colour touch screen
- Ease and simply of use
- 20 Languages
- Easy to understand error description

WHAT IS VRF CONNECTIVITY?

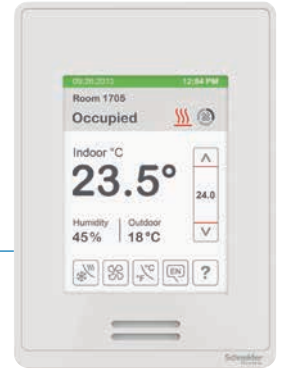

Stand alone Smart Connection

VRF Smart connectivity connects Panasonic ECOi and PACi indoor units by wired or wireless connection.

Wired Solution.

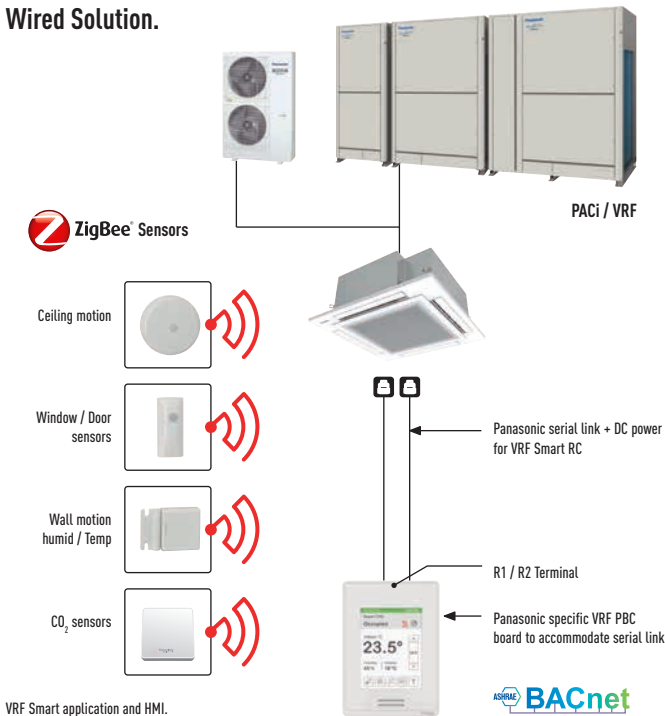

VRF Smart application and HMI.
Powered over communication serial link.
BACnet, Modbus, ZigBee.
One RC to one VRF FCU.

Wireless solution.

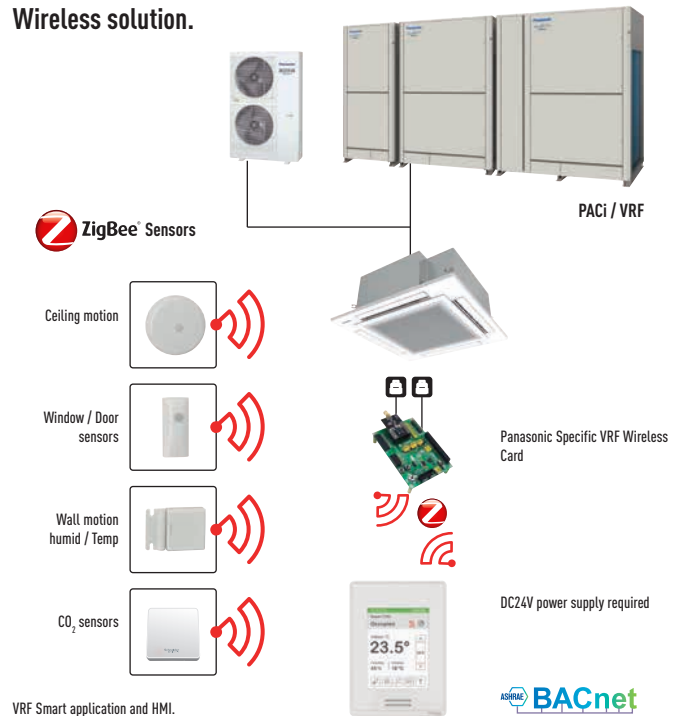

VRF Smart application and HMI.
Normal Power Supply.
BACnet, Modbus, ZigBee.
One RC to one VRF FCU.

Sensing Technology

The wireless solution using sensors born from the collaboration between Panasonic and Schneider Electric enables easy installation in existing and old buildings in which wiring is difficult (installation in a wired environment is also possible). The result is high-quality occupancy control and automatic IAQ control.

The sensors detect the presence or absence of occupants, and the opening and closing of doors and windows to achieve the most efficient energy management for exceptional air-conditioned comfort. Flexible installation is possible to match different applications and building features such as walls, ceilings and closeness to doors and windows. No wiring means extra installation versatility.

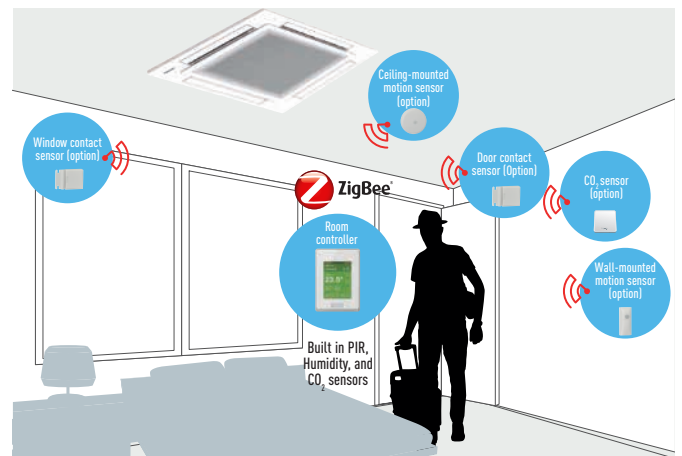

Batteries last for up to five years and are easy to install and replace.

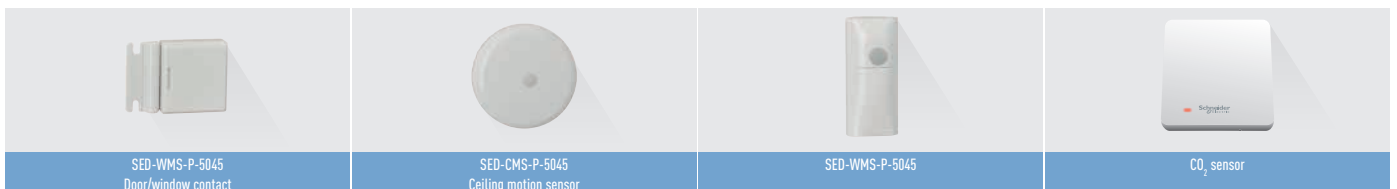

BEMS Smart Connection

The Smarter solution to simplify energy management, optimize building efficiency and drive savings.

Plug and Play BEMS connection.

With Plug and Play, connection to a BEMS is extremely easy. Better still, a remote controller is all that's needed to enable use as a stand-alone system. As well as dramatically reducing the burden on system integrators, this cuts costs.

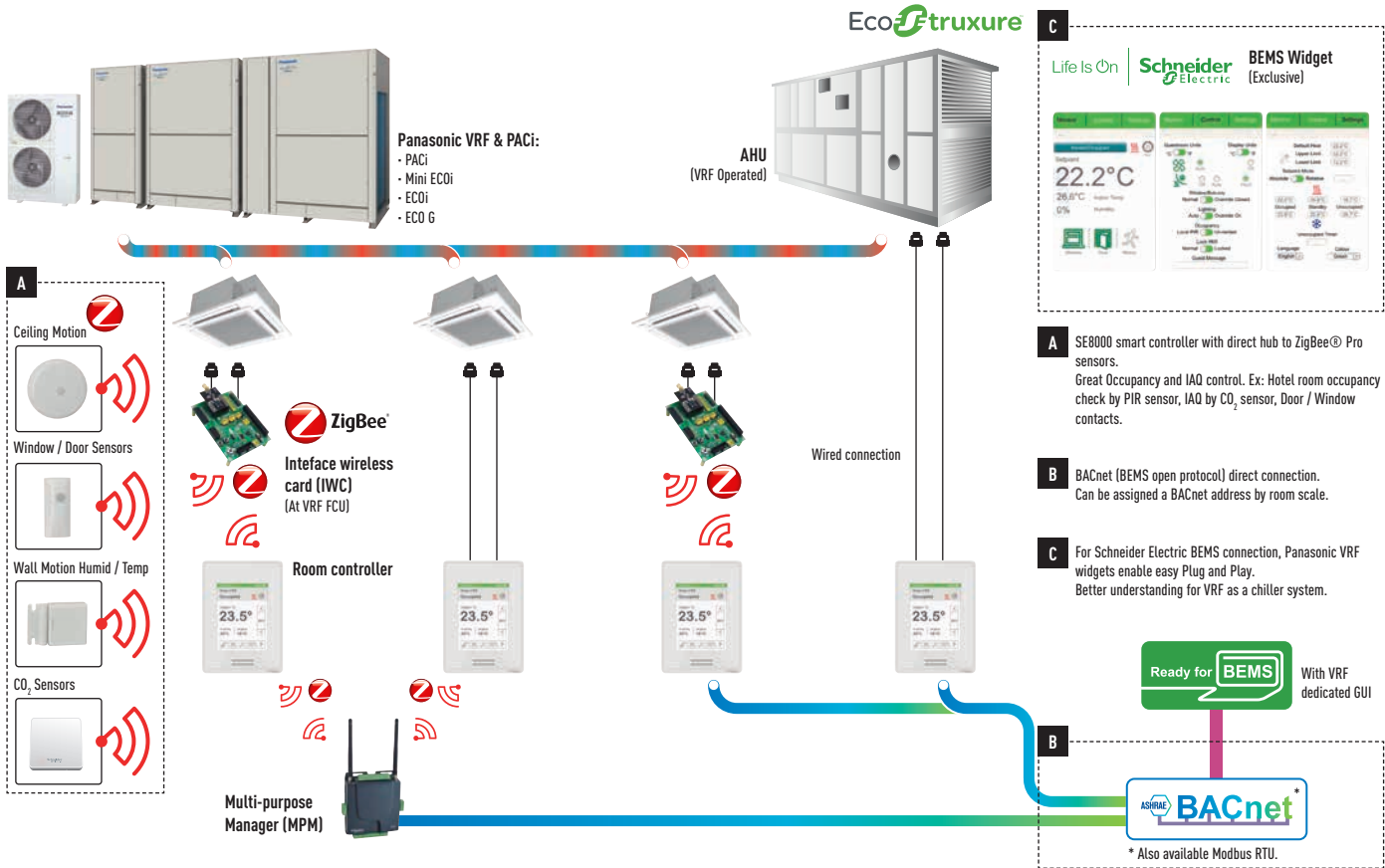

BEMS conventional system vs VRF Smart Connectivity

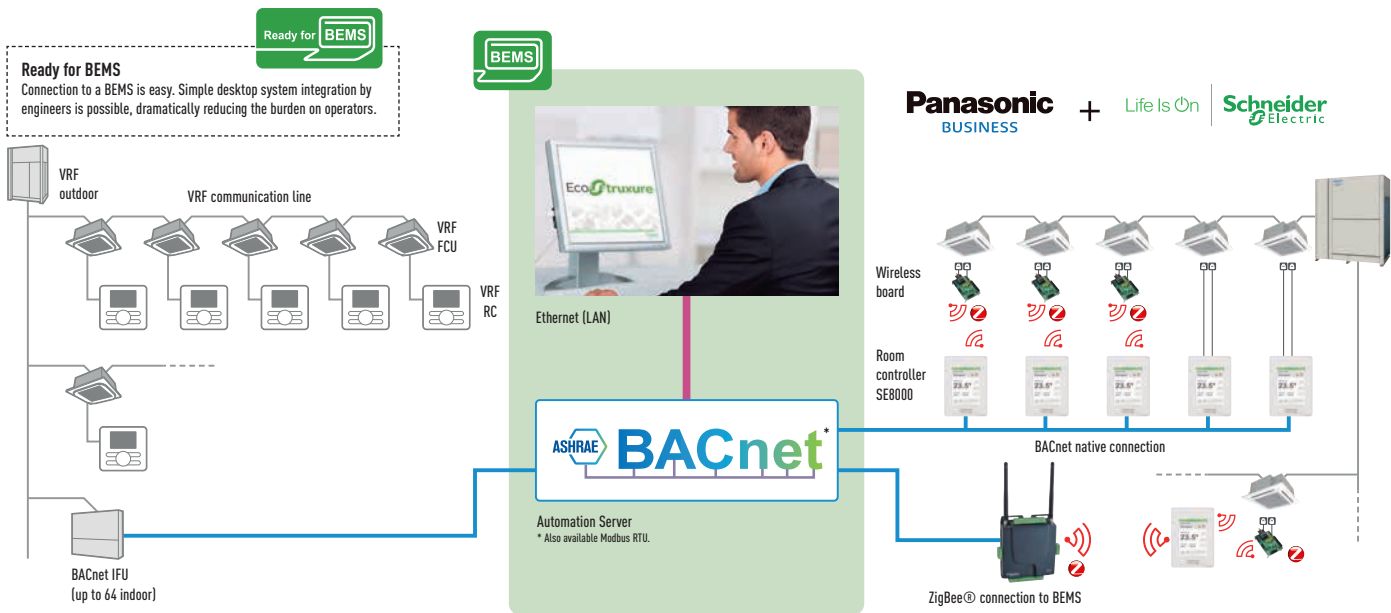

	Conventional	VRF Smart Connectivity	Advantage
Hardware connection	Need 2 Hardware CZ-CFUNC1 + BMS I/F	Required BACnet objects manual Wired/wireless)	CapEx: Saving interfaces
Integration	Manual system integration per indoor	Advanced plug & play connection	CapEx: Integrator time
	Required BACnet objects manual	Advanced plug & play connection	CapEx: Integrator time / OpEx: Full Integration of VRF signals

INNOVATIVE AND UNRIVALLED ADVANTAGES

Stand alone Smart Connection VRF.

CO₂ and humidity sensors for high IAQ

CO₂ sensors taking measurements in units of ppm, and humidity sensors enable fine air quality control. This creates the most comfortable space for occupants while contributing to improved employee satisfaction.

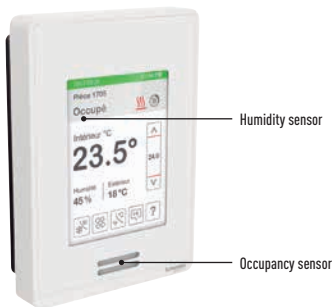

VRF / PACi wireless connection

Layout is extremely important because it decides how members of staff spend their time and work in an office. Until now, changing the layout of an office was difficult because of the complicated wiring involved, but with wireless VRF / PACi connection it's no trouble at all and more flexible layout is possible.



Energy management for high return on investment (ROI)

Avoid the huge costs that occur when the control of air conditioning is left to staff with a tailor-made solution. Automatically controlled operation with precise settings reduces both wasted energy and running costs. This in turn contributes to improved ROI which is directly linked to management.



Colour and design to match office interiors

When creating an office environment, a stylish appearance that complements the design of the office rather than interfering with it is an important consideration. Colour combinations and design can be set to match different facilities.

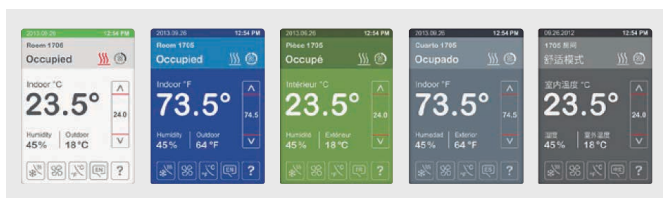

Installation possible during business hours without closing the store

To install a new system, it was previously necessary to close stores and restaurants. Now, thanks to Panasonic's wireless technology, smart installation is possible without closing an establishment or performing building work such as knocking down walls. And the enjoyment of customers isn't interrupted.

Easy-to-understand Error Description

Error description during an emergency is easy to understand, enabling staff to respond quickly. By eliminating the wasted cost of calling a service person every time there's a problem, this reduces total annual maintenance costs.



Guest room Management solutions for hotels.
Deliver exceptional guest satisfaction while optimizing energy and operational efficiency.

Customization in approx. 20 languages possible

The display can be customized to match the native languages of guests to enable smooth, stress-free communication for hospitality at its finest.



Occupancy sensors enabling automatic control for outstanding efficiency

Sensors in the room and on the controller detect the presence or absence of occupants and the opening and closing of windows and doors. While maintaining the optimum air-conditioned environment guests expect, automatic control ensures the most efficient operation when they are away or when windows are open. This contributes to an appreciable reduction in operation costs.

A truly comfortable experience for guests

Easy-to-understand, refined on-screen images enable display of hotel logos and original welcoming messages. Colour and design can also be customized for different facilities to create an even more comfortable environment for guests.



VRF Smart Connectivity Devices

2 types of devices depending on type connection with indoor units wireless or wired.
Wireless connection to indoor unit requires ZigBee interface for indoor unit.



Remote Controller Part Number	Description
SER8150A0B1194P	Panasonic Net Con, RH, No PIR, ZigBee®
SER8150A5B1194P	Panasonic Net Con, RH, PIR, ZigBee®
SER8150R0B1194	Panasonic Net Con, RH, No PIR, R1/R2
SER8150R5B1194	Panasonic Net Con, RH, PIR, R1/R2
Interface Part Number	Description
VCM8000R5094	Panasonic R1/R2 to ZigBee® I/F
Sensor Part Number	Description
SED-WMS-P-5045	SED SEN OCC WALL ZP
SED-WDS-P-5045	SED SW DOR/WIN ZP
SED-CMS-P-5045	SED SEN OCC CEIL ZP

Features

- Up to 5-year battery life, batteries included
- Battery level is a point
- Sensor points visible in SBO when SE8000 is integrated via BACnet MS/TP
- Sensor status and battery level visible in SBE when SE8000 is integrated via ZigBee® Pro
- Integration to SBE only recommended when each MPM is connected to Ethernet and are set as ZigBee® Coordinator nodes

SOLUTIONS FOR RESTAURANTS

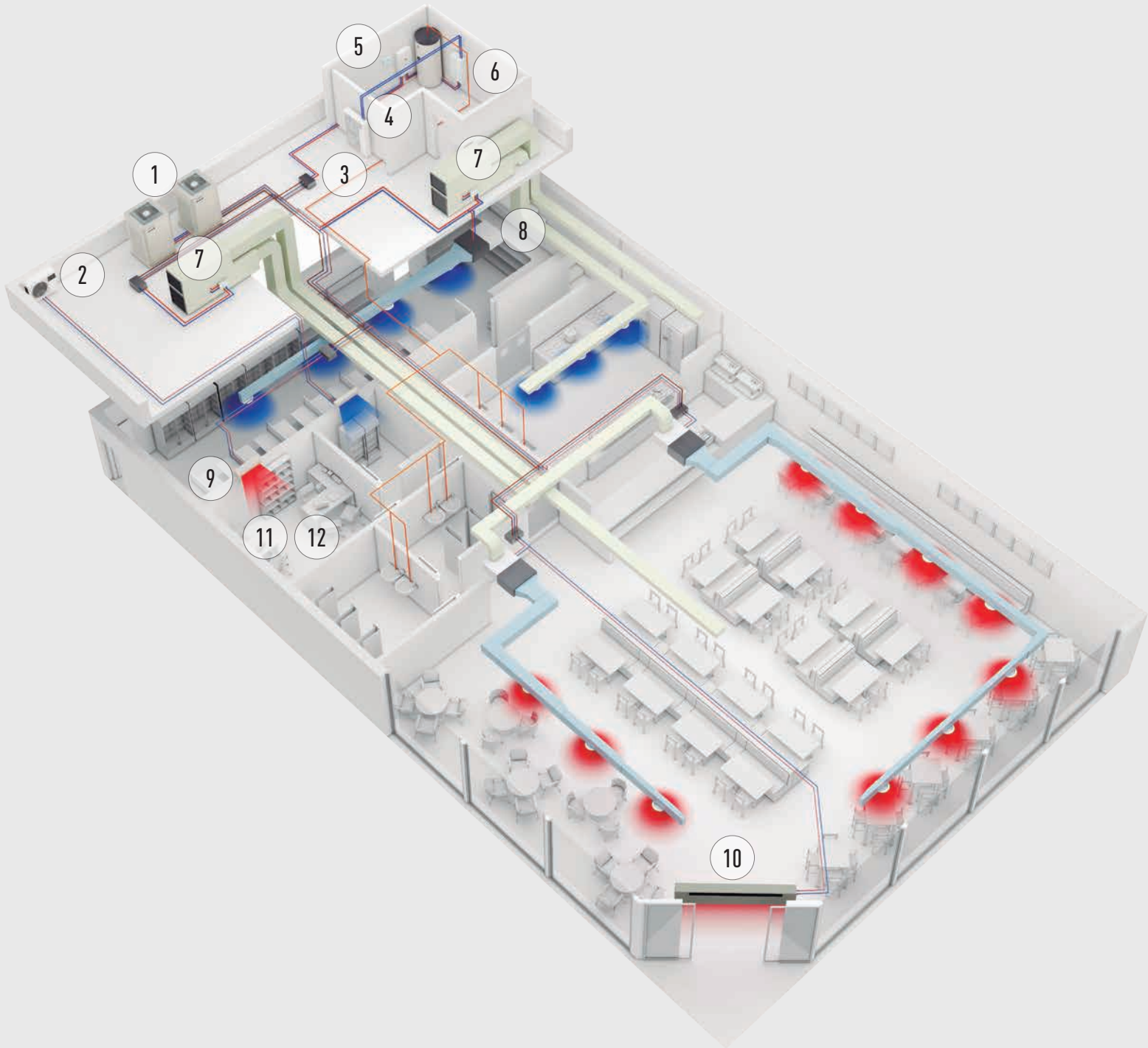

Full heating, cooling and DHW solutions for Restaurants

Super high efficiency at part load conditions

Panasonic has the most efficient solutions for optimising the installation of cooling, heating and DHW production. While the kitchen needs cooling, heating is needed for DHW and also for heating the public area, with the advantage of 100% fresh air that removes odours. Combining smartly all these needs with Panasonic technology, result in a simple and flexible system adaptable to any restaurant requests, with lower utility bills. Additionally, Panasonic is the unique offering solution for areas where electric power is limited, using ECO G, VRF units powered mainly by Natural Gas or Propane, bringing comfort and DHW anywhere.



1 ECOi (Electric VRF).

ECOi electrical VRF is specifically designed for the most demanding hotels. High efficiency system. Extended operating range to provide heating at outdoor temperature as low as -25°C. Suitable for refurbishment projects.



2 PKEA outdoor unit for server room.

Steady cooling, nonstop, even at -20°C and still with high efficiency. Ready for continuous operation and easy to connect 2 systems to automatically alternate and ensure server rooms are kept cool with maximum operating guaranteed.

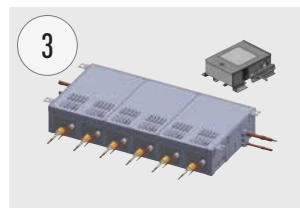

3 3-Pipe control box kit.

New Heat Recovery box to connect multiple indoor units with just one box, 4, 6 and up to 8 indoor units or groups. This is good advantage specially in hotels applications, where space for connecting several boxes is limited.



4 Aquarea T-CAP.

Ideal for heating, cooling and for production of big quantities of hot water at 65°C, Aquarea have a extremely quick return on investment and a low CO₂ footprint.



5

Control your way.

Wide variety of controls, from simple user control to full system control via remote access functionality. Touch panel, web server, consumption control, smartphone control... everything is possible.



6

Hydrokit for ECOi. Water at 45°C.

Produces LT hot water it is compatible with both ECOi, heat pump and heat recovery outdoors.

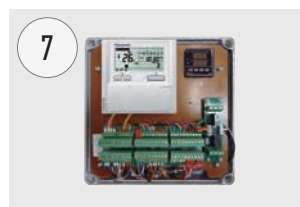

7

Air Handling Unit kits for efficient ventilation.

The new AHU kit is specially designed to improve the efficiency of the pre-heating or pre-cooling process of the ventilation.



8

Hide Away, for power and efficiency.

Super silent units deliver the ideal air supply. Units available from 1,5kW providing precise temperature control even in small rooms. Two models available: slim unit for height restricted areas (MM unit only 200mm deep), another which allows 100% fresh air (MF).



9

Wall Mounted.

The K2/K1 Type wall mounted unit has a stylish smooth panel which not only looks good but is also easy to clean. The unit is also smaller, lighter and substantially quieter than previous models making it ideal for small offices and other commercial applications.



10

Air Curtain with DX Coil.

The Panasonic range of air curtains is designed for smooth operation and efficient performance.



11

Protocol friendly.

Great flexibility for integration into your KNX / Modbus / LonWorks / BACnet projects allows fully bi-directional monitoring and control of all the functioning parameters. Range of solutions to control locally or remotely the full system in bi-directional mode.



12

New Aquarea Smart Cloud.

Starting with complete functions, CZ-TAW1 platform will incorporate more functions to convert Aquarea in the most saving system at home, making installer maintenance works simpler.

YOUR ENTIRE HOTEL WITH MAXIMUM SAVINGS, CONTROL AND COMFORT

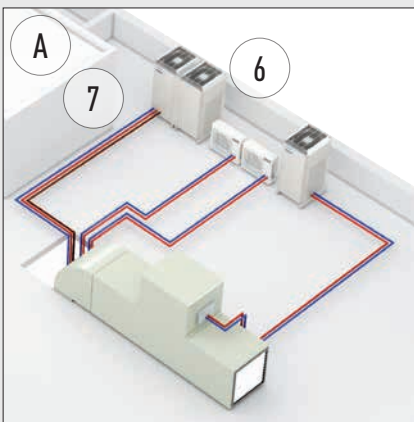
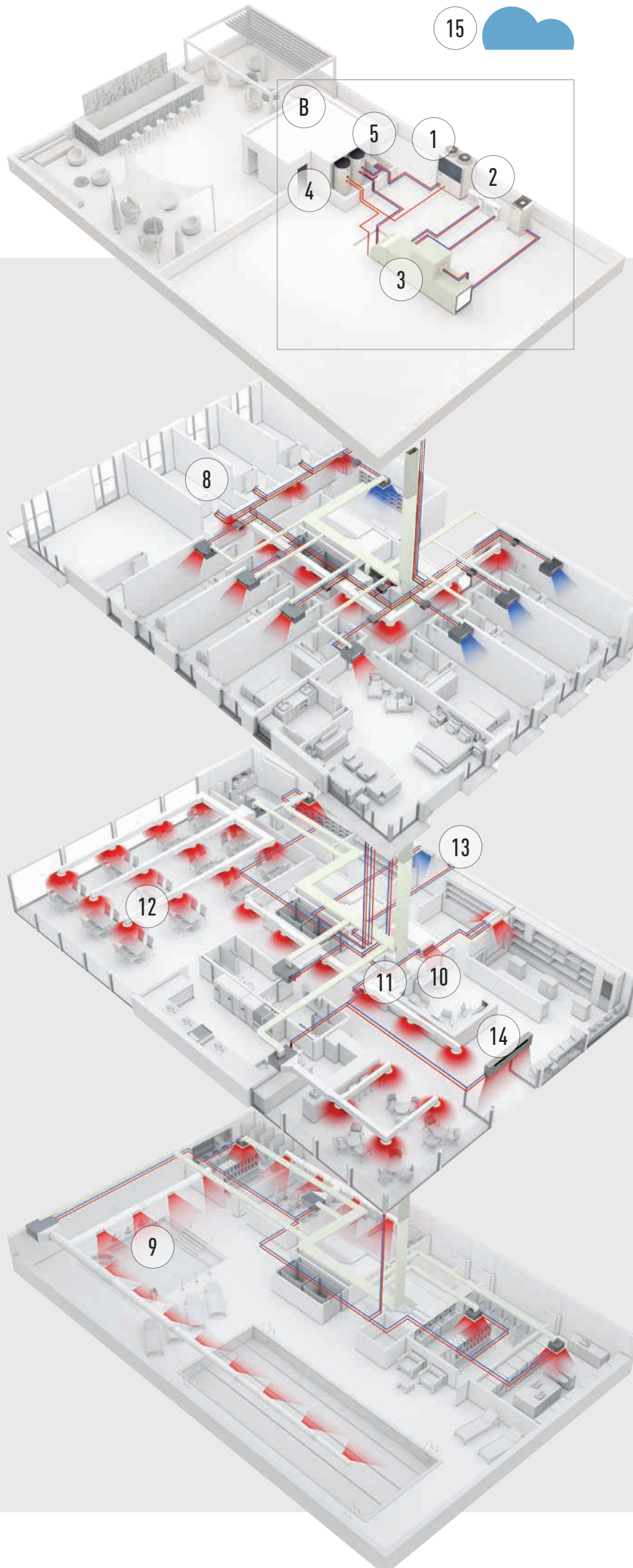

A

Option A: Hybrid Solution. Gas + Electric: When large quantities of hot/cold water is needed.

- ECO G (Gas heat pump)
- Water heat exchanger
- Aquarea HT to produce hot water up to 65°C
- Air Handling Unit kit to connect the ECO G to the Air Handling Unit
- PKEA wall mounted to cool the server rooms efficiently

B

Option B: Full Electric Solution 2 and 3-Pipe. When flexibility is needed and electricity power availability is not an issue.

- ECOi (Electric VRF)
- Direct expansion indoor units
- Air Handling Unit (AHU) kit to connect the ECOi to the AHU
- PKEA wall mounted to cool the server rooms efficiently
- New Panasonic Pump Down System: Detect refrigerant leakage and activate Pump Down solution

Panasonic helps your entire hotel achieve maximum savings, maximum control and maximum comfort

Panasonic offers the widest range in HVAC, DHW and ventilation available. That enables us to offer the most suitable solution to ANY project. And this all with the peace of mind provided by a fast customer service which is available 24 hours a day, 365 days a year.

The energy savings provided by our solutions, plus the available choice between electricity and gas, will enable you to reduce your CO₂ emissions. Panasonic solutions not only ensure a higher customer satisfaction but also the peace of mind that the wide Panasonic experience brings about in this field, plus a lower energy bill.



ECO G (Gas heat pump).
ECO G gas VRF is specially designed for buildings where the electricity is restricted or CO₂ emissions must be reduced. Very high preliminary efficiency ratio. Very low electrical consumption. Sanitary hot water is produced freely in summer.



PKEA outdoor unit for server room.
Steady cooling, nonstop, even at -20°C and still with high efficiency. Ready for continuous operation and easy to connect 2 systems to automatically alternate and ensure server rooms are kept cool with maximum operating guaranteed.



Air Handling Unit kits for efficient ventilation.
The new AHU kit is specially designed to improve the efficiency of the pre-heating or pre-cooling process of the ventilation.

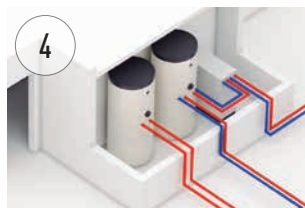

Domestic Hot Water production and buffer tanks.
Panasonic has developed a wide range of efficient domestic hot water tanks and buffer tanks.



Hydronic units.
For obtaining hot and cold water for heating and refrigeration (Aquarea Air radiators, underfloor heating, radiators...)



ECOi (Electric VRF).
ECOi electric VRF is specifically designed for the most demanding hotels. High efficiency system. Extended operating range to provide heating at outdoor temperature as low as -25°C. Suitable for refurbishment projects.



Improving security, detect refrigerant leaks early!
Panasonic's innovative Pump Down Systems help to detect refrigerant leaks that offer complete assurance and protection for end users, building occupiers and the environment.

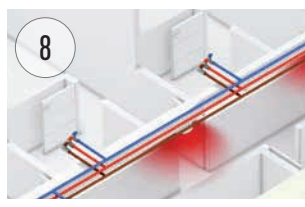

Cutoff valves.
When there are plans for future expansion, the installation can be built using the units sized for future expansion requirements.



Maximum savings on hot water production.
Hot water for swimming pool, spa and laundry for free thanks to the residual heat generated by the ECO G units.



Protocol friendly.
Great flexibility for integration into your KNX / Modbus / LonWorks / BACnet projects allows fully bi-directional monitoring and control of all the functioning parameters. Range of solutions to control locally or remotely the full system in bi-directional mode.



Control your way.
Wide variety of controls, from simple user control to full system control via remote access functionality. Touch panel, web server, consumption control, smartphone control... everything is possible.



Wide range of indoor units.
Complete range of indoor units that fits any need. All units provided with supply air temperature sensor and low operation sound level to guarantee maximum guests comfort. From 1,5kW up to 30kW.

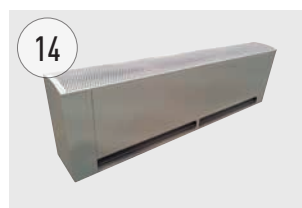

Air Curtain with DX Coil.
The Panasonic range of air curtains is designed for smooth operation and efficient performance.



Panasonic AC Smart Cloud.
Take control of all your shops around the world from a single device. Centralise control of your business premises, from wherever you are, 24/7.

INNOVATIVE SOLUTIONS FOR RETAIL

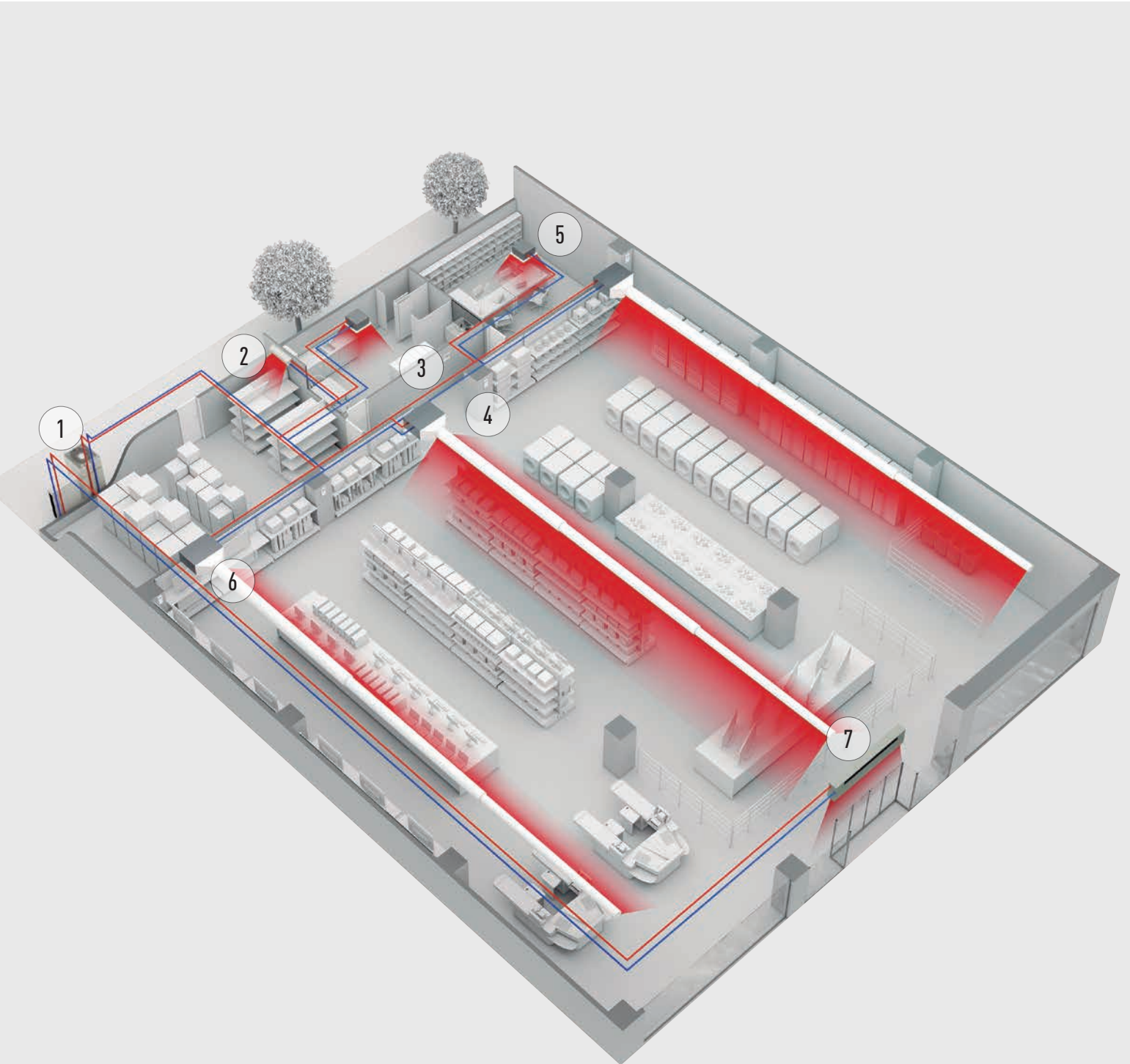

Heating and cooling solutions for retail applications.

Panasonic has developed solutions for retail applications and office applications where return on investment is a key factor! The comfort inside the shop is key for a good customer experience in the shop. From local control or from Panasonic new cloud control system, a detail status of the heating and cooling system can be displayed, analysed and optimised in order to improve the efficiency, reduce the running time and increase the life time of the units.

8 reason why Panasonic is the best solution for your Retail:

- Complete solution
- Flexibility and adaptation
- Go green retail: lowest CO₂ emissions
- Comfort - maximum satisfaction
- Future expansion
- Panasonic is definitely the most efficient system over the years
- High quality of service with Panasonic pro-partner installation team
- The system will still operate up to 25% of the connected indoor units. System will not stop when up to 25% of indoor units have power supply breakdown when they are on mode



Multi energy solutions, gas or electric.

The Multi energy solution (Gas and Electric) from Panasonic gives the best of the energy saving and on the flexibility of the installation. Panasonic solutions can be connect to direct expansion systems, water chiller installations and ventilation systems as air handling units.

- 1a: Gas VRF. ECO G
- 1b: Electric VRF. ECOi
- 1c: Electric VRF. Mini ECOi
- 1d: Electric 1x1. PACi
- 1e: Electric A2W. Aquarea



PKEA outdoor unit for server room.

Steady cooling, nonstop, even at -20°C and still with high efficiency. Ready for continuous operation and easy to connect 2 systems to automatically alternate and ensure server rooms are kept cool with maximum operating guaranteed.

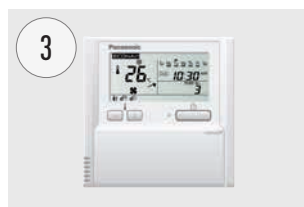

Control your way.

Wide variety of controls, from simple user control to full system control via remote access functionality. Touch panel, web server, consumption control, smartphone control... everything is possible.



Econavi Sensor.

The all new Econavi Sensor detects presence in the room, and quietly adapts the PACi or VRF air conditioning system in order to improve comfort and maximise energy savings.



Wide range of indoor units.

Complete range of indoor units that fits any need. All units provided with supply air temperature sensor and low operation sound level to guarantee maximum guests comfort. From 1,5kW up to 30kW.



Hide Away, for power and efficiency.

Super silent units deliver the ideal air supply. Units available from 1,5kW providing precise temperature control even in small rooms. Two models available: slim unit for height restricted areas (MM unit only 200mm deep), another which allows 100% fresh air (MF).



Air Curtain with DX Coil.

The Panasonic range of air curtains is designed for smooth operation and efficient performance.



Protocol friendly.

Great flexibility for integration into your KNX / Modbus / LonWorks / BACnet projects allows fully bi-directional monitoring and control of all the functioning parameters. Range of solutions to control locally or remotely the full system in bi-directional mode.



Air Handling Unit kits for efficient ventilation.

The new AHU kit is specially designed to improve the efficiency of the pre-heating or pre-cooling process of the ventilation.



Energy Recovery unit for high efficiency of the system.

Panasonic Energy Recovery Ventilators can reduce the outside air load because they efficiently recover the heat lost by ventilation during the heat recovery process.

BEST EFFICIENCY ECOi SERIES FROM PANASONIC



The ECOi series is designed for energy savings, easy installation, and high efficiency. Always continuing to evolve, Panasonic uses advanced technologies to meet the requirements of diverse situations and contribute to the creation of comfortable living spaces.

Mini ECOi Series



The 2-Pipe heat pump small VRF system specifically designed for the European market.

New 2-Pipe ECOi EX



The VRF system delivering energy-saving performance, powerful operation, reliability and comfort surpassing anything previously possible.

3-Pipe ECOi MF2 6N Series



The VRF system that offers high-efficiency and performance for simultaneous heating and cooling.

Lower running and life cycle costs.

Panasonic ECOi systems are amongst the most efficient VRF systems on the market, offering COPs in excess of 4,0 at full load conditions. The system is also designed to make sure that we reduce the running cost of each system by using our unique road map control routine to ensure that the most efficient combination of compressors are running at any one time. Improved defrost sequencing also reduces running costs by defrosting each outdoor coil in turn when conditions allow.

Up to 64 indoor units can be connected up to a capacity of 200% indexed indoor unit loads, enabling the system to be used effectively on highly

diversified building loads: this large connectivity feature makes it an easy-to-design solution for schools, hotels, hospitals and other large buildings. Up to 1000m in pipe length enables the VRF ECOi series to be used in very large buildings, with maximum design flexibility. The ECOi system is also easy to control. It has more than 8 types of control from standard wired remote controls to touch screen panels or web access interfaces.

DC-inverter control technology for rapid and powerful cooling & heating. The ever-evolving Panasonic ECOi series.

ECOi Series benefits

Ease of installation.

R410A has a higher operating pressure with a lower pressure loss than previous refrigerants. This enables smaller pipe sizes to be used and allows reduced refrigerant charges.

Simple to design.

Panasonic rECO Gnise that designing, selecting and preparing a professional VRF quotation can be a time consuming and costly process, especially as it is often also a speculative exercise. So we have designed proprietary software which is quick and easy to use and produces a full schematic layout of pipework and controls, as well as a full materials list and performance data.

Easy to control.

A wide variety of control options are available to ensure that the ECOi system provides the user with the degree of control that they desire, from simple room controllers through to state of the art BMS controls.

Simple to commission.

Simple set-up procedure including automatic addressing of connected indoor units. Configuration settings can be made from an outdoor unit or via a remote controller.

Easy to position.

The compact design of the ECOi outdoor units means that sizes 8HP to 10HP fit into a standard lift and are easy to handle and position when on site. The small footprint and modular appearance of the units ensure a cohesive appearance to an installation.

Wide selection and connectivity.

With 11 indoor model styles available, ECOi systems are the ideal choice for multiple small capacity indoor unit installations, with the ability to connect up to 40 indoor units to systems of 24HP or greater for 3-Pipe ECOi MF2 6N Series.

Easy to maintain.

Each system allows the use of prognostic and diagnostic controls routines, from refrigerant charge control through to complex fault code diagnostics, all designed to reduce the speed of maintenance calls and unit down time.

Lower running and life cycle costs.

Panasonic ECOi systems are amongst the most efficient VRF systems on the market. The system is also designed to make sure that we reduce the running cost of each system by using our unique road map control routine to ensure that the most efficient combination of compressors are running at any one time. Improved defrost sequencing also reduces running costs by defrosting each outdoor coil in turn when conditions allow.

2-PIPE MINI ECOi LE1 SERIES



Panasonic has unveiled its new, large capacity, Mini VRF side blow system. Available now from 4 to 10HP, this compact system is the ideal solution for applications where outdoor space is at a minimum, but where a quality and reliable heating and cooling solution is paramount.

Cooling and Heating type Single Phase and Three Phase

For small-scale commercial and residential use.

Panasonic 2-Pipe Mini ECOi, the 2-Pipe heat pump is specifically designed for the most demanding applications. Mini ECOi is available in 5 sizes with cooling capacities ranging from 12,1kW to 28kW and connectable up to 15 indoor units (applicable for 28kW).

An expansion from the Panasonic VRF line up, the Mini ECOi is compatible with the same indoor units and controls as the rest of the ECOi range.

Wide design operation conditions.

The operating range for heating operation is to -20°C, the cooling range is to -10°C. The remote controller temperature setting offers a range from 16°C to 30°C.

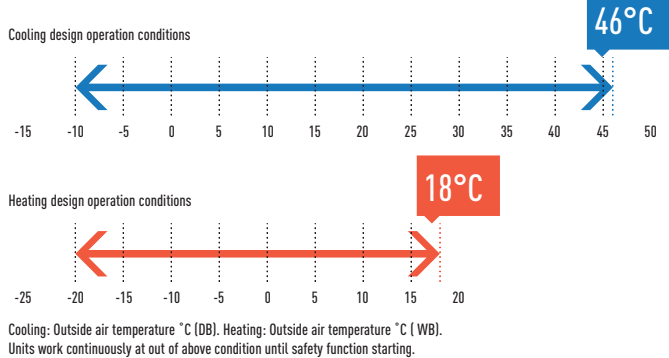

Heating and cooling solutions

Perfect solution for small shops, offices, large residential properties or condominiums where outdoor space is minimal, as well as larger, commercial applications including hotels or larger office buildings where the outdoor system should not intrude on the exterior décor.

Bluefin (only for 8-10HP)

Bluefin treatment protect the coil itself against corrosion, ensuring that the unit continues to function with the same outstanding thermal exchange efficiency and performance over time.

New Inverter compressor (only for 8-10HP)

Thanks to its top class COP, high heat exchange performance due to its wide heat exchanger and extensive Inverter compressor range, which provides a high efficiency operation by the load, it is also incredibly energy saving.

Silent mode

Maximum 7dB(A) can be reduced by setting. External input signal is also available. In case of the installation at Condominium, quiet operation performance is important, especially in night time.

Increased piping length for greater design flexibility

Adaptable to various building types and sizes.

Actual piping length: 120m (equivalent piping length 140m).

Maximum piping length: 150m.

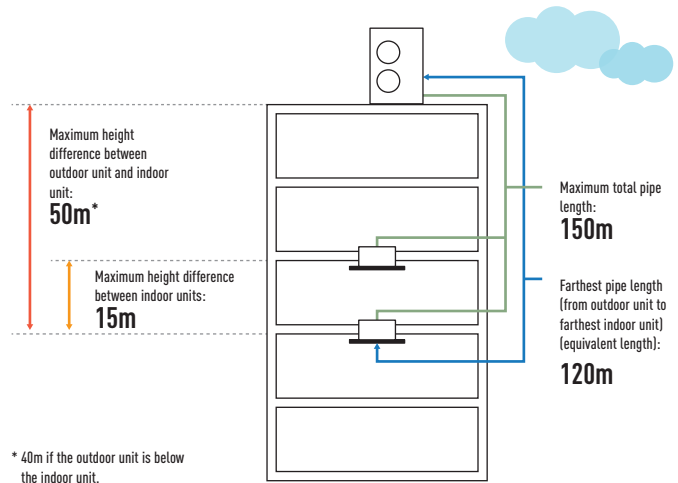

Flexible pipework

Category	Item	Description	Max length (m)
Allowable pipework length	L1	Maximum pipe run	Actual length: 120 Equivalent length: 140
		L2-L3	Difference between maximum length and minimum length from the first distribution joint
	L3 L4 Ln	Maximum length of each distribution joint	30
	L1+L3+L4	Maximum total pipe run length	150
Allowable height difference	H1	When outdoor unit installed higher	50
	H2	When outdoor unit installed lower	40
	H2	Maximum difference between indoor units	15

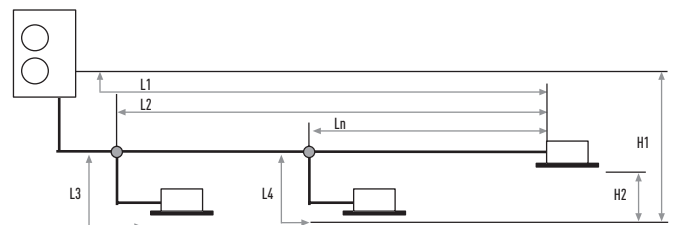

Up to 15 indoor units per system

System / HP	4HP	5HP	6HP	8HP	10HP
Maximum number of connectable indoor units	6	8	9	15	15

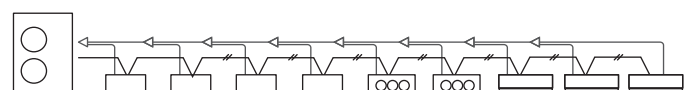

MINI ECOi HIGH EFFICIENCY 4-6HP

Panasonic's new Mini VRF system combines a high performance to position itself as one of the most compact and powerful VRF systems available within the European market.

For light commercial use

Panasonic's Mini ECOi, the 2-Pipe heat pump small VRF system, is specifically designed for the most demanding applications. Offering between 12,1kW and 15,5kW cooling capacity in 3 sizes and up to 9 indoor units connected, the Mini ECOi sets standards of performance and flexibility. Utilising R410A and DC inverter technology, Panasonic offers VRF to a new and growing market.

Forming a new key part of the Panasonic VRF line up, the Mini ECOi is compatible with the same indoor units and controls as the rest of the ECOi range.



Technical focus

- Single Phase or Three Phase power supply
- One Amp start current
- DC inverter technology combined with R410A
- Diversity ratio 50~130%
- Cooling operation to -10°C
- Compact outdoor unit 1.330 x 940 x 410mm

HP			4HP						5HP						6HP					
Model			U-4LE1E5			U-4LE1E8			U-5LE1E5			U-5LE1E8			U-6LE1E5			U-6LE1E8		
Power supply	Voltage	V	220	230	240	380	400	415	220	230	240	380	400	415	220	230	240	380	400	415
	Phase		Single Phase			Three Phase			Single Phase			Three Phase			Single Phase			Three Phase		
	Frequency	Hz	50Hz			50Hz			50Hz			50Hz			50Hz			50Hz		
Cooling capacity	kW	12,1			12,1			14,0			14,0			15,5			15,5			
EER ¹⁾	W/W	4,30			4,30			4,20			4,20			3,45			3,45			
Running amperes	A	13,9	13,3	12,7	4,9	4,7	4,5	16,3	15,6	14,9	5,7	5,4	5,2	21,5	20,5	19,7	7,5	7,1	6,9	
Input power cooling	kW	2,81			2,81			3,33			3,33			4,49			4,49			
Heating capacity	kW	12,5			12,5			16,0			16,0			18,0			18,0			
COP ¹⁾	W/W	4,62			4,62			4,30			4,30			3,95			3,95			
Running amperes	A	13,2	12,7	12,1	4,7	4,5	4,3	18,0	17,2	16,5	6,3	6,0	5,8	21,6	20,7	19,8	7,5	7,2	6,9	
Input power heating	kW	2,71			2,71			3,72			3,72			4,56			4,56			
Starting amperes	A	1,0	1,0	1,0	1,0	1,0	1,0	1,0	1,0	1,0	1,0	1,0	1,0	1,0	1,0	1,0	1,0	1,0	1,0	
Maximum amperes	A	21,0	21,0	21,0	8,5	8,5	8,5	24,5	24,5	24,5	10,0	10,0	10,0	28,0	28,0	28,0	12,0	12,0	12,0	
Maximum Input power	kW	4,44	4,64	4,84	5,15	5,42	5,62	5,17	5,41	5,64	6,06	6,37	6,61	5,91	6,18	6,45	7,27	7,65	7,94	
Maximum number of connectable indoor units			6			6			8			8			9			9		
Air volume	Cooling / Heating	m ³ /min	95			95			104			104			104			104		
Sound pressure	Cooling (Hi / Lo)	dB(A)	50 / 47			50 / 47			51 / 48			51 / 48			52 / 49			52 / 49		
	Heating (Hi / Lo)	dB(A)	52 / 49			52 / 49			53 / 50			53 / 50			55 / 52			55 / 52		
Sound power	Cooling (Hi)	dB	68			68			69			69			70			70		
	Heating (Hi)	dB	70			70			71			71			73			73		
Dimensions	H x W x D	mm	1.330 x 940 x 340			1.330 x 940 x 340			1.330 x 940 x 340			1.330 x 940 x 340			1.330 x 940 x 340			1.330 x 940 x 340		
Net weight		kg	104			103			104			103			104			103		
Piping connections	Liquid pipe	Inch (mm)	3/8 (9,52)			3/8 (9,52)			3/8 (9,52)			3/8 (9,52)			3/8 (9,52)			3/8 (9,52)		
	Gas pipe	Inch (mm)	5/8 (15,88)			5/8 (15,88)			5/8 (15,88)			5/8 (15,88)			3/4 (19,05)			3/4 (19,05)		
Refrigerant (R410A)		kg / TCO ₂ Eq.	3,5 / 7,308			3,5 / 7,308			3,5 / 7,308			3,5 / 7,308			3,5 / 7,308			3,5 / 7,308		
Operating range	Cooling Min - Max	°C	-10 ~ +46			-10 ~ +46			-10 ~ +46			-10 ~ +46			-10 ~ +46			-10 ~ +46		
	Heating Min - Max	°C	-20 ~ +24 / -20 ~ +18			-20 ~ +24 / -20 ~ +18			-20 ~ +24 / -20 ~ +18			-20 ~ +24 / -20 ~ +18			-20 ~ +24 / -20 ~ +18			-20 ~ +24 / -20 ~ +18		

1) EER and COP classification is at 400 V in accordance with EU directive 2002/31/EC.



MINI ECOi

HIGH EFFICIENCY 8-10HP

Prepare to be blown away by Panasonic's New Mini VRF system. The New Mini VRF compact system is the ideal solution for minimum outdoor space. Panasonic extends the Mini VRF range by 8 and 10HP units.

Increase external static pressure

When unit is installed at the narrow balcony, the fence at front side will be the obstacle. High external static pressure feature will keep the operating capacity and good advantage.

High ambient temperature performance

Cooling operation range up to 46°C. The system can maintain the rated (100%) capacity up to 40°C by 8HP model & up to 37°C by 10HP model.

Technical focus

- Piping flexibility 150m maximum piping length
- High efficiency
- 15 indoor units connectable
- Quiet operation mode (one of the lowest in the market)
- High ambient temp performance
- High static pressure 35Pa



HP			8HP			10HP		
Model			U-8LE1E8*			U-10LE1E8*		
Power supply	Voltage	V	380	400	415	380	400	415
	Phase		Three Phase			Three Phase		
	Frequency	Hz	50Hz			50Hz		
Cooling capacity		kW	22,40			28,00		
EER ¹⁾		W/W	3,80			3,11		
Running amperes		A	9,60	9,15	8,80	14,70	14,00	13,50
Input power cooling		kW	5,89			9,00		
Heating capacity		kW	25,00			28,00		
COP ¹⁾		W/W	4,02			3,93		
Running amperes		A	10,20	9,65	9,30	11,60	11,10	10,70
Input power heating		kW	6,22			7,13		
Starting amperes		A	1,00			1,00		
Maximum amperes		A	13,70			19,60		
Maximum Input power		kW	9,16			13,10		
Maximum number of connectable indoor units			15 ²⁾			15 ²⁾		
External static pressure		Pa	0 - 35			0 - 35		
Air volume	Cooling / Heating	m ³ /min	150			160		
	Cooling	dB(A)	60			63		
Sound pressure	Cooling (Silent 1 / 2 / 3)	dB(A)	57 / 55 / 53			60 / 58 / 56		
	Heating	dB(A)	64			65		
Sound power	Cooling / Heating	dB	81 / 85			84 / 86		
Dimensions / Net weight	H x W x D	mm / kg	1.500 x 980 x 370 / 132			1.500 x 980 x 370 / 133		
	Liquid pipe	Inch (mm)	3/8 (9,52) ³⁾ / 1/2 (12,70) ⁴⁾			3/8 (9,52) ³⁾ / 1/2 (12,70) ⁴⁾		
Piping connections	Gas pipe	Inch (mm)	3/4 (19,05) ³⁾ / 7/8 (22,22) ⁴⁾			7/8 (22,22) ³⁾ / 1 (25,40) ⁴⁾		
	Max piping length range (total)	m	7,5 - 150 (7,5 - 300)			7,5 - 150 (7,5 - 300)		
Elevation difference (in/out)		m	50 (Outdoor unit upper) / 40 (Outdoor unit lower)			50 (Outdoor unit upper) / 40 (Outdoor unit lower)		
Refrigerant (R410A)		kg / TCO ₂ Eq.	6,3 (24,0) / 13,1544			6,6 (24,0) / 13,7808		
Maximum allowable indoor / outdoor capacity ratio		%	50 - 130			50 - 130		
Operating range	Cooling / Heating Min - Max	°C	-10 ~ +46 / -20 ~ +18			-10 ~ +46 / -20 ~ +18		

1) EER and COP classification is at 400 V in accordance with EU directive 2002/31/EC. 2) If the heating utilized, it is necessary to increase 1 size with respect to the main liquid pipe, depending on the combination of the indoor unit. 3) Under 90m for ultimate indoor unit. 4) Over 90m for ultimate indoor unit. If the longest piping equivalent length exceeds 90m, increase the sizes of the main tubes by 1 rank for gas and liquid pipes. * Tentative data.



NEW 2-PIPE ECOi EX THE GAME CHANGER



VRF with extraordinary energy-saving performance and powerful operation EER 4,70 (8HP model).



A game-changing VRF system delivering energy-saving performance, powerful operation, reliability and comfort surpassing anything previously possible. It represents a true paradigm shift in air conditioning solutions. Taking quality to the extreme — that's the Panasonic challenge.

1

High performance at extreme conditions

ECOi EX is highly reliable, with strong cooling & heating power, even when operating at extreme ambient temperatures. The units can operate at 100% of capacity at 43°C, reaching a great cooling operation up to 52°C and in heating -25°C.

Also, the ECOi EX features include Bluefin in newly designed heat exchanger improving efficiency as well in marine ambient. A silicone coated PCB (Printed Circuit Board) protects the unit from being damaged by environmental factors such as moisture and dust.

2

TOP efficiency and comfort

The new ECOi EX system is designed to dramatically increase energy efficiency by delivering the highest ESEER rating, as well as high efficiency for part-load operations.

The system has reduced energy costs thanks to "All-Inverter Compressors", with independent control to deliver highly flexible performance. Also, the ECOi EX features an enlarged heat exchanger with triple surfaces that allow for improved heat transfer and a newly designed curved air discharge bell-mouth for better aerodynamics. The three-stage oil recovery design makes it able to minimise the frequency of forced oil recovery, leading to reduced energy costs and sustained comfort.

3

Superior flexibility

With its up to 1000 meters of pipeline, its maximum 30 meters height difference between indoor units and its 200 meters length, the design possibilities have grown exponentially making the new ECOi EX the ideal air conditioning option for long haul buildings, such as train stations, airports, schools or hospitals. These advantages are enhanced with the wide range of indoor unit models and capacities facilitating the perfect adaptation to all kind of projects. The careful selection of controls and peripherals such as the Pump Down, the AHU or/and the chiller, enables an optimum system use. Connectable Maximum allowable indoor / outdoor capacity ratio up to 200%.



NEW TWIN ROTARY INVERTER COMPRESSOR

New twin rotary inverter compressor

Two independently controlled inverter compressors achieve high efficiency. Redesigned components in the body provide performance improvement especially in the rated cooling condition and EER performance.

- Wider and flexible control on Inverter compressor
- Better oil lubrication
- Smooth start up



Extraordinary energy-saving performance

Designed for Actual Operation Performance. Panasonic builds air conditioning systems not only with a high EER for rated operation, but also with Seasonal-EER appropriate to the customer's actual environment of use. For instance, with rated operation, outdoor temperature is constant at 35°C, but in reality the outdoor temperature is continuously changing. Consequently, required air conditioning performance also changes. That's why Panasonic implements the following kind of proprietary control.

1. Set temperature is rapidly attained; full-load operating time is kept to a minimum.
 2. The frequency of forced oil recovery is minimised. The volume of oil within the compressors is monitored precisely by sensors, so forced oil recovery under full-load operation is conducted only when necessary. Since this suppresses noise due to oil recovery, comfort is maintained.
 3. Panasonic pursues a high EER, of course, as well as high EER in part load, for energy saving performance under a broad range of loads.
- Panasonic's design concept contributes to substantial energy cost reductions.

Compressor efficiency electric system VRF.

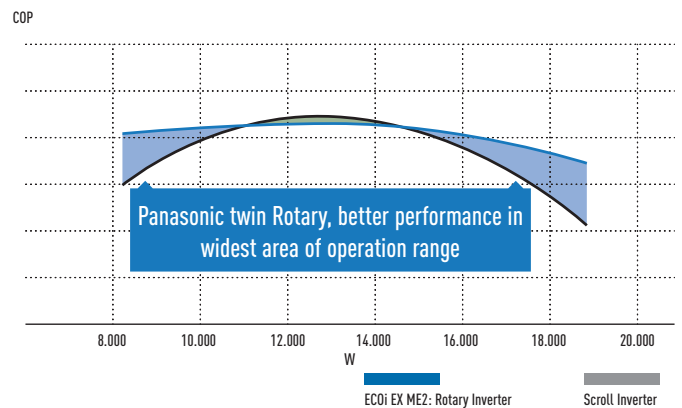

Number of Inverter compressors

Size	Small		Medium		Large		
	8HP	10HP	12HP	14HP	16HP	18HP	20HP
Number	1 pc.		1 pc.	2 pcs.		2 pcs.	

Actual operation data graph of Panasonic VRF

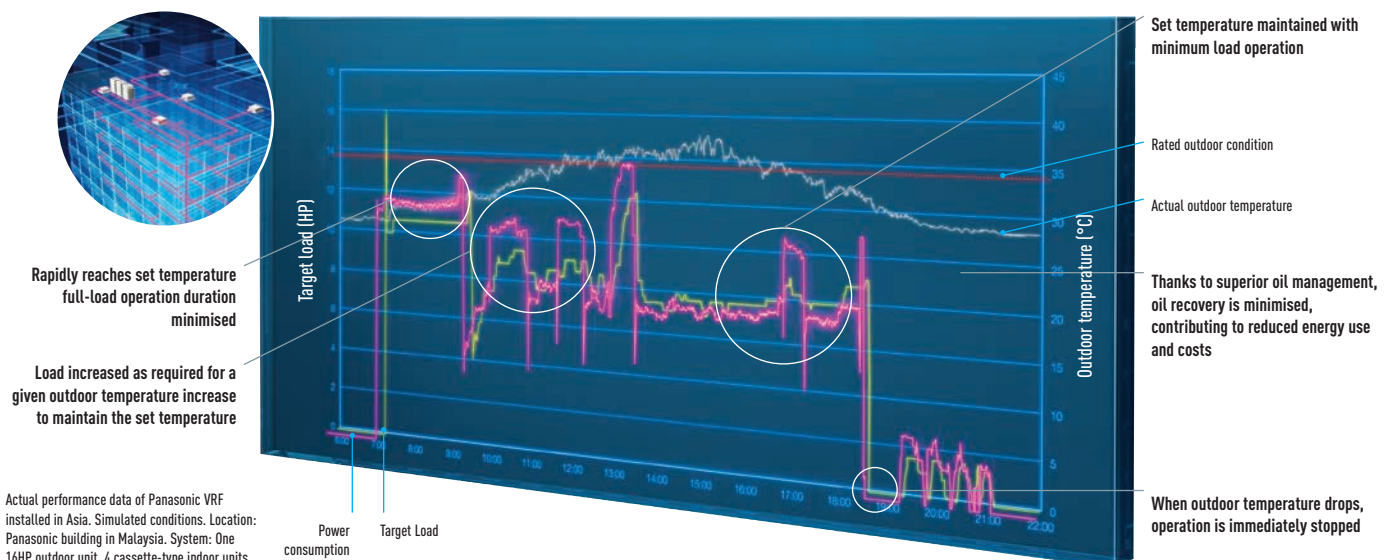

HIGH PERFORMANCE AT EXTREME CONDITIONS

The ECOi EX can still operate at 100% capacity when the outside temperature is as high as 43°C. This high power capability enables reliable operation even under extremely high temperature conditions.

Trusted reliability even under high and low temperature conditions

Designed to be durable enough to withstand extreme heat, ECOi EX ensures reliable cooling operation over an extended operation range up to 52°C, and heating operation also at minus -25°C.

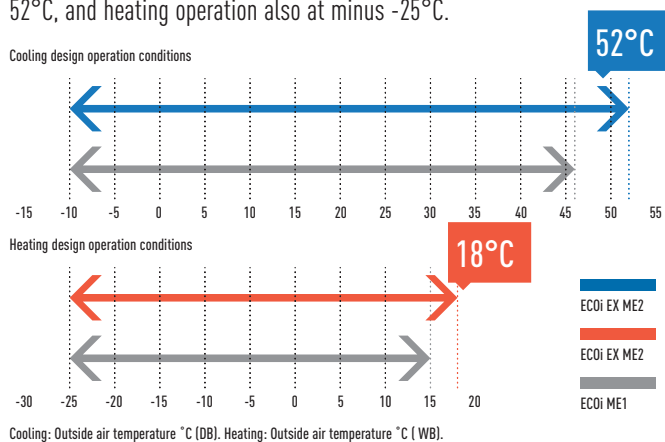

Extremely high capacity at -20°C and unique heating capacity at -25°C

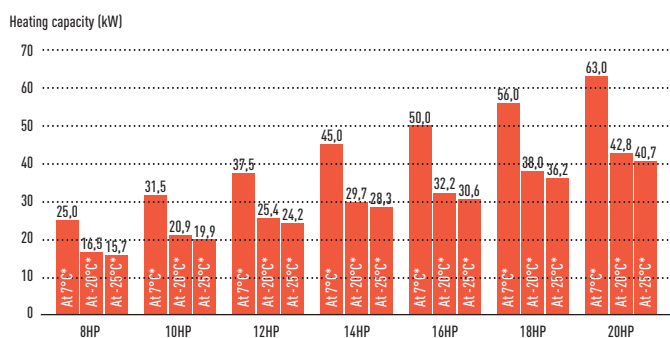

Hi-durability outdoor unit

Corrosion-resistance treated for high resistance to rust and salty air to assure long-lasting performance.

Specially protected parts

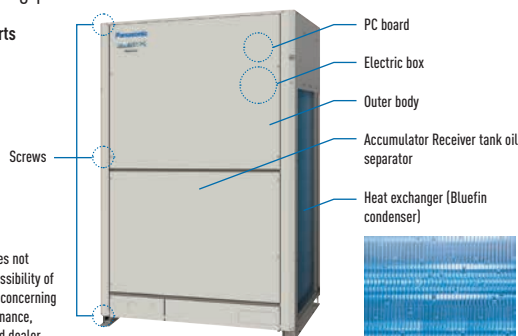

Note: Selecting this unit does not completely eliminate the possibility of rust developing. For details concerning unit installation and maintenance, please consult an authorised dealer.

Bluefin full line up EX

Optimised and new design heat exchanger for better surface area with triple surface*.

The new heat exchanger features a triple-surface construction. Compared to the divided dual-surface construction in current models, there is no division of space and the area for heat exchange is larger. Also, highly efficient piping pattern increases heat exchange performance by 5%.

* For 8 & 10HP unit, the heat exchanger is 2 row design.

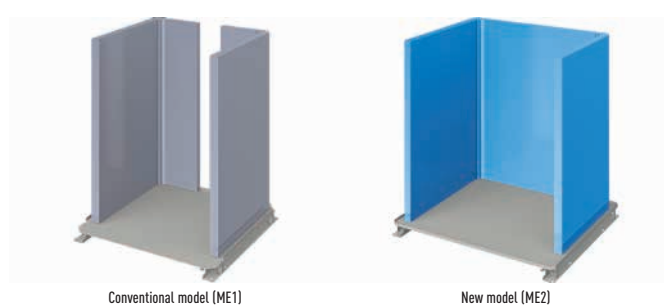

Extreme outdoor ambient conditions.

Including Bluefin in a newly designed heat exchanger improves efficiency, especially in marine environments.

A silicone coated PCB (Printed Circuit Board) protects the unit from being damaged by environmental factors such as moisture and dust.

High safety operation in case of breakdown!

Automatic Back-Up operation. Ensures heating and cooling.

It is possible for the system to keep working, even if the compressors, fan motor and the temperature sensor are damaged (even when compressor fails in single unit with 2 compressor inside).

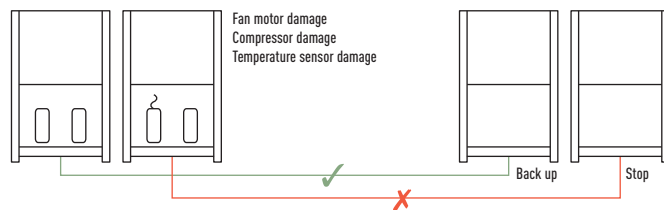

The system will still operate up to 25% of the connected indoor units.

System will not stop when up to 25% of indoor units have power supply breakdown when they are ON Mode.

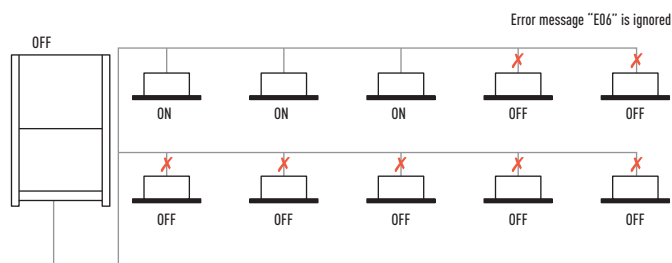

TOP EFFICIENCY AND COMFORT

Remarkable improvement on key components: extraordinary energy-saving performance and redesigned for smooth and better air discharge.

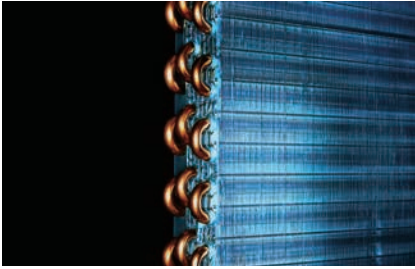

Enlarged heat exchanger surface area with triple surface.

* For 8 & 10HP unit, the heat exchanger is 2 row design.



Multiple large-capacity all inverter compressors (more than 14HP).



Newly designed curved air discharge bell mouth for better aerodynamics.

Improvements on refrigerant circuit

Compressor.

Redesigned components in the body provide performance improvement especially in the rated cooling condition and AEER performance.



Accumulator.

New oil returning circuit with control valve makes efficient oil recovery to compressor.

Oil separator.

Modified tank design makes efficient oil separation with less pressure drop.



Receiver tank less design.

Improved refrigerant control program recovers the remaining refrigerant gas in the system back to the accumulator tank effectively.



Smooth exhaust flow by new bell-mouth

The new curved shape with integrated top and bottom assure smooth exhaust flow. This gives more air-volume with same sound level, less input power at same air volume.

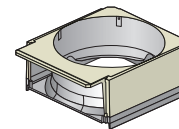

Conventional model (ME1)

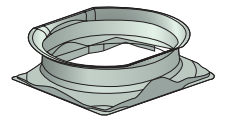

New model (ME2)

Sound pressure dB(A)

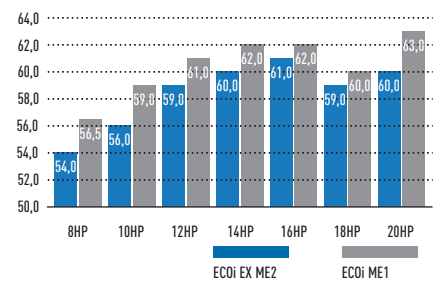

Combined 3 surface heat exchanger

The highly efficient piping pattern increases heat exchange performance by 5%.

The new heat exchanger features a 3 surface construction.

Compared to the divided dual-surface construction in current models, there is no divided space and the face area of heat exchanger becomes larger.



Conventional model (ME1)



New model (ME2)

OIL RECOVERY INTELLIGENT CONTROL

Intelligent 3-stage Oil Management System

In a VRF system, where lengthy piping and a large number of indoor units need to be controlled collectively, the key to maintaining the system's reliability is to ensure an appropriate amount of oil is secured in the compressors. In order to avoid oil shortage in the compressor, maximum operation is normally forcibly conducted at regular intervals to recover oil from indoor units. This method, typically employed in a standard VRF, causes the system to overheat or overcool and thus waste energy.

In Panasonic VRF systems, a sensor for detecting oil levels is mounted in each compressor. In installations with multiple outdoor units, a shortage of oil in one compressor can be compensated for by recovering oil either from another compressor in the same unit, from a compressor in an adjacent outdoor unit, or from a connected indoor unit. Panasonic VRF systems provide users with a comfortable environment whilst saving energy.

Oil recovery intelligent control advantages:

1. Higher efficiency
2. Durability
3. Comfort:
 - Continuous operation
 - Low noise
 - Low vibration

Features of oil recovery design

Oil sensors installed in each compressor.

Oil sensors installed in each Panasonic compressor precisely monitor oil levels, eliminating unnecessary oil recovery.

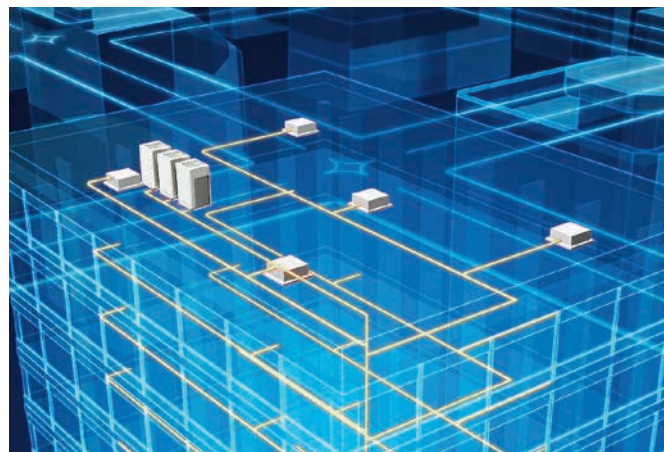
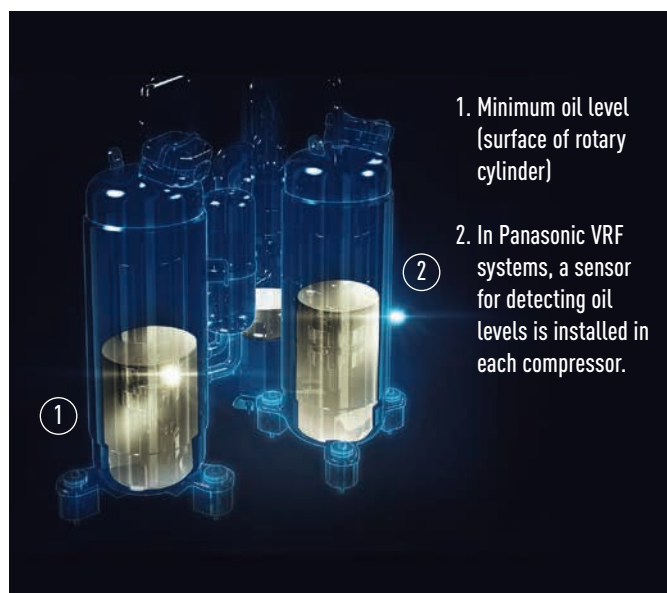

The Panasonic system efficiently manages oil recovery in three stages; minimising the frequency of forced oil recovery while reducing energy cost and maintaining comfort.

STAGE-1: Panasonic compressors are equipped with sensors which monitor oil levels precisely at all times. If oil levels fall, oil can be transferred from other compressors within the same outdoor unit.

STAGE-2: If oil levels in all compressors within the outdoor unit fall, oil can be replenished from adjacent outdoor units.

STAGE-3: Forced oil recovery is implemented only if oil levels become insufficient in spite of above measures. The Panasonic system's design concept is radically different from conventional oil systems.

Highly functional oil separator.

Thanks to extended separate piping, oil recovery efficiency reaches 90%, minimising the oil to be discharged from the compressor.



EXTRAORDINARY PARTIAL LOAD AND SEER/SCOP

Efficiency in VRF systems

The only way to compare so far, was the nominal efficiency at outdoor ambient temperature of 35°C (EER) in Cooling and at 7°C in heating (COP). With new EN-14825 seasonal efficiency will be shown, the result will be SEER and SCOP. New ECOi EX is reaching excellent performance without using any additional saving functions.

The highest EER/COP rating in most capacities

Compared to conventional model ECOi (ME1)

The ECOi EX marks a revolutionary step forward in VRF efficiency. A look at the incredible EER/COP value clearly indicates that. What's more, this high EER/COP value is achieved even during part load operation. This shows the extraordinary energy-saving performance the ECOi EX is capable of providing.

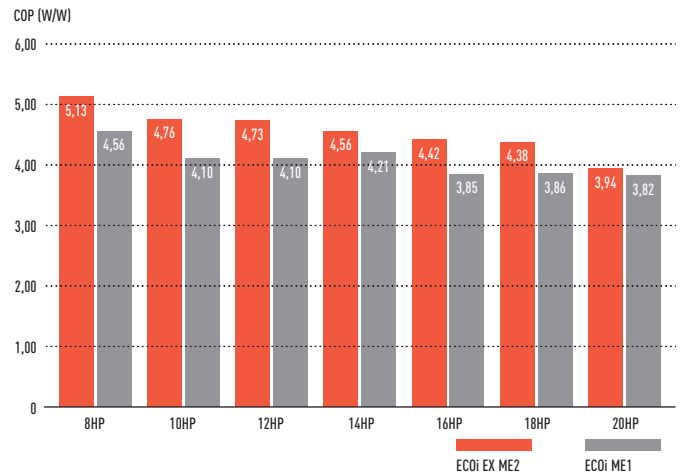
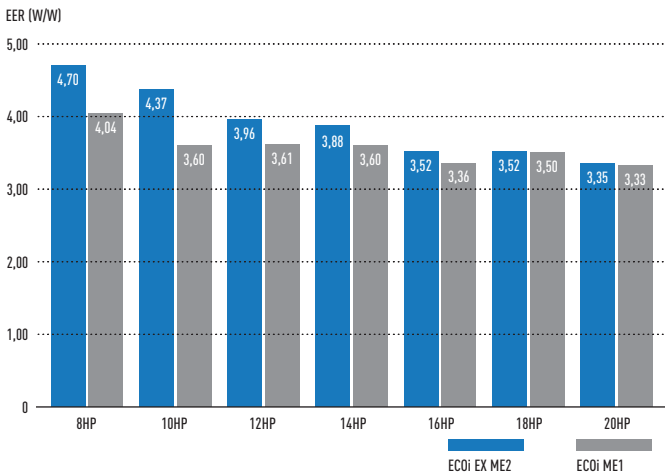

Partial load for seasonal and real system efficiency

VRF units are designed to adapt to the heating and cooling demand, adapting its performance to different outdoor conditions. When compressor runs at lower than 100% capacity, the system is working at partial load. A wider compressor operating range results in better system performance both at full load and partial load conditions. Panasonic ECOi EX partial load is excellent, reaching a minimum of 15% of compressor capacity.

Excellent efficiency at any condition and partial load

In both heating and cooling mode, Panasonic ECOi EX is reaching exceptional levels of efficiency.

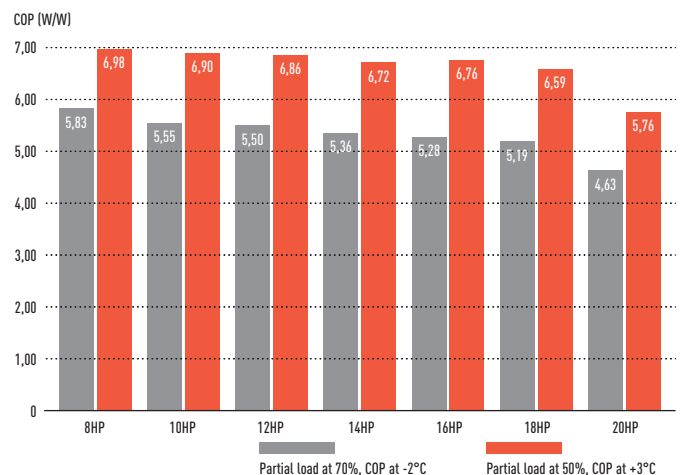
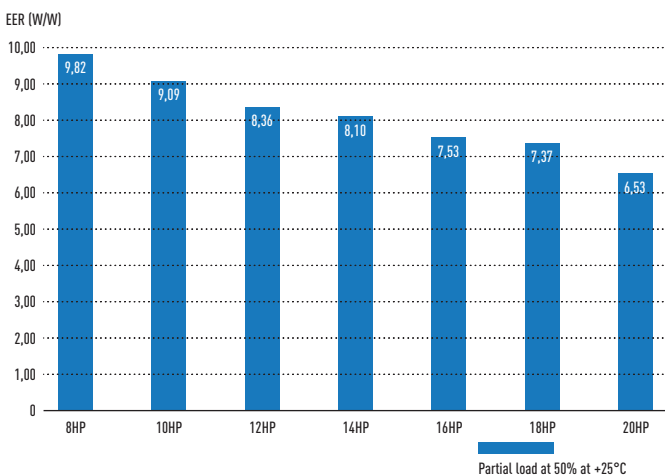

SEER and SCOP according to EN-14825

When better partial load, better efficiency is achieved in real operation. New EN-14825 is showing the way to calculate considering full year operation hours at different conditions. New Panasonic ECOi EX is designed to save energy in any partial load conditions. Most of operation hours system is under partial load conditions, 80% of total operation hours is less than 70% of full load. In below graphs is the example for average ambient conditions, this uses Strasbourg ambient conditions for calculation.

Outside temperature distribution

Time distribution (hours / year)

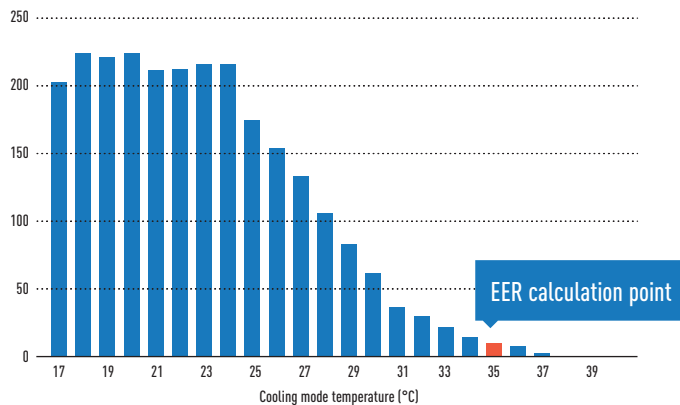

Outside temperature distribution

Time distribution (hours / year)

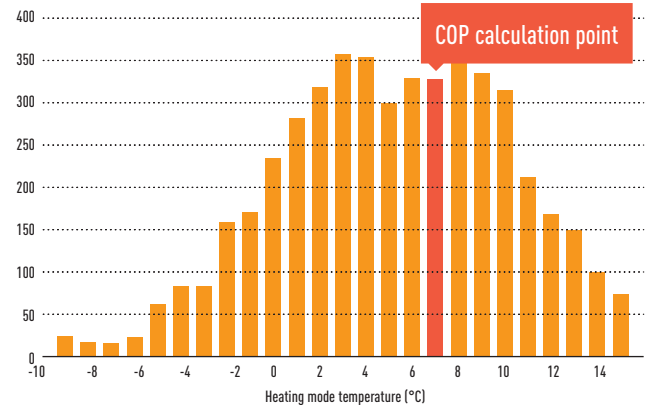

In the characteristics EER and COP only a single temperature for the assessment of the efficiency is taken as a basis in each case. Data calculated under EN-14825 conditions, not additional saving function considered for this calculation. Compressor frequency according to ambient temperature and building design.

Pure SEER and SCOP values

Considering Strasbourg operation hours at different ambient temperatures we can calculate real SEER and SCOP under EN-14825 calculation. For this calculation Panasonic is NOT using any additional saving function that could increase the efficiency.

SEER/SCOP (W/W)

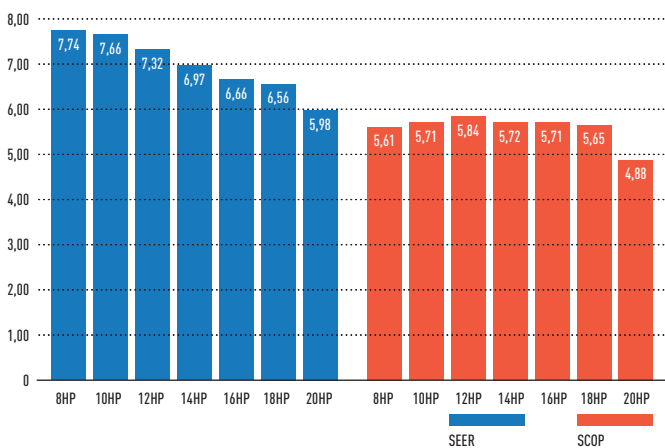

However, if it was necessary by setting on commissioning Panasonic, can increase efficiency additionally by "20%" increasing evaporation refrigerant temperature range, for a higher efficiency and lower energy consumption.

ESEER (W/W)

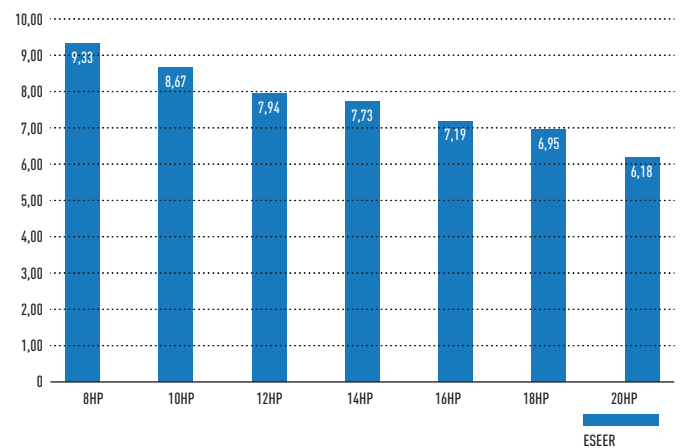

PIPING DESIGN

Select installation locations so that the lengths and sizes of refrigerant piping are within the allowable ranges shown in the figure below.

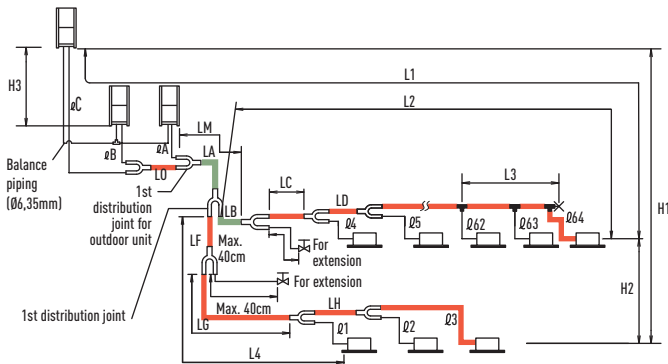

- Main piping length (maximum piping size) LM= LA + LB ...
- Main distribution tubes LC - LH are selected according to the capacity after the distribution joint.
- Sizes of indoor unit connection piping Ø1 - Ø64 are determined by the connection piping sizes on the indoor units.
- Distribution joint (CZ: optional parts)
- T-joint (field supply)
- Ball valve (field supply)
- Solidly welded shut (pinch weld)

The outdoor connection main piping (LO portion) is determined by the total capacity of the outdoor units that are connected to the tube ends.
 Note: Be sure to use special R410A distribution joints (CZ: optional parts) for outdoor unit connections and piping branches.

- R410A distribution joint**
 CZ-P680PJ2 (for outdoor unit)
 CZ-P1350PJ2 (for outdoor unit)
 CZ-P160BK2 (for indoor unit)
 CZ-P680BK2 (for indoor unit)
 CZ-P1350BK2 (for indoor unit)

Ranges that apply to refrigerant piping lengths and to differences in installation heights

Items	Mark	Contents	Length (m)
Allowable piping length	L1	Maximum piping length	Actual length ≤200 ¹⁾ Equivalent length ≤210 ¹⁾
	Δ L (L2-L4)	Difference between Maximum length and min. length from the 1st distribution joint	≤50 ²⁾
	LM	Maximum length of main piping (at maximum size) * Even after 1st distribution joint, LM is allowed if at maximum piping length.	≤3 ³⁾
	Ø1, Ø2- Ø64	Maximum length of each distribution tube	≤50 ⁴⁾
	L1+ Ø1+ Ø2- Ø63+ ØA+ ØB+LF+LG+LH	Total Maximum piping length including length of each distribution tube (only liquid piping)	≤1000
	ØA, ØB+LO, ØC+LO	Maximum piping length from outdoor's 1st distribution joint to each outdoor unit	≤10
Allowable elevation difference	H1	When outdoor unit is installed higher than indoor unit When outdoor unit is installed lower than indoor unit	≤50 ≤40
	H2	Maximum difference between indoor units	≤15 ⁵⁾
	H3	Maximum difference between outdoor units	≤4
Allowable length of joint piping	L3	T-joint piping (field-supply); Maximum piping length between the first T-joint and solidly welded-shut end point	≤2

L = Length, H = Height

1) If the longest piping length (L1) exceeds 90m (equivalent length), increase the sizes of the main tubes (LM) by 1 rank for gas tubes and liquid tubes. Use a field supply reducer. Select the tube size from the table of main piping sizes (Table 3) and from the table of refrigerant piping sizes (Table 8) on the second following page. 2) When the piping length exceeds 40m, increase a longer liquid or gas piping by 1 rank. Refer to the Technical Data for the details. 3) If the longest main piping length (LM) exceeds 50m, increase the main piping size at the portion before 50m by 1 rank for the gas tubes. Use a field supply reducer. Determine the length less than the limitation of allowable maximum piping length. For the portion that exceeds 50m, set based on the main piping size (LA) listed in Table 3. 4) If any of the piping length exceeds 30m, increase the size of the liquid and gas tubes by 1 rank. 5) If the total distribution piping length exceeds 500m, maximum allowable elevation difference (H2) between the indoor units is calculated by the following formula. Make sure the indoor unit's actual elevation difference should fall within the figure calculated as follows. Unit of account (meter): 15 x (L - total piping length(m) ÷ 500)

* The outdoor connection main piping (LO portion) is determined by the total capacity of the outdoor units that are connected to the tube ends. If the size of the existing piping is already larger than the standard piping size, it is not necessary to further increase the size.
 ** If the existing piping is used, and the amount of on-site refrigerant charge exceeds the value listed below, then change the size of the piping to reduce the amount of refrigerant. Total amount of refrigerant for the system with 1 outdoor unit: 50kg. Total amount of refrigerant for the system with 2 outdoor units: 80kg. Total amount of refrigerant for the system with 3 outdoor units or 4 outdoor units: 105kg.

Necessary amount of additional refrigerant charge per outdoor unit.

U-8ME2E8	U-10ME2E8	U-12ME2E8	U-14ME2E8	U-16ME2E8
5,5kg	5,5kg	7,0kg	7,0kg	7,0kg

System limitations.

Maximum number allowable connected outdoor units	4 ¹⁾
Maximum capacity allowable connected outdoor units	224kW (80HP)
Maximum connectable indoor units	64 ²⁾
Maximum allowable indoor / outdoor capacity ratio	50-130% ³⁾

- 1) Up to 4 units can be connected if the system has been extended.
- 2) In the case of 38HP or smaller units, the number is limited by the total capacity of the connected indoor units.
- 3) If the following conditions are satisfied, the effective range is above 130% and below 200%.
 - i) Obey the limited number of connectable indoor units.
 - ii) The lower limit of operating range for heating outdoor temperature is limited to -10°C WB (standard -25°C WB).
 - iii) Simultaneous operation is limited to less than 130% of connectable indoor units.

Additional refrigerant charge.

Liquid piping size Inch (mm)	Amount of refrigerant charge/m (g/m)
1/4 (6,35)	26
3/8 (9,52)	56
1/2 (12,7)	128
5/8 (15,88)	185
3/4 (19,05)	259
7/8 (22,22)	366
1 (25,4)	490

Refrigerant piping (existing piping can be used).

Piping size (mm)		Material Temper - 0		Material Temper - 1/2 H, H	
Ø6,35	t 0,8	Ø15,88	t 1,0	Ø22,22	t 1,0
Ø9,52	t 0,8	Ø19,05	t 1,2	Ø25,4	t 1,0
Ø12,7	t 0,8			Ø28,58	t 1,0
				Ø31,75	t 1,1
				Ø38,1	over t 1,35
				Ø41,28	over t 1,45
				Ø44,45	over t1,55

* When bending the tubes, use a bending radius that is at least 4 times the outer diameter of the tubes. In addition, take sufficient care to avoid crushing or damaging the tubes when bending them.

2-PIPE ECOi EX ME2 SERIES HIGH EFFICIENCY MODEL

Units			8HP	10HP	12HP	14HP	16HP
Model name			U-8ME2E8	U-10ME2E8	U-12ME2E8	U-14ME2E8	U-16ME2E8
Power supply	Voltage	V	380 / 400 / 415	380 / 400 / 415	380 / 400 / 415	380 / 400 / 415	380 / 400 / 415
	Phase		Three Phase	Three Phase	Three Phase	Three Phase	Three Phase
	Frequency	Hz	50	50	50	50	50
Cooling capacity	kW		22,4	28,0	33,5	40,0	45,0
EER	W/W		4,70	4,37	3,96	3,88	3,52
ESSER	W/W		9,33	8,67	7,94	7,73	7,19
SEER ¹⁾	W/W		7,74	7,66	7,32	6,97	6,66
Running current cooling	A		7,40 / 7,14	10,20 / 9,80	13,00 / 12,50	16,50 / 15,90	20,10 / 19,40
Input power cooling	kW		4,77	6,41	8,47	10,30	12,80
Heating capacity	kW		25,0	31,5	37,5	45,0	50,0
COP	W/W		5,13	4,76	4,73	4,56	4,42
SCOP ²⁾	W/W		5,61	5,71	5,84	5,72	5,71
Running current heating	A		7,56 / 7,29	10,50 / 10,10	12,30 / 11,80	15,80 / 15,20	17,90 / 17,30
Input power heating	kW		4,87	6,62	7,92	9,86	11,30
Starting current	A		1	1	1	2	2
External static pressure (Max)	Pa		80	80	80	80	80
Air volume	m ³ /min		224	224	232	232	232
Sound pressure	Normal mode	dB(A)	54,0	56,0	59,0	60,0	61,0
	Silent mode	dB(A)	51,0	53,0	56,0	57,0	58,0
Sound power	Normal mode	dB	75,0	77,0	80,0	81,0	82,0
Dimensions	H x W x D	mm	1.842 x 770 x 1.000	1.842 x 770 x 1.000	1.842 x 1.180 x 1.000	1.842 x 1.180 x 1.000	1.842 x 1.180 x 1.000
Net weight	kg		210	210	270	315	315
Piping connections ³⁾	Liquid pipe	Inch (mm)	3/8 (9,52) / 1/2 (12,70)	3/8 (9,52) / 1/2 (12,70)	1/2 (12,70) / 5/8 (15,88)	1/2 (12,70) / 5/8 (15,88)	1/2 (12,70) / 5/8 (15,88)
	Gas pipe	Inch (mm)	3/4 (19,05) / 7/8 (22,22)	7/8 (22,22) / 1 (25,40)	1 (25,40) / 1-1/8 (28,58)	1 (25,40) / 1-1/8 (28,58)	1-1/8 (28,58) / 1-1/4 (31,75)
	Balance pipe	Inch (mm)	1/4 (6,35)	1/4 (6,35)	1/4 (6,35)	1/4 (6,35)	1/4 (6,35)
Refrigerant (R410A)	kg / TCO: Eq.		5,6 / 11,6928	5,6 / 11,6928	8,3 / 17,3304	8,3 / 17,3304	8,3 / 17,3304
Maximum allowable indoor / outdoor capacity ratio % ⁴⁾			50 - 130 (200)	50 - 130 (200)	50 - 130 (200)	50 - 130 (200)	50 - 130 (200)
Operating range	Cooling Min - Max	°C	-10 - +52	-10 - +52	-10 - +52	-10 - +52	-10 - +52
	Heating Min - Max	°C	-25 - +18	-25 - +18	-25 - +18	-25 - +18	-25 - +18

Combinations			18HP	20HP	22HP	24HP	26HP	28HP	30HP	32HP	34HP	36HP	
Model name			U-18ME2E8	U-20ME2E8	U-22ME2E8	U-24ME2E8	U-26ME2E8	U-28ME2E8	U-30ME2E8	U-32ME2E8	U-34ME2E8	U-36ME2E8	
Model name			U-8ME2E8 U-10ME2E8	U-10ME2E8 U-12ME2E8	U-10ME2E8 U-12ME2E8	U-12ME2E8 U-12ME2E8	U-10ME2E8 U-16ME2E8	U-12ME2E8 U-16ME2E8	U-14ME2E8 U-16ME2E8	U-16ME2E8 U-16ME2E8	U-10ME2E8 U-12ME2E8	U-10ME2E8 U-12ME2E8	U-12ME2E8 U-12ME2E8
Power supply	Voltage	V	380 / 400 / 415	380 / 400 / 415	380 / 400 / 415	380 / 400 / 415	380 / 400 / 415	380 / 400 / 415	380 / 400 / 415	380 / 400 / 415	380 / 400 / 415	380 / 400 / 415	
	Phase		Three Phase	Three Phase	Three Phase	Three Phase	Three Phase	Three Phase	Three Phase	Three Phase	Three Phase	Three Phase	
	Frequency	Hz	50	50	50	50	50	50	50	50	50	50	
Cooling capacity	kW		50,0	56,0	61,5	68,0	73,0	78,5	85,0	90,0	96,0	101,0	
EER	W/W		4,55	4,38	4,13	3,93	3,80	3,69	3,68	3,52	4,05	3,95	
Running current cooling	A		17,3 / 16,6	20,3 / 19,6	23,1 / 22,3	26,6 / 25,6	30,1 / 29,0	33,1 / 31,9	36,6 / 35,3	40,2 / 38,7	36,8 / 35,5	39,3 / 37,9	
Input power cooling	kW		11,0	12,8	14,9	17,3	19,2	21,3	23,1	25,6	23,7	25,6	
Heating capacity	kW		56,0	63,0	69,0	76,5	81,5	87,5	95,0	100,0	108,0	113,0	
COP	W/W		4,96	4,77	4,76	4,69	4,55	4,56	4,48	4,42	4,72	4,73	
Running current heating	A		17,7 / 17,1	20,9 / 20,2	22,7 / 21,9	25,3 / 24,4	28,4 / 27,4	30,1 / 29,0	33,6 / 32,4	35,8 / 34,6	35,9 / 34,6	37,1 / 35,8	
Input power heating	kW		11,3	13,2	14,5	16,3	17,9	19,2	21,2	22,6	22,9	23,9	
Starting current	A		2	2	2	2	3	3	4	4	3	3	
External static pressure (Max)	Pa		80	80	80	80	80	80	80	80	80	80	
Air volume	m ³ /min		448	448	456	464	456	464	464	464	688	696	
Sound pressure	Normal mode	dB(A)	58,5	59,0	61,0	62,0	62,5	63,5	63,5	64,0	63,0	64,0	
	Silent mode	dB(A)	55,5	56,0	58,0	59,0	59,5	60,5	60,5	61,0	60,0	61,0	
Sound power	Normal mode	dB	79,5	80,0	82,0	83,0	83,5	84,5	84,5	85,0	84,0	85,0	
Dimensions	H x W x D	mm	1.842 x 1.600 x 1.000	1.842 x 1.600 x 1.000	1.842 x 2.010 x 1.000	1.842 x 2.420 x 1.000	1.842 x 2.010 x 1.000	1.842 x 2.420 x 1.000	1.842 x 2.420 x 1.000	1.842 x 2.420 x 1.000	1.842 x 3.250 x 1.000	1.842 x 3.660 x 1.000	
Net weight	kg		420	420	480	540	535	585	630	630	750	810	
Piping connections ³⁾	Liquid pipe	Inch (mm)	5/8 (15,88) / 3/4 (19,05)	5/8 (15,88) / 3/4 (19,05)	5/8 (15,88) / 3/4 (19,05)	5/8 (15,88) / 3/4 (19,05)	3/4 (19,05) / 7/8 (22,22)	3/4 (19,05) / 7/8 (22,22)	3/4 (19,05) / 7/8 (22,22)	3/4 (19,05) / 7/8 (22,22)	3/4 (19,05) / 7/8 (22,22)	3/4 (19,05) / 7/8 (22,22)	
	Gas pipe	Inch (mm)	1-1/8 (28,58) / 1-1/4 (31,75)	1-1/8 (28,58) / 1-1/4 (31,75)	1-1/8 (28,58) / 1-1/4 (31,75)	1-1/8 (28,58) / 1-1/4 (31,75)	1-1/4 (31,75) / 1-1/2 (38,10)	1-1/4 (31,75) / 1-1/2 (38,10)	1-1/4 (31,75) / 1-1/2 (38,10)	1-1/4 (31,75) / 1-1/2 (38,10)	1-1/4 (31,75) / 1-1/2 (38,10)	1-1/2 (38,10) / 1-5/8 (41,28)	
	Balance pipe	Inch (mm)	1/4 (6,35)	1/4 (6,35)	1/4 (6,35)	1/4 (6,35)	1/4 (6,35)	1/4 (6,35)	1/4 (6,35)	1/4 (6,35)	1/4 (6,35)	1/4 (6,35)	
R410A refrigerant amount	kg / TCO: Eq.		11,2 / 23,3856	11,2 / 23,3856	13,9 / 29,0232	16,6 / 34,6608	13,9 / 29,0232	16,6 / 34,6608	16,6 / 34,6608	16,6 / 34,6608	22,2 / 46,3536	24,9 / 51,9912	
Maximum allowable indoor / outdoor capacity ratio % ⁴⁾			50 - 130 (200)	50 - 130 (200)	50 - 130 (200)	50 - 130 (200)	50 - 130 (200)	50 - 130 (200)	50 - 130 (200)	50 - 130 (200)	50 - 130 (200)	50 - 130 (200)	
Operating range	Cooling Min - Max	°C	-10 - +52	-10 - +52	-10 - +52	-10 - +52	-10 - +52	-10 - +52	-10 - +52	-10 - +52	-10 - +52	-10 - +52	
	Heating Min - Max	°C	-25 - +18	-25 - +18	-25 - +18	-25 - +18	-25 - +18	-25 - +18	-25 - +18	-25 - +18	-25 - +18	-25 - +18	



1) Data obtained with setting by Panasonic commissioning. 2) Tentative data. 3) Pipe diameter under 90m for ultimate indoor unit / over 90m for ultimate indoor unit (if the longest piping equivalent length exceeds 90m, increase the sizes of the main tubes by 1 rank for gas tubes and liquid tubes). 4) If the following conditions are satisfied, the effective range is above 130 % and below 200 %: A. Obey the limited number of connectable indoor units. B. The lower limit of operating range for heating outdoor temperature is limited to -10°C WB (standard -25°C WB). C. Simultaneous operation is limited to less than 130% of connectable indoor units.



	38HP	40HP	42HP	44HP	46HP	48HP	50HP	52HP	54HP	56HP	58HP	60HP	62HP	64HP
	U-38ME2E8	U-40ME2E8	U-42ME2E8	U-44ME2E8	U-46ME2E8	U-48ME2E8	U-50ME2E8	U-52ME2E8	U-54ME2E8	U-56ME2E8	U-58ME2E8	U-60ME2E8	U-62ME2E8	U-64ME2E8
	U-10ME2E8 U-12ME2E8 U-16ME2E8	U-12ME2E8 U-12ME2E8 U-16ME2E8	U-10ME2E8 U-16ME2E8 U-16ME2E8	U-12ME2E8 U-16ME2E8 U-16ME2E8	U-14ME2E8 U-16ME2E8 U-16ME2E8	U-16ME2E8 U-16ME2E8 U-16ME2E8	U-10ME2E8 U-12ME2E8 U-12ME2E8 U-16ME2E8	U-12ME2E8 U-12ME2E8 U-12ME2E8 U-16ME2E8	U-10ME2E8 U-12ME2E8 U-12ME2E8 U-16ME2E8	U-12ME2E8 U-12ME2E8 U-16ME2E8 U-16ME2E8	U-10ME2E8 U-16ME2E8 U-16ME2E8 U-16ME2E8	U-12ME2E8 U-16ME2E8 U-16ME2E8 U-16ME2E8	U-14ME2E8 U-16ME2E8 U-16ME2E8 U-16ME2E8	U-16ME2E8 U-16ME2E8 U-16ME2E8 U-16ME2E8
	380 / 400 / 415	380 / 400 / 415	380 / 400 / 415	380 / 400 / 415	380 / 400 / 415	380 / 400 / 415	380 / 400 / 415	380 / 400 / 415	380 / 400 / 415	380 / 400 / 415	380 / 400 / 415	380 / 400 / 415	380 / 400 / 415	380 / 400 / 415
	Three Phase	Three Phase	Three Phase	Three Phase	Three Phase	Three Phase	Three Phase	Three Phase	Three Phase	Three Phase	Three Phase	Three Phase	Three Phase	Three Phase
	50	50	50	50	50	50	50	50	50	50	50	50	50	50
	107,0	113,0	118,0	124,0	130,0	135,0	140,0	145,0	151,0	156,0	162,0	168,0	174,0	180,0
	3,84	3,75	3,69	3,62	3,62	3,52	3,87	3,82	3,75	3,71	3,65	3,60	3,60	3,52
	43,8 / 42,2	46,7 / 45,0	50,2 / 48,4	53,2 / 51,3	56,9 / 54,9	60,2 / 58,1	66,2 / 54,2	59,0 / 56,8	63,2 / 60,9	65,3 / 63,0	69,7 / 67,1	73,3 / 70,6	75,8 / 73,0	80,3 / 77,4
	27,9	30,1	32,0	34,3	35,9	38,4	36,2	38,0	40,3	42,1	44,4	46,7	48,3	51,2
	119,0	127,0	132,0	138,0	145,0	150,0	155,0	160,0	169,0	175,0	182,0	189,0	195,0	201,0
	4,61	4,57	4,49	4,50	4,46	4,42	4,65	4,66	4,56	4,56	4,47	4,47	4,45	4,42
	40,5 / 39,0	43,6 / 42,0	46,6 / 44,9	48,2 / 46,4	51,5 / 49,7	53,8 / 51,8	52,2 / 50,4	53,8 / 51,9	58,8 / 56,7	60,2 / 58,1	64,6 / 62,2	67,1 / 64,7	69,5 / 67,0	72,2 / 69,6
	25,8	27,8	29,4	30,7	32,5	33,9	33,3	34,3	37,1	38,4	40,7	42,3	43,8	45,5
	4	4	5	5	6	6	5	5	6	6	7	7	8	8
	80	80	80	80	80	80	80	80	80	80	80	80	80	80
	688	696	688	696	696	696	920	928	920	928	920	928	928	928
	64,0	64,5	65,0	65,5	65,5	66,0	65,5	66,0	66,0	66,5	66,5	67,0	67,0	67,0
	61,0	61,5	62,0	62,5	62,5	63,0	62,5	63,0	63,0	63,5	63,5	64,0	64,0	64,0
	85,0	85,5	86,0	86,5	86,5	87,0	86,5	87,0	87,0	87,5	87,5	88,0	88,0	88,0
	1.842 x 3.250 x 1.000	1.842 x 3.660 x 1.000	1.842 x 3.250 x 1.000	1.842 x 3.660 x 1.000	1.842 x 3.660 x 1.000	1.842 x 3.660 x 1.000	1.842 x 4.490 x 1.000	1.842 x 4.900 x 1.000	1.842 x 4.490 x 1.000	1.842 x 4.900 x 1.000	1.842 x 4.900 x 1.000	1.842 x 4.900 x 1.000	1.842 x 4.900 x 1.000	1.842 x 4.900 x 1.000
	795	855	840	900	945	945	1.065	1.125	1.110	1.170	1.155	1.215	1.260	1.260
	3/4 (19,05) / 7/8 (22,22)	3/4 (19,05) / 7/8 (22,22)	3/4 (19,05) / 7/8 (22,22)	3/4 (19,05) / 7/8 (22,22)	3/4 (19,05) / 7/8 (22,22)	3/4 (19,05) / 7/8 (22,22)	3/4 (19,05) / 7/8 (22,22)	3/4 (19,05) / 7/8 (22,22)	3/4 (19,05) / 7/8 (22,22)	3/4 (19,05) / 7/8 (22,22)	3/4 (19,05) / 7/8 (22,22)	3/4 (19,05) / 7/8 (22,22)	3/4 (19,05) / 7/8 (22,22)	3/4 (19,05) / 7/8 (22,22)
	1-1/2 (38,10) / 1-5/8 (41,28)	1-1/2 (38,10) / 1-5/8 (41,28)	1-1/2 (38,10) / 1-5/8 (41,28)	1-1/2 (38,10) / 1-5/8 (41,28)	1-1/2 (38,10) / 1-5/8 (41,28)	1-1/2 (38,10) / 1-5/8 (41,28)	1-1/2 (38,10) / 1-5/8 (41,28)	1-1/2 (38,10) / 1-5/8 (41,28)	1-1/2 (38,10) / 1-5/8 (41,28)	1-1/2 (38,10) / 1-5/8 (41,28)	1-1/2 (38,10) / 1-5/8 (41,28)	1-1/2 (38,10) / 1-5/8 (41,28)	1-5/8 (41,28) / 1-3/4 (44,45)	1-5/8 (41,28) / 1-3/4 (44,45)
	1/4 (6,35)	1/4 (6,35)	1/4 (6,35)	1/4 (6,35)	1/4 (6,35)	1/4 (6,35)	1/4 (6,35)	1/4 (6,35)	1/4 (6,35)	1/4 (6,35)	1/4 (6,35)	1/4 (6,35)	1/4 (6,35)	1/4 (6,35)
	22,2 / 46,3536	24,9 / 46,3536	22,2 / 51,9912	24,9 / 51,9912	24,9 / 51,9912	24,9 / 51,9912	30,5 / 63,6840	33,2 / 69,3216	30,5 / 63,6840	33,2 / 69,3216	30,5 / 63,6840	33,2 / 69,3216	33,2 / 69,3216	33,2 / 69,3216
	50 - 130 (200)	50 - 130 (200)	50 - 130 (200)	50 - 130 (200)	50 - 130 (200)	50 - 130 (200)	50 - 130 (200)	50 - 130 (200)	50 - 130 (200)	50 - 130 (200)	50 - 130 (200)	50 - 130 (200)	50 - 130 (200)	50 - 130 (200)
	-10 ~ +52	-10 ~ +52	-10 ~ +52	-10 ~ +52	-10 ~ +52	-10 ~ +52	-10 ~ +52	-10 ~ +52	-10 ~ +52	-10 ~ +52	-10 ~ +52	-10 ~ +52	-10 ~ +52	-10 ~ +52
	-25 ~ +18	-25 ~ +18	-25 ~ +18	-25 ~ +18	-25 ~ +18	-25 ~ +18	-25 ~ +18	-25 ~ +18	-25 ~ +18	-25 ~ +18	-25 ~ +18	-25 ~ +18	-25 ~ +18	-25 ~ +18

Rating Conditions: Cooling Indoor 27°C DB / 19°C WB. Cooling Outdoor 35°C DB. Heating Indoor 20°C DB. Heating Outdoor 7°C DB / 6°C WB. (DB: Dry Bulb; WB: Wet Bulb)
 Specifications subject to change without notice. For detailed information about ErP, please visit our websites www.aircon.panasonic.eu or www.ptc.panasonic.eu.

2-PIPE ECOI EX ME2 SERIES SPACE SAVING MODEL

Units			8HP	10HP	12HP	14HP	16HP	18HP	20HP
Model name			U-8ME2E8	U-10ME2E8	U-12ME2E8	U-14ME2E8	U-16ME2E8	U-18ME2E8	U-20ME2E8
Power supply	Voltage	V	380 / 400 / 415	380 / 400 / 415	380 / 400 / 415	380 / 400 / 415	380 / 400 / 415	380 / 400 / 415	380 / 400 / 415
	Phase		Three Phase	Three Phase	Three Phase	Three Phase	Three Phase	Three Phase	Three Phase
	Frequency	Hz	50	50	50	50	50	50	50
Cooling capacity		kW	22,4	28,0	33,5	40,0	45,0	50,0	56,0
EER		W/W	4,70	4,37	3,96	3,88	3,52	3,52	3,35
ESSER		W/W	9,33	8,67	7,94	7,73	7,19	6,95	6,18
SEER ¹⁾		W/W	7,74	7,66	7,32	6,97	6,66	6,56	5,98
Running current cooling		A	7,40 / 7,14	10,20 / 9,80	13,00 / 12,50	16,50 / 15,90	20,10 / 19,40	22,00 / 21,20	25,40 / 24,50
Input power cooling		kW	4,77	6,41	8,47	10,30	12,80	14,20	16,70
Heating capacity		kW	25,0	31,5	37,5	45,0	50,0	56,0	63,0
COP		W/W	5,13	4,76	4,73	4,56	4,42	4,38	3,94
SCOP ²⁾		W/W	5,61	5,71	5,84	5,72	5,71	5,65	4,88
Running current heating		A	7,56 / 7,29	10,50 / 11,10	12,30 / 11,80	15,80 / 15,20	17,90 / 17,30	20,10 / 19,40	24,60 / 23,70
Input power heating		kW	4,87	6,62	7,92	9,86	11,30	12,80	16,00
Starting current		A	1	1	1	2	2	2	2
External static pressure (Max)		Pa	80	80	80	80	80	80	80
Air volume		m ³ /min	224	224	232	232	232	405	405
Sound pressure	Normal mode	dB(A)	54,0	56,0	59,0	60,0	61,0	59,0	60,0
	Silent mode	dB(A)	51,0	53,0	56,0	57,0	58,0	56,0	57,0
Sound power		Normal mode	dB	75,0	77,0	80,0	81,0	82,0	81,0
Dimensions	H x W x D	mm	1.842 x 770 x 1.000	1.842 x 770 x 1.000	1.842 x 1.180 x 1.000	1.842 x 1.180 x 1.000	1.842 x 1.180 x 1.000	1.842 x 1.540 x 1.000	1.842 x 1.540 x 1.000
Net weight		kg	210	210	270	315	315	375	375
Piping connections ³⁾	Liquid pipe	Inch (mm)	3/8 (9,52) / 1/2 (12,70)	3/8 (9,52) / 1/2 (12,70)	1/2 (12,70) / 5/8 (15,88)	1/2 (12,70) / 5/8 (15,88)	1/2 (12,70) / 5/8 (15,88)	5/8 (15,88) / 3/4 (19,05)	5/8 (15,88) / 3/4 (19,05)
	Gas pipe	Inch (mm)	3/4 (19,05) / 7/8 (22,22)	7/8 (22,22) / 1 (25,40)	1 (25,40) / 1-1/8 (28,58)	1 (25,40) / 1-1/8 (28,58)	1-1/8 (28,58) / 1-1/4 (31,75)	1-1/8 (28,58) / 1-1/4 (31,75)	1-1/8 (28,58) / 1-1/4 (31,75)
	Balance pipe	Inch (mm)	1/4 (6,35)	1/4 (6,35)	1/4 (6,35)	1/4 (6,35)	1/4 (6,35)	1/4 (6,35)	1/4 (6,35)
Refrigerant (R410A)		kg / TCO: Eq.	5,6 / 11,6928	5,6 / 11,6928	8,3 / 17,3304	8,3 / 17,3304	8,3 / 17,3304	9,5 / 19,836	9,5 / 19,836
Maximum allowable indoor / outdoor capacity ratio % ⁴⁾			50 - 130 (200)	50 - 130 (200)	50 - 130 (200)	50 - 130 (200)	50 - 130 (200)	50 - 130 (200)	50 - 130 (200)
Operating range	Cooling Min - Max	°C	-10 - +52	-10 - +52	-10 - +52	-10 - +52	-10 - +52	-10 - +52	-10 - +52
	Heating Min - Max	°C	-25 - +18	-25 - +18	-25 - +18	-25 - +18	-25 - +18	-25 - +18	-25 - +18

			22HP	24HP	26HP	28HP	30HP	32HP	34HP	36HP	38HP	40HP	42HP	44HP	46HP	
Combinations			U-22ME2E8	U-24ME2E8	U-26ME2E8	U-28ME2E8	U-30ME2E8	U-32ME2E8	U-34ME2E8	U-36ME2E8	U-38ME2E8	U-40ME2E8	U-42ME2E8	U-44ME2E8	U-46ME2E8	
Model name			U-10ME2E8 U-12ME2E8	U-12ME2E8 U-12ME2E8	U-10ME2E8 U-16ME2E8	U-12ME2E8 U-16ME2E8	U-14ME2E8 U-16ME2E8	U-16ME2E8 U-16ME2E8	U-14ME2E8 U-20ME2E8	U-16ME2E8 U-20ME2E8	U-18ME2E8 U-20ME2E8	U-20ME2E8 U-20ME2E8	U-10ME2E8 U-16ME2E8	U-12ME2E8 U-16ME2E8	U-14ME2E8 U-16ME2E8	
Power supply	Voltage	V	380 / 400 / 415	380 / 400 / 415	380 / 400 / 415	380 / 400 / 415	380 / 400 / 415	380 / 400 / 415	380 / 400 / 415	380 / 400 / 415	380 / 400 / 415	380 / 400 / 415	380 / 400 / 415	380 / 400 / 415	380 / 400 / 415	
	Phase		Three Phase	Three Phase	Three Phase	Three Phase	Three Phase	Three Phase	Three Phase	Three Phase	Three Phase	Three Phase	Three Phase	Three Phase	Three Phase	
	Frequency	Hz	50	50	50	50	50	50	50	50	50	50	50	50	50	
Cooling capacity		kW	61,5	68,0	73,0	78,5	85,0	90,0	96,0	101,0	107,0	113,0	118,0	124,0	130,0	
EER		W/W	4,13	3,93	3,80	3,69	3,68	3,52	3,56	3,42	3,42	3,34	3,69	3,62	3,62	
Running current cooling		A	23,1 / 22,3	26,6 / 25,6	30,1 / 29,0	33,1 / 31,9	36,6 / 35,3	40,2 / 38,7	41,9 / 40,4	45,3 / 43,7	48,1 / 46,3	51,4 / 49,5	50,2 / 48,4	53,2 / 51,3	56,9 / 54,9	
Input power cooling		kW	14,9	17,3	19,2	21,3	23,1	25,6	27,0	25,9	31,3	33,8	32,0	34,3	35,9	
Heating capacity		kW	69,0	76,5	81,5	87,5	95,0	100,0	108,0	113,0	119,0	127,0	132,0	138,0	145,0	
COP		W/W	4,76	4,69	4,55	4,56	4,48	4,42	4,17	4,14	4,13	3,92	4,49	4,50	4,46	
Running current heating		A	22,7 / 21,9	25,3 / 24,4	28,4 / 27,4	30,1 / 29,0	33,6 / 32,4	35,8 / 34,6	40,6 / 39,2	42,4 / 40,8	44,7 / 43,1	49,8 / 48,0	46,6 / 44,9	48,2 / 46,4	51,5 / 49,7	
Input power heating		kW	14,5	16,3	17,9	19,2	21,2	22,6	25,9	27,3	28,8	32,4	29,4	30,7	32,5	
Starting current		A	2	2	3	3	4	4	4	4	4	4	5	5	6	
External static pressure (Max)		Pa	80	80	80	80	80	80	80	80	80	80	80	80	80	
Air volume		m ³ /min	456	464	456	464	464	464	637	637	810	810	688	696	696	
Sound pressure	Normal mode	dB(A)	61,0	62,0	62,5	63,5	63,5	64,0	63,0	63,5	62,5	63,0	65,0	65,5	65,5	
	Silent mode	dB(A)	58,0	59,0	59,5	60,5	60,5	61,0	60,0	60,5	59,5	60,0	62,0	62,5	62,5	
Sound power		Normal mode	dB	82,0	83,0	83,5	84,5	84,5	85,0	84,0	84,5	83,5	84,0	86,0	86,5	
Dimensions	H x W x D	mm	1.842 x 2.010 x 1.000	1.842 x 2.420 x 1.000	1.842 x 2.010 x 1.000	1.842 x 2.420 x 1.000	1.842 x 2.420 x 1.000	1.842 x 2.420 x 1.000	1.842 x 2.780 x 1.000	1.842 x 2.780 x 1.000	1.842 x 3.140 x 1.000	1.842 x 3.140 x 1.000	1.842 x 3.250 x 1.000	1.842 x 3.660 x 1.000	1.842 x 3.660 x 1.000	
Net weight		kg	480	540	525	585	630	630	690	690	750	750	840	900	945	
Piping connections ³⁾	Liquid pipe	Inch (mm)	5/8 (15,88) / 3/4 (19,05)	5/8 (15,88) / 3/4 (19,05)	3/4 (19,05) / 7/8 (22,22)	3/4 (19,05) / 7/8 (22,22)	3/4 (19,05) / 7/8 (22,22)	3/4 (19,05) / 7/8 (22,22)	3/4 (19,05) / 7/8 (22,22)	3/4 (19,05) / 7/8 (22,22)	3/4 (19,05) / 7/8 (22,22)	3/4 (19,05) / 7/8 (22,22)	3/4 (19,05) / 7/8 (22,22)	3/4 (19,05) / 7/8 (22,22)	3/4 (19,05) / 7/8 (22,22)	
	Gas pipe	Inch (mm)	1-1/8 (28,58) / 1-1/4 (31,75)	1-1/8 (28,58) / 1-1/4 (31,75)	1-1/4 (31,75) / 1-1/2 (38,10)	1-1/4 (31,75) / 1-1/2 (38,10)	1-1/4 (31,75) / 1-1/2 (38,10)	1-1/4 (31,75) / 1-1/2 (38,10)	1-1/4 (31,75) / 1-1/2 (38,10)	1-1/4 (31,75) / 1-1/2 (38,10)	1-1/2 (38,10) / 1-5/8 (41,28)	1-1/2 (38,10) / 1-5/8 (41,28)	1-1/2 (38,10) / 1-5/8 (41,28)	1-1/2 (38,10) / 1-5/8 (41,28)	1-1/2 (38,10) / 1-5/8 (41,28)	1-1/2 (38,10) / 1-5/8 (41,28)
	Balance pipe	Inch (mm)	1/4 (6,35)	1/4 (6,35)	1/4 (6,35)	1/4 (6,35)	1/4 (6,35)	1/4 (6,35)	1/4 (6,35)	1/4 (6,35)	1/4 (6,35)	1/4 (6,35)	1/4 (6,35)	1/4 (6,35)	1/4 (6,35)	
Refrigerant (R410A)		kg / TCO: Eq.	13,9 / 23,3856	16,6 / 34,6608	13,9 / 29,232	16,6 / 34,6608	16,6 / 34,6608	16,6 / 34,6608	17,8 / 37,1664	17,8 / 37,1664	19,0 / 39,672	19,0 / 39,672	22,2 / 46,3536	24,9 / 51,9912	24,9 / 51,9912	
Maximum allowable indoor / outdoor capacity ratio % ⁴⁾			50 - 130 (200)	50 - 130 (200)	50 - 130 (200)	50 - 130 (200)	50 - 130 (200)	50 - 130 (200)	50 - 130 (200)	50 - 130 (200)	50 - 130 (200)	50 - 130 (200)	50 - 130 (200)	50 - 130 (200)	50 - 130 (200)	
Operating range	Cooling Min - Max	°C	-10 - +52	-10 - +52	-10 - +52	-10 - +52	-10 - +52	-10 - +52	-10 - +52	-10 - +52	-10 - +52	-10 - +52	-10 - +52	-10 - +52	-10 - +52	
	Heating Min - Max	°C	-25 - +18	-25 - +18	-25 - +18	-25 - +18	-25 - +18	-25 - +18	-25 - +18	-25 - +18	-25 - +18	-25 - +18	-25 - +18	-25 - +18	-25 - +18	



1) Data obtained with setting by Panasonic commissioning. 2) Tentative data. 3) Pipe diameter under 90m for ultimate indoor unit / over 90m for ultimate indoor unit (if the longest piping equivalent length exceeds 90m, increase the sizes of the main tubes by 1 rank for gas tubes and liquid tubes). 4) If the following conditions are satisfied, the effective range is above 130 % and below 200 %: A. Obey the limited number of connectable indoor units. B. The lower limit of operating range for heating outdoor temperature is limited to -10°C WB (standard -25°C WB). C. Simultaneous operation is limited to less than 130% of connectable indoor units.



NEW TECHNOLOGY
17



	48HP	50HP	52HP	54HP	56HP	58HP	60HP	62HP	64HP	66HP	68HP	70HP	72HP	74HP	76HP	78HP	80HP
	U-48ME2E8	U-50ME2E8	U-52ME2E8	U-54ME2E8	U-56ME2E8	U-58ME2E8	U-60ME2E8	U-62ME2E8	U-64ME2E8	U-66ME2E8	U-68ME2E8	U-70ME2E8	U-72ME2E8	U-74ME2E8	U-76ME2E8	U-78ME2E8	U-80ME2E8
	U-16ME2E8	U-14ME2E8	U-16ME2E8	U-14ME2E8	U-16ME2E8	U-18ME2E8	U-20ME2E8	U-14ME2E8	U-16ME2E8	U-10ME2E8	U-12ME2E8	U-10ME2E8	U-16ME2E8	U-16ME2E8	U-16ME2E8	U-18ME2E8	U-20ME2E8
	U-16ME2E8	U-16ME2E8	U-16ME2E8	U-20ME2E8	U-20ME2E8	U-20ME2E8	U-20ME2E8	U-16ME2E8	U-16ME2E8	U-16ME2E8	U-16ME2E8	U-20ME2E8	U-20ME2E8	U-18ME2E8	U-20ME2E8	U-20ME2E8	U-20ME2E8
	U-16ME2E8	U-20ME2E8	U-20ME2E8	U-20ME2E8	U-20ME2E8	U-20ME2E8	U-20ME2E8	U-16ME2E8	U-16ME2E8	U-20ME2E8	U-20ME2E8	U-20ME2E8	U-20ME2E8	U-20ME2E8	U-20ME2E8	U-20ME2E8	U-20ME2E8
	380 / 400 / 415	380 / 400 / 415	380 / 400 / 415	380 / 400 / 415	380 / 400 / 415	380 / 400 / 415	380 / 400 / 415	380 / 400 / 415	380 / 400 / 415	380 / 400 / 415	380 / 400 / 415	380 / 400 / 415	380 / 400 / 415	380 / 400 / 415	380 / 400 / 415	380 / 400 / 415	380 / 400 / 415
	Three Phase	Three Phase	Three Phase	Three Phase	Three Phase	Three Phase	Three Phase	Three Phase	Three Phase	Three Phase	Three Phase	Three Phase	Three Phase	Three Phase	Three Phase	Three Phase	Three Phase
	50	50	50	50	50	50	50	50	50	50	50	50	50	50	50	50	50
	135.0	140.0	145.0	151.0	156.0	162.0	168.0	174.0	180.0	185.0	190.0	196.0	202.0	208.0	213.0	219.0	224.0
	3.52	3.55	3.46	3.49	3.41	3.40	3.35	3.60	3.52	3.52	3.49	3.47	3.42	3.42	3.39	3.38	3.35
	60.2 / 58.1	61.1 / 58.9	65.0 / 62.7	66.5 / 64.1	70.3 / 67.8	73.1 / 70.4	76.1 / 73.4	75.8 / 73.0	80.3 / 77.4	80.8 / 77.8	83.7 / 80.7	86.8 / 83.6	90.6 / 87.3	93.4 / 90.0	96.6 / 93.1	98.3 / 94.7	101.5 / 97.8
	38.4	39.4	41.9	43.3	45.8	47.6	50.1	48.3	51.2	52.6	54.5	56.5	59.0	60.8	62.9	64.7	66.8
	150.0	155.0	160.0	169.0	175.0	182.0	189.0	195.0	201.0	207.0	213.0	219.0	226.0	233.0	239.0	245.0	252.0
	4.42	4.29	4.27	4.11	4.08	4.06	3.94	4.45	4.42	4.16	4.18	4.05	4.14	4.12	4.03	4.03	3.94
	53.8 / 51.8	56.6 / 54.6	58.8 / 56.7	63.8 / 61.5	66.6 / 64.2	69.5 / 67.0	73.7 / 71.0	69.5 / 67.0	72.2 / 69.6	77.1 / 74.3	79.2 / 76.3	83.1 / 80.1	84.7 / 81.7	87.7 / 84.5	92.0 / 88.7	93.4 / 90.0	98.3 / 94.7
	33.9	36.1	37.5	41.1	42.9	44.8	48.0	43.8	45.5	49.7	51.0	54.1	54.6	56.5	59.3	60.8	64.0
	6	6	6	6	6	6	6	8	8	7	7	7	8	8	8	8	8
	80	80	80	80	80	80	80	80	80	80	80	80	80	80	80	80	80
	696	869	869	1,042	1,042	1,215	1,215	928	928	1,266	1,274	1,439	1,274	1,447	1,447	1,620	1,620
	66.0	65.5	65.5	65.0	65.5	64.5	65.0	67.0	67.0	66.0	66.5	65.5	66.5	66.5	66.5	66.0	66.0
	63.0	62.5	62.5	62.0	62.5	61.5	62.0	64.0	64.0	63.0	63.5	62.5	63.5	63.5	63.5	63.0	63.0
	87.0	86.5	86.5	86.0	86.5	85.5	86.0	88.0	88.0	87.0	87.5	86.5	87.5	87.5	87.5	87.0	87.0
	1.842 x 3.660	1.842 x 4.020	1.842 x 4.020	1.842 x 4.380	1.842 x 4.380	1.842 x 4.740	1.842 x 4.740	1.842 x 4.900	1.842 x 4.900	1.842 x 5.210	1.842 x 5.620	1.842 x 5.620	1.842 x 5.620	1.842 x 5.980	1.842 x 5.980	1.842 x 6.340	1.842 x 6.340
	x 1.000	x 1.000	x 1.000	x 1.000	x 1.000	x 1.000	x 1.000	x 1.000	x 1.000	x 1.000	x 1.000	x 1.000	x 1.000	x 1.000	x 1.000	x 1.000	x 1.000
	945	1,005	1,005	1,065	1,065	1,125	1,125	1,260	1,260	1,275	1,335	1,335	1,440	1,440	1,500	1,500	1,500
	3/4 (19.05) / 7/8 (22.22)	3/4 (19.05) / 7/8 (22.22)	3/4 (19.05) / 7/8 (22.22)	3/4 (19.05) / 7/8 (22.22)	3/4 (19.05) / 7/8 (22.22)	3/4 (19.05) / 7/8 (22.22)	3/4 (19.05) / 7/8 (22.22)	3/4 (19.05) / 7/8 (22.22)	3/4 (19.05) / 7/8 (22.22)	3/4 (19.05) / 7/8 (22.22)	7/8 (22.22) / 1 (25.04)	7/8 (22.22) / 1 (25.04)	7/8 (22.22) / 1 (25.04)	7/8 (22.22) / 1 (25.04)	7/8 (22.22) / 1 (25.04)	7/8 (22.22) / 1 (25.04)	7/8 (22.22) / 1 (25.04)
	1-1/2 (38.10) / 1-1/2 (38.10)	1-1/2 (38.10) / 1-1/2 (38.10)	1-1/2 (38.10) / 1-1/2 (38.10)	1-1/2 (38.10) / 1-1/2 (38.10)	1-1/2 (38.10) / 1-1/2 (38.10)	1-1/2 (38.10) / 1-1/2 (38.10)	1-1/2 (38.10) / 1-1/2 (38.10)	1-5/8 (41.28) / 1-5/8 (41.28)	1-5/8 (41.28) / 1-5/8 (41.28)	1-5/8 (41.28) / 1-5/8 (41.28)	1-5/8 (41.28) / 1-5/8 (41.28)	1-5/8 (41.28) / 1-5/8 (41.28)	1-3/4 (44.45) / 2 (50.80)	1-3/4 (44.45) / 2 (50.80)	1-3/4 (44.45) / 2 (50.80)	1-3/4 (44.45) / 2 (50.80)	1-3/4 (44.45) / 2 (50.80)
	1-5/8 (41.28)	1-5/8 (41.28)	1-5/8 (41.28)	1-5/8 (41.28)	1-5/8 (41.28)	1-5/8 (41.28)	1-5/8 (41.28)	1-3/4 (44.45)	1-3/4 (44.45)	1-3/4 (44.45)	1-3/4 (44.45)	1-3/4 (44.45)	2 (50.80)	2 (50.80)	2 (50.80)	2 (50.80)	2 (50.80)
	1/4 (6.35)	1/4 (6.35)	1/4 (6.35)	1/4 (6.35)	1/4 (6.35)	1/4 (6.35)	1/4 (6.35)	1/4 (6.35)	1/4 (6.35)	1/4 (6.35)	1/4 (6.35)	1/4 (6.35)	1/4 (6.35)	1/4 (6.35)	1/4 (6.35)	1/4 (6.35)	1/4 (6.35)
	24.9 / 51,9912	26.1 / 54,4968	26.1 / 54,4968	27.3 / 57,0024	27.3 / 57,0024	28.5 / 59,508	28.5 / 59,508	33.2 / 69,3216	33.2 / 69,3216	32.9 / 68,6952	35.6 / 74,3328	34.1 / 19,836	35.8 / 68,6952	36.8 / 19,836	36.8 / 19,836	38.0 / 79,344	38.0 / 79,344
	50 ~ 130 (200)	50 ~ 130 (200)	50 ~ 130 (200)	50 ~ 130 (200)	50 ~ 130 (200)	50 ~ 130 (200)	50 ~ 130 (200)	50 ~ 130 (200)	50 ~ 130 (200)	50 ~ 130 (200)	50 ~ 130 (200)	50 ~ 130 (200)	50 ~ 130 (200)	50 ~ 130 (200)	50 ~ 130 (200)	50 ~ 130 (200)	50 ~ 130 (200)
	-10 ~ +52	-10 ~ +52	-10 ~ +52	-10 ~ +52	-10 ~ +52	-10 ~ +52	-10 ~ +52	-10 ~ +52	-10 ~ +52	-10 ~ +52	-10 ~ +52	-10 ~ +52	-10 ~ +52	-10 ~ +52	-10 ~ +52	-10 ~ +52	-10 ~ +52
	-25 ~ +18	-25 ~ +18	-25 ~ +18	-25 ~ +18	-25 ~ +18	-25 ~ +18	-25 ~ +18	-25 ~ +18	-25 ~ +18	-25 ~ +18	-25 ~ +18	-25 ~ +18	-25 ~ +18	-25 ~ +18	-25 ~ +18	-25 ~ +18	-25 ~ +18

Rating Conditions: Cooling Indoor 27°C DB / 19°C WB. Cooling Outdoor 35°C DB. Heating Indoor 20°C DB. Heating Outdoor 7°C DB / 6°C WB. (DB: Dry Bulb; WB: Wet Bulb)
Specifications subject to change without notice. For detailed information about ErP, please visit our websites www.aircon.panasonic.eu or www.ptc.panasonic.eu.

3-PIPE ECOi MF2 6N SERIES



Simultaneous heating and cooling VRF system.
The Panasonic 3-Pipe MF2 Series offers the best solution
for the most demanding customers.

- The 3-Pipe units have only one chassis size, with a very small footprint (only 0,93m²)
- 1 body for all sizes: 1.758 x 1.000 x 930mm, for 8, 10, 12, 14 and 16HP

- Maximum capacity size as 48HP by 3 unit combinations
- Up to 52 indoor units connectable
- Connectable indoor/outdoor unit capacity ratio up to 150%

Market-leading COP (at full load), High Efficiency Combination.

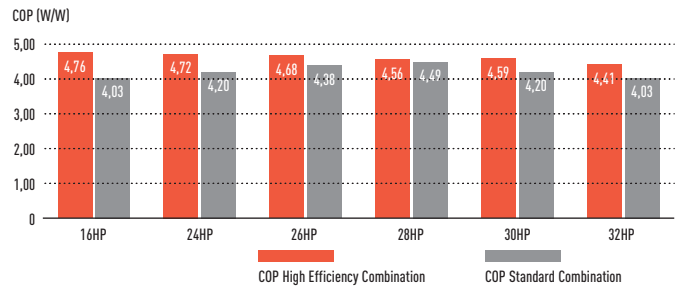
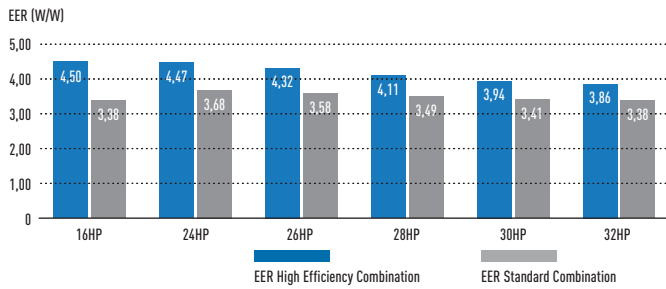

Market-leading COP (at full load), standard efficiency.

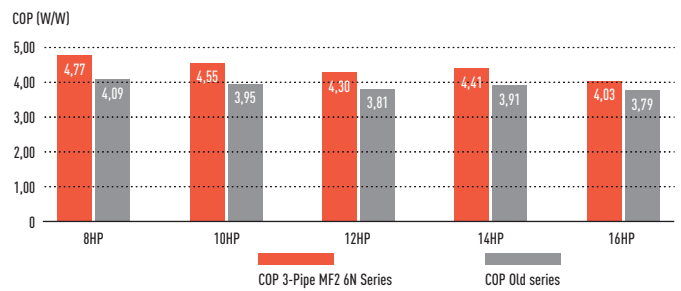
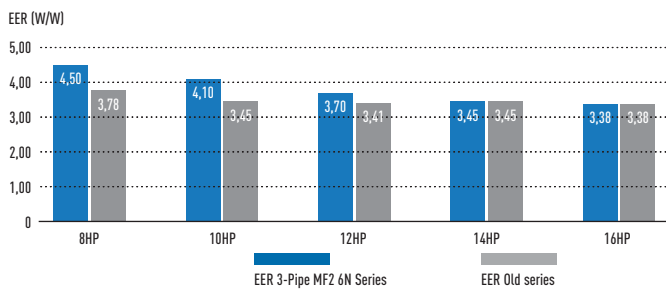

3-Pipe Control Box Kit / Multiple connection type

New Heat Recovery Box to connect multiple indoor units with just one box, 4, 6 and up to 8 indoor units or groups.

This is good advantage specially in hotel applications, where space for connecting several boxes is limited.

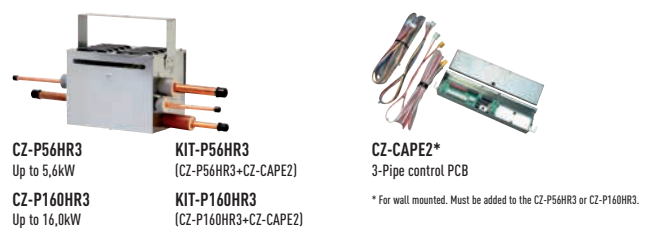
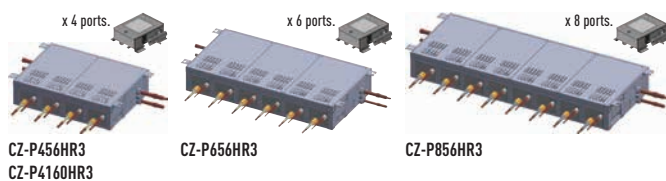

Individual control of multiple indoor units with solenoid valve kits.

- Any design and layout can be used in a single system.
- Cooling operation is possible up to an outdoor temperature of -10°C.

System structure.

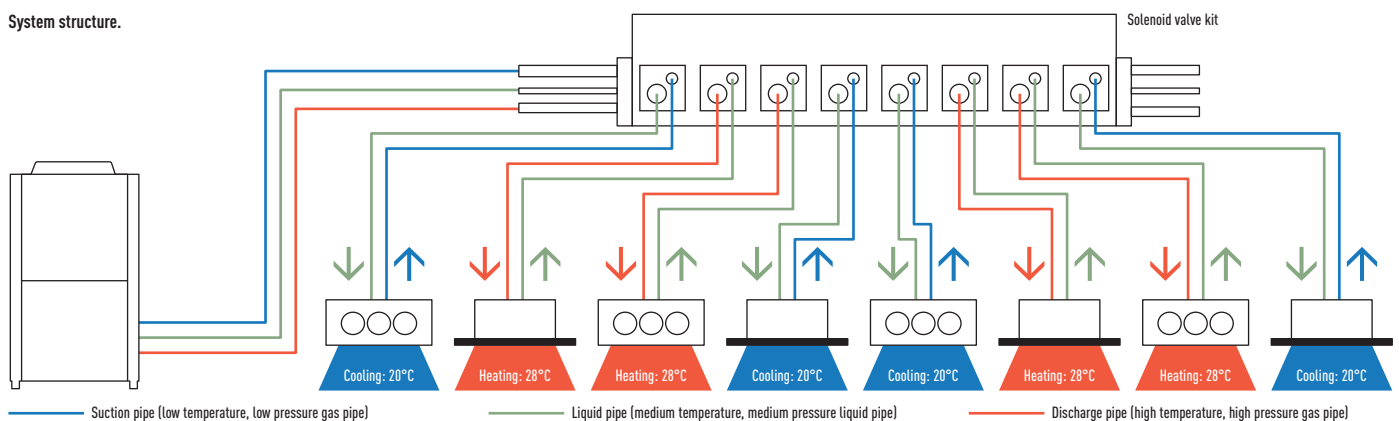

3-PIPE ECOi MF2 6N SERIES

Extended design operation conditions

Cooling design operation conditions: The cooling operation range has been extended to -10°C by changing the outdoor fan to an inverter type.

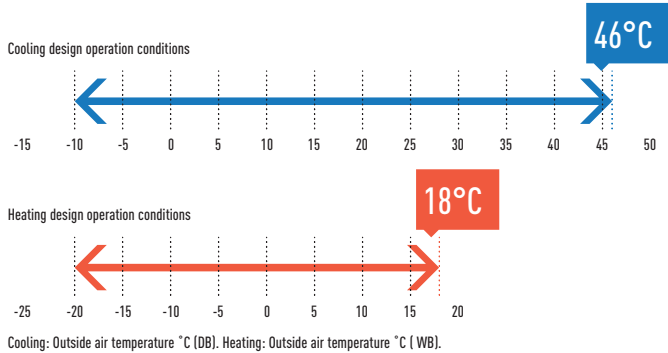

Heating design operation conditions: Stable heating operation even with an outside air temperature of -20°C. The heating operation range has been extended to -20°C by use of a compressor with a high-pressure vessel.

Wide temperature setting range.

Wired remote control heating temperature setting range is 16 to 30°C.

Large combination of outdoor units, up to 48HP

Unit	System (HP)																					
	8	10	12	14	16	18	20	22	24	26	28	30	32	34	36	38	40	42	44	46	48	
8	1					1	1	1	1						1	1	1	1				
10		1				1																
12			1				1			1					1							
14				1				1		1	1	2	1		1	2	1		3	2	1	
16					1				1			1	2			1	2		1	2	3	

High efficiency combination

Unit	System (HP)					
	16	24	26	28	30	32
8	2	3	2	2	2	1
10			1			
12				1		2
14					1	

Power suppression control for energy saving (Demand control)¹

The 3-Pipe ECOi MF2 6N Series has a built-in demand function which uses the inverter characteristics. With this demand function, the power consumption can be set in three steps, and operation² at optimum performance is performed according to the setting and the power consumption. This function is useful to reduce the annual power consumption and to save electricity costs while maintaining comfort.

¹ An outdoor Seri-Para I/O unit is required for demand input.
² Setting is possible as 0% or in the range from 40 to 100% (in steps of 5%). At the time of shipping, setting has been done to the three steps of 0%, 70%, and 100%.

Non-stop operation during maintenance

Even when an indoor unit needs maintenance, the other indoor units can be kept operating by setting. (Not applicable for all situations)

Compact design for superb space saving and low noise level

5 types of outdoor units with different capacities have been standardized to one compact casing.

Uniquely constructed with two compartments, the upper chamber contains the heat exchange, with the lower chamber stores the compressors. The benefits are two-fold - superb space saving and low noise level.

Installation space: 0,93m²

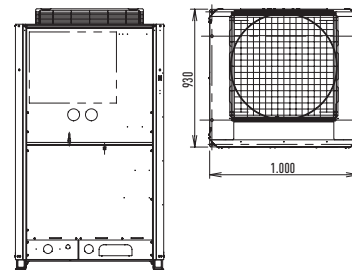

Operating sound dB(A)

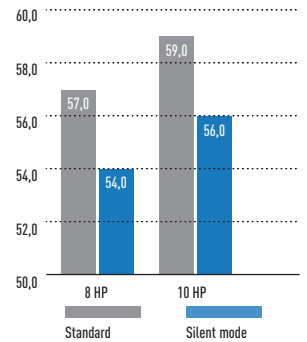

Increased piping lengths and design flexibility

Adaptable to various building types and sizes. Actual piping length: 180m. Maximum piping length: 500m.

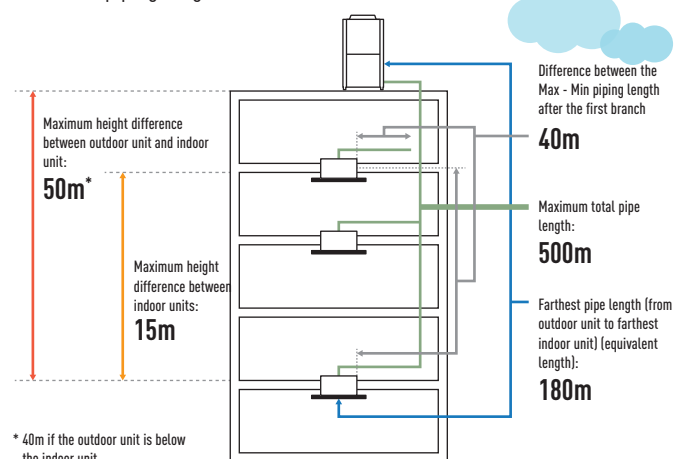

Additional refrigerant charge (g/m)

Liquid piping size	6,35	9,52	12,7	15,88	19,05	22,22	25,40
Amount of refrigerant charge	26	56	128	185	259	366	490

Refrigerant piping (Piping size (mm))

Material	Outer diameter		Wall thickness	
	6,35	9,52	12,70	15,88
0 material	6,35	9,52	12,70	15,88
	0,80	0,80	0,80	1,00
	1,00	1,00	1,10	over 1,35
1/2 H, H material	25,40	28,58	31,75	38,10
	1,00	1,00	1,10	over 1,35

Note: When pipe bending is to be performed, the bending radius shall be at least 4 times the outer diameter. Also, take sufficient care to prevent pipe collapse and damage at the time of bending.

Excellent cost saving and smaller piping size

By using R410A with low pressure loss, pipe sizes for discharge, suction and liquid are all reduced. This makes it possible to aim for reduced piping space, improved workability at the site, and reduction of the piping material costs.

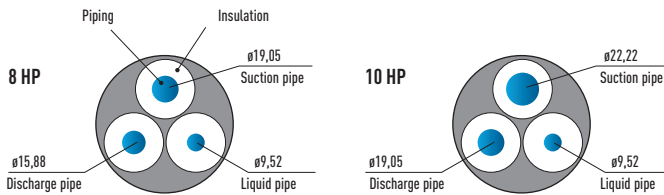

3-Pipe wind protection shield

PAW-WPH1	1 long side of the outdoor unit (624 x 983 x 489)
PAW-WPH2	1 long side of the outdoor units (853 x 983 x 489)
PAW-WPH3	2 long sides of the outdoor units (744 x 983 x 289) (2ER SET)

Extended compressor life by uniform compressor operation time

The total run-time of compressors are monitored by a built-in microcomputer, which ensures that operation times of all compressors within the same refrigerant circuit are balanced. Compressors with histories showing shorter run times are selected first, ensuring equal wear and tear across all units and extended the working life of the system.

System example

A,C: DC inverter compressor
B,D: Constant speed compressor

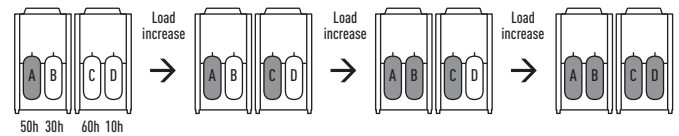

* Depend on accumulated operation time of each compressors.
* Compressor priority has possibility to be changed.
(e.g) Case 1: A → C → B → D, Case 2: C → A → D → B, Case 3: A → C → D → B, Case 4: C → A → B → D
* Also other cases available.

Piping design

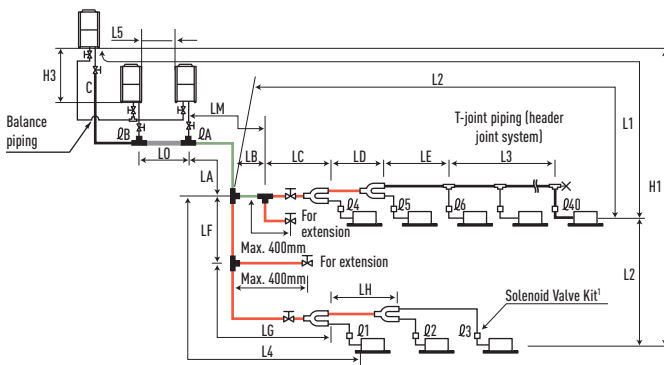

— Main piping length $LM = LA + LB...$
— Main distribution pipes LC-LH are selected according to the capacity after the distribution joint.
— Size of indoor unit connection piping 1-40 is determined by the connection piping size on the indoor units.
 Distribution joint (CZ, option).
 Ball valve (BV, option).
 T-joint (field supply).
 Solidly welded shut (pinch weld).

The outdoor connection main piping (L0 portion) is determined by the total capacity of the outdoor units that are connected to the tube end.
Note: Do not use commercial T-pieces for the liquid pipes of the distribution joint.

- R410A distribution joint**
 CZ-P680PH2 (for outdoor unit)
 CZ-P1350PH2 (for outdoor unit)
 CZ-P224HK2 (for indoor unit)
 CZ-P680HK2 (for indoor unit)
 CZ-P1350HK2 (for indoor unit)

Ranges that apply to refrigerant piping lengths and to differences in installation heights

Items	Marks	Contents	Length (m)
Allowable piping length	L1	Maximum piping length	Actual piping length $\leq 180^1$ Equivalent piping length ≤ 200
	$\Delta L (L2-L4)$	Difference between the Maximum length and the minimum length from the No. 1 distribution	≤ 40
	LM	Maximum length of main piping (at Maximum diameter)	≤ 2
	$\phi 1, \phi 2-\phi 40$	Maximum length of each distribution	≤ 30
	$L1 + \phi 1 + \phi 2 + \dots + \phi 39 + \phi A + \phi B + LF + LG + LH$	Total Maximum piping length including length of each distribution (only liquid piping)	$\leq 500^3$
Allowable elevation difference	L5	Distance between outdoor units	≤ 10
	H1	When outdoor unit is installed higher than indoor unit	≤ 50
		When outdoor unit is installed lower than indoor unit	≤ 40
	H2	Maximum difference between indoor units	≤ 15
H3	Maximum difference between outdoor units	≤ 4	
Allowable length of joint piping	L3	T-joint piping (field-supply); Maximum piping length between the first T-joint and solidly welded-shut end point	≤ 2

L = Length, H = Height
 1) If the longest piping length (L1) exceeds 90m (equivalent length), increase the sizes of the main tubes (LM) by 1 rank for the discharge tubes, suction tubes, and narrow tubes (field supplied).
 2) If the longest main tube length (LM) exceeds 50m, increase the main tube size at the portion before 50m by 1 rank for the suction tubes and discharge tubes (field supplied).
 (For the portion that exceeds 50m, set based on the main tube sizes (LA) listed in the table on the following page).
 3) 24HP - 30HP of high efficiency combination is 300m.

3-PIPE ECOi MF2 6N SERIES HIGH EFFICIENCY COMBINATION FROM 16 TO 32HP

With simultaneous heating and cooling operation heat recovery type.

ECOi 3-Pipe is one of the most advanced VRF systems available. Not only offering high-efficiency and performance for simultaneous heating and cooling, its sophisticated design makes installation and maintenance much easier.

- Achieves COP 4,76 as the top class in the industry (average cooling and heating value for 8HP outdoor unit).
- Simultaneous cooling or heating operation for up to 52 indoor units.
- Small installation space, top class in the industry.
- Rotation operation function and back-up operation function provided.



Technical focus

- Standardisation of outdoor unit to one compact casing size
- Improved operation efficiency
- The constant-speed compressor adopts a high-performance internal high-pressure scroll
- Improvement of the heat exchanger
- Redesign of structural parts
- Close side-by-side installation is possible

HP		16HP	24HP	26HP	28HP	30HP	32HP
High Efficiency model		U-8MF2E8 U-8MF2E8	U-8MF2E8 U-8MF2E8 U-8MF2E8	U-8MF2E8 U-8MF2E8 U-10MF2E8	U-8MF2E8 U-8MF2E8 U-12MF2E8	U-8MF2E8 U-8MF2E8 U-14MF2E8	U-8MF2E8 U-12MF2E8 U-12MF2E8
Power supply	V	380 / 400 / 415	380 / 400 / 415	380 / 400 / 415	380 / 400 / 415	380 / 400 / 415	380 / 400 / 415
		Three Phase / 50 Hz	Three Phase / 50 Hz	Three Phase / 50 Hz	Three Phase / 50 Hz	Three Phase / 50 Hz	Three Phase / 50 Hz
Cooling capacity	kW	45,0	68,0	73,0	78,5	85,0	90,0
EER ¹⁾	W/W	4,50	4,47	4,32	4,11	3,94	3,86
Running current	380 / 400 / 415 V	17,3 / 16,4 / 16,0	26,2 / 24,9 / 24,3	28,5 / 27,4 / 26,7	32,2 / 31,0 / 30,2	36,5 / 35,0 / 34,1	38,9 / 37,4 / 36,4
Input power	kW	10,0	15,2	16,9	19,1	21,6	23,3
Heating capacity	kW	50,0	76,5	81,5	87,5	95,0	100,0
COP ¹⁾	W/W	4,76	4,72	4,68	4,56	4,59	4,41
Running current	380 / 400 / 415 V	17,9 / 17,0 / 16,6	27,7 / 26,3 / 25,6	29,4 / 27,9 / 27,5	32,4 / 31,1 / 30,4	35,0 / 33,6 / 32,7	38,3 / 36,8 / 35,9
Input power	kW	10,5	16,2	17,4	19,2	20,7	22,7
Air volume	m ³ /min	316	474	494	528	528	582
Sound pressure	Hi / Lo	60,0 / 57,0	62,0 / 59,0	62,5 / 59,5	63,5 / 60,5	64,0 / 61,0	65,0 / 62,0
Sound power	Normal mode	74,5 / 71,5	76,5 / 73,5	77,0 / 74,0	78,0 / 75,0	78,5 / 75,5	79,5 / 76,5
Dimensions (Combination)	H x W x D	1.758 x 2.060 x 930	1.758 x 3.120 x 930	1.758 x 3.120 x 930	1.758 x 3.120 x 930	1.758 x 3.120 x 930	1.758 x 3.120 x 930
Net weight	kg	538	807	807	852	860	897
Piping connections	Suction pipe	Inch (mm)	1-1/8 (28,58)	1-1/8 (28,58)	1 1/4 (31,75)	1 1/4 (31,75)	1 1/4 (31,75)
	Discharge pipe	Inch (mm)	7/8 (22,22)	1 (25,40)	1 (25,40)	1-1/8 (28,58)	1-1/8 (28,58)
	Liquid pipe	Inch (mm)	1/2 (12,70)	5/8 (15,88)	3/4 (19,05)	3/4 (19,05)	3/4 (19,05)
	Balance pipe	Inch (mm)	1/4 (6,35)	1/4 (6,35)	1/4 (6,35)	1/4 (6,35)	1/4 (6,35)
Refrigerant (R410A)	kg / TCO ₂ Eq.	16,6 / 34,6608	24,9 / 51,9912	25,1 / 52,4088	25,4 / 53,0352	25,9 / 54,0792	25,9 / 54,0792
Operating range	Cooling Min ~ Max	°C	-10 ~ +46	-10 ~ +46	-10 ~ +46	-10 ~ +46	-10 ~ +46
	Heating Min ~ Max	°C	-20 ~ +18	-20 ~ +18	-20 ~ +18	-20 ~ +18	-20 ~ +18
	Simultaneous operation	°C	-10 ~ +24	-10 ~ +24	-10 ~ +24	-10 ~ +24	-10 ~ +24

1) EER and COP classification is at 400V in accordance with EU directive 2002/31/EC.

Solenoid valve kit

KIT-P56HR3	KIT-P56HR3	3-Pipe control solenoid valve kit (up to 5,6kW)
	CZ-P56HR3	Solenoid valve kit (up to 5,6kW)
	CZ-CAPE2	3-Pipe control PCB
KIT-P160HR3	KIT-P160HR3	3-Pipe control solenoid valve kit (from 5,6kW to 10,6kW)
	CZ-P160HR3	Solenoid valve kit (up to 16,0kW)
CZ-CAPEK2	CZ-CAPE2	3-Pipe control PCB
		3-Pipe control PCB for wall mounted

3-Pipe control box kit

CZ-P456HR3	4 ports 3 pipe box (up to 5,6kW)
CZ-P656HR3	6 ports 3 pipe box (up to 5,6kW)
CZ-P856HR3	8 ports 3 pipe box (up to 5,6kW)
CZ-P4160HR3	4 ports 3 pipe box (up to 16,0kW)



3-PIPE ECOi MF2 6N SERIES FROM 8 TO 16HP

With simultaneous heating and cooling operation heat recovery type.

ECOi 3-Pipe is one of the most advanced VRF systems available. Not only offering high-efficiency and performance for simultaneous heating and cooling, but also its sophisticated installation and maintenance much easier.

- Achieves COP 4,77 as the top class in the industry (average cooling and heating value for 8HP outdoor unit).
- Simultaneous cooling or heating operation for up to 26 indoor units.
- Small installation space, top class in the industry.
- Rotation operation function and back-up operation function provided.

Technical focus

- Standardisation of outdoor unit to one compact casing size
- Improved operation efficiency
- The constant-speed compressor adopts a high-performance internal high-pressure scroll
- Improvement of the heat exchanger
- Redesign of structural parts
- Close side-by-side installation is possible



HP			8HP	10HP	12HP	14HP	16HP
Standard model			U-8MF2E8	U-10MF2E8	U-12MF2E8	U-14MF2E8	U-16MF2E8
Power supply	V		380 / 400 / 415	380 / 400 / 415	380 / 400 / 415	380 / 400 / 415	380 / 400 / 415
			Three Phase / 50 Hz	Three Phase / 50 Hz	Three Phase / 50 Hz	Three Phase / 50 Hz	Three Phase / 50 Hz
Cooling capacity	kW		22,4	28,0	33,5	40,0	45,0
EER ¹⁾	W/W		4,50	4,10	3,70	3,45	3,38
Running current	380 / 400 / 415 V	A	8,60 / 8,20 / 8,00	11,3 / 10,8 / 10,6	15,1 / 14,5 / 14,1	19,2 / 18,4 / 17,9	22,0 / 21,1 / 20,6
Input power	kW		4,98	6,83	9,05	11,00	13,00
Heating capacity	kW		25,0	31,5	37,5	45,0	50,0
COP ¹⁾	W/W		4,77	4,55	4,30	4,41	4,03
Running current	380 / 400 / 415 V	A	8,95 / 8,50 / 8,30	11,6 / 11,0 / 10,7	14,7 / 14,1 / 13,8	17,0 / 16,4 / 15,9	20,7 / 19,9 / 19,4
Input power	kW		5,24	6,92	8,72	10,2	12,4
Air volume	m ³ /min		158	178	212	212	212
Sound pressure	Hi / Lo	dB(A)	57,0 / 54,0	59,0 / 56,0	61,0 / 58,0	62,0 / 59,0	62,0 / 59,0
Sound power	Normal mode	dB	71,5 / 68,5	73,5 / 70,5	75,5 / 72,5	76,5 / 73,5	76,5 / 73,5
Dimensions	H x W x D	mm	1.758 x 1.000 x 930	1.758 x 1.000 x 930	1.758 x 1.000 x 930	1.758 x 1.000 x 930	1.758 x 1.000 x 930
Net weight		kg	269	269	314	322	322
Piping connections	Suction pipe	Inch (mm)	3/4 (19,05)	7/8 (22,22)	1 (25,40)	1 (25,40)	1-1/8 (28,58)
	Discharge pipe	Inch (mm)	5/8 (15,88)	3/4 (19,05)	3/4 (19,05)	7/8 (22,22)	7/8 (22,22)
	Liquid pipe	Inch (mm)	3/8 (9,52)	3/8 (9,52)	1/2 (12,70)	1/2 (12,70)	1/2 (12,70)
	Balance pipe	Inch (mm)	1/4 (6,35)	1/4 (6,35)	1/4 (6,35)	1/4 (6,35)	1/4 (6,35)
Refrigerant (R410A)	kg / TCO ₂ Eq.		8,3 / 17,3304	8,5 / 17,748	8,8 / 18,3744	9,3 / 19,4184	9,3 / 19,4184
Operating range	Cooling Min ~ Max	°C	-10 ~ +46	-10 ~ +46	-10 ~ +46	-10 ~ +46	-10 ~ +46
	Heating Min ~ Max	°C	-20 ~ +18	-20 ~ +18	-20 ~ +18	-20 ~ +18	-20 ~ +18
	Simultaneous operation	°C	-10 ~ +24	-10 ~ +24	-10 ~ +24	-10 ~ +24	-10 ~ +24

1) EER and COP classification is at 400V in accordance with EU directive 2002/31/EC.

Solenoid valve kit

KIT-P56HR3	KIT-P56HR3	3-Pipe control solenoid valve kit (up to 5,6kW)
	CZ-P56HR3	Solenoid valve kit (up to 5,6kW)
	CZ-CAPE2	3-Pipe control PCB
KIT-P160HR3	KIT-P160HR3	3-Pipe control solenoid valve kit (from 5,6kW to 10,6kW)
	CZ-P160HR3	Solenoid valve kit (up to 16,0kW)
CZ-CAPEK2	CZ-CAPE2	3-Pipe control PCB
		3-Pipe control PCB for wall mounted

3-Pipe control box kit

CZ-P456HR3	4 ports 3 pipe box (up to 5,6kW)
CZ-P656HR3	6 ports 3 pipe box (up to 5,6kW)
CZ-P856HR3	8 ports 3 pipe box (up to 5,6kW)
CZ-P4160HR3	4 ports 3 pipe box (up to 16,0kW)



3-PIPE ECOi MF2 6N SERIES COMBINATION FROM 18 TO 48HP

With simultaneous heating and cooling operation heat recovery type.

ECOi 3-Pipe is one of the most advanced VRF systems available. Not only offering high-efficiency and performance for simultaneous heating and cooling, its sophisticated design makes installation and maintenance much easier.

- Achieves COP 4,63 as the top class in the industry (average cooling and heating value for 18HP outdoor unit).
- Simultaneous cooling or heating operation for up to 52 indoor units.
- Small installation space, top class in the industry.
- Rotation operation function and back-up operation function provided.

Technical focus

- Standardisation of outdoor unit to one compact casing size
- Improved operation efficiency
- The constant-speed compressor adopts a high-performance internal high-pressure scroll
- Improvement of the heat exchanger
- Redesign of structural parts
- Close side-by-side installation is possible

HP		18HP	20HP	22HP	24HP	26HP	28HP	30HP	
Standard model		U-8MF2E8 U-10MF2E8	U-8MF2E8 U-12MF2E8	U-8MF2E8 U-14MF2E8	U-8MF2E8 U-16MF2E8	U-12MF2E8 U-14MF2E8	U-14MF2E8 U-14MF2E8	U-14MF2E8 U-16MF2E8	
Power supply	V	380 / 400 / 415	380 / 400 / 415	380 / 400 / 415	380 / 400 / 415	380 / 400 / 415	380 / 400 / 415	380 / 400 / 415	
		Three Phase / 50 Hz	Three Phase / 50 Hz	Three Phase / 50 Hz	Three Phase / 50 Hz	Three Phase / 50 Hz	Three Phase / 50 Hz	Three Phase / 50 Hz	
Cooling capacity	kW	50,4	56,0	61,5	68,0	73,0	78,5	85,0	
EER ¹⁾	W/W	4,27	3,97	3,80	3,68	3,58	3,49	3,41	
Running current	380 / 400 / 415 V	A	19,7 / 18,9 / 18,4	23,8 / 22,9 / 22,3	27,0 / 26,0 / 25,3	30,9 / 29,7 / 28,9	33,7 / 32,4 / 31,5	37,2 / 35,7 / 34,8	41,1 / 39,5 / 38,5
Input power	kW	11,8	14,1	16,2	18,5	20,4	22,5	24,90	
Heating capacity	kW	56,5	63,0	69,0	76,5	81,5	87,5	95,0	
COP ¹⁾	W/W	4,63	4,47	4,57	4,20	4,38	4,49	4,20	
Running current	380 / 400 / 415 V	A	20,4 / 19,6 / 19,1	23,8 / 22,9 / 22,3	25,2 / 24,2 / 23,6	30,4 / 29,2 / 28,5	31,1 / 29,8 / 29,1	32,6 / 31,3 / 30,5	37,7 / 36,2 / 35,3
Input power	kW	12,2	14,1	15,1	18,2	18,6	19,5	22,6	
Air volume	m ³ /min	336	370	370	370	424	424	424	
Sound pressure	Hi / Lo	dB(A)	61,0 / 58,0	62,5 / 59,5	63,0 / 60,0	63,0 / 60,0	64,5 / 61,5	65,0 / 62,0	65,0 / 62,0
Sound power	Normal mode	dB	75,5 / 72,5	77,0 / 74,0	77,5 / 74,5	77,5 / 74,5	79,0 / 76,0	79,5 / 76,5	79,5 / 76,5
Dimensions	H x W x D	mm	1.758 x 2.060 x 930	1.758 x 2.060 x 930	1.758 x 2.060 x 930	1.758 x 2.060 x 930	1.758 x 2.060 x 930	1.758 x 2.060 x 930	1.758 x 2.060 x 930
Net weight		kg	538	538	591	591	636	644	644
Piping connections	Suction pipe	Inch (mm)	1-1/8 (28,58)	1-1/8 (28,58)	1-1/8 (28,58)	1-1/8 (28,58)	1 1/4 (31,75)	1 1/4 (31,75)	1 1/4 (31,75)
	Discharge pipe	Inch (mm)	7/8 (22,22)	7/8 (22,22)	1 (25,40)	1 (25,40)	1 (25,40)	1-1/8 (28,58)	1-1/8 (28,58)
	Liquid pipe	Inch (mm)	5/8 (15,88)	5/8 (15,88)	5/8 (15,88)	5/8 (15,88)	3/4 (19,05)	3/4 (19,05)	3/4 (19,05)
	Balance pipe	Inch (mm)	1/4 (6,35)	1/4 (6,35)	1/4 (6,35)	1/4 (6,35)	1/4 (6,35)	1/4 (6,35)	1/4 (6,35)
Refrigerant (R410A)	kg / TCO ₂ Eq.	16,8 / 35,0784	17,1 / 35,7048	17,6 / 36,7488	17,6 / 36,7488	18,1 / 37,7928	18,6 / 38,8368	18,6 / 38,8368	
Operating range	Cooling Min ~ Max	°C	-10 ~ +46	-10 ~ +46	-10 ~ +46	-10 ~ +46	-10 ~ +46	-10 ~ +46	-10 ~ +46
	Heating Min ~ Max	°C	-20 ~ +18	-20 ~ +18	-20 ~ +18	-20 ~ +18	-20 ~ +18	-20 ~ +18	-20 ~ +18
	Simultaneous operation	°C	-10 ~ +24	-10 ~ +24	-10 ~ +24	-10 ~ +24	-10 ~ +24	-10 ~ +24	-10 ~ +24

1) EER and COP classification is at 400 V in accordance with EU directive 2002/31/EC.

Solenoid valve kit

KIT-P56HR3	KIT-P56HR3	3-Pipe control solenoid valve kit (up to 5,6kW)
	CZ-P56HR3	Solenoid valve kit (up to 5,6kW)
	CZ-CAPE2	3-Pipe control PCB
KIT-P160HR3	KIT-P160HR3	3-Pipe control solenoid valve kit (from 5,6kW to 10,6kW)
	CZ-P160HR3	Solenoid valve kit (up to 16,0kW)
CZ-CAPEK2	CZ-CAPE2	3-Pipe control PCB
		3-Pipe control PCB for wall mounted

3-Pipe control box kit

CZ-P456HR3	4 ports 3 pipe box (up to 5,6kW)
CZ-P656HR3	6 ports 3 pipe box (up to 5,6kW)
CZ-P856HR3	8 ports 3 pipe box (up to 5,6kW)
CZ-P4160HR3	4 ports 3 pipe box (up to 16,0kW)





	32HP	34HP	36HP	38HP	40HP	42HP	44HP	46HP	48HP
	U-16MF2E8 U-16MF2E8	U-8MF2E8 U-12MF2E8 U-14MF2E8	U-8MF2E8 U-14MF2E8 U-14MF2E8	U-8MF2E8 U-14MF2E8 U-16MF2E8	U-8MF2E8 U-16MF2E8 U-16MF2E8	U-14MF2E8 U-14MF2E8 U-14MF2E8	U-14MF2E8 U-14MF2E8 U-16MF2E8	U-16MF2E8 U-16MF2E8 U-16MF2E8	U-16MF2E8 U-16MF2E8 U-16MF2E8
	380 / 400 / 415	380 / 400 / 415	380 / 400 / 415	380 / 400 / 415	380 / 400 / 415	380 / 400 / 415	380 / 400 / 415	380 / 400 / 415	380 / 400 / 415
	Three Phase / 50 Hz	Three Phase / 50 Hz	Three Phase / 50 Hz	Three Phase / 50 Hz	Three Phase / 50 Hz	Three Phase / 50 Hz	Three Phase / 50 Hz	Three Phase / 50 Hz	Three Phase / 50 Hz
	90,0	96,0	101,0	107,0	113,0	118,0	124,0	130,0	135,0
	3,38	3,74	3,66	3,60	3,55	3,48	3,43	3,40	3,38
	43,9 / 42,2 / 41,1	42,9 / 41,2 / 39,7	46,1 / 44,3 / 43,1	49,6 / 47,6 / 46,4	53,1 / 51,0 / 49,7	56,0 / 53,8 / 52,4	59,6 / 57,3 / 55,8	63,8 / 61,3 / 59,7	65,9 / 63,3 / 61,7
	26,6	25,7	27,6	29,7	31,8	33,9	36,1	38,2	39,9
	100,0	108,0	113,0	119,0	127,0	132,0	138,0	145,0	150,0
	4,03	4,44	4,52	4,33	4,12	4,46	4,30	4,14	4,03
	41,7 / 40,1 / 39,1	41,0 / 39,4 / 38,4	41,6 / 39,9 / 38,9	46,1 / 44,3 / 43,1	52,2 / 49,6 / 47,8	49,3 / 47,3 / 46,1	53,8 / 51,6 / 50,3	58,8 / 56,5 / 55,0	62,6 / 60,1 / 58,6
	24,8	24,3	25,0	27,5	30,8	29,6	32,1	35,0	37,2
	424	582	582	582	582	636	636	636	636
	65,0 / 62,0	65,0 / 62,0	65,5 / 62,5	65,5 / 62,5	65,5 / 62,5	67,0 / 64,0	67,0 / 64,0	67,0 / 64,0	67,0 / 64,0
	79,5 / 76,5	79,5 / 76,5	80,0 / 77,0	80,0 / 77,0	80,0 / 77,0	81,5 / 78,5	81,5 / 78,5	81,5 / 78,5	81,5 / 78,5
	1.758 x 2.060 x 930	1.758 x 3.120 x 930	1.758 x 3.120 x 930	1.758 x 3.120 x 930	1.758 x 3.120 x 930	1.758 x 3.120 x 930	1.758 x 3.120 x 930	1.758 x 3.120 x 930	1.758 x 3.120 x 930
	644	905	913	913	913	966	966	966	966
	1 1/4 (31,75)	1 1/4 (31,75)	1-1/2 (38,10)	1-1/2 (38,10)	1-1/2 (38,10)	1-1/2 (38,10)	1-1/2 (38,10)	1-1/2 (38,10)	1-1/2 (38,10)
	1-1/8 (28,58)	1-1/8 (28,58)	1-1/8 (28,58)	1 1/4 (31,75)	1 1/4 (31,75)	1 1/4 (31,75)	1 1/4 (31,75)	1 1/4 (31,75)	1 1/4 (31,75)
	3/4 (19,05)	3/4 (19,05)	3/4 (19,05)	3/4 (19,05)	3/4 (19,05)	3/4 (19,05)	3/4 (19,05)	3/4 (19,05)	3/4 (19,05)
	1/4 (6,35)	1/4 (6,35)	1/4 (6,35)	1/4 (6,35)	1/4 (6,35)	1/4 (6,35)	1/4 (6,35)	1/4 (6,35)	1/4 (6,35)
	18,6 / 38,8368	26,4 / 55,1232	26,9 / 56,1672	26,9 / 56,1672	26,9 / 56,1672	27,9 / 58,2552	27,9 / 58,2552	27,9 / 58,2552	27,9 / 58,2552
	-10 ~ +46	-10 ~ +46	-10 ~ +46	-10 ~ +46	-10 ~ +46	-10 ~ +46	-10 ~ +46	-10 ~ +46	-10 ~ +46
	-20 ~ +18	-20 ~ +18	-20 ~ +18	-20 ~ +18	-20 ~ +18	-20 ~ +18	-20 ~ +18	-20 ~ +18	-20 ~ +18
	-10 ~ +24	-10 ~ +24	-10 ~ +24	-10 ~ +24	-10 ~ +24	-10 ~ +24	-10 ~ +24	-10 ~ +24	-10 ~ +24

ECO G, THE GAS DRIVEN VRF

NEW VRF
TECHNOLOGY

'17





The advanced Gas Driven VRF system offers increased efficiency and performance across the range. Improvements include increased part load performance, reduced gas consumption with a Miller-cycle engine and reduced electrical consumption by using DC-Fan motors.

New ECO G GE3 Series



Reduce by 30% electrical energy consumption giving better energy efficiency.

ECO G GF2 3-Pipe



3-Pipe heat recovery system with simultaneous heating & cooling.

What is GHP? The Gas Heat Pump (GHP)

Panasonic Gas Heat Pump is a direct expansion system with compressor as same as VRF system. Gas engine is used as driving source of compressor instead of electric motor. This gas engine compressor drive has 2 advantages:

1. Waste heat from the gas engine available
2. No need for motor power consumption thanks to gas engine

GHP is the natural choice for commercial projects, especially for those projects where power restrictions apply.

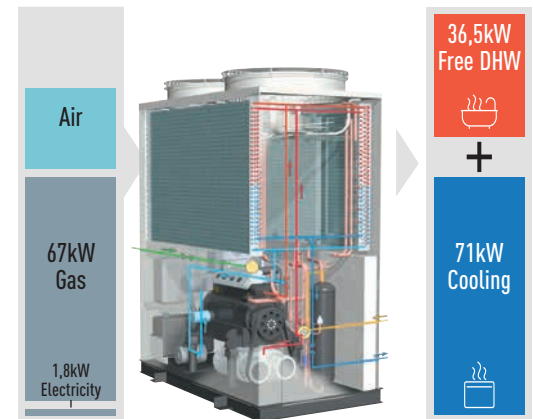
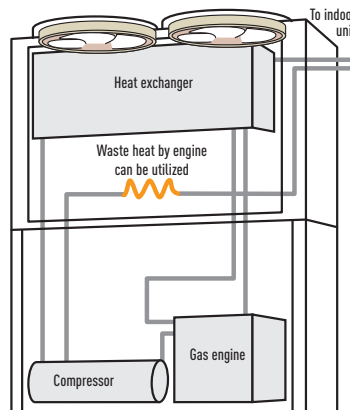

* Regarding a 25HP model.

4 benefit points of ECO G Series

1 Limited electric supply.
Electric consumption of ECO G is only 9% compared to ECOi because gas engine is utilized for the compressor driving source.

2 High demand of DHW with heating and cooling cogeneration.
DHW is produced effectively thanks to heat from engine exhaust during heating and cooling.

3 Open and flexible design.
ECO G system is designed to connect various Indoor units and controllers which is available for ECOi system. With new GE3 series, Pump sown system has been also implemented to answer commercial needs.

4 Heating at low ambient temperature up to -20°C.
Stable heating capacity has been realized with waste heat recovery from the engine even if outside temperature is quite low.

Comparison of heating capacity.

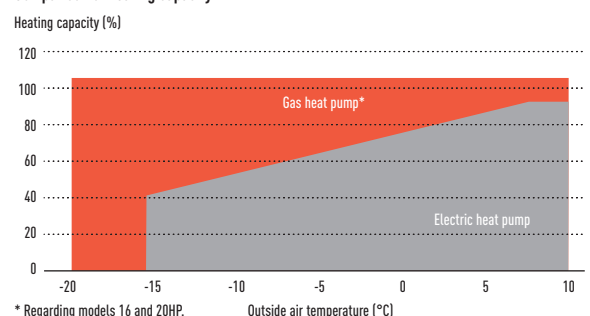

* Regarding models 16 and 20HP.

ECO G, THE GAS DRIVEN VRF

ECO G satisfies special requirement for your application and environmentally friendly solution by Panasonic professional technology.

Reliable quality by long development history since 1985.

Our GHP VRF range of commercial systems is leading the industry in the development of efficient and flexible systems



Power supply problems?

If you are short of electric power, our ECO G is a perfect solution.

- Runs on natural gas or LPG and just needs single phase supply
- Enables the building's electrical power supply to be used for other critical electrical demands
- Reduces capital cost to upgrade power substations to run heating and cooling systems
- Reduces power loadings within a building especially during peak periods
- Electricity supply freed up for other uses such as IT servers, commercial refrigeration, manufacturing, lighting, etc...

Limited electricity area. Comparison of electrical consumption on a 71kW outdoor unit.

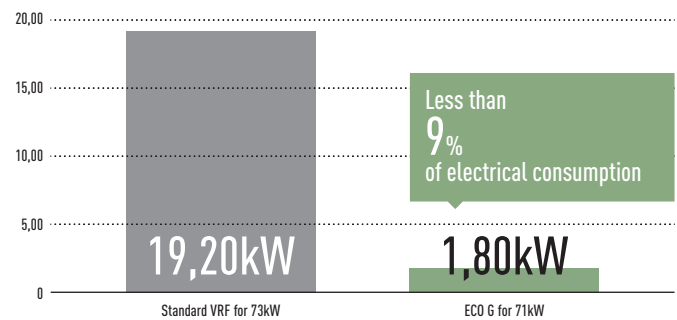

High demand of Domestic Hot Water in heating and cooling

Generates electricity during heating or cooling operation.

Generates electricity and air conditioning (heating or cooling) at the same time by using remaining engine power.

The rejected heat from the engine is available for DHW production and can supply up to 46kW of hot water at 65°C. DHW at 65°C is also ready to use in heating without additional electric heaters.

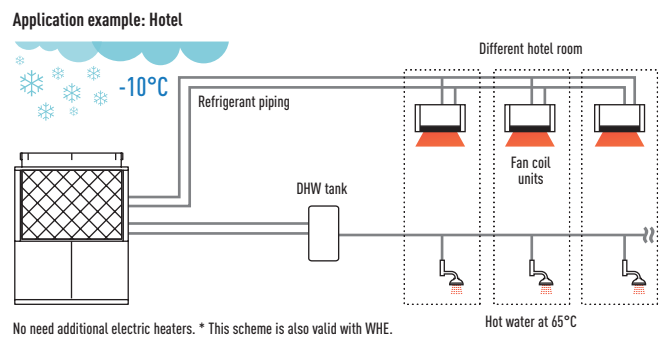

Quick start up and great heating capacity at low ambient temperature

Waste heat from gas engine is utilized to raise temperature quicker than electric VRF system.

This contributes great heating capacity at extremely low ambient temperature.

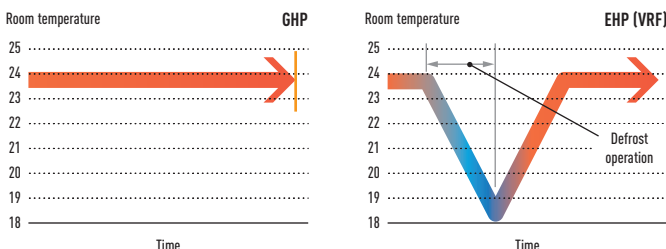

Lowest nitrogen oxide emissions.

The GHP VRF systems have the lowest nitrogen oxide emissions. In a pioneering development, the Panasonic GHP features a brand new lean-burn combustion system that utilizes air fuel ratio feedback control to reduce NOx emissions to an all time low.

Water chiller option.

Our GHP system is also available with a water chiller option, which can be combined with individual outdoor units or as part of a DX chilled water mix of indoor units. The system can be operated via a BMS system or a Panasonic supplied control panel, with chilled water set points from -15°C ~ +15°C and heating set points 35°C ~ +55°C.

Application

Application	Condition	ECO G
Hotel	High DHW demand	✓ Energy recovery of ECO G system can fulfill different requirement
Hotel	Needs to warm up swimming pool	✓
Office	Quick start up is necessary	✓ Speed of start up is quicker than VRF system
Winery	1) Outlet water demand at specific temperature 2) Needs high amount of power temporary (not every month)	✓ 1) Chiller application with hydro module (ECO G + WHE) can make this special process 2) Running cost can be saved since fixed Gas tariff per month is cheaper than fixed electric tariff.
Any building	In a city with power restriction	✓ - No need an additional power transformer - Space and cost can be saved
	At extremely low ambient condition	✓ Heating capacity is kept up to -20°C without defrost process

Project Case Studies



Savills HQ Dublin & Google Block R. Ireland.

ECO G 3-way units with a 243kW load.
The project has been such a success that it has recently been awarded a Panasonic PRO Award for Best Contribution of efficient projects within Europe.



Thomas Cook's Sunprime Atlantic View resort.

A holiday resort in the Canaries. Spain.
229 rooms plus full spa and swimming pool facility.



CAPITA call centre. UK.

11 ECO G 3-way units.
Over 150 indoor units in meeting rooms and open-plan areas.
Intelligent touch screen controller, the CZ-256ESMC2.



French winery Gennevilliers, France.

ECO G 3-way units. One of the best solution utilized our ECO G solution for wine production process.



NEW ECO G GE3 SERIES

Improvement in blast efficiency

New 3-blades fan.

Propeller shape with 3 blades is more efficient. Max. 30% of fan electrical consumption is saved compared to conventional fan.

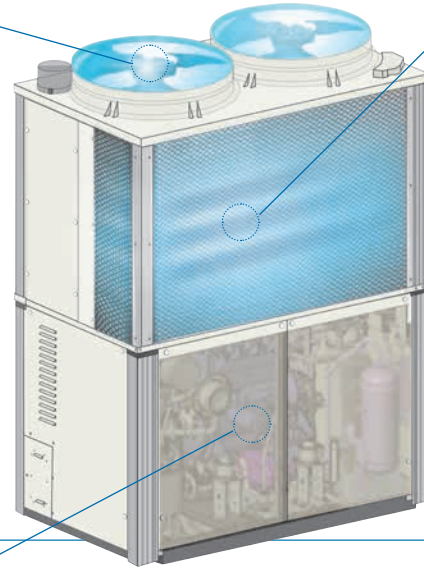
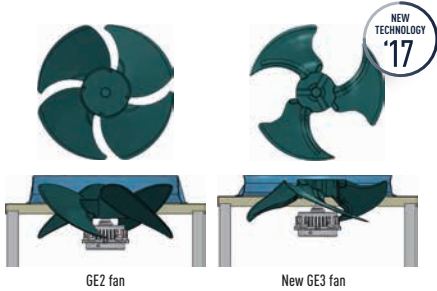

New "L" type heat exchanger

Heat exchanger surface area is included by 25% compared to conventional model to optimize efficiency.

Heat exchanger surface area **25% up**

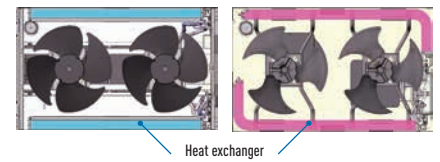

Better partial load control

Reduce start / stop loss has reduced by expanding the are where continuous operation is possible. Annual operation efficiency has further improved by better efficiency at lower partial load.

Compressor.

- Amount of internal leakage has reduced by the reduction of clearance, the compressor efficiency in the low load and low rotation region has been greatly improved.
- Moreover, efficiency of high speed and high load is also improved by reduction of suction pressure loss due to expansion of suction path
- Optimize compressor capacity

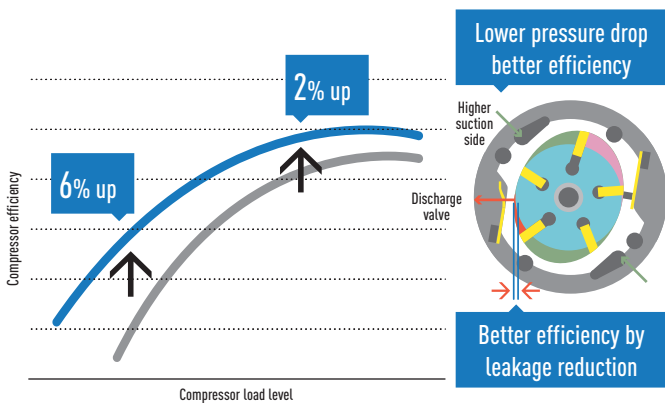

Engine.

- Continuous operation area has expanded at lower partial load by expanding operation area of lower speed
- Engine efficiency has improved by shifting output points to higher torque side

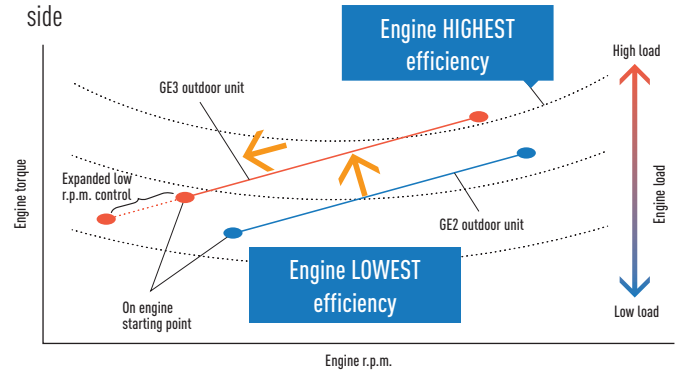

Engine pulley.

- Bigger diameter of engine pulley contributes the optimization of the compressor rotation speed ratio with engine speed
- Higher engine pulley diameter giving better performance at partial load and reducing ON/OFF operation.

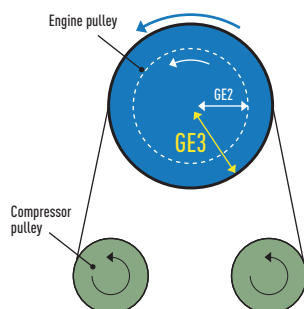

New line up of W-Multi

- For new or renewal
- Available for water heat exchanger
- Maximum 60HP combination

Introducing new ECO G GE3 Series.
Optimized energy saving with reliable Panasonic technologies.

High power efficiency of W-Multi system

GE3 system offers seasonal efficiency which has been drastically improved with new heat exchanger design, blast efficiency, partial load control.

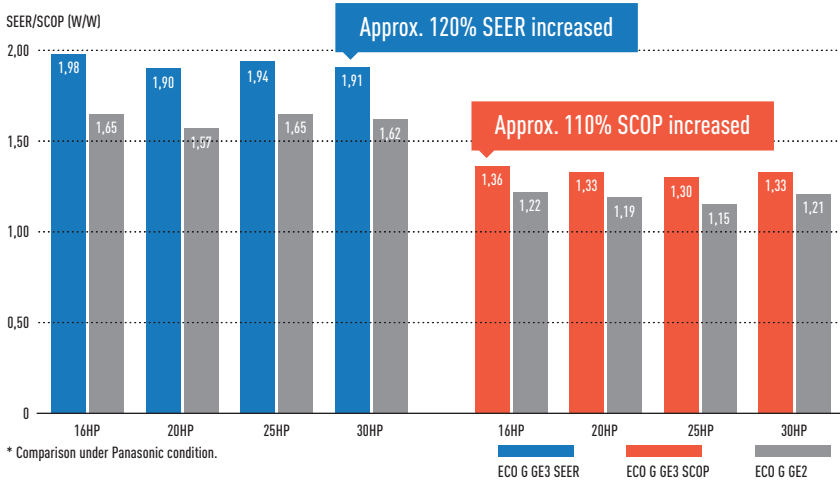

Compared to conventional model ECO G GE2.

All models are newly developed and have maximum 21% of SEER, 13% of SCOP better than conventional model.

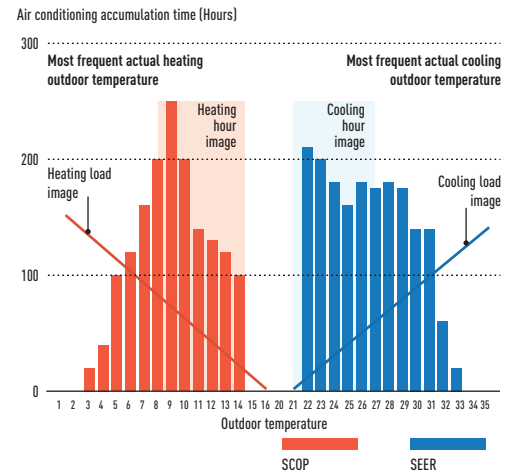

Heating design operation conditions

Operating range in heating has been expanded up to 24°C (WB) for air to water system to meet the demand of swimming pool application.

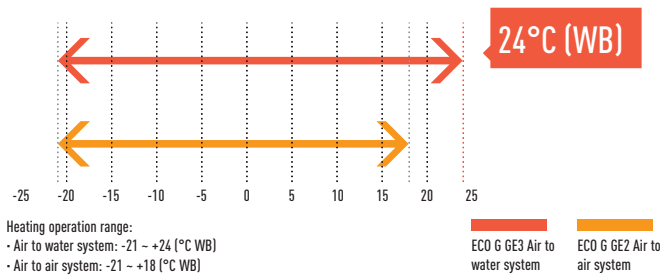

DHW priority mode setting in heating

Ambient temperature range for DHW production is expandable by setting depending on DHW needs. Hot water at 65°C is available in heating without additional electric heaters.

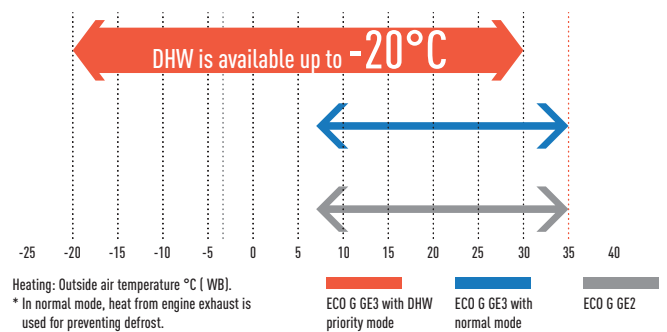

Automatic refrigerant leak detection is available

One of the big advantage is that new GE3 series can be connected to pump down system. Now refrigerant leak is detected automatically in not only ECOi system but also ECO G system.

No defrost requirement

No defrost mode is selectable to get higher capacity under low ambient temperature.

Flexible design with wide line up of indoor units

The advanced GE3 series can connect up to 64 indoor units.

Series	16HP	20HP	25HP	30HP	32HP	36HP	40HP	45HP	50HP	55HP	60HP
GE2 2-Pipe	24	24	24	32	48	48	48	48	48	48	48
GE3 2-Pipe	26	33	41	50	52	59	64	64	64	64	64

NEW ECO G GE3 SERIES 2-PIPE

New ECO G GE3 Series 2-Pipe.

The new GE3 Series has a top level of seasonal efficiency in this category. In addition, this product fits with special needs for commercial application thanks to DHW priority setting and Auto pump down functions.

Technical focus

- 20% of SEER and 10% of SCOP have been improved
- Operating range in heating up to 35°C
- DHW priority setting
- Auto pump down system available
- 0-10V control demand by a connection with 3rd party controllers (CZ-CAPBC2 required)
- Option of DX or chilled water for indoor heat exchange

HP			16HP	20HP	25HP	30HP
Model			U-16GE3E5	U-20GE3E5	U-25GE3E5	U-30GE3E5
Power supply	Voltage	V	220 / 230 / 240	220 / 230 / 240	220 / 230 / 240	220 / 230 / 240
	Phase		Single Phase	Single Phase	Single Phase	Single Phase
	Frequency	Hz	50	50	50	50
Cooling capacity		kW	45,0	56,0	71,0	85,0
Input power cooling		kW	1,17	1,12	1,80	1,80
Hot water in cooling mode (at 65°C outlet)		kW	23,6	29,1	36,4	46,0
SEER		W/W	1,98	1,90	1,94	1,91
Max COP in hot water		W/W	1,55	1,55	1,49	1,47
Gas consumption cooling	Standard / Low temperature	kW	41,1	52,1	67,2	84,1
Heating capacity	Standard / Low temperature	kW	50,0 / 53,0	63,0 / 67,0	80,0 / 78,0	95,0 / 90,0
Input power heating			0,56	1,05	0,91	1,75
SCOP	A2A	W/W	1,36	1,33	1,30	1,33
Gas consumption heating	Standard / Low temperature	kW	38,0 / 45,4	51,1 / 62,7	68,6 / 60,7	75,3 / 73,9
Starter amperes		A	30	30	30	30
External static pressure		Pa	10	10	10	10
Air volume		m ³ /min	370	420	460	460
Sound pressure	Normal / Silent	dB(A)	80 / 77	80 / 77	84 / 81	84 / 81
Dimensions	H x W x D	mm	2.255 x 1.650 x 1.000	2.255 x 1.650 x 1.000	2.255 x 2.026 x 1.000	2.255 x 2.026 x 1.000
Net weight		kg	765	765	870	880
Piping connections	Liquid pipe	Inch (mm)	1/2 (12,70)	5/8 (15,88)	5/8 (15,88)	3/4 (19,05)
	Gas pipe	Inch (mm)	1-1/8 (28,58)	1-1/8 (28,58)	1-1/8 (28,58)	1-1/4 (31,75)
	Balance pipe	Inch (mm)	—	—	—	—
Elevation difference (in/out)		m	50	50	50	50
Refrigerant (R410A)		kg / TCO: Eq.	11,5 / 24,0	11,5 / 24,0	11,5 / 24,0	11,5 / 24,0
Maximum number of connectable indoor units			26	33	41	50
Operating range	Cooling Min - Max	°C (DB)	-10 - +43	-10 - +43	-10 - +43	-10 - +43
	Heating Min - Max	°C (WB)	-21 - +18	-21 - +18	-21 - +18	-21 - +18

Hot water take out function added, EU safety regulation standard cleared. 25HP chassis enlarged due to specification improvement.
Pre-coat corrosion fin. Auto pump down function.





HP			32HP	36HP	40HP	45HP	50HP	55HP	60HP
Model			U-16GE3E5	U-16GE3E5	U-20GE3E5	U-20GE3E5	U-25GE3E5	U-25GE3E5	U-30GE3E5
Power supply	Voltage	V	220 / 230 / 240	220 / 230 / 240	220 / 230 / 240	220 / 230 / 240	220 / 230 / 240	220 / 230 / 240	220 / 230 / 240
	Phase		Single Phase	Single Phase	Single Phase	Single Phase	Single Phase	Single Phase	Single Phase
	Frequency	Hz	50	50	50	50	50	50	50
Cooling capacity		kW	90	101	112	127	142	156	170
Input power cooling		kW	2,34	2,29	2,24	2,92	3,6	3,6	3,6
Hot water in cooling mode (at 65°C outlet)		kW	47,2	52,7	58,2	65,5	72,8	82,42	92,04
SEER		W/W	1,98	1,94	1,90	1,92	1,94	1,92	1,91
Max COP in hot water		W/W	1,55	1,55	1,55	1,52	1,49	1,48	1,47
Gas consumption cooling	Standard / Low temperature	kW	82,20	93,20	104,20	119,30	134,40	151,30	168,20
Heating capacity	Standard / Low temperature	kW	100 / 106	113 / 120	126 / 134	143 / 145	160 / 156	175 / 168	190 / 180
Input power heating			1,12	1,61	2,10	1,96	1,82	2,66	3,50
SCOP	A2A	W/W	1,36	1,34	1,33	1,31	1,30	1,31	1,33
Gas consumption heating	Standard / Low temperature	kW	76,0 / 90,8	89,1 / 108,1	102,2 / 125,4	119,7 / 123,4	137,2 / 121,4	143,9 / 134,6	150,6 / 147,8
Starter amperes		A	30	30	30	30	30	30	30
External static pressure		Pa	10	10	10	10	10	10	10
Air volume		m ³ /min	370 / 370	370 / 420	420 / 420	420 / 460	460 / 460	460 / 460	460 / 460
Sound pressure	Normal / Silent	dB(A)	83 / 80	83 / 80	83 / 80	86 / 83	87 / 84	87 / 84	87 / 84
	Height	mm	2.255	2.255	2.255	2.255	2.255	2.255	2.255
	Width	mm	1.650 + 100 + 1.650	1.650 + 100 + 1.650	1.650 + 100 + 1.650	1.650 + 100 + 2.026	2.026 + 100 + 2.026	2.026 + 100 + 2.026	2.026 + 100 + 2.026
Dimensions	Depth	mm	1.000	1.000	1.000	1.000	1.000	1.000	1.000
	Net weight	kg	1.530 (765 + 765)	1.530 (765 + 765)	1.530 (765 + 765)	1.635 (765 + 870)	1.740 (870 + 870)	1.750 (870 + 880)	1.760 (880 + 880)
Piping connections	Liquid pipe	Inch (mm)	3/4 (19,05)	3/4 (19,05)	3/4 (19,05)	3/4 (19,05)	3/4 (19,05)	7/8 (22,22)	7/8 (22,22)
	Gas pipe	Inch (mm)	1-1/4 (31,75)	1-1/4 (31,75)	1-1/2 (38,10)	1-1/2 (38,10)	1-1/2 (38,10)	1-1/2 (38,10)	1-1/2 (38,10)
	Balance pipe	Inch (mm)	—	—	—	—	—	—	—
Elevation difference (in/out)		m	50	50	50	50	50	50	
Refrigerant (R410A)		kg / TCO ₂ Eq.	2x 11,5 / 24,0	2x 11,5 / 24,0	2x 11,5 / 24,0	2x 11,5 / 24,0	2x 11,5 / 24,0	2x 11,5 / 24,0	
Maximum number of connectable indoor units			52	59	64	64	64	64	
Operating range	Cooling Min ~ Max	°C (DB)	-10 ~ +43	-10 ~ +43	-10 ~ +43	-10 ~ +43	-10 ~ +43	-10 ~ +43	-10 ~ +43
	Heating Min ~ Max	°C (WB)	-21 ~ +18	-21 ~ +18	-21 ~ +18	-21 ~ +18	-21 ~ +18	-21 ~ +18	-21 ~ +18

Hot water take out function added, EU safety regulation standard cleared. 25HP chassis enlarged due to specification improvement. Pre-coat corrosion fin. Auto pump down function.



ECO G GF2 3-PIPE



Power supply problems?

If you are short of electrical power, our gas heat pump could be the perfect solution:

- Runs on natural gas or LPG and just needs Single Phase supply
- Enables the building's electrical power supply to be used for other critical electrical demands
- Reduces capital cost to upgrade power substations to run heating and cooling systems
- Reduces power loadings within a building especially during peak periods
- Electricity supply freed up for other uses such as IT servers, commercial refrigeration, manufacturing, lighting etc.

GHP Outdoor Heat Exchanger

- Integrated DX and hot water coil
- No defrost required
- Faster reaction to demand for heating

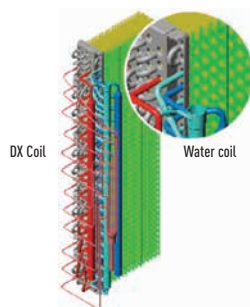

Excellent performance

Panasonic 3-Pipe Multi system is capable of simultaneous heating/cooling and individual operation of each indoor unit by only one outdoor unit. As a result, efficient individual air conditioning is possible in buildings having diverse room temperatures.

System example.

Improved maintenance intervals. The unit only needs to be serviced every 10,000 hours. This is the best in the industry.

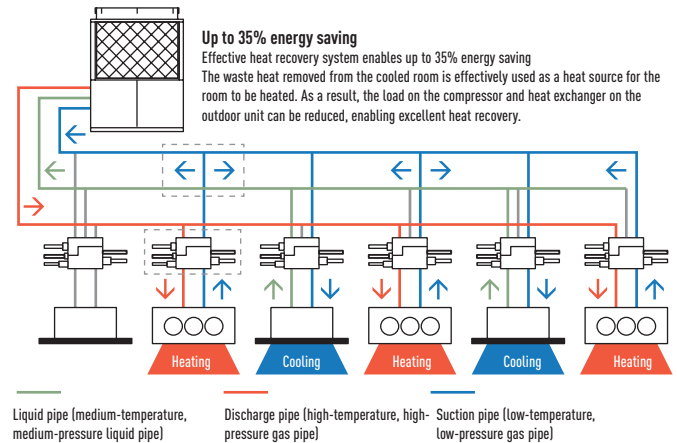

Solenoid valve kit.

To be fitted on all 'zones' to allow simultaneous heating and cooling. Up to 36 indoor units are capable of simultaneous heating/cooling operation. Oil-recovery operation to gives more stable comfort air-conditioning control.

3-Pipe control Solenoid valve kit

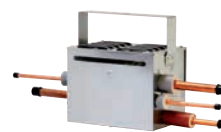

CZ-P56HR3
Up to 5,6kW
CZ-P160HR3
Up to 16,0kW

KIT-P56HR3
(CZ-P56HR3+CZ-CAPE2)
KIT-P160HR3
(CZ-P160HR3+CZ-CAPE2)

3-Pipe control PCB



CZ-CAPE2*
3-Pipe control PCB

* For wall mounted. Must be added to the CZ-P56HR3 or CZ-P160HR3.

Comparison of heating capacity.

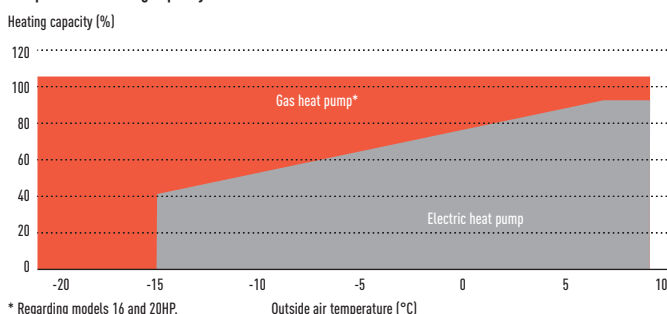

Comparison of the start times for heating operation.

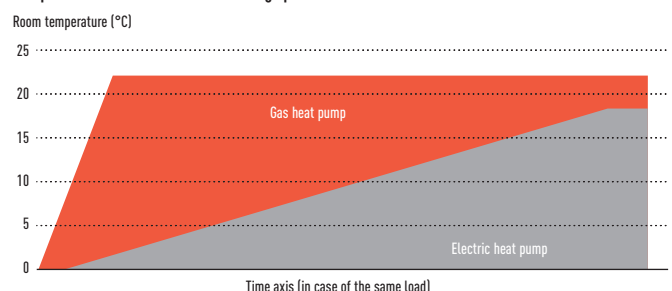

ECO G GF2 3-PIPE

3-Pipe heat recovery system with simultaneous heating & cooling.

The only 3-Pipe GHP system in Europe, the S Series ECO G GF2 3-Pipe offers even more performance and outstanding features when you need simultaneous heating and cooling. Now with capacities available from 16HP to 25HP, Panasonic offers the greatest choice and flexibility to solve any power problem or site requirement.

Technical focus

- Reduced gas consumption by Miller-cycle engine
- Reduced electrical power consumption by using DC Motors
- Capacity ratio 50–200%
- Quiet mode offers a further 2dB(A) reduction
- Part load efficiencies increased
- Connectivity increased to up to 24 indoor units
- 145m maximum allowable piping length (L1)
- Extended pipe runs (total 780m)
- Option of using LPG as a power supply (increases flexibility and avoids problems of potential site restrictions in the future. The purer fuel is also excellent for further reductions in CO₂ emissions)
- Full heating capacity down to -21°C
- No defrost cycle



* Assuming 3,120 running hours per year - 12 h x 5 days x 52 weeks

HP			16HP	20HP	25HP
Model			U-16GF2E5	U-20GF2E5	U-25GF2E5
Cooling capacity		kW	45,00	56,00	71,00
Input power cooling		kW	0,71	1,02	1,33
EER (Calorific Value) ¹	Hi / Lo	W/W	1,48 / 1,64	1,40 / 1,55	1,15 / 1,28
Cooling gas consumption		kW	29,7	39,1	60,4
Heating capacity	Standard	kW	50,00	63,00	80,00
	Low temperature ²	kW	53,00	67,00	78,00
Input power heating		kW	0,60	0,64	0,83
COP (Calorific Value) ¹	Hi / Lo	W/W	1,51 / 1,68	1,46 / 1,62	1,48 / 1,64
Gas consumption	Standard	kW	32,5	42,5	53,2
	Low temperature ²	kW	41,5	56,4	62,3
COP	Average		1,50	1,43	1,32
Starter amperes		A	30	30	30
Operation sound		dB(A)	57	58	62
Dimensions	H x W x D	mm	2,273 x 1,650 x 1,000 (+80)	2,273 x 1,650 x 1,000 (+80)	2,273 x 1,650 x 1,000 (+80)
Net weight		kg	775	775	805
Pipe Connections	Gas	Inch (mm)	1 1/8 (28,58)	1 1/8 (28,58)	1 1/8 (28,58)
	Liquid	Inch (mm)	3/4 (19,05)	3/4 (19,05)	3/4 (19,05)
	Discharge	Inch (mm)	7/8 (22,22)	1 (25,40)	1 (25,40)
	Fuel gas		R3/4	R3/4	R3/4
	Exhaust drain port	mm	25	25	25
Refrigerant (R410A)		kg / TCO ₂ Eq.	10,5 / 21,9	11,5 / 24,0	11,5 / 24,0
Maximum allowable indoor / outdoor capacity ratio			50–200% ³	50–200% ³	50–200% ³
Maximum number of connectable indoor units			24	24	24

1) Referred to Natural Gas (HCV 37,78 MJ/Nm³ or 55,56 MJ/kg; LCV 34,00 MJ/Nm³ or 50,00 MJ/kg). 2) Low temperature condition: outdoor temperature 2°C. 3) Indoor unit can be connected to up to 16kW model (model size 60). Cooling and heating capacities in the tables are determined under the test conditions of JIS B 8627. Effective heating requires that the outdoor air intake temperature be at least -20°C DB or -21°C WB. Gas consumption is the total (high) calorific value standard. Outdoor unit operating sound is measured 1m from the front and 1,5m above the floor (in an anechoic environment). Actual installations may have larger values due to ambient noise and reflections.

Solenoid valve kit

KIT-P56HR3	KIT-P56HR3	3-Pipe control solenoid valve kit (up to 5,6kW)
	CZ-P56HR3	Solenoid valve kit (up to 5,6kW)
	CZ-CAPE2	3-Pipe control PCB
KIT-P160HR3	KIT-P160HR3	3-Pipe control solenoid valve kit (from 5,6kW to 10,6kW)
	CZ-P160HR3	Solenoid valve kit (up to 10,6kW)
	CZ-CAPE2	3-Pipe control PCB
CZ-CAPEK2		3-Pipe control PCB for wall mounted

3-Pipe control box kit

CZ-P456HR3	4 ports 3 pipe box (up to 5,6kW)
CZ-P656HR3	6 ports 3 pipe box (up to 5,6kW)
CZ-P856HR3	8 ports 3 pipe box (up to 5,6kW)
CZ-P4160HR3	4 ports 3 pipe box (up to 16,0kW)

Service kits model

Material included	Kit CZ-PSK560SP
Oil filter	1
Air cleaner element	1
Spark plug	4
V Belt (for compressor)	1
V Belt (for generator)	1
Oil absorption mats	1
Drain filter packing	1



WATER HEAT EXCHANGER FOR HYDRONIC APPLICATIONS



When a top London restaurant opened, it needed large volumes of fresh air to ensure the optimum dining environment. GHP units connected to the cooling coils within the air handling equipment ensured the air was introduced in the right condition in both summer and winter.

Chiller replacement. Chilled water supply to fan coils

Chiller replacement.

When some old chillers needed replacing at the end of their operational lifetime, GHPs with Water Heat Exchangers enabled the project to be carried out in stages whilst still utilising the existing water pipe work and fan coils. This enabled the project to be delivered on time, to a restricted budget and avoided all issues regarding refrigerant in confined spaces.



Connection to 'close control' computer equipment

Computer room applications.

When all available electrical power needed to be utilised for the IT equipment for a leading international bank, the cooling load of over 450kW had to be powered by gas. The outdoor units were connected via Water Heat Exchangers to cooling coils inside the 'close control' units thereby maintaining a conditioned environment for temperature and humidity. By utilising the hot water function over 100kW of hot water are supplied to the building and therefore the additional benefit of considerable CO₂ savings is ensured.

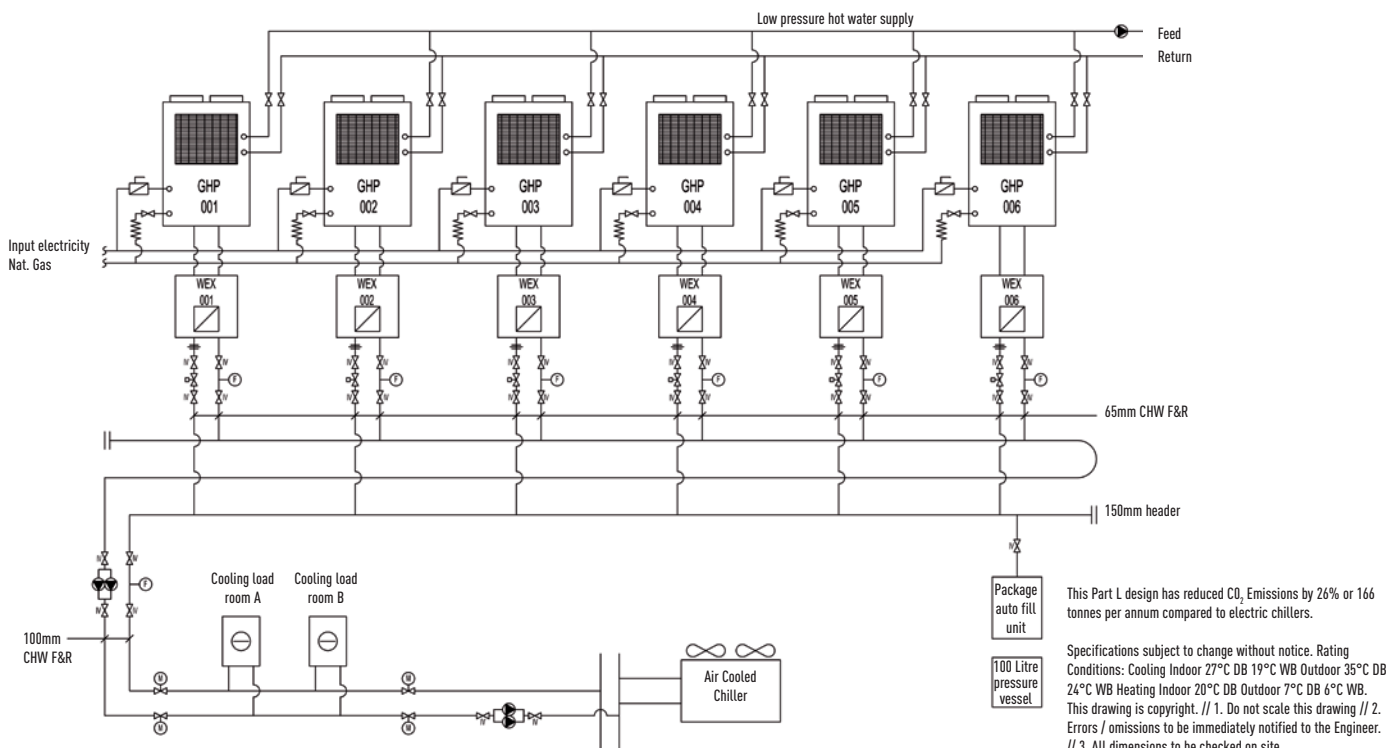

ECOi 2-PIPE WITH WATER HEAT EXCHANGER FOR CHILLED AND HOT WATER PRODUCTION



The Panasonic solution for chilled and hot water production!

For hydronic applications

Water Heat Exchanger (WHE) for ECOi. Operation and control by timer remote control CZ-RTC4. Energy-efficient capacity control. Stainless steel plate heat exchanger with anti-freeze protection control. Change-over between heating and cooling operation.

Technical focus

- A class water pump included
- 4 Way valve included
- Heating, cooling and DHW
- Increased energy efficiency and low CO₂ emissions
- Water connections R2" f for 28kW and R2,5" f for 50kW
- Maximum distance between outdoor unit and WHE: 170m
- Maximum hot water outlet temperature: 45°C
- Minimum chilled water outlet temperature: 5°C
- Outdoor temperature range in cooling mode: +5°C to +43°C
- Outdoor temperature range in heating mode: -11°C to +15°C (with low temperature kit -25°C)

ECOi Water Heat Exchanger

Electrical VRF with Water Heat Exchanger

- With this easy to install Water Heat Exchanger unit, you can now cover projects up to 51kW hot water demand or 44kW on chilled application on a efficient way and cost effective

System example

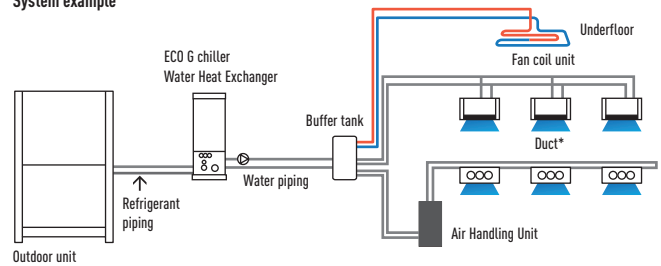

A Buffer tank of minimum 280l for 28kW and 500l for 50kW is always needed.

New electrical panel with new algorithm

- Optimized heat exchanger to increase drastically the efficiency
- Liquid receiver to outperform the functionality of the WHE
- Unique 4 way valve in order always have counterflow fluid circulation in heating and cooling fluid circulation on both sides of the cross flow. This optimizes efficiency!



Optional Controller. Wired remote controller CZ-RTC5A Compatible with Econavi



Optional Controller. Timer remote controller CZ-RTC4 Compatible with Econavi

Hydrokit with A class water pump*		PAW-250WX2E5N		PAW-500WX2E5N	
Hydrokit without pump		PAW-250WX2E5N2		PAW-500WX2E5N2	
Cooling capacity at 35°C, water outlet 7°C	kW	25,0		50,0	
Heating capacity	kW	28,0		56,0	
Heating capacity at +7°C, heating water temperature at 45°C	kW	28,0		56,0	
COP at +7°C with heating water temperature at 45°C	W/W	2,97		3,10	
Heating Energy Efficiency class at 35°C		A+		A++	
Dimensions	H x W x D	1.010 x 570 x 960		1.010 x 570 x 960	
Net weight	kg	120		145	
Water pipe connector		Rp2 Female Thread (50A)		Rp2 Female Thread (50A)	
Heating water flow (ΔT=5 K, 35°C)	m ³ /h	4,3		8,6	
Capacity of integrated electric heater	kW	Not equipped		Not equipped	
Input power	kW	0,01 + (min. 0,05 / max. 0,13 for water pump)		0,01 + (min. 0,19 / max. 0,31 for water pump)	
Maximum current	A	0,07 + (min. 0,37 / max. 0,95 for water pump)		0,07 + (min. 0,88 / max. 1,37 for water pump)	
Outdoor Unit		U-10ME2E8		U-20ME2E8	
Sound pressure	dB(A)	59		63	
Dimensions / Net weight	H x W x D	1.758 x 770 x 930 / 234		1.758 x 1.540 x 930 / 421	
Piping connections	Liquid pipe / Gas pipe	3/8 (9,52) / 7/8 (22,22)		5/8 (15,88) / 1-1/8 (28,58)	
Refrigerant (R410A)	kg	6,8 *Need Additional gas amount at site		9,0 *Need Additional gas amount at site	
Pipe length range / Elevation difference (in/out)	m	170 / 50 (OD above) 35 (OD below)		170 / 50 (OD above) 35 (OD below)	
Pipe length for nominal capacity	m	7,5		7,5	
Pipe length for additional gas / Additional gas amount (R410A)	m / g/m	0 < / Refer to manual		0 < / Refer to manual	
Operation range	Heating Min - Max	-11 ~ +15 ¹⁾		-11 ~ +15 ¹⁾	
Water outlet at 5 / 15 ²⁾	°C	35 ~ 45		35 ~ 45	

* PAW-250WX2E5N includes pump with 0-10 Volt Control by default / PAW-500WX2E5N includes pump with 0-10 Volt with optional IF.

1) With accessory low temperature kit -25 ~ +15°C.

Performance calculation in agreement with Eurovent. Sound pressure measured at 1m from the outdoor unit and at 1,5m height.

ECO G WITH WATER HEAT EXCHANGER FOR CHILLED AND HOT WATER PRODUCTION



Excellent applicability when there is a thermal demand for heat, DHW and cooling, as well as additional thermal usages.

For hydronic applications

Water Heat Exchanger. Operation and control by timer remote control CZ-RTC4. Energy-efficient capacity control. Stainless steel plate heat exchanger with anti-freeze protection control. Change-over between heating and cooling operation.

Technical focus

- A class water pump included (only in N model)
- No cascade installation up to 80kW
- Water connections R2,5" f
- Maximum distance between outdoor units and WHE: 170m
- Possibility to mix DX and Water Heat Exchanger systems
- Super silent outdoor units
- Hot water outlet temperatures from 35°C to 55°C
- Chilled water outlet temperatures from -15°C to +15°C
- Outdoor temperature range in cooling mode: -10°C to +43°C
- Minimum outdoor temperature in heating mode: -21°C

Case Study, Hotel Application

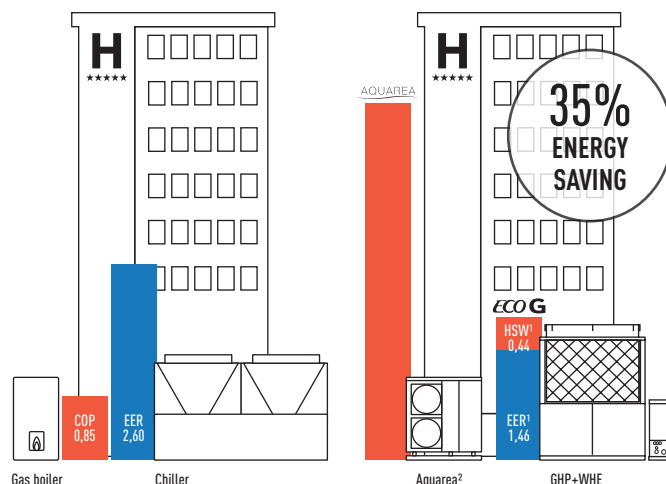

1) Total COP= 1,90, calculated in primary energy (U-20GE2E8). Equivalent EER (2007/749)= 3,73.
2) Electric to support pick of consumption on domestic hot water.

Example of Hotel renewal of existing Chiller and Boiler system with Panasonic GHP and Aquarea mixed solution

GHP and Aquarea are the smart solution for renewal Chiller/Boiler applications with annual running cost savings around 13.600€.



Optional Controller. Wired remote controller CZ-RTC5A. Compatible with Econavi



Optional Controller. Timer remote controller CZ-RTC4. Compatible with Econavi

Hydrokit with A class water pump*			PAW-500WX2E5N	PAW-710WX2E5N
Hydrokit without pump			PAW-500WX2E5N2	PAW-710WX2E5N2
Heating Capacity		kW	60,0	80,0
Heating Capacity at +7°C, heating water temperature at 35°C		kW	60,9	81,2
COP at +7°C with heating water temperature at 35°C		W/W	1,15	1,18
Heating Capacity at +7°C, heating water temperature at 45°C		kW	60,0	80,0
COP at +7°C with heating water temperature at 45°C		W/W	1,02	1,04
Heating Capacity at -7°C, heating water temperature at 35°C		kW	48,2	50,8
COP at -7°C, heating water temperature at 35°C		W/W	0,80	0,80
Heating Capacity at -15°C, heating water temperature at 35°C		kW	46,3	50,0
COP at -15°C with heating water temperature at 35°C		W/W	0,80	0,80
SCOP		W/W	1,30	1,27
Cooling capacity		kW		
Cooling capacity at +35°C, outlet temperature 7°C, inlet temperature 12°C		kW	50	67
EER at +35°C, outlet temperature 7°C, inlet temperature 12°C		W/W	0,78	0,89
SEER		W/W	1,75	1,72
Dimensions / Weight	H x W x D	mm / kg	1.010 x 570 x 960 / 145	1.010 x 570 x 960 / 180
Water pipe connector				
Heating water flow $\Delta T=5$ K, 35°C		m ³ /h	10,32	13,76
Capacity of integrated electric heater		kW		
Input power		kW		
Maximum current		A		
Outdoor Unit			U-20GE3E5	U-30GE3E5
Sound pressure power level	Normal / Silent	dB(A)	83 / 80	84 / 81
Dimensions / Weight	H x W x D	mm / kg		
Piping connections	Liquid pipe / Gas pipe	mm	5/8 (15,88) / 1-1/8 (28,58)	3/4 (19,05) / 1-1/4 (31,75)
Pipe length / for nominal capacity	Max.	m	7 / 170	7 / 170
Elevation difference (in/out)		m	50 (OD above) 35 (OD below)	50 (OD above) 35 (OD below)
Operation range	Heating Min - Max	°C	-21 - 24 (until outlet temperature 45)	-21 - 24 (until outlet temperature 45)
Water outlet at -15 / 15°		°C	35 - 55	35 - 55

Performance calculation in agreement with Eurovent. Sound pressure measured at 1m from the outdoor unit and at 1,5m height. * PAW-500WX2E5N and PAW-710WX2E5N includes pump with 0-10 Volt with optional IF.

LEAK DETECTION AND AUTOMATIC REFRIGERANT PUMP DOWN



Improving safety and the environment

Panasonic has developed an innovative solution to detect refrigerant leaks that offer complete assurance and protection for end users, building occupiers and the environment. Panasonic's Pump Down System is ideal for hotels, offices and public buildings where safety for occupants and the building owners is of utmost importance.

The system monitors refrigerant leakage continually and provides a warning before refrigerant leaks, preventing major refrigerant loss and potentially damaging the system's efficiency. The new system can improve potential refrigerant loss to approximately 90%.

As well as ensuring safe and reliable operation, Panasonic's Pump Down System contributes to a building qualifying for additional BREEAM points and enables compliance with current EN378 2008 standards, covering applications where refrigeration concentration levels exceed practical safety limits of 0,44 kg/m³.

Panasonic has developed two detection methods that can operate simultaneously to offer complete protection for owners, building occupiers and the environment.

Pump Down system

This innovative pump down system can be connected in two ways:

- With sensor leakage
- Without sensor leakage, using only an innovative algorithm

Basic pump down function:

- Detect the leakage
- Activate pump down process
- Collect the gas in the tank
- Close the valves to isolate the gas

Key points:

- Comply with legislation
- Protect personnel
- Protect the environment
- Save on operating costs

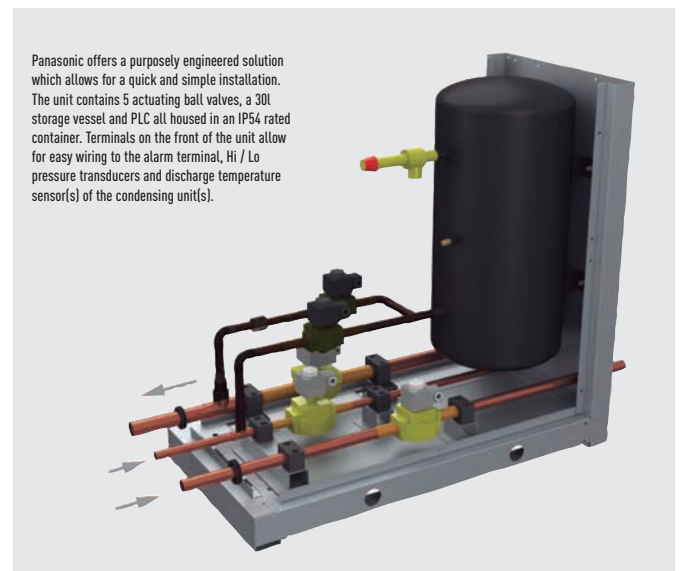

Panasonic offers a purposely engineered solution which allows for a quick and simple installation. The unit contains 5 actuating ball valves, a 30l storage vessel and PLC all housed in an IP54 rated container. Terminals on the front of the unit allow for easy wiring to the alarm terminal, Hi / Lo pressure transducers and discharge temperature sensor(s) of the condensing unit(s).

R22 Renewal

Panasonic's advanced technology enables the system to work with previously installed pipe work by managing the working pressure within the system down to R22 (33 bar) levels, this ensures the system works safely and efficiently without loss of capacity.

The new equipment can offer increased COP/EER by using state of the art inverter compressor and heat exchanger technology.

Having contacted your Panasonic supplier regarding pipe work restrictions and gained approval to use the Panasonic Renewal System there are three

main tests that have to be carried out to ensure that the system can be used effectively. Firstly a thorough inspection of the pipe work must be carried out and any damage must be repaired. Secondly an oil test has to be carried out to ensure that the system has not been subject to a compressor burnout during its lifetime. Lastly a VRF Renewal Kit (CZ-SLK2) has to be installed within the pipe work to ensure that the system is cleaned of any remnants of oil.



DESIGN SUPPORT SOFTWARE FOR VRF



Features the unique **Mounting Scheme** function providing more thorough spec-in and tender quotation support for easier, faster completion of work

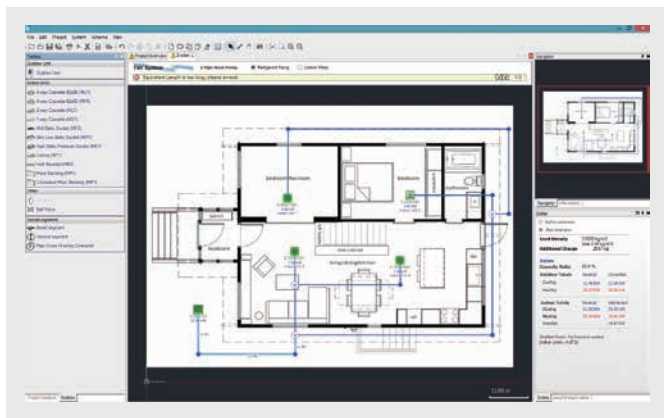

The **Panasonic VRF Designer** software can be used for all **Panasonic VRF ME2, LE1 and MF2**.

Panasonic has identified the importance of ever-increasing demands for fast and accurate responses to customer requests in our industry. More and more emphasis is being placed upon energy-efficiency in our marketplace. The ability to calculate cooling/heating loads and produce information of actual design conditions is a major advantage to any architect, consultant, contractor or end user.

Panasonic understands the time-poor and demanding industry we are in and we are pleased to announce the launch of the next generation of our system design software program.

The Panasonic VRF Designer software has been customised to make the selection and design process as quick and easy as possible.

The design package utilises system wizards and import tools to enable both simple and complex systems to be created. In addition, the system will allow outdoor and indoor units to be dragged on an interactive desktop. This allows users to create everything from realistic floor plans with detailed piping and wiring schematics to send out with quotations, through to installation guidance drawings.

Features include:

- Mounting scheme. Design selection from building floor drawing
- Any kind of drawing format. (dxf, jpg, png..etc.)
- Conventional principal scheme
- Easy to use system wizards
- Auto piping and wiring features
- Converted duties for conditions and pipework
- Auto(CAD) (dxf), Excel and PDF export
- Detailed wiring and pipework diagrams
- Automatic price quotation
- Automatic tender document assist
- SEER, SCOP
- ESEER

Panasonic's Advanced VRF software with AutoCAD® compatibility makes design easier than ever

Panasonic provides bespoke software helping system designers, installers and dealers to very quickly design and size systems, create wiring diagrams and issue bills of quantities at the push of a button.



Panasonic VRF Service Checker

Panasonic will make available to installers and commissioning companies the VRF Service Checker as a communication interface to Panasonic VRF systems. This easy to manage tool checks all parameters of the system.

The VRF Service Checker allows:

- On ECOi and Mini ECOi connect anywhere on the P-Link
- Search the P-Link to validate systems that are connected
- Monitor all indoor and outdoor units simultaneously on 1 screen
- Monitor all Temperature data, Pressure data, Valve position, and alarm status on 1 screen
- Data can be viewed in Graph or number format
- Controlling the indoor unit ON/OFF, MODE, SET POINT, FAN, and TEST mode
- Switching between various systems on same communication P-Link (ECOi only)
- Monitor and record at a set interval time
- Record and review the data at a later date
- Update software as ROM flash writer

This Panasonic VRF Service Checker is available from your service partner.

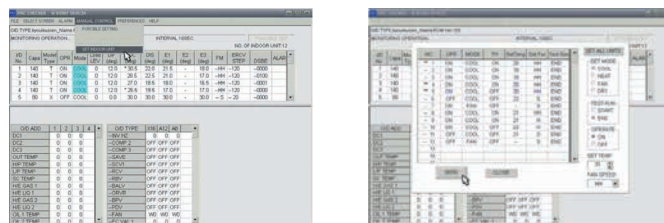





















Interface Box

NEW VRF SYSTEMS INDOOR UNITS

















































ECOi AND ECO G SYSTEMS INDOOR UNITS RANGE

	1,5kW	2,2kW	2,8kW	3,0kW	3,6kW	4,0kW	4,5kW
NEW U2 Type. 4 Way 90x90 Cassette							
		S-22MU2E5A	S-28MU2E5A		S-36MU2E5A		S-45MU2E5A
U1 Type. 4 Way 90x90 Cassette							
		S-22MU1E5A	S-28MU1E5A		S-36MU1E5A		S-45MU1E5A
Y2 TYPE. 4 Way 60x60 Cassette							
	S-15MY2E5A	S-22MY2E5A	S-28MY2E5A		S-36MY2E5A		S-45MY2E5A
L1 Type. 2 Way Cassette							
		S-22ML1E5	S-28ML1E5		S-36ML1E5		S-45ML1E5
D1 Type. 1 Way Cassette							
			S-28MD1E5		S-36MD1E5		S-45MD1E5
F2 Type. Variable Static Pressure Hide Away							
	S-15MF2E5A	S-22MF2E5A	S-28MF2E5A		S-36MF2E5A		S-45MF2E5A
M1 Type. Slim Variable Static Pressure Hide Away							
	S-15MM1E5A	S-22MM1E5A	S-28MM1E5A		S-36MM1E5A		S-45MM1E5A
E2 Type. High Static Pressure Hide Away							
Heat Recovery with DX Coil							
				PAW-500ZDX2N		PAW-800ZDX2N	PAW-01KZDX2N
T2 Type. Ceiling							
					S-36MT2E5A		S-45MT2E5A
K2/K1 Type. Wall Mounted							
	S-15MK2E5A	S-22MK2E5A	S-28MK2E5A		S-36MK2E5A		S-45MK1E5A
P1 Type. Floor Standing							
		S-22MP1E5	S-28MP1E5		S-36MP1E5		S-45MP1E5
R1 Type. Concealed Floor Standing							
		S-22MR1E5	S-28MR1E5		S-36MR1E5		S-45MR1E5
Hydrokit for ECOi, water at 45°C							

Wide choice of models depending on the indoor requirements.

	16,0kW	28,0kW	56,0kW	84,0kW	112,0kW	140,0kW	168,0kW
AHU Connection Kit 16, 28 and 56kW							
	PAW-160MAH2	PAW-280MAH2	PAW-560MAH2	PAW-280MAH2 + PAW-560MAH2	PAW-560MAH2 x 2	PAW-280MAH2 + PAW-560MAH2 x 2	PAW-560MAH2 x 3

5,6kW	6,0kW	7,3kW	9,0kW	10,6kW	14,0kW	16,0kW	22,4kW	28,0kW
 S-56MU2E5A	 S-60MU2E5A	 S-73MU2E5A	 S-90MU2E5A	 S-106MU2E5A	 S-140MU2E5A	 S-160MU2E5A		
 S-56MU1E5A	 S-60MU1E5A	 S-73MU1E5A	 S-90MU1E5A	 S-106MU1E5A	 S-140MU1E5A	 S-160MU1E5A		
 S-56MY2E5A								
 S-56ML1E5		 S-73ML1E5						
 S-56MD1E5		 S-73MD1E5						
 S-56MF2E5A	 S-60MF2E5A	 S-73MF2E5A	 S-90MF2E5A	 S-106MF2E5A	 S-140MF2E5A	 S-160MF2E5A		
 S-56MM1E5A								
							 S-224MEZE5	 S-280MEZE5
 S-56MT2E5A		 S-73MT2E5A		 S-106MT2E5A	 S-140MT2E5A			
 S-56MK1E5A		 S-73MK1E5A		 S-106MK1E5A				
 S-56MP1E5		 S-71MP1E5						
 S-56MR1E5		 S-71MR1E5						
			 S-80MW1E5		 S-125MW1E5			

	11,4kW	25,0kW	31,5kW	37,5kW
Air Curtain Jet-Flow with DX Coil	 PAW-10EAIRC-MJ	 PAW-15EAIRC-MJ	 PAW-20EAIRC-MJ	 PAW-25EAIRC-MJ
Air Curtain Standard with DX Coil	 PAW-10EAIRC-MS		 PAW-20EAIRC-MS	

U2 TYPE 4 WAY 90x90 CASSETTE SEMI CONCEALED

Large capacity VRF. Trusted power and high efficiency. These cassettes offer upgraded Econavi and nanoe™ purification system as accessories for making application space more comfortable, healthy and efficient.

Thanks to advances in design and technology such as the new high performance turbo fan, more efficient and silent, the nanoe™ air cleaner, for total healthy and the floor temperature & humidity sensor to more control, the new U2 Panasonic 4 Way 90x90 Cassette is the best Industry in energy savings, healthy and comfort.

Always fresh and clean air with nanoe™

New nanoe™ is available by the advanced technology of room air conditioning.

- Purificating operation can work simultaneously or independently from heating/cooling operation.
- Inhibiting viruses, bacteria & deodorisation (bacteria, fungus, pollen, virus and cigarette smoke). OH radicals in nanoe™ pull bacteria's hydrogen out and it is effectively deodorised be sterilised
- Clean inside by nanoe™ + Dry control: inside of indoor unit can be cleaned by short operation circuit with nanoe™ and drying

CZ-RTC5A and optional accessory CZ-CNEXU1 are required to use nanoe™ function.

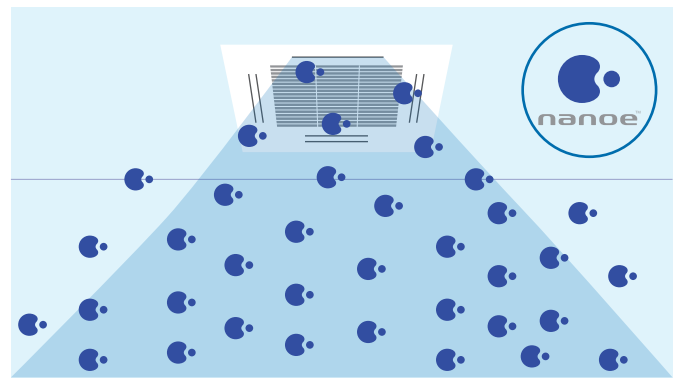

Econavi intelligent sensor

Human activity sensor and floor temperature sensor can reduce energy by optimising air conditioner operation.



Advanced Econavi functions.

2 sensors (movement and floor temperature) can find waste of energy and control effectively. Floor temperature can detect up to 5m ceiling height.

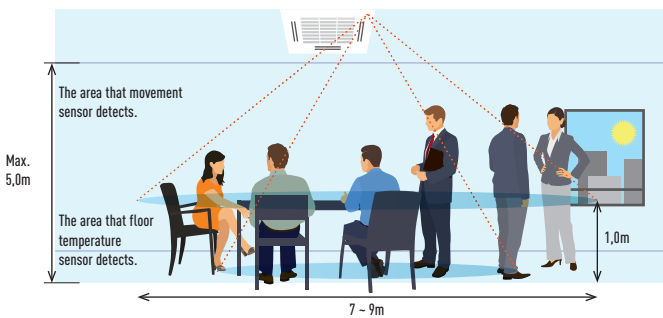

Econavi exclusive panel. Optional (CZ-KPU3A)



Floor temperature sensor.
This sensor detects average floor temperature and operates circulation if floor is low temperature.



Movement sensor.
This sensor detects the amount of human activity, and operates effectively.



Wired remote controller CZ-RTC5A is required.

Humidity sensor.

New humidity sensor has added on air suction part, and realises comfort and energy saving based on temperature and humidity.

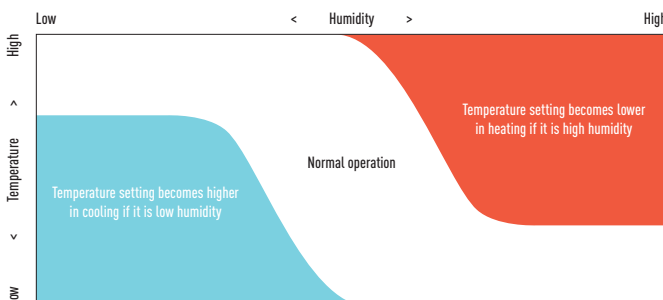

Group control, circulation function.

Circulating operation is activated when nobody is there, and mix air in the whole room. Minimize temperature gap in both heating and cooling operation.

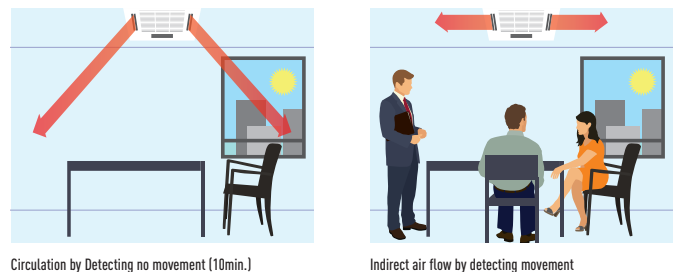



The new U2 Panasonic 4 Way 90x90 Cassettes with new panel design and 2 types of body with height difference.

2 types of body with height difference (same as current ones)

25,6cm and 31,9cm.

Technical focus

- New high performance turbo fan, new path system for heat exchanger
- Lower noise in slow fan operation
- Ceiling height up to 5,0m
- Industry top light weight, easy piping
- Econavi: Floor temperature and humidity sensor added. Activity amount detection and new circulator
- Nanoe™: The first 10x for CAC (10 times more purification power). Inside cleaning by 10x nanoe™ + dry control
- Powerful drain pump gives 850mm lift
- Fresh air knockout
- Branch duct connection
- Optional air-intake plenum CZ-FDU2

Panasonic introduces new flat panel design which is modern and matching well with your space. These cassettes have developed to satisfy today's customer needs such as highest energy saving, maximum comfort and healthier air.

The drain pipe can be raised to a maximum height of 850mm from the bottom of the ceiling

Do not attempt to raise it higher than 850mm. Doing so will result in water leakage.

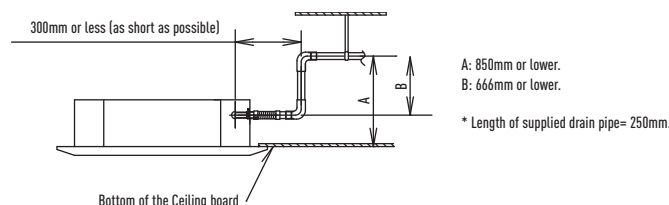

New Panel design

Flat design, well-matched with interior, building. Position of 4 air wings can be set individually.

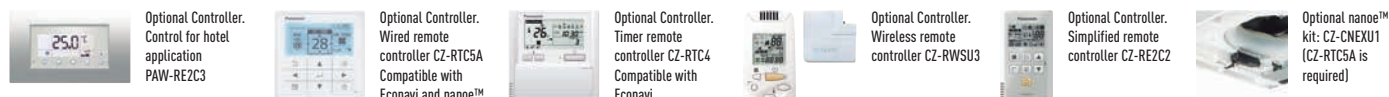

Model		S-22MU2E5A	S-28MU2E5A	S-36MU2E5A	S-45MU2E5A	S-56MU2E5A	S-60MU2E5A	S-73MU2E5A	S-90MU2E5A	S-106MU2E5A	S-140MU2E5A	S-160MU2E5A	
Power source		Single Phase / 220 / 230 / 240V / 50 Hz – 220 / 230V / 60Hz											
Cooling capacity	kW	2,2	2,8	3,6	4,5	5,6	6,0	7,3	9,0	10,6	14,0	16,0	
Input power cooling	W	20	20	20	20	25	35	40	40	95	100	115	
Operating current cooling	A	0,19	0,19	0,19	0,19	0,22	0,31	0,33	0,36	0,71	0,76	0,89	
Heating capacity	kW	2,5	3,2	4,2	5,0	6,3	7,1	8,0	10,0	11,4	16,0	18,0	
Input power heating	W	20	20	20	20	25	35	40	40	85	100	105	
Operating current heating	A	0,17	0,17	0,17	0,17	0,20	0,30	0,32	0,34	0,65	0,73	0,80	
Fan type		Turbo fan											
Air volume	Hi / Med / Lo	m³/min	14,5 / 13,0 / 11,5	14,5 / 13,0 / 11,5	14,5 / 13,0 / 11,5	15,5 / 13,0 / 11,5	17,0 / 13,5 / 11,5	21,0 / 16,0 / 13,0	22,5 / 16,0 / 13,0	23,0 / 18,5 / 14,0	35,0 / 26,0 / 20,0	36,0 / 27,0 / 21,5	37,0 / 29,0 / 25,0
Sound pressure	Hi / Med / Lo	dB(A)	30 / 29 / 28	30 / 29 / 28	30 / 29 / 28	31 / 29 / 28	33 / 30 / 28	36 / 32 / 29	37 / 32 / 29	38 / 35 / 32	44 / 38 / 34	45 / 39 / 35	46 / 40 / 38
Sound power	Hi / Med / Lo	dB	45 / 44 / 43	45 / 44 / 43	45 / 44 / 43	46 / 44 / 43	48 / 45 / 43	51 / 47 / 44	52 / 47 / 44	53 / 50 / 47	59 / 53 / 49	60 / 54 / 50	61 / 55 / 53
Dimensions (H x W x D)	Indoor	mm	256 x 840 x 840										
	Panel	mm	33,5 x 950 x 950										
Net weight (Panel)		kg	21	21	21	21	21	21	21	25	25	25	
Pipe connections	Liquid	Inch (mm)	1/4 (6,35)										
	Gas	Inch (mm)	1/2 (12,7)										
Drain piping			VP-25										

Rating Conditions: Cooling Indoor 27°C DB / 19°C WB. Cooling Outdoor 35°C DB / 24°C WB. Heating Indoor 20°C DB. Heating Outdoor 7°C DB / 6°C WB. DB: Dry Bulb; WB: Wet Bulb.
* Sound pressure with no refrigerant flow.



ECONAVI AND INTERNET CONTROL: Optional.



U1 TYPE 4 WAY 90x90 CASSETTE SEMI CONCEALED



The award winning range of U1 type cassettes are smaller, shallower and lighter than previous models and feature a 950 x 950mm panel throughout. The DC-Fan motor and air discharge louvre ensure quiet, optimum air distribution.

Technical focus

- Compact design
- Reduced sound levels (from previous models)
- DC-Fan motor for increased efficiency
- Powerful drain pump gives 850mm lift
- Lightweight design
- Fresh air knockout
- Branch duct connection
- Optional air-intake plenum CZ-FDU2

Air intake chamber

1. Air intake box CZ-BCU2 for main unit.
2. Air intake box CZ-ATU2* for Air intake plenum. CZ-CFU2 Part to close airflow for the cassette 90x90 series U1.



* When using Air intake box (CZ-ATU2), Air intake plenum (CZ-FDU2) is required.

Lighter and Slimmer, Easier Installation

A lightweight unit at 24kg, the unit is also very slim with a height of only 256mm, making installation possible even in narrow ceiling voids.

A drain height of approximately 850mm from the ceiling surface

The drain height can be increased by approximately 350mm over the conventional value by using a high-lift drain pump, and long horizontal piping is possible.

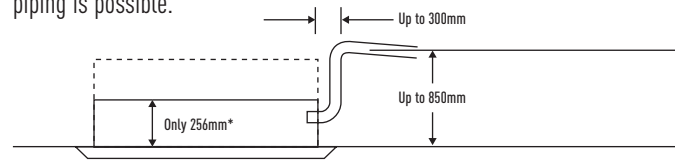

* For 6,0kW / 7,1kW.

Air flow directed to avoid ceiling marks

The condensation and dirt appearing near the discharge ports for conventional ceiling cassettes has been reduced.

Conventional

The discharged air hits the ceiling and causes dirt.

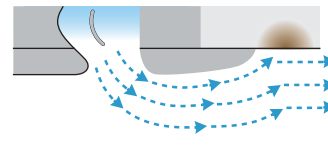

U1 Type Cassette

Upward air flow is suppressed.

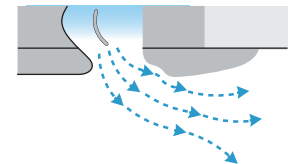

Optional Controller. Control for hotel application PAW-RE2C3



Optional Controller. Wired remote controller CZ-RTCSA Compatible with Econavi



Optional Controller. Timer remote controller CZ-RTC4 Compatible with Econavi



Optional Econavi Sensor. CZ-CENS1



Optional Controller. Wireless remote controller CZ-RWSU2N



Optional Controller. Simplified remote controller CZ-RE2C2

Model		S-22MU1E5A	S-28MU1E5A	S-36MU1E5A	S-45MU1E5A	S-56MU1E5A	S-60MU1E5A	S-73MU1E5A	S-90MU1E5A	S-106MU1E5A	S-140MU1E5A	S-160MU1E5A
Power source		230 V / Single Phase / 50 Hz										
Cooling capacity	kW	2,2	2,8	3,6	4,5	5,6	6,0	7,3	9,0	10,6	14,0	16,0
Input power cooling	W	20	20	20	20	25	35	40	40	95	100	115
Operating current cooling	A	0,19	0,19	0,19	0,19	0,22	0,31	0,33	0,36	0,71	0,76	0,89
Heating capacity	kW	2,5	3,2	4,2	5,0	6,3	7,1	8,0	10,0	11,4	16,0	18,0
Input power heating	W	20	20	20	20	25	35	40	40	85	100	105
Operating current heating	A	0,17	0,17	0,17	0,17	0,20	0,30	0,32	0,34	0,65	0,73	0,80
Fan type		Turbo fan	Turbo fan	Turbo fan	Turbo fan	Turbo fan	Turbo fan	Turbo fan	Turbo fan	Turbo fan	Turbo fan	Turbo fan
Air volume	Hi / Med / Lo	m ³ /min	14,0 / 12,0 / 11,0	14,0 / 12,0 / 11,0	14,0 / 12,0 / 11,0	15,0 / 13,0 / 12,0	16,0 / 13,5 / 12,0	21,0 / 17,0 / 14,0	22,0 / 17,0 / 14,0	23,0 / 19,0 / 15,0	33,0 / 27,0 / 21,0	35,0 / 28,0 / 22,0
Sound pressure	Hi / Med / Lo	dB(A)	30 / 29 / 28	30 / 29 / 28	30 / 29 / 28	31 / 29 / 28	33 / 30 / 28	36 / 32 / 29	37 / 32 / 29	38 / 35 / 32	44 / 38 / 34	45 / 39 / 35
Dimensions	Indoor	mm	256 x 840 x 840	256 x 840 x 840	256 x 840 x 840	256 x 840 x 840	256 x 840 x 840	256 x 840 x 840	256 x 840 x 840	256 x 840 x 840	319 x 840 x 840	319 x 840 x 840
	Panel	mm	33,5 x 950 x 950	33,5 x 950 x 950	33,5 x 950 x 950	33,5 x 950 x 950	33,5 x 950 x 950	33,5 x 950 x 950	33,5 x 950 x 950	33,5 x 950 x 950	33,5 x 950 x 950	33,5 x 950 x 950
Net weight (Panel)		kg	23 (4)	23 (4)	23 (4)	23 (4)	23 (4)	24 (4)	24 (4)	24 (4)	27 (4)	27 (4)
Pipe connections	Liquid	Inch (mm)	1/4 (6,35)	1/4 (6,35)	1/4 (6,35)	1/4 (6,35)	1/4 (6,35)	3/8 (9,52)	3/8 (9,52)	3/8 (9,52)	3/8 (9,52)	3/8 (9,52)
	Gas	Inch (mm)	1/2 (12,70)	1/2 (12,70)	1/2 (12,70)	1/2 (12,70)	1/2 (12,70)	5/8 (15,88)	5/8 (15,88)	5/8 (15,88)	5/8 (15,88)	5/8 (15,88)
	Drain piping		VP-25	VP-25	VP-25	VP-25	VP-25	VP-25	VP-25	VP-25	VP-25	VP-25

Rating Conditions: Cooling Indoor 27°C DB / 19°C WB. Cooling Outdoor 35°C DB / 24°C WB. Heating Indoor 20°C DB. Heating Outdoor 7°C DB / 6°C WB. DB: Dry Bulb; WB: Wet Bulb.



Y2 TYPE 4 WAY 60x60 CASSETTE MINI SEMI CONCEALED



Designed to fit exactly into a 600 x 600mm ceiling grid without the need to alter the bar configuration, the Y2 is ideal for small commercial and retrofit applications. In addition, the improvements to efficiency make this one of the most advanced units in the industry.

Technical focus

- Mini cassette fits into a 600 x 600mm ceiling grid
- Fresh air knock out
- Multidirectional airflow
- Powerful drain pump gives 850mm lift
- Turbo fans and heat exchanger fins with improved design
- DC-Fan motors with variable speed, new heat exchangers, etc. ensure an efficient power consumption

Special designed flap

The flap can be removed easily for washing with water.

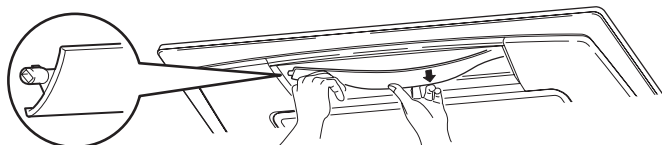

A drain height of approximately 850mm from the ceiling surface

The drain height can be increased by approximately 350mm over the conventional value by using a high-lift drain pump, and long horizontal piping is possible.

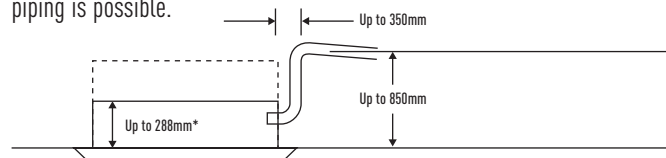

A lightweight unit at 18,4kg the unit is also very slim with a height of only 288mm, making installation possible even in narrow ceilings.

Anti-Mould Long-Life Air Filter

Anti-mould and anti-bacteria washable filter ensures clean, healthy air.



Optional Controller. Control for hotel application PAW-RE2C3



Optional Controller. Wired remote controller CZ-RTC5A Compatible with Econavi



Optional Controller. Timer remote controller CZ-RTC4 Compatible with Econavi



Optional Econavi Sensor. CZ-CENSC1



Optional Controller. Wireless remote controller CZ-RWSK2



Optional Controller. Simplified remote controller CZ-RE2C2

Model		S-15MY2E5A	S-22MY2E5A	S-28MY2E5A	S-36MY2E5A	S-45MY2E5A	S-56MY2E5A
Power source		230 V / Single Phase / 50 Hz					
Cooling capacity	kW	1,5	2,2	2,8	3,6	4,5	5,6
Input power cooling	W	35	35	35	40	40	45
Operating current cooling	A	0,30	0,30	0,30	0,30	0,32	0,35
Heating capacity	kW	1,7	2,5	3,2	4,2	5,0	6,3
Input power heating	W	30	30	30	35	35	40
Operating current heating	A	0,25	0,25	0,30	0,30	0,30	0,30
Fan type		Centrifugal fan					
Air volume	Cooling m³/min	8,9 / 8,2 / 5,6	9,1 / 8,2 / 5,6	9,3 / 8,4 / 5,6	9,7 / 8,7 / 6,0	10,0 / 9,3 / 8,2	10,4 / 9,8 / 8,5
	Heating m³/min	9,1 / 8,4 / 5,6	9,3 / 8,4 / 5,6	9,6 / 8,7 / 5,6	9,9 / 9,1 / 6,0	10,3 / 9,6 / 8,2	11,1 / 9,8 / 8,7
Sound pressure	Hi / Med / Lo dB(A)	34 / 31 / 25	35 / 31 / 25	35 / 31 / 25	36 / 32 / 26	38 / 34 / 28	40 / 37 / 34
Sound power	Hi / Med / Lo dB	49 / 46 / 40	50 / 46 / 40	50 / 46 / 40	51 / 47 / 41	53 / 49 / 43	55 / 52 / 49
Dimensions H x W x D	Indoor mm	288 x 583 x 583	288 x 583 x 583	288 x 583 x 583	288 x 583 x 583	288 x 583 x 583	288 x 583 x 583
	Panel (3A) mm	31 x 700 x 700	31 x 700 x 700	31 x 700 x 700	31 x 700 x 700	31 x 700 x 700	31 x 700 x 700
	Panel (3B) mm	31 x 625 x 625	31 x 625 x 625	31 x 625 x 625	31 x 625 x 625	31 x 625 x 625	31 x 625 x 625
Net weight (Panel)	kg	18 (2,4)	18 (2,4)	18 (2,4)	18 (2,4)	18 (2,4)	18 (2,4)
	Liquid Inch (mm)	1/4 (6,35)	1/4 (6,35)	1/4 (6,35)	1/4 (6,35)	1/4 (6,35)	1/4 (6,35)
Pipe connections	Gas Inch (mm)	1/2 (12,70)	1/2 (12,70)	1/2 (12,70)	1/2 (12,70)	1/2 (12,70)	1/2 (12,70)
	Drain piping	VP-25	VP-25	VP-25	VP-25	VP-25	VP-25

Rating Conditions: Cooling Indoor 27°C DB / 19°C WB. Cooling Outdoor 35°C DB / 24°C WB. Heating Indoor 20°C DB. Heating Outdoor 7°C DB / 6°C WB. DB: Dry Bulb; WB: Wet Bulb.



ECONAVI and INTERNET CONTROL: Optional.



Panel CZ-KPY3A (size 700 x 700mm) CZ-KPY3B (size 625 x 625mm)

L1 TYPE 2 WAY CASSETTE



Slim, compact and lightweight units. Remarkable size and weight reductions have been achieved by improvement of the design around the fan, the weight of all models now being 30kg.

Technical focus

- Airflow and distribution is automatically altered depending on the operational mode of the unit
- Drain up is possible up to 500mm from the drain port
- Simple maintenance

Simple maintenance

The drain pan is equipped with site wiring and can be removed. The fan case has a split construction, and the fan motor can be removed easily when the lower case is removed.

Auto flap control

Airflow and distribution is automatically altered depending on the operational mode of the unit.

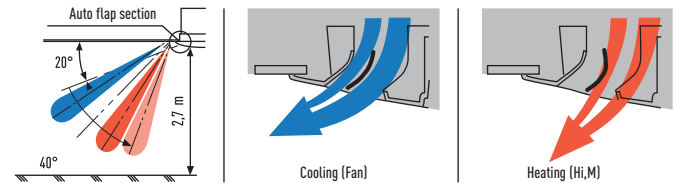

Drain up is possible up to 500mm from the drain port

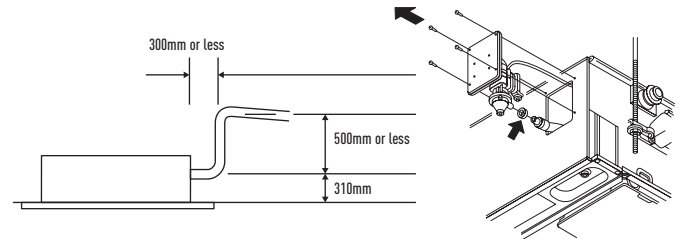

Maintenance of the drain pump is possible from two sides, from the left side (piping side) and from the inside of the unit.



Optional Controller. Control for hotel application PAW-RE2C3



Optional Controller. Wired remote controller CZ-RTCSA Compatible with Econavi



Optional Controller. Timer remote controller CZ-RTC4 Compatible with Econavi



Optional Econavi Sensor. CZ-CENS1



Optional Controller. Wireless remote controller CZ-RWSL2N



Optional Controller. Simplified remote controller CZ-RE2C2

Model		S-22ML1E5	S-28ML1E5	S-36ML1E5	S-45ML1E5	S-56ML1E5	S-73ML1E5	
Power source		230 V / Single Phase / 50 Hz						
Cooling capacity	kW	2,2	2,8	3,6	4,5	5,6	7,3	
Input power cooling	W	90	92	93	97	97	145	
Operating current cooling	A	0,45	0,45	0,45	0,45	0,45	0,65	
Heating capacity	kW	2,5	3,2	4,2	5,0	6,3	8,0	
Input power heating	W	58	60	61	65	65	109	
Operating current heating	A	0,29	0,29	0,29	0,29	0,29	0,48	
Fan type		Sirocco fan						
Air volume	Hi / Med / Lo	m ³ /min	8,0 / 7,0 / 6,0	9,0 / 8,0 / 7,0	9,7 / 8,7 / 7,7	11,0 / 9,0 / 8,0	11,0 / 9,0 / 8,0	19,0 / 16,0 / 14,0
Sound pressure	Hi / Med / Lo	dB(A)	30 / 27 / 24	33 / 29 / 26	34 / 31 / 28	35 / 33 / 29	35 / 33 / 29	38 / 35 / 33
Dimensions (H x W x D)	Indoor	mm	350 x 840 x 600					
	Panel	mm	8 x 1.060 x 680					
Net weight (Panel)		kg	23 (5,5)					
Pipe connections	Liquid	Inch (mm)	1/4 (6,35)					
	Gas	Inch (mm)	1/2 (12,70)					
	Drain piping		VP-25					

Rating Conditions: Cooling Indoor 27°C DB / 19°C WB. Cooling Outdoor 35°C DB / 24°C WB. Heating Indoor 20°C DB. Heating Outdoor 7°C DB / 6°C WB. DB: Dry Bulb; WB: Wet Bulb.



ECONAVI and INTERNET CONTROL: Optional.



Panel CZ-02KPL2 CZ-03KPL2 (for S-73ML1E5)

D1 TYPE 1 WAY CASSETTE



Designed for installation within the ceiling void, the D1 range of slimline 1 way blow cassettes feature powerful yet quiet fans for up to 4,2m.

Technical focus

- Ultra-Slim
- Suitable for standard and high ceilings
- Built-in drain pump provides 590mm lift
- Easy to install and maintain
- Hanging height can be easily adjusted
- Uses a DC-Fan motor to improve energy-efficiency

Drain height

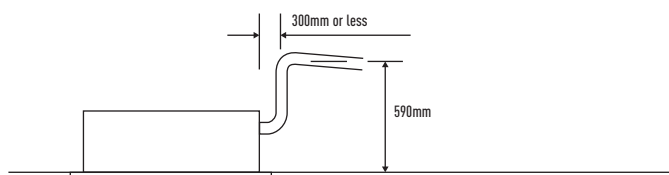

With 3 types of air-blow systems, the units can be used in various ways



1. One-direction “down-blow” system.
Powerful one-direction “down-blow” system reaches the floor even from high ceilings (up to 4,2m).



2. Two-direction ceiling-mounted system.
“Down-blow” and “front-blow” systems are combined in a ceiling-mounted unit to blow air over a wide area.



3. One-direction ceiling-mounted system.
This powerful ceiling-mounted “front-blow” system efficiently air-conditions the space in front of the unit.
(Additional accessories required)



Optional Controller. Control for hotel application PAW-RE2C3



Optional Controller. Wired remote controller CZ-RTCSA Compatible with Econavi



Optional Controller. Timer remote controller CZ-RTC4 Compatible with Econavi



Optional Econavi Sensor. CZ-CENSC1



Optional Controller. Wireless remote controller CZ-RWSD2



Optional Controller. Simplified remote controller CZ-RE2C2

Model			S-28MD1E5	S-36MD1E5	S-45MD1E5	S-56MD1E5	S-73MD1E5
Power source			230 V / Single Phase / 50 Hz				
Cooling capacity	kW		2,8	3,6	4,5	5,6	7,3
Input power cooling	W		51	51	51	60	87
Operating current cooling	A		0,39	0,39	0,39	0,46	0,70
Heating capacity	kW		3,2	4,2	5,0	6,3	8,0
Input power heating	W		40	40	40	48	76
Operating current heating	A		0,35	0,35	0,35	0,41	0,65
Fan type			Sirocco fan		Sirocco fan		Sirocco fan
Air volume	Hi / Med / Lo	m ³ /min	12,0 / 10,0 / 9,0	12,0 / 10,0 / 9,0	12,0 / 11,0 / 10,0	13,0 / 11,5 / 10,0	18,0 / 15,0 / 13,0
Sound pressure	Hi / Med / Lo	dB(A)	36 / 34 / 33	36 / 34 / 33	36 / 35 / 34	38 / 36 / 34	45 / 40 / 36
Dimensions (H x W x D)	Indoor	mm	200 x 1.000 x 710	200 x 1.000 x 710	200 x 1.000 x 710	200 x 1.000 x 710	200 x 1.000 x 710
	Panel	mm	20 x 1.230 x 800	20 x 1.230 x 800	20 x 1.230 x 800	20 x 1.230 x 800	20 x 1.230 x 800
Net weight (Panel)		kg	21 (5,5)	21 (5,5)	21 (5,5)	22 (5,5)	22 (5,5)
Pipe connections	Liquid	Inch (mm)	1/4 (6,35)	1/4 (6,35)	1/4 (6,35)	1/4 (6,35)	3/8 (9,52)
	Gas	Inch (mm)	1/2 (12,70)	1/2 (12,70)	1/2 (12,70)	1/2 (12,70)	5/8 (15,88)
Drain piping			VP-25	VP-25	VP-25	VP-25	VP-25

Rating Conditions: Cooling Indoor 27°C DB / 19°C WB. Cooling Outdoor 35°C DB / 24°C WB. Heating Indoor 20°C DB. Heating Outdoor 7°C DB / 6°C WB. DB: Dry Bulb; WB: Wet Bulb.



ECONAVI and INTERNET CONTROL: Optional.



F2 TYPE VARIABLE STATIC PRESSURE HIDE AWAY



The new F2 type is designed specifically for applications requiring fixed square ducting. The internal filter is equipped as standard.

Technical focus

- Industry-leading low sound levels from 25dB(A)
- Built-in drain pump provides 785mm lift
- Easy to install and maintain
- Air OFF sensor avoids cold air dumping
- Configurable air temperature control

More powerful drain pump

Using a high-lift drain pump, drain piping can be elevated up to 785mm from the base of the unit.

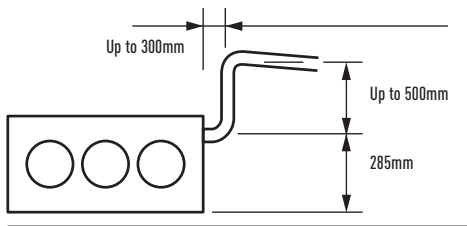

F2 Advantages

Automatic learning function for the required static pressure, to be activated easily by the standard wired timer remote controller. Possible to increase the sensible cooling capacity by adjusting the air volume flow in order to almost completely eliminate latent losses. This is possible due to the outstanding big heat exchanger surface in combination with increasing the air volume flow by a manual selection of higher fan speed curves through the standard wired remote controller when commissioning the system together with the default active off-coil temperature control and the room load based variable evaporation temperature control.

Diagram 1 S-22MF2E5A

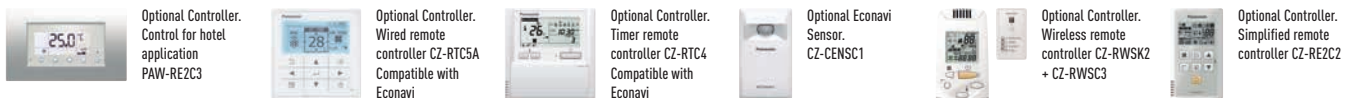
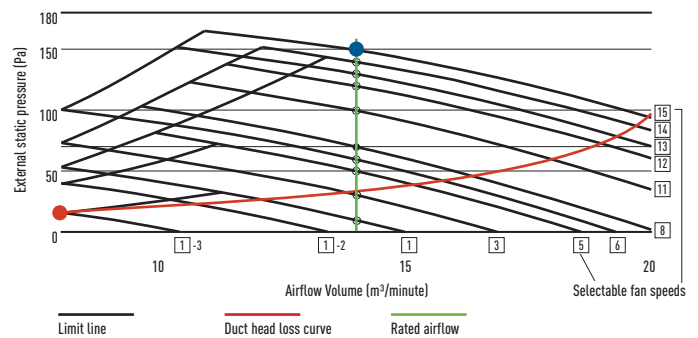

Model	S-15MF2E5A	S-22MF2E5A	S-28MF2E5A	S-36MF2E5A	S-45MF2E5A	S-56MF2E5A	S-60MF2E5A	S-73MF2E5A	S-90MF2E5A	S-106MF2E5A	S-140MF2E5A	S-160MF2E5A		
Power source	230 V / Single Phase / 50 Hz													
Cooling capacity	kW	1,5	2,2	2,8	3,6	4,5	5,6	6,0	7,3	9,0	10,6	14,0	16,0	
Input power cooling	W	70	70	70	70	70	100	120	120	135	195	215	225	
Operating current cooling	A	0,57	0,57	0,57	0,57	0,57	0,74	0,89	0,89	0,97	1,30	1,44	1,50	
Heating capacity	kW	1,7	2,5	3,2	4,2	5,0	6,3	7,1	8,0	10,0	11,4	16,0	18,0	
Input power heating	W	70	70	70	70	70	100	120	120	135	200	210	225	
Operating current heating	A	0,57	0,57	0,57	0,57	0,57	0,74	0,89	0,89	0,97	1,34	1,42	1,50	
Fan type		Sirocco fan	Sirocco fan	Sirocco fan	Sirocco fan	Sirocco fan	Sirocco fan	Sirocco fan	Sirocco fan	Sirocco fan	Sirocco fan	Sirocco fan	Sirocco fan	
Air volume ¹⁾	Hi / Med / Lo	m³/min	14,0 / 13,0 / 9,0	14,0 / 13,0 / 9,0	14,0 / 13,0 / 9,0	14,0 / 13,0 / 9,0	14,0 / 13,0 / 10,0	16,0 / 15,0 / 12,0	21,0 / 19,0 / 15,0	21,0 / 19,0 / 15,0	25,0 / 23,0 / 19,0	32,0 / 26,0 / 21,0	34,0 / 29,0 / 23,0	36,0 / 32,0 / 25,0
External static pressure		Pa	70 (10-150)	70 (10-150)	70 (10-150)	70 (10-150)	70 (10-150)	70 (10-150)	70 (10-150)	70 (10-150)	100 (10-150)	100 (10-150)	100 (10-150)	
Sound pressure ²⁾	Hi / Med / Lo	dB(A)	33 / 29 / 22	33 / 29 / 22	33 / 29 / 22	33 / 29 / 22	34 / 32 / 25	34 / 32 / 25	35 / 32 / 26	35 / 32 / 26	37 / 34 / 28	38 / 34 / 31	39 / 35 / 32	40 / 36 / 33
Sound power ²⁾	Hi / Med / Lo	dB	55 / 51 / 44	55 / 51 / 44	55 / 51 / 44	55 / 51 / 44	56 / 54 / 47	56 / 54 / 47	57 / 54 / 48	57 / 54 / 48	59 / 56 / 50	60 / 56 / 53	61 / 57 / 54	62 / 58 / 55
Dimensions	H x W x D	mm	290 x 800 x 700	290 x 800 x 700	290 x 800 x 700	290 x 800 x 700	290 x 800 x 700	290 x 800 x 700	290 x 1.000 x 700	290 x 1.000 x 700	290 x 1.400 x 700	290 x 1.400 x 700	290 x 1.400 x 700	
Net weight		kg	29	29	29	29	29	29	34	34	46	46	46	
Pipe connections	Liquid	Inch (mm)	1/4 (6,35)	1/4 (6,35)	1/4 (6,35)	1/4 (6,35)	1/4 (6,35)	1/4 (6,35)	3/8 (9,52)	3/8 (9,52)	3/8 (9,52)	3/8 (9,52)	3/8 (9,52)	
	Gas	Inch (mm)	1/2 (12,70)	1/2 (12,70)	1/2 (12,70)	1/2 (12,70)	1/2 (12,70)	1/2 (12,70)	5/8 (15,88)	5/8 (15,88)	5/8 (15,88)	5/8 (15,88)	5/8 (15,88)	
	Drain piping		VP-25	VP-25	VP-25	VP-25	VP-25	VP-25	VP-25	VP-25	VP-25	VP-25	VP-25	

Rating Conditions: Cooling Indoor 27°C DB / 19°C WB. Cooling Outdoor 35°C DB / 24°C WB. Heating Indoor 20°C DB. Heating Outdoor 7°C DB / 6°C WB. DB: Dry Bulb; WB: Wet Bulb.

1)) Value referred to standard settings at shipment (H curve 8, M curve 5, L curve 1). 2) Sound pressure without refrigerant flow.



ECONAVI and INTERNET CONTROL: Optional.

M1 TYPE SLIM VARIABLE STATIC PRESSURE HIDE AWAY CONCEALED DUCT



The ultra slim M1 type is one of the leading products of its type in the industry. With a depth of only 200mm it provides greater flexibility and can be used in far more applications. In addition, its high-efficiency and extremely quiet sound levels make it very popular with many users, including hotels and small offices.

Ultra-slim profile for all models

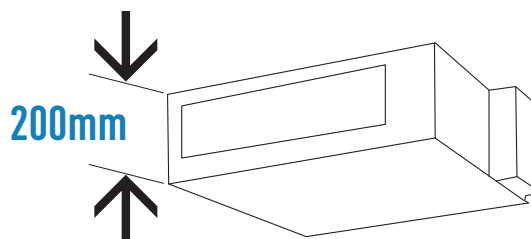

Technical focus

- Ultra-slim profile: 200mm for all models
- DC-Fan motor greatly reduces power consumption
- Ideal for hotel application with very narrow false ceilings
- Easy maintenance and service by external electrical box
- 40Pa static pressure enables ductwork to be fitted.
- Includes drain pump

Drain pump with increased power!

By adoption of a high-lift drain pump, the drain piping rise height can be increased to 785mm from the lower surface of the body.

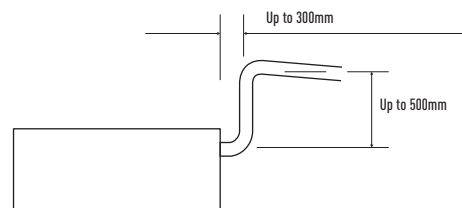

Air Outlet & Inlet Plenum

S-...MM1E5A	Diameters	Air Outlet Plenum	Diameters	Air Inlet Plenum
22 , 28 & 36	2 x Ø200	CZ-DUMPA22MMS2	2 x Ø200	CZ-DUMPA22MMR2
45 & 56	3 x Ø160	CZ-DUMPA45MMS3	2 x Ø200	CZ-DUMPA22MMR3



Optional Controller. Control for hotel application PAW-RE2C3



Optional Controller. Wired remote controller CZ-RTCSA Compatible with Econavi



Optional Controller. Timer remote controller CZ-RTC4 Compatible with Econavi



Optional Econavi Sensor. CZ-CENSC1



Optional Controller. Wireless remote controller CZ-RWSC2 + CZ-RWSC3



Optional Controller. Simplified remote controller CZ-RE2C2

Model	S-15MM1E5A	S-22MM1E5A	S-28MM1E5A	S-36MM1E5A	S-45MM1E5A	S-56MM1E5A	
Power source	230 V / Single Phase / 50 Hz						
Cooling capacity	1,5	2,2	2,8	3,6	4,5	5,6	
Input power cooling	36	36	40	42	49	64	
Operating current cooling	0,26	0,26	0,30	0,31	0,37	0,48	
Heating capacity	1,7	2,5	3,2	4,2	5,0	6,3	
Input power heating	26	26	30	32	39	54	
Operating current heating	0,23	0,23	0,27	0,28	0,34	0,45	
Fan type	Sirocco fan						
Air volume	Hi / Med / Lo	8,0 / 7,0 / 6,0	8,0 / 7,0 / 6,0	8,5 / 7,5 / 6,5	9,0 / 8,0 / 7,0	10,5 / 9,5 / 8,0	12,5 / 11,5 / 10,0
External static pressure	Pa	10 (30)	10 (30)	15 (30)	15 (40)	15 (40)	15 (40)
Sound pressure	Hi / Med / Lo ¹	28 / 27 / 25 (30 / 29 / 27)	28 / 27 / 25 (30 / 29 / 27)	30 / 29 / 27 (32 / 31 / 29)	32 / 30 / 28 (34 / 32 / 30)	34 / 32 / 30 (36 / 34 / 32)	35 / 33 / 31 (37 / 35 / 32)
Sound power	Hi / Med / Lo	43 / 42 / 40	43 / 42 / 40	45 / 44 / 42	47 / 45 / 43	49 / 47 / 45	50 / 48 / 46
Dimensions	H x W x D	200 x 750 x 640	200 x 750 x 640	200 x 750 x 640	200 x 750 x 640	200 x 750 x 640	200 x 750 x 640
Net weight	kg	19	19	19	19	19	19
Pipe connections	Liquid	Inch (mm)	1/4 (6,35)	1/4 (6,35)	1/4 (6,35)	1/4 (6,35)	1/4 (6,35)
	Gas	Inch (mm)	1/2 (12,70)	1/2 (12,70)	1/2 (12,70)	1/2 (12,70)	1/2 (12,70)
	Drain piping		VP-20	VP-20	VP-20	VP-20	VP-20

Rating Conditions: Cooling Indoor 27°C DB / 19°C WB. Cooling Outdoor 35°C DB / 24°C WB. Heating Indoor 20°C DB. Heating Outdoor 7°C DB / 6°C WB. DB: Dry Bulb; WB: Wet Bulb.

1) With booster cable using short circuit connection.



ECONAVI and INTERNET CONTROL: Optional.

E2 TYPE HIGH STATIC PRESSURE HIDE AWAY



2 products in 1: High pressure duct and 100% Fresh air duct function. The E2 range of ducted units offers improved design flexibility for extended duct layouts as a result of their increased external static pressures and reduces energy consumption.

Technical focus

- No need of rap valve
- 100% Fresh air duct function
- DC-Fan motor for more savings
- Complete flexibility for ductwork design
- Can be located into a weatherproof housing for external sitting
- Air OFF sensor avoids cold air dumping
- Configurable air temperature control

System example

An inspection port (450 x 450mm or more) is required at the lower side of the indoor unit body (field supply).

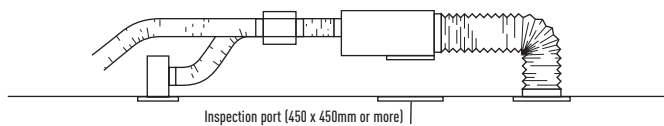

100% Fresh air duct function

The New E2 duct with 100% fresh air duct function have exceptional discharge temperature.

	Discharge Range		
	Min	Max	Default
Cooling	15°C	24°C	18°C
Heating	17°C	45°C	40°C

Plenums

Air Outlet Plenum (suitable for rigid + flexible duct)

	Number of exits with diameters	Model
S-224ME1E5A / S-280ME1E5	1 x 500mm	CZ-TREMIESPW706

Kit for 100% Fresh air function

For 2-Pipe systems		For 3-Pipe systems	
2x CZ-P160RVK2	Rap valve kit	2x CZ-P160HR3	3-Pipe valve kit
2x CZ-CAPE2	3-Pipe control PCB	2x CZ-CAPE2	3-Pipe control PCB
CZ-P680BK2	Distribution Joint kit	CZ-P680BH2	Distribution Joint kit
1x Remote control		1x Remote control	



Optional Controller. Control for hotel application PAW-RE2C3



Optional Controller. Wired remote controller CZ-RTCSA Compatible with Econavi



Optional Controller. Timer remote controller CZ-RTC4 Compatible with Econavi



Optional Econavi Sensor. CZ-CENSC1



Optional Controller. Wireless remote controller CZ-RWSK2 + CZ-RWSC3



Optional Controller. Simplified remote controller CZ-RE2C2

Model	100% Fresh air duct function (by using Kit for 100% Fresh air)				High pressure duct				
	S-224ME2E5		S-280ME2E5		S-224ME2E5		S-280ME2E5		
Power source	230 V / Single Phase / 50 Hz		230 V / Single Phase / 50 Hz		230 V / Single Phase / 50 Hz		230 V / Single Phase / 50 Hz		
Cooling capacity	kW	22.4	28.0	22.4	28.0				
Input power cooling	W	290	350	440	715				
Operating current cooling	A	1.85	2.20	2.45	3.95				
Heating capacity	kW	21.2	26.5	25.0	31.5				
Input power heating	W	290	350	440	715				
Operating current heating	A	1.85	2.20	2.45	3.95				
Fan type	Sirocco DC Fan Motor				Sirocco DC Fan Motor				
Air volume	Hi / Med / Lo	m ³ /min 28,3 / - / -		35,0 / - / -		56,0 / 51,0 / 44,0		72,0 / 63,0 / 53,0	
External static pressure	Pa	200		200		140 (60 / 270) ¹⁾		140 (72 / 270) ¹⁾	
Sound pressure ²⁾	Hi / Med / Lo	dB(A) 43 / - / -		44 / - / -		45 / 43 / 41		49 / 47 / 43	
Sound power	Hi / Med / Lo	dB 75 / - / -		76 / - / -		77 / 75 / 73		81 / 79 / 75	
Dimensions	H x W x D	mm 479 x 1.453 x 1.205		479 x 1.453 x 1.205		479 x 1.453 x 1.205		479 x 1.453 x 1.205	
Net weight	kg	102		106		102		106	
Pipe connections	Liquid	Inch (mm) 3/8 (9,52)		3/8 (9,52)		3/8 (9,52)		3/8 (9,52)	
	Gas	Inch (mm) 3/4 (19,05)		7/8 (22,22)		3/4 (19,05)		7/8 (22,22)	
	Drain piping	VP-25		VP-25		VP-25		VP-25	

Rating Conditions: Cooling Indoor 27°C DB / 19°C WB. Cooling Outdoor 35°C DB / 24°C WB. Heating Indoor 20°C DB. Heating Outdoor 7°C DB / 6°C WB.
Rating Conditions for 100% Fresh air duct function: Cooling Outdoor 33°C DB / 28°C WB. Heating Outdoor 0°C DB / -2,9°C WB. DB: Dry Bulb; WB: Wet Bulb.

1) Available to select the setting by initial setup. 2) Values with 140Pa setting.



ECONAVI and INTERNET CONTROL: Optional.

HEAT RECOVERY WITH DX COIL



Motorised heat recovery by-pass device automatically controlled by unit control to use fresh air free-cooling when convenient.

- Galvanized steel self-supporting panels, internally and externally insulated
- Counterflow air-to-air heat recovery device, made of sheets of special paper with special sealing to keep airflows separate and only permeable to water vapour. Total heat exchange with temperature efficiency up to 77% and enthalpy efficiency up to 63%, also at high level during summer season
- G4 efficiency class filters with synthetic cleanable media, both on fresh air and return air intake
- Removable side panel to access filters and heat recovery in the event of scheduled maintenance
- Low consumption, high efficiency & low noise direct driven fans with 3-speed EC motors
- Supply section complete with DX Coil (R410A) fitted with solenoid control valve, freon filter, contact temperature sensors on liquid and gas line, NTC sensors upstream and downstream airflow
- Built-in electric box equipped with PCB to control internal fan speed and to interconnect outdoor/indoor units
- Duct connection by circular plastic collars
- CZ-RTC4 Timer remote controller (option)

Balanced Ventilation

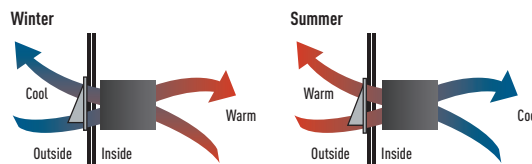

Interconnection to outdoor/indoor units

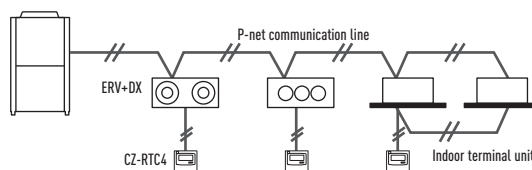

Characteristic curves

The following curves show the unit external static pressure at maximum fan speed for each model.

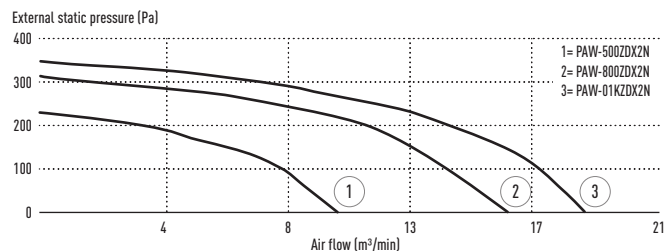

Optional Controller. Control for hotel application PAW-RE2C3



Optional Controller. Wired remote controller CZ-RTC5A Compatible with Econavi



Optional Controller. Timer remote controller CZ-RTC4 Compatible with Econavi



Optional Econavi Sensor. CZ-CENSC1

Model	PAW-500ZDX2N		PAW-800ZDX2N		PAW-01KZDX2N	
Power source	230 V / Single Phase / 50 Hz		230 V / Single Phase / 50 Hz		230 V / Single Phase / 50 Hz	
Air volume	Hi / Med / Lo	m³/min	8,3 / 8,3 / 6,0	13,3 / 11,7 / 10,0	16,7 / 13,0 / 10,8	
External static pressure ¹	Hi / Med / Lo	Pa	135 / 95 / 50	115 / 45 / 25	100 / 70 / 35	
Maximum current		A	2,0	2,8	3,0	
Maximum Input power		W	135	300	310	
Sound pressure ²	Hi / Med / Lo	dB(A)	33 / 31 / 27	38 / 36 / 32	39 / 37 / 33	
Pipe connections	Liquid / Gas	Inch (mm)	1/4 (6,35) / 1/2 (12,70)	1/4 (6,35) / 1/2 (12,70)	1/4 (6,35) / 1/2 (12,70)	
Heat Recovery						
Temperature / Enthalpy efficiency summer mode		%	62,5 / 60,0	59,0 / 57,0	59,5 / 57,5	
Saved power summer mode		kW	1,7	2,5	3,2	
Temperature / Enthalpy efficiency winter mode		%	76,5 (76,5) / 62,3 (64,1)	73,0 (73,0) / 59,0 (60,8)	73,5 (73,5) / 59,5 (61,2)	
Saved power winter mode		kW	4,3 (4,8)	6,5 (7,3)	8,2 (9,0)	
DX Coil						
Total / Sensible cooling capacity		kW	3,0 / 2,0	4,0 / 2,8	4,5 / 3,3	
Off temperature	Cooling	°C	16,5	17,9	18,6	
Off relative humidity	Cooling	%	86	82	81	
Total heating capacity		kW	2,9 (3,1)	4,0 (4,3)	4,6 (5,0)	
Off temperature	Heating	°C	30,1 (29,2)	27,5 (26,5)	26,3 (25,3)	
Off relative humidity	Heating	%	16 (15)	18 (17)	19 (18)	

Nominal summer conditions: Outside air: 32°C DB, RH 50%. Ambient air: 26°C DB, RH 50%. Nominal winter conditions: Outside air: -5°C (-10°C) DB, RH 80%. Ambient air: 20°C DB, RH 50%. Cooling mode air inlet condition: 28.5°C DB, RH 50%; evaporating temp. 4°C. Heating mode air inlet condition: 13°C DB, RH 40% (11°C DB, RH 45%); condensating temperature 49°C. DB: Dry Bulb; RH: Relative Humidity.

1) Referred to the nominal airflow after filter and plate heat exchanger. 2) Referred to 1,5m from inlet in free field condition.



ECONAVI and INTERNET CONTROL - Optional.

T2 TYPE CEILING

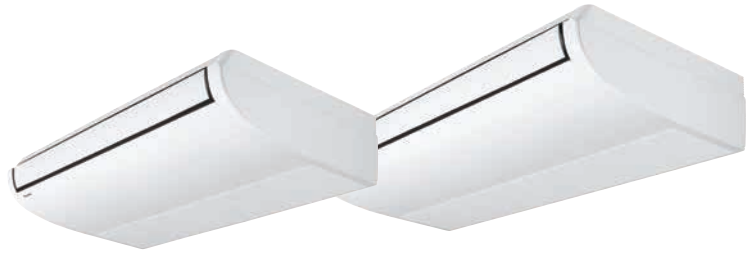

The T2 TYPE ceiling mounted units feature a DC-Fan motor for increased efficiency and reduced operating sound levels. All the units are the same height and depth for a uniform appearance in mixed installations and feature a fresh air knockout for improved air quality.

Further comfort improvement with airflow distribution

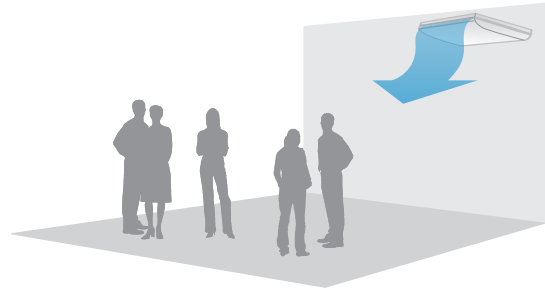

Technical focus

- Low sound levels
- New design, all units just 235mm high
- Large and wide air distribution
- Easy to install and maintain
- Fresh air knockout

Air distribution is automatically altered depending on the operational mode

Further comfort improvement

The wide air discharge opening widens the airflow to the left and the right, so that a comfortable temperature is obtained in the entire room. The unpleasant feeling caused when the airflow directly hits the human body is prevented by the "Draft prevention position", which changes the swing width, so that the degree of comfort is increased.

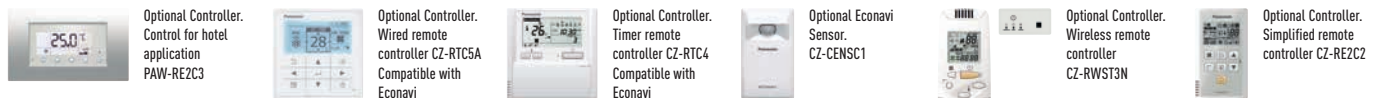
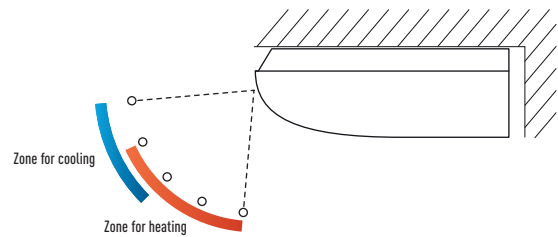
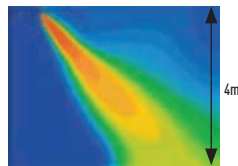

Model	S-36MT2E5A		S-45MT2E5A		S-56MT2E5A		S-73MT2E5A		S-106MT2E5A		S-140MT2E5A	
Power source	230 V / Single Phase / 50 Hz											
Cooling capacity	kW	3,6	4,5	5,6	7,3	10,6	14,0					
Input power cooling	W	35	40	40	55	80	100					
Operating current cooling	A	0,36	0,38	0,38	0,44	0,67	0,79					
Heating capacity	kW	4,2	5,0	6,3	8,0	11,4	16,0					
Input power heating	W	35	40	40	55	80	100					
Operating current heating	A	0,36	0,38	0,38	0,44	0,67	0,79					
Fan type	Sirocco fan											
Air volume	Hi / Med / Lo	m ³ /min	14,0 / 12,0 / 10,5	15,0 / 12,5 / 10,5	15,0 / 12,5 / 10,5	21,0 / 18,0 / 15,5	30,0 / 25,0 / 23,0	32,0 / 28,0 / 24,0				
Sound pressure	Hi / Med / Lo	dB(A)	36 / 32 / 30	37 / 33 / 30	37 / 33 / 30	39 / 35 / 33	42 / 37 / 36	46 / 40 / 37				
Sound power	Hi / Med / Lo	dB	54 / 50 / 48	55 / 51 / 48	55 / 51 / 48	57 / 53 / 51	60 / 55 / 54	62 / 58 / 55				
Dimensions	H x W x D	mm	235 x 960 x 690	235 x 960 x 690	235 x 960 x 690	235 x 1.275 x 690	235 x 1.590 x 690	235 x 1.590 x 690				
Net weight		kg	27	27	27	33	40	40				
Pipe connections	Liquid	Inch (mm)	1/4 (6,35)	1/4 (6,35)	1/4 (6,35)	3/8 (9,52)	3/8 (9,52)	3/8 (9,52)				
	Gas	Inch (mm)	1/2 (12,70)	1/2 (12,70)	1/2 (12,70)	5/8 (15,88)	5/8 (15,88)	5/8 (15,88)				
	Drain piping		VP-20	VP-20	VP-20	VP-20	VP-20	VP-20				

Rating Conditions: Cooling Indoor 27°C DB / 19°C WB. Cooling Outdoor 35°C DB / 24°C WB. Heating Indoor 20°C DB. Heating Outdoor 7°C DB / 6°C WB. DB: Dry Bulb; WB: Wet Bulb.



ECONAVI and INTERNET CONTROL: Optional.

K2/K1 TYPE WALL MOUNTED



The K2/K1 Type wall mounted unit has a stylish smooth panel which not only looks good but is also easy to clean. The unit is also smaller, lighter and substantially quieter than previous models making it ideal for small offices and other commercial applications.

Technical focus

- Closed discharge port
- Lighter and smaller units make the installation easy
- Quiet operation
- Smooth and durable design
- Piping outlet in three directions
- Washable front panel
- Air distribution is automatically altered depending on the operational mode

Closed discharge port

When the unit is turned OFF, the flap closes completely to prevent entry of dust into the unit and to keep the equipment clean. Lighter and smaller units make the installation easy. The width has been decreased by 17% and the units are lighter.

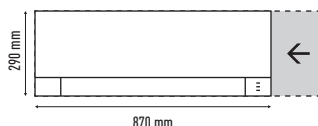

Air distribution is automatically altered depending on the operational mode of the unit

Quiet operation

These units are among the quietest in the industry, making them ideal for hotels and hospitals.

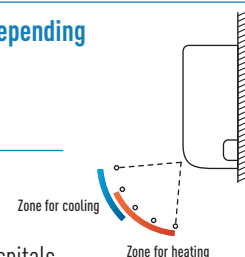

Smooth and durable design

The smooth cover means these units match most modern interiors. Their compact size enables them to blend in, even in small spaces.

Piping outlet in three directions

Piping outlet is possible in the three directions of rear, right, and left, making the installation work easier.

External valve (Optional)

CZ-P56SVK2 (model sizes 15 to 56)
CZ-P160SVK2 (model sizes 73 to 106)



Optional Controller. Control for hotel application PAW-RE2C3



Optional Controller. Wired remote controller CZ-RTCSA Compatible with Econavi



Optional Controller. Timer remote controller CZ-RTC4 Compatible with Econavi



Optional Econavi Sensor. CZ-CENSC1



Optional Controller. Wireless remote controller CZ-RWSK2



Optional Controller. Simplified remote controller CZ-REZC2

Model	S-15MK2E5A	S-22MK2E5A	S-28MK2E5	S-36MK2E5	S-45MK1E5A	S-56MK1E5A	S-73MK1E5A	S-106MK1E5A		
Power source	230 V / Single Phase / 50 Hz									
Cooling capacity	1,5	2,2	2,8	3,6	4,5	5,6	7,3	10,6		
Input power cooling	25	25	25	30	20	30	57	60		
Operating current cooling	0,20	0,21	0,23	0,25	0,26	0,35	0,58	0,62		
Heating capacity	1,7	2,5	3,2	4,2	5,0	6,3	8,0	11,4		
Input power heating	25	25	25	30	20	30	57	68		
Operating current heating	0,20	0,21	0,23	0,25	0,26	0,35	0,58	0,70		
Fan type	Cross flow		Cross flow	Cross flow	Cross flow	Cross flow	Cross flow	Cross flow		
Air volume	Hi / Med / Lo	m ³ /min	7,9 / 7,4 / 6,5	9,0 / 7,5 / 6,5	9,5 / 8,3 / 6,5	10,9 / 9,0 / 6,5	12,0 / 10,5 / 8,5	14,0 / 12,0 / 10,5	18,0 / 14,5 / 11,5	19,0 / 16,5 / 13,0
		m ³ /min	9,0 / 7,7 / 6,8	9,2 / 8,3 / 6,8	9,7 / 8,5 / 6,8	11,2 / 9,5 / 6,8	—	—	—	—
Sound pressure	Hi / Med / Lo	dB(A)	34 / 32 / 29	36 / 33 / 29	37 / 34 / 29	40 / 36 / 29	38 / 34 / 30	40 / 36 / 32	47 / 44 / 40	49 / 45 / 42
Sound power	Hi / Med / Lo	dB	49 / 47 / 44	51 / 48 / 44	52 / 49 / 44	55 / 51 / 44	—	—	—	—
Dimensions	H x W x D	mm	290 x 870 x 214	290 x 870 x 214	290 x 870 x 214	290 x 870 x 214	300 x 1.065 x 230	300 x 1.065 x 230	300 x 1.065 x 230	300 x 1.065 x 230
Net weight		kg	9	9	9	9	13	13	14,5	14,5
Pipe connections	Liquid	Inch (mm)	1/4 (6,35)	1/4 (6,35)	1/4 (6,35)	1/4 (6,35)	1/4 (6,35)	1/4 (6,35)	3/8 (9,52)	3/8 (9,52)
	Gas	Inch (mm)	1/2 (12,70)	1/2 (12,70)	1/2 (12,70)	1/2 (12,70)	1/2 (12,70)	1/2 (12,70)	5/8 (15,88)	5/8 (15,88)
	Drain piping (O.D.)		φ 16	φ 16	φ 16	φ 16	φ 18	φ 18	φ 18	φ 18

Rating Conditions: Cooling Indoor 27°C DB / 19°C WB. Cooling Outdoor 35°C DB / 24°C WB. Heating Indoor 20°C DB. Heating Outdoor 7°C DB / 6°C WB. DB: Dry Bulb; WB: Wet Bulb.



ECONAVI and INTERNET CONTROL: Optional.

P1 TYPE. FLOOR STANDING R1 TYPE. CONCEALED FLOOR STANDING



P1 Type. The compact floor standing P1 units are the ideal solution for providing perimeter air conditioning. The standard wired controller can be incorporated into the body of the unit.

R1 Type. At just 229mm deep, the R1 unit can be easily concealed in perimeter areas to provide powerful and effective air conditioning.

Technical focus

- Pipes can be connected to either side of the unit from the bottom or rear
- Easy to install
- Front panel opens fully for easy maintenance
- Removable air discharge grille gives flexible airflow
- Room for condensate pump
- For build-in remote control, only CZ-RTC2 is suitable

Technical focus

- Chassis unit for discreet installation
- Complete with removable filters
- Pipes can be connected to either side of the unit from the bottom or rear
- Easy to install

Effective perimeter handling

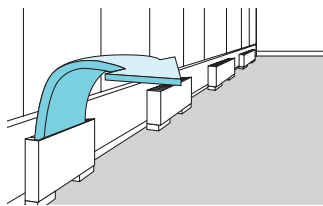

A remote control can be installed



Perimeter air conditioning with high interior quality

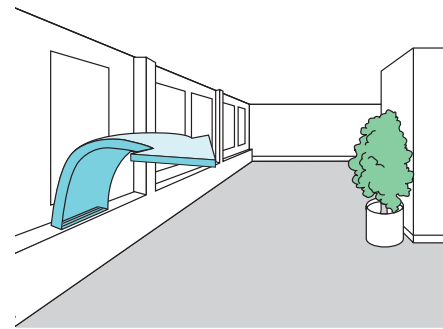

Optional Controller. Control for hotel application PAW-RE2C3



Optional Controller. Timer remote controller CZ-RTC2



Optional Controller. Wired remote controller CZ-RTC5A Compatible with Econavi



Optional Econavi Sensor. CZ-CENSC1



Optional Controller. Wireless remote controller CZ-RWSK2 + CZ-RWSC3



Optional Controller. Simplified remote controller CZ-RE2C2

Model P1 Type		S-22MP1E5	S-28MP1E5	S-36MP1E5	S-45MP1E5	S-56MP1E5	S-71MP1E5
Model R1 Type		S-22MR1E5	S-28MR1E5	S-36MR1E5	S-45MR1E5	S-56MR1E5	S-71MR1E5
Power source		230 V / Single Phase / 50 Hz					
Cooling capacity	kW	2,2	2,8	3,6	4,5	5,6	7,1
Input power cooling	W	56	56	85	126	126	160
Operating current cooling	A	0,25	0,25	0,38	0,56	0,56	0,72
Heating capacity	kW	2,5	3,2	4,2	5,0	6,3	8,0
Input power heating	W	40	40	70	91	91	120
Operating current heating	A	0,18	0,18	0,31	0,41	0,41	0,54
Fan type		Sirocco fan		Sirocco fan	Sirocco fan	Sirocco fan	
Air volume	Hi / Med / Lo m ³ /min	7,0 / 6,0 / 5,0	7,0 / 6,0 / 5,0	9,0 / 7,0 / 6,0	12,0 / 9,0 / 8,0	15,0 / 13,0 / 11,0	17,0 / 14,0 / 12,0
Sound pressure	Hi / Med / Lo dB(A)	33 / 30 / 28	33 / 30 / 28	39 / 35 / 29	38 / 35 / 31	39 / 36 / 31	41 / 38 / 35
Dimensions P1 Type	H x W x D mm	615 x 1.065 x 230		615 x 1.065 x 230	615 x 1.380 x 230	615 x 1.380 x 230	
Net weight P1 Type	kg	29		29	39	39	
Dimensions R1 Type	H x W x D mm	616 x 904 x 229		616 x 904 x 229	616 x 1.219 x 229	616 x 1.219 x 229	
Net weight R1 Type	kg	21		21	28	28	
Pipe connections	Liquid	1/4 (6,35)		1/4 (6,35)	1/4 (6,35)	1/4 (6,35)	
	Gas	1/2 (12,70)		1/2 (12,70)	1/2 (12,70)	1/2 (12,70)	
	Drain piping	VP-20		VP-20	VP-20	VP-20	

Rating Conditions: Cooling Indoor 27°C DB / 19°C WB. Cooling Outdoor 35°C DB / 24°C WB. Heating Indoor 20°C DB. Heating Outdoor 7°C DB / 6°C WB. DB: Dry Bulb; WB: Wet Bulb.



ECONAVI and INTERNET CONTROL: Optional.

HYDROKIT FOR ECOi WATER AT 45°C



Connect the Hydrokit to your VRF system, together with other indoor units.

Technical focus

- Only with 3-Pipe ECOi MF2 6N Series outdoor units
- Remote controller CZ-RTC5A common use with DX Coil indoor units ECOi and PACi

Basic principle & advantage

Hydrokit module provides hot water by using waste heat that is recovered from standard air-conditioning indoor unit in cooling mode. Total system performs high energy efficiency by this heat recovering operation, and it gives an advantage for the environmental-friendly assessment scheme (ex. BREEAM in UK).

Hydrokit control function / CZ-RTC5A

- CZ-RTC5A is updated version from CZ-RTC3. It can be used for hydrokit and also normal indoor unit. CZ-RTC5A checks the type of connected unit and switch hydrokit or air conditioner style of display automatically

- Operating mode on hydrokit style to be set at initial setting of the system from following modes: tank mode or air conditioning mode

Overview: hydromodule in VRF system

- Multiple hydromodule connection in same circuit is available
- Each module can be set different operation mode either hot water supply mode or space heating mode (both operation modes are not able to set at 1 hydromodule)
- 3-Pipe control solenoid valve kit is necessary for each indoor unit and hydromodule

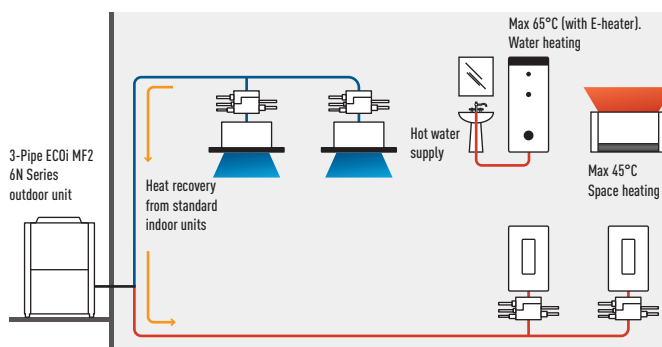

* Cold water also available.



Optional Controller. Control for hotel application PAW-RE2C3



Optional Controller. Wired remote controller CZ-RTC5A Compatible with Econavi



Optional Econavi Sensor. CZ-CENSC1

Model*				S-80MW1E5		S-125MW1E5	
Power source				230 V / Single Phase / 50 Hz		230 V / Single Phase / 50 Hz	
Cooling capacity		kW	8,0		12,5		
Heating capacity		kW	9,0		14,0		
Power input heating (hydrokit)		W	—		—		
Operating current heating (hydrokit)		A	—		—		
Maximum temperature		°C	-45 / -65 ¹		-45 / -65 ¹		
Dimensions		H x W x D	892 x 502 x 353		892 x 502 x 353		
Net weight		kg	—		—		
Water pipe connector		inch	R1 1/4		R1 1/4		
Water pump (built-in)			DC motor (A class)		DC motor (A class)		
Water flow rate		Cooling	l/min	22,9	35,8		
		Heating	l/min	25,8	40,1		
Sound pressure			dB(A)	—	—		
Pipe connections		Liquid	inch (mm)	3/8 (9,52)	3/8 (9,52)		
		Gas	inch (mm)	5/8 (15,88)	5/8 (15,88)		
Drain piping			15 - 17mm (inner size)	15 - 17mm (inner size)			
Operation range		Cooling Min ~ Max	Ambient / Water	°C	+10 ~ +43 / +5 ~ +20		
		Heating Min ~ Max	Ambient / Water	°C	-20 ~ +32 / +25 ~ +45		
Connectable system				3-Pipe (heat recovery type) VRF system (system capable up to 48HP)			
Maximum Indoor ratio (connectable hydrokit module capacity ratio)				Total indoor unit + Hydrokit capacity: up to 130 % (** - **% vs. total outdoor unit capacity)			

Rating Conditions: Cooling Indoor 27°C DB / 19°C WB. Cooling Outdoor 35°C DB / 24°C WB. Heating Indoor 20°C DB. Heating Outdoor 7°C DB / 6°C WB. DB: Dry Bulb; WB: Wet Bulb.
1) Max 45°C by refrigerant circuit (heat pump cycle), over 45°C is provided by electric heater operation. * Tentative Data.



ECONAVI: Optional.

AQUAREA AIR RADIATORS FAN COILS FOR HEAT PUMP APPLICATION

New line up of Super low temperature radiators for Heat Pump application: Aquarea Air 200/700/900 with radiating effect

The slimline Panasonic Aquarea Air radiators deliver high efficiency climate control. With a depth of just under 13 cm they are at the cutting edge of the market. Blending easily into the home, Aquarea Air's elegant design and product refinements are clear to see in every detail. The Aquarea Air's slimline profile has been achieved thanks to the innovative layout of the ventilation unit and the heat exchanger. The fan is tangential with asymmetric blades and the large surface heat exchanger enables high airflows to be achieved with low pressure loss and low noise levels. Exceptional ventilation efficiency means the motor uses considerably less energy (low wattage). The fan speed is continuously modulated by the temperature controller with proportional integral logic, with undoubted advantages for regulating the temperature and humidity in summer mode.



Line up of super low temperature radiators for Heat Pump application

During winter, the operating principle is based on micro fans with very low power consumption and minimum noise, that send hot air coming from the heat exchanger, to the inside of the front panel of the device and therefore heat it effectively. With this principle, the terminal also provides significant power while heating, without running the main fan. Comfort temperatures are therefore maintained, without air movements and in silence. In summer mode, the airflow generated by the micro fans is stopped to avoid any dew formation on the terminal's front surface.

With standard cast radiators.

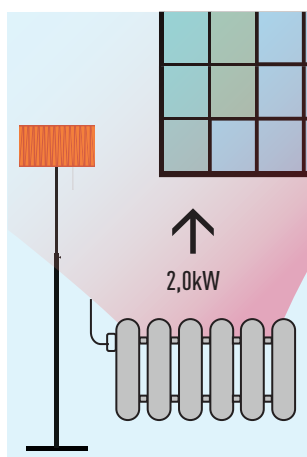

Water at 65°C needed.

With Aquarea Air.

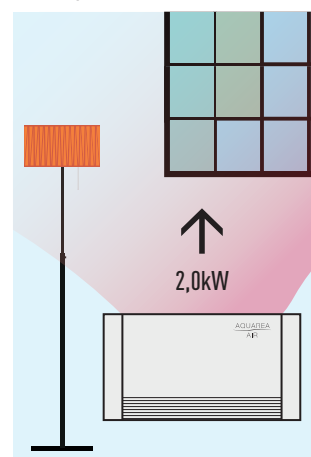

Water at 35°C needed.

Technical focus:

- Front panel heating with radiant effect
- High heating capacity (without main fan running)
- 4 fan speeds and capacities
- Exclusive design
- Extremely compact (only 12,9 cm deep)
- Cooling and dehumidification functions possible (drain is needed)
- 3-way valve included (no overflow valve needed on the installation if more than 3 radiators installed)
- Touch screen thermostat

All temperature curves and capacity are available on www.panasonicproclub.com

AQUAREA AIR

During winter, the operating principle is based on micro fans with very low power consumption and minimum noise, that send hot air coming from the heat exchanger, to the inside of the front panel of the device and therefore heat it effectively.

With this principle, the terminal also provides significant power while heating, without running the main fan. Comfort temperatures are therefore maintained, without air movements and in silence. In summer mode, the airflow generated by the micro fans is stopped to avoid any dew formation on the terminal's front surface.

Technical focus

- Front panel heating with radiant effect
- High heating capacity (without main fan running)
- 4 fan speeds and capacities
- Exclusive design
- Extremely compact (only 12,9cm deep)
- Cooling and dehumidification functions possible (drain is needed)
- 3-way valve included (no overflow valve needed on the installation if more than 3 radiators installed)
- Touch screen thermostat

Operating on heating mode with radiator using only radiant effect.

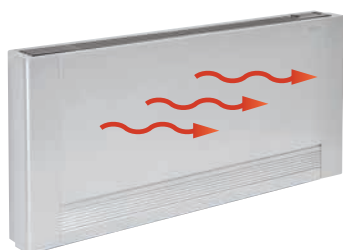

Operating on heating mode with radiant effect and fan mode.

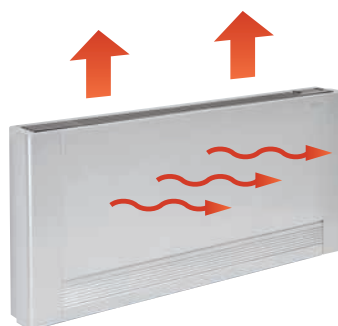

Operating on cooling mode with fan.

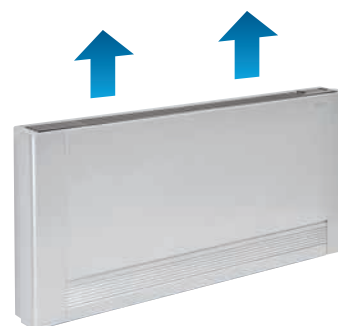

Fan Coils for Heat Pump application		PAW-AAIR-200-1					PAW-AAIR-700-1					PAW-AAIR-900-1				
Total heating capacity	W	138	160	217	470	570	223	360	708	1.032	1.188	273	475	886	1.420	1.703
Water flow	kg/h	23,7	27,5	37,3	80,8	98,0	38,4	61,9	121,8	177,5	204,3	47,0	81,7	152,4	244,2	292,9
Water pressure drop	kPa	0,1	0,2	0,4	2,0	2,9	0,1	0,1	0,3	0,8	1,0	0,1	0,2	0,5	1,6	2,2
Air flow	m³/min	0,5	0,6	0,9	1,9	2,7	0,7	1,4	2,6	4,2	5,3	0,9	1,8	4,1	6,1	7,7
	Speed	Main Fan Off	Super Min	Min	Med	Max	Main Fan Off	Super Min	Min	Med	Max	Main Fan Off	Super Min	Min	Med	Max
Maximum input power	W	2	5	7	9	13	3	9	14	18	22	3	11	16	20	24
Sound pressure	dB(A)	17,6	18,8	24,7	33,2	39,4	18,4	19,6	25,8	34,1	40,2	18,4	22,3	26,2	34,4	42,2
Inlet water temperature	°C	35	35	35	35	35	35	35	35	35	35	35	35	35	35	35
Outlet water temperature	°C	30	30	30	30	30	30	30	30	30	30	30	30	30	30	30
Inlet air temperature	°C	19	19	19	19	19	19	19	19	19	19	19	19	19	19	19
Outlet air temperature	°C	34,5	32,6	38,9	32,0	30,0	34,9	32,4	33,3	31,8	30,6	34,8	32,5	30,2	31,1	30,6
Dimensions (H x W x D)	mm	579 x 735 x 129					579 x 935 x 129					579 x 1.135 x 129				
Weight	kg	17					20					23				
3-ways valve included		Yes					Yes					Yes				
Touch screen thermostat		Yes					Yes					Yes				

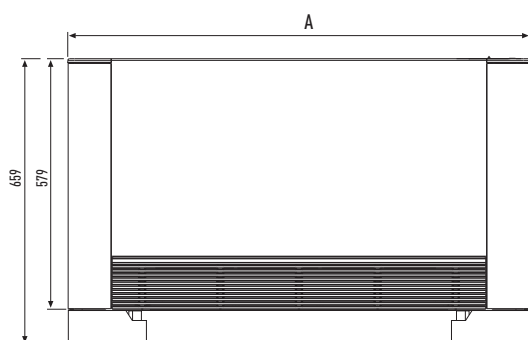

	200	700	900
A	735	935	1.135

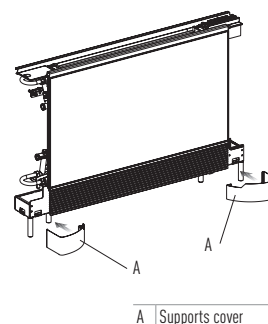

PANASONIC VENTILATION SOLUTIONS

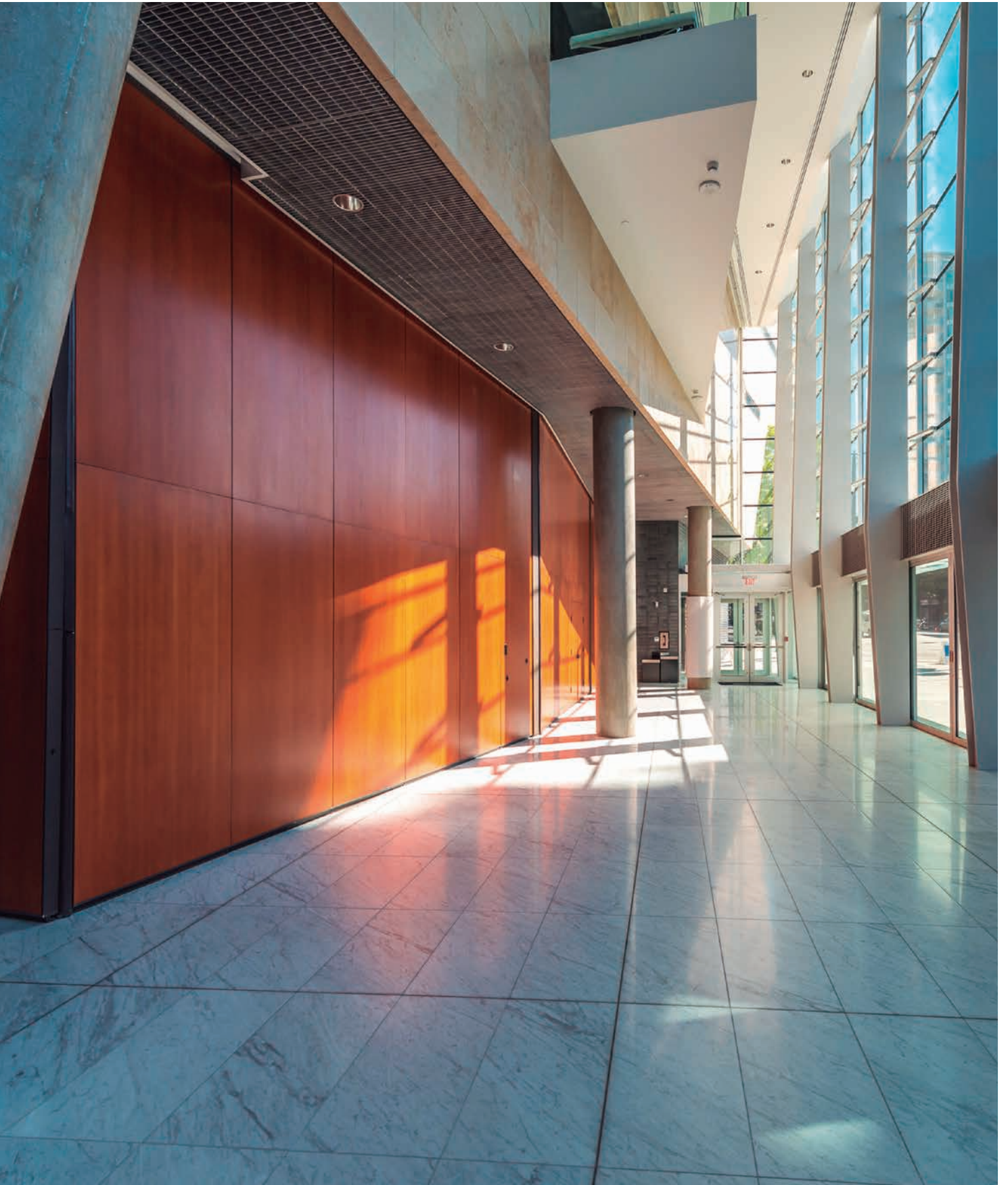

For maximum savings and easy integration.

AHU connection kit 16kW, 28kW and 56kW

AHU connection kit contains: IP65 box with PCBs and terminal connections mounted inside, expansion valve and sensors.

Heat exchanger, fan & fan motor to be mounted in the AHU itself shall be provided in the field.

Application: Hotels, offices, server rooms or all large buildings where air quality control such as humidity control and fresh air and is needed.



AHU Kit combine air conditioning and fresh air in just one solution.

New AHU Kits connect ECOi systems to air handling unit systems, using the same refrigerant circuit as the VRF system.

Large connectivity possibilities mean the Panasonic AHU Kit can be easily integrated.

3 types of AHU Kit: Deluxe, Medium and Light.

Model Code	IP 65	0-10V demand control*	Outdoor temperature shift compensation. Cold draft prevention
PAW-160MAH2 / PAW-280MAH2 / PAW-560MAH2	Yes	Yes	Yes
PAW-160MAH2M / PAW-280MAH2M / PAW-560MAH2M	Yes	Yes	No
PAW-160MAH2L / PAW-280MAH2L / PAW-560MAH2L	Yes	No	No

* With CZ-CAPBC2.

Heat Recovery With DX Coil

Motorised heat recovery by-pass device automatically controlled by unit control to use fresh air free-cooling when convenient.



- Galvanized steel self-supporting panels, internally and externally insulated
- Counterflow air-to-air heat recovery device, made of sheets of special paper with special sealing to keep airflows separate and only permeable to water vapour. Total heat exchange with temperature efficiency up to 77% and enthalpy efficiency up to 63%, also at high level during summer season
- G4 efficiency class filters with synthetic cleanable media, both on fresh air and return air intake
- Removable side panel to access filters and heat recovery in the event of scheduled maintenance
- Low consumption, high efficiency & low noise direct driven fans with 3-speed EC motors
- Supply section complete with DX Coil (R410A) fitted with solenoid control valve, freon filter, contact temperature sensors on liquid and gas line, NTC sensors upstream and downstream airflow
- Built-in electric box equipped with PCB to control internal fan speed and to interconnect outdoor/indoor units

Air Curtain with DX Coil

Highly efficient heating effect.

The combined air stream, which has a desirable low air current induction factor (mixing factor), can carry the selected initial temperature effect over long distances, and will reach the floor area while still at room temperature. This is necessary to avoid cooling down the interior spaces.



The Panasonic range of air curtains is designed for smooth operation and efficient performance. Air curtains produce a continuous stream of air blown from the top to the bottom of an open doorway and create a barrier that people and products can flow across, but air can't. Designed to improve energy efficiency, minimise heat loss from a building, and to allow retailers to keep doors open to encourage customers, our Air Curtains are suitable for connection to both VRF and PACi Systems.

Heating capacity comparison: Electrical air curtain / Panasonic air curtain

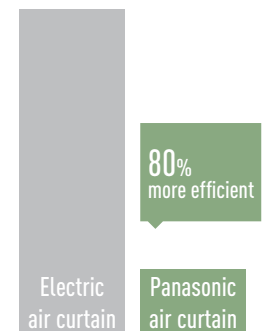

* With the U-100PE1ESA on the PAW-20PAIRC-MS. Calculation method: Taking as consideration SCOP of the Panasonic combination of 6,0. If 100 is the energy needed for a air curtain, Panasonic Air curtain will need 1/(1-6)*100=20.

Energy Recovery Ventilation

Panasonic Energy Recovery Ventilators help you with your comfort and energy-saving plan.



Panasonic Energy Recovery Ventilators can reduce the outside air load because they efficiently recover the heat lost by ventilation during the heat recovery process. This results in energy-saving ventilation and lower running costs for air-conditioning and heating equipment.

Furthermore, by designing our current models with an counter-flow heat-exchange element, we achieved products with slim body shapes and quiet operation that create a comfortable and pleasant air-conditioned environment while saving energy.

Dramatic energy savings achieved through adoption of a high-efficiency counter-flow heat-exchange element

- Counter-flow heat exchange element used for reduced noise and slimmer, more compact body shape
- All maintenance can be performed through a single inspection hole
- Straight air supply / exhaust system used for easier installation

When a regular ventilation fan is used¹ When a Energy Recovery Ventilator is used²

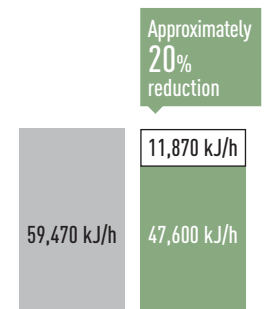

1) Two FY-27FPK7 units. 2) One FY-500Z0Y8 unit.

AHU CONNECTION KIT 16, 28 AND 56kW FOR ECOi AND GHP



Panasonic AHU Kit, 16-56kW connected to ECOi or ECO G

PCB, Transformer, Solenoid Control Valve, Thermistor x 4 pcs, Terminal Base and Electrical Component Box.

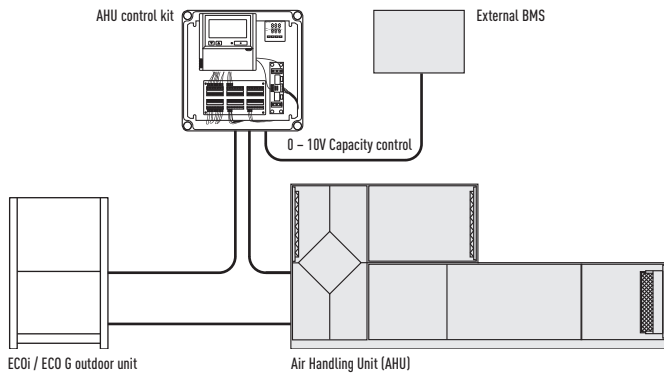

Demand control on the outdoor unit managed by external 0-10 V signal.

System example for large capacity (more than 56kW)
3 x [PCB, Transformer, Solenoid Control Valve, Thermistor x 4 pcs, Terminal Base and Electrical Component Box].
Example 140kW system

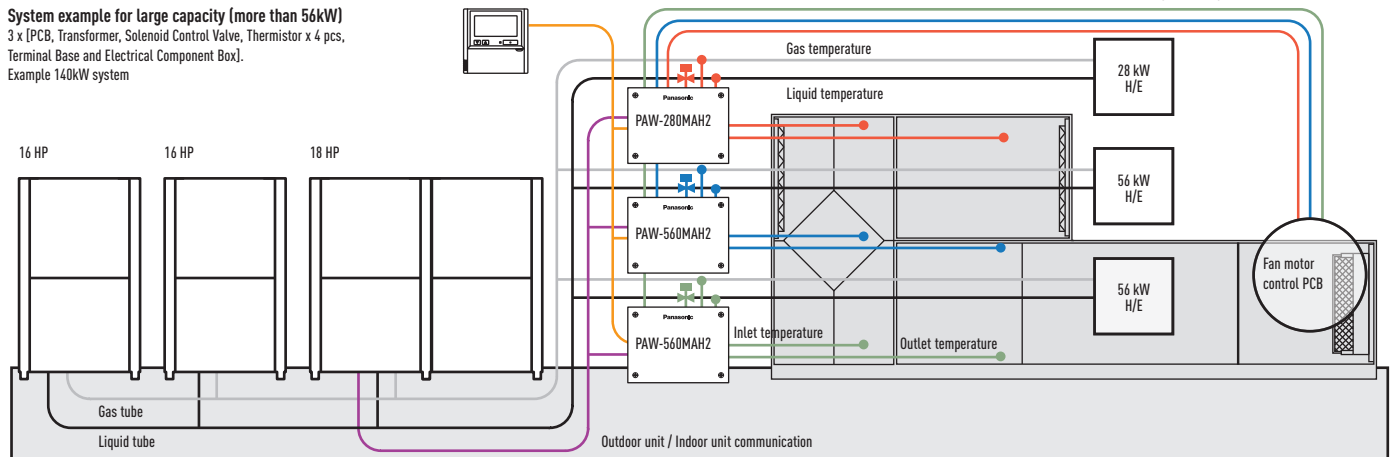

Main components of mechanical ventilation systems

The main components of a mechanical ventilation system are the following: Air Handling Unit (AHU), air ducts and air distribution elements.

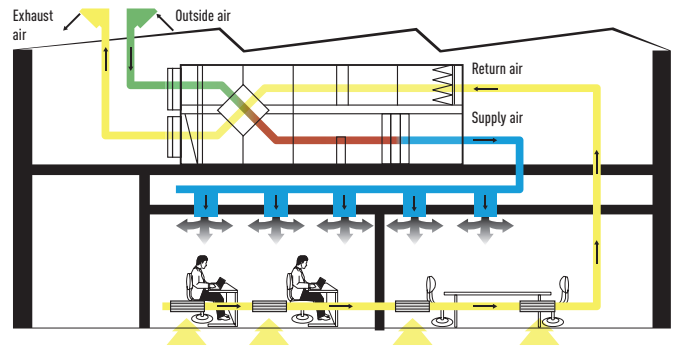

Optional parts: Following functions are available by using different control accessories:

CZ-RTC4 Timer remote controller.

- Operation-ON/OFF
- Mode select
- Temperature setting

* Fan operation signal can be taken from the PCB.

CZ-T10 terminal.

- Input signal= Operation ON/OFF
- Remote controller prohibition
- Output signal= Operating-ON status
- Alarm output (by DC12V)

PAW-OCT, DC12 V outlet. OPTION terminal.

- Output signal= Cooling/Heating/Fan status
- Defrost
- Thermostat-ON

CZ-CAPBC2 Mini seri-para I/O unit.

- Demand control 40% to 120% (5% steps) by 0-10V input signal
- Temperature setting by 0-10V or 0-140 Ω input signal
- Room (inlet air) temp outlet by 4-20mA
- Mode select or/and ON/OFF control
- Fan operation control
- Operation status output/ Alarm output
- Thermostat ON/OFF control

PAW-T10 PCB to connect to T10 connector.

- A Dry contact PCB has been developed to easily control the unit
- Input signal operation ON/OFF
- Remote control prohibition
- Output signal Operation ON status maximum 230V 5A (NO/NC)
- Output signal alarm status max. 230 V 5 A (NO/NC)
- Additional available contacts:
 - External humidifier control (ON/OFF) 230 VAC 3A
 - External fan control (ON/OFF) 12V DC
 - External filter status signal potential free
 - External float switch signal potential free
 - External leakage detection sensor or TH. OFF contact potential free (possible usage for external blow out temperature control)

ECOi 2-Pipe 6N Series outdoor unit shall be used for AHU Connection Kit.
3 models for VRF system: 5HP (PAW-160MAH2/M/L), 10HP (PAW-280MAH2/M/L) and 20HP (PAW-560MAH2/M/L).

With GHP outdoor units:

- One AHU kit may be used for one GHP unit (2-Pipe, 56kW). Multiple AHU kits cannot be used
- Mixed with standard indoor units is not allowed
- Power specifications are Single Phase 220V to 240V

Technical focus

- Maximum capacity/system: 60HP (168kW)
- Maximum piping length: 100m (120m equivalent)
- Elevation difference (indoor unit / indoor unit): 4m
- In/Out capacity ratio: 50~100%
- Maximum indoor unit number: 3 units*
- Outdoor temperature range in heating: -20 ~ +15°C
- Available temperature range for the suction air at AHU Kit: cool: +18 ~ +32°C / heat: +16 ~ +30°C

* To be simultaneous operation controlled by one remote controller sensor.

- The systems is controlled by the suction air (or room return air) temperature (same as standard indoor unit). (Selectable mode: Automatic / Cooling / Heating / Fan / Dry (but same as Cool))
- The discharge air temperature is also controlled to prevent too-low air discharge in cooling or too-high air discharge in heating (in case of VRF)
- Demand control (Forcible thermostat-OFF control by operating current)
- Defrost operation signal, Thermo-ON/OFF states output
- Drain pump control (Drain-pump and the float switch to be supplied in local)
- External target temperature setting via Indoor/Outdoor signal interface is available with CZ-CAPBC2 (Ex. 0 – 10V)
- Demand control 40% to 120% (5% steps) by 0-10V input signal
- Connectable with P-Link system. Special care for electrical noise may be necessary depending on the on-side system
- Fan control signal from the PCB can be used for control the air volume (high/mid/low and LL for Th-OFF). Need to change the fan control circuit wiring at field

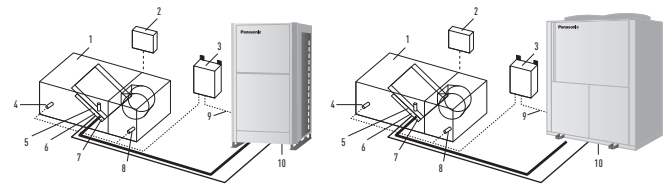

System & regulations. System overview

- 1. AHU Unit equipment (field supplied)
- 2. AHU Unit system controller (field supplied)
- 3. AHU Kit controller box (with control PCB)
- 4. Thermistor for discharge air
- 5. Electronic expansion valve
- 6. Thermistor for gas pipe (E3)
- 7. Thermistor for liquid pipe (E1)
- 8. Thermistor for suction air
- 9. Inter-unit wiring
- 10. Outdoor unit



Optional Controller.
Timer remote controller CZ-RTC4
Compatible with Econavi

HP			5HP	10HP	20HP	30HP	40HP	50HP	60HP
			PAW-160MAH2/M/L	PAW-280MAH2/M/L	PAW-560MAH2/M/L	PAW-280MAH2/M/L + PAW-560MAH2/M/L	PAW-560MAH2/M/L + PAW-560MAH2/M/L	PAW-560MAH2/M/L + PAW-560MAH2/M/L + PAW-280MAH2/M/L	PAW-560MAH2/M/L + PAW-560MAH2/M/L + PAW-560MAH2/M/L
Nominal cooling capacity @ 50Hz	kW		14,0	28,0	56,0	84,0	112,0	140,0	168,0
Nominal heating @ 50Hz	kW		16,0	31,5	63,0	95,0	127,0	155,0	189,0
Cooling airflow	Hi / Lo	m³/min	2.600 / 1.140	5.000 / 3.500	10.000 / 7.000	15.000 / 10.500	20.000 / 14.000	25.000 / 17.500	30.000 / 21.000
Bypass factor			0,9 (recommended)	0,9 (recommended)	0,9 (recommended)	0,9 (recommended)	0,9 (recommended)	0,9 (recommended)	0,9 (recommended)
Dimensions / Weight	H x W x D	mm / kg	303 x 232 x 110 / 3,2	404 x 425 x 78 / 6,3	404 x 425 x 78 / 6,3	404 x 425 x 78 / 6,3	404 x 425 x 78 / 6,3	404 x 425 x 78 / 6,3	404 x 425 x 78 / 6,3
Piping length	Min / Max	m	10 / 100	10 / 100	10 / 100	10 / 100	10 / 100	10 / 100	10 / 100
Elevation difference (in/out)	Max	m	10	10	10	10	10	10	10
Piping connections	Liquid pipe	Inch (mm)	3/8 (9,52)	3/8 (9,52)	5/8 (15,88)	3/4 (19,05)	3/4 (19,05)	3/4 (19,05)	3/4 (19,05)
	Gas pipe	Inch (mm)	5/8 (15,88)	7/8 (22,22)	1 1/8 (28,58)	1 1/4 (31,75)	1 1/2 (38,15)	1 1/2 (38,15)	1 1/2 (38,15)
Intake temperature of AHU Kit	Cooling Min - Max	°C	+18 ~ +32 (+13 ~ +23)	+18 ~ +32 (+13 ~ +23)	+18 ~ +32 (+13 ~ +23)	+18 ~ +32 (+13 ~ +23)	+18 ~ +32 (+13 ~ +23)	+18 ~ +32 (+13 ~ +23)	+18 ~ +32 (+13 ~ +23)
	Heating Min - Max	°C	+16 ~ +30	+16 ~ +30	+16 ~ +30	+16 ~ +30	+16 ~ +30	+16 ~ +30	+16 ~ +30
Ambient temperature of outdoor unit	Cooling Min - Max	°C	-10 ~ +43	-10 ~ +43	-10 ~ +43	-10 ~ +43	-10 ~ +43	-10 ~ +43	-10 ~ +43
	Heating Min - Max	°C	-20 ~ +15	-20 ~ +15	-20 ~ +15	-20 ~ +15	-20 ~ +15	-20 ~ +15	-20 ~ +15

AHU connection kit / System combination

Capacity (HP)	Outdoor unit combination	AHU kit combination
28kW (10HP)	U-10ME2E81	PAW-280MAH2
56kW (20HP)	U-20ME2E81	PAW-560MAH2
84kW (30HP)	U-16ME2E81	PAW-560MAH2
112kW (40HP)	U-20ME2E81	PAW-560MAH2
140kW (50HP)	U-18ME2E81	PAW-560MAH2
168kW (60HP)	U-20ME2E81	PAW-560MAH2
		PAW-280MAH2
		PAW-560MAH2
56kW (20HP)	U-20GE3E5	PAW-560MAH2

AIR CURTAIN WITH DX COIL, CONNECTED TO THE VRF OR PACi SYSTEMS

High efficiency air curtain connected to your VRF installation. EC Fan motor for a smooth operation and efficient performance. 2 types of air flow available: Jet-Flow and Standard. Easy cleaning and servicing.

Highly efficient heating effect

The combined air stream, which has a desirable low air current induction factor (mixing factor), can carry the selected initial temperature effect over long distances, and will reach the floor area while still at room temperature. This is necessary to avoid cooling down the interior spaces. Available in different lengths to suit requirements between 1,0 and 2,5m, both air curtains have outlet grilles that can be adjusted to five different positions. The jet flow model can be installed up to a height of 3,5m with the standard model up to 3,0m. The outlet grilles can be easily adjusted into five positions to suit different installations requirements and the air filter can be accessed without the need for specialist tools.

- Super-efficient with new EC fan motor (40% lower running costs compared to a standard AC fan motor)
 - Easy Cleaning and Servicing
 - Can be connected to either Panasonic VRF or PACi systems
 - Built-in drain for cooling operation
 - Standard and Jet Flow air curtains can be controlled via Panasonic's range of remote internet controls
- The new standard and jet-flow models are ideal for connection to a ECOi or PACi system. With simple "plug and play" installation, both are fitted with an EC fan motor for a smooth operation and efficient performance. This new fan guarantees 40% lower running cost than with a standard AC fan motor. With air curtains often running for 12 hours a day as a minimum, this can lead to considerable savings.

Internet Control

An app added to your tablet or smartphone or via the Internet allows you to control and manage the system remotely. There is also the option to integrate into existing BMS systems by using other Panasonic interfaces.

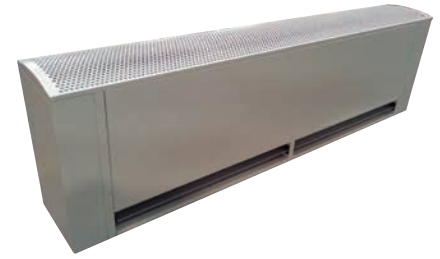
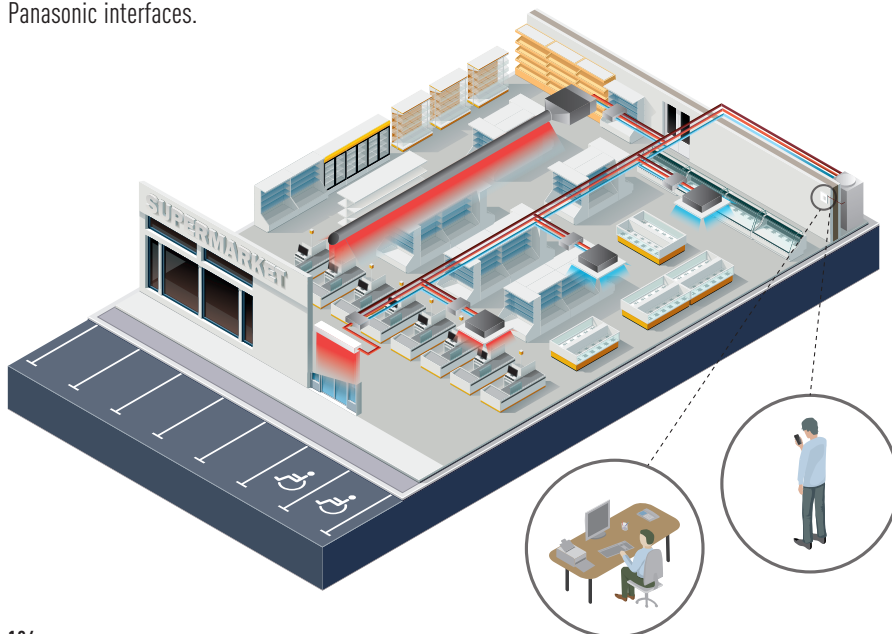

Intelligent Operation

Our air curtains combine airflow and heating / cooling technology to ensure optimum comfort and energy efficiency whilst also creating an effective barrier between indoor and outdoor environments. Design and installation is key to achieving the correct height / temperature settings to achieve optimum performance. Our air curtains are designed to answer the demands of the retail, commercial and industrial markets.

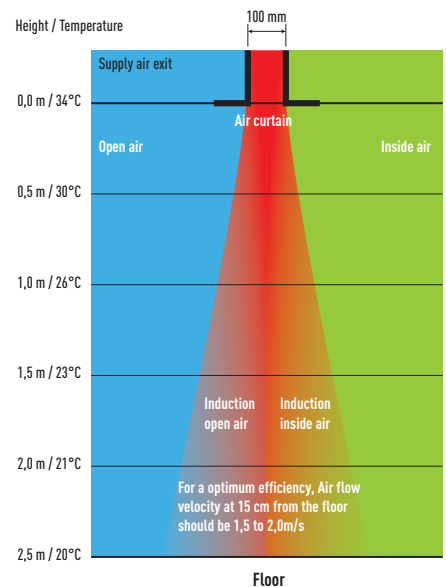

How does it work?

Stale air from the room is taken in and ejected near the door. This creates a 'roll of air' that shields the door area, mixing with the colder incoming air. It then turns away from the door, back into the room and toward the intake screen, where it is partly drawn in again. This flow of air helps to create a barrier for heat loss yet at the same time refreshes room air

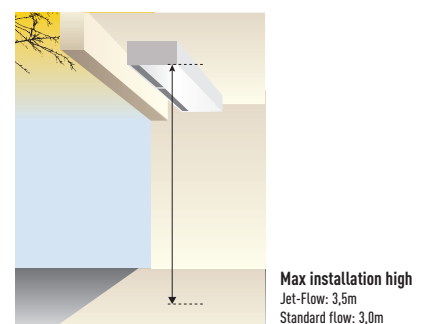



Technical focus

- Save up to 40% Energy Costs by use of the integrated EC Fan Technology (Higher efficiency than conventional AC fan, soft start and longer motor duration)
- 3 Lengths of Air Curtains Jet-Flow, from 1,0 to 2,0m and 2 lengths of Air Curtains Standard, 1,0 and 2,0m
- Installation Height up to 3,5m (Jet-Flow) and 3,0m (Standard)
- Outlet Grilles can be adjusted in five positions, to suite different Indoor and installation requirements (Jet-Flow)
- Control with Panasonic Remote Control systems (optional)
- Direct integration to BMS by optional Panasonic Interfaces
- Drain included for cooling operation

Features

Comfort.

- Easy redirection of Airflow by means of manual deflector (Jet-Flow)

Ease of use.

- Speed selector (high and low) on the unit itself

Easy installation and maintenance.

- Easy installation
- Compact dimensions improve installation and positioning (Jet-Flow)
- Easy cleaning of grid without opening of the unit

Optimised airflow velocity

1. Energy losses, no air curtain installed
2. Too low velocity air curtain – air curtain not efficient
3. Optimum results with the Tekadood air curtain connected to Panasonic VRF
4. Too high velocity air curtain – considerable turbulence, energy lost to the outside, air curtain not efficient

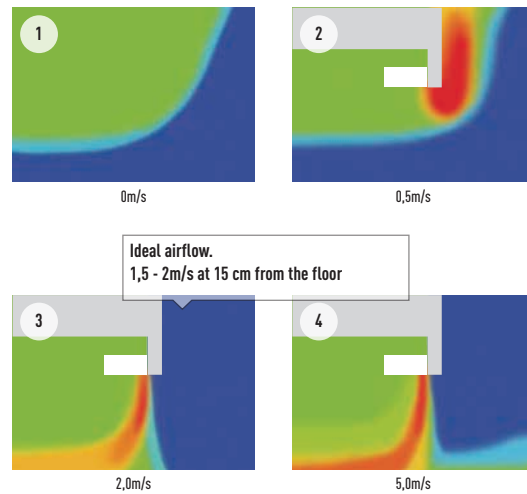

HP	4HP		6HP		8HP		14HP		4HP		8HP	
Air Curtain	PAW-10EAIRC-MJ		PAW-15EAIRC-MJ		PAW-20EAIRC-MJ		PAW-25EAIRC-MJ		PAW-10EAIRC-MS		PAW-20EAIRC-MS	
Air flow type	Jet-Flow						Standard					
Airflow Length (A)	1,0		1,5		2,0		2,5		1,0		2,0	
Air volume	Hi / Med / Lo	m ³ /min	30,0 / 25,0 / 20,0	45,0 / 38,3 / 31,7	60,0 / 50,0 / 41,7	75,0 / 63,3 / 51,7	30,0 / 25,0 / 20,0	45,0 / 38,3 / 31,7				
Cooling capacity		kW	9,2	17,5	23,1	24,4	9,2	17,5				
Heating capacity		kW	11,4	25,0	31,5	31,5	11,4	31,5				
Heating capacity with air in 20°C, air out 40°C / 35°C / 30°C		kW	11,9 / 8,9 / 5,9	17,9 / 13,4 / 8,9	23,9 / 17,9 / 11,9	29,9 / 22,4 / 14,9	11,9 / 8,9 / 5,9	17,9 / 13,4 / 8,9				
Max installation height	Good / Normal / Bad condition	m	3,5 / 3,1 / 2,7	3,5 / 3,1 / 2,7	3,5 / 3,1 / 2,7	3,5 / 3,1 / 2,7	3 / 2,7 / 2,4	3 / 2,7 / 2,4				
Refrigerant			R410A	R410A	R410A	R410A	R410A	R410A				
Hot gas temperature / Condensing temperature		°C	70 / 50	70 / 50	70 / 50	70 / 50	70 / 50	70 / 50				
Subcooling		K	5	5	5	5	5	5				
Pressure		bar	45	45	45	45	45	45				
Liquid pipe / Gas pipe		Inch (mm)	3/8 (9,52) / 5/8 (15,88)	3/8 (9,52) / 3/4 (19,05)	3/8 (9,52) / 7/8 (22,22)	3/8 (9,52) / 7/8 (22,22)	3/8 (9,52) / 7/8 (22,22)	3/8 (9,52) / 7/8 (22,22)	3/8 (9,52) / 5/8 (15,88)	3/8 (9,52) / 7/8 (22,22)		
Fan			230V / 50Hz / 1 / N / PE	230V / 50Hz / 1 / N / PE	230V / 50Hz / 1 / N / PE	230V / 50Hz / 1 / N / PE	230V / 50Hz / 1 / N / PE	230V / 50Hz / 1 / N / PE				
Fan type			EC	EC	EC	EC	EC	EC				
Currency	Hi / Med / Lo	A	2,1 / 0,8 / 0,3	2,8 / 1,1 / 0,4	4,2 / 1,6 / 0,6	4,9 / 1,9 / 0,7	2,1 / 0,8 / 0,3	4,2 / 1,6 / 0,6				
Electrical Consumption	Hi / Med / Lo	kW	0,44 / 0,17 / 0,06	0,59 / 0,23 / 0,08	0,89 / 0,34 / 0,12	1,03 / 0,40 / 0,14	0,44 / 0,17 / 0,06	0,89 / 0,34 / 0,12				
Protecting Fuse		A	M16A	M16A	M16A	M16A	M16A	M16A				
Noise		dB(A)	40 - 55	40 - 56	40 - 57	40 - 58	40 - 55	40 - 57				
Dimensions / Weight	W x H x D	mm / kg	1.210 x 260 x 590 / 70	1.710 x 260 x 590 / 100	2.210 x 260 x 590 / 138	2.710 x 260 x 590 / 160	1.210 x 260 x 490 / 60	2.210 x 260 x 490 / 128				
Mini ECOi with air out 40°C			U-4LE1E5/8 ¹	U-6LE1E5/8 ¹	—	—	U-4LE1E5/8 ¹	U-6LE1E5/8 ¹				
Mini ECOi with air out 35°C			U-4LE1E5/8 ¹	U-4LE1E5/8 ¹	U-6LE1E5/8 ¹	—	U-4LE1E5/8 ¹	U-4LE1E5/8 ¹				
Mini ECOi with air out 30°C			U-4LE1E5/8 ¹	U-4LE1E5/8 ¹	U-4LE1E5/8 ¹	U-5LE1E5/8 ¹	U-4LE1E5/8 ¹	U-4LE1E5/8 ¹				
ECOi with air out 40°C			All models	All models	All models	All models without 8HP	All models	All models				
ECOi with air out 30°C or 35°C			All models	All models	All models	All models	All models	All models				
GHP all temperatures			All models	All models	All models	All models	All models	All models				

1) or bigger size.



Rated Conditions Cooling Outdoor +35°C DB Indoor +27°C DB/+19°C WB, Discharge temperature ³ 16°C. All combinations under rated conditions: Heating Outdoor +7°C DB/+4°C WB Indoor +20°C DB. In case of lower outdoor temperatures a higher capacity outdoor unit model may be necessary. Specifications subject to change without notice. For detailed information about ErP, please visit our websites www.aircon.panasonic.eu or www.ptc.panasonic.eu.

ENERGY RECOVERY VENTILATION

Suppresses indoor temperature changes while providing fresh air. Recovers up to 77% of the heat in the outgoing air, for an ecological and energy efficient building.

Energy efficiency and ecology

Energy consumption is dramatically reduced by using a counter-flow heat-exchange element. Air conditioning load is reduced by approximately 20%, resulting in significant energy savings.

Comparison of former and current elements

With the cross-flow element, air moves in a straight line across the element; with the counter-flow element, air flows through the element for a longer time (longer distance), so the heat-exchange effect remains unchanged even if the element is made thinner.

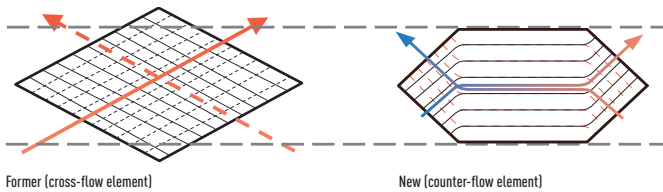

Heat exchange ventilation and normal ventilation

Energy-saving ventilation can be achieved through the proper use of heat-exchange ventilation and normal ventilation.

Heat exchange ventilation.

When a room is cooled or heated, the exhausted cooling / heating energy is recovered by heat-exchange ventilation.

Normal ventilation.

This is used in the spring and autumn, when rooms are not cooled or heated, that is, when there is little difference between the indoor and outdoor air conditions. In addition, at night during the hot season, when the outside air temperature drops the outside air is drawn inside without heat exchange, alleviating the load on the air conditioning equipment. The heat exchanger is made up of a membrane manufactured from a special material covered in resin for optimal heat transmission. The nylon/ polyester fibre filter offers high dust retention capacity. We have also redesigned the air ducts to obtain a long-lasting heat exchange system which does not need periodic cleaning.

Heat exchanger

With the cross-flow element, air moves in a straight line across the element. With the counter-flow element, airflows through the element for a longer time (longer distance), so the heat-exchange effect remains unchanged even if the element is made thinner.



More comfort

Quiet operation

Low noise operation results in noticeably quieter units. All models with capacities below 500m³/h run at noise levels below 32dB (High setting) and even our largest 1.000m³/h-capacity model runs at only 37,5dB (High setting).

Long service life of heat-exchange element

We used a nonwoven cloth filter with a high dust collection efficiency and redesigned the air flow passages to achieve a durable heat-exchange element that requires no periodic cleaning.

Changes in airflow resistance based on number of years in service.

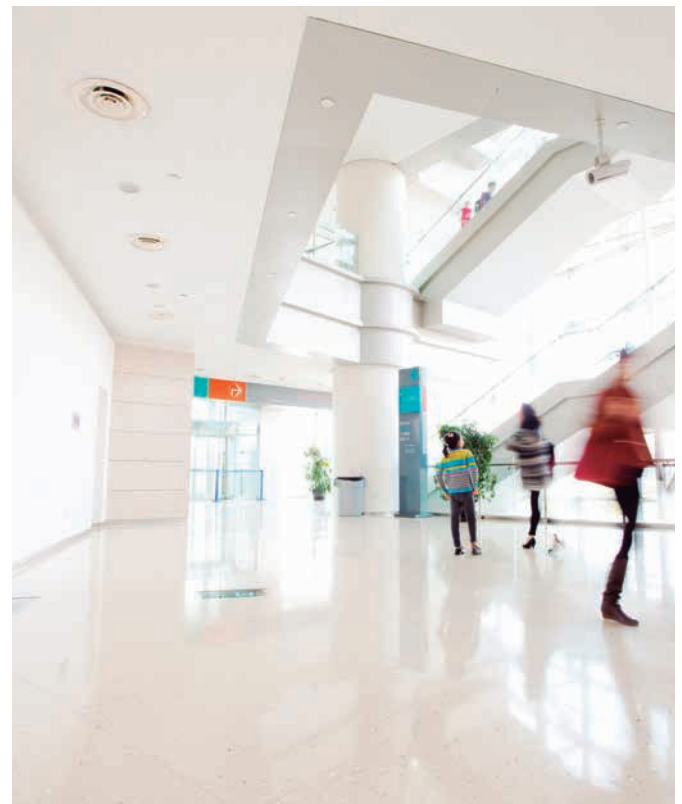

Technical focus

- High energy saving, up to 20%
- Counter Cross Flow technology for better efficiency
- Long life element core
- Easy installation and 20% less thickness
- Easy connection to air conditioning units
- Super quiet units

Features

Energy efficiency and ecology.

- Up to 20% energy saving in the installation
- Recovers up to 77% of the heat in the outgoing air

Comfort.

- Cleaning reduced due to the revolutionary structure (every 6 months)
- Ideal for indoor spaces without windows

Easy installation and maintenance.

- 6 models for easier selection
- Reduced system height (270mm and 388mm)
- Side opening for cleaning (inspection of filter, motor and other parts)
- Installation can be reversed to share an inspection opening between 2 machines
- Easy connection to the air conditioning unit (without additional elements)
- Installation in false ceilings
- Units operate at 220 - 240V
- High static pressure for easier installation

Healthy air.

- The filter guarantees healthier air

Balanced ventilation

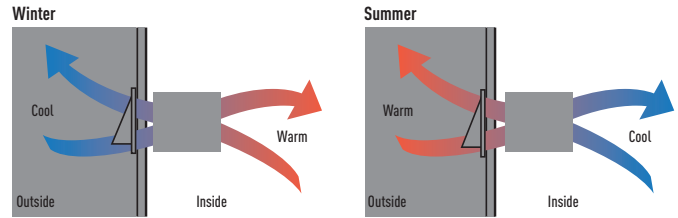

Easy installation and maintenance

Slim shape and easier installation.

Counter-flow heat exchange element used for reduced noise and slimmer, more compact body shape.

270mm Height: FY-250ZDY8 // FY-350ZDY8 // FY-500ZDY8

388mm Height: FY-800ZDY8 // FY-01KZDY8A

Reverse mountable direct air supply / exhaust system.

Adoption of straight air supply / exhaust system: Duct design is simplified because the air supply / exhaust ducts are straight.

Since each unit can be mounted in reverse position, only one inspection hole is needed for two units: Two units can share one inspection hole so duct work is easier and more flexible.

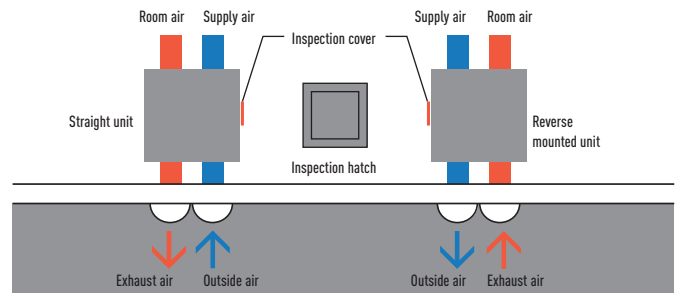

Rated flow rate Models	250m³/h FY-250ZDY8			350m³/h FY-350ZDY8			500m³/h FY-500ZDY8			800m³/h FY-800ZDY8			1.000m³/h FY-01KZDY8A			
Power source	220 / 240 V / 50 Hz															
Heat exchange ventilation	E-High	High	Low	E-High	High	Low	E-High	High	Low	E-High	High	Low	E-High	High	Low	
Input	W	112 / 128	108 / 123	87 / 96	182 / 190	178 / 185	175 / 168	263 / 289	204 / 225	165 / 185	387 / 418	360 / 378	293 / 295	437 / 464	416 / 432	301 / 311
Air volume	m³/h	250	250	190	350	350	240	500	500	440	800	800	630	1.000	1.000	700
External static pressure	Pa	105	95	45	140	60	45	120	60	35	140	110	55	105	80	75
Sound power	dB	30,0 / 31,5	29,5 / 30,5	23,5 / 26,5	32,5 / 33,0	30,5 / 31,0	22,5 / 25,5	36,5 / 37,5	34,5 / 35,5	31,0 / 32,5	37,0 / 37,5	36,5 / 37,0	33,5 / 34,5	37,5 / 38,5	37,0 / 37,5	33,5 / 34,5
Temp. exchange efficiency	%	75	75	77	75	75	78	75	75	76	75	75	76	75	75	79
Normal ventilation	E-High	High	Low	E-High	High	Low	E-High	High	Low	E-High	High	Low	E-High	High	Low	
Input	W	112 / 128	108 / 123	87 / 96	182 / 190	178 / 185	175 / 168	263 / 289	204 / 225	165 / 185	387 / 418	360 / 378	293 / 295	437 / 464	416 / 432	301 / 311
Air volume	m³/h	250	250	190	350	350	240	500	500	440	800	800	630	1.000	1.000	700
External static pressure	Pa	105	95	45	140	60	45	120	60	35	140	110	55	105	80	75
Sound power	dB	30,0 / 31,5	29,5 / 30,5	23,5 / 26,5	32,5 / 33,0	30,5 / 31,0	22,5 / 25,5	37,5 / 38,5	37,0 / 38,0	31,0 / 32,5	37,0 / 37,5	36,5 / 37,0	33,5 / 34,5	39,5 / 40,5	39,0 / 39,5	35,5 / 36,5
Temp. exchange efficiency	%	—	—	—	—	—	—	—	—	—	—	—	—	—	—	—
Dimensions (W x D x H)	mm	882 x 599 x 270			1.050 x 804 x 317			1.090 x 904 x 317			1.322 x 884 x 388			1.322 x 1.134 x 388		
Weight	kg	29			49			57			71			83		

This noise of the product is the value which was measured at the acoustic room. Actually, in the established condition, that undergo influence by the echoing of the room and so that become bigger than the display numerical value. The input, the current and the exchange efficiency are values at the time of the mentioned air volume. The noise level shall be measured 1,5m below the centre of the unit. The temperature exchange efficiency averages that of when cooling and when heating.

HEAT RECOVERY WITH DX COIL

Panasonic launches an heat recovery solution for greater energy efficiency and cleaner lungs.

Panasonic's heat recovery solution performs well in extreme weather conditions and can achieve up to 77% efficiency (63% in enthalpy efficiency).

The counter-flow heat exchanger reduces the air conditioning load, enabling customers – typically owners of hotels, restaurants and other large commercial buildings – to reduce their energy consumption and save on the cost of maintaining comfortable room temperatures.

Energy efficiency

As the latest example of Panasonic's continued commitment to developing unbeatable, energy-efficient air conditioning technologies for commercial applications, the company has introduced a heat recovery device. The unit features a DX Coil designed to recover up to 77% of the heat from outgoing air, and a air purifying system which helps to improve air quality.

In even the most demanding commercial applications, business owners will benefit from the unit's ability to by-pass the heat exchange process when the outside air temperature is cool enough for fresh air to be drawn directly inside (free cooling).

This alleviates the load on the air conditioning equipment and consequently reduces energy bills.



Supply section complete

The supply section comes complete with the DX coil (using the environmentally-friendly R410A refrigerant) – fitted with a solenoid control valve, freon filter, contact temperature sensors on the liquid and gas line, and NTC sensors on the upstream and downstream airflows. The built-in electric box is equipped with a PCB to control the internal fan speed and to interconnect the outdoor and indoor units, and the ducts are connected by circular plastic collars.

Characteristic curves

The following curves show the unit external static pressure at maximum fan speed for each model.

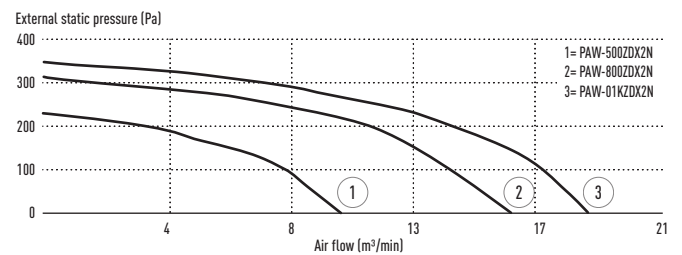

Balanced Ventilation

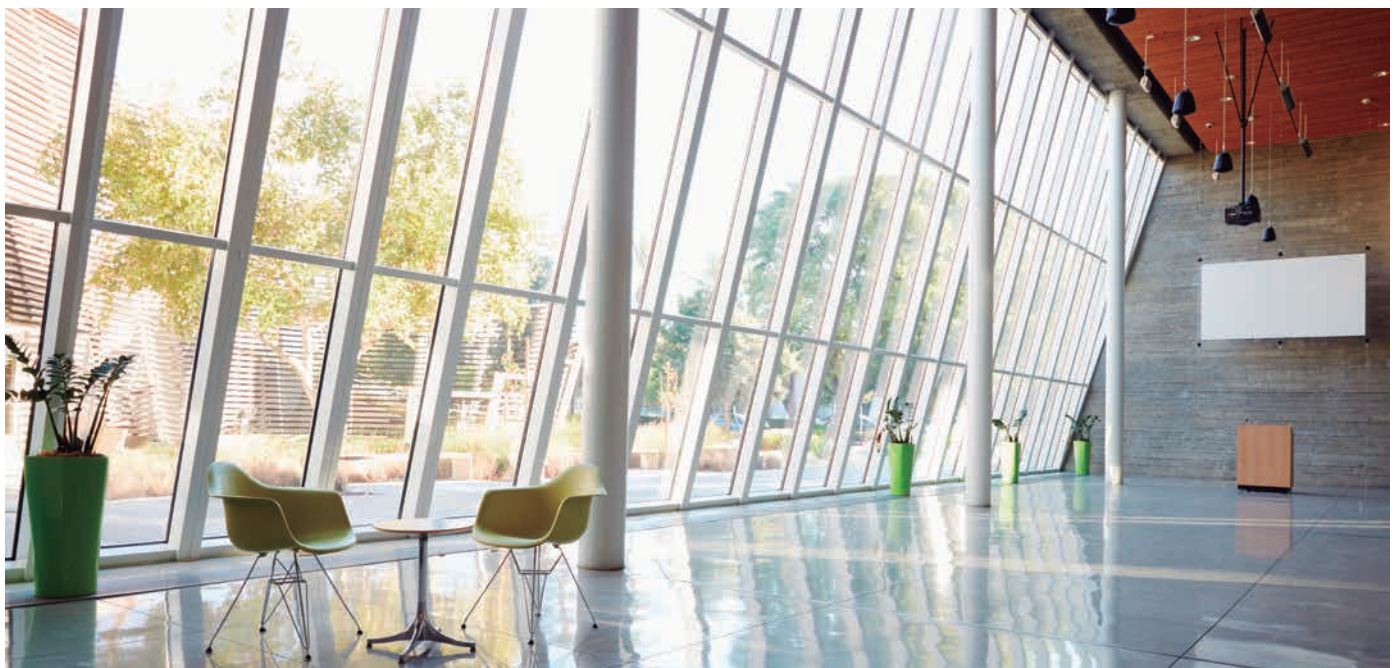
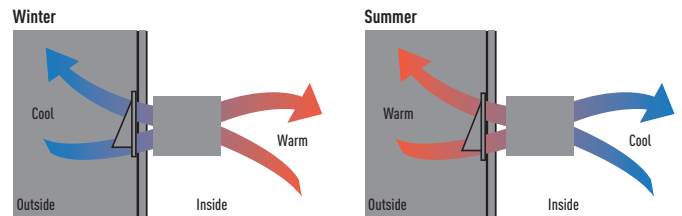

Interconnection

This ventilation unit is connected to an ECOi indoor unit (3,0kW, 4,0kW or 4,5kW) and can be controlled by the easy-to-use ECOi remote controller CZ-RTC4.

This capability makes the system an excellent choice for hotels, offices (large and small), educational settings and other buildings requiring different temperatures in multiple rooms. The system also integrates easily with building management systems.

Technical focus

- Motorised heat recovery by-pass device automatically controlled by unit control to use fresh air free-cooling when convenient

General characteristics

- Galvanized steel self-supporting panels, internally and externally insulated
- Counterflow air-to-air heat recovery device, made of sheets of special paper with special sealing to keep airflows separate and only permeable to water vapour. Total heat exchange with temperature efficiency up to 77% and enthalpy efficiency up to 63%, also at high level during summer season

- G4 efficiency class filters with synthetic cleanable media, both on fresh air and return air intake
- Removable side panel to access filters and heat recovery in the event of scheduled maintenance
- Low consumption, high efficiency & low noise direct driven fans with 3-speed EC motors
- Supply section complete with DX Coil (R410A) fitted with solenoid control valve, freon filter, contact temperature sensors on liquid and gas line, NTC sensors upstream and downstream airflow
- Built-in electric box equipped with PCB to control internal fan speed and to interconnect outdoor/indoor units
- Duct connection by circular plastic collars
- CZ-RTC4 Timer remote controller (option)

Interconnection to outdoor/indoor units

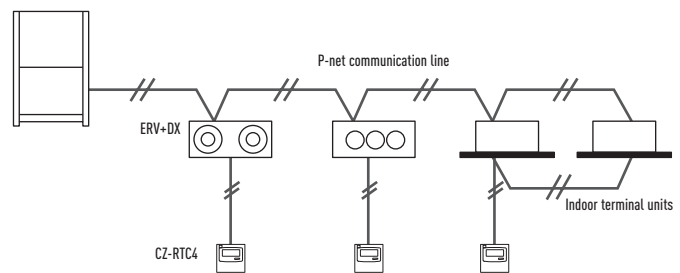

Optional Controller. Wired remote controller CZ-RTC5A. Compatible with Econavi



Optional Controller. Timer remote controller CZ-RTC4. Compatible with Econavi

Model	PAW-500ZDX2N		PAW-800ZDX2N		PAW-01KZDX2N	
Power source	230 V / Single Phase / 50 Hz		230 V / Single Phase / 50 Hz		230 V / Single Phase / 50 Hz	
Air volume	Hi / Med / Lo	m ³ /h	500 / 500 / 360	800 / 700 / 600	1.000 / 780 / 650	
External static pressure ¹	Hi / Med / Lo	Pa	135 / 95 / 50	115 / 45 / 25	100 / 70 / 35	
Maximum current		A	2,0	2,8	3,0	
Maximum Input power		W	135	300	310	
Sound pressure ³	Hi / Med / Lo	dB(A)	33 / 31 / 27	38 / 36 / 32	39 / 37 / 33	
Pipe connections	Liquid / Gas	Inch (mm)	1/4 (6,35) / 1/2 (12,70)	1/4 (6,35) / 1/2 (12,70)	1/4 (6,35) / 1/2 (12,70)	
HEAT RECOVERY			Summer mode	Winter mode	Summer mode	Winter mode
Temperature efficiency	%		62,5	76,5 (76,5)	59,5	73,5 (73,5)
Enthalpy efficiency	%		60	62,3 (64,1)	57	59,5 (61,2)
Saved power	kW		1,7	4,3 (4,8)	2,5	8,2 (9,0)
DX COIL			Cooling	Heating	Cooling	Heating
Total capacity	kW		3,0	2,9 (3,1)	4,0	4,0 (4,3)
Sensible cooling capacity	kW		2,0	—	2,8	—
Off temperature	°C		16,5	30,1 (29,2)	17,9	27,5 (26,5)
Off relative humidity	%		86	16 (15)	82	18 (17)

Nominal summer conditions: Outside air: 32°C DB, RH 50%. Ambient air: 26°C DB, RH 50%. Nominal winter conditions: Outside air: -5°C (-10°C) DB, RH 80%. Ambient air: 20°C DB, RH 50%. Cooling mode air inlet condition: 28.5°C DB, RH 50%; evaporating temp. 4°C. Heating mode air inlet condition: 13°C DB, RH 40% (11°C DB, RH 45%); condensating temperature 49°C. DB: Dry Bulb; RH: Relative Humidity.
 1) Referred to the nominal airflow after filter and plate heat exchanger. 3) Referred to 1,5m from inlet in free field condition.



INTERNET CONTROL: Optional.

CONTROL AND CONNECTIVITY

NEW VRF
TECHNOLOGY
'17



Panasonic has developed the largest range of control systems to offer the best option to each need.

From the individual remote control for the residential single units up to the newest technology to control each your buildings around the world from an easy to use software in the cloud by your portable device.

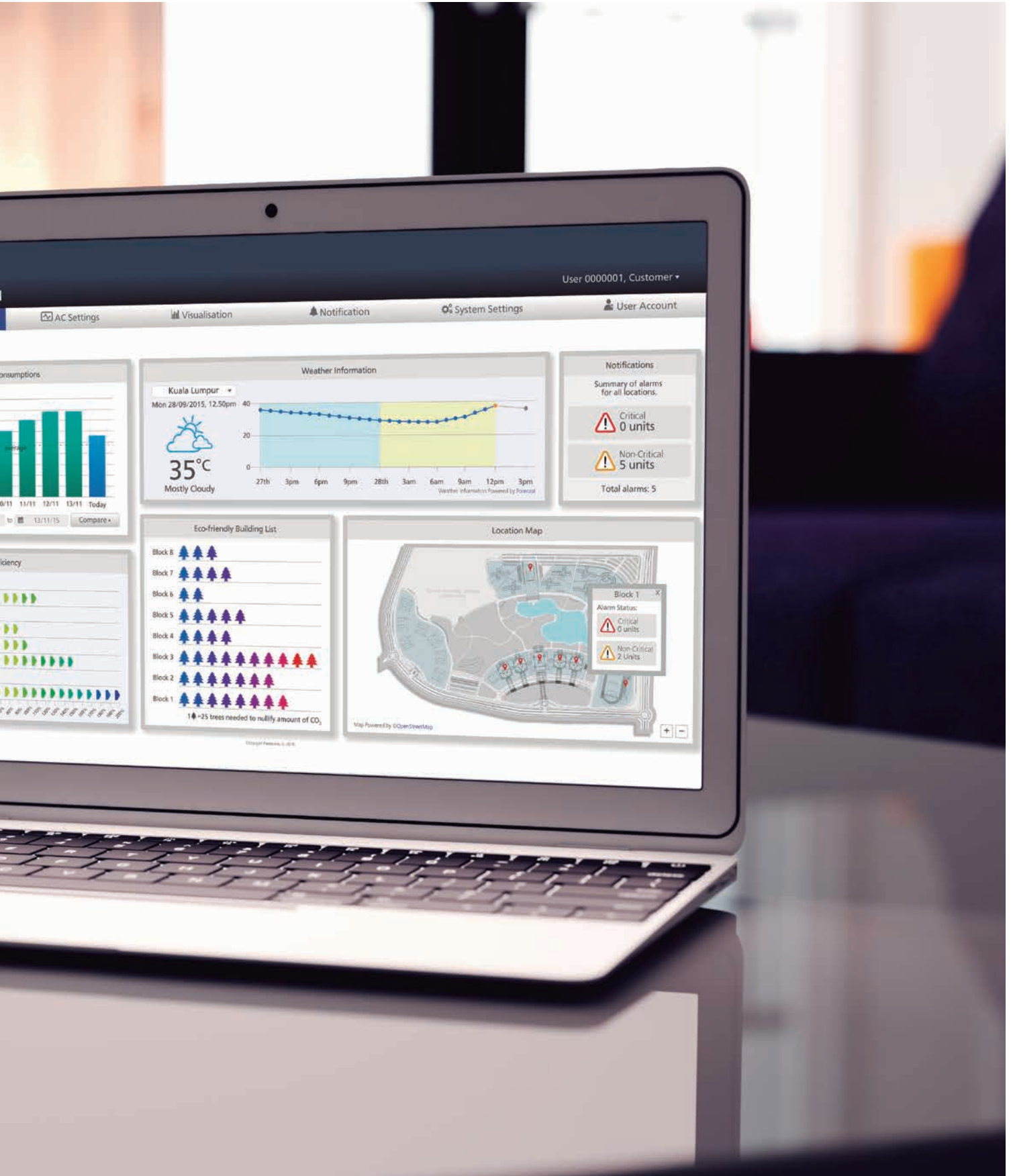

PANASONIC AC SMART CLOUD





Flexible solution and scalable solution

- Energy saving
- Zero downtime
- Site(s) management

Centralize control of your business premises, from wherever you are, 24/7/365. It doesn't matter how many sites you have, or where they are! The AC Smart Cloud system from Panasonic allows you to have complete control of all your installations, from your tablet or from your computer. In a simple click, all your units from several locations, receive status updates in real-time of all your installations, preventing breakdowns and optimizing costs.

With Panasonic AC Smart Cloud, have your business under control, and start saving!

Flexible solution for your business.

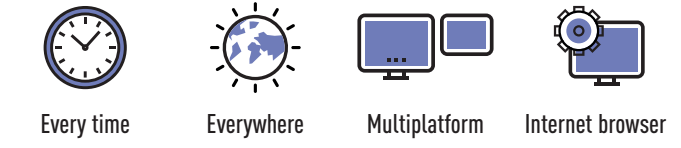

Scalable solution for your business.

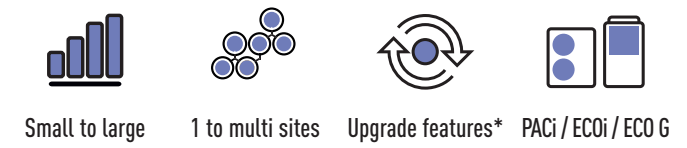

*Customized to meet user demand / Upgraded new functions / Upgraded by new products / IT smart management.

Key functions and uniqueness

Multi site monitoring.

- It doesn't matter how many sites you have, easy to manage, operate, compare per sites, locations, rooms.



Schedule setting.

- Weekly / holiday timer setting as you want
- One setting can be copied to other sites

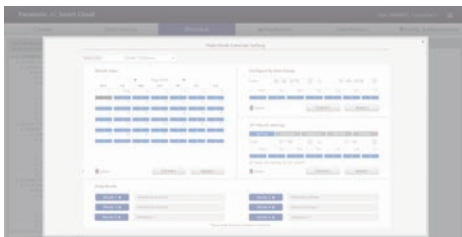

User customization.

Site administrator can create users as desired and assign customized profiles.

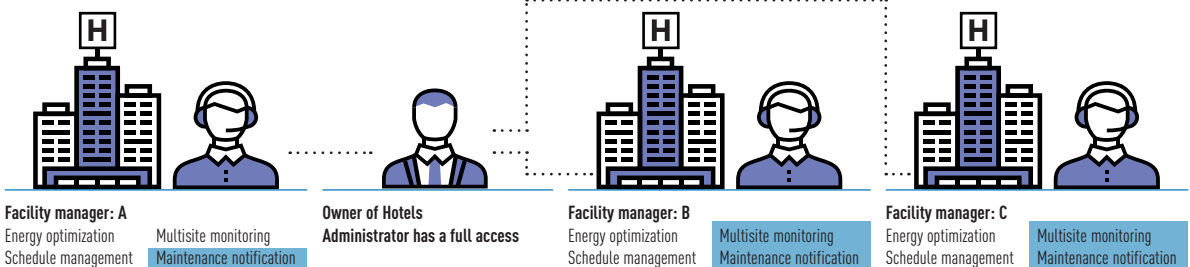

Powerful statistics for energy savings.

- Power consumption, capacity, efficiency level can be compared per different parameters (Yearly / monthly / weekly/ daily bases)



Maintenance notification.

- Error notification by email and with floor layout
- Maintenance notification of ECOi / ECO G outdoor units



One of our uniqueness is "Stable and secured communication package"

- Connectivity is included in the service. Customers do not have to take time to find and prepare suitable connectivity.
- With an all inclusive service offering, the customer has peace of mind and a one stop shop for all AC Smart Cloud issues they may face including connectivity



CONNECT TO THE FUTURE. VRF SMART CONNECTIVITY

NEW
TECHNOLOGY
'17

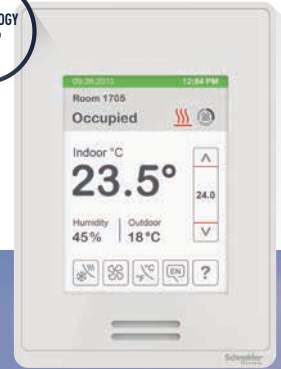

Through thorough energy management, Panasonic's VRF Smart Connectivity is a completely new, state-of-the-art solution providing energy saving and comfort as well as simple installation, operation and running.

Panasonic, passionately pursuing the ultimate in energy saving through the application of cutting-edge technology, and Schneider Electric, an advanced global energy management specialist offering innovative control systems. This collaboration has set the new standard for creating the next generation of contemporary buildings.

VRF Smart Connectivity Advantages:

-  Easy Design and Plug and Play to Reduce CapEx
-  Dramatic Reduction of OpEx with Outstanding IAQ
-  Ultimate Customization
-  User-/Owner-friendly

VRF Smart Connectivity.
The future of Control.

Life Is On



BEMS Smart Connection

The Smarter solution to simplify energy management, optimize building efficiency and drive savings.

Plug and Play BEMS connection.

With Plug and Play, connection to a BEMS is extremely easy. Better still, a remote controller is all that's needed to enable use as a stand-alone system. As well as dramatically reducing the burden on system integrators, this cuts costs.

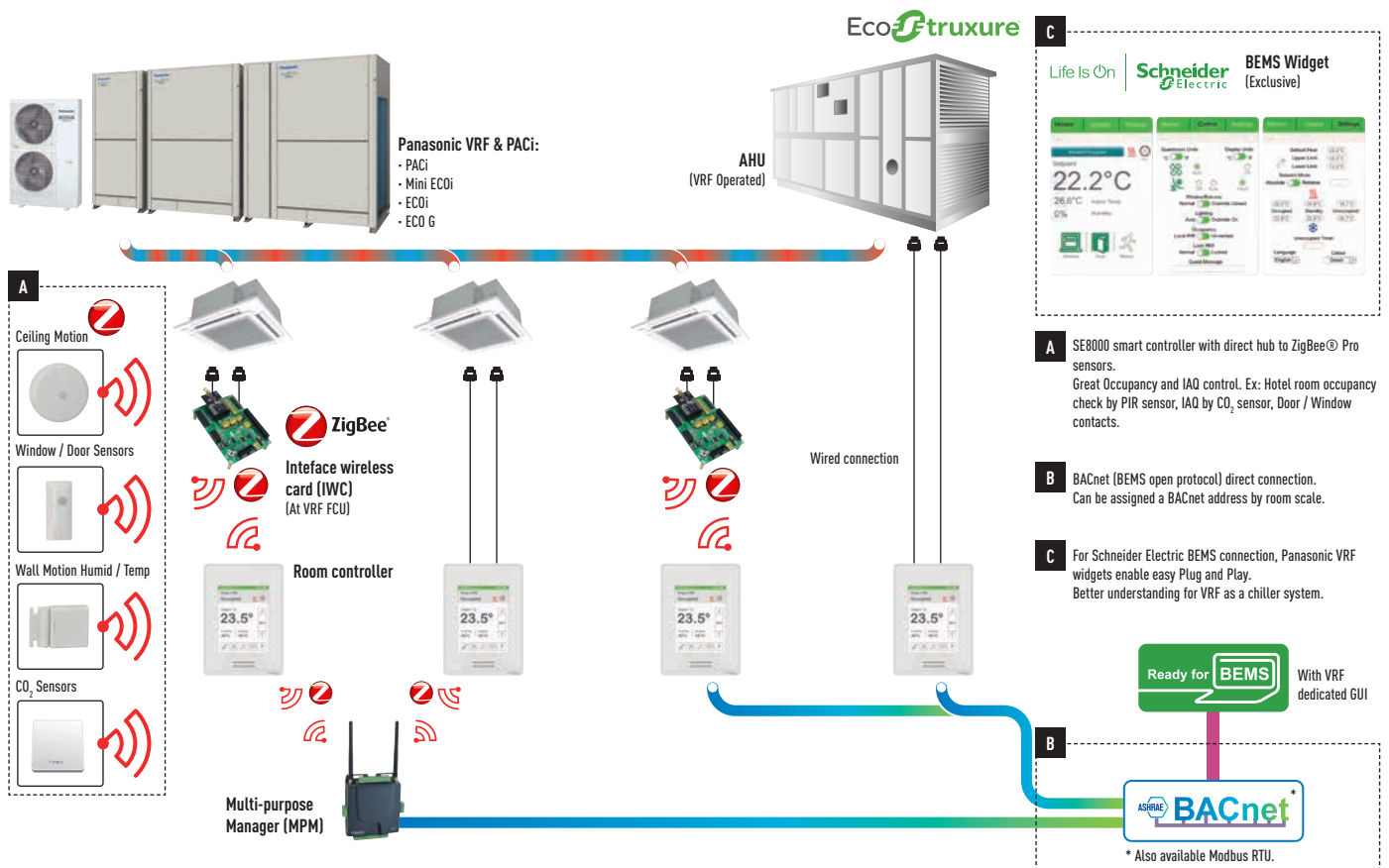

VRF Smart Connectivity Devices

2 types of devices depending on type connection with indoor units wireless or wired.
Wireless connection to indoor unit requires ZigBee interface for indoor unit.

Remote Controller Part Number	Description
SER8150A0B1194P	Panasonic Net Con, RH, No PIR, ZigBee®
SER8150A5B1194P	Panasonic Net Con, RH, PIR, ZigBee®
SER8150R0B1194	Panasonic Net Con, RH, No PIR, R1/R2
SER8150R5B1194	Panasonic Net Con, RH, PIR, R1/R2
Interface Part Number	Description
VCM8000R5094	Panasonic R1/R2 to ZigBee® I/F
Sensor Part Number	Description
SED-WMS-P-5045	SED SEN OCC WALL ZP
SED-WDS-P-5045	SED SW DOR/WIN ZP
SED-CMS-P-5045	SED SEN OCC CEIL ZP



REMOTE CONTROLLER WITH ECONAVI

NEW
TECHNOLOGY
'17

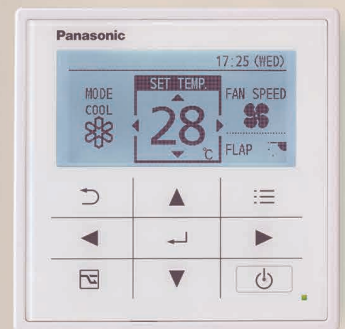

Easy to use, attractive, clear design, with new demand control functions and energy consumption display! This useful feature makes this remote control unique!

Design

The new CZ-RTC5A wired remote control is ideal for integration into the most demanding interior architectures. The touch panel features a very sleek and easy to use display, which with its compact display is only 120 x 120 x 16mm.

Display of information

The information is mainly based on pictograms to ensure easy understanding. The minimal amount of text is available in 4 languages (English / German / French / Spanish / Italian). The screen is back lit to enable reading even during the night.

Easy Access to the menus.

With the new pictograms, the navigation, the selection and the settings are simple and easy to follow.

Key Functions

- Easy setup of the timer and settings of the indoor unit
- Energy consumption display (only available with PACi units with the reference ending with A)
- Limitation of the energy consumption (Demand control) by timer.

Basic function (Operation display & indication)

All functions are easily available on the remote controller.

- OFF/ON timer • Weekly timer • Quiet operation • Remote control sensor • Operation prohibit • Filter sign • Energy saving • Centralized control indication • Mode change prohibit • Automatic temperature return • Temperature range limitation • OFF remind • Schedule demand control • Ventilation • Out Function

1. Name of the room (Max.16 characters)
 2. Time & Day of the week
 3. Mode: Hot / Cool / Dry / Fan Auto
 4. Status: Heating stand-by / Defrost operation / Stand-by (GHP system)
 5. Set temperature
 6. Flap setting
 7. Fan speed: H / M / L / Auto

Easy operation and quick access to all menus

1. Set temperature will be selected, when any arrow button is touched
2. Select the item (Mode or Fan speed) by left/right ◀▶ key
3. Change the setting by up/down ▲▼ key

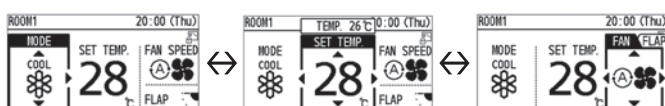

Backup control by using CZ-RTC5A

Group wiring of 2 systems of PACi can do auto individual control.

- Rotation operation
- Backup operation
- Support operation

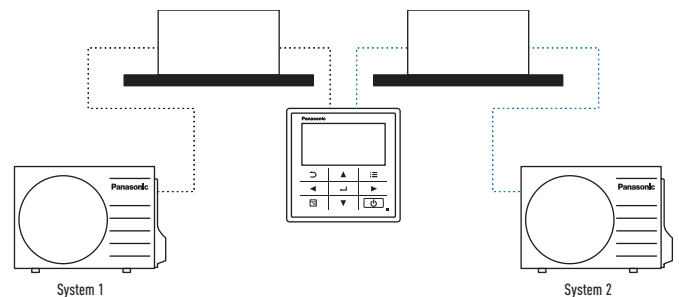

Example of easy access to the functions: Air direction setting

1. Select "Air direction" and press "determine" key
2. Select the unit number by up/down key
3. Select the flap position by up/down key
4. Press "Return" key to go back the Menu display

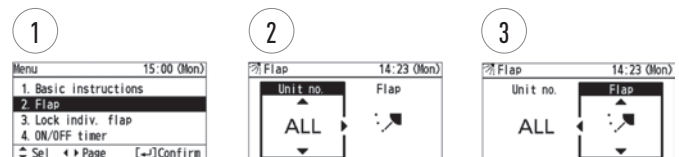

Functions available on the CZ-RTC5A

Control item	Controllability	Indoor Units		
		PACi Standard	PACi Elite	All VRF
Basic Operation	Operation, Mode, Temperature setting, Airflow volume, Airflow direction	✓	✓	✓
	Time display	✓	✓	✓
Timer function	Easy ON/OFF timer	✓	✓	✓
	Weekly Program timer	✓	✓	✓
Energy saving	Outing function	✓	✓	✓
	Temperature auto return	✓	✓	✓
	Temperature setting range limitation	✓	✓	✓
	OFF remind	✓	✓	✓
	Energy saving mode	✓	✓	✓
	Schedule demand control	—	✓	✓
	Energy monitoring	—	✓	—
Maintenance	System failure information	—	✓	—
	Service contact registration	✓	✓	✓
	Filter sign (rest time display) & Reset	✓	✓	✓
	Auto-address, Test run	✓	✓	✓
	Sensor value monitor	✓	✓	✓
Others	Simple / Detail setting mode	✓	✓	✓
	Key lock	✓	✓	✓
	Ventilation fan control	✓	✓	✓
	Display contrast adjustment	✓	✓	✓
	Remote controller sensor	✓	✓	✓
	Quiet operation mode	—	✓	—
	Prohibit setting control from Central controller	✓	✓	✓

All specifications subject to change without notice.

ECONAVI SENSOR



The all new Econavi Sensor detects presence in the room, and quietly adapts the PACi or VRF air conditioning system in order to improve comfort and maximise energy savings.

- Detects human activity and adjusts temperature by 2 degrees (up or down) to optimize comfort and efficiency
- If there is no activity detected for a set time, the Econavi will stop the unit or move to a new temperature previously set
- The Econavi device is installed independently of the indoor unit, and is located in the area best suited for detection

Applications

Saving Energy for Offices: if the air conditioning is left on after the last employee leaves the office, Econavi will automatically react, reducing or stopping the system.

Increased comfort in hotel rooms: when presence is detected in the room, the temperature is automatically adjusted to achieve best comfort.

Key points

- Compatible with Cassette, Wall Mounted, Hide Away and Ceiling
- Improves efficiency
- Better Comfort
- Can be installed in the best place of the room for detection purposes

Sensor location image

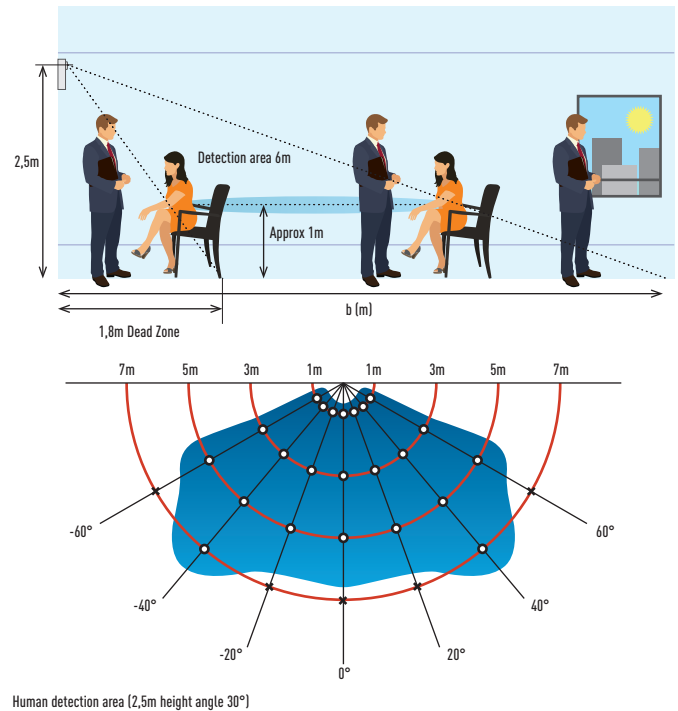

Providing outstanding energy-saving performance, Panasonic's Inverter system can be connected to Econavi to detect when energy is being wasted. Econavi senses the presence or absence of people and the level of activity in each area of an office. When unnecessary heating or cooling is detected, indoor units are individually controlled to match office conditions for energy-saving operation.

Detection of the level of activity enables precise power saving.

Presence or absence of people at their desks and the level of activity in the office are detected in real time. Set temperature is automatically adjusted to optimise the lower power consumption.



Remote Econavi sensor allows optimum energy operation.

Pillars, walls, cabinets and other fittings obstruct the sensor, reducing the area of detection and lowering the energy-saving effect. Taking into consideration blind spots, Panasonic enables the optimum layout for sensors in any office.



In the morning.
Thorough cooling when there is a high level of activity

In the afternoon.
Reduced cooling when there are fewer people

At night.
Automatic Thermo Off depending on conditions at the end of the day

NEW INTELLIGENT CONTROLLER

NEW
TECHNOLOGY
'17



This controller is the smart solution for your advanced requirement in buildings.

Intuitive operation

The screens used for operations all follow a common pattern, with the screens being easy to read and easy to use.

- Enlarged screen (10,4 inch) with colour LCD
- Smartphone-like operations (Swiping, flicking)

Large screen display. Enlarged by 60%.



Easy Swipe or flick operation.

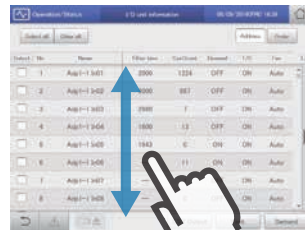

Swipe.
This is an operation where the finger is slid in a direction (up or down) on the touch panel. This is used to scroll slowly.

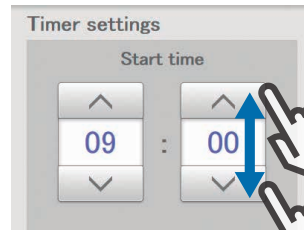

Select.
This is an up and down movement of the finger touching the screen, used to pick settings in elements such as spin boxes.



Pull out.
This is an operation where the finger on the touch panel is flicked in a direction (up or down). This is used to scroll quickly.

Enhanced functions for energy saving as standards

- Set temperature auto return settings, Auto shutoff, Set temperature range limit settings
- Demand control function

Screen of Set temperature auto return setting.

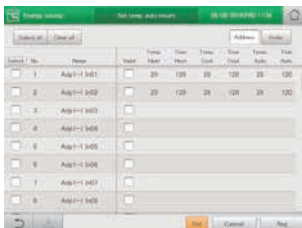

Auto shutoff.



Screen of Outdoor demand control.

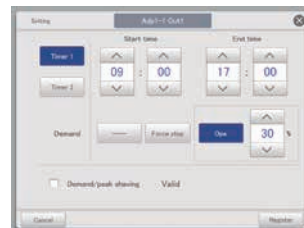

- Outdoor demand input and timer settings possible
- Indoor can be set at $\pm 1^{\circ}\text{C}$ / $\pm 2^{\circ}\text{C}$ or thermostat OFF
- Indoor units controlled in sequence at 10-minute intervals

Energy Visualization

- Energy-saving plans are supported with graph display function
- Displays electricity & gas usage distribution

Screen of graph display.

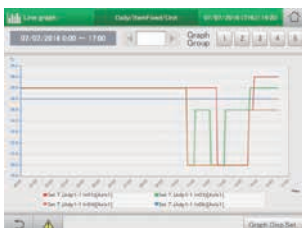

Useful parameters are shown for your better energy saving.
Ex.) Bar graph:

- Indoor Unit: Total operating time, thermostat ON operation time (Min.)
Amount used (electricity, gas)
Electricity or gas charges
- Outdoor unit: Outdoor unit operation cycles (# cycles)
Engine time in operation (Hrs.)
Cumulative Inverter power output
Cumulative PV power output

Pulse value selection per different data intervals 1 hour/1 day/ 1 month compared with last year.

Main new function

Gesture function (Flick, Swipe)	✓
Graph display (Trends, comparisons)	✓
Web functions (Max. 64 users)	✓
Recipient setting for warning email	✓ (Maximum 8)
Automatic return to setting temperature	✓
Limitation of setting temperature range	✓
Left-on prevention	✓
Quiet operation of outdoor unit	✓
Occupant sensor linkage	✓
Demand function	✓
Charge calculation	✓
Log display	Warning 10.000 items Status change 50.000 items
Linked control Event definition 50 events, Input: 32, Output: 32	✓
Under maintenance (Under inspection registration)	✓

CONTROL FOR HOTEL APPLICATION



More easier to install, cheaper to integrate one only control to integrate all devices. Nice, easy and cost effective!
Panasonic has developed an innovative line up of remote controls specially designed for applications.

- Easy to install
- Cost effective installation as all electrical cable are centralized on this remote
- Architect inspired attractive design
- Direct connection to the Indoor unit with most of the functions of the indoor unit
- 3 options available: Stand-Alone, Modbus or LonWorks communication
- 2 frame colours: White and aluminium

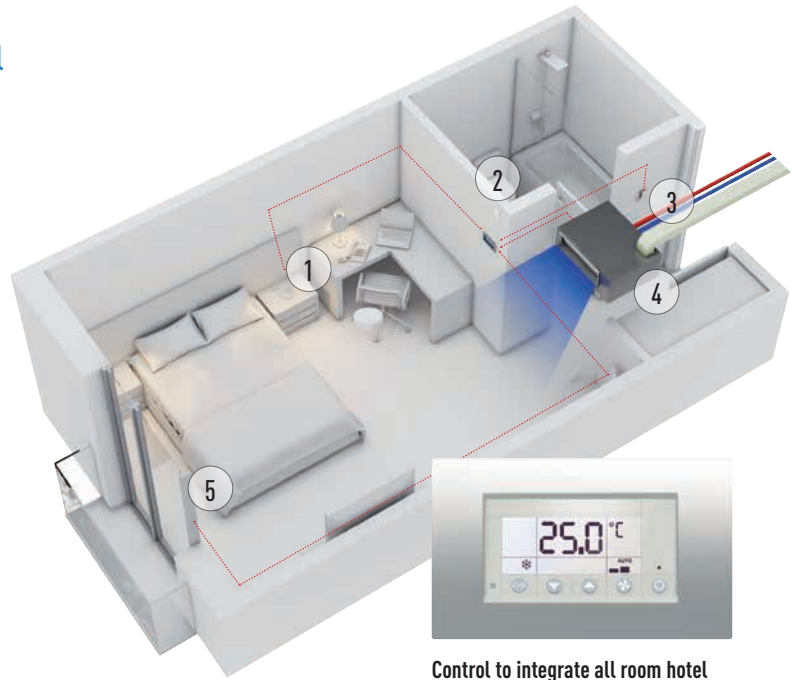

From this remote control: The lighting, card contact, motion detector, window contact and the air conditioning are controlled.

Energy saving functions included on the device: Turns Off air conditioning and lighting when room is unoccupied. Disables air conditioning when window is open. Maximum/minimum setpoint temperature configurable

Easy remote control: The hotel customer will have access to limited functions to control the air conditioning:

ON/OFF, Temperature (under a certain limit fixed during the start up) and Fan speed

Easy set up: Stand-Alone model with easy configuration menu to access all parameters. The installation is simplified as all the cables should arrive to the remote control. A pre-define scenario can be uploaded on the remote control connected to a computer to make installation on site plug and play (only on the Modbus and LonWorks models).

Control to integrate all room hotel needs in one device:

Card switch. Heating and cooling control. Light control. Window control. Possible to connect to Modbus



Lighting control.



Indoor unit. Variable static pressure hide away.

- 3. Room card switch*
- 2. Human sensor

- 5. Window contact*
- * Field supply

Four preconfigured systems (option 1 to 4)

The remote control have a 4 preconfigured systems in order to easily integrate it.

4 options available I/O configurations: Inputs.

Configurations	Digital 1-2	Digital 3-4	Digital 5-6	Analog 7-8
Option 1	Card	Window	Lighting	Temperature
Option 2	Card	Window	Blinds up	Blinds down
Option 3	Motion sensor	Window	Door contact	Temperature
Option 4	Lighting	Window	Blinds up	Blinds down

Available I/O Configurations: Outputs.

Configurations	Relay 15-16	Relay 13-14	Relay 11-12	Relay 9-10
Option 1	Courtesy	Lighting	Not used	Valve actuator
Option 2	Courtesy	Lighting	Blinds up	Blinds down
Option 3	Courtesy	Lighting	Not used	Valve actuator
Option 4	Not used	Lighting	Blinds up	Blinds down

I/O Definitions: Inputs.

Description	Functionality
Card	Occupancy room status. Enable HVAC Control and automatically switches ON Courtesy and Lighting outputs
Window	Temporary disables HVAC System
Lighting	Push button to turn ON/OFF Lighting Output when room occup.
Temperature	Analog input for Valve Actuator output control on 2nd zone
Blinds up	Push button for Blind Up motor output control
Blinds down	Push button for Blind Down motor output control
Motion sensor	In combination with Door Contact, enables HVAC Control and automatically switches ON Courtesy and Lighting outputs
Door contact	In combination with Motion Sensor, enables HVAC Control and automatically switches ON Courtesy and Lighting outputs

I/O Definitions: Outputs.

Description	Functionality
Courtesy	Automatically turns ON when room changes to occupied or unoccupied mode. It turns to OFF after a configurable time-out
Lighting	Automatically turns ON/OFF when room changes to occupied/unoccupied. Manual override with Lighting input
Valve actuator	HVAC Control for a 2nd zone
Blinds up	Output for Blind Up motor control
Blinds down	Output for Blind Down motor control

Example I/O: Wiring configuration for Option 2.

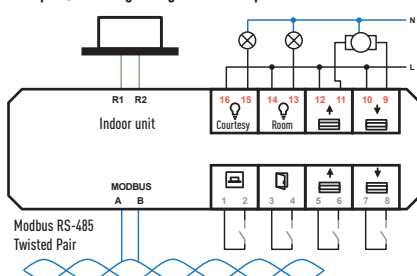

Example I/O: Option 2.

Terminals	Description	Type
A, b	Modbus RS-485	Bi-directional
R1, r2	Indoor unit	Bi-directional
1, 2	Card contact	Digital input
3, 4	Window contact	Digital input
5, 6	Blinds up	Digital input
7, 8	Blinds down	Analog input
9, 10	Blinds down	Relay output
11, 12	Blinds up	Relay output
13, 14	Lighting room	Relay output
15, 16	Lighting courtesy	Relay output

Panasonic Reference.

PAW-RE2C3-WH	Stand-Alone with I/O White frame
PAW-RE2C3-GR	Stand-Alone with I/O Grey Frame
PAW-RE2C3-MOD-WH	Modbus RS-485 with I/O White frame
PAW-RE2C3-MOD-GR	Modbus RS-485 with I/O Grey frame
PAW-RE2C3-LON-WH	LonWorks TP/FT-10 with I/O White frame
PAW-RE2C3-LON-GR	LonWorks TP/FT-10 with I/O Grey frame

CONTROL AND CONNECTIVITY

Centralized Control Systems

BMS System. PC Base.



P-AIMS. Basic Software
Up to 1024 groups. Controls 1024 units.
CZ-CSWKC2

Connection with 3rd Party Controller.



Seri-Para I/O unit for outdoor unit.
Up to 4 outdoor units.
CZ-CAPDC2



Local adaptor for ON/OFF control.
Controls 1 to 8 units.
CZ-CAPC2



Mini Seri-Para I/O Unit 0 - 10V.
Controls 1 to 8 units.
CZ-CAPBC2



Communication Adaptor.
Up to 128 groups. Controls 128 units.
CZ-CFUNC2

AC Smart Cloud.



Cloud internet control.
Up to 128 groups. Controls 128 units.
CZ-CFUSCC1

New Domestic integration to P-Line - CZ-CAPRA1

Can connect all ranges to P-Line. Full control is now possible.

Integrates any unit in big system control.

- PKEA Server room integration
- Small offices with Domestic indoors
- Tender for refurbishment (old system Domestic and VRF in one installation)

Centralized Control Systems: 64 Indoor Units

Intelligent Controller / Web Server: 256 Indoor Units

P-AIMS: 1.024 Indoor Units

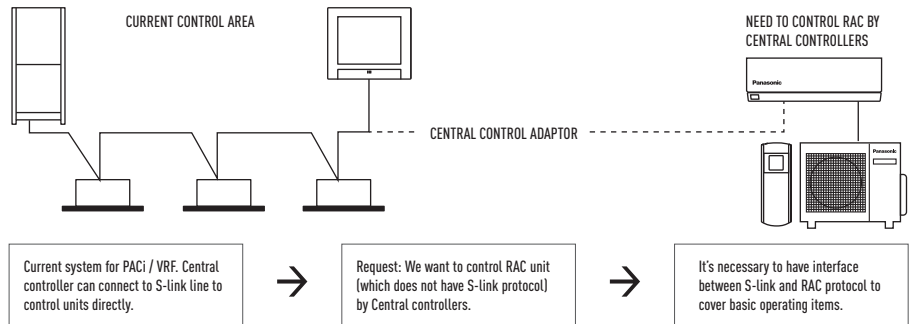

Basic operation items

ON/OFF	✓
Mode select	✓
Temperature setting	✓
Fan speed	✓
Flap setting	✓
Remote control prohibit	✓
Econavi ON/OFF	✓

External input

ON/OFF control signal	✓
Abnormal stop signal	✓

External output for Relay¹

Operation status (ON/OFF)	✓
Alarm status output	✓

1) Because current CN-CNT connector can not provide the power for external output relay, additional Input power for external relay is necessary.

Easy connection to KNX, Modbus, LonWorks and BACnet

Great flexibility for integration into your KNX / Modbus / LonWorks / BACnet projects allows fully bi-directional monitoring and control of all the functioning parameters.

For more information, contact Panasonic.

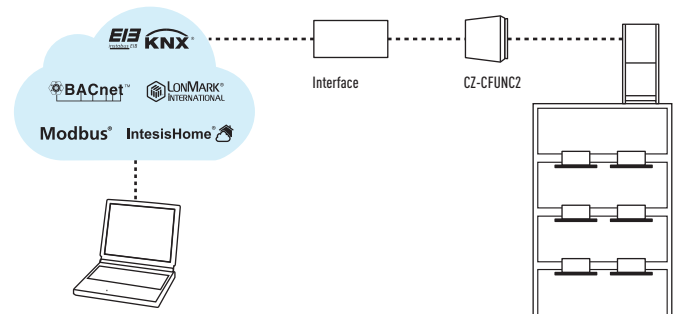

			Econavi control	Built-in thermostat	Indoor units which can be controlled	Use limitations	Function ON/OFF	Mode setting	Fan speed setting	Temperature setting	Air flow direction	Permit/Prohibit switching	Weekly program	BMS protocol	
Individual Controllers															
Control for hotel application. Intelligent Controller		PAW-RE2C3-WH /-GR PAW-RE2C3-MOD-WH /-GR PAW-RE2C3-LON-WH /-GR White / Grey	-	✓	1 indoor unit	-	✓	✓	✓	✓	-	✓	-	Stand alone Modbus or Lonworks	
Wired remote controller. Normal operation		CZ-RTC4	✓	✓	1 group, 8 units	· Up to 2 controllers can be connected per group	✓	✓	✓	✓	✓	-	✓	-	
Wired remote controller. Design wired remote controller		CZ-RTC5A	✓	✓	1 group, 8 units	· Up to 2 controllers can be connected per group	✓	✓	✓	✓	✓	-	✓	-	
Wired remote controller. Normal operation		CZ-RTC2 (for Floor Standing (MP1) indoor units)	-	✓	1 group, 8 units	· Up to 2 controllers can be connected per group	✓	✓	✓	✓	✓	-	✓	-	
Wireless remote controller		CZ-RWSU3 / CZ-RWSL2N / CZ-RWSK2 / CZ-RWSD2 / CZ-RWST3N / CZ-RWSK2 + CZ-RWSC3	-	✓	1 group, 8 units	· Up to 2 controllers can be connected per group	✓	✓	✓	✓	✓ ¹	-	-	-	
Quick and easy operation Simplified remote controller		CZ-RE2C2	-	✓	1 group, 8 units	· CZ-RE2C2: up to 2 controllers can be connected per group	✓	✓	✓	✓	✓ ¹	-	-	-	
Centralized Controllers															
Central controller with weekly timer		CZ-64ESMC3	✓	-	64 groups, maximum 64 units	· Up to 10 controllers, can be connected to one system · Main unit/sub unit (1 main unit + 1 sub unit) connection is possible · Use without remote controller is possible	✓	✓	✓	✓	✓ ¹	✓	✓	-	
Only ON/OFF operation from center station. ON/OFF Controller		CZ-ANC2 CZ-ANC3 (available in September 2017)	-	-	16 groups, maximum 64 units	· Up to 8 controllers (4 main units + 4 sub units) can be connected to one system · Use without remote controller is impossible	✓	-	-	-	-	✓	-	-	
Simplified load distribution ratio (LDR) for each tenant. Intelligent Controller (Touch screen panel)		CZ-256ESMC3	✓	-	Main unit: 128. Up to 256 units can be expanded	· Communication adaptor CZ-CFUNC2 is necessary for connection with more than 128 units	✓	✓	✓	✓	✓ ¹	✓	✓	-	

1. Setting is not possible when a remote control unit is present (use the remote control for setting). * All specifications subject to change without notice.

INDIVIDUAL CONTROLLERS

Control for hotel application. Intelligent Controller (for VRF)



PAW-RE2C3-WH // PAW-RE2C3-GR // PAW-RE2C3-MOD-WH // PAW-RE2C3-MOD-GR // PAW-RE2C3-LON-WH // PAW-RE2C3-LON-GR

- Easy to install
- Cost effective installation as all electrical cable are centralized on this remote
- Architect inspired attractive design
- Direct connection to the Indoor unit with most of the functions of the indoor unit
- 3 options available: Stand-Alone, Modbus or LonWorks communication
- 2 frame colours: White and aluminium

From this remote control.

The lighting, card contact, motion detector, window contact and the air conditioning are controlled.

Energy saving functions included on the device.

- Turns Off air conditioning and lighting when room is unoccupied
- Disables air conditioning when window is open
- Maximum/minimum setpoint temperature configurable

Wired remote controller. Normal operation with Econavi



CZ-RTC4

- Time Function 24 hours real time clock (week day indicator)
- Weekly programme function (a maximum of 6 actions can be programmed for each day)
- Sleeping function (this function controls the room temperature for comfortable sleeping)
- Maximum 8 indoor units can be controlled from one remote controller
- Remote control by main remote controller and sub controller is possible (maximum 2 remote controllers (main remote controller and sub controller) can be installed for one indoor unit)
- Possible to connect to the outdoor unit using PAW-MRC cable for servicing purposes

- Outing function (this function can prevent the room temperature from dropping or rising when the occupants are out for a long time)
- Dimensions (H x W x D:) 120 x 120 x 20mm
- Weight: 160 g

Basic remote controller ON/OFF.

- Econavi compatible
- Operation mode changeover (Cooling, Heating, Dry, Auto, Fan)
- Temperature setting (Cooling / Dry: 18-30°C Heating: 16-30°C)
- Fan speed setting High / Medium / Low and Auto
- Air flow direction adjustment

Wired remote controller. Design wired remote controller



CZ-RTC5A

- Power consumption monitor (only for PACi)
- Flat face design & Touch sensor switch for stylish design and operating usability
- New functions such as for Energy saving & monitoring and for Service use are available on the Full dot LCD (3,5" display)
- Improved illumination
- White LED backlit
- Blink when alarm occurs

Basic Operation.

- Operation - Mode - Temperature setting - Airflow volume
- Airflow direction

Timer function.

- Outing function - Weekly Program timer - Easy ON/OFF timer
- Time display

Energy saving.

- Outing function - Temperature setting range limitation
- Temperature auto return - OFF remind - Schedule demand control - Energy saving mode - Energy monitoring

Others.

- Key lock - Ventilation fan control - Display contrast adjustment
- Remote controller sensor - Quiet operation mode - Prohibit setting control from Central controller

* Several functions can not use on some outdoor unit. Ex. Power consumption monitor is not available for PACi Standard, Backup/Rotation control for PACi system.

Control contents	Part name, model No.	Quantity
Standard Control	Timer remote controller: CZ-RTC4 // CZ-RTC5A Wired remote controller: CZ-RE2C2 // CZ-RE2C3 Wireless remote controller: CZ-RWSU3 // CZ-RWSL2N // CZ-RWSK2 // CZ-RE2C2 // CZ-RE2C3	1 unit each
(1) Group control	Timer remote controller: CZ-RTC4 // CZ-RTC5A Wired remote controller: CZ-RE2C2 // CZ-RE2C3 Wireless remote controller: CZ-RWSU3 // CZ-RWSL2N // CZ-RWSK2 // CZ-RE2C2 // CZ-RE2C3	1 unit
(2) Main/sub remote control	Main or sub. Timer remote controller: CZ-RTC4 // CZ-RTC5A Wireless remote controller: CZ-RWSU3 // CZ-RWSL2N // CZ-RWSK2 // CZ-RE2C2 // CZ-RE2C3	As required

Wired remote controller. Normal operation (for Floor Standing (MP1) indoor units)

CZ-RTC2

- Time Function 24 hours real time clock (week day indicator)
- Weekly programme function (a maximum of 6 actions can be programmed for each day)
- Sleeping function (this function controls the room temperature for comfortable sleeping)
- Maximum 8 indoor units can be controlled from one remote controller
- Remote control by main remote controller and sub controller is possible (maximum 2 remote controllers (main remote controller and sub controller) can be installed for one indoor unit)

- Possible to connect to the outdoor unit using PAW-MRC cable for servicing purposes
- Outing function (this function can prevent the room temperature from dropping or rising when the occupants are out for a long time)

Basic remote controller ON/OFF.

- Operation mode changeover (Cooling, Heating, Dry, Auto, Fan)
- Temperature setting (Cooling / Dry: 18-30°C Heating: 16-30°C)
- Fan speed setting High / Medium / Low and Auto
- Air flow direction adjustment
- Dimensions (H x W x D): 120 x 120 x 16mm



Wireless remote controller



CZ-RWSC3
For 4 Way 90x90 Cassette.



CZ-RWSL2N
For 2 Way Cassette.



CZ-RWSK2
For Wall Mounted and 4 Way
60x60 (with CZ-KPY3A).



CZ-RWSD2
For 1 Way Cassette.



CZ-RWST3N
For Ceiling.



CZ-RWSK2 + CZ-RWSC3
Combination for all indoor units.

CZ-RWSC3 // CZ-RWSL2N // CZ-RWSK2 // CZ-RWSD2 // CZ-RWST3N // CZ-RWSK2 + CZ-RWSC3

- Easy installation for the 4 Way cassette type simply by replacing the corner part
- 24 hour timer function
- Remote control by main remote controller and sub controller is possible (Max. 2 remote controllers (main remote controller and sub controller) can be installed for one indoor unit)

- When CZ-RWSC3 is used, wireless control becomes possible for all indoor units (1: when a separate receiver is set up in a different room, control from that room also becomes possible. 2: automatic operation by means of the emergency operation button is possible even when the remote controller has been lost or the batteries have been exhausted)
- Operation of separate energy recovery ventilators (When commercial ventilation fans or heat-exchange ventilation fans have been installed, they can be operated with this remote control (interlocked operation with the indoor unit or independent ventilation ON/OFF))

Simplified remote controller. Quick and easy operation

CZ-RE2C2. A remote controller with simple functions and basic operation.

- Suitable for open rooms or hotels where detailed functions are not required
- ON/OFF, operation mode switching, temperature setting, air speed switching, air flow direction setting, alarm display, and remote controller self-diagnosis can be performed

- Batch group control for up to 8 indoor units
- Remote control by main remote controller and sub controller is possible with a simplified remote controller or a wired remote controller (up to two units)
- Dimensions (H x W x D): 120 x 70 x 16mm



Remote sensor

CZ-CSRC3

- This remote sensor can be connected to any indoor unit. Please use it to detect the room temperature when no remote controller sensor or body sensor is used (connection to a system without a remote controller is possible)
- For joint use with a remote control switch, use the remote control switch as main remote controller
- Batch group control for up to 8 indoor units

- Appearance design based on simplified remote controller chassis
- Dimensions (H x W x D): 120 x 70 x 17mm
- Weight: 70 g
- Temperature/Humidity range: 0 °C to 40 °C / 20 % to 80 % (no condensation) (indoor use only)
- Power Source: DC16 V (supplied from indoor unit)
- Maximum number of connectable indoor units: Up to 8 units



CENTRALISED CONTROLLERS

New System Controller with Schedule timer. Operation with various function from center station



Sample display image / Operation status display

Operation Status ALL



Operation Status ZONE



Operation Status GROUP



NEW TECHNOLOGY 17

CZ-64ESMC3

Panasonic unveils state-of-the-art digital controller.

Panasonic has launched its latest controller, an innovative and easy to use interface that offers full functionality with an integrated schedule timer and system controller, making managing heating and cooling systems easier than ever before. The CZ-64ESMC3 includes Panasonic's popular schedule timer, which gives users full flexibility over when they want their property heated or cooled. Users can adjust the system for holidays, pausing operations for long periods of time so that energy isn't wasted heating or cooling an empty home or office. The controller also allows six operations per day to be programmed.

Mix of current 2 controllers: System controller + Schedule timer.

New system controller will be designed by taking priority on these 2 operations with following technical key points:

- Same operation feeling as new wired remote controller by touch-key panel
- High visibility and usability by Full-dot LCD
- Based on High wired remote controller
- Maximum 64 group of indoor units, Individual control for 64 units
- 4 zone control; 1 zone = Maximum 16 groups
- Several energy saving function (based on CZ-RTC5A)
- 6 timer program per day for 1 week (7 days) operation (Total 6 x 7 = 42 programs)
- Basic setting items (Temperature, Mode, Fan speed, Flap position) can be set by same manner as CZ-RTC5A

Function list.

From CZ-64ESMC2 System controller:

- Central control / individual setting
 - Start-stop prohibition for remote controller
 - Start-stop / Mode change / Temperature setting prohibition for remote controller
 - Mode change / Temperature setting prohibition for remote controller
 - Mode change prohibition for remote controller
 - Select items for prohibition

- Filter information
 - Filter sign
 - Filter sign reset
- Ventilation setting

From CZ-ESWC2 Schedule timer:

- Weekly Timer
 - Timer setting Enable / Disable
 - Copy of Timer setting
- Maintenance
 - External signal (Start / Stop) (Demand control)
 - Centralized control master-slave setting
 - Alarm history
- Initial setting
 - Clock

From CZ-RTC5A

- Energy-saving control
 - Econavi On/Off
- Filter information
 - Filter sign and Hour counter display
- Maintenance
 - Service contact
- Initial setting
 - Clock display setting
 - Name Setting
 - Operation lock setting
 - Operation sound setting
 - LCD contrast setting
 - LCD backlight setting
 - Select displayed language (EN / FR / IT / ES / DE)
 - Administrator password
- Setting information list

ON/OFF Controller. Only ON/OFF operation from center station



CZ-ANC2 / CZ-ANC3 (available in September 2017).

- 16 groups of indoor units can be controlled
- Collective control and individual group (unit) control can also be performed
- Up to 8 ON/OFF controller (4 main, 4 sub) can be installed in one link system
- The operation status can be determined immediately
- Dimensions (H x W x D): 121 x 122 x 14 + 52mm (embedding dimension)

Power supply: AC 220 to 240V.

I/O part: Remote input (effective voltage: within DC 24V): All ON/OFF.

Remote output (allowable voltage: within DC 30V): All ON, All alarm.

Note: As operation mode and temperature settings are not possible with the ON/OFF controller, it must be used together with a remote controller, a system controller etc.

Intelligent Controller (Touch screen panel). Simplified load distribution ratio (LDR) for each tenant

CZ-256ESMC3

Dimensions (H x W x D): 240 x 280 x 20 (+60)mm.
 Power supply: Single phase 100-240V ~ 50/60Hz.
 Number of connectable units per link¹: Up to 100 units of the combined total of the following:
 • Indoor unit: Up to 64 units²
 • Outdoor unit: Up to 30 units
 • Central control device: Up to 10 units
 Enlarged Display Screen: 10,4 inch Touch-panel colour LCD.
 Pursuing visibility, ease of use.
 Retrieve data from USB memory: Place the USB port inside the panel (USB memory available in stores).
 Communication adaptor: CZ-CFUNC2.

1) The maximum number of connectable units is shown below:
 • When using only this unit: 128 indoor units and 60 outdoor units
 • When connecting a communication adaptor: 256 indoor units and 120 outdoor units
 2) The number of indoor units includes the interface adaptor.

New Functions.

- Graph display (trends, comparisons)
- Econavi ON/OFF
- Outdoor unit quiet operation ON/OFF
- Energy-saving functions: Set temperature auto return settings, Auto shutoff, Set temperature range limit settings, Energy saving for PAC current value, etc.
- Event control (such as equipment linkage)
- Performs closing at end of any period

Operation and status.

You can check to operational status (ON/OFF, operating mode, alarms, etc.) of all indoor units and outdoor units in real time. You can also select indoor units to change their settings.

Operation scheduling.

You can register daily operation schedules (ON/OFF time, operating modes, set temperatures, etc.) for individual indoor units or groups of indoor units. Operations can be schedule for up to 2 years in advance.

Distributing air conditioner energy.

You can view cumulative operating times for indoor units, engine operating times for outdoor units, and operation cycles in a list (cumulative values). Using these data, you can calculate the distribution ratio of electricity or gas consumed for air conditioning and volumes used (kWh, m³) per indoor unit or in an area, then show these calculations in a list.

Remote control.

The LAN terminal on this unit enables you connect it to a network. Connecting to Internet will enable you to operate the unit and check the status using a PC from a remote location.

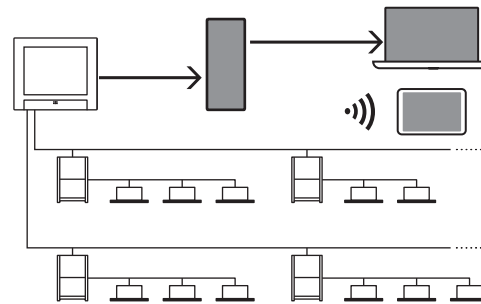

New back up tool to save your commissioning time.

Various data such as distribution, setting, log history etc. can be saved by CSV file. Setting data of CSV file is available to edit and import to the controller again. You can save time for commissioning and change setting flexibly and easily by your PC.
 • Customize data
 • Data recovery
 Data can be imported again by general USB.

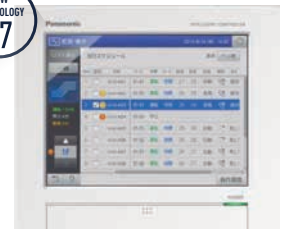
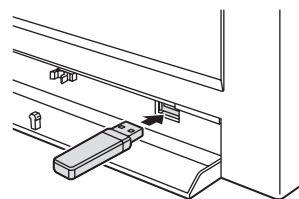

System Configuration Example.

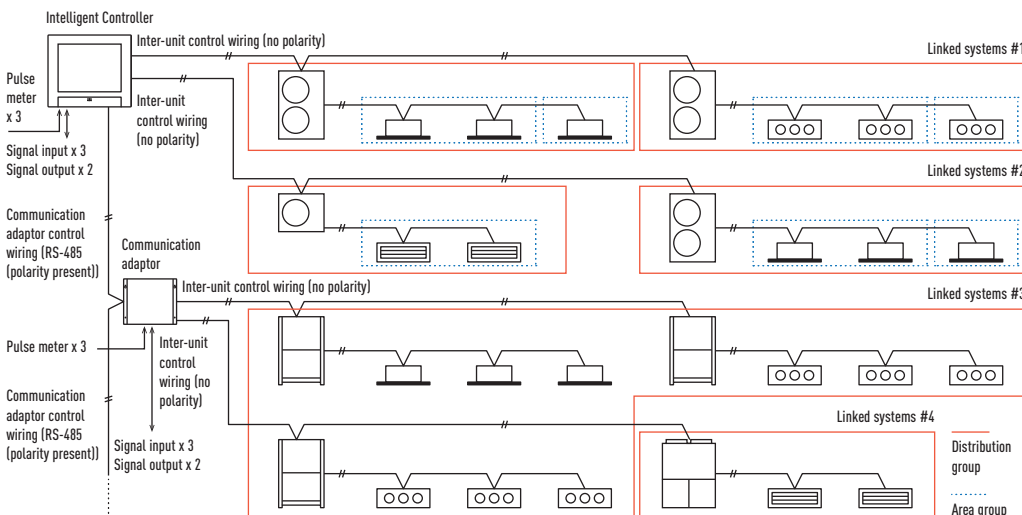

CENTRALISED CONTROLLERS

P-AIMS. Panasonic Total Air Conditioning Management System



CZ-CSWKC2 / P-AIMS Basic software.

Up to 1024 indoor units can be controlled by one PC.

Functions of basic software.

- Standard remote control for all indoor units.
- Many timer schedule programs can be set on the calendar.
- Detailed information display for alarms.
- CSV file output with alarm history, operating status.
- Automatic data backup to HDD.

P-AIMS is suitable for large shopping centers and universities with many areas/ buildings. 1 "P-AIMS" PC can have 4 independent systems at once.

Each system can have maximum 8 C/A units, and control maximum 512 units. In total, 1024 indoor units can be controlled by 1 "P-AIMS" PC.

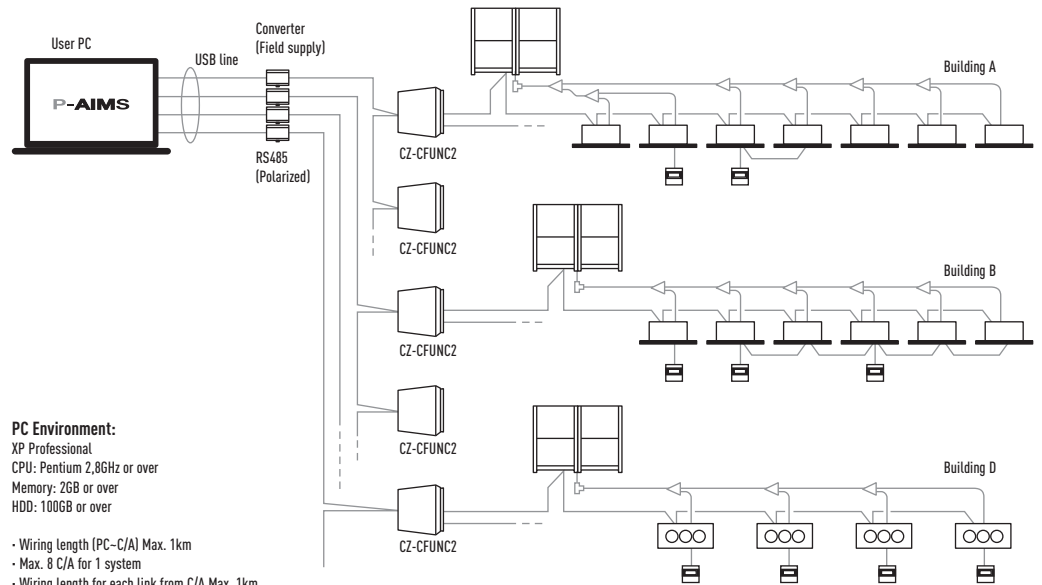

PC Environment:

XP Professional
 CPU: Pentium 2.8GHz or over
 Memory: 2GB or over
 HDD: 100GB or over

- Wiring length (PC-C/A) Max. 1km
- Max. 8 C/A for 1 system
- Wiring length for each link from C/A Max. 1km

P-AIMS optional software CZ-CSWAC2 for Load distribution. Load distribution calculation for each tenant.

- Air-conditioner load distribution ratio is calculated for each unit (tenant) with used energy consumption data (m³, kWh)
- Calculated data is stored as a CSV type file
- Data from the last 365 days is stored

P-AIMS optional software CZ-CSWGC2 for Object layout display. Whole system can be controlled visually.

- Operating status monitor is available on the layout display
- Object's layout and indoor unit's location can be checked at once
- Each unit can be controlled by virtual remote controller on the display
- Max. 4 layout screens are shown at once

P-AIMS optional software CZ-CSWWC2 for Web application.

Web access & control from remote station.

- Accessing P-AIMS software from remote PC
- You can monitor/operate ECOi 6N system by using Web browser (Internet Explorer)

P-AIMS optional software CZ-CSWBC2 for BACnet software interface. Connectable to BMS system.

- Can communicate with other equipment by BACnet protocol
- ECOi 6N system can be controlled by both BMS and P-AIMS
- Max. 255 indoor units can be connected to 1 PC (that has P-AIMS basic & BACnet software).

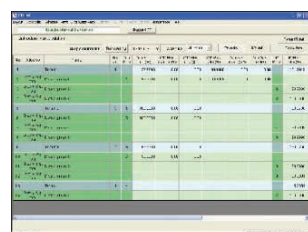

With 4 upgrade packages the basic software can be upgraded to suit individual requirements.

Seri-Para I/O unit for outdoor unit. Connection with 3rd Party Controller

CZ-CAPDC2 for ECOi / CZ-CAPDC3 for Mini ECOi and PACi.

- This unit can control up to 4 outdoor units
- From the central control device, mode changing and batch operation/batch stop are possible
- Required for demand control

Dimensions (H x W x D): 80 x 290 x 260mm.
 Power supply: Single Phase 100/200V (50/60Hz), 18W.
 Input: Batch operation/Batch stop (non-voltage contact/DC 24 V, pulse signal). Cooling/Heating (non-voltage contact/static signal). Demand 1/2 (non-voltage contact/static signal) (Local stop by switching).

Output: Operation output (non-voltage contact). Alarm output (non-voltage contact).
 Wiring length: Indoor/Outdoor operation lines: Total length 1km.
 Digital signal: 100m or shorter.

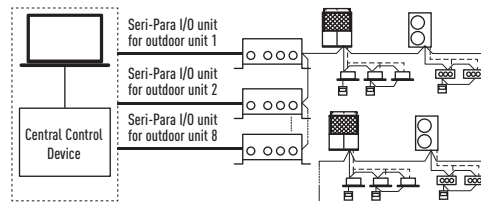

Local adaptor for ON/OFF control. Connection with 3rd Party Controller

CZ-CAPC2 / CZ-CAPC3 (available in December 2017).

- Control and status monitoring is possible for individual indoor unit (or any external electrical device up to 250 V AC, 10 A) by contact signal

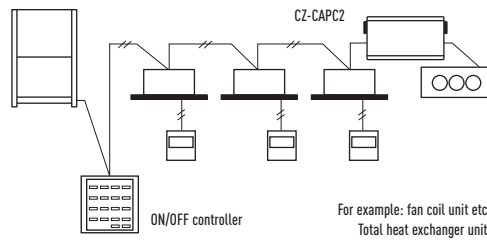

MINI Seri-Para I/O Unit 0 -10V. Connection with 3rd Party Controller

CZ-CAPBC2

- Control and status monitoring is possible for individual indoor unit (1 group)
- In addition to operation and stop, there is a digital input function for air speed and operation mode
- Temperature setting and measuring of the indoor suction temperature can be performed from central monitoring
- Power is supplied from the CZ-T10 terminal of the indoor units
- The analog input for demand of the outdoor capacity by 20 steps (from 40% to 120%) by 0-10V

- The analog input for temperature setting is 0 to 10V, or 0 to 140 Ohm
- Separate power supply also is possible (in case of suction temperature measuring)

* Ask to your distributor.

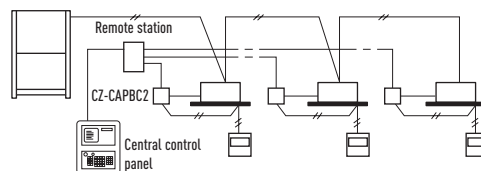

Communication adaptor for VRF Connectivity

CZ-CFUNC2

This communication interface is required to connect a ECOi and GHP systems to a BMS. An additional interface is needed to convert the information into KNX/Modbus/Bacnet language. CZ-CFUNC2 is very easy to operate and to connect to the Panasonic P-Link, which is the ECOi bus. From the CZ-CFUNC2, all

the indoor and outdoor units of the installation can be easily control. Two linked wiring systems can be connected to one CZ-CFUNC2.

Dimensions (H x W x D): 260 x 200 x 68mm

* As this is not a splash-proof design, it must be installed indoors or in the control panel, etc.



CENTRALISED CONTROLLERS

Centralised Control Systems

A custom web application to manage the centralized operation of A2W and GHP systems.

Operation and monitoring of devices connected to the new Management System can be realized both remotely/locally from any device with connection to the internet (Laptop, Tablet, Mobile)

The new system will make the interaction with air conditioning systems easier, improving the operation set as well as the global control of installations.

The application will act with various units, regardless of whether they are available in the same intranet or in different locations, transparently to users at any time. In this way, our solution allows to overcome main restrictions like onsite maintenance or the lack of centralization.

In addition, the application offers significant improvements in terms of control:

- Aircon units can be grouped in a totally custom way
- Possibility to realize group commands and batch commands (in succession)
- Alarms and events can be controlled more efficiently and a lot more...

Current installation .

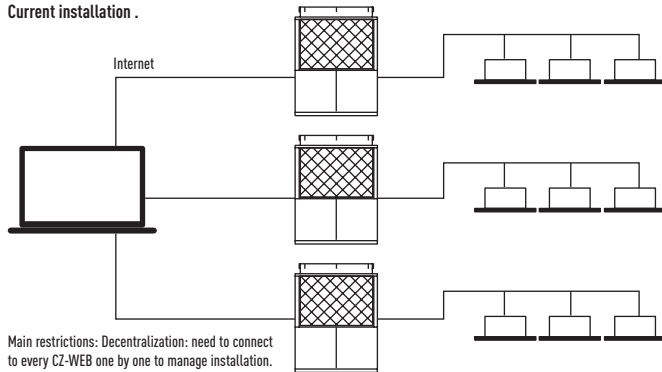

Main restrictions: Decentralization: need to connect to every CZ-WEB one by one to manage installation.
On-site maintenance: Access limited to local network.

Features of current system.

- Operation Functions
- Start & Stop
 - Temperature settings
 - Operation mode selection
 - Fan speed, Fan direction settings
 - Prohibition of use of remote controller

Operation Monitoring.

- Monitoring of operation status and alarms
- Monitoring of filter cleaning signs
- Display of alarm logs

Program Timers.

- Up to 50 types of weekly timer
- Holiday and Special Days

Benefits.

The new solution offers significant benefits for the different actors involved in its management:

For the building Ownership:

- Maximum equipment performance
- Energy saving
- Increased lifetime of equipment
- Savings in maintenance costs

For Maintenance companies:

- Instant knowledge of any incident
- Possibility of preventive alarms
- Reduction of systematic visits (warning and remote control)
- More effective maintenance support

Offer reliable solution to improve existing functionalities.

- Running timer
- Remote control through Web Cloud Application or local. Accessible anytime, anywhere, via a device with internet connection
- Centralized Control: Manage several installations in one single interface. Ideal for multi-site organizations
- Easy monitoring and maintenance thanks to group commands, and batch commands. Easy supervision of complex installations
- Secure Remote Access. Powerful identity protection and convenient access control

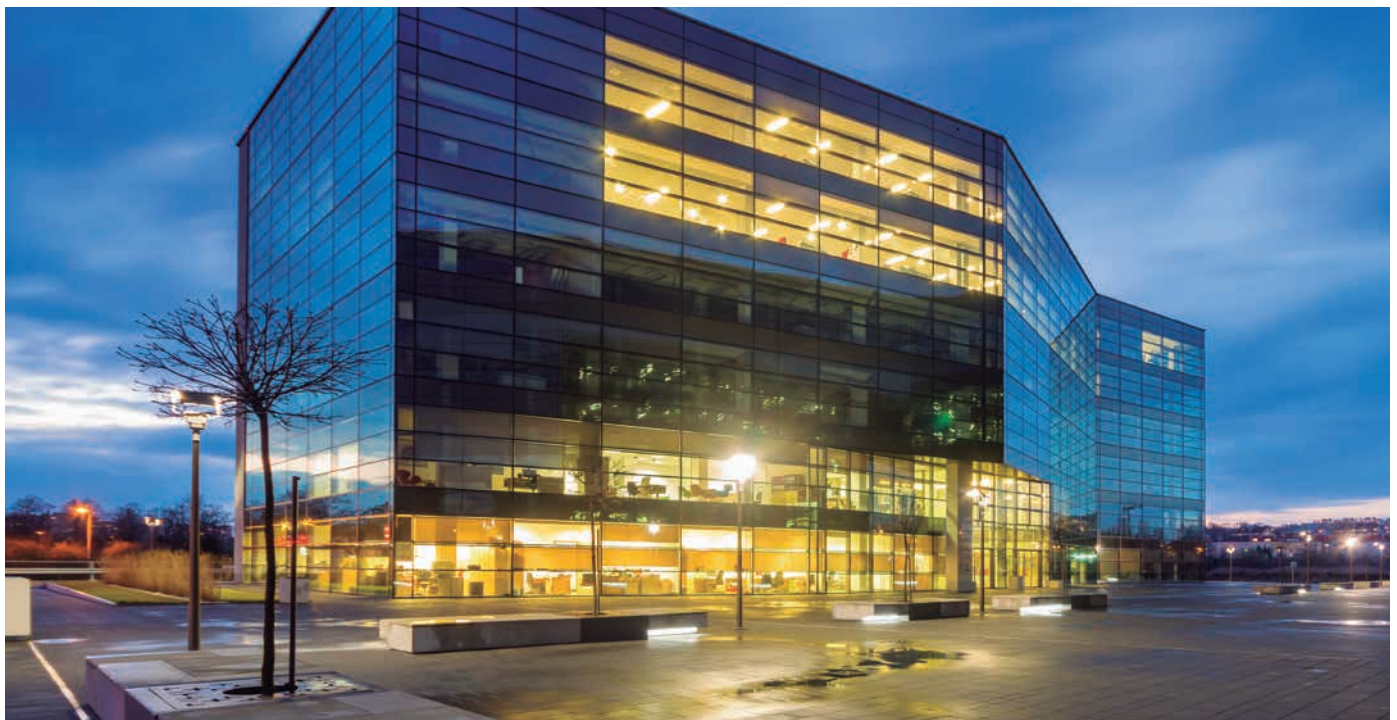

PACi AND VRF CONNECTIVITY & CONTROL

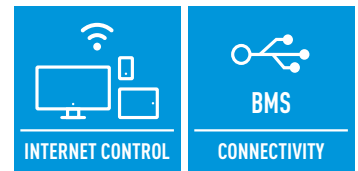

Aware of the importance of both control and connectivity in offering the best comfort at the lowest price, Panasonic offers its customers cutting-edge technology, specially designed to ensure our air conditioning systems deliver maximum performance. You can properly manage the air conditioning and perform comprehensive monitoring and control, with all of the features the remote control provides at home, from anywhere in the world thanks to the internet applications Panasonic has created for you.

Internet Control

Control your air conditioning system with your smart device -smartphone & internet for PACi and VRF Systems.

What's Internet Control?

Internet Control is a next generation system providing user-friendly remote control of air conditioning or heat pump units from anywhere, by the simple use of an Android or iOS smartphone, tablet or PC via internet. With the option of the Wired Room temperature sensor, the system can display the temperature.

Simple Installation.

Just connect the Internet Control device to the air conditioner or heat pump with the supplied wire and then link it to your WIFI Access point.

KX-UT670 Smart Desktop Phone from Panasonic.



Airzone. Control of the PACi Hide Aways

Airzone has developed interfaces to easily connect to Panasonic PACi Hide Away units. Ensuring optimum performance, comfort and energy savings, the new system is efficient and easy to install.

Airzone full range of accessories for any duct project.



Different type of outlets



Also plenum automatic doors



Full range of RC (wired/wireless, ...)

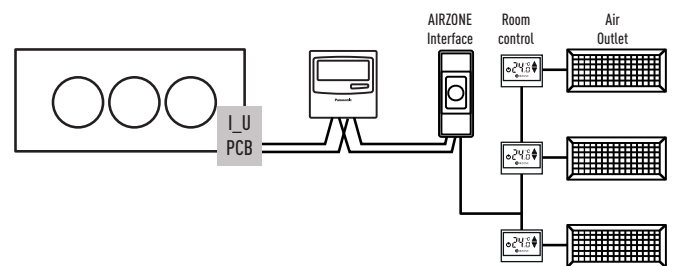

ECOi and GHP Connectivity

New Plug and play interface connected directly to the P-Link.

The interface has been designed specifically for Panasonic and provides complete monitoring, control and full functionality of the line-up from IntesisHome, KNX, EnOcean, Modbus, BacNet and Lonworks installations.

This connectivity solution is made by a third party company, please contact Panasonic for more information.

1) Interface Modbus RTU/TCP is needed in case if Modbus TCP connection. PAW-MBS-TCP2RTU (ModBus RTU Slave devices).
2) Interface CZ-CFUNC2 needed.

	Model name	Interface	Maximum number of indoor units connected
ECOi / PACi Indoor Units	PAW-RC2-KNX-1i	KNX	1 (1 Group of Indoor units)
	PAW-RC2-MBS-1	Modbus RTU ¹	1 (1 Group of Indoor units)
	PAW-RC2-MBS-4	Modbus	4 indoor/groups
	PAW-RC2-ENO-1i	EnOcean	1 (1 Group of Indoor units)
	PA-RC2-WIFI-1	IntesisHome	1 (1 Group of Indoor units)
ECOi P-Link	PAW-AC-KNX-64	KNX ²	64
	PAW-AC-KNX-128	KNX ²	128
	PAW-AC-MBS-64	Modbus	64
	PAW-AC-MBS-128	Modbus	128
	PAW-TM-MBS-RTU-64	Modbus RTU ²	64
	PAW-TM-MBS-TCP-128	Modbus TCP ²	128
	PAW-AC-BAC-1	Bacnet	1
	PAW-AC-BAC-64	Bacnet ²	64
PAW-AC-BAC-128	Bacnet ²	128	
	CZ-CLNC2	Lonworks	16 groups of max. 8 indoor units, in total max. 64 indoor units

ECOi, ECO G AND PACi CONNECTIVITY INDOOR UNITS

PCB's and cables for ECOi, ECO G and PACi indoor units

Name of the cables	Function	Comment
CZ-T10	All T10 functions	Requires field supplied accessory
PAW-FDC	Operate external fan	Requires field supplied accessory
PAW-OCT	All option monitoring signals	Requires field supplied accessory
CZ-CAPE2	Option monitoring signals wo. fan	Requires additional wires from spare part supply
PAW-EXCT	Forced Thermo OFF/Leakage D.	Requires field supplied accessory
Name of the PBC	Function	Comment
PAW-T10	All T10 functions	Allows easy connection "Plug & Play"
PAW-T10V	All T10 functions + powermonitoring	Same like PAW-T10 + monitoring the power supply of indoor unit
PAW-T10H	ON/OFF; Prohibit 5VDC & 230VAC	Specials for single hotel card or window contact
PAW-T10HW	ON/OFF; Prohibit 5VDC	For hotel card + window contact at same time
PAW-PACR3	Redundancy of 2 or 3 systems; for ECOi and PACi	Redundancy of 2 or 3 ECOi or PACi systems including temperature monitoring, error indication, backup, alternative run
PAW-SERVER-PKEA	Redundancy of 2 units PKEA	Redundancy of 2 units PKEA including temperature monitoring, error indication, backup, alternative run

T10 connector (CN015)



CZ-T10

Panasonic has developed an optional accessory (consisting of plug + wires) called CZ-T10 to enable an easy connection to this T10 connector.

Connecting an ECOi indoor unit to an external device is easy. The T10 terminal featured in the electronic circuit board of all indoor units enables digital connection to external devices.

T10 terminal Specification (T10: CN015 at indoor unit PCB).

- Control items: 1. Start/stop input
- 2. Remote controller prohibit input
- 3. Start signal output
- 4. Alarm signal output

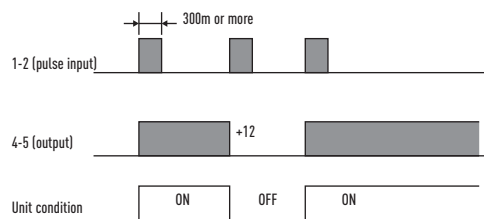

NOTE: The wire length from indoor unit to the Relay must be within 2,0m. Pulse signal changeable to static with JP cutting. (Refer to JP001)

Condition

- 1-2 (Pulse input): Unit ON/OFF condition switching with a pulse signal. (1 pulse signal: shortage status more than 300msec. or more)
- 2-3 (Static input): Open / Operation with Remote is permitted (Normal condition) Close / Remote controller is prohibited
- 4-5 (Static output): 12V output during the unit ON / No output at OFF
- 5-6 (Static output): 12V output when some errors occur / No output at normal

Example of wiring

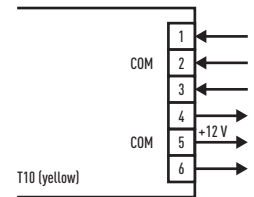

Usage Example.

Forced OFF control.

Term 1 & 2: Free contact for ON/OFF signal (cut *JP1* for static signal) when the hotel card is it connected the contact must be close (the unit can be used).

Term 2 & 3: Free contact to prohibit all function in the remote controller install in the room when the hotel card is it removed the contact must be closed (the unit can not work).

Terminal = T10

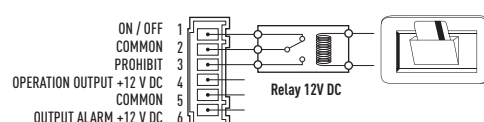

Operation ON/OFF signal output.

Condition:

4-5 (Static output): 12V output during the unit ON / No output at OFF

Example of wiring

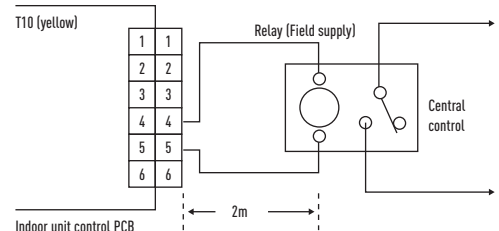

NOTE: The wire length from indoor unit to the Relay must be within 2,0m. Pulse signal changeable to static with JP cutting. (Refer to JP001)

Fan Drive Connector (CN032)

PAW-FDC

Panasonic has developed an optional accessory (consisting of plug + wires) called PAW-FDC to enable an easy connection to this Fan Drive Connector (CN032).

- Operating the ventilation fan from the remote controller
- Start / stop of external ventilation and total heat exchanger fans
 - Works even if indoor unit is stopped
 - In case of group control → all fans will operate; no individual control

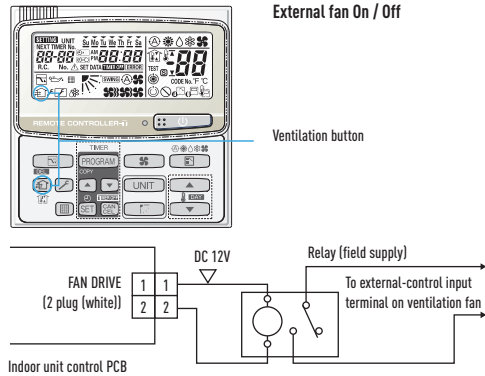

Option Connector (CN060) Output external signals

PAW-OCT

Panasonic has developed an optional accessory (consisting of plug + wires) called PAW-OCT to enable an easy connection to this Option Connector (CN060).

With the combination of the T10 and the option CN060 an external control of the indoor units is possible!

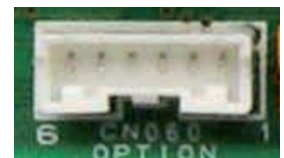
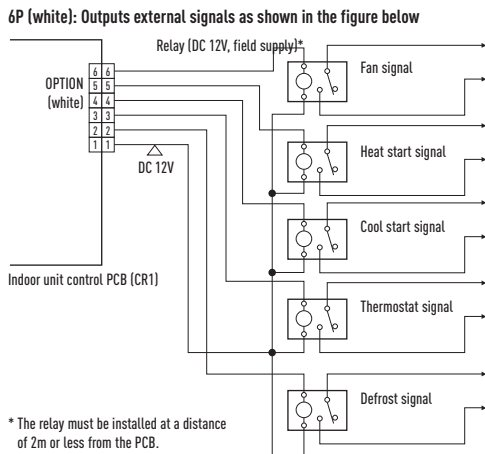

EXCT Connector (CN009)

PAW-EXCT

Panasonic has developed an optional accessory (consisting of plug + wires) called PAW-EXCT to enable an easy connection to this EXCT Connector (CN009).

A) With static input.

→ STATIC INPUT → THERMO OFF → ENERGY SAVING

2P plug (red): Can be used for demand control. When input is present, forces the unit to operate with the thermostat OFF.

Note: The length of the wiring from the indoor unit control PCB to the relay must be 2m or less.
* Lead wire with 2P plug (special—order part: WIRE K/854 05280 75300)

• Examples of wiring:

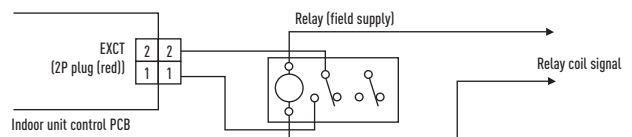

B) Example: In connection with a refrigerant sensor.

- Signal from leakage detector: non voltage, static.
- Indoor unit setting: Code 0b → 1
- Connector for leak detector: EXCT
- Outdoor unit setting:
 - Code C1 → 1 power output if alarm from O2 connector 230V
 - Code C1 → 2 power output if alarm from O2 connector 0V
- Displayed alarm message P14

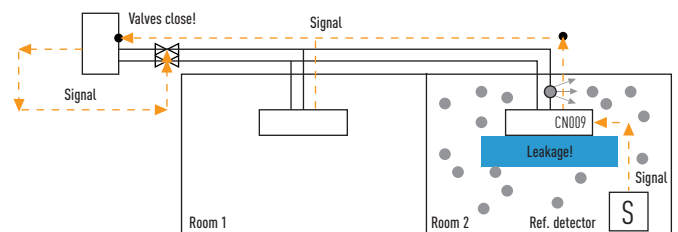

DIMENSIONS

Mini ECOi High Efficiency 4-6HP

4 x Ø32 holes (holes for drain)
Of the 4 Ø32 holes, use 1 of the 2 holes specified for drain use to install the port.
Use rubber plugs to seal the remaining 3 holes.

Top view

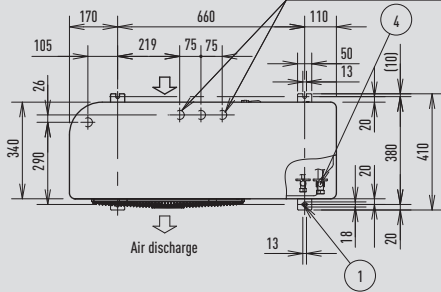

Front view

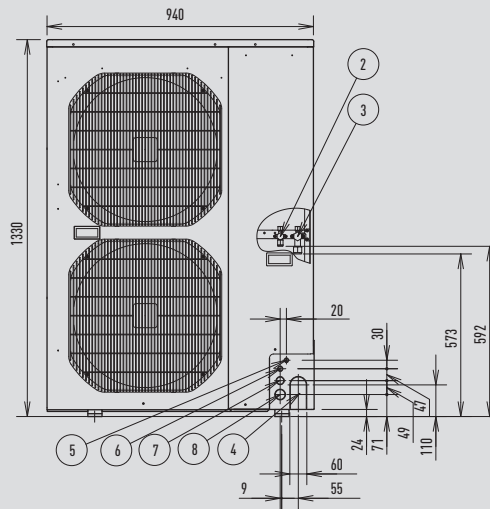

Side view

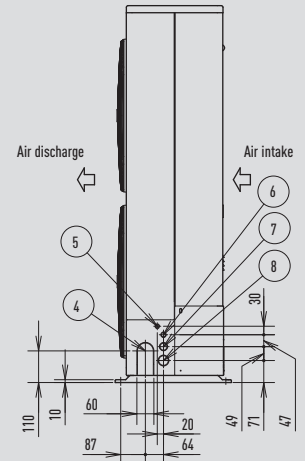

	Size (mm)
1 Mounting hole (4-R6.5), anchor bolt:	M10
2 Refrigerant piping (liquid tube), flared connection	Ø9,52
3 Refrigerant piping (gas tube), flared connection	15,88 or 19,05
4 Refrigerant piping port	
5 Electrical wiring port	Ø16
6 Electrical wiring port	Ø19
7 Electrical wiring port	Ø29
8 Electrical wiring port	Ø38

Unit: mm

Mini ECOi High Efficiency 8-10HP

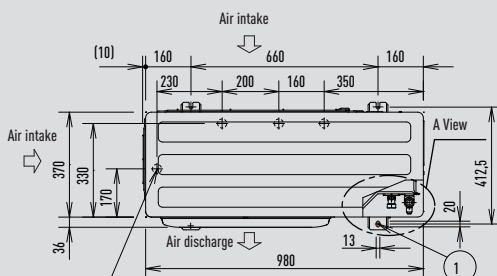

4xØ32 holes (holes for drain)
When using a drain pipe, install the drain socket (field supply) onto the drain port. Seal the other drain port with the rubber cap.

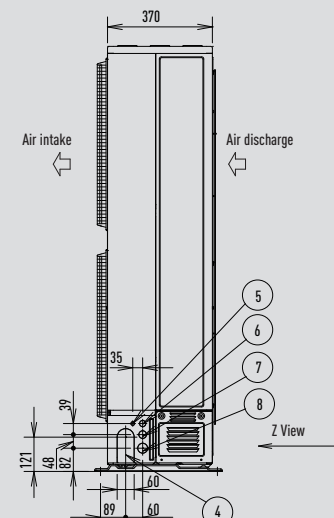
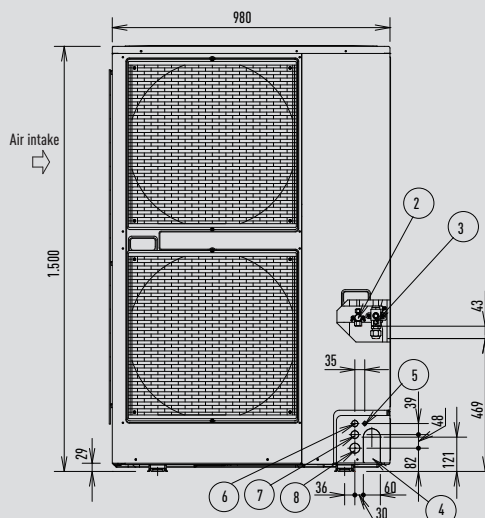
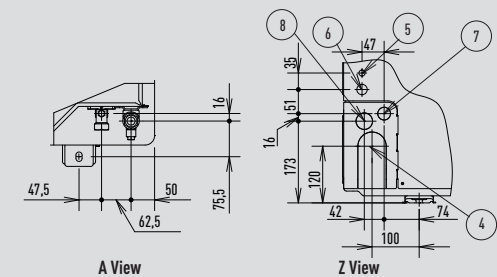

1 Mounting hole (4-R6.5), anchor bolt: M10
2 Refrigerant piping (liquid tube), flared connection (Ø9,52)
3 Refrigerant piping (gas tube), flared connection (Ø19,05)
4 Refrigerant piping port
5 Electrical wiring port (Ø13)
6 Electrical wiring port (Ø22)
7 Electrical wiring port (Ø27)
8 Electrical wiring port (Ø35)

The piping of the gas main has a diameter of Ø22.22, but the connection to the service valve of the outdoor unit has a diameter of Ø19.05, so a flare has to be used. Consequently, be sure to use the enclosed joint tube B and joint tube A in making connections (brazing).

Unit: mm

2-Pipe ECOi EX ME2 Series 8 / 10HP

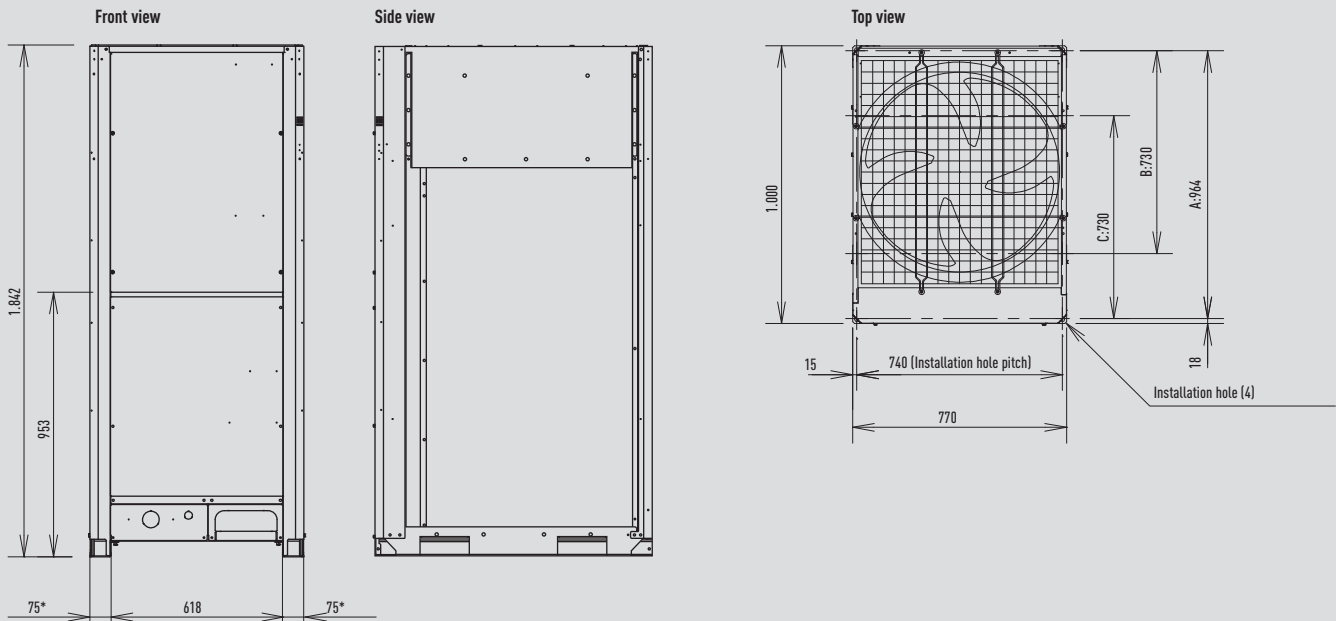

According to the installation site, you may choose the setting position in the depth direction of the anchor bolt from A, B or C.

- A: 964 (Installation hole pitch) (the piping is routed out from the front)
- B: 730 (Installation hole pitch) * The piping is routed out from the bottom
- C: 730 (Installation hole pitch)

* Installation fixing bracket. Installation side

Dimensions: mm

2-Pipe ECOi EX ME2 Series 12 / 14 / 16HP

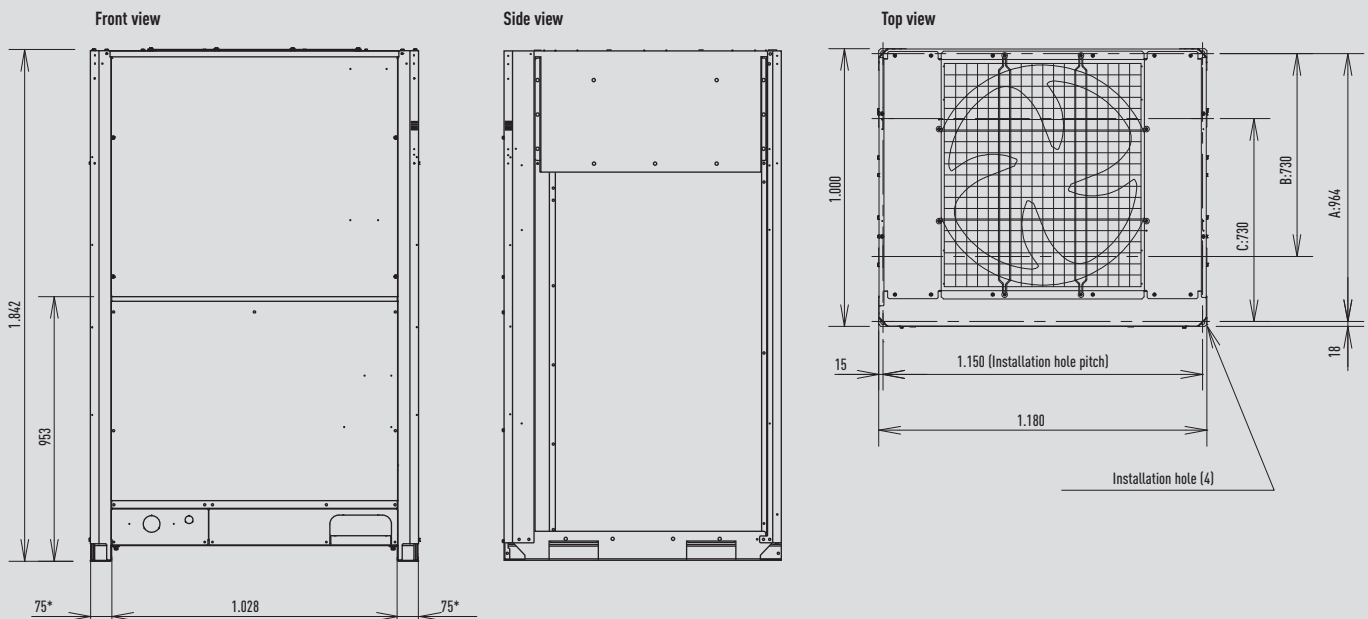

According to the installation site, you may choose the setting position in the depth direction of the anchor bolt from A, B or C.

- A: 964 (Installation hole pitch) (the piping is routed out from the front)
- B: 730 (Installation hole pitch) * The piping is routed out from the bottom
- C: 730 (Installation hole pitch)

* Installation fixing bracket. Installation side

Dimensions: mm

2-Pipe ECOi EX ME2 Series 18 / 20HP

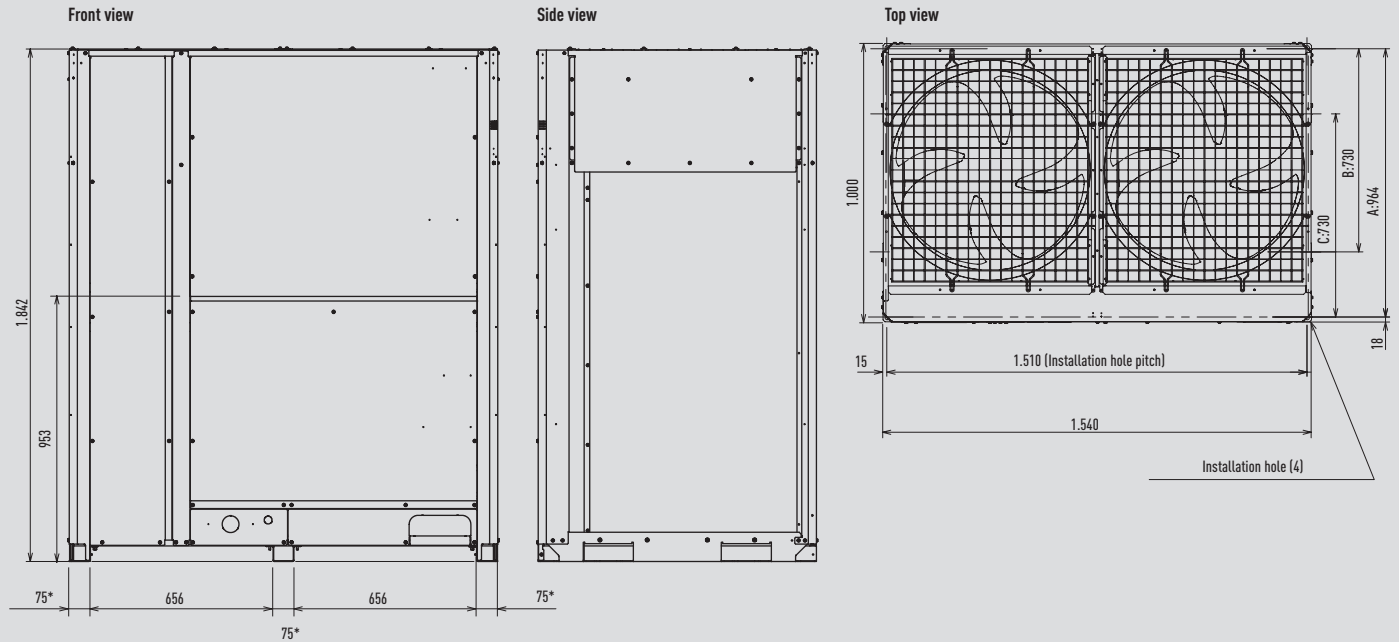

According to the installation site, you may choose the setting position in the depth direction of the anchor bolt from A, B or C.

- A: 964 (Installation hole pitch) [the piping is routed out from the front]
- B: 730 (Installation hole pitch) * The piping is routed out from the bottom
- C: 730 (Installation hole pitch)

* Installation fixing bracket. Installation side

Dimensions: mm

3-Pipe ECOi MF2 6N Series 8-16HP

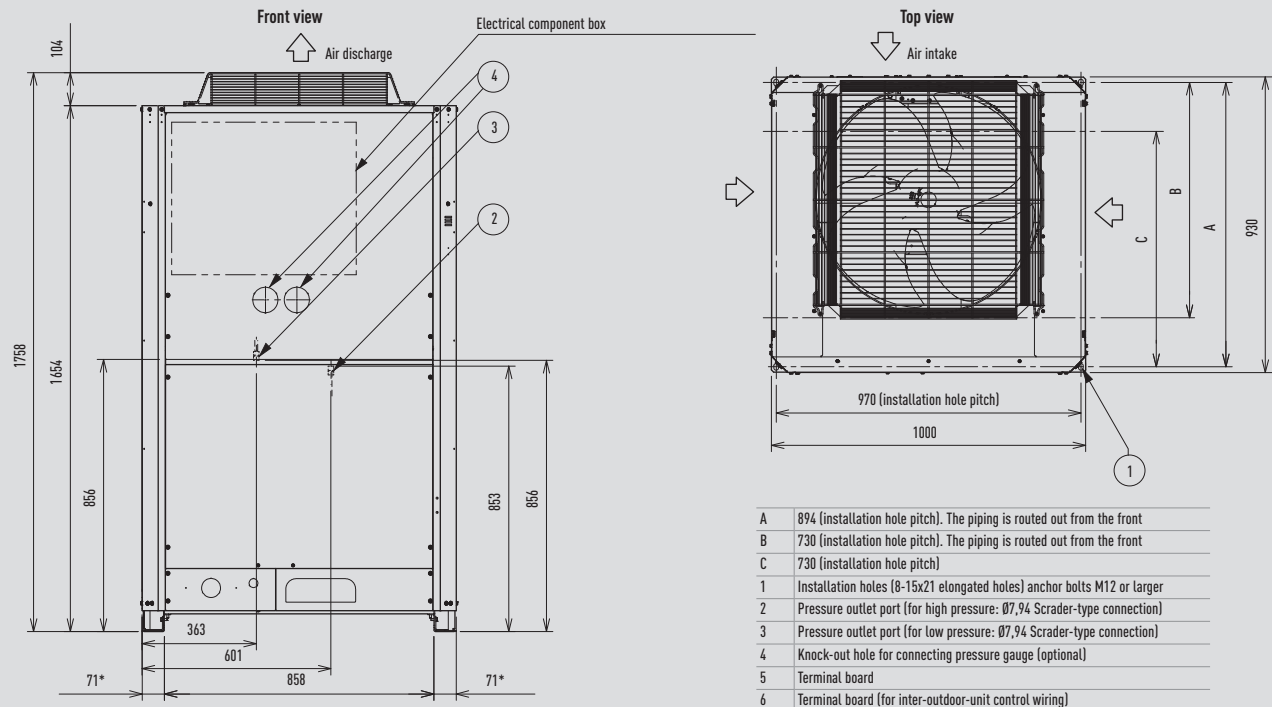

- A 894 (installation hole pitch). The piping is routed out from the front
- B 730 (installation hole pitch). The piping is routed out from the front
- C 730 (installation hole pitch)
- 1 Installation holes (8-15x21 elongated holes) anchor bolts M12 or larger
- 2 Pressure outlet port (for high pressure: Ø7,94 Scraeder-type connection)
- 3 Pressure outlet port (for low pressure: Ø7,94 Scraeder-type connection)
- 4 Knock-out hole for connecting pressure gauge (optional)
- 5 Terminal board
- 6 Terminal board (for inter-outdoor-unit control wiring)

* Installation fixing bracket, installation side.

3-Pipe Control Box Kit / Multiple connection type

Heat Recovery Box Dimensions

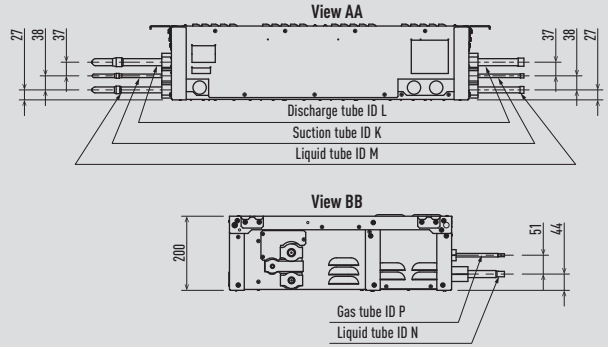
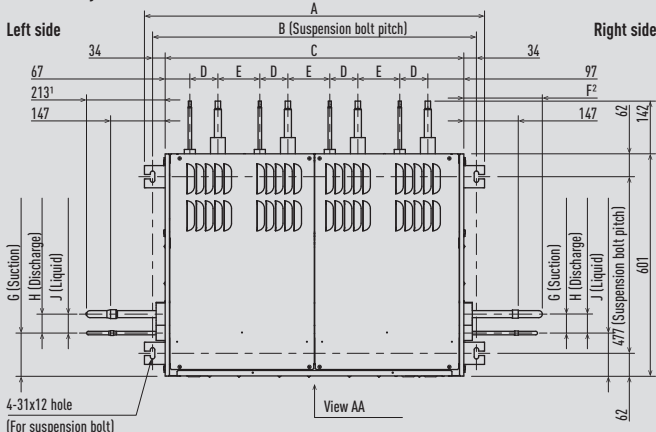

	A	B	C	D	E	F	G	H	J	K	L	M	N	P
Type 456	919	874	807	67	113	213	51	51	117	Ø19,05	Ø15,88	Ø9,52	Ø6,35	Ø12,7
Type 4160	919	874	807	67	113	207	55	54	113	Ø9,52	Ø15,88	Ø28,58	Ø25,4	Ø15,88
Type 656	1.297	1.253	1.185	67	113	213	54	55	115	Ø25,4	Ø19,05	Ø12,7	Ø6,35	Ø12,7
Type 856	1.675	1.631	1.563	67	113	213	53	53	115	Ø28,58	Ø22,22	Ø12,7	Ø6,35	Ø12,7

- 1) In case of right side connection.
- 2) Including the protection tubes when connecting to the left side.

Valve Dimensions

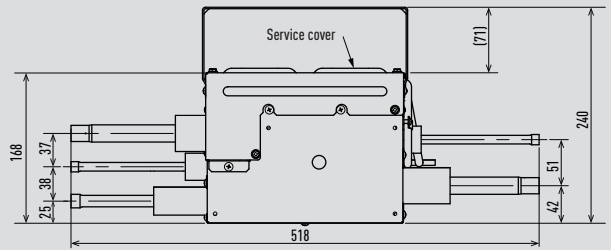
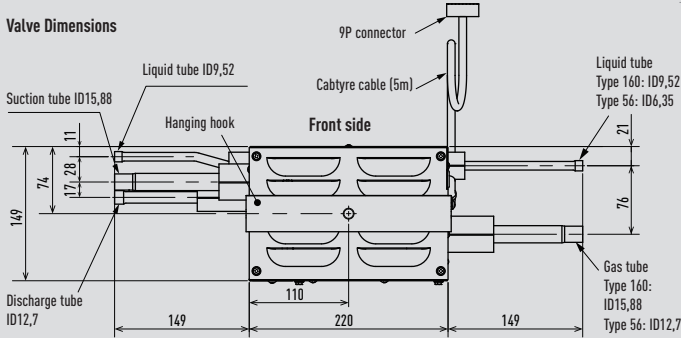

Unit: mm

ECO G GE3 Series 16 and 20HP

Service clearances for installation

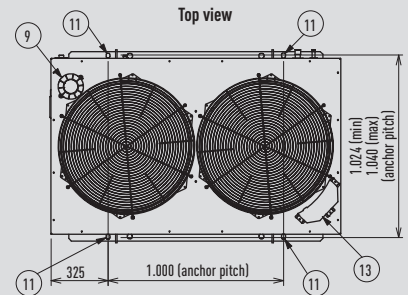
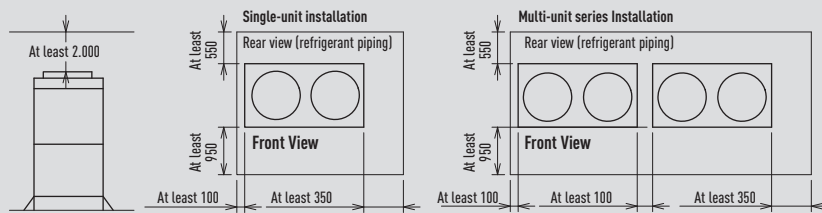

Type	45,0kW	56,0kW
1 Gas refrigerant pipe	Ø28,58	
2 Liquid refrigerant pipe	Ø12,7	Ø15,88
3 Exhaust gas drain port	HOSE OD: Ø25 (accessory)	
4 Electrical power supply port	Ø28	
5 Inter-unit cable port	Ø28	
6 Fuel gas port	R3/4	
7 Condensation drain opening	Ø20	
8 Rain and condensation outlet		
9 Engine exhaust outlet		
10 Suspension holes 4-Ø20x30		
11 Anchor holes 4-22x30		
12 Segmented display		
13 Coolant intake (top)		
14 Air intake		
15 Coolant level		
16 Hot water inlet	Rp3/4	
17 Hot water outlet	Rp3/4	

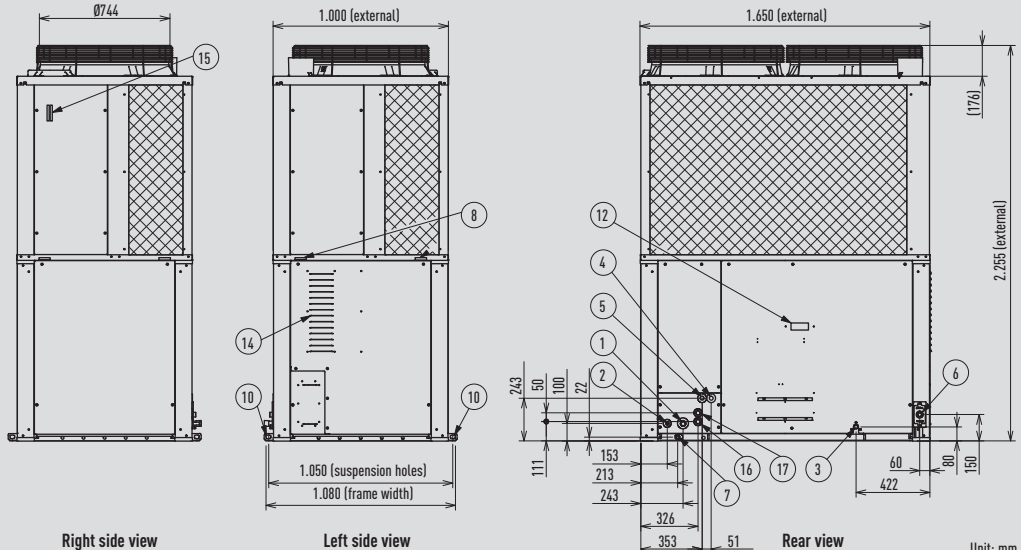

Unit: mm

ECO G GE3 Series 25 and 30HP

Service clearances for installation

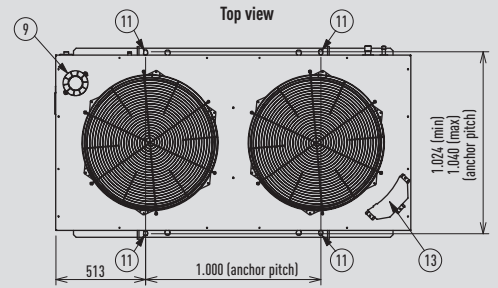
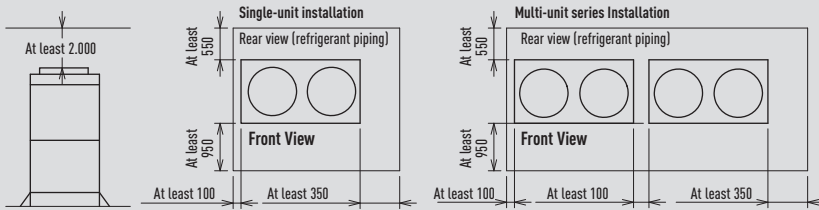

Type	71,0kW	85,0kW
1 Gas refrigerant pipe	Ø28,58	Ø31,75
2 Liquid refrigerant pipe	Ø15,88	Ø19,05
3 Exhaust gas drain port	HOSE OD: Ø25 (accessory)	
4 Electrical power supply port	Ø28	
5 Inter-unit cable port	Ø28	
6 Fuel gas port	R3/4	
7 Condensation drain opening	Ø20	
8 Rain and condensation outlet		
9 Engine exhaust outlet		
10 Suspension holes 4-Ø20x30		
11 Anchor holes 4-22x30		
12 Segmented display		
13 Coolant intake (top)		
14 Air intake		
15 Coolant level		
16 Hot water inlet	Rp3/4	
17 Hot water outlet	Rp3/4	

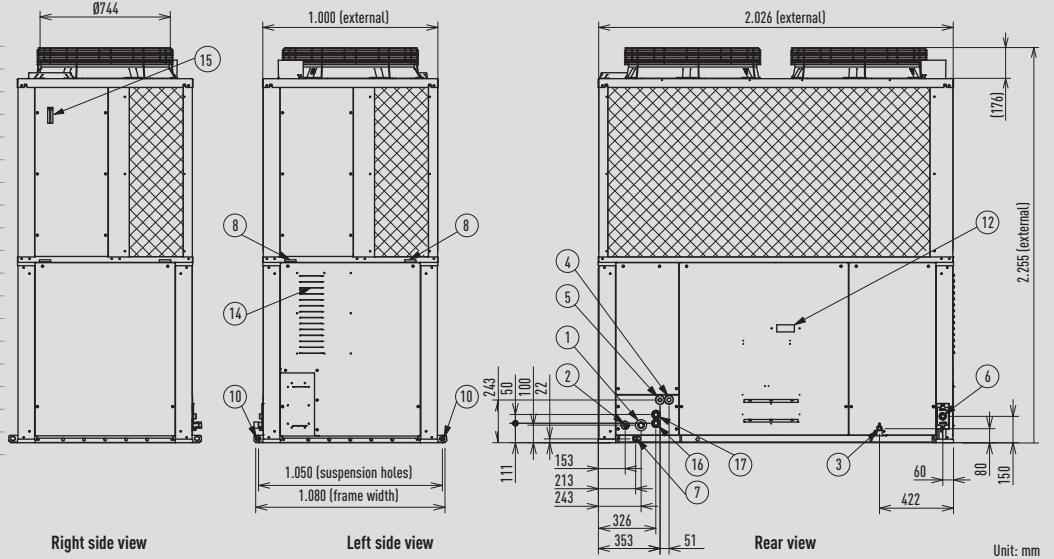

ECO G GF2 3-Pipe

Service clearances for installation

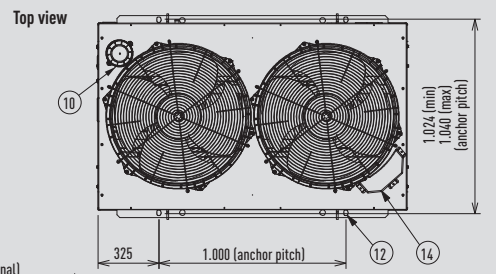
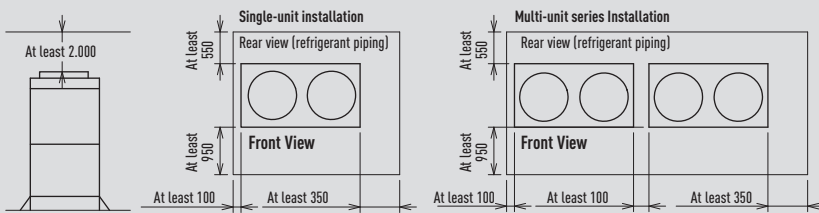

Type	45,0kW	56,0-71,0 kW
1 Suction refrigerant pipe	Ø28,58	
2 Discharge refrigerant pipe	Ø22,22	Ø25,4
3 Liquid refrigerant pipe	Ø19,05	
4 Exhaust gas drain port	HOSE OD Ø25 (accessory)	
5 Electrical power supply port	Ø28	
6 Inter-unit cable port	Ø28	
7 Fuel gas port	R3/4	
8 Condensation drain opening	Ø20	
9 Rain and condensation outlet		
10 Engine exhaust outlet		
11 Suspension holes 4-Ø20x30		
12 Anchor holes 4-Ø22x30		
13 Segmented display		
14 Coolant intake (top)		
15 Vent		

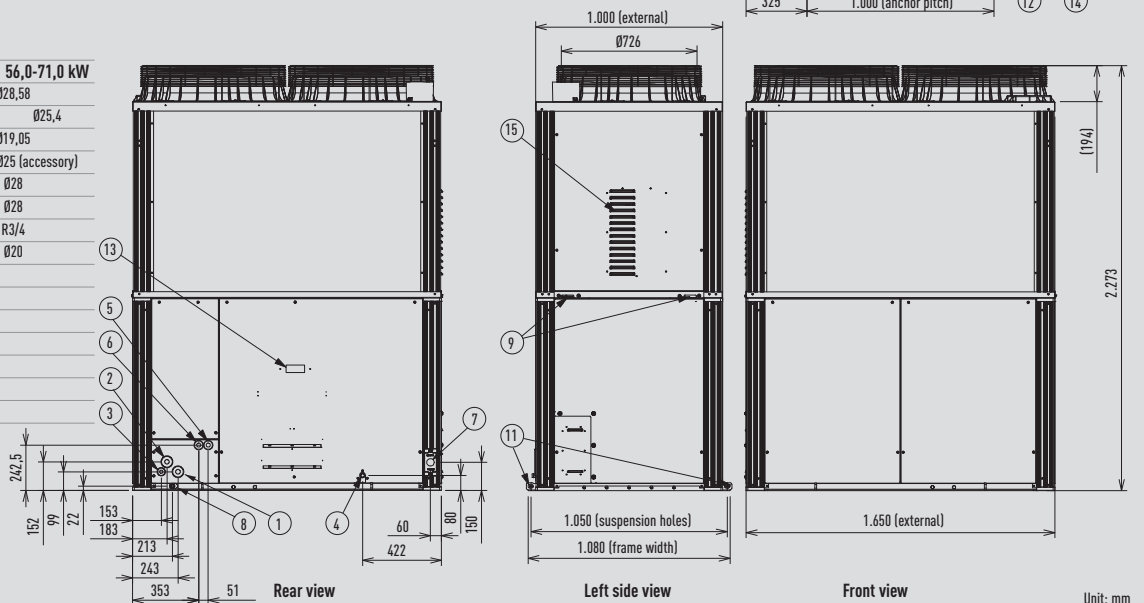

Water Heat Exchanger for chilled and hot water production

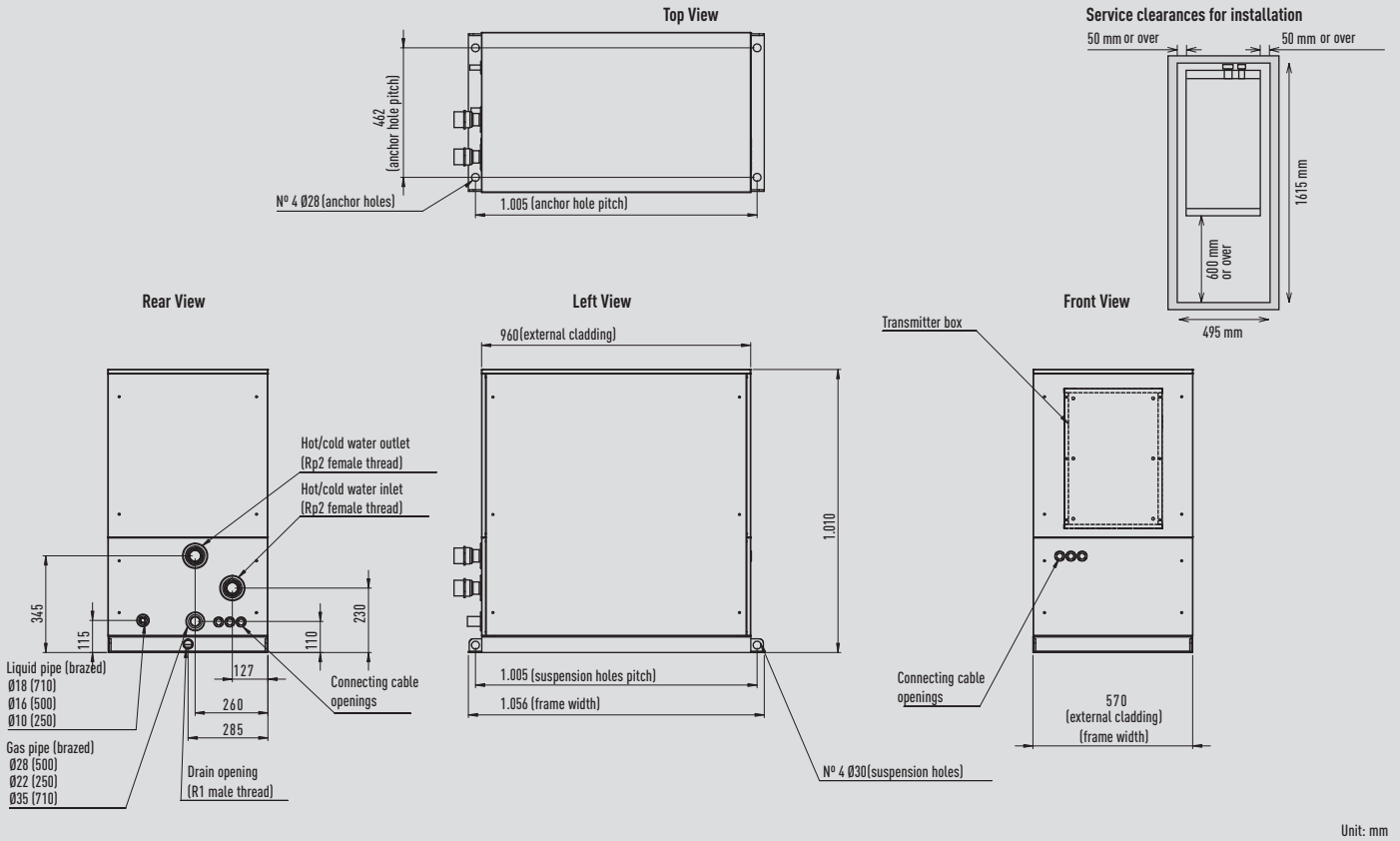

U2 Type. 4 Way 90x90 Cassette

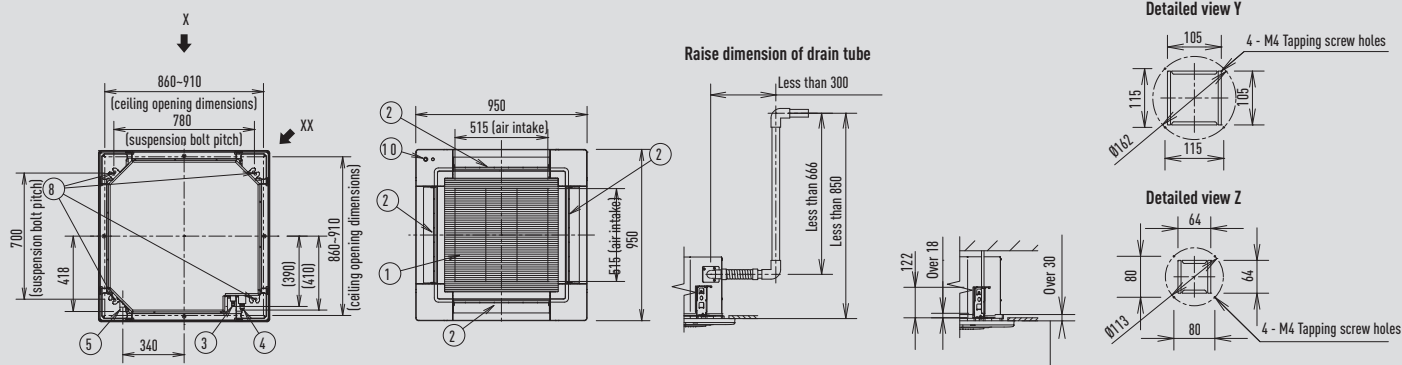

S-22MU2E5A // S-28MU2E5A // S-36MU2E5A // S-45MU2E5A // S-56MU2E5A // S-60MU2E5A // S-73MU2E5A // S-90MU2E5A

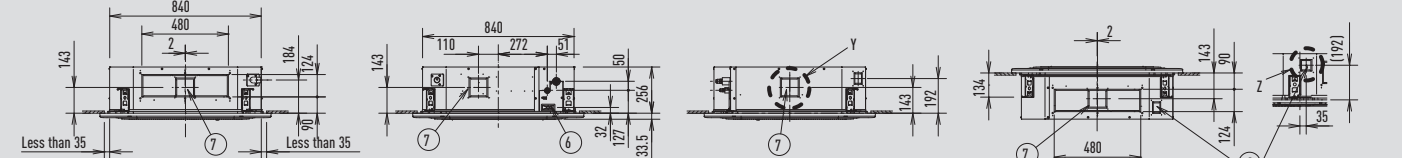

S-106MU2E5A // S-140MU2E5A // S-160MU2E5A

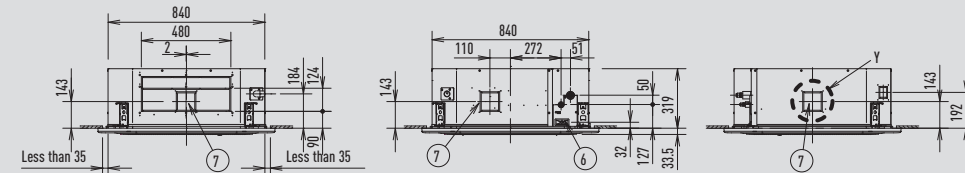

The length of the suspension bolts should be selected so that there is a gap of 30mm or more below the lower surface of the ceiling (18mm or more below the lower surface of the main unit), as shown in the figure at right. If the suspension bolt is too long, it will contact the ceiling panel and the unit cannot be installed.
Filter dimension: 520 x 520 x 15mm.

Type	22-90	106-160
1 Air intake		
2 Discharge outlet		
3 Refrigerant piping (liquid tube)	Ø6,35 (flared)	Ø9,52 (flared)
4 Refrigerant piping (gas tube)	Ø12,7 (flared)	Ø15,88 (flared)
5 Drain tube connection port VP25 (outer diameter Ø32)		
6 Power supply port		
7 Suspension bolt hole (4-12x30 elongated hole)		
8 Fresh air intake duct connection port (Ø100)*		
9 Suspension bolt hole (4-12x30 elongated hole)		
10 Econavi sensor (Only CZ-KPU3A)		

* Necessary to attach duct connecting flange(field supplied).

Unit: mm

U1 Type. 4 Way 90x90 Cassette

Type	22-56	60-160
1 Air intake grill		
2 Air discharge outlet		
3 Refrigerant piping (liquid pipes)	Ø6,35 (flared)	Ø9,52 (flared)
4 Refrigerant piping (gas pipes)	Ø12,7 (flared)	Ø15,88 (flared)
5 Drain outlet VP50	Outer diameter 32mm	
6 Power supply port		
7 Discharge duct	Ø150	
8 Suspension bolt hole	4-12x30 slot	
9 Fresh air intake duct connection port	Ø100 ¹	

1 Air inlet kit is necessary.
Filter size: 520 x 520 x 16

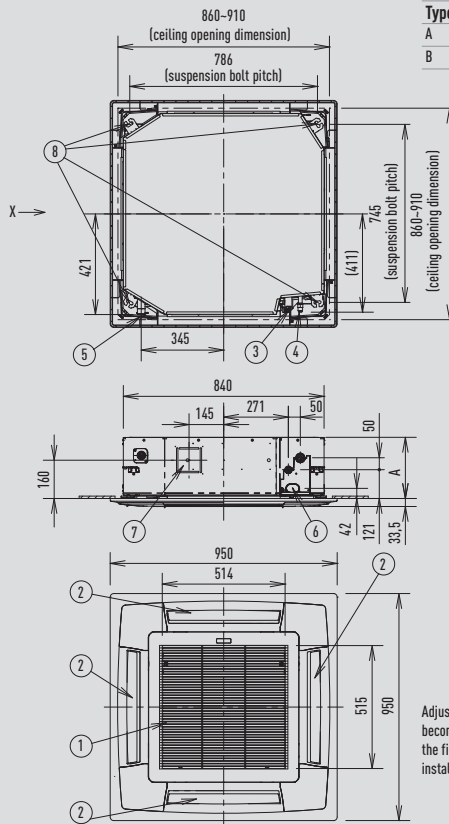
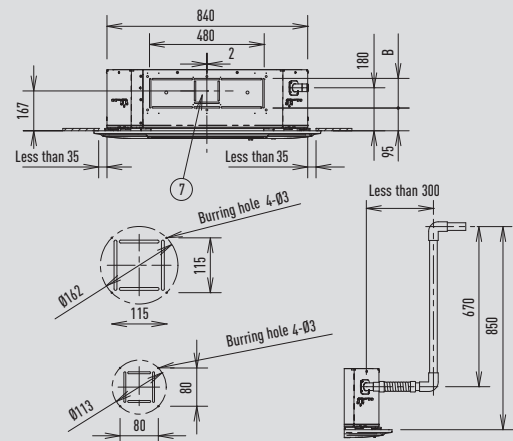

Type	22-90	106-160
A	256	319
B	124	187

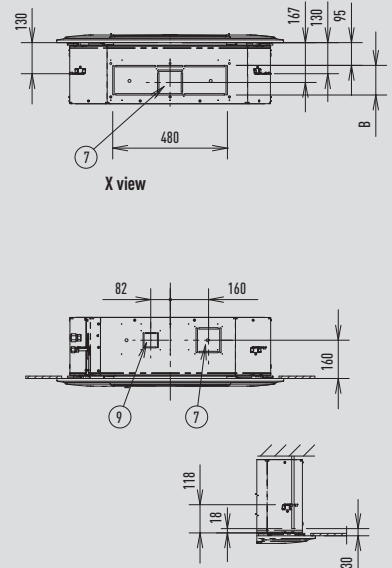

Adjust the suspension bolt length so that the gap from the lower ceiling surface becomes 30mm or more (18mm or more from the lower surface of the body) as shown in the figure. When the suspension bolt length is long, it hits the ceiling panel and installation is not possible.

Unit: mm

Y2 Type. 4 Way 60x60 Cassette

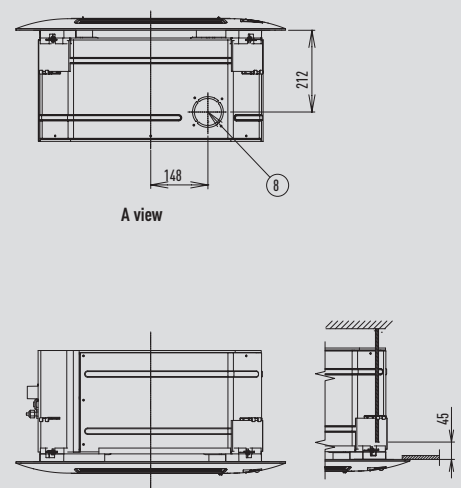
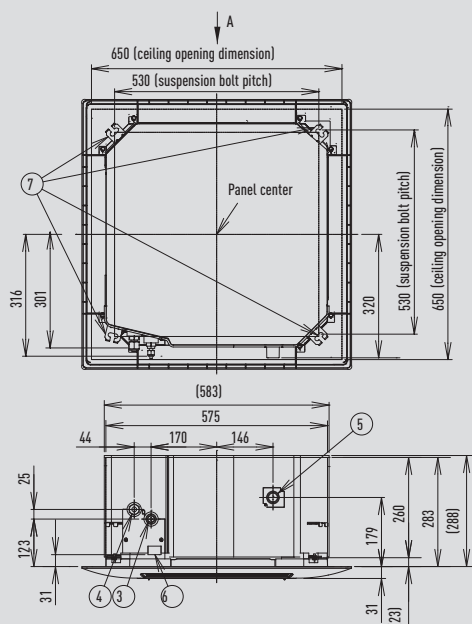
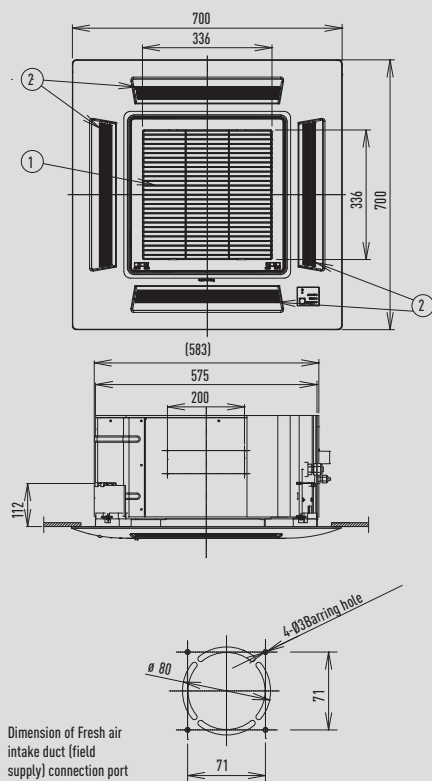

1 Air intake	
2 Discharge outlet	
3 Refrigerant piping (liquid tube)	Ø6,35 (flared)
4 Refrigerant piping (gas tube)	Ø12,7 (flared)
5 Drain tube connection port VP25	Outer dia. Ø32
6 Power supply port	
7 Suspension bolt hole	4-11 x 26 hole
8 Fresh air intake duct connection port	Ø80

Adjust the suspension bolt length so that the gap from the lower ceiling surface becomes 45mm or more, as shown in the figure at right. If the suspension bolts is too long, it will contact the ceiling panel and the unit cannot be installed.

Unit: mm

M1 Type. Slim Variable Static Pressure Hide Away

1	Refrigerant piping joint (narrow tube)	
2	Refrigerant piping joint (wide tube)	
3	Upper and bottom drain port	Outer diameter 26mm
4	Suspension lug	
5	Power supply outlet	2-Ø30
6	Flange for air intake duct	
7	PL cover	
8	Electrical component box	
9	Frame filter	
10	Signal output board	ACC-SG-AGB: optional

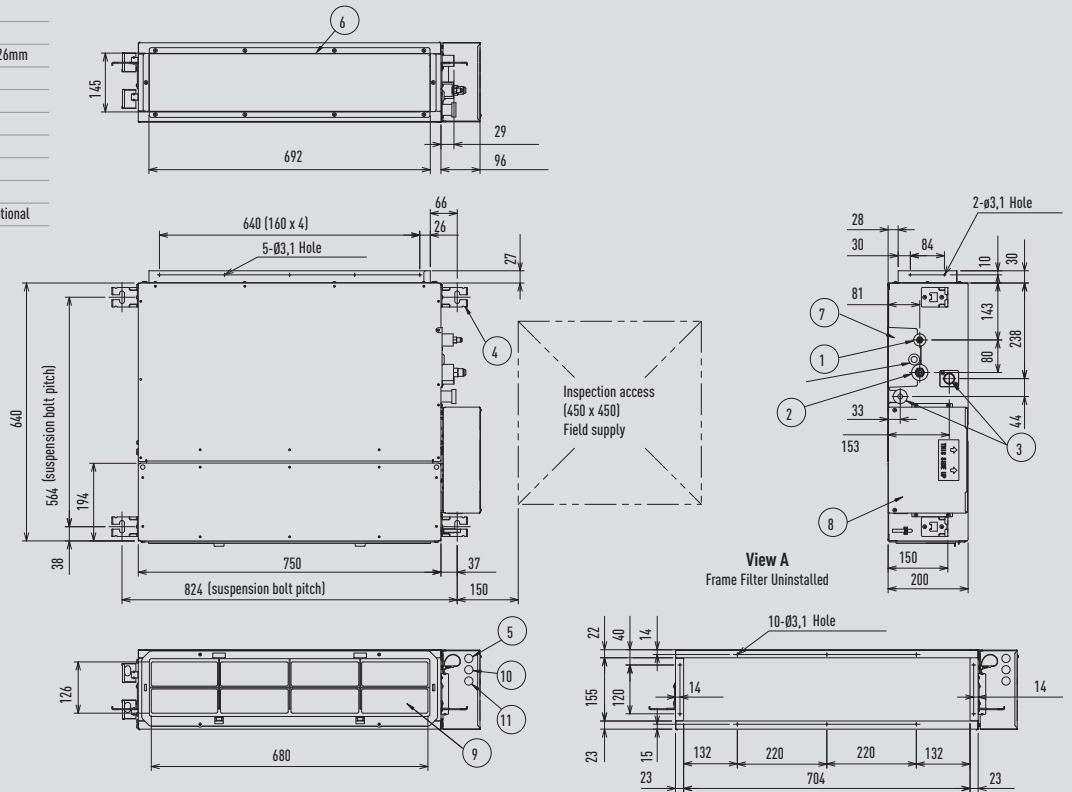

Unit: mm

E2 Type. High Static Pressure Hide Away

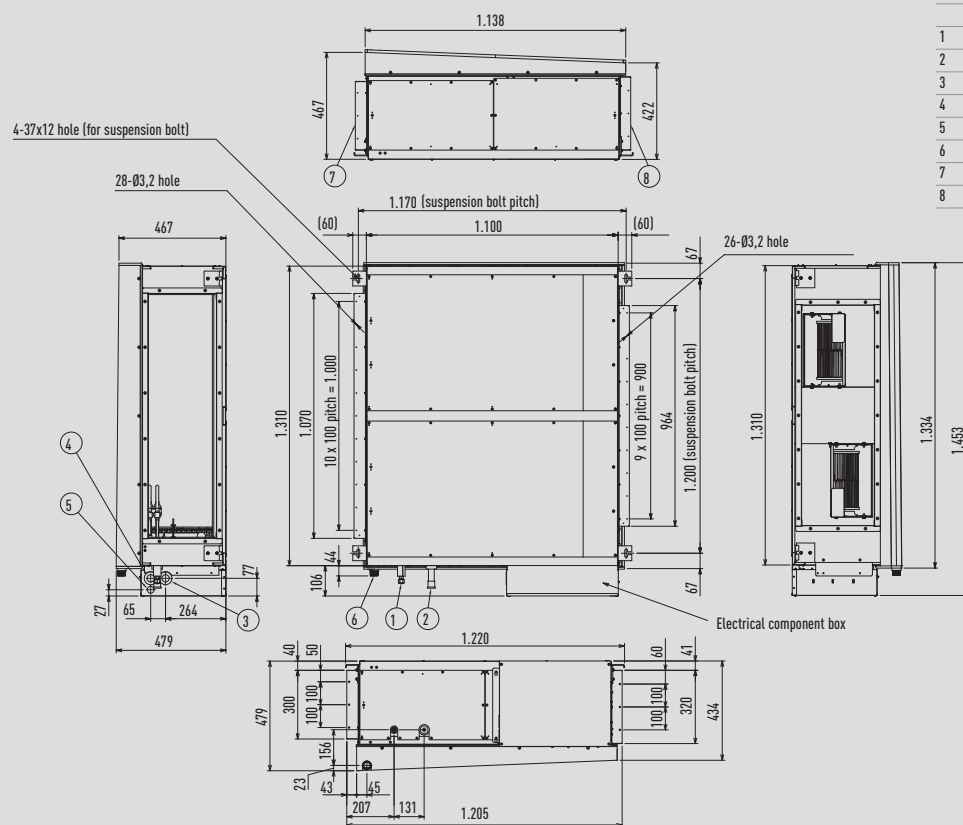

	224	280
1	Refrigerant liquid piping (Flare)	Ø9,52
2	Refrigerant gas piping (Brazing)	Ø19,05 Ø22,22
3	Power supply port	
4	Communication wiring port	
5	Port for optional wiring part	
6	Drain port 25A	
7	Air intake duct connecting side flange	
8	Air discharge duct connecting side flange	

Unit: mm

F2 Type. Variable Static Pressure Hide Away

S-15MF2E5A // S-22MF2E5A // S-28MF2E5A // S-36MF2E5A // S-45MF2E5A // S-56MF2E5A

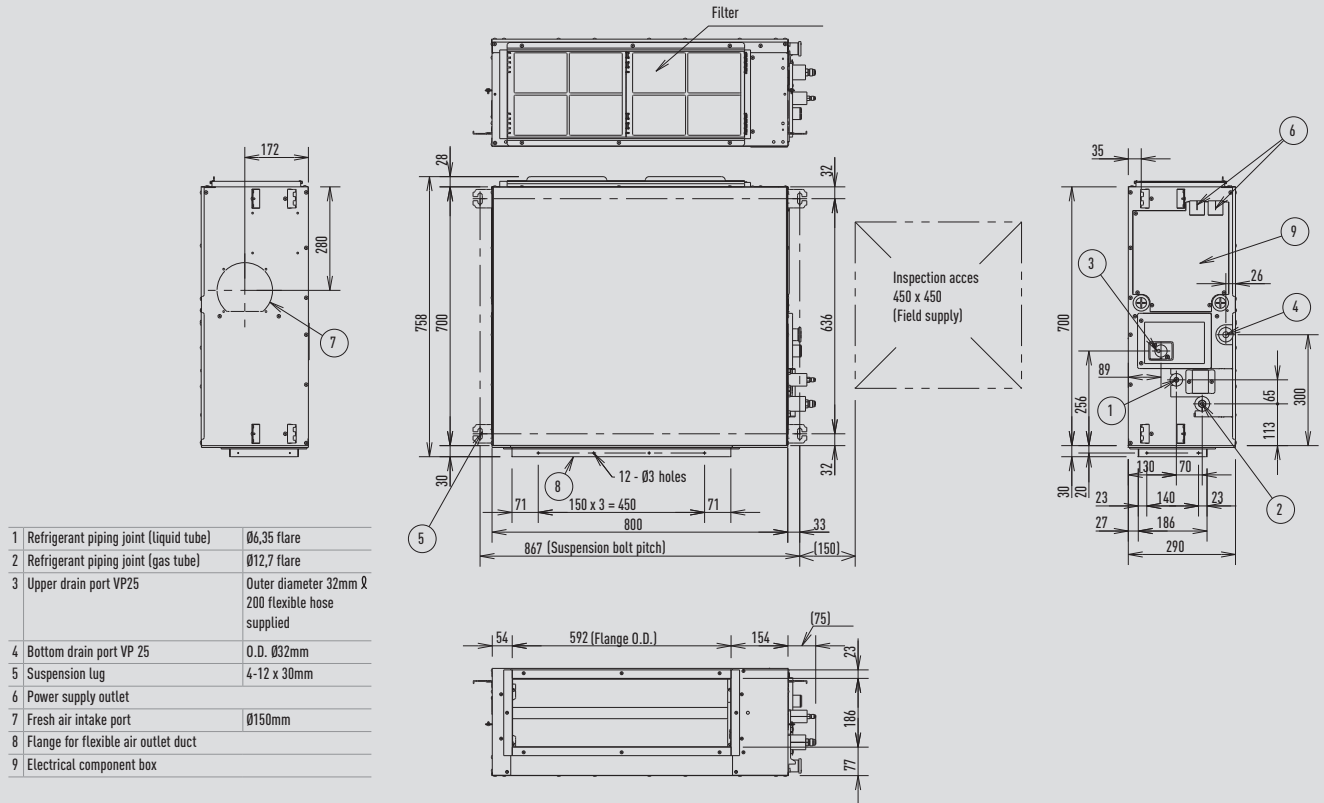

S-60MF2E5A // S-73MF2E5A // S-90MF2E5A

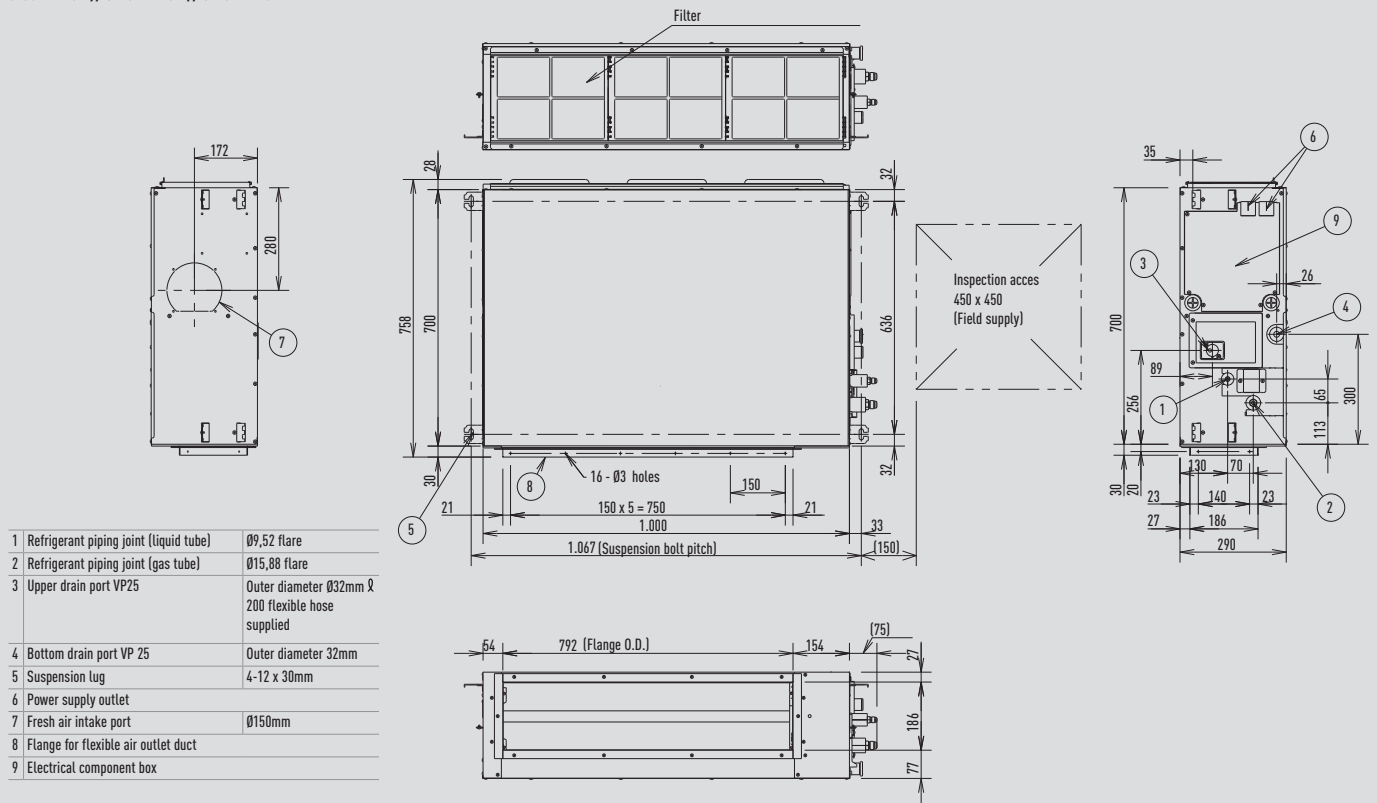

F2 Type. Variable Static Pressure Hide Away

S-106MF2E5A // S-140MF2E5A // S-160MF2E5A

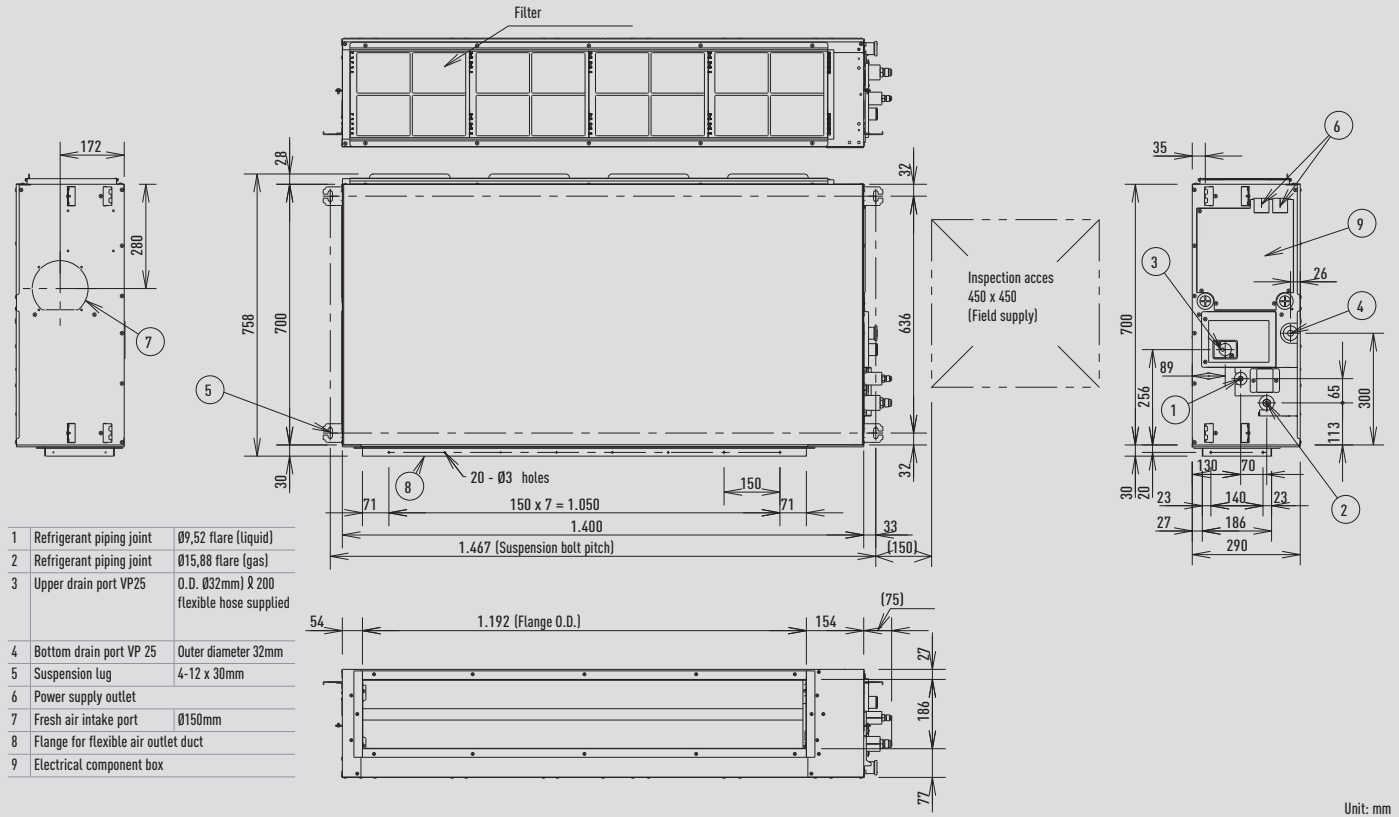

Heat Recovery with DX Coil

	A	A1	A2	B	B1	B2	C	D	D1	Ød	E	Net weight
PAW-500ZDX2N	1.822	1.752	1.986	882	936	994	390	431	431	250	169	81
PAW-800ZDX2N	1.822	1.752	1.986	1.132	1.186	1.244	390	431	431	250	169	87
PAW-01KZDX2N	1.822	1.752	1.986	1.132	1.186	1.244	390	681	532	250	169	87

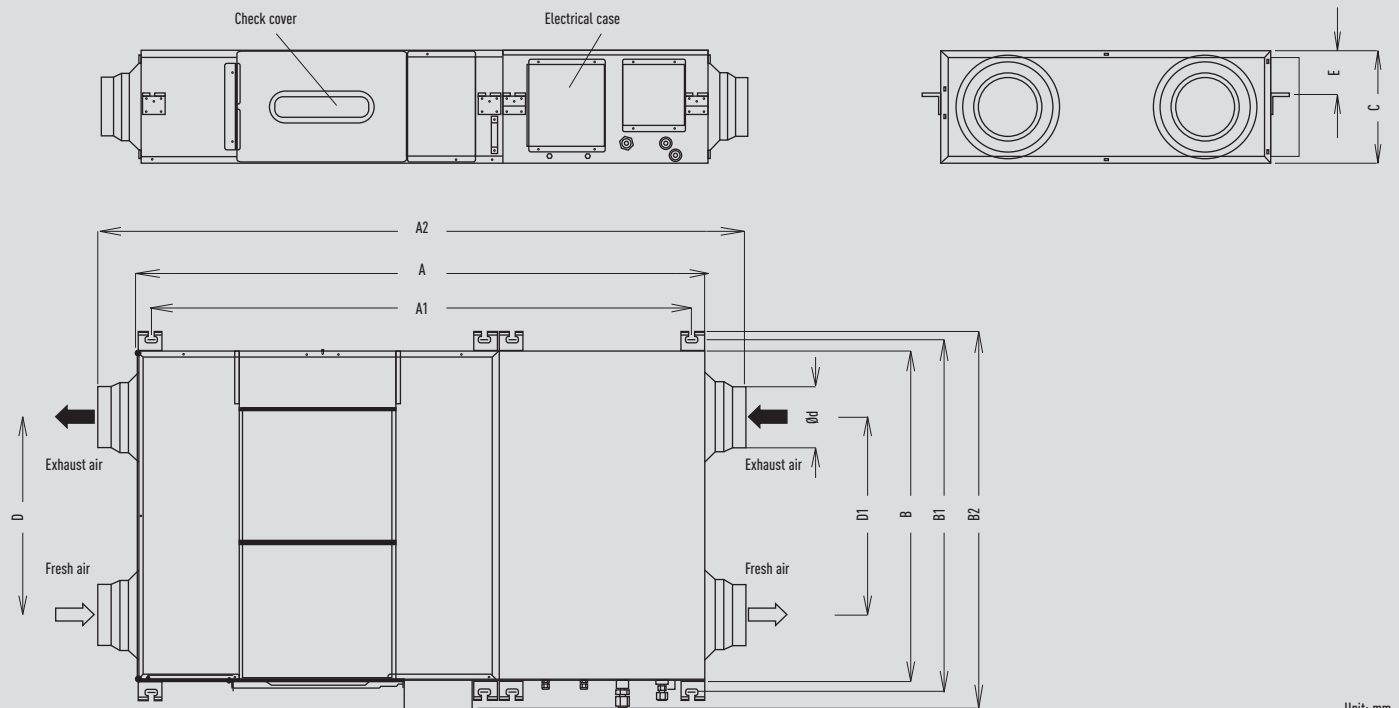

T2 Type. Ceiling

S-36MT2E5A // S-45MT2E5A // S-56MT2E5A

1	Drain port VP20	Inside diameter Ø26mm, drain hose supplied
2	Left drain position	
3	Refrigerant liquid piping	Ø9,52mm, flare connection
4	Refrigerant gas piping	Ø15,88mm, flare connection
5	Left side drain hose outlet port (cutout)	
6	Piping hole on wall surface	Ø100mm
7	Upper side piping port	
8	Right side drain hose outlet port (cutout)	
9	Wireless remote controller receiver installation location	

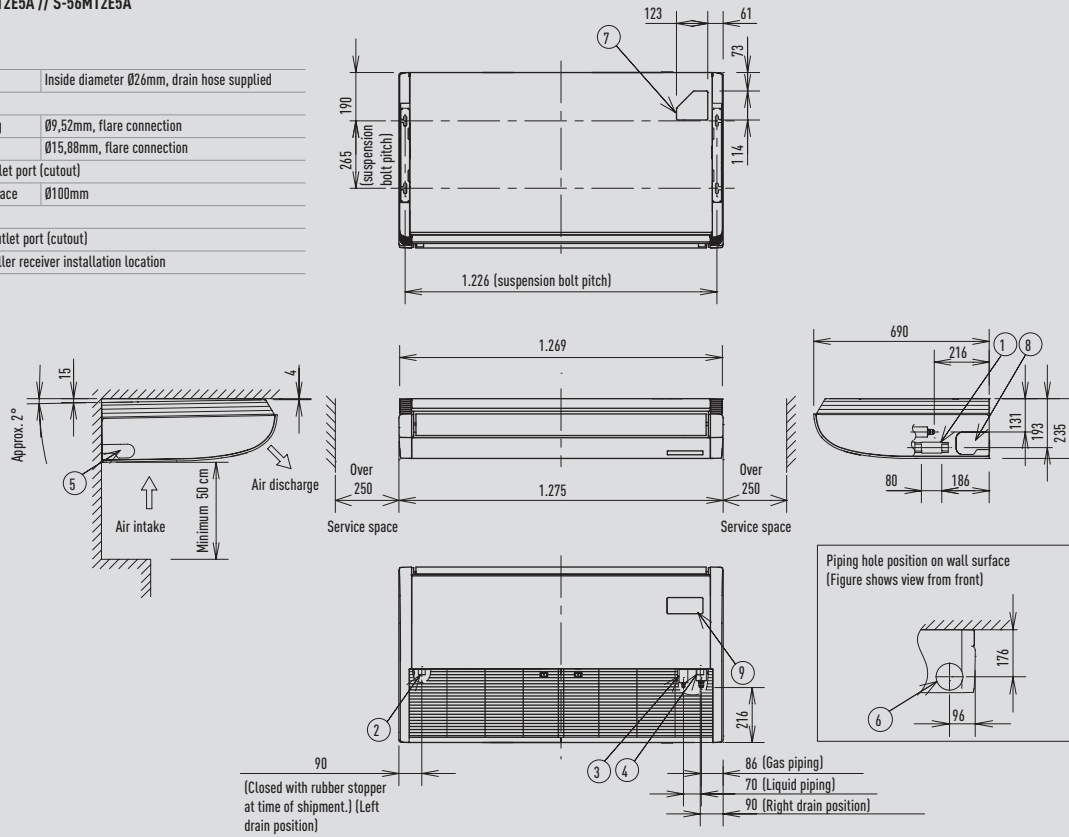

S-73MT2E5A // S-106MT2E5A // S-140MT2E5A

	A	B	C	D	E
106-140 type	1.590	235	690	1.584	1.541
140 type	1.275	235	690	1.269	1.226

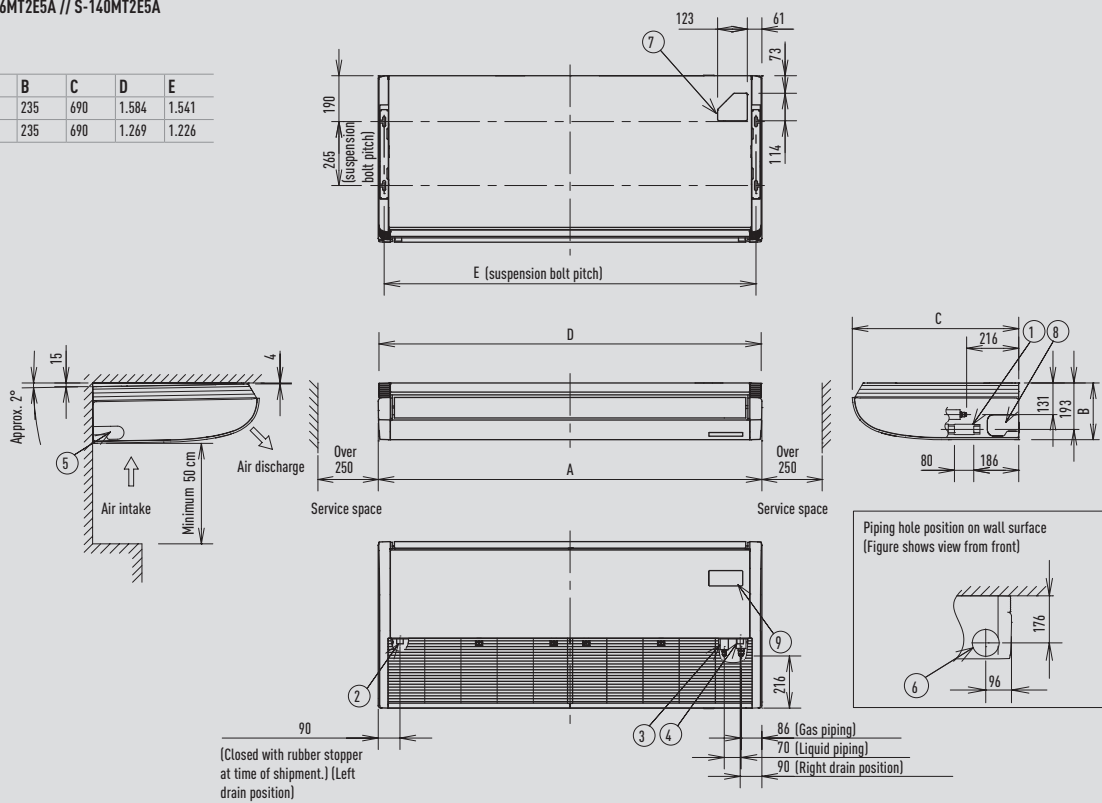

K2/K1 Type. Wall Mounted

S-15MK2E5A / S-22MK2E5A / S-28MK2E5A / S-36MK2E5A

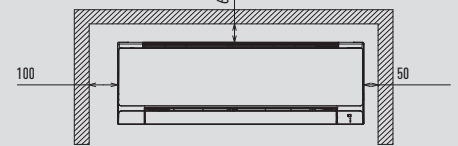
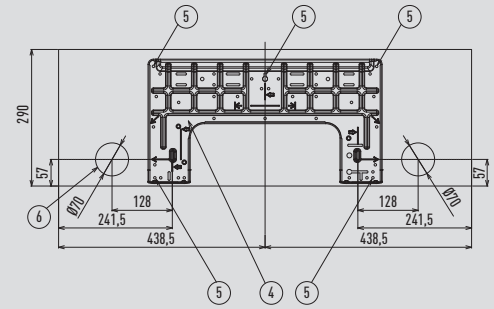
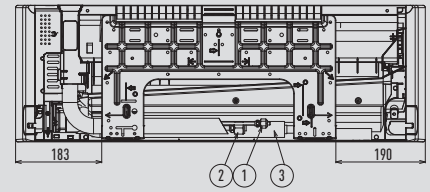
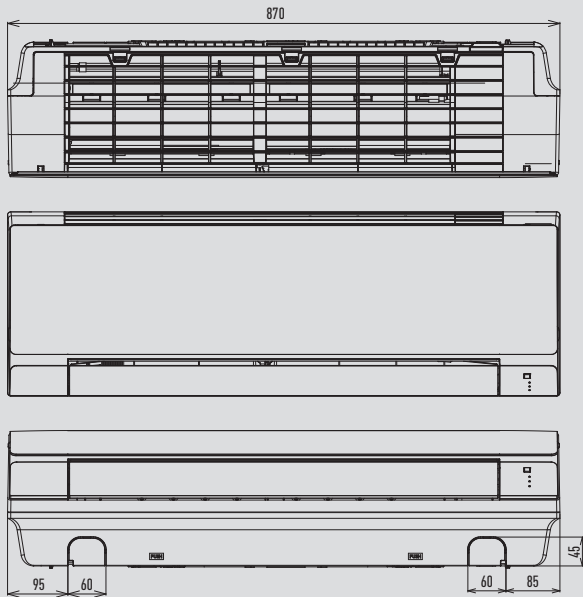

1	Refrigerant piping (liquid tube)	Ø6,35 (flared)
2	Drain hose	Outer diameter 16mm
3	Rear panel	PL Back
4	Refrigerant piping (gas tube)	Ø12,7 (flared)
5	Rear panel fixing holes	
6	Piping and wiring holes	Ø70

S-45MK1E5A / S-56MK1E5A / S-73MK1E5A / S-106MK1E5A

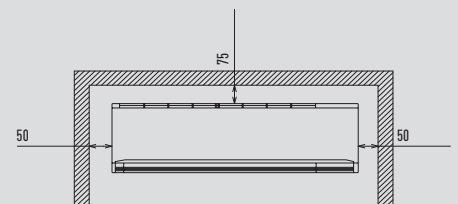
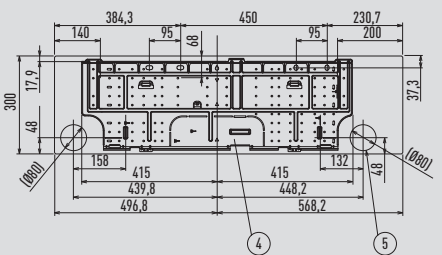
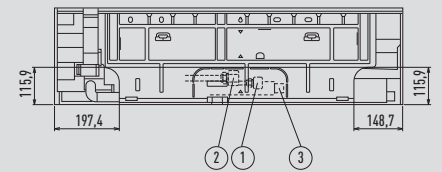
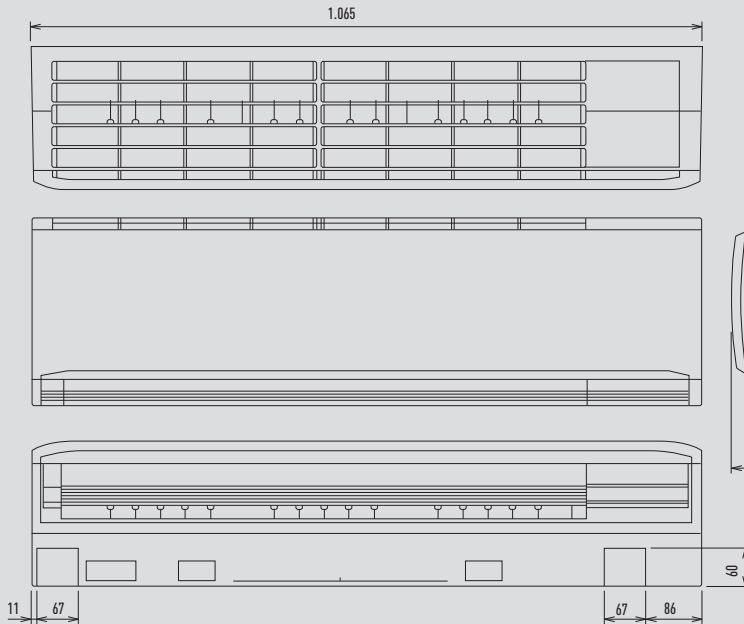

	45-56	73-106
1	Refrigerant piping (liquid tube)	Ø6,35 (flared) / Ø9,52 (flared)
2	Refrigerant piping (gas tube)	Ø12,7 (flared) / Ø15,88 (flared)
3	Drain hose VP13	Outer diameter 18mm
4	Rear panel	PL BACK
5	Piping and wiring holes	Ø80

P1 Type. Floor Standing

- 1 4-Ø12 hole (For fastening the indoor unit to the floor with screws.)
- 2 Air filter
- 3 Refrigerant connection outlet (liquid tube)
- 4 Refrigerant connection outlet (gas tube)
- 5 Level adjusting bolt
- 6 Drain outlet (20 A)
- 7 Power cord outlet (downward, rear)
- 8 Refrigerant piping outlet (downward, rear)
- 9 Location for mounting the remote controller (Remote controller can be attached within the room.)

	A	B	C	Liquid pipes	Gas pipes
22-36	1065	665	632	Ø6,35	Ø12,7
45					
56	1380	980	947		
71				Ø9,52	Ø15,88

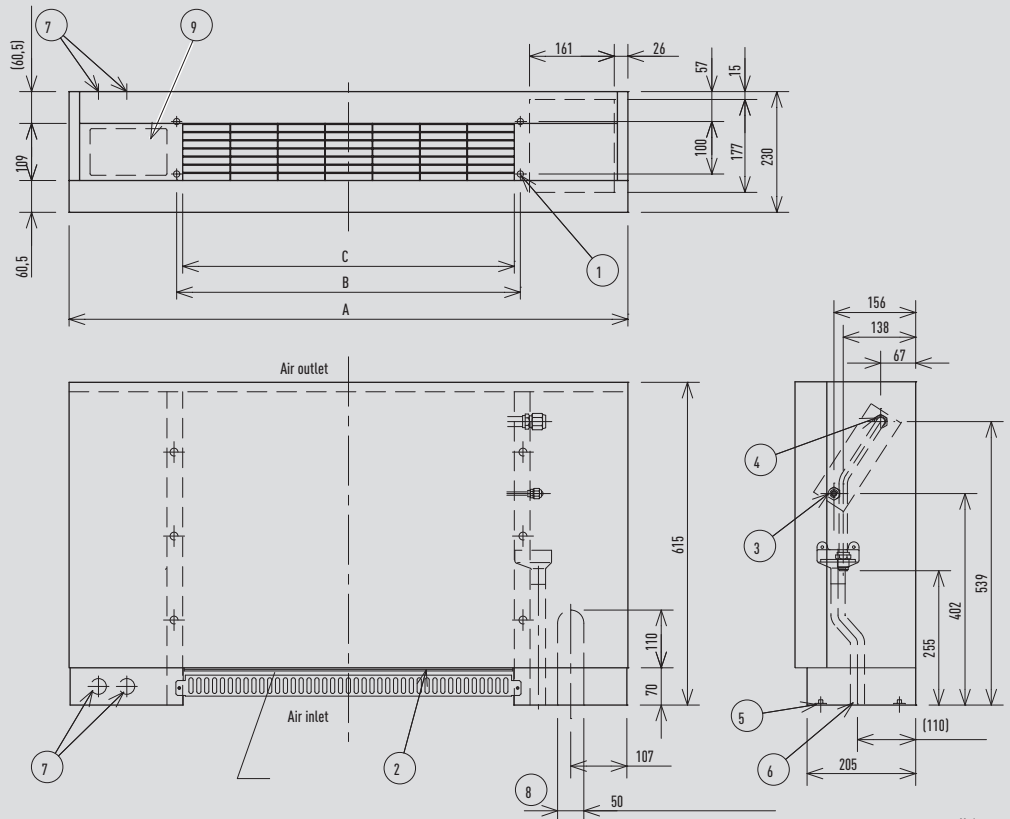

Unit: mm

R1 Type. Concealed Floor Standing

- 1 4-Ø12 hole (For fastening the indoor unit to the floor with screws.)
- 2 Air filter
- 3 Refrigerant connection outlet (liquid tube)
- 4 Refrigerant connection outlet (gas tube)
- 5 Level adjusting bolt
- 6 Drain outlet (20 A)
- 7 Flange for the air-outlet duct

	A	B	C	D	E	F	Liquid pipes	Gas pipes
22-36	904	692	672	665	500	86	Ø6,35	Ø12,7
45								
56	1,219	1,007	1,002	980	900	51		
71							Ø9,52	Ø15,88

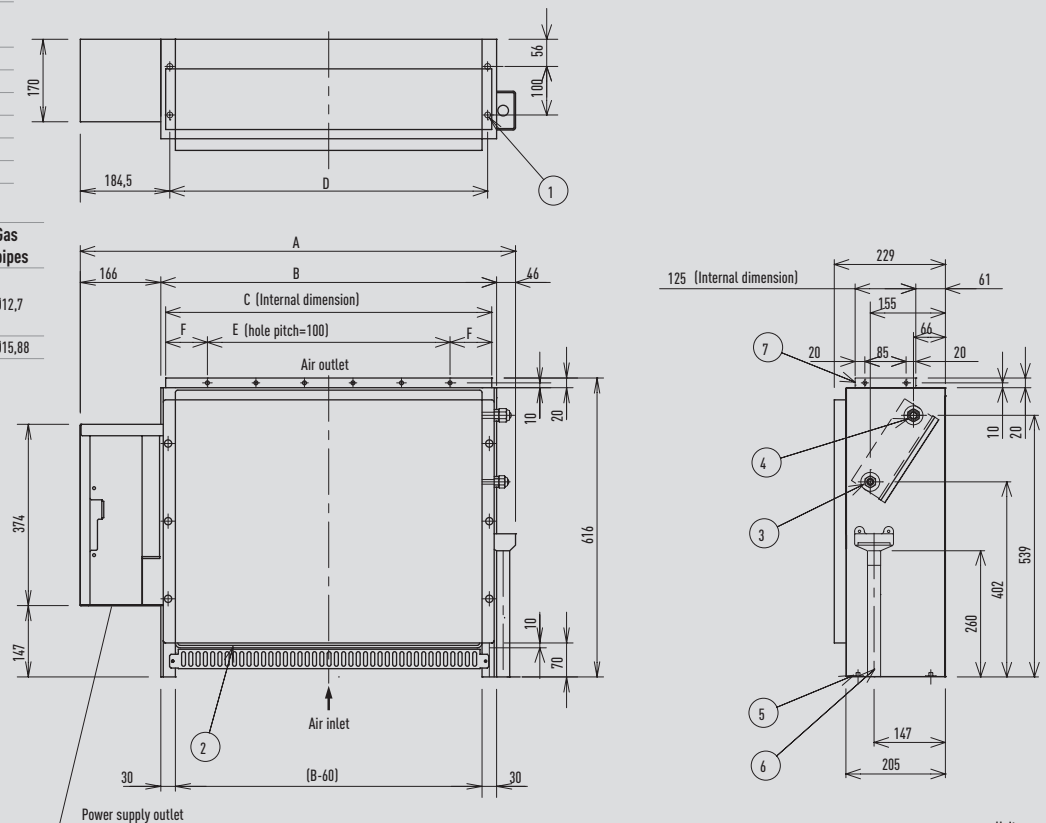

Unit: mm

AHU Connection Kit

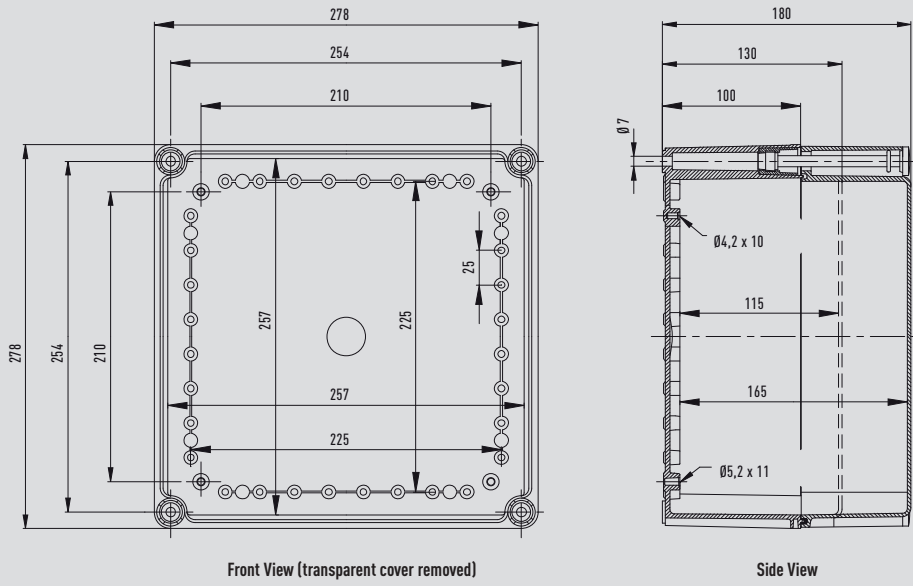

Unit: mm

Air Curtain with DX Coil

Jet-Flow dimensions

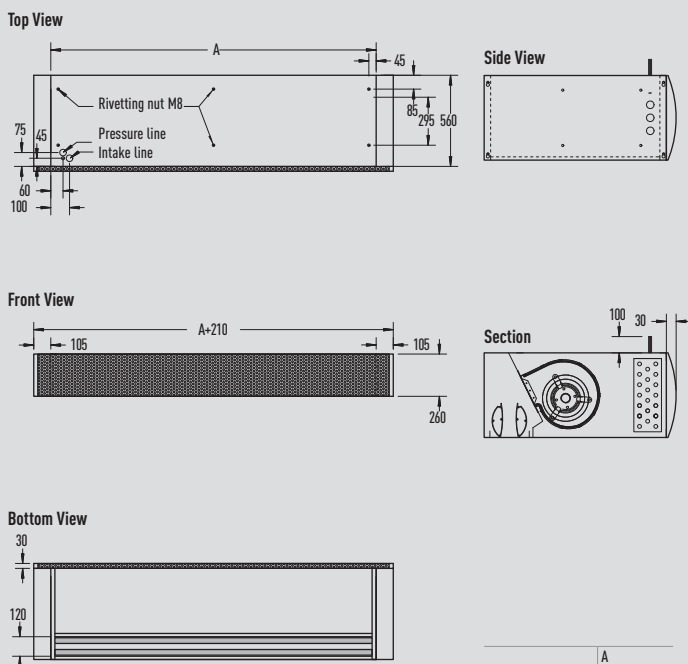

	A
PAW-10PAIRC-MJ	1.000
PAW-15PAIRC-MJ	1.500
PAW-20PAIRC-MJ	2.000
PAW-25EAIRC-MJ	2.500

Standard dimensions

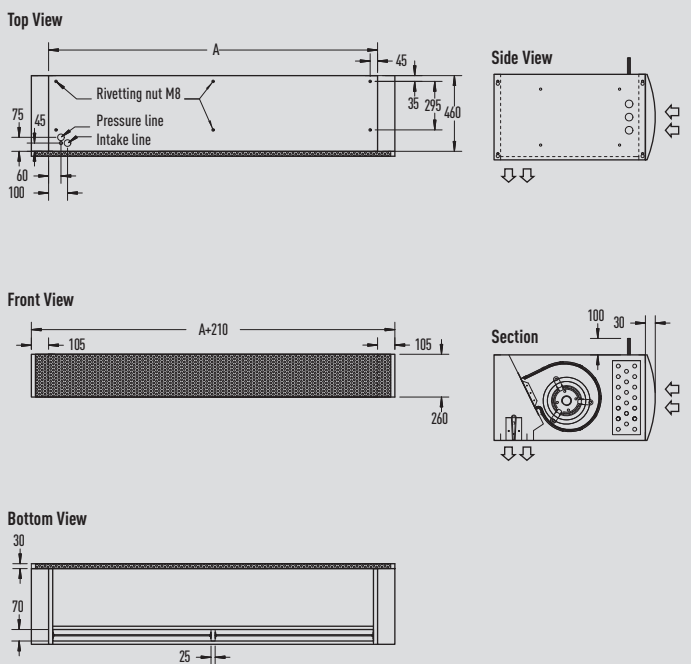

	A
PAW-10PAIRC-MS	1.000
PAW-20PAIRC-MS	2.000

Unit: mm

Energy Recovery Ventilation System

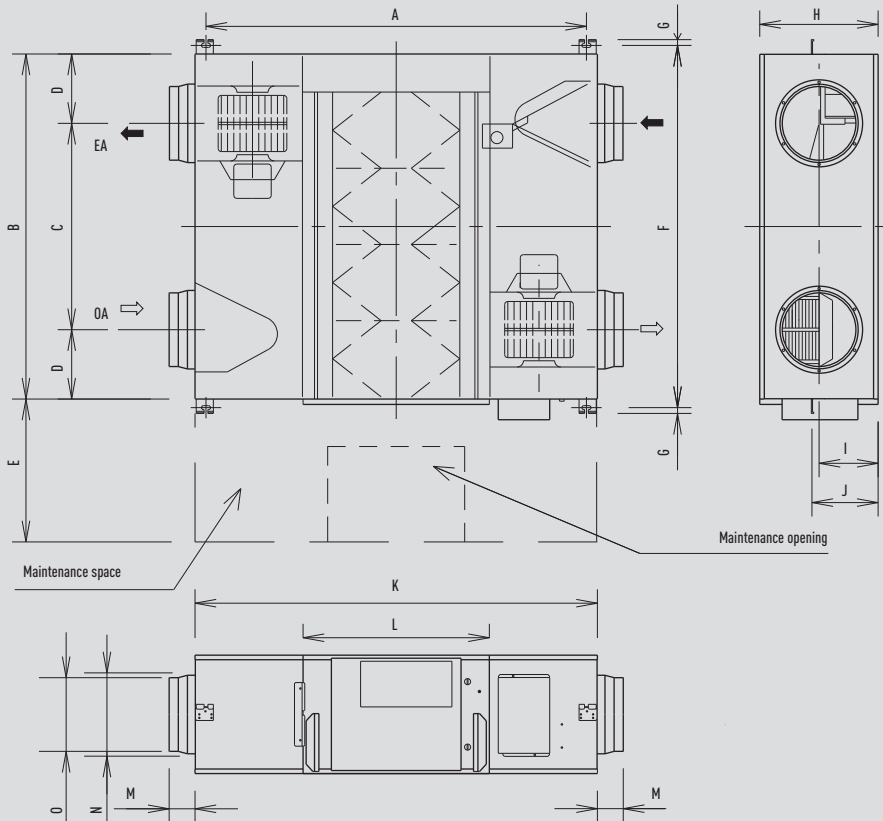

	FY-250ZDY8	FY-350ZDY8	FY-500ZDY8	FY-800ZDY8	FY-01KZDY8A
A	810	810	890	1.250	1.250
B	599	804	904	884	1.134
C	315	480	500	428	678
D	142	162	202	228	228
E	600	600	600	600	600
F	655	860	960	940	1.190
G	19	19	19	19	19
H	270	317	317	288	388
I	135	145	145	194	194
J	159	159	159	218	218
K	882	882	962	1.322	1.322
L	414	414	414	612	612
M	95	95	107	85	85
N	219	219	246	258	258
O	144	144	194	242	242

Unit: mm

REFRIGERANT BRANCH PIPES FOR 2-PIPE ME2 SERIES

Optional Distribution Joint Kits

See the installation instructions packaged with the distribution joint kit for the installation procedure.

* In case the total capacity of indoor units connected after distribution exceeds the total capacity of the outdoor units, select the distribution piping size for the total capacity of the outdoor units.

Model name	Cooling capacity after distribution	Remarks
1. CZ-P680PJ2	68,0kW or less	For outdoor unit
2. CZ-P1350PJ2	More than 68,0kW	For outdoor unit
3. CZ-P160BK2	22,4kW or less*	For indoor unit
4. CZ-P680BK2	68,0kW or less*	For indoor unit
5. CZ-P1350BK2	More than 68,0kW*	For indoor unit

Piping size (with thermal insulation)

1. CZ-P680PJ2

For outdoor unit (capacity after distribution joint is 68,0kW or less).

Gas piping

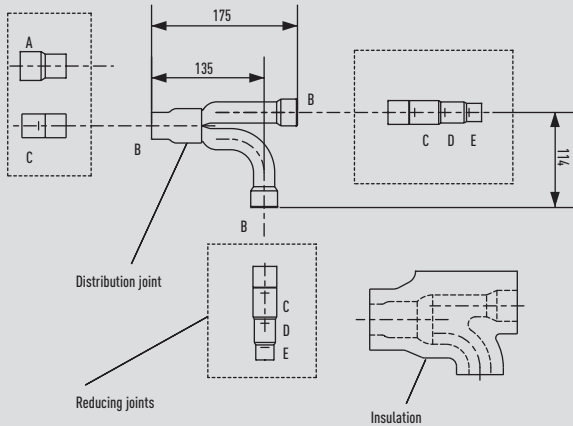

Liquid piping

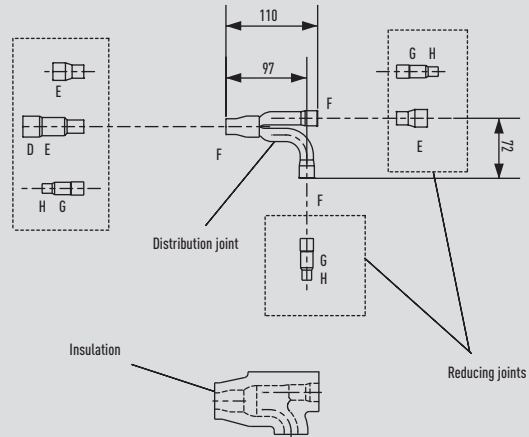

Unit: mm

Size of connection point on each part (shown are inside diameters of piping)

Size	Part A	Part B	Part C	Part D	Part E	Part F	Part G	Part H	
Dimension	mm	31,75	28,58	25,40	22,22	19,05	15,88	12,70	9,52
	Inches	1-1/4	1-1/8	1	7/8	3/4	5/8	1/2	3/8

2. CZ-P1350PJ2

For outdoor unit (capacity after distribution joint is more than 68,0kW).

Gas piping

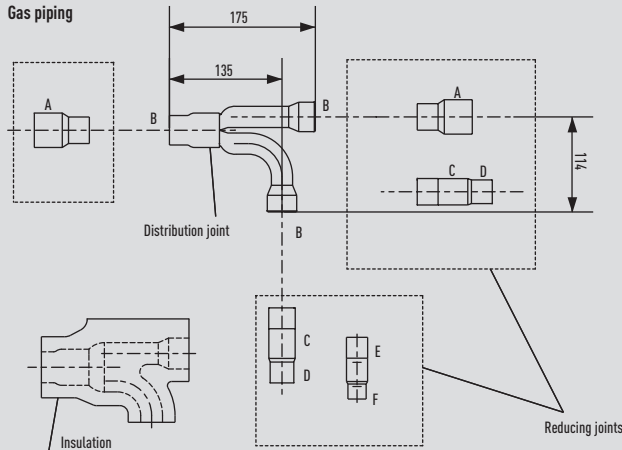

Liquid piping

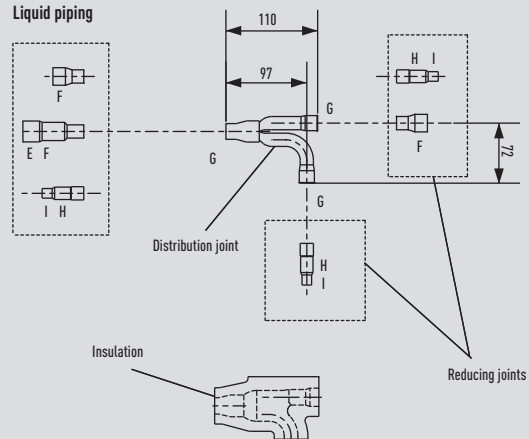

Unit: mm

Size of connection point on each part (shown are inside diameters of piping)

Size	Part A	Part B	Part C	Part D	Part E	Part F	Part G	Part H	Part I	
Dimension	mm	38,10	31,75	28,58	25,40	22,22	19,05	15,88	12,70	9,52
	Inches	1-1/2	1-1/4	1-1/8	1	7/8	3/4	5/8	1/2	3/8

* If the tube diameter is more than 38.1, use field-supply reducer.

3. CZ-P160BK2

Use: For indoor unit (Capacity after distribution joint is 22,4kW or less)*.

Gas piping

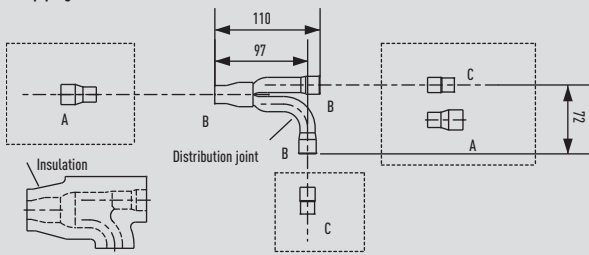

Liquid piping

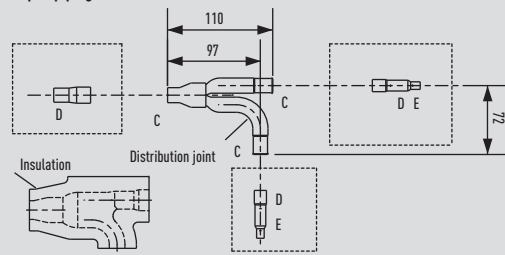

Unit: mm

Size of connection point on each part (shown are inside diameters of piping)

Size	Part A	Part B	Part C	Part D	Part E
Dimension	mm	19,05	15,88	12,70	9,52
	Inches	3/4	5/8	1/2	3/8
					1/4

4. CZ-P680BK2

Use: For indoor unit (capacity after distribution joint is more than 22,4kW and no more than 68,0kW*).

Gas piping

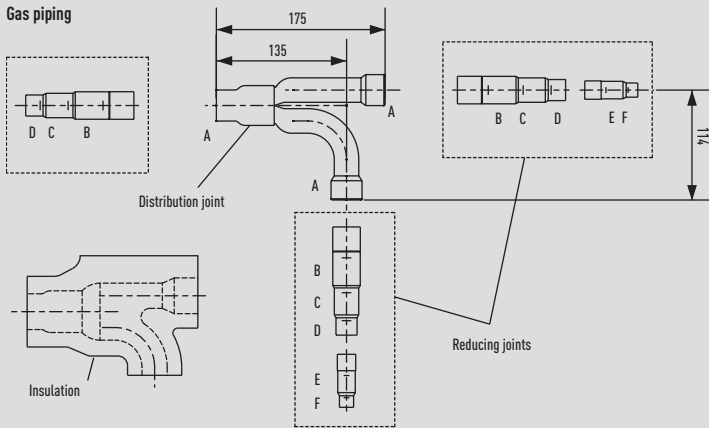

Liquid piping

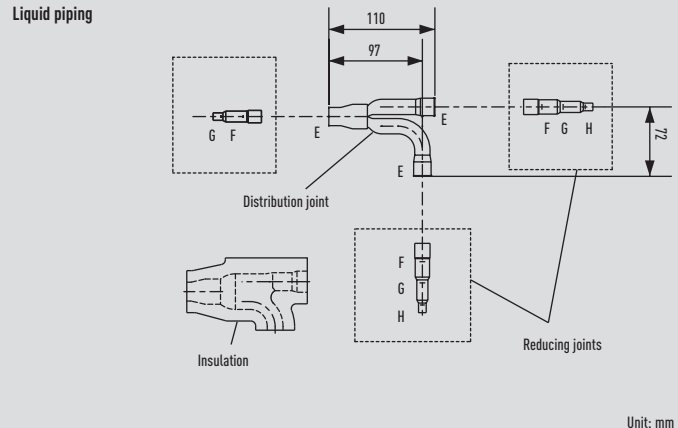

Unit: mm

Size of connection point on each part (shown are inside diameters of piping)

Size	Part A	Part B	Part C	Part D	Part E	Part F	Part G	Part H
Dimension	mm	28,58	25,40	22,22	19,05	15,88	12,70	9,52
	Inches	1-1/8	1	7/8	3/4	5/8	1/2	3/8
								1/4

5. CZ-P1350BK2

Use: For indoor unit (capacity after distribution joint is more than 68,0kW*).

Gas piping

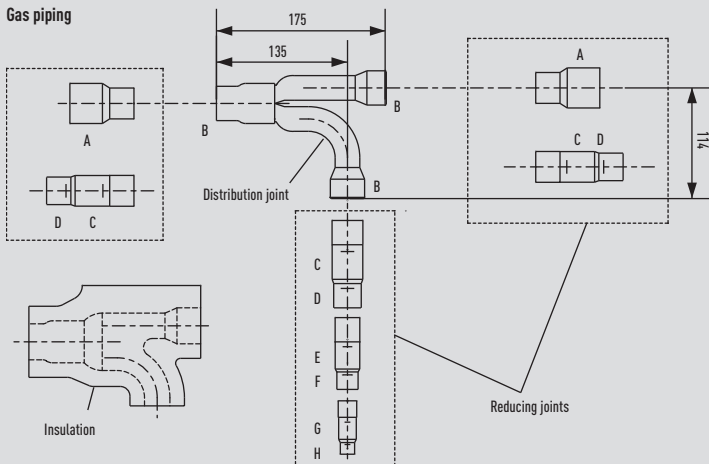

Liquid piping

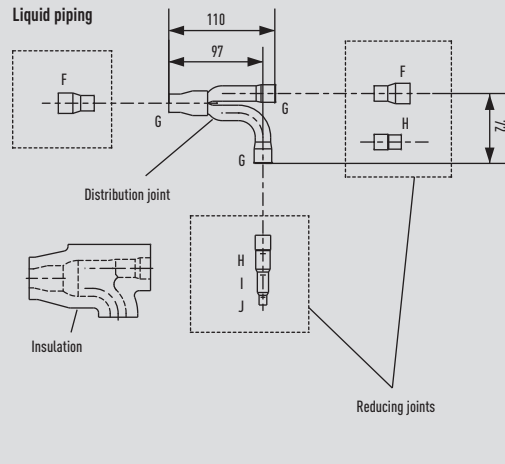

Unit: mm

Size of connection point on each part (shown are inside diameters of piping)

Size	Part A	Part B	Part C	Part D	Part E	Part F	Part G	Part H	Part I	Part J
Dimension	mm	38,10	31,75	28,58	25,40	22,22	19,05	15,88	12,70	9,52
	Inches	1-1/2	1-1/4	1-1/8	1	7/8	3/4	5/8	1/2	3/8
										1/4

*If the tube diameter is more than 38.1, use field-supply reducer.

* In case the total capacity of indoor units connected after distribution exceeds the total capacity of the outdoor units, select the distribution piping size for the total capacity of the outdoor units.

BRANCHES AND HEADERS FOR 3-PIPE ECOi AND MINI ECOi

Optional distribution joint Kits for 3-Pipe ECOi 6N Systems (MF2)

See the installation instructions packaged with the distribution joint kit for the installation procedure.

* In case the total capacity of indoor units connected after distribution exceeds the total capacity of the outdoor units, select the distribution piping size for the total capacity of the outdoor units.

Model name	Cooling capacity after distribution	Remarks
1. CZ-P680PJ2BM	68,0kW or less	For outdoor unit
2. CZ-P1350PJ2BM	Greater than 68,0kW and no more than 135,0kW	For outdoor unit
3. CZ-P224BH2BM	22,4kW or less	For indoor unit
4. CZ-P680BH2BM	Greater than 22,4kW and no more than 68,0kW	For indoor unit
5. CZ-P1350BH2BM	Greater than 68,0kW and no more than 135,0kW	For indoor unit

Piping size for 3-Pipe ECOi 6N Systems (MF2)

1. CZ-P680PJ2BM

For outdoor unit side (capacity after distribution joint is 68,0kW or less).

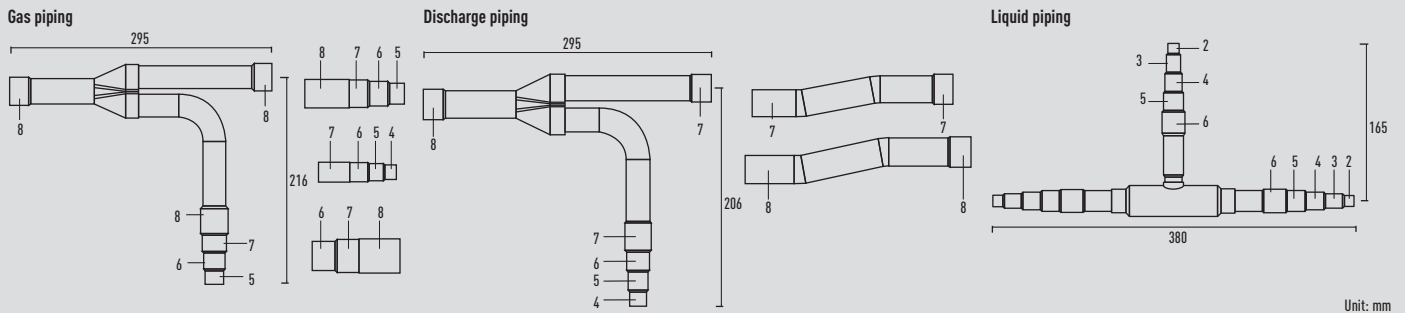

2. CZ-P1350PJ2BM

For outdoor unit side (capacity after distribution joint is greater than 68,0kW and no more than 135,0kW).

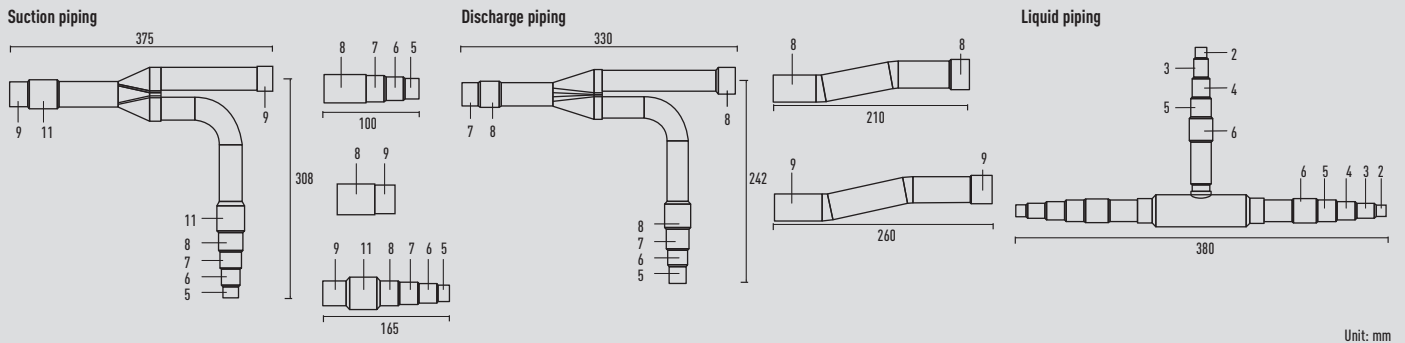

3. CZ-P224BH2BM

For indoor unit side (capacity after distribution joint is 22,4kW or less).

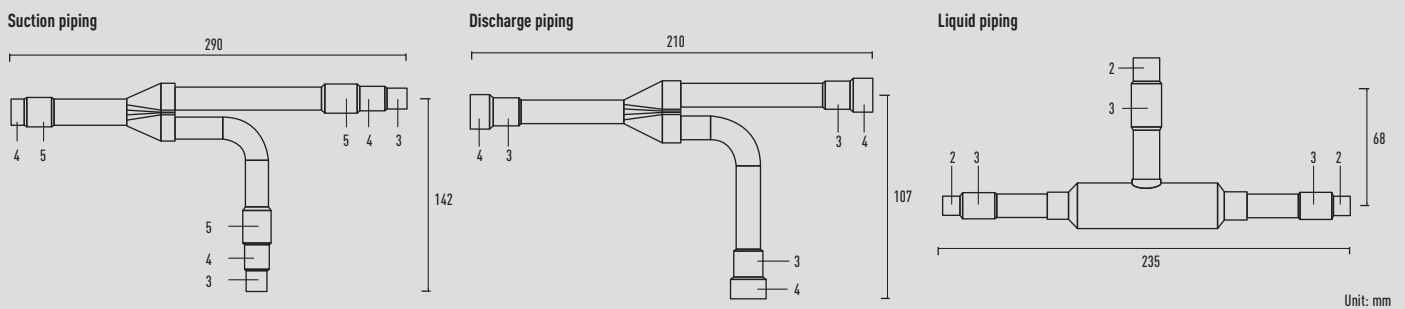

Size of connection point on each part (shown are inside diameters of piping)

Size	Part 1	Part 2	Part 3	Part 4	Part 5	Part 6	Part 7	Part 8	Part 9	Part 10	Part 11	Part 12	Part 13	Part 14
Dimension	mm	6,35	9,52	12,70	15,88	19,05	22,40	25,40	28,57	31,75	34,92	38,10	41,28	44,45
	Inches	1/4	3/8	1/2	5/8	3/4	7/8	1	1 1/8	1 1/4	13/8	11/2	15/8	13/4

4. CZ-P680BH2BM

For indoor unit side (capacity after distribution joint is greater than 22,4kW and no more than 68,0kW).

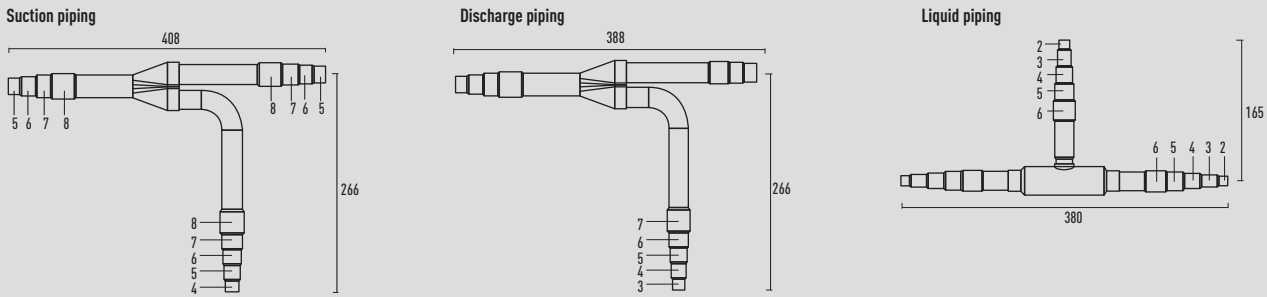

Unit: mm

5. CZ-P1350BH2BM

For indoor unit side (capacity after distribution joint is greater than 68,0kW and no more than 135,0kW).

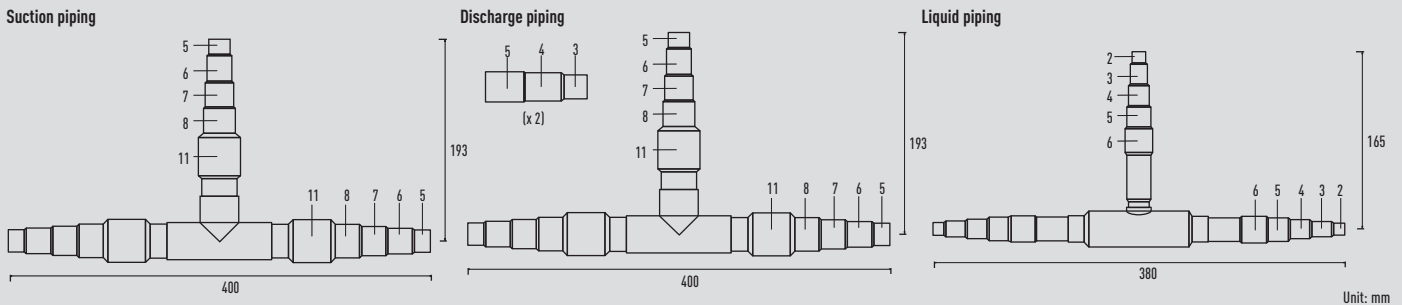

Unit: mm

Header pipe set for 3-Pipe ECOi 6N Systems (MF2)

CZ-P4HP3C2BM

Header pipe model for 3-Pipe systems.

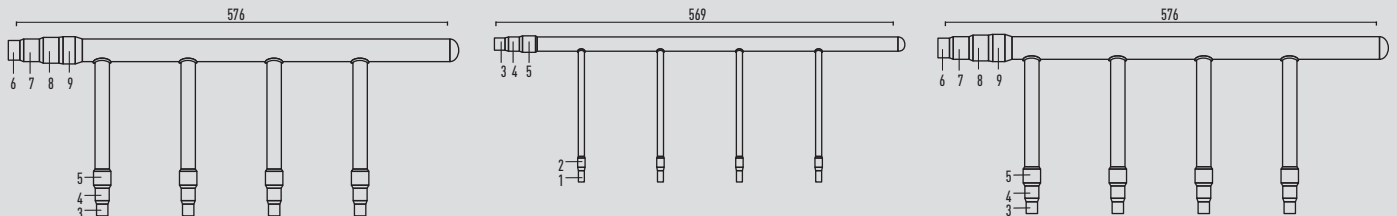

Size of connection point on each part (shown are inside diameters of piping)

Size	Part 1	Part 2	Part 3	Part 4	Part 5	Part 6	Part 7	Part 8	Part 9	Part 10	Part 11	
Dimension	mm	6,35	9,52	12,70	15,88	19,05	22,40	25,40	28,57	31,75	34,92	38,10
	Inches	1/4	3/8	1/2	5/8	3/4	7/8	1	1 1/8	1 1/4	13/8	11/2

Distribution joint Kits for 2-Pipe Mini ECOi LE1 Series

CZ-P160BK2

For indoor unit (capacity after distribution joint is 22,4kW or less).

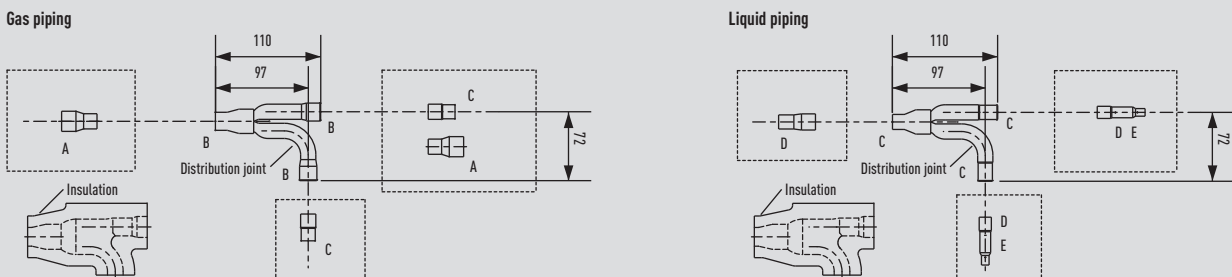

Unit: mm

Size of connection point on each part (shown are inside diameters of piping)

Size	Part A	Part B	Part C	Part D	Part E	
Dimension	mm	19,05	15,88	12,70	9,52	6,35
	Inches	3/4	5/8	1/2	3/8	1/4

PAW-RE2C3 Intelligent Controller

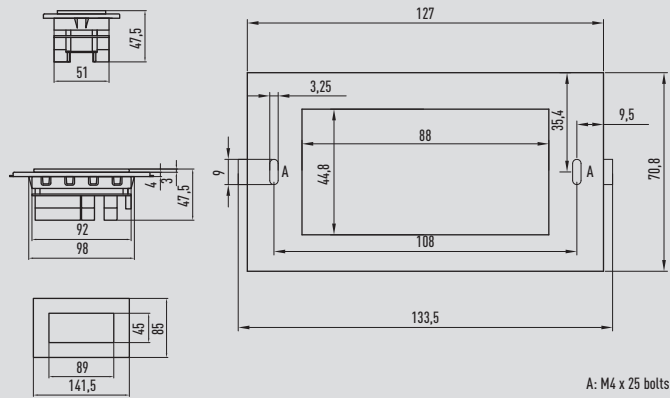

CZ-RTC4 Wired remote controller

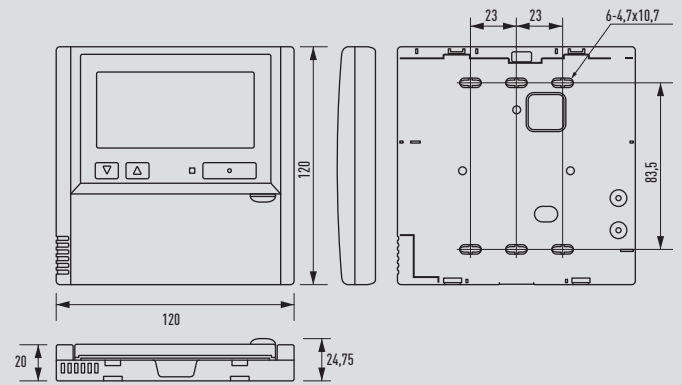

CZ-RTC5A Design wired remote controller

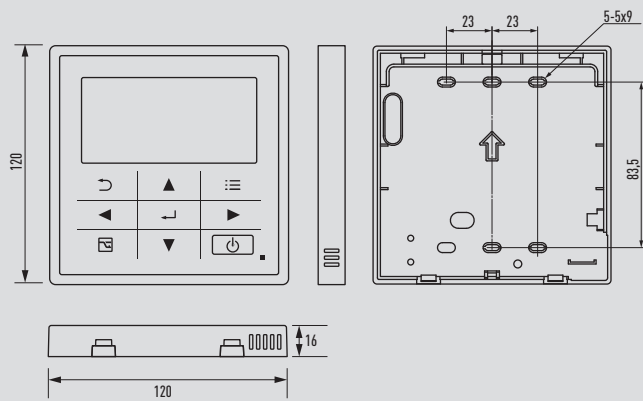

CZ-RTC2 Wired remote controller. Normal operation

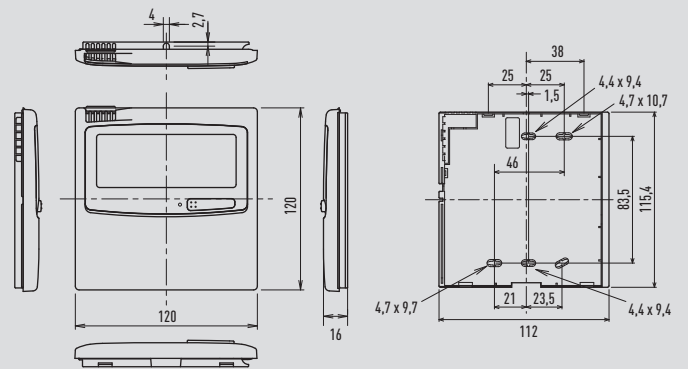

Wireless remote controller

CZ-RWSC3

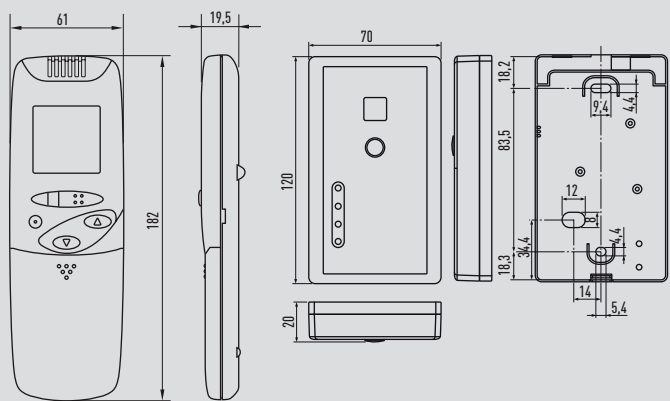

CZ-RE2C2 Simplified remote controller

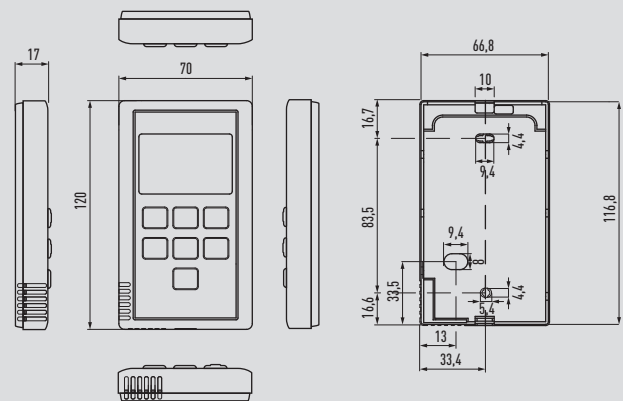

CZ-CSRC3 Remote sensor

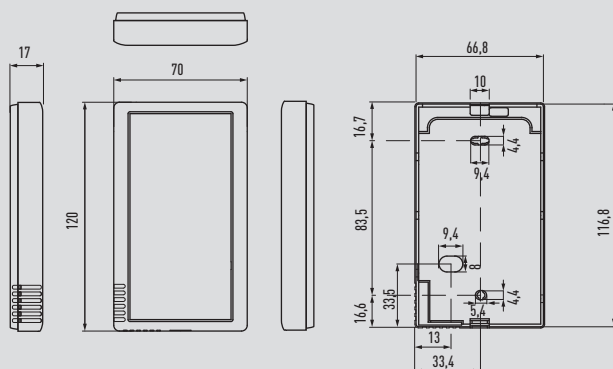

CZ-64ESMC3 System Controller with Schedule timer

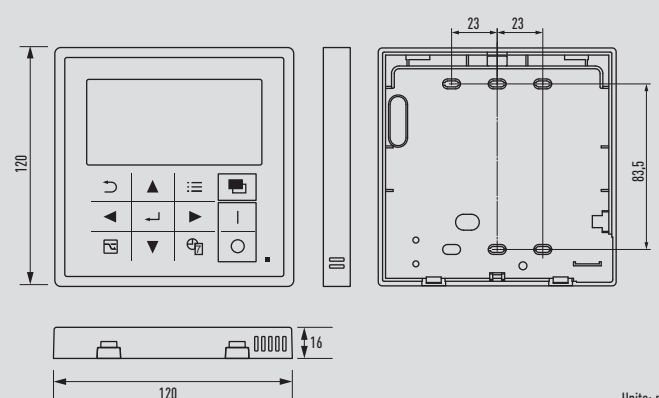

CZ-ANC2 ON/OFF Controller

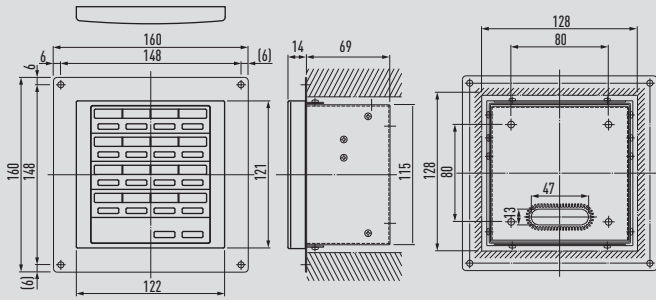

CZ-256ESMC3 Intelligent Controller (Touch screen panel)

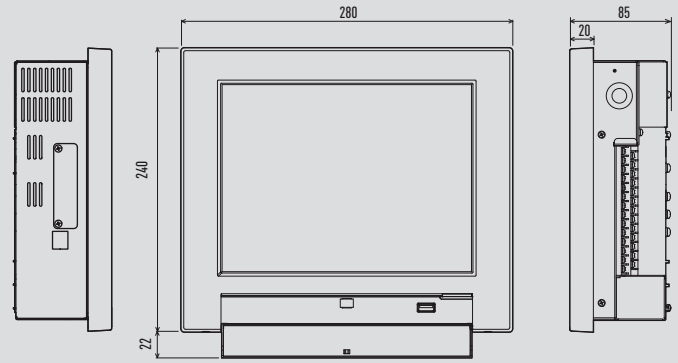

CZ-CAPDC2 Seri-Para I/O unit for outdoor unit

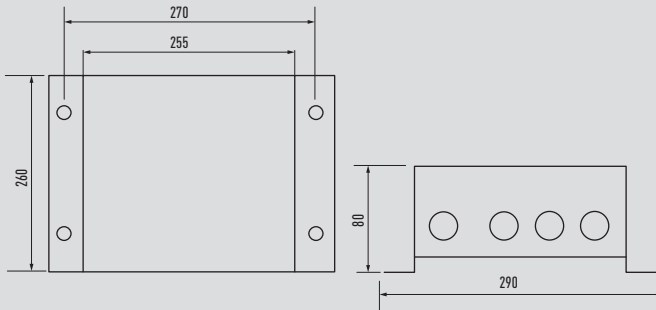

CZ-CAPC2 Local adaptor for ON/OFF control

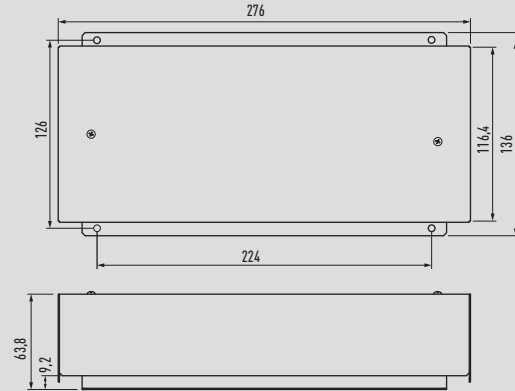

CZ-CAPBC2 Mini Seri-Para I/O Unit 0 - 10V

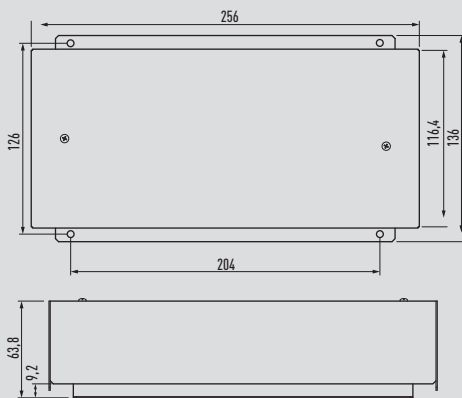

CZ-CFUNC2 Communication Adaptor

