



Palstar products are designed by Hams for Hams carrying on the Palstar tradition for high-quality products designed and manufactured in Ohio, USA.

## AT2KD 2000 Watt Antenna Tuner

### Specifications Summary

- 2000 W PEP SSB, 1500 W single tone
- 160 m to 10m
- Dual-stator differential capacitor with vernier drive
- Dual movement cross needle meter
- 5" x 14.5" x 13.5"

9676 N. Looney Rd,  
Piqua, OH 45356 USA  
(937) 773-6255  
(800) 773-7931  
(937) 773-8003 (Fax)  
[www.palstar.com](http://www.palstar.com)



## AT2KD 2000 Watt Antenna Tuner Technical Manual



**Designed and Manufactured in the USA**

Copyright 2014 Palstar, Inc.

## AT2KD SPECIFICATIONS

- **METERING:** Dual movement cross-needle power and frequency compensated coupler
- **INPUT & ANTENNA TUNING:** Dual-stator differential capacitor 430 pF 5 Kv, 6:1 precision Vernier Drive
- **INDUCTANCE:** 25  $\mu$ H roller inductor; 12 ga. wire wound on steatite ceramic core, silver plated bar and wheel
- **ANTENNA SELECTOR SWITCH:** 6 position:
  - Coax 1 - tuned and tuner bypass
  - Coax 2 - tuned and tuner bypass
  - Bypass
  - Switch wafers are 3 kV rated
- **POWER RANGE SWITCH:** 2 position 300 W / 3000 W
- **REAR PANEL CONNECTORS:**
  - SO-239: RF Input, Coax 1 & 2, Bypass
  - COAX: Balanced line (optional balun)
  - END FED WIRE: High Voltage Nylon66™ terminal post & ground post
  - 12 VDC INPUT: 14mm connector, 2.1mm ID, 5.5mm OD, center positive, 200 ma
- **FREQUENCY COVERAGE:** 1.8 - 54 MHz
- **POWER MAXIMUM:** 2000 W PEP SSB, 1500 W single tone
- **IMPEDANCE RANGE:** 20 to 1500  $\Omega$ , 160m to 10m (assuming resistive load)  
Reduce power for lower Z-range
- **BALANCED OUPUT:** with optional external balun
- **DIMINSIONS:** 5.75" H x 13.2" W x 12" D
- **WEIGHT:** 12 LBS, 6 Kg
- **CHASSIS & COVER:** 11 ga., .090 Iridite Treated Aluminium

## AT2KD GENERAL DESCRIPTION



The Palstar AT2KD Antenna Tuner is an American made impedance matching network that can provide unbalanced and balanced output (with an optional external balun).

The AT2KD optimizes the performance of your antenna and transmitter or SWL receiver by adjustable impedance matching using a T-type circuit configuration with a dual-stator differential variable capacitor.

The AT2KD also measures the power (upgraded to include a PEAK/PEAK HOLD function) and Voltage Standing Wave Ratio (VSWR or SWR), which allows you to tune the SWR to the lowest possible for the selected transmission frequency.

The AT2KD also features a precision roller inductor with a steatite ceramic core. The innovative differential capacitor design simplifies operation by reducing the number of knobs and eliminates false peaks while tuning. It also results in a more compact case that takes up less room.

Tuning is achieved with the front panel mounted controls. The 6:1 ratio Vernier dial allows for tuning with precision and accuracy, while the Inductor dial crank handle facilitates coarse adjustments. The range of the meter (300W/3000W) is selected by a push button switch located on the front panel.

# INSTALLATION

## UNPACKING

Carefully remove the AT2KD from the shipping carton and inspect it for signs of damage. If any damage is apparent, notify the transportation carrier or dealer immediately. **KEEP THE PACKING CARTON for moving, storing, or reshipping the tuner for repair if required.**

## LOCATION

Select a location for the AT2KD that allows the connectors to be free from any possible contact with people, pets, or objects during operation and with unrestricted air flow for cooling.

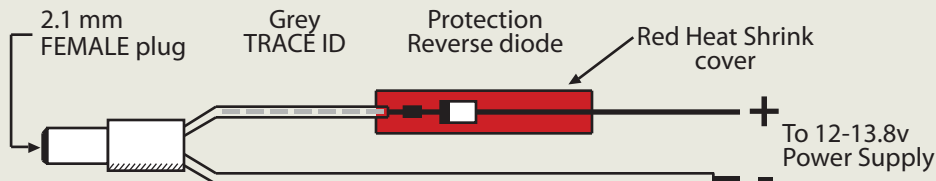

**AT2KD DC POWER CORD**

## INSTALLATION PROCEDURE

Connect a coax cable from your transmitter to the RF INPUT connector on the rear panel. Keep the cable as short as possible. If you use a linear amplifier, connect your transmitter to the linear amplifier input and the linear amplifier output to the AT2KD.

**DO NOT USE MORE THAN 1000 WATTS (single tone) through the tuner.**

# REAR PANEL

**COAX 1** coaxial connector for output to Antenna 1

**RF INPUT** coaxial connector for input from transmitter or amplifier

**COAX 2** coaxial connector for output to Antenna 2

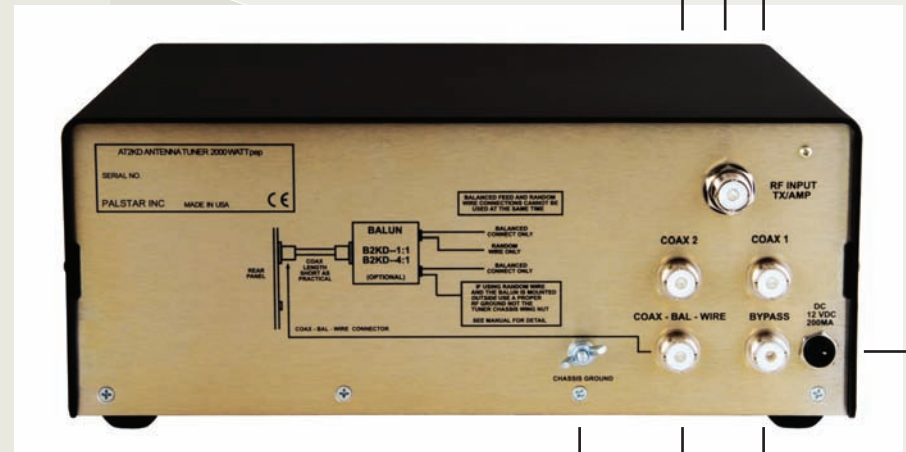

**GROUND** post/wing nut ground connector

**COAX-BAL-WIRE** Use this connector to connect an optional external 1:1 or 4:1 balun for balanced or wire feed antennas

**BYPASS** coaxial connector for output to dummy load or third coax output. Bypasses tuner, but meter circuits are on if AC adapter is connected to rear panel

**12 VDC INPUT** (2.1 mm plug, center pin +) 12 VDC adapter 200 mA to power the meter lamp

## FRONT PANEL DESCRIPTION

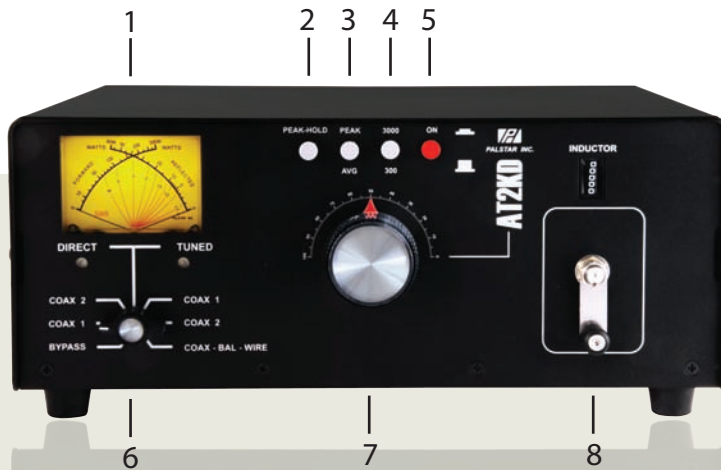

1. **POWER/SWR METER** Dual needle meter displays FORWARD and REFLECTED power in watts. SWR is measured where the two needles intersect on the red scale. SWR is printed on meter face.
2. **PEAK HOLD** Select to read Peak Hold on the SWR meter. Peak switch [3] must be in PEAK position.
3. **PEAK** Selects between PEAK and AVERAGE power metering display.
4. **RANGE** Two-position switch selects the range of FORWARD and REFLECTED power displayed on the power meter. When the RANGE button is OUT, the FORWARD meter scale reads 300 watts full scale and the REFLECTED meter scale reads 60 watts full scale. When the RANGE button is IN, the FORWARD meter scale reads 3000 watts full scale and the REFLECTED meter scale reads 600 watts full scale.
5. **ON** Select to turn on the backlight in the meter and enable metering, and 160 meter functions. The jack on the back panel must be supplied with 12 VDC for these functions to work.
6. **DIRECT-TUNED MODE SWITCH** Six-position rotary switch selects an output connector as follows:

- a. **DIRECT BYPASS** selects BYPASS COAX CONNECTOR bypassing the impedance matching circuit, but providing SWR, FORWARD, and REFLECTED power meter readings.
  - b. **DIRECT COAX 1** selects COAX 1 CONNECTOR bypassing the tuner matching circuit, but providing SWR, FORWARD, and REFLECTED meter readings.
  - c. **DIRECT COAX 2** selects COAX 2 CONNECTOR bypassing the tuner matching circuit, but providing SWR, FORWARD, and REFLECTED meter readings.
  - d. **TUNED COAX 1** selects COAX 1 CONNECTOR through the impedance matching T circuit.
  - e. **TUNED COAX 2** selects COAX 2 CONNECTOR through the impedance matching T circuit.
7. **TUNING CAPACITOR** Single rotor differential capacitor.
  8. **INDUCTOR** 25  $\mu$ H continuously variable ceramic roller inductor driven by a crank handle. Coupled to the crank handle is a gear-driven precision mechanical counter. The end stop readings on the turns counter are ZERO and 279.

***Zero is maximum inductance and  
279 is minimum inductance.***

# AT2KD SCHEMATIC

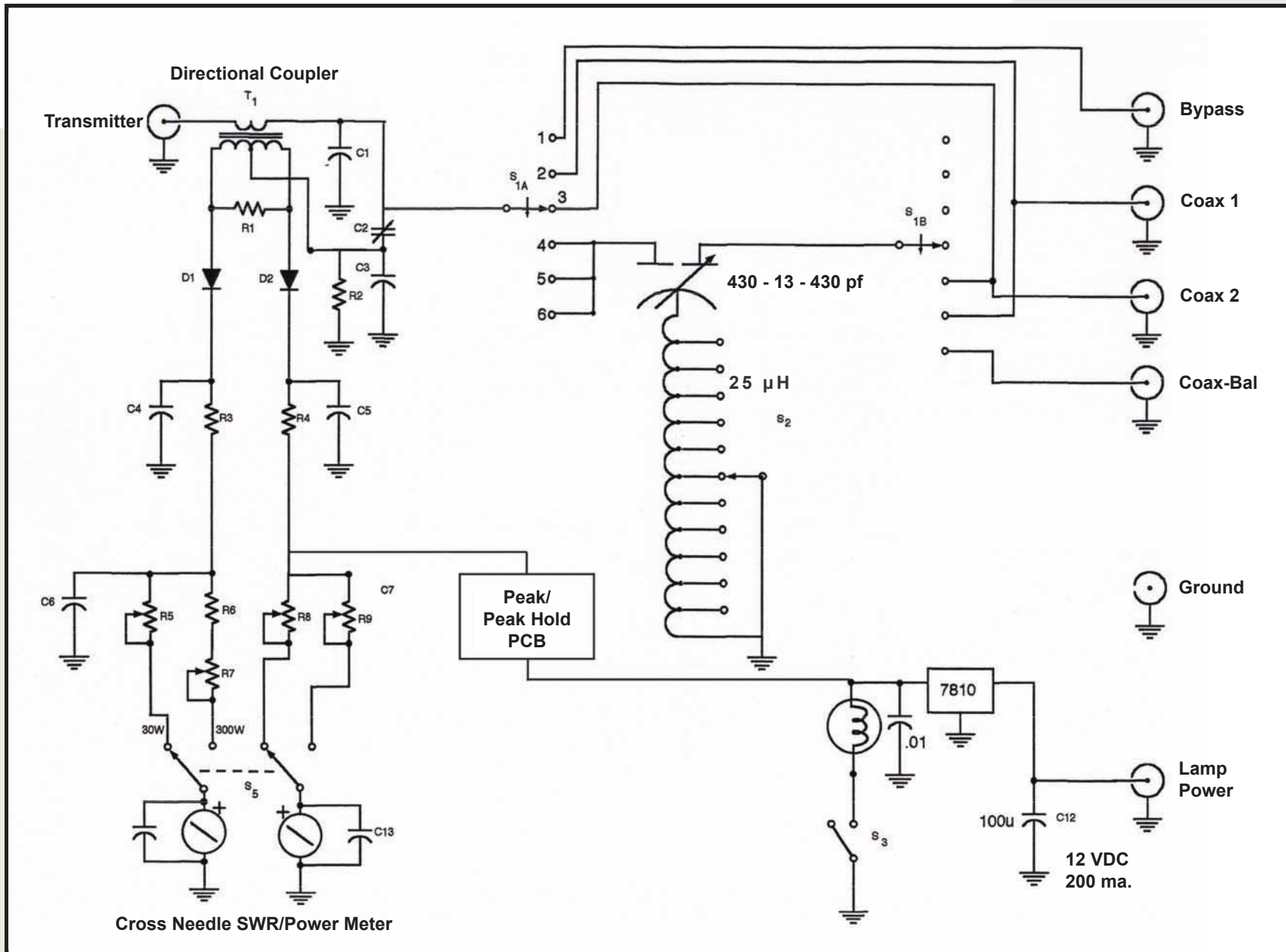

# METER BOARD ADJUSTMENTS

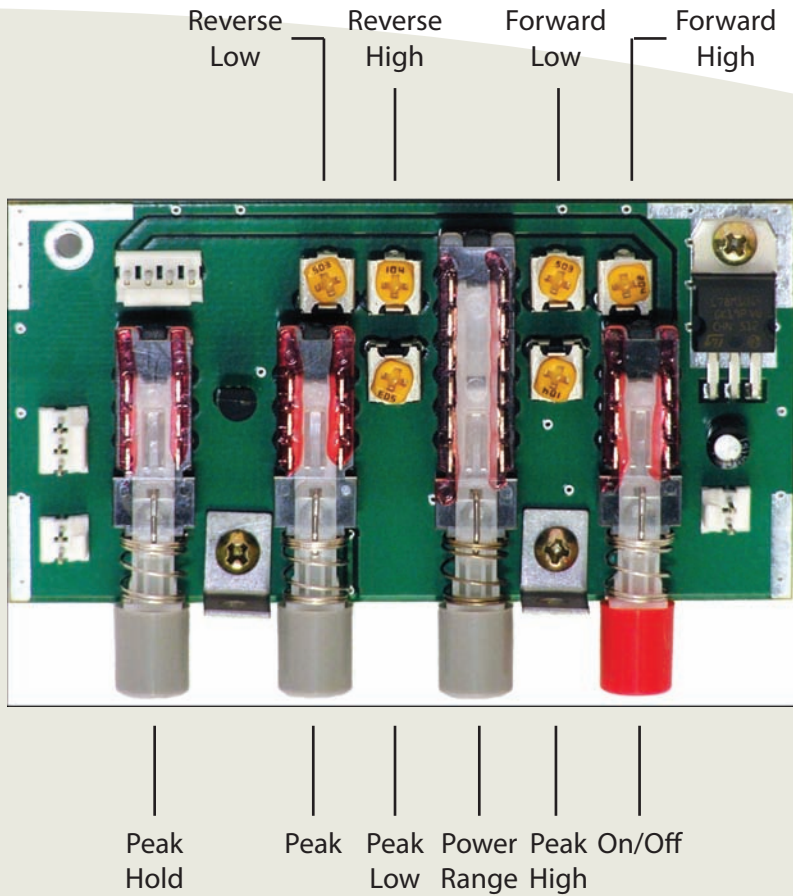

# INSIDE VIEW

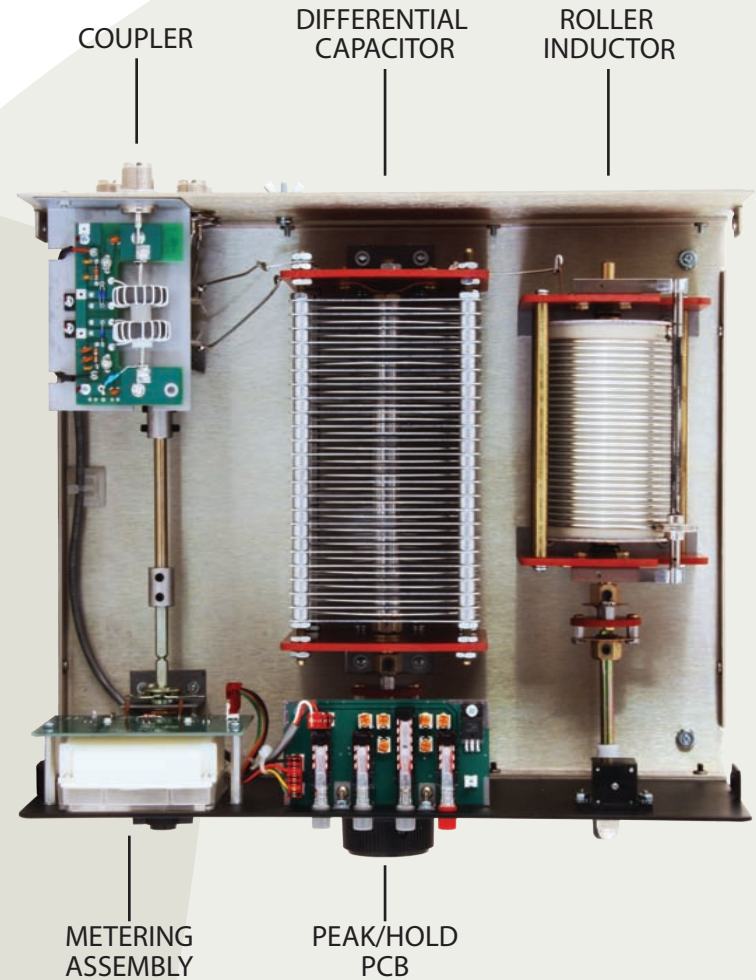

# OPERATING YOUR AT2KD

## BEFORE OPERATING

1. To avoid possible damage to the AT2KD set TUNE (CAP), INDUCTOR, and POWER RANGE switches as outlined in the chart below before applying transmitter power.
2. Begin tuning with your transmitter/amp feeding the tuner set at a low output power setting (50-100 Watts max).

**WARNING: DO NOT OPERATE THE AT2KD WITH THE COVER OFF.**

## TUNING

1. Select the band and frequency of desired operation.
2. Set TUNE and INDUCTOR controls to the suggested setting before applying transmitter power (see chart). Actual settings will vary from antenna to antenna.
3. Set your transmitter/amplifier to a low power output. If your transmitter has a TUNE position, select that position.
4. If you use a linear amplifier, set it to STANDBY. **Do not use the linear amplifier until the AT2KD is tuned.**

BAND	TUNE		INDUCTOR	
	SUGGESTED	ACTUAL	SUGGESTED	ACTUAL
160 M	50		32	
80 M	55		183	
40 M	45		239	
20 M	50		264	
17 M	50		267	
15 M	24		268	
12 M	24		271	
10 M	26		274	
6 M	40		265	

## DO NOT EXCEED 1000 WATTS AVERAGE (SINGLE TONE)

5. Set RANGE switch to 300 W (button out).
6. Set the DIRECT/TUNED mode switch to the TUNED position matching your antenna connection. To tune your antenna, the switch selection must be set to: COAX 1 TUNED, COAX 2 TUNED, or BALANCED LINE. Selecting COAX 1 DIRECT, COAX 2 DIRECT, or BYPASS bypasses the tuning circuitry and tuning is not possible.
7. Rotate the TUNING CAPACITOR and INDUCTOR controls for maximum noise or signal as heard on your receiver. Refer to preset tuning chart on the opposite page.
8. Key your transmitter and adjust the power level for a reading of 50-100 watts on the FORWARD scale. Adjust the TUNE CAPACITOR and INDUCTOR controls for a minimum REFLECTED reading while maintaining a FORWARD reading of 50-100 watts using your transmitter power control.
9. Read the SWR on the red scale at the point where the two needles intersect. Repeat TUNING the TUNE controls until the lowest SWR reading is obtained. The SWR should be 2:1 or lower.
10. When you have tuned your antenna to the best SWR, record the settings of the TUNE and INDUCTANCE controls on the chart above for future reference. When you retune, use these settings as your starting point.

## OPERATING YOUR AT2KD

When approaching the end stops of the roller inductor (readings of Zero or 279) **SLOW DOWN**. Slamming the roller wheel into the mechanical end stops on either end of the roller inductor *will decrease the pressure of the wheel* against the wire wound on the ceramic form.

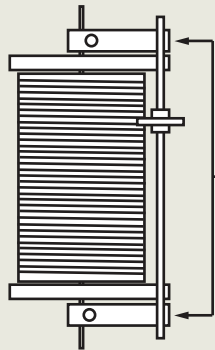

**To RESTORE wheel pressure on the inductor push down on the flat springs soldered to the wheel shaft located on each end of the shaft.**

## NOTES:

1. A SWR of 1:1 is best, but an SWR as high as 2:1 may be acceptable. Check your transmitter/amplifier manual for details.
2. If you cannot get an acceptable SWR, lengthen or shorten your antenna and/or feedlines and retune.
3. If you get low SWR readings at more than one setting, use the setting that gives:
  - highest FORWARD power reading
  - lowest REFLECTED power reading
  - uses the largest capacitance (highest number) on the INPUT and ANTENNA controls.
4. Any time a new or different antenna is connected, it is necessary to repeat the turning procedure for each antenna.
5. Once every 4-6 months clean the roller coil with Deoxit D5 contact cleaner and a clean cotton cloth. Do not remove the conducting grease on the rod that guides the roller wheel. Do not transfer any of the conducting grease from the rod to the roller coil body, as this will contaminate the windings.