



Measurement instruments

Multi-function meter of electrical system parameters

Sonel MPI-540



Much more than a multifunctional meter

page 12



High-current fault loop impedance meters

Sonel MZC-330S / 320S

page 43

Multimeters Sonel CMM-60 / CMM-11



page 114/116

Mobile application

Sonel Multimeter Mobile



The application is intended for transfer and storage of measurement results in the memory of mobile devices

page 118

Reflectometer

Sonel TDR-420



page 84

Thermal imagers

Sonel KT-400 / 385 / 200 / 195



page 62

Electrical safety measurements**6**Multi-function instruments
NEW! Sonel MPI-540
NEW! Sonel MPI-535**10-24**Residual current device measurements
Accessories**25-28**Insulation resistance measurement
NEW! Sonel MIC-10s1 / MIC-05s1
Accessories**29-40**Fault loop measurements
NEW! Sonel MZC-330S / MZC-320S
Accessories**41-49**Earth (ground) measurement
Accessories**50-58****Contactless temperature measurements****59**Thermal imagers
NEW! Sonel KT-400 / KT-385 / KT-200 / KT-195
NEW! Sonel KT-320 / 250 / 165
Pyrometers, corona camera
Accessories**61-69**

Sonel ThermoAnalyze software

65**Low resistance measurements****70**Low resistance meters
Accessories**72-75****Location of conductors and cables****76**Cable and underground infrastructure locators
Reflectometers
NEW! Sonel TDR-420
Accessories**78-85****Illuminance measurements****86**Illuminance meters
Accessories**87****Power quality analysis****88**Power quality analyzers
Accessories**90-97**

Sonel Analysis software

98**Safety of electrical equipment****99**Safety of electrical equipment
Accessories**100-108**

Sonel PAT Analysis software

107**Multi-task equipment****109**

Clamp meters

110-113Multimeters
NEW! Sonel CMM-60
NEW! Sonel CMM-11
NEW! Sonel Multimeter Mobile
Accessories**114-119**Voltage testers
NEW! Sonel P-6 / P-5 / P-4**120**

Phase sequence testers

121Ultrasonic leak and electrical discharge detector
NEW! Sonel TUD-1
NEW! Sonel GUD-1
NEW! Sonel TG-1**122**

Leakage current alarm signaller

123

Demonstration boards

124-125

Laboratory equipment

126-127**SMT and THT assembly****128****Laboratory****129**

Time has allowed us to gain experience. We are a leader on the market!

- 1989** The beginning of activity as the Innovation Implementation Centre in Wrocław
- 1990** The first digital fault loop tester is created
- 1994** The production plant in Świdnica is opened
- 1995** The first Polish microprocessor-based insulation resistance meter is created
- 1996** Export sales of meters are initiated
- 1997** Start-up of surface mounting process in an automated line, and the creation of the first Polish microprocessor-based fault loop impedance meter
- 1998** Change of company name and legal entity
- 1999** The first Polish microprocessor-based earth resistance meter is manufactured
- 2001** Implementation and certification of quality management system
- 2004** First multi-function meter
- 2006** Sales in over 20 countries around the world
- 2008** Relocation to new headquarters and purchase of the most modern SMT assembly line in the world
- 2008** Debut on the Warsaw Stock Exchange
- 2008** Over 200 employees barrier exceeded
- 2010** Thermal imagers added to offer
- 2011** Creation of the first Polish safety tester of electrical equipment
- 2012** Implementation of SPS production management system
- 2013** Expansion into new markets
- 2013** Foxytech founded
- 2015** Start of cooperation with Lincoln Electric and acquisition of Lower Silesian Economic Certificate
- 2016** Won gold medal at the ENERGETAB trade fair in Bielsko-Biała - the largest electrotechnics and energy exhibition in Poland
- 2017** Acquisition of accreditation of Polish Centre for Accreditation
- 2018** Won gold medal at the ENERGETAB trade fair for MPI-540: multi-function meter of electrical system parameters
- 2019** We are celebrating 25 years on the market



Quality and safety

Our products have achieved a high position on the market thanks to the continuous development of the technologies and functions of the products we offer and their adaptation to market requirements. This has been confirmed by the following international certificates: **Quality Management System ISO 9001:2008, Environmental Management System ISO 14001:2005, and Occupational Health and Safety Management System PN-N-18001:2004.** Manufactured instruments are compliant with standards **EN 61557, EN 61010 as well as the electromagnetic compatibility directive**, which allows us to bear the full responsibility that comes with the CE mark that we place on our products.



Be up to date with updates. Visit us online!

Complete product support is available on our website - including current: **meter firmware, drivers, instruction manuals, technical specifications and practical articles** that help to expand knowledge about the theory and practice of taking measurements.



for the latest news, visit:

www.sonel.pl/en

facebook.com/sonel.measurement.instruments

youtube.com/sonelsafilm



Modern technologies for you

Our offer is not limited to measuring instruments only. We also provide calibration and rating services in our accredited Calibration and Research Laboratory. The calibration offer applies to all electrical safety meters. Besides such instruments, we also test many other meters of electrical values, including thermal imagers, pyrometers, illuminance meters and similar instruments.

We offer SMT surface mounting assembly services on a professional, automated assembly line manufactured by FUJI. We have two SMT surface assembly lines, a THT through-hole assembly line and inspection stations. All Assembly process are fulfill in accordance to IPC-A-610D standard.

We sincerely invite you to cooperate with us!

Products from SONEI S.A. are sold in nearly 50 countries around the world.



We care about our customers. Grow with us!

Excellent products, good logistical support, efficient guarantee and post-guarantee service as well as customer support after purchase are the most important elements of our success.

During numerous trainings, conferences and meetings organized by us, we systematically analyze the current needs of our clients

To satisfy these needs, we create new designs of measuring instruments that are fully adapted to users' expectations.

We are also preparing increasingly interesting training formulas. Over the course of training seminars and conferences, our specialists present the latest technological solutions, supported by an interpretation of currently applicable regulations and standards, and conduct practical demonstrations of measurement techniques.

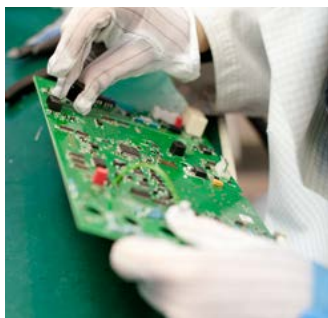

Electrical safety measurements

Current regulations require the measurements of electrical systems both during commissioning (after completing the installation, after any change or extension of the system), as well as regularly during the operation. The scope of acceptance or periodic inspection is specified in standard PN-HD 60364-6. Requirements for measuring instruments are defined in standard EN 61557. Protective measures include, depending on needs, the measurement of fault loop impedance, insulation resistance, continuity of protection and equipotential bonding, earthing resistance and parameters of residual current devices. Devices used for this type of measurement shall have a document confirming their technical efficiency. Pursuant to the Metrology Act, this document shall be a calibration certificate. The period between checks of the instrument, recommended by the manufacturer is 13 months.

Measurement of fault loop impedance

One of measures for electric shock protection is a protection against indirect contact in circuits equipped with overcurrent protection - it is based on automatic disconnection of power supply in case of a dangerous touch voltage on the exposed conductive elements. In such case, the current will flow in the circuit of phase-protective conductor, and it is called the short-circuit current which should trip the overcurrent switch and power supply. As the exposed elements cannot remain too long under dangerous touch voltage, the protection has to trip in a sufficient time, which is specified in binding standards. The condition for correct protection is specified by the following formula:

$$Z_s = U_n / I_A$$

where: Z_s - fault loop impedance, I_A - current triggering overcurrent protection in required time (depending on the time-current characteristic of applied protection and required disconnection time), U_n - rated voltage of the network in relation to the earth.

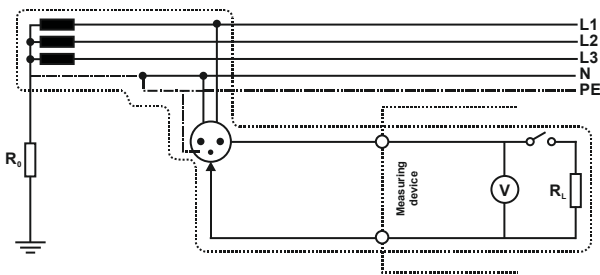

The impedance value Z_s (needed to determine whether the protection is correct) shall be measured. During fault loop measurement performed by the technical "method, an "artificial short circuit" is generated. The instrument measures the voltage without load and after that during a short-term load from short-circuit resistor. Fault loop impedance is calculated based on the difference in voltage drops. This measurement may be performed using the following fault loop impedance meters: MZC-304, MZC-306, MZC-310S, MZC-320S i MZC-330S and multifunctional devices: MPI-502, MPI-520, MPI-525 i MPI-530 - all of them indicate also components of the impedance, resistance and reactance.

$$Z = \sqrt{R^2 + X^2}$$

Fault loop impedance meters (except MZC-310S, MZC-320S and MZC-330S) provide also the measurement in L-PE circuits in systems protected by RCDs without any interference in the circuit. This measurement is carried out with current lower than 15 mA and it is extended in time, while the resolution of the result, is the same as for other measurements, i.e. 0.01 Ω . High current meters MZC-310S, MZC-320S and MZC-330S provide measurements with a result resolution of 0.1 m Ω (supply points, switchgear centres, transformer stations) applying the test current up to 300 A, which provides measurements in accordance with EN 61557 standard, even for circuits where the value of the fault loop impedance is in milli-ohm order.

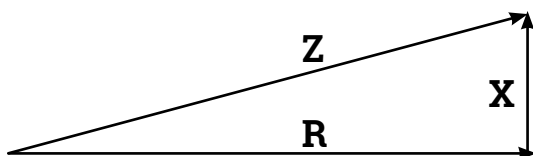

Fault loop impedance meters may be used for measuring the earth resistance by using an auxiliary voltage source (phase conductor of the network). The measured value is then overstated - the measurement result is the sum of resistance of the measured earth electrode, operational earthing system, source and phase conductor.

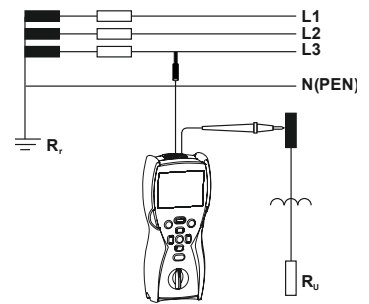

MZC-306 offers the measurements

- » for any AC voltages
- » up to 750 V – also in industrial systems.

Measurement of insulation resistance

The insulation condition is crucial for the operational safety and proper functioning of the system and electric appliances, guaranteeing also protection against direct contact. Systematic inspection of the insulation is necessary to detect its deterioration and it is a permanent element of measurement and control works. In case of measurements on industrial equipment it is crucial to determine the tendency of changes in the resistance, which may indicate a gradual deterioration of the insulation. The basic factors causing the insulation degradation include: electrical and mechanical exposures, chemical attack, thermal exposure and environmental pollution; their impact during normal operation of electrical system causes insulation wear and tear. Insulation resistance measurements are performed with direct current (DC), to eliminate the impact of capacity on the results. The method of measuring insulation resistance and the required test voltages are specified in standards: PN-HD 60364-6; PN-E-04700; EN 61557-2. During the measurements, after applying the voltage, the insulation conducts electricity. During the resistance measurement, the current flowing through the insulation (1) consists of the following components:

- » capacitance charging current (2) - it depends on the capacity (e.g. on the length of the tested cable),
- » polarization (absorption) current (3) - the result of charges and dipoles moved by electric field,
- » insulation leakage current (4) - the sum of currents flowing through the material and on its surface.

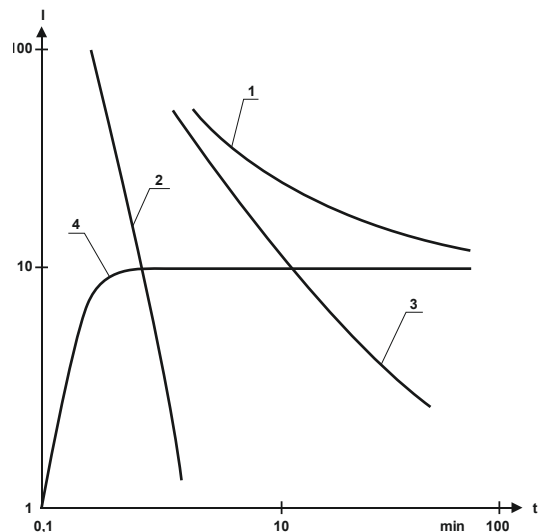

Due to the nature of the current flowing through the insulation, the measured insulation resistance value is affected by the time of measurement as well as by humidity, temperature, measurement voltage and surface cleanliness of the insulating material.

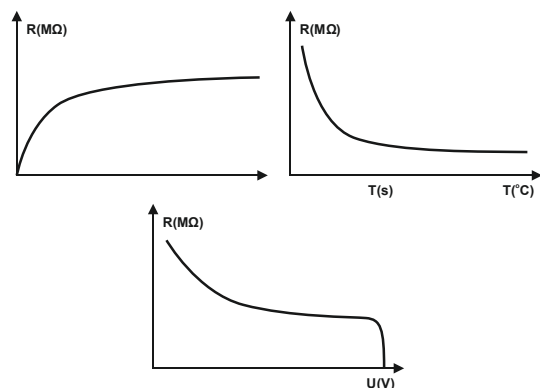

The 3-wire method, used in all advanced instruments, allows user to eliminate the impact of surface leakage current. In case of cables, wrap the core insulation with metal foil, which is connected to the shield terminal of the meter - only leakage current flowing through the insulation is measured. The measurement by 3-wire method is recommended for large areas exposed to pollutants (cables of large diameter, HV bushings, transformers, HV switches):

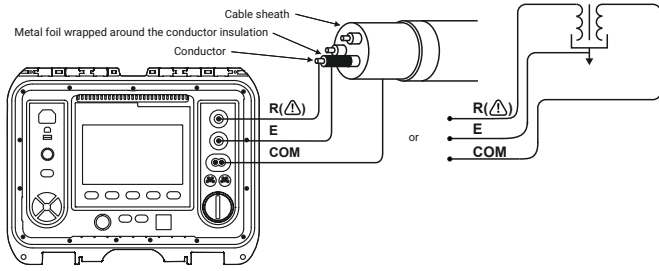

Using the 3-wire method is important in the case of measurements of objects with very large resistance values (100 M)

Meters MIC-10s1, MIC-10k1, MIC-5050, MIC-5010, MIC-5005, MIC-5001, MIC-30, MIC-2501 and MPI-525 multifunctional meter, perform measurements at a specified time and provide readouts in intervals set by the user. The obtained results are used to calculate one or two absorption coefficients, providing information about the condition of the insulation. Before the measurements, make sure that the tested object is disconnected from the mains. Upon detection of voltage on the object (or when voltage appears during the measurements), the device stops the measurement signals the anomaly. During the measurement, the device displays the current, instantaneous value of the resistance or the current value of the leakage current. After completing the measurement, the devices save the values measured at the end of periods sets by the user (the range from 1 to 600 s) and the tested object is discharged by the device.

Measurements of RCD parameters

The main function of the Residual Current Device (RCD) is an additional protection against electric shock by disconnecting the protected circuit from power supply, when the circuit is subject to earth overcurrent.

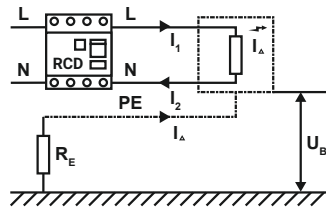

When the circuit protected by the RCD is free from damage (differential current $I_{\Delta} = 0$), the inflow current I_1 is equal to outflow current I_2 . In case of any damage (e.g. punctured insulation) fault current I_{Δ} starts to flow and value of I_2 current is lower than I_1 .

The RCD will trip (disconnecting power supply) if the measured difference of currents I and I_2 exceeds a certain characteristic for the RCD value. When a fault current flows, U_B voltage will appear on the housing of the protected device, which in accordance with Ohm's law is:

$$U_B = I_{\Delta} * R_E$$

Rating current of the circuit breaker $I_{\Delta n}$ should be selected in a way ensuring that the contact voltage generated during fault current flow does not exceed the allowable long-term voltage U_L :

$$I_{\Delta n} < U_L / R_E$$

A system equipped with RCD must have, for safety reasons, a protective earthing conductor (PE). Therefore, the RCDs cannot be installed in networks without a dedicated protective conductor. RCD does not limit the fault current value, but only the time of its flow. However, as the criterion for tripping the RCD is the fault current exceeding the rated current of the RCD, it must be chosen appropriately to the type of protected devices. Due to the response time, the residual current devices are divided into: normal, short-time delay [G] - intended for receivers and circuits, where momentarily, small leakage currents and selective may occur. [S] - having a delayed triggering time, which is the minimum time, during which the device does not trip, despite the difference between the current flowing in and flowing out to/from the circuit. Depending on the shape of the fault current that causes tripping, the switches may be divided into: AC circuit breakers marked with [~], responding to a differential sinusoidal current, type A, marked with [A] responding to the sinusoidal, unidirectional pulsating current and pulsating current with constant component up to 6 mA, and B type switches marked with [B] responding to the sinusoidal, unidirectional pulsating current and pulsating current with constant component and to direct current Measurements on RCDs may be performed with MRP-201

meter or by multifunctional meters MPI-502, MPI-505, MPI-508, MPI-520, MPI-525 and MPI-530.

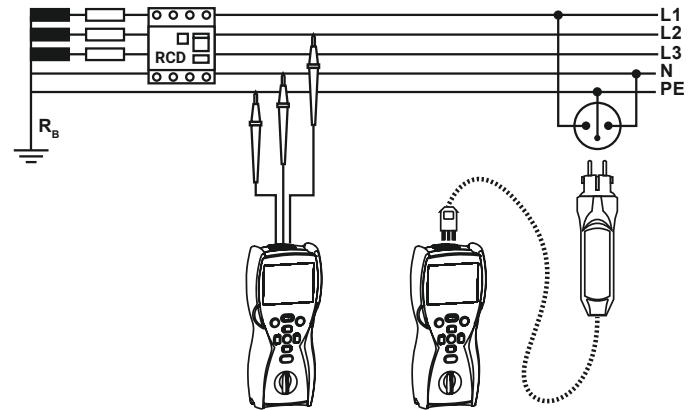

During each measurement procedure (except AC voltage measurements), the meter controls whether the resulting contact voltage does not exceed the predetermined voltage allowable for longer periods. If this value is exceeded, the measurement will be automatically interrupted (i.e. the differential test current is switched off). The value of the long-term allowable touch voltage can be set to 25 V or 50 V and for selective switches additionally at 12.5 V. The tripping time of RCD is measured from the start of differential current flow until the tripping of RCD - the user may select the initial phase (or polarity) as positive or negative. The maximum measured value of the triggering time is 300 ms, and with selected measurement of selective switches it is 500 ms. Tripping current of RCD is measured after enforcing a differential current increasing linearly in the tested circuit. The increases from approx. 30% of $I_{\Delta n}$ until RCD is tripped or $I_{\Delta n}$ exceeded for AC breakers (140% and 200% for A and B respectively).

With the touch electrode installed in the devices, instruments for RCD measurements may check the correctness of connections in the socket. When the voltage between the touch electrode and the protective conductor (PE) connected to the socket exceeds 50 V, the device will inform the user about it.

Measurements of resistance-to-earth

Earthing is an essential element of any electrical system regardless of its rated voltage. The efficient earthing system is important for:

- » human safety during the operation of electrical devices,
- » proper operation of electrical equipment,
- » elimination or significant reduction of the impact of lightning.

Earthing systems may be called differently depending on their destination. e.g.:

- » protective,
- » functional (working),
- » lightning protection,
- » auxiliary.

Checking the effectiveness of earthing, i.e. measuring its resistance or impedance, is carried out to determine whether the received value will effectively drain fault current. Term "effectiveness" means that the resistance does not exceed the maximum value allowed for the particular case and the type of the earth electrode.

Earthing system is subject to periodic checks, during the operation in order to assess whether corrosion or changes in soil resistivity do not significantly affect its performance.

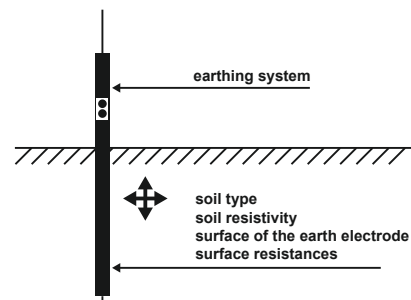

Methods of performing measurements are described in detail at www.sonel.pl

Earthing measurements may be carried out with multifunctional meters having the appropriate function and with specialist meters of MRU series. The method most commonly used for measuring earth resistance is the technical method, where the meter calculates the resistance by measuring the voltage across its terminals after applying test current. For measurements of individual earthing systems, the most commonly used is 3-pole method of potential drop, which enforces current flow in the following circuit: the meter - tested earthing system - current electrode - the meter. Distances between the electrodes should be as large as possible; the current electrode should be at the distance of least 10-fold greater than the physical length of the measured earthing; In practice, the distance is approx. 40 m between the tested earth electrode and the current electrode.

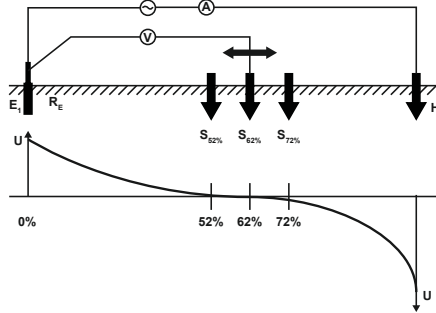

Distribution of voltage during the flow of the test current

Voltage electrode is driven into the ground between the measured earth electrode and the current electrode in the area of the so-called zero potential. In practice, it is recommended to perform three measurements, changing the position of the voltage electrode by 1-2 meters in a direction from and to the tested earthing. If the results are identical, the place of driving the electrode into the ground has been chosen correctly. The measurement is performed with a current at a frequency that allows to avoid interference and distortion having the frequency of the network (50 Hz or 60 Hz) and its harmonics. Advanced earth resistance/resistivity meters of MRU series check and indicate the size of interference voltages before starting the measurement. In addition, these meters calculate the additional error related with too high resistance of probes.

Advanced devices have the ability to perform measurements using 4-wire, eliminating the impact of the resistance of cable used to connect the meter with tested earthing system.

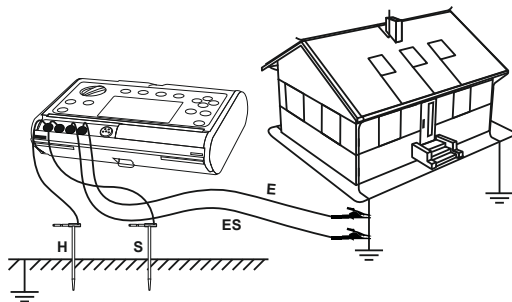

Measurement of resistance to earth - the 4P method

Nuisance arising from the need to disconnect individual earth electrodes when testing the systems with multiple electrodes may be eliminated by using the technical method with additional clamps (MRU-30, MRU-120, MRU-200, MRU-200-GPS). Current and voltage electrodes are arranged similarly to the 3-pole method, but the current is measured with clamps attached to the tested earthing. The meter calculates the resistance knowing that part of the current which flows through the tested earth electrode. The method of measurement with clamps cannot be used in multiple systems, which have individual earth electrodes connected to each other underground.

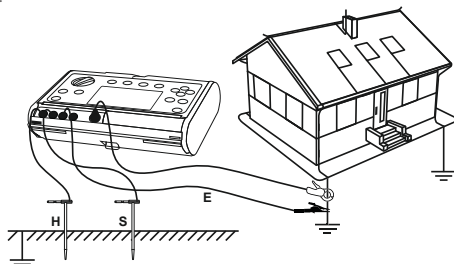

Measurement of resistance to earth - the 3P method + clamps

The two-clamp method (MRU-30, MRU-120, MRU-200, MRU-GPS-200, MPI-530) allows the user to measure the resistance of multiple earthing systems, without the need to drive auxiliary probes into the ground. During this measurement, the current generated by transmission clamps is closed within the following circuit: tested earthing system + parallel connection of other earthing probes and it is measured by the receiving clamps to provide data for calculating the circuit resistance. As the parallel connection of a few resistances generates the resultant resistance of much lower value, the result is higher than the tested resistance. The difference is the smaller, the more earthing electrodes is within the tested object.

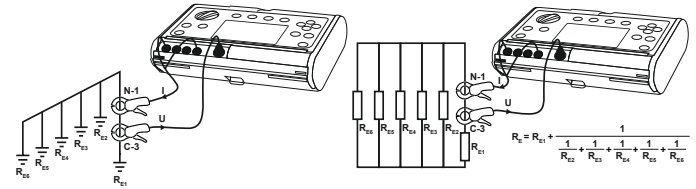

Connection of the meter in the 2-clamp method

Equivalent circuit of multiple earthing system in the 2-clamp method

The 2-clamp method is used for measurements of systems with multiple earthing electrodes not connected with each other underground. If the earthing electrodes are also connected underground, this method allows user to measure only the continuity of the circuit.

In the earthing system assessed for electric shock protection, it is important to maintain currents of low frequency (50, 60 Hz). The task of the lightning protection earthing systems is to discharge lightning strikes into the ground. The pulsed nature of such discharge makes the inductive component of the earth electrode quite important, as the lightning current is effectively discharged only by a part of the earth electrode, located in the immediate vicinity of the discharge. Therefore an earth electrode with low static resistance, which provides good basic protection does not ensure adequate lightning protection parameters - especially in the case of extensive earthing systems, having low static resistance, but several times higher dynamic impedance. The measurement using the impact method (MRU-200), in accordance with: EN 62305 and withdrawn, but still applied PN-86/E-05003, enables user to diagnose the parameters of dynamic lightning protection earthing systems. The pulsed nature of the measurement does not require the disconnection of the earthing in case of multiple earthing probes or live objects, as the test current pulse, similarly to lightning stroke, operates only within a limited distance. The measurement is carried out in accordance with the description specified in EN 62305 standard. This method allows to determine the theoretical value of the surge impedance (Z_d), which is the ratio of peak voltage to peak current.

The surge impedance specified in the standard is a theoretical value, as generally peaks of voltage and current do not occur simultaneously. The surge impedance is considered an indicator of the effectiveness of earthing systems in the conditions of stricter or special protection.

Parameters of the test pulse (which simulates the shape of the lightning) are defined by two numbers: the pulse leading edge duration t_1 and a time to half-peak t_2 . MRU-200 meter provides a selection of three pulse shapes: 10/350 μs , 8/20 μs and 4/10 μs . Pursuant to EN 62305, the pulse with a shape of 10/350 μs is typical for the first stroke of the lightning current. The same pulse is specified as a reference pulse in EN62305-1 standard. Pulse 4/10 μs has parameters resulting from PN-92/E-04060.

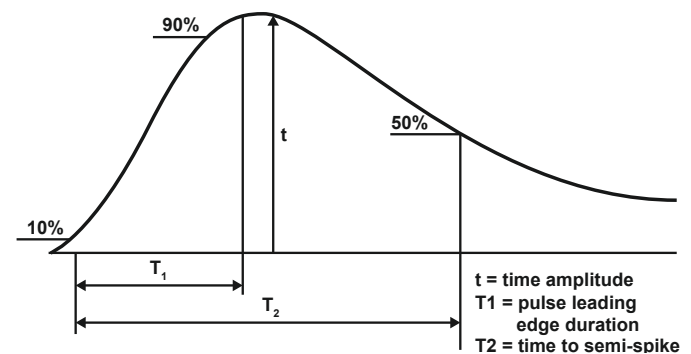

The shape of test pulse in the impact method

When the impact method is used for measurements on multiple earthing systems, connected both above and under the ground, the test pulse operates only in the close proximity of tested earthing electrode, which allows user to carry out the measurement without the need to disconnect testing terminals and equipotential bondings - i.e. without the need to disconnect the power supply of the object.

All devices comply with European directives on electromagnetic compatibility and safety and are marked with CE

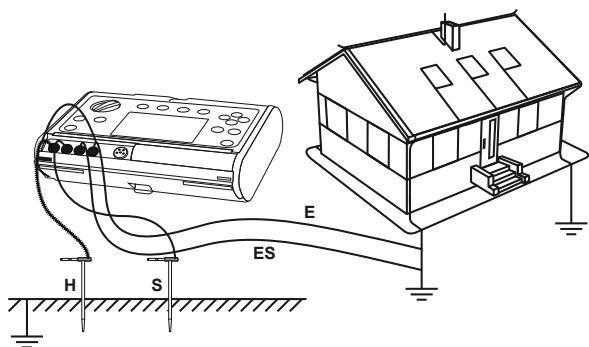

Earthing impedance measurement system (4P impulse method)

The impulse method may also be used to measure the impedance of earthing used for HV poles; it allows also to determine the earthing impedance of the entire pole, including both ground band systems as well as the resistance of pole legs, and it may be used without the need to disconnect the tested HV line or to remove components of the earthing system.

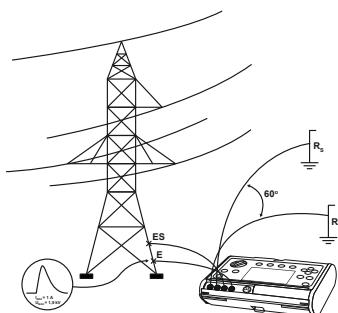

Measurements of HV pole earthing

Knowledge of the soil resistivity value (MRU-30, MRU-120, MRU-200, MRU-200-GPS) is important at the stage of designing the earthing system.

Knowing the cross-section of the soil, the user may select the appropriate type of earthing system - e.g. for low resistivity values occurring only at a certain depth, the single earth electrode may be designed as deeply immersed, whereas for soil with low resistivity at the shallower area; or rock base with a greater depth - it will be a set of shorter earthing electrodes connected by a vertical metal band.

Soil resistivity measurement is performed using four electrodes arranged linearly at equal distances (Wenner method). The soil resistivity is measured at the depth equal to $0.7 \cdot d$ of the distance between the probes.

Facilitating the measurements

During measurements carried out under voltage (earth fault loop impedance, RCD parameters, voltage, sequence of phases) conductors ended with blade probes or crocodile clips may be used (of adequate measuring categories with a shape prevent slipping or disconnecting), as well as adapters suitable for measuring terminals/sockets.

Meters connected to the system equipped with sockets by a cable terminated with a mains plug, or by wires, automatically check the correctness of connections and signal any abnormalities. Measurements in single-phase sockets may be carried out using adapters ended with Uni-Schuko plug; the measurements are performed also in the case of exchanging the phase conductor with neutral conductor (without the need for manual switching or using additional adapters). In addition, WS-01 and WS-03 adapters have buttons for triggering measurements and saving recorded values. For the measurements in three-phase or HV sockets, one of the following adapters may be optionally used: for three-phase sockets AGT-16P, AGT-32P, AGT-63P AGT-16C, AGT-32C and for HV sockets AGT-16T and AGT-32T.

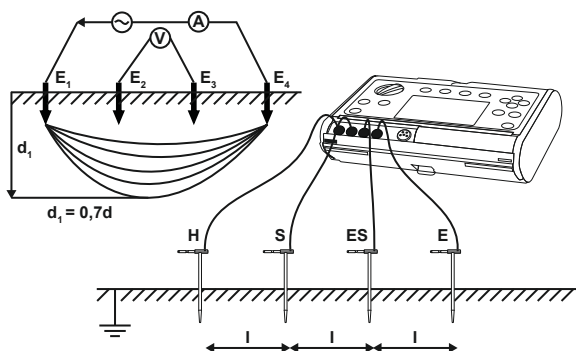

Family of AutoISO adapters facilitate the insulation measurements carried out with suitable devices on insulation of 3-, 4- and 5-wire cables, without the need of manual selection of pairs and combinations of the measured wires. Adapter cables ended with crocodile clips (depending on the position 3, 4 or all 5) are attached to the tested cable cores; when the measurement is started, the adapter connected with the meters, performs the sequence of all required tests.

AutoISO-2500 adapter used with MPI-525 meter allows user to perform tests on cables under 2500 V voltage. In other hand, for **AutoISO-5000** adapter, dedicated to MIC-10k1 and MIC-5050 meters, the test voltage is as high as 5000 .



AutoISO-1000



AutoISO-2500



AutoISO-5000



TWR-1J

TWR-1J adapter enables user to check RCD parameters before installing it within the system.

Instruments for measuring earth resistance are delivered with many ergonomic accessories that simplify measurements. Cables used for testing earthing systems, due to their length (50, 30, 25,15 meters) are wound on drums made of a material resistant to frost and strokes, allowing fast winding and unwinding by the user.

Sonel offers also long probes (80 cm) with a suitable cover, clamps of high sensitivity and accuracy (C-3, N-1) for earthing measurements without the need to disconnect the test connections or for current measurements, as well as special terminals guaranteeing adequate contact.

Measuring devices are supplied in appropriate casings or suitcases fitted to their sizes with inner compartments for transporting measuring accessories.

Detailed lists of standard and optional accessories can be found at the end of product groups.



**Multi-function meters
of electrical system parameters**

Touchscreen

MPI-540
MPI-535

Standard

MPI-530-IT
MPI-530
MPI-525
MPI-520
MPI-520 Start

Handheld

MPI-502
MRP-201

Comparison of multi-function meters



MPI-540 / MPI-535

MPI-530 / MPI-530-IT

MPI-525

MPI-520 / 520 Start

MPI-502

	MPI-540 / MPI-535	MPI-530 / MPI-530-IT	MPI-525	MPI-520 / 520 Start	MPI-502
Display	7" LCD touchscreen	LCD graphic	LCD graphic	LCD graphic	segmented LCD
Network parameters registrator	three-phases / –	one-phase / –	–	–	–
Autotest	✓	–	–	–	–
Energy losses calculator	✓ / –	–	–	–	–
Fault loop impedance resolution [Ω]	0...1999	0...1999	0...1999	0...1999	0...1999
Maximum resolution of fault loop impedance measurement [Ω]	0.001	0.001	0.01	0.01	0.01
Measurement voltages [V]	95...440	95...440	95...440	95...440	180...460
Resolution of fault loop impedance measurement without RCD tripping [Ω]	0,01	0,01	0,01	0,01	0,01
Calculation of fault current according to rated voltage	✓	✓	✓	✓	✓
Calculation of fault current according to measured voltage	✓	✓	✓	✓	–
Residual current device measurements	AC, A, F, B, B+ <input type="checkbox"/> <input checked="" type="checkbox"/> <input checked="" type="checkbox"/> <input checked="" type="checkbox"/>	AC, A, F, B, B+ <input type="checkbox"/> <input checked="" type="checkbox"/> <input checked="" type="checkbox"/> <input checked="" type="checkbox"/>	AC, A, F, B, B+ <input type="checkbox"/> <input checked="" type="checkbox"/> <input checked="" type="checkbox"/> <input checked="" type="checkbox"/>	AC, A, F, B, B+ <input type="checkbox"/> <input checked="" type="checkbox"/> <input checked="" type="checkbox"/> <input checked="" type="checkbox"/>	AC, A <input type="checkbox"/> <input checked="" type="checkbox"/> <input type="checkbox"/> <input type="checkbox"/>
Auto Rejestrator parametrów sieci matic measurement of the full set of parameters	✓	✓	✓	✓	✓
Measurement of tripping current I_{Δ} with rising current	10, 30, 100, 300, 500, 1000	10, 30, 100, 300, 500, 1000	10, 30, 100, 300, 500, 1000	10, 30, 100, 300, 500, 1000	10, 30, 100, 300, 500
Simultaneous measurement of I_{Δ} and t_{Δ} in one RCD trip	✓	✓	✓	✓	✓
Measurement of tripping time for factor of rated current	$1/2, 1, 2, 5$	$1/2, 1, 2, 5$	$1/2, 1, 2, 5$	$1/2, 1, 2, 5$	$1/2, 1, 2, 5$
Measurement of touch voltage UB	✓	✓	✓	✓	✓
Detection of L and N swapping	✓	✓	✓	✓	✓
Measurement of insulation resistance	✓	✓	✓	✓	–
Measurement voltages [V]	50, 100, 250, 500, 1000	50, 100, 250, 500, 1000	50, 100, 250, 500, 1000, 2500	50, 100, 250, 500, 1000	–
Measuring range [Ω]	10G / 3G	10G	10G	3G	–
Automatic discharging of object after measurement	✓	✓	–	✓	–
Protection against appearance of voltage	✓	✓	✓	✓	–
Automatic discharging of object after measurement	✓	✓	✓	✓	–
Automatic measurement of multi-core cords with AutoISO adapter	✓	✓	✓	✓	–
Automatic measurement of multi-core cables with AutoISO adapter	–	–	✓	–	–
Sound signaling of time intervals for characteristics	✓	✓	✓	✓	–
Calculation of absorption coefficients	–	–	✓	–	–
Continuity testing with current $\geq 200\text{mA}$	✓	✓	✓	✓	✓
Low-voltage resistance measurement	✓	✓	✓	✓	✓
Earth resistance measurement	3p, 4p, 3p+clamps, double-clamp	3p, 4p, 3p+clamps, double-clamp	3p	3p	–
Capability of setting limit for every function	✓	✓	–	–	–
Quick check of PE connection	✓	✓	✓	✓	✓
Voltage measurement [V]	0...500	0...500	0...500	0...500	0...500
Frequency measurement [Hz]	✓	✓	✓	✓	✓
Alternating current measurement [A]	optionally 0...3000	optionally 0...3000	–	optionally 0...400	–
Power and $\cos\varphi$ measurement	✓ / –	✓	–	✓	–
Measurement of U harmonics: I up to the 40th	✓ / –	✓	–	–	–
THD measurement for U and I	✓ / –	✓	–	–	–
Phase sequence check [V]	95...500	95...500	95...500	95...500	–
Memory (records)	unlimited	10 000 for every measurement type	990	990	990
Power supply	rechargeable batteries	rechargeable batteries / batteries	rechargeable batteries / batteries	rechargeable batteries / batteries	rechargeable batteries / batteries
Built-in quick charger	✓	✓	✓	✓	–
Data transmission	USB, Bluetooth / Wi-Fi	USB, Bluetooth	USB	USB	Bluetooth
Weight [kg]	2.5	2.2	2.2	2.2	0.6
Dimensions [mm]	288 x 223 x 75	288 x 223 x 75	288 x 223 x 75	288 x 223 x 75	220x98x58
Weight [kg]	2.5	2.2	2.2	2.2	0.6

SONEL MPI-540

index: WMGBMPI540

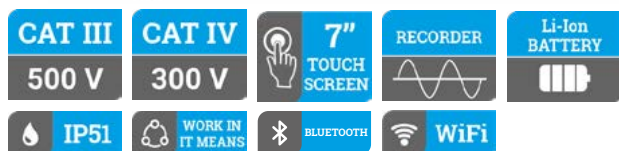

Fault loop impedance measurements:

- » impedance measurement with 23 A current (40 A for phase-to-phase voltage), max. resolution 0.001 Ω,
- » fault current-limiting resistor: 10 Ω,
- » range of measurement voltages: 95...440 V, frequencies 45...65 Hz,
- » **fast (up to 5 s) fault loop impedance measurement with resolution up to 0.01 Ω in systems protected with RCDs not tripping at $I_{\Delta n} \geq 30$ mA,**
- » automatic calculation of fault current on the basis of nominal or measured voltage; differentiation of phase-to-neutral and phase-to-phase voltage,
- » measurements using UNI-Schuko plug with measurement triggering button (including case with swapped L and N leads) or 1.2 m, 5 m, 10 m, 20 m test leads, with optional use of three-phase socket adapters (AGT),
- » selection of installation protections and automatic evaluation of measurement results.

Testing of AC, A, F, B and B+ residual current devices:

- » **MPI-540 also enables measurements in IT networks,**
- » measurement of general, short-time delay and selective RCDs with rated residual currents of 10, 30, 100, 300, 500 and 1000 mA,
- » function of automatic measurement of all RCD parameters (after pressing the "START" button once, the meter performs the entire defined cycle of measurements, including the capability of earth fault loop impedance measurement with 15 mA current),
- » shape of the input leakage current selected by the user: sinusoidal (start from rising or falling edge), unidirectional pulsating (positive or negative), unidirectional pulsating with direct current offset (positive or negative), constant (positive or negative),
- » measurement of tripping current I_A with rising current,
- » measurement of tripping time t_A with currents $0.5 I_{\Delta n}$, $1 I_{\Delta n}$, $2 I_{\Delta n}$ and $5 I_{\Delta n}$,
- » measurement of touch voltage U_B and protective conductor resistance R_E without tripping the RCD,
- » detection of L and N phase swapping in a socket; does not affect measurements,
- » capability of measuring tripping current I_A as well as actual tripping time t_A with just one RCD trip,
- » voltage measurements within the range of 95...270 V.

Measurement of insulation resistance:

- » measurement voltages: 50 V, 100 V, 250 V, 500 V, 1000 V,
- » measurement of insulation resistance up to 10 GΩ,
- » capability measurement in-socket by means of UNI-Schuko adapter,
- » sound signalling of five-second time intervals, facilitating capture of time characteristics,
- » meter protected against the presence of voltage on the object and the appearance of voltage during measurement,
- » automatic discharge of the measured object's capacitance after completion of measurement,
- » **automatic measurement of all resistance combinations of 3-, 4- and 5-core cords by means of the optional AutoISO-1000C adapter**

Earth resistance measurements:

- » according to 3- or 4-lead technical method with 2 auxiliary electrodes,
- » according to 3-lead method with additional clamp,
- » **according to double-clamp method,**
- » internal power source with frequency appropriate for 50 Hz or 60 Hz power network

Standard accessories of the meter:

WS-03 adapter with START button with UNI-Schuko plug	WAADWS03
Test lead 1.2 m, red, 1 kV (banana plugs)	WAPRZ1X2REBB
Test lead 1.2 m, blue, 1 kV (banana plugs)	WAPRZ1X2BUBB
Test lead 1.2 m, yellow, 1 kV (banana plugs)	WAPRZ1X2YEBB
Test lead 1.2 m, black, 1 kV (banana plugs)	WAPRZ1X2BLBBN
Test lead 15 m, blue (on a reel)	WAPRZ015BUBBSZ
Test lead 30 m, red (banana plugs, on a reel)	WAPRZ030REBBSZ
USB cable	WAPRZUSB
Crocodile clip, red, 1 kV, 20 A	WAKRORE20K02
Crocodile clip, blue, 1 kV, 20 A	WAKROBU20K02
Crocodile clip, yellow, 1 kV, 20 A	WAKROYE20K02
Crocodile clip, black, 1 kV, 20 A	WAKROBL20K01
Pin probe, red 1 kV (banana socket)	WASONREOGB1
Pin probe, blue 1 kV (banana socket)	WASONBUOGB1
Pin probe, yellow 1 kV (banana socket)	WASONYEOGB1
Earth contact test probe (rod), 30 cm	WASONG30
Voltage adapter with M4/M6 thread (5 pcs.)	WAADAM4M6
Z7 power supply	WAZASZ7
Mains cable with IEC C7 plug	WAPRZLAD230
Cable for battery charging from car cigarette lighter socket (12 V)	WAPRZLAD12SAM
L2 carrying case	WAFUTL2
L2 hanging straps (set)	WAPZOSZEKPL
Li-Ion battery 11.1 V 3.4 Ah	WAAKU15
MicroSD card	
F-3A flexible clamps (Φ=120 mm)	WACEGF3AOKR
PC software: Sonel Reader	WAPROREADER
PC software: Sonel Analysis	WAPROANALIZA4
Calibration certificate	

Soil resistivity measurements according to the Wenner method:

- » measuring range: 0.5 Ωm...9.99 kΩm,
- » distances between electrodes can be set in meters (1...30 m) or feet (1...90 ft).

Low-voltage continuity testing of protective conductors and equipotential bonding:

- » measuring range according to EN 61557-4: 0.12...400 Ω, max. resolution 0.01 Ω,
- » measurement of protective conductor continuity with current ≥ 200 mA in two directions,
- » low-current measurement with sound signaling,
- » voltage on open terminals: 4...9 V,
- » automatic calibration of test leads - leads of any length can be used.

Illuminance measurement:

- » display range: 0.001/0.01/1 lx...399.9 klx,
- » measurement in lux (lx) or foot-candles (fc),
- » measurement by means of external photodetectors (optional)

Additional functions of the meter:

- » **real time display of network parameters,**
- » **autotests - pre-programmed measurement sequences,**
- » **quick check of correct connection of PE conductor by means of contact electrode,**
- » **check of phase sequence and direction of motor rotation,**
- » **tree-like memory structure with dynamic management**
- » **ability to add a photo or a voice note,**
- » **data transmission to PC via USB or Bluetooth®,**
- » **replaceable microSD memory card,**
- » **capability of charging from the power grid or 12 V car lighter socket.**

Other technical specifications:

- » type of insulation double, as per EN 61010-1 and EN 61557
- » power supply Li-Ion battery 11.1 V 3.4 Ah 37.7 Wh
- » operating temperature range 0...+50°C

Measurement of fault loop impedance Z_{L-PE} , Z_{L-N} , Z_{L-L} in 23/40 A mode

Measurement with 23/40 A current - measuring range according to EN 61557: 0.130 ...1999 Ω (for 1.2 m test lead):

Display range	Resolution	Accuracy
0.00...19.999 Ω	0.001 Ω	$\pm(5\% \text{ m.v.} + 0.03 \Omega)$
20.00...199.99 Ω	0.01 Ω	$\pm(5\% \text{ m.v.} + 0.3 \Omega)$
200.00...1999.9 Ω	0.1 Ω	$\pm(5\% \text{ m.v.} + 3 \Omega)$

Nominal voltage: 95...270 V (for Z_{L-PE} and Z_{L-N}) or 95...440 V (for Z_{L-L} - only mode 23/40 A). Frequency: 45...65 Hz.

Measurement of the Z_{L-PE} fault loop impedance in the RCD mode

Measurement with 15 mA current - measuring range according to EN 61557: 0.50...1999 Ω

Display range	Resolution	Accuracy
0.00...19.99 Ω	0.01 Ω	$\pm(6\% \text{ m.v.} + 10 \text{ digits})$
20.00...199.99 Ω	0.1 Ω	$\pm(6\% \text{ m.v.} + 5 \text{ digits})$
200...1999 Ω	1 Ω	

Nominal voltage: 95...270 V

Frequency: 45...65 Hz

Earthing resistance measurement with two clamps

Display range	Resolution	Accuracy
0.00...9.99 Ω	0.01 Ω	$\pm(10\% \text{ m.v.} + 4 \text{ digits})$
10.0...19.9 Ω	0.1 Ω	
20.0...99.9 Ω		$\pm(20\% \text{ m.v.} + 4 \text{ digits})$

Measurement of insulation resistance

Measuring range according to EN 61557-2:

- » for $U_n = 50 \text{ V}$: 50 k Ω ...250 M Ω » for $U_n = 500 \text{ V}$: 500 k Ω ...2 G Ω
- » for $U_n = 100 \text{ V}$: 100 k Ω ...500 M Ω » for $U_n = 1000 \text{ V}$: 1000 M Ω ...9.99 G Ω
- » for $U_n = 250 \text{ V}$: 250 k Ω ...99 M Ω

Display range	Resolution	Accuracy
0...1999 k Ω	1 k Ω	$\pm(3\% \text{ m.v.} + 8 \text{ digits})$
2.00...19.99 M Ω	0.01 M Ω	
20.0...199.9 M Ω		
200...999 M Ω	1 M Ω	$\pm(4\% \text{ m.v.} + 6 \text{ digits})$
1.00...4.99 G Ω	0.01 G Ω	
5...9.99 G Ω	0.01 G Ω	(non-specified)

Indication of phase sequence

- » Indication of phase sequence: compliant, non-compliant, display of phase-to-phase voltages
- » U_{L-L} power system voltage range: 95...500 V (45...65 Hz)

AC current measurement (True RMS) with clamp

Clamp	Display range	Resolution	Accuracy
F-1A, F-2A, F-3A	0...3000 A (10 kA _{pp} @ 50Hz)	0.01% I_{nom}	$\pm 0.1\%$
C-4A	0...1000 A (3600 A _{pp})	0.01% I_{nom}	0.1...10 A: $\pm(3\% + 0.1 \text{ A})$ 10 A: $\pm 3\%$ 50 A: $\pm 1.5\%$ 200 A: $\pm 0.75\%$ 1000...1200 A: $\pm 0.5\%$
C-5A	0...1000 A (3600 A _{pp})	0.01% I_{nom}	0.5...100 A: $\leq(1.5\% + 1 \text{ A})$ 100...800 A: $\leq 2.5\%$ 800...1000 A AC: $\leq 4\%$ 800...1400 A DC: $\leq 4\%$
C-6A	0...10 A (36 A _{pp})	0.01% I_{nom}	0.01...0.1 A: $\pm(3\% + 1 \text{ mA})$ 0.1...1 A: $\pm 2.5\%$ 1...12 A: $\pm 1\%$
C-7A	0...100 A (360 A _{pp})	0.01% I_{nom}	0...100 A: $\pm(0.5\% + 0.02 \text{ A})$ (45...65 Hz) 0...100 A: $\pm(1.0\% + 0.04 \text{ A})$ (40...1000 Hz)

Illuminance measurement*

Display range [lx]	Resolution [lx]	Spectral uncertainty	Accuracy
0...3.999	0.001	f1 < 2%	$\pm(2\% \text{ m.v.} + 5 \text{ digits})$
4.00...39.99	0.01		
40.0...399.9	0.1		
400...3999	1		
4.00 k...39.99 k	0.01 k		
40.0 k...399.9 k	0.1 k		

*) for the LP-10A measuring probe

Measurements of RCD parameters (working voltage range 95...270V):

RCD trip test and measurement of tripping time t_A (for t_A measurement function)

RCD type	Factor	Range (general and short-time delay)	Range (selective)	Res.	Accuracy
General, short-time delay and selective	0,5*I _{Δn}	0...300 ms	0...500 ms	1 ms	$\pm(2\% \text{ m.v.} + 2 \text{ digits})$ (for RCD of I _{Δn} = 10 mA of the measurement with 0,5*I _{Δn} error: $\pm(2\% \text{ m.v.} + 3 \text{ digits})$)
	1*I _{Δn}				
	2*I _{Δn}	0...150 ms	0...200 ms		
	5*I _{Δn}	0...40 ms	0...150 ms		

Residual current input accuracy: for 0.5*I_{Δn} -8...0% for 1*I_{Δn}, 2*I_{Δn}, 5*I_{Δn} 0...8%

Measurement of RCD trip current I_A for sinusoidal residual current (AC type)

Nominal current	Measuring range	Resolution	Measurement current	Accuracy
10 mA	3.0...10.0 mA	0.1 mA	0,3*I _{Δn} ...1,0*I _{Δn}	$\pm 5\% I_{\Delta n}$
30 mA	9.0...30.0 mA			
100 mA	30...100 mA	1 mA		
300 mA	90...300 mA			
500 mA	150...500 mA			
1000 mA	300...1000 mA			

Measurement can be started from the positive or negative half-period of the input leakage current (AC)



MPI-540 meter enables accurate measurement of fault loop impedance, including in L-PE loops in networks equipped with RCDs, as well as measurements in sockets with swapped L and N conductors.

Measurement of RCD trip current I_A for uni-directional residual current and uni-directional current with 6 mA direct current offset (type A)

Nominal current	Measuring range	Resolution	Measurement current	Accuracy
10 mA	3.5...20.0 mA	0.1 mA	0,35*I _{Δn} ...2,0*I _{Δn}	$\pm 10\% I_{\Delta n}$
30 mA	10.5...42.0 mA			
100 mA	35...140 mA	1 mA		
300 mA	105...420 mA			
500 mA	175...700 mA			

Measurement can be started from the positive or negative half-period of the input leakage current (AC)

Measurement of RCD trip current I_A for residual direct current (type B)

Nominal current	Measuring range	Resolution	Measurement current	Accuracy
10 mA	2.0...20.0 mA	0.1 mA	0,2*I _{Δn} ...2,0*I _{Δn}	$\pm 10\% I_{\Delta n}$
30 mA	6...60 mA			
100 mA	20...200 mA	1 mA		
300 mA	60...600 mA			
500 mA	100...1000 mA			

Measurement is possible for positive or negative input leakage current I_{Δn} - nominal value of residual current



MPI-540 meter enables measurement of the actual tripping time and trip current of an RCD with just one trip.

Measurement of R_e earth resistance using 3-lead, 4-lead, or 3-lead + clamp technical method

Measuring range according to EN 61557-5: 0.50 Ω ...1.99 k Ω for U = 50 V (3-lead, 4-lead):

Display range	Resolution	Accuracy 3p, 4p	Accuracy 3-lead with clamp
0.00...9.99 Ω	0.01 Ω	$\pm(2\% \text{ m.v.} + 4 \text{ digits})$	$\pm(8\% \text{ m.v.} + 4 \text{ digits})$
10.0...99.9 Ω	0.1 Ω		
100...999 Ω	1 Ω		
1.00...1.99 k Ω	0.01 k Ω	$\pm(2\% \text{ m.v.} + 3 \text{ digits})$	

"m.v." = "measured value"

The instrument meets the requirements set forth in the standards:

- » EN 61010-1 (general and particular requirements related to safety)
- » EN 61010-031 (general and particular requirements related to safety)
- » EN 61326 (electromagnetic compatibility)
- » EN 61557 (requirements for measurement instruments)
- » HD 60364-6 (performance of measurements - checking)
- » HD 60364-4-41 (performance of measurements - shock protection)
- » PN-PN-E 04700 (performance of measurements - commissioning tests)
- » EN 12464 (lighting workplaces)

Three-phase power network data logger

» **Measured parameters:**

- voltages L1, L2, L3, N (four measurement inputs), minimum and maximum values within the range up to 550 V, interoperability with voltage transformers,
- currents L1, L2, L3 (three measurement inputs), average, minimum and maximum values, current measurement within the range up to 3 kA (depends on used clamps), interoperability with current transformers,
- frequency within the range of 40 Hz...70 Hz,
- active power (P), reactive power (Q), apparent power (S), inactive power Sn
- power registration: IEEE 1459,
- active energy (E_p), reactive energy (E_q), apparent energy (E_s),
- power factor (PF), cosφ,
- harmonics up to the 40th in voltage and current, total harmonic distortion THD for current and voltage,
- asymmetry of voltages (in compliance with IEC 61000-4-30 class S) and currents,
- energy cost calculator,
- energy losses calculator.

» **The instrument is intended for operation in networks:**

- with rated frequency 50/60 Hz,
- with rated voltages: 64/110 V; 110/190 V; 115/200 V; 127/220 V; 220/380 V; 230/400 V; 240/415 V; 254/440 V; 290/500 V,
- with direct current.

» **Supported network configurations:**

- single-phase,
- two-phase with common N,
- three-phase - star with and without N conductor,
- three-phase - delta.



MPI-540 meter enables estimation of power losses and related costs of poor power quality, through built-in energy loss calculator.

Recorder parameters

Parameter		Measuring range	Max. resolution	Accuracy
Alternating voltage (TRMS)	–	0.0...500 V	0.01% U _{nom}	±0.5% U _{nom}
Alternating voltage TRMS	–	depending on clamp*	0.01% I _{nom}	±2% m.v. if m.v. ≥ 10% I _{nom} ±2% I _{nom} if m.v. < 10% I _{nom} error does not account for clamp error)
Frequency:	–	40.00...70.00 Hz	0.01 Hz	±0.05 Hz
Active, reactive, apparent and distortion power	–	depending on configuration (instrument transformers, clamp)	up to four places after the decimal point	depending on configuration (instrument transformers, clamp)
Active, reactive apparent energy	–	depending on configuration (instrument transformers, clamp)	up to four places after the decimal point	as power error
cosφ and power factor (PF)	–	0.00...1.00	0.01	±0.03
Harmonics	Voltage	as for alternating voltage True RMS	as for alternating voltage True RMS	±5% m.v. if m.v. ≥ 3% U _{nom} ±0.15% U _{nom} if m.v. < 3% U _{nom}
	Current	as for alternating voltage True RMS	as for alternating voltage True RMS	±5% m.v. if m.v. ≥ 10% I _{nom} ±0.5% I _{nom} if m.v. < 10% I _{nom}
THD	Voltage	0.0...100.0% (relative to RMS value)	0.1%	±5%
	Current			
Asymmetry factor	Voltage and current	0.0...10.0%	0.1%	±0.15% (absolute error)

*Clamp F-1A, F-2A, F-3A: 0...3000 A AC (10 000 A_{pp}) • Clamp C-4A: 0...1000 A AC (3600 A_{pp}) • Clamp C-5A: 0...1000 A AC/DC (3600 A_{pp}) • Clamp C-6A: 0...10 A AC (36 A_{pp}) • Clamp C-7A: 0...100 A AC (360 A_{pp})



Selected features of the Sonel MPI-540 meter



Fault loop impedance measurement

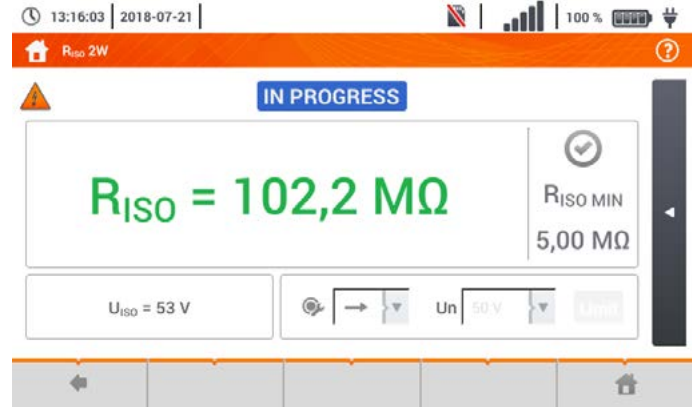

Insulation resistance measurement



Network parameters recorder

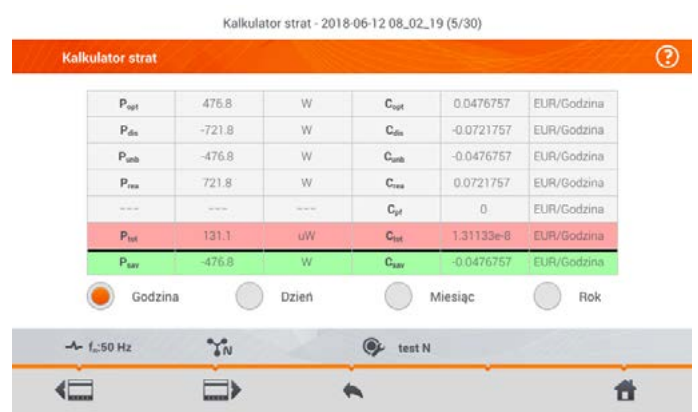

Energy cost calculator



Phase sequence tester

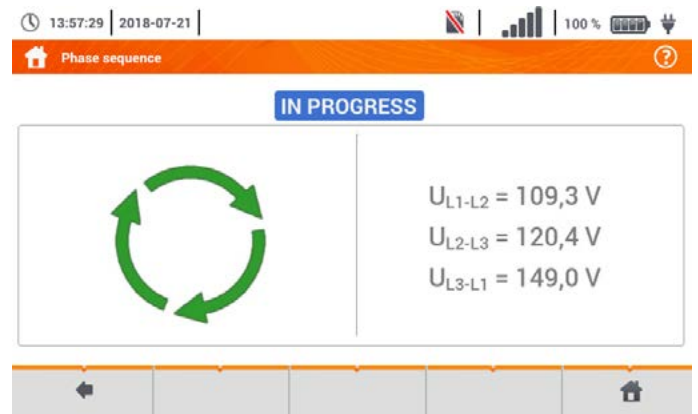

Earthing resistance measurement

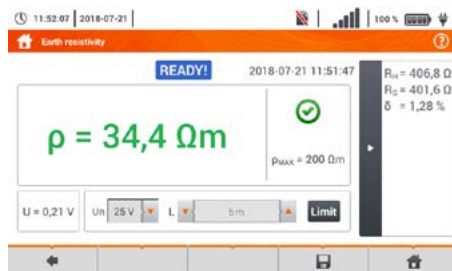

Ground resistivity measurement

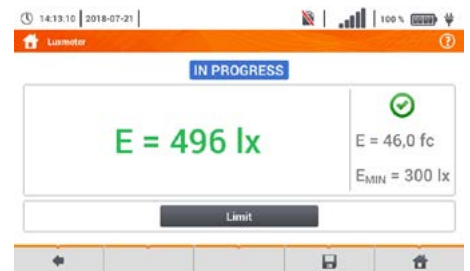

Lighting intensity measurement

SONEL MPI-535

index: WMGBMPI535



Fault loop impedance measurements:

- » impedance measurement with 23 A current (40 A for phase-to-phase voltage), max. resolution 0.001 Ω,
- » fault current-limiting resistor: 10 Ω,
- » range of measurement voltages: 95...440 V, frequencies 45...65 Hz,
- » **fast (up to 5 s) fault loop impedance measurement with resolution up to 0.01 Ω in systems protected with RCDs not tripping at $I_{\Delta n} \geq 30$ mA,**
- » automatic calculation of fault current on the basis of nominal or measured voltage; differentiation of phase-to-neutral and phase-to-phase voltage,
- » measurements using UNI-Schuko plug with measurement triggering button (including for swapped L and N leads) or 1.2 m, 5 m, 10 m, 20 m test leads, with optional use of three-phase socket adapters (AGT),
- » selection of installation protections and automatic evaluation of measurement results.

Testing of AC, A, F, B and B+ residual current devices:

- » measurement of general, short-time delay and selective RCDs with rated residual currents of 10, 30, 100, 300, 500 and 1000 mA,
- » function of automatic measurement of all RCD parameters (after pressing the "START" button once, the meter performs the entire defined cycle of measurements, including the capability of earth fault loop impedance measurement with 15 mA current),
- » shape of the input leakage current selected by the user: sinusoidal (start from rising or falling edge), unidirectional pulsating (positive or negative), unidirectional pulsating with direct current offset (positive or negative), constant (positive or negative),
- » measurement of tripping current I_{Δ} with rising current,
- » measurement of tripping time t_A with currents $0.5 I_{\Delta n}$, $1 I_{\Delta n}$, $2 I_{\Delta n}$ and $5 I_{\Delta n}$,
- » measurement of touch voltage U_B and protective conductor resistance R_E without tripping the RCD,
- » detection of L and N phase swapping in a socket; does not affect measurements,
- » capability of measuring tripping current I_{Δ} as well as actual tripping time t_{AI} with just one RCD trip,
- » voltage measurements within the range of 95...270 V.

Measurement of insulation resistance:

- » measurement voltages: 50 V, 100 V, 250 V, 500 V, 1000 V,
- » measurement of insulation resistance up to 3 GΩ,
- » capability measurement in-socket by means of UNI-Schuko adapter,
- » sound signalling of five-second time intervals, facilitating capture of time characteristics,
- » meter protected against the presence of voltage on the object and the appearance of voltage during measurement,
- » automatic discharge of the measured object's capacitance after completion of measurement,
- » **automatic measurement of all resistance combinations of 3-, 4- and 5-core cords by means of the optional AutoISO-1000C adapter**

Earth resistance measurements:

- » according to 3- or 4-lead technical method with 2 auxiliary electrodes,
- » according to double-clamp method,
- » internal power source with frequency appropriate for 50 Hz or 60 Hz power network

Standard accessories of the meter:

WS-03 adapter with START button with UNI-Schuko plug	WAADAWS03
Test lead 1.2 m, red, 1 kV (banana plugs)	WAPRZ1X2REBB
Test lead 1.2 m, blue, 1 kV (banana plugs)	WAPRZ1X2BUBB
Test lead 1.2 m, yellow, 1 kV (banana plugs)	WAPRZ1X2YEBB
Test lead 1.2 m, black, 1 kV (banana plugs)	WAPRZ1X2BLBBN
Test lead 15 m, blue (on a reel)	WAPRZ015BUBBSZ
Test lead 30 m, red (banana plugs, on a reel)	WAPRZ030REBBSZ
USB cable	WAPRZUSB
Crocodile clip, red, 1 kV, 20 A	WAKRORE20K02
Crocodile clip, blue, 1 kV, 20 A	WAKROBU20K02
Crocodile clip, yellow, 1 kV, 20 A	WAKROYE20K02
Crocodile clip, black, 1 kV, 20 A	WAKROBL20K01
Pin probe, red 1 kV (banana socket)	WASONREOGB1
Pin probe, blue 1 kV (banana socket)	WASONBUOGB1
Pin probe, yellow 1 kV (banana socket)	WASONYEGB1
Earth contact test probe (rod), 30 cm	WASONG30
Z7 Power supply	WAZASZ7
Mains cable with IEC C7 plug	WAPRZLAD230
L2 carrying case	WAFUTL2
L2 hanging straps (set)	WAPZOSZEKPL
Li-Ion battery 11.1 V 3.4 Ah	WAAKU15
PC software: Sonel Reader	WAPROREADER
Calibration certificate	

Soil resistivity measurements according to the Wenner method:

- » measuring range: 0.5 Ωm...9.99 kΩm,
- » distances between electrodes can be set in meters (1...30 m) or feet (1...90 ft).

Low-voltage continuity testing of protective conductors and equipotential bonding:

- » measuring range according to EN 61557-4: 0.12...400 Ω, max. resolution 0.01 Ω,
- » measurement of protective conductor continuity with current ≥ 200 mA in two directions,
- » low-current measurement with sound signalling,
- » voltage on open terminals: 4...9 V,
- » automatic calibration of test leads - leads of any length can be used.

Additional functions of the meter:

- » **quick check of correct connection of PE conductor by means of contact electrode,**
- » **check of phase sequence and direction of motor rotation,**
- » **capability of charging from the power grid or 12 V car lighter socket,**
- » **tree-like memory structure with dynamic management,**
- » **data transmission to PC via USB.**

Other technical specifications:

- » type of insulation double, as per EN 61010-1 and EN 61557
- » power supply Li-Ion rechargeable battery 11.1 V 3.4 Ah 37.7 Wh
- » operating temperature range 0...+50°C

Measurement of fault loop impedance Z_{L-PE} , Z_{L-N} , Z_{L-L} in 23/40 A mode

Measurement with 23/40 A current - measuring range according to EN 61557: 0.130 ...1999 Ω (for 1.2 m test lead):

Display range	Resolution	Accuracy
0.00...19.999 Ω	0.001 Ω	$\pm(5\% \text{ m.v.} + 0.03 \Omega)$
20.00...199.99 Ω	0.01 Ω	$\pm(5\% \text{ m.v.} + 0.3 \Omega)$
200.00...1999.9 Ω	0.1 Ω	$\pm(5\% \text{ m.v.} + 3 \Omega)$

Nominal voltage: 95...270 V (for Z_{L-PE} and Z_{L-N}) or 95...440 V (for Z_{L-L} - only mode 23/40 A). Frequency: 45...65 Hz.

Measurement of the Z_{L-PE} fault loop impedance in the RCD mode

Measurement with 15 mA current - measuring range according to EN 61557: 0.50...1999 Ω

Display range	Resolution	Accuracy
0.00...19.99 Ω	0.01 Ω	$\pm(6\% \text{ m.v.} + 10 \text{ digits})$
20.00...199.99 Ω	0.1 Ω	$\pm(6\% \text{ m.v.} + 5 \text{ digits})$
200...1999 Ω	1 Ω	

Nominal voltage: 95...270 V

Frequency: 45...65 Hz

Earthing resistance measurement with two clamps

Display range	Resolution	Accuracy
0.00...9.99 Ω	0.01 Ω	$\pm(10\% \text{ m.v.} + 4 \text{ digits})$
10.0...19.9 Ω	0.1 Ω	
20.0...99.9 Ω		$\pm(20\% \text{ m.v.} + 4 \text{ digits})$

Measurement of insulation resistance

Measuring range according to EN 61557-2:

- » for $U_n = 50 \text{ V}$: 50 k Ω ...250 M Ω
- » for $U_n = 100 \text{ V}$: 100 k Ω ...500 M Ω
- » for $U_n = 250 \text{ V}$: 250 k Ω ...999 M Ω
- » for $U_n = 500 \text{ V}$: 500 k Ω ...2.00 G Ω
- » for $U_n = 1000 \text{ V}$: 1000 k Ω ...3.00 G Ω

Display range	Resolution	Accuracy
0...1999 k Ω	1 k Ω	$\pm(3\% \text{ m.v.} + 8 \text{ digits})$
2.00...19.99 M Ω	0.01 M Ω	
20.0...199.9 M Ω		
200...999 M Ω	1 M Ω	
1.00...4.99 G Ω	0.01 G Ω	$\pm(4\% \text{ m.v.} + 6 \text{ digits})$



MPI-535 meter enables accurate measurement of fault loop impedance, including in L-PE loops in networks equipped with RCDs, as well as measurements in sockets with swapped L and N wires.

Indication of phase sequence

- » Indication of phase sequence: compliant, non-compliant, display of phase-to-phase voltages
- » U_{L-L} power system voltage range: 95...500 V (45...65 Hz)

Measurements of RCD parameters (operating voltage range 95...270V):

RCD trip test and measurement of tripping time t_A (for t_A measurement function)

RCD type	Factor	Range (general and short-time delay)	Range (selective)	Res.	Accuracy
General, short-time delay and selective	$0.5 \cdot I_{\Delta n}$	0...300 ms	0...500 ms	1 ms	$\pm(2\% \text{ m.v.} + 2 \text{ digits})$ (for RCD of $I_{\Delta n} = 10 \text{ mA}$ of the measurement with $0.5 \cdot I_{\Delta n}$ error: $\pm(2\% \text{ m.v.} + 3 \text{ digits})$)
	$1 \cdot I_{\Delta n}$				
	$2 \cdot I_{\Delta n}$				
	$5 \cdot I_{\Delta n}$				

Residual current input accuracy: for $0.5 \cdot I_{\Delta n}$ -8...0% for $1 \cdot I_{\Delta n}$, $2 \cdot I_{\Delta n}$, $5 \cdot I_{\Delta n}$ 0...8%

Measurement of RCD trip current I_A for sinusoidal residual current (AC type)

Nominal current	Measuring range	Resolution	Measurement current	Accuracy
10 mA	3.0...10.0 mA	0.1 mA	$0.3 \cdot I_{\Delta n}$... $1.0 \cdot I_{\Delta n}$	$\pm 5\% I_{\Delta n}$
30 mA	9.0...30.0 mA			
100 mA	30...100 mA			
300 mA	90...300 mA	1 mA		
500 mA	150...500 mA			
1000 mA	300...1000 mA			

Measurement can be started from the positive or negative half-period of the input leakage current (AC)

Measurement of RCD trip current I_A for uni-directional residual current and uni-directional current with 6 mA direct current offset (type A)

Nominal current	Measuring range	Resolution	Measurement current	Accuracy
10 mA	3.5...20.0 mA	0.1 mA	$0.35 \cdot I_{\Delta n}$... $2.0 \cdot I_{\Delta n}$	$\pm 10\% I_{\Delta n}$
30 mA	10.5...42.0 mA			
100 mA	35...140 mA	1 mA		
300 mA	105...420 mA			
500 mA	175...700 mA			

Measurement can be started from the positive or negative half-period of the input leakage current (AC)



MPI-535 meter enables measurement of the actual tripping time and trip current of an RCD with just one trip.

Measurement of RCD trip current I_A for residual direct current (type B)

Nominal current	Measuring range	Resolution	Measurement current	Accuracy
10 mA	2.0...20.0 mA	0.1 mA	$0.2 \cdot I_{\Delta n}$... $2.0 \cdot I_{\Delta n}$	$\pm 10\% I_{\Delta n}$
30 mA	6...60 mA	1 mA		
100 mA	20...200 mA			
300 mA	60...600 mA			
500 mA	100...1000 mA			

Measurement is possible for positive or negative input leakage current $I_{\Delta n}$ - nominal value of residual current

Measurement of R_E earth resistance using 3-lead, 4-lead, or 3-lead + clamp technical method

Measuring range according to EN 61557-5: 0.50 Ω ...1.99 k Ω for $U = 50 \text{ V}$ (3-lead, 4-lead):

Display range	Resolution	Accuracy 3p, 4p	Accuracy 3-lead with clamp
0.00...9.99 Ω	0.01 Ω	$\pm(2\% \text{ m.v.} + 4 \text{ digits})$	$\pm(8\% \text{ m.v.} + 4 \text{ digits})$
10.0...99.9 Ω	0.1 Ω		
100...999 Ω	1 Ω		
1.00...1.99 k Ω	0.01 k Ω	$\pm(2\% \text{ m.v.} + 3 \text{ digits})$	

"m.v." = "measured value"

The instrument meets the requirements set forth in the standards:

- » EN 61010-1 (general and particular requirements related to safety)
- » EN 61010-031 (general and particular requirements related to safety)
- » EN 61326 (electromagnetic compatibility)
- » EN 61557 (requirements for measurement instruments)
- » HD 60364-6 (performance of measurements - checking)
- » HD 60364-4-41 (performance of measurements - shock protection)
- » PN-PN-E 04700 (performance of measurements - commissioning tests)
- » EN 12464 (lighting workplaces)



SONEL MPI-530 / MPI-530-IT

index: WMGBMPI530 / WMGBMPI530IT



Fault loop impedance measurements:

- » impedance measurement with 23 A current (40 A for phase-to-phase voltage), max. resolution 0.001 Ω,
- » fault current-limiting resistor: 10 Ω,
- » range of measurement voltages: 95...440 V, frequencies 45...65 Hz,
- » **fault loop impedance measurement with resolution up to 0.01 Ω in systems protected with RCDs not tripping at $I_{\Delta n} \geq 30$ mA,**
- » automatic calculation of fault current on the basis of nominal or measured voltage; differentiation of phase-to-neutral and phase-to-phase voltage,
- » measurements using UNI-Schuko plug with measurement triggering button (including for swapped L and N leads) or 1.2 m, 5 m, 10 m or 20 m test leads, with optional use of three-phase socket adapters (AGT),
- » selection of installation protections and automatic evaluation of measurement results.

Testing of AC, A, F, B and B+ residual current devices:

- » **MPI-530-IT also enables measurements in IT networks,**
- » measurement of general, short-time delay and selective RCDs with rated residual currents of 10, 30, 100, 300, 500 and 1000 mA,
- » function of automatic measurement of all RCD parameters (after pressing the "START" button once, the meter performs the entire defined cycle of measurements, including the capability of earth fault loop impedance measurement with 15 mA current),
- » shape of the input leakage current selected by the user: sinusoidal (start from rising or falling edge), unidirectional pulsating (positive or negative), unidirectional pulsating with direct current offset (positive or negative), constant (positive or negative),
- » measurement of tripping current I_A with rising current,
- » measurement of tripping time t_A with currents $0.5 I_{\Delta n}$, $1 I_{\Delta n}$, $2 I_{\Delta n}$ and $5 I_{\Delta n}$,
- » measurement of touch voltage U_B and protective conductor resistance R_E without tripping the RCD,
- » detection of L and N phase swapping in a socket; does not affect measurements,
- » capability of measuring tripping current I_A as well as actual tripping time t_{A1} with just one RCD trip,
- » voltage measurements within the range of 95...270 V.

Measurement of insulation resistance:

- » measurement voltages: 50 V, 100 V, 250 V, 500 V, 1000 V,
- » measurement of insulation resistance up to 10 GΩ,
- » capability measurement in-socket by means of UNI-Schuko adapter,
- » sound signaling of five-second time intervals, facilitating capture of time characteristics,
- » meter protected against the presence of voltage on the object and the appearance of voltage during measurement,
- » automatic discharge of the measured object's capacitance after completion of measurement,
- » **automatic measurement of all resistance combinations of 3-, 4- and 5-core cords by means of the optional AutoISO-1000C adapter**

Earth resistance measurements:

- » according to 3- or 4-lead technical method with 2 auxiliary electrodes,
- » according to 3-lead method with additional clamp,
- » **according to double-clamp method,**
- » internal power source with frequency appropriate for 50 Hz or 60 Hz power network

Standard accessories of the meter:

WS-03 adapter with START button with UNI-SCHUKO plug	WAADAWS03
NiMH battery 4.8 V 4.2 Ah	WAAKU07
L2 carrying case	WAFUTL2
Crocodile clip, red, 1 kV, 20 A	WAKRORE20K02
Crocodile clip, blue, 1 kV, 20 A	WAKROBU20K02
Crocodile clip, yellow, 1 kV, 20 A	WAKROYE20K02
Mini Bluetooth keyboard	WAADAMK
Test lead 1.2 m, red, 1 kV (banana plugs)	WAPRZ1X2REBB
Test lead 1.2 m, blue, 1 kV (banana plugs)	WAPRZ1X2BUBB
Test lead 1.2 m, yellow, 1 kV (banana plugs)	WAPRZ1X2YEBB
Test lead 15 m, blue (on a reel)	WAPRZ015BUBBSZ
Test lead 30 m, red (banana plugs, on a reel)	WAPRZ030REBBSZ
Cable for battery charging from car cigarette lighter socket (12 V)	WAPRZLAD12SAM
USB cable	WAPRZUSB
Mains cable with IEC C7 plug	WAPRZLAD230
2x earth contact test probe (rod), 30 cm	WASONG30
Pin probe, red 1 kV (banana socket)	WASONREOGB1
Pin probe, blue 1 kV (banana socket)	WASONBUOGB1
Pin probe, yellow 1 kV (banana socket)	WASONYEGB1
L2 hanging straps (set)	WAPZSZSEKPL
Z7 Power supply	WAZASZ7
Sone! MPI Mobile	
Sone! Reader software	WAPROREADER
Calibration certificate	

Soil resistivity measurements according to the Wenner method:

- » measuring range: 0.5 Ωm...9.99 kΩm,
- » distances between electrodes can be set in meters (1...30 m) or feet (1...90 ft).

Low-voltage continuity testing of protective conductors and equipotential bonding:

- » measuring range according to EN 61557-4: 0.12...400 Ω, max. resolution 0.01 Ω,
- » measurement of protective conductor continuity with current ≥ 200 mA in two directions,
- » low-current measurement with sound signaling,
- » voltage on open terminals: 4...9 V,
- » automatic calibration of test leads - leads of any length can be used.

Illuminance measurement:

- » display range: 0.001/0.01/1 lx...399.9 klx,
- » measurement in lux (lx) or foot-candles (fc),
- » measurement by means of external photodetectors (optional)

Additional functions of the meter:

- » Analysis and registration of single-phase network parameters (U, I, cosφ, P, PF, Q, S, Sn),
- » THD of voltage and current harmonics up to the 40th,
- » Quick check of correct connection of PE conductor by means of contact electrode,
- » Check of phase sequence and direction of motor rotation,
- » Power supply from rechargeable battery or batteries (optional), built-in quick charger,
- » Capability of charging from the power grid or 12 V car lighter socket,
- » Tree-structure memory with dynamic management (max. 10,000 entries for each type of measurement),
- » Data transmission to PC via USB or Bluetooth®.

Other technical specifications:

- » type of insulation double, as per EN 61010-1 and EN 61557
- » power supply of the meter Ni-MH rechargeable battery
- » LR14 alkaline batteries (4 pcs.) (optional)
- » operating temperature range 0...+50°C

SONEL MPI MOBILE



A mobile version of the program cooperating with a multifunctional Sone! instrument: MPI-530-IT / MPI-530 / MPI-502 meters of electrical system parameters. It can be downloaded from the www.sone!.pl/en website or by scanning the QR code placed above.

Measurement of fault loop impedance Z_{L-PE} , Z_{L-N} , Z_{L-L} in 23/40A mode

Measurement with 23/40 A current - measuring range according to EN 61557: 0.130 ...1999 Ω (for 1.2 m lead):

Display range	Resolution	Accuracy
0.00...19.999 Ω	0.001 Ω	$\pm(5\% \text{ m.v.} + 0.03 \Omega)$
20.00...199.99 Ω	0.01 Ω	$\pm(5\% \text{ m.v.} + 0.3 \Omega)$
200.0...1999.9 Ω	0.1 Ω	$\pm(5\% \text{ m.v.} + 3 \Omega)$

Nominal voltage: 95...270 V (for Z_{L-PE} and Z_{L-N}) or 95...440 V (for Z_{L-L} - only mode 23/40 A). Frequency: 45...65 Hz.

Measurement of the Z_{L-PE} fault loop impedance in the RCD mode

Measurement with 15 mA current - measuring range acc. to EN 61557: 0.50...1999 Ω

Display range	Resolution	Accuracy
0.00...19.99 Ω	0.01 Ω	$\pm(6\% \text{ m.v.} + 10 \text{ digits})$
20.0...199.9 Ω	0.1 Ω	$\pm(6\% \text{ m.v.} + 5 \text{ digits})$
200...1999 Ω	1 Ω	

Rated voltage: 95...270 V; frequency: 45...65 Hz

Earthing resistance measurement with two clamps

Display range	Resolution	Accuracy
0.00...9.99 Ω	0.01 Ω	$\pm(10\% \text{ m.v.} + 4 \text{ digits})$
10.0...19.9 Ω	0.1 Ω	
20.0...99.9 Ω		$\pm(20\% \text{ m.v.} + 4 \text{ digits})$

Measurement of insulation resistance

Measuring range according to EN 61557-2:

- » for $U_n = 50 \text{ V}$: 50 k Ω ...250 M Ω
- » for $U_n = 100 \text{ V}$: 100 k Ω ...500 M Ω
- » for $U_n = 250 \text{ V}$: 250 k Ω ...99 M Ω
- » for $U_n = 500 \text{ V}$: 500 k Ω ...2 G Ω
- » for $U_n = 1000 \text{ V}$: 1000 M Ω ...9.99 G Ω

Display range	Resolution	Accuracy
0...1999 k Ω	1 k Ω	$\pm(3\% \text{ m.v.} + 8 \text{ digits})$
2.00...19.99 M Ω	0.01 M Ω	
20.0...199.9 M Ω		
200...999 M Ω	1 M Ω	$\pm(4\% \text{ m.v.} + 6 \text{ digits})$
1.00...9.99 G Ω	0.01 G Ω	

Indication of phase sequence

- » Indication of phase sequence: compliant, non-compliant, display of phase-to-phase voltages
- » U_{L-L} power system voltage range: 95...500 V (45...65 Hz)

Analysis and recording of single-phase system

- » Measurement of voltage U_{L-N} : 0...500 V, power measurement P, Q, S: 0...1.5 M (W, var, VA).
- » Frequency range of measured voltages: 45...65 Hz.
- » Frequency measurement within range 45.0...65.0 Hz for voltages 50...500 V (Accuracy within a maximum of $\pm 0.1\% \text{ m.v.} + 1 \text{ digit}$).
- » $\cos\phi$ measurement: 0.00...1.00 (resolution 0.01).
- » Measurement of current and voltage harmonics (up to the 40th).
- » THD measurement relative to first harmonic (for U and I).
- » AC current measurement (True RMS) with clamp:

Clamp	Display range	Resolution	Accuracy
C-3, C-6	0.0...99.9 mA	0.1 mA	$\pm(5\% \text{ m.v.} + 3 \text{ digits})$
	100...999 mA	1 mA	
C-3, C-6, F-2, F-3	1.00...9.99 A	0.01 A	$\pm(5\% \text{ m.v.} + 5 \text{ digits})$ (C-3, C-6)
	10.0...99.9 A	0.1 A	
	100...999 A	1 A	
F-1, F-2, F-3	1.00...3.00 kA	0.01 kA	$\pm(0,1\% \text{ In} + 2 \text{ digits})$ (F-1, F-2, F-3)

Illuminance measurement*

Display range [lx]	Resolution [lx]	Spectral uncertainty	Base uncertainty (accuracy)
0...3.999	0.001	$f_1 < 2\%$	$\pm(2\% + 5 \text{ digits})$
4.00...39.99	0.01		
40.0...399.9	0.1		
400...3999	1		
4.00 k...39.99 k	0.01 k		
40.0 k...399.9 k	0.1 k		

*) for LP-10A measuring probe.



MPI-530 / MPI-530-IT meters enable accurate measurement of fault loop impedance, including in L-PE loops in networks equipped with RCDs, as well as measurements in sockets with swapped L and N conductors.

Measurements of RCD parameters (working voltage range 95...270 V):

RCD trip test and measurement of tripping time t_A (for t_A measurement function)

RCD type	Factor	Range (general and short-time delay)	Range (selective)	Resolution	Accuracy
General, short-time delay and selective	$0.5 \cdot I_{\Delta n}$	0...300 ms	0...500 ms	1 ms	$\pm(2\% \text{ m.v.} + 2 \text{ digits})$ (for RCD of $I_{\Delta n} = 10 \text{ mA}$ and the measurement with $0,5 \cdot I_{\Delta n}$ error: $\pm(2\% \text{ m.v.} + 3 \text{ digits})$)
	$1 \cdot I_{\Delta n}$				
	$2 \cdot I_{\Delta n}$	0...150 ms	0...200 ms		
	$5 \cdot I_{\Delta n}$	0...40 ms	0...150 ms		

Residual current input accuracy: for $0,5 \cdot I_{\Delta n}$ -8...0% for $1 \cdot I_{\Delta n}$, $2 \cdot I_{\Delta n}$, $5 \cdot I_{\Delta n}$ 0...8%

Measurement of RCD trip current I_A for sinusoidal residual current (AC type)

Nominal current	Measuring range	Resolution	Measurement current	Accuracy
10 mA	3.3...10.0 mA	0.1 mA	$0,35 \cdot I_{\Delta n} \dots 1,0 \cdot I_{\Delta n}$	$\pm 5\% I_{\Delta n}$
30 mA	9.0...30.0 mA			
100 mA	33...100 mA	1 mA		
300 mA	90...300 mA			
500 mA	150...500 mA			
1000 mA	330...1000 mA			

Measurement can be started from the positive or negative half-period of the input leakage current (AC)

Measurement of RCD trip current I_A for uni-directional residual current and uni-directional current with 6mA direct current offset (type A)

Nominal current	Measuring range	Resolution	Measurement current	Accuracy
10 mA	3.5...20.0 mA	0.1 mA	$0,35 \cdot I_{\Delta n} \dots 2,0 \cdot I_{\Delta n}$	$\pm 10\% I_{\Delta n}$
30 mA	10.5...42.0 mA			
100 mA	35...140 mA	1 mA		
300 mA	105...420 mA			
500 mA	175...700 mA			

Measurement can be started from a positive or negative half-period of the input leakage current



MPI-530 / MPI-530-IT meters enable automatic insulation resistance measurement of 3-, 4- and 5-core cords with optional AutoISO-1000C adapter.

Measurement of RCD trip current I_A for residual direct current (type B)

Nominal current	Measuring range	Resolution	Measurement current	Accuracy
10 mA	2.0...20.0 mA	0.1 mA	$0,2 \cdot I_{\Delta n} \dots 2,0 \cdot I_{\Delta n}$	$\pm 10\% I_{\Delta n}$
30 mA	6...60 mA			
100 mA	20...200 mA	1 mA		
300 mA	60...600 mA			
500 mA	100...1000 mA			

Measurement is possible for positive or negative input leakage current $I_{\Delta n}$ - nominal value of residual current

Measurement of RE earth resistance using 3-lead, 4-lead, or 3-lead + clamp technical method

Measuring range according to EN 61557-5: 0.50 Ω ...1.99 k Ω for $U = 50 \text{ V}$ (3-lead, 4-lead):

Display range	Resolution	Accuracy 3-lead, 4-lead	Accuracy 3-lead with clamp
0.00...9.99 Ω	0.01 Ω	$\pm(2\% \text{ m.v.} + 4 \text{ digits})$	$\pm(8\% \text{ m.v.} + 4 \text{ digits})$
10.0...99.9 Ω	0.1 Ω		
100...999 Ω	1 Ω	$\pm(2\% \text{ m.v.} + 3 \text{ digits})$	
1.00...1.99 k Ω	0.01 k Ω		

"m.v." = "measured value"



MPI-530 / MPI-530-IT meters enable measurement of the actual tripping time and trip current of an RCD with just one trip.

The instrument meets the requirements set forth in the standards:

- » EN 61010-1 (general and particular requirements related to safety)
- » EN 61010-031 (general and particular requirements related to safety)
- » EN 61326 (electromagnetic compatibility)
- » EN 61557 (requirements for measurement instruments)
- » HD 60364-6 (performance of measurements - checking)
- » HD 60364-4-41 (performance of measurements - shock protection)
- » PN-PN-E 04700 (performance of measurements - commissioning tests)
- » EN 12464 (lighting workplaces)

SONEL MPI-525

index: WMGBMPI525



Fault loop impedance measurements:

- » impedance measurement with 23 A current (40 A for phase-to-phase voltage),
- » fault current-limiting resistor: 10 Ω,
- » range of measurement voltages: 95...440 V, frequencies 45...65 Hz,
- » **fault loop impedance measurement with resolution up to 0.01 Ω in systems protected with RCDs not tripping at $I_{\Delta n} \geq 30$ mA,**
- » **automatic fault current calculation; differentiation of phase and phase-to-phase voltage,**
- » measurements using UNI-Schuko plug with measurement triggering button (including for swapped L and N leads) or 1.2 m, 5 m, 10 m, 20 m test leads, with optional use of three-phase socket adapters (AGT).

Testing of AC, A, F, B and B+ residual current devices:

- » measurement of general, short-time delay and selective RCDs with rated residual currents of 10, 30, 100, 300, 500 and 1000 mA,
- » **function of automatic measurement of all RCD parameters (after pressing the "START" button once, the meter performs the entire defined cycle of measurements, including the capability of earth fault loop impedance measurement with 15 mA current),**
- » shape of the input leakage current selected by the user: sinusoidal (start from rising or falling edge), unidirectional pulsating (positive or negative), unidirectional pulsating with direct current offset (positive or negative), constant (positive or negative),
- » measurement of tripping current I_{Δ} with rising current,
- » measurement of tripping time t_{Δ} for currents: $0.5I_{\Delta n}$, $1I_{\Delta n}$, $2I_{\Delta n}$ and $5I_{\Delta n}$,
- » measurement of touch voltage U_b and protective conductor resistance R_e without tripping the RCD,
- » detection of L and N phase swapping in a socket; does not affect measurements,
- » capability of measuring tripping current I_{Δ} as well as actual tripping time t_{Δ} with just one RCD trip,
- » voltage measurements within the range of 95...270 V.

Measurement of insulation resistance:

- » measurement voltages: 50 V, 100 V, 250 V, 500 V, 1000 V and 2500 V,
- » measurement of insulation resistance up to 10 GΩ,
- » sound signaling of five-second time intervals, facilitating capture of time characteristics,
- » measurement of 2 absorption coefficients (DAR, PI or Ab1, Ab2)
- » timing of T1, T2, T3 within the range of 1...600 s,
- » meter protected against the presence of voltage on the object and the appearance of voltage during measurement,
- » automatic discharge of the measured object's capacitance after completion of measurement,
- » **automatic measurement of all resistance combinations of 3-, 4- and 5-core cords and power cords by means of the optional AutoISO-2500 adapter.**

Earth resistance measurements:

- » measurement according to 3- or 4-lead technical method with 2 auxiliary electrodes,
- » internal power source with frequency appropriate for 50 Hz or 60 Hz power network (selected in the meter).

Standard accessories of the meter:

WS-03 adapter with START button with UNI-SCHUKO plug	WAADAWS03
NiMH battery 4.8 V 4.2 Ah	WAAKU07
L2 carrying case	WAFUTL2
Crocodile clip, black, 11 kV, 32 A	WAKROBL32K09
Crocodile clip, yellow, 1 kV, 20 A	WAKROYE20K02
Test lead 1.2 m, red, 1 kV (banana plugs)	WAPRZ1X2REBB
Test lead 1.2 m, blue, 1 kV (banana plugs)	WAPRZ1X2BUBB
Test lead 1.2 m, yellow, 1 kV (banana plugs)	WAPRZ1X2YEBB
Test lead 1.8 m, black, 5 kV (banana plugs, shielded)	WAPRZ1X8BLBB
Test lead 1.8 m, red, 5 kV (banana plugs)	WAPRZ1X8REBB
Test lead 15 m, blue (on a reel)	WAPRZ015BUBBSZ
Test lead 30 m, red (banana plugs, on a reel)	WAPRZ030REBBSZ
USB cable	WAPRZUSB
Mains cable with IEC C7 plug	WAPRZLAD230
Earth contact test probe (rod), 30 cm	WASONG30
Pin probe, red 1 kV (banana socket)	WASONREOGB1
Pin probe, red 5 kV (banana socket)	WASONREOGB2
Pin probe, blue 1 kV (banana socket)	WASONBUOGB1
Pin probe, yellow 1 kV (banana socket)	WASONYE0GB1
L2 hanging straps (set)	WAPOZSZEKPL
Z7 Power supply	WAZASZ7
PC software: Sone! Reader	WAPROREADER
Calibration certificate	



The MPI-525 meter is one of the few multi-function meters capable of measuring insulation resistance with 2500 V voltage.

Low-voltage resistance measurement of protective conductors and equipotential bonding:

- » measurement of protective conductor continuity with current ≥ 200 mA in two directions (according to standard EN 61557-4),
- » low-current measurement with sound and light signaling,
- » automatic calibration of test leads - leads of any length can be used.

Additional functions of the meter:

- » Quick check of correct connection of PE conductor by means of contact electrode,
- » Check of phase sequence,
- » Memory storing up to 990 records (57,500 individual results), data transmission to PC via USB,
- » Power supply from rechargeable battery or battery (optional), built-in quick charger,
- » Real-time clock (RTC) - time of measurement saved to memory.



MPI-525 enables measurements in sockets with swapped L and N conductors.

Other technical specifications:

- » type of insulation double, as per EN 61010-1 and EN 61557
- » power supply of the meter Ni-MH battery
..... or LR14 alkaline batteries (4 pcs. - optional)
- » operating temperature range 0...+50°C

Measurement of fault loop impedance Z_{L-PE} , Z_{L-N} , Z_{L-L}

Measurement with 23 / 40 A current - measuring range according to EN 61557-3: 0.13...1999 Ω (for 1.2 m test lead):

Display range	Resolution	Accuracy
0.00...19.99 Ω	0.01 Ω	$\pm(5\% \text{ m.v.} + 3 \text{ digits})$
20.0...199.9 Ω	0.1 Ω	
200...1999 Ω	1 Ω	

Nominal voltage: 95...270V (for Z_{L-PE} and Z_{L-N}) or 95...440 V (for Z_{L-L})

Frequency: 45...65Hz

Measurement of the Z_{L-PE} fault loop impedance in the RCD mode

Measurement with 15 mA current, measuring range according to EN 61557-3: 0.50...1999 Ω

Display range	Resolution	Accuracy
0.00...19.99 Ω	0.01 Ω	$\pm(6\% \text{ m.v.} + 10 \text{ digits})$
20.0...199.9 Ω	0.1 Ω	
200...1999 Ω	1 Ω	

Rated voltage: 95...270 V

Frequency: 45...65 Hz

Earth resistance R_E measurement

Measuring range according to EN 61557-5:

0.50 Ω ...1.99 k Ω for 50 V measurement voltage
0.56 Ω ...1.99 k Ω for 25 V measurement voltage

Display range	Resolution	Accuracy
0.00...9.99 Ω	0.01 Ω	$\pm(2\% \text{ m.v.} + 4 \text{ digits})$
10.0...99.9 Ω	0.1 Ω	
100...999 Ω	1 Ω	
1.00...1.99 k Ω	0.01 k Ω	$\pm(2\% \text{ m.v.} + 3 \text{ digits})$

Measurement of insulation resistance

Measuring range according to EN 61557-2:

for $U_n = 50 \text{ V}$: 50 k Ω ...250 M Ω for $U_n = 500 \text{ V}$: 500 k Ω ...2.00 G Ω
for $U_n = 100 \text{ V}$: 100 k Ω ...500 M Ω for $U_n = 1000 \text{ V}$: 1000 k Ω ...3.00 G Ω
for $U_n = 250 \text{ V}$: 250 k Ω ...999 M Ω for $U_n = 2500 \text{ V}$: 2.50 M Ω ...9.99 G Ω

Display range *)	Resolution	Accuracy
0...1999 k Ω	1 k Ω	$\pm(3\% \text{ m.v.} + 8 \text{ digits})$
2.00...19.99 M Ω	0.01 k Ω	
20.0...199.9 M Ω	0.1 k Ω	
200...999 M Ω	1 k Ω	
1.00...9.99 G Ω	0.01 G Ω	$\pm(4\% \text{ m.v.} + 6 \text{ digits})$

**) no greater than the measuring range for a given voltage.



The MPI-525 meter enables automatic insulation resistance measurement of cables and 3-, 4- and 5-core cords by means of the optional AutoISO-2500 adapter.

Indication of phase sequence

- » Indication of phase sequence: compliant, non-compliant
- » U_{L-L} power system voltage range: 95...500 V (45...65 Hz)
- » Display of phase-to-phase voltage values

Low-voltage measurement of circuit continuity and resistance

Testing of protective conductor continuity with $\pm 200 \text{ mA}$ current measuring range according to EN 61557-4: 0.12...400 Ω

Display range	Resolution	Accuracy
0.00...19.99 Ω	0.01 Ω	$\pm(2\% \text{ m.v.} + 3 \text{ digits})$
20.0...199.9 Ω	0.1 Ω	
200...400 Ω	1 Ω	

- » Voltage on open terminals: 4...9 V
- » Output current at $R < 2 \Omega$: min. 200 mA
- » Automatic calibration of test leads
- » Measurements for both current polarities



The MPI-525 meter is one of the few meters capable of accurately measuring fault loop impedance, including in L-PE loops, in networks equipped with residual current devices (measurement with 15 mA current).

Measurements of RCD parameters (working voltage range 95...270 V):

RCD trip test and measurement of tripping time t_A (for t_A measurement function)

RCD mode	Factor	Range	Resolution	Accuracy
General and short-time delay	0.5*I $_{\Delta n}$	0...300 ms	1 ms	$\pm(2\% \text{ m.v.} + 2 \text{ digits})$ (for RCD of $I_{\Delta n}=10 \text{ mA}$ and the measurement 0.5*I $_{\Delta n}$ error: $\pm(2\% \text{ m.v.} + 3 \text{ digits})$)
	1*I $_{\Delta n}$			
	2*I $_{\Delta n}$			
Selective	0.5*I $_{\Delta n}$	0...500 ms		
	1*I $_{\Delta n}$			
	2*I $_{\Delta n}$			
	5*I $_{\Delta n}$	0...150 ms		

Residual current input accuracy: for 0.5*I $_{\Delta n}$ -8...0%
for 1*I $_{\Delta n}$, 2*I $_{\Delta n}$, 5*I $_{\Delta n}$ 0...8%

Measurement of RCD trip current I_A for sinusoidal residual current (AC type)

Nominal current	Measuring range	Resolution	Measurement current	Accuracy
10 mA	3.3...10.0 mA	0.1 mA	0.3*I $_{\Delta n}$...1.0*I $_{\Delta n}$	$\pm 5\% I_{\Delta n}$
30 mA	9.0...30.0 mA			
100 mA	30...100 mA			
300 mA	90...300 mA	1 mA		
500 mA	150...500 mA			
1000 mA	300...1000 mA			

Measurement can be started from the positive or negative half-period of the input leakage current (AC)

Measurement of RCD trip current I_A for uni-directional residual current and uni-directional current with 6 mA direct current offset (type A, F)

Nominal current	Measuring range	Resolution	Measurement current	Accuracy
10 mA	3.5...20.0 mA	0.1 mA	0.35*I $_{\Delta n}$...2.0*I $_{\Delta n}$	$\pm 10\% I_{\Delta n}$
30 mA	10.5...42.0 mA			
100 mA	35...140 mA	1 mA		
300 mA	105...420 mA			
500 mA	175...700 mA			

Measurement can be started from a positive or negative half-period of the input leakage current

Measurement of RCD trip current I_A for residual direct current (type B, B+)

Nominal current	Measuring range	Resolution	Measurement current	Accuracy
10 mA	2.0...20.0 mA	0.1 mA	0.2*I $_{\Delta n}$...2.0*I $_{\Delta n}$	$\pm 10\% I_{\Delta n}$
30 mA	6...60 mA			
100 mA	20...200 mA	1 mA		
300 mA	60...600 mA			
500 mA	100...1000 mA			

Measurement is possible for both a positive or negative input leakage current $I_{\Delta n}$ - nominal value of residual current

"m.v." = "measured value"



The MPI-525 meter enables measurement of the actual tripping time and trip current of an RCD with just one trip.

The instrument meets the requirements set forth in the standards:

- » EN 61010-1 (general and particular requirements related to safety)
- » EN 61010-031 (general and particular requirements related to safety)
- » EN 61326 (electromagnetic compatibility)
- » EN 61557 (requirements for measurement instruments)
- » HD 60364-6 (performance of measurements - checking)
- » HD 60364-4-41 (performance of measurements - shock protection)
- » PN-E 04700 (performance of measurements - commissioning tests)

SONEL MPI-520 / MPI-520 Start

index: WMGBMPI520 (MPI-520) / WMGBMPI520S (MPI-520 Start)



Fault loop impedance measurements:

- » impedance measurement with 23 A current (40 A for phase-to-phase voltage),
- » fault current-limiting resistor: 10 Ω,
- » range of measurement voltages: 95...440 V, frequencies 45...65 Hz,
- » **fault loop impedance measurement with resolution up to 0.01 Ω in systems protected with RCDs not tripping at $I_{\Delta n} \geq 30$ mA,**
- » automatic fault current calculation; differentiation of phase and phase-to-phase voltage,
- » measurements using UNI-Schuko plug with measurement triggering button (including for swapped L and N leads) or 1.2 m, 5 m, 10 m, 20 m test leads, with optional use of three-phase socket adapters (AGT).

Testing of AC, A, F, B and B+ residual current devices:

- » measurement of general, short-time delay and selective RCDs with rated residual currents of 10, 30, 100, 300, 500 and 1000 mA,
- » function of automatic measurement of all RCD parameters (after pressing the "START" button once, the meter performs the entire defined cycle of measurements, including the capability of earth fault loop impedance measurement with 15 mA current),
- » shape of the input leakage current selected by the user: sinusoidal (start from rising or falling edge), unidirectional pulsating (positive or negative), unidirectional pulsating with direct current offset (positive or negative), constant (positive or negative),
- » measurement of tripping current I_{Δ} with rising current,
- » measurement of tripping time t_{Δ} for currents: $0.5 I_{\Delta n}$, $1 I_{\Delta n}$, $2 I_{\Delta n}$ and $5 I_{\Delta n}$,
- » measurement of touch voltage U_B and protective conductor resistance R_E without tripping the RCD,
- » detection of L and N phase swapping in a socket; does not affect measurements,
- » capability of measuring tripping current I_{Δ} as well as actual tripping time t_{Δ} with just one RCD trip,
- » voltage measurements within the range of 95...270 V.

Measurement of insulation resistance:

- » measurement voltages: 50 V, 100 V, 250 V, 500 V, 1000 V,
- » measurement of insulation resistance up to 3 GΩ,
- » capability of in-socket measurement by means of UNI-Schuko adapter,
- » sound signaling of five-second time intervals, facilitating capture of time characteristics,
- » meter protected against the presence of voltage on the object and the appearance of voltage during measurement,
- » automatic discharge of the measured object's capacitance after completion of measurement,
- » automatic measurement of all resistance combinations of 3-, 4- and 5-core cords by means of the optional AutoISO-1000C adapter.

Earth resistance measurements:

- » measurement according to 3-lead technical method with 2 auxiliary electrodes,
- » internal power source with frequency appropriate for 50 Hz or 60 Hz power network (selected in the meter).

Standard accessories of the meter:

WS-03 adapter for triggering measurement (UNI-Schuko plug)	WAADAWS03
L-2 carrying case	WAFUTL2
Red "crocodile" clip 1 kV 20 A	WAKRORE20K02
Yellow "crocodile" clip 1 kV 20 A	WAKROYE20K02
Battery container	WAPQJ1
Test lead with banana plugs; 1 kV; 1.2 m; red	WAPRZ1X2REBB
Test lead with banana plugs; 1 kV; 1.2 m; blue	WAPRZ1X2BUBB
Test lead with banana plugs; 1 kV; 1.2 m; yellow	WAPRZ1X2YEBB
Earthing measurement test lead with banana plugs on reel; 15 m; blue (MPI-520)	WAPRZ015BUBBSZ
Earthing measurement test lead with banana plugs on reel; 30 m; red (MPI-520)	WAPRZ030REBBSZ
USB data transmission cable	WAPRZUSB
2x earth contact test probe (30 cm) (MPI-520)	WASONG30
Test probe with banana socket; 1 kV; red	WASONREOGB1
Test probe with banana socket; 1 kV; blue	WASONBUOGB1
Test probe with banana socket; 1 kV; yellow	WASONYEOGB1
Meter strap (type L-2)	WAPQZSZEKPL
SoneI Reader software	WAPROREADER
Calibration certificate	



The MPI-520 and MPI-520 Start meters enable automatic insulation resistance measurement of 3-, 4- and 5-core cords with optional AutoISO-1000C adapter.

Low-voltage resistance measurement of protective conductors and equipotential bonding:

- » measurement of protective conductor continuity with current ≥ 200 mA in two directions (according to standard EN 61557-4),
- » low-current measurement with sound signaling,
- » automatic calibration of test leads - leads of any length can be used.

Additional functions of the meters:

- » measurement of voltage, frequency and - additionally with a clamp - alternating current, $\cos\phi$ and power (active, reactive, apparent).
- » quick check of correct connection of PE conductor by means of contact electrode.
- » check of phase sequence.
- » memory storing up to 990 records (57,500 individual results), data transmission to PC via USB,
- » power supply from batteries or rechargeable batteries (optional), built-in quick charger.

Other technical specifications:

- » type of insulation double, as per EN 61010-1 and EN 61557
- » power supply of the meter alkaline batteries (4 pcs.)
- or Ni-MH rechargeable battery (optional)
- » operating temperature range 0...+50°C



MPI-520 and MPI-520 Start enable measurements in sockets with swapped L and N conductors.

Measurement of fault loop impedance Z_{L-PE} , Z_{L-N} , Z_{L-L}

Measurement with 23/40 A current - measuring range according to EN 61557-3: 0.13...1999 Ω (for 1.2 m test lead):

Display range	Resolution	Accuracy
0.00...19.99 Ω	0.01 Ω	$\pm(5\% \text{ m.v.} + 3 \text{ digits})$
20.0...199.9 Ω	0.1 Ω	
200...1999 Ω	1 Ω	

Nominal voltage: 95...270 V (for Z_{L-PE} and Z_{L-N}) or 95...440 V (for Z_{L-L})
Frequency: 45...65 Hz

Measurement of the Z_{L-PE} fault loop impedance in the RCD mode

Measurement with 15 mA current, measuring range according to EN 61557-3: 0.50...1999 Ω

Display range	Resolution	Accuracy
0.00...19.99 Ω	0.01 Ω	$\pm(6\% \text{ m.v.} + 10 \text{ digits})$
20.0...199.9 Ω	0.1 Ω	$\pm(6\% \text{ m.v.} + 5 \text{ digits})$
200...1999 Ω	1 Ω	

Rated voltage: 95...270 V
Frequency: 45...65 Hz

Earth resistance R_E measurement

Measuring range according to EN 61557-5:
0.50 Ω ...1.99 k Ω for 50 V measurement voltage
0.56 Ω ...1.99 k Ω for 25 V measurement voltage

Display range	Resolution	Accuracy
0.00...9.99 Ω	0.01 Ω	$\pm(2\% \text{ m.v.} + 4 \text{ digits})$
10.0...99.9 Ω	0.1 Ω	$\pm(2\% \text{ m.v.} + 3 \text{ digits})$
100...999 Ω	1 Ω	
1.00...1.99 k Ω	0.01 k Ω	

Measurement of insulation resistance

Measuring range according to EN 61557-2:
for $U_n = 50 \text{ V}$: 50 k Ω ...250 M Ω for $U_n = 500 \text{ V}$: 500 k Ω ...2.00 G Ω
for $U_n = 100 \text{ V}$: 100 k Ω ...500 M Ω for $U_n = 1000 \text{ V}$: 1000 k Ω ...3.00 G Ω
for $U_n = 250 \text{ V}$: 250 k Ω ...999 k Ω

Display range *	Resolution	Accuracy
0...1999 k Ω	1 k Ω	$\pm(3\% \text{ m.v.} + 8 \text{ digits})$
2.00...19.99 M Ω	0.01 M Ω	
20.0...199.9 M Ω	0.1 M Ω	
200...999 M Ω	1 M Ω	
1.00...3.00 G Ω	0.01 G Ω	$\pm(4\% \text{ m.v.} + 6 \text{ digits})$

** no greater than the measuring range for a given voltage.

** an additional error of $\pm 2\%$ is present in measurements when the UNI-Schuko plug is used.

Low-voltage measurement of circuit continuity and resistance

Testing of protective conductor continuity with $\pm 200 \text{ mA}$ current measuring range according to EN 61557-4: 0.12...400 Ω

Display range	Resolution	Accuracy
0.00...19.99 Ω	0.01 Ω	$\pm(2\% \text{ m.v.} + 3 \text{ digits})$
20.0...199.9 Ω	0.1 Ω	
200...400 Ω	1 Ω	

- » Voltage on open terminals: 4...9 V
- » Output current at $R < 2 \Omega$: min. 200 mA
- » Automatic calibration of test leads
- » Measurements for both current polarities

Indication of phase sequence

- » Indication of phase sequence: compliant, non-compliant
- » U_{L-L} power system voltage range: 95...500 V (45...65 Hz)
- » Display of phase-to-phase voltage values

Measurement of alternating voltage and current, $\cos\phi$ and power

- » Power measurement P, Q, S: 0...200k (W, var, VA).
- » Measurement of alternating current (True RMS) using clamp (0...400 A), max. resolution 0.1 mA
- » Measurement of voltage U_{L-N} : 0...500 V
- » Frequency range of measured voltages: 45.0...65.0 Hz
- » Frequency measurement for voltages 50...500 V within the range of 45.0...65.0 Hz (Accuracy to a maximum of $\pm 0.1\% \text{ m.v.} + 1 \text{ digit}$)
- » $\cos\phi$ measurement: 0.00...1.00 (resolution 0.01)



The MPI-520 and MPI-520 Start meters are two of the few meters capable of accurately measuring fault loop impedance, including in L-PE loops, in networks equipped with residual current devices (measurement with 15 mA current).

Measurements of RCD parameters (working voltage range 95...270 V):

RCD trip test and measurement of tripping time t_A (for t_A measurement function)

RCD mode	Factor	Range	Resolution	Accuracy
General and short-time delay	$0.5 \cdot I_{\Delta n}$	0...300 ms	1 ms	$\pm(2\% \text{ m.v.} + 2 \text{ digits})$ (for RCD of $I_{\Delta n} = 10 \text{ mA}$ and the measurement $0.5 \cdot I_{\Delta n}$ error: $\pm(2\% \text{ m.v.} + 3 \text{ digits})$)
	$1 \cdot I_{\Delta n}$			
	$2 \cdot I_{\Delta n}$	0...150 ms		
Selective	$5 \cdot I_{\Delta n}$	0...40 ms		
	$0.5 \cdot I_{\Delta n}$	0...500 ms		
	$1 \cdot I_{\Delta n}$			
	$2 \cdot I_{\Delta n}$	0...200 ms		
	$5 \cdot I_{\Delta n}$	0...150 ms		

Residual current input accuracy: for $0.5 \cdot I_{\Delta n}$ -8...0%
for $1 \cdot I_{\Delta n}$, $2 \cdot I_{\Delta n}$, $5 \cdot I_{\Delta n}$ 0...8%

Measurement of RCD trip current I_A for sinusoidal residual current (AC type)

Nominal current	Measuring range	Resolution	Measurement current	Accuracy
10 mA	3.3...10.0 mA	0.1 mA	$0.3 \cdot I_{\Delta n}$... $1.0 \cdot I_{\Delta n}$	$\pm 5\% I_{\Delta n}$
30 mA	9.0...30.0 mA			
100 mA	30...100 mA	1 mA		
300 mA	90...300 mA			
500 mA	150...500 mA			
1000 mA	300...1000 mA			

Measurement can be started from the positive or negative half-period of the input leakage current (AC)

Measurement of RCD trip current I_A for uni-directional residual current and uni-directional current with 6 mA direct current offset (type A, F)

Nominal current	Measuring range	Resolution	Measurement current	Accuracy
10 mA	3.5...20.0 mA	0.1 mA	$0.35 \cdot I_{\Delta n}$... $2.0 \cdot I_{\Delta n}$	$\pm 10\% I_{\Delta n}$
30 mA	10.5...42.0 mA			
100 mA	35...140 mA	1 mA		
300 mA	105...420 mA			
500 mA	175...700 mA			

Measurement can be started from a positive or negative half-period of the input leakage current

Measurement of RCD trip current I_A for residual direct current (type B, B+)

Nominal current	Measuring range	Resolution	Measurement current	Accuracy
10 mA	2.0...20.0 mA	0.1 mA	$0.2 \cdot I_{\Delta n}$... $2.0 \cdot I_{\Delta n}$	$\pm 10\% I_{\Delta n}$
30 mA	6...60 mA			
100 mA	20...200 mA	1 mA		
300 mA	60...600 mA			
500 mA	100...1000 mA			

Measurement is possible for both a positive or negative input leakage current $I_{\Delta n}$ - nominal value of residual current

"m.v." = "measured value"



The MPI-520 and MPI-520 Start meters enable measurement of the actual tripping time and trip current of an RCD with just one trip.

The instrument meets the requirements set forth in the standards:

- » EN 61010-1 (general and particular requirements related to safety)
- » EN 61010-031 (general and particular requirements related to safety)
- » EN 61326 (electromagnetic compatibility)
- » EN 61557 (requirements for measurement instruments)
- » HD 60364-6 (performance of measurements - checking)
- » HD 60364-4-41 (performance of measurements - shock protection)
- » PN-E 04700 (performance of measurements - commissioning tests)

SONEL MPI-502

index: WMGBMPI502

- CAT III
- 600 V
- CAT IV
- 300 V
- IP67
- BLUETOOTH



MPI-502 is the smallest multi-function meter on the market.

Measurement of fault loop parameters:

- » fault loop impedance measurement in networks with rated voltages: 220/380 V, 230/400 V, 240/415 V with frequencies of 45...65 Hz, operating voltage range: 180...460 V,
- » readings of fault loop resistance R and fault loop reactance X,
- » **measurement of fault loop impedance with 15 mA current without tripping residual current devices,**
- » maximum measurement current: 7.6 A (at 230 V), 13.3 A (at 400 V).

Testing of AC and A residual current devices:

- » measurement of no-delay, short-time delay and selective RCDs with nominal residual currents of 10, 30, 100, 300 and 500 mA,
- » measurement of trip current $I_{\Delta n}$ and tripping time t_A for currents of $0.5 I_{\Delta n}$, $1 I_{\Delta n}$, $2 I_{\Delta n}$, $5 I_{\Delta n}$
- » measurement of R_E and U_B without RCD tripping,
- » expanded AUTO function for RCD measurement, with capability of measuring Z_{L-PE} with low current,
- » measurement of I_A and t_A in one RCD trip.

Resistance measurement of protective conductors and equipotential bonding:

- » testing of the continuity of protective conductors with current ± 200 mA according to standard EN 61557-4,
- » automatic calibration of test leads - any leads can be used,
- » low-current resistance measurement with sound signaling.

Additional functions of the meter:

- » Detection of L and N phase swapping in a socket and automatic unswapping.
- » Check of correct connection of PE conductor by means of contact electrode.
- » Measurement of network voltage (0...500 V) and frequency.
- » Power supply from LR6 batteries, NiMH rechargeable batteries can optionally be applied.
- » Memory storing up to 990 results, wireless data transmission to computer.
- » Backlit keyboard.

MPI-502 meets the requirements set forth in standards:

- » EN 61010-1 (general and particular requirements related to safety)
- » EN 61010-031 (general and particular requirements related to safety)
- » EN 61326 (electromagnetic compatibility)
- » EN 61557 (requirements for measurement instruments)
- » HD 60364-6 (performance of measurements - checking)
- » HD 60364-4-41 (performance of measurements - shock protection)
- » PN-E 04700 (performance of measurements - commissioning tests)



MPI-502 enables measurements in sockets with swapped L and N conductors.

SONEL MPI MOBILE



A mobile version of the program cooperating with a multifunctional Sonei instrument: MPI-530-IT / MPI-530 / MPI-502 meters of electrical system parameters. It can be downloaded from the www.sonei.pl/en website or by scanning the QR code placed above.

Standard accessories of the meter:

WS-05 adapter (UNI-Schuko angle plug)	WAADAWS05
M-6 carrying case	WAFUTM6
Yellow "crocodile" clip 1 kV 20 A	WAKROYE20K02
Test lead with banana plugs; 1 kV; 1.2 m; red	WAPRZ1X2REBB
Test lead with banana plugs; 1 kV; 1.2 m; blue	WAPRZ1X2BUBB
Test lead with banana plugs; 1 kV; 1.2 m; yellow	WAPRZ1X2YEBB
Test probe with banana socket; 1 kV; red	WASONREOGB1
Test probe with banana socket; 1 kV; blue	WASONBUOGB1
Meter strap (type M-1)	WAPOZSZE4
M-1 housing holder - hanger	WAPOZUCH1
Sonei MIC Mobile	
Sonei Reader software	WAPROREADER
Calibration certificate	

Measurement of fault loop impedance Z_{L-PE} , Z_{L-N} , Z_{L-L}

Measurement with 7.6/13.3 A current - measuring range according to EN 61557-3: 0.13...1999 Ω :

Display range	Resolution	Accuracy
0.00...19.99 Ω	0.01 Ω	±(5% m.v. + 3 digits)
20.0...199.9 Ω	0.1 Ω	
200...1999 Ω	1 Ω	

Measurement of earth fault loop impedance Z_{L-PE} in RCD mode

Measurement with 15mA current, measuring range according to EN 61557-3: 0.50...1999 Ω

Display range	Resolution	Accuracy
0.00...19.99 Ω	0.01 Ω	±(6% m.v. + 10 digits)
20.0...199.9 Ω	0.1 Ω	
200...1999 Ω	1 Ω	±(6% m.v. + 5 digits)

Measurements of RCD parameters (operating voltage range 180...270 V):

RCD trip test and measurement of tripping time t_A (for t_A measurement function)

RCD mode	Factor	Range	Resolution	Accuracy
General and short-time delay	$0.5^* I_{\Delta n}$	0...300 ms	1 ms	±(2% m.v. + 2 digits)
	$1^* I_{\Delta n}$			
	$2^* I_{\Delta n}$	0...150 ms		
Selective	$5^* I_{\Delta n}$	0...40 ms		
	$0.5^* I_{\Delta n}$	0...500 ms		
	$1^* I_{\Delta n}$			
	$2^* I_{\Delta n}$	0...200 ms		
	$5^* I_{\Delta n}$	0...150 ms		

Measurement of RCD trip current I_A for sinusoidal residual current

Nominal current	Measuring range	Resolution	Measurement current	Accuracy
10 mA	3.0...10.0 mA	0.1 mA	$0.3^* I_{\Delta n}$... $1.0^* I_{\Delta n}$	±5% $I_{\Delta n}$
30 mA	9.0...30.0 mA			
100 mA	30...100 mA			
300 mA	90...300 mA	1 mA		
500 mA	150...500 mA			

- » Measurement can be started from the positive or negative half-period of the input current

Measurement of RCD trip current I_A for uni-directional pulsating residual current

Nominal current	Measuring range	Resolution	Measurement current	Accuracy
10 mA	4.0...20.0 mA	0.1 mA	$0.35^* I_{\Delta n}$... $2.0^* I_{\Delta n}$	±10% $I_{\Delta n}$
30 mA	12.0...42.0 mA			
100 mA	40...140 mA	1 mA		
300 mA	120...420 mA			

- » Measurement for positive or negative half-periods of the input leakage current

SONEL MRP-201

index: WMGBMRP201



- CAT III**
- 600 V**
- CAT IV**
- 300 V**
- IP67**

Testing RCD breakers of AC, A and B types:

- » testing of general, short delay and selective RCDs for the rated current values $I_{\Delta n} = 10, 30, 100, 300, 500$ mA,
- » measurement of triggering current I_A and trip time t_A for currents $0.5 I_{\Delta n}, 1 I_{\Delta n}, 2 I_{\Delta n}, 5 I_{\Delta n}$
- » simultaneous measurement of triggering current I_A and trip time t_A
- » measurement of R_E and U_B without RCD tripping,
- » AUTO RCD test function (automatic measurement of subsequent selected parameters without triggering),
- » automatic measurement for all current shapes for RCDs of type AC, A and B.



MRP-201 measures all kinds of RCDs (general, short delay, selective - type AC, A, B).

Additional functions of the meter:

- » measurement of AC voltage and frequency,
- » checking the correctness of the connection of PE conductor,
- » memory of measurement results (990 cells, 10 000 entries),
- » communication with PC using OR-1 radio interface,
- » backlit keyboard.

The instrument meets the requirements set forth in the standards:

- » EN 61010-1 (general and particular requirements related to safety)
- » EN 61010-031 (general and particular requirements related to safety)
- » EN 61326 (electromagnetic compatibility)
- » EN 61557 (requirements for measurement instruments)
- » HD 60364-6 (performance of measurements - checking)
- » HD 60364-4-41 (performance of measurements - shock protection)
- » PN-PN-E 04700 (performance of measurements - commissioning tests)



MRP-201 has two kinds of automatic measurement mode, especially useful when measuring type A and B circuit breakers.

Other technical specifications:

- » type of insulation double, as per EN 61010-1 and EN 61557
- » power supply alkaline batteries (AA, 4 pcs) or rechargeable batteries set (option)
- » weight 0.7 kg
- » dimensions 220 x 98 x 58 mm

Nominal operating conditions:

- » operating temperature -10...+50°C
- » storage temperature -20...+70°C

Standard accessories of the meter:

WS-05 adapter with UNI-SCHUKO angular plug	WAADAWS05
M6 carrying case	WAFUTM6
Crocodile clip, yellow, 1 kV, 20 A	WAKROYE20K02
Test lead 1,2 m, red, 1 kV (banana plugs)	WAPRZ1X2REBB
Test lead 1,2 m, blue, 1 kV (banana plugs)	WAPRZ1X2BUBB
Test lead 1,2 m, yellow, 1 kV (banana plugs)	WAPRZ1X2YEBB
Pin probe, red 1 kV (banana socket)	WASONREOGB1
Pin probe, blue 1 kV (banana socket)	WASONBUOGB1
M1 hanging straps	WAPOZSZE4
4 x R6 battery	
Calibration certificate	

RCD trigger test and response time measurement t_A

Measurement range according to IEC 61557:

0 ms...to the upper limit of the displayed value

RCD type	Rated current multiplication factor	Range	Resolution	Accuracy
General or short delay	0.5 $I_{\Delta n}$	0...300 ms	1 ms	$\pm(2\% \text{ m.v.} + 2 \text{ digits})$
	1 $I_{\Delta n}$			
	2 $I_{\Delta n}$	0...150 ms		
	5 $I_{\Delta n}$	0...40 ms		
Selective	0.5 $I_{\Delta n}$	0...500 ms		
	1 $I_{\Delta n}$	0...200 ms		
	5 $I_{\Delta n}$	0...150 ms		

- » residual current setting accuracy:
for 1 $I_{\Delta n}$, 2 $I_{\Delta n}$ and 5 $I_{\Delta n}$: 0...8%;
for 0.5 $I_{\Delta n}$: -8...0%,
- » operating voltage range: 180...270 V
- » operating frequency range: 45...65 Hz

RCD tripping current I_A for sine AC current

Measurement range acc. to IEC 61557-6: $(0.3...1.0)I_{\Delta n}$

Selected rated RCD current	Range	Resolution	Measuring current	Accuracy
10 mA	3.0...10.0 mA	0.1 mA	$0.3 I_{\Delta n} \dots 1.0 I_{\Delta n}$	$\pm 5\% I_{\Delta n}$
30 mA	9.0...30.0 mA			
100 mA	30...100 mA	1 mA		
300 mA	90...300 mA			
500 mA	150...500 mA			

- » start of the measurement from the positive or negative half sine period of the test current
- » test current flow time at $f = 50.0$ Hz max. 7510 ms

Measurement of RCD tripping current I_A for unidirectional pulsed residual current and unidirectional pulsed current with a 6 mA DC offset

Measurement range acc. to IEC 61557-6:

$(0.15...1.4)I_{\Delta n}$ for $I_{\Delta n} > 30$ mA

$(0.15...2)I_{\Delta n}$ for $I_{\Delta n} = 10$ mA

Selected rated RCD current	Range	Resolution	Measuring current	Accuracy
10 mA	1.5...20.0 mA	0.1 mA	$0.15 I_{\Delta n} \dots 2.0 I_{\Delta n}$	$\pm 10\% I_{\Delta n}$
30 mA	4.5...42.0 mA			
100 mA	15...140 mA	1 mA		
300 mA	45...420 mA			

- » start of the measurement from the positive or negative half sine period of the test current
- » test current flow time at $f = 50.0$ Hz max. 14 710 ms

RCD tripping current I_A for the residual DC current

Measurement range acc. to IEC 61557-6: $(0.2...2)I_{\Delta n}$

Selected rated RCD current	Range	Resolution	Measuring current	Accuracy
10 mA	2.0...20.0 mA	0.1 mA	$0.2 I_{\Delta n} \dots 2.0 I_{\Delta n}$	$\pm 10\% I_{\Delta n}$
30 mA	6...60 mA			
100 mA	20...200 mA	1 mA		
300 mA	60...600 mA			

- » Measurement possible for positive or negative residual current
- » test current flow time at $f=50.0$ Hz max. 4500 ms.

MPI / MRP

Set of standard and optional accessories

1, 2, 4 - number of basic accessories
- - optional accessories

Photo	Name	Index	MPI-540	MPI-535	MPI-530/530-IT	MPI-525	MPI-520	MPI-520 Start	MPI-502	MRP-201
	AGT-16C three-phase socket adapter 16 A	WAADAAGT16C	•	•	•	•	•	•	•	•
	AGT-16P three-phase socket adapter 16 A	WAADAAGT16P	•	•	•	•	•	•	•	•
	AGT-16T industrial socket adapter 16 A	WAADAAGT16T	•	•	•	•	•	•	•	•
	AGT-32C three-phase socket adapter 32 A	WAADAAGT32C	•	•	•	•	•	•	•	•
	AGT-32P three-phase socket adapter 32 A	WAADAAGT32P	•	•	•	•	•	•	•	•
	AGT-32T industrial socket adapter 32 A	WAADAAGT32T	•	•	•	•	•	•	•	•
	AGT-63P three-phase socket adapter 63 A	WAADAAGT63P	•	•	•	•	•	•	•	•
	adapter AUTO ISO-1000C	WAADAAISO10C	•	•	•			•	•	
	AutoISO-2500 adapter	WAADAAISO25				•				
	Voltage adapter with M4/M6 thread	WAADAM4M64	1							
	AC-16 line splitter	WAADAAC16			•		•	•		
	TWR-1J - RCD breaker testing adapter	WAADATWR1J	•	•	•	•	•	•	•	•
	WS-01 adapter with START button with UNI-Schuko plug	WAADAWS01							•	•
	WS-03 adapter with START button with UNI-Schuko plug	WAADAWS03	1	1	1	1	1	1		
	WS-04 adapter with START button with UNI-Schuko plug	WAADAWS04	•	•	•	•	•	•		
	WS-05 adapter with START button with UNI-Schuko plug	WAADAWS05							1	1
	WS-06 adapter	WAADAWS06	•	•						
	AZ-2 power supply adapter (IEC C7 plug/banana connectors)	WAADAAZ2	•	•						

Photo	Name	Index	MPI-540	MPI-535	MPI-530/530-IT	MPI-525	MPI-520	MPI-520 Start	MPI-502	MRP-201
	Li-Ion battery 11,1 V 3,4 Ah	WAAKU15	1	1						
	NiMH battery 4,8 V 4,2 Ah	WAAKU07			1	1	•	•		
	F-1A flexible clamps (Φ=360 mm)	WACEGF1AOKR	•	•						
	F-2A flexible clamps (Φ=235 mm)	WACEGF2AOKR	•	•						
	F-3A flexible clamps (Φ=120 mm)	WACEGF3AOKR	1	•						
	N-1 transmitting clamps (Φ=52 mm)	WACEGN1BB	•	•	•					
	C-3 current clamps (Φ=52 mm)	WACEGC3OKR	•	•	•		•	•		
	C-4A current clamps (Φ=52 mm)	WACEGC4AOKR	•	•						
	C-5A current clamps (Φ=39 mm)	WACEGC5AOKR	•	•						
	C-6A current clamps (Φ=20 mm)	WACEGC6AOKR	•	•	•					
	C-7A current clamps (Φ=24 mm)	WACEGC7AOKR	•	•						
	L2 carrying case	WAFUTL2	1	1	1	1	1			
	L3 carrying case for a 80 cm rods	WAFUTL3			•	•	•	•		
	L4 carrying case	WAFUTL4								1
	M6 carrying case	WAFUTM6								1
	S4 carrying case	WAFUTS4			•					
	MPI-520 charging set (charger + battery)	WAKPLADMPI520			•	•	•	•		

MPI / MRP

Set of standard and optional accessories

1, 2, 4 - number of basic accessories
 - - optional accessories

Photo	Name	Index	MPI-540	MPI-535	MPI-530/530-IT	MPI-525	MPI-520	MPI-520 Start	MPI-502	MRP-201
	Crocodile clip, black, 11 kV, 32 A	WAKROBL32K09				1				
	Crocodile clip, red, 1 kV, 20 A	WAKRORE20K02			1	•	1	1	•	•
	Crocodile clip, red, 11 kV, 32 A	WAKRORE32K09				•				
	Crocodile clip, blue, 1 kV, 20 A	WAKROBU20K02			1	•	•	•	•	•
	Crocodile clip, yellow, 1 kV, 20 A	WAKROYE20K02			1	1	1	1	1	1
	Mini bluetooth keyboard	WAADAMK			1					
	Mini bluetooth keyboard with armband case	WAADAMKZ			•					
	OR-1 USB wireless receiver	WAADAUSBOR1				•	•	•		•
	Battery container	WAPOJ1			•	•	1	1		
	PC software: Sonel Reader	WAPROREADER	1	1	1	1	1	1	1	1
	Test lead 1,2 m, red, 1 kV (banana plugs)	WAPRZ1X2REBB	1	1	1	1	1	1	1	1
	Test lead 1,2 m, blue, 1 kV (banana plugs)	WAPRZ1X2BUBB	1	1	1	1	1	1	1	1
	Test lead 1,2 m, yellow, 1 kV (banana plugs)	WAPRZ1X2YEBB	1	1	1	1	1	1	1	1
	Test lead 1,2 m, black, 1 kV (banana plugs)	WAPRZ1X2BLBB	1	1						
	Test lead 1,8 m, black, 5 kV (banana plugs, shielded)	WAPRZ1X8BLBB				1				
	Test lead 1,8 m, red, 5 kV (banana plugs)	WAPRZ1X8REBB				1				
	Test lead 10 m, red, 1 kV (banana plugs)	WAPRZ010REBB	•	•	•	•	•	•	•	•
	Test lead 15 m, blue (on a reel)	WAPRZ015BUBBSZ	1	1	1	1	1	•		

Photo	Name	Index	MPI-540	MPI-535	MPI-530/530-IT	MPI-525	MPI-520	MPI-520 Start	MPI-502	MRP-201
	Test lead 25 m, blue (banana plugs, on a reel)	WAPRZ025BUBBSZ	•	•						
	Test lead 30 m, red (banana plugs, on a reel)	WAPRZ030REBBSZ	1	1						
	Test lead 50 m, yellow (banana plugs, on a reel)	WAPRZ050YEBBSZ	•	•						
	Test lead 20 m, red, 1 kV (banana plugs)	WAPRZ020REBB	•	•	•	•	•	•	•	•
	Test lead 30 m, red (banana plugs, on a reel)	WAPRZ030REBBSZ			1	1	1	•		
	Test lead 5 m, red, 1 kV (banana plugs)	WAPRZ005REBB	•	•	•	•	•	•	•	•
	Cable for battery charging from car cigarette lighter socket (12 V)	WAPRZLAD12SAM	1	1	1	•	•	•		
	USB cable	WAPRZUSB	1	1	1	1	1	1		
	Mains cable with IEC C7 plug	WAPRZLAD230	1	1	1	1	•	•		
	CS-5kV calibration box	WAADACS5KV				•				
	PRS-1 resistance test probe	WASONPRS1GB			•	•	•	•		
	Earth contact test probe (rod), 30 cm	WASONG30	2	2	2	2	2	•		
	Earth contact test probe (rod), 80 cm	WASONG80	•	•	•	•	•	•		
	LP-1 light meter probe (MiniDIN-4P plug)	WAADALP1	•	•						
	LP-1 light meter probe for MPI (set, WS-06 plug)	WAADALP1KPL	•	•						
	LP-10A light meter probe (MiniDIN-4P plug)	WAADALP10A	•	•						

1, 2, 4 - number of basic accessories
 - - optional accessories

Photo	Name	Index	MPI-540	MPI-535	MPI-530/530-IT	MPI-525	MPI-520	MPI-520 Start	MPI-502	MRP-201
	LP-10A light meter probe for MPI (set, WS-06 plug)	WAADALP10AKPL	•	•						
	LP-10B light meter probe (MiniDIN-4P plug)	WAADALP10B	•	•						
	LP-10B light meter probe for MPI (set, WS-06 plug)	WAADALP10BKPL	•	•						
	Pin probe, black 5 kV (banana socket)	WASONBLOGB2				•				
	Foldable pin probe, 1 kV, 2 m (banana socket)	WASONSP2M			•	•	•	•	•	•
	Pin probe, red 1 kV (banana socket)	WASONREOGB1	1	1	1	1	1	1	1	1
	Pin probe, red 5 kV (banana socket)	WASONREOGB2				1				
	Pin probe, blue 1 kV (banana socket)	WASONBUOGB1	1	1	1	1	1	1	1	•
	Pin probe, yellow 1 kV (banana socket)	WASONYEGB1	1	1	1	1	1	•	•	•
	Crocodile clip, black, 1 kV, 20 A	WAKROBL20K02	1	1						
	Crocodile clip, red, 1 kV, 20 A	WAKRORE20K02	1	1						

Photo	Name	Index	MPI-540	MPI-535	MPI-530/530-IT	MPI-525	MPI-520	MPI-520 Start	MPI-502	MRP-201
	Crocodile clip, blue, 1 kV, 20 A	WAKROBU20K02	1	1						
	Crocodile clip, yellow, 1 kV, 20 A	WAKROYE20K02	1	1						
	CS-1 cable simulator	WAADACS1			•	•	•	•		
	L2 hanging straps (short)	WAPOZSZE2								
	L2 hanging straps (set)	WAPOZSZEKPL	1	1	1	1	1	1		
	M1 hanging straps	WAPOZSZE4							1	1
	Test wire reel	WAPOZSZP1			•	•	•	•		
	M1 hanging hook straps	WAPOZUCH1								1
	Cramp	WAZACIMA1			•	•	•	•		
	Z7 Power supply	WAZASZ7	1	1	1	1	•	•		



Insulation resistance meters

MIC-10s1
MIC-10k1
MIC-05s1
MIC-5050

MIC-5010
MIC-5005
MIC-5001
MIC-2501

MIC-30
MIC-10

Comparison of insulation resistance meters

												
	MIC-10s1 MIC-10k1	MIC-05s1 MIC-5050	MIC-5010	MIC-5005	MIC-5001	MIC-2501	MIC-30	MIC-10	MPI-540 MPI-535	MPI-530-IT MPI-530	MPI-525	MPI-520 MPI-520 Start
Measurement voltage [V]	50...10 000	50...5000	50...5000	50...5000	50...5000	100...2500	50...1000	50, 100, 250, 500, 1000	50, 100, 250, 500, 1000	50, 100, 250, 500, 1000	50, 100, 250, 500, 1000, 2500	50, 100, 250, 500, 1000
Measuring range	10 kΩ...40 TΩ	20 kΩ...20 TΩ	20 kΩ...15 TΩ	20 kΩ...15 TΩ	50 kΩ...5 TΩ	50 kΩ...2 TΩ	50 kΩ...100 GΩ	50 kΩ...10 GΩ	50 kΩ...9,99 GΩ	50 kΩ...9,99 GΩ	50 kΩ...9,99 GΩ	50 kΩ...3 GΩ
Setting of 3 measurement times *	1...600 s	1...600 s	1...600 s	1...600 s	1...600 s	1...600 s	1...600 s	–	–	–	1...600 s	–
Maximum setting of measurement time	99'59"	99'59"	99'59"	99'59"	10'	10'	10'	–	–	–	5'	–
Measurement of insulation resistance using the three-terminal method	✓	✓	✓	✓	✓	✓	✓	✓	–	–	–	–
Measurement of 2 absorption coefficients	✓	✓	✓	✓	✓	✓	✓	–	–	–	✓	–
Measurement of leakage current during insulation resistance measurement	✓	✓	✓	✓	✓	✓	✓	–	–	–	–	–
Automatic discharging of object after measurement	✓	✓	✓	✓	✓	✓	✓	✓	✓	✓	✓	✓
Built-in quick charger	✓	✓	✓	✓	✓	✓	–	–	✓	✓	✓	✓
Power supply	rechargeable battery	rechargeable battery	rechargeable battery	rechargeable battery	rechargeable battery	rechargeable battery	AA batteries or rechargeable batteries	AA batteries or rechargeable batteries	rechargeable battery	rechargeable battery or batteries	rechargeable battery or batteries	batteries or rechargeable batteries
Low-voltage resistance measurement	–	–	–	–	–	–	✓	✓	✓	✓	✓	✓
Continuity test with current $\geq 200\text{mA}$ (resolution 0.01Ω)	–	–	✓	–	–	✓	✓	✓	✓	✓	✓	✓
Automatic measurement of 3-, 4- and 5-core cords by means of AutoISO-2500 adapter	✓	✓	–	–	–	–	–	–	–	✓	✓	✓
Automatic measurement of 3-, 4- and 5-core cables by means of AutoISO5000 adapter	✓	✓	–	–	–	–	–	–	–	–	✓	–
Voltage measurement	0...750 V	0...750 V	0...600 V	0...600 V	0...750 V	0...750 V	0...600 V	0...600 V	0...500 V	0...500 V	0...500 V	0...500 V
Temperature measurement	✓	✓	–	–	–	–	–	–	–	–	–	–
Plotting of insulation resistance and leakage current characteristics	✓	✓	–	–	✓	✓	–	–	–	–	–	–
Automatic in-socket measurement	–	–	–	–	–	–	✓	–	✓	✓	–	✓
Capacitance measurement	✓	✓	✓	✓	–	–	✓	✓	–	–	–	–
Memory (number of records)	10 000	10 000	990	990	990	990	990	–	UNLIMITED	10 000	990	990
Data transmission	USB, Bluetooth	USB, Bluetooth	USB, Bluetooth	USB, Bluetooth	USB	USB	Bluetooth	–	USB, Bluetooth	USB, Bluetooth	USB, Bluetooth	USB, Bluetooth
Dimensions [mm]	390 x 310 x 170	390 x 310 x 170	390 x 310 x 170	390 x 310 x 170	200 x 180 x 77	200 x 180 x 77	200 x 150 x 60	220 x 100 x 60	288 x 223 x 75	295 x 223 x 75	288 x 223 x 75	288 x 223 x 75
Weight [kg]	5.6	5.6	5.6	5.6	0.9	0.9	0.6	0.6	2.5	2.2	2.2	2.2

* - for calculation of Ab1, Ab2, PI, DAR

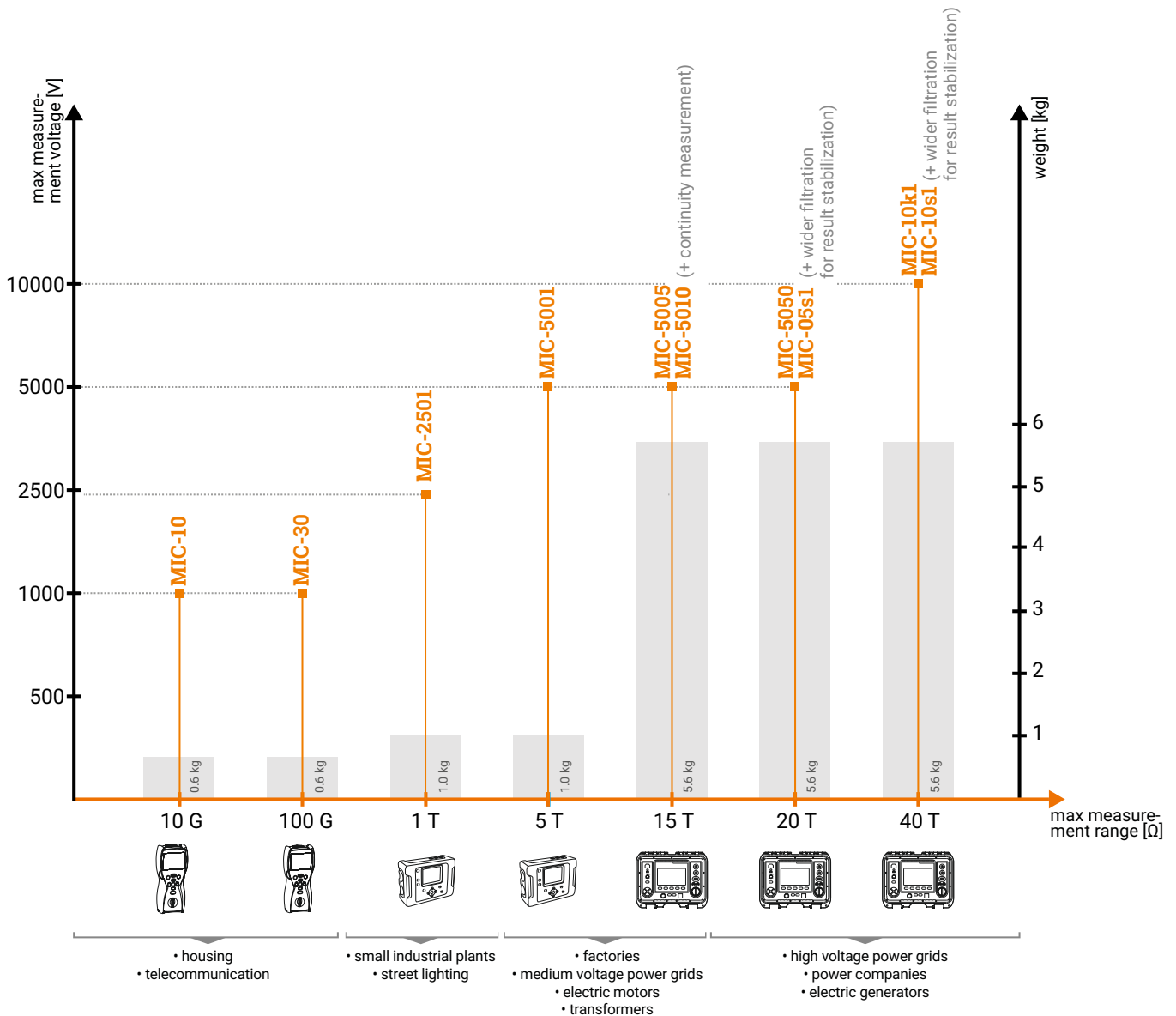

In addition to specific meters you can also purchase:

Probe for measurement of floor and wall resistances

SONEL PRS-1

index: WASONPRS1GB



Insulation resistance measurements:

- » Sonel PRS-1 tripod measuring probe, with the shape of an equilateral triangle, has been manufactured according to the guidelines given in standards HD 60364-6 and EN 1081.
- » optional for MIC and MPI meters

Adapter for measuring insulation resistance

SONEL AutoISO-5000

index: WAADAAISO50



Insulation resistance measurements:

- » insulation measurement of 3-, 4- and 5-wire cables and wires using test voltage up to 5 kV
- » optional for MIC-10s1, MIC-10k1, MIC-05s1, MIC-5050

SONEL MIC-10s1 / MIC-10k1 / MIC-05s1 / MIC-5050

index: WMGBMIC10S1 / WMGBMIC10K1 / WMGBMIC05S1 / WMGBMIC5050



Standard accessories of the meters:

L4 carrying case	WAFUTL4
Crocodile clip, black, 11 kV, 32 A	WAKROBL32K09
Crocodile clip, red, 11 kV, 32 A	WAKRORE32K09
Crocodile clip, blue, 11 kV, 32 A	WAKROBU32K09
PC software: Sonel Reader	WAPROREADER
Test lead 3 m, black, 11 kV (banana plugs, shielded)	WAPRZ003BLBBE10K
Test lead 3 m, red, 11 kV (banana plugs)	WAPRZ003REBB10K
Test lead 3 m, blue, 11 kV (banana plugs)	WAPRZ003BUBB10K
USB cable	WAPRZUSB
Mains cable with IEC C13 plug	WAPRZ1X8BLIEC
Temperature probe ST-1	WASONT1
Calibration certificate	

Measurement of insulation resistance

Measuring range in compliance with EN 61557-2:

$$R_{ISOmin} = \frac{U_{ISOonom}}{I_{ISOmax}} = 5 \text{ M}\Omega \dots 40 \text{ T}\Omega \quad (I_{ISOmax} = 1.2 \text{ mA, 3 mA or } (6 \pm 15\%) \text{ mA})$$

Display range	Resolution	Accuracy
0...999 kΩ	1 kΩ	±(3% m.v. + 10 digits)
1.00...9.99 MΩ	0.01 MΩ	
10.0...99.9 MΩ	0.1 MΩ	
100...999 MΩ	1 MΩ	
1.00...9.99 GΩ	0.01 GΩ	±(3.5% m.v. + 10 digits)
10.0...99.9 GΩ	0.1 GΩ	
100...999 GΩ	1 GΩ	±(7.5% m.v. + 10 digits)
1.00...9.99 TΩ	0.01 TΩ	
10.0...20.0 TΩ*	0.1 TΩ	±(12.5% m.v. + 10 digits)
10.0...40.0 TΩ**		

* - only MIC-05s1 / MIC-5050

** - only MIC-10s1 / MIC-10k1

Values of measured resistance depending on measuring voltage

Display range	Measuring range	Measuring range for AutoISO-5000
50 V	200 GΩ	20.0 GΩ
100 V	400 GΩ	40.0 GΩ
250 V	1.00 TΩ	100 GΩ
500 V	2.00 TΩ	200 GΩ
1000 V	4.00 TΩ	400 GΩ
2500 V	10.0 TΩ	400 GΩ
5000 V	20.0 TΩ	400 GΩ
10000 V*	40.0 TΩ	-

* - only MIC-10s1 / MIC-10k1

Electrical safety:

- » type of insulation double, as per EN 61010-1 and EN 61557
- » measurement category CAT IV 600 V (CAT III 1000 V) according to EN 61010-1
- » housing protection rating according to EN 60529 IP40 (IP67 with closed housing cover)

Nominal operating conditions:

- » operating temperature range -20...+50°C
- » storage temperature -25...+70°C
- » humidity 20...90%
- » elevation above sea level ≤3000 m
- » reference temperature +23°C ± 2°C
- » reference humidity 40...60%

Other technical specifications:

- » power supply built-in Li-Ion rechargeable battery 14.8 V 5.3 Ah from network: 90 V ÷ 260 V 50/60 Hz
- » weight approx. 5.6 kg
- » dimensions 390 x 310 x 170 mm
- » display graphic LCD 5.6"
- » transmission of results USB link or Bluetooth®

Measurement of insulation resistance:

- » up to 40 TΩ for MIC-10s1 / MIC-10k1,
- » up to 20 TΩ for MIC-05s1 / MIC-5050,
- » measurement voltages selected within the range of:
 - 50...5000 V for MIC/05s1 / MIC-5050 (50...1000 V with step of 10 V, 1...5 kV with step of 25 V)
 - 50...10000 V for MIC-10s1 / MIC-10k1 (50...1000 V with step of 10 V, 1...10 kV with step of 25 V),
- » continuous readings of measured insulation resistance and leakage current,
- » automatic discharge of the measured object's capacitance upon completion of insulation resistance measurement,
- » sound signaling of five-second time intervals, facilitating capture of time characteristics,
- » measurement time setting - up to 99'59",
- » timing of measurement times T₁, T₂ and T₃ for measurement of one or two absorption coefficients, within the range of 1...600 s,
- » measurement of absorption coefficients Ab1, Ab2, DAR, PI,
- » reading of actual measurement voltage during measurement,
- » measurement current 1.2 mA, 3 mA or 6 mA,
- » two- or three-lead method of insulation resistance measurement,
- » measurements with lead lengths up to 20 m,
- » protection against measurement of live object,
- » supports AutoISO-5000 (for MIC-10s1 / MIC-10k1 at voltage up to 5 kV),
- » capacitance measurement during measurement of R_{ISO},
- » temperature measurement (with the use of the optional ST-1 temperature probe),
- » measurement with step voltage (SV),
- » dielectric discharge (DD) test,
- » damage location (burning function),
- » digital filters for measurements with strong disturbances.

Additional functions of the meters:

- » high immunity to disturbances - in compliance with standard EN-61326,
- » stable measurement in 765 kV substations (optional - only MIC-10s1 and MIC-05s1),
- » measurement of leakage current during insulation resistance measurement,
- » measurement of direct and alternating voltages within the range of 0...750 V,
- » charts plotted on display during measurements,
- » memory storing up to 10,000 results of each type of measurement, including descriptions of measurement points, objects, client names,
- » data transmission to PC via USB connection, Bluetooth® or capability of data transfer via USB flash drives,
- » supports external wireless Bluetooth® keyboard (optional),
- » easy-to-read, backlit 5.6" LCD graphic display,
- » backlit keyboard,
- » power supply from rechargeable battery packs or power grid,
- » charging during measurement.

VIRTUAL INSTRUMENTS



We invite you to use the **virtual instruments** application. Thanks to it you can familiarize yourself with features of a selected device, its interface and capabilities.

The application gives you the opportunity to change the selected meter's configuration and perform measurements in a way you would in reality.

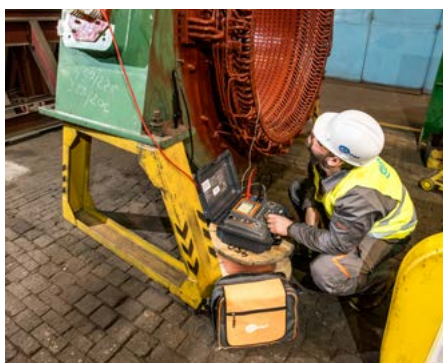

Professional diagnostic tool



Designed for the most demanding objects



Several measurements in one connection

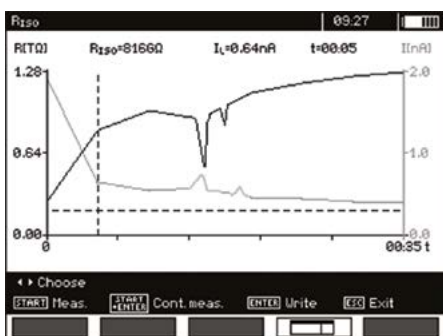

Graphic interpretation of results

Application

MIC-10k1 meter is designed to measure the insulation resistance of electro-power objects, i.e. single- and multi-core cables, transformers, motors and generators, capacitors, switches and other devices installed in power stations. MIC-10s1 meter is a reinforced version of MIC-10k1, dedicated for measurements in areas with very high electromagnetic disturbances, e.g. electrical substations with 765 kV voltage or higher.

Features of the device

Highly efficient HV inverter, with test voltage of 10 kV and current of 6 mA, suitable for measuring the insulation resistance up to 40 TΩ. Achieving such a result makes these meters unrivalled devices. Three-wire resistance measurement, performed using a "GUARD" wire, eliminates surface leakage currents caused by contaminated insulation, thereby increasing the reliability of obtained results.

The meter measures temperature of tested object, which is necessary to determine the temperature correction factor for R_{iso} . In addition, it indicates the absorption coefficient (DAR - Dielectric Absorption Ratio), Polarization Index (PI) and the value of Dielectric Discharge (DD). The device allows user to assess the condition of the insulation, by applying the test voltage incrementally in steps (SV). This solution ensures that a dielectric in good condition will provide the same results, regardless of the applied voltage. Deviations in obtained resistance values of approx. 25%, observed on the chart in the individual steps, may indicate the potential insulation defects.

MIC-10s1 and MIC-10k1 have the unique ability to perform measurements on multi-core cables, within one connection step, using the AutoISO-5000 adapter. This solution reduces the duration of measurements on repetitive of objects, such as cables of street lighting systems. Inverter with a power of almost 60 W is able to intensify the point of cable damage, which facilitates finding the location of the fault using a reflectometric method e.g. with TDR-420 device.

Built-in digital filters, with averaging time of 10, 30, 60 sec. (and additionally 100, 200 sec. in MIC-10s1) and "smart" solution guarantee stable measurement results in areas of strong electromagnetic interference.

Data analysis

The device, with its backlight graphical screen may display a waveform of insulation resistance, voltage and current as a function of time. The operator, basing on the trend shown by the waveform, may quickly assess the insulation condition right after starting the measurement. This provides full control over the tested object and clear image of the tested insulation. In addition, with movable tags, the operator may trace the course of the measurement and check resistance values obtained for any time of the current measurement and of measurements made in the past.

After installing mobile application, as a part of the set the user receives Sonel Reader software for collecting historical data and comparing it with current results, transferred from the extensive memory of the meter. This solution helps user to prepare a measurements report, track the insulation degradation and plan the maintenance / repair works.

Comparison of meters

	MIC-10k1	MIC-5050	MIC-10s1	MIC-05s1
maximum measuring voltage	10 000 V	5000 V	10 000 V	5000 V
maximum measuring range	40 TΩ	20 TΩ	40 TΩ	20 TΩ
resistance to external interference voltages	up to 750 V	up to 750 V	up to 1550 V	up to 1550 V
advanced, digital interference filtration	10 / 30 / 60 seconds	10 / 30 / 60 seconds	10 / 30 / 60 / 100 / 200 seconds and SMART	10 / 30 / 60 / 100 / 200 seconds and SMART
test leads lock	no	no	yes	yes

SONEL MIC MOBILE



Mobile version of the program cooperating with insulation resistance meters **MIC-10s1**, **MIC-10k1**, **MIC-05s1** and **MIC-5050**.

With the application, you can **connect directly to the device** via Bluetooth and download measurement data from the meter. After reading the measurements from the device, they can be easily and quickly **viewed**, and also **sent from the place of measurement** to the person who can help in the interpretation of data or make a measurement report.

The application provides **access to the meter's manual**. Additional functionalities will be useful: assigning a photo, text or voice note to a given measurement.

Moreover, there is a possibility to convert the **k20 temperature coefficient**.

It can be downloaded from the www.sonel.pl/en website or by scanning the QR code placed above.

Insulation resistance meters

SONEL MIC-5010 / MIC-5005

index: WMGBMIC5010 / WMGBMIC5005



Measurement of insulation resistance:

- » measurement voltage selected within the range of 50...1000 V in steps of 10 V, within the range of 1000 V...5000 V in steps of 25 V,
- » continuous reading of measured insulation resistance or leakage current,
- » automatic discharge of the measured object's capacitance upon completion of insulation resistance measurement,
- » sound signaling of five-second time intervals, facilitating capture of time characteristics,
- » measurement time setting - up to 99'59",
- » timing of measurement times T_1 , T_2 and T_3 for measurement of one or two absorption coefficients, within the range of 1...600 s,
- » measurement of absorption coefficients Ab1, Ab2, DAR, PI,
- » reading of actual measurement voltage during measurement,
- » measurement current 1.2 mA or 3 mA,
- » protection against measurement of live objects,
- » two- or three-lead method of insulation resistance measurement,
- » measurements with lead lengths up to 20 m,
- » measurement with step voltage (SV),
- » dielectric discharge (DD) test.
- » immunity to disturbances - digital filters for measurements with strong disturbances (10 s, 30 s, 60 s).

Additional functions of the meters:

- » high immunity to disturbances - in compliance with standard EN-61326,
- » testing of the continuity of protective conductors and equipotential bonding with current >200 mA in compliance with standard EN 61557-4 (MIC-5010),
- » configurable limits of minimum and maximum insulation resistance R_{cont} (MIC-5010),
- » capacitance measurement during measurement of R_{SOR} ,
- » measurement of leakage current during insulation resistance measurement,
- » measurement of direct and alternating voltages within the range of 0...600 V,
- » 990-cell memory (11,880 entries) with the capability of wireless data transmission to a PC (via Bluetooth® or via USB cable),
- » power supply from rechargeable battery packs, built-in quick charger,
- » backlit keyboard (MIC-5010),
- » instruments meet the requirements laid down by standard EN 61557.

Electrical safety:

- » type of insulation double, as per EN 61010-1 and EN 61557
- » measurement category CAT IV 600 V (CAT III 1000 V) according to EN 61010-1
- » housing protection rating according to EN 60529 IP40 (IP67 with closed housing cover)

Nominal operating conditions:

- » operating temperature range -20...+50°C
- » storage temperature -25...+70°C
- » humidity 20%...90%
- » elevation above sea level ≤3000 m
- » reference temperature +23°C ± 2°C
- » reference humidity 40...60%

Other technical specifications:

- » power supply of the meter built-in Li-Ion rechargeable battery 14.8 V 5.3 Ah
- » weight approx. 5.6 kg
- » dimensions 390 x 310 x 170 mm
- » display segmented LCD
- » transmission of results USB link or Bluetooth®

Standard accessories of the meters:

L4 carrying case	WAFUTL4
Crocodile clip, black, 11 kV, 32 A	WAKROBL32K09
Crocodile clip, red, 11 kV, 32 A	WAKRORE32K09
Crocodile clip, blue, 11 kV, 32 A	WAKROBU32K09
PC software: SoneI Reader	WAPROREADER
Test lead 1.8 m, black, 11 kV (banana plugs, shielded)	WAPRZ1X8BLBBE10K
Test lead 1.8 m, red, 11 kV (banana plugs)	WAPRZ1X8REBB10K
Test lead 1.8 m, blue, 11 kV (banana plugs)	WAPRZ1X8BUBB10K
USB cable	WAPRZUSB
Mains cable with IEC C13 plug	WAPRZ1X8BLIEC
Pin probe, black 11 kV (banana socket)	WASONBLOGB11
Pin probe, red 11 kV (banana socket)	WASONREOGB11
W1 hanging straps	WAPOZSZE5
Calibration certificate	

Measurement of insulation resistance

Measuring range in compliance with EN 61557-2:

$$R_{ISOmin} = U_{ISOnom} / I_{ISOmax} = 50 \text{ k}\Omega \dots 15 \text{ T}\Omega \quad (I_{ISOmax} = 1.2 \text{ mA or } 3 \text{ mA})$$

Display range	Resolution	Accuracy
0...999 kΩ	1 kΩ	±(3% m.v. + 10 digits)
1.00...9.99 MΩ	0.01 MΩ	
10.0...99.9 MΩ	0.1 MΩ	
100...999 MΩ	1 MΩ	
1.00...9.99 GΩ	0.01 GΩ	
10.0...99.9 GΩ	0.1 GΩ	±(3.5% m.v. + 10 digits)
100...999 GΩ	1 GΩ	
1.00...9.99 TΩ	0.01 TΩ	
10.0...15.0 TΩ	0.1 TΩ	±(10% m.v. + 10 digits)

- » Temperature stability of voltage better than 0.2% /°C



The MIC-10k1, MIC-5050, MIC-5010 and MIC-5005 meters are capable of operating in the presence of very large disturbances at substations and switching stations.

Maximum measured resistance values depending on measurement voltage

Voltage	Measured resistance
250 V	500 GΩ
500 V	1.00 TΩ
1000 V	2.00 TΩ
2500 V	5.00 TΩ
5000 V	15.0 TΩ

Test of the continuity of protective conductors and equipotential bonding with current >200 mA (MIC-5010)

Measuring range according to EN 61557-4: 0.12...999 Ω

Display range	Resolution	Accuracy
0.00...19.99 Ω	0.01 Ω	±(2% m.v. + 3 digits)
20.0...199.9 Ω	0.1 Ω	
200...999 Ω	1 Ω	±(4% m.v. + 3 digits)

- » Voltage on open terminals: 4...24 V
- » Output current at $R < 15 \Omega$: $I_{min} > 200 \text{ mA}$ (I_{sc} : 200...250 mA)
- » Compensation of test lead resistance
- » Current flows in two directions, mean resistance value displayed

Capacitance measurement

Display range	Resolution	Accuracy
1...999 nF	1 nF	±(5% m.v. + 5 digits)
1.00...49.99 μF	0.01 μF	

- » Capacitance measurement result displayed after measurement of R_{ISO}

"m.v." = "measured value"

Instruments meet the requirements set forth in the standards:

- » EN 61010-1 (general and particular requirements related to safety)
- » EN 61010-031 (general and particular requirements related to safety)
- » EN 61326 (electromagnetic compatibility)
- » EN 61557 (requirements for measurement instruments)
- » HD 60364-6 (performance of measurements - checking)
- » HD 60364-4-41 (performance of measurements - shock protection)
- » PN-E 04700 (performance of measurements - commissioning tests)

Insulation resistance meter

SONEL MIC-5001

index: WMGBMIC5001

- CAT III**
- 600 V**
- CAT IV**
- 300 V**
- IP65**



Measurement of insulation resistance:

- » measurement voltage selected within the range of 50...500 V with steps of 50 V and from 500 to 5000 V with steps of 100 V,
- » continuous reading of measured insulation resistance or leakage current,
- » automatic discharge of the measured object's capacitance upon completion of insulation resistance measurement,
- » sound signaling of five-second time intervals, facilitating capture of time characteristics,
- » timing of measurement time T_1 , T_2 and T_3 for measurement of dielectric absorption ratio (DAR) and polarization index (PI),
- » reading of actual measurement voltage during measurement,
- » protection against measurement of live objects,
- » two- or three-lead method of insulation resistance measurement,
- » insulation resistance measurement according to the RampTest method and breakdown voltage measurement with ramping rate up to ~1 kV/s,
- » measurement of direct and alternating voltages within the range of 0...750 V,
- » 990-cell memory (11,880 entries), data transmission to PC via USB cable,
- » power supplied by rechargeable battery,
- » instruments meet the requirements laid down by standard EN 61557,
- » the meter can be powered and charged from an external power adapter or from a car lighter socket.

Electrical safety:

- » type of insulation double, as per EN 61010-1 and IEC 61557
- » measurement category CAT IV 600 V (CAT III 1000 V) according to EN 61010-1
- » housing protection rating according to EN 60529 IP65

Other technical specifications:

- » power supply of the meter SONEL NiMH LSD 9.6 V 2 Ah rechargeable battery pack
- 12 V, 2.5 A external power supply
- » meter weight approx. 0.9 kg
- » dimensions 200 x 180 x 77 mm
- » display segmented LCD
- » memory 990 cells, 11,880 entries
- » transmission of results insulated USB cable
- » operating humidity 20...90%

Standard accessories of the meter:

M-8 carrying case	WAFUTM8
Black "crocodile" clip 11 kV 32 A	WAKROBL32K09
Red "crocodile" clip 11 kV 32 A	WAKRORE32K09
Blue "crocodile" clip 11 kV 32 A	WAKROBU32K09
Sonel Reader software	WAPROREADER
Shielded test lead with banana plugs; 5 kV; 1.8 m; black	WAPRZ1X8BLBB
Test lead with banana plugs; 5 kV; 1.8 m; red	WAPRZ1X8REBB
Test lead with banana plugs; 5 kV; 1.8 m; blue	WAPRZ1X8BUBB
USB data transmission cable	WAPRZUSB
230 V power cord (IEC C7 plug)	WAPRZLAD230
Test probe with banana socket; 5 kV; black	WASONBLOGB2
Test probe with banana socket; 5 kV; red	WASONREOGB2
Meter power adapter (type Z7)	WAZASZ7
Calibration certificate	

Insulation resistance measurement (two-lead)

Measuring range according to IEC 61557-2:

$$R_{ISOmin} = U_{ISONom} / I_{ISOmax} \leq 5 T\Omega \quad (I_{ISOmax} = 1 \text{ mA})$$

Display range	Resolution	Accuracy
0.0...999.9 kΩ	0.1 kΩ	±(3% m.v. + 20 digits)
1.000...9.999 MΩ	0.001 MΩ	
10.00...99.99 MΩ	0.01 MΩ	
100.0...999.9 MΩ	0.1 MΩ	
1.000...9.999 GΩ	0.001 GΩ	
10.00...99.99 GΩ	0.01 GΩ	±(4% m.v. + 50 digits)
100.0...999.9 GΩ	0.1 GΩ	
1.000...5.000 TΩ	1 GΩ	

Measured resistance values depending on measurement voltage

Voltage U_{ISO}	Measuring range
up to 100 V	50 GΩ
200...400 V	100 GΩ
500...900 V	250 GΩ
1000...2400 V	500 GΩ
2500 V	2500 GΩ
5000 V	5000 GΩ

Insulation resistance measurement in Ramp Test mode

Display range	Resolution	Accuracy
0.0...999.9 kΩ	0.1 kΩ	±(5% m.v. + 40 digits)
1.000...9.999 MΩ	0.001 MΩ	
10.00...99.99 MΩ	0.01 MΩ	
100.0...999.9 MΩ	0.1 MΩ	
1.000...9.999 GΩ	0.001 GΩ	
10.00...99.99 GΩ	0.01 GΩ	
100.0...999.9 GΩ	0.1 GΩ	
1.000...4.999 TΩ	0.001 TΩ	

Breakdown voltage measurement in Ramp Test mode

Range	Resolution	Selected U_{ISO}	Accuracy
25.0 ... 99.0 V	0.1 V	≤600 V	±(5% m.v. + 10 digits)
100 ... 600 V	1 V	≤600 V	±(5% m.v. + 4 digits)
25 ... 999 V	1 V	>600 V	±(5% m.v. + 5 digits)
1.00 ... 5.00 kV	10V	>600 V	±(5% m.v. + 4 digits)

Measurement of direct and alternating voltage

Range	Resolution	Accuracy
0...299.9 V	0.1 V	±(3% m.v. + 2 digits)
300...750 V	1 V	

» frequency range: 45...65 Hz



SONEL MIC-2501

index: WMGBMIC2501



CAT IV	CAT III	IP65
600 V	1000 V	

Measurement of insulation resistance:

- » measurement voltage within the range of 100...2500 V, selected in steps of 100 V,
- » continuous reading of measured insulation resistance or leakage current,
- » automatic discharge of the measured object's capacitance upon completion of insulation resistance measurement,
- » sound signaling of five-second time intervals, facilitating capture of time characteristics,
- » timed measurement times T_1 , T_2 and T_3 for measurement of absorption coefficients (Ab/PI/DAR) at 15, 60 and 600 s and polarization index,
- » reading of actual measurement voltage during measurement,
- » protection against measurement of live objects.

Additional functions of the meter:

- » two- or three-lead method of insulation resistance measurement,
- » low-voltage measurement of circuit continuity and resistance,
- » measurement of leakage current during insulation resistance measurement,
- » measurement of direct and alternating voltages within the range of 0...750 V,
- » 990-cell memory (11,880 entries), data transmission to PC via USB cable,
- » power supplied by rechargeable battery,
- » the instrument meets the requirements laid down by standard EN 61557,
- » the meter can be powered and charged from an external power adapter or from a car lighter socket.

Electrical safety:

- » type of insulation double, as per EN 61010-1 and EN 61557
- » measurement category CAT IV 600 V (CAT III 1000 V) according to EN 61010-1
- » housing protection rating according to EN 60529 IP65

Other technical specifications:

- » power supply of the meter SONE! NiMH LSD 9.6 V rechargeable battery pack external power supply 12 V, 2.5 A
- » meter weight approx. 0.9 kg
- » dimensions 200 x 180 x 77 mm
- » display segmented LCD
- » memory 990 cells, 11,880 entries
- » transmission of results USB

Standard accessories of the meter:

M-8 carrying case	WAFUTM8
Black "crocodile" clip 11 kV 32 A	WAKROBL32K09
Red "crocodile" clip 11 kV 32 A	WAKRORE32K09
Blue "crocodile" clip 11 kV 32 A	WAKROBU32K09
Sone! Reader software	WAPROREADER
Shielded test lead with banana plugs; 5 kV; 1.8 m; black	WAPRZ1X8BLBB
Test lead with banana plugs; 5 kV; 1.8 m; red	WAPRZ1X8REBB
Test lead with banana plugs; 5 kV; 1.8 m; blue	WAPRZ1X8BUBB
USB data transmission cable	WAPRZUSB
230 V power cord (IEC C7 plug)	WAPRZLAD230
Test probe with banana socket; 5 kV; black	WASONBLOGB2
Test probe with banana socket; 5 kV; red	WASONREOGB2
Meter power adapter (type Z7)	WAZASZ7
Calibration certificate	

Measurement of insulation resistance

Measuring range acc. to EN 61557-2 for $R_{ISOmin} = \frac{U_{ISOnom}}{I_{ISOmax}} \leq 1 T\Omega$
 $(I_{ISOnom} = 1 \text{ mA})$

Display range	Resolution	Accuracy
0.0...999.9 kΩ	0.1 kΩ	±(3% m.v. + 20 digits)
1.000...9.999 MΩ	0.001 kΩ	
10.00...99.99 MΩ	0.01 kΩ	
100.0...999.9 MΩ	0.1 kΩ	
1.000...9.999 GΩ	0.001 GΩ	
10.00...99.99 GΩ	0.01 GΩ	
100.0...999.9 GΩ	0.1 GΩ	

"m.v." = "measured value"

U_{ISO} - measurement voltage.

Maximum measured resistance values depending on measurement voltage:

Voltage	Measured resistance
up to 100 V	50 GΩ
200...400 V	100 GΩ
500...900 V	250 GΩ
1000...2400 V	500 GΩ
2500 V	1000 GΩ



You can charge the meter during the measurement using any Power Bank 12 V / 2 Ah with a 5.5 mm / 2.1 mm power supply.

Test of the continuity of protective conductors and equipotential bonding with 200 mA current

Measuring range according to EN 61557-4: 0.10...999 Ω

Display range	Resolution	Accuracy
0.00...19.99 Ω	0.01 Ω	±(2% m.v. + 3 digits)
20.0...199.9 Ω	0.1 Ω	
200...999 Ω	1 Ω	

- » Voltage on open terminals: 4...24 V
- » Output current at $R < 2 \Omega$: $I_{SC} > 200 \text{ mA}$
- » Compensation of test lead resistance
- » Current flows in two directions, mean resistance value displayed

Measurement of direct and alternating voltage

Display range	Resolution	Accuracy
0...299.9 V	0.1 V	±(3% m.v. + 2 digits)
300...750 V	1 V	

- » frequency range: 45...65 Hz

SONEL MIC-30

index: WMGBMIC30



- CAT III**
- 1000 V**
- CAT IV**
- 600 V**
- IP67**
- BLUETOOTH**

Measurement of insulation resistance:

- » measurement voltage selected from: 50, 100, 250, 500, 1000 V or freely configurable within the range of 50...1000 V in steps of 10 V,
- » automatic measurement in sockets by means of UNI-Schuko adapter with the capability of configuring pairs of measured conductors,
- » continuous reading of measured insulation resistance or leakage current,
- » automatic discharge of the measured object's capacitance upon completion of insulation resistance measurement,
- » sound signaling of five-second time intervals, facilitating capture of time characteristics,
- » timing of measurement times T_1 , T_2 and T_3 for measurement of one or two absorption coefficients, within the range of 1... 600 seconds.
- » readings of actual measurement voltage during measurement,
- » protection against measurement of live objects,
- » three-lead measurement,
- » measurement of leakage current,
- » capacitance measurement during measurement of R_{ISO} .

Continuity test of protective conductors and equipotential bonding:

- » with current ≥ 200 mA flowing in two directions in compliance with EN 61557-4.

Additional functions of the meter:

- » Low-voltage measurement of circuit continuity and resistance.
- » Measurement of direct and alternating voltages within the range of 0...600 V.
- » 990-cell memory (11,880 entries) with the capability of wireless
- » data transmission to a PC via Bluetooth®.
- » Backlit keyboard and display.

Other technical specifications:

- » type of insulation double, as per EN 61010-1 and EN 61557
- » power supply of the meter 4 LR6 batteries or Ni-MH AA rechargeable batteries
- » display segmented LCD

The instrument meets the requirements set forth in the standards:

- » EN 61010-1 (general and particular requirements related to safety)
- » EN 61010-031 (general and particular requirements related to safety)
- » EN 61326 (electromagnetic compatibility)
- » EN 61557 (requirements for measurement instruments)
- » HD 60364-6 (performance of measurements - checking)
- » HD 60364-4-41 (performance of measurements - shock protection)
- » PN-E 04700 (performance of measurements - commissioning tests)



MIC-30 makes it possible to perform automatic resistance measurement for all combinations or for any pair of conductors in the socket.

Standard accessories of the meter:

M-6 carrying case	WAFUTM6
Blue "crocodile" clip 1 kV 20 A	WAKROBU20K02
Sonel Reader software	WAPROREADER
Shielded test lead with banana plugs; 1 kV; 1.2 m; black	WAPRZ1X2BLBBE
Test lead with banana plugs; 1 kV; 1.2 m; red	WAPRZ1X2REBB
Test lead with banana plugs; 1 kV; 1.2 m; blue	WAPRZ1X2BUBB
Test probe with banana socket; 1 kV; black	WASONBLOGB1
Test probe with banana socket; 1 kV; red	WASONREOGB1
Meter strap (type M-1)	WAPZOSZE4
M-1 housing holder - hanger	WAPZUCH1
Calibration certificate	

Measurement of insulation resistance

Measuring range according to EN 61557-2 for

- » $U_n=50V$: **50 kΩ...250.0 MΩ**
- » $U_n=100V$: **100 kΩ...500.0 MΩ**
- » $U_n=250V$: **250 kΩ...2.000 GΩ**
- » $U_n=500V$: **500 kΩ...20.00 GΩ**
- » $U_n=1000V$: **1000 kΩ...100.0 GΩ**

Display range	Resolution	Accuracy
0.0...999.9 kΩ	0.1 kΩ	
1.000...9.999 MΩ	0.001 MΩ	
10.00...99.99 MΩ	0.01 MΩ	
100.0...250.0 MΩ (for $U_n = 50$ V)	0.1 MΩ	±(3% m.v. + 8 digits) [±(5% m.v. + 8 digits)]*
100.0...500.0 MΩ (for $U_n = 100$ V)		
100.0...999.9 MΩ (for $U_n \geq 250$ V)		
1.000...2.000 GΩ (for $U_n = 250$ V)	0.001 GΩ	
1.000...9.999 GΩ (for $U_n \geq 500$ V)	0.001 GΩ	
10.00...20.00 GΩ (for $U_n \geq 500$ V)**	0.01 GΩ	
10.00...99.99 GΩ (for $U_n = 1000$ V)		
100.0 GΩ (for $U_n = 1000$ V)	0.1 GΩ	

*for WS-04 adapter

**for WS-04 adapter, range up to 10 GΩ

- » measurements with voltage up to 500 V for WS-04 lead

Capacitance measurement

Display range	Resolution	Accuracy
1...999 nF	1 nF	±(5% m.v. + 10 digits)
1.00...9.99 μF	0.01 μF	

- » Capacitance measurement result displayed after measurement of R_{ISO}
- » For measurement voltages below 100 V and measured resistance of less than 10 MΩ, the error of capacitance measurement is unspecified

Test of the continuity of protective conductors and equipotential bonding with 200 mA current

Measuring range according to EN 61557-4: 0.10...1999 Ω

Display range	Resolution	Accuracy
0.00...19.99 Ω	0.01 Ω	±(2% m.v. + 3 digits)
20.0...199.9 Ω	0.1 Ω	
2000...1999 Ω	1 Ω	±(4% m.v. + 3 digits)

SONEL MIC-10

index: WMGBMIC10



- CAT III**
- 1000 V**
- CAT IV**
- 600 V**
- IP67**

Measurement of insulation resistance:

- » measurement voltage selected from: 50, 100, 250, 500, 1000 V,
- » continuous reading of measured insulation resistance,
- » automatic discharge of the measured object's capacitance upon completion of insulation resistance measurement,
- » sound signaling of five-second time intervals, facilitating capture of time characteristics,
- » readings of actual measurement voltage during measurement,
- » protection against measurement of live objects,
- » three-lead measurement,
- » capacitance measurement during measurement of R_{ISO} .

Continuity test of protective conductors and equipotential bonding:

- » with current ≥ 200 mA flowing in two directions in compliance with EN 61557-4.

Additional functions of the meter:

- » Low-voltage measurement of circuit continuity and resistance.
- » Measurement of direct and alternating voltages within the range of 0...600 V.
- » Backlit keyboard and display.

Besides measuring insulation resistance, MIC-10 is capable of performing continuity tests of protective conductors and equipotential bonding in accordance with standard EN 61557.

Other technical specifications:

- » type of insulation double, as per EN 61010-1 and EN 61557
- » power supply of the meter 4 alkaline batteries or Ni-MH rechargeable batteries - size AA
- » display segmented LCD

The instrument meets the requirements set forth in the standards:

- » EN 61010-1 (general and particular requirements related to safety)
- » EN 61010-031 (general and particular requirements related to safety)
- » EN 61326 (electromagnetic compatibility)
- » EN 61557 (requirements for measurement instruments)
- » HD 60364-6 (performance of measurements - checking)
- » HD 60364-4-41 (performance of measurements - shock protection)
- » PN-E 04700 (performance of measurements - commissioning tests)

Standard accessories of the meter:

M-6 carrying case	WAFUTM6
Black "crocodile" clip 1 kV 20 A	WAKROBL20K01
Test lead with banana plugs; 1 kV; 1.2 m; black	WAPRZ1X2BLBB
Test lead with banana plugs; 1 kV; 1.2 m; red	WAPRZ1X2REBB
Test probe with banana socket; 1 kV; black	WASONBLOGB1
Test probe with banana socket; 1 kV; red	WASONREOGB1
Meter strap (type M-1)	WAPOZSZE4
M-1 housing holder - hanger	WAPOZUCH1
Calibration certificate	

Measurement of insulation resistance

Measuring range according to EN 61557-2 for

- » $U_n = 50$ V: **50 kΩ...250.0 MΩ**
- » $U_n = 100$ V: **100 kΩ...500.0 MΩ**
- » $U_n = 250$ V: **250 kΩ...2.000 GΩ**
- » $U_n = 500$ V: **500 kΩ...5.000 GΩ**
- » $U_n = 1000$ V: **1000 kΩ...10.00 GΩ**

Display range	Resolution	Accuracy
0.0...999.9 kΩ	0.1 kΩ	±(3% m.v. + 8 digits)
1.000...9.999 MΩ	0.001 MΩ	
10.00...99.99 MΩ	0.01 MΩ	
100.0...250.0 MΩ (for $U_n = 50$ V)	0.1 MΩ	
100.0...500.0 MΩ (for $U_n = 100$ V)		
100.0...999.9 MΩ (for $U_n \geq 250$ V)		
1.000...2.000 GΩ (for $U_n = 250$ V)	0.001 GΩ	±(4% m.v. + 6 digits)
1.000...5.000 GΩ (for $U_n \geq 500$ V)	0.001 GΩ	
1.000...9.999 GΩ (for $U_n = 1000$ V)		
10.00 GΩ (for $U_n = 1000$ V)		

Capacitance measurement

Display range	Resolution	Accuracy
1...999 nF	1 nF	±(5% m.v. + 10 digits)
1.00...9.99 μF	0.01 μF	

- » Capacitance measurement result displayed after measurement of R_{ISO} .
- » For measurement voltages below 100 V and measured resistance of less than 10 MΩ, the error of capacitance measurement is unspecified.

Test of the continuity of protective conductors and equipotential bonding with 200 mA current

Measuring range according to EN 61557-4: 0.10...1999 Ω

Display range	Resolution	Accuracy
0.00...19.99 Ω	0.01 Ω	±(2% m.v. + 3 digits)
20.0...199.9 Ω	0.1 Ω	
2000...1999 Ω	1 Ω	±(4% m.v. + 3 digits)

MIC

Set of standard and optional accessories

1, 2, 4 - number of basic accessories
 - optional accessories

Photo	Name	Index	MIC-10s1	MIC-05s1	MIC-10k1	MIC-5050	MIC-5010	MIC-5005	MIC-5001	MIC-2501	MIC-30	MIC-10
	AGT-16C three-phase socket adapter 16 A (PEN)	WAADAAGT16C										• •
	AGT-16P three-phase socket adapter 16 A	WAADAAGT16P										• •
	AGT-16T industrial socket adapter 16 A	WAADAAGT16T										• •
	AGT-32C three-phase socket adapter 32 A (PEN)	WAADAAGT32C										• •
	AGT-32P three-phase socket adapter 32 A	WAADAAGT32P										• •
	AGT-32T industrial socket adapter 32 A	WAADAAGT32T										• •
	AGT-63P three-phase socket adapter 63 A	WAADAAGT63P										• •
	AutoISO-2500 adapter	WAADAAISO25										
	AutoISO-5000 adapter	WAADAAISO5	• • • •									
	WS-04 adapter with UNI-Schuko angular plug	WAADAWS04										•
	L4 carrying case	WAFUTL4	1 1 1 1 1 1									
	M6 carrying case	WAFUTM6										1 1
	M7 carrying case	WAFUTM7										
	M8 carrying case	WAFUTM8							1 1			
	Crocodile clip, black, 1 kV, 20 A	WAKROBL20K01										• 1
	Crocodile clip, black, 11 kV, 32 A	WAKROBL32K09	1 1 1 1 1 1 1 1									
	Crocodile clip, red, 1 kV, 20 A	WAKRORE20K02										• •
	Crocodile clip, red, 11 kV, 32 A	WAKRORE32K09	1 1 1 1 1 1 1 1									
	Crocodile clip, blue, 1 kV, 20 A	WAKROBU20K02										1 •
	Crocodile clip, blue, 11 kV, 32 A	WAKROBU32K09	1 1 1 1 1 1 1 1									

Photo	Name	Index	MIC-10s1	MIC-05s1	MIC-10k1	MIC-5050	MIC-5010	MIC-5005	MIC-5001	MIC-2501	MIC-30	MIC-10
	Mini bluetooth keyboard	WAADAMK	• • • •									
	PC software: Sonel Reader	WAPROREADER	1 1 1 1 1 1 1 1									
	Test lead 1,2 m, black, 1 kV (banana plugs)	WAPRZ1X2BLBB										1
	Test lead 1,2 m, black, 1 kV (banana plugs, shielded)	WAPRZ1X2BLBBE										1 •
	Test lead 1,2 m, red, 1 kV (banana plugs)	WAPRZ1X2REBB										1 1
	Test lead 1,2 m, blue, 1 kV (banana plugs)	WAPRZ1X2BUBB										1 •
	Test lead 1,8 m, black, 11 kV (banana plugs, shielded)	WAPRZ1X8BLBBE10K	• • • •				1 1					
	Test lead 1,8 m, black, 5 kV (banana plugs, shielded)	WAPRZ1X8BLBB							1 1			
	Test lead 1,8 m, red, 11 kV (banana plugs)	WAPRZ1X8REBB10K	• • • •				1 1					
	Test lead 1,8 m, red, 5 kV (banana plugs)	WAPRZ1X8REBB							1 1			
	Test lead 1,8 m, blue, 11 kV (banana plugs)	WAPRZ1X8BUBB10K	• • • •				1 1					
	Test lead 1,8 m, blue, 5 kV (banana plugs)	WAPRZ1X8BUBB							1 1			
	Test lead 10 m, black, 11 kV (banana plugs, shielded)	WAPRZ010BLBBE10K	• • • • •									
	Test lead 10 m, black, 5 kV (banana plugs, shielded)	WAPRZ010BLBBE5K							• •			
	Test lead 10 m, red, 11 kV (banana plugs)	WAPRZ010REBB10K	• • • • •									
	Test lead 10 m, red, 5 kV (banana plugs)	WAPRZ010REBB5K							• •			
	Test lead 10 m, blue, 5 kV (banana plugs)	WAPRZ010BUBB5K							• • • •			
	Test lead 20 m, black, 11 kV (banana plugs)	WAPRZ020BLBBE10K	• • • • •									
	Test lead 20 m, red, 11 kV (banana plugs)	WAPRZ020REBB10K	• • • • •									

Photo	Name	Index	MIC-10s1	MIC-05s1	MIC-10k1	MIC-5050	MIC-5010	MIC-5005	MIC-5001	MIC-2501	MIC-30	MIC-10
	Test lead 20 m, blue, 11 kV (banana plugs)	WAPRZ020BUBB10K	•	•	•	•	•	•				
	Test lead 3 m, black, 11 kV (banana plugs, shielded)	WAPRZ003BLBBE10K	1	1	1	1	•	•				
	Test lead 3 m, red, 11 kV (banana plugs)	WAPRZ003REBB10K	1	1	1	1	•	•				
	Test lead 3 m, blue, 11 kV (banana plugs)	WAPRZ003BUBB10K	1	1	1	1	•	•				
	Test lead 5 m, black, 1 kV (banana plugs, shielded)	WAPRZ005BLBBE										• •
	Test lead 5 m, black, 11 kV (banana plugs, shielded)	WAPRZ005BLBBE10K	•	•	•	•	•	•				
	Test lead 5 m, black, 5 kV (banana plugs, shielded)	WAPRZ005BLBBE5K							•	•		
	Test lead 5 m, red, 1 kV (banana plugs)	WAPRZ005REBB										• •
	Test lead 5 m, red, 11 kV (banana plugs)	WAPRZ005REBB10K	•	•	•	•	•	•				
	Test lead 5 m, red, 5 kV (banana plugs)	WAPRZ005REBB5K							•	•		
	Test lead 5 m, blue, 1 kV (banana plugs)	WAPRZ005BUBB										• •
	Test lead 5 m, blue, 5 kV (banana plugs)	WAPRZ005BUBB10K	•	•	•	•	•	•				
	Test lead 5 m, blue, 11 kV (banana plugs)	WAPRZ005BUBB5K							•	•		
	Cable for battery charging from car cigarette lighter socket (12 V)	WAPRZLAD12SAM							•	•		
	USB cable	WAPRZUSB	1	1	1	1	1	1	1	1		
	Mains cable with IEC C13 plug	WAPRZ1X8BLIEC	1	1	1	1	1	1				
	Mains cable with IEC C7 plug	WAPRZLAD230							1	1		

Photo	Name	Index	MIC-10s1	MIC-05s1	MIC-10k1	MIC-5050	MIC-5010	MIC-5005	MIC-5001	MIC-2501	MIC-30	MIC-10
	CS-5kV calibration box	WAADACS5KV		•		•	•	•	•			
	PRS-1 resistance test probe	WASONPRS1GB	•	•	•	•	•	•	•	•	•	•
	Temperature probe ST-1	WASONT1	1	1	1	1						
	Pin probe, black 1 kV (banana socket)	WASONBLOGB1										1 1
	Pin probe, black 11 kV (banana socket)	WASONBLOGB11					1	1				
	Pin probe, black 5 kV (banana socket)	WASONBLOGB2							1	1		
	Pin probe, red 1 kV (banana socket)	WASONREOGB1										1 1
	Pin probe 11 kV with banana connector - red	WASONREOGB11					1	1				
	Pin probe, red 5 kV (banana socket)	WASONREOGB2							1	1		
	Pin probe, blue 1 kV (banana socket)	WASONBUOGB1										• • •
	CS-1 cable simulator	WAADACS1										• • •
	L2 hanging straps (short)	WAPOZSZE2										
	M1 hanging straps	WAPOZSZE4										1 1
	W1 hanging straps	WAPOZSZE5					1	1				
	M1 hanging hook straps	WAPOZUCH1										1 1
	Z7 Power supply	WAZASZ7							1	1		

Fault loop impedance meters

MZC-330S
MZC-320S
MZC-310S

MZC-306

MZC-304
MZC-20E

Comparison of fault loop impedance meters



	MZC-330S	MZC-320S	MZC-310S	MZC-306	MZC-304	MZC-20E	MPI-540 MPI-535	MPI-530-IT MPI-530	MPI-525 MPI-520 MPI-520 Start	MPI-502
Rated voltage [V]	110/190 115/200 127/220 220/380 230/400 240/415 290/500 400/690	110/190 115/200 127/220 220/380 230/400 240/415 290/500	220/380 230/400	110/190 115/200 127/220 220/380 230/400 240/415 290/500 400/690	220/380 230/400 240/415	220/380 230/400 240/415	110/190 115/200 127/220 220/380 230/400 240/415	110/190 115/200 127/220 220/380 230/400 240/415	110/190 115/200 127/220 220/380 230/400 240/415	220/380 230/400 240/415
Operating voltage range	100...750	100...550	187...440	100...750	180...460	180...440	95...440	95...440	95...440	180...460
Display range [Ω]	0...1999	0...1999	0...199.9	0...1999	0...1999	0...200	0...1999.9	0...1999	0...1999	0...1999
Maximum resolution [Ω]	0.001	0.001	0.001	0.01	0.01	0.01	0.001	0.001	0.01	0.01
Maximum resolution for measurement with 15 mA current [Ω]	–	–	–	0.01	0.01	0.01	0.01	0.01	0.01	0.01
Max. measurement current [A]	130/280	130/280	160/280	12.2...36.7	7.6/13.3	15.3/26.7	23/44	23/44	23/44	7.6/13.3
Measuring range according to EN 61557 [Ω]	0.0072...1999	0.0072...1999	0.0072...199.9	0.13...1999	0.13...1999	0.24...200	0.50...1999	0.13...1999	0.13...1999	0.13...1999
Display of fault loop resistance and reactance	✓	✓	✓	✓	✓	✓	✓	✓	✓	✓
Calculation of prospective fault current on the basis of rated voltage	✓	✓	✓	✓	✓	✓	✓	✓	✓	✓
Calculation of prospective fault current on the basis of measured voltage	–	–	–	–	✓	–	✓	✓	–	–
Memory (number of each type of measurement)	990	990	990	990	990	–	UNLIMITED	10 000	990	990
4-lead method	✓	✓	✓	–	–	–	–	–	–	–
Measurement of prospective touch and shock voltage	✓	✓	✓	–	–	–	–	–	–	–
Selection of test lead length	✓	✓	✓	✓	✓	✓	✓	✓	✓	✓
In-socket measurement by means of adapter - plug	–	–	–	Option	✓	–	✓	✓	✓	✓
Triggering of measurements by adapter	–	–	–	Option	Option	–	✓	✓	✓	Option
Alternating voltage measurement	✓	✓	✓	✓	✓	✓	✓	✓	✓	✓
Dimensions [mm]	390 x 308 x 172	390 x 308 x 172	295 x 222 x 95	288 x 223 x 75	220 x 98 x 58	220 x 98 x 58	288 x 223 x 75	288 x 223 x 75	288 x 223 x 75	220 x 98 x 58
Weight [kg]	6.5	6.5	2.2	2.2	1	0.5	2.5	2.2	2.2	1



High-current fault loop impedance meters

SONEL MZC-330S / MZC-320S

index: WMGBMZC330 / WMGBMZC320



MEASUREMENTS
IN NETWORKS
UP TO
750 V

CAT IV



IP67

600 V

Fault loop impedance measurement:

- » measurement of very low short circuit loop impedances (with resolution 0,1 mΩ) with a current of 130 A at 230 V; maximum 300 A at 690 V (500 V in MZC-320S) or with a current 24 A at 230 V, maximum 37 A at 690 V (maximum 27 A at 500 V in MZC-320S) with resolution 0,01 Ω,
- » measurements in installations with rated voltages between: 110/190 V, 115/200 V, 127/220 V, 220/380 V, 230/400 V, 240/415 V, 290/500 V and 400/690 V (MZC-330S only) and frequencies 45...65 Hz,
- » ability to perform measurements in short circuit system: phase-phase, phase to protective earth, phase-neutral
- » differentiation between the phase voltage and the inter-phase voltage while calculating the short circuit current
- » ability to change the length of test lead,
- » four-pole method, test leads do not require calibration (measurement with current up to 300 A).

Additional functions of the meter:

- » touch voltage and touch shock voltage measurement with resistor 1 kΩ),
- » AC voltage measurement in range 0...750 V (550 V in MZC-320S),
- » memory of 990 measurement results with an ability to transfer the data to a PC,
- » ability to transmit data through USB and Bluetooth,
- » the device meets the requirements of EN 61557 standard.

Electric security:

- » type of insulation double, according to EN 61010-1 and IEC 61557
- » measurement category IV 600 V acc. to EN 61010-1
- » protection class acc. EN 60529 IP67 (IP20 with front cover open)

Other technical specifications:

- » power supply built in Li-Ion 7.2 V / 8.8 Ah rechargeable battery
- » resistor limiting the current: for 4 pole method (4p) 1.8 Ω for U≤550 V
- » 2.5 Ω for U>550 V (MZC-330S)
- » for two pole method (2p) 9.4 Ω for U≤253 V
- » 19 Ω for U>253 V
- » number of short circuit loop measurements min. 4000 (2/min)
- » temperature coefficient ±0,1% of measured value/°C
- » dimensions 390 mm x 308 mm x 172 mm
- » weight 6.5 kg

Nominal operating conditions:

- » operating temperature range -10...+40°C

Standard accessories of the meters:

Test lead 1.2 m, black, 1 kV (banana plugs)	WAPRZ1X2BLBB
Test lead 1.2 m, yellow, 1 kV (banana plugs)	WAPRZ1X2YEBB
Pin probe, black 1 kV (banana socket)	WASONBLOGB1
Pin probe, yellow 1 kV (banana socket)	WASONYEOGB1
Doble-wire test lead 3 m (10 A / 25 A) U1/I1	WAPRZ003DZBBU111
Doble-wire test lead 3 m (10 A / 25 A) U2/I2	WAPRZ003DZBBU212
Crocodile clip, black, 1 kV, 32 A	WAKROBL30K03
Kelvin clamp, 1 kV, 25 A	WAKROKELK06
High-current pin probe 1 kV (banana sockets)	WASONSPGB1
Power supply adaptor Z19	WAZASZ19
L-14 carrying case	WAFUTL14
USB cable	WAPRZUSB
PC software: Sonel Reader	WAPROREADER
Calibration certificate	

High-current measurement of fault loop parameters (4-lead $I_{max} = 300 A$)

High-current measurement of fault loop impedance Z_s :

measuring range according to EN 61557-3: 7.2 mΩ...1999 mΩ

Display range	Resolution	Accuracy
0...199.9 mΩ	0.1 mΩ	±(2% m.v. + 2 mΩ)
200...1999 mΩ	1 mΩ	

Short circuit current indication

Measuring range according to IEC 61557

for $U_n = 230 V$ 115.0 A...32.9 kA for $U_n = 400 V$ 200 A...55.5 kA

for $U_n = 500 V$ 250 A...69.4 kA for $U_n = 690 V$ 345 A...95.8 kA (MZC-330S)

Display range	Resolution	Accuracy
115.0...199.9 A	0.1 A	Calculated on the basis of error for fault loop
200...1999 A	1 A	
2.00...19.99 kA	0.01 kA	
20.0...199.9 kA	0.1 kA	
200 kA... *	1 kA	

*max 690 kA for MZC-330S, max 500 kA for MZC-320S

Touch voltage measurements U_{ST} and shock voltage U_T

Display range	Resolution	Accuracy
0...100 V	1 V	±(10% m.v. + 2 digits)

Short circuit loop parameters measurement using standards current (2p, $I_{max} = 37 A$)

Measuring range according to IEC61557: 0,13 Ω...199,9 Ω for test leads length 1,2 m

Display range	Resolution	Accuracy
0.00...19.99 Ω	0.01 Ω	±(2% m.v. + 3 digits)
20.0...199.9 Ω	0.1 Ω	±(3% m.v. + 3 digits)



The MZC-310S, 320S and 330S meters are the only meters on the market that also enable touch voltage or shock voltage measurement, which can be employed during safety assessment of a tested system.

SONEL MZC-310S

index: WMGBMZC310



CAT III

600 V

CAT IV

300 V

IP20

Fault loop impedance measurement:

- » measurements of very low fault loop impedances (with 0.1 mΩ resolution) with current of 150 A at 230 V; maximum 280 A at 440 V,
- » measurements with current of 23 A at 230V, maximum 42 A at 440 V,
- » measurements in networks with rated voltages: 220/380 V and 230/400 V and frequencies 45...65 Hz,
- » measurement in fault loops: phase to phase, phase to protective earth, phase to neutral,
- » differentiation of phase and phase-to-phase voltage during calculations of fault current,
- » selection of test lead length (23/42 A measurement),
- » four-lead method, no test lead calibration required (150/280 A),
- » measurement and display of fault loop impedance components: resistance R_s and reactance X_s

Additional functions of the meter:

- » Measurement of prospective touch voltage or shock touch voltage (with 1 kΩ resistor).
- » Alternating voltage measurement within the range of 0...440 V.
- » Measurement of frequency.
- » Memory storing up to 990 measurement results, with the capability of data transmission to a PC.

The instrument meets the requirements set forth in the standards:

- » EN 61010-1 (general and particular requirements related to safety)
- » EN 61010-031 (general and particular requirements related to safety)
- » EN 61326 (electromagnetic compatibility)
- » EN 61557 (requirements for measurement instruments)
- » HD 60364-6 (performance of measurements - checking)
- » HD 60364-4-41 (performance of measurements - shock protection)
- » PN-E 04700 (performance of measurements - commissioning tests)

Other technical specifications:

- » type of insulation double, as per EN 61010-1 and EN 61557
- » power supply of the meter LR14 alkaline batteries (size C) (5 pcs.)
- » current-limiting resistor for 4-lead measurement: 1.5 Ω, for 2-lead measurement: 10 Ω
- » number of fault loop measurements (alkaline batteries) at least 4000 (2/min.)
- » temperature coefficient ±0,1% of measured value/°C

Nominal operating conditions:

- » operating temperature range 0...+40°C

Standard accessories of the meter:

L10 carrying case	WAFUTL10
Crocodile clip, black, 1 kV, 20 A	WAKROBL20K01
Crocodile clip, black, 1 kV, 32 A	WAKROBL30K03
Kelvin clamp, 1 kV, 25 A	WAKROKELK06
Mini Bluetooth keyboard	WAADAMK
PC software: SoneI Reader	WAPROREADER
Test lead 1,2 m, black, 1 kV (banana plugs)	WAPRZ1X2BLBB
Test lead 1,2 m, yellow, 1 kV (banana plugs)	WAPRZ1X2YEBB
Double-wire test lead 3 m (10 A / 25 A) U1/I1	WAPRZ003DZBBU1I1
Double-wire test lead 3 m (10 A / 25 A) U2/I2	WAPRZ003DZBBU2I2
RS-232 serial transmission cable	WAPRZRS232
Mains cable with IEC C13 plug	WAPRZ1X8BLIEC
Pin probe, black 1 kV (banana socket)	WASONBLOGB1
Pin probe, yellow 1 kV (banana socket)	WASONYEOGB1
High-current pin probe 1 kV (banana sockets)	WASONSPGB1
UNI-SONEL hanging straps	WAPZSZSE1
Test wire reel	WAPZSZSP1
Calibration certificate	

High-current measurement of fault loop parameters (4-lead, $I_{max} = 280 A$)

High-current measurement of fault loop impedance Z_s :
measuring range according to EN 61557-3: 7.2 mΩ...1999 mΩ

Display range	Resolution	Accuracy
0...199.9 mΩ	0.1 mΩ	±(2% m.v. + 2 mΩ)
200...1999 mΩ	1 mΩ	



Fault current readings

Measuring range according to EN 61557- 3:

for $U_n = 230 V$ 115.0 A...32.0 kA
for $U_n = 400 V$ 200 A...55.7 kA

Display range	Resolution	Accuracy
115.0...199.9 A	0.1 A	Calculated on the basis of error for fault loop
200...1999 A	1 A	
2.00...19.99 kA	0.01 kA	
20.0...199.9 kA	0.1 kA	
200kA...*	1 kA	

*230 kA for U_{L-N} 400 kA for U_{L-L}



The MZC-310S, 320S and 330S meters are the only meters on the market that also enable touch voltage or shock voltage measurement, which can be used during safety assessment of a tested system.

Measurement of touch voltage U_{ST} and shock voltage U_T

Display range	Resolution	Accuracy
0...100 V	1 V	±(10% m.v. + 2 digits)

Measurement of fault loop impedance Z_s with standard current (2-lead, $I_{max} = 42 A$)

measuring range for 1.2 m test leads according to EN 61557: 0.13 Ω...199.9 Ω

Display range	Resolution	Accuracy
0.00...19.99 Ω	0.01 Ω	±(2% m.v. + 3 digits)
20.0...199.9 Ω	0.1 Ω	±(3% m.v. + 3 digits)

Fault loop impedance meter

SONEL MZC-306

index: WMGBMZC306

MEASUREMENTS
IN NETWORKS
UP TO
750 V



- CAT IV**
- 600 V**
- CAT III**
- 1000 V**
- IP54**

Fault loop impedance measurement:

- » fault loop impedance measurement with 0.01Ω resolution,
- » low-current impedance measurement in circuits protected by RCD ≥ 30mA with 0.01 Ω resolution (100...440 V),
- » operates in networks with voltages 110/190 V, 115/200 V, 127/220 V, 220/380 V, 230/400 V, 240/415 V, 290/500 V and 400/690 V (**operating range 100...750 V**), operating frequency 45...65 Hz,
- » calculation of fault current,
- » automatic differentiation between phase and phase-to-phase voltage,
- » possibility of applying 1.2; 5; 10; 20 m test leads or an adapter terminated by a power network plug,
- » measurement with swapped L and N conductors,
- » measurement of resistance and reactance components.

Additional functions of the meters:

- » Voltage measurement up to 750 V AC with 0.1 V resolution up to 250 V.
- » Memory storing up to 990 records, data transmission via USB.
- » Battery or rechargeable battery power supply (4 x AA).
- » Check of correct connection of PE terminal by means of contact electrode.

Instruments meet the requirements set forth in the standards:

- » EN 61010-1 (general and particular requirements related to safety)
- » EN 61010-031 (general and particular requirements related to safety)
- » EN 61326 (electromagnetic compatibility)
- » EN 61557 (requirements for measurement instruments)
- » HD 60364-6 (performance of measurements - checking)
- » HD 60364-4-41 (performance of measurements - shock protection)
- » PN-E 04700 (performance of measurements - commissioning tests)



Meter calculates the value of prospective fault current in compliance with standard HD 60364-6.

Electrical safety:

- » type of insulation double, as per EN 61010-1 and EN 61557
- » test leads EN 61010-2-031

Other technical specifications:

- » meter power supply rechargeable battery pack or (optional) alkaline batteries
- » rechargeable battery or alkaline battery performance at least 5000 measurements (2/min)
- » display backlit LED

Nominal operating conditions:

- » operating temperature range 0...+45°C
- » humidity 20...80%

Standard accessories of the meter:

WS-05 adapter with UNI-SCHUKO angular plug	WAADAWS05
NiMH battery 4.8 V 4.2 Ah	WAAKU07
L4 carrying case	WAFUTL4
Crocodile clip, blue, 1 kV, 20 A	WAKROBU20K02
PC software: Sonel Reader	WAPROREADER
Test lead 0.7 m, black (banana plugs)	WAPRZ0X7BLBB
Test lead 1.2 m, red, 1 kV (banana plugs)	WAPRZ1X2REBB
Test lead 1.2 m, blue, 1 kV (banana plugs)	WAPRZ1X2BUBB
Test lead 1.2 m, yellow, 1 kV (banana plugs)	WAPRZ1X2YEBB
USB cable	WAPRZUSB
Mains cable with IEC C7 plug	WAPRZLAD230
Pin probe, black 5 kV (banana socket)	WASONBLOGB2
Pin probe, red 1 kV (banana socket)	WASONREOGB1
Pin probe, red 5 kV (banana socket)	WASONREOGB2
Pin probe, blue 1 kV (banana socket)	WASONBUOGB1
Pin probe, yellow 1 kV (banana socket)	WASONYE0GB1
L2 hanging straps (short)	WAPOZSZE2
M1 hanging straps	WAPOZSZE4
Z7 Power supply	WAZASZ7
Calibration certificate	

Measurement of fault loop impedance Z_{L-PE} , Z_{L-N} , Z_{L-L}

Measuring range acc. to EN 61557-3 for 1.2 m test leads: **0.13...1999 Ω**

Display range	Resolution	Accuracy
0.00...19.99 Ω	0.01 Ω	±(5% m.v. + 3 digits)
20.0...199.9 Ω	0.1 Ω	±(4% m.v. + 3 digits)
200...1999 Ω	1 Ω	

Nominal voltage: 100...440 V (for Z_{L-PE} and Z_{L-N}) or 100...750 V (for Z_{L-L})



MZC-306 meter performs fault loop impedance measurements in industrial networks of any voltage up to 750V.

Measurement of earth fault loop impedance Z_{L-PE} in RCD mode

Measuring range according to EN 61557-3 for 1,2 m leads: **0.43...1999 Ω**

Display range	Resolution	Accuracy
0.00...19.99 Ω	0.01 Ω	±(6% m.v. + 10 digits)
20.0...199.9 Ω	0.1 Ω	±(6% m.v. + 5 digits)
200...1999 Ω	1 Ω	



Fault loop impedance meter

SONEL MZC-304

index: WMGBMZC304



CAT III

600 V

CAT IV

300 V

IP67

Measurement of fault loop parameters:

- » fault loop impedance measurement in networks with rated voltages: 220/380 V, 230/400 V, 240/415 V and frequencies 45...65 Hz,
- » measurement of fault loop impedance with 15 mA current without tripping residual current devices,
- » **detection of L and N phase swapping in a socket and automatic unswapping in the meter,**
- » operating voltage range: 180...270 V (for Z_{L-PE} and Z_{L-N}) or 180...460 V (for Z_{L-L})
- » operating frequency range: 45...65 Hz,
- » maximum measurement current: 7.6 A for 230 V (3x10 ms), 13.3 A for 400 V (3x10 ms),
- » calculation of fault current for nominal voltages,
- » readings of fault loop resistance R_s and reactance X_s .

Low-voltage resistance measurement of protective conductors and equipotential bonding:

- » continuity test of protective conductors with current ± 200 mA - in compliance with EN 61557,
- » automatic calibration of test leads - any leads can be used,
- » low-current resistance measurement with sound signaling.

Additional functions of the meter:

- » Quick check of correct connection of PE conductor by means of contact electrode.
- » Measurement of network voltage and frequency.
- » Power supply from LR6 batteries, Ni-MH rechargeable batteries can optionally be applied.
- » Memory storing up to 990 results, wireless data transmission to computer via Bluetooth®.
- » Backlit keyboard and display.



The MZC-304 meter calculates the value of prospective fault current in compliance with standard HD 60364-6.

Electrical safety:

- » type of insulation double, as per EN 61010-1 and EN 61557
- » test leads EN 61010-2-031
- » measurement category CAT III 600 V (CAT IV 300 V) according to EN 61010-1
- » housing protection rating according to EN 60529 IP67

Other technical specifications:

- » power supply of the meter ... pack of rechargeable batteries or alkaline batteries (size AA, 4 pcs.)
- » rechargeable battery life at least 5000 measurements (2/min)

Nominal operating conditions:

- » operating temperature range 0...+50°C
- » humidity 20...80%

Standard accessories of the meter:

WS-05 adapter with UNI-Schuko angular plug	WAADAWS05
M6 carrying case	WAFUTM6
Crocodile clip, yellow, 1 kV, 20 A	WAKROYE20K02
PC software: SoneI Reader	WAPROREADER
Test lead 1,2 m, red, 1 kV (banana plugs)	WAPRZ1X2REBB
Test lead 1,2 m, blue, 1 kV (banana plugs)	WAPRZ1X2BUBB
Test lead 1,2 m, yellow, 1 kV (banana plugs)	WAPRZ1X2YEBB
Pin probe, red 1 kV (banana socket)	WASONREOGB1
Pin probe, red 5 kV (banana socket)	WASONREOGB2
Pin probe, blue 1 kV (banana socket)	WASONBUOGB1
M1 hanging straps	WAPOZSZE4

Calibration certificate



The MZC-304 meter measures fault loop impedance with 0.01 Ω resolution, including in circuits protected by RCDs, without tripping them.

Measurement of fault loop impedance Z_{L-PE} , Z_{L-N} , Z_{L-L} , fault loop resistance and reactance.

Measuring range for 1.2 m test leads according to EN 61557-3: 0.13 Ω...1999 Ω

Display range	Resolution	Accuracy
0.00...19.99 Ω	0.01 Ω	±(5% m.v. + 3 digits)
20.0...199.9 Ω	0.1 Ω	
200...1999 Ω	1 Ω	

Measurement of earth fault loop impedance Z_{L-PE} in RCD mode (without tripping RCD)

Measuring range for 1.2 m leads according to EN 61557-3: 0.51 Ω...1999 Ω

Display range	Resolution	Accuracy
0.00...19.99 Ω	0.01 Ω	±(6% m.v. + 10 digits)
20.0...199.9 Ω	0.1 Ω	
200...1999 Ω	1 Ω	±(6% m.v. + 5 digits)

- » does not trip RCDs with $I_{\Delta N} \geq 30$ mA,



The instrument meets the requirements set forth in the standards:

- » EN 61010-1 (general and particular requirements related to safety)
- » EN 61010-031 (general and particular requirements related to safety)
- » EN 61326 (electromagnetic compatibility)
- » EN 61557 (requirements for measurement instruments)
- » HD 60364-6 (performance of measurements - checking)
- » HD 60364-4-41 (performance of measurements - shock protection)
- » PN-E 04700 (performance of measurements - commissioning tests)



MZC-304 always measures total fault loop impedance as well as its components – resistance and reactance – regardless of the phase shift value.

Fault loop impedance meter

SONEL MZC-20E

index: WMGBMZC20E



CAT III

300 V

IP67

Fault loop impedance measurement

This meter is dedicated for electrical fitters and testers who render services in single- and multi-family buildings, office buildings, industrial plants and any other buildings equipped with a low-voltage electrical system. The meter is also intended for electrical operation maintenance services.

Other technical specifications:

- » type of insulation double, as per EN 61010-1 and IEC 61557
- » measurement category CAT III 300 V according to EN 61010-1
- » housing protection rating according to EN 60529 IP67

Other technical specifications:

- » power supply of the meter LR6 alkaline batteries or AA Ni-MH rechargeable batteries
- » dimensions 220x98x58 mm
- » meter weight with battery pack 509 g
- » storage temperature -20...+70 °C
- » operating temperature range -10...+50 °C
- » humidity 20...80%
- » reference temperature +23...± 2 °C
- » reference humidity 40...60%
- » elevation above sea level <2000 m
- » time until Auto-OFF max. 900 seconds
- » number of Z measurements (for rechargeable batteries) >5000 (2 measurements/minute)
- » display segmented LCD
- » quality standard development, design and production in compliance with ISO 9001
- » the instrument meets the requirements set forth in the standards IEC 61557
- » the instrument is compliant with standards EN 61326-1 and EN 61326-2-2



Standard accessories of the meter:

M10 carrying case	WAFUTM10
Crocodile clip, red, 1 kV, 20 A	WAKRORE20K02
Test lead 1,2 m, red, 1 kV (banana plugs)	WAPRZ1X2REBB
Test lead 1,2 m, blue, 1 kV (banana plugs)	WAPRZ1X2BUBB
Pin probe, red 1 kV (banana socket)	WASONREOGB1
Pin probe, blue 1 kV (banana socket)	WASONBUOGB1
M1 hanging straps	WAPOZSZE4
M1 hanging hook straps	WAPOZUCH1
Calibration certificate	

Measurement of fault loop impedance Z_s within the range of 0.24...200 Ω

Fault current I_k : 0.115÷1769 A ($U_n=230$ V)

AC voltage measurement: 0÷440 V

Display range	Resolution	Accuracy
0.00...19.99 Ω	0.01 Ω	±(2.5% m.v. + 5 digits)
20.0...99.9 Ω	0.1 Ω	±(2.5% m.v. + 3 digits)
100...200 Ω	1 Ω	±(3% m.v. + 3 digits)

- » Nominal operating voltage U_{L-N}/U_{L-L} : 220/380 V, 230/400 V, 240/415 V
- » Operating voltage range: 180...270 V (for Z_{L-PE} and Z_{L-N}) and 180...440 V (for Z_L)
- » Nominal network frequency f_n : 50 Hz, 60 Hz
- » Operating frequency range: 45...65 Hz
- » Maximum measurement current: 15.3 A for 230 V (10 ms) and 26.7 A for 400 V (10 ms)

Readings of fault loop resistance R_s and fault loop reactance Z_s :

Display range	Resolution	Accuracy
0.00...9.99 Ω	0.01 Ω	±(5% m.v. + 5 digits) of Z_s value

- » Calculated and displayed for $Z_s < 10$ Ω

Readings of fault current I_k

Measuring ranges according to EN 61557 can be calculated on the basis of Z_s measurement ranges and nominal voltages.

Display range	Resolution	Accuracy
1.15...9.99 A	0.01 A	Calculated on the basis of uncertainty for fault loop
10.0...99.9 A	0.1 A	
100...999 A	1 A	
1.00...9.99 kA	0.01 kA	
10.0...40.0 kA	0.1 kA	

Voltage measurement

Display range	Resolution	Accuracy
0...440 V	1 V	±(2.5% m.v. + 3 digits)

Measurement of fault loop impedance Z_s

Test lead	Z_s measuring range
1.2 m	0.24...200 Ω
5 m	0.26...200 Ω
10 m	0.28...200 Ω
20 m	0.35...200 Ω

MZC

Set of standard and optional accessories

1, 2, 4 - number of basic accessories
• - optional accessories

Photo	Name	Index	MZC-330S	MZC-320S	MZC-310S	MZC-306	MZC-304	MZC-20E
	USB/RS-232 converter	WAADAUSBRS232			•			
	AGT-16C three-phase socket adapter 16 A (PEN)	WAADAAGT16C			•	•	•	•
	AGT-16P three-phase socket adapter 16 A	WAADAAGT16P			•	•	•	•
	AGT-16T industrial socket adapter 16 A	WAADAAGT16T			•	•	•	•
	AGT-32C three-phase socket adapter 32 A (PEN)	WAADAAGT32C			•	•	•	•
	AGT-32P three-phase socket adapter 32 A	WAADAAGT32P			•	•	•	•
	AGT-32T industrial socket adapter 32 A	WAADAAGT32T			•	•	•	•
	AGT-63P three-phase socket adapter 63 A	WAADAAGT63P			•	•	•	•
	WS-01 adapter with START button with UNI-SCHUKO plug	WAADAWS01				•	•	
	WS-05 adapter with UNI-SCHUKO angular plug	WAADAWS05				1	1	
	WS-07 adapter for measuring Z(L-N)	WAADAWS07					•	
	NiMH battery 4,8 V 4,2 Ah	WAAKU07				1		
	L10 carrying case	WAFUTL10			1			
	L14 carrying case	WAFUTL14	1	1				
	L2 carrying case	WAFUTL2			•			
	L4 carrying case	WAFUTL4	•	•		1		
	M10 carrying case	WAFUTM10						1
	M6 carrying case	WAFUTM6					1	
	Crocodile clip, black, 1 kV, 20 A	WAKROBL20K01			1			

Photo	Name	Index	MZC-330S	MZC-320S	MZC-310S	MZC-306	MZC-304	MZC-20E
	Crocodile clip, black, 1 kV, 32 A	WAKROBL30K03	4	4	4			
	Crocodile clip, red, 1 kV, 20 A	WAKRORE20K02					•	• 1
	Kelvin clamp, 1 kV, 25 A	WAKROKELK06	2	2	2			
	Crocodile clip, blue, 1 kV, 20 A	WAKROBU20K02					1	•
	Crocodile clip, yellow, 1 kV, 20 A	WAKROYE20K02					•	1
	Mini bluetooth keyboard	WAADAMK			1			
	OR-1 USB wireless receiver	WAADAUSBOR1					•	
	PC software: Sonei Reader	WAPROREADER	1	1	1	1	1	
	Test lead 0,7m, black (banana plugs)	WAPRZ0X7BLBB					1	
	Test lead 1,2 m, black, 1 kV (2,5 mm2, banana plugs)	WAPRZ1X2BLBB2X5	1	1				
	Test lead 1,2 m, black, 1 kV (banana plugs)	WAPRZ1X2BLBB			1			
	Test lead 1,2 m, red, 1 kV (banana plugs)	WAPRZ1X2REBB				1	1	1
	Test lead 1,2 m, blue, 1 kV (banana plugs)	WAPRZ1X2BUBB				1	1	1
	Test lead 1,2 m, yellow, 1 kV (banana plugs)	WAPRZ1X2YEBB	1	1	1	1	1	
	Test lead 10 m, red, 1 kV (banana plugs)	WAPRZ010REBB					•	• •
	Test lead 10 m, yellow, 1 kV (banana plugs)	WAPRZ010YEBB	•	•	•			
	Test lead 20 m, red, 1 kV (banana plugs)	WAPRZ020REBB					•	• • •
	Test lead 20 m, yellow, 1 kV (banana plugs)	WAPRZ020YEBB	•	•	•			
	Doble-wire test lead 3 m (10 A / 25 A) U1/I1	WAPRZ003DZBBU1I1	1	1	1			

Photo	Name	Index							Photo	Name	Index								
			MZC-330S	MZC-320S	MZC-310S	MZC-306	MZC-304	MZC-20E				MZC-330S	MZC-320S	MZC-310S	MZC-306	MZC-304	MZC-20E		
	Doble-wire test lead 3 m (10 A / 25 A) U2/I2	WAPRZ003DZBBU2I2	1	1	1					Pin probe, red 1 kV (banana socket)	WASONREOGB1					1	1	1	
	Test lead 5 m, red, 1 kV (banana plugs)	WAPRZ005REBB								Pin probe, red 11 kV (banana socket)	WASONREOGB11								
	Test lead 5 m, red, 11 kV (banana plugs)	WAPRZ005REBB10K								Pin probe, red 5 kV (banana socket)	WASONREOGB2					1	1		
	Test lead 5 m, yellow, 1 kV (banana plugs)	WAPRZ005YEBB								Pin probe, blue 1 kV (banana socket)	WASONBUOGB1						1	1	1
	Cable for battery charging from car cigarette lighter socket (12 V)	WAPRZLAD12SAM								Pin probe, yellow 1 kV (banana socket)	WASONYE0GB1	1	1	1	1				
	microUSB cable	WAPRZUSBMICRO	1	1						High-current pin probe 1 kV (banana sockets)	WASONSPGB1	2	2	2					
	USB cable	WAPRZUSB					1			L2 hanging straps (short)	WAPOZSZE2					1			
	RS-232 serial transmission cable	WAPRZRS232						1		M1 hanging straps	WAPOZSZE4					1	1	1	
	Mains cable with IEC C13 plug	WAPRZ1X8BLIEC						1		UNI-SONEL hanging straps	WAPOZSZE1				1				
	Mains cable with IEC C7 plug	WAPRZLAD230						1		reel for long test lead	WAPOZSZP1					1			
	Pin probe, black 1 kV (banana socket)	WASONBLOGB1						1		M1 hanging hook straps	WAPOZUCH1							1	
	Pin probe, black 5 kV (banana socket)	WASONBLOGB2						1		Z7 Power supply	WAZASZ7					1			
	Foldable pin probe, 1 kV, 2 m (banana socket)	WASONSP2M								Power supply adaptor Z19	WAZASZ19	1	1						



Earth resistance meters

MRU-200-GPS
MRU-200
MRU-120
MRU-21



MRU-30

MRU-10



Set of instruments for earth measurements



	MRU-200-GPS MRU-200	MRU-120	MRU-30	MRU-21	MRU-10	MPI-540 MPI-535	MPI-530-IT MPI-530	MPI-525 / MPI-520 / MPI-520 Start
Earth resistance measurement according to 3-lead method	✓	✓	✓	✓	✓	✓	✓	✓
Earth resistance measurement according to 4-lead method	✓	✓	✓	–	–	✓	✓	–
Maximum resolution [Ω]	0.001	0.01	0.01	0.01	0.01	0.01	0.01	0.01
Measurement of multiple earthing systems according to the technical method using an additional clamp	✓	✓	✓	–	–	✓	✓	–
Earth measurement according to impulse method	✓	–	–	–	–	–	–	–
Earth measurement according to double-clamp method	✓	✓	✓	–	–	✓	✓	–
Current measurement with clamp	✓	–	✓	–	–	✓	✓	MPI-520 / 520 Start
Current measurement with flexible clamp (Rogowski coil)	✓	–	–	–	–	✓	✓	– / ✓ / ✓
Continuity test of protective conductors and equipotential bonding according to standard EN 61557	✓	✓	✓	✓	–	✓	✓	✓
Soil resistivity measurement	✓	✓	✓	–	–	✓	✓	–
Internal power source	✓	✓	✓	✓	✓	✓	✓	✓
Resistance measurement	✓	✓	✓	✓	–	✓	✓	✓
Quick charger, rechargeable battery	✓	✓	✓	–	–	✓	✓	✓ / OPTIONAL / OPTIONAL
Charging from car lighter socket	✓	OPTIONAL	OPTIONAL	–	–	✓	✓	OPTIONAL
Memory (records)	990	990	990	990	–	UNLIMITED	10 000	990
Measurement of disturbance voltages	✓	✓	✓	✓	✓	✓	✓	✓
Resistance measurement of auxiliary probes	✓	✓	✓	✓	✓	✓	✓	✓
Dimensions [mm]	288 x 223 x 75	288 x 223 x 75	200 x 180 x 74	288 x 223 x 75	221 x 102 x 62	288 x 223 x 75	288 x 223 x 75	288 x 223 x 75
Weight [kg]	2	2	1.2	1.4	0.7	2.5	2.2	2.2

Earth resistance measurements adapter

SONEL ERP-1

index: WAADAERP1 / WAADAERP1V2 / WAADAERP1V3



Earth resistance measurements

The SONEL ERP-1 adapter, as well as MRU-200 and MRU-200-GPS meters, serves for measuring of multiple groundings without disconnecting control connection clamps. The flexible, big diameter Rogowski coil allows to measure earth resistance of e.g. transmission towers - including lattice poles - without shutting down the power line.

The user may choose 3-lead method including measurement clamps. The adapter's ergonomic and convenient housing as well as its simple operation make earth resistance measurements of transmission towers and pylons quick and problem-free.

The adapter is compatible with meters:

- » Sonel MRU-200,
- » Sonel MRU-200-GPS

Contents of set:

- » Sonel ERP-1 adapter
- » 3x AA (LR6) 1.5 V battery
- » user manual

Additional accessories:

FSX-3 flexible clamp	WACEGFSX30KR
FS-2 flexible clamp	WACEGFS20KR
XL8 hard briefcase	WAWALXL8
M6 adapter carrying case	WAFUTM6

Bundle sets:

ERP-1 adapter	WAADAERP1
ERP-1 adapter with FS-2 flexible clamp and carrying case	WAADAERP1V2
ERP-1 adapter with FSX-3 flexible clamp and carrying case	WAADAERP1V3

Other specifications:

- » storage temperature -20...+80°C
- » relative humidity of storage 20...90%
- » operating temperature range -10...+50°C
- » operating humidity 20...85%
- » exterior dimensions 146 x 88 x 33 mm
- » weight with batteries / without batteries 340 g / 270 g
- » protection rating IP67

Electrical specifications:

- » measuring range up to 5 A
- » operating frequency 125 Hz (in 50 Hz networks)
150 Hz (in 60 Hz networks)
- » power supply ... 3 x LR6 1.5 V battery or 3 x Ni-MH LR6 1.2 V rech. battery
- » measurement category CAT IV 300 V according to EN 61010-1

SONEL MRU-200 / MRU-200-GPS

index: WMGBMRU200 / WMGBMRU200GPS



**BUILT-IN
GPS
RECEIVER**

CAT III 600 V **CAT IV 300 V** **IP54**

Earthing resistance measurements:

- » with auxiliary electrodes (3-lead, 4-lead),
- » with auxiliary electrodes and clamp (for measurement of multiple earthing systems - 3-lead + clamp),
- » with a pair of clamps (without the need to use auxiliary electrodes).

Additional measurements:

- » auxiliary electrode resistances R_s and R_H ,
- » voltage and frequency of disturbance signal,
- » in the presence of disturbance voltages in networks with frequency 16 2/3 Hz, 50 Hz and 60 Hz as well as 400 Hz (with automatic or manual selection of relevant measurement signal frequency),
- » selection of maximum measurement voltage (25 V and 50 V),
- » calibration of applied clamp,
- » interoperability with ERP-1 adapter.

MRU-200-GPS is the only earthing resistance and impedance meter with the function of determining the geographical coordinates of the location of measurement.

Earthing impedance measurement:

- » impulse method (without the need to disconnect measured earth electrodes),
- » three types of measurement impulse (4/10 μ s, 8/20 μ s, 10/350 μ s)

Soil resistivity measurements (Wenner method):

- » distances between electrodes can be input in meters (m) or feet (ft).

Continuity tests of protective conductors and equipotential bondings:

- » with auto-zeroing function - with current ≥ 200 mA - according to EN 61557-4.

Additional functions of the meter:

- » Memory storing 990 measurements (10 banks with 99 cells each).
- » Built-in GPS receiver (MRU-200-GPS only).
- » Real-time clock (RTC).
- » Data transmission to computer (USB).
- » Reading of battery charge state, built-in quick charger.

MRU-200 is a unique meter employing all known methods of measurement and performing measurements with a resolution of 0.001 Ω .



SONEL MRU MOBILE

Mobile version of the program supports ground resistance and ground resistivity meters **MRU-200** and **MRU-200-GPS**. It can be downloaded from the www.sonel.pl/en website.

Standard accessories of the meters:

NiMH battery 4.8 V 4.2 Ah	WAAKU07
L2 carrying case	WAFUTL2
Crocodile clip, black, 1 kV, 20 A	WAKROBL20K01
Crocodile clip, red, 1 kV, 20 A	WAKRORE20K02
PC software: Sonel Reader	WAPROREADER
Test lead 1.2 m, red, 1 kV (banana plugs)	WAPRZ1X2REBB
Test lead 2.2 m, black, 1 kV (banana plugs)	WAPRZ2X2BLBB
Test lead 25 m, red (banana plugs, on a reel)	WAPRZ025REBBSZ
Test lead 25 m, blue (banana plugs, on a reel)	WAPRZ025BUBBSZ
Test lead 50 m, yellow (banana plugs, on a reel, shielded)	WAPRZ050YEBBSZE
Cable for battery charging from car cigarette lighter socket (12 V)	WAPRZLAD12SAM
USB cable	WAPRZUSB
Mains cable with IEC C7 plug	WAPRZLAD230
Earth contact test probe (rod), 30 cm	WASONG30
L2 hanging straps (set)	WAPROZSZEKPL
Cramp	WAZACIMA1
Z7 Power supply	WAZASZ7
Calibration certificate	

Earthing resistance measurement (3- and 4-lead method)

measuring range according to EN 61557-5: 0.100 Ω ...19.99 k Ω

Display range	Resolution	Accuracy
0.000...3.999 Ω	0.001 Ω	$\pm(2\% \text{ m.v.} + 4 \text{ digits})$
4.00...39.99 Ω	0.01 Ω	$\pm(2\% \text{ m.v.} + 2 \text{ digits})$
40.0...399.9 Ω	0.1 Ω	
400...3999 Ω	1 Ω	$\pm(5\% \text{ m.v.} + 2 \text{ digits})$
4.00 k Ω ...19.99 k Ω	0.01 k Ω	

Resistance measurement of multiple earthing systems with clamp (3-lead + clamp)

Display range	Resolution	Accuracy
0.000...3.999 Ω	0.001 Ω	$\pm(8\% \text{ m.v.} + 4 \text{ digits})$
4.00...39.99 Ω	0.01 Ω	$\pm(8\% \text{ m.v.} + 3 \text{ digits})$
40.0...399.9 Ω	0.1 Ω	
400...1999 Ω	1 Ω	

Measurement of multiple earthing systems with two clamps

Display range	Resolution	Accuracy
0.00...19.99 Ω	0.01 Ω	$\pm(10\% \text{ m.v.} + 3 \text{ digits})$
20.0...149.9 Ω	0.1 Ω	$\pm(20\% \text{ m.v.} + 3 \text{ digits})$

Measurement of earthing impedance (Z_p) using the impulse method (4-lead)

Display range	Resolution	Accuracy
0.0...99.9 Ω	0.1 Ω	$\pm(2.5\% \text{ m.v.} + 3 \text{ digits})$
100...199 Ω	1 Ω	

The instrument meets the requirements set forth in standards:

- » EN 62305-1 (lightning protection)
- » EN 61010-1 (general and particular requirements related to safety)
- » EN 61010-031 (general and particular requirements related to safety)
- » EN 61326 (electromagnetic compatibility)
- » EN 61557 (requirements for measurement instruments)
- » HD 60364-6 (performance of measurements - checking)
- » HD 60364-4-41 (performance of measurements - shock protection)
- » PN-E 04700 (performance of measurements - commissioning tests)

Other technical specifications:

- » type of insulation double, as per EN 61010-1 and EN 61557
- » measurement category ... CAT IV 300 V (CAT III 600 V) acc. to EN 61010-1
- » number of measurements provided by set of batteries >1500

Nominal operating conditions:

- » operating temperature range -10...+50°C
- » storage temperature -20...+80°C
- » humidity 20...90%

Earthing resistance meter

SONEL MRU-120

index: WMGBMRU120



Earthing resistance measurements:

- » with auxiliary electrodes (3-lead, 4-lead),
- » with auxiliary electrodes and clamp (for measurement of multiple earthing systems),
- » with a pair of clamps (without the need to use auxiliary electrodes),
- » frequency of measurement current: 125 Hz (for 50 Hz network) or 150 Hz (for 60 Hz network),

Additional measurements:

- » auxiliary electrode resistances R_s and R_{tr} ,
- » disturbance voltage,
- » frequency of disturbance signal,
- » in the presence of disturbance voltages in networks with frequencies of 50 Hz and 60 Hz,
- » selection of maximum measurement voltage (25 V or 50 V),
- » interoperability with ERP-1 adapter.

Soil resistivity measurements (Wenner method):

- » distances between electrodes can be input in meters (m) or feet (ft).

Continuity tests of protective conductors and equipotential bondings:

- » with auto-zeroing function - with current ≥ 200 mA
- » in compliance with EN 61557-4.

Additional functions of the meter:

- » Memory storing 990 measurements (10 banks with 99 cells each).
- » Real-time clock (RTC).
- » Data transmission to computer (USB).
- » Reading of battery charge status, built-in quick charger.



MRU-120 makes it possible to measure earthings, even without the use of auxiliary probes, by means of the double-clamp method.

The instrument meets the requirements set forth in the standards:

- » EN 61010-1 (general and particular requirements related to safety)
- » EN 61010-031 (general and particular requirements related to safety)
- » EN 61326 (electromagnetic compatibility)
- » EN 61557 (requirements for measurement instruments)
- » HD 60364-6 (performance of measurements - checking)
- » HD 60364-4-41 (performance of measurements - shock protection)
- » PN-E 04700 (performance of measurements - commissioning tests)

Other technical specifications:

- » type of insulation double, as per EN 61010-1 and EN 61557
- » measurement category CAT IV 300 V (CAT III 600 V) acc. to EN 61010-1
- » number of measurements provided by set of batteries >1100

Nominal operating conditions:

- » operating temperature range -10...+50°C
- » storage temperature -20...+80°C
- » humidity 20...85%

Standard accessories of the meter:

NiMH battery 4.8 V 3.2 Ah	WAAKU08
L2 carrying case	WAFUTL2
Crocodile clip, black, 1 kV, 20 A	WAKROBL20K01
PC software: Sonel Reader	WAPROREADER
Test lead 1.2 m, red, 1 kV (banana plugs)	WAPRZ1X2REBB
Test lead 2.2 m, black, 1 kV (banana plugs)	WAPRZ2X2BLBB
Test lead 25 m, red (banana plugs, on a reel)	WAPRZ025REBBSZ
Test lead 25 m, blue (banana plugs, on a reel)	WAPRZ025BUBBSZ
Test lead 50 m, yellow (banana plugs, on a reel)	WAPRZ050YEBBSZ
USB cable	WAPRZUSB
Mains cable with IEC C7 plug	WAPRZLAD230
Earth contact test probe (rod), 30 cm	WASONG30
Pin probe, red 1 kV (banana socket)	WASONREOGB1
L2 hanging straps (set)	WAPOZSZEKPL
Z7 Power supply	WAZASZ7

Calibration certificate

Earthing resistance measurement (3- and 4-lead method)

measuring range according to EN 61557-5: 0.30 Ω ...19.9 k Ω

Display range	Resolution	Accuracy
0.00...19.99 Ω	0.01 Ω	$\pm(2\% \text{ m.v.} + 2 \text{ digits})$
20.0...199.9 Ω	0.1 Ω	
200...1999 Ω	1 Ω	
2.0...9.99 k Ω	0.01 k Ω	$\pm(5\% \text{ m.v.} + 2 \text{ digits})$
10.0...19.9 k Ω	0.1 k Ω	

Resistance measurement of multiple earthing systems with clamp (3-lead + clamp)

Display range	Resolution	Accuracy
0.00...19.99 Ω	0.01 Ω	$\pm(8\% \text{ m.v.} + 3 \text{ digits})$
20.0...199.9 Ω	0.1 Ω	
200...1999 Ω	1 Ω	

Measurement of multiple earthing systems with two clamps

Display range	Resolution	Accuracy
0.00...19.99 Ω	0.01 Ω	$\pm(10\% \text{ m.v.} + 3 \text{ digits})$
20.0...149.9 Ω	0.1 Ω	$\pm(20\% \text{ m.v.} + 3 \text{ digits})$



MRU-120 allows for measurements of multiple earthing systems without disconnection of test connections, by means of the 3-lead and clamp method or double-clamp method.



Earthing resistance meter

SONEL MRU-30

index: WMGBMRU30



CAT III **IP65**
300 V

Earthing resistance measurements:

- » with auxiliary electrodes (3-lead and 4-lead),
- » with auxiliary electrodes and clamp (for measurement of multiple earthing systems),
- » with two clamps (for measurement of earthings where it is not possible to apply auxiliary electrodes),
- » soil resistivity (Wenner method),
- » continuity of protective conductors and equipotential bonding (meeting the requirements of EN 61557-4, with auto-zeroing function - with ≥ 200 mA current).

Additional functions of the meter:

- » measurement of auxiliary electrode resistances R_s and R_{ip} ,
- » measurement of disturbance voltage,
- » measurement in the presence of disturbance voltages in networks with frequencies of 50 Hz and 60 Hz,
- » selection of maximum measurement voltage (25 V and 50 V),
- » in soil resistivity measurements, distances between electrodes can be input in meters (m) or feet (ft),
- » memory storing 990 measurements (10 banks with 99 cells each),
- » calibration of test clamps,
- » data transmission to computer (USB),
- » reading of battery charge status.

Other technical specifications:

- » type of insulation double, as per EN 61010-1 and EN 61557
- » measurement category CAT III 300V according to EN 61010-1
- » housing protection rating according to EN 60529 IP65
- » LCD display segmented, with backlight
- » dimensions 200 x 150 x 73 mm

Nominal operating conditions:

- » operating temperature range -10...+50°C
- » storage temperature -20...+60°C
- » humidity 20...90%

Earthing resistance measurement (3- and 4-lead method)

measurement method: technical, in compliance with EN 61557-5
measuring range according to EN 61557-5:2007: **0.53 Ω...9999 Ω** (for 50 V)

Display range	Resolution	Accuracy
0.00...19.99 Ω	0.01 Ω	±(3% m.v. + 3 digits)
20.0...199.9 Ω	0.1 Ω	
200...1999 Ω	1 Ω	±5% m.v.
2000...9999 Ω	1 Ω	±8% m.v.

- » measurement method: technical, 3-lead and 4-lead,
- » measurement current: >20 mA upon closing of circuit,
- » voltage on open terminals: 25 V AC or 50 V AC available for selection,
- » frequency of measurement current: 125 (for 50 Hz network) or 150 Hz (for 60 Hz network), measurement frequency can be selected in the menu.

Standard accessories of the meter:

L10 carrying case	WAFUTL10
M9 carrying case	WAFUTM9
Crocodile clip, black, 1 kV, 20 A	WAKROBL20K01
PC software: Sonel Reader	WAPROREADER
Test lead 1.2 m, red, 1 kV (banana plugs)	WAPRZ1X2REBB
Test lead 2.2 m, black, 1 kV (banana plugs)	WAPRZ2X2BLBB
Test lead 25 m, red (banana plugs, on a reel)	WAPRZ025REBBSZ
Test lead 50 m, yellow (banana plugs, on a reel)	WAPRZ050YEBBSZ
USB cable	WAPRZUSB
Mains cable with IEC C7 plug	WAPRZLAD230
Earth contact test probe (rod), 30 cm	WASONG30
Pin probe, red 1 kV (banana socket)	WASONREOGB1
Cramp	WAZACIMA1
Z7 Power supply	WAZASZ7
Calibration certificate	

Resistance measurement of multiple earthing systems with clamp (3-lead + clamp)

Display range	Resolution	Accuracy
0.00...19.99 Ω	0.01 Ω	±(3% m.v. + 3 digits)
20.0...199.9 Ω	0.1 Ω	
200...1999 Ω	1 Ω	±5% m.v.
2000...9999 Ω	1 Ω	±8% m.v.

- » measurement method: technical with the use of clamp and auxiliary electrodes,
- » voltage on open terminals: 25 V AC or 50 V AC available for selection,
- » measurement current: >20 mA upon closing of circuit,
- » frequency of measurement current: 125 (for 50 Hz network) or 150 Hz (for 60 Hz network), manual selection of measurement frequency

Resistance measurement of multiple earthing systems with two clamps

Display range	Resolution	Accuracy
0.00...19.99 Ω	0.01 Ω	±(10% m.v. + 8 digits)
20.0...199.9 Ω	0.1 Ω	±(20% m.v. + 3 digits)

- » measurement current frequency 125 Hz (for 50 Hz network) or 150 Hz (for 60 Hz network)

Wenner method of measurement: soil resistivity measurement $\rho = 2\pi rL R_E$

Display range	Resolution	Accuracy
0.00...9.99 Ωm	0.01 Ωm	depends on accuracy of R_E measurement in 4-lead method, but no lower than ±1 digit
10.0...99.9 Ωm	0.1 Ωm	
100...999 Ωm	1 Ωm	
1.00...9.99 kΩm	0.01 kΩm	
10.0...99.9 kΩm	0.1 kΩm	
100...999 kΩm	1 kΩm	

L – distance between measurement probes: 1...50 m

Measurement of auxiliary electrode resistances R_H and R_{sp}

Display range	Resolution	Accuracy
0...999 Ω	1 Ω	±(5%($R_s+R_E+R_{ip}$) + 8 digits)
1.00k...9.99 kΩ	0.01 kΩ	
10.0...19.9 kΩ	0.1 kΩ	

Continuity tests of protective conductors and equipotential bondings:

measuring range according to EN 61557-4:2007: **0.13 Ω...1999 Ω**

Display range	Resolution	Accuracy
0.00...9.99 Ω	0.01 Ω	±(2% m.v. + 3 digits)
10.0...99.9 Ω	0.1 Ω	
100...1999 Ω	1 Ω	

- » method of measurement: technical two-lead,
- » measurement current: >200 mA upon closing of circuit,
- » auto-zeroing of test leads.

Measurement of disturbance voltage U_N (RMS)

Display range	Resolution	Accuracy
0...100 V	1 V	±(5% m.v. + 2 digits)

Earthing resistance meters

SONEL MRU-21

index: WMGBMRU21



Earthing resistance measurement:

- » with auxiliary electrodes by means of the 3-lead method, measurement for auxiliary electrode resistance up to a maximum of 50 kΩ,

In addition:

- » measurement of auxiliary electrode resistances R_s and R_{pr} ,
- » measurement of disturbance voltage,
- » measurement in the presence of disturbance voltages in the network,
- » selection of maximum measurement voltage (25 V and 50 V).

2-lead resistance measurement:

- » auto-zeroing of test leads

Continuity test of protective conductors and equipotential bonding:

- » meeting the requirements of EN 61557-4, with auto-zeroing function - with ≥ 200 mA current.

Additional functions of the meters:

- » Memory storing up to 990 results, data transmission to computer via USB cable.
- » Reading of battery or rechargeable battery charge status.
- » Power supply from batteries or rechargeable batteries.
- » Automatic power down after 5 minutes.

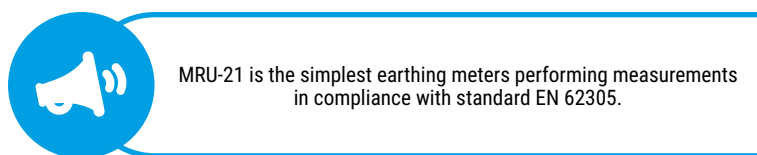

Other technical specifications:

- » type of insulation double, as per EN 61010-1 and EN 61557
- » measurement category CAT IV 300V according to EN 61010-1
- » LCD display segmented, with backlight
- » number of measurements provided by set of alkaline batteries 1000 (5 Ω, 2/min)
- » dimensions 260 x 190 x 60 mm
- » weight including batteries 1.4 kg
- » this product meets EMC requirements in compliance with standards EN 61326-1 and EN 61326-2-2
- » power supply of the meter 4 x 1.5 V batteries or type C rechargeable batteries

Nominal operating conditions:

- » operating temperature range -10...+55°C
- » storage temperature -20...+70°C
- » humidity 20...90%

Standard accessories of the meter:

L4 carrying case	WAFUTL4
Crocodile clip, black, 1 kV, 20 A	WAKROBL20K01
Crocodile clip, blue, 1 kV, 20 A	WAKROBU20K02
Battery container	WAPOJ1
PC software: Sonel Reader	WAPROREADER
Test lead 1.2 m, blue, 1 kV (banana plugs)	WAPRZ1X2BUBB
Test lead 15 m, blue (on a reel)	WAPRZ015BUBBSZ
Test lead 2.2 m, black, 1 kV (banana plugs)	WAPRZ2X2BLBB
Test lead 30 m, red, (banana plugs, on a reel)	WAPRZ030REBBSZ
USB cable	WAPRZUSB
2 x earth contact test probe (rod), 30 cm	WASONG30
L2 hanging straps (set)	WAPOZSZEKPL
L2 hanging straps (short)	WAPOZSZE2
L2 hanging straps (set)	WAPOZSZEKPL
Calibration certificate	

Earthing resistance measurement (3-lead)

measuring range according to EN 61557-5:

0.50 Ω...1.99 kΩ for $U_n = 50$ V; 0.68 Ω...1.99 kΩ for $U_n = 25$ V;

Display range	Resolution	Accuracy
0.00...9.99 Ω	0.01 Ω	±(2% m.v. + 3 digits)
10.0...99.9 Ω	0.1 Ω	
100...999 Ω	1 Ω	
1.00...1.99 kΩ	0.01 kΩ	

- » measurement current: > 20 mA upon closing of circuit
- » frequency of measurement current: 125 Hz

Continuity tests of protective conductors and equipotential bondings:

measuring range according to EN 61557-4: 0.13 Ω...199 Ω

Display range	Resolution	Accuracy
0.00...9.99 Ω	0.01 Ω	±(2% m.v. + 3 digits)
10.0...99.9 Ω	0.1 Ω	
100...199 Ω	1 Ω	

Instruments meet the requirements set forth in the standards:

- » EN 61010-1 (general and particular requirements related to safety)
- » EN 61010-031 (general and particular requirements related to safety)
- » EN 61326 (electromagnetic compatibility)
- » EN 61557 (requirements for measurement instruments)
- » HD 60364-6 (performance of measurements - checking)
- » HD 60364-4-41 (performance of measurements - shock protection)
- » E 04700 (performance of measurements - commissioning tests)



Earthing resistance meter

SONEL MRU-10

index: WMGBMRU10



CAT IV

150 V

CAT III

300 V

IP67

It allows to take the measurements of:

- » earthing resistance using auxiliary electrodes,
- » earthing resistance using 2-pole method,
- » interference voltage to 100 V,
- » resistance of auxiliary electrodes R_H and R_S .

Additional functions of the meter:

- » indication of battery state,
- » Auto-OFF function,
- » selection of maximum measuring voltage (25 V and 50 V).

Standard accessories of the meter:

M6 carrying case	WAFUTM6
Crocodile clip, black, 1 kV, 20 A	WAKROBL20K01
Test lead with banana plug; 15 m; red	WAPRZ015REBBN
Test lead with banana plugs; 30 m; yellow	WAPRZ030YEBBN
Test lead 2,2 m, black, 1 kV (banana plugs)	WAPRZ2X2LB
Earth contact test probe (rod), 15 cm	WASONG25
M1 hanging straps	WAPOZSZE4
M1 hanging hook straps	WAPOZUCH1
4x AA battery, LR6	

Calibration certificate

Other technical specifications:

- » type of insulation double, as per EN 61010-1 and EN 61557
- » measurement category CAT IV 150 V (III 300 V) according to EN 61010-1
- » housing protection rating according to EN 60529 IP67
- » power supply of the meter alkaline batteries or NiMH AA rechargeable batteries (4 pcs)
- » LCD display segment, backlit
- » the meter meets the EMC requirements acc. to standards EN 61326-1 and EN 61326-2-2
- » dimensions 221 x 102 x 62 mm
- » weight with batteries approx. 660 g

Nominalne warunki użytkowania:

- » operating temperature -10...+50°C
- » storage temperature -20...+60°C
- » reference temperature +23...±2°C
- » humidity 20...90%

Measurement of earthing resistance (method 3-pole) R_E3P

measurement range to IEC 61557-5:2007: 0.53 Ω...9999 Ω for $U_n=50$ V

Display range	Resolution	Accuracy
0.00...19.99 Ω	0.01 Ω	±(3% m.v. + 3 digits)
20.0...199.9 Ω	0.1 Ω	
200...1999 Ω	1 Ω	±5% m.v.
2000...9999 Ω	1 Ω	±8% m.v.

- » Measurement current: under short circuit >20 mA, frequency 125 Hz or 150 Hz, voltage selectable 25 V or 50 V.
- » Maximum interference voltage, at which R_E measurement is performed, equals 24 V.

Measurement of earthing resistance (method 2-pole) R_E2P

Display range	Resolution	Accuracy
0.00...19.99 Ω	0.01 Ω	±(3% m.v. + 3 digits)
20.0...199.9 Ω	0.1 Ω	
200...1999 Ω	1 Ω	±5% m.v.
2000...9999 Ω	1 Ω	±8% m.v.

- » Measurement current: under short circuit >20 mA, frequency 125 Hz or 150 Hz, voltage selectable 25 V or 50 V.
- » Maximum interference voltage, at which R_E measurement is performed, equals 24 V.

Measurement of resistance of auxiliary electrodes R_H i R_S

Display range	Resolution	Accuracy
0...999 Ω	1 Ω	±(5% m.v. + 8 digits)
1.00...9.99 kΩ	0.01 kΩ	
10.0...19.9 kΩ	0.1 kΩ	

Measurement of interference voltage U_N (RMS)

Display range	Resolution	Accuracy
0...100 V	1 V	±(10% m.v. + 1 digit)



MRU

Set of standard and optional accessories

1, 2, 4 - number of basic accessories
 - - optional accessories

Photo	Name	Index	MRU-200-GPS	MRU-200	MRU-120	MRU-30	MRU-21	MRU-10
	ERP-1 adapter for earth resistance measurements	WAADAERP1	•	•				
	ERP-1 adapter for earth resistance measurements with FS-2 flexible clamps	WAADAERP1V2	•	•				
	ERP-1 adapter for earth resistance measurements with FSX-3 flexible clamps	WAADAERP1V3	•	•				
	AC-16 line splitter	WAADAAC16	•	•				
	NiMH battery 4,8 V 3,2 Ah	WAAKU08	•	•	1			
	NiMH battery 4,8 V 4,2 Ah	WAAKU07	1	1	•			
	F-1A flexible clamps (Φ=360 mm)	WACEGF1AOKR	•	•				
	F-2A flexible clamps (Φ=235 mm)	WACEGF2AOKR	•	•				
	F-3A flexible clamps (Φ=120 mm)	WACEGF3AOKR	•	•				
	F-4A flexible clamps (Φ=630 mm)	WACEGF4OKR	•	•				
	FS-2 flexible clamps (Φ=1260 mm)	WACEGFS2OKR	•	•				
	FSX-3 flexible clamps (Φ=630 mm)	WACEGFSX3OKR	•	•				
	N-1 transmitting clamps (Φ=52 mm)	WACEGN1BB	•	•	•	•		
	C-3 current clamps (Φ=52 mm)	WACEGC3OKR	•	•	•	•		
	L10 carrying case	WAFUTL10					1	
	L2 carrying case	WAFUTL2	1	1	1			
	L3 carrying case for a 80 cm rods	WAFUTL3	•	•	•	•	•	•
	L4 carrying case	WAFUTL4					1	
	M6 carrying case	WAFUTM6						1
	M9 carrying case	WAFUTM9				1		
	Crocodile clip, black, 1 kV, 20 A	WAKROBL20K01	1	1	1	1	1	1
	Crocodile clip, red, 1 kV, 20 A	WAKRORE20K02	1	1	•	•	•	•
	Crocodile clip, blue, 1 kV, 20 A	WAKROBU20K02	•	•	•	•	1	
	Crocodile clip, yellow, 1 kV, 20 A	WAKROYE20K02	•	•	•	•	•	•
	Battery pack	WAPOJ1	•	•	•		1	

Photo	Name	Index	MRU-200-GPS	MRU-200	MRU-120	MRU-30	MRU-21	MRU-10
	Battery container	WAPOJ2						
	PC software: Sonel Reader	WAPROREADER	1	1	1	1	1	
	Test lead 1,2 m, black, 1 kV (banana plugs)	WAPRZ1X2BLBB	•	•	•	•	•	
	Test lead 1,2 m, red, 1 kV (banana plugs)	WAPRZ1X2REBB	1	1	1	1	•	
	Test lead 1,2 m, blue, 1 kV (banana plugs)	WAPRZ1X2BUBB	•	•	•	•	1	
	Test lead 1,2 m, yellow, 1 kV (banana plugs)	WAPRZ1X2YEBB	•	•	•	•	•	
	Test lead 100 m, red (banana plugs, on a reel)	WAPRZ100REBBSZ	•	•	•	•	•	•
	Test lead 100 m, blue (banana plugs, on a reel)	WAPRZ100BUBBSZ	•	•	•	•	•	
	Test lead 100 m, yellow (banana plugs, on a reel)	WAPRZ100YEBBSZ	•	•	•	•	•	
	Test lead 100 m, yellow (banana plugs, on a reel, shielded)	WAPRZ100YEBBSZE	•	•	•	•	•	
	Test lead 15 m, blue (on a reel)	WAPRZ015BUBBSZ	•	•	•	•	1	
	Test lead with banana plug; 15 m; red	WAPRZ015REBBN						1
	Double-wire test lead 2 m, for N-1 clamps (banana plugs)	WAPRZ002DZBB	•	•	•	•		
	Test lead 2,2 m, black, 1 kV (banana plugs)	WAPRZ2X2BLBB	1	1	1	1	1	1
	Test lead 200 m, red, (banana plugs, on a reel)	WAPRZ200REBBSZ	•	•	•	•	•	
	Test lead 200 m, blue (banana plugs, on a reel)	WAPRZ200BUBBSZ	•	•	•	•	•	
	Test lead 200 m, yellow (banana plugs, on a reel)	WAPRZ200YEBBSZ	•	•	•	•	•	•
	Test lead 200 m, yellow (banana plugs, on a reel, shielded)	WAPRZ200YEBBSZE	•	•				
	Test lead 25 m, red (banana plugs, on a reel)	WAPRZ025REBBSZ	1	1	1	1	•	•
	Test lead 25 m, blue (banana plugs, on a reel)	WAPRZ025BUBBSZ	1	1	1	•	•	
	Test lead 30 m, red (banana plugs, on a reel)	WAPRZ030REBBSZ	•	•	•	•	1	
	Test lead with banana plugs; 30 m; yellow	WAPRZ030YEBBN						1
	Test lead 50 m, yellow (banana plugs, on a reel)	WAPRZ050YEBBSZ	•	•	1	1	•	•
	Test lead 50 m, yellow (banana plugs, on a reel, shielded)	WAPRZ050YEBBSZE	1	1				
	Test lead 75 m, red (banana plugs, on a reel)	WAPRZ075REBBSZ	•	•	•	•	•	

Photo	Name	Index	MRU-200-GPS	MRU-200	MRU-120	MRU-30	MRU-21	MRU-10
	Test lead 75 m, blue (banana plugs, on a reel)	WAPRZ075BUBBSZ	•	•	•	•	•	
	Test lead 75 m, yellow (banana plugs, on a reel)	WAPRZ075YEBBSZ	•	•	•	•	•	
	Test lead 75 m, yellow (banana plugs, on a reel, shielded)	WAPRZ075YEBBSZE	•	•				
	Cable for battery charging from car cigarette lighter socket (12 V)	WAPRZLAD12SAM	1	1	•	•		
	USB cable	WAPRZUSB	1	1	1	1	1	
	Mains cable with IEC C7 plug	WAPRZLAD230	1	1	1	1		
	Earth contact test probe (rod), 15 cm	WASONG25						2
	Earth contact test probe (rod), 30 cm	WASONG30	4	4	4	2	2	•
	Earth contact test probe (rod), 80 cm	WASONG80	•	•	•	•	•	•
	Pin probe, black 1 kV (banana socket)	WASONBLOGB1	•	•	•	•	•	
	Pin probe, red 1 kV (banana socket)	WASONREOGB1	•	•	1	1	•	
	Pin probe, blue 1 kV (banana socket)	WASONBUOGB1	•	•	•	•	•	
	Pin probe, yellow 1 kV (banana socket)	WASONYEGB1	•	•	•	•	•	
	L2 hanging straps (short)	WAPOZSZE2						
	L2 hanging straps (set)	WAPOZSZEKPL	1	1	1		1	
	M1 hanging straps	WAPOZSZE4						1
	Test wire reel	WAPOZSZP1	•	•	•	•	•	
	XL8 carrying case for ERP-1	WAWALXL8	•	•				
	XL3 carrying case for MRU-200	WAWALXL3	•	•				
	M1 hanging hook straps	WAPOZUCH1						1
	Cramp	WAZACIMA1	1	1	•	1	•	•
	Z7 Power supply	WAZASZ7	1	1	1	1		

SONEL MRU MOBILE



Mobile version of the program cooperating with ground resistance and ground resistivity meters **MRU-200** and **MRU-200-GPS**. It can be downloaded from the www.sonel.pl/en website or by scanning the QR code placed above.

Thanks to the application, you can **connect directly to the device** via Bluetooth and download measurement data from the meter. After reading the measurements from the device, they can be easily and quickly **viewed**, and also **sent from the place of measurement** to a person who can help in interpretation of data or make a measurement report.

Thanks to the application, you can enrich the measurement with a photo, comments or voice memo. From the application level, we also have **access to the meter's manual** and help regarding various measurement methods.

Users who do not have a meter can use the set of **sample data** implemented in demo mode.

SONEL REPORTS PLUS



Sonel Reports Plus supports creation of documentation after testing of electrical installation. The software communicates with Sonel test instruments, downloads data from memory of the devices and creates necessary documentation. Many useful functions are included in order to help creating documentation of the measurements. Sonel Reports Plus supports **MPI-540** and **MPI-530** by reading, downloading and uploading test structure from/to test instrument.

- » Every report can contain description page.
- » Tree structure presents a clear picture of the tested building and its rooms. Test structure can be uploaded to the meter and downloaded from it together with test results.
- » User can print labels for test points.
- » For every room user can add picture or scheme of electrical installation.
- » Software contains library of fuses.
- » For every room user can create separate table with test results.



Thermal imagers

KT-670
KT-650
KT-560

KT-400
KT-385
KT-200
KT-195

KT-320
KT-250
KT-165
KT-145
KT-80

DIT-500
DIT-130

UV-260

Contactless temperature measurements



Thermal imaging is a process based on **processing infrared radiation**, that is the heat emitted by objects, **into a visible image**, making possible to assess temperature distribution on the surface of the observed object without contact.

This is important wherever it is necessary to measure temperature at inaccessible or hazardous locations and also allows for:

- » quick temperature measurement on surfaces of any size,
- » or lightning-fast location of heat escape points invisible to the naked eye related to failures in buildings' insulation and construction errors (thermal bridges for example).

In thermographic analysis, **contactless measurement in the infrared spectrum** is used to determine the temperature of a surface from a distance. Since all objects with a temperature above absolute zero emit thermal radiation of similar characteristics (called black-body radiation), by measuring the radiation and with knowledge of the emissivity coefficient of a given object, its temperature can be determined.

Professional radiometric thermal imaging cameras register temperature separately for each point of the image. For example, in the case of a camera with a 640 x 480 resolution, temperature is registered simultaneously for each of the 307200 points. This makes it possible to conduct detailed analysis of saved thermal images, which display different temperatures as different colors.

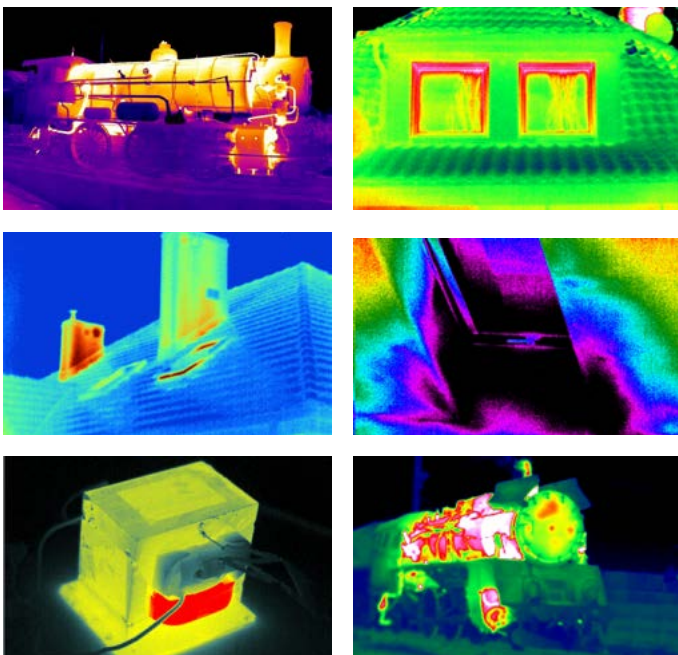

All information saved in a thermogram can be used by specialized software delivered with the thermal imaging camera. During analysis of a thermogram, points with maximum or minimum temperature can be determined, the emissivity coefficient of the whole thermogram or a part of it can be corrected, temperature can be read at any point of the thermogram, mean temperature can be calculated, temperature distribution can be presented in the form of histograms or isotherms, the thermal image can be combined with the real image, just as on the screen of the

camera, which makes it possible to precisely locate places with a specific temperature, and the color palette can be changed arbitrarily to best represent the temperature distribution.

One useful function of thermal imaging cameras is the **capability of taking real-life photographs** as well as **combined image modes** enabling combination of the real-life image with the thermal image and displaying an image in which the thermal image overlaps with the real-life image.

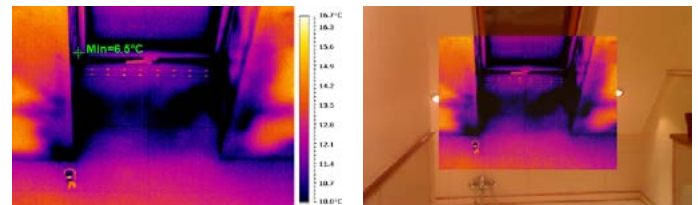

A thermal image is presented on-screen in the color palette selected by the user that best represents individual temperature ranges:

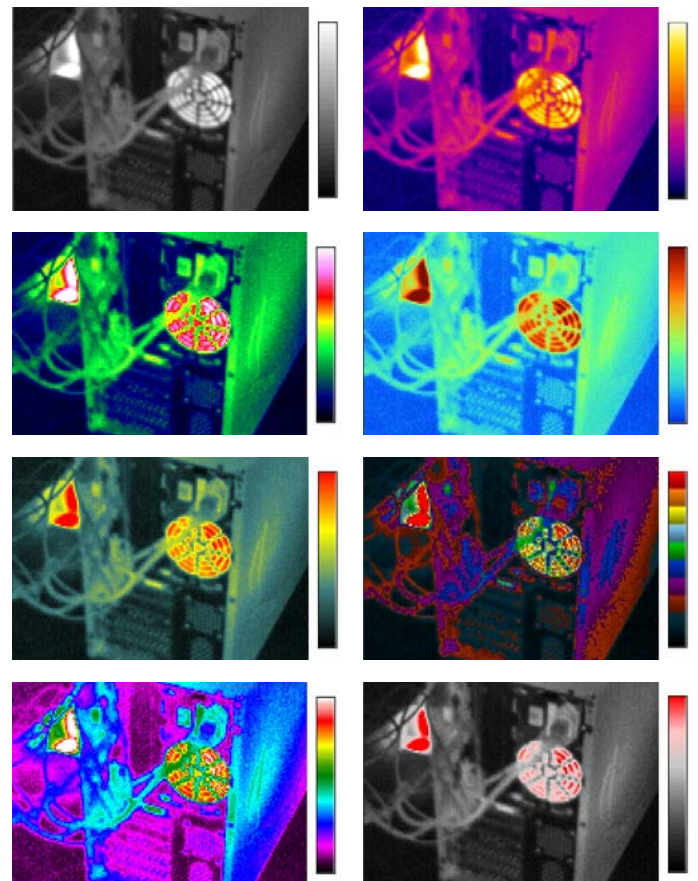

Infrared thermometers are also devices that serve for contactless temperature measurement, and they operate on the basis of **analysis of the thermal radiation** emitted by the tested object. These devices are applied whenever it is required to measure wide range of temperatures.

The main **parameters** characterizing an infrared thermometer are: measured temperature ranges, accuracy and **D:S ratio**, which is the ratio of the distance from the object to the diameter of the field for which the measurement is made.

Thanks to their design, pyrometers allow to measure temperature of small objects, also from great distance. The bigger D:S ratio is, the smaller objects can be measured from big distance.



Thermal imagers

SONEL KT-670 / KT-650 / KT-560

index: WMXXKT670 / WMXXKT650 / WMXXKT560



	KT-670	KT-650	KT-560
Detector type	640 x 480		384 x 288
Spectral range	8~14 μm		
Sensitivity	30 mK	40 mK	50 mK
Lens (field of vision / focal distance)	24.6° x 18.5°/25 mm optionally: 45.4° x 34.9°/13 mm 11.3° x 8.5°/55 mm 7.3° x 5.5°/85 mm		21.7° x 16.4°/25 mm optionally: 40.5° x 31.0°/13 mm 10.0° x 7.5°/55 mm 6.7° x 5.1°/85 mm
Display	high-quality 5", 1280 x 720, touch-screen LCD		
Viewfinder	1280 x 960 LCOS		
Image mode	IR / Visual / Infracusion MIF/ PiP		
Zoom	1...10		1...4
Temperature range	Range 1: -20°C...150°C Range 2: 150°C...800°C optionally: 2000°C		
Accuracy	±2°C or 2% of reading		
Image analysis mode	10 points, 10 lines, 10 areas. Temperature readings: min., max., average. Isotherms. Dew point. Temp. alarm	8 points, 8 lines, 8 areas. Temperature readings: min., max., average. Isotherms. Dew point. Temp. alarm	5 points, 2 lines, 5 areas. Temperature readings: min., max., average. Isotherms. Dew point. Temp. alarm
Palettes	10	8	
Emissivity coefficient	set from 0.01 to 1.00 or selected from list of materials		
Measurement correction	configurable distance, relative humidity, ambient temperature (reflected)		
Image file format	JPG		
Notes on IR images	audio (60 s), text, graphical, additional visual photographs	audio (60 s), text, graphical	
Reports module	PDF reports, report printing via Wi-Fi		
Video file format	AVI, IRV (with temperature data)		
Built-in functions	5 Mpix visual photo camera, LED flashlight, GPS, laser pointer, microphone, speaker, digital compass, lighting sensor		
Wireless communication	Wi-Fi + Bluetooth	Wi-Fi	
Interfaces	SD card port, LAN 1 Gb/s, mini HDMI, microUSB 2.0		
Power supply	Li-Ion rechargeable battery (operating time >4 hours), built-in charger, AC 110-230 V, 50/60 Hz power supply		
Operating temperature range	-15°C...+50°C		
Storage temperature	-40°C...+70°C		
Humidity	10%...95%		
Resistance to shocks / vibrations	25G, IEC 60068-2-29 / 2G, IEC 60068-2-6		
Housing	IP54		
Weight	approx. 1.3 kg (with battery)		

Features:

Based on IR image sensor with 640 x 480 pixel resolution (KT-560: 384 x 288) enables high-quality registration of fully radiometric IR images. The new model combines high quality measurement specifications with innovative and intuitive interface software based on a new operating system, creating an intelligent solution in the field of thermal imaging tests.

Operating the camera by means of its large, movable touch display is very convenient, and together with the tilting part of the body containing a high-class lens, this is an ideal solution that takes convenience of the camera's use to new heights, particularly at locations where the instrument cannot be held in the standard manner. Strong outdoor lighting is no longer a problem thanks to the application of a built-in viewfinder.

Besides IR, visual and PIP mode, the camera has a new image mixing mode, superimposing contours of the visible image onto the IR image. The user can also choose to take static photographs or record video. The series of software tools that is available allows for image analysis in the camera itself, including in live image mode. Every saved IR image can additionally be assigned a description: text, audio and/or graphical.

Thanks to its built-in GPS and compass, the camera automatically saves the location where the image was taken. On-site reporting is made possible by a built-in editor of reports in PDF format.

The camera has a series of capabilities in terms of connecting to external devices, both wired (LAN, USB, HDMI) and wireless (Wi-Fi, Bluetooth).



Imagers have built-in tools for analysis and generating reports on-site.

Camera features:

- » image files saved in JPG format (complete image data)
- » recording of IR videos (on SD memory card or computer hard disk)
- » built-in reports module
- » new image combining mode: MIF
- » extensive image analysis tools
- » built-in camera for capturing images within the visible light spectrum: 5 Mpix
- » built-in: GPS, digital compass, LED flashlight, laser pointer
- » interfaces: microUSB 2.0, Wi-Fi, Gigabit Ethernet, mini HDMI and SD memory card slot (KT-670: Bluetooth)
- » 10x digital zoom for KT-670, 4x for KT-560 and KT-650
- » stable and clear images without a tripod

Standard accessories

Li-Ion battery 11.1 V 2.9 Ah for KT-670/650/560	WAAKU18
SD card 16 GB	WAPOZSD16
Shoulder harness	WAPOZPAS3
MicroUSB cable	WAPRZUSBMICRO
HDMI cable	WAPRZHDMI
LAN cable (RJ45)	WAPRZRJ45
XL9 carrying case for KT-560/650/670	WAWALXL9
Power supply adaptor Z13	WAZASZ13
External battery charger Z14 (KT-670 only)	WAZASZ14
Calibration certificate	
ThermoAnalyze2® software	WAPROANALIZA4



SONEL KT-400 / KT-385 / KT-200 / KT-195

index: WMXXKT400 / WMXXKT385 / WMXXKT200 / WMXXKT195



Characteristic

Regardless of whether you take photos or record videos, the newest cameras supplied by Sonel, equipped with **modern detectors**, a **wide range of temperature measurement** and high-quality lenses, ensure highly detailed images and accurate measurements. The cameras are available in several versions, thus enabling the appropriate configuration for the user's needs.

More to see, less to hold

A **large display** combined with innovative data processing electronics is placed in a **compact housing**, thus ensuring a perfect balance between high performance and small dimensions – the best choice for everyday use. Moreover, due to the centrally located navigation button supported by a menu on the touchscreen, this model ensures simple and intuitive operation.

Thermal imaging is not everything

Cameras are additionally equipped with visual lenses and related image mixing technologies: PIP, MIF. Support from the built-in LED torch and laser improves operational quality by facilitating photography and then image interpretation.

The picture is just the beginning

The built-in report module allows for the preparation and printing out of reports directly from the camera. Built-in communication interfaces ensure constant communication between the camera and the computer or mobile device, also over a wireless network.

Thanks to **state-of-the-art technologies and solutions**, the cameras ensure **full control and flexibility** in various situations, and are an **ideal tool for both novice users and professional thermographic inspectors**.

Camera features

- » high sensitivity of detectors and a wide temperature range
- » comprehensive image analysis tools
- » intuitive user interface
- » IR video recording (on the SD card or computer disc)
- » built-in report module
- » different imaging modes: IR, visual, PIP, MIF
- » built-in visual camera: 5 Mpix
- » built-in: LED torch, laser pointer
- » interfaces: Micro USB 2.0, Wi-Fi, Mini HDMI, microSD slot

Standard accessories

7.4 V 3.2 Ah Li-Ion rechargeable battery	WAAKU24
micro-USB data transfer cable	WAPRZUSBMICRO
Wrist strap	WAPZPAS4
HDMI cable	WAPRZHDMI
Touchscreen work gloves	WAREK1
microSD 16GB card	WAPZMSD16
Z13 battery charger	WAZASZ13
Hard suitcase for KT-400	WAWALL6
Stiffened case (only for KT-195 / 200 / 385)	WAFUTL16
User manual and software on disk	



Model	KT-195	KT-385	KT-200	KT-400
Detector resolution	192 x 144	384 x 288	192 x 144	384 x 288
Spectral range	8~14 μm			
Pixel size	25 μm			
Thermal sensitivity	50 mK	45 mK	50 mK	45 mK
Focusing	fixed focal		manual	
IFOV (standard lens)	3.45 mrad	1.29 mrad	3.45 mrad	1.29 mrad
Lens (field of view/focal length)	37.8° x 28.8°/7 mm	28.4° x 21.5°/19 mm	37.8° x 28.8°/7 mm optional: 14.4° x 10.8°/19 mm	28.4° x 21.5°/19 mm optional: 57.0° x 45.0°/8.8 mm 13.7° x 10.3°/40 mm
Display	4", high-quality LCD touchscreen			
Imaging mode	IR / Visual / Infrarusion MIF / PiP			
Zoom	1.1...4			
Temperature range	-20°C...350°C		range 1: -20°C...150°C range 2: 150°C...600°C range 3: 600°C...1500°C (optional)	
Accuracy	±2°C or 2% of reading (for ambient temperatures between 15°C and 35°C and object temperature above 0°C)			
Image analysis mode	5 points, 2 lines, 5 areas. Temp. readings: min., max., mean. Isotherms. Temp. difference Alarm temp. Dew point.			
Palettes	8			
Emissivity coefficient	adjustable from 0.01 to 1.00 or taken from material list			
Measurement correction	settable distance, relative humidity, ambient temperature (reflected)			
Photo image format	JPG			
Notes to IR photos	audio (60 seconds), text, graphic, photo			
Report module	PDF reports, report printing through Wi-Fi			
Video file format	AVI, IRV (including information on temperature)			
Built-in functions	visual camera 5 MPix, LED torch, laser pointer, microphone, speaker.			
Wireless communication	Wi-Fi			
Interfaces	microSD card port, mini HDMI, microUSB 2.0			
Power supply	Li-Ion battery (operating time >4 hours), built-in charger, AC 110-230 V (50/60 Hz) / 12V power supply adapter			
Operating temperature	-10°C...+50°C			
Storage temperature	-40°C...+70°C			
Humidity	10%...95%			
Shock/vibration resistance	30g 11 ms (IEC 60068-2-27) / 10 Hz~150 Hz~10 Hz 0.15 mm (IEC 60068-2-6)			
Housing	IP54			
Weight	approx. 0.74 kg (with battery)		approx. 0.84 kg (with battery)	
Dimensions (with standard lens and battery)	274 x 97 x 78 mm		274 x 106 x 78 mm	274 x 110 x 78 mm

Thermal imagers

KT-320 / KT-250 / KT-165

index: WMXXKT320 / WMXXKT250 / WMXXKT165



Description

Solid and portable tool for daily tasks. This is the main goal when designing a line of budget cameras with a visible spectrum lens.

Various imaging modes

Modern IR sensors available in three resolution versions are supported with the visible spectrum lens, which allows operation in four modes: IR, visual, PIP (picture in picture) and MIF (contours visible on IR image). A high-quality image is presented on a clear display with backlighting adjustment.

Built-in thermoanalysis essentials

Despite the low price, the camera has been equipped with a set of essential, but necessary tools for analysing and correcting images/measurements. The results of the work can be saved on an SD card or sent via USB or Wi-Fi for further processing. Professional software for thermo-gram analysis completes the unit. This makes the camera an ideal tool for maintenance personnel, electricians, the construction industry and others, in their daily tasks.

Thanks to state-of-the-art technologies and solutions, the cameras of the Soneil company ensure full control and flexibility in various situations, and are an ideal tool for both novice users and professional thermographic inspectors.

Camera features

- » solid and portable tool,
- » intuitive user interface
- » 1-hand operation,
- » high-capacity, replaceable Li-Ion battery
- » different imaging modes: IR, visual, PIP, MIF
- » built-in visual camera: 5 Mpx

Standard accessories

Rechargeable Li-Ion battery 7.4 V 2.3 Ah (KT-165 – 1 pc, KT-250 and KT-320 – 2 pcs)	WAAKU26
micro-USB data transfer cable	WAPRZUSBMICRO
Wrist strap	WAPOZPAS1
SD card	WAPOZSD
USB charger for the battery	WAZASZ20
M-11 camera case	WAFUTM11
User manual and software on disk	

Model	KT-165	KT-250	KT-320
Detector resolution	160 x 120	256 x 192	320 x 240
Spectral range		8~14 um	
Pixel size		25 um	
Thermal sensitivity	80 mK	60 mK	60 mK
Focusing		Fixed focal	
IFOV (standard lens)	3.30 mrad	2.36 mrad	2.33 mrad
Minimum focus distance (standard lens)		0.5 m	
Lens (field of view/focal length)	30.0°*23.0°/5 mm	34.5°*26.5°/7 mm	42.5°*32.5°/7 mm
Display		3.5", high-quality LCD	
Imaging mode		IR / Visual / MIF / PIP	
Zoom		x2 / x4	
Temperature range		-20°C...350°C	
Accuracy		±2°C or 2% of reading (for ambient temperatures between 15°C and 35°C and an object temperature of above 0°C)	
Image analysis mode		Temp. readings: min., max. temp. alarm	
Palettes		6	
Emissivity coefficient		Adjustable from 0.01 to 1.00 or taken from the material list.	
Measurement correction		Settable distance, relative humidity, ambient (reflected) temperature	
Photo image format		JPG	
Video		Sending images via USB or Wi-Fi (option)	
Built-in functions		Visual camera 5 MPix	
Wireless communication		Wi-Fi	
Interfaces		SD card port, microUSB 2.0	
Power supply		Li-Ion battery (operating time >4 hours), built-in charger, AC 110-230 V (50/60 Hz) power supply adapter	
Humidity		-10°C...+50°C	
Storage temperature		-20°C...+60°C	
Humidity		10%...95%	
Shock/vibration resistance		30 g 11 ms (IEC 60068-2-27) / 10 HZ~150 HZ~10 HZ 0.15 mm (IEC 60068-2-6)	
Housing		IP43	
Weight		approx. 0.72 kg (with battery)	
Dimensions (with standard lens and battery)		258 mm x 98 mm x 90 mm	



Thermal imagers

SONEL KT-145 / KT-80

index: WMXXKT145V11 (KT-145v11) / WMXXKT80 (KT-80)



IP43

UP TO 4H CONTINUOUS WORK

WiFi

Common features of KT-80 and KT-145

Radiometric camera	Temperature registered for every point of the image
File format	JPG with thermogram data
Detector type	FPA microbolometer (160x120 pixels in KT-145, 80x80 in KT-80)
Spectral range	8...14 μm
Thermal sensitivity	$\leq 0.08^\circ\text{C}$ at 30°C
Accuracy	$\pm 2^\circ\text{C}$ or $\pm 2\%$ of reading
Emissivity coefficient	Adjustable from 0.01 to 1.00 (in steps of 0.01)
Optical transmission correction	Automatic based on signals from sensors
Display	LCD with high brightness, 3.5" LCD (320 x 240 pixels), three-level LCD lighting regulation
Power supply	Li-Ion 3.7 V 4200 mAh
Charging system	Battery charged while in camera or in an external charger
Battery performance	over 4 hours of continuous operation
External power supply	110/230 V AC, 50/60 Hz
Operating temperature	-10°C ... $+50^\circ\text{C}$
Storage temperature	-20°C ... $+60^\circ\text{C}$
Humidity	10% to 95% without condensation
Housing	IP43
Shocks	25G, IEC 68-2-29
Vibrations	2G, IEC 68-2-29
Communication	USB, SD memory card (or optionally: SD Wi-Fi)
Weight	755 g
Dimensions	103 x 98 x 258 mm

Features:

- » a friendly interface, easy to use without special training
- » a quick and inexpensive way to start performing infrared diagnostic tests
- » replaceable high-capacity Li-Ion rechargeable battery
- » over 4 hours of continuous operation
- » large 3.5-inch screen with high brightness
- » durable rubber-lined housing
- » microUSB interface for transmitting data and charging the battery
- » Wi-Fi wireless communication (optional)



KT-80 and KT-145 are effective, inexpensive and professional thermal imagers

Standard accessories:

Li-Ion rechargeable battery 3.7 V 4.2 Ah	WAAKU13
M11 carrying case (KT-145)	WAFUTM11
SD memory card	WAPZSD1
Wristband	WAPZPAS1
Micro-USB data transmission cable	WAPRZUSBMICRO
USB charger for the battery	WAZASZ20
User manual and software on disk	



KT-80 and KT-145 have a user-friendly interface that makes it possible to use them even without special training

Parameter	KT-145v11	KT-80
Lens	11 mm	8 mm
Image sensor resolution	160 x 120	80 x 80
Focal length / Field of vision	15.5° x 20.6° / 11 mm	18.5° x 18.5° / 8 mm
Zoom	x2	-
Palettes	6	4
Range of measured temperatures	-20°C ... $+350^\circ\text{C}$	0°C ... $+250^\circ\text{C}$
Correction of measurement conditions	Emissivity (0.01-1.00)	
	Ambient temperature	-
	Distance	
	Relative humidity	
Measurement functions	Central point, point with max. temperature, point with min. temperature	
Alarm	Alarm for maximum temperature, Alarm for minimum temperature	-



Software

SONEL THERMOANALYZE 2

index: WAPROTHERMOANALYZE2



Software for analyses and reports, included with the set of thermal imagers.

Capability of correcting the emissivity coefficient throughout the entire thermogram or part of it – the coefficient can be corrected individually for each selected area.

Analyzed areas selection – drawing of a rectangular area, oval area, area of any shape.

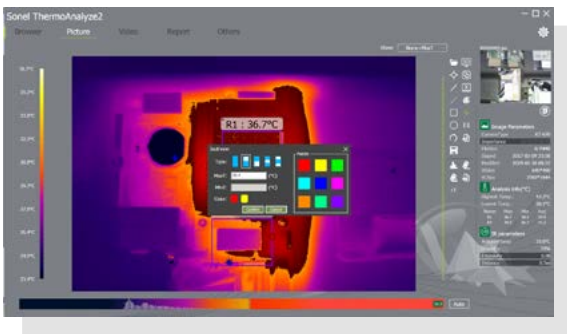

Temperature reading at any point – after scrolling the cursor over to the “Information” window, temperature readouts are displayed continuously along with current coordinates, and other recorded information is also available (maximum temperature, humidity, emissivity).

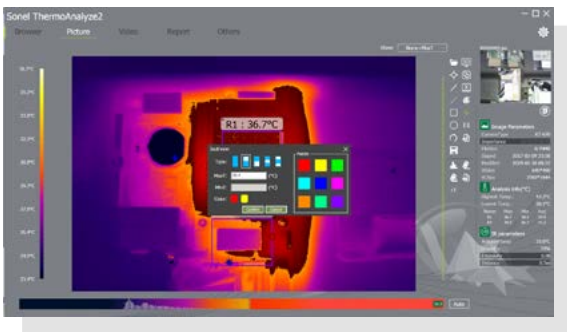

Infra Fusion technology – a thermogram is superimposed onto a part of the visible image, in any palette selected by the user. The thermogram is applied with the selected transparency, making it possible to optimally display and mark areas of interest, particularly when it is difficult to visually compare points on the thermogram with details on the visible image of the observed object.

SONEL KT MOBILE



A mobile version of the program supporting Sonel thermal imaging cameras. With the application, you can get a preview of the actual image on your phone, and remotely perform a series of other activities by managing the camera from a mobile device. It can be downloaded from the www.sonel.pl/en website or by scanning the QR code placed above.

Determination and reading of minimum, maximum and mean temperature for the entire area and in every marked area of interest. Selection of segment (straight line or polyline).

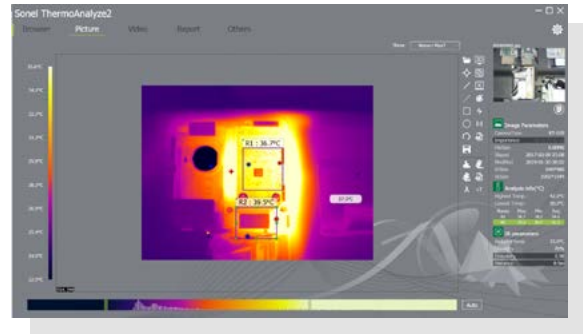

Easy report creation, “drag-and-drop” desired elements into the report – thermograms and the visible images corresponding to them.

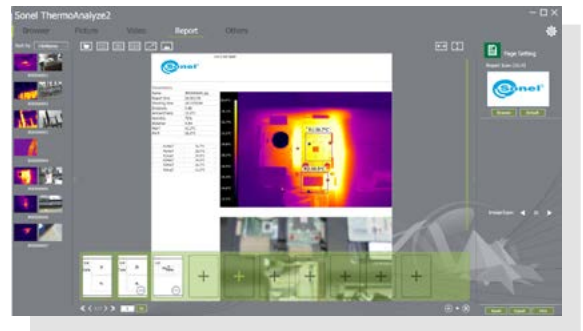

All corrections applied and characteristic points are saved for further analysis at a later time. Selection of the visually optimal color palette (among 9 available in the application) for the best visualization of temperature changes. Configuration of the temperature range for the best imaging of temperature distribution (manual or automatic mode available).

The software has an unlimited license - it can be used simultaneously on multiple devices.



SONEL DIT-500 / DIT-130

index: WMXXDIT500 / WMXXDIT130



Measurements

- » accurate contactless temperature measurement
- » temperature measurement with K probe
- » automatic range selection
- » digitally regulated emissivity coefficient
- » °C/°F unit selector

Additional functions of the meters

- » Data HOLD
- » Auto-OFF
- » display of maximum, minimum, average and differential temperature MAX/MIN/AVG/DIF
- » continuous measurement
- » alarm for high and low temperature values
- » single laser sight (DIT-130)
- » double laser sight (DIT-500)

Standard accessories of DIT-500 meter:

Mini-USB data transmission cable	WAPRZUSBMNB5
Temperature measurement probe (type K)	WASONTEMK
Mini tripod	WAPOZSTATYW

Standard accessories of DIT-130 meter:

Temperature measurement probe (type K)	WASONTEMK
--	-----------

Basic technical data

	DIT-500 All advanced measurements in industrial environments	DIT-130 Basic measurements in plants, electrical, mechanical and HVAC areas
D:S ratio	50:1	13:1
IR temperature range	-50...1600°C	-32...380°C
Resolution	to 0.1°C	0.1°C
Accuracy	to ±(1.0% m.v. + 1°C)	to ±(1.5% m.v. + 2°C)
Temperature range for Type-K input		-50...1370°C
Resolution for Type-K input		0.1°C
Accuracy for Type-K input		±(1.5% m.v. + 3°C)
Emissivity		0.10...1.00
Spectral sensitivity		8...14 μm
Response time	150 ms	<1 s

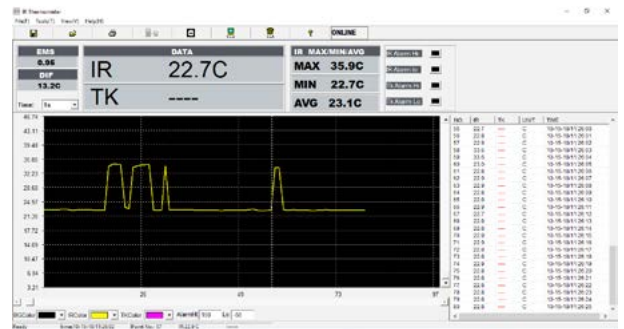

IR Thermometer software view (only for DIT-500)

Other technical data

	DIT-500	DIT-130
memory	100 cells	20 cells
data transmission to PC	✓	–
LCD display	segmented, with backlight	
power supply	9 V alkaline battery, NEDA 1604A or IEC 6LR61	
operating temperature	0...50°C 32...122°F	
storage temperature	-20...+60°C -4...+140°F	
humidity	10...90%	
diode laser	output	<1 mW
	wavelength	630~670 nm
	class	2(II)
over range indication	symbol "----"	symbol "0L", "0L"
response time	150 ms	<1 s
size	230 x 155 x 54 mm	190 x 111 x 48 mm
weight	350 g	290 g



SONEL UV-260

index: WMXXV260



Specifications of UV section

Image type	Monochromatic
Minimum UV sensitivity	3×10^{-18} W/cm ²
Minimum detectable discharge	1.5 pC from a distance of 8 meters
Spectral range	UV 240 ... 280 nm
Field of vision (WxS)	5.5°x 4.0°
Sharpness setting	Automatic and manual (UV and visible spectrum)
Sharpness range	2 m. ... ∞
Detector life	Non-consumable
Frequency:	50 Hz / 60 Hz

Specifications of visible spectrum section

Image type	Full color
Accuracy of UV/visible image superposition	Better than 1 milliradian
Minimum sensitivity	0.1 lux
Zoom	26x optical and 12x digital

Display

Type	Unfolding 5.7" VGA touch LCD
Video standard	PAL/NTSC
Imaging modes	Combined (UV & visible) / only UV / only visible
Discharge color	White, red, blue

Processing and communication

Video standard	H.264
Alarm	LED
Operation	Buttons and touch LCD
Audio module	Microphone input for audio notes
GPS module	Yes

Data storage

Memory type	SD memory card
Image file format	JPG
Video file format	AVI
Memory capacity	8000 images or >4 hours of video (for 2 GB card)
File transfer	Via card reader

Power supply

Power consumption	10 W
Battery type	Li-Ion (2 pcs. in set)
Operating time on battery power	2 hours
Charging	External or internal charger
External power supply	9-12 V, 10 VA
Power adapter	110-240 V AC, 50/60 Hz / 12 V DC 3.8 A

Other specifications

Operating temperature range	-10°C ... +50°C
Storage temperature	-25°C ... +60°C
Relative Humidity	95% without condensation
Dimensions	238 mm x 165 mm x 91 mm
Weight	2.5 kg
Power input	YES
SD card slot	YES
Video output	BNC
Audio input / output	Microphone / headphones

Standard accessories of the instrument:

2x Li-Ion rechargeable battery 7.2 V 2.2 Ah	WAAKU22
Battery charging cable for 12 V car sockets	WAPRZLAD12SAM1
RCA/RCA video cable	WAPRZVIDRCA
Camera strap	WAPOZSZEUV260
Hard briefcase	WAWALXL11
External battery charger	WAADALB220

Description of the device:

The UV-260 is a high-class, professional, and simultaneously lightweight and intuitive device enabling quick and simple remote diagnostics of a system without interfering in its operation. Its design, placing emphasis on high functionality, allows for detection and monitoring of corona, arc and surface discharges in power engineering. This is a way to continuously analyze the technical condition of equipment, e.g. an HV power line, and locate problems before damage or serious failure occurs.



UV-260 is an innovative solution in the field of UV radiation detection!

Additional features:

- » precise location of discharge sources,
- » recording and playback of videos and images,
- » high UV sensitivity,
- » automatic sharpness for UV and visible image,
- » automatic noise reduction,
- » 5.7" touch LCD,
- » no sensitivity to sunlight during operation in full daylight,
- » additional LED alarm in the event of UV radiation detection,
- » built-in GPS,
- » UV Analysis software for data transmission and generating reports.

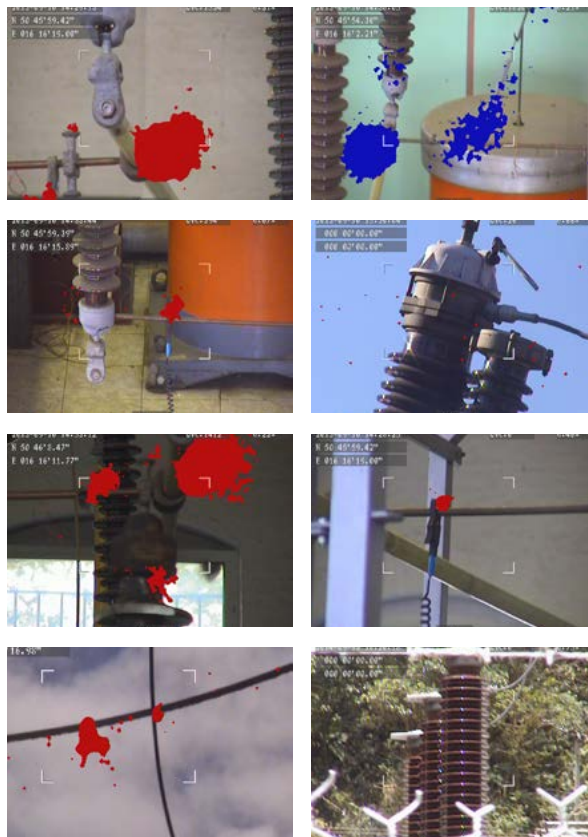





















DIT / KT / UV

Set of standard and optional accessories

1, 2, 4 - number of basic accessories
 - - optional accessories

Photo	Name	Index	DIT-500	DIT-130	KT-670	KT-650	KT-560	KT-195	KT-200	KT-385	KT-400	KT-165	KT-250	KT-320	KT-145	KT-80	UV-260
	Adapter – converter HDMI / RCA	WAADAHDMIXRCP			•	•	•										
	Rechargeable Li-Ion battery 7.4 V 3.2Ah	WAAKU24						2	2	2	2						
	Rechargeable Li-Ion battery 7.4 V 2.3 Ah	WAAKU26										1	2	2			
	Li-Ion battery 11,1 V 2,9 Ah for KT-670/650/560	WAAKU18			2	2	2										
	Li-Ion battery 3,7 V 4,2 Ah for KT-80/145	WAAKU13													1	1	
	Li-Ion battery 7,2 V 2,2 Ah for UV-260	WAAKU22															2
	High temperature filter (up to 2000°C)	WAADAOF1			•	•	•										
	High temperature filter (up to 1500°C)	WAADAOF2							•		•						
	Carrying case	WAFUTM11			•	•	•	•	•	•	•	1	1	1	1	1	
	SD card	WAPOZSD1										1			1	1	
	SD card 16 GB	WAPOZSD16			1	1	1	1	1	1	1		1	1			
	Wi-Fi SD card 4 GB	WAPOZSDWIFI4										•		•	•	•	
	Wi-Fi SD card 8 GB	WAPOZSDWIFI8										•		•	•	•	
	Wide-angle IR lens 13 mm (42,1°x32,2°)	WAADA013V560					•										
	Wide-angle IR lens 13 mm (45,4°x34,9°)	WAADA013V650			•	•											
	Tele IR lens 55 mm (10,4°x7,8°)	WAADA055V560					•										
	Tele IR lens 55 mm (11,3°x8,5°)	WAADA055V650			•	•											
	Tele IR lens 85 mm (6,7°x5,1°)	WAADA085V560					•										
	Tele IR lens 85 mm (7,3°x5,5°)	WAADA085V650			•												
	Wide-angle IR lens 8.8 mm (57.0°x45.0°)	WAADA08X8									•						
	Tele IR lens 40 mm (13.7°x10.3°)	WAADA040									•						
	Tele IR lens 19 mm (14.4°x10.8°)	WAADA019							•								
	Wristband	WAPOZPAS1								1	1	1	1		1	1	
	Wristband	WAPOZPAS4						1	1	1							
	Shoulder harness	WAPOZPAS3			1	1	1										
	Cable for battery charging from car cigarette lighter socket (12 V)	WAPRZLAD12SAM1															1
	MicroUSB cable	WAPRZUSBMICRO			1	1	1	1	1	1	1	1	1	1	1	1	
	USB cable MINI-B 5	WAPRZUSBMNIB5	1														
	HDMI cable	WAPRZHDMI			1	1	1	1	1	1	1						
	LAN cable (RJ45)	WAPRZRJ45			1	1	1										

Photo	Name	Index	DIT-500	DIT-130	KT-670	KT-650	KT-560	KT-195	KT-200	KT-385	KT-400	KT-165	KT-250	KT-320	KT-145	KT-80	UV-260
	RCA video cable	WAPRZVIDRCA															1
	Type K Temperature Probe	WASONTEMK	1	1													
	Temperature probe (type K, metal)	WASONTEMK2	•	•													
	M10 carrying case	WAFUTM10	•														
	S1 carrying case	WAFUTS1		•													
	Additional Pin Probe with banana plugs	WASONTEMP	•	•													
	UV-260 hanging straps	WAPOZSZEUV260															1
	XL9 carrying case for KT-560/650/670	WAWALXL9			1	1	1										
	L3 carrying case for KT-160	WAWALL3													•	•	
	XL11 carrying case for UV-260	WAWALXL11															1
	Power supply adaptor Z13	WAZASZ13			1	1	1	1	1	1	1						
	Power supply adaptor Z20	WAZASZ20										1	1	1	1	1	
	External battery charger Z18	WAZASZ18						•	•	•	•						
	External battery charger Z14	WAZASZ14			1	•	•										
	External battery charger Z12	WAZASZ12								•	•	•			•	•	
	Power supply adaptor	WAADALB220															1
	Hard carrying case	WAWALL6									1						
	Stiffened case	WAFUTL16						1	1	1							
	Mini tripod	WAPOZSTATYW	1														
	Protective gloves (for operating the touchscreen)	WAREK1						1	1	1	1						

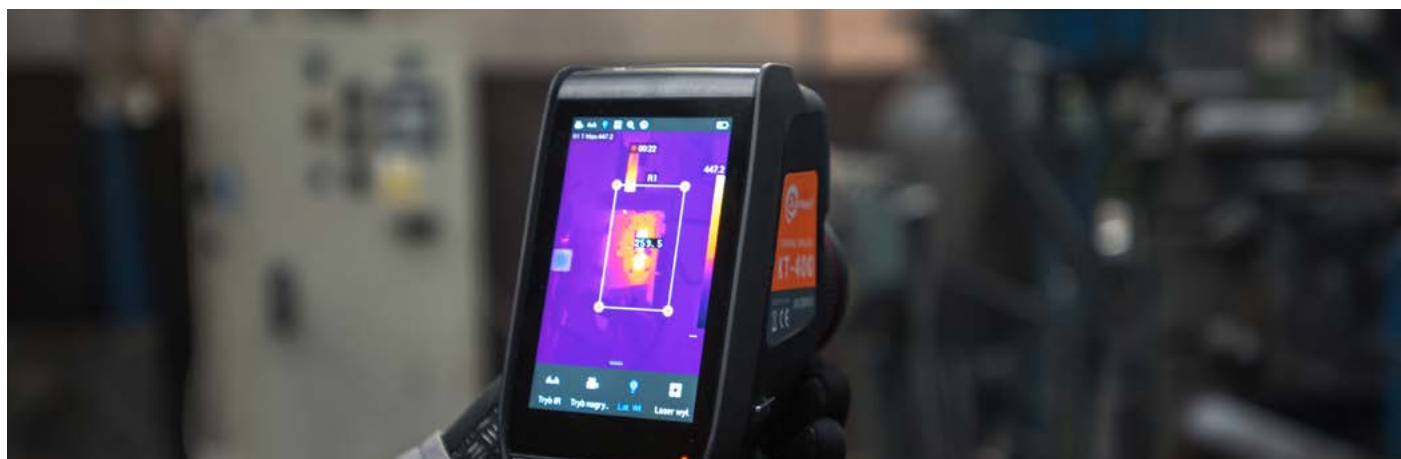

Low resistance meters

MMR-6700
MMR-6500



MMR-650



MMR-630
MMR-620

Low resistance measurements

Low resistance measurements are made when testing the resistance of the following connections: welded, equipotential, contacts, cable connections and coils of low resistance. Meters for low resistance measurement are also used to test motor and transformer windings. These tests also include testing the quality of solder joints or continuity of earthing cables.

Low resistance measurements may be performed by several methods. The most popular is the **technical method**.

For small resistance values (microohms), the wiring and contact resistances in connection points are of significant importance. Therefore, the design of the bridge provides separate current and voltage terminals at the R and R resistors. It is recommended that all other resistors have a resistivity 1000 times greater than the resistance of the leads.

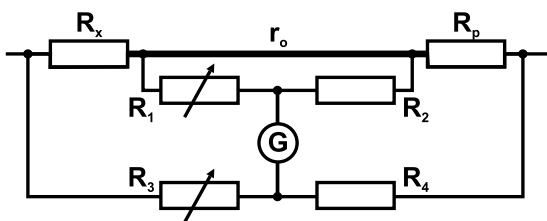

Circuit diagram of Thomson bridge

At the balanced state of the bridge, the current flowing in the branch of the galvanometer is equal to zero. The formula for the measured resistance is as follows:

$$R_x = \frac{R_p R_1}{R_2}$$

The accuracy of the measurement with Thomson bridge is affected insensitivity deviation, which for low resistances of $R_x = 10^{-6} \dots 10^{-5} \Omega$ order is particularly evident. The accuracy also depends on the error in recreating the model, which is related to the quality of particular elements of the bridge. During the measurement, there may be additional errors due to current overloads of the tested and reference resistors, temperature changes and the presence of additional electromotive forces in the system.

Due to defectiveness and limitations of traditional technical bridges, currently we witness a tendency to construct electronic meters for the measurement of low resistances in the range from single micro-ohms to several hundred ohms. Instruments can measure very small resistances even with a resolution of $0.1 \mu\Omega$. An important feature of modern micro-ohm meters is ease of use, application of different measurement modes and the option to cooperate with a computer. These devices measure the resistance using the technical method. Any conductive element may be described by the formula according to Ohm's law:

$$R_x = \frac{U_x}{I}$$

U_x - voltage drop in tested object,
 I - intensity of flowing current,
 R_x - measured resistance.

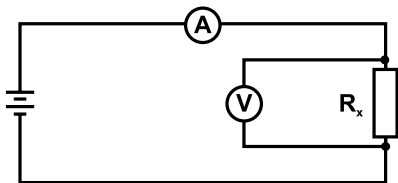

Resistance measurement using technical method (circuit with correctly measured voltage)

The circuit with correctly measured voltage is used for small resistances, when the current flowing through the tested object is several times greater than the current of the voltmeter, which measures the voltage drop on the object. The resistance obtained by the measurement is calculated from the formula:

$$R_x = \frac{U_x}{I - I_v}$$

I_v - current flowing through the voltmeter.



Measurements with MMR-650

With a voltmeter of very high resistance, the current flowing in its circuit is negligibly low, so the measurement result is not affected by the resistance of test leads. This is so called 4-pole method. This type of measurement, which eliminates the impact of the resistance of wires, is used in low resistance meters of MMR series.

Due to very low values of the measured resistance, the four-wire method is used, which allows user to perform accurate measurements without taking into account the impact of the resistance of test leads. Therefore, the manual calibration of the meter and test leads is not necessary, but it is possible (e.g. when using other type of test probes). In addition, it is always possible to restore the factory calibration settings of the device.

Before starting the measurement, select the maximum measurement current (range: from 0.1 mA to 10 A). The measuring range (and thus the current) is selected manually or automatically. In some cases (e.g. exceeding the allowable power generated at the object), it may be desirable to limit the maximum current flowing through the tested object. MMR devices have a lock that allows user to set the upper limit of the measuring current.

The device measures the resistance by causing a current to flow through the tested object (using current leads), at the same time controlling the voltage drop across the terminals of the voltage lines. A break in any circuit will be adequately signalled and the resistance measurement will not be possible.

Operating mode

The user selects the measurement method in one of available modes:

- » in manual mode, each measurement must be triggered by the operator by pressing "Start" button;
- » in automatic mode, the measurement starts at the moment of connecting the last measurement terminal
- » for the continuous mode, measurements are performed every three seconds (resistive mode) or continuously (inductive mode).

The measurements may be performed using the current:

- » flowing only in one direction or
- » flowing in two opposite directions.

Testing with unidirectional current makes the measurements faster, whereas using bidirectional current eliminates errors resulting caused by the presence of internal voltages and electrothermal forces in the tested object. The main result of measurements using the bidirectional current is the average of two measurements of the resistance with the currents flowing in opposite directions. In addition, supplemental results are displayed, i.e. R_f resistance with the current flowing in theoretical "forward" direction and R_b resistance with the current flowing in theoretical "backward" direction.

The normal duration of the measurement is 3 seconds. In order to measure an inductive object, the extended measurement time may be selected. For objects with a high inductance, the measurement time is extended to a few minutes and after completed measurement, the tested object is discharged.

There is an option of using fast measurement mode for inductive devices/objects (FAST mode), which at a slightly lower accuracy accelerates the measurement procedure.

Another operation mode is the window mode, which allows the user to set the upper and lower limits for the measurement result. Results outside this range are additionally signalled by the meter.

The limits of the acceptable range of variability of results are determined by the user.

When using the automatic and continuous mode, exceeding the pre-set range limits will interrupt a series of measurements and the meter will wait for a reaction of the user.

Contact resistance meters

SONEL MMR-6700 / MMR-6500

index: WMGBMMR6700 / WMGBMMR6500

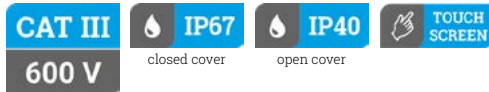

Measurements of resistive objects

Range [Ω]	Resolution [Ω]	Accuracy	Test current
0.0...999.9 μ	0.1 μ	±(0.25% + 2 digits)	100 A < I ≤ 200 A*
0.0...999.9 μ	0.1 μ		50 A < I ≤ 100 A
1.0000...1.9999 m	0.0001 m		20 A < I ≤ 50 A
0.0...999.9 μ	0.1 μ		10 A < I ≤ 20 A
1.0000...3.9999 m	0.0001 m		
0.0...999.9 μ	0.1 μ		

* MMR-6700 only

Measurements of inductive objects

Range [Ω]	Resolution [Ω]	Accuracy	Test current
0 μ...999.9 μ	0.1 μ	±(0.25% + 2 digits)	10 A
1.0000 m...1.9999 m	0.0001 m		10 A
2.000 m...19.999 m	0.001 m		10 A / 1 A
20.00 m...199.99 m	0.01 m		1 A / 0.1 A
200.0 m...999.9 m	0.1 m		0.1 A
1.0000...1.9999	0.0001		10 mA
2.000...19.999	0.001		
20.00...199.99	0.01		
200.0...1999.9	0.1		

Standard accessories:

Crocodile clip, black, 1 kV, 32 A	WAKROBL30K03
Kelvin clamp, 1 kV, 25 A	WAKROKELK06
Current carrying test lead 3 m black I1 (200 A, 25 mm ²)	WAPRZ003BLI1
Current carrying test lead 3 m black I2 (200 A, 25 mm ²)	WAPRZ003BLI2
Test lead 3 m blue 1 kV U1 (banana plug)	WAPRZ003BUBBU1
Test lead 3 m blue 1 kV U2 (banana plug)	WAPRZ003BUBBU2
Doble-wire test lead 3 m (10 A / 25 A) U1/I1	WAPRZ003DZBBU1I1
Doble-wire test lead 3 m (10 A / 25 A) U2/I2	WAPRZ003DZBBU2I2
USB cable	WAPRZUSB
Mains cable with IEC C19 plug	WAPRZZAS1
ST-3 temperature probe	WASONT3
Case L12	WAFUTL12
Calibration certificate	
Sonei Reader software	WAPROREADER

Application

MMR-6xxx micrometers series are devices with a **state of art design** with unprecedented approach to measuring small resistances. The instruments allow to **measure resistive objects with a high current** and have a unique in his measurement class module for inductive current objects **up to 10 A**.

Device capabilities

Sonei microohmmeter MMR-6xxx series thanks to the use of special algorithms, measuring functions and a stabilized, non-pulsing measurement current allow user to work in difficult conditions. Possibility of use measurement current **up to 200 A** and a high power source allows you to measure the contacts of the HV switch with basic uncertainty from 0.25%.

Simplicity of readings

The MMR-6700 microcontroller is equipped with readable, touch screen, 5 inch colored display with a resolution of 800x480 pixels for convenience of readings measurement results.

Help system

The use of a large, readable display allowed for use helpful appetent drawings how to use the meter.

Product features

- » measurements of resistive objects with current up to **100/200 A**
- » measurements of induction objects **up to 10 A**
- » measurements of objects earthed on both sides (i.e. main joints of HV switches)
- » measurement with one- or both-way current flow
- » high immunity to outside interference
- » measurements temperature of windings
- » automatic compensation temperature of objects measured
- » a state of the art interface with a touch screen and expanded memory
- » work with a printer and a 2D barcode reader
- » Wi-Fi, USB and LAN communication
- » IP67

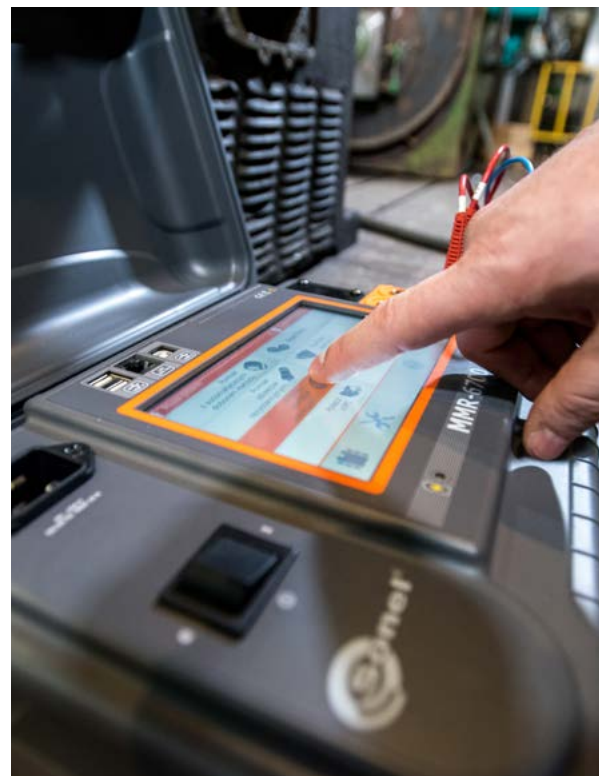

Microohmmeter

SONEL MMR-650

index: WMGBMMR650



CAT III
600 V

CAT IV
300 V

IP67
closed cover

IP54
open cover

TOUCH SCREEN

Product features

- » measurement of winding resistance (inductive objects including amorphous core transformers)
- » measurement of very low resistance
- » transformer core demagnetization function
- » automatic temperature compensation function (temperature probe)
- » function of determining the temperature of a motor under load
- » high immunity to disturbances
- » 4-lead measurement

Application

The MMR-650 winding resistance and low resistance meter is designed to measure very low very low resistance of both windings - including amorphous core transformers - and resistive objects. This product is made to be used in power plants, railways and maintenance companies to measure:

- » windings of power transformers and motors,
- » breakers, contacts,
- » earthing conductors, equipotential bondings,
- » welded and soldered connections,
- » bolted connections,
- » and other resistive and inductive objects.

MMR-650 can be also utilized on production lines (eg. at the final production control stage).

Device capabilities

The MMR-650 winding resistance and low resistance meter provides an innovative combination of a high-performance measuring device with a modern user interface and advanced data management system. Wireless data transmission, enhanced system of 2D codes and ability to print labels to identify test items, all contribute to bringing new quality of work and allow the user to perform a wide range of measurements.

Easy readout

The MMR-650 winding resistance and low resistance meter is equipped with a readable colour touchscreen that, due to its 800 x 480 pixel resolution, provides both high comfort of interacting with the interface and high readability of the measurement results.

Durable and practical casing

In response to the customers needs the MMR-650 microohmmeter has been designed to operate in difficult environmental conditions. A unique casing with the IP67 ingress protection rating ensures that the device is both waterproof and dustproof.



MMR-650 enables measurements of resistant and inductive objects, including amorphous core transformers.

Resistance measurement

Range [Ω]	Resolution [Ω]	Accuracy*	Test current
0...999.9 μ	0.1 μ	±(0.25% + 2 digits)	10 A
1.0000...1.9999 m	0.0001 m		10A
2.000...19.999 m	0.001 m		10 A/1 A
20.00...199.9 m	0.01 m		1 A/0.1 A
200.0...999.9 m	0.1 m		0.1 A
1.0000...1.9999	0.0001		10 mA
2.000...19.999	0.001		1 mA
20.00...199.99	0.01		
200.0...1999.9	0.1		

*for resistive objects

Standard accessories of the meter:

L11 carrying case	WAFUTL11
Kelvin clamp, 1 kV, 25 A	WAKROKELK06
Doble-wire test lead 3 m (10 A / 25 A) U1/I1	WAPRZ003DZBBU11
Doble-wire test lead 3 m (10 A / 25 A) U2/I2	WAPRZ003DZBBU212
Mains cable with IEC C13 plug	WAPRZ1X8BLIEC
Mains cable with IEC C7 plug	WAPRZLAD230
USB cable	WAPRZUSB
2x double-tip Kelvin probe (banana sockets)	WASONKEL20GB
ST-3 temperature probe	WASONT3
PC software: Sonel Reader	WAPROREADER
Li-Ion 7.2 V rechargeable battery	WAAKU27
Calibration certificate	



SONEL MMR-630 / MMR-620

index: WMGBMMR630 / WMGBMMR620



CAT III

300 V

IP54

Measurements of objects resistive in nature:

- » welded and soldered connections, equipotential bondings, earthing conductors,
- » contacts, welds of rails, conductors and cables,
- » measurement according to the four-lead method.

Measurements of objects inductive in nature:

- » motor and transformer windings, low-resistance coils.

Additional functions of the meters:

Automatic or manual selection of measuring range (measurement of objects of an inductive nature).

Selection of measurement mode according to the type of measured object:

- » fast measurement (3 seconds) for measurement of objects of a resistive nature,
- » extended measurement for testing of objects of an inductive nature (accelerated mode, with slightly worse accuracy, available); with automatic discharging of the object after measurement.

Selection of measurement mode depending on application (including control of product series):

- » measurement in **normal** mode - triggered when the "START" button is pressed,
- » measurement in **automatic** mode - the instrument awaits connection of all four test leads to the object, after which it automatically start measurement in one or both directions and calculates the mean resistance value,
- » measurement in **continuous** mode - the meter repeats successive measurement cycles with breaks every 3 seconds (for objects of a resistive nature) or performs measurement continuously (for objects of an inductive nature).

Window mode:

- » makes possible to set an upper and lower limit within the measurement result should remain; sound signal triggered when the result is beyond set range,
- » capability of performing measurements even under disturbances of a value five times greater than the measured signal.

Instruments meet the requirements set forth in the standards:

- » EN 61010-1 (general and particular requirements related to safety)
- » EN 61010-031 (general and particular requirements related to safety)
- » EN 61326 (electromagnetic compatibility)
- » HD 60364-6 (performance of measurements - checking)
- » HD 60364-4-41 (performance of measurements - shock protection)



Micro-ohmmeters from the MMR series enable accurate winding resistance measurements of electrical motors and power transformers.

Standard accessories of the meters:

NiMH rechargeable battery 4.8 V 3 Ah	WAAKU03
L-1 carrying case	WAFUTL1
4x black "crocodile" clip 1 kV 32 A	WAKROBL30K03
2x Kelvin clamp 1 kV 25 A	WAKROKELK06
Two-core cord; 3m (10 / 25 A) U1/I1	WAPRZ003DZBBU111
Two-core cord; 3m (10 / 25 A) U2/I2	WAPRZ003DZBBU212
230 V power cord (IEC C7 plug) (MMR-630)	WAPRZLAD230
RS-232 serial transmission cable	WAPRZRS232
2x double-tip Kelvin probe (banana sockets)	WASONKEL20GB
Meter strap (Unisonel type)	WAPOZSZE1
Calibration certificate	

Resistance measurement

MMR-620		MMR-630		Test current
Range [Ω]	Resolution [Ω]	Range [Ω]	Resolution [Ω]	
0...999 μ*	1 μ	0...999.9 μ*	0.1 μ	10 A
1.000...1.999 m	0.001 m	1.0000...1.9999 m	0.0001 m	
2.00...19.99 m	0.01 m	2.000...19.999 m	0.001 m	
20.0...199.9 m	0.1 m	20.00...199.99 m	0.01 m	1 A
200...999 m	1 m	200.0...999.9 m	0.1 m	0.1 A
1.000...1.999	0.001	1.0000...1.9999	0.0001	
2.00...19.99	0.01	2.000...19.999	0.001	
20.0...199.9	0.1	20.00...199.99	0.01	
200...1999	1	200.0...1999.9	0.1	

Accuracy ±(0.25% m.v. + 2 digits)

"m.v." = "measured value"

Other technical specifications:

- » type of insulation double, as per EN 61010-1 and IEC 61557
- » meter power supply SONEL/Ni-MH 4.8 V rechargeable battery pack
- » charger built-in
- » battery charging time approx. 2.5 hours
- » number of measurements with 10 A current 300
- » time until auto-OFF 120 seconds
- » electric hum immunity additional error ≤1% for 50 Hz voltage ≤100 mV RMS
- » maximum lead resistance for 10A current 0.1 Ω
- » maximum inductance of measured object 40 H
- » measurement current input accuracy ±10%
- » time of resistance measurement:
 - resistance mode, with two-directional current flow 3 seconds
 - induction mode max 10 min (depends on R and L of the object)
- » dimensions 295 x 222 x 95 mm
- » meter weight approx. 1.7 kg
- » operating temperature range 0...+40°C



MMR

Set of standard and optional accessories

1, 2, 4 - number of basic accessories
 - - optional accessories

Photo	Name	Index	MMR-6700	MMR-6500	MMR-650	MMR-630	MMR-620
	Adapter - converter USB / RS-232	WAADAUSBRS232					• •
	NiMH battery 4,8 V 3,2 Ah for MMR-620/630	WAAKU03					1 1
	C-5A current clamps (φ=39 mm)	WACEGC5AOKR	•	•			
	Barcode scanner 2D (USB)	WAADACK2D	•	•	•	•	•
	D2 portable USB report / barcode printer (Sato)	WAADAD2	•	•	•	•	•
	L1 carrying case	WAFUTL1					1 1
	L11 carrying case	WAFUTL11			1		
	L12 carrying case	WAFUTL12	1	1			
	Crocodile clip, black, 1 kV, 32 A	WAKROBL30K03	2	2		4	4
	Kelvin clamp, 1 kV, 25 A	WAKROKELK06	2	2	2	2	2
	PC software: Sonel Reader	WAPROREADER				1	1 1
	Double-wire test lead 10 m (Kelvin crocodile clip / banana plug)	WAPRZ010DZBKEL				•	
	Double-wire test lead 25 m (Kelvin crocodile clip / banana plug)	WAPRZ025DZBKEL				•	
	Doble-wire test lead 3 m (10 A / 25 A) U1/I1	WAPRZ003DZBBU1I1	1	1	1	1	1
	Doble-wire test lead 3 m (10 A / 25 A) U2/I2	WAPRZ003DZBBU2I2	1	1	1	1	1
	Current carrying test lead 3 m black I1 (200 A, 25 mm²)	WAPRZ003BLI1	1	1			
	Current carrying test lead 3 m black I2 (200 A, 25 mm²)	WAPRZ003BLI2	1	1			
	Current carrying test lead black I1 6 m / 10 m / 15 m	WAPRZ006BLI1 WAPRZ010BLI1 WAPRZ015BLI1	•	•			
	Current carrying test lead black I2 6 m / 10 m / 15 m	WAPRZ006BLI2 WAPRZ010BLI2 WAPRZ015BLI2	•	•			

Photo	Name	Index	MMR-6700	MMR-6500	MMR-650	MMR-630	MMR-620
	Test lead 3 m blue 1 kV U1 (banana plug)	WAPRZ003BUBBU1	1	1			
	Test lead 3 m blue 1 kV U2 (banana plug)	WAPRZ003BUBBU2	1	1			
	Test lead blue 1 kV U1 (banana plug) 6 m / 10 m / 15 m	WAPRZ006BUBBU1 WAPRZ010BUBBU1 WAPRZ015BUBBU1	•	•			
	Test lead blue 1 kV U2 (banana plug) 6 m / 10 m / 15 m	WAPRZ006BUBBU2 WAPRZ010BUBBU2 WAPRZ015BUBBU2	•	•			
	USB cable	WAPRZUSB	1	1	1		
	RS-232 serial transmission cable	WAPRZRS232					1 1
	Mains cable with IEC C13 plug	WAPRZ1X8BLIEC			1		
	Mains cable with IEC C19 plug	WAPRZZAS1	1	1			
	Mains cable with IEC C7 plug	WAPRZLAD230			1	1	
	LAN cable (RJ45)	WAPRZRJ45	•	•	•		
	Protective gloves (for operating the touchscreen)	WAREK1	•	•			
	Temperature probe ST-1	WASONT1	•	•	•		
	ST-3 temperature probe	WASONT3	1	1	1		
	Double pin Kelvin probe with banana connector	WASONKEL20GB	•	•	2	2	2
	UNI-SONEL hanging straps	WAPOZSZE1				1	1
	Label Roll - Black on White for D2 printer (SATO)	WANAKD2	•	•	•	•	•
	Ribbon for D2 printer (SATO)	WANAKD2BAR	•	•	•	•	•
	Kelvin vice with cables	WAZACKEL1	•	•	•	•	•
	Li-Ion battery Li-Ion 7.2 V	WAAKU27				1	



Location of hidden infrastructure

LKZ-2000

A worker in a high-visibility vest and hard hat is operating a trenching machine in front of a building with horizontal siding. A large pile of dirt is visible in the foreground.

LKZ-1500

A worker in a high-visibility vest is kneeling in a grassy field, working with a device in a case. The device has several cables connected to it.

LKZ-1000

A worker in a high-visibility vest is kneeling in a field, working with a device in a case. The device has several cables connected to it.

LKZ-720

A close-up of a hand holding a cable connector in front of a rack of equipment. The equipment has various ports and cables connected to it.

Detecting cables and underground infrastructures



Earthworks that include various types of excavation, but also installation of sewer and water pipes or cables - are associated with a **high risk of damage to underground systems**, which could lead to a dangerous accident. European Union law requires from the contractor of such works to ensure safety to employees, third parties and private property. In order to reduce the risk of accidents, a number of activities are carried out, including the mandatory detection of existing underground installations and systems. The contractors are never absolutely sure whether all underground utilities are shown on the maps. Therefore, in order to identify all potentially hazardous installations and systems, **additional checks are necessary**, which may be performed with cable locators.

LKZ-1000 is a set for locating wires and pipes, **which precisely determine the depth and direction** of conductive systems (power and telecommunications cables, metal pipes) and with additional probes it is able to detect plastic and concrete pipes. Earthworks are carried out in difficult conditions (moisture, dirt), so both devices meet the requirements of IP54, while the transmitter with closed cover provides ingress protection of IP67.

Location and tracking underground infrastructure elements is performed in a wide range of conditions. LKZ-1000 can operate in several different modes, adapted to different situations:

Power - used to locate electric cables. It is a **passive mode**, where the transmitter is not required: the signal is generated by the live cable itself.

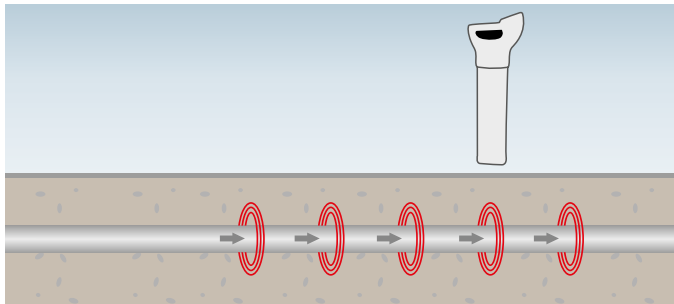

Radio - used to locate metal objects (pipes, reinforcement elements), which re-emit radio signals. It is also a **passive method**: the signal is present in the tested object, which re-emits radio waves.

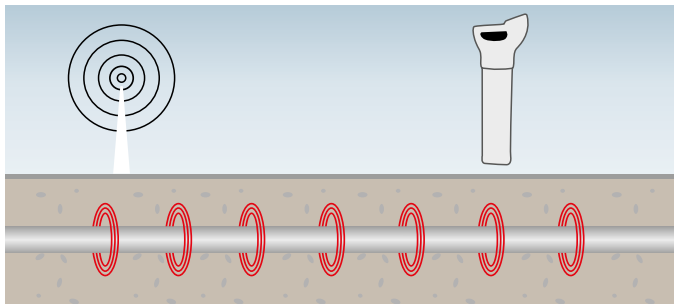

8 kHz - used for precise location of a particular type of systems (cables, pipes, etc.). The frequency of the generated signal (8 kHz) has better range than 33 kHz and lower tendency to transfer the signal to other objects. This is an active method, because it requires the use of a signal generator.

33 kHz - used for location of a particular type of systems (cables, pipes, etc.). This frequency is most often used to locate underground installations. It ensures the highest efficiency, but it has a greater tendency to transfer the signal to other systems/installations. This method also requires the use of a signal generator (**active method**).

LKN-1000 generator (transmitter) generates a signal which is tracked in the detected system. Depending on the situation, in active modes, the transmitter may be connected as shown in one of the following images.

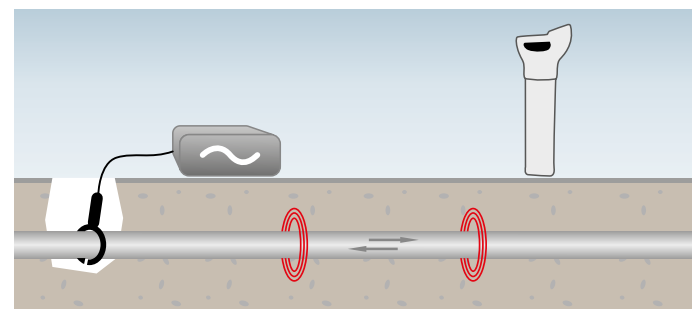
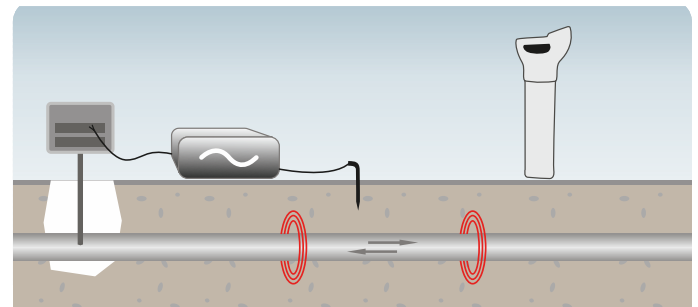
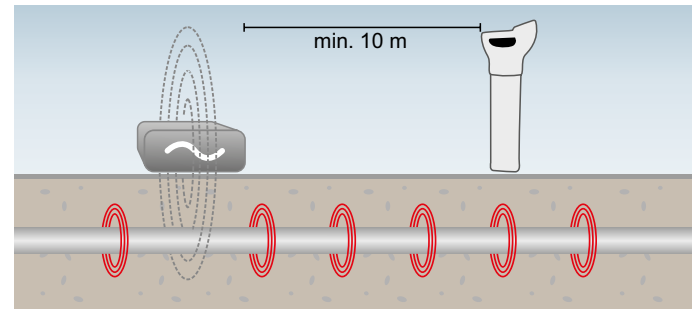

Auto Mode combines the advantages of Radio and Power mode. It is very convenient for initial screening of the area.

Additionally, LKZ-1000 set allows the user to precisely determine the depth of a particular system within 3 meters. In such detection, the device must operate in active modes of 8 kHz or 33 kHz, which use the transmitter and receiver.

In metal systems, the signal may be generated without wires by induction or by direct connection of test leads or by using transmitting clamps. In non-conductive systems, the signal may be generated by introducing a transmitting probe (in the form of a coiled cable or "floating" probe) directly to the detected system (plastic, concrete pipes etc.). In addition to determining the direction and depth of pipes, the user may also locate their blockages by using additional probes.

With the intuitive menu and transparent graphic display, LKO-1000 receiver is very user-friendly. It also has a number of options and features designed to improve safety and comfortable use.



SONEL LKZ-2000

index: WMXXLKZ2000



IP65

A new model in the LKZ series - stronger and easier to use!

The diversity and concentration of underground infrastructure are still growing. Identifying underground systems was never as difficult and important a task as it is today. Location allows us to infer the actual position of an underground system and determine the proper location for current works, as well as to prevent accidents caused by damage to the underground objects.

The Sonel LKZ-2000 locator set has a series of unique functions that assist in selecting the appropriate location mode. The most important feature distinguishing this instrument from the competition is its capability of analyzing disturbances present at the place where location is performed, facilitating selection of the best frequency under difficult conditions. This makes it possible to avoid selection of an ineffective frequency, significantly accelerating and facilitating work with the locator.

The best system under the most demanding conditions:

- » power engineering
- » construction
- » railway
- » telecommunications
- » refineries
- » sanitary infrastructure
- » heat distribution networks
- » transmission pipelines

Locator

- » **Mode / Frequency:** POWER passive mode: 50 Hz, 100 Hz, 450 Hz / 60 Hz, 120 Hz, 540 Hz, RADIO passive mode: 15 kHz to 60 kHz, Active mode (with transmitter): 512 Hz, 3140 Hz, 8192 Hz, 32768 Hz and 83.1kHz
- » **Antenna configuration:** Single peak value, double peak value, neutral point, full field
- » **Depth measurement range:** POWER mode up to 3 m., RADIO mode up to 2 m., modes with active transmitter up to 4.6 m., probe mode up to 6 m.
- » **Accuracy of measurement (error):** 5% depth in linear or probe mode (from 0.2 m to 4.6 m.), 10% depth in probe mode (from 4.6 m to 6 m).
- » **Bluetooth:** for remote transmitter control
- » **Batteries:** 2 x LR20
- » **Operating time with battery power for LKO:** up to 60 hours (at 20°C)
- » **Auto-OFF:** Capability of selecting auto-OFF time after 5, 10, 20 or 30 minutes
- » **Operating temperature range:** -20°C...+50°C
- » **Dimensions:** 700 mm (H) x 325 mm (L) x 122 mm (W)
- » **Weight:** 2.18 kg including batteries
- » **IP rating:** IP65

Transmitter

- » **Operating frequencies:** 512 Hz, 3140 Hz, 8192 Hz, 32768 Hz, 83,1 kHz, 200 kHz
- » **Output power control:** 5 levels
- » **Power in induction mode (max):** 3 W
- » **Power for galvanic connection (max):** 12 W (for impedance of connected object: 100 Ω)
- » **Batteries:** up to 100 hours (level 2 output power at 20°C)
- » **Auto-OFF:** Capability of selecting auto-OFF time, after 1, 2, 3, 4, 5, 6, 7, 8 hours
- » **Operating temperature range:** -20°C...50°C
- » **Dimensions:** 255 mm (H) x 190 mm (D) x 305 mm (W)
- » **Weight:** 3.5 kg including batteries
- » **IP rating:** IP65



LKO-2000 enables remote control and configuration of the transmitter.

Standard accessories of the meter:

L9 carrying case for LKZ-2000	WAFUTL9
-------------------------------	---------

Additional accessories of the meter:

"A" Frame - adapter for LKZ-2000	WAADALKZRA
N-3 transmitting clamps for LKZ-2000 (Φ=125 mm)	WACEGN3
PN-30 wire to locate non-metallic installations 30 m	WAPRZPN30
PN-50 wire to locate non-metallic installations 50 m	WAPRZPN50
Reeled transmission wire to locate non-metallic installations 80 m	WAPRZPN80
BIK - Probe for wireless identification of cables	WASONBIK
Earth contact test probe (rod), 25 cm	WASONG15
NAD-1 Transmission probe	WASONNAD1



Using the A-frame, a cable earth fault can be located.



SONEL LKZ-1500

index: WMXXLKZ1500

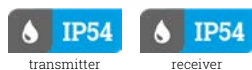

The LKZ-1500 locator set, consisting of a transmitter and receiver, allows for location, identification and tracking of the route of objects buried in the earth, i.e.:

- » power cords and cables, control cables, telecommunications cables,
- » underground elements of lightning protection systems, cathodic protection systems,
- » water and sewage systems,
- » fuel transmission systems (pipelines, gas pipelines)
- » heating systems and pre-insulated pipes.

The locator is intended for electrical power and fitting companies, companies that perform earthworks, construction, railway engineering, refineries, water mains and sanitary systems, heating companies and geodetic companies.

Locator functions:

- » determination of cable orientation, cable position relative to receiver's axis (equipped with "compass" function),
- » determination of current value and cable depth, in both active mode (with transmitter) and passive mode (without transmitter),
- » plotting the route of the object on the map. Memory up to 10,000 points-coordinates,
- » capability of locating cable damage.

Thanks to any GPS module and dedicated software (LKZ Terminal), the instrument will make it possible to plot the route of an object or mark its position on the map. Wireless communication of receiver with GPS module (Bluetooth).

Standard accessories of the meter:

LKN-1500 cable locator - transmitter	WMXXLKN1500
LKO-1500 cable locator - receiver	WMXXLKO1500
Test lead 5 m, blue, 1 kV (banana plugs)	WAPRZ005BUBB
Test lead 5 m, red, 1 kV (banana plugs)	WAPRZ005REBB
Crocodile clip, blue, 1 kV, 20 A	WAKROBU20K02
Crocodile clip, red, 1 kV, 20 A	WAKRORE20K02
Ground probe 23cm	WASONG23
Battery charger Z16 (transmitter)	WAZASZ16
Battery charger Z17 (receiver)	WAZASZ17
Bag L13	WAFUTL13
Sun - protecting cover	WAPOZSL4
Rechargeable battery NiMH 6 V, 2 Ah	WAAKU23
Battery compartment	WAPOJ3

SONEL LKZ TERMINAL

LKZ Terminal is a dedicated program for handling data stored in LKO-1500.

It allows you to map a route from your location and read the data stored in the receiver. The data includes:

- » coordinates of the place of measurement according to GPS information,
- » reading the depth of the object and value of current flowing in it,
- » the direction of the forced current,
- » operating frequency,
- » date and local time at the time of measurement according to GPS information.

System requirements:

- » Windows XP SP2 or newer;
- » presence in Internet (for on-line cards).

Recommended GPS module: RCV 3000.

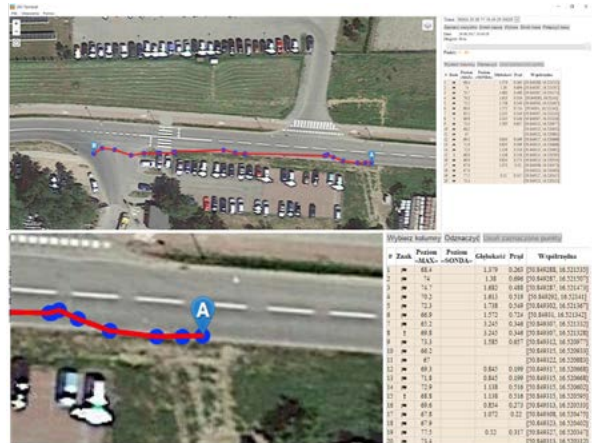

Thanks to the saved coordinates of the located object, it is possible to recreate its position during subsequent works.

Transmitter:

- » transmitter power: 10 W (in steps of 1 W, 2 W, 5 W, 10 W),
- » operation in direct galvanic or inductive connection mode: clamp (N-1) or internal transmitting antenna,
- » transmission in continuous mode or with a constant interval, which extends the rechargeable battery's operating time (12 V/7 Ah battery)
- » briefcase housing, segmented display,
- » operating temperature range -20°C...+55°C
- » dimensions: 275 mm x 250 mm x 180 mm

Receiver:

- » Operation in a broad frequency range – passive mode (50...60 Hz, 100 Hz, 300 Hz, 550 Hz, 1450 Hz):
 - power (50 Hz),
 - ether (48 Hz...14 kHz),
 - radio (10 kHz...36 kHz),
- » transmitter frequency: 273 Hz, 526 Hz, 1024 Hz, 8928 Hz, 33 kHz,
- » detection of damages in cables – earth faults (A-frame or DK1 probe),
- » power supply from replaceable rechargeable battery or batteries (5x LR6 AA),
- » graphic display visualizing the orientation and depth of the object as well as the direction of current flow.
- » depth of location up to 6 m
- » dimensions: 700 x 300 x 140 mm
- » operating temperature range from -20°C...+55°C

Thanks to the application of the DKI-E probe, the instrument is capable of locating cable damage (exterior cable sheath to earth) at locations where it is not possible to apply the A-frame (e.g. concrete, asphalt pavement).

SONEL LKZ-1000

Index: WMXXLKZ1000

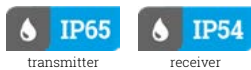

The improved LKN-1000 transmitter generates a signal that is 10 times stronger than in the previous model, allowing for:

- » tracking of underground systems over longer distances,
- » better detection of underground systems under adverse conditions with strong disturbances,
- » easier depth determination,
- » better detectability of multiple underground systems simultaneously,
- » four adjustable output signal power levels, up to 10 W,
- » durable, water-resistant housing with IP65 protection rating, more compact and lightweight, designed for work under difficult conditions,
- » three operating modes to choose from: **passive, active, automatic** (passive+active),
- » easy-to-read visual and sound signals facilitating operation,
- » additional built-in test function enabling independent checking of all functions before starting work,
- » control buttons found on the housing's exterior, allowing for control while the housing is closed, affording better protection against mechanical and water damage.

Functions of the set:

- » passive or active tracing modes,
- » detection of live underground cables,
- » detection of underground cables not carrying current (radio mode),
- » detection of underground cables not carrying current using the transmitter (galvanic or inductive connection, or by means of clamp),
- » tracing of metal or non-conducting pipes by means of additional probe,
- » tracing of non-conducting pipelines by means of "floating" probe,
- » tracing of a specific cable,
- » determination of cable depth,
- » automatic detection sensitivity regulation,
- » 5 operating modes,
- » shallow cable warning,
- » cable depth measurement up to 3 m,
- » determination of direction of cable route,
- » contrast display, automatic LCD backlight.

Electrical safety:

- » protection rating of LKN-1000 transmitter housing according to EN 60529 IP65 (closed cover)
..... IP54 (open cover)
- » housing protection rating of LKO-1000 receiver according to EN 60529 IP54

Other technical specifications:

- » transmitter power supply 4 x LR20 battery
- » transmitter dimensions 180 mm x 280 mm x 260 mm
- » transmitter weight < 2.4 kg
- » maximum locator range 3 m
- » receiver power supply 6 x LR6 battery
- » receiver dimensions 760 mm x 250 mm x 85 mm
- » receiver weight < 2.9 kg

Standard accessories of the meter:

LKO-1000 receiver	WMXXLKO1000
LKN-1000 transmitter	WMXXLKN1000
L6 carrying case	WAFUTL6
Earth contact pin probe	WASONG15
Batteries	

Work modes:

- » passive 50 Hz and 60 Hz - enables location of live conductors and cables (POWER)
- » passive RADIO (15...30 kHz) - enables quick, non-selective location of underground infrastructure of a minimum length of 100 m (metal installations)
- » active (with transmitter) (8 kHz and 33 kHz) enables:
 - location in induction mode (it is enough to place the transmitter above the located object)
 - location by means of direct connection of the transmitter to an object not carrying electrical current
 - location by means of transmission clamp (the clamp is to be fastened onto the tested object)
 - location with the use of a transmission lead or transmission probes (enables location of non-metal objects)
 - location by means of splitting adapter (direct connection of LKN-1000 transmitter to a 230 V network socket).

The set also has a series of options and functions that improve safety and convenience of work:

- » **Hazard zone** – this function generates an alarm signal indicating the proximity (within a radius of approx. 30 cm) of cables being located. It works in Power, 8 kHz or 33 kHz operating modes, as well as in automatic mode.
- » **Auto-test** – allows for independent receiver control. After the test is passed, the receiver's display will read PAS, if the test is not passed, ERR will be displayed.
- » **Automatic mode** - combines the benefits of simultaneous detection in Power and Radio mode. Makes it possible to confirm the presence of underground infrastructure in the initial phase of location, making detection easier and safer.
- » **Automatic display backlighting** – the installed lighting sensor automatically activates display backlighting when it is necessary.
- » **Digital signal strength reading** – this function additionally activates digital reading of signal strength on the display, facilitating location of underground installations.



Automatic mode - combines the benefits of simultaneous detection in power and radio mode, making it possible to confirm the presence of underground infrastructure in the initial location phase.

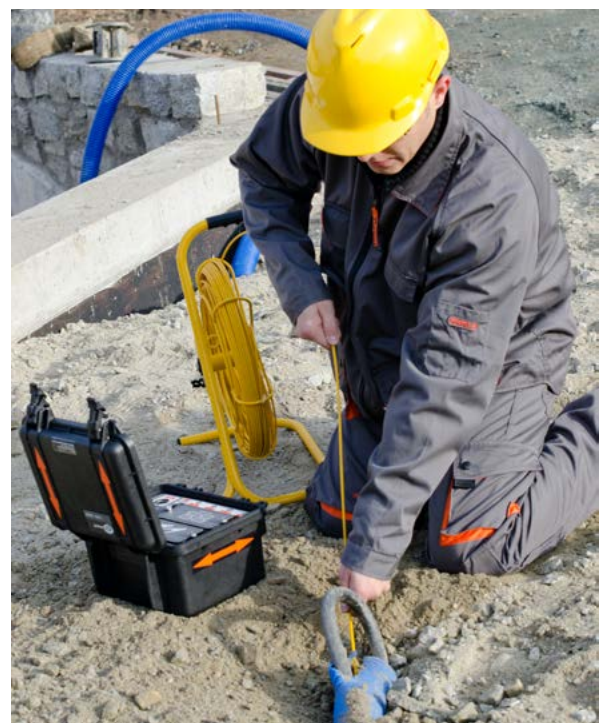

Detecting cables and wires

Works on detecting underground cables and wires and their routes are always challenging and quite difficult for people performing this task. Despite **good practice and guidelines included in standards and recommendations, which define places for routing cables in the walls, contractors often perform their tasks inconsistently and negligently.** In result electric wires are found often in at least expected places. Naturally, floors and ceilings are also areas used for installing cables. Therefore, **electrical systems can be found in many locations,** causing problems during renovation and finishing works. Performing works without prior routing of cables and wires may cause their damage by drilling, puncture, or short-circuit by a metal screw.

SONEL S.A., due to its continuous contact with installers and contractors, thoroughly recognizes the problems faced by specialists repairing electrical installations. This resulted in designing and producing **LKZ-720** a locator of wires and pipes, intended mainly for **detecting cables in buildings with various construction environments (concrete, brick, wood).** Apart from tracking cables in ceilings, walls and floors, detecting interrupted and shorted circuits, LKZ-720 has the ability to detect 50/60 Hz electric field (non-contact voltage tester) and identify system safety devices such as circuit breakers, differential switches. The device is equipped with a special 3D spatial antenna, which significantly facilitates detection and provides transfer of many useful information.

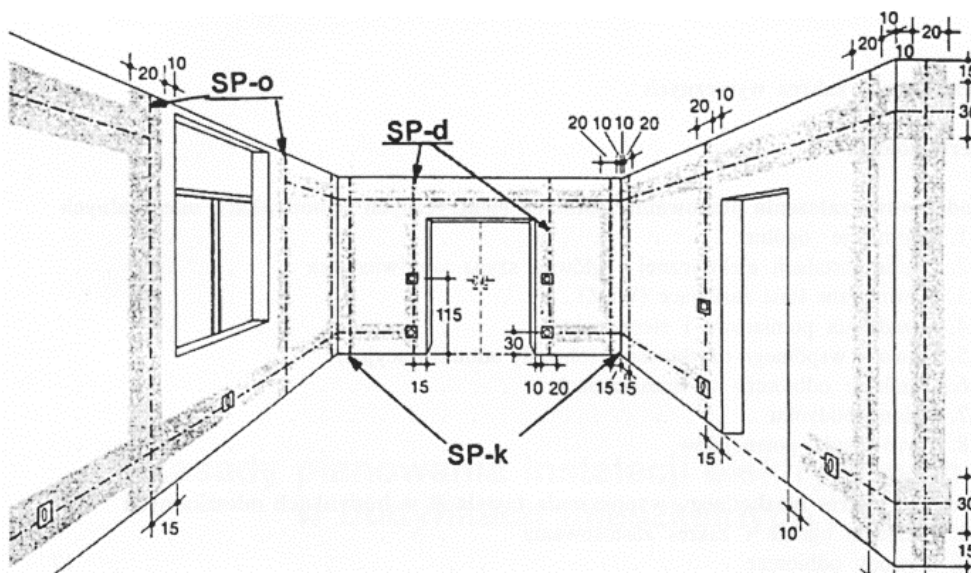

Recommended areas for laying cables in residential premises...

... and cables immediately before installation

Another problem often encountered after completed finishing works is **the difficulty in finding termination of cables and pipes, which disappeared from eyesight after plastering.** Inventorying old systems (often installed in a surprising way), identification of safety devices, finding short-circuits and interrupted electrical circuits are difficult tasks, even for experienced professionals.

In order to determine the routing of wires and to locate their damages, the device uses physical phenomena, especially the propagation of the electromagnetic field. After connecting an open circuit to the transmitter, which emits a modulated signal of AC voltage, this circuit acts as an antenna emitting an electric field. When the transmitter is connected to a closed circuit, or a circuit under voltage, a magnetic field will be generated. The receiver is designed to present the received signal strength in numerical and graphical form. Changes in presented indications allow user **determine the position of an object** that emits electromagnetic field.

Due to its features, **LKZ-720 set** (LKN-720 transmitter and LKO-720 receiver) enables user to easily, fast and precisely locate cable and wire routes, as well as their potential defects. Definitely, the easiest method is to use a two-step technique:

- » quickly and roughly locate the searched object using the 2D method, and then
- » use the 3D method to precisely determine the position of the object or location of the defect.

This is **particularly useful**, when dealing with the **effect of work that does not match the documentation of the system.** During the tracking process, the receiver informs the user about the direction from which the signal is transmitted, i.e. the place of connecting the transmitter. In addition, the indicators on the display show the direction and position of the localized conductor in relation to the receiver. With this information, determining the location is quick, efficient and very intuitive.

RECEIVER INDICATIONS

- Indicator of the receiver location with respect to the object being localized
- Setting received from the transmitter
- Swings of the bar graph indicate the cable location
- Direction of the force of the current as indicated by the arrow on the clamps

See the manual in images and video tutorials that available on the product website and on YouTube.



Manual in images



Video tutorials

Wire tracer

SONEL LKZ-720

index: WMGBLKZ720



Location of conductors and cables, both live and inactive:

- » detection of conductors in ceilings, walls and floors,
- » location of breaks in conductors,
- » tracing the route of installations throughout the entire building,
- » identification of sockets and switches in the building's installation,
- » location of faults between conductors,
- » tracing the route of shielded cables,
- » tracing the route of conductors in metal pipes,
- » fuse identification in a switchgear,
- » cable tracking,
- » tracking of the route of conducting pipes of the water or central heating system,
- » contactless detection of live conductors.

Additional functions of locators:

- » 3D function in receiver – detection of the direction of transmitted current flow and precise location of the object,
- » phase detection mode,
- » receiver operation with four transmitters at the same time - when detecting breaks or differentiating conductors,
- » flashlight with bright LED diode,
- » headphone socket in receiver,
- » backlit screens for work in the darkness,
- » transmission of battery charge status and transmitter settings to receiver,
- » operation in a broad rated voltage range, up to 500 V RMS,
- » voltage measurement of object up to 500 V RMS,
- » three levels of transmitted signal,
- » automatic or manual selection of transmission modes,
- » five transmission modes – voltage, current, current-voltage, power and clamp,
- » software updating via USB,
- » additional accessories enabling more precise location – such as a contact or contactless probe and measurement clamp.

Electrical safety:

- » type of insulation double, as per EN 61010-1
- » LKN-720 transmitter measurement category CAT III 600 V according to EN 61010-1
- » LKN-720 transmitter housing protection rating according to EN 60529 IP67
- » LKO-720 receiver housing protection rating according to EN 60529 IP40

Other technical specifications:

- » LKN-720 transmitter power supply four AA alkaline batteries or Ni-MH rechargeable batteries
- » LKO-720 receiver power supply 9 V 6LR61 alkaline battery
- » maximum operating voltage of LKN-720 transmitter 500 V (RMS)
- » maximum depth of the analysed object ("I" mode) 2 m
- » maximum range of contactless neon probe 50 cm (in air)
5 cm (in concrete)

Nominal operating conditions:

- » operating temperature range -10...+50°C

Standard accessories of the meter:

M6 carrying case	WAFUTM6
Crocodile clip, red, 1 kV, 20 A	WAKRORE20K02
Crocodile clip, blue, 1 kV, 20 A	WAKROBU20K02
Test lead 1.2 m, red, 1 kV (banana plugs)	WAPRZ1X2REBB
Test lead 1.2 m, blue, 1 kV (banana plugs)	WAPRZ1X2BUBB
Test lead 20 m, red, 1 kV (on a reel, banana plugs)	WAPRZ020REBBSZ
USB cable MINI-B 5	WAPRZUSBMNB5
Non-contact probe	WASONBDOT
Earth contact test probe (rod), 26 cm	WASONG26
Pin probe, red 1 kV (banana socket)	WASONREOGB1
Pin probe, blue 1 kV (banana socket)	WASONBUOGB1
M1 hanging straps	WAPOZSZE4

Additional accessories of the meter:

LKO-720 C-3/C-8 adapter	WAADALKOC8
Magnetic voltage adapter, black	WAADAUMAGKBL
Magnetic voltage adapter, blue	WAADAUMAGKBU
N-1 transmitting clamps (Φ=52 mm)	WACEGN1BB
C-8 Clamp probe	WASONCEGC8
Double-wire test lead 2 m, for N-1 clamps (banana plugs)	WAPRZ002DZBB
Contact probe	WASONDOT
Pin probe, black 11 kV (banana socket)	WASONBLOGB11
M1 hanging hook straps	WAPOZUCH1



LKZ

Set of standard and optional accessories

1, 2, 4 - number of basic accessories
 - - optional accessories

Photo	Name	Index	LKZ-2000	LKZ-1500	LKZ-1000	LKZ-720	Photo	Name	Index	LKZ-2000	LKZ-1500	LKZ-1000	LKZ-720
	"A" Frame - adapter for LKZ-2000	WAADALKZRA	•					PN-30 wire to locate non-metallic installations 30 m	WAPRZPN30	•	•	•	
	LKO-720 C-3/C-8 adapter	WAADALKOC8				•		Test lead 5 m, red, 1 kV (banana plugs)	WAPRZ005REBB		1		
	Magnetic voltage adapter, black	WAADAUMAGKBL				•		Test lead 5 m, blue, 1 kV (banana plugs)	WAPRZ005BUBB		1		
	Magnetic voltage adapter, blue	WAADAUMAGKBU				•		PN-50 wire to locate non-metallic installations 50 m	WAPRZPN50	•	•	•	
	AS-1 Separating adapter	WAADAAS1PL			•			PN-80 wire to locate non-metallic installations 80 m	WAPRZPN80	•	•	•	
	Rechargeable battery NiMH 6V, 2Ah	WAAKU23		1				USB cable MINI-B 5	WAPRZUSBMNIB5				1
	N-1 transmitting clamps (Φ=52 mm)	WACEGN1BB		•		•		Non-contact probe	WASONBDOT				1
	N-2 transmitting clamps for LKZ-1000 (Φ=125 mm)	WACEGN2XLR			•			BIK-Probe for wireless identification of cables	WASONBIK	•			
	N-3 transmitting clamps for LKZ-2000 (Φ=125 mm)	WACEGN3	•					Earth contact test probe (rod), 15 cm	WASONG15	•		1	
	C-8 Clamp probe	WASONCEGC8				•		Ground probe 23cm	WASONG23		1		
	Bag L13	WAFUTL13		1				Earth contact test probe (rod), 25 cm	WASONG25				1
	L6 carrying case for LKZ-1000	WAFUTL6			1			Sonda DKI	WASONDKI		•		
	L9 carrying case for LKZ-2000	WAFUTL9	1					Contact probe	WASONDOT				•
	M6 carrying case	WAFUTM6				1		GPS adapter RCV-3000	WAADARCV300		•		
	Li-Ion battery 3,6 V 4,5 Ah	WAAKU11	•					Adapter - A frame	WAADALKZRA2		•		
	Crocodile clip, red, 1 kV, 20 A	WAKRORE20K02		1		1		NAD-1 Transmission probe	WASONNAD1	•		•	
	Crocodile clip, blue, 1 kV, 20 A	WAKROBU20K02		1		1		Pin probe, black 11 kV (banana socket)	WASONBLOGB11				•
	Sun - protecting cover	WAPOZOSL4		1				Pin probe, red 1 kV (banana socket)	WASONREOGB1				1
	Battery compartment	WAPOJ3		1				Pin probe, blue 1 kV (banana socket)	WASONBUOGB1				1
	Test lead 1,2 m, red, 1 kV (banana plugs)	WAPRZ1X2REBB				1		M1 hanging straps	WAPOZSZE4				1
	Test lead 1,2 m, blue, 1 kV (banana plugs)	WAPRZ1X2BUBB				1		M1 hanging hook straps	WAPOZUCH1				•
	Double-wire test lead 2 m, for N-1 clamps (banana plugs)	WAPRZ002DZBB				•		Battery charger Z16 (transmitter)	WAZASZ16		1		
	Test lead 20 m, red, 1 kV (on a reel, banana plugs)	WAPRZ020REBBSZ				1		Battery charger Z17 (receiver)	WAZASZ17		1		

Reflectometers

SONEL TDR-420 / TDR-410

index: WMGBTDR420 / WMGBTDR410



IP67

IP54

Diagnose faults with instruments from the TDR series

- » fault location in power and telecommunication cables
- » two independent cursors to indicate two fault locations and the distance between them (TDR-420)
- » fault location in coaxial cables
- » fault location in infrastructure cables
- » detection of breaks, short-circuits, damage caused by moisture and other changes in cable impedance
- » graphic presentation of cable faults with an indication of the distance to the fault on the display

Standard accessories of the meters:

Double-wire test lead 0.6 m for TDR (banana plugs)	WAPR20X6DZBB
Crocodile clip, red, 1 kV, 20 A	WAKRORE20K02
Crocodile clip, black, 1 kV, 20 A	WAKROBL20K01
4x batteries alkaline 1.5 V AA	
M6 carrying case (TDR-420)	WAFUTM6
M2 carrying case (TDR-410)	WAFUTM2



Application

TDR-410 and TDR-420 time-domain reflectometers are designed for faults locating in metal wires. These products are designed for electrical wholesalers and cable dealers, electrical installation companies, maintenance personnel at manufacturing plants and building personnel. These devices meet the expectations of all those who have to accurately locate a fault and wire end in either power or telecommunication cables.

Device capabilities

SONEL reflectometers are distinguished for their long operating range (up to **6,000 m for TDR-420**), very low margin of error in measurement (in the order of 1%) and the ability to adjust both the velocity of propagation and the impedance of the cable which is under investigation. By using **two cursors** there should be no problem with determining both the distance to two faults and the distance between them.

Easy readout

The TDR-420 reflectometer is equipped with a readable **colour display** that, due to its 320 x 240 pixel resolution, allows the fault location to be indicated even more accurately.

Integrated Help

In the TDR-420 device a **handy help** function has been added to facilitate the interpretation of the result obtained during measurement. Thanks to this function, a user can quickly determine the type of anomaly that is present in the cable segment which is being examined, by comparing the displayed reflectogram with typical fault shapes.

Durable and practical casing

In response to the customers needs the **new model of TDR-420** has been designed to operate in difficult environmental conditions. A unique **casing with the IP67 ingress protection rating** ensures that the device is both waterproof and dustproof. An additional advantage is the elastomer coating of the casing that prevents the device from slipping out of the hands and provides protection if accidentally dropped.



	TDR-420 Advanced reflectometric measurements in all fields	TDR-410 Basic cable faults measurements
measuring ranges	7 m, 15 m, 30 m, 60 m, 120 m, 250 m, 500 m, 1 km, 2 km, 3 km, 6 km 20, 45, 90, 180, 360, 750, 1500, 3000, 6000, 10000, 20000 [ft]	7 m, 15 m, 30 m, 60 m, 120 m, 250 m, 500 m, 1 km, 2 km, 3 km, 4 km 20, 45, 90, 180, 360, 750, 1500, 3000, 6000, 10000, 14000 [ft]
accuracy	1% of selected range	
resolution	approx. 1% of range	
minimum cable length	4 m	
velocity of propagation	within 10...99% or 15...148.5 m/μs	within 1...99% or 1...148 m/μs
output impulse	5 V _{pp} for an open circuit	
output impedance	25, 50, 75, 100, 125, 200 Ω	25, 50, 75, 100 Ω
impulse width	3 ns...3 μs (depending on the range)	
scanning type	up to 3 scans/s or a single scan (ONCE mode)	2 scans/s or a single scan
tone generator	810 – 1100 Hz	
operating time on a full battery	up to 8 hours of continuous scanning	up to 30 hours of continuous scanning
power supply	4 x alkaline batteries 1.5 V AA type or 4 x NiMH AA rechargeable batteries	4 x alkaline batteries 1.5 V AA type
auto-off function	1, 3, 5, 10, 15 minutes or deactivated	1, 2, 3, 5 minutes or deactivated
display	colour 3.5" LCD TFT, 320 x 240 pixels	graphical, backlit, 128 x 64 pixels
overvoltage protection	400 V DC / 250 V AC	
operating temperature	-20...+70°C	-10...+50°C
storage temperature	-30...+80°C	-20...+70°C
dimensions	220 x 98 x 58 mm	165 x 90 x 37 mm
weight	487 g	350 g
electromagnetic compatibility standards (EMC)	EN 61326-1	
ingress protection	IP67	IP54



Illuminance measurements

Our perceptive capability and psychophysical condition depend to a very large extent on the surrounding environment. Light stimuli are decisive factors in the psychological comfort. Prolonged exposure to artificial light may accelerate fatigue and contribute to eyesight defects and other diseases. Negative **impact of improper lighting** on people is particularly important in terms of safety and **work efficiency**. The perception of light stimuli, although dependent on the individual characteristics of a person, is in general similar for majority of people. Therefore, regulations have been defined to define values and types of lighting in places where people live and work. The light visible to humans is an electromagnetic wave with a length from approx. 380 nm to approx. 780 nm. The sensitivity of a human eye is not the same in all conditions - it results from its structure and location of receptors, as well as from the nature of the light. In daylight conditions the eye is most sensitive to green colour, whereas at night or in poor lighting, the eye sensitivity shifts to blue colour - this is why we have a subjective impression that at night everything is grey.

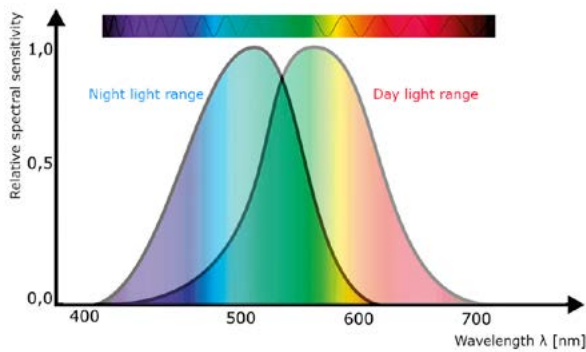

Fig. 1. Visible range of electromagnetic waves during the day and night

Despite the adaptability of the eye to changing light intensity, the measurements require to set the measuring at device to have a sensitivity similar to an eye adapted to bright daylight. Spectral curve that corresponds to this sensitivity is called the photopic curve $V(\lambda)$. It is useful to calculate photometric values. In determining the criteria for proper lighting parameters, consider the following:

- » recommendations of the International Commission on Illumination (CIE) (determination of optimal conditions for the illumination of rooms, depending on their use)
- » local regulations (i.e. GB 50034, JIES-008, CIE S 008/E-2001, SNiP 23-05-95, AS 1680.1-2006).

For testing workplace lighting, it is recommended to observe guidelines defined in **binding standard EN 12464**. When discussing illuminance measurements, it is useful to define the illuminance. It is the ratio of luminous flux on a specified area and the surface of this area. The unit of illuminance is lux (lx) [lm/m^2]. In addition, CIE provides recommended **illuminance uniformity E_m** in the field of view, i.e. the way of lighting the workplace. High irregularity of illumination (e.g. exposed light sources in the field of view) creates a risk of glare which may reduce the ability to recognize details or cause a discomfort. In addition, due to the time needed for eyes to adapt to changes, the illumination uniformity should be maintained over time. Therefore, the level of ripple is important and this relates to flicker.

The light colour is another factor that has a significant impact on the well-being of people present in the room. For a man the most optimal lighting has the spectral composition most similar to daylight. Light sources are classified according to the colour temperature into warm, cool and neutral light. The colour temperature may be determined based on **colour rendering index R_a** , which reflects the difference between the colour of object illuminated by natural light and the object illuminated by tested light. Light sources with relatively high R_a index include standard bulbs, halogen bulbs or LEDs. Sources with R_a below 70 include sodium and mercury lamps. Measurements of parameters that help to assess lighting conditions should be carried out during the acceptance of new lighting devices and during the modernization of existing devices or periodically every 5 years. **It is recommended to carry out the tests at least every two years.** The tests shall be carried out:

- » after dark or with curtains drawn
- » in operating conditions - the test area shall not be specially prepared (creating unrealistic conditions) for the tests.

Luminaires with discharge lamps must be switched on at least 30 minutes before testing. Other types of light sources such as halogen bulbs or LEDs, may be examined directly after switching on. Discharge lamps must not be new; they should operate at least 100 hours before measurements; in case light bulbs and halogen lighting this operation period is only one hour. The person performing the measurements can not affect the results. Therefore, it is advisable to wear dark clothing, and the distance from the measuring device should be as large as possible. Measurements should be performed in the plane of the task (e.g. desk surface) with the photometer head set in parallel and directly on the test surface.

Measurements should be performed in the plane of the task (e.g. desk surface) with the photometer head set in parallel and directly on the test surface.

EN 12464-1:2012 introduces a new term: **illuminance of the immediate surrounding area**. It depends on illuminance in the task area and it shall provide an even distribution of luminance in the field of view. This standard recommends minimum dimensions of the task area and related dimensions of the immediate surrounding area (a strip with a width of at least 0.5 m around the task area) and a background area (a strip with a width of at least 3 m adjacent to immediate surrounding area).

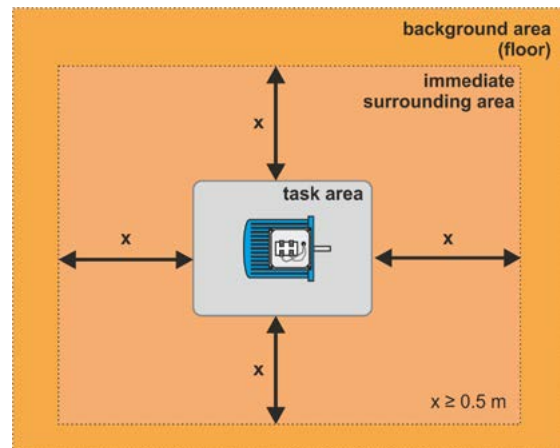

Fig. 2. Visual task, immediate surrounding area and background area

In order to determine the measuring points of all three areas, create grid with a mesh of approximately square shape. The ratio of length to width of the mesh should be between 0.5 and 2. The measurement points should be located inside the mesh of the lighting grid. The maximum grid size shall be:

$$p = 0,2 \cdot 5^{\log_{10} d}$$

where:

- p - maximum dimension of the grid [m],
- d - longer dimension of the calculated area [m].

Basing on the measurements, **lighting uniformity U_0** may be calculated for a given workplace.

To measure lighting in interiors with daylight, carry out the measurements that determine the daylight index. For this purpose, use two luxmeters to perform measurements simultaneously outside and inside the rooms lit via windows or skylights. On the other hand, when **measuring emergency lighting** the illuminance values are very low. The requirements in this matter are defined in standard **EN 1838:2013**. It should be mentioned that for escape routes with a width of 2 meters, the minimum value of illuminance measured at the floor is **1 lux**, which affects the selection of an appropriate measuring device. In recent years, LED illumination sources become more and more popular. Their measurements are currently based on the same requirements as other types of light sources. In case of **measurements on white LED light**, consider the guidelines of CIE concerning parameter f'_1 , i.e. the size of mismatch between luxmeter sensitivity and curve $V(\lambda)$. The Commission recommends the use of luxmeter with f' **not exceeding 3%**.

Sonei LXP-10A light meter of Class A meets this condition. In case of light meters LXP-10B and LXP-2 of Class B, having the declared error value of spectral correction $f'_1 < 6\%$, the error value f_1 must be also taken into account, which results from differences in spectral distribution of the measured and calibration light source. The illuminance measurement formula requires taking into account the correction factors for the LED light. As in luxmeters of Class A and B, the correction factors k take values close to 1, they do not have a significant impact on the measured illuminance value.

When selecting the measuring instrument, **attention should be paid to a valid calibration certificate, which confirms its efficiency and the fact that it meets declared levels of basic and spectral uncertainty. The photoelectric cell, which is used as a sensor, is ageing over time**, so it should be subject to metrological periodic checks.

Illuminance meter

SONEL LXP-10A / LXP-10B / LXP-2

index: WMXXLP10A / WMXXLP10B / WMXXLP2



LXP-10A

Device of the highest class A thanks to cooperation with LP-10A measuring probe. LXP-10A has all advantages that can be found in LXP-10B. Furthermore, it allows to make the most accurate measurements in industrial zones and public facilities. In addition, the instrument has the ability to wirelessly send data to Sonel Reader PC software.

LXP-10B

Model with resolution 0.01 lx allows to accurate lighting measurements in workplaces and emergency lighting in escape routes. It works with LP-10B measuring probe (class B). The device has internal memory of 999 measurements and additional logger for recording data with a selectable sampling rate.

LXP-2

Model for everyone who makes basic lighting measurements of indoor and outdoor workplaces. The device works with LP-1 measuring probe (class B) which allows to proceed with measurements in a reliable way. The non-integrated probe eliminates the influence of the user to the measurement result.

Main features

- » measurements of all types of light
- » no need to using correction factors
- » displaying results in lux and foot-candle
- » measurements of emergency lighting

Product functions

- » data HOLD
- » PEAK HOLD
- » MAX and MIN results save
- » measurements of relative (REL) values
- » data logger with memory
- » auto power off



LXP-10B and LXP-10A enable wireless data transfer to a PC via the OR-1 adapter

Basic technical specifications:

	LXP-10A	LXP-10B	LXP-2
	the most recommended for professionals	for measurements of emergency lighting	basic measurements of workplaces
class	A	B	B
measurement range	0.000...399.9k lx 0.000...39.99k fc	0.00...399.9k lx 0.000...39.99k fc	0.0...19.99k lx 0.00...1999 fc
resolution (lx/fc)	up to 0.001	up to 0.01	
accuracy	±(2% + 5 digits)	±(5% + 5 digits)	
spectral uncertainty f_1'	<2%	<6%	
cosine matching error f_2	±3%		
number of ranges	6	5	3
sampling rate	1.3 Hz		
spectral sensitivity	CIE spectral sensitivity (CIE human eye sensitivity)		
photodetector	one silicon photodiode and spectral sensitivity filter		

Other technical specifications:

- » memory 99 results (LXP-2), 999 results (LXP-10)
- » memory of recorder 16,000 results
- » communication interface USB and radio link (only LXP-10B, LXP-10A)
- » display 3½ digits, LCD with 40-segment bar indicator
- » power source 9 V battery or 8.4 V rechargeable battery
- » exceeding of range „OL” symbol
- » operating temperature 0...50°C
- » storage temperature -20...+70°C
- » relative humidity 0...80%
- » storage relative humidity 0...70%
- » photodetector lead length approx. 150 cm
- » photodetector dimensions 115 mm × 60 mm × 20 mm
- » meter dimensions 170 mm × 80 mm × 40 mm
- » weight 390 g

Standard accessories of the meters:

USB cable MINI-B 5	WAPRZUSBMNIB5
Calibration certificate	
PC software: Sonel Reader	WAPROREADER
LP-1 light meter probe (miniDIN-4P)	WAADALP1
LP-10A light meter probe (miniDIN-4P)	WAADALP10A
LP-10B light meter probe (miniDIN-4P)	WAADALP10B

LXP

Set of standard and optional accessories

1, 2, 4 - number of basic accessories
• - optional accessories

Photo	Name	Index	LXP-10A	LXP-10B	LXP-2
	OR-1 USB wireless receiver	WAADAKEY1	•	•	•
	PC software: FOTON2	WAADAUSBOR1	•	•	
	Free software to transfer data from meters	WAPROREADER	1	1	1
	LP-1 light meter probe (MiniDIN-4P plug)	WAPRZUSBMNIB5	1	1	1
	LP-10A light meter probe (MiniDIN-4P plug)	WAADALP1			1
	LP-10B light meter probe (MiniDIN-4P plug)	WAADALP10A	1		
	sonda luksomierza LP-10B (wytyk miniDIN-4P)	WAADALP10B		1	



**Top class of mains network analyzers
with transients capture**

PQM-711
PQM-703



**Class A high accuracy
mains network analyzers**

PQM-710
PQM-702T
PQM-702

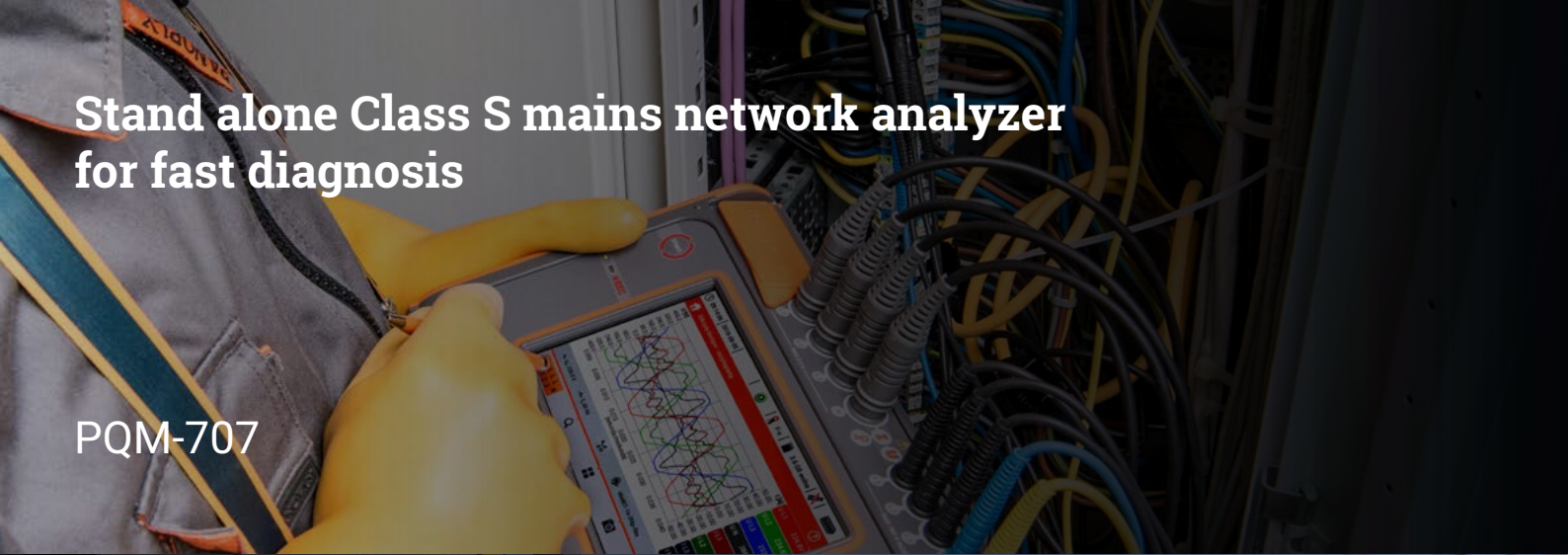

**Stand alone Class S mains network analyzer
for fast diagnosis**

PQM-707



**Portable Class S analyzer
for basic and long term analysis**

PQM-700

Power quality analysis

Electricity produced in electric power industry is a typical commercial product. Therefore, it is subject to the same rules as all goods available on the market, taking into account the fact that both the provider and the receiver use the same power grid, which affects the final quality of the power supply. The industry clearly defined power quality parameters, criteria and conditions for their evaluation and rules of distribution and control. Power distribution requires the control of power quality parameters, conditions of receiving process and recording all incidents of exceeded tolerance values. Data gathered in the control process is used for statistical evaluation of the compliance of recorded parameters with applicable standards, legal requirements and contracts. The final result is a confirmation of correctness which ends the assessment or a non-compliance statement, which is related to further analysis of the problem to indicate the responsibility for exceeding limits, which may result in financial consequences.

Wide availability of electricity means that the public networks supply industrial facilities, public buildings, and the vast majority of households. Rapid technological progress resulted in a situation, where typical electric line machines, such as motors, light bulbs, resistive heaters are provided with additional power electronics that ensure easy control of the energy flow, power control and improved efficiency. The consequences of this progress, supported by the need to minimize costs, are significantly simpler solutions that cause higher levels of current and voltage distortion and interference. Power networks are now exposed to new types of impacts that deteriorate power quality, causing additional losses, which is particularly visible with increasing use of new devices.

Consumer electronics involves small power devices, but a very large number of them may significantly affect the quality of power supply in public networks.

Power electronics in industry is related to much higher values of active and passive power, systematically repeated changes of load and type of reactive power, asymmetries of single-phase and two-phase loads, current distortion, voltage dips caused by temporary network overloads and equipment failures. Therefore, the industry supply networks experience troublesome voltage fluctuations causing light flickering lights, short voltage dips, higher levels of harmonic voltages and currents as well as dangerous resonance phenomena. Other adverse incidents include discontinuities and interruptions of power supply that cause losses in production or even hazards to the life of employees. The increased amount of negative impacts causes faster and unpredictable wear of machine parts, making it difficult to plan maintenance activities. Moreover, the risk of losses due to unforeseen failures also significantly increases.

Instruments for analysing and diagnosing power quality are required to provide two basic functionalities. The first one is to assess the conformity or non-conformity of power supply parameters with binding standards and law requirements. This function is provided by all instruments offered on the market. The second functionality is to capture the phenomena that deteriorate power quality and those, which disturb proper and efficient operation of power equipment, providing flexibility to diagnose different types of networks with different nominal voltages. Presence of this feature in offered devices depends mainly on the initiative of producers of measuring equipment.

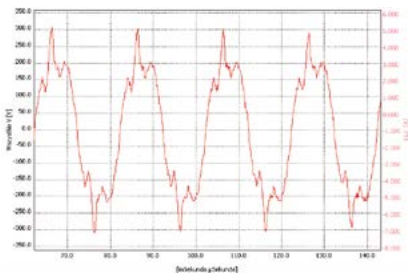

Example of the deformed current wavelength

The offer of our company includes a wide range of products tailored to the needs of users:

- » Class S: **PQM-700, PQM-707,**
- » Class A: **PQM-702, PQM-702T, PQM-703, PQM-710, PQM-711.**

The main tasks of PQM-7xx analyzers, equipped with a wide range of accessories, include the use of a high-speed memory to simultaneously record up to 4500 network parameters, including: average values, MIN and MAX values, waveforms of voltages and currents at the end of each averaging cycle. Monitored parameters include voltage increases, dips and interruptions with recorded waveforms and RMS (1/2) graphs. In addition, instruments check for exceeding tolerance values, acceptable levels or other parameters. PQM-703/711 analyzers offer also quick waveform recording of transient currents up to 8000 V. Smart solutions used in the analyzers enable them to operate continuously **with power supply from the tested network, up to 760 V AC for CAT IV 600 V** of overvoltage resistance over a wide temperature range. The analyzers also maintain full functionality for a few hours on their own battery power. Class A devices have a **built-in GPS**, which provides high time accuracy and a GSM modem for distant remote communication.

For close communication, the analyzers use USB connection and some types have built-in additional OR-1 radio or Wi-Fi modules.

The measurement results provided by PQM analyzers may be used for the following purposes:

Assessment of the quality of power supply in relation to the regulations binding in Poland or to EN 50160 standard. The conformity assessment report indicates which parameters are exceeded in relation to their threshold values, showing percentage values on the observation period scale. The assessment covers average values of voltages and frequencies, asymmetry, flicker factor Plt, THD U, voltage harmonics and additionally the maximum average active power of 15 min and tg, when necessary.

Diagnosis and identification of voltage dips to indicate their cause. Basing on simultaneous recording of average and limit values, as well as RMS (1/2) of voltages and currents, it is possible to indicate whether the dips were caused by outside factors or by own operation of devices. Recording the oscillograms helps to capture transients during power outages, returns or high voltage surges.

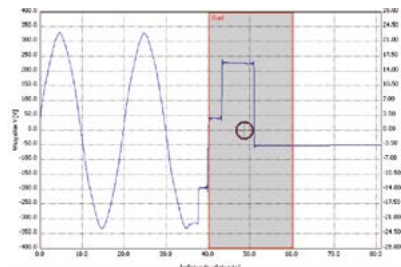

Example of power supply failure

Diagnosis of voltage fluctuations and flicker that presents the levels of voltage fluctuations and the degree of flicker nuisance, indicating the relation with the turbulent operation of

own devices. Relating the high level of changes in active and reactive power to the waveform of the P_{ST} factor and propagation of changes with synchronous recording in several points of the network allows identifying the direction leading to the source of disturbed loads.

Diagnosis of active and reactive power helps to select parameters of the compensator that eliminate penalties for exceeding the reactive power limits and to verify the effectiveness and conditions of operating the battery compensating the reactive power, ensuring trouble-free operation.

Diagnosis of voltages and currents, used for assessing the operational conditions for electrical machines with rotating field, basing on the behaviour of symmetrical components of voltages and currents. Uneven operation of three-phase motors powered directly from the network, interferences in the work of transformers with the risk of ferro-resonances may be identified basing on the interdependence of the various parameters in combination with the waveforms of symmetrical components. The detection of these phenomena may reduce the risk of failure, increasing operational reliability of machines.

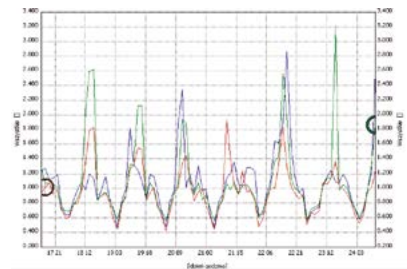

Example of exceeded P_{L1} indicator

Diagnosis of harmonics based on the behaviour of voltage, current and power harmonics, which enables the user to evaluate the effects of power supply to non-line devices and their impact on the parameters of the power grid and power quality. High level of harmonics causes additional heat losses of the energy system elements, endangering the operation of these devices and generating additional costs. It is also possible to assess these risks for other power equipment supplied from the network that increase the risk of unexpected failure.

Diagnosis of interharmonics allows user to identify transients and dangerous behaviour of the grid that may threaten the operation of other devices. These phenomena may occur at any frequency. Interharmonics complement the harmonics in the analysis of 0 - 2500 Hz band.

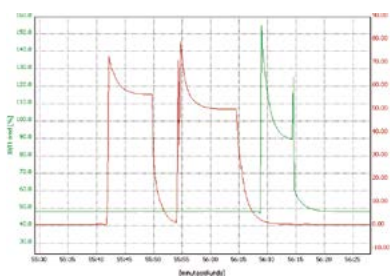

Example of asymmetry caused by connection process

Diagnosis of transients based on high-speed recording of voltage, sampled at a frequency up to 10 MHz in the voltage range of +/- 8000 V. It is possible to detect quick surges threatening the power electronics devices, and insulating elements. Their presence may indicate the absence or failure of surge protection or device malfunction, which in turn can lead to breakdowns and unnecessary loss.

Comparison of power quality analyzers



	PQM-711	PQM-710	PQM-707	PQM-703	PQM-702T	PQM-702	PQM-700
STANDARDS							
Compliance class acc. IEC 61000-4-30	A	A	A	A	A	S	S
Certificate from independent laboratory	√	√	√	√	-	-	√
EN 50160	√	√	√	√	√	√	√
GOST 32144	√	√	√	√	√	√	√
AS 61000.3.100	√	√	√	√	√	√	√
MEASUREMENT INPUTS							
Number of voltage inputs	5	5	5	5	5	5	4
Number of current inputs	4	4	4	4	4	4	4
Number of temperature inputs	-	-	-	-	1	-	-
GPS input	1	1	1	1	1	-	-
MEASUREMENTS							
1-phase, split-phase, 3-phase system	√	√	√	√	√	√	√
Frequency	√	√	√	√	√	√	√
TRMS voltage	√	√	√	√	√	√	√
Crest factor U	√	√	√	√	√	√	√
Voltage THD and harmonics	√	√	√	√	√	√	√
Voltage TID and interharmonics	√	√	√	√	√	-	-
Voltage unbalance	√	√	√	√	√	√	√
Voltage transients (10 MHz sampling)	√	√	-	-	-	-	-
Short term flicker	√	√	√	√	√	√	√
Long term flicker	√	√	√	√	√	√	√
TRMS current	√	√	√	√	√	√	√
Crest factor I	√	√	√	√	√	√	√
Current THD and harmonics	√	√	√	√	√	√	√
Current TID and interharmonics	√	√	√	√	√	-	-
Current unbalance	√	√	√	√	√	√	√
Inrush	√	√	√	√	√	√	√
Harmonic power	√	√	√	√	√	√	-
Angles between harmonics	√	√	√	√	√	-	-
K-factor	√	√	√	√	√	-	-
Mains signalling	√	√	√	√	√	-	-
Power (P, Q, D, S) acc. to IEEE 1459 or Budeanu method	√	√	√	√	√	√	√
Power factor	√	√	√	√	√	√	√
Cos(φ)	√	√	√	√	√	√	√
Tan(φ)	√	√	√	√	√	√	√
Energy (E _p , E _q , E _s)	√	√	√	√	√	√	√
4-quadrants energy measurements	√	√	√	√	√	-	-
Maximal number of parameters measurements at the same time	3655	3655	3655	3655	3655	1200	1300
Maximal recording time	100 years	100 years	100 years	100 years	100 years	18 years	10 years
Integration period	half cycle ... 120 min	half cycle ... 120 min	half cycle ... 120 min	half cycle ... 120 min	half cycle ... 120 min	1 s ... 30 min	half cycle ... 30 min
SAFETY							
Measurement category	CAT IV 600 V / III 760 V	CAT IV 600 V / III 760 V	CAT IV 600 V / III 760 V	CAT IV 600 V / III 760 V	CAT IV 600 V / III 760 V	CAT IV 600 V / III 760 V	CAT IV 300 V / III 600 V
EN 61010	√	√	√	√	√	√	√
EN 61326	√	√	√	√	√	√	√
Anti-theft function	√	√	√	√	√	-	-
ENVIRONMENTAL CONDITIONS							
Working temperature [°C]	-20..+55	-20..+55	-20..+55	-20..+55	-20..+55	-10..+50	-20..+55
Built-in heater	√	√	√	√	√	-	√
Ingress protection	IP65	IP65	IP65	IP65	IP65	IP51	IP65
All-weather measurements	√	√	√	√	√	-	√
Pole mounting	√	√	√	√	√	-	√
DIN rail mounting	√	√	√	√	√	-	√



PQM-711



PQM-710



PQM-707



PQM-703



PQM-702T



PQM-702



PQM-700

MEMORY AND COMMUNICATION

Memory	8 GB (max. 32 GB)	8 GB (max. 32 GB)	8 GB (max. 32 GB)	8 GB (max. 32 GB)	8 GB (max. 32 GB)	4 GB (max. 32 GB)	4 GB (max. 32 GB)
Replaceable memory card	-	-	-	-	-	√	√
USB	-	-	-	-	-	√	√
USB 2.0 High Speed	√	√	√	√	√	-	-
Wi-Fi	√	√	-	-	-	-	-
GSM (UMTS) modem	√	√	√	√	√	-	-
Wireless transmission	-	-	√	√	-	-	-

POWER SUPPLY

Built-in Li-Ion battery	√	√	√	√	√	-	√
Replaceable Li-Ion battery	-	-	-	-	-	√	-
Battery operating time	min. 2 h	min. 2 h	min. 2 h	min. 2 h	min. 2 h	min. 6 h	min. 6 h
Battery charger	internal	internal	internal	internal	internal	external	internal
USB charging	-	-	-	-	-	√	-

GENERAL

LCD display	√	√	√	√	√	-	-
LCD touch screen	-	-	-	-	-	√	-
GPS time synchronisation	√	√	-	√	√	√	-
Multilanguage Sonel Analysis software	√	√	√	√	√	√	√
Paper and PDF user manual	√	√	√	√	√	√	√
Weight	1.6 kg	1.6 kg	1.6 kg	1.6 kg	1.6 kg	1.75 kg	1.6 kg
Dimensions	200x175x75 mm	200x175x75 mm	200x175x75 mm	200x175x75 mm	200x175x75 mm	216x111x45 mm	200x175x75 mm

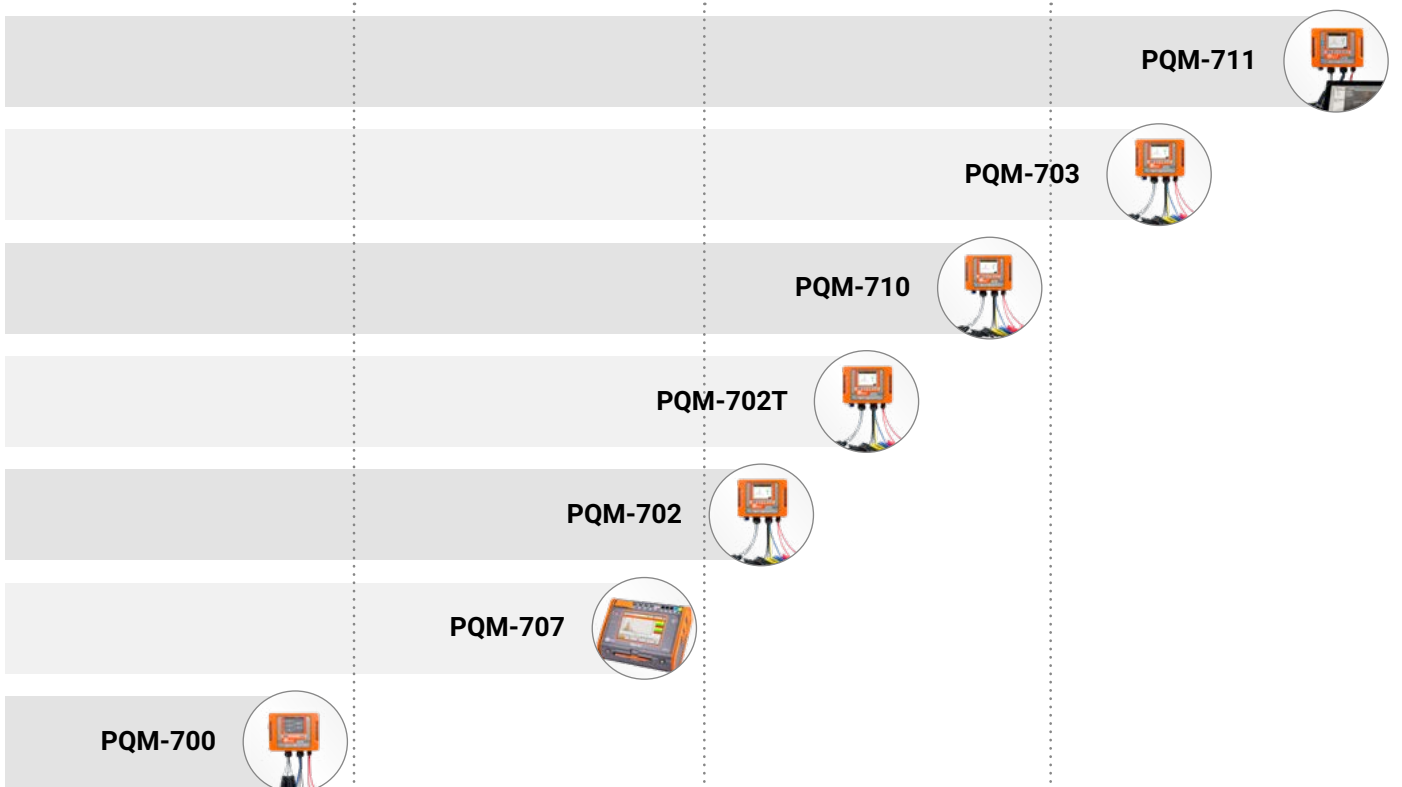

PQM-711



PQM-703



PQM-710



PQM-702T



PQM-702



PQM-707



PQM-700



Portable Class S analyzer for basic and long term analysis

Stand alone Class S mains network analyzer for fast diagnosis

Class A high accuracy mains network analyzer

Top class of mains network analyzers with transients capture

SONEL PQM-711 / PQM-710

index: WMGBPQM711 / WMGBPQM710



- CLASS A**
EN 61000-4-30
- CAT IV**
600 V
- IP65**
- GPS**
- WiFi**
- GSM**
- HEAVY DUTY**
55°C
-20°C
- EVENTS**
- TRANSIENT RECORDER**

The instrument is intended for operation in networks:

- » with rated frequency 50/60 Hz,
- » with rated voltages: 64/110 V, 110/190 V, 115/200 V, 120/208 V, 127/220 V, 220/380 V, 230/400 V, 240/415 V, 254/440 V 277/480 V, 290/500 V, 400/690 V,
- » with direct current,
- » in the following configurations:
 - single-phase,
 - two-phase with common N,
 - three-phase - star with and without N conductor,
 - three-phase - delta.
- » A built-in rechargeable battery allows for at least two hours of operation.

Measured parameters:

- » voltages L1, L2, L3, N-PE (five measurement inputs) – mean, minimum and maximum values, instant values within the range up to 1000 V, interoperability with voltage transformers,
- » currents L1, L2, L3, N (four measurement inputs) - mean, minimum and maximum values, instant values, direct current measurement within the range up to 3 kA (depending on applied current clamp), interoperability with current transformers,
- » crest factors for current (CFI) and voltage (CFV),
- » frequency within the range of 40 Hz – 70 Hz,
- » active power (P), reactive power (Q), distortion power (D), apparent power (S) with identification of the nature of reactive power (capacitive, inductive),
- » calculation of reactive power using the:
 - Budeanu method,
 - IEEE 1459,
- » active energy (E_p), reactive energy (E_q), apparent energy (E_s),
- » power factor (PF), cosφ, tgφ,
- » K factor (transformer overload due to harmonics),
- » harmonics up to the 50th in voltage and current,
- » interharmonics measured as groups,
- » total harmonic distortion THD for current and voltage,
- » short-term (P_{st}) and long-term (P_{lt}) light flicker index (in compliance with EN 61000-4-15 class A),
- » asymmetry of voltages and currents,
- » registration of overvoltages, voltage dips and breaks along with oscillograms,
- » event logging for current along with oscillograms (up to 1 s) as well as 10 ms RMS charts with maximum registration time of 30 s,
- » registration of current and voltage oscillograms after every averaging period,
- » measurement of control signals up to 3000 Hz,
- » measurement of transients up to ±8000 V with maximum sampling frequency of 10 MHz. The minimum transient time that can be registered is 650 ns (only PQM-711),
- » all parameters in compliance with Class A of IEC 61000-4-30.

Thanks to Wi-Fi communication built in the PQM-711/710 analyzers, as well as included as standard 10" tablet, it is possible to wirelessly configure the measurements and analyze measurement data using Sonei Analysis PC software.

SONEL ANALYSIS MOBILE



Mobile version of the program supports PQM-711 and PQM-710 power quality analyzers. It can be downloaded from the www.sonei.pl/en website or by scanning the QR code placed above.

Standard accessories of the meters:

Magnetic voltage adapter (set - 4 pcs)	WAADAUMAGKPL
Voltage adapter with M4/M6 thread (5 pcs.)	WAADAM4M6
AC-16 line splitter	WAADAAC16
Li-Ion battery 3.6 V 4.5 Ah	WAAKU11
AZ-1 power supply adapter (mains plug/ banana inputs)	WAADAAZ1
L8 carrying case, backpack for PQM	WAFUTL8
Crocodile clip, black, 1 kV, 20 A	WAKROBL20K01
Crocodile clip, red, 1 kV, 20 A	WAKRORE20K02
Crocodile clip, blue, 1 kV, 20 A	WAKROBU20K02
Crocodile clip, yellow, 1 kV, 20 A	WAKROYE20K02
2x Fasteners and bands for mounting the analyzer on a pole	WAPOZUCH4
Straps for mounting on the pole for PQM (set)	WAPOZOPAKPL
USB cable	WAPRZUSB
Tablet	Tablet
DIN rail mounting bracket with positioning catches	WAPOZUCH3
Calibration certificate	
Sonei Analysis 4 PC software	WAPROANALIZA4

The instrument meets the requirements set forth in the standards:

- » EN 61000-4-30 (class A) (electromagnetic compatibility - measurement methods)
- » EN 61000-4-7 (class I) (measurements of harmonics)
- » EN 61000-4-15 (class A) (light flicker)
- » EN 50160 (supply voltage measurements)
- » EN 61010-1 (safety of measuring instruments)

Other technical specifications on page 95.

PQM-711/710 have an independent power source, making them particularly suited for measurements with voltage transducers.



PQM-711 enables measurement of transients up to ±8000 V with maximum sampling frequency of 10 MHz.

Power quality analyzers

SONEL PQM-707

index: WMGBPQM707 / WMGBPQM707NC (without F3A clamps)



Measured parameters:

- » Voltages L1, L2, L3, N-PE (five measurement inputs) – mean, minimum and maximum values within the range up to 760 V, interoperability with voltage transformers,
- » Currents L1, L2, L3, N (four measurement inputs) - mean, minimum and maximum values, current measurement within the range up to 3 kA (depending on applied current clamp), interoperability with current transformers,
- » Crest factors for current (CFI) and voltage (CFU),
- » Frequency within the range of 40 Hz – 70 Hz,
- » Active power (P), reactive power (Q), distortion power (D), apparent power (S) with identification of the nature of reactive power (capacitive, inductive),
- » Power registration: Budeanu method, IEEE 1459,
- » Active energy (E_p), reactive energy (E_q), apparent energy (E_s),
- » Power factor (PF), cosφ, tgφ,
- » Harmonics up to the 50th in voltage and current,
- » Total harmonic distortion THD for current and voltage,
- » Short-term (P_{st}) and long-term (P_{lt}) light flicker index (in compliance with EN 61000-4-15 class S),
- » Asymmetry of voltages (in compliance with EN 61000-4-30 class S) and currents,
- » Event logging for current and voltage along with oscillograms and half-period RMS charts,
- » Inrush current,
- » Energy cost calculator,
- » **All parameters are registered in compliance with class S according to standard IEC 61000-4-30.**

Analyzer parameters

Parameter		Measuring range	Max. resolution	Accuracy
Alternating voltage (TRMS)	–	0.0...760.0 V	0.01% U _{nom}	±0.5% U _{nom}
Crest factor	Voltage	1.00...10.00 (≤1.65 for 690 V voltage)	0.01	±5%
	Current	1.00...10.00 (≤3.6 I _{nom})	0.01	±5% m.v.
Alternating voltage TRMS	–	depending on clamp*	0.01% I _{nom}	±2% m.v. for m.v ≥ 10% I _{nom} ±2% I _{nom} for m.v < 10% I _{nom} (error does not account for clamp error)
Frequency:	–	40.00...70.00 Hz	0.01 Hz	±0.05 Hz
Active, reactive, apparent and distortion power	–	depending on configuration (instrument transformers, clamp)	up to four places after the decimal point	depending on configuration (instrument transformers, clamp)
Active, reactive apparent energy	–	depending on configuration (instrument transformers, clamp)	up to four places after the decimal point	as power error
cosφ and power factor (PF)	–	0.00...1.00	0.01	±0.03
tg φ	–	0.00...10.00	0.01	depends on error of active and reactive power
Harmonics	Voltage	as for alternating voltage True RMS	as for alternating voltage True RMS	±5% m.v. for m.v ≥ 3% U _{nom} ±0.15% U _{nom} for m.v < 3% U _{nom}
	Current	as for alternating current True RMS	as for alternating current True RMS	±5% m.v. for m.v ≥ 10% I _{nom} ±0.5% I _{nom} for m.v < 10% I _{nom}
THD	Voltage	0.0...100.0% (relative to RMS value)	0.1%	±5%
	Current			±5%
Flicker index	–	0.40...10.00	0.01	±10%
Asymmetry factor	Voltage and current	0.0...10.0%	0.1%	±0.15% (absolute error)
Inrush current	Current	depending on clamp*	0.01% I _{nom}	±4% m.v. for m.v ≥ 10% I _{nom} ±4% I _{nom} for m.v < 10% I _{nom} (RMS1/2)

*F-1A, F-2A, F-3A clamp: 0...3000 A AC (10 000 A_{pp}) • C-4A clamp: 0...1000 A AC (3600 A_{pp}) • C-5A clamp: 0...1000 A AC/DC (3600 A_{pp}) • C-6A clamp: 0...10 A AC (36 A_{pp}) • C-7A clamp: 0...100 A AC(360 A_{pp})

Standard accessories of the meter:

Magnetic voltage adapter (set - 4 pcs)	WAADAUMAGKPL
AC-16 line splitter	WAADAAC16
AZ-2 power supply adapter (IEC C7 plug/ banana connectors)	WAADAAZ2
Li-Ion battery 11.1 V 3,4 Ah	WAAKU15
F-3A flexible clamps (Φ=120 mm)	WACEGF3AOKR
L4 carrying case	WAFUTL4
Sonel Analysis PC software	WAPROANALIZA4
Crocodile clip, black, 1 kV, 20 A	WAKROBL20K01
Crocodile clip, red, 1 kV, 20 A	WAKRORE20K02
Crocodile clip, blue, 1 kV, 20 A	WAKROBU20K02
Crocodile clip, yellow, 1 kV, 20 A	WAKROYE20K02
Test lead 2.2 m, black, 1 kV (banana plugs)	WAPRZ2X2BLBB
Test lead 2.2 m, blue, 1 kV (banana plugs) N	WAPRZ2X2BUBB
Test lead 2.2 m, yellow / green, 1 kV (banana plugs) PE	WAPRZ2X2YEBB
Mains cable with IEC C7 plug	WAPRZLAD230
Cable for battery charging from car cigarette lighter socket (12 V)	WAPRZLAD12SAM
USB cable	WAPRZUSB
L2 hanging straps (set)	WAPOZSZEKPL
Z7 Power supply	WAZASZ7
Calibration certificate	

The instrument is intended for operation in networks:

- » with rated frequency 50/60 Hz,
- » with rated voltages: 58/100 V, 64/110 V;110/190 V; 115/200 V; 120/208 V, 127/220 V; 133/230 V, 220/380 V; 230/400 V; 240/415 V; 254/440 V; 290/500 V, 400/690 V,
- » with direct current.

Supported network configurations:

- » single-phase,
- » two-phase with common N,
- » three-phase - star with and without N conductor,
- » three-phase - triangle.

SONEL PQM-703 / PQM-702T / PQM-702

index: WMGBPQM703 / WMGBPQM702T / WMGBPQM702



The instrument is intended for operation in networks:

- » with rated frequency 50/60 Hz,
- » with rated voltages: 64/110V, 110/190 V, 115/200 V, 120/280V, 127/220 V, 220/380 V, 230/400 V, 240/415 V, 254/440 V, 277/480V, 290/500 V, 400/690 V,
- » with direct current,
- » in the following configurations:
 - single-phase,
 - two-phase with common N,
 - three-phase - star with and without N conductor,
 - three-phase - delta.
- » a built-in rechargeable battery allows for at least two hour of operation.

PQM-703/702 series analyzers can be powered from the L phase and are intended for direct use in all types of networks from 64 V to 690 V, with particular emphasis on measurements on low-voltage pylons, due to the simplicity of their connection.

Measured parameters:

- » voltages L1, L2, L3, N-PE (five measurement inputs) - mean, minimum and maximum values, instant values within the range up to 1000 V, interoperability with voltage transformers,
- » currents L1, L2, L3, N (four measurement inputs) - mean, minimum and maximum values, instant values, direct current measurement within the range up to 3 kA (depending on applied current clamp), interoperability with current transformers, crest factors for current (CFI) and voltage (CFU),
- » frequency within the range of 40 Hz – 70 Hz,
- » active power (P), reactive power (Q), distortion power (D), apparent power (S) with identification of the nature of reactive power (capacitive, inductive),
- » calculation of reactive power using the:
 - Budeanu method,
 - IEEE 1459,
- » active energy (E_p), reactive energy (E_q), apparent energy (E_s),
- » power factor (PF), $\cos\phi$, $\tan\phi$,
- » K factor (transformer overload due to harmonics),
- » harmonics up to the 50th in voltage and current,
- » interharmonics measured as groups,
- » total harmonic distortion THD for current and voltage,
- » short-term (P_{ST}) and long-term (P_{LT}) light flicker index (in compliance with EN 61000-4-15 class A),
- » asymmetry of voltages and currents,
- » registration of overvoltages, voltage dips and breaks along with oscillograms,
- » event logging for current along with oscillograms (up to 1 s) as well as 10 ms RMS charts with maximum registration time of 30 s,
- » registration of current and voltage oscillograms after every averaging period,
- » measurement of control signals up to 3000 Hz,
- » **measurement of transients up to ± 8000 V with maximum sampling frequency of 10 MHz.** The minimum transient time that can be registered is 650 ns (only PQM-703),
- » **all parameters in compliance with Class A of IEC 61000-4-30.**

Standard accessories of the meters:

Magnetic voltage adapter (set - 4 pcs)	WAADAUMAGKPL
Voltage adapter with M4/M6 thread (5 pcs.)	WAADAM4M6
AC-16 line splitter	WAADAAC16
Li-Ion battery 3,6 V 4,5 Ah	WAAKU11
AZ-1 power supply adapter (mains plug/banana inputs)	WAADAAZ1
Crocodile clip, black, 1 kV, 20 A	WAKROBL20K01
Crocodile clip, red, 1 kV, 20 A	WAKRORE20K02
Crocodile clip, blue, 1 kV, 20 A	WAKROBU20K02
Crocodile clip, yellow, 1 kV, 20 A	WAKROYE20K02
2x Fasteners and bands for mounting the analyzer on a pole	WAPOZUCH4
DIN rail mounting bracket with positioning catches	WAPOZUCH3
OR-1 USB wireless receiver	WAADAUSBOR1
Straps for mounting on the pole for PQM (set)	WAPOZOPAKPL
USB cable	WAPRZUSB
DIN rail mounting bracket with positioning catches	WAPOZUCH3
XL2 carrying case for PQM-700/702/703/710/711	WAWALXL2
Calibration certificate	
Sonei Analysis 4 software	WAPROANALIZA4
Temperature probe ST-2 (for PQM-702T)	WASONT2

The instrument meets the requirements set forth in the standards:

- » EN 61000-4-30 (class A) (electromagnetic compatibility - measurement methods)
- » EN 61000-4-7 (class I) (measurements of harmonics)
- » EN 61000-4-15 (class A) (light flicker)
- » EN 50160 (supply voltage measurements)
- » EN 61010-1 (safety of measuring instruments)

Other technical specifications on page 95.

PQM-703/702 have a built-in GSM modem and GPS module with an anti-theft function, sending a text message notification in case of changing location.



Parameters of PQM-711, PQM-710, PQM-703, PQM-702T, PQM-702 analyzers

Parameter		Measuring range	Max. resolution	Accuracy
Alternating voltage (TRMS)	–	0.0...1000.0 V	0.01% U_n	$\pm 0.1\% U_n$
Crest factor	Voltage	1.00...10.00 (≤ 1.65 for 690 V voltage)	0.01	$\pm 5\%$
	Current	1.00...10.00 ($\leq 3.6 I_{nom}$)	0.01	$\pm 5\%$ m.v.
Alternating voltage (TRMS)	–	depending on clamp*	0.01% of nominal range	$\pm 0.1\%$ of nominal range (error does not account for clamp error)
Frequency:	–	40.00...70.00 Hz	0.01 Hz	± 0.01 Hz
Active, reactive, apparent and distortion power	–	depending on configuration (instrument transformers, clamp)	up to four places after the decimal point	depending on configuration (instrument transformers, clamp)
Active, reactive apparent energy	–	depending on configuration (instrument transformers, clamp)	up to four places after the decimal point	as power error
cos ϕ and power factor (PF)	–	0.00...1.00	0.01	± 0.03
tg ϕ	–	0.00...10.00	0.01	depends on error of active and reactive power
Harmonics and inter-harmonics	Voltage	as for alternating voltage True RMS	as for alternating current True RMS	$\pm 5\% U_h$ for $U_h \geq 1\% U_n$ $\pm 0.05\% U_n$ for $U_h < 1\% U_n$
	Current	as for alternating current True RMS	as for alternating current True RMS	$\pm 5\% I_h$ for $I_h \geq 3\% I_n$ $\pm 0.15\% I_n$ for $I_h < 3\% I_n$
THD	Voltage	0.0...100.0% (relative to RMS value)	0.1%	$\pm 5\%$
	Current			$\pm 5\%$
Active and reactive power of harmonics	–	depending on configuration (instrument transformers, clamp)	depends on minimum current and voltage values	–
Angle between current and voltage harmonics	–	-180.0...+180.0°	0.1°	$\pm (h \times 1^\circ)$
K-Factor	–	1.0...50.0	0.1	$\pm 10\%$
Flicker index	–	0.20...10.00	0.01	$\pm 5\%$
Voltage asymmetry	Voltage and current	0.0...20.0%	0.1%	$\pm 0.15\%$ (absolute error)
Measurement of control signals	Voltage	5...3000 Hz	0.01 Hz	$\pm 0.15\% U_h$ for $1...3\% U_h$ $5\% U_n$ for $3...15\% U_h$
Measurement of transients (PQM-711/703)	Voltage	± 8000 V	5 V	$\pm (5\% + 25$ V)

*F-1A, F-2A, F-3A clamp: 0...3000 A AC (10 000 A_{pp}) • C-4A clamp: 0...1000 A AC (3600 A_{pp}) • C-5A clamp: 0...1000 A AC/DC (3600 A_{pp}) • C-6A clamp: 0...10 A AC (36 A_{pp}) • C-7A clamp: 0...100 A AC(360 A_{pp})

Optional accessories for analyzer



C-4A WACEGC4AOKR **C-5A** WACEGC5AOKR **C-6A** WACEGC6AOKR **C-7A** WACEGC7AOKR **F-1A** WACEGF1AOKR **F-2A** WACEGF2AOKR **F-3A** WACEGF3AOKR

Rated current	1000 A AC	1000 A AC 1400 A DC	10 A AC	100 A AC	3000 A AC		
Max. overload current	1200 A AC	1000 A AC 3000 A DC	20 A AC	100 A AC	10 kA AC		
Minimum measurable current	100 mA	500 mA	10 mA	20 mA	1 A		
Frequency:	30 Hz...10 kHz	DC...5 kHz	40 Hz...10 kHz	40 Hz...1 kHz	40 Hz...10 kHz		
Output signal level	1 mV / 1 A	1mV / 1 A	100 mV / 1 A	5 mV / 1 A	38.8 μ V / 1 A		
Max. diameter of measured conductor	52 mm	39 mm	20 mm	24 mm	360 mm	235 mm	120 mm
Minimum accuracy	$\leq 0.5\%$	$\leq 1.5\%$	$\leq 1\%$	0.5%	1%		
Battery power	–	✓	–	–	–		
Lead length	2.2 m	2.2 m	2.2 m	3 m	2.2 m		
Measurement category	IV 300 V	IV 300 V	IV 300 V	III 300 V	IV 600 V		
IP rating	IP40				IP67		



SONEL PQM-700

index: WMGBPQM700

CLASS S
IEC 61000-4-30

CAT IV
300 V

IP65

55°C
HEAVY
DUTY
20°C

EVENTS

SAMPLING
FREQUENCY
10.24 kHz



Standard accessories of the meter:

Magnetic voltage adapter (set - 4 pcs)	WAADAUMAGKPL
AZ-1 power supply adapter (mains plug/banana inputs)	WAADAAZ1
Li-Ion battery 3,6 V 4,5 Ah	WAAKU11
L5 carrying case	WAFUTL5
Crocodile clip, black, 1 kV, 20 A	WAKROBL20K01
Crocodile clip, red, 1 kV, 20 A	WAKRORE20K02
Crocodile clip, blue, 1 kV, 20 A	WAKROBU20K02
2x Fasteners and bands for mounting the analyzer on a pole	WAPOZUCH4
Straps for mounting on the pole for PQM (set)	WAPOZOPAKPL
USB cable	WAPRZUSB
DIN rail mounting bracket with positioning catches	WAPOZUCH3
Calibration certificate	
Sonei Analysis 4 software	WAPROANALIZA4

Measured parameters (EN 50160-4-30 class S):

- » voltages L1, L2, L3 (four measurement inputs) – mean, minimum and maximum values, instant values within the range up to 760 V, interoperability with voltage transformers,
- » currents L1, L2, L3, N (four measurement inputs) - mean, minimum and maximum values, instant values, current measurement within the range up to 3 kA (depending on applied current clamp), interoperability with current transformers,
- » crest factors for current (CFI) and voltage (CFV),
- » frequency within the range of 40 Hz – 70 Hz,
- » active power (P), reactive power (Q), distortion power (D), apparent power (S) with identification of the nature of reactive power (capacitive, inductive),
- » calculation of reactive power using the:
 - Budeanu method,
 - IEEE 1459,
- » active energy (E_p), reactive energy (E_q), apparent energy (E_s),
- » power factor (PF), cosφ, tgφ,
- » harmonics up to the 40th in voltage and current,
- » total harmonic distortion THD for current and voltage,
- » short-term (P_{ST}) and long-term (P_{LT}) light flicker index (in compliance with EN 61000-4-15 class S),
- » asymmetry of voltages (in compliance with EN 61000-4-30 class S) and currents,
- » event logging for current and voltage along with oscillograms and half-period RMS charts,
- » all parameters are registered in compliance with class S according to standard EN 61000-4-30.

The instrument is intended for operation in networks:

- » with rated frequency 50/60 Hz,
- » with rated voltages: 64/110 V; 110/190 V; 115/200 V; 120/208 V; 127/220 V; 220/380 V; 230/400 V; 240/415 V; 254/440 V; 277/480 V, 290/500 V, 400/690 V,
- » with direct current,
- » in the following configurations:
 - single-phase,
 - two-phase with common N,
 - three-phase - star with and without N conductor,
 - three-phase - triangle.

The device conforms to class S according to EN 61000-4-30

- » EN 61000-4-30 (electromagnetic compatibility - measurement methods)
- » EN 61000-4-7 (measurements of harmonics)
- » EN 61000-4-15 (light flicker)
- » EN 50160 (supply voltage measurements)
- » EN 61010-1 (safety of measuring instruments)
- » EN 61326 (electromagnetic compatibility - electrical equipment for measurement)

PQM-700 has an independent power source, making it particularly suited for measurements with voltage transducers.

Analyzer parameters

Parameter		Measuring range	Max. resolution	Accuracy
Alternating voltage (TRMS)	–	0.0...760.0 V	0.01% Un	±0.5% Un
Crest factor	Voltage	1.00...10.00 (≤1.65 for 690 V voltage)	0.01	±5%
	Current	1.00...10.00 (≤3.6 I _{nom})	0.01	± 5% m.v.
Alternating voltage TRMS	–	depending on clamp*	0.01% of nominal range	±1% of nominal range (error does not account for clamp error)
Frequency:	–	40.00...70.00 Hz	0.01 Hz	±0.05 Hz
Active, reactive, apparent and distortion power	–	depending on configuration (instrument transformers, clamp)	up to four places after the decimal point	depending on configuration (instrument transformers, clamp)
Active, reactive apparent energy	–	depending on configuration (instrument transformers, clamp)	up to four places after the decimal point	as power error
cosφ and power factor (PF)	–	0.00...1.00	0.01	±0.03
tg φ	–	0.00...10.00	0.01	depends on error of active and reactive power
Harmonics	Voltage	as for alternating voltage True RMS	as for alternating voltage True RMS	±5% U _n for U _n ≥ 1% U _n ±0.05% U _n for U _n < 1% U _n
	Current	as for alternating voltage True RMS	as for alternating voltage True RMS	± 5% I _n for I _n ≥ 3% I _n ± 0.15% I _n for I _n < 3% I _n
THD	Voltage	0.0...100.0% (relative to RMS value)	0.1%	±5%
	Current			±5%
Flicker index	–	0.40...10.00	0.01	±10%
Asymmetry factor	Voltage and current	0.0...10.0%	0.1%	±0.3% (absolute error)

*F-1A, F-2A, F-3A clamp: 0...3000 A AC (10 000 A_{pp}) • C-4A clamp: 0...1000 A AC (3600 A_{pp}) • C-5A clamp: 0...1000 A AC/DC (3600 A_{pp}) • C-6A clamp: 0...10 A AC (36 A_{pp}) • C-7A clamp: 0...100 A AC(360 A_{pp})

PQM

Set of standard and optional accessories

1, 2, 4 - number of basic accessories
 • - optional accessories

Photo	Name	Index	PQM-711	PQM-710	PQM-707	PQM-703	PQM-702T	PQM-702	PQM-700
	AGT-16C three-phase socket adapter 16 A (PEN)	WAADAAGT16C	•	•	•	•	•	•	•
	AGT-16P three-phase socket adapter 16 A	WAADAAGT16P	•	•	•	•	•	•	•
	AGT-16T industrial socket adapter 16 A	WAADAAGT16T	•	•	•	•	•	•	•
	AGT-32C three-phase socket adapter 32 A (PEN)	WAADAAGT32C	•	•	•	•	•	•	•
	AGT-32P three-phase socket adapter 32 A	WAADAAGT32P	•	•	•	•	•	•	•
	AGT-32T industrial socket adapter 32 A	WAADAAGT32T	•	•	•	•	•	•	•
	AGT-63P three-phase socket adapter 63 A	WAADAAGT63P	•	•	•	•	•	•	•
	Magnetic voltage adapter (set - 4 pcs)	WAADAUMAGKPL	1	1	1	1	1	1	1
	Magnetic voltage adapter, black	WAADAUMAGKBL	•	•	•	•	•	•	•
	Magnetic voltage adapter, blue	WAADAUMAGKBU	•	•	•	•	•	•	•
	Voltage adapter with M4/M6 thread (5 pcs.)	WAADAM4M6	1	1	•	1	1	1	•
	AC-16 line splitter	WAADAAC16	1	1	1	1	1	1	•
	AZ-1 power supply adapter (mains plug/banana inputs)	WAADAAZ1	1	1		1	1	1	1
	AZ-2 power supply adapter (IEC C7 plug/banana connectors)	WAADAAZ2			1				
	Li-Ion battery 11,1 V 3,4 Ah	WAAKU15			1				
	Li-Ion battery 3,6 V 4,5 Ah	WAAKU11	1	1		1	1	1	1
	GPS antenna (10 m lead)	WAPOZANT10GPS	•	•		•	•		
	F-1A flexible clamps (φ=360 mm)	WACEGF1AOKR	•	•	•	•	•	•	•
	F-2A flexible clamps (φ=235 mm)	WACEGF2AOKR	•	•	•	•	•	•	•
	F-3A flexible clamps (φ=120 mm)	WACEGF3AOKR	•	•	4	•	•	•	•
	C-4A current clamps (φ=52 mm)	WACEGC4AOKR	•	•	•	•	•	•	•
	C-5A current clamps (φ=39 mm)	WACEGC5AOKR	•	•	•	•	•	•	•
	C-6A current clamps (φ=20 mm)	WACEGC6AOKR	•	•	•	•	•	•	•
	C-7A current clamps (φ=24 mm)	WACEGC7AOKR	•	•	•	•	•	•	•
	L4 carrying case	WAFUTL4			1				
	test clips with steel jaws	WASONKGB1KPL	•	•	•	•	•	•	•

Photo	Name	Index	PQM-711	PQM-710	PQM-707	PQM-703	PQM-702T	PQM-702	PQM-700
	L5 carrying case	WAFUTL5							1
	L8 carrying case, backpack for PQM	WAFUTL8	1	1					
	Crocodile clip, black, 1 kV, 20 A	WAKROBL20K01	3	3	3	3	3	3	3
	Crocodile clip, red, 1 kV, 20 A	WAKRORE20K02	2	2	2	2	2	2	2
	Crocodile clip, blue, 1 kV, 20 A	WAKROBU20K02	1	1	1	1	1	1	1
	Crocodile clip, yellow, 1 kV, 20 A	WAKROYE20K02	1	1	1	1	1	1	1
	Fasteners and bands for mounting the analyzer	WAPOZUCH4	2	2		2	2	2	2
	OR-1 USB wireless receiver	WAADAUSBOR1				1	1	1	
	Straps for mounting on the pole for PQM (set)	WAPOZOPAKPL	1	1		1	1	1	1
	Test lead 2,2 m, black, 1 kV (banana plugs)	WAPRZ2X2BLBB			3				
	Test lead 2,2 m, blue, 1 kV (banana plugs) N	WAPRZ2X2BUBB			1				
	Test lead 2,2 m, yellow / green, 1 kV (banana plugs) PE	WAPRZ2X2YEBB			1				
	Cable for battery charging from car cigarette lighter socket (12 V)	WAPRZLAD12SAM			1				
	USB cable	WAPRZUSB	1	1	1	1	1	1	1
	Mains cable with IEC C7 plug	WAPRZLAD230			1				
	Pin probe, black 1 kV (banana socket)	WASONBLOGB1			•				
	Pin probe, red 1 kV (banana socket)	WASONREOGB1			•				
	Pin probe, blue 1 kV (banana socket)	WASONBUOGB1			•				
	Pin probe, yellow 1 kV (banana socket)	WASONYE0GB1			•				
	L2 hanging straps (set)	WAPOZSZEKPL			1				
	Tablet	Tablet	1	1					
	L2 carrying case for clamps	WAWALL2	•	•	•	•	•	•	•
	PQM magnetic strap (set)	WAPOZUCH5	•	•	•	•	•	•	•
	XL2 carrying case for PQM-700/702/703/710/711	WAWALXL2	•	•		1	1	1	•
	DIN rail mounting bracket with positioning catches	WAPOZUCH3	1	1		1	1	1	1
	Z7 Power supply	WAZASZ7			1				
	Temperature probe	WASONT2					1		

SONEL ANALYSIS

index: WAPROANALIZA4



“SONEL Analysis” software - application delivered as standard accessory, indispensable for working with PQM-series analyzers. It enables:

- » analyzer configuration,
- » data reading from logger,
- » preview of network parameters in real time (with capability of reading via GSM modem),
- » deletion of data in the analyzer,
- » data presentation in tables,
- » data presentation in charts,
- » data analysis in compliance with standard EN 50160 (reports) and other user-defined reference conditions,
- » independent support of multiple analyzers,
- » analyzer firmware updates.

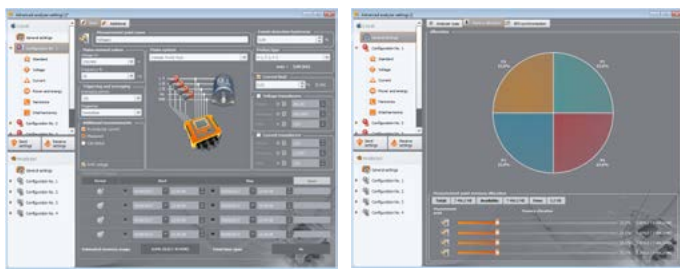

Analyzer configuration

The application enables configuration of all analyzer settings. Configuration is performed on a computer and then sent to the analyzer. A configuration can also be saved on a hard disk or other data carriers for later use.

The application enables configuration of, among other things:

- » selection of measurement points and arbitrary memory assignment to individual measurement points,
- » configurable analyzer time,
- » button blockade,
- » PIN code protection against unauthorized access by third parties,
- » configurable averaging time,
- » selection of current and voltage transformers,
- » selection of triggering mode (instant after an event occurs or according to set time schedule),
- » selection of clamp type, selection of additional parameters to be registered in N and PE conductors,
- » selection of the network type for which the analyzer will register all parameters set by the user.

The analyzer has four, mutually independent measurement points. Each measurement point can be configured separately so that four different registrations can be performed later without the need for reprogramming the analyzer in each instance.

The following can be configured for each measurement point:

- » whether the analyzer is to perform registration in terms of compliance with standard EN 50160 (and the Minister's Regulation on power quality standards) and/or according to user-defined parameters,
- » the user may define whether the logger will save instant, mean, maximum or minimum values for each parameter,
- » limits can be defined for most parameters, and the analyzer will log an event if these limits are crossed.

Readout of current data

SoneI Analysis software enables readout of selected parameters and their visualization on the computer screen in real time. These parameters are measured independently from the registration saved on the memory card.

The user can view:

- » charts of voltage and current progression (oscilloscope),
- » charts of voltage and current over time,
- » phasor diagrams,
- » measurements of multiple parameters,
- » harmonics and harmonic powers,
- » inter-harmonics.

Data analysis

Using the application, the user can read and analyze data saved on the memory card. Read data can also be saved on the computer's hard disk for later processing. Thanks to this, archiving of data from successive registrations is possible.

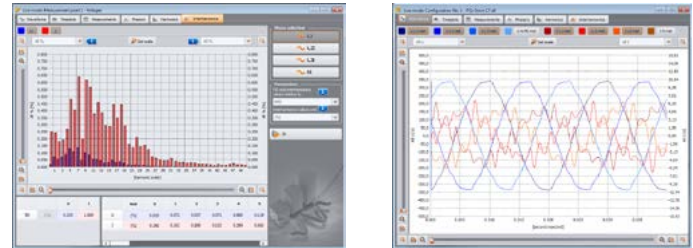

After data reading, the user can conduct analysis. There are three windows to choose from:

- » **General** – all individual types of data are displayed in the form of dots (Measurements, Events and Oscillograms),
- » **Measurements** – all measurement types registered are displayed in the form of dots according to averaging time (voltage, frequency, etc.),
- » **Events** – all types of detected events are displayed in the form of dots (dips, overvoltages, breaks, etc.),
- » **Configuration** – all settings with which data was registered are displayed.

Various types of charts are available in the application, enabling the user to view data registered by the analyzer in a simple way:

- » **Time chart** – displays the progressions of selected parameters over time,
- » **Oscillogram** – instant progressions of voltages and currents during events or at the end of an averaging cycle,
- » **Harmonics chart** – bar graph presenting the level of harmonics of orders 1...50,
- » **Value/Time chart** – displays events in the form of dots as a function of the duration of these events.

User-defined reports can be generated using data read from the analyzer, which can then be saved to a hard disk in PDF, HTML, CSV or TXT file format. The application enables generation of a report on compliance with standard EN 50160 and the systems regulation.

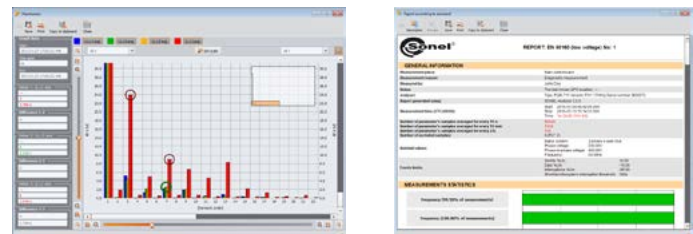

SONEL ANALYSIS MOBILE



Mobile version of the program cooperating with PQM-700 and PQM-711 from SoneI company. With the application, you can connect directly to your device via the Wi-Fi interface and check of current readings of network parameters to which the analyzer is connected.



Useful for users can be remotely start/stop recording, and to change the measurement point (configuration) in the analyzer.

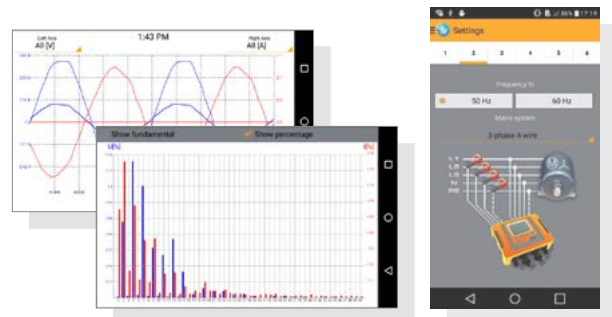

Portable appliance testers

PAT-820
PAT-815



PAT-806

PAT-10
PAT-2E
PAT-2





PAT-820 PAT-815 PAT-806 PAT-10 PAT-2E PAT-2

	PAT-820	PAT-815	PAT-806	PAT-10	PAT-2E	PAT-2
MEASUREMENT FUNCTIONS						
measurement of resistance of protective conductor (PE) using test current of 200 mA	•	•	•	•	•	•
measurement of resistance of protective conductor (PE) using test current of 10 A	•	•	•	•		
measurement of resistance of protective conductor (PE) using test current of 25 A	•	•	•			
measurement of insulation resistance using test voltage of 100 V	•	•	•			
measurement of insulation resistance using test voltage of 250 V	•	•	•	•	•	
measurement of insulation resistance using test voltage of 500 V	•	•	•	•	•	•
measurement of substitute leakage current	•	•	•	•	•	•
measurement of PE leakage current	•	•	•			
measurement of differential leakage current	•	•	•	•	•	
measurement of touch leakage current	•	•	•	•	•	
measurement of power	•	•	•			
test of IEC power cord	•	•	•	•	•	•
checking the resistance of L-N circuit			•			
checking of fuse			•			
measurement of voltage and frequency in networks	•	•	•	•	•	•
measurement of current consumption	•	•	•	•	•	•
autoranging	•	•	•	•	•	•
autotests	•	•	•	•	•	•
autotests with the option of describing them with the name of the standards or name set by user	•	•				
function of automatic measurement of the full set of RCD and PRCD parameters	•	•		•	•	
measurement of current using clamps	•	•				
MEASUREMENTS OF WELDING APPLIANCES						
measurement of rated voltage of welding appliances in unloaded state			•			
measurement of leakage current of welding circuit I_L			•			
measurement of primary leakage current			•			
automatic three-lead insulation resistance measurement - three test voltages: 100 V, 250 V and 500 V			•			
COMMUNICATION WITH COMPUTER						
communication with computer via USB	•	•	•	•	•	•
cooperation with software: SoneI Reader and SoneI PAT Analysis (optional)	•	•	•	•	•	•
configuration of measurements and meter settings from the level of both the meter's interface and computer	•	•	•	•	•	•
MEMORY						
990 memory cells for measurement results with the possibility of sending them to computer or printing			•	•	•	•
cooperation with USB memory stick	•	•	•			
saving to memory along with initial description of examined appliances, location of measurements and data of client, assigning serial number and index to the measured appliance, capability of adding notes to the tested appliance	•	•				
database of appliances, clients, description of appliances, damages	•	•				
USABLE FUNCTIONS						
highly ergonomic operation	•	•		•	•	•
operating of QWERTY keyboard on a big and readable touchscreen with backlit	•	•				
possibility of adding several PAT users with the option of logging in	•	•				
help available on the screen - containing instructions on how to connect the tested appliance and perform the measurement	•	•				
big, readable screen with the possibility of backlit	•	•	•	•	•	•
cooperation with printer and scanner (optional)						
cooperation with barcode scanner	•	•	•			
cooperation with 2D codes scanner, reading data of the tested power tool and test codes	•	•				
cooperation with printer	•	•	•	•	•	•
printing measurements results, printing two stickers for a single test (for an appliance and detachable cable)	•	•				

Safety of electrical equipment

The rules and obligations concerning use of various types of electrical equipment, in both private and professional life, are defined by a broad range of regulations, which, besides imposing the obligation of creating products compliant with the relevant standards on the manufacturer, also **impose responsibility for the technical condition of this equipment and tools on their owners**. These regulations additionally define proper performance of regular tests and inspections as well as checks of equipment after repairs. Therefore, it is worth inspecting the technical condition of owned electrical equipment in the proper manner and with the appropriate frequency. Defective equipment, often damaged without the user's knowledge, poses a great threat to the user, but it can also be the cause of serious financial loss, e.g. in the event of a fire. In such a case, if it is proven that equipment was not fully operational (e.g. damaged insulation), **the manufacturer's liability for the incident is transferred to the owner**. In addition, this may constitute grounds for the insurer's refusal to pay damages.

In Poland, there are currently no clearly defined standards setting forth the responsibility for, scope or time-periods of tests of electric tools and other electrical equipment (including equipment that is often neglected in terms of safety - extension cords, power cords, office appliances) over the course of operation. **However, there is an obligation to proceed in accordance with recognized technical principles**. According to the current legal status, electrical equipment must be operated and inspected according to the guidelines given in the instruction manual provided by the manufacturer. However, the information found in instruction manuals is often insufficient, and in such a case, other sources of knowledge can be used, as long as the information contained therein do not contradict the instruction manual. The subject of tests is raised in many regulations and directives, such as: the Labor Code, Regulation of the Minister of Economy, Act on fire safety, in construction law, energy law, etc. Additionally, standards such as EN 60745-1 lay down the rules of performing such tests for manufacturers, including tolerable values of measured parameters. European standards can also be applied, including the most well-known VDE 701 and VDE 702.

Every tester who uses a safety meter for electrical equipment assumes great responsibility for the both the health and life of users, as well as for their property, when making the decision on whether or not to approve tested equipment for use. Such a person should have a professional meter at their disposal, guaranteeing high accuracy and correct results.

The functions and technical specifications of testers for electrical equipment should allow for complete inspection of the technical condition of electrical equipment and tools, including checks of basic parameters of three-phase equipment. In addition, to ensure the user's work safety and proper measurement results, instruments should be capable of measuring the parameters of the power network (i.e. voltage, frequency, continuity resistance and voltage on protective conductor) immediately after start-up. The capability of performing tests is very useful considering:

- » **automatic mode** – with configuration of custom measurement sequences of parameters selected by the user,
- » **manual mode I** – due to the diversity of tests and standards for different equipment.

Preliminary test, visual inspection of tested device - the meter does a preliminary check of L-N circuit continuity and enables fuse checking, then indicates the moment at which visual inspection of the tested equipment is to take place on its screen - for obvious reasons, the user must perform visual inspection on their own before performing further measurements. After visual inspection is complete, the user inputs a positive or negative assessment. A visual inspection should consist of:

- » housing check (absence of mechanical damage),
- » check of network power switch (can it be switched on and off),
- » check of the power cord and plug (no breaks in insulation, overheating),
- » fuse check (does value conform to specifications).

Resistance measurement of protective earth conductor (PE) with current of 200mA, 10A or 25A - different standards required measurements using one among the listed current values, and it must additionally be possible to perform auto-zeroing of test leads in order to eliminate additional measurement error (or the 4-lead method is applied). The device inputting current must have high performance, supplying direct current. Continuity tests must be performed in two ways, with the involvement of the measured socket or conductors by themselves, which allows for testing of cables or equipment without a network power plug.

Insulation resistance testing. 500V voltage is required, however the instrument may also provide other measurement voltages that may be useful if the test is based on specific regulations. Two possibilities of performing measurement should be available, with the involvement of the measured socket or cables by themselves.

Leakage current measurement – capability of measuring equivalent leakage current, differential leakage current, touch leakage current and PE leakage current. The instrument should enable measurements within a wide frequency band.

Power measurement – inspection of whether the device consumes the power specified by the manufacturer, including the voltage and current measured during inspection.

IEC cable and extension cord test - automatic inspection of basic parameters of IEC cables, and additionally, after the proper adapter is applied, of extension cords and cables terminated by the IEC-60320-C5 plug, a.k.a. the “cloverleaf”. The sequence of measurements is performed automatically, and it includes

- » insulation resistance measurement of PE conductor,
- » (continuity) resistance measurement of PE conductor,
- » continuity test of L and N wires and check for short-circuit between them,
- » polarity test.

In all measurement functions where it is necessary, measurement duration settings and result limits are adjustable, enabling comparison of a received result with the set limit and automatic “positive” or “negative” assessment.

The capability of saving results to memory or printing results immediately after measurement is a very useful and convenient feature of measuring instruments. Both measurement sequences and individual measurements (performed in manual mode) can be saved. It is possible to assign barcodes according to the type of measured equipment.

Software making it possible to keep a database of tested equipment (and reminding of the time of next inspection), create and print abbreviated and expanded measurement reports, and to create reports compliant with the relevant standards (VDE 0701:1, VDE 0701:200, VDE 0701:240, VDE 0701:260, DIN VDE 0702, EN 61010, EN 60335, EN 60950, IEC 601.1) is a helpful addition.

	First start-up and modifications	Tests after repair		Periodical tests				Type tests / procedural tests									
	DIN VDE 0751:2001	DIN VDE 0701-0702	DIN VDE 0751:2001	EN 62353	IEC 60601	DIN VDE 0701-0702	E-08400:1988	DIN VDE 0751:2001	British standards	EN 62353	IEC 60601	EN 60974-4	DIN EN 60950/50116	EN 61010	DIN EN 60335/50106	EN 60745-1	IEC 60601
Equipment tested in compliance with standards																	
Laboratory instruments		•			•			•									
Measuring and inspection instruments		•			•			•						•			
Voltage-generating equipment			•			•		•									
Electric tools			•			•	•	•							•	•	
Heating equipment			•			•		•							•		
Equipment with electrical drive			•			•	•	•							•	•	
Lighting lamps			•			•		•							•		
Multimedia and telecommunications devices			•			•		•							•		
Cable reels, extension cords, connector cables			•			•		•							•		
Data processing devices and office appliances			•			•								•			
Electrical equipment for medical applications, components of applications	•		•	•	•			•	•	•							•
Welding equipment												•					

Safety tester for electrical equipment

SONEL PAT-820 / PAT-815

index: WMGBPAT820 / WMGBPAT815



Basic functions of the tester:

- » resistance measurement of protective conductor with current: 200 mA, 10 A and 25 A (protection class I),
- » insulation resistance measurement - three measurement voltages: 100 V, 250 V, 500 V,
- » measurement of equivalent leakage current,
- » measurement of differential leakage current,
- » measurement of touch leakage current,
- » power measurement,
- » measurement of electricity consumption,
- » IEC cable test,
- » measurement of network voltage and frequency,
- » testing of RCD parameters,
- » current measurement with clamp,
- » flash test / high-voltage test (PAT-820 only).

Additional functions of the tester:

- » automatic selection of measuring range,
- » professional software for data processing and report generation,
- » supports barcode reader and printer,
- » supports USB flash drive storage devices,
- » large, easy-to-read touch display,
- » ergonomic operation.

Electrical safety:

- » this product meets EMC requirements in compliance with standard EN 61326-1 and EN 61326-2-2
- » type of insulation CAT II 300 V according to EN 61010-1
- » housing protection rating according to EN 60529 IP40 (IP67 when case is closed)

Other technical specifications:

- » power supply of the meter 195...265 V, 50 Hz
- » load current max. 16 A (230 V)
- » data transmission to PC computer USB 2.0 cable
- » dimensions 390 x 305 x 175 mm
- » meter weight approx. 5.7 kg
- » elevation above sea level <2000 m.
- » display LCD TFT 7" 800 x 480

Nominal operating conditions:

- » operating temperature range -10...+50°C
- » storage temperature -20...+70°C
- » humidity 20...80%

Standard accessories of the meters:

Fuse 0314 015.VXP 15 A 250 VAC 6.3x32 mm Littlefuse	WAPOZB15PAT
Test lead 1.8 m, red, 5 kV (banana plugs)	WAPRZ1X8REBB
Test lead 1.8 m, orange, (10 A / 25 A, terminated in a crocodile clip)	WAPRZ1X8ORKS
USB cable	WAPRZUSB
Mains cable with IEC C19 plug	WAPRZZAS1
Pin probe, red 5 kV (banana socket)	WASONREOGB2
PC software: Sonel Reader	WAPROREADER

Resistance measurement of protective earth conductor I=200 mA (protection class I)

Display range	Resolution	Accuracy
0.00...0.99 Ω	0.01 Ω	±(4% m.v. + 2 digits)
1.00...1.99 Ω		±(4% m.v. + 3 digits)

- » measurement current: ≥200 mA for R<0.2...1.99 Ω
- » configurable upper limit within the range: 10 mΩ ...1.99 Ω with resolution of 0.01 Ω
- » configurable measurement time 1...60 s with resolution of 1 s

Resistance measurement of protective earth conductor I=10 A (protection class I)

Display range	Resolution	Accuracy
0...999 mΩ	1 mΩ	±(3% m.v. + 4 digits)
1.00...1.99 Ω	0.01 Ω	

- » technical method of measurement ensuring high accuracy of obtained results
- » measurement current: ≥10 A for R ≤ 0.5 Ω

Resistance measurement of protective earth conductor I=25A (protection class I)

Display range	Resolution	Accuracy
0...999 mΩ	1 mΩ	±(3% m.v. + 4 digits)
1.00...1.99 Ω	0.01 Ω	

- » technical method of measurement ensuring high accuracy of obtained results
- » measurement current: ≥25 A for R ≤ 0.2 Ω

Flash test / high-voltage test (only PAT-820)

Display range	Resolution	Accuracy
0.00...2.5 mA	0.01 mA	±(5% m.v. + 5 digits)

- » measurement voltage: 1500 V AC, 3000 V AC
- » measurement time: configurable within the range of: 2...180 s

Measurement of insulation resistance

Measuring range according to IEC 61557-2 for:

Un=100 V: 100 kΩ...99.9 MΩ (PAT-820/815 only)

Un=250 V: 250 kΩ...199.9 MΩ (PAT-820/815 only)

Un=500 V: 500 kΩ...599.9 MΩ

U _d displayed	Display range	Resolution	Accuracy
100 V	0...1999 kΩ	1 kΩ	±(5% m.v. + 8 digits)
	2.0...19.99 MΩ	0.01 MΩ	
	20.0...99.9 MΩ	0.1 MΩ	
250 V	0...1999 kΩ	1 kΩ	
	2.00...19.99 MΩ	0.01 MΩ	
	20.0...199.9 MΩ	0.1 MΩ	
500 V	0...1999 kΩ	1 kΩ	
	2...19.99 MΩ	0.01 MΩ	
	20.0...599.9 MΩ	0.1 MΩ	

- » automatic discharge of the measured object's capacitance upon completion of measurement
- » protection against measurement of live objects
- » max. output current 1.4 mA

Measurement of PE leakage current and differential leakage current:

Display range	Resolution	Accuracy
0.00...3.99 mA	0.01 mA	±(5% m.v. + 2 digits)
4.0...19.9 mA	0.1 mA	

- » configurable measurement limit within the range: 0.01...19.9 mA with resolution 0.01 mA/0.1 mA
- » configurable measurement time: continuous measurement (Cont) or 1...60 s with resolution of 1 s
- » at half of the measurement time, the meter automatically changes the polarity of the measuring network socket and displays a greater value

Measurement of equivalent leakage current:

Display range	Resolution	Accuracy
0.00...3.99 mA	0.01 mA	±(5% m.v. + 2 digits)
4.0...19.9 mA	0.1 mA	

- » configurable measurement limit within the range: 0.01...19.9 mA with resolution 0.01 mA/0.1 mA
- » configurable measurement time: continuous measurement (Cont) or 1...60 s with resolution of 1 s
- » open-circuit voltage: 25...50 V

Measurement of touch leakage current:

Display range	Resolution	Accuracy
0.000...4.999 mA	0.001 mA	±(5% m.v. + 3 digits)
5.000...19.999 mA	0.01 mA	

- » configurable measurement limit within the range: 0.01...1.99 mA with resolution of 0.01 mA
- » configurable measurement time: continuous measurement (Cont) or 1...60 s with resolution of 1 s

Testing of RCD parameters

RCD trip test and measurement of tripping time t_A

RCD type	Factor	Range	Resolution	Accuracy
General	0.5 $I_{\Delta n}$	0...300 ms	1 ms	±(2% m.v. + 2 digits)*
	1 $I_{\Delta n}$			
	2 $I_{\Delta n}$	0...150 ms		
	5 $I_{\Delta n}$	0...40 ms		

*for RCD of $I_{\Delta n} = 10$ mA and the measurement 0.5 $I_{\Delta n}$ error: ± (2% m.v. + 3 digits)
 Measurement of RCD trip current I_A for sinusoidal residual current
 Measuring range according to IEC 61557: (0.3...1.0) $I_{\Delta n}$

Nominal current	Measuring range	Resolution	Measurement current	Accuracy
10 mA	3.3...10.0 mA	0.1 mA	0.3 $I_{\Delta n}$...1.0 $I_{\Delta n}$	±5% $I_{\Delta n}$
15 mA	4.5...15.0 mA			
30 mA	9.0...30.0 mA			

- » measurement can be started from a positive or negative half-period of the input leakage current
- » max. measurement current flow time 3200 ms

Apparent power measurement

Display range	Resolution	Accuracy
0...999 VA	1 VA	±(5% m.v. + 3 digits)
1...3.99 kVA	0.01 kVA	

configurable measurement time: continuous measurement (Cont) or 1...60 s with resolution of 1 s

Active power measurement

Display range	Resolution	Accuracy
0...999 W	1 VA	±(5% m.v. + 3 digits)
1.00...3.99 kW	0.01 kW	

configurable measurement time: continuous measurement (Cont) or 1...60s with resolution of 1 s

Power factor PF

Display range	Resolution	Accuracy
0.00...1.00	0.01	±(10% m.v. + 5 digits)

Current measurement during power measurement

Display range	Resolution	Accuracy
0.00...15.99 A	0.01 A	±(2% m.v. + 3 digits)

Current measurement with clamp during power measurement

Display range	Resolution	Accuracy
100...999 mA	1 mA	±(5% m.v. + 5 digits)
1.00...9.99 A	0.01 A	
10.0...24.9 A	0.1 A	

The accuracy given in the table does not account for the accuracy of the measuring clamp

The instrument enables measurements in compliance with:

- » EN 60745-1 Hand-held motor-operated electric tools. Safety. Part 1: General requirements.
- » EN 61029 Safety of transportable motor-operated electric tools. General requirements.
- » EN 60335-1 Household and similar electrical appliances. Safety. General requirements.
- » EN 60950 Safety of information technology equipment.
- » EN 61557-6 Electrical safety in low voltage distribution systems up to 1000 V a.c. and 1500 V d.c. - Equipment for testing, measuring or monitoring of protective measures - Part 6: Effectiveness of residual current devices (RCD) in TT, TN and IT systems.
- » VDE 0404-1 Prüf- und Messeinrichtungen zum Prüfen der elektrischen Sicherheit von elektrischen Geräten. Teil 1: Allgemeine Anforderungen.
- » VDE 0404-2 Prüf- und Messeinrichtungen zum Prüfen der elektrischen Sicherheit von elektrischen Geräten. Teil 2: Prüfeinrichtungen für Prüfungen nach Instandsetzung, Änderung oder für Wiederholungsprüfungen.
- » VDE 0701-0702 Prüfung nach Instandsetzung, Änderung elektrischer Geräte. Wiederholungsprüfung elektrischer Geräte. Allgemeine Anforderungen für die elektrische Sicherheit.
- » AS/NZS 3760:2010 In-service safety inspection and testing of electrical equipment.



SONEL PAT-806

index: WMGBPAT806



- EN
- 60974-4
- CAT II
- 300 V
- IP40

Basic functions of the instrument:

- » measurement of arc welding equipment parameters (EN 60974-4):
 - measurement of rated voltage of welding equipment in a no-load state,
 - measurement of leakage current of welding circuit I_L
 - measurement of primary leakage current.
- » resistance measurement of protective conductor with current: 200 mA, 10 A, 25 A (protection class I),
- » insulation resistance measurement - three measurement voltages: 100 V, 250 V and 500 V,
- » measurement of equivalent leakage current,
- » measurement of PE leakage current,
- » measurement of differential leakage current,
- » measurement of touch leakage current,
- » power measurement,
- » measurement of electricity consumption,
- » IEC cable test,
- » fuse check (voltage: 4..8 V AC, max. current 5 mA)
- » check of L-N circuit resistance,
- » measurement of network voltage and frequency.

Additional meter features:

- » automatic selection of measuring range,
- » 990 memory cells for storing measurement results with the capability of data transmission to a PC via USB cable or printing,
- » professional software for data processing and report generation,
- » compatibility with barcode reader and printer,
- » compatibility with pendrive portable storage devices,
- » large, easy-to-read display with backlighting,
- » ergonomic operation.

Electrical safety:

- » this product meets EMC requirements in compliance with standard EN 61326-1 and EN 61326-2-2
- » type of insulation according to EN 61010-1 and IEC 61557
- » housing protection rating according to EN 60529 IP40

Other technical specifications:

- » power supply of the meter 187..265 V, 50 Hz
- » load current max. 16 A (230 V)
- » memory 990 cells
- » data transmission to PC computer USB cable
- » dimensions 330 x 235 x 120 mm
- » meter weight approx. 4.75 kg

Nominal operating conditions:

- » operating temperature range 0...+40°C
- » storage temperature -20...+70°C
- » humidity 20..80%

Standard accessories of the meter:

Fuse 0314 015.VXP 15 A 250 V AC 6.3x32 mm Littlefuse	WAPOZB15PAT
L5 carrying case	WAFUTL5
Crocodile clip, black, 1 kV, 32 A	WAKROBL30K03
Kelvin clamp, 1 kV, 25 A	WAKROKELK06
PC software: SoneI Reader	WAPROREADER
Test lead 1.2 m, black, 1 kV (2.5 mm ² , banana plugs)	WAPRZ1X2BLBB2X5
Doble-wire test lead 1,2 m (10 A/25 A) U2/I2	WAPRZ1X2DZBB2
USB cable	WAPRZUSB
Mains cable with IEC C19 plug	WAPRZZAS1
Pin probe, black 1 kV (CAT II 1000 V, banana socket)	WASONBLOGB3
High-current pin probe 1 kV (banana sockets)	WASONSPGB1

Measurement of rated voltage of welding equipment in a no-load state:

U_R (RMS) voltage measurement

Display range	Resolution	Accuracy
5.0...170.0 V	0.1 V	±(2.5% m.v. + 5 digits)

configurable upper limit within the range: 5.0...170.0 V resolution 1 V

U_p (peak) voltage measurement:

Display range	Resolution	Accuracy
5.0...240.0 V	0.1 V	±(2.5% m.v. + 5 digits)

configurable upper limit within the range: 5.0...240.0 V resolution 1 V

Measurement of leakage current of welding circuit I_L :

Display range	Resolution	Accuracy
0.00...14.99 mA	0.01 mA	±(5% m.v. + 2 digits)

- » current measurement band arises from applied measuring system, compliant with EN 60974-4
- » configurable upper limit within the range: 0.10 mA...14.90 mA resolution 0.1 mA
- » configurable measurement time within the range: 6 s...60 s with resolution 1 s
- » a system according to standard EN 60974-4 was used

Resistance measurement of protective earth conductor

- » configurable upper limit within the range: 10 mΩ ...1.99 Ω with resolution of 0.01 Ω
- » configurable measurement time 1...60 s with resolution of 1 s

Resistance measurement of protective earth conductor I=200 mA (only protection class I)

Display range	Resolution	Accuracy
0.00...0.99 Ω	0.01 Ω	±(4% m.v. + 2 digits)
1.00...19.99 Ω		±(4% m.v. + 3 digits)

- » measurement current: 200 mA for R=0.2...1.99 Ω

Resistance measurement of protective earth conductor I=10 A (only protection class I)

Display range	Resolution	Accuracy
0...999 mΩ	1 mΩ	±(3% m.v. + 4 digits)
1.00...1.99 Ω	0.01 Ω	±(3% m.v. + 40 digits)*

* for two-lead measurement

- » voltage on output under no load <12 V AC
- » technical method of measurement ensuring high accuracy of obtained results
- » measurement current: ≥10 A for R≤0.5 Ω

PAT-806 performs measurements with an actual current of 25 A up to the resistance value of 0.2 Ω.

Resistance measurement of protective earth conductor I=25 A (protection class I)

Display range	Resolution	Accuracy
0...999 mΩ	1 mΩ	±(3% m.v. + 4 digits)
1.00...1.99 Ω	0.01 Ω	±(3% m.v. + 40 digits)*

* for two-lead measurement

- » technical method of measurement ensuring high accuracy of obtained results
- » measurement current: ≥25 A for R ≤ 0.2 Ω

L-N circuit resistance measurement

Display range	Resolution	Accuracy
0.0...999 Ω	1 Ω	±(5% m.v. +5 digits)
1.00...4.99 kΩ	0.01 kΩ	

- » measurement voltage: 4...8 V AC, short-circuit current: max. 5 mA
- » short-circuit current: max. 5 mA

Measurement of PE leakage current and differential leakage current:

Display range	Resolution	Accuracy
0.00...3.99 mA	0.01 mA	±(5% m.v. +2 digits)
4.0...19.9 mA	0.1 mA	

- » configurable measurement limit within the range: 0.01...9.9 mA with resolution 0.01 mA/0.1 mA
- » configurable measurement time: continuous measurement (Cont) or 1...60 s with resolution of 1 s
- » at half of the measurement time, the meter automatically changes the polarity of the measuring network socket and displays a greater value
- » current measurement band 40 Hz...100 kHz (for PE leakage current) or 20 Hz...100 kHz (for differential current)

Measurement of equivalent leakage current:

Display range	Resolution	Accuracy
0.00...3.99 mA	0.01 mA	±(5% m.v. +2 digits)
4.0...19.9 mA	0.1 mA	

- » configurable measurement limit within the range: 0.01...9.9 mA with resolution 0.01 mA/0.1 mA
- » configurable measurement time: continuous measurement (Cont) or 1...60 s with resolution of 1 s
- » open-circuit voltage: 25...50V

Measurement of touch leakage current:

Display range	Resolution	Accuracy
0.000...4.999 mA	0.001 mA	±(5% m.v. +3 digits)

- » configurable measurement limit within the range: 0.01...1.99 mA with resolution of 0.01 mA
- » configurable measurement time: continuous measurement (Cont) or 1...60 s with resolution of 1 s

Apparent power measurement:

Display range	Resolution	Accuracy
0...999 VA	1 VA	±(5% m.v. +3 digits)
1...3.99 kVA	0.01 kVA	

configurable measurement time: continuous measurement (Cont) or 1...60 s with resolution of 1 s

Measurement of electricity consumption:

Display range	Resolution	Accuracy
0.00...15.99A	0.01A	±(2% m.v. + 3 digits)

configurable measurement time: continuous measurement (Cont) or 1...60 s with resolution of 1 s

Measurement of network voltage and voltage on measured socket:

Display range	Resolution	Accuracy
187.0...265.0 V	0.1 V	±(2% m.v. + 2 digits)

Network frequency measurement:

Display range	Resolution	Accuracy
45.0...55.0 Hz	0.1 Hz	±(2% m.v. + 2 digits)

configurable measurement time: continuous measurement (Cont) or 1...60 s with resolution of 1 s

Network PE voltage measurement:

Display range	Resolution	Accuracy
0.0...59.9 V	0.1 V	±(2% m.v. + 2 digits)

measurement of network voltage between PE and N of meter's power supply
* - accuracy unspecified for $U < 5 V$

Measurement of insulation resistance

Measuring range according to IEC 61557-2 for: $U_n=100 V$: 100 kΩ...99.9 MΩ
 $U_n=250 V$: 250 kΩ...199.9 MΩ, $U_n=500 V$: 500 kΩ...599.9 MΩ

U_n	Display range	Resolution	Accuracy
100 V / 250 V / 500 V	0...1999 kΩ	1 kΩ	±(5% m.v. +8 digits)
	2.0...19.99 MΩ	0.01 MΩ	
100 V	20.0...99.9 MΩ	0.1 MΩ	
250 V	20.0...199.9 MΩ	0.1 MΩ	
500 V	20.0...599.9 MΩ	0.1 MΩ	

- » configurable measurement limit within the range: 0.01...9.9 MΩ with resolution of 0.1 MΩ
- » configurable measurement time: continuous measurement (Cont) or from 4 s to 3 min. with resolution of 1 s
- » automatic discharge of the measured object's capacitance upon completion of measurement
- » protection against measurement of live objects
- » max. output current 1.4 mA



PAT-806 is also intended for inspecting three-phase equipment.

The instrument enables measurements in compliance with:

- » EN 60745-1: Hand-held motor-operated electric tools. Safety. Part 1: General requirements.
- » EN 61029: Safety of transportable motor-operated electric tools. General requirements.
- » EN 60335-1: Household and similar electrical appliances. General requirements.
- » EN 60950: Safety of information technology equipment.
- » EN 60974-4: Arc welding equipment - Part 4: Periodic inspection and testing.
- » VDE 0404-1: Prüf- und Messeinrichtungen zum Prüfen der elektrischen Sicherheit von elektrischen Geräten. Teil 1: Allgemeine Anforderungen.
- » VDE 0404-2: Prüf- und Messeinrichtungen zum Prüfen der elektrischen Sicherheit von elektrischen Geräten. Teil 2: Prüfeinrichtungen für Prüfungen nach Instandsetzung, Änderung oder für Wiederholungsprüfungen.
- » VDE 0701-0702 Prüfung nach Instandsetzung, Änderung elektrischer Geräte. Wiederholungsprüfung elektrischer Geräte. Allgemeine Anforderungen für die elektrische Sicherheit.
- » VDE 0701-0702 Prüfung nach Instandsetzung, Änderung elektrischer Geräte. Wiederholungsprüfung elektrischer Geräte. Allgemeine Anforderungen für die elektrische Sicherheit.



SONEL PAT-10 / PAT-2E / PAT-2

index: WMGBPAT10 / WMGBPAT2E / WMGBPAT2



CAT II

300 V

IP40



Features

Innovative combination of **small overall dimensions** (and the transportability of the device related to this) with **advanced measurement systems** allowing for complete performance of automatic measurements for electrical devices as well as IEC cables and extension cords (including those with PRCD).

Complete set of tests performed after just one press of the START button. The meter's configuration capabilities allow for modification of the method of the instrument's operation, which makes it **even better adapted to the user's needs**. In situations where it is necessary to perform unit measurements without the need to perform the entire, complex measurement procedure, PATs from Sonel enable **operation in single measurement mode** (of a given type - so-called manual measurements).

All meters in this series additionally enable performance of **basic measurements without an external power source**, in emergency situations where there is no network power, simplified test sets can be initiated in battery operating mode.

Small overall dimensions, light weight and a specially designed carrying case for the meter and accessories provide **convenience** of use and **high mobility of the instrument**. Wireless communication with a printer* allows for organization of the location where measurements are performed without a tangle of unnecessary cables. Saving of results to memory* and integration of results in PC software additionally broaden the instrument's functionality.

Basic functions of the PAT-10 instrument

- » diode indicating result assessment,
- » quick access to measurement procedures,
- » compact housing, ergonomic carrying case,
- » automatic selection of measuring ranges,
- » resistance measurement of protective conductor with current: 200 mA, 10 A.
- » measurement of insulation resistance.
- » measurement of PRCD trip time.
- » measurement of equivalent, differential and touch leakage current,
- » IEC cable test,
- » saving of results to memory,
- » compatibility with Sonel Reader and Sonel PAT plus software (optional).

Basic accessories - PAT-10/2E/2

Fuse 16 A, 250 VAC, 5 x 20 mm	WAPOZB16PAT
M12 carrying case	WAFUTM12
PC software: Sonel Reader	WAPROREADER
Test lead 1.2 m, red, 1 kV (terminated in a crocodile clip)	WAPRZ1X2REBK
USB cable	WAPRZUSB
Power cord 1.8 m (orange IEC plug)	WAPRZ1X8REIEC

PAT-1 Basic accessories

orange "crocodile" K02; red	WAKRORE20K02
test lead; 1.2 m; red	WAPRZ1X2REBB2X5
test probe; red	WASONREOGB1
IEC power cord; orange plug	WAPRZ1X8REIEC
Sonel Reader	WAPROREADER

The instrument can be used for tests of equipment, including tests compliant with standards:

- » EN 60745 - 1: Hand-held motor-operated electric tools. Safety. Part 1: General requirements.
- » EN 61029: Safety of transportable motor-operated electric tools. General requirements.
- » EN 60335 - 1: Household and similar electrical appliances. General requirements.
- » EN 60950: Safety of information technology equipment.
- » EN 61557-6 Electrical safety in low voltage distribution systems up to 1000 V a.c. and 1500 V d.c. - Equipment for testing, measuring or monitoring of protective measures - Part 6: Effectiveness of residual current devices (RCD) in TT, TN and IT systems.
- » VDE 0701-0702 Prüfung nach Instandsetzung, Änderung elektrischer Geräte. Wiederholungsprüfung elektrischer Geräte. Allgemeine Anforderungen für die elektrische Sicherheit.

Model	PAT-10	PAT-2E	PAT-2
Visual assessment	✓	✓	✓
Resistance measurement of protective earth conductor I = 200 mA	0.01...19.99 Ω	0.01...19.99 Ω	0.01...19.99 Ω
Resistance measurement of protective earth conductor I = 10 A	0.01...1.99 Ω	-	-
Insulation resistance measurement U = 250 V	0.25...99.9 MΩ	0.25...99.9 MΩ	-
Insulation resistance measurement U = 500 V	0.50...99.9 MΩ	0.50...99.9 MΩ	0.50...99.9 MΩ
Measurement of substitute leakage current	0.01...19.9 mA	0.01...19.9 mA	0.01...19.9 mA
Measurement of touch leakage current	0.001...4.999 mA	0.001...4.999 mA	-
Measurement of differential leakage current	0.10...19.9 mA	0.10...19.9 mA	-
IEC cable test (R _{iso} , R _{pe} , polarity)	✓	✓	✓
PRCD test (tripping time for I _{Δn} ; x1/x5; 0° and 180°)	10 mA, 30 mA	10 mA, 30 mA	-
Built-in memory for results / transmission to computer	✓	✓	✓
Wi-Fi	✓	✓	✓
Compatible with printer	✓	✓	✓
Meter configuration from computer	✓	✓	✓
Power supply	Network power supply: 220 V; 230 V; 240 V 50/60 Hz Built-in rechargeable battery	Network power supply: 220 V; 230 V; 240 V 50/60 Hz Built-in rechargeable battery	Built-in rechargeable battery (measurements can be performed during charging)
Measurement category CAT II 300V	✓	✓	✓
Weight / size	approx. 1.40 kg / 200 x 180 x 77 mm	approx. 1.40 kg / 200 x 180 x 77 mm	approx. 1.40 kg / 200 x 180 x 77 mm

Software

SONEL PAT ANALYSIS

index: WAPROSONPAT3

This software is intended for companies that perform safety measurements of electrical equipment.

Applications are compatible with Sonel PAT-series testers. Data saved by the meter is entered into the test report for the selected item of equipment.

- » Perfect for production plants, electrical tool rental services, repair and maintenance services, etc.
- » Hierarchical data entry structure - a device is assigned to a specific company or department.
- » Capability of gathering information about a given piece of equipment.
- » Tracking the test history of a device.
- » Capability of advanced meter configuration via software.
- » Label printing on standard adhesive papers.
- » Capability of creating a custom measurement standard using the report editor.
- » Capability of scheduling measurements - every device contains a "Measurement cycle" list - the application automatically displays devices whose testing deadline is approaching or has expired.

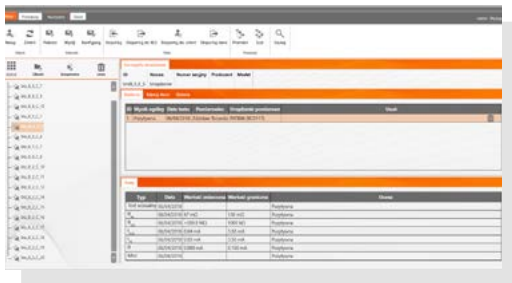

Available report forms:

- » full report on one test - on an A4 page, with complete data about the device and a complete series of tests,
- » test history for device - all measurement results are printed according to defined criteria (from a given period),
- » abbreviated report/record sheet - prints the test history with basic information about the device and information on approval for use.

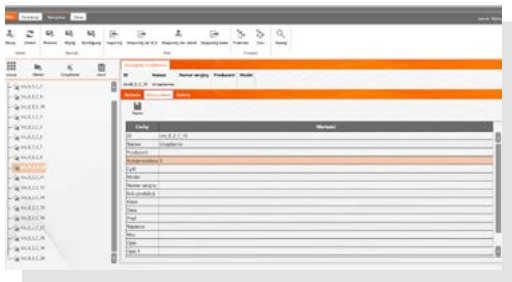

Report printing according to the following standards:

VDE 0701:1, VDE 0701:200, VDE 0701:240, VDE 0701:260, DIN VDE 0702, EN 61010, EN 60335, EN 60950, IEC 60601, EN62353

Hardware requirements:

Windows XP SP2, Windows Vista, Windows 7, Windows 8/8.1
Internet Explorer: 6.0 or higher
FrameWork 2.0 or higher

SONEL PAT MOBILE



The **mobile application** extends the capabilities of Sonel PAT testers series. Sonel PAT Mobile is available on Android, iOS and Windows Phone system.

Sonel PAT Mobile:

- » connects wirelessly to the selected tester
- » displays the measurement results on the device screen
- » receives, saves and presents data from the tester
- » provides transfer of measurement results to external media

In addition, the application allows you to read 2D codes, analogously to the PAT-820 and PAT-815 testers.

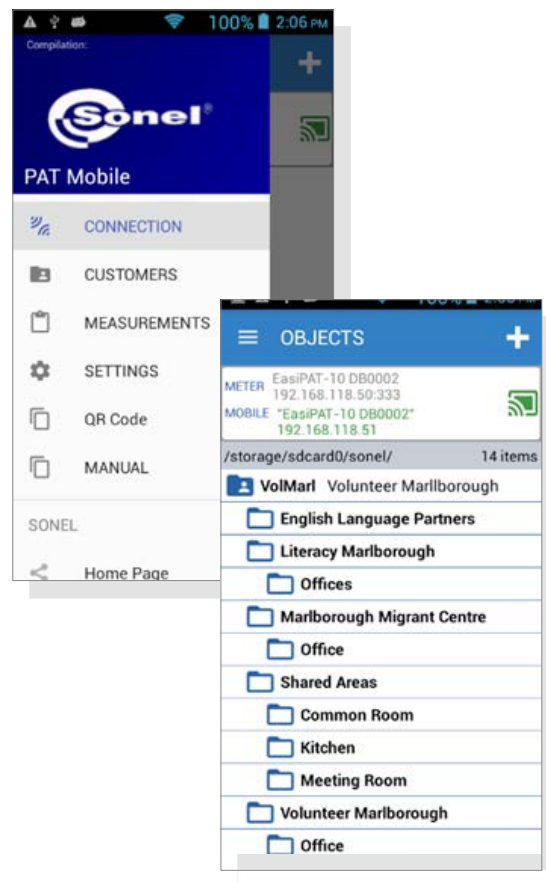

PAT

Set of standard and optional accessories

1, 2, 4 - number of basic accessories

• - optional accessories

Photo	Name	Index	PAT-820	PAT-815	PAT-806/806-IT	PAT-10	PAT-2E	PAT-2	PAT-1
	PAT16-F1 industrial socket adapter 16 A for PAT	WAADAPAT16F1	•	•	•	•	•	•	•
	PAT32-F1 industrial socket adapter 32 A for PAT	WAADAPAT32F1	•	•	•	•	•	•	•
	PAT16-P three-phase socket adapter 16 A for PAT	WAADAPAT16P	•	•	•	•	•	•	•
	PAT16-PR three-phase socket adapter 16 A for PAT (switchable)	WAADAPAT16PR	•	•	•	•	•	•	•
	PAT32-P three-phase socket adapter 32 A for PAT	WAADAPAT32P	•	•	•	•	•	•	•
	PAT32-PR three-phase socket adapter 32 A for PAT (switchable)	WAADAPAT32PR	•	•	•	•	•	•	•
	PAT16-C three-phase socket adapter 16 A for PAT (4P)	WAADAPAT16C	•	•	•	•	•	•	•
	PAT16-CPR three-phase socket adapter 16 A for PAT (4P, switchable)	WAADAPAT16CPR	•	•	•	•	•	•	•
	PAT32-C three-phase socket adapter 32 A for PAT (4P)	WAADAPAT32C	•	•	•	•	•	•	•
	PAT32-CPR three-phase socket adapter 32 A for PAT (4P, switchable)	WAADAPAT32CPR	•	•	•	•	•	•	•
	Li-Ion battery 7,2 V 1,9 Ah for Brother printer	WAAKU19				•	•	•	
	Fuse 0314 015,VXP 15 A 250 VAC 6.3x32 mm Littlefuse	WAPOZB15PAT	2	2	2				
	Fuse 16 A, 250 VAC, 5 x 20 mm	WAPOZB16PAT				2	2		
	C-3 current clamps (φ=52 mm)	WACEGC30KR	•	•					
	Barcode scanner 1D (USB)	WAADACK1			•				
	Barcode scanner 2D (USB)	WAADACK2D	•	•					
	D1 portable USB report / barcode printer (Brother)	WAADAD1			•				
	D2 portable USB report / barcode printer (Sato)	WAADAD2	•	•					
	D3 portable Wi-Fi / USB report / barcode printer (Brother)	WAADAD3				•	•	•	
	L5 carrying case	WAFUTL5			1				
	M12 carrying case	WAFUTM12				1	1	1	•
	Crocodile clip, black, 1 kV, 20 A	WAKROBL20K01			•				
	Crocodile clip, black, 1 kV, 32 A	WAKROBL30K03			2				
	Crocodile clip, red, 1 kV, 20 A	WAKRORE20K02	•	•		•	•	•	•
	Kelvin clamp, 1 kV, 25 A	WAKROKELK06	•	•	1				
	Crocodile clip, blue, 1 kV, 20 A	WAKROBU20K02	•	•					

Photo	Name	Index	PAT-820	PAT-815	PAT-806/806-IT	PAT-10	PAT-2E	PAT-2	PAT-1
	PC software: Sonei PAT Analysis	WAPROSONPAT3EN	•	•	•	•	•	•	•
	PC software: Sonei Reader	WAPROREADER	1	1	1	1	1	1	1
	IEC Test adapter (Shuko)	WAADAPATIEC1	•	•	•	•	•	•	•
	IEC C6 to C13 adapter.	WAADAPATIEC2	•	•	•	•	•	•	•
	Test lead 1,2 m, black, 1 kV (2,5 mm2, banana plugs)	WAPRZ1X2BLB2X5			2				
	Test lead 1,2 m, red, 1 kV (2,5 mm2, banana plugs)	WAPRZ1X2REBB2X5				•	•	•	•
	Test lead 1,2 m, red, 1 kV (terminated in a crocodile clip)	WAPRZ1X2REBK				1	1	1	1
	Doble-wire test lead 1,2 m (10 A / 25 A) U1/I1	WAPRZ1X2DZBB1			•				
	Doble-wire test lead 1,2 m (10 A/25 A) U2/I2	WAPRZ1X2DZBB2			1				
	Test lead 1,8 m, red, 5 kV (banana plugs)	WAPRZ1X8REBB	2						
	Test lead 1,8 m, orange, (10 A / 25 A, terminated in a crocodile clip)	WAPRZ1X8ORKS	1	1					
	Double-wire test lead 2,1 m (IEC C13 / banana plug)	WAPRZ2X1DZIECB	•	•					
	Double-wire test lead 1,5 m (PAT/banana plug)	WAPRZ1X5DZBB	•	•					
	USB cable	WAPRZUSB	1	1	1	1	1	1	•
	Power cord 1,8 m (orange IEC plug)	WAPRZ1X8REIEC				1	1	1	1
	Mains cable with IEC C19 plug	WAPRZZAS1	1	1	1				
	Pin probe, black 1 kV (CAT II 1000 V, banana socket)	WASONBLOGB3			1				
	Pin probe, red 1 kV (banana socket)	WASONREOGB1	•	•		•	•	•	•
	Pin probe, red 5 kV (banana socket)	WASONREOGB2	2						
	Brush probe for PAT Testers	WASONSZ1	•	•	•	•	•	•	•
	High-current pin probe 1 kV (banana sockets)	WASONSPGB1	•	•	1				
	Ribbon for printer	WANAKD1			•				
	Label Roll - Black on White for D3 printer (BROTHER)	WANAKD3				•	•	•	
	Label Roll - Black on White for D2 printer (SATO)	WANAKD2	•	•					
	Ribbon for D2 printer (SATO)	WANAKD2BAR	•	•					
	PAT IPE Adapter	WAADAPATPE			•				



Clamp meters

CMP-2000
CMP-1006
CMP-401
CMP-400
CMP-200



Digital multimeters

CMM-60
CMM-40
CMM-11
CMM-10



Voltage testers

P-6
P-5
P-4

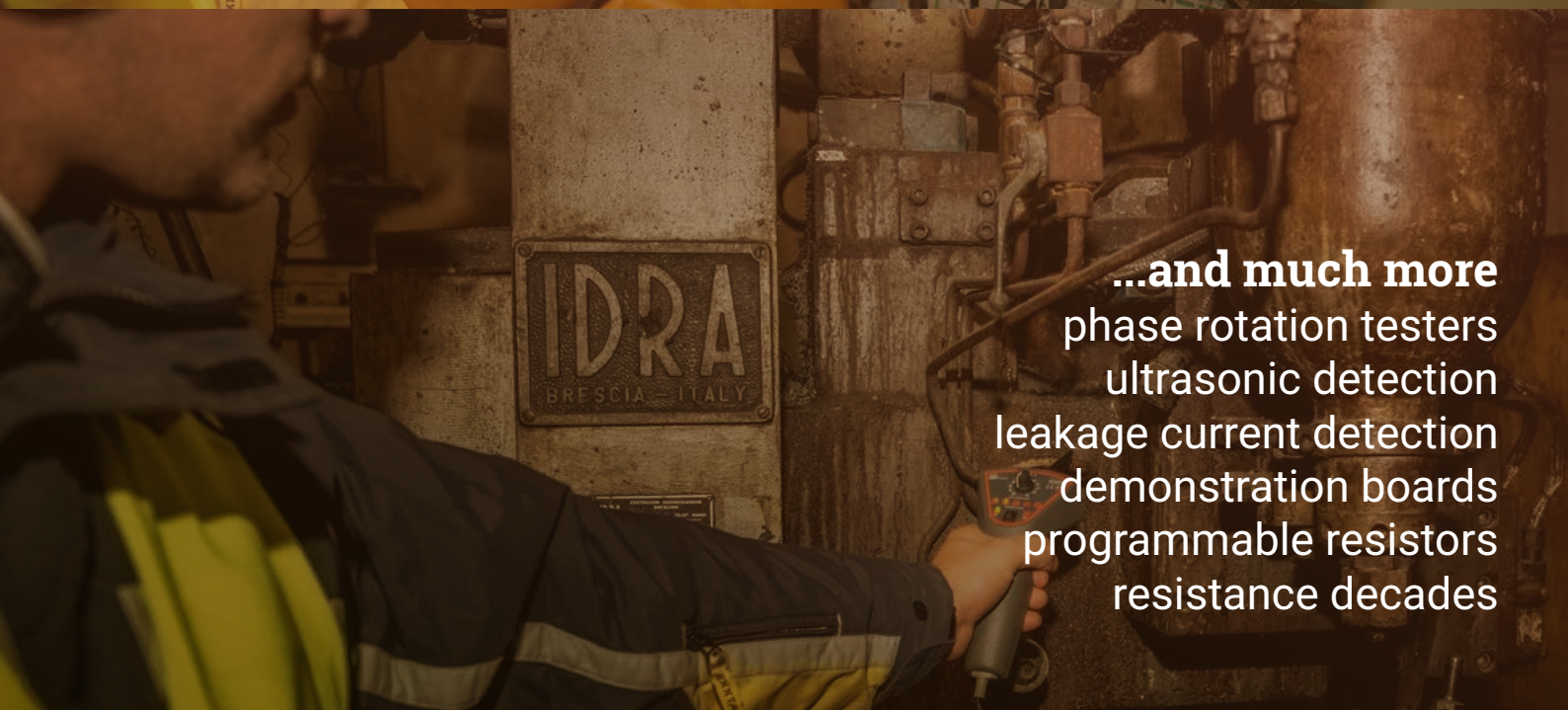

...and much more
phase rotation testers
ultrasonic detection
leakage current detection
demonstration boards
programmable resistors
resistance decades

Clamp meter

SONEL CMP-2000

index: WMXXCMP2000



- INRUSH CURRENT**
- CAT IV**
600 V
- CAT III**
1000 V
- IP20**

Standard accessories of the meter:

Test lead with probe for CMM/CMP (set)	WAPRZCMP1
Temperature measurement probe (type K)	WASONTEMK
9 V battery	
Calibration certificate	

Product features

- » 12 measuring functions
- » True RMS AC voltage and current measurement for accurate and reliable readings of non-sinusoidal signals
- » INRUSH function for measuring current drawn by an electrical device when first turned on
- » large clamps allow the measurement of conductors up to 57 mm in diameter
- » current measurement up to 2000 A DC and 1500 A AC
- » temperature measurement in Fahrenheit and Celsius
- » automatic selection of measuring ranges
- » HOLD function, allowing for freezing the result on the display
- » holding of MAX/MIN results
- » Delta ZERO function, relative measurement mode for direct current - capability of zeroing the instrument at any time and returning to measurement in absolute mode
- » double LCD to display more than one value at the same time
- » auto-off function

Direct current measurement

Display range	Resolution	Accuracy (AC)
0.0...659.9 A	0.1 A	±(2.0% m.v. + 5 digits)
660...2000 A	1 A	(3.0% m.v. + 5 digits) for 660...1000 A ±(5.0% m.v. + 5 digits) for 1000...2000 A

Alternating (TRUE RMS) current measurement

Display range	Resolution	Accuracy
0.0...659.9 A	0.1 A	±(2.0% m.v. + 10 digits) for 50...60 Hz ±(3.0% m.v. + 10 digits) for 61...400 Hz
660...1500 A	1 A	±(2.5% m.v. + 10 digits) for 50...60 Hz and 660...1000 A ±(3.5% m.v. + 10 digits) for 61...400 Hz and 660...1000 A ±(5.0% m.v. + 10 digits) for 50...400 Hz and 1000...1500 A

Direct voltage measurement

Display range	Resolution	Accuracy
0.000...6.599 V	0.001 V	±(0.5% m.v. + 2 digits)
6.60...65.99 V	0.01 V	
66.0...659.9 V	0.1 V	
660...1000 V	1 V	

Alternating voltage measurement (True RMS)

Display range	Resolution	Accuracy
0.000...6.599 V	0.001 V	±(1.5% m.v. + 8 digits) for 50...500 Hz
6.60...65.99 V	0.01 V	
66.0...659.9 V	0.1 V	
660...750 V	1 V	

Resistance measurement

Display range	Resolution	Accuracy
0.0...659.9 Ω	0.1 Ω	±(1.0% m.v. + 5 digits)
0.660...6.599 kΩ	0.001 kΩ	
6.60...65.99 kΩ	0.01 kΩ	
66.0...659.9 kΩ	0.1 kΩ	
0.660...6.599 MΩ	0.001 MΩ	±(2.0% m.v. + 5 digits)
6.60...66.00 MΩ	0.01 MΩ	±(3.5% m.v. + 5 digits)

Capacitance measurement

Display range	Resolution	Accuracy
0.0...6.599 nF	0.001 nF	±(3.0% m.v. + 30 digits)
6.60...65.99 nF	0.01 nF	±(3.0% m.v. + 10 digits)
66.0...659.9 nF	0.1 nF	±(3.0% m.v. + 30 digits)
6.660...6.599 μF	0.001 μF	±(3.0% m.v. + 10 digits)
6.60...65.99 μF	0.01 μF	
66.0...659.9 μF	0.1 μF	
0.660...6.599 mF	0.001 mF	
		±(5% m.v. + 10 digits)

Frequency measurement

Display range	Resolution	Accuracy
10.00...65.99 Hz	0.01 Hz	±(0.1% m.v. + 5 digits)
66.0...659.9 Hz	0.1 Hz	
0.660...6.599 kHz	0.001 kHz	
6.60...65.99 kHz	0.01 kHz	
66.0...659.9 kHz	0.1 kHz	
0.660...1.000 MHz	0.001 MHz	

Duty cycle measurement

Display range	Resolution	Accuracy
5...95%	0.1%	±(3.0% m.v. + 30 digits)

frequency range: 40 Hz...20 kHz.

"m.v." = "measured value"

Other technical specifications:

- » display readout of 6600 readings, 66-segment bargraph
backlit LCD
- » power supply 9 V battery, type 6LR61
- » indication of range overflow 'OL' symbol is displayed
- » internal clamp diameter 57 mm
- » continuity test threshold 30 Ω
- » diode test I = 0.8 mA
- » sampling rate nominal: 2.8 Hz
analog bar graph: 28 Hz
- » input impedance approx. 10 MΩ
- » auto-off timeout 30 minutes
- » operating temperature range 0...+50°C
- » storage temperature -20...+60°C
- » dimensions 281 x 108 x 53 mm
- » weight with battery 570 g
- » compliance with standards EN 61010-1, EN 61010-2-032
- » quality standard ISO 9001

Clamp meter

SONEL CMP-1006

index: WMXXCMP1006



Resistance measurement

Display range	Resolution	Accuracy
0.0...659.9 Ω	0.1 Ω	±(1.0% m.v. + 4 digits)
0.660...6.599 kΩ	0.001 kΩ	±(1.5% m.v. + 2 digits)
6.60...65.99 kΩ	0.01 kΩ	
66.0...659.9 kΩ	0.1 kΩ	±(2.5% m.v. + 3 digits)
0.660...6.599 MΩ	0.001 MΩ	
6.6...66.0 MΩ	0.1 MΩ	±(3.5% m.v. + 5 digits)

"m.v." = "measured value"

Other technical specifications

- » display 6600 readings, backlit LCD
- » power supply of the meter 9 V battery, type 6LR61
- » indication of range overflow 'OL' symbol
- » interior clamp diameter 36 mm
- » continuity test threshold 40 Ω; measurement current < 0.5 mA
- » diode test typical measurement current 0.3 mA
typical voltage of open circuit < 3 V DC
- » sampling rate 2 Hz
- » input impedance 10 MΩ (V DC and V AC)
- » auto-off timeout 25 min
- » operating temperature +5...+40°C
- » storage humidity <80%
- » dimensions 229 x 80 x 49 mm
- » weight 303 g
- » measuring category CAT III 600 V (CAT IV 300 V)
- » compliance with standards EN 61010-1, EN 61010-2-032

Standard accessories of the meter:

Test lead with probe for CMM/CMP (set)	WAPRZCMP1
Temperature measurement probe (type K)	WASONTEMK
9 V battery	
Calibration certificate	

Product features

- » 11 measuring functions
- » True RMS AC voltage and current measurement for accurate and reliable readings of non-sinusoidal signals
- » INRUSH function for measuring current drawn by an electrical device when first turned on
- » clamps allow the measurement of conductors up to 36 mm in diameter
- » current measurement up to 1000 A AC/DC
- » temperature measurement in Fahrenheit and Celsius
- » automatic selection of measuring ranges
- » HOLD function, allowing for freezing the result on the display
- » holding of MAX/MIN values
- » relative measurement mode for direct current - DCA ZERO function
- » automatic power down
- » shock resistant rugged case

Direct and alternating (TRUE RMS) current measurement

Display range	Resolution	Accuracy (DC)	Accuracy (AC)
0...659.9 A	0.1 A	±(2.5% m.v. + 5 digits)	±(2.5% m.v. + 8 digits) for f = 45...65 Hz
660...1000 A	1 A	±(2.8% m.v. + 8 digits)	±(2.8% m.v. + 8 digits) for f = 45...65 Hz

Direct and alternating (TRUE RMS) voltage measurement

Display range	Resolution	Accuracy (DC)	Accuracy (AC)
0...6.599 V	0.001 V	±(1.5% m.v. + 3 digits)	±(1.8% m.v. + 5 digits) for f = 45...65 Hz
6.60...65.99 V	0.01 V		
66.0...600.0 V	0.1 V		

Measurement of frequency

Display range	Resolution	Accuracy
30.0...659.9 Hz	0.1 Hz	±(1.2% m.v. + 2 digits)
0.660...6.599 kHz	0.001 kHz	
6.60...15.00 kHz	0.01 kHz	

sensitivity:

30...5 kHz:10 V RMS min.

5 kHz...15 kHz:40 V RMS min. for 20%...80% of duty cycle



Clamp meters

SONEL CMP-401 / CMP-400

index: WMXXCMP401 / WMXXCMP400



CAT IV

300 V

CAT III

600 V

IP40

Product features

- » 11 measuring functions (CMP-401) and 9 measuring functions (CMP-400)
- » clamps allow the measurement of conductors up to 30 mm in diameter
- » current measurement up to 400 A AC i DC (CMP-401) or up to 400 A AC (CMP-400)
- » temperature measurement in Fahrenheit and Celsius
- » non-contact voltage indication
- » automatic and manual selection of measuring ranges
- » **HOLD** function, allowing for freezing the result on the display
- » relative measurement function
- » automatic power down - **Auto-OFF** function
- » shock resistant rugged case

Other technical specifications:

» display	4000 readings, backlit LCD
» power supply of the meter	9 V battery, type 6LR61
» indication of range overflow	'OL' symbol is displayed
» clamp size	opening 30 mm (1.2")
» continuity test	I < 0.5 mA, acoustic signal for R < 50 Ω
» diode test	I = 0.3 mA, U ₀ = 1.5 V DC
» sampling rate	2 Hz
» input impedance	10 MΩ (V DC and V AC)
» auto-off timeout	approx. 30 minutes
» operating temperature range	+5...+40°C
» storage temperature	-20...+60°C
» dimensions	197 x 70 x 40 mm
» weight	183 g
» measuring category	CAT III 600 V (CAT IV 300 V)
» compliance with standards	EN 61010-1, EN 61010-2-032
» quality standard	ISO 9001

Standard accessories of the meters:

Test lead with probe for CMM/CMP (set)	WAPZCAMP1
Temperature measurement probe (type K)	WASONTEMK
9 V battery	
Calibration certificate	

Direct and alternating voltage measurement

Display range	Resolution	Accuracy		Accuracy
		CMP-400 (AC)	CMP-401 (AC)	CMP-400,-401 (DC)
400.0 mV	0.1 mV	±(1.5% m.v. + 30 digits)	±(1.5% m.v. + 30 digits)	±(0.8% m.v. + 2 digits)
4.000 V	0.001 V	±(1.8% m.v. + 8 digits)	±(1.5% m.v. + 5 digits)	±(1.5% m.v. + 2 digits)
40.00 V	0.01 V			
400.0 V	0.1 V			
600.0 V	1 V	±(2.5% m.v. + 8 digits)	±(2% m.v. + 5 digits)	±(2% m.v. + 2 digits)

frequency range: 50 Hz...400 Hz

Alternating current measurement

Display range	Resolution	Accuracy CMP-400	Accuracy CMP-401
4.000 A	0.001 A	±(2.5% m.v. + 12 digits)	no range
40.00 A	0.01 A	±(2.5% m.v. + 8 digits)	±(2.5% m.v. + 8 digits)
400.0 A	0.1 A	±(2.8% m.v. + 8 digits)	±(2.8% m.v. + 5 digits)

frequency range: 50 Hz...60 Hz

Direct current measurement (only CMP-401)

Display range	Resolution	Accuracy
4.00 A	0.01 A	±(2.5% m.v. + 5 digits)
400.0 A	0.1 A	±(2.8% m.v. + 5 digits)

Resistance measurement

Display range	Resolution	Accuracy
400.0 Ω	0.1 Ω	±(1% m.v. + 4 digits)
4.000 kΩ	0.001 kΩ	±(1.5% m.v. + 2 digits)
40.00 kΩ	0.01 kΩ	
400.0 kΩ	0.1 kΩ	±(2.5% m.v. + 3 digits)
4.000 MΩ	0.001 MΩ	
40.00 MΩ	0.01 MΩ	±(3.5% m.v. + 5 digits)

"m.v." = "measured value"

Leakage current clamp meter

SONEL CMP-200

index: WMXXCMP200



Measurement of alternating current up to 200 A:

- » high resolution (0.1 mA),
- » 3 measuring subranges: 200 mA, 2 A, 200 A.

Additional functions of the meter:

- » 3½-digit display (max. 1999),
- » white backlighting of display,
- » interior clamp diameter 30 mm (1.2"),
- » **HOLD** function, allowing for freezing the measurement result on the display,
- » **MAX** function, freezing of maximum values,
- » automatic power down of instrument when not in use,
- » reinforced, impact resistant enclosure.

CAT II

600 V

IP40

Pomiar prądu

Display range	Resolution	Accuracy
199.9 mA	0.1 mA	±(5% m.v. + 8 digits)
1.999 A	0.001 A	±(5% m.v. + 10 digits)
199.9 A	0.1 A	±(2.5% m.v. + 10 digits)



Comparison of clamp multimeters



CMP-2000
High-end model
for industry area



CMP-1006
Various applications
in industry



CMP-401
For general use



CMP-400
For general use



CMP-200
Leakage current

	CMP-2000	CMP-1006	CMP-401	CMP-400	CMP-200
Measurement functions					
AC/DC voltage	750 V / 1000 V	600.0 V / 600.0 V	600 V / 600 V	600 V / 600 V	- / -
AC/DC current	1500 A / 2000 A	1000 A / 1000 A	400.0 A / 400.0 A	400.0 A / -	200 A / -
Resistance	60.00 MΩ	66.00 MΩ	40.00 MΩ	40.00 MΩ	-
Frequency	1.000 MHz	15.00 kHz	10 kHz	10 kHz	-
Capacitance	6.599 mF	-	100.0 μF	-	-
Temperature	1000°C	760°C	760°C	760°C	-
Non-contact voltage indication	-	-	✓	✓	-
Duty cycle (%)	✓	✓	✓	✓	-
Continuity / diode test	✓ / ✓	✓ / ✓	✓ / ✓	✓ / ✓	-
Inrush current	✓	✓	-	-	-
Basic features					
True RMS measurement	✓	✓	-	-	-
Automatic / manual range selection	✓ / ✓	✓ / ✓	✓ / ✓	✓ / ✓	- / ✓
Maximum diameter of measured conductor	57 mm (conductor) 70 x 18 mm (bus bar)	36 x 52 mm	30 mm	30 mm	30 mm
Input impedance	10 MΩ	10 MΩ	10 MΩ	10 MΩ	-
Advanced features					
MAX / MIN / AVG measurement	✓ / ✓ / -	✓ / ✓ / -	- / - / -	- / - / -	✓ / - / -
HOLD	✓	✓	✓	✓	✓
PEAK HOLD	-	-	-	-	-
Relative measurement	✓	✓	✓	✓	-
Other features					
Automatic power down	✓	✓	✓	✓	✓
Battery indicator	✓	✓	✓	✓	✓
Built-in flashlight	-	-	-	-	-
Beeper	✓	✓	✓	✓	-
Dimensions	281 x 108 x 53 mm	229 x 80 x 49 mm	197 x 70 x 40 mm	197 x 70 x 40 mm	182 x 61 x 34 mm
Weight	570 g	303 g	183 g	183 g	225 g
Display					
Count	Double 6.600	6.600	4.000	4.000	1.999
Segmented	✓	✓	✓	✓	✓
Screen backlight	✓	✓	✓	✓	✓
Safety and conditions of use					
Measurement category (EN 61010)	CAT IV 600 V CAT III 1000 V	CAT IV 300 V CAT III 600 V	CAT IV 300 V CAT III 600 V	CAT IV 300 V CAT III 600 V	CAT II 600 V
Ingress protection	IP20	IP40	IP40	IP40	IP40
Operating temperature	0...50°C	5...40°C	5...40°C	5...40°C	0...50°C



SONEL CMM-60

index: WMXXCMM60

- CAT III**
- 1000 V**
- CAT IV**
- 600 V**
- IP67**
- BLUETOOTH**
- RECORDER**



Measurements

- » over 14 measuring functions
- » AC & DC voltage
- » AC & DC current
- » resistance
- » capacitance
- » temperature
- » duty cycle & impulse width
- » frequency
- » current loop 4-20 mA%
- » ...and much more

Additional functions

- » the **AC + DC function** allows you to simultaneously display the value of the constant and variable component or the sum of both components during voltage measurement
- » **True RMS for AC voltage and current** for measuring the effective value of distorted waveforms
- » **4~20 mA** function used for, among others, measurement of the control circuits of temperature, pressure, pH or flow sensors
- » fast and easy reading is provided by a **colour display** with a resolution 320 x 240 pixels and a diagonal of 3.5", enabling reading the result under wide angle and in dark locations
- » built-in **low-pass filter**, thanks to which the voltage measurements will be more accurate by eliminating the influence of interference generated by machines and electronic devices
- » displaying **PEAK** values
- » the relative **REL** measurement
- » **real-time clock** that allows adding date and time of measurement to each stored result
- » **built-in memory for 2000 measurements**
- » possibility of quick detection of irregularities due to the registration of measurement results in graphical form of the trend, thanks to the **Trend Capture function** and the built-in recorder with the possibility of recording up to 10,000 samples
- » built-in **Bluetooth module** for sending live measurement results to **Android mobile devices** and - for PCs - **CMM-60 Multimeter Software**
- » registration of maximum and minimum values and calculation of the average of current measurements
- » integrated **HELP** function
- » manual and automatic range selection
- » freezing the measurement result thanks to **HOLD and Auto HOLD function**
- » auto power-off thanks to **Auto-OFF function** after selecting of a specific idle period
- » extremely hermetic (**IP67**) and reinforced, shock-protected housing **covered with elastomer**

Direct and alternating (TRUE RMS) voltage measurement

Display range	Resolution	Accuracy (DC)	Accuracy (AC)
50.000 mV	0.001 mV	±(0.05% m.v. + 20 digits)	f = 50/60 Hz
500.00 mV	0.01 mV		±(0.3% m.v. + 25 digits)
5.0000 V	0.0001 V	±(0.025% m.v. + 5 digits)	f < 1 kHz
50.000 V	0.001 V		±(0.5% m.v. + 25 digits)
500.00 V	0.01 V	±(0.05% m.v. + 5 digits)	f < 5 kHz
1000.0 V	0.1 V		±(3% m.v. + 25 digits)

frequency range 50...10 kHz

Direct and alternating (TRUE RMS) current measurement

Display range	Resolution	Accuracy (DC)	Accuracy (AC)
500.00 µA	0.01 µA	±(0.1% m.v. + 20 digits)	f = 50/60 Hz
5000.0 µA	0.1 µA		±(0.6% m.v. + 25 digits)
50.000 mA	0.001 mA	±(0.15% m.v. + 20 digits)	f < 1 kHz
500.00 mA	0.01 mA		±(1.5% m.v. + 25 digits)
10.000 A	0.001 A	±(0.3% m.v. + 20 digits)	f < 5 kHz
20 A			±(3% m.v. + 25 digits)

maximum 30 seconds with reduced accuracy

SONEL MULTIMETER MOBILE



Sonel Multimeter Mobile application is intended for transferring and storing measurement results in the memory of mobile devices based on the Android system. It can be downloaded from the www.sonel.pl/en website or by scanning the QR code placed above.

Standard accessories of the meter:

Test leads set for CMM (CAT IV, M)	WAPRZCMM2
Temperature probe (type K, metal)	WASONTEMK2
Type K temperature probe adapter	WAADATEMK
Battery charger for CMM-60	WAZASZ21
Charging adapter for CMM-60	WAADALAD1
CMM-RR radio receiver for CMM-60	WAADACMRRR
Li-Poly battery 7.4 V, 2.4 Ah for CMM-60	WAAKU25
2x socket protective plug	
Sonel CMM-60 Multimeter Software	
Calibration certificate	

Resistance measurement

Display range	Resolution	Accuracy
50.000 Ω	0.001 Ω	±(0.5% m.v. + 20 digits)
500.00 Ω	0.01 kΩ	
5.0000 kΩ	0.0001 kΩ	±(0.05% m.v. + 10 digits)
50.000 kΩ	0.001 kΩ	
500.00 kΩ	0.01 kΩ	±(0.1% m.v. + 10 digits)
5.0000 MΩ	0.0001 MΩ	
50.000 MΩ	0.001 MΩ	±(2% m.v. + 20 digits)

Capacitance measurement

Display range	Resolution	Accuracy
5.000 nF	0.001 nF	±(2% m.v. + 40 digits)
50.00 nF	0.01 nF	
500.0 nF	0.1 nF	
5.000 µF	0.001 µF	±(5% m.v. + 40 digits)
50.00 µF	0.01 µF	
500.0 µF	0.1 µF	
10.00 mF	1 mF	

Electronic frequency measurement

Display range	Resolution	Accuracy
50.000 Hz	0.001 Hz	±(0.01% m.v. + 10 digits)
500.00 Hz	0.01 Hz	
5.0000 kHz	0.0001 kHz	
50.000 kHz	0.001 kHz	
500.00 kHz	0.01 kHz	
5.0000 MHz	0.0001 MHz	
10.000 MHz	0.001 MHz	

Other technical specifications

- » display backlit LCD with bargraph
- » power supply Li-Pol 7.2 V rechargeable battery
- » indication of range overflow "OL" symbol
- » crest factor ≤ 3 for full 500 V range
- » continuity test decreasing linearly to ≤ 1.5 at 1000 V
- » diode test I < 0.35 mA, sound signal for R < 25 Ω
- » sampling rate I=0.9 mA, U₀=3.2 V DC
- » input impedance 20 Hz
- » auto-off timeout >10 MΩ (V DC), >9 MΩ (V AC)
- » fuses 15 min
- » operating temperature range mA, µA range: 0.8 A/1000 V fast-acting ceramic
- » storage temperature A range: 10 A/1000 V fast-acting ceramic
- » dimensions +5...+40°C
- » weight -20...+60°C
- » measurement category 220 x 97 x 58 mm
- » compliance with standards 342 g
- » CAT III 1000 V (CAT IV 600 V)
- » EN 61010-1, EN 61010-2-032

Industrial multimeter

SONEL CMM-40

index: WMXXCMM40

- CAT III**
- 1000 V**
- CAT IV**
- 600 V**
- IP67**



Measurements

- » 12 measuring functions
- » AC & DC voltage
- » AC & DC current
- » resistance
- » capacitance
- » temperature
- » duty cycle
- » frequency
- » current loop 4-20 mA%
- » diode test and continuity

Additional functions

- » the **AC + DC function** allows you to simultaneously display the value of the constant and variable component or the sum of both components during voltage measurement
- » **True RMS for AC voltage and current** allows to measure the effective value of distorted waveforms
- » the **4~20 mA function** used for, among others, measurement of the control circuits of temperature, pressure, pH or flow sensors
- » displaying **PEAK** values
- » the **relative REL measurement function**
- » dual display to show several results at the same time
- » built-in memory for 2000 measurements
- » registration of maximum and minimum values
- » **automatic and manual range selection**
- » HOLD function
- » auto power-off thanks to **Auto-OFF function** after selecting of a specific idle period
- » extremely hermetic (**IP67**) and reinforced, shock-protected housing **covered with elastomer**

Direct and alternating (TRUE RMS) voltage measurement

Display range	Resolution	Accuracy (DC)	Accuracy (AC)
400.00 mV	0.01 mV		±(1% m.v. + 40 digits)
4.0000 V	0.0001 V	±(0.06% m.v. + 4 digits)	
40.000 V	0.001 V		
400.00 V	0.01 V		±(1% m.v. + 30 digits)
1000.0 V	0.1 V		±(0.1% m.v. + 5 digits)

frequency range 50...1000Hz.

Direct and alternating (TRUE RMS) current measurement

Display range	Resolution	Accuracy (DC)	Accuracy (AC)
400.00 µA	0.01 µA		
4000.0 µA	0.1 µA	±(1.0% m.v. + 3 digits)	±(1.5% m.v. + 30 digits)
40.000 mA	0.001 mA		
400.00 mA	0.01 mA		
10.000 A	0.001 A		
20 A		maximum 30 seconds with reduced accuracy.	

Standard accessories of the meter:

Test leads set for CMM (CAT IV, M)	WAPRZCMM2
Temperature measurement probe (type K)	WASONTEMK2
Type K temperature probe adapter	WAADATEMK
2x socket protective plug	
Carrying case	
9 V battery	
Calibration certificate	

Resistance measurement

Display range	Resolution	Accuracy
400.00 Ω	0.01 Ω	±(0.3% m.v. + 9 digits)
4.0000 kΩ	0.0001 kΩ	
40.000 kΩ	0.001 kΩ	±(0.3% m.v. + 4 digits)
400.00 kΩ	0.01 kΩ	
4.0000 MΩ	0.0001 MΩ	±(2.0% m.v. + 10 digits)
40.000 MΩ	0.001 MΩ	

Capacitance measurement

Display range	Resolution	Accuracy
40.000 nF	0.001 nF	±(3.5% m.v. + 40 digits)
400.00 nF	0.01 nF	
4.0000 µF	0.0001 µF	±(3.5% m.v. + 10 digits)
40.000 µF	0.001 µF	
400.00 µF	0.01 µF	±(5.0% m.v. + 10 digits)
4000.0 µF	0.1 µF	
40.000 mF	0.001 mF	

Electronic frequency measurement

Display range	Resolution	Accuracy
40.000 Hz	0.001 Hz	±(0.1% m.v. + 1 digit)
400.00 Hz	0.01 Hz	
4.0000 kHz	0.0001 kHz	
40.000 kHz	0.001 kHz	
400.00 kHz	0.01 kHz	
4.0000 MHz	0.0001 MHz	
40.000 MHz	0.001 MHz	
100.00 MHz	0.01 MHz	

Other technical specifications:

- » display LCD with bar graph, 4% digits (max. 40,000)
- » power supply of the meter 9 V battery, type 6LR61
- » indication of range overflow "OL" symbol
- » crest factor ≤ 3 for full 500 V range
..... decreasing linearly to ≤ 1.5 at 1000 V
- » continuity test I < 0.35 mA, sound signal for R < 35 Ω
- » diode test I=0.9 mA, U₀=2.8 V DC
- » sampling rate 2 Hz
- » input impedance >10 MΩ (V DC), >9 MΩ (V AC)
- » auto-off timeout 15 min
- » fuses mA, µA range: 0.5 A / 1000 V fast-acting ceramic
..... A range: 10 A / 1000 V fast-acting ceramic
- » operating temperature range 0...+40°C
- » storage temperature -20...+60°C
- » dimensions 187 x 81 x 55 mm
- » weight 342 g
- » measurement category CAT III 1000 V (CAT IV 600 V)
- » type of insulation double, as per EN 61010-1, EN 61010-2-032



SONEL CMM-11

index: WMXXCMM11



- CAT III**
- 600 V**
- IP65**
- BUILT IN FLASHLIGHT**
- BLUETOOTH**

Measurements

- » 10 measuring functions
- » AC & DC voltage
- » AC & DC current
- » resistance
- » capacitance
- » duty cycle
- » frequency
- » diode and continuity test

Additional functions

- » True RMS for AC voltage and current allows to measure the effective value of distorted waveforms
- » function MAX MIN for displaying extreme values
- » automatic and manual range selection
- » HOLD function
- » built-in Bluetooth module for sending data to mobile devices with Android system
- » built-in flashlight for illuminating dark measurement places
- » Auto-OFF function
- » hermetic (IP65) and reinforced housing resistant to shocks, covered with elastomer

Direct and alternating (TRUE RMS) voltage measurement

Display range	Resolution	Accuracy (DC)	Accuracy (AC)
400.0 mV	0.1 mV	±(1.0% m.v. + 8 digits)	-
4.000 V	0.001 V	±(1.0% m.v. + 3 digits)	±(1.0% m.v. + 5 digits)
40.00 V	0.01 V		
400.0 V	0.1 V		
600 V	1 V	±(1.2% m.v. + 3 digits)	±(1.2% m.v. + 5 digits)

- » input impedance: 10 MΩ
- » frequency range: 50...60 Hz

Direct and alternating (TRUE RMS) current measurement

Display range	Resolution	Accuracy (DC)	Accuracy (AC)
400.0 μA	0.1 μA	±(1.0% m.v. + 3 digits)	±(2.0% m.v. + 5 digits)
4000 μA	1 μA	±(1.5% m.v. + 3 digits)	±(2.5% m.v. + 5 digits)
40.00 mA	0.01 mA		
400.0 mA	0.1 mA		
10.00 A	0.01 A	±(2.5% m.v. + 5 digits)	±(3.0% m.v. + 7 digits)

SONEL MULTIMETER MOBILE



Sonel Multimeter Mobile application is intended for transferring and storing measurement results in the memory of mobile devices based on the Android system. It can be downloaded from the www.sonel.pl/en website or by scanning the QR code placed above.

Standard accessories of the meter:

Set of test leads for CMM meter (CAT IV, S)	WAPRZCMM1
2x battery AAA 1.5 V	
Calibration certificate	

Resistance measurement

Display range	Resolution	Accuracy
400.0 Ω	0.1 Ω	±(1.0% m.v. + 4 digits)
4.000 kΩ	0.001 kΩ	
40.00 kΩ	0.01 kΩ	
400.0 kΩ	0.1 kΩ	±(1.5% m.v. + 5 digits)
4.000 MΩ	0.001 MΩ	
40.00 MΩ	0.01 MΩ	

Capacitance measurement

Display range	Resolution	Accuracy
40.00 nF	0.01 nF	±(5.0% m.v. + 35 digits)
400.0 nF	0.1 nF	
4.000 μF	0.001 μF	±(3.0% m.v. + 5 digits)
40.00 μF	0.01 μF	
400.0 μF	0.1 μF	±(4.0% m.v. + 5 digits)
4000 μF	1 μF	

Electronic frequency measurement

Display range	Resolution	Accuracy
9.999 Hz	0.001 Hz	±(1.0% m.v. + 5 digits)
99.99 Hz	0.01 Hz	
999.9 Hz	0.1 Hz	
9.999 kHz	0.001 kHz	
99.99 kHz	0.01 kHz	

Duty cycle measurement

Display range	Resolution	Accuracy
0.1...99.9%	0.1%	±(1.2% m.v. + 2 digits)

Other technical specifications:

- » display 4 digit with backlit, 9999 counts with function indicators
- » power supply 2 x AAA 1.5 V battery or 2 x AAA NiMH 1.2 V rechargeable battery
- » indication of range overflow "OL" symbol
- » continuity test I < 0.5 mA, sound signal for R < 50 Ω
- » diode test I=0.3 mA, U₀<3.3 V DC
- » sampling rate 2 Hz
- » input impedance 10 MΩ (V AC/DC)
- » auto-off timeout 15 minutes
- » fuses mA, μA range: 0.5 A/600 V fast-acting A range: 10 A/600 V fast-acting
- » operating temperature range +5...+40°C at humidity <80%
- » storage temperature -20...+60°C at humidity <80%
- » dimensions 121 x 67 x 45 mm
- » weight 204 g
- » measurement category CAT III 600 V
- » compliance with standards EN 61010-1 EN 61010-2-031, EN 61010-2-033 EN 61326-1, EN 61326-2-2

SONEL CMM-10

index: WMXXCMM10



CAT II
600 V
IP40

Measurements

- » 11 measuring functions
- » AC & DC voltage
- » AC & DC current
- » resistance
- » capacitance
- » temperature
- » duty cycle
- » frequency
- » diode and continuity test

Additional functions

- » automatic and manual range selection
- » freezing the measurement result thanks to HOLD function
- » REL function enabling performance of relative measurement
- » auto-OFF function
- » resistant to impacts strengthened housing, covered with elastomer

Direct and alternating voltage measurement

Display range	Resolution	Accuracy (DC)	Accuracy (AC)
400.0 mV	0.1 mV	±(0.5% m.v. + 2 digits)	±(1.5% m.v. + 70 digits)
4.000 V	0.001 V	±(1.2% m.v. + 3 digits)	±(1.2% m.v. + 3 digits)
40.00 V	0.01 V		±(1.5% m.v. + 3 digits)
400.0 V	0.1 V	±(1.5% m.v. + 2 digits)	±(1.5% m.v. + 3 digits)
600 V	1 V		±(2.0% m.v. + 4 digits)

- » input impedance: 7.8 MΩ
- » frequency range: 50...400 Hz

Direct and alternating current measurement

Display range	Resolution	Accuracy (DC)	Accuracy (AC)
400.0 μA	0.1 μA	±(1.0% m.v. + 3 digits)	±(1.5% m.v. + 30 digits)
4000 μA	1 μA	±(1.5% m.v. + 3 digits)	±(1.8% m.v. + 5 digits)
40.00 mA	0.01 mA		±(1.5% m.v. + 3 digits)
400.0 mA	0.1 mA	±(1.5% m.v. + 2 digits)	±(3.0% m.v. + 7 digits)
4.000 A	0.001 A		±(1.5% m.v. + 2 digits)
10.00 A	0.01 A		

Standard accessories of the meter:

Test lead with probe for CMM/CMP (set)	WAPRZCMP1
Temperature measurement probe (type K)	WASONTEMK
Type K temperature probe adapter	WAADATEMK
9 V battery	

Resistance measurement

Display range	Resolution	Accuracy
400.0 Ω	0.1 Ω	±(1.2% m.v. + 4 digits)
4.000 kΩ	0.001 kΩ	±(1.0% m.v. + 2 digits)
40.00 kΩ	0.01 kΩ	
400.0 kΩ	0.1 kΩ	±(1.2% m.v. + 2 digits)
4.000 MΩ	0.001 MΩ	
40.00 MΩ	0.01 MΩ	±(2.0% m.v. + 3 digits)

Capacitance measurement

Display range	Resolution	Accuracy
40.00 nF	0.01 nF	±(5.0% m.v. + 7 digits)
400.0 nF	0.1 nF	±(3.0% m.v. + 5 digits)
4.000 μF	0.001 μF	
40.00 μF	0.01 μF	±(5.0% m.v. + 5 digits)
100.0 μF	0.1 μF	

Electronic frequency measurement

Display range	Resolution	Accuracy
5.000 Hz	0.001 Hz	±(1.5% m.v. + 5 digits)
50.00 Hz	0.01 Hz	
500.0 Hz	0.1 Hz	±(1.2% m.v. + 3 digits)
5.000 kHz	0.001 kHz	
50.00 kHz	0.01 kHz	
500.0 kHz	0.1 kHz	
5.000 MHz	0.001 MHz	±(1.5% m.v. + 4 digits)
10.00 MHz	0.01 MHz	

sensitivity: minimum effective voltage value 8 V.

Duty cycle measurement

Display range	Resolution	Accuracy
0.1...99.9%	0.1%	±(1.2% m.v. + 2 digits)

Other technical specifications:

- » display LCD, 5000 reading with function indicators
- » power supply of the meter 9 V battery, type 6LR61
- » indication of range overflow "OL" symbol
- » continuity test <0.3 mA, sound signal for R<50 Ω
- » diode test I=0.3mA, U0=1.5 V DC
- » sampling rate 2 Hz
- » input impedance 7.8 MΩ (V AC/DC)
- » auto-off timeout 30 minutes
- » fuses mA, μA range: 0.5 A/1000 V fast-acting
..... range: 10 A/1000 V fast-acting
- » operating temperature 0...+50°C at humidity <70%
- » storage temperature -20...+60°C at humidity <80%
- » dimensions 138 x 68 x 37 mm
- » weight 210 g
- » measurement category CAT II 600 V
- » compliance with standards EN 61010-1, EN 61010-2-032



Comparison of multimeters



CMM-60
High-end industrial meter



CMM-40
Industrial area meter



CMM-11
Compact meter for general purpose



CMM-10
Pocket meter for basic measurements

Measurement functions				
AC/DC voltage	1000.0 V	1000.0 V	600 V	600 V
AC/DC current	10.000 A	10.000 A	10.00 A	10.00 A
Resistance	50.000 MΩ	40.000 MΩ	40.00 MΩ	40.00 MΩ
Frequency	10.000 MHz	100.00 MHz	100.0 kHz	10.00 MHz
Capacitance	10.00 mF	40.000 mF	4000 μF	100.0 μF
Temperature	1000.0°C	1200.0°C	-	760°C
dB	✓	-	-	-
Duty cycle (%)/ impulse width (ms)	✓/✓	✓/-	✓/-	✓/-
Continuity / diode test	✓/✓	✓/✓	✓/✓	✓/✓
4-20 mA% current loop measurement	✓	✓	-	-
Low-pass filter	✓	-	-	-
Basic features				
Display	50.000	40.000	4.000	4.000
True RMS measurement	✓	✓	✓	-
automatic / manual range selection	✓/✓	✓/✓	✓/✓	✓/✓
Advanced features				
MAX / MIN / AVG measurement	✓/✓/✓	✓/✓/✓	✓/✓/✓	-/-/-
HOLD	✓	✓	✓	✓
PEAK HOLD	✓	✓	-	-
Crest factor	✓	-	-	-
AC + DC	✓	✓	-	-
Relative measurement	✓	✓	-	✓
Recorder	✓	✓	-	-
Trend capture function	✓	-	-	-
Memory	✓	✓	in mobile application	-
Bluetooth	✓	-	✓	-
Sone! Multimeter Mobile	✓	-	✓	-
Other features				
Clock	✓	-	-	-
Easy access to fuses A / mA	-/✓	-/-	✓/✓	✓/✓
Automatic shutdown	✓	✓	✓	✓
Battery indicator	✓	✓	✓	✓
Built-in flashlight	-	-	✓	-
Beeper	✓	✓	✓	✓
Display				
TFT color	✓	-	-	-
Segmented	-	✓	✓	✓
Backlit	✓	✓	✓	✓
Safety and conditions of use				
Measurement category (EN 61010)	CAT IV 600 V CAT III 1000 V	CAT IV 600 V CAT III 1000 V	CAT III 600 V	CAT II 600 V
Ingress protection	IP67	IP67	IP65	IP40
Operating temperature	5...40°C	0...40°C	5...40°C	0...50°C

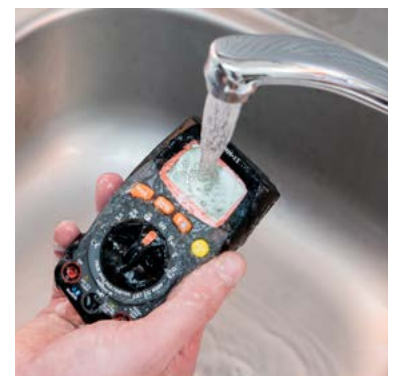
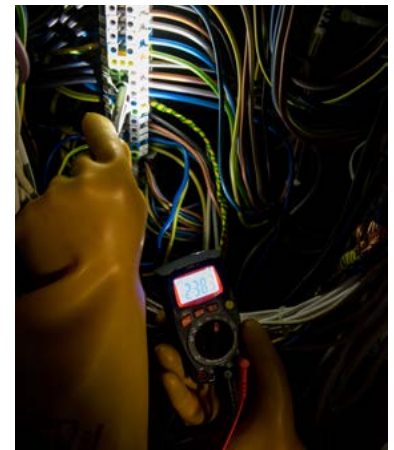
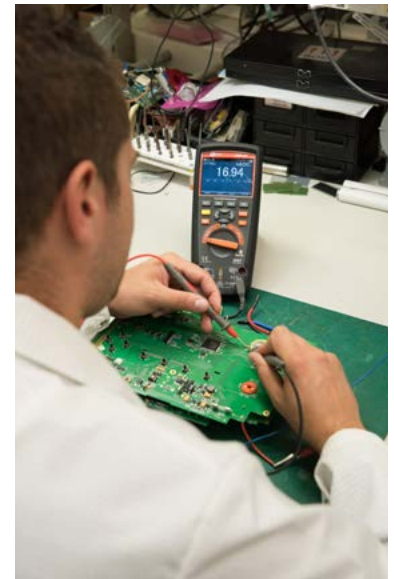

SONEL MULTIMETER MOBILE



Sone! Multimeter Mobile application is intended for transferring and storing measurement results in the memory of mobile devices based on the Android system. Currently the application supports **CMM-60** and **CMM-11** multimeters. It can be downloaded from the www.sone!.pl/en website or by scanning the QR code placed above.

The application enables:

- » reading the multimeter's measurement results in live mode, thanks to Bluetooth wireless data transfer,
- » saving results as a project and complete it with notes and photos from measurement places,
- » reading saved results in two forms: list with date and hour of the measurement, as well as in form of a chart for easier analysis of changes and distortions.

Additional application features i.a.:

- » setting sampling rate and duration of the measurement,
- » setting upper and lower limit with acoustic signal in case of exceeding the set limits,
- » controlling measurement subfunctions, i.e. MAX/MIN, REL or RANGE,
- » fast access to the instrument's website,
- » sending data via e-mail,
- » possibility of saving data to .csv file.

CMP / CMM

Set of standard and optional accessories

1, 2, 4 - number of basic accessories
 * - optional accessories

Photo	Name	Index	CMM-60	CMM-40	CMM-11	CMM-10	CMP-2000	CMP-1006	CMP-401/400	CMP-200
	AC-16 line splitter	WAADAAC16					*	*	*	*
	M3 carrying case	WAFUTM3					*	*		
	M5 carrying case	WAFUTM5		*						
	M10 carrying case	WAFUTM10	*							
	S1 carrying case	WAFUTS1				*	*	*	*	
	Test lead with probe for CMM/CMP (set)	WAPRZCMP1				1	1	1	1	
	Test leads set for CMM (CAT IV, S)	WAPRZCMM1			1					
	Test leads set for CMM (CAT IV, M)	WAPRZCMM2	1	1		*				
	Type K temperature probe adapter	WAADATEMK	1	1		1	1	1	1	
	Temperature probe (type K)	WASONTEMK		1		1	1	1	1	
	Temperature probe (type K, metal)	WASONTEMK2	1	*		*	*	*	*	
	Temperature probe (type K, bayonet)	WASONTEMP	*	*		*	*	*	*	
	M1 hanging hook straps	WAPOZUCH1	*							
	Battery charger for CMM-60	WAZASZ21	1							
	Charging adapter for CMM-60	WAADALAD1	1							
	CMM-RR radio receiver for CMM-60	WAADACMMRR	1							
	Li-Pol battery 7.4 V, 2.4 Ah for CMM-60	WAAKU25	1							



Line splitter

SONEL AC-16

index: WAADAAC16

- » ratio x1, x10
- » voltage, maximum current: 230 V AC
- » 16 A max

THE ADAPTER CAN BE APPLIED WITH ANY TYPE OF CLAMP METER.



Non-contact AC voltage detector

SONEL VT-2

index: WMXXVT2

CAT III
1000 V

- » signaling: light and sound
- » voltage range: 90~1000 V AC (50/60 Hz)
- » measurement category: III 1000 V
- » power supply: 2x 1.5 V (LR03) batteries



Two-pole voltage testers

SONEL P-6 / P-5 / P-4

index: WMXXP6 / WMXXP5 / WMXXP4



Product description

SoneI P-6, P-5 and P-4 are reliable, particularly durable and safe 2-pole multi-purpose testers, which enable testing voltage, circuit continuity and phase sequence. They have been designed for use in extreme conditions both in industry and commercial applications. Advanced technology, a high level of safety and user-friendliness are the key features of the P-line voltage testers.

Main functions and attributes of the P-line instruments

- » phase identification (P-6) - unique feature in voltage indicators worldwide
- » automatic voltage test up to 1000 V AC/DC
- » optical indication by a LED bar (P-4) and additional LCD display (P-6, P-5)
- » sound indication when dangerous voltage levels of 50 V AC and 120 V DC are exceeded
- » RCD trip test with switchable load
- » automatic continuity test upon connection to the loadpoint
- » 2-pole test of phase rotation direction
- » single-pole indication of 100 V presence
- » resistance measurement up to 1999 Ω (P-6, P-5)
- » HOLD function for freezing the measurement results
- » robust, two-component housing protecting from mechanical damages and impacts
- » integrated torch light and backlit display (P-6, P-5) for tests in poorly lit areas
- » IP65 ingress protection guarantees protection against dust and water
- » safety provided by measuring class compliant with CAT IV 600 V and CAT III 1000 V

Technical specifications:

» measurement category acc. to EN 61010-1 III 1000 V / IV 600 V
» protection class acc. to EN 60529 IP65
» insulation type acc. to EN 61010-1 double-insulation, class II
» instrument power supply 2 x LR03 AAA 1.5 V (recommended alkaline cells)
» operating frequency range 16...400 Hz
» min. recovery time after operating for 30 s 240 s
» continuity test: light and sound signal for R ≤ 400 kΩ
» range of resistance measurement (P-6, P-5) 1...1999 Ω
» input impedance approx. 300 kΩ
» range for 2-pole indication of phase order: voltage 100...1000 V
» minimum activation voltage ±6 V AC/DC
» operating / storage temperature -15...+55°C / -20...+70°C
» max. humidity 95%
» max. operating altitude 2000 m
» auto-off time 10 s / 30 s (HOLD mode)
» display LCD, 3½ digits, 1999 read-out with function indicators
» dimensions 275 x 82 x 36 mm
» weight incl. batteries / excl. batteries 291 g / 267 g
» electromagnetic compatibility in accordance with standards EN 61326-1, EN 61326-2-2
» conformance with the requirements of standards EN 61010-1, EN 61243-3
» quality standard ISO 9001



Residual-current device trip testing

In response to the needs of clients, our new P-line voltage testers allow to check the RCD in a fully controllable way. With buttons on both probes, the user can reduce the internal impedance of the instrument, which makes it possible to trip the RCD. Additionally, pressing both buttons activates an additional loadpoint - a vibration motor. In this way, voltage can be measured in a tested circuit with no impact of stray currents on the result.



Durability and comfort of use

The housing has been designed for use in harsh industrial environments, where the application of personal protection equipment, such as voltage insulation safety gloves, is required. At the same time, the instrument's ergonomic shape allows for one hand use.



Versatility and safety

Voltage testers are provided with a set of test probes. The probes reduce metal exposure to 4 mm length, which eliminates the risk of accidental contact with the wrong conductor when performing measurements on a wire harness. Additional screw-on metal adapters are used for applications where tips with 4 mm diameter are required. It is particularly important for tests in electrical sockets, where the user must be sure that contact between the probe and the conductor is kept. All elements of the set are stored in a special case so the probe tips can be replaced when needed. The case also includes an adapter that is helpful for unlocking the UK-type sockets.

Parameter	P-6	P-5	P-4
measurement category	CAT III 1000 V / IV 600 V		
range of voltage	6.0 ... 1000 V AC/DC		12 ... ≥690 V AC/DC
LED bar	7 segments		
backlit LCD display	✓	✓	-
continuity test	✓	✓	✓
10 mA / 30 mA RCD trip test	✓	✓	✓
built-in torch light	✓	✓	✓
single-pole phase tester	✓	✓	✓
2-pole phase rotation tester	✓	✓	✓
IP65 protection class	✓	✓	✓
resistance test	✓	✓	-
freeze display	✓	✓	-
phase identification	✓	-	-

Phase sequence testers

SONEL TKF-13 / TKF-12

index: WMGBTKF13 / WMGBTKF12



CAT III

600 V

CAT IV

300 V

IP42

Standard equipment:

Crocodile clip, black, 1 kV, 20 A	WAKROBL20K01
Test lead 1,2 m, black, 1 kV (banana plugs)	WAPRZ1X2BLBB
Test lead 1,2 m, red, 1 kV (banana plugs)	WAPRZ1X2REBB
Test lead 1,2 m, yellow, 1 kV (banana plugs)	WAPRZ1X2YEBB
Pin probe, black 1 kV (banana socket)	WASONBLOGB1
Pin probe, red 1 kV (banana socket)	WASONREOGB1
Pin probe, yellow 1 kV (banana socket)	WASONYEGB1

Additional equipment:

AGT-16C three-phase socket adapter 16 A (PEN)	WAADAAGT16C
AGT-16P three-phase socket adapter 16 A	WAADAAGT16P
AGT-32C three-phase socket adapter 32 A (PEN)	WAADAAGT32C
AGT-32P three-phase socket adapter 32 A	WAADAAGT32P
AGT-63P three-phase socket adapter 63 A	WAADAAGT63P
S3 carrying case	WAFUTS3
Crocodile clip, red, 1 kV, 20 A	WAKRORE20K02
Crocodile clip, yellow, 1 kV, 20 A	WAKROYE20K02

TKF-13:

- » indication of phase sequence (field rotation direction) in networks with nominal phase-to-phase voltages 120...690 V AC by means of LEDs,
- » operation in networks with frequency 2...70 Hz,
- » indication of the presence of voltages in individual phases by means of neon lamps,
- » indication of the direction of motor revolutions:
 - in voltage-free state with the use of test leads,
 - without contact, while the motor is running,
- » magnetic field detection,
- » automatic power off of meter when not in use.

TKF-12:

- » indication of phase sequence (field rotation direction) in networks with nominal phase-to-phase voltages 120...690 V AC by means of LEDs,
- » operation in networks with frequency 10...70 Hz,
- » indication of the presence of voltages in individual phases by means of neon lamps,
- » power supply from tested network (continuous operation up to 15 minutes at max. voltage),
- » protection against incorrect reading of field rotation direction (reading only when connected to three different phases).

The instrument meets the requirements set forth in the standards:

- » EN 61010-1 (general and particular requirements related to safety)
- » EN 61010-031 (general and particular requirements related to safety)
- » EN 61326 (electromagnetic compatibility)
- » EN 61557 (requirements for measurement instruments)
- » HD 60364-6 (performance of measurements - checking)
- » HD 60364-4-41 (performance of measurements - shock protection)
- » EN 04700 (performance of measurements - commissioning tests)

Parameter	TKF-13	TKF-12
	Professional model with motor testing	Basic model for rotation field measurement
Other technical specifications		
type of insulation	double, as per EN 61010-1	
power supply	6LR61 (9 V) alkaline battery	from tested network, up to 15 min. for max. voltage
dimensions (with holster and without leads)	130 mm x 72 mm x 31 mm	
weight without leads	150 g	200 g
battery charge diode flash period	ok. 1 s	–
idle time until automatic power off	ok. 5 min	–
Nominal operating conditions		
range of operating phase-to-phase voltages	120...690 V AC	
maximum operating phase-to-phase voltage	760 V AC	
range of motor EMF voltages	1...760 V AC	–
frequency range	2...70 Hz	10...70 Hz
operating temperature range	-10...+45°C	
storage temperature	-20...+60°C	
operating humidity	20...80%	



TKF-13 makes it possible to determine the direction of motor rotation, in both no-voltage state and without contact while the motor is running.



Ultrasonic leak and electrical discharge detector

SONEL TUD-1 / GUD-1 / TG-1

index: WMXXTUD1 / WMXXGUD1 / WMXXTG1



Features

- » Identification of acoustic-wave defects in the range of ultrasounds (40±1) kHz
- » Stepless adjustment of gain
- » Easy and clear interpretation of results visually on the LED scale and acoustically via earphones
- » Additional probes selected for different methods of analyzing the leakage spot

Description of the product

Sone! TUD-1 is a compact, portable device that receives ultrasonic waves and transforms them into acoustic waves in a range that is audible for the human ear.

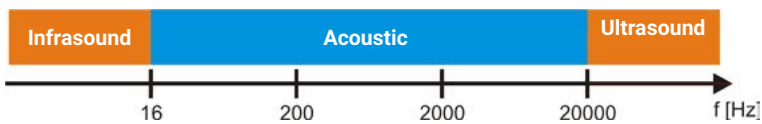

Additionally, the unit strengthens the waves and presents the signals via the LED scale and via sounds in the earphone set.

Sone! TUD-1 is a professional, portable device that allows:

- » sources of electrical discharge that can be located on such elements as power grid lines, insulators, generators, transformers,
- » searching for leaks in pneumatic and hydraulic systems
- » leak checks on systems that supply water and gas, such as pipelines, taps, valves, hydraulic components, pumps, compressors,
- » diagnostics of the condition of mechanical components, including bearings, gears, drive shafts, pumps, compressors, generators.

Other technical specifications:

- » centre frequency of the detection range (40±1) kHz
- » dynamic range ≥60 dB
- » power consumption ≤0.35 W
- » power supply 9 V battery (6LR61 / MN1604)
- » time of continuous operations ≥20 h
- » weight with battery installed ≤0.22 kg
- » dimensions 190 x 60 x 70 mm
- » relative operating humidity 80% at +20°C
- » operating temperature -20°C...+45°C
- » maximum operating altitude 2000 m
- » storage temperature -20...+60°C
- » max. relative humidity of storage 80% at temp. up to 31°C
..... linearly decreasing to 50% with temp. increasing to 40°C

Standard accessories

Type 1 ultrasonic probe	
Type 2 ultrasonic probe	
Type 3 ultrasonic probe	
Headphones	
Probe socket plug	
M6 carrying case	WAFUTM6
9 V battery (6LR61 / MN1604)	
User manual	



SONEL MPU-1

index: WMGBMPU1



IP67

Features:

MPU-1 is intended for monitoring (measurement) of leakage current in power networks of alternating current, low and medium voltage, and serves for performing measurements whose results determine the safety status of the monitored system from the perspective of flowing leakage current. The instrument enables setting of the safe threshold value of flowing leakage current, above which a visual and sound alarm is activated.

The most important features of the MPU-1 instrument include:

- » continuous monitoring of alternating current flowing through earthing,
- » measurement on one or two clamps simultaneously, in the case of measurement using two clamps, the current value is summed, and this provides the capability of measuring spun poles with independent clamps for each component pole,
- » diode indicator of operating mode,
- » alarm in the event of flow of current higher than the alarm threshold (factory setting 1 A), sound and visual alarm (speaker built into the housing),
- » measurement with flexible Sonel F-series clamps (Rogowski coil) with a max. length of 2 m,
- » measurements in low- and medium-voltage networks with frequency of 50 Hz or 60 Hz,
- » automatic selection of measuring range,
- » monitoring of battery level,
- » ergonomic operation.

Measurement of leakage currents flowing through clamp:

Display range	Resolution	Accuracy
0.1...9.9 A	0.01 A	±(5% m.v. + 2 digits)
10...299 A	0.1 A	

- » frequency range: 50 Hz or 60 Hz
- » flexible current clamp – F-1



Operation in medium-voltage mode - the display reads the value of the set alarm threshold and indicates the battery charge status.

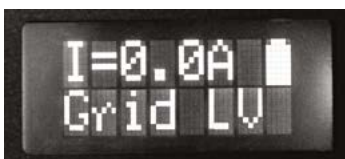

Operation in low-voltage mode - the display reads the value of the measured current flowing through the clamp and indicates the battery charge state.

Standard equipment:

Straps for mounting on the pole for PQM (set)	WAPOZOPAKPL
Mains cable with IEC C7 plug	WAPRZLAD230
L5 carrying case for MPU-1	WAWALL5
Power supply adaptor Z11	WAZASZ11
Calibration certificate	

Additional equipment:

F-1A flexible clamps (Φ=360 mm)	WACEGF1AOKR
F-2A flexible clamps (Φ=235 mm)	WACEGF2AOKR
F-3A flexible clamps (Φ=120 mm)	WACEGF3AOKR
F-4 flexible clamps (Φ=630 mm)	WACEGF4OKR
Cable for battery charging from car cigarette lighter socket (12 V)	WAPRZLAD12V2



The standard kit includes a transport briefcase for the signaler, standard and additional accessories.

Technical data:

- » housing protection rating according to EN 60529 IP67
- » instrument power supply rechargeable battery pack
SONEL NiMH 9.4V 2.1 Ah
- » parameters of battery charger power adapter 100 V...240 V,
50 Hz...60 Hz
- » operating time for standby mode >18 h
- » operating time for alarm mode 3 h
- » alarm threshold setting range 0.5A...9.9 A
- » dimensions 125 x 150 x 95 mm
- » weight of instrument with rechargeable batteries approx. 1.1 kg
- » operating temperature range -10...+50°C
- » charger operating temperature range +10...+35°C
- » reference temperature 23 ± 2°C
- » storage temperature -20...+80°C
- » relative humidity 20...90%
- » nominal relative humidity 40...60%
- » elevation above sea level <2000 m
- » quality standard
..... development, design and production in compliance with ISO 9001
- » this product meets EMC requirements in compliance with standards
EN 613261 and EN 61326-2-2



Demonstration board

SONEL DB-1

index: WMGBDB1



The DB-1 board makes it possible to demonstrate the method of performing the following tests:

- » fault loop impedance for assessment of the automatic power cutoff condition,
- » RCD parameters,
- » earthing resistance,
- » soil resistivity,
- » continuity test of equipotential bonding,
- » insulation resistance,
- » power network voltage.

It is possible to simulate typical failures and irregularities in the electrical network.

Technical specifications of DB-1 board and features of individual functions:

- » Fault loop impedance:
 - measurement of L-N short-circuit with impulse currents up to 25 A and 60 ms,
 - measurement of L-PE earth fault loop with impulse currents up to 20 mA.
- » RCD parameters (30 mA RCD):
 - measurement of RCD trip time,
 - measurement of RCD trip current,
 - earth resistance measurement,
 - touch voltage measurement.
- » Soil resistivity:
 - resistivity measurement for three soil types (14 Ωm; 300 Ωm; 6.2 kΩm).
- » Earthing resistance.
 - Measurement by method:
 - two-lead,
 - three-lead,
 - four-lead,
 - three-lead with clamp,
 - double clamp,
 - with the use of fault loop meter.
- » Continuity of connections:
 - measurement of equipotential bonding and connections of accessible parts.
- » Insulation resistance:
 - measurement of L-N insulation,
 - measurement of L-PE insulation,
 - measurement of N-PE insulation.
- » Voltage measurement:
 - voltage measurement in power socket.
- » Simulation of irregularities:
 - no continuity of earth conductor (R_e),
 - safe voltage exceeded during RCD measurement (U_B),
 - leakage current (I_{err}),
 - insufficient L-N insulation resistance ($R_{iso}(L-N)$),
 - insufficient L-PE insulation resistance ($R_{iso}(L-PE)$),
 - excessive fault loop impedance (Z_L),
- » 230 V network socket.

Standard accessories:

Test lead 0.7 m, black (banana plugs)	WAPRZ0X7BLBB
Mains cable with IEC C13 plug	WAPRZ1X8BLIEC
Configuration jumper (4 pcs.)	WAPOZZW1
User manual	

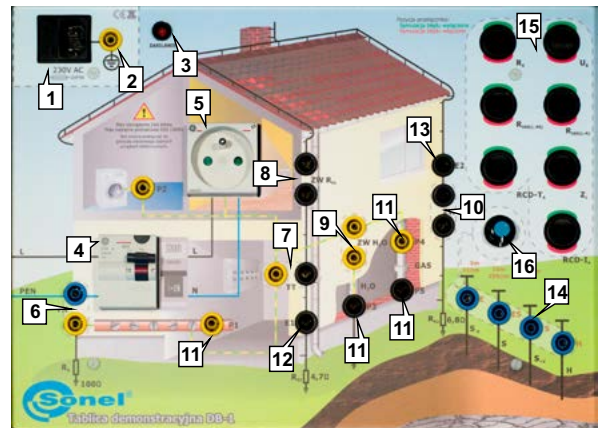

- 1) Power socket 230 V
- 2) Additional PE socket.
- 3) 230 V power indicator lamp.
- 4) Residual current device (RCD)
- 5) Measurement socket.
- 6) TN network clamp.
- 7) TT network clamp.
- 8) Socket of earth electrode R_{E1} (ZW R_{E1}).
- 9) Socket of equipotential bonding of H₂O pipe (ZW H₂O).
- 10) Socket of earth electrode R_{E2} (ZW R_{E2}).
- 11) Measurement points P1, P2, P3, P4, P5.
- 12) Measurement point of earth electrode R_{E1} (E1).
- 13) Measurement point of earth electrode R_{E2} (E2).
- 14) Measuring electrode sockets.
- 15) Irregularity selection switches.
- 16) Soil type switch for soil resistivity measurements.



The DB-1 demonstration board makes it possible to simulate various faults and irregularities in an electrical network.

Other technical specifications:

- » power supply from network 230 V
- » dimensions 405 x 300 x 140 mm
- » weight of device approx. 3.6 kg
- » quality standard development, design and production in compliance with ISO 9001
- » protection 2 x T3 14A 250 V
or 2 x F 4 A 250 V
- » power consumption approx. 15 mW
- » RCD type 30 mA type AC

Nominal operating conditions:

- » operating temperature range +10...+40°C
- » storage temperature -20...+60°C
- » humidity 20...80%

Demonstration board

SONEL DB-THERMO

index: WMGBDBTHERMO



Standard accessories:

Heating panel screening plate	WAPOZOSL3
Power cord	WAPRZ1X8BLIEC
User manual	

The DB-THERMO board is an indispensable device during any training on contactless temperature measurements and thermal imaging with the use of thermographic cameras. DB-Thermo helps to understand the phenomena related to the emissivity of different materials and the influence of surface type on temperature measurement.

The DB-THERMO set includes instructions describing all topics concerning thermal imaging.

The device is enclosed in a solid briefcase housing with a detachable cover.

DB-THERMO has a heating panel with an emissivity of 0.98 as well as plates made of various typical materials, with matte and polished surfaces. A programmable controller keeps watch over the temperature of the heating panel. The user may select a temperature from within the range of 40-60°C. The LED display reads the current panel temperature.

Main plate (110 x 110 mm) emissivity

blackened aluminum: 0.98

The DB-THERMO demonstration board has a built-in programmable controller that stands vigil over the temperature of the heating panel.

Emissivity of materials (70 x 30 mm plates):

Material	Emissivity	
	polished	matte
Copper	0.03	0.20
Aluminium	0.10	0.30
Brass	0.04	0.33
Polycarbonate	0.88	0.91
Glass	0.84	0.90
Stainless steel	0.84	0.90

Other technical specifications:

- » plate temperature regulation range from 40°C to 60°C
- » max. power consumption 250 VA
- » plate temperature reading accuracy ±1%
- » resolution of temperature readings 0.1°C
- » resolution of temperature settings 0.1°C
- » hysteresis ±3°C
- » temperature stabilization time 3 min
- » power supply from network 230 V
- » dimensions (width/length/height) 330 x 260 x 140 mm
- » weight of device approx. 3 kg
- » display LED, 4 digits (11 mm) with graphical icons
- » heating panel dimensions 275 x 110 mm

Electrical safety:

- » protection 2 x F 1 A 250 V
- » thermal protection 75°C



Standard programmable resistors

SRP-10G0-10T0 / SRP-50k0-5T0 / SRP-50k0-10G0 / SRP-50k0-100G0

index: WMXXSRP10G010T0 / WMXXSRP50K05T0 / WMXXSRP50K010G0 / WMXXSRP50K0100G0



The SRP-50k0-5T0 programmable resistor allows to set any resistance from range 50 kΩ...5 TΩ for 5 kV DC voltage.

Standard programmable resistors are a source of high resistances used as standard equipment for calibration and testing of analog and digital insulation resistance meters.

The resistance obtained thanks to these resistors can be kept for a long time under external direct voltage up to **5000 V (SRP-50k0-5T0)**, **2500 V (SRP-50k0-10G0 and SRP-50k0-100G0)**, under the condition that current in the measurement circuit does not exceed the value of 1.5 mA (3 mA for SRP-50k0-5T0) or **10 kV (SRP-10G0-10T0)**.

The required resistance is set by the user by means of the standard resistor's touch keyboard or external PC application (except SRP-10G0-10T0). Setting of the required value is automatic thanks to commutation of a precision resistance matrix. The control processor calculates the required combination of resistors providing the proper precision of the resultant resistance.

Standard accessories for SRP-10G0-10T0:

Mains cable with IEC C13 plug	WAPRZ1X8BLIEC
Test lead 1.8 m, blue, 11 kV (banana plugs)	WAPRZ1X8BUBB10K
Test lead 1.8 m, red, 11 kV (banana plugs)	WAPRZ1X8REBB10K
Test lead 2.2 m, black, 11 kV (banana plugs)	WAPRZ2X2BLBBE10K

Standard accessories for SRP-50k0-10G0 / SRP-50k0-100G0 / SRP-50k0-10G0:

Mains cable with IEC C13 plug	WAPRZ1X8BLIEC
SRP software	
Test lead 1.8 m, blue, 5 kV (banana plugs)	WAPRZ1X8BUBB
Test lead 1.8 m, red, 5 kV (banana plugs)	WAPRZ1X8REBB
Test lead 2.2 m, black, 1 kV (banana plugs)	WAPRZ2X2BLBB

Standard programmable resistors are intended for operation at ambient temperatures within the range from 10 to 30°C, relative humidity of air from 25 to 60%, and atmospheric pressure from 630 to 800 mm Hg.

Technical specifications of SRP-10G0-10T0

$U_{max} = 10\ 000\ V\ DC$

Display range	Resolution	Accuracy
10...990 GΩ	10 GΩ	1% s.v.
1.0...10.0 TΩ	0.1 TΩ	1.5% s.v.

Technical specifications of SRP-50k0-5T0

$U_{max} = 5000\ V\ DC$

Display range	Resolution	Accuracy
0.05...999.95 MΩ	0.05 MΩ	1.5% s.v.
0.001...999.999 GΩ	0.001 GΩ	
0.0001...5.0000 TΩ	0.0001 TΩ	

Technical specifications of SRP-50k0-100G0

$U_{max} = 2500\ V\ DC$

Display range	Resolution	Accuracy
50...950 kΩ	50 kΩ	0.05% s.v.
1.00...99.95 MΩ	0.05 MΩ	0.1% s.v.
100.0...999.9 MΩ	0.1 MΩ	0.5% s.v.
1.00...100.00 GΩ	0.01 GΩ	

Technical specifications of SRP-50k0-10G0

$U_{max} = 2500\ V\ DC$

Display range	Resolution	Accuracy
50...950 kΩ	50 kΩ	0.1% s.v.
1.00...99.95 MΩ	0.05 MΩ	0.2% s.v...
100.0...999.9 MΩ	0.1 MΩ	1% s.v.
1.00...10.00 GΩ	0.01 GΩ	1% s.v.

"s.v." = "set value"

Other technical specifications:

- » supply voltage U 100...240 V AC (50/60 Hz)
- » maximum power consumption 75 VA
- » operating temperature range +10...+30°C
- » maximum current in measuring circuit 3 mA
- » maximum operating voltage SRP-10G0-10T0 10 000 V DC
- SRP-50k0-5T0 5000 V DC
- SRP-50k0-100G0 2500 V DC
- SRP-50k0-10G0 2500 V DC
- » long-term resistor stability <1%
- » dimensions 540 x 450 x 200 mm
- » weight ok.15 kg
- » max. operating elevation 2000 m

SRP calibration software

The SRP application serves for inter-operation between resistance calibrators and a computer. The calibrator connects to a computer via USB port.

The application is easy to use and a useful tool in the process of testing devices by means of a calibrator.

Capabilities of the application:

- » remote calibrator control,
- » creation and saving of automatic programs for testing of equipment,
- » resistor settings include a keyboard lock and time until switching to sleep mode,
- » change of display brightness and keyboard response sounds,
- » language selection in application,
- » firmware update from computer via USB interface.
- » software upgrade from a computer via a USB interface.

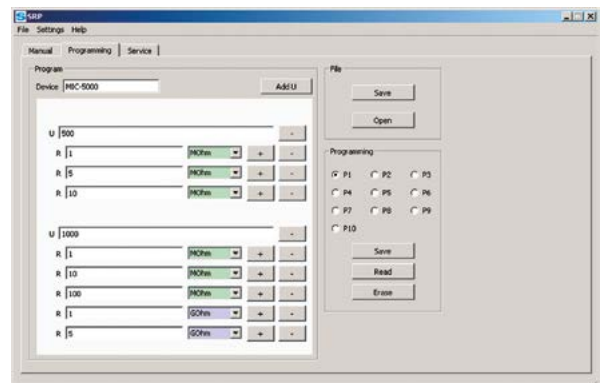
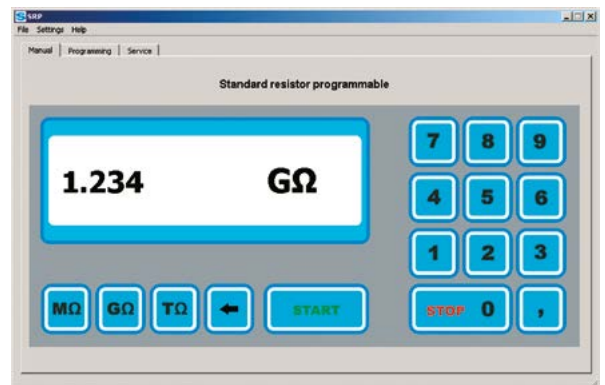

SRM resistance decade boxes

SRM-x-y/z

index: WMXXSRM



SRM series resistance decade boxes have been developed with laboratories and institutions requiring the most accurate readings in mind. **High-precision decade boxes** meet the expectations of even the most demanding customers. Applied resistors are characterized by **excellent accuracy and long-term stability**.

Descriptions on the housing clearly inform the user of the set resistance value. Test jacks make it possible to connect the instrument by means of a banana plug, spade plug and insulated lead terminations.

A **metal housing** effectively protects the instrument against mechanical damage. The housing has rubber legs that stabilize the instrument's position on the measurement table. The resistance decade box also includes the instruction manual and calibration certificate.

Functions of the instrument:

- » High accuracy, up to 0.05%
- » Ranges from 0.1 Ω to 111,111,111 Ω
- » Easy-to-read and comprehensive graphical description of the instrument
- » Functional test jacks
- » Durable and resistant design
- » Available in variants with 3, 6 and 9 sections

Comparison of simulated resistance and maximum acceptable current ranges

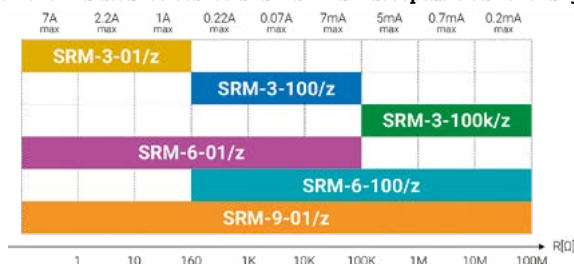

Comparison of relative errors according to measuring ranges of SRM resistance decade boxes

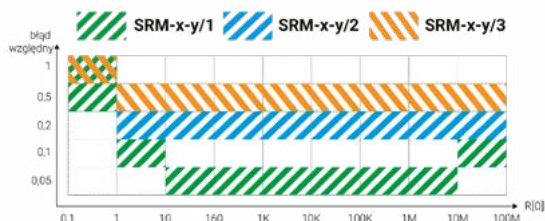

x - number of decades (3, 6 or 9)

y - minimum resistance range:

01 - (0.1 Ω; 3, 6, 9 decades)

100 - (100 Ω; 3, 6 decades)

100k - (100 kΩ; 3 decades)

z - accuracy class:

1 - high (0.05%)

2 - medium (0.2%)

3 - low (0.5%)

Technical specifications - SRM-x-y/z:

- » stability up to ±20 ppm/year
- » long-term stability up to ±25 ppm/3 years
- » temperature coefficient up to ±5 ppm/°C
- » initial resistance $R_0 \leq 0.025 \pm 0.0025 [Ω]$
- » insulation test voltage 2000 V
- » insulation resistance 10 GΩ
- » operating temperature range 10-35°C
- » relative humidity 25-80%

Dimensions:

- » SRM-3-y/z 215x147x160 mm
- » SRM-6-y/z 540x147x160 mm
- » SRM-9-y/z 472x260x160 mm

Weight:

- » SRM-3-y/z approx. 3 kg
- » SRM-6-y/z approx. 6 kg
- » SRM-9-y/z approx. 9 kg

Fault loop resistance decade box

SONEL SRM-0R1-4k1

index: WMXXSRM0R14K1



The SRM-0R1-4k1 decade uses a built-in cooling system powered from 230 V AC 50 Hz mains.

Functions of the instrument:

- » High accuracy, up to 0.05%,
- » Ranges from 0.1 Ω to 4111 Ω,
- » Easy-to-read and comprehensive descriptions of the decade,
- » Functional test jacks,
- » Durable and resistant design,
- » Built-in cooling system.

Technical specifications - SRM-0R1-4k1

- » stability up to ±50 ppm/year
- » long-term stability up to ±75 ppm/3 years
- » temperature coefficient up to ±5 ppm/°C
- » initial resistance $R_0 \leq 0.025 \pm 0.0025 [Ω]$
- » maximum operating voltage 450 V
- » insulation resistance ≥100 MΩ
- » measurement cycle time T_{meas} ≤30-40 ms
- » cooling time (pause) T_{paus} for U_{pom} up to 230 V ≥20 s,
- » for U_{pom} up to 450 V ≥25 s.
- » dimensions 500 x 340 x 170 mm
- » weight no greater than 12 kg
- » operating temperature range 10...30°C
- » relative humidity 25...60%



SMT AND THT ASSEMBLY

Our meters are manufactured based on the latest SMT and THT electronics assembly technologies. Besides manufacturing measuring instruments, we also render comprehensive surface mounting and through-hole assembly.

Designing

The creation of a new product depends on the designing process. For this purpose, we have picked a specialized team of designers, who will create the perfect solution for you needs through their determination and enormous potential.

Tester construction

In order to dispel all doubts as to the proper functioning of our electronic systems, they undergo tests individually designed by us.

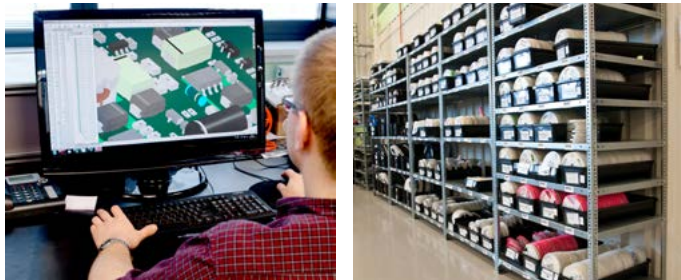

Production

We understand production to be the process of product creation. In our book, production means quality, precision, time, and above all, a perfectly filled order, in which we apply modern technology combined with a vast pool of knowledge.



Production line

SMT:

- » MPM MOMENTUM screen printer,
- » FUJI NXT automatic mounter, 6 modules,
- » ERSА HOTFLOW 2/20 reflow soldering furnace (soldering in nitrogen atmosphere with residual oxygen analyzer),
- » ASYS conveyor line,
- » DEK 265 screen printer,
- » FUJI GL2 dispenser,
- » FUJI FCP-III-4000 high speed chip placer,
- » FUJI FIP-III universal automatic chip placer (additionally featuring a coplanarity check).



THT:

- » ERSА-WAVE 330 wave soldering system (soldering in nitrogen atmosphere).
- » 70 stations of manual and supplementary assembly.

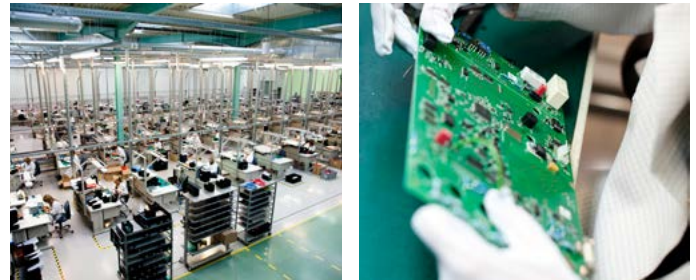

- » Inspection and testing
- » AOI ORBOTECH S-22 automatic optical tester, equipped with nine cameras,
- » electrical testing of printed circuits,
- » AOI (Automatic Optical Inspection),
- » ionic cleanliness test (Ionograph),
- » function tests.

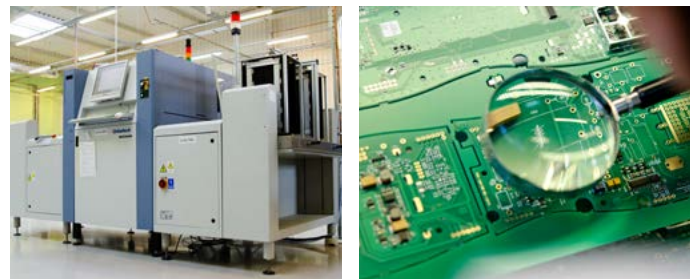

Protective coatings

Programmable selective casting (capability of selecting any area on a circuit board's surface) with lacquer or resin protective coating is performed automatically. Because of this, we achieve better productivity and save valuable time in the entire production process.

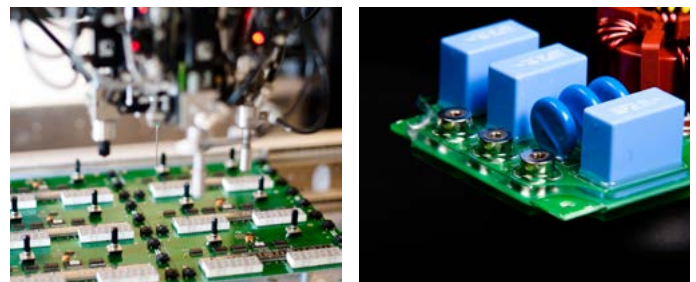

Repair and maintenance

We offer assembly and disassembly, repair and maintenance of elements as an additional service.

Quality and environment

We perform every order with the appropriate accuracy in the proper environment (ionic cleanliness tests), and thus, we ensure that your product is of the highest quality.

LABORATORY

SONEL Testing and Calibration Laboratory has been accredited by the Polish Center for Accreditation (PCA) - certificate no. AP 173.

Laboratory offers calibration for the following instruments that are used for measuring electrical and non-electrical parameters.

METERS FOR MEASUREMENTS OF ELECTRICAL PARAMETERS

- » voltage meters,
- » current meters (including clamp meters),
- » resistance meters,
- » insulation resistance meters,
- » earth resistance and resistivity meters,
- » RCD meters,
- » short-circuit loop impedance meters,
- » power quality analyzers,
- » portable appliance testers (PAT),
- » power meters,
- » active and passive electric energy meters,
- » multimeters,
- » multifunction meters covering the functions of the above-mentioned instruments,

ELECTRICAL STANDARDS

- » calibrators,
- » resistance standards,

METERS FOR MEASUREMENTS OF NON-ELECTRICAL PARAMETERS

- » pyrometers,
- » lux meters,
- » thermo-imaging cameras.

The Calibration Certificate is a document that presents a relation between the calibration standard of known accuracy and meter indications with associated measurement uncertainties. The calibration standards are normally traceable to the national standard held by the National Metrological Institute.

According to ILAC-G24 „Guidelines for determination of calibration intervals of measuring instruments”, SONEL S.A. recommends periodical metrological inspection of the instruments it manufactures no less frequently than once every 12 months.

For new instruments provided with the Calibration Certificate or Validation Certificate at the factory, re-calibration should be performed within 12 months from the date of purchase, however, no later than 24 months from the date of purchase.



AP 173

ATTENTION!

The person performing the measurements should be absolutely sure about the efficiency of the device being used. Measurements made with an inefficient meter can contribute to an incorrect assessment of the effectiveness of health protection and even human life.



A large area of the page is filled with horizontal dotted lines, providing a template for writing or drawing.



A large area of the page filled with horizontal dotted lines, serving as a template for writing or notes.

SONEL S.A.
Wokulskiego 11
58-100 Świdnica, Poland

www.sonel.pl/en
export@sonel.pl

tel. +48 74 85 83 800
fax. +48 74 85 83 809

© Copyright SONEL S.A. 2019. All rights reserved.
SONEL S.A. reserves the right to introduce changes
to the described products without prior notification.
The present catalogue does not constitute
a commercial offer under the Civil Code, and is published
with no legal responsibility and for informational purpose only.

your distributor: