

# NCP4390GEVB

## Implementing High Power Supply Evaluation Board User's Manual

### High Power Supply with the NCP1616, NCP1072 and NCP4390

#### Description

This evaluation board user's manual provides elementary information about a high efficiency, low light load power consumption reference design that is targeting power adapter or similar type of equipments that accepts 24 V.

The design utilizes NCP1616 for PFC front stage to assure unity power factor, NCP4390 for current mode LLC power stage with secondary side SR drive. And NCP1072 control the fly-back converter for secondary side VCC power supply.

The NCP1616 is a high voltage PFC controller with CrM operation. Additionally, it has an innovative Current Controlled Frequency Foldback (CCFF) method to maximizes the efficiency at both nominal and light load condition.

The NCP1072 integrate a fixed frequency current mode controller with a 700 V MOSFET. The NCP1072 offer a high level of integration, including soft-start, frequency-jittering, short-circuit protection, skip-cycle, a maximum peak current set point, ramp comensation, and a Dynamim Self-Supply.

The NCP4390 is an advanced Pulse Frequency Modulated (PFM) controller for LLC resonant converters with Synchronous Rectification (SR) that offers best in class efficiency for isolated DC/DC converters. It employs a current mode control technique based on a charge control, where the triangular waveform from the oscillator is combined with the integrated switch current information to determine the switching frequency. Closed-loop soft start prevents saturation of the error amplifier and allows monotonic rising of the output voltage regardless of load condition. A dual edge tracking adaptive dead time control minimizes the body diode conduction time thus maximizing efficiency.

#### Key Features

- High Voltage Start-Up Circuit with Integrated Brownout Detection
- Wide Input voltage Range
- High Efficiency
- Fast Line / Load Transient Compensation
- PWM operation mode in light load condition for Improved Efficiency
- Overvoltage Protection
- Auto recovery Overload Protection
- Auto recovery Over Current Protection
- Auto recovery Output Short Circuit Protection
- Adaptive Synchronous Rectification Control with Dual Edge Tracking
- Programmable Dead Times for primary side switches and secondary side Synchronous Rectifiers



ON Semiconductor®

[www.onsemi.com](http://www.onsemi.com)

#### EVAL BOARD USER'S MANUAL

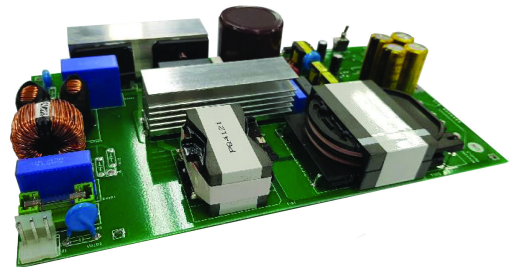

Figure 1. NCP4390GEVB Evaluation Board

# NCP4390GEVB

**Table 1. GENERAL INFORMATIONS**

Parameter	Test Conditions	Min	Typ	Max	Unit
Input Voltage	$V_{AC}$	90	–	264	$V_{AC}$
Input Voltage Brown Ouput		–	70	–	$V_{AC}$
Output voltage	No Load Condition	–	24	–	$V_{DC}$
	Full Load Condition	–	24	–	$V_{DC}$
Maximum Output Current		–	12	–	A
Output Power		–	312	–	W
Operating Frequency of LLC	Full Load Condition	100	105	110	kHz
System Efficiency	110 $V_{AC}$ @ Full Load	–	92.74	–	%
	220 $V_{AC}$ @ Full Load	–	95.05	–	%
Power Factor	90 VAC ~ 264 VAC @ Over 50% Load	–	0.95	0.99	$\eta$
Board Dimension		–	215 x 125	–	mm

## CIRCUIT DESCRIPTION

For the PFC front stage, utilizes the NCP1616 to optimize the efficiency and Power Factor throughout the load range. NCP1616 has an integrated high voltage start up circuit accessible by the HV pin. The rectified input voltage supplies to HV pin at start up. After then Supply to VCC directly from the auxiliary winding of LLC transformer. In operation mode, the NCP1616 achieves power factor correction using the Current Controlled Frequency Foldback (CCFF) topology. In CCFF the circuit operates in the classical Critical Conduction Mode (CrM) when the inductor current exceeds a programmable value. Once the current falls below this preset level, the frequency is linearly reduced, reaching about 26 kHz when the current is zero. Also NCP1616 enter to skip mode at the Input current near the line zero crossing where the current is very low. Both CCFF and Skip mode optimize PFC stage efficiency. To protect the application system under abnormal condition, the NCP1616 has OVP, OCP, Brown Out and FB pin open protection.

In the secondary side, the NCP4390 LLC controller provides a high efficiency and high power density by zero voltage switching (ZVS) of half-bridge MOSFETs. The

power stage operates in above resonance area at around the resonant frequency caused by a resonant capacitor  $C_r$  and a resonance inductor  $L_r$ . It can provide PWM operation for higher efficiency with less frequency variation for light load condition.

The NCP4390 included secondary side SR driver for higher efficiency without additional circuit. It uses a dual edge tracking adaptive gate drive method that anticipates the SR current zero crossing instant with respect to two different time references. The first tracking circuit measures SR conduction time using  $dv/dt$  of SR MOSFET drain voltage and uses this information to generate the first adaptive drive signal. The second tracking circuit measures the turn-off extension time which is defined as time duration from the falling edge of the primary side drive to the corresponding SR turn-off instant. This information is then used to generate the second adaptive darive signal and compensation next switching cycle.

To protect the application system under abnormal condition, the NCP4390 has OLP, OCP, OVP and OSP protection.







# NCP4390GEVB

## BOARD PICTURES

Board Dimension: 170 mm x 100 mm

PCB material: FR4

Copper Thickness: 2 oz

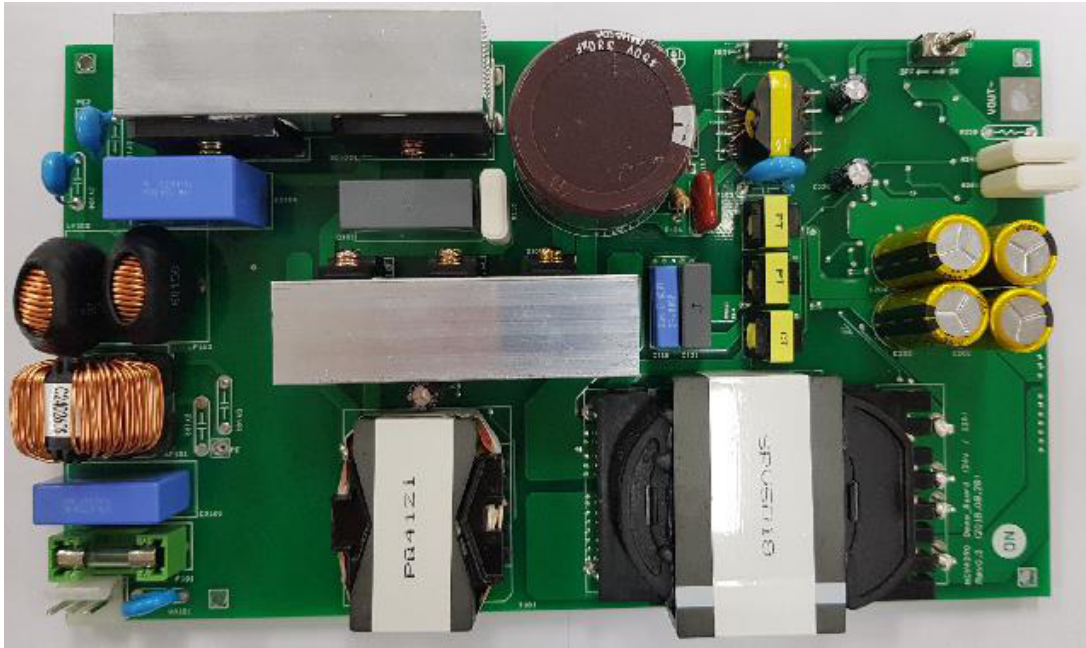

Figure 5. TOP Side View

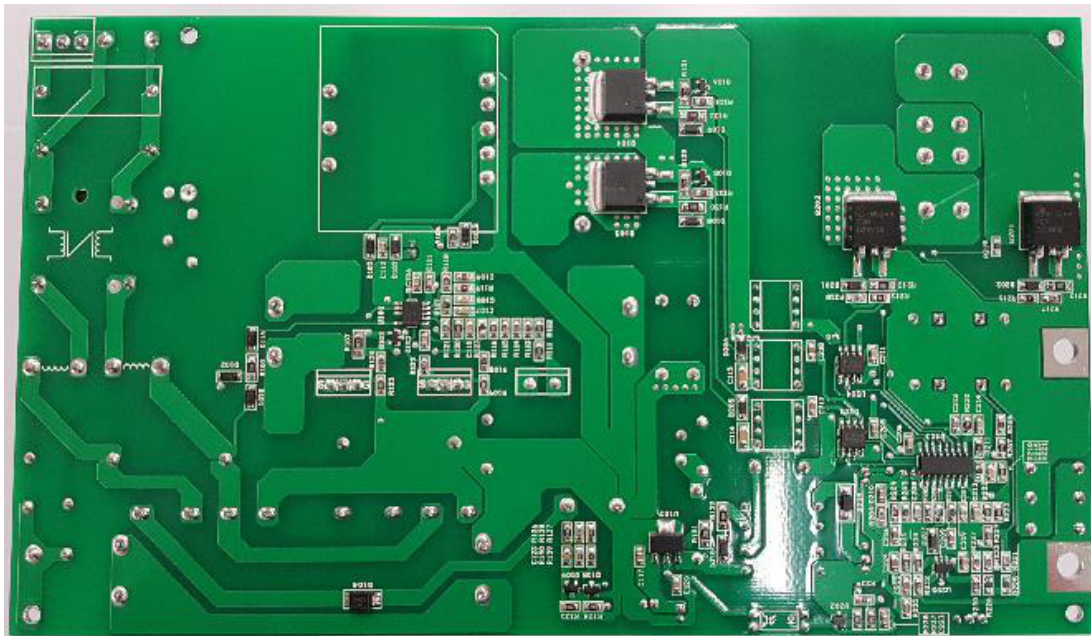

Figure 6. BOTTOM Side View

# NCP4390GEVB

**Table 2. BILL OF MATERIALS**

Reference	Vendor	Part Number	Type	Value	PC/Board
BD101, BD102	ON Semiconductor	DFB2560	TS-6P-4L	600 V / 25 A	2
CX101	PILKO	PCX2 337 / 470 nF (Pitch: 22.5 mm)	MKP RADIAL	275 Vac / 470 nF	1
CX102	PILKO	PCX2 337 / 1 $\mu$ F (Pitch: 22.5 mm)	MKP RADIAL	275 Vac / 1 $\mu$ F	1
CY103	TDK	CD45B2GA472K	Y-Cap	400 V / 4.7 nF	1
CY104, CY105	TDK	CD45B2GA222K	Y-Cap	400 V / 2.2 nF	2
C101	PILKOR	PCMP 372J / 1 $\mu$ F (Pitch: 22.5 mm)	MKP RADIAL	500 V / 1 $\mu$ F	1
C102	SAMYOUNG	KMF-series: 35 x 37	KMF	450 V / 330 $\mu$ F	1
C105, C119, C222, C225	SAMYOUNG	KMF-series: 5 x 11	KMF	50 V / 47 $\mu$ F	4
C106, C107, C113, C117, C205, C206, C210, C211, C213, C219	TDK	C2012X7R1E105K085AB	MLCC_2012	25 V / 1 $\mu$ F	10
C108, C112	TDK	C2012CH1H472J085AA	MLCC_2012	50 V / 4.7 nF	2
C109, C216	TDK	C2012X7R1H224K125AE	MLCC_2012	50 V / 220 nF	2
C110, C123	TDK	C2012C0G1H103J060AA	MLCC_2012	50 V / 10 nF	2
C111, C208	TDK	C2012 C0G1E101J060AA	MLCC_2012	25 V / 100 pF	2
C114, C115	Yageo	RC1206JR-07000RL	CHIP_R_3216	0 R	2
C116	Rubicon	FILM Capacitor (10 mm Pitch)	Lead type	650 V / 2.2 nF	1
C118	PILKOR	PCMP 384 / 33 nF 630 V (Pitch: 15 mm)	33 nF	630 V / 33 nF	1
C120	TDK	C2012C0G1H153J060AA	MLCC_2012	25 V / 15 nF	1
C121	PILKOR	PCMP 384 / 15 nF 630 V (Pitch: 15 mm)	MMKP RADIAL	630 V / 15 nF	1
C201, C202, C203, C204	SAMYOUNG	NXH-series: 12.5 x 25	NXH	35 V / 1200 $\mu$ F	4
C207, C209	TDK	C2012C0G1H152J060AA	MLCC_2012	25 V / 1.5 nF	2
C212	TDK	C2012 C0G1E200J060AA	MLCC_2012	25 V / 20 pF	1
C214	TDK	C2012 C0G1E471J060AA	MLCC_2012	25 V / 470 pF	1
C215	TDK	C2012C0G1H102J060AA	MLCC_2012	25 V / 1 nF	1
C217, C218	Yageo	RC0805JR-075R6L	CHIP_R_2012	5.6 R	2
C221, C224	TDK	C2012X7R1H154K125AE	MLCC_2012	50 V / 150 nF	2
C223	TDK	C2012X7R1H104K125AE	MLCC_2012	50 V / 100 nF	1
D101, D102, D116	ON Semiconductor	US1MFA	SOD-123FA	1000 V / 1 A	3
D103, D105, D118, D219	ON Semiconductor	S210FA	SOD-123FA	100 V / 2 A	4
D104	ON Semiconductor	S3MB	SMB	1000 V / 3 A	1
D106	ON Semiconductor	FFPF30UA60S	TO-220F-2L	600 V / 30 A	1
D107	ON Semiconductor	MMSZ18T1G (Zener Diode)	SOD-123	18 V / 0.5 W	1
D108, D109, D201, D202, D207	ON Semiconductor	MBR0540	SOD-123	40 V / 0.5 A	5
D117	ON Semiconductor	UF4007	DO-41	1000 V / 1 A	1
D205, D206	ON Semiconductor	OPEN	OPEN	OPEN	2
F101 (Fuse)	Little Fuse	021 7004.MXP Fast-acting	5 x 20	250 Va / 4 A	1
F101 (Holder)	STELVIO	PTF78	5 x 20	Fuse Holder	1

## NCP4390GEVB

**Table 2. BILL OF MATERIALS** (continued)

Reference	Vendor	Part Number	Type	Value	PC/Board
ISO1	ON Semiconductor	FOD817B	4-pin DIP	Optocoupler	1
J1	MOLEX	5273-03A	3-pin	Connector	1
LF101	EMC parts	CV240260SK	133T-F	300 Va / 4 A	1
LF102, LF103	TNC	NVL200N-60150	Vertical	150 $\mu$ H / 6 A	2
PT101, PT102	FEELUX	EE10/11		2 mH	2
Q101, Q107	ON Semiconductor	FCPF125N65S3	TO-220F	650 V / 24 A	2
Q102, Q105, Q106	ON Semiconductor	NSS20200L	SOT-23	-20 A / 4 A	3
Q103, Q104	ON Semiconductor	FCB199N65S3	D2 PAK	650 V / 14 A	2
Q108, Q109	ON Semiconductor	2N7002	SOT-23	60 V / 115mA	2
Q201, Q202	ON Semiconductor	FDB045AN08A0	D2 PAK	75 V / 235 A	2
R101	Yageo	RC1206JR-07272RL	CHIP_R_3216	2.7 k $\Omega$	1
R106	Yageo	RC0805JR-07622RL	CHIP_R_2012	6.2k $\Omega$	1
R107	Yageo	RC1206JR-07620RL	CHIP_R_3216	62 $\Omega$	1
R108, R124	Yageo	RC0805JR-07100RL	CHIP_R_2012	10 $\Omega$	2
R109, R125, R128, R135, R234	Yageo	RC0805JR-07103RL	CHIP_R_2012	10 k $\Omega$	5
R110	PILKO	MPR5W 0.02 $\square$ J	Metal plate R	0.02 $\Omega$	1
R111, R112	Yageo	RC0805JR-07185RL	CHIP_R_2012	1.8 M $\Omega$	2
R113, R114	Yageo	RC0805JR-07155RL	CHIP_R_2012	1.5 M $\Omega$	2
R115	Yageo	RC0805JR-07184RL	CHIP_R_2012	180 k $\Omega$	1
R116	Yageo	RC0805JR-07433RL	CHIP_R_2012	43 k $\Omega$	1
R117, R214, R219	Yageo	RC0805JR-07303RL	CHIP_R_2012	30 k $\Omega$	3
R118	Yageo	RC0805JR-07753RL	CHIP_R_2012	75 k $\Omega$	1
R119	Yageo	RC0805JR-07154RL	CHIP_R_2012	150 k $\Omega$	1
R120, R232, R238	Yageo	RC0805JR-07203RL	CHIP_R_2012	20 k $\Omega$	3
R121, R137, R138, R139	Yageo	RC0805JR-07204RL	CHIP_R_2012	200 k $\Omega$	4
R122	Yageo	RC0805JR-07392RL	CHIP_R_2012	3.9 k $\Omega$	1
R126	Yageo	Axial type 1/2W	Axial 1/2W	150 k $\Omega$	1
R127	Yageo	RC1206JR-07100RL	CHIP_R_3216	10 $\Omega$	1
R129, R131	Yageo	RC1206JR-07103RL	CHIP_R_3216	10 k $\Omega$	2
R130, R132	Yageo	RC1206JR-07560RL	CHIP_R_3216	56 $\Omega$	2
R133, R134	Yageo	RC0805JR-07301L	CHIP_R_2012	300 $\Omega$	2
R136	Yageo	RC0805JR-07474RL	CHIP_R_2012	470 k $\Omega$	1
R140	Yageo	RC0805JR-07622RL	CHIP_R_2012	6.2 k $\Omega$	1
R141	Yageo	RC1206JR-07302RL	CHIP_R_3216	3 k $\Omega$	1
R204	Yageo	RC0805JR-07203RL	CHIP_R_2012	20 k $\Omega$	1
R205, R206	Yageo	RC0805JR-07153L	CHIP_R_2012	15 k $\Omega$	2
R207	Yageo	RC0805JR-07332L	CHIP_R_2012	3.3 k $\Omega$	1
R208	Yageo	RC0805JR-07222L	CHIP_R_2012	2.2 k $\Omega$	1
R209	Yageo	RC0805JR-07223L	CHIP_R_2012	22 k $\Omega$	1
R211	Yageo	RC0805JR-07513RL	CHIP_R_2012	51 k $\Omega$	1
R212, R213	Yageo	RC1206JR-07203RL	CHIP_R_3216	20 k $\Omega$	2

## NCP4390GEVB

**Table 2. BILL OF MATERIALS** (continued)

Reference	Vendor	Part Number	Type	Value	PC/Board
R215, R216	Yageo	RC0805JR-07000RL	CHIP_R_2012	0 $\Omega$	2
R217, R218	Yageo	RC0805JR-072R2L	CHIP_R_2012	2.2 $\Omega$	2
R220	Yageo	RC0805JR-07272L	CHIP_R_2012	2.7 k $\Omega$	1
R221	Yageo	RC0805JR-07303L	CHIP_R_2012	30 k $\Omega$	1
R222	Yageo	RC0805JR-07300RL	CHIP_R_2012	30 $\Omega$	1
R223, R229	Yageo	RC0805JR-07201L	CHIP_R_2012	200 $\Omega$	2
R224	Yageo	RC0805JR-07302L	CHIP_R_2012	3 k $\Omega$	1
R227, R233	Yageo	RC0805JR-07122L	CHIP_R_2012	1.2 k $\Omega$	2
R230	Yageo	RC0805JR-07152L	CHIP_R_2012	1.5 k $\Omega$	1
R231	Yageo	RC0805JR-07183L	CHIP_R_2012	18 k $\Omega$	1
R235, R237	Yageo	RC0805JR-07823L	CHIP_R_2012	82 k $\Omega$	1
R236	Yageo	RC0805JR-07472L	CHIP_R_2012	4.7 k $\Omega$	1
R239	Yageo	RC0805JR-07102RL	CHIP_R_2012	1 k $\Omega$	1
R240, R241	PILKO	MPR5W 0.01 $\Omega$ J	Metal plate R	0.01 $\Omega$	2
SW101	DECO	AT1D-2M3	Toggle SW	3 pin	1
CT101	FEELUX	EE10/11		45:1	1
T101	FEELUX	PQ4121		230 $\mu$ H	1
T102	FEELUX	SRV5018		300 $\mu$ H	1
T103	FEELUX	RM6-8pin		1.2 mH	1
U101	ON Semiconductor	NCP1616	SOIC-9	PFC	1
U102	ON Semiconductor	NCP1072	SOT-223	Flyback	1
U103	ON Semiconductor	NCP4390	SOIC-16	LLC	1
U202	ON Semiconductor	LM431SBCM3X	SOT-23	Shunt	1
U203, U204	ON Semiconductor	FAN3225	SOIC-8	Gate Driver	2
U205	ON Semiconductor	NCP4352	TSOP-6	CC/CV	1
VA101	HIEL	HVR431D10	VARISTOR		1



# NCP4390GEVB

## TRANSFORMER SPECIFICATIONS

There are five kinds of transformer used in this EVB.  
PFC, LLC, Fly-back, Current Sensing transformer and Pulse Transformer.

PQ4121

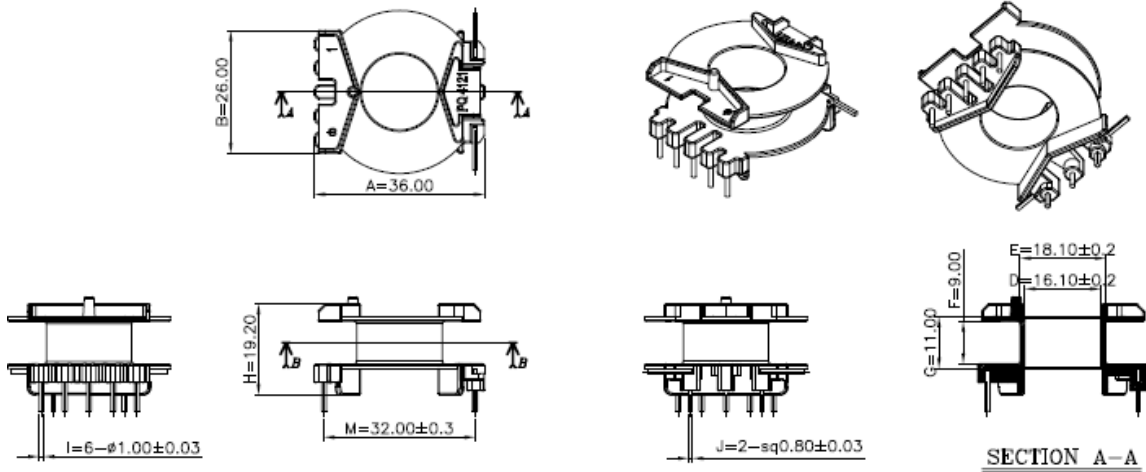

Figure 7. Transformer Dimension and Shapes (PFC)

Table 3. TRANSFORMER SPECIFICATION (PFC)

	Pin (Start → Finish)	Wire	Turns	Winding Method	Barrier Tape		
					TOP	BOT	Ts
$N_p$	6 → 8	0.1 $\phi$ x 60 USTC	44	Solenoid winding	-	-	-
Insulation: Polyester Tape t = 0.025 mm, 2 Layers							
$N_A$	4 → 3	0.2 $\phi$	2		3 mm	3 mm	1
Insulation: Polyester Tape t = 0.025 mm, 2 Layers							
$N_B$	1 → 2	0.2 $\phi$	6		3 mm	3 mm	1
Insulation: Polyester Tape t = 0.025 mm, 2 Layers							
Copper Tape	→ 5	Copper	1	9 mm	-	-	-
Insulation: Polyester Tape t = 0.025 mm, 2 Layers							

	Pin	Spec.	Remark
Inductance	6 – 8	230 $\mu$ H	100 kHz, 1 V

# NCP4390GEVB

SRV5018EV

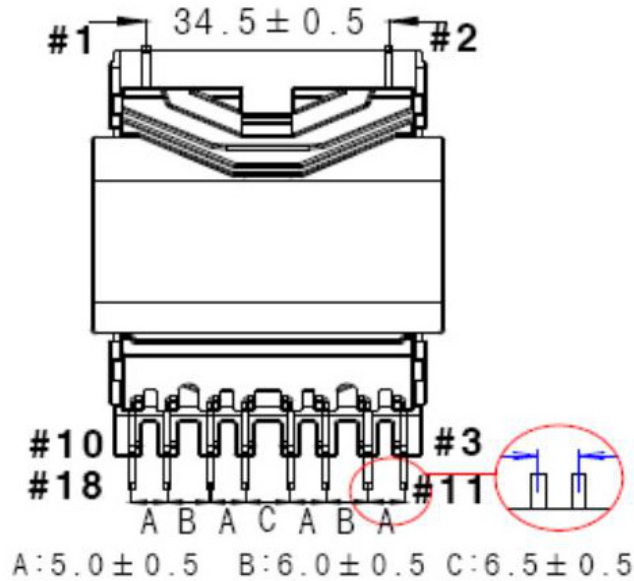

**Figure 8. Transformer Dimension and Shapes (LLC)**

**Table 4. TRANSFORMER SPECIFICATION (LLC)**

	Pin (Start → Finish)	Wire	Turns	Winding Method	Barrier Tape		
					TOP	BOT	Ts
$N_p$	1 → 2	0.1 $\phi$ x 60 USTC	28	Solenoid winding	-	-	-
Insulation: Polyester Tape t = 0.025 mm, 2 Layers							
$N_s$	4 → 7 12 → 15	0.10 $\phi$ x 150 USTC	3	Bifilar	-	-	-
Insulation: Polyester Tape t = 0.025 mm, 2 Layers							
$N_s$	6 → 9 14 → 17	0.10 $\phi$ x 150 USTC	3	Bifilar	-	-	-
Insulation: Polyester Tape t = 0.025 mm, 2 Layers							

	Pin	Spec.	Remark
Inductance $L_m$	1 - 2 (other pin open)	330 $\mu$ H	100 kHz, 1 V
Inductance $L_{lk}$	1 - 2 (secondary side pins all short)	58 $\mu$ H	100 kHz, 1 V

# NCP4390GEVB

RM6-8pin

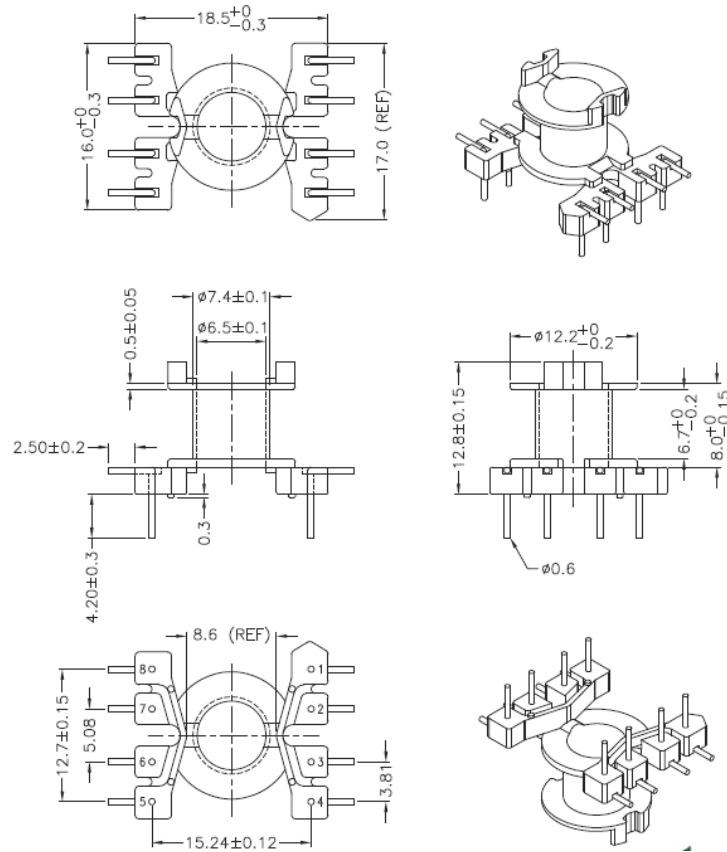

Figure 9. Transformer Dimension and Shapes (Fly-back)

Table 5. TRANSFORMER SPECIFICATION (FLY-BACK)

	Pin (Start → Finish)	Wire	Turns	Winding Method	Barrier Tape		
					TOP	BOT	Ts
$N_p$	1 → 4	0.2 $\phi$	48	Solenoid winding	-	-	-
Insulation: Polyester Tape $t = 0.025$ mm, 2 Layers							
$N_A$	3 → 2	0.2 $\phi$	6		2 mm	2 mm	1
Insulation: Polyester Tape $t = 0.025$ mm, 2 Layers							
$N_S$	5 → 8	0.2 $\phi$	7		2 mm	2 mm	1
Insulation: Polyester Tape $t = 0.025$ mm, 2 Layers							

	Pin	Spec.	Remark
Inductance	1 - 4	1.2 mH	100 kHz, 1 V

# NCP4390GEVB

EE1011

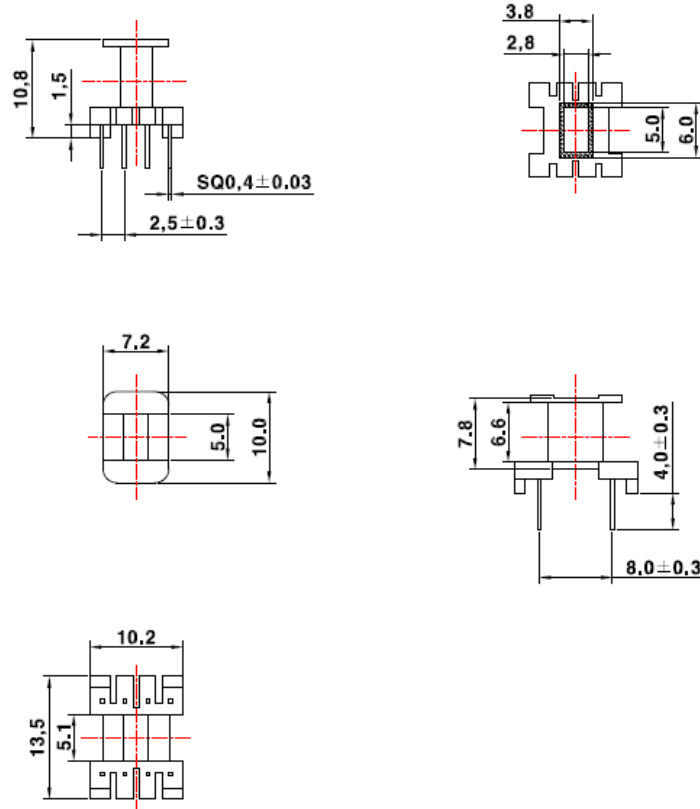

Figure 10. Transformer Dimension and Shapes (Current Sensing Transformer)

Table 6. TRANSFORMER SPECIFICATION (CURRENT SENSING TRANSFORMER)

	Pin (S → F)	Wire	Turns	Winding Method	Barrier Tape		
					TOP	BOT	Ts
N <sub>s</sub>	8 → 5	0.15 φ	44	Solenoid	1.5	1.5	3
Insulation: Polyester Tape t, 3 Layers							
N <sub>p</sub>	1 → 4	0.6 φ	1	Solenoid	1.5	1.5	1
Insulation: Polyester Tape t, 3 Layers							

	Pin	Spec.	Remark
Inductance	8 – 5	–	100 kHz, 1 V

# NCP4390GEVB

EE1011

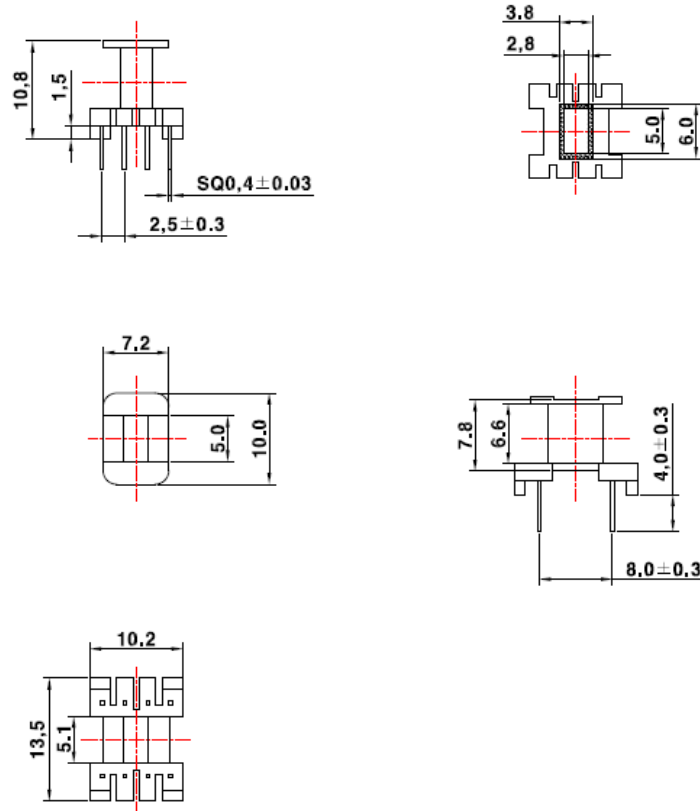

Figure 11. Transformer Dimension and Shapes (Pulse Transformer)

Table 7. TRANSFORMER SPECIFICATION (PULSE TRANSFORMER)

	Pin (S → F)	Wire	Turns	Winding Method	Barrier Tape		
					TOP	BOT	Ts
$N_p$	1 → 4	0.15 $\phi$	50	Solenoid	0	0	0
Insulation: Polyester Tape t, 3 Layers							
$N_s$	5 → 8	0.15 $\phi$	50	Solenoid	1.5	1.5	3
Insulation: Polyester Tape t, 3 Layers							

	Pin	Spec.	Remark
Inductance	1 - 4, 5 - 8	2 mH	100 kHz, 1 V



**START UP PFC STAGE**

Figure 12 show that the NCP1616 start up waveforms by high voltage start up circuit. The output voltage reflects rectified voltage around 150 V by bridge diodes until the  $V_{CC}$  voltage reaches start up threshold 17 V. Once  $V_{CC}$  is charged to the start up threshold voltage, the HV start up

regulator is disabled and the controller is enabled. After PFC start up switching by Dynamic Self Supply of NCP1616,  $V_{CC}$  bias comes from the auxiliary winding of PFC transformer. After then PFC stage operating by  $V_{cc}$  supply of PFC transformer auxiliary winding and the PFC output voltage regulated target voltage.

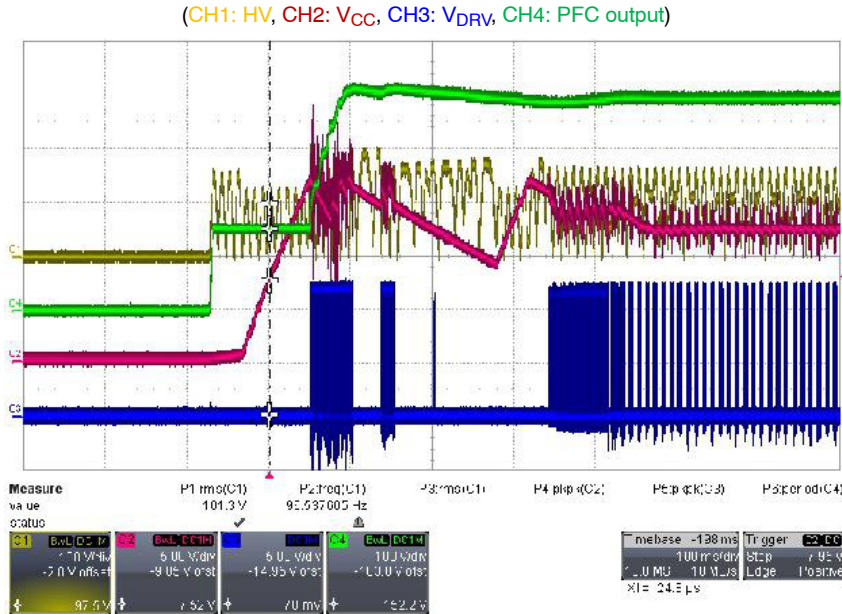

Figure 12. PFC Stage Start Up Waveforms

**START UP FLY-BACK STAGE**

When the power supply is first powered from the Drain pin, the internal current source is biased and charges up the  $V_{cc}$  capacitor. Once the voltage on this  $V_{cc}$  reaches the  $V_{cc}$  on level, the current source turns off and pulses are delivered by the output stage. And then auxiliary  $V_{cc}$  winding supply to the  $V_{cc}$ . But the PFC output detection circuit is include for

stable start up LLC stage. When the  $V_{cc}$  voltage reaches turn on threshold level, PFC output detection circuit pull down the FB pin voltage til the output voltage reaches around 370 V. During this time, NCP1072 is not transfer to the output. After then the PFC output voltage over than around 370 V, Fly-back start up and supply  $V_{cc}$  voltage for LLC stage.

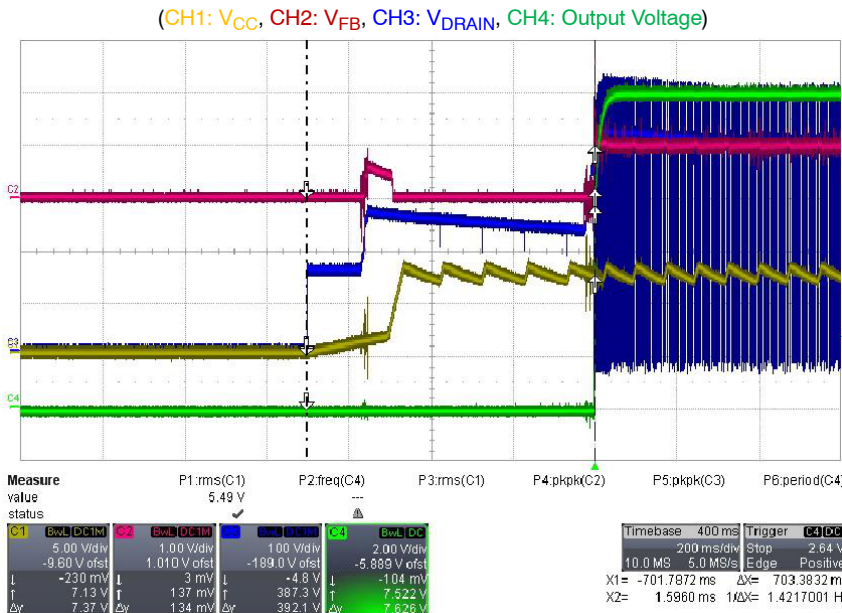

Figure 13. Flyback Stage Start Up Waveforms

# NCP4390GEVB

## START UP LLC STAGE

The NCP4390 located in the secondary side and the supply voltage is charged by the NCP1072. To prevent OCP at start up condition, the  $V_{CC}$  voltage should be supply after the PFC output voltage reaches around target level. As you

can see the below waveforms,  $V_{CC}$  voltage supply to the LLC stage after the PCB voltage reaches around target level. When the  $V_{CC}$  voltage reaches turn on threshold level, NCP4390 start up switching and the LLC output start with Soft Start function.

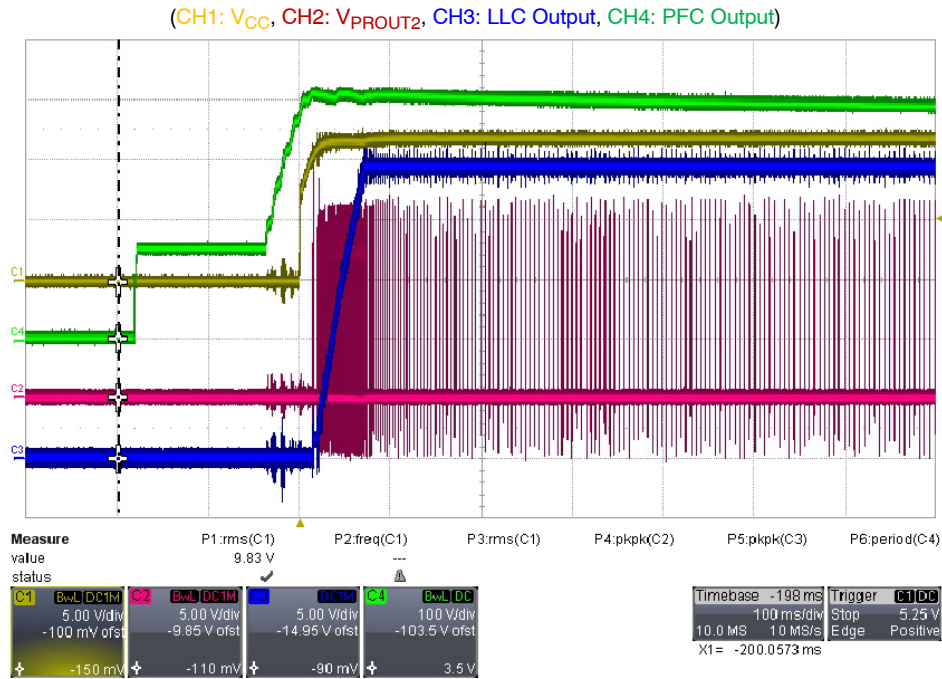

Figure 14. LLC Stage Start Up Waveforms

## START UP SR STAGE

The NCP4390 integrated in SR driver with LLC controller and directly driving SR MOSFET in secondary side. During no load or light load condition, NCP4390 is not generate SR gate signal. When the output load increased, the Current

Sensing Transformer reflect a primary side average current information to Vics pin. When the Vics pin peak voltage reaches threshold level around 0.2 V, NCP4390 generate SR gate signal as like below waveforms.

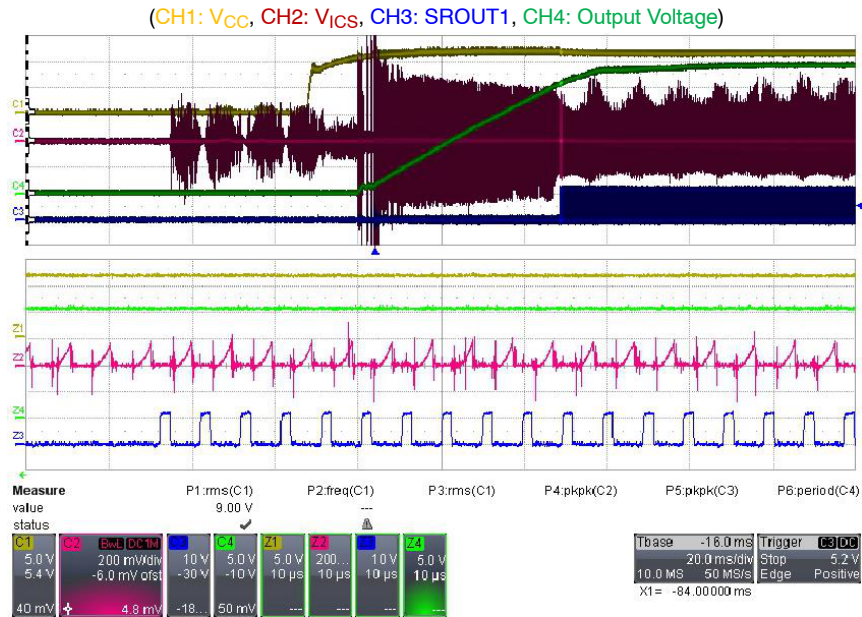

Figure 15. SR Stage Start Up Waveforms

# NCP4390GEVB

## CURRENT CONTROLLED FREQUENCY FOLDBACK

The NCP1616 PFC controller achieves power factor correction using the novel Current Controlled Frequency Foldback (CCFF) topology. In this mode, the circuit operates in classical Critical Conduction Mode (CrM) with ZCD when the inductor current exceeds a programmable

value. When the current falls below this preset level, the NCP1616 linearly reduces the operating frequency down to a minimum of about 26 kHz when input current reaches zero.

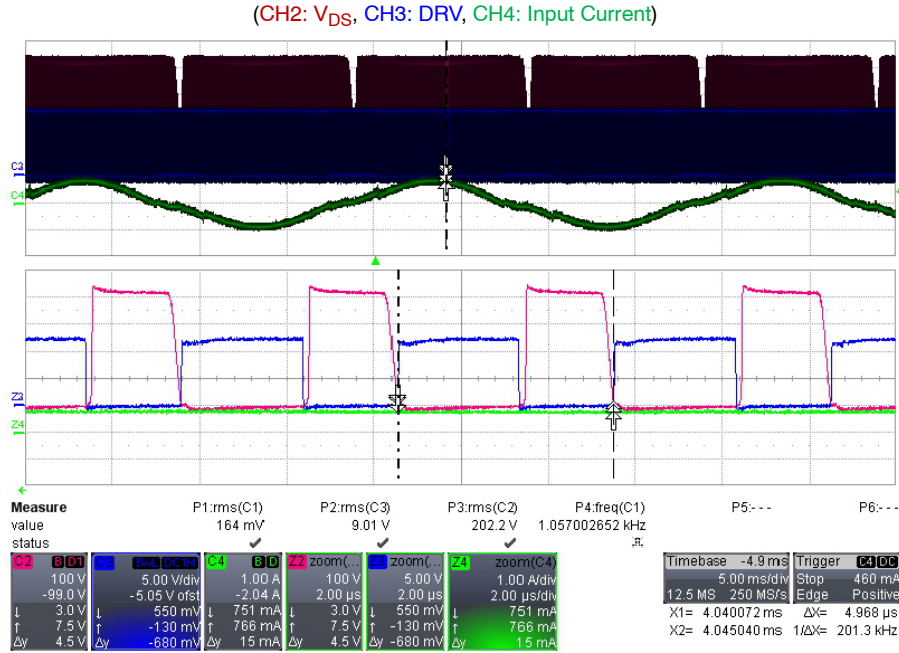

Figure 16. Critical Conduction Mode Operation

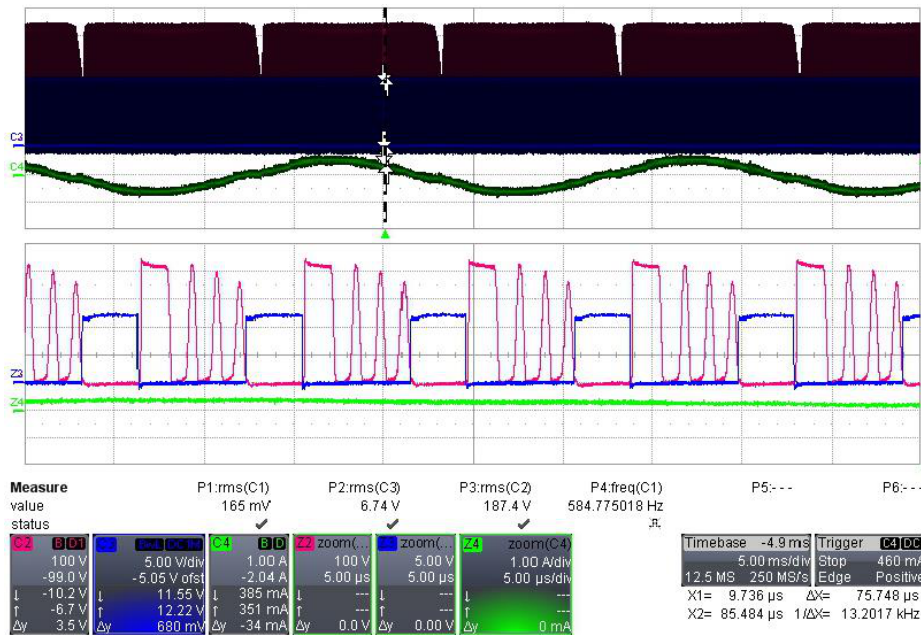

Figure 17. Current Controlled Frequency Foldback Operation



# NCP4390GEVB

## PWM OPERATION AT LIGHT LOAD CONDITION

The conventional PFM control method at the light load condition, it has a poor efficiency due to the high frequency operation and the large circulating primary side current. To improve the light load efficiency, NCP4390 employs PFM operation at light load condition. In the PWM control, the

switching frequency is fixed by the clamped internal COMP voltage and the duty cycle is determined by the difference between COMP voltage and the PWM mode threshold voltage. The PWM operation threshold can be programmed between 1.5 V and 1.9 V using a resistor on the PWM pin.

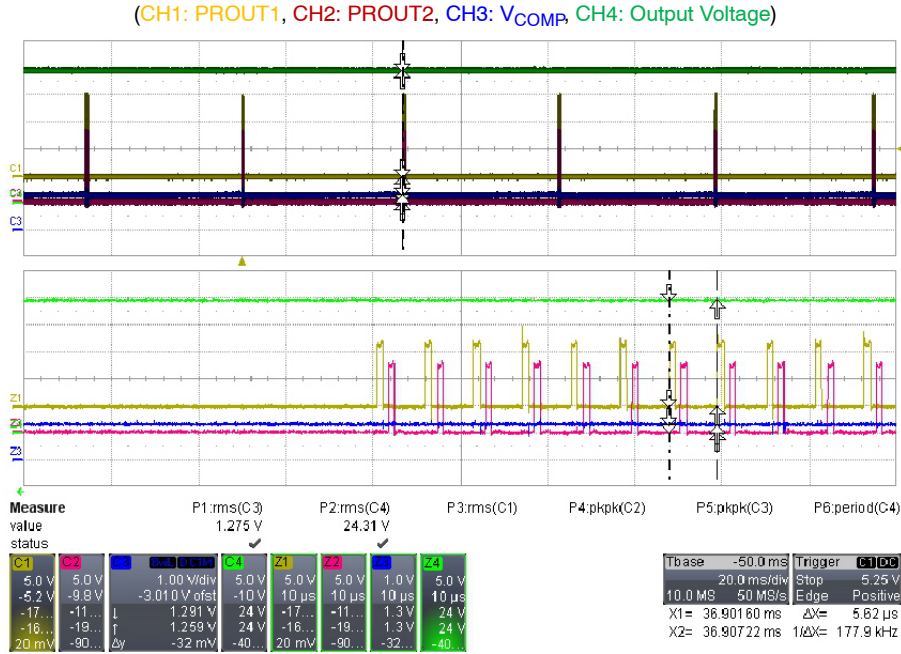

Figure 18. PWM Control Operation Waveforms

## LLC OPERATION

Below waveform is normal operation mode of LLC in heavy load condition. The LLC operated in above resonance area.

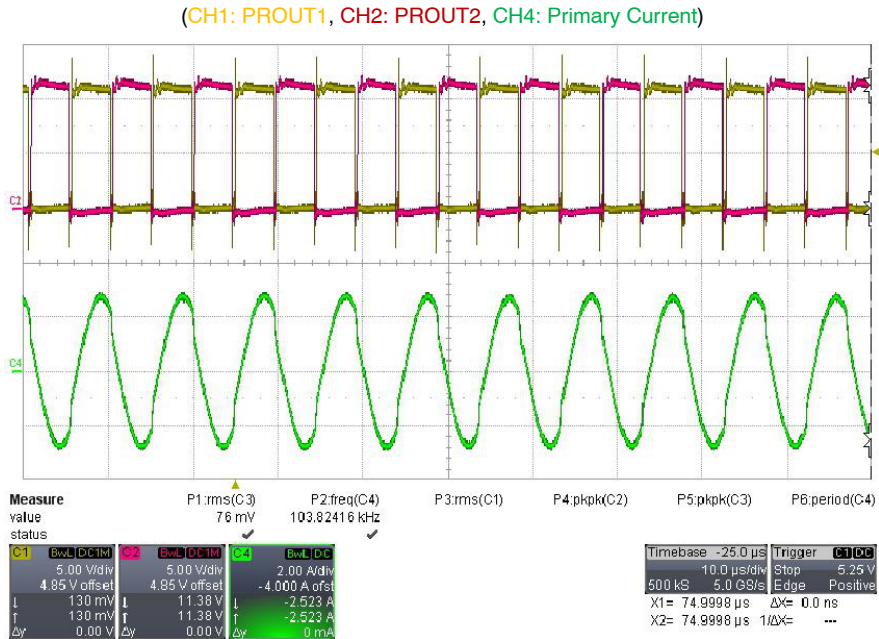

Figure 19. LLC Operation Waveforms

# NCP4390GEVB

## SYNCHRONOUS RECTIFICATION CONTROL AND NORMAL OPERATION

The NCP4390 controls the SR MOSFET using the  $dv/dt$  of SR MOSFET drain voltage. Before SR gate is turned on, SR body diode conducts as the conventional diode rectifier. When the Vics peak voltage reaches threshold level around 0.2 V, NCP4390 generate the SR gate signal. At this time, to

guarantee stable SR operation during light load operation, the NCP4390 operate in Shrink mode. During this time, the SR dead time is increased resulting in SR gate shrink. And then, the SR dead time is reduced to the programmed value when Vics peak value rises about 0.25 V.

(CH1: SROUT1, CH2: SROUT2, CH3:  $V_{ICs}$ , CH4: SR1DS)

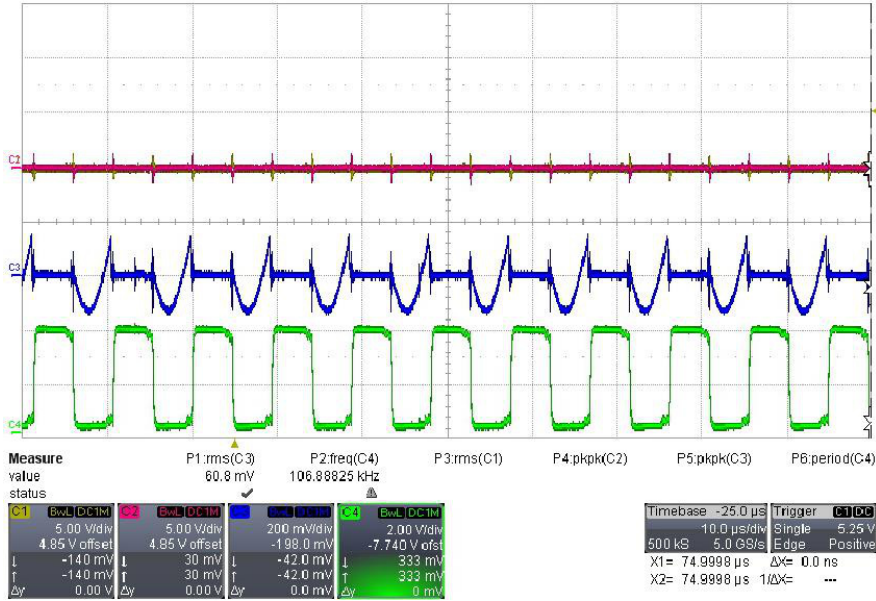

Figure 20. SR Operation at Light Load Condition

(CH1: SROUT1, CH2: SROUT2, CH3:  $V_{ICs}$ , CH4: SR1DS)

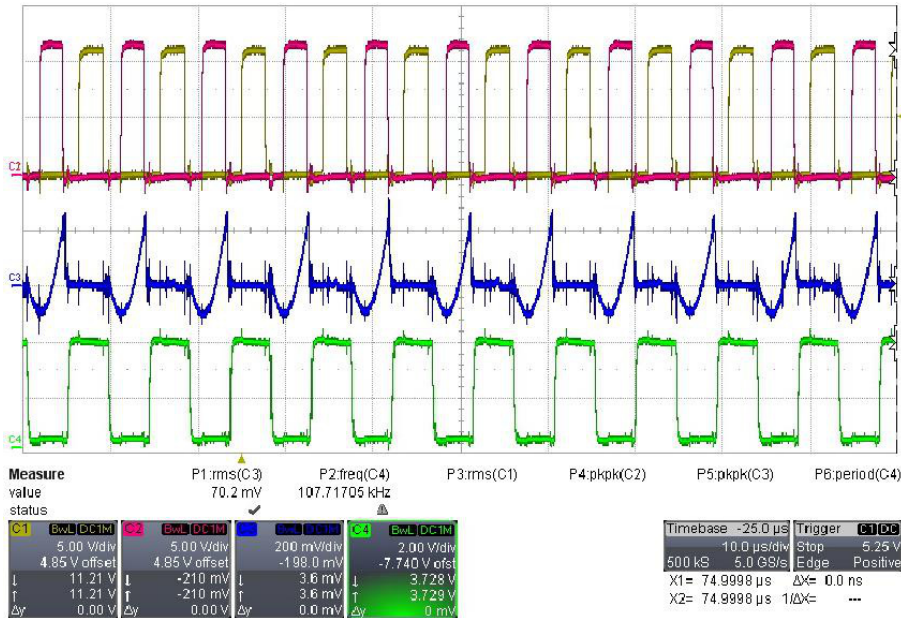

Figure 21. SR Gate Operation at Light Load Condition



# NCP4390GEVB

(CH1: SROUT1, CH2: SROUT2, CH3: V<sub>ICS</sub>, CH4: SR1DS)

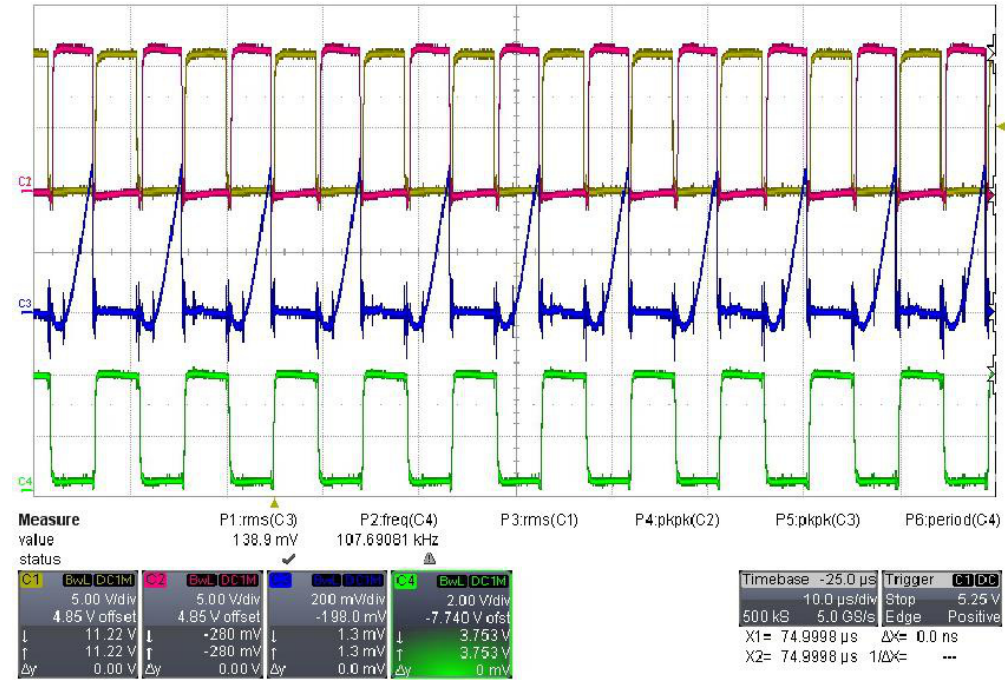

Figure 22. SR Gate Operation at Middle Load Condition

(CH1: SROUT1, CH2: SROUT2, CH3: V<sub>ICS</sub>, CH4: SR1DS)

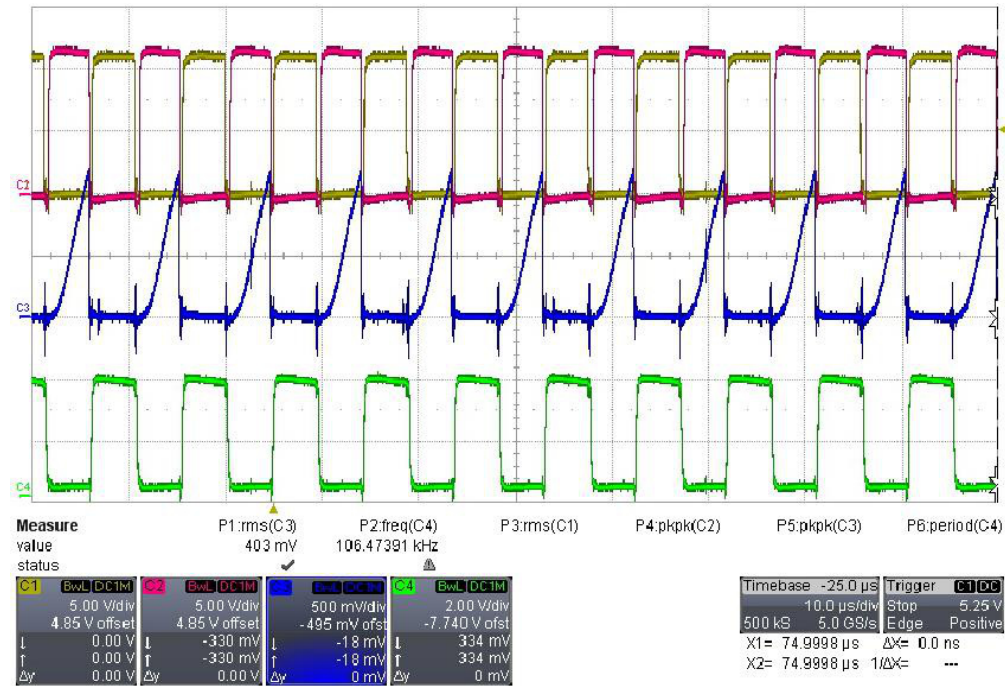

Figure 23. SR Gate Operation at Heavy Load Condition

# NCP4390GEVB

## SYSTEM EFFICIENCY & PF

Figure 24 presents the system efficiency of the EVB with various input voltage. The EVB demonstrated that the 288 W power application can approach 95% peak system

efficiency at high line. Also the PF is over 0.96 at wide input range.

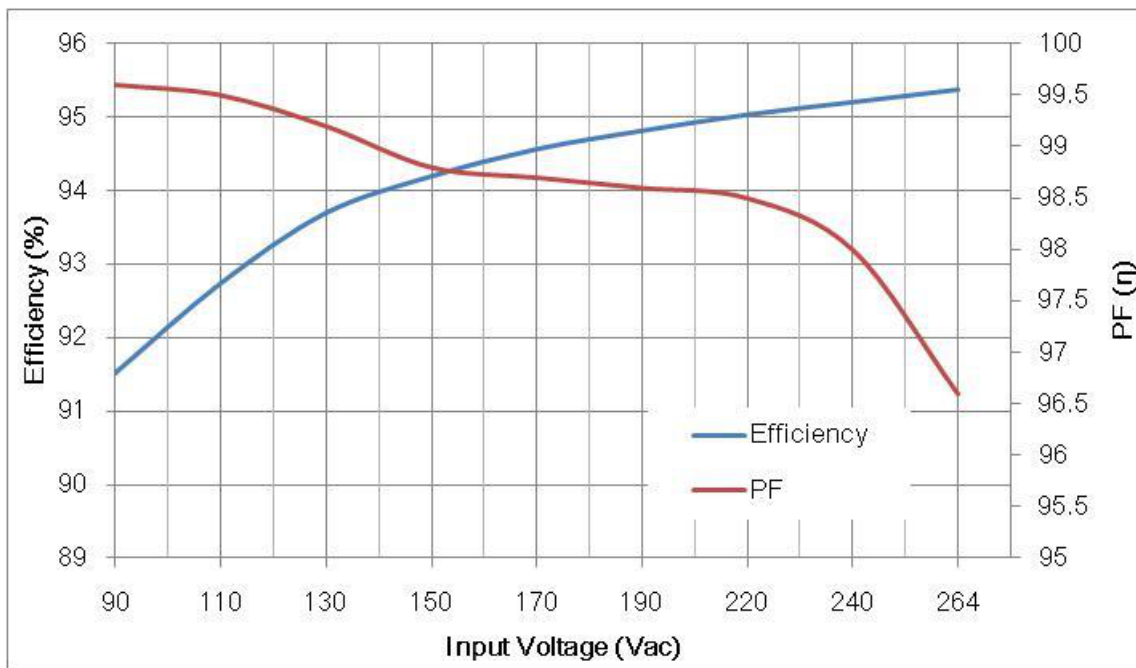

Figure 24. System Efficiency by the Input Voltage

Table 8. MEASURING RESULTS OF EFFICIENCY & PF

Vac	90	110	130	150	170	190	220	240	264
Efficiency	91.52%	92.74%	93.70%	94.20%	94.57%	94.82%	95.04%	95.21%	95.38%
PF	99.60%	99.50%	99.20%	98.80%	98.70%	98.60%	98.50%	98.00%	96.60%

## NCP4390GEVB

Figure 25 and Figure 26 show system efficiency & PF by the output load condition, respectively.

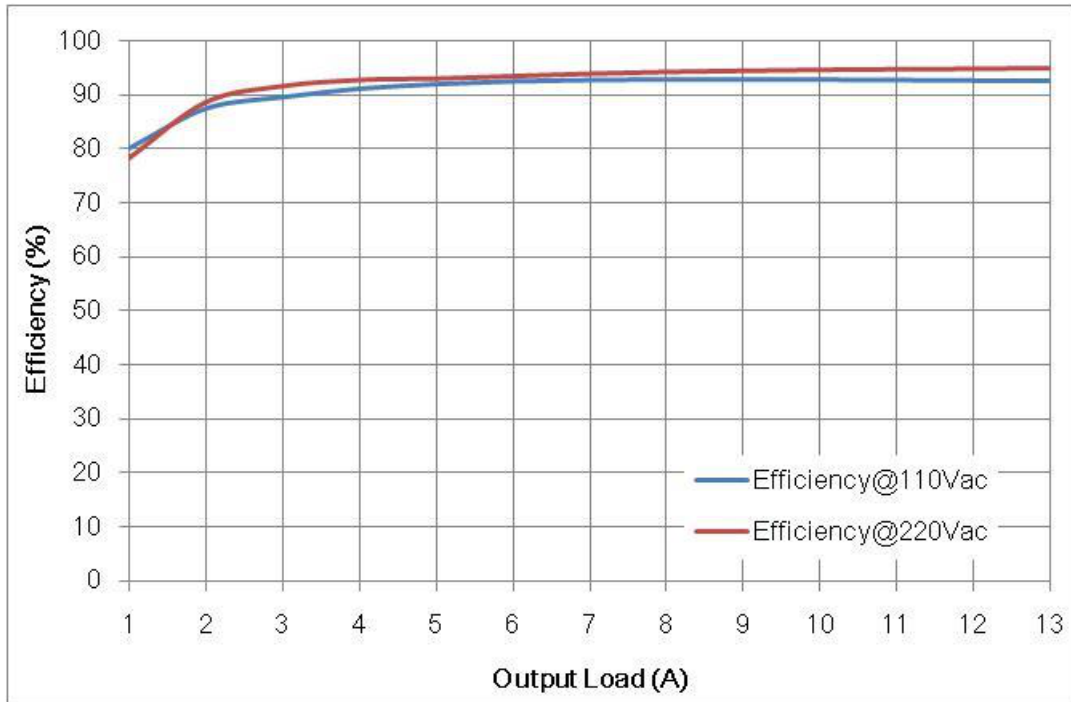

**Figure 25. Comparison Efficiency by the Low and High Line**

**Table 9. MEASURING RESULTS OF EFFICIENCY BY LOAD CONDITION**

<b>Output Current</b>	<b>1 A</b>	<b>2 A</b>	<b>3 A</b>	<b>4 A</b>	<b>5 A</b>	<b>6 A</b>
<b>Efficiency @ 110 Vac</b>	80.27%	87.65%	89.73%	91.31%	92.14%	92.67%
<b>Efficiency @ 220 Vac</b>	78.45%	88.77%	91.72%	92.88%	93.11%	93.57%
<b>Output Current</b>	<b>7 A</b>	<b>8 A</b>	<b>9 A</b>	<b>10 A</b>	<b>11 A</b>	<b>12 A</b>
<b>Efficiency @ 110 Vac</b>	92.91%	93.01%	93.01%	92.99%	93.15%	92.82%
<b>Efficiency @ 220 Vac</b>	94.02%	94.34%	94.55%	94.59%	94.73%	94.93%

# NCP4390GEVB

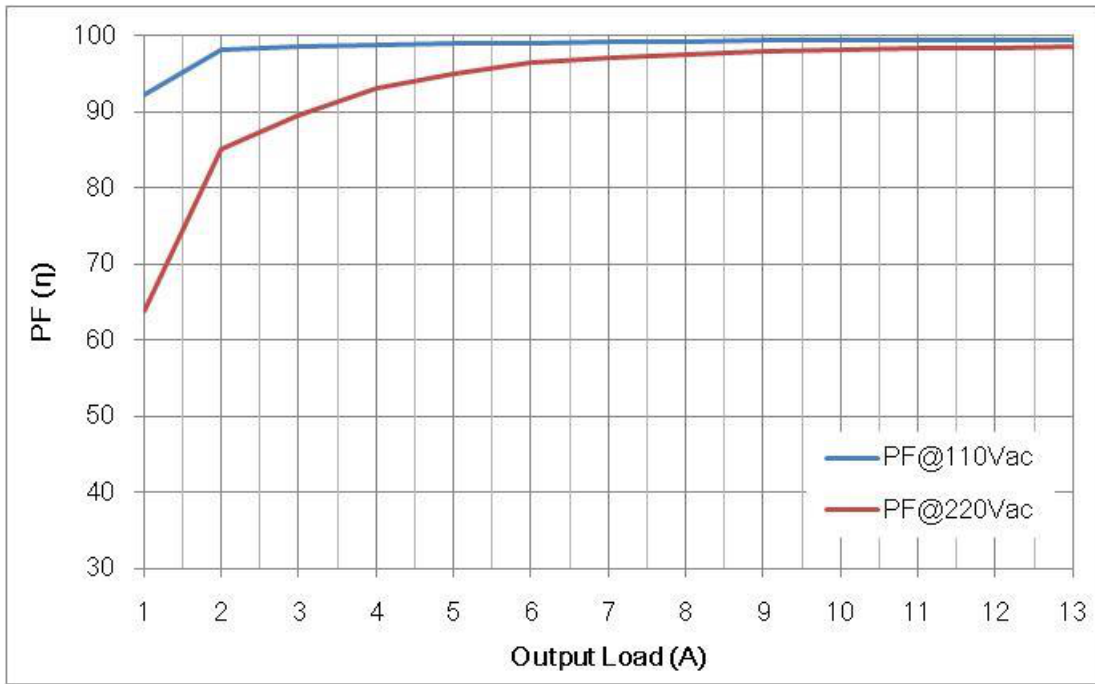

Figure 26. Comparison PF by the Low and High Line

Table 10. MEASURING RESULTS OF PF BY LOAD CONDITION

<b>Output Current</b>	<b>1 A</b>	<b>2 A</b>	<b>3 A</b>	<b>4 A</b>	<b>5 A</b>	<b>6 A</b>
<b>PF @ 110 Vac</b>	92.2%	98.2%	98.6%	98.8%	98.9%	99.1%
<b>PF @ 220 Vac</b>	63.9%	85.0%	89.6%	93.0%	95.0%	96.5%
<b>Output Current</b>	<b>7 A</b>	<b>8 A</b>	<b>9 A</b>	<b>10 A</b>	<b>11 A</b>	<b>12 A</b>
<b>PF @ 110 Vac</b>	99.2%	99.3%	99.4%	99.4%	99.5%	99.5%
<b>PF @ 220 Vac</b>	97.2%	97.6%	97.9%	98.1%	98.3%	98.4%

# NCP4390GEVB

## CONDUCTED EMISSION

The following figures illustrate conducted EMI signatures under full loading for different input line voltage levels.

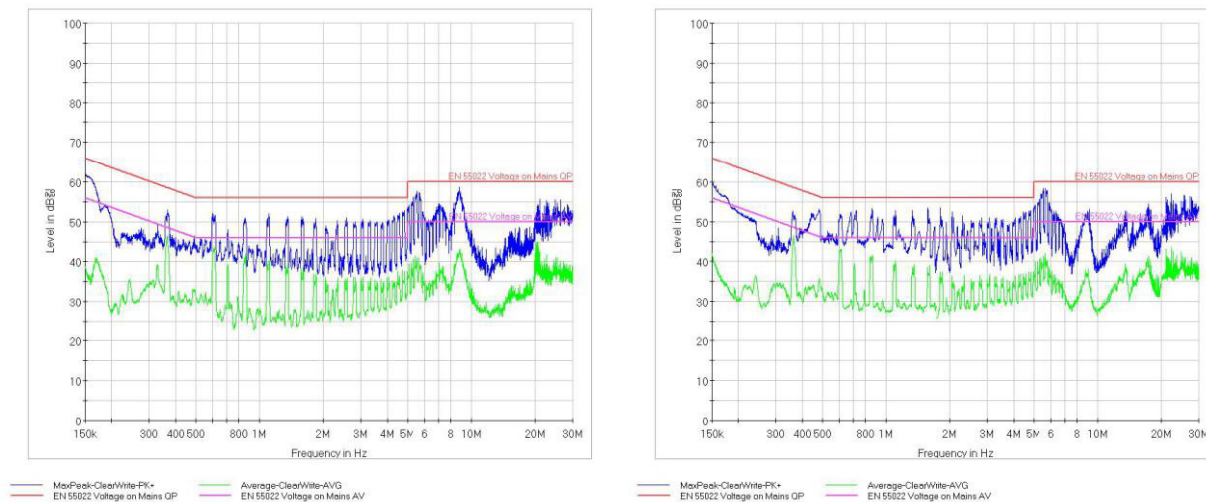

Figure 27. EMI Result both 110 VAC and 220 VAC & Full-Load



**onsemi**, **Onsemi**, and other names, marks, and brands are registered and/or common law trademarks of Semiconductor Components Industries, LLC dba "**onsemi**" or its affiliates and/or subsidiaries in the United States and/or other countries. **onsemi** owns the rights to a number of patents, trademarks, copyrights, trade secrets, and other intellectual property. A listing of **onsemi**'s product/patent coverage may be accessed at [www.onsemi.com/site/pdf/Patent-Marking.pdf](http://www.onsemi.com/site/pdf/Patent-Marking.pdf). **onsemi** is an Equal Opportunity/Affirmative Action Employer. This literature is subject to all applicable copyright laws and is not for resale in any manner.

The evaluation board/kit (research and development board/kit) (hereinafter the "board") is not a finished product and is not available for sale to consumers. The board is only intended for research, development, demonstration and evaluation purposes and will only be used in laboratory/development areas by persons with an engineering/technical training and familiar with the risks associated with handling electrical/mechanical components, systems and subsystems. This person assumes full responsibility/liability for proper and safe handling. Any other use, resale or redistribution for any other purpose is strictly prohibited.

**THE BOARD IS PROVIDED BY ONSEMI TO YOU "AS IS" AND WITHOUT ANY REPRESENTATIONS OR WARRANTIES WHATSOEVER. WITHOUT LIMITING THE FOREGOING, ONSEMI (AND ITS LICENSORS/SUPPLIERS) HEREBY DISCLAIMS ANY AND ALL REPRESENTATIONS AND WARRANTIES IN RELATION TO THE BOARD, ANY MODIFICATIONS, OR THIS AGREEMENT, WHETHER EXPRESS, IMPLIED, STATUTORY OR OTHERWISE, INCLUDING WITHOUT LIMITATION ANY AND ALL REPRESENTATIONS AND WARRANTIES OF MERCHANTABILITY, FITNESS FOR A PARTICULAR PURPOSE, TITLE, NON-INFRINGEMENT, AND THOSE ARISING FROM A COURSE OF DEALING, TRADE USAGE, TRADE CUSTOM OR TRADE PRACTICE.**

**onsemi** reserves the right to make changes without further notice to any board.

You are responsible for determining whether the board will be suitable for your intended use or application or will achieve your intended results. Prior to using or distributing any systems that have been evaluated, designed or tested using the board, you agree to test and validate your design to confirm the functionality for your application. Any technical, applications or design information or advice, quality characterization, reliability data or other services provided by **onsemi** shall not constitute any representation or warranty by **onsemi**, and no additional obligations or liabilities shall arise from **onsemi** having provided such information or services.

**onsemi** products including the boards are not designed, intended, or authorized for use in life support systems, or any FDA Class 3 medical devices or medical devices with a similar or equivalent classification in a foreign jurisdiction, or any devices intended for implantation in the human body. You agree to indemnify, defend and hold harmless **onsemi**, its directors, officers, employees, representatives, agents, subsidiaries, affiliates, distributors, and assigns, against any and all liabilities, losses, costs, damages, judgments, and expenses, arising out of any claim, demand, investigation, lawsuit, regulatory action or cause of action arising out of or associated with any unauthorized use, even if such claim alleges that **onsemi** was negligent regarding the design or manufacture of any products and/or the board.

This evaluation board/kit does not fall within the scope of the European Union directives regarding electromagnetic compatibility, restricted substances (RoHS), recycling (WEEE), FCC, CE or UL, and may not meet the technical requirements of these or other related directives.

FCC WARNING – This evaluation board/kit is intended for use for engineering development, demonstration, or evaluation purposes only and is not considered by **onsemi** to be a finished end product fit for general consumer use. It may generate, use, or radiate radio frequency energy and has not been tested for compliance with the limits of computing devices pursuant to part 15 of FCC rules, which are designed to provide reasonable protection against radio frequency interference. Operation of this equipment may cause interference with radio communications, in which case the user shall be responsible, at its expense, to take whatever measures may be required to correct this interference.

**onsemi** does not convey any license under its patent rights nor the rights of others.

LIMITATIONS OF LIABILITY: **onsemi** shall not be liable for any special, consequential, incidental, indirect or punitive damages, including, but not limited to the costs of requalification, delay, loss of profits or goodwill, arising out of or in connection with the board, even if **onsemi** is advised of the possibility of such damages. In no event shall **onsemi**'s aggregate liability from any obligation arising out of or in connection with the board, under any theory of liability, exceed the purchase price paid for the board, if any.

The board is provided to you subject to the license and other terms per **onsemi**'s standard terms and conditions of sale. For more information and documentation, please visit [www.onsemi.com](http://www.onsemi.com).

## ADDITIONAL INFORMATION

### TECHNICAL PUBLICATIONS:

Technical Library: [www.onsemi.com/design/resources/technical-documentation](http://www.onsemi.com/design/resources/technical-documentation)  
onsemi Website: [www.onsemi.com](http://www.onsemi.com)

ONLINE SUPPORT: [www.onsemi.com/support](http://www.onsemi.com/support)

For additional information, please contact your local Sales Representative at [www.onsemi.com/support/sales](http://www.onsemi.com/support/sales)