



VE-Trac™ Dual EZ Kit Quickstart Guide

This document is intended to be a guide to explain the connectivity and usage of the evaluation kit described in the table below. The evaluation kit is designed to quickly perform benchmarking or product evaluation at specific operating conditions in a lab environment. *The product should only be operated and handled by qualified personnel with sufficient electrical engineering training and experience.*

Applies to the following parts.

Table 1.

NVG800A75L4DSC-EVK	750 V, 800 A based 3-ph Evaluation kit
--------------------	--

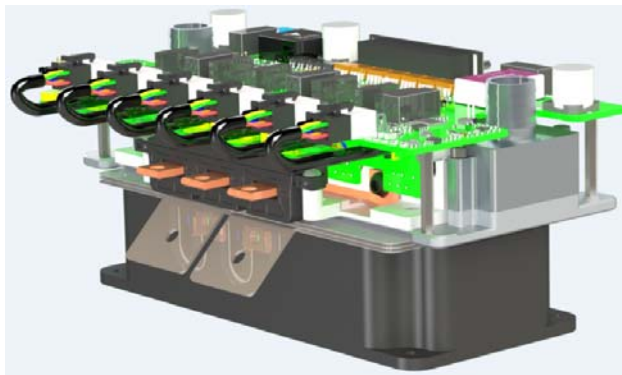

Figure 1. NVG800A75L4DSC-EVK

INTRODUCTION

The VE-Trac Dual Evaluation Kit consists of three VE-Trac Dual power modules (NVG800A75L4DSC) mounted on dual side cooling heatsink, with a 6-ch Gate driver board, DC Link capacitor and external hall-effect current sense feedback for motor control. The kit does not include a PWM controller. The user must use their own PWM controller to operate the system. The evaluation kit allows the customers to evaluate VE-Trac Dual power module performances in their early stage of inverter development. The kit can be used as a double pulse tester to measure key switching parameters or used as a 3-ph inverter for motor control.

EVAL BOARD USER'S MANUAL

VE-Trac Dual evaluation kit features:

- Inverter evaluation Hardware kit for EV/HEV Traction Inverter applications (up to 150 kW)
- VE-Trac Dual NVG800A75L4DSC with 800 A, 750 V Field stop 4 IGBT/Diode chipset
- Automotive Isolated high current and high efficiency IGBT gate driver with internal galvanic isolation, NCD57000
- Implementation of Faster and simpler OCP enabled by On-Chip Current Sensing feature in the power modules
- Implementation of faster and closer to true Tvj OTP with integrated to On-Chip Temperature Sensing feature in the power modules
- Custom designed dual side cooler offers low pressure drop with excellent thermal performance
- Custom Film DC Link capacitor rated up to 500 VDC, 500 μ F.

TECHNICAL DETAILS

ON Semiconductor's latest generation of IGBTs and Diodes are incorporated into the VE-Trac Dual products. The 750 V products use the latest 4th Generation of FS4 IGBTs from ON Semiconductor.

Block Diagram

In this section, we describe the evaluation kit in detail, including block diagram, operating conditions, key components, On-chip current/temperature sensing and protection features.

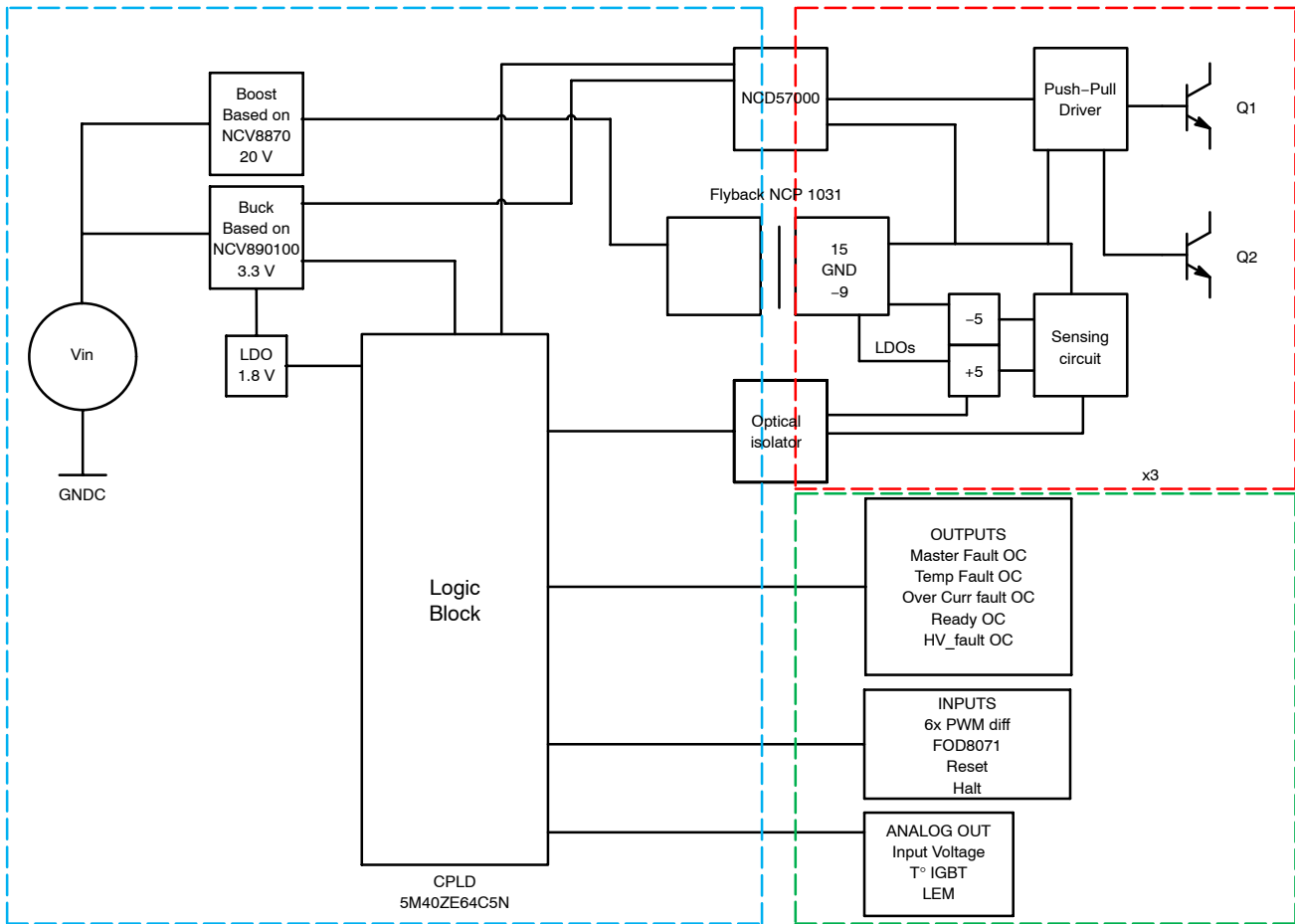

Figure 2. Simplified Block Diagram

The simplified block diagram gives a quick overview of the evaluation kit. The dotted lines show the different isolated sections of the system.

Maximum Ratings

The VE-Trac Dual Evaluation kit is intended to be operated in a lab testing environment and should not be regarded as a protected system. Parts of the design have

exposed high voltage and high temperatures that when accidentally contacted can result in electrical shock or severe burns. Therefore, it should only be handled by professionals with sufficient electrical engineering training and experience. Moreover, the operating conditions especially the thermal limits described below should be followed strictly.

Table 2. SUMMARY OF OPERATING CONDITIONS

Parameter	Symbol	Min	Max	Conditions
Gate Driver Board Control Power	V_{Driv}	9 V	15 V	
DC Link Voltage	V_{BUS}	0 V	500 V	Limited by Capacitor
Peak Collector Phase Current (1 ms)	I_{CPEAK}	-1600 A	1600 A	Limited by T_{vj_Max}
Maximum IGBT/FWD Junction Temperature	T_{VJ_Max}	-40°C	175°C	
Wait time after short circuit	SC	1 s	-	
PCB Temperature	T_{PCB}	-	85°C	
Switching frequency	F_{SW}	-	12 kHz	
Coolant Temperature	T_c	-40°C	65°C	

Key Components

The evaluation kit is shipped in a hard plastic case with the following contents:

- ✓ Full assembled evaluation kit hardware
- ✓ USB Drive containing all the required documentation

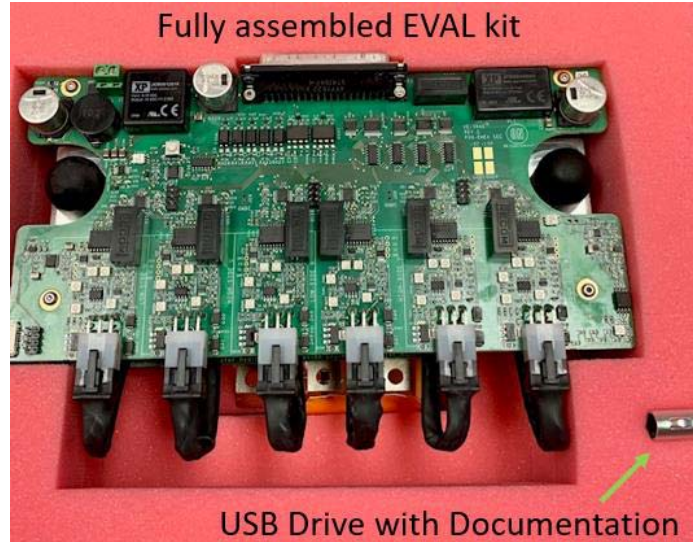

Figure 3. Shipping Contents in Case

The assembled evaluation kit assembly itself consists of the following major components.

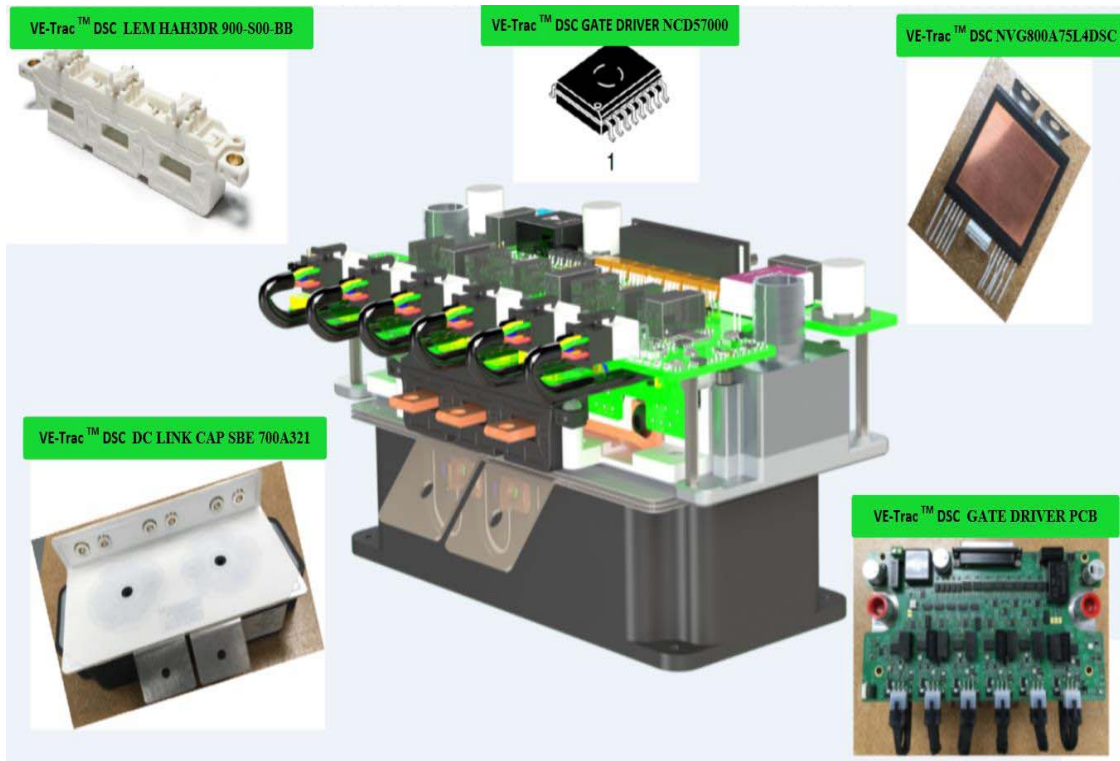

Figure 4. Major Components that Make Up the Evaluation Kit

Table 3. SUPPLIERS FOR THE MAJOR COMPONENTS OF THE EVALUATION HARDWARE

Part Number	Manufacturer	Description
NVG800A75L4DSC with reference heatsink stack	ON Semiconductor	Automotive VE-Trac Dual power module with FS4 750 V 800 A IGBT and Diode
NCD57000	ON Semiconductor	Automotive Isolated Gate Driver
Dual side cooler	ON Semiconductor	ON Semi design with outsourced manufacturing.
700A321	SBE	DC Link Capacitor 500 V, 500 μ F
HAH3DR 900-S00-BB	LEM	Hall Current Transducer. \pm 900 A

On-chip Current Sensing and Temperature Sensing

One of the key advantage of the VE-Trac Dual power modules is the integrated On-chip current sensing and On-chip temperature sensing. The Evaluation kit offers users the option of monitoring the junction temperature and

current of all six IGBTs in real time. OCP/OTP protections is implemented using the on-chip sensors. Below schematics show how On-chip current sensing is implemented as well as test points for verification purpose.

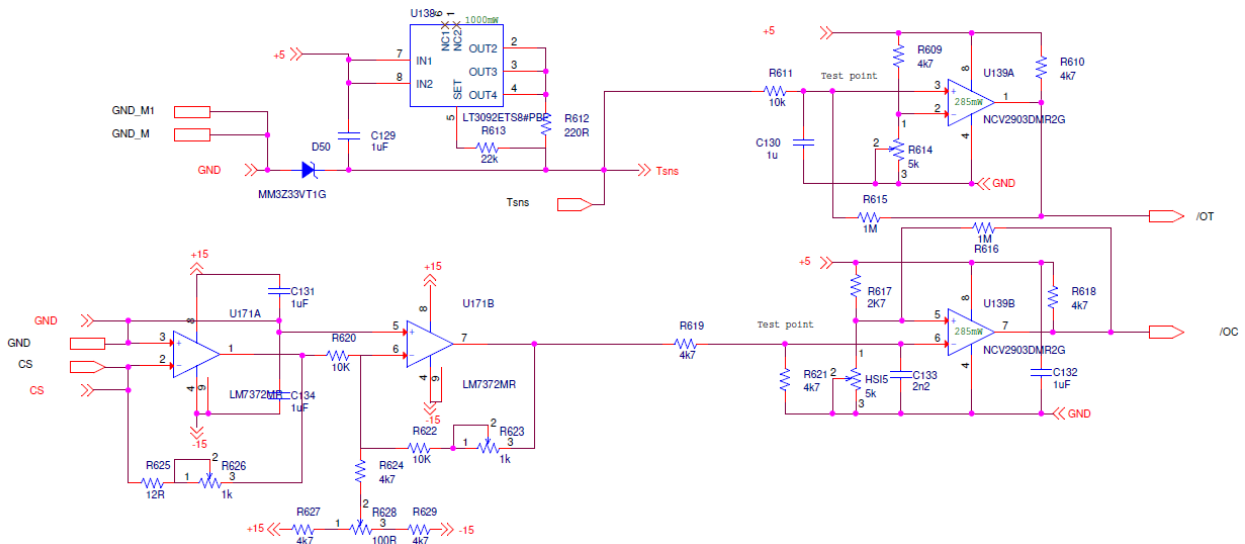
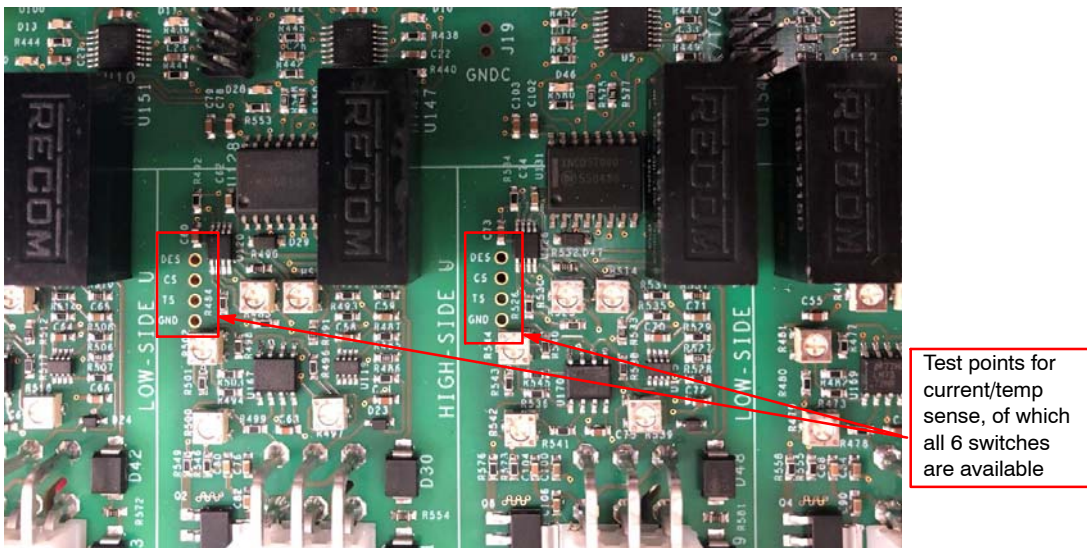

Figure 5. Schematics of Implementing On-chip Current Sensing



Test points for current/temp sense, of which all 6 switches are available

Figure 6. Test Points for On-chip Current and Temperature Sense

Protection Features

Over Current Protection (OCP) and Over Temperature Protection (OTP) are implemented by sensing the On-chip current sensor and On-chip temperature sensor respectively. Besides this, the traditional desaturation protection is also implemented to allow users to compare it with the On-chip current sense protection. The protection trigger levels are set as below:

- Over Current Protection (OCP) for all phases set to 1600 A

- Over Temperature Protection (OTP) for all phases set to 150°C
- DC Link Over Voltage Fault Threshold set to 550 VDC

NOTE: All faults are the latching type and requires a reset to clear the fault latch to start operating again. During a fault incident, a LED is lit to help the user to identify the cause of the fault. Below is Fault Indication LED Matrix for the VE-Trac Dual evaluation kit. Normal operation indication LEDs are off when fault occurs, refer to Figure 11 for locations of fault LEDs

Table 4. FAULT INDICATION LED MATRIX

Phases	OCP_FAULT_LED	OTP_FAULT_LED	DRIVER_FAULT_LED
Phase_U_HS	D12	D10	D28
Phase_U_LS	D13	D11	D40
Phase_V_HS	D16	D14	D61
Phase_V_LS	D17	D15	D64
Phase_W_HS	D20	D18	D34
Phase_W_LS	D21	D19	D54

PCBs AND CONNECTORS

There is a total of five (5) PCBs in the evaluation kit assembly.

1. Power Module interface boards (3)
2. Gate driver board (1)
3. Current sensor board (1)

Power Module Interface boards are not accessible to the user and is soldered to the signal pins of each of the three VE-Trac Dual modules. An interface cable with a signal

connector extends from the interface boards to connect to the gate driver board. The purpose this arrangement is to make it easy to remove the driver board for replacement or for trouble shooting purpose.

Gate driver board is the main PCB with several connectors on it. It interfaces with the user's Motor Control Unit (MCU), the hall-effect current sensors, Power modules and aux. power input.

EVBUM2704

Table 5. CONNECTOR X1:

Pin#	Signal	Function	Specification
1	POWER_VSS	Aux. Power RTN	Ground return for External Power Input
2	POWER_VSS	Aux. Power RTN	Ground return for External Power Input
3	LEM_PHASE_W	Analog Output	0 – 10 V LEM Phase W output
4	GND_I/O	Ground reference	Ground reference for LEM PCB
5	READY	Digital I/O	3.3 – 5 V Gate driver ready status
6	GND_RDY	Ground reference	Ground reference for driver ready status
7	OC I/O_FLT	Digital I/O	3.3 V – 5 V Digital output Over Current Fault
8	GND_FLT	Ground reference	Ground reference for Digital outputs
9	MASTER_FAULT	Digital I/O	3.3 V – 5 V Digital output Driver Fault
10	+15_I/O1	Power supply	Power supply for LEM PCB
11	HALT_CMD	Digital I/O	0 – 3.3 V OR 5V Digital input
12	GND_I/O1	Ground reference	Ground reference for LEM PCB
13	PWM_IN-_U_H	Digital I/O	0 – 3.3 V OR 5 V PWM Logic input
14	PWM_IN+_U_H	Digital I/O	0 – 3.3 V OR 5 V PWM Logic input
15	PWM_IN-_V_H	Digital I/O	0 – 3.3 V OR 5 V PWM Logic input
16	PWM_IN+_V_H	Digital I/O	0 – 3.3 V OR 5 V PWM Logic input
17	PWM_IN-_W_H	Digital I/O	0 – 3.3 V OR 5 V PWM Logic input
18	PWM_IN+_W_H	Digital I/O	0 – 3.3 V OR 5 V PWM Logic input
19	CGND1	Ground reference	Ground reference for digital logic.
20	POWER_VDD	Aux. Power IN	9 V to 15 V External Power input
21	POWER_VDD	Aux. Power IN	9 V to 15 V External Power input
22	LEM_PHASE_U	Analog Output	0 – 10 V LEM Phase U output
23	LEM_PHASE_V	Analog Output	0 – 10 V LEM Phase V output
24	RES I/O	Digital I/O	0 – 3.3 V OR 5 V external reset input
25	GND RES_I/O	Ground reference	Ground reference for Reset / Halt-Cmd
26	HV_FAULT_I/O	Digital I/O	3.3 V – 5 V Digital output HVDC Fault
27	GND_I/O2	Ground reference	Ground reference for DC_LINK+/W_I/O
28	W_I/O	Analog Output	0 – 10 V Phase W Temp Sensing
29	DC_LINK+	Analog Output	0 – 10 V DC BUS Voltage Sensing
30	T I/O_FAULT	Digital I/O	3.3 V – 5 V Digital output over Temp Fault
31	GND_I/O2	Ground reference	Ground reference for DC_LINK+/W_I/O
32	PWM_IN-_U_L	Digital I/O	0 – 3.3 V OR 5 V PWM Logic input
33	PWM_IN+_U_L	Digital I/O	0 – 3.3 V OR 5 V PWM Logic input
34	PWM_IN-_V_L	Digital I/O	0 – 3.3 V OR 5 V PWM Logic input
35	PWM_IN+_V_L	Digital I/O	0 – 3.3 V OR 5 V PWM Logic input
36	PWM_IN-_W_L	Digital I/O	0 – 3.3 V OR 5 V PWM Logic input
37	PWM_IN+_W_L	Digital I/O	0 – 3.3 V OR 5 V PWM Logic input

Table 6. CONNECTOR J18

Pin#	Signal	Function	Specification
1	POWER_VDD	Aux. Power IN	9 – 15 VDC, 4 A
2	POWER_VSS	Aux. Power RTN	GND return for Aux. power

EVBUM2704

Table 7. CONNECTOR LEM1

Pin#	Signal	Function	Specification
1	+15VI/O	Power	+15 V Power supply for Isolated Signal
2	GND_I/O	Ground	Ground return for +15 VI/O
3	IU	Sensor output	LEM Phase U output
4	IV	Sensor output	LEM Phase V output
5	IW	Sensor output	LEM Phase W output
6	GND_I/O	Ground	Ground return for +15 VI/O

Table 8. CONNECTOR J11/J12/J13

Pin#	Signal	Function	Specification
1	FLT-H	Protection	Gate Driver fault High Side
2	FLT-L	Protection	Gate Driver fault Low Side
3	OTS_HS	Protection	Over Temperature High Side
4	OTS_LS	Protection	Over Temperature Low Side
5	OCS_HS	Protection	Over Current High Side
6	OCS_LS	Protection	Over Current Low Side
7	IN+_H	PWM Logic	PWM Logic High Side
8	IN+_L	PWM Logic	PWM Logic Low Side

Table 9. CONNECTOR J16

Pin#	Signal	Function	Specification
1	IW	Signal	LEM Sensor Phase W output
2	NC	-	-
3	IV	Signal	LEM Sensor Phase V output
4	NC	-	-
5	IU	Signal	LEM Sensor Phase U output
6	NC	-	-
7	TEMP_IGBTW_I/O	Analog output	Phase W Low side temperature sensor output
8	GND_I/O	Ground	Ground return for +15 VI/O

Current Sensor Board conditions the feedback signals from the hall-effect sensors and interfaces with the gate driver board via a flat ribbon cable.

Table 10. CONNECTOR J2

Pin#	Signal	Function	Specification
1	+15VI/O	Power	+15 V Power supply for Isolated Signal
2	GND_I/O	Ground	Ground return for +15 VI/O
3	IU	Sensor output	LEM Phase U output
4	IV	Sensor output	LEM Phase V output
5	IW	Sensor output	LEM Phase W output
6	GND_I/O	Ground	Ground return for +15 VI/O

OPEN LOOP OPERATION

This section gives a quick start guide for operating VE-Trac Dual evaluation kit in open loop operation and provides a list of equipment needed.

Equipment for Evaluation of VE-Trac Dual Evaluation Kit

- Power Supply: 9 V – 15 V, 4 A
- HVDC Power Supply: 0 – 500 V 40 A (depends on the load)
- Load: Passive 3 ph Inductive load or AC Induction Machine
- Scope: 4 channel digital scope
- HV Differential Probe: 1500 Vpk 200 MHz Bandwidth
- Current Probe: 6000 A 30 MHz Bandwidth

- DVM: General Digital Multi-meter
- MCU or DSP Eval Board: Open loop PWM control algorithm software
- Cooling System : 50/50 Ethylene Glycol/Water Flow rate 8 – 10 LPM
- Hose: 3/4" ID, 1" OD, rated to 100°C, 45 PSI @ 25°C
- Cooling System for Load: Liquid or Air-cooled.

Connections with Control Power and MCU/DSP Interface

The evaluation kit requires an external MCU or DSP Eval Board for PWM control signals for open loop operation. The interface features a standard DB-37 connector. Below figure and table show the pin out definitions.

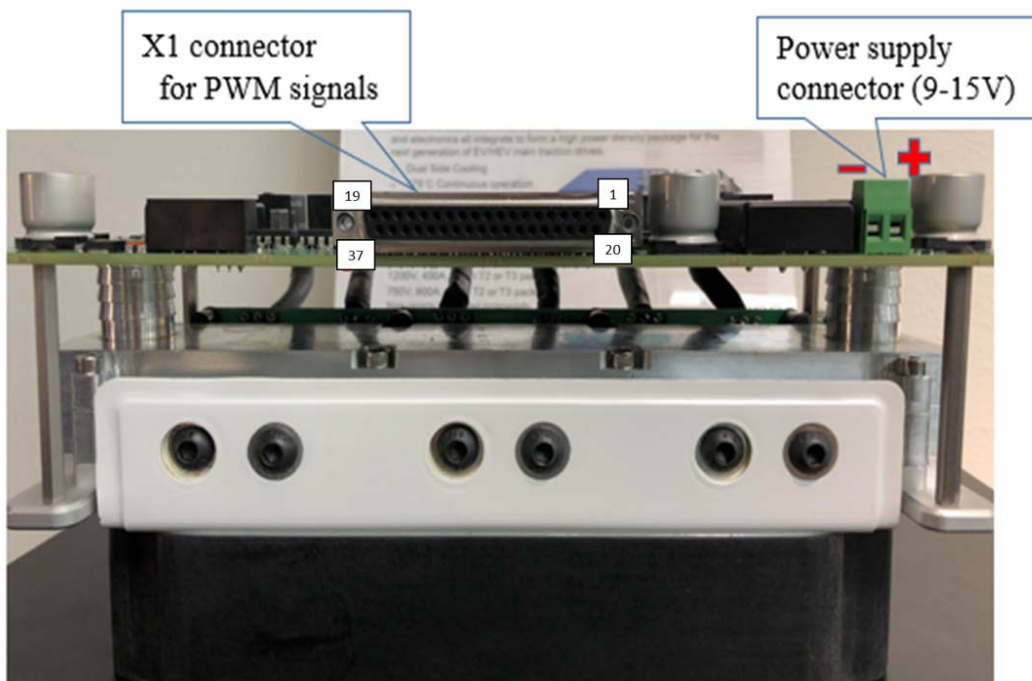

Figure 7. Controller Interface

Table 11. CONTROLLER INTERFACE SIGNAL USED

Pin#	Signal	Function	Specification																
1	Vss	Ground	To be connected to ground																
2	Vss	Ground	To be connected to ground																
13	PWM_IN- _U_H	PWM signal	Differential pairs																
14	PWM_IN+ _U_H	PWM signal	Differential pairs																
15	PWM_IN- _V_H	PWM signal	Differential pairs																
16	PWM_IN+ _V_H	PWM signal	Differential pairs																
17	PWM_IN- _W_H	PWM signal	Differential pairs																
18	PWM_IN+ _W_H	PWM signal	Differential pairs																
32	PWM_IN- _U_L	PWM signal	Differential pairs																
33	PWM_IN+ _U_L	PWM signal	Differential pairs </tr <tr> <td>34</td> <td>PWM_IN- _V_L</td> <td>PWM signal</td> <td>Differential pairs</td> </tr> <tr> <td>35</td> <td>PWM_IN+ _V_L</td> <td>PWM signal</td> <td>Differential pairs</td> </tr> <tr> <td>36</td> <td>PWM_IN- _W_L</td> <td>PWM signal</td> <td>Differential pairs</td> </tr> <tr> <td>37</td> <td>PWM_IN+ _W_L</td> <td>PWM signal</td> <td>Differential pairs</td> </tr>	34	PWM_IN- _V_L	PWM signal	Differential pairs	35	PWM_IN+ _V_L	PWM signal	Differential pairs	36	PWM_IN- _W_L	PWM signal	Differential pairs	37	PWM_IN+ _W_L	PWM signal	Differential pairs
34	PWM_IN- _V_L	PWM signal	Differential pairs																
35	PWM_IN+ _V_L	PWM signal	Differential pairs																
36	PWM_IN- _W_L	PWM signal	Differential pairs																
37	PWM_IN+ _W_L	PWM signal	Differential pairs																

VE-Trac DSC Drive Connection for HVDC and LOAD

Figure 8 shows the right connection of HVDC power supply and loads. Make sure a good electrical contact between the power tabs to avoid generating excessive heat.

We recommend monitor the temperature of the power terminals during operation and take corrective actions when they are overheated.

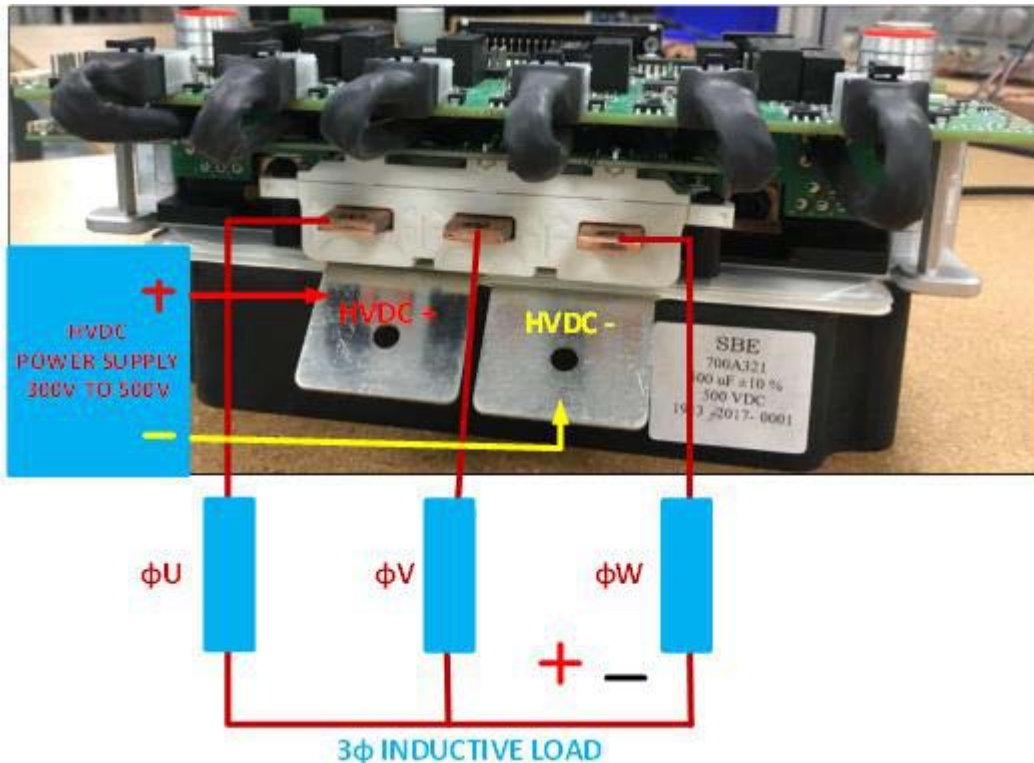

Figure 8. Power and Load Connection

VE-Trac Dual Evaluation Kit Cooling System

The cooler can be connected with a 3/4 inch Inside Dimension and 1inch Outside Dimension flexible hose interface. Use 50% Water/50% Ethylene Glycol as cooling

fluid and make sure that cooling fluid corrosion protection is compatible with aluminum heatsink. We strongly recommend not use pure water as cooling fluid because it might damage the heatsink.

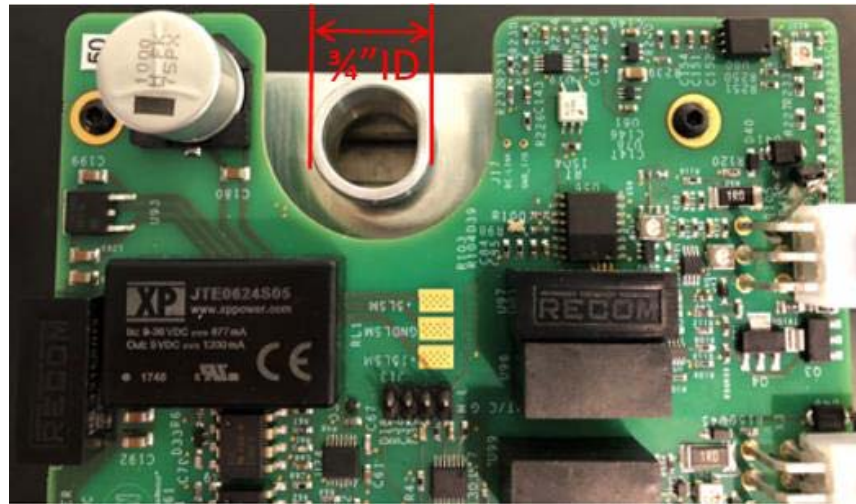

Figure 9. Cooling Interface Appearance

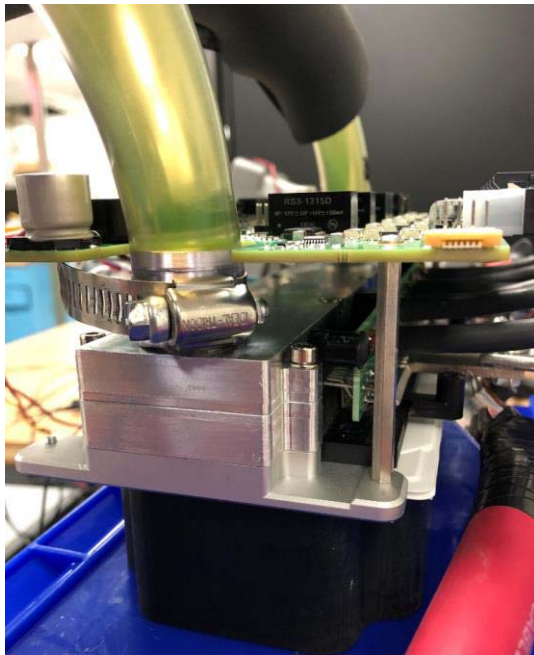

Figure 10. Example with Hose Interface Connected

Run the VE-Trac Dual Evaluation Kit in Open Loop Configuration

Following are the steps to run the inverter in open loop operation.

- Turn off all the power supplies
- Connect control power supply to Inverter at connector J18, refer to Figure 7
- Connect logic PWM signal from DSP/MCU to gate driver board at DB37 pin connector as shown in Figure 7

- Connect voltage/current probes to signals of interest, for example PWM signal, phase current, IGBT collector voltage etc.
- Connect DVM to monitor the IGBT virtual junction temperature to the test points as shown in Figure 6
- Power on the DSP/MCU Board
- Connect USB from DSP/MCU Board to Host computer for commanding the PWM signals duty ratio and Inverter fundamental output frequency to the Inverter
- Set the control power supply as the following
 - ♦ Voltage: 12 V
 - ♦ Current Limit = 3 A
- Turn on the control power supply and all the fault LEDs will be lit. Press the reset switch (see Figure 11) to clear all the faults.
- Set the HVDC Power Supply to 400 V
- Turn on the HVDC Power supply
- Set the cooler system flow rate to desired value. eg 10 LPM to the power module.
- Turn on the cooling system to the Power module
- Turn on the cooling system to the Load
- Enable the Inverter by turning on the PWM Logic via host computer
- Adjust the Duty ratio and Inverter fundamental frequency to get desired output current
- Monitor the IGBT Junction Temperature
- Record the Cooler System Inlet and Outlet Temperature
- Record the output phase current



Figure 11. Location of Reset Switch

TEST RESULT SUMMARY

Following the steps listed above, inverter testing has been done to verify the function of the evaluation kit as well as the performance of the VE-Trac Dual power module. Driving capability of the power module with reference cooling

heatsink was verified by monitoring On-chip temperature sensor vs Phase current.

**Test Results under the Condition of: Tcoolant = 25°C
DC BUS = 400 V Fsw = 8 kHz / 10 kHz.
Flow rate = 10 LPM**

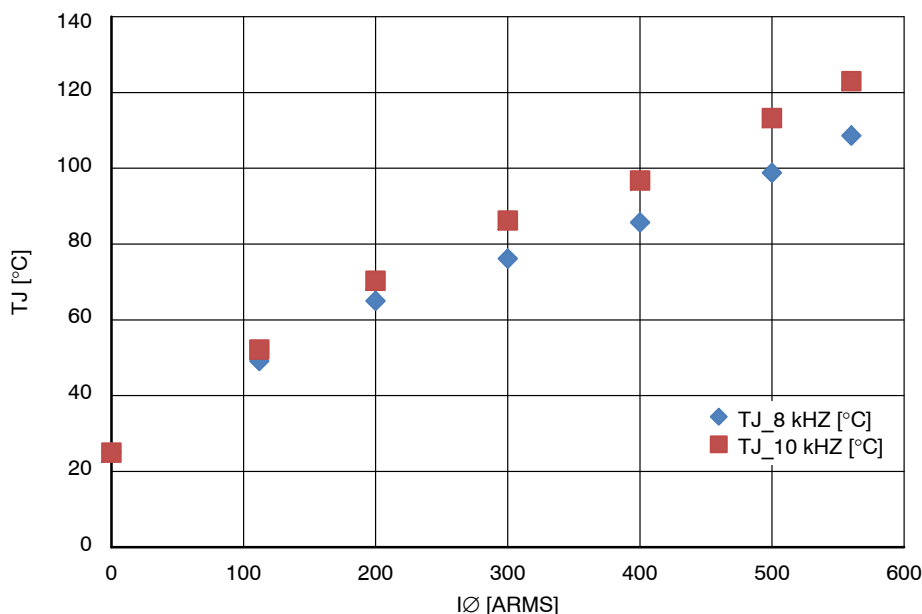

Figure 12. IGBT Junction Temperature vs Phase Current; Tcoolant = 25°C Flow Rate = 10 LPM, Bus Voltage = 400 V, Switching Freq = 8 & 10 kHz

EVBUM2704

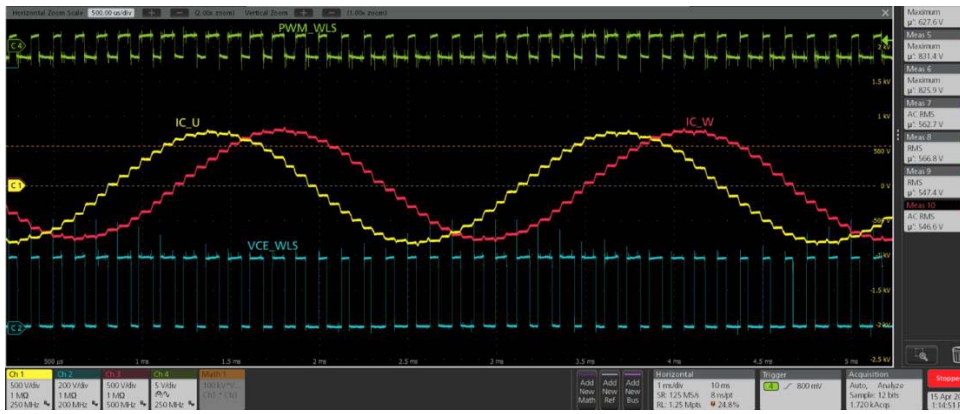

Figure 13. Switching Waveforms, C1: U Phase Current; C2: W Phase Voltage (Low Side Switch); C3: W Phase Current; C4: Input PWM Signal (W Phase Low Side)

Test Results under the Condition of: Tcoolant = 65° C
 DC BUS = 400 V Fsw = 8 kHz / 10 kHz.
 Flow rate = 10 LPM

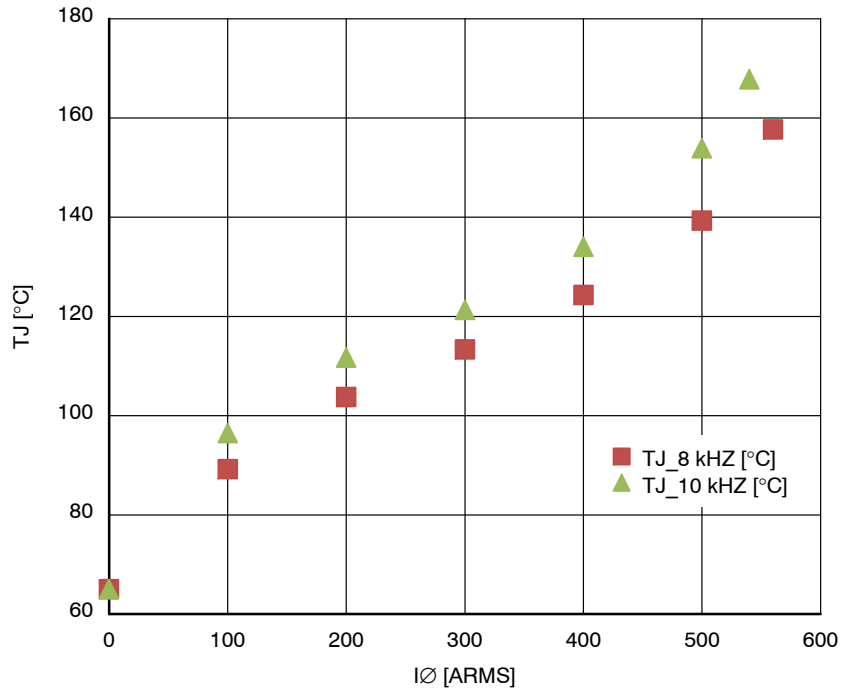

Figure 14. IGBT Junction Temperature vs Phase Current; Tcoolant = 65°C Flow Rate = 10 LPM, Bus Voltage = 400 V, Switching Freq = 8 kHz / 10 kHz

EVBUM2704

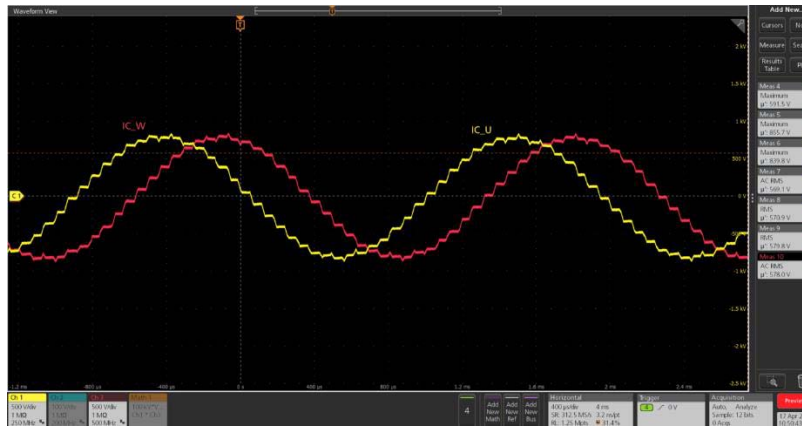

Figure 15. Switching Waveforms, C1: U Phase Current; C3: W Phase Current

onsemi, **Onsemi**, and other names, marks, and brands are registered and/or common law trademarks of Semiconductor Components Industries, LLC dba "**onsemi**" or its affiliates and/or subsidiaries in the United States and/or other countries. **onsemi** owns the rights to a number of patents, trademarks, copyrights, trade secrets, and other intellectual property. A listing of **onsemi**'s product/patent coverage may be accessed at www.onsemi.com/site/pdf/Patent-Marking.pdf. **onsemi** is an Equal Opportunity/Affirmative Action Employer. This literature is subject to all applicable copyright laws and is not for resale in any manner.

The evaluation board/kit (research and development board/kit) (hereinafter the "board") is not a finished product and is not available for sale to consumers. The board is only intended for research, development, demonstration and evaluation purposes and will only be used in laboratory/development areas by persons with an engineering/technical training and familiar with the risks associated with handling electrical/mechanical components, systems and subsystems. This person assumes full responsibility/liability for proper and safe handling. Any other use, resale or redistribution for any other purpose is strictly prohibited.

THE BOARD IS PROVIDED BY ONSEMI TO YOU "AS IS" AND WITHOUT ANY REPRESENTATIONS OR WARRANTIES WHATSOEVER. WITHOUT LIMITING THE FOREGOING, ONSEMI (AND ITS LICENSORS/SUPPLIERS) HEREBY DISCLAIMS ANY AND ALL REPRESENTATIONS AND WARRANTIES IN RELATION TO THE BOARD, ANY MODIFICATIONS, OR THIS AGREEMENT, WHETHER EXPRESS, IMPLIED, STATUTORY OR OTHERWISE, INCLUDING WITHOUT LIMITATION ANY AND ALL REPRESENTATIONS AND WARRANTIES OF MERCHANTABILITY, FITNESS FOR A PARTICULAR PURPOSE, TITLE, NON-INFRINGEMENT, AND THOSE ARISING FROM A COURSE OF DEALING, TRADE USAGE, TRADE CUSTOM OR TRADE PRACTICE.

onsemi reserves the right to make changes without further notice to any board.

You are responsible for determining whether the board will be suitable for your intended use or application or will achieve your intended results. Prior to using or distributing any systems that have been evaluated, designed or tested using the board, you agree to test and validate your design to confirm the functionality for your application. Any technical, applications or design information or advice, quality characterization, reliability data or other services provided by **onsemi** shall not constitute any representation or warranty by **onsemi**, and no additional obligations or liabilities shall arise from **onsemi** having provided such information or services.

onsemi products including the boards are not designed, intended, or authorized for use in life support systems, or any FDA Class 3 medical devices or medical devices with a similar or equivalent classification in a foreign jurisdiction, or any devices intended for implantation in the human body. You agree to indemnify, defend and hold harmless **onsemi**, its directors, officers, employees, representatives, agents, subsidiaries, affiliates, distributors, and assigns, against any and all liabilities, losses, costs, damages, judgments, and expenses, arising out of any claim, demand, investigation, lawsuit, regulatory action or cause of action arising out of or associated with any unauthorized use, even if such claim alleges that **onsemi** was negligent regarding the design or manufacture of any products and/or the board.

This evaluation board/kit does not fall within the scope of the European Union directives regarding electromagnetic compatibility, restricted substances (RoHS), recycling (WEEE), FCC, CE or UL, and may not meet the technical requirements of these or other related directives.

FCC WARNING – This evaluation board/kit is intended for use for engineering development, demonstration, or evaluation purposes only and is not considered by **onsemi** to be a finished end product fit for general consumer use. It may generate, use, or radiate radio frequency energy and has not been tested for compliance with the limits of computing devices pursuant to part 15 of FCC rules, which are designed to provide reasonable protection against radio frequency interference. Operation of this equipment may cause interference with radio communications, in which case the user shall be responsible, at its expense, to take whatever measures may be required to correct this interference.

onsemi does not convey any license under its patent rights nor the rights of others.

LIMITATIONS OF LIABILITY: **onsemi** shall not be liable for any special, consequential, incidental, indirect or punitive damages, including, but not limited to the costs of requalification, delay, loss of profits or goodwill, arising out of or in connection with the board, even if **onsemi** is advised of the possibility of such damages. In no event shall **onsemi**'s aggregate liability from any obligation arising out of or in connection with the board, under any theory of liability, exceed the purchase price paid for the board, if any.

The board is provided to you subject to the license and other terms per **onsemi**'s standard terms and conditions of sale. For more information and documentation, please visit www.onsemi.com.

ADDITIONAL INFORMATION

TECHNICAL PUBLICATIONS:

Technical Library: www.onsemi.com/design/resources/technical-documentation
onsemi Website: www.onsemi.com

ONLINE SUPPORT: www.onsemi.com/support

For additional information, please contact your local Sales Representative at www.onsemi.com/support/sales