

Infinity S Power System

Compact, Dual Voltage, Rack Mounted Power System



Table of contents

03	Overview
04	Infinity Rectifiers and Converters Information
06 - 08	Pulsar Plus Controller Information
09 - 13	System Information
12 - 44	Step 1: System Ordering Information
14 - 18	-48V Base Infinity S System - No Battery Breaker or LVD Option
19 - 24	-48V Infinity S System with Battery Breaker and LVD Option
26 - 30	-48/+24V Infinity S Dual Voltage - No LVD Option
31 - 35	-48/+24V Infinity S Dual Voltage - LVD Option
36 - 38	-48/+12V Infinity S Dual Voltage - LVD Option
39 - 41	-48/-58V Infinity S Dual Voltage - No LVD Option
42 - 46	+24/-48V Infinity S Dual Voltage - LVD Option
47 - 48	Step 2: Expansion Kits and AC Accessories
49 - 50	Step 3: Rectifiers and Converters
51 - 53	Step 4: Distribution Components
54	Step 5: Alarm Input/Output Cables
54 - 55	Step 6: Battery Monitoring
55 - 56	Service and Warranty

Overview

The OmniOn Infinity S DC energy system is a compact power plant that supports dual voltage (+12V/+24V/-48V/-58V) operation through the use of a comprehensive range of advanced rectifiers and DC-DC converters. Primary voltage is supported by rectifiers and battery reserve, while secondary voltage is supported by DC-DC converter modules. Primary voltage can be -48V or +24V.

The Infinity S Power System has primary voltage capacity for +24V power up to 1,200A and -48V power up to 1000A. Secondary voltage capacity is up to 600A (-48V out, 24V in), 600A (-58V out, -48V in), 300A (+12V out, -48V in) and 600A (24V out, -48V in).

Shelf / Bay Options

Infinity S systems features mounting rails for field install applications and may be equipped in a 7 ft 23" relay rack; or a half height rack for mounting on battery stands. The distribution module is 4U tall and accommodates up to 26 single voltage or selectable voltage bullet breaker positions (20 positions in 19" systems). Universal shelves are 1U tall with four slots that accept any Infinity series rectifier or converter interchangeably in any power slot. This allows the available slots to be filled with the mix of power modules desired.

The only restriction is whether AC power is applied to the shelf. This gives extreme flexibility in the provisioning of power modules within the system.

Infinity Rectifier and Converter Family

The Infinity Series offers DC rectifiers and converters for both +24V to -48V, -48V to +24V, -48V to +12V, and -48V to -58V applications. For easy module selection, the rectifiers and converters are color coded to quickly identify voltage, module type and input voltage type (AC or DC).

Galaxy Pulsar* Plus Controller

The Galaxy Pulsar Plus is used throughout many of the OmniOn DC Power products including Infinity, CP, and SPS with the only differentiator being the form factor which is scaled to meet the nature of the application. The controller utilizes standard network management protocols allowing for advanced network supervision with SNMP communications to deliver extensive monitoring and control features with both local and remote access.

Advantages

- Dual Voltage power system with ultimate flexibility
- -48V up to 1000A or +24V up to 1200A
- Secondary voltage up to 600A
- High availability wireless telecom applications
- Telecom service providers
- Wireless service providers
- Industrial and Rail communication systems
- Efficiency approaching 97%
- ECO Priority ready

Infinity Rectifiers and Converters

- Compact – 1RU form factor providing high power density (24 W/in³)
- Dual Voltage compatibility-the unique connector pin designation allows the rectifier to be used in a “universal” power shelf, alongside rectifiers or DC-DC converters with different output voltages.
- Plug and Play-installation of the rectifier in a shelf connected to a compatible system controller initializes all set up parameters automatically. No adjustments are needed.
- Extended service life – parallel operation with automatic load sharing ensures that parallel units are not unduly stressed even when a unit fails or is removed.
- Monitoring / control – the built in microprocessor controls and monitors all critical rectifier functions and communicates with the system controller using the built in Galaxy Protocol serial interface.
- Fail safe performance – hot insertion capabilities allow for converter replacement without system shutdown; soft start and inrush current protection prevent nuisance tripping of upstream breakers.



Applications

- Telecommunications Networks
- Digital Subscriber Line (DSL)
- Indoor/Outdoor Wireless
- Routers/Switches
- Fiber in the Loop
- Transmission
- Data Networks
- Distributed Antenna Systems
- Off-Grid/On-Grid Renewable Energy Sites

Key Features

- Extended temperature range
- Redundant fan cooling
- Front panel LED indicators
- 1U height, hi power density
- 277/220/110V AC input
- Digital load sharing
- Hot pluggable
- RoHS compliant
- Direct solar input (no inverter required)

Rectifier Specifications

INPUT	NE050AC48ATEZ	NE075AC48ATEZ	NE100AC24ATEZ
	NE050ECO48ATEZ	NE075AC48ATEZ+	NE100ECO24ATEZ
Voltage Range	95-305Vac	95-305Vac	95-305Vac
Input Current	15-12A @ 100-120Vac 15-12A @ 200-277Vac	15-12A @ 100-120Vac 22-15.5A @ 200-277Vac	15-12A @ 100-120Vac 15-12A @ 200-277Vac
Input Frequency	45 – 66Hz	45 - 66Hz	45 – 66Hz
Power Factor	0.98 at>50% load	0.98 at>50% load	0.98 at>50% load
Efficiency	> 96% (Peak 96.5%)	95% Standard NE075 >97% NE075+	> 95% (Peak 95.6%)
Total Harmonic Distortion	<5% @loads over 50%	<5% @loads over 50%	<5% @loads over 50%

Pulsar Plus Controller

The Pulsar Plus family of controllers provides system monitoring and control features for Infinity, CP, and other power systems. These controllers monitor and control system components including rectifiers, converters, and distribution modules via a multi-drop RS485 digital communications bus. System status, parameters, settings, and alarm thresholds can be viewed and configured from the controller's front panel display. Assignment and configuration of alarm inputs and output relays can be performed from a laptop computer connected to a local RS-232 or Ethernet port, or by remote access is through a secure network connection to the World Wide Web (internet) or your enterprise network (intranet). An optional modem is also available.

This controller utilizes standard network management protocols allowing for advanced network supervision. The OmniOn Galaxy Manager* software is the centralized visibility and control component of a comprehensive power management system designed to meet engineering, operations and maintenance needs. The Galaxy Manager client-server architecture enables remote access to system controllers across the power network, featuring ECO Priority advanced monitoring features which provides detailed energy source analysis to help better customize your renewable energy resources.



Applications

- Telecommunications Networks
- Digital Subscriber Line (DSL)
- Indoor/Outdoor Wireless
- Routers/Switches
- Fiber in the Loop
- Transmission
- Off-Grid/On-Grid Renewable Energy Sites
- Data Networks
- PBX
- DHCP for plug-n-play
- FTPS for rapid backup and upgrades
- HTTPS for standard web pages and browsers
- Compatible with Galaxy Manager and other management packages
- Shielded RJ-45 interface referenced to chassis ground
- Password protected security levels: User, Super-User, Administrator for all access
- Ground-referenced RS232 system port
- ANSI T1.317 command-line interface

Key Features

Remote Access and Features

- Integrated 10/100Base-T Ethernet Network
 - TCP/IP with IPV6 Capability
 - SNMP V3 for management
 - SMTP for email
 - Telnet for command line interface
- Modem access support
 - Remote via external modem
 - Callback security
- EasyView2, Windows-based GUI software for local terminal or Modem access
- ECO Priority controls and features
 - Advanced generator controls to help minimize fuel consumption for off grid applications

Rectifier Specifications (Continued)

Output	NE050AC48ATEZ	NE075AC48ATEZ	NE100AC24ATEZ
	NE050ECO48ATEZ	NE075AC48ATEZ+	NE100ECO24ATEZ
Voltage Adjust Range	42-58Vdc	42-58Vdc	21-29Vdc
Voltage Nominal	54.5V	54.5V	27.25V
Regulation (with controller)	±0.5%	±0.5%	±0.5%
Ripple	100mVrms	100mVrms	100mVrms
Output Current	57A @48V	82A@48V	114A @24V
• High-Line	50A @54.5V	75A @54.5V	100A @27.25V
• Low-Line	22A @54.5V	22A @54.5V	44A @27.25V
Heat Dissipation @ max output	158W / 539 BTU/hr	249W / 850 BTU/hr	174W / 594 BTU/hr

¹Special room cooling may be required.

Converter Specifications

INPUT	NE075DC24ATEZ	NE070DC58ATEZ	NE075DC12ATEZ	NE030DC48AZ	NE040DC48AZ
Voltage Range	40-60Vdc	40-60Vdc	40-60Vdc	21-30Vdc	21-30Vdc
Min. Turn On Voltage	40Vdc	40Vdc	40Vdc	21Vdc	21Vdc
Input Current	42A @ 54.5Vdc 54A @ 41Vdc	94A @ 54.5Vdc 108A @ 41Vdc	24A @ 54.5Vdc 30A @ 40Vdc	63A @ 27Vdc 81A @ 21Vdc	94A @ 27Vdc 108A @ 21Vdc
Inrush Current	<65A	<85A	<35A	<120A	<120A
Efficiency	94%	94%	92%	93%	93%

Output	NE075DC24ATEZ	NE070DC58ATEZ	NE075DC12ATEZ	NE030DC48AZ	NE040DC48AZ
Voltage Adjust Range	23-28Vdc	54-58Vdc	21-29Vdc	46-57Vdc	46-57Vdc
Voltage Nominal	27.25V	58V	27.25V	52.0V	52.0V
Regulation (with controller)	±0.5%	±0.5%	±0.5%	±0.5%	±0.5%
Ripple	100mVrms	100mVrms	100mVrms	100mVrms	100mVrms
Output Current					
• Nominal	75A @27.25V	70A @ 58V	75A @ 12V	30A @ 52V	40A @ 52V
• Maximum	86A @ 24V	75A @ 54V	90A @ 10V	33A @ 48V	44A @ 48V
Heat Dissipation @ max out 1	158W / 539 BTU/hr	249W / 850 BTU/hr	174W / 594 BTU/hr	154W / 525 BTU/hr	205W / 700 BTU/hr

¹Special room cooling may be required.

Key Features (Continued)

- ECO Energy Management allowing for non-ECO sources outputs to be minimized while ECO resources are available
- Source and load trend logging

Standard System Features

- Monitor and control of more than 40 connected devices
 - Robust RS485 system bus
- Standard and user defined alarms
 - Alarm test
 - Assignable alarm severity: Critical, Major, Minor, Warning, and record-only
 - 10 alarm relays (7 user assigned)
- Rectifier management features
 - Automatic rectifier restart
 - Active Rectifier Management ARM (energy efficiency)
 - Remote rectifier (on/off)
 - Reserve Operation
 - Automatic rectifier sequence control
 - N + X redundancy check
- Multiple Low Voltage Load and Low Voltage Battery Disconnect thresholds
- Configuration, statistics, and history
 - All stored in non-volatile memory
 - Remote/local backup and restore of configuration data
- Industry standard defaults
 - Customer specific configuration available
- Remote/local software upgrade
- Basic, busy hour, and trend statistics
- Detailed event history
- User defined events and derived channels

Standard Battery Management Features

- Float/boost mode control
 - Manual boost
 - Manual timed boost locally, T1.317, and remotely initiated
 - Auto boost terminated by time or current
- Battery discharge testing
 - Manual (local/remote)
 - Periodic
 - Plant Battery Test (PBT) input driven
 - Configurable threshold or 20% algorithm
 - Graphical discharge data
 - Rectifiers on-line during test
- Slope thermal compensation
 - High temperature
 - Low temperature
 - Step temperature
 - STC Enable/Disable, low temperature Enable/Disable
 - Configurable mV/°C slopes
- State of charge indication
- High temperature disconnect setting
- Reserve-time prediction
- Recharge current limit
- Emergency Power-Off input

Integrated Monitoring Inputs/Outputs

- System plant voltage (accuracy $\pm 0.5\%$, resolution 0.01V)
- One system shunt (accuracy $\pm 0.5\%$ full scale, resolution 1A)
 - Battery or load
 - Mounted in the return side of DC bus
- Up to 15 binary inputs
 - 6 inputs close/open to battery
 - 9 input close/open to return

Key Features (Continued)

- User assignable
- Up to 7 Form-C output alarms (60VDC @ .5A)
 - User assignable
- 1-Wire™ bus devices
 - Up to 16 temperature probes (QS873)
 - Up to 6 mid-string monitors (ES771)

Galaxy Manager Compatible

- Centralized web server and database with multiple user access to live or managed data with drill down

to problem details

- Monitor and control of more than 40 connected devices
- Management information from polling or alarms received from alarm traps from multiple sites are available on one screen via the inter/intranet
- Trend user selected data over time
- Automatic or manual report generation
- Standard engineering tools like reserve time calculators and cable voltage drop analyzer

Specifications

GENERAL	
Operating Voltage	±24 Vdc, ±48 Vdc (Range: ±18 to ±60 Vdc)
Input Power	Less than 7W
Operating Temperature Range	-40°C to +75°C (-40°F to 167°F)
Operating Relative Humidity	0 - 95% (non-condensing)
Storage Temperature Range	-40°C to +85°C (-40°F to 185°F)
Physical Specifications	Sizes vary by packaging option
Display	8-line by 40-character with alarm context sensitive backlit LCD

SAFETY AND STANDARDS COMPLIANCE

NEBs	Evaluated by independent NRTL test lab to Telcordia GR63, Issue 3 and GR1089-CORE, Issue 6
Safety	ANSI/UL60950-1-2014 and CAN/CSA C22.2 No. 60950-1-07, Second Edition + A2:2014 (MOD), dated October 14, 2014
RoHS	Compliant to RoHS II EU Directive 2002/95/EC/RoHS 6/6
EMC	European Directive 2014/30/EU; EN55032, Class A, EN55035; FCC, Class A; GR1089-CORE, Issue 6

AGENCY CERTIFICATIONS

NEBs Level 3	Evaluated by independent NRTL test lab to Telcordia GR63, Issue 3 and GR1089-CORE, Issue 6
EMC	European Directive 2014/30/EU; EN55032, (CISPR32) Class A, EN55035 (CISPR24)
Safety	Underwriters Laboratories (UL) Listed per Subject Letter 1801: Power Distribution Center for (CSA 22.2 950): Safety of Information Technology Equipment

Infinity S System

Infinity S may be configured as a +24V or -48V single voltage power system or as a dual voltage power system that supports rectifiers and converters. The primary voltage is supported by +24V or -48V rectifiers and battery reserve, while secondary voltage is supported by DC-DC converters. Infinity-S includes dedicated 24V, 48V and return buses. The primary voltage capacity is 1,200A at 24V and 1000A at 48V. Secondary (-48V) voltage capacity is up to 120A, (24V) voltage capacity is up to 300A. The system includes low voltage battery disconnect option for the primary voltage. A low voltage load disconnect option can be used for load shedding to maintain critical loads.



Applications

- Wireless Telecom Networks
- Indoor/Outdoor Wireless
- Transmission
- Data Networks
- Off-Grid/On-Grid
- Renewable Energy Sites

Key Features

- Dual Voltage Flexibility
- Redundant Fan Cooling
- Front Panel LED Indicators
- 1U Height, Hi Power Density
- 220/110 V AC Input
- Digital Load Sharing
- Hot Pluggable
- RoHS Compliant
- ECO Priority Ready

Specifications

INPUT	MIN	TYP	MAX
Voltage Range			
• High-Line	175Vac	220Vac	305Vac
• Low-Line	85Vac	110Vac	140Vac
Frequency	45Hz	60Hz	66Hz
Power Factor	98%	99.5%	
Total Harmonic Distortion			5%

PRIMARY OUTPUT		
Nominal Voltage	24Vdc	-48Vdc
Output Current	1200A	800A
Vo Setpoint (factory)	27.2Vdc±1%	-54.5Vdc±1%
Vo Range	+21Vdc to +29Vdc	-42Vdc to -58Vdc
Regulation	±0.5%	±0.5%

Specifications (Continued)

SECONDARY OUTPUT				
Nominal Voltage	-48Vdc	-58Vdc	+12Vdc	+24Vdc
Output Current	600A / NA	600A / 600A	300A / 225A	600A / 600A
Vo Setpoint (factory)	-54.5Vdc±1%	-58Vdc±1%	+12Vdc±1%	27.25Vdc±1%
Vo Range	-42Vdc to -58Vdc	-54Vdc to -58Vdc	+10Vdc to +14Vdc	+21Vdc to +29Vdc
Regulation	±0.5%	±0.5%	±0.5%	±0.5%

MECHANICAL	SYSTEM ONLY	FRAME MOUNTED SYSTEM
Height (in. /mm)	21.25 / 540 (Base system with 4 power shelves and 2 distributions)	84 / 2134
Width (in. /mm)	19 / 482.6 or 23 / 584.2	23 / 584.2 or 26 / 660.4
Depth (in. /mm)	21/533	21/533
Weight (lb / Kg)	108 / 49 (Base system with 4 power shelves and 2 distributions) 292 / 132.5 (Base system in 23" Frame with 4 power shelves and 2 distributions)	292/132

ENVIRONMENTAL	
Operating Temperature	-40°C to +75°C (-40°F to 167 °F)
Storage Temperature	-40°C to +85°C (-40°F to 185°F)
Humidity	95% non-condensing
Altitude	4000M (for altitudes above 2000M, peak operating temperature de-rates 0.656° C /100M; 4000M peak temperature rating is 62° C)

SAFETY AND STANDARDS COMPLIANCE	
NEBs	Evaluated by independent NRTL test lab to Telcordia GR63-CORE and GR1089-CORE [Level 3] ISSUE 6
Safety	ANSI/UL62368-1-2014 and CAN/CSA C22.2 No. 60950-1-07, Second Edition + A2:2014 (MOD), dated October 14,2014
RoHS	Compliant to RoHS II EU Directive 2002/95/EC/RoHS 6/6
EMC	European Directive 2014/30/EU; EN55032, Class A; EN55035; FCC, Class A; GR1089-CORE ISSUE 6

AGENCY CERTIFICATIONS	
CSA	ANSI/UL60950-1-2014 and CAN/CSA C22.2 No. 60950-1-07, Second Edition + A2:2014 (MOD), dated
EMI/EMC	European Directive 2014/30/EU; EN55032 (CISPR22) Class A; EN55035 (CISPR24)
NEBS LEVEL 3	GR1089-CORE Special equipment room cooling may be needed - heat dissipation exceeds values of

Specifications (Continued)

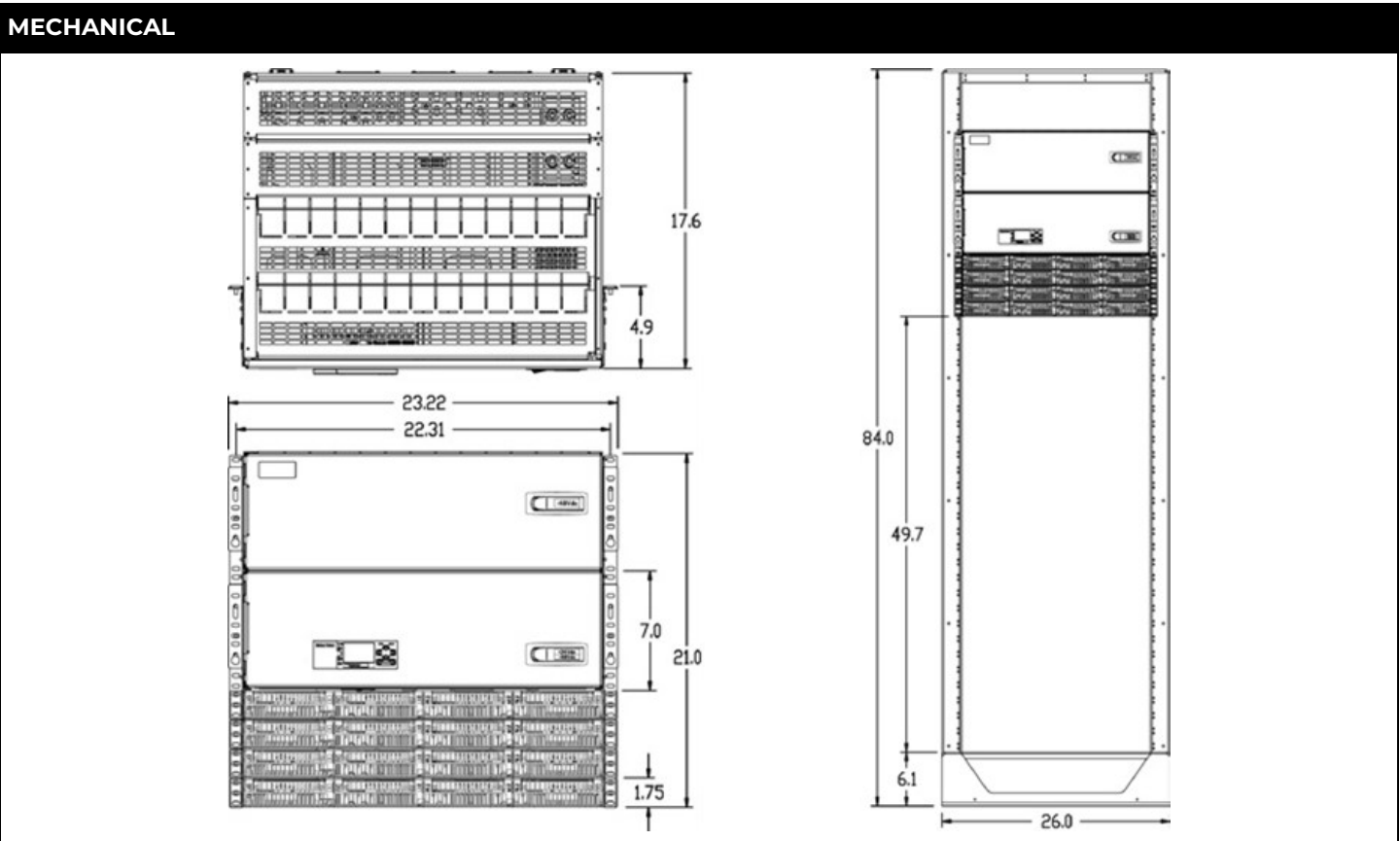

Shelf Specifications

MECHANICAL	
Height	4RU main cabinet plus 1RU per power shelf – Base system 5RU (8.75 inches / 222mm)
Width (with mounting ears)	23 inches (584mm)
Depth	18 inches (457mm), 21 inches (533mm) for systems equipped with AC5 input
Weight (without rectifiers)	Approximately 42lbs (19kg) – Base system with 1 rectifier shelf

SAFETY AND STANDARDS COMPLIANCE	
NEBs	Evaluated by independent NRTL test lab to Telcordia GR63-CORE and GR1089-CORE ISSUE 6 [Level 3]
Safety	ANSI/UL60950-1-2014 and CAN/CSA C22.2 No. 60950-1-07, Second Edition + A2:2014 (MOD), dated October 14, 2014
RoHS	Compliant to RoHS EU Directive 2002/95/EC/RoHS 6/6
EMC	European Directive 2014/30/EU; EN55032, Class A; EN55035; FCC, Class A; GR1089-CORE ISSUE 6

AGENCY CERTIFICATIONS	
UL	ISSUE 6
EMI/EMC	European Directive 2014/30/EU; EN55032 (CISPR22) Class A; EN55035 (CISPR24)
NEBS LEVEL 3	GR1089-CORE ISSUE 6

Ordering information-Infinity S Power System

Ordering Guide

Infinity S may be configured as a +24V or -48V single voltage power system or as a “dual voltage” power system that supports rectifiers and converters. The primary voltage is supported by +24V or -48V rectifiers and battery reserve, while secondary voltage is supported by DC-DC converters. The primary voltage capacity is 1,200A at 24V and 800A at 48V. Secondary voltage capacity is up to 300A (-48V), 600A (-58V), 600A (24V), and 300A (12V).





Infinity S systems may be equipped in a 7ft framework, a half height (42”) frame for mounting on battery stands, integrated into cabinet applications, or supplied frameless for field install applications.

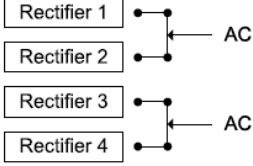

Features

- Infinity Series Rectifiers for +24V and -48V applications.
- Dual Voltage Bus architecture for easy growth and voltage migration
- DC-DC Converter support for dual voltage systems
- DC Distribution for both voltages, with Selectable Voltage panel availability
- Temperature hardened harsh environments. (-40°C to +75°C)
- Compact size: Base System with 1 power shelf occupies 5 RU (8.75 in) of 19” or 23” rack space (18”-21” depth)
- Frame options-Factory installed in 7ft or 42” tall, 19” or 23” wide frame or field installed in user supplied frame
- Battery connections, LVBD and LVLD options.
- Plug-N-Play Pulsar Plus controller with Web based interface for local and remote (LAN) access.
- Distribution options include 3A-250A bullet style circuit breakers, and GMT fuses

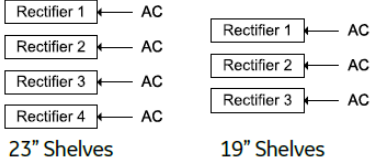
AC Input Types

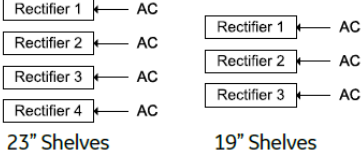
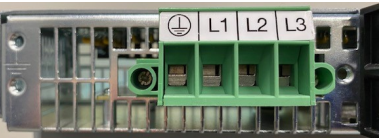
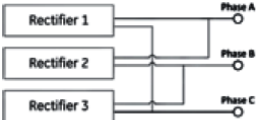
TYPE	DESCRIPTION	SCHEMATIC
AC1	Dual Feed, Molex Mini-fit Sr (23" Shelves Only)	
		
AC3	Individual Feed, IEC-320 C19 Receptacles	
		
AC5/AC5H	Individual Feed, Terminal Strip, 3/4" Conduit or Cord Grip	
		
AC6	Three Phase, terminal strip input Rear cover is equipped with a 1" conduit knockout (19" Shelves Only)	
		

Infinity S -48V Power Systems

Base Level 48V Systems

Infinity S –48V power systems are designed to support DC loads ranging from 150A to 800A. The systems are either 19" or 23" rack mountable. The output load bus accommodates bullet breaker, pluggable TPS fuses, and plug in GMT modules. Battery connections are in the rear of the plant and the system does not support LVD's.



Infinity S –48V systems may be equipped in a 7ft framework, a half height (42") frame for mounting on battery stands, integrated into cabinet applications, or supplied frameless for field install applications.

Key Features

- Infinity Series Rectifiers -48V applications.
- Temperature hardened harsh environments. (-40°C to +75°C)
- Compact size: Base System with 1 power shelf occupies 5 RU (8.75 in) of 19" or 23" rack space (18"-21" depth)
- Frame options-Factory installed in 7ft or 42" tall, 19" or 23" wide frame or field installed in user supplied frame
- Rear Bulk Battery connections
- Plug-N-Play Pulsar Plus controller with Web based interface for local and remote (LAN) access.
- Distribution options include 3A-300A bullet style circuit breakers, and GMT fuses

System Specifications

	19 Inch System	23 Inch System
Nominal Voltage	-48Vdc	-48Vdc
Maximum Output Current DC1ES	450A	600A
Maximum Output Current DC2ES	600A	800A
System Shunt	1200A 50mV	1200A 50mV
Bulk Battery (No Battery Breaker Dist.)	5 x 5/16" on 1"	6 x 5/16" on 1"

Product Documentation

CC848815341	Advanced Features User Guide for the Pulsar Plus Controller, 167-792-183
CC848908475	Infinity S (NE-S) -48V Power System Quick Start Guide

DC Output Types

Single Voltage Systems - No Battery Breaker Bus

Type	Description	Schematic
DC1ES / DC2ES	<p>20 Positions for 19" or 26 Positions for 23" Configuration; No Battery Breaker or LVD Option</p> <p>DC2ES Adds a second load distribution panel with 20 Positions for 19" and 26 Positions for 23"</p> <p>Ratings: DC1ES 450A Output for 19", 600A Output for 23"</p> <p>DC2ES 600A Output for 19", 800A Output for 23"</p>	

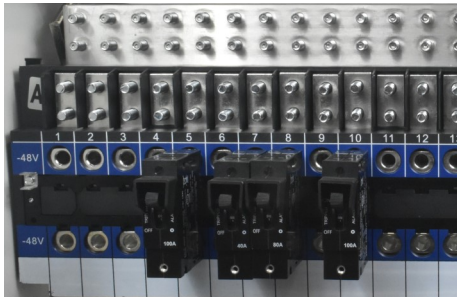

Bulk Battery Connections

19" Single Voltage system without Battery Breaker Bus 23" Single Voltage system without Battery Breaker bus

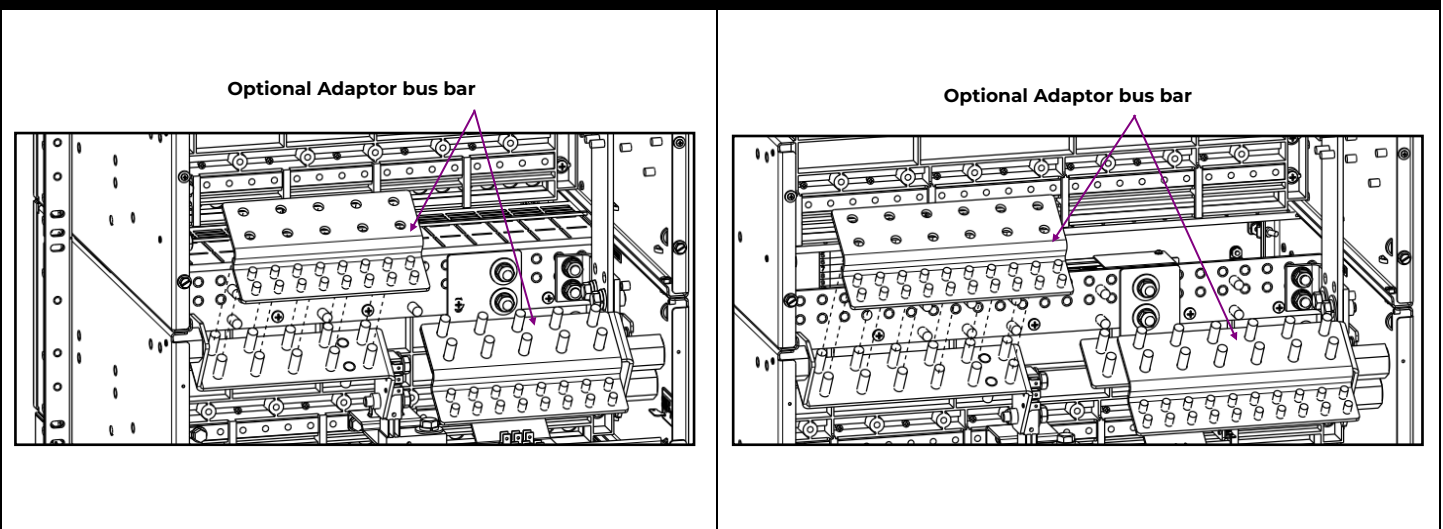

Step 1: Select the Base Power System

Single Voltage System -48V Bulk Battery Input, 19" Width

OUTPUT RATING	DESCRIPTION	AC INPUT	LVD	FRAME	ORDERING CODE	MODEL	PHOTO
-48V 225A	225A Infinity S Power system equipped with 3 rectifier positions and 20 distribution positions. System - 5RU	AC5	NO		150033064	NES48-19-AC5-PS3-DC1ES	
		AC6	NO		150033083	NES48-19-AC6-PS3-DC1ES	
-48V 450A	450A Infinity S Power system equipped with 6 rectifier positions and 20 distribution positions. System - 6RU	AC5	NO		150033065	NES48-19-AC5-PS6-DC1ES	
		AC6	NO		150033084	NES48-19-AC6-PS6-DC1ES	
-48V 450A	450A Infinity S Power system equipped with 6 rectifier positions and 40 distribution positions. System - 10RU	AC5	NO		150033070	NES48-19-AC5-PS6-DC2ES	
		AC6	NO		150033087	NES48-19-AC6-PS6-DC2ES	
-48V 600A	600A Infinity S Power system equipped with 9 rectifier positions and 20 distribution positions. System - 7RU	AC5	NO		150033066	NES48-19-AC5-PS9-DC1ES	
		AC6	NO		150033085	NES48-19-AC6-PS9-DC1ES	
-48V 600A	600A Infinity S Power system equipped with 9 universal positions and 40 total distribution positions. System - 11RU	AC5	NO		150033071	NES48-19-AC5-PS9-DC2ES	
		AC6	NO		150033088	NES48-19-AC6-PS9-DC2ES	
-48V 450A	450A Infinity S Power system equipped with 12 rectifier positions and 20 distribution positions. System - 8RU	AC5	NO		150033067	NES48-19-AC5-PS12-DC1ES	
		AC6	NO		150033086	NES48-19-AC6-PS12-DC1ES	
-48V 450A	600A Infinity S Power system equipped with 12 universal positions and 40 total distribution positions. System - 12RU	AC5	NO		150033072	NES48-19-AC5-PS12-DC2ES	
		AC6	NO		150033089	NES48-19-AC6-PS12-DC2ES	



Step 1: Select the Base Power System

Single Voltage System -48V Bulk Battery Input, 23" Width

OUTPUT RATING	DESCRIPTION	AC INPUT	LVD	FRAME	ORDERING CODE	MODEL	PHOTO
-48V 200A	200A Infinity S Power system equipped with 4 rectifier positions and 26 distribution positions System - 5RU	AC1	NO		CC109163696	NES48-23-AC1-PS4-DC1ES	
		AC3	No		CC109163663	NES48-23-AC3-PS4-DC1ES	
-48V 300A	300A Infinity S Power system equipped with 4 rectifier positions and 26 distribution positions System - 5RU	AC5H	No		150045731	NES48-23-AC5H-PS4-DC1ES	
-48V	400A Infinity S Power system equipped with 8 rectifier positions and 26 distribution positions System - 6RU	AC1	No		CC109163705	NES48-23-AC1-PS8-DC1ES	
		AC3	No		CC109163671	NES48-23-AC1-PS8-DC1ES	
-48V 600A	600A Infinity S Power system equipped with 8 rectifier positions and 26 distribution positions System - 6RU	AC5H	No		150045732	NES48-23-AC5H-PS8-DC1ES	
		AC5H	No		1600401815A	NES48-23-AC5H-PS8-DC1ES-M*	
-48V 600A	600A Infinity S Power system equipped with 12 rectifier positions and 26 distribution positions System - 7RU	AC1	No		CC109163713	NES48-23-AC1-PS12-DC1ES	
		AC3	No		CC109163688	NES48-23-AC3-PS12-DC1ES	
-48V 600A	600A Infinity S Power system equipped with 12 rectifier positions and 26 distribution positions System - 7RU	AC5H	No		150045733	NES48-23-AC5H-PS12-DC1ES	
-48V 600A	600A Infinity S Power system equipped with 8 rectifier positions and 52 distribution positions System - 10RU	AC5H	No		150052309	NES48-23-AC5H-PS8-DC2ES	
-48V 800A	800A Infinity S Power system equipped with 12 rectifier positions and 52 distribution positions System - 11RU	AC5H	No		150045734	NES48-23-AC5H-PS12-DC2ES	

Step 1: Select the Base Power System

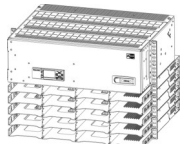
Single Voltage System -48V Bulk Battery Input, 23" Width

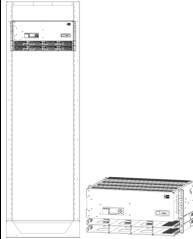
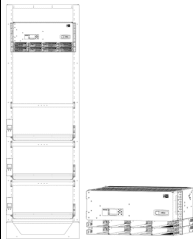
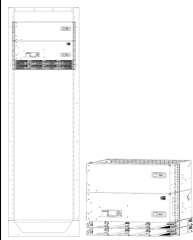
OUTPUT RATING	DESCRIPTION	AC INPUT	LVD	FRAME	ORDERING CODE	MODEL	PHOTO
-48V 600A	600A Infinity S Power system equipped with 16 rectifier positions and 26 distribution positions System - 8RU	AC5H	No		150045735	NES48-23-AC5H-PS16-DC1ES	
-48V 600A	600A Infinity S Power system equipped with 20 rectifier positions and 26 distribution positions System - 9RU	AC5H	No		150045744	NES48-23-AC5H-PS20-DC1ES	
-48V 800A	800A Infinity S Power system equipped with 16 rectifier positions and 52 distribution positions System - 12RU	AC5H	No		150045736	NES48-23-AC5H-PS16-DC2ES	
-48V 600A	600A Infinity S Power system equipped with 8 rectifier positions, 26 distribution positions and mounted in a 7' Zone 4 frame. System - 84"	AC5H	No	Yes	150045745	NES48-23-AC5H-PS8-DC1ES-7FTR	
-48V 600A	600A Infinity S Power system equipped with 8 rectifier positions, 26 distribution positions and mounted in a 7' Zone 4 frame with 3, 24" Deep battery trays. System - 84"	AC5H	No	Yes	1600286544A	NES48-23-AC5H-PS8-DC1ES-7FTR-3BT3	
-48V 600A	600A Infinity S Power system equipped with 8 rectifier positions, 52 distribution positions, and mounted in a 7' Zone 4 frame System - 84"	AC5H	No	Yes	150045747	NES48-23-AC5H-PS8-DC2ES-7FTR	

* Integrated MODBUS adapter included and attached to the system controller

Infinity S -48V Power Systems

Battery Breaker 48V Systems with LVD Options

Infinity S -48V power systems are designed to support DC loads ranging from 150A to 800A. The systems are either 19" or 23" rack mountable. The output load bus accommodates bullet breaker, pluggable TPS fuses, and plug in GMT modules. The bottom 26 breaker positions are selectable between battery and load. Additional bulk battery connections are available in the rear of the plant. Options for Low Voltage Load and Battery disconnects are available.



Infinity S -48V systems may be equipped in a 7ft framework, a half height (42") frame for mounting on battery stands, integrated into cabinet applications, or supplied frameless for field install applications.

Key Features

- Infinity Series Rectifiers -48V applications.
- Battery Breaker Bus and rear bulk Battery Bus
- Optional Low Voltage Battery and Load Disconnects
- Temperature hardened harsh environments. (-40°C to +75°C)
- Compact size: Base System with 1 power shelf occupies 5 RU (8.75 in) of 19" or 23" rack spac(18"-21" depth)
- Frame options-Factory installed in 7ft or 42" tall, 19" or 23" wide frame or field installed in user supplied frame
- Plug-N-Play Pulsar Plus controller with Web based interface for local and remote (LAN) access.
- Distribution options include 3A-300A bullet style circuit breakers, and GMT fuses

System Specifications

	19 Inch System	23 Inch System
Nominal Voltage	-48Vdc	-48Vdc
Maximum Output Current DC1E	450A	600A
Maximum Output Current DC2E	450A	600A
System Shunt	1200A 50mV	1200A 50mV
LVD	600A	600A
Bulk Battery	4 x 5/16" on 1"	4 x 5/16" on 1"

Product Documentation

CC848815341	Advanced Features User Guide for the Pulsar Plus Controller, 167-792-183
8600374238P	Infinity S 48V with Battery Bus Quick Start Guide

DC Output Types

Single Voltage Systems - Battery Breaker Support



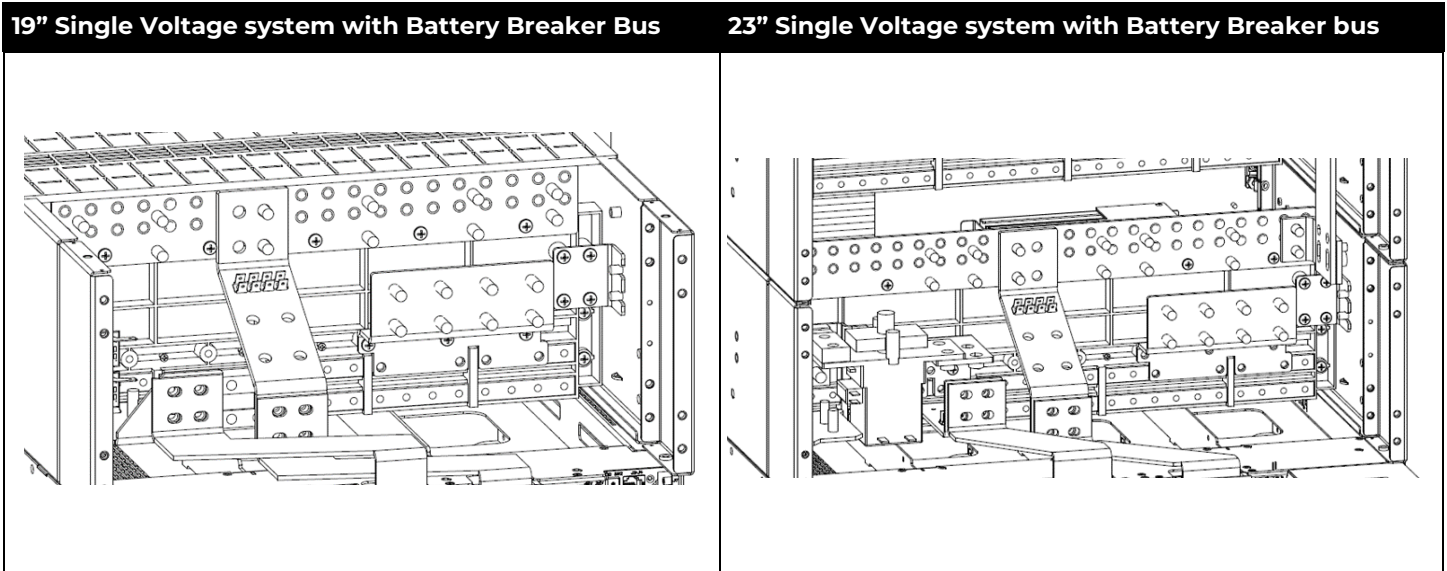

Type	Description	Schematic
DC1E / DC2E	<p>20 Positions for 19" or 26 Positions for 23" Configuration; Each Position Selectable between Battery and Load</p> <p>DC2ES Adds a second load distribution panel with 20 Positions for 19" and 26 Positions for 23"</p> <p>Ratings: DC1E 450A Output for 19", 600A Output for 23" (450A Max with LVD)</p> <p>DC2E 600A Output for 19", 800A Output for 23" (600A Max with LVD)</p>	<p>Optional LVBD</p> <p>Rectifiers</p> <p>1 to A Positions</p> <p>Configurable Battery Breaker Positions; 2-Hole ¼" studs on 5/8" centers</p> <p>1 to A Positions</p> <p>Configurable Load Breaker Positions; 2-Hole ¼" studs on 5/8" centers</p> <p>1 to B Positions</p> <p>Optional Supplemental Load Breaker Positions; 2-Hole ¼" studs on 5/8" centers</p> <p>A = 20 Positions for a 19" and 26 Positions for a 23" System; Each position is configurable between battery and load. B = 20 Positions for a 19" and 26 Positions for a 23" System; Each position is a load breaker position only</p>

Bulk Battery Connections







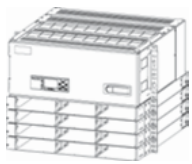

Step 1: Select the Base Power System

Single Voltage System -48V Battery Breaker Input, 19" Width

OUTPUT RATING	DESCRIPTION	AC INPUT	LVD	FRAME	ORDERING CODE	MODEL	PHOTO
-48V 225A	225A Infinity S Power system equipped with 3 rectifier positions and 20 distribution positions. System - 5RU	AC5	LVBD		150032370	NES48-19-AC5-PS3-DC1E-LVBD	
		AC6	LVBD		150033093	NES48-19-AC6-PS3-DC1E-LVBD	
-48V 450A	450A Infinity S Power system equipped with 6 rectifier positions and 20 distribution positions. System - 6RU	AC5	LVBD		150033073	NES48-19-AC5-PS6-DC1E-LVBD	
		AC6	LVBD		150033094	NES48-19-AC6-PS6-DC1E-LVBD	
-48V 450A	450A Infinity S Power system equipped with 6 rectifier positions and 40 distribution positions. System - 10RU	AC5	LVBD		150033078	NES48-19-AC5-PS6-DC2E-LVBD	
		AC6	LVBD		150033097	NES48-19-AC6-PS6-DC2E-LVBD	
		AC5	No		1600476294 A	NES48-19-AC5-PS6-DC2E	
-48V 600A	600A Infinity S Power system equipped with 9 rectifier positions and 20 distribution positions. System-7RU	AC5	LVBD		150033074	NES48-19-AC5-PS9-DC1E-LVBD	
		AC6	LVBD		150033095	NES48-19-AC6-PS9-DC1E-LVBD	
-48V 600A	600A Infinity S Power system equipped with 9 universal positions and 40 total distribution positions. System - 11RU	AC5	LVBD		150033079	NES48-19-AC5-PS9-DC2E-LVBD	
		AC6	LVBD		150033098	NES48-19-AC6-PS9-DC2E-LVBD	
		AC5	LVBD/LVLD		150044453	NES48-19-AC5-PS9-DC2E-LVBD-LVLD	
-48V 450A	450A Infinity S Power system equipped with 12 rectifier positions and 20 distribution positions. System - 8RU	AC5	LVBD		150033075	NES48-19-AC5-PS12-DC1E-LVBD	
		AC6	LVBD		150033096	NES48-19-AC6-PS12-DC1E-LVBD	

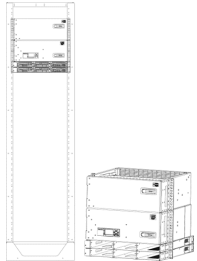
Step 1: Select the Base Power System

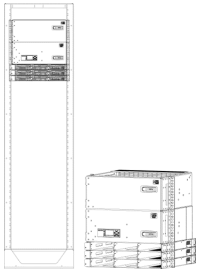
Single Voltage System -48V Battery Breaker Input, 19" Width

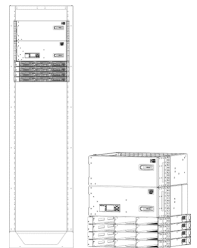
OUTPUT RATING	DESCRIPTION	AC INPUT	LVD	FRAME	ORDERING CODE	MODEL	PHOTO
 600A	600A Infinity S Power system equipped with 12 rectifier positions and 40 distribution positions System - 8RU	AC5	LVBD		150033080	NES48-19-AC5-PS12-DC2E-LVBD	
		AC6	LVBD		150045744	NES48-19-AC6-PS12-DC2E-LVBD	
 450A	450A Infinity S Power system equipped with 6 rectifier positions and 40 distribution positions System - 10RU	AC5	LVBD / LVLD	Yes	150049897	NES48-19-AC5-PS6-DC2E-LVBD-LVLD-7FTR	
 600A	600A Infinity S Power system equipped with 9 rectifier positions, 40 distribution positions and mounted in a 7' Zone 4 frame. System - 84"	AC5	LVBD / LVLD	Yes	150049898	NES48-19-AC5-PS9-DC2E-LVBD-LVLD-7FTR	
 600A	600A Infinity S Power system equipped with 12 rectifier positions, 40 distribution positions and mounted in a 7' Zone 4 frame. System - 84"	AC5	LVBD / LVLD	Yes	150049899	NES48-19-AC5-PS12-DC2E-LVBD-LVLD-7FTR	

Step 1: Select the Base Power System

Single Voltage System -48V Battery Breaker Input, 23" Width

OUTPUT RATING	DESCRIPTION	AC INPUT	LVD	FRAME	ORDERING CODE	MODEL	PHOTO
-48V 200A	200A Infinity S Power system equipped with 4 rectifier positions and 26 distribution positions. System - 5RU	AC1	LVBD		CC109160438	NES48-23-AC1-PS4-DC1E-LVBD	
		AC3	LVBD		CC109167904	NES48-23-AC3-PS4-DC1E-LVBD	
-48V 300A	300A Infinity S Power system equipped with 4 rectifier positions and 26 distribution positions. System - 5RU	AC5H	None		1600441812A	NES48-23-AC5H-PS4-DC1E	
		AC5H	LVBD		150045737	NES48-23-AC5H-PS4-DC1E-LVBD	
-48V 400A	400A Infinity S Power system equipped with 8 rectifier positions and 26 distribution positions. System - 6RU	AC1	LVBD		CC109165998	NES48-23-AC1-PS8-DC1E-LVBD	
		AC3	None		CC109165981	NES48-23-AC3-PS8-DC1E-LVBD	
-48V 600A	600A Infinity S Power system equipped with 8 rectifier positions and 26 distribution positions. System-6RU	AC5H	LVBD		150045738	NES48-23-AC5H-PS8-DC1E-LVBD	
-48V 600A	600A Infinity S Power system equipped with 12 rectifier positions and 26 distribution positions. System - 7RU	AC1	LVBD		CC109167912	NES48-23-AC3-PS12-DC1E-LVBD	
		AC3	LVBD		CC109167920	NES48-23-AC1-PS12-DC1E-LVBD	
-48V 600A	600A Infinity S Power system equipped with 12 rectifier positions and 26 distribution positions. System - 7RU	AC5H	LVBD		150045739	NES48-23-AC5H-PS12-DC1E-LVBD	
-48V 600A	600A Infinity S Power system equipped with 8 rectifier positions and 52 distribution positions. System - 10RU	AC5H	None		1600445103A	NES48-23-AC5H-PS8-DC2E	

Step 1: Select the Base Power System

Single Voltage System -48V Battery Breaker Input, 23" Width

OUTPUT RATING	DESCRIPTION	AC INPUT	LVD	FRAME	ORDERING CODE	MODEL	PHOTO
-48V 800A	800A Infinity S Power system equipped with 12 rectifier positions and 52 distribution positions System - 11RU	AC5H	None		1600441811A	NES48-23-AC5H-PS12-DC2E	
		AC5H	LVBD		150045740	NES48-23-AC5H-PS12-DC2E-LVBD	
-48V 800A	800A Infinity S Power system equipped with 16 rectifier positions and 52 distribution positions System - 12RU	AC5H	LVBD		150045743	NES48-23-AC5H-PS16-DC2E-LVBD	
-48V 600A	600A Infinity S Power system equipped with 8 rectifier positions, 26 distribution positions and mounted in a 7' Zone 4 frame.	AC5H	LVBD	Yes	150048142	NES48-23-AC5H-PS8-DC1E-LVBD-7FTR	
-48V 600A	600A Infinity S Power system equipped with 8 rectifier positions, 52 distribution positions and mounted in a 7' Zone 4 frame.	AC5H	LVBD	Yes	150045748	NES48-23-AC5H-PS8-DC2E-LVBD-7FTR	
		AC5H	LVBD / LVLD	Yes	150045747	NES48-23-AC5H-PS8-DC2E-LVBD-LVLD-7FTR	
-48V 800A	800A Infinity S Power system equipped with 12 rectifier positions, 52 distribution positions and mounted in a 7' Zone 4 frame.	AC5H	LVBD / LVLD	Yes	150051020	NES48-23-AC5H-PS12-DC2E-LVBD-LVLD-7FTR	

Page 24 * Integrated MODBUS adapter included and attached to the system controller

Infinity S Dual Voltage Power Systems

+24V and -48V Primary Dual Voltage Plants

Infinity S Dual Voltage power systems are designed to support DC loads ranging from 200A to 1,200A. The systems are rack mountable in 19" or 23" frames. The output load bus accommodates bullet breaker, pluggable TPS fuses, and plug in GMT modules. Up to 56 breaker positions with the bottom-tier breaker positions selectable between primary and secondary loads. Plants feature the following voltage outputs:

- -48V Primary and +12V Secondary
- -48V Primary and +24V Secondary
- -48V Primary and -58V Secondary
- +24V Primary and -48V Secondary

Bulk battery connections are available in the rear of the plant. The quantity and size of these connections vary based on the variety of the primary distribution. Options for Low Voltage Load and Battery disconnects are available.

Infinity S dual voltage systems may be equipped in a 7ft framework, a half height (42") frame for mounting on battery stands, integrated into cabinet applications, or supplied frameless for field install applications.



Key Features

- Infinity Series -48V and +24V Rectifiers
- Infinity Series -48/+12V, -48/+24V, -48/-58V, and +24V/-48V Converters
- Bulk battery bus connections in rear of plant
- Optional expansion bus bars for battery inputs
- Optional Low Voltage Battery Disconnects
- Temperature hardened harsh environments. (-40°C to +75°C)
- Compact size: Base System with 1 power shelf occupies 5 RU (8.75 in) 19" of 23" rack space (18"-21" depth)
- Frame options-Factory installed in 7ft or 42" tall, 19" or 23" wide frame or field installed in user supplied frame
- Plug-N-Play Pulsar Plus controller with Web based interface for local and remote (LAN) access.
- Distribution options include 3A-300A bullet style circuit breakers, and GMT fuses

Infinity S -48/24V Power Systems

Dual Voltage Power System No LVD Option

Infinity S -48/24V power systems are designed to support DC loads ranging from 150A to 800A on the primary -48V bus and up to 600A on the secondary +24V bus. The systems are either 19" or 23" rack mountable. The output load bus accommodates bullet breaker, pluggable TPS fuses, and plug in GMT modules. The bottom breaker positions are selectable between primary and secondary voltages. Bulk battery connections are available in the rear of the plant. Options for Low Voltage Load and Battery disconnects are available.

Infinity S dual voltage systems may be equipped in a 7ft framework, a half height (42") frame for mounting on battery stands, integrated into cabinet applications, or supplied frameless for field install applications.



Key Features

- Infinity Series Rectifiers -48V applications.
- Bulk Battery Bus in rear of plant
- Optional Low Voltage Battery and Load Disconnects
- Temperature hardened harsh environments. (-40°C to +75°C)
- Compact size: Base System with 1 power shelf occupies 5 RU (8.75 in) of 19" or 23" rack spac(18"-21" depth)
- Frame options-Factory installed in 7ft or 42" tall, 19" or 23" wide frame or field installed in user supplied frame
- Plug-N-Play Pulsar Plus controller with Web based interface for local and remote (LAN) access.
- Distribution options include 3A-300A bullet style circuit breakers, and GMT fuses

System Specifications

	19 Inch System	23 Inch System
Nominal Voltage	-48Vdc / +24Vdc	-48Vdc / +24Vdc
Maximum Output Current DC1E	600A / 300A	600A / 600A
Maximum Output Current DC2E	600A / 300A	800A / 600A
System Shunt	800A 50mV	1200A 50mV
LVD	N/A	N/A
Bulk Battery	4 x 5/16" on 1"	4 x 5/16" on 1" and 12 x 1/4"-20 on 5/8"

Product Documentation

CC848815341	Advanced Features User Guide for the Pulsar Plus Controller, 167-792-183
850022389	Infinity S 23" Dual Voltage with LVD Option Quick Start Guide

DC Output Types

Dual Voltage System - 48V Primary and 24V Secondary No LVD Option

Type	Description	Schematic
DC1ES / DC2ES	20 Positions for 19" or 26 Positions for 23" Configuration; No Battery Breaker or LVD Option DC2ES Adds a second load distribution panel with 20 Positions for 19" and 26 Positions for 23" Ratings: DC1ES 450A/450A Output for 19", 600A /600A Output for 23" DC2ES 600A /600A Output for 19", 800A/600A Output for 23"	<p>A = 20 Positions for a 19" and 26 Positions for a 23" System; Each position is configurable between Primary and Secondary Voltage. B = 20 Positions for a 19" and 26 Positions for a 23" System; Each position is a load breaker position only</p>

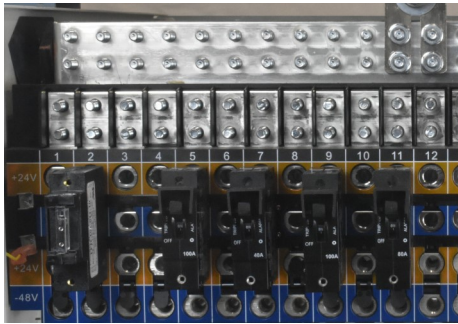











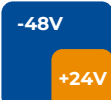

Bulk Battery Connections

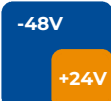
19" Dual Voltage system no LVD Option	23" Dual Voltage system no LVD Option
<p>Optional Adaptor bus bar</p>	<p>Optional Adaptor bus bar</p>



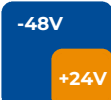





Step 1: Select the Base Power System

Dual Voltage -48V Primary and 24V Secondary, 23" Width (Not LVD Compatible)

OUTPUT RATING	DESCRIPTION	AC INPUT	LVD	FRAME	ORDERING CODE	MODEL	PHOTO
 400A / 225A	400A Infinity S Dual Voltage Power system equipped w/ 8 universal power positions, 26 distribution positions selectable between -48V and +24V. System - 6RU	AC1	No	No	150022649	NES4824-23-AC1-PS8-DC1ES	
 600A / 450A	600A Infinity S Dual Voltage Power system equipped w/16 universal power positions, 26 distribution positions selectable between -48V and +24V. System - 8RU	AC1	No	No	150022651	NES4824-23-AC1-PS16-DC1ES	
 800A / 450A	800A Infinity S Dual Voltage Power system equipped w/16 universal power positions, 52 distribution positions 26 of which are selectable between -48V and +24V. System - 12RU	AC1	No	No	CC109172508	NES4824-23-AC1-PS16-DC2ES	
 400A / 225A	400A Infinity S Dual Voltage Power system equipped w/ 8 universal power positions, 26 distribution positions selectable between -48V and +24V. System - 6RU	AC3	No	No	150022653	NES4824-23-AC3-PS8-DC1ES	
 600A / 450A	600A Infinity S Dual Voltage Power system equipped w/16 universal power positions, 26 distribution positions selectable between -48V and +24V. System - 8RU	AC3	No	No	150022655	NES4824-23-AC3-PS16-DC1ES	
 800A / 450A	800A Infinity S Dual Voltage Power system equipped w/16 universal power positions, 52 distribution positions 26 of which are selectable between -48V and +24V. System - 12RU	AC3	No	No	150022657	NES4824-23-AC3-PS16-DC2ES	

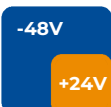

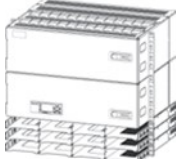

Step 1: Select the Base Power System

Dual Voltage –48V Primary and 24V Secondary, 23” Width (Not LVD Compatible)

OUTPUT RATING	DESCRIPTION	AC INPUT	LVD	FRAME	ORDERING CODE	MODEL	PHOTO
 600A / 225A	600A Infinity S Dual Voltage Power system equipped w/ 8 universal power positions, 26 distribution positions selectable between – 48V and +24V. System - 6RU	AC5H	No	No	150045762	NES4824-23-AC5H-PS8-DC1ES	
 600A / 525A	600A Infinity S Dual Voltage Power system equipped w/16 universal power positions, 26 distribution positions selectable between – 48V and +24V. System - 8RU	AC5H	No	No	150045768	NES4824-23-AC5H-PS16-DC1ES	
 600A / 225A	600A Infinity S Dual Voltage Power system equipped w/8 universal power positions, 52 distribution positions 26 of which are selectable between – 48V and +24V. System - 10RU	AC5H	No	No	150045765	NES4824-23-AC5H-PS8-DC2ES	
 800A / 375A	800A Infinity S Dual Voltage Power system equipped w/12 universal power positions, 52 distribution positions selectable between – 48V and +24V. System - 11RU	AC5H	No	No	1600138837A	NES4824-23-AC5H-PS12-DC2ES	
 800A / 525A	800A Infinity S Dual Voltage Power system equipped w/16 universal power positions, 52 distribution positions selectable between – 48V and +24V. System - 12RU	AC5H	No	No	150045771	NES4824-23-AC5H-PS16-DC2ES	

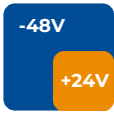
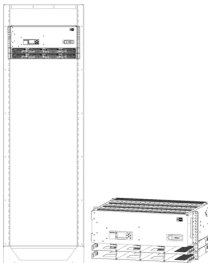
Step 1: Select the Base Power System

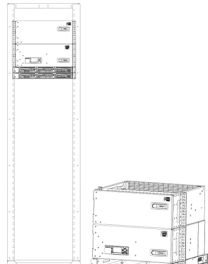
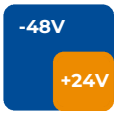
Dual Voltage –48V Primary and 24V Secondary, 23” Width (Not LVD Compatible)

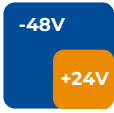
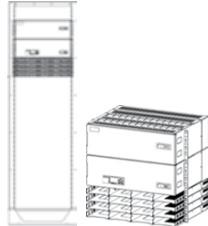
OUTPUT RATING	DESCRIPTION	AC INPUT	LVD	FRAME	ORDERING CODE	MODEL	PHOTO
 600A / 225A	600A Infinity S Dual Voltage Power system equipped w/ 8 universal power positions, 26 distribution positions selectable between –48V and +24V, and mounted in a 7' frame. System - 84"	AC5H	No	Yes	150045764	NES4824-23-AC5H-PS8-DC1ES-7FTR	
 600A / 225A	600A Infinity S Dual Voltage Power system equipped w/8 universal power positions, 52 distribution positions selectable between –48V and +24V, and mounted in a 7' frame. System - 84"	AC5H	No	Yes	150045767	NES4824-23-AC5H-PS8-DC2ES-7FTR	
 600A / 525A	600A Infinity S Dual Voltage Power system equipped w/16 universal power positions, 52 distribution positions 26 selectable between –48V and +24V, and mounted in a 7' frame. System - 84"	AC5H	No	Yes	150045770	NES4824-23-AC5H-PS16-DC1ES-7FTR	
 800A / 525A	800A Infinity S Dual Voltage Power system equipped w/16 universal power positions, 52 distribution positions 26 of which are selectable between –48V and +24V, and mounted in a 7' frame. System - 84"	AC5H	No	Yes	150045773	NES4824-23-AC5H-PS16-DC2ES-7FTR	

Infinity S -48/24V Power Systems

Dual Voltage Power System with LVD Options

Infinity S -48/24V power systems are designed to support DC loads ranging from 150A to 800A on the primary -48V bus and up to 180A on the secondary +24V bus. The systems are either 19" or 23" rack mountable. The output load bus accommodates bullet breaker, pluggable TPS fuses, and plug in GMT modules. The bottom breaker positions are selectable between primary and secondary voltages. Bulk battery connections are available in the rear of the plant. Options for Low Voltage Load and Battery disconnects are available.

Infinity S -48V systems may be equipped in a 7ft framework, a half height (42") frame for mounting on battery stands, integrated into cabinet applications, or supplied frameless for field install applications.



Key Features

- Infinity Series Rectifiers -48V applications.
- Bulk Battery Bus in rear of plant
- Optional Low Voltage Battery and Load Disconnects
- Temperature hardened harsh environments. (-40°C to +75°C)
- Compact size: Base System with 1 power shelf occupies 5 RU (8.75 in) of 19" or 23" rack spac(18"-21" depth)
- Frame options-Factory installed in 7ft or 42" tall, 19" or 23" wide frame or field installed in user supplied frame
- Plug-N-Play Pulsar Plus controller with Web based interface for local and remote (LAN) access.
- Distribution options include 3A-300A bullet style circuit breakers, and GMT fuses

System Specifications

	19 Inch System	23 Inch System
Nominal Voltage	-48Vdc / +24Vdc	-48Vdc / +24Vdc
Maximum Output Current DC1E	600A / 180A	600A / 180A
Maximum Output Current DC2E	600A / 180A	800A / 180A
System Shunt	800A 50mV	2000A 50mV
LVD	600A	2000A
Bulk Battery	4 x 5/16" on 1"	4 x 5/16" on 1" and 12 x 1/4"-20 on 5/8"

Product Documentation

CC848815341	Advanced Features User Guide for the Pulsar Plus Controller, 167-792-183
850022389	Infinity S 23" Dual Voltage with LVD Option Quick Start Guide

DC Output Types

Single Voltage Systems - No Battery Breaker Bus



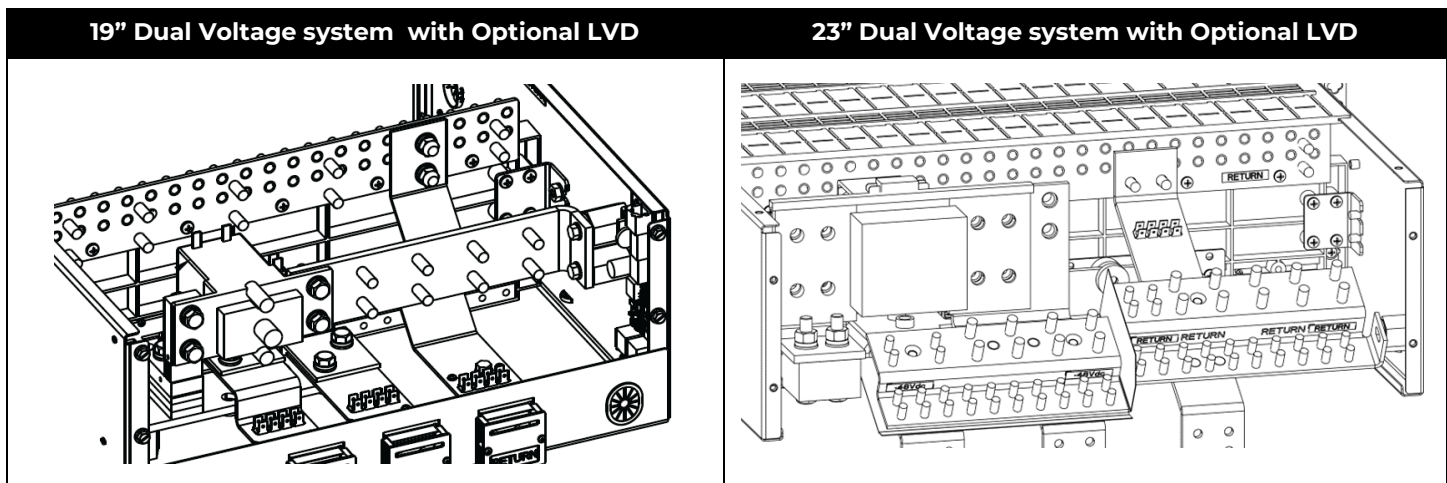

Type	Description	Schematic
DC1ES / DC2ES	<p>20 Positions for 19" or 26 Positions for 23" Configuration; No Battery Breaker or LVD Option</p> <p>DC2ES Adds a second load distribution panel with 20 Positions for 19" and 26 Positions for 23"</p> <p>Ratings: DC1ES 450A/180A Output for 19", 600A /180A Output for 23"</p> <p>DC2ES 600A /180A Output for 19", 800A/180A Output for 23"</p>	<p>The schematic shows a power distribution system. On the left, a vertical stack of 'Rectifiers' feeds into a horizontal bus. This bus connects to three 'Converters'. Below each converter is a 'Configurable Load Breaker Position' (labeled '1 to A Positions'). The first two are 'Configurable Load Breaker Positions; 2-Hole 1/4" studs on 5/8" centers'. The third is an 'Optional Supplemental Load Breaker Position; 2-Hole 1/4" studs on 5/8" centers'. A dashed line indicates a connection from the converters to a second set of breaker positions labeled '1 to B Positions'. Below the breaker positions are arrows pointing up to a common return bus.</p> <p>A = 20 Positions for a 19" and 26 Positions for a 23" System; Each position is configurable between Primary and Secondary Voltage. B = 20 Positions for a 19" and 26 Positions for a 23" System; Each position is a load breaker position only</p>

Bulk Battery Connections

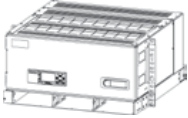

Step 1: Select the Base Power System

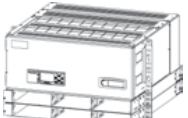
Dual Voltage –48V Primary and 24V Secondary, 19” Width with LVBD Optional

OUTPUT RATING	DESCRIPTION	AC INPUT	LVD	FRAME	ORDERING CODE	MODEL	PHOTO
 225A / 75A	225A Infinity S Power system equipped with 3 universal power positions, 20 distribution positions selectable between – 48V and +24V. System - 5RU	AC5H	No	No	1600099231A	NES4824-19-AC5H-PS3-DC1E	
 450A / 150A	450A Infinity S Power system equipped with 6 universal power positions, 20 distribution positions selectable between – 48V and +24V. System - 6RU	AC5H	No	No	1600099232A	NES4824-19-AC5H-PS6-DC1E	
 600A / 300A	650A Infinity S Power system equipped with 9 universal power positions, 20 distribution positions selectable between – 48V and +24V. System - 7RU	AC5H	No	No	1600099233A	NES4824-19-AC5H-PS9-DC1E	

Step 1: Select the Base Power System

Dual Voltage –48V Primary and 24V Secondary, 23” Width with LVBD Optional

OUTPUT RATING	DESCRIPTION	AC INPUT	LVD	FRAME	ORDERING CODE	MODEL	PHOTO
 600A / 225A	600A Infinity S Dual Voltage Power system equipped w/ 8 universal power positions, 26 distribution positions selectable between –48V and +24V, and equipped with an LVBD System - 6RU	AC5H	LVBD	No	150045763	NES4824-23-AC5H-PS8-DC1E-LVBD	
 600A / 225A	600A Infinity S Dual Voltage Power system equipped w/ 8 universal power positions, 52 distribution positions 26 of which are selectable between –48V and +24V, and equipped with an LVBD System - 10RU	AC5H	LVBD	No	150045766	NES4824-23-AC5H-PS8-DC2E-LVBD	
 600A / 525A	600A Infinity S Dual Voltage Power system equipped w/16 universal power positions, 26 distribution positions selectable between –48V and +24V, and equipped with an LVBD System - 8RU	AC5H	LVBD	No	150045769	NES4824-23-AC5H-PS16-DC1E-LVBD	
 800A / 525A	800A Infinity S Dual Voltage Power system equipped w/16 universal power positions, 52 distribution positions 26 of which are selectable between –48V and +24V, and equipped with an LVBD System - 12RU	AC5H	LVBD	No	150045772	NES4824-23-AC5H-PS16-DC2E-LVBD	
 800A / 525A	800A Infinity S Dual Voltage Power system equipped w/20 universal power positions, 52 distribution positions 26 of which are selectable between –48V and +24V, and equipped with an LVBD and LVLD that feeds the top 26 loads. System - 13RU	AC5H	LVBD / LVLD	No	150045775	NES4824-23-AC5H-PS20-DC2E-LVBD-LVLD	

Step 1: Select the Base Power System

Dual Voltage –48V Primary and 24V Secondary, 23” Width with LVBD Optional

OUTPUT RATING	DESCRIPTION	AC INPUT	LVD	FRAME	ORDERING CODE	MODEL	PHOTO
 800A / 525A	800A Infinity S Power system equipped with 16 universal power positions, 52 distribution positions 26 of which are selectable between –48V and +24V, equipped with an LVBD and mounted in a 7' frame. System - 84"	AC5H	LVBD	Yes	150045774	NES4824-23-AC5H-PS16-DC2E-LVBD-7FTR	

Infinity S -48/12V Power Systems

Dual Voltage Power System

Infinity S -48/12V power systems are designed to support DC loads ranging from 150A to 800A on the primary -48V bus and up to 300A on the secondary +12V bus. The systems are either 19" or 23" rack mountable. The output load bus accommodates bullet breaker, pluggable TPS fuses, and plug in GMT modules. The bottom breaker positions are selectable between primary and secondary voltages. Bulk battery connections are available in the rear of the plant. Options for Low Voltage Load and Battery disconnects are available.

Infinity S -48V systems may be equipped in a 7ft framework, a half height (42") frame for mounting on battery stands, integrated into cabinet applications, or supplied frameless for field install applications.



Key Features

- Infinity Series Rectifiers -48V applications.
- Bulk Battery Bus in rear of plant
- Optional Low Voltage Battery and Load Disconnects
- Temperature hardened harsh environments. (-40°C to +75°C)
- Compact size: Base System with 1 power shelf occupies 5 RU (8.75 in) of 19" or 23" rack spac(18"-21" depth)
- Frame options-Factory installed in 7ft or 42" tall, 19" or 23" wide frame or field installed in user supplied frame
- Plug-N-Play Pulsar Plus controller with Web based interface for local and remote (LAN) access.
- Distribution options include 3A-300A bullet style circuit breakers, and GMT fuses

System Specifications

	19 Inch System	23 Inch System
Nominal Voltage	-48Vdc / +12Vdc	-48Vdc / +12Vdc
Maximum Output Current DC1E	450A / 300A	600A / 300A
Maximum Output Current DC2E	450A / 300A	600A / 300A
System Shunt	800A 50mV	800A 50mV
LVD	600A	600A
Bulk Battery	4 x 5/16" on 1"	4 x 5/16" on 1"

Product Documentation

CC848815341	Advanced Features User Guide for the Pulsar Plus Controller, 167-792-183
8600243957P	Infinity S -48V Dual Voltage Quick Start Guide

DC Output Types

Dual Voltage Systems - No Battery Breaker Bus

Type	Description	Schematic
DC1E / DC2E	20 Positions for 19" or 26 Positions for 23" Configuration; No Battery Breaker or LVD Option DC2ES Adds a second load distribution panel with 20 Positions for 19" and 26 Positions for 23" Ratings: DC1E 450A Output for 19", 600A Output for 23" (450A Max with LVD) DC2E 600A Output for 19", 800A Output for 23" (600A Max with LVD)	<p>A = 20 Positions for a 19" and 26 Positions for a 23" System; Each position is configurable between Primary and Secondary Voltage. B = 20 Positions for a 19" and 26 Positions for a 23" System; Each position is a load breaker position only</p>

Bulk Battery Connections

19" Dual Voltage System with 48V Primary & 12V Secondary Bus

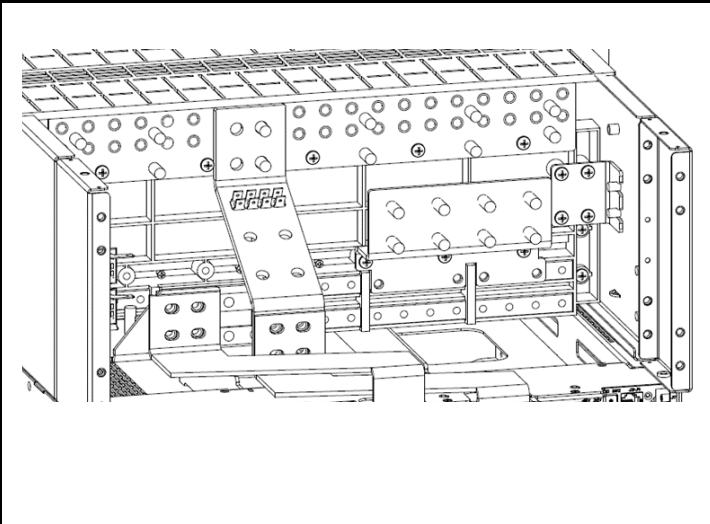

23" Dual Voltage System with 48V Primary & 12V Secondary Bus

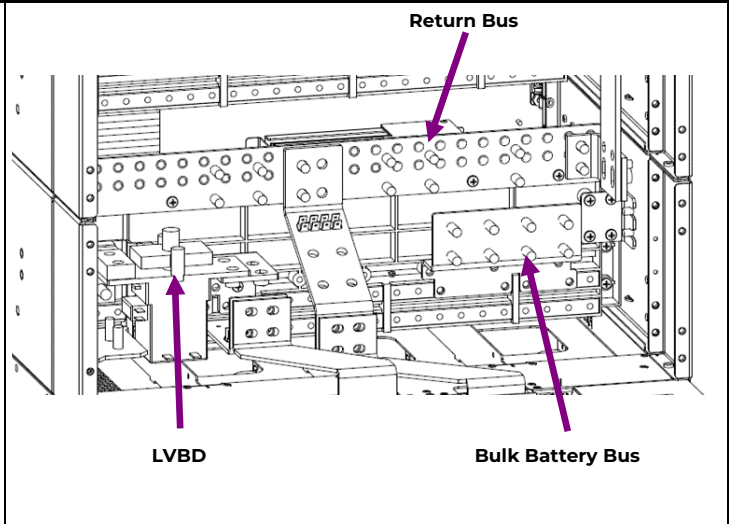

Step 1: Select the Base Power System

Dual Voltage -48V Primary and 12V Secondary

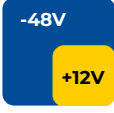
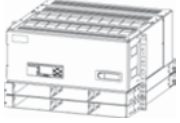
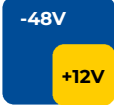
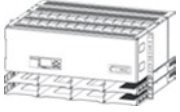
OUTPUT RATING	DESCRIPTION	AC INPUT	LVD	FRA ME	ORDERING CODE	MODEL	PHOTO
 450A / 150A	450A Infinity S Power system equipped with 6 universal power positions, 20 distribution positions selectable between -48V and +12V, and equipped with an LVBD System - 6RU	AC5	LVB D	No	150050183	NES4812-19-AC5-PS6-DC1E-LVBD	
 480A / 225A	480A Infinity S Power system equipped with 8 universal power positions, 26 distribution positions selectable between -48V and +12V, and equipped with an LVBD System - 6RU	AC5H	LVB D	No	150051209	NES4812-23-AC5H-PS8-DC1E-LVBD	

Infinity S -48/-58V Power Systems

Dual Voltage Power System

Infinity S -48/-58V power systems are designed to support DC loads ranging from 150A to 800A on the primary -48V bus and up to 300A on the secondary -58V bus. The systems are either 19" or 23" rack mountable. The output load bus accommodates bullet breaker, pluggable TPS fuses, and plug in GMT modules. The bottom breaker positions are selectable between primary and secondary voltages. Bulk battery connections are available in the rear of the plant. Options for Low Voltage Load and Battery disconnects are available.

Infinity S -48/58V systems may be equipped in a 7ft framework, a half height (42") frame for mounting on battery stands, integrated into cabinet applications, or supplied frameless for field install applications.



Key Features

- Infinity Series Rectifiers -48V applications.
- Bulk Battery Bus in rear of plant
- Temperature hardened harsh environments. (-40°C to +75°C)
- Compact size: Base System with 1 power shelf occupies 5 RU (8.75 in) of 19" or 23" rack spac(18"-21" depth)
- Frame options-Factory installed in 7ft or 42" tall, 19" or 23" wide frame or field installed in user supplied frame
- Plug-N-Play Pulsar Plus controller with Web based interface for local and remote (LAN) access.
- Distribution options include 3A-300A bullet style circuit breakers, and GMT fuses

System Specifications

	19 Inch System	23 Inch System
Nominal Voltage	-48Vdc / -58Vdc	-48Vdc / -58Vdc
Maximum Output Current DC1E	480A / 300A	600A / 300A
Maximum Output Current DC2E	600A / 300A	800A / 300A
System Shunt	800A 50mV	1200A 50mV
Optional LVD	600A	N/A
Bulk Battery	4 x 5/16" on 1"	6 x 5/16" on 1"

Product Documentation

CC848815341	Advanced Features User Guide for the Pulsar Plus Controller, 167-792-183
8600243957P	Infinity S -48V Dual Voltage Quick Start Guide

DC Output Types

Single Voltage Systems - No Battery Breaker Bus

Type	Description	Schematic
DC1ES / DC2ES	20 Positions for 19" or 26 Positions for 23" Configuration; No Battery Breaker or LVD Option DC2ES Adds a second load distribution panel with 20 Positions for 19" and 26 Positions for 23" Ratings: DC1ES 450A/180A Output for 19", 600A /180A Output for 23" DC2ES 600A /180A Output for 19", 800A/180A Output for 23"	<p>A = 20 Positions for a 19" and 26 Positions for a 23" System; Each position is configurable between Primary and Secondary Voltage. B = 20 Positions for a 19" and 26 Positions for a 23" System; Each position is a load breaker position only</p>

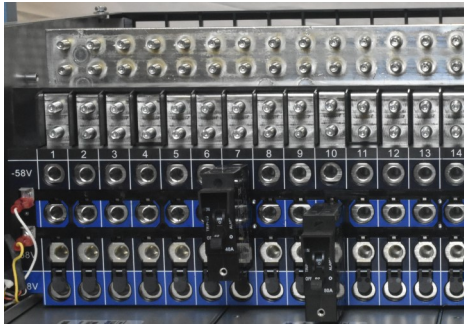

Bulk Battery Connections

19" Dual Voltage system no LVD Option

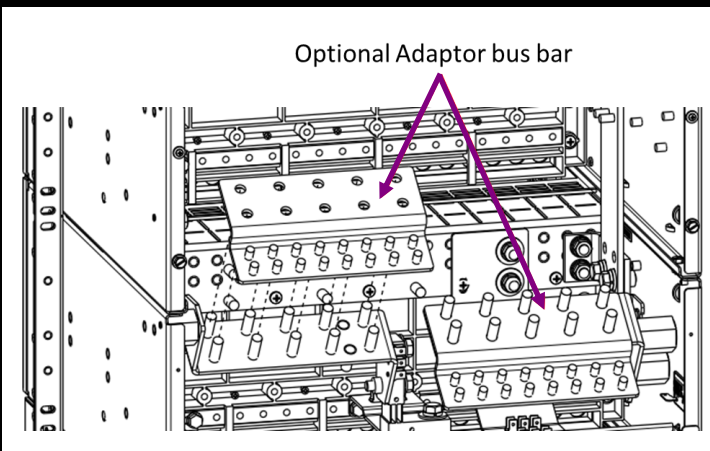



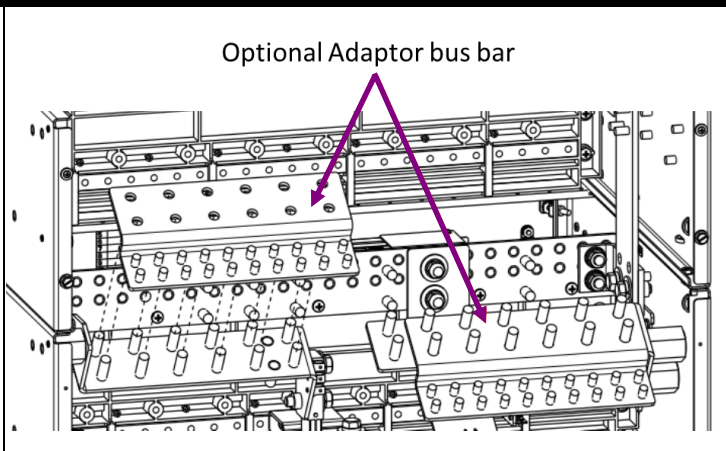

23" Dual Voltage system no LVD Option

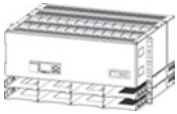

Step 1: Select the Base Power System (Continued)

Dual Voltage -48V Primary and -58V Secondary, 23" Width (Not LVD Compatible)

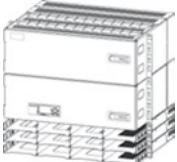
OUTPUT RATING	DESCRIPTION	AC INPUT	LVD	FRAME	ORDERING CODE	MODEL	PHOTO
 600A / 300A	450A Infinity S Power system equipped with 8 universal power positions, 26 distribution positions selectable between -48V and -58V. System - 6RU	AC5H	No	No	1600452911A	NES4858-23-AC5H-PS8-DC1ES	
 600A / 300A	600A Infinity S Power system equipped with 12 universal power positions, 26 distribution positions selectable between -48V and -58V,. System - 7RU	AC5H	No	No	1600452912A	NES4858-23-AC5H-PS12-DC1ES	
 800A / 300A	800A Infinity S Power system equipped with 12 universal power positions, 52 distribution positions with 26 selectable between -48V and -58V. System - 11RU	AC5H	No	No	1600452913A	NES4858-23-AC5H-PS12-DC2ES	

Infinity S +24V/-48V Power Systems

Dual Voltage Power System with LVD Options

Infinity S +24V power systems are designed to support DC loads ranging from 400A to 1,200A. The systems are rack mountable in 23" frames. The output load bus accommodates bullet breaker, pluggable TPS fuses, and plug in GMT modules. The bottom 26 breaker positions are selectable between +24V primary and -48V secondary loads. Bulk battery connections are available in the rear of the plant. Options for Low Voltage Load and Battery disconnects are available.

Infinity S +24V systems may be equipped in a 7ft framework, a half height (42") frame for mounting on battery stands, integrated into cabinet applications, or supplied frameless for field install applications.



Key Features

- Infinity Series Rectifiers +24V applications.
- Bulk Battery Bus in rear of plant
- Optional Low Voltage Battery and Load Disconnects
- Temperature hardened harsh environments. (-40°C to +75°C)
- Compact size: Base System with 1 power shelf occupies 5 RU (8.75 in) of 23" rack space (18"-21" depth)
- Frame options-Factory installed in 7ft or 42" tall, 23" wide frame or field installed in user supplied frame
- Plug-N-Play Pulsar Plus controller with Web based interface for local and remote (LAN) access.
- Distribution options include 3A-300A bullet style circuit breakers, and GMT fuses

System Specifications

	19 Inch System	23 Inch System
Nominal Voltage	N/A	+24Vdc / -48Vdc
Maximum Output Current DC1E	N/A	900A / 120A
Maximum Output Current DC2E	N/A	1000A / 120A
System Shunt	N/A	2000A 50mV
Optional LVD	N/A	2000A
Bulk Battery	N/A	4 x 5/16" on 1" and 12 x 1/4"-20 on 5/8"

Product Documentation

CC848815341	Advanced Features User Guide for the Pulsar Plus Controller, 167-792-183
850022389	Infinity S 23" Dual Voltage with LVD Option Quick Start Guide

DC Output Types

Single Voltage Systems - No Battery Breaker Bus







Type	Description	Schematic
DC1E(S) / DC2E(S)	26 Positions for 23" Configuration; No Battery Breaker Option DC2E(S) Adds a second load distribution panel with 20 Positions for 19" and 26 Positions for 23" Ratings: DC1E(S) 1000A/525A Output for 23" DC2E(S) 1000A /525A Output for 23"	<p>The schematic illustrates the power distribution from Rectifiers through Converters to three types of load breaker positions:</p> <ul style="list-style-type: none"> Optional LVBD: A load breaker position at the top left. 1 to A Positions: Configurable Load Breaker Positions; 2-Hole 1/4" studs on 5/8" centers. 1 to B Positions: Optional Supplemental Load Breaker Positions; 2-Hole 1/4" studs on 5/8" centers. <p>Legend: A = 20 Positions for a 19" and 26 Positions for a 23" System; Each position is configurable between Primary and Secondary Voltage. B = 20 Positions for a 19" and 26 Positions for a 23" System; Each position is a load breaker position only</p>

Bulk Battery Connections

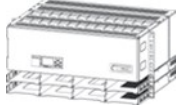
19" Dual Voltage system with Optional LVD	23" Dual Voltage system with Optional LVD







Step 1: Select the Base Power System

Dual Voltage +24V Primary and -48V Secondary, 23" Width (Not LVD Compatible)

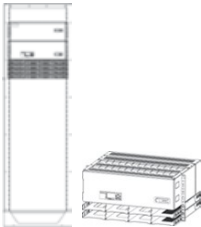
OUTPUT RATING	DESCRIPTION	AC INPUT	LVD	FRAME	ORDERING CODE	MODEL	PHOTO
 800A / 120A	800A Infinity S Dual Voltage Power system equipped w/ 8 universal power positions, 26 distribution positions selectable between +24V and -48V. System - 6RU	AC5H	No	No	150045749	NES2448-23-AC5H-PS8-DC1ES	
 900A / 120A	900A Infinity S Dual Voltage Power system equipped w/16 universal power positions, 26 distribution positions selectable between +24V and -48V. System - 8RU	AC5H	No	No	150045755	NES2448-23-AC5H-PS16-DC1ES	
 800A / 120A	800A Infinity S Dual Voltage Power system equipped w/8 universal power positions, 52 distribution positions 26 of which are selectable between +24V and -48V. System - 10RU	AC5H	No	No	150045752	NES2448-23-AC5H-PS8-DC2ES	
 1000A / 120A	1000A Infinity S Dual Voltage Power system equipped w/16 universal power positions, 52 distribution positions selectable between +24V and -48V. System - 12RU	AC5H	No	No	150045758	NES2448-23-AC5H-PS16-DC2ES	

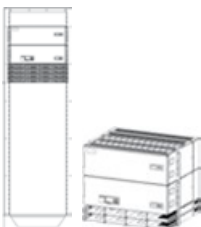

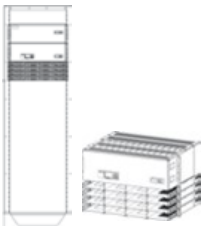

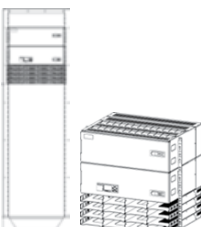

Step 1: Select the Base Power System

Dual Voltage +24V Primary and -48V Secondary, 23" Width (Not LVD Compatible)

OUTPUT RATING	DESCRIPTION	AC INPUT	LVD	FRAME	ORDERING CODE	MODEL	PHOTO
 800A / 120A	800A Infinity S Dual Voltage Power system equipped w/ 8 universal power positions, 26 distribution positions selectable between +24V and -48V, and mounted in a 7' frame. System - 84"	AC5H	No	Yes	150045751	NES2448-23-AC5H-PS8-DC1ES-7FTR	
 800A / 120A	800A Infinity S Dual Voltage Power system equipped w/8 universal power positions, 26 distribution positions selectable between +24V and -48V, and mounted in a 7' frame. System - 84"	AC5H	No	Yes	150045754	NES2448-23-AC5H-PS8-DC2ES-7FTR	
 900A / 120A	900A Infinity S Dual Voltage Power system equipped w/16 universal power positions, 52 distribution positions 26 of which are selectable between +24V and -48V, and mounted in a 7' frame. System - 84"	AC5H	No	Yes	150045757	NES2448-23-AC5H-PS16-DC1ES-7FTR	
 1000A / 120A	1000A Infinity S Dual Voltage Power system equipped w/16 universal power positions, 52 distribution positions 26 of which are selectable between +24V and -48V, and mounted in a 7' frame. System - 84"	AC5H	No	Yes	150045760	NES2448-23-AC5H-PS16-DC2ES-7FTR	

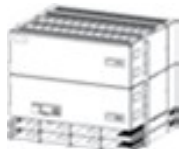
Step 1: Select the Base Power System

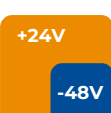
Dual Voltage +24V Primary and -48V Secondary, 23" Width with LVBD Optional

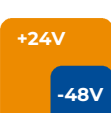
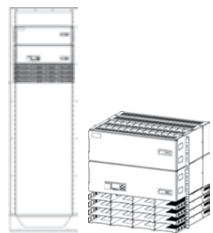
OUTPUT RATING	DESCRIPTION	AC INPUT	LVD	FRAME	ORDERING CODE	MODEL	PHOTO
 800A / 120A	800A Infinity S Dual Voltage Power system equipped w/ 8 universal power positions, 26 distribution positions selectable between +24V and -48V, and equipped with an LVBD System - 6RU	AC5H	LVBD	No	150045750	NES2448-23-AC5H-PS8-DC1E-LVBD	
 800A / 120A	800A Infinity S Dual Voltage Power system equipped w/ 8 universal power positions, 52 distribution positions 26 of which are selectable between +24V and -48V, and equipped with an LVBD System - 10RU	AC5H	LVBD	No	150045753	NES2448-23-AC5H-PS8-DC2E-LVBD	
 900A / 120A	900A Infinity S Dual Voltage Power system equipped w/16 universal power positions, 26 distribution positions selectable between +24V and -48V, and equipped with an LVBD System - 8RU	AC5H	LVBD	No	150045756	NES2448-23-AC5H-PS16-DC1E-LVBD	
 1000A / 120A	1000A Infinity S Dual Voltage Power system equipped w/16 universal power positions, 52 distribution positions 26 of which are selectable between +24V and -48V, and equipped with an LVBD System - 12RU	AC5H	LVBD	No	150045759	NES2448-23-AC5H-PS16-DC2E-LVBD	
 1000A / 120A	1000A Infinity S Dual Voltage Power system equipped w/16 universal power positions, 52 distribution positions 26 of which are selectable between +24V and -48V, equipped with an LVBD and mounted in 7' Frame System - 84"	AC5H	LVBD	Yes	150045761	NES2448-23-AC5H-PS16-DC2E-LVBD-7FTR	

Step 2: Select Expansion Kits and AC Input Accessories

Battery Bus Extension Kits - Used for expanding battery bus connections in single voltage systems

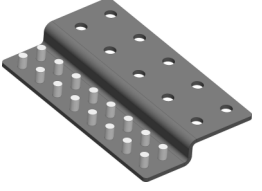
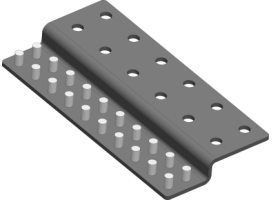
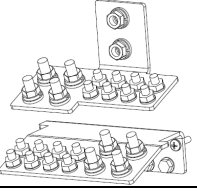
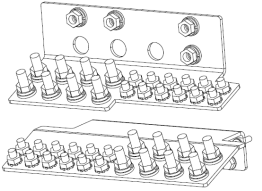
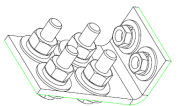
ORDERING CODE	DESCRIPTION	SYSTEM COMPATIBILITY	REF. PAGES	
1600363768A	8 POSITION ADAPTOR BUS KIT	19" 48V Base Level Plants	15 - 19	
	Adds 8, 1/4"-20 lug connections. Ships with 2 bus bars and 32, 1/4" - 20 nuts	19" 48V Dual Voltage 48/24	25 - 28	
		19" 48V Dual Voltage 48/24 Plants	38 - 40	
1600363390A	10 POSITION ADAPTOR BUS KIT	23" 48V Base Level Plants	15 - 19	
	Adds 10, 1/4"-20 lug connections. Ships with 2 bus bars and 40, 1/4" - 20 nuts	23" Dual Voltage 48/24 Plants	25 - 28	
		23" Dual Voltage 48/58 Plants	38 - 40	
1600272239A	NES-19 BATTERY BUS EXPANSION	19" 48V Plants with LVD Options	20 - 23	
	Expands battery bus to 2, 3/8" on 1" and 4, 1/4"-20 lug pos.	19" 48/12V Plants	35 - 37	
1600232360A	NES-V2 BATTERY BUS EXPANSION	23" 48V Plants with LVD Options	20 - 23	
	Expands battery bus to 4, 3/8" on 1" and 6, 1/4"-20 lug pos.	23" 48/12V Plants	35 - 37	
850022254	Battery Lug Connection Bus Kit	All Systems	15 - 45	

Supplemental Rectifier Shelf Kits - Used for Installing Additional Rectifier Shelves to an Infinity S System in the Field

ORDERING CODE	DESCRIPTION	Notes:
150050584	NES AC3 19in Single Voltage Supplemental Shelf Kit	Each kit includes: Rectifier shelf with mounting hardware, busbar interconnects with hardware and inter-shelf communication cable
150041585	NES AC5 19in Single Voltage Supplemental Shelf Kit	
150041586	NES AC6 19in Single Voltage Supplemental Shelf Kit	
150041583	NES AC1 23in Single Voltage Supplemental Shelf Kit	
150041587	NES AC1 23in Dual Voltage Supplemental Shelf Kit	
150050606	NES AC5H 23in Single Voltage Supplemental Shelf Kit	
150050607	NES AC5H 23in Dual Voltage Supplemental Shelf Kit	

Step 2: Select AC Accessories

Step 7: Select AC Accessories

Example: 208/240VAC for a NES48-AC1-PS4-DC1E-LVBD shelf using 50A rectifiers would use a 848710711 AC 8 gauge which provides 2 AC cords; enough to power 4 rectifiers. Customer should provide one 40A protecting circuit breaker per two rectifiers. For AC3 cable sets, it is recommended that a 20A circuit breaker is used per rectifier. Note: If PS# of your shelf model number is not listed in table, choose the next higher number. AC cords are 10 feet long and unterminated on the end. See optional accessories for twist lock connectors.

ORDERING CODE	AC TYPE	GAUGE	SHELF TERMINATION	ORDER # OF CORDS			CORD TYPE	LENGTH	USER TERMINATION	120 VAC	208/240 VAC
				SHELF	DUAL	INDIV.					
CC848801977	AC1	8	Molex	1	x		Sleeved	3'	Unterminated	x	x
CC848830522			Molex	1	x		Sleeved	4'	Unterminated		
848710711			Molex	1	x		Sleeved	10'	Unterminated		
CC848906586			Molex	2	x		SO	10'	Unterminated		
850031034		8	Molex	2	x		SO		Unterminated		
CC848847368	AC3	12	IEC - No Plug	4		x	SO	8'	Unterminated	x	x
CC848850801		12	IEC 5 - 20P	4		x	SO	8'	5 -20P	x	
CC848850834		12	IEC 6 - 20P	4		x		8'	6 -20P		x
CC848850842		12	IEC L6 - 20P	4		x		8'	L6 -20P		x













The following AC Covers can be used to replace the individual AC Covers on the 23" AC5 or AC5H shelf with a single larger cover to allow for fewer conduit runs to the system. Each Kit comes with 2 covers, one for each side of the system.

ORDERING CODE	AC COVER KIT
150037979	2 Shelf AC Cover Kit
150037980	3 Shelf AC Cover Kit
150037981	4 Shelf AC Cover Kit

Step 3: Select Rectifier and Converter Modules

Rectifier Modules

Infinity rectifiers are designed to operate in all Infinity based power systems. They are designed and qualified to operate 40°C to +55°C with extended operation to +75°C. The 48V rectifiers are programmable from 42 - 58Vout, whereas the 24V rectifiers are programmable from 21 - 29Vout. All rectifiers of the same output voltage type will operate in parallel and load share based on the percentage of load capacity of each rectifier, ensuring that no one rectifier is loaded more than others.

Ordering code	Description	Input	Output	Float	Max	Picture
CC109158878 	NE050AC48ATEZ	95 - 145Vac	1200W	44A	25A (48V)	
		175 - 305Vac	2725W	100A	57A (48V)	
		Input Current	15A - 12A			
		Heat Release	158 Watts	539 BTU/hr.		
CC109163473 	NE075AC48ATEZ	95 - 145Vac	1200W	22A	25A (48V)	
		175 - 305Vac	4085W	75A	82A (48V)	
		Input Current	22A - 16A			
		Heat Release	249 Watts	652 BTU/hr.		
1600248701A 	NE075AC48ATEZ+ 97+ Efficiency	95 - 145Vac	1200W	22A	25A (48V)	
		175 - 305Vac	4085W	75A	82A (48V)	
		Input Current	22A - 16A			
		Heat Release	191 Watts	594 BTU/hr.		
150025074 	NE050ECO48ATEZ	95 - 145Vac	1200W	44A	50A (48V)	
		175 - 305Vac	2725W	100A	114A (48V)	
		Solar 100 - 300Vdc	Full output above 250Vdc			
		Input Current	15A - 12A			
		Heat Release	174 Watts	594 BTU/hr.		
CC109160834 	NE100AC24ATEZ	95 - 145Vac	1200W	44A	50A (24V)	
		175 - 305Vac	2725W	100A	114A (24V)	
		Input Current	15A - 12A			
		Heat Release	174 Watts	594 BTU/hr.		
150025075 	NE100ECO24ATEZ	95 - 145Vac	1200W	44A	50A (24V)	
		175 - 305Vac	2725W	100A	114A (24V)	
		Solar 100 - 300Vdc	Full output above 250Vdc			
		Input Current	15A - 12A			
		Heat Release	174 Watts	594 BTU/hr.		

Step 3: Select Rectifier and Converter Modules (cont.)

Converter Modules

Infinity converters are designed to operate in all dual voltage Infinity based power systems. They are designed and qualified to operate 40°C to +55°C with extended operation to +75°C. The 48V converters are programmable from 42 - 58Vout, whereas the 24V converters are programmable from 21 - 29Vout.

Ordering code	Description	Input	Output	Nominal	Max	Picture
 150046488	NE075DC12A	42 - 60Vdc	1040W	75A (13.6V)	87A (12V)	
		Input Nominal	Nominal 21A @ 54.5Vdc			
	94% Efficiency	Input Maximum	Maximum 30A @ 40Vdc			
		Heat Release	103 Watts	350 BTU/hr.		
 CC108142881	NE075DC24A	42 - 60Vdc	2080W	75A (27.25)	87A (24V)	
		Input Nominal	Nominal 42A @ 54.5Vdc			
	94% Efficiency	Input Maximum	Maximum 60A @ 40Vdc			
		Heat Release	205 Watts	700 BTU/hr.		
 1600405449A	NE070DC58AZ	42 - 60Vdc	4060W	70A (54.5)	75A (48V)	
		Input Nominal	Nominal 85A @ 54.5Vdc			
	92% Efficiency	Input Maximum	Maximum 115A @ 42Vdc			
		Heat Release	191 Watts	594 BTU/hr.		
 CC109112471	NE030DC48A	21 - 30Vdc	1635W	30A (54.5)		
		Input Nominal	Nominal 63A @ 27Vdc			
	92% Efficiency	Input Maximum	Maximum 81A @ 21Vdc			
		Heat Release	162 Watts	553 BTU/hr.		
 150023619	NE040DC48AZ	21 - 30Vdc	2080W	40A (54.5)		
		Input Nominal	Nominal 85A @ 27Vdc			
	92% Efficiency	Input Maximum	Maximum 115A @ 21Vdc			
		Heat Release	191 Watts	594 BTU/hr.		

Miscellaneous

Ordering Code	Description	Picture
CC109170668	Infinity Rectifier/Converter slot filler (empty chassis)	
CC848798702	Blank front cover for use in empty rectifier / converter positions	

Step 4: Distribution Components



Bullet Style Load Circuit Breakers

Infinity distribution panels support plug-in (bullet style) breakers modules. Larger breakers can be 2 or even 3 poles. The multi-pole breakers require output bus bar adapters, with returns either using the battery return bus or additional adapters connected to the load return bus.



Ordering Code	Amperage	CB Positions	Min Wire Gauge	Picture
407998137	3	1	10	
407998145	5	1	10	
407998152	10	1	10	
407998160	15	1	10	
407998178	16	1	10	
407998186	20	1	10	
407998194	25	1	10	
407998202	30	1	10	
408213486	40	1	10	
407998210	45	1	8	
407998228	50	1	8	
407998236	60	1	6	
407998244	70	1	6	
407998251	80	1	4	
407998269	90	1	4	
407998277	100	1	2	
CC848808551	100	2	2	
408185353	125	2	2	
408185346	150	2	1	
408544076	200	2	3/0	
408564941	200	3	3/0	
408573975	225	3	3/0	
408535752	250	3	4/0	
450046922	300	3	4/0	
CC848756916	2-pole Adapter bus for 100-200A breakers; used for ¼"-20 on 5/8" lugs (order 2 per 2 pole breaker to accommodate load and return lugs)			
850021775	2-pole Adapter bus for 100-200A breakers; used for 3/8" on 1" lugs (order 2 per 2 pole breaker to accommodate load and return lugs)			
CC848756924	3-pole Adapter bus for 200-300A breakers; used for 3/8" on 1" lugs; off-center connection (order 2 per 3 pole breaker to accommodate load and return lugs)			
850021955	3-pole Adapter bus for 200-300A breakers; used for 3/8" on 1" lugs; center connection (order 2 per 3 pole breaker to accommodate load and return lugs)			

Step 4: Distribution Components (cont.)

Bullet Style TPS/TLS Fuse Holders and TPS/TLS Fuses

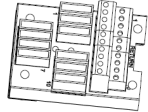

Ordering Code	Amperage	Picture
406700567	3	
406700583	5	
406700591	6	
406700609	10	
406700617	15	
406700625	20	
406700633	25	
406700641	30	
406700658	40	
406700674	50	
406700682	60	
406700690	70	
CC408618020	80	
CC408618037	90	
CC408618045	100	
CC408618061	125 (Max of 3, 125A fuses per side. A Space must be left between fuses)	
407845197	0.18 Alarm Fuse	
406473959	Bullet Fuse Holder, TFD-101-011-09 (Alarm on Removal or Blown Fuse)	
CC109103157	Bullet Fuse Holder, TFD-101-011-10 (Alarm on Removal or Blown Fuse)	

Bullet Style GMT Fuse Holders and GMT Fuses

Ordering Code	Amperage	Picture
405006222	0.25	
3150439	0.5	
405673146	1.33	
405181983	2	
406976985	3	
406159061	5	
405725433	7.5	
406159236	10	
407845197	12	
406473959	15	
CC109103157	6-pos GMT Bullet Fuse Holder (Requires 2 bullet positions) Note: Max Fuse Load is 12A	
1600316837A	10-pos GMT Bullet Fuse Holder (Requires 3 bullet positions) Note: Max Fuse Load is 15A	
408515823	Fuse Puller	

Step 4: Select Distribution Component (Continued)

Bullet Battery Circuit Breakers (Yellow Handle) (Alarms on Mid-Trip and in Off Position)

ORDERING CODE	AMPERAGE	PHOTO
CC408612758	30	
CC408612766	40	
CC408612774	45	
CC408574370	50	
408560123	60	
CC408574387	70	
CC408574395	100	
CC408574404	125 (2-pole)	
CC408574412	150 (2-pole)	
CC408574420	200 (2-pole)	
CC408645295	250A (3-pole)	
CC109106548	100A battery bullet bus strap (substitute for battery breaker)	

Step 5: Select Alarm Output and Input Cables

Ordering Code	Description	Picture
CC848890153	5ft Auxiliary input alarm cable for Pulsar Plus Controller	
CC848865980	15ft Auxiliary input alarm cable for Pulsar Plus Controller	
CC848817651	50ft Auxiliary input alarm cable for Pulsar Plus Controller	
CC848817668	150ft Auxiliary input alarm cable for Pulsar Plus Controller	
CC109157442	15ft alarm output cable for Pulsar Plus Controller	
CC848817635	50ft alarm output cable for Pulsar Plus Controller	
CC848817643	150ft alarm output cable for Pulsar Plus Controller	

Step 6: Select Battery Monitoring

Ordering Code	Description	Application	Picture
CC109142980	QS873A Thermal Probe	(A)	
150026698	QS873B Ambient Probe	(A)	
CC848817024	10 ft wire set	(B: thermal probe to controller)	
CC109157434	20 ft wire set	(B: thermal probe to controller)	
850052679	40 ft wire set	(B: thermal probe to controller)	
CC848822560	1 ft wire set	(C: thermal probe to thermal probe)	
848719803	5 ft wire set	(C: thermal probe to thermal probe)	
CC848822321	10 ft wire set	(C: thermal probe to thermal probe)	
850027334	20 ft wire set	(C: thermal probe to thermal probe)	
7000253598A	30 ft wire set	(C: thermal probe to thermal probe)	
8600089209P	40 ft wire set	(C: thermal probe to thermal probe)	
108958422	ES771A Battery Voltage Monitor Card		
CC848791517	2-1/2 ft. wire set	(D: ES771A to thermal probe)	
CC848797290	6 ft. wire set	(D: ES771A to thermal probe)	
848719829	10 ft. wire set	(D: ES771A to thermal probe)	
CC848791500	4 ft. wire set	(G:ES771A to ES771A or controller)	
848652947	10 ft wire set	(G:ES771A to ES771A or controller)	
555052-1	In Line Coupler	(G: extension coupler)	
<p>Temperature probes are needed for battery monitoring . They are connected to each battery or battery string to provide slope thermal compensation and temperature alarms</p>			

Step 6: Select Battery Monitoring (Continued)

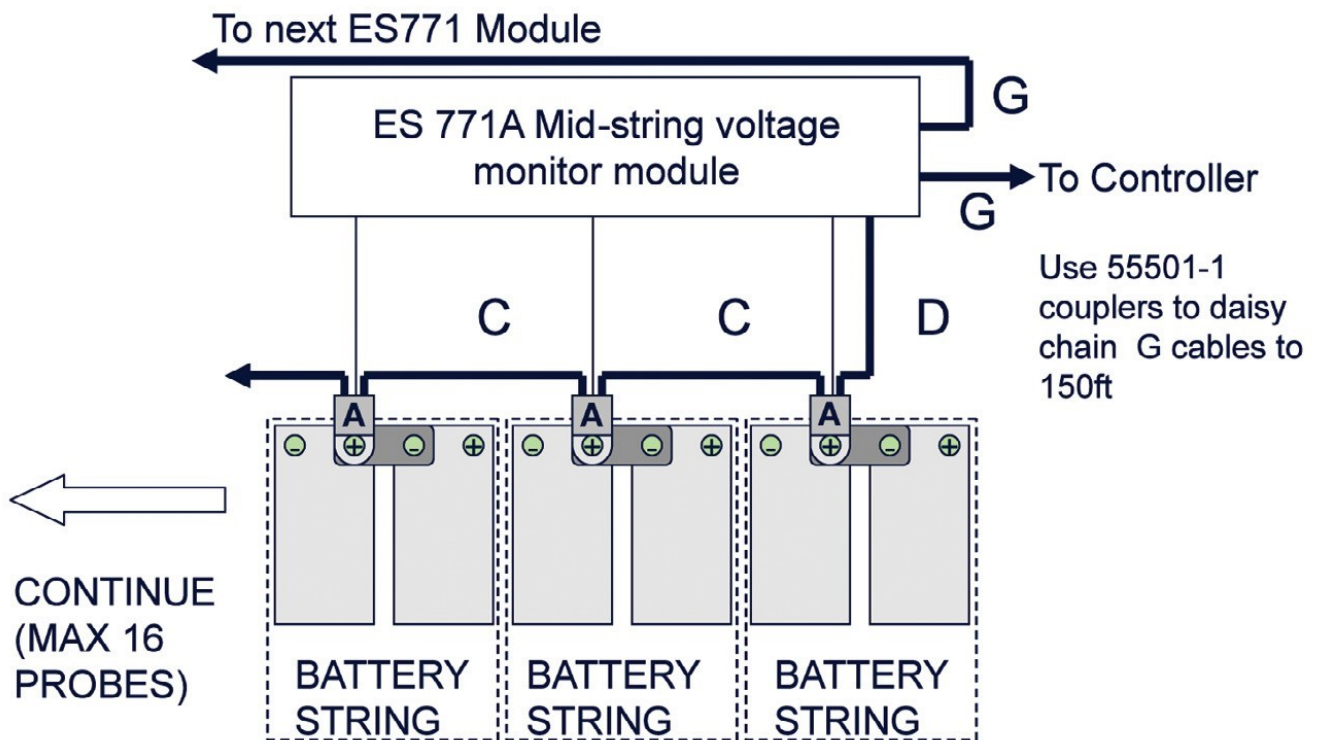
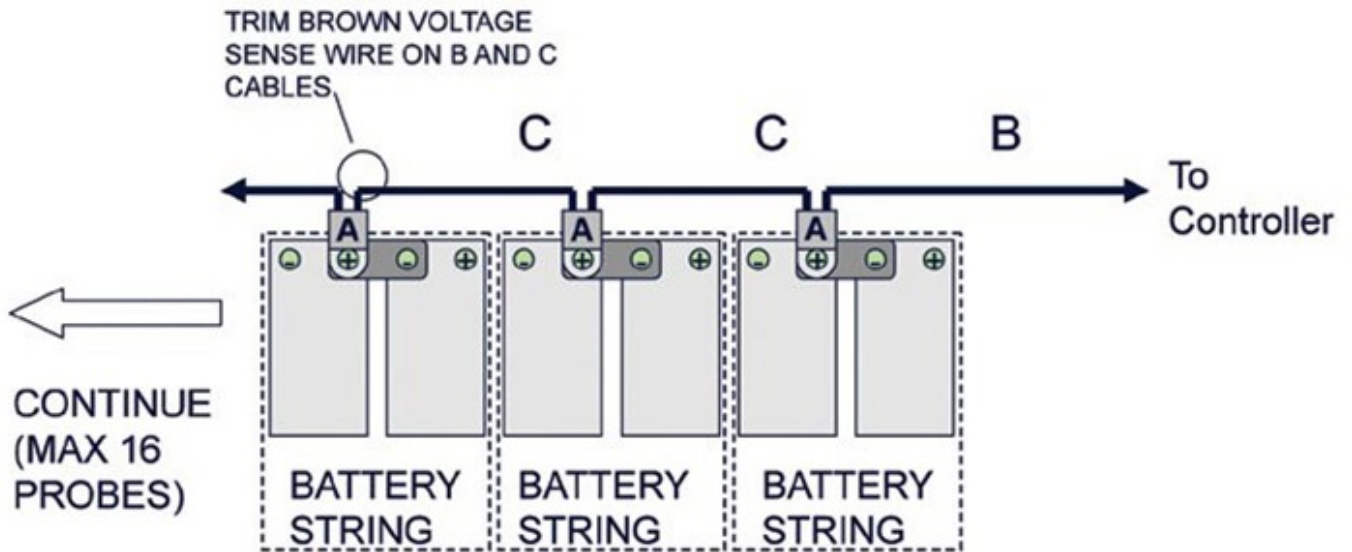

Reliability

- Distributed fault tolerance
- Proven field performance
- Controller continuity Intelligence
- Industry leading controller features
- Ethernet interface for remote access
- Centralized network management Investment Protection
- Module Compatibility
- Power Shelf Growth
- Renewable Energy Ready
- Flexible Upgrade Options On Time Delivery
- Standard building blocks
- 4 - 6 week availability
- 24/7 technical support

Management Visibility

Galaxy Manager* software is the centralized visibility and control component of a comprehensive power management system designed to meet engineering, operations and maintenance needs. The Galaxy Manager client-server architecture enables remote access to system controllers across the power network.

- Dashboard display with one-click access to management information database
- Trend analysis
- Scheduled or on demand reports
- Fault, configuration, asset, and performance management

Training

OmniOn offers on-site and classroom training options based on certification curriculum. Technical training can be tailored to individual customer needs. Training enables customers and partners to more effectively manage and support the power infrastructure. We have built our training program on practical learning objectives that are relevant to specific technologies or infrastructure design objectives.

Service & Support

OmniOn field service and support personnel are trusted advisors to our customers always available to answer questions and help with any project, large or small. Our certified professional services team consists of experts in every aspect of power conversion with the resources and experience to handle large turnkey projects along with custom approaches to complex challenges. Proven systems engineering and installation best practices are designed to safely deliver results that exceed our customers' expectations.

Warranty

OmniOn is committed to providing quality products and solutions. We have developed a comprehensive warranty that protects you and provides a simple way to get your products repaired or replaced as soon as possible.

For full warranty terms and conditions please go to

[omnionpower.com](https://www.omnionpower.com)

OmniOn Power Inc.

601 Shiloh Rd.
Plano, TX USA

omnionpower.com

We reserve the right to make technical changes or modify the contents of this document without prior notice. OmniOn Power does not accept any responsibility for errors or lack of information in this document and makes no warranty with respect to and assumes no liability as a result of any use of information in this document.

We reserve all rights in this document and in the subject matter and illustrations contained therein. Any reproduction, disclosure to third parties or utilization of its contents – in whole or in parts – is forbidden without prior written consent of OmniOn Power. This document does not convey license to any patent or any intellectual property right. Copyright© 2023 OmniOn Power Inc. All rights reserved.