

Infinity M HC Power System

Dual Voltage Capable, Rack Mounted Power System



TABLE OF CONTENT

03 – 04	Overview
05 – 06	Specifications
06 – 14	Controller
15 – 31	Ordering Guides Information
32 – 33	Notes

Infinity M HC Power System

Dual Voltage Capable, Rack Mounted Power System

Overview

The OmniOn Infinity M DC energy system is a modular power plant that supports dual voltage (+24V/-48V) operation through the use of a comprehensive range of advanced rectifiers and DC-DC converters. Primary voltage is supported by rectifiers and battery reserve, while secondary voltage is supported by DC-DC converter modules. Primary voltage can be -48V or +24V.

The Infinity M Power System has primary voltage capacity for +24V and -48V power up to 2,100A; secondary voltage capacity is up to 600A per expansion module.

Shelf / Bay Options

Infinity M systems may be equipped in a 7ft 23" relay rack; a half height rack for mounting on battery stands; indoor or outdoor power cabinets; or mounting rails for field install applications. The distribution module is either 10U (17.5"), 14U (24.5") or 18U (31.5") tall and accommodates up to 104 single voltage or selectable voltage bullet breaker positions or up to 24 Large Breaker positions that support GJ style breakers and TPL Fuses. Universal shelves are 1U tall with four slots that accept any Infinity series rectifier or converter interchangeably in any power slot. This allows the available slots to be filled with the mix of power modules desired. The only restriction is whether AC power is applied to the shelf. This gives extreme flexibility in the provisioning of power modules within the system.

Infinity Rectifier and Converter Family

The Infinity Series offers DC rectifiers and converters for both +24V to -48V and -48V to +24V applications. For easy module selection, the rectifiers and converters are color coded to quickly identify voltage, module type and input voltage type (AC or DC).

Galaxy Pulsar* Plus Controller

The Galaxy Pulsar Plus is used throughout many of the GE DC Power products including GPS, Infinity, CP, and SPS with the only differentiator being the form factor which is scaled to meet the nature of the application. The controller utilizes secure network management protocols allowing for advanced network supervision with SNMP communications to deliver extensive monitoring and control features with both local and remote access.

Galaxy Millennium* II Controller

The Galaxy Millennium II controller combines sophisticated power monitoring and secure remote management. This flagship controller simplifies operations and maintenance while lowering administrative costs. Remote peripheral modules support over 500 monitoring points for GJ, TPL and Bullet Breaker current monitoring as well as external OmniOn or third party devices. Ethernet, SNMP Modbus, and TL1 provide integration with power engineering and NOC workflow.

Advantages

- Dual Voltage power system with ultimate flexibility
- -48V up to 2100amps and expandable to 4200amp with Supplemental bay
- Secondary voltage up to 600A
- High availability applications
- Hardened for extreme environments
- Efficiency approaching 97%

Infinity Rectifiers and Converters

- Compact - 1RU form factor providing high power density (24 W/in³)
- Dual Voltage compatibility – the unique connector pin designation allows the rectifier to be used in a “universal” power shelf, alongside rectifiers or DC-DC converters with different output voltages.
- Plug and Play – installation of the rectifier in a shelf connected to a compatible system controller initializes all set up parameters automatically. No adjustments are needed.
- Extended service life – parallel operation with automatic load sharing ensures that parallel units are not unduly stressed even when a unit fails or is removed.
- Monitoring / control – the built in microprocessor controls and monitors all critical rectifier functions and communicates with the system controller using the built in Galaxy Protocol serial interface.
- Fail safe performance – hot insertion capabilities allow for rectifier replacement without system shutdown; soft start and inrush current protection prevent nuisance tripping of upstream breakers.



Applications

- Telecommunications networks
- Digital subscriber line (DSL)
- Indoor/outdoor wireless
- Routers/switches
- Fiber in the loop
- Transmission
- Data networks
- PBX

Features

- Extended temperature range
- Redundant fan cooling
- Front panel LED indicators
- 1U height, hi power density
- 277/220/110 V AC input
- Digital load sharing
- Hot pluggable
- RoHS compliant

Specifications

INPUT	NE050AC48ATEZ	NE075AC48ATEZ	NE075DC24
Voltage Range	95-305Vac	95-305Vac	42-60Vdc
Input Current	15-12A @100-120Vac 15-12A @ 200-277Vac	15-12A @ 100-120Vac 22-15.5A @ 200-277Vac	41A @54.5Vdc 54A @42Vdc
Input Frequency	45 – 66Hz	45 - 66Hz	-
Power Factor	0.98 at>50% load	0.98 at>50% load	-
Efficiency	> 95.6% (Peak 95.6%)	> 94.5% (Peak 94.9%)	93%
Total Harmonic Distortion	< 5% @loads over 50%	< 5% @loads over 50%	-

OUTPUT	NE050AC48ATEZ	NE075AC48ATEZ	NE075DC24
Voltage Adjust Range	42-58Vdc	42-58Vdc	23-28Vdc
Voltage Nominal	54.5V	54.5V	27.2V
Regulation (with controller)	±0.05%	±0.05%	±0.05%
Ripple	100mV rms	100mVrms	100mV rms
Sophomoric Noise	2 mV		2 mV
Output Current			
High-Line	57A @48V 50A @54.5V	82A@48V 75A @54.5V	75A @27.2V -
Low-Line	22A @54.5V	22A @54.5V	-
Heat Dissipation @max out1	158W / 539 8TU/hr	249W / 850 BTU/hr	202W / 689 BTU/hr

1 Special room cooling may be required.

ENVIRONMENTAL	
Operating Temperature	-40°C to +75°C (-40°F to 167°F) Full capacity up to 55°C; output derates 2%/°C from 55°C to 75°C
Storage Temperature	-40°C to +85°C (-40°F to 185°F)
Humidity	< 95% non-condensing
Altitude	4000M (for altitudes above 2000M, peak operating temperature de-rates 0.656°C /100M; 4000M peak temperature rating is 62° C

MECHANICAL	
Length (inch/mm)	13.85 / 352
Width (inch/mm)	5.23 / 133
Height (inch/mm)	1.63 / 42
Weight (lb/Kg)	5.05 / 2.2

SAFETY AND STANDARDS COMPLIANCE	
NEBs	Evaluated by independent NRTL test lab to Telcordia GR63-CORE and GR1089-CORE [Level 3]
Safety	CE mark to Low Voltage Directive 2006/95/EC and EMC Directive 2004/108/E (Rectifiers only) UL 60950 -1, 2nd Ed. Recognized CSA C22.2 No. 60950-1-07, 2nd Ed. + A1:2001 (MOD)
RoHS	Compliant to RoHS EU Directive 2002/95/EC; RoHS 6/6 models with Z suffix (RoHS 5/6 all other models)
EMC	European Directive 2004/108/EC; EN55022, Class A; EN55024; FCC, Class A; GR1089-CORE
ESD	EN61000-4-2, Level 4

Specifications (continued)

OUTLINE DRAWING

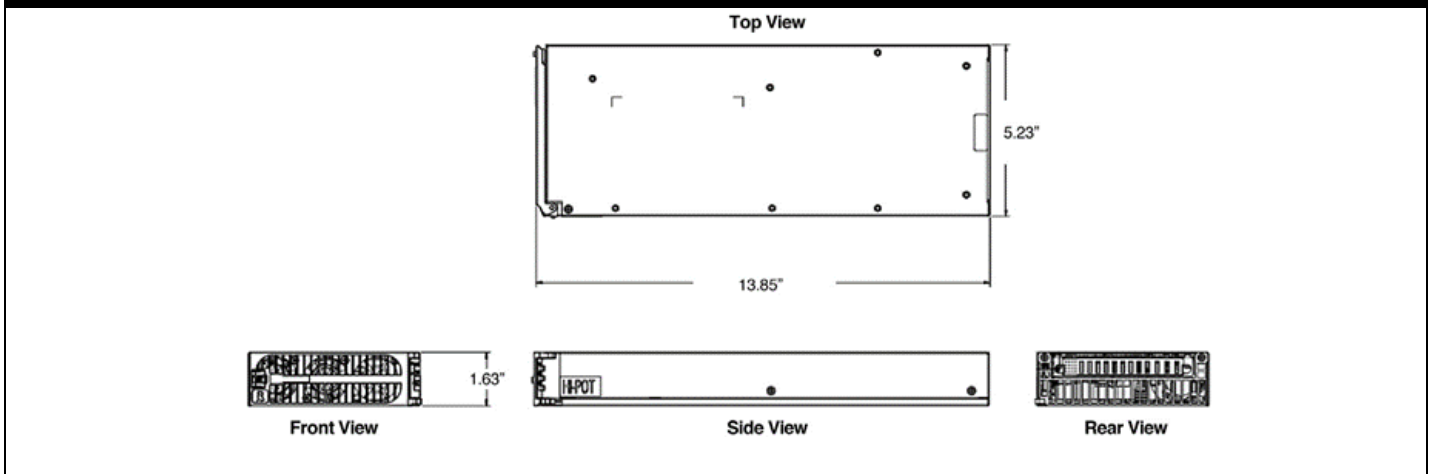

Pulsar Plus Controller

The Pulsar Plus family of controllers provides system monitoring and control features for Infinity, CP, and other power systems. These controllers monitor and control system components including rectifiers, converters, and distribution modules via a multi-drop RS485 digital communications bus. System status, parameters, settings, and alarm thresholds can be viewed and configured from the controller's front panel



display. Assignment and configuration of alarm inputs and output relays can be performed from a laptop computer connected to a local RS-232 or Ethernet port, or by remote access is through a network connection to the World Wide Web (internet) or your enterprise network (intranet). An optional modem is also available.

This controller utilizes standard network management protocols allowing for advanced network supervision. OmniOn Galaxy Manager™ software is the centralized visibility and control component of a comprehensive power management system designed to meet engineering, operations and maintenance needs. The Galaxy Manager client-server architecture enables remote access to system controllers across the power network, featuring ECO Priority advanced monitoring features which provides detailed energy source analysis to help better customize your renewable energy resources.

Applications

- Telecommunications Networks
- Digital Subscriber Line (DSL)
- Indoor/Outdoor Wireless
- Routers/Switches
- Fiber in the Loop
- Transmission
- Data Networks
- PBX
- Off-Grid/On-Grid Renewable Energy Sites

Key Features

Remote Access and Features

- Integrated 10/100Base-T Ethernet Network
 - TCP/IP (IPv6 and IPv4 compatible)
 - SNMP (V3, V2c, V1) for management
 - SMTP for email
 - Telnet/SSH for command line interface
 - DHCP for plug-n-play
 - FTP/SFTP for rapid backup and upgrades
 - HTTP/HTTPs for standard web pages and browsers
 - NTP for clock synchronization
 - Compatible with Galaxy Manager and other management packages
 - Shielded RJ-45 interface referenced to chassis ground
- Password protected security levels: User, Super-User, Administrator for all access
- Ground-referenced RS232 system port
- ANSI T1.317 command-line interface
- Modem access support
 - Remote via external modem
 - Callback security
- EasyView2, Windows-based GUI software for local terminal or Modem access
- Optional 1U Display with context alarm indicating backlight feature
- Supporting the following Protocols:
 - SNMP V3
 - SSL
 - SSH
- ECO Priority controls and features
 - Advanced generator controls to help minimize fuel consumption for off grid applications
 - ECO Energy Management allowing for non-ECO sources outputs to be minimized while ECO resources are available

- Source and load trend logging

Standard System Features

- Monitor and control of more than 60 connected devices
 - Robust RS485 system bus
- Standard and user defined alarms
 - Alarm test
 - Assignable alarm severity: Critical, Major, Minor, Warning, and record-only
 - 10 Alarm Relays (7 Users assigned)
- Rectifier management features
 - Automatic rectifier restart
 - Active Rectifier Management ARM (energy efficiency)
 - Remote rectifier (on/off)
 - Reserve Operation
 - Automatic rectifier sequence control
 - N + X redundancy check
- Multiple Low Voltage Load and Low Voltage Battery Disconnect thresholds
- Configuration, statistics, and history
 - All stored in non-volatile memory
 - Remote/local backup and restore of configuration data
- Industry standard defaults
 - Customer specific configurations available
- Remote/local software upgrade
- Basic, busy hour, and trend statistics
- Detailed event history
- User defined events and derived channels

Standard Battery Management Features

- Float/boost mode control
 - Manual boost
 - Manual timed boost locally, T1.317, and remotely initiated
 - Auto boost terminated by time or current
- Battery discharge testing
 - Manual (local/remote)
 - Periodic
 - Plant Battery Test (PBT) input driven
 - Configurable threshold or 20% algorithm
 - Graphical discharge data
 - Rectifiers on-line during test
- Slope thermal compensation
 - High temperature
 - Low temperature
 - Step temperature
 - STC Enable/Disable, low temperature Enable/Disable
 - Configurable mV/°C slopes
- State of charge indication
- High temperature disconnect setting
- Reserve-time prediction
- Recharge current limit
- Emergency Power-Off input

Integrated Monitoring Inputs/Outputs

- System plant voltage (accuracy $\pm 0.04\%$, resolution 0.01V)
- One system shunt (accuracy $\pm 0.5\%$ full scale, resolution 1A)
 - Battery or load
 - Mounted in the return side of DC bus

- Up to 15 binary inputs
 - 6 inputs close/open to battery
 - 9 input close/open to return
 - User assignable
- Up to 7 Form-C output alarms (60VDC @ .5A)
 - User assignable
- 1-Wire™ bus devices
 - Up to 16 temperature probes (QS873)
 - Up to 6 mid-string monitors (ES771)

Galaxy Manager Compatible

- Centralized web server and database with multiple user access to live or managed data with drill down to problem details
- Monitor and control of more than 40 connected devices
- Management information from polling or alarms received from alarm traps from multiple sites are available on one screen via the inter/intranet
- Trend user selected data over time
- Automatic or manual report generation
- Standard engineering tools like reserve time calculators and cable voltage drop analyzer

Specifications

GENERAL	
Operating Voltage	±24 Vdc, ±48 Vdc (Range: ±18 to ±60 Vdc)
Input Power	Less than 7W
Operating Temperature Range	-40°C to +75°C (-40°F to 167°F)
Operating Relative Humidity	0 - 95% (non-condensing)
Storage Temperature Range	-40°C to +85°C (-40°F to 185°F)
Physical Specifications	Sizes vary by packaging option
Display	8-line by 40-character with alarm context sensitive backlit LCD

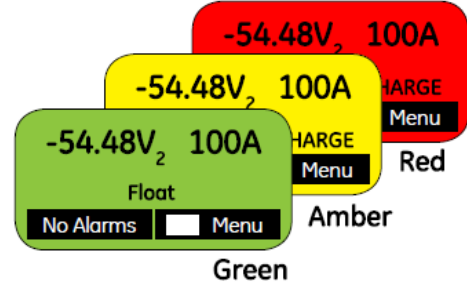

SAFETY AND STANDARDS COMPLIANCE	
NEBs	Evaluated by independent NRTL test lab to Telcordia GR63, Issue 3 and GR1089-CORE, Issue 5
Safety	ANSI/UL60950-1-2014 and CAN/CSA C22.2 No. 60950-1-07, Second Edition + A2:2014 (MOD), dated October 14, 2014
RoHS	Compliant to RoHS EU Directive 2002/95/EC RoHS 6/6
EMC	European Directive 2004/108/EC; EN55032, Class A, EN55024; FCC, Class A; GR1089-CORE, Issue 5

AGENCY CERTIFICATIONS	
NEBs Level 3	Evaluated by independent NRTL test lab to Telcordia GR63, Issue 3 and GR1089-CORE, Issue 5
EMC	European Directive 2004/108/EC; EN55032, (CISPR22) Class A, EN55024 (CISPR24)
Safety	Underwriters Laboratories (UL) Listed per Subject Letter 1801: Power Distribution Center for Communications Equipment, and cUL Certified (CSA 22.2 950): Safety of Information Technology Equipment

Galaxy Millennium* II Controller

Galaxy Millennium II is our flagship controller designed to meet the needs of the most advanced power systems. Building on the Galaxy Millennium platform, the Galaxy Millennium II delivers state-of-the-art performance by combining sophisticated control, monitoring, and remote network access previously on three separate circuit packs into a single integrated unit. The controller has been designed to simplify plant administrative and surveillance routines as well as reduce operating, provisioning, and personnel expenses.



Configuration of the Galaxy Millennium II can be performed via menu based front panel display, a local terminal or remote modem using EasyView2, or through a local or remote network connection utilizing standard web browsers or network protocols. In addition to its standard integrated monitoring capabilities, this controller offers extensive external monitoring using bay interface cards (BICs), distribution control cards, and remote peripheral monitoring modules (RPMs) designed for various inputs and transducers. Additional external relay contacts are also available. The Galaxy Millennium II, with integrated network access, allows for advanced network supervision using standard network management protocols and available network management software. The OmniOn Energy Galaxy Manager network management software can be used to meet power system engineering, operations and maintenance needs. Via the World Wide Web, users gain access to live data and information logged into Galaxy Manager's centralized server from each monitored system controller across the power network.

Applications

- Infinity NE-M
- CPS6000-M2
- GPS 4848/100
- GPS4830
- GPS 4812/24
- GPS 2424
- Galaxy Vector Controller upgrades
- Stand-alone monitoring applications
- Galaxy Millenium upgrades and replacements

Key Features

Remote Access and Features

- Integrated 10/100Base-T Ethernet Network
 - TCP/IP (IPv6 and IPv4 compatible)
 - SNMP (V3, V2c, V1) for management SMTP for email
 - Telnet/SSHforcommandlineinterface
 - TL-1
 - DHCPfor network plug-n-play
 - FTP/SFTPfor rapid backupand upgrades
 - HTTP/HTTPs for standardweb pages and browsers
 - Compatible with Galaxy Managerand other standard network management packages
 - Standard shielded RJ-45 interface referenced to chassis ground
- MODBUS Communications protocol
- Optional Data switch
 - Connections to 3 standard RS-232 devices for pass-through and alarm management
 - BSN extension to provide 3 additional
- Configurable RS-232/485 port for remote via TL1/X.25
- EasyView2, Windows-based software,for configuration and reporting through local terminal or Modem connections
- Multiple password-protected security levels:

Standard System Features

- Monitoring and control of up to 85RS485 serial connected devices
 - Maximum of 85 serialswitch mode rectifiers

Key Features (continued)

- Various levels of configuration, statistics, and history
 - All stored in non-volatile memory
 - Remote and local backup and restore of configuration data
- Remote and local software upgrade
- Basic, busy hour, and trend statistics kept
- Detailed history kept
- Maintenance reminders
- Inventory management
- User defined events and derived channels
- Hardware DIP switch access control

Standard Battery Management Features

- Float/boost mode control
 - Manual front panel boost
 - Manual timed boost locally, T1.317, and remotely initiated
 - External timed boost
 - Battery thermal protect module (BTP)
 - Auto boost terminated by time or current
- Battery discharge testing
 - Manual
 - Periodic
 - Plant Battery Test (PBT) input driven
- Slope thermal compensation
 - High temperature Compensation
 - Low temperature Compensation
 - Step temperature
 - STC Enable/Disable, low temperature Enable/Disable
 - mV/°C adjustment
- High temperature disconnect/step setting
- Sophisticated reserve-time prediction
 - User configurable system reserve low alarm during normal operation
 - User configurable reserve time low alarm
- Recharge current limit
- Integrated "At Rate Calculator" for estimation purposes

- Battery discharge trace data
- Emergency Power-Off Input
- Lithium battery fail input

Features

Integrated Outputs

- Traditional office alarm interface with 19 Form-C alarm outputs (60VDC @.3A)
 - Standard default assignments: Power Critical-Audio, Power Critical-Visual, Power Critical- External, Power Major-Audio, Power Major-Visual, Power Major-External, Power Minor- Audio, Power Minor-Visual, Power Minor-External, Major Fuse (MJF), Minor Fuse (MNF), Battery On Discharge (BD), AC Fail (ACF), Rectifier Fail, High Voltage (HV), Very Low Voltage (VLV), Controller Fail, User Relay 1, User Relay 2
 - 16 Form-Cs are user assignable
- 11/3A Auxiliary Battery Supply (ABS) Output

Remote Peripheral Monitoring & Control

- Modular monitor and control growth options for up to 95 monitoring modules optimized for DC voltage and shunt monitoring, binary input detection, temperature monitoring, external transducer monitoring
- Additional Form-C relay output control available
- Devices managed and powered by the controller via one twisted-pair cable over distances of 300m or more
- Daisy-chain connections from module to module reduce installation costs and cable congestion
- Modules can be located near monitored source
- Various panels for rack- mounting available

Key Features (continued)

Enhanced Battery Management Features

- Battery discharge test options including periodic and manual tests (local/ remote) with configurable thresholds or 20% discharge algorithm
- State of charge indication
- Rectifiers on-line during test (minimize risk to service)
- Discharge data stored in non-volatile memory. Graphical data available
- Accurate battery reserve time calculations that factor in battery specific parameters, plant voltage, load, temperature, number of battery strings and number of cells per string
- Thermal compensation (STC) and recharge current limit to maximize battery life
- Monitor and control of more than 40 connected devices
- Management information from polling or alarms received from alarm traps from multiple sites are available on one screen via the inter/intranet
- Trend user selected data over time
- Automatic or manual report generation
- Standard engineering tools like reserve time calculators and cable voltage drop analyzer

Extensive Plant and Monitoring Statistics

- Real-time data and historical statistics help analyze critical performance parameters
- Statistics for planning preventive or corrective maintenance before serious problems occur

Derived Channels

- 32 derived channels enable arithmetic and Boolean operations to be performed on measured values to allow customer specific parameters such as output power to be calculated and managed

Rectifier Management

- Energy Efficiency, provides ability to automatically shutdown selected rectifiers during low plant loads maintaining maximum battery plant efficiency without sacrificing reliability
- Provides Reserve Operation feature for maintaining designated number of rectifiers on during Engine runs as well as proper sequencing for generators
- Provides ability to transfer rectifiers (TR1-TR4) on in certain sequences for return of AC

Galaxy Manager Compatible

- Centralized web server and database with multiple user access to live or managed data with drill down to problem details

Specifications

GENERAL	
Operating Voltage	± 24Vdc, ± 48Vdc (Range: ± 18 to ± 60Vdc)
Input Power	36W (depending on options)
Operating Temperature Range	-40°C to +75°C (-40 to 167°F)
Storage Temperature Range	-40°C to +85°C (-40 to 185°F)
Operating Relative Humidity	0 - 95% (non-condensing)
Physical Specifications	9.24" H x 20.76" W x 2.14" D
Display	8-line by 40-character backlit LCD

SAFETY AND STANDARDS COMPLIANCE	
NEBs	Evaluated by independent NRTL test lab to Telcordia GR63, Issue 3 and GR1089-CORE, Issue 5
Safety	ANSI/UL60950-1-2014 and CAN/CSA C22.2 No. 60950-1-07, Second Edition + A2:2014 (MOD), dated October 14, 2014
RoHS	Compliant to RoHS EU Directive 2002/95/EC RoHS 6/6
EMC	European Directive 2004/108/EC; EN55022, Class A, EN55024; FCC, Class A; GR1089-CORE, Issue 5

AGENCY CERTIFICATIONS	
NEBs	Evaluated by independent NRTL test lab to Telcordia GR63, Issue 3 and GR1089-CORE, Issue 6 (including level 3 testing)
EMC (Emissions)	European Directive 2014/30/EU; EN55022, (CISPR22) Class B, EN55035 (CISPR24)
Safety	Underwriters Laboratories (UL) Listed per Subject Letter 1801: Power Distribution Center for (CSA 22.2 950); Safety of Information Technology Equipment

Infinity M

Infinity M may be configured as a +24V or -48V single voltage power system or as a dual voltage power system that supports rectifiers and converters. The primary voltage is supported by +24V or -48V rectifiers and battery reserve, while secondary voltage is supported by DC-DC converters. Infinity-M includes dedicated 24V, 48V and return buses. The primary voltage capacity is 2,100A at 24V and 2,100A at 48V. Secondary voltage capacity is up to 600A. The system includes low voltage battery disconnect option for the primary voltage. A low voltage load disconnect option can be used for load shedding to maintain critical loads.



Applications

- Wireless Telecom Networks
- Central Office
- Cable Facilities
- Remote Radio Sites
- Data Networks
- Off-Grid/On-Grid Renewable Energy Sites

Features

- Dual Voltage Flexibility
- Redundant fan cooling
- Front panel LED indicators
- 1U height, high power density
- 277/220/110 V AC input
- Digital load sharing
- Hot pluggable
- RoHS compliant
- ECO Priority ready

Specifications

INPUT	MIN	TYP	MAX
Voltage Range			
High-Line	175Vac	220Vac	305Vac
Low-Line	85Vac	110Vac	140Vac
Frequency	45Hz	60Hz	66Hz
Power Factor	98%	99.5%	
Total Harmonic Distortion			5%

PRIMARY OUTPUT		
Nominal Voltage	24Vdc	-48Vdc
Output Rating	2,100A	2,100A
Vo Setpoint (factory)	27.2Vdc±1%	-54.5Vdc±1%
Vo Range	+21Vdc to +29Vdc	-42Vdc to -58Vdc
Regulation	±0.5%	

SECONDARY OUTPUT		
Nominal Voltage	-48Vdc	24Vdc
Output Rating	600A	600A
Vo Setpoint (factory)	-54.5Vdc±1%	27.2Vdc±1%
Vo Range	-42Vdc to -58Vdc	+21Vdc to +29Vdc
Regulation	±0.5%	

MECHANICAL	
Height (in./mm)	31.5 / 800 (Base system with 4 power shelves)
Width (in./mm)	23 / 584.2 (Standard Frame)
Depth (in./mm)	21 / 533.4
Weight (lb / Kg)	350 / 159 (Base System with 4 power shelves and 7ft frame, no rectifiers)

ENVIRONMENTAL	
Operating Temperature	-40°C to +75°C (-40°F to 167°F)
Storage Temperature	-40°C to +85°C (-40°F to 185°F)
Relative Humidity	95% max, non-condensing
Altitude	4000M (for altitudes above 2000M, peak operating temperature de-rates 0.656°C /100M; 4000M peak temperature rating is 62°C)

SAFETY AND STANDARDS COMPLIANCE	
NEBs	Evaluated by independent NRTL test lab to Telcordia GR63-CORE and GR1089-CORE Issue 6 [Level 3]
Safety	ANSI/UL60950-1-2014 and CAN/CSA C22.2 No. 60950-1-07, Second Edition + A2:2014 (MOD), dated October 14, 2014
RoHS	Compliant to RoHS EU Directive 2002/95/EC RoHS 6/6
EMC	European Directive 2014/30/EU; EN55022, Class A; EN55035; FCC, Class A; GR1089-CORE Issue 6

Specifications (continued)

AGENCY CERTIFICATIONS

CSA	CAN/CSA C22.2 No. 60950-1-07, Second Edition + A2:2014 (MOD), dated October 14, 2014
EMI/EMC	European Directive 2014/30/EU; EN55022 (CISPR22) Class A; EN55035 (CISPR24)
NEBS LEVEL 3	GR1089-CORE, Issue 6 Special equipment room cooling may be needed - heat dissipation exceeds values of GR-63 Table 4-5

OUTLINE DRAWING (FOR VISUAL REFERENCE ONLY)

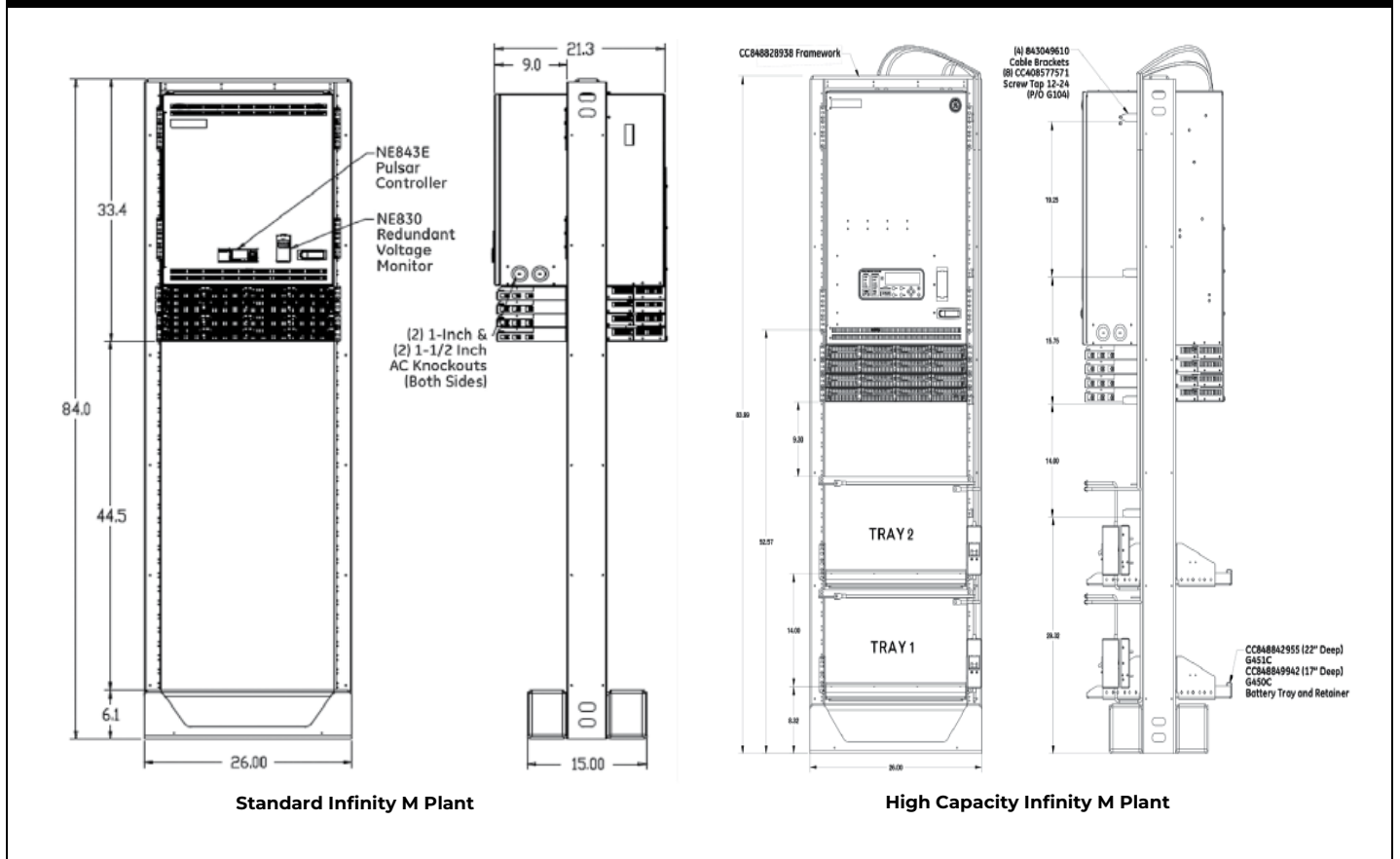

Ordering Information – Infinity M Power System

Infinity M may be configured as a +24V or -48V single voltage power system or as a “dual voltage” power system that supports rectifiers and converters. The primary voltage is supported by +24V or -48V rectifiers and battery reserve, while secondary voltage is supported by DC-DC converters. The primary voltage capacity is 2,100A at 24V and up to 2,100A at 48V. When equipped, secondary voltage capacity is up to 600A per horizontal panel.

The high capacity Infinity M can range from 1,200 to 2,100amp in single bay which can be expanded with a supplemental bay for total system capacity of 4,200amps.

Infinity M systems may be equipped in a 7ft framework, a half height (42”) frame for mounting on battery stands, or supplied frameless for field install applications.

Features

- Infinity Series Rectifiers for +24V and -48V applications.
 - Dual Voltage Bus architecture for easy growth and voltage migration
 - DC-DC Converter support for dual voltage systems
 - DC Distribution for both voltages, with Selectable Voltage panel availability
- 
- Temperature hardened harsh environments. (-40°C to +75°C)
 - Compact size: Base System with 4 power shelves occupies 18 RU (31.5 in) of 23" wide rack space (21" depth)
 - Frame options – Factory installed in 7ft or 42" tall, 23" wide frame or field installed in user supplied frame
 - Battery connections, LVBD and LVLD options.
 - Plug-N-Play, Secure Protocol Pulsar Plus controller with Web based interface for local and remote IPV6 (LAN) access.
 - Distribution options include 3A-300A bullet style circuit breakers, large G-J breakers to 600A, TPL fuses up to 600A and GMT fuses











Additional Information

Product Documentation

H5692448	Ordering Guide A copy of the appropriate installation manuals below ship with each system.
CC848815325	H5692448 Installation Guide
CC848815341	Advanced Features User Guide for the Pulsar Plus Controller, 167-792-183
850050111	Infinity NE-M High Capacity Install Guide
850043539	NE-M CB Shunt Monitoring Install Guide

Step 1: Select the Base Power System

Infinity M High Capacity Systems with Millennium 2 Controller

OUTPUT	ORDERING CODE	MODEL	MODEL	PHOTO
	150047135	1,200A -48V single voltage, includes horizontally mounted shunt monitored bullet panels with 52 bullet breaker positions, plus 12 positions for larger GJ breakers, 4 universal power shelves in 7ft Zone 4 frame, door mounted Millennium 2 controller, 1 shunt RPM. H5692448 G104, G804, G224L, G631(2), G636, G600A	7ft x 23" (Approx. 37.5" of open space) System Width 23"	
	150052096	1,200A -48V single voltage NEM Power Plant equipped with a door mounted Millennium 2 controller, 2 - 12 Position Large Distribution panel for GJ Breakers or TPL Fuse holders, 2 RPM Module for shunt monitoring large distribution positions and 4 power shelves mounted in a 7ft Zone 4 frame. H5692448 G104, G804, G224L, G636, G638, G600A(2)	7ft x 23" (Approx. 37.5" of open space) System Width 23"	
	150052457	1,200A -48V single voltage, includes 3 horizontally mounted shunt monitored bullet panels with 78 bullet breaker positions, plus 12 positions for larger GJ breakers, 4 universal power shelves in 7ft Zone 4 frame, door mounted Millennium 2 controller, 2 shunt RPM. H5692448 G104, G804, G224L, G631(3), G637, G600A(2) Note: Return connections for the larger GJ breakers or TPL fuse positions will take place on main battery return bus located on top of bay. Extension bars, lug adaptors and external returns are available in section 2 and section 8 for cable terminations	7ft x 23" (Approx. 37.5" of open space) System Width 23"	
	150047410	1200A -48v single voltage, includes 4 horizontally mounted shunt monitored bullet panels with 104 bullet breaker positions, 4 universal power shelves in 7ft Zone 4 frame, door mounted Millennium 2 controller, 1 shunt RPM H5692448 G104, G804, G224L, G631(4), G600A	7ft x 23" (Approx. 37.5" of open space) System Width 23"	

Step 1: Select the Base Power System (continued)

Infinity M High Capacity Systems with Millennium 2 Controller

OUTPUT	ORDERING CODE	MODEL	FRAME	PHOTO
	150051978	1,200A -48V single voltage NEM Power Plant equipped with a door mounted Millennium 2 controller, 2 – 12 Position Large Distribution panel for GJ Breakers or TPL Fuse holders (Comes Equipped with 2 – 300A & 2 – 600A breakers), 2 RPM Module for shunt monitoring large distribution positions and 4 power shelves mounted in a 7ft Zone 4 frame. H5692448 G104, G804, G222L, G636, G600A, G600F(2), G600H(2), G310	7ft x 23" (Approx. 37.5" of open space) System Width 23"	
	150047141	1,200A -48V single voltage, includes 2 horizontally mounted shunt monitored bullet panels with 52 bullet breaker positions, plus 12 positions for larger GJ breakers, 4 universal power shelves in 7ft Zone 4 frame, door mounted Millennium 2 controller, 1 shunt RPM, (2) 22" deep factory installed battery trays with 200A disconnect breaker assemblies. H5692448 G104, G804, G224L, G631(2), G636, G600A, G451C(2), G461(2)	9.5" of open space System Width 23"	
	150047412	1,200A -48V single voltage, includes 4 horizontally mounted shunt monitored bullet panels with 104 bullet breaker positions, 4 universal power shelves in 7ft Zone 4 frame, door mounted Millennium 2 controller, 1 shunt RPM, (2) 22" deep factory installed battery trays with 200A disconnect breaker assemblies. H5692448 G104, G804, G224L, G631(4), 600A, G451C(2), G461(2)	7ft x 23" (Approx. 9.5" of open space) System Width 23"	

Step 1: Select the Base Power System (continued)

Infinity M High Capacity Systems with Millennium 2 Controller

OUTPUT	ORDERING CODE	MODEL	FRAME	PHOTO
	150047136	1,500A -48V single voltage, includes 2 horizontally mounted shunt monitored bullet panels with 52 bullet breaker positions, plus 12 positions for larger GJ breakers, 5 universal power shelves in 7ft Zone 4 frame, door mounted Millennium 2 controller, 1 shunt RPM. H5692448 G104, G804, G224L, G631(2), G636, G600A, G310	7ft x 23" (Approx. 35.75" of open space) System Width 23"	
	150052097	1,500A 48V single voltage NEM Power Plant equipped with a door mounted Millennium 2 controller, 2 – 12 Position Large Distribution panel for GJ Breakers or TPL Fuse holders, 2 RPM Module for shunt monitoring large distribution positions and 5 power shelves mounted in a 7ft Zone 4 frame. H5692448 G104, G804, G224L, G636, G638, G600A(2), G310	7ft x 23" (Approx. 35.75" of open space) System Width 23"	

Step 1: Select the Base Power System (continued)

Infinity M High Capacity Systems with Millennium 2 Controller

OUTPUT	ORDERING CODE	MODEL	FRAME	PHOTO
 1500A	150047142	1,500A -48V single voltage, includes 2 horizontally mounted shunt monitored bullet panels with 52 bullet breaker positions, plus 12 positions for larger GJ breakers, 5 universal power shelves in 7ft Zone 4 frame, door mounted Millennium 2 controller, 1 shunt RPM, (2) 22" deep factory installed battery trays with 200A disconnect breaker assemblies. H5692448 G104, G804, G224L, G631(2), G636, G600A, G310, G451C(2), G461(2)	7ft x 23" (Approx. 7.75" of open space) System Width 23"	
 2100A	150047137	2,100A -48V single voltage, includes 2 horizontally mounted shunt monitored bullet panels with 52 bullet breaker positions, plus 12 positions for larger GJ breakers, 7 universal power shelves in 7ft Zone 4 frame, door mounted Millennium 2 controller, 1 shunt RPM. H5692448 G104, G804, G224L, G631(2), G636, G600A, G31(3)	7ft x 23" (Approx. 32.25" of open space) System Width 23"	
 2100A	150052458	2100A -48V single voltage, includes 3 horizontally mounted shunt monitored bullet panels with 78 bullet breaker positions, plus 12 positions for larger GJ breakers, 7 universal power shelves in 7ft Zone 4 frame, door mounted Millennium 2 controller, 2 shunt RPM. H5692448 G104, G804, G224L, G631(3), G637, G600A(2), G310(3) Note: Return connections for the larger GJ breakers or TPL fuse positions will take place on main battery return bus located on top of bay. Extension bars, lug adaptors and external returns are available in section 2 and section 8 for cable terminations.	7ft x 23in Approx. 32,25 inches of open space System width 23"	
 2100A	150047714	2,100A -48V single voltage, includes 2 horizontally mounted shunt monitored bullet panels with 52 bullet breaker positions, 4 - 600amp GJ breakers , 7 universal power shelves in 7ft Zone 4 frame, door mounted Millennium 2 controller, 1 shunt RPM. H5692448 G104, G804, G224L, G631(2), G636, G600A, G600H(4), G310(3)	7ft x 23" (Approx. 32.25" of open space) System Width 23"	
 2100A	150049580	2,100A -48V single voltage NEM Power Plant equipped with a door mounted Millennium 2 controller, 2 - 26 Position shunt monitored bullet breaker panels, 6 - 600A rated TPL Fuse holders, 2 RPM Module for shunt monitoring large distribution positions and 7 power shelves mounted in a 7ft Zone 4 frame. H5692448 G104, G804, G224L, G631(2), G636, G600A(2), G600M(6), G310(3)	7ft x 23" (Approx. 32.25" of open space) System Width 23"	









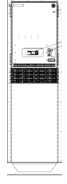

Step 1: Select the Base Power System (continued)

Infinity M High Capacity Systems with Millennium 2 Controller

OUTPUT	ORDERING CODE	MODEL	FRAME	PHOTO
 2100A	150047143	2,100A -48V single voltage, includes 2 horizontally mounted shunt monitored bullet panels with 52 bullet breaker positions, plus 12 positions for larger GJ breakers, 7 universal power shelves in 7ft Zone 4 frame, door mounted Millennium 2 controller, 1 shunt RPM, (2) 22" deep factory installed battery trays with 200A disconnect breaker assemblies H5692448 G104, G804, G224L, G631(2), G636, G600A, G310(3), G451C(2), G461(2)	7ft x 23" (Approx. 4.25" of open space) System Width 23"	
 2100A	150050704	2,100A -48V single voltage NEM Power Plant equipped with a door mounted Millennium 2 controller, 2 - 26 Position shunt monitored bullet breaker panels, 6 - 600A rated TPL Fuse holders, 2 RPM Module for shunt monitoring large distribution positions, 7 power shelves and 2 battery shelves with 200A Breaker Disconnects mounted in a 7ft Zone 4 frame. H5692448 G104, G804, G224L, G631(2), G636, G600A(2), G600M(6), G310(3), G451C(2), G461(2)	7ft x 23" (Approx. 4.25" of open space) System Width 23"	
 2100A	150050438	2,100A -48V single voltage NEM Power Plant equipped with a door mounted Millennium 2 controller, 2 - 12 Position Large Distribution panel for GJ Breakers or TPL Fuse holders, 2 RPM Module for shunt monitoring large distribution positions and 7 power shelves mounted in a 7ft Zone 4 frame. H5692448 G104, G804, G224L, G636, G638, G600A(2), G310(3)	7ft x 23" (Approx. 4.25" of open space) System Width 23"	
 2100A	150050702	2,100A -48V single voltage NEM Power Plant equipped with a door mounted Millennium 2 controller, 2 - 12 Position Large Distribution panel for GJ Breakers or TPL Fuse holders, 2 RPM Module for shunt monitoring large distribution positions, 7 power shelves and 2 battery shelves with 200A Breaker Disconnects mounted in a 7ft Zone 4 frame. H5692448 G104, G804, G224L, G636, G638, G600A(2), G310(3), G451C(2), G461(2)	7ft x 23" (Approx. 4.25" of open space) System Width 23"	
 2100A	150049040	2,100A -48V single voltage NEM Power Plant equipped with a door mounted Millennium 2 controller, 12 - 600A rated TPL Fuse holders, 2 RPM Module for shunt monitoring large distribution positions and 7 power shelves mounted in a 7ft Zone 4 frame. H5692448 G104, G804, G224L, G636, G638, G600A(2), G600M(12), G310(3)	7ft x 23" (Approx. 4.25" of open space) System Width 23"	
 2100A	150050703	2,100A -48V single voltage NEM Power Plant equipped with a door mounted Millennium 2 controller, 12 - 600A rated TPL Fuse holders, 2 RPM Module for shunt monitoring large distribution positions, 7 power shelves and 2 battery shelves with 200A Breaker Disconnects mounted in a 7ft Zone 4 frame. H5692448 G104, G804, G224L, G636, G638, G600A(2), G600M(12), G310(3), G451C(2), G461(2)	7ft x 23" (Approx. 4.25" of open space) System Width 23"	
 2100A	150047411	1200A -48v single voltage, includes 4 horizontally mounted shunt monitored bullet panels with 104 bullet breaker positions, 4 universal power shelves in 7ft Zone 4 frame, door mounted Millennium 2 controller, 1 shunt RPM H5692448 G104, G804, G224L, G631(4), G600A	7ft x 23in Approx. 32,25 inches of open space System width 23"	

Step 1: Select the Base Power System (continued)

Infinity M High Capacity Systems with Millennium 2 Controller

OUTPUT	ORDERING CODE	MODEL	FRAME	PHOTO
 2100A	150047413	2,100A -48V single voltage, includes 4 horizontally mounted shunt monitored bullet panels with 104 bullet breaker positions, 7 universal power shelves in 7ft Zone 4 frame, door mounted Millennium 2 controller, (2) 22" deep factory installed battery trays with 200A disconnect breaker assemblies. H5692448 G104, G804, G224L, G631(4), 600A, G310(3), G451C(2), G461(2)	7ft x 23" (Approx. 4.25" of open space) System Width 23"	
 1200A	150046461	1,200A -48V single voltage, includes 4 horizontally mounted bullet panels with 104 bullet breaker positions, 4 universal power shelves in 7ft Zone 4 frame, door mounted Pulsar Plus controller. H5692448,G104, G842, G224L, G630-4	7ft x 23" (Approx. 37.5" of open space) System Width 23"	
 1200A	150047414	1,200A -48V single voltage, includes 4 horizontally mounted bullet panels with 104 bullet breaker positions, 4 universal power shelves in 7ft Zone 4 frame, door mounted Pulsar Plus controller, (2) 22" deep factory installed battery trays with 200A disconnect breaker assemblies. H5692448,G104, G842, G224L, G630-4, G451C(2), G461(2)	7ft x 23" (Approx. 9.5" of open space) System Width 23"	
 1500A	150046460	1,500A -48V single voltage, includes 4 horizontally mounted bullet panels with 104 bullet breaker positions, 5 universal power shelves in 7ft Zone 4 frame, door mounted Pulsar Plus controller. H5692448, G104, G842, G224L, G630-4, G310	7ft x 23" (Approx. 35.75" of open space) System Width 23"	
 2100A	150047659	2,100A -48V single voltage, includes 4 horizontally mounted bullet panels with 104 bullet breaker positions, 7 universal power shelves in 7ft Zone 4 frame, door mounted Pulsar Plus controller. H5692448,G104, G842, G224L, G630-4	7ft x 23" (Approx. 32.25" of open space) System Width 23"	
 2100A	150047415	2,100A -48V single voltage, includes 4 horizontally mounted bullet panels with 104 bullet breaker positions, 7 universal power shelves in 7ft Zone 4 frame, door mounted Pulsar Plus controller, (2) 22" deep factory installed battery trays with 200A disconnect breaker assemblies. H5692448,G104, G842, G224L, G630-4, G451C(2), G461(2)	7ft x 23" (Approx. 4.25" of open space) System Width 23"	

Step 1: Select the Base Power System (continued)

Infinity M High Capacity Systems with Millennium 2 Controller

OUTPUT	ORDERING CODE	MODEL	FRAME	PHOTO
 1200A	150051530	1,200A -48v single voltage supplemental bay with tie bar, includes 2 – 12 Position Large Distribution panel for GJ Breakers or TPL Fuse holders, 2 RPM Modules for shunt monitoring large distribution positions and 4 power shelves mounted in a 7ft zone 4 frame H5692448 G104, G820, G224L, G636, G638, G600A(2)	7ft x 23" (Approx. 37.5" of open space) System Width 23"	
 2100A	150051531	2,100A -48v single voltage supplemental bay with tie bar, includes 2 – 12 Position Large Distribution panel for GJ Breakers or TPL Fuse holders, 2 RPM Modules for shunt monitoring large distribution positions and 7 power shelves mounted in a 7ft zone 4 frame H5692448 G104, G820, G224L, G636, G638, G600A(2), G300(3)	7ft x 23in Approx. 32,25 inches of open space System width 23"	
 1200A	150051532	1,200A -48v single voltage supplemental bay with tie bar, includes 2 horizontally mounted shunt monitored bullet panels with 52 bullet breaker positions, 12 Position Large Distribution panel for GJ Breakers or TPL Fuse holders, 2 RPM Modules for shunt monitoring large distribution positions , 4 universal power shelves in 7ft Zone 4 frame, H5692448 G104, G820, G224L, G631(2), G636, G600A(2)	7ft x 23" (Approx. 37.5" of open space) System Width 23"	
 2100A	150051533	2,100A -48v single voltage supplemental bay with tie bar, includes 2 horizontally mounted shunt monitored bullet panels with 52 bullet breaker positions, 12 Position Large Distribution panel for GJ Breakers or TPL Fuse holders, 2 RPM Modules for shunt monitoring large distribution positions , 7 universal power shelves in 7ft Zone 4 frame, H5692448 G104, G820, G224L, G631(2), G636, G600A(2), G300(3)	7ft x 23in Approx. 32,25 inches of open space System width 23"	

PHOTO







Step 2: Battery Support Options

ORDERING CODE	DESCRIPTION	PHOTO
CC848842955	23" Battery Tray (22" Depth) Typically Batteries include: NorthStar (NSB110FT, NSB170FT) Energysys (12V155FS, 12V170F), 12V190F Gnb (M12V125FT, M12V155FT), M12V180FT Dynasty (TEL12-90, TEL12-105, TEL12-125), TEL12-155F, TEL12-180F	
850033993	23" Battery Tray (24" depth) * East Penn Deka 12AVR200	
CC109147501	J2008002L007: 100A Battery Disconnect Breaker Assembly equipped with 10 ft. of 2 gauge red and black wire. For use with standard battery trays listed above.	
CC109149778	J2008002L008: 200A Battery Disconnect Breaker Assembly equipped with 10 ft. of 2/0 gauge red and black wire. For use with standard battery trays listed above.	
848724971	2 gauge, 10 ft. battery cable kit with Anderson Disconnect. For use with standard battery trays listed above. Not fore use with Lithium battery trays.	
CC848809104	2 gauge, 10 ft. battery cable kit (includes terminal lugs)	
CC848860734	2/0 gauge, 10 ft. battery cable kit (includes terminal lugs)	
850036381	Battery bus and return bus extension Kit (Order 2)	

ORDERING CODE	DESCRIPTION	PHOTO
150037405	Battery Frame 48V; 5 trays with 200A breakers	
848385878	Lug adaptor allow cables connected to lower hole section of top battery bus bar additional clearance for termination.	

Step 3: Select Rectifiers and Converters

Rectifiers

ORDERING CODE	MODEL	PHOTO
 50A	CC109158878 95 - 145Vac input, 48V, 22A output (max. 25A @48V) 175 - 305Vac input, 48V, 50A output (max. 57A @48V) 145 - 175 linear output increase from 22A to 50A NE050AC48ATEZ	
 75A	CC109163473 95 - 145Vac input, 48V, 22A output (max. 25A@48V) 175 - 305 Vac input, 48V, 75A output (max. 82A@48V) 145 - 175 linear output increase from 22A to 75A NE075AC48ATEZ	

Step 4: Select Alarm Cables





Alarm Cables

ORDERING CODE	MODEL	PHOTO
CC848817651	50ft Auxiliary input alarm cable (J3) for Pulsar Plus Controller	
CC848817668	150ft Auxiliary input alarm cable (J3) for Pulsar Plus Controller	
CC848817635	50ft output alarm cable (J4) for Pulsar Plus Controller	
CC848817643	150ft output alarm cable (J4)for Pulsar Plus Controller	

Step 5: Select Distribution Components

Bullet Style Load Circuit Breakers

Note: Infinity M systems all support plug-in (bullet style) breakers or fuse modules. Larger breakers can be 2 or even 3 poles. The multi-pole breakers MUST be used with the appropriate multi-pole adapter to parallel the poles for proper operation.



ORDERING CODE	AMPERAGE	CB POSITIONS (POLES)	MIN WIRE GAUGE	PHOTO
407998137	3	1	10	
407998145	5	1	10	
407998152	10	1	10	
407998160	15	1	10	
407998178	16	1	10	
407998186	20	1	10	
407998194	25	1	10	
407998202	30	1	10	
408213486	40	1	8	
407998210	45	1	8	
407998228	50	1	6	
407998236	60	1	6	
407998244	70	1	2	
407998251	80	1	2	
407998269	90	1	2	
407998277	100	1	2	
CC848808551	100	2	2	
408185353	125	2	2	
408185346	150	2	1/0	
408564941	200	3	2/0	
CC408573975	225	3	4/0	
408535752	250	3	4/0	
450046922	300	3	350	
CC848756916	2-pole Adapter bus for 100-150A breakers; used with 3/4"-20 on 5/8" lugs (order 2 per 2 pole breaker to accommodate load and return lugs)			
CC848756924	3-pole Adapter bus for 200-250A breakers; off-center connection; used with 3/8" on 1" lugs (order 2 per 3 pole breaker to accommodate load and return lugs)			

Step 5: Select Distribution Components (continued)

Bullet Style Fuse Holder and TPS Fuses



ORDERING CODE	AMPERAGE	WP-92461 LIST	MIN WIRE GAUGE	PHOTO
406700567	3	100	10	
406700583	5	101	10	
406700591	6	102	10	
406700609	10	103	10	
406700617	15	104	10	
406700625	20	105	10	
406700633	25	106	10	
406700641	30	107	10	
406700658	40	108	10	
406700674	50	109	8	
406700682	60	110	6	
406700690	70	111	6	
402328926	0.18 Alarm Fuse			
408548944	Bullet Fuse Holder, TFD-101-011-09 (Alarms on Blown Fuse or Fuse Head Removal)			
CC408617410	Bullet Fuse Holder, TFD-101-011-10 (Alarms on Blown Fuse Only)			

Bullet Style GMT Fuse Holder and GMT Fuses

ORDERING CODE	AMPERAGE			PHOTO
405006222	0.25A			
3150439	0.5A			
405673146	1.33A			
405181983	2A			
406976985	3A			
406159061	5A			
405725433	7.5A			
406159236	10A			
407845197	12A			
406473959	15A			
CC109103157	6-pos GMT Bullet Fuse Holder (Requires 2 bullet positions) Note: Max Fuse Load is 12A			
408515823	Fuse Puller			
402099436	Dummy Fuse			

Step 5: Select Distribution Components (continued)

KS22012 GJ Style Breaker Kits for Field Installation of Group 617 / 614 / 636 / 638 Distributions

ORDERING CODE	DESCRIPTION	PHOTO
CC109127635	150A Single Pole Breaker (G600B)	
150050651	200A Single Pole Breaker (G600C)	
150050652	225A Single Pole Breaker (G600D)	
CC109127627	250A Single Pole Breaker (G600E)	
150046312	300A Two Pole Breaker (G600F)	
CC109127486	400A Two Pole Breaker (G600G)	
150050653	500A Three Pole Breaker (G600J)	
CC109151767	600A Three Pole Breaker (G600H)	
150051312	600A TPL-C Fuse Holder with Shunt (G600M)	

TPL Fuse Block Kit

ORDERING CODE	AMERAGE	MAX # WIRES PER POSITION	MIN WIRE GAUGE	PHOTO
408472322	70-250A Fuse Holder Head (only required for 2 Position 70A-600A TPL Fuse Panel)			
402328926	0.18A Alarm Fuse			
406794776	70	3	6	
408239648	80	3	4	
406794784	100	3	2	
406925685	125	3	2	
406794792	150	3	1/0	
406794818	200	3	4/0	
406794982	225	3	4/0	
406794842	250	3	4/0	
406794867	300	3	2 x 4/0	
406794875	400	3	2 x 4/0	
406794883	500	3	2 x 4/0	
406794891	600	3	3 x 4/0	

Terminal Lugs for Bullet Style Breakers and TPS Fuses (1/4" Bolt on 5/8" Centers)

ORDERING CODE	STR WIRE GA (CLASS B)	FLEX WIRE GA (CLASS I)	WP-91412 LIST	PHOTO
406021626	8	8	75	
405347519	6	6	3	
405347576	4	4	5	
405348202	2	-	54	
405347683	-	2	8	

Terminal Lugs for Battery and Large Breakers (3/8" Bolt on 1" Centers)

ORDERING CODE	STR WIRE GA (CLASS B)	FLEX WIRE GA (CLASS I)	WP-91412 LIST	PHOTO
406338665	2	-	-	
405348228	1/0	-	-	
405348236	2/0	1/0	-	
406021725	-	2/0	-	
405348251	4/0	-	-	
405347923	-	4/0	-	

Terminal Lugs for Battery and Large Breakers (3/8" Bolt on 1" Centers)

- Large Wire Lugs

ORDERING CODE	STR WIRE GA (CLASS B)	FLEX WIRE GA (CLASS I)	WP-91412 LIST	PHOTO
407890763	350	-	-	
407890748	-	350	-	
406335141	750	-	-	
407890730	-	750	-	

Step 6: Select Battery Monitoring

ORDERING CODE	DESCRIPTION		PHOTO
CC109142980	QS873A Thermal Probe (A)		
150026698	QS873B Ambient Thermal Probe (A)		
CC848817024	10 ft wire set	(B: thermal probe to controller)	
CC109157434	20 ft wire set	(B: thermal probe to controller)	
CC848822560	1 ft wire set	(C: thermal probe to thermal probe)	
848719803	5 ft wire set	(C: thermal probe to thermal probe)	
CC848822321	10 ft wire set	(C: thermal probe to thermal probe)	
850027334	20 ft wire set	(C: thermal probe to thermal probe)	
108958422	ES771A Battery Voltage Monitor Card		
CC848791517	2-1/2 ft wire set	(D: ES771A to thermal probe)	
CC848797290	6 ft wire set	(D: ES771A to thermal probe)	
848719829	10 ft wire set	(D: ES771A to thermal probe)	
CC848791500	4 ft wire set	(G: ES771A to ES771A or controller)	
848652947	10 ft wire set	(G: ES771A to ES771A or controller)	
555052-1	In-Line Coupler (for extending item G above)		

OUTLINE DRAWING

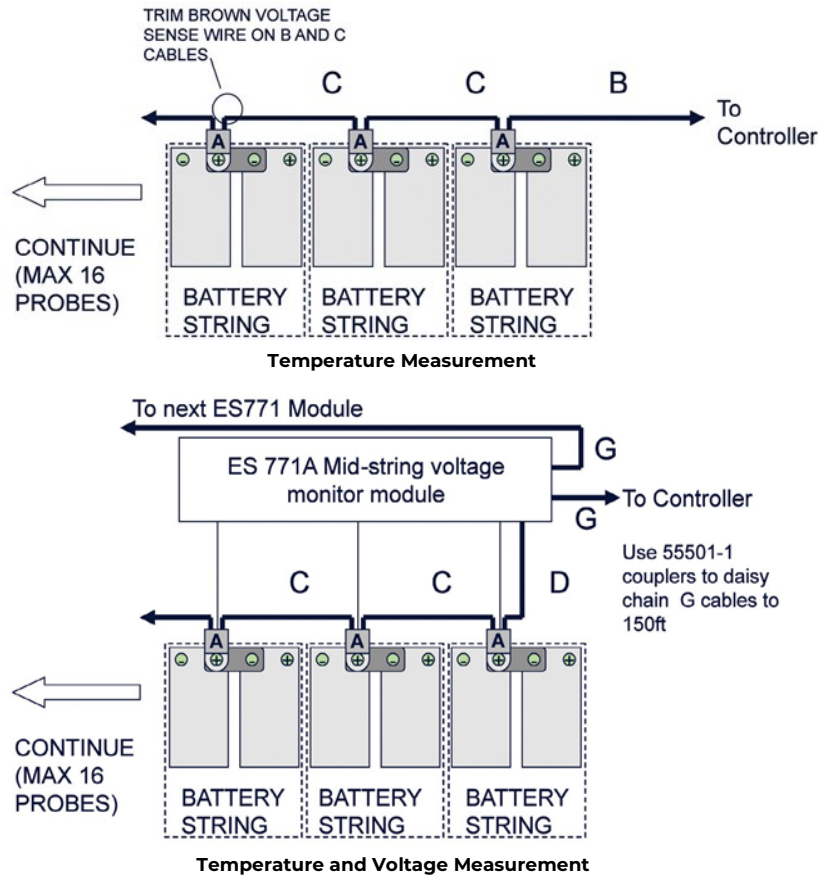

Step 7: Select Remote Peripheral Monitoring Options (Millennium 2 Controller Only)

Modules

ORDERING CODE	DESCRIPTION	# INPUTS	# TEMP	PHOTO
108469461	J85501G1L21 RPM Shunt Monitoring (221F)	6	1	
108469479	J85501G1L22 RPM Voltage 0-200VDC (221D)	6	1	
108469495	J85501G1L23 RPM Transducers (221J)	6	1	
108298431	J85501G1L24 RPM Voltage 0-3VDC (221A)	6	1	
108298498	J85501G1L25 RPM Voltage 0-16VDC (221B)	6	1	
108469503	J85501G1L26 RPM Voltage 0-70VDC (221C)	6	1	
108298449	J85501G1L27 RPM Binary (222A)	6	1	
108483538	J85501G1L28 RPM Temperature (223T)	0	7	
108298456	J85501G1L9 RPM Control Relay (214A)	3	0	

Supporting Material

ORDERING CODE	DESCRIPTION	PHOTO
407377704	Connecting Cable for RPMs (Order by foot)	
848535332	Panel for mounting 6 modules on the top of a GPS cabinet	
848412367	White panel for mounting 6 modules in a 23-inch frame	
847307410	12' Cable to be used with Temperature Probes	
847917879	1/2" Diameter Ring Terminal Temperature Probe (Cable Required)	
848528881	5/16" Diameter Ring Terminal Temperature Probe (Cable Required)	
405298308	Termination Resistor (1 per bus)	
406712968	Ferrite Bead (1 per bus)	
403607955	Monitor Channel cable KS13385 22AWG stranded pair, R&Bk (order by the foot)	
108984477	23" grey panel, 6 RPM mounting panel for Lorain plants	

OUTLINE DRAWING

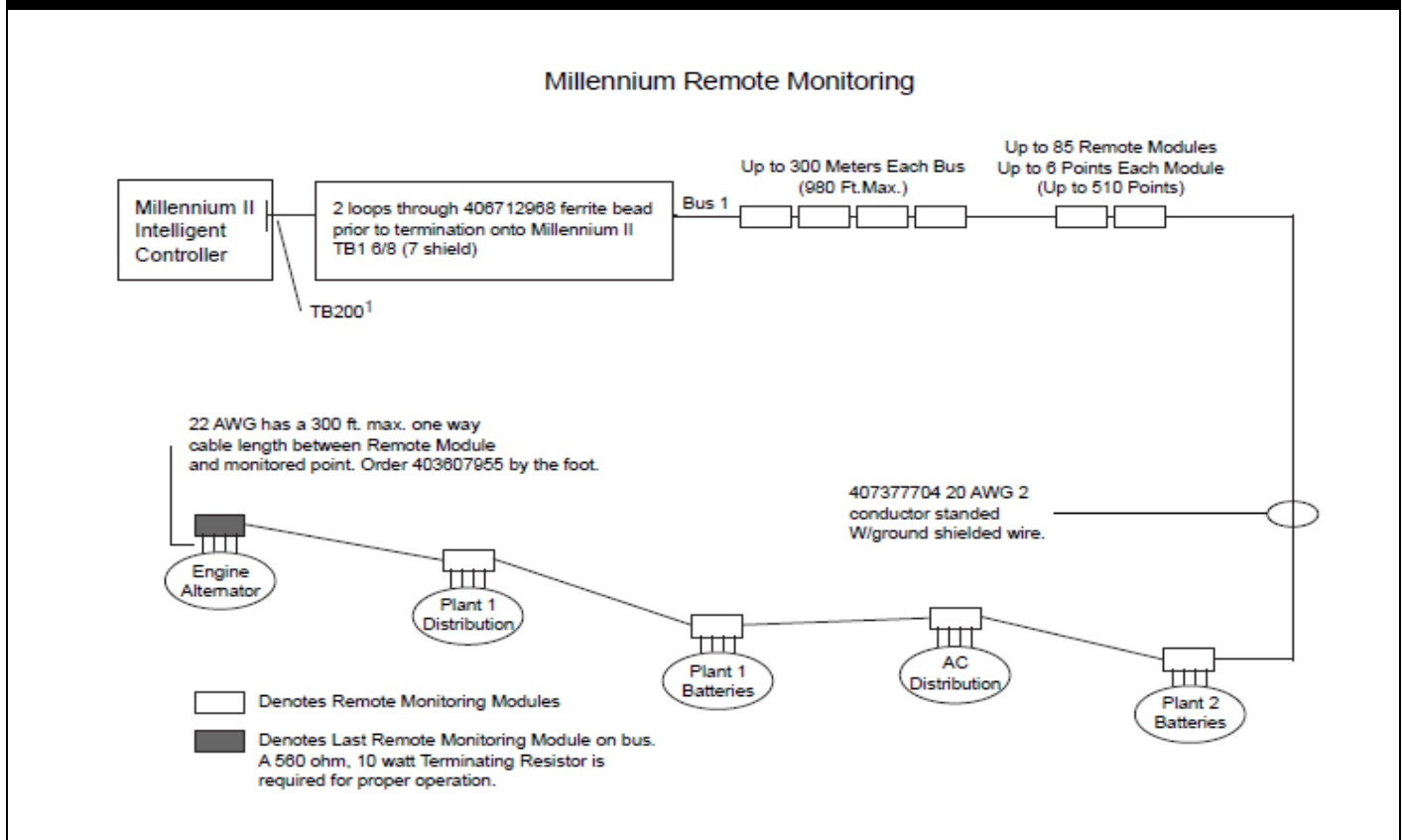

Step 8: Optional External Return Bar

Ordering Code External Return Bus Assembly Options

ORDERING CODE	DESCRIPTION
150021156	One 2400A External DC Return bus for mounting on 15 or 20 inch cable rack (1st Tier)
150021157	One Supplementary 2400A DC Return bus for stacking on a 150021156 bus. (Order 1 for a 2 Tier arrangement. Order 2 for a 3 Tier arrangement)

OUTLINE DRAWING

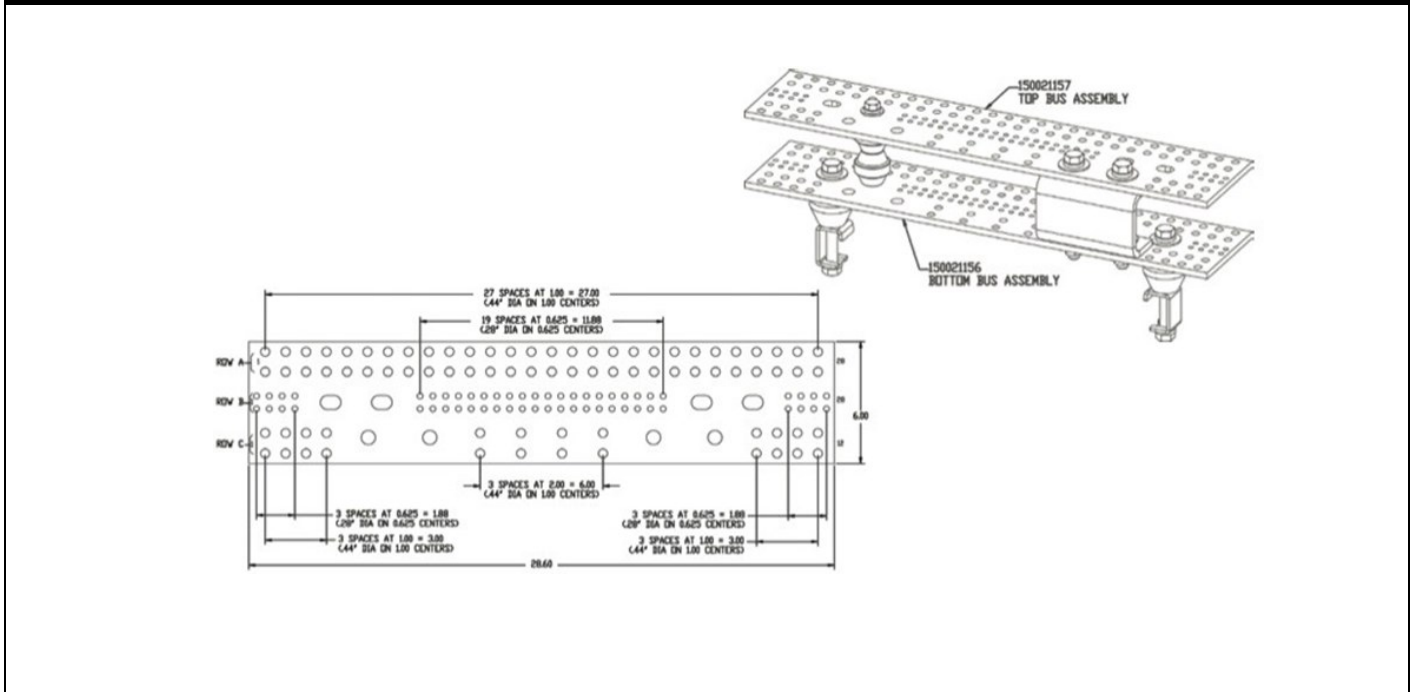

Reliability

- Distributed fault tolerance
- Proven field performance
- Controller continuity

Intelligence

- Industry-leading controller features
- Ethernet interface for remote access
- Centralized network management

Investment Protection

- Module compatibility
- Power shelf growth
- Secondary voltage flexibility +24V/-48V
- Flexible upgrade options

Management Visibility

Galaxy Manager* software is the centralized visibility and control component of a comprehensive power management system designed to meet engineering, operations and maintenance needs. The Galaxy Manager client-server architecture enables remote access to system controllers across the power network.

- Dashboard display with one-click access to management information database
- Trend analysis
- Scheduled or on-demand reports
- Fault, configuration, asset, and performance management

Training

OmniOn offers on-site and classroom training options based on certification curriculum. Technical training can be tailored to individual customer needs. Training enables customers and partners to more effectively manage and support the power infrastructure. We have built our training program on practical learning objectives that are relevant to specific technologies or infrastructure design objectives.

Service & Support

OmniOn field service and support personnel are trusted advisors to our customers always available to answer questions and help with any project, large or small. Our certified professional services team consists of experts in every aspect of power conversion with the resources and experience to handle large turnkey projects along with custom approaches to complex challenges. Proven systems engineering and installation best practices are designed to safely deliver results that exceed our customers' expectations.

Warranty

OmniOn is committed to providing quality products and solutions. We have developed a comprehensive warranty that protects you and provides a simple way to get your products repaired or replaced as soon as possible.

For full warranty terms and conditions please visit

omnionpower.com

OmniOn Power Inc.

601 Shiloh Rd.
Plano, TX USA

omnionpower.com

We reserve the right to make technical changes or modify the contents of this document without prior notice. OmniOn Power does not accept any responsibility for errors or lack of information in this document and makes no warranty with respect to and assumes no liability as a result of any use of information in this document.

We reserve all rights in this document and in the subject matter and illustrations contained therein. Any reproduction, disclosure to third parties or utilization of its contents – in whole or in parts – is forbidden without prior written consent of OmniOn Power. This document does not convey license to any patent or any intellectual property right. Copyright© 2023 OmniOn Power Inc. All rights reserved.