

ORDERING GUIDE

# BPS-Flex Stackable Plants

## Low Profile -48VDC Rack Mounted Power System



## Table of contents

04 – 09	BPS-Flex Stackable Specifications
10 – 11	Ordering Information—BPS-Flex Power System
12 - 13	Ordering Information—Build Your Own BPS-Flex
13 – 13	Ordering Information—Supplemental Distribution and Rectifier Shelves
14 – 14	Ordering Information—Controller
14 – 14	Ordering Information—AC Input Adapters and Cords
15 – 15	Ordering Information—Rectifiers
15 – 16	Ordering Information—Distribution Components
17 – 17	Ordering Information—Alarm Cables
17 – 18	Ordering Information—Battery Management

## Ordering Guide Revision Updates

REVISION	DATE	CHANGES/NOTES	IMPLEMENTATION DATE
1.0	May 2023	Preliminary Release	May 22, 2023
2.0	Sept 2023	Updated Descriptions on shelves, added Snapak® breaker list, updated to OmniOn Power	September 21, 2023
2.1	10/31/2023	Updated As per OmniOn template	10/31/2023
3.0	3/4/2024	Added 4 new system codes. Added IEC input shelves and initial rectifier shelves. Added AC input adapters and IEC cables	3/5/2024

# BPS-Flex Specifications

BPS-Flex is a -48V voltage power system based around the compact 1RU BP040 rectifier in a 19" rack mount bulk output shelf. BPS-Flex is configurable with a single rectifier shelf and one primary distribution panel and/or additional supplemental distribution panels (Pictured: 2 Circuit Breaker Load & 12 GMT Fuses with 2 Batter Breaker Inputs). The primary distribution panel can be configured with an optional low voltage battery disconnect. Options for GMT Fuses, Snapak Breakers, and Bullet Breaker outputs.



Input	MIN	TYPICAL	MAX
<b>Voltage Range</b>			
• High-Line	175VAC	220VAC	265VAC
• Low-Line	85VAC	110VAC	140VAC
<b>Frequency</b>	45Hz	60Hz	66Hz
<b>Power Factor</b>	98%	99.5%	99.8%
<b>Total Harmonic Distortion</b>			5%

Primary Output	
<b>Nominal Voltage</b>	-48Vdc
<b>Output Rating</b>	150A
<b>Vo Setpoint (Factory)</b>	-54.5Vdc±1%
<b>Vo Range</b>	-42Vdc to -58Vdc
<b>Regulation</b>	±0.5%

Mechanical	
<b>Height (in./mm)</b>	3.5 / 89 (Base system with one power shelves and one distribution)
<b>Width (in./mm)</b>	19 / 484 (System Only - No Frame)
<b>Depth (in./mm)</b>	12.1 / 307 (No AC Cover); 13.65 / 349 (with AC cover)
<b>Weight (Lb/Kg)</b>	14 / 6.35 (Base System with one power shelves and one distribution)

Environmental	
<b>Operating Temperature</b>	-40°C to +65°C (-40°F to 149°F)
<b>Storage Temperature</b>	-40°C to +85°C (-40°F to 185°F)
<b>Relative Humidity</b>	95% max, non-condensing
<b>Altitude</b>	4000M (for altitudes above 2000M, peak operating temperature de-rates 0.656°C /100M; 4000M peak temperature rating is 62°C)

# Specifications (continued)

Safety And Standards Compliance	
<b>NEBS</b>	Evaluated by independent NRTL test lab to Telcordia GR63-CORE & GR1089-CORE Issue 6 [Level 3]
<b>Safety</b>	ANSI/UL62368-1-2014 and CAN/CSA C22.2 No. 60950-1-07, Second Edition + A2:2014 (MOD), dated October 14,2014
<b>RoHS</b>	Compliant to RoHS EU Directive 2002/95/EC RoHS 6/6
<b>EMC</b>	European Directive 2014/30/EU; EN55032, Class A; EN55035; FCC, Class A; GR1089-CORE Issue 6

Agency Certifications	
<b>CSA / UL</b>	ANSI/UL60950-1-2014 and CAN/CSA C22.2 No. 60950-1-07, Second Edition + A2:2014 (MOD), dated October 14, 2014
<b>EMI/EMC</b>	European Directive 2014/30/EU; EN55032 (CISPR22) Class A; EN55035 (CISPR24)
<b>NEBS Level 3</b>	GR1089-CORE, Issue 6 Special equipment room cooling may be needed heat dissipation exceeds values of GR-63 Table 4-5

## Drawings

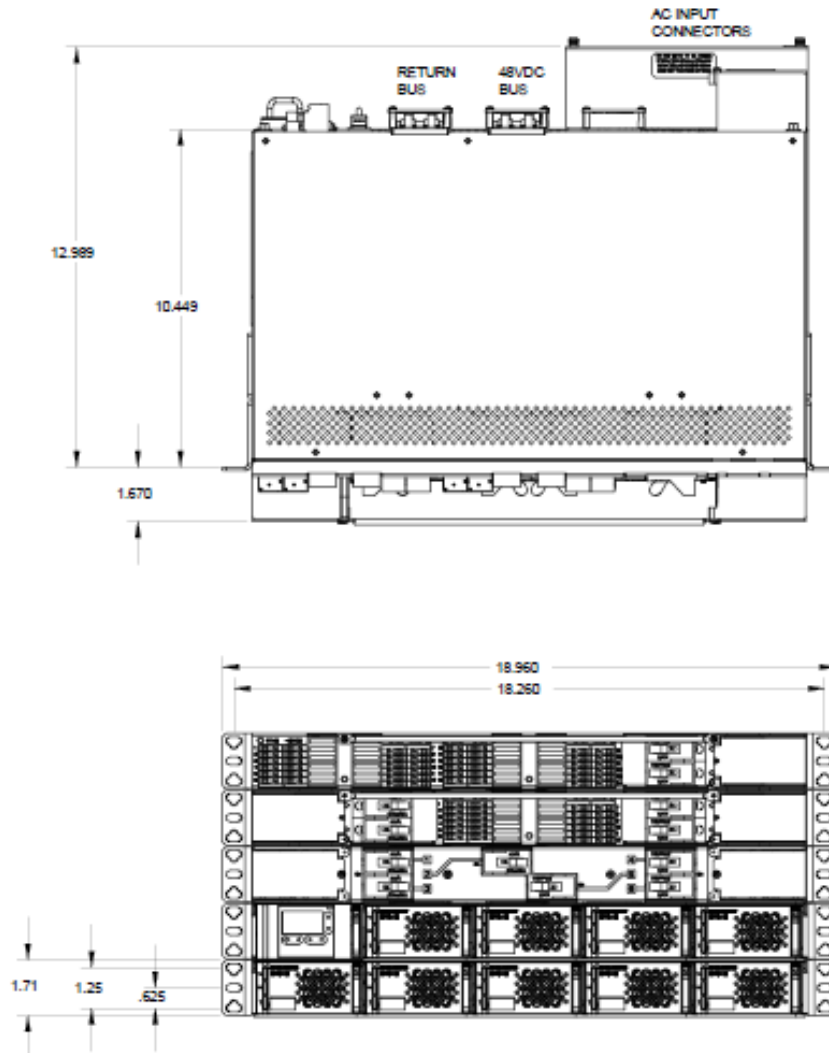

## BP040 Rectifier

- Compact – 1RU form factor providing high power density (42 W/in<sup>3</sup>)
- Shallow depth to allow for systems to be installed in ETSI depth applications where plant depth is a concern.
- Plug and Play-installation of the rectifier in a shelf connected to a compatible system controller initializes all set up parameters automatically. No adjustments are needed.
- Extended service life – parallel operation with automatic load sharing ensures that parallel units are not unduly stressed even when a unit fails or is removed.
- Monitoring / control – the built in microprocessor controls and monitors all critical rectifier functions and communicates with the system controller using the built in Galaxy Protocol serial interface.
- Fail safe performance – hot insertion capabilities allow for converter replacement without system shutdown; soft start and inrush current protection prevent nuisance tripping of upstream breakers.



## Applications

- Telecommunications Networks
- Digital Subscriber Line (DSL)
- Indoor/Outdoor Wireless
- Routers/Switches
- Fiber in the Loop
- Transmission
- Data Networks
- Distributed Antenna Systems

## Key Features

- Extended temperature range
- Front panel LED indicators
- 1U height, hi power density
- 240/ 230 / 208 / 120V AC input
- Digital load sharing
- Hot pluggable
- RoHS compliant

## Rectifier Specifications

INPUT		BP040AC48TEZ
Voltage Range		95-265Vac
Input Current		13.2-11A @100-120Vac 10.7-8.9A @ 200-240Vac
Input Frequency		45 – 66Hz
Power Factor		0.98 at>50% load
Efficiency		> 96% (Peak 96.2%)
Total HarmonicDistortion		<5% @loads over 50%

Output		BP040AC48TEZ
Voltage AdjustRange		42-58Vdc
Voltage Nominal		54.5V
Regulation (with controller)		±0.05%
Ripple		100mVrms
Output Current		41.7A @48V (Maximum)
• High-Line		37A @54.5V
• Low-Line		22A @54.5V
Heat Dissipation @ max output		70W / 238 BTU/hr.

## Pulsar Edge Controller

The SPS Pulsar Edge controller delivers large system intelligence in a small system form factor. This family of controllers functions as network interface cards (NIC) and as a full-featured battery plant controller. Its thin modular plug-in form factor minimizes shelf space consumption allowing maximum power module and distribution capabilities.

The controller is used to manage battery plants in telecommunications and data networks or as an interface in bulk power applications in data centers and enterprise applications. Ethernet connectivity with SNMP facilitates remote network management. Optional 1U display version allows convenient access to all controller functions without requiring external cable connections. The display also features alarm context sensitive backlighting for at-a-glance system status.

As a battery plant controller, it provides a complete set of features to monitor and control rectifiers, batteries, and distribution. A flexible set of configurable inputs allow the Pulsar Edge controller to monitor a wide variety of system equipment and incorporate appropriate state information enabling a centralized point of management.

The controller utilizes standard network management protocols allowing for advanced network supervision. OmniOn Power Galaxy Manager\* software is the centralized visibility and control component of a comprehensive power management system designed to meet engineering, operations and maintenance needs. The Galaxy Manager client-server architecture enables remote access to system controllers across the power network.



## Applications

- Telecommunications networks
- Data Networks
- Digital subscriber line (DSL)
- Indoor/outdoor wireless
- Routers/switches
- Fiber in the loop
- Transmission
- PBX

## Key Features

### Remote Access and Features

- Integrated 10/100Base-T Ethernet Network
  - TCP/IP
  - SNMP V3 for management
  - SMTP for email
  - Telnet for command line interface
  - DHCP for plug-n-play
  - FTP for rapid backup and upgrades
  - HTTP for standard web pages and browsers
  - Compatible with Galaxy Manager and other management packages
  - Shielded RJ-45 interface referenced to chassis ground
- Password protected security levels: User, Super-User, Administrator for all access
- Ground-referenced RS232 system port
- ANSI T1.317 command-line interface
- Modem access support
  - Remote via external modem
  - Call back security
- EasyView2, Windows-based GUI software for local terminal or Modem access
- Optional 1U display with alarm indicating backlight feature

### Standard System Features

- Monitor and control of more than 40 connected devices
  - Maximum of 32 rectifiers
  - Maximum of 6 distribution control cards
  - Robust RS485 system bus
- Standard and user defined alarms
  - Alarm test
  - Assignable alarm severity: Critical, Major, Minor, Warning, and record-only

- Rectifier management features
  - Automatic rectifier restart
  - Adaptive Rectifier Management (energy efficiency)
  - Remote rectifier (on/off)
  - Reserve Operation
  - Automatic rectifier sequence control
  - N + X redundancy check
- Multiple Low Voltage Load and Low Voltage Battery Disconnect thresholds (4)
- Configuration, statistics, and history
  - All stored in non-volatile memory
  - Remote/local backup and restore of configuration data
- Industry standard defaults
  - Customer specific configurations available
- Remote/local software upgrade
- Basic, busy hour, and trend statistics
- Detailed event history
- User defined events and derived channels

### Standard Battery Management Features

- Float/boost mode control
  - Manual boost
  - Manual timed boost locally, T1.317, and remotely initiated
  - Auto boost terminated by time or current
- Battery discharge testing
  - Manual (local/remote)
  - Periodic
  - Plant Battery Test (PBT) input driven
  - Configurable threshold or 20% algorithm
  - Graphical discharge data
  - Rectifiers on-line during test
- Slope thermal compensation



- High temperature
- Low temperature
- Step temperature
- STC Enable/Disable, low temperature Enable/Disable
- Configurable mV/°C slopes
- State of charge indication
- High temperature disconnect setting
- Reserve-time prediction
- Recharge current limit
- Emergency Power-Off input

- 1-Wire\* bus devices
  - Up to 16 temperature probes (QS873)
  - Up to 6 mid-string monitors (ES771)

#### Galaxy Manager Compatible

- Centralized web server and database with multiple user access to live or managed data with drill down to problem details
- Monitor and control of more than 40 connected devices
- Management information from polling or alarms received from alarm traps from multiple sites are available on one screen via the inter/intranet
- Trend user selected data over time
- Automatic or manual report generation
- Standard engineering tools like reserve time calculators and cable voltage drop analyzer

#### Integrated Monitoring Inputs/Outputs

- System plant voltage (accuracy  $\pm 0.5\%$ , resolution 0.01V)
- One system shunt (accuracy  $\pm 1\%$  full scale, resolution 1A)
  - Battery or load
  - Mounted in the return side of DC bus
- Up to 15 binary inputs
  - Six inputs close/open to battery
  - 9 input close/open to return (number is dependent upon number of output alarms)
  - User assignable
- Up to 6 user assignable Form-C output alarms (50VDC @.3A)







General	
Operating Voltage	$\pm 24$ Vdc, $\pm 48$ Vdc (Range: $\pm 18$ to $\pm 60$ Vdc)
Input Power	Less than 7W
Operating Temperature Range	-40°C to +70°C (-40°F to 167°F)
Operating Relative Humidity	0 - 95% (non-condensing)
Storage Temperature Range	-40°C to +85°C (-40°F to 185°F)
Physical Specifications	1.75 in. H, 0.75 in. W, 8.00 in. D; 0.5lb
Display	8-line by 40-character backlit LCD
EMC	FCC/EN55032 Class A, CISPR32 Level A

Agency Certifications	
Electrostatic Discharge	EN 61000-4-2 level 4
Radiated Emissions	FCC, Class A; EN 55032, Class A
Safety	UL Listed Component as Part of CPL or SPS Power System



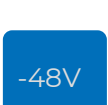

## Step 1: Select Base Power System - BPS-Flex

### BPS-Flex

The below list contains BPS-Flex plants, supplemental distribution modules and rectifier shelves. Systems can be purchased complete or assembled together in the field as customers prefer. Systems are 19" rack mountable with output capacity dependent on the distribution panel solution chosen as show in the system table shown.

Comcode	Description	Feature	Qty
1600481917A 	150A BPS-Flex Power system equipped with 1 power shelf, 4 Bullet Breaker & 12 GMT distribution with rear bulk battery inputs, and an Edge controller slot BPS48-2U-AC5-PS4-4DC12BR	Plug-in Breakers	4
		GMT Positions	12
		Battery Input	2 Bulk Rear
		AC Input	Ind Term Block
1600481918A 	150A BPS-Flex Power system equipped with 1 power shelf, 4 Bullet Breaker & 12 GMT distribution with rear bulk battery inputs, LVBD, and an Edge controller slot BPS48-2U-AC5-PS4-4DC12BR-LVBD	Plug-in Breakers	4
		GMT Positions	12
		Battery Input	2 Bulk Rear LVD
		AC Input	Ind Term Block
1600481919A 	150A BPS-Flex Power system equipped with 1 power shelf, 8 Bullet Breaker & 12 GMT distribution with rear bulk battery inputs, LVBD, and an Edge controller slot BPS48-3U-AC5-PS4-8DC12BR-LVBD	Plug-in Breakers	8
		GMT Positions	12
		Battery Input	2 Bulk Rear LVD
		AC Input	Ind Term Block
1600481915A 	150A BPS-Flex Power system equipped with 1 power shelf, 8 Snapak Breaker distribution with 2 front breaker battery inputs, LVBD, and an Edge controller slot BPS48-2U-AC5-PS4-8DCB-LVBD	Snapak Breakers	8
		GMT Positions	0
		Battery Input	2 Breaker Front LVD
		AC Input	Ind Term Block
1600482710A 	150A BPS-Flex Power system equipped with 1 power shelf, 2 Bullet Breaker & 12GMT distribution with 2 front battery breaker inputs, and an Edge controller slot BPS48-2U-AC5-PS4-2DC12B	Plug-in Breakers	2
		GMT Positions	12
		Battery Input	2 Breaker Front
		AC Input	Ind Term Block
1600481916A 	150A BPS-Flex Power system equipped with 1 power shelf, 2 Bullet Breaker & 12GMT distribution with 2 front battery breaker inputs, LVBD, and an Edge controller slot BPS48-2U-AC5-PS4-2DC12B-LVBD	Plug-in Breakers	2
		GMT Positions	12
		Battery Input	2 Breaker Front LVD
		AC Input	Ind Term Block
1600481921A 	150A BPS-Flex Power system equipped with 1 power shelf, 6 Bullet Breaker distribution with rear bulk battery inputs, and an Edge controller slot BPS48-2U-AC5-PS4-6DCBR	Plug-in Breakers	6
		GMT Positions	0
		Battery Input	2 Bulk Rear
		AC Input	Ind Term Block

## Step 1: Select Base Power System - BPS-Flex (Cont.)











Comcode	Description	Feature	Qty
1600481920A 	150A BPS-Flex Power system equipped with 1 power shelf, 6 Bullet Breaker distribution with rear bulk battery inputs, LVBD, and an Edge controller slot BPS48-2U-AC5-PS4-6DCBR-LVBD	Plug-in Breakers	6
		GMT Positions	0
		Battery Input	2 Bulk Rear LVD
		AC Input	Ind Term Block
1600483143A 	150A BPS-Flex Power system equipped with 1 power shelf, 2 Bullet Breaker & 12 GMT distribution with 2 front breaker battery inputs, LVBD, and an Edge controller slot BPS48-2U-AC3-PS4-2DC12B-LVBD	Plug-in Breakers	2
		GMT Positions	12
		Battery Input	2 Breaker Front LVD
		AC Input	Ind9 IEC C19
1600483436A 	150A BPS-Flex Power system equipped with 1 power shelf, 4 Bullet Breaker & 12 GMT distribution with rear bulk battery inputs, LVBD, and an Edge controller slot BPS48-2U-AC3-PS4-4DC12BR-LVBD	Plug-in Breakers	4
		GMT Positions	12
		Battery Input	2 Bulk Rear LVD
		AC Input	Ind9 IEC C19
1600483437A 	160A BPS-Flex Power system equipped with 1 power shelf, 4 Bullet Breaker & 12 GMT distribution and an Edge controller slot (No Battery Input) BPS48-2U-AC3-PS4-4DC12	Plug-in Breakers	4
		GMT Positions	12
		Battery Input	None
		AC Input	Ind9 IEC C19

## Step 1A: Build Your Own - BPS-Flex

### Build Your Own BPS-Flex

The below list contains BPS-Flex Initial Distribution panels and rectifiers shelves. Select the initial distribution that meets the site requirements. Select one of the initial rectifier shelves that connects directly to the initial distribution. If additional distribution or rectification is required, proceed to step 1B.

### Step 1A1: Select Initial Distributions

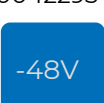





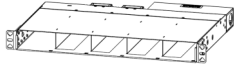

Comcode	Description	Feature	Qty	Picture
150032396 	150A Initial distribution: 2 Bullet Breaker with 2 front breaker battery inputs. Model: J2013001 L101	Plug-in Breakers	2	
		GMT Positions	0	
		DC Input	2 Breaker Front LVD	
		Rating	150A	
150032397 	150A Initial distribution: 2 Bullet Breaker with 2 front breaker battery inputs on an LVBD Model: J2013001 L101B	Plug-in Breakers	2	
		GMT Positions	0	
		DC Input	2 Breaker Front LVD	
		Rating	150A	
150032343 	150A Initial distribution: 2 Bullet Breaker and 12 GMTs with 2 front breaker battery inputs. Model: J2013001 L102	Plug-in Breakers	2	
		GMT Positions	12	
		DC Input	2 Breaker Front	
		Rating	150A	
150032344 	150A Initial distribution: 2 Bullet Breaker and 12 GMTs with 2 front breaker battery inputs on an LVBD Model: J2013001 L102B	Plug-in Breakers	2	
		GMT Positions	12	
		DC Input	2 Breaker Front LVD	
		Rating	150A	
150038445 	150A Initial distribution: 8 Snapak Breakers with 2 front breaker battery inputs on an LVBD Model: J2013001 L108B	Plug-in Breakers	8	
		GMT Positions	0	
		DC Input	2 Breaker Front LVD	
		Rating	150A	
150036963 	150A Initial distribution: 4 Bullet Breaker and 12 GMTs with rear bulk battery inputs. Model: J2013001 L112	Plug-in Breakers	4	
		GMT Positions	0	
		DC Input	Bulk Rear	
		Rating	150A	
150036964 	150A Initial distribution: 4 Bullet Breaker and 12 GMTs with rear bulk battery inputs on an LVBD Model: J2013001 L112B	Plug-in Breakers	4	
		GMT Positions	0	
		DC Input	Bulk Rear LVBD	
		Rating	150A	
150042292 	250A Initial distribution: 6 Bullet Breaker with rear bulk battery inputs. Model: J2013001 L115	Plug-in Breakers	6	
		GMT Positions	0	
		DC Input	Bulk Rear	
		Rating	250A	
150042293 	150A Initial distribution: 6 Bullet Breaker with rear bulk battery inputs on an LVBD Model: J2013001 L115B	Plug-in Breakers	6	
		GMT Positions	0	
		DC Input	Bulk Rear LVBD	
		Rating	150A	

## Step 1A: Build Your Own - BPS-Flex (Continued)

### Step 1A2: Select Initial Rectifier Shelves

Comcode	Description	Feature	Qty	Picture
1600483732A	19" BPS Rectifier Shelf with 5 positions. J5964806 L211 (AC3)	AC Input	Individual IEC C19	
		Rating	160A	
1600483413A	19" BPS Rectifier Shelf with 5 positions. J5964806 L215 (AC5)	AC Input	Individual Screw	
		Rating	160A	

### Step 1B: Select Supplemental Distributions

Comcode	Description	Feature	Qty	Picture
150032399 	250A BPS-Flex Distribution 4 Plug-In Breaker position and 12 GMT output. Model: J2013001 L105	Plug-in Breakers	4	
		GMT Positions	12	
		DC Input	Bulk Bus	
		Rating	250A	
150032400 	250A BPS-Flex Distribution 4 Plug-In Breaker position output. Model: J2013001 L106	Plug-in Breakers	4	
		GMT Positions	0	
		DC Input	Bulk Bus	
		Rating	250A	
150032401 	250A BPS-Flex Distribution 36 position GMT output. Model: J2013001 L107	Plug-in Breakers	0	
		GMT Positions	36	
		DC Input	Bulk Bus	
		Rating	150A	
150041092 	250A BPS-Flex Distribution 6 Plug-In Breaker position output. Model: J2013001 L116	Plug-in Breakers	8	
		GMT Positions	0	
		DC Input	Bulk Bus	
		Rating	250A	

### Step 1C: Select Supplemental Rectifier Shelves

Comcode	Description	Feature	Qty	Picture
1600482805A	19" BPS Rectifier Shelf with 5 positions. J5964806 L212 (AC3)	AC Input	Individual IEC C19	
		Rating	200A	
1600449176A	19" BPS Rectifier Shelf with 5 positions. J5964806 L216 (AC5)	AC Input	Individual Screw	
		Rating	200A	



## Step 1D: Select Controller - BPS-Flex

Comcode	Description	Feature	Type	Qty	Picture
1600481780A	Pulsar Edge Controller equipped with 6 Relay Output preprogrammed to Verizon Wireless Alarm configuration . Controller has Display, SNMPV3, IPV6 and Secure Protocol interface. BPS841A_016R_DS	Outputs	Form-C	6	
		Inputs	Close to Battery	4	
		Local Connect		RS232	
		Remote Connect		RJ-45	

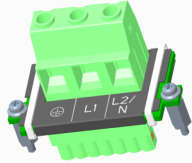
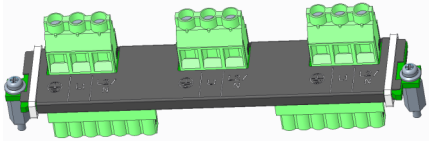
## Step 1E: AC Input Adapters

ORDERING CODE	DESCRIPTION	Notes:
1600483880A	BPS AC5 3 TO 1 AC INPUT ADAPTER KIT Kit includes 2 adapters for 19" or 23" shelves (Input for 8 or 6AWG)	
1600483882A	BPS AC5 6 TO 3 AC INPUT ADAPTER KIT Kit includes 1 adapter for 19" or 23" to convert 5 or 6 inputs to 3 inputs (Input for 10 to 8AWG)	



## Step 1F: IEC Input Cables

ORDERING CODE	DESCRIPTION	Images
8600481880P	SJT Cord, 12AWG, 8ft (Min.), 3 conductors, 105°C Termination: Shelf End IEC C19 /C21 Other End: NEMA 5-20P, 20A, 125V	
8600481881P	SJT Cord, 12AWG, 8ft (Min.), 3 conductors, 105°C Termination: Shelf End IEC C19 /C21 Other End: NEMA 6-20P, 20A, 250V	
8600481882P	SJT Cord, 12AWG, 8ft (Min.), 3 conductors, 105°C Termination: Shelf End IEC C19 /C21 Other End: NEMA L6-20P, 20A, 250V	

## Step 2: Select Rectifier Modules

### Rectifier Modules

BP040 rectifiers are designed to operate in all BPS based power systems. They are designed and qualified to operate -40°C to +55°C with extended operation to +75°C. The 48V rectifiers are programmable from V- 58V output. All BP040 rectifiers will operate in parallel and load share based ensuring that no one rectifier is loaded more than others.

Comcode	Description	Input	Output	Float	Max	Picture
1600420226A 	BP040AC48ATEZ	95 - 140Vac	1200W	22A	24A (50V)	
		175 - 305Vac	2000W	37A	40A (50V)	
		Input Current	12A - 8.9A			
		Heat Release	70 Watts	238 BTU/hr.		

### Slot Fillers

Comcode	DESCRIPTION	Picture
8600482221P	BP040 SLOT FILLER (Used to fill empty rectifier slots in shelf)	

## Step 3: Distribution Components

### Bullet Style Load Circuit Breakers

Plug-in (bullet style) breakers shown in the table below are for 1RU distribution panels with full sized breaker positions. 4 position distribution panels can accommodate up to 100A per position, whereas the 6-position panel is restricted to 60A.

ORDERING CODE	AMPERAGE	CB POSITIONS	MIN WIRE GAUGE	PICTURE
407998137	3	1	10	
407998145	5	1	10	
407998152	10	1	10	
407998160	15	1	10	
407998178	16	1	10	
407998186	20	1	10	
407998194	25	1	10	
407998202	30	1	10	
408213486	40	1	10	
407998210	45	1	8	
407998228	50	1	8	
407998236	60	1	6	
407998244	70	1	6	
407998251	80	1	4	
407998269	90	1	4	
407998277	100	1	2	

## Step 3: Distribution Components



### Snapak® Plug-in Breakers

ORDERING CODE	AMPERAGE	PICTURE
450017886	1	
450023452	2	
450023455	3	
450023456	4	
450017887	5	
450023457	6	
450023460	7.5	
450023461	10	
CC408648884	15	
CC408651252	20	
450023462	25	
CC408638605	30	

### GMT Fuses

ORDERING CODE	AMPERAGE	PICTURE
4600218580P	0.25	
4600483302P	0.5	
406530725	1.33	
406421032	2	
406204230	3	
406203976	5	
4600483304P	7.5	
406203190	10	
407845197	12	
450036522	15	
408515823	Fuse Puller	

### Bullet Battery Circuit Breakers (Yellow Handle) (Alarms on Mid-Trip and in Off Position)



ORDERING CODE	AMPERAGE	PHOTO
CC408612758	30	
CC408612766	40	
CC408612774	45	
CC408574370	50	
408560123	60	
CC408574387	70	
CC408574395	100	
CC109106548	100A battery bullet bus strap (substitute for battery breaker)	



## Step 4: Select Alarm Output and Input Cables

Ordering Code	Description	Picture
CC848890153	5ft Auxiliary output alarm cable for Pulsar Edge Controller	
CC848865980	15ft Auxiliary output alarm cable for Pulsar Edge Controller	
CC848817651	50ft Auxiliary output alarm cable for Pulsar Edge Controller	
CC848890203	5ft Auxiliary input alarm cable for Pulsar Edge Controller	
CC848853614	15ft alarm input cable for Pulsar Edge Controller	
CC848890211	50ft alarm input cable for Pulsar Edge Controller	

## Step 5: Select Battery Monitoring

Ordering Code	Description	Application	Picture
CC109142980	QS873A Thermal Probe	(A)	
150026698	QS873B Ambient Probe	(A)	
CC848817024	10 ft wire set	(B: thermal probe to controller)	
CC109157434	20 ft wire set	(B: thermal probe to controller)	
850052679	40 ft wire set	(B: thermal probe to controller)	
CC848822560	1 ft wire set	(C: thermal probe to thermal probe)	
848719803	5 ft wire set	(C: thermal probe to thermal probe)	
CC848822321	10 ft wire set	(C: thermal probe to thermal probe)	
850027334	20 ft wire set	(C: thermal probe to thermal probe)	
7000253598A	30 ft wire set	(C: thermal probe to thermal probe)	
8600089209P	40 ft wire set	(C: thermal probe to thermal probe)	
108958422	ES771A Battery Voltage Monitor Card		
CC848791517	2-1/2 ft. wire set	(D: ES771A to thermal probe)	
CC848797290	6 ft. wire set	(D: ES771A to thermal probe)	
848719829	10 ft. wire set	(D: ES771A to thermal probe)	
CC848791500	4 ft. wire set	(G:ES771A to ES771A or controller)	
848652947	10 ft wire set	(G:ES771A to ES771A or controller)	
555052-1	In Line Coupler	(G: extension coupler)	
<p>Temperature probes are needed for battery monitoring, and are connected to each battery or battery string to provide slope thermal compensation and temperature alarms.</p>			

## Step 6: Select Battery Monitoring (Continued)

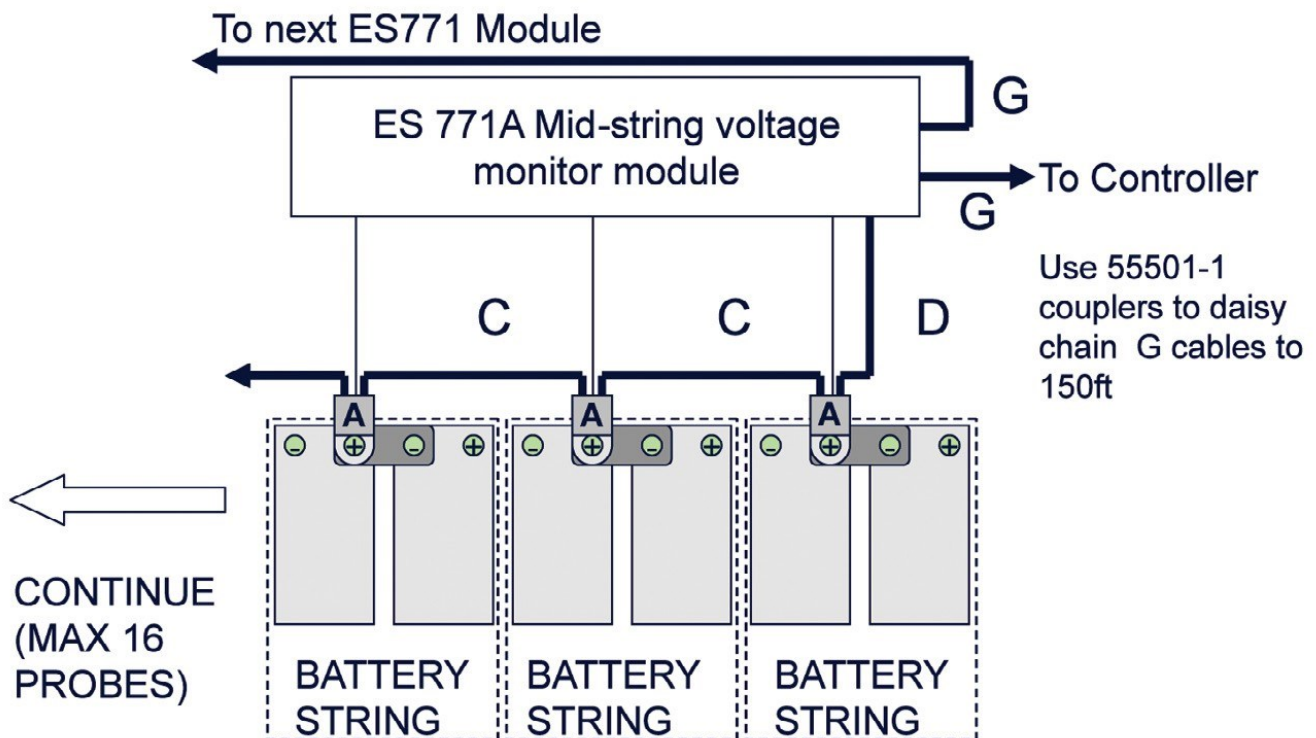
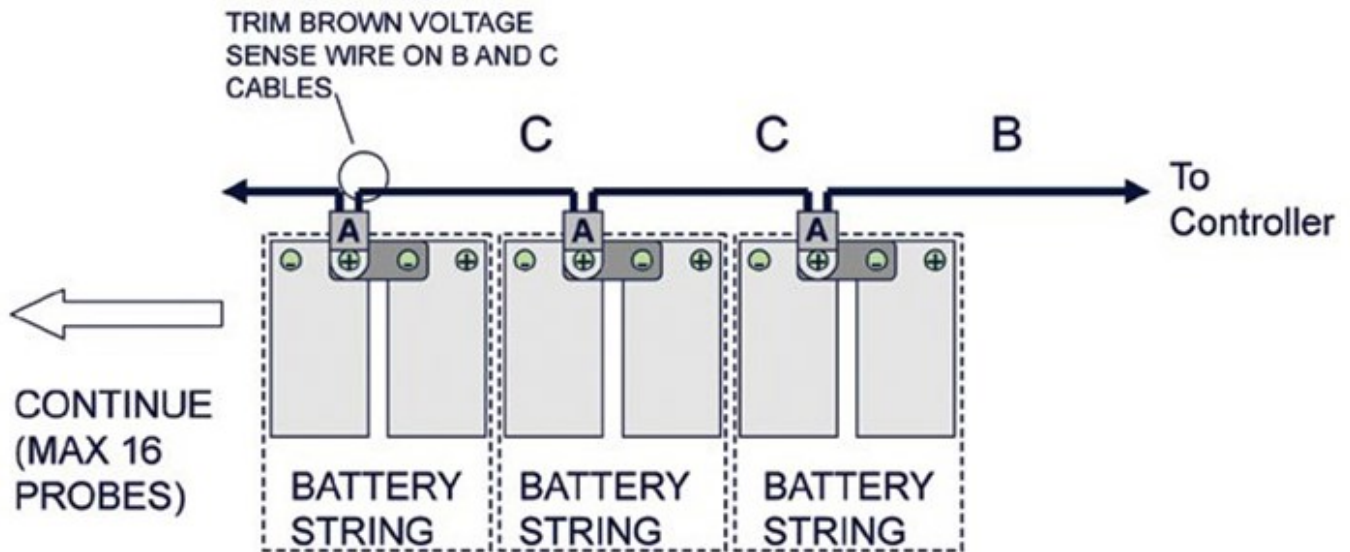

## Additional Information

### Product Documentation for BPS-Flex

Ordering Code	Description
BPS-Flex-Systems	BPS-Flex Configuration drawing
CC848836981	User Guide for the Galaxy Pulsar Edge System Controller
850042636	Edge Supplement
850033855	1U Stackable Dist Shelf J2013001

**OmniOn Power Inc.**

601 Shiloh Rd.  
Plano, TX USA

[omnionpower.com](http://omnionpower.com)

We reserve the right to make technical changes or modify the contents of this document without prior notice. OmniOn Power does not accept any responsibility for errors or lack of information in this document and makes no warranty with respect to and assumes no liability as a result of any use of information in this document.

We reserve all rights in this document and in the subject matter and illustrations contained therein. Any reproduction, disclosure to third parties or utilization of its contents – in whole or in parts – is forbidden without prior written consent of OmniOn Power. This document does not convey license to any patent or any intellectual property right. Copyright© 2024 OmniOn Power Inc. All rights reserved.