



**IT- og Telestyrelsen**

Ministeriet for Videnskab  
Teknologi og Udvikling

# OIOUBL Guideline

OIOUBL Creditnote

UBL 2.0 Creditnote

G14

Version 1.1



This release is protected by Creative Commons License, Naming 2.5 

# Colophon

**Contact:**

National IT and Telecom Agency

E-mail: [oioubl@itst.dk](mailto:oioubl@itst.dk)

:

**April 2007**  
**Ministry of Science, Technology and Innovation**  
**National IT and Telecom Agency**

Data Standardization Office  
Holsteinsgade 63  
DK-2100 Copenhagen Ø  
Phone +45 3545 0000  
Fax +45 3545 0010  
<http://www.itst.dk>  
[itst@itst.dk](mailto:itst@itst.dk)

Copyrights for this release in accordance with Creative Common, Naming 2.5:

**Permission is granted to:**

- *produce processed works based on this document*
- *reproduce and make the document available to the public*
- *use the document for commercial purposes*  
*provided that the Danish National IT & Telecom Agency be clearly referenced as the source of this release.*

Further information about these rights is available at <http://creativecommons.org/licenses/by/2.5/deed.da>.

# Contents

<b>1. How to read this document.....</b>	<b>5</b>
1.1 Structure of this document.....	5
1.2 Figure definitions .....	5
1.3 Term definitions .....	6
1.4 References.....	7
<b>2. How to fill in OIOUBL document instances.....</b>	<b>8</b>
2.1 Namespace.....	8
2.2 Comments.....	8
2.3 Process instructions.....	9
2.4 Relations to instances of other customizations.....	9
2.5 Code example.....	9
<b>3. CreditNote.....</b>	<b>10</b>
3.1. CreditNote.....	11
3.2. CreditNote.DiscrepancyResponse.....	20
3.3. CreditNote.OrderReference.....	22
3.3.1. CreditNote.OrderReference.DocumentReference.....	25
3.3.1.1. CreditNote.OrderReference.DocumentReference.Attachment.....	27
3.4. CreditNote.BillingReference.....	29
3.4.1. CreditNote.BillingReference.InvoiceDocumentReference.....	31
3.4.1.1. CreditNote.BillingReference.InvoiceDocumentReference.Attachment.....	33
3.4.2. CreditNote.BillingReference.SelfBilledInvoiceDocumentReference.....	35
3.4.2.1. CreditNote.BillingReference.SelfBilledInvoiceDocumentReference.Attachment.....	37
3.4.3. CreditNote.BillingReference.CreditNoteDocumentReference.....	39
3.4.3.1. CreditNote.BillingReference.CreditNoteDocumentReference.Attachment.....	41
3.4.4. CreditNote.BillingReference.SelfBilledCreditNoteDocumentReference.....	43
3.4.4.1. CreditNote.BillingReference.SelfBilledCreditNoteDocumentReference.Attachment.....	45
3.4.5. CreditNote.BillingReference.ReminderDocumentReference.....	47
3.4.5.1. CreditNote.BillingReference.ReminderDocumentReference.Attachment.....	49
3.5. CreditNote.DespatchDocumentReference.....	51
3.5.1. CreditNote.DespatchDocumentReference.Attachment.....	53
3.6. CreditNote.ReceiptDocumentReference.....	55
3.6.1. CreditNote.ReceiptDocumentReference.Attachment.....	57
3.7. CreditNote.ContractDocumentReference.....	59
3.7.1. CreditNote.ContractDocumentReference.Attachment.....	61
3.8. CreditNote.AccountingSupplierParty.....	63
3.8.1. CreditNote.AccountingSupplierParty.Party.....	65
3.9. CreditNote.AccountingCustomerParty.....	69
3.9.1. CreditNote.AccountingCustomerParty.Party.....	71
3.9.1.1. CreditNote.AccountingCustomerParty.Party.Contact.....	75
3.10. CreditNote.PayeeParty.....	77
3.11. CreditNote.TaxExchangeRate.....	80
3.11.1. CreditNote.TaxExchangeRate.ForeignExchangeContract.....	83
3.11.1.1. CreditNote.TaxExchangeRate.ForeignExchangeContract.ContractDocumentReference.....	86
3.11.1.1.1. CreditNote.TaxExchangeRate.ForeignExchangeContract.ContractDocumentReference.Attachment.....	88
3.12. CreditNote.PricingExchangeRate.....	90
3.12.1. CreditNote.PricingExchangeRate.ForeignExchangeContract.....	93
3.12.1.1. CreditNote.PricingExchangeRate.ForeignExchangeContract.ContractDocumentReference.....	96
3.12.1.1.1. CreditNote.PricingExchangeRate.ForeignExchangeContract.ContractDocumentReference.Attachment.....	98
3.13. CreditNote.PaymentExchangeRate.....	100
3.13.1. CreditNote.PaymentExchangeRate.ForeignExchangeContract.....	103
3.13.1.1. CreditNote.PaymentExchangeRate.ForeignExchangeContract.ContractDocumentReference.....	106
3.13.1.1.1. CreditNote.PaymentExchangeRate.ForeignExchangeContract.ContractDocumentReference.Attachment.....	108
3.14. CreditNote.PaymentAlternativeExchangeRate.....	110
3.14.1. CreditNote.PaymentAlternativeExchangeRate.ForeignExchangeContract.....	113
3.14.1.1. CreditNote.PaymentAlternativeExchangeRate.ForeignExchangeContract.ContractDocumentReference.....	116

3.14.1.1.1.	CreditNote.PaymentAlternativeExchangeRate.ForeignExchangeContract.ContractDocumentReference.Attachment	118
3.15.	CreditNote.CreditNoteLine	120
3.15.1.	CreditNote.CreditNoteLine.DiscrepancyResponse	125
3.15.2.	CreditNote.CreditNoteLine.BillingReference	127
3.15.2.1.	CreditNote.CreditNoteLine.BillingReference.InvoiceDocumentReference	129
3.15.2.1.1.	CreditNote.CreditNoteLine.BillingReference.InvoiceDocumentReference.Attachment	131
3.15.2.2.	CreditNote.CreditNoteLine.BillingReference.SelfBilledInvoiceDocumentReference	133
3.15.2.2.1.	CreditNote.CreditNoteLine.BillingReference.SelfBilledInvoiceDocumentReference.Attachment	135
3.15.2.3.	CreditNote.CreditNoteLine.BillingReference.CreditNoteDocumentReference	137
3.15.2.3.1.	CreditNote.CreditNoteLine.BillingReference.CreditNoteDocumentReference.Attachment	139
3.15.2.4.	CreditNote.CreditNoteLine.BillingReference.SelfBilledCreditNoteDocumentReference	141
3.15.2.4.1.	CreditNote.CreditNoteLine.BillingReference.SelfBilledCreditNoteDocumentReference.Attachment	143
3.15.2.5.	CreditNote.CreditNoteLine.BillingReference.ReminderDocumentReference	145
3.15.2.5.1.	CreditNote.CreditNoteLine.BillingReference.ReminderDocumentReference.Attachment	147
3.15.3.	CreditNote.CreditNoteLine.Delivery	149
3.15.4.	CreditNote.CreditNoteLine.Item	152
3.15.4.1.	CreditNote.CreditNoteLine.Item.BuyersItemIdentification	159
3.15.4.2.	CreditNote.CreditNoteLine.Item.SellersItemIdentification	161
3.15.4.3.	CreditNote.CreditNoteLine.Item.ManufacturersItemIdentification	163
3.15.4.4.	CreditNote.CreditNoteLine.Item.StandardItemIdentification	165
3.15.4.5.	CreditNote.CreditNoteLine.Item.CatalogueItemIdentification	167
3.15.4.6.	CreditNote.CreditNoteLine.Item.AdditionalItemIdentification	169
3.15.4.7.	CreditNote.CreditNoteLine.Item.CatalogueDocumentReference	171
3.15.4.7.1.	CreditNote.CreditNoteLine.Item.CatalogueDocumentReference.Attachment	173

## 1. How to read this document

This guideline covers the use of an invoice in OIOUBL. The guideline must be read in correlation with the remaining documents included in the OIOUBL package.

### 1.1 Structure of this document

This document should be seen as the normative description of an invoice. In case of any conflict, the most specific description will always apply. For example, the description on the lines of a specific element takes precedence of the description at document level. Hence, the descriptions at document level are default values for the lines. The examples in this document and related common guidelines should be seen as descriptive. The guideline text takes precedence of the figures.

The document includes a reading instruction, a description of how to fill in document instances, as well as the actual class specification. The actual specification is composed of:

- A figure showing the class elements that are included in OIOUBL.
- A text specification of the class.
- A list of the UBL elements that from a business perspective make no sense in the specific context.
- A list of the fields that are included in the class.
- A list of the sub-classes that are included in the class.
- A table of key data such as definitions, names, references, and business rules for each of the class fields.
- A table of key data such as definitions, names, references, and business rules for the sub-classes of the class.
- For each of the sub-classes that is used differently that described in the class library, OIOUBL\_GUIDE\_LIBRARY (ref 30), a subsection contains a corresponding specification. Hence, the sub-classes that have been included in the specification are not selected based on relevance, but solely based on whether they deviate from the general definition of the library.

### 1.2 Figure definitions

In the class specifications, the class is shown as schema documentation.

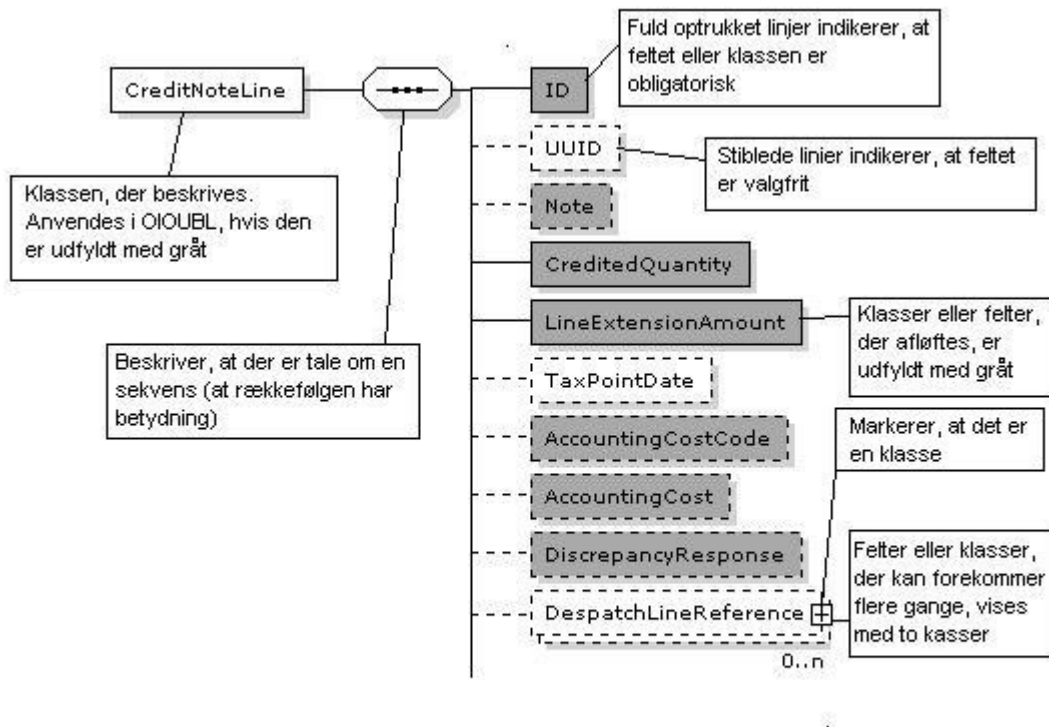

### 1.3 Term definitions

In this specification, the following terms will be used in the tables:

	<b>Term</b>	<b>Explanation</b>
UBL name		The name that is found in the UBL 2.0 schemas
DK-name		The name in Danish
Use		Describes the cardinality, i.e. the rule describing how many instances of the business information entity are allowed: [1] specifies that one and only one instance is allowed. [0..1] means that the business information entity is optional. [0..n] means that null to infinity instances may occur. [1..n] means that no less than one instance to an infinite number of instances may occur.
Alternative term		Specifies a term which is also used to describe the business information entity.
Used		Determines whether the receiver should be expected to be able to decode the described business information, if it is attached. Information that is not used may still, however, be used upon bilateral agreement.
Business rule		Describes the rules that are attached to the business information entity. Business rules are normative, and will be part of the validation of the document in question.
Recommended		Specifies that common practice requires the described business information entity to be attached. This is a

non-normative guide to the use of the business information entity.

Allowed values:

Describes the value set that the business information entity should conform with.

Codelist

Refers to the codelist that the value set should be found in.

Class

A structure of coherent business information.

## 1.4 References

In this document reference is made to other documents within the OIOUBL package.

Filnavn	Titel	Ref
OIOUBL_GUIDE_INTRO	Introduktion til OIOUBL Guidelines	G01
<b>Documentguidelines</b>		
OIOUBL_GUIDE_APPRESPONSE	UBL 2.0 ApplicationResponse	G02
OIOUBL_GUIDE_CATALOGUE	UBL 2.0 Catalogue	G03
OIOUBL_GUIDE_CATALOGUEREQUEST	UBL 2.0 CatalogueRequest	G04
OIOUBL_GUIDE_CATALOGUEDELETION	UBL 2.0 CatalogueDeletion	G05
OIOUBL_GUIDE_CATALOGUEITEMSPECIFICATIONUPDATE	UBL 2.0 CatalogueItemSpecificationUpdate	G06
OIOUBL_GUIDE_CATALOGUEPRICINGUPDATE	UBL 2.0 CataloguePricingUpdate	G07
OIOUBL_GUIDE_ORDER	UBL 2.0 Order	G08
OIOUBL_GUIDE_ORDERRESPONSE	UBL 2.0 OrderResponse	G09
OIOUBL_GUIDE_ORDRERESPONSESIMPLE	UBL 2.0 OrdreResponseSimple	G10
OIOUBL_GUIDE_ORDERCHANGE	UBL 2.0 OrderChange	G11
OIOUBL_GUIDE_ORDERCANCELLATION	UBL 2.0 OrderCancellation	G12
OIOUBL_GUIDE_CREDITNOTE	UBL 2.0 CreditNote	G13
OIOUBL_GUIDE_REMINDER	UBL 2.0 Reminder	G14
OIOUBL_GUIDE_STATEMENT	UBL 2.0 Statement	G15
OIOUBL_GUIDE_INVOICE	UBL 2.0 Invoice	G16
<b>Common guidelines</b>		
OIOUBL_GUIDE_ALLOWANCECHARGE	UBL 2.0 AllowanceCharge	G17
OIOUBL_GUIDE_CURRENCYEXCHANGERATES	UBL 2.0 CurrencyExchangeRates	G18
OIOUBL_GUIDE_DELIVERY	UBL 2.0 Delivery and Delivery Party	G19
OIOUBL_GUIDE_DELIVERYTERMS	OIOUBL Leveringsbetingelser - UBL 2.0 Delivery Terms	G20
OIOUBL_GUIDE_DOCUMENTREF	OIOUBL Dokumentreference - UBL 2.0 Document Reference	G21
OIOUBL_GUIDE_ENDPOINTS	OIOUBL EndepunktID - UBL 2.0 Endpoints	G22
OIOUBL_GUIDE_PARTY	OIOUBL Part - UBL 2.0 Party	G23
OIOUBL_GUIDE_BETALING	OIOUBL Betalingsmåder og betingelser - UBL 2.0 Payment means og payment terms	G24
OIOUBL_GUIDE_PRISER	OIOUBL Priser - UBL 2.0 Prices	G25
OIOUBL_GUIDE_PROFILER	OIOUBL Profiler - UBL 2.0 Profiles	G26
OIOUBL_GUIDE_SKAT	OIOUBL Skat - UBL 2.0 Tax	G27
OIOUBL_GUIDE_TOTALER	OIOUBL Totaler - UBL 2.0 Totals	G28
OIOUBL_GUIDE_DATATYPER	OIOUBL Datatyper - UBL 2.0 Datatypes	G29
OIOUBL_GUIDE_BIBLIOTEK	OIOUBL Fælles klassebibliotek - UBL 2.0 CommonLibrary	G30
OIOUBL_GUIDE_SIGNATUR	OIOUBL Signatur - UBL 2.0 Signature	G31
OIOUBL_GUIDE_UUID	OIOUBL UUID - UBL 2.0 UUID	G32
OIOUBL_GUIDE_UDVIDELSER	OIOUBL Udvidelse - UBL 2.0 Extension	G33

OIOUBL_GUIDE_KONTAKT	OIOUBL Kontakt - UBL 2.0 Contact	G34
OIOUBL_GUIDE_RESPONS	OIOUBL Bekræftelse - UBL 2.0 Respons	G35
OIOUBL_GUIDE_ADRESSER	OIOUBL Adresser - UBL 2.0 Adress	G36
<b>Katalogspecifikke tværgående guidelines</b>		
OIOUBL_GUIDE_KATALOG_ID	OIOUBL Identifikation, versionering og gyldighedsperioder i kataloger	G37
OIOUBL_GUIDE_KATALOG_VAREBESKRIV	OIOUBL Varebeskrivelser og kategorisering i kataloger	G38
OIOUBL_GUIDE_KATALOG_PARTER	OIOUBL Parter i kataloger	G39
OIOUBL_GUIDE_KATALOG_PRISER	OIOUBL Pris og mængde i kataloger	G40
<b>Scenarie pakker</b>		
OIOUBL_SCENARIE_INTRO	Introduction to OIOUBL Procurement Scenarios	S01
OIOUBL_SCENARIE_ADVORD	OIOUBL ADVORD - Advanced Ordering Procurement Cycle	S02
OIOUBL_SCENARIE_BASPRO	OIOUBL BASPRO - Basic procurement Cycle	S03
OIOUBL_SCENARIE_CATEXE	OIOUBL CATEXE - Catalogue Exchange	S04
OIOUBL_SCENARIE_COMDEL	OIOUBL COMDEL - Complex Delivery Procurement Cycle	S05
OIOUBL_SCENARIE_COMORG	OIOUBL COMORG - Complex Organisations Procurement Cycle	S06
OIOUBL_SCENARIE_COMPAY	OIOUBL COMPAY - Complex Payment Cycle	S07

## 2. How to fill in OIOUBL document instances

An Invoice must follow the related UBL schema, and conform to the rules of this guideline. The instances follow the W3C XML specifications, which means that, unless otherwise stated, the normal XML rules apply. It is therefore recommended that an xml encoder is used for reading the documents.

### 2.1 Namespace

A Namespace is a semantic space in which names are unique and attached to a specific interpretation.

Namespaces often occur as libraries, and may be referenced via an alias-variable. The expression:

```
<... xmlns:cac="urn:oasis:names:specification:ubl:schema:xsd:CommonAggregateComponents-2" ...>
```

means that elements with the prefix “cac” (alias variable) belongs to the “... CommomAggregateComponents-2” namespace. The namespace that is referenced by the actual document is

indicated by “xmlns=...”, i.e. without an alias variable. It is recommended to use the alias variables that are specified in UBL, but this is not a requirement. For an OIOUBL document instance to be validated the following namespaces must be specified:

Alias variable	Namespace
	urn:oasis:names:specification:ubl:schema:xsd:Invoice-2
cac	urn:oasis:names:specification:ubl:schema:xsd:CommonAggregateComponents-2
ccts	urn:oasis:names:specification:ubl:schema:xsd:CoreComponentParameters-2
cbc	urn:oasis:names:specification:ubl:schema:xsd:CommonBasicComponents-2
sdt	urn:oasis:names:specification:ubl:schema:xsd:SpecializedDatatypes-2
udt	urn:un:unece:uncefact:data:specification:UnqualifiedDataTypesSchemaModule:2
ext	urn:oasis:names:specification:ubl:schema:xsd:CommonExtensionComponents-2
xsi	http://www.w3.org/2001/XMLSchema-instance

### 2.2 Comments

Comments may be used in document instances to facilitate any manual processing of the document. This is particularly relevant during the introduction phase of new systems that use OIOUBL. For those who wish to formalize these comments, we recommend the Dublin-Core metadata definitions, see ”



































<http://dublincore.org/documents/dcmi-terms/>". The following terms are used in the examples of the scenario descriptions [S01-S07] :

DC-Term	Description	Example
Title	Describes the title of the document instance	BASPRO_01_01_00_Invoice_v2p0.xml
Replaces	Reference to the preceding instance	BASPRO_01_01_00_Invoice_v0p1.xml
Publisher	Describes who is responsible for the document instance.	"IT og Telestyrelsen"
Creator	Describes the person or the system that created the instance.	"OIOERP v 1.0.2 release 34"
Created	Date (and possibly time) of the creation of the document.	2006-09-08
Modified	Date (and possibly time) when the document was last modified.	2006-09-08
Issued	Date (and possibly time) when it was issued.	2006-09-08
ConformsTo	Description of the context that it belongs to.	OIOUBL_ScenarioPackage_BASPRO
Description	General description	"This document is produced as part of the OIOUBL Basic procurement scenario package"
Rights	Any copyrights that apply to the instance.	"It can be used following the Common Creative License"

Only use meta data that you consider applicable, and only enter valid data. From the above list we particularly recommend using the "Creator" term, as this may ease the troubleshooting at the receiver's system. Comments should be specified within the root element of the document.

## 2.3 Process instructions

Process instructions are instructions that are not covered by the OIOUBL standard, but which may be used for controlling other logics. For example, when specifying that an instance is used for test purposes. A process instruction is specified by "                                  

---

### 3. CreditNote

## 3.1. CreditNote

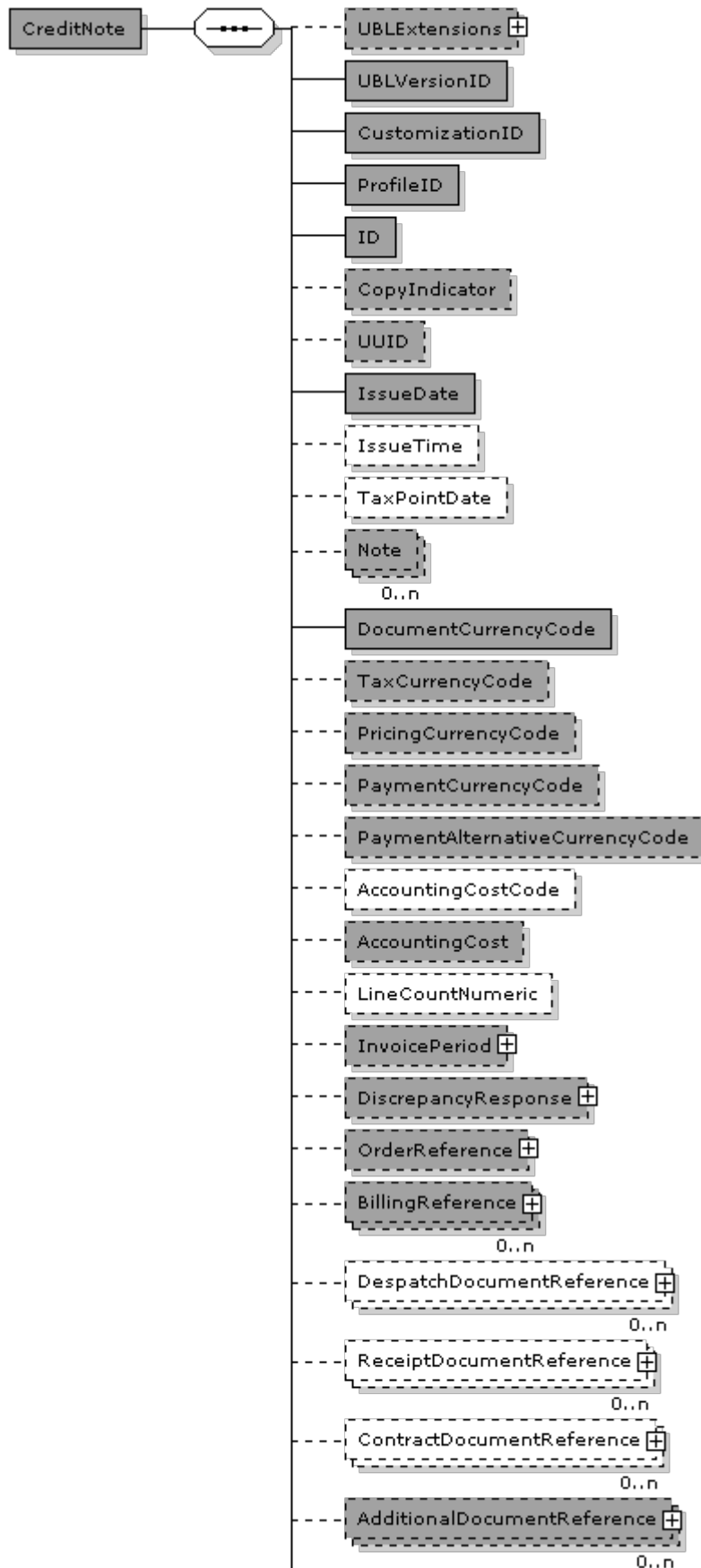

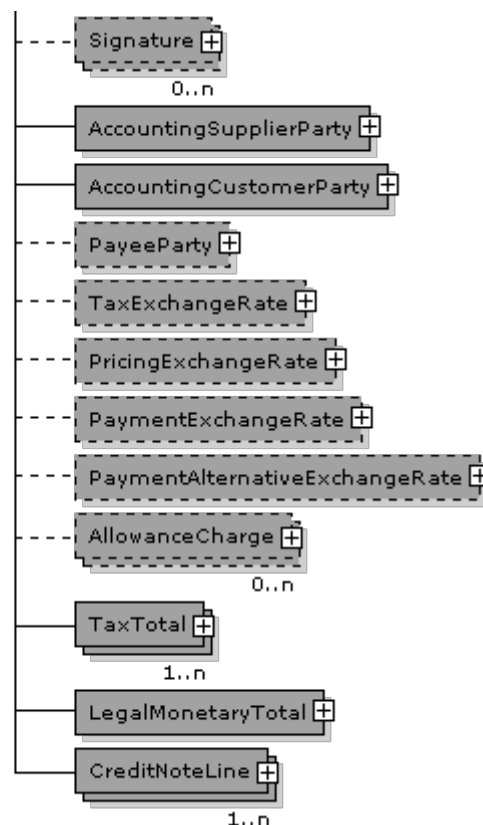

### CreditNote specification

Name	CreditNote	Alternative term
Definition	<p>OIOUBL Invoice is an official document for the exchange of electronic creditnotes. CreditNote can be used in a single creditnote as well as a creditnote which is part of a coherent order-to-invoice flow. The CreditNote is structured following the principles in the UBL Party model for identification of the different parties involved in the order process and the roles they play. The primary parties in a credit note are AccountingCustomerParty and AccountingSupplierParty. The CreditNote is structured to fulfill the formal requirements for a valid creditnote for use in Denmark as well as in foreign countries, including taxnumber, time of delivery, specifications etc. Apart from the formal demands on sender and receiver and the creditnote content, the electronic version must contain EndPointID, a Personreference and usually an order number or request number. It also has to fulfill the requirements in this document guideline. EndPointID is used to identify the "electronic mailbox" where the electronic document is to be delivered and also provides the basis for routing the message. EndPointID must be registered in the mandatory address register for the routing of electronic documents. PersonReference is used to identify the person responsible for processing the received electronic document. Order number or requisition number is used in cases where a creditnote is issued with a reference to a previous order or requisition. In certain cases where no previous order exists, the number can be omitted if the electronic creditnote is sent with a ProfileID that doesn't need an order number or request number. References: For a basic understanding of this document guideline and the associated general classes guidelines and codelists it is recommended that one reads the documents "Introduction to the OIOUBL package" and "Introduction to OIOUBL Procurement Scenarios".</p>	

**Fields**

UBL-Name	Name	Datatype	Usage	Cardinality
UBLVersionID	UBLVersionID	Identifier	Yes	1
CustomizationID	CustomizationID	Identifier	Yes	1
ProfileID	ProfileID	Identifier	Yes	1
ID	ID	Identifier	Yes	1
CopyIndicator	CopyIndicator	Indicator	Yes	0..1
UUID	UUID	Identifier	Yes	0..1
IssueDate	IssueDate	Date	Yes	1
IssueTime	IssueTime	Time	Bilateral	0..1
TaxPointDate	TaxPointDate	Date	Bilateral	0..1
Note	Note	Text	Yes	0..n
DocumentCurrencyCode	DocumentCurrencyCode	Code	Yes	1
TaxCurrencyCode	TaxCurrencyCode	Code	Yes	0..1
PricingCurrencyCode	PricingCurrencyCode	Code	Yes	0..1
PaymentCurrencyCode	PaymentCurrencyCode	Code	Yes	0..1
PaymentAlternativeCurrencyCode	PaymentAlternativeCurrencyCode	Code	Yes	0..1
AccountingCostCode	AccountingCostCode	Code	Bilateral	0..1
AccountingCost	AccountingCost	Text	Yes	0..1
LineCountNumeric	LineCountNumeric	Numeric	Bilateral	0..1

**Subclasses in class CreditNote**

UBL-Name	Name	Usage	Cardinality	Reference
UBLExtensions	UBLExtensions	Yes	0..1	G22
InvoicePeriod	InvoicePeriod	Yes	0..1	G30 3.78
DiscrepancyResponse	DiscrepancyResponse	Yes	0..1	3.2
OrderReference	OrderReference	Yes	0..1	3.3
BillingReference	BillingReference	Yes	0..n	3.4
DespatchDocumentReference	DespatchDocumentReference	Bilateral	0..n	3.5
ReceiptDocumentReference	ReceiptDocumentReference	Bilateral	0..n	3.6
ContractDocumentReference	ContractDocumentReference	Bilateral	0..n	3.7
AdditionalDocumentReference	AdditionalDocumentReference	Yes	0..n	G30 3.36
Signature	Signature	Yes	0..n	G30 3.96
AccountingSupplierParty	AccountingSupplierParty	Yes	1	3.8
AccountingCustomerParty	AccountingCustomerParty	Yes	1	3.9
PayeeParty	PayeeParty	Yes	0..1	3.10
TaxExchangeRate	TaxExchangeRate	Yes	0..1	3.11
PricingExchangeRate	PricingExchangeRate	Yes	0..1	3.12
PaymentExchangeRate	PaymentExchangeRate	Yes	0..1	3.13
PaymentAlternativeExchangeRate	PaymentAlternativeExchangeRate	Yes	0..1	3.14
AllowanceCharge	AllowanceCharge	Yes	0..n	G30 3.4
TaxTotal	TaxTotal	Yes	1..n	G30 3.104
LegalMonetaryTotal	LegalMonetaryTotal	Yes	1	G30 3.64
CreditNoteLine	CreditNoteLine	Yes	1..n	3.15

## Field specifications

### *UBLVersionID*

<b>Fieldname</b>	UBLVersionID	<b>Alternative term</b>	
<b>Cardinality</b>	1	<b>Usage</b>	Yes
<b>Datatype</b>	Identifier		
<b>Definition</b>	The earliest version of the UBL 2 schema for this document type that defines all of the elements that might be encountered in the current instance.		
<b>Legal values</b>	2.0		
<b>Example</b>	2.0		

### *CustomizationID*

<b>Fieldname</b>	CustomizationID	<b>Alternative term</b>	
<b>Cardinality</b>	1	<b>Usage</b>	Yes
<b>Datatype</b>	Identifier		
<b>Definition</b>	Identifies a user-defined customization of UBL for a specific use.		
<b>Legal values</b>	OIOUBL-2.01		
<b>Example</b>	OIOUBL-2.0		

### *ProfileID*

<b>Fieldname</b>	ProfileID	<b>Alternative term</b>	
<b>Cardinality</b>	1	<b>Usage</b>	Yes
<b>Datatype</b>	Identifier		
<b>Definition</b>	Identifies a user-defined profile of the customization of UBL being used.		
<b>Id list</b>	urn:oiubl:id:profileid-1.1		
<b>Example</b>	Procurement-OrdSim-BilSim-1.0		

### *ID*

<b>Fieldname</b>	ID	<b>Alternative term</b>	
<b>Cardinality</b>	1	<b>Usage</b>	Yes
<b>Datatype</b>	Identifier		
<b>Definition</b>	An identifier for the Credit Note assigned by the Creditor.		
<b>Businessrules</b>	Most important information must be at the end of the ID		
<b>Recommendation</b>	Maximum 35 characters is recommended		
<b>Example</b>	2760708		

### *CopyIndicator*

<b>Fieldname</b>	CopyIndicator	<b>Alternative term</b>	
<b>Cardinality</b>	0..1	<b>Usage</b>	Yes
<b>Datatype</b>	Indicator		
<b>Definition</b>	Indicates whether the Credit Note is a copy (true) or not (false).		
<b>Example</b>	false		

### *UUID*

<b>Fieldname</b>	UUID	<b>Alternative term</b>	OIOUBL_GUIDE_UUID
<b>Cardinality</b>	0..1	<b>Usage</b>	Yes
<b>Datatype</b>	Identifier		
<b>Definition</b>	A computer-generated universally unique identifier (UUID) for the Credit Note instance.		
<b>See also</b>	OIOUBL_GUIDE_UUID ( G32 )		
<b>Example</b>	4e39f644-8819-1029-857a-e388fe63f399		

### *IssueDate*

<b>Fieldname</b>	IssueDate	<b>Alternative term</b>	
<b>Cardinality</b>	1	<b>Usage</b>	Yes
<b>Datatype</b>	Date		
<b>Definition</b>	The date assigned by the Creditor on which the Credit Note was issued.		
<b>Example</b>	2006-11-01		

### *IssueTime*

<b>Fieldname</b>	IssueTime	<b>Alternative term</b>	
<b>Cardinality</b>	0..1	<b>Usage</b>	Bilateral
<b>Datatype</b>	Time		
<b>Definition</b>	The time assigned by the Creditor on which the Credit Note was issued.		
<b>Example</b>	12:35:00		

**TaxPointDate**

<b>Fieldname</b>	TaxPointDate	<b>Alternative term</b>	
<b>Cardinality</b>	0..1	<b>Usage</b>	Bilateral
<b>Datatype</b>	Date		
<b>Definition</b>	The date of the Credit Note used Indicates the point at which tax becomes applicable.		
<b>Businessrules</b>	Not used in Denmark		

**Note**

<b>Fieldname</b>	Note	<b>Alternative term</b>	
<b>Cardinality</b>	0..n	<b>Usage</b>	Yes
<b>Datatype</b>	Text		
<b>Definition</b>	Free-form text applying to the Credit Note. This element may contain notes or any other similar information that is not contained explicitly in another structure.		
<b>Businessrules</b>	Only one language allowed		
<b>Example</b>	Ifølge aftale		

**DocumentCurrencyCode**

<b>Fieldname</b>	DocumentCurrencyCode	<b>Alternative term</b>	OIOUBL_GUIDE_CURRENC Y
<b>Cardinality</b>	1	<b>Usage</b>	Yes
<b>Datatype</b>	Code		
<b>Definition</b>	The default currency for the Credit Note. This can be the same currency as Price or Tax		
<b>Codelist</b>	urn:un:unece:unefact:codelist:specification:54217:2001		
<b>See also</b>	OIOUBL_GUIDE_CURRENCY ( OIO )		
<b>Example</b>	DKK		

**TaxCurrencyCode**

<b>Fieldname</b>	TaxCurrencyCode	<b>Alternative term</b>	OIOUBL_GUIDE_CURRENC Y
<b>Cardinality</b>	0..1	<b>Usage</b>	Yes
<b>Datatype</b>	Code		
<b>Definition</b>	The currency used for tax amounts in the Credit Note.		
<b>Codelist</b>	urn:un:unece:unefact:codelist:specification:54217:2002		
<b>See also</b>	OIOUBL_GUIDE_CURRENCY ( OIO )		

**PricingCurrencyCode**

<b>Fieldname</b>	PricingCurrencyCode	<b>Alternative term</b>	OIOUBL_GUIDE_CURRENC Y
<b>Cardinality</b>	0..1	<b>Usage</b>	Yes
<b>Datatype</b>	Code		
<b>Definition</b>	The currency used for prices in the Credit Note.		
<b>Codelist</b>	urn:un:unece:unefact:codelist:specification:54217:2001		
<b>See also</b>	OIOUBL_GUIDE_CURRENCY ( OIO )		
<b>Example</b>	USD		

**PaymentCurrencyCode**

<b>Fieldname</b>	PaymentCurrencyCode	<b>Alternative term</b>	OIOUBL_GUIDE_CURRENC Y
<b>Cardinality</b>	0..1	<b>Usage</b>	Yes
<b>Datatype</b>	Code		
<b>Definition</b>	The currency used for payment in the Credit Note.		
<b>Codelist</b>	urn:un:unece:unefact:codelist:specification:54217:2001		
<b>See also</b>	OIOUBL_GUIDE_CURRENCY ( OIO )		
<b>Example</b>	EUR		

**PaymentAlternativeCurrencyCode**

<b>Fieldname</b>	PaymentAlternativeCurrencyCode	<b>Alternative term</b>	OIOUBL_GUIDE_CURRENC Y
<b>Cardinality</b>	0..1	<b>Usage</b>	Yes
<b>Datatype</b>	Code		
<b>Definition</b>	The alternative currency used for payment in the Credit Note.		
<b>Codelist</b>	urn:un:unece:uncefact:codelist:specification:54217:2001		
<b>See also</b>	OIOUBL_GUIDE_CURRENCY ( OIO )		
<b>Example</b>	SEK		

**AccountingCostCode**

<b>Fieldname</b>	AccountingCostCode	<b>Alternative term</b>	
<b>Cardinality</b>	0..1	<b>Usage</b>	Bilateral
<b>Datatype</b>	Code		
<b>Definition</b>	The Buyer's accounting code applied to the Credit Note as a whole.		
<b>Businessrules</b>	Bilateral		
<b>Example</b>	5050		

**AccountingCost**

<b>Fieldname</b>	AccountingCost	<b>Alternative term</b>	
<b>Cardinality</b>	0..1	<b>Usage</b>	Yes
<b>Datatype</b>	Text		
<b>Definition</b>	The Buyer's accounting code applied to the Credit Note as a whole, expressed as text.		
<b>Businessrules</b>	Only use if code not present		

**LineCountNumeric**

<b>Fieldname</b>	LineCountNumeric	<b>Alternative term</b>	
<b>Cardinality</b>	0..1	<b>Usage</b>	Bilateral
<b>Datatype</b>	Numeric		
<b>Definition</b>	The number of lines in the document.		

**Class Specification****InvoicePeriod**

<b>Classname</b>	InvoicePeriod	<b>Alternative term</b>	
<b>Cardinality</b>	0..1	<b>Usage</b>	Yes
<b>Datatype</b>	Period		
<b>Definition</b>	An association to period(s) to which the Invoices related to the Credit apply.		
<b>See section</b>	G30 3.78		

**DiscrepancyResponse**

<b>Classname</b>	DiscrepancyResponse	<b>Alternative term</b>	
<b>Cardinality</b>	0..1	<b>Usage</b>	Yes
<b>Datatype</b>	Response		
<b>Definition</b>	An association to a reason for the Credit Note as a whole.		
<b>Businessrules</b>	Use to explain the discrepancy that leads to the credit		
<b>See section</b>	3.2		

**OrderReference**

<b>Classname</b>	OrderReference	<b>Alternative term</b>	
<b>Cardinality</b>	0..1	<b>Usage</b>	Yes
<b>Datatype</b>	OrderReference		
<b>Definition</b>	An association to an Order.		
<b>Businessrules</b>	Mandatory for public sector, if not invoice only profile		
<b>Profile Dependency</b>	Mandatory in: Procurement-OrdSim-BiSim-1.0 (+R), Procurement-OrdAdv-BiSim-1.0 (+R) and urn:www.nesubl.eu:profiles:profile7:ver1.0		
<b>See section</b>	3.3		

**BillingReference**



<b>Classname</b>	BillingReference	<b>Alternative term</b>	
<b>Cardinality</b>	0..n	<b>Usage</b>	Yes
<b>Datatype</b>	BillingReference		
<b>Definition</b>	An association to other billing documents.		
<b>Businessrules</b>	Mandatory if an Invoice is credited		
<b>See section</b>	3.4		

**DespatchDocumentReference**

<b>Classname</b>	DespatchDocumentReference	<b>Alternative term</b>	
<b>Cardinality</b>	0..n	<b>Usage</b>	Bilateral
<b>Datatype</b>	DocumentReference		
<b>Definition</b>	An association to a Despatch Advice.		
<b>See section</b>	3.5		

**ReceiptDocumentReference**

<b>Classname</b>	ReceiptDocumentReference	<b>Alternative term</b>	
<b>Cardinality</b>	0..n	<b>Usage</b>	Bilateral
<b>Datatype</b>	DocumentReference		
<b>Definition</b>	An association to a Receipt Advice.		
<b>See section</b>	3.6		

**ContractDocumentReference**

<b>Classname</b>	ContractDocumentReference	<b>Alternative term</b>	OIOUBL_GUIDE_DOCUMENTREF
<b>Cardinality</b>	0..n	<b>Usage</b>	Bilateral
<b>Datatype</b>	DocumentReference		
<b>Definition</b>	An association to a framework agreement or contract.		
<b>See section</b>	3.7		
<b>See also</b>	OIOUBL_GUIDE_DOCUMENTREF ( OIO )		

**AdditionalDocumentReference**

<b>Classname</b>	AdditionalDocumentReference	<b>Alternative term</b>	OIOUBL_GUIDE_DOCUMENTREF
<b>Cardinality</b>	0..n	<b>Usage</b>	Yes
<b>Datatype</b>	DocumentReference		
<b>Definition</b>	An association to other documents.		
<b>Businessrules</b>	AdditionalDocumentReference can be used to specify, if the document contains personal data. If DocumentTypeCode is "PersonalSecure" the security level (1, 2 eller 3) that applies to the document must be specified in ID. Group 1 level comprise regular person data as CVR-number, name, address, civil status etc. Group 2 level comprise sensitive person data like race, religion, health and sexual related issues etc. Group 3 level comprise other personal data like criminal involvement, significant social problems and other strictly private issues.		
<b>See section</b>	G30 3.36		
<b>See also</b>	OIOUBL_GUIDE_DOCUMENTREF ( OIO )		

**Signature**

<b>Classname</b>	Signature	<b>Alternative term</b>	OIOUBL_GUIDE_SIGNATURE
<b>Cardinality</b>	0..n	<b>Usage</b>	Yes
<b>Datatype</b>	Signature		
<b>Definition</b>	Associates the Credit Note with zero or more signatures.		
<b>See section</b>	G30 3.96		
<b>See also</b>	OIOUBL_GUIDE_SIGNATURE ( OIO )		

**AccountingSupplierParty**

<b>Classname</b>	AccountingSupplierParty	<b>Alternative term</b>	
<b>Cardinality</b>	1	<b>Usage</b>	Yes
<b>Datatype</b>	SupplierParty		
<b>Definition</b>	An association to the Accounting Supplier Party.		
<b>See section</b>	3.8		

**AccountingCustomerParty**

<b>Classname</b>	AccountingCustomerParty	<b>Alternative term</b>	
<b>Cardinality</b>	1	<b>Usage</b>	Yes
<b>Datatype</b>	CustomerParty		
<b>Definition</b>	An association to the Accounting Customer Party.		
<b>See section</b>	3.9		

**PayeeParty**

<b>Classname</b>	PayeeParty	<b>Alternative term</b>	OIOUBL_GUIDE_PARTIES
<b>Cardinality</b>	0..1	<b>Usage</b>	Yes
<b>Datatype</b>	Party		
<b>Definition</b>	An association to the Payee.		
<b>See section</b>	3.10		
<b>See also</b>	OIOUBL_GUIDE_PARTIES ( OIO )		

**TaxExchangeRate**

<b>Classname</b>	TaxExchangeRate	<b>Alternative term</b>	OIOUBL_GUIDE_CURRENC Y
<b>Cardinality</b>	0..1	<b>Usage</b>	Yes
<b>Datatype</b>	ExchangeRate		
<b>Definition</b>	An association to Exchange Rate between the Document Currency and the Tax Currency.		
<b>See section</b>	3.11		
<b>See also</b>	OIOUBL_GUIDE_CURRENCY ( OIO )		

**PricingExchangeRate**

<b>Classname</b>	PricingExchangeRate	<b>Alternative term</b>	OIOUBL_GUIDE_CURRENC Y
<b>Cardinality</b>	0..1	<b>Usage</b>	Yes
<b>Datatype</b>	ExchangeRate		
<b>Definition</b>	An association to Exchange Rate between the Document Currency and the Pricing Currency.		
<b>See section</b>	3.12		
<b>See also</b>	OIOUBL_GUIDE_CURRENCY ( OIO )		

**PaymentExchangeRate**

<b>Classname</b>	PaymentExchangeRate	<b>Alternative term</b>	OIOUBL_GUIDE_CURRENC Y
<b>Cardinality</b>	0..1	<b>Usage</b>	Yes
<b>Datatype</b>	ExchangeRate		
<b>Definition</b>	An association to Exchange Rate between the Document Currency and the Payment Currency.		
<b>See section</b>	3.13		
<b>See also</b>	OIOUBL_GUIDE_CURRENCY ( OIO )		

**PaymentAlternativeExchangeRate**

<b>Classname</b>	PaymentAlternativeExchangeRate	<b>Alternative term</b>	OIOUBL_GUIDE_CURRENC Y
<b>Cardinality</b>	0..1	<b>Usage</b>	Yes
<b>Datatype</b>	ExchangeRate		
<b>Definition</b>	An association to Exchange Rate between the Document Currency and the Payment Alternative Currency.		
<b>See section</b>	3.14		
<b>See also</b>	OIOUBL_GUIDE_CURRENCY ( OIO )		

**AllowanceCharge**

<b>Classname</b>	AllowanceCharge	<b>Alternative term</b>	OIOUBL_GUIDE_ALLOWAN CE
<b>Cardinality</b>	0..n	<b>Usage</b>	Yes
<b>Datatype</b>	AllowanceCharge		
<b>Definition</b>	An association to Allowances and Charges that apply to the Credited billing document as a whole.		
<b>See section</b>	G30 3.4		
<b>See also</b>	OIOUBL_GUIDE_ALLOWANCE ( OIO )		

**TaxTotal**

<b>Classname</b>	TaxTotal	<b>Alternative term</b>	OIOUBL_GUIDE_TAX
<b>Cardinality</b>	1..n	<b>Usage</b>	Yes
<b>Datatype</b>	TaxTotal		
<b>Definition</b>	An association to Tax Total for specific tax types/rates.		
<b>See section</b>	G30 3.104		
<b>See also</b>	OIOUBL_GUIDE_TAX ( OIO )		

**LegalMonetaryTotal**

<b>Classname</b>	LegalMonetaryTotal	<b>Alternative term</b>	OIOUBL_GUIDE_TOTALS
<b>Cardinality</b>	1	<b>Usage</b>	Yes
<b>Datatype</b>	MonetaryTotal		
<b>Definition</b>	An association to the total amount payable on the Credit Note, including Allowances, Charges, and Taxes.		
<b>See section</b>	G30 3.64		
<b>See also</b>	OIOUBL_GUIDE_TOTALS ( OIO )		

**CreditNoteLine**

<b>Classname</b>	CreditNoteLine	<b>Alternative term</b>	
<b>Cardinality</b>	1..n	<b>Usage</b>	Yes
<b>Datatype</b>	CreditNoteLine		
<b>Definition</b>	An association to one or more Credit Note Lines.		
<b>See section</b>	3.15		

**Excluded classes and fields in CreditNote**

Name	Name	Type
TaxRepresentativeParty	TaxRepresentativeParty	Class

### 3.2. CreditNote.DiscrepancyResponse

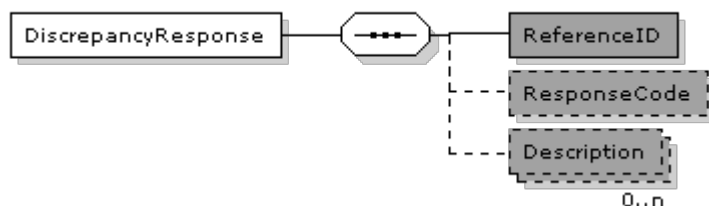

#### DiscrepancyResponse (CreditNote.DiscrepancyResponse) specification

<b>Name</b>	CreditNote.DiscrepancyResponse	<b>Alternative term</b>	
<b>Definition</b>	Information about responses to a document (at the application level)		

#### Fields

UBL-Name	Name	Datatype	Usage	Cardinality
ReferenceID	ReferenceID	Identifier	Yes	1
ResponseCode	ResponseCode	Code	Yes	0..1
Description	Description	Text	Yes	0..n

#### Subclasses in class DiscrepancyResponse (CreditNote.DiscrepancyResponse)

None

**Field specifications****ReferenceID**

<b>Fieldname</b>	ReferenceID	<b>Alternative term</b>	
<b>Cardinality</b>	1	<b>Usage</b>	Yes
<b>Datatype</b>	Identifier		
<b>Definition</b>	a reference to identify the section (or line) of the document to which the response applies		

**ResponseCode**

<b>Fieldname</b>	ResponseCode	<b>Alternative term</b>	
<b>Cardinality</b>	0..1	<b>Usage</b>	Yes
<b>Datatype</b>	Code		
<b>Definition</b>	A code for the description of the response to the transaction document.		
<b>Businessrules</b>	Use either Description or ResponseCode		
<b>Codelist</b>	urn:oiubl:codelist:discrepancyresponsecode-1.1		
<b>Dependency</b>	../Description		

**Description**

<b>Fieldname</b>	Description	<b>Alternative term</b>	
<b>Cardinality</b>	0..n	<b>Usage</b>	Yes
<b>Datatype</b>	Text		
<b>Definition</b>	the description of the response to the transaction document.		
<b>Businessrules</b>	Only one per Language		
<b>Dependency</b>	../ResponseCode		

**Excluded classes and fields in DiscrepancyResponse (CreditNote.DiscrepancyResponse)**

None

### 3.3. CreditNote.OrderReference

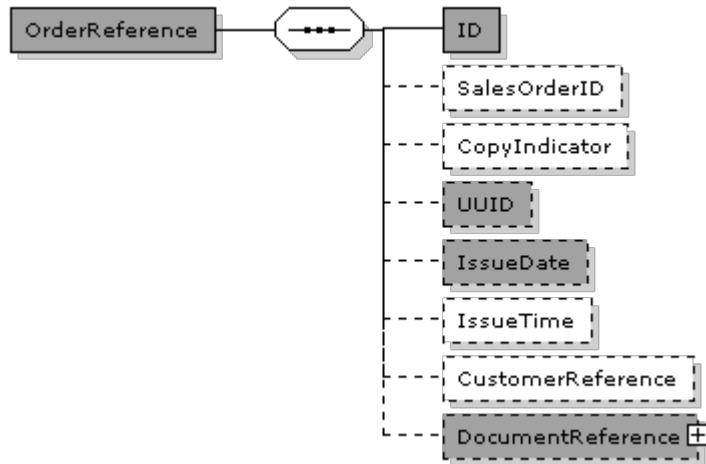

#### OrderReference (CreditNote.OrderReference) specification

<b>Name</b>	CreditNote.OrderReference	<b>Alternative term</b>	
<b>Definition</b>	Information about an Order Reference		

#### Fields

UBL-Name	Name	Datatype	Usage	Cardinality
ID	ID	Identifier	Yes	1
SalesOrderID	SalesOrderID	Identifier	Bilateral	0..1
CopyIndicator	CopyIndicator	Indicator	Bilateral	0..1
UUID	UUID	Identifier	Yes	0..1
IssueDate	IssueDate	Date	Yes	0..1
IssueTime	IssueTime	Time	Bilateral	0..1
CustomerReference	CustomerReference	Text	Bilateral	0..1

#### Subclasses in class OrderReference (CreditNote.OrderReference)

UBL-Name	Name	Usage	Cardinality	Reference
DocumentReference	DocumentReference	Yes	0..1	3.3.1

**Field specifications****ID**

<b>Fieldname</b>	ID	<b>Alternative term</b>	
<b>Cardinality</b>	1	<b>Usage</b>	Yes
<b>Datatype</b>	Identifier		
<b>Definition</b>	The identifier for the referenced Order assigned by the Buyer		

**SalesOrderID**

<b>Fieldname</b>	SalesOrderID	<b>Alternative term</b>	
<b>Cardinality</b>	0..1	<b>Usage</b>	Bilateral
<b>Datatype</b>	Identifier		
<b>Definition</b>	The identifier for the referenced Order assigned by the Seller		

**CopyIndicator**

<b>Fieldname</b>	CopyIndicator	<b>Alternative term</b>	
<b>Cardinality</b>	0..1	<b>Usage</b>	Bilateral
<b>Datatype</b>	Indicator		
<b>Definition</b>	Indicates whether the referenced Order is a copy (true) or the original (false)		

**UUID**

<b>Fieldname</b>	UUID	<b>Alternative term</b>	
<b>Cardinality</b>	0..1	<b>Usage</b>	Yes
<b>Datatype</b>	Identifier		
<b>Definition</b>	A computer-generated universally unique identifier (UUID) for the referenced Order instance		

**IssueDate**

<b>Fieldname</b>	IssueDate	<b>Alternative term</b>	
<b>Cardinality</b>	0..1	<b>Usage</b>	Yes
<b>Datatype</b>	Date		
<b>Definition</b>	The date on which the referenced Order was issued		

**IssueTime**

<b>Fieldname</b>	IssueTime	<b>Alternative term</b>	
<b>Cardinality</b>	0..1	<b>Usage</b>	Bilateral
<b>Datatype</b>	Time		
<b>Definition</b>	The time on which the referenced Order was issued		

**CustomerReference**

<b>Fieldname</b>	CustomerReference	<b>Alternative term</b>	
<b>Cardinality</b>	0..1	<b>Usage</b>	Bilateral
<b>Datatype</b>	Text		
<b>Definition</b>	A supplementary reference for the referenced Order		

**Class Specification****DocumentReference**

<b>Classname</b>	DocumentReference	<b>Alternative term</b>	OIOUBL_GUIDE_DOCUMENTREF
<b>Cardinality</b>	0..1	<b>Usage</b>	Yes
<b>Datatype</b>	DocumentReference		
<b>Definition</b>	An association to Document Reference		
<b>See section</b>	3.3.1		
<b>See also</b>	OIOUBL_GUIDE_DOCUMENTREF ( OIO )		

**Excluded classes and fields in OrderReference (CreditNote.OrderReference)**

None





### 3.3.1. CreditNote.OrderReference.DocumentReference

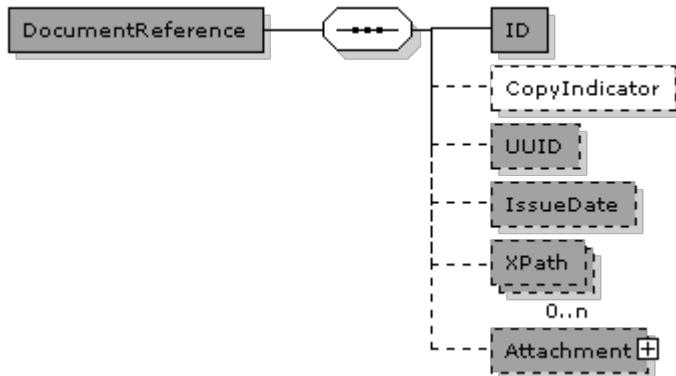

#### DocumentReference (CreditNote.OrderReference.DocumentReference) specification

<b>Name</b>	CreditNote.OrderReference.DocumentReference	<b>Alternative term</b>	OIOUBL_GUIDE_DOCUMENTREF
<b>Definition</b>	Information about a Document referred to in another Document		
<b>See also</b>	OIOUBL_GUIDE_DOCUMENTREF ( OIO )		

#### Fields

UBL-Name	Name	Datatype	Usage	Cardinality
ID	ID	Identifier	Yes	1
CopyIndicator	CopyIndicator	Indicator	Bilateral	0..1
UUID	UUID	Identifier	Yes	0..1
IssueDate	IssueDate	Date	Yes	0..1
XPath	XPath	Text	Yes	0..n

#### Subclasses in class DocumentReference (CreditNote.OrderReference.DocumentReference)

UBL-Name	Name	Usage	Cardinality	Reference
Attachment	Attachment	Yes	0..1	3.3.1.1

**Field specifications****ID**

<b>Fieldname</b>	ID	<b>Alternative term</b>	
<b>Cardinality</b>	1	<b>Usage</b>	Yes
<b>Datatype</b>	Identifier		
<b>Definition</b>	The identifier for the Document being referred to		
<b>Example</b>	428.34		

**CopyIndicator**

<b>Fieldname</b>	CopyIndicator	<b>Alternative term</b>	
<b>Cardinality</b>	0..1	<b>Usage</b>	Bilateral
<b>Datatype</b>	Indicator		
<b>Definition</b>	Indicates whether the referenced Document is a copy (true) or the original (false)		
<b>Example</b>	false		

**UUID**

<b>Fieldname</b>	UUID	<b>Alternative term</b>	OIOUBL_GUIDE_UUID
<b>Cardinality</b>	0..1	<b>Usage</b>	Yes
<b>Datatype</b>	Identifier		
<b>Definition</b>	A computer-generated universally unique identifier (UUID) for the referenced Document instance		
<b>See also</b>	OIOUBL_GUIDE_UUID ( G32 )		

**IssueDate**

<b>Fieldname</b>	IssueDate	<b>Alternative term</b>	
<b>Cardinality</b>	0..1	<b>Usage</b>	Yes
<b>Datatype</b>	Date		
<b>Definition</b>	The date assigned by the sender of the referenced Document on which the referenced Document was issued		
<b>Example</b>	2006-09-01		

**XPath**

<b>Fieldname</b>	XPath	<b>Alternative term</b>	
<b>Cardinality</b>	0..n	<b>Usage</b>	Yes
<b>Datatype</b>	Text		
<b>Definition</b>	Refers to another part of the same document instance		
<b>Example</b>	/DocumentReference[ID='428.22']		

**Class Specification****Attachment**

<b>Classname</b>	Attachment	<b>Alternative term</b>	
<b>Cardinality</b>	0..1	<b>Usage</b>	Yes
<b>Datatype</b>	Attachment		
<b>Definition</b>	An attached document, external referred to, referred in the MIME location or embedded.		
<b>See section</b>	3.3.1.1		

**Excluded classes and fields in DocumentReference  
(CreditNote.OrderReference.DocumentReference)**

Name	Name	Type
DocumentTypeCode	DocumentTypeCode	Field
DocumentType	DocumentType	Field

### 3.3.1.1. CreditNote.OrderReference.DocumentReference.Attachment

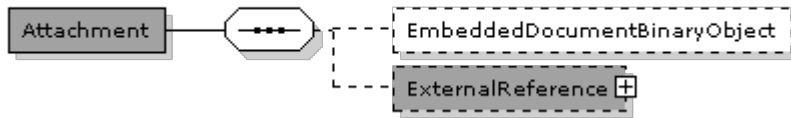

#### Attachment (CreditNote.OrderReference.DocumentReference.Attachment) specification

<b>Name</b>	CreditNote.OrderReference.DocumentReference.Attachment	<b>Alternative term</b>	OIOUBL_GUIDE_ATTACHMENT
<b>Definition</b>	Information about an attached document. An attachment can be referred to externally (with the URI element), internally (with the MIME reference element) or contained within the document itself (with the EmbeddedDocument element).		
<b>See also</b>	OIOUBL_GUIDE_ATTACHMENT ( OIO )		

#### Fields

UBL-Name	Name	Datatype	Usage	Cardinality
EmbeddedDocumentBinaryObject	EmbeddedDocumentBinaryObject	Binary Object	Bilateral	0..1

#### Subclasses in class Attachment (CreditNote.OrderReference.DocumentReference.Attachment)

UBL-Name	Name	Usage	Cardinality	Reference
ExternalReference	ExternalReference	Yes	0..1	G30 3.41

#### Field specifications

##### *EmbeddedDocumentBinaryObject*

<b>Fieldname</b>	EmbeddedDocumentBinaryObject	<b>Alternative term</b>	
<b>Cardinality</b>	0..1	<b>Usage</b>	Bilateral
<b>Datatype</b>	Binary Object		
<b>Definition</b>	Contains an embedded document as a BLOB,		
<b>Businessrules</b>	Only allowed if no ExternalReference is specified and if bilateral agreed.		
<b>Dependency</b>	../ExternalReference		

#### Class Specification

##### *ExternalReference*

### 3.3.1.1. CreditNote.OrderReference.DocumentReference.Attachment

<b>Classname</b>	ExternalReference	<b>Alternative term</b>	
<b>Cardinality</b>	0..1	<b>Usage</b>	Yes
<b>Datatype</b>	ExternalReference		
<b>Definition</b>	An attached document, external referred to, referred in the MIME location or embedded.		
<b>Businessrules</b>	Used if no EmbeddedDocumentBinaryObject specified		
<b>Dependency</b>	../EmbeddedDocumentBinaryObject		
<b>See section</b>	G30 3.41		

#### Excluded classes and fields in Attachment (CreditNote.OrderReference.DocumentReference.Attachment)

None

### 3.4. CreditNote.BillingReference

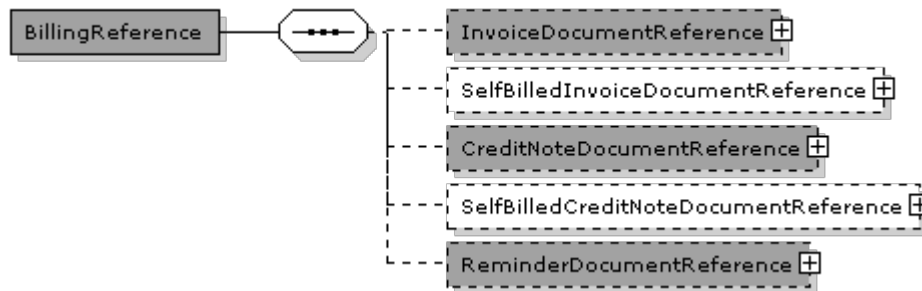

#### BillingReference (CreditNote.BillingReference) specification

<b>Name</b>	CreditNote.BillingReference	<b>Alternative term</b>	
<b>Definition</b>	information directly relating to a related document		

#### Fields

None

#### Subclasses in class BillingReference (CreditNote.BillingReference)

UBL-Name	Name	Usage	Cardinality	Reference
InvoiceDocumentReference	InvoiceDocumentReference	Yes	0..1	3.4.1
SelfBilledInvoiceDocumentReference	SelfBilledInvoiceDocumentReference	Bilateral	0..1	3.4.2
CreditNoteDocumentReference	CreditNoteDocumentReference	Yes	0..1	3.4.3
SelfBilledCreditNoteDocumentReference	SelfBilledCreditNoteDocumentReference	Bilateral	0..1	3.4.4
ReminderDocumentReference	ReminderDocumentReference	Yes	0..1	3.4.5

#### Class Specification

##### InvoiceDocumentReference

<b>Classname</b>	InvoiceDocumentReference	<b>Alternative term</b>	
<b>Cardinality</b>	0..1	<b>Usage</b>	Yes
<b>Datatype</b>	DocumentReference		
<b>Definition</b>	Provides a means of associating a Line (optionally) with one or more invoices which are being related		
<b>See section</b>	3.4.1		

##### SelfBilledInvoiceDocumentReference

<b>Classname</b>	SelfBilledInvoiceDocumentReference	<b>Alternative term</b>	
<b>Cardinality</b>	0..1	<b>Usage</b>	Bilateral
<b>Datatype</b>	DocumentReference		
<b>Definition</b>	Provides a means of associating a Line (optionally) with one or more self billed invoices which are being related		
<b>See section</b>	3.4.2		

**CreditNoteDocumentReference**

<b>Classname</b>	CreditNoteDocumentReference	<b>Alternative term</b>	
<b>Cardinality</b>	0..1	<b>Usage</b>	Yes
<b>Datatype</b>	DocumentReference		
<b>Definition</b>	Provides a means of associating a Line (optionally) with one or more credit notes		
<b>See section</b>	3.4.3		

**SelfBilledCreditNoteDocumentReference**

<b>Classname</b>	SelfBilledCreditNoteDocumentReference	<b>Alternative term</b>	
<b>Cardinality</b>	0..1	<b>Usage</b>	Bilateral
<b>Datatype</b>	DocumentReference		
<b>Definition</b>	Provides a means of associating a Line (optionally) with one or more self billed credit notes		
<b>See section</b>	3.4.4		

**ReminderDocumentReference**

<b>Classname</b>	ReminderDocumentReference	<b>Alternative term</b>	
<b>Cardinality</b>	0..1	<b>Usage</b>	Yes
<b>Datatype</b>	DocumentReference		
<b>Definition</b>	Provides a means of associating a Line (optionally) with one or more reminders		
<b>See section</b>	3.4.5		

**Excluded classes and fields in BillingReference (CreditNote.BillingReference)**

Name	Name	Type
DebitNoteDocumentReference	DebitNoteDocumentReference	Class
AdditionalDocumentReference	AdditionalDocumentReference	Class
BillingReferenceLine	BillingReferenceLine	Class

### 3.4.1. CreditNote.BillingReference.InvoiceDocumentReference

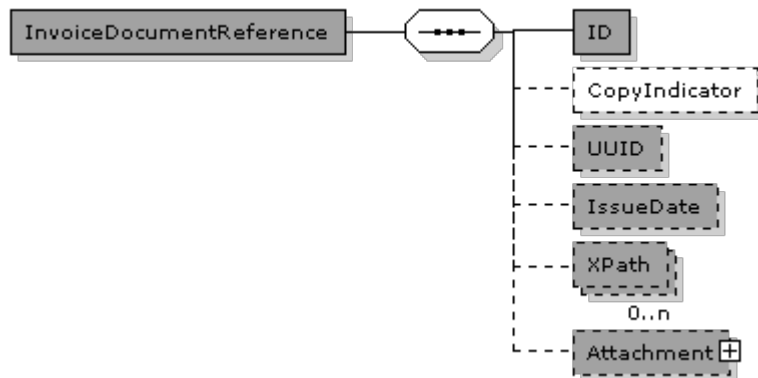

#### InvoiceDocumentReference (CreditNote.BillingReference.InvoiceDocumentReference) specification

<b>Name</b>	CreditNote.BillingReference.InvoiceDocumentReference	<b>Alternative term</b>	OIOUBL_GUIDE_DOCUMENTREF
<b>Definition</b>	Information about a Document referred to in another Document		
<b>See also</b>	OIOUBL_GUIDE_DOCUMENTREF ( OIO )		

#### Fields

UBL-Name	Name	Datatype	Usage	Cardinality
ID	ID	Identifier	Yes	1
CopyIndicator	CopyIndicator	Indicator	Bilateral	0..1
UUID	UUID	Identifier	Yes	0..1
IssueDate	IssueDate	Date	Yes	0..1
XPath	XPath	Text	Yes	0..n

#### Subclasses in class InvoiceDocumentReference (CreditNote.BillingReference.InvoiceDocumentReference)

UBL-Name	Name	Usage	Cardinality	Reference
Attachment	Attachment	Yes	0..1	3.4.1.1

**Field specifications****ID**

<b>Fieldname</b>	ID	<b>Alternative term</b>	
<b>Cardinality</b>	1	<b>Usage</b>	Yes
<b>Datatype</b>	Identifier		
<b>Definition</b>	The identifier for the Document being referred to		
<b>Example</b>	428.34		

**CopyIndicator**

<b>Fieldname</b>	CopyIndicator	<b>Alternative term</b>	
<b>Cardinality</b>	0..1	<b>Usage</b>	Bilateral
<b>Datatype</b>	Indicator		
<b>Definition</b>	Indicates whether the referenced Document is a copy (true) or the original (false)		
<b>Example</b>	false		

**UUID**

<b>Fieldname</b>	UUID	<b>Alternative term</b>	OIOUBL_GUIDE_UUID
<b>Cardinality</b>	0..1	<b>Usage</b>	Yes
<b>Datatype</b>	Identifier		
<b>Definition</b>	A computer-generated universally unique identifier (UUID) for the referenced Document instance		
<b>See also</b>	OIOUBL_GUIDE_UUID ( G32 )		

**IssueDate**

<b>Fieldname</b>	IssueDate	<b>Alternative term</b>	
<b>Cardinality</b>	0..1	<b>Usage</b>	Yes
<b>Datatype</b>	Date		
<b>Definition</b>	The date assigned by the sender of the referenced Document on which the referenced Document was issued		
<b>Example</b>	2006-09-01		

**XPath**

<b>Fieldname</b>	XPath	<b>Alternative term</b>	
<b>Cardinality</b>	0..n	<b>Usage</b>	Yes
<b>Datatype</b>	Text		
<b>Definition</b>	Refers to another part of the same document instance		
<b>Example</b>	/DocumentReference[ID='428.22']		

**Class Specification****Attachment**

<b>Classname</b>	Attachment	<b>Alternative term</b>	
<b>Cardinality</b>	0..1	<b>Usage</b>	Yes
<b>Datatype</b>	Attachment		
<b>Definition</b>	An attached document, external referred to, referred in the MIME location or embedded.		
<b>See section</b>	3.4.1.1		

**Excluded classes and fields in InvoiceDocumentReference (CreditNote.BillingReference.InvoiceDocumentReference)**

Name	Name	Type
DocumentTypeCode	DocumentTypeCode	Field
DocumentType	DocumentType	Field

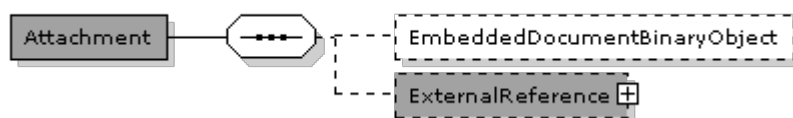

**3.4.1.1.****CreditNote.BillingReference.InvoiceDocumentReference.Attachment****Attachment (CreditNote.BillingReference.InvoiceDocumentReference.Attachment) specification**

<b>Name</b>	CreditNote.BillingReference.InvoiceDocumentReference.Attachment	<b>Alternative term</b>	OIOUBL_GUIDE_ATTACHMENT
<b>Definition</b>	Information about an attached document. An attachment can be referred to externally (with the URI element), internally (with the MIME reference element) or contained within the document itself (with the EmbeddedDocument element).		
<b>See also</b>	OIOUBL_GUIDE_ATTACHMENT ( OIO )		

**Fields**

UBL-Name	Name	Datatype	Usage	Cardinality
EmbeddedDocumentBinaryObject	EmbeddedDocumentBinaryObject	Binary Object	Bilateral	0..1

**Subclasses in class Attachment (CreditNote.BillingReference.InvoiceDocumentReference.Attachment)**

UBL-Name	Name	Usage	Cardinality	Reference
ExternalReference	ExternalReference	Yes	0..1	G30 3.41

**Field specifications****EmbeddedDocumentBinaryObject**

<b>Fieldname</b>	EmbeddedDocumentBinaryObject	<b>Alternative term</b>	
<b>Cardinality</b>	0..1	<b>Usage</b>	Bilateral
<b>Datatype</b>	Binary Object		
<b>Definition</b>	Contains an embedded document as a BLOB.		
<b>Businessrules</b>	Only allowed if no ExternalReference is specified and if bilateral agreed.		
<b>Dependency</b>	../ExternalReference		

**Class Specification**

**ExternalReference**

<b>Classname</b>	ExternalReference	<b>Alternative term</b>	
<b>Cardinality</b>	0..1	<b>Usage</b>	Yes
<b>Datatype</b>	ExternalReference		
<b>Definition</b>	An attached document, external referred to, referred in the MIME location or embedded.		
<b>Businessrules</b>	Used if no EmbeddedDocumentBinaryObject specified		
<b>Dependency</b>	../EmbeddedDocumentBinaryObject		
<b>See section</b>	G30 3.41		

**Excluded classes and fields in Attachment  
(CreditNote.BillingReference.InvoiceDocumentReference.Attachment)**

None

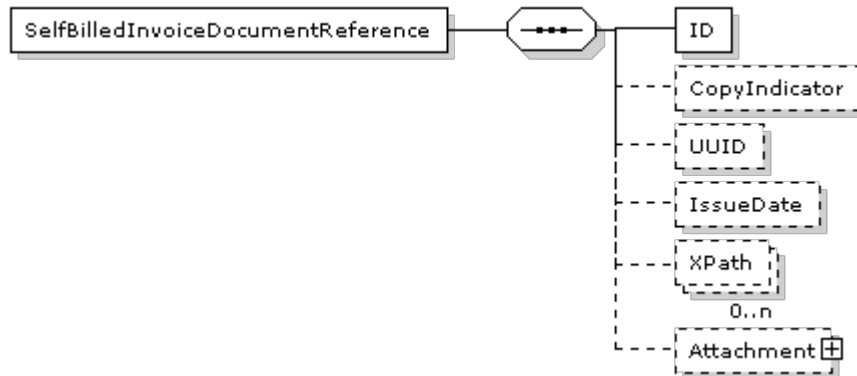
**3.4.2. CreditNote.BillingReference.SelfBilledInvoiceDocumentReference**

**SelfBilledInvoiceDocumentReference**  
**(CreditNote.BillingReference.SelfBilledInvoiceDocumentReference) specification**

<b>Name</b>	CreditNote.BillingReference.SelfBilledInvoiceDocumentReference	<b>Alternative term</b>	OIOUBL_GUIDE_DOCUMENTRENTREF
<b>Definition</b>	Information about a Document referred to in another Document		
<b>See also</b>	OIOUBL_GUIDE_DOCUMENTREF ( OIO )		

**Fields**

UBL-Name	Name	Datatype	Usage	Cardinality
ID	ID	Identifier	Bilateral	1
CopyIndicator	CopyIndicator	Indicator	Bilateral	0..1
UUID	UUID	Identifier	Bilateral	0..1
IssueDate	IssueDate	Date	Bilateral	0..1
XPath	XPath	Text	Bilateral	0..n

**Subclasses in class SelfBilledInvoiceDocumentReference**  
**(CreditNote.BillingReference.SelfBilledInvoiceDocumentReference)**

UBL-Name	Name	Usage	Cardinality	Reference
Attachment	Attachment	Bilateral	0..1	3.4.2.1

**Field specifications****ID**

<b>Fieldname</b>	ID	<b>Alternative term</b>	
<b>Cardinality</b>	1	<b>Usage</b>	Bilateral
<b>Datatype</b>	Identifier		
<b>Definition</b>	The identifier for the Document being referred to		
<b>Example</b>	428.34		

**CopyIndicator**

<b>Fieldname</b>	CopyIndicator	<b>Alternative term</b>	
<b>Cardinality</b>	0..1	<b>Usage</b>	Bilateral
<b>Datatype</b>	Indicator		
<b>Definition</b>	Indicates whether the referenced Document is a copy (true) or the original (false)		
<b>Example</b>	false		

**UUID**

<b>Fieldname</b>	UUID	<b>Alternative term</b>	OIOUBL_GUIDE_UUID
<b>Cardinality</b>	0..1	<b>Usage</b>	Bilateral
<b>Datatype</b>	Identifier		
<b>Definition</b>	A computer-generated universally unique identifier (UUID) for the referenced Document instance		
<b>See also</b>	OIOUBL_GUIDE_UUID ( G32 )		

**IssueDate**

<b>Fieldname</b>	IssueDate	<b>Alternative term</b>	
<b>Cardinality</b>	0..1	<b>Usage</b>	Bilateral
<b>Datatype</b>	Date		
<b>Definition</b>	The date assigned by the sender of the referenced Document on which the referenced Document was issued		
<b>Example</b>	2006-09-01		

**XPath**

<b>Fieldname</b>	XPath	<b>Alternative term</b>	
<b>Cardinality</b>	0..n	<b>Usage</b>	Bilateral
<b>Datatype</b>	Text		
<b>Definition</b>	Refers to another part of the same document instance		
<b>Example</b>	/DocumentReference[ID='428.22']		

**Class Specification****Attachment**

<b>Classname</b>	Attachment	<b>Alternative term</b>	
<b>Cardinality</b>	0..1	<b>Usage</b>	Bilateral
<b>Datatype</b>	Attachment		
<b>Definition</b>	An attached document, external referred to, referred in the MIME location or embedded.		
<b>See section</b>	3.4.2.1		

**Excluded classes and fields in SelfBilledInvoiceDocumentReference (CreditNote.BillingReference.SelfBilledInvoiceDocumentReference)**

Name	Name	Type
DocumentTypeCode	DocumentTypeCode	Field
DocumentType	DocumentType	Field

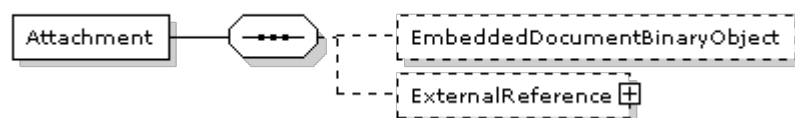
**3.4.2.1.****CreditNote.BillingReference.SelfBilledInvoiceDocumentReference.Attachment****Attachment (CreditNote.BillingReference.SelfBilledInvoiceDocumentReference.Attachment) specification**

<b>Name</b>	CreditNote.BillingReference.SelfBilledInvoiceDocumentReference.Attachment	<b>Alternative term</b>	OIOUBL_GUIDE_ATTACHM ENT
<b>Definition</b>	Information about an attached document. An attachment can be referred to externally (with the URI element), internally (with the MIME reference element) or contained within the document itself (with the EmbeddedDocument element).		
<b>See also</b>	OIOUBL_GUIDE_ATTACHMENT ( OIO )		

**Fields**

UBL-Name	Name	Datatype	Usage	Cardinality
EmbeddedDocumentBinaryObject	EmbeddedDocumentBinaryObject	Binary Object	Bilateral	0..1

**Subclasses in class Attachment****(CreditNote.BillingReference.SelfBilledInvoiceDocumentReference.Attachment)**

UBL-Name	Name	Usage	Cardi nality	Reference
ExternalReference	ExternalReference	Bilateral	0..1	G30 3.41

**Field specifications****EmbeddedDocumentBinaryObject**

<b>Fieldname</b>	EmbeddedDocumentBinaryObject	<b>Alternative term</b>	
<b>Cardinality</b>	0..1	<b>Usage</b>	Bilateral
<b>Datatype</b>	Binary Object		
<b>Definition</b>	Contains an embedded document as a BLOB,		
<b>Businessrules</b>	Only allowed if no ExternalReference is specified and if bilateral agreed.		
<b>Dependency</b>	../ExternalReference		

**Class Specification***ExternalReference*

<b>Classname</b>	ExternalReference	<b>Alternative term</b>	
<b>Cardinality</b>	0..1	<b>Usage</b>	Bilateral
<b>Datatype</b>	ExternalReference		
<b>Definition</b>	An attached document, external referred to, referred in the MIME location or embedded.		
<b>Businessrules</b>	Used if no EmbeddedDocumentBinaryObject specified		
<b>Dependency</b>	../EmbeddedDocumentBinaryObject		
<b>See section</b>	G30 3.41		

**Excluded classes and fields in Attachment  
(CreditNote.BillingReference.SelfBilledInvoiceDocumentReference.Attachment)**

None

### 3.4.3. CreditNote.BillingReference.CreditNoteDocumentReference

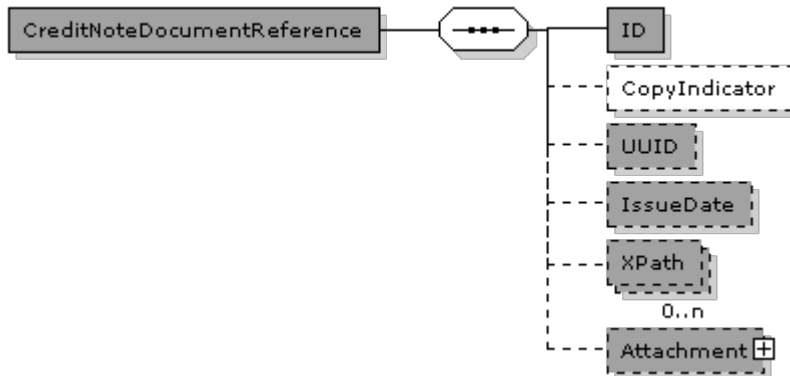

#### CreditNoteDocumentReference (CreditNote.BillingReference.CreditNoteDocumentReference) specification

<b>Name</b>	CreditNote.BillingReference.CreditNoteDocumentReference	<b>Alternative term</b>	OIOUBL_GUIDE_DOCUMENTREF
<b>Definition</b>	Information about a Document referred to in another Document		
<b>See also</b>	OIOUBL_GUIDE_DOCUMENTREF ( OIO )		

#### Fields

UBL-Name	Name	Datatype	Usage	Cardinality
ID	ID	Identifier	Yes	1
CopyIndicator	CopyIndicator	Indicator	Bilateral	0..1
UUID	UUID	Identifier	Yes	0..1
IssueDate	IssueDate	Date	Yes	0..1
XPath	XPath	Text	Yes	0..n

#### Subclasses in class CreditNoteDocumentReference (CreditNote.BillingReference.CreditNoteDocumentReference)

UBL-Name	Name	Usage	Cardinality	Reference
Attachment	Attachment	Yes	0..1	3.4.3.1

**Field specifications****ID**

<b>Fieldname</b>	ID	<b>Alternative term</b>	
<b>Cardinality</b>	1	<b>Usage</b>	Yes
<b>Datatype</b>	Identifier		
<b>Definition</b>	The identifier for the Document being referred to		
<b>Example</b>	428.34		

**CopyIndicator**

<b>Fieldname</b>	CopyIndicator	<b>Alternative term</b>	
<b>Cardinality</b>	0..1	<b>Usage</b>	Bilateral
<b>Datatype</b>	Indicator		
<b>Definition</b>	Indicates whether the referenced Document is a copy (true) or the original (false)		
<b>Example</b>	false		

**UUID**

<b>Fieldname</b>	UUID	<b>Alternative term</b>	OIOUBL_GUIDE_UUID
<b>Cardinality</b>	0..1	<b>Usage</b>	Yes
<b>Datatype</b>	Identifier		
<b>Definition</b>	A computer-generated universally unique identifier (UUID) for the referenced Document instance		
<b>See also</b>	OIOUBL_GUIDE_UUID ( G32 )		

**IssueDate**

<b>Fieldname</b>	IssueDate	<b>Alternative term</b>	
<b>Cardinality</b>	0..1	<b>Usage</b>	Yes
<b>Datatype</b>	Date		
<b>Definition</b>	The date assigned by the sender of the referenced Document on which the referenced Document was issued		
<b>Example</b>	2006-09-01		

**XPath**

<b>Fieldname</b>	XPath	<b>Alternative term</b>	
<b>Cardinality</b>	0..n	<b>Usage</b>	Yes
<b>Datatype</b>	Text		
<b>Definition</b>	Refers to another part of the same document instance		
<b>Example</b>	/DocumentReference[ID='428.22']		

**Class Specification****Attachment**

<b>Classname</b>	Attachment	<b>Alternative term</b>	
<b>Cardinality</b>	0..1	<b>Usage</b>	Yes
<b>Datatype</b>	Attachment		
<b>Definition</b>	An attached document, external referred to, referred in the MIME location or embedded.		
<b>See section</b>	3.4.3.1		

**Excluded classes and fields in CreditNoteDocumentReference (CreditNote.BillingReference.CreditNoteDocumentReference)**

Name	Name	Type
DocumentTypeCode	DocumentTypeCode	Field
DocumentType	DocumentType	Field

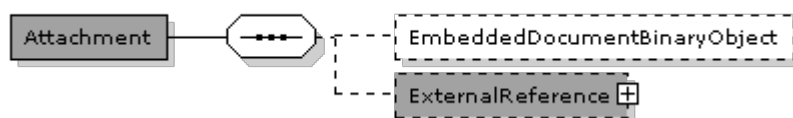

**3.4.3.1.*****CreditNote.BillingReference.CreditNoteDocumentReference.Attachment*****Attachment (CreditNote.BillingReference.CreditNoteDocumentReference.Attachment) specification**

<b>Name</b>	CreditNote.BillingReference.CreditNoteDocumentReference.Attachment	<b>Alternative term</b>	OIOUBL_GUIDE_ATTACHMENT
<b>Definition</b>	Information about an attached document. An attachment can be referred to externally (with the URI element), internally (with the MIME reference element) or contained within the document itself (with the EmbeddedDocument element).		
<b>See also</b>	OIOUBL_GUIDE_ATTACHMENT ( OIO )		

**Fields**

UBL-Name	Name	Datatype	Usage	Cardinality
EmbeddedDocumentBinaryObject	EmbeddedDocumentBinaryObject	Binary Object	Bilateral	0..1

**Subclasses in class Attachment (CreditNote.BillingReference.CreditNoteDocumentReference.Attachment)**

UBL-Name	Name	Usage	Cardinality	Reference
ExternalReference	ExternalReference	Yes	0..1	G30 3.41

**Field specifications*****EmbeddedDocumentBinaryObject***

<b>Fieldname</b>	EmbeddedDocumentBinaryObject	<b>Alternative term</b>	
<b>Cardinality</b>	0..1	<b>Usage</b>	Bilateral
<b>Datatype</b>	Binary Object		
<b>Definition</b>	Contains an embedded document as a BLOB,		
<b>Businessrules</b>	Only allowed if no ExternalReference is specified and if bilateral agreed.		
<b>Dependency</b>	../ExternalReference		

**Class Specification**

**ExternalReference**

<b>Classname</b>	ExternalReference	<b>Alternative term</b>	
<b>Cardinality</b>	0..1	<b>Usage</b>	Yes
<b>Datatype</b>	ExternalReference		
<b>Definition</b>	An attached document, external referred to, referred in the MIME location or embedded.		
<b>Businessrules</b>	Used if no EmbeddedDocumentBinaryObject specified		
<b>Dependency</b>	../EmbeddedDocumentBinaryObject		
<b>See section</b>	G30 3.41		

**Excluded classes and fields in Attachment  
(CreditNote.BillingReference.CreditNoteDocumentReference.Attachment)**

None

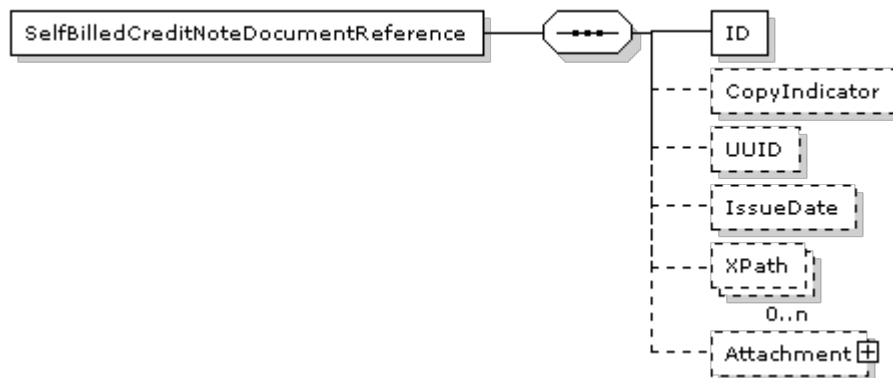
**3.4.4.****CreditNote.BillingReference.SelfBilledCreditNoteDocumentReference**
**SelfBilledCreditNoteDocumentReference  
 (CreditNote.BillingReference.SelfBilledCreditNoteDocumentReference) specification**

<b>Name</b>	CreditNote.BillingReference.SelfBilledCreditNoteDocumentReference	<b>Alternative term</b>	OIOUBL_GUIDE_DOCUMENTREF
<b>Definition</b>	Information about a Document referred to in another Document		
<b>See also</b>	OIOUBL_GUIDE_DOCUMENTREF ( OIO )		

**Fields**

UBL-Name	Name	Datatype	Usage	Cardinality
ID	ID	Identifier	Bilateral	1
CopyIndicator	CopyIndicator	Indicator	Bilateral	0..1
UUID	UUID	Identifier	Bilateral	0..1
IssueDate	IssueDate	Date	Bilateral	0..1
XPath	XPath	Text	Bilateral	0..n

**Subclasses in class SelfBilledCreditNoteDocumentReference  
 (CreditNote.BillingReference.SelfBilledCreditNoteDocumentReference)**

UBL-Name	Name	Usage	Cardinality	Reference
Attachment	Attachment	Bilateral	0..1	3.4.4.1

**Field specifications****ID**

<b>Fieldname</b>	ID	<b>Alternative term</b>	
<b>Cardinality</b>	1	<b>Usage</b>	Bilateral
<b>Datatype</b>	Identifier		
<b>Definition</b>	The identifier for the Document being referred to		
<b>Example</b>	428.34		

**CopyIndicator**

<b>Fieldname</b>	CopyIndicator	<b>Alternative term</b>	
<b>Cardinality</b>	0..1	<b>Usage</b>	Bilateral
<b>Datatype</b>	Indicator		
<b>Definition</b>	Indicates whether the referenced Document is a copy (true) or the original (false)		
<b>Example</b>	false		

**UUID**

<b>Fieldname</b>	UUID	<b>Alternative term</b>	OIOUBL_GUIDE_UUID
<b>Cardinality</b>	0..1	<b>Usage</b>	Bilateral
<b>Datatype</b>	Identifier		
<b>Definition</b>	A computer-generated universally unique identifier (UUID) for the referenced Document instance		
<b>See also</b>	OIOUBL_GUIDE_UUID ( G32 )		

**IssueDate**

<b>Fieldname</b>	IssueDate	<b>Alternative term</b>	
<b>Cardinality</b>	0..1	<b>Usage</b>	Bilateral
<b>Datatype</b>	Date		
<b>Definition</b>	The date assigned by the sender of the referenced Document on which the referenced Document was issued		
<b>Example</b>	2006-09-01		

**XPath**

<b>Fieldname</b>	XPath	<b>Alternative term</b>	
<b>Cardinality</b>	0..n	<b>Usage</b>	Bilateral
<b>Datatype</b>	Text		
<b>Definition</b>	Refers to another part of the same document instance		
<b>Example</b>	/DocumentReference[ID='428.22']		

**Class Specification****Attachment**

<b>Classname</b>	Attachment	<b>Alternative term</b>	
<b>Cardinality</b>	0..1	<b>Usage</b>	Bilateral
<b>Datatype</b>	Attachment		
<b>Definition</b>	An attached document, external referred to, referred in the MIME location or embedded.		
<b>See section</b>	3.4.4.1		

**Excluded classes and fields in SelfBilledCreditNoteDocumentReference (CreditNote.BillingReference.SelfBilledCreditNoteDocumentReference)**

Name	Name	Type
DocumentTypeCode	DocumentTypeCode	Field
DocumentType	DocumentType	Field

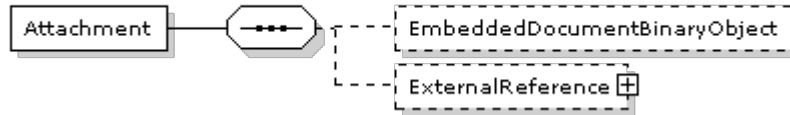
**3.4.4.1.****CreditNote.BillingReference.SelfBilledCreditNoteDocumentReference.Attachment****Attachment****(CreditNote.BillingReference.SelfBilledCreditNoteDocumentReference.Attachment) specification**

<b>Name</b>	CreditNote.BillingReference.SelfBilledCreditNoteDocumentReference.Attachment	<b>Alternative term</b>	OIOUBL_GUIDE_ATTACHM ENT
<b>Definition</b>	Information about an attached document. An attachment can be referred to externally (with the URI element), internally (with the MIME reference element) or contained within the document itself (with the EmbeddedDocument element).		
<b>See also</b>	OIOUBL_GUIDE_ATTACHMENT ( OIO )		

**Fields**

UBL-Name	Name	Datatype	Usage	Cardinality
EmbeddedDocumentBinaryObject	EmbeddedDocumentBinaryObject	Binary Object	Bilateral	0..1

**Subclasses in class Attachment****(CreditNote.BillingReference.SelfBilledCreditNoteDocumentReference.Attachment)**

UBL-Name	Name	Usage	Cardi nality	Reference
ExternalReference	ExternalReference	Bilateral	0..1	G30 3.41

**Field specifications****EmbeddedDocumentBinaryObject**

<b>Fieldname</b>	EmbeddedDocumentBinaryObject	<b>Alternative term</b>	
<b>Cardinality</b>	0..1	<b>Usage</b>	Bilateral
<b>Datatype</b>	Binary Object		
<b>Definition</b>	Contains an embedded document as a BLOB.		
<b>Businessrules</b>	Only allowed if no ExternalReference is specified and if bilateral agreed.		
<b>Dependency</b>	../ExternalReference		

**Class Specification****ExternalReference**

<b>Classname</b>	ExternalReference	<b>Alternative term</b>	
<b>Cardinality</b>	0..1	<b>Usage</b>	Bilateral
<b>Datatype</b>	ExternalReference		
<b>Definition</b>	An attached document, external referred to, referred in the MIME location or embedded.		
<b>Businessrules</b>	Used if no EmbeddedDocumentBinaryObject specified		
<b>Dependency</b>	../EmbeddedDocumentBinaryObject		
<b>See section</b>	G30 3.41		

**Excluded classes and fields in Attachment  
(CreditNote.BillingReference.SelfBilledCreditNoteDocumentReference.Attachment)**

None

### 3.4.5. CreditNote.BillingReference.ReminderDocumentReference

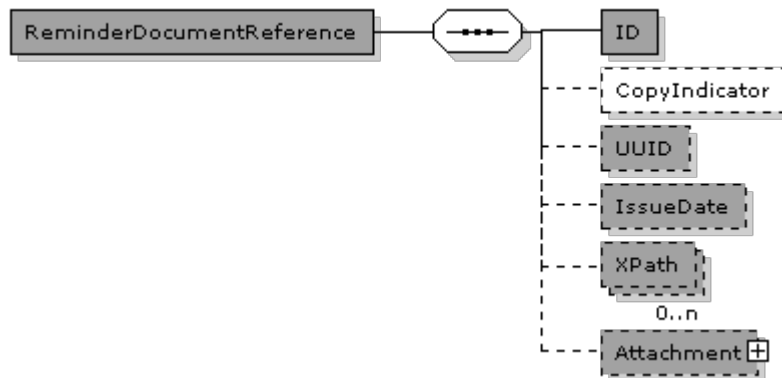

#### ReminderDocumentReference (CreditNote.BillingReference.ReminderDocumentReference) specification

<b>Name</b>	CreditNote.BillingReference.ReminderDocumentReference	<b>Alternative term</b>	OIOUBL_GUIDE_DOCUMENTREF
<b>Definition</b>	Information about a Document referred to in another Document		
<b>See also</b>	OIOUBL_GUIDE_DOCUMENTREF ( OIO )		

#### Fields

UBL-Name	Name	Datatype	Usage	Cardinality
ID	ID	Identifier	Yes	1
CopyIndicator	CopyIndicator	Indicator	Bilateral	0..1
UUID	UUID	Identifier	Yes	0..1
IssueDate	IssueDate	Date	Yes	0..1
XPath	XPath	Text	Yes	0..n

#### Subclasses in class ReminderDocumentReference (CreditNote.BillingReference.ReminderDocumentReference)

UBL-Name	Name	Usage	Cardinality	Reference
Attachment	Attachment	Yes	0..1	3.4.5.1

**Field specifications****ID**

<b>Fieldname</b>	ID	<b>Alternative term</b>	
<b>Cardinality</b>	1	<b>Usage</b>	Yes
<b>Datatype</b>	Identifier		
<b>Definition</b>	The identifier for the Document being referred to		
<b>Example</b>	428.34		

**CopyIndicator**

<b>Fieldname</b>	CopyIndicator	<b>Alternative term</b>	
<b>Cardinality</b>	0..1	<b>Usage</b>	Bilateral
<b>Datatype</b>	Indicator		
<b>Definition</b>	Indicates whether the referenced Document is a copy (true) or the original (false)		
<b>Example</b>	false		

**UUID**

<b>Fieldname</b>	UUID	<b>Alternative term</b>	OIOUBL_GUIDE_UUID
<b>Cardinality</b>	0..1	<b>Usage</b>	Yes
<b>Datatype</b>	Identifier		
<b>Definition</b>	A computer-generated universally unique identifier (UUID) for the referenced Document instance		
<b>See also</b>	OIOUBL_GUIDE_UUID ( G32 )		

**IssueDate**

<b>Fieldname</b>	IssueDate	<b>Alternative term</b>	
<b>Cardinality</b>	0..1	<b>Usage</b>	Yes
<b>Datatype</b>	Date		
<b>Definition</b>	The date assigned by the sender of the referenced Document on which the referenced Document was issued		
<b>Example</b>	2006-09-01		

**XPath**

<b>Fieldname</b>	XPath	<b>Alternative term</b>	
<b>Cardinality</b>	0..n	<b>Usage</b>	Yes
<b>Datatype</b>	Text		
<b>Definition</b>	Refers to another part of the same document instance		
<b>Example</b>	/DocumentReference[ID='428.22']		

**Class Specification****Attachment**

<b>Classname</b>	Attachment	<b>Alternative term</b>	
<b>Cardinality</b>	0..1	<b>Usage</b>	Yes
<b>Datatype</b>	Attachment		
<b>Definition</b>	An attached document, external referred to, referred in the MIME location or embedded.		
<b>See section</b>	3.4.5.1		

**Excluded classes and fields in ReminderDocumentReference  
(CreditNote.BillingReference.ReminderDocumentReference)**

Name	Name	Type
DocumentTypeCode	DocumentTypeCode	Field
DocumentType	DocumentType	Field

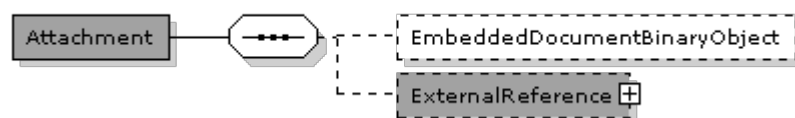

**3.4.5.1.****CreditNote.BillingReference.ReminderDocumentReference.Attachment****Attachment (CreditNote.BillingReference.ReminderDocumentReference.Attachment) specification**

<b>Name</b>	CreditNote.BillingReference.ReminderDocumentReference.Attachment	<b>Alternative term</b>	OIOUBL_GUIDE_ATTACHMENT
<b>Definition</b>	Information about an attached document. An attachment can be referred to externally (with the URI element), internally (with the MIME reference element) or contained within the document itself (with the EmbeddedDocument element).		
<b>See also</b>	OIOUBL_GUIDE_ATTACHMENT ( OIO )		

**Fields**

UBL-Name	Name	Datatype	Usage	Cardinality
EmbeddedDocumentBinaryObject	EmbeddedDocumentBinaryObject	Binary Object	Bilateral	0..1

**Subclasses in class Attachment (CreditNote.BillingReference.ReminderDocumentReference.Attachment)**

UBL-Name	Name	Usage	Cardinality	Reference
ExternalReference	ExternalReference	Yes	0..1	G30 3.41

**Field specifications****EmbeddedDocumentBinaryObject**

<b>Fieldname</b>	EmbeddedDocumentBinaryObject	<b>Alternative term</b>	
<b>Cardinality</b>	0..1	<b>Usage</b>	Bilateral
<b>Datatype</b>	Binary Object		
<b>Definition</b>	Contains an embedded document as a BLOB.		
<b>Businessrules</b>	Only allowed if no ExternalReference is specified and if bilateral agreed.		
<b>Dependency</b>	../ExternalReference		

**Class Specification**

**ExternalReference**

<b>Classname</b>	ExternalReference	<b>Alternative term</b>	
<b>Cardinality</b>	0..1	<b>Usage</b>	Yes
<b>Datatype</b>	ExternalReference		
<b>Definition</b>	An attached document, external referred to, referred in the MIME location or embedded.		
<b>Businessrules</b>	Used if no EmbeddedDocumentBinaryObject specified		
<b>Dependency</b>	../EmbeddedDocumentBinaryObject		
<b>See section</b>	G30 3.41		

**Excluded classes and fields in Attachment  
(CreditNote.BillingReference.ReminderDocumentReference.Attachment)**

None

### 3.5. CreditNote.DespatchDocumentReference

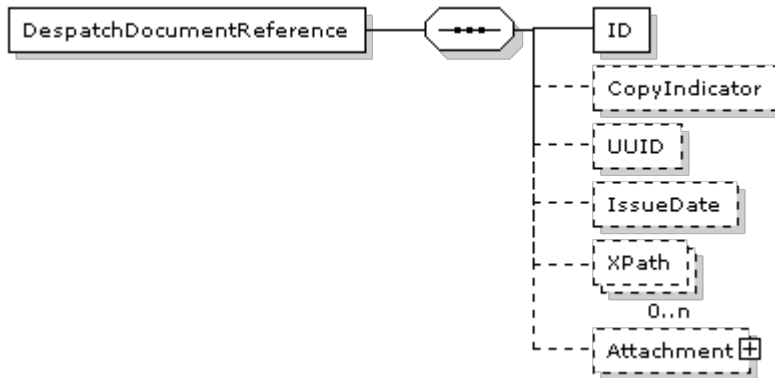

#### DespatchDocumentReference (CreditNote.DespatchDocumentReference) specification

<b>Name</b>	CreditNote.DespatchDocumentReference	<b>Alternative term</b>	OIOUBL_GUIDE_DOCUMENTRENTREF
<b>Definition</b>	Information about a Document referred to in another Document		
<b>See also</b>	OIOUBL_GUIDE_DOCUMENTREF ( OIO )		

#### Fields

UBL-Name	Name	Datatype	Usage	Cardinality
ID	ID	Identifier	Bilateral	1
CopyIndicator	CopyIndicator	Indicator	Bilateral	0..1
UUID	UUID	Identifier	Bilateral	0..1
IssueDate	IssueDate	Date	Bilateral	0..1
XPath	XPath	Text	Bilateral	0..n

#### Subclasses in class DespatchDocumentReference (CreditNote.DespatchDocumentReference)

UBL-Name	Name	Usage	Cardinality	Reference
Attachment	Attachment	Bilateral	0..1	3.5.1

**Field specifications****ID**

<b>Fieldname</b>	ID	<b>Alternative term</b>	
<b>Cardinality</b>	1	<b>Usage</b>	Bilateral
<b>Datatype</b>	Identifier		
<b>Definition</b>	The identifier for the Document being referred to		
<b>Example</b>	428.34		

**CopyIndicator**

<b>Fieldname</b>	CopyIndicator	<b>Alternative term</b>	
<b>Cardinality</b>	0..1	<b>Usage</b>	Bilateral
<b>Datatype</b>	Indicator		
<b>Definition</b>	Indicates whether the referenced Document is a copy (true) or the original (false)		
<b>Example</b>	false		

**UUID**

<b>Fieldname</b>	UUID	<b>Alternative term</b>	OIOUBL_GUIDE_UUID
<b>Cardinality</b>	0..1	<b>Usage</b>	Bilateral
<b>Datatype</b>	Identifier		
<b>Definition</b>	A computer-generated universally unique identifier (UUID) for the referenced Document instance		
<b>See also</b>	OIOUBL_GUIDE_UUID ( G32 )		

**IssueDate**

<b>Fieldname</b>	IssueDate	<b>Alternative term</b>	
<b>Cardinality</b>	0..1	<b>Usage</b>	Bilateral
<b>Datatype</b>	Date		
<b>Definition</b>	The date assigned by the sender of the referenced Document on which the referenced Document was issued		
<b>Example</b>	2006-09-01		

**XPath**

<b>Fieldname</b>	XPath	<b>Alternative term</b>	
<b>Cardinality</b>	0..n	<b>Usage</b>	Bilateral
<b>Datatype</b>	Text		
<b>Definition</b>	Refers to another part of the same document instance		
<b>Example</b>	/DocumentReference[ID='428.22']		

**Class Specification****Attachment**

<b>Classname</b>	Attachment	<b>Alternative term</b>	
<b>Cardinality</b>	0..1	<b>Usage</b>	Bilateral
<b>Datatype</b>	Attachment		
<b>Definition</b>	An attached document, external referred to, referred in the MIME location or embedded.		
<b>See section</b>	3.5.1		

**Excluded classes and fields in DespatchDocumentReference  
(CreditNote.DespatchDocumentReference)**

Name	Name	Type
DocumentTypeCode	DocumentTypeCode	Field
DocumentType	DocumentType	Field

### 3.5.1. CreditNote.DespatchDocumentReference.Attachment

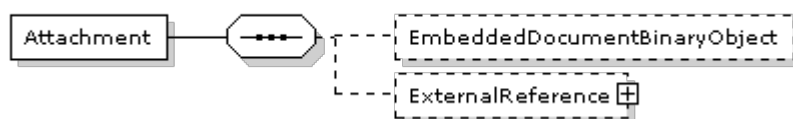

#### Attachment (CreditNote.DespatchDocumentReference.Attachment) specification

<b>Name</b>	CreditNote.DespatchDocumentReference.Attachment	<b>Alternative term</b>	OIOUBL_GUIDE_ATTACHM ENT
<b>Definition</b>	Information about an attached document. An attachment can be referred to externally (with the URI element), internally (with the MIME reference element) or contained within the document itself (with the EmbeddedDocument element).		
<b>See also</b>	OIOUBL_GUIDE_ATTACHMENT ( OIO )		

#### Fields

UBL-Name	Name	Datatype	Usage	Cardinality
EmbeddedDocumentBinaryObject	EmbeddedDocumentBinaryObject	Binary Object	Bilateral	0..1

#### Subclasses in class Attachment (CreditNote.DespatchDocumentReference.Attachment)

UBL-Name	Name	Usage	Cardinality	Reference
ExternalReference	ExternalReference	Bilateral	0..1	G30 3.41

#### Field specifications

##### *EmbeddedDocumentBinaryObject*

<b>Fieldname</b>	EmbeddedDocumentBinaryObject	<b>Alternative term</b>	
<b>Cardinality</b>	0..1	<b>Usage</b>	Bilateral
<b>Datatype</b>	Binary Object		
<b>Definition</b>	Contains an embedded document as a BLOB,		
<b>Businessrules</b>	Only allowed if no ExternalReference is specified and if bilateral agreed.		
<b>Dependency</b>	../ExternalReference		

#### Class Specification

##### *ExternalReference*

### 3.5.1. CreditNote.DespatchDocumentReference.Attachment

<b>Classname</b>	ExternalReference	<b>Alternative term</b>	
<b>Cardinality</b>	0..1	<b>Usage</b>	Bilateral
<b>Datatype</b>	ExternalReference		
<b>Definition</b>	An attached document, external referred to, referred in the MIME location or embedded.		
<b>Businessrules</b>	Used if no EmbeddedDocumentBinaryObject specified		
<b>Dependency</b>	../EmbeddedDocumentBinaryObject		
<b>See section</b>	G30 3.41		

#### Excluded classes and fields in Attachment (CreditNote.DespatchDocumentReference.Attachment)

None

### 3.6. CreditNote.ReceiptDocumentReference

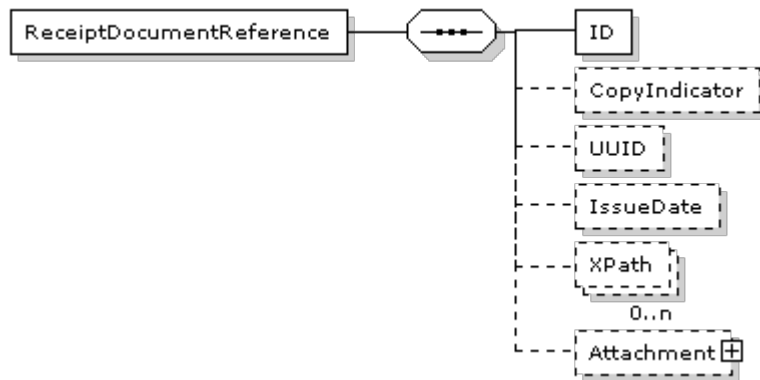

#### ReceiptDocumentReference (CreditNote.ReceiptDocumentReference) specification

<b>Name</b>	CreditNote.ReceiptDocumentReference	<b>Alternative term</b>	OIOUBL_GUIDE_DOCUMENTRENTREF
<b>Definition</b>	Information about a Document referred to in another Document		
<b>See also</b>	OIOUBL_GUIDE_DOCUMENTREF ( OIO )		

#### Fields

UBL-Name	Name	Datatype	Usage	Cardinality
ID	ID	Identifier	Bilateral	1
CopyIndicator	CopyIndicator	Indicator	Bilateral	0..1
UUID	UUID	Identifier	Bilateral	0..1
IssueDate	IssueDate	Date	Bilateral	0..1
XPath	XPath	Text	Bilateral	0..n

#### Subclasses in class ReceiptDocumentReference (CreditNote.ReceiptDocumentReference)

UBL-Name	Name	Usage	Cardinality	Reference
Attachment	Attachment	Bilateral	0..1	3.6.1

**Field specifications****ID**

<b>Fieldname</b>	ID	<b>Alternative term</b>	
<b>Cardinality</b>	1	<b>Usage</b>	Bilateral
<b>Datatype</b>	Identifier		
<b>Definition</b>	The identifier for the Document being referred to		
<b>Example</b>	428.34		

**CopyIndicator**

<b>Fieldname</b>	CopyIndicator	<b>Alternative term</b>	
<b>Cardinality</b>	0..1	<b>Usage</b>	Bilateral
<b>Datatype</b>	Indicator		
<b>Definition</b>	Indicates whether the referenced Document is a copy (true) or the original (false)		
<b>Example</b>	false		

**UUID**

<b>Fieldname</b>	UUID	<b>Alternative term</b>	OIOUBL_GUIDE_UUID
<b>Cardinality</b>	0..1	<b>Usage</b>	Bilateral
<b>Datatype</b>	Identifier		
<b>Definition</b>	A computer-generated universally unique identifier (UUID) for the referenced Document instance		
<b>See also</b>	OIOUBL_GUIDE_UUID ( G32 )		

**IssueDate**

<b>Fieldname</b>	IssueDate	<b>Alternative term</b>	
<b>Cardinality</b>	0..1	<b>Usage</b>	Bilateral
<b>Datatype</b>	Date		
<b>Definition</b>	The date assigned by the sender of the referenced Document on which the referenced Document was issued		
<b>Example</b>	2006-09-01		

**XPath**

<b>Fieldname</b>	XPath	<b>Alternative term</b>	
<b>Cardinality</b>	0..n	<b>Usage</b>	Bilateral
<b>Datatype</b>	Text		
<b>Definition</b>	Refers to another part of the same document instance		
<b>Example</b>	/DocumentReference[ID='428.22']		

**Class Specification****Attachment**

<b>Classname</b>	Attachment	<b>Alternative term</b>	
<b>Cardinality</b>	0..1	<b>Usage</b>	Bilateral
<b>Datatype</b>	Attachment		
<b>Definition</b>	An attached document, external referred to, referred in the MIME location or embedded.		
<b>See section</b>	3.6.1		

**Excluded classes and fields in ReceiptDocumentReference  
(CreditNote.ReceiptDocumentReference)**

Name	Name	Type
DocumentTypeCode	DocumentTypeCode	Field
DocumentType	DocumentType	Field



### 3.6.1. CreditNote.ReceiptDocumentReference.Attachment

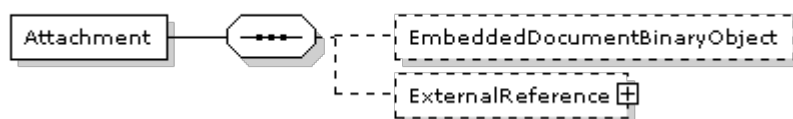

#### Attachment (CreditNote.ReceiptDocumentReference.Attachment) specification

<b>Name</b>	CreditNote.ReceiptDocumentReference.Attachment	<b>Alternative term</b>	OIOUBL_GUIDE_ATTACHMENT
<b>Definition</b>	Information about an attached document. An attachment can be referred to externally (with the URI element), internally (with the MIME reference element) or contained within the document itself (with the EmbeddedDocument element).		
<b>See also</b>	OIOUBL_GUIDE_ATTACHMENT ( OIO )		

#### Fields

UBL-Name	Name	Datatype	Usage	Cardinality
EmbeddedDocumentBinaryObject	EmbeddedDocumentBinaryObject	Binary Object	Bilateral	0..1

#### Subclasses in class Attachment (CreditNote.ReceiptDocumentReference.Attachment)

UBL-Name	Name	Usage	Cardinality	Reference
ExternalReference	ExternalReference	Bilateral	0..1	G30 3.41

#### Field specifications

##### *EmbeddedDocumentBinaryObject*

<b>Fieldname</b>	EmbeddedDocumentBinaryObject	<b>Alternative term</b>	
<b>Cardinality</b>	0..1	<b>Usage</b>	Bilateral
<b>Datatype</b>	Binary Object		
<b>Definition</b>	Contains an embedded document as a BLOB,		
<b>Businessrules</b>	Only allowed if no ExternalReference is specified and if bilateral agreed.		
<b>Dependency</b>	../ExternalReference		

#### Class Specification

##### *ExternalReference*

## 3.6.1. CreditNote.ReceiptDocumentReference.Attachment

<b>Classname</b>	ExternalReference	<b>Alternative term</b>	
<b>Cardinality</b>	0..1	<b>Usage</b>	Bilateral
<b>Datatype</b>	ExternalReference		
<b>Definition</b>	An attached document, external referred to, referred in the MIME location or embedded.		
<b>Businessrules</b>	Used if no EmbeddedDocumentBinaryObject specified		
<b>Dependency</b>	../EmbeddedDocumentBinaryObject		
<b>See section</b>	G30 3.41		

**Excluded classes and fields in Attachment  
(CreditNote.ReceiptDocumentReference.Attachment)**

None

### 3.7. CreditNote.ContractDocumentReference

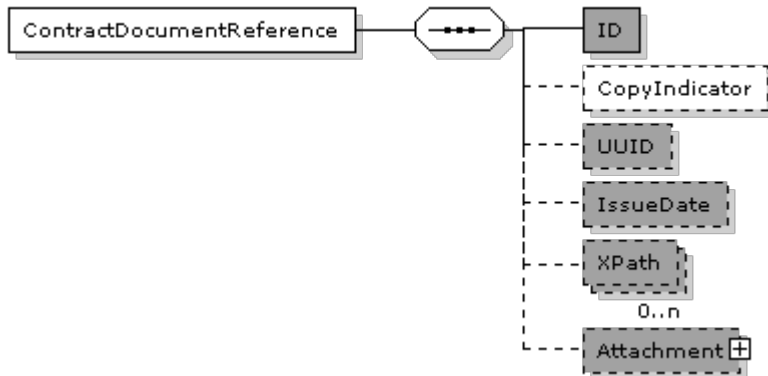

#### ContractDocumentReference (CreditNote.ContractDocumentReference) specification

<b>Name</b>	CreditNote.ContractDocumentReference	<b>Alternative term</b>	OIOUBL_GUIDE_DOCUMENTRENTREF
<b>Definition</b>	Information about a Document referred to in another Document		
<b>See also</b>	OIOUBL_GUIDE_DOCUMENTREF ( OIO )		

#### Fields

UBL-Name	Name	Datatype	Usage	Cardinality
ID	ID	Identifier	Yes	1
CopyIndicator	CopyIndicator	Indicator	Bilateral	0..1
UUID	UUID	Identifier	Yes	0..1
IssueDate	IssueDate	Date	Yes	0..1
XPath	XPath	Text	Yes	0..n

#### Subclasses in class ContractDocumentReference (CreditNote.ContractDocumentReference)

UBL-Name	Name	Usage	Cardinality	Reference
Attachment	Attachment	Yes	0..1	3.7.1

**Field specifications****ID**

<b>Fieldname</b>	ID	<b>Alternative term</b>	
<b>Cardinality</b>	1	<b>Usage</b>	Yes
<b>Datatype</b>	Identifier		
<b>Definition</b>	The identifier for the Document being referred to		
<b>Example</b>	428.34		

**CopyIndicator**

<b>Fieldname</b>	CopyIndicator	<b>Alternative term</b>	
<b>Cardinality</b>	0..1	<b>Usage</b>	Bilateral
<b>Datatype</b>	Indicator		
<b>Definition</b>	Indicates whether the referenced Document is a copy (true) or the original (false)		
<b>Example</b>	false		

**UUID**

<b>Fieldname</b>	UUID	<b>Alternative term</b>	OIOUBL_GUIDE_UUID
<b>Cardinality</b>	0..1	<b>Usage</b>	Yes
<b>Datatype</b>	Identifier		
<b>Definition</b>	A computer-generated universally unique identifier (UUID) for the referenced Document instance		
<b>See also</b>	OIOUBL_GUIDE_UUID ( G32 )		

**IssueDate**

<b>Fieldname</b>	IssueDate	<b>Alternative term</b>	
<b>Cardinality</b>	0..1	<b>Usage</b>	Yes
<b>Datatype</b>	Date		
<b>Definition</b>	The date assigned by the sender of the referenced Document on which the referenced Document was issued		
<b>Example</b>	2006-09-01		

**XPath**

<b>Fieldname</b>	XPath	<b>Alternative term</b>	
<b>Cardinality</b>	0..n	<b>Usage</b>	Yes
<b>Datatype</b>	Text		
<b>Definition</b>	Refers to another part of the same document instance		
<b>Example</b>	/DocumentReference[ID='428.22']		

**Class Specification****Attachment**

<b>Classname</b>	Attachment	<b>Alternative term</b>	
<b>Cardinality</b>	0..1	<b>Usage</b>	Yes
<b>Datatype</b>	Attachment		
<b>Definition</b>	An attached document, external referred to, referred in the MIME location or embedded.		
<b>See section</b>	3.7.1		

**Excluded classes and fields in ContractDocumentReference (CreditNote.ContractDocumentReference)**

Name	Name	Type
DocumentTypeCode	DocumentTypeCode	Field
DocumentType	DocumentType	Field

### 3.7.1. CreditNote.ContractDocumentReference.Attachment

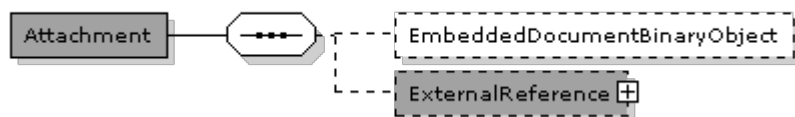

#### Attachment (CreditNote.ContractDocumentReference.Attachment) specification

<b>Name</b>	CreditNote.ContractDocumentReference.Attachment	<b>Alternative term</b>	OIOUBL_GUIDE_ATTACHM ENT
<b>Definition</b>	Information about an attached document. An attachment can be referred to externally (with the URI element), internally (with the MIME reference element) or contained within the document itself (with the EmbeddedDocument element).		
<b>See also</b>	OIOUBL_GUIDE_ATTACHMENT ( OIO )		

#### Fields

UBL-Name	Name	Datatype	Usage	Cardinality
EmbeddedDocumentBinaryObject	EmbeddedDocumentBinaryObject	Binary Object	Bilateral	0..1

#### Subclasses in class Attachment (CreditNote.ContractDocumentReference.Attachment)

UBL-Name	Name	Usage	Cardinality	Reference
ExternalReference	ExternalReference	Yes	0..1	G30 3.41

#### Field specifications

##### *EmbeddedDocumentBinaryObject*

<b>Fieldname</b>	EmbeddedDocumentBinaryObject	<b>Alternative term</b>	
<b>Cardinality</b>	0..1	<b>Usage</b>	Bilateral
<b>Datatype</b>	Binary Object		
<b>Definition</b>	Contains an embedded document as a BLOB,		
<b>Businessrules</b>	Only allowed if no ExternalReference is specified and if bilateral agreed.		
<b>Dependency</b>	../ExternalReference		

#### Class Specification

##### *ExternalReference*

### 3.7.1. CreditNote.ContractDocumentReference.Attachment

<b>Classname</b>	ExternalReference	<b>Alternative term</b>	
<b>Cardinality</b>	0..1	<b>Usage</b>	Yes
<b>Datatype</b>	ExternalReference		
<b>Definition</b>	An attached document, external referred to, referred in the MIME location or embedded.		
<b>Businessrules</b>	Used if no EmbeddedDocumentBinaryObject specified		
<b>Dependency</b>	../EmbeddedDocumentBinaryObject		
<b>See section</b>	G30 3.41		

#### Excluded classes and fields in Attachment (CreditNote.ContractDocumentReference.Attachment)

None

### 3.8. CreditNote.AccountingSupplierParty

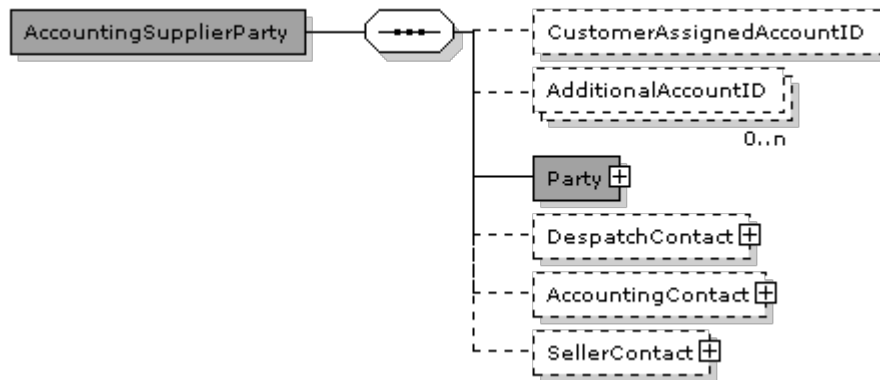

#### AccountingSupplierParty (CreditNote.AccountingSupplierParty) specification

<b>Name</b>	CreditNote.AccountingSupplierParty	<b>Alternative term</b>	
<b>Definition</b>	Information about the Supplier Party		

#### Fields

UBL-Name	Name	Datatype	Usage	Cardinality
CustomerAssignedAccountID	CustomerAssignedAccountID	Identifier	Bilateral	0..1
AdditionalAccountID	AdditionalAccountID	Identifier	Bilateral	0..n

#### Subclasses in class AccountingSupplierParty (CreditNote.AccountingSupplierParty)

UBL-Name	Name	Usage	Cardinality	Reference
Party	Party	Yes	1	3.8.1
DespatchContact	DespatchContact	Bilateral	0..1	G30 3.21
AccountingContact	AccountingContact	Bilateral	0..1	G30 3.21
SellerContact	SellerContact	Bilateral	0..1	G30 3.21

#### Field specifications

##### CustomerAssignedAccountID

<b>Fieldname</b>	CustomerAssignedAccountID	<b>Alternative term</b>	
<b>Cardinality</b>	0..1	<b>Usage</b>	Bilateral
<b>Datatype</b>	Identifier		
<b>Definition</b>	An identifier for the Supplier assigned by the Customer; the Customer's internal reference for the Supplier		

##### AdditionalAccountID

<b>Fieldname</b>	AdditionalAccountID	<b>Alternative term</b>	
<b>Cardinality</b>	0..n	<b>Usage</b>	Bilateral
<b>Datatype</b>	Identifier		
<b>Definition</b>	An identifier for the Supplier assigned by a third party		

**Class Specification****Party**

<b>Classname</b>	Party	<b>Alternative term</b>	
<b>Cardinality</b>	1	<b>Usage</b>	Yes
<b>Datatype</b>	Party		
<b>Definition</b>	An association to Party		
<b>See section</b>	3.8.1		

**DespatchContact**

<b>Classname</b>	DespatchContact	<b>Alternative term</b>	
<b>Cardinality</b>	0..1	<b>Usage</b>	Bilateral
<b>Datatype</b>	Contact		
<b>Definition</b>	An association to Despatch		
<b>See section</b>	G30 3.21		

**AccountingContact**

<b>Classname</b>	AccountingContact	<b>Alternative term</b>	
<b>Cardinality</b>	0..1	<b>Usage</b>	Bilateral
<b>Datatype</b>	Contact		
<b>Definition</b>	An association to the Supplier Accounting Contact		
<b>See section</b>	G30 3.21		

**SellerContact**

<b>Classname</b>	SellerContact	<b>Alternative term</b>	
<b>Cardinality</b>	0..1	<b>Usage</b>	Bilateral
<b>Datatype</b>	Contact		
<b>Definition</b>	An association to the Seller		
<b>See section</b>	G30 3.21		

**Excluded classes and fields in AccountingSupplierParty  
(CreditNote.AccountingSupplierParty)**

Name	Name	Type
DataSendingCapability	DataSendingCapability	Field



### 3.8.1. CreditNote.AccountingSupplierParty.Party

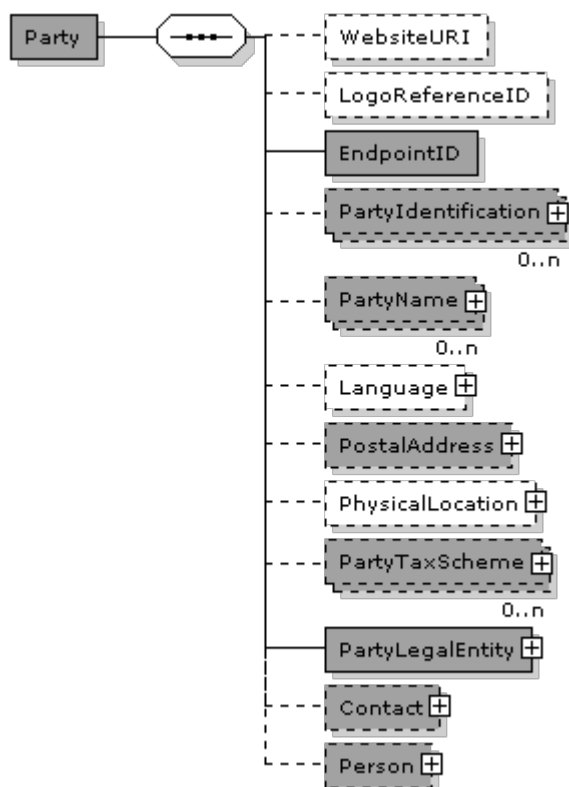

#### Party (CreditNote.AccountingSupplierParty.Party) specification

<b>Name</b>	CreditNote.AccountingSupplierParty.Party	<b>Alternative term</b>	OIOUBL_GUIDE_PARTIES
<b>Definition</b>	Information about an organisation, sub-organisation or individual fulfilling a role in a business process		
<b>See also</b>	OIOUBL_GUIDE_PARTIES ( OIO )		

#### Fields

UBL-Name	Name	Datatype	Usage	Cardinality
WebsiteURI	WebsiteURI	Identifier	Bilateral	0..1
LogoReferenceID	LogoReferenceID	Identifier	Bilateral	0..1
EndpointID	EndpointID	Identifier	Yes	1

**Subclasses in class Party (CreditNote.AccountingSupplierParty.Party)**

UBL-Name	Name	Usage	Cardinality	Reference
PartyIdentification	PartyIdentification	Yes	0..n	G30 3.71
PartyName	PartyName	Yes	0..n	G30 3.73
Language	Language	Bilateral	0..1	G30 3.56
PostalAddress	PostalAddress	Yes	0..1	G30 3.1
PhysicalLocation	PhysicalLocation	Bilateral	0..1	G30 3.30,1
PartyTaxScheme	PartyTaxScheme	Yes	0..n	G30 3.74
PartyLegalEntity	PartyLegalEntity	Yes	1	G30 3.72
Contact	Contact	Yes	0..1	G30 3.21
Person	Person	Yes	0..1	G30 3.79

**Field specifications****WebsiteURI**

Fieldname	WebsiteURI	Alternative term	
Cardinality	0..1	Usage	Bilateral
Datatype	Identifier		
Definition	The Uniform Resource Identifier (URI) of the Party		

**LogoReferenceID**

Fieldname	LogoReferenceID	Alternative term	
Cardinality	0..1	Usage	Bilateral
Datatype	Identifier		
Definition	A Party's logo		

**EndpointID**

Fieldname	EndpointID	Alternative term	OIOUBL_GUIDE_ENDPOINT
Cardinality	1	Usage	Yes
Datatype	Identifier		
Definition	Identifies the end point of the routing service, e.g. EAN Location Number, GLN		
Id schemelist	urn:oiubl:scheme:endpointid-1.1		
See also	OIOUBL_GUIDE_ENDPOINT ( OIO )		

**Class Specification****PartyIdentification**

Classname	PartyIdentification	Alternative term	
Cardinality	0..n	Usage	Yes
Datatype	PartyIdentification		
Definition	An association to Party Identification		
See section	G30 3.71		

**PartyName**

Classname	PartyName	Alternative term	
Cardinality	0..n	Usage	Yes
Datatype	PartyName		
Definition	An association to Party Name. Party Name must be used where no Party Identification is used.		
Businessrules	Mandatory if PartyIdentification.ID not used. Only use more than 1 if multilanguage.		
Recommendation	At Header level PartyName should be supplied		
Dependency	../PartyIdentification		
See section	G30 3.73		

**Language**

## 3.8.1. CreditNote.AccountingSupplierParty.Party

<b>Classname</b>	Language	<b>Alternative term</b>	
<b>Cardinality</b>	0..1	<b>Usage</b>	Bilateral
<b>Datatype</b>	Language		
<b>Definition</b>	An association to Language		
<b>See section</b>	G30 3.56		

**PostalAddress**

<b>Classname</b>	PostalAddress	<b>Alternative term</b>	OIOUBL_GUIDE_ADDRESS
<b>Cardinality</b>	0..1	<b>Usage</b>	Yes
<b>Datatype</b>	Address		
<b>Definition</b>	The Party's postal address		
<b>Recommendation</b>	The Address should be specified on header level and must be of the type StructuredDK.		
<b>See section</b>	G30 3.1		
<b>See also</b>	OIOUBL_GUIDE_ADDRESS ( OIO )		

**PhysicalLocation**

<b>Classname</b>	PhysicalLocation	<b>Alternative term</b>	
<b>Cardinality</b>	0..1	<b>Usage</b>	Bilateral
<b>Datatype</b>	Location		
<b>Definition</b>	The Party's visiting address		
<b>Recommendation</b>	Only if different from PostalAddress		
<b>See section</b>	G30 3.30,1		

**PartyTaxScheme**

<b>Classname</b>	PartyTaxScheme	<b>Alternative term</b>	OIOUBL_GUIDE_TAX
<b>Cardinality</b>	0..n	<b>Usage</b>	Yes
<b>Datatype</b>	PartyTaxScheme		
<b>Definition</b>	An association to Party Tax Scheme		
<b>See section</b>	G30 3.74		
<b>See also</b>	OIOUBL_GUIDE_TAX ( OIO )		

**PartyLegalEntity**

<b>Classname</b>	PartyLegalEntity	<b>Alternative term</b>	OIOUBL_GUIDE_TAX
<b>Cardinality</b>	1	<b>Usage</b>	Yes
<b>Datatype</b>	PartyLegalEntity		
<b>Definition</b>	An association to Party Legal Entity		
<b>See section</b>	G30 3.72		
<b>See also</b>	OIOUBL_GUIDE_TAX ( OIO )		

**Contact**

<b>Classname</b>	Contact	<b>Alternative term</b>	OIOUBL_GUIDE_CONTACT
<b>Cardinality</b>	0..1	<b>Usage</b>	Yes
<b>Datatype</b>	Contact		
<b>Definition</b>	An association to Contact		
<b>See section</b>	G30 3.21		
<b>See also</b>	OIOUBL_GUIDE_CONTACT ( G23 )		

**Person**

<b>Classname</b>	Person	<b>Alternative term</b>	
<b>Cardinality</b>	0..1	<b>Usage</b>	Yes
<b>Datatype</b>	Person		
<b>Definition</b>	An association to a Person.		
<b>See section</b>	G30 3.79		

**Excluded classes and fields in Party (CreditNote.AccountingSupplierParty.Party)**

Name	Name	Type
MarkCareIndicator	MarkCareIndicator	Field
MarkAttentionIndicator	MarkAttentionIndicator	Field
AgentParty	AgentParty	Class



### 3.9. CreditNote.AccountingCustomerParty

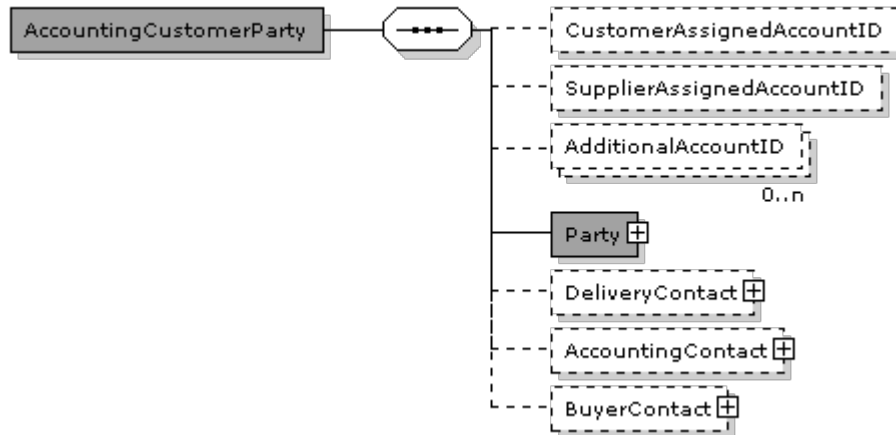

#### AccountingCustomerParty (CreditNote.AccountingCustomerParty) specification

<b>Name</b>	CreditNote.AccountingCustomerParty	<b>Alternative term</b>	
<b>Definition</b>	Information about the Customer Party		

#### Fields

UBL-Name	Name	Datatype	Usage	Cardinality
CustomerAssignedAccountID	CustomerAssignedAccountID	Identifier	Bilateral	0..1
SupplierAssignedAccountID	SupplierAssignedAccountID	Identifier	Bilateral	0..1
AdditionalAccountID	AdditionalAccountID	Identifier	Bilateral	0..n

#### Subclasses in class AccountingCustomerParty (CreditNote.AccountingCustomerParty)

UBL-Name	Name	Usage	Cardinality	Reference
Party	Party	Yes	1	3.9.1
DeliveryContact	DeliveryContact	Bilateral	0..1	G30 3.29
AccountingContact	AccountingContact	Bilateral	0..1	
BuyerContact	BuyerContact	Bilateral	0..1	

**Field specifications****CustomerAssignedAccountID**

<b>Fieldname</b>	CustomerAssignedAccountID	<b>Alternative term</b>	
<b>Cardinality</b>	0..1	<b>Usage</b>	Bilateral
<b>Datatype</b>	Identifier		
<b>Definition</b>	An identifier referring to an account for the Customer assigned by the Customer itself		

**SupplierAssignedAccountID**

<b>Fieldname</b>	SupplierAssignedAccountID	<b>Alternative term</b>	
<b>Cardinality</b>	0..1	<b>Usage</b>	Bilateral
<b>Datatype</b>	Identifier		
<b>Definition</b>	An identifier referring to an account for the Customer assigned by the Supplier		

**AdditionalAccountID**

<b>Fieldname</b>	AdditionalAccountID	<b>Alternative term</b>	
<b>Cardinality</b>	0..n	<b>Usage</b>	Bilateral
<b>Datatype</b>	Identifier		
<b>Definition</b>	An identifier referring to an account for the Customer assigned by a third party		

**Class Specification****Party**

<b>Classname</b>	Party	<b>Alternative term</b>	
<b>Cardinality</b>	1	<b>Usage</b>	Yes
<b>Datatype</b>	Party		
<b>Definition</b>	An association to Party		
<b>See section</b>	3.9.1		

**DeliveryContact**

<b>Classname</b>	DeliveryContact	<b>Alternative term</b>	
<b>Cardinality</b>	0..1	<b>Usage</b>	Bilateral
<b>Datatype</b>	Contact		
<b>Definition</b>	An association to Delivery Contact.		
<b>See section</b>	G30 3.29		

**AccountingContact**

<b>Classname</b>	AccountingContact	<b>Alternative term</b>	
<b>Cardinality</b>	0..1	<b>Usage</b>	Bilateral
<b>Datatype</b>	Contact		
<b>Definition</b>	An association to Customer Accounting Contact.		
<b>See section</b>	G30 3.		

**BuyerContact**

<b>Classname</b>	BuyerContact	<b>Alternative term</b>	
<b>Cardinality</b>	0..1	<b>Usage</b>	Bilateral
<b>Datatype</b>	Contact		
<b>Definition</b>	An association to Buyer Contact.		
<b>See section</b>	G30 3.		

**Excluded classes and fields in AccountingCustomerParty (CreditNote.AccountingCustomerParty)**

None

### 3.9.1. CreditNote.AccountingCustomerParty.Party

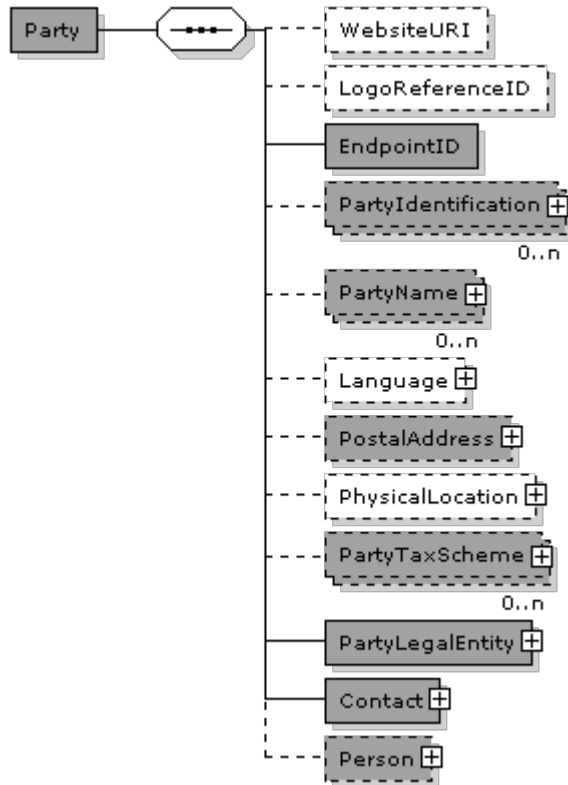

#### Party (CreditNote.AccountingCustomerParty.Party) specification

<b>Name</b>	CreditNote.AccountingCustomerParty.Party	<b>Alternative term</b>	OIOUBL_GUIDE_PARTIES
<b>Definition</b>	Information about an organisation, sub-organisation or individual fulfilling a role in a business process		
<b>See also</b>	OIOUBL_GUIDE_PARTIES ( OIO )		

#### Fields

UBL-Name	Name	Datatype	Usage	Cardinality
WebsiteURI	WebsiteURI	Identifier	Bilateral	0..1
LogoReferenceID	LogoReferenceID	Identifier	Bilateral	0..1
EndpointID	EndpointID	Identifier	Yes	1

**Subclasses in class Party (CreditNote.AccountingCustomerParty.Party)**

UBL-Name	Name	Usage	Cardinality	Reference
PartyIdentification	PartyIdentification	Yes	0..n	G30 3.71
PartyName	PartyName	Yes	0..n	G30 3.73
Language	Language	Bilateral	0..1	G30 3.56
PostalAddress	PostalAddress	Yes	0..1	G30 3.1
PhysicalLocation	PhysicalLocation	Bilateral	0..1	G30 3.30,1
PartyTaxScheme	PartyTaxScheme	Yes	0..n	G30 3.74
PartyLegalEntity	PartyLegalEntity	Yes	1	G30 3.72
Contact	Contact	Yes	1	3.9.1.1
Person	Person	Yes	0..1	G30 3.79

**Field specifications****WebsiteURI**

Fieldname	WebsiteURI	Alternative term	
Cardinality	0..1	Usage	Bilateral
Datatype	Identifier		
Definition	The Uniform Resource Identifier (URI) of the Party		

**LogoReferenceID**

Fieldname	LogoReferenceID	Alternative term	
Cardinality	0..1	Usage	Bilateral
Datatype	Identifier		
Definition	A Party's logo		

**EndpointID**

Fieldname	EndpointID	Alternative term	OIOUBL_GUIDE_ENDPOINT
Cardinality	1	Usage	Yes
Datatype	Identifier		
Definition	Identifies the end point of the routing service, e.g. EAN Location Number, GLN		
Id schemelist	urn:oiubl:scheme:endpointid-1.1		
See also	OIOUBL_GUIDE_ENDPOINT ( OIO )		

**Class Specification****PartyIdentification**

Classname	PartyIdentification	Alternative term	
Cardinality	0..n	Usage	Yes
Datatype	PartyIdentification		
Definition	An association to Party Identification		
See section	G30 3.71		

**PartyName**

Classname	PartyName	Alternative term	
Cardinality	0..n	Usage	Yes
Datatype	PartyName		
Definition	An association to Party Name. Party Name must be used where no Party Identification is used.		
Businessrules	Mandatory if PartyIdentification.ID not used. Only use more than 1 if multilanguage.		
Recommendation	At Header level PartyName should be supplied		
Dependency	../PartyIdentification		
See section	G30 3.73		

**Language**



## 3.9.1. CreditNote.AccountingCustomerParty.Party

<b>Classname</b>	Language	<b>Alternative term</b>	
<b>Cardinality</b>	0..1	<b>Usage</b>	Bilateral
<b>Datatype</b>	Language		
<b>Definition</b>	An association to Language		
<b>See section</b>	G30 3.56		

**PostalAddress**

<b>Classname</b>	PostalAddress	<b>Alternative term</b>	OIOUBL_GUIDE_ADDRESS
<b>Cardinality</b>	0..1	<b>Usage</b>	Yes
<b>Datatype</b>	Address		
<b>Definition</b>	The Party's postal address		
<b>Recommendation</b>	The Address should be specified on header level and must be of the type StructuredDK.		
<b>See section</b>	G30 3.1		
<b>See also</b>	OIOUBL_GUIDE_ADDRESS ( OIO )		

**PhysicalLocation**

<b>Classname</b>	PhysicalLocation	<b>Alternative term</b>	
<b>Cardinality</b>	0..1	<b>Usage</b>	Bilateral
<b>Datatype</b>	Location		
<b>Definition</b>	The Party's visiting address		
<b>Recommendation</b>	Only if different from PostalAddress		
<b>See section</b>	G30 3.30,1		

**PartyTaxScheme**

<b>Classname</b>	PartyTaxScheme	<b>Alternative term</b>	OIOUBL_GUIDE_TAX
<b>Cardinality</b>	0..n	<b>Usage</b>	Yes
<b>Datatype</b>	PartyTaxScheme		
<b>Definition</b>	An association to Party Tax Scheme		
<b>See section</b>	G30 3.74		
<b>See also</b>	OIOUBL_GUIDE_TAX ( OIO )		

**PartyLegalEntity**

<b>Classname</b>	PartyLegalEntity	<b>Alternative term</b>	OIOUBL_GUIDE_TAX
<b>Cardinality</b>	1	<b>Usage</b>	Yes
<b>Datatype</b>	PartyLegalEntity		
<b>Definition</b>	An association to Party Legal Entity		
<b>See section</b>	G30 3.72		
<b>See also</b>	OIOUBL_GUIDE_TAX ( OIO )		

**Contact**

<b>Classname</b>	Contact	<b>Alternative term</b>	OIOUBL_GUIDE_CONTACT
<b>Cardinality</b>	1	<b>Usage</b>	Yes
<b>Datatype</b>	Contact		
<b>Definition</b>	An association to Contact		
<b>See section</b>	3.9.1.1		
<b>See also</b>	OIOUBL_GUIDE_CONTACT ( G23 )		

**Person**

<b>Classname</b>	Person	<b>Alternative term</b>	
<b>Cardinality</b>	0..1	<b>Usage</b>	Yes
<b>Datatype</b>	Person		
<b>Definition</b>	An association to a Person.		
<b>See section</b>	G30 3.79		

**Excluded classes and fields in Party (CreditNote.AccountingCustomerParty.Party)**

Name	Name	Type
MarkCareIndicator	MarkCareIndicator	Field
MarkAttentionIndicator	MarkAttentionIndicator	Field
AgentParty	AgentParty	Class



### 3.9.1.1. CreditNote.AccountingCustomerParty.Party.Contact

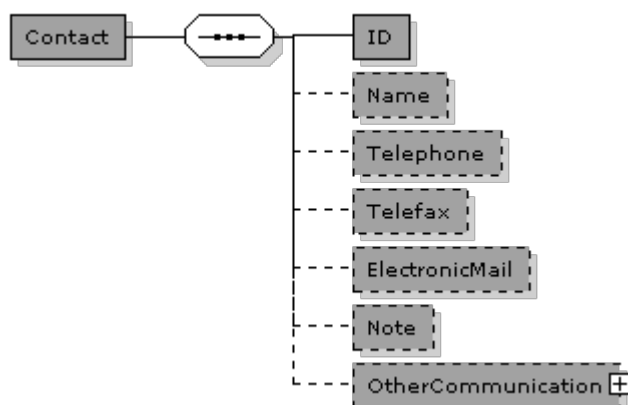

#### Contact (CreditNote.AccountingCustomerParty.Party.Contact) specification

<b>Name</b>	CreditNote.AccountingCustomerParty.Party.Contact	<b>Alternative term</b>	
<b>Definition</b>	Information about a contactable person or organisation department		

#### Fields

UBL-Name	Name	Datatype	Usage	Cardinality
ID	ID	Identifier	Yes	1
Name	Name	Name	Yes	0..1
Telephone	Telephone	Text	Yes	0..1
Telefax	Telefax	Text	Yes	0..1
ElectronicMail	ElectronicMail	Text	Yes	0..1
Note	Note	Text	Yes	0..1

#### Subclasses in class Contact (CreditNote.AccountingCustomerParty.Party.Contact)

UBL-Name	Name	Usage	Cardinality	Reference
OtherCommunication	OtherCommunication	Yes	0..1	G30 3.19

**Field specifications****ID**

<b>Fieldname</b>	ID	<b>Alternative term</b>	
<b>Cardinality</b>	1	<b>Usage</b>	Yes
<b>Datatype</b>	Identifier		
<b>Definition</b>	An identifier for the Contact		
<b>Businessrules</b>	The customer reference to the person initiating the process		

**Name**

<b>Fieldname</b>	Name	<b>Alternative term</b>	
<b>Cardinality</b>	0..1	<b>Usage</b>	Yes
<b>Datatype</b>	Name		
<b>Definition</b>	The name of the Contact		

**Telephone**

<b>Fieldname</b>	Telephone	<b>Alternative term</b>	
<b>Cardinality</b>	0..1	<b>Usage</b>	Yes
<b>Datatype</b>	Text		
<b>Definition</b>	The telephone number of the Contact		

**Telefax**

<b>Fieldname</b>	Telefax	<b>Alternative term</b>	
<b>Cardinality</b>	0..1	<b>Usage</b>	Yes
<b>Datatype</b>	Text		
<b>Definition</b>	The fax number of the Contact		
<b>Example</b>	89113434		

**ElectronicMail**

<b>Fieldname</b>	ElectronicMail	<b>Alternative term</b>	
<b>Cardinality</b>	0..1	<b>Usage</b>	Yes
<b>Datatype</b>	Text		
<b>Definition</b>	The Email address of the Contact		
<b>Example</b>	pa@ubl.dk		

**Note**

<b>Fieldname</b>	Note	<b>Alternative term</b>	
<b>Cardinality</b>	0..1	<b>Usage</b>	Yes
<b>Datatype</b>	Text		
<b>Definition</b>	A note describing the circumstances in which the Contact can be used such as 'Emergency' or 'After Hours'		
<b>Example</b>	Can only be used between 14 and 17		

**Class Specification****OtherCommunication**

<b>Classname</b>	OtherCommunication	<b>Alternative term</b>	
<b>Cardinality</b>	0..1	<b>Usage</b>	Yes
<b>Datatype</b>	Communication		
<b>Definition</b>	An association to Other Communication		
<b>See section</b>	G30 3.19		

**Excluded classes and fields in Contact (CreditNote.AccountingCustomerParty.Party.Contact)**

None

### 3.10. CreditNote.PayeeParty

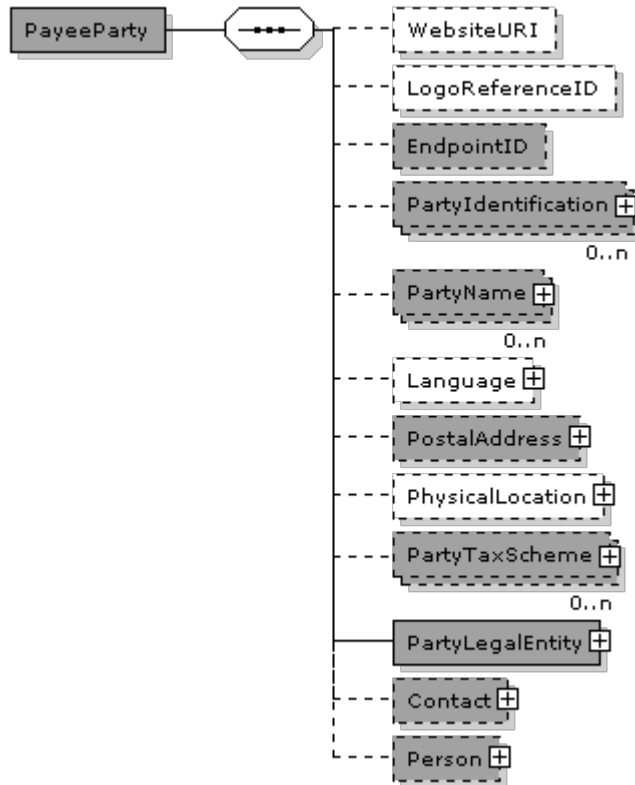

#### PayeeParty (CreditNote.PayeeParty) specification

<b>Name</b>	CreditNote.PayeeParty	<b>Alternative term</b>	
<b>Definition</b>	Information about the Customer Party		

#### Fields

UBL-Name	Name	Datatype	Usage	Cardinality
WebsiteURI	WebsiteURI	Identifier	Bilateral	0..1
LogoReferenceID	LogoReferenceID	Identifier	Bilateral	0..1
EndpointID	EndpointID	Identifier	Yes	0..1

#### Subclasses in class PayeeParty (CreditNote.PayeeParty)

UBL-Name	Name	Usage	Cardinality	Reference
PartyIdentification	PartyIdentification	Yes	0..n	G30 3.71
PartyName	PartyName	Yes	0..n	G30 3.73
Language	Language	Bilateral	0..1	G30 3.56
PostalAddress	PostalAddress	Yes	0..1	G30 3.1
PhysicalLocation	PhysicalLocation	Bilateral	0..1	G30 3.30,1
PartyTaxScheme	PartyTaxScheme	Yes	0..n	G30 3.74
PartyLegalEntity	PartyLegalEntity	Yes	1	G30 3.72
Contact	Contact	Yes	0..1	G30 3.21
Person	Person	Yes	0..1	G30 3.79

## Field specifications

### WebsiteURI

<b>Fieldname</b>	WebsiteURI	<b>Alternative term</b>	
<b>Cardinality</b>	0..1	<b>Usage</b>	Bilateral
<b>Datatype</b>	Identifier		
<b>Definition</b>	The Uniform Resource Identifier (URI) of the Party		

### LogoReferenceID

<b>Fieldname</b>	LogoReferenceID	<b>Alternative term</b>	
<b>Cardinality</b>	0..1	<b>Usage</b>	Bilateral
<b>Datatype</b>	Identifier		
<b>Definition</b>	A Party's logo		

### EndpointID

<b>Fieldname</b>	EndpointID	<b>Alternative term</b>	OIOUBL_GUIDE_ENDPOINT
<b>Cardinality</b>	0..1	<b>Usage</b>	Yes
<b>Datatype</b>	Identifier		
<b>Definition</b>	Identifies the end point of the routing service, e.g. EAN Location Number, GLN		
<b>Id schemelist</b>	urn:oiubl:scheme:endpointid-1.1		
<b>See also</b>	OIOUBL_GUIDE_ENDPOINT ( OIO )		

## Class Specification

### PartyIdentification

<b>Classname</b>	PartyIdentification	<b>Alternative term</b>	
<b>Cardinality</b>	0..n	<b>Usage</b>	Yes
<b>Datatype</b>	PartyIdentification		
<b>Definition</b>	An association to Party Identification		
<b>See section</b>	G30 3.71		

### PartyName

<b>Classname</b>	PartyName	<b>Alternative term</b>	
<b>Cardinality</b>	0..n	<b>Usage</b>	Yes
<b>Datatype</b>	PartyName		
<b>Definition</b>	An association to Party Name. Party Name must be used where no Party Identification is used.		
<b>Businessrules</b>	Mandatory if PartyIdentification.ID not used. Only use more than 1 if multilanguage.		
<b>Recommendation</b>	At Header level PartyName should be supplied		
<b>Dependency</b>	../PartyIdentification		
<b>See section</b>	G30 3.73		

### Language

<b>Classname</b>	Language	<b>Alternative term</b>	
<b>Cardinality</b>	0..1	<b>Usage</b>	Bilateral
<b>Datatype</b>	Language		
<b>Definition</b>	An association to Language		
<b>See section</b>	G30 3.56		

### PostalAddress

<b>Classname</b>	PostalAddress	<b>Alternative term</b>	
<b>Cardinality</b>	0..1	<b>Usage</b>	Yes
<b>Datatype</b>	Address		
<b>Definition</b>	The Party's postal address		
<b>Recommendation</b>	The Address should be specified on header level and must be of the type StructuredDK.		
<b>See section</b>	G30 3.1		

### PhysicalLocation

<b>Classname</b>	PhysicalLocation	<b>Alternative term</b>	
<b>Cardinality</b>	0..1	<b>Usage</b>	Bilateral
<b>Datatype</b>	Location		
<b>Definition</b>	The Party's visiting address		
<b>Recommendation</b>	Only if different from PostalAddress		
<b>See section</b>	G30 3.30,1		

**PartyTaxScheme**

<b>Classname</b>	PartyTaxScheme	<b>Alternative term</b>	OIOUBL_GUIDE_TAX
<b>Cardinality</b>	0..n	<b>Usage</b>	Yes
<b>Datatype</b>	PartyTaxScheme		
<b>Definition</b>	An association to Party Tax Scheme		
<b>See section</b>	G30 3.74		
<b>See also</b>	OIOUBL_GUIDE_TAX ( OIO )		

**PartyLegalEntity**

<b>Classname</b>	PartyLegalEntity	<b>Alternative term</b>	OIOUBL_GUIDE_TAX
<b>Cardinality</b>	1	<b>Usage</b>	Yes
<b>Datatype</b>	PartyLegalEntity		
<b>Definition</b>	An association to Party Legal Entity		
<b>See section</b>	G30 3.72		
<b>See also</b>	OIOUBL_GUIDE_TAX ( OIO )		

**Contact**

<b>Classname</b>	Contact	<b>Alternative term</b>	OIOUBL_GUIDE_CONTACT
<b>Cardinality</b>	0..1	<b>Usage</b>	Yes
<b>Datatype</b>	Contact		
<b>Definition</b>	An association to Contact		
<b>See section</b>	G30 3.21		
<b>See also</b>	OIOUBL_GUIDE_CONTACT ( G23 )		

**Person**

<b>Classname</b>	Person	<b>Alternative term</b>	
<b>Cardinality</b>	0..1	<b>Usage</b>	Yes
<b>Datatype</b>	Person		
<b>Definition</b>	An association to a Person.		
<b>See section</b>	G30 3.79		

**Excluded classes and fields in PayeeParty (CreditNote.PayeeParty)**

Name	Name	Type
MarkCareIndicator	MarkCareIndicator	Field
MarkAttentionIndicator	MarkAttentionIndicator	Field
AgentParty	AgentParty	Class

### 3.11. CreditNote.TaxExchangeRate

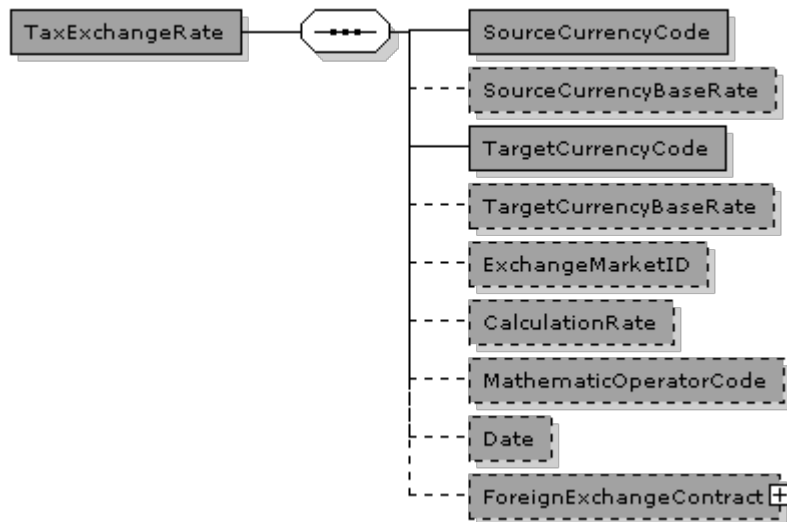

#### TaxExchangeRate (CreditNote.TaxExchangeRate) specification

<b>Name</b>	CreditNote.TaxExchangeRate	<b>Alternative term</b>	OIOUBL_GUIDE_CURRENCY
<b>Definition</b>	Information about Exchange Rate		
<b>See also</b>	OIOUBL_GUIDE_CURRENCY ( OIO )		

#### Fields

UBL-Name	Name	Datatype	Usage	Cardinality
SourceCurrencyCode	SourceCurrencyCode	Code	Yes	1
SourceCurrencyBaseRate	SourceCurrencyBaseRate	Rate	Yes	0..1
TargetCurrencyCode	TargetCurrencyCode	Code	Yes	1
TargetCurrencyBaseRate	TargetCurrencyBaseRate	Rate	Yes	0..1
ExchangeMarketID	ExchangeMarketID	Identifier	Yes	0..1
CalculationRate	CalculationRate	Rate	Yes	0..1
MathematicOperatorCode	MathematicOperatorCode	Code	Yes	0..1
Date	Date	Date	Yes	0..1

#### Subclasses in class TaxExchangeRate (CreditNote.TaxExchangeRate)

UBL-Name	Name	Usage	Cardinality	Reference
ForeignExchangeContract	ForeignExchangeContract	Yes	0..1	3.11.1



## Field specifications

**SourceCurrencyCode**

<b>Fieldname</b>	SourceCurrencyCode	<b>Alternative term</b>	
<b>Cardinality</b>	1	<b>Usage</b>	Yes
<b>Datatype</b>	Code		
<b>Definition</b>	The reference currency for the Exchange Rate; the currency from which the exchange is being made (CC Definition)		
<b>Codelist</b>	urn:un:unece:uncefact:codelist:specification:54217:2001		
<b>Example</b>	DKK		

**SourceCurrencyBaseRate**

<b>Fieldname</b>	SourceCurrencyBaseRate	<b>Alternative term</b>	
<b>Cardinality</b>	0..1	<b>Usage</b>	Yes
<b>Datatype</b>	Rate		
<b>Definition</b>	The unit base of the source currency for currencies with small denominations.		
<b>Businessrules</b>	Only used for minor currencies.		
<b>Example</b>	0.34		

**TargetCurrencyCode**

<b>Fieldname</b>	TargetCurrencyCode	<b>Alternative term</b>	
<b>Cardinality</b>	1	<b>Usage</b>	Yes
<b>Datatype</b>	Code		
<b>Definition</b>	The target currency for the Exchange Rate; the currency to which the exchange is being made (CC Definition)		
<b>Codelist</b>	urn:un:unece:uncefact:codelist:specification:54217:2001		
<b>Example</b>	EUR		

**TargetCurrencyBaseRate**

<b>Fieldname</b>	TargetCurrencyBaseRate	<b>Alternative term</b>	
<b>Cardinality</b>	0..1	<b>Usage</b>	Yes
<b>Datatype</b>	Rate		
<b>Definition</b>	The unit base of the target currency for currencies with small denominations.		
<b>Businessrules</b>	Only used for minor currencies.		
<b>Example</b>	3.21		

**ExchangeMarketID**

<b>Fieldname</b>	ExchangeMarketID	<b>Alternative term</b>	
<b>Cardinality</b>	0..1	<b>Usage</b>	Yes
<b>Datatype</b>	Identifier		
<b>Definition</b>	The identifier for the currency exchange market used as the source of the Exchange Rate		
<b>Example</b>	Danmarks Nationalbank		

**CalculationRate**

<b>Fieldname</b>	CalculationRate	<b>Alternative term</b>	
<b>Cardinality</b>	0..1	<b>Usage</b>	Yes
<b>Datatype</b>	Rate		
<b>Definition</b>	The factor applied to the source currency to calculate the target currency		
<b>Example</b>	0.1300		

**MathematicOperatorCode**

<b>Fieldname</b>	MathematicOperatorCode	<b>Alternative term</b>	
<b>Cardinality</b>	0..1	<b>Usage</b>	Yes
<b>Datatype</b>	Code		
<b>Definition</b>	An identifier for whether the Calculation Rate should be used to multiply or to divide; expressed as a code		
<b>Codelist</b>	urn:oasis:names:specification:ubl:schema:xsd:OperatorCode		
<b>Example</b>	Multiply		

**Date**

<b>Fieldname</b>	Date	<b>Alternative term</b>	
<b>Cardinality</b>	0..1	<b>Usage</b>	Yes
<b>Datatype</b>	Date		
<b>Definition</b>	The date of the Exchange		
<b>Example</b>	39041		

## Class Specification

### *ForeignExchangeContract*

<b>Classname</b>	ForeignExchangeContract	<b>Alternative term</b>	
<b>Cardinality</b>	0..1	<b>Usage</b>	Yes
<b>Datatype</b>	Contract		
<b>Definition</b>	An association to Foreign Exchange Contract		
<b>See section</b>	3.11.1		

## Excluded classes and fields in TaxExchangeRate (CreditNote.TaxExchangeRate)

None

### 3.11.1. CreditNote.TaxExchangeRate.ForeignExchangeContract

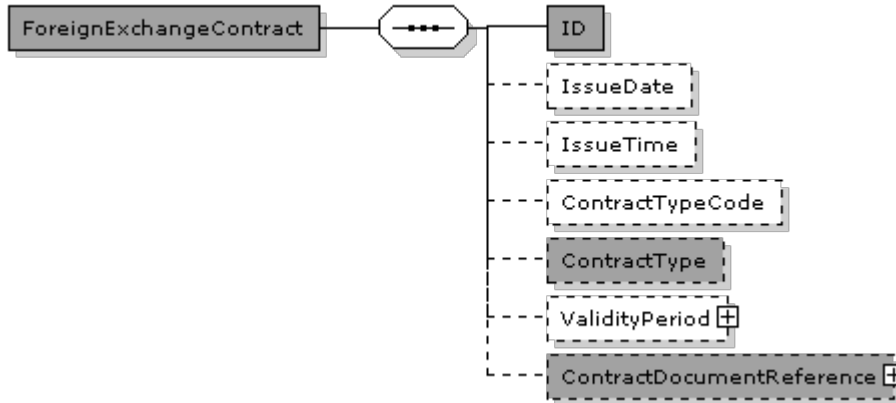

#### ForeignExchangeContract (CreditNote.TaxExchangeRate.ForeignExchangeContract) specification

<b>Name</b>	CreditNote.TaxExchangeRate.ForeignExchangeContract	<b>Alternative term</b>	
<b>Definition</b>	Information about a Contract		

#### Fields

UBL-Name	Name	Datatype	Usage	Cardinality
ID	ID	Identifier	Yes	1
IssueDate	IssueDate	Date	Bilateral	0..1
IssueTime	IssueTime	Time	Bilateral	0..1
ContractTypeCode	ContractTypeCode	Code	Bilateral	0..1
ContractType	ContractType	Text	Yes	0..1

#### Subclasses in class ForeignExchangeContract (CreditNote.TaxExchangeRate.ForeignExchangeContract)

UBL-Name	Name	Usage	Cardinality	Reference
ValidityPeriod	ValidityPeriod	Bilateral	0..1	G30 3.78
ContractDocumentReference	ContractDocumentReference	Yes	0..1	3.11.1.1

**Field specifications****ID**

<b>Fieldname</b>	ID	<b>Alternative term</b>	
<b>Cardinality</b>	1	<b>Usage</b>	Yes
<b>Datatype</b>	Identifier		
<b>Definition</b>	The identifier for the Contract		
<b>Businessrules</b>	An identifier known by relevant parties		
<b>Example</b>	CC23		

**IssueDate**

<b>Fieldname</b>	IssueDate	<b>Alternative term</b>	
<b>Cardinality</b>	0..1	<b>Usage</b>	Bilateral
<b>Datatype</b>	Date		
<b>Definition</b>	The date on which the Contract was issued.		

**IssueTime**

<b>Fieldname</b>	IssueTime	<b>Alternative term</b>	
<b>Cardinality</b>	0..1	<b>Usage</b>	Bilateral
<b>Datatype</b>	Time		
<b>Definition</b>	The time at which the Contract was issued.		

**ContractTypeCode**

<b>Fieldname</b>	ContractTypeCode	<b>Alternative term</b>	
<b>Cardinality</b>	0..1	<b>Usage</b>	Bilateral
<b>Datatype</b>	Code		
<b>Definition</b>	The type of Contract expressed as a code		
<b>Businessrules</b>	A bilateral specified code if applicable		
<b>Example</b>	D1		

**ContractType**

<b>Fieldname</b>	ContractType	<b>Alternative term</b>	
<b>Cardinality</b>	0..1	<b>Usage</b>	Yes
<b>Datatype</b>	Text		
<b>Definition</b>	The type of Contract expressed as text		
<b>Businessrules</b>	Use if no code is applicable.		
<b>Dependency</b>	../ContractTypeCode		
<b>Example</b>	Framework contract		

**Class Specification****ValidityPeriod**

<b>Classname</b>	ValidityPeriod	<b>Alternative term</b>	
<b>Cardinality</b>	0..1	<b>Usage</b>	Bilateral
<b>Datatype</b>	Period		
<b>Definition</b>	An association to Validity Period		
<b>See section</b>	G30 3.78		

**ContractDocumentReference**

<b>Classname</b>	ContractDocumentReference	<b>Alternative term</b>	
<b>Cardinality</b>	0..1	<b>Usage</b>	Yes
<b>Datatype</b>	DocumentReference		
<b>Definition</b>	An association to Contract Document Reference		
<b>See section</b>	3.11.1.1		

**Excluded classes and fields in ForeignExchangeContract (CreditNote.TaxExchangeRate.ForeignExchangeContract)**

None

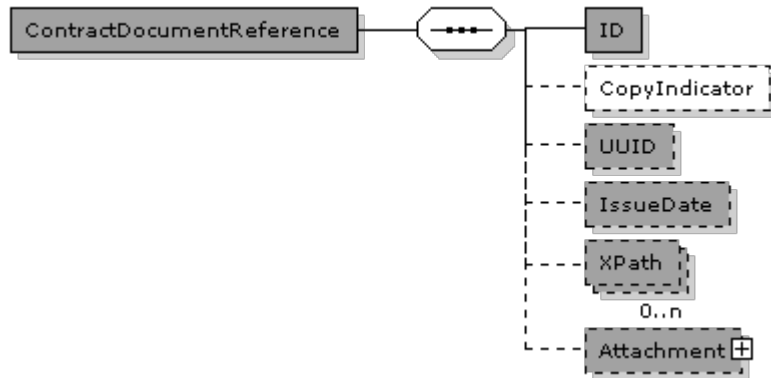

**3.11.1.1.****CreditNote.TaxExchangeRate.ForeignExchangeContract.ContractDocumentReference****ContractDocumentReference****(CreditNote.TaxExchangeRate.ForeignExchangeContract.ContractDocumentReference) specification**

<b>Name</b>	CreditNote.TaxExchangeRate.ForeignExchangeContract.ContractDocumentReference	<b>Alternative term</b>	OIOUBL_GUIDE_DOCUMENTREF
<b>Definition</b>	Information about a Document referred to in another Document		
<b>See also</b>	OIOUBL_GUIDE_DOCUMENTREF ( OIO )		

**Fields**

UBL-Name	Name	Datatype	Usage	Cardinality
ID	ID	Identifier	Yes	1
CopyIndicator	CopyIndicator	Indicator	Bilateral	0..1
UUID	UUID	Identifier	Yes	0..1
IssueDate	IssueDate	Date	Yes	0..1
XPath	XPath	Text	Yes	0..n

**Subclasses in class ContractDocumentReference****(CreditNote.TaxExchangeRate.ForeignExchangeContract.ContractDocumentReference)**

UBL-Name	Name	Usage	Cardinality	Reference
Attachment	Attachment	Yes	0..1	3.11.1.1.1

**Field specifications****ID**

<b>Fieldname</b>	ID	<b>Alternative term</b>	
<b>Cardinality</b>	1	<b>Usage</b>	Yes
<b>Datatype</b>	Identifier		
<b>Definition</b>	The identifier for the Document being referred to		
<b>Example</b>	428.34		

**CopyIndicator**

<b>Fieldname</b>	CopyIndicator	<b>Alternative term</b>	
<b>Cardinality</b>	0..1	<b>Usage</b>	Bilateral
<b>Datatype</b>	Indicator		
<b>Definition</b>	Indicates whether the referenced Document is a copy (true) or the original (false)		
<b>Example</b>	false		

**UUID**

<b>Fieldname</b>	UUID	<b>Alternative term</b>	OIOUBL_GUIDE_UUID
<b>Cardinality</b>	0..1	<b>Usage</b>	Yes
<b>Datatype</b>	Identifier		
<b>Definition</b>	A computer-generated universally unique identifier (UUID) for the referenced Document instance		
<b>See also</b>	OIOUBL_GUIDE_UUID ( G32 )		

**IssueDate**

<b>Fieldname</b>	IssueDate	<b>Alternative term</b>	
<b>Cardinality</b>	0..1	<b>Usage</b>	Yes
<b>Datatype</b>	Date		
<b>Definition</b>	The date assigned by the sender of the referenced Document on which the referenced Document was issued		
<b>Example</b>	2006-09-01		

**XPath**

<b>Fieldname</b>	XPath	<b>Alternative term</b>	
<b>Cardinality</b>	0..n	<b>Usage</b>	Yes
<b>Datatype</b>	Text		
<b>Definition</b>	Refers to another part of the same document instance		
<b>Example</b>	/DocumentReference[ID='428.22']		

**Class Specification****Attachment**

<b>Classname</b>	Attachment	<b>Alternative term</b>	
<b>Cardinality</b>	0..1	<b>Usage</b>	Yes
<b>Datatype</b>	Attachment		
<b>Definition</b>	An attached document, external referred to, referred in the MIME location or embedded.		
<b>See section</b>	3.11.1.1.1		

**Excluded classes and fields in ContractDocumentReference (CreditNote.TaxExchangeRate.ForeignExchangeContract.ContractDocumentReference)**

Name	Name	Type
DocumentTypeCode	DocumentTypeCode	Field
DocumentType	DocumentType	Field

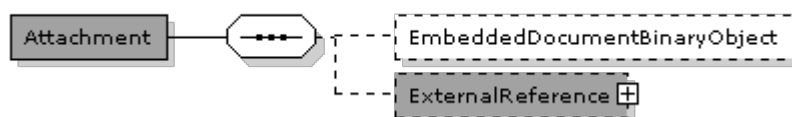
**3.11.1.1.1.****CreditNote.TaxExchangeRate.ForeignExchangeContract.ContractDocumentReference.Attachment****Attachment****(CreditNote.TaxExchangeRate.ForeignExchangeContract.ContractDocumentReference.Attachment) specification**

<b>Name</b>	CreditNote.TaxExchangeRate.ForeignExchangeContract.ContractDocumentReference.Attachment	<b>Alternative term</b>	OIOUBL_GUIDE_ATTACHMENT
<b>Definition</b>	Information about an attached document. An attachment can be referred to externally (with the URI element), internally (with the MIME reference element) or contained within the document itself (with the EmbeddedDocument element).		
<b>See also</b>	OIOUBL_GUIDE_ATTACHMENT ( OIO )		

**Fields**

UBL-Name	Name	Datatype	Usage	Cardinality
EmbeddedDocumentBinaryObject	EmbeddedDocumentBinaryObject	Binary Object	Bilateral	0..1

**Subclasses in class Attachment****(CreditNote.TaxExchangeRate.ForeignExchangeContract.ContractDocumentReference.Attachment)**

UBL-Name	Name	Usage	Cardinality	Reference
ExternalReference	ExternalReference	Yes	0..1	G30 3.41



**Field specifications*****EmbeddedDocumentBinaryObject***

<b>Fieldname</b>	EmbeddedDocumentBinaryObject	<b>Alternative term</b>	
<b>Cardinality</b>	0..1	<b>Usage</b>	Bilateral
<b>Datatype</b>	Binary Object		
<b>Definition</b>	Contains an embedded document as a BLOB.		
<b>Businessrules</b>	Only allowed if no ExternalReference is specified and if bilateral agreed.		
<b>Dependency</b>	../ExternalReference		

**Class Specification*****ExternalReference***

<b>Classname</b>	ExternalReference	<b>Alternative term</b>	
<b>Cardinality</b>	0..1	<b>Usage</b>	Yes
<b>Datatype</b>	ExternalReference		
<b>Definition</b>	An attached document, external referred to, referred in the MIME location or embedded.		
<b>Businessrules</b>	Used if no EmbeddedDocumentBinaryObject specified		
<b>Dependency</b>	../EmbeddedDocumentBinaryObject		
<b>See section</b>	G30 3.41		

**Excluded classes and fields in Attachment**

**(CreditNote.TaxExchangeRate.ForeignExchangeContract.ContractDocumentReference.Attachment)**

None

### 3.12. CreditNote.PricingExchangeRate

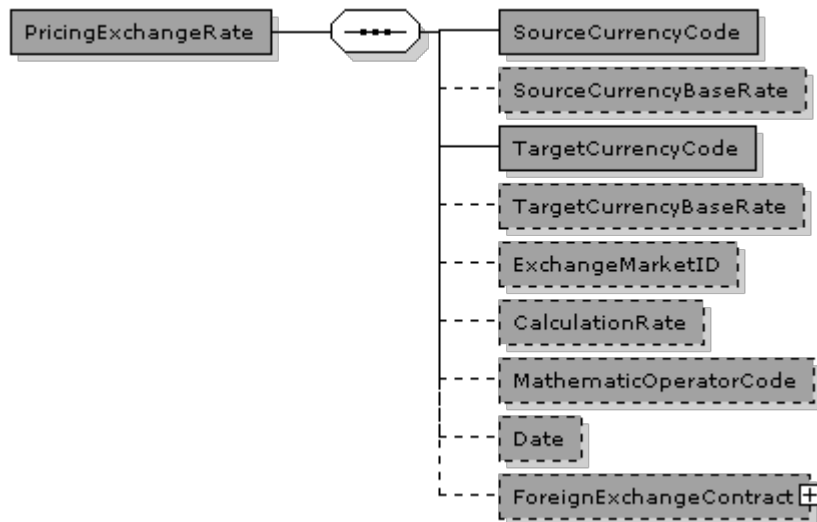

#### PricingExchangeRate (CreditNote.PricingExchangeRate) specification

<b>Name</b>	CreditNote.PricingExchangeRate	<b>Alternative term</b>	OIOUBL_GUIDE_CURRENCY
<b>Definition</b>	Information about Exchange Rate		
<b>See also</b>	OIOUBL_GUIDE_CURRENCY ( OIO )		

#### Fields

UBL-Name	Name	Datatype	Usage	Cardinality
SourceCurrencyCode	SourceCurrencyCode	Code	Yes	1
SourceCurrencyBaseRate	SourceCurrencyBaseRate	Rate	Yes	0..1
TargetCurrencyCode	TargetCurrencyCode	Code	Yes	1
TargetCurrencyBaseRate	TargetCurrencyBaseRate	Rate	Yes	0..1
ExchangeMarketID	ExchangeMarketID	Identifier	Yes	0..1
CalculationRate	CalculationRate	Rate	Yes	0..1
MathematicOperatorCode	MathematicOperatorCode	Code	Yes	0..1
Date	Date	Date	Yes	0..1

#### Subclasses in class PricingExchangeRate (CreditNote.PricingExchangeRate)

UBL-Name	Name	Usage	Cardinality	Reference
ForeignExchangeContract	ForeignExchangeContract	Yes	0..1	3.12.1

## Field specifications

### SourceCurrencyCode

<b>Fieldname</b>	SourceCurrencyCode	<b>Alternative term</b>	
<b>Cardinality</b>	1	<b>Usage</b>	Yes
<b>Datatype</b>	Code		
<b>Definition</b>	The reference currency for the Exchange Rate; the currency from which the exchange is being made (CC Definition)		
<b>Codelist</b>	urn:un:unece:uncefact:codelist:specification:54217:2001		
<b>Example</b>	DKK		

### SourceCurrencyBaseRate

<b>Fieldname</b>	SourceCurrencyBaseRate	<b>Alternative term</b>	
<b>Cardinality</b>	0..1	<b>Usage</b>	Yes
<b>Datatype</b>	Rate		
<b>Definition</b>	The unit base of the source currency for currencies with small denominations.		
<b>Businessrules</b>	Only used for minor currencies.		
<b>Example</b>	0.34		

### TargetCurrencyCode

<b>Fieldname</b>	TargetCurrencyCode	<b>Alternative term</b>	
<b>Cardinality</b>	1	<b>Usage</b>	Yes
<b>Datatype</b>	Code		
<b>Definition</b>	The target currency for the Exchange Rate; the currency to which the exchange is being made (CC Definition)		
<b>Codelist</b>	urn:un:unece:uncefact:codelist:specification:54217:2001		
<b>Example</b>	EUR		

### TargetCurrencyBaseRate

<b>Fieldname</b>	TargetCurrencyBaseRate	<b>Alternative term</b>	
<b>Cardinality</b>	0..1	<b>Usage</b>	Yes
<b>Datatype</b>	Rate		
<b>Definition</b>	The unit base of the target currency for currencies with small denominations.		
<b>Businessrules</b>	Only used for minor currencies.		
<b>Example</b>	3.21		

### ExchangeMarketID

<b>Fieldname</b>	ExchangeMarketID	<b>Alternative term</b>	
<b>Cardinality</b>	0..1	<b>Usage</b>	Yes
<b>Datatype</b>	Identifier		
<b>Definition</b>	The identifier for the currency exchange market used as the source of the Exchange Rate		
<b>Example</b>	Danmarks Nationalbank		

### CalculationRate

<b>Fieldname</b>	CalculationRate	<b>Alternative term</b>	
<b>Cardinality</b>	0..1	<b>Usage</b>	Yes
<b>Datatype</b>	Rate		
<b>Definition</b>	The factor applied to the source currency to calculate the target currency		
<b>Example</b>	0.1300		

### MathematicOperatorCode

<b>Fieldname</b>	MathematicOperatorCode	<b>Alternative term</b>	
<b>Cardinality</b>	0..1	<b>Usage</b>	Yes
<b>Datatype</b>	Code		
<b>Definition</b>	An identifier for whether the Calculation Rate should be used to multiply or to divide; expressed as a code		
<b>Codelist</b>	urn:oasis:names:specification:ubl:schema:xsd:OperatorCode		
<b>Example</b>	Multiply		

### Date

<b>Fieldname</b>	Date	<b>Alternative term</b>	
<b>Cardinality</b>	0..1	<b>Usage</b>	Yes
<b>Datatype</b>	Date		
<b>Definition</b>	The date of the Exchange		
<b>Example</b>	39041		

## Class Specification

### *ForeignExchangeContract*

<b>Classname</b>	ForeignExchangeContract	<b>Alternative term</b>	
<b>Cardinality</b>	0..1	<b>Usage</b>	Yes
<b>Datatype</b>	Contract		
<b>Definition</b>	An association to Foreign Exchange Contract		
<b>See section</b>	3.12.1		

## Excluded classes and fields in PricingExchangeRate (CreditNote.PricingExchangeRate)

None

### 3.12.1. CreditNote.PricingExchangeRate.ForeignExchangeContract

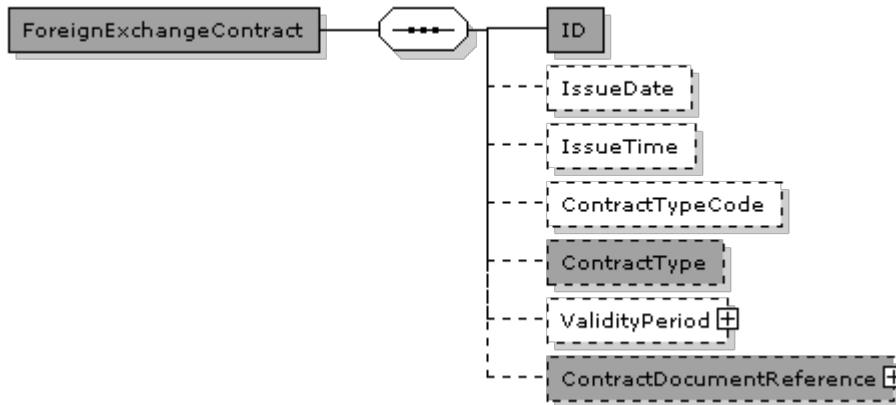

#### ForeignExchangeContract (CreditNote.PricingExchangeRate.ForeignExchangeContract) specification

<b>Name</b>	CreditNote.PricingExchangeRate.ForeignExchangeContract	<b>Alternative term</b>	
<b>Definition</b>	Information about a Contract		

#### Fields

UBL-Name	Name	Datatype	Usage	Cardinality
ID	ID	Identifier	Yes	1
IssueDate	IssueDate	Date	Bilateral	0..1
IssueTime	IssueTime	Time	Bilateral	0..1
ContractTypeCode	ContractTypeCode	Code	Bilateral	0..1
ContractType	ContractType	Text	Yes	0..1

#### Subclasses in class ForeignExchangeContract (CreditNote.PricingExchangeRate.ForeignExchangeContract)

UBL-Name	Name	Usage	Cardinality	Reference
ValidityPeriod	ValidityPeriod	Bilateral	0..1	G30 3.78
ContractDocumentReference	ContractDocumentReference	Yes	0..1	3.12.1.1

**Field specifications****ID**

<b>Fieldname</b>	ID	<b>Alternative term</b>	
<b>Cardinality</b>	1	<b>Usage</b>	Yes
<b>Datatype</b>	Identifier		
<b>Definition</b>	The identifier for the Contract		
<b>Businessrules</b>	An identifier known by relevant parties		
<b>Example</b>	CC23		

**IssueDate**

<b>Fieldname</b>	IssueDate	<b>Alternative term</b>	
<b>Cardinality</b>	0..1	<b>Usage</b>	Bilateral
<b>Datatype</b>	Date		
<b>Definition</b>	The date on which the Contract was issued.		

**IssueTime**

<b>Fieldname</b>	IssueTime	<b>Alternative term</b>	
<b>Cardinality</b>	0..1	<b>Usage</b>	Bilateral
<b>Datatype</b>	Time		
<b>Definition</b>	The time at which the Contract was issued.		

**ContractTypeCode**

<b>Fieldname</b>	ContractTypeCode	<b>Alternative term</b>	
<b>Cardinality</b>	0..1	<b>Usage</b>	Bilateral
<b>Datatype</b>	Code		
<b>Definition</b>	The type of Contract expressed as a code		
<b>Businessrules</b>	A bilateral specified code if applicable		
<b>Example</b>	D1		

**ContractType**

<b>Fieldname</b>	ContractType	<b>Alternative term</b>	
<b>Cardinality</b>	0..1	<b>Usage</b>	Yes
<b>Datatype</b>	Text		
<b>Definition</b>	The type of Contract expressed as text		
<b>Businessrules</b>	Use if no code is applicable.		
<b>Dependency</b>	../ContractTypeCode		
<b>Example</b>	Framework contract		

**Class Specification****ValidityPeriod**

<b>Classname</b>	ValidityPeriod	<b>Alternative term</b>	
<b>Cardinality</b>	0..1	<b>Usage</b>	Bilateral
<b>Datatype</b>	Period		
<b>Definition</b>	An association to Validity Period		
<b>See section</b>	G30 3.78		

**ContractDocumentReference**

<b>Classname</b>	ContractDocumentReference	<b>Alternative term</b>	
<b>Cardinality</b>	0..1	<b>Usage</b>	Yes
<b>Datatype</b>	DocumentReference		
<b>Definition</b>	An association to Contract Document Reference		
<b>See section</b>	3.12.1.1		

**Excluded classes and fields in ForeignExchangeContract (CreditNote.PricingExchangeRate.ForeignExchangeContract)**

None



### 3.12.1.1.

## CreditNote.PricingExchangeRate.ForeignExchangeContract.ContractDocumentReference

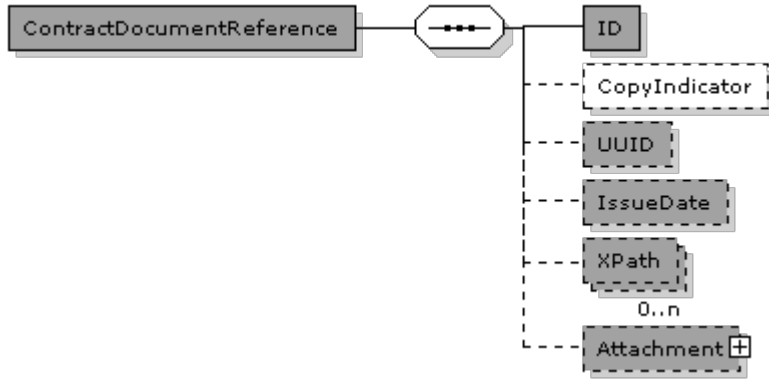

### ContractDocumentReference

#### (CreditNote.PricingExchangeRate.ForeignExchangeContract.ContractDocumentReference) specification

<b>Name</b>	CreditNote.PricingExchangeRate.ForeignExchangeContract.ContractDocumentReference	<b>Alternative term</b>	OIOUBL_GUIDE_DOCUMENTREF
<b>Definition</b>	Information about a Document referred to in another Document		
<b>See also</b>	OIOUBL_GUIDE_DOCUMENTREF ( OIO )		

### Fields

UBL-Name	Name	Datatype	Usage	Cardinality
ID	ID	Identifier	Yes	1
CopyIndicator	CopyIndicator	Indicator	Bilateral	0..1
UUID	UUID	Identifier	Yes	0..1
IssueDate	IssueDate	Date	Yes	0..1
XPath	XPath	Text	Yes	0..n

### Subclasses in class ContractDocumentReference

#### (CreditNote.PricingExchangeRate.ForeignExchangeContract.ContractDocumentReference)

UBL-Name	Name	Usage	Cardinality	Reference
Attachment	Attachment	Yes	0..1	3.12.1.1.1



**Field specifications****ID**

<b>Fieldname</b>	ID	<b>Alternative term</b>	
<b>Cardinality</b>	1	<b>Usage</b>	Yes
<b>Datatype</b>	Identifier		
<b>Definition</b>	The identifier for the Document being referred to		
<b>Example</b>	428.34		

**CopyIndicator**

<b>Fieldname</b>	CopyIndicator	<b>Alternative term</b>	
<b>Cardinality</b>	0..1	<b>Usage</b>	Bilateral
<b>Datatype</b>	Indicator		
<b>Definition</b>	Indicates whether the referenced Document is a copy (true) or the original (false)		
<b>Example</b>	false		

**UUID**

<b>Fieldname</b>	UUID	<b>Alternative term</b>	OIOUBL_GUIDE_UUID
<b>Cardinality</b>	0..1	<b>Usage</b>	Yes
<b>Datatype</b>	Identifier		
<b>Definition</b>	A computer-generated universally unique identifier (UUID) for the referenced Document instance		
<b>See also</b>	OIOUBL_GUIDE_UUID ( G32 )		

**IssueDate**

<b>Fieldname</b>	IssueDate	<b>Alternative term</b>	
<b>Cardinality</b>	0..1	<b>Usage</b>	Yes
<b>Datatype</b>	Date		
<b>Definition</b>	The date assigned by the sender of the referenced Document on which the referenced Document was issued		
<b>Example</b>	2006-09-01		

**XPath**

<b>Fieldname</b>	XPath	<b>Alternative term</b>	
<b>Cardinality</b>	0..n	<b>Usage</b>	Yes
<b>Datatype</b>	Text		
<b>Definition</b>	Refers to another part of the same document instance		
<b>Example</b>	/DocumentReference[ID='428.22']		

**Class Specification****Attachment**

<b>Classname</b>	Attachment	<b>Alternative term</b>	
<b>Cardinality</b>	0..1	<b>Usage</b>	Yes
<b>Datatype</b>	Attachment		
<b>Definition</b>	An attached document, external referred to, referred in the MIME location or embedded.		
<b>See section</b>	3.12.1.1.1		

**Excluded classes and fields in ContractDocumentReference (CreditNote.PricingExchangeRate.ForeignExchangeContract.ContractDocumentReference)**

Name	Name	Type
DocumentTypeCode	DocumentTypeCode	Field
DocumentType	DocumentType	Field

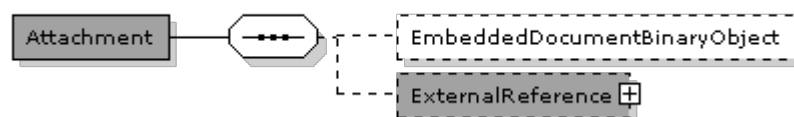
**3.12.1.1.1.*****CreditNote.PricingExchangeRate.ForeignExchangeContract.ContractDocumentReference.Attachment*****Attachment****(CreditNote.PricingExchangeRate.ForeignExchangeContract.ContractDocumentReference.Attachment) specification**

<b>Name</b>	CreditNote.PricingExchangeRate.ForeignExchangeContract.ContractDocumentReference.Attachment	<b>Alternative term</b>	OIOUBL_GUIDE_ATTACHMENT
<b>Definition</b>	Information about an attached document. An attachment can be referred to externally (with the URI element), internally (with the MIME reference element) or contained within the document itself (with the EmbeddedDocument element).		
<b>See also</b>	OIOUBL_GUIDE_ATTACHMENT ( OIO )		

**Fields**

UBL-Name	Name	Datatype	Usage	Cardinality
EmbeddedDocumentBinaryObject	EmbeddedDocumentBinaryObject	Binary Object	Bilateral	0..1

**Subclasses in class Attachment****(CreditNote.PricingExchangeRate.ForeignExchangeContract.ContractDocumentReference.Attachment)**

UBL-Name	Name	Usage	Cardinality	Reference
ExternalReference	ExternalReference	Yes	0..1	G30 3.41

**Field specifications*****EmbeddedDocumentBinaryObject***

<b>Fieldname</b>	EmbeddedDocumentBinaryObject	<b>Alternative term</b>	
<b>Cardinality</b>	0..1	<b>Usage</b>	Bilateral
<b>Datatype</b>	Binary Object		
<b>Definition</b>	Contains an embedded document as a BLOB.		
<b>Businessrules</b>	Only allowed if no ExternalReference is specified and if bilateral agreed.		
<b>Dependency</b>	../ExternalReference		

**Class Specification*****ExternalReference***

<b>Classname</b>	ExternalReference	<b>Alternative term</b>	
<b>Cardinality</b>	0..1	<b>Usage</b>	Yes
<b>Datatype</b>	ExternalReference		
<b>Definition</b>	An attached document, external referred to, referred in the MIME location or embedded.		
<b>Businessrules</b>	Used if no EmbeddedDocumentBinaryObject specified		
<b>Dependency</b>	../EmbeddedDocumentBinaryObject		
<b>See section</b>	G30 3.41		

**Excluded classes and fields in Attachment**

**(CreditNote.PricingExchangeRate.ForeignExchangeContract.ContractDocumentReference.Attachment)**

None

### 3.13. CreditNote.PaymentExchangeRate

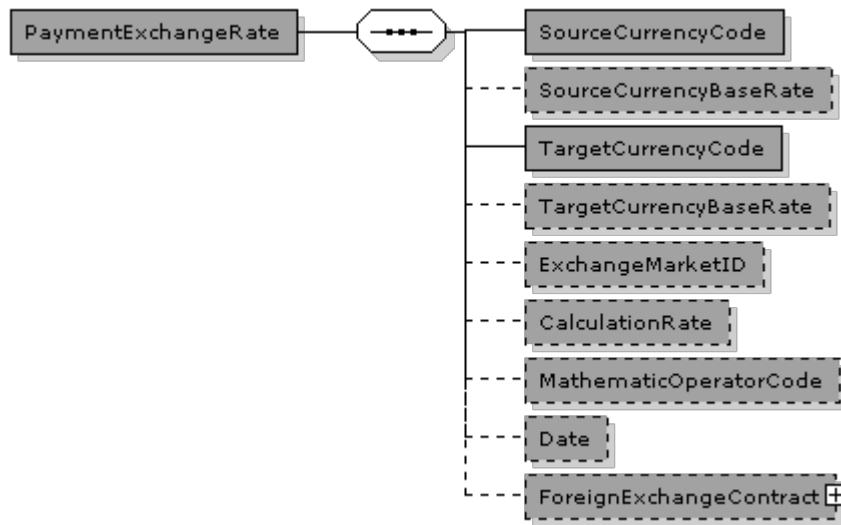

#### PaymentExchangeRate (CreditNote.PaymentExchangeRate) specification

<b>Name</b>	CreditNote.PaymentExchangeRate	<b>Alternative term</b>	OIOUBL_GUIDE_CURRENCY
<b>Definition</b>	Information about Exchange Rate		
<b>See also</b>	OIOUBL_GUIDE_CURRENCY ( OIO )		

#### Fields

UBL-Name	Name	Datatype	Usage	Cardinality
SourceCurrencyCode	SourceCurrencyCode	Code	Yes	1
SourceCurrencyBaseRate	SourceCurrencyBaseRate	Rate	Yes	0..1
TargetCurrencyCode	TargetCurrencyCode	Code	Yes	1
TargetCurrencyBaseRate	TargetCurrencyBaseRate	Rate	Yes	0..1
ExchangeMarketID	ExchangeMarketID	Identifier	Yes	0..1
CalculationRate	CalculationRate	Rate	Yes	0..1
MathematicOperatorCode	MathematicOperatorCode	Code	Yes	0..1
Date	Date	Date	Yes	0..1

#### Subclasses in class PaymentExchangeRate (CreditNote.PaymentExchangeRate)

UBL-Name	Name	Usage	Cardinality	Reference
ForeignExchangeContract	ForeignExchangeContract	Yes	0..1	3.13.1

## Field specifications

**SourceCurrencyCode**

<b>Fieldname</b>	SourceCurrencyCode	<b>Alternative term</b>	
<b>Cardinality</b>	1	<b>Usage</b>	Yes
<b>Datatype</b>	Code		
<b>Definition</b>	The reference currency for the Exchange Rate; the currency from which the exchange is being made (CC Definition)		
<b>Codelist</b>	urn:un:unece:uncefact:codelist:specification:54217:2001		
<b>Example</b>	DKK		

**SourceCurrencyBaseRate**

<b>Fieldname</b>	SourceCurrencyBaseRate	<b>Alternative term</b>	
<b>Cardinality</b>	0..1	<b>Usage</b>	Yes
<b>Datatype</b>	Rate		
<b>Definition</b>	The unit base of the source currency for currencies with small denominations.		
<b>Businessrules</b>	Only used for minor currencies.		
<b>Example</b>	0.34		

**TargetCurrencyCode**

<b>Fieldname</b>	TargetCurrencyCode	<b>Alternative term</b>	
<b>Cardinality</b>	1	<b>Usage</b>	Yes
<b>Datatype</b>	Code		
<b>Definition</b>	The target currency for the Exchange Rate; the currency to which the exchange is being made (CC Definition)		
<b>Codelist</b>	urn:un:unece:uncefact:codelist:specification:54217:2001		
<b>Example</b>	EUR		

**TargetCurrencyBaseRate**

<b>Fieldname</b>	TargetCurrencyBaseRate	<b>Alternative term</b>	
<b>Cardinality</b>	0..1	<b>Usage</b>	Yes
<b>Datatype</b>	Rate		
<b>Definition</b>	The unit base of the target currency for currencies with small denominations.		
<b>Businessrules</b>	Only used for minor currencies.		
<b>Example</b>	3.21		

**ExchangeMarketID**

<b>Fieldname</b>	ExchangeMarketID	<b>Alternative term</b>	
<b>Cardinality</b>	0..1	<b>Usage</b>	Yes
<b>Datatype</b>	Identifier		
<b>Definition</b>	The identifier for the currency exchange market used as the source of the Exchange Rate		
<b>Example</b>	Danmarks Nationalbank		

**CalculationRate**

<b>Fieldname</b>	CalculationRate	<b>Alternative term</b>	
<b>Cardinality</b>	0..1	<b>Usage</b>	Yes
<b>Datatype</b>	Rate		
<b>Definition</b>	The factor applied to the source currency to calculate the target currency		
<b>Example</b>	0.1300		

**MathematicOperatorCode**

<b>Fieldname</b>	MathematicOperatorCode	<b>Alternative term</b>	
<b>Cardinality</b>	0..1	<b>Usage</b>	Yes
<b>Datatype</b>	Code		
<b>Definition</b>	An identifier for whether the Calculation Rate should be used to multiply or to divide; expressed as a code		
<b>Codelist</b>	urn:oasis:names:specification:ubl:schema:xsd:OperatorCode		
<b>Example</b>	Multiply		

**Date**

<b>Fieldname</b>	Date	<b>Alternative term</b>	
<b>Cardinality</b>	0..1	<b>Usage</b>	Yes
<b>Datatype</b>	Date		
<b>Definition</b>	The date of the Exchange		
<b>Example</b>	39041		

### Class Specification

#### *ForeignExchangeContract*

<b>Classname</b>	ForeignExchangeContract	<b>Alternative term</b>	
<b>Cardinality</b>	0..1	<b>Usage</b>	Yes
<b>Datatype</b>	Contract		
<b>Definition</b>	An association to Foreign Exchange Contract		
<b>See section</b>	3.13.1		

### Excluded classes and fields in PaymentExchangeRate (CreditNote.PaymentExchangeRate)

None

### 3.13.1. CreditNote.PaymentExchangeRate.ForeignExchangeContract

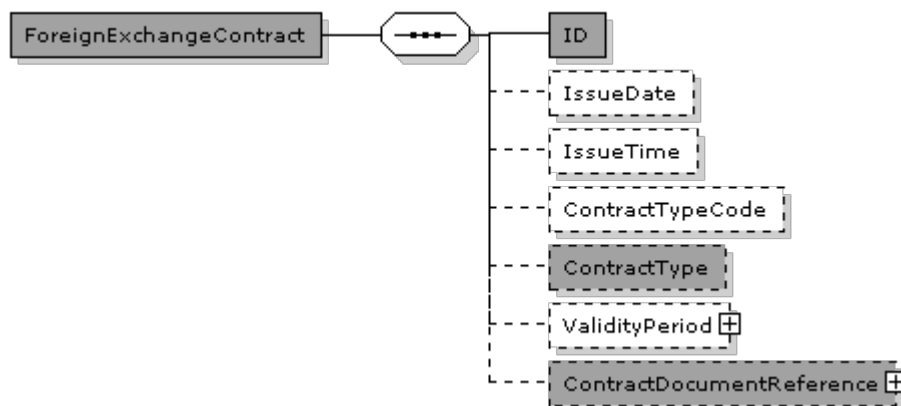

#### ForeignExchangeContract (CreditNote.PaymentExchangeRate.ForeignExchangeContract) specification

<b>Name</b>	CreditNote.PaymentExchangeRate.ForeignExchangeContract	<b>Alternative term</b>	
<b>Definition</b>	Information about a Contract		

#### Fields

UBL-Name	Name	Datatype	Usage	Cardinality
ID	ID	Identifier	Yes	1
IssueDate	IssueDate	Date	Bilateral	0..1
IssueTime	IssueTime	Time	Bilateral	0..1
ContractTypeCode	ContractTypeCode	Code	Bilateral	0..1
ContractType	ContractType	Text	Yes	0..1

#### Subclasses in class ForeignExchangeContract (CreditNote.PaymentExchangeRate.ForeignExchangeContract)

UBL-Name	Name	Usage	Cardinality	Reference
ValidityPeriod	ValidityPeriod	Bilateral	0..1	G30 3.78
ContractDocumentReference	ContractDocumentReference	Yes	0..1	3.13.1.1

**Field specifications****ID**

<b>Fieldname</b>	ID	<b>Alternative term</b>	
<b>Cardinality</b>	1	<b>Usage</b>	Yes
<b>Datatype</b>	Identifier		
<b>Definition</b>	The identifier for the Contract		
<b>Businessrules</b>	An identifier known by relevant parties		
<b>Example</b>	CC23		

**IssueDate**

<b>Fieldname</b>	IssueDate	<b>Alternative term</b>	
<b>Cardinality</b>	0..1	<b>Usage</b>	Bilateral
<b>Datatype</b>	Date		
<b>Definition</b>	The date on which the Contract was issued.		

**IssueTime**

<b>Fieldname</b>	IssueTime	<b>Alternative term</b>	
<b>Cardinality</b>	0..1	<b>Usage</b>	Bilateral
<b>Datatype</b>	Time		
<b>Definition</b>	The time at which the Contract was issued.		

**ContractTypeCode**

<b>Fieldname</b>	ContractTypeCode	<b>Alternative term</b>	
<b>Cardinality</b>	0..1	<b>Usage</b>	Bilateral
<b>Datatype</b>	Code		
<b>Definition</b>	The type of Contract expressed as a code		
<b>Businessrules</b>	A bilateral specified code if applicable		
<b>Example</b>	D1		

**ContractType**

<b>Fieldname</b>	ContractType	<b>Alternative term</b>	
<b>Cardinality</b>	0..1	<b>Usage</b>	Yes
<b>Datatype</b>	Text		
<b>Definition</b>	The type of Contract expressed as text		
<b>Businessrules</b>	Use if no code is applicable.		
<b>Dependency</b>	../ContractTypeCode		
<b>Example</b>	Framework contract		

**Class Specification****ValidityPeriod**

<b>Classname</b>	ValidityPeriod	<b>Alternative term</b>	
<b>Cardinality</b>	0..1	<b>Usage</b>	Bilateral
<b>Datatype</b>	Period		
<b>Definition</b>	An association to Validity Period		
<b>See section</b>	G30 3.78		

**ContractDocumentReference**

<b>Classname</b>	ContractDocumentReference	<b>Alternative term</b>	
<b>Cardinality</b>	0..1	<b>Usage</b>	Yes
<b>Datatype</b>	DocumentReference		
<b>Definition</b>	An association to Contract Document Reference		
<b>See section</b>	3.13.1.1		

**Excluded classes and fields in ForeignExchangeContract (CreditNote.PaymentExchangeRate.ForeignExchangeContract)**

None





### 3.13.1.1.

## CreditNote.PaymentExchangeRate.ForeignExchangeContract.Contract DocumentReference

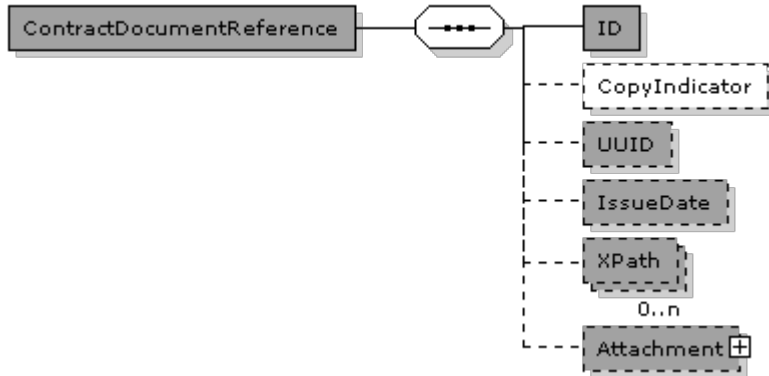

### ContractDocumentReference

#### (CreditNote.PaymentExchangeRate.ForeignExchangeContract.ContractDocumentReference) specification

<b>Name</b>	CreditNote.PaymentExchangeRate.ForeignExchangeContract.ContractDocumentReference	<b>Alternative term</b>	OIOUBL_GUIDE_DOCUMENTREF
<b>Definition</b>	Information about a Document referred to in another Document		
<b>See also</b>	OIOUBL_GUIDE_DOCUMENTREF ( OIO )		

### Fields

UBL-Name	Name	Datatype	Usage	Cardinality
ID	ID	Identifier	Yes	1
CopyIndicator	CopyIndicator	Indicator	Bilateral	0..1
UUID	UUID	Identifier	Yes	0..1
IssueDate	IssueDate	Date	Yes	0..1
XPath	XPath	Text	Yes	0..n

### Subclasses in class ContractDocumentReference

#### (CreditNote.PaymentExchangeRate.ForeignExchangeContract.ContractDocumentReference)

UBL-Name	Name	Usage	Cardinality	Reference
Attachment	Attachment	Yes	0..1	3.13.1.1.1

**Field specifications****ID**

<b>Fieldname</b>	ID	<b>Alternative term</b>	
<b>Cardinality</b>	1	<b>Usage</b>	Yes
<b>Datatype</b>	Identifier		
<b>Definition</b>	The identifier for the Document being referred to		
<b>Example</b>	428.34		

**CopyIndicator**

<b>Fieldname</b>	CopyIndicator	<b>Alternative term</b>	
<b>Cardinality</b>	0..1	<b>Usage</b>	Bilateral
<b>Datatype</b>	Indicator		
<b>Definition</b>	Indicates whether the referenced Document is a copy (true) or the original (false)		
<b>Example</b>	false		

**UUID**

<b>Fieldname</b>	UUID	<b>Alternative term</b>	OIOUBL_GUIDE_UUID
<b>Cardinality</b>	0..1	<b>Usage</b>	Yes
<b>Datatype</b>	Identifier		
<b>Definition</b>	A computer-generated universally unique identifier (UUID) for the referenced Document instance		
<b>See also</b>	OIOUBL_GUIDE_UUID ( G32 )		

**IssueDate**

<b>Fieldname</b>	IssueDate	<b>Alternative term</b>	
<b>Cardinality</b>	0..1	<b>Usage</b>	Yes
<b>Datatype</b>	Date		
<b>Definition</b>	The date assigned by the sender of the referenced Document on which the referenced Document was issued		
<b>Example</b>	2006-09-01		

**XPath**

<b>Fieldname</b>	XPath	<b>Alternative term</b>	
<b>Cardinality</b>	0..n	<b>Usage</b>	Yes
<b>Datatype</b>	Text		
<b>Definition</b>	Refers to another part of the same document instance		
<b>Example</b>	/DocumentReference[ID='428.22']		

**Class Specification****Attachment**

<b>Classname</b>	Attachment	<b>Alternative term</b>	
<b>Cardinality</b>	0..1	<b>Usage</b>	Yes
<b>Datatype</b>	Attachment		
<b>Definition</b>	An attached document, external referred to, referred in the MIME location or embedded.		
<b>See section</b>	3.13.1.1.1		

**Excluded classes and fields in ContractDocumentReference  
(CreditNote.PaymentExchangeRate.ForeignExchangeContract.ContractDocumentReference)**

Name	Name	Type
DocumentTypeCode	DocumentTypeCode	Field
DocumentType	DocumentType	Field

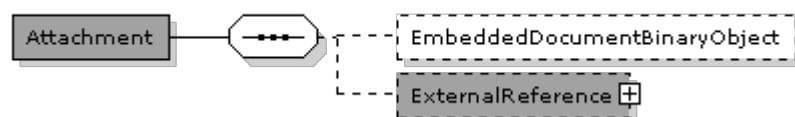
**3.13.1.1.1.****CreditNote.PaymentExchangeRate.ForeignExchangeContract.ContractDocumentReference.Attachment****Attachment****(CreditNote.PaymentExchangeRate.ForeignExchangeContract.ContractDocumentReference.Attachment) specification**

<b>Name</b>	CreditNote.PaymentExchangeRate.ForeignExchangeContract.ContractDocumentReference.Attachment	<b>Alternative term</b>	OIOUBL_GUIDE_ATTACHMENT
<b>Definition</b>	Information about an attached document. An attachment can be referred to externally (with the URI element), internally (with the MIME reference element) or contained within the document itself (with the EmbeddedDocument element).		
<b>See also</b>	OIOUBL_GUIDE_ATTACHMENT ( OIO )		

**Fields**

UBL-Name	Name	Datatype	Usage	Cardinality
EmbeddedDocumentBinaryObject	EmbeddedDocumentBinaryObject	Binary Object	Bilateral	0..1

**Subclasses in class Attachment****(CreditNote.PaymentExchangeRate.ForeignExchangeContract.ContractDocumentReference.Attachment)**

UBL-Name	Name	Usage	Cardinality	Reference
ExternalReference	ExternalReference	Yes	0..1	G30 3.41

**Field specifications*****EmbeddedDocumentBinaryObject***

<b>Fieldname</b>	EmbeddedDocumentBinaryObject	<b>Alternative term</b>	
<b>Cardinality</b>	0..1	<b>Usage</b>	Bilateral
<b>Datatype</b>	Binary Object		
<b>Definition</b>	Contains an embedded document as a BLOB.		
<b>Businessrules</b>	Only allowed if no ExternalReference is specified and if bilateral agreed.		
<b>Dependency</b>	../ExternalReference		

**Class Specification*****ExternalReference***

<b>Classname</b>	ExternalReference	<b>Alternative term</b>	
<b>Cardinality</b>	0..1	<b>Usage</b>	Yes
<b>Datatype</b>	ExternalReference		
<b>Definition</b>	An attached document, external referred to, referred in the MIME location or embedded.		
<b>Businessrules</b>	Used if no EmbeddedDocumentBinaryObject specified		
<b>Dependency</b>	../EmbeddedDocumentBinaryObject		
<b>See section</b>	G30 3.41		

**Excluded classes and fields in Attachment**

**(CreditNote.PaymentExchangeRate.ForeignExchangeContract.ContractDocumentReference.Attachment)**

None

### 3.14. CreditNote.PaymentAlternativeExchangeRate

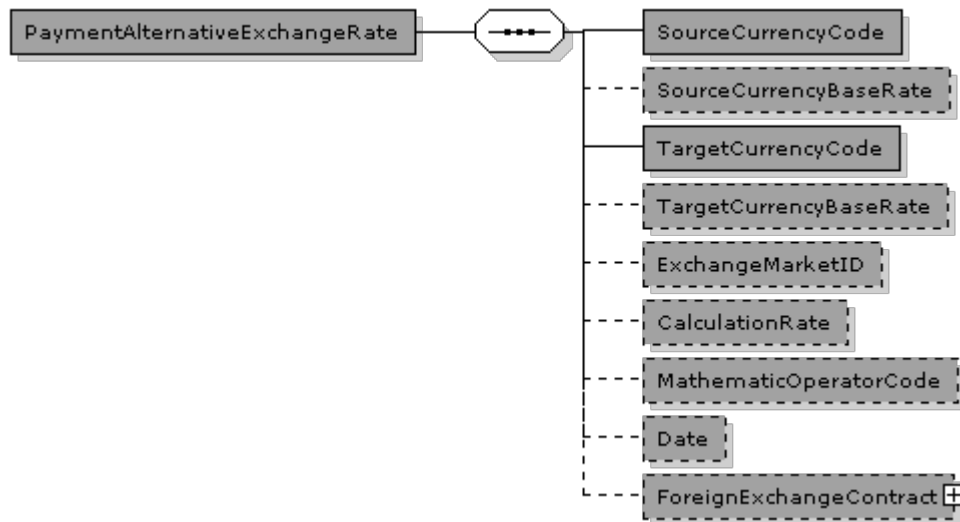

#### PaymentAlternativeExchangeRate (CreditNote.PaymentAlternativeExchangeRate) specification

<b>Name</b>	CreditNote.PaymentAlternativeExchangeRate	<b>Alternative term</b>	OIOUBL_GUIDE_CURRENCY
<b>Definition</b>	Information about Exchange Rate		
<b>See also</b>	OIOUBL_GUIDE_CURRENCY ( OIO )		

#### Fields

UBL-Name	Name	Datatype	Usage	Cardinality
SourceCurrencyCode	SourceCurrencyCode	Code	Yes	1
SourceCurrencyBaseRate	SourceCurrencyBaseRate	Rate	Yes	0..1
TargetCurrencyCode	TargetCurrencyCode	Code	Yes	1
TargetCurrencyBaseRate	TargetCurrencyBaseRate	Rate	Yes	0..1
ExchangeMarketID	ExchangeMarketID	Identifier	Yes	0..1
CalculationRate	CalculationRate	Rate	Yes	0..1
MathematicOperatorCode	MathematicOperatorCode	Code	Yes	0..1
Date	Date	Date	Yes	0..1

#### Subclasses in class PaymentAlternativeExchangeRate (CreditNote.PaymentAlternativeExchangeRate)

UBL-Name	Name	Usage	Cardinality	Reference
ForeignExchangeContract	ForeignExchangeContract	Yes	0..1	3.14.1

## Field specifications

**SourceCurrencyCode**

<b>Fieldname</b>	SourceCurrencyCode	<b>Alternative term</b>	
<b>Cardinality</b>	1	<b>Usage</b>	Yes
<b>Datatype</b>	Code		
<b>Definition</b>	The reference currency for the Exchange Rate; the currency from which the exchange is being made (CC Definition)		
<b>Codelist</b>	urn:un:unece:uncefact:codelist:specification:54217:2001		
<b>Example</b>	DKK		

**SourceCurrencyBaseRate**

<b>Fieldname</b>	SourceCurrencyBaseRate	<b>Alternative term</b>	
<b>Cardinality</b>	0..1	<b>Usage</b>	Yes
<b>Datatype</b>	Rate		
<b>Definition</b>	The unit base of the source currency for currencies with small denominations.		
<b>Businessrules</b>	Only used for minor currencies.		
<b>Example</b>	0.34		

**TargetCurrencyCode**

<b>Fieldname</b>	TargetCurrencyCode	<b>Alternative term</b>	
<b>Cardinality</b>	1	<b>Usage</b>	Yes
<b>Datatype</b>	Code		
<b>Definition</b>	The target currency for the Exchange Rate; the currency to which the exchange is being made (CC Definition)		
<b>Codelist</b>	urn:un:unece:uncefact:codelist:specification:54217:2001		
<b>Example</b>	EUR		

**TargetCurrencyBaseRate**

<b>Fieldname</b>	TargetCurrencyBaseRate	<b>Alternative term</b>	
<b>Cardinality</b>	0..1	<b>Usage</b>	Yes
<b>Datatype</b>	Rate		
<b>Definition</b>	The unit base of the target currency for currencies with small denominations.		
<b>Businessrules</b>	Only used for minor currencies.		
<b>Example</b>	3.21		

**ExchangeMarketID**

<b>Fieldname</b>	ExchangeMarketID	<b>Alternative term</b>	
<b>Cardinality</b>	0..1	<b>Usage</b>	Yes
<b>Datatype</b>	Identifier		
<b>Definition</b>	The identifier for the currency exchange market used as the source of the Exchange Rate		
<b>Example</b>	Danmarks Nationalbank		

**CalculationRate**

<b>Fieldname</b>	CalculationRate	<b>Alternative term</b>	
<b>Cardinality</b>	0..1	<b>Usage</b>	Yes
<b>Datatype</b>	Rate		
<b>Definition</b>	The factor applied to the source currency to calculate the target currency		
<b>Example</b>	0.1300		

**MathematicOperatorCode**

<b>Fieldname</b>	MathematicOperatorCode	<b>Alternative term</b>	
<b>Cardinality</b>	0..1	<b>Usage</b>	Yes
<b>Datatype</b>	Code		
<b>Definition</b>	An identifier for whether the Calculation Rate should be used to multiply or to divide; expressed as a code		
<b>Codelist</b>	urn:oasis:names:specification:ubl:schema:xsd:OperatorCode		
<b>Example</b>	Multiply		

**Date**

### 3.14. CreditNote.PaymentAlternativeExchangeRate

<b>Fieldname</b>	Date	<b>Alternative term</b>	
<b>Cardinality</b>	0..1	<b>Usage</b>	Yes
<b>Datatype</b>	Date		
<b>Definition</b>	The date of the Exchange		
<b>Example</b>	39041		

### Class Specification

#### *ForeignExchangeContract*

<b>Classname</b>	ForeignExchangeContract	<b>Alternative term</b>	
<b>Cardinality</b>	0..1	<b>Usage</b>	Yes
<b>Datatype</b>	Contract		
<b>Definition</b>	An association to Foreign Exchange Contract		
<b>See section</b>	3.14.1		

### Excluded classes and fields in PaymentAlternativeExchangeRate (CreditNote.PaymentAlternativeExchangeRate)

None

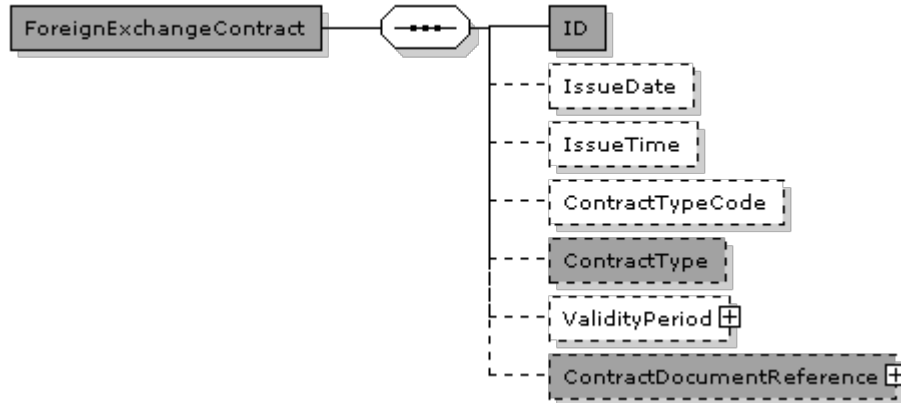

**3.14.1.****CreditNote.PaymentAlternativeExchangeRate.ForeignExchangeContract**
**ForeignExchangeContract**  
**(CreditNote.PaymentAlternativeExchangeRate.ForeignExchangeContract) specification**

<b>Name</b>	CreditNote.PaymentAlternativeExchangeRate.ForeignExchangeContract	<b>Alternative term</b>	
<b>Definition</b>	Information about a Contract		

**Fields**

UBL-Name	Name	Datatype	Usage	Cardinality
ID	ID	Identifier	Yes	1
IssueDate	IssueDate	Date	Bilateral	0..1
IssueTime	IssueTime	Time	Bilateral	0..1
ContractTypeCode	ContractTypeCode	Code	Bilateral	0..1
ContractType	ContractType	Text	Yes	0..1

**Subclasses in class ForeignExchangeContract**  
**(CreditNote.PaymentAlternativeExchangeRate.ForeignExchangeContract)**

UBL-Name	Name	Usage	Cardinality	Reference
ValidityPeriod	ValidityPeriod	Bilateral	0..1	G30 3.78
ContractDocumentReference	ContractDocumentReference	Yes	0..1	3.14.1.1

**Field specifications****ID**

<b>Fieldname</b>	ID	<b>Alternative term</b>	
<b>Cardinality</b>	1	<b>Usage</b>	Yes
<b>Datatype</b>	Identifier		
<b>Definition</b>	The identifier for the Contract		
<b>Businessrules</b>	An identifier known by relevant parties		
<b>Example</b>	CC23		

**IssueDate**

<b>Fieldname</b>	IssueDate	<b>Alternative term</b>	
<b>Cardinality</b>	0..1	<b>Usage</b>	Bilateral
<b>Datatype</b>	Date		
<b>Definition</b>	The date on which the Contract was issued.		

**IssueTime**

<b>Fieldname</b>	IssueTime	<b>Alternative term</b>	
<b>Cardinality</b>	0..1	<b>Usage</b>	Bilateral
<b>Datatype</b>	Time		
<b>Definition</b>	The time at which the Contract was issued.		

**ContractTypeCode**

<b>Fieldname</b>	ContractTypeCode	<b>Alternative term</b>	
<b>Cardinality</b>	0..1	<b>Usage</b>	Bilateral
<b>Datatype</b>	Code		
<b>Definition</b>	The type of Contract expressed as a code		
<b>Businessrules</b>	A bilateral specified code if applicable		
<b>Example</b>	D1		

**ContractType**

<b>Fieldname</b>	ContractType	<b>Alternative term</b>	
<b>Cardinality</b>	0..1	<b>Usage</b>	Yes
<b>Datatype</b>	Text		
<b>Definition</b>	The type of Contract expressed as text		
<b>Businessrules</b>	Use if no code is applicable.		
<b>Dependency</b>	../ContractTypeCode		
<b>Example</b>	Framework contract		

**Class Specification****ValidityPeriod**

<b>Classname</b>	ValidityPeriod	<b>Alternative term</b>	
<b>Cardinality</b>	0..1	<b>Usage</b>	Bilateral
<b>Datatype</b>	Period		
<b>Definition</b>	An association to Validity Period		
<b>See section</b>	G30 3.78		

**ContractDocumentReference**

<b>Classname</b>	ContractDocumentReference	<b>Alternative term</b>	
<b>Cardinality</b>	0..1	<b>Usage</b>	Yes
<b>Datatype</b>	DocumentReference		
<b>Definition</b>	An association to Contract Document Reference		
<b>See section</b>	3.14.1.1		

**Excluded classes and fields in ForeignExchangeContract  
(CreditNote.PaymentAlternativeExchangeRate.ForeignExchangeContract)**

None

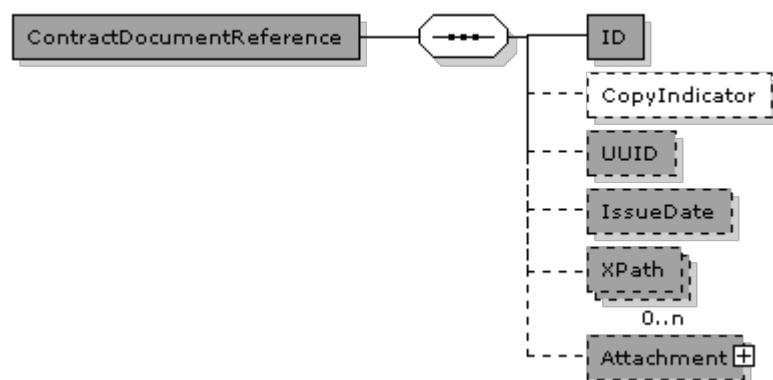

**3.14.1.1.****CreditNote.PaymentAlternativeExchangeRate.ForeignExchangeContract.ContractDocumentReference****ContractDocumentReference****(CreditNote.PaymentAlternativeExchangeRate.ForeignExchangeContract.ContractDocumentReference) specification**

<b>Name</b>	CreditNote.PaymentAlternativeExchangeRate.ForeignExchangeContract.ContractDocumentReference	<b>Alternative term</b>	OIOUBL_GUIDE_DOCUMENTREF
<b>Definition</b>	Information about a Document referred to in another Document		
<b>See also</b>	OIOUBL_GUIDE_DOCUMENTREF ( OIO )		

**Fields**

UBL-Name	Name	Datatype	Usage	Cardinality
ID	ID	Identifier	Yes	1
CopyIndicator	CopyIndicator	Indicator	Bilateral	0..1
UUID	UUID	Identifier	Yes	0..1
IssueDate	IssueDate	Date	Yes	0..1
XPath	XPath	Text	Yes	0..n

**Subclasses in class ContractDocumentReference****(CreditNote.PaymentAlternativeExchangeRate.ForeignExchangeContract.ContractDocumentReference)**

UBL-Name	Name	Usage	Cardinality	Reference
Attachment	Attachment	Yes	0..1	3.14.1.1.1

**Field specifications****ID**

<b>Fieldname</b>	ID	<b>Alternative term</b>	
<b>Cardinality</b>	1	<b>Usage</b>	Yes
<b>Datatype</b>	Identifier		
<b>Definition</b>	The identifier for the Document being referred to		
<b>Example</b>	428.34		

**CopyIndicator**

<b>Fieldname</b>	CopyIndicator	<b>Alternative term</b>	
<b>Cardinality</b>	0..1	<b>Usage</b>	Bilateral
<b>Datatype</b>	Indicator		
<b>Definition</b>	Indicates whether the referenced Document is a copy (true) or the original (false)		
<b>Example</b>	false		

**UUID**

<b>Fieldname</b>	UUID	<b>Alternative term</b>	OIOUBL_GUIDE_UUID
<b>Cardinality</b>	0..1	<b>Usage</b>	Yes
<b>Datatype</b>	Identifier		
<b>Definition</b>	A computer-generated universally unique identifier (UUID) for the referenced Document instance		
<b>See also</b>	OIOUBL_GUIDE_UUID ( G32 )		

**IssueDate**

<b>Fieldname</b>	IssueDate	<b>Alternative term</b>	
<b>Cardinality</b>	0..1	<b>Usage</b>	Yes
<b>Datatype</b>	Date		
<b>Definition</b>	The date assigned by the sender of the referenced Document on which the referenced Document was issued		
<b>Example</b>	2006-09-01		

**XPath**

<b>Fieldname</b>	XPath	<b>Alternative term</b>	
<b>Cardinality</b>	0..n	<b>Usage</b>	Yes
<b>Datatype</b>	Text		
<b>Definition</b>	Refers to another part of the same document instance		
<b>Example</b>	/DocumentReference[ID='428.22']		

**Class Specification****Attachment**

<b>Classname</b>	Attachment	<b>Alternative term</b>	
<b>Cardinality</b>	0..1	<b>Usage</b>	Yes
<b>Datatype</b>	Attachment		
<b>Definition</b>	An attached document, external referred to, referred in the MIME location or embedded.		
<b>See section</b>	3.14.1.1.1		

**Excluded classes and fields in ContractDocumentReference (CreditNote.PaymentAlternativeExchangeRate.ForeignExchangeContract.ContractDocumentReference)**

Name	Name	Type
DocumentTypeCode	DocumentTypeCode	Field
DocumentType	DocumentType	Field

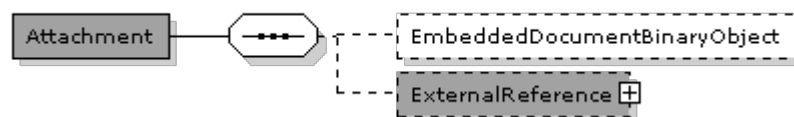
**3.14.1.1.1.****CreditNote.PaymentAlternativeExchangeRate.ForeignExchangeContract.ContractDocumentReference.Attachment****Attachment****(CreditNote.PaymentAlternativeExchangeRate.ForeignExchangeContract.ContractDocumentReference.Attachment) specification**

<b>Name</b>	CreditNote.PaymentAlternativeExchangeRate.ForeignExchangeContract.ContractDocumentReference.Attachment	<b>Alternative term</b>	OIOUBL_GUIDE_ATTACHMENT
<b>Definition</b>	Information about an attached document. An attachment can be referred to externally (with the URI element), internally (with the MIME reference element) or contained within the document itself (with the EmbeddedDocument element).		
<b>See also</b>	OIOUBL_GUIDE_ATTACHMENT ( OIO )		

**Fields**

UBL-Name	Name	Datatype	Usage	Cardinality
EmbeddedDocumentBinaryObject	EmbeddedDocumentBinaryObject	Binary Object	Bilateral	0..1

**Subclasses in class Attachment****(CreditNote.PaymentAlternativeExchangeRate.ForeignExchangeContract.ContractDocumentReference.Attachment)**

UBL-Name	Name	Usage	Cardinality	Reference
ExternalReference	ExternalReference	Yes	0..1	G30 3.41

CreditNote.PaymentAlternativeExchangeRate.ForeignExchangeContract.ContractDocumentReference.Attachment

## Field specifications

### *EmbeddedDocumentBinaryObject*

<b>Fieldname</b>	EmbeddedDocumentBinaryObject	<b>Alternative term</b>	
<b>Cardinality</b>	0..1	<b>Usage</b>	Bilateral
<b>Datatype</b>	Binary Object		
<b>Definition</b>	Contains an embedded document as a BLOB,		
<b>Businessrules</b>	Only allowed if no ExternalReference is specified and if bilateral agreed.		
<b>Dependency</b>	../ExternalReference		

## Class Specification

### *ExternalReference*

<b>Classname</b>	ExternalReference	<b>Alternative term</b>	
<b>Cardinality</b>	0..1	<b>Usage</b>	Yes
<b>Datatype</b>	ExternalReference		
<b>Definition</b>	An attached document, external referred to, referred in the MIME location or embedded.		
<b>Businessrules</b>	Used if no EmbeddedDocumentBinaryObject specified		
<b>Dependency</b>	../EmbeddedDocumentBinaryObject		
<b>See section</b>	G30 3.41		

## Excluded classes and fields in Attachment

(CreditNote.PaymentAlternativeExchangeRate.ForeignExchangeContract.ContractDocumentReference.Attachment)

None

### 3.15. CreditNote.CreditNoteLine



#### CreditNoteLine (CreditNote.CreditNoteLine) specification

Name	CreditNote.CreditNoteLine	Alternative term	
Definition	Information about a CreditNote Line		



**Fields**

UBL-Name	Name	Datatype	Usage	Cardinality
ID	ID	Identifier	Yes	1
UUID	UUID	Identifier	Bilateral	0..1
Note	Note	Text	Yes	0..1
CreditedQuantity	CreditedQuantity		Yes	1
LineExtensionAmount	LineExtensionAmount	Amount	Yes	1
TaxPointDate	TaxPointDate	Date	Bilateral	0..1
AccountingCostCode	AccountingCostCode	Code	Bilateral	0..1
AccountingCost	AccountingCost	Text	Yes	0..1

**Subclasses in class CreditNoteLine (CreditNote.CreditNoteLine)**

UBL-Name	Name	Usage	Cardinality	Reference
DiscrepancyResponse	DiscrepancyResponse	Yes	0..n	3.15.1
DespatchLineReference	DespatchLineReference	Bilateral	0..n	G30 3.58
ReceiptLineReference	ReceiptLineReference	Bilateral	0..n	G30 3.58
BillingReference	BillingReference	Yes	0..1	3.15.2
DocumentReference	DocumentReference	Yes	0..n	G30 3.36
PricingReference	PricingReference	Bilateral	0..1	G30 3.83
Delivery	Delivery	Yes	0..n	3.15.3
TaxTotal	TaxTotal	Yes	1	G30 3.104
Item	Item	Yes	0..1	3.15.4
Price	Price	Yes	0..1	G30 3.81

**Field specifications****ID**

<b>Fieldname</b>	ID	<b>Alternative term</b>	
<b>Cardinality</b>	1	<b>Usage</b>	Yes
<b>Datatype</b>	Identifier		
<b>Definition</b>	The identifier for the CreditNote Line		

**UUID**

<b>Fieldname</b>	UUID	<b>Alternative term</b>	OIOUBL_GUIDE_UUID
<b>Cardinality</b>	0..1	<b>Usage</b>	Bilateral
<b>Datatype</b>	Identifier		
<b>Definition</b>	A computer-generated universally unique identifier (UUID) for the CreditNote Line instance		
<b>See also</b>	OIOUBL_GUIDE_UUID ( G32 )		

**Note**

<b>Fieldname</b>	Note	<b>Alternative term</b>	
<b>Cardinality</b>	0..1	<b>Usage</b>	Yes
<b>Datatype</b>	Text		
<b>Definition</b>	Free form text applying to the CreditNote Line. This element may contain notes or any other similar information that is not contained explicitly in another structure.		

**CreditedQuantity**

<b>Fieldname</b>	CreditedQuantity	<b>Alternative term</b>	
<b>Cardinality</b>	1	<b>Usage</b>	Yes
<b>Datatype</b>			
<b>Definition</b>	The quantity (of Items) on the CreditNote Line		

**LineExtensionAmount**

<b>Fieldname</b>	LineExtensionAmount	<b>Alternative term</b>	
<b>Cardinality</b>	1	<b>Usage</b>	Yes
<b>Datatype</b>	Amount		
<b>Definition</b>	The total amount for the CreditNote Line including Allowance Charges but net of taxes		
<b>Example</b>	5000.00		

**TaxPointDate**

<b>Fieldname</b>	TaxPointDate	<b>Alternative term</b>	
<b>Cardinality</b>	0..1	<b>Usage</b>	Bilateral
<b>Datatype</b>	Date		
<b>Definition</b>	The date of the CreditNote Line used to indicate the point at which tax becomes applicable.		

**AccountingCostCode**

<b>Fieldname</b>	AccountingCostCode	<b>Alternative term</b>	
<b>Cardinality</b>	0..1	<b>Usage</b>	Bilateral
<b>Datatype</b>	Code		
<b>Definition</b>	The Buyer's accounting code applied to the CreditNote Line		
<b>Businessrules</b>	Use in standalone Creditnote and/or required by the buyer		

**AccountingCost**

<b>Fieldname</b>	AccountingCost	<b>Alternative term</b>	
<b>Cardinality</b>	0..1	<b>Usage</b>	Yes
<b>Datatype</b>	Text		
<b>Definition</b>	The Buyer's accounting code applied to the Creditnote Line		
<b>Businessrules</b>	Use if a codelist is not applicable and the accountingCostCode is demanded from the customer.		

**Class Specification****DiscrepancyResponse**

<b>Classname</b>	DiscrepancyResponse	<b>Alternative term</b>	
<b>Cardinality</b>	0..n	<b>Usage</b>	Yes
<b>Datatype</b>	Response		
<b>Definition</b>	References to DiscrepancyResponse, i.e. the reason for the credit		
<b>Businessrules</b>	Use to explain the discrepancy that leads to the credit. Only one per language		
<b>See section</b>	3.15.1		

**DespatchLineReference**

<b>Classname</b>	DespatchLineReference	<b>Alternative term</b>	
<b>Cardinality</b>	0..n	<b>Usage</b>	Bilateral
<b>Datatype</b>	LineReference		
<b>Definition</b>	References to a line in the despatch document		
<b>See section</b>	G30 3.58		

**ReceiptLineReference**

<b>Classname</b>	ReceiptLineReference	<b>Alternative term</b>	
<b>Cardinality</b>	0..n	<b>Usage</b>	Bilateral
<b>Datatype</b>	LineReference		
<b>Definition</b>	References to a line in the receipt document		
<b>See section</b>	G30 3.58		

**BillingReference**

<b>Classname</b>	BillingReference	<b>Alternative term</b>	OIOUBL_GUIDE_DOCUMENTREF
<b>Cardinality</b>	0..1	<b>Usage</b>	Yes
<b>Datatype</b>	BillingReference		
<b>Definition</b>	An association to BillingReference		
<b>Businessrules</b>	Used only if the creditnote applies to more than one invoice		
<b>See section</b>	3.15.2		
<b>See also</b>	OIOUBL_GUIDE_DOCUMENTREF ( OIO )		

**DocumentReference**

<b>Classname</b>	DocumentReference	<b>Alternative term</b>	
<b>Cardinality</b>	0..n	<b>Usage</b>	Yes
<b>Datatype</b>	DocumentReference		
<b>Definition</b>	An association to Document Reference		
<b>See section</b>	G30 3.36		

**PricingReference**

<b>Classname</b>	PricingReference	<b>Alternative term</b>	OIOUBL_GUIDE_DOCUMENTREF
<b>Cardinality</b>	0..1	<b>Usage</b>	Bilateral
<b>Datatype</b>	PricingReference		
<b>Definition</b>	An association to PriceReference		
<b>Businessrules</b>	Used to reference the agreed prices. Explanation of the credited amount		
<b>See section</b>	G30 3.83		
<b>See also</b>	OIOUBL_GUIDE_DOCUMENTREF ( OIO )		

**Delivery**

<b>Classname</b>	Delivery	<b>Alternative term</b>	
<b>Cardinality</b>	0..n	<b>Usage</b>	Yes
<b>Datatype</b>	Delivery		
<b>Definition</b>	An association to Delivery		
<b>See section</b>	3.15.3		

**TaxTotal**

## 3.15. CreditNote.CreditNoteLine

<b>Classname</b>	TaxTotal	<b>Alternative term</b>	OIOUBL_GUIDE_TAX
<b>Cardinality</b>	1	<b>Usage</b>	Yes
<b>Datatype</b>	TaxTotal		
<b>Definition</b>	An association to TaxTotal		
<b>Businessrules</b>	Must be a copy of the taxtotal in the accounting documentLine		
<b>See section</b>	G30 3.104		
<b>See also</b>	OIOUBL_GUIDE_TAX ( OIO )		

*Item*

<b>Classname</b>	Item	<b>Alternative term</b>	
<b>Cardinality</b>	0..1	<b>Usage</b>	Yes
<b>Datatype</b>	Item		
<b>Definition</b>	An association to Item		
<b>Businessrules</b>	Mandatory if BillingReference is not specified		
<b>See section</b>	3.15.4		

*Price*

<b>Classname</b>	Price	<b>Alternative term</b>	OIOUBL_GUIDE_PRICES
<b>Cardinality</b>	0..1	<b>Usage</b>	Yes
<b>Datatype</b>	Price		
<b>Definition</b>	An association to agreed Price		
<b>Businessrules</b>	Mandatory if BillingReference is not specified		
<b>See section</b>	G30 3.81		
<b>See also</b>	OIOUBL_GUIDE_PRICES ( OIO )		

**Excluded classes and fields in CreditNoteLine (CreditNote.CreditNoteLine)**

None

### 3.15.1. CreditNote.CreditNoteLine.DiscrepancyResponse

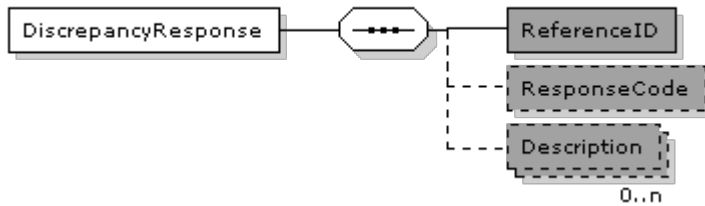

#### DiscrepancyResponse (CreditNote.CreditNoteLine.DiscrepancyResponse) specification

<b>Name</b>	CreditNote.CreditNoteLine.DiscrepancyResponse	<b>Alternative term</b>	
<b>Definition</b>	Information about responses to a document (at the application level)		

#### Fields

UBL-Name	Name	Datatype	Usage	Cardinality
ReferenceID	ReferenceID	Identifier	Yes	1
ResponseCode	ResponseCode	Code	Yes	0..1
Description	Description	Text	Yes	0..n

#### Subclasses in class DiscrepancyResponse (CreditNote.CreditNoteLine.DiscrepancyResponse)

None

**Field specifications****ReferenceID**

<b>Fieldname</b>	ReferenceID	<b>Alternative term</b>	
<b>Cardinality</b>	1	<b>Usage</b>	Yes
<b>Datatype</b>	Identifier		
<b>Definition</b>	a reference to identify the section (or line) of the document to which the response applies		

**ResponseCode**

<b>Fieldname</b>	ResponseCode	<b>Alternative term</b>	
<b>Cardinality</b>	0..1	<b>Usage</b>	Yes
<b>Datatype</b>	Code		
<b>Definition</b>	A code for the description of the response to the transaction document.		
<b>Businessrules</b>	Use either Description or ResponseCode		
<b>Codelist</b>	urn:oiubl:codelist:discrepancyresponsecode-1.1		
<b>Dependency</b>	../Description		

**Description**

<b>Fieldname</b>	Description	<b>Alternative term</b>	
<b>Cardinality</b>	0..n	<b>Usage</b>	Yes
<b>Datatype</b>	Text		
<b>Definition</b>	the description of the response to the transaction document.		
<b>Businessrules</b>	Only one per Language		
<b>Dependency</b>	../ResponseCode		

**Excluded classes and fields in DiscrepancyResponse  
(CreditNote.CreditNoteLine.DiscrepancyResponse)**

None

### 3.15.2. CreditNote.CreditNoteLine.BillingReference

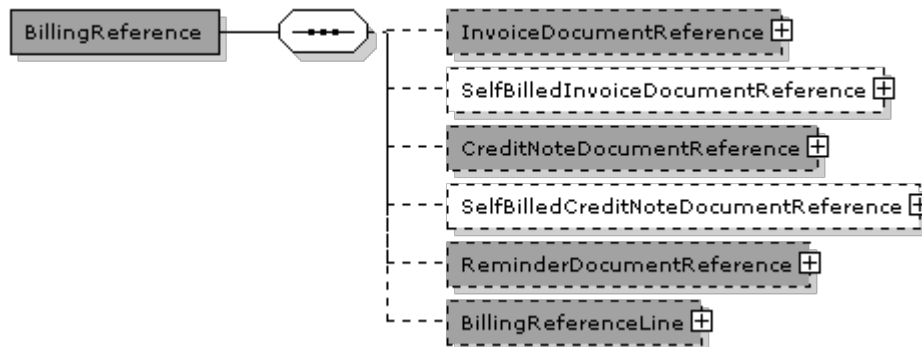

#### BillingReference (CreditNote.CreditNoteLine.BillingReference) specification

<b>Name</b>	CreditNote.CreditNoteLine.BillingReference	<b>Alternative term</b>	
<b>Definition</b>	information directly relating to a related document		

#### Fields

None

#### Subclasses in class BillingReference (CreditNote.CreditNoteLine.BillingReference)

UBL-Name	Name	Usage	Cardinality	Reference
InvoiceDocumentReference	InvoiceDocumentReference	Yes	0..1	3.15.2.1
SelfBilledInvoiceDocumentReference	SelfBilledInvoiceDocumentReference	Bilateral	0..1	3.15.2.2
CreditNoteDocumentReference	CreditNoteDocumentReference	Yes	0..1	3.15.2.3
SelfBilledCreditNoteDocumentReference	SelfBilledCreditNoteDocumentReference	Bilateral	0..1	3.15.2.4
ReminderDocumentReference	ReminderDocumentReference	Yes	0..1	3.15.2.5
BillingReferenceLine	BillingReferenceLine	Yes	0..1	G30 3.7

#### Class Specification

##### InvoiceDocumentReference

<b>Classname</b>	InvoiceDocumentReference	<b>Alternative term</b>	
<b>Cardinality</b>	0..1	<b>Usage</b>	Yes
<b>Datatype</b>	DocumentReference		
<b>Definition</b>	Provides a means of associating a Line (optionally) with one or more invoices which are being related		
<b>See section</b>	3.15.2.1		

##### SelfBilledInvoiceDocumentReference

## 3.15.2. CreditNote.CreditNoteLine.BillingReference

<b>Classname</b>	SelfBilledInvoiceDocumentReference	<b>Alternative term</b>	
<b>Cardinality</b>	0..1	<b>Usage</b>	Bilateral
<b>Datatype</b>	DocumentReference		
<b>Definition</b>	Provides a means of associating a Line (optionally) with one or more self billed invoices which are being related		
<b>See section</b>	3.15.2.2		

**CreditNoteDocumentReference**

<b>Classname</b>	CreditNoteDocumentReference	<b>Alternative term</b>	
<b>Cardinality</b>	0..1	<b>Usage</b>	Yes
<b>Datatype</b>	DocumentReference		
<b>Definition</b>	Provides a means of associating a Line (optionally) with one or more credit notes		
<b>See section</b>	3.15.2.3		

**SelfBilledCreditNoteDocumentReference**

<b>Classname</b>	SelfBilledCreditNoteDocumentReference	<b>Alternative term</b>	
<b>Cardinality</b>	0..1	<b>Usage</b>	Bilateral
<b>Datatype</b>	DocumentReference		
<b>Definition</b>	Provides a means of associating a Line (optionally) with one or more self billed credit notes		
<b>See section</b>	3.15.2.4		

**ReminderDocumentReference**

<b>Classname</b>	ReminderDocumentReference	<b>Alternative term</b>	
<b>Cardinality</b>	0..1	<b>Usage</b>	Yes
<b>Datatype</b>	DocumentReference		
<b>Definition</b>	Provides a means of associating a Line (optionally) with one or more reminders		
<b>See section</b>	3.15.2.5		

**BillingReferenceLine**

<b>Classname</b>	BillingReferenceLine	<b>Alternative term</b>	
<b>Cardinality</b>	0..1	<b>Usage</b>	Yes
<b>Datatype</b>	BillingReferenceLine		
<b>Definition</b>	an association to Billing Reference Line		
<b>See section</b>	G30 3.7		

**Excluded classes and fields in BillingReference (CreditNote.CreditNoteLine.BillingReference)**

Name	Name	Type
DebitNoteDocumentReference	DebitNoteDocumentReference	Class
AdditionalDocumentReference	AdditionalDocumentReference	Class

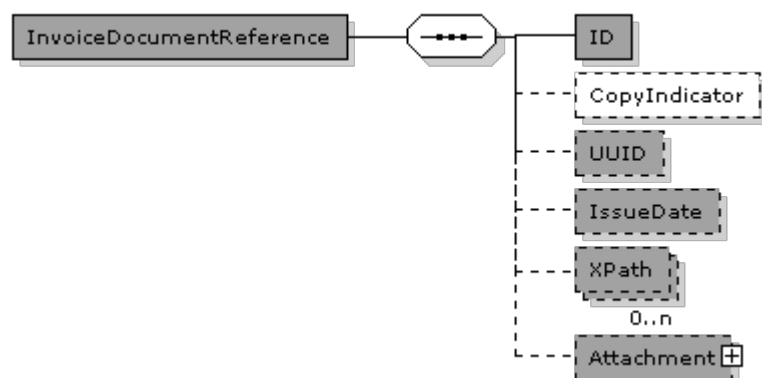

**3.15.2.1.****CreditNote.CreditNoteLine.BillingReference.InvoiceDocumentReference**
**InvoiceDocumentReference  
 (CreditNote.CreditNoteLine.BillingReference.InvoiceDocumentReference) specification**

<b>Name</b>	CreditNote.CreditNoteLine.BillingReference.InvoiceDocumentReference	<b>Alternative term</b>	OIOUBL_GUIDE_DOCUMENTREF
<b>Definition</b>	Information about a Document referred to in another Document		
<b>See also</b>	OIOUBL_GUIDE_DOCUMENTREF ( OIO )		

**Fields**

UBL-Name	Name	Datatype	Usage	Cardinality
ID	ID	Identifier	Yes	1
CopyIndicator	CopyIndicator	Indicator	Bilateral	0..1
UUID	UUID	Identifier	Yes	0..1
IssueDate	IssueDate	Date	Yes	0..1
XPath	XPath	Text	Yes	0..n

**Subclasses in class InvoiceDocumentReference  
 (CreditNote.CreditNoteLine.BillingReference.InvoiceDocumentReference)**

UBL-Name	Name	Usage	Cardinality	Reference
Attachment	Attachment	Yes	0..1	3.15.2.1.1

**Field specifications****ID**

<b>Fieldname</b>	ID	<b>Alternative term</b>	
<b>Cardinality</b>	1	<b>Usage</b>	Yes
<b>Datatype</b>	Identifier		
<b>Definition</b>	The identifier for the Document being referred to		
<b>Example</b>	428.34		

**CopyIndicator**

<b>Fieldname</b>	CopyIndicator	<b>Alternative term</b>	
<b>Cardinality</b>	0..1	<b>Usage</b>	Bilateral
<b>Datatype</b>	Indicator		
<b>Definition</b>	Indicates whether the referenced Document is a copy (true) or the original (false)		
<b>Example</b>	false		

**UUID**

<b>Fieldname</b>	UUID	<b>Alternative term</b>	OIOUBL_GUIDE_UUID
<b>Cardinality</b>	0..1	<b>Usage</b>	Yes
<b>Datatype</b>	Identifier		
<b>Definition</b>	A computer-generated universally unique identifier (UUID) for the referenced Document instance		
<b>See also</b>	OIOUBL_GUIDE_UUID ( G32 )		

**IssueDate**

<b>Fieldname</b>	IssueDate	<b>Alternative term</b>	
<b>Cardinality</b>	0..1	<b>Usage</b>	Yes
<b>Datatype</b>	Date		
<b>Definition</b>	The date assigned by the sender of the referenced Document on which the referenced Document was issued		
<b>Example</b>	2006-09-01		

**XPath**

<b>Fieldname</b>	XPath	<b>Alternative term</b>	
<b>Cardinality</b>	0..n	<b>Usage</b>	Yes
<b>Datatype</b>	Text		
<b>Definition</b>	Refers to another part of the same document instance		
<b>Example</b>	/DocumentReference[ID='428.22']		

**Class Specification****Attachment**

<b>Classname</b>	Attachment	<b>Alternative term</b>	
<b>Cardinality</b>	0..1	<b>Usage</b>	Yes
<b>Datatype</b>	Attachment		
<b>Definition</b>	An attached document, external referred to, referred in the MIME location or embedded.		
<b>See section</b>	3.15.2.1.1		

**Excluded classes and fields in InvoiceDocumentReference  
(CreditNote.CreditNoteLine.BillingReference.InvoiceDocumentReference)**

Name	Name	Type
DocumentTypeCode	DocumentTypeCode	Field
DocumentType	DocumentType	Field

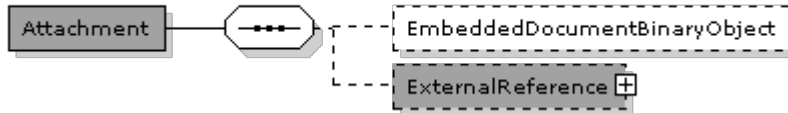
**3.15.2.1.1.****CreditNote.CreditNoteLine.BillingReference.InvoiceDocumentReference.Attachment**
**Attachment**  
**(CreditNote.CreditNoteLine.BillingReference.InvoiceDocumentReference.Attachment)**  
**specification**

<b>Name</b>	CreditNote.CreditNoteLine.BillingReference.InvoiceDocumentReference.Attachment	<b>Alternative term</b>	OIOUBL_GUIDE_ATTACHM ENT
<b>Definition</b>	Information about an attached document. An attachment can be referred to externally (with the URI element), internally (with the MIME reference element) or contained within the document itself (with the EmbeddedDocument element).		
<b>See also</b>	OIOUBL_GUIDE_ATTACHMENT ( OIO )		

**Fields**

UBL-Name	Name	Datatype	Usage	Cardinality
EmbeddedDocumentBinaryObject	EmbeddedDocumentBinaryObject	Binary Object	Bilateral	0..1

**Subclasses in class Attachment**  
**(CreditNote.CreditNoteLine.BillingReference.InvoiceDocumentReference.Attachment)**

UBL-Name	Name	Usage	Cardi nality	Reference
ExternalReference	ExternalReference	Yes	0..1	G30 3.41

**Field specifications****EmbeddedDocumentBinaryObject**

<b>Fieldname</b>	EmbeddedDocumentBinaryObject	<b>Alternative term</b>	
<b>Cardinality</b>	0..1	<b>Usage</b>	Bilateral
<b>Datatype</b>	Binary Object		
<b>Definition</b>	Contains an embedded document as a BLOB.		
<b>Businessrules</b>	Only allowed if no ExternalReference is specified and if bilateral agreed.		
<b>Dependency</b>	../ExternalReference		

**Class Specification****ExternalReference**

<b>Classname</b>	ExternalReference	<b>Alternative term</b>	
<b>Cardinality</b>	0..1	<b>Usage</b>	Yes
<b>Datatype</b>	ExternalReference		
<b>Definition</b>	An attached document, external referred to, referred in the MIME location or embedded.		
<b>Businessrules</b>	Used if no EmbeddedDocumentBinaryObject specified		
<b>Dependency</b>	../EmbeddedDocumentBinaryObject		
<b>See section</b>	G30 3.41		

**Excluded classes and fields in Attachment  
(CreditNote.CreditNoteLine.BillingReference.InvoiceDocumentReference.Attachment)**

None

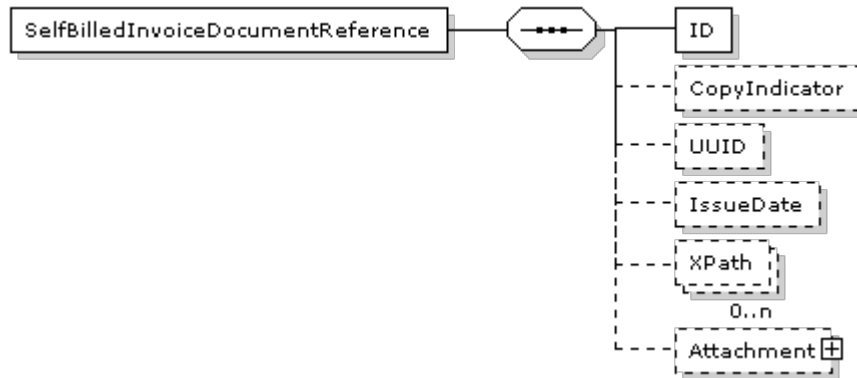
**3.15.2.2.****CreditNote.CreditNoteLine.BillingReference.SelfBilledInvoiceDocument Reference**

**SelfBilledInvoiceDocumentReference**  
**(CreditNote.CreditNoteLine.BillingReference.SelfBilledInvoiceDocumentReference)**  
**specification**

<b>Name</b>	CreditNote.CreditNoteLine.BillingReference.SelfBilledInvoiceDocumentReference	<b>Alternative term</b>	OIOUBL_GUIDE_DOCUMENTREF
<b>Definition</b>	Information about a Document referred to in another Document		
<b>See also</b>	OIOUBL_GUIDE_DOCUMENTREF ( OIO )		

**Fields**

UBL-Name	Name	Datatype	Usage	Cardinality
ID	ID	Identifier	Bilateral	1
CopyIndicator	CopyIndicator	Indicator	Bilateral	0..1
UUID	UUID	Identifier	Bilateral	0..1
IssueDate	IssueDate	Date	Bilateral	0..1
XPath	XPath	Text	Bilateral	0..n

**Subclasses in class SelfBilledInvoiceDocumentReference**  
**(CreditNote.CreditNoteLine.BillingReference.SelfBilledInvoiceDocumentReference)**

UBL-Name	Name	Usage	Cardinality	Reference
Attachment	Attachment	Bilateral	0..1	3.15.2.2.1

**Field specifications****ID**

<b>Fieldname</b>	ID	<b>Alternative term</b>	
<b>Cardinality</b>	1	<b>Usage</b>	Bilateral
<b>Datatype</b>	Identifier		
<b>Definition</b>	The identifier for the Document being referred to		
<b>Example</b>	428.34		

**CopyIndicator**

<b>Fieldname</b>	CopyIndicator	<b>Alternative term</b>	
<b>Cardinality</b>	0..1	<b>Usage</b>	Bilateral
<b>Datatype</b>	Indicator		
<b>Definition</b>	Indicates whether the referenced Document is a copy (true) or the original (false)		
<b>Example</b>	false		

**UUID**

<b>Fieldname</b>	UUID	<b>Alternative term</b>	OIOUBL_GUIDE_UUID
<b>Cardinality</b>	0..1	<b>Usage</b>	Bilateral
<b>Datatype</b>	Identifier		
<b>Definition</b>	A computer-generated universally unique identifier (UUID) for the referenced Document instance		
<b>See also</b>	OIOUBL_GUIDE_UUID ( G32 )		

**IssueDate**

<b>Fieldname</b>	IssueDate	<b>Alternative term</b>	
<b>Cardinality</b>	0..1	<b>Usage</b>	Bilateral
<b>Datatype</b>	Date		
<b>Definition</b>	The date assigned by the sender of the referenced Document on which the referenced Document was issued		
<b>Example</b>	2006-09-01		

**XPath**

<b>Fieldname</b>	XPath	<b>Alternative term</b>	
<b>Cardinality</b>	0..n	<b>Usage</b>	Bilateral
<b>Datatype</b>	Text		
<b>Definition</b>	Refers to another part of the same document instance		
<b>Example</b>	/DocumentReference[ID='428.22']		

**Class Specification****Attachment**

<b>Classname</b>	Attachment	<b>Alternative term</b>	
<b>Cardinality</b>	0..1	<b>Usage</b>	Bilateral
<b>Datatype</b>	Attachment		
<b>Definition</b>	An attached document, external referred to, referred in the MIME location or embedded.		
<b>See section</b>	3.15.2.2.1		

**Excluded classes and fields in SelfBilledInvoiceDocumentReference (CreditNote.CreditNoteLine.BillingReference.SelfBilledInvoiceDocumentReference)**

Name	Name	Type
DocumentTypeCode	DocumentTypeCode	Field
DocumentType	DocumentType	Field

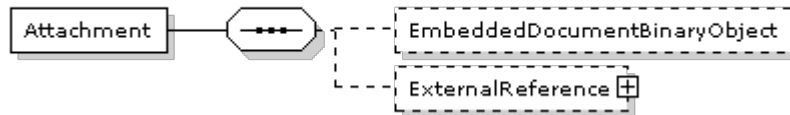
**3.15.2.2.1.****CreditNote.CreditNoteLine.BillingReference.SelfBilledInvoiceDocumentReference.Attachment****Attachment****(CreditNote.CreditNoteLine.BillingReference.SelfBilledInvoiceDocumentReference.Attachment) specification**

<b>Name</b>	CreditNote.CreditNoteLine.BillingReference.SelfBilledInvoiceDocumentReference.Attachment	<b>Alternative term</b>	OIOUBL_GUIDE_ATTACHM ENT
<b>Definition</b>	Information about an attached document. An attachment can be referred to externally (with the URI element), internally (with the MIME reference element) or contained within the document itself (with the EmbeddedDocument element).		
<b>See also</b>	OIOUBL_GUIDE_ATTACHM ENT ( OIO )		

**Fields**

UBL-Name	Name	Datatype	Usage	Cardinality
EmbeddedDocumentBinaryObject	EmbeddedDocumentBinaryObject	Binary Object	Bilateral	0..1

**Subclasses in class Attachment****(CreditNote.CreditNoteLine.BillingReference.SelfBilledInvoiceDocumentReference.Attachment)**

UBL-Name	Name	Usage	Cardinality	Reference
ExternalReference	ExternalReference	Bilateral	0..1	G30 3.41

**Field specifications*****EmbeddedDocumentBinaryObject***

<b>Fieldname</b>	EmbeddedDocumentBinaryObject	<b>Alternative term</b>	
<b>Cardinality</b>	0..1	<b>Usage</b>	Bilateral
<b>Datatype</b>	Binary Object		
<b>Definition</b>	Contains an embedded document as a BLOB,		
<b>Businessrules</b>	Only allowed if no ExternalReference is specified and if bilateral agreed.		
<b>Dependency</b>	../ExternalReference		

**Class Specification*****ExternalReference***

<b>Classname</b>	ExternalReference	<b>Alternative term</b>	
<b>Cardinality</b>	0..1	<b>Usage</b>	Bilateral
<b>Datatype</b>	ExternalReference		
<b>Definition</b>	An attached document, external referred to, referred in the MIME location or embedded.		
<b>Businessrules</b>	Used if no EmbeddedDocumentBinaryObject specified		
<b>Dependency</b>	../EmbeddedDocumentBinaryObject		
<b>See section</b>	G30 3.41		

**Excluded classes and fields in Attachment**

**(CreditNote.CreditNoteLine.BillingReference.SelfBilledInvoiceDocumentReference.Attachment)**

None

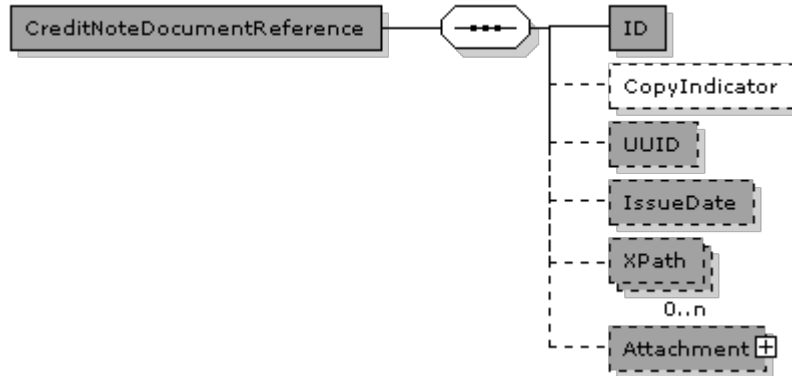

**3.15.2.3.****CreditNote.CreditNoteLine.BillingReference.CreditNoteDocumentReference****CreditNoteDocumentReference****(CreditNote.CreditNoteLine.BillingReference.CreditNoteDocumentReference) specification**

<b>Name</b>	CreditNote.CreditNoteLine.BillingReference.CreditNoteDocumentReference	<b>Alternative term</b>	OIOUBL_GUIDE_DOCUMENTREF
<b>Definition</b>	Information about a Document referred to in another Document		
<b>See also</b>	OIOUBL_GUIDE_DOCUMENTREF ( OIO )		

**Fields**

UBL-Name	Name	Datatype	Usage	Cardinality
ID	ID	Identifier	Yes	1
CopyIndicator	CopyIndicator	Indicator	Bilateral	0..1
UUID	UUID	Identifier	Yes	0..1
IssueDate	IssueDate	Date	Yes	0..1
XPath	XPath	Text	Yes	0..n

**Subclasses in class CreditNoteDocumentReference****(CreditNote.CreditNoteLine.BillingReference.CreditNoteDocumentReference)**

UBL-Name	Name	Usage	Cardinality	Reference
Attachment	Attachment	Yes	0..1	3.15.2.3.1

**Field specifications****ID**

<b>Fieldname</b>	ID	<b>Alternative term</b>	
<b>Cardinality</b>	1	<b>Usage</b>	Yes
<b>Datatype</b>	Identifier		
<b>Definition</b>	The identifier for the Document being referred to		
<b>Example</b>	428.34		

**CopyIndicator**

<b>Fieldname</b>	CopyIndicator	<b>Alternative term</b>	
<b>Cardinality</b>	0..1	<b>Usage</b>	Bilateral
<b>Datatype</b>	Indicator		
<b>Definition</b>	Indicates whether the referenced Document is a copy (true) or the original (false)		
<b>Example</b>	false		

**UUID**

<b>Fieldname</b>	UUID	<b>Alternative term</b>	OIOUBL_GUIDE_UUID
<b>Cardinality</b>	0..1	<b>Usage</b>	Yes
<b>Datatype</b>	Identifier		
<b>Definition</b>	A computer-generated universally unique identifier (UUID) for the referenced Document instance		
<b>See also</b>	OIOUBL_GUIDE_UUID ( G32 )		

**IssueDate**

<b>Fieldname</b>	IssueDate	<b>Alternative term</b>	
<b>Cardinality</b>	0..1	<b>Usage</b>	Yes
<b>Datatype</b>	Date		
<b>Definition</b>	The date assigned by the sender of the referenced Document on which the referenced Document was issued		
<b>Example</b>	2006-09-01		

**XPath**

<b>Fieldname</b>	XPath	<b>Alternative term</b>	
<b>Cardinality</b>	0..n	<b>Usage</b>	Yes
<b>Datatype</b>	Text		
<b>Definition</b>	Refers to another part of the same document instance		
<b>Example</b>	/DocumentReference[ID='428.22']		

**Class Specification****Attachment**

<b>Classname</b>	Attachment	<b>Alternative term</b>	
<b>Cardinality</b>	0..1	<b>Usage</b>	Yes
<b>Datatype</b>	Attachment		
<b>Definition</b>	An attached document, external referred to, referred in the MIME location or embedded.		
<b>See section</b>	3.15.2.3.1		

**Excluded classes and fields in CreditNoteDocumentReference  
(CreditNote.CreditNoteLine.BillingReference.CreditNoteDocumentReference)**

Name	Name	Type
DocumentTypeCode	DocumentTypeCode	Field
DocumentType	DocumentType	Field

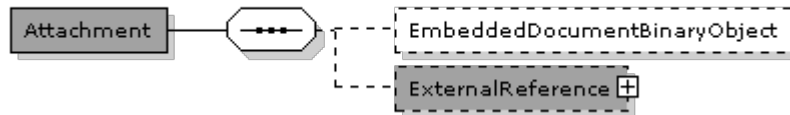
**3.15.2.3.1.****CreditNote.CreditNoteLine.BillingReference.CreditNoteDocumentReference.Attachment**
**Attachment**  
**(CreditNote.CreditNoteLine.BillingReference.CreditNoteDocumentReference.Attachment)**  
**specification**

<b>Name</b>	CreditNote.CreditNoteLine.BillingReference.CreditNoteDocumentReference.Attachment	<b>Alternative term</b>	OIOUBL_GUIDE_ATTACHM ENT
<b>Definition</b>	Information about an attached document. An attachment can be referred to externally (with the URI element), internally (with the MIME reference element) or contained within the document itself (with the EmbeddedDocument element).		
<b>See also</b>	OIOUBL_GUIDE_ATTACHMENT ( OIO )		

**Fields**

UBL-Name	Name	Datatype	Usage	Cardinality
EmbeddedDocumentBinaryObject	EmbeddedDocumentBinaryObject	Binary Object	Bilateral	0..1

**Subclasses in class Attachment**  
**(CreditNote.CreditNoteLine.BillingReference.CreditNoteDocumentReference.Attachment)**

UBL-Name	Name	Usage	Cardi nality	Reference
ExternalReference	ExternalReference	Yes	0..1	G30 3.41

**Field specifications****EmbeddedDocumentBinaryObject**

<b>Fieldname</b>	EmbeddedDocumentBinaryObject	<b>Alternative term</b>	
<b>Cardinality</b>	0..1	<b>Usage</b>	Bilateral
<b>Datatype</b>	Binary Object		
<b>Definition</b>	Contains an embedded document as a BLOB.		
<b>Businessrules</b>	Only allowed if no ExternalReference is specified and if bilateral agreed.		
<b>Dependency</b>	../ExternalReference		

**Class Specification****ExternalReference**

<b>Classname</b>	ExternalReference	<b>Alternative term</b>	
<b>Cardinality</b>	0..1	<b>Usage</b>	Yes
<b>Datatype</b>	ExternalReference		
<b>Definition</b>	An attached document, external referred to, referred in the MIME location or embedded.		
<b>Businessrules</b>	Used if no EmbeddedDocumentBinaryObject specified		
<b>Dependency</b>	../EmbeddedDocumentBinaryObject		
<b>See section</b>	G30 3.41		

**Excluded classes and fields in Attachment  
(CreditNote.CreditNoteLine.BillingReference.CreditNoteDocumentReference.Attachment)**

None

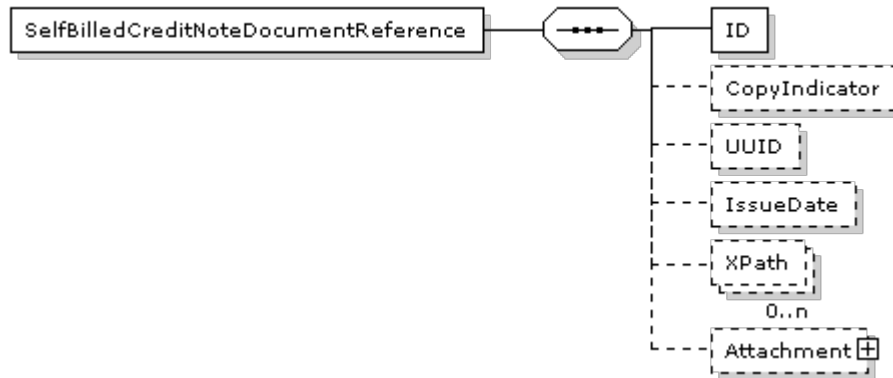
**3.15.2.4.****CreditNote.CreditNoteLine.BillingReference.SelfBilledCreditNoteDocumentReference**

**SelfBilledCreditNoteDocumentReference**  
**(CreditNote.CreditNoteLine.BillingReference.SelfBilledCreditNoteDocumentReference)**  
 specification

<b>Name</b>	CreditNote.CreditNoteLine.BillingReference.SelfBilledCreditNoteDocumentReference	<b>Alternative term</b>	OIOUBL_GUIDE_DOCUMENTREF
<b>Definition</b>	Information about a Document referred to in another Document		
<b>See also</b>	OIOUBL_GUIDE_DOCUMENTREF ( OIO )		

**Fields**

UBL-Name	Name	Datatype	Usage	Cardinality
ID	ID	Identifier	Bilateral	1
CopyIndicator	CopyIndicator	Indicator	Bilateral	0..1
UUID	UUID	Identifier	Bilateral	0..1
IssueDate	IssueDate	Date	Bilateral	0..1
XPath	XPath	Text	Bilateral	0..n

**Subclasses in class SelfBilledCreditNoteDocumentReference**  
**(CreditNote.CreditNoteLine.BillingReference.SelfBilledCreditNoteDocumentReference)**

UBL-Name	Name	Usage	Cardinality	Reference
Attachment	Attachment	Bilateral	0..1	3.15.2.4.1

**Field specifications****ID**

<b>Fieldname</b>	ID	<b>Alternative term</b>	
<b>Cardinality</b>	1	<b>Usage</b>	Bilateral
<b>Datatype</b>	Identifier		
<b>Definition</b>	The identifier for the Document being referred to		
<b>Example</b>	428.34		

**CopyIndicator**

<b>Fieldname</b>	CopyIndicator	<b>Alternative term</b>	
<b>Cardinality</b>	0..1	<b>Usage</b>	Bilateral
<b>Datatype</b>	Indicator		
<b>Definition</b>	Indicates whether the referenced Document is a copy (true) or the original (false)		
<b>Example</b>	false		

**UUID**

<b>Fieldname</b>	UUID	<b>Alternative term</b>	OIOUBL_GUIDE_UUID
<b>Cardinality</b>	0..1	<b>Usage</b>	Bilateral
<b>Datatype</b>	Identifier		
<b>Definition</b>	A computer-generated universally unique identifier (UUID) for the referenced Document instance		
<b>See also</b>	OIOUBL_GUIDE_UUID ( G32 )		

**IssueDate**

<b>Fieldname</b>	IssueDate	<b>Alternative term</b>	
<b>Cardinality</b>	0..1	<b>Usage</b>	Bilateral
<b>Datatype</b>	Date		
<b>Definition</b>	The date assigned by the sender of the referenced Document on which the referenced Document was issued		
<b>Example</b>	2006-09-01		

**XPath**

<b>Fieldname</b>	XPath	<b>Alternative term</b>	
<b>Cardinality</b>	0..n	<b>Usage</b>	Bilateral
<b>Datatype</b>	Text		
<b>Definition</b>	Refers to another part of the same document instance		
<b>Example</b>	/DocumentReference[ID='428.22']		

**Class Specification****Attachment**

<b>Classname</b>	Attachment	<b>Alternative term</b>	
<b>Cardinality</b>	0..1	<b>Usage</b>	Bilateral
<b>Datatype</b>	Attachment		
<b>Definition</b>	An attached document, external referred to, referred in the MIME location or embedded.		
<b>See section</b>	3.15.2.4.1		

**Excluded classes and fields in SelfBilledCreditNoteDocumentReference (CreditNote.CreditNoteLine.BillingReference.SelfBilledCreditNoteDocumentReference)**

Name	Name	Type
DocumentTypeCode	DocumentTypeCode	Field
DocumentType	DocumentType	Field

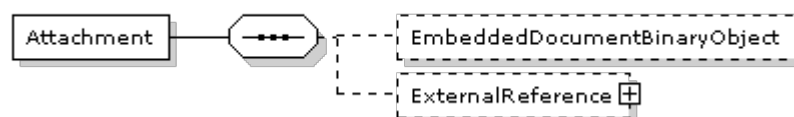
**3.15.2.4.1.****CreditNote.CreditNoteLine.BillingReference.SelfBilledCreditNoteDocumentReference.Attachment****Attachment****(CreditNote.CreditNoteLine.BillingReference.SelfBilledCreditNoteDocumentReference.Attachment) specification**

<b>Name</b>	CreditNote.CreditNoteLine.BillingReference.SelfBilledCreditNoteDocumentReference.Attachment	<b>Alternative term</b>	OIOUBL_GUIDE_ATTACHM ENT
<b>Definition</b>	Information about an attached document. An attachment can be referred to externally (with the URI element), internally (with the MIME reference element) or contained within the document itself (with the EmbeddedDocument element).		
<b>See also</b>	OIOUBL_GUIDE_ATTACHMENT ( OIO )		

**Fields**

UBL-Name	Name	Datatype	Usage	Cardinality
EmbeddedDocumentBinaryObject	EmbeddedDocumentBinaryObject	Binary Object	Bilateral	0..1

**Subclasses in class Attachment****(CreditNote.CreditNoteLine.BillingReference.SelfBilledCreditNoteDocumentReference.Attachment)**

UBL-Name	Name	Usage	Cardi nality	Reference
ExternalReference	ExternalReference	Bilateral	0..1	G30 3.41

**Field specifications*****EmbeddedDocumentBinaryObject***

<b>Fieldname</b>	EmbeddedDocumentBinaryObject	<b>Alternative term</b>	
<b>Cardinality</b>	0..1	<b>Usage</b>	Bilateral
<b>Datatype</b>	Binary Object		
<b>Definition</b>	Contains an embedded document as a BLOB.		
<b>Businessrules</b>	Only allowed if no ExternalReference is specified and if bilateral agreed.		
<b>Dependency</b>	../ExternalReference		

**Class Specification*****ExternalReference***

<b>Classname</b>	ExternalReference	<b>Alternative term</b>	
<b>Cardinality</b>	0..1	<b>Usage</b>	Bilateral
<b>Datatype</b>	ExternalReference		
<b>Definition</b>	An attached document, external referred to, referred in the MIME location or embedded.		
<b>Businessrules</b>	Used if no EmbeddedDocumentBinaryObject specified		
<b>Dependency</b>	../EmbeddedDocumentBinaryObject		
<b>See section</b>	G30 3.41		

**Excluded classes and fields in Attachment**

**(CreditNote.CreditNoteLine.BillingReference.SelfBilledCreditNoteDocumentReference.Attachment)**

None

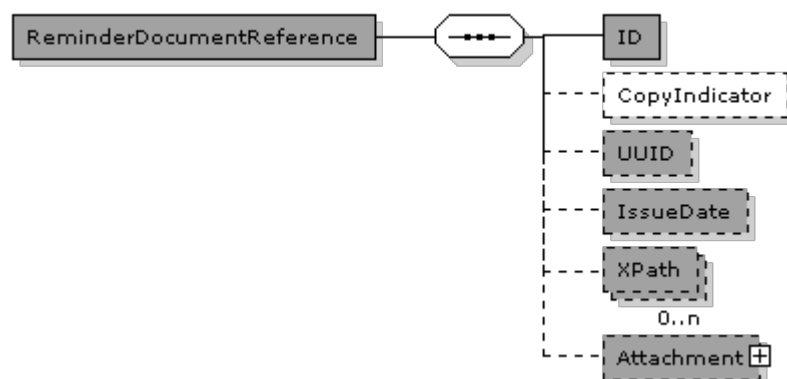

**3.15.2.5.****CreditNote.CreditNoteLine.BillingReference.ReminderDocumentReference****ReminderDocumentReference****(CreditNote.CreditNoteLine.BillingReference.ReminderDocumentReference) specification**

<b>Name</b>	CreditNote.CreditNoteLine.BillingReference.ReminderDocumentReference	<b>Alternative term</b>	OIOUBL_GUIDE_DOCUMENTREF
<b>Definition</b>	Information about a Document referred to in another Document		
<b>See also</b>	OIOUBL_GUIDE_DOCUMENTREF ( OIO )		

**Fields**

UBL-Name	Name	Datatype	Usage	Cardinality
ID	ID	Identifier	Yes	1
CopyIndicator	CopyIndicator	Indicator	Bilateral	0..1
UUID	UUID	Identifier	Yes	0..1
IssueDate	IssueDate	Date	Yes	0..1
XPath	XPath	Text	Yes	0..n

**Subclasses in class ReminderDocumentReference****(CreditNote.CreditNoteLine.BillingReference.ReminderDocumentReference)**

UBL-Name	Name	Usage	Cardinality	Reference
Attachment	Attachment	Yes	0..1	3.15.2.5.1

**Field specifications****ID**

<b>Fieldname</b>	ID	<b>Alternative term</b>	
<b>Cardinality</b>	1	<b>Usage</b>	Yes
<b>Datatype</b>	Identifier		
<b>Definition</b>	The identifier for the Document being referred to		
<b>Example</b>	428.34		

**CopyIndicator**

<b>Fieldname</b>	CopyIndicator	<b>Alternative term</b>	
<b>Cardinality</b>	0..1	<b>Usage</b>	Bilateral
<b>Datatype</b>	Indicator		
<b>Definition</b>	Indicates whether the referenced Document is a copy (true) or the original (false)		
<b>Example</b>	false		

**UUID**

<b>Fieldname</b>	UUID	<b>Alternative term</b>	OIOUBL_GUIDE_UUID
<b>Cardinality</b>	0..1	<b>Usage</b>	Yes
<b>Datatype</b>	Identifier		
<b>Definition</b>	A computer-generated universally unique identifier (UUID) for the referenced Document instance		
<b>See also</b>	OIOUBL_GUIDE_UUID ( G32 )		

**IssueDate**

<b>Fieldname</b>	IssueDate	<b>Alternative term</b>	
<b>Cardinality</b>	0..1	<b>Usage</b>	Yes
<b>Datatype</b>	Date		
<b>Definition</b>	The date assigned by the sender of the referenced Document on which the referenced Document was issued		
<b>Example</b>	2006-09-01		

**XPath**

<b>Fieldname</b>	XPath	<b>Alternative term</b>	
<b>Cardinality</b>	0..n	<b>Usage</b>	Yes
<b>Datatype</b>	Text		
<b>Definition</b>	Refers to another part of the same document instance		
<b>Example</b>	/DocumentReference[ID='428.22']		

**Class Specification****Attachment**

<b>Classname</b>	Attachment	<b>Alternative term</b>	
<b>Cardinality</b>	0..1	<b>Usage</b>	Yes
<b>Datatype</b>	Attachment		
<b>Definition</b>	An attached document, external referred to, referred in the MIME location or embedded.		
<b>See section</b>	3.15.2.5.1		

**Excluded classes and fields in ReminderDocumentReference  
(CreditNote.CreditNoteLine.BillingReference.ReminderDocumentReference)**

Name	Name	Type
DocumentTypeCode	DocumentTypeCode	Field
DocumentType	DocumentType	Field

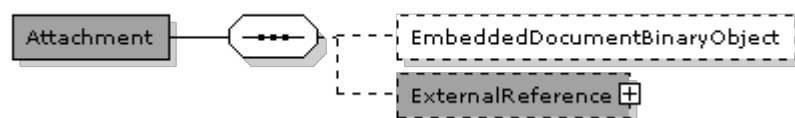
**3.15.2.5.1.****CreditNote.CreditNoteLine.BillingReference.ReminderDocumentReference.Attachment**
**Attachment**  
**(CreditNote.CreditNoteLine.BillingReference.ReminderDocumentReference.Attachment)**  
**specification**

<b>Name</b>	CreditNote.CreditNoteLine.BillingReference.ReminderDocumentReference.Attachment	<b>Alternative term</b>	OIOUBL_GUIDE_ATTACHM ENT
<b>Definition</b>	Information about an attached document. An attachment can be referred to externally (with the URI element), internally (with the MIME reference element) or contained within the document itself (with the EmbeddedDocument element).		
<b>See also</b>	OIOUBL_GUIDE_ATTACHMENT ( OIO )		

**Fields**

UBL-Name	Name	Datatype	Usage	Cardinality
EmbeddedDocumentBinaryObject	EmbeddedDocumentBinaryObject	Binary Object	Bilateral	0..1

**Subclasses in class Attachment**  
**(CreditNote.CreditNoteLine.BillingReference.ReminderDocumentReference.Attachment)**

UBL-Name	Name	Usage	Cardi nality	Reference
ExternalReference	ExternalReference	Yes	0..1	G30 3.41

**Field specifications****EmbeddedDocumentBinaryObject**

<b>Fieldname</b>	EmbeddedDocumentBinaryObject	<b>Alternative term</b>	
<b>Cardinality</b>	0..1	<b>Usage</b>	Bilateral
<b>Datatype</b>	Binary Object		
<b>Definition</b>	Contains an embedded document as a BLOB.		
<b>Businessrules</b>	Only allowed if no ExternalReference is specified and if bilateral agreed.		
<b>Dependency</b>	../ExternalReference		

**Class Specification****ExternalReference**

<b>Classname</b>	ExternalReference	<b>Alternative term</b>	
<b>Cardinality</b>	0..1	<b>Usage</b>	Yes
<b>Datatype</b>	ExternalReference		
<b>Definition</b>	An attached document, external referred to, referred in the MIME location or embedded.		
<b>Businessrules</b>	Used if no EmbeddedDocumentBinaryObject specified		
<b>Dependency</b>	../EmbeddedDocumentBinaryObject		
<b>See section</b>	G30 3.41		

**Excluded classes and fields in Attachment  
(CreditNote.CreditNoteLine.BillingReference.ReminderDocumentReference.Attachment)**

None

### 3.15.3. CreditNote.CreditNoteLine.Delivery



#### Delivery (CreditNote.CreditNoteLine.Delivery) specification

<b>Name</b>	CreditNote.CreditNoteLine.Delivery	<b>Alternative term</b>	
<b>Definition</b>	An association to Delivery		

#### Fields

UBL-Name	Name	Datatype	Usage	Cardinality
ID	ID	Identifier	Bilateral	0..1
Quantity	Quantity	Quantity	Yes	0..1
MinimumQuantity	MinimumQuantity	Quantity	Bilateral	0..1
MaximumQuantity	MaximumQuantity	Quantity	Bilateral	0..1
ActualDeliveryDate	ActualDeliveryDate	Date	Bilateral	0..1
ActualDeliveryTime	ActualDeliveryTime	Time	Bilateral	0..1
TrackingID	TrackingID	Identifier	Bilateral	0..1

#### Subclasses in class Delivery (CreditNote.CreditNoteLine.Delivery)

UBL-Name	Name	Usage	Cardinality	Reference
DeliveryLocation	DeliveryLocation	Yes	0..1	G30 3.30,1
RequestedDeliveryPeriod	RequestedDeliveryPeriod	Yes	0..1	G30 3.78
DeliveryParty	DeliveryParty	Yes	0..1	G30 3.70
Despatch	Despatch	Bilateral	0..1	G30 3.32

**Field specifications****ID**

<b>Fieldname</b>	ID	<b>Alternative term</b>	
<b>Cardinality</b>	0..1	<b>Usage</b>	Bilateral
<b>Datatype</b>	Identifier		
<b>Definition</b>	Identification for Delivery		

**Quantity**

<b>Fieldname</b>	Quantity	<b>Alternative term</b>	
<b>Cardinality</b>	0..1	<b>Usage</b>	Yes
<b>Datatype</b>	Quantity		
<b>Definition</b>	The quantity for a Delivery		

**MinimumQuantity**

<b>Fieldname</b>	MinimumQuantity	<b>Alternative term</b>	
<b>Cardinality</b>	0..1	<b>Usage</b>	Bilateral
<b>Datatype</b>	Quantity		
<b>Definition</b>	The Minimum quantity for a Delivery		

**MaximumQuantity**

<b>Fieldname</b>	MaximumQuantity	<b>Alternative term</b>	
<b>Cardinality</b>	0..1	<b>Usage</b>	Bilateral
<b>Datatype</b>	Quantity		
<b>Definition</b>	The Maximum quantity for a Delivery		

**ActualDeliveryDate**

<b>Fieldname</b>	ActualDeliveryDate	<b>Alternative term</b>	
<b>Cardinality</b>	0..1	<b>Usage</b>	Bilateral
<b>Datatype</b>	Date		
<b>Definition</b>	The actual date of Delivery		

**ActualDeliveryTime**

<b>Fieldname</b>	ActualDeliveryTime	<b>Alternative term</b>	
<b>Cardinality</b>	0..1	<b>Usage</b>	Bilateral
<b>Datatype</b>	Time		
<b>Definition</b>	The actual time of Delivery		

**TrackingID**

<b>Fieldname</b>	TrackingID	<b>Alternative term</b>	
<b>Cardinality</b>	0..1	<b>Usage</b>	Bilateral
<b>Datatype</b>	Identifier		
<b>Definition</b>	The tracking ID of the Delivery (for transport tracking)		

**Class Specification****DeliveryLocation**

<b>Classname</b>	DeliveryLocation	<b>Alternative term</b>	OIOUBL_GUIDE_ADDRESS
<b>Cardinality</b>	0..1	<b>Usage</b>	Yes
<b>Datatype</b>	Location		
<b>Definition</b>	An association to Location		
<b>Businessrules</b>	Use the same delivery location for all deliveries in the same line		
<b>See section</b>	G30 3.30,1		
<b>See also</b>	OIOUBL_GUIDE_ADDRESS ( OIO )		

**RequestedDeliveryPeriod**

### 3.15.3. CreditNote.CreditNoteLine.Delivery

<b>Classname</b>	RequestedDeliveryPeriod	<b>Alternative term</b>	
<b>Cardinality</b>	0..1	<b>Usage</b>	Yes
<b>Datatype</b>	Period		
<b>Definition</b>	The requested Delivery period		
<b>Businessrules</b>	For customer originated messages		
<b>See section</b>	G30 3.78		

#### *DeliveryParty*

<b>Classname</b>	DeliveryParty	<b>Alternative term</b>	OIOUBL_GUIDE_PARTIES
<b>Cardinality</b>	0..1	<b>Usage</b>	Yes
<b>Datatype</b>	Party		
<b>Definition</b>	The Party who the goods/services are delivered to.		
<b>Businessrules</b>	Use if different from the buyer party.		
<b>See section</b>	G30 3.70		
<b>See also</b>	OIOUBL_GUIDE_PARTIES ( OIO )		

#### *Despatch*

<b>Classname</b>	Despatch	<b>Alternative term</b>	
<b>Cardinality</b>	0..1	<b>Usage</b>	Bilateral
<b>Datatype</b>	Despatch		
<b>Definition</b>	The Party who dispatched the Delivery		
<b>See section</b>	G30 3.32		

### Excluded classes and fields in Delivery (CreditNote.CreditNoteLine.Delivery)

Name	Name	Type
LatestDeliveryDate	LatestDeliveryDate	Field
LatestDeliveryTime	LatestDeliveryTime	Field
DeliveryAddress	DeliveryAddress	Class
PromisedDeliveryPeriod	PromisedDeliveryPeriod	Class
EstimatedDeliveryPeriod	EstimatedDeliveryPeriod	Class

## 3.15.4. CreditNote.CreditNoteLine.Item

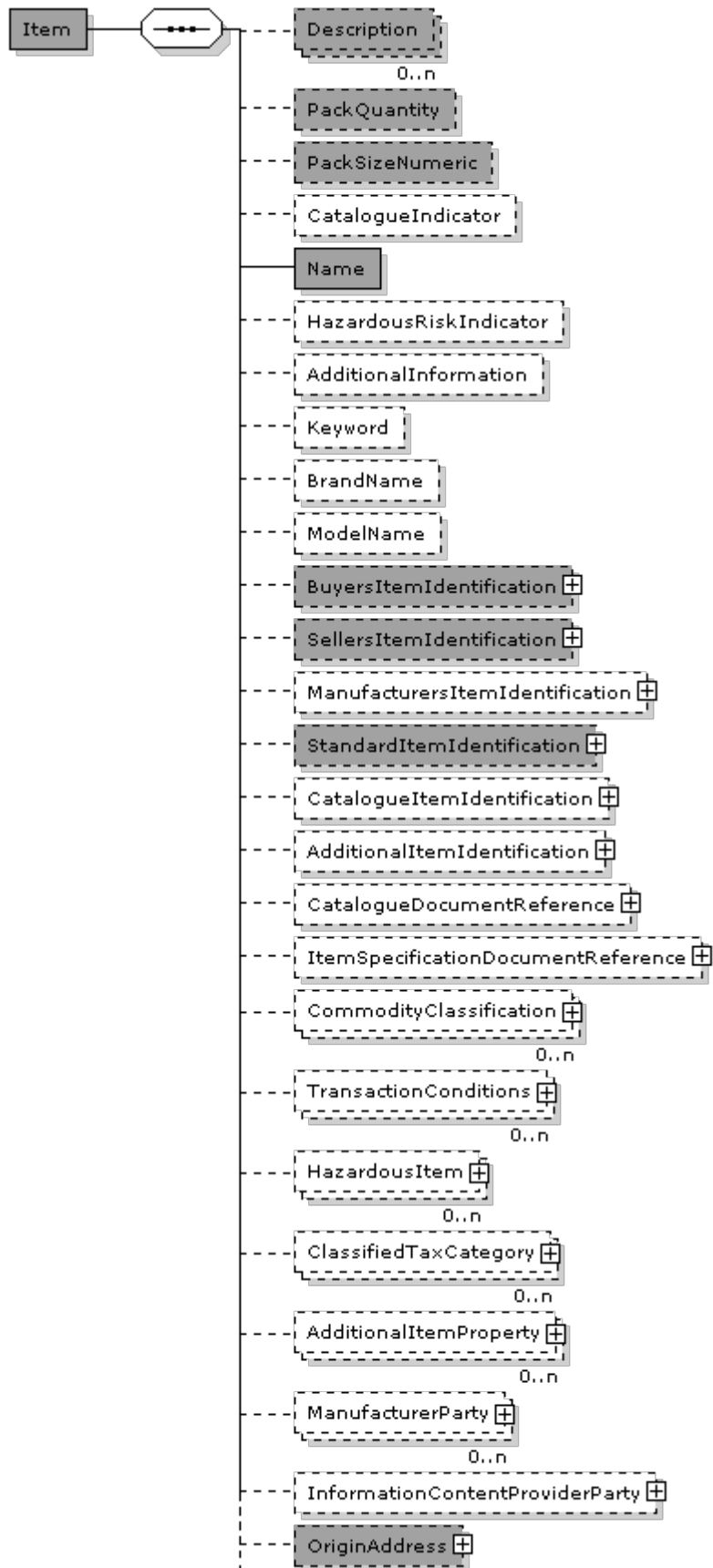



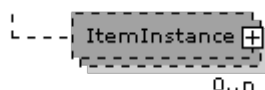

### Item (CreditNote.CreditNoteLine.Item) specification

<b>Name</b>	CreditNote.CreditNoteLine.Item	<b>Alternative term</b>	
<b>Definition</b>	Information directly relating to an item		

### Fields

UBL-Name	Name	Datatype	Usage	Cardinality
Description	Description	Text	Yes	0..n
PackQuantity	PackQuantity	Quantity	Yes	0..1
PackSizeNumeric	PackSizeNumeric	Numeric	Yes	0..1
CatalogueIndicator	CatalogueIndicator	Indicator	Bilateral	0..1
Name	Name	Name	Yes	1
HazardousRiskIndicator	HazardousRiskIndicator	Indicator	Bilateral	0..1
AdditionalInformation	AdditionalInformation	Text	Bilateral	0..1
Keyword	Keyword	Text	Bilateral	0..1
BrandName	BrandName	Name	Bilateral	0..1
ModelName	ModelName	Name	Bilateral	0..1

### Subclasses in class Item (CreditNote.CreditNoteLine.Item)

UBL-Name	Name	Usage	Cardinality	Reference
BuyersItemIdentification	BuyersItemIdentification	Yes	0..1	3.15.4.1
SellersItemIdentification	SellersItemIdentification	Yes	0..1	3.15.4.2
ManufacturersItemIdentification	ManufacturersItemIdentification	Bilateral	0..1	3.15.4.3
StandardItemIdentification	StandardItemIdentification	Yes	0..1	3.15.4.4
CatalogueItemIdentification	CatalogueItemIdentification	Bilateral	0..1	3.15.4.5
AdditionalItemIdentification	AdditionalItemIdentification	Bilateral	0..1	3.15.4.6
CatalogueDocumentReference	CatalogueDocumentReference	Bilateral	0..1	3.15.4.7
ItemSpecificationDocumentReference	ItemSpecificationDocumentReference	Bilateral	0..1	G30 3.36
CommodityClassification	CommodityClassification	Bilateral	0..n	G30 3.18
TransactionConditions	TransactionConditions	Bilateral	0..n	G30 3.107
HazardousItem	HazardousItem	Bilateral	0..n	G30 3.47
ClassifiedTaxCategory	ClassifiedTaxCategory	Bilateral	0..n	G30 3.101
AdditionalItemProperty	AdditionalItemProperty	Bilateral	0..n	G30 3.54
ManufacturerParty	ManufacturerParty	Bilateral	0..n	G30 3.70
InformationContentProviderParty	InformationContentProviderParty	Bilateral	0..1	G30 3.70
OriginAddress	OriginAddress	Yes	0..1	G30 3.1
ItemInstance	ItemInstance	Yes	0..n	G30 3.52

## Field specifications

### Description

<b>Fieldname</b>	Description	<b>Alternative term</b>	
<b>Cardinality</b>	0..n	<b>Usage</b>	Yes
<b>Datatype</b>	Text		
<b>Definition</b>	A free text form field that can be used to give a text description of the item.		

### PackQuantity

<b>Fieldname</b>	PackQuantity	<b>Alternative term</b>	
<b>Cardinality</b>	0..1	<b>Usage</b>	Yes
<b>Datatype</b>	Quantity		
<b>Definition</b>	The unit packaging quantity.		

### PackSizeNumeric

<b>Fieldname</b>	PackSizeNumeric	<b>Alternative term</b>	
<b>Cardinality</b>	0..1	<b>Usage</b>	Yes
<b>Datatype</b>	Numeric		
<b>Definition</b>	The number of items in a pack.		

### CatalogueIndicator

<b>Fieldname</b>	CatalogueIndicator	<b>Alternative term</b>	
<b>Cardinality</b>	0..1	<b>Usage</b>	Bilateral
<b>Datatype</b>	Indicator		
<b>Definition</b>	An indicator that denotes whether the item was ordered from a catalogue (true) or not (false).		

### Name

<b>Fieldname</b>	Name	<b>Alternative term</b>	
<b>Cardinality</b>	1	<b>Usage</b>	Yes
<b>Datatype</b>	Name		
<b>Definition</b>	A shortname (optionally) given to an item, such as a name from a catalogue, as distinct to a description		
<b>Dependency</b>	../SellersItemIdentification		

### HazardousRiskIndicator

<b>Fieldname</b>	HazardousRiskIndicator	<b>Alternative term</b>	
<b>Cardinality</b>	0..1	<b>Usage</b>	Bilateral
<b>Datatype</b>	Indicator		
<b>Definition</b>	An indicator as to whether the item as delivered is hazardous		

### AdditionalInformation

<b>Fieldname</b>	AdditionalInformation	<b>Alternative term</b>	
<b>Cardinality</b>	0..1	<b>Usage</b>	Bilateral
<b>Datatype</b>	Text		
<b>Definition</b>	To provide more details of the item (eg URL of a relevant web page).		

### Keyword

<b>Fieldname</b>	Keyword	<b>Alternative term</b>	
<b>Cardinality</b>	0..1	<b>Usage</b>	Bilateral
<b>Datatype</b>	Text		
<b>Definition</b>	A Seller Party-defined search string for the item. Also could be synonyms.		

### BrandName

<b>Fieldname</b>	BrandName	<b>Alternative term</b>	
<b>Cardinality</b>	0..1	<b>Usage</b>	Bilateral
<b>Datatype</b>	Name		
<b>Definition</b>	The brand name for the item.		

### ModelName

<b>Fieldname</b>	ModelName	<b>Alternative term</b>	
<b>Cardinality</b>	0..1	<b>Usage</b>	Bilateral
<b>Datatype</b>	Name		
<b>Definition</b>	Model name for the item		

## Class Specification

### *BuyersItemIdentification*

<b>Classname</b>	BuyersItemIdentification	<b>Alternative term</b>	
<b>Cardinality</b>	0..1	<b>Usage</b>	Yes
<b>Datatype</b>	ItemIdentification		
<b>Definition</b>	Associates the item with its identification according to the buyers system.		
<b>See section</b>	3.15.4.1		

### *SellersItemIdentification*

<b>Classname</b>	SellersItemIdentification	<b>Alternative term</b>	
<b>Cardinality</b>	0..1	<b>Usage</b>	Yes
<b>Datatype</b>	ItemIdentification		
<b>Definition</b>	Associates the item with its identification according to the sellers system.		
<b>See section</b>	3.15.4.2		

### *ManufacturersItemIdentification*

<b>Classname</b>	ManufacturersItemIdentification	<b>Alternative term</b>	
<b>Cardinality</b>	0..1	<b>Usage</b>	Bilateral
<b>Datatype</b>	ItemIdentification		
<b>Definition</b>	Associates the item with its identification according to the manufacturers system.		
<b>See section</b>	3.15.4.3		

### *StandardItemIdentification*

<b>Classname</b>	StandardItemIdentification	<b>Alternative term</b>	
<b>Cardinality</b>	0..1	<b>Usage</b>	Yes
<b>Datatype</b>	ItemIdentification		
<b>Definition</b>	Associates the item with its identification according to a standard system.		
<b>See section</b>	3.15.4.4		

### *CatalogueItemIdentification*

<b>Classname</b>	CatalogueItemIdentification	<b>Alternative term</b>	
<b>Cardinality</b>	0..1	<b>Usage</b>	Bilateral
<b>Datatype</b>	ItemIdentification		
<b>Definition</b>	Associates the item with its identification according to a cataloging system.		
<b>See section</b>	3.15.4.5		

### *AdditionalItemIdentification*

<b>Classname</b>	AdditionalItemIdentification	<b>Alternative term</b>	
<b>Cardinality</b>	0..1	<b>Usage</b>	Bilateral
<b>Datatype</b>	ItemIdentification		
<b>Definition</b>	Associates the item with other identification means		
<b>See section</b>	3.15.4.6		

### *CatalogueDocumentReference*

<b>Classname</b>	CatalogueDocumentReference	<b>Alternative term</b>	
<b>Cardinality</b>	0..1	<b>Usage</b>	Bilateral
<b>Datatype</b>	DocumentReference		
<b>Definition</b>	Associates the item with the catalogue from which the item was selected.		
<b>See section</b>	3.15.4.7		

### *ItemSpecificationDocumentReference*

<b>Classname</b>	ItemSpecificationDocumentReference	<b>Alternative term</b>	
<b>Cardinality</b>	0..1	<b>Usage</b>	Bilateral
<b>Datatype</b>	DocumentReference		
<b>Definition</b>	An association to item specification		
<b>See section</b>	G30 3.36		

**CommodityClassification**

<b>Classname</b>	CommodityClassification	<b>Alternative term</b>	
<b>Cardinality</b>	0..n	<b>Usage</b>	Bilateral
<b>Datatype</b>	CommodityClassification		
<b>Definition</b>	Associates the item with its classification(s) according to a commodity classifying system.		
<b>See section</b>	G30 3.18		

**TransactionConditions**

<b>Classname</b>	TransactionConditions	<b>Alternative term</b>	
<b>Cardinality</b>	0..n	<b>Usage</b>	Bilateral
<b>Datatype</b>	TransactionConditions		
<b>Definition</b>	Associates the item with sales conditions appertaining to it.		
<b>See section</b>	G30 3.107		

**HazardousItem**

<b>Classname</b>	HazardousItem	<b>Alternative term</b>	
<b>Cardinality</b>	0..n	<b>Usage</b>	Bilateral
<b>Datatype</b>	HazardousItem		
<b>Definition</b>	Associates the item with its hazardous item information.		
<b>See section</b>	G30 3.47		

**ClassifiedTaxCategory**

<b>Classname</b>	ClassifiedTaxCategory	<b>Alternative term</b>	
<b>Cardinality</b>	0..n	<b>Usage</b>	Bilateral
<b>Datatype</b>	TaxCategory		
<b>Definition</b>	Classifies the item using one or more categories of taxes		
<b>See section</b>	G30 3.101		

**AdditionalItemProperty**

<b>Classname</b>	AdditionalItemProperty	<b>Alternative term</b>	
<b>Cardinality</b>	0..n	<b>Usage</b>	Bilateral
<b>Datatype</b>	ItemProperty		
<b>Definition</b>	Associates the item with a set of additional properties		
<b>See section</b>	G30 3.54		

**ManufacturerParty**

<b>Classname</b>	ManufacturerParty	<b>Alternative term</b>	
<b>Cardinality</b>	0..n	<b>Usage</b>	Bilateral
<b>Datatype</b>	Party		
<b>Definition</b>	Associates the manufacturer of the item.		
<b>See section</b>	G30 3.70		

**InformationContentProviderParty**

<b>Classname</b>	InformationContentProviderParty	<b>Alternative term</b>	
<b>Cardinality</b>	0..1	<b>Usage</b>	Bilateral
<b>Datatype</b>	Party		
<b>Definition</b>	Associates the item with the party responsible for the technical specifications of the item.		
<b>See section</b>	G30 3.70		

**OriginAddress**

<b>Classname</b>	OriginAddress	<b>Alternative term</b>	
<b>Cardinality</b>	0..1	<b>Usage</b>	Yes
<b>Datatype</b>	Address		
<b>Definition</b>	Associates the item with the region of origin (i.e. not the country)		
<b>See section</b>	G30 3.1		

**ItemInstance**

<b>Classname</b>	ItemInstance	<b>Alternative term</b>	
<b>Cardinality</b>	0..n	<b>Usage</b>	Yes
<b>Datatype</b>	ItemInstance		
<b>Definition</b>	An association to Item Instance		
<b>See section</b>	G30 3.52		

**Excluded classes and fields in Item (CreditNote.CreditNoteLine.Item)**

Name	Name	Type
OriginCountry	OriginCountry	Class

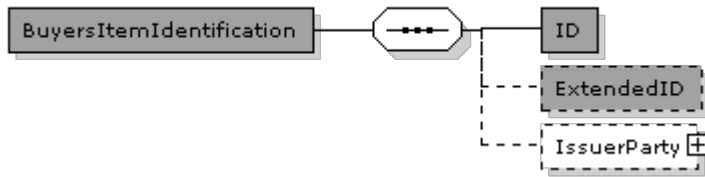
**3.15.4.1. CreditNote.CreditNoteLine.Item.BuyersItemIdentification****BuyersItemIdentification (CreditNote.CreditNoteLine.Item.BuyersItemIdentification) specification**

<b>Name</b>	CreditNote.CreditNoteLine.Item.BuyersItemIdentification	<b>Alternative term</b>	
<b>Definition</b>	Information about Item identification		

**Fields**

UBL-Name	Name	Datatype	Usage	Cardinality
ID	ID	Identifier	Yes	1
ExtendedID	ExtendedID	Identifier	Yes	0..1

**Subclasses in class BuyersItemIdentification (CreditNote.CreditNoteLine.Item.BuyersItemIdentification)**

UBL-Name	Name	Usage	Cardinality	Reference
IssuerParty	IssuerParty	Bilateral	0..1	G30 3.70

**Field specifications****ID**

<b>Fieldname</b>	ID	<b>Alternative term</b>	
<b>Cardinality</b>	1	<b>Usage</b>	Yes
<b>Datatype</b>	Identifier		
<b>Definition</b>	An identifier for an Item		
<b>Example</b>	4732		

**ExtendedID**

<b>Fieldname</b>	ExtendedID	<b>Alternative term</b>	
<b>Cardinality</b>	0..1	<b>Usage</b>	Yes
<b>Datatype</b>	Identifier		
<b>Definition</b>	An extended identifier for the item which identifies the item with specific properties e.g. Item 123 = Chair / Item 123 Ext 45 = Brown chair		
<b>Example</b>	PO3X89		

**Class Specification****IssuerParty**

<b>Classname</b>	IssuerParty	<b>Alternative term</b>	
<b>Cardinality</b>	0..1	<b>Usage</b>	Bilateral
<b>Datatype</b>	Party		
<b>Definition</b>	An association to Issuer Party i.e. the Party that issued the Item Identification		
<b>Recommendation</b>	If "Qualified" ItemIdentification is the issuer of the Identification this is not used		
<b>See section</b>	G30 3.70		

**Excluded classes and fields in BuyersItemIdentification  
(CreditNote.CreditNoteLine.Item.BuyersItemIdentification)**

<b>Name</b>	<b>Name</b>	<b>Type</b>
PhysicalAttribute	PhysicalAttribute	Class
MeasurementDimension	MeasurementDimension	Class

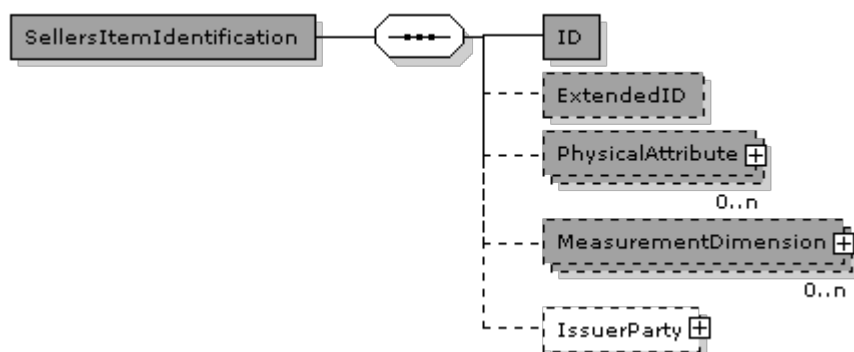
**3.15.4.2. CreditNote.CreditNoteLine.Item.SellersItemIdentification****SellersItemIdentification (CreditNote.CreditNoteLine.Item.SellersItemIdentification) specification**

<b>Name</b>	CreditNote.CreditNoteLine.Item.SellersItemIdentification	<b>Alternative term</b>	
<b>Definition</b>	Information about Item identification		

**Fields**

UBL-Name	Name	Datatype	Usage	Cardinality
ID	ID	Identifier	Yes	1
ExtendedID	ExtendedID	Identifier	Yes	0..1

**Subclasses in class SellersItemIdentification (CreditNote.CreditNoteLine.Item.SellersItemIdentification)**

UBL-Name	Name	Usage	Cardinality	Reference
PhysicalAttribute	PhysicalAttribute	Yes	0..n	G30 3.80
MeasurementDimension	MeasurementDimension	Yes	0..n	G30 3.34
IssuerParty	IssuerParty	Bilateral	0..1	G30 3.70



**Field specifications****ID**

<b>Fieldname</b>	ID	<b>Alternative term</b>	
<b>Cardinality</b>	1	<b>Usage</b>	Yes
<b>Datatype</b>	Identifier		
<b>Definition</b>	An identifier for an Item		
<b>Example</b>	4732		

**ExtendedID**

<b>Fieldname</b>	ExtendedID	<b>Alternative term</b>	
<b>Cardinality</b>	0..1	<b>Usage</b>	Yes
<b>Datatype</b>	Identifier		
<b>Definition</b>	An extended identifier for the item which identifies the item with specific properties e.g. Item 123 = Chair / Item 123 Ext 45 = Brown chair		
<b>Example</b>	PO3X89		

**Class Specification****PhysicalAttribute**

<b>Classname</b>	PhysicalAttribute	<b>Alternative term</b>	
<b>Cardinality</b>	0..n	<b>Usage</b>	Yes
<b>Datatype</b>	PhysicalAttribute		
<b>Definition</b>	An association to Physical Attribute		
<b>See section</b>	G30 3.80		

**MeasurementDimension**

<b>Classname</b>	MeasurementDimension	<b>Alternative term</b>	
<b>Cardinality</b>	0..n	<b>Usage</b>	Yes
<b>Datatype</b>	Dimension		
<b>Definition</b>	An association to Measurement Dimension		
<b>See section</b>	G30 3.34		

**IssuerParty**

<b>Classname</b>	IssuerParty	<b>Alternative term</b>	
<b>Cardinality</b>	0..1	<b>Usage</b>	Bilateral
<b>Datatype</b>	Party		
<b>Definition</b>	An association to Issuer Party i.e. the Party that issued the Item Identification		
<b>Recommendation</b>	If "Qualified" ItemIdentification is the issuer of the Identification this is not used		
<b>See section</b>	G30 3.70		

**Excluded classes and fields in SellersItemIdentification  
(CreditNote.CreditNoteLine.Item.SellersItemIdentification)**

None

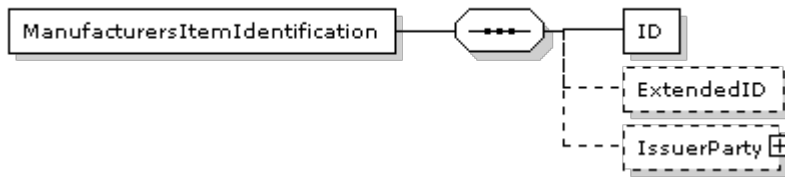
**3.15.4.3.*****CreditNote.CreditNoteLine.Item.ManufacturersItemIdentification*****ManufacturersItemIdentification****(CreditNote.CreditNoteLine.Item.ManufacturersItemIdentification) specification**

<b>Name</b>	CreditNote.CreditNoteLine.Item.ManufacturersItemIdentification	<b>Alternative term</b>	
<b>Definition</b>	Information about Item identification		

**Fields**

UBL-Name	Name	Datatype	Usage	Cardinality
ID	ID	Identifier	Bilateral	1
ExtendedID	ExtendedID	Identifier	Bilateral	0..1

**Subclasses in class ManufacturersItemIdentification****(CreditNote.CreditNoteLine.Item.ManufacturersItemIdentification)**

UBL-Name	Name	Usage	Cardinality	Reference
IssuerParty	IssuerParty	Bilateral	0..1	G30 3.70

**Field specifications****ID**

<b>Fieldname</b>	ID	<b>Alternative term</b>	
<b>Cardinality</b>	1	<b>Usage</b>	Bilateral
<b>Datatype</b>	Identifier		
<b>Definition</b>	An identifier for an Item		
<b>Example</b>	4732		

**ExtendedID**

<b>Fieldname</b>	ExtendedID	<b>Alternative term</b>	
<b>Cardinality</b>	0..1	<b>Usage</b>	Bilateral
<b>Datatype</b>	Identifier		
<b>Definition</b>	An extended identifier for the item which identifies the item with specific properties e.g. Item 123 = Chair / Item 123 Ext 45 = Brown chair		
<b>Example</b>	PO3X89		

**Class Specification****IssuerParty**

<b>Classname</b>	IssuerParty	<b>Alternative term</b>	
<b>Cardinality</b>	0..1	<b>Usage</b>	Bilateral
<b>Datatype</b>	Party		
<b>Definition</b>	An association to Issuer Party i.e. the Party that issued the Item Identification		
<b>Recommendation</b>	If "Qualified" ItemIdentification is the issuer of the Identification this is not used		
<b>See section</b>	G30 3.70		

**Excluded classes and fields in ManufacturersItemIdentification  
(CreditNote.CreditNoteLine.Item.ManufacturersItemIdentification)**

<b>Name</b>	<b>Name</b>	<b>Type</b>
PhysicalAttribute	PhysicalAttribute	Class
MeasurementDimension	MeasurementDimension	Class

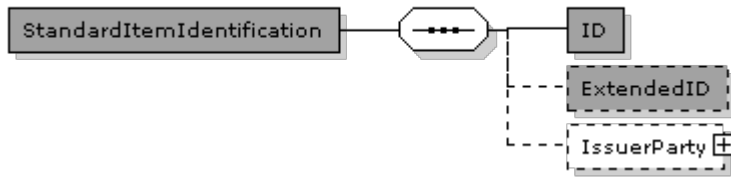
**3.15.4.4. CreditNote.CreditNoteLine.Item.StandardItemIdentification****StandardItemIdentification (CreditNote.CreditNoteLine.Item.StandardItemIdentification) specification**

<b>Name</b>	CreditNote.CreditNoteLine.Item.StandardItemIdentification	<b>Alternative term</b>	
<b>Definition</b>	Information about Item identification		

**Fields**

UBL-Name	Name	Datatype	Usage	Cardinality
ID	ID	Identifier	Yes	1
ExtendedID	ExtendedID	Identifier	Yes	0..1

**Subclasses in class StandardItemIdentification (CreditNote.CreditNoteLine.Item.StandardItemIdentification)**

UBL-Name	Name	Usage	Cardinality	Reference
IssuerParty	IssuerParty	Bilateral	0..1	G30 3.70

**Field specifications****ID**

<b>Fieldname</b>	ID	<b>Alternative term</b>	
<b>Cardinality</b>	1	<b>Usage</b>	Yes
<b>Datatype</b>	Identifier		
<b>Definition</b>	An identifier for an Item		
<b>Example</b>	4732		

**ExtendedID**

<b>Fieldname</b>	ExtendedID	<b>Alternative term</b>	
<b>Cardinality</b>	0..1	<b>Usage</b>	Yes
<b>Datatype</b>	Identifier		
<b>Definition</b>	An extended identifier for the item which identifies the item with specific properties e.g. Item 123 = Chair / Item 123 Ext 45 = Brown chair		
<b>Example</b>	PO3X89		

**Class Specification****IssuerParty**

<b>Classname</b>	IssuerParty	<b>Alternative term</b>	
<b>Cardinality</b>	0..1	<b>Usage</b>	Bilateral
<b>Datatype</b>	Party		
<b>Definition</b>	An association to Issuer Party i.e. the Party that issued the Item Identification		
<b>Recommendation</b>	If "Qualified" ItemIdentification is the issuer of the Identification this is not used		
<b>See section</b>	G30 3.70		

**Excluded classes and fields in StandardItemIdentification  
(CreditNote.CreditNoteLine.Item.StandardItemIdentification)**

<b>Name</b>	<b>Name</b>	<b>Type</b>
PhysicalAttribute	PhysicalAttribute	Class
MeasurementDimension	MeasurementDimension	Class

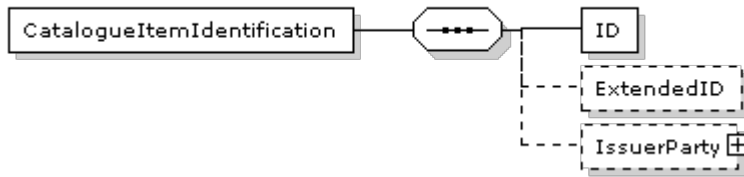
**3.15.4.5. CreditNote.CreditNoteLine.Item.CatalogueItemIdentification****CatalogueItemIdentification (CreditNote.CreditNoteLine.Item.CatalogueItemIdentification) specification**

<b>Name</b>	CreditNote.CreditNoteLine.Item.CatalogueItemIdentification	<b>Alternative term</b>	
<b>Definition</b>	Information about Item identification		

**Fields**

UBL-Name	Name	Datatype	Usage	Cardinality
ID	ID	Identifier	Bilateral	1
ExtendedID	ExtendedID	Identifier	Bilateral	0..1

**Subclasses in class CatalogueItemIdentification (CreditNote.CreditNoteLine.Item.CatalogueItemIdentification)**

UBL-Name	Name	Usage	Cardinality	Reference
IssuerParty	IssuerParty	Bilateral	0..1	G30 3.70

**Field specifications****ID**

<b>Fieldname</b>	ID	<b>Alternative term</b>	
<b>Cardinality</b>	1	<b>Usage</b>	Bilateral
<b>Datatype</b>	Identifier		
<b>Definition</b>	An identifier for an Item		
<b>Example</b>	4732		

**ExtendedID**

<b>Fieldname</b>	ExtendedID	<b>Alternative term</b>	
<b>Cardinality</b>	0..1	<b>Usage</b>	Bilateral
<b>Datatype</b>	Identifier		
<b>Definition</b>	An extended identifier for the item which identifies the item with specific properties e.g. Item 123 = Chair / Item 123 Ext 45 = Brown chair		
<b>Example</b>	PO3X89		

**Class Specification****IssuerParty**

<b>Classname</b>	IssuerParty	<b>Alternative term</b>	
<b>Cardinality</b>	0..1	<b>Usage</b>	Bilateral
<b>Datatype</b>	Party		
<b>Definition</b>	An association to Issuer Party i.e. the Party that issued the Item Identification		
<b>Recommendation</b>	If "Qualified" ItemIdentification is the issuer of the Identification this is not used		
<b>See section</b>	G30 3.70		

**Excluded classes and fields in CatalogueItemIdentification  
(CreditNote.CreditNoteLine.Item.CatalogueItemIdentification)**

Name	Name	Type
PhysicalAttribute	PhysicalAttribute	Class
MeasurementDimension	MeasurementDimension	Class

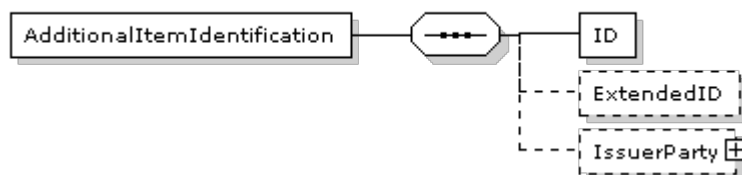
**3.15.4.6. CreditNote.CreditNoteLine.Item.AdditionalItemIdentification****AdditionalItemIdentification (CreditNote.CreditNoteLine.Item.AdditionalItemIdentification) specification**

<b>Name</b>	CreditNote.CreditNoteLine.Item.AdditionalItemIdentification	<b>Alternative term</b>	
<b>Definition</b>	Information about Item identification		

**Fields**

UBL-Name	Name	Datatype	Usage	Cardinality
ID	ID	Identifier	Bilateral	1
ExtendedID	ExtendedID	Identifier	Bilateral	0..1

**Subclasses in class AdditionalItemIdentification (CreditNote.CreditNoteLine.Item.AdditionalItemIdentification)**

UBL-Name	Name	Usage	Cardinality	Reference
IssuerParty	IssuerParty	Bilateral	0..1	G30 3.70



**Field specifications****ID**

<b>Fieldname</b>	ID	<b>Alternative term</b>	
<b>Cardinality</b>	1	<b>Usage</b>	Bilateral
<b>Datatype</b>	Identifier		
<b>Definition</b>	An identifier for an Item		
<b>Example</b>	4732		

**ExtendedID**

<b>Fieldname</b>	ExtendedID	<b>Alternative term</b>	
<b>Cardinality</b>	0..1	<b>Usage</b>	Bilateral
<b>Datatype</b>	Identifier		
<b>Definition</b>	An extended identifier for the item which identifies the item with specific properties e.g. Item 123 = Chair / Item 123 Ext 45 = Brown chair		
<b>Example</b>	PO3X89		

**Class Specification****IssuerParty**

<b>Classname</b>	IssuerParty	<b>Alternative term</b>	
<b>Cardinality</b>	0..1	<b>Usage</b>	Bilateral
<b>Datatype</b>	Party		
<b>Definition</b>	An association to Issuer Party i.e. the Party that issued the Item Identification		
<b>Recommendation</b>	If "Qualified" ItemIdentification is the issuer of the Identification this is not used		
<b>See section</b>	G30 3.70		

**Excluded classes and fields in AdditionalItemIdentification  
(CreditNote.CreditNoteLine.Item.AdditionalItemIdentification)**

Name	Name	Type
PhysicalAttribute	PhysicalAttribute	Class
MeasurementDimension	MeasurementDimension	Class

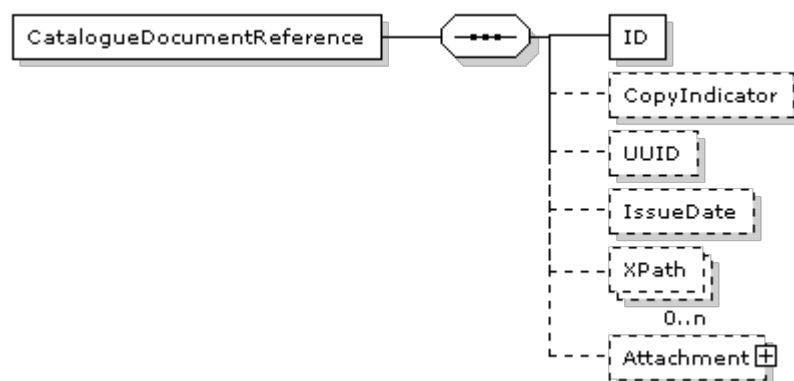
**3.15.4.7. CreditNote.CreditNoteLine.Item.CatalogueDocumentReference**
**CatalogueDocumentReference**  
**(CreditNote.CreditNoteLine.Item.CatalogueDocumentReference) specification**

<b>Name</b>	CreditNote.CreditNoteLine.Item.CatalogueDocumentReference	<b>Alternative term</b>	OIOUBL_GUIDE_DOCUMENTRENTREF
<b>Definition</b>	Information about a Document referred to in another Document		
<b>See also</b>	OIOUBL_GUIDE_DOCUMENTREF ( OIO )		

**Fields**

UBL-Name	Name	Datatype	Usage	Cardinality
ID	ID	Identifier	Bilateral	1
CopyIndicator	CopyIndicator	Indicator	Bilateral	0..1
UUID	UUID	Identifier	Bilateral	0..1
IssueDate	IssueDate	Date	Bilateral	0..1
XPath	XPath	Text	Bilateral	0..n

**Subclasses in class CatalogueDocumentReference**  
**(CreditNote.CreditNoteLine.Item.CatalogueDocumentReference)**

UBL-Name	Name	Usage	Cardinality	Reference
Attachment	Attachment	Bilateral	0..1	3.15.4.7.1

**Field specifications****ID**

<b>Fieldname</b>	ID	<b>Alternative term</b>	
<b>Cardinality</b>	1	<b>Usage</b>	Bilateral
<b>Datatype</b>	Identifier		
<b>Definition</b>	The identifier for the Document being referred to		
<b>Example</b>	428.34		

**CopyIndicator**

<b>Fieldname</b>	CopyIndicator	<b>Alternative term</b>	
<b>Cardinality</b>	0..1	<b>Usage</b>	Bilateral
<b>Datatype</b>	Indicator		
<b>Definition</b>	Indicates whether the referenced Document is a copy (true) or the original (false)		
<b>Example</b>	false		

**UUID**

<b>Fieldname</b>	UUID	<b>Alternative term</b>	OIOUBL_GUIDE_UUID
<b>Cardinality</b>	0..1	<b>Usage</b>	Bilateral
<b>Datatype</b>	Identifier		
<b>Definition</b>	A computer-generated universally unique identifier (UUID) for the referenced Document instance		
<b>See also</b>	OIOUBL_GUIDE_UUID ( G32 )		

**IssueDate**

<b>Fieldname</b>	IssueDate	<b>Alternative term</b>	
<b>Cardinality</b>	0..1	<b>Usage</b>	Bilateral
<b>Datatype</b>	Date		
<b>Definition</b>	The date assigned by the sender of the referenced Document on which the referenced Document was issued		
<b>Example</b>	2006-09-01		

**XPath**

<b>Fieldname</b>	XPath	<b>Alternative term</b>	
<b>Cardinality</b>	0..n	<b>Usage</b>	Bilateral
<b>Datatype</b>	Text		
<b>Definition</b>	Refers to another part of the same document instance		
<b>Example</b>	/DocumentReference[ID='428.22']		

**Class Specification****Attachment**

<b>Classname</b>	Attachment	<b>Alternative term</b>	
<b>Cardinality</b>	0..1	<b>Usage</b>	Bilateral
<b>Datatype</b>	Attachment		
<b>Definition</b>	An attached document, external referred to, referred in the MIME location or embedded.		
<b>See section</b>	3.15.4.7.1		

**Excluded classes and fields in CatalogueDocumentReference  
(CreditNote.CreditNoteLine.Item.CatalogueDocumentReference)**

Name	Name	Type
DocumentTypeCode	DocumentTypeCode	Field
DocumentType	DocumentType	Field

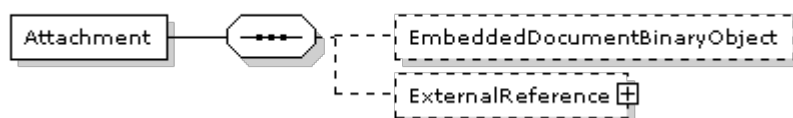
**3.15.4.7.1.****CreditNote.CreditNoteLine.Item.CatalogueDocumentReference.Attachment****Attachment (CreditNote.CreditNoteLine.Item.CatalogueDocumentReference.Attachment) specification**

<b>Name</b>	CreditNote.CreditNoteLine.Item.CatalogueDocumentReference.Attachment	<b>Alternative term</b>	OIOUBL_GUIDE_ATTACHMENT
<b>Definition</b>	Information about an attached document. An attachment can be referred to externally (with the URI element), internally (with the MIME reference element) or contained within the document itself (with the EmbeddedDocument element).		
<b>See also</b>	OIOUBL_GUIDE_ATTACHMENT ( OIO )		

**Fields**

UBL-Name	Name	Datatype	Usage	Cardinality
EmbeddedDocumentBinaryObject	EmbeddedDocumentBinaryObject	Binary Object	Bilateral	0..1

**Subclasses in class Attachment****(CreditNote.CreditNoteLine.Item.CatalogueDocumentReference.Attachment)**

UBL-Name	Name	Usage	Cardinality	Reference
ExternalReference	ExternalReference	Bilateral	0..1	G30 3.41

**Field specifications****EmbeddedDocumentBinaryObject**

<b>Fieldname</b>	EmbeddedDocumentBinaryObject	<b>Alternative term</b>	
<b>Cardinality</b>	0..1	<b>Usage</b>	Bilateral
<b>Datatype</b>	Binary Object		
<b>Definition</b>	Contains an embedded document as a BLOB,		
<b>Businessrules</b>	Only allowed if no ExternalReference is specified and if bilateral agreed.		
<b>Dependency</b>	../ExternalReference		

**Class Specification***ExternalReference*

<b>Classname</b>	ExternalReference	<b>Alternative term</b>	
<b>Cardinality</b>	0..1	<b>Usage</b>	Bilateral
<b>Datatype</b>	ExternalReference		
<b>Definition</b>	An attached document, external referred to, referred in the MIME location or embedded.		
<b>Businessrules</b>	Used if no EmbeddedDocumentBinaryObject specified		
<b>Dependency</b>	../EmbeddedDocumentBinaryObject		
<b>See section</b>	G30 3.41		

**Excluded classes and fields in Attachment  
(CreditNote.CreditNoteLine.Item.CatalogueDocumentReference.Attachment)**

None