

AGENDA
REGULAR MEETING BOARD OF DIRECTORS
ORANGE COUNTY WATER DISTRICT
18700 Ward Street, Fountain Valley, CA (714) 378-3200
Wednesday, June 1, 2016 – 5:30 p.m.

PLEDGE OF ALLEGIANCE

ROLL CALL

ITEMS RECEIVED TOO LATE TO BE AGENDIZED

RECOMMENDATION: Adopt resolution determining need to take immediate action on item(s) and that the need for action came to the attention of the District subsequent to the posting of the Agenda (requires two-thirds vote of the Board members present, or, if less than two-thirds of the members are present, a unanimous vote of those members present.)

VISITOR PARTICIPATION

Time has been reserved at this point in the agenda for persons wishing to comment for up to three minutes to the Board of Directors on any item that is not listed on the agenda, but within the subject matter jurisdiction of the District. By law, the Board of Directors is prohibited from taking action on such public comments. As appropriate, matters raised in these public comments will be referred to District staff or placed on the agenda of an upcoming Board meeting.

At this time, members of the public may also offer public comment for up to three minutes on any item on the Consent Calendar. While members of the public may not remove an item from the Consent Calendar for separate discussion, a Director may do so at the request of a member of the public.

CONSENT CALENDAR (ITEMS NO. 1 - 3)

All matters on the Consent Calendar are to be approved by one motion, without separate discussion on these items, unless a Board member or District staff request that specific items be removed from the Consent Calendar for separate consideration.

1. **APPROVAL OF CASH DISBURSEMENTS**

RECOMMENDATION: Ratify/authorize payment of bills

2. **RATIFICATION OF JOB CLASSIFICATION CHANGES**

RECOMMENDATION: Ratify the following job classification changes:

- 1) Placement of the Network Administrator job classification at salary grade R-15;
- 2) Addition of a Senior Network Administrator at salary grade R-17; and
- 3) Addition of a Principal Network Administrator at salary grade R-19

3. **POSEIDON CONFIDENTIALITY AGREEMENT**

RECOMMENDATION: Authorize execution of the Poseidon Confidentiality Agreement Amendment No. 2

WORKSHOP

4. WATER QUALITY STUDY FOR POSEIDON DESALINATION PROJECT

MATTERS FOR CONSIDERATION

5. POSEIDON RESOURCES CALIFORNIA ENVIRONMENTAL QUALITY ACT (CEQA) REIMBURSEMENT AGREEMENT

RECOMMENDATION: Authorize the following actions:

- 1) Commence preparation of CEQA documents for the project;
- 2) Execute Poseidon CEQA Reimbursement Agreement; and
- 3) Issue necessary agreements with CEQA consultants to assist with this effort

INFORMATIONAL ITEMS

6. SANTA ANA WATERSHED PROJECT AUTHORITY ACTIVITIES - VERBAL REPORT

7. CONFERENCE/MEETING REPORTS

- Reports on Conferences/Meetings Attended at District Expense (at which a quorum of the Board was present)

8. **VERBAL REPORTS**

- PRESIDENT'S REPORT
- GENERAL MANAGER'S REPORT
- DIRECTORS' REPORTS
 - ▶ Reports on Conferences/Meetings Attended at District Expense (at which a quorum of the Board was present)
- GENERAL COUNSEL REPORT

ADJOURNMENT TO CLOSED SESSION

- **CONFERENCE WITH LEGAL COUNSEL – ANTICIPATED LITIGATION - SIGNIFICANT EXPOSURE TO LITIGATION - [Government Code Section 54956.9(b) – One potential case]**

Agenda Posting: In accordance with the requirements of California Government Code Section 54954.2, this agenda has been posted in the main lobby of the Orange County Water District, 18700 Ward Street, Fountain Valley, CA and on the OCWD website: www.ocwd.com not less than 24 hours prior to the meeting date and time above. All written materials relating to each agenda item are available for public inspection in the office of the Assistant District Secretary. Backup material for the Agenda is available at the District offices for public review and can be viewed online at the District's website: www.ocwd.com.

Accommodations to the Disabled: Pursuant to the Americans with Disabilities Act, persons with a disability who require a disability-related modification or accommodation in order to participate in a meeting, including auxiliary aids or services, may request such modification or accommodation from the District Secretary at (714)378-3233, by email at jdurant@ocwd.com by fax at (714) 378-3373. Notification 24 hours prior to the meeting will enable District staff to make reasonable arrangements to assure accessibility to the meeting.

Availability of Agenda Material: As a general rule, agenda reports or other written documentation that has been prepared or organized with respect to each item of business listed on the agenda can be reviewed at www.ocwd.com. Copies of these materials and other disclosable public records distributed to all or a majority of the members of the Board of Directors in connection with an open session agenda item are also on file with and available for inspection at the Office of the District Secretary, 18700 Ward Street, Fountain Valley, California, during regular business hours, 8:00 a.m. to 5:00 p.m., Monday through Friday. If such writings are distributed to members of the Board of Directors on the day of a Board meeting, the writings will be available at the entrance to the Board of Directors meeting room at the Orange County Water District office.

AGENDA ITEM SUBMITTAL

Meeting Date: June 1, 2016

Budgeted: N/A

To: Board of Directors

Budgeted Amount: N/A

Cost Estimate \$7,436,364.32

Funding Source: N/A

From: Mike Markus

Program/Line Item No. N/A

General Counsel Approval: N/A

Engineers/Feasibility Report: N/A

Staff Contact: M. Ochoa

CEQA Compliance: N/A

Subject: **APPROVAL OF CASH DISBURSEMENTS**

SUMMARY

For the period May 12, 2016 through May 25, 2016 including manual checks and wire transfers, staff is presenting cash disbursements totaling \$ 7,436,364.32 disbursed for each period as follows.

Accounts Payable:

05/12/2016 to 05/18/2016	\$ 1,529,898.76
--------------------------	-----------------

05/19/2016 to 05/25/2016	\$ 4,908,581.32
--------------------------	-----------------

Payroll:	\$ 997,884.24
----------	---------------

Total Disbursements	\$ 7,436,364.32
----------------------------	------------------------

RECOMMENDATION

Ratify/Authorize payment of bills

PRIOR RELEVANT BOARD ACTION(S)

Semi-monthly

Orange County Water District

Check Register

Begin Date: 05/12/2016

End Date: 05/18/2016

Page 1

Accounts Payable Check Register Presented for Board Ratification and/or Approval

Check No.	Date	Vendor Name	Invoice #	Purpose	Invoice Amount	Check Amount	FYTD
71796	11/24/2015	Nguyen, Dina	Inv# OCTOBER 2015 TRAVEL Meetings	Oct15 OCWD Various	(\$48.30)		
Total for Check: 71796						(\$48.30)	\$352.23
72762	02/03/2016	BRENDAN SCREENPRINTING	Inv# 29799	POLO SHIRT/JACKETS	(\$75.60)		
72762	02/03/2016	BRENDAN SCREENPRINTING	Inv# 29799	POLO SHIRT/JACKETS	(\$110.16)		
72762	02/03/2016	BRENDAN SCREENPRINTING	Inv# 29799	POLO SHIRT/JACKETS	(\$106.92)		
72762	02/03/2016	BRENDAN SCREENPRINTING	Inv# 29799	POLO SHIRT/JACKETS	(\$91.80)		
72762	02/03/2016	BRENDAN SCREENPRINTING	Inv# 29799	POLO SHIRT/JACKETS	(\$86.40)		
72762	02/03/2016	BRENDAN SCREENPRINTING	Inv# 29799	POLO SHIRT/JACKETS	(\$77.76)		
72762	02/03/2016	BRENDAN SCREENPRINTING	Inv# 29799	POLO SHIRT/JACKETS	(\$58.32)		
72762	02/03/2016	BRENDAN SCREENPRINTING	Inv# 29799	POLO SHIRT/JACKETS	(\$75.84)		
72762	02/03/2016	BRENDAN SCREENPRINTING	Inv# 29799	POLO SHIRT/JACKETS	(\$116.64)		
72762	02/03/2016	BRENDAN SCREENPRINTING	Inv# 29799	POLO SHIRT/JACKETS	(\$73.44)		
72762	02/03/2016	BRENDAN SCREENPRINTING	Inv# 29799	POLO SHIRT/JACKETS	(\$73.44)		
72762	02/03/2016	BRENDAN SCREENPRINTING	Inv# 29799	POLO SHIRT/JACKETS	(\$71.28)		
72762	02/03/2016	BRENDAN SCREENPRINTING	Inv# 29799	POLO SHIRT/JACKETS	(\$58.32)		
72762	02/03/2016	BRENDAN SCREENPRINTING	Inv# 29799	POLO SHIRT/JACKETS	(\$58.32)		
72762	02/03/2016	BRENDAN SCREENPRINTING	Inv# 29799	POLO SHIRT/JACKETS	(\$77.76)		
72762	02/03/2016	BRENDAN SCREENPRINTING	Inv# 29799	POLO SHIRT/JACKETS	(\$142.56)		
72762	02/03/2016	BRENDAN SCREENPRINTING	Inv# 29799	POLO SHIRT/JACKETS	(\$758.16)		
72762	02/03/2016	BRENDAN SCREENPRINTING	Inv# 29799	POLO SHIRT/JACKETS	(\$220.32)		
72762	02/03/2016	BRENDAN SCREENPRINTING	Inv# 29799	POLO SHIRT/JACKETS	(\$194.40)		
72762	02/03/2016	BRENDAN SCREENPRINTING	Inv# 29799	POLO SHIRT/JACKETS	(\$192.00)		
72762	02/03/2016	BRENDAN SCREENPRINTING	Inv# 29799	POLO SHIRT/JACKETS	(\$174.96)		
72762	02/03/2016	BRENDAN SCREENPRINTING	Inv# 29799	POLO SHIRT/JACKETS	(\$110.16)		
72762	02/03/2016	BRENDAN SCREENPRINTING	Inv# 29799	POLO SHIRT/JACKETS	(\$171.68)		
72762	02/03/2016	BRENDAN SCREENPRINTING	Inv# 29799	POLO SHIRT/JACKETS	(\$116.64)		
72762	02/03/2016	BRENDAN SCREENPRINTING	Inv# 29799	POLO SHIRT/JACKETS	(\$142.56)		
72762	02/03/2016	BRENDAN SCREENPRINTING	Inv# 29799	POLO SHIRT/JACKETS	(\$136.08)		
72762	02/03/2016	BRENDAN SCREENPRINTING	Inv# 29799	POLO SHIRT/JACKETS	(\$136.08)		
72762	02/03/2016	BRENDAN SCREENPRINTING	Inv# 29799	POLO SHIRT/JACKETS	(\$128.52)		
72762	02/03/2016	BRENDAN SCREENPRINTING	Inv# 29799	POLO SHIRT/JACKETS	(\$128.52)		
72762	02/03/2016	BRENDAN SCREENPRINTING	Inv# 29799	POLO SHIRT/JACKETS	(\$55.08)		

Orange County Water District

Check Register

Begin Date: 05/12/2016

End Date: 05/18/2016

Page 2

Accounts Payable Check Register Presented for Board Ratification and/or Approval

Check No.	Date	Vendor Name	Invoice #	Purpose	Invoice Amount	Check Amount	FYTD
72762	02/03/2016	BRENDAN SCREENPRINTING	Inv# 29799	POLO SHIRT/JACKETS	(\$174.96)		
72762	02/03/2016	BRENDAN SCREENPRINTING	Inv# 29799	POLO SHIRT/JACKETS	(\$10.80)		
72762	02/03/2016	BRENDAN SCREENPRINTING	Inv# 29799	POLO SHIRT/JACKETS	(\$58.32)		
72762	02/03/2016	BRENDAN SCREENPRINTING	Inv# 29799	POLO SHIRT/JACKETS	(\$18.36)		
72762	02/03/2016	BRENDAN SCREENPRINTING	Inv# 29799	POLO SHIRT/JACKETS	(\$18.36)		
72762	02/03/2016	BRENDAN SCREENPRINTING	Inv# 29799	POLO SHIRT/JACKETS	(\$18.36)		
72762	02/03/2016	BRENDAN SCREENPRINTING	Inv# 29799	POLO SHIRT/JACKETS	(\$18.36)		
72762	02/03/2016	BRENDAN SCREENPRINTING	Inv# 29799	POLO SHIRT/JACKETS	(\$18.36)		
72762	02/03/2016	BRENDAN SCREENPRINTING	Inv# 29799	POLO SHIRT/JACKETS	(\$19.44)		
72762	02/03/2016	BRENDAN SCREENPRINTING	Inv# 29799	POLO SHIRT/JACKETS	(\$10.80)		
72762	02/03/2016	BRENDAN SCREENPRINTING	Inv# 29799	POLO SHIRT/JACKETS	(\$19.44)		
72762	02/03/2016	BRENDAN SCREENPRINTING	Inv# 29799	POLO SHIRT/JACKETS	(\$9.72)		
72762	02/03/2016	BRENDAN SCREENPRINTING	Inv# 29799	POLO SHIRT/JACKETS	(\$9.72)		
72762	02/03/2016	BRENDAN SCREENPRINTING	Inv# 29799	POLO SHIRT/JACKETS	(\$9.72)		
72762	02/03/2016	BRENDAN SCREENPRINTING	Inv# 29799	POLO SHIRT/JACKETS	(\$5.40)		
72762	02/03/2016	BRENDAN SCREENPRINTING	Inv# 29799	POLO SHIRT/JACKETS	(\$5.40)		
72762	02/03/2016	BRENDAN SCREENPRINTING	Inv# 29799	POLO SHIRT/JACKETS	(\$5.40)		
72762	02/03/2016	BRENDAN SCREENPRINTING	Inv# 29799	POLO SHIRT/JACKETS	(\$16.20)		
72762	02/03/2016	BRENDAN SCREENPRINTING	Inv# 29799	POLO SHIRT/JACKETS	(\$37.84)		
72762	02/03/2016	BRENDAN SCREENPRINTING	Inv# 29799	POLO SHIRT/JACKETS	(\$54.00)		
72762	02/03/2016	BRENDAN SCREENPRINTING	Inv# 29799	POLO SHIRT/JACKETS	(\$48.60)		
72762	02/03/2016	BRENDAN SCREENPRINTING	Inv# 29799	POLO SHIRT/JACKETS	(\$48.60)		
72762	02/03/2016	BRENDAN SCREENPRINTING	Inv# 29799	POLO SHIRT/JACKETS	(\$43.20)		
72762	02/03/2016	BRENDAN SCREENPRINTING	Inv# 29799	POLO SHIRT/JACKETS	(\$19.44)		
72762	02/03/2016	BRENDAN SCREENPRINTING	Inv# 29799	POLO SHIRT/JACKETS	(\$38.88)		
72762	02/03/2016	BRENDAN SCREENPRINTING	Inv# 29799	POLO SHIRT/JACKETS	(\$37.80)		
72762	02/03/2016	BRENDAN SCREENPRINTING	Inv# 29799	POLO SHIRT/JACKETS	(\$36.72)		
72762	02/03/2016	BRENDAN SCREENPRINTING	Inv# 29799	POLO SHIRT/JACKETS	(\$29.16)		
72762	02/03/2016	BRENDAN SCREENPRINTING	Inv# 29799	POLO SHIRT/JACKETS	(\$23.76)		
72762	02/03/2016	BRENDAN SCREENPRINTING	Inv# 29799	POLO SHIRT/JACKETS	(\$23.76)		
72762	02/03/2016	BRENDAN SCREENPRINTING	Inv# 29799	POLO SHIRT/JACKETS	(\$21.60)		
72762	02/03/2016	BRENDAN SCREENPRINTING	Inv# 29799	POLO SHIRT/JACKETS	(\$19.44)		

Orange County Water District

Check Register

Begin Date: 05/12/2016

End Date: 05/18/2016

Page 3

Accounts Payable Check Register Presented for Board Ratification and/or Approval

Check No.	Date	Vendor Name	Invoice #	Purpose	Invoice Amount	Check Amount	FYTD
72762	02/03/2016	BRENDAN SCREENPRINTING	Inv# 29799	POLO SHIRT/JACKETS	(\$38.88)		
		Total for Check: 72762				(\$4,988.52)	\$28,361.24
73382	03/09/2016	FITCH RATINGS	Inv# 7119032340	C.O.P. SERIES A & B	(\$25,000.00)		
		Total for Check: 73382				(\$25,000.00)	\$17,000.00
74544	05/18/2016	SONTEK/YSI	Inv# 636770	REPAIR FLOWTRACKER	\$2,135.80		
74544	05/18/2016	YSI INCORPORATED	Inv# 641329	Xylem 15 PSI Bubbler	\$8,478.00		
74544	05/18/2016	YSI INCORPORATED	Inv# 641261	Xylem 15 PSI Bubbler	\$8,478.00		
74544	05/18/2016	YSI INCORPORATED	Inv# 641261		\$73.24		
		Total for Check: 74544				\$19,165.04	\$31,990.81
74545	05/18/2016	FRONTIER COMMUNICATIONS	Inv# 714 378 3200 060607-5APR1	APRIL 2016	\$2,262.50		
74545	05/18/2016	FRONTIER COMMUNICATIONS	Inv# 714 964 1492 03 0609-5APR		\$154.36		
74545	05/18/2016	FRONTIER COMMUNICATIONS	Inv# 714 965-1308-0823075APR16	4/22/16-5/21/16	\$151.08		
		Total for Check: 74545				\$2,567.94	\$6,213.96
74546	05/18/2016	AMERICAN GEOTECHNICAL, INC.	Inv# 76236	2/28-3/26 LaPalma Recharge	\$2,425.00		
		Total for Check: 74546				\$2,425.00	\$8,762.50
74547	05/18/2016	ACWA/JPIA	Inv# 0410989 JUNE2016	Health Insurance Jun2016	\$360,740.31		
		Total for Check: 74547				\$360,740.31	\$4,228,835.36
74548	05/18/2016	ALTERNATIVE HOSE, INC.	Inv# 5593771	RECHARGE OPERATIONS/WETLANDS	\$207.28		
		Total for Check: 74548				\$207.28	\$1,158.58
74549	05/18/2016	AMERICAN WATER CHEMICAL, INC	Inv# 05-16253/02	Discount correction	\$64.96		
74549	05/18/2016	AMERICAN WATER CHEMICAL, INC	Inv# 05-16277/01	Discount	(\$1,216.20)		
74549	05/18/2016	AMERICAN WATER CHEMICAL, INC	Inv# 05-16253/02	unit price corr-05-16253/01	(\$3,212.00)		
74549	05/18/2016	AMERICAN WATER CHEMICAL, INC	Inv# 05-16277/01	5/10 antiscalant 40540 lbs	\$60,810.00		
		Total for Check: 74549				\$56,446.76	\$1,685,735.18
74551	05/18/2016	ANAHEIM TRUCK & AUTO SERVICE, INC.	Inv# 000111554	SERVICE HYDRAULIC LIFT ON T-98	\$55.00		
74551	05/18/2016	ANAHEIM TRUCK & AUTO SERVICE, INC.	Inv# 000111554	SERVICE HYDRAULIC LIFT ON T-98	\$80.55		
74551	05/18/2016	ANAHEIM TRUCK & AUTO SERVICE, INC.	Inv# 000111554	SERVICE HYDRAULIC LIFT ON T-98	\$4.00		
74551	05/18/2016	ANAHEIM TRUCK & AUTO SERVICE, INC.	Inv# 000111554	SERVICE HYDRAULIC LIFT ON T-98	\$5.49		
74551	05/18/2016	ANAHEIM TRUCK & AUTO SERVICE, INC.	Inv# 000111554	SERVICE HYDRAULIC LIFT ON T-98	\$20.45		

Orange County Water District

Check Register

Begin Date: 05/12/2016

End Date: 05/18/2016

Page 4

Accounts Payable Check Register Presented for Board Ratification and/or Approval

Check No.	Date	Vendor Name	Invoice #	Purpose	Invoice Amount	Check Amount	FYTD
74551	05/18/2016	ANAHEIM TRUCK & AUTO SERVICE, INC.	Inv# 000111554	SERVICE HYDRAULIC LIFT ON T-98	\$53.70		
74551	05/18/2016	ANAHEIM TRUCK & AUTO SERVICE, INC.	Inv# 000111554	SERVICE HYDRAULIC LIFT ON T-98	\$57.34		
74551	05/18/2016	ANAHEIM TRUCK & AUTO SERVICE, INC.	Inv# 000111554	SERVICE HYDRAULIC LIFT ON T-98	\$69.00		
74551	05/18/2016	ANAHEIM TRUCK & AUTO SERVICE, INC.	Inv# 000111554	SERVICE HYDRAULIC LIFT ON T-98	\$172.50		
74551	05/18/2016	ANAHEIM TRUCK & AUTO SERVICE, INC.	Inv# 000111554	SERVICE HYDRAULIC LIFT ON T-98	\$460.00		
74551	05/18/2016	ANAHEIM TRUCK & AUTO SERVICE, INC.	Inv# 000111554	SERVICE HYDRAULIC LIFT ON T-98	\$501.50		
74551	05/18/2016	ANAHEIM TRUCK & AUTO SERVICE, INC.	Inv# 000111554	SERVICE HYDRAULIC LIFT ON T-98	\$69.00		
Total for Check: 74551						\$1,548.53	\$1,548.53
74552	05/18/2016	ANALYTICAL WEST, INC.	Inv# 12204-INV	LABORATORY SUPPLIES	\$1,722.90		
74552	05/18/2016	ANALYTICAL WEST, INC.	Inv# 12204-INV		(\$34.46)		
Total for Check: 74552						\$1,688.44	\$1,928.87
74553	05/18/2016	APLUS FINETEK SENSOR, INC.	Inv# 686	INVENTORY RE-ORDER	\$297.00		
Total for Check: 74553						\$297.00	\$309.97
74554	05/18/2016	AT & T	Inv# 714 630-4323-653-2APR16		\$1,133.13		
Total for Check: 74554						\$1,133.13	\$21,216.06
74555	05/18/2016	AT & T	Inv# 714 630 3232 437 2APR16		\$188.61		
Total for Check: 74555						\$188.61	\$21,216.06
74556	05/18/2016	BENRICH SERVICE COMPANY, INC.	Inv# OC16203	Admin hot and cold water loop	\$124.21		
Total for Check: 74556						\$124.21	\$15,525.84
74557	05/18/2016	BONTERRA PSOMAS (USE IF EXISTING PROJ.)	Inv# 117210 (WO#15 S.SADDLE)	3/4-31 wo#15 Santiago Saddle	\$1,587.50		
74557	05/18/2016	BONTERRA PSOMAS (USE IF EXISTING PROJ.)	Inv# 117205 (WO#14 EW-1)	3/3-31 wo#14 Ejection EW-1 wel	(\$2,135.58)		
74557	05/18/2016	BONTERRA PSOMAS (USE IF EXISTING PROJ.)	Inv# 117205 (WO#14 EW-1)	3/3-31 wo#14 Ejection EW-1 wel	\$2,135.58		
74557	05/18/2016	BONTERRA PSOMAS (USE IF EXISTING PROJ.)	Inv# 117205 (WO#14 EW-1)	3/3-31 wo#14 Ejection EW-1 wel	\$2,135.58		
Total for Check: 74557						\$3,723.08	\$84,892.42
74564	05/18/2016	BRENDAN SCREENPRINTING	Inv# 29799	POLO SHIRT/JACKETS	\$37.80		

Orange County Water District

Check Register

Begin Date: 05/12/2016

End Date: 05/18/2016

Page 5

Accounts Payable Check Register Presented for Board Ratification and/or Approval

Check No.	Date	Vendor Name	Invoice #	Purpose	Invoice Amount	Check Amount	FYTD
74564	05/18/2016	BRENDAN SCREENPRINTING	Inv# 29799	POLO SHIRT/JACKETS	\$19.44		
74564	05/18/2016	BRENDAN SCREENPRINTING	Inv# 29799	POLO SHIRT/JACKETS	\$19.44		
74564	05/18/2016	BRENDAN SCREENPRINTING	Inv# 29799	POLO SHIRT/JACKETS	\$19.44		
74564	05/18/2016	BRENDAN SCREENPRINTING	Inv# 29799	POLO SHIRT/JACKETS	\$21.60		
74564	05/18/2016	BRENDAN SCREENPRINTING	Inv# 29799	POLO SHIRT/JACKETS	\$23.76		
74564	05/18/2016	BRENDAN SCREENPRINTING	Inv# 29799	POLO SHIRT/JACKETS	\$23.76		
74564	05/18/2016	BRENDAN SCREENPRINTING	Inv# 31418	REF.P.O. 34473	\$71.28		
74564	05/18/2016	BRENDAN SCREENPRINTING	Inv# 29799	POLO SHIRT/JACKETS	\$36.72		
74564	05/18/2016	BRENDAN SCREENPRINTING	Inv# 29799	POLO SHIRT/JACKETS	\$18.36		
74564	05/18/2016	BRENDAN SCREENPRINTING	Inv# 29799	POLO SHIRT/JACKETS	\$37.84		
74564	05/18/2016	BRENDAN SCREENPRINTING	Inv# 29799	POLO SHIRT/JACKETS	\$38.88		
74564	05/18/2016	BRENDAN SCREENPRINTING	Inv# 29799	POLO SHIRT/JACKETS	\$38.88		
74564	05/18/2016	BRENDAN SCREENPRINTING	Inv# 29799	POLO SHIRT/JACKETS	\$43.20		
74564	05/18/2016	BRENDAN SCREENPRINTING	Inv# 29799	POLO SHIRT/JACKETS	\$48.60		
74564	05/18/2016	BRENDAN SCREENPRINTING	Inv# 29799	POLO SHIRT/JACKETS	\$29.16		
74564	05/18/2016	BRENDAN SCREENPRINTING	Inv# 29799	POLO SHIRT/JACKETS	\$10.80		
74564	05/18/2016	BRENDAN SCREENPRINTING	Inv# 29799	POLO SHIRT/JACKETS	\$5.40		
74564	05/18/2016	BRENDAN SCREENPRINTING	Inv# 29799	POLO SHIRT/JACKETS	\$5.40		
74564	05/18/2016	BRENDAN SCREENPRINTING	Inv# 29799	POLO SHIRT/JACKETS	\$5.40		
74564	05/18/2016	BRENDAN SCREENPRINTING	Inv# 29799	POLO SHIRT/JACKETS	\$9.72		
74564	05/18/2016	BRENDAN SCREENPRINTING	Inv# 29799	POLO SHIRT/JACKETS	\$9.72		
74564	05/18/2016	BRENDAN SCREENPRINTING	Inv# 29799	POLO SHIRT/JACKETS	\$19.44		
74564	05/18/2016	BRENDAN SCREENPRINTING	Inv# 29799	POLO SHIRT/JACKETS	\$10.80		
74564	05/18/2016	BRENDAN SCREENPRINTING	Inv# 29799	POLO SHIRT/JACKETS	\$18.36		
74564	05/18/2016	BRENDAN SCREENPRINTING	Inv# 29799	POLO SHIRT/JACKETS	\$142.56		
74564	05/18/2016	BRENDAN SCREENPRINTING	Inv# 29799	POLO SHIRT/JACKETS	\$16.20		
74564	05/18/2016	BRENDAN SCREENPRINTING	Inv# 29799	POLO SHIRT/JACKETS	\$18.36		
74564	05/18/2016	BRENDAN SCREENPRINTING	Inv# 29799	POLO SHIRT/JACKETS	\$18.36		
74564	05/18/2016	BRENDAN SCREENPRINTING	Inv# 29799	POLO SHIRT/JACKETS	\$18.36		
74564	05/18/2016	BRENDAN SCREENPRINTING	Inv# 29799	POLO SHIRT/JACKETS	\$48.60		
74564	05/18/2016	BRENDAN SCREENPRINTING	Inv# 29799	POLO SHIRT/JACKETS	\$9.72		
74564	05/18/2016	BRENDAN SCREENPRINTING	Inv# 29799	POLO SHIRT/JACKETS	\$174.96		

Orange County Water District

Check Register

Begin Date: 05/12/2016

End Date: 05/18/2016

Page 6

Accounts Payable Check Register Presented for Board Ratification and/or Approval

Check No.	Date	Vendor Name	Invoice #	Purpose	Invoice Amount	Check Amount	FYTD
74564	05/18/2016	BRENDAN SCREENPRINTING	Inv# 29799	POLO SHIRT/JACKETS	\$110.16		
74564	05/18/2016	BRENDAN SCREENPRINTING	Inv# 29799	POLO SHIRT/JACKETS	\$116.64		
74564	05/18/2016	BRENDAN SCREENPRINTING	Inv# 29799	POLO SHIRT/JACKETS	\$116.64		
74564	05/18/2016	BRENDAN SCREENPRINTING	Inv# 29799	POLO SHIRT/JACKETS	\$128.52		
74564	05/18/2016	BRENDAN SCREENPRINTING	Inv# 29799	POLO SHIRT/JACKETS	\$54.00		
74564	05/18/2016	BRENDAN SCREENPRINTING	Inv# 29799	POLO SHIRT/JACKETS	\$110.16		
74564	05/18/2016	BRENDAN SCREENPRINTING	Inv# 29799	POLO SHIRT/JACKETS	\$171.68		
74564	05/18/2016	BRENDAN SCREENPRINTING	Inv# 29799	POLO SHIRT/JACKETS	\$128.52		
74564	05/18/2016	BRENDAN SCREENPRINTING	Inv# 29799	POLO SHIRT/JACKETS	\$174.96		
74564	05/18/2016	BRENDAN SCREENPRINTING	Inv# 29799	POLO SHIRT/JACKETS	\$192.00		
74564	05/18/2016	BRENDAN SCREENPRINTING	Inv# 29799	POLO SHIRT/JACKETS	\$194.40		
74564	05/18/2016	BRENDAN SCREENPRINTING	Inv# 29799	POLO SHIRT/JACKETS	\$220.32		
74564	05/18/2016	BRENDAN SCREENPRINTING	Inv# 29799	POLO SHIRT/JACKETS	\$758.16		
74564	05/18/2016	BRENDAN SCREENPRINTING	Inv# 29799	POLO SHIRT/JACKETS	\$136.08		
74564	05/18/2016	BRENDAN SCREENPRINTING	Inv# 29799	POLO SHIRT/JACKETS	\$142.56		
74564	05/18/2016	BRENDAN SCREENPRINTING	Inv# 29799	POLO SHIRT/JACKETS	\$58.32		
74564	05/18/2016	BRENDAN SCREENPRINTING	Inv# 29799	POLO SHIRT/JACKETS	\$55.08		
74564	05/18/2016	BRENDAN SCREENPRINTING	Inv# 29799	POLO SHIRT/JACKETS	\$58.32		
74564	05/18/2016	BRENDAN SCREENPRINTING	Inv# 29799	POLO SHIRT/JACKETS	\$136.08		
74564	05/18/2016	BRENDAN SCREENPRINTING	Inv# 29799	POLO SHIRT/JACKETS	\$58.32		
74564	05/18/2016	BRENDAN SCREENPRINTING	Inv# 29799	POLO SHIRT/JACKETS	\$106.92		
74564	05/18/2016	BRENDAN SCREENPRINTING	Inv# 29799	POLO SHIRT/JACKETS	\$71.28		
74564	05/18/2016	BRENDAN SCREENPRINTING	Inv# 29799	POLO SHIRT/JACKETS	\$73.44		
74564	05/18/2016	BRENDAN SCREENPRINTING	Inv# 29799	POLO SHIRT/JACKETS	\$73.44		
74564	05/18/2016	BRENDAN SCREENPRINTING	Inv# 29799	POLO SHIRT/JACKETS	\$75.60		
74564	05/18/2016	BRENDAN SCREENPRINTING	Inv# 29799	POLO SHIRT/JACKETS	\$75.84		
74564	05/18/2016	BRENDAN SCREENPRINTING	Inv# 29799	POLO SHIRT/JACKETS	\$77.76		
74564	05/18/2016	BRENDAN SCREENPRINTING	Inv# 29799	POLO SHIRT/JACKETS	\$91.80		
74564	05/18/2016	BRENDAN SCREENPRINTING	Inv# 29799	POLO SHIRT/JACKETS	\$77.76		
74564	05/18/2016	BRENDAN SCREENPRINTING	Inv# 29799	POLO SHIRT/JACKETS	\$86.40		
74564	05/18/2016	BRENDAN SCREENPRINTING	Inv# 29799	POLO SHIRT/JACKETS	\$58.32		
Total for Check: 74564					\$5,059.80		\$28,361.24

Orange County Water District

Check Register

Begin Date: 05/12/2016

End Date: 05/18/2016

Page 7

Accounts Payable Check Register Presented for Board Ratification and/or Approval

Check No.	Date	Vendor Name	Invoice #	Purpose	Invoice Amount	Check Amount	FYTD
74565	05/18/2016	BRENNTAG PACIFIC INC.	Inv# BPI624125	5/11 citric acid 22.95 tons	\$21,563.83		
74565	05/18/2016	BRENNTAG PACIFIC INC.	Inv# BPI624722	Discount	(\$233.06)		
74565	05/18/2016	BRENNTAG PACIFIC INC.	Inv# BPI624722	5/11 hydro.peroxide 43320 lb	\$11,653.08		
74565	05/18/2016	BRENNTAG PACIFIC INC.	Inv# BPI624550	Discount	(\$114.97)		
74565	05/18/2016	BRENNTAG PACIFIC INC.	Inv# BPI624125	Discount	(\$599.00)		
74565	05/18/2016	BRENNTAG PACIFIC INC.	Inv# BPI624550	5/11 caustic soda 12.4968 tons	\$6,208.41		
Total for Check: 74565						\$38,478.29	\$915,215.61
74566	05/18/2016	Bouyounes, Pauline	Inv# 4/21/16 PASMA TRAVEL	4/21 Orange PASMA Meeting	\$5.02		
74566	05/18/2016	Bouyounes, Pauline	Inv# 4/20/16 TRAVEL	4/20 Anaheim Mtg w/Anaheim Sta	\$10.37		
74566	05/18/2016	Bouyounes, Pauline	Inv# 2/25/16 TRAINING	2/25 San Diego Wtr.Sec.Symposi	\$18.63		
74566	05/18/2016	Bouyounes, Pauline	Inv# 3/17/16 TRAVEL	3/17 Anaheim Recharge Audit	\$10.37		
74566	05/18/2016	Bouyounes, Pauline	Inv# 2/10/16 TRAVEL	2/10 San Diego Water Security	\$97.96		
74566	05/18/2016	Bouyounes, Pauline	Inv# 2/1/16 1ST AID-CPR	2/1 First Aid-CPR train. suppl	\$31.26		
74566	05/18/2016	Bouyounes, Pauline	Inv# 3/22/16 TRAVEL	3/22 Anaheim Mtg w/Fire Dept	\$10.37		
74566	05/18/2016	Bouyounes, Pauline	Inv# 2/23/16 TRAVEL	2/23 Anaheim Mtg w/Anaheim Sta	\$10.38		
Total for Check: 74566						\$194.36	\$814.13
74567	05/18/2016	CAMBRIDGE ISOTOPE LABORATORIES	Inv# 01083044	LABORATORY CHEMICALS	\$270.00		
74567	05/18/2016	CAMBRIDGE ISOTOPE LABORATORIES	Inv# 01083044		\$15.38		
Total for Check: 74567						\$285.38	\$5,910.15
74568	05/18/2016	CDM SMITH INC.	Inv# 80552042/27 (R14026)	2/28-4/2 Sunset GAP	\$2,012.50		
74568	05/18/2016	CDM SMITH INC.	Inv# 80552042/27 (R12030)	2/28-4/2 Sunset GAP	\$478.50		
74568	05/18/2016	CDM SMITH INC.	Inv# 80552042/27 (R12030)	2/28-4/2 GL adj frm R14026	\$478.50		
74568	05/18/2016	CDM SMITH INC.	Inv# 80552042/27 (R12030)	2/28-4/2 GL adj to R12030	(\$478.50)		
Total for Check: 74568						\$2,491.00	\$184,481.96
74569	05/18/2016	CERILLIANT CORPORATION	Inv# 414160	LABORATORY SUPPLIES	\$3,201.56		
Total for Check: 74569						\$3,201.56	\$3,560.40
74570	05/18/2016	CGS PLUMBING	Inv# 02191	Annual Backflow Certification	\$610.00		
74570	05/18/2016	CGS PLUMBING	Inv# 02191	Annual Backflow Certification	\$2,400.00		
Total for Check: 74570						\$3,010.00	\$4,580.00

Orange County Water District

Check Register

Begin Date: 05/12/2016

End Date: 05/18/2016

Page 8

Accounts Payable Check Register Presented for Board Ratification and/or Approval

Check No.	Date	Vendor Name	Invoice #	Purpose	Invoice Amount	Check Amount	FYTD
74571	05/18/2016	CONNOR, FLETCHER & HEDENKAMP LLC	Inv# 13038	NORTH BASIN APPEALS Mar16 North	\$1,295.08		
74571	05/18/2016	CONNOR, FLETCHER & HEDENKAMP LLC	Inv# 13039	NORTHROP Mar16 Northrop-legal	\$4,465.00		
74571	05/18/2016	CONNOR, FLETCHER & HEDENKAMP LLC	Inv# 13040	SABIC Mar16 Sabic-legal	\$74.08		
74571	05/18/2016	CONNOR, FLETCHER & HEDENKAMP LLC	Inv# 13041	SOUTH BASIN APPEALS Mar16 South	\$39,696.92		
Total for Check: 74571						\$45,531.08	\$571,734.96
74572	05/18/2016	CORELOGIC SOLUTIONS LLC	Inv# 81681866	PROPERTY MANAGEMENT	\$100.00		
Total for Check: 74572						\$100.00	\$1,100.00
74573	05/18/2016	COSTCO	Inv# 950715	INVENTORY RE-ORDER	\$537.84		
74573	05/18/2016	COSTCO	Inv# 950715	INVENTORY RE-ORDER	\$306.29		
74573	05/18/2016	COSTCO	Inv# 950715	INVENTORY RE-ORDER	\$1,035.61		
74573	05/18/2016	COSTCO	Inv# 950715	INVENTORY RE-ORDER	\$106.49		
74573	05/18/2016	COSTCO	Inv# 950715	INVENTORY RE-ORDER	\$577.15		
Total for Check: 74573						\$2,563.38	\$21,495.01
74574	05/18/2016	COUNTY OF ORANGE	Inv# FISH & GAME FILING FEEAPR	SOUTH BASIN	\$2,210.25		
Total for Check: 74574						\$2,210.25	\$5,280.25
74575	05/18/2016	CRESCENT CHEMICAL CO., INC.	Inv# 60361	L	\$360.00		
74575	05/18/2016	CRESCENT CHEMICAL CO., INC.	Inv# 60361		\$12.36		
Total for Check: 74575						\$372.36	\$1,803.26
74576	05/18/2016	CRH CALIFORNIA WATER INC	Inv# 1035085	SERVICE BPO	\$181.05		
Total for Check: 74576						\$181.05	\$1,929.55
74577	05/18/2016	CWEA-TCP	Inv# 34526	JEFFERY KIRKWOOD	\$86.00		
Total for Check: 74577						\$86.00	\$796.00
74578	05/18/2016	DAVID WILSON'S VILLA FORD	Inv# 403636	RECHARGE OPERATIONS/WETLANDS	\$55.83		
74578	05/18/2016	DAVID WILSON'S VILLA FORD	Inv# 403736	RECHARGE OPERATIONS/WETLANDS	\$48.00		
Total for Check: 74578						\$103.83	\$1,659.87
74579	05/18/2016	DELL MARKETING L.P.	Inv# XJX4FTX53	MONITOR	\$176.10		
74579	05/18/2016	DELL MARKETING L.P.	Inv# XJX4FTX53	MONITOR	\$4.00		
Total for Check: 74579						\$180.10	\$7,973.63

Orange County Water District

Check Register

Begin Date: 05/12/2016

End Date: 05/18/2016

Page 9

Accounts Payable Check Register Presented for Board Ratification and/or Approval

Check No.	Date	Vendor Name	Invoice #	Purpose	Invoice Amount	Check Amount	FYTD
74580	05/18/2016	DIAMOND ENVIRONMENTAL SERVICES	Inv# 0000685040	PORTA POTTY SERVICE	\$114.58		
Total for Check: 74580						\$114.58	\$1,646.25
74581	05/18/2016	Dunkin, Alicia	Inv# 4/8/16 ACWA SLC TRAVEL Meeting	4/8 SACTO ACWA SLC	\$123.70		
74581	05/18/2016	Dunkin, Alicia	Inv# 5/1-6/16 ACWA TRAVEL Conference	5/1-6 Monterey ACWA	\$654.95		
74581	05/18/2016	Dunkin, Alicia	Inv# 5/10/16 PROP 1 TRAVEL Prop 1	5/10 Huntington Beach	\$42.65		
Total for Check: 74581						\$821.30	\$2,855.04
74582	05/18/2016	ENTHALPY ANALYTICAL, INC.	Inv# 504800	WATER QUALITY	\$30.00		
Total for Check: 74582						\$30.00	\$120.00
74583	05/18/2016	ENVIRONMENTAL RESOURCE ASSOC.	Inv# 788909	SAMPLE ANALYSIS	\$5,489.84		
74583	05/18/2016	ENVIRONMENTAL RESOURCE ASSOC.	Inv# 788909		\$91.78		
74583	05/18/2016	ENVIRONMENTAL RESOURCE ASSOC.	Inv# 788909		\$10.80		
Total for Check: 74583						\$5,592.42	\$19,501.24
74584	05/18/2016	FIRELINE BROADBAND	Inv# 40119	INFORMATION SERVICES	\$599.99		
Total for Check: 74584						\$599.99	\$6,599.89
74585	05/18/2016	FITCH RATINGS	Inv# 7119033659	C.O.P. NOTES	\$17,000.00		
Total for Check: 74585						\$17,000.00	\$17,000.00
74586	05/18/2016	FRUIT GROWERS LABORATORY INC	Inv# 600677A		\$974.00		
74586	05/18/2016	FRUIT GROWERS LABORATORY INC	Inv# 600676A		\$152.00		
Total for Check: 74586						\$1,126.00	\$30,038.00
74587	05/18/2016	FRY'S ELECTRONICS	Inv# 20644872		\$52.54		
74587	05/18/2016	FRY'S ELECTRONICS	Inv# 21394205		\$25.91		
Total for Check: 74587						\$78.45	\$2,499.27
74588	05/18/2016	Field, David M.	Inv# 4/27/16 SCS-13R SUPPLIES	4/27/16 R15020	\$46.28		
Total for Check: 74588						\$46.28	\$46.28
74589	05/18/2016	GAIL MATERIALS	Inv# 85355	DG Material	\$2,176.48		
74589	05/18/2016	GAIL MATERIALS	Inv# 85355	DG Material	\$1,278.34		

Orange County Water District

Check Register

Begin Date: 05/12/2016

End Date: 05/18/2016

Page 10

Accounts Payable Check Register Presented for Board Ratification and/or Approval

Check No.	Date	Vendor Name	Invoice #	Purpose	Invoice Amount	Check Amount	FYTD
74589	05/18/2016	GAIL MATERIALS	Inv# 85361	DG Material	\$3,457.55		
Total for Check: 74589						\$6,912.37	\$25,263.92
74590	05/18/2016	GE ANALYTICAL INSTRUMENTS, INC.	Inv# 98206968		\$1,103.22		
74590	05/18/2016	GE ANALYTICAL INSTRUMENTS, INC.	Inv# 98211424	ANALYZER PM	\$4,902.00		
Total for Check: 74590						\$6,005.22	\$65,778.03
74591	05/18/2016	GE MOBILE WATER, INC.	Inv# 98214136		\$596.16		
Total for Check: 74591						\$596.16	\$7,206.22
74592	05/18/2016	GRAINGER INC.	Inv# 9073810096	Miscellaneous - Grainger	\$237.94		
74592	05/18/2016	GRAINGER INC.	Inv# 9077616739	WATER PRODUCTION/RECHARGE	\$26.98		
74592	05/18/2016	GRAINGER INC.	Inv# 9075850983	CSRT SUPPLIES	\$310.62		
74592	05/18/2016	GRAINGER INC.	Inv# 9073810096	Miscellaneous - Grainger	\$32.10		
74592	05/18/2016	GRAINGER INC.	Inv# 9073810096	Miscellaneous - Grainger	\$163.88		
74592	05/18/2016	GRAINGER INC.	Inv# 9073810088	Miscellaneous - Grainger	\$103.03		
74592	05/18/2016	GRAINGER INC.	Inv# 9073810096	Miscellaneous - Grainger	\$121.13		
Total for Check: 74592						\$995.68	\$122,242.97
74593	05/18/2016	HARGIS + ASSOCIATES, INC.	Inv# 810795 (SBGPP NCP) conting.compli	Mar16 SBGPP NCP	\$3,106.25		
Total for Check: 74593						\$3,106.25	\$116,320.90
74595	05/18/2016	IRVINE PIPE & SUPPLY	Inv# 820328		\$253.96		
74595	05/18/2016	IRVINE PIPE & SUPPLY	Inv# 820328	DISCOUNT	(\$5.25)		
74595	05/18/2016	IRVINE PIPE & SUPPLY	Inv# 820479	REF INV# 820375	(\$13.06)		
74595	05/18/2016	IRVINE PIPE & SUPPLY	Inv# 820375	DISCOUNT	(\$0.43)		
74595	05/18/2016	IRVINE PIPE & SUPPLY	Inv# 820375		\$13.06		
74595	05/18/2016	IRVINE PIPE & SUPPLY	Inv# 820328	SHIPPING	\$8.31		
74595	05/18/2016	IRVINE PIPE & SUPPLY	Inv# 819806		\$243.96		
74595	05/18/2016	IRVINE PIPE & SUPPLY	Inv# 819736	DISCOUNT	(\$0.99)		
74595	05/18/2016	IRVINE PIPE & SUPPLY	Inv# 820375	SHIPPING	\$8.31		
74595	05/18/2016	IRVINE PIPE & SUPPLY	Inv# 819736		\$49.30		
74595	05/18/2016	IRVINE PIPE & SUPPLY	Inv# 819472	DISCOUNT	(\$1.82)		
74595	05/18/2016	IRVINE PIPE & SUPPLY	Inv# 819472	SHIPPING	\$8.31		
74595	05/18/2016	IRVINE PIPE & SUPPLY	Inv# 819472		\$82.51		

Orange County Water District

Check Register

Begin Date: 05/12/2016

End Date: 05/18/2016

Page 11

Accounts Payable Check Register Presented for Board Ratification and/or Approval

Check No.	Date	Vendor Name	Invoice #	Purpose	Invoice Amount	Check Amount	FYTD
74595	05/18/2016	IRVINE PIPE & SUPPLY	Inv# 819806	DISCOUNT	(\$4.88)		
Total for Check: 74595						\$641.29	\$172,379.54
74596	05/18/2016	Kalinowski, James J.	Inv# 4/25/16 TRAVEL	4/25 Anaheim Mtg w/Anaheim sta	\$19.98		
74596	05/18/2016	Kalinowski, James J.	Inv# 5/2/16 TRAVEL	5/2 Anaheim Mtg w/Anaheim Staf	\$19.98		
74596	05/18/2016	Kalinowski, James J.	Inv# 5/9/16 TRAVEL	5/9 Anaheim Mtg w/Anaheim Staf	\$19.98		
Total for Check: 74596						\$59.94	\$1,922.07
74597	05/18/2016	LEXISNEXIS A DIV. OF REED ELSEVIER INC.	Inv# 3190006754	PERIOD 4/1/16-4/30/16	\$172.00		
Total for Check: 74597						\$172.00	\$1,874.00
74598	05/18/2016	LHOIST NORTH AMERICA	Inv# 1160210504	4/17 lime 25.22 tons	\$4,876.28		
74598	05/18/2016	LHOIST NORTH AMERICA	Inv# 1160210697	4/19 lime 25.08 tons	\$4,849.22		
Total for Check: 74598						\$9,725.50	\$609,781.52
74599	05/18/2016	LONG BEACH WATER DEPARTMENT	Inv# 40881	Mar16 Alamitos 189.4af@\$947	\$200,953.40		
Total for Check: 74599						\$200,953.40	\$1,975,911.65
74600	05/18/2016	MAIL DISPATCH, LLC	Inv# 146192	MailPickup&Delivery May16	\$330.12		
Total for Check: 74600						\$330.12	\$3,631.32
74601	05/18/2016	MCFADDEN-DALE HARDWARE CO.	Inv# 239366/5	DISCOUNT	(\$1.03)		
74601	05/18/2016	MCFADDEN-DALE HARDWARE CO.	Inv# 239463/5		\$4.31		
74601	05/18/2016	MCFADDEN-DALE HARDWARE CO.	Inv# 239463/5	DISCOUNT	(\$0.12)		
74601	05/18/2016	MCFADDEN-DALE HARDWARE CO.	Inv# 239366/5		\$36.94		
74601	05/18/2016	MCFADDEN-DALE HARDWARE CO.	Inv# 239193/5	DISCOUNT	(\$0.99)		
74601	05/18/2016	MCFADDEN-DALE HARDWARE CO.	Inv# 237264/5	CRANE REPAIR	\$6.78		
74601	05/18/2016	MCFADDEN-DALE HARDWARE CO.	Inv# 239193/5		\$35.73		
Total for Check: 74601						\$81.62	\$6,264.05
74603	05/18/2016	MCMaster-CARR SUPPLY COMPANY	Inv# 59224499		\$78.90		
74603	05/18/2016	MCMaster-CARR SUPPLY COMPANY	Inv# 59447507	DISCOUNT	(\$0.58)		
74603	05/18/2016	MCMaster-CARR SUPPLY COMPANY	Inv# 59447507	SHIPPING	\$5.25		
74603	05/18/2016	MCMaster-CARR SUPPLY COMPANY	Inv# 59447507		\$5.35		
74603	05/18/2016	MCMaster-CARR SUPPLY COMPANY	Inv# 59447507		\$6.83		

Orange County Water District

Check Register

Begin Date: 05/12/2016

End Date: 05/18/2016

Page 12

Accounts Payable Check Register Presented for Board Ratification and/or Approval

Check No.	Date	Vendor Name	Invoice #	Purpose	Invoice Amount	Check Amount	FYTD
74603	05/18/2016	MCMaster-CARR SUPPLY COMPANY	Inv# 59447507		\$7.79		
74603	05/18/2016	MCMaster-CARR SUPPLY COMPANY	Inv# 59447507		\$8.94		
74603	05/18/2016	MCMaster-CARR SUPPLY COMPANY	Inv# 59372705	DISCOUNT	(\$1.18)		
74603	05/18/2016	MCMaster-CARR SUPPLY COMPANY	Inv# 59372705	SHIPPING	\$5.25		
74603	05/18/2016	MCMaster-CARR SUPPLY COMPANY	Inv# 59006666	SHIPPING	\$5.53		
74603	05/18/2016	MCMaster-CARR SUPPLY COMPANY	Inv# 59372705		\$59.02		
74603	05/18/2016	MCMaster-CARR SUPPLY COMPANY	Inv# 59006666		\$92.88		
74603	05/18/2016	MCMaster-CARR SUPPLY COMPANY	Inv# 59006666	DISCOUNT	(\$1.86)		
74603	05/18/2016	MCMaster-CARR SUPPLY COMPANY	Inv# 59141257		\$236.71		
74603	05/18/2016	MCMaster-CARR SUPPLY COMPANY	Inv# 59141257	SHIPPING	\$5.25		
74603	05/18/2016	MCMaster-CARR SUPPLY COMPANY	Inv# 59141257	DISCOUNT	(\$4.73)		
74603	05/18/2016	MCMaster-CARR SUPPLY COMPANY	Inv# 59224499	DISCOUNT	(\$1.58)		
74603	05/18/2016	MCMaster-CARR SUPPLY COMPANY	Inv# 59224499	SHIPPING	\$4.75		
Total for Check: 74603						\$512.52	\$56,438.78
74604	05/18/2016	MOTION INDUSTRIES, INC.	Inv# CA11-664997	DISCOUNT	(\$8.37)		
74604	05/18/2016	MOTION INDUSTRIES, INC.	Inv# CA11-664997	FREIGHT	\$55.78		
74604	05/18/2016	MOTION INDUSTRIES, INC.	Inv# CA11-664997	SMALL PACK ORDER FEE	\$27.00		
74604	05/18/2016	MOTION INDUSTRIES, INC.	Inv# CA11-664997	INVENTORY RE-ORDER	\$877.15		
Total for Check: 74604						\$951.56	\$5,348.76
74605	05/18/2016	Markus, Michael R.	Inv# 4/25-27/16 TRAVEL	4/25-27 D.C. Legislative Meeti	\$1,615.54		
74605	05/18/2016	Markus, Michael R.	Inv# 5/5-6/16 WATEREUSE TRAVEL	5/5-6 Chicago, IL WteReuse Brd	\$171.10		
74605	05/18/2016	Markus, Michael R.	Inv# 5/3-4/16 ACWA TRAVEL	5/3-4 Monterey ACWA 2016	\$708.09		

Orange County Water District

Check Register

Begin Date: 05/12/2016

End Date: 05/18/2016

Page 13

Accounts Payable Check Register Presented for Board Ratification and/or Approval

Check No.	Date	Vendor Name	Invoice #	Purpose	Invoice Amount	Check Amount	FYTD
74605	05/18/2016	Markus, Michael R.	Inv# 4/13/16 TRAVEL	4/13 Fountain Valley Mtg/M.Moo	\$37.28		
74605	05/18/2016	Markus, Michael R.	Inv# 3/11/16 TRAVEL	3/11 Los Angeles ACOE Meeting	\$22.00		
74605	05/18/2016	Markus, Michael R.	Inv# 3/4/16 TRAVEL	3/4 Fountain Valley Mtg w/OCSD	\$24.90		
Total for Check: 74605						\$2,578.91	\$8,273.89
74607	05/18/2016	NAPA/ORANGE COUNTY AUTO PARTS	Inv# 269839	DISCOUNT	(\$0.59)		
74607	05/18/2016	NAPA/ORANGE COUNTY AUTO PARTS	Inv# 270830		\$87.48		
74607	05/18/2016	NAPA/ORANGE COUNTY AUTO PARTS	Inv# 270690	DISCOUNT	(\$1.00)		
74607	05/18/2016	NAPA/ORANGE COUNTY AUTO PARTS	Inv# 270690		\$50.09		
74607	05/18/2016	NAPA/ORANGE COUNTY AUTO PARTS	Inv# 270094	DISCOUNT	(\$1.00)		
74607	05/18/2016	NAPA/ORANGE COUNTY AUTO PARTS	Inv# 270094		\$50.09		
74607	05/18/2016	NAPA/ORANGE COUNTY AUTO PARTS	Inv# 270830	DISCOUNT	(\$1.75)		
74607	05/18/2016	NAPA/ORANGE COUNTY AUTO PARTS	Inv# 269839		\$29.42		
74607	05/18/2016	NAPA/ORANGE COUNTY AUTO PARTS	Inv# 269832	DISCOUNT	(\$1.03)		
74607	05/18/2016	NAPA/ORANGE COUNTY AUTO PARTS	Inv# 269832		\$51.71		
74607	05/18/2016	NAPA/ORANGE COUNTY AUTO PARTS	Inv# 269831	DISCOUNT	(\$2.07)		
74607	05/18/2016	NAPA/ORANGE COUNTY AUTO PARTS	Inv# 269831		\$103.42		
74607	05/18/2016	NAPA/ORANGE COUNTY AUTO PARTS	Inv# 267052	REF #256640/265811/238084	(\$130.80)		
74607	05/18/2016	NAPA/ORANGE COUNTY AUTO PARTS	Inv# 269950	DISCOUNT	(\$0.09)		
74607	05/18/2016	NAPA/ORANGE COUNTY AUTO PARTS	Inv# 269950		\$4.63		
Total for Check: 74607						\$238.51	\$17,683.29
74608	05/18/2016	NORTHERN TOOL & EQUIPMENT CO.	Inv# 35021279		\$1,799.96		

Orange County Water District

Check Register

Begin Date: 05/12/2016

End Date: 05/18/2016

Page 14

Accounts Payable Check Register Presented for Board Ratification and/or Approval

Check No.	Date	Vendor Name	Invoice #	Purpose	Invoice Amount	Check Amount	FYTD
74608	05/18/2016	NORTHERN TOOL & EQUIPMENT CO.	Inv# 35021279		\$1,359.96		
74608	05/18/2016	NORTHERN TOOL & EQUIPMENT CO.	Inv# 35021279	FREIGHT	\$607.30		
74608	05/18/2016	NORTHERN TOOL & EQUIPMENT CO.	Inv# 35021279		\$359.96		
Total for Check: 74608						\$4,127.18	\$8,405.20
74609	05/18/2016	Nguyen, Dina	Inv# OCTOBER 2015 TRAVEL Meetings	Oct15 OCWD Various	\$48.30		
Total for Check: 74609						\$48.30	\$352.23
74610	05/18/2016	Nguyen, Viethuong T.	Inv# INTERNET REIMB MAY16 VTN	InternetReimb May16	\$42.99		
Total for Check: 74610						\$42.99	\$420.62
74611	05/18/2016	OFFICE DEPOT	Inv# 834960425001		\$29.66		
Total for Check: 74611						\$29.66	\$965.67
74612	05/18/2016	OLIN CHLOR ALKALI PRODUCTS	Inv# 2154773	4/19 sod.hypochlorite 4940 gal	\$2,712.06		
74612	05/18/2016	OLIN CHLOR ALKALI PRODUCTS	Inv# 2154774	4/19 sod.hypochlorite 4916 gal	\$2,698.88		
74612	05/18/2016	OLIN CHLOR ALKALI PRODUCTS	Inv# 2154775	4/19 sod.hypochlorite 5006 gal	\$2,748.29		
74612	05/18/2016	OLIN CHLOR ALKALI PRODUCTS	Inv# 2155881	4/21 sod.hypochlorite 5040 gal	\$2,766.96		
74612	05/18/2016	OLIN CHLOR ALKALI PRODUCTS	Inv# 2155882	4/21 sod.hypochlorite 5000 gal	\$2,745.00		
74612	05/18/2016	OLIN CHLOR ALKALI PRODUCTS	Inv# 2155883	4/21 sod.hypochlorite 4900 gal	\$2,690.10		
74612	05/18/2016	OLIN CHLOR ALKALI PRODUCTS	Inv# 2156476	4/22 sod.hypochlorite 4898 gal	\$2,689.00		
74612	05/18/2016	OLIN CHLOR ALKALI PRODUCTS	Inv# 2156477	4/22 sod.hypochlorite 4892 gal	\$2,685.71		
74612	05/18/2016	OLIN CHLOR ALKALI PRODUCTS	Inv# 2156478	4/22 sod.hypochlorite 4944 gal	\$2,714.26		
Total for Check: 74612						\$24,450.26	\$1,148,922.13
74613	05/18/2016	ORACLE AMERICA INC	Inv# 43113105		\$328.44		
Total for Check: 74613						\$328.44	\$96,007.79
74614	05/18/2016	PACIFIC CLIPPINGS	Inv# 704	NewsPaperClips Apr16	\$103.96		
Total for Check: 74614						\$103.96	\$961.16
74615	05/18/2016	PARSAM CONSTRUCTION, INC.	Inv# #5 (GA-2015-1)	Prog.Pmt#5 (GA-2015-1)	\$36,822.00		
74615	05/18/2016	PARSAM CONSTRUCTION, INC.	Inv# #5 (GA-2015-1)	Prog.Pmt#5 (GA-2015-1)	\$14,123.65		
Total for Check: 74615						\$50,945.65	\$490,582.85
74616	05/18/2016	PLATINUM COMPUTER SUPPORT	Inv# 22836	INVENTORY RE-ORDER	\$928.80		
74616	05/18/2016	PLATINUM COMPUTER SUPPORT	Inv# 22836	INVENTORY RE-ORDER	\$653.40		

Orange County Water District

Check Register

Begin Date: 05/12/2016

End Date: 05/18/2016

Page 15

Accounts Payable Check Register Presented for Board Ratification and/or Approval

Check No.	Date	Vendor Name	Invoice #	Purpose	Invoice Amount	Check Amount	FYTD
74616	05/18/2016	PLATINUM COMPUTER SUPPORT	Inv# 22836	INVENTORY RE-ORDER	\$388.80		
Total for Check: 74616						\$1,971.00	\$44,370.75
74617	05/18/2016	PRECISION INSTRUMENTATION CO.	Inv# 201604094	Fabricate #3 RO Pilot System -	\$233.28		
74617	05/18/2016	PRECISION INSTRUMENTATION CO.	Inv# 201604094	SHIPPING	\$8.11		
Total for Check: 74617						\$241.39	\$3,201.67
74618	05/18/2016	PROWEST PAINTING & WATERPROOFING	Inv# 16-97	PAINTING OF ADMIN LUNCHROOM	\$3,990.00		
74618	05/18/2016	PROWEST PAINTING & WATERPROOFING	Inv# 16-97	PAINTING OF ADMIN LUNCHROOM	\$1,254.00		
Total for Check: 74618						\$5,244.00	\$10,505.00
74619	05/18/2016	PSOMAS	Inv# 117213	Mar16 La Palma archae/paleo	\$4,955.57		
Total for Check: 74619						\$4,955.57	\$21,583.75
74620	05/18/2016	Patel, Mehul	Inv# 5/5/16 TRAVEL	5/5 Pomona Industry Advisor Ct	\$7.00		
Total for Check: 74620						\$7.00	\$2,258.03
74621	05/18/2016	RESILIENT COMMUNICATIONS INC	Inv# 801515	FireWall Software Upgrade	\$400.00		
74621	05/18/2016	RESILIENT COMMUNICATIONS INC	Inv# 801511	configuration services	\$1,200.00		
74621	05/18/2016	RESILIENT COMMUNICATIONS INC	Inv# 801511	configuration services	\$700.00		
74621	05/18/2016	RESILIENT COMMUNICATIONS INC	Inv# 801511	configuration services	\$200.00		
Total for Check: 74621						\$2,500.00	\$19,346.55
74622	05/18/2016	Reynoso, Octavio	Inv# 1/24-2/23/16 STIPEND	1/24-2/23/16 cell phone stipen	\$40.00		
Total for Check: 74622						\$40.00	\$400.00
74623	05/18/2016	SAN DIEGO FLUID SYSTEM TECHNOLOGIES	Inv# 444312		\$9.00		
74623	05/18/2016	SAN DIEGO FLUID SYSTEM TECHNOLOGIES	Inv# 444312		(\$1.27)		
74623	05/18/2016	SAN DIEGO FLUID SYSTEM TECHNOLOGIES	Inv# 444312	INVENTORY RE-ORDER	\$137.16		
Total for Check: 74623						\$144.89	\$3,251.15
74624	05/18/2016	SANDWOOD ENTERPRISES INC.	Inv# OC 01501998	LABOR 5/1-5/6/16	\$1,920.00		
74624	05/18/2016	SANDWOOD ENTERPRISES INC.	Inv# OC 01501998	DISCOUNT	(\$38.40)		
74624	05/18/2016	SANDWOOD ENTERPRISES INC.	Inv# OC 01502150	labor 5/9-5/12/16	\$864.00		
74624	05/18/2016	SANDWOOD ENTERPRISES INC.	Inv# OC 01502150	DISCOUNT	(\$17.28)		

Orange County Water District

Check Register

Begin Date: 05/12/2016

End Date: 05/18/2016

Page 16

Accounts Payable Check Register Presented for Board Ratification and/or Approval

Check No.	Date	Vendor Name	Invoice #	Purpose	Invoice Amount	Check Amount	FYTD
74624	05/18/2016	SANDWOOD ENTERPRISES INC.	Inv# OC 01502190	LABOR 5/2-5/6/16	\$1,056.00		
74624	05/18/2016	SANDWOOD ENTERPRISES INC.	Inv# OC 01502190	DISCOUNT	(\$20.92)		
Total for Check: 74624						\$3,763.40	\$82,980.92
74625	05/18/2016	SC FUELS	Inv# 1916801	ALL DEPARTMENTS	\$533.09		
74625	05/18/2016	SC FUELS	Inv# 1916801	ALL DEPARTMENTS	\$0.63		
74625	05/18/2016	SC FUELS	Inv# 1916801	ALL DEPARTMENTS	\$31.96		
74625	05/18/2016	SC FUELS	Inv# 1916801	ALL DEPARTMENTS	\$41.61		
74625	05/18/2016	SC FUELS	Inv# 1916801	ALL DEPARTMENTS	\$48.11		
74625	05/18/2016	SC FUELS	Inv# 1916801	ALL DEPARTMENTS	\$225.43		
74625	05/18/2016	SC FUELS	Inv# 1916801	ALL DEPARTMENTS	\$225.12		
74625	05/18/2016	SC FUELS	Inv# 1916801	ALL DEPARTMENTS	\$729.18		
74625	05/18/2016	SC FUELS	Inv# 1916801	ALL DEPARTMENTS	\$963.13		
74625	05/18/2016	SC FUELS	Inv# 1916801	ALL DEPARTMENTS	\$71.04		
Total for Check: 74625						\$2,869.30	\$55,474.69
74626	05/18/2016	SCION INSTRUMENTS	Inv# 570115	LJ for GGA	\$1,240.00		
74626	05/18/2016	SCION INSTRUMENTS	Inv# 570115		\$9.00		
Total for Check: 74626						\$1,249.00	\$2,878.73
74627	05/18/2016	SMART & FINAL	Inv# 4180050171764	KAREN WARREN	\$77.91		
Total for Check: 74627						\$77.91	\$323.13
74628	05/18/2016	SOCAL PACIFIC CONSTRUCTION CORP. dba	Inv# 6 FINAL (R11003)	Prog.Pmt#6 (FINAL) FV-2015-1	\$18,050.00		
74628	05/18/2016	SOCAL PACIFIC CONSTRUCTION CORP. dba	Inv# 6 FINAL (R11003)	Prog.Pmt#6 (FINAL) FV-2015-1	\$8,969.90		
74628	05/18/2016	SOCAL PACIFIC CONSTRUCTION CORP. dba	Inv# 6 FINAL (R11003)	Prog.Pmt#6 (FINAL) FV-2015-1	\$7,220.00		
Total for Check: 74628						\$34,239.90	\$566,097.40
74629	05/18/2016	SOCIETY OF HUMAN RESOURCE MGMT	Inv# 9006534483	ID#00887526 YRL.2017	\$190.00		
Total for Check: 74629						\$190.00	\$190.00
74630	05/18/2016	SOLTIS AND COMPANY, INC.	Inv# 111437	Thru 4/20 Warner Basin landsca	\$52,542.00		
Total for Check: 74630						\$52,542.00	\$469,376.00
74631	05/18/2016	SOUTH COAST AIR QUALITY MGMT.	Inv# 2946065	HOT SPOTS FEE	\$122.53		
Total for Check: 74631						\$122.53	\$1,181.02

Orange County Water District

Check Register

Begin Date: 05/12/2016

End Date: 05/18/2016

Page 17

Accounts Payable Check Register Presented for Board Ratification and/or Approval

Check No.	Date	Vendor Name	Invoice #	Purpose	Invoice Amount	Check Amount	FYTD
74632	05/18/2016	SOUTHERN CALIFORNIA EDISON CO.	Inv# 3-013-4094-34APR16	ACCT#2-10-379-6371	\$1,885.39		
74632	05/18/2016	SOUTHERN CALIFORNIA EDISON CO.	Inv# 3-015-7214-86APR16	ACCT.#2-20-236-0772	\$3,900.00		
74632	05/18/2016	SOUTHERN CALIFORNIA EDISON CO.	Inv# 3-017-8551-74APR16	ACCT#2-21-529-0578	\$5,785.51		
74632	05/18/2016	SOUTHERN CALIFORNIA EDISON CO.	Inv# 3-018-4099-58APR16	ACCT# 2-22-416-4533	\$67.16		
74632	05/18/2016	SOUTHERN CALIFORNIA EDISON CO.	Inv# 3-024-1041-07APR16	ACCT# 2-26-106-9751	\$398,411.56		
74632	05/18/2016	SOUTHERN CALIFORNIA EDISON CO.	Inv# 3-03-3084-84APR16	ACCT# 2-26-106-9751	\$46.55		
74632	05/18/2016	SOUTHERN CALIFORNIA EDISON CO.	Inv# 3-033-1467-28APR16	ACCT#2-31-381-2869	\$731.58		
74632	05/18/2016	SOUTHERN CALIFORNIA EDISON CO.	Inv# 3-003-7100-85APR16	ACCT#2-19-908-3726	\$17,355.77		
Total for Check: 74632						\$428,183.52	\$5,303,823.26
74633	05/18/2016	SPARKLETTS	Inv# 6144555 042216	WQ/R&D/WATER PRODUCTION	\$6.90		
Total for Check: 74633						\$6.90	\$4,005.35
74634	05/18/2016	SPRINT	Inv# 459104313-173APR16	ACCT#459104313-173	\$219.70		
Total for Check: 74634						\$219.70	\$2,779.18
74635	05/18/2016	STANTEC CONSULTING INC.	Inv# 1036920	Thru 3/25 LaPalma Grndwtr.Rech	\$7,720.06		
Total for Check: 74635						\$7,720.06	\$90,051.89
74636	05/18/2016	STAPLES	Inv# 3299860990	OFFICE SUPPLIES	\$26.31		
Total for Check: 74636						\$26.31	\$32,081.36
74637	05/18/2016	STARNA CELLS, INC.	Inv# 161617		\$17.07		
74637	05/18/2016	STARNA CELLS, INC.	Inv# 161617	LABORATORY SUPPLIES	\$918.00		
Total for Check: 74637						\$935.07	\$2,468.64
74638	05/18/2016	SUNSTATE EQUIPMENT	Inv# 6533755-001	ROLLER RENTAL - WARNER	\$753.84		
74638	05/18/2016	SUNSTATE EQUIPMENT	Inv# 6539954-002	ROLLER RENTAL - WARNER	\$272.57		
Total for Check: 74638						\$1,026.41	\$4,915.41
74639	05/18/2016	Sanders, Curtis	Inv# 5/4/16 AWWA CERTIFICATION	5/4 AWWA certification/Riversi	\$90.00		
Total for Check: 74639						\$90.00	\$90.00
74640	05/18/2016	TAB ANSWER NETWORK CALL CENTER	Inv# 1505405122016	ACCT# 15054	\$47.23		

Orange County Water District

Check Register

Begin Date: 05/12/2016

End Date: 05/18/2016

Page 18

Accounts Payable Check Register Presented for Board Ratification and/or Approval

Check No.	Date	Vendor Name	Invoice #	Purpose	Invoice Amount	Check Amount	FYTD
		Total for Check:	74640			\$47.23	\$571.13
74641	05/18/2016	TELEDYNE INSTRUMENTS INC	Inv# S020122155	REFURBISH KIT	\$5,003.26		
74641	05/18/2016	TELEDYNE INSTRUMENTS INC	Inv# S020122155		\$101.61		
74641	05/18/2016	TELEDYNE INSTRUMENTS INC	Inv# S020122155		\$25.00		
		Total for Check:	74641			\$5,129.87	\$7,430.09
74642	05/18/2016	TETRA TECH, INC.	Inv# 51039722	Thru 3/25 Mid-Basin Centennial	\$77,315.50		
74642	05/18/2016	TETRA TECH, INC.	Inv# 51039809	Thru 3/25 Burris Sta-design	\$1,305.00		
		Total for Check:	74642			\$78,620.50	\$647,740.17
74643	05/18/2016	THE GAS COMPANY	Inv# 044 409 2900 0APR16	18700 WARD F.V.	\$231.64		
74643	05/18/2016	THE GAS COMPANY	Inv# 113 758 3304 0APR16	18700 WART ST.	\$2,800.15		
		Total for Check:	74643			\$3,031.79	\$30,873.03
74644	05/18/2016	TIME WARNER COMMUNICATIONS	Inv# 8448 40 080410454MAY16	CMF FOR IS	\$110.21		
74644	05/18/2016	TIME WARNER COMMUNICATIONS	Inv# 8448 40 0080410454APR16	CMF FOR IS	\$220.42		
		Total for Check:	74644			\$330.63	\$17,459.54
74645	05/18/2016	TOSHIBA BUSINESS SOLUTIONS	Inv# 12762977	K. WARREN	\$770.20		
		Total for Check:	74645			\$770.20	\$11,054.83
74646	05/18/2016	TRIPAC FASTENERS	Inv# 5693636	FPW pipeline repairs - isolati	\$207.36		
74646	05/18/2016	TRIPAC FASTENERS	Inv# 5693636	FPW pipeline repairs - isolati	\$84.67		
74646	05/18/2016	TRIPAC FASTENERS	Inv# 5693636		\$16.52		
74646	05/18/2016	TRIPAC FASTENERS	Inv# 5693636		(\$6.17)		
		Total for Check:	74646			\$302.38	\$302.38
74647	05/18/2016	TRUCPARCO	Inv# 368191	WP/RECH/PRADO/NATRES	\$10.97		
74647	05/18/2016	TRUCPARCO	Inv# 368191		\$1.08		
		Total for Check:	74647			\$12.05	\$18,642.98
74648	05/18/2016	UCT LLC	Inv# IN53904	LABORATORY SUPPLIES	\$1,210.68		
		Total for Check:	74648			\$1,210.68	\$20,613.42
74649	05/18/2016	ULTRA SCIENTIFIC INC.	Inv# 371511	LABORATORY CHEMICALS	\$175.00		
74649	05/18/2016	ULTRA SCIENTIFIC INC.	Inv# 371511	LABORATORY CHEMICALS	\$60.00		
74649	05/18/2016	ULTRA SCIENTIFIC INC.	Inv# 371510	LABORATORY CHEMICALS	\$94.72		
74649	05/18/2016	ULTRA SCIENTIFIC INC.	Inv# 371510	LABORATORY CHEMICALS	\$105.00		
74649	05/18/2016	ULTRA SCIENTIFIC INC.	Inv# 371511	LABORATORY CHEMICALS	\$230.00		
		Total for Check:	74649			\$664.72	\$20,592.43
74650	05/18/2016	UNI REFRIGERATION	Inv# 041816A	EQUIP. SERIVCE	\$1,785.00		

Orange County Water District

Check Register

Begin Date: 05/12/2016

End Date: 05/18/2016

Page 19

Accounts Payable Check Register Presented for Board Ratification and/or Approval

Check No.	Date	Vendor Name	Invoice #	Purpose	Invoice Amount	Check Amount	FYTD
74650	05/18/2016	UNI REFRIGERATION	Inv# 041816A	EQUIP. SERVICE	\$80.40		
Total for Check: 74650						\$1,865.40	\$9,704.55
74651	05/18/2016	UNITED PARCEL SERVICE	Inv# 0000X81601196		\$18.49		
Total for Check: 74651						\$18.49	\$3,201.35
74652	05/18/2016	UNITED RENTALS	Inv# 136818680	Forklift rental - MF header	\$917.71		
Total for Check: 74652						\$917.71	\$3,834.88
74653	05/18/2016	UNITED STATES PLASTIC CORP.	Inv# 4782085	LABORATORY SUPPLIES	\$154.80		
74653	05/18/2016	UNITED STATES PLASTIC CORP.	Inv# 4782085		\$17.77		
Total for Check: 74653						\$172.57	\$2,870.33
74654	05/18/2016	UNIVERSITY OF NEVADA LAS VEGAS	Inv# 104	OUTSIDE SAMPLING	\$2,500.00		
Total for Check: 74654						\$2,500.00	\$5,500.00
74655	05/18/2016	US POSTAL SERVICE	Inv# P.O. BOX 20845 2016	ANNUAL PO BOX 20845	\$1,174.00		
Total for Check: 74655						\$1,174.00	\$2,398.00
74656	05/18/2016	UTILIQUEST LLC	Inv# 233796-Q 9932	4/10-16 screen/mark pipes	\$9.96		
74656	05/18/2016	UTILIQUEST LLC	Inv# 233796-Q 9908	4/10-16 screen/mark pipes	\$60.20		
74656	05/18/2016	UTILIQUEST LLC	Inv# 233796-Q 9911	4/10-16 screen/mark pipes	\$841.91		
74656	05/18/2016	UTILIQUEST LLC	Inv# 233796-Q 9922	4/10-16 screen/mark pipes	\$491.12		
Total for Check: 74656						\$1,403.19	\$72,216.03
74657	05/18/2016	UTILITY COST MANAGEMENT LLC	Inv# 21405	SCE ELECT.SERVICE	\$7,490.44		
Total for Check: 74657						\$7,490.44	\$82,983.05
74659	05/18/2016	VWR INTERNATIONAL, INC.	Inv# 8044126814	R&D Supplies	\$64.70		
74659	05/18/2016	VWR INTERNATIONAL, INC.	Inv# 8044185601	INVENTORY RE-ORDER	\$3,176.28		
74659	05/18/2016	VWR INTERNATIONAL, INC.	Inv# 8044836139	INVENTORY RE-ORDER	\$2,005.28		
74659	05/18/2016	VWR INTERNATIONAL, INC.	Inv# 8044836139		\$104.28		
74659	05/18/2016	VWR INTERNATIONAL, INC.	Inv# 8044836139		(\$21.10)		
74659	05/18/2016	VWR INTERNATIONAL, INC.	Inv# 8044839930	INVENTORY RE-ORDER	\$1,177.46		
74659	05/18/2016	VWR INTERNATIONAL, INC.	Inv# 8044839930	INVENTORY RE-ORDER	\$774.47		
74659	05/18/2016	VWR INTERNATIONAL, INC.	Inv# 8044839930	INVENTORY RE-ORDER	\$773.06		
74659	05/18/2016	VWR INTERNATIONAL, INC.	Inv# 8044839930		\$47.79		
74659	05/18/2016	VWR INTERNATIONAL, INC.	Inv# 8044839930		(\$27.73)		
74659	05/18/2016	VWR INTERNATIONAL, INC.	Inv# 8044856389	INVENTORY RE-ORDER	\$4,016.30		
74659	05/18/2016	VWR INTERNATIONAL, INC.	Inv# 8044856389		(\$40.16)		

Orange County Water District

Check Register

Begin Date: 05/12/2016

End Date: 05/18/2016

Page 20

Accounts Payable Check Register Presented for Board Ratification and/or Approval

Check No.	Date	Vendor Name	Invoice #	Purpose	Invoice Amount	Check Amount	FYTD
74659	05/18/2016	VWR INTERNATIONAL, INC.	Inv# 8044117279	LABORATORY SUPPLIES	\$138.51		
		Total for Check:	74659			\$12,189.14	\$189,838.94
74660	05/18/2016	Woodside, Greg	Inv# 5/3-6/16 ACWA TRAVEL Conference	5/3-6 Monterey ACWA	\$68.45		
		Total for Check:	74660			\$68.45	\$2,563.04
Run Date: 5/18/2016						\$1,529,898.76	



Orange County Water District

Check Register

Begin Date: 05/19/2016

End Date: 05/25/2016

Page 1

Accounts Payable Check Register Presented for Board Ratification and/or Approval

Check No.	Date	Vendor Name	Invoice #	Purpose	Invoice Amount	Check Amount	FYTD
801057	05/25/2016	EVOQUA WATER TECHNOLOGIES LLC	Inv# 902569273	MF MEMBRANE REPLACEMENT	\$43,934.40		
801057	05/25/2016	EVOQUA WATER TECHNOLOGIES LLC	Inv# 902605855	MF MEMBRANE REPLACEMENT	\$275,322.24		
801057	05/25/2016	EVOQUA WATER TECHNOLOGIES LLC	Inv# 902607701	MF MEMBRANE REPLACEMENT	\$492,065.28		
801057	05/25/2016	EVOQUA WATER TECHNOLOGIES LLC	Inv# 902608306	R&D/WATER PRODUCTION	\$165.30		
801057	05/25/2016	EVOQUA WATER TECHNOLOGIES LLC	Inv# 902569273	MF MEMBRANE REPLACEMENT	\$940,196.16		
Total for Check: 801057						\$1,751,683.38	\$2,485,461.81
801058	05/25/2016	EWING IRRIGATION	Inv# 1345965	VARIOUS	\$507.43		
801058	05/25/2016	EWING IRRIGATION	Inv# 1441943	CRD. MEMO REF.BPO 33663	(\$42.15)		
Total for Check: 801058						\$465.28	\$5,977.38
801059	05/25/2016	FEDERAL EXPRESS CORPORATION	Inv# 5-400-46717	Package Delivery	\$294.81		
Total for Check: 801059						\$294.81	\$14,285.51
801060	05/25/2016	FISHER SCIENTIFIC CO.	Inv# 2628043		\$313.00		
801060	05/25/2016	FISHER SCIENTIFIC CO.	Inv# 2628042		\$560.05		
801060	05/25/2016	FISHER SCIENTIFIC CO.	Inv# 2628040	SHIPPING	\$179.23		
801060	05/25/2016	FISHER SCIENTIFIC CO.	Inv# 2545555		\$861.62		
801060	05/25/2016	FISHER SCIENTIFIC CO.	Inv# 2628040		\$2,133.97		
Total for Check: 801060						\$4,047.87	\$136,469.83
801061	05/25/2016	IRON MOUNTAIN	Inv# 200958615		\$398.16		
Total for Check: 801061						\$398.16	\$33,495.38
801062	05/25/2016	RAINBOW ENVIRONMENTAL SERVICES	Inv# 0605-000290819	WATER PRODUCTION	\$2,841.30		
Total for Check: 801062						\$2,841.30	\$32,920.99
801063	05/25/2016	SIGMA-ALDRICH INC.	Inv# 538745615		\$28.31		
801063	05/25/2016	SIGMA-ALDRICH INC.	Inv# 538752632	SUPPLIES	\$1,576.80		
801063	05/25/2016	SIGMA-ALDRICH INC.	Inv# 538752632		\$24.40		
801063	05/25/2016	SIGMA-ALDRICH INC.	Inv# 538767094	LABORATORY CHEMICALS	\$91.80		
801063	05/25/2016	SIGMA-ALDRICH INC.	Inv# 538767094		\$13.01		
801063	05/25/2016	SIGMA-ALDRICH INC.	Inv# 538745615	LABORATORY CHEMICALS	\$180.58		
Total for Check: 801063						\$1,914.90	\$26,823.42

Orange County Water District

Check Register

Begin Date: 05/19/2016

End Date: 05/25/2016

Page 2

Accounts Payable Check Register Presented for Board Ratification and/or Approval

Check No.	Date	Vendor Name	Invoice #	Purpose	Invoice Amount	Check Amount	FYTD
801064	05/25/2016	SPEX CERTIPREP, LLC	Inv# 320244	LABORATORY CHEMICALS	\$140.80		
Total for Check: 801064						\$140.80	\$20,742.40
801065	05/25/2016	WECK LABORATORIES, INC.	Inv# W6D1389-OCWD	WATER QUALITY	\$199.00		
801065	05/25/2016	WECK LABORATORIES, INC.	Inv# W6D1389-OCWD	WATER QUALITY	\$1.00		
Total for Check: 801065						\$200.00	\$30,292.75
801066	05/25/2016	WESTAIR GASES & EQUIPMENT	Inv# 10299512	Lab-HE 6pk, nitrog 6pk	\$2,852.80		
801066	05/25/2016	WESTAIR GASES & EQUIPMENT	Inv# 80083270B	Apr16 cylinder rental/Hydrogeo	\$13.80		
801066	05/25/2016	WESTAIR GASES & EQUIPMENT	Inv# 80083270B	Apr16 cylinder rental/Wtr.Prod	\$217.34		
801066	05/25/2016	WESTAIR GASES & EQUIPMENT	Inv# 80083270B	Apr16 cylinder rental/Lab	\$560.74		
801066	05/25/2016	WESTAIR GASES & EQUIPMENT	Inv# 80083270A	Apr16 cylinder rental/Recharge	\$6.90		
801066	05/25/2016	WESTAIR GASES & EQUIPMENT	Inv# 80083269*	Apr16 cylinder rental-Recharge	\$61.70		
801066	05/25/2016	WESTAIR GASES & EQUIPMENT	Inv# 80083269	Apr16 cylinder rental-Recharge	\$138.40		
801066	05/25/2016	WESTAIR GASES & EQUIPMENT	Inv# 10299512	Lab-HE 6pk, nitrog 6pk	\$566.48		
801066	05/25/2016	WESTAIR GASES & EQUIPMENT	Inv# 80083271	Apr16 cylinder rental-Lab	\$231.25		
801066	05/25/2016	WESTAIR GASES & EQUIPMENT	Inv# 80083268	Apr16 cylinder rental-Wtr.Prod	\$62.10		
Total for Check: 801066						\$4,711.51	\$79,164.33

Run Date: 5/24/2016

\$1,766,698.01

Orange County Water District

Check Register

Begin Date: 05/19/2016

End Date: 05/25/2016

Page 1

Accounts Payable Check Register Presented for Board Ratification and/or Approval

Check No.	Date	Vendor Name	Invoice #	Purpose	Invoice Amount	Check Amount	FYTD
72497	01/13/2016	SAME LOS ANGELES POST	Inv# LA POST ANNUAL	BREAKFAST WITH THE CHIEF	(\$55.00)		
Total for Check: 72497						(\$55.00)	\$55.00
74519	05/11/2016	THE METROPOLITAN WATER DISTRICT	Inv# 42914	LICENSE TEMP.ACCESS	(\$1,420.00)		
Total for Check: 74519						(\$1,420.00)	\$2,840.00
74661	05/25/2016	QUINN COMPANY	Inv# PC830332136	RECHARGE OPERATIONS/WETLANDS	\$720.36		
74661	05/25/2016	QUINN RENTAL SERVICES	Inv# V7607001	Warner Berm Renovation	\$1,080.00		
74661	05/25/2016	QUINN RENTAL SERVICES	Inv# V7607001	Warner Berm Renovation	\$389.33		
74661	05/25/2016	QUINN RENTAL SERVICES	Inv# V7607001		\$118.16		
Total for Check: 74661						\$2,307.85	\$304,702.79
74662	05/25/2016	COSTCO	Inv# 41814069	Replacement patio umbrella -	\$111.19		
74662	05/25/2016	COSTCO	Inv# 41814069		\$20.00		
74662	05/25/2016	COSTCO	Inv# 926990		\$311.03		
Total for Check: 74662						\$442.22	\$21,937.23
74663	05/25/2016	AB SCIEX LLC	Inv# 210053671	MAINTENANCE CONTRACT	\$8,170.00		
74663	05/25/2016	AB SCIEX LLC	Inv# 210053673	MAINTENANCE CONTRACT	\$33,628.70		
74663	05/25/2016	AB SCIEX LLC	Inv# 210053672	MAINTENANCE CONTRACT	\$4,281.90		
74663	05/25/2016	AB SCIEX LLC	Inv# 210053672	MAINTENANCE CONTRACT	\$3,348.80		
Total for Check: 74663						\$49,429.40	\$94,038.18
74664	05/25/2016	ACCUSONIC TECHNOLOGIES, INC.	Inv# 53196.01-0416	POWER SUPPLY FOR FLOWMETER	\$993.60		
74664	05/25/2016	ACCUSONIC TECHNOLOGIES, INC.	Inv# 53196.01-0416		\$18.00		
Total for Check: 74664						\$1,011.60	\$4,003.20
74665	05/25/2016	AECOM USA, INC.	Inv# 37736568	3/5-4/8 Prado investig/F.S.	\$26,693.64		
Total for Check: 74665						\$26,693.64	\$103,076.74
74666	05/25/2016	ALLEN TIRE COMPANY	Inv# 323839	TR-64 4 NEW TIRES	\$425.09		
74666	05/25/2016	ALLEN TIRE COMPANY	Inv# 323839	TR-64 4 NEW TIRES	\$10.80		
74666	05/25/2016	ALLEN TIRE COMPANY	Inv# 323839	TR-64 4 NEW TIRES	\$7.00		
Total for Check: 74666						\$442.89	\$10,712.53
74667	05/25/2016	ALLISON MECHANICAL, INC.	Inv# 64147	BILL DUNIVIN	\$1,217.00		
74667	05/25/2016	ALLISON MECHANICAL, INC.	Inv# 64086	BILL DUNIVIN	\$5,192.00		
74667	05/25/2016	ALLISON MECHANICAL, INC.	Inv# 64090	A/C service call - MF west (gy	\$566.20		

Orange County Water District

Check Register

Begin Date: 05/19/2016

End Date: 05/25/2016

Page 2

Accounts Payable Check Register Presented for Board Ratification and/or Approval

Check No.	Date	Vendor Name	Invoice #	Purpose	Invoice Amount	Check Amount	FYTD
Total for Check:		74667				\$6,975.20	\$66,206.94
74668	05/25/2016	AMBERTEK SYSTEMS, INC.	Inv# 23611	EQUIP. SERVICE	\$309.74		
Total for Check:		74668				\$309.74	\$39,076.41
74669	05/25/2016	ANAHEIM ELEMENTARY SCHOOL DISTRICT	Inv# 04J10127	CWEF - BUS REIMBURSEMENT	\$300.00		
Total for Check:		74669				\$300.00	\$300.00
74673	05/25/2016	ANAHEIM, CITY OF	Inv# 0138802000MAY16	04/12-05/10/16 KWH 0	\$14.56		
74673	05/25/2016	ANAHEIM, CITY OF	Inv# 0128282300MAY16	04/12-05/10/16 HCF77	\$203.59		
74673	05/25/2016	ANAHEIM, CITY OF	Inv# 0128283000MAY16	04/12-05/10/16 KWH 720	\$1,059.98		
74673	05/25/2016	ANAHEIM, CITY OF	Inv# 0128284000MAY16	04/12-05/10/16 KWH 229	\$57.62		
74673	05/25/2016	ANAHEIM, CITY OF	Inv# 0128660002MAY16	04/11-05/10/16	\$608.13		
74673	05/25/2016	ANAHEIM, CITY OF	Inv# 0129051000MAY16	04/14-5/13/16 KWH2	\$15.46		
74673	05/25/2016	ANAHEIM, CITY OF	Inv# 0131487000MAY16	04/12-05/10/16 KWH 137	\$40.33		
74673	05/25/2016	ANAHEIM, CITY OF	Inv# 0134144000MAY16	4/12-5/10/16 KWH 160	\$44.65		
74673	05/25/2016	ANAHEIM, CITY OF	Inv# 0134145000MAY16	4/11-5/10/2016 KWH 160	\$45.17		
74673	05/25/2016	ANAHEIM, CITY OF	Inv# 0128280300MAY16	04/12-05/10/16 HCF	\$55.35		
74673	05/25/2016	ANAHEIM, CITY OF	Inv# 0139824000MAY16	4/12-5/10/16 KWH 5944	\$41.65		
74673	05/25/2016	ANAHEIM, CITY OF	Inv# 0140776000APR16	04/15-05/16/16 KWH 307	\$51.04		
74673	05/25/2016	ANAHEIM, CITY OF	Inv# 0145085300APR16	04/15-05/16/16 HCF 0	\$18.72		
74673	05/25/2016	ANAHEIM, CITY OF	Inv# 0145086300APR16	04/15-05/16/16 HCF0	\$18.72		
74673	05/25/2016	ANAHEIM, CITY OF	Inv# 0134965000MAY16	4/11-5/9/16 KWH 234	\$58.57		
74673	05/25/2016	ANAHEIM, CITY OF	Inv# 0118602000APR16	04/15-05/16/16 KWH 7	\$17.43		
74673	05/25/2016	ANAHEIM, CITY OF	Inv# 0110198000MAY16	4/14-5/13/16 KWH 190	\$116.67		
74673	05/25/2016	ANAHEIM, CITY OF	Inv# 0110199000MAY16	04/15-05/16/16KWH 2100	\$2,940.69		
74673	05/25/2016	ANAHEIM, CITY OF	Inv# 0110452300APR16	04/15-05/16/16 HCF33	\$249.08		
74673	05/25/2016	ANAHEIM, CITY OF	Inv# 0110561300APR16	04/15-05/16/16 344 HCF	\$833.47		
74673	05/25/2016	ANAHEIM, CITY OF	Inv# 0110562000APR16	04/15-05/16/16 KW 1800	\$2,232.30		
74673	05/25/2016	ANAHEIM, CITY OF	Inv# 0128279000MAY16	04/12-05/10/16 4800	\$1,270.43		
74673	05/25/2016	ANAHEIM, CITY OF	Inv# 0137310300APR16	04/15-05/16/16 HCF 1	\$21.07		
74673	05/25/2016	ANAHEIM, CITY OF	Inv# 0110196000MAY16	04/14-05/13/16 KWH361	\$95.48		
74673	05/25/2016	ANAHEIM, CITY OF	Inv# 0127464300MAY16	04/11-05/09/16HCF445	\$1,068.39		
74673	05/25/2016	ANAHEIM, CITY OF	Inv# 0127602300MAY16	04/11-05/09/16 HCF0	\$55.35		
74673	05/25/2016	ANAHEIM, CITY OF	Inv# 0127603000MAY16	04/11-05/09/16 KWH0	\$45.13		

Orange County Water District

Check Register

Begin Date: 05/19/2016

End Date: 05/25/2016

Page 3

Accounts Payable Check Register Presented for Board Ratification and/or Approval

Check No.	Date	Vendor Name	Invoice #	Purpose	Invoice Amount	Check Amount	FYTD
74673	05/25/2016	ANAHEIM, CITY OF	Inv# 0127704000MAY16	4/11-5/10/16 KWH 2440	\$473.89		
74673	05/25/2016	ANAHEIM, CITY OF	Inv# 0128276000MAY16	04/12-05/10/16 KWH 5020	\$840.39		
74673	05/25/2016	ANAHEIM, CITY OF	Inv# 0128277000MAY16	04/12-05/10/16 KWH 9200	\$1,585.71		
74673	05/25/2016	ANAHEIM, CITY OF	Inv# 0111128000APR16	04/15-05/16/16 KWH 400	\$248.52		
Total for Check: 74673						\$14,427.54	\$198,780.26
74674	05/25/2016	AQUILOGIC, INC.	Inv# 002-04-13 (SBGPP NCP)	2/27-3/25 SBGPP NCP	\$2,973.51		
			data mgmt				
74674	05/25/2016	AQUILOGIC, INC.	Inv# 002-04-13 (SBGPP NCP)	2/27-3/25 SBGPP NCP	\$19.29		
			data mgmt				
Total for Check: 74674						\$2,992.80	\$74,699.44
74675	05/25/2016	AT & T	Inv# 714 974-3616-025-5MAY16		\$34.99		
Total for Check: 74675						\$34.99	\$21,251.05
74676	05/25/2016	Anthony, Philip L.	Inv# APRIL 2016 TRAVEL	Apr16 OCWD Various	\$219.24		
			Meetings				
Total for Check: 74676						\$219.24	\$2,320.58
74677	05/25/2016	B & H PHOTO-VIDEO	Inv# 109920271	VIDEO CARD FOR TYLER	\$164.99		
Total for Check: 74677						\$164.99	\$4,848.97
74680	05/25/2016	BAVCO	Inv# 756353	Annual backflow certification	\$4.86		
74680	05/25/2016	BAVCO	Inv# 756353	Annual backflow certification	\$27.11		
74680	05/25/2016	BAVCO	Inv# 756353	Annual backflow certification	\$13.50		
74680	05/25/2016	BAVCO	Inv# 756353	Annual backflow certification	\$4.33		
74680	05/25/2016	BAVCO	Inv# 756353	Annual backflow certification	\$12.96		
74680	05/25/2016	BAVCO	Inv# 756353	Annual backflow certification	\$63.18		
74680	05/25/2016	BAVCO	Inv# 756353	Annual backflow certification	\$11.56		
74680	05/25/2016	BAVCO	Inv# 756353	Annual backflow certification	\$5.83		
74680	05/25/2016	BAVCO	Inv# 756353	Annual backflow certification	\$4.86		
74680	05/25/2016	BAVCO	Inv# 756353	Annual backflow certification	\$4.86		
74680	05/25/2016	BAVCO	Inv# 756353	Annual backflow certification	\$28.08		
74680	05/25/2016	BAVCO	Inv# 756353	Annual backflow certification	\$9.07		
74680	05/25/2016	BAVCO	Inv# 756353	Annual backflow certification	\$48.60		
74680	05/25/2016	BAVCO	Inv# 756353	Annual backflow certification	\$48.60		
74680	05/25/2016	BAVCO	Inv# 756353	Annual backflow certification	\$60.26		
74680	05/25/2016	BAVCO	Inv# 756353	Annual backflow certification	\$70.00		

Orange County Water District

Check Register

Begin Date: 05/19/2016

End Date: 05/25/2016

Page 4

Accounts Payable Check Register Presented for Board Ratification and/or Approval

Check No.	Date	Vendor Name	Invoice #	Purpose	Invoice Amount	Check Amount	FYTD
74680	05/25/2016	BAVCO	Inv# 756353	Annual backflow certification	\$139.64		
74680	05/25/2016	BAVCO	Inv# 756353	Annual backflow certification	\$152.06		
74680	05/25/2016	BAVCO	Inv# 756353	Annual backflow certification	\$434.16		
74680	05/25/2016	BAVCO	Inv# 756353	Annual backflow certification	\$434.16		
74680	05/25/2016	BAVCO	Inv# 756353	Annual backflow certification	\$750.60		
74680	05/25/2016	BAVCO	Inv# 756353	Annual backflow certification	\$37.58		
74680	05/25/2016	BAVCO	Inv# 756353	Annual backflow certification	\$50.44		
Total for Check: 74680						\$2,416.30	\$3,087.21
74681	05/25/2016	BC TRAFFIC SPECIALIST	Inv# 0006772-IN	Type 2 Barricades	\$138.24		
74681	05/25/2016	BC TRAFFIC SPECIALIST	Inv# 0006783-IN	Type 2 Barricades	\$30.24		
74681	05/25/2016	BC TRAFFIC SPECIALIST	Inv# 0006783-IN	Type 2 Barricades	\$41.56		
74681	05/25/2016	BC TRAFFIC SPECIALIST	Inv# 0006772-IN	Type 2 Barricades	\$67.26		
74681	05/25/2016	BC TRAFFIC SPECIALIST	Inv# 0006772-IN	Type 2 Barricades	\$17.80		
Total for Check: 74681						\$295.10	\$295.10
74682	05/25/2016	BEARCOM	Inv# 4471429	CWEF - PAYMENT FOR MISSING MIC	\$85.32		
Total for Check: 74682						\$85.32	\$1,204.20
74683	05/25/2016	BEAVENS SYSTEMS, INCORPORATED	Inv# 5077 (WO#2 FLETCHER) Basin desi	Mar16 wo#2 Fletcher	\$9,900.00		
Total for Check: 74683						\$9,900.00	\$35,420.72
74684	05/25/2016	BEE BUSTERS	Inv# 01-0051059	HYDROGEOLOGY	\$300.00		
Total for Check: 74684						\$300.00	\$300.00
74685	05/25/2016	BENDER CCP, INC.	Inv# 216-0024-4	GAP influent pump A02 rebuild	\$17,289.00		
74685	05/25/2016	BENDER CCP, INC.	Inv# 216-0024-4	GAP influent pump A02 rebuild	\$5,005.00		
74685	05/25/2016	BENDER CCP, INC.	Inv# 216-0027-1	GAP SAR effluent pump A02 rebu	\$13,357.50		
74685	05/25/2016	BENDER CCP, INC.	Inv# 216-0027-1	GAP SAR effluent pump A02 rebu	\$5,336.00		
Total for Check: 74685						\$40,987.50	\$40,987.50
74686	05/25/2016	BENRICH SERVICE COMPANY, INC.	Inv# MOC13454	PDOPLITO	\$150.00		
Total for Check: 74686						\$150.00	\$15,675.84
74687	05/25/2016	BRYWOOD ELEMENTARY SCHOOL	Inv# 0111070010-5716	CWEF - BUS REIMBURSEMENT	\$556.00		
Total for Check: 74687						\$556.00	\$556.00
74688	05/25/2016	BUENA PARK SCHOOL DISTRICT	Inv# AR000455	CWEF - BUS REIMBURSEMENT	\$260.00		
Total for Check: 74688						\$260.00	\$260.00

Orange County Water District

Check Register

Begin Date: 05/19/2016

End Date: 05/25/2016

Page 5

Accounts Payable Check Register Presented for Board Ratification and/or Approval

Check No.	Date	Vendor Name	Invoice #	Purpose	Invoice Amount	Check Amount	FYTD
74689	05/25/2016	Bilodeau, Denis	Inv# 4/19-20/16 DC TRAVEL	4/19-20 D.C. Legislative	\$1,260.76		
			Heari				
74689	05/25/2016	Bilodeau, Denis	Inv# APRIL 2016 TRAVEL	Apr16 OCWD Various	\$170.10		
			Meetings				
Total for Check: 74689						\$1,430.86	\$4,694.85
74690	05/25/2016	Brandman, Jordan	Inv# APRIL 2016 TRAVEL	Apr16 OCWD Various	\$88.56		
			Meetings				
74690	05/25/2016	Brandman, Jordan	Inv# IPAD REIMBURSEMENT FY16	reimb/on-line Board	\$702.00		
			Agenda				
Total for Check: 74690						\$790.56	\$1,030.65
74691	05/25/2016	Buis, Matt T.	Inv# 5/10-12/16 TRAINING	5/10-12 Wtr Log	\$64.15		
			Train/Logan,UT				
Total for Check: 74691						\$64.15	\$144.15
74692	05/25/2016	CALGON CARBON CORPORATION	Inv# 90016777	WATER QUALITY	\$1,490.40		
74692	05/25/2016	CALGON CARBON CORPORATION	Inv# 90016900	WATER QUALITY	\$558.96		
Total for Check: 74692						\$2,049.36	\$8,405.14
74693	05/25/2016	CENTRALIA SCHOOL DISTRICT	Inv# 1516-111	CWEF - BUS REIMBURSEMENT	\$942.48		
Total for Check: 74693						\$942.48	\$942.48
74694	05/25/2016	CONTROLLED MOTION SOLUTIONS	Inv# 00906163	GAP air regulators	\$246.51		
74694	05/25/2016	CONTROLLED MOTION SOLUTIONS	Inv# 00906163		\$19.94		
74694	05/25/2016	CONTROLLED MOTION SOLUTIONS	Inv# 00906163		\$11.69		
Total for Check: 74694						\$278.14	\$629.52
74695	05/25/2016	CORNER BAKERY CAFE	Inv# 11016456200228	CATERING SERVICES	\$102.00		
74695	05/25/2016	CORNER BAKERY CAFE	Inv# 11016456200228		\$10.20		
Total for Check: 74695						\$112.20	\$2,771.53
74696	05/25/2016	CPI INTERNATIONAL	Inv# 00233750	LABORATORY CHEMICALS	\$353.74		
74696	05/25/2016	CPI INTERNATIONAL	Inv# 00233750	LABORATORY CHEMICALS	\$77.87		
74696	05/25/2016	CPI INTERNATIONAL	Inv# 00233750		(\$8.63)		
74696	05/25/2016	CPI INTERNATIONAL	Inv# 00233849	LABORATORY CHEMICALS	\$417.15		
74696	05/25/2016	CPI INTERNATIONAL	Inv# 00233849		(\$8.34)		
Total for Check: 74696						\$831.79	\$3,097.34
74697	05/25/2016	DAVID WILSON'S VILLA FORD	Inv# 404066	RECHARGE OPERATIONS/WETLANDS	\$68.85		

Orange County Water District

Check Register

Begin Date: 05/19/2016

End Date: 05/25/2016

Page 6

Accounts Payable Check Register Presented for Board Ratification and/or Approval

Check No.	Date	Vendor Name	Invoice #	Purpose	Invoice Amount	Check Amount	FYTD
Total for Check:		74697				\$68.85	\$1,728.72
74698	05/25/2016	DELTA-Q, INC.	Inv# 036684		\$68.22		
74698	05/25/2016	DELTA-Q, INC.	Inv# 036684	R&D CEC Project Supplies	\$145.15		
74698	05/25/2016	DELTA-Q, INC.	Inv# 036684	R&D CEC Project Supplies	\$1,317.39		
74698	05/25/2016	DELTA-Q, INC.	Inv# 036684	R&D CEC Project Supplies	\$1,476.14		
74698	05/25/2016	DELTA-Q, INC.	Inv# 036684		(\$60.14)		
Total for Check:		74698				\$2,946.76	\$11,357.07
74699	05/25/2016	DEPARTMENT OF CONSUMER AFFAIRS	Inv# CERT.# 63267	RYAN BOULEY	\$172.50		
Total for Check:		74699				\$172.50	\$172.50
74700	05/25/2016	DICK JONES COMMUNICATIONS	Inv# 3169	Apr16 Public Relations	\$300.00		
Total for Check:		74700				\$300.00	\$1,237.50
74701	05/25/2016	Dewane, Shawn	Inv# APRIL 2016 TRAVEL Meetings	Apr16 OCWD Various	\$61.56		
Total for Check:		74701				\$61.56	\$796.75
74702	05/25/2016	Dosier, Bruce	Inv# 5/3-6/16 INTEROP TRAVEL INTEROP	5/3-6 Las Vegas, NV	\$750.39		
Total for Check:		74702				\$750.39	\$1,701.13
74703	05/25/2016	Dunkin, Alicia	Inv# 5/1-6 ACWA TRAVEL DEDUCT expense	5/1-6 deduct fuel	(\$43.43)		
74703	05/25/2016	Dunkin, Alicia	Inv# 5/17-18/16 CSDA TRAVEL	5/17-18 SACTO CSDA	\$212.78		
Total for Check:		74703				\$169.35	\$3,024.39
74704	05/25/2016	ELECTRONIC DATA SOLUTIONS	Inv# 19725	Data logger - barrier group	\$772.74		
74704	05/25/2016	ELECTRONIC DATA SOLUTIONS	Inv# 19725		\$21.60		
Total for Check:		74704				\$794.34	\$8,463.32
74705	05/25/2016	EVANTEC LAB SUPPLY	Inv# 160829	LABORATORY CHEMICALS	\$74.52		
74705	05/25/2016	EVANTEC LAB SUPPLY	Inv# 160829	LABORATORY CHEMICALS	\$18.59		
74705	05/25/2016	EVANTEC LAB SUPPLY	Inv# 160829	LABORATORY CHEMICALS	\$24.62		
74705	05/25/2016	EVANTEC LAB SUPPLY	Inv# 160829	LABORATORY CHEMICALS	\$25.00		
74705	05/25/2016	EVANTEC LAB SUPPLY	Inv# 160829	LABORATORY CHEMICALS	\$49.84		
74705	05/25/2016	EVANTEC LAB SUPPLY	Inv# 160829	LABORATORY CHEMICALS	\$50.00		
74705	05/25/2016	EVANTEC LAB SUPPLY	Inv# 160829	LABORATORY CHEMICALS	\$56.16		
74705	05/25/2016	EVANTEC LAB SUPPLY	Inv# 160829	LABORATORY CHEMICALS	\$55.08		
Total for Check:		74705				\$353.81	\$1,824.87

Orange County Water District

Check Register

Begin Date: 05/19/2016

End Date: 05/25/2016

Page 7

Accounts Payable Check Register Presented for Board Ratification and/or Approval

Check No.	Date	Vendor Name	Invoice #	Purpose	Invoice Amount	Check Amount	FYTD
74706	05/25/2016	FERGUSON WATERWORKS #1082	Inv# 0551212	PWPS pipeline reinforcing	\$2,980.80		
Total for Check: 74706						\$2,980.80	\$6,335.54
74707	05/25/2016	FRY'S ELECTRONICS	Inv# 21404133		\$107.89		
Total for Check: 74707						\$107.89	\$2,607.16
74708	05/25/2016	Friberg, Chris	Inv# 5/10-12/16 TRAINING	5/10-12 Wtrlog Train/Logan, UT	\$87.55		
Total for Check: 74708						\$87.55	\$87.55
74709	05/25/2016	GEIGER	Inv# 3067645	Discount	(\$23.59)		
74709	05/25/2016	GEIGER	Inv# 3067645	RE-ORDER OCWD LIP BALM	\$2,225.48		
74709	05/25/2016	GEIGER	Inv# 3067645	Shipping	\$133.22		
Total for Check: 74709						\$2,335.11	\$44,782.32
74710	05/25/2016	GOVERNMENTJOBS.COM, INC.	Inv# INV17794	Job Post: Programmer/Analyst	\$175.00		
Total for Check: 74710						\$175.00	\$4,200.00
74712	05/25/2016	GRAINGER INC.	Inv# 9079338381		\$29.52		
74712	05/25/2016	GRAINGER INC.	Inv# 9079338399	INVENTORY RE-ORDER	\$244.62		
74712	05/25/2016	GRAINGER INC.	Inv# 9079338399	INVENTORY RE-ORDER	\$125.20		
74712	05/25/2016	GRAINGER INC.	Inv# 9080059927	SPENT CARBON SHIPMENT	\$170.06		
74712	05/25/2016	GRAINGER INC.	Inv# 9080296032		\$680.18		
74712	05/25/2016	GRAINGER INC.	Inv# 9080296032		\$3.60		
74712	05/25/2016	GRAINGER INC.	Inv# 9081369382	BATTERIES	\$83.00		
74712	05/25/2016	GRAINGER INC.	Inv# 9081369390	SPENT CARBON SHIPMENT	\$340.11		
74712	05/25/2016	GRAINGER INC.	Inv# 9082230229		\$134.24		
74712	05/25/2016	GRAINGER INC.	Inv# 9082230237		\$111.78		
74712	05/25/2016	GRAINGER INC.	Inv# 9079093952		\$41.51		
Total for Check: 74712						\$1,963.82	\$124,206.79
74713	05/25/2016	GREAT WESTERN SANITARY SUPPLIES	Inv# 258826	INVENTORY RE-ORDER	\$480.60		
74713	05/25/2016	GREAT WESTERN SANITARY SUPPLIES	Inv# 258826	INVENTORY RE-ORDER	\$272.70		
74713	05/25/2016	GREAT WESTERN SANITARY SUPPLIES	Inv# 258826	Discount	(\$7.53)		
Total for Check: 74713						\$745.77	\$2,063.68
74714	05/25/2016	Green, Catherine T.	Inv# 4/25-27/16 PRADO LEG. TRA	4/25-27 D.C. Prado Legislative	\$1,967.40		

Orange County Water District

Check Register

Begin Date: 05/19/2016

End Date: 05/25/2016

Page 8

Accounts Payable Check Register Presented for Board Ratification and/or Approval

Check No.	Date	Vendor Name	Invoice #	Purpose	Invoice Amount	Check Amount	FYTD
74714	05/25/2016	Green, Catherine T.	Inv# APRIL 2016 TRAVEL Meetings	Apr16 OCWD Various	\$93.96		
Total for Check: 74714						\$2,061.36	\$10,833.28
74715	05/25/2016	HABITAT WEST	Inv# 88306	Apr16 wo#4 maintenance	\$1,751.19		
Total for Check: 74715						\$1,751.19	\$40,123.17
74716	05/25/2016	HACH COMPANY	Inv# 9901462		\$1,263.61		
74716	05/25/2016	HACH COMPANY	Inv# 9901462	FREIGHT	\$66.39		
Total for Check: 74716						\$1,330.00	\$48,345.76
74718	05/25/2016	HARRINGTON INDUSTRIAL PLASTICS	Inv# 002J4454	WATER MITIGATION PARTS	\$70.50		
74718	05/25/2016	HARRINGTON INDUSTRIAL PLASTICS	Inv# 002J5598	INVENTORY RE-ORDER	\$2,637.34		
74718	05/25/2016	HARRINGTON INDUSTRIAL PLASTICS	Inv# 002J4454	Discount	(\$22.97)		
74718	05/25/2016	HARRINGTON INDUSTRIAL PLASTICS	Inv# 002J4454	WATER MITIGATION PARTS	\$27.73		
74718	05/25/2016	HARRINGTON INDUSTRIAL PLASTICS	Inv# 002J5598	Discount	(\$52.75)		
74718	05/25/2016	HARRINGTON INDUSTRIAL PLASTICS	Inv# 002J4454	WATER MITIGATION PARTS	\$34.03		
74718	05/25/2016	HARRINGTON INDUSTRIAL PLASTICS	Inv# 002J4454	WATER MITIGATION PARTS	\$68.04		
74718	05/25/2016	HARRINGTON INDUSTRIAL PLASTICS	Inv# 002J4454	WATER MITIGATION PARTS	\$258.29		
74718	05/25/2016	HARRINGTON INDUSTRIAL PLASTICS	Inv# 002J4454	WATER MITIGATION PARTS	\$592.49		
74718	05/25/2016	HARRINGTON INDUSTRIAL PLASTICS	Inv# 002I6262	Credit 002I5287/00284451	(\$828.45)		
74718	05/25/2016	HARRINGTON INDUSTRIAL PLASTICS	Inv# 002J4454	WATER MITIGATION PARTS	\$39.08		
74718	05/25/2016	HARRINGTON INDUSTRIAL PLASTICS	Inv# 002J4454	WATER MITIGATION PARTS	\$58.49		
Total for Check: 74718						\$2,881.82	\$16,940.63
74719	05/25/2016	Hillman, Carolyn	Inv# CK#1184 PR#26-1	Interim PR CK#1184	\$609.32		
Total for Check: 74719						\$609.32	\$609.32
74720	05/25/2016	IDEXX LABORATORIES, INC.	Inv# 3001995540		\$856.92		

Orange County Water District

Check Register

Begin Date: 05/19/2016

End Date: 05/25/2016

Page 9

Accounts Payable Check Register Presented for Board Ratification and/or Approval

Check No.	Date	Vendor Name	Invoice #	Purpose	Invoice Amount	Check Amount	FYTD
74720	05/25/2016	IDEXX LABORATORIES, INC.	Inv# 3001995540	SHIPPING	\$51.18		
Total for Check: 74720						\$908.10	\$10,164.30
74721	05/25/2016	IGOR CARAGODIN	Inv# 656498	NATURAL RESOURCES	\$250.00		
Total for Check: 74721						\$250.00	\$2,909.00
74722	05/25/2016	INSIGHT PUBLIC SECTOR	Inv# 1100473016	Replacement Laptop	\$1,808.32		
Total for Check: 74722						\$1,808.32	\$14,074.64
74723	05/25/2016	INSTITUTE FOR ENVIRONMENTAL HEALTH INC	Inv# 160247		\$300.00		
74723	05/25/2016	INSTITUTE FOR ENVIRONMENTAL HEALTH INC	Inv# 160040		\$200.00		
74723	05/25/2016	INSTITUTE FOR ENVIRONMENTAL HEALTH INC	Inv# 160040		\$100.00		
Total for Check: 74723						\$600.00	\$9,332.48
74726	05/25/2016	IRVINE PIPE & SUPPLY	Inv# 820813		\$277.67		
74726	05/25/2016	IRVINE PIPE & SUPPLY	Inv# 819327	Hydrant tie in (for plant shut	\$322.94		
74726	05/25/2016	IRVINE PIPE & SUPPLY	Inv# 819327	Hydrant tie in (for plant shut	\$172.76		
74726	05/25/2016	IRVINE PIPE & SUPPLY	Inv# 819327	Frt Incoming	\$13.66		
74726	05/25/2016	IRVINE PIPE & SUPPLY	Inv# 819327	Shipping	\$10.06		
74726	05/25/2016	IRVINE PIPE & SUPPLY	Inv# 819327	Discount	(\$10.39)		
74726	05/25/2016	IRVINE PIPE & SUPPLY	Inv# 820104	Cartridge filter ball valves i	\$2,588.24		
74726	05/25/2016	IRVINE PIPE & SUPPLY	Inv# 820104	DISCOUNT	(\$51.76)		
74726	05/25/2016	IRVINE PIPE & SUPPLY	Inv# 820420		\$265.69		
74726	05/25/2016	IRVINE PIPE & SUPPLY	Inv# 820946	Discount	(\$0.65)		
74726	05/25/2016	IRVINE PIPE & SUPPLY	Inv# 820813		\$527.92		
74726	05/25/2016	IRVINE PIPE & SUPPLY	Inv# 820813	FREIGHT	\$3.87		
74726	05/25/2016	IRVINE PIPE & SUPPLY	Inv# 820813	FREIGHT	\$2.08		
74726	05/25/2016	IRVINE PIPE & SUPPLY	Inv# 820813	DISCOUNT DISCOUNT	(\$16.23)		
74726	05/25/2016	IRVINE PIPE & SUPPLY	Inv# 820856	WATER PRODUCTION/WATER QUALITY	\$48.87		
74726	05/25/2016	IRVINE PIPE & SUPPLY	Inv# 820856	Discount	(\$0.98)		
74726	05/25/2016	IRVINE PIPE & SUPPLY	Inv# 820909	WATER PRODUCTION/WATER QUALITY	\$172.54		
74726	05/25/2016	IRVINE PIPE & SUPPLY	Inv# 820909	Discount	(\$3.45)		
74726	05/25/2016	IRVINE PIPE & SUPPLY	Inv# 820946	WATER PRODUCTION/WATER QUALITY	\$24.41		
74726	05/25/2016	IRVINE PIPE & SUPPLY	Inv# 820946	Shipping	\$8.31		

Orange County Water District

Check Register

Begin Date: 05/19/2016

End Date: 05/25/2016

Page 10

Accounts Payable Check Register Presented for Board Ratification and/or Approval

Check No.	Date	Vendor Name	Invoice #	Purpose	Invoice Amount	Check Amount	FYTD
74726	05/25/2016	IRVINE PIPE & SUPPLY	Inv# 820420	DISCOUNT	(\$5.31)		
Total for Check: 74726						\$4,350.25	\$176,729.79
74727	05/25/2016	JENSEN DRILLING COMPANY	Inv# 4 (AB-2015-1)	Prog.Pmt#4 (AB-2015-1)	\$731,929.87		
74727	05/25/2016	JENSEN DRILLING COMPANY	Inv# 4 (AB-2015-1)	Prog.Pmt#4 (AB-2015-1)	\$4,315.79		
Total for Check: 74727						\$736,245.66	\$1,649,480.20
74728	05/25/2016	KNOW BE4	Inv# INV-06721	ONLINE TRAINING CLASSES	\$5,822.91		
Total for Check: 74728						\$5,822.91	\$5,822.91
74729	05/25/2016	L.A. COUNTY DEPT. PUBLIC WORKS	Inv# SA160000417 (H0321551) FY15-16 1st hal	LADPW Alamitos	\$392,560.00		
Total for Check: 74729						\$392,560.00	\$992,326.58
74730	05/25/2016	LEIGHTON CONSULTING INC	Inv# 22803	Apr16 sediment analysis	\$720.00		
Total for Check: 74730						\$720.00	\$7,497.00
74731	05/25/2016	LHOIST NORTH AMERICA	Inv# 1160210924A	4/23 lime 25.13 tons	\$1,433.27		
74731	05/25/2016	LHOIST NORTH AMERICA	Inv# 1160210924B	4/21 lime 25.13 tons	\$3,425.61		
74731	05/25/2016	LHOIST NORTH AMERICA	Inv# 1160211342	4/25 lime 24.37 tons	\$4,711.94		
74731	05/25/2016	LHOIST NORTH AMERICA	Inv# 1160211817	4/27 lime 24 tons	\$4,640.40		
Total for Check: 74731						\$14,211.22	\$623,992.74
74732	05/25/2016	MAGNOLIA BIRD FARMS	Inv# 17611		\$55.80		
Total for Check: 74732						\$55.80	\$1,642.99
74733	05/25/2016	MCCONNELL, JAMES F.	Inv# MAY 2, 2016	Apr16 legis.support/D.C.	\$7,500.00		
Total for Check: 74733						\$7,500.00	\$88,078.52
74734	05/25/2016	MCFADDEN-DALE HARDWARE CO.	Inv# 240262/5		\$81.22		
74734	05/25/2016	MCFADDEN-DALE HARDWARE CO.	Inv# 240422/5	DISCOUNT	(\$0.55)		
74734	05/25/2016	MCFADDEN-DALE HARDWARE CO.	Inv# 235579/5	CRANE REPAIR	\$46.44		
74734	05/25/2016	MCFADDEN-DALE HARDWARE CO.	Inv# 240422/5		\$19.87		
74734	05/25/2016	MCFADDEN-DALE HARDWARE CO.	Inv# 240262/5	DISCOUNT	(\$2.26)		
Total for Check: 74734						\$144.72	\$6,408.77
74735	05/25/2016	MITCHELL1	Inv# 3976538	ANNUAL RENEWAL OF AUTOMOTIVE P	\$1,574.14		
Total for Check: 74735						\$1,574.14	\$1,574.14
74737	05/25/2016	NAPA/ORANGE COUNTY AUTO PARTS	Inv# 271375	Discount	(\$1.15)		
74737	05/25/2016	NAPA/ORANGE COUNTY AUTO PARTS	Inv# 271597	Discount	(\$0.42)		

Orange County Water District

Check Register

Begin Date: 05/19/2016

End Date: 05/25/2016

Page 11

Accounts Payable Check Register Presented for Board Ratification and/or Approval

Check No.	Date	Vendor Name	Invoice #	Purpose	Invoice Amount	Check Amount	FYTD
74737	05/25/2016	NAPA/ORANGE COUNTY AUTO PARTS	Inv# 271597	WATER PRODUCTION	\$21.03		
74737	05/25/2016	NAPA/ORANGE COUNTY AUTO PARTS	Inv# 271580	Discount	(\$0.21)		
74737	05/25/2016	NAPA/ORANGE COUNTY AUTO PARTS	Inv# 271440	Credit Inv#270094	\$50.09		
74737	05/25/2016	NAPA/ORANGE COUNTY AUTO PARTS	Inv# 271375	WATER PRODUCTION	\$57.60		
74737	05/25/2016	NAPA/ORANGE COUNTY AUTO PARTS	Inv# 271350	WATER PRODUCTION	\$44.39		
74737	05/25/2016	NAPA/ORANGE COUNTY AUTO PARTS	Inv# 271012	Discount	(\$8.53)		
74737	05/25/2016	NAPA/ORANGE COUNTY AUTO PARTS	Inv# 271012	WATER PRODUCTION	\$426.39		
74737	05/25/2016	NAPA/ORANGE COUNTY AUTO PARTS	Inv# 270147	Credit Inv 269131	(\$11.75)		
74737	05/25/2016	NAPA/ORANGE COUNTY AUTO PARTS	Inv# 269131	WATER PRODUCTION	\$65.52		
74737	05/25/2016	NAPA/ORANGE COUNTY AUTO PARTS	Inv# 268826	WATER PRODUCTION	\$80.67		
74737	05/25/2016	NAPA/ORANGE COUNTY AUTO PARTS	Inv# 271350	Discount	(\$0.89)		
74737	05/25/2016	NAPA/ORANGE COUNTY AUTO PARTS	Inv# 271580	WATER PRODUCTION	\$10.47		
Total for Check: 74737						\$733.21	\$18,416.50
74738	05/25/2016	NORTHWEST MOSQUITO AND VECTOR	Inv# 1305	WETLAND OPERATIONS	\$131.39		
Total for Check: 74738						\$131.39	\$88,966.84
74739	05/25/2016	Nguyen, Dina	Inv# APRIL 2016 TRAVEL Meetings	Apr16 OCWD Various	\$37.80		
Total for Check: 74739						\$37.80	\$390.03
74741	05/25/2016	OLIN CHLOR ALKALI PRODUCTS	Inv# 2168311	CM for #2166919	(\$2,533.09)		
74741	05/25/2016	OLIN CHLOR ALKALI PRODUCTS	Inv# 2166919	billing error, see CM#2168311	\$2,533.09		
74741	05/25/2016	OLIN CHLOR ALKALI PRODUCTS	Inv# 2159608	4/29 sod.hypochlorite 4938 gal	\$2,710.96		
74741	05/25/2016	OLIN CHLOR ALKALI PRODUCTS	Inv# 2159607	4/29 sod.hypochlorite 4970 gal	\$2,728.53		
74741	05/25/2016	OLIN CHLOR ALKALI PRODUCTS	Inv# 2159606	4/29 sod.hypochlorite 4980 gal	\$2,734.02		
74741	05/25/2016	OLIN CHLOR ALKALI PRODUCTS	Inv# 2159048	4/28 sod.hypochlorite 4954 gal	\$2,719.75		

Orange County Water District

Check Register

Begin Date: 05/19/2016

End Date: 05/25/2016

Page 12

Accounts Payable Check Register Presented for Board Ratification and/or Approval

Check No.	Date	Vendor Name	Invoice #	Purpose	Invoice Amount	Check Amount	FYTD
74741	05/25/2016	OLIN CHLOR ALKALI PRODUCTS	Inv# 2159050	4/28 sod.hypochlorite 4898 gal	\$2,689.00		
74741	05/25/2016	OLIN CHLOR ALKALI PRODUCTS	Inv# 2157866	4/26 sod.hypochlorite 5010 gal	\$2,750.49		
74741	05/25/2016	OLIN CHLOR ALKALI PRODUCTS	Inv# 2157865	4/26 sod.hypochlorite 4896 gal	\$2,687.90		
74741	05/25/2016	OLIN CHLOR ALKALI PRODUCTS	Inv# 2157864	4/26 sod.hypochlorite 4916 gal	\$2,698.88		
74741	05/25/2016	OLIN CHLOR ALKALI PRODUCTS	Inv# 2159049	4/28 sod.hypochlorite 4960 gal	\$2,723.04		
Total for Check: 74741						\$24,442.57	\$1,173,364.70
74742	05/25/2016	ONESOURCE DISTRIBUTORS INC.	Inv# S5143568.001	Freight	\$9.18		
74742	05/25/2016	ONESOURCE DISTRIBUTORS INC.	Inv# S5143568.001	VARIOUS	\$8.40		
74742	05/25/2016	ONESOURCE DISTRIBUTORS INC.	Inv# S5143568.001	Discount	(\$0.08)		
Total for Check: 74742						\$17.50	\$96,421.13
74743	05/25/2016	ONTRAC	Inv# 8423917	PACKAGE DELIVERY	\$13.27		
Total for Check: 74743						\$13.27	\$232.71
74744	05/25/2016	ORANGE COUNTY EMPLOYEE ASSOCIATION	Inv# MAY 2016	OCEA Dues May 2016	\$2,443.48		
Total for Check: 74744						\$2,443.48	\$27,984.58
74745	05/25/2016	OSTERBAUER COMPRESSOR SERVICE	Inv# 10017700		\$700.30		
74745	05/25/2016	OSTERBAUER COMPRESSOR SERVICE	Inv# 10017700	FREIGHT	\$24.21		
Total for Check: 74745						\$724.51	\$14,168.50
74746	05/25/2016	OVIVO USA, LLC	Inv# 8468409	Screening facility shaft beari	\$1,915.92		
74746	05/25/2016	OVIVO USA, LLC	Inv# 8468409	Screening facility shaft beari	\$1,915.92		
Total for Check: 74746						\$3,831.84	\$7,663.68
74747	05/25/2016	PACIFIC HYDROTECH CORPORATION	Inv# 20 (B-2014-1)	Prog.Pmt#20 (B-2014-1)	\$1,218,057.70		
74747	05/25/2016	PACIFIC HYDROTECH CORPORATION	Inv# 20 (B-2014-1)	Prog.Pmt#20 (B-2014-1)	\$3,485.07		
Total for Check: 74747						\$1,221,542.77	\$16,458,943.44
74748	05/25/2016	PACIFIC HYDROTECH CORPORATION	Inv# ESC 0030301823 RET#20 B-2014-1	Ret#20 P.Hydrot	\$64,108.30		
74748	05/25/2016	PACIFIC HYDROTECH CORPORATION	Inv# ESC 0030301823 RET#20 B-2014-1	Ret#20 P.Hydrot	\$183.43		
Total for Check: 74748						\$64,291.73	\$838,692.24
74749	05/25/2016	PACIFIC OFFICE AUTOMATION	Inv# 121116	SERVICE AGREEMENT FOR KONICA	\$183.28		
Total for Check: 74749						\$183.28	\$1,078.38

Orange County Water District

Check Register

Begin Date: 05/19/2016

End Date: 05/25/2016

Page 13

Accounts Payable Check Register Presented for Board Ratification and/or Approval

Check No.	Date	Vendor Name	Invoice #	Purpose	Invoice Amount	Check Amount	FYTD
74750	05/25/2016	PENHALL COMPANY	Inv# 1166	RUSH! WARNER PROJECT	\$1,085.00		
Total for Check: 74750						\$1,085.00	\$2,305.00
74751	05/25/2016	PERKINELMER HEALTH SCIENCES, INC.	Inv# 5303633250	EQUIPMENT SERVICE PLAN	\$12,120.00		
Total for Check: 74751						\$12,120.00	\$79,553.40
74752	05/25/2016	PIPELINE PRODUCTS, INC	Inv# 53978	Valve operator extension	\$89.64		
74752	05/25/2016	PIPELINE PRODUCTS, INC	Inv# 53978	Shipping	\$46.44		
74752	05/25/2016	PIPELINE PRODUCTS, INC	Inv# 53978	Valve operator extension	\$95.04		
Total for Check: 74752						\$231.12	\$231.12
74753	05/25/2016	PLATINUM COMPUTER SUPPORT	Inv# 22844		\$581.04		
Total for Check: 74753						\$581.04	\$44,951.79
74754	05/25/2016	PRAXIS CORPORATION	Inv# 20160428	Electrical Safety Training	\$8,000.00		
Total for Check: 74754						\$8,000.00	\$8,000.00
74755	05/25/2016	PREMIER FITNESS SERVICE LLC	Inv# 37514		\$150.00		
Total for Check: 74755						\$150.00	\$1,978.78
74756	05/25/2016	R.S. HUGHES	Inv# 76202056-00	PAT LEWIS/FRANK SIMONE	\$44.45		
74756	05/25/2016	R.S. HUGHES	Inv# 76202056-00		(\$0.22)		
74756	05/25/2016	R.S. HUGHES	Inv# 76202057-00	PAT LEWIS/FRANK SIMONE	\$112.27		
74756	05/25/2016	R.S. HUGHES	Inv# 76202057-00		(\$0.56)		
Total for Check: 74756						\$155.94	\$819.41
74757	05/25/2016	RESILIENT COMMUNICATIONS INC	Inv# 801503	CISCO NETWORK HARDWARE	\$2,201.80		
74757	05/25/2016	RESILIENT COMMUNICATIONS INC	Inv# 801517	CISCO NETWORK HARDWARE	\$184.80		
74757	05/25/2016	RESILIENT COMMUNICATIONS INC	Inv# 801513	CISCO NETWORK HARDWARE	\$11,788.80		
74757	05/25/2016	RESILIENT COMMUNICATIONS INC	Inv# 801503	CISCO NETWORK HARDWARE	\$27,522.50		
74757	05/25/2016	RESILIENT COMMUNICATIONS INC	Inv# 801500	CISCO NETWORK HARDWARE	\$129.36		
74757	05/25/2016	RESILIENT COMMUNICATIONS INC	Inv# 801500	CISCO NETWORK HARDWARE	\$1,617.00		
74757	05/25/2016	RESILIENT COMMUNICATIONS INC	Inv# 801517	CISCO NETWORK HARDWARE	\$2,310.00		
Total for Check: 74757						\$45,754.26	\$65,100.81
74758	05/25/2016	Reyna, Roman	Inv# APRIL 2016 TRAVEL Meetings	Apr16 OCWD Various	\$106.92		
Total for Check: 74758						\$106.92	\$507.60
74759	05/25/2016	Reynoso, Octavio	Inv# 2/24-3/23/16 STIPEND stipen	2/24-3/23/16 cell phone	\$40.00		

Orange County Water District

Check Register

Begin Date: 05/19/2016

End Date: 05/25/2016

Page 14

Accounts Payable Check Register Presented for Board Ratification and/or Approval

Check No.	Date	Vendor Name	Invoice #	Purpose	Invoice Amount	Check Amount	FYTD
74759	05/25/2016	Reynoso, Octavio	Inv# 3/24-4/23/16 STIPEND	3/24-4/23/16 cell phone	\$40.00		
Total for Check: 74759						\$80.00	\$480.00
74760	05/25/2016	S & P GLOBAL RATINGS	Inv# 11308073	CUST# 1000047392	\$5,000.00		
Total for Check: 74760						\$5,000.00	\$7,165.00
74761	05/25/2016	SAME LOS ANGELES POST	Inv# LA POST ANNUAL	BREAKFAST WITH THE CHIEF	\$55.00		
Total for Check: 74761						\$55.00	\$55.00
74762	05/25/2016	SAN DIEGO FLUID SYSTEM TECHNOLOGIES	Inv# 444607		(\$18.58)		
74762	05/25/2016	SAN DIEGO FLUID SYSTEM TECHNOLOGIES	Inv# 444607	Fabricate #3 RO Pilot System -	\$2,006.21		
74762	05/25/2016	SAN DIEGO FLUID SYSTEM TECHNOLOGIES	Inv# 444607		\$10.21		
Total for Check: 74762						\$1,997.84	\$5,248.99
74763	05/25/2016	SANTA ANA WATERSHED ASSOC.	Inv# 2016-026	Bird Monitoring & Surveying	\$40,000.00		
74763	05/25/2016	SANTA ANA WATERSHED ASSOC.	Inv# 2016-025	Bird Monitoring & Surveying	\$40,000.00		
74763	05/25/2016	SANTA ANA WATERSHED ASSOC.	Inv# 2016-024	Bird Monitoring & Surveying	\$35,000.00		
Total for Check: 74763						\$115,000.00	\$192,247.44
74764	05/25/2016	SANTA ANA, CITY OF	Inv# 5-3995.300MAY16	3201 S. BEAR ST.	\$122.72		
Total for Check: 74764						\$122.72	\$744.89
74765	05/25/2016	SC FUELS	Inv# 1922255	ALL DEPARTMENTS	\$68.33		
74765	05/25/2016	SC FUELS	Inv# 1922255	ALL DEPARTMENTS	\$0.68		
74765	05/25/2016	SC FUELS	Inv# 1922255	ALL DEPARTMENTS	\$63.09		
74765	05/25/2016	SC FUELS	Inv# 1922255	ALL DEPARTMENTS	\$68.61		
74765	05/25/2016	SC FUELS	Inv# 1922255	ALL DEPARTMENTS	\$167.52		
74765	05/25/2016	SC FUELS	Inv# 1922255	ALL DEPARTMENTS	\$251.38		
74765	05/25/2016	SC FUELS	Inv# 1922255	ALL DEPARTMENTS	\$340.35		
74765	05/25/2016	SC FUELS	Inv# 1922255	ALL DEPARTMENTS	\$652.42		
74765	05/25/2016	SC FUELS	Inv# 1922255	ALL DEPARTMENTS	\$720.56		
74765	05/25/2016	SC FUELS	Inv# 1922255	ALL DEPARTMENTS	\$61.41		
Total for Check: 74765						\$2,394.35	\$57,869.04
74766	05/25/2016	SCION INSTRUMENTS	Inv# 500294	LJ FOR ASL/LY	\$21,970.50		
Total for Check: 74766						\$21,970.50	\$24,849.23

Orange County Water District

Check Register

Begin Date: 05/19/2016

End Date: 05/25/2016

Page 15

Accounts Payable Check Register Presented for Board Ratification and/or Approval

Check No.	Date	Vendor Name	Invoice #	Purpose	Invoice Amount	Check Amount	FYTD
74767	05/25/2016	SCOTT A. SOMMER, ESQ.	Inv# TAKATA (NBGPP NCP) APR16	Apr16 NBGPP NCP compliance	\$1,680.00		
Total for Check: 74767						\$1,680.00	\$34,870.72
74768	05/25/2016	SHEAKLEY PENSION ADMINISTRATION, INC	Inv# FLEX00006462	FSA Fees Apr16	\$165.00		
Total for Check: 74768						\$165.00	\$1,898.00
74769	05/25/2016	SIERRA SPRINGS/DS WATERS	Inv# 507-6-OCWD 4/29/2016	WETLAND OPERATIONS	\$66.00		
74769	05/25/2016	SIERRA SPRINGS/DS WATERS	Inv# 507-6-OCWD 5/13/16	WETLAND OPERATIONS	\$42.50		
Total for Check: 74769						\$108.50	\$1,259.50
74770	05/25/2016	SOUTHERN CALIFORNIA EDISON CO.	Inv# 3-017-9360-14MAY16	ACCT# 2-21-992-6482	\$32.76		
74770	05/25/2016	SOUTHERN CALIFORNIA EDISON CO.	Inv# 3-021-9405-46MAY16	ACCT# 2-22-308-7081	\$2,045.05		
74770	05/25/2016	SOUTHERN CALIFORNIA EDISON CO.	Inv# 3-044-7967-96MAY16	ACCT# 2-38-482-1559	\$410.18		
74770	05/25/2016	SOUTHERN CALIFORNIA EDISON CO.	Inv# 3-023-2096-60MAY16	ACCT# 2-25-170-5067	\$89.03		
74770	05/25/2016	SOUTHERN CALIFORNIA EDISON CO.	Inv# 3-017-9139-64MAY16	ACCT# 2-21-975-5279	\$27.59		
74770	05/25/2016	SOUTHERN CALIFORNIA EDISON CO.	Inv# 3-017-7474-01MAY16	ACCT# 2-22-397-5590	\$30.53		
74770	05/25/2016	SOUTHERN CALIFORNIA EDISON CO.	Inv# 0132538000MAY16	04/12-05/10/16 KWH 1703.46	\$332.72		
74770	05/25/2016	SOUTHERN CALIFORNIA EDISON CO.	Inv# 3-017-9140-39MAY16	ACCT# 2-21-975-6301	\$27.84		
Total for Check: 74770						\$2,995.70	\$5,306,818.96
74771	05/25/2016	SPRINGBROOK ELEMENTARY SCHOOL	Inv# 0115070010-5716SPRINGBROO	CWEF - BUS REIMBURSEMENT	\$784.00		
Total for Check: 74771						\$784.00	\$784.00
74772	05/25/2016	ST IRENAEUS SCHOOL	Inv# CPR 2021	CWEF - BUS REIMBURSEMENT	\$496.25		
Total for Check: 74772						\$496.25	\$496.25
74773	05/25/2016	STAPLES	Inv# 3301063289	NEW CHAIR FOR DAN BOTT	\$524.88		
74773	05/25/2016	STAPLES	Inv# 3301507531	TONER FOR FAX	\$251.21		
74773	05/25/2016	STAPLES	Inv# 3302145102	Replacement Fuser Kit	\$403.64		
Total for Check: 74773						\$1,179.73	\$33,261.09
74774	05/25/2016	SUNSTATE EQUIPMENT	Inv# 6531675-001		\$8.00		

Orange County Water District

Check Register

Begin Date: 05/19/2016

End Date: 05/25/2016

Page 16

Accounts Payable Check Register Presented for Board Ratification and/or Approval

Check No.	Date	Vendor Name	Invoice #	Purpose	Invoice Amount	Check Amount	FYTD
74774	05/25/2016	SUNSTATE EQUIPMENT	Inv# 6531675-001	ROLLER RENTAL - WARNER	\$1,133.13		
74774	05/25/2016	SUNSTATE EQUIPMENT	Inv# 6531675-001	ROLLER RENTAL - WARNER	\$433.51		
Total for Check: 74774						\$1,574.64	\$6,490.05
74775	05/25/2016	Simala, Danny	Inv# 5/10-12/16 TRAINING	5/10-12 Wtrlog	\$68.31		
			Train/Logan,UT				
Total for Check: 74775						\$68.31	\$68.31
74776	05/25/2016	TAIT ENVIRONMENTAL SERVICES, INC.	Inv# 828193	W.HUNT	\$180.00		
Total for Check: 74776						\$180.00	\$5,964.38
74777	05/25/2016	TESTAMERICA	Inv# 44229811	WATER QUALITY	\$416.50		
74777	05/25/2016	TESTAMERICA	Inv# 44229811	WATER QUALITY	\$162.50		
74777	05/25/2016	TESTAMERICA	Inv# 44229818	WATER QUALITY	\$289.50		
74777	05/25/2016	TESTAMERICA	Inv# 44230187	WATER QUALITY	\$868.50		
74777	05/25/2016	TESTAMERICA	Inv# 44230189	WATER QUALITY	\$353.00		
74777	05/25/2016	TESTAMERICA	Inv# 44230357	WATER QUALITY	\$31.50		
Total for Check: 74777						\$2,121.50	\$14,647.00
74778	05/25/2016	THE METROPOLITAN WATER DISTRICT	Inv# 42914	LICENSE TEMP.ACCESS	\$1,420.00		
Total for Check: 74778						\$1,420.00	\$2,840.00
74779	05/25/2016	TOWNSEND PUBLIC AFFAIRS, INC.	Inv# 11668	Apr16 legis.support/SACTO	\$10,000.00		
Total for Check: 74779						\$10,000.00	\$110,000.00
74780	05/25/2016	TRUCPARCO	Inv# 367774	OPERATING SUPPLIES	\$92.83		
Total for Check: 74780						\$92.83	\$18,735.81
74781	05/25/2016	U.S. BANK CORPORATE PAYMENT SYSTEM	Inv# APRIL 2016 CC PAYMENT	Apr16 US Bank credit card pmt	\$38,775.05		
74781	05/25/2016	U.S. BANK CORPORATE PAYMENT SYSTEM	Inv# DEDUCT FRAUDULENT-HERNAND	Hernandocaf fraudulent charge	(\$83.95)		
74781	05/25/2016	U.S. BANK CORPORATE PAYMENT SYSTEM	Inv# APRIL 2016 CC BH#38	91 Express 4/11/16 deposit	\$400.00		
74781	05/25/2016	U.S. BANK CORPORATE PAYMENT SYSTEM	Inv# DEDUCT FRAUDULENT-WALMAR	Walmart-fraudulent charges	(\$818.76)		
74781	05/25/2016	U.S. BANK CORPORATE PAYMENT SYSTEM	Inv# APRIL 2016 CC BH#38*	91 Express 4/11/16 deposit	(\$400.00)		
Total for Check: 74781						\$37,872.34	\$357,330.55
74782	05/25/2016	UCT LLC	Inv# IN53945	LABORATORY SUPPLIES	\$605.34		

Orange County Water District

Check Register

Begin Date: 05/19/2016

End Date: 05/25/2016

Page 17

Accounts Payable Check Register Presented for Board Ratification and/or Approval

Check No.	Date	Vendor Name	Invoice #	Purpose	Invoice Amount	Check Amount	FYTD
Total for Check: 74782						\$605.34	\$21,218.76
74783	05/25/2016	UNITED PARCEL SERVICE	Inv# 0000X81601206		\$50.23		
Total for Check: 74783						\$50.23	\$3,251.58
74784	05/25/2016	UNITED RENTALS	Inv# 136818680-001	Forklift rental - MF header ch	\$694.50		
74784	05/25/2016	UNITED RENTALS	Inv# 136818680-001		\$7.00		
Total for Check: 74784						\$701.50	\$4,536.38
74785	05/25/2016	UNIVAR USA	Inv# LA237765	5/23 sulfuric acid 25.57 ton	\$3,937.78		
74785	05/25/2016	UNIVAR USA	Inv# LA237766	Discount	(\$78.72)		
74785	05/25/2016	UNIVAR USA	Inv# LA237765	Discount	(\$78.76)		
74785	05/25/2016	UNIVAR USA	Inv# LA235522	Discount	(\$77.15)		
74785	05/25/2016	UNIVAR USA	Inv# LA235522	5/16 sulfuric acid 25.05 ton	\$3,857.70		
74785	05/25/2016	UNIVAR USA	Inv# LA235521	Discount	(\$74.23)		
74785	05/25/2016	UNIVAR USA	Inv# LA235521	5/16 sulfuric acid 24.10 ton	\$3,711.40		
74785	05/25/2016	UNIVAR USA	Inv# LA237766	5/23 sulfuric acid 25.56 ton	\$3,936.24		
Total for Check: 74785						\$15,134.26	\$371,602.93
74786	05/25/2016	UTILIQUEST LLC	Inv# 234026-Q 9908	4/17-23 screen/mark pipes	\$76.67		
74786	05/25/2016	UTILIQUEST LLC	Inv# 234026-Q 9911	4/17-23 screen/mark pipes	\$1,072.27		
74786	05/25/2016	UTILIQUEST LLC	Inv# 234026-Q 9922	4/17-23 screen/mark pipes	\$625.49		
74786	05/25/2016	UTILIQUEST LLC	Inv# 234026-Q 9932	4/17-23 screen/mark pipes	\$12.69		
Total for Check: 74786						\$1,787.12	\$74,003.15
74787	05/25/2016	VALIN CORPORATION	Inv# 3123344	INVENTORY RE-ORDER	\$3,520.56		
74787	05/25/2016	VALIN CORPORATION	Inv# 3123344		\$44.09		
74787	05/25/2016	VALIN CORPORATION	Inv# 3123344		\$6.95		
74787	05/25/2016	VALIN CORPORATION	Inv# 3123344		(\$35.72)		
Total for Check: 74787						\$3,535.88	\$14,885.13
74788	05/25/2016	VALLEY CITIES/GONZALES FENCE INC.	Inv# 5461	WARNER PROJECT	\$29,400.00		
Total for Check: 74788						\$29,400.00	\$29,400.00
74789	05/25/2016	VHG LABORATORIES	Inv# 105061110		\$21.00		
74789	05/25/2016	VHG LABORATORIES	Inv# 105061110	SUPPLIES	\$106.00		
Total for Check: 74789						\$127.00	\$660.00
74790	05/25/2016	VWR INTERNATIONAL, INC.	Inv# 8044944627	INVENTORY RE-ORDER	\$464.68		
74790	05/25/2016	VWR INTERNATIONAL, INC.	Inv# 8044944627		(\$4.65)		

Orange County Water District

Check Register

Begin Date: 05/19/2016

End Date: 05/25/2016

Page 18

Accounts Payable Check Register Presented for Board Ratification and/or Approval

Check No.	Date	Vendor Name	Invoice #	Purpose	Invoice Amount	Check Amount	FYTD
Total for Check:		74790				\$460.03	\$190,298.97
74792	05/25/2016	XEROX CORPORATION	Inv# 084466918	KAREN WARREN	\$10.00		
74792	05/25/2016	XEROX CORPORATION	Inv# 08446919	KAREN WARREN	\$10.00		
74792	05/25/2016	XEROX CORPORATION	Inv# 084466920	KAREN WARREN	\$106.00		
74792	05/25/2016	XEROX CORPORATION	Inv# 084466917	KAREN WARREN	\$10.00		
74792	05/25/2016	XEROX CORPORATION	Inv# 084466916	KAREN WARREN	\$10.00		
74792	05/25/2016	XEROX CORPORATION	Inv# 084466914	ENGINEERING	\$38.00		
74792	05/25/2016	XEROX CORPORATION	Inv# 084466913	KAREN WARREN	\$10.00		
74792	05/25/2016	XEROX CORPORATION	Inv# 084466912	KAREN WARREN	\$10.00		
74792	05/25/2016	XEROX CORPORATION	Inv# 084466911	KAREN WARREN	\$286.20		
74792	05/25/2016	XEROX CORPORATION	Inv# 084466921	KAREN WARREN	\$6.38		
74792	05/25/2016	XEROX CORPORATION	Inv# 084466915	ENGINEERING	\$20.00		
Total for Check:		74792				\$516.58	\$9,893.39
74793	05/25/2016	YSI INCORPORATED	Inv# 642612	SON TEK METER	\$615.60		
74793	05/25/2016	YSI INCORPORATED	Inv# 642612		\$9.00		
74793	05/25/2016	YSI INCORPORATED	Inv# 642612	SON TEK METER	\$1,317.60		
Total for Check:		74793				\$1,942.20	\$33,933.01
74794	05/25/2016	Yoh, Roger	Inv# APRIL 2016 TRAVEL Meetings	Apr16 OCWD Various	\$34.56		
Total for Check:		74794				\$34.56	\$829.46
975705	07/13/2015	Brown, Don	Inv# CK#1196 PR#15	Interim PR CK#1196	(\$3.01)		
Total for Check:		975705				(\$3.01)	\$0.00
975806	12/29/2015	Hillman, Carolyn	Inv# CK#1184 PR#26-1	Interim PR CK#1184	(\$609.32)		
Total for Check:		975806				(\$609.32)	\$609.32
975896	05/25/2016	CITIBANK NA NEW YORK, ABA	Inv# MAY 25,2016 OCWD2005A PYMT.	OCWD 2005A SWAP	\$139,138.93		
Total for Check:		975896				\$139,138.93	\$2,201,214.33
975897	05/24/2016	WELLS FARGO BANK	Inv# MAY 25, 2016 PR#11	May 25, 2016 PR#11 WFZBA	\$748,337.71		
Total for Check:		975897				\$748,337.71	\$17,817,972.11
975898	05/24/2016	PRUDENTIAL RETIREMENT SERVICE	Inv# MAY 25, 2016 PR#11	May 25, 2016 PR#11 401a	\$200,248.18		
Total for Check:		975898				\$200,248.18	\$4,754,587.59
975899	05/24/2016	PRUDENTIAL RETIRMENT	Inv# MAY 25, 2016 PR#11	May 25, 2016 PR#11 457b	\$49,298.35		

Orange County Water District

Check Register

Begin Date: 05/19/2016

End Date: 05/25/2016

Page 19

Accounts Payable Check Register Presented for Board Ratification and/or Approval

Check No.	Date	Vendor Name	Invoice #	Purpose	Invoice Amount	Check Amount	FYTD
		Total for Check:	975899			\$49,298.35	\$1,266,525.73
<i>Run Date:</i>	5/25/2016					\$4,139,767.55	

AGENDA ITEM SUBMITTAL

Meeting Date: June 1, 2016

To: Board of Directors

From: Mike Markus

Staff Contact: S. Dosier

Budgeted: N/A

Budgeted Amount: N/A

Cost Estimate: N/A

Funding Source: N/A

Program/Line Item: N/A

General Counsel Approval: N/A

Engineers Report Approved: N/A

CEQA Compliance: N/A

SUBJECT: RATIFICATION OF JOB CLASSIFICATION CHANGES

SUMMARY

Staff met with the Board in closed session back on February 17 to review staff's recommendation to add new job classifications within the Network Administrator job series in the Information Services (IS) Department, and obtain authorization to meet and confer with the Orange County Employee Association (OCEA) regarding the proposed addition. Following the meeting with the Board, staff presented the request to OCEA. OCEA has no objections with the additions; therefore, staff is requesting ratification of the new job classification series.

RECOMMENDATION:

Ratify the following job classification changes:

- 1) Placement of the Network Administrator job classification at salary grade R-15;
- 2) Addition of a Senior Network Administrator at salary grade R-17; and
- 3) Addition of a Principal Network Administrator at salary grade R-19.

PRIOR RELEVANT BOARD ACTION(S): N/A

AGENDA ITEM SUBMITTAL

Meeting Date: June 1, 2016

To: Board of Directors

From: Mike Markus

Staff Contact: J. Kennedy

Budgeted: N/A

Budgeted Amount: N/A

Cost Estimate: N/A

Funding Source: N/A

Program/Line Item No.: N/A

General Counsel Approval: N/A

Engineers/Feasibility Report: N/A

CEQA Compliance: N/A

Subject: POSEIDON CONFIDENTIALITY AGREEMENT

SUMMARY

The District entered into a Confidentiality Agreement with Poseidon Resources in 2010 along with several other Orange County water agencies. The agreement was extended and modified (Amendment #1) with the District in 2013 but expired in April 2016. Amendment #2 would extend the Confidentiality Agreement to December 2017.

Attachments:

- Original Poseidon Confidentiality Agreement
- Amendment #1 to Confidentiality Agreement
- Amendment #2 to Confidentiality Agreement

RECOMMENDATION

Authorize execution of the Poseidon Confidentiality Agreement Amendment No. 2

BACKGROUND/ANALYSIS

The District originally entered into a Confidentiality Agreement with Poseidon Water in April 2010 along with other interested Orange County water agencies. The agreement with OCWD was amended and extended in July 2013 (Amendment # 1) but has recently expired. The agreement allows for Poseidon to share and discuss confidential information with the District.

OCWD Legal counsel confirms that any information provided by Poseidon that is claimed to be confidential complies with applicable laws to be labeled such. Confidential documents:

1. Must contain trade secrets containing materials subject to confidentiality protection under state law; or
2. Are deliberative process materials/memoranda, protected from disclosure by Govt. Code 6254(a), that are not kept in the ordinary course of business, and the disclosure of which would expose OCWD's agency's decision making process in such a way as to discourage candid discussion within OCWD of an important governmental project; or
3. Contain "corporate proprietary information" that contains "information relating to siting within the state furnished to a government agency by a private

company for the purpose of permitting the agency to work with the company in retaining, locating, or expanding a facility within California.”

With Poseidon’s consent, the confidential information would eventually be provided to the general public in its entirety and/or summarized only if a water purchase agreement with Poseidon was executed by the District.

The attached Confidentiality Agreement Amendment No. 2 would extend the term of the agreement to December 2019.

PRIOR RELEVANT BOARD ACTIONS

03/17/10, R10-3-46 – Amendment #1 to MOU with Poseidon Resources along with other OC agencies to consider purchasing ocean desalination water.

03/17/10, R10-3-46 - Entered into Confidentiality Agreement with Poseidon Resources along with other OC agencies to receive project information.

01/16/13, R13-1-6 - Adopted resolution stating it is the District’s goal to achieve and sustain a 75% Basin Production Percentage.

05/22/13, R13-5-48 - Adopt resolution stating that ocean desalination supplies should be considered in the District’s water supply portfolio and that OCWD should ensure sufficient water supplies are always available to the residents and businesses.

07/24/13 R13-7-97 - Authorize execution of a Confidentiality Agreement and receive information from Poseidon Resources to study the economic feasibility of a seawater desalination facility in Huntington Beach that may lead to a water purchase agreement for the entire productive capacity of the plant; and Establish a “Citizen’s Advisory Committee” for the potential project.

11/11/13, M13-157 - Support California Coastal Commission approval of the proposed Poseidon Project.

01/08/14, M14-2 – Received a project financial report and directed staff to arrange a Board meeting with the consultants used by San Diego County Water Authority for their Carlsbad desalination project.

02/19/14, M04-36 - Request proposals from the three firms that assisted the SDCWA with the City of Carlsbad desalination project.

04/02/14, M14-61 - Authorize staff to issue financial RFP’s.

05/21/14, M14-87 - Defer action to select a financial consultant to June 4, 2014.

06/04/14, R14-6-80 - Approve agreement to Clean Energy Capital for \$49,720 to provide financial analysis on the proposed Poseidon Resources City of Huntington Beach Ocean Desalination Project.

12/17/14, M14-185 - Receive and file the Long Term Facilities Plan 2014 Update which included the proposed Poseidon project as one of 17 prioritized projects that should receive focused consideration.

12/03/14, R14-12-155– Increase the Clean Energy Capital contract by \$27,000 to respond to comments on the financial analysis report.

01/07/15, M15-5 – Direct staff to begin negotiating a Term Sheet with Poseidon Resources and began establishing a Citizens Advisory Committee.

03/18/15, M15-57 - Directed that meetings of the Ocean Desalination Citizens' Advisory Committee begin.

5/14/15 – M15-84 - Approved a Term Sheet with Poseidon.

2/3/16, M16-18 - Eliminated options 1A, 1B and 1C from the original eight distribution options considered for the project.

3/2/16, M16-37 - Eliminated options 1D and 4 from the original eight distribution options considered for the project.

CONFIDENTIALITY AGREEMENT

THIS CONFIDENTIALITY AGREEMENT ("Agreement"), entered into and made effective as of April the 7th day of 2010, is by and between Orange County Water District ("OCWD") and Poseidon Resources (Surfside) LLC ("Poseidon") (collectively the "Parties").

WITNESSETH:

WHEREAS, the Parties, along with other agencies providing water service (collectively, OCWD and such other agencies are referred to as the "Water Agencies"), have entered into discussions and negotiations concerning the possibility of a public-private partnership regarding Poseidon's Huntington Beach desalination project (the "Project"); and

WHEREAS, in order to proceed with the next stage of the discussions and negotiations, OCWD has requested, and Poseidon is willing to provide, certain information that Poseidon considers proprietary and confidential; and

WHEREAS, Poseidon wishes to protect its proprietary and confidential information against unauthorized use and disclosure by OCWD;

NOW, THEREFORE, in consideration of the mutual promises and covenants made herein, and with the intent to be legally bound hereby, the Parties agree as follows:

- I. Confidential Information. The term "Confidential Information," as used in this Agreement, shall mean information, other than information described in one or more of clauses (a) through (d) below in this Section, that is provided by Poseidon to OCWD. When Poseidon provides Confidential Information in documentary form, whether hardcopy or electronic, it shall clearly mark it "Confidential." When Poseidon provides Confidential Information to OCWD verbally, it shall notify OCWD of the confidential nature of the information in writing prior to or immediately after verbally conveying the information. In addition to the foregoing requirements, each item of Confidential Information provided either in documentary form or verbally shall be accompanied by a writing stating the grounds for Poseidon's assertion that the information is of the nature described in Section 6 below and is not within any of the exclusions listed in clauses (a) through (d) in this Section. Poseidon shall have the right to determine, in its sole judgment, what information it will provide to OCWD. Confidential Information shall not include the following:
 - (a) Information that, at the time of disclosure by Poseidon, is publicly available or generally known or available to third parties, or information that later becomes publicly available or generally known or available to third parties through no act or omission by OCWD;

- (b) Information that OCWD can demonstrate was in its possession prior to disclosure by Poseidon;
 - (c) Information received by OCWD from a third party who, to OCWD's knowledge and reasonable belief, did not acquire such information on a confidential basis either directly or indirectly from Poseidon; and
 - (d) Information OCWD can demonstrate was independently developed by it or a third party or for it or a third party and that was not obtained, in whole or in part, from Poseidon.
2. Disclosure and Use of Confidential Information. OCWD shall not, without Poseidon's prior written consent, disclose to any third party, firm, corporation or entity such Confidential Information, provided, however, OCWD may discuss Confidential Information with other Water Agenc(ies) that have entered into a confidentiality agreement with Poseidon. Internally, OCWD shall limit the disclosure of the Confidential Information to only those officers, employees and agents (including its governing board or committees, attorneys, accountants, bankers and consultants) of OCWD reasonably necessary to evaluate the Confidential Information and/or the Project. If OCWD internally evaluates Confidential Information and/or the Project with its governing board or committees, OCWD shall do so without disclosing the Confidential Information in a public meeting, to the extent permitted by Section 54950 *et seq.* of the California Government Code. Should OCWD staff determine that a need exists to disclose Confidential Information in a public meeting, OCWD will notify Poseidon of this need and identify the information to be disclosed prior to posting the agenda for the meeting. OCWD shall use the Confidential Information received from Poseidon under this Agreement only for the purpose of its internal evaluation of the Project. In complying with its obligations under this Agreement, OCWD shall use reasonable means to prevent unauthorized disclosure and to protect the confidentiality of the Confidential Information. Notwithstanding OCWD's exercise of its right to discuss Confidential Information with another Water Agenc(ies) that have entered into a confidentiality agreement with Poseidon, OCWD shall not have any obligation with regard to limiting or preventing disclosure of Confidential Information by such other Water Agenc(ies) or with regard to such other Water Agenc(ies)' performance of their confidentiality agreements, and OCWD's and such other Water Agenc(ies)' obligations under their respective confidentiality agreements shall not be construed as joint and several.
3. Required Disclosure. In the event OCWD is requested or required by oral questions, interrogatories, requests for information or documents, subpoena, civil investigation, demand or similar process to disclose any Confidential Information received pursuant to this Agreement, OCWD will notify Poseidon immediately of such request(s) and will use reasonable efforts to lawfully delay disclosure until an appropriate protective order may be sought by Poseidon and/or a waiver of

compliance with the provisions of this Agreement granted by Poseidon; provided, however, such measures shall not include initiating or defending litigation or otherwise contesting the validity of a demand for disclosure pursuant to law or order of a court or regulatory body, unless OCWD and Poseidon first reach agreement regarding the engagement of legal counsel for OCWD and the payment of OCWD's legal and related expenses in such litigation or contest. If by the earlier of seven (7) days after being notified by OCWD of such request(s) or two (2) days prior to the disclosure date, Poseidon does not either grant a waiver or seek a protective order, then OCWD may comply with the request(s) and such disclosure of Confidential Information will not constitute a breach of this Agreement.

4. Return of Documents. Either Party may elect at any time to terminate this Agreement. OCWD will return any and all Confidential Information upon written request from Poseidon, including all originals, copies, translations, transcriptions or any other form of said material, without retaining any copy or duplicate thereof. To the extent permitted by law and if Poseidon has not requested the return thereof pursuant to the preceding sentence, OCWD shall promptly destroy any and all electronic and hardcopy versions of Confidential Information, as well as any documents consisting of excerpts or portions of materials previously identified by Poseidon as Confidential Information. OCWD will not retain any Confidential Materials in its agency files.
5. Survival of Obligations. Regardless of any termination of any business relationship between the Parties, the obligations and commitments established by this Agreement shall remain in full force and effect for four (4) years from the day and year first hereinabove written or until such time as the Parties have entered into an agreement providing otherwise.
6. Nature of Information. OCWD hereby accepts the representations of Poseidon that the Confidential Information is of a special, unique, unusual, extraordinary, and intellectual character, that money damages would not be a sufficient remedy for any breach of this Agreement by OCWD, and that specific performance and injunctive or other equitable remedies for any such breach shall be available to it. The Parties also acknowledge that the interests of Poseidon in such Confidential Information may be irreparably injured by disclosure of such Confidential Information. The remedy stated above may be pursued in addition to any other remedies applicable at law or equity for breach of this Agreement. Should litigation be instituted to enforce any provision hereof, the Party that prevails will be entitled to recover all costs, including reasonable legal fees, expert costs and costs of investigation.
7. Governing Law. The laws of the State of California shall govern this Agreement.
8. No Other Agreement. It is expressly understood that this Confidentiality Agreement is not and shall not be construed as any form of a letter of intent or agreement to enter into any type of transaction.

9. No License or Rights. Neither this Agreement, nor the transfer of Confidential Information hereunder, shall be construed as granting to OCWD any license or rights to any information or data now or hereafter owned or controlled by Poseidon.
10. Except as may be required by law, without the prior consent of Poseidon, OCWD will not (a) confirm or deny any statement made by a third party regarding the Confidential Information, (b) disclose to any person the fact that Confidential Information has been made available to it by Poseidon, or (c) disclose any of the terms or conditions of this Agreement.

IN WITNESS WHEREOF, the Parties hereto have entered into this Agreement on the day and year first herein above written.

ORANGE COUNTY WATER DISTRICT

BY Kathryn L. Barr
Kathryn L. Barr [NAME]

President [TITLE]

DATE _____

BY Michael R. Markus
Michael R. Markus
General Manager

DATE 04-02-10

POSEIDON RESOURCES (SURFSIDE) LLC

BY Scott Malow
Scott Malow [NAME]

Vice President [TITLE]

DATE March 26, 2010

APPROVED AS TO FORM

By [Signature]
General Counsel for
Orange County Water District

AMENDMENT NO. 1 TO CONFIDENTIALITY AGREEMENT

THIS AMENDMENT NO. 1 (the "Amendment") entered into and made effective as of the 24 day of July, 2013, is by and between Orange County Water District ("OCWD") and Poseidon Resources (Surfside) LLC ("Poseidon") (collectively the "Parties") and amends that certain CONFIDENTIALITY AGREEMENT (as amended, the "Agreement") dated as of April 7, 2010 by and between the Parties. Capitalized terms used in this Amendment without definition shall have the meanings set forth in the Agreement.

NOW, THEREFORE, in consideration of the mutual promises and covenants made herein, and with the intent to be legally bound hereby, the Parties agree as follows:

1. Term of Agreement and Survival of Obligations. Section 5 of the Agreement is amended as follows: The Parties agree that the obligations and commitments established by the Agreement shall remain in full force and effect until April 7, 2016 or such time as the Parties have entered into an agreement providing otherwise.
2. Confidential Information. The fourth sentence of Section 1 of the Agreement is amended to read as follows:

"In addition to the foregoing requirements, each item of Confidential Information provided either in documentary form or verbally shall be accompanied by a writing from Poseidon, specifying the specific legal authority that would authorize OCWD to withhold each individual item of Confidential Information from public disclosure under applicable law, and stating the grounds and factual basis for Poseidon's assertion that the information is of the nature described in Section 6 below and is not within any of the exclusions listed in clauses (a) through (d) in this Section."

3. Disclosure and Use of Confidential information. Section 2 of the Agreement is amended to read as follows:

"OCWD shall not, without Poseidon's prior written consent (which may include consent obtained from Poseidon through e-mail or text message), disclose to any third party, firm, corporation or entity such Confidential Information, provided, however, following Poseidon's written consent with respect to each specific Water Agency, which shall not be unreasonably withheld, OCWD may discuss Confidential Information with such other Water Agency(ies) that have entered into a confidentiality agreement with Poseidon, or which otherwise have expressed potential interest in entering into a future agreement with Poseidon and OCWD. Internally, OCWD shall limit the disclosure of the Confidential Information to only those officers, employees and agents (including its governing board or committees, attorneys, accountants, bankers and consultants) of OCWD reasonably necessary to evaluate the Confidential Information and/or the Project. If OCWD internally evaluates Confidential Information and/or the Project with its governing board or committees, OCWD shall do so without disclosing the Confidential Information in a public meeting, to the extent permitted by Section 54950 *et seq.* of the California Government Code. Notwithstanding the above, following consultation with Poseidon, OCWD may prepare and disclose summaries of any Confidential Information in a public meeting, the purpose of which is to evaluate, consider, deliberate, or act to approve any Project agreement(s) or necessary OCWD Board actions that precede the potential approval of any Project agreement. Should OCWD staff, in preparing for a public meeting, determine that a need exists to disclose Confidential Information that cannot be adequately summarized, OCWD will notify Poseidon of this need and identify the information to be disclosed prior to posting the agenda for the meeting. Poseidon expressly acknowledges and agrees that OCWD shall not be responsible or liable in any way to Poseidon for any losses that Poseidon may suffer from disclosure of any Confidential Information during the course of a public meeting in compliance with this Agreement. OCWD shall use the Confidential Information received from Poseidon under this

Agreement only for the purpose of its internal evaluation of the Project. In complying with its obligations under this Agreement, OCWD shall use reasonable means to prevent unauthorized disclosure and to protect the confidentiality of the Confidential Information. Notwithstanding OCWD's exercise of its right, following Poseidon's written consent, to discuss Confidential Information with other Water Agenc(ies) in accordance with this paragraph, OCWD shall not have any obligation with regard to limiting or preventing disclosure of Confidential Information by such other Water Agenc(ies) or with regard to such other Water Agenc(ies)' performance of their confidentiality agreements, and OCWD's and such other Water Agenc(ies)' obligations under their respective confidentiality agreements shall not be construed as joint and several."

4. Required Disclosure. Section 3 of the Agreement is amended to read as follows:

"In the event OCWD is requested or required by oral questions, interrogatories, requests for information or documents, subpoena, civil investigation, demand or similar process to disclose any Confidential Information received pursuant to the Agreement, OCWD will notify Poseidon immediately of such request(s) and will use reasonable efforts to lawfully delay disclosure until an appropriate protective order may be sought by Poseidon and/or a waiver of compliance with the provisions of this Agreement granted by Poseidon; provided, however, such measures shall not include initiating or defending litigation or otherwise contesting the validity of a demand for disclosure pursuant to law or order of a court or regulatory body. It is Poseidon's responsibility, as the real party in interest, to defend at its sole cost any court action, or any other proceeding, related to requests for Confidential Information received by OCWD, and further, Poseidon shall hold OCWD harmless and pay any reasonable costs or attorneys' fees incurred by OCWD, and/or awarded against OCWD, in the event an action is brought to obtain Confidential Information from OCWD and OCWD withholds Confidential Information from public disclosure in accordance with this Agreement. If by the earlier of seven (7) days after being notified by OCWD of such request(s) or two (2) days prior to the disclosure date, Poseidon does not either grant a waiver or seek a protective order, then OCWD may comply with the request(s) and such disclosure of Confidential Information will not constitute a breach of this Agreement. If OCWD is in compliance with this Agreement, OCWD shall not be responsible or liable in any way for any losses that Poseidon may suffer from disclosure of any documents which are released pursuant to a court order, or other legal authority, in any lawsuit related to requests for Confidential Information."

5. Nature of Information. Section 6 of the Agreement is amended to read as follows:

"If OCWD disagrees with Poseidon that information disclosed is confidential under the law cited by Poseidon, OCWD shall return the information to Poseidon within fifteen (15) days, and shall not retain it. If the information is not returned within fifteen (15) days, OCWD will be considered to have accepted the representations of Poseidon that the information disclosed is confidential under the law. OCWD agrees that the Confidential Information is of a special, unique, unusual, extraordinary, and intellectual character, that money damages would not be a sufficient remedy for any breach of this Agreement by OCWD, and that specific performance and injunctive or other equitable remedies for any such breach shall be available to it. The Parties also acknowledge that the interests of Poseidon in such Confidential Information may be irreparably injured by disclosure of such Confidential Information. The remedy stated above may be pursued in addition to any other remedies applicable at law or equity for breach of this Agreement."

6. Section 10 of the Agreement is amended to read as follows:

"OCWD shall use its professional discretion, with the intention of carrying out the intent and spirit of this Agreement, in responding to requests to: (a) confirm or deny any statement made by a third party regarding the Confidential Information, (b) disclose the fact that Confidential Information has been made available to it by Poseidon, or (c) disclose the existence of this Agreement and discussions with Poseidon; provided that OCWD shall not disclose the terms or conditions of this Agreement or the content of any Confidential Information except as may be required by law or otherwise in accordance with this Agreement. OCWD shall promptly notify Poseidon of such requests, and of any response provided. OCWD shall not be responsible or liable in any way for any losses that Poseidon may suffer from any disclosure made in response to such requests, except as otherwise provided for in this Agreement."

7. Each Party represents that it is duly authorized to execute this Amendment and perform its obligations hereunder.

8. All other terms, covenants, and conditions in the Agreement as amended shall remain in full force and effect and shall be applicable to this Amendment.

IN WITNESS WHEREOF, the Parties hereto have entered into this Amendment on the day and year first herein above written.

ORANGE COUNTY WATER DISTRICT

By: 

Name: Shawn Dewane

Title: President

Date: 7-24-13

By: 

Name: Michael R. Markus

Title: General Manager

Date: 7-24-13

POSEIDON RESOURCES (SURFSIDE) LLC

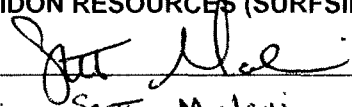
By: 

Name: Scott Maloni

Title: Vice President

Date: July 24, 2013

APPROVED AS TO FORM

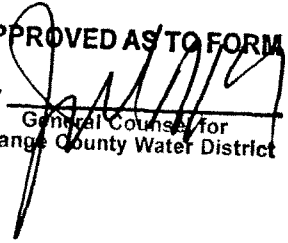
By: 
General Counsel for
Orange County Water District

AMENDMENT NO. 2 TO CONFIDENTIALITY AGREEMENT

THIS AMENDMENT NO. 2 (the "Amendment") entered into and made effective as of the ___ day of May, 2016, is by and between Orange County Water District ("OCWD") and Poseidon Resources (Surfside) LLC ("Poseidon") (collectively the "Parties") and amends that certain CONFIDENTIALITY AGREEMENT (as amended, the "Agreement") dated as of April 7, 2010, as previously amended on June 17, 2013, by and between the Parties. Capitalized terms used in this Amendment without definition shall have the meanings set forth in the Agreement.

NOW, THEREFORE, in consideration of the mutual promises and covenants made herein, and with the intent to be legally bound hereby, the Parties agree as follows:

1. Term of Agreement and Survival of Obligations. Section 5 of the Agreement is amended as follows: The Parties agree that the obligations and commitments established by the Agreement shall remain in full force and effect until December 31, 2019 or such time as the Parties have entered into an agreement providing otherwise.
2. Each Party represents that it is duly authorized to execute this Amendment and perform its obligations hereunder.
3. All other terms, covenants, and conditions in the Agreement as amended shall remain in full force and effect and shall be applicable to this Amendment.

IN WITNESS WHEREOF, the Parties hereto have entered into this Amendment on the day and year first herein above written.

ORANGE COUNTY WATER DISTRICT

By: _____
Name: _____
Title: _____
Date: _____

POSEIDON RESOURCES (SURFSIDE) LLC

By: 
Name: Scott Maloni
Title: Vice President
Date: May 11, 2016

AGENDA ITEM SUBMITTAL

Meeting Date: June 1, 2016

To: Board of Directors

From: Mike Markus

Staff Contact: J. Dadakis / M. Wehner

Budgeted: Yes

Budgeted Amount: \$45,896

Cost Estimate: \$45,896

Funding Source: General Fund

Program/Line Item No.: N/A

General Counsel Approval: N/A

Engineers/Feasibility Report: N/A

CEQA Compliance: N/A

Subject: WATER QUALITY STUDY FOR POSEIDON DESALINATION PROJECT

SUMMARY

Trussell Technologies was hired by the District to assess water quality impacts and related potential regulatory compliance issues associated with the distribution and recharge/injection of desalinated ocean water from the proposed Poseidon Resources Huntington Beach project. Trussell Technologies recently completed a technical memorandum documenting its findings and recommendations. Staff will present an overview of the most important issues identified by the study.

Attachment(s):

- Curriculum Vitae for Rhodes Trussell and David Hokanson of Trussell Technologies
- Trussell Technologies Technical Memorandum dated April 13, 2016

RECOMMENDATION

Informational

BACKGROUND/ANALYSIS

When the Board approved a non-binding Term Sheet with Poseidon Resources in May 2015, it also authorized staff to hire and execute contracts with consultants to review project issues related to distribution and water quality. Staff subsequently hired Trussell Technologies, an engineering consulting firm based in Pasadena, to assess water quality impacts and any related potential regulatory compliance issues associated with the distribution and recharge/injection of desalinated ocean water from the proposed Poseidon Resources Huntington Beach project. The not-to-exceed budget for the study was \$45,896. The study was led by Rhodes Trussell and David Hokanson of Trussell Technologies and their curriculum vitae are included as attachments.

Trussell Technologies was directed by District staff to focus on potential water quality-related impacts to:

1. the distribution system and related infrastructure
2. end user water quality for direct delivery customers

3. groundwater quality from the recharge and injection of desalinated water

Trussell Technologies scope of work included the following tasks:

- Initial review of “Attachment A” Water Quality Table from May 2015 Term Sheet
- Distribution system corrosion assessment based analysis of pipeline materials
- Injection well and recharge basin fouling assessment based on potential for scaling/precipitation at the soil-water interface and physical plugging
- Predict distribution system performance and related regulatory compliance, including nitrification, iron and manganese mobilization, disinfectant residual and disinfection by-product (DBP) formation
- Identify potential end user impacts for direct distribution, including taste, odor, premise plumbing integrity, home appliance operation (e.g., hot water heaters), and outdoor irrigation
- Predict final water quality for each operating scenario (see below) including total dissolved solids (TDS), sodium, chloride, boron, nitrate, nitrite, chlorine residual, and DBPs and other relevant compounds of aesthetic or regulatory interest
- Analyze and predict water quality impacts for across three operational scenarios:
 - 1) Winter operations
 - a. 3 MGD desal to City of Huntington Beach (direct)
 - b. 15 MGD desal water to Talbert Seawater Intrusion Barrier (100% desal)
 - c. 35 MGD desal + 100 MGD GWRS blend to all other injection wells + Forebay recharge basins
 - 2) Summer operations
 - a. 3 MGD to City of Huntington Beach (direct)
 - b. 36 MGD desal water to Talbert Seawater Intrusion Barrier (100% desal)
 - c. 14 MGD desal + 100 MGD GWRS blend to all other injection wells + Forebay recharge basins
 - 3) 100% Desalination operations (during a shutdown of the GWRS AWPf)
 - a. 3 MGD to City of HB (direct)
 - b. 50 MGD of unblended desal water to all injection/recharge locations
- Provide recommendations for OCWD regarding necessary and desirable additions, deletions, or other modifications to May 2015 Term Sheet Water Quality Table to protect water quality, public health, and infrastructure

Trussell Technologies documented its review, analysis, findings, and recommendations for the District in a document entitled *Technical Memorandum - Review of Proposed Water Quality Requirements for Huntington Beach Desalter, prepared for the Orange County Water District*, dated April 13, 2016 (see attachment). A summary of the findings and recommendations is provided below:

- The primary driver for the desalination facility design will be the required chloride concentration, which is currently set at an annual average not to exceed 75 milligrams per liter (mg/L) in the Term Sheet. If the facility is designed and operated to meet the chloride limit, many of the Term Sheet's other water quality requirements (e.g., TDS, sodium, boron) should be achieved.
- The City of Huntington Beach will be required by the state Division of Drinking Water (DDW) to perform additional Lead and Copper Rule (LCR) monitoring for 6-12 months as required by the federal Environmental Protection Agency (EPA) after the introduction of desalinated ocean water into their distribution system. With proper post-treatment to achieve calcium carbonate saturation, LCR requirements should be met, although previous desalination integration studies have observed a 1-3 month period of elevated metal levels within distribution system before metal surfaces came to equilibrium with the new water quality.
- Past experiences (e.g., Tucson, Tampa, and Fresno) have indicated distribution systems comprised of unlined cast iron, ductile iron, and galvanized iron piping can release red water when a new water source is introduced. Remineralization with calcium carbonate has been shown to be a successful strategy for establishing a stable scale on the surface of iron pipe, but often a period of instability generally occurs within the first 30 to 60 days. Based on information provided by the City of Huntington Beach, only 0.07% of its water distribution system pipe length is comprised of unlined cast iron or ductile iron material; 98% of its system is comprised of asbestos-cement pipe (ACP). Based on a review of the District's pipeline infrastructure, both existing and that proposed to connect to the desalination facility, no difficulties are anticipated so long as a positive Langelier Saturation Index (LSI) is maintained.
- The formation of disinfection byproducts is rarely a problem with desalinated ocean water supplies. However, in systems that use chloramines (combined chlorine) for the required disinfectant residual, the presence of elevated bromide in desalinated ocean water has been shown to cause difficulty in maintaining the necessary chloramine residual concentration. The City of Huntington Beach currently uses a free chlorine residual in its system, which can be achieved at the desalination facility and for which bromine-related instability is not anticipated. However, should other direct customers beyond Huntington Beach that use chloramine be added to the project, then additional accommodations would be necessary.
- Desalinated ocean water features elevated boron concentrations relative to current local groundwater and imported water supplies, as well as greater than those found in water produced by the Groundwater Replenishment System (GWRS). The Term Sheet sets an annual average not to exceed boron concentration of 0.75 mg/L. Such concentrations will meet drinking water standards and should not have an effect on agriculture production. However, an extensive study was conducted in 2005 to determine the possible effects on Carlsbad's landscapes and acceptable landscape appearance by irrigating with desalinated ocean water. Common plants found to be adversely affected were:

Camelia, Crape Myrtle, Gardenia, Giant Bird of Paradise, Heavenly Bamboo, Hydrangea, Lily of the Nile, Orange, Lemon, Philodendron, Photinia, Pink Trumpet Vine, Rose, Southern Magnolia, Violet trumpet vine, Wheeler's dwarf pittosporum, and xylosma. Given that the results of such a study depend on local conditions (e.g., soil, microclimate, specific plants common to a community, and preferences of local garden clubs/nursery owners/park managers), a localized study in Huntington Beach would be advantageous to better assess any potential impacts.

- Trussell Technologies predicted the likely water quality produced by the desalination facility. In comparison to typical MWD imported water supplies, it would feature lower concentrations of TDS, sodium, and chloride, but a greater concentration of boron. In comparison to GWRS water, the desalinated ocean water would contain greater concentrations of TDS, sodium, chloride, boron, and other constituents.
- Compared to the current 100 million gallon per day (MGD) GWRS project, the recharge/injection of 50 MGD of ocean desalinated water would contribute 38% more TDS, 136% more sodium, 396% more chloride, and 3% more boron to the groundwater basin on a mass basis. Increases in the concentration of these constituents would be most significant in the vicinity of the Talbert Seawater Intrusion Barrier due to the injection of 100% desalinated ocean water (displacing the current injection of GWRS water), with a smaller increase occurring in the Anaheim Forebay and future Mid-Basin Injection project areas due to the blending of ocean desalinated water and GWRS water in the GWR pipeline that currently conveys GWRS water from Fountain Valley to the Anaheim Forebay recharge basins.
- Trussell Technologies recommends a number of changes to the "Attachment A" Water Quality Table from May 2015 Term Sheet as a part of any future Final Water Purchase Agreement with Poseidon. These included adding in a requirement for the bromide concentration, reducing the boron limit from 0.75 mg/L to 0.4 – 0.5 mg/L, adding a specific requirement for chlorine residual and chloraminated water, reducing the temperature limit to improve aesthetics, increasing the required calcium concentration, adding a silt density index (SDI) requirement to help avoid injection well plugging, and adding additional parameters to ensure corrosion control and aquifer stability. Some of these revisions are proposed to be added explicitly to the Water Purchase Agreement. Others are proposed as target ranges where it is recommended that the District retain the right to designate a specific concentration within the specified range that could be reasonably achieved through Poseidon's adjustment of the post-treatment process; this would permit flexibility to adjust the desalinated water quality based on future observations within the distribution system and the groundwater basin aquifers. For such water quality targets where the District would retain the right to make adjustments within a specified range, it is suggested that the cost of post-treatment chemicals above a certain level could be a pass through cost from Poseidon to the District in the contract.

PRIOR RELEVANT BOARD ACTIONS

5/14/15, M15-84 – Approve Term Sheet with Poseidon Resources for the Proposed Huntington Beach Desalination Project and authorize staff to hire and execute contracts with consultants for a total amount not to exceed \$230,000 to review project issues relating to distributing the Poseidon water, water quality, considering alternative supplies, and financial issues. Staff is further authorized to seek bond funding for such project.



R. Rhodes Trussell, Ph.D., P.E., BCEE

EDUCATION:

Ph.D., Sanitary Engineering, *University of California, Berkeley*

M.S., Sanitary Engineering, *University of California, Berkeley*

B.S., Civil Engineering, *University of California, Berkeley*

Graduate, *Stanford Executive Program*

SUMMARY:

Rhodes Trussell is the Founder of Trussell Technologies a consulting firm that specializes in the interface between science and applied technology in the drinking water field. A member of the National Academy of Engineers since 1995, Trussell has been a member of eight NRC Committees; has been chair of NRC's Water Science and Technology Board and is a former chair of the drinking Water Committee for EPA's SAB.

R. Rhodes Trussell, Ph.D., P.E., BCEE

The founder of Trussell Technologies, Inc., R. Rhodes Trussell, has a B.S., M.S., and Ph.D. in Environmental Engineering from University of California at Berkeley. Dr. Trussell is a registered Civil and Corrosion Engineer in the State of California with more than 40 years of experience who has authored more than 200 publications. He is recognized, worldwide, as an authority in methods and criteria for water quality and in the development of advanced processes for treating water or wastewater to achieve the highest standards. He has worked on the process design for more than 100 water treatment plants, ranging from less than one to more than 900 mgd in capacity and has experience with virtually every physiochemical process and most biological processes as well. Dr. Trussell has a

special interest in emerging water quality problems and potable reuse.

Dr. Trussell was associated with James M. Montgomery Consulting Engineers, Inc./Montgomery Watson/MWH (recently acquired by Stantec, Inc.) from 1966 until 2003. There he rose to become Director of Corporate Development and served 15 years on the Executive Committee and Board of Directors. In 2003, he left MWH to form Trussell Technologies, Inc. a firm that specializes in the interface between science and applied technology in the drinking water industry.

Dr. Trussell served for more than ten years on EPA's Science Advisory Board, including a period as Chair of the Board's Committee on Drinking Water as well as serving on Committees of the EPA Board of Scientific Counselors and on the Science Advisory Panel. He has also served on eight committees for the National Academies on Drinking Water Issues and as Chair of the Academies' Water Science and Technology Board. He has also served on several editorial Boards for technical journals, including the ES&T, JAWWA, and AQUA. For the International Water Association, Dr. Trussell served on the Scientific and Technical Council and on the Program Committee for World Congresses in Buenos Aires, Madrid, Paris, Melbourne, Berlin, Marrakesh, Beijing, and Vienna. He is presently an IWA Distinguished Fellow.

Trussell has been the Kappe Lecturer for AAEEES, received the DR Boyd Award from AMWA, the F Pohland Award from AAEEES/AAEES, the AP Black Award from AWWA, The Global Water Award from IWA, and the Clark Water Prize from the National Water Research Institute. In 2012, U.C. Berkeley selected Dr. Trussell as an inaugural member of its Academy of Distinguished Alumni. He was elected to the National Academy of Engineers in 1995.



David Hokanson, Ph.D., P.E

EDUCATION:

Ph.D., Environmental Engineering, *Michigan Technological University*

M.S., Civil Engineering, *Michigan Technological University*

B.S., Environmental Engineering, *Michigan Technological University*

REGISTRATION:

Civil Engineer, State of California – No. 70254
Professional Engineer, State of Michigan - No. 6201052273

CERTIFICATION:

Board Certified Environmental Engineer,
American Academy of Environmental
Engineers –No. 09-10037

SUMMARY:

Dr. Hokanson is an expert on physical and chemical processes applied to water treatment with over 14 years of experience and more than 45 publications. He has developed engineering design tools for water treatment for the EPA & for wastewater reuse onboard the International Space Station for NASA. Select projects include Temporary Ocean Desalination Demonstration Project and Red Tide for West Basin Municipal Water District, and; Corrosion Control Treatment for Lead and Copper Rule Compliance for the San Francisco Public Utilities Commission and Camp Pendleton; seawater desalination for Marina Coast and Puerto Penasco; and groundwater desalination for San Juan Capistrano and Camarillo. Dr. Hokanson currently serves as Vice Chair of the Research Committee for the CA-NV Section of the American Water Works Association.

PROJECT EXPERIENCE (Select projects):

MWH/EBMUD

Title: Mokelumne Aqueduct Corrosion Optimization Study

Year: 2014-2016

Trussell Technologies, Inc. was retained to perform an evaluation of corrosion control strategies for the East Bay Municipal Utilities District (EBMUD), as a sub-consultant to MWH. EBMUD provides water to over 1.3 million customers east of San Francisco Bay. The primary source of the District's water is Pardee Reservoir, which is fed by the Mokelumne River basin snowmelt. Water from Pardee Reservoir is transported over 90 miles through the three Mokelumne Aqueducts to the service area. The cement mortar lining (CML) in two of the aqueducts has shown signs of deterioration and EBMUD hired the Trussell Tech/MWH team to evaluate different aqueduct lining alternatives and various water quality strategies to manage corrosion. Trussell Technologies began by reviewing the historical and existing corrosion control strategies and the condition of the existing aqueduct linings. Trussell Technologies developed a framework for defining the potential aqueduct lining materials and water quality options, and presented various alternatives. Once the preferred alternative was selected, Trussell Technologies worked with EBMUD to refine the water quality goals. Preliminary design was completed in 2016 for the selected alternative to add lime and CO₂ to protect the aqueduct. CO₂ was added to reduce pH and aid coagulation at the WTPs. Caustic was added to raise pH back up and protect pipes in the distribution system.

Role: *Chemical Corrosion Control Lead*

Orange County Water District

Title: *Desalination Water Quality Consultant*

Year: 2015 - Present

The Orange County Water District is negotiating to acquire 50 mgd of desalinated seawater from the Huntington Beach Desalination Plant and the District has asked Trussell Technologies, Inc. to evaluate the potential water quality impacts of desalinated seawater on their distribution system for different operational scenarios including blends

with water from the Groundwater Replenishment System, on direct delivery end users, and on resulting groundwater quality from recharge and injection of Ocean Water. Trussell Technologies evaluation includes: 1) distribution system corrosion assessment based analysis of a list of pipeline materials of concern provided by OCWD, including a discussion of Langelier Saturation Index (LSI), calcium carbonate precipitation potential (CCCP) and aggressive index (AI); 2) An assessment of injection well and recharge basin fouling based on potential for scaling and precipitation at soil-water interface and physical plugging, considering the silt density index (SDI), the modified fouling index (MFI), and the experience of others; 3) An assessment of distribution system performance and related regulatory compliance, including nitrification, iron and manganese mobilization, disinfection residual stability, disinfection by-product formation (e.g. THMs, HAAs, NDMA, etc.) and lead and copper release in consumer plumbing; 4) An assessment of potential end user impacts for direct distribution, including taste, odor, premise plumbing integrity, home appliance operation (e.g., hot water heaters), and outdoor irrigation; 5) Prediction of final water quality including TDS, sodium, chloride, bromide and ammonia; and 6) preliminary recommendations on any changes to the product water quality specification to assure OCWD's needs are met.

Role: *Project Manager*

Monterey Regional Water Pollution Control Agency (MRWPCA)

Title: Pure Water Monterey - Groundwater Recharge Project

Year: 2013-present

Trussell Technologies designed the Pure Water Monterey Advanced Water Treatment Facility product water stabilization system. Trussell Technologies developed a model to determine chemical dosing requirements and to develop the decarbonator design requirements. Trussell Technologies validated the model with bench-top testing, and created process and instrumentation drawings, mechanical drawings and control narratives. Trussell Technologies also considered kinetic implications of reactions to ensure that the

system could be reliably controlled. In addition, Trussell Technologies also designed and started-up a demonstration-scale production water stabilization system for the Pure Water Monterey AWTF demonstration facility.

Role: *Project Engineer*

RMC Environment/ Marina Coast Water District

Title: Marina Coast Regional Desalination Project

Year: 2009-2012

The Marina Coast Water District was working with Cal Am and Monterey County to develop a 10 mgd regional desalination project. Trussell Tech did the preliminary process design including flow sheet, design criteria, process modeling, water quality goals, and equipment selection and interaction with the California Department of Health. The effort included extensive evaluation of GWUDI criteria, alternatives for disinfection and an extensive examination of alternatives for corrosion control, including a preliminary design.

Role: *Project Engineer*

San Francisco Public Utilities Commission

Title: Comprehensive Report on Lead and Copper Rule Compliance

Year: 2005-2006

Trussell Technologies, Inc. was retained to prepare a comprehensive report on implementation on the implementation of the lead and copper rule in the San Francisco Water System, and in the Regional Water Systems also served by SFPUC. The study addressed past and current practices, compared it to the practices of several other U.S. cities treating similar water supplies and recommended pH adjustment as corrosion control treatment. The results of SFPUC's monitoring of consumer plumbing to confirm the success of the program demonstrated a reduction in lead levels based on implementation of the project recommendations. Dr. Hokanson analyzed lead and copper data for SFPUC and various utilities across the country and compared their corrosion control strategies and performance. He also analyzed water quality and DBP data at various points in the SFPUC system.

Role: *Project Engineer*



Technical Memorandum

Review of Proposed Water Quality Requirements for the Huntington Beach Desalter

Prepared for Orange County Water District (OCWD)

Date: January 25, 2016

OCWD Comments Received: February 9, 2016

Revision 1 (final draft): February 28, 2016

Final Report: April 13, 2016

To: Jason Dadakis, OCWD

Prepared by: Trussell Technologies, Inc.

David Hokanson, Ph.D., P.E., BCEE

M. Teresa Venezia

R. Rhodes Trussell, Ph.D., P.E., BCEE

Subject: Review of Proposed Water Quality Requirements for the
Huntington Beach Desalter

1 Executive Summary

The Orange County Water District (OCWD) is considering a commitment to purchase water to be produced by a new 50 mgd desalination plant to be built by Poseidon in Huntington Beach and has signed a Water Reliability Agreement (WRA) with Poseidon. Included in the WRA is Attachment A, a proposed specification regarding the quality of the water to be delivered. The purpose of this study is to assess the water quality impacts and any related regulatory compliance issues that may be caused by the introduction of the desalinated ocean water on: a) the distribution system and related infrastructure, b) end user water quality for direct delivery customers, and c) resulting groundwater quality from recharge and injection of desalinated ocean water.

This report compares the requirements of Attachment A with the specifications used for 17 other desalination projects; examines which requirements are most important to the cost of the desalination project; summarizes research recently conducted on a wide variety of

issues which have been raised with respect to desalination and water quality; uses Poseidon’s Intake Water Quality Specifications, data from the Southern California Coastal Ocean Observing System and a commercial model of desalination systems to characterize the overall water quality likely to be produced by the project; uses that data to examine several possible scenarios OCWD is considering for the use of the desalinated water; and proposes changes in Attachment A for OCWD’s consideration.

1.1 Introduction

The composition of seawater is remarkably consistent worldwide, particularly along the coast of California. The typical mineral composition of seawater is shown in Table ES-1 and illustrated in Figure ES-1. Together, sodium, chloride, sulfate and magnesium constitute more than 97% of the minerals in seawater. Most RO membranes being used for seawater desalination today are very efficient at removing sodium and chloride, even more efficient at removing magnesium and sulfate, but much less effective in removing boron. As a consequence, the important constituents of desalinated water are usually sodium, chloride and boron.

Table ES-1 and Figure ES-1 Major Minerals in Seawater
(Adapted from Millero, 2013, 4th Edition for 25°C and a density of 1.025 Kg/L)

Mineral	mg/L
Chloride	19,837
Sodium	11,051
Sulfate	2,780
Magnesium	1,316
Calcium	422
Potassium	409
Bicarbonate	107
Bromide	69
Strontium	8.1
Boron	4.6
Fluoride	1.3

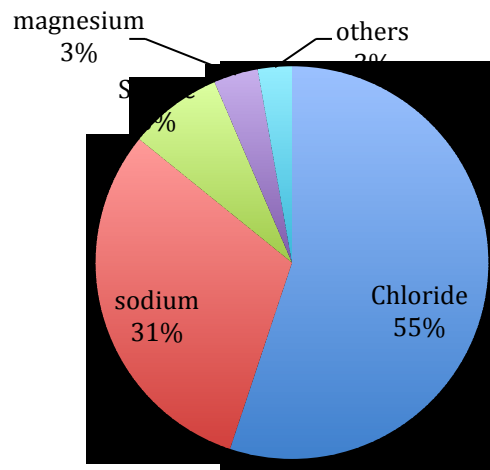

The specifications for 17 other desalination projects were examined and compared with Attachment A. Thirteen of those projects are operating today or have recently been operational. Also included is the Charles E. Meyer Plant in Santa Barbara, currently under refurbishment; the Monterey Peninsula Desalination Plant, which is under contract, and waiting for the finalization of its EIR; and the West Basin Municipal Water District (WBMWD), project EIR is to be completed in June 2016. Table ES-2 summarizes the water quality specifications for the minerals that likely had the greatest influence on each of these desalination plant designs. These are shown in red in the table. The quality being produced by the GWRS is included for comparison.

Table ES-2. Critical Water Quality Specifications¹

Project	2 nd Pass	TDS	Chloride	Bromide	Boron	Sodium
Tampa (Ph 2)	Partial	500	100	0.45	-	80
Ashkelon	Partial	40 ⁷	20	-	0.4	-
Tuas 1	Full	415µS/cm	100	-	0.5	-
Perth 1	Full	200	250	0.1	2	180
Valdelentisco	None ³	2,500µS/cm	250	-	1	-
Gold Coast	Partial	220	50	0.1	1	-
Sur	Partial	200-500	250	-	0.5	-
Barcelona	Partial	-	100	-	1	-
Sydney	Partial	115	40	0.1	1	-
Fujairah 2	Partial	100-200	100	-	1	-
Perth 2	Full	200	-	0.1	2	-
Melbourne	Full	120/140 ⁶	60	0.1	0.5	-
WBMWD	Partial	450	100	0.3	0.5	-
Carlsbad ⁸	Partial	320/375/600	120/150/-	0.4/0.7/-	0.75 ² /1.0 ⁹ /-	-
Santa Barbara	TBD	450	155	0.8	1.1	110 ⁹
Monterey ⁵	Partial	-/500	60/100	0.3/0.5	0.5/0.7	35/60
Attachment A ⁵	TBD	350/500	75/100 ⁵	-	0.75/1.0	60/80
GWRS ⁴	-	54	7.5	0.01	0.26	9.6

1-Generally an average that cannot be exceeded. At Carlsbad, cannot be exceeded more then 50% of the time.

2-Allows for adjustments if the water temperature exceeds 73.4°C

3-Substantial pH adjustment is used to enhance boron removal

4 - - Average for 2014

5 - Mean/maximum

6 - ≥ 120 mg/l for no more than 1800 minutes/month (4% of time); ≥ 140 mg/l for no more than 600 minutes per month (2% of time)

7 - before post treatment

8 - central tendency (mean or median)/extreme (90%)/Maximum - Sodium Adsorption Ratio < 9 to 12;

9 - 95% of daily samples must be below 1.0 (can be exceeded no more than 18 days per year)

1.2 Considerations for Poseidon in complying with the Term Sheet

As OCWD discusses water quality requirements with Poseidon, its important that both parties have perspective on which constituents may have the most impact on the project cost; which constituents may control the design, specifically the influence of temperature.

Certain water quality requirements have more impact on design and operation and, as a result, the cost of water than do the others. Divalent ions like calcium, magnesium and sulfate are almost completely removed by SWRO. The monovalent ions, like sodium and chloride are also well removed, nevertheless they make up the bulk of the TDS in the SWRO permeate, thus setting lower criteria for either of these may impact cost. Boron is poorly removed by conventional SWRO membranes, so requirements for lower levels of boron often have an important impact. Limits on bromide are sometimes imposed and these have similar impact as does chloride. The temperature of the water coming into the desalter is also important. A higher influent temperature reduces the pressure required to operate the reverse osmosis process but, at the same time, increasing temperature also reduces salt removal. As a result, the design of the SWRO facility is generally focused around meeting

the water quality specifications during the warmest period of operation. When a plant draws water directly from the ocean this means the times of the year with the warmest temperature control design – usually the late summer. SWRO plants that are located near power plants also have the option of drawing warmer water from the power plant’s condenser. The condenser in a power plant uses water drawn from the ocean to cool the exhaust steam from the plant turbines. Cooling the exhaust steam improves the efficiency of the turbines in producing power. When a SWRO plant draws warmer water from the condenser then both the season of the year and the load on the power plant influence the temperature. Poseidon has indicated that they do plan to take warmer water after the power plant condenser while it is available.

1.3 Estimating the quality of the desalinated water.

For this project, a commonly used commercial RO model (ToraySD™) was used to estimate the quality of the water to be produced by the HB desalter. Given the temperature and complete composition of the seawater this model can be used to examine the relationship between the design of desalination system and the water quality requirements being considered – like those in the term sheet (Attachment A). The model can be used to explore which requirements in Attachment A is most difficult to meet and to round out the rest of the water quality produced by a given design.

1.3.1 The mineral quality of the feed water

Table ES-3 summarizes results of the effort to estimate the mineral quality of the seawater entering the desalter. Poseidon provided a preliminary summary of their Intake Water Quality Specifications, the maximum water quality conditions that might be used in a contract to build the desalination plant at Huntington Beach. The table compares the Poseidon Specification with the requirements of Attachment A, the results of a balanced model of seawater developed by Frank Millero, and, finally in the right hand column is the mineral quality used in the modeling effort. The details are discussed in section 3.3.1 on feedwater quality.

Table ES-3. Feedwater Quality Modeling^a

Constituent	Intake WQ Specification	Draft Term Sheet Attachment A	Millero Model	Used in RO Model
Chloride	18,500	75	18,500	18,500
Sodium	11,000	60	10,309	10,309
Sulfate	2,800	-	2,593	2,593
Magnesium	2,520	TBD	1,227	1,227
Potassium	822	-	382	382
Calcium	500	20	394	394
Alkalinity	150	-	109	
Bromide	75	-	64	64
Boron	5.0	0.75	-	5.0
TDS	34,500	350	33,621	33,594

a-Intake WQ specification is for maximums. Average values are shown for term sheet.

1.3.2 Temperature

Feed water temperature is an important consideration in the design and operation of the desalination plant at Huntington Beach. Three cases with respect to temperature were considered in the evaluation of the water quality at the Huntington Beach Desalination plant. These are summarized below:

- **Case 1** – Normal Operations on cold seawater (based on 2010-15 average temperature)
- **Case 2** – Normal Operations on warm seawater from power plant condenser (based on Case 1 + 11 °F)
- **Case 3** – Estimated Warmest Day on seawater from power plant condenser (warmest month elevated to achieve an average of 85°F)

The first two cases are the most important for operations and are intended to represent normal operations once the plant is built. The first case being the average temperature of seawater in the area near the Huntington Beach intake and the second case being that same temperature elevated 11°F by the condenser at the Huntington beach power plant. The third case relates to the highest temperature the desalter is likely to experience during the warmest month allowed in Attachment A (a month with an average temperature of 85°F).

In order to understand what those temperatures might be, six years of data were downloaded from the Southern California Coastal Ocean Observing System (SCCOOS) for temperatures at the Newport Beach Pier. The proximity of the pier to the AES site is shown in Figure ES-2. The SCCOOS database at the Newport Pier includes measurements made every 5 minutes, more than 600,000 measurements over the 6-year period.

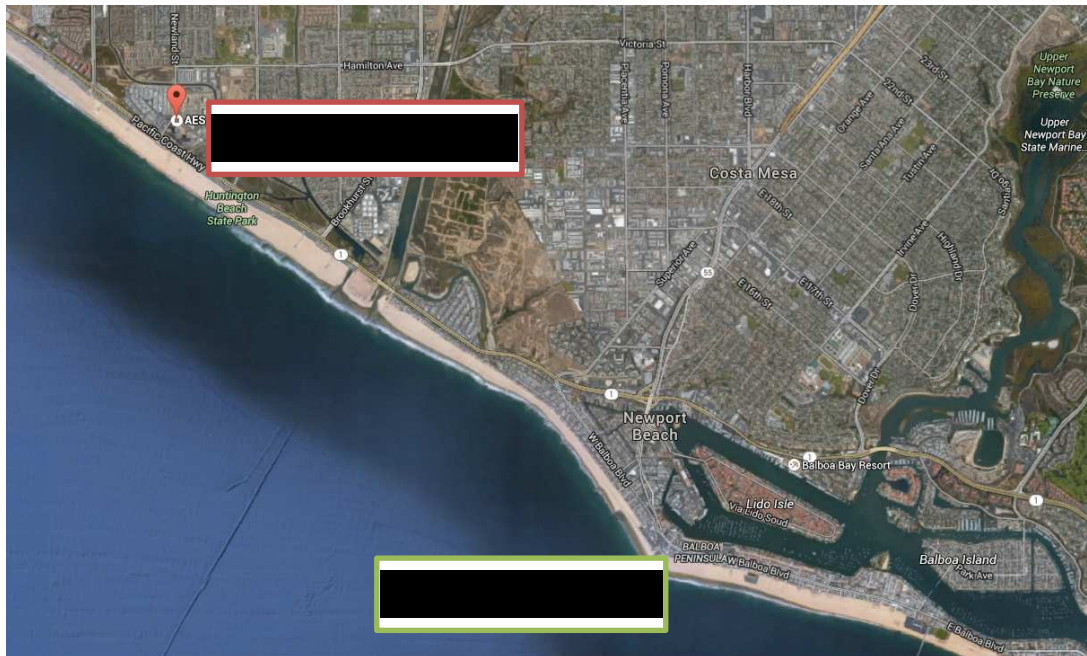

Figure ES-2. Proximity of Newport Beach Pier to the Desalination Facility co-located with AES Huntington Beach

Table ES-4 summarizes the data gathered. From this data it was concluded that Case 1 would be 63°F, Case 2 would be 74°F and Case 3 would be 87°F.

Table ES-4 . Determination of Average Temperature and Max. Month 2010-15.

Month avg	Temperature (°F)					
	2010	2011	2012	2013	2014	2015
Jan avg	59.2	57.5	58.2	56.0	59.9	61.5
Feb avg	59.7	58.3	58.3	56.7	60.3	62.7
Mar avg	59.5	57.6	56.2	58.3	61.8	63.4
Apr avg	59.7	60.3	57.6	59.7	58.7	62.5
May avg	60.4	56.5	64.8	66.0	64.1	61.7
Jun avg	66.3	63.4	66.0	66.9	68.2	66.1
Jul avg	65.5	65.9	64.5	67.1	69.3	68.2
Aug avg	59.6	65.3	68.7	64.2	67.9	71.3
Sep avg	62.8	64.6	66.8	64.7	69.2	73.8
Oct avg	59.2	62.7	67.5	66.1	69.8	71.7
Nov avg	59.7	60.9	61.9	62.9	66.1	67.0
Dec avg	No data	58.4	60.0	60.2	64.2	No Data
YEARLY AVERAGE	61.0	61.0	62.5	62.4	65.0	66.4
AVERAGE 2010-2015	Case 1: 63 °F (normal operations cold water)					
AVERAGE + 11 °F	Case 2: 74 °F (normal operations warm water)					
YEARLY MAX	66.3	65.9	68.7	67.1	69.8	73.8
MONTHLY AVERAGE	June	July	August	July	October	September
MAX MONTHLY AVERAGE 2010-15	74 Sep 2015					
Max Monthly + 11 °F	85 °F					
Variation to Peak Day	+2 °F					
MAXIMUM DAY (85+2)	Case 3: 87 °F (warm water, hottest day and mo.)					

The Case 1 and Case 2 temperatures are the most important as they provide information on the typical performance of the SWRO system and also on the typical water quality it might produce. Nevertheless the information behind Case 3 is also informative because it illustrates how warm the oceans have recently become in Southern California (Figure ES-3).

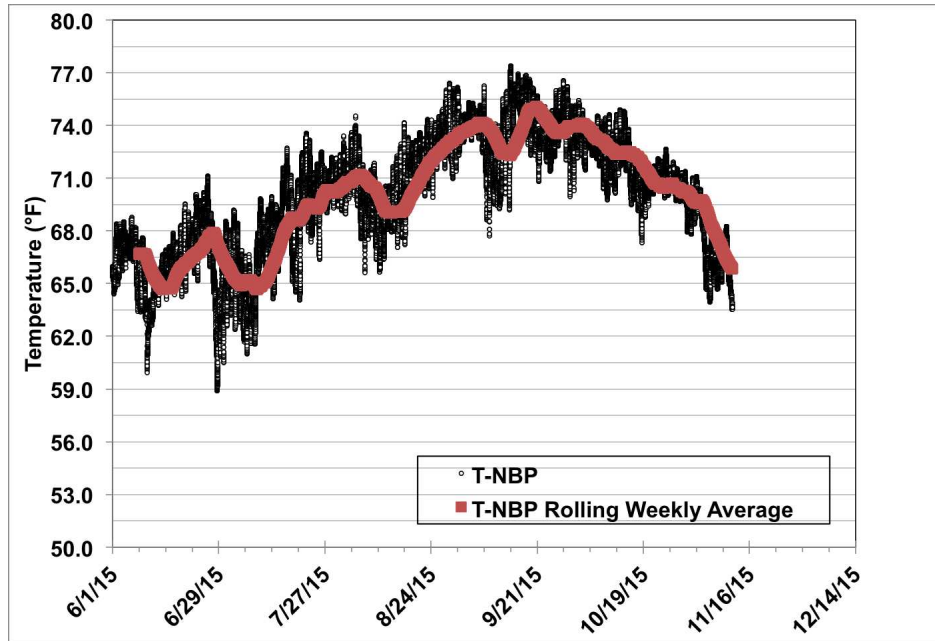

Figure ES-3. Temperature Data from SCCOOS for Newport Beach Pier for Summer/Fall 2015.

1.3.3 Model Estimate of Water Quality to be Delivered From the Desalter

Using the information described above a model was configured in ToraySD™ and estimates were made of the permeate to be produced from the desalination system. Then a post treatment model Trussell Technologies, Inc. maintains in-house was used to produce an estimate of the final desalinated product water.

1.3.3.1 Design Configuration

The assumed RO design configuration consists of a first pass with a partial second pass. The first pass is assumed to be a seawater reverse osmosis (SWRO) system, and the second pass is assumed to be a brackish water reverse osmosis (BWRO) system. There will be a greater amount of second pass as temperature increases due to greater salt leakage, provided the water quality goals are the same. There is assumed to be no second pass concentrate recycle.

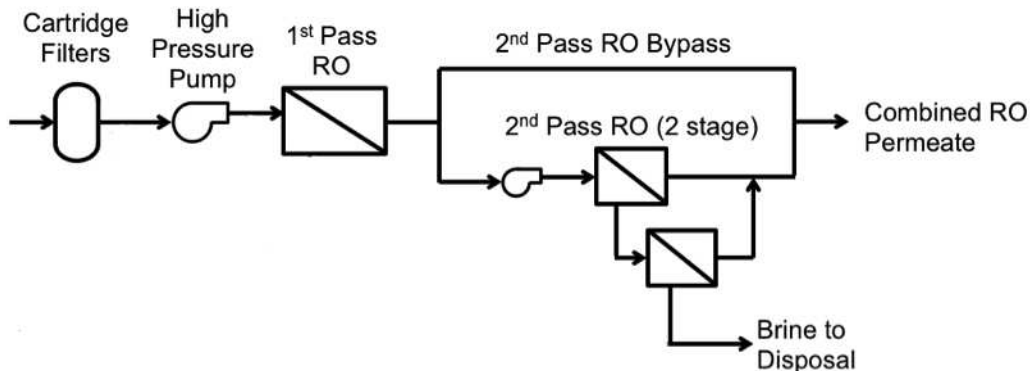

Figure ES-4 Overall Configuration Assumed in Simplified RO Model

1.3.3.2 Model Results

The results from the modeling runs are summarized in Table ES-4. Chloride is highlighted because it turned out that chloride was the controlling variable in all the modeling runs. Cases 1 and 2 are designed to comply with the required annual average from Attachment A, shown in column 2. Case 3 is designed to comply with the required maximum in Attachment A, shown in the last column. It should be noted that a second pass would only be required for 5 percent of the SWRO permeate for Case 1, whereas both Cases 2 and 3 call for a 20 percent second pass.

Table ES-4. Results From RO Model

Parameter or Constituent	Required Annual Average ^a	Case 1	Case 2	Case 3	Required Maximum ^a
Temperature	≤ 74°F	63°F	74°F	87°F	85°F ^b
Second Pass	-	5%	20%	20%	-
TDS, mg/L	≤ 350	129	124	170	500
Boron, mg/L	≤ 0.75	0.54	0.60	0.87	1.0
Chloride, mg/L	≤ 75	74	71	98	100
Sodium, mg/L	≤ 60	45	44	60	80

a - From Attachment A

b - The maximum is a monthly average. Temperature studies showed a month averaging 85°F may reach 87°F for one day

1.3.3.3 Estimate of typical water quality produced

As is the case for the GWRS, desalinated water requires post treatment to manage its corrosive character. Experimental testing by McGuire at Carlsbad for the Poseidon desalination project there concluded that an alkalinity target of 60 mg/L as CaCO₃ was appropriate. At the same time, desalination projects typically target a positive LSI. For this reason, an alkalinity of 60 mg/L as CaCO₃ and a LSI of 0.15 were targeted in this effort. The result of adding lime and carbon dioxide to achieve an alkalinity of 60 mg/L as CaCO₃ is shown in Table ES-5 for case 1 and 2 studied earlier. The lime and CO₂ doses required to hit the alkalinity and LSI targets are also summarized. It should be noted that adding lime to achieve the same alkalinity as Poseidon used in the corrosion tests with Carlsbad causes the calcium to rise to 24 mg/L when attachment A calls for a limit on calcium of 20 mg/L. Sticking to the 20 mg/L limit would mean limiting the alkalinity to 50 mg/L.

Table ES-6 summarizes the post treatment results are of the earlier RO modeling, the modifications resulting from post treatment and compares them with the requirements in Attachment A. These results show a very good quality water with a low TDS. As mentioned before the calcium is 20 percent above the requirements in Attachment A, but these levels are consistent with the Carlsbad tests. If the post treatment were operated to the same LSI and the lower hardness, the alkalinity would drop to 50 mg/L as CaCO₃ and the pH would rise to 8.6.

Table ES-5 Summary of Results of Post Treatment Strategy

Constituent or	Case 1	Case 2	Term Sheet	
Chemical Dose	T = 63 °F	T = 74 °F	Avg.	Maximum
Calcium (mg/L as Ca)	24.2	24.1	20	< 20
Alkalinity (mg/L as CaCO ₃)	60	60	-	-
pH	8.4	8.3	7.0-8.0	>6.5, <8.5
TDS (mg/L)	153	148	350	500
Temperature, °F	63	74	74	85
Temperature, °C	17	23	-	-
Lime Dose (mg/L)	33	33	-	-
CO ₂ Dose (mg/L)	37	42	-	-
LSI	0.15	0.14	-	-
CCPP (mg/L)	0.83	0.81	-	-

Table ES-6 – Estimated Product Water Quality: RO Product Water and Final Product Water After Post-Treatment for Case 1 (Normal Operations for Cold Seawater, 63°F)

Parameter	Units	RO Product Water	Final Product Water	Attachment A Requirements
TDS	mg/L	129	153	≤ 500
Sodium	mg/L	45	45	≤ 80
Magnesium	mg/L	1.4	1.4	-
Calcium	mg/L	0.45	24	< 20
Potassium	mg/L	2.4	2.4-	-
Strontium	mg/L	0.0086	0.0086	-
Chloride	mg/L	74	74	≤75
Nitrate nitrogen	mg/L	0	0	-
Sulfate	mg/L	3.3	3.3	-
Fluoride	mg/L	0.009	0.009	-
Bromide	mg/L	0.26	0.26	-
Hardness	mg/L as CaCO ₃	6.8	60	-
Bicarbonate	mg/L	0.85	71	-
Carbonate	mg/L	0.0008		-
Silica	mg/L	0.04	0.9	-
Barium	µg/L	0	0	-
Boron	mg/L	0.54	0.54	≤ 0.75
pH	pH units	5.17	8.4	-
Alkalinity	mg/L as CaCO ₃	0.7	60	-

1.4 Water Quality Issues of Concern in Desalination

A number of water quality issues have either been suggested and/or identified in connection with the use of desalinated water. The purpose of this chapter is to review

what is known about each of these issues and to do preliminary assessment of their significance for the application anticipated in Orange County.

1.4.1 Corrosion

The corrosiveness of desalinated water has been known for more than 50 years, since it was first studied full-scale in San Diego. Subsequently studies, many of them shown in figure ES-5 have examined each of the issues of importance.

Where lead and copper corrosion are concerned these studies have shown that desalinated water re-mineralized to achieve CaCO₃ saturation meets lead and copper rule requirements. Also, in California, regulation of lead is tight and sources of lead in consumer plumbing are rapidly diminishing. Because of EPA and DDW requirements, The City of Huntington Beach will probably be required to do extra monitoring in the first six months of their new supply.

Where red water is concerned, studies have shown that in systems with unlined cast iron, ductile iron and galvanized iron piping, desalinated waters re-mineralized to achieve CaCO₃ saturation may cause iron or manganese release to increase in the first few weeks but will eventually stabilize and frequent changes from one water quality to another should be avoided. These studies also show desalinated, water re-mineralized to achieve Calcium carbonate saturation, gives satisfactory service with cement mortar lined pipe

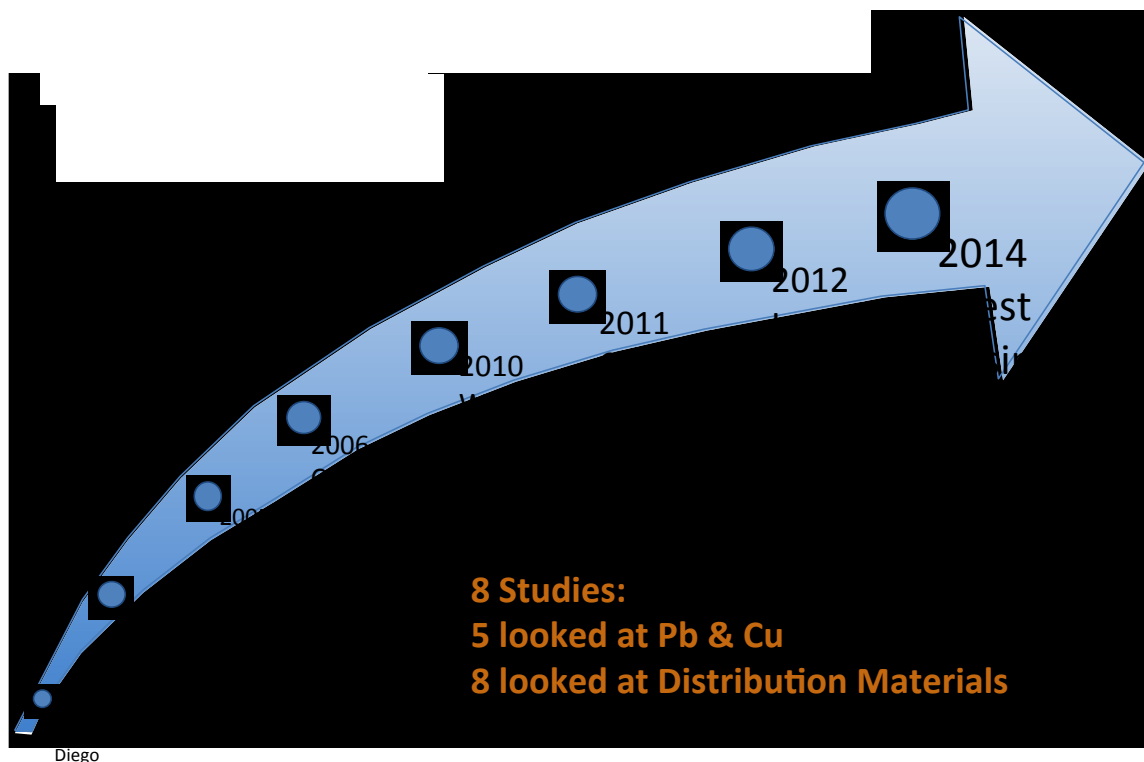

Figure ES-5 A Graphical Summary of the eight corrosion studies that have been carried out on desalinated water over the past several decades

1.4.2 Health Issues

Several health issues have been raised in connection with desalinated water but few of these have significance for the Huntington Beach Project.

1.4.2.1 Disinfection

Several studies have examined the significance of disinfection byproducts formed in desalinated water. These studies show that DBPs are rarely a problem in desalinated water. There are exceptions when desalinated water high in bromide is blended with groundwater high in TOC – not expected to be an issue in Orange County. The stability of disinfectant residuals, has, on the other hand, been demonstrated to be a problem. This was, in fact, discovered in early work for the Huntington Beach project and has subsequently been studied in several other places. High bromide in desalinated water has been shown to cause short-term instability in chloramine residuals. While this problem can be successfully managed, no bromide-related residual instability is anticipated if OCWD and Huntington Beach continue with their plans to use a free chlorine residual

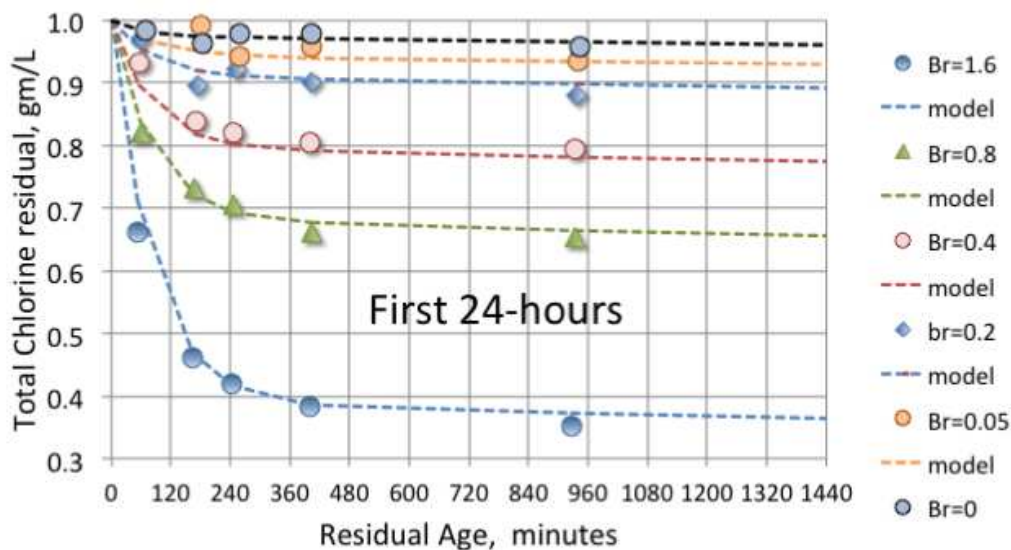

$$C = xC_0e^{-k_1t} + (1-x)C_0e^{-k_2t}$$

Where:

$$X = 0.0337 + 0.3633Br, K_1 = 0.012, \text{ \& } k_2 = 0.00001 + 0.00002Br$$

Figure ES-6. Influence of bromide ion on the decay of total combined chlorine residuals in Desalinated water. Symbols are lab results, dashed lines are model results (after Tiwari & Trussell, 2013)

1.4.2.2 Boron

Boron was once the principal health issue raised in connection with desalinated water, but our understanding of the toxicity of boron to humans has changed significantly during the past decade and guidance values, once as low as 0.5 mg/L, now range from 1.4 to 6.7 mg/L. Nevertheless the Notification limit in California is 1 mg/L. OCWD may benefit from

discussions with DDW regarding enforcement. Boron is also a horticultural issue and circumstances are such that boron is likely to accumulate in the groundwater basin ... this will be discussed later.

1.4.2.3 Algal toxins

Biotoxins, such as domoic acid, released by harmful algal blooms, like the red tide, are frequently found along the California coast. In fact this season, conditions favoring red tides all along the coast have decimated the Dungeness crab season in Northern California. Fortunately rigorous testing conducted by SPI, Trussell Tech and USC on behalf of West Basin Municipal Water District has shown that these algal toxins are consistently removed by SWRO

1.4.3 *The Consumer Experience*

The consumer experience is another important consideration for any drinking water source. Issues to be considered are the flavor of desalinated water, its temperature relative to conventional supplies and its influence on scaling or corrosion of home appliances.

1.4.3.1 Taste

Extensive testing by McGuire Environmental Consultants on behalf of the San Diego Water Authority demonstrated that consumers can easily distinguish desalinated water from conventional supplies and would generally prefer the latter. Nevertheless, the flavor of desalinated water is acceptable. The lesson may be that changes from one to the other and back again should be avoided

1.4.3.2 Temperature

It is expensive to heat water. Cooling it is less expensive but still, it is not ordinary practice for drinking water. As a nation, Americans are fond of cold beverages, including water. The idea of a “tepid” water supply does not appeal to some. On the other hand, acceptable temperatures are poorly defined. Because of its exceptionally high heat capacity the water is likely to stay warm to the consumer’s tap – even when it is in the ground. If Poseidon plans to operate on the warm side of the power plant for extended periods, this may be an issue worth further exploration.

1.4.3.3 Scaling of Home Appliances

Calcium carbonate is the principal mineral of interest where the scaling of consumer appliances is concerned. It turns out that calcium carbonate management is of general interest to the water districts as well. The water purchase agreement should have the flexibility to allow for changes in the future.

1.4.4 *Horticulture (irrigation at the home and in public landscapes)*

There are a number of ways to judge the suitability of a water for irrigation. Generally published criteria address impacts on agricultural production, but homeowners and managers of public landscapes are concerned about appearance, not just production and generally this is a more sensitive criterion.

A classic criterion where the tightness of soil is concerned is the sodium adsorption ratio (SAR). This ratio is already adequately addressed in the criteria proposed by Poseidon. Additional concerns are the toxicity of boron, chloride and sodium. These are illustrated in Figure ES-7. The sensitivity to each of these toxicants varies a great deal from one plant to the next. For sensitive plants these effects are often observed in areas irrigated by reclaimed water, because of its high TDS. Neither the chloride or sodium levels proposed in Attachment A are of much concern. Boron is a more complicated matter. An extensive study was conducted in 2005 to determine the possible effects on Carlsbad’s landscapes and acceptable landscape appearance by irrigating with desalinated water. Common plants found to be adversely affected were: Camelia, Crape Myrtle, Gardenia, Giant Bird of Paradise, Heavenly Bamboo, Hydrangea, Lily of the Nile, Orange, Lemon, Philodendron, Photinia, Pink Trumpet Vine, Rose, Southern Magnolia, Violet trumpet vine, Wheeler’s dwarf pittosporum, and xylosma



Chlorosis of leaves caused by excess boron



Necrosis of leaf tips and margins caused by excess chloride



Yellowing and burning of leaf tips caused by excess sodium

Figure ES-7 Examples of leaf damage caused by boron, chloride and sodium toxicity

Given the large number of common plants that may be impacted by the elevated boron that might be expected with a desalination water source and noting that the study is dependent on local conditions such that the results from Carlsbad are not directly applicable to Huntington Beach, a similar study would be advantageous for consideration in Huntington Beach. Factors affecting horticulture that necessitate a localized study in Huntington Beach include the specific plants common in the community, the local microclimate, soil conditions and the preferences of stakeholders in the community (e.g. the president of the garden club, nursery owners, park managers, etc.).

1.4.5 Boron Accumulation in the Orange County Aquifer

Chances are that at the beginning of the 20th century the Orange County aquifer had very little boron. But, the Santa Ana River is importing boron into the Orange County basin. Between 1976 and 2005, most of the boron in Orange County’s domestic sewage went to the ocean but a small portion was introduced into the Talbert Aquifer through Water Factory 21. Since 2008, the GWRS has captured an increasing fraction of the OCS

discharge and has purified it to make drinking water. The GWRS is not particularly efficient at removing boron so the GWRS has now become the most important contributor to boron in the basin. If the Huntington Beach desalter operates at boron of 0.54 mg/L, the concentration estimated in the RO product water above, it will contribute more boron to the basin than the GWRS. Figure ES-8 illustrates the situation. If the Huntington Beach desalter were to operate with a boron concentration of 0.75 mg/L, the situation would be more dramatic, with 57 tons per year (TPY) from desalination compared to 38 TPY from the GWRS. A detailed examination of this question is beyond the scope of this report, so all the numbers in the figure are rough approximations.

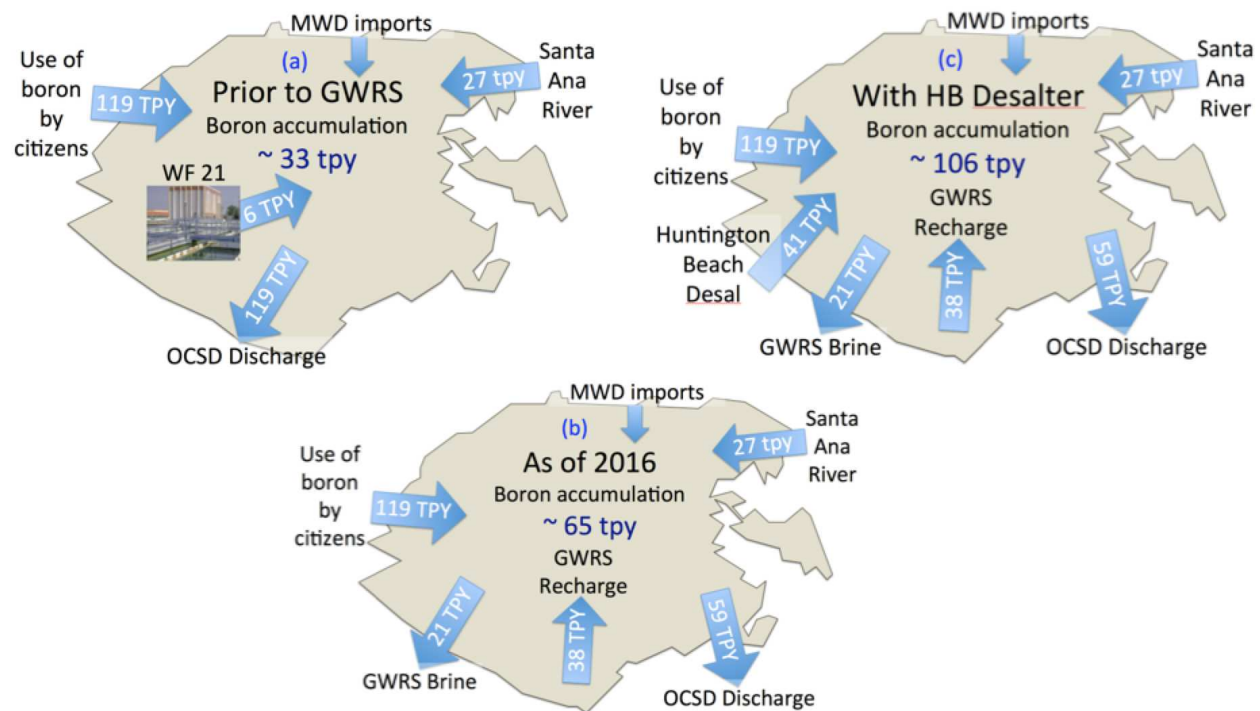

Figure ES-8 Approximations of the changing mass balances of boron in the Orange County Groundwater Basin. a) Prior to GWRS, b) as of today, and c) with the proposed 50 mgd desalter.

From this analysis, it is clear that changes have already taken place with regard to the importation of boron into the Orange County Groundwater Basin in the past and that the operation of the proposed Huntington Beach Desalter would substantially accelerate those changes. What is less clear is the consequence of these changes and the time period over which these changes might have impact. Any impacts are likely to be slow to develop and their consequences are not likely to be felt for some time. Nevertheless, beginning with the imports from the Santa Ana River and Water Factory 21, some of these changes have been in place a long time and a simple survey of boron levels in groundwater illustrates some effects. Table 4-2 lists the concentrations of boron in the groundwater near the Santa Ana River (SAR) based some OCWD data and on the Annual Water Quality Reports for various cities in the basin. Figure 4-22 shows the levels of boron throughout the basin based some OCWD data and on the Annual Water Quality Reports for various cities therein. Impacts from the SAR and recycled water activities are evident. For the moment, there are

important new sources of boron being introduced into the basin, but there is no clear mechanism for export and the basin's long-term trajectory is not clear. Studies to gain a better perspective on the long term prognosis are recommended.

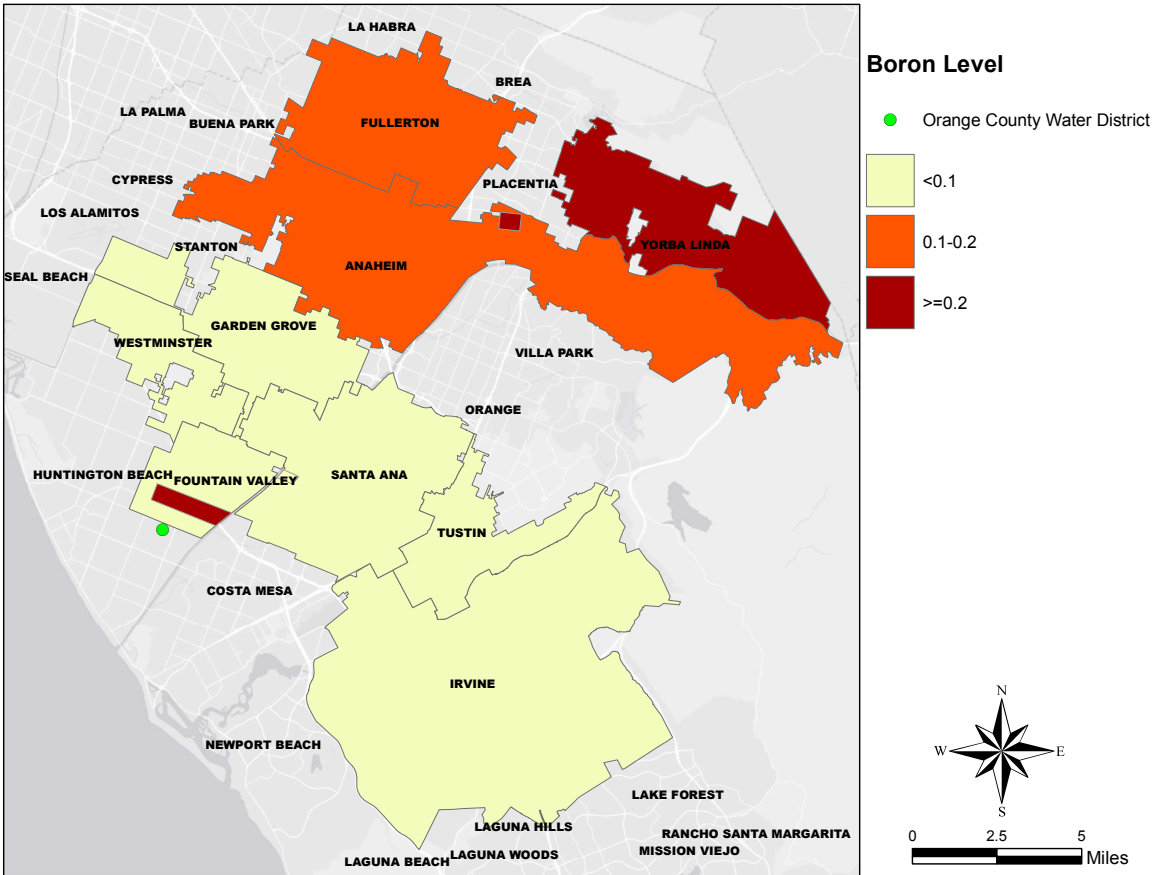

Figure ES-9 – Map of the SAR basin showing average boron concentration (mg/L)

1.5 A Review of the Three Scenarios Posed by OCWD

Three operational scenarios were proposed by OCWD:

- Scenario 1 - Winter/Low Overdraft Operations
- Scenario 2 - Summer/High Overdraft Operations
- 100% Desalination Operations (during shutdown of GWRS AWPf)

The scenarios are described as follows.

Scenario 1) - Winter operations

- 3 MGD desalinated water to City of Huntington Beach
- 15 MGD desalinated water to Talbert Intrusion Barrier
- 35 MGD desalinated water + 100 MGD GWRS blend to all other injection wells + Forebay basins

Scenario 2) - Summer operations

- 3 MGD desalinated water to City of Huntington Beach

- b. 36 MGD desalinated water to Talbert Intrusion Barrier
- c. 14 MGD desalinated water + 100 MGD GWRS blend to all other injection wells + Forebay basins

Scenario 3) 100% Desalination operations (during a shutdown of the GWRS AWPf)

- a. 3 MGD desalinated water to City of Huntington Beach
- b. 50 MGD of unblended desalinated water to all injection and recharge locations

Groundwater mass loading of key constituents was addressed during the scenarios analysis. Key constituents evaluated with respect to the scenarios were TDS, sodium, chloride, and boron. A summary of concentrations for key constituents for all scenarios is provided in Figure ES-7. The 100% desalination cases were determined based on the RO modeling results presented above. The GWRS concentrations used to produce the blend were taken from the 2014 GWRS annual report. Data for Huntington Beach groundwater was provided by the City of Huntington Beach, along with demand data for 2014. The MWD data largely from Diemer Water Treatment Plant (MWD) was taken from the City of Huntington Beach 2014 Annual Water Quality Report.

Table ES-7. Summary of concentrations for constituents of most interest including TDS, Sodium, Chloride, and Boron for all scenarios

Parameter	Scenario					
	1a/2a/3a (HB Blend)	1b (Talbert)	1c (Forebay + Other Injection Blend)	2b (Talbert)	2c (Forebay + Other Injection Blend)	3b (HB + Talbert + Forebay)
Total Flow (mgd)	24.8	15	135	36	114	50
%Desal	12.1%	100%	25.9%	100%	12.3%	100%
TDS (mg/L)	373	148	78.4	148	66.5	148
Sodium (mg/L)	53.3	45.4	18.9	45.4	14.0	45.4
Chloride (mg/L)	72.3	74.1	24.8	74.1	15.7	74.1
Boron (mg/L)	0.123	0.536	0.332	0.536	0.294	0.536

1.5.1 Scenarios 1a, 2a, and 3a – 3 mgd of desalinated water to City of Huntington Beach

All three scenarios involve distribution of the same amount of water to Huntington Beach in terms of potential direct impacts to the City. As such, all three of these scenarios are identical and were treated as such in the analysis. The City takes water from local groundwater wells, imports water from MWD and would take 3 mgd of desalinated water from the Huntington Beach desalter. The 3 mgd desalinated water will allow the City to import 3 mgd less water from MWD to levels shown in Table ES-8. A proportional blend of the three water sources is presented in Table ES-8.

Table ES-8. Huntington Beach Blended Water Quality for Scenarios 1a, 2a, and 3a^{1,2,3}

Constituent or Parameter	Desal Water	HB GW	Imported MWD	Blended Water
	12%	72%	16%	
Flow (mgd)	3	17.9	3.86	24.8
TDS (mg/L)	148	375	540	373
Sodium (mg/L)	45.4	48	84	53.3
Chloride (mg/L)	74.1	69	86	72.3
Boron (mg/L)	0.536	0.05	0.14	0.123
Alkalinity (mg/L)	60	155	110	137
Calcium (mg/L)	24.2	65	60	59.3
Magnesium (mg/L)	1.40	9.9	22	10.8
Fluoride	0.01	0.8	0.8	0.70
pH	8.3	8.0	8.1	7.83
Temperature (°F)	63	69.9	68	68.2
SAR	2.43	1.34	2.01	1.51
LSI	0.15	0.57	0.44	0.30
CCPP	0.83	13.8	6.16	6.83

¹ TT freely available blending model (www.trusselltech.com) used to determine pH, alkalinity, and temperature of blends with other parameters determined by mass balance

²TT freely available CaCO₃ indices model (www.trusselltech.com) used to determine LSI and CCPP

³No mass loadings are presented for Scenarios 1a, 2a, and 3a because water is going to the HB distribution system and none of this water is going to the injection or recharge basins.

From Table ES-8, it is observed for the blend that the LSI of 0.3 is within the range of 0 to 0.5 often used as a target for LSI for desal. The CCPP at 6.83 is also in a range common for drinking water. While there are no problems expected for this water given the limited amount of iron pipe in the system and the relatively small fraction of desalinated water compared to the total supply, care should be taken when the system goes online to be prepared for concerns expressed related to the differing water quality.

1.5.2 Scenario 1 – Winter Operations – distribution to injection and recharge basins

The results of Scenarios 1b and 1c that involve discharge to the recharge and injection basins in OCWD are summarized in Table ES-9. This scenario involves sending 15 mgd of desalinated water to Talbert Seawater Intrusion Basin (100% desal) and blending 35 mgd of desalinated water with 100 mgd from the GWRS. Mass loading was determined based on concentrations presented in Table ES-7 and also on additional concentrations for the breakdown of the GWRS/desal blend provided in Section 6 of the report.

Table ES-9. Summary of groundwater mass loadings for Scenario 1 in tons per year (TPY) for constituents of most interest including TDS, Sodium, Chloride, and Boron (excludes distribution to City of Huntington Beach).

Parameter	Scenario (Mass Loadings in TPY)			SCENARIO 1 (TOTAL)	
	1b Talbert (desal)	1c Forebay + Other Injection (desal)	1c Forebay + Other Injection (GWRS)		1c Forebay + Other Injection (blend)
Total Flow (mgd)	15	35	100	135	150
%Flow=Desal	100%	100%	0%	26%	33%
TDS	3,380	7,900	8,200	16,100	19,500
Sodium	1,035	2,420	1,460	3,880	4,900
Chloride	1,690	3,960	1,140	5,100	6,800
Boron	12.3	28.5	39.6	68	80

Results for TDS, boron, chloride, and boron are presented. As an example, with respect to the desalination source, TDS varied from mass loading of 3,380 TPY at 15 mgd (1b) to 7,900 TPY at 35 mgd (desal portion of 1c). The total mass loading of TDS in the blend of GWRS/desal water was 16,100 TPY. The total mass loading for each constituent for Scenario 1 is shown in the far right column, to be discussed below.

1.5.3 Scenario 2 – Summer Operations – distribution to injection and recharge basins

The results of Scenarios 2b and 2c that involve discharge to the recharge and injection basins in OCWD are summarized in Table ES-10. This scenario involves sending 36 mgd of desalinated water to Talbert Seawater Intrusion Basin (100% desal) and blending 14 mgd of desalinated water with 100 mgd from the GWRS. Mass loading was determined based on concentrations presented in Table ES-7 and also on additional concentrations for the breakdown of the GWRS/desal blend provided in Section 6 of the report.

Table ES-10. Summary of groundwater mass loadings for Scenario 2 in tons per year (TPY) for constituents of most interest including TDS, Sodium, Chloride, and Boron (excludes distribution to City of Huntington Beach).

Parameter	Scenario (Mass Loadings in TPY)				SCENARIO 2 (TOTAL)
	2b Talbert (desal)	2c Forebay + Other Injection (desal)	2c Forebay + Other Injection (GWRS)	2c Forebay + Other Injection (blend)	
Total Flow (mgd)	36	14	100	114	150
%Flow=Desal	100%	100%	0%	12.3%	33%
TDS	8,100	3,150	8,200	11,350	19,500
Sodium	2,490	970	1,460	2,430	4,900
Chloride	4,060	1,580	1,140	2,720	6,800
Boron	29.4	11	40	51.0	80

Results for TDS, boron, chloride, and boron are presented. As an example, boron varies from mass loading of 29 TPY at 36 mgd (2b) to 11 TPY at 35 mgd (desal portion of 1c). Boron also varies from 29 TPY in 2b (Talbert) to 51 TPY in the blend of GWRS/desal water (2c). The total mass loading for each constituent for Scenario 2 is shown in the far right column. It should be observed in Tables ES-9 and ES-10 that while the distribution of mass loadings at the different injection and recharge locations for different constituents varies, the total amount of mass loading is identical for both Scenario 1 and Scenario 2. This is because both scenarios involve injection and/or recharge of 100 mgd of GWRS water and 50 mgd of desalinated water from the Huntington Beach desalter.

1.5.4 Scenario 3 – 100% desalination @ 50 mgd (GWRS AWPF shutdown)

Mass loadings in pounds per year for TDS, sodium, chloride, and boron are presented in Table 6-15 for Scenario 3 (100% Desalination for GWRS Emergency Shutdown). The 100% desalination. For 50 mgd of desalinated water, the mass loading of boron at 41 TPY agrees with the mass balance conducted in Section 4.3.2.

Table ES-11. Summary of groundwater mass loadings for Scenario 3 for TDS, Sodium, Chloride, and Boron (excludes distribution to City of Huntington Beach).

Parameter (mass loadings in TPY)	Scenario 3b (100% Desal Alone)	SCENARIO 3 (TOTAL)
Total Flow (mgd)	50	50
%Flow=Desal	100%	100%
TDS	11,300	11,300
Sodium	3,450	3,450
Chloride	5,650	5,650
Boron	41	41

The groundwater mass loadings associated with the proposed Huntington Beach desalter can be compared to those associated with the current GWRS project by comparing the Scenario 3 100% Desal results (Table ES-11) with the 100% GWRS results (Tables ES-9 and ES-10). The 50 MGD Huntington Beach desalter would contribute 38% more TDS, 136% more sodium, 396% more chloride, and 3% more boron than the current 100 MGD GWRS project.

1.6 A Review of Possible Changes in Attachment A

A revised version of Attachment A is provided in Table ES-12. The parameters in the revised table are broken into four categories with respect to water quality and two categories with respect to operations. Where water quality is concerned, the four categories are 1) mineral quality, 2) disinfection, 3) physical properties and 4) control of corrosion and aquifer interface. Where operations are concerned the two categories are: 1) quality parameters where the target and maximum values will be set in the Term Sheet and 2) quality parameters which shall be adjustable at OCWD’s discretion, from time to time, during the course of the project’s operation. For the latter, a range within which OCWD may select is specified in the term sheet in order to facilitate design. The adjustable quality parameters all address the operation of the desalination plant’s post treatment system, recognizing that there is uncertainty in the information available today for making some of these operational choices.

Table ES-12 Proposed Revised Term Sheet

Parameter	units	Sampling ¹		Concentration		Selected by OCWD ⁴		
		Compliance period	Measurement frequency	Target ²	Maximum ³	Target Range ⁴	Required Precision ⁴	
Minerals								
Sodium	mg/L	one year	bi-weekly ⁵	60	80	-	-	
Chloride	mg/L	one year	bi-weekly ⁵	75	100	-	-	
Bromide	mg/L	one year	bi-weekly ⁵	0.25*	0.4*	-	-	
Boron	mg/L	one year	bi-weekly ⁵	0.5*	1.0	-	-	
TDS	mg/L	one year	bi-weekly ⁵	350	500	-	-	
Disinfection								
SDS-THM	µg/L	one year	monthly	≤ 64	72	-	-	
SDS-HAA5	µg/L	one year	monthly	≤ 36	56	-	-	
SDS-NDMA	µg/L	one year	monthly	≤ 8	9	-	-	
Total chlorine residual	mg/L	daily	continuous ⁶	-	-	1.0 to 4.0	±10%	
Cl ₂ /NH ₃ -N ratio	-	daily	daily ⁷	-	-	3.0 to 5.0	±0.3	
Physical properties								
Temperature	°F	one year	continuous ⁶	65	75	-	-	
Turbidity	ntu	daily	continuous ⁶	0.5	1.0	-	-	
SDI	-	one year	daily ⁷	1.0*	2.0*	-	-	
Control of Corrosion and Aquifer Interface								
Calcium	mg/L as CaCO ₃	one year	bi-weekly ⁵	60*	-	40 to 120	±10%	
Magnesium	mg/L	one year	bi-weekly ⁵	-	-	tbd	±10%	
pH		daily	continuous ⁶	8.4*	-	7.5 to 8.7	±10%	
LSI		monthly	daily ⁷	0.15*	-	(-0.2) to (+0.2)	±10%	
Orthophosphate	mg/L as P	weekly	daily ⁷	-	-	0 to 4.0	±10%	
Alkalinity	mg/L as CaCO ₃	monthly	daily ⁷	60*	-	40 to 120	±10%	
CCPP	mg/L as CaCO ₃	monthly	daily ⁷	0.8*	-	(-5) to (+15)	±10%	

* - This Parameter is proposed as a placeholder as further study may be required

- 1 - All samples to be taken at mutually agreed upon delivery point and analyzed using mutually agreed Standard Methods (EPA, ASTM or SM On Line)
- 2 - Average over compliance period must less than or equal to this value
- 3 - No measurement may exceed this value
- 4 - The desalination plant is to be designed so that it is capable of meeting any concentration in the Target Range. OCWD shall, from time to time, select a concentration in the Target Range and Poseidon shall be responsible for meeting the target with the Required Precision
- 5 - every other week.
- 6- Continuously monitored by instrument ith values stored in SCADA every 15 minutes
- 7 - Measured daily or calculated daily, using most up-to-date information available

The following is a brief discussion of differences in requirements between the Table ES-12 and Attachment A as presented by Poseidon in in October:

1.6.1 Table Format

The format of the table has been revised to display only the basic requirements necessary for negotiation of the Term Sheet. Parameters of interest are noted, along with their frequency of measurement and compliance period. Two types of targets are described: 1) targets, which will be determined in the negotiations and 2) target ranges for areas of water quality where it is recommended that OCWD retain the right to designate a water quality target being sought, changing it from time to time as the District deems appropriate. Parameters in this target range are all selected so that they can be manipulated by Poseidon in the post treatment process. For all parameters the point of compliance is a mutually agreed upon point of delivery and all measurement methods are to be selected by mutual agreement between the two parties. For water quality targets where it is recommended that OCWD retain the right to change water quality targets from time to time, the cost of chemicals should be a pass through in the contract.

Discussion of several specific parameters follows.

1.6.2 Bromide ion

A target of 0.25 mg/L has been tentatively proposed for bromide ion. This target is proposed in order to facilitate more effective management of chloramine residuals. As illustrated in Figure ES-6, reducing bromide ion to 0.25 mg/L or below limits short-term effects on residual stability to less than 15%. The necessity for this requirement is closely linked to the use of chloramines. There is some uncertainty about the need to accommodate the management of chloramine residuals in the project. In early meetings with OCWD and Huntington Beach, both utilities indicated an intention to continue using a free chlorine residual. However, should distribution be extended to utilities using a chloramine residual, additional accommodation would be required. For this reason, the bromide targets in Table ES-12 are marked with an asterisk, indicating that they are proposed as a “placeholder as further study may be required”. Based on the modeling work done in this report, a plant designed to meet the chloride and boron requirements in the October version of Attachment A (75 and 0.75 mg/L, respectively) would produce water with bromide level of approximately 0.25 mg/L (Table 3-15, Combined RO product water), so this requirement should not place additional stress on the design. It will, however, join the chloride requirement of 75 mg/L as one of the principal constraints on the design.

1.6.3 Boron

A target of between 0.4 and 0.5 mg/L has been proposed for boron. The level of 0.5 mg/L is included in Figure ES-12 as a placeholder in the draft, revised Attachment A until the issue can be evaluated further for the reasons discussed below. This requirement is proposed in an attempt to reduce the amount of boron imported into the Orange County Aquifer and possible long-term impacts on horticulture (Section 4.1.8). A review of the requirements

imposed on other projects (Table ES-2) shows that, while a requirement of 0.5 mg/L for boron is not unusual, there are several projects that have a goal of 1 mg/L. Carlsbad has a limit of average boron of 0.75 mg/L and a maximum of 1 mg/L. The differences in these requirements are, in part, a reflection of changes in our understanding of the health effects of boron during the last decade. The Huntington Beach project is somewhat unique in that most of the water will be used to recharge a groundwater basin, thus there is a need to review the mass balance of boron in the basin and the prospects for long-term changes. This report contains the very preliminary aspects of a mass balance for boron and it would appear that the project as originally proposed (boron of 0.75 mg/L) would substantially increase the importation of boron into the basin. Importantly the GWRS project, which is the largest salt exporter out of the basin is relatively ineffective in rejecting boron. It is recommended that OCWD pursue resolution of the issue in three parallel paths: 1) propose a stricter boron standard on the desalter, 2) conduct a study on the impacts of boron and chloride changes on horticulture in the area and 3) conduct a study on long-term projections on of boron levels in the aquifer given increased boron imports.

Modeling work conducted as part of this study suggests that complying with a boron level of between 0.4 and 0.5 mg/L may have a substantial impact on the design of the desalter. A design striving to meet the requirements of the October version of Attachment A is estimate to produce boron levels between 0.5 to 0.6 mg/L.

1.6.4 Disinfection

The revised attachment includes the same requirements for disinfection byproducts but provisions are also made in the contract for Poseidon to provide the capability to deliver a chlorine residual between 1.0 and 4.0 mg/L and also to deliver chloraminated water should that be desirable. As written the document envisions that OCWD may desire to change either the form of residual or its concentration from time to time in the future.

1.6.5 Temperature

As proposed by Poseidon, Attachment A allows for a maximum average monthly temperature of 85°F and, according to the data collected at the Newport Beach Pier, this would allow maximum days as high as 87°F. Thus this requirement is designed to permit operation of the SWRO on the condenser side of the power plant, which allows for more efficient operation of the desalter. On the other hand the use of warm water raises consumer acceptance issues that must be resolved and it also results in some increased costs in the operation of the desalter. None of these considerations necessarily make the project unacceptable, but they do require resolution and they make the negotiations between the parties more complex and it appears that the power plant won't be operating its cooling system much longer, as a result it's not clear that the economic gains to be achieved by warmer operation are sufficient to justify the additional complexity. Thus, lower limits are included in the proposed criteria, designed to be consistent with ambient seawater temperatures.

1.6.6 Silting Density Index

The revised attachment includes an additional requirement for the Silting Density Index (SDI). OCWD has long maintained a focus on doing everything it can to minimize clogging of both in its spreading basins and injection well operations. Historically clogging has also been an issue in other Southern California seawater injection barriers as well. Evidence suggests that turbidity is not an adequate index for this purpose. In recent years, OCWD has maintained an SDI for GWRS between 3 and 4. With recent investments OCWD has brought SDI levels to between 1 and 2. The proposal is that Poseidon be asked to provide water with an SDI comparable to that which OCWD has been able to maintain, averaging 2.0 or less and not exceeding 3.0.

1.6.7 Corrosion Control

The revised attachment includes several additional provisions designed to manage corrosion control. First, although management of calcium carbonate saturation had been successful in desalination projects to date, the addition of orthophosphate is the gold standard for control of both lead and copper corrosion, but also for corrosion of iron. For this reason the specification has been written to require that provisions be made to make the addition of this chemical possible should it become necessary. The remaining requirements all pertain to requiring facilities that will enable Poseidon to provide a water designed to meet the level of alkalinity and hardness and the degree of calcium carbonate saturation that OCWD deems necessary for the optimum protection of its distribution system. Each provision, pH, calcium hardness, alkalinity, Langelier Saturation Index (LSI) and calcium carbonate precipitation potential (CCPP) is set up with the idea that a flexible system should be provided, such as is currently available at the GWRS that can “dial in” the specific goals which OCWD seeks to attain. Once again, a system with excellent control will be necessary because the District will be balancing the need for saturation with calcium carbonate in its distribution system over against the need to avoid excessive calcium saturation, which might cause cementation in its aquifer injection systems. Although the Attachment envisions a system capable of operating over a wide range (LSI -0.2 to LSI +0.2) and a wide range of pHs (7.5 to 8.7), it seems likely that operations will be much closer a neutral LSI. A much wider range of calcium and alkalinity are also provided ranging from the low levels found in some mountain supplies to levels approaching those in local groundwaters. These will allow for a positive LSI at lower temperatures as well as higher levels of calcium to aid in the control of arsenic adsorption in the aquifer. As shown in figure 4-20, the more alkalinity that is added in the post treatment system the lower the pH that can be maintained while still providing the protection of calcium carbonate saturation. Higher alkalinities are also thought to be beneficial in protecting mortar linings because a high alkalinity can react quickly to precipitate calcium hydroxide as it seeks to leach out of the cement matrix, forming a CaCO_3 “plug” in any pores where calcium hydroxide may leach out of the cement paste. Placeholders have been proposed for consideration as the project begins.

1.6.8 Aquifer Interface, Arsenic release

Results of work conducted at Stanford University show that both calcium and magnesium reduce the release of arsenic from aquifer sediments to groundwater, but magnesium is more effective. Recognizing the need to suppress arsenic release near new injection wells, a higher level of calcium and alkalinity could be proposed than that shown in the proposed revision. At present the table leaves room for include discussions about provisions for magnesium addition (TBD). That having been said, from the standpoint of technology, adding more calcium is much more straight-forward than adding both calcium and magnesium. Chemical feed systems for adding calcium are much better established. Magnesium oxide does not have the same properties as does lime. Moreover almost all magnesium salts are hygroscopic (they adsorb water from the air), hence they are difficult to handle and feed. It is expected significant additional study will be required before it is clear whether the insight from the Stanford study can be translated into a practical outcome.

TABLE OF CONTENTS

1	Executive Summary	1
1.1	Introduction	2
1.2	Considerations for Poseidon in complying with the Term Sheet.....	3
1.3	Estimating the quality of the desalinated water.....	4
1.3.1	The mineral quality of the feed water.....	4
1.3.2	Temperature	5
1.3.3	Model Estimate of Water Quality to be Delivered From the Desalter.....	7
1.4	Water Quality Issues of Concern in Desalination	9
1.4.1	Corrosion	10
1.4.2	Health Issues	11
1.4.3	The Consumer Experience	12
1.4.4	Horticulture (irrigation at the home and in public landscapes).....	12
1.4.5	Boron Accumulation in the Orange County Aquifer	13
1.5	A Review of the Three Scenarios Posed by OCWD	15
1.5.1	Scenarios 1a, 2a, and 3a – 3 mgd of desalinated water to City of Huntington Beach	16
1.5.2	Scenario 1 – Winter Operations – distribution to injection and recharge basins.....	17
1.5.3	Scenario 2 – Summer Operations – distribution to injection and recharge basins.....	18
1.5.4	Scenario 3 – 100% desalination @ 50 mgd (GWRS AWPf shutdown)	19
1.6	A Review of Possible Changes in Attachment A	19
1.6.1	Table Format.....	22
1.6.2	Bromide ion.....	22
1.6.3	Boron.....	22
1.6.4	Disinfection.....	23
1.6.5	Silting Density Index.....	23
1.6.6	Corrosion Control	23
1.6.7	Aquifer Interface, Arsenic release.....	24
2	Introduction	29
2.1	Background	29
2.2	Project Approach	29
3	The quality of the water likely to be supplied by Poseidon	30
3.1	Comparison of Attachment A with other water quality specifications	32
3.1.1	Critical Minerals.....	33
3.1.2	Corrosion-related Criteria.....	34
3.1.3	Miscellaneous criteria	34
3.2	Considerations for Poseidon in meeting the term sheet	35
3.2.1	Which constituent controls the design	35
3.2.2	Influence of temperature	35
3.2.3	Influence of membrane age	36
3.2.4	Influence of membrane fouling.....	36
3.2.5	Influence of design strategy and the use of a second pass.....	36
3.3	Application of RO modeling to predict water quality	37
3.3.1	Feedwater Quality	38
3.3.2	Varying temperature in RO modeling	39
3.3.3	Summary of Water Quality Goals	43
3.3.4	Design Configuration.....	43

3.3.5	RO Modeling Results.....	44
3.3.6	Selection of Case (1, 2, and/or 3) to use in continued water quality evaluation and in development of Scenarios.....	48
3.3.7	Estimate WQ to be delivered by Poseidon: Ca, Mg, Na, K, Cl, Br, SO4, F, B, pH, LSI and CCP	49
3.3.8	Post Treatment.....	50
4	Water quality issues of concern regarding the introduction of seawater into the OCWD system	53
4.1	Issues that commonly arise in desalination projects.....	53
4.1.1	Previous Studies on corrosion.....	53
4.1.2	Lead and copper	55
4.1.3	Corrosion and Red Water	56
4.1.4	Manganese Mobilization	58
4.1.5	Cementitious materials	58
4.1.6	Health issues	59
4.1.7	The consumer experience	65
4.1.8	Horticulture (irrigation at the home and in public landscapes).....	69
4.2	Issues that arise in desalination projects with groundwater storage.....	75
4.2.1	Impact on clogging of groundwater injection wells.....	75
4.2.2	Impact on release of contaminants from the aquifer (e.g. As)	80
4.2.3	Impact of the desalination project on boron in the Orange County Aquifer	86
5	Distribution System and Related Infrastructure.....	90
5.1	HB distribution system.....	90
5.2	OCWD distribution system	91
6	Review of the Three Scenarios Posed by OCWD	93
6.1	Scenario 1 - Winter/Low Overdraft Operations.....	95
6.2	Scenario 2 - Summer/High Overdraft Operations.....	101
6.3	Scenario 3 - 100% Desalination Operations (during shutdown of GWRS AWPF)	104
6.4	Summary of Results for Scenarios 1b, 1c, 2b, 2c, and 3b	105
7	Review of possible changes in Attachment A.....	108
7.1	Table Format.....	108
7.2	Bromide ion.....	109
7.3	Boron	110
7.4	Disinfection	110
7.5	Silting Density Index.....	111
7.6	Corrosion Control.....	111
7.7	Aquifer Interface, Arsenic release	111
Appendix 1	Water Quality Specifications	116
Attachment A to the Water Reliability Agreement Term sheet.....		116
Assessment of Existing Seawater Desalination Integration Practices		118
Table 5-5 from Appendix 5 of the Poseidon/SDCWA water purchase agreement.....		118
Appendix 2- Attachment 3 from the Monterey RFP.....		118

2 Introduction

The Orange County Water District (OCWD) is considering a commitment to purchase water to be produced by a new 50 mgd desalination plant to be built by Poseidon in Huntington Beach and has signed a Water Reliability Agreement (WRA) with Poseidon. Included in the WRA is Attachment A, a proposed specification regarding the quality of the water to be delivered. The purpose of this study is to assess the water quality impacts and any related regulatory compliance issues that may be caused by the introduction of the desalinated ocean water on: a) the distribution system and related infrastructure, b) end user water quality for direct delivery customers, and c) resulting groundwater quality from recharge and injection of desalinated ocean water.

2.1 Background

OCWD is a special District formed in 1933 by an act of the California Legislature in response to declining groundwater supplies. Groundwater has been the main source of water supply in the watershed, providing about 70 percent of the consumptive water demand. This supply needs to be managed and used responsibly to avoid depletion of this important freshwater source and to be able to support an ever-growing population. A managed aquifer recharge program comprised of local surface water, stormwater, imported surface water, and recycled water is an important component of the hydrologic cycle in the Santa Ana Basin. Also discharge from upstream wastewater-treatment facilities is an important part of the hydrologic cycle. These activities describe the many factors affecting water availability and quality in the Basin.

Recently, OCWD has been negotiating a partnership with Poseidon Water to acquire water produced by the proposed Huntington Beach desalter. The desalinated water will be taken from the proposed Huntington Beach Desalination Facility and distributed into OCWD's distribution system, including direct delivery to end users and groundwater recharge.

The main purpose of this work is to evaluate the potential water quality impacts of desalinated seawater on the OCWD distribution system and infrastructure and analyze water quality impacts under different operational scenarios.

2.2 Project Approach

In this report the following issues are considered and analyzed:

- 1) Estimate the water quality to be supplied by Poseidon by modeling RO permeate water quality and comparing results with key water quality goals based on the term sheet (Attachment A).

- 2) Summarize the water quality issues which commonly arise in seawater desalination projects, such as: corrosion and mobilization of dissolved materials associated with scale in the distribution system piping; health issues such as boron, disinfectant residual stability, algal toxins or impact on DBPs; consumer issues like off-flavors, tepid water, impacts on consumer appliances, and impacts on irrigated agriculture or horticulture.

- 3) Identify water quality issues of potential concern in projects due to groundwater recharge, mainly the possibility for clogging of the injection wells and the mobilization of contaminants in the aquifer itself, particularly arsenic.
- 4) Review of the conduit materials in the OCWD & Huntington Beach distribution systems to examine the effect of desalinated water specifically on old, unlined iron pipes (mostly galvanized, cast or ductile iron) such as corrosion and mobilization of dissolved materials associated with scale in the distribution system piping. Impacts on cement-based surfaces will also be addressed.
- 5) Analyze water quality impacts for each of the three operational scenarios, listed below, identified by the District for the distribution system and related infrastructure, for the end user for direct delivery customers and for the resulting groundwater from recharge and injection of desalinated water:

Scenario 1) - Winter operations

- d. 3 MGD desalinated water to City of Huntington Beach
- e. 15 MGD desalinated water to Talbert Intrusion Barrier
- f. 35 MGD desalinated water + 100 MGD GWRS blend to all other injection wells + Forebay basins

Scenario 2) - Summer operations

- d. 3 MGD desalinated water to City of Huntington Beach
- e. 36 MGD desalinated water to Talbert Intrusion Barrier
- f. 14 MGD desalinated water + 100 MGD GWRS blend to all other injection wells + Forebay basins

Scenario 3) 100% Desalination operations (during a shutdown of the GWRS AWPf)

- c. 3 MGD desalinated water to City of Huntington Beach
- d. 50 MGD of unblended desalinated water to all injection and recharge locations

- 6) Identify possible changes to Attachment A that would benefit OCWD

3 The quality of the water likely to be supplied by Poseidon

The quality of water provided by Poseidon will be governed by water quality requirements of the water purchase agreement. A draft of these requirements is shown as Attachment A in the *Water Reliability Term Sheet*. Once the necessary water purchase agreements and regulatory permits are in place, Poseidon will organize a team to design and operate the desalination facility to meet requirements like those in Attachment A over the term of the project. Which of these requirements has the most impact on the design and operation of the facility depends on the details of design, but, where water quality is concerned, normally chloride, bromide and boron are the most important considerations.

Historically desalination projects, both inside and outside the U.S. have been implemented with a greater degree of private sector involvement than is customary in conventional water sector projects in the U.S. As a consequence these projects almost always include

formal requirements for the minimum water quality that must be delivered by the project. The project proposed at Huntington Beach is no exception. Typically, these requirements are broken into two parts. The first part is a requirement that the water comply with all Federal, State and local requirements for potable water, including all maximum contaminant limits (MCLs) specified by the State of California and/or the U.S. EPA as well as California Notification Levels (NLs). The second part has to do with unique requirements that derive from special considerations that arise when seawater desalination is proposed as a new water source. These are often modified to reflect the circumstances of the local community to be served.

The term sheet should not be viewed as a simple summary of the quality of the water to be provided by the project. Rather the quality specifications in the term sheet present constraints, which the designers and operators of the desalination plant must meet. The actual quality of the water the plant will produce depends on how the Poseidon team chooses to meet these constraints.

It is likely that the desalination plant will provide the best water quality when its membranes are new and when the water being treated is cold – though flexibility of design and operation can compensate for these circumstances as well.

This section introduces the proposed term sheet, compares it to several others, which have been used for desalination projects around the world and uses a model of a typical, but simple, desalination plant design to estimate the overall quality of the final product water.

The composition of seawater is remarkably consistent worldwide, particularly along the coast of California. The typical mineral composition of seawater is shown in Table 3-1 and illustrated in Figure 3-1. Together, sodium, chloride, sulfate and magnesium constitute more than 97% of the minerals in seawater. Most RO membranes being used for seawater desalination today are very efficient at removing sodium and chloride, even more efficient at removing magnesium and sulfate, but much less effective in removing boron. As a consequence, the important constituents of desalinated water are usually sodium, chloride and boron.

Table 3-1 and Figure 3-1 Major Minerals in Seawater
(Adapted from Millero, 2013, 4th Edition for 25°C and a density of 1.025 Kg/L)

Mineral	mg/L
Chloride	19,837
Sodium	11,051
Sulfate	2,780
Magnesium	1,316
Calcium	422
Potassium	409
Bicarbonate	107
Bromide	69
Strontium	8.1
Boron	4.6
Fluoride	1.3

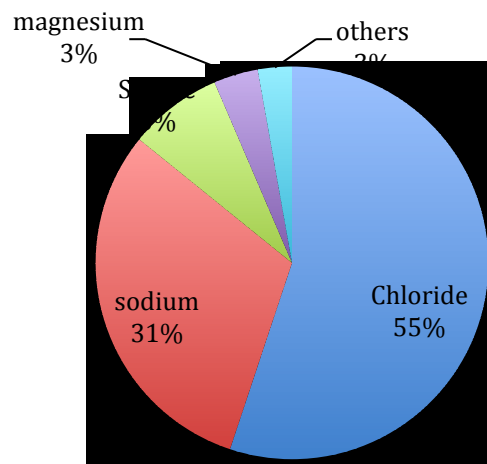

3.1 Comparison of Attachment A with other water quality specifications

Attachment A to the Water Reliability Agreement Term sheet is included in Appendix 1 to this report. Also included, as Supplement 1, is a report prepared by Arcadis for MWD in 2012, which summarizes similar specifications for 10 desalination plants throughout the world (Arcadis, 2012); as Supplement 2, Table 5-5 from Appendix 5 of the Poseidon/SDCWA water purchase agreement, as well as the specifications from Appendix 5 of the Carlsbad project water purchase agreement; and, as Supplement 3, Appendix 2- Attachment 3 from the Monterey RFP by California American Water, the specifications for the Monterey Peninsula Water Supply Project; the performance guarantees from the Perth 1 and Perth 2 projects in Australia; Table 3-7a specifying the current product water quality standards for Tampa Bay and Table H.1, the finished water quality standards for Santa Barbara. Table 3-2 provides a brief summary of the projects reviewed.

Table 3-2. Summary of the Seventeen Desalination Projects Reviewed

Date	Project	Country	Capacity mgd	Second pass	Post Treatment
2003	Tampa	USA	25	Partial	Lime+CO ₂
2005	Ashkelon	Israel	98	Partial	Lime+CO ₂
2005	TUAS	Singapore	36	Full	Lime+CO ₂
2006	Perth 1	Australia	33	Full	Lime+CO ₂
2007	Valdelentisco	Spain	36	None	Lime+CO ₂
2009	Gold Coast	Australia	33	Partial	Lime+CO ₂
2009	Sur	Oman	21	Partial	Limestone
2009	Barcelona	Spain	53	Partial	Limestone
2010	Sydney	Australia	66	Partial	Lime+CO ₂
2010	Fujairah 2	UAE	36	Partial	Lime+CO ₂
2011	Perth 2	Australia	66	Partial	Lime+CO ₂
2012	Melbourne	Australia	108	Full	Lime+CO ₂
2015	Carlsbad	USA	53	Partial	Limestone
2016	Santa Barbara	USA	3	TBD	TBD
2018 (est)	Monterey	USA	9.6	Partial	Lime+CO ₂ ¹
2020	WBMWD ²	USA	-	Partial	-
-	Huntington Beach	USA	56	TBD	TBD

1-lime system will use CalFlo™ rather than using a lime saturator

2-Criteria used for West Basin Municipal Water District's (WBMWD) Temporary Desal Demonstation in Redondo Beach

The first twelve projects are operating today. The Charles E. Meyer Plant in Santa Barbara is currently under refurbishment; The Monterey Peninsula Desalination Plant is under contract, and is now waiting for the results of its EIR; and the West Basin Municipal Water District (WBMWD) project EIR is to be completed in June 2016. Monterey is included because it is the most recent specification and because, as envisioned in Orange County, this project is designed with the idea that some of the water produced will be used for groundwater injection. WBMWD is included because extensive studies have been conducted on integration issues. These projects represent the full range of experience, from smaller to larger and including both those with no second pass (Valdelentisco), several with a partial second pass and those with a full second pass (TUAS, Perth 1 and

Melbourne). Post treatment options include both the lime and CO₂, the option that OCWD uses with its GWRS and limestone contactors (Sur and Carlsbad). Calcite contactor experience has also been gained by interviewing the Barcelona facility, a 53 mgd desalination plant that uses Drintec™ contactors.

3.1.1 Critical Minerals

Table 3-3 summarizes the water quality specifications for the minerals that likely had the greatest influence on these desalination plant designs. It is difficult to predict which of these water quality parameters has the most impact on the seawater reverse osmosis (SWRO) system design. This is particularly true where boron is concerned as some strategies for boron removal can operate independently from processes that remove sodium, chloride, and bromide. Nevertheless, most of these projects chose to address these water quality requirements by employing a brackish water RO system that treats the permeate from the main SWRO process, usually referred to as a “second pass” RO system. Assuming a simple strategy of that kind, the water quality parameter(s) that may control the design (i.e., most difficult to meet) were identified for each project. These are shown in red in the table.

Table 3-3. Critical Water Quality Specifications¹

Project	2 nd Pass	TDS	Chloride	Bromide	Boron	Sodium
Tampa (Ph 2)	Partial	500	100	0.45	-	80
Ashkelon	Partial	40 ⁷	20	-	0.4	-
Tuas 1	Full	415µS/cm	100	-	0.5	-
Perth 1	Full	200	250	0.1	2	180
Valdelentisco	None ³	2,500µS/cm	250	-	1	-
Gold Coast	Partial	220	50	0.1	1	-
Sur	Partial	200-500	250	-	0.5	-
Barcelona	Partial	-	100	-	1	-
Sydney	Partial	115	40	0.1	1	-
Fujairah 2	Partial	100-200	100	-	1	-
Perth 2	Full	200	-	0.1	2	-
Melbourne	Full	120/140 ⁶	60	0.1	0.5	-
WBMWD	Partial	450	100	0.3	0.5	-
Carlsbad ⁸	Partial	320/375/600	120/150/-	0.4/0.7/-	0.75 ² /1.0 ⁹ /-	-
Santa Barbara	TBD	450	155	0.8	1.1	110 ⁹
Monterey ⁵	Partial	-/500	60/100	0.3/0.5	0.5/0.7	35/60
Attachment A ⁵	TBD	350/500	75/100 ⁵	-	0.75/1.0	60/80
GWRS ⁴	-	54	7.5	0.01	0.26	9.6

1-Generally an average that cannot be exceeded. At Carlsbad, cannot be exceeded more than 50% of the time.

2-Allows for adjustments if the water temperature exceeds 73.4°C

3-Substantial pH adjustment is used to enhance boron removal

4 - - Average for 2014

5 - Mean/maximum

6 - ≥ 120 mg/l for no more than 1800 minutes/month (4% of time); ≥ 140 mg/l for no more than 600 minutes per month (2% of time)

7 - before post treatment

8 - central tendency (mean or median)/extreme (90%)/Maximum - Sodium Adsorption Ratio < 9 to 12;

9 – 95% of daily samples must be below 1.0 (can be exceeded no more than 18 days per year)

3.1.2 Corrosion-related Criteria

Table 3-4 Summarizes the water quality specifications for control of corrosion and corrosion by-products. Chloride is included because it is the most aggressive ion in most water systems (Crittenden, et al. 2013) and alkalinity, calcium hardness (in footnotes), and pH are the principal components which are managed to adjust the solubility of calcium carbonate, the most common method for adjusting the impact of desalinated water on corrosion and the release of corrosion by-products. Two corrosion indices commonly used to evaluate calcium carbonate saturation are Langelier Saturation Index (LSI) and calcium carbonate precipitation potential (CCPP), both of which are presented throughout this report.

Table 3-4. Corrosion-Related Water Quality Specifications

Project	Post Treatment	Chloride	Alk ¹	pH	LSI	CCPP ¹
Tampa (Ph 2)	Lime+CO ₂	100	>40	6.5-8.5	> 0	> 0
Ashkelon	Partial	20	-	-	0 to 0.5	-
Tuas 1	Full	100	-	7-9	-	-
Perth 1 ⁶	Full	250	- ²	7.5-8	> -0.5	-
Valdelentisco	None ³	250	-	9.5	-	-
Gold Coast	Partial	50	-	-	-	-5 to -3
Sur	Partial	250	-	6.5-8.5	-	-
Sydney	Partial	40	40-50	7.2-8.3	-0.3 to -0.5	-
Fujairah 2	Partial	100	-	7-9.2	0 to 0.5	-
Perth 2	Full	-	> 50	7.5-8.0	-0.5-0	-
Melbourne	Full	60	50	-	-	-5 to 0
WBMWD	Partial	100	0.3	0.5	-	-
Carlsbad	Partial	120	> 45 ⁵	8.5±0.3	> 0	> 0
Santa Barbara ⁶	TBD	155	≥ 30	8.0-8.9	-	3-10
Monterey ³	Partial	60	40-100 ³	7.7-8.7 ³	0-0.2 ³	0-5 ³
<i>Attachment A</i>	<i>TBD</i>	<i>75</i>	<i>-</i>	<i>7.0-8.0</i>	<i>-</i>	<i>-</i>
<i>GWRS⁴</i>	<i>Lime+CO₂</i>	<i>7.5</i>	<i>28</i>	<i>8.2</i>	<i>-0.7</i>	<i>-2.7</i>

1-mg/L as CaCO₃

2-Ca Hardness; 50 to 250 in Tampa; > 50 in Perth 1

3-Owner can select in this range (Hardness also 40-100). Orthophosphate can also be specified (≤ 3.5 mg/L as PO₄)

4 - Calculated for 25°C

5 - Also Ca-hardness > 40 mg/L as CaCO₃

6 - Larson's ratio also specified as < 5

3.1.3 Miscellaneous criteria

There are also other considerations that come up from time to time. For example, using warmer seawater can reduce its viscosity and, hence the operating pressure (i.e., the operating cost) of SWRO. Hence designers are often tempted to select designs that use warmer water, but warm water is generally not viewed as aesthetically attractive for consumers. Warmer water has also been associated with higher rates of corrosion. As a result, some projects have attempted to incorporate temperature into the water quality

specification. The Carlsbad specification calls for a maximum monthly average temperature of 85°F. Perth 1 limits the temperature to 25°C (77°F). Perth 2 limits the desalinated water to a temperature no more than 2°C warmer than the seawater. The other specifications are silent on temperature. It is not particularly costly to cool warm water with an evaporative cooler, but doing so would probably eliminate the cost benefit from using warmer water in the first place. Some specifications also include parameters appropriate for irrigation, such as the sodium adsorption ratio. Others include provision for control of MCLs, which EPA enforces in the distribution system, like the Disinfectants and Disinfection Byproducts Rules or in consumer plumbing, like the Lead and Copper Rule. For example, Monterey envisions that the water purveyor may try several strategies for corrosion control before a final choice is selected. The Orange County Water District strategy envisions using the bulk of the desalinated water to help replenish the aquifers of the Orange County groundwater basin, partially through spreading, but also partially through injection. This means that the quality of the desalinated water must be examined for its suitability for groundwater injection and also for cumulative impact it might have on the quality of the water in the basin in the coming decades.

3.2 Considerations for Poseidon in meeting the term sheet

The Pacific Ocean of Huntington Beach has an average salinity near 34,000 mg/L. Most potable water supplies have a salinity between 50 and 500 mg/L. The basic purpose of a seawater desalination plant is to bring the salinity of the seawater down to potable levels. But experience using desalted seawater and speculation about certain water quality problems that might occur, have brought certain issues to the fore. It is appropriate to review these issues in order to make a determination as to which might be relevant to the OCWD situation and how they might be addressed. The following sections discuss some of the more salient points regarding factors that influence performance and, hence the design and operation of the plant.

3.2.1 Which constituent controls the design

Certain water quality requirements have more impact on design and operation and, as a result, the cost of water than do the others. Divalent ions like calcium, magnesium and sulfate are almost completely removed by SWRO. The monovalent ions, sodium and chloride are also well removed, nevertheless they make up the bulk of the TDS in the SWRO permeate, thus setting lower criteria for either of these may impact cost. Boron is poorly removed by conventional SWRO membranes, so lower standards for boron often have important impact. Limits on bromide have similar impact on SWRO costs as do limits on chloride. Some strategies, like the use of a simple second pass using brackish water RO membranes (operating at higher flux, lower pressure and cost than the primary SWRO membranes) can impact all these parameters. Other treatment options, like ion exchange, influence only one of them (usually boron).

3.2.2 Influence of temperature

Greater influent temperature does reduce the pressure required to operate the reverse osmosis process but, at the same time, increasing temperature also increases salt passage (i.e., reduces salt removal). As a result, the design of the SWRO facility is generally focused around meeting the water quality specifications during the warmest period of operation.

When a plant draws water directly from the ocean this means the times of the year with the warmest temperature control design – usually the late summer. SWRO plants are located near power plants also have the option of drawing warmer water from the power plant’s condenser. The condenser in such a power plant uses water drawn from the ocean to cool the exhaust steam from the power plant turbines. Cooling the exhaust steam improves the efficiency of the turbines in producing power. When a SWRO plant draws warmer water from the condenser then both the season of the year and the load on the power plant influence the temperature, but generally the SWRO must be designed for a temperature of 5 to 6 °C (9 to 11 °F) above the warmest ambient temperature in the ocean. Temperature could be an important design consideration and in early meetings Poseidon has indicated that they do plan to take water after the power plant condenser while it is available.

3.2.3 Influence of membrane age

The original cellulose acetate RO membranes of the last century showed serious decline in performance with age and this decline was inherent in the basic chemistry of the membrane material. While modern thin film composite membranes do not show the same rate of decline, salt leakage does increase with time, particularly after exposure to oxidants, fouling and/or cleaning that occur during normal SWRO operations. Thus as a rule, some rate of increase in salt leakage is assumed for each year of membrane aging. This decline in salt rejection can be counter-balanced by more frequent membrane replacement, but frequent membrane replacement is costly. For the purposes of this analysis, membrane replacement is assumed to be at 5 year intervals and the increase in salt leakage is assumed to be 7% per year. These assumptions were developed during the concept design of the 10 mgd desalter for the Monterey Peninsula Water Supply Project after extensive discussions with membrane manufacturers and candidate project design teams.

3.2.4 Influence of membrane fouling

Membrane fouling also has important impact on performance and membrane life. In spite of the fact that seawater is very low in nutrients when compared to most fresh water supplies, most plants drawing water from the open ocean are exposed to a serious risk of biological fouling, which must be successfully managed. In wastewater reuse applications this problem has been largely resolved through 1) the use of membrane filtration (e.g., microfiltration or ultrafiltration) prior to reverse osmosis to reduce the number of seed organisms reaching the membrane and 2) the maintenance of a chloramine residual through the reverse osmosis process itself. Fortunately, chloramine is effective in preventing biofilm growth without causing undue oxidation of the rejection layer on modern RO membranes. Unfortunately this strategy has not, so far, proven successful in SWRO because when chlorine is added to seawater it rapidly reacts with bromide ion and the combined chloramine residual formed includes bromamine, which is very aggressive to SWRO membranes. Thus biological fouling remains an important consideration in the operation and maintenance of SWRO systems. This issue has important impacts on the life of the membranes in an SWRO system, but it’s not clear that it is influenced in any way by the specifications for finished water.

3.2.5 Influence of design strategy and the use of a second pass

The strategy for the design of SWRO systems and the specifications for finished water quality can interact in complex ways. Perhaps the most common way of improving performance is the installation of a second pass of RO using brackish water membranes. Because the permeate from the first stage SWRO is nearly dead soft (i.e., contains no divalent ions) and has almost no TOC, both the recovery and the design flux in these second pass systems can be very high. Often the pH in the second pass influent is also elevated in order to improve the removal of boron by converting it to a large proportion of the ionized form near pH 10. More recently designs segregate the permeate from the first and second half of the first stage SWRO vessels, using the better quality permeate from the first half directly and sending the permeate from the second half through a second pass. The Poseidon project in Carlsbad reportedly uses a Four-stage cascade process patented by IDE, the plant's designer (Gasia et al. 2015). This is a further enhancement of the permeate split idea where the poorer quality permeate from the second half of the first stage is further polished through a second pass containing a cascade of four RO stages where removal of TDS and other contaminants can occur through a flexible combination of different membrane types working at different pH levels (Figure 3-2).

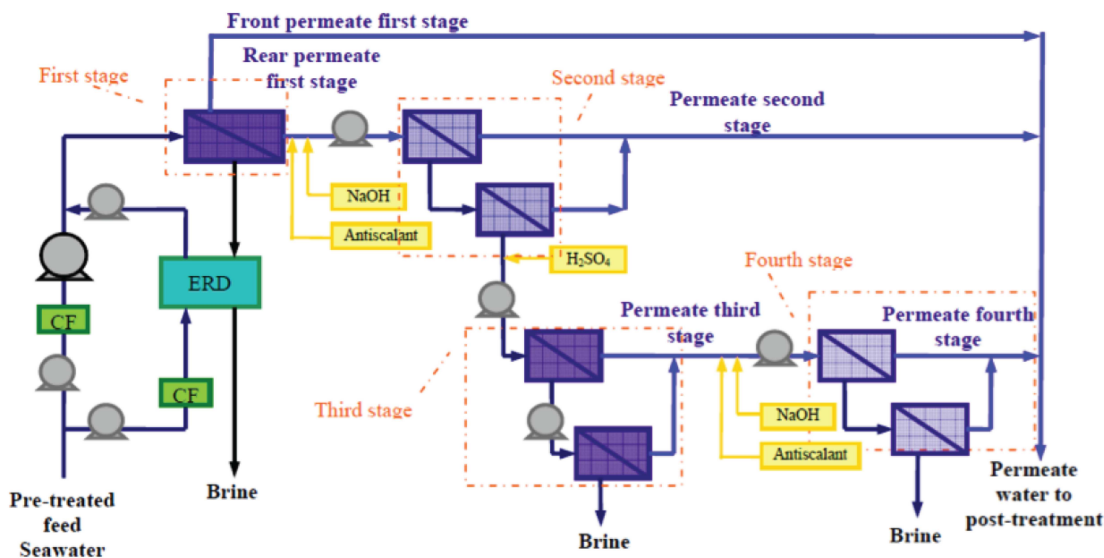

Figure 3-2. Diagram of IDE's patented Four Stage Cascade Process adapted from (Gasia et al. 2015)

Most RO manufacturers also offer tighter membranes, which can meet lower boron objectives in a single pass, but generally these are not seeing a lot of use as they also lead to higher pressures, energy requirements, and operating costs.

3.3 Application of RO modeling to predict water quality

The RO membrane manufacturers maintain models, which can predict the performance of desalination systems using their membrane elements. These models are publicly available at no cost through their websites and can be used to examine the relationship between the

cost of constructing and operating the desalination system and the water quality requirements being considered – like those in the term sheet (Attachment A). For the purposes of this project, an RO model developed by Toray Industries Inc. called TorayDS™ was used. The software is available for download from www.toraywater.com. The model was configured to use a first pass with seawater RO (SWRO membranes) and a partial second pass with brackish water RO (BWRO membranes). As discussed earlier, membrane age influences performance, so the model was set to examine performance in the 5th year of operation assuming a 7% increase in salt leakage during each year of operation. As discussed above in Section 3.2.5 a second pass of BWRO is one of the most common ways to meet targets for chloride and boron. The purpose of the simplified second pass modeling is to provide a general discussion of impact that water quality conditions may have on the seawater desalination project, not to provide a specific discussion of the alternatives a specific vendor might provide to meet these requirements, such as the IDE 4-stage cascading design implemented by IDE for Poseidon in Carlsbad.

3.3.1 Feedwater Quality

To predict the performance of the desalination system with an RO model, it is necessary to know the quality of the seawater entering the desalter. Poseidon provided a preliminary summary of the maximum water quality conditions that might be used in a contract to build the desalination plant at Huntington Beach. The important aspects of the seawater’s mineral quality in that specification are shown in column one of Table 3-5 and labeled, “Intake WQ Specification”. This quality information cannot be used in the model without alteration, because an RO model requires that the input water quality comply with the principle of electroneutrality (cations and anions must be equal when expressed in meq/L) and Poseidon’s specification is intended to set a maximum for each individual parameter but does not address electroneutrality.

For years ocean chemists have known that the major minerals in seawater maintain the same relationship to each other in all the seas around the world. Thus a fairly accurate, balanced estimate of the detailed mineral quality of seawater from a particular locale can be produced if its salinity is known. For the purposes of this exercise the model of F. Millero was used (Millero, 2013). Even then the salinity used to develop a balanced mineral profile must correspond to the salinity, which would have the most impact on the desalter’s ability to meet the water quality specified in the term sheet and yet comply with the Poseidon specification. Thus the second column in Table 3-5, labeled, “Term Sheet, Attachment A” displays some key mineral quality requirements on the term sheet. Comparing columns 1 and 2 in the table, based on experience with other desalination projects, it is clear that the requirements for boron and chloride will be the most difficult to meet. Boron is not a charged ion, so its concentration does not influence electroneutrality and can be directly used in the model’s feed water quality. Thus the Millero model was used to produce an estimate of all the minerals in a balanced seawater with a chloride concentration of 18,500 mg/L and boron was directly entered at 5 mg/L. The results used in the desalination model are shown in column three of Table 3-5 and labeled “Millero results”.

Table 3-5. Feedwater Quality Modeling^a

Constituent	Intake WQ Specification	Draft Term Sheet Attachment A	Millero Model	Used in RO Model
Chloride	18,500	75	18,500	18,500
Sodium	11,000	60	10,309	10,309
Sulfate	2,800	-	2,593	2,593
Magnesium	2,520	TBD	1,227	1,227
Potassium	822	-	382	382
Calcium	500	20	394	394
Alkalinity	150	-	109	109
Bromide	75	-	64	64
Boron	5.0	0.75	-	5.0
TDS	34,500	350	33,589	33,594

a-Intake WQ specification is for maximums. Average values are shown for term sheet.

3.3.2 Varying temperature in RO modeling

Feed water temperature is an important consideration in the design and operation of the desalination plant at Huntington Beach. Three cases with respect to temperature were considered in the evaluation of the water quality at the Huntington Beach Desalination plant. The first two cases are the most important for operations and are intended to represent normal operations once the plant is built. The first case being the average temperature of seawater in the area near the Huntington Beach intake and the second case being that same temperature elevated 11°F by the condenser at the Huntington Beach AES power plant. The third case relates to the highest temperature the desalter is likely to experience during the warmest month allowed in Attachment A (a month with an average temperature of 85°F). The three temperature cases are summarized below:

- **Case 1** – Normal Operations on cold seawater (based on 2010-15 average temperature)
- **Case 2** – Normal Operations on warm seawater from power plant condenser (based on Case 1 + 11 °F)
- **Case 3** – Estimated Warmest Day on seawater from power plant condenser (warmest month elevated to achieve an average of 85°F)

Each case will be explained further below.

The temperature data was taken from the Southern California Coastal Ocean Observing System (SCCOOS) for seawater at the Newport Beach Pier. This location is in close proximity to the Huntington Beach desalination plant intake, as shown on Figure 3-3, and representative of the temperature to be experienced at the desalination facility. It is important to note that the temperature data used in this evaluation was from the ocean and did not consider any change in temperature that may occur in the condenser at the AES plant. Over the six years, data was continuously recorded online every two to four seconds resulting in about 350 to 700 data points to analyze in a single day, about 10,000 to 20,000 data points per month.

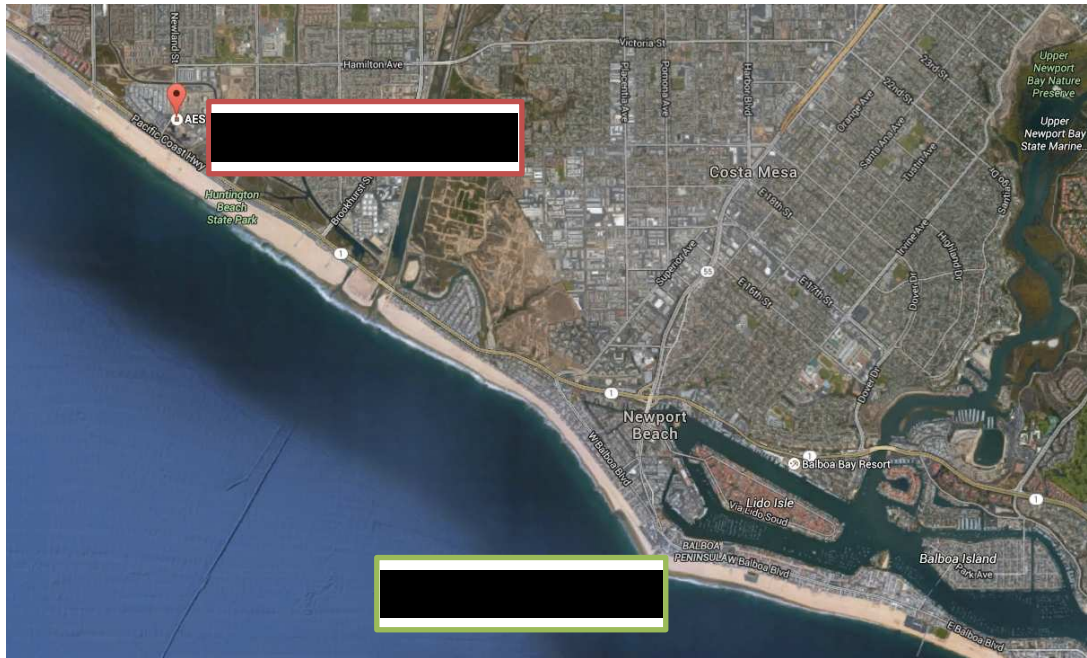

Figure 3-3. Proximity of Newport Beach Pier to the Desalination Facility co-located with AES Huntington Beach

Case 1 - RO Modeling for Normal Operations on Cold Seawater. The temperature data for Case 1 represents the average temperature at Newport Beach Pier collected over nearly six years. This temperature data is representative of the power plant intake. The average temperature determined based on the 2010-15 data was 63 °F, the temperature used for the RO modeling in Case 1. The method of determination of this temperature is summarized in Table 3-6. The data was averaged for each of the six years, with the average over all the years determined to be the 63 °F. This case is assumed to be representative of the temperature at which actual operations will typically occur in the desalter when operating on cold seawater, given the basis of several years of data. In the RO modeling, the average (mean) performance allowed in the draft Term Sheet (Attachment A) was assumed as a basis to determine the controlling constituent for Case 1 (and also for Case 2). The Term Sheet average (mean) levels for constituents with a possibility to control are: Cl≤75 mg/L, B≤0.75 mg/L, or Na≤60 mg/L).

Case 2 - Normal Operations on warm seawater from power plant condenser (based on Case 1 + 11 °F): The temperature data for Case 2 represents the average temperature estimated for normal operations on warm seawater. This temperature data is representative of the power plant condenser. The average temperature from the power plant condenser was estimated to be 74 °F by adding 11 °F to the normal operations temperature for cold seawater. Therefore, 74 °F was the temperature used for the RO modeling in Case 2. The method of determination of this temperature is summarized in Table 3-6. In the RO modeling, the average (mean) performance allowed in the draft Term Sheet (Attachment A) was assumed as a basis to determine the controlling constituent for Case 2 (like for Case 1) as Case 2 represents normal operations for warm water. The Term Sheet average (mean) levels for constituents with a possibility to control are: Cl≤75 mg/L,

B≤0.75 mg/L, or Na≤60 mg/L). This temperature of 74 °F is also the average (mean) temperature allowed in draft Attachment A. With its elevated temperature, Case 2 may require more stringent design conditions to allow the plant to meet the Term Sheet (Attachment A).

Table 3-6 . Determination of Average Temperature and Max. Month 2010-15.

Month avg	Temperature (°F)					
	2010	2011	2012	2013	2014	2015
Jan avg	59.2	57.5	58.2	56.0	59.9	61.5
Feb avg	59.7	58.3	58.3	56.7	60.3	62.7
Mar avg	59.5	57.6	56.2	58.3	61.8	63.4
Apr avg	59.7	60.3	57.6	59.7	58.7	62.5
May avg	60.4	56.5	64.8	66.0	64.1	61.7
Jun avg	66.3	63.4	66.0	66.9	68.2	66.1
Jul avg	65.5	65.9	64.5	67.1	69.3	68.2
Aug avg	59.6	65.3	68.7	64.2	67.9	71.3
Sep avg	62.8	64.6	66.8	64.7	69.2	73.8
Oct avg	59.2	62.7	67.5	66.1	69.8	71.7
Nov avg	59.7	60.9	61.9	62.9	66.1	67.0
Dec avg	No data	58.4	60.0	60.2	64.2	No Data
YEARLY AVERAGE	61.0	61.0	62.5	62.4	65.0	66.4
AVERAGE 2010-2015	Case 1: 63 °F (normal operations cold water)					
AVERAGE + 11 °F	Case 2: 74 °F (normal operations warm water)					
YEARLY MAX MONTHLY AVERAGE	66.3 June	65.9 July	68.7 August	67.1 July	69.8 October	73.8 September
MAX MONTHLY AVERAGE 2010-15	74 Sep 2015					
Max Monthly + 11 °F	85 °F					
Variation to Peak Day	+2 °F					
MAXIMUM DAY (85+2)	Case 3: 87 °F (warm water, hottest day and mo.)					

Case 3 – RO Modeling for Estimated Warmest Day on seawater from power plant condenser (hottest day in warmest month elevated to achieve an average of 85°F). The draft Term Sheet (Attachment A) specifies a maximum temperature of 85 °F to be determined on a monthly average basis. To estimate the warmest day that might occur in a month, consideration of the temperature of the warmest day of the warmest month assuming the desalter runs on warm water from the power plant condenser is an appropriate approach to use. Temperature data from the power plant condenser was not available at the time of the analysis, so an estimate of the warmest day based on ocean water data from Newport Beach Pier discussed above was employed. The maximum month was determined for each of the six years based on the monthly average data at the top of Table 3-6. This data is summarized in the row called *Yearly Max Monthly Average* in Table 3-6. Based on this data, it is shown that the maximum month occurred in September

2015, at a value of 74 °F. It appears to be coincidental that the maximum monthly temperature over six years of data is identical to the draft Term Sheet (Attachment A) average (mean) temperature allowed. The maximum monthly data for September 2015 was adjusted so the monthly average would be 85 °F to estimate the impact of using power plant condenser feed water. This was accomplished by adding 11 °F (the difference between the target of 85 °F and the monthly average of 74 °F for Sep. 2015 in Table 3-6) to the data for each day in the month of September 2015. This resulted in an average monthly temperature of 85 °F as expected, but the temperature of interest is the estimated maximum day in this estimated maximum month at average temperature of 85 °, which is determined as 87°F based on the variation that was observed in the maximum month. This estimated maxima (warmest day of warmest month of warmest year with the desalter on warm water from the power plant condenser) essentially occurred in a mid-September time frame. Case 3 is to be considered as a design issue, more than as an operational issue. In the RO modeling, the maximum performance allowed in the draft Term Sheet (Attachment A) was assumed as a basis to determine the controlling constituent for Case 3 (unlike Cases 1 and 2). The draft Term Sheet maximum levels for constituents with a possibility to control are: Cl≤100 mg/L, B≤1.0 mg/L, or Na≤80 mg/L). This temperature of 87 °F exceeds the maximum temperature of 85°F allowed in the draft Term Sheet (Attachment A). The implication is that a month with a 30-day average of 85 °F will have the possibility to exceed the maximum temperature on a given day. This is a facet that Poseidon may want to consider in the design. That said, the hottest day greater than the draft Term Sheet requirement does not represent non-compliance as long as the 30-day average temperature meets the 85 °F requirement. As discussed above, Sep. 2015 was the warmest month over 2010 – 2015. The year 2015 was also the warmest year as shown in Table 3-6. For this reason, it is useful to look the data shown on Figure 3-4 that encompasses the summer months of 2015 to observe the variation of temperature seasonally and the maximum month itself in September 2015.

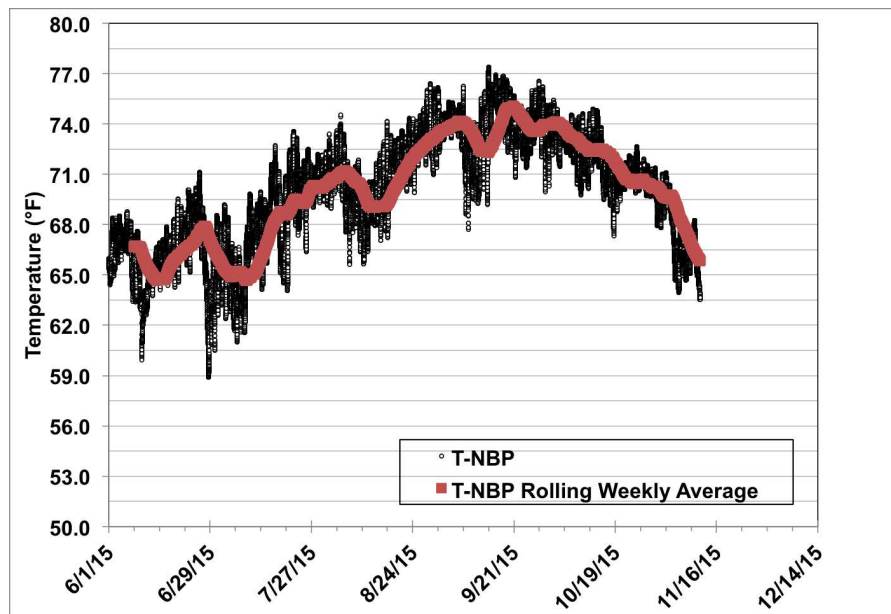

Figure 3-4. Temperature Data from SCCOOS for NBP for Summer/Fall 2015.

3.3.3 Summary of Water Quality Goals

The water quality goals for the combined RO permeate are summarized in Table 3-7. The simplified second pass approach to RO modeling will be applied to each case. The criterion for completing the RO modeling for Case 1, 2, and 3 will be meeting each of the criteria shown in Table 3-7 with a minimum amount of flow treated by the partial second pass.

Table 3-7 – Water Quality Goals for the Combined RO Permeate

Parameter	Units	Combined RO Permeate		
		Case 1	Case 2	Case 3
RO Modeling Conditions				
Brief Case Description		Normal Operations on Cold Seawater	Normal Operations on Warm Seawater from Power Plant Condenser	Warm Water from Power Plant Condenser Hottest day, hottest mo.
Temperature	°F	63	74	87
Water Quality Goals from Draft Term Sheet (Attachment A)				
Term Sheet Conditions		Average (Mean)	Average (Mean)	Maximum
Total Dissolved Solids (TDS)	mg/L	350	350	500
Boron	mg/L	0.75	0.75	1
Chloride	mg/L	75	75	100
Sodium	mg/L	60	60	80

3.3.4 Design Configuration

Figure 3-5 details the RO design configuration assumed for the RO modeling presented in this report. As mentioned above the TorayDS model from Toray Industries was used to predict the performance of RO throughout this report. The assumed RO design configuration consists of a first pass with a partial second pass. The first pass is assumed to be a seawater reverse osmosis (SWRO) system, and the second pass is assumed to be a brackish water reverse osmosis (BWRO) system. There will be a greater amount of second pass as temperature increases due to greater salt leakage, provided the water quality goals are the same. There is assumed to be no second pass concentrate recycle. Table 3-8 describes further the RO system design assumptions.

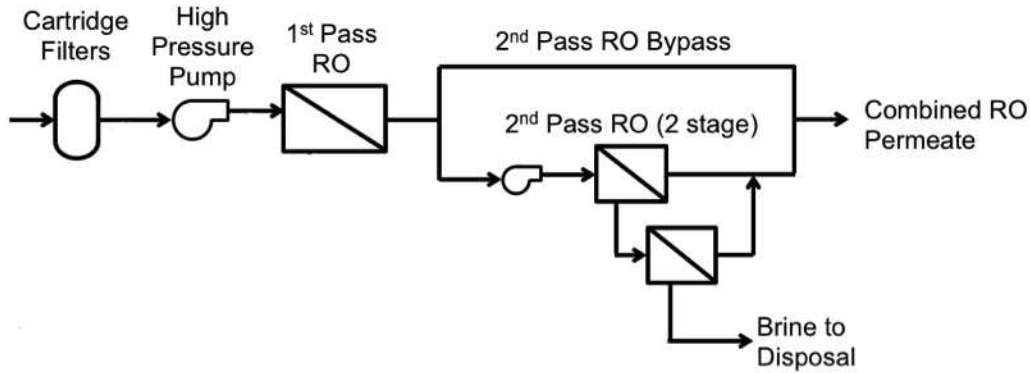

Figure 3-5- RO Design Configuration for Modeling

Table 3-8 - First and Second Pass RO System Design Assumptions

Parameter	Units	Value
Combined RO System		
Total Product Flowrate	gpm	1110
Total Product Flowrate	MGD	1.6
First Pass (SWRO) Membrane System		
Maximum Flux Rate	gfd	8.75
Recovery	%	45
Number of Pressure Vessels Per Train	no.	70
SWRO Membrane Element Diameter	in	8
SWRO Membrane Elements per Vessel	no.	7
SWRO Membrane Surface Area per Element	sf	400
SWRO Membrane Age	yr	5
SWRO Fouling Factor	-	0.77
SWRO Salt Passage Increase	%/yr	7.0
First Pass Feed pH	-	8.3
Second Pass (BWRO) Membrane System		
Maximum Flux Rate	gfd	18
Recovery	%	85
BWRO Membrane Element Diameter	in	8
BWRO Membrane Elements per Vessel	no.	7
BWRO Membrane Surface Area per Element	sf	400
BWRO Membrane Age	yr	5
BWRO Fouling Factor	-	0.77
BWRO Salt Passage Increase	%/yr	7.0
Second Pass Feed pH	-	10.0

3.3.5 RO Modeling Results

The parameters varied for RO modeling included feedwater temperature and percent of first pass RO permeate fed to a second pass. The three feedwater temperatures for each

case (63 °F, 74 °F, and 87 °F) were input and the percent second pass was varied multiple times for each case (1, 2, and 3) to find the minimum percent second pass, at which, all the water quality goals in Table 3-7 were met. Table 3-9 shows the parameters varied for RO modeling for each of the three cases, with feedwater quality held constant (see Table 3-5) and water quality goals as shown in Table 3-7.

Table 3-9 – Parameters Varied for RO Modeling¹

Parameter	Case 1	Case 2	Case 3
Brief Case Description	Normal Operations on Cold Seawater	Normal Operations on Warm Seawater from Power Plant Condenser	Warm Water from Power Plant Condenser Hottest day, hottest mo.
Feedwater Temperature	63 °F	74 °F	87 °F
Percent Second Pass ²	5%	20%	20%

¹0% 2nd Pass Same for Case 2 and Case 3 despite different temperature due to different water quality goals

²Multiple RO model runs were performed for each case with different 2nd pass percentages until minimum 2nd pass percentage meeting the water quality goals was determined.

Table 3-10 shows the configuration of the second pass vessels for each train in the TorayDS model. The results are presented for Case 1, Case 2, and Case 3, each of which has a different fraction of water purveyed through the second pass and a different configuration of second pass vessels.

Table 3-10 – Second Pass Vessel Configuration per Train

Parameter	No. of Vessels ¹ (Stage 1:Stage 2)
Case 1: 5% 2 nd Pass	2:1
Case 2: 20% 2 nd Pass	4:2
Case 3: 20% 2 nd Pass	4:2

¹Seven elements per vessel

Table 3-11 summarizes the specific model numbers and characteristics of the first pass SWRO and second pass BWRO Toray membranes. As discussed above, the SWRO membranes are high pressure membranes to treat the high levels of salts in the seawater. The BWRO membranes for the second pass are low pressure, as the quality of the first pass RO permeate is really high.

Table 3-11 – Membrane Model and Characteristics

Manufacturer	Model	Characteristics
Toray	TM 820 V – 400	SWRO, High Permeability, High Pressure, 400 sf (I pass)
	TM 720 – 400	BWRO, High Rejection, Low Pressure, 400sf (II pass)

As shown on Figure 3-4, with a partial second pass, a portion of the first pass RO permeate is fed to the second pass and another portion bypasses the 2nd pass and is later blended

with the 2nd pass permeate to produce the combined RO product water. The combined 1st pass RO permeate refers to the portion that feeds the 2nd pass and the portion that bypasses the second pass, which are of differing quality. The bypass is taken from the lead part of the elements and of higher water quality while the tail end elements feed the second pass at lower water quality. The combined 1st pass RO water quality would represent the quality of the combined RO product water with the SWRO Toray elements evaluated, if there were no 2nd pass in place. Table 3-12 shows the combined 1st pass RO permeate and the combined product water permeate concentrations for Case 1: Normal Operations on Cold Seawater (T=63 °F). RO modeling results are shown for constituents of interest TDS, boron, chloride, bromide, and sodium. As discussed above, chloride, boron, and sodium are most likely to be the controlling constituents. TDS and bromide are included as they are important constituents with respect to desalination water quality. As shown in Table 3-12, the first pass RO permeate does not meet all the water quality goals in Table 3-7. Most notably, the chloride concentration is 77.6 mg/L in the combined first pass permeate compared to the water quality goal of 75 mg/L (see yellow highlight). With the 5% second pass, the chloride at 74.1 mg/L meets the treatment objective of 75 mg/L and all constituents shown in Table 3-12 meet their water quality goals in the combined RO product water. The controlling contaminant, chloride, is highlighted in light blue in the table in the combined RO product water column.

Table 3-12. RO Modeling Results for Case 1: Normal Operations on Cold seawater)

Parameter or Constituent	Combined 1 st Pass RO Permeate	Combined RO Product Water	Requirement (Table 3-7)
RO No. of Elements	1 st Pass: 490; 2 nd Pass: 11		
T (°F)	63	63	74
Percent Second Pass	5%		
TDS (mg/L)	135	129	350
Boron (mg/L)	0.553	0.536	0.75
Chloride (mg/L)	77.6	74.1	75
Sodium (mg/L)	47.4	45.4	60
Bromide (mg/L)	0.269	0.258	-

Table 3-13 shows the combined RO first pass permeate and the combined product water permeate concentrations for Case 2: Normal Operations on warm seawater from the power plant condenser (T=74 °F). RO modeling results are shown for constituents of interest TDS, boron, chloride, bromide, and sodium. As shown in Table 3-13, the combined first pass RO permeate does not meet all the water quality goals in Table 3-7. Most notably, the chloride concentration is 90.8 mg/L in the combined first pass permeate compared to the water quality goal of 75 mg/L, much more significantly over the requirement than for Case 1 (see yellow highlight in Table 3-13). Additionally, while boron and sodium did not exceed their water quality goals for the combined 1st pass RO permeate, it was close (0.694 mg/L compared to the goal of 0.75 mg/L for boron; 55.6 mg/L compared to the goal of 60 mg/L for sodium). With the 20% second pass, the chloride meets the treatment objective of 75 mg/L, the boron and sodium easily meet their water quality goals, and all constituents shown in Table 3-13 meet their water quality goals. The controlling contaminant, chloride,

is highlighted in light blue in the table. In considering the results, recall that Case 2 is most useful for design to assure the plant meets the term sheet on challenging days as it is not representative of normal operations.

Table 3-13. RO Modeling Results for Case 2: Normal Operations on warm seawater from power plant condenser

Parameter or Constituent	Combined 1 st Pass RO Permeate	Combined RO Product Water	Requirement (Table 3-7)
RO No. of Elements	1 st Pass: 490; 2 nd Pass: 42		
T (°F)	74	74	74
Percent Second Pass	20%		
TDS (mg/L)	158	124	350
Boron (mg/L)	0.694	0.595	0.75
Chloride (mg/L)	90.8	71.1	75
Sodium (mg/L)	55.6	43.5	60
Bromide (mg/L)	0.315	0.247	-

Table 3-14 shows the combined RO first pass permeate and the combined product water permeate concentrations for Case 3: Warm Water from Power Plant Condenser on the Hottest day in the Hottest Month (T=87 °F). This is the highest temperature case, as described above. As such, the maximum concentration requirements from the draft Term Sheet (Attachment A) were used in the RO modeling for this case (see Table 3-7). RO modeling results are shown for constituents of interest TDS, boron, chloride, bromide, and sodium. As shown in Table 3-14, the combined first pass RO permeate does not meet all the water quality goals in Table 3-7. Most notably, the chloride concentration is 126 mg/L in the combined first pass permeate compared to the water quality goal of 100 mg/L for this high temperature case (see yellow highlight in Table 3-14). Boron did not exceed its water quality goal for the combined 1st pass RO permeate but it was right on the target (1.00 mg/L compared to the goal of 1.0 mg/L, see gray highlight). Sodium again was slightly below the requirement for Case 3 (77.3 mg/L compared to the water quality goal of 80 mg/L, see yellow highlight). With a 20% second pass, the chloride meets the treatment objective of 100 mg/L, the sodium easily meets the 80 mg/L treatment objective, the boron meets the 1.0 mg/L treatment objective and all constituents shown in Table 3-12 meet their water quality goals. The controlling contaminant, chloride, is highlighted in light blue in the table. The 20% 2nd pass requirements are the same for Case 2 and Case 3, which seems counterintuitive given the higher temperature and greater salt passage in Case 3 (see Column 2 in Tables 3-13 and 3-14). The reason is that the water quality goals are different in Case 2 (Average/Mean) and Case 3 (Maximum) from the draft Term Sheet (Attachment A) and the chloride concentration is allowed to go higher (to 100 mg/L in Case 3 versus 75 mg/L in Case 2) and still meet the draft Term Sheet (Attachment A). In considering the results, recall that Case 3 is most useful for design as it is not representative of normal operations. As discussed above, the estimated hottest day in the hottest month of 87 °F does not represent non-compliance with the draft Term Sheet (Attachment A) as it represents a single day temperature and compliance with the temperature requirements in the term sheet are based on a 30-day average.

Table 3-14. RO Modeling Results for Case 2: Warm Water from Power Plant Condenser on the Hottest day in the Hottest Month

Parameter or Constituent	Combined 1 st Pass RO Permeate	Combined RO Product Water	Requirement (Table 3-7)
RO No. of Elements	1 st Pass: 490; 2 nd Pass: 42		
T (°F)	87	87	85
Percent Second Pass	20%		
TDS (mg/L)	219	170	500
Boron (mg/L)	1.00	0.872	1.0
Chloride (mg/L)	126	97.9	100
Sodium (mg/L)	77.3	60.0	80
Bromide (mg/L)	0.439	0.341	-

From Table 3-12, it is observed that the combined first pass RO permeate exceeds the draft Term Sheet (Attachment A) average (mean) concentration for chloride, necessitating a second pass based on the Toray membranes used in the analysis, representative of SWRO membranes commercially available. From Table 3-13, it is observed that the combined first pass RO permeate exceeds the term sheet average concentrations for chloride, necessitating a second pass. From Table 3-14, it is observed that the combined first pass RO permeate exceeds the term sheet average concentrations for chloride, necessitating a second pass, with boron in the 1st pass RO permeate right at the requirement. It is also observed that salt passage increases as temperature increases, affecting the fraction of partial second pass required.

3.3.6 Selection of Case (1, 2, and/or 3) to use in continued water quality evaluation and in development of Scenarios

As discussed above, RO modeling was conducted for three cases, each at a different temperature. As temperature increases salt passage increases, which may have an impact on the design. In the evaluation, three temperature cases were considered. Selection, if appropriate, of a specific case, as opposed to multiple cases, to carry forward in developing the operational scenarios will now be discussed. Case 1 represented normal operations with cold seawater (T=63 °F). Case 2 represented normal operations for warm seawater from the condenser (T=74 °F). Case 3 represented warm seawater from the condenser on the hottest day in the hottest month. As mentioned above, Case 3 represents an atypical situation with warm water from the condenser on the hottest day in the hottest month. It is appropriate to evaluate for design considerations, but not for normal operations. Therefore, Case 3 is ruled out with respect to evaluating the operational scenarios.

A summary of the RO modeling results presented above for Case 1 and Case 2 is shown below in Table 3-15 for key constituents TDS, boron, chloride, sodium, and bromide. A comparison to the term sheet (Column 6) is made both for the combined 1st pass RO permeate (Columns 2 and 3) and the combined RO product water (Columns 4 and 5). What is observed is that the results for Case 1 (cold seawater) and Case 2 (warm seawater) are

not dramatically different noting that a 5% second pass is required for Case 1 and a 20% 2nd pass is required for Case 2. In particular, the water qualities of the combined RO product water are especially similar. For this reason, only Case 1 (normal operations with cold seawater at T = 63 °F) will be carried forward in the additional water quality discussion below and in the Scenarios Evaluation.

Table 3-15 – Comparison of RO Modeling Results for Case 1 and Case 2: Combined First Pass RO versus Combined RO Product Water

Constituent	Combined 1st Pass RO Permeate		Combined RO Product Water		Term Sheet (average)
	Case 1 Normal Ops Cold Water Plant Intake	Case 2 Normal Ops Warm Water Condenser	Case 1 Normal Ops Cold Water Plant Intake	Case 2 Normal Ops Warm Water Condenser	
Temperature (° F)	63	74	63	74	74
TDS (mg/L)	135	158	129	124	350
Boron (mg/L)	0.553	0.694	0.536	0.595	0.75
Chloride (mg/L)	77.6	90.8	74.1	71.1	75
Sodium (mg/L)	47.4	55.6	45.4	43.5	60
Bromide (mg/L)	0.269	0.315	0.258	0.247	-

3.3.7 Estimate WQ to be delivered by Poseidon: Ca, Mg, Na, K, Cl, Br, SO4, F, B, pH, LSI and CCPP

Additional constituents and physical properties are presented for Case 1 beyond what was presented in the analysis above that focused on the constituents most likely to control the operation (e.g. TDS, boron, chloride, and sodium). The purpose of including additional constituents of interest is to address additional parts of the evaluation (e.g. for corrosion control evaluation and for OCWD’s specific areas of concern (Scenarios 1-3, etc.).

The product water quality for the desalinated water prior to post-treatment is compared to the current draft of the Term Sheet (Attachment A) in Table 3-16. The column labeled “Term Sheet Requirement” presents the term sheet water quality targets. As discussed above, the RO modeling was conducted to achieve the water quality objectives in Table 3-7. For the average case, chloride controlled the operation, which is demonstrated again in Table 3-16 by comparing product water quality to term sheet requirements. Finally, there is a comparison to the GWRS permit for a limited number of constituents that are in the permit. As shown in the table, the only constituent of concern is chloride, with levels in the GWRS permit lower than the levels in the desalinated water. It is important that the GWRS permit chloride level applies only to the GWRS recycled water and not to the desalinated water. There is also no issue with the current basin plan standards of 580 mg/L for TDS and nitrate-N of 3.4 mg/L. The TOC levels are expected to be extremely low out of seawater RO membranes, likely <0.1 mg/L and no more than 0.2 mg/L as the membranes age, on an average basis.

Table 3-16 – Estimated Product Water Quality from RO Modeling Prior to Post-Treatment for Case 1 (Normal Operations for Cold Seawater) at 63 °F

Parameter	Units	RO Product Water ⁽¹⁾	Requirement in Attachment A ⁽²⁾	GWRS Permit Table IV Talbert Gap Barrier-Kraemer/Miller Basins	
TDS	mg/L	129	350	500	600
Sodium	mg/L	45.4	60	45	60
Magnesium	mg/L	1.40	TBD	-	-
Calcium	mg/L	0.449	20	-	-
Potassium	mg/L	2.35	-	-	-
Strontium	mg/L	0.0086	-	-	-
Chloride	mg/L	74.1	75	55 ^(3,4)	65 ^(3,4)
Nitrate nitrogen	mg/L	0.0	-	3	3
Sulfate	mg/L	3.32	-	100	120
Fluoride	mg/L	0.0086	-	-	-
Bromide	mg/L	0.258	-	-	-
Hardness	mg/L as CaCO ₃	6.84	-	240	290
Bicarbonate	mg/L	0.852	-	-	-
Carbonate	mg/L	0.0008	-	-	-
Silica	mg/L	0.0362	-	-	-
Barium	µg/L	0	-	-	-
Boron	mg/L	0.536	0.75	-	-
pH	pH units	5.17	7.0-8.0	-	-
Alkalinity	mg/L as CaCO ₃	0.700	-	-	-

1- Prior to post treatment

2- Water quality requirements in Term sheet Attachment A (average)

3-Regulations only apply to GWRS water per conversations with OCWD

4-While not expected by OCWD, if desalinated water held to the same standard, a greater second pass would be required.

3.3.8 Post Treatment

Post treatment concepts were discussed in detail elsewhere in this report. Column 2 in Table 3-17 shows the corrosion indices LSI and CCPP prior to post treatment. It is observed that desalinated water is dead soft (LSI = -6.5) and requires post treatment prior to distribution to consumers. The approach used in the evaluation was to add lime and carbon dioxide to achieve water quality targets for alkalinity and LSI. This is a common approach in the water industry.

Experimental testing by McGuire at Carlsbad for the Poseidon desalination project there concluded that an alkalinity target of 60 mg/L as CaCO₃ was appropriate. At the same time, desalination projects typically target a positive LSI. For this reason, an alkalinity of 60 mg/L as CaCO₃ and a LSI of 0.15 were targeted in this project. The result of adding lime and carbon dioxide to achieve an alkalinity of 60 mg/L as CaCO₃ is shown in Table 3-17 for each of the three cases studied in the RO modeling section of this report. Trussell Tech maintains a corrosion indices model freely available on its web site, which was used for the calculations (Kenny et al., 2015). The strategy was to add enough lime to hit the alkalinity target of 60 mg/L as CaCO₃ and enough CO₂ to hit the LSI target. It should be observed that the pH ranges from 8.2 to 8.4, below the pH 8.5 upper limit (maximum in draft Term Sheet (Attachment A)).

The lime and CO₂ doses required to hit the alkalinity and LSI targets are summarized in Table 3-17 (Columns 2-4, rows 8-9). It should be observed that the lime dose is 33.2 mg/L in all cases and that there is a relatively small variation in CO₂ dose from 37 for Case 1 (T=63 °F normal operations for cold seawater to approximately 42 for Cases 2 and 3). It should also be observed that for each temperature, the resultant calcium was nearly identical (which is obvious given the constant lime dose) with a small variation in pH to achieve the target LSI. The calcium hardness in mg/L as CaCO₃ is also presented in Table 17. When adding lime to achieve an alkalinity target, the same amount of Ca in mg/L as CaCO₃ is added. The addition of this amount of calcium is not expected to not cause a problem for the finished water. Additional considerations for proposed changes for calcium levels in the Term Sheet were shown in the Executive Summary and will be discussed in Section 7 on proposed changes to the Term Sheet. The maximum level of < 20 in the draft Term Sheet would not allow for achieving the alkalinity target of 60, so a change in calcium limits in the term sheet will be recommended.

Impact of Post Treatment on Sodium Adsorption Ratio

It should be observed that the RO modeling results presented above focused on the constituents most likely to control desalination operations based on past experience, namely boron, chloride, sodium, and bromide. Because RO is so effective at removing divalent ions, the calcium and magnesium concentrations are extraordinarily low and approach non-detect levels using standard analytical methods. Monovalent sodium, while still extremely low, is an order of magnitude higher than magnesium or calcium. This results in an elevated level of sodium adsorption ratio for desalinated water prior to post treatment. The sodium adsorption ratio is a measure of whether sodium present in a water to be discharged (e.g., for recharge/irrigation, etc.) will cause problems with respect to soil permeability. A more detailed discussion of sodium adsorption ratio is provided in Section 4.1.8 on horticulture.

Table 3-17 Summary of Results of Post Treatment Strategy Targeting Alkalinity of 60 and LSI of 0.15

Constituent or Chemical Dose	Case 1 T = 63 °F		Case 2 T = 74 °F	Case 3 T = 87 °F	Term Sheet	
	Prior to Post Treatment	After Post Treatment	After Post Treatment	After Post Treatment	Avg/ Mean	Maximum
Calcium (mg/L as Ca)	0.449	24.2	24.1	24.3	20	<20
Calcium (mg/L as CaCO ₃)	1.12	60.5	60.2	60.8	50 ³	<50 ³
Alkalinity (mg/L as CaCO ₃)	0.700	60	60	60	-	-
pH	5.17	8.4	8.3	8.2	7.0-8.0	>6.5, <8.5
TDS (mg/L)	129	153	148	194	350	500
Temperature, °F	63	63	74	87	74	85
Temperature, °C	17.2	17.2	23.3	30.6	-	-
Lime Dose (mg/L) ¹	none	33.2	33.2	33.2	-	-
CO ₂ Dose (mg/L) ²	none	36.7	41.5	42.7	-	-
LSI	-6.5	0.15	0.14	0.15	-	-
CCPP (mg/L)	-36	0.83	0.81	0.96	-	-

¹In Trussell Tech corrosion model, first add enough lime to hit the alkalinity target of 60 mg/L as CaCO₃

²Then add enough carbon dioxide to hit the LSI target of +0.15

³Values for CaCO₃ in mg/L as CaCO₃ do not appear in the term sheet, these values are calculated based on the term sheet limits (20 mg/L and <20 mg/L). Ca (mg/L as CaCO₃) = Ca (mg/L) × 50/20.

The equation for determining Sodium Adsorption Ratio (SAR) as provided in the draft Term Sheet (Attachment A) is:

$$SAR = \left[\frac{Na^+}{\sqrt{\frac{1}{2}(Ca^{2+} + Mg^{2+})}} \right]$$

in which Na⁺ = sodium (meq/L), Ca²⁺ = calcium (meq/L), and Mg²⁺ = magnesium (meq/L).

The impact on Sodium Adsorption Ratio by the post treatment strategy is shown in Table 3-18. The SAR varies from 2.3 to 3.2 for the three cases after post treatment with the target alkalinity discussed above. The post treatment strategy increased calcium to 24 mg/L, which is the reason for the decrease in SAR (sodium and magnesium did not change). As shown in Table 3-18, the sodium adsorption ratio for the RO modeling for the normal operations for cold seawater case (Case 1) demonstrated an estimated product water sodium adsorption ratio of 7.55 in exceedance of the term sheet level of 5 prior to post treatment.

This is not a significant issue in terms of compliance with the Term Sheet provided the post treatment, as expected, will raise the calcium and reduce the sodium adsorption ratio to a level that meets the term sheet. At the level of calcium shown in Table 3-18 after post treatment at 63 °F, the sodium adsorption ratio will decrease to 2.43 and meet the term sheet easily. For Case 2 (normal operations for warm seawater) after post treatment, the SAR is 2.33, again complying with the term sheet value of 5. For Case 3, the SAR at 3.16 complies with the term sheet value of 6 for this maximum case.

Table 3-18 - Summary of Results of Post Treatment Strategy Targeting Alkalinity of 60 and LSI of 0.15 on Sodium Adsorption Ratio

Constituent or Chemical Dose	Case 1 - T = 63 °F		Case 2 T = 74 °F	Case 3 T = 87 °F	Term Sheet	
	Prior to Post Treatment	After Post Treatment	After Post Treatment	After Post Treatment	Avg/ Mean	Maximum
Concentrations in mg/L						
Sodium (mg/L)	45.4	45.4	43.5	60	-	-
Calcium (mg/L as Ca)	0.449	24.2	24.1	24.3	20	<20
Magnesium (mg/L)	1.4	1.4	1.33	1.82	-	-
Concentrations in meq/L						
Sodium (meq/L)	1.97	1.97	1.89	2.61	-	-
Calcium (meq/L)	0.0225	1.21	1.21	1.22	-	-
Magnesium (meq/L)	0.114	0.114	0.1086	0.1486	-	-
Sodium Adsorption Ratio (SAR)						
SAR	7.55	2.43	2.33	3.16	5	6

4 *Water quality issues of concern regarding the introduction of seawater into the OCWD system*

A number of water quality issues have either been suggested and/or identified in connection with the use of desalinated water. The purpose of this chapter is to review what is known about each of these issues and to do preliminary assessment of their significance for the application anticipated in Orange County.

4.1 *Issues that commonly arise in desalination projects.*

Issues that commonly arise in connection with desalination projects include: corrosion and the mobilization of dissolved materials associated with scale in the distribution system piping; health issues such as boron, disinfectant residual stability, algal toxins or impact on DBPs; consumer issues like off-flavors, tepid water, impacts on consumer appliances, and impacts on irrigated agriculture or horticulture.

4.1.1 *Previous Studies on corrosion*

Even before reverse osmosis, the dream of seawater desalting was first studied at full scale in San Diego. Many of the issues we face today came up in that work. There was concern that the low TDS water would be "tasteless", not acceptable to the consumer; that the desalination plant would have to operate at a fixed rate, independent of consumer demand; and that the water would be aggressive to both cement and metal water distribution facilities. In fact early studies conducted by the City confirmed that desalinated water did cause immediate disruption of the accumulated deposits of corrosion products on pipes from the City's distribution system as well as softening of Portland cement in asbestos-cement pipe or in cement-lined cast-iron pipe (Dodson, et al. 1965). In extensive subsequent testing (see Figure 4-1), the City, in cooperation with Cal American Water, identified many of the solutions we see proposed today. Problems could be overcome through blending with higher TDS water or by adjustment of the pH, hardness and alkalinity of the desalinated water itself (Crossley and Waters, 1970).

What we knew in 2005:

- 1. Left untreated, desalinated water is corrosive to metal and cement-based surfaces*
- 2. Experience in the Middle East had shown that post treatment to adjust calcium carbonate saturation solves this problem*



Figure 4-1 Author Eugene Crossley looking over One of San Diego's four corrosion test beds

Following the studies conducted in San Diego, there was little desalination activity in the United States but extensive desalination activity in the Middle East. In the Middle East, re-mineralization to through the addition of lime and carbon dioxide to adjust calcium carbonate saturation became the accepted standard for treatment.

Around the turn of the century interest in desalination has seen renewed interest in the U.S. Although remineralization to achieve calcium carbonate saturation had been successful in the Middle East a few additional issues remained unresolved. The first was

the problem of meeting the lead and copper rule, promulgated in the U.S. in 1992 and further revised in 2007. U.S. experience had been that water systems with low TDS water supplies were more likely to have difficulty in meeting the requirements of this rule (Snoeyink, and Wagner, 1996). The second problem was that of red water and other problems associated with the deposits on pipe, particularly old, unlined iron pipe (galvanized iron, cast iron or ductile iron). It was uncertain whether Middle Eastern experience was applicable here.

Since the renewed interest in desalination in the U.S., numerous studies have been conducted to further examine the effects of desalinated water. Eight of these studies are summarized in Figure 4-2. All eight looked at the impact of desalinated water on distribution materials and five looked at the impact of a system using desalinated water to meet the requirements of EPA's lead and copper rule.

What we did not know in 2005:

5. Will remineralized, desalinated water meet EPA's lead and copper rule
6. Will remineralized, desalinated water prevent red water in existing systems

Figure 4-2: Testing on Integration

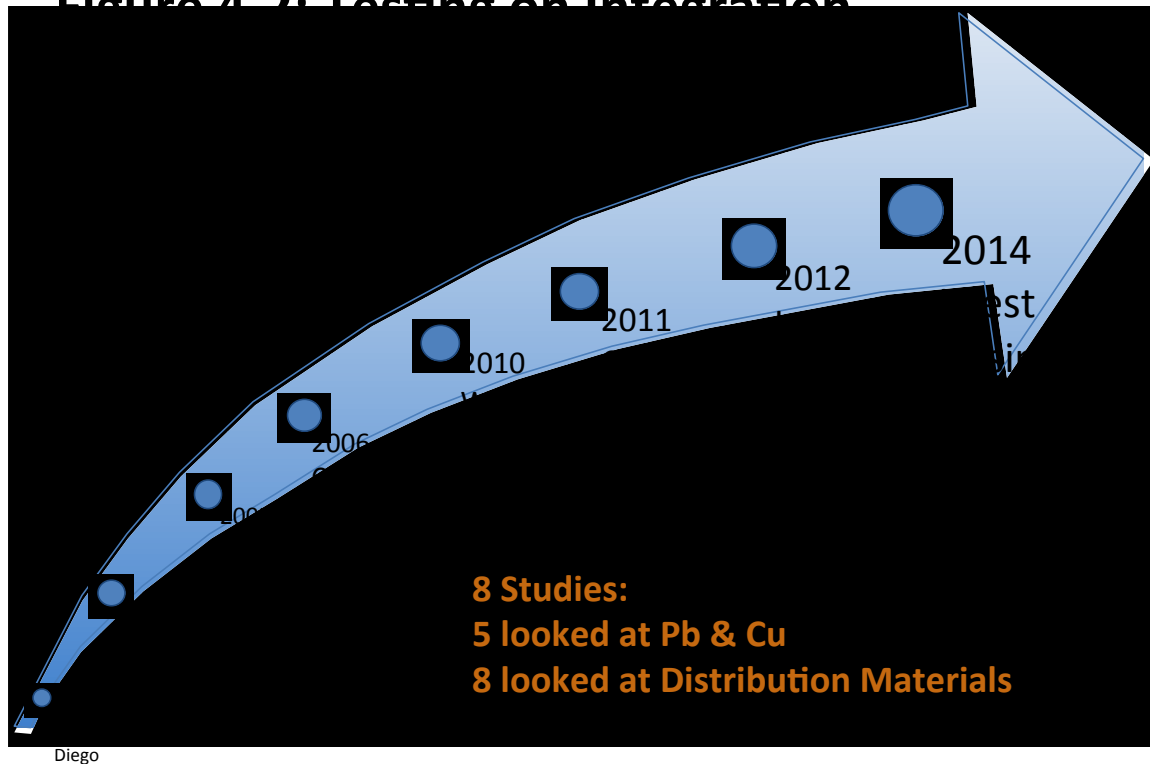

4.1.2 Lead and copper

Overall, the American water industry's approach to studying lead and copper rule compliance is well developed. Pipe loop studies of copper with 50/50 lead/tin solder in standing water have been shown to be a reliable predictor of performance in consumer plumbing (Kirmeyer et al., 1994; Snoeyink & Wagner, 1996). Five pipe-loop studies of this

kind have been conducted with desalinated water: 1) Tampa Bay Water (Taylor et al. 2005), 2) Poseidon-Carlsbad (McGuire et al. 2006), 3) WRF (Loveland, 2010), 4) Long Beach (Zhang, et al. 2011) and 5) West Basin (Pickard, J., et al. 2014). Important portions of the WRF study were done at El Segundo with West Basin support (Figure 4-3). There were also two bench top studies conducted: 1) Marin Municipal MWD (Ryder, et al. 2006)

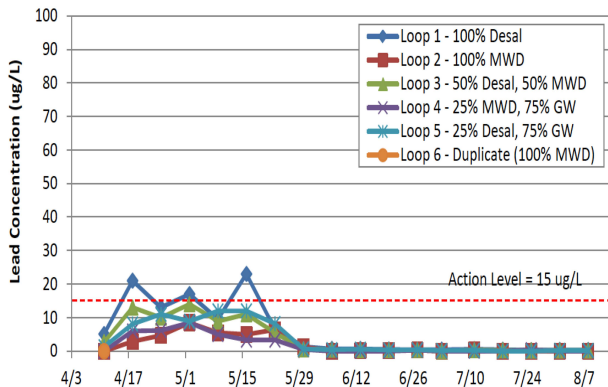

Figure 4-3 Lead levels in West Basin Test Loops

and 2) Santa Cruz/Soquel Creek (Liu, et al. 2009). None of the studies found significant problems in meeting lead and copper rule requirements, with desalinated water, which had been re-mineralized to achieve calcium carbonate saturation, although in most cases a period of one to three months of elevated metal levels were observed before the metal surfaces in the system came to equilibrium with the new water quality.

Lead has also been effectively banned from solder and lead service lines are no longer allowed. The 1986 SDWA prohibited both 50/50 lead solder and lead service lines. The same act also required that brass be “lead free” (defined as $\leq 8\%$ by weight), but it soon became clear that 8% was too high and new brass faucets were the cause of high lead at the tap in many places. California’s Prop 65 (passed in 1986) eventually resulted in very strict limits on the leaching of lead from brass faucets in California. In 1997, national legislation set requirements on leaching of lead from brass (a test run by NSF, which proved much more liberal than Prop 65). Then in 2006, the AB1953 Lead Law was passed which redefined “lead free” as $\leq 0.25\%$ lead. The net result is that new faucets in California have been truly “lead free” for the past decade.

Thus changes in plumbing practice, particularly in California, have made lead much less common in consumer plumbing and research available today has demonstrated that lead and copper issues can be effectively managed using the traditional practice of managing calcium carbonate saturation even when 50/50 lead solder is present. Nevertheless the 2007 Lead and Copper Rule Revisions (U.S. EPA, 2007), require that the State be notified of changes in treatment or introduction of a new source water, and that the water utility receive State approval of any treatment change(s) or new source water prior to implementation. These new rules may necessitate a change in the Corrosion Control Treatment (CCT) plan and/or in the optimal water quality parameter (OWQP) specifications (i.e., optimal range for pH, alkalinity, orthophosphate, etc. set as part of the CCT plan), particularly for the City of Huntington Beach. Also in accordance with the Lead and Copper rule (LCR), as adopted by the State of California, the City of Huntington

Conclusions on lead and copper:
 1-Studies show desalinated water re-mineralized to achieve $CaCO_3$ saturation meets lead and copper rule requirements.
 2-In CA, sources of lead in consumer plumbing are rapidly diminishing.
 3-The City of Huntington Beach may be required to do extra monitoring.
 4-Groundwater changes should be slow to come but similar in the results of GWRS.

Beach may be required to conduct a full round of LCR compliance monitoring within six months following the introduction of the new water supply, to be followed by another full round of monitoring within the following six months. Once it demonstrates optimal Corrosion Control Treatment in two successive sample periods, the City will be able return to the reduced monitoring schedule.

Where the Orange County Groundwater basin is concerned, water quality changes will be much more gradual, and, where the lead and copper rule is concerned, it seems unlikely that there will be any consequences to the use of desalinated water beyond those already in play as a result of the introduction of GWRS water.

4.1.3 Corrosion and Red Water

The red water question is more complex. It is well-known that red water sometimes occurs when a new water source is introduced into an existing system. Experiences at Tucson, Tampa and Fresno are notable examples. Red water has also long been a concern with desalinated water (Dodson et al. 1965). Red water complaints are typically associated with iron pipe, especially unlined cast iron and galvanized mains and galvanized service connections. New galvanized pipe does not cause red water, but it behaves like iron pipe once the protective galvanized layer has corroded away, usually after less than ten years of service (Snoeyink & Wagner, 1996; Crittenden, et al. 2013). It was once thought that controlling the corrosion of iron pipe was the key to controlling red water and the water industry spent decades studying the subject, however, in the past few decades it has become clear that managing the stability of the “Scale” of corrosion products on the interior surface of the pipe is often more important.

As a result, in recent years tests conducted to the alternatives for controlling red water typically unlined cast iron or galvanized pipe harvested from distribution system. Samples of the pipe are to waters of different qualities under controlled conditions in order to assess the impact of water on iron release. Such studies have been conducted Municipalities in Boston, MA; Tucson, AZ; Coachella and La Crescenta in CA; Corpus Cristi, Antonio, Austin, and Sugarland in TX and the City Tampa in FL and probably many others. Studies on desalinated water have been also conducted for Bay Water (Taylor et al. 2005) Poseidon-Carlsbad (McGuire et al., 2006), for Cal American-Monterey (Sekeroglu, 2011, see Figure 4-4), by the Long Beach (Zhang, et al. 2012, see Figure 4-5) and for West Basin MWD (Pickard, et al. 2014). More limited benchtop studies were also conducted for Santa Cruz and Monterey Municipal.



Figure 4-4. Tuburculated CI Pipe in testing for CalAM Monterey

assess
rely on
the
exposed

quality
by the
Fresno,
San
of
focused
Tampa

City of

The following are some of the key findings of these studies and others on red water in general:

1. The scales on existing pipes are most stable when the new supply and existing supplies have the same quality, specifically the same pH, hardness, alkalinity and redox potential (DO, type and level of chlorine residual, etc.).
2. The calcium carbonate re-mineralization strategy has been shown to be a successful strategy for establishing a stable scale on the surface of old iron pipe, but often a period of instability generally occurs for the first 30 to 60 days.
3. Frequent changes in water quality increase the risk of continuing red water problems.

Conclusions Red Water:

1-Studies show desalinated water re-mineralized to achieve CaCO₃ saturation may cause iron release to increase in the first few weeks but will eventually stabilize.
2-Frequent changes in water quality should be avoided

4.1.4 *Manganese Mobilization*

Manganese release can also be a problem as was demonstrated for desalinated water, in particular, by the recent study conducted by Hazen and Sawyer for West Basin MWD (Hazen and Sawyer, 2014), but like iron release, it settled to normal levels after a period of stabilization.

According to Reiber (February 2015) if the manganese is bound up in the mortar or concrete lining, the manganese will remain fixed to the mortar (or leach only slowly) as long as the stability of the mortar is maintained.



Figure 4-5. Long Beach Test Loops

and subsequent precipitation as MnO₂. The use of polyphosphates to sequester manganese is also discussed in a report by HDR (USEPA, 2006).

Conclusions Manganese Mobilization:

Studies show desalinated water re-mineralized to achieve CaCO₃ saturation may cause manganese release in the first few weeks but will eventually stabilize.

If the manganese exists as manganese dioxide (MnO₂) and is simply deposited on the pipe walls, it may be subject to scouring and entrainment in the bulk water, and thus a hydraulic issue. If particulate MnO₂ becomes a problem when new water is introduced, polyphosphates can be added to the water to possibly sequester the manganese, but the most effective immediate response to particulate MnO₂ problems associated with entrainment of loose sediments is unidirectional flushing. Polyphosphates are most effective at preventing oxidation of reduced manganese (Mn²⁺) by chlorine

4.1.5 *Cementitious materials*

The studies conducted by San Diego showed that desalinated water, without additional post-treatment is aggressive to cementitious materials (Crossley, 1970). Three subsequent studies examined the aggressiveness of re-mineralized, desalinated water to cement mortar linings: 1) Tampa bay (Taylor, et al. 2005), 2) Carlsbad (McGuire, et al. 2006), and 3) West Basin (Pickard, 2014) and none of these studies identified deleterious effects. The principal observations made were the leaching of calcium and aluminum from the pipe surface, but even here leaching levels were beneath levels of concern and the re-mineralization/calcium carbonate stabilization strategy reduced leaching to levels below those associated with each of the domestic supplies. The Long Beach tests included new cement mortar lined ductile iron pipe (CML-DI) and new cement mortar lined AC pipe (CML-AC), the former differed in that it also had an epoxy-like seal coating covering the CML. Whereas the CML-AC pipe showed evidence of leaching of the components of the cement mortar lining the CML-DI did not, an indication that the seal coating on new pipe provides additional protection. The only other observations of interest were that chlorine residuals were generally more stable in mortar-lined pipe – because the corrosion reaction on the surface of the iron reduces chlorine. So no unusual adverse effects are expected with desalinated water in mortar-lined pipe, provided the water has been re-mineralized to achieve calcium carbonate stabilization.

The other relevant question is what measures should be taken to maximize the long-term life of the mortar lining. This topic is beyond the scope of this report, but the following is a brief summary of our understanding of the situation: Whereas cement-based surfaces were once thought to be stable in water for the long term, it is now clear that this is not true (Trussell, 2015). The calcium silicate matrix that makes up the bulk of hardened cement paste in concrete structures and mortar linings is inherently unstable in water but is protected by the high pH of the paste matrix, which is maintained by the pockets of saturated calcium hydroxide located throughout (Mehta & Monteiro, 1996). When the calcium hydroxide is removed the calcium silicates deteriorate by a process called incongruent dissolution (or calcium leaching) resulting in an amorphous material with little strength. This can be observed in many older cement mortar linings. Actions that prevent the leaching of calcium hydroxide from of the cement paste delay the time when the paste will deteriorate. A simple example of such an action is maintaining the water in the pipe saturated with respect to calcium carbonate. Such an action requires careful control however, because maintaining saturation at too high a level could result in the formation of deposits in the injection wells. The goal should be to maintain a very low level of calcium carbonate supersaturation (i.e. an LSI between approximately 0 and 0.2) to protect cement-based surfaces but to avoid excessive supersaturation (high LSI) in order to prevent cementation in the aquifer.

OCWD would be wise to negotiate terms where it retains control of the parameters of calcium carbonate saturation so changes can be made in the future. The best measure of calcium carbonate saturation is the Langelier Saturation Index (LSI), which may be accurately calculated using a free spreadsheet, which can be downloaded from the Trussell Technologies, Inc. website (Kenney et al, 2015). The

Conclusions Cementitious Materials:
Studies show desalinated water re-mineralized to achieve Calcium carbonate saturation gives satisfactory service with cement mortar lined pipe.

aggressiveness index is a simplification of the LSI that was developed by the manufacturers of cement-based pipe (specifically the Johns-Manville Co. for their asbestos cement pipe) in the 1960's before the advent of personal computers. In today's world the value of the additional accuracy of a proper LSI calculation far outweighs the convenience afforded by the AI calculation, which makes no corrections for temperature or ionic strength.

4.1.6 Health issues

4.1.6.1 DBP formation

The type of DBPs formed during the chlorination of low-bromide waters (e.g., surface and groundwater) is altered when higher bromide waters are used (e.g., desalinated seawater). This switch leads to a greater preponderance of brominated trihalomethanes (THMs) and halo-acetic acids (HAAs), both of which are carcinogenic DBPs. As a result, bromide-containing DBPs have become a problem that has characterized State Project Water (SPW), particularly during periods when seawater intrusion into the Delta becomes an issue. As a rule of thumb, bromide-containing DBPs begin to surface in SPW when bromide exceeds 0.2 mg/L but become more critical as concentrations rise above these levels. Concentrations as high as 0.6 mg/L have been observed for short periods and these have caused concern. There is also evidence that the presence of bromide ion increases the molar yield of DBP formation (Trussell and Umphres, 1978). Finally because bromine's atomic weight is more than double that of chlorine, even at the same molar yield, DBPs containing bromide result in higher DBP concentrations on a mass basis. All this is generally not an issue in 100% desalinated water because of its low TOC. Keep in mind, the DBPs are reformed when halogens act on the natural organic matter in the water. Fortunately SWRO reduces the TOC to extremely low levels.

Another side of the same issue is the possible formation of DBPs within the distribution system when disinfected seawater is mixed with existing drinking water sources. Although this question was examined in several studies, Huntington Beach (McGuire, 2004; Reich, 2004), Tampa Bay Water (Taylor, et al, 2005), WRF (Loveland, et al. 2010), Santa Cruz (CDM, 2010), Long Beach, (Zhang, et al, 2012), and West Basin(Pickard, 2014)), the problem was only observed to be significant in the Santa Cruz studies. In this case two water sources that did not have DBP problems individually, but the act of blending them did increase DBP formation. Such a problem is more likely if the existing water sources

Conclusions DBP Formation:

Studies show that DBPs are rarely a problem in desalinated water. There are exceptions when desalinated water high in bromide is blended with groundwater high in TOC.

have organic precursors not present in the desalinated water itself. As mostly groundwater sources are involved and these sources do not show elevated DBPs at the present time, a scenario with DBPs elevated to a level of concern seems unlikely. The simulated distribution

system (SDS) test can be used to further reduce any uncertainty about this outcome. The SDS test measures changes in DBPs in a test designed to simulate DBP formation within the distribution system. Various scenarios can be easily assayed to cover the wide range of conditions encountered in the distribution systems. This includes measuring the DBP

formation of the unblended water sources alone, in addition to the different possible blends.

4.1.6.2 Residual stability

Another issue with desalination is the stability of residuals of combined chlorine. This issue was identified by the McGuire group in their first work on SDS DBP formation for the Huntington Beach project (McGuire, 2004). Subsequent research has confirmed that this problem is caused by the rapid decay of a brominated component of the total chlorine residual, which rapidly decays over the first 24-h (Zhang et al. , 2012; Tiwari & Trussell, 2013). Work done by Tiwari and Trussell (2013) illustrates the problem (Figure 4-6).

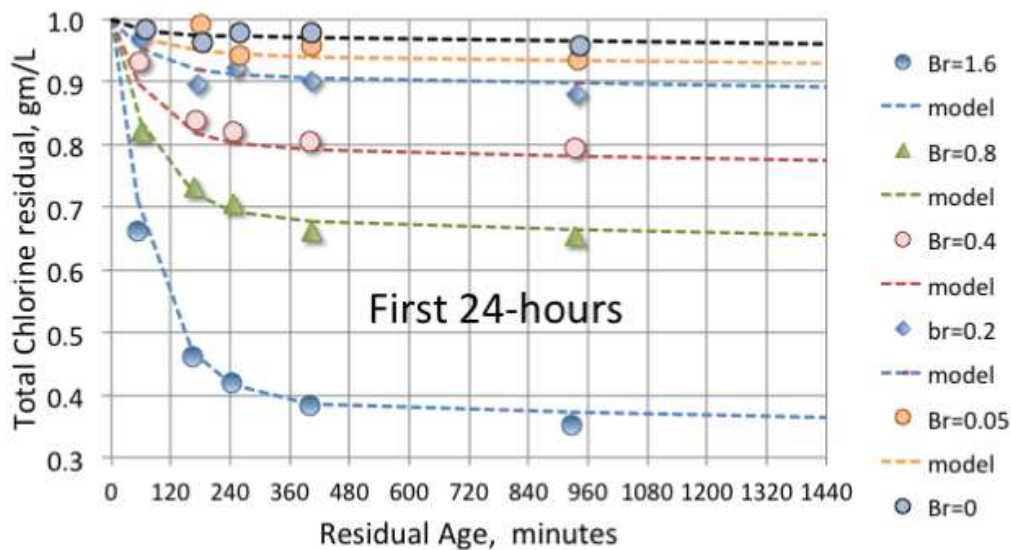

$$C = xC_0e^{-K_1t} + (1-x)C_0e^{-k_2t}$$

Where:

$$X = 0.0337 + 0.3633Br, K_1 = 0.012, \text{ \& } k_2 = 0.00001 + 0.00002Br$$

Figure 4-6. Influence of bromide ion on the decay of total combined chlorine residuals in Desalinated water. Symbols are lab results, dashed lines are model results (after Tiwari & Trussell, 2013)

Zhang et al. (2012) found similar results in desalinated water at Long Beach. It should be noted that the residual becomes much more stable after a period of time. Consequently, work done in support of the Poseidon/SDCWA project in Carlsbad (McGuire, 2005; Erdal, et al. 2013) and in support of the West Basin Integration study (Pickard, 2014) has demonstrated that this issue can be resolved by delivering water that has been held for period of time (typically 24-h) following the ammonia addition (McGuire, 2004). Significantly these same studies have shown little or no impact of bromide on the stability of free chlorine residuals – presumably because the instability results from the short half life of bromamines formed in the chloramine formation process. Also the work conducted on behalf of the SDCWA also demonstrated that rechlorination of these stabilized residuals in desalinated seawater does not cause the stability problem to reappear (Erdal, et al.

2013). In the case of both OCWD and Huntington Beach, discussions in our kick-off meeting envision the use free chlorine. So long as free chlorine is the method chosen for maintaining a residual in the distribution system, no bromide-related residual instability is anticipated, however if direct distribution customers who use chloramines are to be considered, then a specific limit to bromide would become a consideration in the term sheet – or other specific outcomes to achieve chloramine stability. Australian projects typically sought a bromide level of less than 0.1 mg/L to address this issue. Figure 4-6 and the equation beneath it will allow OCWD and its customers to explore the effects of various bromide levels.

Conclusions Residual Stability:

High bromide in desalinated water has been shown to cause short-term instability in chloramine residuals. While this problem can be successfully managed, no bromide-related residual instability is anticipated if OCWD and Huntington Beach continue with their plans to use a free chlorine residual.

Boron

The boron in SWRO permeate exists as boric acid and boric acid in drinking water is absorbed from the gastrointestinal tract and appears in the blood, tissues, and urine. Elimination of boron is largely by excretion in the urine. Toxic effects have been observed, but generally at very high doses (USEPA 2008b). The recent history on boron regulation has been dynamic and OCWD may find it useful to discuss the matter with the Division of Drinking Water (DDW).

The notification level for boron in California today is 1 mg/L. Other states also have similar regulatory limits: Wisconsin, 0.9 mg/L; Florida, Maine, and New Hampshire, 0.63 mg/L; and Minnesota, 0.6 mg/L (USEPA, 2008b). The detailed nature of these limits is not known. It is likely that these limits are largely based on a 1972 study, which observed that boric acid fed to beagles caused atrophy of their testes (Weir and Fischer, 1972). As of 1998, WHO had a provisional guideline of 0.5 mg/L for boron in drinking water (WHO, 1998) and this guideline was reissued in 2003 (WHO, 2003).

Since Weir and Fischer, numerous additional studies have been conducted and these are summarized in an EPA Health Effects Support Document for Boron (USEPA 2008a). In light of these studies both WHO and EPA have now proposed more liberal guidelines. In 2008, EPA issued a new assessment as part of the CCL2 process (USEPA, 2008a, 2008b, 2008c), proposing a health advisory level of 6.7 mg/L (USEPA, 2008b) and a health reference level of 1.4 mg/L (USEPA 2008a) and announcing a decision not to promulgate a boron MCL as doing so did not present a meaningful opportunity for health risk reduction (USEPA 2008c). In 2009, WHO did a new background document on boron in drinking water (WHO, 2009) and revised its guideline value from 0.5 mg/L to 2.4 mg/L (WHO, 2011).

Conclusions on Boron as a Health Issue:

Our understanding of the toxicity of boron to humans has changed significantly during the past decade and guidance values, once as low as 0.5 mg/L, now range from 1.4 to 6.7 mg/L. Nevertheless the Notification limit in California is 1 mg/L. OCWD may benefit from discussions with DDW regarding enforcement.

As it stands today, DDW still has a Notification Limit (NL) of 1 mg/L, there is little prospect that EPA will promulgate an MCL and California's Office of Environmental Health Hazard Assessment (OEEHA) has not published Public Health Goal on the matter. Strictly speaking, monitoring for chemicals with notification levels is not required, but it would seem appropriate since boron is known to be an issue in desalination and the boron in seawater is between 4 and 5 mg/L. Notification levels are advisory, not enforceable, but if an NL is exceeded chemical is present over its notification level, §116455 of the Health and Safety Code requires notification and, when a water system continues to serve water with a contaminant above the NL, DDW recommends notification of local governments and direct notification of consumers about the exceedance, the degree of exceedance and the reasons for continued use of the water. Unlike MCLs, NLs do not have an official sampling period, so potentially these actions could be required following the occurrence of one exceedance followed by a follow-up sample whose value is high enough so that the two average above the NL. In a desalination plant, both these samples might be taken during one hot summer week when boron levels in the SWRO permeate are unusually high.

4.1.6.3 Algal Toxins

Phytoplankton blooms, commonly referred to as 'red tides' or harmful algal blooms (HABs), are capable of producing toxic metabolic byproducts exhibiting a variety of size, structure and reactivity characteristics. Although scientific research has identified specific marine biotoxins produced by various phytoplankton species, the underlying conditions and mechanisms contributing to the biotoxin production are poorly understood. A literature review prepared by Dr. David Caron on behalf of West Basin MWD identified domoic acid, saxitoxin, brevetoxin, okadaic acid and yessotoxin as the biotoxins of concern for southern California (Caron et al, 2010), illustrated in Figure 4-7 below.

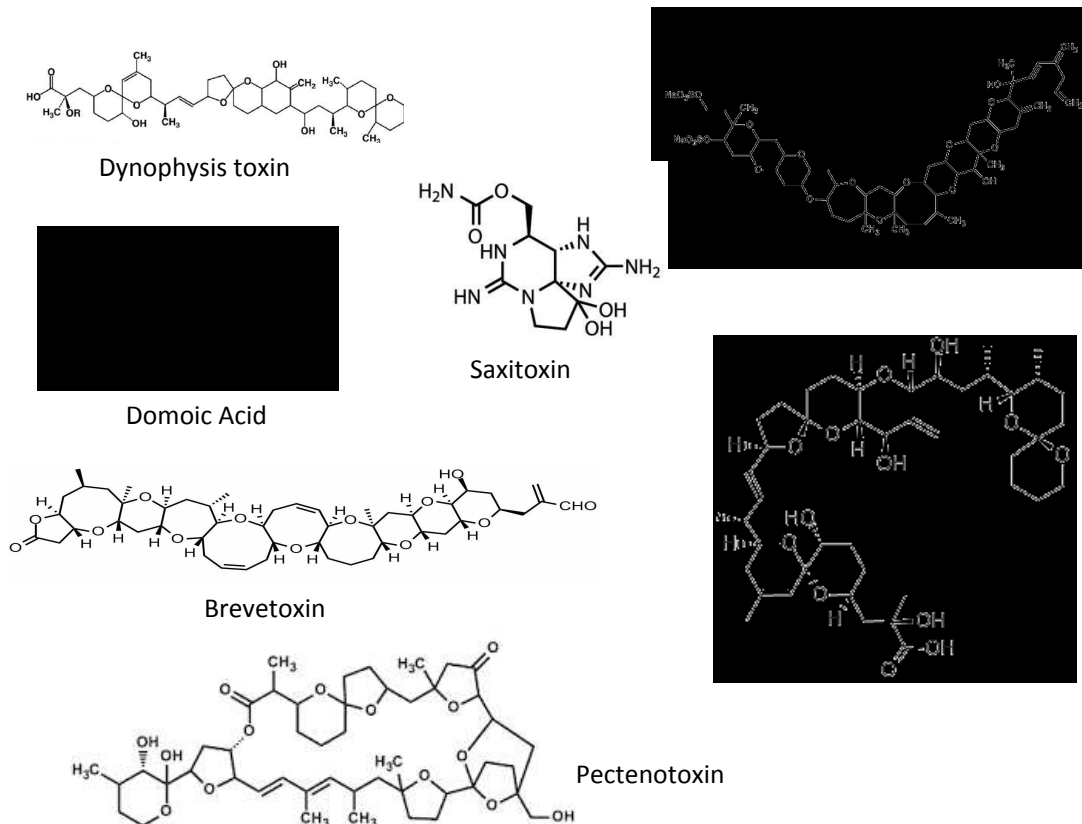

Figure 4-7. Chemical structures of commonly encountered toxins produced by microalgae in U.S. coastal waters (after Caron et al, 2010).

These toxins vary in molecular weight from 299 for saxitoxin to 1,145 for yessotoxin, so none of them are likely to pass through reverse osmosis. Of these, by far the most common biotoxin identified along the California coast is domoic acid (MW 311 amu). Figure 4-8, also from Caron, shows the mean monthly averages and maximum values of domoic acid measured on the California coast.

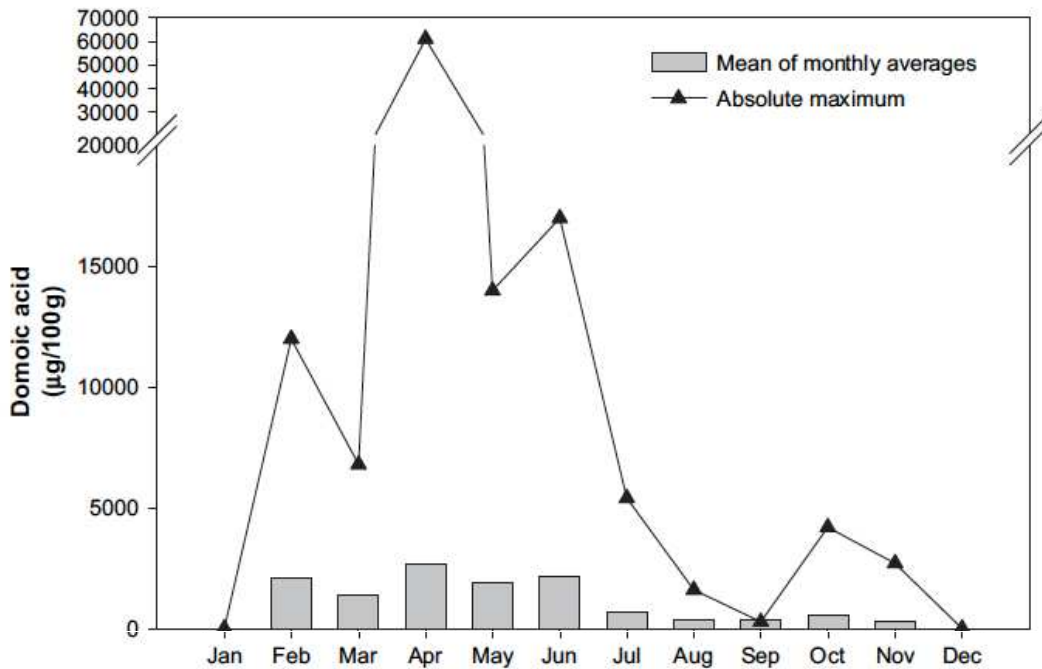

Figure 4-8 Seasonal levels of domoic acid along the CA coast. Bars are monthly means for 15 coastal counties for the years 2007-2007. Also shown is the maximum value observed along the entire coast for each month (Caron, et al, 2010).

Clearly the marine biotoxins are sometimes present in ocean waters. Studies on removal were conducted by Poseidon at Carlsbad, by CDM at the Santa Cruz pilot plant and more extensively by West Basin MWD. West Basin conducted bench studies, pilot studies in El Segundo and full-scale studies at their Redondo Beach demonstration facility (Hokanson, et al. 2009; Seubert, et al, 2012). Figure 4-9 displays the Domoic acid concentrations in the El Segundo pilot plant intake during a period of slightly more than two years. The biotoxin was observed in slightly more than 40 percent of the samples taken, the median sample likely to be between 10 and 100 ng/L (below the detection limit of the method used). Although the toxin was observed on numerous occasions in the intake, it was never found in the Pilot's SWRO permeate. This was still true later in 2008/2009 when the detection limit was moved to below 10 ng/L. Bench work, conducted with seeded domoic acid, saxitoxin and brevetoxin also showed complete rejection (Seubert et al., 2012).

Conclusions Algal Toxins:
 Biotoxins, such as domoic acid, released by harmful algal blooms, like the red tide, are frequently found along the California coast. Fortunately testing has shown that they are consistently removed by SWRO.

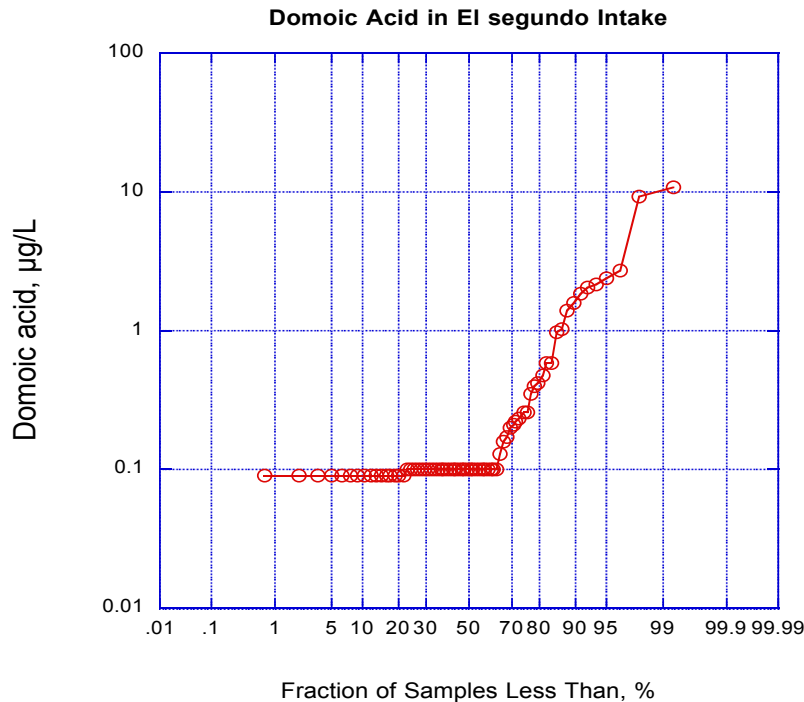

Figure 4-9. Probability plot of Domoic acid concentrations in the el Segundo pilot intake over a period between May 2005 and March 2008.

4.1.7 The consumer experience

The consumer experience is another important consideration for any drinking water source. Issues to be considered are the flavor of desalinated water, its temperature relative to conventional supplies and its influence on scaling or corrosion of home appliances.

4.1.7.1 Taste

Many factors can influence the flavor of water. Perhaps the most noticeable where desalinated water is concerned is its mineral content and mineral content does make important contribution to the flavor of a water (Deitrich et al, 2013). Not that the low mineral content of desalinated water is a bad thing, on the contrary, low mineral content is generally a good thing, although distilled water is often perceived as “Flat”. Many projects featuring desalination components, like the GWRS, have engaged in informal consumer taste testing. Such consumer tasting was conducted at the Carlsbad pilot plant, at West Basin’s Redondo Beach Temporary Demonstration Facility, and at the Santa Cruz/Soquel Creek (SCWWD²) Pilot plant. In a publically held “blind” water taste event, using a panel including prominent citizens elected officials and media, the SCWWD² project concluded that, “desalinated water tasted similar to treated water from the existing supplies.” West Basin maintained a Tasting station at its Redondo Beach facility and offered a tasting experience to most visitors. On its website, they report, “Thousands of visitors to our desal demonstration facility have tasted the desal water and tap water for a taste comparison. Some cannot tell the difference, but most can taste a difference and prefer the taste of the desalted ocean water.” The West Basin taste tests compared desalinated water, which had undergone post treatment with the local municipal supply. Perhaps the most serious effort

to examine this question was the 2004 study that McGuire Environmental Consultants (MEC) undertook on behalf of the San Diego Water Authority as the Authority first began to investigate its own independent seawater desalination program (MEC, 2004; McGuire et al. 2007). This study used professional flavor profile panels and carefully designed consumer panels to evaluate and compare desalinated water (DW) with treated water from the State Project (SPW) and the Colorado River (CRW). The consumer panels included 72 persons from 44 zip codes in the San Diego area and at all levels of both age and income.

The qualities of the three waters tested are summarized in Table 4-1. The professional panels managed by MEC looked at: 1) Varying the alkalinity in steps from 0 to 100 mg/L, 2) Free and combined chlorine residuals ranging from 0.2 to 1.6 mg/L and 0 to 4.4 mg/L, respectively, and at temperatures of 72.5 & 86°F, and 3) Blends of DW, SPW and CRW. Table 4-2 presents a summary of the water quality scenarios examined by both the professional and consumer panels. “Skinner Water” (SW) was simulated with a 50/50 blend of SPR and CRW.

Table 4-1. Summary of the mineral quality of the three waters evaluated in MEC testing.

Constituent	Units	Raw Seawater	State Project Water Mills	Colorado River Water Hinds	Unadusted RO Permeate
Alkalinity	mg/l	109	65.6	129	2.07
Bicarb Alk	mg/l	133	79.6	156	2.54
Total Hardness	mg/l	5920	106	304	34.2
TDS	mg/l	35300	280	680	280
Calcium	mg/l	390	21	74	2.3
CO2	mg/l	2.66	1	1.24	1.28
CO3	mg/l	0.864	0.82	2.55	
Sulfate	mg/l	2400	44	260	8.7
Chloride	mg/l	19000	76	91	160
Bromide	µg/l	63000	20	11	580
As	µg/l		1.3	2.9	1
Copper	µg/l		2.1		
Iron	mg/l				
Mg	mg/l	1200	13	29	6.9
Potassium	mg/l	350	2.6	4.5	3.5
Sodium	mg/l	10000	53	97	87
Total Nitrate	mg/l		0.67		
Lab pH	units	8	8.2	8.4	6.6

TABLE 4-2-A Summary of the blend scenarios examined by the MEC/SDCWA consumer panels

<p>Skinner Water Treatment Plant Treated Water</p>	<ul style="list-style-type: none"> ❑ 50:50 blend of Colorado River Water (Hinds) and State Project Water (Mills) Calculated TDS based upon Lab analysis = 480 mg/L ❑ Chloramine residual: 2.5 mg/L adjusted with sodium hypochlorite (5%) ❑ Temperature: Room temperature
<p>Desalinated Seawater</p>	<ul style="list-style-type: none"> ❑ Total dissolved solids = 350 mg/L ❑ Alkalinity Targets: 50, 75 & 100 mg/L ❑ Chloramine residual: 2.5 mg/L adjusted with sodium hypochlorite (5%) ❑ Temperature: Room temperature
<p>Blend</p>	<ul style="list-style-type: none"> ❑ Alkalinity Targets: 50, 75 & 100 mg/L ❑ Chloramine residual ; 2.5 mg/L adjusted with sodium hypochlorite (5%) ❑ Temperature: Room temperature ❑ 75% desalinated seawater/25% Skinner water; 50%:50% & 25% desalinated seawater/75% Skinner water blends generated

The following are a few of the highlights that came out of the MEC/SDCWA study:

1. When comparing unblended DW with SW, consumers could easily distinguish between the two (>97%) and, of panelists that correctly made the distinction, 93% preferred the SW.
2. Although panelists could distinguish the two and generally preferred the conventional supply (SW), they also found the DW acceptable.
3. Increasing the alkalinity of the DW had little impact on the consumer experience.
4. Consumers found it difficult to distinguish among the blends of SW and DW.
5. At the levels tested, chlorine residuals (free or combined) had little impact on the consumer experience.
6. Based on this work, MEC did believe the difference in consumer perception was significant enough to warrant special blending facilities to mitigate the aesthetic quality differences between imported water supplies and desalinated seawater.

Taste:
 Testing by MEC showed consumers can easily distinguish desalinated water from conventional supplies and would generally prefer the latter. Nevertheless, the flavor of desalinated water is acceptable. The lesson may be that changes from one to the other and back again should be avoided

not

4.1.7.2 Temperature

Among world travelers, it is well known that one of the unique things about Americans is that we like our water cold ... we even like it with ice in it. In fact our love of cold drinks extends beyond water to drinks of all kinds. Americans are well known for going overseas and rejecting a beer, because it was served to them at room temperature. No one knows exactly why that is, but one plausible story ties this to the history of marketing ice and a

certain enterprising entrepreneur in Boston, name Frederic Tudor (“the Ice king”). Rumor has it that he revolutionized the ice trade when he promoted the idea of iced cocktails. Soon any drink served with ice was viewed as special. In any case the idea that “tepid” drinking water is undesirable is probably more an issue in the U.S. than any other country. What is tepid? No one is certain, but probably at or above room temperature.

There have been few studies directly examining the impact of temperature on the consumer’s perception of drinking water. The MEC/SDCWA study looked at the effect of very warm water (90°F) on their professional panel’s judgment of the intensity of chlorinous odors and found little effect (McGuire, 2007). There have also been other studies on the effect of temperature on the perception of odors in water (Whelton, 2001) and on the impact of water temperature on the perception of foods (Mony, et al.2013), but no studies directly addressing the subject of the impact of water temperature on the consumer acceptance of the water itself. Of these, the studies on the impact of drinking water on the temperature of food are probably the most interesting. For example Mony et al (2013) found chocolate was not as flavorful when consumed with colder water.

The implications seem more directly applicable to the City of Huntington Beach, which plans to take desalinated water directly into their system. As shown below, the average temperature for Huntington Beach groundwater over the past five years was 69.9 °F, about midway between the two temperature cases involving normal operations (Case 1 – normal operations for cold seawater at 63 °F and Case 2 - normal operations for warm seawater from the power plant condenser at 74°F). The situation may be more complex for the OCWD, which plans to spread and inject the desalinated water in the ground, allowing for blending prior to the point when the water reaches the consumer’s tap. On the other hand, the specific heat of water is exceptionally high, nearly six times that of quartz. As a consequence the temperature of water isn’t easily changed and the temperature of water is often used as a tracer for the movement of water long distances in the ground. At the present, Poseidon indicates it plans to desalinate water drawn from the condenser on the warm water side of the Huntington Beach Power Plant while it is available. The question of plant feed temperature deserves closer examination.

Temperature:
As a nation, Americans are fond of cold beverages, including water. The idea of a “tepid” water supply does not appeal to some. On the other hand, acceptable temperatures are poorly defined. Because of its exceptionally high heat capacity the water is likely to stay warm to the consumer’s tap. Thus the issue deserves further study.

4.1.7.3 Scaling of home appliances

The formation of scales and encrustation on the bottom of teapots, coffee makers and in valves and fittings around the home is a common experience in southern California, and other in areas with hard water. In fact former Chief Engineer of the Orange County Water District, Mack Wesner, did his Ph.D on the question of the

Scaling of home appliances:
Calcium carbonate is the principal mineral of interest where the scaling of consumer appliances is concerned. It turns out that calcium carbonate management is of general interest to the water districts as well. The water purchase agreement should have the flexibility to allow for changes in the future.

impact of hard water on consumer costs and the USBR once published a formal study on the issue. The most insoluble mineral in most drinking waters is calcium carbonate, so more often than not, it is the prime culprit. Today a well understood aspect of water quality management is managing the solubility of minerals, generally accomplished by adjusting the Langelier Solubility Index (LSI) and the Calcium Carbonate Precipitation Potential (CCPP). Thus the issue may require that a feedback loop be built into the water purchase agreement so that the water utilities can modify conditions if change is required. Also the optimum conditions for direct use in Huntington Beach may turn out to be a bit different than those for groundwater replenishment.

4.1.8 Horticulture (irrigation at the home and in public landscapes)

Another issue that often comes up in connection with desalinated water is its suitability for irrigation of landscapes, both public and private. The fact that desalinated waters are higher in concentrations of salts, particularly boron, chloride and sodium, is the main cause of concern. At low concentrations, these ions are helpful for plant growth or, at least, don't damage them. Problems occur when a plant accumulates an excess of these ions. In fact excesses of sodium, chloride, and boron can interfere with a plant's metabolic processes making other nutrients unavailable.

Irrigation Water Quality

Plants and soil lose water through evapotranspiration (ET). ET describes the loss of water from the soil into the atmosphere due to the combined effects of evaporation and plant transpiration. Irrigation water and/or rainwater (applied water) must be provided to satisfy ET requires adding a sufficient amount of water to meet this demand. The applied water percolates through the soil surface and into the root zone where is known as soil water. Plants draw from the soil water, making use of favorable pressure (and osmotic) gradients, extracting more solvent (water) than solutes (salts). Over time, the salt concentration in the soil water increases as water is preferentially drawn up through the root system, leaving the salts behind. Also during evaporation, water is lost to the atmosphere leaving the salts in the soil. The concentrated solution of salts can decrease water availability, by decreasing the pressure gradients (by decreasing the osmotic pressure gradient), which can lead to drought symptoms.

When the applied water supply is equal to the evapotranspiration demand, salt enters the system through the applied water and only exits the system through plant uptake. If the level of salts in the irrigation water exceeds the amount that is taken up by the plants, the salts will build up in the root zone. One method for mitigating an excess of salt accumulation is the application of a leaching fraction, or an excess fraction of applied water beyond the ET demand (known as salt leaching, where the leaching fraction quantifies the level of salt leaching). The principle of the leaching factor is that the extra water will wash the accumulated salts deeper into the soil and away from the root zone (Equation below).

$$\text{Leaching Factor} = 1 - \frac{\text{Evapotranspiration}}{\text{Volume of Applied Water}}$$

The LF that needs to be applied to maintain acceptable root zone salinity depends on the tolerance of the plants to the accumulated salts and the salinity of the water used for irrigation. Higher leaching fractions produce more uniform salt profiles along the root zone, while low LF lead to higher salt concentrations near the bottom of the root zone. A balance must be maintained to achieve sufficient leaching without an excessive wasting of water or a loss of essential plant nutrients from the root zone (Nable, Banuelos et al. 1997). In well-managed irrigation, leaching fractions are selected based on the quality of irrigation waters and plant sensitivity in order to avoid the negative effects of salinity on water availability and to avoid accumulation of specific salts that can be toxic.

The quality of the supply water can also affect soil infiltration if the water has a disproportionately high concentration of sodium ions compared to the divalent ions magnesium and calcium. In this case, the sodium ions substitute for the magnesium and calcium ions in the soil, decreasing soil particle attraction. The soil particles become more dispersed, which can lead to the clogging of soil pores, swelling, and the reduction of infiltration rates. The relationship between the sodium ion and the magnesium and calcium ions can be characterized by the Sodium Adsorption Ratio (SAR):

$$SAR = \frac{[Na^+]}{\sqrt{\frac{1}{2}([Mg^{2+}] + [Ca^{2+}])}}$$

In addition to SAR, infiltration is also typically affected by the total concentration of salts in the supply water. An increased salt concentration tends to lead to the flocculation of soil particles and the formation of soil aggregates, which allow for infiltration, drainage and root penetration. Thus, both SAR and salinity impact infiltration, with decreasing SAR and increasing salinity leading to increased infiltration.

As mentioned above, specific ions in the supply water can cause toxicity in some plants if they are accumulated in sufficient concentrations. The ions whose concentrations are of concern in typical supply waters are boron, chloride, and sodium. Typically, these ions enter through the root system, or foliage when sprinklers are used. Sensitivity to specific ion toxicity varies by plant, cultivar, and rootstock, where some root systems are better able to exclude ions minimizing toxic effects.

Boron

Boron (B) is one of the essential elements for plant growth but is needed in relatively small amounts. It is a salt of particular concern given that plants can tolerate a narrow range of concentrations in the soil-water. Excessive levels in irrigation water can lead to accumulation of B in plant leaves, causing yellowing, also known as chlorosis, and ultimately leaf death. The primary B source for plants is the water that bathes their root system; therefore, the concentration of boron in the soil-water is the most important parameter to determine the effect of B on plant health and does not equal the concentration of B in the irrigation water. The concentration of B in the soil-water is not

always easy to determine and is affected by the boron concentration in the irrigation water, the type of soil, moisture content and climate. Climatic conditions also affect the plant response in that hotter, more arid climates drive higher rates of transpiration. Because B accumulates in the leaves at the end of transpiration stream, the climatic conditions affect the degree to which B accumulates. Knowing the soil-water boron concentration for a specific site is important since can be used to determine safe irrigation water B concentrations. Figure 4-10 shows chlorosis of lemon tree leaves caused by excess boron.



Figure 4-10 – Chlorosis of leaves caused by excess boron

Chloride

Chloride primarily enters the soil through the application of irrigation water, which contains chloride ions. After up taking the water through the root system when the plant draws water from the soil, the chloride and water are transported to the leaves where it is accumulated. At the leaf, water escapes through stomata when carbon dioxide is converted to carbohydrate to support plant growth during the process of photosynthesis, leaving the chloride behind. As transpiration continues, chloride accumulates. Leaf drop, which occurs roughly every two years, allows for the wasting of the chloride from the plant. Tip burn occurs when the chloride accumulation exceeds the threshold tolerance of the leaf prior to leaf drop. In general, a plant affected by excessive chloride has smaller leaves, a slower rate of growth, leaves with dead tips and discoloration known as bronzing, yellowed leaves that separate from their stems, and yellowed tissue. Figure 4-11 shows necrosis of leaves caused by excess chloride.



Figure 4-11 – Necrosis of leaf tips and margins caused by excess chloride (HortScience, Inc.)

Sodium

Sodium is a mineral that is generally not needed in plants. A few varieties of plants need sodium to help concentrate carbon dioxide, but most plants use only a trace amount to promote metabolism. Excess sodium produces an effect called osmotic stress, which causes important water in plant tissues to be diverted impairing the plant ability to even uptake adequate amount of water. A plant injured by excessive sodium first displays mottled leaves or yellowed tissue between the veins of leaves. This is followed by leaves that are dead at their tips, at their margins, and in areas between their veins. Excessive levels of sodium may also cause an imbalance in the mineral nutrition of plants, such as a deficiency of calcium. Figure 4-12 shows yellowing of leaf tips caused by excess sodium.



Figure 4-12 – Yellowing and burning of leaf tips caused by excess sodium (New South Wales Government)

Water Quality Considerations

As mentioned above, the salinity of waters may affect plants due to osmotic effects, plants need to use more energy to extract water from the soil when that water is more saline, and plants may suffer slowed growth, damaged leaves, and death in the severest cases. Plants have a wide range of tolerance of salinity, and many could be irrigated with desalinated water. General water quality guidelines, based on the water quality impacts presented above, can be found in a standard agricultural reference developed for the State Water Resources Control Board (SWRCB). The most extensive studies on the effect of boron, chloride and sodium on plant life are focused on the impact on crop yield in commercial settings. For example boron can have a significant impact on the productivity of citrus and chloride is notorious for its adverse effect on avocado and strawberry production. These issues seem generally less important in Orange County today. But these same minerals can have adverse impacts on decorative plants at lower levels, because their first impact (as shown in Figures 4-10, 4-11 and 4-12) is on aesthetic appearance. Very little information is available on landscape plant sensitivity and tolerance to salinity. HortScience conducted an extensive study in 2005 (Matheny, 2005) to determine the possible effects on Carlsbad's landscapes and acceptable landscape appearance by irrigating with desalinated water. In order to establish the effect of boron and chloride levels in irrigational waters, three different categories of water were tested:

- **Category 1:** B=0.8-1.0 ppm; Cl=180-240 ppm
- **Category 2:** B=0.55-0.75 ppm; Cl=120-160 ppm
- **Category 3:** B=0.55 ppm; Cl=56 ppm

Key findings of the study were that: 1) Category 1 water, which represents the worst-case scenario, was acceptable to irrigate the majority of the ornamental plants in Carlsbad, maintaining an acceptable landscape appearance; 2) Using categories 2 and 3 waters, did not result in a significant benefits in term of improving Carlsbad’s landscape appearance; 3) Salt sensitive plants had a better appearance when using waters with lower boron and chloride concentrations only if closely viewed. In general the plant appearance was satisfactory if viewed from a distance; 4) Most people didn’t notice small salt damages.

Horticulture:

Given the large number of common plants that may be impacted by the elevated boron levels that might be expected with a desalination water source and noting that the study is dependent on local conditions such that the results from Carlsbad are not directly applicable to Huntington Beach, a similar study is recommended for consideration in Huntington Beach. Factors affecting horticulture that necessitate a localized study in Huntington Beach include the specific plants common in the community, the local microclimate, soil conditions and the preferences of stakeholders in the community (e.g. the president of the garden club, nursery owners, park managers, etc.).

For Category 1 water, which is representative of the desalted water quality proposed in Carlsbad, the following common plants were rated unacceptable:

Camelia, Crape Myrtle, Gardenia, Giant Bird of Paradise, Heavenly Bamboo, Hydrangea, Lily of the Nile, Orange, Lemon, Philodendron, Photinia, Pink Trumpet Vine, Rose, Southern Magnolia, Violet trumpet vine, Wheeler’s dwarf pittosporum, xylosma

4.2 Issues that arise in desalination projects with groundwater storage

Over the past several years, both in Southern California and elsewhere, issues unique to injection wells have also come to the fore. Principal among these are the potential for clogging of the injection wells and the mobilization of contaminants in the aquifer itself, particularly arsenic.

4.2.1 Impact on clogging of groundwater injection wells

Early efforts by Orange County Water District identified injection well clogging as an important issue (Hennessey, et al. 1966) and the Water Factory 21 was not built until a satisfactory method of treatment was found (at that time high lime treatment followed by filtration through multimedia and GAC). Since that time an extensive literature has developed on the subject and research has been carried out all over the developed world. Much of this research is summarized in a report by the European Union (EC, 2001). This research identifies three broad categories of issues: 1) clogging due to particulates, 2) clogging due to the development of biofilms and 3) clogging due to chemical precipitation. Since all the water from the GWRS and all the water from the proposed Huntington Beach Desalter pass through RO, most of these clogging mechanisms would seem a remote prospect. Precipitation due to deposition of calcium carbonate is likely to occur with a strategy to maintain calcium carbonate saturation (slightly positive LSI) to protect the cement surfaces in the District’s distribution piping, but it is an unlikely outcome with this

approach that scaling problems will occur distribution system pipelines. In contrast, keeping the water below saturation to avoid precipitation will limit the life of the cement lining. So there is a careful balance that must be maintained. OCWD's experience with the fouling by particulates of its percolation basins for the Santa Ana River also support the idea that low levels of particulates are likely to lead to lower maintenance and higher percolation rates.

Nevertheless experience with other Southern California injection projects has shown that clogging can be an issue. The Los Angeles Department of Public Works (LACDPW), which operates three seawater barriers, the West Coast Barrier (WCB), the Dominguez Gap Barrier (DGB), and the Alamitos Barrier (AB), has commissioned studies on the issue. In studies conducted by for LACDPW, the specific capacity for injection (SC_i), the ratio of the injection rate to the increase in head above static conditions was evaluated. Under a constant injection rate losses in SC_i occur over time due to biological, chemical, or physical clogging. Studies of LACDPW's injection wells have shown continual declining trends in SC_i (CH2M HILL, 1998; CH2M HILL, 2003). Most of the wells exhibited rapid losses in SC_i following redevelopment, declining to near pre-redevelopment levels within a year or less. In addition to the short-term losses between redevelopments, an overall trend of successively lower initial SC_i from following each redevelopment effort was observed. CH2M HILL estimated that an overall decrease in SC_i of one order of magnitude or greater had occurred at most barrier injection wells since their initial installation. For most of that time, the wells had been operated with imported water, but increasingly, there has been a trend to use a supply of recycled water.

As a result, a study was commissioned to develop appropriate quality standards for the recycled water (Carollo, 2008) and a set of standards were subsequently issued (LACDPW, 2009). The water quality Specifications proposed by Carollo are summarized in Table 4-5 and the standards adopted by LACDPW are summarized in Table 4-6. Whereas Carollo proposed specifications for both the AWT effluent and the barrier itself, the LCDPW standards only apply to the former.

Table 4-5. Water Quality Specifications Proposed in Carollo Study
(Carollo, 2008)

Clogging Influence	Parameter	Criterion	Sample Location	Monitoring Frequency	Frequency of compliance
Corrosion	pH	6.5 < pH < 8.5	Plant effluent	Continuous	99% of time
		6 < pH < 9			100% of time
	LSI	-0.5 < LSI < 0.5	Plant effluent	24-h composite or daily grab	running qtrly average
	CCPP	> 0	Plant effluent	24-h composite or daily grab	running qtrly average
	Corrosion Rate	< 1 mpy ¹	representative barrier location	continuous	running qtrly average
Biological	Total Cl ₂	3 < TC < 4	Plant Effluent	continuous	running qtrly average
		2 < TC < 4	Representative injection well	weekly grab	running qtrly average
Particulate	MFI ²	< 2.1	Plant Effluent	1 grab/wk	Avg ³
		< 2.5			Max ³
	Turbidity	< 0.2 ntu	Plant Effluent	continuous	Avg ⁴
		< 0.5 ntu			Max ⁴

1- Carollo states, "Corrosion rates less than 1 mil/yr should be maintained at all times. Corrosion rates can be measured utilizing weight loss coupons or electrical resistance monitoring." but no particular metal or alloy was selected for this measure.

2-Because particulates were understood to result from lime addition, stricter requirements (1.25 avg, 2.1 max) were to apply if corrosion criteria are not met

3-Specification says, "meets average and Max values at all times"

4-Specification says, "> 95% of a 24-h period"

Table 4-6. Water Quality Specifications Adopted by LACDPW¹
(LACDPW, 2009)

Clogging Influence	Parameter	Criterion	Monitoring Frequency	Frequency of compliance
Corrosion	LSI	-0.5 < LSI < 0.5	24-h composite or daily grab	running qtrly average
Biological	Total Cl ₂ ²	3 < TC < 4	continuous	running qtrly average
Particulate	MFI	< 2	1 grab/wk	Avg ³
		< 2.5		Max ³
	Turbidity	< 0.2 ntu	continuous	Avg ⁴
		< 0.5 ntu		Max ⁴

1- All requirements apply to the AWT Plant effluent.

2- As part of the expansion of the TIWRP, the City of Los Angeles plans to switch from combined to free chlorine. The City has retained a consultant to advise on the appropriate free chlorine residual.

3-Specification says, "meets average and Max values at all times"

4-Specification says, "> 95% of a 24-h period"

According to Carollo, the CH2M reports largely pointed to biofouling as the principal cause of SC_i decline, however the evidence cited was not specifically described. Data collected by Carollo in all three LACDPW barriers seemed to suggest that corrosion byproducts could also be an important fouling component. The MFI filter pads of water samples taken throughout both barriers are displayed in Figure 4-14.

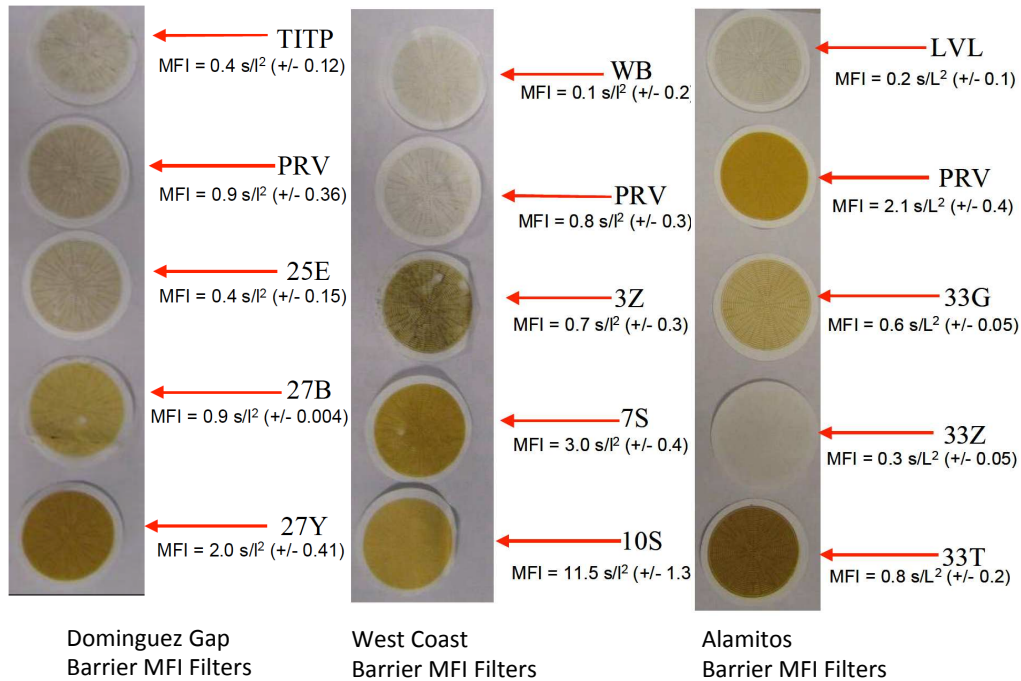
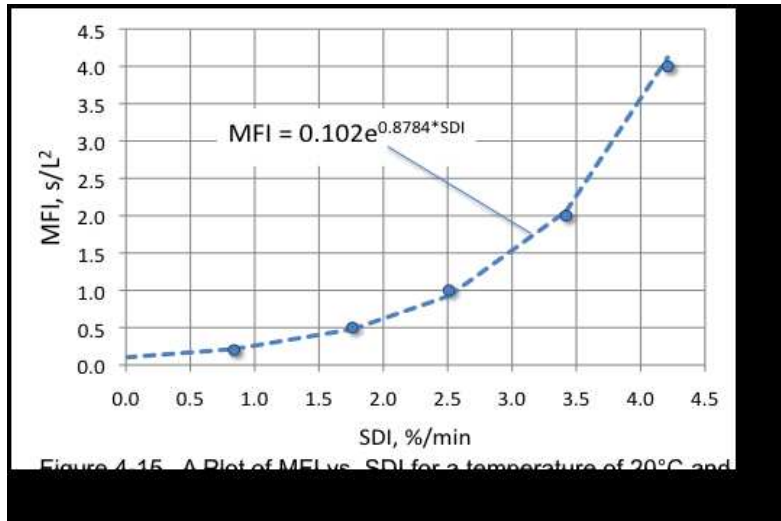

Figure 4-14 MFI Filters collected in the Carollo Study from each of the LACDPW injection barrier systems.

Figure 4-14 also displays the MFI values determined by Carollo at each of the field sites in the study.

The MFI (Modified Fouling Index) was proposed by the Dutch Water Research institute (KIWA) as a substitute for the SDI (Silt density index) in evaluating the potential for membrane fouling because it relates more linearly to the concentration of colloidal foulants and because it has a sounder basis in science, being derived from the principles of gel filtration (Schippers & Verdouw, 1980). It found its way into the criteria for groundwater injection when the same Dutch organization published one of the first comprehensive monographs on clogging of injection wells (Olsthoorn, 1982). In that monograph a $MFI < 3$ s/L² was identified as a good condition for injection water (and $MFI > 10$ to 15 as bad). It also showed that MFI is more sensitive than turbidity, especially for turbidities under 0.2 ntu. Subsequent studies for LACDPW picked up the MFI criterion (CH2M HILL, 1998) and it has been carried forward (CH2M HILL, 2003; Carollo, 2008).

The Silt Density Index (SDI), developed by Du Pont for USBR in the early days of reverse osmosis, is now the industry standard for assessing the potential for the presence of particulate matter in water and correlates with the fouling tendency of RO/NF systems. The SDI is calculated from the rate of plugging of a 0.45 μm membrane filter when water is passed through at a constant applied pressure of 30 psig. The method is described in ASTM D4189 (ASTM, 2002). The MFI is proportional to the concentration of suspended matter and is intended to be a more accurate index than the SDI for predicting the tendency of a water to foul RO/NF membranes (Schipper and Verdouw, 1980). The test method is the same as for the SDI except that the volume is recorded every 30 seconds over a 15 minute filtration period and the index (MFI) is obtained graphically. Alhadidi, et al. (2011) studied the relationship between the SDI and the MFI extensively and showed that there is a mathematical relationship between the two. Using a plot of their data for a temperature of 20°C and a pressure of 2 bars is shown in Figure 4-15 along with a simple empirical equation showing the relationship.



An MFI value of <1.5 corresponds to a SDI value of about <3 and can be considered as sufficiently low to control colloidal and particulate fouling. More recently, UF membranes have been used for MFI measurements (Boerlage, et al., 2003).

To date, no seawater desalination project has been built with groundwater recharge and/or injection mind, however, the Monterey specification was prepared in anticipation of that use. Monterey considered the LACDPW standards but adopted only turbidity requirements for particulates (turbidity 0.15 average, 0.5 maximum) because of uncertainty, at the time, about the additional value the MFI provides and about the performance of the preferred treatment alternatives where MFI is concerned (CAW, 2013).

OCWD has a long record of measurements assessing the fouling potential of the final product water (FPW) for the GWRS and OCWD has observed generally excellent performance in the fouling of its percolation basins using GWRS water, hence it seems reasonable that measurements of fouling potential and particulate level in the GWRS-FPW represent conditions that should be achievable in a similar remineralization process applied to the water produced by the Huntington desalter and also that the project would benefit if similar results were achieved.

Figure 4-16 summarizes the measurements made by OCWD in an attempt to assess the fouling potential of GWRS-FPW from July 2014 to the present. It should be noted that the

SDI and consequently the estimates of the MFI show significant improvement following the introduction of the RDP Tekkem lime system in early 2015. Prior to that time the SDI ran between 3 and 4 and the estimated MFI between 1.5 and 2.7. Since the RDP Tekkem has been fully implemented, the SDI is running between 1 and 1.5 and the estimated MFI has been below 0.5, far below the criteria being used by the LACDPW.

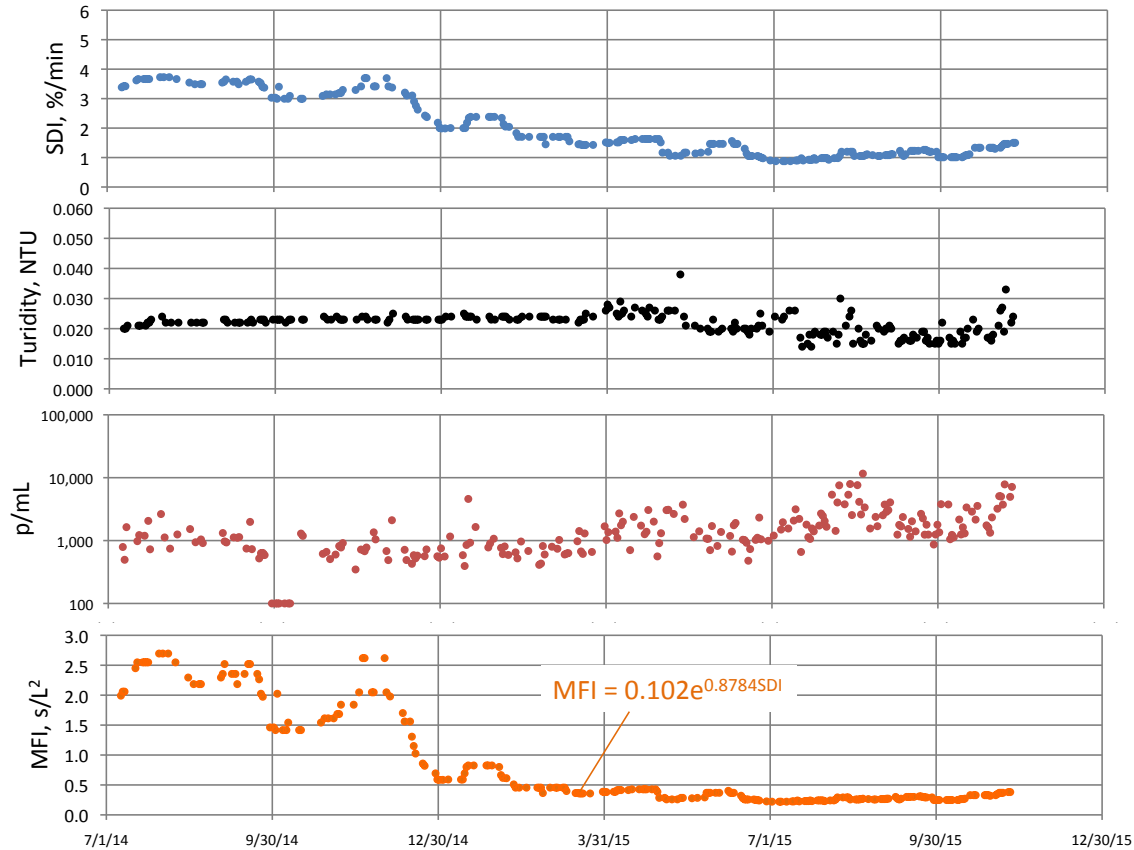

Figure 4-16. Characterization of particulates and fouling potential of GWRS final product water (FPW) between July 2014 and mid November 2015. MFI values are estimated from SDI values using an empirical equation based on the work of Alhadidi et al. 2011.

While the fouling indices have consistently improved the particle counts have actually increased while the turbidity has shown a modest, but inconsistent reduction. Measures that are more selective in particle size may be less appropriate for the intended purpose.

Clogging of injection wells:
 Studies to date suggest three issues must be controlled: 1) excessive particulates, 2) biofouling, and corrosion. Particulates are normally controlled with a limit on turbidity and the MFI. Biofouling is normally controlled through residual maintenance and corrosion is normally controlled by maintaining a positive LSI. Based on GWRS experience a turbidity of < 0.05 ntu and an SDI of < 2 seem achievable.

Most lime and limestone products have relatively high levels of inerts and, as a result, particulates are often a problem in drinking water following lime addition. This has been

the experience at GWRS as well. Hence it would seem appropriate to impose criteria for particulate and fouling for the desalinated water as well. Based on the GWRS experience an average turbidity of 0.05 and an average SDI of < 2 should be easily achieved.

4.2.2 *Impact on release of contaminants from the aquifer (e.g. As)*

Just as the introduction of new water of different quality can cause the destabilization of corrosion deposits on the surface of old metal pipe the introduction of new water of different quality can also destabilize hydrogeological deposits in the aquifer. Arsenic, iron, manganese, and uranium are among the metals, for which mobilization has been observed (Arthur, et al. 2002). Notable among these is the potential for the release of arsenic from old anoxic deposits when a new water supply with higher redox potential is introduced, (Arthur, et al. 2002; ASR Systems, 2007). Spectral analysis of minerals found in the Floridian aquifer suggested arsenic substitution in iron pyrites as the most likely source. Pyrites in the location studied ranged from < 2 to > 5% by weight (Arthur et al. 2002). Arsenic mobilization continues to trouble practitioners of aquifer storage and recovery in Florida today (Mirecki, et al., 2013). Influencing factors of traditional interest are pH and dissolved oxygen. Less traditional factors affecting the ORP are nitrate (prevents extremely low ORPs) and oxidants like free and combined chlorine (which raise the ORP). In the case of the GWRS supply, it is possible that the presence of residual hydrogen peroxide due to the advanced oxidation process (AOP) is also important. Using data from Trussell Tech files, Figure 4-17 was constructed to illustrate the effect of combined and free chlorine on the ORP of the seawater in Redondo Beach. These data, collected in seawater, are used to display the importance of oxidants to the ORP. Salinity has a limited impact on the ORP, so the effects are appropriately illustrated. It should be noted that the ORP increases rapidly when the oxidant is first added, leveling off thereafter. This is rooted in the fact that the Eh must be consistent with the Nernst equation where the measured potential (Eh) is a function of the standard potential of the oxidant (E^o) plus a fraction of the log of its concentration.

$$E_h = E^o + \frac{RT}{zF} \ln \left[\frac{a_{ox}}{a_{red}} \right]$$

Copeland et al. (2004) studied these curves for several oxidants at different pHs in fresh water and found the E_{h-max} values shown as summarized in Table 4-7. Hydrogen peroxide is not included in the Copeland results, but based on the standard potential of its half reaction, it may be slightly above that of free chlorine.

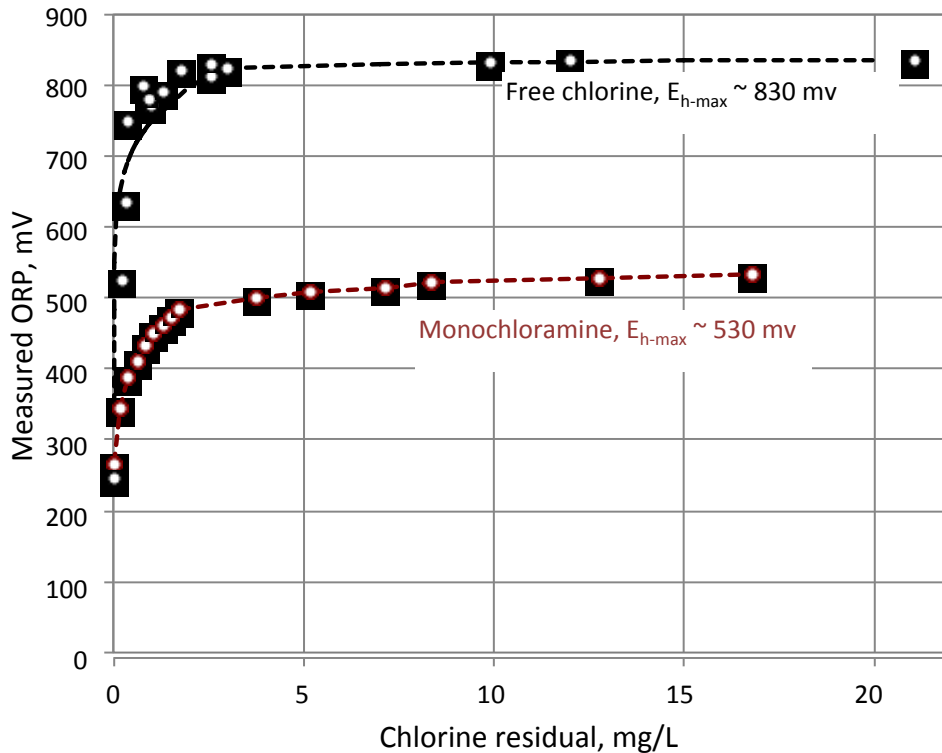

Figure 4-17 Effect of the type and concentration of chlorine residual on ORP of Redondo Beach Seawater

Table 4-7. The Approximate Maximum Eh (mV) as a function of pH and oxidant type - actual levels may vary

Oxidant	pH 7	pH 8	pH 9
Oxygen	582	552	508
Monochloramine	806	716	660
KMnO ₄	812	795	672
ClO ₂	980	943	912
Free chlorine	1020	922	769

Other aspects of changing water quality can also result in the mobilization of contaminants. These include basic changes in solubility caused by changes in pH or alkalinity and changes in ionic strength or the concentration of divalent cations like calcium and magnesium, which can influence adsorption/desorption (Fakhreddeine et al., 2015).

Aware of the mobilization issue from the beginning of the GWRS project, OCWD and its National Water Research Institute (NWRI) Independent Advisory Panel (IAP) began considering the issue early on, including preliminary column experiments, analysis of OCWD aquifer samples for metals, concluding that, “.. the mobilization of metals is not expected to be a serious issue. (NWRI, 2006).” The panel did recommend that OCWD seek the advice of a geochemist familiar with the issue and do some fate assessment for arsenic prior to GWRS startup, but those results showed such a wide range of possible responses that they weren’t particularly helpful. Nevertheless, the discussion focused the discussion

on the issue and OCWD conducted additional metals monitoring in groundwater from the very beginning of the project.

In fact the OCWD monitoring program did show arsenic release begin to appear in some monitoring wells in the vicinity of the Miller and Kraemer spreading basins in early 2009. Increasing arsenic levels corresponded to declining chloride levels, an indication of their correspondence to the arrival of GWRS water. There was no initial evidence of arsenic release in the Talbert Gap monitoring wells near the seawater intrusion barrier injection wells, possibly because arsenic may have been previously flushed by WF 21 water in earlier years. Subsequent monitoring at the Talbert Gap and the Demonstration Mid-Basin Injection project has shown some increases in arsenic at monitoring wells within close proximity to injection wells associated with the presence of GWRS water.

The 2010 Supplemental Report provided to the NWRI IAP for the GWRS suggested the following factors that might be controlling arsenic mobilization:

1. Higher pH - GWRS product water (FPW) had a higher pH than the groundwater in the vicinity of Miller and Kraemer Basins (pH 9.0 vs. pH 7.4). The pH is often “master variable” controlling adsorption of arsenic to oxides and oxyhydroxides of iron, aluminum, and manganese, common in Orange County sediments.
2. Low TDS - The relatively low alkalinity and ionic strength of GWRS water may:
 - a. Alter surface charge of mineral surfaces, changing ion exchange behavior and affecting arsenic sorption.
 - b. Accelerate dissolution reactions, the dispersion behavior of clays, and associated desorption of trace metals.
3. Higher ORP - The highly positive oxidation-reduction potential (ORP) of GWRS water may affect the oxidation state of arsenic adsorbed to aquifer sediments and increase its solubility and mobility. As mentioned earlier, arsenic mobilization has been observed at aquifer storage and recovery (ASR) sites where high ORP waters have been injected into aquifers with reducing conditions and sulfide minerals.

The subsequent 2011 Supplemental Report examined the pH and ORP hypotheses using data collected through May 2011. Figures 4-18a, 4-18b and 4-18c examine these questions for monitoring well KBS-4/1, a well in the vicinity of the Kraemer spreading basin which showed the most dramatic arsenic increase. Using low chloride levels as an indication of the presence of GWRS water, the Figure 4-18a confirms that arsenic rises steeply in early 2009 with the arrival of GWRS water. It is also worth noting (as noted on the figure) that the level of arsenic generally declines thereafter.

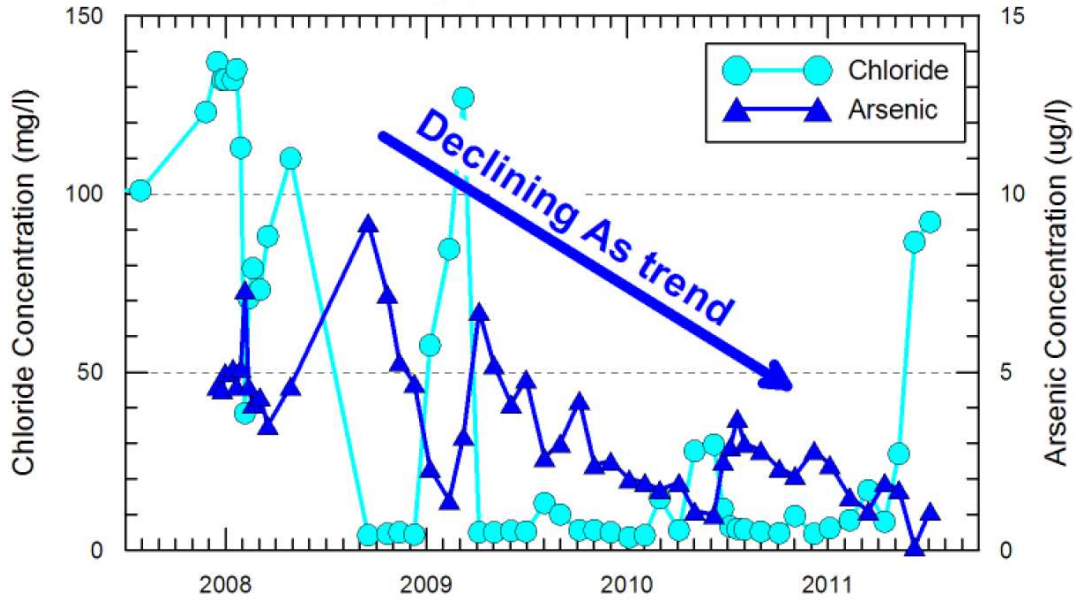

Figure 4-18a. Field measurements of arsenic and chloride in monitoring well KBS-4/1 from early 2008 through mid 2011.

Figures 4-18b and 4-18c display data on field measurements of ORP and pH in the same monitoring well during the same period. Figure 4-18b shows a lot of scatter, the reasons for this scatter are difficult to know, but the ORP levels start low, perhaps as low as -100 mV, indicating the underlying groundwater is somewhat low in oxygen, making accurate ORP measurements difficult to achieve. The arrival of GWRS water brought the ORP up, to approximately 200 to 300 mV. Long term ORP levels in the presence of GWRS water seem to be settling out in the range of 50 to 150 mV.

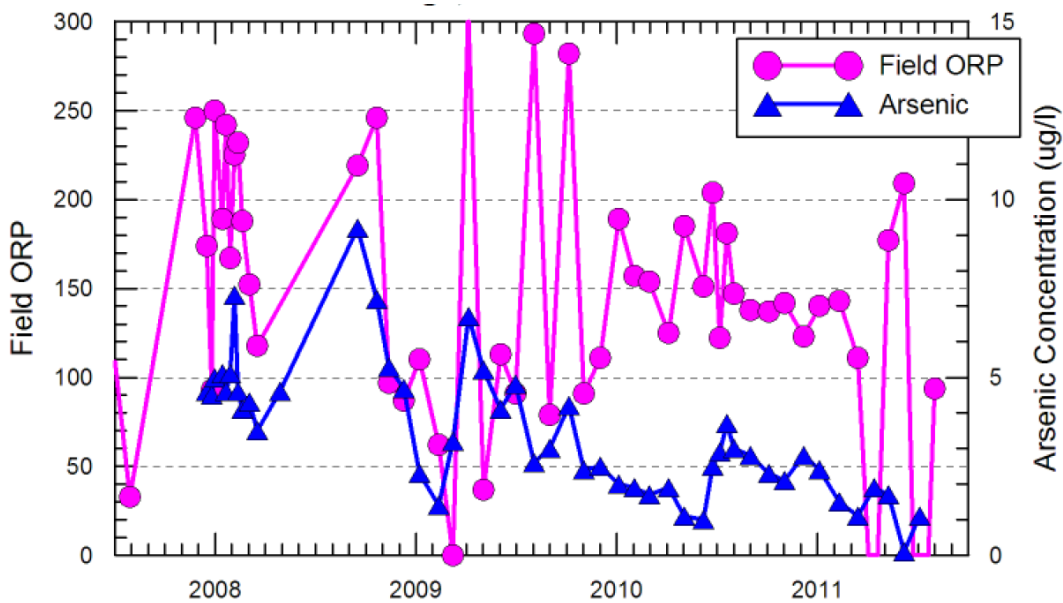

Figure 4-18b Display of the variation of field measurements of ORP and arsenic

In Figure 4-18c the pH starts around 7.5 and rapidly climbs to nearly 8.5 with the arrival of GWRS water. After some time in the presence of the GWRS, the pH stabilizes at between 7.6 and 8.1. Based on this work, neither pH nor ORP, alone seem to offer an adequate explanation.

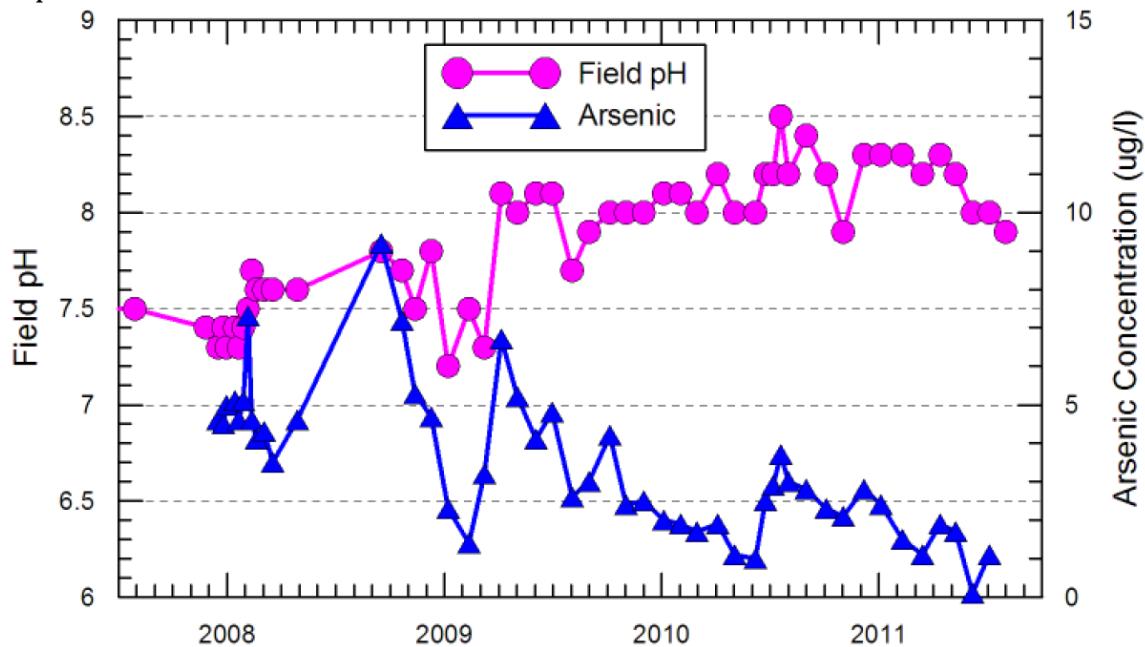

Figure 4-18c Display of the variation of field measurements of pH and arsenic

Subsequent to this work, OCWD has engaged Scott Fendorf, Ph.D., a professor in Earth Sciences at Stanford University, to help examine the issue. Work by Fendorf suggests that the arsenic mobilization in the wells near the Kraemer and Miller spreading basins is a result of the reduced concentration of calcium and magnesium ions in the GWRS water relative to the antecedent (background) groundwater, the idea being that these ions play an important role in the adsorption of arsenate ion to the mineral matrix. The introduction of the softer GWRS water causes a re-adjustment of this equilibrium, resulting in the release of some arsenic. Using column elution studies, the Stanford Group also examined the effect of pH and divalent cations on arsenic using benchtop columns. Some of that work has been replotted in Figure 4-19.

These plots suggest that, small changes in pH have little effect, elevated levels of calcium depress arsenic elution, but a combination of both magnesium and calcium is even more effective. This would suggest that adjustment of calcium carbonate saturation may result in small improvements and the addition of magnesium (MgO or MgCl₂) may result in greater improvements if they are required. It is instructive to look at the effect of these ion concentrations on the hardness of the water. At a calcium of 6.6, 29, and 200 mg/L, the water has a hardness of less than 17, 73 and 500 mg/L as CaCO₃. At a calcium of 22 and a magnesium of 27, the water has a hardness of 168 mg/L as CaCO₃. Water is generally considered soft if it's hardness is less than 80 mg/L as CaCO₃. SPW and CRW generally have a hardness of 125 and 290 mg/L as CaCO₃, respectively. OCWD could consider the

addition of magnesium salts in order to reduce the initial and temporary increases observed in groundwater near the spreading basins in Anaheim..

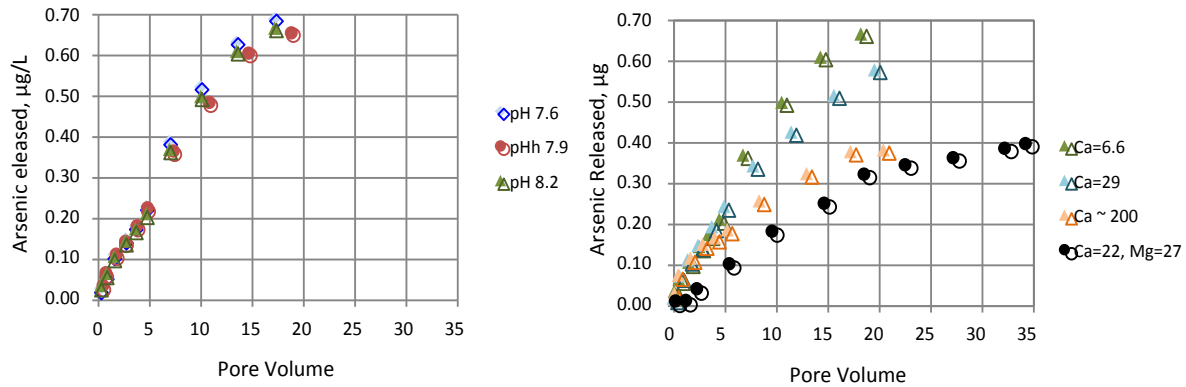

Figure 4-19. Impact of pH, calcium and magnesium on elution of arsenic from Mira Loma sediment. (data from Fakhreddine, et al. 2015)

In considering how such amendments might influence the strategy for post treatment of desalinated water it is useful to consider the range of conditions that would normally be considered. The most common post treatment for stabilization is adjustment of calcium carbonate saturation by increasing the calcium hardness and alkalinity of the desalinated supply. The preceding discussion in the document gives good reason for optimism that such a strategy would be successful. Figure 4-20 illustrates the pH that would be required to support an LSI of +0.1 in desalinated water adjusted to various ranges of hardness.

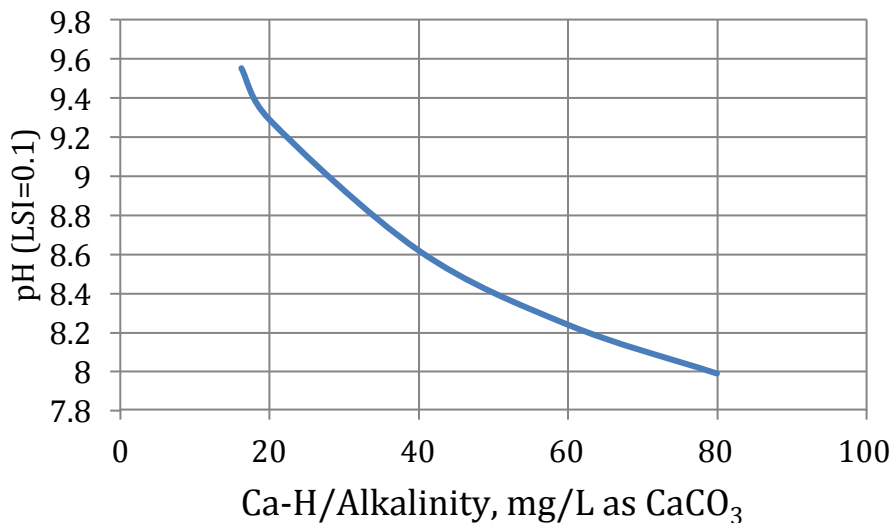

Figure 4-20. The pH required to maintain an LSI of +0.1 in desalinated water versus the goals for calcium hardness and alkalinity.

4.2.3 Impact of the desalination project on boron in the Orange County Aquifer

Chances are that at the beginning of the 20th century the Orange County aquifer had very little boron. This evidenced by the fact that boron levels are below 0.1 mg/L even today. But, over the past five or six decades, the wastewater discharges to the Santa Ana River have increased and, as a result, boron concentrations in the river are now on the order of 0.25 mg/L and thus river recharge is importing boron into the Orange County Basin. Chances are the citizens of Orange County use an even larger amount of boron in their homes and most of it appears in the sewage. Between 1976 and 2005, most of that boron went to the ocean via the OCSD outfall but a small portion was introduced into the Talbert Aquifer through the activities of the Water Factory 21. Since 2008, the GWRS has captured an increasing fraction of the OCSD discharge and has purified it to make drinking water. The GWRS is not particularly efficient at removing boron so the GWRS has now become the most important contributor to boron in the basin. The RO modeling presented above estimated a boron concentration of 0.54 mg/L in the RO product water, with chloride controlling the design based on the current draft Term Sheet. At this concentration of boron, the desalinated water will contribute more boron to the basin than the GWRS. Figure 4-21 illustrates the situation. If the Huntington Beach ocean desalter were to operate with a boron concentration of 0.75 mg/L, it will contribute even more boron to the basin (57 TPY desalination versus 38 TPY GWRS).

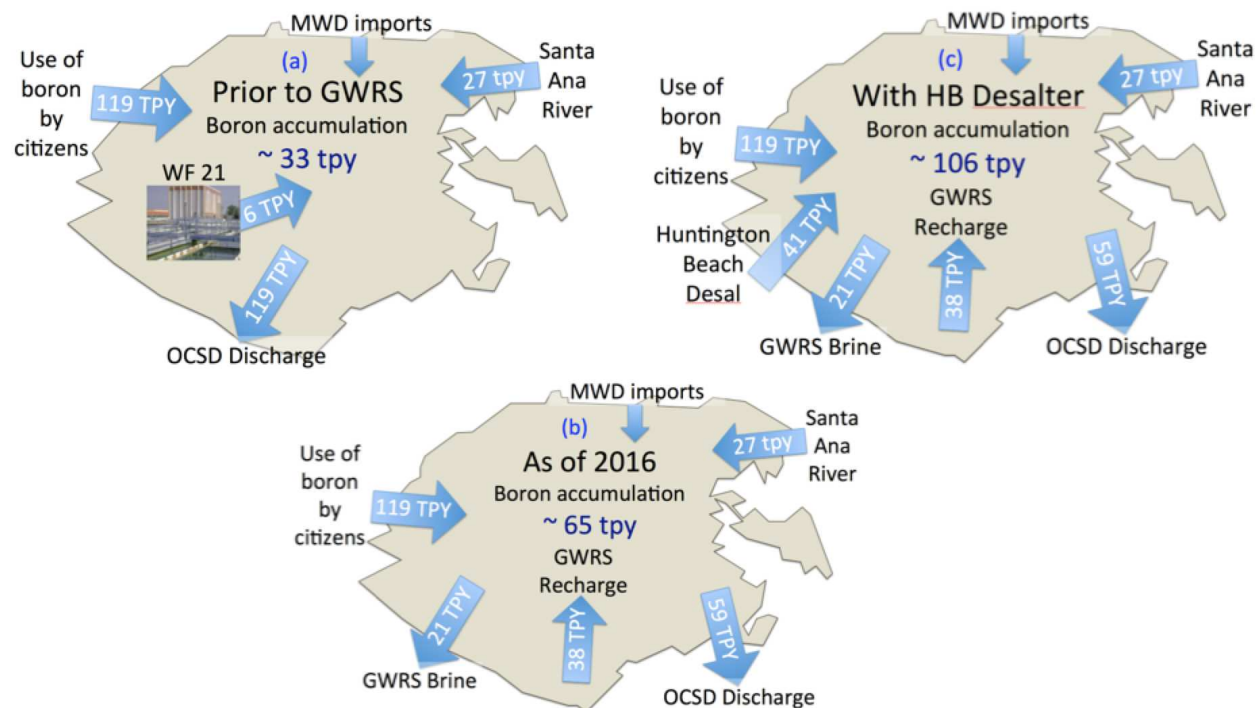

Figure 4-21 Approximations of the changing mass balances of boron in the Orange County Groundwater Basin. a) Prior to GWRS, b) as of today, and c) with the proposed 50 mgd desalter.

The mass balances in Figure 4-21 are rough approximations based on the following assumptions:

- a) *Prior to GWRS*: Assumes an average flow of 71 MGD for the river and a boron concentration of 0.25 mg/L in its flow, importing roughly 27 tons of boron into the basin each year. Also assumes that Water Factory 21 operated at an average of 12 mgd with boron at 0.35 mg/L, importing about 6 tons per year. Assumes that the boron used by citizens is reflected in the sewage. Recent data suggest the sewage collected by the Orange County Sanitation District has a boron concentration of approximately 0.4 mg/L (OCWD, 2008, 2009, 2010, 2011, 2013, & 2014). If the flow to OCSD averages approximately 195 mgd, its boron loading would correspond to approximately 119 tons per year. This comes into the county, but goes right out again in OCSD's sewage outfall. Total net importation of boron $27+6 = 33$ TPY.
- b) *As of Today*: W.F. 21 is no longer operating, but the GWRS returns 100 mgd of purified water to the basin with a boron concentration of approximately 0.25 mg/L, importing approximately 38 tons of boron to the basin each year. Total net importation of boron $27+38 = 65$ TPY.
- c) *With the Proposed HB Desalter*: As proposed at 50 mgd and with a boron level of 0.54 mg/L, the desalter would import an additional 41 tons of boron into the basin each year. Total net importation of boron $27 + 38 + 41 = \sim 106$ TPY. Should the plant operate at 0.75 mg/L boron, total net importation would jump to $27+38+57 = 122$ TPY.

From this analysis, it is clear that changes have taken place with regard to the importation of boron into the Orange County Groundwater Basin in the past and that the operation of the proposed Huntington Beach Desalter would substantially accelerate those changes. What is less clear is the consequence of these changes and the time period over which these changes might have impact. The Orange County Groundwater Basin is a huge aquifer and any clay layers in the aquifer are likely to adsorb boron, moderating its rate of increase. As a result any impacts are likely to be slow to develop and their consequences are not likely to be felt for some time. Nevertheless, beginning with the imports from the Santa Ana River and Water Factory 21, some of these changes have been in place a long time and a simple survey of boron levels in groundwater illustrates some effects. Table 4-2 lists the concentrations of boron in the groundwater near the Santa Ana River (SAR) based on the Annual Water Quality Reports for various cities in the basin.

Looking at the data, it is evident how the boron concentration averages 0.2 mg/L, regions of the basin with proximity to the SAR and in the lower region near the Talbert barrier monitoring wells. It seems likely that these increased levels near the SAR are due to the SAR's increasingly high wastewater content in recent decades. The boron found in the Talbert monitoring wells is likely due to the influence of purified recycled water injection from the WF 21 and GWRS. The GWRS currently has an average boron concentration of 0.26 mg/L (2014 GWRS Annual Report). Figure 4-22 shows the same data in the form of a map. Impacts from the SAR are immediately evident.

Table 4-2 – Average Boron Concentration in the SAR basin

Location	Avg. Boron Concentration (mg/L)
Talbert Barrier Monitoring Wells (2014) ¹	0.2
Mid basin monitoring wells SAR10 and SAR11 (2014) ¹	<0.1
Santa Ana (2014) ²	0.02
Garden Grove (2014) ²	<0.1
Tustin (2015) ²	<0.1
Irvine (2015) ²	0.053
Anaheim (2015) ²	0.14
Fullerton (2015) ²	0.18
Yorba Linda (2015) ²	0.25
Fountain Valley (2015) ²	<0.1
Westminster (2015) ²	<0.1
Spreading basins - Miller and Miraloma (2014) ¹	0.2

¹ GWRS 2014 Annual Report

² Orange County Annual Water Quality Reports

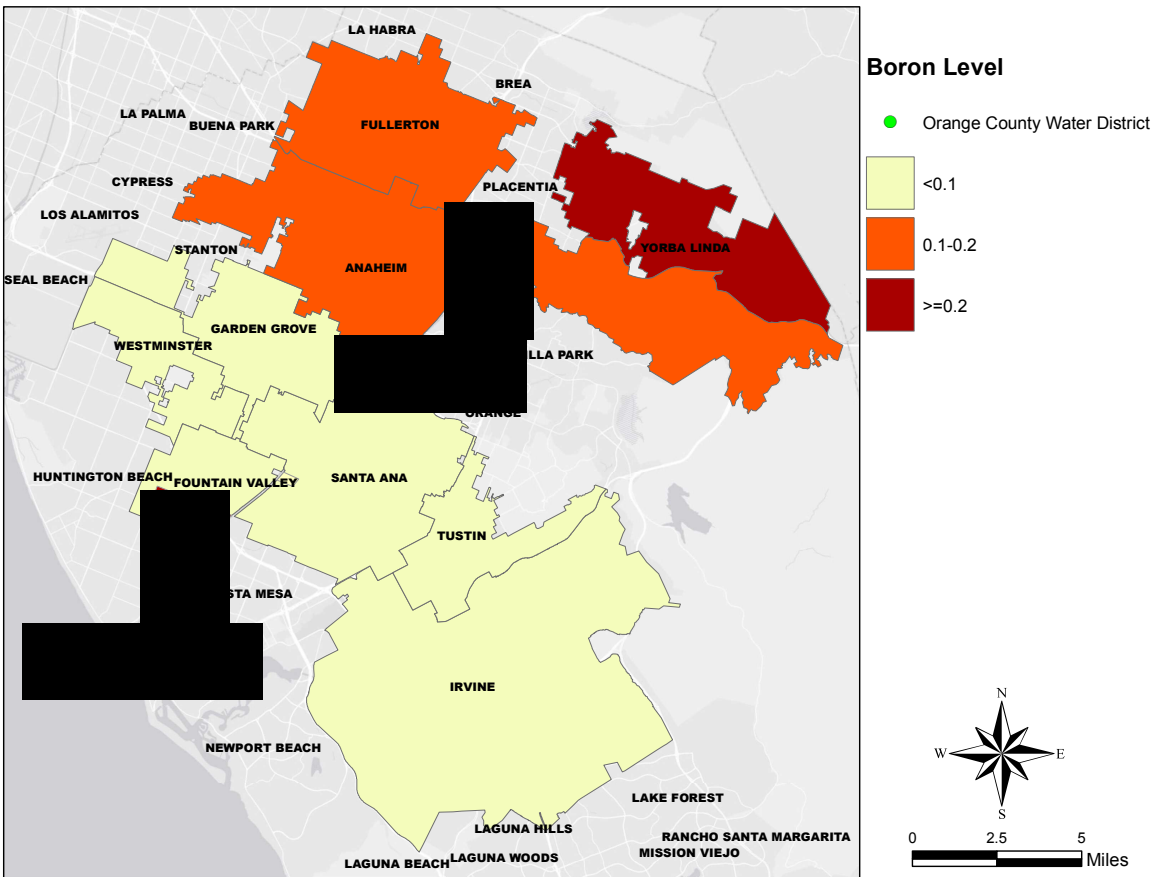

Figure 4-22 – Map of the SAR basin showing average boron concentration (mg/L)

The analysis conducted in this section is very preliminary in nature and is based on limited data, nevertheless it would appear that, where boron is concerned, the Orange County Groundwater Basin is on a path to significant long-term changes. The same could be said with respect to the accumulation of other salts, but the GWRS is very efficient at rejecting most minerals so their increase will be more limited. Boron is a special exception. For the moment, there are important new sources of boron being introduced into the basin, but there is no clear mechanism for export and the basin's long-term trajectory is not clear. It is recommended that the District consider commissioning two new studies, one a hydrogeological/geochemistry study to more tightly tie up the mass balances represented in Figure 4-21 and extend them to other salts as well, particularly chloride and a second horticultural study to help understand the likely consequences to the plant life in the basin. In order to provide preliminary support for that work, estimates of mass loading to the basin for boron and chloride due to desalinated water compared to GWRS water are provided for each scenario in Section 6 below.

*Boron in the OC GW Basin:
Boron levels are increasing over
the long-term and the use of
desalinated water will
accelerate the process. Studies
recommended*

5 Distribution System and Related Infrastructure

As discussed in Sections 4.1.1 through 4.1.4, without post treatment, desalinated seawater is generally very soft and acidic, properties that have been demonstrated to promote corrosion and release of red water from older, unlined cast iron or ductile iron pipe and to accelerate the breakdown of mortar linings as well. Provided Poseidon follows the common practice of adjusting the calcium carbonate saturation of the desalinated product water as it did in the Carlsbad corrosion study (McGuire et al., 2006), most of these problems should be less important, but most testing also suggests that the destabilization of old corrosion deposits may result in red water events in the first few months of operation in systems with significant amounts of unlined cast iron and ductile iron pipe. During that period mobilization of manganese may also be an issue if significant manganese has been present in water supplied in the past. A few months after the transition to desalinated water these problems should diminish unless portions of the system with old unlined pipe cycle back and forth from one water quality to another. Obviously, in order to understand the impact of the desalinated water on the distribution systems and related infrastructure, it is necessary to survey the inventory of materials.

5.1 HB distribution system

Pipe materials in the Huntington Beach system, provided by City of Huntington Beach staff are listed in Table 5.1. By far and away the most common material is Asbestos-Cement (ACP) pipe, constituting 98% of the pipe in length. Combining unlined cast iron, ductile iron with pipe of unknown composition still suggests that less than 0.07% of the system's total pipe length is vulnerable to red water or corrosion problems. While it is possible that scales originating directly from the water that has been used in the past may persist on the

remainder of the system’s pipe and that these scales could be mobilized as well, based on testing done to date at other sites, this seems unlikely. Thus, provided Poseidon adjusts the desalinated water to achieve positive Langelier Saturation Index (LSI), the Huntington Beach distribution system should be relatively unaffected. Huntington Beach would be wise to continue its program of replacement in area where unlined pipe remains.

Table 5.1. Composition of the water pipeline for Huntington Beach

Pipe Material	Length (ft)	Water Type
Asbestos - Cement	1,381,262	Domestic
Cast Iron	994	Domestic
Copper	165	Domestic
STL-STL CYL - STL CYL CM/L	7,355	Domestic
Plastic (HDPE+PVC)	230,451	Domestic; Reclaimed Irrigation; Sub-potable
Ductile Iron	3,441	Domestic
Unknown	3,861	Domestic; Reclaimed Irrigation; Sub-potable

5.2 OCWD distribution system

Some possible OCWD facilities are shown in Figure 5-1, taken from an early draft of the OCWD *Distribution of Desal Water Concept Report*. It is anticipated that OCWD would connect to Poseidon Water’s intake using a 54-inch steel pipe which is cement mortar lined and coated (shown in blue). The pipeline route will be a total of 225,500 linear feet and will be able to convey 50 MGD of desalinated water. OCWD is also considering using an existing 30-inch asbestos cement pipe (ACP) that runs from the AES HB power station to the OCWD GWRS facility (shown in magenta), but further investigations are needed. If this pipeline is used, another pipeline would still be required to make up the capacity to convey 50 MGD. At Adams Avenue, a new 18-in pipeline would be constructed to serve the existing Southeast Talbert (Barrier) Injection wells. Assuming new pipes would also be CML&C steel and that Poseidon maintains a positive LSI in the desalted water, no difficulties are expected with these materials.

From the GWRS facility, a seasonally variable amount of desalinated water would be sent to the Talbert Barrier injection wells. The remaining desalinated water would then be distributed for injection and recharge as blend of with GWRS water. The water produced in this blend will be discussed in more detail in the context of the scenarios, however GWRS water and the desalinated water will be substantially the same with the exception of significantly greater concentrations sodium, chloride and boron in the desalinated supply. From the standpoint of corrosion and metals release these water qualities are substantially the same and no significant differences in behavior are expected from present GWRS experience.

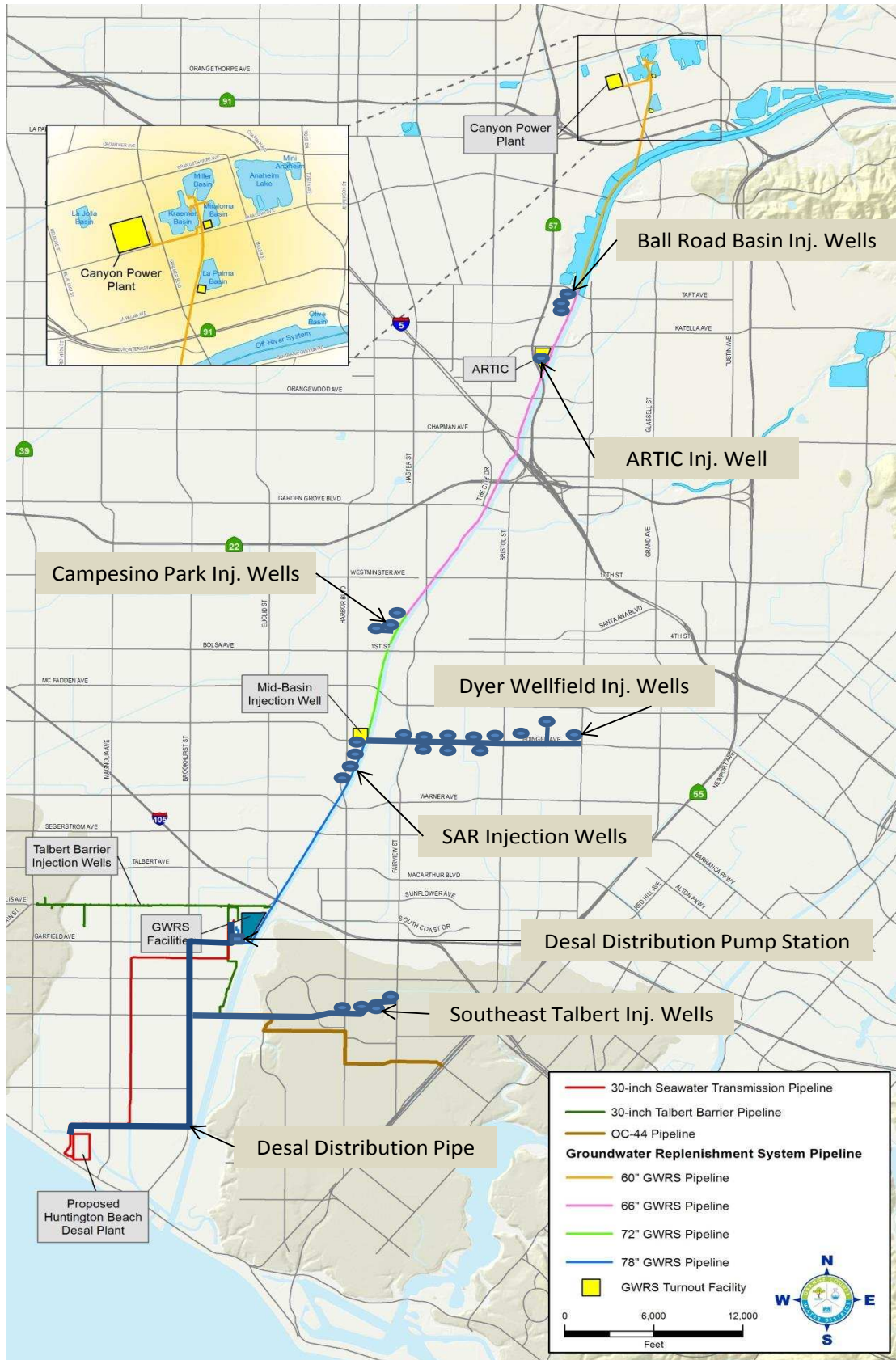

Figure 5-1. Map of Proposed Facilities. (OCWD, Oct. 2015)

6 *Review of the Three Scenarios Posed by OCWD*

The Orange County Water District (OCWD) put together a series of scenarios of interest in their evaluation of the impact of introducing 50 mgd of desalinated water from Poseidon's Huntington Beach Desalter on their injection and recharge locations. In addition, the City of Huntington Beach will take 3 mgd of the desalinated water in each of the three scenarios (item 1a, 2a, and 3a below). There are three scenarios and the water sources included in the blends are described below and not repeated here, if there is no new information to add. For the Huntington Beach scenario, a blend with their local groundwater and with their imported water from MWD is evaluated in Scenarios 1a, 2a, and 3a.

Based on prior RO modeling results for seawater desalination and on water quality for the GWRS, this section will present water quality and mass loading results for the constituents of that have the most potential impact on the cost of desalination, including TDS, boron, chloride, sodium, and bromide. These constituents also have the potential for impacts that go beyond cost. In addition, constituents needed to determine Langelier Saturation Index (LSI), the Calcium Carbonate Precipitation Potential (CCPP), and the Sodium Adsorption Ratio (SAR) will be carried through the scenarios analysis. For the reasons discussed above (see Section 3.3.6), Case 1 (normal operations for cold seawater @ T=63°F) will be used in the scenarios analysis.

Huntington Beach Local Groundwater and Imported Water from MWD

The City of Huntington Beach provided flow data for their local groundwater for the year 2014. They also provided water quality data for 2011 – 2015. This data is used in the analysis. As discussed above, temperature and alkalinity are two particularly important constituents of interest with respect to post treatment and consumer acceptance. Temperature and alkalinity data, respectively, collected over 2011 – 2015 for all of Huntington Beach's wells are averaged and presented in s Figures 6-1 and 6-2, respectively.

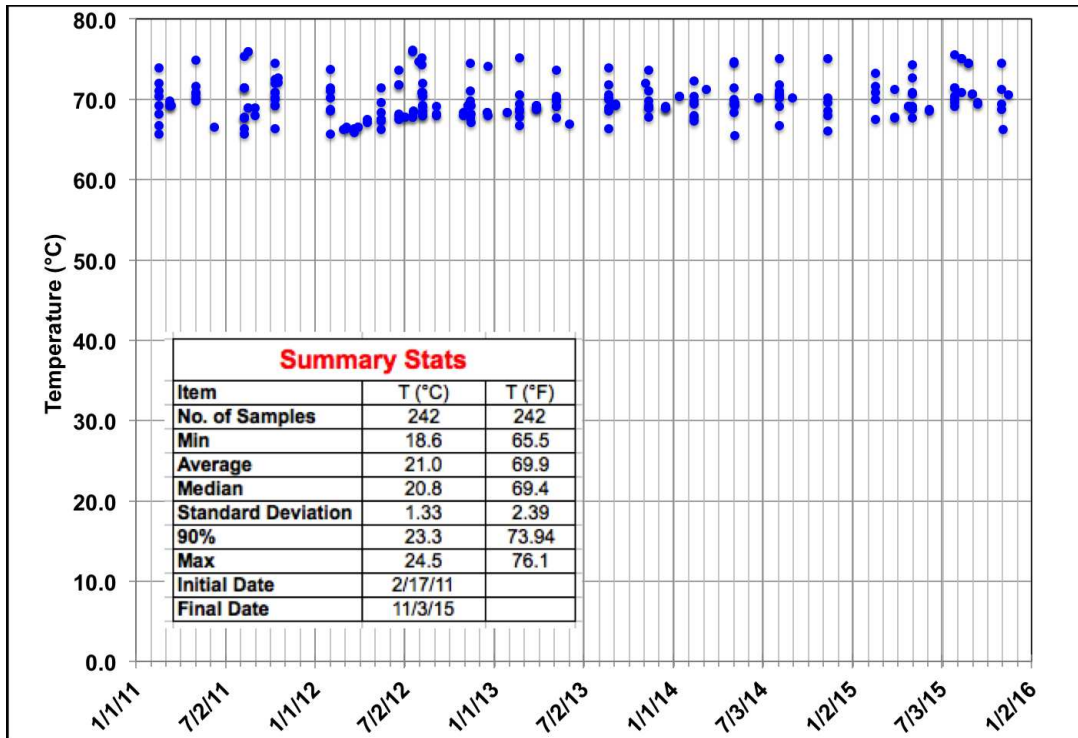

Figure 6-1 Temperature Data for Huntington Beach Groundwater

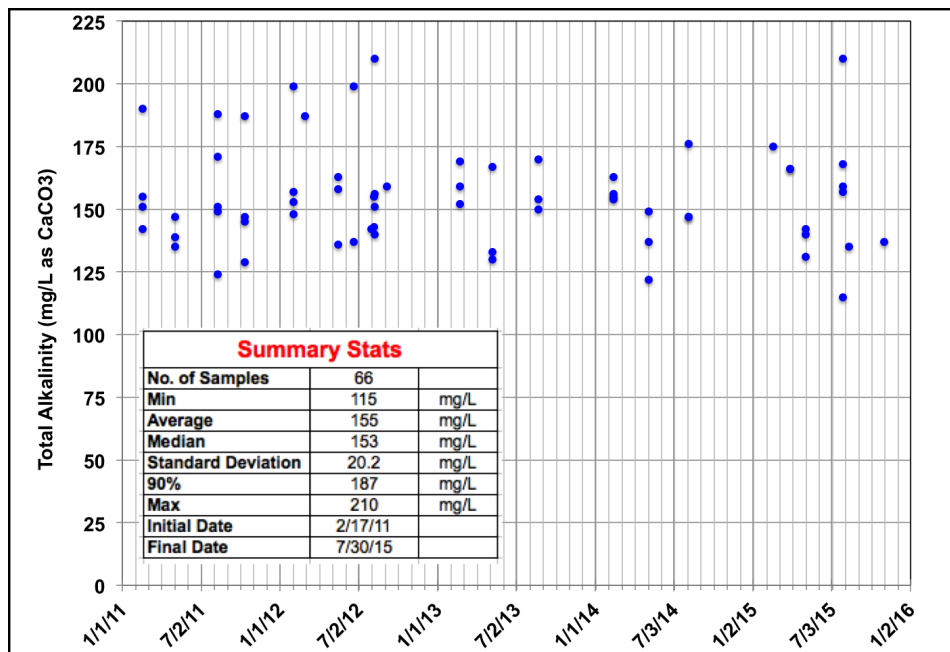

Figure 6-2 Alkalinity Data for Huntington Beach Groundwater

TDS, chloride, boron, calcium, and pH are additional constituents of interest for Huntington Beach groundwater. These parameters are used in the corrosion evaluation and in the comparison to post treated desalinated water in general. It is the average value shown that will be used in the Scenarios evaluation.

Table 6-1. Statistics on Huntington Beach Water Quality 2011-2015

Parameter	Units	Alkalinity ¹	Temp-erature ²	TDS	Chloride	Boron	Calcium	pH
No. of Samples		66	242	70	68	65	66	66
Min	mg/L	115	65.5	194	12.9	<0.1	20.9	7.60
Average	mg/L	155	69.9	375	68.8	<0.1	64.6	8.00
Median	mg/L	153	69.4	366	43.2	<0.1	62.3	8.00
Standard Deviation	mg/L	20.2	2.4	144	58.0	<0.1	30.6	0.13
90%	mg/L	187	73.9	577	124	0.1	105	8.15
Max	mg/L	210	76.1	924	277	0.13	153	8.30

¹Units of alkalinity are mg/L as CaCO₃

²Units of temperature are °F

Huntington Beach also uses imported water from MWD for a portion of its supply. The water quality for imported water from MWD is taken primarily from the Diemer water treatment plant. This water quality for MWD was taken from the City of Huntington Beach 2014 Annual Water Quality Report and is presented in the discussion of Scenarios 1a, 2a, and 3a below. The flows for the analysis were taken from demand data provided by the City of Huntington Beach for fiscal year 2014 and are summarized as follows: average local groundwater flow = 17.9 mgd, imported MWD water flow = 6.86 mgd, total flow = 24.8 mgd. This represents 72% local groundwater flow and 28% imported MWD water flow. These represent the flows prior to introducing the desalinated water source.

6.1 Scenario 1 - Winter/Low Overdraft Operations

Scenario 1 proposes the following distribution of desalinated water from Poseidon’s Huntington Beach desalter during winter operations:

1a. 3 mgd of desalinated water to City of Huntington Beach (direct)

All three scenarios involve providing 3 mgd of desalinated water to the City of Huntington Beach. For this reason, Scenarios 1a, 2a, and 3a that cover Huntington Beach are identical and will be discussed in this part of the report under Scenario 1a alone. The current groundwater and imported flows for Huntington Beach were discussed above. As shown above, the current amount of imported water is 6.86 mgd. The analysis for Scenario 1a, 2a, and 3a assumes that when 3 mgd of desalinated water is introduced into the system, the amount of water imported from MWD will be reduced by the same amount. The flows for the blend in Scenarios 1a, 2a, and 3a are summarized in Table 6-2 below.

Table 6-2. Summary of Flows and Percent of Total Flow for Scenarios 1a, 2a, and 3a

Water Source	Flow	% of Total Flow
Flow Desal (mgd)	3	12.1%
Flow GW (mgd)	17.9	72.3%
Flow Imported (mgd)	3.86	15.6%
Flow OC GWRS (mgd)	0	0.0%
Total Flow (mgd)	24.8	100%

These flows and percent of total flow values are carried into Table 6-3 below as they are used in then mass balance and water quality analysis to determine the water quality of the desalination, Huntington Beach Groundwater and MWD blend used in the analysis. It is observed that the desalinated water flow represents 12% of the total flow and allows the imported MWD water to be reduced to 16% of City’s total flow for this representative example based on 2014 data. The results of the water quality evaluation for Scenario 1a, 2a, and 3a are summarized in Table 6-3.

Table 6-3. Summary of Blended Water Quality for Scenarios 1a, 2a, and 3a^{1,2,3}

Constituent or Parameter	Desal Water	HB GW	Imported MWD	Blended Water
	12%	72%	16%	
Flow (mgd)	3	17.9	3.86	24.8
TDS (mg/L)	148	375	540	373
Sodium (mg/L)	45.4	48	84	53.3
Chloride (mg/L)	74.1	69	86	72.3
Boron (mg/L)	0.536	0.05	0.14	0.123
Alkalinity (mg/L)	60	155	110	137
Calcium (mg/L)	24.2	65	60	59.3
Magnesium (mg/L)	1.40	9.9	22	10.8
Fluoride	0.01	0.8	0.8	0.70
pH	8.3	8.0	8.1	7.83
Temperature (°F)	63	69.9	68	68.2
SAR	2.43	1.34	2.01	1.51
LSI	0.15	0.57	0.44	0.30
CCPP	0.83	13.8	6.16	6.83

¹ TT freely available blending model (www.trusselltech.com) used to determine pH, alkalinity, and temperature of blends with other parameters determined by mass balance

²TT freely available CaCO₃ indices model (www.trusselltech.com) used to determine LSI and CCPP

³No mass loadings are presented for Scenarios 1a, 2a, and 3a because water is going to the HB distribution system and none of this water is going to the injection or recharge basins.

The TT CaCO₃ indices model described above (footnote to Table 6-3) was used in all scenarios (with the blending model used in all scenarios involving blending). From Table 6-3 it is observed for the blend that the LSI of 0.3 is within the range of 0 to 0.5 often used as a target for LSI for desal. The CCPP at 6.83 is also in a range common for drinking water utilities to target (4-10 mg/L). The boron at 0.12 mg/L is well below the term sheet, below levels of horticultural concern and below the Division of Drinking Water (DDW) Notification Level (NL) of 1 mg/L. The alkalinity of the blend, at 137 mg/L as CaCO₃, is similar to the blend that would be achieved with imported water. If this blend is used throughout the HB system, little impact on the system infrastructure of on the consumer experience would be expected.

On the other hand, in discussions with HB, it appeared that the desalinated water will be substituted directly in the system without prior blending. The proposed target alkalinity of 60 mg/L as CaCO₃ is substantially below both HB groundwater (155 mg/L) and MWD imported water (110 mg/L). Other utilities have observed problems like red water when introducing desalinated seawater at much lower alkalinity into their distribution system in regions where unlined cast iron, ductile iron or galvanized pipe are used. Fortunately as discussed in section 5.1 HB has only a small amount of these sensitive materials in their system. Thus, as stated earlier, provided Poseidon adjusts the desalinated water to achieve a positive LSI, the Huntington Beach distribution system should be relatively unaffected. Huntington Beach would, nevertheless, be wise to continue its program of replacement in area where unlined pipe remains.

1b.15 mgd of desalinated water to Talbert Seawater Intrusion Basin (100% desal)

Detailed analysis was conducted to evaluate Scenario 1b based on the RO modeling and post treatment results presented earlier in this report. The results will look at mass loading to the Talbert Seawater Intrusion Basin at 15 mgd with 100% desalinated water. A detailed evaluation of water quality data for Scenario 1b (100% desal) is shown in Table 6-4. The data presented represents desalinated water after post treatment and any potential issues with the water were discussed above. Recommendations for changes to the Term Sheet (Attachment A) for Orange County to consider are provided in Section 7.

The concentration, flow rate, and mass loading of various parameters of interest for the Scenario 1b of discharging 15 mgd of desalinated water into the Talbert Seawater intrusion basin are shown in Table 6-5. These include TDS, sodium, chloride, and boron. It is observed that the salt loading for TDS, sodium, and chloride are substantive. The boron level is consistent with the level determined earlier in the section on the mass balance (Section 4.2.3) noting that the flowrate is lower for Scenario 1b than for the full desalinated water flow used in the mass balance. A comparison of mass loadings for the scenarios that involve loading the basin will be presented following demonstration of all the scenarios.

Table 6-4. Scenario 1b Water Quality (15 MGD 100% Desal Water to Talbert Barrier)

Parameter	Scenarios 1b
	100% Desal Water
Total Flow (mgd)	15
%Desal	100%
Sodium (mg/L)	45.4
Magnesium (mg/L)	1.4
Calcium (mg/L as Ca)	24.2
Potassium (mg/L)	2.35
Strontium (mg/L)	0.009
Chloride (mg/L)	74.1
Sulfate (mg/L)	3.32
Fluoride (mg/L)	0.009
Bromide (mg/L)	0.258
Alkalinity (mg/L as CaCO ₃)	60
Boron (mg/L)	0.536
TDS (mg/L)	148
SAR	1.96
pH	8.30
LSI	0.15
CCPP	0.83

Table 6-5. Mass Loading for Scenario 1b (15 MGD 100% desal to Talbert Barrier)

Parameter or Constituent	Concentration (mg/L) or Flow Rate (mgd)	Mass Loading (TPY)
Total Flow (mgd)	15	15
%Flow=Desal	100	100%
TDS	148	3,380
Sodium	45.4	1,035
Chloride	74.1	1,690
Boron	0.536	12.2

1c. Blend of 35 mgd of desalinated water + 100 mgd GWRS water to all other injection wells + forebay basins

Detailed analysis was conducted to evaluate Scenario 1c based on the RO modeling and post treatment results presented earlier in this report and on GWRS water quality taken from the 2014 annual report. A blend was produced in the manner discussed for Huntington beach. The results will look at mass loading to the all other injection wells and forebay basins at 35 mgd of desalinated water and 100 mgd of GWRS water in the blend. A detailed evaluation of water quality data for Scenario 1c (26%/74% blend desal/GWRS) is shown in Table 6-6. The data presented represents desalinated water after post treatment and any potential issues with the water were discussed above. The GWRS water quality comes from their 2014 annual report. Recommendations for changes to the Term Sheet (Attachment A) for Orange County to consider are provided in Section 7.

Table 6-6. Scenario 1c Water Quality (Blend Desal/GWRS to Forebay + other injection wells)

Parameter	Scenario 1c		
	Desal Water	GWRS	Blended Water
Total Flow (mgd)	35	100	135
%Desal	26%	74%	100%
Sodium (mg/L)	45.4	9.6	18.9
Magnesium (mg/L)	1.4	0.5	0.733
Calcium (mg/L as Ca)	24.2	9.0	12.9
Potassium (mg/L)	2.35	0.7	1.13
Strontium (mg/L)	0.009	0.02	0.0171
Chloride (mg/L)	74.1	7.5	24.8
Sulfate (mg/L)	3.32	0.2	1.01
Fluoride (mg/L)	0.009	0.1	0.076
Bromide (mg/L)	0.258	0.01	0.0743
Alkalinity (mg/L as CaCO ₃)	60	27.7	36.1
Boron (mg/L)	0.536	0.26	0.332
TDS (mg/L)	148	54	78.4
SAR	1.96	0.84	1.38
pH	8.30	8.2	8.17
LSI	0.15	-0.74	-0.50
CCPP	0.83	-2.7	-1.92

It is observed in Table 6-6 that the desal/GWRS blend has a LSI equal to -0.5 a level below the LSI targets being contemplated for the desalination water quality. The concentration, flow rate, and mass loading of various parameters of interest for the Scenario 1c of discharging 35 mgd of desalinated water blended with 100 mgd of GWRS water into the all other injection basins and forebay basins are shown in Table 6-7. These include TDS, sodium, chloride, and boron. It is observed that the salt loading for TDS, sodium, and chloride are substantive. The boron level is higher with the level determined earlier in the section on the mass balance (Section 4.2.3) noting that the flowrate is higher for Scenario 1b with both desalinated water and GWRS water used in the mass balance. A comparison of mass loadings for the scenarios that involve loading the basin will be presented following demonstration of all the scenarios.

Table 6-7. Mass loading for Scenario 1c (Blend Desal/GWRS to Forebay + other injection wells)

Parameter or Constituent	Blend (mg/L) or Flow Rate (mgd)	Mass Loading (TPY)
Total Flow (mgd)	135	135
%Flow=Desal	24%	100%
TDS	78.4	16,100
Sodium	18.9	3,880
Chloride	24.8	5,100
Boron	0.332	68

6.2 Scenario 2 - Summer/High Overdraft Operations

Scenario 2 proposes the following distribution of desalinated water from Poseidon’s Huntington Beach desalter during summer operations:

2a. 3 mgd of desalinated water to City of Huntington Beach (direct)

Scenario 2a is identical to Scenario 1a (see discussion above)

2b. 36 mgd of desalinated water to Talbert Seawater Intrusion Basin (100% desal)

Detailed analysis was conducted to evaluate Scenario 2b based on the RO modeling and post treatment results presented earlier in this report. The results will look at mass loading to the Talbert Seawater Intrusion Basin at 36 mgd with 100% desalinated water. Scenario 2b is very similar to Scenario 1b, only the flowrate changes from 15 to 36 mgd into the Talbert Seawater Intrusion basin with 100% desalinated water. The water quality for 100% desalinated water used in the Scenarios analysis was presented in Table 6-4. Only the flowrate changes for Scenario 2b.

The concentration, flow rate, and mass loading of various parameters of interest for the Scenario 2b of discharging 36 mgd of desalinated water into the Talbert Seawater intrusion basin are shown in Table 6-8. These include TDS, sodium, chloride, and boron. It is

observed that the salt loading for TDS, sodium, and chloride are substantive. The boron level is consistent with the level determined earlier in the section on the mass balance (Section 4.2.3) noting that the flowrate is lower for Scenario 1b than for the full desalinated water flow used in the mass balance. A comparison of mass loadings for the scenarios that involve loading the basin will be presented following demonstration of all the scenarios.

Table 6-8. Mass loading for Scenario 2b (36 MGD 100% Desal to Talbert Barrier)

Parameter or Constituent	Concentration (mg/L) or Flow Rate (mgd)	Mass Loading (TPY)
Total Flow (mgd)	36	15
%Flow=Desal	100	100%
TDS	148	8,100
Sodium	45.4	2,490
Chloride	74.1	4,060
Boron	0.536	29

2c. Blend of 14 mgd of desalinated water + 100 mgd GWRS water to all other injection wells + forebay basins

This scenario is similar to Scenario 1c, just the flows differ. The results will look at mass loading to the OC Intrusion Basin at 14 mgd of desalinated water and 100 mgd of GWRS water. A detailed evaluation of water quality data for Scenario 2c (12%/88% blend desal/GWRS) is shown in Table 6-9. The data presented represent desalinated water after post treatment and any potential issues with the water were discussed above. The GWRS water quality comes from their 2014 annual report. Recommendations for changes to the Term Sheet (Attachment A) for Orange County to consider are provided in Section 7.

It is observed in Table 6-9 that the desal/GWRS blend has a LSI equal to -0.6 a level below the LSI targets being contemplated for the desalination water quality. The concentration, flow rate, and mass loading of various parameters of interest for the Scenario 1c of discharging 14 mgd of desalinated water blended with 100 mgd of GWRS water into the all other injection basins and forebay basins are shown in Table 6-10. These include TDS, sodium, chloride, and boron. It is observed that the salt loading for TDS, sodium, and chloride are substantive. The boron level is higher with the level determined earlier in the section on the mass balance (Section 4.2.3) noting that the flowrate is higher for Scenario 1b with both desalinated water and GWRS water used in the mass balance. A comparison of mass loadings for the scenarios that involve loading the basin will be presented following demonstration of all the scenarios.

Table 6-9. Scenario 2c Water Quality (Blend Desal/GWRS to Forebay + other injection wells)

Parameter	Scenario 2c		
	Desal Water	GWRS	Blended Water
Total Flow (mgd)	14	100	114
%Desal	12%	88%	100%
Sodium (mg/L)	45.4	9.6	14.0
Magnesium (mg/L)	1.4	0.5	0.611
Calcium (mg/L as Ca)	24.2	9.0	10.9
Potassium (mg/L)	2.35	0.7	0.90
Strontium (mg/L)	0.009	0.02	0.0186
Chloride (mg/L)	74.1	7.5	15.7
Sulfate (mg/L)	3.32	0.2	0.583
Fluoride (mg/L)	0.009	0.1	0.09
Bromide (mg/L)	0.258	0.01	0.0405
Alkalinity (mg/L as CaCO ₃)	60	27.7	31.7
Boron (mg/L)	0.536	0.26	0.294
TDS (mg/L)	148	54	66.5
SAR	1.96	0.84	1.12
pH	8.30	8.2	8.20
LSI	0.15	-0.74	-0.59
CCPP	0.83	-2.7	-2.16

Table 6-10. Scenario 2c Mass loading (Blend Desal/GWRS to Forebay + other injection wells)

Parameter or Constituent	Blend (mg/L) or Flow Rate (mgd)	Mass Loading (TPY)
Total Flow (mgd)	114	114
%Flow=Desal	12%	100%
TDS	78.4	11,400
Sodium	18.9	2,430
Chloride	24.8	2,720
Boron	0.332	51

6.3 Scenario 3 - 100% Desalination Operations (during shutdown of GWRS AWPf)

Scenario 3 proposes the following distribution of desalinated water from Poseidon’s Huntington Beach desalter during 100% desalination operations:

3a. 3 mgd of desalinated water to City of Huntington Beach (direct)

Scenario 2a is identical to Scenario 1a (see discussion above)

3b. 50 mgd of unblended desalinated water to all other injection and recharge locations

Detailed analysis was conducted to evaluate Scenario 3b based on the RO modeling and post treatment results presented earlier in this report. The results will look at mass loading to the all other injection and recharge locations during a shutdown of the GWRS at 50 mgd with 100% desalinated water. The results will look at mass loading to the Talbert Seawater Intrusion Basin at 36 mgd with 100% desalinated water. Scenario 3b is very similar to Scenarios 1b and 2b, only the flowrate changes from 15 to 36 to 50 mgd with 100% desalinated water. One difference is that Scenario 3b revolves around a potential shutdown of the GWRS where the 100% desalinated water could go to any of the injection and recharge locations, not just to the Talbert Seawater Intrusion Basin. The water quality for 100% desalinated water used in the Scenarios analysis was presented in Table 6-4. Only the flowrate changes for Scenario 3b..

The concentration, flow rate, and mass loading of various parameters of interest for the Scenario 3b of discharging 50 mgd of desalinated water into all the injection and recharge basins is shown in Table 6-11. These include TDS, sodium, chloride, and boron. It is observed that the salt loading for TDS, sodium, and chloride are substantive. The boron level is equal to the level determined earlier in the section on the mass balance (Section 4.2.3) given that Scenario 3b involves use of all the desalinated water in a single approach (with the exception of the small amount of Huntington Beach water). A comparison of mass loadings for the scenarios that involve loading the basin will be presented below.

Table 6-11. Scenario 3b Mass Loading (100% Desal to all injection & recharge)

Parameter or Constituent	Concentration (mg/L) or Flow Rate (mgd)	Mass Loading (TPY)
Total Flow (mgd)	50	50
%Flow=Desal	100	100%
TDS	148	11,250
Sodium	45.4	3,455
Chloride	74.1	5,650
Boron	0.536	41

6.4 Summary of Results for Scenarios 1b, 1c, 2b, 2c, and 3b

This section will discuss results for Scenarios 1b, 1c, 2b, 2c, and 3b. For purposes of discussion, it will be broken down into two sub-sections, scenarios with 100% desalinated water and scenarios with GWRs/desalinated water blends. The tables will include results for all five scenarios and discussed according to the sub-sections.

Concentrations of TDS, Sodium, Boron, and Chloride for All Scenarios

The 100% desalinated water quality presented above is summarized in Table 6-12 for the focus of the scenarios analysis on constituents of potential concern to the basin including TDS, sodium, chloride and boron. The reasons these constituents are of particular interest have been discussed throughout the TM and include but are not limited to impact on salt and boron mass loading in the basin, pipe corrosion, clogging of wells, arsenic release, horticulture, public health, and consumer acceptance. What is presented below is a summary of these constituents in the context of the discussion above.

The concentrations of the constituents of interest are summarized in Table 6-12. In cases where a blend was involved, it is the blend concentration that is presented. All the scenarios involving 100% desalinated water have the same concentrations (Scenarios 1b, 2b, 3b). One observation from Table 6-12, which includes the City of Huntington Beach blend of desalinated ocean water, groundwater, and imported MWD water (see column labeled 1a/2a/3a blend) is that the 100% desalinated water (see columns 1b/2b/3b) has lower TDS, lower sodium, and very similar chloride when compared to the HB blend (boron is higher in the desalinated water).

Table 6-12. Summary of concentrations for constituents of most interest including TDS, Sodium, Chloride, and Boron for all scenarios

Parameter	Scenario					
	1a/2a/3a (HB Blend)	1b (Talbert)	1c (Forebay + Other Injection Blend)	2b (Talbert)	2c (Forebay + Other Injection Blend)	3b (HB + Talbert + Forebay)
Total Flow (mgd)	24.8	15	135	36	114	50
%Desal	12.1%	100%	25.9%	100%	12.3%	100%
TDS (mg/L)	373	148	78.4	148	66.5	148
Sodium (mg/L)	53.3	45.4	18.9	45.4	14.0	45.4
Chloride (mg/L)	72.3	74.1	24.8	74.1	15.7	74.1
Boron (mg/L)	0.123	0.536	0.332	0.536	0.294	0.536

Mass Loading Results for Scenario 1 (Winter Operations)

Mass loadings in pounds per year for TDS, sodium, chloride, and boron are presented in Table 6-13 for Scenario 1 (Winter Operations). The 100% desalination portions of Scenario 1 (Scenario 1b-Talbert, part of GWRS/desal blend for Task 1c), with mass desalinated water mass loadings increasing with flow rate. For example, TDS varies from mass loading of 3,380 TPY at 15 mgd (1b) to 7,900 TPY at 35 mgd (desal portion of 1c). With respect to the desal/GWRS blend at 135 mgd (1c), compared to Talbert at 15 mgd (1b), the blend contributes 5,100 TPY chloride to other recharge basin and injection wells while 1,690 TPY chloride is contributed by Talbert alone with 100% desalinated water. The Scenario 1 total contribution for boron (1b + 1c) is 80 TPY to Talbert Seawater Intrusion basin (12.3 TPY for 1b-Talbert and 68 TPY for 1c-26%/74% desal/GWRS blend).

Table 6-13. Summary of mass loadings for Scenario 1 in tons per year (TPY) for constituents of most interest including TDS, Sodium, Chloride, and Boron (excludes distribution to City of Huntington Beach).

Parameter	Scenario (Mass Loadings in TPY)				SCENARIO 1 (TOTAL)
	1b Talbert (desal)	1c Forebay + Other Injection (desal)	1c Forebay + Other Injection (GWRS)	1c Forebay + Other Injection (blend)	
Total Flow (mgd)	15	35	100	135	150
%Flow=Desal	100%	100%	0%	26%	33%
TDS	3,380	7,900	8,200	16,100	19,500
Sodium	1,035	2,420	1,460	3,880	4,900
Chloride	1,690	3,960	1,140	5,100	6,800
Boron	12.3	28.5	39.6	68	80

Mass Loading Results for Scenario 2 (Summer Operations)

Mass loadings in pounds per year for TDS, sodium, chloride, and boron are presented in Table 6-14 for Scenario 2 (Summer Operations). The 100% desalination portions of Scenario 2 (Scenario 2b-Talbert, part of GWRS/desal blend for Task 2c), with mass desalinated water mass loadings increasing with flow rate. For example, TDS varies from mass loading of 8,100 TPY at 36 mgd (2b) to 3,150 TPY at 14 mgd (desal portion of 2c). With respect to the desal/GWRS blend at 114 mgd (1c), compared to Talbert at 36 mgd (1b), the blend contributes 2,720 TPY chloride to other recharge basin and injection wells while 4,060 TPY is contributed by Talbert alone with 100% desalinated water. The Scenario 2 total contribution for boron (2b + 2c) is 80 TPY to Talbert Seawater Intrusion basin (29.4 TPY for 2b-Talbert and 51 TPY for 2c-26%/74% desal/GWRS blend).

Table 6-14. Summary of mass loadings for Scenario 2 in tons per year (TPY) for constituents of most interest including TDS, Sodium, Chloride, and Boron (excludes distribution to City of Huntington Beach).

Parameter	Scenario (Mass Loadings in TPY)				SCENARIO 2 (TOTAL)
	2b Talbert (desal)	2c Forebay + Other Injection (desal)	2c Forebay + Other Injection (GWRS)	2c Forebay + Other Injection (blend)	
Total Flow (mgd)	36	14	100	114	150
%Flow=Desal	100%	100%	0%	12.3%	33%
TDS	8,100	3,150	8,200	11,350	19,500
Sodium	2,490	970	1,460	2,430	4,900
Chloride	4,060	1,580	1,140	2,720	6,800
Boron	29.4	11	40	51.0	80

It should be observed in Tables 6-13 and 6-13 that while the distribution of mass loadings at the different injection and recharge locations for different constituents varies, the total amount of mass loading is identical for both Scenario 1 and Scenario 2. This is because both scenarios involve injection and/or recharge of 100 mgd of GWRS water and 50 mgd of desalinated water from the Huntington Beach desalter.

Mass Loading Results for Scenario 3 (100% desal at 50 mgd-GWRS shutdown)

Mass loadings in pounds per year for TDS, sodium, chloride, and boron are presented in Table 6-15 for Scenario 3 (100% Desalination for GWRS Emergency Shutdown). For 50 mgd of desalinated water, the mass loading of boron at 41 TPY agrees with the mass balance conducted in Section 4.3.2 The TDS, sodium and chloride mass loadings are 11,300 TPY, 3,450 TPY, and 5,650 TPY, respectively.

Table 6-15. Summary of mass loadings for Scenario 3 in tons per year (TPY) for constituents of most interest including TDS, Sodium, Chloride, and Boron (excludes distribution to City of Huntington Beach).

Parameter (mass loadings in TPY)	Scenario 3b (100% Desal Alone)	SCENARIO 3 (TOTAL)
Total Flow (mgd)	50	50
%Flow=Desal	100%	100%
TDS	11,300	11,300
Sodium	3,450	3,450
Chloride	5,650	5,650
Boron	41	41

The groundwater mass loadings associated with the proposed Huntington Beach desalter can be compared to those associated with the current GWRS project by comparing the Scenario 3 100% Desal results (Table 6-15) with the 100% GWRS results (Tables 6-13 and 6-14). The 50 MGD Huntington Beach desalter would contribute 38% more TDS, 136% more sodium, 396% more chloride, and 3% more boron than the current 100 MGD GWRS project.

7 Review of possible changes in Attachment A

Table 7-1 is the summary of a proposed revision of Attachment A. The parameters in the revised table are broken into four categories with respect to water quality and two categories with respect to operations. Where water quality is concerned, the four categories are 1) mineral quality, 2) disinfection, 3) physical properties and 4) control of corrosion and aquifer interface. Where operations are concerned the two categories are: 1) quality parameters where the target and maximum values will be set in the Term Sheet and 2) quality parameters which shall be adjustable at OCWD's discretion, from time to time, during the course of the project's operation. For the latter, a range within which OCWD may select is specified in the term sheet in order to facilitate design. The adjustable quality parameters all address the operation of the desalination plant's post treatment system, recognizing that there is uncertainty in the information available today for making some of these operational choices. The following is a brief discussion of differences in requirements between the Table 7-1 and Attachment A as presented in October.

7.1 Table Format

The format of the table has been revised to display only the basic requirements necessary for negotiation of the Term Sheet. Parameters of interest are noted, along with their frequency of measurement and compliance period. Two types of targets are described: 1) targets, which will be determined in the negotiations and 2) target ranges for areas of water quality where it is recommended that OCWD retain the right to designate a water quality target being sought, changing it from time to time as the District deems appropriate. Parameters in this target range are all selected so that they can be manipulated by Poseidon in the post treatment process. For all parameters the point of compliance is a mutually agreed upon point of delivery and all measurement methods are to be selected by mutual agreement between the two parties. Discussion of specific parameters follows.

Table 7-1 Proposed, Revised Attachment A for the Term Sheet

Parameter	units	Sampling ¹		To be set in the Term Sheet		To be selected by OCWD ⁴	
		Compliance period	Measurement frequency	Target concentration ²	Maximum concentration ³	Target Range ⁴	Required Precision ⁴
Minerals							
Sodium	mg/L	one year	bi-weekly ⁵	60	80	-	-
Chloride	mg/L	one year	bi-weekly ⁵	75	100	-	-
Bromide	mg/L	one year	bi-weekly ⁵	0.25*	0.4*	-	-
Boron	mg/L	one year	bi-weekly ⁵	0.5*	1.0	-	-
TDS	mg/L	one year	bi-weekly ⁵	350	500	-	-
Disinfection							
SDS-THM	µg/L	one year	monthly	≤ 64	72	-	-
SDS-HAA5	µg/L	one year	monthly	≤ 36	56	-	-
SDS-NDMA	µg/L	one year	monthly	≤ 8	9	-	-
Total chlorine residual	mg/L	daily	continuous ⁶	-	-	1.0 to 4.0	±10%
Cl ₂ /NH ₃ -N ratio	-	daily	daily ⁷	-	-	3.0 to 5.0	±0.3
Physical properties							
Temperature	°F	one year	continuous ⁶	65	75	-	-
Turbidity	ntu	daily	continuous ⁶	0.5	1.0	-	-
SDI	-	one year	daily ⁷	1.0*	2.0*	-	-
Control of Corrosion and Aquifer Interface							
Calcium	mg/L as CaCO ₃	one year	bi-weekly ⁵	60*	-	40 to 120	±10%
Magnesium	mg/L	one year	bi-weekly ⁵	-	-	tbd	±10%
pH		daily	continuous ⁶	8.4*	-	7.5 to 8.7	±10%
LSI		monthly	daily ⁷	0.15*	-	(-0.2) to (+0.2)	±10%
Orthophosphate	mg/L as P	weekly	daily ⁷	-	-	0 to 4.0	±10%
Alkalinity	mg/L as CaCO ₃	monthly	daily ⁷	60*	-	40 to 120	±10%
CCPP	mg/L as CaCO ₃	monthly	daily ⁷	0.8*	-	(-5) to (+15)	±10%

* - This Parameter is proposed as a placeholder as further study may be required

1 - All samples to be taken at mutually agreed upon delivery point and analyzed using mutually agreed Standard Methods (EPA, ASTM or SM On Line)

2 - Average over compliance period must less than or equal to this value

3 - No measurement may exceed this value

4 - The desalination plant is to be designed so that it is capable of meeting any concentration in the Target Range. OCWD shall, from time to time, select a concentration in the Target Range and Poseidon shall be responsible for meeting the target with the Required Precision

5 - every other week.

6- Continuously monitored by instrument with values stored in SCADA every 15 minutes

7 - Measured daily or calculated daily, using most up-to-date information available

7.2 Bromide ion

A target of 0.25 mg/L has been tentatively proposed for bromide ion. This target is proposed in order to facilitate more effective management of chloramine residuals according to the discussion in section 4.1.6.2 on residual stability. As illustrated in Figure 4.6, reducing bromide ion to 0.25 mg/L or below limits short-term effects on residual stability to less than 15%. The necessity for this requirement is closely linked to the use of chloramines. As shown in Table 3.3, the proposed requirements lower than the limit of 0.4 mg/L in the Carlsbad water quality specification, but more liberal than the bromide requirements in the Australian desalination projects. Chloramines are important in all these projects. The residual stability problem is addressed in the Carlsbad project by chloraminating after corrosion control treatment and then allowing the residual to be stabilized before it is introduced into the rest of the San Diego Water Authority's system. This approach is discouraged because it has not been demonstrated that a high chlorine to ammonia ratio can be maintained under these conditions and this could lead to increased nitrification, already a common problem in water systems in Orange County, which use chloramines.

There is some uncertainty about the need to accommodate the management of chloramine residuals in the project. In early meetings with OCWD and Huntington Beach, both utilities indicated an intention to continue using a free chlorine residual. However, should distribution be extended to utilities using a chloramine residual, additional accommodation would be required. For this reason, the bromide targets in Table 7-1 are marked with an asterisk, indicating that they are proposed as a “placeholder as further study may be required”. Based on the modeling work done in this report, a plant designed to meet the chloride and boron requirements in the October version of Attachment A (75 and 0.75 mg/L, respectively) would produce water with bromide level of approximately 0.25 mg/L (Table 3-15, Combined RO product water), so this requirement should not place additional stress on the design. It will, however, join the chloride requirement of 75 mg/L as one of the principal constraints on the design.

7.3 Boron

A target of between 0.4 and 0.5 mg/L has been proposed for boron. The level of 0.5 mg/L is included in Figure 7-1 as a placeholder in the draft, revised Attachment A until the issue can be evaluated further for the reasons discussed below. This requirement is proposed in an attempt to reduce the amount of boron imported into the Orange County Aquifer and possible impacts on horticulture (Section 4.1.8). A review of the requirements imposed on other projects (Table 3.3) shows that, while a requirement of 0.5 mg/L for boron is not unusual, there are several projects that have a goal of 1 mg/L. Carlsbad has a limit of average boron of 0.75 mg/L and a maximum of 1 mg/L. The differences in these requirements are, in part, a reflection of changes in our understanding of the health effects of boron during the last decade. The Huntington Beach project is somewhat unique in that most of the water will be used to recharge a groundwater basin, thus there is a need to review the mass balance of boron in the basin and the prospects for long term changes. This report contains the very preliminary aspects of a mass balance for boron and it would appear that the project as originally proposed (boron of 0.75 mg/L) would substantially increase the importation of boron into the basin. Importantly the GWRS project, which is the largest salt exporter out of the basin is relatively ineffective in rejecting boron. It is recommended that OCWD pursue resolution of the issue in three parallel paths: 1) propose a stricter boron standard on the desalter, 2) conduct a study on the impacts of boron and chloride changes on horticulture in the area and 3) conduct a study on long-term projections on of boron levels in the aquifer given increased boron imports.

Modeling work conducted as part of this study suggests that complying with a boron level of between 0.4 and 0.5 mg/L may have a substantial impact on the design of the desalter. A design striving to meet the requirements of the October version of Attachment A is estimated to produce boron levels between 0.5 to 0.6 mg/L.

7.4 Disinfection

The revised attachment includes the same requirements for disinfection byproducts but provisions are also made in the contract for Poseidon to provide the capability to deliver a chlorine residual between 1.0 and 4.0 mg/L and also to deliver chloraminated water should that be desirable. As written the document envisions that OCWD may desire to change either the form of residual or its concentration from time to time in the future.

7.5 Temperature

As proposed by Poseidon, Attachment A allows for a maximum average monthly temperature of 85°F and, according to the data collected at the Newport Beach Pier, this would allow maximum days as high as 87°F. Thus this requirement is designed to permit operation of the SWRO on the condenser side of the power plant, which allows for more efficient operation of the desalter. On the other hand the use of warm water raises consumer acceptance issues that must be resolved and it also results in some increased costs in the operation of the desalter. None of these considerations necessarily make the project unacceptable, but they do require resolution and they make the negotiations between the parties more complex and it appears that the power plant won't be operating its cooling system much longer, as a result it's not clear that the economic gains to be achieved by warmer operation are sufficient to justify the additional complexity. Thus, lower limits are included in the proposed criteria, designed to be consistent with ambient seawater temperatures.

7.6 *Silting Density Index*

The revised attachment includes an additional requirement for the Silting Density Index (SDI). OCWD has long maintained a focus on doing everything it can to minimize clogging of both in its spreading basins and injection well operations. Historically clogging has also been an issue in other Southern California seawater injection barriers as well. Evidence suggests that turbidity is not an adequate index for this purpose. In recent years, OCWD has maintained an SDI for GWRS between 3 and 4. With recent investments OCWD has brought SDI levels to between 1 and 2. The proposal is that Poseidon be asked to provide water with an SDI comparable to that which OCWD has been able to maintain, averaging 2.0 or less and not exceeding 3.0.

7.7 *Corrosion Control*

The revised attachment includes several additional provisions designed to manage corrosion control. First, although management of calcium carbonate saturation had been successful in desalination projects to date, the addition of orthophosphate is the gold standard for control of both lead and copper corrosion, but also for corrosion of iron. For this reason the specification has been written to require that provisions be made to make the addition of this chemical possible should it become necessary. The remaining requirements all pertain to requiring facilities that will enable Poseidon to provide a water designed to meet the level of alkalinity and hardness and the degree of calcium carbonate saturation that OCWD deems necessary for the optimum protection of its distribution system. Each provision, pH, calcium hardness, alkalinity, Langelier Saturation Index (LSI) and calcium carbonate precipitation potential (CCPP) is set up with the idea that a flexible system should be provided, such as is currently available at the GWRS that can “dial in” the specific goals which OCWD seeks to attain. Once again, a system with excellent control will be necessary because the District will be balancing the need for saturation with calcium carbonate in its distribution system over against the need to avoid excessive calcium saturation, which might cause cementation in its aquifer injection systems. Although the Attachment envisions a system capable of operating over a wide range (LSI -0.2 to LSI +0.2) a wide range of pHs (7.5 to 8.7), it seems likely that operations will be much closer a neutral LSI. A much wider range of calcium and alkalinity are also provided ranging from the low levels found in some mountain supplies to levels approaching those in local groundwaters. These will allow for a positive LSI at lower temperatures as well as higher levels of calcium to aid in the control of arsenic adsorption in the aquifer. As shown in Figure 4-20, the more alkalinity that is added in the post treatment system the lower the pH that can be maintained while still providing the protection of calcium carbonate saturation. Higher alkalinities are also thought to be beneficial in protecting mortar linings because a high alkalinity can react quickly to precipitate calcium hydroxide as it seeks to leach out of the cement matrix, forming a CaCO₃ “plug” in any pores where calcium hydroxide may leach out of the cement paste. Placeholders have been proposed for consideration as the project begins.

7.8 *Aquifer Interface, Arsenic release*

The discussion in section 4.2.2 shows the results of work conducted at Stanford University and these results illustrate that both calcium and magnesium reduce the release of arsenic from aquifer sediments to groundwater. Figure 4-19 shows an experiment where a combination of calcium and magnesium (total hardness of 168 mg/L) was slightly more effective in suppressing arsenic release than was a much higher level of calcium alone (total hardness 500 mg/L). Recognizing the need to suppress arsenic release near new injection wells, a higher level of calcium and alkalinity could be proposed than that shown in Table 7-1. At present the table leaves room for include discussions about provisions for magnesium addition (TBD). That having been said, from the standpoint of technology, adding more calcium is much more straight-forward than adding both calcium and magnesium. Chemical feed systems for adding calcium are much more established. Magnesium oxide does not have the same properties as does lime. Moreover almost all magnesium salts are hygroscopic (they absorb water from the air), hence they are difficult to handle and feed. Dolomitic limestone is available that includes both CaCO_3 and MgCO_3 , and it has been used in Germany but its dissolution properties are not well understood either. It seems like the MgCO_3 , which has higher solubility, can preferentially dissolve, increasing the supersaturation of calcium carbonate and resulting in post precipitation. It is expected significant study will be required before it is clear whether the insight from the Stanford study can be translated into a practical outcome.

References

- Arthur, J., Dabous, A., and Cowan, J. 2002, Mobilization of Arsenic and other trace elements during aquifer storage and recovery Southwest Florida, from Aiken, G. and Kuniandy, E., Ed. U.S. Geological Survey Artificial Recharge proceedings, Sacramento, CA, April, 2-4, 2002.
- Alhadidi, A., Kempman, A., Blankert, B., Schippers, J., Wessling, M., van der Meer, W., 2011, Silt Density Index and Modified Fouling Index relation, and effect of pressure, temperature and membrane resistance, *Desalination*, V273, pp48-56.
- ARCADIS, 2012, Assessment of Existing Seawater Desalination Integration Practices, Prepared for Metropolitan Water District of Southern California, March.
- ASR Systems, 2007, Evaluation of Arsenic Mobilization Processes Occurring During Aquifer Storage Recovery Activities, (H-046), prepared for Southwest Florida water Management District.
- ASTM (2002) ASTM D4189-95 Standard Test Method for Silt Density Index (SDI) of Water, ASTM
- Boerlage, S., Kennedy, M., Aniye, M., Abogrean, E., Tarawneh, Z., and Schippers, J., 2003, The MFI-UF as a water quality test and monitor, *J Membrane Science*, V211, pp271-289
- Caron, D., Garneau, M., Seubet, E., Howard, M., Darjany, L., Schntze, A., Cetinic, I., Filteau, J., Lauri, P., Jones, B., and Trussell, S., 2010, Harmful algae and their potential impacts on desalination operations off southern California, *Water Research*, V44, PP385-416.
- Carollo, 2008, Recycled Water Quality Standards Study: Final Report, prepared for the West Basin Municipal Water District, Carson, CA

- CAW, 2013, Request for proposals for the California American Water Monterey Peninsula Water Supply Project Desalination Infrastructure, California American Water, Monterey Peninsula Division, 511 Forest Lodge Rd, Suite 100 Pacific Grove, CA
- CDM, 2010, Seawater Reverse Osmosis Desalination Pilot Test Program Report, Santa Cruz Water Department & Soquel Creek Water district.
- CH2M HILL, 1998, Well Redevelopment Study – Los Angeles Coastal Basin Injection Barriers Report. Prepared for Los Angeles County Department of Public Works. Dated June 9, 1998.
- CH2M HILL, 2003. Well Redevelopment Study Phase II – Periodic Redevelopment Demonstration Project. Prepared for Los Angeles County Department of Public Works. Dated July 2003.
- Crossley E., and Waters, F., 1969, Corrosion Effects of Desalted Water, *JAWWA* V62(3) 188-194.
- Dietrich, A., and Gallagher, C., 2013, Consumer ability to detect taste of total dissolved solids, *JAWWA*, pE255-263.
- Dodson, R. and Mulford, S., 1965, Use of Distilled Seawater at San Diego, *JAWWA*, V57(9) p 1106-1110.
- Fakhreddine, S., Dittmar, J., Phipps, D., Dadakis, J., and Fendorf, S., 2015, Geochemical triggers of arsenic mobilization during managed aquifer recharge, *Environmental Science and Technology*, V49(13) pp7802-7809.
- Erdal, U., Lozier, J., and Suydan, T., 2013, A bench-scale study evaluating the impact of introducing desalinated water into the San Diego County Water Authority's system so it would not adversely impact water quality, *Proceedings AE 13*, Denver, CO.
- Gasia Bruch, E.; Coker, S; Keinan, B; Salgado, B. 2015, Key Aspects of the Membrane Technology Implemented in the Carlsbad Desalination Project. *Proceedings of the IDA World Congress on Desalination and Water Reuse*, San Diego, CA.
- Hennessy, P., Williams, L, and Lin, Y., 1966, Tertiary Treatment of Trickling Filter Effluent at Orange County, CA., *J Water Pollution Control Federation*, V39(11): p1819-1833.
- Hokanson, D., Trussell, R., Tiwari, S., Ownes, E., Chui, J., Wang, JK., Scott, Z., and Trussell S., 2009, Stormwater and Marine Biotoxin Monitoring – Final Report, Prepared for West Basin MWD.
- Kenny, J., Hokanson, D., and Trussell, R., 2015, Technical Note: Calculation of the Langelier Index at High pH, *JAWWA*, v82(3), pp S1-S3.
- Kirmeyer, G., Sandvig, ., Pierson, G., 1994, Development of a Pipe Loop Protocol for Lead Control [Project #604], Water Research Foundation, Denver, CO.
- LACDPW, 2009, Letter from R. Kubomoto of LACDPW to M. Adams of LADWP, entitled, "Dominguez Gap Barrier Project: Revised Recycled Water Quality Requirements", January 7, 2009.
- Liu, H., Korshin, G., and Ferguson, J., 2009, A Report to Santa Cruz Water Department of a Laboratory-based Corrosion Evaluation For the SCWD² SWRO Plant, Dept. of Civil and Environmental Engineering, Univ. Washington, Seattle, WA.
- Loveland, J., Means, E, Amy, G., Reiss, C. 2010 Seawater desalination Implications for Drinking Water Quality, (WRF 4841) Water Research Foundation, Denver, CO.
- Matheny, Nelda. Evaluation of Proposed Irrigation Water Quality on Carlsbad Landscapes Poseidon Resources/Carlsbad Desalination Project. HortScience, Inc., December 2005.

- McGuire Env. 2004, disinfection Byproduct Formation in a Simulated Distribution System: Blending Desalinated Seawater From the Poseidon Resources Corporation Pilot Facility with Local Drinking Water Sources: Final Report, Report to Poseidon Resources, March 2004, Appendix S EIR
- McGuire, M., Reich, K., Blute, N., and West, N. 2006, Poseidon Resources Corporation Corrosion Study, McGuire/Pirnie, Santa Monica, CA.
- McGuire, M., Loveland, J., Means, E., and Garvey, J., 2007, Use of flavor profile and consumer test panels to determine differences between local water supplies and desalinated water. *Water Science and Technology*, V55(5) pp275-278.
- McGuire Environmental Consultants (MEC), 2004, Aesthetic Considerations for Delivery of Desalinated Seawater to Customers of the San Diego County Water Authority, a slide deck prepared for the PBS&J on behalf of the SDCWA.
- Mehta, P. and Monteiro, P., (1996). *Concrete: Microstructure, Properties, and Materials*, McGraw-Hill, N.Y., N.Y.
- Millero, F., 2013, *Chemical Oceanography*, 4th Edition, CRC Press, Boca Raton, FL.
- Mirecki, J., Bennett, M., and López-Baldáez, M., 2013, Arsenic Control during aquifer storage and recovery cycle tests in the Floridian Aquifer, *Ground Water*, V51(4) pp539-5349.
- Mony, P., Tokar, T., Peng, P., Fiegel, A., Meullenet, J-F., and Seo, H-S., 2013, Temperature of served water can modulate sensory perception and acceptance of food, *Food quality and Preference*, V28(2) p449-455.
- Nable, R. O., G. S. Banuelos, et al. (1997). "Boron toxicity." *Plant and Soil* **193**(1-2): 181-198.
- OCWD, 2008, GWRS, Groundwater Replenishment System 2008 Annual Report
- OCWD, 2009, GWRS, Groundwater Replenishment System 2009 Annual Report
- OCWD, 2010, GWRS, Groundwater Replenishment System 2010 Annual Report
- OCWD, 2011, GWRS, Groundwater Replenishment System 2011 Annual Report
- OCWD, 2012, GWRS, Groundwater Replenishment System 2012 Annual Report
- OCWD, 2013, GWRS, Groundwater Replenishment System 2013 Annual Report
- OCWD, 2014, GWRS, Groundwater Replenishment System 2014 Annual Report
- Pickard, J., Blute, N., Wu, X., Chau, K., and Grijalva, West Basin's Water Quality Integration Study, 2014, AWWA-AMTA Membrane Conference, Orlando, FL
- Poseidon/SDCWA, Water Purchase Agreement, Table 5 from Appendix 5, Specifications from Appendix 5 of the Carlsbad Project Water Purchase Agreement
- Reich, K, 2004, Report of Additional SDS Disinfection byproduct Testing, McGuire Env. Memo to Poseidon resources , Appendix S EIR
- Ryder, R., and Reynolds, T., 2006, Corrosivity Testing of Desalinated water and comparison to Water supplies of Marin Municipal MWD, Tech Memo No. 14, Kennedy Jenks Consultants, San Francisco, CA. (K/J 0468029)
- Tiwari, S., and Trussell R., 2013, Inhouse Trussell Tech study on the influence of bromide on residual stability, unpublished
- Schippers, C. and Verdouw, J., 1980, The Modified Fouling Index, a method of determining the fouling characteristics of water, *Desalination* 32, pp137-148.
- Snoeyink, V. and Wagner, I., 1996, *Internal Corrosion of Water Systems*, 2nd Edition, WRF #725, American Water Works research Foundation, Denver, CO. and DVGW-Technologiezentrum Wasser, Karlsruhe, DE.
- Sekeroglu, S., 2011, Introducing desalinated Seawater into an Existing Distribution System: a Corrosion Study, Proceedings of AMTA, Miami Beach FL.

- Seubert, E., Trussell, S., Eagleton, J., Schnetzer, A., Cetinix, I., Lauri, P., Jones, B., and Caron, D., 2012, Algal toxins and reverse osmosis desalination operations: Laboratory bench testing and field monitoring of domoic acid, saxitoxin, brevetoxin and okadaic acid, water research V46, pp6563-6573.
- Taylor, J., Dietz, J., Randall, A., Hong, S., Norris, C., Mulford, L., Arevaldo, J., Imran, S., Puii, M., Mutoti, I., Tang, J., Xaio, W., Cullen, C., Neaviside, R., Mehta, A., Patel, M., Vasquez, F., and Webb, D., 2005, Effects of Blending on Distribution System Water Quality, (WRF 2702) Awwa Research Foundation, Denver, CO.
- Trussell, R., and Umphres, M., 1978, The formation of trihalomethanes, JAWWA V70(11) pp604-612.
- Trussell, R., 2015, Corrosion of cement-based structures in water, in preparation.
- USEPA, 2008a, Health effects Support Document for Boron, USEPA Washington, D.C.
- USEPA, 2008b, Drinking Water Health advisory for Boron, USEPA Washington D.C.
- USEPA, 2008c, Regulatory Determinations Support Document for Selected Contaminants from the Second Drinking Water Contaminant Candidate List (CCL 2): Part II: CCL 2 Contaminants Undergoing Regulatory Determination, USEPA Washington D.C.
- Weir RJ, Fisher RS (1972) Toxicologic studies on borax and boric acid. Toxicology and applied pharmacology, 23:351-364.
- Whelton, J., 2001, Temperature effects on drinking water odor perception, MS Thesis in Environmental Engineering, VPA, Blacksburg, VA.
- WHO, 1998, Guidelines for Drinking-water Quality, 2nd Edition, World Health Organization, Geneva, Switzerland.
- WHO, 2003, Guidelines for Drinking-water Quality, 3rd Edition, World Health Organization, Geneva, Switzerland.
- WHO 2009, Boron in drinking-water: Background document for development of WHO Guidelines for Drinking-water Quality, World Health Organization, Geneva, Switzerland.
- WHO 2011, Guidelines for Drinking-water Quality, 4th Edition, World Health Organization, Geneva, Switzerland.
- Zhang, Y., Tseng, T., Andrews-tate, C., Cheng, R., nd Wattier, K., 2012, Pilot-Scale Evaluation of Blending Desalinated Seawater into a Distribution System, *JAWWA*, V104(7):43-44.

Appendix 1 Water Quality Specifications

Attachment A to the Water Reliability Agreement Term sheet

Water Reliability Agreement Term Sheet
Attachment A

Quality Parameter	Analytical Method ⁽¹⁾	Sampling		Units	Mean ⁽³⁾	Maximum ⁽⁴⁾
		Sampling Period ⁽²⁾	Sample Frequency			
Total Dissolved Solids	2540C	One year	Weekly Grab	mg/L	350	500
Chloride	4110B	One year	Weekly Grab	mg/L	75	100
Boron	3120B	One year	Weekly Grab	mg/L	0.75	1.0
Turbidity	2130B	Daily	Continuous ⁽⁵⁾	NTU	0.5	1.0
DBP – THM ⁽⁶⁾	5710C	One Year	Weekly Grab	µg/L	80% of maximum contaminant level ("MCL")	90% of MCL
DBP – HAA ⁽⁶⁾	5710D	One Year	Weekly Grab	µg/L	80% of MCL	90% of MCL
DBP – NDMA ⁽⁶⁾	521	One Year	Weekly Grab	µg/L	80% of NL	Notification Level (0.010 µg/L)
Temperature	2550	One Year	Daily Grab	°F	74	85
pH	4500	Daily	Continuous ⁽⁵⁾	pH units	7.0-8.0	>6.5,<8.5
Sodium	200.7	One Year	Weekly Grab	mg/L	60	80
Calcium	200.7	One Year	Weekly Grab	mg/L	20	<20
Magnesium	200.7	One Year	Weekly Grab	mg/L	TBD	TBD
Sodium Adsorption Ratio	Footnote (7) below	One Year	Monthly	none	5	6

1. All methods taken from Standard Methods On-Line, published by APHA, AWWA, and WEF or current EPA methods.
2. Sample period - concentration limits are calculated for this period.
3. Mean – not to exceed (or go below for certain of the Quality Parameter) the average over the Sampling Period.

**Water Reliability Agreement Term Sheet
Attachment A**

4. Maximum Concentration Limit - cannot be exceeded at any time with the exception of Temperature which cannot exceed the Maximum over a 30 day average.
5. Continuous analysis - values at 15 minute intervals used in all calculations.
6. Disinfection By-Product (DBP) Formation tests will be used to determine compliance with THM and HAA requirements for the samples collected at the compliance point.

Product Water is to be collected for the DBP tests and held with no modifications in a water bath. The following describes the test conditions:

- (a) pH: No adjustment to collected sample.
- (b) Temperature: Same as Product Water at time of collection $\pm 3^{\circ}\text{C}$.
- (c) Total Cl_2 residual at test end: No adjustment to collected sample.
- (d) Sample to be quenched and analyzed at the end of this period.
- (e)

7. The formula for calculating sodium adsorption ratio is:

$$\text{S.A.R.} = \frac{\text{Na}^+}{\sqrt{\frac{1}{2}(\text{Ca}^{2+} + \text{Mg}^{2+})}}$$

where sodium, calcium, and magnesium are in milliequivalents/liter.

SUPPLEMENTARY MATERIAL

Review of Proposed Water Quality Requirements for the Huntington Beach Desalter

SUPPLEMENT 1

ARCADIS, 2012, *Assessment of Existing Seawater Desalination Integration Practices*, Prepared for Metropolitan Water District of Southern California, March.

SUPPLEMENT 2

Table 5-5 from Appendix 5 of the Poseidon/SDCWA water purchase agreement, as well as the specifications from Appendix 5 of the Carlsbad project water purchase agreement

SUPPLEMENT 3

Appendix 2- Attachment 3 from the Monterey RFP by California American Water

SUPPLEMENT 1

**ARCADIS, 2012, *Assessment of Existing Seawater Desalination
Integration Practices*, Prepared for Metropolitan Water
District of Southern California, March.**



*THE METROPOLITAN WATER DISTRICT
OF SOUTHERN CALIFORNIA*

Assessment of Existing Seawater Desalination Integration Practices

**Final Report
March 2012**



Report No. 1404



Metropolitan Water District of Southern California

700 North Alameda Street • Los Angeles, California 90012

Assessment of Existing Seawater Desalination Integration Practices

Final Report
March 2012

Report No. 1404
Project No. 01500056.0000



The Water Division of ARCADIS



Solutions & Technologies



Report Prepared By:

Malcolm Pirnie
The Water Division of ARCADIS

1525 Faraday Avenue, Suite 290
Carlsbad, California 92008
(760) 602-3800

This page intentionally left blank

Table of Contents

1.0 Introduction	1-1
1.1 Background	1-1
1.2 Purpose and Goals	1-1
1.3 Desalination Plant Selection	1-2
1.4 Survey Overview	1-4
1.4.1 Methodology	1-4
1.4.2 Limitations	1-4
2.0 Survey Results	2-1
Tampa Summary	2-2
Gold Coast Summary	2-4
Melbourne Summary	2-6
Perth 1 Summary	2-8
Sydney Summary	2-10
Ashkelon Summary	2-12
Fujairah 2 Summary	2-14
Sur Summary	2-16
Tuas 1 Summary	2-18
Valdelentisco Summary	2-20
3.0 Summary and Analysis	3-1
3.1 Summary of Key Survey Results	3-1
3.1.1 Boron	3-1
3.1.2 Bromide	3-2
3.1.3 Corrosion	3-3
3.1.4 Advance Planning Studies	3-3
3.1.5 Blending	3-3
3.1.6 Intertie Location	3-4
3.1.7 Operations	3-4
3.2 Lessons Learned	3-5
3.3 Considerations for Metropolitan	3-5
4.0 Bibliography	4-1

Tables

Table 1-1	Overview of Seawater Desalination Plants Surveyed.....	1-3
Table 3-1	Summary of Considerations for Metropolitan	3-6

Figures

Figure 1-1	Global Map of Surveyer Seawater Desalination Facilities	1-2
------------	---	-----

Appendices

A	Survey Instrument	
B	Survey Responses	
C	Presentation to the Board Special Commission on Desalination and Recycling, July 26, 2011	



1.0 Introduction

1.1 Background

The Metropolitan Water District of Southern California (Metropolitan) is a regional water wholesaler delivering imported supplies to over 19 million people in Southern California. Depending on hydrology, Metropolitan provides between 40 to 60 percent of the region's supplies. Metropolitan's long-term Integrated Water Resources Management Plan (IRP) promotes a diversified water resource portfolio to improve overall regional supply reliability. The IRP balances imported supplies with local resource options, including conservation, wastewater recycling, groundwater recovery, and seawater desalination. The role of seawater desalination in the IRP includes helping to meet future local supply goals and contributing to the region's buffer supply for mitigating against uncertainty. Adaptive management is a key principle in the IRP, which also includes regional Foundation Actions for seawater desalination that will position Metropolitan and the member agencies to accelerate future implementation, if needed. This assessment of international integration practices represents such a Foundational Action for seawater desalination.

A number of Metropolitan's member agencies, along with one private company, are currently in various stages of developing seawater desalination projects within Metropolitan's service area. Several of these project developers have proposed integrating or blending desalinated seawater with imported water in Metropolitan's regional system as a means of distribution. In addition, Metropolitan could develop its own seawater desalination capacity in the future. In order to understand the potential issues and challenges associated with blending new sources into an existing distribution system, including both water quality (e.g., corrosion, disinfectant residual decay, disinfection by-product formation, aesthetics [color, taste, and odor], etc.) and operational (e.g., storage, flexibility, hydraulics, etc.) concerns, Metropolitan retained Malcolm Pirnie, the Water Division of ARCADIS (Malcolm Pirnie), along with its partners Veolia and SKM, to survey international seawater desalination integration practices and develop a list of applicable literature.

1.2 Purpose and Goals

The purpose of this project is to evaluate the means by which water utilities have integrated large-scale seawater desalination plants into their existing distribution systems. The study consists of two major components: 1) a survey of major seawater desalination projects around the globe to assess integration issues and strategies associated with water quality and plant/distribution system operations; and 2) a bibliography of select references with information related to seawater desalination integration practices. The information compiled in this study will help Metropolitan understand the applicable considerations associated with integrating desalinated seawater into existing systems. As a Foundational Action, the report will serve as a resource for Metropolitan and its member agencies, helping to guide future investigations of integration issues.

1.3 Desalination Plant Selection

The ten surveyed seawater desalination plants represent a broad diversity of facilities in several focus areas, including geography, on-line date, blend percentage, integration method, and intake mechanism. The plants also varied widely in production, although all ten are considered facilities of comparable capacity to proposed seawater desalination plants within the Metropolitan service area. Similarly, the range of intake mechanisms among the surveyed plants – co-located open intake, dedicated open intake, and beach wells – likewise represents a variety of options under consideration among the proposed facilities in Metropolitan’s service area. Notably, the intake method can influence the treatment processes utilized at a seawater desalination facility, particularly with respect to pretreatment and filtration, which is considered important background information regarding the surveyed facilities. Also, the span of on-line dates for the ten facilities extends over a decade, ranging from 2003 (Tampa) to the anticipated start-up of the Melbourne plant in 2012.

All ten of the plants utilize reverse osmosis (RO) technology, which has been proposed by each of the potential seawater desalination project proponents in Metropolitan’s service area. A map indicating the locations of the ten plants surveyed – spanning four continents – is shown in Figure 1-1. An overview of the plants is provided in Table 1-1, indicating the percent of the utility’s total water supply portfolio comprised of desalinated seawater at the time of the survey, including production from other seawater desalination plants in the service area.

Figure 1-1:
Global Map of Surveyed Seawater Desalination Facilities

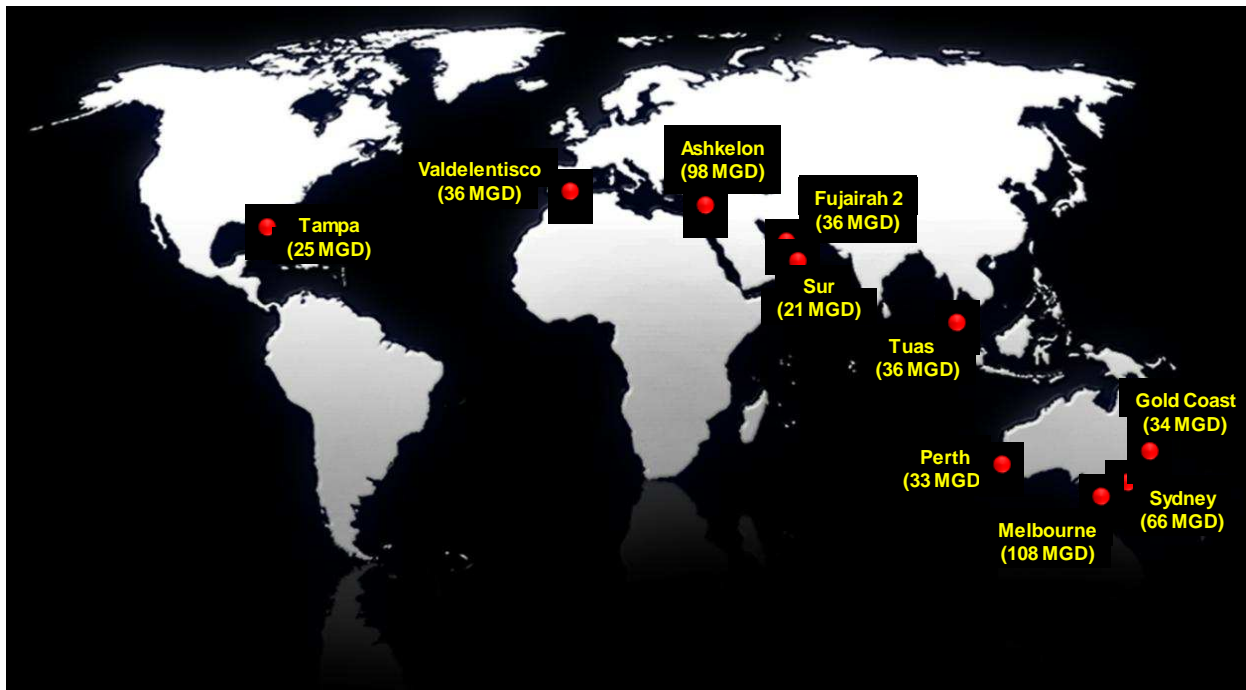

Section 1
Introduction

**Table 1-1:
Overview of Seawater Desalination Plants Surveyed**

Plant Identifier / Location	Country	Capacity (MGD) ¹	On-Line Date	Intake	Contribution of Desalinated Seawater to Supply Portfolio
Tampa	USA	25	2003	Co-located Open Intake	≤ 10%
Gold Coast	Australia	33	2009	Dedicated Open Intake	variable
Melbourne	Australia	108	2012 ²	Dedicated Open Intake	33%
Perth 1	Australia	33	2006	Dedicated Open Intake	15-20%
Sydney	Australia	66	2010	Dedicated Open Intake	15%
Ashkelon	Israel	98	2005	Dedicated Open Intake	15%
Fujairah 2	UAE	36	2010	Co-located Open Intake	95%
Sur	Oman	21	2009	Beach Wells	100%
Tuas 1	Singapore	36	2005	Dedicated Open Intake	10%
Valdelentisco	Spain	36	2007	Dedicated Open Intake	35-45%

1 Current capacity – does not include planned phases

2 Anticipated

1.4 Survey Overview

1.4.1 Methodology

The survey of existing seawater desalination integration practices was developed jointly by Metropolitan and Malcolm Pirnie staff, with questions addressing project background, distribution and treatment plant information, integration methods and strategy, integration issues, water quality considerations, and lessons learned. A copy of the survey instrument is provided in Appendix A for reference. Surveys were administered by Malcolm Pirnie, Veolia, and SKM team members contacting individuals with direct knowledge of the targeted seawater desalination plants, including utility / project proponent staff, contractor project managers and designers, and facility contract operators. If these individuals were not available to address all of the survey questions, supplemental information was compiled from publicly available resources. In these cases, survey responses were vetted by individuals with direct project knowledge prior to submission to Metropolitan. Information was collected via a combination of conducting oral interviews and sending the survey instrument to respondents for their independent completion. For each survey, upon review, Metropolitan staff prepared follow-up questions for respondents. These responses were subsequently captured in the final survey results.

1.4.2 Limitations

Due to the potentially sensitive nature of some of the information requested, there were limitations in collecting complete survey results for some of the targeted facilities. First, the potential points of contact in the best position to respond to the survey may not have had the time to address some or all of the numerous questions. In some cases certain information requested was considered to be proprietary, particularly among agencies or private operators that may leverage strategic knowledge and/or intellectual property for business purposes. It may also be possible that some respondents did not fully disclose seawater desalination integration issues encountered and/or lessons learned due to potential local political concerns. Project time constraints were also a limiting factor in completing some of the surveys.

2.0 Survey Results

A table summarizing some of the key survey results is provided as follows for each of the seawater desalination plants examined. The fields included in the tables represent the information most useful for a broad understanding of each plant and its integration practices, as well as for ease of comparison among the different facilities. Comprehensive survey results for each plant with more detailed information are provided in Appendix B.

Section 2
Survey Results

Tampa (USA)	
Category	Result(s)
General	
Capacity	25 MGD
On-Line Date	2003
Reason(s) Selected	<ul style="list-style-type: none"> • Only major US seawater desalination plant in operation • Tampa Bay Water is a regional wholesaler and blends desalinated seawater with other supplies • US regulatory climate
Treatment Processes	
Intake	Co-located open intake
Pretreatment	<ul style="list-style-type: none"> • Traveling screens • Coagulation (ferric chloride @ 4 - 8 mg/L; no polymer) • Flocculation • Sedimentation
Filtration	<ul style="list-style-type: none"> • Sand filters • Diatomaceous earth filters
RO Configuration	Partial 2 nd pass for blending to meet water quality goals
Post-Treatment	<ul style="list-style-type: none"> • Lime saturator (side stream) • CO₂ addition (full flow) • pH adjustment (full flow, as-needed)
Primary Disinfection	Free chlorine @ 4.0 mg/L
Secondary Disinfection	Chloramines @ 4.0 - 4.2 mg/L
Water Quality Management	
Water Quality Goals	
<i>Chloride</i>	100 mg/L
<i>Bromide</i>	0.45 mg/L (recommends 0.2 - 0.25 mg/L)
<i>Boron</i>	None
<i>Sodium</i>	160 mg/L
<i>Total Dissolved Solids</i>	500 mg/L
<i>Alkalinity</i>	> 40 mg/L as CaCO ₃
<i>pH</i>	6.5 - 8.5
<i>Langelier Saturation Index</i>	Positive
<i>Calcium Carbonate Precipitation Potential</i>	Positive



Section 2
Survey Results

Tampa (USA)	
Category	Result(s)
Boron Management Strategy	Not anticipated to be a problem when the plant was developed
Parameters of Concern	<ul style="list-style-type: none"> • Boron • Bromide and brominated DBPs • Corrosion
Integration Approach	
Blending Location	14 mile pipeline to four (4) 7 million gallon ground level storage tanks for blending at a point prior to the first customer
Blending Supplies	Groundwater and surface water
Onsite / Offsite Storage	5 MG clearwell + four (4) 7 MG ground level tanks
Operational Characteristics	Variable depending on available surface and groundwater supplies
Prior Water Quality Studies	<ul style="list-style-type: none"> • Integration pipe-loop study • Blending study • Disinfection stability study
Other Blending Strategies	Blend before adding ammonia to increase chloramine residual stability
Lessons Learned / Significant Issues / Key Points	
<ul style="list-style-type: none"> • Be cautious of disinfectant stability if chloramines are used for residual disinfection; consider blending desalinated water with other chlorinated supplies prior to adding ammonia to improve residual stability • A knowledgeable owner's agent and a well-written contract are critical • The turndown capability of the other processes in the SWRO plant would ideally be similar to that of the RO system • A bromide goal of 0.2 to 0.25 mg/L is recommended • The measurement point for a bromide water quality goal should be at the RO permeate • Similarly, in addition to downstream points of DBP compliance (e.g., at the point of blending), it is advantageous to have an additional measurement point at the RO permeate; because as-needed shock chlorination at the influent is often practiced, significant DBPs can potentially be formed. Although RO rejects a significant percentage of DBPs, feed concentrations can be high enough such that the permeate contains DBP levels sufficient to warrant monitoring • Consider end-users in the development of water quality goals (e.g., irrigation of boron-sensitive plants) 	



Section 2
Survey Results

Gold Coast (Australia)	
Category	Result(s)
General	
Capacity	33 MGD
On-Line Date	2009
Reason(s) Selected	<ul style="list-style-type: none"> • Similar capacity to SWRO plants proposed in the Metropolitan service area • Regulatory climate similar to the US
Treatment Processes	
Intake	Dedicated open ocean intake
Pretreatment	<ul style="list-style-type: none"> • Drum screens • pH adjustment • Coagulation
Filtration	Dual media filters (sand + anthracite)
RO Configuration	Partial second pass
Post-Treatment	<ul style="list-style-type: none"> • Lime addition • CO₂ addition
Primary Disinfection	Free chlorine
Secondary Disinfection	Free chlorine @ 0.2 - 0.5 mg/L
Water Quality Management	
Water Quality Goals	
<i>Chloride</i>	50 mg/L
<i>Bromide</i>	0.1 mg/L
<i>Boron</i>	1 mg/L
<i>Sodium</i>	None reported
<i>Total Dissolved Solids</i>	220 mg/L
<i>Alkalinity</i>	None reported
<i>pH</i>	None reported
<i>Langelier Saturation Index</i>	None reported
<i>Calcium Carbonate Precipitation Potential</i>	-5 to -3 mg/L
Boron Management Strategy	Partial two-pass RO
Parameters of Concern	None reported



Section 2
Survey Results

Gold Coast (Australia)	
Category	Result(s)
Integration Approach	
Blending Location	15.6 mile pipeline with in-pipe blending at the point of connection to the regional water grid
Blending Supplies	Surface water supplies in the existing regional water grid
Onsite / Offsite Storage	8 MG tank at the SWRO plant
Operating Characteristics	Variable depending on available surface and groundwater supplies
Prior Water Quality Studies	Pilot testing to ensure water quality standard would be achieved
Other Blending Strategies	None reported
Lessons Learned / Significant Issues / Key Points	
<ul style="list-style-type: none"> • A seawater desalination plant can be a good emergency source of supply, even in wet weather; during recent floods, the surface water treatment plants were not able to adequately remove the turbidity; the SWRO plant was ramped up to full capacity to supply potable water during this event • Quality control and factory testing on some material components can help avoid issues during installation and commissioning 	

Section 2
Survey Results

Melbourne (Australia)	
Category	Result(s)
General	
Capacity	108 MGD; Major elements such as tunnels sized for 144.5 MGD
On-Line Date	2012 (anticipated)
Reason(s) Selected	<ul style="list-style-type: none"> • Similar capacity to SWRO plants proposed in the Metropolitan service area • Regional wholesale agency similar to Metropolitan • Regulatory climate similar to the US
Treatment Processes	
Intake	Dedicated open ocean intake
Pretreatment	Not indicated
Filtration	Dual media pressure filters
RO Configuration	Two-pass RO
Post-Treatment	Lime addition
Primary Disinfection	Free chlorine
Secondary Disinfection	Free chlorine @ < 0.4 mg/L
Water Quality Management	
Water Quality Goals	
<i>Chloride</i>	60 mg/L
<i>Bromide</i>	0.1 mg/L
<i>Boron</i>	0.5 mg/L
<i>Sodium</i>	None reported
<i>Total Dissolved Solids</i>	<ul style="list-style-type: none"> • ≤ 120 mg/L for no more than 1,800 minutes in any month • ≤ 140 mg/L for no more than 600 minutes in any month
<i>Alkalinity</i>	50 mg/L as CaCO ₃
<i>pH</i>	None reported
<i>Langelier Saturation Index</i>	None reported
<i>Calcium Carbonate Precipitation Potential</i>	-5 to 0 mg/L
Boron Management Strategy	pH adjustment prior to the second pass of RO
Parameters of Concern	None reported



Section 2
Survey Results

Melbourne (Australia)	
Category	Result(s)
Integration Approach	
Blending Location	51 mile pipeline to blend-point in 233,000 AF Cardinia Reservoir; the pipeline can also deliver supplies from the reservoir to intermediate delivery points.
Blending Supplies	Unfiltered supplies from closed catchments
Onsite / Offsite Storage	On-site: 2 x 9 MG tanks Off-site: 233,000 AF Cardinia Reservoir
Operating Characteristics	Seasonal variation depending on reservoir storage levels
Prior Water Quality Studies	<ul style="list-style-type: none"> • Hydrodynamic modeling of receiving storage for mixing • Water quality variation in deliveries to customers • Disinfection by-product formation • Soil dispersion in the Cardinia Reservoir
Other Blending Strategies	Selection of inlet location into Cardinia Reservoir to promote mixing
Lessons Learned / Significant Issues / Key Points	
<ul style="list-style-type: none"> • No reported lessons learned, as plant is currently under construction • The 51 mile bi-directional pipeline for delivering desalinated supplies into Melbourne’s system increases the overall operational flexibility and reliability southeast of the city. The pipeline alignment includes underground power lines and fiber optic cable. 	



Section 2
Survey Results

Perth 1 (Australia)	
Category	Result(s)
General	
Capacity	33 MGD
On-Line Date	2006
Reason(s) Selected	<ul style="list-style-type: none"> • Similar capacity to SWRO plants proposed in the Metropolitan service area • Regulatory climate similar to the US
Treatment Processes	
Intake	Dedicated open ocean intake
Pretreatment	Screens
Filtration	Media pressure filters (sand)
RO Configuration	Two-pass RO
Post-Treatment	<ul style="list-style-type: none"> • Lime addition • CO₂ addition
Primary Disinfection	Free chlorine
Secondary Disinfection	Free chlorine, w/ chloramines used in one long distribution extension
Water Quality Management	
Water Quality Goals	
<i>Chloride</i>	250 mg/L
<i>Bromide</i>	0.1 mg/L
<i>Boron</i>	2 mg/L
<i>Sodium</i>	180 mg/L
<i>Total Dissolved Solids</i>	200 mg/L
<i>Alkalinity</i>	None reported
<i>pH</i>	7.5 - 8
<i>Langelier Saturation Index</i>	> 0.5
<i>Calcium Carbonate Precipitation Potential</i>	None reported
Boron Management Strategy	pH adjustment prior to the second pass of RO
Parameters of Concern	None reported



Section 2
Survey Results

Perth 1 (Australia)	
Category	Result(s)
Integration Approach	
Blending Location	Six mile pipeline to blend point at 24.3 MG Thomsons Reservoir
Blending Supplies	Surface water and groundwater supplies in the existing reservoir when available; 100% desalinated water can be delivered as well.
Onsite / Offsite Storage	On-site: 1 MG tank for flow balancing Off-site: Thomsons Reservoir
Operating Characteristics	Base-loaded production
Prior Water Quality Studies	None reported
Other Blending Strategies	None reported
Lessons Learned / Significant Issues / Key Points	
<ul style="list-style-type: none"> • Very low bromide in the treated water results in very minimal disinfection by-product formation • Proximity to major water supply infrastructure was a factor in siting the facility • Distribution system infrastructure and operations were modified to enable transfer of desalinated base-load supplies during low demand periods 	

Section 2
Survey Results

Sydney (Australia)	
Category	Result(s)
General	
Capacity	66 MGD; Intake and outfall sized for 132 MGD
On-Line Date	2010
Reason(s) Selected	<ul style="list-style-type: none"> • Similar capacity to SWRO plants proposed in the Metropolitan service area • Regulatory climate similar to the US
Treatment Processes	
Intake	Dedicated open ocean intake
Pretreatment	<ul style="list-style-type: none"> • Ferric chloride and polymer addition for coagulation • Sulfuric acid for pH adjustment
Filtration	Dual media filters
RO Configuration	Partial two-pass RO
Post-Treatment	<ul style="list-style-type: none"> • Lime addition • CO₂ addition
Primary Disinfection	Chloramines @ 0.7 mg/L
Secondary Disinfection	Chloramines @ +/- 0.2 mg/L of the existing supplies at the point of blending
Water Quality Management	
Water Quality Goals	
<i>Chloride</i>	40 mg/L
<i>Bromide</i>	0.1 mg/L
<i>Boron</i>	1 mg/L
<i>Sodium</i>	None reported
<i>Total Dissolved Solids</i>	115 mg/L
<i>Alkalinity</i>	Goal indicated; standard not reported
<i>pH</i>	Goal indicated; standard not reported
<i>Langelier Saturation Index</i>	None reported
<i>Calcium Carbonate Precipitation Potential</i>	None reported
Boron Management Strategy	Two-pass RO
Parameters of Concern	Bromide



Section 2
Survey Results

Sydney (Australia)	
Category	Result(s)
Integration Approach	
Blending Location	11 mile pipeline to gravity-fed distribution main; in-pipe blending; Includes 5 mile submerged pipeline under Botany Bay
Blending Supplies	Local surface water supplies in the existing distribution system
Onsite / Offsite Storage	On-site: 10.5 MG tank
Operating Characteristics	Designed for base-load operation
Prior Water Quality Studies	<ul style="list-style-type: none"> • 1 year of pilot testing • Considerable modeling to ensure that the desalinated seawater supplies (as conditioned) would match existing surface water supplies as closely as possible
Other Blending Strategies	None reported
Lessons Learned / Significant Issues / Key Points	
<ul style="list-style-type: none"> • Bromide is strictly monitored to ensure very low levels in the RO permeate • Thorough hydraulic studies were important to ensure that pressurized supplies from the desalination plant did not adversely impact gravity-fed supplies in the existing distribution system • Facility siting was influenced by the distance to the integration point and to provide a new water supply at an alternative location in the distribution system. • Proactive engagement of the public was essential for understand their concerns, not only for water quality and integration issues, but for all aspects of SWRO plant development 	

Section 2
Survey Results

Ashkelon (Israel)	
Category	Result(s)
General	
Capacity	98 MGD; original capacity was 84.5 MGD; facility was designed for capacity expansion
On-Line Date	2005
Reason(s) Selected	Obtain Israeli perspective on integration issues
Treatment Processes	
Intake	Dedicated open ocean intake
Pretreatment	<ul style="list-style-type: none"> • Ferric sulfate addition for coagulation • Sulfuric acid addition for pH adjustment • Chlorine and polymer addition capability, as needed
Filtration	Dual media gravity filters (sand + anthracite)
RO Configuration	Three-stage with partial two-pass (unique process driven by chloride and boron goals)
Post-Treatment	<ul style="list-style-type: none"> • Lime addition
Primary Disinfection	Free chlorine @ 0.2 - 0.5 mg/L
Secondary Disinfection	Free chlorine
Water Quality Management	
Water Quality Goals	
<i>Chloride</i>	20 mg/L
<i>Bromide</i>	None reported
<i>Boron</i>	0.4 mg/L
<i>Sodium</i>	None reported
<i>Total Dissolved Solids</i>	40 mg/L (before post-treatment remineralization)
<i>Alkalinity</i>	None reported
<i>pH</i>	None reported
<i>Langelier Saturation Index</i>	0 - 0.5
<i>Calcium Carbonate Precipitation Potential</i>	None reported
Boron Management Strategy	Two-pass RO with pH adjustment before the second pass
Parameters of Concern	Boron (for agricultural application), corrosion, and chlorides



Section 2
Survey Results

Ashkelon (Israel)	
Category	Result(s)
Integration Approach	
Blending Location	Integration into national water grid; in-pipe blending
Blending Supplies	Existing distribution system water
Onsite / Offsite Storage	On-site: < 1 MG buffer tank
Operating Characteristics	Base-load with seasonal variation
Prior Water Quality Studies	Minimal piloting
Other Blending Strategies	None reported
Lessons Learned / Significant Issues / Key Points	
<ul style="list-style-type: none"> • There were initial concerns over water quality issues related to changing the direction of flow in parts of the national grid; corrosion concerns were addressed by Langelier Index requirements during start-up • Pressure center design has limitations, as the entire plant must be taken off-line to address problems with the RO feed water header • Caution is advised to limit the discharge of phosphorus to the ocean (e.g., due to the addition of scale inhibitors) • Stakeholder approval is essential prior to proceeding on the critical construction path to avoid delays • Design included the ability manage inlet water quality from storm events through shutting down a percentage of the plant to allow the pretreatment system to manage the change 	

Section 2
Survey Results

Fujairah 2 (United Arab Emirates)	
Category	Result(s)
General	
Capacity	36 MGD
On-Line Date	2010
Reason(s) Selected	<ul style="list-style-type: none"> • Obtain UAE perspective on integration issues • Co-located with power plant and 120 MGD thermal desalination plant
Treatment Processes	
Intake	Co-located open intake
Pretreatment	<ul style="list-style-type: none"> • Coagulant and polymer addition for coagulation • Acid addition for pH adjustment • Dissolved air flotation (DAF)
Filtration	Dual media filtration
RO Configuration	Partial two-pass
Post-Treatment	<ul style="list-style-type: none"> • Lime addition • CO₂ addition
Primary Disinfection	Free chlorine @ 0.5 mg/L
Secondary Disinfection	Free chlorine
Water Quality Management	
Water Quality Goals	
<i>Chloride</i>	100 mg/L
<i>Bromide</i>	None reported
<i>Boron</i>	1 mg/L
<i>Sodium</i>	None reported
<i>Total Dissolved Solids</i>	Minimum: 100 mg/L Maximum: 200 mg/L
<i>Alkalinity</i>	None reported
<i>pH</i>	7 - 9.2
<i>Langelier Saturation Index</i>	0 - 0.5
<i>Calcium Carbonate Precipitation Potential</i>	None reported



Section 2
Survey Results

Fujairah 2 (United Arab Emirates)	
Category	Result(s)
Boron Management Strategy	Blending with thermally desalinated water that is low in boron prior to post-treatment; also, partial two-pass RO
Parameters of Concern	None reported
Integration Approach	
Blending Location	121 mile pipeline from Fujairah to Abu Dhabi distribution system, including storage at a nearby tank farm
Blending Supplies	Other thermally desalinated seawater supplies (multiple plants)
Onsite / Offsite Storage	Both on-site and off-site storage (details not provided)
Operating Characteristics	Production varies based on the operation of the power plant and supplies produced by the MED thermal distillation process
Prior Water Quality Studies	6-month pilot to demonstrate pretreatment
Other Blending Strategies	Blending with thermally desalinated water that is low in boron prior to post-treatment
Lessons Learned / Significant Issues / Key Points	
<ul style="list-style-type: none"> • Site selection / integration approach included geographic diversification of Abu Dhabi's desalinated supplies • Strategic blending with thermally desalinated seawater prior to post-treatment is an effective means of boron control • The co-located thermal desalination plant is more economical during periods of high power demand, when there is more waste heat available • Dissolved air flotation (DAF) has been effective for algae control 	

Section 2
Survey Results

Sur (Oman)	
Category	Result(s)
General	
Capacity	21 MGD
On-Line Date	2009
Reason(s) Selected	<ul style="list-style-type: none"> • Obtain Middle East perspective on integration issues • Largest seawater desalination plant using beach well intake
Treatment Processes	
Intake	Beach wells (also features an open intake back-up)
Pretreatment	DAF (for reserve only) – no other pretreatment used
Filtration	Media and cartridge filters
RO Configuration	Partial two-pass
Post-Treatment	Limestone filters
Primary Disinfection	Free chlorine
Secondary Disinfection	Free chlorine @ 0.5 mg/L
Water Quality Management	
Water Quality Goals	
<i>Chloride</i>	250 mg/L
<i>Bromide</i>	None reported
<i>Boron</i>	0.5 mg/L
<i>Sodium</i>	None reported
<i>Total Dissolved Solids</i>	Minimum: 200 mg/L Maximum: 500 mg/L
<i>Alkalinity</i>	None reported
<i>pH</i>	6.5 - 8.5
<i>Langelier Saturation Index</i>	None reported
<i>Calcium Carbonate Precipitation Potential</i>	None reported
Boron Management Strategy	Partial two-pass RO
Parameters of Concern	TDS (concern over levels being too low), corrosion and aesthetics



Section 2
Survey Results

Sur (Oman)	
Category	Result(s)
Integration Approach	
Blending Location	Integrated into new 93 mile pipeline; new distribution system was also developed; 10 storage tanks and 11 pumping stations used in distribution system
Blending Supplies	Nearly 100% of the area served by the plant now uses desalinated seawater
Onsite / Offsite Storage	On-site: 42 MG tank
Operating Characteristics	Base-load operation
Prior Water Quality Studies	Studies known to have been conducted, but no information available
Other Blending Strategies	Blending may occur if needed at some local community systems with well water
Lessons Learned / Significant Issues / Key Points	
<ul style="list-style-type: none"> • Pipeline alignment is an important planning element that should not be underestimated • Beach wells can significantly reduce pretreatment processes and costs • Need to ensure that the TDS is not too low, a circumstance that would dissolve scale in existing pipelines from either formerly used water sources (e.g., well water, as is the case for the Sur plant) or existing sources with which desalinated seawater is blended • Post-construction system optimization studies can improve membrane performance, chemical use, and energy efficiency 	

Section 2
Survey Results

Tuas 1 (Singapore)	
Category	Result(s)
General	
Capacity	36 MGD
On-Line Date	2005
Reason(s) Selected	<ul style="list-style-type: none"> • Obtain Singapore perspective on integration issues • Singapore Public Utilities Board has sponsored significant desalination research
Treatment Processes	
Intake	Dedicated open intake
Pretreatment	DAF
Filtration	Gravity sand filters
RO Configuration	Full two-pass RO (1 st pass = seawater elements; 2 nd pass = brackish water elements)
Post-Treatment	<ul style="list-style-type: none"> • Lime addition • CO₂ addition
Primary Disinfection	Free chlorine
Secondary Disinfection	Chloramines
Water Quality Management	
Water Quality Goals	
<i>Chloride</i>	100 mg/L
<i>Bromide</i>	None reported
<i>Boron</i>	0.5 mg/L
<i>Sodium</i>	None reported
<i>Total Dissolved Solids</i>	Conductivity < 416 μS/cm (surrogate for TDS)
<i>Alkalinity</i>	None reported
<i>pH</i>	7 - 9
<i>Langelier Saturation Index</i>	None reported
<i>Calcium Carbonate Precipitation Potential</i>	None reported
Boron Management Strategy	Two-pass RO with pH adjustment between passes (using NaOH)
Parameters of Concern	None reported



Section 2
Survey Results

Tuas 1 (Singapore)	
Category	Result(s)
Integration Approach	
Blending Location	7.5 mile pipeline to elevated service reservoir.
Blending Supplies	The desalinated water is blended with existing surface water supplies in a service reservoir before distribution
Onsite / Offsite Storage	On-site: Clearwell: 3.2 MG Off-site: Elevated service reservoir: 24 MG
Operating Characteristics	Base-load supply; with higher production in summer months
Prior Water Quality Studies	No information provided
Other Blending Strategies	None reported
Lessons Learned / Significant Issues / Key Points	
<ul style="list-style-type: none"> • Full two-pass RO results in very low bromide levels in the permeate; Singapore PUB suspects that this is partially why no chloramine decay has been observed • That relatively small percentage of desalinated water supply blended in the distribution system (~10%) may also contribute to the lack of observed chloramine decay • There have been no customer complaints related to water quality associated with desalinated water, even from among those customers that may receive blends with a higher proportion of this supply 	

Section 2
Survey Results

Valdelentisco (Spain)	
Category	Result(s)
General	
Capacity	36 MGD; Sized for expansion to 53 MGD
On-Line Date	2007
Reason(s) Selected	<ul style="list-style-type: none"> • Obtain Spanish / European perspective on integration issues • Spain's regulatory environment is similar to California
Treatment Processes	
Intake	Dedicated open ocean
Pretreatment	<ul style="list-style-type: none"> • Ferric chloride for coagulation • Monthly shock chlorination and sodium bisulfite addition
Filtration	Pressure filters (sand + anthracite)
RO Configuration	Single pass, two-stage RO
Post-Treatment	<ul style="list-style-type: none"> • Lime addition • CO₂ addition
Primary Disinfection	None
Secondary Disinfection	Free chlorine @ 4.7 mg/L to maintain 1 mg/L in the distr. system; Different sources (i.e., surface water, desalinated seawater, and groundwater) are chlorinated at different points in the system
Water Quality Management	
Water Quality Goals	
<i>Chloride</i>	250 mg/L
<i>Bromide</i>	None reported
<i>Boron</i>	1 mg/L
<i>Sodium</i>	None reported
<i>Total Dissolved Solids</i>	Conductivity < 2,500 µS/cm (surrogate for TDS)
<i>Alkalinity</i>	Monitored
<i>pH</i>	9.5
<i>Langelier Saturation Index</i>	None reported
<i>Calcium Carbonate Precipitation Potential</i>	None reported
Boron Management Strategy	Extensively analyzed boron management strategies; adjusts pH as necessary to manage concentrations



Section 2
Survey Results

Valdelentisco (Spain)	
Category	Result(s)
Parameters of Concern	Boron
Integration Approach	
Blending Location	16.5 mile pipeline with two pump stations to regional aqueduct with 719 ft total lift above sea level; In-pipe blending
Blending Supplies	Existing surface and groundwater supplies in the distribution system
Onsite / Offsite Storage	On-site: < 1 MG tank Off-site: < 1 MG tank; 13 MG tank
Operating Characteristics	Varies based on availability of surface supplies
Prior Water Quality Studies	Source water quality studies (over the course of two years)
Other Blending Strategies	None reports
Lessons Learned / Significant Issues / Key Points	
<ul style="list-style-type: none"> • Treatment necessary to reduce boron levels to low levels may not be cost-effective (if not otherwise constrained by regulations) 	

This page intentionally left blank



3.0 Summary and Analysis

A brief discussion of the survey results with respect to some of the key considerations associated with seawater desalination integration practices is provided below, including summaries of boron, bromide, corrosion, advance planning studies, blending, intertie location, and operational issues. Additional sections summarize the most important lessons learned from the survey results and considerations for Metropolitan, respectively.

3.1 Summary of Key Survey Results

3.1.1 Boron

Integration concerns related to boron include potential impacts to irrigated crops and human health. While boron is an important trace element for plant growth, it can be detrimental at higher concentrations. Citrus, avocado and other crops are sensitive to concentrations below 1 mg/L, as are some plants commonly used in Southern California landscaping. Global boron concentrations in seawater are generally about 4.5 mg/L, but can be higher in more arid regions, such as the Persian Gulf, where many seawater desalination plants are located. World Health Organization (WHO) drinking water quality guidelines, which are widely referenced as international benchmarks for water treatment, historically recommended boron concentrations less than 0.5 mg/L, a level that is not typically achievable through single-pass RO treatment process configurations. The WHO guidelines, as well as country-specific boron regulations, have historically prompted many international seawater desalination plants using RO technology to utilize a full or partial two-pass configuration; however, adding a second pass can significantly increase both capital and operating costs. Consequently, boron removal has been a significant consideration at seawater desalination plants using RO.

All of the surveyed plants with the exception of Valdelentisco use full or partial two-pass RO as a boron management strategy. A number of facilities reported use of the supplementary practice of raising the pH between the two passes to enhance boron rejection. Examples of innovative boron control strategies include Ashkelon's integrated multi-stage, partial two-pass RO process and Tuas' full second pass using low pressure RO elements. Blending with other water supplies was also employed to reduce boron levels prior to the point of compliance (if applicable) or to delivery to end-users.

The charge of a species is one of the primary characteristics by which RO membranes reject water quality constituents; higher charged species (either positive or negative) are more efficiently removed. Thus, because boron is uncharged at typical seawater pH levels, boron concentrations in the RO permeate after only a single pass can exceed guidelines for human consumption and agricultural irrigation, as well as regulatory limits.

Valdelentisco was the only facility not reporting two-pass RO as a boron control strategy. Originally, agricultural users in the service area requested maximum boron levels of 0.5 mg/L, which is below the European Union standard of 1 mg/L. After initial bids for the project were

Section 3 Survey Results

received, a cost-benefit analysis was conducted to compare boron goals of 0.5 and 1 mg/L, considering economics, impacts on irrigated plants with boron sensitivity, and human health effects. This analysis demonstrated that a 0.5 mg/L boron goal would increase costs from 13 to 19 percent. As a result, a goal of 1 mg/L was selected, a benchmark that was achievable using only a single pass of RO membranes, supplemented with pH adjustments as needed. Subsequently, this decision was further validated by the WHO's recent revision of the boron guideline from 0.5 mg/L to 2.4 mg/L, based on contemporary research into human health effects.

A single pass RO system may be feasible for regulatory compliance based on the experience at the Valdelentisco plant, particularly if recently developed high boron rejection membranes are employed. However, it is important to note that both the human health effects and the agricultural/horticultural impact of boron be considered in establishment of an appropriate water quality goal. This is reflected in the survey results, where seven of the eight plants reporting Boron goals target 1 mg/L or less. Ultimately, the end use(s) of the desalinated seawater, taking into account blending practices, should determine the appropriate Boron goal, within regulatory compliance standards.

3.1.2 Bromide

Bromide in desalinated seawater can react with disinfectants to form disinfection by-products (DBPs) and also destabilize chloramine residuals in the distribution system. Both of these factors have made bromide a more significant consideration for seawater desalination plants over the past decade. Although bromide is efficiently rejected by RO membranes (unlike boron), even small concentrations can be problematic. As a result, four of the five surveyed facilities with reported bromide goals cited a low benchmark value of 0.1 mg/L. The fifth plant (Tampa) has an associated goal of 0.45 mg/L; however, the survey respondent suggested a level of 0.1 to 0.2 mg/L would be more beneficial in controlling DBP formation and chloramine residual decay. Because chloramines are utilized to provide secondary disinfection in the Metropolitan system, chloramine residual decay is a key integration challenge.

Three of the ten surveyed plants utilize chloramines (vs. free chlorine) for residual disinfection: Tampa, Sydney and Tuas 1. Only the Tuas 1 plant has a full two-pass RO systems, yielding very low bromide in the permeate. In addition, the plant blends desalination seawater with other supplies, further diluting the impact of bromide. (Desalinated seawater represents between 10 to 15 percent of the total water supply for Tuas 1.) The Tampa facility, which subjects only a small portion of the first pass RO permeate to a partial second pass, configuration, relies on blending for bromide management. In order to control disinfectant residual stability, a novel strategy of mixing chlorinated surface water, groundwater, and desalinated seawater supplies prior to the application of ammonia is utilized. (Note that this strategy may not be feasible or practical for all distribution systems.) Because desalinated seawater represents no more than 10 percent of the water supply in the Tampa Bay Water distribution system, the effect of bromide on the blended chloramine residual is significantly reduced.

3.1.3 Corrosion

Because desalinated seawater typically has very low TDS and alkalinity but relatively high chloride concentrations, it has the potential to create a corrosive environment in the distribution system, which can cause long-term pipeline integrity problems, exceedance of lead and copper regulatory standards, and aesthetic concerns. Therefore post-treatment conditioning to mitigate these potential impacts is routinely practiced at seawater desalination plants. Many respondents among the ten surveyed plants reported that studies were conducted in the planning stage of a project in order to determine the most appropriate water quality goals for minimizing corrosion. For example, at the Sydney plant, the objective of one such study was to ensure that chemical conditioning could match the quality of the existing distribution system supplies as closely as possible. Others survey respondents did not report that matching water quality was a particular objective, but rather cited water quality goals for the post-treated desalinated seawater designed to preclude corrosive conditions based on parameters such as pH, alkalinity, Langelier saturation index (LSI), and calcium carbonate precipitation potential (CCPP). No corrosion issues were reported at either Sydney, using the matching strategy, or the plants that relied on common corrosion indices. Blending with other water supplies is another common strategy employed to mitigate the corrosive potential of desalinated seawater.

3.1.4 Advance Planning Studies

In addition to corrosion / pipe-loop and post-treatment testing, a variety of other advance planning studies were conducted in conjunction with the development of the ten plants surveyed. In terms of water quality, these investigations included blending /mixing studies, water quality modeling, disinfectant stability assessments, DBP formation evaluation, and pilot testing to examine the effectiveness of different processes for meeting treatment objectives. In addition, a soil dispersion study was conducted in conjunction with the Melbourne plant, which will discharge desalinated water into an open reservoir. Hydraulic modeling and associated studies were also reported. For example, for the Sydney plant, hydraulic modeling was used to evaluate the introduction of a pressurized supply of desalinated seawater into an existing gravity-fed regional distribution system. Given the similarity of the Sydney and Metropolitan systems, hydraulic studies may be appropriate if this approach is considered in Metropolitan's service area.

3.1.5 Blending

Blending practices varied among the ten surveyed plants, including direct pipe-to-pipe connections (five plants) and the use of storage facilities (four plants). For the latter strategy, both tanks and reservoirs were utilized, and in the case of the Melbourne plant, which is currently under construction, desalinated and post-treated seawater will be discharged into an open regional untreated water reservoir. None of the survey respondents reported specific target blending ratios of desalinated water to existing supplies, but many acknowledged the usefulness of blending for meeting water quality goals. The most notable reported case of leveraging blending for water quality benefits is practiced at the Tampa plant. As discussed in Section 3.1.2, Tampa blends chlorinated surface water, groundwater, and desalinated seawater in regional

Section 3 Survey Results

storage tanks prior to adding ammonia, thereby diluting the impact of bromide on chloramine residual stability. The blending ratio was actively managed to minimize costs at some of the surveyed plants, such that the use of more economical surface and groundwater supplies are maximized, with desalinated seawater only produced as-needed to accommodate the shortfall in demand.

Reported Blending Practices

Direct Pipe-to-Pipe	Storage Facilities	Dedicated Delivery Systems
Ashkelon	Melbourne	Sur
Gold Coast	Perth 1	
Sydney	Tampa	
Valdelentisco	Tuas 1	
Fujairah 2		

3.1.6 Intertie Location

Both regional and nearby intertie approaches for water supply integration were reported among the surveyed plants. The projects using regional interties piped the desalinated seawater to a strategic upstream point, allowing for greater operational flexibility in water supply distribution. Typically, there is a larger flow of existing supply further upstream, not only allowing for increased blending potential (with associated water quality benefits), but also facilitating greater consistency in the quality of water distributed to customers system-wide. Although the use of a nearby intertie may not allow for these same water quality and operational benefits, it does have the advantage of avoiding long transmission lines and the associated costs. These avoided costs include not only construction of the pipeline via an alignment that may be complicated by existing development, but also the cost of pumping the water. In addition, because seawater desalination plants are typically located at low coastal elevations (except in rare cases in which the untreated seawater is conveyed to an inland plant location), the transmission to a regional intertie often involves pumping against potentially significant hydraulic head. Both approaches were successfully employed among the plants surveyed.

3.1.7 Operations

Because desalinated seawater is typically one of the most expensive sources of potable water, the surveyed plants that produced a higher percentage of the overall system water supply also tended to be base loaded facilities. In these cases, the need for desalinated seawater is more acute, and the maximum plant production is needed to meet customer demand. By contrast, in cases in which more traditional surface water and groundwater supplies were available, the associated seawater desalination plants exhibited variable production. One counterintuitive situation in which a variable-production seawater desalination plant was operated at capacity during a wet weather period was identified in conjunction with the Gold Coast plant. The plant was originally built as an emergency supply to offset rapidly declining reservoir supplies in the midst of a severe drought. After the drought ended and the reservoir levels were adequate, the plant was only used on an as-needed basis. However, during a series of severe storms that generated flood



Section 3 Survey Results

conditions, the plentiful surface water supplies proved to be too turbid for the region's conventional treatment plant to accommodate. Thus, the seawater desalination plant was utilized at full capacity during this event to provide emergency supply, providing an operational benefit that was unanticipated by the project proponents.

It should be noted that with the exception of Tampa, the facilities surveyed do not have a long operating history. It is possible that unidentified integration issues could still arise with additional operational experience.

3.2 Lessons Learned

Several of the most significant “lessons learned” from the survey responses are provided below, summarizing the applicable points that respondents indicated were most beneficial to convey from the experience of implementing and operating their respective seawater desalination plants. These key lessons learned are as follows:

- Conducting advance planning studies (e.g., water quality testing and modeling, pipe-loop testing, piloting, hydraulic evaluations, etc.) can help ensure successful integration
- Consider end-uses in the development of water quality goals
- Engage the public and stakeholders early and in all stages of seawater desalination plant integration
- A water quality goal for bromide at the RO permeate, as opposed to at the plant effluent after post-treatment and primary disinfection, can minimize DBP formation and chloramine residual decay
- Conduct a cost-benefit analysis on the appropriate treatment level for boron, accounting for cost, regulatory considerations, and the potential irrigation of boron-sensitive plants
- Plan pretreatment processes carefully to accommodate a range of anticipated feed water quality (e.g., algae blooms)
- A knowledgeable Owner's Agent and a carefully planned and comprehensive water quality performance specification can be essential to control project cost, maximize efficiency, and facilitate successful implementation
- A seawater desalination plant can serve as a valuable emergency asset, providing backup treatment reliability in both dry- and wet-weather conditions

3.3 Considerations for Metropolitan

Based on the key lessons learned summarized in Section 3.2, as well as an analysis of the survey results overall, some of the most important considerations for Metropolitan relative to seawater desalination and integration practices are provided in Table 3.1.

Section 3
Survey Results

**Table 3-1:
Summary of Considerations for Metropolitan**

Thorough water quality studies should be specified and conducted *in advance*.

Hydraulic studies should be performed before blending desalinated seawater into gravity-fed pipelines

Appropriate post-treatment conditioning is essential for stable water quality.

A two-pass RO design can improve water quality and treatment flexibility.

Blending in storage tanks can support water quality and operational flexibility.

Plant site selection should account for the proposed blending point and associated pipeline alignment.

Plants integrated with existing supplies are not necessarily base-loaded.

Integration costs are site specific and can be a major component of the project.

4.0 Bibliography

In conjunction with the plant surveys, a bibliography of references applicable to various aspects of seawater desalination integration practices was compiled for Metropolitan's use as a resource of information. This bibliography was submitted as a separate technical memorandum for the Assessment of Existing Seawater Desalination System Integration Practices project. A copy of the bibliography from this memorandum is provided below.

Agus, E., D.L Sedlak, and N. Voutchkov. 2009. Disinfection By-products and Their Potential Impact on the Quality of Water Produced by Desalination Systems: A Literature Review. *Desalination*, 237(1-3):214-237.

Agus, E., and D.L. Sedlak. 2009. Formation and Fate of Chlorination By-Products in Reverse Osmosis Desalination Systems. *Water Research*. 44(5):1616-1626.

Al-Mudhaf, H.F., A.M. Astel, M.I. Selim, and A.S.I. Abu-Shady. 2009. Self-Organizing Map Approach in Assessment Spatiotemporal Variations of Trihalomethanes in Desalinated Drinking Water in Kuwait. *Desalination*, 252(1-3):97-105.

Al-Rasheed, R., E. Althobity, S. Al-Sulami, and A. Al-Ruwished. 2009. Influence of Different Disinfection Methods on the Presence of Bromate and Chlorate in the Product Water of Seawater Desalination Plants. In *Proc. 2009 IDA World Congress*. Dubai, UAE.

Atassi, A., A. Kashyap, J. Parks, and M. Edwards. 2009. *Impacts of Phosphate Corrosion Inhibitors on Cement Based Pipes and Linings*. Denver, CO: Water Research Foundation.

AWWA (American Water Works Association). 2007. *Reverse Osmosis and Nanofiltration*. Manual of Practice M46. Denver CO: AWWA.

Baoyou, S., and J. Taylor. 2009. Potential Impact of Enhanced Coagulation on Corrosion By-Product Release in a Distribution System. *Desalination*, 207(1-3):260-268.

Barron, O. 2006. Desalination Options and their possible implementation in Western Australia: Potential Role for CSIRO Land and Water: *Water for a Healthy Country National Research Flagship, Canberra, AC*. Australia: Commonwealth Scientific and Industrial Research Organization (CSIRO).

Belluati, M., E. Danesi, G. Petrucci, and M. Rosellini. 2009. Chlorine Dioxide Disinfection Technology to Avoid Bromate Formation in Desalinated Seawater in Potable Waterworks. *Desalination*, 203(1-3):261-271.

Section 4 Bibliography

- Bergman, R.A., and JR. Elarde. 2005. Post-Treatment of Reverse Osmosis and Nanofiltration Systems for Municipal Water Supply. In *Proc. of the 2005 AWWA Membrane Technology Conference*, Phoenix, AZ.
- Bick, A., and G. Oron. 2005. Post-Treatment Design of Seawater Reverse Osmosis Plants: Boron Removal Technology Selection for Potable Water Production and Environmental Control. *Desalination*, 178(1-3):233-246.
- Birnhack, L., and O. Lahav. 2007. Quality Criteria for Desalinated Water Following Post-Treatment. A Literature Review. *Desalination*, 207:286-303.
- Birnhack, L., and O. Lahav. 2008. Quality Criteria for Desalinated Water and Introduction of a Novel: Cost Effective and Advantageous Post Treatment Process. *Desalination*, 221:70-83.
- Birnhack, L., N. Fridman, and O. Lahav. 2009a. Potential Applications of Quarry Dolomite for Post Treatment of Desalinated Water. *Desalination and Water Treatment*, 1:58–67.
- Birnhack, L., N. Voutchkov, and O. Lahav. 2009b. Fundamental Chemistry and Engineering Aspects of Post-Treatment Processes for Desalinated Water. A Literature Review. *Desalination*, 216(1-3): 1-76.
- Birnhack, L., N. Shlesinger, and O. Lahav. 2009c. A Cost Effective Method for Improving the Quality of Inland Desalinated Brackish Water Destined for Agricultural Irrigation. *Desalination*, 262(1-3):152-160.
- Blute, N.K., and M.J. McGuire. et al. 2008. Integration of Desalinated Seawater into a distribution system: A corrosion pilot study. *Jour. AWWA*, 100(9):117-131.
- Blute, N.K., and W. Ying. 2009. Technical Memorandum: Bench Scale Study of BARDP Pilot Study Finished Quality and Compatibility Analysis. Malcolm Pirnie, Inc.
- Bonnelye, V. 2009. Common Practices Around the World Through Four Full Scale Plant Experiences. In *Proc. of the 2009 IDA World Congress*. Dubai, UAE.
- Cheng, R.C., C. Andrews-Tate, T.J. Tseng, and K.L. Wattier. 2009. Issues with Distribution of Desalinated Seawaters: Are Corrosion Indicators Sufficient? In *Proc. of the 2009 AWWA Membrane Technology Conference*, Memphis, TN: AWWA.
- Cheng, C., C. Andrews-Tate, K.L. Wattier, T. Tseng, and Y. Zhang. 2011. *Applying LBWD's Pipe Loop Test Results for the Integration of Desalinated Water*. Denver, CO: Water Research Foundation.
- Cook, D., M. Drikas, C. Pelekani, and G. Kilmore. 2009. Effects of Blending Desalinated Water with Treated Water Chlorination. In *Proc. of the 2009 IDA World Congress*. Dubai, UAE.



Section 4 Bibliography

- Cotruvo, J.A. 2005. Water Desalination Processes and Associated Health Issues. In *Water Conditioning & Purification Magazine*, 47(1):7-13.
(<http://www.wcponline.com/pdf/0105%20Desalination.pdf>).
- Cotruvo, J.A. 2006. Health Aspects of Calcium and Magnesium in Drinking Water. In *Water Conditioning & Purification Magazine*, 48(6):4-40.
(<http://www.wcponline.com/pdf/Cotruvo.pdf>).
- Cotruvo, J.A., and H. Abouzaid. 2007. New World Health Organization Guidance for Desalination. In *Proc. of the Environment 2007 International Conference on Integrated Sustainable Energy Resources in Arid Regions*, Abu Dhabi.
- Cotruvo, J.A., and J. Bartram. 2009. Calcium and Magnesium in Drinking-Water. *Public Health Significance*. Geneva, World Health Organization.
(http://www.who.int/water_sanitation_health/publications/publication_9789241563550/en/index.html).
- Delion, N., G. Mauguin, and P. Corsin. 2004. Importance and Impact of Post Treatments on Design and Operation of SWRO Plants. *Desalination*, 165:323-334.
- Dolnicar, S. and A.I. Schafer. 2009. Desalinated Versus Recycled Water: Public Perception and Profiles of the Accepters. *Journal of Environmental Management*, 90(2):888-900.
- Douglas, S. 2007. Post Treatment Alternatives for Stabilizing Desalinated Water. Master's thesis. University of Central Florida, Orlando, FL.
- Douglas, S., I.C. Watson, N. Pena-Holt, R.J. Pfeiffer-Wilder, and S.J. Duranceau. 2011. Post Treatment Stabilization of Desalted Permeate. Denver, CO: Water Research Foundation.
- Dreizin, Y., A. Tennea and D. Hoffmanb. 2008. Integrating Large Scale Seawater Desalination Plants Within Israel's Water Supply System. *Desalination*, 220:132-149.
- Duranceau, S.J. 1999. Holistic Use of Membrane Processes to Reduce Copper Corrosion and Solve Some Source Water Problems. In *Proc. of the 1999 AWWA Annual Conference*. Denver, CO: AWWA.
- Duranceau, S.J. 2004. Post-Treatment Consideration for Blending Permeate Into Water Into Water Distribution Systems. In *Proc. of the 2004 American Membrane Technology Association (AMTA) Biennial Conference and Exposition*. San Antonio, TX.
- Duranceau, S.J., and W.A. Lovins. 2005. Membrane Post-Treatment Optimization for Blending Permeate Into Water Distribution Systems. In *Proc. of the 2005 AWWA Distribution System Symposium Conference and Exposition*. Denver, CO:AWWA.



Section 4 Bibliography

- Duranceau, S.J. 2006. Post-Treatment and Distribution System Impacts. In *Proc. of the 2006 AWWA Desalination Symposium*, Honolulu, HI.
- Duranceau, S.J. 2009a. Desalination Post-Treatment Considerations. *Florida Water Resources Journal*. November 2009:4-18.
- Duranceau, S.J.. 2009b. Determination of The Total Iodide Content in Desalinated Seawater Permeate. *Desalination*, 261(3):251-254.
- Eltom, E. 2009. Elimination of Bromate from DEWA Potable Water Using Chlorine Dioxide Disinfection Technology. In *Proc. of the 2009 IDA World Congress*. Dubai, UAE.
- Fritzmann, C., J.Lowenberg, and T. Melin, T. Wintgens. 2007. State-of-the-Art of Reverse Osmosis Desalination. *Desalination*, 216(1-3):1-76.
- Ghani, I., A. Dalvi, R. Al-Rasheed, M.A. Javeed. 2009. Haloacetic Acids (HAAs) Formation in Desalination Processes for Disinfectants. *Desalination*, 129(3):261-271.
- Glueckstern, P., M. Priel, and E. Kotzer. 2009. Blending Brackish Water with Desalted Seawater As an Alternative to Brackish Water Desalination. *Desalination*, 178(1-3):227-232.
- Haizhou, L., K.S. Schonberger, G.V. Korshin, J.F. Ferguson, P. Meyerhofer, E. Desormeaux, and H. Luckenbach. 2010. Effects of blending of desalinated water with treated surface drinking water on copper and lead release. *Water Research*, 44(14):4066-4057.
- Hasson, D., and O. Bendrihem. 2006 Modeling Remineralization of Desalinated Water by Limestone Dissolution. *Desalination*, 190(1-3):189-200.
- Lahav, O., and L. Birnhack. 2007. Quality Criteria for Desalinated Water Following Post-Treatment. *Desalination*, 207(1-3):286-303.
- Lin, C., C. Huany, H.H. Yeh, P.H. Chang, and Y.J. Chung. 2005. Comparing Post-Treatment Processes to Reduce Corrosiveness of the Product Water From the Desalination Plant. In *Proc. of the 2005 IDA World Congress*. Singapore.
- Marangou, V.S., and K. Savvides. 2001. First Desalination Plant in Cyprus – Product Water Aggresivity and Corrosion Control. *Desalination*, 138:251-258.
- Magara, Y., T. Aizawa, S. Kunikane, M. Itoh, M. Kohki, M. Kawasaki, and H. Takeuti. 2009. The Behavior of Inorganic Constituents and Disinfection By-Products in Reverse Osmosis Water Desalination Process. *Water Science and Technology*, 34(9):141-148.
- McAree, B.A., J.L. Clancy, and G.L. O’Neill. 2005. Characterization of the Bacterial Population in RO Distribution Systems and Their Ability to Form Biofilms on Pipe Surfaces. In *Proc. of the 2005 AWWA Water Quality Technology Conference*. Quebec City, Quebec.



Section 4 Bibliography

- McGuire Environmental Consultants, Inc. 2004. *Disinfection Byproduct Formation in a Simulated Distribution System: Blending Desalination Seawater From the Poseidon Resources, Inc. Pilot Facility With Local Drinking Water Sources*. Final Report. Santa Monica, CA: McGuire/Malcolm Pirnie.
- McGuire/Malcolm Pirnie. 2006. *Poseidon Resources Corporation Corrosion Pilot Study*. Draft Final Report. Santa Monica, CA: McGuire/Malcolm Pirnie.
- McGuire, M.J., E.G. Means III and J.P. Loveland, and J.Garvey. 2007. Use of Flavour Profile and Consumer Panels to Determine Differences Between Local Water Supplies and Desalinated Seawater. *Water Science & Technology*, 55(5):275-282.
- Means III, E.G., and J.P. Loveland. 2009. *Water Quality Implication for Large Scale Applications of MF/RO Treatment for Seawater Desalination*. Denver, CO: Water Research Foundation.
- Migliorini, G., and R. Meinardi. 2009. 40 MIGD Potabilization Plant at Ras Laffan: Design and Operating Experience. *Desalination*, 182(1-3):275-282.
- Parekh, S. 1988. *Reverse Osmosis Technology Application for High Purity Water Production*. Marcel Dekker, New York.
- Petrucci, G. and M. Rosellini. 2009. Chlorine Dioxide in Seawater for Fouling Control and Post-Disinfection in Potable Waterworks. *Disinfection*, 182(1-3):283-291.
- Plewa, M. E. Wagner, S. Richardson. 2004. Chemical and Biological Characterization of Newly Discovered Iodoacid Drinking Water Disinfection of Drinking Water Rich in Bromide. *Environ. Sci. Technol*, 38(18):22-4713.
- Richardson, S., A. Thurston, Jr., and C. Rav-Acha. 2003. Tribromopyrrole, Brominated Acids, and Other Disinfection By-Products Produced by Disinfection of Drinking Water Rich in Bromide. *Environ. Sci. Technol*, 37(17):93-3782.
- Rygaard, M., E. Arvin, and P.J. Binning. 2009a. The Valuation of Water Quality: Effects of Mixing Different Drinking Water Qualities. *Water Research*, 43(5):1207-1218.
- Rygaard, M. P. Binning, and H. J. Albrechtsen. 2009. Increasing Urban Water Self-Sufficiency: New Era, New Challenges. *Journal of Environmental Management*, 92(1):185-194.
- Seacord, T.F., G. Juby, J.E. Singley, and N. Voutchkov. 2003. Post-Treatment Concepts for Seawater and Brackish Water Desalting. In *Proc. of the 2003 AWWA Membrane Technology Conference*. Atlanta, GA:AWWA.



Section 4 Bibliography

- Soo Oh, B., S. Guen Oh, Y. Yound Hwang, H. W. Yu, J.W. Kang, and S. Kim. 2009. Formation of Hazardous Inorganic By-Products During Electrolysis of Seawater as a Disinfection Process for Desalination. *Science of the Total Environment*, 408(23):5958-5965.
- Taylor, J.S., W.M. Barrett, S.J. Duranceau, and J.F. Goigel. 1989. *Assessment of Potable Water Membrane Applications and Research Needs*. Denver, CO: Water Research Foundation.
- Taylor, J.S., T.L. Lynn, L.A. Mulford, and Y.A. Yousef. 1992. Corrosion Control of Finished Water. *Water Quality*. 433-440.
- Taylor, J.S., J. Dietz, S. Hong, and A. Randall. 2005. Impact of RO-Desalted Water on Distribution Water Qualities. *Water Science Technology*, 51(6-7):285-291.
- Taylor J.S., J. Dietz, A.A. Randall, S.K. Hong, C.D. Norris, L.A. Mulford, J.M. Arevalo, S. Imran, M. Le Puil, S. Lui, I. Mutoti, J. Tang, W. Xiao, C. Cullen, R. Heaviside, A. Mehta, M. Patel, F. Vasquez, and D. Webb. 2006. *Effects of Blending on Distribution System Water Quality*. Denver, CO: AwwaRF.
- Thomas, J.S., and B. Durham. 2009. Integrated Water Resource Management: Looking at The Whole Picture. *Desalination*. 156(1-3):21-28.
- van Leeuwen, J., D. Cook, C. Chow, and M. Drikas. 2009. Disinfectant Dosing of Blended Water. In *Proc. 18th World International Association for Mathematics and Computers in Simulation (IMACS) / MODSIM09 Congress on Modeling and Simulation*. Cairns, Australia: IMACS.
- Walker, S., P. Mattausch, and A. Abbott. 2007 Reverse Osmosis Treatment Facilities: Innovative Post-Treatment Stabilization Solutions. *Florida Water Resources Jour.*, 35-37.
- Wilf, M., L. Awerbuch, C. Bartles. 2007. *The Guidebook to Membrane Desalination Technology. Reverse Osmosis, Nanofiltration and Hybrid Systems Process Design, Applications and Economics*. Rehovot: Balaban Publishers.
- Withers, A. 2005. Options for Recarbonation, Remineralisation and Disinfection for Desalination Plants. *Desalination*, 179(1-3):11-24.
- World Health Organization. 2003. Nutrient Minerals in Drinking-Water and the Potential Health Consequences of Long-Term Consumption of Demineralized and Altered Mineral Content Drinking Waters.
- World Health Organization. 2005a. Nutrients in Drinking-Water. World Health Organization, Geneva.
(http://www.who.int/warer_sanitation_health /dwq/nutrientsindw/en).



Section 4 Bibliography

- World Health Organization. 2005b. Bromate in Drinking-Water. *Background Document for Development of WHO Guidelines for Drinking Water Quality*. World Health Organization (WHO/SDE/WSH/05.08/78), Geneva.
(http://www.who.int/water_sanitation_health/dwq/chemicals/bromide.pdf).
- World Health Organization. 2006. Meeting of Experts on the Possible Protective Effect of Hard Water Against Cardiovascular Disease. Washington, D.C.
- World Health Organization. 2007. Desalination for Safe Water Supply: *Guidance for the Health and Environmental Aspects Applicable to Desalination*. World Health Organization (WHO/SDE/WSH/07/0), Geneva.
(http://www.who.int/water_sanitation_health/gdwqrevision/desalination.pdf).
- World Health Organization. 2008. *Guidelines for Drinking-Water Quality*. 3rd ed. Incorporating First and Second Addenda. World Health Organization, Geneva.
(http://www.who.int/water_sanitation_health/dwq/gdwq3rev/en/index.html).
- World Health Organization. 2009a. Boron in Drinking-Quality. *Background Document for Development of WHO Guideline for Drinking-Water Quality*. World Health Organization (WHO/HSE/WSH/0.04/54), Geneva.
(http://www.who.int/water_sanitation_health/dwq/gdwq3rev/en/index.html).
- World Health Organization. 2009b. WHO Offers Guidance on Desalination. *Membrane Technology*. 2007(9):1.
- Yermiyahu, U., A. Tal, A. Ben-Gal, A. Bar-Tal, J. Tarchitzky, and O. Lahav. 2007. Rethinking Desalinated Water Quality and Agriculture. *Science*, 318:920-291.
- Yoshinari F., M. Kuriharaa, M. Taniguchia, and T. Nishikawaa. 2004. Boron Removal in RO Seawater Desalination. *Desalination*, 167:419-426.
- Xiao, W., S. Hong, Z., Tang, and J. Taylor. 2007. Effects of blending on total copper release in distribution systems. *Jour. AWWA*, 99(1):78-88.
- Xiao, W., S. Hong, Z., Tang, S. Seal, and J. Taylor. 2007. Effects of blending on surface characteristics of copper corrosion products in drinking water distribution systems. *Corrosion Science*, 49(2):449-468.
- Zhang, Y., T.J. Tseng, C. Andrew-Tate, R.C. Cheng, and K.L. Wattier. 2011. Applying Long Beach Water Department's Pipe Loop Test Results for the Integration of Desalinated Water. In *Proc. of the 2011 AWWA Membrane Technology Conference & Exposition*. Long Beach, CA.



This page intentionally left blank

Appendix A

Survey Instrument

Metropolitan Water District of Southern California
Assessment of Existing Seawater Desalination System Integration Practices

Survey Questionnaire

1. Distribution system information

- 1.1. Population served
- 1.2. Basic governance (i.e., elected / appointed Board, municipal government, etc.)
- 1.3. Driver for implementing seawater desalination
- 1.4. Size of geographic area served
- 1.5. General map of distribution system with seawater desalination pipeline
- 1.6. System deliveries:
 - 1.6.1. Average annual deliveries
 - 1.6.2. Description of potable water supply sources
 - 1.6.3. Percent of total supplies represented by desalinated seawater
 - 1.6.4. Type(s) of customers that receive the water (e.g., residential, industrial, agricultural, etc.)
- 1.7. Basic operations before desalinated supply added
 - 1.7.1. Water quality parameters and concerns prior to desalination
 - 1.7.2. Disinfection: type of primary and secondary disinfection, and target levels
- 1.8. Changes to system operations due to seawater desalination

2. Desalination Project Facilities

2.1. Current/planned capacity

2.1.1. Basis of project sizing

2.1.2. Plant staging / capacity expansion (e.g., upsized pipelines, pads and stub-ups for additional RO skids, etc.)

2.2. Basic treatment process

2.2.1. Pretreatment

2.2.2. RO process configuration

2.2.3. Boron management strategy

2.2.4. Post-treatment

2.3. Current/planned desalination project operations

2.3.1. Base-loaded or peaking

2.3.2. Frequency / schedule of plant in-service time

2.3.3. Basic water quality parameters

2.3.3.1. Goals for key parameters (e.g., B, Br, Cl, Na, TDS, Alk, pH, LSI, CCPP, etc.)

2.3.3.2. Point of compliance for key water quality parameters

2.3.3.3. Regulatory context / compliance framework (e.g., country-specific; state- or region-specific; World Health Organization (WHO); etc.)

2.3.3.4. Areas of concern

2.3.3.5. Method(s) of mitigating concerns

3. Integration of desalinated seawater into the existing distribution system

3.1. Pipeline / conveyance

- 3.1.1. Length, capacity, cost, pipe material, urban/rural alignment
- 3.1.2. Elevation or pressure head to overcome at the point of injection of desalinated water into the existing distribution system
- 3.1.3. Onsite/offsite storage
- 3.1.4. Major issues to overcome with new conveyance/distribution system

3.2. Integration point(s)

- 3.2.1. Regional vs. local system integration and rationale
- 3.2.2. Operational integration of desalinated seawater

3.3. Blending

- 3.3.1. Location of blending desalinated seawater into the existing distribution system
- 3.3.2. Method of blending desalinated seawater into the existing distribution system (e.g. blend in pipe, in reservoir, etc.)
- 3.3.3. Blending conducted before or after introducing desalinated seawater into the distribution system?
- 3.3.4. Supplies used to blend with desalinated seawater
- 3.3.5. Blending to meet water quality goals (if applicable)
- 3.3.6. Percent blend goal (if applicable) and any changes to the goal over time

3.4. Monitoring

- 3.4.1. Method of post-blend water quality monitoring
- 3.4.2. Any unexpected results

4. Key factors in choosing the integration approach

- 4.1. Integration concerns that required attention going into the construction of the project
- 4.2. Water quality studies that were performed
- 4.3. Water quality factors (if any) that influenced the methodology on where and how to integrate desalinated seawater into the existing distribution system (e.g., blending, water quality parameters [e.g., B, Br, disinfection by-products, etc.], corrosion, residual decay, temperature, etc.)
- 4.4. Operational factors
 - 4.4.1. Project size
 - 4.4.2. System and hydraulic constraints
 - 4.4.3. Demand constraints
 - 4.4.4. Storage requirements
 - 4.4.5. Shutdowns
 - 4.4.6. Minimum flows
 - 4.4.7. Existing treatment plant flexibility
- 4.5. Flexibility considerations (e.g., bringing desalinated seawater to the head of the system improves overall reliability; etc.)
- 4.6. Other considerations
 - 4.6.1. Cost
 - 4.6.2. Downstream acceptance
 - 4.6.3. Stranded treatment capacity, etc.

5. Integration issues experienced (if any, as applicable)

5.1. Water Quality

- 5.1.1. Taste & odor
- 5.1.2. Customer complaints
- 5.1.3. Corrosion
- 5.1.4. Red or discolored water
- 5.1.5. Disinfection residual decay
- 5.1.6. Blend chemistry

5.2. Operations

- 5.2.1. Shutdowns of seawater desalination plant
 - 5.2.1.1. Frequency, duration, and impacts
 - 5.2.1.2. Economics or system reliability impact of outages
 - 5.2.1.3. Effect of shutdowns on operations
 - 5.2.1.4. Causes of shutdowns (e.g., cost, operational constraints, demands, water quality, etc.)
- 5.2.2. Decision process for choosing supplies during low demands or high supply

6. Lessons learned

- 6.1. Any identified integration issues that would be addressed another / different way now after having operational experience with seawater desalination
- 6.2. Any other lessons or advice

Appendix B

Complete Survey Results

This page intentionally left blank

Metropolitan Water District of Southern California
Assessment of Existing Seawater Desalination System Integration Practices
Survey Questionnaire
TAMPA BAY (UNITED STATES)

CONTACT

Ms. Christine Owen
Water Quality Assurance Officer
Tampa Bay Water
(813) 929-4521
cowen@tampabaywater.org

1. Distribution system information

1.1. Population served
2.4 million

1.2. Basic governance (i.e., elected / appointed Board, municipal government, etc.)
Appointed Board made up of elected official of member governments: 3 counties + 3 cities.
Tampa Bay Water (TBW) is a legislatively-created regional wholesaler. Board makes decisions by majority vote.

1.3. Driver for implementing seawater desalination
Regional water disputes were causing problems, and TBW was facing mandatory cutbacks in groundwater supplies: from 192 MGD to 90 MGD over ten years. The Southwest Florida Water Management District provided \$183M for developing surface water and/or seawater supplies, of which \$85M was ultimately allocated for seawater desalination. Seawater was included in the portfolio targeted because there was insufficient surface water available to make up the shortfall. Also, that fact that seawater is a drought-proof source was also an important consideration.

1.4. Size of geographic area served
Three counties in the Tampa area.

Tampa Bay Survey

1.5. General map of distribution system with seawater desalination pipeline
See attached. Note that TBW only has transmission lines to convey water to its wholesale customers. It does not have what it considers to be “distribution” lines.

1.6. System deliveries:
Capacity = 25 MGD (nominal). However, the plant is permitted for 28.75 MGD, which it can achieve when the water is warm and all trains are running.

1.6.1. Average annual deliveries
System-wide (all sources) = 180 MGD. TBW has budgeted 4-5 MGD for the current fiscal year, but 12 MGD for the next. A big-picture composite figure (i.e., “average”) is tough to figure and is probably misleading.

1.6.2. Description of potable water supply sources
TBW provides a combination of groundwater, surface water, and seawater sources. The agency is prohibited from implementing reuse under its legislative charter, as recycled water is a profit center for local governments.

1.6.3. Percent of total supplies represented by desalinated seawater
This is a difficult number statistic to accurately characterize, as it varies from year-to-year based on demand and other factors. When the desalination plant is operating at 25 MGD, it would typically represent about 10% of the TBW portfolio.

1.6.4. Type(s) of customers that receive the water (e.g., residential, industrial, agricultural, etc.)
TBW only sells water to its member agencies. Most of their member agencies’ customers are residential and industrial. Most agriculture interests (which are very strong in Florida) utilize their own groundwater wells.

1.7. Basic operations before desalinated supply added

1.7.1. Water quality parameters and concerns prior to desalination

Primary concerns prior to implementing seawater desalination were/are total organic carbon (TOC), disinfection by-products (DBPs), and hydrogen sulfide → all from groundwater supplies. (Groundwater can be more challenging to treat in Florida than surface water: higher TOC, presence of hydrogen sulfide, etc.)

1.7.2. Disinfection: type of primary and secondary disinfection, and target levels

Free chlorine is used for primary disinfection. The desalination facility is regulated as a surface water treatment plant, and thus must achieve target pathogen control commensurate with that designation. Chloramines are used for residual disinfection at a target dose of 4.0 mg/L.

1.8. Changes to system operations due to seawater desalination

None.

2. Desalination Project Facilities

2.1. Current/planned capacity

25 MGD (nominal); possible potential to expand by 10 MGD, if needed

2.1.1. Basis of project sizing

25 MGD represented the balance of capacity needed to make up for the shortfall caused by the reduction in groundwater supplies after all other potential resources had been allocated.

2.1.2. Plant staging / capacity expansion (e.g., upsized pipelines, pads and stub-ups for additional RO skids, etc.)

The plant has no infrastructure in place to accommodate expansion, and the existing building cannot house any expansion. The site was also not planned to accommodate expansion, but the potential 10 MGD expansion might fit.

2.2. Basic treatment process

See attached process flow diagram.

2.2.1. Pretreatment

Ferric chloride (4-8 mg/L) + free chlorine (1-2 mg/L); The plant has the capability of adding acid, but this is seldom needed. No polymer is used.

2.2.2. RO process configuration

A partial second pass is used to treat 5% of the total capacity of the plant. This percentage was targeted to treat the minimize flow necessary to meet water quality goals.

2.2.3. Boron management strategy

There is no boron management strategy. However, boron is a concern due to landscape that is sensitive to this element.

2.2.4. Post-treatment

A side stream is passed through a lime saturator, which is subsequently injected into the primary flow → carbon dioxide is added (full flow) → pH adjustment (if needed) → free chlorine → clearwell → 14-mile pipeline → blend with free-chlorinated surface water → THEN add ammonia → distribution. The strategy of blending with surface water prior to adding ammonia is considered important for maintaining a stable chloramine residual. Note that a lime saturator is used because TBW wants carbonate alkalinity to be added rather than simply hydroxyl alkalinity, which has much less buffering capacity.

2.2.5. Primary disinfection (chemical(s), dose(s), etc.)

A free chlorine dose of about 4.0 mg/L is applied to achieve Surface Water Treatment Rule (SWTR) inactivation goals.

2.2.6. Residual disinfection (chemicals(s), dose(s) applied, target doses in the distribution system, etc.)

Tampa Bay Survey

Free chlorine is used in the 14-mile transmission line to the blending point. After blending with surface water, a chloramine residual of 4.0 to 4.2 mg/L is targeted for conveyance to TBW customers. This dose is intentionally on the high side to minimize the trimming requirements of its member agencies.

2.3. Current/planned desalination project operations

2.3.1. Base-loaded or peaking

Peaking; the plant is used only when surface supplies are low

2.3.2. Frequency / schedule of plant in-service time

4-5 months per year

2.3.3. Basic water quality parameters

2.3.3.1. Goals for key parameters (e.g., B, Br, Cl, Na, TDS, Alk, pH, LSI, CCPP, etc.)

Cl: 100 mg/L

Br: 0.450 mg/L (TBW suggests that this should be 0.2 to 0.25 mg/L, ideally)

B: no target

Na: 160 mg/L (regulated in Florida)

TDS: 500 mg/L (regulated in Florida)

Alk: 40 mg/L as CaCO₃ (minimum)

pH: 6.5-8.5 (regulated in Florida)

LSI: positive

CCPP: positive

2.3.3.2. Point of compliance for key water quality parameters

Plant effluent; however, TBW believes that the compliance point for bromide should be at the RO permeate, given the potential for bromide to react to form bromamines and brominated DBPs prior to the plant effluent point.

2.3.3.3. Regulatory context / compliance framework (e.g., country-specific; state- or region-specific; World Health Organization (WHO); etc.)

Florida and USEPA

2.3.3.4. Areas of concern

Boron (due to landscape plants and having no water quality standard)

Bromide / brominated DBPs

Corrosion

2.3.3.5. Method(s) of mitigating concerns

Boron: no mitigation

DBPs: dilution with surface water

Corrosion: they have the ability to add alkalinity (via carbon dioxide and caustic) at the blending point; targets for post-blending: Alk > 100 mg/L as CaCO₃, sulfate < 140 mg/L, chloride < 100 mg/L; also watch the Larson Ratio (a corrosion metric); TBW recommends once-through loop testing for corrosion in the desalination planning stage

3. Integration of desalinated seawater into the existing distribution system

3.1. Pipeline / conveyance

3.1.1. Length, capacity, cost, pipe material, urban/rural alignment
250 miles of conveyance lines: 80% is 84" pipe and nothing smaller than 36"

FRP pipe in the plant → susceptible to breaks due to integrity degradation via UV exposure and any water hammer events

Conveyance consists of steel and pre-stressed concrete pipe

Alignment is rural (keep in mind that TBW has only conveyance lines to its member agencies; development is growing up around their conveyance lines)

3.1.2. Elevation or pressure head to overcome at the point of injection of desalinated water into the existing distribution system

Just the water level in the ground-level storage tank in which blending occurs

Tampa Bay Survey

3.1.3. Onsite/offsite storage

4 x 7 million gallon ground level storage tanks at the point of blending

5 million gallon clearwell in the desalination plant

3.1.4. Major issues to overcome with new conveyance/distribution system

None

3.2. Integration point(s)

3.2.1. Regional vs. local system integration and rationale

Regional integration, as TBW is a regional wholesaler

3.2.2. Operational integration of desalinated seawater

Just the alkalinity addition mentioned previously; also, important to blend the desalinated water prior to adding ammonia to improve disinfectant residual stability

3.3. Blending

(Most of the questions below have already been addressed in context in the previous responses.)

3.3.1. Location of blending desalinated seawater into the existing distribution system

Blending station to mix with surface water supplies

3.3.2. Method of blending desalinated seawater into the existing distribution system (e.g. blend in pipe, in reservoir, etc.)

Ground level storage tanks

3.3.3. Blending conducted before or after introducing desalinated seawater into the distribution system?

Before

Tampa Bay Survey

3.3.4. Supplies used to blend with desalinated seawater
Treated surface water supplies

3.3.5. Blending to meet water quality goals (if applicable)
Yes – blending with other supplies helps to meet DBPs goals due to the high bromide in the desalinated seawater; however, this is not always necessary.

3.3.6. Percent blend goal (if applicable) and any changes to the goal over time
There is no specific numerical goal; the blend goal is to manage so as to minimize costs; this could be the maximum capacity flow of 25 MGD if surface water supplies are low; thus, as demand increases, the target goal for desalinated seawater is likewise increased

3.4. Monitoring

3.4.1. Method of post-blend water quality monitoring
Monitor for ammonia and alkalinity at the plant effluent

Also, at the take off points for sale of water to member agencies (i.e., blending water supplies): pH, temperature, total chlorine, chloramines, alkalinity, conductivity, and TOC

3.4.2. Any unexpected results
Originally, prior to implementing blending with surface water supplies before adding ammonia, the lack of chloramine residual stability was surprising

4. Key factors in choosing the integration approach

4.1. Integration concerns that required attention going into the construction of the project
None

4.2. Water quality studies that were performed
(For reference, the SWRO plant came on-line in 2003)

1. (2000) HDR and the University of South Florida conducted an integration pipe-loop study. No desalinated water from the plant was available at this time, so a surrogate was manufactured in a lab. TBW's opinion is that this study wasn't very practical. It deemphasized the important of Alk and indicated that there would be no conveyance system issues. (This prognosis was ultimately shown to be incorrect.)

2. (2001 to 2007) TBW participated in an AwwaRF study in conjunction with the University of Central Florida to look at blending different sources in the distribution system. Key questions applicable to TBW included the effects of both seasonal changes and various blending ratios on the existing distribution system. TBW specifically asked that the study look at low-alkalinity blends early in the research. This early work demonstrated that alkalinity in the range of 80-100 mg/L as CaCO₃ can minimize red water formation. These early results enabled TBW to incorporate alkalinity addition capabilities to enable dosing of 80-100 mg/L as CaCO₃ just in time for the SWRO plant to come on-line. The AwwaRF report is entitled: "The Effects of Blending on Distribution System Water Quality" (Report No. 91065F).

3. (2003) Reiss Environmental conducted a disinfection stability study. Original practice was to blend chloraminated surface water with chloraminated desal water, then trim downstream, as needed. Based in part on this study, the blending practice was changed so as to mix free-chlorinated desal and surface water and then adding ammonia, which improved disinfectant stability. However, this change was not able to be implemented until 2010 given other significant issues to address at the SWRO plant.

- 4.3. Water quality factors (if any) that influenced the methodology on where and how to integrate desalinated seawater into the existing distribution system (e.g., blending, water quality parameters [e.g., B, Br, disinfection by-products, etc.], corrosion, residual decay, temperature, etc.)

Bromide, DBPs, corrosion, and residual decay

4.4. Operational factors

4.4.1. Project size

Project size did not influence the original integration strategy. However, due to integration concerns, it is more likely that a second, better-designed SWRO plant would be built before the current plant is expanded.

4.4.2. System and hydraulic constraints

There are indirect hydraulic constraints. Because there are three different power providers in the TBW service area, each with different unit energy costs, one consideration is the integration of water supplies (including desal water) and system pressurization in an area where the costs are minimized.

4.4.3. Demand constraints

To the extent possible, treatment is located in areas where higher demand is anticipated (minimizing conveyance costs). This would need to be balanced with water quality issues.

4.4.4. Storage requirements

Blending in storage tanks (rather than in-pipe) provides better operational flexibility.

4.4.5. Shutdowns

Shutdowns did not influence the integration strategy, although TBW acknowledges that SWRO plant shutdowns probably improve system performance relative to corrosion and water quality goals. Chloride levels from the desalinated seawater are much higher than the contract limits, approaching 200 to 240 mg/L. TBW is investigating means to decrease chloride (and therefore bromide) levels in the desalination product water. Pending a solution, during some periods of production, chloride levels remain very

high. Coupled with the sulfate levels in finished water from the TBW freshwater coagulation facility (uses iron sulfate in a high color raw water) we are concerned about corrosion from the high sulfate/chloride levels in the blended finished water.

4.4.6. Minimum flows

Post-treatment processes (which influence integrated water quality) at the TBW plant don't work well at low flow. This is an important consideration given that RO units have extremely limited turndown capability such that plant flow is typically modulated only by turning units on/off. Thus, the turndown capability of the other processes in the SWRO plant would ideally be similar to that of the RO system.

4.4.7. Existing treatment plant flexibility

This was not a factor, but TBW recommends that a project proponent have a very good understanding of the range of water quality that might be observed, and that the treatment processes be as robust as possible / necessary to accommodate this range.

4.5. Flexibility considerations (e.g., bringing desalinated seawater to the head of the system improves overall reliability; etc.)

Flexibility is important / desirable, but fixed factors can limit the flexibility potential (e.g., the location of the ocean vs. the most desirable point of integration; etc.)

4.6. Other considerations

4.6.1. Cost

None

4.6.2. Downstream acceptance

None

4.6.3. Stranded treatment capacity, etc.

This was not an issue when the plant was first implemented, given that it was planned as a base-loaded facility. Thus, for example, only enough 2nd pass RO capacity was

incorporated to meet water quality goals, thereby minimizing costs. Since the plant is not operated as a base-loaded facility, it would be ideal to have the more 2nd pass RO capability, which would allow the option of increasing the amount of water that can be processed via 2nd pass RO, thereby minimizing water quality issues.

5. Integration issues experienced (if any, as applicable)

5.1. Water Quality

5.1.1. Taste & odor

None

5.1.2. Customer complaints

No legitimate complaints are received, typically. TBW does get “phantom” complaints in which customers will call to complain about the water being too salty when the SWRO plant is off-line or when the customer located in an area that doesn’t receive desalinated seawater.

5.1.3. Corrosion

This is a concern, and the alkalinity addition strategy is designed to mitigate this.

5.1.4. Red or discolored water

The alkalinity addition strategy successfully mitigates this.

5.1.5. Disinfection residual decay

This is an issue, as previously discussed. Mitigation is managed through operations. Also, there is also apparently an effect in which the TOC of the surface water blending supplies interferes with bromamine formation. There is an ongoing study to research this.

5.1.6. Blend chemistry

TBW is concerned about this, but there are no operational issues.

5.2. Operations

5.2.1. Shutdowns of seawater desalination plant

Shutdowns only occur due to cost or the co-located power plant shuts down capacity. This latter case reduces the cooling water flow for blending concentrate prior to discharge; a certain minimum of flow is required for the SWRO plant NPDES concentrate discharge permit.

5.2.1.1. Frequency, duration, and impacts

Not applicable to integration issues

5.2.1.2. Economics or system reliability impact of outages

Not applicable to integration issues

Effect of shutdowns on operations

Not applicable to integration issues

5.2.1.3. Causes of shutdowns (e.g., cost, operational constraints, demands, water quality, etc.)

Not applicable to integration issues

5.2.2. Decision process for choosing supplies during low demands or high supply
Cost is the key factor. Desalinated water is the most expensive, and it is therefore normally minimized. However, use of other sources (i.e., groundwater or surface water) can be limited by permit when demand is high. If surface water is available, use of this source is maximized.

6. Lessons learned

6.1. Any identified integration issues that would be addressed another / different way now after having operational experience with seawater desalination

These have been addressed in the context of the other responses.

6.2. Any other lessons or advice

SUMMARY OF LLS

- Be cautious of disinfectant stability if using chloramines
- If chloramines are used for residual disinfection, blend desalinated water with other supplies (all free-chlorinated) prior to adding ammonia to improve residual stability
- A knowledgeable owner's agent and a well-written contract are critical
- The turndown capability of the other processes in the SWRO plant would ideally be similar to that of the RO system
- A bromide standard of 0.2 to 0.25 mg/L is recommended
- The compliance point for bromide should be at the RO permeate
- Similarly, in addition to downstream points of DBP compliance (e.g., at the point of blending), it is advantageous to have an additional compliance point at the RO permeate; because as-needed shock chlorination at the influent is often practiced, significant DBPs can be formed. Although RO rejects a significant percentage of DBPs, feed concentrations can be high enough such that the permeate contains undesirable DBP levels.
- Consider end-users in the development of water quality goals (e.g., irrigation of boron-sensitive plants)

Tampa Bay Water System Map

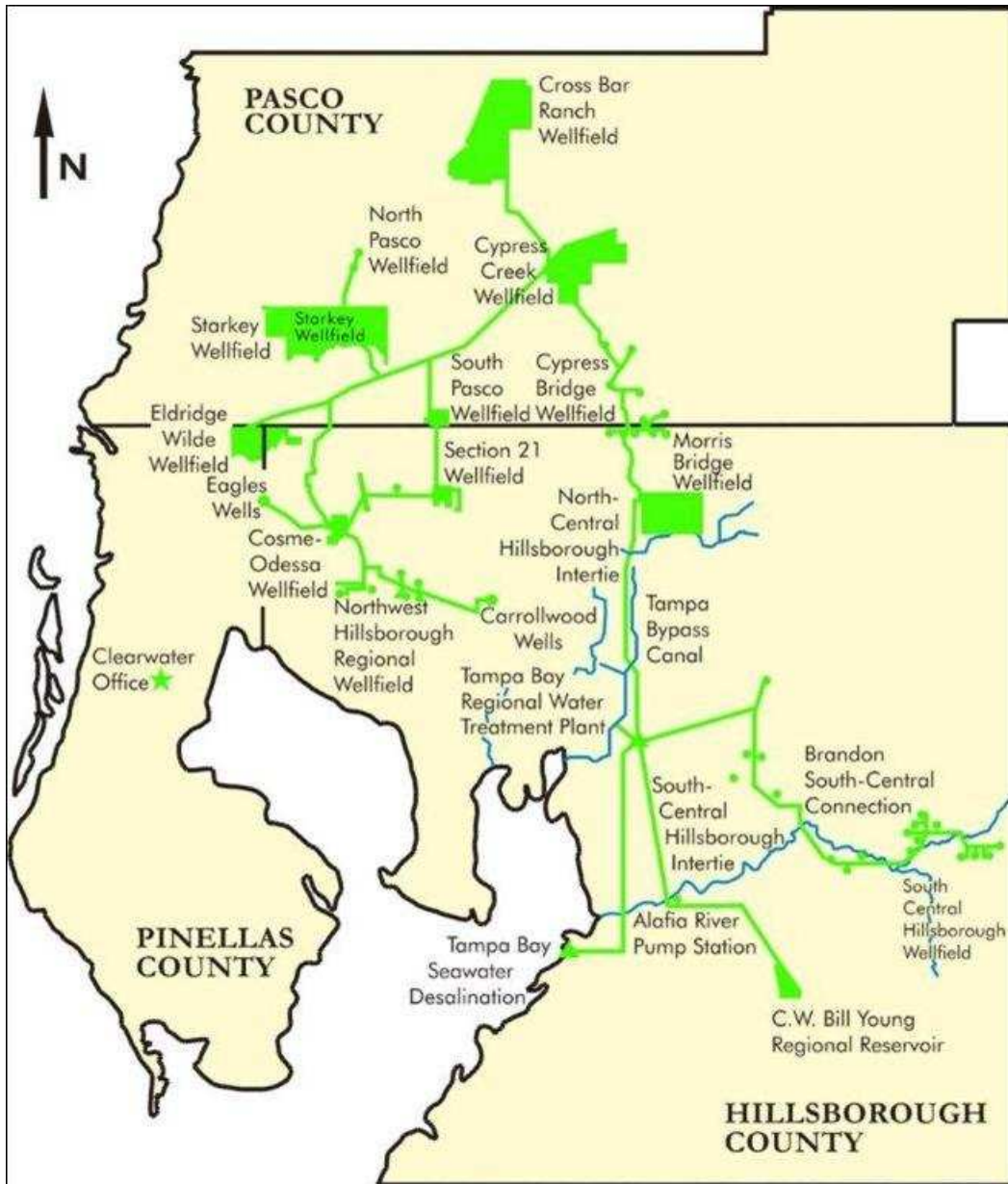

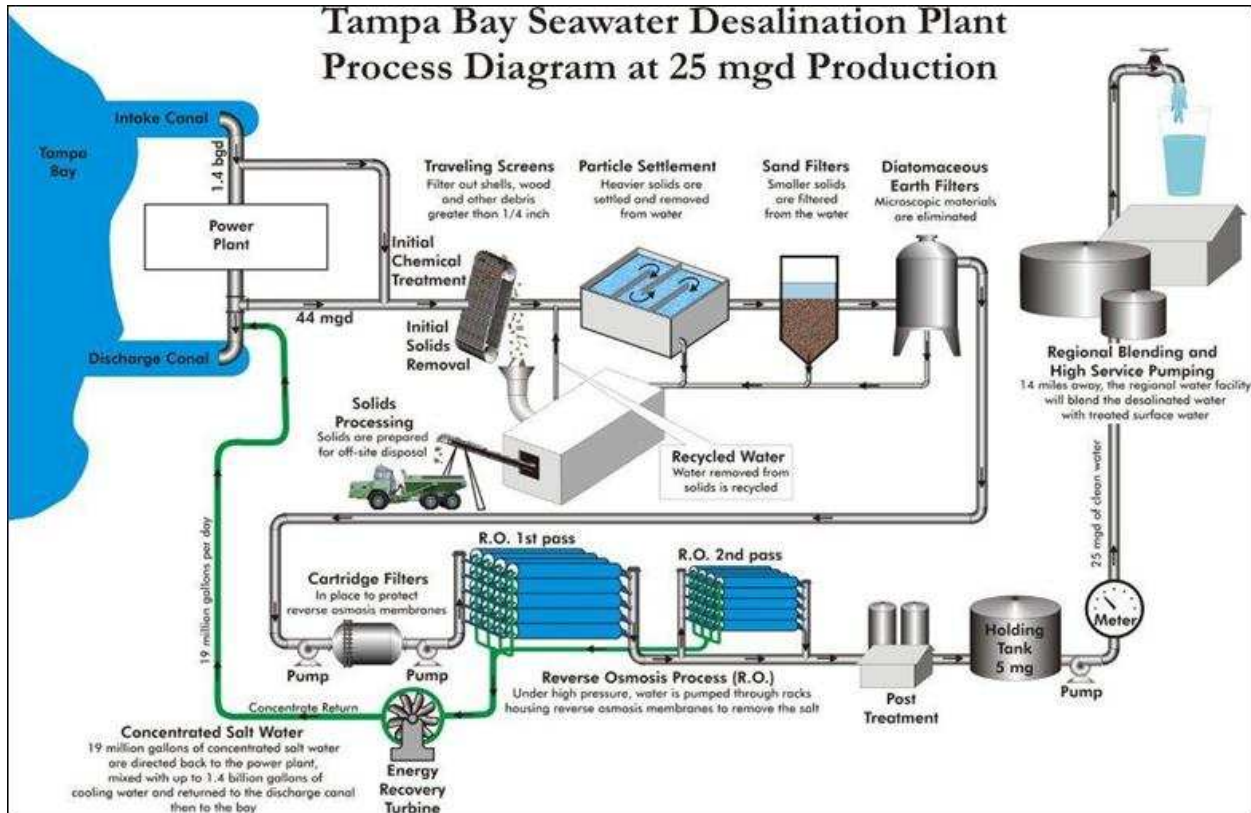

Metropolitan Water District of Southern California
Assessment of Existing Seawater Desalination System Integration Practices
Survey Questionnaire
GOLD COAST (AUSTRALIA)

CONTACTS

Mr. Paul Choules

VP Desalination

Veolia Water Solutions & Technologies, Americas

(281) 227-9050 (voice)

(281) 687-7651 (cell)

paul.choules@veoliawater.com

Mr. Olivier Caumartin

EVP

Veolia Water Solutions & Technologies, Major Projects Group

+33 1 4511 5555

Olivier.caumartin@veoliawater.com

1. Distribution system information

1.1. Population served

Approximately 770,000 people served.

1.2. Basic governance (i.e., elected / appointed Board, municipal government, etc.),

Elected board. The client is WaterSecure a Queensland, Australia government authority set up to manage new water.

1.3. Driver for implementing seawater desalination

Australia was facing a severe draught and water levels in some reservoirs were below 13%.

1.4. Size of geographic area served

City of Gold Coast, Queensland, Australia.

1.5. General map of distribution system with seawater desalination pipeline

An overview of the area is provided at the end of this survey.

1.6. System deliveries:

1.6.1. Average annual deliveries

The capacity of the plant is 125,000 m³/day (33 MGD or 101 acre feet a day).
Contractually we have to guarantee a 94% online availability over a 30 day period.

1.6.2. Description of potable water supply sources

Other than the desalination plant they have surface water stored in reservoirs.

1.6.3. Percent of total supplies represented by desalinated seawater

This varies depending on if the desalination plant is operating and how much water is in the reservoirs.

1.6.4. Type(s) of customers that receive the water (e.g., residential, industrial, agricultural, etc.)

The water is pumped into the network so all users have access to the water.

1.7. Basic operations before desalinated supply added

1.7.1. Water quality parameters and concerns prior to desalination

Due to severe draught the state water authority initiated a water program that included dam expansion, water conservation, water reuse and desalination.

1.7.2. Disinfection: type of primary and secondary disinfection, and target levels, Chlorine with sodium hypochlorite, free chlorine 0.2-0.5 mg/l

1.8. Changes to system operations due to seawater desalination

None other additional monitoring.

2. Desalination Project Facilities

2.1.1. Current/planned capacity

The capacity of the plant is 125,000 m³/day (33 MGD or 101 acre feet a day).

2.1.2. Basis of project sizing

The capacity was selected based on the overall water portfolio, including the existing and new facilities.

2.1.3. Plant staging / capacity expansion (e.g., upsized pipelines, pads and stub-ups for additional RO skids, etc.)

The plant was specifically designed for this capacity due to the site location. Discussion after the start of the construction happened to extend the capacity of the plant by another 35,000 m³/day. Those discussions ended with extended period of rain.

2.2. Basic treatment process

2.2.1. Pretreatment

Seawater passes through a drum screen removing organics and particulates larger than 3 mm. To help remove suspended solids in the filtration system, pH correction and polyelectrolyte coagulant are added. Pre-treatment gravity filtration involves dual media filters or sand and coal. A portion of clean, filtered seawater is used to backwash the pre-treatment filters with the bulk of this water being pushed through 5-micron filters for a final clean.

2.2.2. RO process configuration

A double pass configuration is utilized with the first pass consisting of nine trains (186 x 8 element pressure vessels). The second pass consists of three trains (144 x 8 element pressure vessels).

2.2.3. Boron management strategy

The water quality requirements are as follows: TDS <220 mg/l; Chlorides <50 mg/l; Turbidity <0.3 NTU with maximum value of 0.5 NTU; Bromides <0.1 mg/l; Boron < 1mg/l; CCPP – 5 to -3mgCaCO₃/l; Free chlorine less than 2 mg/l; Australian Drinking Water Guidelines

2.2.4. Post-treatment

Repotabilization with Lime and Carbon dioxide injection.

2.2.5. Primary disinfection (chemical(s), dose(s), etc.)

Chlorination with Sodium Hypochlorite injection

2.2.6. Residual disinfection (chemicals(s), dose(s) applied, target doses in the distribution system, etc.)

Free chlorine 0.2-0.5 mg/l

2.3. Current/planned desalination project operations

2.3.1. Base-loaded or peaking

The plant was to be used when needed during droughts. At this time the plant is shutdown as the reservoirs levels are up. The plant was however operated during the recent flooding as the ground water was too turbid to use.

2.3.2. Frequency / schedule of plant in-service time

At this time the plant is shut down.

2.3.3. Basic water quality parameters

2.3.3.1. Goals for key parameters (e.g., B, Br, Cl, Na, TDS, Alk, pH, LSI, CCPP, etc.),
See information detailed in 2.2.3 above.

2.3.3.2. Point of compliance for key water quality parameters
After storage tanks

2.3.3.3. Regulatory context / compliance framework (e.g., country-specific; state- or region-specific; World Health Organization (WHO); etc.)
See information detailed in 2.2.3 above.

2.3.3.4. Areas of concern
None reported.

2.3.3.5. Method(s) of mitigating concerns
Additional monitoring.

3. Integration of desalinated seawater into the existing distribution system

3.1. Pipeline / conveyance

The project included the design and construction of 25 kms (15.6 miles) pipeline, a 30 megalitre reservoir (8 Million Gals) and 3 x 666 l/sec pump stations (3 x 10,500 gpm).

3.1.1. Length, capacity, cost, pipe material, urban/rural alignment

The pipeline is 25 kms long and connects to regional water grid at that point.

3.1.2. Elevation or pressure head to overcome at the point of injection of desalinated water into the existing distribution system

Limited information on this.

3.1.3. Onsite/offsite storage

Refer to the attached Water Grid for more information on the offsite storage. There is an 8 million gal tank on the site.

3.1.4. Major issues to overcome with new conveyance/distribution system

None that were reported to us.

3.2. Integration point(s)

3.2.1. Regional vs. local system integration and rationale

Locally there is an 8 million gal storage tank. When needed the Desal plant is operated and water is fed into the regional water grid.

3.2.2. Operational integration of desalinated seawater

No issues reported.

3.3. Blending

3.3.1. Location of blending desalinated seawater into the existing distribution system, At the end of the pipeline as it joined the network.

Gold Coast Survey

3.3.2. Method of blending desalinated seawater into the existing distribution system (e.g. blend in pipe, in reservoir, etc.)

The water is blended in the pipeline at the connection point.

3.3.3. Blending conducted before or after introducing desalinated seawater into the distribution system?

At the point of introduction.

3.3.4. Supplies used to blend with desalinated seawater

Nothing specific.

3.3.5. Blending to meet water quality goals (if applicable)

The desalinated water and blended water have to meet the Australian drinking water quality standards.

3.3.6. Percent blend goal (if applicable) and any changes to the goal over time,

Varies depending on the levels of the reservoirs.

3.4. Monitoring

3.4.1. Method of post-blend water quality monitoring

The client monitors the water at the site and at specific points in the network.

Monitoring is remote and periodically with grab samples.

3.4.2. Any unexpected results

None reported.

4. Key factors in choosing the integration approach

4.1. Integration concerns that required attention going into the construction of the project
Piloting showed that the water produced from the Desalination facility met all drinking water quality requirements. The project has been conducted as an Alliance, the client is therefore part of the construction and the operation. All decision making where based on an NPV approach.

Environmental study has been done to ensure minimal modification of the water into the discharge body after the start-up of the plant. Ecotoxicity lab test has been made on local species with test brine at the proposed dilution.

4.2. Water quality studies that were performed

Yes, as part of the SWRO piloting to make sure the drinking water quality requirements would be met.

4.3. Water quality factors (if any) that influenced the methodology on where and how to integrate desalinated seawater into the existing distribution system
(e.g., blending, water quality parameters [e.g., B, Br, disinfection by-products, etc.], corrosion, residual decay, temperature, etc.)

The water produced has to meet Australian drinking quality standards.

4.4. Operational factors

4.4.1. Project size

33 MGD.

4.4.2. System and hydraulic constraints

Site selection took all this into account.

4.4.3. Demand constraints

The plant is only one option for the supply of drinking water.

4.4.4. Storage requirements

There is an 8 million gal tank on site.

4.4.5. Shutdowns

The client determines when to operate the plant based on the level in the reservoirs.

4.4.6. Minimum flows

The plant can operate at 10-15% capacity.

4.4.7. Existing treatment plant flexibility

Not applicable.

4.5. Flexibility considerations (e.g., bringing desalinated seawater to the head of the system improves overall reliability; etc.)

The plant was operated during the recent flooding as it could provide reliable water as the water from the reservoirs was too turbid to use.

4.6. Other considerations

4.6.1. Cost

All choices were done on the basis of the NPV bases. The project cost was \$1B.

4.6.2. Downstream acceptance

Important presentation to local communities from improving of environmental and other acceptance.

4.6.3. Stranded treatment capacity, etc.

None reported.

5. Integration issues experienced (if any, as applicable)

5.1. Water Quality

5.1.1. Taste & odor

None reported.

5.1.2. Customer complaints

None reported.

5.1.3. Corrosion

None reported.

5.1.4. Red or discolored water

None reported.

5.1.5. Disinfection residual decay

None reported.

5.1.6. Blend chemistry

No issues reported.

5.2. Operations

5.2.1. Shutdowns of seawater desalination plant

5.2.1.1. Frequency, duration, and impacts

During the commissioning the weather pattern changed and there was a lot of rain which started to fill the reservoirs. Once the plant was commissioning and operated for approximately 6 months the plant was shut down. It was recently restarted due to the flooding which created high turbidity in the reservoirs.

5.2.1.2. Economics or system reliability impact of outages

The client determines if the plant should be operated.

5.2.1.3. Effect of shutdowns on operations

Limited as the plant was designed for intermittent operation.

5.2.1.4. Causes of shutdowns (e.g., cost, operational constraints, demands, water quality, etc.)

Initially the plant was shut down to fix defects found during startup. It then started to rain so the plant was mothballed until the recent flooding.

5.2.2. Decision process for choosing supplies during low demands or high supply
The plant was built as one of multiple supplemental water facilities. This allows for flexibility in operating the facilities. Mothballing of the plant is done when other water sources availability makes the desalinated water not required.

6. Lessons learned

6.1. Any identified integration issues that would be addressed another / different way now after having operational experience with seawater desalination

Simple lessons we learnt from Ashkelon were incorporated into this project.

6.2. Any other lessons or advice

Due to the fast track nature of the project the selection of some materials of construction were selected based on deliveries instead of suitability, e.g. high pressure piping; Better quality control and factory testing on some material and components would have avoided issues during installation and commissioning.

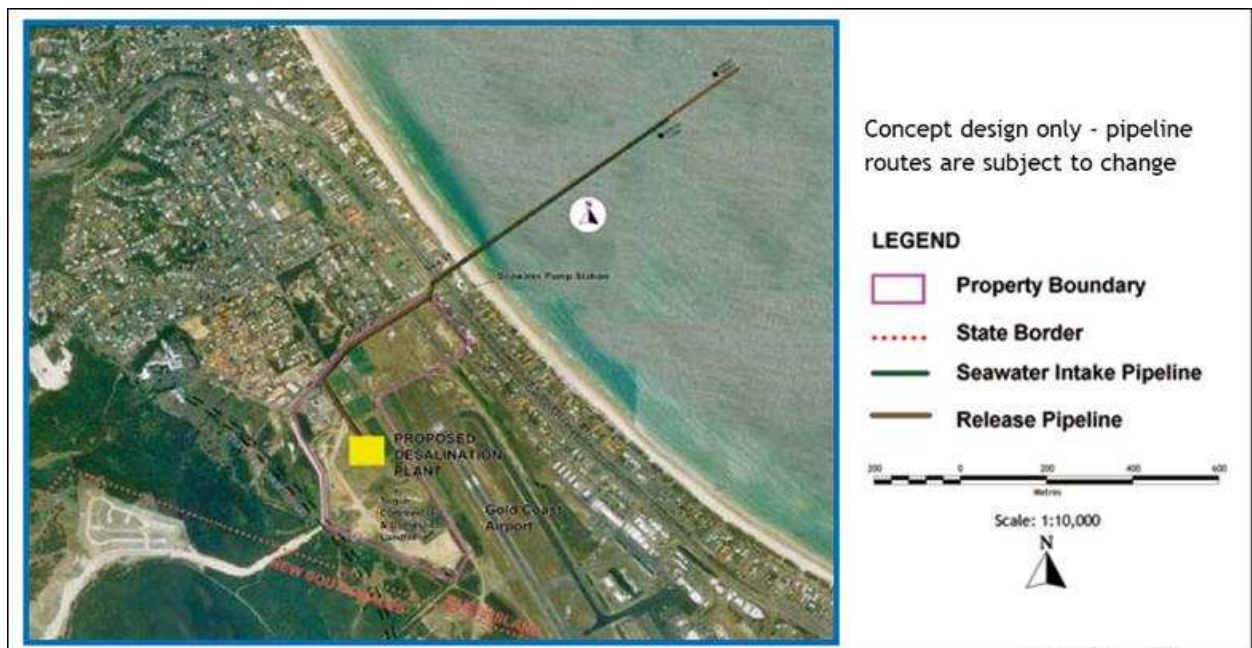

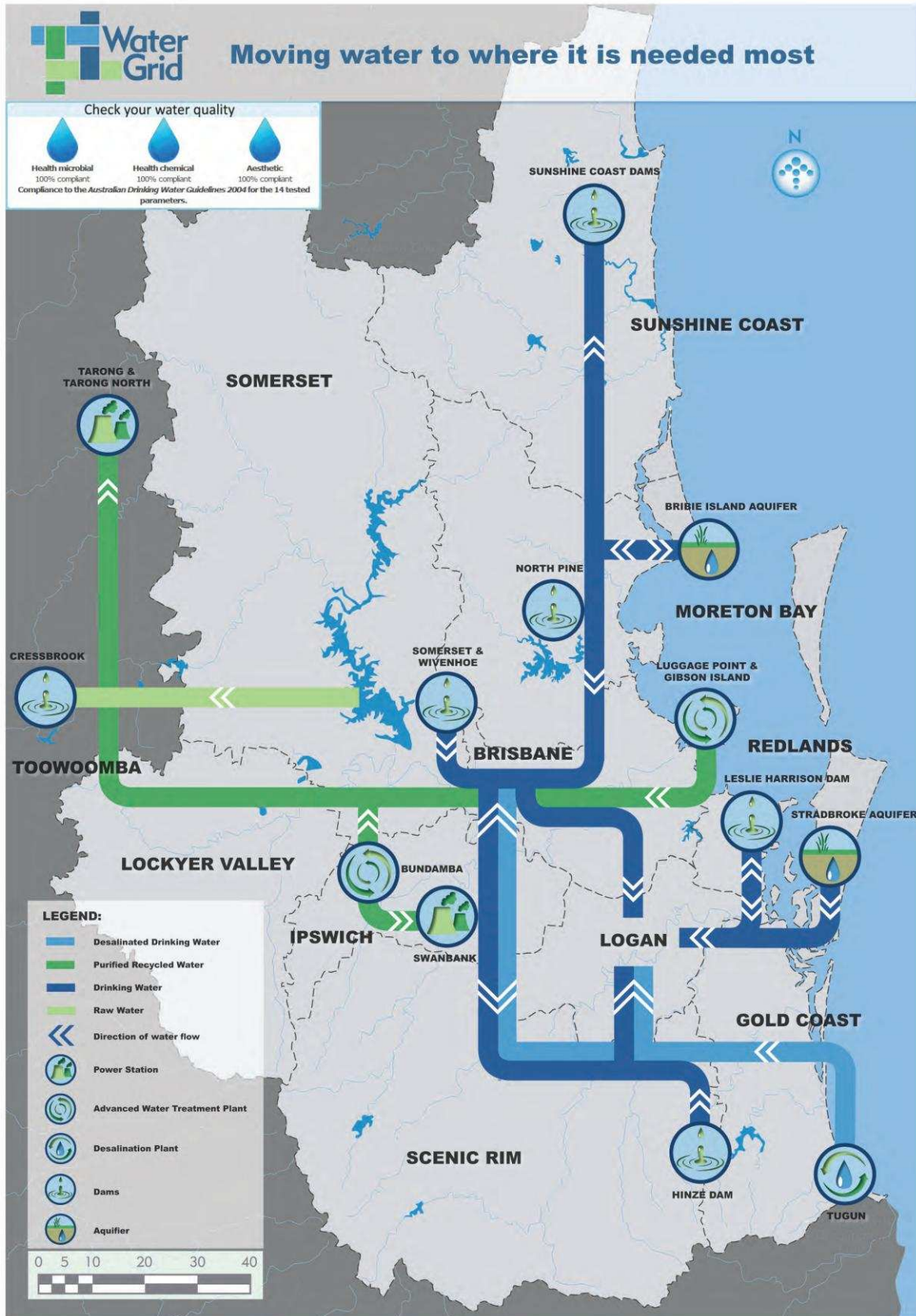

Gold Coast Survey

Metropolitan Water District of Southern California
Assessment of Existing Seawater Desalination System Integration Practices
Survey Questionnaire
MELBOURNE (AUSTRALIA)

Mandi Zonneveldt
Communications and Stakeholder Relations Manager
Victorian Desalination Project
Ph (+61 3) 9948 2831 Fax (+61 3) 9948 2888
mandi.zonneveldt@dse.vic.gov.au
www.water.vic.gov.au/desalination

Doug Franklin (SKM)
DFranklin@skm.com.au
(P) +61 3 8668 3267

1. Distribution system information

1.1. Population served
4.1 Million

1.2. Basic governance (i.e., elected / appointed Board, municipal government, etc.)
Melbourne Water is responsible for the city's distribution system. It is owned by the State of Victoria and responsible to the Minister for Water. Melbourne Water supplies bulk water to 3 state-owned water 'retailers' that operate across the city and suburbs. The Victorian Desalination Project is being delivered as a Public Private Partnership (PPP) under the Victorian Government's *Partnerships Victoria* policy. The Department of Sustainability and Environment's Capital Projects Division is responsible for managing the PPP contract on behalf of the State. The 30-year contract (finance, design, construct, operate maintain) has been let to the AquaSure consortium.

1.3. Driver for implementing seawater desalination
Drought, climate uncertainty, diversification, water security, absence of alternative sources and projected population growth.

Melbourne Survey

1.4. Size of geographic area served

The suburban area of Melbourne covers 2,000 to 2,500 square kilometres depending on the housing density criterion used to define the boundary. Note also that the addition of desal supply is being used to extend supplies from Melbourne to regional centres as a new source for them, eg. Westernport, South Gippsland, Geelong

1.5. General map of distribution system with seawater desalination pipeline

Please refer to interactive map in the following URL

http://www.melbournewater.com.au/content/water_storages/water_supply/water_supply_network.asp

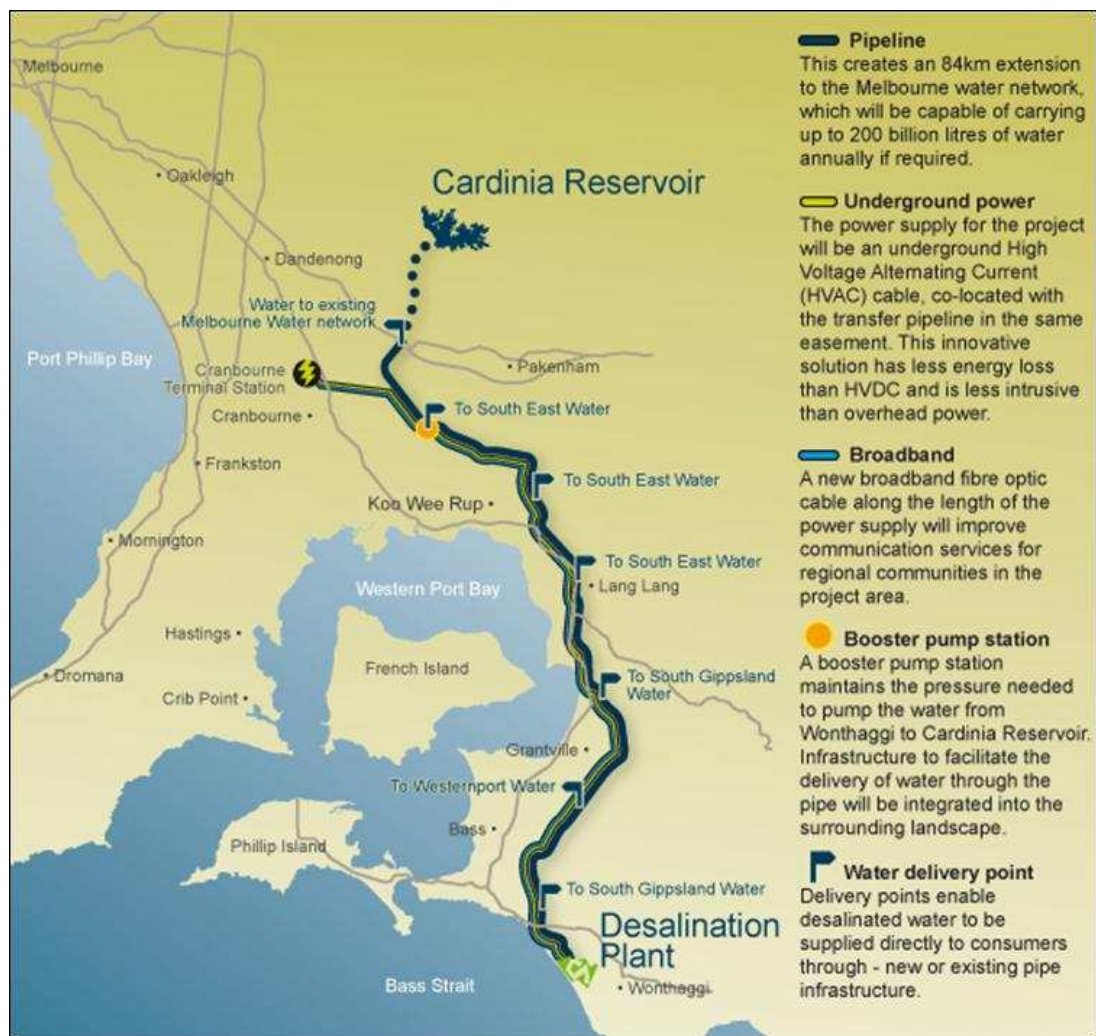

Sourced from <http://www.water.vic.gov.au/programs/desalination/background/pipeline>)

1.6. System deliveries:

1.6.1. Average annual deliveries
1 GL/day (average Daily demand)

1.6.2. Description of potable water supply sources
Surface water, chiefly from forested, mountain catchments.
More information here:
http://www.melbournewater.com.au/content/water_storages/water_supply/water_catchments.asp;
Surface water from open catchments (Winneke)

1.6.3. Percent of total supplies represented by desalinated seawater
About one third per annum if that plant is operating at its full capacity

1.6.4. Type(s) of customers that receive the water (e.g., residential, industrial, agricultural, etc.)
Residential, commercial and industrial.

1.7. Basic operations before desalinated supply added

1.7.1. Water quality parameters and concerns prior to desalination
The majority of Melbourne's water comes from protected catchments, and requires minimal treatment before being supplied to our retail customers.

1.7.2. Disinfection: type of primary and secondary disinfection, and target levels
Disinfection (by chlorination) is used to ensure water is free from microorganisms.
Water is also fluoridated to help prevent tooth decay and pH is corrected with lime.

1.8. Changes to system operations due to seawater desalination

Operational changes will mainly comprise bulk transfer modifications to accommodate the volume of water arriving from a different physical location. Desal water mainly transferred to existing bulk storage reservoir, where it will blend with existing supplies. At times of high demand, desalinated water may flow directly to consumers.

2. Desalination Project Facilities

2.1. Current/planned capacity

150 GL/yr under construction. Major elements such as tunnels sized for 200 GL/yr.

2.1.1. Basis of project sizing

The project was sized based on extensive modeling by Melbourne Water which considered climate variability and population growth.

2.1.2. Plant staging / capacity expansion (e.g., upsized pipelines, pads and stub-ups for additional RO skids, etc.)

The initial capacity of 150 GL/yr can be upsized to 200 GL/yr without significant interruption to the 150 GL/yr plant.

2.2. Basic treatment process

2.2.1. Pretreatment

Dual Media Filter (Pressure)

2.2.2. RO process configuration

Two Pass RO

2.2.3. Boron management strategy

Enhanced Boron Removal by pH control prior to the 2nd Pass RO system.

2.2.4. Post-treatment

Mineralisation, disinfection and fluoridation.

2.3. Current/planned desalination project operations

2.3.1. Base-loaded or peaking

Melbourne Survey

The State will order an annual amount, with flexibility built into the contract to order between 0 GL and 150 GL/yr. The private operator is free to deliver this as it sees fit.

2.3.2. Frequency / schedule of plant in-service time

Plant has to meet annual production target, schedule up to plant operator.

2.3.3. Basic water quality parameters

Appendix S6 of the Project Scope and Project Requirements sets out the water requirements. This is available online at

<https://www.tenders.vic.gov.au/tenders/contract/download.do?id=9265&docIndex=28>

Melbourne Survey

2.3.4. Goals for key parameters (e.g., B, Br, Cl, Na, TDS, Alk, pH, LSI, CCPP, etc.)
See above.

The information in the tables below is extracted from the document referenced above.

Water Quality Parameters	Unit of Measurement	Target Specification	Abatement Criteria	Cease Supply Criteria	Testing Location	Method
Parameters measured at the Desalination Plant						
Chlorine Dose (C ₂)	mg.m ³ /L	>15	30 cumulative minutes less than or equal to the Target Specification number in any month period	180 consecutive minutes less than or equal to the Target Specification	Desalination Plant Outlet	On-Line calculation as described in Schedule B to this Appendix S6.
Free Chlorine	mg/L	>0.4	30 cumulative minutes less than the Target Specification in any month period	30 consecutive minutes in excess of Target Specification	Desalination Plant Outlet	On-line
Turbidity	NTU	≤ 0.15	1800 cumulative minutes in excess of Target Specification in any month period	n/a	Combined flow downstream of 2nd Pass membranes	On-line
Turbidity	NTU	≤ 0.20	30 cumulative minutes in excess of Target Specification in any month period	30 consecutive minutes in excess of Target Specification	Combined flow downstream of 2nd Pass membranes	On-line
TDS	mg/L	≤120	1800 cumulative minutes in excess of Target Specification in any month period	n/a	Desalination Plant Outlet	On-line calculation as described in Schedule B to this Appendix S6.
TDS	mg/l.	≤140	600 cumulative minutes in excess of Target Specification in any month period	>200 for more than 30 consecutive minutes	Desalination Plant Outlet	On-line calculation as described in Schedule B to this Appendix S6.
Fluoride	mg/l.	0.7- to <1.0	600 cumulative minutes in excess of Target Specification in any month period	≥1.5 for longer than 30 consecutive minutes	Desalination Plant Outlet	On-line

Water Quality Parameters	Unit of Measurement	Target Specification	Abatement Criteria	Cease Supply Criteria	Testing Location	Method
Temperature	°C	Within 2° of ambient seawater	1800 cumulative minutes in excess of Target Specification in any month period	n/a	Desalination Plant Outlet	On-line
Parameters measured at Delivery Points						
Free Chlorine	mg/l.	≤ 0.6	600 cumulative minutes in excess of Target Specification in any month period	n/a	DP1	On-line
Free Chlorine	mg/L	≤ 1.0	600 cumulative minutes in excess of Target Specification in any month period	30 consecutive minutes in excess of Target Specification	All Delivery Points	On-line
Turbidity	NTU	≤ 1.0	600 cumulative minutes in excess of Target Specification in any month period	n/a	All Delivery Points	On-line
Turbidity	NTU	≤ 5.0	30 cumulative minutes in excess of Target Specification in any month period	120 consecutive minutes in excess of Target Specification	All Delivery Points	On-line
pH	Units	6.8 to 7.8	600 cumulative minutes outside of Target Specification in any month period	n/a	All Delivery Points	On-line
pH	Units	6.5 to 8.5	30 cumulative minutes outside of Target Specification in any month period	30 consecutive minutes outside of Target Specification	All Delivery Points	On-line

Melbourne Survey

Water Quality Parameters	Unit	Target Specification	Abatement Criteria	Cease Supply Criteria (any Exceedence)	Minimum frequency of testing	Testing Location	Method
Bromide	mg/L	< 0.1	Any exceedence	>0.4	Weekly	Desalination Plant Outlet	Lab analysis
Enterococci	CFU /100mL	Not present in 100 mL	Any exceedence	Any two consecutive failures	Weekly	Desalination Plant Outlet	Lab analysis
Escherichia coli	CFU /100mL	Not present in 100 mL	Any exceedence	Any two consecutive failures	3x/Week	All Delivery Points	Lab analysis
Dichloroacetic acid	mg/L	<0.07	Any exceedence	> 0.100	Monthly	All Delivery Points	Lab analysis
Monochloro-acetic acid	mg/L	<0.10	Any exceedence	> 0.150	Monthly	All Delivery Points	Lab analysis
Trichloroacetic acid	mg/L	<0.07	Any exceedence	> 0.100	Monthly	All Delivery Points	Lab analysis
Total Trihalomethanes	mg/L	< 0.07	Any exceedence	> 0.250	Monthly	All Delivery Points	Lab analysis

2.3.5. Point of compliance for key water quality parameters

Some parameters at the boundary of the 84km pipeline with the Melbourne network; others at the plant site.

2.3.6. Regulatory context / compliance framework (e.g., country-specific; state- or region-specific; World Health Organization (WHO); etc.)

Water quality must meet Australian Drinking Water Guidelines and requirements of the Victorian Safe Drinking Water Act 2003. For information on environmental approvals, see <http://www.water.vic.gov.au/programs/desalination/environment2/approvals>

2.3.7. Areas of concern

Not answered

2.3.8. Method(s) of mitigating concerns

Not answered

3. Integration of desalinated seawater into the existing distribution system

3.1. Pipeline / conveyance

3.1.1. Length, capacity, cost, pipe material, urban/rural alignment

The pipeline comprises 84 km of welded, mild steel cement lined pipes 1930 mm outside diameter and two pumping stations. The pipeline route is through rural land. This pipeline connects to an existing 1750 mm x 12 km pipeline. Information on integration works is available here:

http://www.melbournewater.com.au/content/current_projects/water_supply/getting_ready_for_desalinated_water/getting_ready_for_desalinated_water.asp?bhcp=1

Excerpt from web site above: (Added by Malcolm Pirnie)

Melbourne Water will install new fittings to allow the Victorian Desalination Project to connect to our existing water supply network at the connection point in Berwick. The water will then be piped north through an existing water main (the Cardinia-Pearcedale transfer main), and a new 2.3km section of inlet water main will deliver the desalinated water into Cardinia Reservoir. The desalinated water will mix with other water in Cardinia Reservoir and then be delivered to consumers in the south, south-east, Mornington Peninsula and Pakenham areas. Water will also be pumped north to Silvan Reservoir via a new pump station for delivery to other parts of our distribution network. To complete this project, works are required in various locations including Cardinia Reservoir Park, Soldiers Road in Berwick, and along the existing Cardinia-Pearcedale pipeline

3.1.2. Elevation or pressure head to overcome at the point of injection of desalinated water into the existing distribution system

See Appendix S5 of the Project Scope and Project Requirements (as above)

3.1.3. Onsite/offsite storage

2 x 35 ML storages on-site with provision for a third. On-site storage provided for flow balancing and chlorine contact time, most discharge via a long pipeline to Melbourne Water's existing storage reservoir (a rockfill dam 85m high with 287 GL capacity)

3.1.4. Major issues to overcome with new conveyance/distribution system

Managing transients that may impact some direct supply offtakes.

3.2. Integration point(s)

3.2.1. Regional vs. local system integration and rationale

Most production will go into Melbourne Water's 287GL capacity storage; some supply will be direct to consumers when demand is high.

Note that desalinated water supplements yield from catchments and contributes to total system storage, thereby helping to protect the city from drought. The Cardinia Reservoir Park was a storage of sufficient size and proximity to the desal plant.

3.2.2. Operational integration of desalinated seawater

Most of the supply will be to a defined zone, albeit via a storage reservoir with other sources also available to the storage. Some zones will receive direct desal supply when demand is high.

Plant annual production will be set each year, and will apply for the year unless unusual circumstances force a renegotiation.

Daily turndown up to the plant operator as system is buffered by capacity 287GL storage. Annual order can be for 0,50,75,100,125 or 150GL.

3.3. Blending

3.3.1. Location of blending desalinated seawater into the existing distribution system

Most blending will be in Melbourne Water's 287GL reservoir before entering the distribution system. A relatively small proportion may flow directly to consumers either blended or not blended.

3.3.2. Method of blending desalinated seawater into the existing distribution system (e.g. blend in pipe, in reservoir, etc.)

As Above.

Blending of desalinated seawater and surface water supplies will be conducted in an open reservoir.

3.3.3. Blending conducted before or after introducing desalinated seawater into the distribution system?

As above.

Also, connections directly off the new desal pipeline will be 100% desal when the desal plant is running, and when the desal plant is not running it will be a blend coming back from the Melbourne system (reverse flow).

3.3.4. Supplies used to blend with desalinated seawater

Unfiltered supplies from closed catchments.

3.3.5. Blending to meet water quality goals (if applicable)

Not Applicable.

3.3.6. Percent blend goal (if applicable) and any changes to the goal over time

Not applicable.

3.4. Monitoring

(The plant is being built at the time of survey, hence monitoring information was not available)

3.4.1. Method of post-blend water quality monitoring

Monitoring at Plant and delivery points for compliance.

Existing monitoring program in the Melbourne Water system to continue with addition of some online EC measurement in the Melbourne Water system to verify blend proportions and online pre-dose fluoride monitoring out of the 287GL reservoir to enhance fluoridation control (the desal water will be fluoridated).

3.4.2. Any unexpected results

Not applicable.

4. Key factors in choosing the integration approach

4.1. Integration concerns that required attention going into the construction of the project
Reservoir impacts – biological (algal blooms); soil dispersion; seasonal color variations (delivered unfiltered from the 287 GL storage).

Treatment impacts – fluoride dosing control.

Distribution system impacts – TDS variation for commercial/industrial customers, pH variation, chlorine levels.

4.2. Water quality studies that were performed

Risk assessments and studies by Melbourne Water, eg. To determine the potential for soil dispersion and disinfection byproduct formation.

Hydrodynamic modeling of receiving storage for mixing.

Analysis of likely water quality variations to be delivered to customers (informs communications plans).

4.3. Water quality factors (if any) that influenced the methodology on where and how to integrate desalinated seawater into the existing distribution system (e.g., blending, water quality parameters [e.g., B, Br, disinfection by-products, etc.], corrosion, residual decay, temperature, etc.)

Inlet location into reservoir selected to ensure good mixing.

4.4. Operational factors

4.4.1. Project size

444 ML/d Capacity

4.4.2. System and hydraulic constraints

No system constraints, discharge directly to open reservoir.

4.4.3. Demand constraints

Demand set annually.

4.4.4. Storage requirements

To achieve the flow balancing (btw treatment and transfer) and provide sufficient chlorine contact time.

4.4.5. Shutdowns

Up to private contractor.

4.4.6. Minimum flows

0 ML/d

4.4.7. Existing treatment plant flexibility

Desalination plant will operate independent to other plants.

4.5. Flexibility considerations (e.g., bringing desalinated seawater to the head of the system improves overall reliability; etc.)

Provides an alternative source of water to the south east of Melbourne if the other catchment sources are unavailable for extended periods, eg. Following severe bushfires.

4.6. Other considerations

4.6.1. Cost

Not answered

4.6.2. Downstream acceptance

Not answered

4.6.3. Stranded treatment capacity, etc.

Not answered

5. Integration issues experienced (if any, as applicable)

(The plant is being built at the time of survey, hence the following information was not available)

5.1. Water Quality

5.1.1. Taste & odor

5.1.2. Customer complaints

Melbourne Survey

5.1.3. Corrosion

5.1.4. Red or discolored water

5.1.5. Disinfection residual decay

5.1.6. Blend chemistry

5.2. Operations

5.2.1. Shutdowns of seawater desalination plant

5.2.1.1. Frequency, duration, and impacts

5.2.1.2. Economics or system reliability impact of outages

5.2.1.3. Effect of shutdowns on operations

5.2.1.4. Causes of shutdowns (e.g., cost, operational constraints, demands, water quality, etc.)

5.2.2. Decision process for choosing supplies during low demands or high supply

6. Lessons learned

(The plant is being built at the time of survey, hence the following information was not available)

6.1. Any identified integration issues that would be addressed another / different way now after having operational experience with seawater desalination

6.2. Any other lessons or advice

Melbourne Survey

Metropolitan Water District of Southern California
Assessment of Existing Seawater Desalination System Integration Practices
Survey Questionnaire
PERTH 1 (AUSTRALIA)

CONTACTS

Mark Leathersich

Manager – Infrastructure Planning Branch

(Acting General Manager - Planning & Capability Group- reports to the COO)

Mark.Leathersich@watercorporation.com.au

T: (08) 9420 3724 | F: (08) 9420 3179

Noel Lavery (SKM)

NLavery@skm.com.au

(P) +61 8 9469 4443

1. Distribution system information

1.1. Population served

1.5 Million - refer <http://www.watercorporation.com.au/watersupply/index.html>

1.2. Basic governance (i.e., elected / appointed Board, municipal government, etc.)

Corporation with appointed Board. Western Australian State Government is the sole shareholder and recipient of dividends.

1.3. Driver for implementing seawater desalination

Several drivers: New source required to meet growing population; Climate independent source was preferred option in response to a series of record low rainfall/runoff years (dams very low and lowering water table).; Long term planning strategy - "Security through diversity" of sources; Inter-basin transfer of substantial ground-water source seen as politically "difficult" to sell to the regional community

1.4. Size of geographic area served

All of Western Australia – very large areas

Perth 1 Survey

1.5. General map of distribution system with seawater desalination pipeline

The Water Corporation manages a number of water supply schemes and independent water sources across Western Australia. Our largest scheme is the Integrated Water Supply System (IWSS), which provides water to more than 1.5 million people in Perth, the South West, Wheatbelt, and Goldfields and Agricultural regions. The plan below shows the water sources and the principal inter-connecting trunk mains

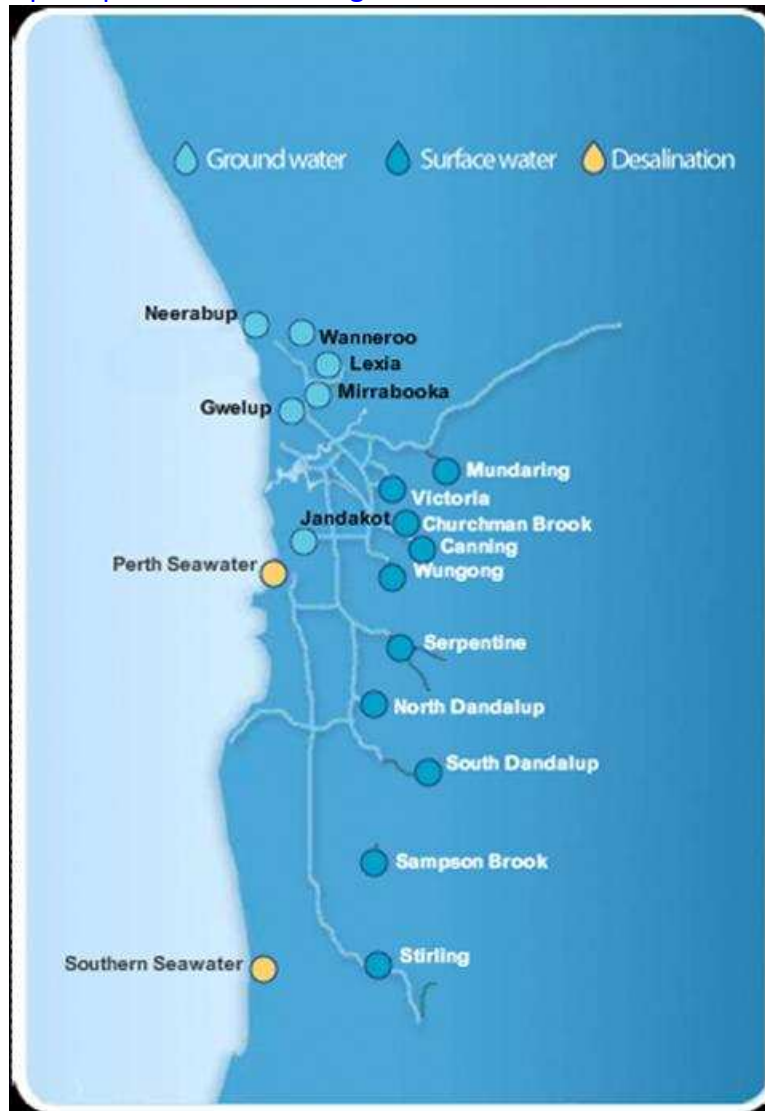

Notes:

1. Approx distance north-south (Neerabup to Southern Seawater) is 250km
2. Pipeline from Mundaring extends eastwards approx 600km to Kalgoorlie, with branches along the way extending up to 200km north and south of the main conduit.
3. Southern desalination plant and connecting pipeline under construction - first water due early 2012

1.6. System deliveries:

1.6.1. Average annual deliveries

280GL/a: 35-50% groundwater; 25-45% surface water; 15-20% desalinated water

1.6.2. Description of potable water supply sources

Surface water from Dams in mostly protected catchments; groundwater from confined aquifers; seawater desalination plant (1 existing 45GL/a and 1 under construction 50GL/a) ; No stormwater reuse for potable purposes however most stormwater in Perth is directed into local "sinks" to recharge unconfined aquifer ; Some wastewater reuse after advanced treatment for industrial process water (potable water substitution); Significant water usage from unconfined aquifers from domestic and industrial bores for non-potable uses.

1.6.3. Percent of total supplies represented by desalinated seawater

Current 15-20% soon to be 30%

1.6.4. Type(s) of customers that receive the water (e.g., residential, industrial, agricultural, etc.)

71% residential; 19% commercial/industrial; 10% unaccounted-for water (presumed leakage); Goldfield and Agricultural water supply extension also provides potable water to agricultural areas for domestic uses and stock watering

1.7. Basic operations before desalinated supply added

1.7.1. Water quality parameters and concerns prior to desalination

Surface waters of good quality requiring only pH correction and disinfection.

1.7.2. Disinfection: type of primary and secondary disinfection, and target levels

Mostly chlorination (free chlorine residual) but chloramination for long (600km) goldfields (Kalgoorlie) extension

It is confirmed that the system uses free chlorine. The chloramination is only for the one extension listed above. It also notes the plant produces water with very low bromides (presumably via the use of the 2nd pass of RO), such that the DBPs are minimal. No unusual free chlorine residual decay or other instability has been reported.

1.8. Changes to system operations due to seawater desalination

Need to transfer water to other areas during winter months when the demand in the "local sub-system network" is less than desalination plant production.

Because the plant is base loaded,

2. Desalination Project Facilities

2.1. Current/planned capacity

2.1.1. Basis of project sizing

Required to meet short-term growth in demand plus some potential loss of surface water source due to drought

2.1.2. Plant staging / capacity expansion (e.g., upsized pipelines, pads and stub-ups for additional RO skids, etc.)

Perth Plant (existing): 45GL/s and not designed for expansion; Binningup Plant (under construction): 50GL/s designed for additional 50GL/a expansion. Civil works (intake, outfall, connecting pipework, potable water PS building, downstream trunk mains) being installed at 100GL/a capacity

2.2. Basic treatment process

2.2.1. Pretreatment

screening followed by pressure filters (sand media)

2.2.2. RO process configuration

cartridge filters followed by two-pass RO system with ERI

2.2.3. Boron management strategy

Enhanced Boron Removal by 2nd Pass RO system

2.2.4. Post-treatment

potabilisation (lime+CO₂); chlorination (gas); fluoridation (fluosilicic acid)

2.3. Current/planned desalination project operations

2.3.1. Base-loaded or peaking

Base load plant; 4 week maintenance shutdown in low demand period (winter); No diurnal variation other than as required by tank levels downstream in network; can be operated at 25% 50% and 75% capacity

It is confirmed that the plant is base loaded.

2.3.2. Frequency / schedule of plant in-service time

Off line approx 4 weeks per year for scheduled maintenance to be completed

Perth 1 Survey

2.3.3. Basic water quality parameters

2.3.3.1. Goals for key parameters (e.g., B, Br, Cl, Na, TDS, Alk, pH, LSI, CCPP, etc.)

Water Quality Parameters	Units	Range
pH		7,5 - 8
True colour	HU	< 5
Temperature	°C	< 28*
Turbidity after 2 nd pass RO	NTU	< 0.1 NTU, 90 % of the time max 0.3
Turbidity after remineralisation	NTU	max 0.5
Total Dissolved Solids (TDS)	mg/l	< 200
Sodium	mg/l	max 180
Boron	mg/l	< 2
Calcium	mg/l	min 20
Manganese	mg/l	max 0.02
Chlorine	mg/l	0.1 to 0.5 after 4 days
Chloride	mg/l	max 250
Bromide	mg/l	< 0.1
Fluoride	mg/l	0.85 ± 0.05
Total Iron	mg/l	min 0.1
Increase of HCO ₃ content	mmol/l	min 0.5 – max 2.0
$S1 = \frac{c(Cl) + 2 c(SO_4)}{c(HCO_3)}$	mol / mol	max 2.0
Langelier Index		min – 0.5

2.3.3.2. Point of compliance for key water quality parameters

[At site boundary - point of sale](#)

2.3.3.3. Regulatory context / compliance framework (e.g., country-specific; state- or region-specific; World Health Organization (WHO); etc.)

[State regulation \(EPA Dept Health\) with some national requirements \(marine\)](#)

2.3.3.4. Areas of concern

(personal observation only) - excellent water quality which is better than alternative supply especially regarding taste, odour, colour, lower chlorine demand)

2.3.3.5. Method(s) of mitigating concerns

No WQ concerns

3. Integration of desalinated seawater into the existing distribution system

3.1. Pipeline / conveyance

3.1.1. Length, capacity, cost, pipe material, urban/rural alignment

approx 5 km DN 1200 mm MSCL pipeline from plant boundary to Thomsons Reservoir (92ML+ 290ML in future)

Subsequent information indicates that this pipeline is actually about 10 km.

3.1.2. Elevation or pressure head to overcome at the point of injection of desalinated water into the existing distribution system

TWL of reservoir RL75.44 m

3.1.3. Onsite/offsite storage

Nil - 4 ML provided on site for flow balancing of Pump station and downstream reservoir

3.1.4. Major issues to overcome with new conveyance/distribution system

Environmental approvals for pipeline route - tree clearance, main roads clearance

3.2. Integration point(s)

3.2.1. Regional vs. local system integration and rationale

Closest logical supply/connection point

3.2.2. Operational integration of desalinated seawater

Desalinated water will supply local area only at high demand but is transferred to other areas depending on demand. Can also be routed into surface storages (dam impoundments) if needed; Desalination plant usually operated at fixed rate whilst still in drought mode with low dam levels - other sources reduced as required; The plant can be operated at 25%, 50% 75% 100% on a seasonal basis

3.3. Blending

3.3.1. Location of blending desalinated seawater into the existing distribution system

Thomsons Reservoir 5km away

It is clarified that this major blending reservoir is about 10 km from the SWRO plant.

Perth 1 Survey

3.3.2. Method of blending desalinated seawater into the existing distribution system (e.g. blend in pipe, in reservoir, etc.)

Thomsons Reservoir feeds other reservoirs which have water from other sources in them as well

3.3.3. Blending conducted before or after introducing desalinated seawater into the distribution system?

Both: depending on time of year, Thomsons reservoir may have only desalinated water or a blend

When other sources are utilized at Thomsons, blending with SWRO water occurs prior to introduction into the existing system. However, when only SWRO water is in Thomsons (as dictated by demand), 100% desal water can be introduced into the system prior to blending with other sources in downstream reservoirs (as indicated in 3.3.2).

3.3.4. Supplies used to blend with desalinated seawater

Could be surface water or ground water or both

3.3.5. Blending to meet water quality goals (if applicable)

Not applicable - desalinated water is "potabilised" before added to the water supply i.e. buffer (lime) added to balance water and pH adjusted to meet ADWG criteria.

3.3.6. Percent blend goal (if applicable) and any changes to the goal over time

Not applicable

It is confirmed that there is no percent goal for desalinated water in the system, and in fact this percentage fluctuates both spatially and temporally within the system. (In other words, the blend varies both with time and location in the system.) Notably, depending on the demand and use of other sources for blending, some customers may get 100% desalinated seawater, while others may receive 0% desalinated seawater.

3.4. Monitoring

3.4.1. Method of post-blend water quality monitoring

Not applicable - Cl₂ residual monitoring only in network

3.4.2. Any unexpected results

Improved water quality throughout network, reduced use of rechlorination facilities, fewer complaints, reduction in THMs

4. Key factors in choosing the integration approach

4.1. Integration concerns that required attention going into the construction of the project
The key issue was not integration but rather the location of the desalination plant. There was very little land available that met the critical criteria: 1. close to ocean for intake/outfall; 2. compatible land use zoning; 3. close proximity to major water supply infrastructure (tanks, trunk mains) ; 4. public acceptance of location; 5. land available for acquisition by Water Corp; 6. could meet environmental conditions imposed by regulator

4.2. Water quality studies that were performed

Only studies to satisfy environmental regulation i.e. near and far field mixing modeling for intake and brine discharge into the ocean (Cockburn Sound).

4.3. Water quality factors (if any) that influenced the methodology on where and how to integrate desalinated seawater into the existing distribution system (e.g., blending, water quality parameters [e.g., B, Br, disinfection by-products, etc.], corrosion, residual decay, temperature, etc.)

Nil

4.4. Operational factors

4.4.1. Project size

140 ML/d approx (45 GL/y average)

4.4.2. System and hydraulic constraints

Constrained by being a large base-load supply source needed to meet summer (high) and winter (low) demands. Some need to transfer "excess" water into other sub-catchments/supply areas in winter.

4.4.3. Demand constraints

Needed to modify operations and construct other facilities (Pump Station) to enable water transfers of excess production

4.4.4. Storage requirements

Apart from on-site "clear water tank" use existing scheme storages

4.4.5. Shutdowns

Scheduled maintenance shutdowns timed annually (summer month when low mixing in receiving water) to meet expected environmental compliance shut-downs (when low DO in Cockburn Sound)

4.4.6. Minimum flows

25% (35 ML/d approx)

4.4.7. Existing treatment plant flexibility

All existing TPs can be shut down completely if required. Some operational flexibility available in every WT plant.

4.5. Flexibility considerations (e.g., bringing desalinated seawater to the head of the system improves overall reliability; etc.)

Complete flexibility was provided within the plant for complete independent commissioning purposes e.g. able to return all seawater intake capacity through all components of the plant and then back to the outfall.

4.6. Other considerations

4.6.1. Cost

Cost controlled through competitive alliance delivery method

4.6.2. Downstream acceptance

No issues were anticipated as already providing a blended supply to customers

4.6.3. Stranded treatment capacity, etc.

No stranded treatment capacity as all other treatment capacity was under stress due to water shortages

5. **Integration issues experienced**

5.1. Water Quality

5.1.1. Taste & odor

Nil - excellent quality

5.1.2. Customer complaints

No discernable change in level of customer complaints

5.1.3. Corrosion

Nil

5.1.4. Red or discolored water

Nil

5.1.5. Disinfection residual decay

Much lower than for other sources

5.1.6. Blend chemistry

Not relevant

5.2. Operations

5.2.1. Shutdowns of seawater desalination plant

5.2.1.1. Frequency, duration, and impacts

Scheduled for four weeks annually to coincide with expected environmental compliance shut-downs

5.2.1.2. Economics or system reliability impact of outages

As above

5.2.1.3. Effect of shutdowns on operations

As above. Base load plant with planned outages

5.2.1.4. Causes of shutdowns (e.g., cost, operational constraints, demands, water quality, etc.)

As above

5.2.2. Decision process for choosing supplies during low demands or high supply

Base load plant - use desal plant as much as possible due to water shortages and stress on surface/ground water reserves

6. Lessons learned

6.1. Any identified integration issues that would be addressed another / different way now after having operational experience with seawater desalination

Nil

6.2. Any other lessons or advice

Metropolitan Water District of Southern California
Assessment of Existing Seawater Desalination System Integration Practices
Survey Questionnaire
SYDNEY (AUSTRALIA)

CONTACTS

Mr. Paul Choules
VP Desalination
Veolia Water Solutions & Technologies, Americas
(281) 227-9050 (voice)
(281) 687-7651 (cell)
paul.choules@veoliawater.com

Mr. Olivier Caumartin
EVP
Veolia Water Solutions & Technologies, Major Projects Group
+33 1 4511 5555
Olivier.caumartin@veoliwater.com

Ms. Susan Trousdale
Desalination Project Environment & Approvals Manager
Sydney Water
+61 2 9551 2258
susan.trousdale@sydneywater.com.au

1. Distribution system information

1.1. Population served

The 4 million people living in Sydney, Illawarra & Blue Mountains, Australia.

1.2. Basic governance (i.e., elected / appointed Board, municipal government, etc.)

The contract was awarded by the Sydney Water an elected government entity.

1.3. Driver for implementing seawater desalination

In 2007, when the project was awarded, the local reservoirs were at 34%. The population of Sydney had grown by 1M people since 1974 and it's expected to grow by another 1M within the next 20 years. Sydney Water launched an aggressive plan to save 145 billion liters of

Sydney Survey

drinking water a year by 2015, by: Recycling wastewater a year, investing A\$100M a year inspecting and repairing leaking pipes; Saving 40 Billion liters of drinking water every year by providing rebates for rainwater tanks and water efficient washing machines. This is in addition to launching the Sydney Desalination facility.

1.4. Size of geographic area served

The city of Sydney and surrounding areas as served by Sydney Water.

1.5. General map of distribution system with seawater desalination pipeline

See general map of the plant at the end of the survey.

1.6. System deliveries:

1.6.1. Average annual deliveries

Design capacity is 250 000 m³/d (66 mgd) at 94% availability

1.6.2. Description of potable water supply sources

Dams

1.6.3. Percent of total supplies represented by desalinated seawater

Up to 15%.

1.6.4. Type(s) of customers that receive the water (e.g., residential, industrial, agricultural, etc.)

The water produced goes into the distribution system so water is blended with other sources. This water is used by all consumers.

1.7. Basic operations before desalinated supply added

Water came from the local reservoirs.

1.7.1. Water quality parameters and concerns prior to desalination

Not answered

1.7.2. Disinfection: type of primary and secondary disinfection, and target levels

Not answered

1.8. Changes to system operations due to seawater desalination

Not answered

2. Desalination Project Facilities

2.1. Current/planned capacity

2.1.1. Basis of project sizing

The plant was designed for 250,000 m³/day (66 MGD or 202 acre feet per day) but the infrastructure (intake and outfall) was designed to increase the capacity to 500,000 m³/day (132 MGD or 404 acre feet per day). During the tender phase the contractor had to give 3 options for 125,000 m³/day (33.0 mgd), 250,000 m³/day (66.0 mgd) and 500,000 m³/day (132.1 mgd). The capacity has been selected after the submission in respect with the low level in the surrounding Dams.

2.1.2. Plant staging / capacity expansion (e.g., upsized pipelines, pads and stub-ups for additional RO skids, etc.)

The intake and outfall were designed for an expansion to 500,000 m³/day (132.1 mgd).

2.2. Basic treatment process

2.2.1. Pretreatment

Ferric, Sulfuric Acid and Polydadmac added for coagulation, pH control of seawater. 2 x 12 dual media filters to remove the floc and achieve a water quality suitable for the reverse osmosis process. 5 micron cartridge filters are included as safety filters prior to the RO system.

2.2.2. RO process configuration

12 duty + 1 standby 1st pass trains with 259 x 8 element pressure vessels. The 2nd pass comprises of 6 + 1 trains, 131 x 8 element pressure vessels in the 1st stage and 44 x 8 element pressure vessels in the 2nd stage.

2.2.3. Boron management strategy

The 2nd pass is included to guarantee the boron water quality.

2.2.4. Post-treatment

Lime and carbon Dioxide to add alkalinity and hardness, fluoride, other elements and pH control.

2.2.5. Primary disinfection (chemical(s), dose(s), etc.)

Monochloramine 0.7ppm.

2.2.6. Residual disinfection (chemicals(s), dose(s) applied, target doses in the distribution system, etc.)

The chloramine levels in the desalinated seawater (prior to blending) are adjusted such that they are within +/- 0.2 mg/L that of the existing surface water supplies at the point of blending.

2.3. Current/planned desalination project operations

2.3.1. Base-loaded or peaking

The plant was designed to be operated as base-load with a guarantee online availability of 94%

2.3.2. Frequency / schedule of plant in-service time

During the design previous experience from other plants was considered to achieve the required online availability. In the case of this project the client requested a spare train which allows the plant to produce excess capacity, if required. When calculating the online availability membrane cleaning, preventive maintenance, routine maintenance and unexpected shutdowns are considered.

2.3.3. Basic water quality parameters

2.3.3.1. Goals for key parameters (e.g., B, Br, Cl, Na, TDS, Alk, pH, LSI, CCPP, etc.)
<115 ppm TDS, <1.0 ppm Boron, Chloride < 40 ppm, Bromide < 0.1 ppm. Has to meet Australian drinking water standards.

2.3.3.2. Point of compliance for key water quality parameters
After storage tanks.

2.3.3.3. Regulatory context / compliance framework (e.g., country-specific; state- or region-specific; World Health Organization (WHO); etc.)
The water produced has to meet Australian drinking water standards.

2.3.3.4. Areas of concern
Not answered

2.3.3.5. Method(s) of mitigating concerns
The water is monitored before distribution and is dumped to waste if it exceeds any of the preset limits.

3. Integration of desalinated seawater into the existing distribution system

3.1. Pipeline / conveyance

3.1.1. Length, capacity, cost, pipe material, urban/rural alignment

After post-treatment the water is stored in a 40,000 m³ (10.5 Million Gal) storage tank and then pumped into the Sydney drinking water network via an 18 km (11 ¼ mile) pipeline.

3.1.2. Elevation or pressure head to overcome at the point of injection of desalinated water into the existing distribution system

Not answered

3.1.3. Onsite/offsite storage

A 40,000 m³ (10.5 million gal) tank is onsite.

3.1.4. Major issues to overcome with new conveyance/distribution system

Not answered

3.2. Integration point(s)

3.2.1. Regional vs. local system integration and rationale

Desalinated seawater is mixed into local supplies and distributed throughout the Sydney Water system.

3.2.2. Operational integration of desalinated seawater

Not answered

3.3. Blending

3.3.1. Location of blending desalinated seawater into the existing distribution system

At the end of the 18 km pipeline from the desalination facility.

3.3.2. Method of blending desalinated seawater into the existing distribution system (e.g. blend in pipe, in reservoir, etc.)

The pressurized 1.8 m (5.9 ft) pipeline from the desalination facility joins into an existing 3 m (5.9 ft) gravity-fed main distribution network pipeline. Thus, blending is accomplished in-pipe.

Sydney Survey

3.3.3. Blending conducted before or after introducing desalinated seawater into the distribution system?

See above.

3.3.4. Supplies used to blend with desalinated seawater

Water from the reservoirs is the main other source.

3.3.5. Blending to meet water quality goals (if applicable)

As the water introduced already meets the drinking water requirements it's not an issue.

3.3.6. Percent blend goal (if applicable) and any changes to the goal over time

Desalinated seawater represents 20% of the water supply; there is no other min/max target.

3.4. Monitoring

3.4.1. Method of post-blend water quality monitoring

The water is monitored prior to disinfection. If the water exceeds any of the preset limits it is dumped to waste so that no out of spec water is introduced into the network. Parameters for which there are water quality requirements are monitored prior to blending to ensure compliance, including: pH, SDI, dissolved oxygen, ammonia, alkalinity, turbidity, bromide, chloramines, conductivity, bacteria & E. coli. A combination of on-line monitoring and grab samples are used.

3.4.2. Any unexpected results

None reported.

4. Key factors in choosing the integration approach

4.1. Integration concerns that required attention going into the construction of the project.
Not answered

4.2. Water quality studies that were performed

Pilot testing has been performed by the client for almost 1 year. Results have been made available to contractor during tender phase.

Sydney Water conducted considerable time and effort modeling the water quality to ensure that the desalinated seawater (as conditioned) and the existing surface water would match as closely as possible.

- 4.3. Water quality factors (if any) that influenced the methodology on where and how to integrate desalinated seawater into the existing distribution system (e.g., blending, water quality parameters [e.g., B, Br, disinfection by-products, etc.], corrosion, residual decay, temperature, etc.)

Br was considered as an important factor in the water quality for the desalinated water production. However later tender has shown relax on this parameter.

Sydney Water clarifies that bromide levels are strictly monitored and must be < 0.1 mg/L 95% of the time. There initial problems with getting accurate readings from the instrument, so it was requested of Sydney Water that the standard be relaxed to < 0.2 mg/L. Subsequently, a better monitoring device was found, so the bromide standard was not relaxed.

4.4. Operational factors

In terms of siting (no specific question in the survey for this item), there are two issues: 1) the distance of the plant to the existing gravity-fed conveyance pipeline (related to integration issues); and 2) proximity to the intake/outfall and the nearest power transmission lines (not related to integration).

4.4.1. Project size

The plant capacity is 250,000 m³/day (66 MGD or 202 acre feet per day).

4.4.2. System and hydraulic constraints

None but this was considered when siting the plant at this site.

Although not a constraint, per se, there was some initial concern about integrating desalinated seawater conveyed in a new 1.8 m (5.9 ft) pressurized pipe (constituting 20% of the blended flow) into the existing 3 m (9.8 ft) gravity fed tunnel (providing 80% of the blended flow). Testing and modeling was done to avoid any issues, and Sydney Water did not report any such issues.

4.4.3. Demand constraints

None but this was considered when siting the plant at this site.

4.4.4. Storage requirements

A 40,000 m³ (10.5 million gal) tank is onsite.

4.4.5. Shutdowns

After commissioning the plant has not reported any shutdowns.

The plant is designed and intended to operate continuously without shutdowns.

4.4.6. Minimum flows

The distribution pumps are designed to vary the flow down to 10% of total capacity.

4.4.7. Existing treatment plant flexibility

There is no impact on existing infrastructure.

4.5. Flexibility considerations (e.g., bringing desalinated seawater to the head of the system improves overall reliability; etc.)

The water produced by the desalination facility is draught proof and provides water at another location in the distribution system, away from the reservoirs. A mothballing possibility of the plant has been foreseen in case Dams level rise and desalinated water is not considered anymore as required for the potable water production.

4.6. Other considerations

4.6.1. Cost

The total cost of the facility, excluding the intake and outfall, was about \$800M.

4.6.2. Downstream acceptance

The water has been accepted with minimal complaints.

The only complaint noted was: "The water makes my skin itchy."

4.6.3. Stranded treatment capacity, etc.,

NA

5. Integration issues experienced (if any, as applicable)

In general, Sydney indicated that there was significant concern (in general) over integrating desalinated seawater into the existing conveyance and distribution system. However, no significant issues were encountered as a result of the integration.

5.1. Water Quality

5.1.1. Taste & odor

No issues reported.

5.1.2. Customer complaints

No major complaints.

5.1.3. Corrosion

No corrosion due to the desalinated water in the network has been reported.

Sydney Survey

It was underscored that the desalinated seawater is conditioned via post-treatment to closely match the water quality in the existing distribution system. Sydney cites this as the reason that there have been no corrosion issues reported to date.

5.1.4. Red or discolored water

None reported.

5.1.5. Disinfection residual decay

None reported.

5.1.6. Blend chemistry

Monitored continuously.

5.2. Operations

5.2.1. Shutdowns of seawater desalination plant

5.2.1.1. Frequency, duration, and impacts

There have not been any shutdowns since the plant was commissioned in 2010.

5.2.1.2. Economics or system reliability impact of outages

N.A.

5.2.1.3. Effect of shutdowns on operations

N.A.

5.2.1.4. Causes of shutdowns (e.g., cost, operational constraints, demands, water quality, etc.)

N.A.

5.2.2. Decision process for choosing supplies during low demands or high supply

Not applicable at this point.

6. Lessons learned

6.1. Any identified integration issues that would be addressed another / different way now after having operational experience with seawater desalination

Lessons learnt from other plants have helped avoid any issues.

6.2. Any other lessons or advice

We continued to incorporate the lessons learnt from other recent plants constructed; We moved away from the pressure center design as used on Ashkelon and Gold Coast to a single 1st pass high pressure pump per train; Decreased the amount of SAF piping; Improved the operational control of each RO train; Installed a spare train to achieve the contractual online availability.

Another point from Sydney's experience is advance preparation. Get the public engaged and understand their concerns proactively. Sydney Water held Q&A sessions with the public, conducted workshops, and set up a hot line for stakeholders to call with any concerns. This is applicable not only to water quality and integration issues, but all aspects of SWRO plant development.

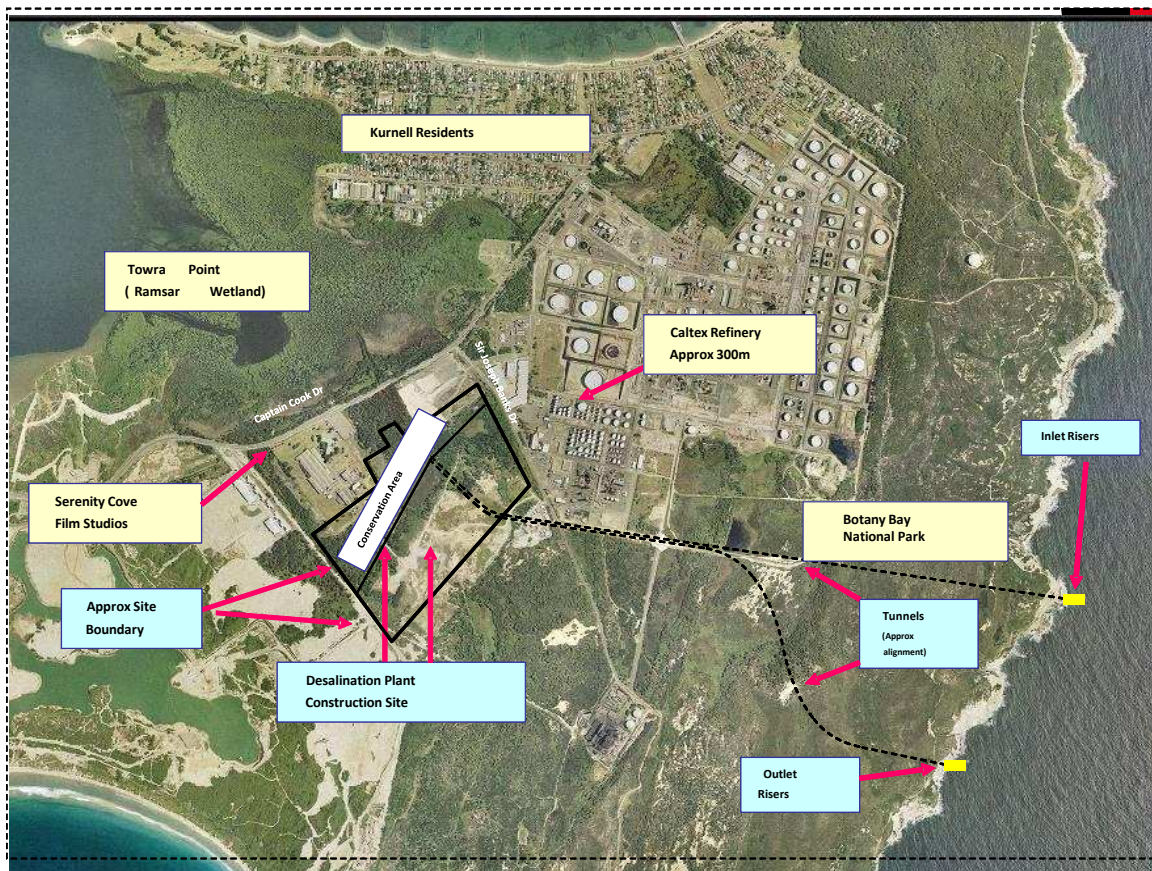

Metropolitan Water District of Southern California
Assessment of Existing Seawater Desalination System Integration Practices
Survey Questionnaire
ASHKELON (ISRAEL)

CONTACTS

Mr. Paul Choules
VP Desalination
Veolia Water Solutions & Technologies, Americas
(281) 227-9050 (voice)
(281) 687-7651 (cell)
paul.choules@veoliawater.com

Mr. Olivier Caumartin
EVP
Veolia Water Solutions & Technologies, Major Projects Group
+33 1 4511 5555
Olivier.caumartin@veoliawater.com

1. Distribution system information

1.1. Population served

The Ashkelon desalination facility pumps into the country wide distribution system. The facility is located in the south of Israel.

1.2. Basic governance (i.e., elected / appointed Board, municipal government, etc.)

The project was awarded by the Water Desalination Administration (WDA) which is an Israeli government entity.

1.3. Driver for implementing seawater desalination

The drivers were: Drought conditions; Limited availability of natural resources due to climate factors; Increase in demand of water due to population growth and economic development – an increase of 60% more water is projected by 2020; Saline ingress into existing water resources

1.4. Size of geographic area served

The desalinated water produced goes into the country wide distribution system. It serves mainly the south of Ashkelon region.

1.5. General map of distribution system with seawater desalination pipeline

No map available, but a photo of the plant is attached. As shown the desalination plant pumps into a local tank and from there the water is pumped into the country wide distribution system.

1.6. System deliveries:

1.6.1. Average annual deliveries

The average annual capacity is 100 – 108 million cubic meters per year (26,420,000,000 gallons/ 81,800 acre-feet a year). The plant has been increased to 120,000,000 m³/year.

1.6.2. Description of potable water supply sources

The potable water supply in Israel is a combination of water surface water and desalination (brackish water and seawater desalination).

1.6.3. Percent of total supplies represented by desalinated seawater

At the time the system became operational it produced as much as 15% of the total water in the country. This ratio is increasing with the start up of new production capacity. The target is 800 million cubic meters per year by the end of 2016.

1.6.4. Type(s) of customers that receive the water (e.g., residential, industrial, agricultural, etc.)

As the water goes into the country wide distribution system, residential, industrial, commercial and agricultural customers all use the water.

1.7. Basic operations before desalinated supply added

1.7.1. Water quality parameters and concerns prior to desalination

The main concern was the boron levels in the water produced due to agricultural use and water reuse for irrigation purposes. At the beginning of the project ground water recharge was also considered as a water usage.

1.7.2. Disinfection: type of primary and secondary disinfection, and target levels, Sodium hypochlorite injection the target at the outlet of the plant is between 0.2 – 0.5 ppm residual chlorine.

1.8. Changes to system operations due to seawater desalination

Not answered

2. Desalination Project Facilities

2.1. Current/planned capacity

2.1.1. Basis of project sizing

The original capacity was 320,000 m³/day (84.5 mgd) pushed to 340,000 m³/day (89.8 mgd) at the start up. The annual production has been increase from 100 million per year to 108 and now 120 due to modification and better operation.

2.1.2. Plant staging / capacity expansion (e.g., upsized pipelines, pads and stub-ups for additional RO skids, etc.)

The facility was designed to have the capacity expanded. This included upsizing the intake system, the pre-treatment system and additional membrane rack space. After four (4) years of operation (2009) the plant capacity was increased by 41,000 m³/day (10.8 MGD/ 33.2 acre feet/day) to produce 371,000 m³/day (98 MGD/ 300 acre feet/year). The plant is now operating at 120,000,000 m³/yr.

2.2. Basic treatment process

2.2.1. Pretreatment

Raw seawater is sent to the pre-treatment stage through two separate lines, each one feeding twenty (20) dual media gravity filters. Chemicals are added and mixed through static mixers before the filtration stage. The use of ferric sulfate as coagulant, and sulfuric acid as pH adjustment, facilitates obtaining a good SDI reduction through the pre-treatment step. Additional chemical injection equipment (shock chlorination & polymer) are installed in case of necessity due to seawater deterioration. The chemical treatment systems are designed for a real-time flow rate adjustment and adequate redundancy has been provided to ensure the availability of the system. Filtration is performed through gravity filters containing quartz sand and anthracite media. The filtration rate is 8 m/hr. The combination of this low velocity, the long retention time a distribution and collection under drain system designed to avoid preferential channel formation, allow to achieve a high filtration efficiency. Even with storm turbidity levels, the filtrated seawater is perfectly suitable for the next steps. The filters are automatically backwashed every two days. A set of 20 micron cartridge micron filters forms a second filtration stage as a final safety barrier before the RO membranes.

2.2.2. RO process configuration

The desalination facility consists of a four passes system. This unusual design has been imposed by the requested permeate water quality (Chloride less than 20 ppm and Boron less than 0.4 ppm) and the membranes performances in respect to boron removal at the time of the project.

Ashkelon

The first pass is a conventional seawater RO system. It is operated with a recovery around 45%. A part of permeate is collected from the feed side (front permeate) of the pressure vessels. This part has a lower concentration of salts (Boron) than the whole permeate, and can be mixed directly with the permeate water of the other stages.

The Rear permeate from the first pass feeds the second pass which operates at a high pH (on the 2 first stages) to increase the Boron reject by the membranes. This pass is operated at 85% recovery. The permeate of this stage is part of the final product.

Permeate is produced by each membrane element in the pressure vessel, and the concentrate from each element becomes the feed for the next element in succession. Thus, the feed water quality to each element is progressively more concentrated. Because the membrane reject a percentage of TDS, the permeate from the first (i.e., the front) element is somewhat better than that from the last (i.e., the rear).

The brine of the 2 first stages is sent as feed to the third and 4th stage after the pH has been lowered those stages acts as softeners of the second pass brine. This pass is operated at 85% recovery and under low pH. Due to acidified environment, there is no fear of scaling on the membrane surface, even at high recovery and high brine concentration. But at low pH, Boron rejection is very low and Boron partly remains with the third pass permeate. Therefore this permeate cannot be considered as product water and must be treated through a Third pass

The third pass operated at 90% recovery and high pH completes the Boron removal of the second pass brine. Thus treated, the third pass permeate is suitable to be mixed with the final product.

A “standard” two passes scheme with the second pass brine directed to the feed of the first pass was not acceptable due to the too high Boron concentration in this brine at the time of the project and the membranes performances. Different alternatives were studied during the design stage, among which the discharge of the brine to the drain, or the use of Boron selective ion-exchangers. Water cost was the key parameter to determine the optimum process and design. The desalination facility consists of thirty two RO trains for the first pass, for the 2nd Pass six First stage, 2nd Stage, 2rd stage, 2⁴ stage, two trains for the third pass. It makes use of 25,600 membranes of seawater type and 15,100 membranes of brackish water type. DOW Filmtec membranes have been selected for the RO operation.

A PFD of the plant is provided at the end of the survey.

2.2.3. Boron management strategy

As described above.

2.2.4. Post-treatment

While the final water quality in terms of Boron and chloride levels is achieved after the multiple pass RO system, post-treatment and lime is used to re-mineralize the product water before distribution in the national water system. This re-mineralization and adjustment of alkalinity, hardness, and pH are necessary to cope with the drinking water quality standards and to prevent any corrosion effects in the distribution network.

2.2.5. Primary disinfection (chemical(s), dose(s), etc.)

Chlorine at a dose between 0.2 and 0.5 ppm

2.2.6. Residual disinfection (chemical(s), dose(s) applied, target doses in the distribution system, etc.),

Chlorination along the network is performed by the network operator as required.

2.3. Current/planned desalination project operations

2.3.1. Base-loaded or peaking

Base-load however production during winter can't be higher than 85% of the summer production. Daily and monthly target are set at the beginning of the year.

2.3.2. Frequency / schedule of plant in-service time

The system is designed with 2 x 50% trains so one can be taken off line for maintenance. Most of the maintenance is schedule during winter time.

2.3.3. Basic water quality parameters

2.3.3.1. Goals for key parameters (e.g., B, Br, Cl, Na, TDS, Alk, pH, LSI, CCPP, etc.),
Guaranteed desalinated water quality: < 40 ppm TDS (before remineralisation),
chloride < 20 ppm, boron < 0.4 ppm, turbidity (after post-treatment) < 0.5 NTU,
Langelier Index – 0 – 0.5.

2.3.3.2. Point of compliance for key water quality parameters

At the outlet of the plant before the water reaches the client pumping station.

2.3.3.3. Regulatory context / compliance framework (e.g., country-specific; state-
or region-specific; World Health Organization (WHO); etc.)

Meets Israeli water standards and exceeds WHO drinking water standards.

2.3.3.4. Areas of concern

Not answered

2.3.3.5. Method(s) of mitigating concerns

Not answered



3. Integration of desalinated seawater into the existing distribution system

3.1. Pipeline / conveyance

The product water is pumped to an adjacent tank from where the client distributes water to the national grid.

3.1.1. Length, capacity, cost, pipe material, urban/rural alignment

NA

3.1.2. Elevation or pressure head to overcome at the point of injection of desalinated water into the existing distribution system

NA

3.1.3. Onsite/offsite storage

A storage tank adjacent to the facility was provided within our scope; however due to its size (3,000 m³) it's only used as buffer tank.

3.1.4. Major issues to overcome with new conveyance/distribution system

Client was having concerns on the operation of the pipe national grid. The water was pumps in the north of the country to feed the south and there were concerns about the water quality as the pipe could be working in the other direction. Corrosion was also a major concern, during start-up client required the LSI to be positive with not more than one occurrence between 0 and 0.2. But no issues have been reported so far by the client.

3.2. Integration point(s)

3.2.1. Regional vs. local system integration and rationale

NA

3.2.2. Operational integration of desalinated seawater

NA

3.3. Blending

3.3.1. Location of blending desalinated seawater into the existing distribution system, At the local storage tank.

3.3.2. Method of blending desalinated seawater into the existing distribution system (e.g. blend in pipe, in reservoir, etc.)

Not in our scope but direct into the National grid.

Ashkelon

3.3.3. Blending conducted before or after introducing desalinated seawater into the distribution system?

Not answered

3.3.4. Supplies used to blend with desalinated seawater

Throughout the National grid.

3.3.5. Blending to meet water quality goals (if applicable)

Israeli water standards.

3.3.6. Percent blend goal (if applicable) and any changes to the goal over time

NA

3.4. Monitoring

3.4.1. Method of post-blend water quality monitoring

By the client

3.4.2. Any unexpected results

NA

4. Key factors in choosing the integration approach

4.1. Integration concerns that required attention going into the construction of the project
The facility was constructed next to an existing power plant. The discharge was combined.
The intake is separate.

4.2. Water quality studies that were performed
Minimal and also minimal piloting prior and during construction.

4.3. Water quality factors (if any) that influenced the methodology on where and how to integrate desalinated seawater into the existing distribution system
(e.g., blending, water quality parameters [e.g., B, Br, disinfection by-products, etc.], corrosion, residual decay, temperature, etc.)
The client provided the site and was responsible for the distribution.

4.4. Operational factors

4.4.1. Project size

The facility was designed to have the capacity expanded. This included upsizing the intake system, the pre-treatment system and additional membrane rack space. After four (4) years of operation (2009) the plant capacity was increased by 41,000 m³/day (10.8 MGD/ 33.2 acre feet/day) to produce 371,000 m³/day (98 MGD/ 300 acre feet/year). Increased to 120,000,000 m³/yr.

4.4.2. System and hydraulic constraints
None. The system was designed to be expanded.

4.4.3. Demand constraints
None.

4.4.4. Storage requirements
An onsite storage tank is included.

4.4.5. Shutdowns
Details are provided within 5.2 below.

4.4.6. Minimum flows
The plant is designed to have 2 x 50% capacity systems so one can be taken down for maintenance. Due to the capacity requirements the plant is designed to operate at over 95% online availability.

4.4.7. Existing treatment plant flexibility

NA.

4.5. Flexibility considerations (e.g., bringing desalinated seawater to the head of the system improves overall reliability; etc.)

Not answered

4.6. Other considerations

4.6.1. Cost

As detailed in the table below.

Key data	
Maximum total production capacity	110 million m ³ /year
Government purchase agreement	100 million m ³ /year
Water price	\$0.527/m ³
Project cost	NIS 1,000 million (\$212 million)
Plant footprint	75000 m ² (300 x 200 m)
Power plant	Dedicated gas turbine – 80 MW capacity
Grid connection	161 kV overhead line
Maximum nominal electrical consumption	< 3.9 kWh/m ³

4.6.2. Downstream acceptance

No feedback.

4.6.3. Stranded treatment capacity, etc.

None reported.

5. Integration issues experienced (if any, as applicable)

5.1. Water Quality

No issues reported.

5.1.1. Taste & odor

5.1.2. Customer complaints

5.1.3. Corrosion

5.1.4. Red or discolored water

The red water issue previously reported in the media concerned iron salts in the brine outfall and was unrelated to the integration of desalinated seawater or the quality or water delivered to customers.

5.1.5. Disinfection residual decay

5.1.6. Blend chemistry

5.2. Operations

5.2.1. Shutdowns of seawater desalination plant

We have been able to meet contractual water supply obligations since the plant was first started.

5.2.1.1. Frequency, duration, and impacts

Due to the contractual agreement and the design of the plant any downtime had to be scheduled well in advance. This was also relevant to routine maintenance and membrane cleaning.

5.2.1.2. Economics or system reliability impact of outages

There was more of an impact on when the plant could be shut down for maintenance as it had to coincide with the time of day as the power rate varies during the day. This means that shutdowns are generally done during peak times.

5.2.1.3. Effect of shutdowns on operations

As above.

5.2.1.4. Causes of shutdowns (e.g., cost, operational constraints, demands, water quality, etc.)

In the case of storm that would affect inlet water quality a percentage of the plant maybe shut down to allow the pre-treatment to manage the change.

5.2.2. Decision process for choosing supplies during low demands or high supply

As we are feeding into the grid this issue has not arisen.

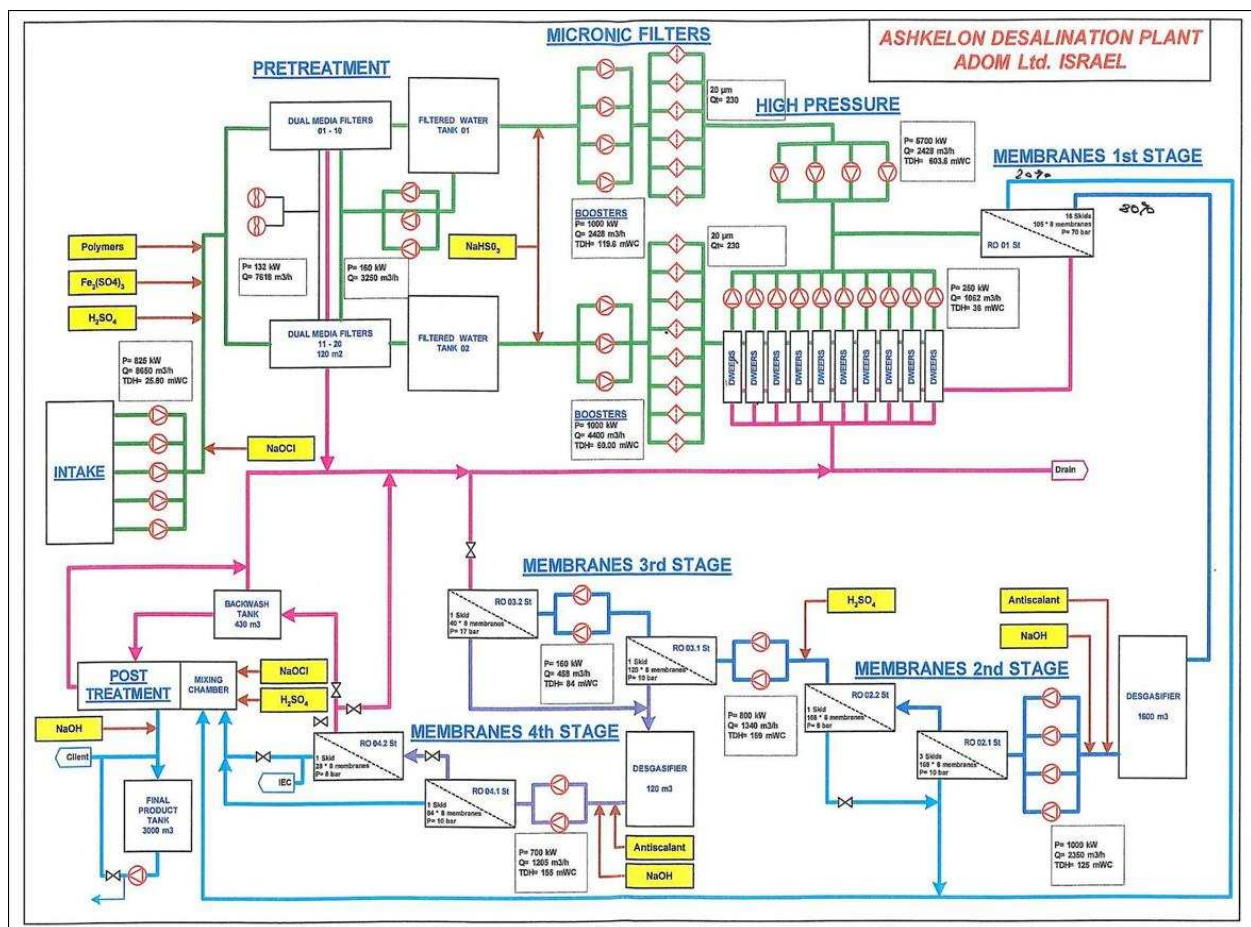

6. Lessons learned

6.1. Any identified integration issues that would be addressed another / different way now after having operational experience with seawater desalination

The three center design (a common piping header connecting all the SWRO trains to the high pressure pumps and energy recovery devices) has its limitations due to the common header. If there is a leak on the header the complete system needs to be shutdown to make the repair;

Even if compliant with the requirements (only on TSS) water discharge added red color to the mixing zone;

Environmental regulation also required to avoid introduction of Phosphorus into the seawater by the brine reject. Antiscalant with low or no phosphorus has been tested but concerns with operation were observed.

6.2. Any other lessons or advice

Project has provided opportunity to test process train design philosophy at a scale comparable to Sydney, i.e. Stage 1 – 163 ML/d (43.1 mgd), Stage 1 and 2 – 326 ML/d (86.1 mgd). Knowledge base will include approximately twelve months of operations data at the commencement of bid phase for the SSDP. This also applies to use of DWEER energy recovery devices at this scale, and selection of other major mechanical equipment items and robustness of procurement strategies; Project provided lessons learned for optimising commissioning plan and procedures for a desalination plant of comparable size to the SSDP; Project suffered delays due to time taken to obtain necessary approvals – essential to gain owner support to obtain necessary stakeholder approvals ahead of construction critical path. Equipment and processes must reliably deliver high quality water at the target operating costs

Ashkelon

Metropolitan Water District of Southern California
Assessment of Existing Seawater Desalination System Integration Practices
Survey Questionnaire
FUJAIRAH 2 (UAE)

CONTACTS

Mr. Paul Choules

VP Desalination

Veolia Water Solutions & Technologies, Americas

(281) 227-9050 (voice)

(281) 687-7651 (cell)

paul.choules@veoliawater.com

Mr. Olivier Caumartin

EVP

Veolia Water Solutions & Technologies, Major Projects Group

+33 1 4511 5555

Olivier.caumartin@veoliawater.com

1. Distribution system information

1.1. Population served

The water produced is pumped from the Emirate of Fujairah to the Emirate of Abu Dhabi where it joins the distribution network.

1.2. Basic governance (i.e., elected / appointed Board, municipal government, etc.)

The contracting entity is the Abu Dhabi Water & Electricity Authority (ADWEA) which is a government entity. The United Arab Emirates (UAE) is ruled by H.E. Sheikh Khalifa bin Zayed al Nahyan. Abu Dhabi and Fujairah are 2 of 7 emirates in the UAE.

1.3. Driver for implementing seawater desalination

This is part of ADWEA's overall master plan. Desalinated water comprises of over 95% of the total water provided to the Emirate of Abu Dhabi.

1.4. Size of geographic area served

The water is pumped into the distribution network that feeds the whole of the Abu Dhabi emirate.

1.5. General map of distribution system with seawater desalination pipeline

Not answered

1.6. System deliveries

1.6.1. Average annual deliveries

The system provided is a hybrid design comprising of thermal and membrane desalination in conjunction with a power plant. This allows for flexibility during the summer months to get maximum power generation from the power plant. The hybrid facility produces 590,000 m³/day (156 MGD or 478 acre feet per day) at a guaranteed online availability of 95%. 30 MIGD (36 mgd) is produced by the RO plant.

1.6.2. Description of potable water supply sources

The vast majority of water in the Emirate of Abu Dhabi comes from desalinated water.

1.6.3. Percent of total supplies represented by desalinated seawater

In excess of 95%.

1.6.4. Type(s) of customers that receive the water (e.g., residential, industrial, agricultural, etc.)

As the water is put into the distribution network it is used by all consumers.

1.7. Basic operations before desalinated supply added

1.7.1. Water quality parameters and concerns prior to desalination

The Emirate of Abu Dhabi has been using desalinated water for over 40 years. The major difference is that in the past the majority of the water came from distillation plants (thermal desalination) so the TDS of the water was quite low (around 100 ppm TDS, after re-mineralization).

1.7.2. Disinfection: type of primary and secondary disinfection, and target levels, Sodium hypochlorite target 0.5ppm

1.8. Changes to system operations due to seawater desalination

There are no operational changes to the system as desalinated water has been in the system for over 30 years.

2. Desalination Project Facilities

2.1. Current/planned capacity

The total combined capacity is 156 MGD (590,000 m³/day) with the SWRO 136,000 (36 MGD or 110 acre feet per day) and MED (thermal desalination) 455,000 m³/day (120 MGD or 370 acre feet per day).

2.1.1. Basis of project sizing

The plant capacity is based on the client's master plan for the Emirate.

2.1.2. Plant staging / capacity expansion (e.g., upsized pipelines, pads and stub-ups for additional RO skids, etc.)

Limited expansion is expected.

2.2. Basic treatment process

2.2.1. Pretreatment

(SWRO Only) Screens at the intake, shock chlorination at the intake, acid, coagulant and polymer prior to the dissolved air floatation (DAF) system (primary use is to remove any oils and deal with algae blooms). This is followed by dual media filtration and cartridge filtration.

2.2.2. RO process configuration

1st and partial 2nd pass RO to deal with boron.

2.2.3. Boron management strategy

The product waters from the MED and SWRO are blended prior to the post-treatment system to achieve the water quality requirements.

2.2.4. Post-treatment

The combined MED & SWRO product waters are lime and CO₂ prior to distribution.

2.2.5. Primary disinfection (chemical(s), dose(s), etc.)

Sodium hypochlorite 0.5 ppm

2.2.6. Residual disinfection (chemical(s), dose(s) applied, target doses in the distribution system, etc.)

The residual chlorine value is monitored throughout the overall system by the client. Seasonal adjustments are made to the dosing rates as and when required.

2.3. Current/planned desalination project operations

2.3.1. Base-loaded or peaking

Flexible operation based on the electrical load and the water demand.

2.3.2. Frequency / schedule of plant in-service time

The combined plant is designed to achieve an online availability of 95%.

2.3.3. Basic water quality parameters

2.3.3.1. Goals for key parameters (e.g., B, Br, Cl, Na, TDS, Alk, pH, LSI, CCPP, etc.),
To meet the UAE drinking water requirements – see below.

Description	Unit	Data
Maximum content of TDS	Ppm	160 revised to 200 after new regulation
Minimum content of TDS	Ppm	80 revised to 100 after new regulation
Chloride	ppm	max. 100
Boron	ppm	< 0.5 revised to 1 with new regulation
Increasing HCO_3^- content by	mol/m^3	target value 1.0 permissible range 0.8 to 1.5
Increasing Ca^{++} content by	mol/m^3	target value 0.5 permissible range 0.4 to 0.7
pH	-	permissible range 7 to 9.2
Maximum content of Residual Chlorine downstream remineralization	Ppm	1
$[c(\text{Cl}^-)+2c(\text{SO}_4^{2-})] / c(\text{HCO}_3^-)$	mol/mol	< 2
$c(\text{HCO}_3^-) / c(\text{SO}_4^{2-})$	mol/mol	> 2
Saturation Index according to DIN 38404-10,	-	permissible range

Description	Unit	Data
calculation mode 2.		0.0 to 0.5
Turbidity (including suspended solids)	NTU	max. 4.0

2.3.3.2. Point of compliance for key water quality parameters
Before the client storage tanks.

2.3.3.3. Regulatory context / compliance framework (e.g., country-specific; state- or region-specific; World Health Organization (WHO); etc.)
To meet the UAE drinking water requirements.

2.3.3.4. Areas of concern
No issues have been reported.

2.3.3.5. Method(s) of mitigating concerns
No concerns reported.

3. Integration of desalinated seawater into the existing distribution system

3.1. Pipeline / conveyance

3.1.1. Length, capacity, cost, pipe material, urban/rural alignment
The water from Fujairah 2 and the adjacent Fujairah 1 facilities are pumping into a storage tank farm near the facilities. From there the water is pumped over the mountains to the emirate of Abu Dhabi. This is done for strategic reasons as it gives Abu Dhabi an alternate source of water other than having to desalinate water from the Persian Gulf.

3.1.2. Elevation or pressure head to overcome at the point of injection of desalinated water into the existing distribution system
Details of this are not available, but the tank farm is within 5 miles. From the tank farm the water is pumped hundreds of kilometers to Abu Dhabi.

3.1.3. Onsite/offsite storage
Offsite storage as the water from F1 & F2 are combined before being pumped to Abu Dhabi.

3.1.4. Major issues to overcome with new conveyance/distribution system
A complete distribution network was developed so water could be pumped from Fujairah to Abu Dhabi. As mentioned above, this was done for strategic reasons.

3.2. Integration point(s)

3.2.1. Regional vs. local system integration and rationale
The integration of F1 & F2 is local but the integration with other desalinated water is regional due to proximity.

3.2.2. Operational integration of desalinated seawater
No issues have been reported with integrating a blend of desalinated water into the distribution network.

3.3. Blending

3.3.1. Location of blending desalinated seawater into the existing distribution system
Blending of F1 & F2 (both hybrid desalination facilities) are done nearby prior to being pumped to Abu Dhabi.

3.3.2. Method of blending desalinated seawater into the existing distribution system
(e.g. blend in pipe, in reservoir, etc.)
Blending is done in tanks and piping.

3.3.3. Blending conducted before or after introducing desalinated seawater into the distribution system?
Blending of local plants (F1 & F2) is done before being pumped to where water is blended with desalinated water from Taweelah and other facilities.

3.3.4. Supplies used to blend with desalinated seawater
No specific supplies used.

3.3.5. Blending to meet water quality goals (if applicable)
The water is blended to meet local water quality requirements.

3.3.6. Percent blend goal (if applicable) and any changes to the goal over time,
Varies depending on consumption and outages at other locations.

3.4. Monitoring

3.4.1. Method of post-blend water quality monitoring

The client monitors the water quality at various locations. Remotely with periodic grab sampling.

3.4.2. Any unexpected results

None reported.

4. Key factors in choosing the integration approach

4.1. Integration concerns that required attention going into the construction of the project
None reported.

4.2. Water quality studies that were performed

Existing plant already in operation next to the new plant. Experience of algae bloom and problems of operation during those events pushed the client to require for much stronger pre-treatment including 3 steps pre-treatment. As allowed by the tender documents Veolia's offer was including only 2 steps pre-treatment (DAF + Filtration) therefore 6 month piloting to demonstrate the efficiency of the pre-treatment has been performed in parallel with design and construction.

4.3. Water quality factors (if any) that influenced the methodology on where and how to integrate desalinated seawater into the existing distribution system
(e.g., blending, water quality parameters [e.g., B, Br, disinfection by-products, etc.], corrosion, residual decay, temperature, etc.)

As boron became an issue the standard was incorporated into the water quality requirements but as the plants were producing low TDS quality boron was not an issue.

4.4. Operational factors

4.4.1. Project size

The hybrid facility produces 590,000 m³/day (156 MGD or 478 acre feet per day) at a guaranteed online availability of 95%.

4.4.2. System and hydraulic constraints

The plant was designed to allow for some flexibility and expansion.

4.4.3. Demand constraints

Abu Dhabi water dispatch require for water production on a day by day basis.

4.4.4. Storage requirements

On site storage has been constructed but is operated by the client.

4.4.5. Shutdowns

The hybrid design allows for flexible operation during varying electrical demand. This is factored into the design.

4.4.6. Minimum flows

As the facility is modular in design, both the thermal and membrane plants, the overall facility can be taken down to about 10% capacity.

4.4.7. Existing treatment plant flexibility

Not applicable.

4.5. Flexibility considerations (e.g., bringing desalinated seawater to the head of the system improves overall reliability; etc.)

The hybrid design allows for local operational flexibility. Flexibility beyond that is determined by the utility when water from multiple facilities is stored and blended.

4.6. Other considerations

4.6.1. Cost

For the hybrid system \$805M.

4.6.2. Downstream acceptance

Good.

4.6.3. Stranded treatment capacity, etc.

N.A.

5. Integration issues experienced (if any, as applicable)

5.1. Water Quality

5.1.1. Taste & odor

None reported.

5.1.2. Customer complaints

None reported.

5.1.3. Corrosion

None reported.

5.1.4. Red or discolored water

None reported.

5.1.5. Disinfection residual decay

None reported.

5.1.6. Blend chemistry

The water quality is monitored prior to distribution. If any of the constituents in the water exceed the limits set the water is dumped prior to it entering the distribution network.

5.2. Operations

5.2.1. Shutdowns of seawater desalination plant

5.2.1.1. Frequency, duration, and impacts

None since startup in 2010.

5.2.1.2. Economics or system reliability impact of outages

N.A.

5.2.1.3. Effect of shutdowns on operations

N.A.

5.2.1.4. Causes of shutdowns (e.g., cost, operational constraints, demands, water quality, etc.)

N.A.

5.2.2. Decision process for choosing supplies during low demands or high supply
The demand of which technology to operate is tied to the power demand. When the power demand is high the MED's utilize the waste heat available. When the power demand is lower it is more economical to operate the SWRO system.

6. Lessons learned

6.1. Any identified integration issues that would be addressed another / different way now after having operational experience with seawater desalination

None to consider at this time.

6.2. Any other lessons or advice

The key point is to integrate the lessons learnt from recently completed projects. The lessons learnt from Ashkelon, Sur, Gold Coast, Sydney and Fujairah 2 are incorporated into the plants we're currently building in Aruba and Kuwait. Efficiency of the DAF (speedFlo) to operated on algae blooms.

Metropolitan Water District of Southern California
Assessment of Existing Seawater Desalination System Integration Practices
Survey Questionnaire
SUR (OMAN)

CONTACTS

Mr. Paul Choules
VP Desalination
Veolia Water Solutions & Technologies, Americas
(281) 227-9050 (voice)
(281) 687-7651 (cell)
paul.choules@veoliawater.com

Mr. Olivier Caumartin
EVP
Veolia Water Solutions & Technologies, Major Projects Group
+33 1 4511 5555
Olivier.caumartin@veoliawater.com

Mr. Sebastien Chauvin
General Manager
Azaliya Water

1. Distribution system information

1.1. Population served

350,000 to 400,000 people in Sharqiyah region of Oman.

1.2. Basic governance (i.e., elected / appointed Board, municipal government, etc.)

Oman is a Sultanate or a kingdom. The contract was awarded by the Sultanate of Oman's Ministry of National Economy.

1.3. Driver for implementing seawater desalination

The project is an expansion of an existing facility.

1.4. Size of geographic area served

See the attached site layout in 3D.

Sur Survey

1.5. General map of distribution system with seawater desalination pipeline

Not available

1.6. System deliveries:

1.6.1. Average annual deliveries

The plant is designed for 80,200 m³/day (21 MGD or 62 acre feet per day). The plant capacity is being ramped up over time to meet the demand of the region. A distribution network is also being installed.

1.6.2. Description of potable water supply sources

Some areas in the region have access to well water otherwise everybody will be given access to the distribution system that come from the desalination facility.

1.6.3. Percent of total supplies represented by desalinated seawater

Over time over 90% of all people in the region will have access to desalinated water. All of the water (100%) distributed in this region of Oman now comes from the SWRO plant.

1.6.4. Type(s) of customers that receive the water (e.g., residential, industrial, agricultural, etc.)

As the water is going into the distribution system everybody will receive the water.

1.7. Basic operations before desalinated supply added

1.7.1. Water quality parameters and concerns prior to desalination

There has been desalination in the region for over 20 years.

1.7.2. Disinfection: type of primary and secondary disinfection, and target levels,

Sodium hypochlorite target 0.5 mg/l

1.8. Changes to system operations due to seawater desalination

None

2. Desalination Project Facilities

2.1. Current/planned capacity

The plant is designed for 80,200 m³/day (21 MGD or 62 acre feet per day). The plant capacity is being ramped up over time to meet the demand of the region.

2.1.1. Basis of project sizing

Based on the Ministry population projections.

2.1.2. Plant staging / capacity expansion (e.g., upsized pipelines, pads and stub-ups for additional RO skids, etc.)

The total capacity is being phased in over a 2 year period.

2.2. Basic treatment process

2.2.1. Pretreatment

Originally the plant was designed to operate with a series of beach wells and an open intake. During construction studies were carried out and it was found all the required seawater could come from wells. However, the banker's engineers insisted that the infrastructure for an open intake and DAF system be constructed should the wells fail to produce. Currently all water is coming from beach wells and the water passes through media filters before going through cartridge filters.

2.2.2. RO process configuration

Partial double pass with 8 SWRO trains and 4 BWRO trains.

2.2.3. Boron management strategy

The partial second pass is included to guarantee the boron water quality requirements. The product water quality requirements are as follows:

Hardness	≤ 100 mg CaCO₃/l
Sulphate	≤ 250 mg/l
Magnesium	≤ 100 mg/l
Sodium	≤ 150 mg/l
Potassium	≤ 12 mg/l
Chloride	≤ 250 mg/l

Sur Survey

Nitrate	≤ 50 mg/l
Boron	≤ 500 µg/l
pH	6.5 ≤ pH ≤ 8.5
TDS	> 200mg/l ≤ 500 mg/l

2.2.4. Post-treatment

4 limestone filters, each 72 m². Lime depth 4 m, normal filtration velocity 6.2 m/h with a contact time of 40 mins.

2.2.5. Primary disinfection (chemical(s), dose(s), etc.)

Sodium hypochlorite

2.2.6. Residual disinfection (chemical(s), dose(s) applied, target doses in the distribution system, etc.)

0.5mg/L

Free chlorine residual is monitored throughout the distribution system and adjusted in localized stations to maintain the target level.

2.3. Current/planned desalination project operations

2.3.1. Base-loaded or peaking

According to demand (2 storage tanks on site)

2.3.2. Frequency / schedule of plant in-service time

Design include 94% availability guaranty

2.3.3. Basic water quality parameters

2.3.3.1. Goals for key parameters (e.g., B, Br, Cl, Na, TDS, Alk, pH, LSI, CCPP, etc.) ,
See details above in 2.2.3

2.3.3.2. Point of compliance for key water quality parameters

Outlet of the RO plant

2.3.3.3. Regulatory context / compliance framework (e.g., country-specific; state- or region-specific; World Health Organization (WHO); etc.)

The water produced has to meet the Omani drinking water standards.

2.3.3.4. Areas of concern

The lower limit of the TDS was a concern as the new membranes performed very well.

This concern was due to the fact that the desalinated seawater was much lower in TDS than the local well supplies that it replaced. Potential issues included aesthetics and corrosion; however, no issues have been reported.

2.3.3.5. Method(s) of mitigating concerns

Over remineralisation was at the beginning performed, than UF pretreatment as been implemented on a small water portion of the seawater to blend with RO water.

Clarification: the system is not now blending seawater.

3. Integration of desalinated seawater into the existing distribution system

3.1. Pipeline / conveyance

3.1.1. Length, capacity, cost, pipe material, urban/rural alignment

The plant is installed about half way along a new 150 Kms pipeline. This distribution pipeline provides water to the communities in the region. This pipeline is then connected to the local distribution system in each of the communities. The pipeline is believed to be HDPE.

Also, about 200 km of distribution system piping was added in conjunction with the new centralized SWRO plant, double the total length to about 400 km. Since all of the water in the system now comes from the SWRO plant, all of the water flows in one direction.

3.1.2. Elevation or pressure head to overcome at the point of injection of desalinated water into the existing distribution system

The water is stored and then pumped into the pressurized distribution pipeline. This is all at the same elevation as the plant. Beyond the site it is mountainous so the elevations vary.

There are about 10 elevated storage tanks and about 11 pumping stations in the distribution system to facilitate the conveyance of desalinated water.

3.1.3. Onsite/offsite storage

There is a 42.3 million gallon tank on the site.

3.1.4. Major issues to overcome with new conveyance/distribution system

There have been no reported issues.

3.2. Integration point(s)

3.2.1. Regional vs. local system integration and rationale

The integration is done at each of the regional communities as the distribution network is new. In some cases the local community distribution network is also new.

3.2.2. Operational integration of desalinated seawater

By pumps from the large tank on site.

3.3. Blending

3.3.1. Location of blending desalinated seawater into the existing distribution system

This is done at each of the regional communities. Some of the local distribution systems are new and some were existing. The existing distribution systems operated from a combination of well water and desalinated water.

Clarification: Water from the desalination plant provides water the 160,000 m³ on-site storage tank. From this point, a pumping station transfers water into the distribution system. The water is now almost entirely comprised of desalinated seawater, but there are some local wells that are still connected to the system, if ever needed. In this case, blending is done in the elevated storage tanks. There are no special provisions to ensure blending / mixing and consistent water quality if the remaining wells ever need to be used.

3.3.2. Method of blending desalinated seawater into the existing distribution system (e.g. blend in pipe, in reservoir, etc.)

Each community has a storage tank that is fed from the new distribution pipeline. Water is blended there, if there is any other source.

See above for additional clarification on this.

3.3.3. Blending conducted before or after introducing desalinated seawater into the distribution system?

No.

3.3.4. Supplies used to blend with desalinated seawater

None.

The system is fed entirely with desalinated seawater.

3.3.5. Blending to meet water quality goals (if applicable)

Yes, to meet local Omani water quality requirements.

Clarification: no blending is being conducted, as supplies are now 100% SWRO water.

3.3.6. Percent blend goal (if applicable) and any changes to the goal over time

No specific goal other than to reduce the amount of ground water used.

3.4. Monitoring

3.4.1. Method of post-blend water quality monitoring

The client monitors the water at the plant before distribution and key points throughout the network. This is done remotely and with grab samples.

3.4.2. Any unexpected results

None reported.

4. Key factors in choosing the integration approach

4.1. Integration concerns that required attention going into the construction of the project

None reported but it was not in the Veolia's scope

4.2. Water quality studies that were performed

The client carried out studies but Veolia had no access to these reports.

4.3. Water quality factors (if any) that influenced the methodology on where and how to integrate desalinated seawater into the existing distribution system (e.g., blending, water quality parameters [e.g., B, Br, disinfection by-products, etc.], corrosion, residual decay, temperature, etc.)

None other than water produced had to meet Omani drinking water quality requirements.

4.4. Operational factors

4.4.1. Project size

The capacity of the plant is 21 MGD.

4.4.2. System and hydraulic constraints

A new distribution system network was built.

4.4.3. Demand constraints

None that we are aware of.

4.4.4. Storage requirements

There is a 160,000 m³ (42.3 million gallons) of water storage at the site.

4.4.5. Shutdowns

Not answered

4.4.6. Minimum flows

Minimum operation flow is 12% of the full production capacity

4.4.7. Existing treatment plant flexibility

The treatment system is all new.

4.5. Flexibility considerations (e.g., bringing desalinated seawater to the head of the system improves overall reliability; etc.)

To handle flexibility a 42 million gal tank was provided at the site.

4.6. Other considerations

4.6.1. Cost

Approximately \$180M.

4.6.2. Downstream acceptance

No issues reported.

4.6.3. Stranded treatment capacity, etc.

None reported.

5. Integration issues experienced (if any, as applicable)

It was indicated that there was general over integrating desalinated seawater into the existing conveyance and distribution system. However, no significant issues were encountered as a result of the integration.

5.1. Water Quality

5.1.1. Taste & odor

None reported.

5.1.2. Customer complaints

None reported.

Customers are reported to be very satisfied with the water quality, given that it's much better than the quality of water from the network of wells that the SWRO plant replaced.

5.1.3. Corrosion

None reported.

It was reiterated that no corrosion issues have been reported due to matching the water quality of the desalinated seawater to that of the existing supply.

5.1.4. Red or discolored water

None reported.

5.1.5. Disinfection residual decay

None reported.

Free chlorine residual is monitored throughout the distribution system and adjusted in localized stations to maintain the target level. As a result, no issues have been report.

5.1.6. Blend chemistry

No issues reported.

5.2. Operations

5.2.1. Shutdowns of seawater desalination plant

5.2.1.1. Frequency, duration, and impacts

The system has only recently come up to 100% capacity. To date there have been no shutdowns. The plant online availability is guaranteed at 94%.

5.2.1.2. Economics or system reliability impact of outages

The system was designed so a 94% online availability (monthly) could be achieved.

5.2.1.3. Effect of shutdowns on operations

The overall system design takes into consideration how to achieve the guaranteed online availability. This is based on experience of operating other similar plants around the world.

5.2.1.4. Causes of shutdowns (e.g., cost, operational constraints, demands, water quality, etc.)

Not answered

5.2.2. Decision process for choosing supplies during low demands or high supply

Plant operation can be brought down to 12% of the full capacity storage also allow for some variation between the demand and the produced water

6. Lessons learned

6.1. Any identified integration issues that would be addressed another / different way now after having operational experience with seawater desalination

Experiences from Ashkelon, Gold Coast and other recent desalination projects were incorporated into this plant design.

6.2. Any other lessons or advice

Some key lessons learnt included: Piping alignment is critical and should not be underestimated. Specific procedures were incorporated which included having vendors come in and validate their systems and components; Don't underestimate the impact of what beach wells can do to minimize the pre-treatment process. The lessons learnt from this project have been incorporated into the Aruba project we're currently constructing; Preservation procedures have been reviewed after preservation issues.

We initiated a System Optimization after the plant passed its performance test. The results have been impressive and include: No membrane cleaning after 18 months ops; No membrane replacement; Cartridge filter replacement 6-8 months; Chemical consumption optimization; Power consumption optimization: Initial – 3.6 kWh/m³ or 13.6 kWh/1,000 gal; Now – 3.5 kWh/m³ or 13.2 kWh/1,000 gal



Sur Survey

Metropolitan Water District of Southern California
Assessment of Existing Seawater Desalination System Integration Practices
Survey Questionnaire
TUAS 1 (SINGAPORE)

CONTACT

Chee Hoe Woo
Senior Manager – Water Quality and Technology Office
Singapore Public Utilities Board
+65 63262956
Email: WOO_Chee_Hoe@pub.gov.sg

Peter Baudish (SKM)
Pbaudish@skm.com.au
(P) +61 2 9928 2449

Gordon Maxted (SKM)
GMaxted@skmconsulting.com.sg
(P) +65 6345 3055

1. Distribution system information

1.1. Population served

4.5 Million

The desalination plant has the capacity to meet about 10% of Singapore's total water demand.

1.2. Basic governance (i.e., elected / appointed Board, municipal government, etc.)

PUB is a statutory board under the Ministry of the Environment and Water Resources. It is the national water agency, managing Singapore's water supply, water catchment and used water in an integrated way. The SingSpring desalination plant was developed under a design-build-own-operate arrangement in which PUB signed a 20-yr agreement to purchase desalinated water from SingSpring.

1.3. Driver for implementing seawater desalination

To reduce reliance on water supplied by Malaysia which is currently 1.06 GL/d (280 mgd); Desalination is a drought proof solution, not subjected to vagaries of weather

1.4. Size of geographic area served

All of Singapore (desalination plant services Western Part of Singapore)

1.5. General map of distribution system with seawater desalination pipeline

Not Supplied (Proprietary)

1.6. System deliveries:

1.6.1. Average annual deliveries

Approx 1.55 GL/day (410 mgd) (average Daily demand)

1.6.2. Description of potable water supply sources

Surface water from Malaysia and Singapore, desalinated water and high-grade reclaimed water (or NEWater)

1.6.3. Percent of total supplies represented by desalinated seawater

The current desal plant capacity can meet about 10% of Singapore's water demand.

1.6.4. Type(s) of customers that receive the water (e.g., residential, industrial, agricultural, etc.)

All, as it is blended with normal potable water, but Industrial and agricultural users get recycled water at a cheaper rate.

1.7. Basic operations before desalinated supply added

1.7.1. Water quality parameters and concerns prior to desalination

Not Applicable (Proprietary)

1.7.2. Disinfection: type of primary and secondary disinfection, and target levels

Primary disinfection: Chlorination; Secondary (Residual) disinfection: Chloramination (Monochloramine)

No chloramine residual decay has been observed, and in fact the residual in the PUB system is reported as being very stable. It is suspected that bromide might not be a factor in contributing to residual decay for two reasons: 1) the full second pass of RO reduces bromide concentrations in the permeate to very low levels; and 2) desalinated seawater comprises at most 10% of supplies, diluting the impact of any bromide on chloramine residual decay.

1.8. Changes to system operations due to seawater desalination

Not Supplied (Proprietary)

2. Desalination Project Facilities

2.1. Current/planned capacity

136 ML/d (35.9 mgd) with plans (now under construction) for a further 318 ML/d (84 mgd) desalination plant on the same site. Giving a future total capacity of 455 ML/d (120.2 mgd)

2.1.1. Basis of project sizing

Not Answered (Proprietary)

2.1.2. Plant staging / capacity expansion (e.g., upsized pipelines, pads and stub-ups for additional RO skids, etc.)

No room for expansion at existing SingSpring plant. Additional 70 imgd (84 mgd) plant being developed on green field site next to SingSpring site; Production capacity is capped at 30 imgd (36 mgd).

2.2. Basic treatment process

2.2.1. Pretreatment

30 imgd (36 mgd) plant: Coarse bar screen and travelling band screens, dissolved air flotation, gravity sand filters and cartridge filters;

70 imgd (84 mgd) plant: Coarse bar screen and travelling band screens, auto strainer, ultrafiltration

2.2.2. RO process configuration

Two Pass RO (1st pass SWRO followed by 2nd pass LPRO)

2.2.3. Boron management strategy

Boron removal first at 1st pass SWRO, then adding caustic soda before 2nd pass LPRO to further remove boron at 2nd pass LPRO

This is a full second pass. The PUB suggests that this is may be a primary reason that it has not observed chloramine decay, as the bromide levels in the second pass permeate are very small.

2.2.4. Post-treatment

Carbon dioxide and lime for pH and LSI correction, chlorine for primary disinfection, chloramination for secondary (residual) disinfection and fluoridation for dental health.

2.3. Current/planned desalination project operations

2.3.1. Base-loaded or peaking

Base loaded

2.3.2. Frequency / schedule of plant in-service time

Every 30 days noting that Plant needs to be available for not less than 98% of the time;
Daily plant output is based on daily dispatch notice given to desalination plant

2.3.3. Basic water quality parameters

2.3.3.1. Goals for key parameters (e.g., B, Br, Cl, Na, TDS, Alk, pH, LSI, CCPP, etc.)

TCR : 0.8 -2ppm, FCR : 0.12ppm max, Turbidity : <3NTU, FI : 0.4 - 0.7ppm, pH : 7-9,
Conductivity : < 416 $\mu\text{s}/\text{cm}$, temp : <40 °C

Other goals:

B: 0.5 mg/L

Br: There is no finished water goal for bromide.

Cl: 100 mg/L

Na: no standard

LSI: > -1

Note that LSI is monitored for corrosion, but PUB is not aware of any corrosion concerns in its conveyance system.

Also, LSI is measured in the desalinated seawater before blending with other supplies.

2.3.3.2. Point of compliance for key water quality parameters

Water quality monitoring is carried out at the product water delivery point after pumping station at the Desal Plant

2.3.3.3. Regulatory context / compliance framework (e.g., country-specific; state- or region-specific; World Health Organization (WHO); etc.)

Country specific NEA code of practice but close to WHO guidelines

2.3.3.4. Areas of concern

No concern. Full compliance met

2.3.3.5. Method(s) of mitigating concerns

Not Applicable

3. Integration of desalinated seawater into the existing distribution system

3.1. Pipeline / conveyance

3.1.1. Length, capacity, cost, pipe material, urban/rural alignment

The Desal plant has a pumping station which pumps the product water via a 12 km long 1.8m diameter pipeline to a service reservoir. Pipe is made of steel with a concrete lining

3.1.2. Elevation or pressure head to overcome at the point of injection of desalinated water into the existing distribution system

Pumping head is in the range of 60-70 meters

3.1.3. Onsite/offsite storage

On site storage (i.e. clear water storage tank) and off-site storage (i.e. elevated service reservoir)

On-site tank capacity: 12,000 m³

Off-site reservoir capacity: 91,000 m³

3.1.4. Major issues to overcome with new conveyance/distribution system

Not Applicable

3.2. Integration point(s)

3.2.1. Regional vs. local system integration and rationale

Not Applicable

Note that customers closer in proximity to the seawater desalination plant should get a higher proportion of desalinated seawater, but the difference is small. No customer complaints have been identified as a result of this.

3.2.2. Operational integration of desalinated seawater

The desalinated water is fed into a service reservoir for mixing with treated water derived from surface water source before distribution.

3.3. Blending

3.3.1. Location of blending desalinated seawater into the existing distribution system

Service Reservoir

- 3.3.2. Method of blending desalinated seawater into the existing distribution system (e.g. blend in pipe, in reservoir, etc.)

Blending in service reservoir

The water quality at the inlets and outlets of the service reservoir are being monitored online to ensure mixing.

- 3.3.3. Blending conducted before or after introducing desalinated seawater into the distribution system?

Before

- 3.3.4. Supplies used to blend with desalinated seawater

Conventionally treated water (from surface water source)

- 3.3.5. Blending to meet water quality goals (if applicable)

Not Applicable

Follow-up confirmed that blending is not used to meet water quality goals.

- 3.3.6. Percent blend goal (if applicable) and any changes to the goal over time

Not Applicable

Singapore PUB confirms that there is no goal for blending. The SWRO is essentially on-line and producing at capacity continuously, and in these circumstances desalinated seawater represents about 10% of supplies. Note that this percentage will change when the new Tuas 2 plant is constructed.

3.4. Monitoring

- 3.4.1. Method of post-blend water quality monitoring

Water quality parameters monitored online through telemetry

- 3.4.2. Any unexpected results

Not Applicable

4. Key factors in choosing the integration approach

- 4.1. Integration concerns that required attention going into the construction of the project

Not Answered

Singapore PUB does not believe that water quality or operational concerns factored into the integration approach; however, this will be examined and they will follow-up if such a factor is identified.

4.2. Water quality studies that were performed

Not Answered

4.3. Water quality factors (if any) that influenced the methodology on where and how to integrate desalinated seawater into the existing distribution system (e.g., blending, water quality parameters [e.g., B, Br, disinfection by-products, etc.], corrosion, residual decay, temperature, etc.)

Singapore PUB indicates that no water issues were a factor in developing the integration and blending strategy.

4.4. Operational factors

4.4.1. Project size

10 hectares of land, with 136,380 m³/day (36 mgd) capacity

4.4.2. System and hydraulic constraints

Surge vessel sized at desalination plant design capacity

4.4.3. Demand constraints

Not Answered

4.4.4. Storage requirements

12,000 m³ (2 hrs retention) at the Desal Plant

4.4.5. Shutdowns

100% capacity available all the time

4.4.6. Minimum flows

7 imgd (8.4 mgd)

Minimum flow at the plant is achieved by three RO skids operating at 23% capacity.

4.4.7. Existing treatment plant flexibility

No room for further expansion

4.5. Flexibility considerations (e.g., bringing desalinated seawater to the head of the system improves overall reliability; etc.)

Not applicable

4.6. Other considerations

4.6.1. Cost

Built in 2006, S\$200million

4.6.2. Downstream acceptance

Good

4.6.3. Stranded treatment capacity, etc.

Not Applicable

5. **Integration issues experienced**

(Not Applicable)

Singapore PUB underscores that they have not had any customer complaints related to water quality associated with desalinated water, even from among those customers that may receive a more significant proportion of desalinated seawater.

5.1. Water Quality

5.1.1. Taste & odor

5.1.2. Customer complaints

5.1.3. Corrosion

It is underscored that corrosion has not been a problem in the Singapore PUB conveyance system.

5.1.4. Red or discolored water

5.1.5. Disinfection residual decay

5.1.6. Blend chemistry

5.2. Operations

5.2.1. Shutdowns of seawater desalination plant

5.2.1.1. Frequency, duration, and impacts

5.2.1.2. Economics or system reliability impact of outages

5.2.1.3. Effect of shutdowns on operations

5.2.1.4. Causes of shutdowns (e.g., cost, operational constraints, demands, water quality, etc.)

5.2.2. Decision process for choosing supplies during low demands or high supply

6. Lessons learned

(Not Applicable)

6.1. Any identified integration issues that would be addressed another / different way now after having operational experience with seawater desalination

Singapore PUB does not know of any particular lessons learned relative to the integration of desalinated seawater. However, since the EPC contractor from Tuas 1 was also awarded Tuas 2, it is thought that the experience from the first SWRO plant would help with the second.

6.2. Any other lessons or advice

Tuas 1 Survey

Metropolitan Water District of Southern California
Assessment of Existing Seawater Desalination System Integration Practices
Survey Questionnaire
VALDELENTISCO (SPAIN)

CONTACT

Dr. Manuel Latorre

Project Manager

+971 50 297 05 80

manlatcar@gmail.com

1. Distribution system information

1.1. Population served

Populations served by MCT (Mancomunidad Canales Taibilla) is 2.5 million but the Valdelentisco plant inject water in an area of 400,000 habitants.

1.2. Basic governance (i.e., elected / appointed Board, municipal government, etc.)

Plant belongs to the Ministerio Medio Ambiente y Medio Rural y Marino of Spain's Government

1.3. Driver for implementing seawater desalination

Plant was developed by Acsegura, today integrated in Acuamed, public companies of Spain's Government. These public companies were established to carry out the Hydraulic Water Plan set by the Spanish government in 2000.

1.4. Size of geographic area served

Murcia Region in the southeast coast; See attached pdf

1.5. General map of distribution system with seawater desalination pipeline

See attached pdf

1.6. System deliveries:

MCT is the public authority that distributes water in the southeast of Spain, Murcia and part of Alicante provinces delivering 221 Hm³(2008) to municipalities and some public companies for drinking and industrial uses.

(Note: "Hm³" is a cubic hectometer, or 1,000,000 m³. Valdelentisco uses this as shorthand for million cubic meters per year. Divide these numbers by 1.382 to get flows in MGD.)

Valdelentisco Survey

1.6.1. Average annual deliveries

Plant deliveries have been as follows:

Year	Produced water (Hm3)	Maximum capacity (Hm3)	Max production as per RO installed (Hm3)	% production/ installed capacity
2008	6.7	72	27	24.8
2009	13	72	49.5	26.2
2010	16	72	49.5	32.3

1.6.2. Description of potable water supply sources

Several consecutive scarcity periods during 90's forced nation government to look for alternative resources to rivers (dark blue) and transfers (green), so as well supplies (red), sources of traditional deliveries. See the attached chart where the supply of desalination water (light blue) has been growing in the last years.

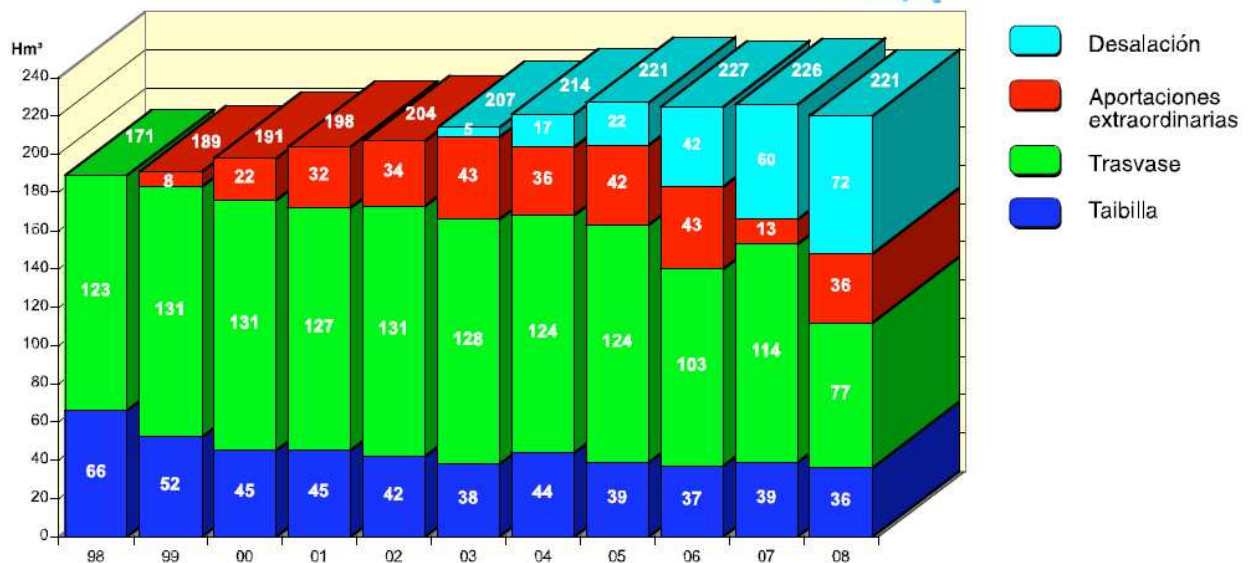

1.6.3. Percent of total supplies represented by desalinated seawater

The percentage moves between 35 and 45 %

1.6.4. Type(s) of customers that receive the water (e.g., residential, industrial, agricultural, etc.)

Valdelentisco Survey

Valdelentisco SWRO plant is designed to supply 20 Hm³ for drinking and 52 Hm³ for irrigation in the future. At present 11 Hm³ are for drinking (through MCT) and 20 Hm³ for irrigation. This distribution is flexible based on the demand of each use.

1.7. Basic operations before desalinated supply added

1.7.1. Water quality parameters and concerns prior to desalination

No water quality concerns, just the scarcity of water to satisfy the demand. Boron topic was issued more politically than technical.

1.7.2. Disinfection: type of primary and secondary disinfection, and target levels

Disinfection is carried out in the MCT system with Hypochlorite in a dosage of 4.69 mg/L to maintain a residual of 1 mg/L in the distribution system piping. There is no primary disinfection at the Valdelentisco plant. The associated residual disinfection is applied at the MCT about 150m from the plant.

1.8. Changes to system operations due to seawater desalination

There have not been changes in the operations as the desalinated water is incorporated into the existing distribution network. The difference now is the distribution system is “reversible” in some areas, as before, all the water was distributed from a single direction due to the inland location of previous sources and now as the new source is located on the coast (Desalination) the overall system is more flexible. Previously the water can just be distributed from “north to south” and now can be distributed “south to north” as well. Desalination has provided more flexibility into the distribution system.

2. Desalination Project Facilities

2.1. Current/planned capacity

2.1.1. Basis of project sizing

Plant maximum capacity will be 72 Hm³ as civil works, intake, pre and post treatment, etc is already prepared for. The RO capacity already installed is by 2011 of 49.5 Hm³. Future RO expansion up to 22.5 Hm³ can be implemented according water demands.

Valdelentisco Survey

2.1.2. Plant staging / capacity expansion (e.g., upsized pipelines, pads and stub-ups for additional RO skids, etc.)

Year	Maximum capacity (Hm3)	Max production as per RO installed (Hm3)
2008	72	27
2009	72	49.5
2010	72	49.5

2.2. Basic treatment process

2.2.1. Pretreatment

In the collection chamber and before the pumping units, the system uses two bar-screens in order to avoid the entrance of solid material larger than 16 mm.

The pressure filters each have a total surface area of 40 m². The first filter stage has 60 MMF, 10.5 m length with a diameter of 3.6 m, made from carbon steel, covered internally with 5 mm ebonite and sand and anthracite as filtration media.

The fine filtration stage is formed by 20 cartridge filters with a 5 micron nominal selection, each fitted with 15 cartridges. The cartridge shells are made in carbon steel with internal layer of ebonite.

Chemical pre-treatment is by the injection of Ferric Chloride as coagulant and antiscalant on continuous mode. Shock doses for chlorination and therefore SBS are injected once a month.

Sodium hydroxide is used to increase the pH during summer to improve Boron rejection.

2.2.2. RO process configuration

From the two 1,200 mm pipelines of filtered water, the high-pressure pumps draw in the water to push it to the reverse osmosis racks. The plant is equipped with 16 HPPs of 1450 KW each, equipped with Pelton turbines as energy recovery devices.

The high-pressure pumps each provide a flow of 1,030 m³/h at 66 bar, with a performance rate of 86%. The second stage uses 6600 m³/h pumps with a differential pressure of 11 bar and is fitted with a 315 kW motor with frequency driver.

The racks are composed of 142 pressure vessels, set out in two stages and with a single pass, with 7 membranes per tube, therefore providing a total of 15,904 membranes for the entire plant. The first stage contains 85 pressurized tubes of 1000 psi while the second stage uses 57 tubes of 1200 psi. The recovery rate is 50%.

Thus, the operating parameters were established in order to achieve a permeate with a Boron content inferior to 1 ppm in a single pass design.

For the first 6 racks the installed membranes were SW30HRLE-400i manufactured by FILMTEC (DOW) In the second expansion of the 5 additional racks the membranes installed were SWC4+MAX and SWC5 MAX from Hydranautics.

2.2.3. Boron management strategy

Initially during the tender phase the irrigation users asked for boron level lower than 0,5 ppm. Once the bids were compared and they noticed that permeate water with boron lower than 0,5 ppm was 15 to 20 % more expensive than the one with level below 1 ppm, they accepted as good water the last one. In this case the investment was also penalized by 20 % for the 0,5 ppm required equipments and installations. Following table shows different bids for 0,5 and 1 ppm options.

Valdelentisco Survey

Table 2

CAPEX (Euros)	Boron level			Difference
	< 1 ppm	< 0,5 ppm	%	Euros
A	89,314,830	104,523,625	17%	15,208,795
B	87,798,694	99,754,669	14%	11,955,975
C	74,622,458	89,050,000	19%	14,427,542
D	76,355,477	88,229,000	16%	11,873,523
E	77,261,180	87,345,550	13%	10,084,370
AVERAGE	81,070,528	93,780,569	16%	12,710,041

An average increase of 16 % was reached for the tendered 43 Hm³ capacity plant. Considering the extension into 72 Hm³ production, the extra cost due to the implementation of the second pass to get a permeate with boron level lower than 0,5 ppm was closed to 20 M Euros.

The decision to select a single pass with Boron level below 1 ppm at pH 8, could carry out a non compliance with water quality requirement for 20 % of the time. Nevertheless some factors were considered to support such risky decision: Boron limit of 1 ppm. There was no clear statement regarding the health effect on humans so as the limit had been changing in the latest WHO revisions and a further new limit could be set. According latest proposed revision of WHO guidelines, the Boron limit will be 2,4 mg/l; pH adjustment through caustic addition between stages could increase the boron rejection if needed for high temperatures; membrane projections showed a higher Boron rejection than guaranteed by membrane manufacturer and a safety factor was used for calculations; Temperature distribution at site was percentil 90 % below 25°C and percentil 96 % below 26 °C, what means boron level are above 1 ppm just 10 % of the time (1 month).

Regarding OPEX, the difference between 1 and 0,5 ppm boron levels was 7 cts Euro/m³, what means more than 125 M Euros for the plant life of 25 years. Therefore the difference in boron levels for the plant is 145 M Euros without considering any financing updating over the 25 years life time.

2.2.4. Post-treatment

In the plant, the remineralisation of permeate is only carried out through the addition of Calcium hydroxide and CO₂. In this way the corrosiveness of permeate is corrected and the alkalinity and hardness are obtained equal to those of Calcium bicarbonate.

The SAR level of the water intended for irrigation is also adjusted to a value less than 8 in order to maintain the soil stability.

2.2.5. Primary disinfection (chemical(s), dose(s), etc.)

Shock doses for chlorination and therefore SBS are injected once a month.

2.2.6. Residual disinfection (chemicals(s), dose(s) applied, target doses in the distribution system, etc.)

In the Valdelentisco installations, no disinfection procedures are carried out since this is done by the Mancomunidad de Canales del Taibilla (MCT) who is in charge of the drinking water supply in the area, through its close pumping installations. (See also answers to 1.7.2) The different sources (including river water, transfers, wells, and desalinated water) are chlorinated at different points – sometimes at the source location and sometimes at intermediate points.

2.3. Current/planned desalination project operations

2.3.1. Base-loaded or peaking

Plant is in operation with 2 racks in winter (9 Hm³) and up to 8 racks in summer (36 Hm³) based on demand.

2.3.2. Frequency / schedule of plant in-service time

Not answered

2.3.3. Basic water quality parameters

2.3.3.1. Goals for key parameters (e.g., B, Br, Cl, Na, TDS, Alk, pH, LSI, CCPP, etc.)
Based on Spanish guidelines RD140/2003

Valdelentisco Survey

Turbidez	5 U.N.F.
pH	9,5 uds. PH
Bicarbonatos	mg/l $\text{CO}_3 \text{H}^-$
Cloruros	250 mg/l Cl^-
Sulfatos	(*) 500 mg/l $\text{SO}_4^{=}$
Nitratos	50 mg/l NO_3^-
Calcio	mg/l Ca^{+2}
Boro	1,0 mg/l B
Conductividad	2.500 $\mu\text{S. cm}^{-1}$
Nitritos	0,1 mg/l NO_2^-
Amoníaco	0,50 mg/l NH_4^+
Oxidabilidad	5,0 mg/l O_2
Trihalometanos	150 $\mu\text{g/l}$

2.3.3.2. Point of compliance for key water quality parameters
[Delivery of product water at desalination plant boundary.](#)

2.3.3.3. Regulatory context / compliance framework (e.g., country-specific; state- or region-specific; World Health Organization (WHO); etc.)
[Based on Spanish guidelines RD140/2003](#)

2.3.3.4. Areas of concern
[Cost of desalinated water is the main concern.](#)

2.3.3.5. Method(s) of mitigating concerns
[Reduce the use of desalinated water if other sources are available based on annual rainfall and scarcity balance.](#)

3. Integration of desalinated seawater into the existing distribution system

3.1. Pipeline / conveyance

3.1.1. Length, capacity, cost, pipe material, urban/rural alignment
[Total length of different section of the distribution pipeline is 26.5 km. Total investment for the distribution system \(except Intermediate tank Mazarron\) was 38 M Euros.](#)

3.1.2. Elevation or pressure head to overcome at the point of injection of desalinated water into the existing distribution system

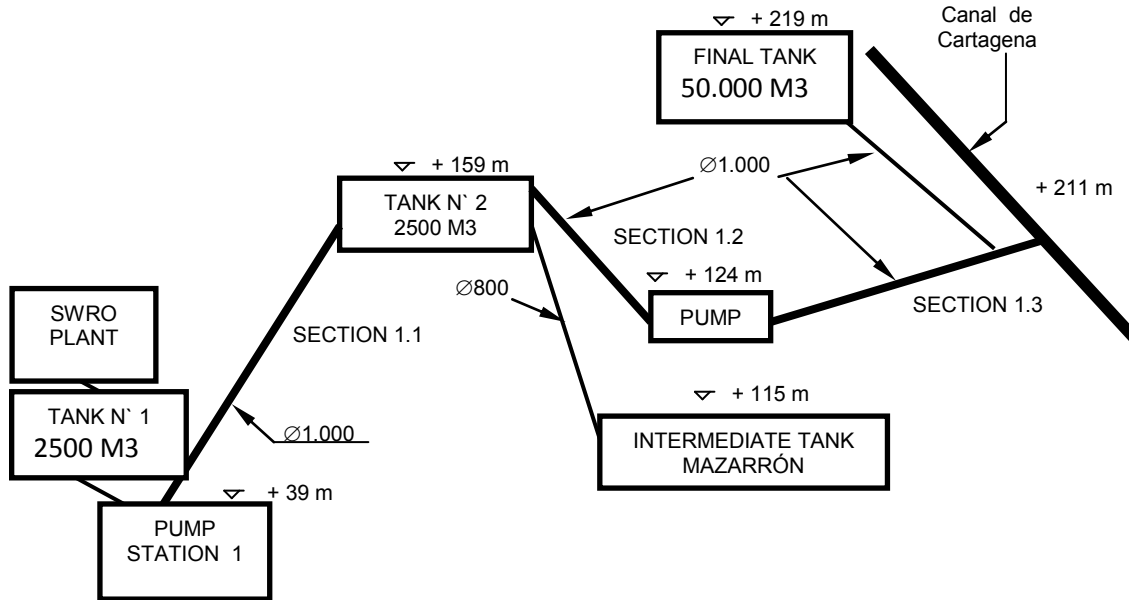

From +39 into + 219 m above sea level

3.1.3. Onsite/offsite storage
See above diagram

3.1.4. Major issues to overcome with new conveyance/distribution system
Issues relate to permits (environmental)

3.2. Integration point(s)

3.2.1. Regional vs. local system integration and rationale

The distribution system of MCT is not related with local systems that are Municipalities responsible for. Therefore no integration has been needed. MCT supply water to Municipalities and they distribute to the end users.

3.2.2. Operational integration of desalinated seawater

Not answered

3.3. Blending

No applicable. Desalinated water is introduced into the existing system in a pipe without any specific blending.

3.3.1. Location of blending desalinated seawater into the existing distribution system

3.3.2. Method of blending desalinated seawater into the existing distribution system (e.g. blend in pipe, in reservoir, etc.)

3.3.3. Blending conducted before or after introducing desalinated seawater into the distribution system?

3.3.4. Supplies used to blend with desalinated seawater

Traditional sources are two rivers : Taibilla (within the distribution area) and Tajo (through a transfer of 400 km). In case of severe drought some emergency wells are also used.

No specific blending is required due to quality issues.

3.3.5. Blending to meet water quality goals (if applicable)

No specific blending is required due to quality issues. There is mixing with traditional sources just to reduce the cost of the m3.

3.3.6. Percent blend goal (if applicable) and any changes to the goal over time

Not applicable

3.4. Monitoring

3.4.1. Method of post-blend water quality monitoring

Continuous readings of pH, temperature, conductivity and free chlorine are monitored. Daily analysis are carried out for permeate quality at site lab. A third party laboratory performs permeate analysis every week.

3.4.2. Any unexpected results

Boron was over the limit (< 1 ppm) in some analysis (0.3 % of the time) but was immediately corrected adjusting the pH.

4. Key factors in choosing the integration approach

4.1. Integration concerns that required attention going into the construction of the project
Water quality parameters as LSI, RSI, pH in order to control the possible corrosive potential of the desalinated were the major concerns.

4.2. Water quality studies that were performed

Water quality studies were carried out during two years for the seawater before the final design of the SWRO plant was implemented. No water studies regarding permeate quality as MCT had been operating some other desalination plants in their system.

4.3. Water quality factors (if any) that influenced the methodology on where and how to integrate desalinated seawater into the existing distribution system
(e.g., blending, water quality parameters [e.g., B, Br, disinfection by-products, etc.], corrosion, residual decay, temperature, etc.)

Boron was an issue due to the reasons explained before.

4.4. Operational factors

Plant has been in operation since 2008 supplying water for irrigation and drinking with no main operations incidents except the typical maintenance problems.

4.4.1. Project size

See 2 and 3 above.

4.4.2. System and hydraulic constraints

There are no main constrains except typical maintenance ones.

4.4.3. Demand constraints

Demand depends on other sources water availability and therefore the plant production is linked to those sources of cheaper water.

4.4.4. Storage requirements

See 3 above

4.4.5. Shutdowns

There have been shutdowns due to technical issues during the first 6 months of operations as a consequence of some minor design issues and setting the operation parameters. After the first year of operation the number of shutdowns has been reduced by 70 %. Actually the un-expected shutdowns are around 1-2 per month due to external reasons (power supply, raw water conditions. Etc)

4.4.6. Minimum flows

Minimum operation flow is the volume produced by one rack 12,360 m³/d

4.4.7. Existing treatment plant flexibility

See 2 above.

4.5. Flexibility considerations (e.g., bringing desalinated seawater to the head of the system improves overall reliability; etc.)

Not answered

4.6. Other considerations

4.6.1. Cost

Cost of desalinated water included post treatment at level + 39 m is 50 ctsEuro per m³.

4.6.2. Downstream acceptance

No objections

4.6.3. Stranded treatment capacity, etc.

Not applicable

5. Integration issues experienced (if any, as applicable)

5.1. Water Quality

5.1.1. Taste & odor

None

5.1.2. Customer complaints

None

5.1.3. Corrosion

Overcome due to alkalinity adjustment for permeate

5.1.4. Red or discolored water

None

5.1.5. Disinfection residual decay

None

5.1.6. Blend chemistry

None

5.2. Operations

5.2.1. Shutdowns of seawater desalination plant

5.2.1.1. Frequency, duration, and impacts

Unexpected shutdowns are mainly due to power supply failures and electrical or mechanical problems. Frequency is approximately 2 to 3 per rack per month.

5.2.1.2. Economics or system reliability impact of outages

There is no significant impacts of outages in the production as the shutdowns are of short duration (2-4 hours).

5.2.1.3. Effect of shutdowns on operations

Adjustments in the maintenance plan

5.2.1.4. Causes of shutdowns (e.g., cost, operational constraints, demands, water quality, etc.)

Planned shutdowns are based on water demand either from MCT or irrigation users. Not shutdowns due to quality or environmental issues (brine disposal limits exceeded)

5.2.2. Decision process for choosing supplies during low demands or high supply Based on availability of other water sources as the cost of desalinated water is the most expensive of all the sources available in the area, either for irrigation or drinking purposes.

6. **Lessons learned**

6.1. Any identified integration issues that would be addressed another / different way now after having operational experience with seawater desalination
Politically desalination has been criticized in Spain after withdraw of the law that address the Ebro River Transfer from the North to the South. The promotion of desalination as a solution by the actual government was strongly used for the opposition to discredit the technology instead of consider it as an alternative source for water supply, complementary to the existing ones as rivers, wells or transfers.

This parties' fight damaged the public perception of desalination and delayed the main projects carried out in Spain in the last years.

Administrative procedures are so tedious and long that make obsolete the technology specified at the feasibility studies or even tender documents, forcing the developers and contractors to modify the projects and therefore the final budgets.

6.2. Any other lessons or advice

The four essential "legs" of any desalination plant are the intake, the brine disposal, the product delivery and the power supply. All considerations related to them must be analyzed prior to the tender of any desalination plant from the environmental and technical perspectives.

Appendix C

Presentation to the Board Special Committee on Desalination and Recycling

July 26, 2011

Slide 1



Slide 2

Project Background

- 2010 Integrated Resources Plan (IRP) Update:
 - Core supply
 - Buffer supply
 - Foundational actions
- Seawater desalination projects may feed into Metropolitan's distribution system
- Ensure successful integration into system
- Areas of interest:
 - Water quality (corrosion, disinfection stability, blending, etc.)
 - Operations (storage, flexibility, hydraulics, peaking, etc.)

Slide 3

Purpose and Goal

Purpose

Evaluate water utility practices for integrating large-scale seawater desalination plants into existing distribution systems

Project Components

- ✓ Bibliography of applicable references
- ✓ Survey of 10 major global seawater desalination plants

Goal

Enable Metropolitan to proactively understand considerations associated with integrating desalinated seawater

Slide 4

Purpose and Goal

Purpose

Evaluate water utility practices for integrating large-scale seawater desalination plants into existing distribution systems

Project Components

- ✓ Bibliography of applicable references
- ✓ Survey of 10 major global seawater desalination plants

Goal

Enable Metropolitan to proactively understand considerations associated with integrating desalinated seawater

Slide 5

Facility Selection Criteria

Ten (10) prominent seawater desalination plants were selected.

Common Characteristics	Diverse Characteristics
RO technology	Geography
Significant size	Production capacity
Constructed within the last 10 years	Integration methods
	Regulatory environment

All ten plants have some key features in common with proposed facilities that may feed into the Metropolitan system.

Slide 6

Surveyed Plant Summary

Plant ID / Location	Country	Capacity (MGD)	On-Line Date	% Seawater Desalination
Tampa	USA	25	2008	≤ 10%
Gold Coast	Australia	33	2008	variable
Melbourne	Australia	108	2012	33%
Perth 1	Australia	33	2006	15-20%
Sydney	Australia	66	2010	15%
Ashkelon	Israel	98	2005	15%
Fujairah 2	UAE	36	2010	95%
Sur	Oman	21	2009	100%
Tuas 1	Singapore	36	2005	10%
Valdelella	Spain	35	2007	35-45%

Slide 7

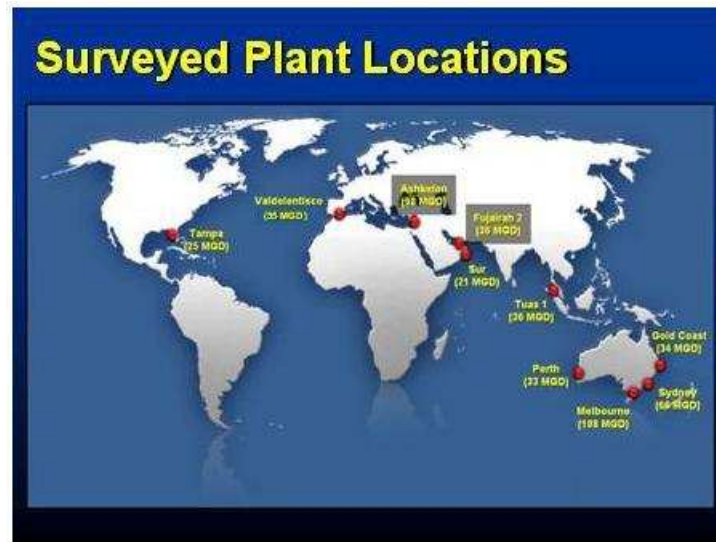

Slide 8

Bromide

Sydney, Australia

- Potential issues:
 - Disinfection by-products
 - Chloramine residual stability
- Half of the plants reported treatment standards

Reported Mitigation Strategies

Blending, two-pass RO process, and/or modifying chloramine residual formation process

Slide 9

Boron

Tuas, Singapore



- Potential impacts to landscape and agriculture
- Eight projects reported boron treatment standards

Reported Mitigation Strategies

Blending and/or two-pass RO process

Slide 10

Corrosion

Fujairah, UAE



- Potential issues
 - System integrity
 - Lead & copper
 - Aesthetics
- Advance studies to evaluate corrosion potential were common

Reported Mitigation Strategies

Meeting corrosion indices goals; Blending;
Post-treatment conditioning to match existing supplies

Slide 11

Water Quality Studies Conducted

- Pipe loop / corrosion testing
- Blending / mixing
- Water quality modeling
- Disinfectant stability
- Disinfection by-product formation
- Pilot testing

Valdelentisco, Spain

An aerial photograph of a large industrial water treatment facility with several rectangular basins and buildings, situated in a dry, hilly landscape.

Slide 12

Blending Practices

- Practices varied:
 - In-pipe
 - Reservoirs
 - Storage tanks
- No plants reported target blending ratios...
- ...However, many acknowledged the usefulness of blending for meeting water quality goals
- Blending ratios vary due to:
 - When lower-cost supplies available
 - Fluctuating demand

Perth, Australia

An aerial photograph of a water treatment facility with multiple large rectangular tanks and buildings, surrounded by greenery and infrastructure.

Slide 13

Intertie Location

- **Upstream intertie:**
 - Piped to a strategic upstream point in the distribution system
 - **Advantages:** operational flexibility, blending potential, larger demands
- **Nearby intertie:**
 - Injected at a nearby point in the distribution system
 - **Advantages:** avoid long transmission, pumping
- **Both reported**

Ashkelon, Israel



Slide 14

Operations

- **Base-loaded production**
 - Reported where seawater desalination is a high percent of supply
- **Variable production**
 - Reported where existing supplies are available
- **Seawater desalination can provide an important emergency supply**

Tampa Bay, Florida



Reported Lessons Learned

- Testing and modeling can help ensure successful integration
- Consider end uses in the development of water quality goals
- A desalination plant can be an emergency asset, providing backup treatment reliability
- Engage the public early and in all stages of development



Gold Coast, Australia



Melbourne, Australia

Considerations for Metropolitan

- ✓ The "Lessons Learned" from the surveyed plants contain good insight.
- ✓ Thorough water quality studies should be specified and conducted *in advance*.
- ✓ Appropriate post-treatment conditioning is essential for stable water quality.
- ✓ A two-pass RO design can improve water quality and treatment flexibility.
- ✓ Blending in storage tanks can support water quality and operational flexibility.
- ✓ Plant site selection should account for the proposed blending point and associated pipeline alignment (as applicable).
- ✓ Projects integrated with existing supplies are not necessarily base-loaded.
- ✓ Integration costs are site specific and can be a major component of the project.

Slide 17

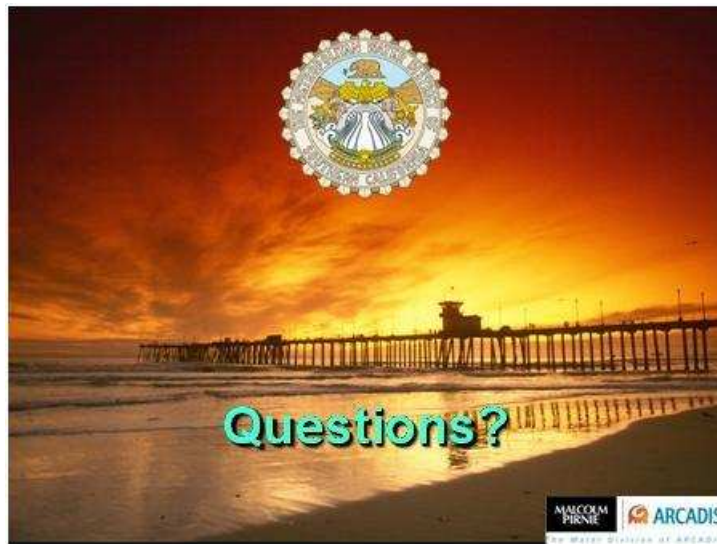

SUPPLEMENT 2

Table 5-5 from Appendix 5 of the Poseidon/SDCWA water purchase agreement, as well as the specifications from Appendix 5 of the Carlsbad project water purchase agreement

APPENDIX 5

MINIMUM PERFORMANCE CRITERIA AND PERFORMANCE TESTING

APPENDIX 5

MINIMUM PERFORMANCE CRITERIA AND PERFORMANCE TESTING

The purpose of the performance test is to establish if the actual Plant performance over a 30 day period meets all Minimum Performance Criteria (as defined below), applicable Contract Standards, and is in compliance with all Applicable Laws (the "Performance Test"). The Performance Test is intended to verify the performance of the Plant in terms of operability, Product Water quality, Product Water quantity, total power consumption, total chemical consumption, cartridge filter performance, and reverse osmosis ("RO") membrane performance.

5.1. PERFORMANCE TESTING PREREQUISITES

The Project Company shall have completed the following before commencing Performance Testing:

- (a) The Project Company shall have obtained the Water Authority's approval of the Performance Test Protocol (as defined below).
- (b) The Project Company has complied with Applicable Law and obtained approval from all applicable Governmental Bodies to commence Performance Testing, and dispose of Unacceptable Water and Off-Specification Product Water.
- (c) The Project Company shall have completed the Full System Test described in subsection 4.2.2(o) of Appendix 4 (Mechanical Completion Requirements).
- (d) The Project Company shall have received written notice from the Water Authority that the Water Authority Improvements and the Product Water Pipeline Improvements have been completed and are ready to receive Product Water.
- (e) The requirements of subsection 7.3(D) (Conditions to Commencement of the Performance Test) of this Water Purchase Agreement have been met.

5.2. PERFORMANCE TEST PROTOCOL

The Project Company shall prepare and submit to the Water Authority for its review and approval a performance test protocol in accordance with Section 7.3 (Performance Testing) of the Water Purchase Agreement and the requirements set forth in this Appendix (the "Performance Test Protocol"). An example table of contents for the Performance Test Protocol is set forth as Attachment 5-1 to this Appendix.

At a minimum, the Performance Test Protocol shall address the following:

- (a) List of all the parameters to be monitored and measurements to be made (stating sampling frequencies) in addition to the parameters set forth in Tables 5-1 to 5-7 of this Appendix.
- (b) Organization, form, content, reporting, and quality assurance / quality control ("QA/QC") components that the Project Company shall use to prepare the Performance Test Report (as defined below) to ensure the clarity of the document. The organization form, content, reporting, and QA/QC components of the Performance Test Report shall be subject to Water Authority approval.

- (c) Written description of the procedures the Project Company shall use for demonstrating compliance with all Minimum Performance Criteria (as defined below), including data and information collection requirements, accuracy requirements, precision requirements, verification requirements (suitable for laboratory analyses by external laboratories, field testing and Project instrumentation), and calculation methods and analyses (including sample calculations).
- (d) Full and complete description of any analytical methods, calculations and other techniques that will be utilized to ensure that all Applicable Law, Contract Standards, and Performance Guarantees are met. In addition, descriptions of how the data collected will be compared with the Minimum Performance Criteria (as defined below), including applicable data handling requirements. Provide examples of any tools such as flow charts, check sheets, calculations, or any other data presentation and evaluation techniques that will be utilized.
- (e) Description of all membrane performance normalization software, calculations and procedures that will be used during the Performance Test.
- (f) Description of the organization of the test team, including identification of normal operations staff, any additional Performance Test support staff, their responsibilities, authority, and decision making protocols for Performance Test start, restart and stop.
- (g) Description of the response procedures for unsuccessful test results including a definition of threshold results that constitute overall Performance Test failure.
- (h) Description of internal and external communications protocols.
- (i) Proposed schedule for Performance Testing.
- (j) Description of the operating and maintenance schedule during testing.
- (k) List of real-time, daily or weekly data and laboratory analyses that will be provided to the Water Authority during the Performance Test.
- (l) List of the operational logs and other operating and maintenance information that will be maintained throughout the test.
- (m) Describe any Contract Standards not set forth in this Appendix that are required to be met to successfully pass the Performance Test.
- (n) Define any applicable standards for equipment performance stated in this Appendix and in Attachment 3A (General Supplemental Design Requirements) of Appendix 3 (Project Design and Construction Work).
- (o) Procedures to prevent Unacceptable Water and Off-Specification Product Water not accepted by the Water Authority from being introduced into the Water Authority Distribution System, and procedures for disposal.
- (p) Procedures for assuring reliable test data with cross-checks where feasible and appropriate for data verification, including procedures for verifying operations interface console readings with process mounted instruments and manually collected samples.

- (q) Operating procedures for an adequate demonstration of Plant performance if the Water Authority determines that it does not want to accept delivery of Product Water at Flow Rates between 50 to 57 MGD during the Performance Test.

5.3. MINIMUM PERFORMANCE CRITERIA

The following are the minimum performance criteria which must be met in order for the Project Company to achieve Provisional Acceptance (the "Minimum Performance Criteria"). Failure to comply with any of the Minimum Performance Criteria shall result in the Project Company failing the Performance Test.

5.3.1 Chemical Consumption.

- (a) The Total Chemical Cost (as defined in Exhibit 5A of this Appendix) shall not exceed 120% of the Maximum Chemical Cost (as defined in Exhibit 5B of this Appendix); and
- (b) The Total Coagulant Amount (as defined in Exhibit 5C of this Appendix) (Ferric Sulfate, FS, or $Fe_2(SO_4)_3$) used during the Performance Test shall not exceed 120% of the Maximum Coagulant Amount (as defined in Exhibit 5C of this Appendix).

5.3.2 Product Water Output During Performance Test.

(a) Minimum Production

- (i) During the Performance Test, the Plant shall operate for a period of 30 consecutive days (such period, as may be adjusted pursuant to subsection 5.6.8 (Plant Shutdown During a Performance Test) of this Appendix, the "Performance Test Period") and produce at least 1,400 MG of Product Water (the "Minimum Production"); provided, that, if the Plant produces more than 57 MG in one day, the excess amount beyond 57 MG in such day shall not be counted when calculating whether the Plant produced Product Water in an amount sufficient to meet the Minimum Production, or for any other purpose under this Appendix.
- (ii) The Plant shall produce not less than the 378 MG of Product Water for a seven consecutive day period during the Performance Test (the "Minimum Seven Day Production"). If the Minimum Seven Day Production has not been met by the end of thirty days, the Project Company may extend the period during which the Performance Test is conducted until the Minimum Seven Day Production requirement has been met. If the Project Company elects to extend the time during which the Performance Test is conducted, the Performance Test Period shall be deemed to be the 30 consecutive days immediately preceding the day that the Minimum Seven Day Production was met.
- (iii) Off-Specification Product Water shall not be counted as Product Water produced by the Plant for purposes of this subsection.

5.3.3 NPDES Project Permit Compliance

- (a) The Plant shall comply with all NPDES Project Permit requirements and all other Applicable Law during the Performance Test.

5.3.4 Power.

The Unit Quantity of Total Plant Power Consumption (as defined below), including the Product Water pump station does not exceed 110% of the Maximum Power Amount (as defined in Exhibit 5D of this Appendix) during the Performance Test. The "Unit Quantity of Total Plant Power Consumption" is defined as the total power consumption measured at the SDG&E billing meters divided by the amount of Product Water produced during the Performance Test.

5.3.5 Permeate and Product Water Quality

All output of the RO system shall be in compliance CDPH regulations applicable to the RO system. Any Unacceptable Water produced by the Plant shall constitute a failure of the Performance Test, and the Performance Test shall immediately terminate. Only the output of the Plant meeting all Contract Standards shall be counted towards meeting the Minimum Performance Criteria. If a sample taken in accordance with Tables 5-5 and 5-6 of this Appendix does not demonstrate the sample is in compliance with all aspects of the Product Water Quality Guarantee (a "Non-Compliant Sample"), then all Plant output produced between the time such Non-Compliant Sample was taken and the time the next Compliant Sample (as defined below) is subsequently taken shall be deemed to be out of compliance with the water quality requirements set forth in Tables 5-5 and 5-6 of this Appendix. A "Compliant Sample" means a sample taken in accordance with Appendix 8 (Supplemental Performance Guarantee Requirements) of this Water Purchase Agreement that demonstrates the sample is in compliance with all aspects of the Product Water Quality Guarantee.

5.3.6 Water Quality Testing

Tables 5-1 through 5-7 of this Water Purchase Agreement set forth the minimum sampling frequencies during the Performance Test. The Project Company may sample the Raw Seawater, internal Plant flows, or the Product Water output of the Plant at more locations and more frequently than the Product Water Quality Sampling Locations and frequencies set forth in Tables 5-1 through 5-7 at its discretion. The analytical results of all valid samples obtained by or on behalf of the Project Company during the Performance Test shall be reported in the Performance Test Report (as defined below) and included in the report's evaluation of Plant performance.

5.4. PERFORMANCE TESTING REQUIREMENTS

5.4.1 General Information

To accomplish a successful Performance Test, Project Company shall operate the following essential process systems in a manner that does not require any extraordinary operational effort or maintenance effort (as determined by subsection 5.4.2(5) of this Appendix) when operated at the ratings established by the equipment manufacturer or designer for the equipment throughout the entire duration of the Performance Test:

- (a) Seawater Intake System
- (b) Pretreatment System
- (c) Reverse Osmosis/ Energy Recovery/ Concentrate Discharge System
- (d) Post-treatment System
- (e) Product Water Storage and Pumping System

- (f) Waste Filter Backwash Treatment System
- (g) Chemical Storage and Delivery Systems
- (h) Solids Handling System

5.4.2 Performance Testing Requirements

The Performance Testing shall be conducted in compliance with the Contract Standards, all Applicable Laws and Governmental Approvals. Samples for analysis shall be analyzed by state-certified laboratories, unless otherwise specifically agreed to in the Performance Test Protocol.

To meet the requirements of the Performance Test, the Project Company must demonstrate that the Plant meets the following criteria at all times during the Performance Test:

1. Any output of the Plant counted towards the Minimum Performance Criteria that meets all aspects of the of the Product Water Quality Guarantee as shall be demonstrated using the tests and frequencies in Tables 5-1 through 5-6 of this Appendix;
2. While in the Three Pump Mode, the Plant shall operate at the following recovery efficiencies:
 - a. For periods when the total suspended solids ("TSS") of the Raw Seawater measured at the intake sampling point are at or below 4.0 mg/L: (i) the clarifier decant flows are recycled to the headworks of the Plant; and (ii) the Plant shall operate at an average ratio of 48 - 52 percent of Product Water produced as a function of the Raw Seawater used.
 - b. Pursuant to Section 2.2 of Appendix 2.1.2 of Attachment 3A (Basic Design Requirements) of Appendix 3 (Project Design and Construction Work), the entire RO system operates at a minimum recovery of 50 percent. In this clause, recovery means the percentage of RO permeate produced as a function of the feedwater applied to the entire membrane system. This includes both the first pass and cascade systems recoveries.
3. Performs in a manner that is consistent with Attachment 3A (Basic Design Requirements for the Plant) of Appendix 3, Attachment 3C (Supplemental Design Requirements) of Appendix 3, all Governmental Approvals, Applicable Law, and the Contract Standards;
4. Has been operated and maintained pursuant to the requirements of the draft preliminary Electronic Operation and Maintenance Manual for the entire duration of the Performance Test;
5. All equipment functions in a manner that does not require any extraordinary operational effort or maintenance effort at the ratings established by the equipment manufacturer or designer for the equipment. Extraordinary operational effort shall be defined as: (1) operation of any equipment outside of the operating conditions envelope recommended by the equipment manufacturer; (2) operation of any equipment in a manner inconsistent with the draft preliminary Electronic Operation and Maintenance Manual; or (3) the need for any material temporary repairs or for material

override of any equipment protective devices to keep equipment running during the Performance Test;

6. Operates properly with automated and computerized systems in full operation (allowing for periodic manual operation consistent with Good Management Practice) and with only the normal complement of employees included in the Project Company's staffing plan for the Project, with the exception of additional Project Company staffing related to collection and analysis of samples and other test data;

7. Solids handling system operates as intended and all solids are removed from the Plant Site in accordance with the draft preliminary Electronic Operation and Maintenance Manual and Applicable Law;

8. Any Unacceptable Water produced by the Plant shall constitute a failure of the Performance Test, and the Performance Test shall immediately terminate. Although Off-Specification Product Water shall not constitute failure of the Performance Test, Off-Specification Product Water shall not be counted as Product Water produced by the Plant for purposes of subsection 5.3.2 of this Appendix;

9. Functions in a manner that safely and reliably conveys Concentrate Discharge and Off-Specification Product Water to the Cabrillo Generating Facility ocean outfall for disposal in accordance with the Contract Standards, all Governmental Approvals, and all requirements of Applicable Law;

10. Pretreatment System functions in a manner that provides RO feedwater in compliance with all applicable membrane manufacturer guidelines and warranty terms for RO feedwater quality at production flow rates up to 57 MGD in accordance with all Governmental Approvals;

11. Operates in a manner consistent with all Applicable Law and Governmental Approvals;

12. Power consumption (including the Product Water pump station) meets all Minimum Performance Criteria standards for the Maximum Power Amount (as defined in Exhibit 5D of this Appendix); and

13. Has achieved the performance specified in Sections 5.3 (Minimum Performance Criteria) and 5.7 (Performance Test Report) of this Appendix.

5.5. DESIGN CONDITIONS

5.5.1 Design Conditions Assessment

As the Performance Test will be conducted under the ambient Raw Seawater quality available at the time of the Performance Test, it is improbable that the actual Raw Seawater quality will demonstrate the overall capability of the Plant's performance over the full specified range of Raw Seawater conditions expected over the Term. Therefore, a section of the Performance Test Report (as defined below) shall describe how certain test data obtained during the Performance Test compares to the expected performance of the process design at those same Raw Seawater conditions for certain treatment systems (the "Design Conditions Assessment"). The Design Conditions Assessment shall include consideration of the Raw Seawater's range of limits for temperature, Total Dissolved Solids ("TDS"), TOC, TSS, turbidity, and pH, set forth in Table 8-4 of Appendix 8 (Supplemental Performance Guarantee Requirements). To perform the Design Conditions Assessment, it is anticipated that the Project Company would conduct an engineering evaluation that contrasts in graphical form, summary data from the Performance

Test results vs. the designer's anticipated performance under the actual seawater temperature, TDS, TOC, TSS, turbidity, and pH conditions experienced during the Performance Test to provide benchmarks for actual performance versus expected performance.

All performance modeling for RO membrane processes and energy recovery devices shall be: (1) conducted in accordance with the current versions of the RO membrane manufacturer's and energy recovery device manufacturer's freeware, assuming an average membrane life of 3.7 years for the first pass, and 5 years for the second pass cascade; (2) use membrane manufacturer's standard assumptions for flux decline percentage per year, fouling factor, and salt passage increase percentage per year; and (3) use the lowest and highest Raw Seawater temperatures and highest Raw Seawater TDS specified in Table 8-4 of Appendix 8.

The Design Conditions Assessment should include the following comparative analyses regarding actual performance during the Performance Test and design capabilities:

- (a) Chemical dosing process design capabilities with actual performance and data during the Performance Test;
- (b) Filter Backwash filter run length design objective with the with actual performance and data during the Performance Test;
- (c) Residual solids handling process design capacity with actual performance during the Performance Test;
- (d) RO system's process design capacity on an overall system basis and a per pass and per stage basis for the cascade with actual performance during the Performance Test. This RO assessment will also include an assessment for the parameters of Chloride, Bromide, and Boron;
- (e) Energy consumption data with the Specific Energy values as determined by Exhibit 5D and including appropriate allowance for increased feedwater pressure necessary to maintain flux rates due to projected membrane fouling. If no fouling factor is included in the membrane warranty, a default value of 0.7 should be used. Energy use for RO system shall be determined using pump and motor operation with a multi-port orifice to be installed during the Performance Test; and
- (f) Influent and Product Water quality.

5.5.2 Design Conditions Assessment Certification

Authorized representatives of the Project Company and the Process Services Contractor shall be required to sign and date the Design Conditions Assessment and certify that the assessment is accurate to the best of his knowledge and was prepared in a manner consistent with Good Design and Construction practice. Further, the Project Company's engineer of record shall be required to seal the assessment with the aforementioned certification.

5.6. PERFORMANCE TEST DATA COLLECTION AND PERFORMANCE REQUIREMENTS

Performance Test data will be monitored as described in Tables 5-1 through 5-7 of this Appendix and as otherwise described in this Appendix.

The Performance Test Protocol shall contain a Plant operation log sheet and report prepared specifically for this project, and approved by the Water Authority before the initiation of the Performance Test. The Plant operation log sheet shall be maintained each day by the Project

Company for the duration of the Performance Test. The Plant operation log sheet shall provide a daily log of all pertinent Plant operating data, flows and conditions and a record of the performance of each item of equipment being monitored. Readings taken from the Plant operations interface console shall be verified by readings taken from process-mounted instruments at least twice per week and, where applicable, manually collected samples (which will be determined in the Performance Test Protocol), where applicable, as defined in the Performance Test Protocol. All settings and set points will be recorded along with the results of all monitored criteria and samples tested. The Performance Test data collection locations, frequency, accuracy, measurement conditions, detection levels and format of presentation and reporting and recordkeeping shall be consistent with meeting all requirements of all applicable Governmental Approvals, Applicable Law, and Subcontractor and equipment vendor warranties.

Further, each laboratory analytical method practical quantification limit ("PQL") will need to be established and stated in the Performance Test Protocol, and the analytical result will need to be above the method's PQL to be valid. PQL's and other laboratory QA/QC reports shall be provided for all sample analyses. Analytic results below method PQL shall be expressed as required by CDPH or Applicable Law when such stipulations apply. Otherwise, analytical results below method PQL shall be expressed as the PQL value. Method Detection limits for all laboratory analyses shall conform to CDPH or current industry standards.

All material Project corrective maintenance activities or other repairs to equipment shall be logged for the duration of the Performance Test. A summary description of all such maintenance activities shall be provided in the Performance Test Report (as defined below) to demonstrate that the Plant has been operated and maintained pursuant to the requirements of the Electronic Operation and Maintenance Manual for the entire duration of the Performance Test and that the Plant Equipment functioned reliably and in a manner that does not require any extraordinary operational effort or maintenance effort at the ratings established by the equipment manufacturer or the designer for the equipment.

All pertinent information that is collected by the Plant's SCADA system and used to support Performance Test findings will also be provided to Water Authority as electronic files on CDs or other acceptable media.

During the Performance Test, the Project Company shall allow Water Authority representatives to witness sampling activities and provide split samples to the Water Authority, if requested. The Water Authority shall: (1) make such representatives available in a manner that accommodates the Project Company's schedule for its sampling activities; (2) not unduly delay the Project Company's sampling activities; and (3) make prior arrangements and coordinate such sampling activities with the Project Company to assure the split samples it desires can be reasonably obtained without an appreciable increase in effort or cost.

The data collection and reporting and process and equipment performance requirements are as follows:

5.6.1 Seawater Intake System

(a) Data Collection and Reporting Requirements

The following Raw Seawater data shall be sampled, collected and reported (daily unless otherwise specified in this Appendix) to Water Authority by Project Company during the Performance Test:

- (i) Water quality characteristics matching the Requirements of Table 5-1 of this Appendix;

- (ii) Flow continuously monitored;
- (iii) If applicable and relevant, chlorine addition frequency, dosage (mg/l) and daily use (lbs/day); and
- (iv) Intake water level, individual pump discharge pressure, and individual motor frequency, if a variable frequency drive ("VFD") is installed on the pump.

5.6.2 Pretreatment System

(a) Minimum Data Collection and Reporting Requirements

The following performance and equipment data shall be collected, logged, and available (daily unless otherwise specified in this Appendix) to Water Authority by Project Company during the Performance Test:

- (i) Pretreatment water quality characteristics matching the requirements of Table 5-2 of this Appendix;
- (ii) Average media filter cell surface loading rate (gpm/sq ft) daily and for the entire Performance Test, tabulated by filter cell;
- (iii) Maximum instantaneous media filter cell surface loading rate (gpm/sq ft) daily and for the entire Performance Test, tabulated by filter cell;
- (iv) Filter backwash volume per backwash and per day (MGD) daily and for the entire Performance Test;
- (v) Filter cell backwash frequency (on a number of backwashes per day basis) daily and for the entire Performance Test, tabulated by filter cell;
- (vi) Differential pressure increase in ft. per cell, between media filter backwashes daily and average for the entire Performance Test tabulated by filter cell;
- (vii) Run times between backwashing for media filtration process units daily and average for the entire Performance Test, tabulated by filter cell;
- (viii) Contact chamber mixer rotational speeds (rpm);
- (ix) Filtrate recovery, per cell (as a total of % throughput), tabulated by filter cell;
- (x) Backwash and air scour, rinse durations (each measured in minutes of duration) tabulated by filter cell;
- (xi) Coagulant and polymer dosage (mg/L) and daily use (lbs/day) and average for the entire Performance Test;
- (xii) Antiscalant dosage (mg/L) and daily use (lbs/day) and average for the entire Performance Test;
- (xiii) Sulfuric acid dosage (mg/L) and daily use (lbs/day) and average for the entire Performance Test;

- (xiv) Chlorine dose residual and average for the entire Performance Test;
- (xv) Sodium bisulfite/sodium meta bisulfite dose and average for the entire Performance Test;
- (xvi) Cartridge filter type and size and number of filters in service;
- (xvii) Cartridge filter element replacements each day, if any;
- (xviii) Cartridge filter element replacement frequency;
- (xix) Filtered seawater quality measured twice per shift upstream and downstream of each cartridge filter bank (feed to high pressure RO pumps and feed to energy recovery devices) in terms of: Silt Density Index ("SDI") (15) pursuant to ASTM D4189 - 07 Standard Test Method for Silt Density Index (SDI) of Water, or later version if applicable (the "SDI Test"). All such SDI Test data shall be logged and trended;
- (xx) Differential pressure across cartridge-filter vessels, psig measured continuously;
- (xxi) Cartridge filter hydraulic loading rate (gpm/10-inch length) daily and average for for the entire Performance Test, tabulated by filter; and
- (xxii) Clearwell water level, individual pump discharge pressure, and individual motor frequency, if a VFD is installed on the pump.

(b) Pretreatment Process and Equipment Performance Requirements

The requirements in the following table shall be met at all times during the Performance Test:

Backwash cycle	≤ 2 backwashes per day per cell
Total daily backwash volume	≤ 6 MGD (for 1 complete backwash) ≤ 12 MGD (for 2 complete backwashes)
Filtrate turbidity downstream of cartridge filtration	≤ 0.3 mg/L for 95 % of the time and < 0.5 mg/L at all times
Filtrate SDI (15) water quality downstream of cartridge filter vessels	≤ 4.0 for 95 % of the time and < 5.0 at all times (unless more stringent requirements apply based on SWRO membrane supplier warranty)
Differential pressure across cartridge filters (other than cartridge filters having a mechanical defect) during the Performance Test above and beyond the initial pressure drop across any of the cartridge filter vessels used at the end of the Performance Test	Demonstrate that: (i) the Plant has operated without replacement of any cartridge filters (other than cartridge filters having a workmanship or materials defect), and (ii) without exceeding a 15 psi differential pressure increase over the initial startup ("clean") differential pressure across any of the cartridge filter vessels used at the end of the

	Performance Test
Number of cartridges replaced per vessel (for each vessel in operation at any time, other than cartridge filters having a mechanical defect)	None

Failure to meet these pretreatment requirements at any time shall constitute a Performance Test failure and the Performance Test will be stopped until the condition is remedied. Thereafter the Performance Test can then be repeated.

5.6.3 Reverse Osmosis, Energy Recovery and Concentrate Discharge System

(a) Minimum Data Collection and Reporting Requirements

The Project Company shall collect and deliver to the Water Authority the following data on daily basis (unless otherwise specified in this Appendix) during the Performance Test:

- (i) RO feedwater, permeate, and concentrate quality characteristics matching the requirements of Table 5-3 of this Appendix;
- (ii) RO system feed pressure (for each RO train), psig, continuously monitored and daily average pressure for the duration of the Performance Test;
- (iii) RO feed water temperature, degrees C, continuously monitored, daily minimum, maximum, and average, and average for the duration of the Performance Test;
- (iv) Concentrate pressure (for each RO train), psig, monitored daily and average for the duration of the Performance Test;
- (v) Pressure of concentrate exiting energy recovery system, psig, continuously monitored and average for the duration of the Performance Test;
- (vi) RO permeate pressure (for each RO train), psig, monitored at least daily and average for the duration of the Performance Test;
- (vii) Permeate production (per train and total per pass and stage), MGD;
- (viii) Percentages of high quality vs. low quality permeate for first pass train, percent;
- (ix) Maximum daily permeate production, MGD;
- (x) RO feedwater flow (per train and total per pass/stage), MGD;
- (xi) Concentrate Discharge flow (per train, total per pass/stage, and daily total discharged), MGD;
- (xii) Recovery each day, (per train, per pass/stage, total RO process, and total plant), percent. All such data shall be trended;

- (xiii) Combined permeate pressure, psig, continuously monitored;
- (xiv) Actual and normalized differential pressure (pressure drop) across each RO train, psig, calculated at 4 hour intervals and average for the Performance Test. All such normalized data shall be trended;
- (xv) Normalized membrane permeability (gfd/psig), calculated at 4 hour intervals and average for the Performance Test. All such normalized data shall be trended;
- (xvi) Actual and normalized salt passage, %, calculated at 4 hour intervals and average for the Performance Test. All such normalized data shall be trended;
- (xvii) SWRO feed pump power use, kWh/kgal Product Water;
- (xviii) ERD and SWRO booster pump power consumption, kWh/kgal Product Water;
- (xix) ERD bank individual and total system recovered power; kWh/kgal Product Water;
- (xx) Average daily power consumption of each pumping component of the RO system (excluding the Product Water pump station), kWh/kgal of Product Water;
- (xxi) Number of pumps in operation and operational hours of each pump, calculated at 4 hour intervals and average for the duration of the Performance Test; and
- (xxii) Other membrane data/normalized trends pursuant to applicable membrane manufacturer's warranty conditions and other guidelines. All such normalized data shall be trended.

The Project Company shall plot all RO train normalized data including salt passage, permeability, and differential pressure on charts so that trends may be observed. Data files will also be collected by the Project Company and converted to Microsoft Excel format. Only authorized membrane manufacturer's normalization programs and algorithms will be used by the Project Company.

(b) RO Process and Equipment Performance Requirements

- (i) All of the following conditions shall be met at all times during the Performance Test:

Reverse osmosis membrane replacement	None (other than membranes having a workmanship or materials defect)
Reverse osmosis membrane end cap, connector, seal, spacer or blank replacement	None
Differential pressure across the RO membrane elements	Demonstrate that the membrane trains do not exceed a five percent increase over the software design differential pressure across

	any of the RO system trains
Normalized permeate flow	Demonstrate that the membrane trains do not lose more than five percent of the software design normalized permeate flow
Normalized salt passage	Demonstrate that the membrane trains do not lose more than five percent of the software design normalized salt passage
RO membrane cleaning	None

(ii) First Stage RO Membrane Performance

First stage RO membrane performance shall be evaluated with respect to compliance with the standards set forth in Table 5-4 of this Appendix throughout the Performance Test. Such testing shall be conducted on an individual RO train basis before any permeate blending or mixing. The Project Company shall include all performance data necessary to substantiate such performance and compare the actual performance during the Performance Test with the membrane manufacturer’s performance projections used as a basis for sizing the RO membrane cascade system in the Performance Test Report (as defined below).

Failure of a RO train to comply with Table 5-4 of this Appendix performance standards during the Performance Test shall not prevent the Project Company from achieving Provisional Acceptance, provided that any such RO train must be brought into compliance as a requirement of achieving Project Completion. Subsequent RO train tests shall be conducted during normal operation with each such RO train being tested demonstrating compliance with the standards in Table 5-4 of this Appendix over a period of 12 consecutive hours.

5.6.4 Post-treatment System

(a) Minimum Data Collection and Reporting Requirements

Product Water flow and pressure shall be measured at the Plant Flow Meter. All Product Water quality parameters shall be measured at the Product Water Quality Sampling Locations unless otherwise set forth in Tables 5-5 and 5-6 of this Appendix as applicable. The Water Authority has determined that to prudently operate its system, that it will be necessary to periodically vary the Chloramine Residual and the Chlorine to Ammonia ratio pursuant to Table 5-5 of this Appendix and the notes thereto.

The following data shall be collected and reported (daily unless otherwise specified in this Appendix) to Water Authority by Project Company during the Performance Test.

- (i) Product Water or Off-Specification Product Water quality characteristics matching the requirements of Tables 5-5 and 5-6 of this Appendix;
- (ii) Calcite, carbon dioxide, sodium hydroxide, sodium hypochlorite, ammonia and sulfuric acid dose (mg/l) and consumption (lbs/day and lbs/MG) – for each chemical;
- (iii) Calcium dissolution rate verified by analysis and material balance; and
- (iv) Chlorine and ammonia dosage (mg/l) and consumption (lbs/day) – for each chemical.

5.6.5 Product Water Storage and Pumping System

(a) Performance Requirements

- (i) The Performance Test shall demonstrate that the Product Water storage and pumping system is capable of delivering, from the Product Water Delivery Point to the TOVWTP, an average daily flow of 54 MGD, with one pump in standby, at the TDH in feet of water utilized in the final design from the Plant Flow Meter for the period of time required by the Performance Test Protocol.
- (ii) The Performance Test shall demonstrate that the Product Water storage and pumping system is capable of operating in accordance with the Operating Protocol while in Three Pump Mode so as to avoid the occurrence of hydraulic transients, which are any sudden, material changes in the flow rate and pressure of the Product Water beyond the Plant Flow Meter at flow rates up to 57 MGD when Product Water pump configurations are varied.
- (iii) The Project Company may assert the occurrence of an Uncontrollable Circumstance, and shall be entitled to schedule, performance and compensation relief on account thereof if there is a material change to the Water Authority Improvements from the description set forth in Appendix 13 (Water Authority Improvements) which (x) causes materially differing conditions from those modeled in the approved final hydraulic transient analysis set forth in Appendix 3 (Project Design and Construction Work), and (y) which materially and adversely affects the ability of the Project Company to meet the requirements of this subsection, or materially increases the costs of meeting these requirements.

(b) Minimum Data Collection and Reporting Requirements

The following data shall be collected and reported (daily unless otherwise specified in this Appendix) to Water Authority by Project Company during the Performance Test:

- (i) Hourly water levels in the product water storage tank;
- (ii) Number of pumps in operation and operational hours of each pump;
- (iii) Product tank water level, individual pump discharge pressure, and individual motor frequency, if VFD is installed on the pump; and
- (iv) Volume of Product Water pumped each shift, summed daily.

5.6.6 Waste Filter Backwash Treatment System and Solids Handling System

(a) Data Collection and Reporting Requirements

The following data shall be collected and reported (daily unless otherwise specified in this Appendix) to Water Authority by Project Company during the Performance Test:

- (i) Waste filter backwash treatment system and solids handling system water quality characteristics matching the requirements of Table 5-7 of this Appendix;

- (ii) Clarifier decant water daily flow gpd and average for the duration of the Performance Test;
- (iii) Clarifier sludge solids concentration, % solids;
- (iv) Dewatering facility press feed solids concentration, % solids (each filter press) daily and average for the duration of the Performance Test;
- (v) Dewatering facility feed sludge flow, gpd, (each filter press); daily and average for the duration of the Performance Test;
- (vi) Dewatered sludge cake concentration, % solids;
- (vii) Daily volume of dewatered sludge, wet tons/day;
- (viii) Filter Press dewatering polymer quantity, dry lbs./day; and
- (ix) Number of operating hours of the dewatering facility per day.

5.6.7 Concentrate Discharge Monitoring

(a) Data Collection and Reporting Requirements

The following data shall be collected and reported (daily unless otherwise specified in this Appendix) to Water Authority by Project Company during the Performance Test:

- (i) Concentrate Discharge monitoring data reporting shall be consistent with all the NPDES Project Permit requirements as delineated by Sections IV and V of the NPDES Project Permit. The Project Company shall provide data sufficient to demonstrate compliance with all such requirements.
- (ii) The Performance Test Protocol shall fully describe the Project Company's methodology for demonstrating compliance with the receiving water limitations of Section V of the NPDES Project Permit including, but not limited to its specific testing and sampling practices related to the mixing and dilution zone defined by Section V of the NPDES Project Permit.

5.6.8 Plant Shutdown During a Performance Test

Any failures, stoppages or interruption of the Plant that occurs during a Performance Test shall not excuse the Project Company from complying with the Performance Test requirements set forth in this Appendix provided, however:

- (a) With respect to any 24-hour period during which the Project Company demonstrates that the Raw Seawater used in Performance Testing has concentration levels or characteristics outside any of the ranges of Specified Raw Seawater Quality Parameters set forth in Table 8-4 of Appendix 8 (Supplemental Performance Guarantee Requirements) which materially and adversely affects the operation of the Plant (an "Excused Period"), the following shall apply:
 - (i) Excused Periods shall not be included as part of the Performance Test.
 - (ii) The Project Company shall have an hour-for-hour extension of the duration of the Performance Test for the duration of the Excused Period.

- (iii) To the extent that the Excused Period results from the occurrence of an Uncontrollable Circumstance as a result of a Raw Seawater quality contamination event described in subsection 9.13(E) (Raw Seawater Quality-Contamination) of this Water Purchase Agreement, the Project Company shall also be eligible for compensation relief for the EPC Contractor's direct on-site management and operating expenses related to maintaining readiness to proceed with the Performance Test. The Company shall not be entitled to any other compensation relief as a result of such Uncontrollable Circumstance event during the Performance Test. The Project Company shall receive the compensation relief set forth in this item in the manner set forth in Section 16.3 (Other Uncontrollable Circumstances) of this Water Purchase Agreement.
 - (iv) The Scheduled Commercial Operation Date shall be extended for the duration of the Excused Period.
- (b) In order to demonstrate that any 24-hour period should be an Excused Period, the Project Company must provide three samples (i.e., an initial sample, followed by two confirmation samples), collected at least 8 hours apart, within such 24-hour period, demonstrating that the Raw Seawater has concentration levels or characteristics that are outside of any of the ranges of Specified Raw Seawater Quality Parameters set forth in Table 8-4 of Appendix 8 (Supplemental Performance Guarantee Requirements). All sampling must be in accordance with the Contract Standards. A replicate QA/QC sample shall be collected for each sample. Samples that are not within 10% of their replicate QA/QC sample shall be disregarded.
- (c) If an Uncontrollable Circumstance occurs during a Performance Test (other than the failure of the intake water to meet the specifications pursuant to item (a) of this subsection), Water Authority shall either:
- (i) Agree to treat the period during which the Uncontrollable Circumstance has occurred as an Excused Period, in which event all the provisions of item (a) of this subsection shall apply; or
 - (ii) Instruct the Project Company to re-start the Performance Test from its beginning, in which event the performances of the Plant prior to the restart of the Performance Test shall not be taken into account.
 - (iii) In either event the Scheduled Commercial Operation Date shall be extended for such time as is reasonable in the circumstances to take account of the effect of the delay in Performance Testing caused by the Uncontrollable Circumstance.

If the Performance Test is interrupted because of an emergency condition occurring within the Water Authority Distribution System which closes all or any portion of the Water Authority Distribution System required to be open for receiving Product Water under sound municipal water utility operating practices, (i) such period of non-acceptance of Product Water by the Water Authority shall not be included as part of the Performance Test, and (ii) the Project Company shall have an hour-for-hour extension of the duration of the Performance Test for the duration of the interruption.

5.6.9 Measurement of Certain Test Parameters

In addition to the measurement frequencies identified within this Appendix, the additional test parameters will be measured with the following frequency:

- (a) Power consumption for operation of the Plant shall be determined based on the kilowatt hour readings from the power supplier's meters used by SDG&E for billing purposes.
- (b) All data for parameters continuously monitored shall be provided continuously by SCADA instrumentation and verified with manual reading verification at least once per day;
- (c) For chemical consumption, the following minimum parameters shall be recorded by the Project Company throughout the Performance Test and available upon request:
 - (i) Chemical concentration and grade (as delivered);
 - (ii) Dosing rate, mg/L;
 - (iii) Changes in dosing rate;
 - (iv) Solution concentration (as dosed); and
 - (v) Day tank and bulk storage tank levels, deliveries, and changes in inventory amounts; and
 - (vi) Chemical dosing information shall be computed as a daily average dose based on actual consumption and compared with dosing set points in the Performance Test Report (as defined below) to confirm the proper functionality of the chemical addition systems. Separate chemical consumption values shall be reported for each chemical used for post treatment and for RO feedwater treatment. Chemicals used for pretreatment and for post treatment shall be reported both individually and as combined totals by the Project Company.

5.6.10 Product Water Flow and Pressure Measurements

Product Water production and pressure measurements shall be completed according to a procedure mutually agreed upon by Water Authority and Project Company. This procedure shall be a mandatory component of the Performance Test Protocol.

5.7. PERFORMANCE TEST REPORT

A Performance Test report shall be prepared by the Project Company at the completion of the Performance Test and shall comply with the requirement of this Section (the "Performance Test Report"). The Project Company will deliver five copies of the Performance Test Report to the Water Authority in indexed and fully-searchable Adobe Acrobat electronic format.

5.7.1 Signed and Sealed Test Report

The Performance Test Report shall be signed and sealed by an engineer licensed in California and certified as true, complete and correct by an officer of the Project Company and an Officer of the EPC Contractor.

5.7.2 Minimum Content of Performance Test Report

At a minimum, the Performance Test Report shall include:

- (a) General.
- (i) All data obtained during the Performance Test, including a detailed calculation of the Minimum Performance Criteria values during the Performance Test.
 - (ii) A chart comparing the actual values to the Minimum Performance Criteria values, and explanations for any failure to achieve such Minimum Performance Criteria. The level of detail of such information shall be sufficient so that all performance metrics cited in the Performance Test Report can be independently calculated and verified.
 - (iii) Any data deemed as outliers shall be presented with an explanation of why such data were judged to be outliers.
 - (iv) An organized comparison of all SCADA data, laboratory analytical data, and Project local instrumentation readings and field measurements that is sufficiently detailed to show how the Project Company crosschecked the data to verify accuracy and precision.
 - (v) Findings of the Design Conditions Assessment conducted pursuant to Section 5.5 (Design Conditions) of this Appendix.
 - (vi) Signed operator's daily logs.
 - (vii) Normalized plots for RO train permeability, salt passage, differential pressure, permeate backpressure.
 - (viii) Electronic form (MS Excel with columns clearly identified) of operating data for intake feed pumps, pretreatment system, RO systems (including all associated pumps and ERDs), post-treatment system, solids handling, and product water system.
 - (ix) All water quality reports prepared by or for Project Company;
 - (x) All instrumentation and control settings (including PID loop control parameters) and any measurements, checks and settings which may be required by operating and maintenance personnel.
 - (xi) Report of all spare parts used.

All calculations used or prepared by the Project Company shall be sufficiently documented so that they can be independently verified.

- (b) A table of results showing the actual performance achieved for the following:
- (i) The total Plant power consumption, as determined from kilowatt hour readings from the power supplier's meters used by SDG&E for billing purposes;
 - (ii) Chemical consumption;
 - (iii) Membrane operating data, and the normalized data in both graphical and Excel formats.

- (c) Applicable data, as agreed upon in the Performance Test Protocol, in tabular format, for
 - (i) Seawater Intake System;
 - (ii) Pretreatment System;
 - (iii) Reverse Osmosis System;
 - (iv) Post-Treatment System;
 - (v) Product Water and Transmission System;
 - (vi) Waste Filter Backwash Treatment System and Solids Handling System;
 - (vii) Plant Discharge Monitoring;
 - (viii) Chemical Storage and Delivery Systems.
- (d) If the Performance Test was aborted, the causes and resolutions;
- (e) If any portion of the Plant is shutdown, the causes and resolutions;

5.8. SURGE PROTECTION SYSTEM TEST

5.8.1 Surge Protection System Test. On the last day of the Performance Test, the Project Company shall perform a full flow Product Water pump failure test of the surge protection system which comprises a portion of the Plant's Product Water pump facilities (the "Surge Protection System Test"). The Surge Protection System Test shall demonstrate whether the surge protection system is able to limit the resulting transient pressures in a manner consistent with the design conditions that will be established in the final hydraulic transient analysis prepared by the Project Company pursuant to Attachment 3C (Supplemental Design Requirements) of Appendix 3 (Project Design and Construction Work). The Project Company shall prepare a Surge Protection System Test report that (i) compares the actual values of the pressure recorded during the Surge Protection System Test by the Project Company and the Water Authority to the values that will be established in the final hydraulic transient analysis prepared by the Project Company pursuant to Attachment 3C of Appendix 3; (ii) discusses whether each piece of equipment in the Plant's Product Water pump facilities functioned in a manner that is consistent with Attachment 3C of Appendix 3; and (iii) if the Plant's Product Water pump facilities failed to meet the requirements of the Surge Protection System Test, the repairs and modifications that need to be made to the Product Water pump facilities (the "Surge Protection System Test Report"). The Surge Protection System Test Report shall be signed and sealed by an engineer licensed in California, and certified as true, complete and correct by an officer of the Project Company and an officer of the EPC Contractor. The Project Company has no obligation to record pressures on the Water Authority Improvements during the Surge Protection System Test.

5.8.2 Retesting of the Surge Protection System. Within five Business Days of receiving the Surge Protection System Test Report, the Water Authority will deliver to the Project Company written notice setting forth which repairs and modifications that: (i) because of their material effect on the safe operation of the Water Authority Improvements and the Product Water Pipeline Improvements, need to be completed prior to Provisional Acceptance (such repairs and modifications include, but are not limited to, any damage that presents a safety concern; visible damage to concrete structures, pipe anchors, pipe supports; pipeline and pipeline appurtenance leaks; any damage to surge suppression system components; damage to

valves, valve actuators, and meters required to control or measure Product Water deliveries or isolate Product Water Pipeline; and damage to any field instruments that allow local automated control of the pump station, flow meter, and surge suppression system); and (ii) may be completed after Provisional Acceptance but prior to Project Completion. If the Water Authority's notice sets forth repairs or modifications which need to be made before Provisional Acceptance, the Project Company shall repeat the Surge Protection Test and comply with the requirements of subsection 5.8.1 (Surge Protection System Test) of this Appendix. The Project Company shall have no obligation to repeat the Surge Protection System Test for modifications or repairs which the Water Authority's notice states may be completed after Provisional Acceptance but prior to Project Completion.

5.8.3 No Water Authority Obligation to Accept Product Water If Failure to Meet Surge Protection System Test Damages the Water Authority Improvements. If the Water Authority Improvements are damaged as a result of a failure by the Product Water pump facilities to meet the transient pressure requirements of the Surge Protection System Test, the Water Authority shall have no obligation to accept or pay for Product Water for five days following the completion of the Surge Protection System Test. During such time, the Water Authority shall make preparations for the reconfiguration and repair of the Water Authority Improvements. The Project Company shall reimburse the Water Authority for the reasonable cost of repair to the Water Authority Improvements. The Project Company shall be responsible for paying for and making any necessary repairs to the Product Water Pipeline Improvements damaged as a result of the failure of the Product Water pump facilities to meet the transient pressure requirements of the Surge Protection System Test.

5.9. CALCULATING MAXIMUM ANNUAL SUPPLY COMMITMENT

5.9.1 General. Depending on the total amount of Product Water produced during the Performance Test (the "Performance Test Product Water Amount"), the Maximum Annual Supply Commitment shall be calculated in accordance with this Section.

5.9.2 Reduction in the Maximum Annual Supply Commitment. If the Performance Test Product Water Amount is 1,564 MG or greater, the Maximum Annual Supply Commitment shall equal 56,000 Acre Feet. If the Performance Test Product Water Amount is less than 1,564 MG, and greater than or equal to 1,400 MG, then the Maximum Annual Supply Commitment shall be calculated as set forth in Section 9.3 (Maximum Annual Supply Commitment and Adjusted Annual Supply Commitment) of this Water Purchase Agreement.

Exhibit 5A

The cost of each chemical listed in the table below shall be determined by multiplying the actual quantities (expressed in dry lbs) of that chemical which are consumed by the Plant during the Performance Test by the corresponding theoretical unit price therein listed. (The columns in the table below entitled Consumption (dry lbs/Kgal) and Maximum Theoretical Chemical Cost (\$/Kgal) are provided as examples of this calculation only.) The Total Chemical Cost (expressed in \$/Kgal) shall be equal to the sum of the individual chemical costs (\$) divided by the total quantity (expressed in kgal) of Product Water produced during the Performance Test. Only chemicals listed in the table below contribute to the Total Chemical Cost.

The Theoretical Unit Price is for 100% active chemical material as delivered, with the exception of Ammonia (or NH₄OH), which for the purposes of the chemical guarantee will be fed as NH₄OH, and for Sodium Hypochlorite (or NaOCl), which for the purposes of the chemical guarantee will be fed as NaOCl.

Chemical/Product	Consumption dry lbs/Kgal (Provided for reference only)	Theoretical Unit Price (\$/dry lbs) (For 100% active material)	Maximum Theoretical Chemical Cost \$/Kgal (Provided for reference only)
Ferric Sulfate, FS	0.197	0.15	0.02955
Polymer - Filter	0.0019	1.08	0.002
Antiscalant	0.0053 (excludes raw water Antiscalant addition)	1.00	0.00525
NaOH	0.185	0.51	0.094
H ₂ SO ₄	0.048	0.2	0.009525
CO ₂	0.247	0.06	0.014
CaCO ₃	0.410	0.04	0.0164
NaOCl*	0.028	0.6	0.0167
NH ₄ OH*	0.012	0.5	0.006
Polymer - Lamella	0.0015	1.02	0.00157
Polymer - Dewatering	0.0001	1.08	8.89E-05

*Guaranteed consumption of NaOCl and NH₄OH are according to the concentration set point shown in Table 5-6 for the Product Water. If the Water Authority reasonably requests a higher value, the Maximum Theoretical Chemical Cost set forth in Table 5-6 will be adjusted accordingly.

Usage/consumption rate of any chemical shown in this Table may vary subject to total usage/consumption not exceeding the Maximum Chemical Cost or the Maximum Coagulant Amount.

Exhibit 5B

The Maximum Chemical Cost expressed as \$/Kgal of product water shall be determined for the weighted average Total Suspended Solids (TSS) during the Performance Test, as determined pursuant to the table below.

Adjustment for TSS

The weighted average TSS of the intake (raw) water (TSS AVG) during the Performance Test shall be determined as follows:

$$TSS\ AVG = \frac{\sum_{j=1}^N (TSS_j \times PWA_j)}{PWA_{Total}}$$

Where

N = the number of four hour periods in the Performance Test.

TSS_j = TSS of the Raw Seawater measured at the intake pit sampling point at the end of any four hour period in the Performance Test (or if no TSS measurement was taken for such four hour period, the most recent TSS measurement), or 4.0 mg/L, whichever is greater, expressed mg/L.

PWA_j = the amount of Product Water delivered to the outlet flange of the Product Water pump station (the "Delivery Point") for any four hour period during the Performance Test, expressed in kgal.

PWA_{Total} = the amount of Product Water delivered to the Delivery Point during the Performance Test, expressed in kgal.

TSS (mg/L)	4	5	8	10	15	20	25	30
Maximum Chemical Cost (\$/kgal)	0.195	0.2	0.208	0.214	0.219	0.222	0.227	0.232

If TSS AVG value is not included in the table above, the TSS AVG value shall be rounded up to a listed value and that TSS value shall be used to select the corresponding Maximum Chemical Cost.

Exhibit 5C

TSS shall be sampled by a composite sampler over 24 hours and measured on a daily basis. If the TSS of the Raw Seawater on any day exceeds 4 mg/L, TSS shall be sampled at four hour intervals, until the Raw Seawater TSS returns to 4 mg/L or less. The measured TSS values will be used in conjunction with the table and equation below to determine the Maximum Coagulant Amount.

The maximum coagulant amount (dry lbs of coagulant, FS, for 100% active material) shall be determined as follows (the "Maximum Coagulant Amount"):

$$N$$

$$\text{MAX COAG AMT} = \sum_{j=1} (\text{ALLOW COAG AMT}_j \times (\text{PWA}_j + \text{CDA}_j))$$

Where

N = the number of four hour periods in the Performance Test

ALLOW COAG AMT_j = the amount of allowable coagulant (FS) to be added to the Raw Seawater measured at the end of any four hour periods in the Performance Test from the table set forth in this Exhibit, based on the TSS measurement for such four hour period, or if no TSS measurement was taken for such four hour period, the most recent TSS measurement, expressed in lbs/kgal of raw water.

PWA_j = the amount of Product Water delivered to the Delivery Point for the corresponding four hour periods in the Performance Test, expressed in kgal.

CDA_j = the amount of Concentrate Discharge discharged to the ocean for the corresponding four hour periods in the Performance Test, expressed in kgal.

TSS (mg/L)	4	5	8	10	15	20	25	30
Allowable Coagulant (FS) Amount lbs/kgal of raw water	0.088	0.109	0.134	0.150	0.167	0.175	0.192	0.209

The values of Coagulant amount in the table above refer to 100% of Fe₂(SO₄)₃

If the measured TSS value is not included in the table above, the TSS value shall be rounded up to a listed value and that TSS value shall be used to select the corresponding Allowable Coagulant Amount.

The TSS level for each sample during the Performance Test to be determined according to SM 2540 D.

The actual weighted average coagulant amount (Total Coagulant Amount) (TOT COAG AMT) of FS consumed for the Performance Test shall be determined as follows:

$$\text{TOT COAG AMT} = \frac{\sum_{j=1}^N (\text{COAG AMT}_j \times \text{PWA}_j)}{\text{PWATotal}}$$

Where N = the number of four hour periods in the Performance Test

COAG AMT_j = the amount of coagulant (FS) added to the Raw Seawater measured at the end of any four hour periods in the Performance Test, expressed in lbs.

PWA_j = the amount of Product Water delivered to the Delivery Point for any four hour periods in the Performance Test, expressed in kgal

PWATotal = the amount of Product Water delivered to the Delivery Point during the Performance Test, expressed in kgal.

Exhibit 5D

Maximum Power Amount

The Maximum Power Amount shall be equal: (i) the kWh/kgal Plant amount of power consumption, adjusted for the weighted average temperature and TDS values for the duration of the Performance Test, as determined pursuant to Table 1 herein, plus (ii) Product Pump Specific Energy of 5.04 kWh/kgal) plus Intake Pump Specific Energy of 0.72 kWh/kgal. The Specific Energy values in Table 1 shall apply to all Product Water output levels produced by the Plant during all Performance Tests.

A. Design Assumption. Maximum Power Amount is calculated and determined on the following design assumption:

- (a) Product Water pump station TDH is 1173 ft.

In the event that the actual Product Water Pump Station TDH is not 1173 ft the Product Pump Specific Energy shall be determined pursuant to the Product Pump Specific Energy formula set forth after Table 1 herein.

B. Adjustment for Temperature and TDS. The weighted average influent water temperature (TEMP-AVG) for the Performance Test shall be determined as follows:

$$\text{TEMP - AVG} = \sum_{j=1}^N (\text{TEMP}_j \times (\text{PWA}_j \div \text{PWATotal}))$$

Where

N = the number of 15 minute periods in the Performance Test.

TEMP_j = the RO feedwater water temperature measured at the discharge of the HPRO pumps at the end of any 15 minute periods in the Performance Test, expressed in degrees Celsius.

PWA_j = the amount of Product Water delivered to the Delivery Point for any 15 minute periods in the Performance Test, expressed in kgal.

PWATotal = the amount of Product Water delivered to the Delivery Point during the Performance Test, expressed in kgal.

The weighted average influent Total Dissolved Solids (TDS-AVG) for the Performance Test shall be determined as follows:

$$\text{TDSAVG} = \sum_{j=1}^N (\text{TDS}_j \times (\text{PWA}_j \div \text{PWATotal}))$$

Where

N = the number of 24 hour periods in the Performance Test.

TDS_j = TDS measured at the end of each twenty-four (24) hour period during the Performance Test pursuant to Table 5-1 hereto, expressed in mg/L.

PWA_j = the amount of Product Water delivered to the Delivery Point during each twenty-four (24) hour period during the Performance Test, expressed in kgal.

PWATotal = the amount of Product Water delivered to the Delivery Point during the Performance Test, expressed in kgal.

Table 1: Specific Energy Guarantee for All Performance Test Product Water Output Levels

TDS, ppm Feed Water Temp, C	28,000 Plant kWh/kgal	33,500 Plant kWh/kgal	34,500 Plant kWh/kgal
12	10.72	11.50	12.03
14	10.42	11.04	11.71
16	10.24	10.98	11.48
18	10.21	10.93	11.29
20	10.15	10.87	11.10
22	10.10	10.81	10.96
24	10.10	10.69	10.83
26	10.10	10.57	10.73
28	10.10	10.45	10.65
30	10.10	10.33	10.58

For the purposes of determining the temperature and TDS to use in conjunction with Table 1 of this Exhibit to determine the Maximum Power Amount:

- (a) The average temperature value shall be rounded down to the preceding Temperature value listed in Table 1 of this Exhibit, and
- (b) The average TDS and Maximum Power Amount values shall be linearly interpolated between the corresponding applicable values listed in Table 1.

Determination of Product Pump Specific Energy if Product Water pump station TDH varies from 1173 ft.:

$$SE\left(\frac{kWh}{Kgal}\right) = \frac{Q(gpm) \times TDH(ft)}{Pe \times Me \times VFDe \times Qp\left(\frac{Kgal}{hr}\right)} \times 1.887 \times 10^{-4} \times Sf$$

Where:

Q (gpm)= average flow Product Water during the Performance Test at the Product Water flow meter located at the Product Water pump station, expressed in gallons per minute (gpm).

TDH (ft) = total dynamic head of the Product Water Pump Station, expressed in ft (feet). The Product Water Pump Station TDH will be determined as the sum of the following three elements (a) the value measured at pressure indicator on the discharge flange of the product pump, (b) height difference between center of pressure indicator on the discharge flange of the product pump and actual water level in product tank, and (c) pressure loss of 1.65 ft at the suction line, in each case, while the Plant is delivering 54 MGD to the maximum water elevation in the clearwells located at the Twin Oaks Valley Water Treatment Plant.

Pe = pump efficiency, expressed as a decimal, determined by the manufacturer's warranty for the Product Water pumps.

Me = motor efficiency, expressed as a decimal, determined by the manufacturer's warranty for the motors associated with the Product Water pump.

VFDe = VFD efficiency, expressed as a decimal, determined by the manufacturer's warranty for the VFD associated with the Product Water pump.

Qp(Kgal/hr)=average flow of Product Water during the Performance Test measured at the Product Water flow meter located at the outlet of the Product Water pump station, expressed in Kgal/hr.

Sf= a safety factor of 1.05.

Table 5-1
Minimum Raw Seawater Quality Analyses

Quality Parameter	Analytical Method ⁽¹⁾	Sampling		Units
		Sampling Location	Sample Frequency and Method ⁽²⁾	
Total Dissolved Solids	2540C	Discharge of the Raw Seawater Pump Station	1 Grab per Day	mg/L
Chloride	4110B	Discharge of the Raw Seawater Pump Station	1 Grab per Day	mg/L
Bromide	4110B	Discharge of the Raw Seawater Pump Station	3 Grabs per Week	mg/L
Boron	3120B	Discharge of the Raw Seawater Pump Station	3 Grabs per Week	mg/L
Turbidity	2130B	Discharge of the Product Water Pump Station	Continuous ⁽³⁾	NTU
Temperature	2550	Discharge of the Raw Seawater Pump Station	Continuous ⁽³⁾	oF
pH	4500	Discharge of the Raw Seawater Pump Station	Continuous ⁽³⁾	SU
Calcium	3500	Discharge of the Raw Seawater Pump Station	3 Grab per week	mg/L as CaCO ₃
Conductivity	2510	Discharge of the Raw Seawater Pump Station	Continuous ⁽³⁾	μS
TOC	5310	Discharge of the Raw Seawater Pump Station	3 Grab per Week	mg/L
TOC ⁽⁴⁾	5310	Discharge of the Raw Seawater Pump Station	1 Grab per Day	mg/L
Total Suspended Solids	2540	Discharge of the Raw Seawater Pump Station	1 Grab per Day	mg/L
Dissolved Oxygen	4500	Discharge of the Raw Seawater Pump Station	1 Grab per Day	mg/L
Total Chlorine Residual	4500	Discharge of the Raw Seawater Pump Station	Continuous ⁽³⁾	mg/L as Cl ₂
Silt Density Index (SDI)	ASTM D4189	Discharge of the Raw Seawater Pump Station	3 per Day (1 per shift)	
Total Alkalinity	2320	Discharge of the Raw Seawater	3 Grab per week	mg/L

Quality Parameter	Analytical Method ⁽¹⁾	Sampling		Units
		Sampling Location	Sample Frequency and Method ⁽²⁾	
		Pump Station		
Total Hardness	5310	Discharge of the Raw Seawater Pump Station	3 Grab per Week	mg/L
Sodium	3500	Discharge of the Raw Seawater Pump Station	3 Grab per Week	mg/L
Magnesium	200.8	Discharge of the Raw Seawater Pump Station	3 Grab per Week	mg/L
Other Constituents Pursuant to Plant NPDES Permit	As needed to comply with all Applicable Law and Governmental Approvals	As needed to comply with all Applicable Law and Governmental Approvals	As needed to comply with all Applicable Law and Governmental Approvals	

Notes to Table 5-1:

1. Analytic Method: All methods taken from *Standard Methods On Line*, published by APHA, AWWA, and WEF or current EPA methods.
2. Sample Period: Concentration limits are calculated for this period, which shall be (i) daily for continuous samples and samples collected every 15 minutes; and (ii) for the Performance Test Period, for samples collected daily or three times per week. All individual values to be reported. Average daily values to be calculated for any parameter for which multiple samples are taken per day.
3. Continuous Sample Frequency and Method: Monitoring, data storage and trending values shall be taken at intervals of 15 minutes or less.
4. Quality Parameter: This Quality Parameter only applied during algal bloom conditions.

Table 5-2
Pretreatment System Water Quality Analyses

Quality Parameter	Analytical Method ⁽¹⁾	Sampling		Units
		Sampling Location	Sample Frequency and Method ⁽²⁾	
Conductivity	2510	Discharge of HPRO Pumps	Continuous ⁽³⁾	µS
pH	4500	First Pass RO feedwater pH downstream of sulfuric acid feed	Continuous ^{(3), (4)}	SU
Turbidity	2130B	First Pass RO feedwater ⁽⁵⁾	Continuous ^{(3), (4)}	NTU
Turbidity	2130B	First Pass RO feedwater ⁽⁶⁾	Continuous ^{(3), (4)}	NTU
Total Organic Carbon (TOC)	5310	Downstream of cartridge filters (high pressure RO pumps and energy recovery devices)	1 Grab per Day	mg/L
Oxidation-Reduction Potential	2580	Downstream of Bisulfite Dosing	Continuous ^{(3), (4)}	Millivolts
Total Chlorine Residual	4500	Downstream of Floc Basins, Upstream of Bisulfite Dosing	Continuous ^{(3), (4)}	mg/L as Cl ₂
Silt Density Index (SDI)	ASTM D4189	First Pass RO feedwater ⁽⁷⁾	Every 4 Hours	
Other Constituents ⁽⁸⁾	TBD	Per Requirements of Membrane Manufacturer's Warranty Conditions	As needed	

Notes to Table 5-2:

1. Analytic Method: All methods taken from *Standard Methods On Line*, published by APHA, AWWA, and WEF or current EPA methods.
2. Sample Period: Concentration limits are calculated for this period, which shall be (i) daily for continuous samples and samples collected every 15 minutes or every 4 hours; and (ii) for the Performance Test Period, for samples collected daily or three times per week. All individual values to be reported. Average daily values to be calculated for any parameter for which multiple samples are taken per day.
3. Continuous Sample Frequency and Method: Monitoring, data storage and trending values shall be taken at intervals of 15 minutes or less.
4. Sample Frequency and Method: Automatic analyzers for pH, Turbidity and Oxidation-Reduction Potential, Total Chlorine Residual to have samples analyzed three times a day manually (on a once per shift basis) for confirmation.
5. Sampling Location: Combined first pass RO feedwater downstream of the cartridge filters feeding the high pressure RO pumps.
6. Sampling Location: Combined first pass RO feedwater downstream of the cartridge filters feeding the energy recovery devices.
7. Sampling Location: Downstream of each cartridge filter bank feeding either a high pressure RO pumps or an energy recovery device.
8. Quality Parameters: Pursuant to RO membrane manufacturer's guidelines and RO membrane warranty requirements.

Table 5-3
RO System Water Quality Analyses

Quality Parameter	Analytical Method ⁽¹⁾	Sampling		Units
		Sampling Location	Sample Frequency and Method ⁽²⁾	
Total Dissolved Solids	2540C	First Pass RO feedwater	1 Grab per Day	mg/L
Total Dissolved Solids	2540C	Second Pass Cascade Combined RO feedwater	1 Grab per Day	mg/L
Chloride	4110B	Combined Concentrate - First Pass and Second Pass Cascade	1 Grab per Day	mg/L
Chloride	4110B	Combined Permeate - First Pass and Second Pass Cascade	1 Grab per Day	mg/L
Bromide	4110B	Combined Concentrate - First Pass and Second Pass Cascade	1 Grab per Day	mg/L
Bromide	4110B	Combined Permeate - First Pass and Second Pass Cascade	1 Grab per Day	mg/L
Boron	3120B	Combined Concentrate - First Pass and Second Pass Cascade	1 Grab per Day	mg/L
Boron	3120B	Combined Permeate - First Pass and Second Pass Cascade	1 Grab per Day	mg/L
Turbidity	2130B	First Pass RO feedwater	Continuous ⁽³⁾ (4)	NTU
Temperature	2550	Second Pass Cascade Combined Concentrate	Continuous ⁽³⁾	oF
pH	4500	First Pass RO feedwater	Continuous ⁽³⁾ (4)	SU
Conductivity	2510	First Pass Concentrate - each RO train	Continuous ⁽³⁾	μS
Conductivity	2510	First Pass Permeate Front - each RO train	Continuous ⁽³⁾	μS
Conductivity	2510	First Pass Permeate Rear - each RO train	Continuous ⁽³⁾	μS
Conductivity	2510	Combined RO feedwater - Second Pass Cascade	Continuous ⁽³⁾	μS
Conductivity	2510	Combined Permeate - Second Pass Cascade	Continuous ⁽³⁾	μS
Conductivity	2510	Combined Concentrate - Second Pass Cascade	Continuous ⁽³⁾	μS
Other Constituents	TBD	Per Requirements of Membrane Manufacturer's Warranty Conditions	As needed ⁽⁵⁾	

Notes to Table 5-3:

1. Analytic Method: All methods taken from *Standard Methods On Line*, published by APHA, AWWA, and WEF or current EPA methods.
2. Sample Period: Concentration limits are calculated for this period, which shall be (i) daily for continuous samples and samples collected every 15 minutes; and (ii) for the Performance Test Period, for samples collected daily or three times per week. All individual values to be reported. Average daily values to be calculated for any parameter for which multiple samples are taken per day.

3. Continuous Sample Frequency and Method: Monitoring, data storage and trending values shall be taken at intervals of 15 minutes or less.
4. Sample Frequency and Method: Automatic analyzers for pH and Turbidity to have samples analyzed three times a day manually (on a once per shift basis) for confirmation.
5. Sample Frequency and Method: Pursuant to any sampling requirements of RO membrane manufacturer's start-up and operating guidelines and the RO membrane warranty conditions for each train in each pass.

Table 5-4
Performance Test
First-Stage RO Train Permeate
Water Quality Requirements

Quality Parameter	Analytical Method ⁽¹⁾	Sample Method ⁽²⁾	Concentration Limit ⁽³⁾ (mg/L)	
			Individual Train	Combined
Total Dissolved Solids	2540C	Daily Grab	Individual Train	Combined
			See Note 4	See Note 5

Notes Table 5-4:

1. Analytic Method: All methods taken from *Standard Methods On Line*, published by APHA, AWWA, and WEF or current EPA methods.
2. Sample Period: Duration of the Performance Test.
3. Concentration Limit: mg/L unless otherwise noted.
4. Individual Train Concentration Limit: Individual train permeate concentration limit shall equal the lower of (i) the concentration value in the table below for the temperature when the sample is taken; and (ii) the warranty concentration value provided by the membrane manufacturer in the warranty for the membranes selected by the Project Company for use in the first stage RO for the appropriate temperature, times a 1.25 safety factor:

Temp.	14	15	16	17	18	19	20	21
TDS	250	265	282	299	317	336	356	377

Temp.	22	23	24	25	26	27	28	29
TDS	399	423	447	473	500	528	557	582

5. Combined Concentration Limit: Concentration permeate concentration limit shall equal the lower of (i) the concentration value in the table below for the temperature when the sample is taken; and (ii) the warranty concentration value provided by the membrane manufacturer in the warranty for the membranes selected by the Project Company for use in the first stage RO for the appropriate temperature, times a 1.15 safety factor:

Temp.	14	15	16	17	18	19	20	21
TDS	230	244	259	275	291	309	327	347

Temp.	22	23	24	25	26	27	28	29
TDS	367	388	411	434	459	485	512	537

Table 5-5
Product Water Quality Analyses

Quality Parameter	Analytical Method ⁽¹⁾	Sampling		Units	Concentration Limits		
		Sampling Location	Sample Frequency and Method ⁽²⁾		Central Tendency ⁽³⁾	Extreme ⁽⁴⁾	Maximum ⁽⁵⁾
Total Dissolved Solids	2540C	Discharge of the Product Water Pump Station	1 Grab per Day	mg/L	320	375	600
Chloride	4110B	Discharge point of the Product Water Pump Station	1 Grab per Day	mg/L	120	150	None
Bromide	4110B	Discharge of the Product Water Pump Station	1 Grab per Day	mg/L	0.4 ⁽¹³⁾	0.7	None
Boron	3120B	Discharge of the Product Water Pump Station	1 Grab per Day	mg/L	0.75 ⁽¹²⁾	1.0 ⁽¹⁰⁾	None
Turbidity	2130B	Discharge of the Product Water Pump Station	Continuous ⁽⁶⁾	NTU	0.5	0.8	1.0
SDS-TTHM ⁽⁹⁾	5710C	Discharge of the Product Water Pump Station	Weekly Grab: 100% Product Water	µg/L		56	80
SDS-HAA5 ⁽⁹⁾	5710D	Discharge of the Product Water Pump Station	Weekly Grab: 100% Product Water	µg/L		43	60
Temperature	2550	Discharge of the Product Water Pump Station	Continuous ⁽⁶⁾	°F		85°F	None
Total Coliform Bacteria ⁽⁷⁾	9221	Discharge point of the Product Water Pump Station	1 Grab per Day	MPN/100m L	Non-detect ("ND")	ND	ND
E. Coli Bacteria ⁽⁷⁾	9221	Discharge point of the Product Water Pump Station	1 Grab per Day	MPN/100m L	ND	ND	ND
pH	4500	Discharge of the Product Water Pump Station	Continuous ⁽⁶⁾	SU		8.5 ± 0.3	8.5 ± 0.5
Calcium	3500	Discharge of the Product Water Pump Station	1 Grab per Day	mg/L as CaCO ₃		>40	None

Quality Parameter	Analytical Method ⁽¹⁾	Sampling		Units	Concentration Limits		
		Sampling Location	Sample Frequency and Method ⁽²⁾		Central Tendency ⁽³⁾	Extreme ⁽⁴⁾	Maximum ⁽⁵⁾
Langelier Saturation Index (LSI)	ASTM D3739	Discharge of the Product Water Pump Station	1 Grab per Day ⁽¹¹⁾			>0	<1
Calcium Carbonate Precipitation Potential (CCCP)	TBD	Discharge of the Product Water Pump Station	Weekly Grab ⁽¹¹⁾			>0	<10
Fluoride	4500	Discharge of the Product Water Pump Station	Daily Grab	mg/L	See Footnote 8		
Iron	200.7	Discharge of the Product Water Pump Station	Weekly Grab	mg/L			0.07
Manganese	200.8	Discharge of the Product Water Pump Station	Weekly Grab	mg/L			0.02
Lead	3111	Discharge of the Product Water Pump Station	Weekly Grab	µg/L			MCL
Copper	3111	Discharge of the Product Water Pump Station	Weekly Grab	mg/L			MCL
Aluminum (if aluminum salts are used in treatment process)	3111	Discharge of the Product Water Pump Station	Weekly Grab	mg/L			0.20
Conductivity	2510	Discharge of the Product Water Pump Station	Continuous ⁽⁶⁾	µS	Monitor Only		
Dissolved Oxygen	4500	Discharge of the Product Water Pump Station	1 Grab per Day	mg/L	Monitor Only		
Total Organic Carbon (TOC)	5310	Discharge of the Product Water Pump Station	1 Grab per Day	mg/L	Monitor Only		
Ammonia	4500	Discharge of the Product Water Pump Station	Daily	mg/L	Monitor Only		
Total Hardness	2340	Discharge of the Product Water Pump Station	1 Grab per Day	mg/L	Monitor Only		

Quality Parameter	Analytical Method ⁽¹⁾	Sampling		Units	Concentration Limits		
		Sampling Location	Sample Frequency and Method ⁽²⁾		Central Tendency ⁽³⁾	Extreme ⁽⁴⁾	Maximum ⁽⁵⁾
Total Alkalinity	2320	Discharge of the Product Water Pump Station	1 Grab per Day	mg/L as CaCO ₃		>45	None
Sodium	3500	Discharge of the Product Water Pump Station	1 Grab per Day	mg/L	Monitor Only		
Magnesium	200.8	Discharge of the Product Water Pump Station	1 Grab per Day	mg/L	Monitor Only		
California Title-22 / CDPH Drinking Water Regulations	As needed to comply with Applicable Law	As needed to comply with Applicable Law	As needed to comply with Applicable Law or Twice per Performance Test, whichever is greater		As needed to comply with Applicable Law	As needed to comply with Applicable Law	As needed to comply with Applicable Law

Notes to Table 5-5:

1. Analytic Method: All methods taken from *Standard Methods On Line*, published by APHA, AWWA, and WEF or current EPA methods.
2. Sample Period: Concentration limits are calculated for this period.
3. Central Tendency Concentration Limit: Concentration limit cannot be exceeded in more than 50% of samples taken over the applicable period, which shall be (i) daily for continuous samples and samples collected every 15 minutes; and (ii) for the duration of the Performance Test, for samples collected daily or weekly. The first sample in any period and any subsequent sample in the period to exceed the said 50% limit will each be referred to hereinafter as a "Non-Compliant Sample", and the first subsequent sample to any Non-Compliant Sample showing compliance with the Central Tendency value will be referred to as a "Relevant Compliant Sample". The output produced from the time that a Non-Compliant Sample is taken to the time that the applicable Compliant Sample is taken shall be deemed Off-Specification Product Water or Unacceptable Water. The Project Company shall be permitted to sample the Product Water more frequently than the sampling frequencies required in this Table. Additional Product Water samples taken shall not increase the sample size for determining compliance with the Central Tendency Concentration Limit during the applicable period. The original sampling schedule and frequency for the applicable sampling period shall be maintained if additional samples are taken within any applicable sampling period. However, any additional sample taken that demonstrates compliance with the Central Tendency value shall be considered a Compliant Sample. When a Quality Parameter is sampled more than once during the Performance Test, the sample set for the Central Tendency Concentration Limit shall be reset for each sampling period.
4. Extreme Concentration Limit: Concentration limit cannot be exceeded in more than 10% of samples taken over the applicable period, which shall be (i) daily for continuous samples and samples collected every 15 minutes; and for the duration of the Performance Test, for samples collected daily or weekly. The first sample in any period and any subsequent sample in the period to exceed the said 10% limit will each be referred to hereinafter as a "Non-Compliant Sample", and the first subsequent sample to any Non-Compliant Sample

showing compliance with the Extreme value will be referred to as a "Compliant Sample". The output produced from the time that a Non-Compliant Sample is taken to the time the applicable Compliant Sample is taken shall be deemed Off-Specification Product Water or Unacceptable Water. The Project Company shall be permitted to sample the Product Water more frequently than the sampling frequencies required in this Table. Additional Product Water samples taken shall not increase the sample size for determining compliance with the Extreme Tendency Concentration Limit during the applicable period. The original sampling schedule and frequency for the applicable sampling period shall be maintained if additional samples are taken within any applicable sampling period. However, any additional sample taken that demonstrates compliance with the Extreme Tendency value shall be considered a Compliant Sample. When a Quality Parameter is sampled more than once during the Performance Test, the sample set for the Extreme Tendency Concentration Limit shall be reset for each sampling period.

5. Maximum Concentration Limit: Concentration limits cannot be exceeded at any time.
6. Continuous Sample Frequency and Method: Monitoring, data storage and trending values shall be taken at intervals of 15 minutes or less.
7. Quality Parameter: Replicate and replacement sampling protocols apply per CA Title 22 before a finding of non-compliance applies.
8. Concentration Limit: The concentration limit for Fluoride shall be 0.7 and shall be maintained at all times within the given precision limits for the parameter as established by CDPH.
9. Quality Parameter: Simulated Distribution System ("SDS") tests will be used to determine compliance with THM and HAA requirements for the samples collected at the compliance point. Product Water is to be collected for the SDS tests and held in a water bath. The following describes the test conditions:
 - a. pH: No adjustment to collected sample.
 - b. Temperature: Same as Product Water at time of collection ± 3 °C.
 - c. Total Cl₂ residual at test end: No adjustment to collected sample.
 - d. Time: 48 \pm 2 hours.

Sampling must be conducted daily during the first 30 days in which Product Water is produced and during the Performance Test.

10. Extreme Concentration Limit: Use 95% percentile for Boron. This concentration limit cannot be exceeded in more than 5% of the samples.
11. Sample Frequency and Method: Daily sampling required following a negative value reading until a positive value reading is restored.
12. Central Tendency shown applies for an average Raw Seawater temperature of 23°C and below during the Performance Test. For an average Raw Seawater temperature above 23°C during the Performance Test, the following equation shall be used to determine a new Central Tendency: $[0.75 + (0.25 * (\text{average Raw Seawater temperature for the entire Performance Test} - 23^\circ\text{C}) / 7)]$.
13. Central Tendency shown applies for an average Raw Seawater temperature of 23°C and below during the Performance Test. For an average Raw Seawater temperature above 23°C during the Performance Test, the following equation shall be used to determine a new

Central Tendency: $[0.4 + (0.11 * (\text{average Raw Seawater temperature for the entire Performance Test} - 23^{\circ}\text{C})/7)]$.

Table 5-6

Product Water Disinfectant Levels⁽¹⁾

Quality Parameter	Analytic Method	Sampling		Units	Concentration Limits		
		Sample Location	Sample Frequency and Type ⁽²⁾		Minimum ⁽³⁾	Payment Set Point	Maximum ⁽⁴⁾
Total Chlorine Residual	4500	Discharge of the Product Water Pump Station	Continuous ⁽⁵⁾	mg/L as Cl ₂	1.5	2.75 ⁽⁶⁾ ± 0.3	4.0
Ammonia	4500	Discharge of the Product Water Pump Station	Daily Grab	mg/L			
Chlorine/Ammonia Ratio	Calculated Value	Discharge of the Product Water Pump Station	1 per Day		4.0	Ratio 5.0 +0.2/-0.3 ⁽⁷⁾	5.2

Notes to Table 5-6:

1. The Water Authority has determined that to prudently operate the Water Authority Distribution System, it will be necessary to periodically vary the Chloramine Residual and the Chlorine to Ammonia ratio pursuant to this Table.
2. Analytic Method: All methods taken from *Standard Methods On Line*, published by APHA, AWWA, and WEF or current EPA methods.
3. Minimum Concentration Limit: Concentration limits cannot be below at any time.
4. Maximum Concentration Limit: Concentration limits cannot be exceeded at any time.
5. Continuous Sample Frequency and Method: Monitoring, data storage and trending values shall be taken at intervals of 15 minutes or less. Average daily values are to be calculated for any parameter for which multiple samples taken per day.
6. Total Chlorine Residual Permitted Variance: This quality parameter cannot be exceeded by an amount greater than ±0.3 in more than 5% of samples taken each day, with no sample exceeding a maximum of twice the permitted variance. The first sample in the day and any subsequent sample in the day to exceed the said 5% limit will each be referred to hereinafter as a Non-Compliant Sample, and the first subsequent sample to any Non-Compliant Sample showing compliance with the Permitted Variance will be referred to as a Compliant Sample. Any sample that exceeds the maximum Permitted Variance will also be deemed a Non-Compliant Sample. The output volume produced from the time that a Non-Compliant Sample is taken to the time that the applicable Compliant Sample is taken shall be deemed Off-Specification Product Water or Unacceptable Water.
7. Chlorine to Ammonia Ratio Permitted Variance: This quality parameter cannot be exceeded by an amount greater than +0.2/-0.3 in more than 5% of samples taken each month, with no sample exceeding a maximum of twice the Permitted Variance. The first sample in the month and any subsequent sample in the month to exceed the said 5% limit will each be referred to hereinafter as a Non-Compliant Sample, and the first subsequent sample to any Non-Compliant Sample showing compliance with the Permitted Variance will be referred to as a Compliant Sample. Any sample that exceeds the maximum Permitted Variance will also be deemed a Non-Compliant Sample. The output volume produced from the time that a Non-Compliant Sample is taken to the time that the applicable Compliant Sample is taken shall be deemed Off-Specification Product Water or Unacceptable Water. The Project Company shall be permitted to sample the Product Water more frequently than the sampling frequencies required in Table 8-2 of this Appendix. Additional Product Water

samples taken shall not increase the sample size for determining compliance with this Permitted Variance Concentration Limit during the applicable period. The original sampling schedule and frequency for the applicable sampling period shall be maintained if additional samples are taken within any applicable sampling period. However, any additional sample taken that demonstrates compliance with the Permitted Variance Concentration Limit shall be considered a Compliant Sample. The sample set for this Permitted Variance Concentration Limit shall be reset for each applicable period.

**Table 5-7
 Waste Filter Backwash Treatment System and Solids Handling System Water Quality
 Analyses**

Quality Parameter	Analytical Method ⁽¹⁾	Sampling		Units
		Sampling Location	Sample Frequency and Method ⁽²⁾	
Total Suspended Solids	TBD	Filter backwash	1 Grab per Day	mg/L
Total Suspended Solids	TBD	Clarifier decant	1 Grab per Day	mg/L
Percent Solids	TBD	Clarifier sludge	1 Grab per Day	mg/L
Percent Solids	TBD	Dewatered sludge cake	1 Grab per Day	mg/L
Other Constituents Pursuant to Applicable Law and disposal facility requirements	As needed to comply with Applicable Law and disposal facility requirements	As needed to comply with Applicable Law and disposal facility requirements	As needed to comply with Applicable Law and disposal facility requirements	

Notes to Table 5-7:

1. Analytic Method: All methods taken from *Standard Methods On Line*, published by APHA, AWWA, and WEF or current EPA methods.
2. Sample Period: Concentration limits are calculated for this period. Daily and average values for the Performance Test shall be provided.

Attachment 5-1- Example Performance Test Protocol

Table of Contents

Section No.	Title
1.	Purpose
2.	Project Company's Performance Testing Team
3.	Project Minimum Acceptance Criteria
4.	Pre-Performance Test Requirements
5.	Performance Test Requirements
5.1.	Performance Test Conditions
5.2.	Performance Test Duration
5.3.	Sampling and Analysis
5.4.	Instrument Calibration
5.5.	Sample Calculations
5.6.	Finished and Pretreatment System Effluent Water Quantity
5.7.	Finished Water and Pretreatment System Effluent Quality
5.8.	Power Consumption
5.9.	Chemical Consumption
6.	Essential Process Systems
6.1.	Raw Seawater System
6.2.	Pretreatment System stem
6.3.	Reverse Osmosis System System
6.4.	Post-treatment System
6.5.	On-site Finished Water Storage and Transfer Pumps System
6.6.	Concentrate Disposal System and Underground Injection Wells
7.	Performance Test Report
8.	Performance Test Schedules
9.	Appendices
9.1.	Company's Performance Test Team Organization Charts
9.2.	Certified Laboratories
9.3.	Sampling and Analysis Requirements
9.4.	
9.5.	Sample Calculations
9.6.	List of Required Test Data and Instrumentation
9.7.	Finished Water Quality Standards
9.8.	Power Guarantees
9.9.	Chemical Inventory Log Sheets
9.10.	Chemical Batch Certificates and Delivery Tickets
9.11.	Specifications for Treatment Chemicals
9.12.	Instrument Calibration Sheets
9.13.	Sample Plant Data Logs
9.14.	
9.15.	
9.16.	
9.17.	
9.18.	Domestic Water Supply Permit

SUPPLEMENT 3

**Appendix 2- Attachment 3 from the Monterey RFP by
California American Water**

**Request for Proposals for California American Water
Monterey Peninsula Water Supply Project
Desalination Infrastructure**

DRAFT 5/2/2013

**APPENDIX 2 – ATTACHMENT 3
FINISHED WATER QUALITY REQUIREMENTS**

Finished water quality Performance Standards and Requirements that will be used as the basis of design and acceptance testing are shown in Table 2, for the pretreatment effluent (RO feed stream), the combined RO permeate and the Finished Water after stabilization for corrosion control and disinfection with chlorine.

Table 1 – Treated Water Performance Standards and Requirements

Parameter	Units	Pretreatment Effluent		Combined RO Permeate		Finished Water After Stabilization	
		Maximum Average Concentration ¹	Not to Exceed Concentration ²	Maximum Average Concentration ¹	Not to Exceed Concentration ²	Maximum Average Concentration ¹	Not to Exceed Concentration ²
General and Inorganic							
Total Dissolved Solids (TDS)	mg/L						500
Turbidity	NTU	0.15 ³	1.0	0.1	0.5	0.15	0.5
Silt Density Index (SDI)	min ⁻¹	3 ³	4 ⁴				
Boron	mg/L			0.5	0.7	0.5	0.7
Chloride	mg/L			60	100	60	100
Bromide	mg/L			0.3	0.5	0.3	0.5
Sodium	mg/L			35	60	35	60
Iron, total	mg/L	0.05	0.07				
Manganese, total	mg/L	0.02	0.05				
Product Water Stabilization⁵							
Hardness, total ⁶	mg/L as CaCO ₃					40 to 100	-
pH ⁶	pH units					7.7 to 8.7	-
Alkalinity, total ⁶	mg/L as CaCO ₃					40 to 100	-
Langelier Saturation Index (LSI) ⁶	-					0 to 0.2	-
Calcium Carbonate Precipitation Potential (CCPP) ⁶	mg/L					0 to 5	-
Orthophosphate	mg/L as PO ₄					Set by CalAm within the range of 1.0 to 3.5 mg/L	3.5
Disinfection and Disinfection Byproducts (DBPs)							

**Request for Proposals for California American Water
Monterey Peninsula Water Supply Project
Desalination Infrastructure**

DRAFT 5/2/2013

Parameter	Units	Pretreatment Effluent		Combined RO Permeate		Finished Water After Stabilization	
		Maximum Average Concentration ¹	Not to Exceed Concentration ²	Maximum Average Concentration 1	Not to Exceed Concentration ²	Maximum Average Concentration ¹	Not to Exceed Concentration ²
Total Chlorine Residual	mg/L as Cl ₂					Set by CalAm within the range of 1.0 to 3.5 mg/L	3.5 mg/L
Trihalomethanes, total (TTHM) ⁷	µg/L					40	64
Haloacetic Acids, total of 5 (HAA5) ⁷	µg/L					30	48
Total Nitrosamines ^{7,8}	ng/L					5	8
Bromate	µg/L					5	8

¹ The **average** of the measured concentrations shall be below this limit at all times. This footnote does not apply to (a) pretreatment effluent turbidity or SDI, or (b) finished water total hardness, pH, alkalinity, LSI or CCP; separate footnotes apply to these parameters.

² No measurement shall exceed this value, at any time.

³ Measured values must be less than the Target Limit 95% of the time.

⁴ The maximum SDI limit applies unless more stringent requirements apply based on the SWRO membrane supplier warranty.

⁵ The Owner will set the conditions for product water stabilization to minimize corrosion in the existing distribution system. Conditions will likely not be set for all of these parameters concurrently.

⁶ Finished water shall be within the target range at all times.

⁷ TTHM, HAA5, and total nitrosamine concentrations shall be determined using the Simulated Distribution (SDS) test method in Standard Methods (Method 5710C). Samples of the finished water where it enters the distribution system shall be collected, with no adjustment of chlorine residual or pH, and held at the temperature of the finished water at the time of collection (±2°C) for a 48-hour holding time.

⁸ Total Nitrosamines includes the 6 nitrosamine compounds on the EPA's UCMR2-List 2; NDEA, NDMA, NDPA, NDPA, NMEA and NPYR.



ORANGE COUNTY WATER DISTRICT

Water Quality Study for proposed Poseidon Desalination Project

Board of Directors

June 1, 2016



Background

- Board approved non-binding Water Reliability Term Sheet w/ Poseidon in May 2015
- Term Sheet included “Attachment A” Water Quality Specification
- Approval of Term Sheet included authorization for staff to hire a consultant to review project water quality issues
- OCWD does not have experience with distributing drinking water
- Staff solicited a proposal from Trussell Technologies for a water quality study



Trussell Technologies



- Founded by Rhodes Trussell, Ph.D., P.E., BCEE
- Specializes in water treatment engineering, water quality, and research
- Strong experience with desalination integration, infrastructure corrosion, purified water stabilization, and drinking water distribution system studies
- Began study in October 2015, focusing on
 - the distribution system and related infrastructure
 - end user water quality for direct delivery customers
 - groundwater quality from recharge and injection of desalinated water



Scope of Work

- Review Term Sheet “Attachment A” Water Quality Specification
- Assess potential for corrosion in distribution system
- Assess disinfectant issues (required residual and by-products)
- Identify potential end user impacts for direct delivery
- Assess potential for injection well/recharge basin fouling
- Predict water quality impacts under three operating scenarios
- Provide recommendations for any changes to Water Quality Specification to protect public health & maintain infrastructure



Analyzed Three Operating Scenarios

- Winter Operations
 - 3 MGD to City of HB (direct)
 - 15 MGD to OCWD Talbert Barrier (100% desal)
 - 35 MGD desal + 100 MGD GWRS to MBI & Forebay
- Summer Operations
 - 3 MGD to City of HB (direct)
 - 36 MGD to OCWD Talbert Barrier (100% desal)
 - 14 MGD desal + 100 MGD GWRS to MBI & Forebay
- 100% Desalination (during GWRS shutdown)
 - 3 MGD to City of HB (direct)
 - 50 MGD to all OCWD recharge/injection locations





Findings: Corrosion

- City of HB will be required to conduct Lead & Copper Rule Monitoring
 - To be performed over first 6-12 months after introduction of new source
 - Similar requirements for utilities receiving water from Carlsbad Desalination Plant
 - Proper post-treatment should make desal water non-corrosive
 - Previous studies have shown initial 1-3 month period of increased metals within distribution system prior to establishing equilibrium with new source
- Iron pipelines can release red water with new water sources
 - Existing mineral scale/passivation layer can potentially dissolve away
 - Intended stabilization with calcium carbonate should maintain scale
 - Potential for 30 – 60 day period of instability during transition
 - Only 0.07% of City of HB pipelines are iron; 98% are asbestos-cement pipe (ACP)
 - OCWD only has a short reach of ductile iron pipeline at Talbert Barrier



Findings: General Water Quality

- Use RO modeling software to predict actual desal facility water quality
- Term Sheet specification for chloride will likely control plant design

Water Quality Parameter	Term Sheet Specification (12-mo average)	Ocean Desal (Predicted)	GWRS (2015)	HB Groundwater	Imported MWD
TDS (mg/L)	350	148	64	375	540
Sodium (mg/L)	60	45.4	11.9	48	84
Chloride (mg/L)	75	74.1	10.6	69	86
Boron (mg/L)	0.75	0.54	0.29	0.05	0.14



Findings: Mass Loadings

- Relative to current 100 MGD GWRS project, the addition of 50 MGD of ocean desalinated water to the groundwater basin would contribute on mass basis:
 - 38% more TDS
 - 136% more sodium
 - 396% more chloride
 - 3% more boron

**(based on model-predicted desal water quality, not term sheet specifications)*
- Greater impact near Talbert Barrier (assumes no GWRS blending)
- Lesser impact for MBI + Forebay due to blend w/ GWRS water



Findings: Effects on plant appearance

- Elevated sodium, chloride, and boron can affect plants
 - Term Sheet Specification for sodium & chloride appear protective
 - Boron is more complicated, can cause chlorosis of leaves
- 2005 HortScience study in Carlsbad identified 16 common plants that would be affected by proposed desal water quality (e.g., Rose, Orange, Lemon)
- Recommendation: consider a similar study in HB and any other direct distribution customer service area(s)
 - Account for local microclimate(s) and soil conditions
 - Consider preferences of local stakeholders (e.g., garden clubs, nursery's, park managers, etc.)





Findings: Disinfectant Residual & By-Products

- Like all surface water supplies, ocean desal water requires disinfection prior to distribution as drinking water
- Formation of disinfection byproducts (DPBs) should not be a problem
- Must provide free chlorine disinfectant residual for HB direct distribution
- Other direct retailers may require a chloramine residual disinfectant
- Chloramine residual instability in ocean desal water due to elevated bromide



Recommended changes to Term Sheet WQ Specs

- Modifications to corrosion control parameters (e.g., Ca, pH, LSI, alkalinity)
 - Set an initial range, but then “dial in” specific target based on observations
 - Flexibility desired to balance corrosion control w/ injection well clogging
 - Based on OCWD experience w/ GWRS post-treatment
 - Variable chemical costs could be a pass through
- Add in specified chlorine/chloramine disinfection residual value
- Add bromide limit to protect chloramine residual for non-HB direct uses
- Reduce boron limit from 0.75 mg/l to 0.5 mg/L to protect horticulture and limit loading to groundwater basin
- Lower temperature limit to improve direct customer aesthetics

Proposed Revised WQ Specification

Parameter	units	Sampling ¹		To be set in the Term Sheet		To be selected by OCWD ⁴	
		Compliance period	Measurement frequency	Target concentration ²	Maximum concentration ³	Target Range ⁴	Required Precision ⁴
Minerals							
Sodium	mg/L	one year	bi-weekly ⁵	60	80	-	-
Chloride	mg/L	one year	bi-weekly ⁵	75	100	-	-
Bromide	mg/L	one year	bi-weekly ⁵	0.25*	0.4*	-	-
Boron	mg/L	one year	bi-weekly ⁵	0.5*	1.0	-	-
TDS	mg/L	one year	bi-weekly ⁵	350	500	-	-
Disinfection							
SDS-THM	µg/L	one year	monthly	≤ 64	72	-	-
SDS-HAAS	µg/L	one year	monthly	≤ 36	56	-	-
SDS-NDMA	µg/L	one year	monthly	≤ 8	9	-	-
Total chlorine residual	mg/L	daily	continuous ⁶	-	-	1.0 to 4.0	±10%
Cl ₂ /NH ₃ -N ratio	-	daily	daily ⁷	-	-	3.0 to 5.0	±0.3
Physical properties							
Temperature	°F	one year	continuous ⁶	65	75	-	-
Turbidity	ntu	daily	continuous ⁶	0.5	1.0	-	-
SDI	-	one year	daily ⁷	1.0*	2.0*	-	-
Control of Corrosion and Aquifer Interface							
Calcium	mg/L as CaCO ₃	one year	bi-weekly ⁵	60*	-	40 to 120	±10%
Magnesium	mg/L	one year	bi-weekly ⁵	-	-	tbd	±10%
pH		daily	continuous ⁶	8.4*	-	7.5 to 8.7	±10%
LSI		monthly	daily ⁷	0.15*	-	(-0.2) to (+0.2)	±10%
Orthophosphate	mg/L as P	weekly	daily ⁷	-	-	0 to 4.0	±10%
Alkalinity	mg/L as CaCO ₃	monthly	daily ⁷	60*	-	40 to 120	±10%
CCPP	mg/L as CaCO ₃	monthly	daily ⁷	0.8*	-	(-5) to (+15)	±10%

* - This Parameter is proposed as a placeholder as further study may be required

1 - All samples to be taken at mutually agreed upon delivery point and analyzed using mutually agreed Standard Methods (EPA, ASTM or SM On Line)

2 - Average over compliance period must less than or equal to this value

3 - No measurement may exceed this value

4 - The desalination plant is to be designed so that it is capable of meeting any concentration in the Target Range. OCWD shall, from time to time, select a concentration in the Target Range and Poseidon shall be responsible for meeting the target with the Required Precision

5 - every other week.

6- Continuously monitored by instrument with values stored in SCADA every 15 minutes

7 - Measured daily or calculated daily, using most up-to-date information available



IRWD staff has communicated concerns with ocean desalination water quality

- Effects of desal water quality on IRWD recycled water quality
 - Regulatory TDS limit on IRWD recycled water system
 - Agricultural customers sensitive to chloride and boron
- IRWD currently enjoys excellent groundwater quality
- OCWD use of desal water for recharge/injection would increase chloride, and possibly TDS, of IRWD groundwater supply over long-term
- Increases in groundwater salinity → increases to recycled water salinity
- IRWD currently developing projections of impacts via modeling study



Initial End User WQ Experiences from Carlsbad Desalination Plant

- Vallecitos Water District
 - Significant area receiving 100% desal water directly
 - No aesthetic or regulatory issues to date
 - Just collected first set of LCR samples
 - Some boron concerns for recycled water end users
- WE&RF Study led by Arcadis
 - 8 participating agencies + Poseidon
 - Focused on documenting WQ integration experiences
 - Will collect data over 1st year of integration



ORANGE COUNTY WATER DISTRICT

End of Presentation

AGENDA ITEM SUBMITTAL

Meeting Date: June 1, 2016

To: Board of Directors

From: Mike Markus

Staff Contact: J. Kennedy/S. Scott

Budgeted: No

Budgeted Amount: N/A

Cost Estimate: up to \$500,000

Funding Source: Poseidon Resources

Program/Line Item No.: N/A

General Counsel Approval: N/A

Engineers/Feasibility Report: N/A

CEQA Compliance: N/A

**Subject: POSEIDON RESOURCES CALIFORNIA ENVIRONMENTAL ACT (CEQA)
REIMBURSEMENT AGREEMENT**

SUMMARY

At a previous workshop Board members discussed the concept of considering a CEQA reimbursement agreement to allow CEQA work to begin on the project while other issues are pending. The attached agreement calls for Poseidon to pay for any CEQA cost incurred by the District and to take the risk the project does not move forward.

Attachment(s): Reimbursement Agreement for CEQA work

RECOMMENDATION

Authorize the following actions:

- 1) Commence preparation of CEQA documents for the project;
- 2) Execute Reimbursement Agreement with Poseidon Resources; and
- 3) Issuance of necessary agreements with CEQA consultants to assist with this effort.

BACKGROUND/ANALYSIS

Regarding the general project schedule, staff is planning to have a third workshop at the July 6, 2016 Board meeting to summarize and discuss the remaining desalinated water distribution options. The California Coastal Commission project hearing will occur this fall. The exact date has yet to be determined.

During this interim period, and as previously mentioned by Board members, the District could begin preparing some CEQA documents that will likely be needed for any of the remaining distribution options being considered.

The District has a preapproved list of CEQA consultants that staff could use to assist in this effort. Staff would request these consultants to provide proposals and cost estimates that would be evaluated prior to selecting one or more of the consultants.

The attached reimbursement agreement provides for Poseidon to reimburse OCWD on any CEQA work regardless of the final outcome of the project for up to \$500,000. If

OCWD ultimately approves moving forward with the Poseidon project, then the District would be responsible for this CEQA expense.

If necessary an EIR would take 9 to 12 months to complete.

PRIOR RELEVANT BOARD ACTIONS

03/17/10, R10-3-46 – Amendment #1 to MOU with Poseidon Resources along with other OC agencies to consider purchasing ocean desalination water.

03/17/10, R10-3-46 - Entered into Confidentiality Agreement with Poseidon Resources along with other OC agencies to receive project information.

01/16/13, R13-1-6 - Adopted resolution stating it is the District's goal to achieve and sustain a 75% Basin Production Percentage.

05/22/13, R13-5-48 - Adopt resolution stating that ocean desalination supplies should be considered in the District's water supply portfolio and that OCWD should ensure sufficient water supplies are always available to the residents and businesses.

07/24/13 R13-7-97 - Authorize execution of a Confidentiality Agreement and receive information from Poseidon Resources to study the economic feasibility of a seawater desalination facility in Huntington Beach that may lead to a water purchase agreement for the entire productive capacity of the plant; and Establish a "Citizen's Advisory Committee" for the potential project.

11/11/13, M13-157 - Support California Coastal Commission approval of the proposed Poseidon Project.

01/08/14, M14-2 – Received a project financial report and directed staff to arrange a Board meeting with the consultants used by San Diego County Water Authority for their Carlsbad desalination project.

02/19/14, M04-36 - Request proposals from the three firms that assisted the SDCWA with the City of Carlsbad desalination project.

04/02/14, M14-61 - Authorize staff to issue financial RFP's.

05/21/14, M14-87 - Defer action to select a financial consultant to June 4, 2014.

06/04/14, R14-6-80 - Approve agreement to Clean Energy Capital for \$49,720 to provide financial analysis on the proposed Poseidon Resources City of Huntington Beach Ocean Desalination Project.

12/17/14, M14-185 - Receive and file the Long Term Facilities Plan 2014 Update which included the proposed Poseidon project as one of 17 prioritized projects that should receive focused consideration.

12/03/14, R14-12-155– Increase the Clean Energy Capital contract by \$27,000 to respond to comments on the financial analysis report.

01/07/15, M15-5 – Direct staff to begin negotiating a Term Sheet with Poseidon Resources and began establishing a Citizens Advisory Committee.

03/18/15, M15-57 - Directed that meetings of the Ocean Desalination Citizens' Advisory Committee begin.

5/14/15 – M15-84 - Approved a Term Sheet with Poseidon.

2/3/16, M16-18 - Eliminated options 1A, 1B and 1C from the original eight distribution options considered for the project.

3/2/16, M16-37 - Eliminated options 1D and 4 from the original eight distribution options considered for the project.

REIMBURSEMENT AGREEMENT BETWEEN THE ORANGE COUNTY WATER DISTRICT AND POSEIDON
RESOURCES (SURFSIDE) LLC

This Reimbursement Agreement (the "Agreement") is made and entered into by and between the Orange County Water District, a special governmental district of the State of California, hereinafter referred to as "OCWD," and Poseidon Resources (Surfside) LLC, a Delaware limited liability company, hereinafter referred to as "Developer."

WHEREAS, in May 2015, OCWD approved a non-binding Term Sheet for a Water Reliability Agreement (the "Term Sheet") for the purchase of substantially all of the product water from the proposed Huntington Beach Seawater Desalination Project (the "Project"); and

WHEREAS, the Term Sheet provides that, if the parties enter into a binding purchase agreement, OCWD would construct, own, operate and maintain the pipeline and booster pumps to deliver product water from the edge of the desalination plant site to its facilities (the "Delivery System"); and

WHEREAS, to complete its due diligence as provided under the Term Sheet related to the Delivery System, OCWD must process and approve CEQA documentation, obtain other approvals and perform related Delivery System design work ("Delivery System Work"); and

WHEREAS, Developer desires that OCWD have sufficient resources available to enable the expeditious processing of applications and other necessary documentation for Delivery System Work.

NOW, THEREFORE, in consideration of the promises and agreements hereinafter made and exchanged, the parties agree as follows:

1. PAYMENT

Developer agrees to reimburse OCWD for its payment for out of pocket professional services for the Delivery System Work that OCWD is not currently doing related to any of its other system improvements (each, an "Eligible Payment"), in an amount not to exceed \$500,000 (the "Aggregate Amount") as follows:

A. Within thirty days of receipt of an invoice and reasonable supporting documentation for eligible Delivery System Work, Developer will reimburse OCWD for each Eligible Payment made or due to be made by OCWD, provided that Developer's reimbursement of all Eligible Payments shall not exceed the Aggregate Amount.

B. If the parties enter into a definitive Water Reliability Agreement pursuant to which OCWD agrees to purchase product water from Developer, OCWD will repay to Developer all Eligible Payments reimbursed by Developer within thirty (30) days following the date of such Water Reliability Agreement.

C. The parties acknowledge that Eligible Payments reimbursed by Developer will be used to pay the professional services funded by this Agreement. Developer acknowledges that the amount

referenced in this Agreement as the Aggregate Amount is OCWD's best estimate of the costs for the services described herein, and the actual cost of said services may be higher.

D. A late payment fee of ten percent (10%) will be assessed if either party receives any payment later than the thirtieth (30th) day after that payment is due but unpaid. In addition, one and one-half percent (1 1/2) interest per month shall be added for each month the payment hereunder is due but unpaid.

Payments mailed to OCWD shall be mailed to:

Orange County Water District
Attention Mr. John Kennedy
10500 Ellis Avenue
PO Box 8300
Fountain Valley, CA 92708

Payments mailed to Poseidon Resources (Surfside) LLC shall be mailed to:

Poseidon Resources (Surfside) LLC
C/O Poseidon Water
75 State Street, Suite Suite 2701A
Boston, Massachusetts 02109

2. EXCLUSIVE CONTROL BY OCWD

OCWD will maintain exclusive control over the Delivery System Work and any related work described herein. Nothing in this Agreement:

A. Shall be deemed to require OCWD to approve any plan, proposal, suggestion, application or request submitted by Developer.

B. Shall be deemed to limit, in any respect whatsoever, OCWD's sole authority to direct and control any employee, planner, consultant or other contractor working on or providing services with respect to OCWD's review of Developer's Project.

C. Shall be deemed to impose any liability on OCWD different from any liability as may otherwise be established by law in the absence of this Agreement.

3. OCWD EMPLOYEES AND OFFICIALS

Developer shall employ no OCWD official nor any regular OCWD employee in the work performed pursuant to this Agreement. No officer or employee of OCWD shall have any direct financial interest in this Agreement. Pursuant to Government Code Section 87103.6, the Parties agree that Developer's payment to OCWD of Eligible Delivery System Work amounts are not a source of income to any person who is retained or employed by OCWD.

4. TERMINATION OF AGREEMENT

Either party may terminate this Agreement at any time with or without cause, upon ten (10) days' prior written notice to the other party. Developer shall be responsible for all costs incurred prior to termination, provided that OCWD shall not incur any additional costs after notice of termination has been given. In case of a termination, OCWD will provide Developer copies of any work product (including work in process) derived from any funding provided by the Developer.

5. TERM

This Agreement shall be effective on the date of its execution. This Agreement shall expire when terminated as provided herein.

6. NOTICES

Any notices, certificates, or other communications hereunder shall be given either by personal delivery to Developer or to OCWD as the situation shall warrant, or by enclosing the same in a sealed envelope, postage prepaid, and depositing the same in the United States Postal Service, to the addresses specified below; provided that OCWD and Developer, by notice given hereunder, may designate different addresses to which subsequent notices, certificates or other communications will be sent:

TO OCWD:

Orange County Water District
Attention Mr. John Kennedy
10500 Ellis Avenue
PO Box 8300
Fountain Valley, CA 92708

TO DEVELOPER:

Poseidon Resources (Surfside) LLC
c/o Poseidon Water LLC
5780 Fleet Street, Suite 140
Carlsbad, CA 92008

7. MODIFICATION

No amendment, waiver or modification of any language in this Agreement shall be valid unless in writing and duly executed by both parties.

8. SECTION HEADINGS

The titles, captions, section, paragraph and subject headings, and descriptive phrases at the beginning of the various sections in this Agreement are merely descriptive and are included solely for convenience of reference only and are not representative of matters included or excluded from such provisions, and do

not interpret, define, limit or describe, or construe the intent of the parties or affect the construction or interpretation of any provision of this Agreement.

9. INTERPRETATION OF THIS AGREEMENT

The language of all parts of this Agreement shall in all cases be construed as a whole, according to its fair meaning, and not strictly for or against any of the parties. If any provision of this Agreement is held by an arbitrator or court of competent jurisdiction to be unenforceable, void, illegal or invalid, such holding shall not invalidate or affect the remaining covenants and provisions of this Agreement. No covenant or provision shall be deemed dependent upon any other unless so expressly provided here. As used in this Agreement, the masculine or neuter gender and singular or plural number shall be deemed to include the other whenever the context so indicates or requires. Nothing contained herein shall be construed so as to require the commission of any act contrary to law, and wherever there is any conflict between any provision contained herein and any present or future statute, law, ordinance or regulation contrary to which the parties have no right to contract, then the latter shall prevail, and the provision of this Agreement which is hereby affected shall be curtailed and limited only to the extent necessary to bring it within the requirements of the law.

10. DUPLICATE ORIGINAL

The original of this Agreement and one or more copies hereto have been prepared and signed in counterparts as duplicate originals, each of which so executed shall, irrespective of the date of its execution and delivery, be deemed an original. Each duplicate original shall be deemed an original instrument as against any party who has signed it.

11. ATTORNEY'S FEES

In the event suit is brought by either party to construe, interpret and/or enforce the terms and/or provisions of this Agreement or to secure the performance hereof, each party shall bear its own attorney's fees.

12. GOVERNING LAW

This Agreement shall be governed and construed in accordance with the laws of the State of California.

13. SIGNATORIES

Each undersigned represents and warrants that its signature herein below has the power, authority and right to bind their respective parties to each of the terms of this Agreement

14. ENTIRETY

This Agreement contains the entire agreement between the parties respecting the subject matter of this Agreement and supersedes all prior understandings and agreements whether oral or in writing between the parties respecting the subject matter hereof.

IN WITNESS WHEREOF, the parties hereto have caused this Agreement to be executed by and through their authorized representatives or officers on June __, 2016.

Orange County Water District

By: _____

Name:

Title:

Poseidon Resources (Surfside) LLC

By: _____

Name:

Title: