

Eaton's Weatherhead®
Hose Assembly Master Catalog



Table of Contents

A	Application Data
B	Hydraulic Hose
C	General Purpose Hose
D	Industrial Hose
E	Fuel Hose
F	Silicone Hose
G	Air Conditioning Hose
H	Truck Hose
I	Teflon® Hose
J	Crimp Fittings
K	Field Attachable Fittings
L	Adapters, Tube Fittings & Connectors
M	Accessories
N	Assembly Equipment
O	Glossary & Index

Application Data	Section A
Safety Information	A-2 thru A-4
Warranty	A-3
Hose Selection	
Chart	A-4 thru A-9
Chemical Compatibility Chart	A-10 thru A-14
Hose Fittings Pressure Chart	A-15 thru A-16
Fitting Identification	A-17 thru A-20
Numbering Systems	
Hose	A-21
Hose Fittings	A-22
Hose Fittings Identification	A-23 thru A-28
Conversion Chart	A-29
Skiving Procedures	A-30
Hose Installation and Failure Analysis	A-31 thru A-32
Qualified Hoses for Marine Applications	A-33
Qualified Hoses for American Bureau of Shipping (ABS)	A-34
Torque Specifications	A-35
Tubing Selection	A-36 thru A-37
Flow/Velocity Chart	A-38
Recommended Wall Thickness Tables	A-39 thru A-42
Hose	
Hydraulic	Section B
General Purpose	Section C
Industrial	Section D
Fuel	Section E
Silicone	Section F
Air Conditioning	Section G
Truck	Section H
Teflon®	Section I
Hose Fittings	
Crimp	Section J
Coll-O-Crimp® 'E' Series Hose Fittings	J-2 thru J-8
Coll-O-Crimp 069 'E' Series Hose Fittings	J-9 thru J-12
Coll-O-Crimp 327 'E' Series Hose Fittings	J-13 thru J-14
Coll-O-Crimp 336 'E' Series Hose Fittings	J-13 thru J-18
Coll-O-Crimp 470 'E' Series Hose Fittings	J-19 thru J-23
Coll-O-Crimp 757 'E' Series Hose Fittings	J-24 thru J-31
Coll-O-Crimp 057 'P' Series Hose Fittings	J-32
Coll-O-Crimp 229 'P' Series Hose Fittings	J-33
Coll-O-Crimp 265 'P' Series Hose Fittings	J-34
Coll-O-Crimp 338 'P' Series Hose Fittings	J-35 thru J-37
Coll-O-Crimp 'S' Series Hose Fittings	J-38
Coll-O-Crimp 'U' Series Hose Fittings	J-39 thru J-57
Coll-O-Crimp 430 'U' Series No Skive Hose Fittings	J-58 thru J-68
WeatherGRIP™ 'Z' Series Hose Fittings	J-69 thru J-94
WeatherTIGHT™ 4SP/6SP Series Hose Fittings	J-95 thru J-105
Field Attachable	Section K
Field Attachable 009 'B' Series Hose Fittings	K-2
Field Attachable 057 'B' Series Hose Fittings	K-3 thru K-4
Field Attachable 100 'B' Series Hose Fittings	K-5 thru K-7
Field Attachable 105 'B' Series Hose Fittings	K-8
Field Attachable 338 'B' Series Hose Fittings	K-9 thru K-11
Field Attachable 069 'D' Series Hose Fittings	K-12 thru K-13
Field Attachable 'K' Series Hose Fittings	K-14
Field Attachable 039 'K' Series Hose Fittings	K-15
Field Attachable 104 'N' Series Hose Fittings	K-16 thru K-18
Field Attachable 213 'N' Series Hose Fittings	K-19 thru K-21
Field Attachable 247 'N' Series Hose Fittings	K-22 thru K-26
Field Attachable 425 'N' Series Hose Fittings	K-27 thru K-29
Field Attachable 436 'N' Series Hose Fittings	K-30 thru K-31

Teflon® is a registered trademark of DuPont used under license by Eaton.

Table of Contents (continued)

E-Z Clip® System	Section K
End Connections and O-Rings	K-32 thru K-33
Hose Fittings	K-34 thru K-58
Cages, Clips and Lifesavers	K-59
Aluminum Lifesaver	K-60
Assembly Tools	K-61
Components Ordering and Identifying	K-62
Assembly Instructions	K-63 thru K-64

Adapters, Tube Fittings and Connectors	Section L
Hose to Order & Size Designation	L-2
Steel Adapters	L-3 thru L-16
Swivel Adapters	L-17 thru L-23
For-Seal® Adapters	L-24 thru L-34
JIC 37° Flare-Twin® Fittings	L-35 thru L-64
Steel Din Fittings	L-65 thru L-67
Straight Thread O-Rings	L-68 thru L-70
Din Connectors	L-71
Metric Connectors	L-72 thru L-73
BSP Connectors	L-74 thru L-76
Special Adapters	L-77
Steel Flareless Ermeto® Connectors	L-78 thru L-88
Split Flange Adapters and Kits	L-89 thru L-92

STC Connectors	
How To Order, STC Overview	L-93 thru L-95
Assembly Method and Verification	L-96
Female STC Cap and Male STC Plug	L-97
STC Adapters	L-98 thru L-106
STC Repair Adapters	L-107
Accessories and Sales Tools	L-108

Accessories	Section M
Hose Abrasion Sleeves, Guards, Firesleeve	M-2 thru M-11
Ready-Made Hose Assemblies	M-12 thru M-18
JetCleaner, Insertion Gauge, Pressure Gauge Kit	M-19
Hose Spacers, Protectors	M-20
Flaretube Seals	M-21
Guardian Sleeves	M-22
Bundling Sleeves	M-23
Bundling Straps	M-24 thru M-25
Hose and Gear Clamps	M-26 thru M-28

Assembly Equipment	Section N
Index to Crimp Packages	N-2 thru N-3
Crimping Machines - Portable	
Coll-O-Crimp Portable T-464 & T-466	N-4
Coll-O-Crimp Portable T-465	N-5 thru N-6
Coll-O-Crimp T-465 Crimping Procedures	N-7
Air Conditioning Portable Crimper, T-477	N-8
T-477 Crimping Procedures	N-9 thru N-12
Coll-O-Crimp Portable T-480	N-13 thru N-15
ET1000 Portable Crimp Machine	N-16
ET1000 Crimp Procedures	N-17
Crimping Machines - Stationary	
Coll-O-Crimp Shop Press Tooling, T-400-17	N-18
Coll-O-Crimp I, T-400, T-407	N-19 thru N-20
Coll-O-Crimp SUPER I, T-420	N-21
Coll-O-Crimp ET4001	N-22
T-440, ET4000 & ET4001 Repair Items	N-23
Crimping Machines - Variable	
Coll-O-Crimp ET4020	N-24
Coll-O-Crimp ET4040	N-25

Tooling and Accessories	
Coll-O-Crimp Collet Kits	N-26 thru N-29
WeatherGRIP Tooling	N-30 thru N-31
Coll-O-Crimp Spacer Rings	N-32
Coll-O-Crimp Air & Hydraulic Pumps	N-33 thru N-35
Competitor Conversion Kits	N-36
Tube Flaring Tools	N-37
Hose Cutting Equipment	N-38 thru N-40
Presetting Tools	N-41
Hose Bore Cleaning Brushes	N-42
Skiving Tools & Wrenches	N-43
Power Steering Assembly	N-44 thru N-46
Cable Controls	N-47 thru N-48
Assortments	N-49 thru N-67
Equipment	
Cabinets, Tool Boxes, and Plastic Bags	N-68 thru N-70
Label Sets & Mylar Hose Labels	N-71
Field Attachable Assembly	N-72 thru N-73

Glossary and Index	Section O
Glossary	O-2 thru O-6
Index	O-7 thru O-16



www.eaton.com/hydraulics

Additional Eaton Fluid Conveyance Products can be found in these catalogs:

Product Line	Catalog Number
Synflex™ Hose and Fittings	E-HOOV-MC001-E1
Eaton Quick Disconnect Couplings	E-MEQD-MC001-E1
Walterscheid™ Tube Fittings	E-MEFI-MC002-E1
Eaton Swivel Joints	E-MESW-MC001-E1
Eaton Brass Products	E-BRFI-MC001-E3
Weatherhead™ Crimp Specifications Manual	W-HOOV-TM001-E2
Eaton Industrial Hose	E-HOOV-MC003-E1

Introduction to Weatherhead

Weatherhead® products, which became part of Eaton Hydraulics in 2002, have one of the industry's broadest offerings of hydraulic hose, hose fittings, assembly equipment, tube fittings, couplings and support accessories. Weatherhead products are widely used in industrial and mobile fluid power and fluid conveyance applications. Eaton also supplies Weatherhead thermoplastic tubing in sizes from 1/8th through 1 inch for use in robotics, air tools, air and water supply, and beverage dispensing.

Eaton's Hydraulics Group is a worldwide leader in the design, manufacture and marketing of a comprehensive line of reliable, high-efficiency hydraulic systems and components for use in mobile and industrial applications. Mobile and industrial markets include agriculture, construction, mining, forestry, utility, material handling, earthmoving, truck and bus, machine tools, molding, primary metals, automotive, power generation, port machinery and entertainment.

Weatherhead has one of the industry's broadest offerings of hose and fittings that are widely used throughout multiple market applications.

Application Data

Table of Contents

Safety Information	A-2 thru A-3	Hose Installation and Failure Analysis	A-31 thru A-32
Hose Selection Chart	A-3 thru A-9	Qualified Hoses for Marine Applications	A-33
Chemical Compatibility Chart	A-10 thru A-14	Qualified Hoses for American Bureau of Shipping (ABS)	A-34
Pressure Charts	A-15 thru A-16	Torque Specifications	A-35
Fitting Identification	A-17 thru A-20	Tubing Selection	A-36 thru A-37
Numbering Systems	A-21 thru A-28	Flow/Velocity Chart	A-38
Conversion Chart	A-29	Recommended Wall Thickness Tables	A-39 thru A-42
Skiving Procedures	A-30		



Important Safety Information

WARNING

Flexible hose lines offer many advantages over rigid tubing including routing ease, vibration absorption, sound deafening and the ability to accommodate movement of connected components. However, hose lines require caution in use not only to provide long service, but also to guard against potentially dangerous failure.

Important

The user should carefully observe the precautions listed in this catalog or brochure, including the recommendations on the selection of hose and fittings on the relevant pages on fluid compatibility. In addition, care should be taken not to exceed the minimum bend radius listed for each hose size and type in the hose section. Maximum operating pressure should not exceed pressures listed in the hose data. Instructions for assembling fittings to different hose should be followed carefully to ensure the performance of the completed assembly.

WARNING

Eaton's Weatherhead fitting tolerances are engineered to match Eaton's Weatherhead hose tolerances. The use of Weatherhead fittings on hose supplied by other manufacturers and/or the use of Weatherhead hoses with fittings supplied by other manufactures may result in the production of unreliable and unsafe hose assemblies and is neither recommended nor authorized by Eaton Corporation or any of its affiliates or subsidiaries.

WARNING

Application considerations must be observed in selecting appropriate components for the application of these products contained herein. The failure to follow the recommendations set forth in this catalog may result in an unstable application which may result in serious personal injury or property damage.

EATON CORPORATION OR ANY OF ITS AFFILIATES OR SUBSIDIARIES SHALL NOT BE SUBJECT TO AND DISCLAIMS ANY OBLIGATIONS OR LIABILITIES (INCLUDING BUT NOT LIMITED TO ALL CONSEQUENTIAL, INCIDENTAL AND CONTINGENT DAMAGES) ARISING FROM TORT CLAIMS (INCLUDING WITHOUT LIMITATION NEGLIGENCE AND STRICT LIABILITY) OR OTHER THEORIES OF LAW WITH RESPECT TO ANY HOSE ASSEMBLIES NOT PRODUCED FROM GENUINE WEATHERHEAD HOSE FITTINGS, HOSE AND WEATHERHEAD APPROVED EQUIPMENT, AND IN CONFORMANCE WITH EATON'S WEATHERHEAD PROCESS AND PRODUCT INSTRUCTIONS FOR EACH SPECIFIC HOSE ASSEMBLY.

Failure to follow these processes and product instructions and limitations could lead to premature hose assembly failures resulting in property damage, serious injury or death.



Routing

If the user follows the recommendations on hose line routing and installation as provided for herein, improved safety and longer service life of any hose installation will result.

Hose Installation

Proper installation of the hose is essential to the proper operation and safe use of the hose and related equipment. Improper installation of the hose can result in serious injury or property damage caused by spraying fluids or flying projectiles. In order to avoid serious bodily injury or property damage resulting from improper installation of the hose, you should carefully review the information in this catalog regarding hose installation.

Some of the factors you must consider in installing the hose properly are:

- Changes in length
- Proper bend radius
- Protection from high temperature sources
- Elbows and adapters to relieve strain
- Rubbing or abrasion
- Twisting
- Improper hose movement

These factors and the other information in this catalog regarding hose installation should be considered by you before installing the hose. If you have any questions regarding proper hose installation, please contact Eaton Technical Support at 1-888-258-0222.

Warranty

Current warranty information can be found at:
www.eaton.com/hydraulics/warranty

Hose Maintenance

Proper maintenance of the hose is essential to the safe use of the hose and related equipment. Hose should be stored in a dry place. Hose should also be visually inspected. Any hose that has a cut or gouge in the cover that exposes the reinforcement should be retired from service. Hoses should also be inspected for kinking or broken reinforcement. If the outside diameter of the hose is reduced by 20% at the spot where it is bent then the hose should be retired from service. Inadequate attention to maintenance of the hose can result in hose leakage, bursting, or other failure which can cause serious bodily injury or property damage from spraying fluids, flying projectiles, or other substances.

Hose and Field Attachable Hose Fittings

Weatherhead Hose and Field Attachable Hose Fittings have been engineered and designed as a complete hose assembly system. Component compatibility along with the use of quality components insures the production of reliable hose assemblies when assembled properly. The use or intermixing of fittings and hose not specifically engineered and designed for use with each other may result in the production of unsafe or unreliable hose assemblies.

This can result in hose assembly leakage, hose separation or other failures which can cause serious bodily injury or property damage from spraying fluids, flying projectiles, or other substances. The Eaton warranty is limited to apply only when Weatherhead Field Attachable Hose Fittings are used on compatible Weatherhead hose. See www.eaton.com/hydraulics/warranty for warranty information.

Weatherhead Hose, Hose Fittings and Assembly Equipment Compatibility

Weatherhead Equipment, Weatherhead Hose Fittings and Weatherhead Hose have been engineered and designed as a complete hose assembly system. Each component of the Weatherhead hose assembly system is compatible with other Weatherhead components to which it relates. Component compatibility, along with the use of quality components, insures the production of reliable hose assemblies when assembled properly. The use or intermixing of fittings and hose not specifically engineered and designed for use with each other and Weatherhead equipment is not recommended and may result in the production of unsafe or unreliable hose assemblies. This can result in hose assembly leakage, hose separation or other failures which can cause serious bodily injury or property damage from spraying fluids, flying projectiles, or other substances. The Eaton warranty is limited to apply only when Weatherhead Hose Fittings and compatible Weatherhead Hose are used with Weatherhead assembly equipment.

Hose Selection Chart

How to use chart: Locate the hose I.D. required and move to the right to the correct pressure. Then move up or down in this column for data on material, temperature, etc. to quickly determine whether the hose meets your requirements. For complete information on any hose refer to hose catalog page number at bottom of column.

⚠ WARNING

Selection of hose: Selection of the proper hose for the application is essential to the proper operation and safe use of the hose and related equipment. Inadequate attention to selection of the hose for your application can result in hose leaking,

bursting, or other failure which can cause serious bodily injury or property damage from spraying fluids or flying projectiles. You should carefully review the information in this catalog.

Hydraulic

HOSE	H017	H039	H104	H114	H145	H145R	H146	H190	H190H	H245	H245L	H280	
Page	B-3	B-2	B-3	B-6	B-6	B-7	B-7	B-4	B-5	B-9	B-10	B-11	
Usage	General Purpose Hydraulic	Suction	Hydraulic	Ag. Hyd. & Hyd. Synthetic	Hydraulic	Construction	Ag. Hyd. & Hyd. Synthetic	Diamond Advantage	High Temp. Hydraulics	Hydraulic	Low Temp Flexing	Diamond Advantage	
Meets	USCG MSHA	USCG ABS MSHA	USCG MSHA ABS	MSHA	ABS USCG MSHA	—	—	MSHA, USCG, ISO 1436a, EN 853 Type 1SN	MSHA, ISO1436a	USCG MSHA ABS	USCG ² MSHA	ABS, USCG, MSHA, ISO 1436, EN 857, Type 2SC	
SAE No.	J1942/1, 100R3	100R4 J1942/1	J1942 1/1 100R1AT	—	J1942/1, 100R17	100R17	—	J1942/1, 100R1 AT, Type S	100R1 AT, 1SN, EN853	J1942 100R16	100R16	J1942, Code H, 100R16, Type S	
Temp. Range °F	-40°F +212°F	-40°F +275°F	-40°F +212°F	-40°F +250°F	See Page 55	-40°F +212°F	-65°F +250°F	-40°F +260°F	-40 - +302°F	-40°F +212°F	-70 - +212°F	-40°F +260°F	
Inner Tube	Nitrile	CPE	Nitrile	Hytrel ¹	Nitrile	Nitrile	Hytrel ¹	Nitrile	CPE	Nitrile	Low Temp. Nitrile	Nitrile	
Reinforcement	2 Fiber Braids	2 Fiber Ply & Helical Wire	1 Steel Braid	1 Steel Braid	1 Steel Braid†	1-2 Steel Braids	1 Steel Braid	1 Steel Braid	1 Steel Braid	2 Steel Braids	2 Wire Braids	2 Steel Braids	
Cover	Neoprene	Neoprene	Neoprene	Neoprene	Neoprene	UHMWPE	Polyester Braid	Weather-SHIELD™	CPE	Neoprene	Weather-SHIELD™	Weather-SHIELD™	
Hose I.D. - Maximum Recommended Operating Pressure - PSI													
3/16													
1/4	1250		2750	3000	3045	3000	3000	3700	3265	5000	6000	6500	
5/16													
3/8	1125		2250	3000	3045	3000	3000	3400	2610	4000	5000	5300	
13/32													
7/16													
1/2	1000		2000	3000	3045	3000	3000	2900	2320	3500	4500	4500	
5/8			1500		3045	3000		1885	1885	2750	4000	4000	
3/4	750	300†	1250		3045	3000		2000	1525	2250	3500	3500	
7/8													
1	565	250†	1000		3045	3000		1500	1275	2000	2800	3000	
1-1/8													
1-1/4	375	200†	625					1000	900	1625	2300	2500	
1-1/2		150						750			2000	2000	
1-3/8													
1-13/16													
2		100						600			1500	1600	
2-3/8													
3													
Hose Fittings													
C-O-C	J-39-57	J-38, J-39-57, J-58-68, J-69-94	J-38, J-39-57, J-69-94	J-38, J-39-57	J-69-94, J-38, J-39-57, J-58-68	J-69-94	J-39-57	J-69-94	J-69-94	J-69-94	J-69-94, J-38, J-39-57, J-58-68	J-69-94	J-69-94
Field Attach.	—	K-14, K-15	K-16-18	—	—	—	—	—	—	—	—	—	

¹ Hypalon® is a registered trademark of E.I. DuPont.

**At 70° F.

² Firesleeve required for fuel applications.

† When used with 'U' Series Ends.

Hose Selection Chart



WARNING
Selection of hose: Selection of the proper hose for the application is essential to the proper operation and safe use of the hose and related equipment. Inadequate attention to selection of the hose for your application can result in hose leaking,

bursting, or other failure which can cause serious bodily injury or property damage from spraying fluids or flying projectiles. You should carefully review the information in this catalog.

Hydraulic

HOSE	H290	H290H	H324	H325	H335	H336	H345	H350	H400	H421	H425	H430	H430R
Page	B-13	B-13	B-2	B-10	B-19	B-19	B-5	B-8	B-9	B-18	B-12	B-14	B-15
Usage	Diamond Advantage	High Temp. Hydraulics	Power Steering	Low Temp. Hydraulic	Thermo-plastic Non-Conductive	Thermo-plastic	Pressure Washer	Hydraulic	Very High Pressure Hydraulic	Hyd. Jacking System	Hydraulic	Very High Pressure Hydraulic	Very High Pressure Hydraulic
Meets	USCG, MSHA, ISO 1436, EN 853, Type 2SN	MSHA	—	—	EN 855 Type R8	EN 855 Type R8	MSHA	MSHA	MSHA	—	USCG MSHA ABS	USCG MSHA, ABS	—
SAE No.	J1942/1, 100R2 AT, Type S	100R2, 2SN, EN853	—	—	100R8 Non-Cond.	100R8	—	—	—	—	J1942/1, 100R2AT	J1942, 100R12	100R12
Temp. Range °F	-40°F +260°F	-40 - +302°F	-40°F +250°F	-67°F +175°F	See page 79	See page 79	See Page 60	-40°F +212°F	-40°F +212°F	-40 - +212°F	-40°F +212°F	-40°F +260°F	-40°F +250°F
Inner Tube	Nitrile	CPE	Neoprene	Synthetic Rubber	Nylon	Nylon	Nitrile	Synthetic Rubber	Nitrile	Synthetic Rubber	Nitrile	Nitrile	Nitrile
Reinforcement	2 Steel Braids	2 Steel Braids	2 Fiber Braids	2 Steel Braids	Multi Yarn Braids	Multi Fiber Braids	1 Steel Braid	2 Steel Braids†	2 Steel Braids	2 Wire Braids	2 Steel Braids	4 Spiral Steel Plies	Steel Plies
Cover	Weather-SHIELD™	CPE	Neoprene	Synthetic Rubber	Orange Polyurethane	Black Polyurethane Perforated	Blue Vinyl Nitrile	Neoprene	Vinyl Nitrile	Synthetic Rubber	Neoprene	Weather-SHIELD™	UHMW
Hose I.D. - Maximum Recommended Operating Pressure - PSI													
3/16					5000	5000							
1/4	6500	5800		5000	5000	5000	3000			10000	5000		
5/16													
3/8	5800	4800	1500	4000	4000	4000	3000	3500		10000	4000	6500	4000
13/32													
7/16													
1/2	5000	4000		3500	3500	3500	3000	3500			3500	6000	4000
5/8	4000	3630						3500	4000		2750	6000	4000
3/4	3500	3120		2250		2250		3500	4000		2250	5500	4000
7/8		2400			2250								
1	3000			2000	2000	2000		3500			2000	5100	4000
1-1/8													
1-1/4	2500	2250									1625	4500	3000
1-1/2	2000	1750									1250	4000	2500
1-3/8													
1-13/16													
2	1600	1500									1125	4000	2500
2-3/8													
3													
Hose Fittings													
C-O-C	J-69-94	J-69-94	J-39-57	J-39-57	J-15-18	J-15-18	J-69-94	J-69-94, J-39-57, J-58-68	J-69-94	J-69-94	J-69-94, J-38, J-39-57, J-58-68	J-58-68	J-58-68
Field Attach.	—	—	—	—	—	—	—	—	—	—	K-27-29	—	—

¹ Hypalon® is a registered trademark of E.I. DuPont.

**At 70° F.

† When used with 'U' Series Ends.

Hose Selection Chart



WARNING

Selection of hose: Selection of the proper hose for the application is essential to the proper operation and safe use of the hose and related equipment. Inadequate attention to selection of the hose for your application can result in hose leaking,

bursting, or other failure which can cause serious bodily injury or property damage from spraying fluids or flying projectiles. You should carefully review the information in this catalog.

Hydraulic									General Purpose				
HOSE	H435	H436	H464	H470	H471	H485	H487	H545	H100	H101	H115	H116	H201
Page	B-20	B-21	B-16	B-15	B-16	B-17	B-17	B-8	C-2	C-3	C-4	C-4	C-5
Usage	Thermo-plastic Non-Conductive	Thermo-plastic	Hydraulics	Very High Pressure Hydraulic	Very High Pressure Hydraulic	Very High Pressure Hydraulics	Very High Pressure Hydraulics	Hydraulic	Air, Oil, Water, Diesel Fuel	Air, Oil, Water, Diesel Fuel	Air Tool & Water	Pneumatic Tools	Air, Oil, Water, Diesel Fuel
Meets	—	—	MSHA	USCG** MSHA, ABS	MSHA	—	EN856, MSHA	—	—	MSHA	—	—	MSHA (Black only)
SAE No.	100R7	100R7	EN856, 4SH†	J1942/1, 100R13	100R13	100R15	—	—	—	—	—	—	—
Temp. Range °F	-40°F +200°F	-40°F +200°F	-40 - +212°F	See page 64	-40 - +260°F	-40 - +250°F	-70 - +212°F	-40°F +250°F	-40°F +212°F	-40°F +212°F	-40°F +160°F	-40 - +180°F	-40°F +200°F
Inner Tube	Nylon 11	Nylon 11	Nitrile	Nitrile	Nitrile	Nitrile	Nitrile	Nitrile	Nitrile	Nitrile	Nitrile	Nitrile	Nitrile
Reinforcement	2 Fiber Braids	2 Fiber Braids	4 Spiral Steel Plies	Multi Spiral Steel	Multi Spiral	Multi-Spiral Steel	Multi Spiral	1 Steel Braid*	1 Fiber Braid	1 Fiber Braid	Multi Fiber Braid	Multi-Fiber Braids	1 Fiber Braid
Cover	Orange Polyurethane	Polyurethane Perforated	Nitrile	Vinyl Nitrile	Weather-SHIELD	Vinyl Nitrile	Vinyl Nitrile	Abrasive Resistant Nylon	Fiber Braid	Neoprene	Red Vinyl Nitrile	Vinyl Nitrile	Neoprene (black), Vinyl Nitrile (colors)
Hose I.D. - Maximum Recommended Operating Pressure - PSI													
3/16							—						
1/4	2750	2750						3000	350	350	300	225	300
5/16	2500	2500							350	350	300	225	
3/8	2250	2250						3000	350	350	300	225	300
13/32													
7/16													
1/2	2000	2000		5000				3000	350	350	300	225	300
5/8								3000	350	350			300
3/4	1250	1250	6090	5000	5076		6090	3000	350	350	300		300
7/8													
1	1000	1000	5510	5000	5076	6000	6090	3000			300		
1-1/8													
1-1/4			5075	5000	5076	6000	6090					225	
1-1/2			4350	5000	5076	6000	6090					225	
1-3/8													
1-13/16													
2			3625	5000	5076		5076						
2-3/8													
3													
Hose Fittings													
C-O-C	J-2-8	J-2-8	J-92-102	J-19-23, J-95-105	J-95-105	J-95-105	J-95-105	J-38, J-39-57, J-58-68	—	—	J-39-57, J-58-68, J-69-94	J-39-57, J-58-68, J-69-94	—
Field Attach.	K-30-31	K-30-31	—	—	—	—	—	—	K-5-7	K-5-7	K-3-4, K-8	K-3-4, K-8	K-5-7

* Minimum Burst Pressure

** Size -12 thru -20.

† 2 Steel Braids -06 thru -12.

4 Steel Spirals size -16.

¹ Hypalon® is a registered trademark of E.I. DuPont.

**At 70° F.

† When used with 'U' Series Ends.

Hose Selection Chart



WARNING
Selection of hose: Selection of the proper hose for the application is essential to the proper operation and safe use of the hose and related equipment. Inadequate attention to selection of the hose for your application can result in hose leaking,

bursting, or other failure which can cause serious bodily injury or property damage from spraying fluids or flying projectiles. You should carefully review the information in this catalog.

	General Purpose						Industrial						
HOSE	H009	H209	H265	H275	H332	H1571	H0105	H0106	H285	H160	H1719	H1776/7	H1812
Page	C-2	C-5	C-6	C-6	C-7	C-7	D-2	D-2	D-3	D-4	D-4	D-5	D-5
Usage	Lube	Car Wash	Air, Water, Air Tools, Washdown	Air & Water	Air, Oil, Water, Diesel Fuel	Air and Water Transfer	Air & Water	Air/Water Apps.	Food & Beverage, Air, Water, Chemicals	Food & Beverage A/C Drainage	General Purpose	Pneumatic Tools	Fertilizer and Pesticides
Meets	USCG MSHA	—	—	—	—	—	—	—	FDA/NSF	FDA/NSF	—	—	—
SAE No.	J1942/1, 100R6	—	—	—	—	—	—	—	—	—	—	—	—
Temp. Range °F	-40°F +212°F	-40°F +200°F	-20°F +180°F	-10°F +150°F	-40 +302°F	-20° +150°F	See page 73	See page 73	-15° +150°F	-15° +150°F	-15° +150°F	-40° +180°F	-40° +180°F
Inner Tube	Nitrile	Nylon 11	Modified PVC	PVC	CPE	Modified PVC	EPDM	EPDM	PVC	PVC	Polyvinyl Chloride PVC	Nitrile	EPDM
Reinforcement	1 Fiber Braid	1 Fiber Braid	2 Fiber Spirals	2 Fiber Spirals	1 Fiber Braid	4 Fiber Spiral	Multi Fiber Spiral	2 Spiral	Fiber	—	2 Fiber Spiral	1 or 2 Fiber Braid	2 Fiber Braid
Cover	Neoprene	Polyurethane	Blue Rubber Modified Thermoplastic	Red PVC	CPE	PVC/Nitrile Blend	Red EPDM	EPDM	PVC	PVC	Polyvinyl Chloride PVC	Red Vinyl Nitrile	Red EPDM
Hose I.D. - Maximum Recommended Operating Pressure - PSI													
3/16									250	55			
1/4	400	2250	350**	250**	250		300†	200	250	55		325	275
5/16	400	1750							250	50		325	
3/8	400	1350	350**	250**	250		300†	200	225	55		325	275
13/32													
7/16													
1/2	400	1000	300**	250**	250		300†	200	200	45		325	250
5/8					250		300	200	200	40	150	325	250
3/4			250**	250**	250	400	225		150	35	150	325	250
7/8										30			
1			200**	200**			200†		125	25		325	250
1-1/8													
1-1/4			150	200			200		100	20		325	250
1-1/2			150	200			200		100	35		325	250
1-3/8													
1-13/16													
2			125	125					75	35			
2-3/8													
3													
Hose Fittings													
C-O-C	J-2-8	J-2-8	J-2-8, J-32, J-69-94	J-2-8, J-32, J-69-94	—	J-39-57, J-69-94	J-39-57	J-39-57	—	—	—	J-39-57, J-58-68, J-69-94	J-39-57, J-58-68, J-69-94
Field Attach.	K-2	—	—	—	K-5-7	—	K-3-4, K-8	K-3-4, K-8	—	—	—	—	—

¹ Hypalon® is a registered trademark of E.I. DuPont.

**At 70° F.

† When used with 'U' Series Ends.

Hose Selection Chart

⚠ WARNING

Selection of hose: Selection of the proper hose for the application is essential to the proper operation and safe use of the hose and related equipment. Inadequate attention to selection of the hose for your application can result in hose leaking,

bursting, or other failure which can cause serious bodily injury or property damage from spraying fluids or flying projectiles. You should carefully review the information in this catalog.

	Industrial			Fuel							Silicone		
HOSE	H1981/2	H1987	H9949	EH049	EH089	H057	H059	H077	H366	H900	EH225	EH226	EH227
Page	D-6	D-7	D-7	E-2	E-2	E-3	E-3	E-4	E-4	E-5	F-2	F-2	F-3
Usage	Air and Water Transfer	Contractors Water	Non-Conductive	Fuel	Fuel	Fuel & Oil	Fuel Oil/Lube	Elec. Fuel Inject.	LPG	Propane	Engine	Engine	Engine
Meets				EPA	EPA	—	ABS NMMA USCG	—	UL 21	UL 21			
SAE No.						30R7	J1942/1	30R9	—		J20R3 Class A	J20R4 Class A	
Temp. Range °F	-40° +180°F	-30°F +160°F	-40°F +180°F	-25°F +150°F	-25°F +150°F	-40°F +275°F	-40°F +212°F	-30°F +275°F	-40°F +300°F	-40°F +140°F	-65°F +350°F	-65°F +350°F	-65°F +500°F
Inner Tube	Blended Nitrile	EPDM	Nitrile (Non-Conductive)	PVDF	PVDF	Nitrile	Nitrile	Fluoro-elastomer Veneer	Nitrile	Nitrile	Silicone	Silicone	Silicone
Reinforcement	2 or 4 Spiral	2 Fiber Spiral	2 Fiber Braid		Fiber	1 Fiber Braid	1 Wire 1 Fiber Braid	Multi Fiber Braid	1 Fiber & 1 S.S. Braid	Fiber Braid	1 Ply Polyester	4 Plies Polyester	4 Plies Aramid
Cover	Neoprene Pinpricked	EPDM Perforated	Vinyle Nitrile (Non-Conductive)	PVC	PVC	Hypalon ¹	Blue Neoprene	ECO	Fiber Braid	Vinyl Nitrile Perforated	Silicone	Silicone	Silicone
Hose I.D. - Maximum Recommended Operating Pressure - PSI													
3/16						50	500						
1/4	200/300		275	50	250	50	500	125		350	400		
5/16	200/300			50	250	50	500	125	350		300	1080	
3/8	200/300		275	50	250	50		125		350	250	1060	
13/32							500		350				
7/16						35							
1/2	200/300		275				500			350	250	872	
5/8	300	600					500				250	797	
3/4	225/300	600	275							350	200	754	
7/8											200	732	
1	200		275				500			350	175	699	
1-1/8												658	
1-1/4												617	
1-1/2												521	
1-3/8												550	
1-13/16													
2												442	
2-3/8												400	
3												317	
Hose Fittings													
C-O-C	J-39-57, J-69-94	—	J-39-57, J-69-94	J-32	J-32	—	K-9-12, K-33	—	J-9-12	J-39-57	—	—	—
Field Attach.	—	—	—	K-3-4	K-3-4	K-3-4	K-22-26	Clamps M-24	K-12-13, K-22-26	—	—	—	—

¹ Hypalon[®] is a registered trademark of E.I. DuPont.

** At 70° F.

† When used with 'U' Series Ends.

Hose Selection Chart



WARNING
Selection of hose: Selection of the proper hose for the application is essential to the proper operation and safe use of the hose and related equipment. Inadequate attention to selection of the hose for your application can result in hose leaking,

bursting, or other failure which can cause serious bodily injury or property damage from spraying fluids or flying projectiles. You should carefully review the information in this catalog.

	A/C		Truck									Teflon	
HOSE	H757	GH134W	H069	H166	H169	H213	H229	H239	H338	H429	H569	H243	H277
Page	G-2	G-2	H-6	H-4	H-4	H-5	H-2	H-2	H-3	H-3	H-7	I-2	I-2
Usage	Air Cond. R12 & R134a	Air Cond. R404a, HFC134a, R22, R407C	Truck & Hydraulic	High Temp. Truck	Hydraulic	High Temp. Truck	Air & Hydraulic	Transmission Oil Cooler, Diesel Fuel, Air Brake	Air Brake	Transmission Oil Cooler, Fuel and Diesel Lines	A/B & Hydraulic	Hydraulic/Air/Steam	Hydraulic/Air/Steam w/ Conductive Static Dissipating Liner
Meets	—	—	DOT All+ ABS	DOT All	MSHA	DOT All	DOT All	DOT All	DOT A	—	ABS* DOT All + USCG	FDA	—
SAE No.	J2064 Type C, CL-1	J2064 Type E Class 1	J1402 All 100R5	J1402 Type All	—	J1402 Type All	J1402 Type All	J1402 Type All	J1402 Type A	J1019	100R5 J1942 /1 J1402 Type All	—	—
Temp. Range °F	See page 49	-40°F +257°F	See page 36	See page 42	-40°F +212°F	See page 43	See page 43	See page 44	-40°F +200°F	-55°F +302°F	See page 53	-65°F +450°F	-65°F +450°F
Inner Tube	Rubber/ Nylon/ Rubber	Polyamide Veneer	Nitrile	Nitrile	Nitrile	CPE	Nitrile	CPE	EPDM	CPE	CPE	Teflon	Teflon
Reinforcement	1 Fiber Braid	Rubber Backing, 1 Fiber Braid	1 Fiber & Steel Braid	1 Fiber & 1 S.S. Braid	1 Steel Braid	1 Fiber & 1 Wire Braid	2 Fiber Braids	2 Fiber	Multi Fiber Braid	1 Wire Braid	1 Fiber & 1 Steel Braid	1 S.S. Braid	1 S.S. Braid
Cover	Butyl Perforated	Chlorobutyl	Fiber Braid	Fiber Braid	Neoprene (Perforated)	Fiber Braid	Fiber Braid	Fiber Braid	EPDM	Fiber Braid	Blue Fiber Braid	Stainless Steel Braid	Stainless Steel Braid
Hose I.D. - Maximum Recommended Operating Pressure - PSI													
3/16			3000	1500	3000	2000	225	225			3000	3000	3000
1/4			3000	500	3000	1500					3000	3000	3000
5/16	400		2250	500	2250	1500	225				2250	2500	2500
3/8		500							225			2000	2000
13/32	400		2000	500	2000	1250	225	225		250	2000		
7/16													
1/2	350	500	1750	450	1750	1000	225	225	225	250	1750	1750	1750
5/8	350	500	1500	450	1500	750	225	225			1500		
3/4		500										1000	1000
7/8			800	250	800	400	225	225			800		
1												1000	1000
1-1/8			625	250	625			225			625		
1-1/4													
1-1/2													
1-3/8			500		500								
1-13/16			350		350								
2													
2-3/8			350										
3			200										
Hose Fittings													
C-O-C	J-24-31	—	J-9-12	J-9-12	J-9-12	—	J-9-12, J-33	J-9-12, J-33	J-24-31	J-24-31, J-32	J-9-12	J-2-8	J-2-8
Field Attach.	—	K-37-58	K-12-13, K-22-26	K-12-13, K-22-26	K-12-13, K-22-26	K-19-21	K-12-12, K-22-26	K-22-26	K-9-11	—	K-22-26	—	—

¹ Hypalon® is a registered trademark of E.I. DuPont.
Teflon® is a registered trademark of DuPont used under license by Eaton.

**At 70° F.
† When used with 'U' Series Ends.

Hose Selection

There are several factors which affect selection of a hose sized such that it will provide the desired rate of flow at the required pressure; these are:

- Hose size
- Hose length
- Hose fittings
- Material conveyed
- Bends
- Static head pressure

Hose Size

Undersized pressure lines produce excessive pressure drop with attendant energy loss and heating, and undersized suction lines cause cavitation at the pump inlet. Oversized hose assemblies, on the other hand, are excessively costly and generally too heavy.

In selecting hose for hydraulic systems, the following empirical values can be used to achieve minimum pressure drop consistent with reasonable hose size (see Chart 2):

Velocity of pressure lines 7 to 15 ft./sec. Velocity of short pressure lines to 20 ft./sec. Velocity of suction lines 2 to 5 ft./sec. To use Chart 2, lay a straight-edge across the chart as shown by the dotted line. To minimize pressure drop, always use the next larger size hose shown if the line passes between sizes listed.

Hose Length

Chart 1 gives the pressure drop in different-sized hoses based on hoses of 100-foot length, and is based on water as the material conveyed. For hoses of a different length, these values must be corrected. For example, a 100-foot length of 1/2" hose causes a pressure drop of 100 lbs./in.² at a flow rate of 10 gal./min. If the hose in question is 50 feet long, the pressure drop derived from Chart 1 must be corrected by multiplying the value by the ratio of the actual length to 100 feet, or 50/100, or 0.5. Therefore, the actual

pressure drop caused by a 50-foot length of 1/2" hose, at a flow rate of 10 gal./min. is 50 lbs./in.² ($0.5 \times 100 = 50$ lb./in.²).

Hose Fittings and Fluid Conveyed

In most cases, the end fitting openings are slightly smaller than the hose itself. However, this varies widely with hose fitting designs from 'full-flow' ends which have the same I.D. as the hose, down to as much as 1/8" smaller I.D. than the hose bore. To allow for this, assume a 10-to-15% greater flow rate than actually measured in the system when determining pressure drop.

Chart 1 is based on water as the material conveyed, and for other fluids it is necessary to correct for the difference in specific gravity and viscosity. Chart 3 lists common fluids, their specific gravities, viscosities, and corresponding correction factors. To determine the pressure drop for a specific fluid, first determine the pressure drop from Chart 1 for the hose length then divide this by the correction factor found in Chart 3. For example, the 50-foot length of 1/2" hose just described had a pressure drop of 50 lbs./in.² at a flow of 10 gal./min. of water. To determine the pressure drop if #2 fuel oil is the material conveyed, divide by 0.752 (from Chart 3) $50 \div 0.752 = 66.5$ lbs./in.² pressure drop. If, on the other hand, the material conveyed is Type #3 gasoline, the pressure drop would be $50 \div 1.19 = 42$ lbs./in.²

⚠ WARNING

For important safety information concerning hose selection, see pages A-2-3 of this catalog.

CHART 1. Hose Flow Rate vs. Pressure Drop

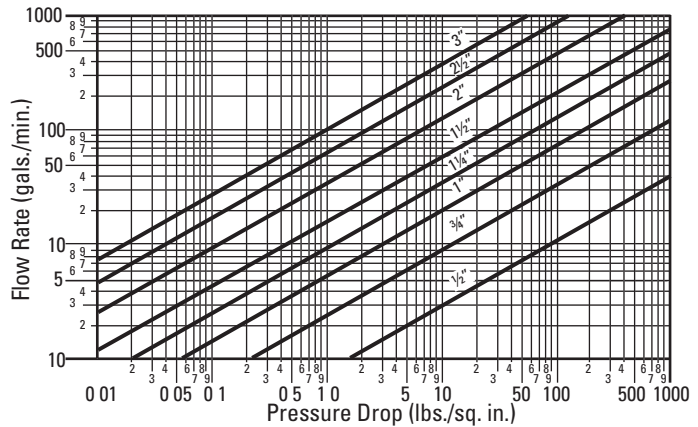
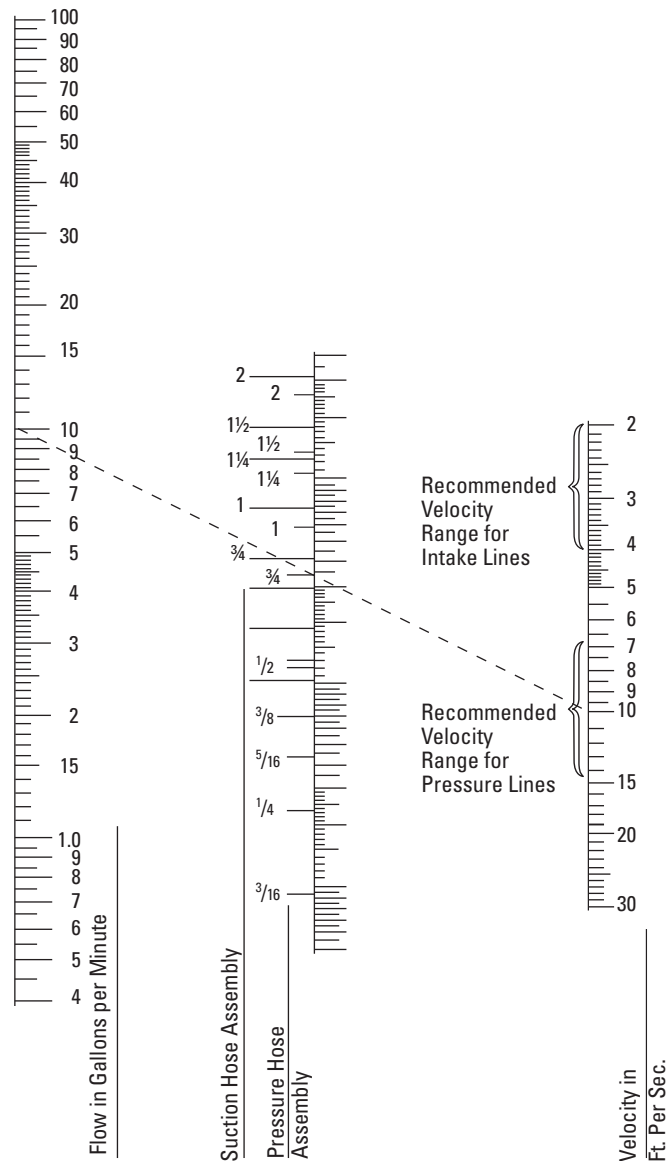

CHART 2. Hose Flow Capacity



Hose Selection



WARNING
For important safety information concerning hose selection, see pages A2-3 of this catalog.

CHART 3. Fluid Flow Correction Factors

Liquid	Specific Gravity	Viscosity Centistokes	Viscosity Centipoises	Correction Factor R.
	CS	CP	CP	
Acetic Acid – 100%	1.05	–	1.3	0.975
Acetic Acid – 70%	1.07	–	2.7	0.843
Ammonia Liquid – 100%	0.66	0.30	–	1.290
Ammonia Liquid – 26%	0.907	–	1.3	0.943
Asphalt* @ 120°F	1.40	–	300.0	0.350
Beer*	1.01	1.15	–	0.990
Benzene Benzol	0.88	0.744	–	1.08
Brine Calcium Chloride – 25%	1.23	3.80	–	0.78
Brine Sodium Chloride – 25%	1.19	2.07	–	0.88
Butyl Alcohol	0.81	3.64	–	0.783
Castor Oil*	0.96	900.00	–	0.27
Crude Petroleum Typical*				
1. Pennsylvania Crude@100°F	0.80	–	3.0	0.78
2. California Crude @ 150°F	0.915	–	9.0	0.64
3. #33 API Crude @ 100°F	0.86	7.2	–	0.685
4. Texas Crude @ 150°F	0.875	–	3.0	0.792
5. Mexican Crude @ 150°F	0.96	–	550.0	0.287
Decane - n	0.73	1.24	–	0.975
Ethyl Alcohol @ 100°F	0.794	–	1.25	0.93
Ethyl Alcohol @ 95°F	0.808	–	1.45	0.904
Ethyl Alcohol @ 40°F	0.939	–	3.00	0.807
Ethyl Glycol	1.12	–	24.00	0.55
Formic Acid	1.22	–	–	0.94
Fuel Oils*				
No. 1 @ 100°F Sp Gr 82-95 Visc 30 to 40 SSU	0.88	2.45	–	0.85
No. 2 @ 100°F Sp Gr 82-95 Visc 35 to 50 SSU	0.88	4.50	–	0.752
No. 3 @ 100°F Sp Gr 82-95 Visc 55 SSU max	0.88	8.6	–	0.66
No. 5 @ 100°F Sp Gr 82-95 Visc 60 to 450 SSU	0.88	55.0	–	0.47
No. 6 @ 122°F Sp Gr 82-95 Visc 430 to 2900 SSU	0.88	38.0	–	0.493
Gasoline (representative)*				
Type #1	0.74	0.88	–	1.04
Type #2	0.72	0.64	–	1.11
Type #3	0.68	0.46	–	1.19
Glycerine (Glycerol) – 100% @ 150°F	1.26	–	75.0	0.45

* These figures are approximate or averages of those values available.

CHART 4. Resistance of 90° Bends

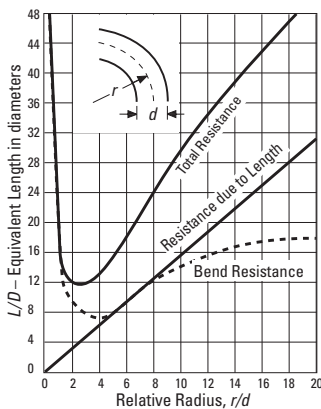

Bends

If a hose of a given length is bent, the pressure drop will increase by some definite amount...the sharper the bend and the smaller the radius of bend the greater the pressure drop. The effect of a bend may be neglected if it is slight or if there are but few bends in a long length of hose. This is because the additional pressure drop caused by these bends is not significant when compared to the total pressure drop.

However, a dock hose may have four sharp 90° bends in a 25-foot length, and if pressure drop is important, these bends must be considered because they constitute a significant portion of the overall pressure drop. The curves in Chart 4 show the effects of resistance due to 90° bends. This data can also be used as a guide for smooth bends less or greater than 90°. For example, a 45° bend has about 4/10 the resistance of a 90° bend.

Problem: Determine the equivalent length, in terms of hose inside diameters, of a 90° and a 180° bend whose relative radii are 12 inches.

Solution: Referring to the "total resistance curve," the equivalent length for a 90° bend is 34.5 hose diameters. The equivalent length of a 180° bend is 34.5 diameters for one 90° bend, 18.7 diameters for resistance due to length, and 15.8 ÷ 2 diameters for bend resistance. Adding these 34.5, 18.7, and 15.8 ÷ 2 = 61.1 diameters for a 180° bend.* Note that this loss is less than the sum of losses through two 90° bends separated by tangents.

Static Head Pressure

Static head is the difference in height between the inlet and outlet ends of a hose. Before using Chart 1, it is necessary to correct for static head pressure because the values in Chart 1 are pressure losses due to friction only. To correct for static head pressure, the difference in height is determined and multiplied by 0.433 to convert the head to an equivalent pressure in PSI (one foot of water exerts 0.433 PSI pressure).

If the inlet is higher than the outlet, the pressure equivalent is added to the pump pressure. If the outlet is higher than the inlet, the pressure equivalent is subtracted from the pump pressure. In both cases, it is assumed that the pump pressure is the pressure available at the inlet end and that the pump is outside of the hose system.

Installation Design

Hose should not be twisted or put in torsion either during the installation or while in service. Sharp or excessive bends may cause the hose to kink or rupture. Be sure to allow enough slack to provide for changes in length which will occur when pressure is applied. This change in length can vary from +2% to -4%. Design the installation so the hose assembly is accessible for inspection and easy removal. Bend radius is important. A good working rule is that the minimum bend radius should be five or more times the O.D. dimension of the hose.

**In a continuous bend of 180 degrees the second 90 degree bend produces approximately one-half the resistance of the first bend.*

Bend radius is important. A good working rule is that the minimum bend radius should be five or more times the O.D. dimension of the hose.

Hose Selection

Chemical Compatibility Chart

These tables alphabetically list commonly used materials of various chemical composition. After each fluid listing you will find the basic hose tube and fitting materials rated according to their chemical resistance to each individual fluid. The chart is intended to be used as a guide only. Consult Eaton Technical Support for further information.

⚠ WARNING

Selection of Hose: Selection of the proper hose for the application is essential to the proper operation and safe use of the hose and related equipment. Inadequate attention to selection of the hose for your application can result in serious bodily injury or property damage from spraying fluids or flying projectiles. In order to avoid serious bodily injury or property damage resulting from selection of the wrong hose, you should carefully review the information in this catalog.

⚠ WARNING

Proper Selection of Hose Fittings: Selection of the proper fittings for the hose fitting application is essential to the proper operation and safe use of the hose and related equipment. Inadequate attention to the selection of the fittings for your application can result in serious bodily injury or property damage resulting from spraying fluids or flying projectiles. In order to avoid serious bodily injury or property damage resulting from selection of the wrong fitting, you should carefully review the information in this catalog.

⚠ WARNING

The following list of chemicals is offered as a guide to the chemical resistance properties of the tube material of the hoses shown. It should be used as a guide only, as the degree of resistance of any elastomer to a particular fluid depends upon such variables as temperature, concentration, pressure conditions, velocity of flow, duration of exposure, aeration, stability of the fluid, etc.

Therefore, when in doubt, it is advisable not to use the hose. If this is not practical, tests should be devised that simulate actual service conditions as nearly as possible. Eaton offers additional technical assistance. Contact your Eaton Customer Support representative for assistance or call Technical Support at 1-888-258-0222.

Teflon® is a registered trademark of DuPont used under license by Eaton.

Chemical Compatibility Chart

FLUID	HOSE MATERIAL											HOSE FITTINGS		
	PVC	Nitrile	Vinyl Nitrile	Neoprene	Teflon	Nylon/Nylon II	EPDM	Hypalon ²	Hytrel ¹	Polyurethane	CPE	Brass	Steel	316 Stainless
Acetaldehyde	X	X	X	X	G	G	G	F	X	X	-	X	X	G
Acetic Acid (Concentrated)	X	X	X	X	G	X	G	X	X	X	G	X	X	G
Acetic Acid (Diluted)	F	X	X	F	G	F	G	F	G	X	G	X	X	G
Acetic Anhydride	X	G	G	X	G	X	G	F	X	X	G	X	F	F
Acetone	X	X	X	X	G	G	G	F	X	G	G	F	G	G
Acrylonitrile	G	X	X	X	G	G	X	X	-	X	G	-	G	G
Air ▲	G	G	G	G	G	G	G	G	G	G	G	G	G	G
Alcohols (Methanol & Ethanol)	X	G	G	G	G	G	G	G	X	G	G	G	F	G
Aluminum Chloride	G	G	G	G	G	X	G	G	G	G	X	X	F	F
Aluminum Fluoride	G	G	G	F	G	X	G	G	-	G	X	X	X	X
Aluminum Hydroxide	G	G	G	G	G	G	G	G	-	G	G	X	F	G
Aluminum Sulfate	G	G	G	G	G	G	G	G	G	G	X	X	G	G
Alums	G	G	G	G	G	F	G	G	X	G	G	X	F	F
Ammonia, Anhydrous	X	X	X	X	X	X	X	X	X	X	X	X	X	X
Ammonia Solution (10%)	G	G	G	F	G	G	G	X	X	X	X	X	G	G
Ammonium Chloride	G	G	G	G	G	X	G	G	G	G	X	X	G	F
Ammonium Hydroxide	X	F	F	F	G	G	G	X	X	G	X	F	G	G
Ammonium Nitrate	G	G	G	G	G	G	G	G	X	G	-	-	G	G
Ammonium Phosphate	F	G	G	G	G	G	G	G	F	G	X	X	X	G
Ammonium Sulfate	G	G	G	G	G	G	G	G	G	G	X	X	F	F
Amyl Acetate	X	X	X	X	G	G	F	X	X	X	X	G	F	G
Amyl Alcohol	X	G	G	F	G	G	G	G	X	G	G	F	F	F
Aniline	X	X	X	X	G	X	X	X	X	X	X	X	X	G
Aniline Dyes	X	F	F	F	G	X	G	X	X	X	X	X	F	F
Animal Oils and Fats	G	G	G	X	G	G	F	F	G	X	F	G	G	G
Anti-Freeze (Glycol Base)	G	G	G	G	G	F	G	G	X	G	G	X	G	G
Aqua Regia	X	X	X	X	G	X	X	X	X	X	-	X	X	X
Asphalt	X	G	G	X	G	G	X	X	-	X	F	G	G	G
Barium Chloride	G	G	G	G	G	X	G	G	G	G	G	X	F	G
Barium Hydroxide	G	G	G	G	G	G	G	G	X	G	X	G	G	G
Barium Sulfide	G	G	G	G	G	X	G	X	G	X	G	X	X	G
Beet Sugar Liquors	G	G	G	G	G	X	G	G	X	G	X	G	G	G
Benzaldehyde	X	X	X	X	G	G	F	X	X	X	X	F	F	G
Benzene, Benzol	X	X	X	X	G	X	X	X	X	X	F	F	X	F
Benzoic Acid	X	X	X	G	G	X	X	X	X	F	F	X	F	F
Black Sulfate Liquor	X	F	F	G	G	F	G	F	G	X	F	X	G	G
Borax	G	F	F	G	G	G	G	G	G	G	G	G	G	G
Boric Acid	G	G	G	G	G	G	G	G	G	G	X	X	X	G
Brake Fluid (Glycol Ether Base)	X	X	X	F	G	G	G	X	-	X	G	G	G	G
Brine	G	G	G	G	G	G	G	G	X	G	-	X	F	F
Butane	Use H366 Hose only													
Butyl Acetate	X	X	X	X	G	G	F	X	F	X	F	G	G	G
Butyl Alcohol, Butanol	X	G	G	G	G	G	G	G	X	G	G	G	G	G

Codes:

- G** Good resistance.
- F** Fair resistance.
- X** Incompatible.
- No data available.
- ▲** In all applications, the cover must be pinpricked.
- 1 Hytrel® is a registered trademark of E.I. DuPont.
- 2 Hypalon® is a registered trademark of E.I. DuPont.

Note: All data given herein is believed to be accurate and reliable, but presented without guarantee, warranty, or responsibility of any kind, express or implied, on our part. Chemical resistance will vary with the wide diversity of possible mixtures and service conditions. It is therefore not possible to give any guarantee whatsoever in individual cases.

Hose Selection

Hose Fitting Pressure Charts

Thread Style Pressure Performance

Eaton closely follows industry standards in design and in application recommendations. A key principle within ISO, SAE and other standards bodies is that the MAXIMUM DYNAMIC WORKING PRESSURE OF THE HOSE OR ADAPTER

ASSEMBLY IS THE LESSER OF THE HOSE AND END CONNECTOR(S) USED. The first table below provides excerpts from standard industry pressure rating charts for connector types as published by SAE (Society of Automotive Engineers).

Note: The tables below are applicable for low carbon free machining steels typically used in Fluid Power connections. For port type connections, the material and design of the port must be considered and may reduce expected strength.

For high pressure applications Eaton recommends the use of more robust connector designs such as Code 62 flange or O ring Face Seal.

Selected SAE Pressure Ratings

Dash Size	Inch Size	37° JIC SAE J514	Pipe SAE J476	Male ORB SAE J1926 ORS Adapt.	Male ORB SAE J1926 Non-ORS Adapt.	Adjustable ORB SAE J1926 ORS Adapt.	Adjustable ORB SAE J1926 Non-ORS Adapt.	ORS SAE J1453	Male Flareless SAE J514	Code 61 SAE J518	Code 62 SAE J518
-2	1/8	5000	5000	-	5000	-	5000	-	5000	-	-
-3	3/16	5000	-	9000	5000	6000	5000	-	5000	-	-
-4	1/4	4500	5000	9000	5000	6000	4500	9000	4500	-	-
-5	5/16	4000	-	9000	5000	6000	4500	9000	4000	-	-
-6	3/8	4000	4000	9000	5000	6000	4000	9000	4000	-	-
-8	1/2	4000	3000	9000	4500	6000	4000	9000	4000	5000	6000
-10	5/8	3000	-	9000	3500	6000	3000	6000	3000	-	-
-12	3/4	3000	2500	6000	3500	6000	3000	6000	3000	5000	6000
-14	7/8	2500	-	6000	3000	6000	2500	6000	2500	-	-
-16	1	2500	2000	6000	3000	5000	2500	6000	2500	5000	6000
-20	1 1/4	2000	1150	4000	2500	4000	2000	3600	2000	4000	6000
-24	1 1/2	1500	1000	4000	2500	3000	2000	3600	1500	3000	6000
-32	2	1125	1000	3000	2000	2500	1500	3000	1125	3000	6000

International Pressure Rating Charts

Maximum Working Pressure (PSI)

Hose Fitting Connection	Code Letter or Number	Hose Fitting Size									
		-04	-05	-06	-08	-10	-12	-16	-20	-24	-32
Male British Pipe (BSP)	150	5,000		4,000	4,000	3,500	4,000	3,500	2,500	2,000	2,000
Female British Pipe (BSP)	05P, 70P, 350	5,000		4,000	4,000	3,500	4,000	3,500	2,500	2,000	2,000
Female Pipe (JIS)	00L	5,000		5,000	5,000		4,000	4,000			

Maximum Working Pressure (PSI)

Hose Fitting Connection	Code Letter or Number	Hose Fitting Size									
		-06	-08	-10	-12	-15	-18	-22	-28	-35	-42
Din Light	00A, 00C, 00D, 50D	3625	3625	3625	3625	3625	2325	2325	1450	1450	1450

Temperature vs. Pressure Table for Reinforced PVC Hose

Temperature		Allowable % of Original Work. Pressure		Temperature		Allowable % of Original Work. Pressure	
°C	°F	2-Spiral	4-Spiral	°C	°F	2-Spiral	4-Spiral
20	68	100%	100%	50	120	40%	53%
25	77	86%	90%	55	131	33%	47%
30	86	75%	81%	60	140	27%	43%
35	95	65%	73%	65	149	23%	40%
40	104	56%	66%	70	158	20%	38%
45	113	47%	59%	75	167	17%	37%
				80	176	15%	35%

Note: For additional information on a specific hose, refer to the hose descriptions on pages B1 thru I-2.

Hose Selection

Hose Fitting Pressure Charts

All Eaton Components

With higher pressures it is critical to know the construction materials and manufacturing method to ensure performance. When all

components in a system are Eaton supplied, for example an Eaton hose fitting is mated with an Eaton adapter or tube fitting, the combination may

be used at higher pressures with confidence. These higher ratings are noted in the chart below. MAXIMUM DYNAMIC WORKING

PRESSURE OF THE HOSE OR ADAPTER ASSEMBLY IS THE LESSER OF THE HOSE AND END CONNECTOR(S) USED.

All Eaton Pressure Ratings¹

Dash Size	Inch Size	37° JIC	Male Pipe	Female Pipe ²	Male ORB ORS Adapters	Male ORB Non-ORS Adapters	Adjustable ORB ORS Adapters	Adjustable ORB Non-ORS Adapters	ORS	Male Flareless	Code 61	Code 62	STC
-2	1/8	-	10000	6000	-	5000	-	5000	-	5000	-	-	-
-3	3/16	-	-	-	9000	5000	6000	5000	-	5000	-	-	-
-4	1/4	7000	9500	5000	9000	5000	6000	4500	9000	4500	-	-	6000
-5	5/16	7000	-	-	9000	5000	6000	4500	-	4000	-	-	-
-6	3/8	5000	8000	4000	9000	5000	6000	4000	9000	4000	-	-	5000
-8	1/2	4000	6000	4000	9000	4500	6000	4000	9000	4000	5000	6000	4250
-10	5/8	3800	-	-	9000	3500	6000	3000	9000	3000	-	-	4000
-12	3/4	3300	5000	3500	6000	3500	6000	3000	6000	3000	5000	6000	4000
-14	7/8	-	-	-	6000	3000	6000	2500	-	2500	-	-	-
-16	1	3500	4000	3000	6000	3000	5000	2500	6000	2500	5000	6000	4000
-20	1 1/4	2500	3000	2000	4000	2500	4000	2000	4500	2000	4000	6000	-
-24	1 1/2	2100	2000	1500	4000	2500	3000	2000	4000	1500	3000	6000	-
-32	2	1750	2000	1500	3000	2000	2500	1500	3000	1125	3000	6000	-

Notes:

- 1) These ratings are based on both brazed and one piece construction, one-piece pressures could be increased. Please contact Eaton in these situations.
- 2) This rating is for thin walled adapters or fittings, the use of manifolds or oversized female ports would allow full rated male pressures.

Dynamic Operating Pressure

– Dynamic operating conditions refers to cyclic pressure impulses, usually considered to be from near zero to the highest system pressure. Hydraulic standards typically represent these as square waves and expect a component to handle on the order of 200,000 to well over one million such cycles with a burst:operating safety factor of 4:1. The above charts are created with Dynamic applications in mind. Most industrial and mobile hydraulic systems fit the dynamic operating pressure profile, for example hydraulic work circuits on construction equipment or on injection molding equipment.

Static Operating Pressure

– Static operating conditions typically range from zero to operating pressure, but with far fewer cycles expected for the system life – perhaps 30,000 to 50,000 cycles and sharp pressure spikes are not expected, allowing a burst:operating safety factor of 3:1 or less. For static operating conditions, the Eaton ratings above can be safely increased by 25-30%. For example, a 3000 psi dynamic rated hose might be used in a 4000 psi static pressure application. Typical examples of static applications are water blast and hydraulic jacking.

Materials – The above tables represent performance using common low carbon steel material. Other materials and their characteristics influence these ratings. Medium carbon steels or heat treated materials can support higher working pressures. Conversely non-ferrous materials such as aluminum or brass will have reduced capability – as much as 50%, or less, pressure handling capability. It is important to consider material properties in designing a system to ensure pressure rating compatibility of all materials.

Design & Application

– Eaton's Fluid Conveyance engineering and support teams have many decades of experience in designing, manufacturing and servicing hydraulic and other fluid conveyance systems globally. Eaton's product line is designed as a comprehensive collection of hose, fittings, connectors, couplings and accessories that allow a system designer to select components to complete a fluid power system or a service technician to replace a component with confidence. The individual product specifications, the above pressure ratings and other technical information are intended as supporting guidelines for system design and service needs and are not to be construed as a guarantee of performance of the system or of individual Eaton components. Eaton provides comprehensive technical support so please call with questions about pressure needs not covered by these charts or for specific application support.

Fitting Identification

Fitting Thread Size Comparison Chart

The male connections have (Male unified thread class 2 fit) UN-2A specification threads and the female connections have (Female unified thread class 2 fit) UN-2B specification threads. The exceptions are male and female pipe threads.

Tube Fittings

There are four basic types of tube fittings: Flare, Flareless, Straight Thread O-ring, and Flat Face O-ring Seal (FOR-SEAL™). Tube fittings seal in two ways. Flare and Flareless fittings use metal to metal contact joints. Straight Thread O-ring and Flat Face O-ring fittings use a rubber O-ring. Where extreme vibration is present, use Flareless, Straight Thread or Flat Face O-ring Seal fittings.

Sizing

For accuracy, it is recommended the male thread be measured. Measure the outside diameter. For our example use 7/16". Next measure the threads per inch – use 20. Our fitting size measures 7/16-20. Refer to the thread chart on this page for appropriate tube size and illustration.

See page N-60 for Thread Measuring Kits.

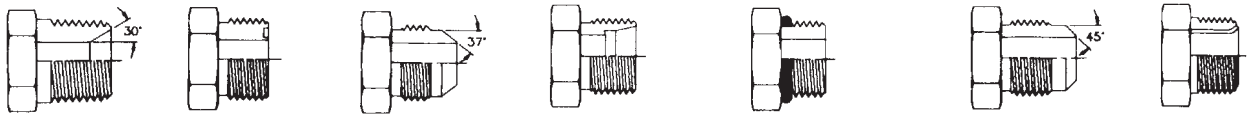
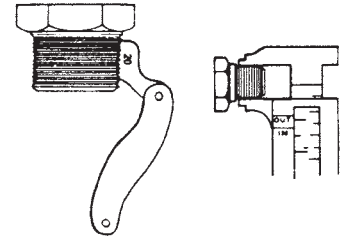

Size	Pipe	FOR-SEAL®	37° Flare Flare-Twin®	Ermeto® 7000 Series	Straight Thread O-ring SAE	45° Flare	Inverted Flare
1/8	1/8-27	—	5/16-24	5/16-24	5/16-24	5/16-24	5/16-28
3/16	—	—	3/8-24	3/8-24	3/8-24	3/8-24	3/8-24
1/4	1/4-18	9/16-18	7/16-20	7/16-20	7/16-20	7/16-20	7/16-24
5/16	—	—	1/2-20	1/2-20	1/2-20	1/2-20	1/2-20
3/8	3/8-18	11/16-16	9/16-18	9/16-18	9/16-18	5/8-18	5/8-18
7/16	—	—	—	—	—	11/16-16	11/16-18
1/2	1/2-14	13/16-16	3/4-16	3/4-16	3/4-16	3/4-16	3/4-18
5/8	—	1-14	7/8-14	7/8-14	7/8-14	7/8-14	7/8-18
3/4	3/4-14	1-3/16-12	1-1/16-12	1-1/16-12	1-1/16-12	1-1/16-14	1-1/16-16
7/8	—	—	1-3/16-12	1-3/16-12	1-3/16-12	—	1-3/16-16
1	1-11-1/2	1-7/16-12	1-5/16-12	1-5/16-12	1-5/16-12	—	1-5/16-16
1 1/4	1-1/4-11-1/2	1-11/16-12	1-5/8-12	1-5/8-12	1-5/8-12	—	—
1 1/2	1-1/2-11-1/2	2-12	1-7/8-12	1-7/8-12	1-7/8-12	—	—
2	2-11-1/2	—	2-1/2-12	2-1/2-12	2-1/2-12	—	—
2 1/2	2-1/2-8	—	3-12	—	—	—	—
3	3-8	—	3-1/2-12	—	—	—	—

Pipe Fittings

The American Society of Automotive Engineers in cooperation with industry set up a standard for improvement in pipe threads. This improvement is known as the Dryseal Pipe Thread. All Weatherhead pipe threads are American Standard Taper Dryseal Pipe Threads (NPTF). The metal to metal seal is formed by contact at the thread crest and root.

Nominal pipe sizes do not agree with either the I.D., O.D., or thread sizes. To determine pipe size (up to 1-1/4") measure the diameter of the threads and subtract 1/4". For example, subtract 1/4" from a 1" pipe to obtain the nominal pipe size of 3/4".

Pipe sizes can also be given in 'dash numbers.' A dash number is always the numerator of an inch over 16th. For instance, if the pipe O.D. measures 1/2" that would be converted to 16ths (8/16), but be written as -8.



Fitting Identification

Identifying metric, or non-USA, threaded connections is similar to identifying the connections that have been commonly used

in the United States. The following text covers how to identify the different styles of metric connections offered by Eaton.

BSPP & BSPT Thread Chart

BSP Thread Size	1/8-28	1/4-19	3/8-19	1/2-14	5/8-14	3/4-14	1-11	1-1/4-11	1-1/2-11	2-11
Male Thread Diameter	9.72 (.375)	13.16 (.518)	16.66 (.656)	20.96 (.825)	22.91 (.902)	26.44 (1.041)	33.25 (1.309)	41.91 (1.650)	47.80 (1.882)	59.51 (2.347)
Female Thread Diameter	8.73 (.343)	11.66 (.459)	15.37 (.605)	18.90 (.744)	20.85 (.821)	24.38 (.960)	30.61 (1.205)	39.24 (1.545)	45.24 (1.781)	55.94 (2.242)
Pitch	.91 (.036)	1.34 (.053)	1.34 (.053)	1.81 (.071)	1.81 (.071)	1.81 (.071)	2.31 (.091)	2.31 (.091)	2.31 (.091)	2.31 (.091)

Figure 4a. Dimension Note: mm (in)

Threads

The thread forms and their corresponding specifications listed below are used on all of the metric styles of connections which will be discussed later. These cover the basic forms of the threads but not the style of connection.

Parallel Threads ('G')

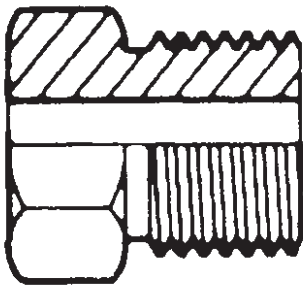

Figure 1.

Tapered Threads ('R')

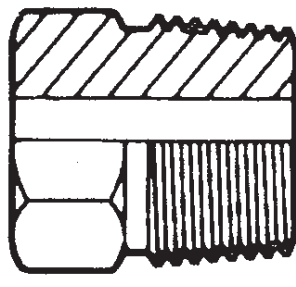

Figure 2.

Note:

BS British Standards Institution

ISO International Standards Organization

DIN Deutsche Industrie Norme

To identify metric connections, you will need instruments that can accurately measure thread inside and outside diameters, thread pitch and fitting seat angles. The TA-1002 Thread Measuring Guide and Tool Kit is a basic kit that will help you in identifying most of the connections you will be encountering on imported equipment.

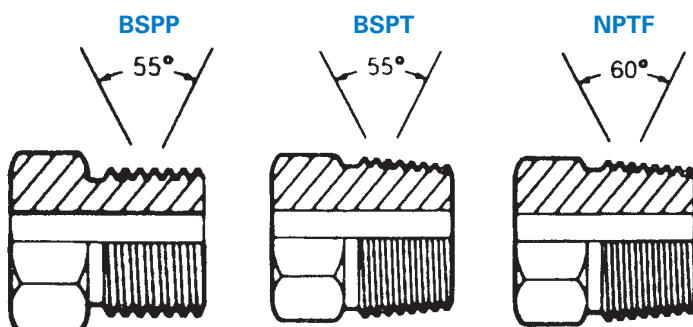

Figure 3.

Thread Type

Specifications

British Parallel Pipe Threads	BS 2779, ISO/R 228
British Taper Pipe Threads	BS 21, ISO/R 7
Metric Parallel Threads	DIN 3852, ISO/R 6149
Metric Taper Threads	DIN 3852

Parallel and Tapered Threads

The first step in identifying thread forms is to determine if the thread is parallel or tapered. Parallel threads are not used for sealing fluids. Sealing is achieved by an elastomeric O-ring, metal seal, machined ring into the hex itself or a seat machined into the end of the fitting. This style is similar to straight thread O-ring port connections where the threads are used for retention of the sealing method against a machine port. Parallel threads can be determined by laying a straight edge along the threads. If the threads are parallel to the center line of the fitting, then the fitting has parallel threads. See Figure 1.

Tapered threads seat by the interference caused by the male and female threads. These threads create a pressure-tight joint by metal deformation when they are tightened. Sealants on the threads are commonly used in this style of connection. Laying a straight edge on the threads, compare this line with the center line of the fitting. If this line tapers slightly away from the center line, then the threads are tapered. See Figure 2.

British Pipe Threads

There are two forms of British Standard Pipe Threads that are used in the world today. They are BSPP (British Standard Pipe Parallel) and BSPT (British Standard Pipe Tapered). The BSPT male thread mates with the female BSPT thread similar to an NPTF connection. The 30° BSPP male adapters connect to a female BSPP thread with a 30° cone. This style is comparable to an NPSM swivel style. These threads are almost identical to the NPTF Pipe Thread except for the flank angle. This angle is 55° versus 60° on the NPTF. See Figure 3. Because of this difference, the two forms are NOT interchangeable.

Fitting Identification

Identifying BSP threads starts with determining if it is a parallel or tapered thread. Next, referencing Figure 4 and 4a, measure the lead thread diameter. Compare this measurement to the listed dimensions to determine size. If instruments are not available to measure this, you can compare it end-to-end with a known NPTF thread to approximately arrive at the nominal BSP size. Finally, measure the pitch and compare it to the chart on Figure 4 to complete the identification. These dimensions will be the same for both BSPP and BSPT.

Metric Threads

Metric threads are similar to inch-sized threads except for the sizing which is based on standard metric units. Identifying metric threads starts with determining if it is a parallel or tapered thread. Next, measure the thread diameter. Compare this measurement to the dimensions listed in Figure 5 to determine size. Finally, measure the pitch and compare to chart. These dimensions will be common for both parallel and tapered threads.

Metric Thread Size	Male Thread Diameter		Female Thread Diameter		Pitch	
	mm	in	mm	in	mm	in
M10 x 1.0	10.0	.394	8.5	.335	1.0	.039
M12 x 1.5	12.0	.472	10.5	.413	1.5	.059
M14 x 1.5	14.0	.551	12.5	.492	1.5	.059
M16 x 1.5	16.0	.630	15.5	.610	1.5	.059
M18 x 1.5	18.0	.709	16.5	.650	1.5	.059
M20 x 1.5	20.0	.787	18.5	.728	1.5	.059
M22 x 1.5	22.0	.866	20.5	.807	1.5	.059
M24 x 1.5	24.0	.945	22.5	.886	1.5	.059
M26 x 1.5	26.0	1.024	24.5	.964	1.5	.059
M27 x 2.0	27.0	1.063	25.5	1.004	2.0	.079
M30 x 2.0	30.0	1.181	28.5	1.122	2.0	.079
M33 x 2.0	33.0	1.299	31.5	1.240	2.0	.079
M36 x 2.0	36.0	1.417	34.5	1.358	2.0	.079
M42 x 2.0	42.0	1.653	40.5	1.594	2.0	.079

Figure 5.

BSPT

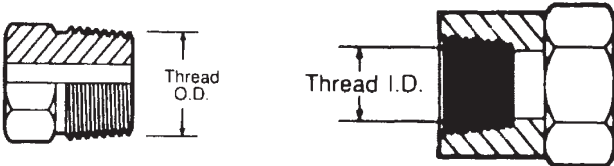

BSPP

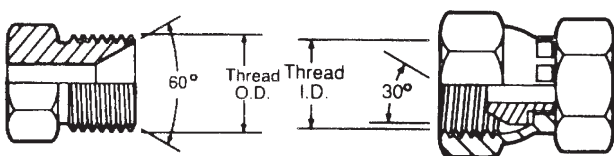

DIN 3901/3902L, 3901/3902S

The most popular metric flareless, or bite-type, fitting style is the 24° Metric Tube Seat. This style incorporates a tapered seat in the fitting body with a bite-type sleeve, or ferrule, for the connection. When the nut is tightened, the tapered seat forces the sleeve into the tube creating a positive seal. This style of connection is available in both a Light and Heavy series and is designed for medium and high pressure applications respectively. The two series have different parallel thread sizes in

relationship to the nominal tube outside diameter, but share a common sleeve. This style can be identified by the combination of the 24° internal seat and a male metric parallel thread. The series can be determined by measuring the seat counterbore, which is the approximate tube outside diameter, and comparing it to the thread size. Compare these dimensions to those shown in Figure 6 to determine the series. The nominal sleeve size is taken directly from the tube outside diameter dimension.

Tube O.D.			Nom. O.D. Light - l.Rh.	Series-Thread Heavy - s.Rh.
mm	in	mm		
8	.315	8	M14 x 1.5	M16 x 1.5
10	.394	10	M16 x 1.5	M18 x 1.5
12	.472	12	M18 x 1.5	M20 x 1.5
14	.551	14	—	M22 x 1.5
15	.591	15	M22 x 1.5	—
16	.630	16	—	M24 x 1.5
18	.709	18	M26 x 1.5	—
20	.787	20	—	M30 x 2.0
22	.866	22	M30 x 2.0	—
25	.984	25	—	M36 x 2.0
28	1.102	28	M36 x 2.0	—
30	1.181	30	—	M42 x 2.0

Figure 6.

See page N-60 for Thread Measuring Kits.

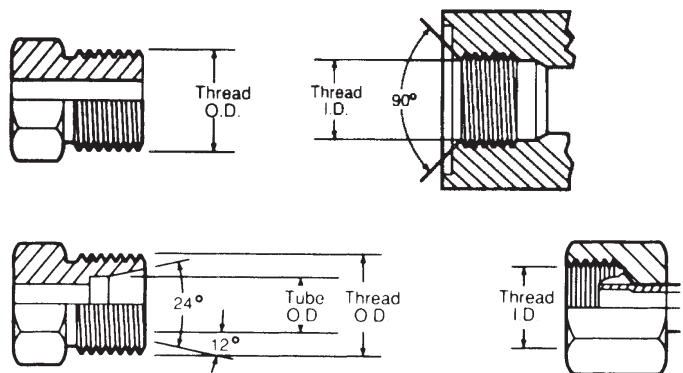

Figure 4.

Metric Flareless Connections Metric 60° Tube Seat DIN 7631

This series combines an internal 60° seat with parallel metric Light series threads. Mating with female metric swivel fittings with a globe seal made to DIN 3863L, this connection provides a metal to metal seal when tightened. This style can be identified by the internal 60° seat on the male metric threaded portion. Reference Figure 7 for thread information.

Japanese 30° Flare

The Japanese 30° flare style is similar to the 37° JIC flare connection except for two things. The seat angle is 30° and threads are metric straight threads. This fitting is often referred to as a 'Komatsu' style connection. To identify this style, first verify the seat angle is 30°. Next establish the metric thread size by measuring the thread outside diameter. Compare this dimension to those shown in Figure 9. The threads in this series will conform to Japanese Industrial Standard (JIS) B 0207.

Japanese 30° Flare (JIS)

Similar to BSPP and a 30° seat. The seal is made when contact is made between the male and female flares, with the threads retaining the connection. The JIS 30° flare is similar to the 37° flare connection. To determine the difference between the JIS 30° flare and the JIC 37° flare, carefully measure the seat angle. The threads in this series conform to Japanese Industrial Standard (JIS) B 0202.

Metric Split Flange Fittings

Metric split flanges are found in applications where high pressure and high vibration conditions exist. A flange clamp is used to secure the split flange head and O-ring against a machined port to provide an elastomeric and metal-to-metal seal. They are used in applications up to 3000 PSI. The physical dimensions are similar to the SAE Code 61 standard pressure series which makes the two styles fully interchangeable. To identify, referencing Figure 10, simply measure the flange head diameter to arrive at the nominal flange size.

Note: To prevent leakage when replacing this type of fitting with standard Code 61 hose fitting, make sure to use the existing flange halves and hardware with a new SAE-style O-ring. Also note that in this series there is a 5/8 nominal size which is a non-standard SAE size and require a special O-ring. Failure to reuse flange halves and hardware will result in an improper connection which could cause the hose assembly to fail.

⚠ WARNING

Proper selection of hose and hose fittings is critical for proper operation and safe use of the hose and hose fittings. See pages A2-3 of this catalog for important safety information.

Figure 7

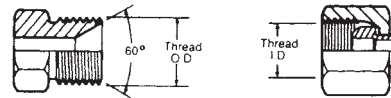

Metric Thread Size	Male Thread Diameter		Female Thread Diameter		Pitch	
	mm	in	mm	in	mm	in
M12 x 1.5	12.0	.472	10.5	.413	1.5	.059
M14 x 1.5	14.0	.551	12.5	.492	1.5	.059
M16 x 1.5	16.0	.630	15.5	.610	1.5	.059
M18 x 1.5	18.0	.709	16.5	.650	1.5	.059
M22 x 1.5	22.0	.866	20.5	.807	1.5	.059
M26 x 1.5	26.0	1.024	24.5	.964	1.5	.059

Figure 8

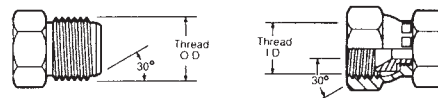

Metric Tube Size mm	Thread Size mm	Male Thread Diameter		Female Thread Diameter		Pitch	
		mm	in	mm	in	mm	in
6	M14x1.5	14	.551	12.5	.492	1.5	.059
9	M18x1.5	18	.709	16.5	.650	1.5	.059
12	M22x1.5	22	.866	20.5	.807	1.5	.059
16	M24x1.5	24	.945	22.5	.886	1.5	.059
19	M30x2.0	30	1.181	28.5	1.122	1.5	.059
25	M33x2.0	33	1.299	31.5	1.240	1.5	.059
32	M42x2.0	42	1.653	40.5	1.594	1.5	.059

Figure 9

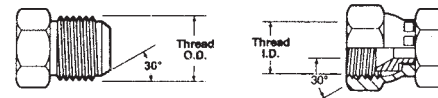

Inch size	Thread size	Male Thread O.D. in	Male Thread O.D. mm	Female Thread I.D. in	Female Thread I.D. mm
1/4	1/4-19	17/32	13.7	1/2	12.4
3/8	3/8-19	11/16	17.2	5/8	16.0
1/2	1/2-14	27/32	21.5	25/32	19.8
3/4	3/4-14	1-1/16	26.9	1	25.4
1	1-11	1-11/32	34.0	1-1/4	31.8
1-1/4	1-1/2-11	1-29/32	48.5	1-27/32	46.2
2	2-11	2-3/8	60.4	2-5/16	58.2

Figure 10



Nominal Flange Size	Flange Head O.D.		O-ring Groove Dia "A"		Dia. "B"		
	mm	in	mm	in	mm	in	
12.7	1/2	30	1.19	18.5	.73	25.0	.98
15.9	5/8	34	1.34	20.1	.79	28.0	1.10
19.0	3/4	38	1.50	21.5	.85	31.0	1.22
25.4	1	44	1.75	28.5	1.12	38.0	1.50
31.8	1-1/4	51	2.00	34.5	1.36	44.0	1.73
38.1	1-1/2	60	2.38	44.4	1.75	54.0	2.12
50.8	2	71	2.81	56.5	2.22	65.0	2.56

Hose

1. Weatherhead hose is generally designated with the letter 'H.'*
2. Each hose is assigned a three or four digit base number from 001-9999, i.e., H069, H425, H470, H571.
3. The last two digits indicate inside hose diameter (I.D.) in sixteenths of an inch. In the example used above 08 is equal to 8/16" – or 1/2" I.D. hose.

Exceptions: H059, H069, H166, H169, H213, H229, H239, H366, H429, H569 and H757. The I.D. sizes of these hose deviate somewhat from the above standard. The sizing method used on these hoses is based on deducting twice the wall thickness from the O.D. of the connecting tubing to determine the I.D. of the hose. In other words, match the inside diameters rather than the dash sizes when going from tubing to hose. See example 1.

Table 1 shows standard hose size and H069 type hose sizes and dash numbers. Wherever these hoses are listed in this catalog, the size is listed and the dash number is the last two digits of the Catalog Number.

Examples:

	Actual Hose I.D.	Nominal Hose I.D.	Tubing I.D.	Tubing O.D.
H06906	5/16	3/8	5/16	3/8
H06910	1/2	5/8	1/2	5/8

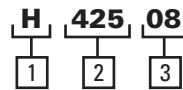

Table 1 – Catalog Numbers for Hose Sizes

Actual Hose I.D.	Standard Catalog Number	H069 Type Catalog Numbers
3/16	03	04
1/4	04	05
5/16	05	06
3/8	06	
13/32		08
7/16	07	
1/2	08	10
5/8	10	12
3/4	12	
7/8		16
1	16	
1-1/8		20
1-1/4	20	
1-3/8		24
1-1/2	24	
1-13/16		32
2	32	
2-3/8		40
3		48

Hose Fittings

Every type of Weatherhead hose fitting is designed to fit a certain group of hose with limiting dimensions and tolerances. For your convenience the hoses used on each fitting style are indicated in the hose fitting catalog listings.

Crimp

- The first two digits indicate hose size (I.D.) in sixteenths of an inch. The exceptions to this are the spiral and truck hose. Spiral hose fittings use the hose base number as a prefix to the size. Example: 47012E. Truck hose fittings use the base number 069 as a prefix to the size. Example: 06908E. Refer to the top of the catalog page where these hose fittings are detailed for recommended hose types.

08 U-2 58

① ② ③ ④

- Hose fitting type and material. Refer to Table 2. This letter is always followed by a dash.
- The first number or letter indicates the style of the end connection. See individual hose fitting catalog listings or refer to the hose fitting configuration chart on pages A-23-28
- The last two digits indicate the size of the end connection in sixteenths of an inch. Refer to individual catalog listing for metric and specialty ends.

425 08 N-2 58

① ② ③ ④ ⑤

Hose Assemblies

Catalog numbers for hose assemblies are basically the same as hose fittings, except both the ends must be specified as well as the overall length. This process is detailed below:

- Type of desired hose (see hose selection guide pages A-4-9 or individual hose listings).
- Hose size (I.D.) in sixteenths of an inch ($04 = 4/16'' = 1/4''$). Exception: $13/32''$ I.D. hose.
- End style and material. Refer to Table 2 (above).
5. Style and size of each hose fitting. Refer to the individual hose fitting catalog listings or the Hose Fitting Configuration Chart on pages A-23-28 for available styles and sizes. Example: P04 Male Straight Thread O-ring $1/4''$, 604 SAE 37° Female Swivel $1/4''$.
- Length of assembly. The first three digits specify a length in inches. The last two digits are for fractions of an inch expressed in decimal hundredths ($01250 = 12\ 1/2''$).

Table 2 – Standard Hose Fitting and Material Code

Code Letter	Coupling Type	Material
B	Field Attachable	Brass
C	Crimped	Brass
D	Field Attachable*	Steel*
E	Crimp	Steel
K	Clamp Type	Steel
N	Field Attachable	Steel
P	Crimp	Brass
S	Crimp Stainless	Steel
T	Field Attachable*	Brass
U	Crimp	Steel
Z	Crimp	Steel

*High Flow Hose Assemblies

Field Attachable

- Description of basic hose. The exceptions are the 247 series and clamp type ends. These ends are designed for use with a variety of hose types. Refer to the top of the catalog page where these hose fittings are detailed for recommended hose types.
- Hose size (I.D.) in sixteenths of an inch, or as shown in Table 1.
- Hose fitting type and material. Refer to Table 2. This letter is always followed by a dash.
- The first number or letter indicates the style of the end connection. See individual hose fitting catalog listings or refer to the hose fitting configuration chart on pages A-23-28.
- The last two digits indicate the size of the end connection in sixteenths of an inch. Refer to individual catalog listing for metric and specialty ends.

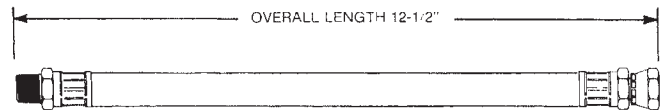

425 04 U - P04 604 01250

① ② ③ ④ ⑤ ⑥

Note: To determine the hose only length when making a hose assembly, subtract each hose fitting cut-off factor from the overall hose assembly length. Please see the individual hose fitting listings for cut-off factor information.

To determine Hose Cut-Off Factors reference page A-30.

Numbering Systems

The chart to the side is designed to offer quick identification of Weatherhead hose fitting series. Included in this chart are: base numbers, descriptions, hose fitting series, and page number in which the configuration appears. Catalog numbers may be derived by adding the size in sixteenths of an inch to the base.

Example: 100 series 3/4" male pipe rigid. $3/4" = 12/16"$ thus $100 + 12 = 112$.

Denotes Coll-O-Crimp Hose Fittings

Part # Suffix	Hose Fitting	Style	009 'B'	057 'B'	100 'B'	105 'B'	057 'P'	338 'B'	069 'D'	'E'	069 'E'	336 'E'	470 'E'	757 'E'	'K'	039 'K'	104 'N'	213 'N'	247 'N'	425 'N'	436 'N'	229 'P'	265 'P'	338 'P'	'S'	'U'	430 'U'	'Z'	4SP/6SP
00A	Male DIN (Light)	Rigid																							J-38	J-89			
00C	Female DIN (Light)	Swivel										J-18													J-44	J-88			
00D	Female DIN 45° (Light)	Swivel																							J-48	J-88			
00E	Female Din 24° 45° Tube Elbow	Swivel																								J-89	J-100		
00F	Male DIN (Heavy)	Rigid											J-17												J-39	J-90			
00K	Female 30° Flare (Komatsu)	Swivel								J-11															J-44	J-87			
00L	Female JIS 30° Flare	Swivel								J-4															J-45	J-87			
00P	Female Flat Face BSPP	Swivel																							J-46				
00S	Ready Lok®	Rigid																							J-46	J-58			
0PW	Pressure Washer	Swivel																											
30T	Straight Tube-Metric	Rigid																							J-47	J-84			
40P	Brit. Std. 60° Cone Parallel Female Pipe 45°	Swivel											J-19												J-50	J-86	J-98		
50C	Female DIN (Heavy)	Swivel																							J-44	J-89	J-100		
50D	Female DIN 90° (Light)	Swivel																							J-52	J-88			
50E	Female DIN 90° (Heavy)	Swivel																							J-52	J-90	J-100		
70P	Brit. Std 60° Cone Parallel Female Pipe 90°	Swivel								J-7			J-21												J-53	J-86	J-98		
050	Female Straight Pipe	Swivel										J-14													J-43	J-69			
100	Male Pipe	Rigid	K-2	K-3	K-5	K-8			K-12	J-2	J-9	J-13	J-17		K-14	K-15	K-16	K-19	K-22	K-27	K-30	J-32	J-34	J-36	J-37	J-55	J-68	J-99	
150	Male Pipe, British Standard Tapered	Rigid																							J-38				
200	Female Pipe	Rigid				K-8						J-14													J-42	J-69			
250	Female Pipe	Swivel			K-6																				J-43	J-69			

The chart to the side is designed to offer quick identification of Weatherhead hose fitting series. Included in this chart are: base numbers, descriptions, hose fitting series, and page number in which the configuration appears. Catalog numbers may be derived by adding the size in sixteenths of an inch to the base.

Example: 100 series 3/4" male pipe rigid. 3/4" = 12/16" thus 100 + 12 = 112.

Denotes Coll-O-Crimp Hose Fittings

Part # Suffix	Hose Fitting	Style	4SP/6SP	'Z'	430 'U'	'U'	'S'	338 'P'	265 'P'	229 'P'	436 'N'	425 'N'	247 'N'	213 'N'	104 'N'	039 'K'	'K'	757 'E'	470 'E'	336 'E'	069 'E'	'E'	069 'D'	338 'B'	057 'P'	105 'B'	100 'B'	057 'B'	009 'B'	
300	SAE 45° Male	Rigid		J-74		J-40							K-23					J-23		J-14							K-5	K-3		
350	Brit. Std 60° Cone Parallel Female Pipe	Swivel		J-85	J-58	J-45												J-18				J-4								
380	SAE 45° Male 45° Elbow	Rigid																J-25												
400	SAE 45° Female	Swivel		J-73		J-44		J-34		J-31								J-24		J-15		J-10					K-7			
440	SAE 45° Female 90° Tube Elbow Long	Swivel		J-74		J-51							K-26					J-27												
460	SAE 45° Female 90° Tube Elbow Short	Swivel											K-26	K-21								J-12								
480	SAE 45° Female 45° Tube Elbow	Swivel		J-73		J-48							K-25	K-21				J-26				J-11								
500	JIC 37° Male	Rigid		J-73		J-40							K-22							J-14		J-9								
550	JIC 37° Female 90° Tube Elbow	Swivel				J-54																								
600	JIC 37° Female	Swivel		J-70	J-57	J-43	J-36						K-24	K-20	K-17	K-15			J-18	J-15	J-10	J-4				K-6			K-2	
640	JIC 37° Female 90° Tube Elbow Long	Swivel		J-72		J-51							K-26		K-18					J-16										
660	JIC 37° Female 90° Tube Elbow	Swivel		J-102	J-63	J-52							K-29	K-29	K-18				J-20	J-16	J-12	J-6								
680	JIC 37° Female 45° Tube Elbow	Swivel		J-102	J-60	J-49							K-28	K-21	K-17				J-19	J-15	J-11	J-6								
750	Flareless Tube Ermeto®	Rigid		J-78		J-41												J-23												
950	Flareless Tube Ermeto® 45°	Rigid		J-78		J-48																								
970	Flareless Tube Ermeto® 90°	Rigid		J-78		J-52																								
A00	Inverted Female	Rigid		J-78																										
A20	Female For-Seal® 90° Tube Elbow Short	Swivel		J-75	J-63	J-53													J-21	J-16		J-8								

Numbering Systems

The chart to the side is designed to offer quick identification of Weatherhead hose fitting series. Included in this chart are: base numbers, descriptions, hose fitting series, and page number in which the configuration appears. Catalog numbers may be derived by adding the size in sixteenths of an inch to the base.

Example: 100 series 3/4" male pipe rigid. 3/4" = 12/16" thus 100 + 12 = 112.

Denotes Coll-O-Crimp Hose Fittings

Part # Suffix	Hose Fitting	Style	4SP/6SP	Z'	430 'U'	'U'	'S'	338 'P'	265 'P'	229 'P'	436 'N'	425 'N'	247 'N'	213 'N'	104 'N'	039 'K'	'K'	757 'E'	470 'E'	336 'E'	069 'E'	'E'	069 'D'	338 'B'	057 'P'	105 'B'	100 'B'	057 'B'	009 'B'
A60	Female For-Seal® 90° Tube Elbow Long	Swivel		J-76	J-63	J-54																J-8							
B00	Inverted Male	Swivel		J-79		J-40							K-23	K-19								J-10					K-6		
B20	Inverted Male Swivel Extended	Swivel									J-48		K-23									J-15							
B40	Inverted Male 45° Tube Elbow	Swivel																				J-5							
B60	Inverted Male 90° Tube Elbow	Swivel		J-80		J-50																J-6						K-4	
BD00	Cat Flange 22.5° Elbow	Code 62	J-96																										
BD30	Cat Flange 30° Elbow	Code 62	J-96																										
BD60	Cat Flange 60° Elbow	Code 62	J-96																										
BE00	Cat Flange 67.5° Elbow	Code 62	J-96																										
C00	Male Pipe 90° Elbow	Rigid																									K-7		
C30	Female Grease Tap	Rigid				J-42																							
C60	SAE 37° Female 60° Tube Elbow	Swivel			J-61																								
D00	Flange Straight	Code 62	J-95		J-59														J-19										
D40	Flange 45° Tube Elbow	Code 62	J-95		J-61														J-20										
D70	Flange 90° Tube Elbow	Code 62	J-95		J-64														J-21										
E00	Inverted Male 90° Elbow	Swivel											K-25	K-21								J-12							
E40	Inverted Male 45° Tube Elbow	Swivel											K-25	K-20								J-11							
E60	Male For-Seal® Straight	Rigid		J-77	J-56	J-39																							
G00	Flange Straight	Code 61	J-94	J-80	J-59	J-46						K-28				K-17			J-18										
G09	Flange Straight (Komatsu)	Special		J-83		J-46																							

Numbering Systems

Application Data

The chart to the side is designed to offer quick identification of Weatherhead hose fitting series. Included in this chart are: base numbers, descriptions, hose fitting series, and page number in which the configuration appears. Catalog numbers may be derived by adding the size in sixteenths of an inch to the base.

Example: 100 series 3/4" male pipe rigid. 3/4" = 12/16" thus 100 + 12 = 112.

Denotes Coll-O-Crimp Hose Fittings

Part # Suffix	Hose Fitting	Style	'009 'B'	'057 'B'	'100 'B'	'105 'B'	'057 'P'	'338 'B'	'069 'D'	'E'	'069 'E'	'336 'E'	'470 'E'	'757 'E'	'K'	'039 'K'	'104 'N'	'213 'N'	'247 'N'	'425 'N'	'436 'N'	'229 'P'	'265 'P'	'338 'P'	'S'	'U'	'430 'U'	'Z'	4SP/6SP
G40	Flange 45° Tube Elbow	Code 61											J-20				K-18									J-49	J-81	J-94	
G69	Flange 45° Tube Elbow (Komatsu)	Special																								J-50	J-83		
G70	Flange 90° Tube Elbow	Code 61											J-21				K-18									J-54	J-82	J-94	
G99	Flange 90° Tube Elbow	Special																									J-83		
H00	Flange 22-1/2° Tube Elbow	Code 61																									J-81		
H20	Flange 30° Tube Elbow	Code 61																											
H50	Flange 60° Tube Elbow	Code 61																										J-82	
H60	Flange 67-1/2° Tube Elbow	Code 61																											
H70	Flange 100° Tube Elbow	Code 61																											
H80	Flange 110° Tube Elbow	Code 61																											
H90	Flange 135° Tube Elbow	Code 61																											
J00	Male Pipe	Swivel								J-2																J-39	J-56	J-68	
J33	Female For-Seal® 90° Tube Elbow Med.	Swivel																								J-53	J-76	J-101	
J63	Female For-Seal® Straight	Swivel																										J-101	
K00	Flange Straight "Cat Flange"	Code 62																										J-96	
K30	Flange 45° Tube Elbow "Cat Flange"	Code 62																										J-96	
K60	Flange 90° Tube Elbow "Cat Flange"	Code 62																										J-96	
L00	Banjo (Ford Tractor)	Special																								J-47			
L10	JIC 37° Female 30° Tube Elbow	Swivel																								J-47	J-71		
L40	Male 45° Tube Elbow O-Ring Port	Swivel																								J-49			

Numbering Systems

The chart to the side is designed to offer quick identification of Weatherhead hose fitting series. Included in this chart are: base numbers, descriptions, hose fitting series, and page number in which the configuration appears. Catalog numbers may be derived by adding the size in sixteenths of an inch to the base.

Example: 100 series 3/4" male pipe rigid. 3/4" = 12/16" thus 100 + 12 = 112.

Denotes Coll-O-Crimp Hose Fittings

Part # Suffix	Hose Fitting	Style	4SP/6SP
L60	Female 45° For-Seal® Tube Elbow	Swivel	J-101
M00	Male Pipe 90° Elbow	Swivel	J-75 J-70
N20	Split Flange 30° Tube Elbow	Code 62	
N50	Split Flange 60° Tube Elbow	Code 62	
N60	Split Flange 67 1/2° Tube Elbow	Code 62	
P00	Male Straight Thread O-Ring	Rigid	J-42 J-56 J-77
P50	Male Pipe, Brit. Std. 60° Cone Parallel	Rigid	J-38 J-55 J-87
R00	Male Straight Thread O-Ring	Swivel	J-41 J-78
R60	Male Straight Thread O-Ring 90° Elbow	Swivel	J-54 J-78
S60	Female For-Seal® Straight	Swivel	J-45 J-58 J-47 J-84
T00	Straight Tube	Rigid	
T50	Straight Tube-Long	Rigid	
W00	Bumped Tube O-Ring Male	Rigid	
W40	Bumped Tube O-Ring Female 45° Tube Elbow	Swivel	
W60	Bumped Tube O-Ring Male 90° Tube Elbow	Rigid	
X00	SAE 45° Flare Male 90° Elbow	Rigid	
430 'U'			J-60
'U'			J-50 J-51
'S'			
338 'P'			
265 'P'			
229 'P'			
436 'N'			
425 'N'			
247 'N'			
213 'N'			
104 'N'			
039 'K'			
'K'			
757 'E'			
470 'E'			J-19 J-20 J-20
336 'E'			J-16 J-14
069 'E'			
'E'			J-6 J-5 J-5
069 'D'			
338 'B'			
057 'P'			
105 'B'			
100 'B'			
057 'B'			
009 'B'			

K, 24

J-23

J-25

J-26

J-26

Numbering Systems

Application Data

The chart to the side is designed to offer quick identification of Weatherhead hose fitting series. Included in this chart are: base numbers, descriptions, hose fitting series, and page number in which the configuration appears. Catalog numbers may be derived by adding the size in sixteenths of an inch to the base.

Example: 100 series 3/4" male pipe rigid. 3/4" = 12/16" thus 100 + 12 = 112.

Denotes Coll-O-Crimp Hose Fittings

Teflon® is a registered trademark of DuPont used under license by Eaton.

Part # Suffix	Hose Fitting	Style	4SP/6SP	'Z'	430 'U'	'U'	'S'	338 'P'	265 'P'	229 'P'	436 'N'	425 'N'	247 'N'	213 'N'	104 'N'	039 'K'	'K'	757 'E'	470 'E'	336 'E'	069 'E'	'E'	069 'D'	338 'B'	057 'P'	105 'B'	100 'B'	057 'B'	009 'B'	
X20	30° Flare Female (P.T.T. Thread for Diesel Applications)	Swivel																												
X60	SAE 37° Male 90° Elbow	Rigid				J-51																								
X80	Compressor Discharge (Teflon® Hose)	Flange																												
Y00	Hose Mender	Rigid																												
Y20	Male Connector	Rigid																												
Y30	Male Connector w/ Spring Guard	Rigid																												
Y33	Hose Splicer	Special																	J-24											
Y50	Air Brake Connection Tube	Rigid																				J-3								
Y60	Air Brake Slider	Rigid																				J-3								
Y70	Air Brake	Swivel																						K-9						
Y80	Female Connector	Swivel																						K-10						
Z00	Bumped Tube O-Ring Male	Swivel																												
Z20	Bumped Tube O-Ring 45° Tube Elbow	Swivel																												
Z40	Bumped Tube O-Ring Female	Swivel																												
Z50	Bumped Tube O-Ring Female w/Service Port	Swivel																												
Z60	Bumped Tube O-Ring Male 90° Tube Elbow	Swivel																												
Z80	Bumped Tube O-Ring Female 90° Tube Elbow	Swivel																												
Z90	Bumped Tube O-Ring 90° Tube Elbow w/Service Port	Swivel																												

Skiving Procedures

Hose Cut-Off Factor

Select the proper hose and ends and cut hose to length. The cut length of the hose is determined by subtracting the cut-off factor for each end from the overall length of the assembly. See individual catalog listings for hose cut-off factors.

Skiving Weatherhead Hose (When using H470 hose with 470 'E' series hose fittings)

The outer protective covering of wire-wrapped hose must be carefully removed (skived) to the wire to allow proper installation of crimped hose fittings and to assure the best possible hose service. When skiving a hose, it is advisable to skive a practice piece of hose to determine:

- That covering is properly removed and that the hose wire-wrap reinforcements are not displaced, damaged or cut in the process.
- The hose should be checked for correct skive length.
- The hose should be checked for 100% cover removal.

Hand-Tool Method

Skiving heads are shipped preset for proper skive length. Depending on hose cover thickness, the skiving blade may require adjustment. The skiving blade may need periodic adjustment. Directions are packed with the skive tool.

1. Clamp hose in a vise or other suitable holding device. Be sure not to clamp so tight as to damage hose.
2. Lubricate hose I.D. and skiving tool mandrel with oil/soap solution.
3. Carefully align mandrel with hose I.D.; apply steady pressure and start mandrel into hose.
4. When cutting head contacts hose fitting, slowly rotate skiving tool clockwise. Cutting head will remove hose covering while threading itself to a preset skive length when bottomed against hose fitting. Continue to rotate skiving tool clockwise to remove excess rubber from wire wrap while slowly pulling tool from hose. (See illustration to right.)
5. Wire-brush hose fitting to remove any remaining cover from wire wrap.
6. Inspect skive for 100% cover removal.

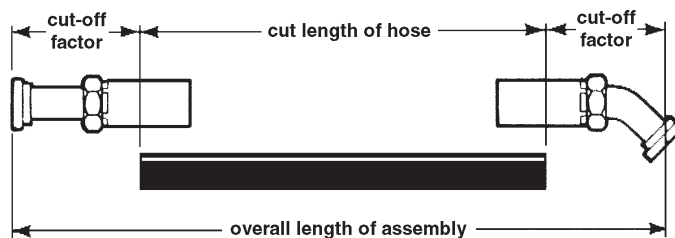

Hose H470

Hose I.D.	Skive Length	Cutting Head
1/2	1-1/4	T-410-50
3/4	1-13/16	T-410-52
1	2-1/8	T-410-53
1-1/4	2-7/8	T-410-54
1-1/2	3-1/8	T-410-55
2	3-3/8	T-410-56
T-410-36 T-410-37	Handle Replacement cutting	

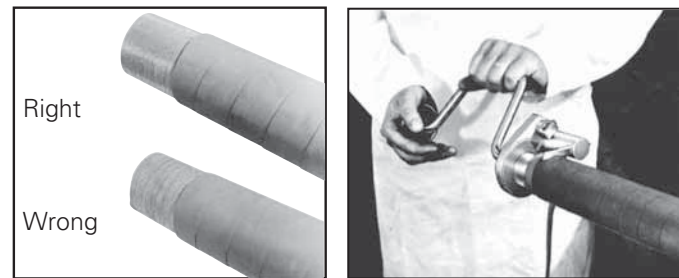

⚠ Important

Clean hose I.D. by brushing, blowing compressed air, or by flushing. By doing so, contaminants are kept out of operating systems.

⚠ WARNING

Clean hose I.D. by brushing, blowing compressed air, or by flushing. By doing so, contaminants are kept out of operating systems.

Hose Installation

1. Provide for length change.

In straight hose installations, allow enough slack in the hose line to provide for changes in length that will occur when pressure is applied. This change in length can be from +2% to -4%.

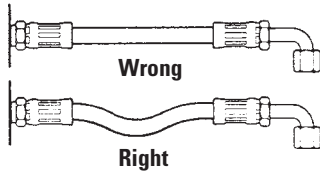

2. Avoid twisting and orient properly.

Do not twist hose during installation. This can be determined by the printed layline on the hose. Pressure applied to a twisted hose can cause hose failure or loosening of connections.

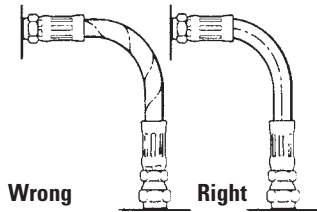

3. Protect from hazardous environment.

Keep hose away from hot parts. High ambient temperature will shorten hose life. If you can not route it away from the heat source, insulate it. (See Spring Guards page M-2.)

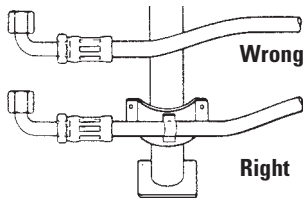

4. Avoid mechanical strain.

Use elbows and adapters in the installation to relieve strain on the assembly and to provide easier and neater installations that are accessible for inspection and maintenance.

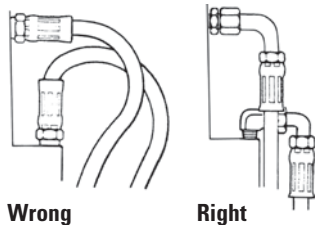

5. Use proper bend radius.

Keep the bend radius of the hose as large as possible to avoid collapsing of the hose and restriction of flow. Follow catalog specs on minimum bend radii.

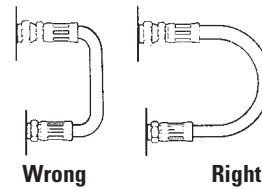

6. Use proper bend radius (cont'd).

Minimum bend radius is measured on the inside bend of the hose. To determine minimum bend, divide the total distance between ends (B length) by 2. For example, B=6, minimum bend radius=3.

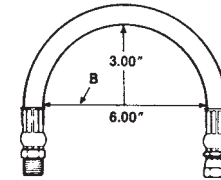

7. Secure for protection.

Install hose runs to avoid rubbing or abrasion. Use Weatherhead Hose Clamps to support long runs of hose or to keep hose away from moving parts. It is important that the clamps not allow the hose to move. This movement will cause abrasion and premature hose failure.

See Hose Clamps pages M-24-26.

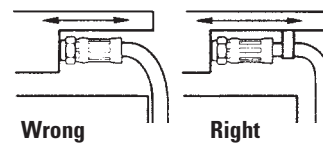

8. Avoid improper hose movement.

Make sure relative motion of the machine components produces bending rather than twisting of the hose. Hose should be routed so that the flex is in the same plane as the equipment movement.

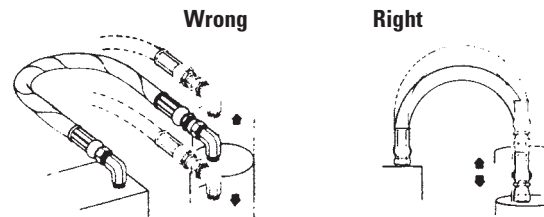

 Refer to safety information regarding Weatherhead hose installation on pages A-2-3.

- 1. Problem:** Hose has burst. Rusted wire, torn and rotted fibers are present. This was caused by abrasion damage. Exposure to elements will accelerate the deterioration.



Solution: Route the hose so it does not rub against other objects while under pressure. Suggest using clamps and spring guards to protect.

- 2. Problem:** Hose has burst on outside bend of hose. This hose has been bent past minimum bend radius. It has also taken a set in a bent position due to a kink in the inner tube or reinforcement.



Solution: Check minimum bend radius for hose. Refer to pages A-31-32 to determine minimum bend radius. Utilize bend tube elbows if possible.

- 3. Problem:** Excessive heat. Hose cover or inner tube is brittle and cracked and is not flexible at room temperature.



Solution: Use hose with higher temperature rating or protect from heat with shields. Examine entire system for potential heat source. For example: undersized lines, excessively long lines, too many bends and/or fittings, reservoir low on oil.

- 4. Problem:** Incompatible fluid. Portions of the inner tube are swollen and/or washed out. Cover may also be swollen.

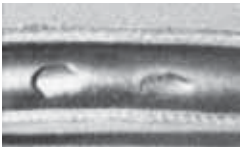

Solution: Make sure hose used is compatible with fluid being used. Refer to chemical compatibility chart.

- 5. Problem:** Hose cover blistered and pulling away from carcass. Gas has effused through the tube and become trapped under the cover.



Solution: Use perforated, pin-pricked or fiber cover hose.

- 6. Problem:** End fitting blown off. Improper assembly procedures, incorrect hose fitting series, mixing competitor's components and Weatherhead components.



Solution: Refer to hose assembly procedures and Hose Fitting and Tool Selector Chart in this catalog. NEVER intermix components. Refer to pages A-2-3 for important safety information.

- 7. Problem:** Hose has burst cleanly with no random wire breakage and cover abrasion. This condition is caused by excessive pressure.



Solution: Use hose with higher pressure rating. Check pressure relief for damage or improper setting.

- 8. Problem:** Hose has burst. Hose is permanently twisted and kinked. Many broken wires in failure area.



Solution: Hose twisting can reduce hose life 90%. Tighten ends properly. Reroute hose to eliminate twist. Route hose to flex in only one plane. Use hose layline for a guide.

- 9. Problem:** End fitting blown off. This condition has been caused by improper skiving. Any remaining cover on hose in the crimping area will prohibit proper end retention.



Solution: Make sure hose is properly skived. Refer to page A-30 for hose skiving instructions.

- 10. Problem:** Hose fitting appears to have been pinched on one side.



Solution: This is an early sign of collet wear. Replace collet. New Weatherhead collets offer the feature of being rebuildable. See the tool section chart in the back of this catalog.

WARNING

Selection of Hose: Selection of the proper hose for the application is essential to the proper operation and safe use of the hose and related equipment. Inadequate attention to selection of hose for application can result in serious bodily injury or property damage. In order to avoid serious bodily injury or property damage resulting from selection of the wrong hose, you should carefully review the information in this catalog. Refer to Selection of Hose and Hose Installation (pages A-4-9 and pages A-31-32) for additional safety information. Hose failures can be caused by conditions such as excessive pressures, fluid incompatibility, extreme temperatures, and many more. Eaton has illustrated above some of the more common failures. If the conditions you are experiencing are not listed, please contact your Eaton representative for further assistance.

Qualified Hoses for Marine Applications

SAE J1942

Application Codes:

MAWP - Maximum Allowable Working Pressure

H - Hydraulic service

F - Fuel and Lube service

Hose Number	App. Code	Hose ID	MAWP (PSI)	Hose Fittings	Fire Sleeve Required
H009	H	1/4	400	009 'H'	--
H009	H	5/16	400	'E', 009 'H'	--
H009	H	3/8	400	'E', 009 'H'	--
H009	H	1/2	400	'E', 009 'H'	--
H017	H	1/4	1250	'U'	--
H017	H	3/8	1125	'U'	--
H017	H	1/2	1000	'U'	--
H017	H	3/4	750	'U'	--
H017	H	1	560	'U'	--
H017	H	1-1/4	375	'U'	--
H039	H	3/4	300	'U', 'S'	--
H039	H	1	250	'U', 'S'	--
H039	H	1-1/4	200	'U', 'S'	--
H039	H	1-1/2	150	430 'U'	--
H039	H	2	100	430 'U'	--
H059	F	3/16	500	069 'E', 229 'P', 247 'N'	--
H059	F	1/4	500	069 'E', 247 'N'	--
H059	F	5/16	500	069 'E', 229 'P', 247 'N'	--
H059	F	13/32	500	069 'E', 229 'P', 247 'N'	--
H059	F	1/2	500	069 'E', 229 'P', 247 'N'	--
H059	F	5/8	500	069 'E', 247 'N'	--
H059	F	7/8	500	069 'E', 247 'N'	--
H104	H	1/4	2750	'U', 104 'N', 'S', 'Z'	--
H104	H	3/8	2250	'U', 104 'N', 'S', 'Z'	--
H104	H	1/2	2000	'U', 104 'N', 'S', 'Z'	--
H104	H	5/8	1500	'U', 'Z'	--
H104	H	3/4	1250	'U', 104 'N', 'S', 'Z'	--
H104	H	1	1000	'U', 104 'N', 'S', 'Z'	--
H104	H	1-1/4	625	'U', 'S', 'Z'	--
H104*	F	1/4	500	'U', 104 'N', 'S', 'Z'	A6912
H104*	F	3/8	500	'U', 104 'N', 'S', 'Z'	A6914
H104*	F	1/2	500	'U', 104 'N', 'S', 'Z'	A6916
H104	F	5/8	500	'U', 'Z'	--
H104	F	3/4	500	'U', 104 'N', 'S', 'Z'	--
H104	F	1	500	'U', 104 'N', 'S', 'Z'	--
H104	F	1-1/4	500	'U', 'S', 'Z'	--
H145	H	1/4	3000	'Z', 'S'	--
H145	H	3/8	3000	'U', 'Z', 'S'	--
H145	H	1/2	3000	'U', 'Z', 'S'	--
--					
H145	H	5/8	3000	'U', 'Z'	--
H145	H	3/4	3000	'U', 'S'	--
H145	H	1	3000	430 'U', 'S'	--
H190	H	1/4	3700	'Z'	--
H190	H	3/8	3400	'Z'	--
H190	H	1/2	2900	'Z'	--
H190	H	5/8	1885	'Z'	--
H190	H	3/4	2000	'Z'	--
H190	H	1	1500	'Z'	--
H245	H	1/4	5000	'U', 'S', 'Z'	--
H245	H	3/8	4000	'U', 'S', 'Z'	--
H245	H	1/2	3500	'U', 'S', 'Z'	--

Hose Number	App Code	Hose ID	MAWP (PSI)	Hose Fittings	Fire Sleeve Required
H245	H	5/8	2750	'U', 'Z'	--
H245	H	3/4	2250	'U', 'S', 430 'U', 'Z'	--
H245	H	1	2000	'U', 'S', 430 'U', 'Z'	--
H245	H	1-1/4	1625	'U', 'S', 430 'U', 'Z'	--
H245*	F	1/4	500	'U', 'S', 'Z'	A6912
H245*	F	3/8	500	'U', 'S', 'Z'	A6914
H245*	F	1/2	500	'U', 'S', 'Z'	A6916
H245*	F	5/8	500	'U', 'Z'	A6920
H245*	F	3/4	500	'U', 'S', 'Z'	A6924
H245*	F	1	500	'U', 'S', 'Z'	A6928
H245*	F	1-1/4	500	'U', 'S', 'Z'	A6936
H280	H	1/4	6500	'Z'	--
H280	H	3/8	5300	'Z'	--
H280	H	1/2	4500	'Z'	--
H280	H	5/8	4000	'Z'	--
H280	H	3/4	3500	'Z'	--
H280	H	1	3000	'Z'	--
H290	H	1/4	6500	'Z'	--
H290	H	3/8	5800	'Z'	--
H290	H	1/2	5000	'Z'	--
H290	H	5/8	4000	'Z'	--
H290	H	3/4	3500	'Z'	--
H290	H	1	3000	'Z'	--
H425	H	1/4	5000	'U', 'S', 'Z'	--
H425	H	3/8	4000	'U', 'S', 425 'N', 'Z'	--
H425	H	1/2	3500	'U', 'S', 425 'N', 'Z'	--
H425	H	5/8	2750	'U', 'Z'	--
H425	H	3/4	2250	'U', 'S', 430 'U', 425 'N', 'Z'	--
H425	H	1	2000	'U', 'S', 430 'U', 425 'N', 'Z'	--
H425	H	1-1/4	1625	'U', 'S', 430 'U', 425 'N', 'Z'	--
H425	H	1-1/2	1250	430 'U', 'Z'	--
H425	H	2	1125	430 'U', 425 'N', 'Z'	--
H425*	F	1/4	500	'U', 'S', 425 'N', 'Z'	A6912
H425*	F	3/8	500	'U', 'S', 425 'N', 'Z'	A6916
H425*	F	1/2	500	'U', 'S', 425 'N', 'Z'	A6920
H425*	F	5/8	500	'U', 'Z'	A6920
H425*	F	3/4	500	'U', 'S', 425 'N', 'Z'	A6924
H425*	F	1	500	'U', 'S', 425 'N', 'Z'	A6928
H425*	F	1-1/4	500	'U', 'S', 425 'N', 'Z'	A6936
H430	H	3/4	5500	430 'U'	--
H430	H	1	5100	430 'U'	--
H430	H	1-1/4	4500	430 'U'	--
H430	H	1-1/2	4000	430 'U'	--
H430	H	2	4000	430 'U'	--
H470	H	3/4	5000	470 'E'	--
H470	H	1	5000	470 'E'	--
H470	H	1-1/4	5000	470 'E'	--
H569	H	3/16	3000	069 'E'	--
H569	H	5/16	2250	069 'E', 247 'N'	--
H569	H	13/32	2000	069 'E', 247 'N'	--
H569	H	1/2	1750	069 'E', 247 'N'	--
H569	H	5/8	1500	069 'E', 247 'N'	--
H569	H	7/8	800	069 'E'	--
H569	H	1-1/8	625	069 'E'	--

*Fire sleeve required for fuel applications

Qualified Hoses for the American Bureau of Shipping

ABS Steel Vessel Rules 2000 (4-6-2/5.7)

Intended Service: Fuel Oil, Hydraulic Fluid and Water Systems for Marine and Offshore Applications

Hose Number	Hose ID	Mawp (PSI)	Hose Fittings Series	Fire Sleeve
H03912	3/4	300	'U', 'S', 039 'K', 'Z'	A6924
H03916	1	250	'U', 'S', 039 'K', 'Z'	A6928
H03920	1-1/4	200	'U', 'S', 039 'K', 'Z'	A6932
H03924	1-1/2	150	430 'U'	A6936
H03932	2	100	430 'U'	A6948
H05904	3/16	500	247 'N', 229 'P', 069 'E'	--
H05905	1/4	500	247 'N', 069 'E'	--
H05906	5/16	500	247 'N', 229 'P', 069 'E'	--
H05908	13/32	500	247 'N', 229 'P', 069 'E'	--
H05910	1/2	500	247 'N', 229 'P', 069 'E'	--
H05912	5/8	500	247 'N', 069 'E'	--
H05916	7/8	500	229 'P', 069 'E'	--
H06904	3/16	3000	069 'E', 247 'N'	--
H06905	1/4	500	069 'E', 247 'N'	--
H06906	5/16	2250	069 'E', 247 'N'	--
H06908	13/32	2000	069 'E', 247 'N'	--
H06910	1/2	1750	069 'E', 247 'N'	--
H06912	5/8	1500	069 'E', 247 'N'	--
H06916	7/8	800	069 'E', 247 'N', 069 'D'	--
H06920	1-1/8	625	069 'E'	--
H06924	1-3/8	500	069 'E'	--
H06932	1-13/16	350	069 'E'	--
H10404	1/4	2750	'U', 'S', 104 'N', 'Z'	--
H10406	3/8	2250	'U', 'S', 104 'N', 'Z'	--
H10408	1/2	2000	'U', 'S', 104 'N', 'Z'	--
H10410	5/8	1500	'U', 'Z'	--
H10412	3/4	1250	'U', 'S', 104 'N', 'Z'	--
H10416	1	1000	'U', 'S', 104 'N', 'Z'	--
H10420	1-1/4	625	'U', 'S', 'Z'	--
H24504	1/4	5000	'U', 'S', 'Z'	--
H24506	3/8	4000	'U', 'S', 'Z'	--
H24508	1/2	3500	'U', 'S', 'Z'	--
H24510	5/8	2750	'U', 'Z'	--
H24512	3/4	2250	'U', 'S', 'Z'	--
H24516	1	2000	'U', 'S', 'Z'	--
H24520	1-1/4	1625	'U', 'S', 'Z'	--

Hose Number	Hose ID	MAWP (PSI)	Hose Fittings Series	Fire Sleeve
H42504	1/4	5000	'U', 'S', 425 'N', 'Z'	--
H42506	3/8	4000	'U', 'S', 425 'N', 'Z'	--
H42508	1/2	3500	'U', 'S', 425 'N', 'Z'	--
H42510	5/8	2750	'U', 'Z'	--
H42512	3/4	2250	'U', 'S', 425 'N', 'Z'	--
H42516	1	2000	'U', 'S', 425 'N', 'Z'	--
H42520	1-1/4	1625	'U', 'S', 425 'N', 'Z'	A6936
H42524	1-1/2	1250	430 'U', 425 'N', 'Z'	--
H42532	2	1125	430 'U', 425 'N', 'Z'	--
H43008	1/2	6000	430 'U'	--
H43012	3/4	5500	430 'U'	--
H43016	1	5100	430 'U'	--
H43020	1-1/4	4500	430 'U'	--
H43024	1-1/2	4000	430 'U'	--
H43032	2	4000	430 'U'	--
H47012	3/4	5000	570 'S'	--
H47016	1	5000	570 'S'	--
H47020	1-1/4	5000	570 'S'	--
H47024	1-1/2	5000	570 'S'	--
H47032	2	5000	570 'S'	--
H56906	5/16	2250	069 'E'	--
H56908	13/32	2000	069 'E'	--
H56910	1/2	1750	069 'E'	--
H56912	5/8	1500	069 'E'	--
H56916	7/8	800	069 'E'	--
H56920	1-1/8	625	069 'E'	--

MAWP - Maximum Allowable Working Pressure

Note: Restrictions on taper thread joints in hydraulic systems for steering gear, controllable pitch propellers, or other systems associated with propulsion or propulsion control are applicable.

See SVR 2000 4-6-2/5.5.5.

Split flanges, such as 570 'S' Series, are not permitted in steering gear systems. Each hose may only utilize end fitting series listed above.

These products/models are covered under ABS Product Design Assessment Certificate #00-HS191306-PDA dated 18-JAN-06. It will remain valid for five years from date of issue or until rules or specifications used in the assessment are revised (whichever occurs first).

JIC 37° and SAE 45° Flare Fittings For Zinc Plated Carbon without Thread Sealant or Lubrication

Size	Fraction	Decimal	Lb./In.	Lb./Ft.	Newton Meters	Add'l Turns of Hex-Flats**
- 04	1/4"	0.250	130-150	11-12	15-17	2
- 05	5/16"	0.312	165-195	14-16	19-22	2
- 06	3/8"	0.375	235-265	20-22	27-30	1-1/4
- 08	1/2"	0.500	525-575	44-48	59-65	1
- 10	5/8"	0.625	600-700	50-58	68-79	1
- 12	3/4"	0.750	950-1050	79-88	107-119	1
- 16	1"	1.000	1400-1500	117-125	158-170	1
- 20	1-1/4"	1.250	1900-2100	158-175	215-237	1
- 24	1-1/2"	1.500	2250-2550	188-213	254-288	1
- 32	2"	2.000	3000-3400	250-283	339-384	1

** Additional turns of Hex-Flats required after finger tightening.
THIS IS THE RECOMMENDED METHOD OF TIGHTENING BOTH 37° SWIVEL and 45° FLARE FITTINGS.

Straight Thread O-ring Fittings For Zinc Plated Steel without Sealant or Lubrication

Size	Fraction	Decimal	Lb./In.	Lb./Ft.	Newton Meters
- 04	1/4"	0.250	156-180	13-15	18-20
- 05	5/16"	0.312	204-228	17-19	23-26
- 06	3/8"	0.375	264-288	22-24	30-33
- 08	1/2"	0.500	480-516	40-43	54-58
- 10	5/8"	0.625	516-576	43-48	58-65
- 12	3/4"	0.750	816-900	68-75	92-102
- 16	1"	1.000	1344-1476	112-123	152-167
- 20	1-1/4"	1.250	1752-1932	146-161	198-218
- 24	1-1/2"	1.500	1848-2040	154-170	209-231
- 32	2"	2.000	2616-2880	218-240	296-325

FOR-SEAL® Fittings For Zinc Plated Steel without Thread Sealant or Lubrication

Size	Fraction	Decimal	For-Seal Swivel Nut Fitting			O-ring Boss Straight Thread O-ring Locknut		
			Lb./In.	Lb./Ft.	Newton Meters	Lb./In.	Lb./Ft.	Newton Meters
- 04	1/4"	0.250	120-144	10-12	14-16	168-192	14-16	19-22
- 06	3/8"	0.375	216-240	18-20	24-27	288-312	24-26	33-35
- 08	1/2"	0.500	384-420	32-35	43-48	600-720	50-60	68-81
- 10	5/8"	0.625	552-600	46-50	62-68	864-960	72-80	98-109
- 12	3/4"	0.750	780-840	65-70	88-95	1500-1620	125-135	170-183
- 16	1"	1.000	1104-1200	92-100	125-136	2400-2640	200-220	271-298
- 20	1-1/4"	1.250	1500-1680	125-140	170-190	2520-3360	210-280	285-380
- 24	1-1/2"	1.500	1800-1980	150-165	203-224	3240-4320	270-360	366-488

Torque Value Conversion Chart

Lb. / Inch	= Pound Foot (Lb./Ft.) x 12	Lb. / Foot	= Pound Inch (Lb./In.) x 0.083
Lb. / Inch	= Newton Meter x 8.850	Lb. / Foot	= Newton Meter x 0.737
Newton Meter	= Pound Inch (Lb./In.) x 0.113	Newton Meter	= Pound Foot (Lb./Ft.) x 1.356

Note: Please consult Eaton for other material torque ratings.

Tubing Types

Commercial tubing is available in a wide variety of materials, types of construction and quality. Each is best suited for certain specific applications.

Steel Tubing - Seamless SAE 1010 fully annealed and SAE welded types suitable for bending and flaring. This is the only tubing material approved without restrictions by SAE standards.

Stainless Steel Tubing - Both seamless *18-8 fully annealed and welded types suitable for bending and flaring. Stainless steeltubing is recommended for use with very high pressures and here large diameter tubing is required. It is also suited for many applications where corrosion is a problem. *(302, 303 and/or 304)

Aluminum Tubing - Seamless annealed is approved by SAE for low pressure applications.

Copper Tubing - Seamless fully annealed coils and fully annealed or quarterhard straight lengths can be used for systems that do not use petroleum based fluids (copper acts as an oil-oxidation catalyst, causing sludge). Copper also tends to work harden when flared or bent and has poor resistance to vibration. Therefore, the use of copper tubing is limited to low-pressure stationary applications and air circuits.

Special Alloy Tubing - May be required for specific corrosion problems. Information on these applications can be obtained from your tubing supplier or from tubing manufacturers.

Tubing Size

The two variables in tubing size are the inside diameter (I.D.) and the wall thickness. Each of these is dependent upon a number of factors.

Inside Diameter - The tubing I.D. will determine the flow and velocity of the fluid in the system. Flow is the volume of fluid that is to be moved through the line to perform a given job within a specified time. Flow rate is expressed in gallons per minute (gpm). Velocity is the rate of speed at which the fluid passes through the line. It is expressed in feet per second (fps). With a given flow rate, the velocity will increase as the inside diameter of the tubing decreases. To determine the appropriate tubing I.D. for specific flow rate and velocity, refer to the Velocity vs. Flow chart on page A-38.

Wall Thickness - The required wall thickness of the tubing depends upon operating pressure, safety factor, temperatures, and tubing material. Operating Pressure is the pressure of the fluid in the system. It is expressed in pounds per square inch (psi). Safety Factor is a multiplier applied to the wall thickness that compensates for additional mechanical strains and hydraulic shocks to which the tubing may be subjected during operation. To determine the appropriate wall thickness, refer to the data on pages A-39-42.

Pressure Drop

Total pressure supplied to a line must equal usable pressure (or output) plus the pressure that is lost through fluid transmission, which is referred to as pressure drop. These pressure drops cause loss of energy and should be kept to a minimum. Elements which cause pressure drop in the transmission of fluids include sudden enlargements or contractions, bends, fittings and valves.

Mathematical analysis of pressure drop, although possible, is not precise because of the interrelationship of factors such as fluid velocity, density, flow area and friction coefficients. Therefore, to obtain optimum efficiency, the system (or the questionable portions of the system) should be mocked-up to obtain empirical pressure drop data.

WARNING

Refer to safety information regarding tubing selection on pages A-2-3.

To select tubing for a particular installation, two factors must be determined:

1. **Tubing Type** - material and construction and
2. **Size** - inside diameter (I.D.) and wall thickness.
Information listed below will aid in your tubing selection.

⚠ WARNING

Refer to safety information regarding tubing selection on pages A-2-3.

Following is a typical problem that illustrates, step by step, the procedure for determining tube size.

Select 1010 steel tubing with the appropriate I.D. and wall thickness for the following conditions:

- Flow 5 gpm
- Velocitynot to exceed 10 fps
- Pressure 2000 psi
- Safety Factor4:1

Solution:

1. Using the Flow/Velocity chart on Page A-38, follow the horizontal flow line (5 gpm) until it intersects the vertical velocity line (10fps). From this point, follow the diagonal line upward to get the required tube I.D. (.444). If the horizontal flow line and the vertical velocity line intersect between two diagonal lines, normally the larger inside diameter would be selected since it would mean less velocity.
2. Refer to the chart of Standard Size Hydraulic Tubing, at right. Note that .444 I.D. tubing is not listed. If you want to use standard tubing, select one with a larger I.D. Do not select a smaller size since this would increase the velocity to over the 10 fps limit. Therefore, by going to the next largest size, you would select the 5/8" O.D. tubing having an I.D. of .459 and a wall thickness of .083.
3. To determine whether this tubing will meet the pressure and safety factor requirements, refer to the Recommended Wall Thickness data on pages 31-34. For 5/8" O.D. tubing at 2000 psi, the chart for 1010 steel indicates that the minimum wall thickness with a safety factor of 4:1 is .04545. Since you have selected a tubing with a .083 wall, this would easily fulfill the requirements. However, for savings on weight and cost, you can select another tubing with a thinner wall that will still meet the performance requirements. Therefore, refer again to the chart on standard size tubing and select a tubing with a wall thickness closer to the minimum requirements. This would be the 5/8" O.D. tubing with a .527 I.D. and a .049 wall. This tubing will handle the pressure requirements of 2000 psi with a safety factor of 4:1, and also provides the required flow while keeping the velocity within the 10 fps limitation.

Tube O.D.	Tube I.D.	Wall	Tube O.D.	Tube I.D.	Wall
1/8"	.055	.035	3/4"	.584	.083
	.061	.032		.606	.072
	.065	.030		.620	.065
3/16"	.069	.028	.634	.058	
	.117	.035	.652	.049	
	.123	.032	.680	.035	
1/4"	.127	.030	7/8"	.657	.109
	.120	.065	.685	.095	
	.134	.058	.709	.083	
5/16"	.152	.049	.731	.072	
	.166	.042	.745	.065	
	.180	.035	.759	.058	
3/8"	.190	.030	.777	.049	
	.182	.065	1"	.760	.120
	.196	.058	.782	.109	
1/2"	.214	.049	.810	.095	
	.228	.042	.834	.083	
	.242	.035	.856	.072	
5/8"	.248	.032	.870	.065	
	.245	.065	.884	.058	
	.259	.058	.902	.049	
3/4"	.277	.049	1-1/4"	.982	.134
	.291	.042	1.010	.120	
	.305	.035	1.032	.109	
1"	.311	.032	1.060	.095	
	.310	.095	1.084	.083	
	.334	.083	1.106	.072	
1-1/8"	.358	.072	1.120	.065	
	.370	.065	1.134	.058	
	.384	.058	1.152	.049	
1-1/4"	.402	.049	1.232	.134	
	.416	.042	1.260	.120	
	.430	.035	1.282	.109	
1-3/8"	.436	.032	1.310	.095	
	.435	.095	1.334	.083	
	.459	.083	1.356	.072	
1-1/2"	.481	.072	1.370	.065	
	.495	.065	1.732	.134	
	.509	.058	1.760	.120	
1-3/4"	.527	.049	1.782	.109	
	.541	.042	1.810	.095	
	.555	.035	1.834	.083	
2"	.532	.109	1.856	.072	
	.560	.095	1.870	.065	

Tubing Selection

To Find the Required Tube I.D. Flow—20 gpm • Velocity—9 fps

Follow horizontal flow line (20 gpm) until it intersects vertical velocity line (9 fps). From this point follow diagonal line to get required Tube I.D.—(.944).

To Find Permissible Flow Velocity—15 fps • Tube I.D.—.495

Follow vertical velocity line (15 fps) until it intersects diagonal line representing .495 tube I.D. Then project this point horizontally to get the permissible flow—(9 gpm).

To Find Velocity of Fluid in System Flow—6 gpm • Tube I.D.—.694

Follow horizontal flow line (6 gpm) until it intersects diagonal line representing .694 tube I.D. Then project this point vertically downward to get the velocity of fluid—(5 fps).

Flow/Velocity Chart

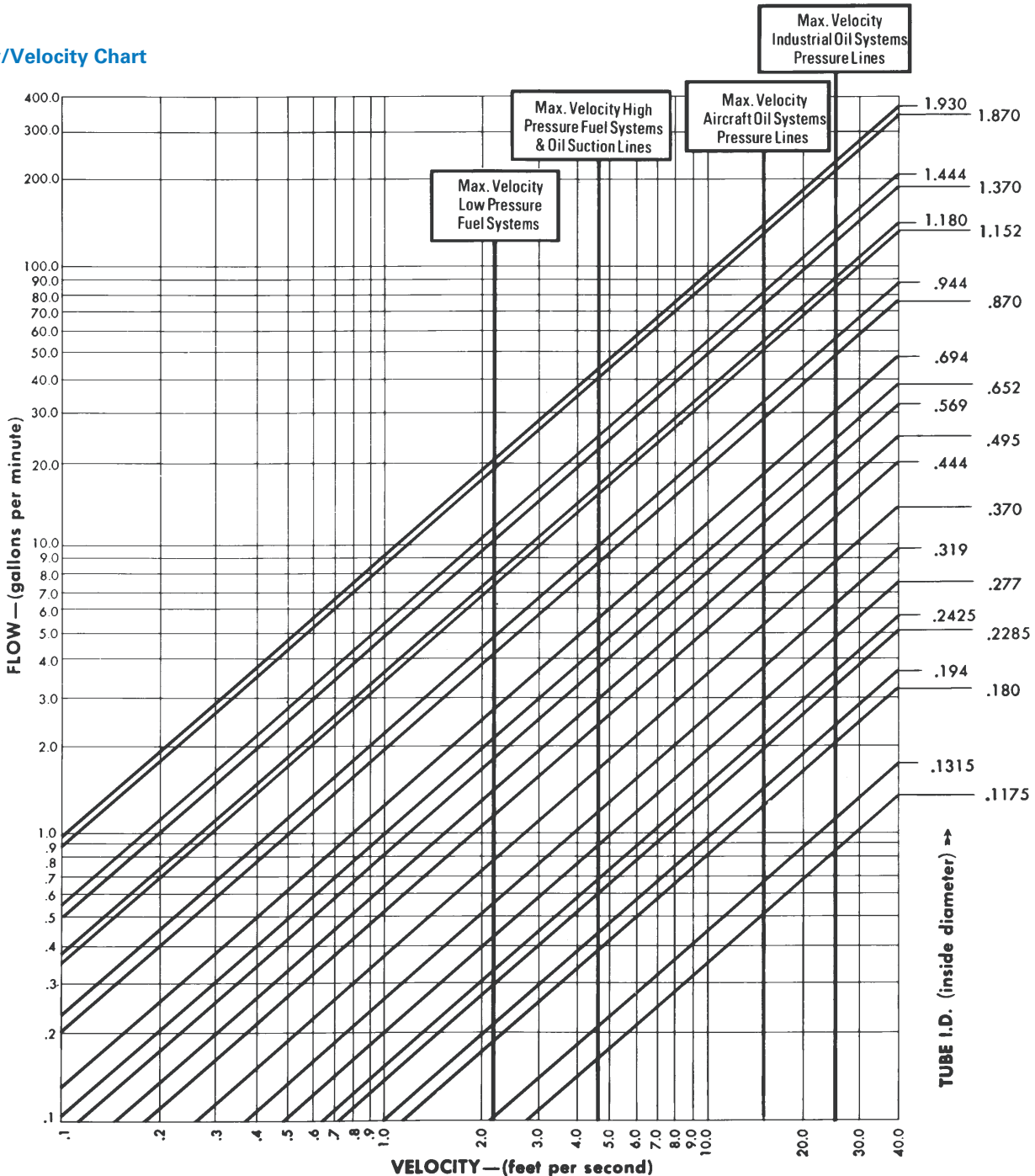

Tubing Selection

⚠ WARNING Refer to safety information regarding tubing selection on pages A-2-3.

With the following Recommended Wall Thickness tables the tubing wall can be selected that is best suited for a particular application. The data given in these tables are raw figures based on the equation – $t = \frac{Dp}{2S}(FS)$

t–wall thickness (inches)

D–O.D. of tube (inches)

p–pressure (psi)

FS–Safety Factor

S–tensile strength of tubing material

Therefore, many of the wall thicknesses given in these tables are not found on standard tubing, but serve to establish the minimum wall required.

Safety Factor – The standard safety factors indicate three grades of severity of service:

4:1 – mechanical and hydraulic shocks not excessive

6:1 – considerable mechanical strain and hydraulic shock

8:1 – hazardous applications with severe service conditions

The wall thickness shown in these tables are based on ultimate strength of material and a safety factor of 4:1.

Recommended Wall Thickness Tables

1010 STEEL Based on 55,000#/in.2 Strength (F S=4)

Hose O.D.	Working Pressure (psi)				
	1,000	2,000	3,000	4,000	5,000
1/8	.00455	.00909	.01364	.01818	.02273
3/16	.00682	.01364	.02045	.02727	.03409
1/4	.00909	.01818	.02727	.03636	.04545
5/16	.01136	.02273	.03409	.04545	.05682
3/8	.01364	.02727	.04091	.05455	.06818
1/2	.01818	.03636	.05455	.07273	.09091
5/8	.02273	.04545	.06818	.09091	.11364
3/4	.02727	.05455	.08182	.10909	.13636
7/8	.03182	.06364	.09545	.12727	.15909
1	.03636	.07273	.10909	.14545	.18182
1-1/4	.04545	.09091	.13636	.18182	.22727
1-1/2	.05455	.10909	.16364	.21818	.27273
2	.07273	.14545	.21818	.29091	.36364

4130 STEEL Based on 90,000#/in.2 Strength (F S=4)

Hose O.D.	Working Pressure (psi)				
	1,000	2,000	3,000	4,000	5,000
1/8	.00278	.00556	.00833	.01111	.01389
3/16	.00417	.00833	.01250	.01667	.02083
1/4	.00556	.01110	.01667	.02222	.02778
5/16	.00694	.01389	.02083	.02778	.03472

Hose O.D.	Working Pressure (psi)				
	1,000	2,000	3,000	4,000	5,000
3/8	.00833	.01667	.02499	.03333	.04167
1/2	.01111	.02222	.03333	.04444	.05556
5/8	.01389	.02778	.04167	.05556	.06944
3/4	.01667	.03333	.04999	.06667	.08333
7/8	.01944	.03889	.05833	.07778	.09722
1	.02222	.04444	.06667	.08889	.11111
1-1/4	.02778	.05556	.08333	.11111	.13889
1-1/2	.03333	.06667	.09999	.13333	.16667
2	.04444	.08889	.13333	.17778	.22222

To obtain the recommended wall for a specific pressure based on a safety factor of 6:1, multiply the wall thickness indicated in the table by 1.5. For a safety factor of 8:1, multiply by 2:

Temperature – The wall thickness found by using these tables can be corrected for temperature by multiplying the wall thickness by the appropriate correction factor given in the chart below. The table is based on strength reduction due to increased temperature.

Temperature	1010 Steel	Stainless Steel	Copper	Aluminum
+100F.	1.00	1.00	1.00	1.00
+200F.	1.00	1.00	1.08	1.00
+300F.	1.00	1.00	1.22	1.08
+400F.	1.00	1.00	2.30	1.41
+500F.	1.00	1.00	–	2.10
+600F.	1.00	1.00	–	–
+700F.	1.00	1.00	–	–
+800F.	1.08	1.07	–	–
+900F.	1.32	1.13	–	–
+1000F.	1.66	1.22	–	–

1020 STEEL Based on 65,000#/in.2 Strength (F S=4)

TUBE O.D.	Working Pressure (psi)				
	1,000	2,000	3,000	4,000	5,000
1/8	.00385	.00790	.01154	.01538	.01923
3/16	.00577	.01154	.01731	.02308	.02885
1/4	.00769	.01538	.02308	.03077	.03846
5/16	.00962	.01923	.02885	.03846	.04808
3/8	.01154	.02308	.03462	.04615	.05769
1/2	.01538	.03077	.04615	.06154	.07692
5/8	.01923	.03846	.05769	.07692	.09615
3/4	.02308	.04615	.06923	.09231	.11538
7/8	.02692	.05385	.08077	.10769	.13462
1	.03077	.06154	.09231	.12308	.15385
1-1/4	.03846	.07692	.11538	.15385	.19231
1-1/2	.04615	.09231	.13846	.18462	.23077
2	.06154	.12308	.18462	.24615	.30769



WARNING

Refer to safety information regarding tubing selection on pages A-2-3.

TUBE O.D.	STAINLESS STEEL (304) ANNEALED BASED ON 75,000#/IN ² STRENGTH (F.S. -4)					STAINLESS STEEL (304) ANNEALED BASED ON 105,000#/IN ² STRENGTH (F.S. -4)				
	working pressure (psi)					working pressure (psi)				
	1,000	2,000	3,000	4,000	5,000	1,000	2,000	3,000	4,000	5,000
1/8	.00333	.00666	.00999	.01333	.01666	.00238	.00476	.00714	.00952	.01190
3/16	.00499	.00999	.01498	.01999	.02499	.00357	.00714	.01071	.01429	.01786
1/4	.00666	.01332	.01998	.02667	.03333	.00476	.00952	.01429	.01905	.02381
5/16	.00833	.01665	.02497	.03333	.04165	.00595	.01190	.01786	.02381	.02976
3/8	.0099	.01998	.02997	.03999	.04998	.00714	.01429	.02143	.02857	.03571
1/2	.01332	.02664	.03996	.05333	.06664	.00957	.01904	.02857	.03810	.04762
5/8	.01665	.03333	.04995	.06666	.08330	.01190	.02381	.03571	.04762	.05952
3/4	.01998	.03996	.05994	.07999	.09996	.01429	.02857	.04286	.05714	.07143
7/8	.02331	.04662	.06996	.09333	.11662	.01667	.03333	.05000	.06666	.08333
1	.02664	.05328	.07992	.10666	.13328	.01904	.03810	.05714	.07619	.09524
1-1/4	.03333	.06666	.09999	.13333	.16666	.02381	.04762	.07143	.09524	.11905
1-1/2	.03996	.07992	.11988	.15999	.19992	.02857	.05714	.08371	.11429	.14286
2	.05328	.10656	.15984	.21333	.26666	.03810	.07619	.11428	.15238	.19048

TUBE O.D.	ANNEALED COPPER BASED ON 30,000#/IN ² STRENGTH (F.S. -4)					COPPER (UNS C12200 LIGHT DRAWN) BASED ON 40,000#/IN ² STRENGTH (F.S. -4)				
	working pressure (psi)					working pressure (psi)				
	1,000	2,000	3,000	4,000	5,000	1,000	2,000	3,000	4,000	5,000
1/8	.00833	.01667	.02500	.03333	.04167	.00625	.01250	.01875	.02500	.03125
3/16	.01250	.02499	.03750	.04999	.06250	.00938	.01875	.02812	.03750	.04688
1/4	.01667	.03333	.05000	.06666	.08333	.01250	.02500	.03750	.05000	.06250
5/16	.02083	.04167	.06250	.08333	.10417	.01562	.03125	.04688	.06250	.07812
3/8	.02499	.04999	.07500	.09999	.12499	.01875	.03750	.05625	.07500	.09375
1/2	.03333	.06667	.10000	.13333	.16667	.02500	.05000	.07500	.10000	.12500
5/8	.04167	.08333	.12500	.16666	.20883	.03125	.06250	.09375	.12500	.15625
3/4	.04999	.09999	.15000	.19999	.24999	.03750	.07500	.11250	.15000	.18750
7/8	.05833	.11667	.17500	.23333	.29166	.04375	.08750	.13125	.17500	.21875
1	.06667	.13333	.20000	.26666	.33333	.05000	.10000	.15000	.20000	.25000
1-1/4	.08333	.16667	.25000	.33333	.41667	.06250	.12500	.18750	.25000	.31250
1-1/2	.09999	.19999	.30000	.39999	.49999	.07500	.15000	.22500	.30000	.37500
2	.13333	.26667	.40000	.53333	.66667	.10000	.20000	.30000	.40000	.50000

TUBE O.D.	ALUMINUM 3003 (H-14) BASED ON 20,000#/IN ² STRENGTH (F.S. -4)					ALUMINUM 5052 (H-32) BASED ON 31,000#/IN ² STRENGTH (F.S. -4)				
	working pressure (psi)					working pressure (psi)				
	1,000	2,000	3,000	4,000	5,000	1,000	2,000	3,000	4,000	5,000
1/8	.01250	.02500	.3750	.05000		.00806	.01613	.02419	.03226	.04032
3/16	.01875	.03750	.05650	.07500		.01210	.02419	.03629	.04839	.06048
1/4	.02500	.05000	.07500	.10000		.01613	.03226	.04839	.06452	.08065
5/16	.03125	.06250	.09375	.12500		.02016	.04032	.06048	.08065	.10081
3/8	.03750	.07500	.11250	.15000		.02419	.04839	.07258	.09677	.12097
1/2	.05000	.10000	.15000	.20000		.03227	.06452	.09677	.12903	.16129
5/8	.06250	.12500	.18750	.25000		.04032	.08065	.12097	.16129	.20161
3/4	.07500	.15000	.22500	.30000		.04839	.09677	.14516	.19355	.24194
7/8	.08750	.17500	.26250	.35000		.05645	.11290	.16935	.22581	.28226
1	.10000	.20000	.30000	.40000		.06452	.12903	.19355	.25806	.32258
1-1/4	.12500	.25000	.37500	.50000		.08065	.16129	.24194	.32258	.40323
1-1/2	.15000	.30000	.45000	.60000		.09677	.19355	.29032	.38710	.48387
2	.20000	.40000	.60000	.80000		.12903	.25806	.38710	.51613	.64516

TUBE O.D.	CUPRO-NICKEL 30% BASED ON 52,000#/IN ² STRENGTH (F.S. -4)				
	working pressure (psi)				
	1,000	2,000	3,000	4,000	5,000
1/8	.00481	.00962	.01442	.01923	.02404
3/16	.00721	.01442	.02163	.02885	.03606
1/4	.00962	.01923	.02885	.03846	.04808
5/16	.01202	.02404	.03606	.04808	.06010
3/8	.01442	.02885	.04327	.05769	.07212
1/2	.01923	.03846	.05769	.07692	.09615
5/8	.02404	.04808	.07212	.09615	.12019
3/4	.02885	.05769	.08654	.11538	.14423
7/8	.03365	.06731	.10096	.13462	.16827
1	.03846	.07692	.11538	.15385	.19231
1-1/4	.04808	.09615	.14423	.19231	.24038
1-1/2	.05769	.11538	.17308	.23077	.28846
2	.07692	.15385	.23077	.30769	.38462

SHADED AREAS

Tubing wall thickness listed in the shaded areas are generally either too light or too heavy for practical applications, and are listed only to provide data for accurate computation.

⚠ WARNING

Refer to safety information regarding tubing selection on pages A-2-3. These tables provide data on required wall thickness for various sizes and pressures, and when to use flared or flareless fittings.

Although heavier wall tubing can be ordered for higher operating pressures, only standard size hydraulic tubing is listed in these tables. High temperature effects are not considered in these tables.

1010 STEEL TUBING WALL THICKNESS

TUBE O.D.	4:1 SAFETY FACTOR					6:1 SAFETY FACTOR					8:1 SAFETY FACTOR				
	working pressure (psi)					working pressure (psi)					working pressure (psi)				
	1,000	2,000	3,000	4,000	5,000	1,000	2,000	3,000	4,000	5,000	1,000	2,000	3,000	4,000	5,000
1/8	.028	.028	.028	.028	.028	.028	.028	.028	.028	.035	.028	.028	.028	.035	-
3/16	.030	.030	.030	.030	.035	.030	.030	.030	-	-	.030	.030	-	-	-
1/4	.030	.030	.030	.042	.049	.030	.030	.042	.058	-	.030	.035	.058	-	-
5/16	.032	.032	.035	.049	.058	.032	.032	.058	.065	-	.032	.049	.065	-	-
3/8	.032	.032	.042	.058	-	.032	.042	.058	-	-	.032	.058	-	-	-
1/2	.032	.042	.058	.072	-	.032	.058	.083	-	-	.042	.072	-	-	-
5/8	.035	.049	.072	.095	-	.035	.072	-	-	-	.049	.095	-	-	-
3/4	.035	.058	.083	.109	-	.049	.083	-	-	-	.058	.109	-	-	-
7/8	.049	.065	.095	-	-	.049	.095	-	-	-	.065	-	-	-	-
1	.049	.072	.109	-	-	.058	.109	-	-	-	.072	-	-	-	-
1-1/4	.049	.095	-	-	-	.072	-	-	-	-	.095	-	-	-	-
1-1/2	.065	.109	-	-	-	.083	-	-	-	-	.109	-	-	-	-
2	.072	-	-	-	-	.109	-	-	-	-	-	-	-	-	-

1020 STEEL TUBING WALL THICKNESS

TUBE O.D.	4:1 SAFETY FACTOR					6:1 SAFETY FACTOR					8:1 SAFETY FACTOR				
	working pressure (psi)					working pressure (psi)					working pressure (psi)				
	1,000	2,000	3,000	4,000	5,000	1,000	2,000	3,000	4,000	5,000	1,000	2,000	3,000	4,000	5,000
1/8	.028	.028	.028	.028	.028	.028	.028	.028	.028	.030	.028	.028	.028	.030	-
3/16	.030	.030	.030	.030	.030	.030	.030	.030	.035	-	.030	.030	.035	-	-
1/4	.030	.030	.030	.030	.042	.030	.030	.035	.049	.058	.030	.030	.049	-	-
5/16	.032	.032	.032	.042	.049	.032	.032	.042	.058	-	.032	.042	.058	-	-
3/8	.032	.032	.035	.049	.058	.032	.035	.058	.065	-	.032	.049	-	-	-
1/2	.032	.032	.049	.065	.083	.032	.049	.072	-	-	.032	.065	-	-	-
5/8	.035	.042	.058	.083	-	.035	.058	.095	-	-	.042	.083	-	-	-
3/4	.035	.049	.072	.095	-	.035	.072	.109	-	-	.049	.095	-	-	-
7/8	.049	.058	.083	-	-	.049	.083	-	-	-	.058	.109	-	-	-
1	.049	.065	.095	-	-	.049	.095	-	-	-	.065	-	-	-	-
1-1/4	.049	.083	.120	-	-	.058	.120	-	-	-	.083	-	-	-	-
1-1/2	.065	.095	-	-	-	.072	-	-	-	-	.095	-	-	-	-
2	.065	-	-	-	-	.095	-	-	-	-	.134	-	-	-	-

 Both SAE 37° SINGLE FLARE FLARE-TWIN or ERMETO® flareless recommended.

 ERMETO® flareless only.

Note: Refer Only Weatherhead Ermeto flareless fittings can be used with high pressure, heavy wall tubing which is impractical to flare.

⚠ WARNING

Refer to safety information regarding tubing selection on pages A-2-3. These tables provide data on required wall thickness for various sizes and pressures, and when to use flared or flareless fittings.

Although heavier wall tubing can be ordered for higher operating pressures, only standard size hydraulic tubing is listed in these tables. High temperature effects are not considered in these tables.

STAINLESS STEEL (304) ANNEALED TUBING WALL THICKNESS

TUBE O.D.	4:1 SAFETY FACTOR					6:1 SAFETY FACTOR					8:1 SAFETY FACTOR				
	working pressure (psi)					working pressure (psi)					working pressure (psi)				
	1,000	2,000	3,000	4,000	5,000	1,000	2,000	3,000	4,000	5,000	1,000	2,000	3,000	4,000	5,000
1/8	.028	.028	.028	.028	.028	.028	.028	.028	.028	.035	.028	.028	.028	.028	.035
3/16	.030	.030	.030	.030	.030	.030	.030	.030	.030	.035	.030	.030	.030	.035	—
1/4	.030	.030	.030	.030	.035	.030	.030	.030	.042	.058	.030	.030	.035	.058	.065
5/16	.032	.032	.032	.035	.042	.032	.032	.035	.058	.065	.032	.032	.049	.065	—
3/8	.032	.032	.032	.042	.058	.032	.042	.065	.083	—	.032	.042	.058	—	—
1/2	.032	.032	.042	.058	.072	.032	.042	.065	.083	—	.032	.058	.083	—	—
5/8	.035	.035	.058	.072	.083	.035	.058	.083	.095	—	.035	.065	—	—	—
3/4	.035	.049	.065	.083	.109	.035	.065	.095	—	—	.049	.083	—	—	—
7/8	.049	.049	.072	.095	—	.049	.072	.109	—	—	.049	.095	—	—	—
1	.049	.058	.083	.109	—	.049	.083	.120	—	—	.058	.109	—	—	—
1-1/4	.049	.072	.109	—	—	.058	.109	—	—	—	.065	.134	—	—	—
1-1/2	.065	.083	.120	—	—	.065	.120	—	—	—	.083	—	—	—	—
2	.065	.109	—	—	—	.083	—	—	—	—	.109	—	—	—	—

STAINLESS STEEL (304) 1/8 HARD TUBING WALL THICKNESS

TUBE O.D.	4:1 SAFETY FACTOR					6:1 SAFETY FACTOR					8:1 SAFETY FACTOR				
	working pressure (psi)					working pressure (psi)					working pressure (psi)				
	1,000	2,000	3,000	4,000	5,000	1,000	2,000	3,000	4,000	5,000	1,000	2,000	3,000	4,000	5,000
1/8	.028	.028	.028	.028	.028	.028	.028	.028	.028	.028	.028	.028	.028	.028	.028
3/16	.030	.030	.030	.030	.030	.030	.030	.030	.030	.030	.030	.030	.030	.030	.035
1/4	.030	.030	.030	.030	.030	.030	.030	.030	.030	.035	.030	.030	.030	.042	.049
5/16	.032	.032	.032	.032	.032	.032	.032	.032	.035	.049	.032	.032	.035	.049	.058
3/8	.032	.032	.032	.032	.042	.032	.032	.032	.042	.058	.032	.032	.042	.058	—
1/2	.032	.032	.032	.042	.049	.032	.032	.042	.058	.072	.032	.042	.058	.083	—
5/8	.035	.035	.042	.049	.065	.035	.035	.058	.072	.095	.035	.049	.072	.095	—
3/4	.035	.035	.049	.058	.072	.035	.049	.065	.095	.109	.035	.058	.095	—	—
7/8	.049	.049	.058	.072	.083	.049	.058	.083	.109	—	.049	.065	.109	—	—
1	.049	.049	.058	.083	.095	.049	.058	.095	—	—	.049	.072	—	—	—
1-1/4	.049	.049	.072	.095	.120	.049	.072	.109	—	—	.049	.095	—	—	—
1-1/2	.065	.065	.095	—	—	.065	.095	—	—	—	.065	—	—	—	—
2	.065	.083	.120	—	—	.065	—	—	—	—	.083	—	—	—	—

 Both SAE 37° SINGLE FLARE FLARE-TWIN or ERMETO® flareless recommended.

 ERMETO® flareless only.

Note: Refer Only Weatherhead Ermeto flareless fittings can be used with high pressure, heavy wall tubing which is impractical to flare.

Hose - Hydraulic

Table of Contents

Rubber Hydraulic

H039	B-2	H280	B-11
H324	B-2	H425	B-12
H017	B-3	H290	B-13
H104	B-3	H290H	B-13
H190	B-4	H430	B-14
H190H	B-5	H430R	B-15
H345	B-5	H470	B-15
H114	B-6	H471	B-16
H145	B-6	H464	B-16
H145R	B-7	H485	B-17
H146	B-7	H487	B-17
H545	B-8	H421	B-18
H350	B-8	Thermoplastic Hydraulic	
H400	B-9	H335	B-19
H245	B-9	H336	B-19
H245L	B-10	H435	B-20
H325	B-10	H436	B-21



H039 Suction Hose

SAE 100R4, 1/2 SAE Bend Radius



B

Hose - Hydraulic

# Part Number	Hose I.D.			Hose O.D.			Working Pressure		Min. Burst Pressure		Min. Bend Radius		Vacuum Service		Hose Weight		Avail. Lengths
	mm	in	fraction	mm	in	fraction	bar	psi	bar	psi	mm	in	Hg	Kg/m	lbs/100ft	feet	
H03912 H03912-100 H03912-150	19,1	0.75	3/4	32,5	1.28	1-9/32	20,1 6,9	300 100*	82,7 27,6	1,200 400*	63,5	2.50	25	20,0	44	50 100 150	
H03916 H03916-100 H03916-150	25,4	1.00	1	38,1	1.50	1-1/2	17,2 4,8	250 70*	69,0 19,3	1,000 280*	76,2	3.00	25	23,6	52	50 100 150	
H03920 H03920-100 H03920-150	31,8	1.25	1-1/4	46,4	1.83	1-53/64	113,8 3,4	200 50*	55,2 13,8	800 200*	101,6	4.00	25	34,0	75	50 100 150	
H03924 H03924-100 H03924-150	38,1	1.50	1-1/2	52,8	2.08	2-5/64	10,3	150	41,4	600	127,0	5.00	25	38,6	85	50 100 150	
H03932 H03932-100 H03932-150	50,8	2.00	2	66,3	2.61	2-39/64	6,9	100	27,6	400	152,4	6.00	25	52,6	116	50 100 150	

Inner Tube: CPE

Reinforcement: 1 helical cable wire between two textile layers. 1 Fiber Braid.

Cover: Neoprene

Temp. Range:
-40°C to +135°C
(-40°F to +275°F)

Typical Application:
Hydraulic Suction Hose

Marine Application
J1942/1 - Hydraulic only.
ABS¹, MSHA Accepted

¹See pages A-33-34 for applicable service pressures, required fire sleeves and qualified hose ends.

*When used with 039 'K' and 'K' Series Ends and 6203 clamps.

Hose Fitting Reference	Page
<i>C-O-C</i>	
'S' Series (-12 to -20)	J-38
'U' Series (-12 to -20)	J-39-57
430 'U' Series (-24 & -32)	J-58-68
'Z' Series	J-69-94
<i>Field Attachable</i>	
'K' Series (-12 to -20)	K-14
039 'K' Series (-12 to -20)	K-15

H324 Power Steering Hose



# Part Number	Hose I.D.			Hose O.D.			Working Pressure		Min. Burst Pressure		Min. Bend Radius		Hose Weight		Avail. Lengths
	mm	in	fraction	mm	in	fraction	bar	psi	bar	psi	mm	in	Kg/m	lbs/100ft	
H32406*	9,5	0.38	3/8	19,1	0.75	3/4	78	1,125	310	4,500	101,6	4.00	9,5	21	50

Inner Tube: Nitrile

Reinforcement:
2 Fiber Braids

Cover: Neoprene

Temp. Range:
-40°C to +120°C
(-40°F to +250°F)

Typical Application:
Passenger Car/Light Truck
power steering hose

*See pages N-79-81 for Power Steering Makeup information.

Hose Fitting Reference	Page
<i>C-O-C</i>	
'U' Series	J-39-57

H017 Hydraulic Hose

SAE 100R3



# Part Number	Hose I.D.			Hose O.D.			Working Pressure		Min. Burst Pressure		Min. Bend Radius		Hose Weight		Avail. Lengths
	mm	in	fraction	mm	in	fraction	bar	psi	bar	psi	mm	in	Kg/m	lbs/100ft	feet
H01704 H01704-250R	6,4	0.25	1/4	14,3	0.56	9/16	86,2	1,250	344,8	5,000	76,2	3.00	5,9	13	50 250
H01706 H01706-250R	9,5	0.38	3/8	19,1	0.75	3/4	77,6	1,125	275,8	4,000	101,6	4.00	10,0	22	50 250
H01708 H01708-250R	12,7	0.50	1/2	23,8	0.94	15/16	69,0	1,000	275,8	4,000	127,0	5.00	12,7	28	50 250
H01712 H01712-250R	19,1	0.75	3/4	31,8	1.25	1-1/4	51,7	750	206,9	3,000	152,4	6.00	19,5	43	50 250
H01716 H01716-250R	25,4	1.00	1	38,1	1.50	1-1/2	31,0	565	155,1	2,250	203,2	8.00	29,0	64	50 250
H01720	31,8	1.25	1-1/4	44,5	1.75	1-3/4	25,9	375	103,4	1,500	254,0	10.00	36,3	80	50

Inner Tube: Nitrile
Reinforcement:
 2 Fiber Braids
Cover: Neoprene
Temp. Range:
 -40°C to +100°C
 (-40°F to +212°F)

Typical Application: Low pressure fuel & oil lines. Hydraulic return lines.
Marine Application
J1942/1/1 - Hydraulic only¹
MSHA Accepted

¹See pages A-33-34 for applicable service pressures, required fire sleeves and qualified hose ends.

Hose Fitting Reference	Page
C-O-C	
'U' Series	J-39-57

H104 Hydraulic Hose

SAE 100R1 TYPE AT, ABS



# Part Number	Hose I.D.			Hose O.D.			Working Pressure		Min. Burst Pressure		Min. Bend Radius		Hose Weight		Avail. Lengths
	mm	in	fraction	mm	in	fraction	bar	psi	bar	psi	mm	in	Kg/m	lbs/100ft	feet
H10404 H10404-250R H10404-500R	6,4	0.25	1/4	13,5	0.53	17/32	189,6	2,750	758,4	11,000	101,6	4.00	6,8	15	50 250 500
H10406 H10406-250R H10406-500R	9,5	0.38	3/8	18,3	0.72	23/32	155,1	2,250	620,6	9,000	127,0	5.00	10,4	23	50 250 500
H10408 H10408-250R H10408-500R	12,7	0.50	1/2	21,4	0.84	27/32	137,9	2,000	551,6	8,000	177,8	7.00	13,2	29	50 250 500
H10410 H10410-250R	15,9	0.63	5/8	24,6	0.97	31/32	103,4	1,500	413,7	6,000	203,2	8.00	15,9	35	50 250
H10412 H10412-250R	19,1	0.75	3/4	28,6	1.13	1-1/8	86,2	1,250	344,8	5,000	241,3	9.50	18,6	41	50 250
H10416 H10416-250R	25,4	1.00	1	36,5	1.44	1-7/16	69,0	1,000	275,8	4,000	304,8	12.00	24,9	55	50 250
H10420 H10420-100	31,8	1.25	1-1/4	44,5	1.75	1-3/4	43,1	625	172,4	2,500	419,1	16.50	38,6	85	50 100

Inner Tube: Nitrile
Reinforcement:
 1 Steel Braid
Cover: Neoprene
Temp. Range:
 -40°C to +100°C
 (-40°F to +212°F)

Typical Application: Most commonly used for medium pressure hydraulic lines. Especially popular for farm implement hydraulic lines.
MSHA Accepted
Marine Application
J1942/1/1 - Fuel and Lube Service, ABS1

¹See pages A-33-34 for applicable service pressures, required fire sleeves and qualified hose ends.

Hose Fitting Reference	Page
C-O-C	
'S' Series (except -10 size)	J-38
'U' Series	J-39-57
'Z' Series (-4 to -16)	J-69-94
<i>Field Attachable</i>	
104 'N' Series (except -10 size)	K-16-18

H190 WeatherSHIELD™ Hydraulic Hose

Meets and exceeds SAE 100R1 AT Type S, EN 853 1SN,
ISO 1436-1 Type ISN Performance



Diamond Advantage

- Pressure
- Temperature
- Abrasion Resistance



B

Hose - Hydraulic

# Part Number	Hose I.D.			Hose O.D.			Working Pressure		Min. Burst Pressure		Min. Bend Radius		Hose Weight		Avail. Lengths
	mm	in	fraction	mm	in	fraction	bar	psi	bar	psi	mm	in	Kg/m	lbs/100ft	feet
H19004 H19004-250R	6,4	0.25	1/4	13,5	0.53	17/32	255	3,700	1,020	14,800	101,6	4.00	7,3	16	50 250
H19006 H19006-250R	9,5	0.38	3/8	17,5	0.69	11/16	235	3,400	940	13,600	127,0	5.00	11,4	25	50 250
H19008 H19008-250R	12,7	0.50	1/2	20,6	0.81	13/16	200	2,900	800	11,600	177,8	7.00	13,6	30	50 250
H19010	15,9	0.63	5/8	23,8	0.94	15/16	130	1,885	520	7,540	203,2	8.00	15,9	35	50
H19012 H19012-250R	19,1	0.75	3/4	27,8	1.09	1-3/32	138	2,000	552	8,000	241,3	9.50	20,5	45	50 250
H19016 H19016-250R	25,4	1.00	1	35,7	1.41	1-13/32	103	1,500	412	6,000	304,8	12.00	30,9	68	50 250
H19020	31,8	1.25	1-1/4	43,4	1.71	1-3/4	69	1,000	276	4,000	419,1	16.50	40,9	88	50
H19024	38,1	1.50	1-1/2	50,6	1.99	2	52	750	208	3,000	508,0	20.00	47,7	105	50
H19032	50,8	2.00	2	64,0	2.52	2-1/2	41	600	164	2,400	635,0	25.00	59,5	131	50

Inner Tube: Synthetic rubber tube

Reinforcement:
1 Steel Braid

Cover: WeatherSHIELD
Synthetic rubber cover

Typical Application:
Hydraulic system service with petroleum and water-based fluids, for general industrial service.

Temp. Range:
Petroleum Based Hydraulic Fluids:
-40°C to +127°C
(-40°F to +260°F)
Water Based Hydraulic Fluids:
-40°C to +70°C
(-40°F to +158°F)
Water:
0°C to 70°C
(+32°F to +158°F).

**MSHA Accepted
ISO 1436a
Marine Application
J1942/1¹ Hydraulic Service**

Hose Fitting Reference	Page
C-0-C	
'Z' Series	J-69-94

¹See pages A-33-34 for applicable service pressures, required fire sleeves and qualified hose ends.

H190H Hydraulic Hose

SAE 100R1 Type AT, EN 853 Type 1SN



# Part Number	Hose I.D.			Hose O.D.			Working Pressure		Min. Burst Pressure		Min. Bend Radius		Hose Weight		Avail. Lengths
	mm	in	fraction	mm	in	fraction	bar	psi	bar	psi	mm	in	Kg/m	lbs/100ft	feet
H190H04	6,4	0.25	1/4	13,5	0.53	17/32	225,1	3,265	900,5	13,060	101,6	4.00	6,8	15	50
H190H06	9,5	0.38	3/8	17,5	0.69	11/16	180,0	2,610	719,8	10,440	127,0	5.00	9,5	21	50
H190H08	12,7	0.50	1/2	20,6	0.81	13/16	160,0	2,320	639,9	9,280	177,8	7.00	12,7	28	50
H190H10	15,9	0.63	5/8	23,8	0.94	15/16	130,0	1,885	519,9	7,540	203,2	8.00	15,0	33	50
H190H12	19,1	0.75	3/4	27,8	1.09	1-3/32	105,1	1,525	420,6	6,100	241,3	9.50	18,6	41	50
H190H16	25,4	1.00	1	35,7	1.41	1-13/32	87,9	1,275	351,6	5,100	304,8	12.00	27,2	60	50
H190H20	31,8	1.25	1-1/4	43,9	1.73	1-3/4	62,0	900	248,0	3,600	420,0	16.50	38,6	85	50

Inner Tube: CPE
Reinforcement: 1 Steel Braid
Cover: CPE Black
Temp. Range: -40°C to +150°C (-40°F to +302°F).

Typical Application:
 Transfer of hydraulic fluid, water and air.
MSHA Accepted
ISO 1436a

Hose Fitting Reference	Page
C-O-C	
'Z' Series	J-69-94

H345 Pressure Washer Hose



# Part Number	Hose I.D.			Hose O.D.			Working Pressure		Min. Burst Pressure		Min. Bend Radius		Hose Weight		Avail. Lengths
	mm	in	fraction	mm	in	fraction	bar	psi	bar	psi	mm	in	Kg/m	lbs/100ft	feet
H34504 H34504-100 H34504-250R H34504-500R	6,4	0.25	1/4	12,3	0.48	31/64	206,9	3,000	827,4	12,000	50,8	2.00	5,9	13	50* 100* 250 500
H34506 H34506-100 H34506-250R H34506-500R	9,5	0.38	3/8	16,3	0.64	41/64	206,9	3,000	827,4	12,000	63,5	2.50	8,2	18	50* 100* 250 500
H34508 H34508-100 H34508-250R H34508-500R	12,7	0.50	1/2	19,8	0.78	25/32	206,9	3,000	827,4	12,000	88,9	3.50	12,7	28	50* 100* 250 500

Inner Tube: Nitrile
Reinforcement:
 1 Steel Braid
Cover: Blue, Vinyl Nitrile
Temp. Range:
 Pressure Washer Service up to 180°C to +93°C (-0°F to +200°F);
 Hydraulic Service -40°C to +121°C (-40°F to +250°F)

Typical Application:
 Pressure washer hose for cold and hot water. Resistant to usual detergents. Not for use with steam applications.
MSHA Accepted, IC - 46/10

*50 and *100 are one continuous length.

Hose Fitting Reference	Page
C-O-C	
'Z' Series	J-69-94

H114 Hydraulic Hose



B
Hose - Hydraulic

# Part Number	Hose I.D.			Hose O.D.			Working Pressure		Min. Burst Pressure		Min. Bend Radius		Hose Weight		Avail. Lengths feet
	mm	in	fraction	mm	in	fraction	bar	psi	bar	psi	mm	in	Kg/m	lbs/100ft	
H11404	6,4	0.25	1/4	12,7	0.50	1/2	206,9	3,000	827,4	12,000	101,6	4.00	5,0	11	50
H11406	9,5	0.38	3/8	16,3	0.64	41/64	206,9	3,000	827,4	12,000	127,0	5.00	8,2	18	50
H11408	12,7	0.50	1/2	20,6	0.81	13/16	206,9	3,000	827,4	12,000	177,8	7.00	11,3	25	50

Inner Tube: Hytrel

Reinforcement:

1 Steel Braid

Cover: Neoprene

Temp. Range:

-40° C to +121° C
(-40° F to +250° F)

Typical Application: 3,000

PSI continuous working pressure hose. Ideal for farm implement high temperature hydraulic lines. Will work with synthetic or petroleum-based fluids.

MSHA Accepted

Hose Fitting

Reference

Page

C-O-C

'S' Series

J-38

'U' Series

J-39-57

H145 Hydraulic Hose

SAE 100R17



# Part Number	Hose I.D.			Hose O.D.			Working Pressure		Min. Burst Pressure		Min. Bend Radius		Hose Weight		Avail. Lengths feet
	mm	in	fraction	mm	in	fraction	bar	psi	bar	psi	mm	in	Kg/m	lbs/100ft	
H14504 H14504-250R H14504-500R	6,4	0.25	1/4	12,7	0.50	1/2	210,0	3,045	840,0	12,180	38,1	2.00	6,8	15	50 250 500
H14506 H14506-250R H14506-500R	9,5	0.38	3/8	16,3	0.64	41/64	210,0	3,045	840,0	12,180	50,8	2.50	10,5	23	50 250 500
H14508 H14508-250R H14508-500R	12,7	0.50	1/2	20,6	0.81	13/16	210,0	3,045	840,0	12,180	58,7	3.50	14,5	32	50 250 500
H14510 H14510-250R	15,9	0.63	5/8	24,6	0.97	31/32	210,0	3,045	840,0	12,180	69,9	4.00	23,2	51	50 250
H14512 H14512-250R	19,1	0.75	3/4	29,4	1.16	1-5/32	210,0	3,045	840,0	12,180	82,6	4.75	28,6	63	50 250
H14516 H14516-250R	25,4	1.00	1	37,3	1.47	1-15/32	210,0	3,045	840,0	12,180	101,6	6.00	41,4	91	50 250

Inner Tube: Nitrile

Reinforcement:

4-6 Size: 1 Steel Braid

8-16 Size: 2 Steel Braids

Cover: Neoprene

Temp. Range:

4-8 Size: -40° C to +121° C
(-40° F to +250° F)

10-16 Size: -40° C to +100° C
(-40° F to +212° F)

Typical Application:

Ideal for use in high pressure lines on off road construction equipment, farm equipment, and other high pressure applications where a small bend radius is needed.

¹See pages A-33-34 for applicable service pressures, required fire sleeves and qualified hose ends.

Marine Application
J1942/1 - Hydraulic only¹

MSHA Accepted

Hose Fitting

Reference

Page

C-O-C

'Z' Series

J-69-94

'S' Series
(except -04 and -10)

J-38

'U' Series (-6 thru -12)

J-39-57

430 'U' Series (-16 only)

J-58-68

H145R RhinoHide II™ Abrasion Resistant Constant Pressure Hydraulic Hose

SAE 100R17



# Part Number	Hose I.D.			Hose O.D.			Working Pressure		Min. Burst Pressure		Min. Bend Radius		Hose Weight		Avail. Lengths
	mm	in	fraction	mm	in	fraction	bar	psi	bar	psi	mm	in	Kg/m	lbs/100ft	feet
H145R04 H145R04-250R	6,4	0.25	1/4	12,7	0.50	1/2	206,9	3,000	827,4	12,000	50,8	2.00	6,8	15	50 250
H145R06 H145R06-250R H145R06-500R	9,5	0.38	3/8	16,7	0.66	21/32	206,9	3,000	827,4	12,000	63,5	2.50	10,4	23	50 250 500
H145R08 H145R08-250R	12,7	0.50	1/2	20,2	0.80	51/64	206,9	3,000	827,4	12,000	88,9	3.50	14,5	32	50 250
H145R10	15,9	0.63	5/8	25,0	0.98	63/64	206,9	3,000	827,4	12,000	101,6	4.00	23,1	51	50
H145R12 H145R12-250R	19,1	0.75	3/4	28,6	1.13	1-1/8	206,9	3,000	827,4	12,000	120,7	4.75	28,6	63	50 250
H145R16 H145R16-250R	25,4	1.00	1	37,3	1.47	1-15/32	206,9	3,000	827,4	12,000	152,4	6.00	37,6	83	50 250

Inner Tube: Nitrile

Reinforcement:

4-8 Size: 1 Steel Braid;
10-16 Size: 2 Steel Braids

Cover: Abrasion resistant UHMWPE

Temp. Range:

-40°C to +100°C
(-40°F to +212°F)

Typical Application:

3,000 PSI constant working pressure hose with abrasion resistant cover. Ideal for logging, construction, mining and other off highway applications.

Hose Fitting Reference

C-O-C

'Z' Series

Page

J-69-94

B
Hose - Hydraulic

H146 3,000 psi Hydraulic Hose



# Part Number	Hose I.D.			Hose O.D.			Working Pressure		Min. Burst Pressure		Min. Bend Radius		Hose Weight		Avail. Lengths
	mm	in	fraction	mm	in	fraction	bar	psi	bar	psi	mm	in	Kg/m	lbs/100ft	feet
H14604-250R	6,4	0.25	1/4	13,1	0.52	33/64	206,9	3,000	827,4	12,000	101,6	4.00	5,0	11	250
H14606-250R	9,5	0.38	3/8	17,1	0.67	43/64	206,9	3,000	827,4	12,000	127,0	5.00	8,2	18	250
H14608-250R	12,7	0.50	1/2	20,6	0.81	13/16	206,9	3,000	827,4	12,000	177,8	7.00	11,3	25	250

Inner Tube: Hytrel™

Reinforcement: 1 Steel Braid

Cover: Abrasion Resistant Fiber Braid

Temp. Range:

-53°C to +121°C
(-65°F to +250°F)

Typical Application: 3,000

psi continuous working pressure hose. Ideal for Arctic cold weather hydraulic applications, as well as for farm implement high temperature hydraulic lines. Will work with synthetic or petroleum-based fluids.

Hytrel is a trademark of E.I. DuPont.

Hose Fitting Reference

C-O-C

'U' Series

Page

J-39-57

H545 RhinoHide™ Abrasion Resistant Constant Pressure Hydraulic Hose



B

Hose - Hydraulic

# Part Number	Hose I.D.			Hose O.D.			Working Pressure		Min. Burst Pressure		Min. Bend Radius		Hose Weight		Avail. Lengths feet
	mm	in	fraction	mm	in	fraction	bar	psi	bar	psi	mm	in	Kg/m	lbs/100ft	
H54504 H54504-250R H54504-500R	6,4	0.25	1/4	13,5	0.53	17/32	206,9	3,000	827,4	12,000	50,8	2.00	6,4	14	50 250 500
H54506 H54506-250R H54506-500R	9,5	0.38	3/8	15,9	0.63	5/8	206,9	3,000	827,4	12,000	63,5	2.50	8,2	18	50 250 500
H54508 H54508-250R H54508-500R	12,7	0.50	1/2	20,6	0.81	13/16	206,9	3,000	827,4	12,000	88,9	3.50	14,5	32	50 250 500
H54510 H54510-250R	15,9	0.63	5/8	23,8	0.94	15/16	206,9	3,000	827,4	12,000	101,6	4.00	16,8	37	50 250
H54512 H54512-250R	19,1	0.75	3/4	28,6	1.13	1-1/8	206,9	3,000	827,4	12,000	120,7	4.75	24,4	54	50 250
H54516 H54516-250R	25,4	1.00	1	35,7	1.41	1-13/32	206,9	3,000	827,4	12,000	152,4	6.00	39,0	86	50 250

Inner Tube: Nitrile

Reinforcement:

4-8 Size: 1 Steel Braid;
10-16 Size: 2 Steel Braids

Cover: Abrasion resistant
(woven nylon)

Temp. Range:

-40°C to +121°C
(-40°F to +250°F)

Typical Application:

3,000 PSI constant working pressure hose with abrasion resistant cover. Ideal for logging, construction, mining and other off highway applications.

Hose Fitting Reference

C-O-C

'S' Series J-38
(sizes -4, -6, -8 & -12 only)

'U' Series (-4 to -12 only) J-39-57

430 'U' Series J-58-68
(size -16 only)

Page

H350 High Pressure Hydraulic Hose



# Part Number	Hose I.D.			Hose O.D.			Working Pressure		Min. Burst Pressure		Min. Bend Radius		Hose Weight		Avail. Lengths feet
	mm	in	fraction	mm	in	fraction	bar	psi	bar	psi	mm	in	Kg/m	lbs/100ft	
H35006 H35006-250R	9,5	0.38	3/8	17,5	0.69	11/16	241,3	3,500	965,3	14,000	63,5	2.50	13,2	29	50 250
H35008 H35008-250R	12,7	0.50	1/2	20,6	0.81	13/16	241,3	3,500	965,3	14,000	88,9	3.50	16,3	36	50 250
H35010	15,9	0.63	5/8	25,4	1.00	1	241,3	3,500	965,3	14,000	101,6	4.00	27,2	60	50
H35012 H35012-250R	19,1	0.75	3/4	29,4	1.16	1-5/32	241,3	3,500	965,3	14,000	120,7	4.75	31,8	70	50 250
H35016 H35016-250R	25,4	1.00	1	38,1	1.50	1-1/2	241,3	3,500	965,3	14,000	304,8	12.00	63,5	140	50 250

Inner Tube: Nitrile

Reinforcement:

6-12 sizes - 2 Steel Braids,
16 size - 4 Spiral-Steel Plies

Cover: Neoprene

Temp. Range: -40°C to
+100°C (-40°F to +212°F)

Typical Application: Most commonly used for high pressure lines on off road equipment, farm equipment and other high pressure applications. Compatible with hydraulic fluids.

Hose Fitting Reference

C-O-C

'Z' Series J-69-94
(sizes -6 to -10 only)

'U' Series J-39-57
(sizes -6 & -8 only)

430 'U' Series J-58-68
(sizes -12 & -16 only)

Page

H400 General Purpose High Pressure Hose



# Part Number	Hose I.D.			Hose O.D.			Working Pressure		Min. Burst Pressure		Min. Bend Radius		Hose Weight		Avail. Lengths
	mm	in	fraction	mm	in	fraction	bar	psi	bar	psi	mm	in	Kg/m	lbs/100ft	feet
H40004 H40004-250R	6,4	0.25	1/4	15,2	0.60	19/32	280,0	4,000	1120,0	16,000	50,8	2.00	10,9	24	50 250
H40006 H40006-250R	9,7	0.38	3/8	19,3	0.76	49/64	280,0	4,000	1120,0	16,000	63,5	2.50	16,4	36	50 250
H40008 H40008-250R	12,7	0.50	1/2	22,6	0.89	57/64	280,0	4,000	1120,0	16,000	88,9	3.50	19,5	43	50 250
H40010 H40010-250R	16,0	0.63	5/8	25,7	1.01	1	280,0	4,000	1120,0	16,000	101,6	4.00	27,3	60	50 250
H40012 H400-250R	19,1	0.75	3/4	30,0	1.18	1-3/16	280,0	4,000	1120,0	16,000	120,7	4.75	32,7	72	50 250

Inner Tube: Nitrile

Reinforcement:
2 Steel Braids

Cover: Vinyl Nitrile

Temp. Range:

-40°C to +100°C
(-40°F to +212°F)

Typical Application:

High pressure lines on off-road equipment, farm equipment and other high pressure applications.

Hose Fitting Reference

C-O-C

'Z' Series

Page

J-69-94

H245 High Pressure Hydraulic Hose

SAE 100R16, ABS



# Part Number	Hose I.D.			Hose O.D.			Working Pressure		Min. Burst Pressure		Min. Bend Radius		Hose Weight		Avail. Lengths
	mm	in	fraction	mm	in	fraction	bar	psi	bar	psi	mm	in	Kg/m	lbs/100ft	feet
H24504 H24504-250R H24504-500R	6,4	0.25	1/4	13,5	0.53	17/32	344,8	5,000	1379,0	20,000	50,8	2.00	8,6	19	50 250 500
H24506 H24506-250R H24506-500R	9,5	0.38	3/8	17,5	0.69	11/16	275,8	4,000	1103,2	16,000	63,5	2.50	13,2	29	50 250 500
H24508 H24508-250R H24508-500R	12,7	0.50	1/2	20,6	0.81	13/16	241,3	3,500	965,3	14,000	88,9	3.50	16,3	36	50 250 500
H24510 H24510-250R	15,9	0.63	5/8	23,8	0.94	15/16	189,6	2,750	758,4	11,000	101,6	4.00	19,1	42	50 250
H24512 H24512-250R	19,1	0.75	3/4	27,8	1.09	1-3/32	155,1	2,250	620,6	9,000	120,7	4.75	24,5	54	50 250
H24516 H24516-250R	25,4	1.00	1	35,7	1.41	1-13/32	137,9	2,000	551,6	8,000	152,4	6.00	36,7	81	50 250
H24520 H24520-150	31,8	1.25	1-1/4	45,2	1.78	1-25/32	112,0	1,625	448,2	6,500	209,6	8.25	51,7	114	50 150

Inner Tube: Nitrile Blend

Reinforcement:
2 Steel Braids

Cover: Neoprene

Temp. Range: -40°C to +100°C (-40°F to +212°F)

Typical Application: Most

commonly used for high pressure lines on off road construction equipment, farm equipment and other high pressure applications. Compatible with generic hydraulic fluids and diesel fuel.

MSHA Accepted, ABS¹

Marine Application J1942 - Fuel and Lube Service.¹

¹See pages A-33-34 for applicable service pressures, required fire sleeves and qualified hose ends.

Hose Fitting Reference Page

C-O-C

'Z' Series

J-69-94

'S' Series (except -10 size) J-38

'U' Series J-39-57

430 'U' Series J-58-68

(sizes -12, -16 & -20)

H245L WeatherFROST™

Meets and exceeds SAE 100R16 Type S, EN857 Type 2SC



Diamond Advantage

- Pressure
- Temperature
- Abrasion Resistance



B

Hose - Hydraulic

# Part Number	Hose I.D.			Hose O.D.			Working Pressure		Min. Burst Pressure		Min. Bend Radius		Hose Weight		Avail. Lengths feet
	mm	in	fraction	mm	in	fraction	bar	psi	bar	psi	mm	in	Kg/m	lbs/100ft	
H245L04 H245L04-250R	6,4	0.25	1/4	14,2	0.56	9/16	414	6,000	1656	24,000	50,8	2.00	9,4	20	50 250
H245L06 H245L06-250R	9,7	0.38	3/8	17,3	0.68	11/16	345	5,000	1380	20,000	63,5	2.50	12,3	27	50 250
H245L08 H245L08-250R	12,7	0.50	1/2	20,8	0.82	53/64	310	4,500	1240	18,000	88,9	3.50	17,7	39	50 250
H245L10 H245L10-250R	15,9	0.63	5/8	24,9	0.98	63/64	276	4,000	1104	16,000	101,6	4.00	22,7	50	50 250
H245L12 H245L12-250R	19,1	0.75	3/4	28,4	1.12	1-1/8	241	3,500	964	14,000	120,7	4.75	28,2	62	50 250
H245L16	25,4	1.00	1	35,8	1.41	1-13/32	193	2,800	772	11,200	152,4	6.00	37,3	82	50
H245L20	31,8	1.25	1-1/4	43,4	1.71	1-23/32	159	2,300	636	9,200	209,6	8.25	48,6	107	50
H245L24	38,1	1.50	1-1/2	51,6	2.03	2-1/16	138	2,000	552	8,000	254,0	10.00	64,5	142	50
H245L32	50,8	2.00	2	63,8	2.51	2-1/2	103	1,500	412	6,000	317,5	12.50	85,5	188	50

Inner Tube: Weatherhead brand exclusive low temperature compound tube

Reinforcement:
2 Wire Braid

Cover: WeatherSHIELD Synthetic rubber cover

Temp. Range:

-57°C to +100°C
(-70°F to +212°F)

Typical Application:

Low temperature flexing and hydraulic system service with petroleum and water-base fluids. For use in frigid environments on construction equipment and other mobile applications.

MSHA Accepted

Hose Fitting Reference

C-O-C

'Z' Series

Page

J-69-94

H325 SUB ZERO™ High Pressure Hydraulic Hose



# Part Number	Hose I.D.			Hose O.D.			Working Pressure		Min. Burst Pressure		Min. Bend Radius		Hose Weight		Avail. Lengths feet
	mm	in	fraction	mm	in	fraction	bar	psi	bar	psi	mm	in	Kg/m	lbs/100ft	
H32504-250R	6,4	0.25	1/4	15,1	0.59	19/32	344,8	5,000	1379,0	20,000	101,6	4.00	11,8	26	250
H32506-250R	9,5	0.38	3/8	19,1	0.75	3/4	275,8	4,000	1103,2	16,000	127,0	5.00	16,8	37	250
H32508-250R	12,7	0.50	1/2	22,2	0.88	7/8	241,3	3,500	965,3	14,000	177,8	7.00	20,4	45	250
H32512-250R	19,1	0.75	3/4	29,4	1.16	1-5/32	155,1	2,250	620,6	9,000	241,3	9.50	30,4	67	250
H32516-250R	25,4	1.00	1	38,1	1.50	1-1/2	137,9	2,000	551,6	8,000	304,8	12.00	44,5	98	250

Inner Tube: Oil and heat resistant black synthetic rubber

Reinforcement:
2 Steel Braids

Cover: Oil, abrasion and weather resistant synthetic rubber.

Temp. Range:

-55°C to +80°C
(-67° to +175°F)

Typical Application: For non-impulse, high pressure hydraulic service, specifically designed for use in frigid environment, where temperatures to -67°F are encountered.

Hose Fitting Reference

C-O-C

'U' Series

Page

J-39-57

H280 WeatherSHIELD™ Hydraulic Hose

Meets and exceeds SAE 100R16 Type S, EN857 2SC,
ISO 11237-1 Type 2SC performance



Diamond Advantage

- Pressure
- Temperature
- Abrasion Resistance



B

Hose - Hydraulic

# Part Number	Hose I.D.			Hose O.D.			Working Pressure		Min. Burst Pressure		Min. Bend Radius		Hose Weight		Avail. Lengths
	mm	in	fraction	mm	in	fraction	bar	psi	bar	psi	mm	in	Kg/m	lbs/100ft	
H28004 H28004-250R H28004-500R	6,4	0.25	1/4	13,5	0.53	17/32	448	6,500	1,792	26,000	50,8	2.00	10,0	22	50 250 500
H28006 H28006-250R H28006-500R	9,5	0.38	3/8	17,5	0.69	11/16	366	5,300	1,464	21,200	63,5	2.50	13,2	29	50 250 500
H28008 H28008-250R H28008-500R	12,7	0.50	1/2	20,6	0.81	13/16	310	4,500	1,240	18,000	88,9	3.50	17,7	39	50 250 500
H28010 H28010-250R	15,9	0.63	5/8	23,8	0.94	15/16	276	4,000	1,104	16,000	101,6	4.00	20,0	44	50 250
H28012 H28012-250R	19,1	0.75	3/4	27,8	1.09	1-3/32	241	3,500	964	14,000	120,7	4.75	24,1	53	50 250
H28016 H28016-250R	25,4	1.00	1	35,7	1.41	1-13/32	207	3,000	828	12,000	152,4	6.00	32,7	72	50 250
H28020 H28020-150	31,8	1.25	1-1/4	41,9	1.65	1-13/20	172	2,500	688	10,000	209,6	8.25	49,5	109	50 150
H28024 H28024-150	38,1	1.50	1-1/2	51,6	2.03	2	138	2,000	552	8,000	254,0	10.00	63,6	140	50 150
H28032	50,8	2.00	2	64,3	2.53	2-1/2	110	1,600	440	6,400	317,5	12.50	86,4	190	50

Inner Tube:

Synthetic rubber tube

Reinforcement:

2 Steel Braids

Cover: WeatherSHIELD

Synthetic rubber cover

Temp. Range:

Petroleum-based
Hydraulic Fluids:
-40°C to +127°C
(-40°F to +260°F)

Water-based Hydraulic Fluids:

-40°C to +70°C
(-40°F to +158°F)

Typical Application:

Hydraulic system service
with petroleum and water-
based fluids, for general
industrial service.

MSHA Accepted

Hose Fitting Reference Page

C-O-C

'Z' Series

J-69-94

H425 High Pressure Hydraulic Hose

SAE 100R2 Type AT



B

Hose - Hydraulic

# Part Number	Hose I.D.			Hose O.D.			Working Pressure		Min. Burst Pressure		Min. Bend Radius		Hose Weight		Avail. Lengths feet
	mm	in	fraction	mm	in	fraction	bar	psi	bar	psi	mm	in	Kg/m	lbs/100ft	
H42504 H42504-250R H42504-500R	6,4	0.25	1/4	15,1	0.59	19/32	344,8	5,000	1379,0	20,000	101,6	4.00	12,7	28	50 250 500
H42506 H42506-250R H42506-500R	9,5	0.38	3/8	19,1	0.75	3/4	275,8	4,000	1103,2	16,000	127,0	5.00	17,2	38	50 250 500
H42508 H42508-250R H42508-500R	12,7	0.50	1/2	22,2	0.88	7/8	241,3	3,500	965,3	14,000	177,8	7.00	20,4	45	50 250 500
H42510 H42510-250R	15,9	0.63	5/8	25,4	1.00	1	189,6	2,750	758,4	11,000	203,2	8.00	23,1	51	50 250
H42512 H42512-250R	19,1	0.75	3/4	29,4	1.16	1-5/32	155,1	2,250	620,6	9,000	241,3	9.50	29,9	66	50 250
H42516 H42516-250R	25,4	1.00	1	38,1	1.50	1-1/2	137,9	2,000	551,6	8,000	304,8	12.00	43,1	95	50 250
H42520 H42520-100	31,8	1.25	1-1/4	47,6	1.88	1-7/8	112,0	1,625	448,2	6,500	419,1	16.50	64,4	142	50 100
H42524 H42524-100	38,1	1.50	1-1/2	54,8	2.16	2-5/32	86,2	1,250	344,8	5,000	501,0	20.00	79,8	176	50 100
H42532	50,8	2.00	2	67,5	2.66	2-21/32	77,6	1,125	310,3	4,500	635,0	25.00	94,3	208	50

Inner Tube: Nitrile

Reinforcement:

2 Steel Braids

Cover: Neoprene

Temp. Range: -40°F to +212°F (-40°C to +100°C)

Typical Application: Most commonly used for high pressure lines on off road construction equipment, farm equipment and other high pressure applications.

¹See pages A-33-34 for applicable service pressures, required fire sleeves and qualified hose ends.

**MSHA Accepted
Marine Application
J1942/¹ - Hydraulic
(-4 thru -32) Fuel
(-4 through -20).¹
ABS¹**

Hose Fitting Reference

Page

C-O-C

'S' Series J-38
(except sizes -10, -24 & -32)

'U' Series J-39-57
(except sizes -24 & -32)

'Z' Series J-69-94
(sizes -4 thru -20)

430 'U' Series J-58-68
(sizes -12 thru -32)

Field Attachable

425 'N' Series K-27-29
(except size -10)

H290 WeatherSHIELD™ Hydraulic Hose

Meets and exceeds SAE 100R2AT Type S, EN853 2SN,
ISO 1436-1 Type 2SN Performance



Diamond Advantage

- Pressure
- Temperature
- Abrasion Resistance



# Part Number	Hose I.D.			Hose O.D.			Working Pressure		Min. Burst Pressure		Min. Bend Radius		Hose Weight		Avail. Lengths
	mm	in	fraction	mm	in	fraction	bar	psi	bar	psi	mm	in	Kg/m	lbs/100ft	
H29004 H29004-250R H29004-500R	6,4	0.25	1/4	15,1	0.59	19/32	448	6,500	1792	26,000	101,6	4.00	11,8	26	50 250 500
H29006 H29006-250R H29006-500R	9,5	0.38	3/8	19,1	0.75	3/4	400	5,800	1600	23,200	127,0	5.00	17,3	38	50 250 500
H29008 H29008-250R H29008-500R	12,7	0.50	1/2	22,2	0.88	7/8	345	5,000	1380	20,000	177,8	7.00	20,1	46	50 250 500
H29010 H29010-250R	15,9	0.63	5/8	25,4	1.00	1	276	4000	1104	16,000	203,2	8.00	24,5	54	50 250
H29012 H29012-250R	19,1	0.75	3/4	29,4	1.16	1-5/32	241	3,500	964	14,000	241,3	9.50	30,0	66	50 250
H29016 H29016-250R	25,4	1.00	1	38,1	1.50	1-1/2	207	3,000	828	12,000	304,8	12.00	45,9	101	50 250
H29020 H29020-150	31,8	1.25	1-1/4	48,8	1.92	1-7/8	172	2,500	688	10,000	419,1	16.50	70,0	154	50 150
H29024	38,1	1.50	1-1/2	54,6	2.15	2-5/32	138	2,000	552	8,000	508,0	20.00	76,4	168	50
H29032	50,8	2.00	2	63,8	2.51	2-1/2	110	1,600	440	6,400	635,0	25.00	100,9	222	50

Inner Tube:

Synthetic rubber tube

Reinforcement: 2 Steel Braids

Cover: WeatherSHIELD
Synthetic rubber cover

Temp. Range:

Petroleum-based
Hydraulic Fluids:
-40°C to +127°C
(-40°F to +260°F)

Water-based Hydraulic Fluids:
-40°C to +70°C
(-40°F to +158°F)

Typical Application: Hydraulic system service with petroleum and water-based fluids, for general industrial service.

Hose Fitting Reference

C-O-C

Z' Series

Page

J-69-94

MSHA Accepted

H290H WeatherBLAZE™

100R2, EN 853, Type 2SN



# Part Number	Hose I.D.			Hose O.D.			Working Press. (PSI)		Min. Burst Pressure		Min. Bend Radius		Hose Weight		Avail. Lengths
	mm	in	fraction	mm	in	fraction	bar	psi	bar	psi	mm	in	Kg/m	lbs/100ft	
H290H04	6,4	0.25	1/4	15,1	0.59	19/32	399,9	5,800	1599,6	23,200	101,6	4.00	10,9	24	50
H290H06	9,5	0.38	3/8	19,1	0.75	3/4	331,0	4,800	1323,8	19,200	127,0	5.00	15,0	33	50
H290H08	12,7	0.50	1/2	22,2	0.88	7/8	275,8	4,000	1103,2	16,000	177,8	7.00	19,1	42	50
H290H10	15,9	0.63	5/8	25,4	1.00	1	250,3	3,630	1001,2	14,520	203,2	8.00	22,7	50	50
H290H12	19,1	0.75	3/4	29,4	1.16	1-5/32	215,1	3,120	860,5	12,480	241,3	9.50	28,6	63	50
H290H16	25,4	1.00	1	38,1	1.50	1-1/2	165,5	2,400	661,9	9,600	304,8	12.00	40,8	90	50
H290H20	31,8	1.25	1-1/4	48,8	1.92	1-23/25	157,0	2250	630,0	9000	419,1	16.50	2,39	1.60	50

Inner Tube: CPE

Reinforcement:
2 Steel braids

Cover: CPE black

Temp. Range: -40°C to +150°C (-40°F to +302°F).

Typical Application: High pressure hose for hydraulic fluid applications.

¹See pages A-33-34 for applicable service pressures, required fire sleeves and qualified hose ends.

MSHA Accepted

Hose Fitting Reference

C-O-C

Z' Series

Page

J-69-94

H430 High Pressure Spiral Hydraulic Hose

Meets and exceeds SAE 100R12, EN856 Type R12, DIN856/4SP Performance (sizes -8 thru -16)



Diamond Advantage

- Pressure
- Temperature
- Abrasion Resistance



B

Hose - Hydraulic

# Part Number	Hose I.D.			Hose O.D.			Working Pressure		Min. Burst Pressure		Min. Bend Radius		Hose Weight		Avail. Lengths
	mm	in	fraction	mm	in	fraction	bar	psi	bar	psi	mm	in	Kg/m	lbs/100ft	feet
H43006 H43006-100	9,5	0.38	3/8	20,1	0.79	53/64	448	6,500	1792	26,000	62,5	2.50	21,4	47	50 100
H43008 H43008-100 H43008-150	12,7	0.50	1/2	23,4	0.92	15/16	414	6,000	1656	24,000	90,0	3.50	26,8	59	50 100 150
H43010	15,9	0.63	5/8	28,2	1.11	1-7/64	414	6,000	1656	24,000	100,0	4.00	31,4	69	50
H43012 H43012-100 H43012-150	19,1	0.75	3/4	30,5	1.20	1-7/32	379	5,500	1516	22,000	120,0	4.75	41,8	92	50 100 150
H43016 H43016-100 H43016-150	25,4	1.00	1	37,6	1.48	1-33/64	352	5,100	1408	20,400	150,0	6.00	55,5	122	50 100 150
H43020 H43020-100 H43020-150	31,8	1.25	1-1/4	46,5	1.83	1-7/8	310	4,500	1240	18,000	210,0	8.25	74,5	164	50 100 150
H43024 H43024-100 H43024-150	38,1	1.50	1-1/2	55,0	2.18	2-1/8	276	4,000	1104	16,000	250,0	10.00	95,5	210	50 100 150
H43032 H43032-100	50,8	2.00	2	68,3	2.69	2-21/32	276	4,000	1104	16,000	320,0	12.50	127,7	281	50 100

Inner Tube:

Synthetic rubber tube

Reinforcement: 4 Spiral Steel Plies

Cover: WeatherSHIELD Synthetic rubber cover

Temp. Range:

-40°C to +127°C
(-40°F to +260°F)

Typical Application:

For very high pressure hydraulic lines subjected to pressure surges and flexing. Typical applications include construction, mining, farming, and high performance industrial equipment.

MSHA Accepted

**Marine Application
J1942/1 - Hydraulic only,
ABS**

Hose Fitting Reference

C-O-C

430 'U' Series
No Skive

Page

J-58-68

H430R RhinoHide II™ High Pressure Hydraulic Hose

SAE 100R12



# Part Number	Hose I.D.			Hose O.D.			Working Pressure		Min. Burst Pressure		Min. Bend Radius		Hose Weight		Avail. Lengths
	mm	in	fraction	mm	in	fraction	bar	psi	bar	psi	mm	in	Kg/m	lbs/100ft	
H430R06	9,5	0.38	3/8	20,1	0.79	53/64	275,8	4,000	1103,2	16,000	127,0	5.00	21,3	47	50
H430R08	12,7	0.50	1/2	23,4	0.92	15/16	275,8	4,000	1103,2	16,000	177,8	7.00	26,8	59	50
H430R10	15,9	0.63	5/8	28,2	1.11	1-7/64	275,8	4,000	1103,2	16,000	203,2	8.00	36,3	80	50
H430R12	19,1	0.75	3/4	30,5	1.20	1-7/32	275,8	4,000	1103,2	16,000	241,3	9.50	41,7	92	50
H430R16	25,4	1.00	1	37,6	1.48	1-33/64	275,8	4,000	1103,2	16,000	304,8	12.00	55,3	122	50
H430R20	31,8	1.25	1-1/4	46,5	1.83	1-7/8	206,9	3,000	827,6	12,000	419,1	16.50	74,4	164	50
H430R24	38,1	1.50	1-1/2	55,1	2.17	2-1/8	172,4	2,500	689,5	10,000	501,0	20.00	91,2	201	50
H430R32	50,8	2.00	2	68,3	2.69	2-21/32	172,4	2,500	689,5	10,000	635,0	25.00	133,4	294	50

Inner Tube: Nitrile

Reinforcement:
4 Spiral Steel Plies
Cover: UHMWPE

Temp. Range:
-40°C to +121°C
(-40°F to +250°F)

Typical Application:
High abrasion applications. Hydraulic system service with petroleum and water-base fluids, for general industrial service.

Hose Fitting Reference	Page
C-O-C	
430 'U' Series No Skive	J-58-68

H470 Very High Pressure Hydraulic Hose

SAE 100R13



# Part Number	Hose I.D.			Hose O.D.			Working Pressure		Min. Burst Pressure		Min. Bend Radius		Hose Weight		Avail. Lengths
	mm	in	fraction	mm	in	fraction	bar	psi	bar	psi	mm	in	Kg/m	lbs/100ft	
H47008	12,7	0.50	1/2	24,6	0.97	31/32	344,8	5,000	1379,0	20,000	177,8	7.00	29,5	65	50
H47012	19,1	0.75	3/4	31,8	1.26	1-1/4	344,8	5,000	1379,0	20,000	241,3	9.50	49,4	105	50
H47016	25,4	1.00	1	38,9	1.52	1-17/32	344,8	5,000	1379,0	20,000	304,8	12.00	64,4	132	50
H47020	31,8	1.25	1-1/4	50,0	1.96	1-31/32	344,8	5,000	1379,0	20,000	419,1	16.50	114,3	246	50
H47024	38,1	1.50	1-1/2	57,2	2.26	2-1/4	344,8	5,000	1379,0	20,000	501,0	20.00	147,4	316	50
H47032	50,8	2.00	2	71,4	2.80	2-13/16	344,8	5,000	1379,0	20,000	635,0	25.00	229,1	478	50

Inner Tube: Nitrile
Reinforcement: Multi-Spiral Steel (8,12,16=4 plies) (20,24,32=6 plies)
Cover: Black Vinyl Nitrile
Temp. Range:
-40°C to +121°C
(-40°F to +250°F)

Typical Application:
For very high pressure hydraulic lines subjected to pressure surges and flexing. Typical applications include construction, mining, farming and high performance industrial equipment

MSHA Accepted Marine Application J1942/1 (-12 thru -20)

Hose Fitting Reference	Page
C-O-C	
470 'E' Series	J-19-23
WeatherTIGHT 4SP Series (-12 & -16)*	J-95-105
WeatherTIGHT 6SP Series (-20 thru -32)*	J-95-105

*Black covered hose only

H471 WeatherFORCE - FLEX 5000™ Hose

Very High Pressure Hydraulics
Meets or Exceeds 100R13 Performance



B
Hose - Hydraulic

# Part Number	Hose I.D.			Hose O.D.			Working Pressure		Min. Burst Pressure		Min. Bend Radius		Hose Weight		Avail. Lengths
	mm	in	fraction	mm	in	fraction	bar	psi	bar	psi	mm	in	Kg/m	lbs/100ft	feet
H47112	19.1	0.75	3/4	32.0	1.26	1-1/4	350	5,076	1,380	20,304	121	4.75	38,2	84	50
H47116	25.4	1.00	1	39.1	1.54	1-9/16	350	5,076	1,380	20,304	152	6.00	56,4	124	50
H47120	31.8	1.25	1-1/4	47.0	1.85	1-27/32	350	5,076	1,380	20,304	210	8.25	76,8	169	50
H47124	38.1	1.50	1-1/2	55.1	2.17	2-3/16	350	5,076	1,380	20,304	254	10.00	102,3	225	50
H47132	50.8	2.00	2	72.6	2.86	2-7/8	350	5076	1380	20304	318	12.50	184,5	406	50

Inner Tube:

Synthetic rubber tube

Reinforcement:

Multiple heavy spiral wire reinforcement

Cover: Synthetic rubber

Temp. Range:

-40°C to +127°C
(-40°F to +260°F)

Typical Application: High pressure hydraulic system service with petroleum and water-base fluids.

For information on additional sizes, please contact your local Eaton sales representative.

Hose Fitting Reference

C-O-C

WeatherTIGHT
4SP Series (-12 to -24) J-95-105

WeatherTIGHT
6SP Series (-32 only) J-95-105

H464 Very High Pressure Hydraulic Hose

EN856 Type 4SH



# Part Number	Hose I.D.			Hose O.D.			Working Pressure		Min. Burst Pressure		Min. Bend Radius		Hose Weight		Avail. Lengths
	mm	in	fraction	mm	in	fraction	bar	psi	bar	psi	mm	in	Kg/m	lbs/100ft	feet
H46412	19,1	0.75	3/4	32,5	1.27	1-9/32	420,0	6,090	1679,6	24,360	279,4	11.00	45,4	100	50
H46416	25,4	1.00	1	38,1	1.50	1-1/2	385,0	5,510	1519,7	22,040	339,9	13.38	62,6	138	50
H46420	31,8	1.25	1-1/4	42,2	1.79	1-25/32	350,0	5,075	1399,7	20,300	460,0	18.11	77,6	171	50
H46424	38,1	1.50	1-1/2	54,0	2.11	2-1/8	300,0	4,350	1199,7	17,400	560,1	22.05	99,8	220	50
H46432	50,8	2.00	2	68,3	2.68	2-11/16	250,0	3,625	999,8	14,500	700,0	27.5	139,7	308	50

Inner Tube: Nitrile

Reinforcement:

4 Spiral Steel Plies

Cover: Nitrile

Temp. Range:

-40°C to +100°C
(-40°F to +212°F)

Typical Application:

Perfect for hydraulic system service with petroleum and water-based fluids requiring premium pressure performance and durability.

This hose is well suited for injection mold and drill rig applications.

MSHA Accepted

Hose Fitting Reference

C-O-C

WeatherTIGHT
4SP Series
No Skive J-95-105

H485 Very High Pressure Hydraulic Hose

SAE 100R15



B

Hose - Hydraulic

# Part Number	Hose I.D.			Hose O.D.			Working Pressure		Min. Burst Pressure		Min. Bend Radius		Hose Weight		Avail. Lengths feet
	mm	in	fraction	mm	in	fraction	bar	psi	bar	psi	mm	in	Kg/m	lbs/100ft	
H48516 H48516-100	25,4	1.00	1	16,7	0.66	21/32	413,7	6,000	1654,8	24,000	304,8	12.00	81,2	179	50 100
H48520 H48520-100	31,8	1.25	1-1/4	49,2	1.95	1-15/16	413,7	6,000	1654,8	24,000	419,1	16.50	110,2	243	50 100
H48524 H48524-100	38,1	1.50	1-1/2	58,7	2.30	2-5/16	413,7	6,000	1654,8	24,000	501,0	20.00	143,8	317	50 100

Inner Tube: Nitrile
Reinforcement: Multi-Spiral Steel (-16 4 plies), (-20, -24 6 plies)
Cover: Vinyl Nitrile
Temp. Range: -40°C to +121°C (-40°F to +250°F)

Typical Application: High-pressure hydraulics, hydrostatic transmissions. For more information on specific fluid applications and high temperature ratings, see pages A-12 to A14.

Hose Fitting Reference	Page
<i>C-O-C</i>	
WeatherTIGHT 4SP Series (-16 only)	J-95-105
WeatherTIGHT 6SP Series (-20 & -24)	J-95-105

H487 WeatherFROST™ Hose



# Part Number	Hose I.D.			Hose O.D.			Working Pressure		Min. Burst Pressure		Min. Bend Radius		Hose Weight		Avail. Lengths feet
	mm	in	fraction	mm	in	fraction	bar	psi	bar	psi	mm	in	Kg/m	lbs/100ft	
H48712	19,1	.750	3/4	33,0	1.29	1-9/32	420	6090	1680	24,360	280	11.00	49,1	108	50
H48716	25,5	1.00	1	39,9	1.57	1-9/16	420	6090	1680	24,360	340	13.50	61,8	136	50
H48720	31,8	1.25	1-1/4	49,4	1.94	1-15/16	420	6090	1680	24,360	420	16.50	108,6	239	50
H48724	38,1	1.50	1-1/2	57,3	2.25	2-1/4	420	6090	1680	24,360	510	20.00	145,0	319	50
H48732	51,0	2.00	2	71,7	2.81	2-7/8	350	5076	1400	20,304	630	25.00	NA	NA	50

Inner Tube: Synthetic rubber inner tube
Reinforcement: Multi-Spiral Steel (-12 & -16 4 plies), (-20 & -24 6 plies)

Cover: WeatherSHIELD™ abrasion resistant synthetic rubber
Temp. Range: -57°C to +100°C (-70°F to +212°F)

Typical Application: High pressure hydraulic systems with petroleum base fluids for low temperature applications.

 For information on additional sizes, please contact your local Eaton distributor.

Hose Fitting Reference	Page
<i>C-O-C</i>	
WeatherTIGHT 4SP Series (-12 & -16)	J-95-105
WeatherTIGHT 6SP Series (-20 & -24)	J-95-105

H421 WeatherJACK™

10,000 psi Jack Hose



B

Hose - Hydraulic

# Part Number	Hose I.D.			Hose O.D.			Working Pressure		Min. Burst Pressure		Min. Bend Radius		Hose Weight		Avail. Lengths
	mm	in	fraction	mm	in	fraction	bar	psi	bar	psi	mm	in	Kg/m	lbs/100ft	feet
H42104 H42104-250R	6,4	0.25	1/4	13,5	0.53	17/32	700,0	10,000	1400,0	20,000	50,8	2.00	10,0	22	50 250
H42106 H42106-250R	9,7	0.38	3/8	17,5	0.69	11/16	700,0	10,000	1400,0	20,000	63,5	2.50	13,2	29	50 250

Inner Tube:

Synthetic Rubber

Reinforcement: 2 Wire Braid

Cover: Synthetic Rubber

Temp. Range:

-40°C to +100°C
(-40°F to +212°F)

Typical Application:

Hydraulic jacking system with petroleum and water-base fluids.

Hose Fitting Reference

C-O-C

'Z' Series

Page

J-69-94

H335 Non-Conductive Hose

SAE 100R8, EN 855 Type R8



# Part Number	Hose I.D.			Hose O.D.			Working Pressure		Min. Burst Pressure		Min. Bend Radius		Hose Weight		Avail. Lengths
	mm	in	fraction	mm	in	fraction	bar	psi	bar	psi	mm	in	Kg/m	lbs/100ft	feet
H33503-250R	4,8	0.19	3/16	13,1	0.52	33/64	344,8	5,000	1379,0	20,000	38,1	1.50	3,6	8	250
H33504 H33504-250R H33504-500R	6,4	0.25	1/4	15,9	0.63	5/8	344,8	5,000	1379,0	20,000	50,8	2.00	5,4	12	50 250 500
H33506 H33506-250R	9,5	0.38	3/8	19,1	0.75	3/4	275,8	4,000	1103,2	16,000	63,5	2.50	6,8	15	50 250
H33508 H33508-250R	12,7	0.50	1/2	22,6	0.89	57/64	241,3	3,500	965,3	14,000	101,6	4.00	8,6	19	50 250
H33512 H33512-200R	19,1	0.75	3/4	29,0	1.14	1-9/64	155,1	2,250	620,6	9,000	165,1	6.50	11,8	26	50 200
H33516 H33516-200R	25,4	1.00	1	37,3	1.47	1-15/32	137,9	2,000	551,6	8,000	254,0	10.00	17,2	38	50 200

Inner Tube: Nylon

Reinforcement:
Multiple Fiber Braids

Cover: Polyurethane

Temp. Range:

Petroleum/Synthetic based Hydraulic Fluids: -40°C to +100°C (-40°F to +212°F)
Water-Based Hydraulic Fluids: -0°C to +70°C (-32°F to +158°F)
Fire Resistant Fluids: -40°C to +70°C (-40°F to +158°F)

Typical Application:

Compatible with most hydraulic fluids, designed for use where electric shock hazards exist. Max. leakage is 50 micro amperes per ft. at 37.5 KV per ft. for five minutes.

Hose Fitting Reference

C-O-C

336 'E' Series

Page

J-15-18

H336 Perforated Cover Hose

SAE 100R8, EN 855 Type R8



# Part Number	Hose I.D.			Hose O.D.			Working Pressure		Min. Burst Pressure		Min. Bend Radius		Hose Weight		Avail. Lengths
	mm	in	fraction	mm	in	fraction	bar	psi	bar	psi	mm	in	Kg/m	lbs/100ft	feet
H33603 H33603-250R	4,8	0.19	3/16	13,1	0.52	33/64	344,8	5,000	1379,0	20,000	38,1	1.50	3,6	8	50 250
H33604 H33604-250R	6,4	0.25	1/4	15,9	0.63	5/8	344,8	5,000	1379,0	20,000	50,8	2.00	5,4	12	50 250
H33606 H33606-250R	9,5	0.38	3/8	19,1	0.75	3/4	275,8	4,000	1103,2	16,000	63,5	2.50	6,8	15	50 250
H33608 H33608-250R	12,7	0.50	1/2	22,6	0.89	57/64	241,3	3,500	965,3	14,000	101,6	4.00	8,6	19	50 250
H33612 H33612-200R	19,1	0.75	3/4	29,0	1.14	1-9/64	155,1	2,250	620,6	9,000	165,1	6.50	11,8	26	50 200
H33616 H33616-200R	25,4	1.00	1	37,3	1.47	1-15/32	137,9	2,000	551,6	8,000	254,0	10.00	17,2	38	50 200

Inner Tube: Nylon

Reinforcement:
Multiple Fiber Braids

Cover: Perforated Polyurethane

Temp. Range:

Petroleum/Synthetic based Hydraulic Fluids: -40°C to +100°C (-40°F to +212°F)
Water-Based Hydraulic Fluids: -0°C to +70°C (-32°F to +158°F)
Fire Resistant Fluids: -40°C to +70°C (-40°F to +158°F)

Typical Application:

General hydraulic applications, High Pressure Pneumatic systems. H336 is compatible with petroleum and synthetic based hydraulic fluids.

Hose Fitting Reference

C-O-C

336 'E' Series

Page

J-15-18

H435 Non-Conductive Hose

SAE 100R7



B
Hose - Hydraulic

# Part Number	Hose I.D.			Hose O.D.			Working Pressure		Min. Burst Pressure		Min. Bend Radius		Hose Weight		Avail. Lengths
	mm	in	fraction	mm	in	fraction	bar	psi	bar	psi	mm	in	Kg/m	lbs/100ft	feet
H43504 H43504-500R	6,4	0.25	1/4	11,5	0.45	29/64	189,6	2,750	758,4	11,000	25,4	1.00	2,3	5	50 500
H43505 H43505-500R	7,9	0.31	5/16	14,3	0.56	9/16	172,4	2,500	689,5	10,000	38,1	1.50	3,2	7	50 500
H43506 H43506-250R	9,5	0.38	3/8	15,9	0.63	5/8	155,1	2,250	620,6	9,000	50,8	2.00	3,6	8	50 250
H43508 H43508-250R	12,7	0.50	1/2	20,6	0.81	13/16	137,9	2,000	551,6	8,000	63,5	2.50	5,4	12	50 250
H43512	19,1	0.75	3/4	27,0	1.06	1-1/16	86,2	1,250	344,8	5,000	241,3	9.50	8,6	19	50
H43516	25,4	1.00	1	34,9	1.38	1-3/8	69,0	1,000	275,8	4,000	304,8	12.00	11,3	25	50

Inner Tube: Nylon 11

Reinforcement:

2 Fiber Braids

Cover: Orange, Non-Conductive Polyurethane

Temp. Range:

-40°C to +93°C

(-40°F to +200°F)

Typical Application:

Compatible w/most hydraulic fluids, designed for use where electric shock hazards exist. Max. leakage is 50 Micro Amperes per ft. at 375 KV per ft. for five minutes.

Hose Fitting Reference

Page

C-O-C

'E' Series

J-2-8

Field Attachable

436 'N' Series

K-30-31

H435 Twin Line Non-Conductive Hose

SAE 100R7, Multi-Tube

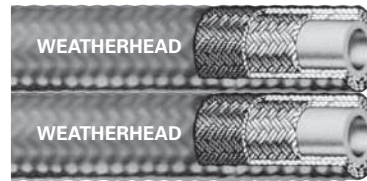

# Part Number	Hose #1 I.D.			Hose #2 I.D.			Working Pressure		Min. Bend Radius		Hose Weight		Avail. Lengths
	mm	in	fraction	mm	in	fraction	bar	psi	mm	in	Kg/m	lbs/100ft	feet
H43544 H43544-250R	6,4	0.25	1/4	6,4	0.25	1/4	Same as H435		25,4	1.00	4,5	10	50 250
H43545 H43545-250R	6,4	0.25	1/4	7,9	0.31	5/16			38,1	1.50	5,4	12	50 250
H43546 H43546-250R	6,4	0.25	1/4	9,5	0.38	3/8			50,8	2.00	5,9	13	50 250
H43555 H43555-250R	7,9	0.31	5/16	7,9	0.31	5/16			38,1	1.50	6,4	14	50 250
H43556 H43556-250R	7,9	0.31	5/16	9,5	0.38	3/8			50,8	2.00	6,8	15	50 250
H43558 H43558-250R	7,9	0.31	5/16	12,7	0.50	1/2			63,5	2.50	8,6	19	50 250
H43566 H43566-250R	9,5	0.38	3/8	9,5	0.38	3/8			50,8	2.00	7,3	16	50 250
H43568 H43568-250R	9,5	0.38	3/8	12,7	0.50	1/2			63,5	2.50	9,1	20	50 250
H43588 H43588-250R	12,7	0.50	1/2	12,7	0.50	1/2			63,5	2.50	10,9	24	50 250

Inner Tube: Nylon 11

Reinforcement:

2 Fiber Braids

Cover: Non-Conductive Polyurethane

Temp. Range:

-40°C to +93°C

(-40°F to +200°F)

Typical Application:

Compatible w/most hydraulic fluids, designed for use where electric shock hazards exist. Max. leakage is 50 Micro Amperes per ft. at 375 KV per ft. for five minutes.

Hose Fitting Reference

Page

C-O-C

'E' Series

J-2-8

Field Attachable

436 'N' Series

K-30-31

H436 Perforated Cover Hose

SAE 100R7

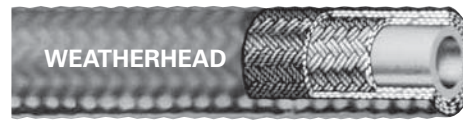

# Part Number	Hose I.D.			Hose O.D.			Working Pressure		Min. Burst Pressure		Min. Bend Radius		Hose Weight		Avail. Lengths
	mm	in	fraction	mm	in	fraction	bar	psi	bar	psi	mm	in	Kg/m	lbs/100ft	feet
H43604 H43604-500R	6,4	0.25	1/4	11,5	0.45	29/64	189,6	2,750	758,4	11,000	25,4	1.00	2,3	5	50 500
H43605 H43605-500R	7,9	0.31	5/16	14,3	0.56	9/16	172,4	2,500	689,5	10,000	38,1	1.50	3,2	7	50 500
H43606 H43606-250R	9,5	0.38	3/8	15,9	0.63	5/8	155,1	2,250	620,6	9,000	50,8	2.00	3,6	8	50 250
H43608 H43608-250R	12,7	0.50	1/2	20,2	0.80	51/64	137,9	2,000	551,6	8,000	63,5	2.50	5,4	12	50 250
H43612	19,1	0.75	3/4	27,0	1.06	1-1/16	86,2	1,250	344,8	5,000	241,3	9.50	8,6	19	50
H43616	25,4	1.00	1	34,9	1.38	1-3/8	69,0	1,000	275,8	4,000	304,8	12.00	11,3	25	50

* See information below

H436 Twin Line Perforated Cover Hose

SAE 100R7, Multi-Tube

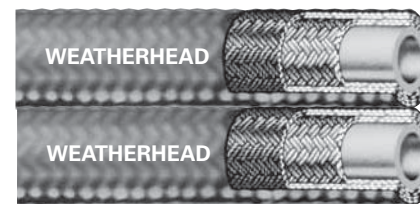

# Part Number	Hose #1 I.D.			Hose #2 I.D.			Working Pressure		Min. Bend Radius		Hose Weight		Avail. Lengths
	mm	in	fraction	mm	in	fraction	mm	in	mm	in	Kg/m	lbs/100ft	feet
H43644 H43644-250R	6,4	0.25	1/4	6,4	0.25	1/4	Same as H436		25,4	1.00	4,5	10	50 250
H43645 H43645-250R	6,4	0.25	1/4	7,9	0.31	5/16			38,1	1.50	5,4	12	50 250
H43646 H43646-250R	6,4	0.25	1/4	9,5	0.38	3/8			50,8	2.00	5,9	13	50 250
H43648 H43648-250R	6,4	0.25	1/4	12,7	0.50	1/2			63,5	2.50	7,7	17	50 250
H43655 H43655-250R	7,9	0.31	5/16	7,9	0.31	5/16			38,1	1.50	6,4	14	50 250
H43656 H43656-250R	7,9	0.31	5/16	9,5	0.38	3/8			50,8	2.00	6,8	15	50 250
H43658 H43658-250R	7,9	0.31	5/16	12,7	0.50	1/2			63,5	2.50	8,6	19	50 250
H43666 H43666-250R	9,5	0.38	3/8	9,5	0.38	3/8			50,8	2.00	7,3	16	50 250
H43668 H43668-250R	9,5	0.38	3/8	12,7	0.50	1/2			63,5	2.50	8,2	18	50 250
H43688 H43688-250R	12,7	0.50	1/2	12,7	0.50	1/2			63,5	2.50	10,9	24	50 250

Inner Tube: Nylon 11

Reinforcement: 2 Fiber Braids

Cover: Black, Polyurethane (Perforated)

Temp. Range:

-40°F to +200°F
(-40°C to +93°C)

Typical Application: In addition to its compatibility with most hydraulic fluids, the low effusion rate of this hose makes it ideally suited for CO₂ and nitrogen. Perforated cover permits breathing, eliminating condensation and blistering.

Hose Fitting Reference	Page
C-0-C	
'E' Series	J-2-8
Field Attachable	
436 'N' Series	K-30-31

Hose - General Purpose

Table of Contents

H009	C-2		
H100	C-2	H209	C-5
H101	C-3	H265	C-6
H115	C-4	H275	C-6
H116	C-4	H332	C-7
H201	C-5	H1571	C-7



H009 General Purpose Hose

SAE 100R6



C Hose - General Purpose

# Part Number	Hose I.D.			Hose O.D.			Working Pressure		Min. Burst Pressure		Min. Bend Radius		Hose Weight		Avail. Lengths
	mm	in	fraction	mm	in	fraction	bar	psi	bar	psi	mm	in	Kg/m	lbs/100ft	
H00904-25R H00904-50R H00904-250R	6,4	0.25	1/4	12,7	0.50	1/2	27,6	400	110,3	1,600	63,5	2.50	4,5	10	25 50 250
H00905-25R H00905-50R H00905-250R	7,9	0.31	5/16	14,3	0.56	9/16	27,6	400	110,3	1,600	76,2	3.00	5,5	12	25 50 250
H00906-25R H00906-50R H00906-250R	9,5	0.38	3/8	15,9	0.63	5/8	27,6	400	110,3	1,600	76,2	3.00	6,4	14	25 50 250
H00908* H00908-25R H00908-250R	12,7	0.50	1/2	19,8	0.78	25/32	27,6	400	110,3	1,600	101,6	4.00	9,1	20	25 250

Inner Tube: Nitrile

Reinforcement:

1 Fiber Braid

Cover: Neoprene

Temp. Range:

-40°C to +100°C
(-40°F to +212°F)

Typical Application:

General purpose air, oil and water lines. Low pressure hydraulic service.

¹See pages A-33-34 for applicable service pressures, required fire sleeves and qualified hose ends.

* 50 foot carton

Hose Fitting Reference

C-0-C

'E' Series (-5 to -8)

Page

J-2-8

Field Attachable

009 'B' Series (-04 only)

K-2

H100 General Purpose Hose

(Fabric Cover)



# Part Number	Hose I.D.			Hose O.D.			Working Pressure		Min. Burst Pressure		Min. Bend Radius		Hose Weight		Avail. Lengths
	mm	in	fraction	mm	in	fraction	bar	psi	bar	psi	mm	in	Kg/m	lbs/100ft	
H10004 H10004-250R	6,4	0.25	1/4	12,7	0.50	1/2	24,1	350	96,5	1,400	76,2	3.00	4,5	10	50 250
H10005 H10005-250R	7,9	0.31	5/16	14,3	0.56	9/16	24,1	350	96,5	1,400	76,2	3.00	4,5	10	50 250
H10006 H10006-250R	9,5	0.38	3/8	15,9	0.63	5/8	24,1	350	96,5	1,400	76,2	3.00	5,0	11	50 250
H10008 H10008-250R	12,7	0.50	1/2	19,1	0.75	3/4	24,1	350	96,5	1,400	127,0	5.00	5,4	12	50 250
H10010 H10010-250R	15,9	0.63	5/8	23,0	0.91	29/32	24,1	350	96,5	1,400	152,4	6.00	8,2	18	50 250
H10012 H10012-250R	19,1	0.75	3/4	26,2	1.03	1-1/32	24,1	350	96,5	1,400	177,8	7.00	9,5	21	50 250

Inner Tube: Nitrile

Reinforcement:

1 Fiber Braid

Cover: Fiber Braid - Black

Temp. Range:

-40°C to +100°C
(-40°F to +212°F)

Typical Application:

General purpose low pressure air, diesel fuel, oil, and water lines.

Hose Fitting Reference

Field Attachable

100 'B' Series

Page

K-5-7

H101 General Purpose Hose

(Rubber Cover)



# Part Number	Hose I.D.			Hose O.D.			Working Pressure		Min. Burst Pressure		Min. Bend Radius		Hose Weight		Avail. Lengths
	mm	in	fraction	mm	in	fraction	bar	psi	bar	psi	mm	in	Kg/m	lbs/100ft	feet
H10104 H10104-250R H10104-500R	6,4	0.25	1/4	12,7	0.50	1/2	24,1	350	96,5	1,400	76,2	3.00	4,1	9	50 250 500
H10105 H10105-250R	7,9	0.31	5/16	14,3	0.56	9/16	24,1	350	96,5	1,400	76,2	3.00	5,0	11	50 250
H10106 H10106-250R H10106-370R	9,5	0.38	3/8	15,9	0.63	5/8	24,1	350	96,5	1,400	76,2	3.00	5,9	13	50 250 370
H10108 H10108-250R	12,7	0.50	1/2	19,1	0.75	3/4	24,1	350	96,5	1,400	127,0	5.00	6,8	15	50 250
H10110 H10110-250R	15,9	0.63	5/8	23,0	0.91	29/32	24,1	350	96,5	1,400	152,4	6.00	10,4	23	50 250
H10112 H10112-250R	19,1	0.75	3/4	26.2	1.03	1-1/32	24,1	350	96,5	1,400	177,8	7.00	11,8	26	50 250

Inner Tube: Nitrile

Reinforcement:

1 Fiber Braid

Cover: Neoprene

Temp. Range:

-40°C to +100°C
(-40°F to +212°F)

Typical Application:

General purpose low pressure air, oil, water and diesel fuel lines.

MSHA Accepted

Hose Fitting Reference

Field Attachable

100 'B' Series

Page

K-5-7

H115 Performer II Oil Resistant General Purpose Hose

(Air/Water)



Hose - General Purpose

# Part Number	Hose I.D.			Hose O.D.			Working Pressure		Min. Burst Pressure		Min. Bend Radius		Hose Weight		Avail. Lengths
	mm	in	fraction	mm	in	fraction	bar	psi	bar	psi	mm	in	Kg/m	lbs/100ft	feet
H11504 H11504-550R	6,4	0.25	1/4	15,1	0.59	19/32	20,1	300	82,7	1,200	76,2	3.00	6,8	15	50 550
H11505-550R	7,9	0.31	5/16	16,7	0.66	21/32	20,1	300	82,7	1,200	88,9	3.50	7,7	17	550
H11506 H11506-550R	9,5	0.38	3/8	18,3	0.72	23/32	20,1	300	82,7	1,200	88,9	3.50	8,6	19	50 550
H11508 H11508-550R	12,7	0.50	1/2	22,2	0.88	7/8	20,1	300	82,7	1,200	114,3	4.50	12,2	27	50 550
H11512 H11512-550R	19,1	0.75	3/4	29,4	1.16	1-5/32	20,1	300	82,7	1,200	146,1	5.75	18,6	41	50 550
H11516 H11516-300R	25,4	1.00	1	36,5	1.44	1-7/16	17,2	250	68,9	1000	184,2	7.25	28,1	62	50 300
H11520 H11520-300R	31,8	1.25	1-1/4	44,5	1.75	1-3/4	15,5	225	62,1	900	222,3	8.75	45,8	101	50 300
H11524 H11524-300R	38,1	1.50	1-1/2	50,8	2.00	2	15,5	225	62,1	900	254,0	10.00	48,1	106	50 300

Inner Tube: Nitrile

Reinforcement:
Multi-Fiber Braids

Cover: Vinyl Nitrile

Temp. Range:
-40°C to +82°C
(-40°F to +180°F)

Typical Application:

Medium oil resistant, water.
Ideal for pneumatic tool operation.

Hose Fitting Reference

Page

C-0-C

'U' Series J-39-57
(except size -05 & -24)

430 'U' Series (-24) J-58-68

'Z' Series J-69-94

Field Attachable

057 'B' Series K-3-4
(except size -8, -16, -20 & -24)

105 'B' Series (-4 to -12) K-8

H116 Performer II Oil Resistant General Purpose Hose

(Air/Water)



# Part Number	Hose I.D.			Hose O.D.			Working Pressure		Min. Burst Pressure		Min. Bend Radius		Hose Weight		Avail. Lengths
	mm	in	fraction	mm	in	fraction	bar	psi	bar	psi	mm	in	Kg/m	lbs/100ft	feet
H11604-550R	6,4	0.25	1/4	12,7	0.50	1/2	15,5	225	62,1	900	76,2	3.00	4,5	10	550
H11605-550R	7,9	0.31	5/16	15,9	0.63	5/8	15,5	225	62,1	900	88,9	3.50	6,4	14	550
H11606-550R	9,5	0.38	3/8	16,7	0.66	21/32	15,5	225	62,1	900	88,9	3.50	6,8	15	550
H11608-550R	12,7	0.50	1/2	20,1	0.82	13/16	15,5	225	62,1	900	114,3	4.50	9,5	21	550

Inner Tube: Nitrile

Reinforcement:
Multi-Fiber Braids

Cover: Vinyl Nitrile

Temp. Range:
-40°C to +82°C
(-40°F to +180°F)

Typical Application:

Medium oil resistant, water.
Ideal for pneumatic tool operation.

Hose Fitting Reference

Page

C-0-C

'U' Series J-39-57
(except size -05 & -24)

430 'U' Series (-24) J-58-68

'Z' Series J-69-94

Field Attachable

057 'B' Series K-3-4
(except size -8, -16, -20 & -24)

105 'B' Series (-4 to -12) K-8

H201 Easy Couple Air and Multi-Purpose Hose



# Part Number	Hose I.D.			Hose O.D.			Working Pressure		Min. Burst Pressure		Min. Bend Radius		Hose Weight		Avail. Lengths
	mm	in	fraction	mm	in	fraction	bar	psi	bar	psi	mm	in	Kg/m	lbs/100ft	
H20104BK H20104BK-250R H20104BK-500R	6,4	0.25	1/4	12,7	0.50	1/2	20,7	300	82,7	1,200	76,2	3.00	3,6	8	50 250 500
H20106BK H20106BK-250R H20106BK-500R	9,5	0.38	3/8	16,7	0.65	21/32	20,7	300	82,7	1,200	76,2	3.00	5,9	13	50 250 500
H20108BK H20108BK-250R H20108BK-500R	12,7	0.50	1/2	19,1	0.75	3/4	20,7	300	82,7	1,200	127,0	5.00	6,8	15	50 250 500
H20110BK H20110BK-250R	15,9	0.63	5/8	23,8	0.93	15/16	20,7	300	82,7	1,200	152,4	6.00	9,1	20	50 250
H20112BK H20112BK-250R	19,1	0.75	3/4	26,2	1.03	1-1/32	20,7	300	82,7	1,200	177,8	7.00	11,8	26	50 250

Inner Tube: Nitrile

Reinforcement:

1 Fiber Braid

Cover: Neoprene (Black),
Vinyl Nitrile (Colored Hoses)

Temp. Range:

-40°C to +100°C
(-40°F to +212°F)

Typical Application:

General purpose hose. Air and diesel fuel applications.

MSHA Approved (Black only)

Note:

For colors change BK to: Gray (GY), Red (RD), Green (GN) & Yellow (YW), Blue (BU)

Hose Fitting Reference

Field Attachable

100 'B' Barb-Tite® Series K-5-7

H209 General Purpose Hose



# Part Number	Hose I.D.			Hose O.D.			Working Pressure		Min. Burst Pressure		Min. Bend Radius		Hose Weight		Avail. Lengths
	mm	in	fraction	mm	in	fraction	bar	psi	bar	psi	mm	in	Kg/m	lbs/100ft	
H20904-500R	4,8	0.25	1/4	11,5	0.45	29/64	155,1	2,250	620,6	9,000	38,1	1.50	2,3	5	500
H20906-250R	9,5	0.38	3/8	14,3	0.56	9/16	93,1	1,350	372,3	5,400	63,5	2.50	3,2	7	250
H20908-250R	12,7	0.50	1/2	17,9	0.70	45/64	69,0	1,000	275,8	4,000	88,9	3.50	4,1	9	250

Inner Tube: Nylon 11

Reinforcement:

1 Fiber Braid

Cover: Polyurethane

Temp. Range:

-40°C to +93°C
(-40°F to +200°F)

Typical Application:

General hydraulic and pneumatic service; high temperature industrial cleaning and car wash applications.

Hose Fitting Reference

C-O-C

'E' Series J-2-8

H265 Ultraforce

Air and Multipurpose,
Low Working Pressure

Assemblies Available

EATON® ULTRAFORCE HOSE



C Hose - General Purpose

# Part Number	Hose I.D.			Hose O.D.			Working Pressure		Min. Bend Radius		Hose Weight		Avail. Lengths
	mm	in	fraction	mm	in	fraction	bar	psi	mm	in	Kg/m	lbs/100ft	
H26504BU H26504BU-600R	6,4	0.25	1/4	12,7	0.50	1/2	24,1	350	19,1	.75	4,1	9	50 600
H26506BU H26506BU-600R	9,5	0.38	3/8	16,3	0.64	41/64	24,1	350	31,8	1.25	5,4	12	50 600
H26508BU H26508BU-500R	12,7	0.50	1/2	19,8	0.78	25/32	34,5	300	50,8	2.00	7,7	17	50 500
H26510BU-500R	15,9	0.63	5/8	22,2	0.88	7/8	17,2	250	-	-	9,1	20	500
H26512BU H26512BU-500R	19,1	0.75	3/4	26,9	1.06	1-1/16	17,2	250	63,5	2.50	11,8	26	50 500
H26516BU H26516BU-200R	25,4	1.00	1	33,3	1.31	1-5/16	13,8	200	-	-	15,9	35	50 200
H26520BU-100	31,8	1.25	1-1/4	42,9	1.69	1-11/16	10,3	150	-	-	27,7	61	100
H26524BU-100	38,1	1.50	1-1/2	49,2	1.94	1-15/16	10,3	150	-	-	33,1	73	100
H26532BU-100	50,8	2.00	2	63,5	2.50	2-1/2	8,6	125	-	-	47,6	105	100

Inner Tube: Modified Vinyl

Reinforcement:

Fiber, 2 Spiral

Cover: Rubber modified, non-marking thermoplastic/pinpricked

Temp. Range:

-40°C to +65°C
(-20°F to +150°F)

Typical Application:

Transfer air and water, air tools, robotics, water washdown

Stated working pressures are tested at 68°F. Working pressure decreases as temperature increases.

See chart on page A-15 showing the relationship between working pressure and temperature for reinforced PVC hose.

Hose Fitting Reference

C-0-C

Reference	Page
'E' Series	J-2-8
265 'P' Series	J-34
'Z' Series	J-69-94

H275 Polyforce II Hose

Air and Multipurpose, Low Working Pressure

EATON® POLYFORCE II HOSE



# Part Number	Hose I.D.			Hose O.D.			Working Pressure (at 70°F)		Working Pressure (at 150°F)		Min. Burst Pressure		Min. Bend Radius		Hose Weight		Avail. Lengths
	mm	in	fraction	mm	in	fraction	bar	psi	bar	psi	bar	psi	mm	in	Kg/m	lbs/100ft	
H27504RD H27504RD-600R	6,4	0.25	1/4	12,7	0.50	1/2	17,2	250	3,4	50	69,0	1,000	25,4	1.00	3,2	7	50 600
H27506RD H27506RD-600R	9,5	0.38	3/8	15,9	0.63	5/8	17,2	250	3,4	50	69,0	1,000	38,1	1.50	5,4	12	50 600
H27508RD H27508RD-500R	12,7	0.50	1/2	19,1	0.75	3/4	17,2	250	3,4	50	69,0	1,000	54,0	2.13	6,8	15	50 500
H27510RD-500R	15,9	0.625	5/8	22,6	0.89	57/64	17,2	250	3,4	50	69,0	1,000	—	—	9,5	21	500
H27512RD-500R	19,1	0.75	3/4	26,2	1.03	1-1/32	17,2	250	3,4	50	69,0	1,000	63,5	2.50	10,4	23	500
H27516RD-200R	25,4	1.00	1	33,3	1.31	1-5/16	13,8	200	2,8	40	55,2	800	88,9	3.50	15,4	34	200
H27520RD-100	31,8	1.25	1-1/4	42,9	1.69	1-11/16	13,8	200	2,8	40	55,2	800	—	—	23,6	52	100
H27524RD-100	38,1	1.50	1-1/2	49,2	1.94	1-15/16	13,8	200	2,8	40	55,2	800	—	—	27,7	61	100
H27532RD-100	50,9	2.00	2	63,5	2.50	2-1/2	8,6	125	1,9	29	34,4	500	—	—	41,3	91	100

Inner Tube: PVC

Reinforcement:

Fiber, 2 Spiral

Cover: PVC/Pinpricked

Temp. Range:

-23°C to +65°C
(-10°F to +150°F)

Typical Application:

Suitable for transferring air and water.

Note:

Available in other colors on a made to order basis.

Stated working pressures are tested at 68°F. Working pressure decreases as temperature increases.

See chart on page A-15 showing the relationship between working pressure and temperature for reinforced PVC hose.

Hose Fitting Reference

C-0-C

Reference	Page
'E' Series (-06 to -16)	J-2-8
265 'P' Series (-04 to -12)	J-34
'Z' Series (-04 to -16)	J-69-94

H332 General Purpose Hose



# Part Number	Hose I.D.			Hose O.D.			Working Pressure		Min. Burst Pressure		Min. Bend Radius		Hose Weight		Avail. Lengths
	mm	in	fraction	mm	in	fraction	bar	psi	bar	psi	mm	in	Kg/m	lbs/100ft	feet
H33204-50C H33204-250R	6,4	0.25	1/4	12,4	0.49	1/2	20,7	300	82,7	1,200	76,2	3.00	4,5	10	50 250
H33206-50C H33206-250R	9,5	0.38	3/8	16,0	0.63	5/8	20,7	300	82,7	1,200	76,2	3.00	5,0	11	50 250
H33208-50C H33208-250R	12,7	0.50	1/2	19,1	0.75	3/4	20,7	300	82,7	1,200	127,0	5.00	5,4	12	50 250
H33210-50C H33210-250R	15,9	0.63	5/8	23,1	0.91	29/32	20,7	300	82,7	1,200	152,4	6.00	8,2	18	50 250
H33212-50C H33212-250R	19,1	0.75	3/4	26,4	1.04	1-1/32	20,7	300	82,7	1,200	177,8	7.00	9,5	21	50 250

Inner Tube: CPE

Reinforcement:

1 Fiber Braid

Cover: CPE

Temp. Range:

-40°C to +150°C

(-40°F to +302°F)

Air not to exceed +121°C

(+250°F) and water not to

exceed +82°C (+180°F).

Typical Application:

General purpose low pressure air, diesel fuel, oil, and water lines.

Hose Fitting Reference

Field Attachable

100 'B' Series

Page

K-5-7

H1571 Mineforce®



# Part Number	Hose I.D.			Hose O.D.			Working Pressure		Min. Burst Pressure		Hose Weight		Avail. Lengths
	mm	in	fraction	mm	in	fraction	bar	psi	bar	psi	Kg/m	lbs/100ft	feet
H157112 H157112-100	19,1	0.75	3/4	31,2	1.19	1-3/16	27,6	400	110,3	1,600	18,1	40	50 100

Inner Tube: Modified PVC

Reinforcement:

4 Fiber Spirals

Cover: PVC/Nitrile Blend

Wrapped Impression Finish

Temp. Range:

-29°C to +65°C

(-20°F to +150°F)

Typical Application:

Transfer air and water. High pressure air tools and water washdown.

Stated working pressures are tested at 68° F. Working pressure decreases as temperature increases.

See chart on page A-15 showing the relationship between working pressure and temperature for reinforced PVC hose.

Hose Fitting Reference

C-O-C

'U' Series

'Z' Series

Page

J-39-57

J-69-94

Hose - Eaton Industrial

Table of Contents

H0105	D-2	H1776/77	D-5
H0106	D-2	H1812	D-5
H160	D-3	H1981/82	D-6
H285	D-4	H1987	D-7
H1719	D-4	H9949	D-7



H0105 Bosflex A/W

Air/Water General Purpose Hose



D

Hose - Eaton Industrial

# Part Number	Hose I.D.			Hose O.D.			Working Pressure		Min. Burst Pressure		Min. Bend Radius		Hose Weight		Avail. Lengths
	mm	in	fraction	mm	in	fraction	bar	psi	bar	psi	mm	in	Kg/m	lbs/100ft	feet
H010504RD H010504RD-600R H010504BK-600R	6,4	0.25	1/4	15,9	0.63	5/8	20,1	300**	82,7	1,200**	76,2	3.00	21	14	50 600 600
H010506RD H010506RD-600R	9,5	0.38	3/8	19,1	0.75	3/4	20,1	300**	82,7	1,200**	88,9	3.50	27	18	50 600
H010508RD H010508RD-600R	12,7	0.50	1/2	22,2	0.88	7/8	20,1	300**	82,7	1,200**	114,3	4.50	34	23	50 600
H010510RD-600R	15,9	0.63	5/8	26,2	1.03	1-1/32	20,1	300**	82,7	1,200**			45	30	600
H010512RD H010512RD-600R	19,1	0.75	3/4	31,2	1.19	1-3/16	15,3	225**	62,1	900**	146,1	5.75	55	37	50 600
H010516RD H010516RD-400R H010516BK-400R	25,4	1.00	1	36,5	1.44	1-7/16	13,8	200	55,2	800	184,2	7.25	89	60	50 400 400
H010520BK-300R	31,8	1.25	1-1/4	44,5	1.75	1-3/4	13,8	200	55,1	800	222,3	8.75	97	65	300
H010524BK-300R	38,1	1.50	1-1/2	50,8	2.00	2	13,8	200	55,1	800	254,0	10.0	122	82	300

Inner Tube: EPDM

Reinforcement: Multi-Fiber Spiral

Cover: EPDM

Temp. Range:

-40°C to +82°C
(-40°F to +180°F)

Colors: RD-Red, BK-Black

Typical Application:

Air and water applications where petroleum contact is limited; some agricultural solutions.

* When used with 105 'B' and 057 'B' Series Ends and 6203 clamps.

**When used with 'U' or 'Z' Series only.

Hose Fitting Reference	Page
C-O-C	
'U' Series (-6 to -16)	J-39-57
'Z' Series	J-69-94
Field Attachable	
057 'B' Series (except -8 & -16)	K-3-4
105 'B' Series (-4 to -12)	K-8

H0106 Bosflex A/W

Air/Water General Purpose Hose

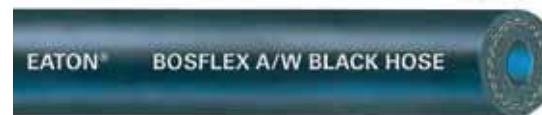

# Part Number	Hose I.D.			Hose O.D.			Working Pressure		Min. Burst Pressure		Min. Bend Radius		Hose Weight		Avail. Lengths
	mm	in	fraction	mm	in	fraction	bar	psi	bar	psi	mm	in	Kg/m	lbs/100ft	feet
H010604RD H010604RD-600R H010604BK-600R	6,4	0.25	1/4	12,7	0.63	1/2	20,1	200**	55,1	800**	76,2	3.00	15	10	50 600 600
H010605RD	9,5	0.38	3/8	15,1	0.75	23/32	20,1	200**	55,1	800**	82,5	3.25	22	13	50
H010606RD H010606RD-600R H010606BK-600R	9,5	0.38	3/8	17,5	0.75	11/16	20,1	200**	55,1	800**	88,9	3.50	22	15	50 600 600
H010608RD H010608RD-600R H010608BK-600R	12,7	0.50	1/2	20,6	0.88	13/16	20,1	200**	55,1	800**	114,3	4.50	28	19	50 600 600
H010610RD-600R H010610BK-600R	9,5	0.38	3/8	24,6	0.75	31/32	20,1	200**	55,1	800**	133,4	5.25	42	28	600 600
H010612RD-250R H010612RD-600R	19,1	0.75	3/4	30,2	1.19	1-3/16	20,1	300**	62,1	1,200**	146,1	5.75	60	40	250 600

Inner Tube: EPDM

Reinforcement: 2 Spiral

Cover: EPDM

Temp. Range:

-40°C to +82°C
(-40°F to +180°F)

Colors: RD-Red, BK-Black

Typical Application:

Air and water applications where petroleum contact is limited; some agricultural solutions.

* When used with 105 'B' and 057 'B' Series Ends and 6203 clamps.

**When used with 'U' or 'Z' Series only.

Hose Fitting Reference	Page
C-O-C	
'U' Series (-6 to -16)	J-39-57
'Z' Series	J-69-94
Field Attachable	
057 'B' Series (except -8 & -16)	K-3-4
105 'B' Series (-4 to -12)	K-8

H16 Clearforce - NR

General Purpose Tubing



# Part Number	Hose I.D.			Hose O.D.			Working Pressure		Min. Burst Pressure		Hose Weight		Avail. Lengths
	mm	in	fraction	mm	in	fraction	bar	psi	bar	psi	Kg/m	lbs/100ft	feet
H160204-100	3,2	.125	1/8	6,4	.250	1/4	4,5	65	13,4	195	3	1.88	100*
H160305-100	4,7	.188	3/16	7,9	.313	5/16	3,8	55	11,4	165	4	2.53	100*
H160406-100	6,4	.250	1/4	9,5	.375	3/8	3,8	55	11,4	165	5	3.14	100*
H160408-100	6,4	.250	1/4	12,7	.500	1/2	4,0	60	12,4	180	12	7.86	100*
H160507-100	7,9	.313	5/16	11,1	.438	7/16	3,5	50	10,3	150	6	3.73	100*
H160608-100	9,5	.375	3/8	12,7	.500	1/2	3,1	45	9,3	135	7	4.78	100*
H160609-100	9,5	.375	3/8	14,3	.563	9/16	3,5	50	10,3	150	—	—	100*
H160610-100	9,5	.375	3/8	15,9	.625	5/8	3,8	55	11,4	165	16	10.48	100*
H160810-100	12,7	.500	1/2	15,9	.625	5/8	2,1	30	6,2	90	8	5.38	100*
H160811-100	12,7	.500	1/2	17,3	.688	11/16	2,8	40	8,3	120	13	8.94	100*
H160812-100	12,7	.500	1/2	19,1	.750	3/4	3,0	45	9,3	135	11	7.12	100*
H161013-100	15,9	.625	5/8	20,6	.813	13/16	2,4	35	7,2	105	17	11.11	100*
H161014-100	15,9	.625	5/8	22,2	.875	7/8	2,8	40	8,3	120	23	15.72	100*
H161216-100	19,1	.750	3/4	25,4	1.000	1	2,4	35	7,2	105	27	18.04	100**
H161418-100	22,2	.875	7/8	28,6	1.125	1-1/8	2,1	30	6,2	90	31	20.61	100**
H161620-100	25,4	1.000	1	31,8	1.250	1-1/4	1,7	25	5,2	75	34	22.60	100**
H162024-100	31,8	1.250	1-1/4	38,1	1.500	1-1/2	1,4	20	4,1	60	41	27.62	100**
H162430-100	38,1	1.500	1-1/2	47,6	1.875	1-7/8	1,7	25	5,2	75	33	22.32	100**
H162432-100	38,1	1.500	1-1/2	50,1	2.000	2	2,4	35	7,2	105	109	73.36	100**
H163240-100	50,1	2.000	2	63,5	2.500	2-1/2	2,4	35	7,2	105	136	91.68	100**

Inner Tube: Clear PVC
Cover: Non-marking
Temp. Range:
 -9°C to +65°C
 (+15°F to +150°F)

Color: Clear
Typical Application:
 Food/beverage dispensing,
 bottling plants, ice making
 machines, and AC, refrigeration
 and furnace drainage

Stated working pressures are tested at 68°F. Working pressure decreases as temperature increases. Contact Eaton for further information.
 * Standard length pattern in boxes.
 ** Standard length pattern in coils.

Hose Fitting Reference **Page**
Barbed inserts with outer sleeve, ferrule or clamps.

FDA approved material, NSF-51 Certified

D
Hose - Eaton Industrial

H285 Clearforce - R

Reinforced General Purpose Hose



D

Hose - Eaton Industrial

# Part Number	Hose I.D.			Hose O.D.			Working Pressure		Min. Burst Pressure		Min. Bend Radius		Hose Weight		Avail. Lengths
	mm	in	fraction	mm	in	fraction	bar	psi	bar	psi	mm	in	Kg/m	lbs/100ft	feet
H28503-300	4,7	.188	3/16	9,5	.375	3/8	17	250	69	1000	19,1	.75	7	5	300
H28504 H28504-300R	6,4	.250	1/4	11,5	.453	29/64	17	250	69	1000	25,4	1.00	7	7	50 300
H28505-300R	7,9	.313	5/16	13,5	.531	17/32	17	250	69	1000	28,6	1.13	11	8	300
H28506 H28506-300R	9,5	.375	3/8	15,1	.594	19/32	16	225	62	900	31,8	1.25	14	9	50 300
H28508 H28508-300R	12,7	.500	1/2	19,1	.750	3/4	14	200	55	800	50,8	2.00	19	15	50 300
H28510-300R	15,9	.625	5/8	22,2	.875	7/8	14	200	55	800	63,5	2.50	23	17	300
H28512 H28512-300R	19,1	.750	3/4	26,2	1.031	1-1/32	10	150	41	600	63,5	2.50	29	23	50 300
H28516 H28516-200R	25,4	1.000	1	33,3	1.313	1-5/16	9	125	34	500	88,9	3.50	42	32	50 200
H28520-100	31,8	1.250	1-1/4	42,9	1.688	1-11/16	7	100	28	400	TBD	TBD	76	58	100
H28524-100	38,1	1.500	1-1/2	49,2	1.938	1-15/16	7	100	28	400	TBD	TBD	89	69	100
H28532-100	50,1	2.000	2	63,5	2.500	2-1/2	5	75	21	300	TBD	TBD	128	100	100

Inner Tube: Clear PVC

Reinforcement:

2 Spiral

Cover: Clear PVC

Temp. Range:

-9°C to +65°C
(+15°F to +150°F)

Color: Clear

Typical Application:

Spraying and conveying fertilizer and pesticides, Food and beverage dispensing; powdered food manufacturing; bottling plants; dish washer manufacturers, Water and bilge lines; washdown hose, etc., In-plant air and water service

Stated working pressures are tested at 68°F. Working pressure decreases as temperature increases.

* 95% one piece coils.

Hose Fitting Reference

C-0-C

'E' Series

Page

J-2-8

265 'P' Series

J-34

Barbed Inserts, Quick Acting, Short or Long Shank. Clamps—Band, Brass Collars, or Single Bolt. Do not use internal expanded couplings.

FDA approved material, NSF-51 Certified

H1719 Contrac-Force®

General Purpose Hose



# Part Number	Hose I.D.			Hose O.D.			Working Press. (PSI)		Min. Burst Pressure*		Hose Weight		Avail. Lengths
	mm	in	fraction	mm	in	fraction	bar	psi	bar	psi	Kg/m	lbs/ft	feet
H171910-50C	15,9	0.63	5/8	21,0	0.83	53/64	10,3	150	41,4	600	8,2	18	5-50's
H171912-50C	19,1	0.75	3/4	26,6	1.05	1-3/64	10,3	150	41,4	600	10,9	24	5-50's

Inner Tube: Polyvinyl Chloride (PVC)

Reinforcement:

2 Fiber Spiral

Cover: Black Polyvinyl Chloride (PVC)

Temp. Range:

-9°C to +66°C
(-15°F to +150°F)

Typical Application: Low pressure general purpose water transfer hose that is abrasion, age and ozone resistant.

Stated working pressures are tested at 70° F. Working pressure decreases as temperature increases.

MTO min. order quantity 5,000

*3:1 Design Factor

Hose Fitting Reference

Machined brass hex head GHT

Page

H1776/H1777 Perfection 300®



# Part Number	Hose I.D.			Hose O.D.			Working Pressure		Min. Burst Pressure		Hose Weight		Avail. Lengths feet
	mm	in	fraction	mm	in	fraction	bar	psi	bar	psi	Kg/m	lbs/100ft	
H177704-500R	6,4	0.25	1/4	12,7	0.50	1/2	22,4	325	89,6	1,300	5,0	11	500
H177604-500R	6,4	0.25	1/4	15,1	0.59	19/32	22,4	325	89,6	1,300	6,8	15	500
H177705-500R	7,9	0.31	5/16	15,9	0.63	5/8	22,4	325	89,6	1,300	7,7	17	500
H177706-500R	9,5	0.38	3/8	16,7	0.66	21/32	22,4	325	89,6	1,300	7,7	17	500
H177606-500R	9,5	0.38	3/8	18,3	0.72	23/32	22,4	325	89,6	1,300	9,1	20	500
H177708-500R	12,7	0.50	1/2	20,6	0.82	13/16	22,4	325	89,6	1,300	10,9	24	500
H177608-500R	12,7	0.50	1/2	22,2	0.88	7/8	22,4	325	89,6	1,300	14,1	31	500
H177610-500R	15,9	0.63	5/8	25,4	1.00	1	22,4	325	89,6	1,300	16,3	36	500
H177612-500R	19,1	0.75	3/4	29,4	1.16	1-5/32	22,4	325	89,6	1,300	20,2	44	500
H177616-300R	25,4	1.00	1	36,5	1.44	1-7/16	22,4	325	89,6	1,300	20,9	46	300
H177620-300R	31,8	1.25	1-1/4	44,5	1.75	1-3/4	22,4	325	89,6	1,300	29,5	65	300
H177624-300R	38,1	1.50	1-1/2	50,8	2.00	2	22,4	325	89,6	1,300	37,2	82	300

Inner Tube: Nitrile (RMA Class A)

Reinforcement: 1 or 2 Fiber Braids

Cover: Red Vinyl Nitrile

Temp. Range:
-40°C to +82°C
(-40°F to +180°F)

Typical Application:

Pneumatic tools and conveying of air and water. High oil resistance.

Hose Fitting Reference

C-O-C	Page
'U' Series (-4 to -20)	J-39-57
430 'U' Series (-24 only)	J-58-68
'Z' Series (-4 to -20, except -05)	J-69-94

H1812 Industrial A/W



# Part Number	Hose I.D.			Hose O.D.			Working Pressure		Min. Burst Pressure		Hose Weight		Avail. Lengths feet
	mm	in	fraction	mm	in	fraction	bar	psi	bar	psi	Kg/m	lbs/100ft	
H181204-500R	6,4	0.25	1/4	15,1	0.59	19/32	19,0	275	77,0	1,100	7,3	16	500
H181206-500R	9,5	0.38	3/8	18,3	0.72	23/32	19,0	275	77,0	1,100	8,6	19	500
H181208-500R	12,7	0.50	1/2	22,2	0.88	7/8	17,2	250	70,0	1,000	12,2	27	500
H181210-500R	15,9	0.63	5/8	25,4	1.00	1	17,2	250	70,0	1,000	16,3	36	500
H181212-500R	19,1	0.75	3/4	29,4	1.16	1-5/32	17,2	250	70,0	1,000	18,6	41	500
H181216-300R	25,4	1.00	1	36,5	1.44	1-7/16	17,2	250	70,0	1,000	20,9	46	300
H181220-300R	31,8	1.25	1-1/4	44,5	1.75	1-3/4	17,2	250	70,0	1,000	29,5	65	300
H181224-300R	38,1	1.50	1-1/2	50,8	2.00	2	17,2	250	70,0	1,000	37,2	82	300

Inner Tube: EPDM

Reinforcement: 2 Fiber Braids

Cover: Red EPDM

Temp. Range:
-40°C to +82°C
(-40°F to +180°F)

Typical Application:

Spraying and conveying water-based liquid fertilizers and pesticides. Transfer air and water; pneumatic tools.

Hose Fitting Reference

C-O-C	Page
'U' Series (-4 to -20)	J-39-57
430 'U' Series (-24 only)	J-58-68
'Z' Series (-4 to -20)	J-69-94

D

Hose - Eaton Industrial

H1981/H1982 Boston Marathoner

Air and Multi-Purpose Hose

EATON[®] BOSTON MARATHONER HOSE Non Conductive



D
Hose - Eaton Industrial

# Part Number	Hose I.D.			Hose O.D.			Working Pressure		Min. Burst Pressure		Hose Weight		Avail. Lengths
	mm	in	fraction	mm	in	fraction	bar	psi	bar	psi	Kg/m	lbs/100ft	
H198104RD-600R	6,4	0.25	1/4	12,7	0.50	1/2	13,8	200	56	800	4,5	10	600
H198204RD-600R	6,4	0.25	1/4	15,9	0.63	5/8	20,1	300	84	1,200	5,9	13	600
H198105RD-600R	7,9	0.31	5/16	15,9	0.63	5/8	13,8	200	56	800	5,4	12	600
H198205RD-600R	7,9	0.31	5/16	17,5	0.69	11/16	20,1	300	84	1,200	5,9	13	600
H198106RD-600R	9,5	0.38	3/8	17,5	0.69	11/16	13,8	200	56	800	6,8	15	600
H198206RD-600R	9,5	0.38	3/8	19,1	0.75	3/4	20,1	300	84	1,200	8,2	18	600
H198206GN-600R													600
H198206BK-600R													600
H198108RD-600R	12,7	0.50	1/2	20,6	0.81	13/16	13,8	200	56	800	8,6	19	600
H198208RD-600R	12,7	0.50	1/2	22,2	0.88	7/8	20,1	300	84	1,200	10,4	23	600
H198208GN-600R													600
H198208BK-600R													600
H198208YW-600R													600
H198210RD-600R	15,9	0.63	5/8	26,2	1.03	1-1/32	20,1	300	84	1,200	11,3	25	600
H198210GN-600R	15,9	0.63	5/8	26,2	1.03	1-1/32	20,1	300	84	1,200	11,3	25	600
H198112RD-250	19,1	0.75	3/4	31,2	1.19	1-3/16	15,5	225	63	900	16,8	37	5-50's
H198112RD-600R													600
H198212RD-250	19,1	0.75	3/4	31,2	1.19	1-3/16	20,1	300	84	1,200	16,8	37	5-50's
H198212RD-600R													600
H198212BK-600R													600
H198212YW-600R													600
H198216RD-400R	25,4	1.00	1	36,5	1.44	1-7/16	20,1	300	84	1,200	29,0	64	400
H198216GN-400R													400

Inner Tube: Blended Nitrile

Reinforcement:

2 or 4 Spiral

Cover: Neoprene/Pinpricked

Temp. Range:

-40°C to +82°C
(-40°F to +180°F)

Typical Application:

Transfer air and water
and pneumatic tools on
production line.

Available in other colors on a made
to order basis.

**Hose Fitting
Reference**

C-O-C

'U' Series (except -05) J-39-57

'Z' Series (except -05) J-69-94

Page

H1987 Contractors Water®

Water Hose



# Part Number	Hose I.D.			Hose O.D.			Working Pressure		Min. Burst Pressure		Hose Weight		Avail. Lengths feet
	mm	in	fraction	mm	in	fraction	bar	psi	bar	psi	Kg/m	lbs/100ft	
H198710 H198710-50C H198710-600R	15,9	0.63	5/8	24,6	0.94	15/16	10,3	150	41,4	600	34,2	23	50 5-50's coupled 600
H198712 H198712-50C H198712-600R	19,1	0.75	3/4	27,8	1.09	1-3/32	10,3	150	41,4	600	44,6	30	50 5-50's coupled 600

Inner Tube: EPDM

Reinforcement:
2 Fiber Spiral

Cover: EPDM/Perforated

Temp. Range:
-34°C to +71°C
(-30°F to +160°F)

Typical Application:

Low pressure general purpose water transfer hose that is abrasion, age, heat and water resistant.

Hose Fitting Reference	Page
Machined brass hex head GHT	

H9949 Shock-Safe®

Air and Multi-Purpose Hose

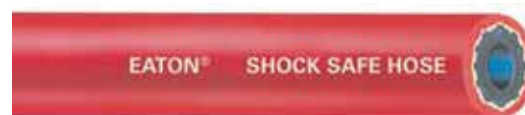

# Part Number	Hose I.D.			Hose O.D.			Working Pressure		Min. Burst Pressure		Hose Weight		Avail. Lengths feet
	mm	in	fraction	mm	in	fraction	bar	psi	bar	psi	Kg/m	lbs/100ft	
H994904-500R	6,4	0.25	1/4	15,1	0.59	19/32	19,0	275	75,8	1,100	22,3	15	500
H994906-500R	9,5	0.38	3/8	18,3	0.72	23/32	19,0	275	75,8	1,100	28,3	19	500
H994908-500R	12,7	0.50	1/2	22,2	0.88	7/8	19,0	275	75,8	1,100	40,2	27	500
H994912-500R	19,1	0.75	3/4	29,4	1.16	1-5/32	19,0	275	75,8	1,100	61,0	41	500
H994916-300R	25,4	1.00	1	36,5	1.44	1-7/16	19,0	275	75,8	1,100	95,0	64	300

Inner Tube: Nitrile (non-conductive)

Reinforcement:
2 Fiber Braids

Cover: Vinyl Nitrile (non-conductive)

Temp. Range:
-40°C to +82°C
(-40°F to +180°F)

Typical Application:

General purpose air and water hose used where hose must be non-conductive.

* Each reel factory tested to exceed minimum electrical resistivity of one megaohm per inch at 1,000 volts D.C.

Hose Fitting Reference	Page
C-0-C	
'U' Series	J-39-57
'Z' Series	J-69-94

D
Hose - Eaton Industrial

Hose - Fuel

Table of Contents

EH049	E-2	H059	E-3
EH089	E-2	H077	E-4
GH100	E-2	H366	E-4
H057	E-3	H900	E-5



EH049 ESP Tubing and EH089 ESP Hose

Meets EPA and CARB

EATON® EH04908 ESP® EPA CERTIFIED ETH-EVAPNR-09-02

EATON® EH08904 ESP® EPA CERTIFIED ETH-EVAPNR-09-02

# Part Number	Hose I.D.			Hose O.D.			Working Pressure*		Hose Weight		Standard Length		Package
	mm	in	fraction	mm	in	fraction	bar	psi	Kg/m	lb/ft	m	ft	
EH049-04	6,35	.250	1/4	9,53	.375	3/8	3,5	50	1,4	3.0	30,48	100	Coil/Box
EH049-05	7,92	.312	5/16	11,13	.438	7/16	3,5	50	1,6	3.6	30,48	100	Coil/Box
EH049-06	9,53	.375	3/8	12,70	.500	1/2	3,5	50	2,0	4.3	30,48	100	Coil/Box
EH089-04	6,35	.250	1/4	12,45	.490	15/32	25,8	335	3,8	8.3	30,48	100	Coil/Box
EH089-05	7,92	.312	5/16	14,10	.555	9/16	17,2	250	4,4	9.6	30,48	100	Coil/Box
EH089-06	9,53	.375	3/8	15,88	.625	5/8	18,9	275	4,8	10.5	30,48	100	Coil/Box

Inner Tube: PVDF

Reinforcement: Polyester

Cover: MPR

Temp. Range:

-32°C to +66°C
(-25°F to +150°F)

Typical Application:

For use between the fuel tank and engine on marine outboard fuel systems and small gasoline-powered lawn, garden, and turf equipment.

* Working pressure at 20°C (68°F)

Meets the requirements of the International Marine Certification Institute's Recreational Craft Directive 94/25/EC

Qualified to applicable portions of SAE J1527B1 and SAE J30R6, R9, and R11 specifications

Hose Fitting Reference

Hose Fitting Reference	Page
C-0-C	
265 'P' Series*	J-2-8
Field Attachable	
057 'B' Series	K-3-4

*EH089 Only

Hose - Fuel

GH100 Biodiesel Hose

And High Temperature Oils

# Part Number	Hose I.D.			Hose O.D.			Working Pressure		Min. Burst Pressure		Min. Bend Radius		Hose Weight	
	mm	in	fraction	mm	in	fraction	bar	psi	bar	psi	mm	in	Kg/m	lbs/100ft
GH100-4	6,4	0.25	1/4	13,3	0.53	1/2	28	400	112	1,600	31,8	1.25	3,6	8
GH100-6	9,5	0.38	3/8	15,9	0.62	5/8	28	400	112	1,600	38,1	1.50	4,5	10
GH100-8	12,7	0.50	1/2	19,1	0.75	3/4	28	400	112	1,600	50,8	2.00	5,9	13
GH100-10	15,9	0.63	5/8	23,1	0.91	7/8	24	350	96	1,400	63,5	2.50	8,2	18
GH100-12	19,2	0.75	3/4	27,9	1.10	1-1/8	24	350	96	1,400	76,2	3.00	9,1	20

Inner Tube: HNBR

Reinforcement: Aramid Braid

Cover: Fiber Braid

Temp. Range:

Up to B20
-40°C to +150°C
(-40°F to +302°F)

Up to B100
-40°C to +125°C
(-40°F to +257°F)

Typical Application:

On engine fuel systems for diesel & biodiesel use.

Hose Fitting Reference

Hose Fitting Reference	Page
C-0-C	
327 'E' Series	J-13-14

H057 Fuel Line Hose

SAE 30R7



# Part Number	Hose I.D.			Hose O.D.			Working Pressure		Min. Burst Pressure		Min. Bend Radius		In. Merc. Vac.		Hose Weight		Avail. Lengths
	mm	in	fraction	mm	in	fraction	bar	psi	bar	psi	mm	in	Hg*	Kg/m	lbs/100ft	feet	
H05703-25R H05703-100R	4,8	0.19	3/16	10,3	0.41	13/32	3,4	50	17,2	250	50,8	2.00	24	2,7	6	25 100	
H05704-25R H05704-100R H05704-250R H05704-500R	6,4	0.25	1/4	12,7	0.50	1/2	3,4	50	17,2	250	63,5	2.50	24	4,1	9	25 100 250 500	
H05705-25R H05705-100R H05705-500R	7,9	0.31	5/16	14,3	0.56	9/16	3,4	50	17,2	250	69,8	2.75	24	5,0	11	25 100 500	
H05706-25R H05706-50R H05706-250R	9,5	0.38	3/8	15,9	0.63	5/8	3,4	50	17,2	250	76,2	3.00	24	5,4	12	25 50 250	
H05707-25R H05707-50R	11,1	0.47	7/16	17,5	0.69	11/16	2,4	35	9,7	140	82,6	3.25	24	7,3	16	25 50	

Inner Tube: Nitrile

Reinforcement: 1 Fiber Braids

Cover: Hypalon*

Temp. Range:

-40°C to +125°C
(-40°F to +257°F)

Typical Application:

Low pressure/high temperature fuel for passenger cars and light trucks; also small engine applications

Note:

Not intended for fuel injection applications.

* Hypalon is a trademark of E.I. DuPont.

Hose Fitting Reference	Page
Field Attachable	
057 'B' Series	K-3-4

H059 Marine Fuel-Oil-Lube Hose

SAE J1942/1, NMMA³, 33CFR183, ABS



# Part Number	Hose I.D.			Hose O.D.			Working Pressure		Min. Burst Pressure		Min. Bend Radius		Hose Weight		Avail. Lengths
	mm	in	fraction	mm	in	fraction	bar	psi	bar	psi	mm	in	Kg/m	lbs/100ft	feet
H05904	4,8	0.19	3/16	13,1	0.52	33/64	34,5	500	137,9	2,000	19,1	.75	7,3	16	50
H05905	6,4	0.25	1/4	14,7	0.58	37/64	34,5	500	137,9	2,000	25,4	1.00	9,1	20	50
H05906	7,9	0.31	5/16	17,1	0.67	43/64	34,5	500	137,9	2,000	31,8	1.25	11,8	26	50
H05908	10,3	0.41	13/32	19,4	0.77	49/64	34,5	500	137,9	2,000	44,5	1.75	13,2	29	50
H05910	12,7	0.50	1/2	23,4	0.92	59/64	34,5	500	137,9	2,000	57,2	2.25	18,1	40	50
H05912	15,9	0.63	5/8	28,4	1.08	1-5/64	34,5	500	137,9	2,000	69,8	2.75	20,9	46	50
H05916	22,2	0.88	7/8	31,4	1.23	1-15/64	34,5	500	137,9	2,000	88,9	3.50	21,8	48	50

Inner Tube:

Special Blended Nitrile

Reinforcement:

1 Fiber Braid - 1 Steel Braid
- 1 Nomex® Braid

Cover: CPE

Temp. Range:

-20°C to +100°C
(-4°F to +212°F)

Typical Application: Marine

fuel, oil and lube hose is specially designed for gas and diesel marine engines. Its blue cover makes it easily identified in marine environments.

Marine Application SAE J1942/1 Fuel and Lube Service, ABS¹

³ Size -5 Does not meet NMMA standards

® Nomex is a trademark of E.I. DuPont

Hose Fitting Reference	Page
C-O-C	
069 'E' Series	J-9-12
229 'P' Series (-6, -8 & -10)	J-33
Field Attachable	
247 'N' Series	K-22-26

H077 Fuel Injection Hose

SAE 30R9



# Part Number	Hose I.D.			Hose O.D.			Working Pressure		Min. Burst Pressure		Min. Bend Radius		Hose Weight		Avail. Lengths
	mm	in	fraction	mm	in	fraction	bar	psi	bar	psi	mm	in	Kg/m	lbs/100ft	
H07704-10	6,4	0.25	1/4	12,7	0.50	1/2	8,6	125	62,1	900	76,2	3.00	5,0	11	10
H07705-10 H07705-300	7,9	0.31	5/16	14,3	0.56	9/16	8,6	125	62,1	900	95,3	3.75	5,9	13	10 300
H07706-10	9,2	0.38	3/8	15,9	0.63	5/8	8,6	125	62,1	900	114,3	4.50	7,3	16	10

Inner Tube:
Fluoroelastomer Veneer

Reinforcement:
Multi-Fiber Braids

Cover: ECO
(Epichlorohydrin Copolymer)

Temp. Range:
-34°C to +135°C
(-30°F to +275°F)

Typical Application:
Designed specifically for electronic fuel injection systems

Hose Fitting Reference	Page
E.F.I	
Clamps	M-24

E

Hose - Fuel

H366 LPG Hose

UL File Number MH 6776, ULMH 10198



# Part Number	Hose I.D.			Hose O.D.			Working Pressure		Min. Burst Pressure		Min. Bend Radius		Hose Weight		Avail. Lengths
	mm	in	fraction	mm	in	fraction	bar	psi	bar	psi	mm	in	Kg/m	lbs/100ft	
H36606 H36606-250R	7,9	0.31	5/16	17,1	0.67	43/64	24,1	350	120,7	1,750	101,6	4.00	8,2	18	50 250
H36608	10,3	0.41	13/32	19,4	0.77	49/64	24,1	350	120,7	1,750	117,5	4.625	9,5	21	50

Inner Tube: Nitrile
Reinforcement: 1 Fiber Braid – 1 Stainless Steel Braid

Cover: Fiber Braid

Temp. Range:
-40°C to +149°C
(-40°F to +300°F)

Typical Application:
Most commonly used for medium pressure LP gas service. UL listed for LP gas applications

Hose Fitting Reference	Page
C-D-C	
069 'E' Series	J-9-12
Field Attachable	
069 'D' Series	K-12-13
247 'N' Series	K-22-26

H900 Black Line® Liquid Propane Gas (LPG)

UL 21 Approved LP-Gas



# Part Number	Hose I.D.			Hose O.D.			Working Press. (PSI)		Min. Burst Pressure		Hose Weight		Avail. Lengths
	mm	in	fraction	mm	in	fraction	bar	psi	bar	psi	Kg/m	lbs/ft	feet
H90004-500R	6,4	0.25	1/4	14,7	0.58	37/64	24,1	350	122,0	1,750	5,4	12	500
H90006-500R	9,5	0.38	3/8	18,3	0.72	23/32	24,1	350	122,0	1,750	7,7	17	500
H90008-500R	12,7	0.50	1/2	23,1	0.91	29/32	24,1	350	122,0	1,750	10,9	24	500
H90012-500R	19,1	0.75	3/4	27,4	1.08	1-5/64	24,1	350	122,0	1,750	18,6	41	500
H90016-150 H90016-300R	25,4	1.00	1	38,1	1.50	1-1/2	24,1	350	122,0	1,750	23,6	52	150 300

Inner Tube: Nitrile

Reinforcement: Fiber Braid
(1" has 2 Stainless Steel
Static Wires)

Cover: Vinyl Nitrile,
Pinpricked

Temp. Range:

-40°C to +60°C
(-40°F to +140°F)
Hose is capable of this
rating. LP-Gas should never
be elevated above 37.8°C
(100°F).

Typical Application:

Transfer and delivery of
propane and butane.

**Hose Fitting
Reference**

C-D-C

'U' Series

Page

J-39-57

E

Hose - Fuel

W

Hose - Fuel

Hose - Silicone

Table of Contents

EH225	F-2		
EH226	F-2	EH227	F-3



EH225 Heater Hose

Meets SAE J20 R3 Class A



# Part Number	Hose I.D.		Hose O.D.		Min. Burst Pressure		Box Package
	mm	in	mm	in	bar	psi	
EH22504	6,40	.25	11,70	.46	28	400	25
EH22505	7,90	.31	13,20	.52	21	300	25
EH22506	9,70	.38	16,30	.64	17	250	25
EH22508	12,70	.50	19,30	.76	17	250	25
EH22510	16,00	.63	23,60	.93	17	250	25
EH22512	19,10	.75	27,20	1.07	14	200	25
EH22514	22,40	.88	31,50	1.24	14	200	25
EH22516	25,40	1.00	35,10	1.38	12	175	25

Inner Tube: Silicone

Reinforcement: 1 Ply
Polyester Braid

Cover: Blue

Temp. Range:
-54°C to +177°C
(-65°F to +350°F)

Typical Application:
Engine

F

Hose - Silicone

EH226 Coolant Hose

Meets SAE J20 R1 Class A



# Part Number	Hose I.D.		Hose O.D.		Min. Burst Pressure		Lengths
	mm	in	mm	in	bar	psi	
EH22605	7.90	0.31	17.50	0.69	74.50	1080	3
EH22606	8.70	0.38	19.10	0.75	73.10	1060	3
EH22608	12.70	0.50	22.10	0.87	60.10	872	3
EH22610	15.70	0.62	25.10	0.99	55.00	797	3
EH22612	19.10	0.75	28.40	1.12	52.70	764	3
EH22614	22.40	0.88	31.80	1.25	50.50	732	3
EH22616	25.40	1.00	34.80	1.37	48.20	699	3
EH22617	26.90	1.06	36.60	1.44	46.70	678	3
EH22618	28.70	1.13	38.10	1.50	45.40	658	3
EH22620	31.80	1.25	41.10	1.62	42.50	617	3
EH22622	35.10	1.38	44.40	1.75	37.90	550	3
EH22624	38.10	1.50	47.50	1.87	35.90	521	3
EH22626	41.10	1.62	50.50	1.99	34.50	501	3
EH22628	44.40	1.75	53.80	2.12	32.60	473	3
EH22630	47.80	1.88	57.20	2.25	31.00	450	3
EH22632	50.80	2.00	60.20	2.37	30.50	442	3
EH22634	54.10	2.13	63.50	2.50	29.30	425	3
EH22636	57.20	2.25	66.50	2.62	28.50	413	3
EH22638	60.50	2.38	69.90	2.75	27.60	400	3

Inner Tube: Silicone
Reinforcement: 4 Plies
Polyester

Cover: Blue
Temp. Range:
-54°C to +177°C
(-65°F to +350°F)

# Part Number	Hose I.D.		Hose O.D.		Min. Burst Pressure		Lengths
	mm	in	mm	in	bar	psi	
EH22640	63.50	2.50	72.90	2.87	26.10	379	3
EH22642	66.50	2.62	75.90	2.99	24.20	351	3
EH22644	69.80	2.75	79.20	3.12	23.30	338	3
EH22646	73.20	2.88	82.60	3.25	22.10	321	3
EH22648	76.20	3.00	85.60	3.37	21.90	317	3
EH22650	79.50	3.13	88.90	3.50	21.20	308	3
EH22652	82.60	3.25	91.90	3.62	20.50	298	3
EH22654	85.90	3.38	95.20	3.75	19.00	275	3
EH22656	86.90	3.50	98.30	3.87	18.20	264	3
EH22658	92.20	3.63	101.60	4.00	17.60	256	3
EH22660	95.20	3.75	104.60	4.12	17.20	249	3
EH22664	101.60	4.00	111.00	4.37	16.10	233	3
EH22666	104.90	4.13	114.60	4.51	N/A	N/A	3
EH22668	108.00	4.25	117.90	4.84	N/A	N/A	3
EH22672	114.30	4.50	123.70	4.87	N/A	N/A	3
EH22680	127.00	5.00	136.40	5.37	N/A	N/A	3
EH22688	139.70	5.50	149.10	5.87	N/A	N/A	3
EH22696	152.40	6.00	161.80	6.37	N/A	N/A	3

Typical Application:
Engine

EH227 Turbo Hose



# Part Number	Hose I.D.		Hose O.D.		Lengths ft
	mm	in	mm	in	
EH22704	6.40	0.25	14.50	0.57	3
EH22706	9.70	0.38	17.80	0.70	3
EH22708	12.70	0.50	20.80	0.82	3
EH22710	16.00	0.63	24.10	0.95	3
EH22712	19.10	0.75	27.20	1.07	3
EH22714	22.40	0.88	30.50	1.20	3
EH22716	25.40	1.00	33.50	1.32	3
EH22717	26.90	1.06	35.10	1.38	3
EH22718	28.70	1.13	36.80	1.45	3
EH22720	31.80	1.25	39.90	1.57	3
EH22721	33.30	1.31	41.40	1.63	3
EH22722	35.10	1.38	43.20	1.70	3
EH22724	38.10	1.50	46.20	1.62	3
EH22726	41.10	1.62	49.30	1.94	3
EH22728	44.40	1.75	52.60	2.07	3
EH22730	47.80	1.88	55.90	2.20	3
EH22732	50.80	2.00	58.90	2.32	3
EH22734	54.10	2.13	62.20	2.45	3

# Part Number	Hose I.D.		Hose O.D.		Lengths ft
	mm	in	mm	in	
EH22736	57.20	2.25	65.30	2.57	3
EH22738	60.50	2.38	68.60	2.70	3
EH22740	63.50	2.50	71.60	2.82	3
EH22742	66.50	2.62	74.70	2.94	3
EH22744	69.80	2.75	78.00	3.07	3
EH22746	73.20	2.88	81.30	3.20	3
EH22748	76.20	3.00	84.30	3.32	3
EH22750	79.50	3.13	87.60	3.45	3
EH22752	82.60	3.25	90.70	3.57	3
EH22754	85.90	3.38	94.00	3.70	3
EH22756	88.90	3.50	97.00	3.82	3
EH22758	92.20	3.63	100.30	3.95	3
EH22760	95.20	3.75	103.40	4.07	3
EH22764	101.60	4.00	109.70	4.32	3
EH22772	114.30	4.50	122.40	4.82	3
EH22780	127.00	5.00	135.10	5.32	3

Inner Tube: Silicone
Reinforcement: 4 Plies
 Aramid
Cover: Red
Temp. Range:
 -54°C to +260°C
 (-65°F to +500°F)

Typical Application:
 Engine

F
 Hose - Silicone

Table of Contents

<u>GH134W</u>	<u>G-2</u>	<u>H757</u>	<u>G-2</u>
---------------	------------	-------------	------------



GH134W Multi-Refrigerant Hose

SAE J2064 Type E, Class 1



# Part Number	Hose I.D.			Hose O.D.			Working Pressure		Min. Burst Pressure		Min. Bend Radius		Hose Weight		Avail. Lengths
	mm	in	fraction	mm	in	fraction	bar	psi	bar	psi	mm	in	Kg/m	lbs/100ft	feet
GH134-6WR50 GH134-6WR200	7,9	0.31	5/16	14,7	0.58	37/64	34,5	500	137,9	2,000	50,8	2.00	4,1	9	50 200
GH134-8WR50 GH134-8WR200	10,3	0.41	13/32	17,8	0.70	45/64	34,5	500	137,9	2,000	63,5	2.50	5,5	12	50 200
GH134-10WR50 GH134-10WR200	12,7	0.50	1/2	19,8	0.78	25/32	34,5	500	137,9	2,000	76,2	3.00	6,8	15	50 200
GH134-12WR50 GH134-12WR200	15,9	0.63	5/8	24,9	0.98	63/64	34,5	500	137,9	2,000	101,6	4.00	8,2	18	50 200
*GH134-16WR50 *GH134-16WR200	22,2	0.875	7/8	31,2	1.23	1-11/50	34,5	500	137,9	2,000	127,0	7.00	10,0	22	50 200

Temp. Range:

-40°C to +135°C
(-40°F to +275°F)

Typical Application:

Transportation, refrigeration and air conditioning systems.

R404a Effusion:

.8 kg./m²/yr. at 60°C
(.2 lbs./ft²/yr. at 140°F)

HFC 134a Effusion:

2.42 kg./m²/yr. at 80°C
(.50 lbs./ft²/yr. at 176°F)

R407C Effusion:

20 kg./m²/yr. at 80°C

Moisture Ingression:

.013/cm²/yr. (.08 gm./in²/yr.)

For more information on EZ Clip, see document #W-HOAC-MC001-E3

Hose available in reels, by ordering part number, size and WRL

Hose Fitting Reference

EZ Clip

Series

Page

K-32-64

G

Hose - Air Conditioning

H757 Air Conditioning Hose

SAE J2064 Type C, Class 1



# Part Number	Hose I.D.			Hose O.D.			Working Pressure		Min. Burst Pressure		Min. Bend Radius		Hose Weight		Avail. Lengths
	mm	in	fraction	mm	in	fraction	bar	psi	bar	psi	mm	in	Kg/m	lbs/100ft	feet
H75706 H75706-100 H75706-250	7,9	0.31	5/16	14,3	0.56	9/16	27,6	400	137,9	2,000	50,8	2.00	4,5	10	50 100 250
H75708 H75708-100 H75708-250	10,3	0.41	13/32	17,5	0.69	11/16	27,6	400	137,9	2,000	63,5	2.50	5,4	12	50 100 250
H75710 H75710-100 H75710-250	12,7	0.50	1/2	19,1	0.75	3/4	24,1	350	120,7	1,750	76,2	3.00	5,9	13	50 100 250
H75712 H75712-100 H75712-250	15,9	0.63	5/8	23,8	0.94	15/16	24,1	350	120,7	1,750	101,6	4.00	10,4	23	50 100 250

Inner Tube:

Rubber/Nylon/Rubber

Reinforcement:

1 Fiber Braid

Cover: Butyl (perforated)

Temp. Range:

-30°C to +120°C
(-22°F to +248°F) for R12;
-30°C to +125°C (-22°F to +257°F) for R134a

Typical Application:

A refrigerant hose recommended for R134a and R12 applications. Ideal for heavy duty truck use as well as industrial and automotive applications.

Hose Fitting Reference

C-O-C

757 'E' Series

Page

J-24-31

Hose - Truck

Table of Contents

		H166	H-4
H229	H-2	H169	H-4
H239	H-2	H213	H-5
H338	H-3	H069	H-6
H429	H-3	H569	H-7



H229 Truck Hose

SAE J1402 TYPE AII,
DOT AII



# Part Number	Hose I.D.			Hose O.D.			Working Pressure		Min. Burst Pressure		Min. Bend Radius		Hose Weight		Avail. Lengths
	mm	in	fraction	mm	in	fraction	bar	psi	bar	psi	mm	in	Kg/m	lbs/100ft	
H22904	4,8	0.19	3/16	12,7	0.50	1/2	15,5	225	137,9	2,000	38,1	1.50	3,2	7	50
H22906 H22906-250R	7,9	0.31	5/16	19,1	0.75	3/4	15,5	225	137,9	2,000	50,8	2.00	5,0	11	50 250
H22908 H22908-250R	10,3	0.41	13/32	23,0	0.91	29/32	15,5	225	137,9	2,000	58,7	2.31	6,4	14	50 250
H22910	12,7	0.50	1/2	27,0	1.06	1-1/16	15,5	225	124,1	1,800	69,9	2.75	9,5	21	50
H22910	15,9	0.63	5/8	31,8	1.25	1-1/4	15,5	225	124,1	1,800	82,6	3.25	12,2	27	50
H22916*	22,2	0.88	7/8	38,1	1.50	1-1/2	15,5	225	68,9	1,000	101,6	4.00	14,1	31	50

Inner Tube: Nitrile

Reinforcement: 2 Fiber Braids

Cover: Fiber Braids

Temp. Range:

Hydraulic: -40°C to +100°C
(-40°F to +212°F)

Air Brake: -40°C to +100°C
(-40°F to +212°F)

Typical Application:

General purpose truck hose. High temperature hydraulic, air brake and diesel fuel applications.

*16 size not SAE or DOT approved for air brake applications.

Hose Fitting Reference

Page

C-O-C

069 'E' Series J-9-12

229 'P' Series (-6 to -10) J-33

Field Attachable

069 'D' Series K-12-13

247 'N' Series K-22-26

H239 Truck Hose

SAE J1402 TYPE AII, DOT AII



# Part Number	Hose I.D.			Hose O.D.			Working Pressure		Min. Burst Pressure		Min. Bend Radius		Hose Weight		Avail. Lengths
	mm	in	fraction	mm	in	fraction	bar	psi	bar	psi	mm	in	Kg/m	lbs/100ft	
H23904 H23904-250R	4,8	0.19	3/16	12,7	0.50	1/2	15,5	225	137,9	2,000	38,1	1.50	3,2	7	50 250
H23906 H23906-250R	7,9	0.31	5/16	16,7	0.66	21/32	15,5	225	137,9	2,000	50,8	2.00	5,0	11	50 250
H23908 H23908-250R	10,3	0.41	13/32	19,1	0.75	3/4	15,5	225	137,9	2,000	58,7	2.31	6,4	14	50 250
H23910 H23910-250R	12,7	0.50	1/2	23,0	0.91	29/32	15,5	225	124,1	1,800	69,9	2.75	9,5	21	50 250
H23912 H23912-250R	15,9	0.63	5/8	27,0	1.06	1-1/16	15,5	225	124,1	1,800	82,6	3.25	12,2	27	50 250
H23916* H23916-250R*	22,2	0.88	7/8	31,8	1.25	1-1/4	15,5	225	68,9	1,000	101,6	4.00	14,1	31	50 250
H23920* H23920-250R*	28,6	1.13	1-1/8	38,1	1.50	1-1/2	15,5	225	68,9	1,000	139,7	5.50	18,6	41	50 250

Inner Tube: CPE

Reinforcement: 2 Fiber Braids

Cover: Black Fiber Braid

Temp. Range:

Hot Oil: -40°C to +150°C
(-40°F to +302°F)

Air Brake: -40°C to +93°C
(-40°F to +200°F)

Typical Application:

High temperature medium pressure truck hose for use in transmission oil cooler lines, fuel lines, diesel fuel and air brake lines. Resistant to air, diesel fuel and petroleum base fluids.

*Sizes 16 and 20 are not SAE nor DOT approved for air brake applications.

Hose Fitting Reference

Page

C-O-C

069 'E' Series J-9-12

229 'P' Series (-6 to -10) J-33

Field Attachable

247 'N' Series K-22-26

H338 Air Brake Hose

SAE J1402 A DOT All



# Part Number	Hose I.D.			Hose O.D.			Working Pressure		Min. Burst Pressure		Min. Bend Radius		Hose Weight		Avail. Lengths
	mm	in	fraction	mm	in	fraction	bar	psi	bar	psi	mm	in	Kg/m	lbs/100ft	feet
H33806 H33806-250R	9,5	0.38	3/8	19,1	0.75	3/4	15,5	225	62,1	900	88,9	3.50	10,9	24	50 250
H33808 H33808-250R	12,7	0.50	1/2	22,2	0.88	7/8	15,5	225	62,1	900	114,3	4.00	13,2	27	50 250

Inner Tube: EPDM

Reinforcement:
Multi-Fiber Braids

Temp. Range:

-40°C to +93°C
(-40°F to +200°F)

Cover: EPDM

Typical Application:
Air brake hose lines

Hose Fitting Reference

C-O-C

338 'P' Series

Page

J-35-37

Field Attachable

338 'B' Series

K-9-11

H429 Truck Hose

SAE J1019



# Part Number	Hose I.D.			Hose O.D.			Working Pressure		Min. Burst Pressure		Min. Bend Radius		Hose Weight		Avail. Lengths
	mm	in	fraction	mm	in	fraction	bar	psi	bar	psi	mm	in	Kg/m	lbs/100ft	feet
H42908 H42908-250R	10,3	0.41	13/32	17,5	0.69	11/16	17,2	250	69,0	1,000	44,5	1.75	10,9	24	50 250
H42910 H42910-250R	12,7	0.50	1/2	19,1	0.75	3/4	17,2	250	69,0	1,000	57,2	2.25	16,8	37	50 250

Inner Tube: CPE

Reinforcement:
1 Wire Braid

Cover: Fiber Braid

Temp. Range:
-48°C to +150°C
(-55°F to +302°F)

Typical Application: High temperature truck hose for use in transmission oil cooler lines, fuel lines and diesel fuel lines. Oil and temperature resistant tube.

Hose Fitting Reference

C-O-C

757 'E' Series

Page

J-24-31

057 'P' Series

J-32

H166 Truck Hose

SAE J1402 TYPE AII, DOT AII



# Part Number	Hose I.D.			Hose O.D.			Working Pressure		Min. Burst Pressure		Min. Bend Radius		Hose Weight		Avail. Lengths feet
	mm	in	fraction	mm	in	fraction	bar	psi	bar	psi	mm	in	Kg/m	lbs/100ft	
H16604	4,8	0.19	3/16	13,1	0.52	33/64	103,4	1,500	413,7	6,000	38,1	1.50	5,0	11	50
H16605	6,4	0.25	1/4	14,7	0.58	37/64	34,5	500	137,9	2,000	44,5	1.75	5,9	13	50
H16606	7,9	0.31	5/16	17,2	0.67	43/64	34,5	500	137,9	2,000	50,8	2.00	8,2	18	50
H16608	10,3	0.41	13/32	19,4	0.77	49/64	34,5	500	137,9	2,000	58,7	2.31	9,5	21	50
H16610	12,7	0.50	1/2	23,4	0.92	59/64	31,0	450	124,1	1,800	69,8	2.75	13,2	29	50
H16612	15,9	0.63	5/8	28,4	1.08	1-5/64	31,0	450	124,1	1,800	82,6	3.25	16,8	37	50
H16616*	22,2	0.88	7/8	31,4	1.23	1-15/64	17,2	250	69,0	1,000	101,6	4.00	17,2	38	50
H16620*	28,6	1.13	1-1/8	38,5	1.52	1-33/64	17,2	250	69,0	1,000	139,7	5.50	20,9	46	50

Inner Tube: Nitrile

Reinforcement: 1 Fiber Braid – 1 Stainless Steel Braid

Cover: Fiber Braid

Temp. Range:

Air Brake: -40°C to +93°C (-40°F to +200°F)

Hydraulic Fluid: -40°C to +121°C (-40°F to +250°F)

Typical Application:

General purpose truck hose. For use in air brake, fuel, diesel fuel and high temperatures petroleum oil applications.

*16 and 20 sizes not SAE or DOT approved for air brake applications.

Hose Fitting Reference

Reference	Page
<i>C-O-C</i>	
069 'E' Series	J-9-12
<i>Field Attachable</i>	
069 'D' Series	K-12-13
247 'N' Series (except -20 size)	K-22-26

H169 Hydraulic Hose



# Part Number	Hose I.D.			Hose O.D.			Working Pressure		Min. Burst Pressure		Min. Bend Radius		Hose Weight		Avail. Lengths feet
	mm	in	fraction	mm	in	fraction	bar	psi	bar	psi	mm	in	Kg/m	lbs/ft	
H16906 H16906-250R	7,9	0.31	5/16	17,1	0.67	43/64	155,1	2,250	620,6	9,000	101,6	4.00	10,4	23	50 250
H16908 H16908-250R	10,3	0.41	13/32	19,4	0.77	49/64	137,9	2,000	551,6	8,000	117,5	4.63	12,2	27	50 250
H16910	12,7	0.50	1/2	23,4	0.92	59/64	120,7	1,750	482,7	7,000	139,7	5.50	16,3	36	50
H16912	15,9	0.63	5/8	28,4	1.08	1-5/64	103,4	1,500	413,7	6,000	165,1	6.50	20,0	44	50
H16916	22,2	0.88	7/8	31,4	1.23	1-15/64	55,2	800	220,6	3,200	187,7	7.39	20,9	46	50
H16920	28,6	1.13	1-1/8	38,1	1.50	1-1/2	43,1	625	172,4	2,500	228,6	9.00	23,1	51	50
H16924	34,9	1.38	1-3/8	44,5	1.75	1-3/4	34,5	500	137,9	2,000	266,7	10.50	28,1	62	50
H16932	46,0	1.81	1-13/16	56,4	2.22	2-7/32	24,1	350	96,5	1,400	336,6	13.25	38,6	85	50

Inner Tube: Nitrile

Reinforcement: 1 Steel Braid

Cover: Neoprene

Temp. Range:

-40°F to +212°F (-40°C to +100°C)

Typical Application:

Medium pressure hydraulic, air, grease, oil, truck and power steering lines.

MSHA Accepted

Hose Fitting Reference

Reference	Page
<i>C-O-C</i>	
069 'E' Series (except -32 size)	J-9-12
<i>Field Attachable</i>	
069 'D' Series	K-12-13
247 'N' Series (except -20, -24 & -32 sizes)	K-22-26

H213 Truck Hose

SAE J1402 TYPE AI, DOT AI



# Part Number	Hose I.D.			Hose O.D.			Working Pressure		Min. Burst Pressure		Min. Bend Radius		Hose Weight		Avail. Lengths
	mm	in	fraction	mm	in	fraction	bar	psi	bar	psi	mm	in	Kg/m	lbs/100ft	
H21304 H21304-250R	4,8	0.19	3/16	12,3	0.48	31/64	137,9	2,000	551,6	8,000	19,1	.75	5,4	12	50 250
H21305 H21305-250R	6,4	0.25	1/4	13,9	0.55	35/64	103,4	1,500	413,7	6,000	25,4	1.00	5,9	13	50 250
H21306 H21306-250R	7,9	0.31	5/16	15,5	0.61	39/64	103,4	1,500	413,7	6,000	31,8	1.25	7,3	16	50 250
H21308 H21308-250R	10,3	0.41	13/32	18,7	0.73	47/64	86,2	1,250	344,8	5,000	44,5	1.75	8,6	19	50 250
H21310 H21310-250R	12,7	0.50	1/2	21,0	0.83	53/64	69,0	1,000	275,8	4,000	57,2	2.25	9,5	21	50 250
H21312 H21312-250R	15,9	0.63	5/8	24,2	0.95	61/64	51,7	750	206,9	3,000	69,8	2.75	11,8	26	50 250
H21316* H21316-250R	22,2	0.88	7/8	30,6	1.20	1-13/64	27,6	400	110,3	1,600	88,9	3.50	14,5	32	50 250

Inner Tube: CPE

Reinforcement: 1 Fiber Braid - 1 Steel Braid.

Cover: Fiber Braid

Temp. Range:

Air Brake: -40°C to +93°C (-40°F to +200°F)

Hot Oil: -45°C to +150°C (-50°F to +302°F)

Typical Application:

General purpose truck hose. For use in air brake, fuel, diesel fuel and high temperature petroleum oil applications.

*16 size is not SAE J1402 or DOT approved for air brake applications.

Hose Fitting Reference

Field Attachable

213 'N' Series

Page

J-19-21

H069 General Purpose Truck Hose

SAE 100R5, SAE J1402 TYPE II†, DOT AII†, ABS¹



# Part Number	Hose I.D.			Hose O.D.			Working Pressure		Min. Burst Pressure		Min. Bend Radius		Hose Weight		Avail. Lengths
	mm	in	fraction	mm	in	fraction	bar	psi	bar	psi	mm	in	Kg/m	lbs/100ft	feet
H06904 H06904-250R	4,8	0.19	3/16	13,1	0.52	33/64	206,9	3,000	827,4	12,000	76,2	3.00	7,3	16	50 250
H06905 H06905-250R	6,4	0.25	1/4	14,7	0.58	37/64	206,9	3,000	827,4	12,000	86,1	3.39	9,1	20	50 250
H06906 H06906-250R	7,9	0.31	5/16	17,1	0.67	43/64	155,1	2,250	620,6	9,000	101,6	4.00	10,4	23	50 250
H06908 H06908-250R	10,3	0.41	13/32	19,4	0.77	49/64	137,9	2,000	551,6	8,000	117,5	4.625	12,2	27	50 250
H06910 H06910-250R	12,7	0.50	1/2	23,4	0.92	59/64	120,7	1,750	482,7	7,000	139,7	5.50	16,3	36	50 250
H06912 H06912-250R	15,9	0.63	5/8	28,4	1.08	1-5/64	103,4	1,500	413,7	6,000	165,1	6.50	20,0	44	50 250
H06916 H06916-250R	22,2	0.88	7/8	31,4	1.23	1-15/64	55,2	800	220,6	3,200	187,7	7.39	20,9	46	50 250
H06920 H06920-150	28,6	1.13	1-1/8	38,1	1.50	1-1/2	44,8	650	172,4	2,500	228,6	9.00	23,1	51	50 150
H06924 H06924-100	34,9	1.38	1-3/8	44,5	1.75	1-3/4	34,5	500	137,9	2,000	266,7	10.50	28,1	62	50 150
H06932 H06932-100	46,0	1.81	1-13/16	56,4	2.22	2-7/32	24,1	350	96,5	1,400	336,6	13.25	38,6	85	50 100
H06940	60,3	2.38	2-3/8	73,0	2.88	2-7/8	24,1	350	96,5	1,400	609,6	24.00	64,9	143	50

H

Hose - Truck

Inner Tube: Nitrile

Reinforcement: 1 Fiber Braid - 1 Steel Braid

Cover: Fiber Braid

Temp. Range:

Hydraulic: -40°C to +100°C (-40°F to +212°F);

Air Brake: -40°C to +93°C (-40°F to +200°F);

Hot Oil: -40°C to +121°C (-40°F to +250°F);

Typical Application:

General purpose truck and hydraulic hose. For use in air brake, fuel, grease lines, high temperature petroleum oils and medium pressure hydraulic applications. -16 thru -40 sizes are not SAE or DOT approved for air brake applications.

†Sizes -4 thru -12 only

¹See pages A-33-34 for applicable service pressures, required fire sleeves and qualified hose ends.

Hose Fitting Reference

Page

C-O-C

069 'E' Series J-9-12
(except size -40)

Field Attachable

069 'D' Series K-12-13
247 'N' Series K-22-26
(sizes -4 to -16)

H569 Hydraulic Hose

SAE 100R5, SAE J1402 TYPE AII, DOT AII*, ABS



# Part Number	Hose I.D.			Hose O.D.			Working Pressure		Min. Burst Pressure		Min. Bend Radius		Hose Weight		Avail. Lengths
	mm	in	fraction	mm	in	fraction	bar	psi	bar	psi	mm	in	Kg/m	lbs/100ft	
H56904 H56904-250R	4,8	0.19	3/16	13,1	0.52	33/64	206,9	3,000	827,4	12,000	76,2	3.00	7,3	16	50 250
H56905 H56905-250R	6,4	0.25	1/4	14,7	0.58	37/64	206,9	3,000	827,4	12,000	86,1	3.39	9,1	20	50 250
H56906 H56906-250R	7,9	0.31	5/16	17,1	0.67	43/64	155,1	2,250	620,6	9,000	101,6	4.00	10,4	23	50 250
H56908 H56908-250R	10,3	0.41	13/32	19,4	0.77	49/64	137,9	2,000	551,6	8,000	117,5	4.625	12,2	27	50 250
H56910 H56910-250R	12,7	0.50	1/2	23,4	0.92	59/64	120,7	1,750	482,7	7,000	139,7	5.50	16,3	36	50 250
H56912 H56912-250R	15,9	0.63	5/8	28,4	1.08	1-5/64	103,4	1,500	413,7	6,000	165,1	6.50	20,0	44	50 250
H56916 H56916-250R	22,2	0.88	7/8	31,4	1.23	1-15/64	55,2	800	220,6	3,200	187,7	7.39	20,9	46	50 250
H56920 H56920-250R	28,6	1.13	1-1/8	38,1	1.50	1-1/2	43,1	625	172,4	2,500	228,6	9.00	23,1	51	50 250

Inner Tube: CPE

Reinforcement: 2 Fiber Braids and 1 Steel Braid

Cover: Fiber Braid

Temp. Range:

Hydraulic Fluid: -48°C to +150°C (-55°F to +302°F)

Air Brake: -40°C to +93°C (-40°F to +200°F)*

Air: -40°C to +100°C (-40°F to +212°F)

Intermittent to +250°F

Typical Application:

General purpose truck, marine and hydraulic hose. For use in air brake*, diesel fuel, grease lines, high temperature petroleum oils and medium pressure hydraulic applications.

*Air brake applications, sizes -04 through -12 only.

¹See pages A-33-34 for applicable service pressures, required fire sleeves and qualified hose ends.

Marine Application - Hydraulic only¹

ABS approved for sizes 5/16 through 1-1/8 inches.¹

Hose Fitting Reference

Page

C-O-C

069 'E' Series

J-9-12

Field Attachable

247 'N' Series

(sizes -6 to -12)

K-22-26



Table of Contents

H243	I-2	H277	I-2
------	-----	------	-----

Teflon® is a registered trademark of DuPont used under license by Eaton.



H243 Teflon® Hose



# Part Number	Hose I.D.			Hose O.D.			Working Pressure		Min. Burst Pressure		Min. Bend Radius		Hose Weight		Avail. Lengths feet
	mm	in	fraction	mm	in	fraction	bar	psi	bar	psi	mm	in	Kg/m	lbs/100ft	
H24303 H24303-150R	4,8	0.19	3/16	7,9	0.31	5/16	206,9	3,000	827,4 661,9	12,000 9,600*	50,8	2.00	2,7	6	50 150
H24304 H24304-100R	6,4	0.25	1/4	9,1	0.36	23/64	206,9	3,000	827,4 661,9	12,000 9,600*	76,2	3.00	3,6	8	50 100
H24305 H24305-100R	7,9	0.31	5/16	10,7	0.42	27/64	172,4	2,500	689,5 551,6	10,000 8,000*	101,6	4.00	4,5	10	50 100
H24306 H24306-100R	9,5	0.38	3/8	12,7	0.50	1/2	137,9	2,000	551,6 413,7	8,000 6,000*	127,0	5.00	5,4	12	50 100
H24308 H24308-100R	12,7	0.50	1/2	16,3	0.64	41/64	120,7	1,750	482,7 379,2	7,000 5,500*	165,1	6.50	6,8	15	50 100
H24312	19,1	0.75	3/4	22,6	0.89	57/64	69,0	1,000	275,8 241,3	4,000 3,500*	228,6	9.00	10,0	22	50
H24316	25,4	1.00	1	28,6	1.13	1-1/8	69,0	1,000	275,8 224,1	4,000 3,250*	304,8	12.00	22,2	49	50

Inner Tube: Teflon

Reinforcement: Single Stainless Steel Braid, 1" Size Double Stainless Steel Braid (Type 304)

Temp. Range:
-54°C to +232°C
(-65°F to +450°F)

Typical Application:

Hydraulic, air and steamlines. Particularly suited for air compressor discharge lines where vibration and high temp are present.

FDA Accepted Material

*For applications above +300°F (+149°C)

Note:

Not for use in applications requiring static dissipation.

For more information on Teflon hose options refer to the Everflex Catalog, document number E-HOEV-MC001-E2.

Teflon® is a registered trademark of DuPont used under license by Eaton.

Hose Fitting Reference

C-O-C

'E' Series

Page

J-2-8

H277 Conductive Teflon® Hose



# Part Number	Hose I.D.			Hose O.D.			Working Pressure		Min. Burst Pressure		Min. Bend Radius		Hose Weight		Avail. Lengths feet
	mm	in	fraction	mm	in	fraction	bar	psi	bar	psi	mm	in	Kg/m	lbs/100ft	
H27703 H27703-150R	4,8	0.19	3/16	7,9	0.31	5/16	206,9	3,000	827,4 661,9	12,000 9,600*	50,8	2.00	2,7	6	50 150
H27704 H27704-100R	6,4	0.25	1/4	9,1	0.36	23/64	206,9	3,000	827,4 661,9	12,000 9,600*	76,2	3.00	3,6	8	50 100
H27705 H27705-100R	7,9	0.31	5/16	10,7	0.42	27/64	172,4	2,500	689,5 551,6	10,000 8,000*	101,6	4.00	4,5	10	50 100
H27706 H27706-100R	9,5	0.38	3/8	12,7	0.50	1/2	137,9	2,000	551,6 413,7	8,000 6,000*	127,0	5.00	5,4	12	50 100
H27708 H27708-100R	12,7	0.50	1/2	16,3	0.64	41/64	120,7	1,750	482,7 379,2	7,000 5,500*	165,1	6.50	6,8	15	50 100
H27712	19,1	0.75	3/4	22,6	0.89	57/64	69,0	1,000	275,8 231,0	4,000 3,350*	228,6	9.00	10,0	22	50
H27716	25,4	1.00	1	28,6	1.13	1-1/8	69,0	1,000	275,8 231,0	4,000 3,350*	304,8	12.00	22,2	49	50

Inner Tube: Conductive black Teflon tube

Reinforcement: Single Stainless Steel Braid, 1" Size Double Stainless Steel Braid (Type 304)

Temp. Range:
-54°C to +232°C
(-65°F to +450°F)

Typical Application:

Hydraulic, air and steam lines. Particularly suited for air compressor discharge lines where vibration and high temp are present.

Note:

For use in applications requiring static dissipation.

*For applications above +300°F (+149°C)

For more information on Teflon hose options refer to the Everflex Catalog, document number E-HOEV-MC001-E2.

Hose Fitting Reference

C-O-C

'E' Series

Page

J-2-8

Teflon® is a registered trademark of DuPont used under license by Eaton.

Hose Ends - Crimp

Table of Contents

Coll-O-Crimp		229 'P' Series	J-33
'E' Series	J-2 thru J-8	265 'P' Series	J-34
069 'E' Series	J-9 thru J-12	338 'P' Series	J-35 thru J-37
327 'E' Series	J-13 thru J-14	'S' Series	J-38
336 'E' Series	J-15 thru J-18	'U' Series	J-39 thru J-57
470 'E' Series	J-19 thru J-23	430 'U' Series	J-58 thru J-68
757 'E' Series	J-24 thru J-31	WeatherGRIP™ 'Z' Series	J-69 thru J-94
057 'P' Series	J-32	WeatherTIGHT™ '4SP/6SP' Series	J-95 thru J-105



Coll-O-Crimp

'E' Series

Hose End 'E' Series

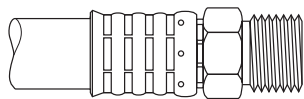

Refer to the Weatherhead Hose End and Tool Selector Chart W-HOOV-TM001-E2 for qualified sizes.

⚠ WARNING

For Teflon® hose applications, 'E' series fittings must be used with H243 and H277 .030" thin wall hose only.

Ordering Information: Order individually part number.

⚠ Refer to important safety information on pages A-2-3.

Teflon® is a registered trademark of DuPont used under license by Eaton.

Application: General purpose low- and medium-pressure hydraulics. Use H277 or H435 where shock hazards exist.

Compatible Hose

H009, H209, H243, H265, H275, H277, H285, H435, H436

Pressure: Determined by maximum operating pressure for hose size and hose end configuration whichever is lesser. See pages A-15-16 for operating pressure ratings for hose end configurations.

Material: Low Carbon Steel

Plating: Zinc; Clear Trivalent Chromate

To determine the correct length of hose, subtract the cut-off factor for each end fitting from the overall length of assembly.

Advantages: Wide selection of hose and end configurations allowing for a diverse number of applications where hose compatibility is a problem.

Assemble With: ET1000, ET4000, T-400-1, T-410-1, T-420-1, T-440-1, T-460, T-462, T-465-1, T480.

Label Set: FS-1200

Note: Refer to current price list for availability of cataloged items. Configurations and dimensions subject to change without notice.

Male Pipe Rigid

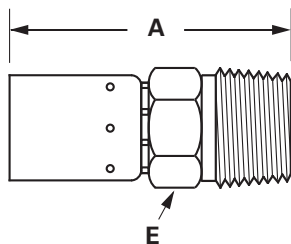

Hose I.D.	Pipe Size	Part Number	Thread Size	A	Hose Cut-Off Factor	Hole Dia.	Hex E
3/16	1/8	03E-102	1/8-27	1.58	.75	.09	7/16
3/16	1/4	03E-104	1/4-18	1.83	1.00	.09	9/16
1/4	1/8	04E-102	1/8-27	1.60	.75	.16	7/16
1/4	1/4	04E-104	1/4-18	1.79	1.00	.16	9/16
1/4	3/8	04E-106	3/8-18	1.82	1.00	.16	11/16
5/16	1/4	05E-104	1/4-18	1.86	.94	.22	9/16
5/16	3/8	05E-106	3/8-18	1.89	1.00	.22	11/16
3/8	1/4	06E-104	1/4-18	1.90	1.00	.27	9/16
3/8	3/8	06E-106	3/8-18	1.93	1.00	.27	11/16
3/8	1/2	06E-108	1/2-14	2.17	1.25	.27	7/8
1/2	3/8	08E-106	3/8-18	2.02	1.00	.38	3/4
1/2	1/2	08E-108	1/2-14	2.27	1.25	.38	7/8
3/4	3/4	12E-112	3/4-14	2.51	1.31	.61	1-1/16
1	1	16E-116	1-11-1/2	2.95	1.63	.84	1-3/8

Male Pipe Swivel

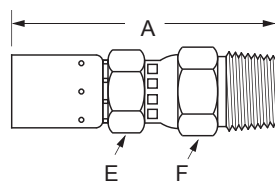

Hose I.D.	Pipe Size	Part Number	Thread Size	A	Hose Cut-Off Factor	Hole Dia.	Hex E	Hex F
1/4	1/4	04E-J04	1/4-18	2.68	1.81	.16	5/8	13/16
5/16	1/4	05E-J04	1/4-18	2.75	1.81	.22	5/8	13/16
3/8	3/8	06E-J06	3/8-18	2.79	1.81	.27	11/16	7/8
1/2	1/2	08E-J08	1/2-14	3.03	2.00	.39	3/4	7/8
3/4	3/4	12E-J12	3/4-14	3.73	2.50	.61	1-1/4	1-1/4

Note:

Swivel for installation purposes only. (Not for temperatures above 212°F.)

J Hose Ends - Crimp

Coll-O-Crimp

'E' Series

To determine the correct length of hose, subtract the cut-off factor for each end fitting from the overall length of assembly.

JIC 37° Male Rigid

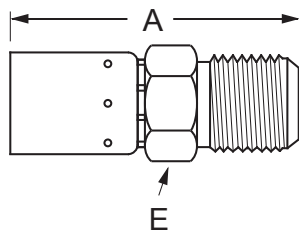

Hose I.D.	Tube Size	Part Number	Thread Size	A	Hose Cut-Off Factor	Hole Dia.	Hex E
1/4	1/4	04E-504	7/16-20	1.78	.94	.16	1/2
1/4	5/16	04E-505	1/2-20	1.78	.94	.19	9/16
1/4	3/8	04E-506	9/16-18	1.82	1.00	.22	5/8
5/16	5/16	05E-505	1/2-20	1.86	.94	.22	9/16
3/8	3/8	06E-506	9/16-18	1.92	1.00	.27	5/8
3/8	1/2	06E-508	3/4-16	2.08	1.19	.27	13/16
1/2	1/2	08E-508	3/4-16	2.18	1.19	.27	13/16
1/2	5/8	08E-510	7/8-14	2.31	1.25	.42	15/16
3/4	3/4	12E-512	1-1/16-12	2.63	1.44	.61	1-1/8
1	1	16E-516	1-5/16-12	2.83	1.50	.84	1-3/8

Inverted Male Swivel Straight

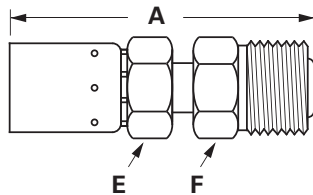

Hose I.D.	Pipe Size	Part Number	Thread Size	A	Hose Cut-Off Factor	Hole Dia.	Hex E	Hex F
1/4	3/16	04E-B03	3/8-24	3.06	2.19	.12	7/16	3/8
1/4	1/4	04E-B04	7/16-24	2.44	1.63	.15	7/16	7/16
1/4	5/16	04E-B05	1/2-20	3.71	2.88	.16	7/16	1/2
5/16	5/16	05E-B05	1/2-20	2.57	1.61	.21	9/16	1/2
3/8	5/16	06E-B05	1/2-20	2.56	1.63	.21	9/16	1/2
3/8	3/8	06E-B06	5/8-18	2.81	1.81	.24	5/8	5/8
1/2	1/2	08E-B08	3/4-18	3.14	2.06	.33	3/4	3/4

Air Brake Connection - Tube

(For Use With H243 Teflon Hose Only)

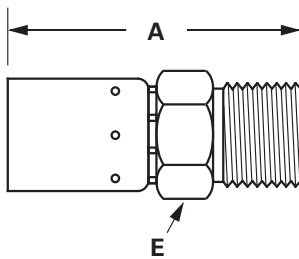

Hose I.D.	Tube Size	Part Number	Thread Size	A	Hose Cut-Off Factor	Hole Dia.	Hex E	Tube Size	Part Number Sleeve	Part Number Nut
1/2	1/2	08E-Y58	11/16-20	2.12	1.06	.38	3/4	3/8	1360x6	1361x6
1/2	5/8	08E-Y60	13/16-18	2.18	1.13	.38	7/8	1/2	1360x8	1361x8
3/4	5/8	12E-Y60	13/16-18	2.31	1.13	.53	1	5/8	1360x10	1361x10
3/4	3/4	12E-Y62	1-18	2.38	1.19	.61	1	3/4	1360x12	1361x12

Teflon® is a registered trademark of DuPont used under license by Eaton.

Flareless Tube Rigid

(With Ermeto Nut and Sleeve)

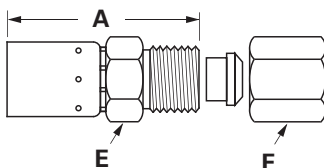

Hose I.D.	Tube Size	Part Number	Thread Size	A	Hose Cut-Off Factor	Hole Dia.	Hex E	Hex F
5/16	3/8	05E-756	9/16-18	1.88	1.00	.22	5/8	11/16
3/8	5/16	06E-755	1/2-20	1.78	.88	.23	9/16	5/8
3/8	3/8	06E-756	9/16-18	1.82	.88	.27	5/8	11/16
1/2	1/2	08E-758	3/4-16	2.08	1.06	.38	13/16	7/8

(For replacement nuts and sleeves, see page L-80.)

J

Hose Ends - Crimp

Coll-O-Crimp

'E' Series

To determine the correct length of hose, subtract the cut-off factor for each end fitting from the overall length of assembly.

^a Swivel nuts are universal — both SAE 37° and 45° connections.

JIC 37° Female Swivel

(Exceptions Noted)

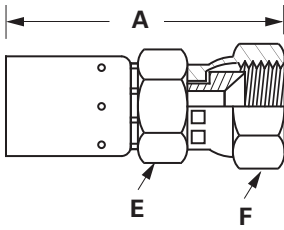

Hose I.D.	Tube Size	Part Number	Thread Size	A	Hose Cut-Off Factor	Hole Dia.	Hex E	Hex F
3/16	1/4	03E-604 ^a	7/16-20	1.89	1.00	.09	7/16	9/16
1/4	1/4	04E-604 ^a	7/16-20	1.92	1.13	.16	7/16	9/16
1/4	5/16	04E-605 ^a	1/2-20	2.00	1.19	.16	1/2	5/8
1/4	3/8	04E-606	9/16-18	2.06	1.25	.16	9/16	11/16
5/16	5/16	05E-605 ^a	1/2-20	2.07	1.19	.22	1/2	5/8
5/16	3/8	05E-606	9/16-18	2.12	1.19	.22	9/16	11/16
3/8	3/8	06E-606	9/16-18	2.19	1.25	.27	9/16	11/16
3/8	1/2	06E-608 ^a	3/4-16	2.30	1.38	.27	3/4	7/8
1/2	1/2	08E-608 ^a	3/4-16	2.39	1.38	.38	3/4	7/8
1/2	5/8	08E-610 ^a	7/8-14	2.51	1.50	.38	7/8	1
3/4	3/4	12E-612	1-1/16-12	2.76	1.56	.61	1	1-1/4
1	1	16E-616	1-5/16-12	3.05	1.75	.84	1-1/4	1-1/2

SAE 45° Female Swivel

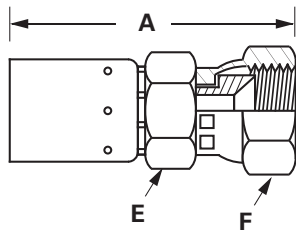

Hose I.D.	Tube Size	Part Number	Thread Size	A	Hose Cut-Off Factor	Hole Dia.	Hex E	Hex F
5/16	3/8	05E-406	5/8-18	2.03	1.13	.22	9/16	3/4
3/8	3/8	06E-406	5/8-18	2.06	1.13	.27	9/16	3/4
3/4	3/4	12E-412	1-1/16-14	2.76	1.56	.61	1	1-1/4

British Standard (BSPP) 60° Cone Female Pipe Swivel

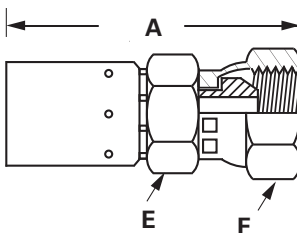

Hose I.D.	Tube Size	Part Number	Thread Size	A	Hose Cut-Off Factor	Hole Dia.	Hex E	Hex F
3/16	1/4	03E-354	G-1/4-19*	2.01	1.19	.16	9/16	11/16
1/4	1/4	04E-354	G-1/4-19*	2.07	1.25	.16	9/16	3/4
3/8	3/8	06E-356	G-3/8-19*	2.09	1.13	.27	3/4	7/8
3/8	1/2	06E-358	G-1/2-14*	2.47	1.50	.27	13/16	1
1/2	1/2	08E-358	G-1/2-14*	2.56	1.50	.39	13/16	1
1/2	5/8	08E-360	G-5/8-14*	2.70	1.63	.39	7/8	1-3/16
3/4	3/4	12E-362	G-3/4-14*	2.94	1.69	.61	1	1-1/4
1	1	16E-366	G-1-11*	3.38	2.00	.84	1-1/4	1-1/2

*G as part of thread size is ISO designation for parallel thread.

Female Swivel JIS 30° Flare Parallel Pipe Swivel

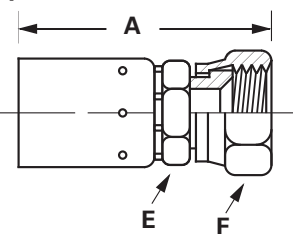

Hose I.D.	Tube Size	Part Number	Thread Size	A	Hose Cut-Off Factor	Hole Dia.	Hex E	Hex F
1/4	1/4	04E-04L	G-1/4-19*	2.03	1.19	.16	9/16	3/4
3/8	3/8	06E-06L	G-3/8-19*	2.22	1.25	.27	11/16	7/8
1/2	1/2	08E-08L	G-1/2-14*	2.30	1.25	.39	13/16	1-1/16
3/4	3/4	12E-12L	G-3/4-14*	2.75	1.50	.81	1	1-5/16
1	1	16E-16L	G-1-11*	3.15	1.81	.84	1-1/4	1-1/2

*G as part of thread size is ISO designation for parallel thread.

J Hose Ends - Crimp

Coll-O-Crimp

'E' Series

To determine the correct length of hose, subtract the cut-off factor for each end fitting from the overall length of assembly.

Female FOR-SEAL® Swivel Straight

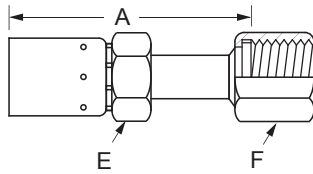

Hose I.D.	Tube Size	Part Number	Thread Size	A	Hose Cut-Off Factor	Hole Dia.	Hex E	Hex F
1/4	1/4	04E-S64	9/16-18	2.14	1.31	.15	5/8	11/16
1/4	3/8	04E-S66	11/16-16	2.20	1.38	.16	5/8	13/16
5/16	3/8	05E-S66	11/16-16	2.28	1.38	.22	9/16	13/16
3/8	3/8	06E-S66	11/16-16	2.37	1.44	.24	9/16	13/16
3/8	1/2	06E-S68	13/16-16	2.65	1.69	.24	5/8	15/16
1/2	1/2	08E-S68	13/16-16	2.74	1.69	.33	3/4	15/16
1/2	5/8	08E-S70	1-14	2.83	1.81	.39	3/4	1-1/8
3/4	3/4	12E-S72	1-3/16-12	3.10	1.88	.59	1	1-3/8
1	1	16E-S76	1-7/16-12	3.76	2.44	.78	1-1/4	1-5/8

Straight Tube — Brass

(For Use With H243 Teflon Hose Only)

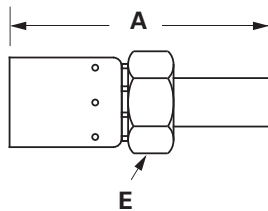

Hose I.D.	Tube Size	Part Number	A	Hose Cut-Off Factor	Hole Dia.	Hex E
1/2	1/2	08E-T58	3.32	2.31	.39	3/4
1/2	5/8	08E-T60	3.45	2.44	.47	3/4
3/4	5/8	12E-T60	3.66	2.44	.47	1
3/4	3/4	12E-T62	4.00	2.81	.61	1

Insert — Brass
Collar — Steel

Teflon® is a registered trademark of DuPont used under license by Eaton.

Compatible Air Brake Nuts & Sleeves (order separately)

Tube Size	Part Number Sleeve	Part Number Nut
1/2	1360x8	1361x8
5/8	1360x10	1361x10
3/4	1360x12	1361x12

Compressor Discharge Flange End — GM Bus Only

(For Use With H243 Teflon Hose Only)

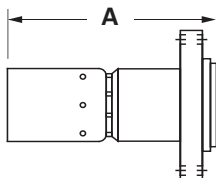

Hose I.D.	Part Number	A	Hose Cut-Off Factor	Hole Dia.
3/4	12E-X92	2.64	1.38	.61

Note:
Part will not crimp in T-420 press.

Teflon® is a registered trademark of DuPont used under license by Eaton.

Inverted Male Swivel 45° Tube Elbow

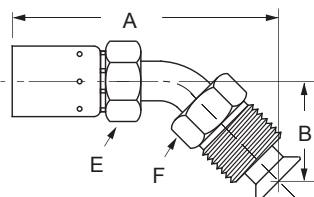

Hose I.D.	Tube Size	Part Number	Thread Size	A	B	Hose Cut-Off Factor	Hole Dia.	Hex E	Hex F
1/4	3/16	04E-B43	3/8-24	2.82	.69	2.00	.12	7/16	3/8
1/4	1/4	04E-B44	7/16-24	2.94	.93	2.13	.15	7/16	7/16
3/8	5/16	06E-B45	1/2-20	3.37	1.14	2.44	.21	9/16	1/2
3/8	3/8	06E-B46	5/8-18	3.63	1.34	2.69	.24	5/8	5/8
1/2	1/2	08E-B48	3/4-18	4.32	1.58	3.25	.33	3/4	3/4
1/2	5/8	08E-B50	7/8-18	4.45	1.75	3.44	.39	3/4	7/8

J
Hose Ends - Crimp

Coll-O-Crimp

'E' Series

To determine the correct length of hose, subtract the cut-off factor for each end fitting from the overall length of assembly.

^a Swivel nuts are universal — both SAE 37° and 45° connections.

JIC 37° Female Swivel 45° Tube Elbow

(Exceptions Noted)

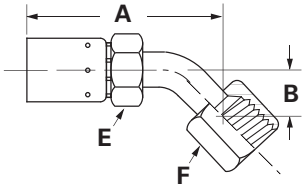

Hose I.D.	Tube Size	Part Number	Thread Size	A	B	Hose Cut-Off Factor	Hole Dia.	Hex E	Hex F
1/4	1/4	04E-684 ^a	7/16-20	2.37	.33	1.56	.15	7/16	9/16
1/4	5/16	04E-685 ^a	1/2-20	2.50	.36	1.63	.16	7/16	5/8
5/16	3/8	05E-686	9/16-18	2.65	.39	1.69	.22	9/16	11/16
3/8	3/8	06E-686	9/16-18	2.74	.39	1.75	.24	5/8	11/16
3/8	1/2	06E-688 ^a	3/4-16	2.99	.56	2.00	.27	5/8	7/8
1/2	1/2	08E-688 ^a	3/4-16	2.88	.56	1.78	.33	3/4	7/8
1/2	5/8	08E-690 ^a	7/8-14	3.28	.63	2.25	.39	3/4	1
3/4	3/4	12E-692	1-1/16-12	3.72	.78	2.38	.58	1	1-1/4
1	1	16E-696	1-5/16-12	4.67	1.10	3.31	.83	1-1/4	1-1/2

Female FOR-SEAL[®] Swivel 45° Tube Elbow

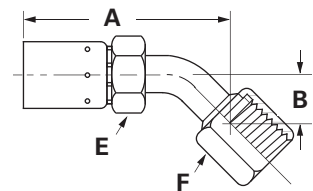

Hose I.D.	Tube Size	Part Number	Thread Size	A	B	Hose Cut-Off Factor	Hole Dia.	Hex E	Hex F
1/4	1/4	04E-L64	9/16-18	2.46	.41	1.63	.15	7/16	11/16
1/4	3/8	04E-L66	11/16-16	2.69	.43	1.75	.15	5/8	13/16
5/16	3/8	05E-L66	11/16-16	2.70	.43	1.75	.22	9/16	13/16
3/8	3/8	06E-L66	11/16-16	2.79	.43	1.81	.24	5/8	13/16
1/2	1/2	08E-L68	13/16-16	3.14	.60	2.13	.33	3/4	15/16
3/4	3/4	12E-L72	1-3/16-12	3.83	.83	2.63	.59	1	1-3/8
1	1	16E-L76	1-7/16-12	4.31	.94	3.00	.76	1-1/4	1-5/8

Inverted Male Swivel 90° Tube Elbow

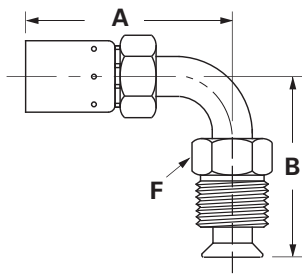

Hose I.D.	Tube Size	Part Number	Thread Size	A	B	Hose Cut-Off Factor	Hole Dia.	Hex E	Hex F
1/4	3/16	04E-B63	3/8-24	2.23	1.06	1.38	.12	7/16	3/8
1/4	1/4	04E-B64	7/16-24	2.25	1.36	1.31	.15	7/16	7/16
3/8	5/16	06E-B65	1/2-20	2.49	1.61	1.56	.21	9/16	1/2
3/8	3/8	06E-B66	5/8-18	2.92	1.97	1.94	.24	5/8	5/8
1/2	1/2	08E-B68	3/4-18	3.03	2.32	2.00	.33	3/4	3/4

JIC 37° Female Swivel 90° Tube Elbow

(Exceptions Noted)

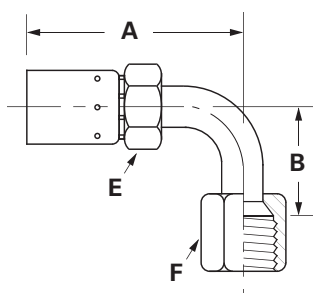

Hose I.D.	Tube Size	Part Number	Thread Size	A	B	Hose Cut-Off Factor	Hole Dia.	Hex E	Hex F
1/4	1/4	04E-664 ^a	7/16-20	2.27	.68	1.44	.15	7/16	9/16
1/4	5/16	04E-665 ^a	1/2-20	2.47	.77	1.63	.16	7/16	5/8
5/16	5/16	05E-665 ^a	1/2-20	2.58	.77	1.63	.21	9/16	5/8
5/16	3/8	05E-666	9/16-18	2.57	.85	1.62	.22	9/16	11/16
3/8	3/8	06E-666	9/16-18	2.63	.85	1.68	.24	5/8	11/16
3/8	1/2	06E-668 ^a	3/4-16	2.76	1.09	1.81	.27	5/8	7/8
1/2	1/2	08E-668 ^a	3/4-16	2.82	1.09	1.75	.33	3/4	7/8
1/2	5/8	08E-670 ^a	7/8-14	3.34	1.23	2.31	.39	3/4	1
3/4	3/4	12E-672	1-1/16-12	3.70	1.82	2.50	.59	1	1-1/4
1	1	16E-676	1-5/16-12	4.39	2.14	3.00	.83	1-1/4	1-1/2

J Hose Ends - Crimp

Coll-O-Crimp

'E' Series

To determine the correct length of hose, subtract the cut-off factor for each end fitting from the overall length of assembly.

^a Swivel nuts are universal — both SAE 37° and 45° connections.

SAE 45° Female Swivel 90° Tube Elbow

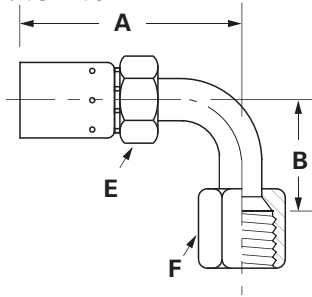

Hose I.D.	Tube Size	Catalog Number	Thread Size	A	B	Hose Cut-Off Factor	Hole Dia.	Hex E	Hex F
3/8	3/8	06E-466	5/8-18	2.72	.85	1.75	.24	5/8	3/4

JIC 37° Female Swivel Long Drop 90° Tube Elbow

(Exceptions Noted)

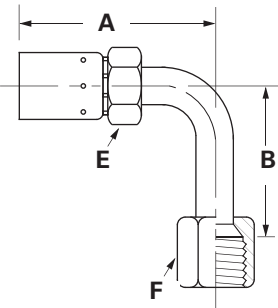

Hose I.D.	Tube Size	Part Number	Thread Size	A	B	Hose Cut-Off Factor	Hole Dia.	Hex E	Hex F
1/4	1/4	04E-644 ^a	7/16-20	2.27	1.80	1.42	.15	7/16	9/16
1/4	5/16	04E-645 ^a	1/2-20	2.51	1.80	1.63	.16	7/16	5/8
5/16	3/8	05E-646	9/16-18	2.63	2.18	1.69	.22	9/16	11/16
3/8	3/8	06E-646	9/16-18	2.66	2.18	1.69	.24	5/8	11/16
3/8	1/2	06E-648 ^a	3/4-16	2.83	2.43	1.88	.27	5/8	7/8
1/2	1/2	08E-648 ^a	3/4-16	2.82	2.43	1.75	.33	3/4	7/8
1/2	5/8	08E-650 ^a	7/8-14	2.96	2.57	1.94	.39	3/4	1
3/4	3/4	12E-652	1-1/16-12	3.74	3.73	2.50	.58	1	1-1/4
1	1	16E-656	1-5/16-12	4.36	4.33	3.00	.83	1-1/4	1-1/2

British Standard (BSPP) 60° Cone Female Pipe Swivel 90° Elbow

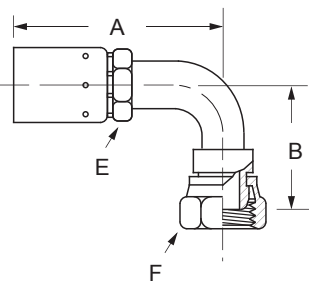

Hose I.D.	BSPP Pipe Size	Part Number	Thread Size	A	B	Hose Cut-Off Factor	Hole Dia.	Hex E	Hex F
1/4	1/4	04E-74P	G-1/4-19*	2.89	1.50	2.06	.16	7/16	3/4
3/8	3/8	06E-76P	G-3/8-19*	2.96	1.66	2.00	.27	5/8	7/8
1/2	1/2	08E-78P	G-1/2-14*	2.95	1.73	1.88	.37	3/4	1
3/4	3/4	12E-82P	G-3/4-14*	3.83	2.43	2.61	.61	1	1-1/4

*G as part of thread size is ISO designation for parallel thread.

J
Hose Ends - Crimp

Coll-O-Crimp

'E' Series

To determine the correct length of hose, subtract the cut-off factor for each end fitting from the overall length of assembly.

Female FOR-SEAL® Swivel Short Drop 90° Elbow

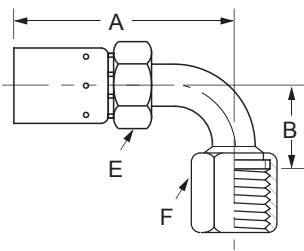

Hose I.D.	Tube Size	Part Number	Thread Size	A	B	Hose Cut-Off Factor†	Hole Dia.	Hex E	Hex F
1/4	1/4	04E-A24	9/16-18	2.27	.81	1.44	.21	7/16	11/16
1/4	3/8	04E-A26	11/16-16	2.54	.90	1.69	.16	5/8	13/16
5/16	3/8	05E-A26	11/16-16	2.62	.90	1.69	.22	9/16	13/16
3/8	3/8	06E-A26	11/16-16	2.71	.90	1.75	.24	5/8	13/16
3/8	1/2	06E-A28	13/16-16	2.81	1.15	1.88	.27	5/8	15/16
1/2	1/2	08E-A28	13/16-16	2.90	1.15	1.88	.33	3/4	15/16
3/4	3/4	12E-A32	1-3/16-12	3.70	1.88	2.50	.59	1	1-3/8
1	1	16E-A36	1-7/16-12	4.01	2.21	2.69	.76	1-1/4	1-5/8

Female FOR-SEAL Swivel Long Drop 90° Tube Elbow

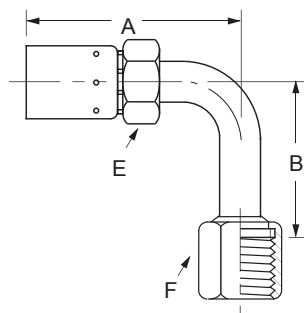

Hose I.D.	Tube Size	Part Number	Thread Size	A	B	Hose Cut-Off Factor	Hole Dia.	Hex E	Hex F
1/4	1/4	04E-A64	9/16-18	2.41	1.80	1.56	.21	7/16	11/16
5/16	3/8	05E-A66	11/16-16	2.73	2.12	1.81	.22	9/16	13/16
3/8	3/8	06E-A66	11/16-16	2.82	2.12	1.88	.24	5/8	13/16
3/8	1/2	06E-A68	13/16-16	2.80	2.50	1.88	.27	5/8	15/16
1/2	1/2	08E-A68	13/16-16	2.89	2.50	1.88	.33	3/4	15/16

J

Hose Ends - Crimp

Coll-O-Crimp

069 'E' Series

To determine the correct length of hose, subtract the cut-off factor for each end fitting from the overall length of assembly.

Hose End 069 'E' Series

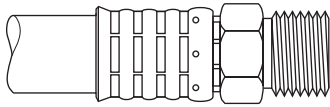

⚠ Refer to important safety information on pages A-2-3.

Ordering Information: Order individually by part number.

Application: General purpose low- and medium-pressure hydraulics. Generally used for truck and off-road vehicle applications.

Compatible Hose: H059, H069, H166, H169, H229, H239, H366, H569

Pressure: Determined by maximum working pressure for hose size and hose end configuration whichever is lesser. See page 16 for working pressure ratings for hose end configurations.

Material: Low Carbon Steel

Plating: Zinc; Clear Trivalent Chromate

Advantages: Wide selection of hose and end configurations allowing for a diverse number of applications. Limited competition and economical cost.

Assemble With: T-400-1, T-410-1, T-420-1, T-440-1, T-460, T-462, T-465-1, T-480, ET4000, ET4001

Label Set: FS-1500

Male Pipe Rigid

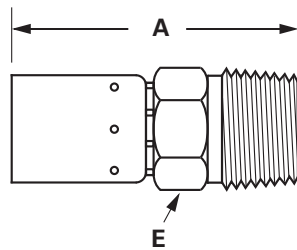

Hose I.D.	Tube Size	Part Number	Thread Size	A	Hose Cut-Off Factor	Hole Dia.	Hex E
3/16	1/8	06904E-102	1/8-27	1.70	.75	.13	7/16
3/16	1/4	06904E-104	1/4-18	1.88	1.00	.13	9/16
1/4	1/4	06905E-104	1/4-18	1.88	1.00	.18	9/16
5/16	1/4	06906E-104	1/4-18	2.04	1.00	.24	5/8
5/16	3/8	06906E-106	3/8-18	2.03	1.00	.24	11/16
13/32	3/8	06908E-106	3/8-18	2.04	1.00	.31	3/4
13/32	1/2	06908E-108	1/2-14	2.29	1.25	.31	7/8
1/2	1/2	06910E-108	1/2-14	2.41	1.38	.39	7/8
1/2	3/4	06910E-112	3/4-14	2.47	1.38	.39	1-1/16
5/8	3/4	06912E-112	3/4-14	2.52	1.25	.51	1-1/16
7/8	3/4	06916E-112	3/4-14	2.69	1.44	.71	1-1/8
7/8	1	06916E-116	1-11-1/2	2.88	1.63	.75	1-3/8
1-1/8	1-1/4	06920E-120	1-1/4-11-1/2	3.06	1.69	1.00	1-11/16
1-3/8	1-1/2	06924E-124	1-1/2-11-1/2	3.37	2.00	1.25	2
1-13/16	2	06932E-132	2-11-1/2	3.38	2.00	1.63	2-1/2

JIC 37° Male Rigid

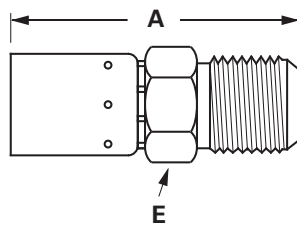

Hose I.D.	Tube Size	Part Number	Thread Size	A	Hose Cut-Off Factor	Hole Dia.	Hex E
3/16	1/4	06904E-504	7/16-20	1.87	1.00	.13	1/2
1/4	5/16	06905E-505	1/2-20	1.87	1.00	.18	9/16
5/16	3/8	06906E-506	9/16-18	2.03	1.00	.24	5/8
13/32	1/2	06908E-508	3/4-16	2.19	1.19	.31	13/16
1/2	5/8	06910E-510	7/8-14	2.43	1.25	.39	15/16
5/8	3/4	06912E-512	1-1/16-12	2.63	1.38	.51	1-1/8
7/8	1	06916E-516	1-5/16-12	2.85	1.50	.75	1-3/8
1-1/8	1-1/4	06920E-520	1-5/8-12	3.06	1.63	1.00	1-11/16
1-3/8	1-1/2	06924E-524	1-7/8-12	3.17	1.81	1.25	2

J

Hose Ends - Crimp

Coll-O-Crimp

069 'E' Series

To determine the correct length of hose, subtract the cut-off factor for each end fitting from the overall length of assembly.

^a Swivel nuts are universal — both SAE 37° and 45° connections.

Inverted Male Swivel Straight

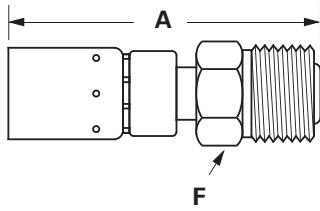

Hose I.D.	Tube Size	Part Number	Thread Size	A	Hose Cut-Off Factor	Hole Dia.	Hex F
3/16	1/4	06904E-B04	7/16-24	2.58	1.56	.13	7/16
1/4	5/16	06905E-B05	1/2-20	2.63	1.63	.18	1/2
5/16	3/8	06906E-B06	5/8-18	2.87	1.78	.24	5/8
13/32	1/2	06908E-B08	3/4-18	3.24	2.06	.31	3/4

JIC 37° Female Swivel

(Exceptions Noted)

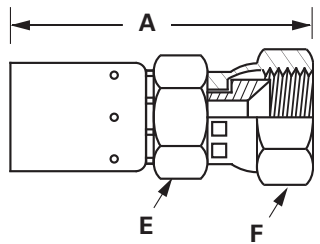

Hose I.D.	Tube Size	Part Number	Thread Size	A	Hose Cut-Off Factor	Hole Dia.	Hex E	Hex F
3/16	1/4	06904E-604 ^a	7/16-20	2.01	1.06	.13	7/16	9/16
1/4	5/16	06905E-605 ^a	1/2-20	2.09	1.19	.18	7/16	5/8
5/16	3/8	06906E-606	9/16-18	2.26	1.19	.24	9/16	11/16
5/16	1/2	06906E-608 ^a	3/4-16	2.41	1.31	.24	3/4	7/8
13/32	1/2	06908E-608 ^a	3/4-16	2.41	1.38	.31	3/4	7/8
1/2	1/2	06910E-608 ^a	3/4-16	2.53	1.44	.39	13/16	7/8
1/2	5/8	06910E-610 ^a	7/8-14	2.62	1.50	.39	13/16	1
5/8	3/4	06912E-612	1-1/16-12	2.77	1.50	.51	1	1-1/4
7/8	1	06916E-616	1-5/8-12	3.11	1.75	.75	1-1/4	1-1/2
1-1/8	1-1/4	06920E-620	1-5/8-12	3.30	1.81	1.00	1-9/16	2
1-3/8	1-1/2	06924E-624	1-7/8-12	3.45	2.13	1.25	2	2-1/4
1-13/16	2	06932E-632	2-1/2-12	4.15	2.81	1.63	2-1/2	3

SAE 45° Female Swivel

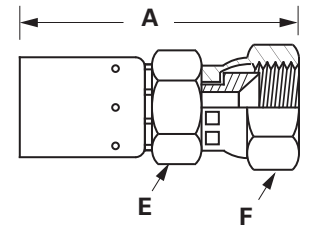

Hose I.D.	Tube Size	Part Number	Thread Size	A	Hose Cut-Off Factor	Hole Dia.	Hex E	Hex F
5/16	3/8	06906E-406	5/8-18	2.18	1.13	.24	9/16	3/4
5/8	3/4	06912E-412	1-1/16-14	2.81	1.50	.51	1	1-1/4

30° Flare Female Swivel

(PTT Thread For Diesel Applications)

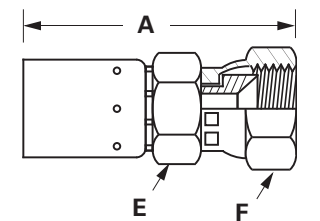

Hose I.D.	Tube Size	Part Number	Thread Size	A	Hose Cut-Off Factor	Hole Dia.	Hex E	Hex F
7/8	1	06916E-X26	1-5/16-14	2.96	1.69	.75	1-1/4	1-1/2

J Hose Ends - Crimp

Coll-O-Crimp

069 'E' Series

To determine the correct length of hose, subtract the cut-off factor for each end fitting from the overall length of assembly.

^a Swivel nuts are universal — both SAE 37° and 45° connections.

Female Swivel 30° Flare

(Komatsu, Linkbelt)

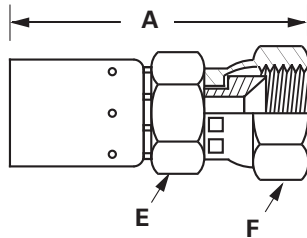

Hose I.D.	Part Number	Thread Size	A	Hose Cut-Off Factor	Hole Dia.	Hex E	Hex F
5/8	06912E-24K	M24x1.5	2.88	1.56	.52	1	1-1/4
5/8	06912E-30K	M30x1.5	2.90	1.63	.52	1-1/4	1-3/8
7/8	06916E-33K	M33x1.5	3.11	1.81	.75	1-1/4	1-1/2
1-3/8	06924E-42K	M42x1.5	3.55	2.19	1.25	2	2-1/8

Inverted Male Swivel 45° Tube Elbow

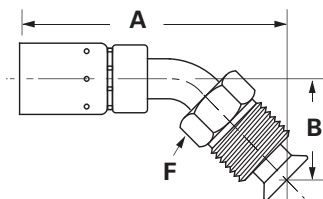

Hose I.D.	Tube Size	Part Number	Thread Size	A	B	Hose Cut-Off Factor	Hole Dia.	Hex F
3/16	1/4	06904E-E44	7/16-24	3.08	.93	2.06	.12	7/16
1/4	5/16	06905E-E45	1/2-20	3.42	1.14	2.44	.18	1/2
5/16	3/8	06906E-E46	5/8-18	3.65	1.34	2.56	.21	5/8

JIC 37° Female Swivel 45° Tube Elbow

(Exceptions Noted)

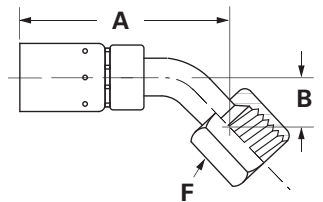

Hose I.D.	Tube Size	Part Number	Thread Size	A	B	Hose Cut-Off Factor	Hole Dia.	Hex F
3/16	1/4	06904E-684 ^a	7/16-20	2.50	.33	1.50	.13	9/16
1/4	5/16	06905E-685 ^a	1/2-20	2.63	.36	1.63	.18	5/8
5/16	3/8	06906E-686	9/16-18	2.78	.38	1.69	.24	11/16
13/32	1/2	06908E-688 ^a	3/4-16	3.07	.55	1.83	.31	7/8
1/2	5/8	06910E-690 ^a	7/8-14	3.39	.63	2.31	.45	1
5/8	3/4	06912E-692	1-1/16-12	3.70	.78	2.38	.52	1-1/4
7/8	1	06916E-696	1-5/16-12	4.68	1.10	3.38	.75	1-1/2

SAE 45° Female Swivel 45° Tube Elbow

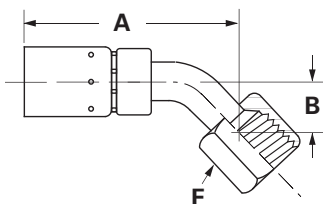

Hose I.D.	Tube Size	Part Number	Thread Size	A	B	Hose Cut-Off Factor	Hole Dia.	Hex F
5/16	3/8	06906E-486	5/8-18	2.77	.39	1.69	.24	3/4
5/8	3/4	06912E-492	1-1/16-14	3.74	.78	2.44	.52	1-1/4

J

Hose Ends - Crimp

Coll-O-Crimp

069'E' Series

To determine the correct length of hose, subtract the cut-off factor for each end fitting from the overall length of assembly.

^a Swivel nuts are universal — both SAE 37° and 45° connections.

Inverted Male Swivel 90° Tube Elbow

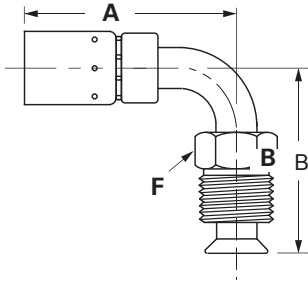

Hose I.D.	Tube Size	Part Number	Thread Size	A	B	Hose Cut-Off Factor	Hole Dia.	Hex F
3/16	1/4	06904E-E04	7/16-24	2.31	1.36	1.25	.13	7/16
1/4	5/16	06905E-E05	1/2-20	2.59	1.61	1.56	.18	1/2
5/16	1/4	06906E-E04	7/16-24	2.43	1.36	1.31	.15	7/16
5/16	5/16	06906E-E05	1/2-20	2.66	1.61	1.56	.21	1/2
5/16	3/8	06906E-E06	5/8-18	2.94	1.97	1.85	.24	5/8

JIC 37° Female Swivel 90° Tube Elbow

(Exceptions Noted, Refer to Footnotes)

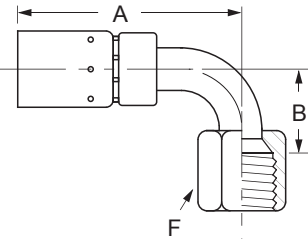

Hose I.D.	Tube Size	Part Number	Thread Size	A	B	Hose Cut-Off Factor	Hole Dia.	Hex F
3/16	1/4	06904E-664 ^a	7/16-20	2.41	.68	1.38	.13	9/16
1/4	5/16	06905E-665 ^a	1/2-20	2.62	.77	1.63	.21	5/8
5/16	3/8	06906E-666	9/16-18	2.73	.85	1.78	.24	11/16
13/32	1/2	06908E-668 ^a	3/4-16	2.87	1.09	1.75	.31	7/8
1/2	5/8	06910E-670 ^a	7/8-14	3.52	1.23	2.44	.39	1
5/8	3/4	06912E-672	1-1/16-12	3.66	1.82	2.31	.58	1-1/4
7/8	1	06916E-676	1-5/16-12	4.40	2.14	3.13	.76	1-1/2
1-1/8	1-1/4*	06920E-657 ^Δ	1-5/8-12	4.32	5.38	2.90	1.00	2
1-1/8	1-1/4*	06920E-677	1-5/8-12	4.27	3.25	2.90	1.01	2
1-3/8	1-1/2*	06924E-678	1-7/8-12	4.09	3.05	2.70	1.25	2-1/2

* 20 and 24 size ends have crimped nuts.

^Δ Long drop elbow.

SAE 45° Female Swivel 90° Tube Elbow

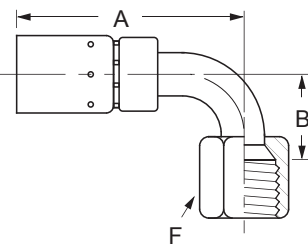

Hose I.D.	Tube Size	Part Number	Thread Size	A	B	Hose Cut-Off Factor	Hole Dia.	Hex F
5/16	3/8	06906E-466	5/8-18	2.76	.85	1.56	.24	3/4
5/8	3/4	06912E-472	1-1/16-14	3.64	1.82	2.31	.52	1-1/4

J

Hose Ends - Crimp

Coll-O-Crimp

327 'E' Series

To determine the correct length of hose, subtract the cut-off factor for each end fitting from the overall length of assembly.

Hose Fitting 327 'E' Series

Refer to the Weatherhead Hose End and Tool Selector Chart W-HOOV-TM001-E2 for qualified sizes.

Ordering Information: Order individually part number.

 Refer to important safety information on pages A-2-3.

Application: General purpose low- and medium-pressure hydraulics.

Compatible Hose
GH100

Pressure: Determined by working pressure for hose and hose size.

Material: Low Carbon Steel

Plating: Clear Trivalent Chromate

Assemble With: ET1000, ET4000, T-400-1, T-410-1, T-420-1, T-440-1, T-460, T-462, T-465-1, T480.

Label Set: FS-1200

Note:

Refer to current price list for availability of cataloged items. Configurations and dimensions subject to change without notice.

Female JIC, SAE 37° Swivel

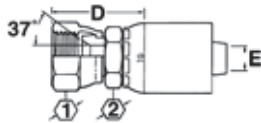

Hose I.D.	Tube Size	Part Number	Thread Size	A	Hose Cut-Off Factor	Hole Dia.	Hex E	Hex F
6	6	32706E-606	9/16-18	2.19	1.19	0.26	11/16	11/16
8	8	32708E-608	3/4-16	2.63	1.46	0.38	7/8	13/16
10	10	32710E-610	7/8-14	2.77	1.61	0.5	1	15/16
12	12	32712E-612	1 1/6-12	2.84	1.65	0.61	1 1/4	1 1/8

Female JIC/SAE 37° Swivel 45° Tube Elbow

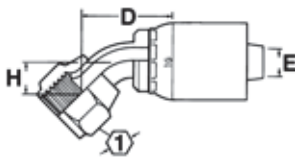

Hose I.D.	Tube Size	Part Number	Thread Size	A	H	Hose Cut-Off Factor	Hole Dia.	Hex
6	6	32706E-686	9/16-18	2.31	0.39	1.31	.24	11/16
8	8	32708E-688	3/4-16	2.82	0.55	1.65	.37	7/8
10	10	32710E-690	7/8-14	2.94	0.59	1.79	.46	1
12	12	32712E-692	1 1/6-12	3.43	0.78	2.24	.58	1 1/4

Female JIC/SAE 37° Swivel 90° Tube Elbow

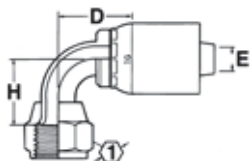

Hose I.D.	Tube Size	Part Number	Thread Size	A	H	Hose Cut-Off Factor	Hole Dia.	Hex
6	6	32706E-666	9/16-18	2.21	0.84	1.22	.24	11/16
8	8	32708E-668	3/4-16	2.59	1.09	1.42	.37	7/8
10	10	32710E-670	7/8-14	2.7	1.19	1.55	.46	1
12	12	32712E-672	1 1/6-12	3.36	1.8	2.17	.58	1 1/4

Coll-O-Crimp

327 'E' Series

To determine the correct length of hose, subtract the cut-off factor for each end fitting from the overall length of assembly.

Female FOR Seal

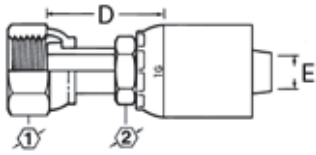

Hose I.D.	Tube Size	Part Number	Thread Size	A	Hose Cut-Off Factor	Hole Dia.	Hex E	Hex F
6	6	32706E-S66	11/16-16	2.23	1.24	0.26	13/16	11/16
8	8	32708E-S68	13/16-16	2.67	1.5	0.38	15/16	7/8
10	10	32710E-S70	1-14	2.76	1.61	0.48	1 1/8	15/16
12	12	32712E-S72	1 3/16-12	2.91	1.72	0.61	1 3/8	1-1/8

Female FOR Seal 45° Elbow

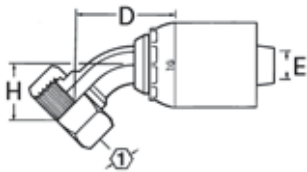

Hose I.D.	Tube Size	Part Number	Thread Size	A	H	Hose Cut-Off Factor	Hole Dia.	Hex
6	6	32706E-L66	11/16-16	2.43	0.43	1.43	.26	13/16
8	8	32708E-L68	13/16-16	2.96	0.59	1.79	.36	15/16
12	12	32712E-L72	1 3/16-12	3.57	0.83	2.38	.55	1 3/8

J

Hose Ends - Crimp

Female FOR Seal 90° Elbow

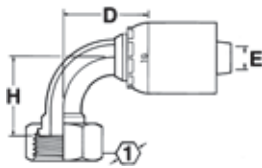

Hose I.D.	Tube Size	Part Number	Thread Size	A	H	Hose Cut-Off Factor	Hole Dia.	Hex
6	6	32706E-A26	11/16-16	2.34	0.9	1.34	.26	13/16
8	8	32708E-A28	13/16-16	2.84	1.15	1.67	.36	15/16
12	12	32710E-A30	1 3/16-12	3.49	1.88	2.3	.55	1 3/8

Coll-O-Crimp

336 'E' Series

To determine the correct length of hose, subtract the cut-off factor for each end fitting from the overall length of assembly.

Hose End 336 'E' Series

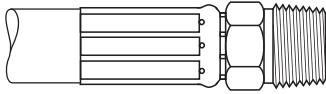

 Refer to important safety information on pages A-2-3.

Ordering Information: Order individually by part number.

Application: General purpose high-pressure hydraulics. Use H335 non-conductive hose where shock hazards exist.

Compatible Hose: H335, H336

Pressure: Determined by maximum operating pressure for hose size and hose end configuration whichever is less. See pages A-4-9 for operating pressure ratings for hose end configurations.

Material: Low Carbon Steel

Plating: Zinc; Clear Trivalent Chromate

Advantages: Wide selection of hose and end configurations allowing for a diverse number of applications where hose compatibility is a problem.

Assemble With: ET1000, ET4000, T-400-1, T-410-1, T-420-1, T-440-1, T-460, T-462, T-465, T-480

Label Set: FS-3500

Note: Refer to current price list for availability of cataloged items. Configurations and dimensions subject to change without notice.

Male Pipe Rigid

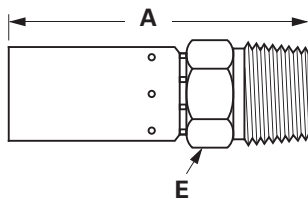

Hose I.D.	Tube Size	Part Number	Thread Size	A	Hose Cut-Off Factor	Hole Dia.	Hex E
3/16	1/8	33603E-102	1/8-27	1.88	1.06	.11	9/16
3/16	1/4	33603E-104	1/4-18	2.06	1.25	.11	11/16
1/4	1/8	33604E-102	1/8-27	2.13	1.06	.16	5/8
1/4	1/4	33604E-104	1/4-18	2.31	1.25	.16	11/16
1/4	3/8	33604E-106	3/8-18	2.40	1.31	.16	3/4
3/8	1/4	33606E-104	1/4-18	2.59	1.15	.28	3/4
3/8	3/8	33606E-106	3/8-18	2.59	1.15	.28	3/4
3/8	1/2	33606E-108	1/2-14	2.84	1.41	.28	15/16
1/2	3/8	33608E-106	3/8-18	2.78	1.13	.39	7/8
1/2	1/2	33608E-108	1/2-14	3.03	1.38	.39	15/16
3/4	3/4	33612E-112	3/4-14	3.22	1.38	.63	1-1/8
1	1	33616E-116	1-11-1/2	3.97	1.62	.81	1-3/8

Male Pipe Swivel

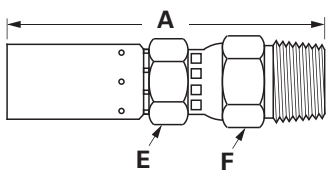

Hose I.D.	Tube Size	Part Number	Thread Size	A	Hose Cut-Off Factor	Hole Dia.	Hex E	Hex F
3/16	1/4	33603E-J04	1/4-18	2.64	1.84	.11	5/8	11/16
1/4	1/4	33604E-J04	1/4-18	2.87	1.79	.16	5/8	11/16
3/8	3/8	33606E-J06	3/8-18	3.15	1.72	.28	3/4	3/4
3/8	1/2	33606E-J08	1/2-14	3.31	1.88	.28	3/4	7/8
1/2	1/2	33608E-J08	1/2-14	3.61	1.97	.39	7/8	15/16

Note:

Swivel for installation purposes only. (Not for temperatures above 212°F.)

Coll-O-Crimp

336 'E' Series

To determine the correct length of hose, subtract the cut-off factor for each end fitting from the overall length of assembly.

JIC 37° Male Rigid

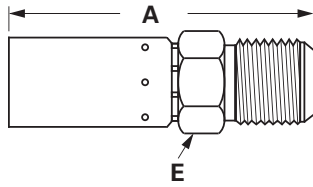

Hose I.D.	Tube Size	Part Number	Thread Size	A	Hose Cut-Off Factor	Hole Dia.	Hex E
3/16	1/4	33603E-504	7/16-20	2.05	1.25	.11	9/16
1/4	1/4	33604E-504	7/16-20	2.30	1.22	.16	5/8
1/4	5/16	33604E-505	1/2-20	2.30	1.23	.16	5/8
3/8	3/8	33606E-506	9/16-18	2.59	1.13	.28	3/4
3/8	1/2	33606E-508	3/4-16	2.69	1.25	.28	13/16
1/2	1/2	33608E-508	3/4-16	2.88	1.25	.39	7/8
1/2	5/8	33608E-510	7/8-14	3.10	1.42	.39	15/16
1/2	3/4	33608E-512	1-1/16-12	3.15	1.52	.39	1-1/8
3/4	3/4	33612E-512	1-1/16-12	3.32	1.52	.61	1-1/8

SAE 45° Flare Male Rigid

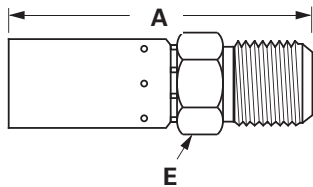

Hose I.D.	Tube Size	Part Number	Thread Size	A	Hose Cut-Off Factor	Hole Dia.	Hex E
3/16	1/4	33603E-304	7/16-20	2.00	1.19	.11	9/16
3/8	3/8	33606E-306	5/8-18	2.65	1.19	.28	3/4
1/2	1/2	33608E-308	3/4-16	3.03	1.31	.39	7/8

Male Straight Thread O-Ring Rigid

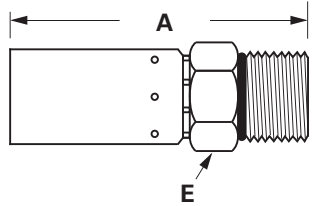

Hose I.D.	Port Size	Part Number	Thread Size	A	Hose Cut-Off Factor	Hole Dia.	Hex E
3/16	1/4	33603E-P04	7/16-20	1.86	1.06	.11	9/16
1/4	5/16	33604E-P05	1/2-20	2.11	1.03	.16	5/8
1/4	3/8	33604E-P06	9/16-18	2.14	1.06	.16	11/16
3/8	3/8	33606E-P06	9/16-18	2.42	1.00	.28	3/4
3/8	1/2	33606E-P08	3/4-16	2.47	1.03	.28	7/8
1/2	1/2	33608E-P08	3/4-16	2.78	1.03	.39	15/16
1/2	5/8	33608E-P10	7/8-14	2.84	1.16	.39	1-1/16

Female Pipe Rigid

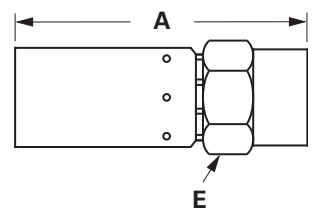

Hose I.D.	Pipe Size	Part Number	Thread Size	A	Hose Cut-Off Factor	Hole Dia.	Hex E
1/4	1/4	33604E-204	1/4-18	2.34	1.25	.16	3/4
1/2	1/2	33608E-208	1/2-14	3.03	1.31	.39	1-1/16

Female Straight Pipe Swivel

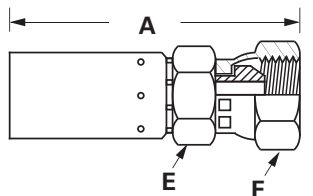

Hose I.D.	Tube Size	Part Number	Thread Size	A	Hose Cut-Off Factor	Hole Dia.	Hex E	Hex F
1/4	1/4	33604E-054	1/4-18	2.38	1.31	.16	5/8	3/4
3/8	3/8	33606E-056	3/8-18	2.66	1.22	.28	3/4	7/8
1/2	1/2	33608E-058	1/2-14	3.06	1.38	.39	1	1
3/4	3/4	33612E-062	3/4-14	3.43	1.62	.63	1-1/8	1-1/8

Note:
For use with male pipe fittings with internal seat.

J
Hose Ends - Crimp

Coll-O-Crimp

336 'E' Series

To determine the correct length of hose, subtract the cut-off factor for each end fitting from the overall length of assembly.

^a Swivel nuts are universal – both SAE 37° and 45° connections.

JIC 37° Female Swivel

(Exceptions Noted)

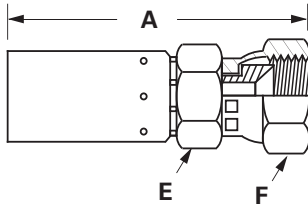

Hose I.D.	Tube Size	Part Number	Thread Size	A	Hose Cut-Off Factor	Hole Dia.	Hex E	Hex F
3/16	1/4	33603E-604 ^a	7/16-20	2.16	1.38	.11	9/16	5/8
3/16	5/16	33603E-605 ^a	1/2-20	2.16	1.38	.11	9/16	3/4
1/4	1/4	33604E-604 ^a	7/16-20	2.53	1.44	.16	5/8	5/8
1/4	5/16	33604E-605 ^a	1/2-20	2.53	1.44	.16	5/8	3/4
1/4	3/8	33604E-606	9/16-18	2.53	1.44	.16	5/8	3/4
3/8	3/8	33606E-606	9/16-18	2.81	1.38	.28	3/4	3/4
3/8	1/2	33606E-608 ^a	3/4-16	2.81	1.38	.28	3/4	15/16
1/2	1/2	33608E-608 ^a	3/4-16	3.16	1.63	.39	7/8	15/16
1/2	5/8	33608E-610 ^a	7/8-14	3.16	1.63	.39	7/8	1-1/16
3/4	3/4	33612E-612	1-1/16-12	3.44	1.63	.63	1-1/8	1-1/4
1	1	33616E-616	1-5/16-12	4.06	1.75	.81	1-3/8	1-1/2

SAE 45° Female Swivel

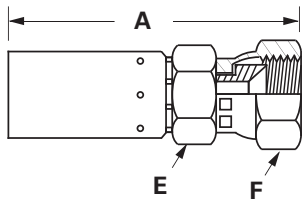

Hose I.D.	Tube Size	Part Number	Thread Size	A	Hose Cut-Off Factor	Hole Dia.	Hex E	Hex F
1/4	3/8	33604E-406	5/8-18	2.53	1.44	.16	5/8	13/16
3/8	3/8	33606E-406	5/8-18	2.81	1.38	.28	3/4	13/16

Female FOR-SEAL[®] Swivel Straight

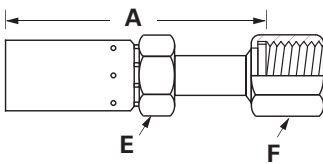

Hose I.D.	Tube Size	Part Number	Thread Size	A	Hose Cut-Off Factor	Hole Dia.	Hex E	Hex F
1/4	1/4	33604E-S64	9/16-18	2.60	1.52	.16	5/8	11/16
3/8	3/8	33606E-S66	11/16-16	2.92	1.61	.21	3/4	13/16
1/2	1/2	33608E-S68	13/16-16	3.29	1.72	.38	7/8	15/16
3/4	3/4	33612E-S72	1-3/16-12	3.71	1.95	.61	1-1/8	1-3/8
1	1	33616E-S76	1-7/16-12	4.36	2.11	.81	1-3/8	1-5/8

JIC 37° Female Swivel 45° Tube Elbow

(Exceptions Noted)

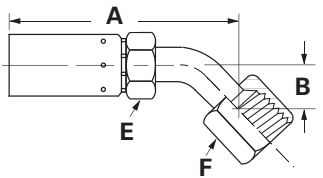

Hose I.D.	Tube Size	Part Number	Thread Size	A	B	Hose Cut-Off Factor	Hole Dia.	Hex E	Hex F
3/16	1/4	33603E-684 ^a	7/16-20	2.30	.47	1.50	.11	9/16	9/16
1/4	5/16	33604E-685 ^a	1/2-20	2.65	.53	1.56	.16	5/8	5/8
3/8	3/8	33606E-686	9/16-18	2.92	.59	1.48	.28	3/4	11/16
3/8	1/2	33606E-688 ^a	3/4-16	3.10	.71	1.66	.28	3/4	7/8
1/2	1/2	33608E-688 ^a	3/4-16	3.28	.71	1.66	.39	7/8	7/8
1/2	5/8	33608E-690 ^a	7/8-14	3.52	.84	1.84	.39	7/8	1
3/4	3/4	33612E-692	1-1/16-12	4.33	1.12	2.44	.62	1-1/8	1-1/4

Inverted Male Swivel 45° Tube Elbow

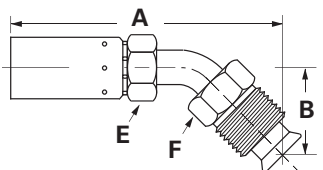

Hose I.D.	Tube Size	Part Number	Thread Size	A	B	Hose Cut-Off Factor	Hole Dia.	Hex E	Hex F
3/8	3/8	33606E-B46	5/8-18	3.30	.97	1.88	.28	3/4	5/8

J

Hose Ends - Crimp

Coll-O-Crimp

336 'E' Series

To determine the correct length of hose, subtract the cut-off factor for each end fitting from the overall length of assembly.

^a Swivel nuts are universal – both SAE 37° and 45° connections.

Male Pipe Swivel 90° Elbow

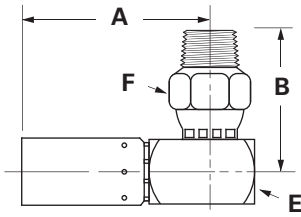

Hose I.D.	Tube Size	Part Number	Thread Size	A	B	Hose Cut-Off Factor	Hole Dia.	Hex E	Hex F
3/8	3/8	33606E-M06	3/8-18	2.19	1.64	.88	.28	.81	3/4
1/2	1/2	33608E-M08	1/2-14	2.48	1.95	.94	.39	1	15/16

Note:
Swivel for installation purposes only.
(Not for temperatures above 212°F.)

JIC 37° Female Swivel 90° Tube Elbow

(Exceptions Noted)

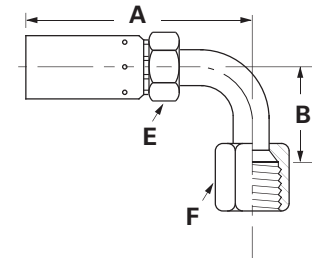

Hose I.D.	Tube Size	Part Number	Thread Size	A	B	Hose Cut-Off Factor	Hole Dia.	Hex E	Hex F
1/4	1/4	33604E-664 ^a	7/16-20	2.28	.88	1.31	.16	5/8	9/16
1/4	5/16	33604E-665 ^a	1/2-20	2.38	1.00	1.31	.16	5/8	5/8
3/8	3/8	33606E-666	9/16-18	2.63	1.13	1.19	.28	3/4	11/16
3/8	1/2	33606E-668 ^a	3/4-16	2.75	1.38	1.31	.28	3/4	7/8
1/2	1/2	33608E-668 ^a	3/4-16	2.94	1.38	1.31	.39	7/8	7/8
1/2	5/8	33608E-670 ^a	7/8-14	3.06	1.63	1.44	.39	7/8	1
3/4	5/8	33612E-670 ^a	7/8-14	3.38	1.63	1.56	.50	1-1/8	1
3/4	3/4	33612E-672	1-1/16-12	3.88	2.31	2.06	.62	1-1/8	1-1/4
1	1	33616E-676	1-5/16-12	4.75	2.50	2.31	.58	1-3/8	1-1/2

JIC 37° Female Swivel Long Drop 90° Tube Elbow

(Exceptions Noted)

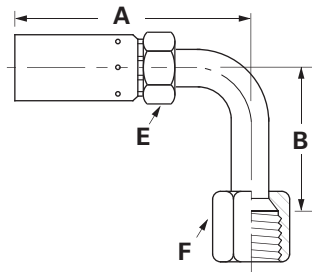

Hose I.D.	Tube Size	Part Number	Thread Size	A	B	Hose Cut-Off Factor	Hole Dia.	Hex E	Hex F
1/4	5/16	33604E-645	1/2-20	2.38	1.77	1.30	.16	5/8	5/8
3/8	3/8	33606E-646	9/16-18	2.63	2.18	1.19	.28	3/4	11/16
3/8	1/2	33606E-648	3/4-16	2.75	2.43	1.31	.28	3/4	7/8
1/2	5/8	33608E-650	7/8-14	3.06	2.57	1.44	.39	7/8	1
3/4	3/4	33612E-652	1-1/16-12	3.88	3.73	2.06	.62	1-1/8	1-1/4

Female FOR-SEAL® Swivel Short Drop 90° Elbow

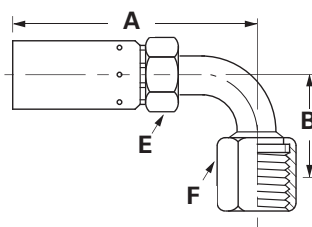

Hose I.D.	Tube Size	Part Number	Thread Size	A	B	Hose Cut-Off Factor	Hole Dia.	Hex E	Hex F
1/4	1/4	33604E-A24	9/16-18	2.31	.78	1.23	.16	5/8	11/16
3/8	3/8	33606E-A26	11/16-16	2.74	.90	1.43	.28	3/4	13/16
1/2	1/2	33608E-A28	13/16-16	3.04	1.15	1.48	.39	7/8	15/16
3/4	3/4	33612E-A32	1-3/16-12	3.78	1.88	2.02	.63	1-1/8	1-3/8

J Hose Ends - Crimp

Coll-O-Crimp

470 'E' Series

To determine the correct length of hose, subtract the cut-off factor for each end fitting from the overall length of assembly.

Hose End 470 'E' Series

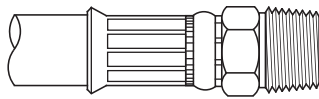

⚠ WARNING

47032E ends can ONLY be crimped on the T-440 or ET4000.

⚠ Refer to important safety information on pages A-2-3.

Ordering Information: Order individually by part number; reference individual hose end listings for details. For split flange kits, refer to pages L-89-92.

Application: Very high pressure hydraulic lines subjected to extreme pressure surges and flexing. Some applications include mining, construction, farming and high performance industrial equipment.

Compatible Hose: H470

Pressure: Determined by maximum operating pressure for hose size and hose end configuration whichever is lesser. See pages A-4-9 for operating pressure ratings for hose end configurations.

Material: Low Carbon Steel

Plating: Zinc; Clear Trivalent Chromate

Advantages: Excellent series for very high pressure

hydraulics. Compatible with Caterpillar, John Deere, and most major manufacturers of equipment using high pressure applications.

Assemble With: T-410-1 Coll-O-Crimp II, T-420-1 Coll-O-Crimp Super I, T-440-1 Coll-O-Crimp II Plus, T-480, ET4001 or ET4000 depending on size.

Label Set: FS-1800

Male Pipe Rigid

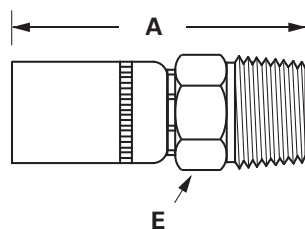

Hose I.D.	Pipe Size	Part Number	Thread Size	A	Hose Cut-Off Factor	Hole Dia.	Hex E
1/2	1/2	47008E-108	1/2-14	2.79	1.38	.38	7/8
3/4	3/4	47012E-112	3/4-14	3.80	1.75	.61	1-1/16
1	1	47016E-116	1-11-1/2	4.30	1.94	.80	1-3/8
1-1/4	1-1/4	47020E-120	1-1/4-11-1/2	5.56	2.44	1.00	1-3/4
1-1/2	1-1/2	47024E-124	1-1/2-11-1/2	5.61	2.25	1.25	2-1/8
2	2	47032E-132	2-11-1/2	6.53	2.75	1.56	2-3/4

Male DIN 24° Seat s.Rh. (Heavy)

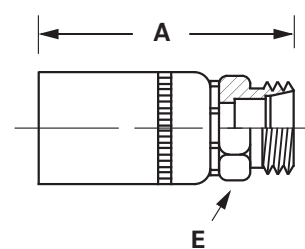

Hose I.D.	Pipe Size	Part Number	Thread Size	A	Hose Cut-Off Factor	Hole Dia.	Hex E
3/4	25	47012E-25F	M36-2.0	3.56	1.61	.58	1-3/8
1	30	47016E-30F	M42-2.0	4.26	1.88	.79	1-3/4
1-1/4	38	47020E-38F	M52-2.0	5.22	3.81	1.00	2-1/4

JIC 37° Female Swivel

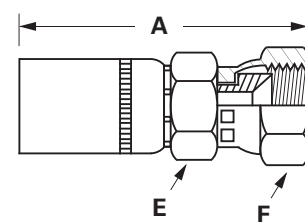

Hose I.D.	Tube Size	Part Number	Thread Size	A	Hose Cut-Off Factor	Hole Dia.	Hex E	Hex F
1/2	1/2	47008E-608	3/4-16	2.97	1.56	.39	7/8	7/8
3/4	3/4	47012E-612	1-1/16-12	3.90	1.88	.58	1-1/16	1-1/4
3/4	1	47012E-616	1-5/16-12	3.98	1.94	.58	1-1/4	1-1/2
1	1	47016E-616	1-5/16-12	4.34	2.00	.80	1-3/8	1-1/2
1-1/4	1-1/4	47020E-620	1-5/8-12	5.72	2.56	1.00	1-3/4	2
1-1/2	1-1/2	47024E-624	1-7/8-12	6.04	2.63	1.25	2-1/8	2-1/4
2	2	47032E-632 ^Δ	2-1/2-12	6.98	3.22	1.56	2-3/4	3

⚠ **WARNING:** ^Δ Before crimping this fitting on a ET4000 C-O-C machine, refer to ET4000 crimping procedures on page N-29.

J
Hose Ends - Crimp

Coll-O-Crimp

470 'E' Series

To determine the correct length of hose, subtract the cut-off factor for each end fitting from the overall length of assembly.

Female Swivel DIN 24° Seat

s. Rh. DKO (Heavy)

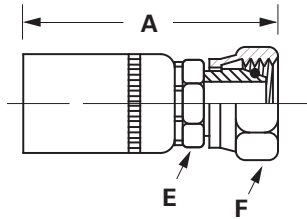

Hose I.D.	Tube Size (mm)	Part Number	Thread Size	A	Hose Cut-Off Factor	Hole Dia.	Hex E	Hex F
3/4	25	47012E-75C	M36x2.0	3.94	1.88	.58	1-5/16	1-13/16
1	30	47016E-80C	M42x2.0	4.60	2.25	.79	1-5/8	2
1-1/4	38	47020E-88C	M52x2.0	5.96	2.63	1.00	2	2-3/8

(Includes o-ring)

British Standard (BSPP) 60° Cone Female Pipe Swivel

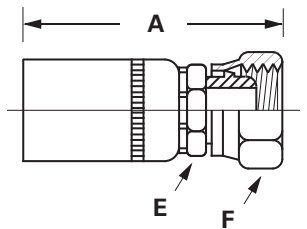

Hose I.D.	BSPP Pipe Size	Part Number	Thread Size	A	Hose Cut-Off Factor	Hole Dia.	Hex E	Hex F
3/4	3/4	47012E-362	G-3/4-14*	3.99	1.69	.58	1-1/16	1-1/4
1	1	47016E-366	G-1-11*	4.75	2.23	.79	1-3/8	1-1/2
1-1/4	1-1/4	47020E-370	G-1-1/4-11*	6.26	2.44	1.00	1-7/8	1-7/8
1-1/2	1-1/2	47024E-374	G-1-1/2-11*	6.46	3.04	1.18	2	2-1/4
2	2	47032E-375	G-2-11*	6.85	3.06	1.56	2-3/4	2-3/4

*G as part of thread size is ISO designation for parallel thread.

Swivel Nut style may vary.

Female FOR-SEAL Swivel Straight

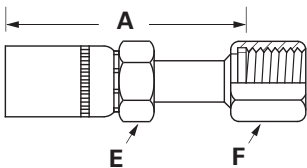

Hose I.D.	Tube Size	Part Number	Thread Size	A	Hose Cut-Off Factor	Hole Dia.	Hex E	Hex F
3/4	3/4	47012E-S72	1-3/16-12	4.20	2.16	.55	1-1/8	1-3/8
1	1	47016E-S76	1-7/16-12	4.65	2.31	.79	1-3/8	1-5/8
1	1-1/4	47016E-S80	1-11/16-12	4.65	2.31	.79	1-3/8	1-7/8
1-1/4	1-1/4	47020E-S80	1-11/16-12	5.76	2.62	1.00	1-3/4	1-7/8

Split Flange Straight

(SAE Code 61)

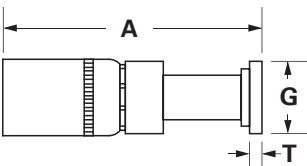

Hose I.D.	Nominal Flange Size	Part Number	Thread Size	A	Hose Cut-Off Factor	Hole Dia.	Dia. G	Nominal
1/2	1/2	47008E-G08	8x252	3.79	2.38	.38	1.19	.265
3/4	3/4	47012E-G12	12x252	4.46	2.44	.58	1.50	.265
3/4	1	47012E-G16	16x252	4.46	2.44	.58	1.75	.315
1	1	47016E-G16	16x252	4.91	2.56	.77	1.75	.315
1-1/4	1-1/4	47020E-G20	20x252	5.84	2.69	1.00	2.00	.315
1-1/2	1-1/2	47024E-G24	24x252	6.83	3.50	1.25	2.38	.315
2	2	47032E-G32	32x252	7.82	4.06	1.81	2.81	.375

(For Split Flange Kits, see pages L-89 thru L-92.)

J

Hose Ends - Crimp

Coll-O-Crimp

470 'E' Series

To determine the correct length of hose, subtract the cut-off factor for each end fitting from the overall length of assembly.

Split Flange Straight (SAE Code 62)

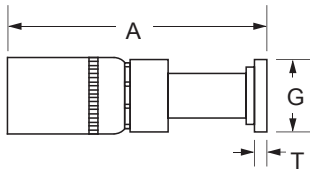

Hose I.D.	Nominal Flange Size	Part Number	Replacement O-Ring (Not Included)	A	Hose Cut-Off Factor	Hole Dia.	Dia. G	T Nominal
3/4	3/4	47012E-D12	12x252	4.75	2.75	.58	1.62	.345
3/4	1	47012E-D16	16x252	4.94	2.88	.58	1.88	.375
1	1	47016E-D16	16x252	4.91	2.56	.77	1.88	.375
1	1-1/4	47016E-D20	20x252	5.10	2.75	.77	2.12	.405
1	1-1/2	47016E-D24	24x252	5.30	2.94	.77	2.50	.495
1-1/4	1-1/4	47020E-D20	20x252	5.73	2.63	1.00	2.12	.405
1-1/4	1-1/2	47020E-D24	24x252	5.91	2.75	1.00	2.50	.495
1-1/2	1-1/4	47024E-D20	20x252	6.87	3.44	1.00	2.12	.405
1-1/2	1-1/2	47024E-D24	24x252	6.71	3.31	1.25	2.50	.495

(For Split Flange Kits, see pages L-89 thru L-92.)

Split Flange 30° Tube Elbow (SAE Code 62)

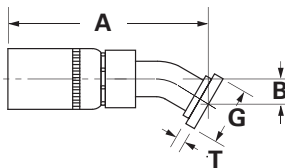

Hose I.D.	Nominal Flange Size	Part Number	Replacement O-Ring (Not Included)	A	B	Hose Cut-Off Factor	Hole Dia.	Dia. G	T Nominal
1	1-1/2	47016E-N25	24x252	6.46	1.11	4.06	.75	2.50	.495
1-1/4	1-1/2	47020E-N25	24x252	7.45	1.09	4.31	1.06	2.50	.495

(For Split Flange Kits, see pages L-89 thru L-92.)

JIC 37° Female Swivel 45° Tube Elbow

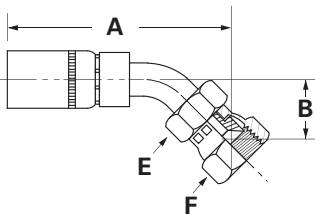

Hose I.D.	Tube Size	Part Number	Thread Size	A	B	Hose Cut-Off Factor	Hole Dia.	Hex E	Hex F
1/2	1/2	47008E-688	3/4-16	4.24	1.14	2.81	.39	7/8	7/8
3/4	3/4	47012E-692	1-1/16-12	5.79	1.66	3.75	.61	1-1/8	1-1/4
1	1	47016E-696	1-5/16-12	6.35	1.72	3.98	.80	1-3/16	1-1/2

British Standard (BSPP) 60° Cone Female Pipe Swivel 45° Elbow

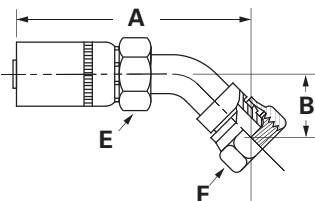

Hose I.D.	Tube Size	Part Number	Thread Size	A	B	Hose Cut-Off Factor	Hole Dia.	Hex E	Hex F
3/4	3/4	47012E-52P	G-3/4-14*	5.80	1.66	3.75	.61	1-1/16	1-1/4
1	1	47016E-56P	G-1-11*	6.54	1.92	4.19	.75	1-3/8	1-1/2

*G as part of thread size is ISO designation for parallel thread.

J

Hose Ends - Crimp

Coll-O-Crimp

470 'E' Series

To determine the correct length of hose, subtract the cut-off factor for each end fitting from the overall length of assembly.

Split Flange 45° Tube Elbow (SAE Code 61)

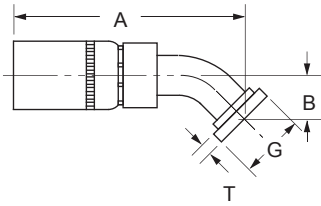

Hose I.D.	Nominal Flange Size	Replacement Part Number	O-Ring (Not Included)	A	B	Hose Cut-Off Factor	Hole Dia.	Dia. G	T Nominal
1/2	1/2	47008E-G41	8x252	3.94	.78	2.50	.38	1.19	.265
3/4	3/4	47012E-G42	12x252	5.50	1.38	3.46	.58	1.50	.265
1	1	47016E-G46	16x252	5.88	1.25	3.12	.75	1.75	.315
1-1/4	1-1/4	47020E-G50	20x252	7.16	1.50	4.02	1.00	2.00	.315
1-1/2	1-1/2	47024E-G54	24x252	7.81	1.41	4.38	1.25	2.38	.315
2	2	47032E-G62	32x252	9.17	2.00	5.40	1.81	2.81	.375

(For Split Flange Kits, see pages L-89 thru L-92.)

Split Flange 45° Tube Elbow (SAE Code 62)

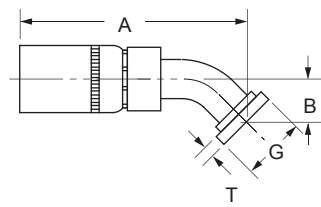

Hose I.D.	Nominal Flange Size	Part Number	Replacement O-Ring (Not Included)	A	B	Hose Cut-Off Factor	Hole Dia.	Dia. G	T Nominal
3/4	3/4	47012E-D42	12x252	5.50	1.38	3.45	.58	1.62	.345
3/4	1	47012E-D46	16x252	5.50	1.38	3.45	.58	1.88	.375
1	1	47016E-D46	16x252	5.88	1.25	3.52	.79	1.88	.375
1	1-1/4	47016E-D50	20x252	5.88	1.25	3.52	.79	2.12	.405
1-1/4	1-1/4	47020E-D50	20x252	7.16	1.50	4.02	1.00	2.12	.405
1-1/4	1-1/2	47020E-D54	24x252	7.16	1.50	4.02	1.00	2.50	.495
1-1/2	1-1/2	47024E-D54	24x252	8.00	1.60	4.59	1.19	2.50	.495

Split Flange 60° Tube Elbow (SAE Code 62)

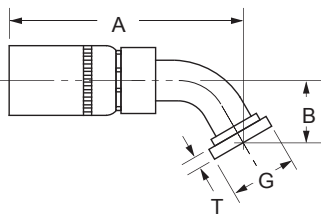

Hose I.D.	Nominal Flange Size	Part Number	Replacement O-Ring (Not Included)	A	B	Hose Cut-Off Factor	Hole Dia.	Dia. G	T Nominal
1-1/4	1-1/2	47020E-N55	24x252	7.36	2.28	4.21	1.06	2.50	.495

(For Split Flange Kits, see pages L-89 thru L-92.)

Split Flange 67 1/2° Tube Elbow (SAE Code 62)

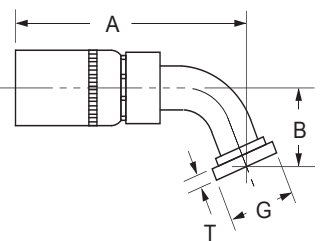

Hose I.D.	Nominal Flange Size	Part Number	Replacement O-Ring (Not Included)	A	B	Hose Cut-Off Factor	Hole Dia.	Dia. G	T Nominal
1	1	47016E-N63	16x252	6.02	2.24	3.63	.75	1.88	.375

(For Split Flange Kits, see pages L-89 thru L-92.)

JIC 37° Female Swivel 90° Tube Elbow

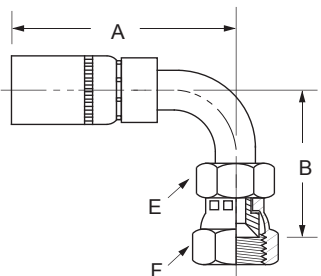

Hose I.D.	Nominal Flange Size	Part Number	Replacement O-Ring (Not Included)	A	B	Hose Cut-Off Factor	Hole Dia.	Dia. G	T Nominal
1/2	1/2	47008E-668	3/4-16	3.53	2.12	2.11	.39	7/8	7/8
3/4	3/4	47012E-672	1-1/16-12	5.00	2.88	2.95	.61	1-1/8	1-1/4
1	1	47016E-676	1-5/16-12	5.52	3.46	3.16	.80	1-3/16	1-1/2

Hose Ends - Crimp

Coll-O-Crimp

470 'E' Series

To determine the correct length of hose, subtract the cut-off factor for each end fitting from the overall length of assembly.

Female FOR-SEAL Swivel 90° Tube Elbow Short Drop

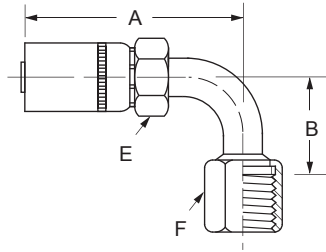

Hose I.D.	Tube Size	Part Number	Thread Size	A	B	Hose Cut-Off Factor	Hole Dia.	Hex E	Hex F
1-1/4	1-1/4	47020E-A40	1-11/16-12	6.37	2.50	3.22	1.00	1-3/4	1-7/8

British Standard (BSPP) 60° Cone Female Pipe Swivel 90° Elbow

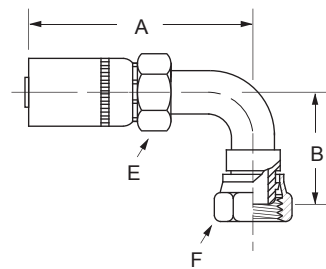

Hose I.D.	Tube Size	Part Number	Thread Size	A	B	Hose Cut-Off Factor	Hole Dia.	Hex E	Hex F
3/4	3/4	47012E-82P	G-3/4-14*	4.98	2.49	2.94	.61	1-1/8	1-1/4
1	1	47016E-86P	G-1-11*	5.52	3.43	3.13	.75	1-3/8	1-1/2

*G as part of thread size is ISO designation for parallel thread.

Split Flange 90° Tube Elbow (SAE Code 61)

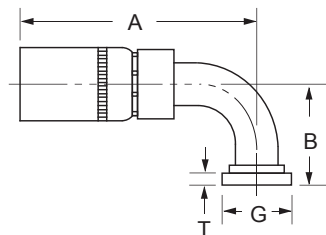

Hose I.D.	Nominal Flange Size	Part Number	Replacement O-Ring (Not Included)	A	B	Hose Cut-Off Factor	Hole Dia.	Dia. G	T Nominal
1/2	1/2	47008E-G71	8x252	3.59	1.62	2.17	.50	1.19	.265
3/4	3/4	47012E-G72	12x252	5.00	2.66	2.95	.61	1.50	.265
3/4	1	47012E-G76	16x252	5.00	2.66	2.95	.58	1.75	.315
1	1	47016E-G76	16x252	5.52	2.80	3.16	.75	1.75	.315
1-1/4	1-1/4	47020E-G80	20x252	6.43	2.62	3.29	1.12	2.00	.315
1-1/2	1-1/2	47024E-G84	24x252	7.66	3.13	4.24	1.44	2.38	.315
2	2	47032E-G92	32x252	8.85	4.50	5.08	1.81	2.81	.375

(For Split Flange Kits, see pages L-89 thru L-92.)

Split Flange 90° Tube Elbow (SAE Code 62)

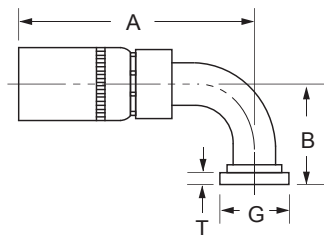

Hose I.D.	Nominal Flange Size	Part Number	Replacement O-Ring (Not Included)	A	B	Hose Cut-Off Factor	Hole Dia.	Dia. G	T Nominal
3/4	3/4	47012E-D72	12x252	5.01	2.62	2.94	.64	1.62	.345
3/4	1	47012E-D76	16x252	5.01	2.81	2.94	.60	1.88	.375
1	1	47016E-D76	16x252	5.52	2.79	3.13	.86	1.88	.375
1	1-1/4	47016E-D80	20x252	5.52	2.94	3.13	.86	2.12	.405
1	1-1/2	47016E-D84	24x252	5.75	3.42	3.39	.75	2.50	.495
1-1/4	1-1/4	47020E-D80	20x252	6.61	3.02	3.50	1.03	2.12	.405
1-1/4	1-1/4	47020E-D80L47	20x252	6.61	4.70	3.50	1.03	2.12	.405
1-1/4	1-1/4	47020E-D80L60	20x252	6.61	6.00	3.50	1.03	2.12	.405
1-1/4	1-1/2	47020E-D84	24x252	6.61	3.68	3.50	1.03	2.50	.495
1-1/2	1-1/4	47024E-D80	20x252	6.77	3.02	3.38	1.03	2.12	.405
1-1/2	1-1/2	47024E-D84	24x252	7.57	3.68	4.19	1.28	2.50	.495

(For Split Flange Kits, see pages L-89 thru L-92.)

Hose Ends - Crimp

Coll-O-Crimp

757 'E' Series

Hose End 757 'E' Series

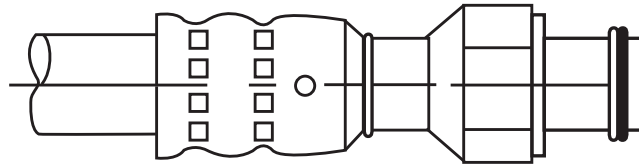

Ordering Information:

Order individually by catalog number.

 Refer to important safety information on pages A-2-3.

Typical Applications:

Used with R134a and R12 applications. Ideal for heavy duty truck use as well as industrial and automotive applications.

Compatible Hose: H757

Pressure: Determined by hose burst pressure. See pages A-15-16 for operating pressure ratings for hose end configurations.

Material: Carbon steel

Plating: Zinc; Clear Trivalent Chromate

Advantages: Wide selection of hose ends which include the flareless ends, allowing use of existing tubing. Steel hose ends handle heavy duty demands.

Assemble With: T-400-1, T-410-1, T-420-1, T-440-1, T-460, T-462, T-465-1, T-475-1, T-480, ET4000, ET4001

Label Set: FS-3200

Note:

Refer to current price list for availability of cataloged items. Configurations and dimensions subject to change without notice.

757 'E' Series Air Conditioning Procedure

The Coll-O-Crimp system can be used to make original equipment assemblies using factory replacement ends as listed on pages J-23 to J-29. If the required hose end is not found, our Flareless hose end can be used. By following the instructions on this page, a new hose assembly can be made by combining Weatherhead hose end with the original equipment end configuration.

- Typical original equipment assembly
- Typical assembly of a Flareless hose end used with an old original equipment end configuration
- Weatherhead replacement assemblies using original equipment tubing with Weatherhead 757 'E' Series hose ends.

Preparation – Flareless Tube Assembly

1. Remove the bad tube assembly or if room permits, perform the cutting procedure in place. Cut the tube squarely and as close to the hose connection as possible. Allow an adequate straight area for the flareless nut and sleeve to move freely for installation purposes. Deburr the inside and outside diameters of the tubing.

Make Presetting Operation

1. Slide nut and then sleeve onto tube. Shoulder of sleeve must be toward nut.
2. Lubricate threads, seat in hose end, and flareless sleeve with a good grade of lubricant. Insert tube into seat of hose end, making sure that tube is bottomed, **TIGHTEN HAND TIGHT** and then tighten an **ADDITIONAL 1 to 1-1/6 turns** with a wrench.

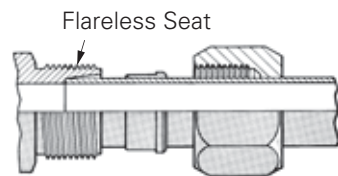
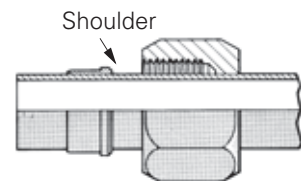
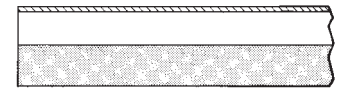

Note:

Compensate for tubing being removed by adding to the over all length of the replacement hose assembly.

Coll-O-Crimp

757 'E' Series

To determine the correct length of hose, subtract the cut-off factor for each end fitting from the overall length of assembly. All dimensions shown in inches.

Bumped Tube O-Ring Male Rigid

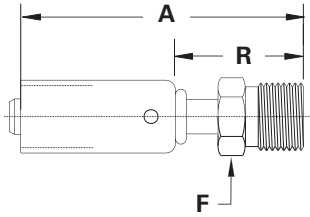

Hose I.D.	Tube Size	Part Number	Thread Size	Length A	Run R	Hose Cut-Off Factor	Hex F
5/16	3/8	75706E-W06	5/8-18	2.94	1.54	1.63	5/8
13/32	1/2	75708E-W08	3/4-16	3.26	1.86	2.00	3/4
1/2	5/8	75710E-W10	7/8-14	3.35	1.95	2.13	7/8
5/8	5/8	75712E-W10	7/8-14	3.56	2.06	2.25	7/8
5/8	3/4	75712E-W12	1-1/16-14	3.56	2.06	2.25	1-1/16

Bumped Tube O-Ring Male Swivel

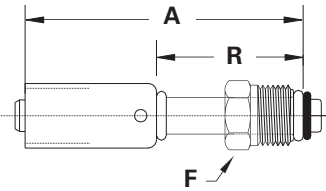

Hose I.D.	Tube Size	Part Number	Thread Size	Length A	Run R	Hose Cut-Off Factor	Hex F	O-Ring
5/16	3/8	75706E-Z06	5/8-18	2.94	1.54	1.63	5/8	ZW74706
5/16	1/2	75706E-Z08	3/4-18	3.15	1.75	1.88	3/4	ZW74708
13/32	1/2	75708E-Z08	3/4-18	3.26	1.86	2.00	3/4	ZW74708
1/2	5/8	75710E-Z10	7/8-18	3.35	1.95	2.13	7/8	ZW74710
1/2	3/4	75710E-Z12	1-1/16-16	3.46	2.06	2.25	1-1/16	ZW74712
5/8	5/8	75712E-Z10	7/8-18	3.56	2.06	2.25	7/8	ZW74710
5/8	3/4	75712E-Z12	1-1/16-16	3.56	2.06	2.25	1-1/16	ZW74712

(Includes o-ring).

Male Rigid Compression Fitting (With Nut and Sleeve)

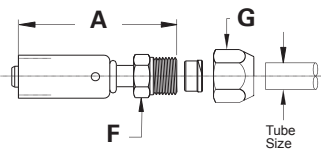

Hose I.D.	Tube Size	Part Number	Thread Size	Length A	Hose Cut-Off Factor	Hex F	Hex G
5/16	3/8	75706E-756	5/8-18	2.59	1.38	5/8	3/4
5/16	1/2	75706E-758	3/4-16	2.71	1.50	3/4	7/8
13/32	3/8	75708E-756	5/8-18	2.65	1.38	5/8	3/4
13/32	1/2	75708E-758	3/4-16	2.78	1.50	3/4	7/8
13/32	5/8	75708E-760	7/8-14	2.90	1.63	7/8	1-1/16
1/2	1/2	75710E-758	3/4-16	2.84	1.63	3/4	7/8
1/2	5/8	75710E-760	7/8-14	2.90	1.63	7/8	1-1/16
5/8	5/8	75712E-760	7/8-14	3.13	1.75	7/8	1-1/16
5/8	3/4	75712E-762	1-1/16-14	3.25	1.88	1-1/16	1-1/4

SAE 45° Male Rigid

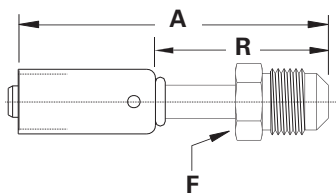

Hose I.D.	Tube Size	Part Number	Thread Size	Length A	Run R	Hose Cut-Off Factor	Hex F
5/16	3/8	75706E-306	5/8-18	3.28	1.88	2.00	5/8
13/32	1/2	75708E-308	3/4-16	3.40	2.00	2.13	3/4
1/2	5/8	75710E-310	7/8-14	3.71	2.31	2.50	7/8
5/8	3/4	75712E-312	1-1/16-14	4.00	2.50	2.75	1-1/16

Coll-O-Crimp

757 'E' Series

To determine the correct length of hose, subtract the cut-off factor for each end fitting from the overall length of assembly. All dimensions shown in inches.

Bumped Tube O-Ring Female Swivel

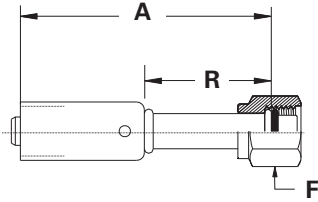

Hose I.D.	Tube Size	Part Number	Thread Size	Length A	Run R	Hose Cut-Off Factor	Hex F	O-Ring
5/16	3/8	75706E-Z47	5/8-18	2.78	1.38	1.50	3/4	ZW74706
5/16	1/2	75706E-Z49	3/4-16	2.90	1.50	1.63	7/8	ZW74708
13/32	1/2	75708E-Z49	3/4-16	3.06	1.66	1.75	7/8	ZW74708
13/32	5/8	75708E-Z51	7/8-14	3.09	1.69	1.88	1-1/16	ZW74710
1/2	5/8	75710E-Z51	7/8-14	3.09	1.69	1.88	1-1/16	ZW74710
1/2	3/4	75710E-Z53	1-1/16-14	3.21	1.81	2.00	1-1/4	ZW74712
5/8	5/8	75712E-Z51	7/8-14	3.31	1.81	2.00	1-1/16	ZW74710
5/8	3/4	75712E-Z53	1-1/16-14	3.31	1.81	2.00	1-1/4	ZW74712

(Includes o-ring).

Bumped Tube O-Ring Female Swivel W/R134a Service Port

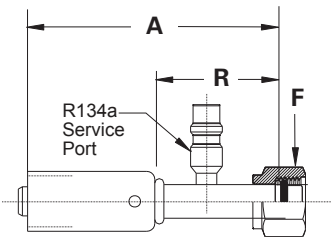

Hose I.D.	Tube Size	Part Number	Thread Size	Length A	Run R	Hose Cut-Off Factor	Hex F	O-Ring
5/16	3/8	75706E-Z57*	5/8-18	4.28	1.88	3.00	3/4	ZW74706
13/32	1/2	75708E-Z59*	3/4-16	4.28	1.88	3.00	7/8	ZW74708
1/2	5/8	75710E-Z61**	7/8-14	4.52	2.12	3.25	1-1/16	ZW74710
5/8	5/8	75712E-Z61**	7/8-14	4.62	3.05	3.25	1-1/16	ZW74710

*High Side Port

**Low Side Port

(Includes o-ring)

SAE 45° Flare Female Swivel

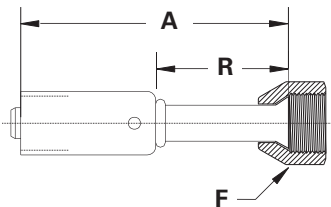

Hose I.D.	Tube Size	Part Number	Thread Size	Length A	Run R	Hose Cut-Off Factor	Hex F
5/16	3/8	75706E-406	5/8-18	2.78	1.38	1.50	3/4
5/16	1/2	75706E-408	3/4-16	2.90	1.50	1.75	7/8
13/32	1/2	75708E-408	3/4-16	2.84	1.44	1.56	7/8
1/2	5/8	75710E-410	7/8-14	3.09	1.69	1.81	1-1/16
5/8	5/8	75712E-410	7/8-14	3.25	1.75	2.00	1-1/16
5/8	3/4	75712E-412	1-1/16-14	3.25	1.75	2.00	1-1/4

Hose Splicer

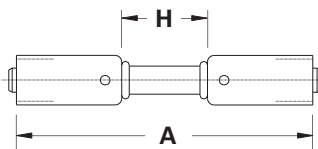

Hose I.D.	Hose I.D.	Part Number	Length A	Run R	Hose Cut-Off Factor
5/16	5/16	75706E-Y36	4.30	1.50	1.50
5/16	13/32	75706E-Y38	4.30	1.50	1.50
13/32	13/32	75708E-Y38	4.30	1.50	1.50
13/32	1/2	75708E-Y40	4.43	1.63	1.63
1/2	1/2	75710E-Y40	4.43	1.63	1.63
1/2	5/8	75710E-Y41	4.65	1.75	1.75
5/8	5/8	75712E-Y41	4.75	1.75	1.75

(For crimping information, refer to document W-HOOV-TM001-E2.)

J Hose Ends - Crimp

Coll-O-Crimp

757 'E' Series

To determine the correct length of hose, subtract the cut-off factor for each end fitting from the overall length of assembly. All dimensions shown in inches.

Hose Splicer W/R134a Service Port

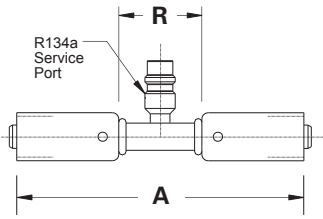

Hose I.D.	Hose I.D.	Part Number	Length A	Run A	Hose Cut-Off Factor
5/16	5/16	75706E-Y47*	5.42	2.62	1.50
13/32	13/32	75708E-Y48*	5.42	2.62	1.50
1/2	1/2	75710E-Y49**	5.42	2.62	1.63
5/8	5/8	75712E-Y50**	5.62	2.62	1.75

(For crimping information refer to document W-HOOV-TM001-E2.)

*High Side Port

**Low Side Port

SAE 45° Flare Male Rigid 45° Tube Elbow

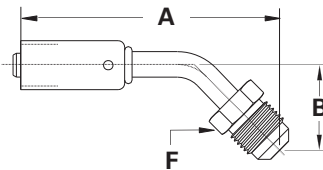

Hose I.D.	Tube Size	Part Number	Thread Size	Length A	Drop B	Hose Cut-Off Factor	Hex F
13/32	1/2	75708E-388	3/4-16	3.65	1.25	2.50	3/4
1/2	5/8	75710E-390	7/8-14	4.21	1.56	3.00	7/8

Bumped Tube O-Ring Male Swivel 45° Tube Elbow

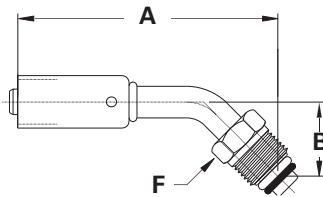

Hose I.D.	Tube Size	Part Number	Thread Size	Length A	Run R	Hose Cut-Off Factor	Hex F	O-Ring
5/16	3/8	75706E-Z26	5/8-18	3.09	.88	1.88	5/8	ZW74706
13/32	1/2	75708E-Z28	3/4-18	3.59	1.03	2.38	3/4	ZW74708
1/2	5/8	75710E-Z30	7/8-18	3.71	1.06	2.50	7/8	ZW74710
5/8	5/8	75712E-Z30	7/8-18	4.19	1.19	2.88	7/8	ZW74710
5/8	3/4	75712E-Z32	1-1/16-16	4.19	1.19	2.88	1-1/16	ZW74712

(Includes o-ring).

Bumped Tube O-Ring Female Swivel 45° Tube Elbow

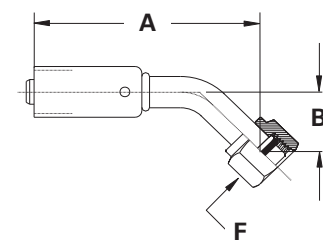

Hose I.D.	Tube Size	Part Number	Thread Size	Length A	Run R	Hose Cut-Off Factor	Hex F	O-Ring
5/16	3/8	75706E-W47	5/8-18	3.51	.68	2.25	3/4	ZW74706
13/32	1/2	75708E-W49	3/4-16	3.63	1.05	2.25	7/8	ZW74708
1/2	5/8	75710E-W51	7/8-14	3.65	1.19	2.50	1-1/16	ZW74710
5/8	5/8	75712E-W51	7/8-14	4.00	1.29	2.75	1-1/16	ZW74710
5/8	3/4	75712E-W53	1-1/16-14	3.84	.94	2.50	1-1/4	ZW74712

(Includes o-ring).

J

Hose Ends - Crimp

Coll-O-Crimp

757 'E' Series

To determine the correct length of hose, subtract the cut-off factor for each end fitting from the overall length of assembly. All dimensions shown in inches.

SAE 45° Flare Female Swivel 45° Tube Elbow

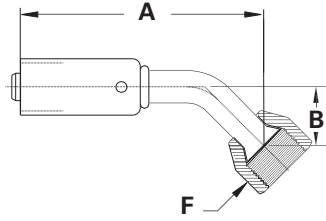

Hose I.D.	Tube Size	Part Number	Thread Size	Length A	Drop B	Hose Cut-Off Factor	Hex F
5/16	3/8	75706E-486	5/8-18	3.42	.55	2.00	3/4
13/32	1/2	75708E-488	3/4-16	3.72	.58	2.50	7/8
1/2	5/8	75710E-490	7/8-14	4.34	.72	3.00	1-1/16
5/8	5/8	75712E-490	7/8-14	5.00	1.00	3.50	1-1/16
5/8	3/4	75712E-492	1-1/16-14	4.44	.72	3.00	1-1/4

SAE 45° Male Rigid 90° Elbow

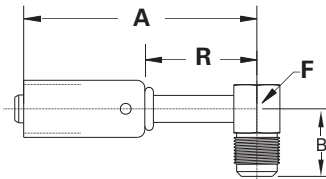

Hose I.D.	Tube Size	Part Number	Thread Size	Length A	Run R	Drop B	Hose Cut-Off Factor	Hex Square F
5/16	3/8	75706E-X06	5/8-18	4.07	2.67	.91	3.00	5/8
13/32	1/2	75708E-X08	3/4-16	4.14	2.74	1.47	3.00	7/8
1/2	5/8	75710E-X10	7/8-14	4.25	2.85	1.47	3.00	7/8
5/8	3/4	75712E-X12	1-1/16-14	4.45	2.95	1.56	3.00	1-1/16

Bumped Tube O-Ring Male Rigid 90° Tube Elbow

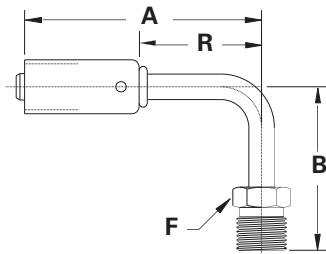

Hose I.D.	Tube Size	Part Number	Thread Size	Length A	Run R	Drop B	Hose Cut-Off Factor	Hex F
5/16	3/8	75706E-W66	5/8-18	4.00	2.60	1.53	2.75	5/8
13/32	1/2	75708E-W68	3/4-16	4.07	2.67	2.12	2.75	3/4
1/2	5/8	75710E-W70	7/8-14	4.15	2.75	2.21	2.88	7/8

Bumped Tube O-Ring Male Swivel 90° Tube Elbow

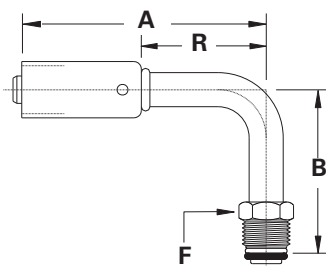

Hose I.D.	Tube Size	Part Number	Thread Size	Length A	Run R	Drop B	Hose Cut-Off Factor	Hex F	O-Ring
5/16	3/8	75706E-Z66	5/8-18	4.00	2.60	1.53	2.75	5/8	ZW74706
5/16	1/2	75706E-Z68	3/4-18	4.07	2.67	1.53	2.75	3/4	ZW74708
13/32	3/8	75708E-Z66	5/8-18	4.00	2.60	1.77	2.75	5/8	ZW74706
13/32	1/2	75708E-Z68	3/4-18	4.07	2.67	2.12	2.75	3/4	ZW74708
1/2	5/8	75710E-Z70	7/8-18	4.15	2.75	2.21	2.88	7/8	ZW74710
1/2	3/4	75710E-Z72	1-1/16-16	4.25	2.85	2.35	3.00	1-1/16	ZW74712
5/8	5/8	75712E-Z70	7/8-18	4.24	2.74	2.25	2.88	7/8	ZW74710
5/8	3/4	75712E-Z72	1-1/16-16	4.35	2.85	2.87	3.00	1-1/16	ZW74712

(Includes o-ring).

J Hose Ends - Crimp

Coll-O-Crimp

757 'E' Series

To determine the correct length of hose, subtract the cut-off factor for each end fitting from the overall length of assembly. All dimensions shown in inches.

Bumped Tube O-Ring Female Swivel 90° Tube Elbow

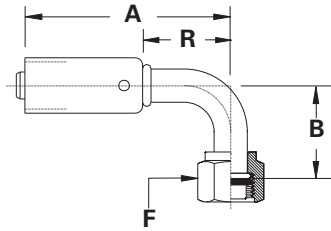

Hose I.D.	Tube Size	Part Number	Thread Size	Length A	Run R	Drop B	Hose Cut-Off Factor	Hex F	O-Ring
5/16	3/8	75706E-Z87	5/8-18	4.07	2.67	1.12	2.75	3/4	ZW74706
5/16	1/2	75706E-Z89	3/4-16	4.14	2.74	1.31	2.88	7/8	ZW74708
13/32	3/8	75708E-Z87	5/8-18	4.07	2.67	1.31	2.75	3/4	ZW74706
13/32	1/2	75708E-Z89	3/4-16	4.14	2.74	1.50	2.88	7/8	ZW74708
1/2	5/8	75710E-Z91	7/8-14	4.25	2.85	1.75	3.00	1-1/16	ZW74710
5/8	5/8	75712E-Z91	7/8-14	4.35	2.85	1.75	3.00	1-1/16	ZW74710
5/8	3/4	75712E-Z93	1-1/16-14	4.45	2.95	1.75	3.13	1-1/4	ZW74712

(Includes O-Ring)

Bumped Tube O-Ring Female Swivel 90° Tube Elbow W/R134a Service Port

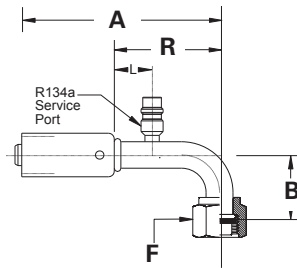

Hose I.D.	Tube Size	Part Number	A	Thread Size	Run R	Drop B	Hose Cut-Off Factor	Hex F	Length L	O-Ring
5/16	3/8	75706E-Z97*	2.52	5/8-18	2.12	1.12	2.75	3/4	1.50	ZW74706
13/32	1/2	75708E-Z99*	4.15	3/4-16	2.75	1.68	2.88	7/8	1.50	ZW74708
1/2	5/8	75710E-Z01**	3.78	7/8-14	2.38	1.50	3.00	1-1/16	1.50	ZW74710
5/8	5/8	75712E-Z01**	4.61	7/8-14	3.11	1.95	3.00	1-1/16	1.50	ZW74710

(Includes o-ring).

(For crimping information refer to document W-HOOV-TM001-E2.)

*High Side Port

**Low Side Port

SAE 45° Flare Female Swivel 90° Tube Elbow

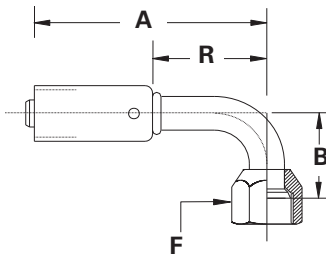

Hose I.D.	Tube Size	Part Number	A	Thread Size	Run R	Drop B	Hose Cut-Off Factor	Hex F
5/16	3/8	75706E-466	4.07	5/8-18	2.67	1.12	2.75	3/4
13/32	1/2	75708E-468	4.14	3/4-16	2.74	1.31	2.88	7/8
1/2	5/8	75710E-470	4.25	7/8-14	2.85	1.56	3.00	1-1/16
5/8	5/8	75712E-470	4.35	7/8-14	2.85	1.50	3.00	1-1/16
5/8	3/4	75712E-472	4.45	1-1/16-14	2.95	1.75	3.13	1-1/4

Bumped Tube O-Ring Service Port Adapter W/R134a Service Port

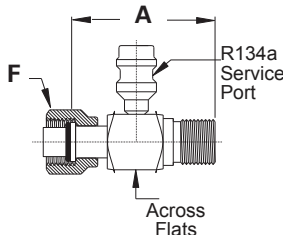

Tube A	Part Number	Thread Size	Length A	Across Flats	Hex F	O-Ring
3/8	75701*	5/8-18	2.02	5/81	3/4	ZW74706
1/2	75702*	3/4-16	2.22	7/8	7/8	ZW74708
5/8	75704**	7/8-14	2.63	7/8	1-1/16	ZW74710
3/4	75706**	1-1/16-14	2.89	1-1/16	1-1/4	ZW74712

(Includes o-ring).

*High Side Port

**Low Side Port

J

Hose Ends - Crimp

Coll-O-Crimp

757 'E' Series

To determine the correct length of hose, subtract the cut-off factor for each end fitting from the overall length of the assembly. All dimensions shown in inches.

Bumped Tube O-Ring Service Port Adapter W/R12 Service Port

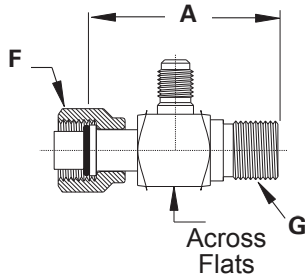

Tube Size	Part Number	Thread Size G	Length A	Across Flats	Hex F	Service Port Thread	O-Ring
3/8	R12-Z56*	5/8-18	2.02	5/81	3/4	3/8-24	ZW74706
1/2	R12-Z58*	3/4-16	2.22	7/8	7/8	3/8-24	ZW74708
5/8	R12-Z60**	7/8-14	2.63	7/8	1-1/16	3/8-24	ZW74710
3/4	R12-Z62**	1-1/16-14	2.89	1-1/16	1-1/4	7/16-20	ZW74712

(Includes o-ring).
*High Side Port
**Low Side Port

90° Bumped Tube O-Ring R134a Service Port Adapter

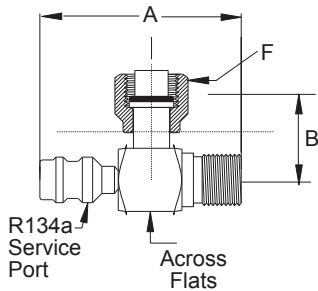

Tube Size	Part Number	Thread Size G	Length A	Drop B	Across Flats	Hex F	O-Ring
3/8	75729*	5/8-18	2.40	1.05	5/8	3/4	ZW74706
1/2	75730*	3/4-16	2.60	1.15	7/8	7/8	ZW74708
5/8	75731**	7/8-14	2.74	1.30	7/8	1-1/16	ZW74710
3/4	75732**	1-1/16-14	3.10	1.39	1-1/16	1-1/4	ZW74712

(Includes o-ring).
*High Side Port
**Low Side Port

90° Bumped Tube O-Ring R12 Service Port Adapter

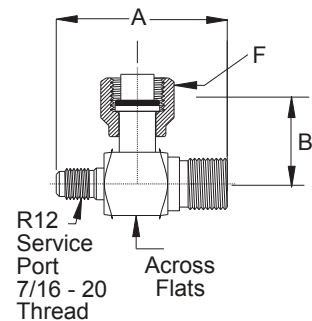

Tube Size	Part Number	Thread Size G	Length A	Drop B	Across Flats	Hex F	O-Ring
3/8	R12-Z96*	5/8-18	2.07	1.05	5/8	3/4	ZW74706
1/2	R12-Z97*	3/4-16	2.27	1.15	7/8	7/8	ZW74708
5/8	R12-Z98**	7/8-14	2.41	1.30	7/8	1-1/16	ZW74710
3/4	R12-Z99**	1-1/16-16	2.77	1.39	1-1/16	1-1/4	ZW74712

(Includes o-ring).
*High Side Port
**Low Side Port

Replacement O-Rings



Tube O.D.	Part Number
3/8	ZW74706
1/2	ZW74708
5/8	ZW74710
3/4	ZW74712

Material: Hydrogenated Nitrile (HNBR), 70 Durometer

Temperature Range: -40°F to +250°F (-40°C to +121°C)
Color: Green

Coll-O-Crimp

757 'E' Series

To determine the correct length of hose, subtract the cut-off factor for each end fitting from the overall length of the assembly. All dimensions shown in inches.

Rotalok to MIO

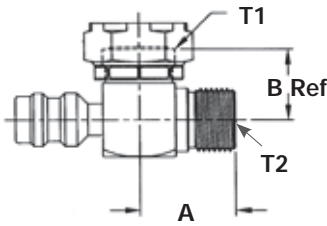

Part Number	Tube Size	Thread Size (T1)	Thread Size (T2)	Drop A	Ref Drop	B Port	Ref
75750	1/2	1-14	3/4-16	1.15	0.84	Hi-Side	—
75751	5/8	1-14	7/8-16	1.29	0.84	Low-Side	—
75760*	Same as 75750, except includes threaded cap for Rotalock end.					—	—
75761*	Same as 75751, except includes threaded cap for Rotalock end.					—	—

* High Side Port
 ** Low Side Port

Service Instructions for Replacement of Damaged O.E. Hose Assemblies

Weatherhead service port adapters offer an alternative to the high cost of replacement and time out of service which can occur when an air conditioning assembly is damaged. By using the Weatherhead adapter, service personnel can remove the damaged end and replace it with a standard Weatherhead 757 'E' series hose end used in conjunction with a Weatherhead service port adapter. This is a welcome solution to get your customer back on the road without special orders and long delays.

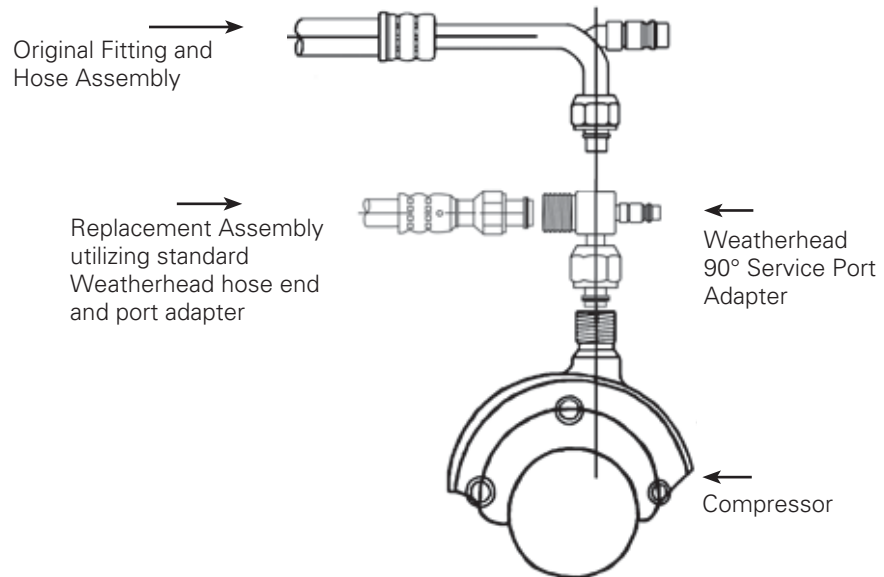

Hose Ends - Crimp

Coll-O-Crimp

057 'P' Series

Hose End 057 'P' Series

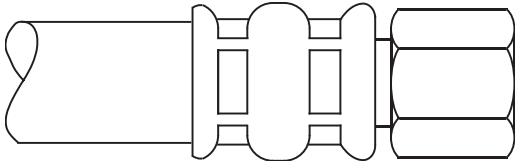

Ordering Information: Order individually by part number.

 Refer to important safety information on pages A-2-3.

Application: High pressure truck hose for use in transmission oil cooler lines, fuel lines and diesel fuel lines.

Compatible Hose: H429

Pressure: Determined by hose burst pressure. See pages A-15-16 for operating pressure ratings for hose end configurations.

Material: CA 360 Brass

Advantages: For use with hot oil and high temperature petroleum oils.

Assemble With: T-400-1, T-410-1, T-420-1, T-440-1, T-460, T-462, T-465-1, T-480, ET4000, ET4001

To determine the correct length of hose, subtract the cut-off factor for each end fitting from the overall length of assembly.

SAE 45° Female Swivel

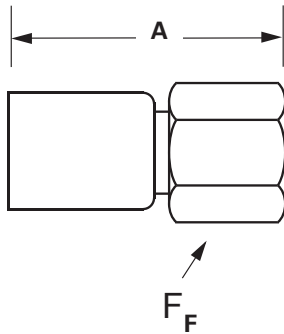

Hose I.D.	Tube Size	Part Number	Thread Size	A	Hose Cut-Off Factor	Hose Dia.	Hex F
1/2	1/2	05708P-408	7/8-14	1.96	.99	.34	7/8
5/8	5/8	05710P-410	3/7-16	1.08	1.10	.44	1

J

Hose Ends - Crimp

Coll-O-Crimp

229 'P' Series

Hose End 229 'P' Series

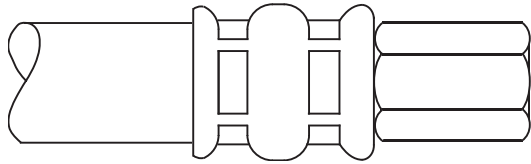

Ordering Information:

Order individually by catalog number.

Refer to important safety information on pages A-2-3.

Application: Medium pressure air, fuel, grease, oil, truck and power steering lines.

Compatible Hose: H059, H229, H239

Pressure: Determined by maximum operating pressure for hose size. See pages A-15-16 for operating pressure ratings for hose end configurations.

Material: CA360 Brass

Advantages: A permanent hose end saves time and is easy to assemble. Brass material offers excellent resistance against corrosion.

Assemble With: T-400-1, T-410-1, T-420-1, T-440-1, T-460, T-462, T-465-1, T-480, ET4000, ET4001

Note: Refer to current price list for availability of cataloged items. Configurations and dimensions subject to change without notice.

SAE 45° Flare Female Swivel

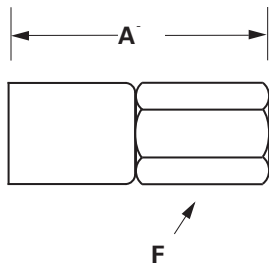

Hose I.D.	Tube Size	Part Number	Thread Size	A	Hose Cut-Off Factor	Hose DIA.	Hex F
5/16	3/8	22906P-406	5/8-18	1.80	.81	.25	3/4
13/32	1/2	22908P-408	3/4-16	1.96	1.00	.34	7/8
1/2	5/8	22910P-410	7/8-14	2.08	1.12	.44	1

Note:
Collar is not attached to insert.

To determine the correct length of hose, subtract the cut-off factor for each end fitting from the overall length of assembly.

Componentry for 229 'P' & 265 'P' Series Hose Ends

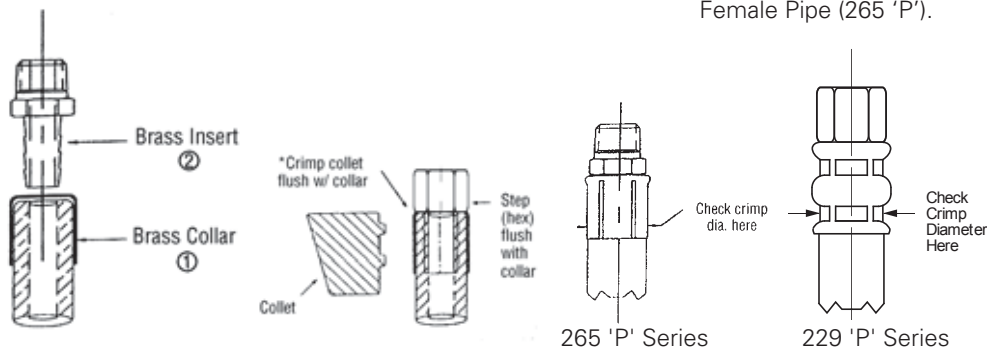

1. Brass Collar

2. Brass Insert.

Female SAE 45° Swivel (229 'P'), Male Pipe or Female Pipe (265 'P').

Assembly Instructions for 229 'P' & 265 'P' Series Hose Ends

1. Push collar onto hose until bottomed.
2. Push insert into hose until step on insert (or hex) is flush with collar.
3. Check for bottoming by checking collar movement along insert. Hose is bottomed when collar cannot slide along insert.
4. Position top of collar so that it is flush with the top of the collet. Follow recommended Coll-O-Crimp operating procedures found in the back of this catalog.

J

Hose Ends - Crimp

Coll-O-Crimp

265 'P' Series

Hose End 265 P Series

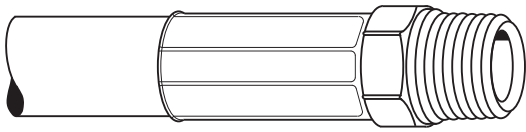

Ordering Information:

Order individually by catalog number. To order replacement collar only, use base number followed by "COO" suffix. (Example: 26504P-COO)

Refer to important safety information on pages A-2-3.

Typical Application: General purpose low- pressure air and water lines.

Compatible Hose:

H265, H275, H285

Pressure: Determined by maximum operating pressure for hose size.

Material: CA360 Brass

Advantages: One piece construction, easy to assemble, corrosion resistant.

Assemble With: T-400-1, T-410-1, T-420-1, T-440-1, T-460, T-462, T-465-1, T-480, ET4000, ET4001

Note:

For Assembly Instructions see page J-31.

To determine the correct length of hose, subtract the cut-off factor for each end fitting from the overall length of assembly.

Male Pipe Rigid

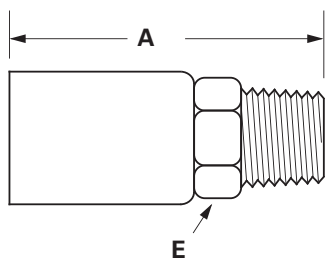

Hose I.D.	Pipe Size	Part Number	Thread Size	A	Hose Cut-Off Factor	Hole Dia.	Hex E
1/4	1/8	26504P-102	1/8-27	1.56	.56	.18	7/16
1/4	1/4	26504P-104	1/4-18	1.63	.63	.18	9/16
1/4	3/8	26504P-106	3/8-18	1.75	.75	.18	11/16
3/8	1/8	26506P-102	1/8-27	1.56	.56	.25	7/16
3/8	1/4	26506P-104	1/4-18	1.75	.75	.31	9/16
3/8	3/8	26506P-106	3/8-18	1.74	.75	.28	11/16
3/8	1/2	26506P-108	1/2-14	1.94	1.00	.28	7/8
1/2	1/4	26508P-104	1/4-18	1.73	.75	.37	9/16
1/2	3/8	26508P-106	3/8-18	1.71	.75	.37	11/16
1/2	1/2	26508P-108	1/2-14	1.94	1.00	.37	7/8
1/2	3/4	26508P-112	3/4-18	1.94	1.00	.37	1-1/8
3/4	1/2	26512P-108	1/2-14	1.94	1.00	.37	1-1/8
3/4	3/4	26512P-112	3/4-14	1.92	1.00	.56	1-1/8

Note:

Collar is not attached to insert.

Female Pipe Rigid

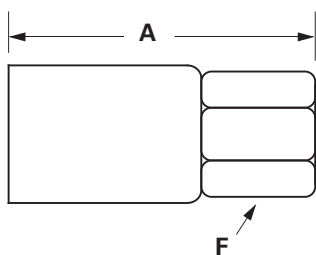

Hose I.D.	Pipe Size	Part Number	Thread Size	A	Hose Cut-Off Factor	Hole Dia.	Hex F
1/4	1/8	26504P-202	1/8-27	1.49	.50	.18	9/16
1/4	1/4	26504P-204	1/4-18	1.60	.63	.18	11/16
3/8	1/8	26506P-202	1/8-27	1.49	.50	.28	9/16
3/8	1/4	26506P-204	1/4-18	1.60	.63	.28	11/16
3/8	3/8	26506P-206	3/8-18	1.66	.69	.28	13/16
1/2	1/4	26508P-204	1/4-18	1.57	.63	.37	11/16
1/2	3/8	26508P-206	3/8-18	1.63	.69	.37	13/16
1/2	1/2	26508P-208	1/2-14	1.85	.88	.37	1

Note:

Collar is not attached to insert.

Coll-O-Crimp

338 'P' Series

Hose End 338 'P' Series

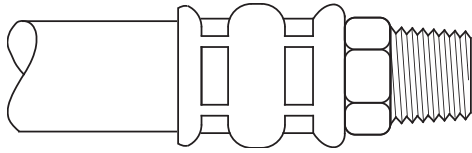

Ordering Information: Order individually by part number.

 Refer to important safety information on pages A-2-3.

Application: Air brake hose lines

Compatible Hose: H338

Pressure: Determined by hose burst pressure. See pages A-15-16 for operating pressure ratings for hose end configurations.

Material: CA360 Brass

Advantages: A permanent hose end saves time and is easy to assemble. Brass material offers excellent resistance against corrosion.

Assemble With: T-400-1, T-410-1, T-420-1, T-440-1, T-460, T-462, T-465, T-480, ET4000 and ET4001

(For Field Attachable Ends refer to Section K.)

Label Set: FS-2900

Note:

See page N-48 for important hose labeling information.

Componentry

1. Brass Collar
2. Brass Insert. Male pipe or brass swivel insert with brass SAE nut.
3. Brass A.B.S. insert with steel A.B.S. swivel nut.

Assembly Instructions

1. Push collar onto hose until bottomed.
2. Push insert into hose until step on insert (or hex) is flush with collar.

Note:

Swivel fittings require the use of a mandrel or an assembled adapter to push on the insert for assembly. Adapter can be removed after fitting assembly. Light lubricant may be required to assemble fitting into hose.

3. Check for bottoming by checking collar movement along insert. Hose is bottomed when collar cannot slide along insert.
4. Depending on Coll-O-Crimp system, follow recommended operating procedures.

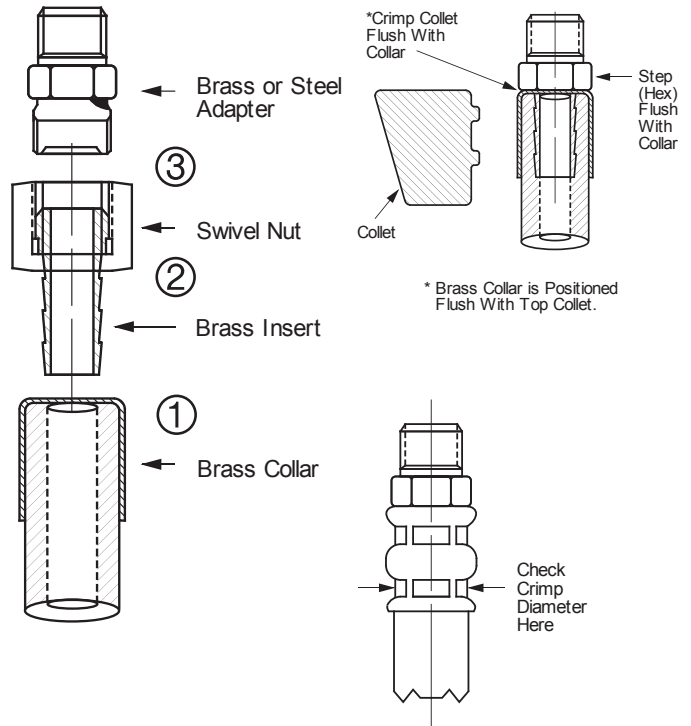

Hose Ends - Crimp

Coll-O-Crimp

338 'P' Series

To determine the correct length of hose, subtract the cut-off factor for each end fitting from the overall length of assembly.

Male Pipe Rigid

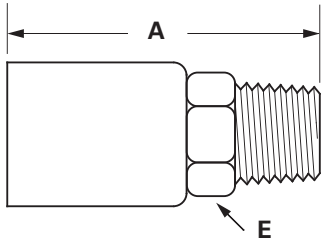

Hose I.D.	Part Size	Catalog Number	Thread Size	A	Hose Cut-Off Factor	Hole Dia.	Hex E
3/8	1/4	33806P-104	1/4-18	1.71	.75	.28	9/16
3/8	3/8	33806P-106	3/8-18	1.72	.81	.28	11/16
3/8	1/2	33806P-108	1/2-14	1.95	1.00	.28	7/8
1/2	3/8	33808P-106	3/8-18	1.73	.81	.38	11/16
1/2	1/2	33808P-108	1/2-14	1.94	1.00	.38	7/8

Male Pipe Swivel

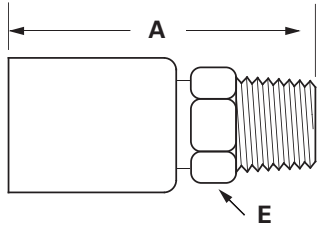

Hose I.D.	Pipe Size	Part Number	Thread Size	A	Hose Cut-Off Factor	Hole Dia.	Hex E
3/8	3/8	33806P-J06	3/8-18	1.66	.81	.28	11/16

Note:
Swivel for installation purposes only.

SAE 45° Female Swivel

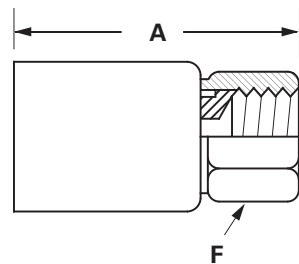

Hose I.D.	Tube Size	Part Number	Thread Size	A	Hose Cut-Off Factor	Hole Dia.	Hex F
3/8	3/8	33806P-406	5/8-18	1.31	1.00	.28	3/4
1/2	1/2	33808P-408	3/4-16	1.36	1.00	.38	7/8

Air Brake Slider Line

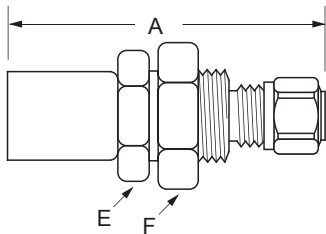

Hose I.D.	Tube Size	Part Number	Thread Size	A	Hose Cut-Off Factor	Hole Dia.	Hex E	Hex F
3/8	3/8	33806P-Y66	17/32-24	2.41	1.00	.28	1-1/16	1-1/8
3/8	1/2	33806P-Y68	11/16-20	2.51	1.00	.28	1-1/16	1-1/8
1/2	1/2	33808P-Y68	11/16-20	2.69	1.28	.41	7/8	13/16

J
Hose Ends - Crimp

Coll-O-Crimp

338 'P' Series

To determine the correct length of hose, subtract the cut-off factor for each end fitting from the overall length of assembly.

Air Brake Swivel

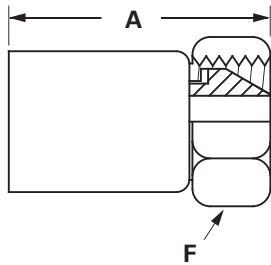

Hose I.D.	ABS Size	Part Number	Thread Size	A	Hose Cut-Off Factor	Hole Dia.	Hex F
3/8	3/8	33806P-Y76	3/4-20	1.38	1.00	.28	7/8
1/2	3/8	33808P-Y76	3/4-20	1.38	1.00	.28	7/8
1/2	1/2	33808P-Y78	7/8-20	1.44	1.00	.38	1

Adapter

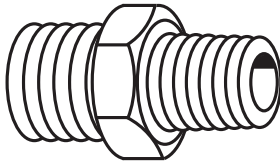

ABS Thread Size	Pipe Size	Part Number	Overall Length	ABS Thread Size
3/8	1/4	1390x6	1.18	3/4-20
3/8	3/8	1390x6x6	1.18	3/4-20
3/8	1/2	1390x6x8	1.37	3/4-20
1/2	3/8	1390x8	1.18	7/8-20
1/2	1/2	1390x8x8	1.37	7/8-20

Coll-O-Crimp

'S' Series

Hose End 'S' Series (Stainless Steel)

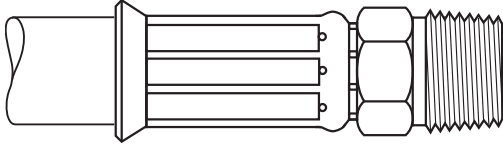

Note:

Refer to current price list for availability of cataloged items. Configurations and dimensions subject to change without notice.

Ordering Information: Order individually by part number.

Refer to important safety information on pages A-2-3.

Application: Low, medium, and high pressure hydraulic applications calling for corrosion resistance. Marine, logging, mining.

Compatible Hose:

H039, H104, H114, H145, H245, H425

Pressure: Determined by the maximum operating pressure for hose size and hose end configuration, whichever is lesser. See pages A-15-16 for operating pressure ratings for hose end configurations.

Material:

316 Stainless Steel

Advantages: Stainless steel protection from the elements.

Assemble With:

T-400-1, T-410-1, T-420-1, T-440-1, T-460, T-462, T-465-1, T-480, ET4000, ET4001

†To determine the correct length of hose, subtract the cut-off factor for each end fitting from the overall length of assembly.

^a Swivel nuts are universal – both SAE 45° and 37° connections.

Male Pipe Rigid

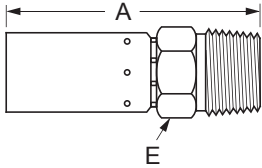

Hose I.D.	Pipe Size	Part Number	Thread Size NPTF	A	Hose Cut-Off Factor	Hole Dia.	Hex E
1/4	1/4	04S-104	1/4-18	2.49	1.00	.16	5/8
3/8	3/8	06S-106	3/8-18	2.52	1.00	.25	3/4
1/2	1/2	08S-108	1/2-14	2.75	1.31	.36	7/8
3/4	3/4	12S-112	3/4-14	3.61	1.44	.61	1-1/8
1	1	16S-116	1-11-1/2	4.23	2.00	.81	1-3/8
1-1/4	1-1/4	*20S-120	1-1/4-11-1/2	4.61	2.31	1.02	1-11/16

*Part number will crimp in Coll-O-Crimp ET4000, T-410-1, T-420-1, T-440-1, and T-480-1 presses only.

JIC 37° Female Swivel (Refer to Footnotes)

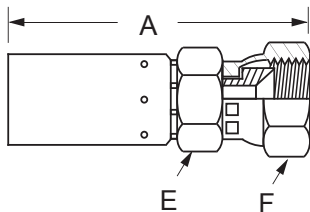

Hose I.D.	Pipe Size	Part Number	Thread Size NPTF	A	Hose Cut-Off Factor	Hole Dia.	Hex E	Hex F
1/4	1/4	04S-604 ^a	7/16-20	2.61	1.13	.16	9/16	9/16
3/8	3/8	06S-606	9/16-18	2.77	1.31	.25	11/16	11/16
1/2	1/2	08S-608 ^a	3/4-16	2.79	1.38	.36	13/16	7/8
1/2	5/8	08S-610 ^a	7/8-14	3.00	1.56	.36	13/16	1
3/4	3/4	12S-612	1-1/16-12	3.86	1.69	.61	1	1-1/4
1	1	16S-616	1-5/16-12	4.46	2.25	.81	1-1/4	1-1/2
1-1/4	1-1/4	*20S-620	1-5/8-12	4.90	2.63	1.02	1-11/16	2

*Part number will crimp in Coll-O-Crimp ET4000, T-410-1, T-420-1, T-440-1, and T-480-1 presses only.

Hose Ends - Crimp

J

Coll-O-Crimp

'U' Series

U Series Part Description	Part Number Example	Page Number
General Information		J-38
Male Pipe Rigid	04U-104	J-38
British Standard Tapered Male Pipe (BSPT/JIS) Rigid	06U-156	J-39
British Standard 60° (BSPP) Cone Male Pipe Rigid	06U-P56	J-39
Male DIN 24° Seat (Light)	04U-08A	J-39
Male DIN 24° Seat (Heavy)	08U-16F	J-40
Male Pipe Swivel	06U-J06	J-40
FOR-SEAL Male Rigid	06U-E70	J-40
JIC/37° Male Rigid	06U-506	J-41
SAE 45° Female Swivel	06U-306	J-41
Inverted Male Swivel Straight	04U-B03	J-41
Flareless Tube Rigid Ermeto 7000 Series	06U-754	J-42
Male Straight Thread O-ring Swivel	06U-R04	J-42
Male Straight Thread O-ring Rigid	08U-P12	J-43
Female Grease Tap	04U-C34	J-43
Female Pipe Rigid	06U-206	J-43
Female Pipe Swivel	06U-256	J-44
JIC/37° Female Swivel	04U-606	J-44
Female Straight Pipe Swivel (NPSM)	04U-054	J-44
SAE 45° Female Swivel	06U-406	J-45
Female Swivel DIN Universal Seat (Light)	04U-08C	J-45
Female Swivel DIN 24° Seat (Heavy)	06U-64C	J-45
Female Swivel 30° Flare	08U-22K	J-45
British Standard (BSPP) 60° Cone Female Pipe Swivel	08U-360	J-46
Female JIS 30° Flare Parallel Pipe Swivel	16U-16L	J-46
Female FOR-SEAL [®] Swivel Straight	12U-S72	J-46
BSPP Flat Face Female Swivel	08U-12P	J-47
READY-LOK [®] Male Connector	04U-04S	J-47
Split Flange Straight (SAE Code 61)	12U-G12	J-47
Metric Split Flange Straight (Komatsu, Linkbelt, etc.)	10U-G09	J-47
Banjo	06U-L06	J-48
Metric Standpipe Straight Tube	06U-44T	J-48
Standpipe Straight Tube	06U-T06	J-48
SAE 37° Female Swivel 30° Tube Elbow	10U-L22	J-48
Inverted Male Swivel 45° Tube Elbow	04U-B43	J-49
SAE 37° Female Swivel 45° Tube Elbow	06U-486	J-49
Female Swivel DIN Universal Seat 45° Tube Elbow	04U-08D	J-49
Flareless 45° Tube Elbow 7000 Ermeto Series	06U-956	J-49
JIC 37° Female Swivel 45° Tube Elbow	06U-686	J-50
Male Swivel 45° Tube Elbow O-ring Port	08U-L50	J-50
Split Flange 45° Tube Elbow (SAE Code 61)	08U-G41	J-50
British Standard (BSPP) 60° Cone Female 45° Tube Elbow	08U-48P	J-51
Female FOR-SEAL [®] Swivel 45° Tube Elbow	06U-L68	J-51
Metric Split Flange 45° Tube Elbow (Komatsu, Linkbelt, etc.)	10U-G69	J-51
Inverted Male Swivel 90° Tube Elbow	04U-B63	J-51
SAE 37° Male Rigid 90° Elbow	06U-X60	J-52
Male Pipe Swivel 90° Elbow	08U-M08	J-52
JIC/37° Female Swivel 90° Long Drop Tube Elbow	04U-644	J-52
SAE 45° Female Swivel Long Drop 90° Tube Elbow	06U-446	J-52
Flareless 90° Tube Elbow 7000 Ermeto Series	06U-976	J-53
JIC/37° Female Swivel 90° Tube Elbow	04U-666	J-53
Female Swivel DIN Universal Seat 90° Tube Elbow (Light)	08U-65D	J-53
Female Swivel DIN 24° Seat 90° Tube Elbow	08U-66E	J-53
British Standard (BSPP) 60° Cone Female Pipe Swivel 90° Tube Elbow	08U-78P	J-54
Female FOR-SEAL [®] Swivel Short Drop 90° Elbow	06U-A28	J-54
Female FOR-SEAL [®] Swivel Medium Drop 90° Tube Elbow	06U-J38	J-54
JIC 37° Female Swivel 90° Elbow	04U-554	J-55
Male Straight Thread O-ring Swivel 90° Elbow	08U-R68	J-55
Female FOR-SEAL [®] Swivel Long Drop 90° Tube Elbow	06U-A68	J-55
Split Flange 90° Tube Elbow (SAE Code 61)	08U-G71	J-55

Coll-O-Crimp

'U' Series

To determine the correct length of hose, subtract the cut-off factor for each end fitting from the overall length of assembly.

Hose End 'U' Series

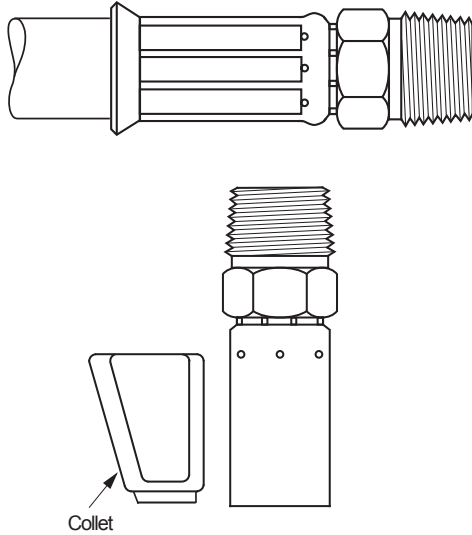

Note:

Refer to current price list for availability of cataloged items. Configurations and dimensions subject to change without notice.

Ordering Information:

Order individually by part number. O-rings not supplied with flange hose ends. Order o-rings by catalog number; reference individual listings for details. For split flange kits, refer to pages L-89-92.

Refer to important safety information on pages A-2-3.

Application: General purpose low, medium, and high pressure hydraulic.

Compatible Hose: H017, H039, H104, H114, H115, H145, H146, H245, H324, H325, H350, H425, H545, H900, H1812, H0105, H0106, H116, H1981, H1982, H9949, H1776, H1777, H1571, H6002 (-8 & -20)

Pressure: Determined by maximum operating pressure for hose size and hose end configuration whichever is lesser. See pages A-15-16 for operating pressure ratings for hose end configurations.

Material: Low Carbon Steel

Plating: Zinc; Clear Trivalent Chromate

Advantages:

Wide selection of hose and end configurations allowing a diverse number of applications. An ideal series to introduce hydraulics.

Assemble With:

T-400-1, T-410-1, T-420-1, T-440, T-460, T-462, T-465, T-480, ET1000, ET4000, and ET4001.

Label Set: FS-1100

Male Pipe Rigid

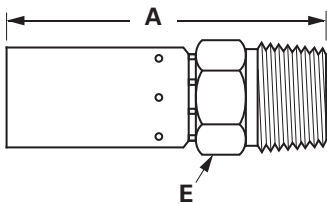

Hose I.D.	Pipe Size	Part Number	Thread Size	A	Hose Cut-Off Factor	Hole Dia.	Hex E
1/4	1/8	04U-102	1/8-27	2.31	.75	.16	9/16
1/4	1/4	04U-104	1/4-18	2.49	.94	.16	9/16
1/4	3/8	04U-106	3/8-18	2.52	1.00	.16	11/16
1/4	1/2	04U-108	1/2-14	2.77	1.06	.16	7/8
3/8	1/4	06U-104	1/4-18	2.52	1.00	.25	11/16
3/8	3/8	06U-106	3/8-18	2.52	1.00	.25	11/16
3/8	1/2	06U-108	1/2-14	2.77	1.25	.25	7/8
1/2	1/4	08U-104	1/4-18	2.56	.88	.28	13/16
1/2	3/8	08U-106	3/8-18	2.57	1.14	.36	3/4
1/2	1/2	08U-108	1/2-14	2.75	1.31	.36	13/16
1/2	3/4	08U-112	3/4-14	2.83	1.28	.36	1-1/16
5/8	3/8	10U-106	3/8-18	3.12	1.13	.48	15/16
5/8	1/2	10U-108	1/2-14	3.31	1.38	.48	15/16
5/8	3/4	10U-112	3/4-14	3.31	1.30	.48	1-1/16
3/4	1/2	12U-108	1/2-14	3.62	1.44	.61	1
3/4	3/4	12U-112	3/4-14	3.61	1.44	.61	1-1/16
3/4	1	12U-116	1-11-1/2	3.84	1.69	.61	1-3/8
1	3/4	16U-112	3/4-14	4.23	1.88	.81	1-1/4
1	1	16U-116	1-11-1/2	3.90	1.69	.81	1-3/8
1-1/4	1-1/4	20U-120	1-1/4-11-1/2	4.61	2.31	1.02	1-11/16

J
Hose Ends - Crimp

British Standard Tapered Male Pipe (BSPT/JIS) Rigid

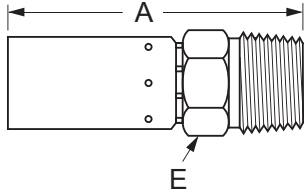

Hose I.D.	BSPT Pipe Size	Part Number	Thread Size	A	Hose Cut-Off Factor	Hole Dia.	Hex E
1/4	1/4	04U-154	R-1/4-19*	2.51	1.00	.16	3/4
3/8	3/8	06U-156	R-3/8-19*	2.54	1.06	.25	11/16
1/2	1/2	08U-158	R-1/2-14*	2.78	1.31	.36	7/8
3/4	3/4	12U-162	R-3/4-14*	3.62	1.44	.61	1-1/8
1	1	16U-166	R-1-11*	4.23	2.00	.81	1-3/8

*R as part of thread size is ISO designation for tapered thread.

British Standard 60° (BSPP) Cone Male Pipe Rigid

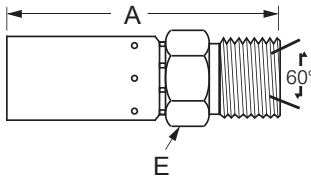

Hose I.D.	BSPT Pipe Size	Part Number	Thread Size	A	Hose Cut-Off Factor	Hole Dia.	Hex E
1/4	1/4	04U-P54	G-1/4-19**	2.38	.88	.16	11/16
3/8	3/8	06U-P56	G-3/8-19**	2.48	.94	.25	3/4
3/8	1/2	06U-P58	G-1/2-14**	2.62	1.06	.25	1
1/2	3/8	08U-P56	G-3/8-19**	2.54	1.13	.32	13/16
1/2	1/2	08U-P58	G-1/2-14**	2.62	1.19	.36	1
5/8	5/8	10U-P60	G-5/8-14**	3.25	1.31	.48	1-1/8
3/4	3/4	12U-P62	G-3/4-14**	3.65	1.50	.61	1-1/8
1	1	16U-P66	G-1-11**	3.91	1.69	.81	1-3/8
1-1/4	1-1/4	20U-P67	G-1-1/4-11**	4.41	2.13	1.02	1-3/4

**G as part of thread size is ISO designation for parallel thread.

Male DIN 24° Seat

I. Rh. (Light)

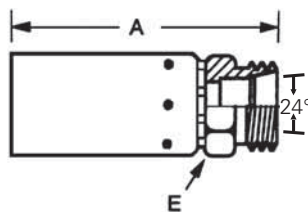

Hose I.D.	Tube Size (mm)	Part Number	Thread Size	A	Hose Cut-Off Factor	Hole Dia.	Hex E
1/4	8	04U-08A	M14x1.5	2.27	.81	.16	9/16
1/4	10	04U-10A	M16x1.5	2.36	.88	.16	11/16
3/8	10	06U-10A	M16x1.5	2.36	.94	.25	11/16
3/8	12	06U-12A	M18x1.5	2.36	.94	.25	3/4
1/2	15	08U-15A	M22x1.5	2.42	1.00	.36	7/8
5/8	18	10U-18A	M26x1.5	2.99	1.06	.48	1-1/16
3/4	22	12U-22A	M30x2.0	3.45	1.31	.61	1-1/4
1	28	16U-28A	M36x2.0	3.73	1.50	.81	1-1/2

Coll-O-Crimp

'U' Series

To determine the correct length of hose, subtract the cut-off factor for each end fitting from the overall length of assembly.

Male DIN 24° Seat

s. Rh. (Heavy)

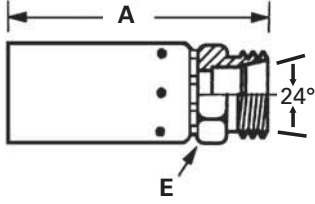

Hose I.D.	Tube Size (mm)	Part Number	Thread Size	A	Hose Cut-Off Factor	Hole Dia.	Hex E
1/4	8	04U-08F	M16x1.5	2.39	.88	.16	11/16
1/4	10	04U-10F	M18x1.5	2.40	.88	.16	3/4
3/8	10	06U-10F	M18x1.5	2.40	.94	.25	3/4
3/8	12	06U-12F	M20x1.5	2.42	1.00	.25	13/16
3/8	14	06U-14F	M22x1.5	2.50	1.06	.25	7/8
1/2	16	08U-16F	M24x1.5	2.57	1.13	.36	1
5/8	20	10U-20F	M30x2	3.21	1.28	.48	1-1/4
3/4	20	12U-20F	M30x2	3.53	1.38	.61	1-1/4
3/4	25	12U-25F	M36x2	3.71	1.56	.61	1-1/2
1	30	16U-30F	M42x2	3.98	1.75	.81	1-11/16

Male Pipe Swivel

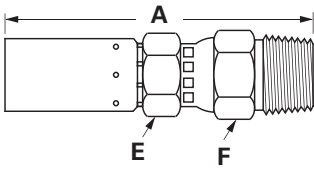

Hose I.D.	Tube Size (mm)	Part Number	Thread Size	A	Hose Cut-Off Factor	Hole Dia.	Hex E	Hex F
1/4	1/4	04U-J04	1/4-18	3.38	1.88	.16	5/8	13/16
3/8	1/4	06U-J04	1/4-18	3.40	1.94	.25	11/16	13/16
3/8	3/8	06U-J06	3/8-18	3.38	1.94	.25	11/16	7/8
3/8	1/2	06U-J08	1/2-14	3.60	2.13	.25	3/4	7/8
1/2	3/8	08U-J06	3/8-18	3.45	2.00	.36	13/16	7/8
1/2	1/2	08U-J08	1/2-14	3.60	2.19	.36	13/16	7/8
3/4	3/4	12U-J12	3/4-14	4.73	2.56	.61	1	1-1/4
1	1	16U-J16	1-11-1/2	4.83	2.63	.80	1-1/4	1-3/8

Note:

Swivel for installation purposes only. (Not for temperatures above 212°F.)

J

Hose Ends - Crimp

FOR-SEAL Male Rigid

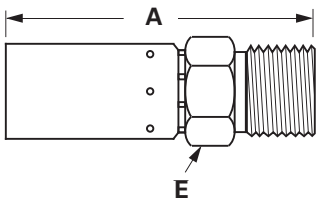

Hose I.D.	Tube Size	Part Number	Thread Size	O-Ring	A	Hose Cut-Off Factor	Hole Dia.	Hex E
1/4	1/4	04U-E64	9/16-18	4629x4	2.34	.88	.16	5/8
3/8	3/8	06U-E66	11/16-16	4629x6	2.43	1.00	.25	13/16
3/8	1/2	06U-E68	13/16-16	4629x8	2.54	1.13	.38	7/8
3/8	5/8	06U-E70	1-14	4629x10	2.70	1.27	.25	1-1/16
1/2	1/2	08U-E68	13/16-16	4629x8	2.54	1.13	.36	7/8
1/2	5/8	08U-E70	1-14	4629x10	2.78	1.35	.36	1-1/16
1/2	3/4	08U-E72	1-3/16-12	4629x12	2.76	1.31	.36	1-1/4
5/8	5/8	10U-E70	1-14	4629x10	3.20	1.25	.48	1-1/16
5/8	3/4	10U-E72	1-3/16-12	4629x12	3.45	1.50	.48	1-1/4
3/4	3/4	12U-E72	1-3/16-12	4629x12	3.58	1.44	.61	1-1/4
3/4	1	12U-E76	1-7/16-12	4629x16	3.60	1.44	.61	1-1/2
1	1	16U-E76	1-7/16-12	4629x16	3.73	1.50	.81	1-1/2
1-1/4	1-1/4	20U-E80	1-11/16-12	4629x20	4.10	1.81	1.02	1-3/4

Does not include o-ring. See page L-34 for o-rings.

Coll-O-Crimp

'U' Series

To determine the correct length of hose, subtract the cut-off factor for each end fitting from the overall length of assembly.

JIC 37° Male Rigid

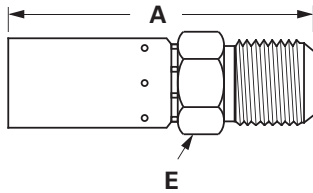

Hose I.D.	Tube Size	Part Number	Thread Size	A	Hose Cut-Off Factor	Hole Dia.	Hex E
1/4	1/4	04U-504	7/16-20	2.48	1.00	.16	1/2
1/4	5/16	04U-505	1/2-20	2.51	1.00	.16	9/16
1/4	3/8	04U-506	9/16-18	2.55	1.00	.16	5/8
3/8	3/8	06U-506	9/16-18	2.54	1.00	.25	11/16
3/8	1/2	06U-508	3/4-16	2.67	1.25	.25	13/16
3/8	5/8	06U-510	7/8-14	2.83	1.31	.25	15/16
1/2	1/2	08U-508	3/4-16	2.70	1.19	.38	13/16
1/2	5/8	08U-510	7/8-14	2.83	1.31	.36	15/16
1/2	3/4	08U-512	1-1/16-12	2.87	1.44	.36	1-1/8
5/8	1/2	10U-508	3/4-16	3.22	1.31	.39	15/16
5/8	5/8	10U-510	7/8-14	3.32	1.38	.48	15/16
5/8	3/4	10U-512	1-1/16-12	3.42	1.44	.48	1-1/8
3/4	5/8	12U-510	7/8-14	3.64	1.44	.43	1
3/4	3/4	12U-512	1-1/16-12	3.74	1.56	.61	1-1/16
3/4	7/8	12U-514	1-3/16-12	3.81	1.63	.61	1-1/4
3/4	1	12U-516	1-5/16-12	3.81	1.63	.61	1-3/8
1	7/8	16U-514	1-3/16-12	4.18	1.94	.72	1-1/4
1	1	16U-516	1-5/16-12	4.20	2.00	.81	1-3/8
1	1-1/4	16U-520	1-5/8-12	4.02	1.81	.81	1-11/16
1-1/4	1-1/4	20U-520	1-5/8-12	4.60	2.31	1.02	1-11/16

SAE 45° Flare Male Rigid

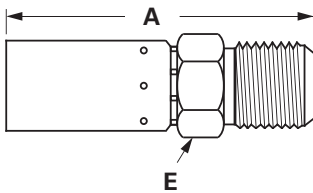

Hose I.D.	Tube Size	Part Number	Thread Size	A	Hose Cut-Off Factor	Hole Dia.	Hex E
3/8	3/8	06U-306	5/8-18	2.60	1.13	.28	11/16
3/4	3/4	12U-312	1-1/16-14	3.87	1.69	.61	1-1/8

Inverted Male Swivel Straight

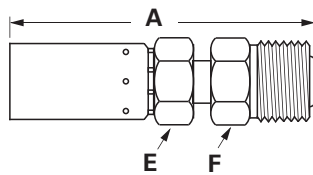

Hose I.D.	Tube Size	Part Number	Thread Size	A	Hose Cut-Off Factor	Hole Dia.	Hex E	Hex F
1/4	3/16	04U-B03	3/8-24	3.75	2.25	.12	9/16	3/8
1/4	1/4	04U-B04	7/16-24	3.14	1.69	.16	9/16	7/16
1/4	5/16	04U-B05	1/2-20	3.13	1.63	.21	9/16	1/2
3/8	1/4	06U-B04	7/16-24	3.13	1.69	.16	11/16	7/16
3/8	5/16	06U-B05	1/2-20	3.16	1.75	.21	11/16	1/2
3/8	3/8	06U-B06	5/8-18	3.33	1.94	.24	11/16	5/8
3/8	7/16	06U-B07	11/16-18	3.33	1.94	.24	11/16	11/16
1/2	1/2	08U-B08	3/4-18	3.69	2.25	.33	13/16	3/4
1/2	5/8	08U-B10	7/8-18	3.43	2.00	.33	13/16	7/8

Hose Ends - Crimp

Coll-O-Crimp

'U' Series

To determine the correct length of hose, subtract the cut-off factor for each end fitting from the overall length of assembly.

Flareless Tube Rigid Ermeto 7000 Series

(With Nut and Sleeve)

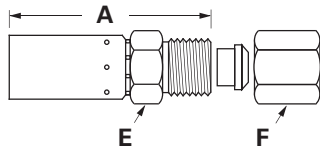

Hose I.D.	Tube Size	Part Number	Thread Size	A	Hose Cut-Off Factor	Hole Dia.	Hex E	Hex F
1/4	1/4	04U-754	7/16-20	2.38	.94	.16	9/16	9/16
1/4	5/16	04U-755	1/2-20	2.41	.93	.16	11/16	5/8
3/8	1/4	06U-754	7/16-20	2.40	1.00	.20	11/16	9/16
3/8	5/16	06U-755	1/2-20	2.40	1.00	.23	11/16	5/8
3/8	3/8	06U-756	9/16-18	2.42	1.00	.25	11/16	11/16
1/2	1/2	08U-758	3/4-16	2.51	1.13	.36	13/16	7/8
1/2	5/8	08U-760	7/8-14	2.64	1.25	.36	15/16	1
3/4	3/4	12U-762	1-1/16-12	3.55	1.38	.61	1-1/8	1-1/4
1	1	16U-766	1-5/16-12	3.98	1.75	.81	1-3/8	1-1/2
1-1/4	1-1/4	20U-770	1-5/8-12	4.35	2.00	1.02	1-11/16	2

(For replacement ermeto nuts and sleeves, see page L-80.)

Male Straight Thread O-Ring Swivel

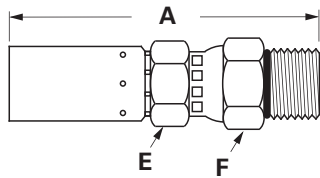

Hose I.D.	Port Size	Part Number	Thread Size	A	Hose Cut-Off Factor	Hole Dia.	Hex E	Hex F
1/4	1/4	04U-R04	7/16-20	3.33	1.81	.16	5/8	13/16
3/8	3/8	06U-R06	9/16-18	3.29	1.86	.25	11/16	7/8
3/8	1/2	06U-R08	3/4-16	3.25	1.75	.25	11/16	7/8
1/2	1/2	08U-R08	3/4-16	3.27	1.81	.36	13/16	7/8
1/2	5/8	08U-R10	7/8-14	3.41	2.00	.36	13/16	1-1/8
1/2	3/4	08U-R12	1-1/16-12	3.57	2.06	.36	13/16	1-1/4
5/8	1/2	10U-R08	3/4-16	3.96	1.88	.42	15/16	1-1/8
3/4	5/8	12U-R10	7/8-14	4.23	2.06	.50	1	1-1/8

(Includes o-ring. for replacement o-ring, see page L-64.)

Note:

Swivel for installation purposes only. (Not for temperatures above 212°F.)

Coll-O-Crimp

'U' Series

To determine the correct length of hose, subtract the cut-off factor for each end fitting from the overall length of assembly.

Male Straight Thread O-Ring Rigid

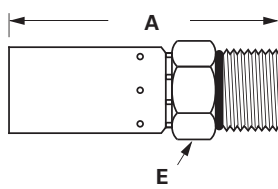

Hose I.D.	Port Size	Part Number	Thread Size	A	Hose Cut-Off Factor	Hole Dia.	Hex E
1/4	1/4	04U-P04	7/16-20	2.29	.81	.16	9/16
1/4	5/16	04U-P05	1/2-20	2.32	.88	.16	5/8
1/4	3/8	04U-P06	9/16-18	2.35	.88	.16	11/16
3/8	3/8	06U-P06	9/16-18	2.35	.94	.25	11/16
3/8	1/2	06U-P08	3/4-16	2.46	1.06	.25	7/8
3/8	5/8	06U-P10	7/8-14	2.57	1.13	.25	1
1/2	1/2	08U-P08	3/4-16	2.46	1.06	.36	7/8
1/2	5/8	08U-P10	7/8-14	2.55	1.13	.36	1
1/2	3/4	08U-P12	1-1/16-12	2.66	1.25	.36	1-1/4
5/8	1/2	10U-P08	3/4-16	3.00	1.13	.48	15/16
5/8	5/8	10U-P10	7/8-14	3.06	1.13	.48	1
5/8	3/4	10U-P12	1-1/16-12	3.15	1.25	.48	1-1/4
3/4	5/8	12U-P10	7/8-14	3.36	1.19	.50	1
3/4	3/4	12U-P12	1-1/16-12	3.49	1.31	.61	1-1/4
3/4	1	12U-P16	1-5/16-12	3.50	1.31	.61	1-1/2
1	1	16U-P16	1-5/16-12	3.63	1.44	.81	1-1/2
1-1/4	1-1/4	20U-P20	1-5/8-12	4.23	1.94	1.02	1-7/8

(Includes O-ring. For replacement O-ring, see page L-64.)

Female Grease Tap

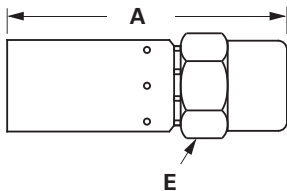

Hose I.D.	Part Number	Thread Size	A	Cut-Off Factor	Hose Hole Dia.	Hex E
1/4	04U-C34	.511-27	2.45	.90	.16	3/4
3/8	06U-C36	.511-27	2.44	.90	.25	3/4

Female Pipe Rigid

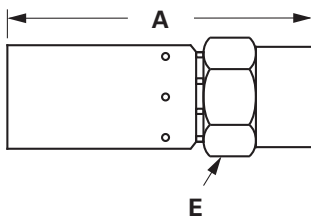

Hose I.D.	Pipe Size	Part Number	Thread Size	A	Hose Cut-Off Factor	Hole Dia.	Hex E
1/4	1/8	04U-202	1/8-27	2.20	.75	.16	5/8
1/4	1/4	04U-204	1/4-18	2.43	.94	.16	3/4
3/8	1/4	06U-204	1/4-18	2.46	1.06	.25	3/4
3/8	3/8	06U-206	3/8-18	2.57	1.13	.25	7/8
1/2	1/2	08U-208	1/2-14	2.82	1.38	.36	1-1/8
3/4	3/4	12U-212	3/4-14	3.71	1.56	.61	1-3/8



Hose Ends - Crimp

Coll-O-Crimp

'U' Series

To determine the correct length of hose, subtract the cut-off factor for each end fitting from the overall length of assembly.

^a Swivel nuts are universal – both SAE 37° and 45° connections.

Female Pipe Swivel

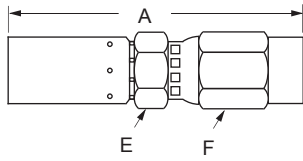

Hose I.D.	Pipe Size	Part Number	Thread Size	A	Hose Cut-Off Factor	Hole Dia.	Hex E	Hex F
1/4	1/4	04U-254	1/4-18	3.52	2.06	.20	5/8	13/16
3/8	3/8	06U-256	3/8-18	3.61	2.19	.32	11/16	7/8
1/2	1/2	08U-258	1/2-14	3.85	2.38	.43	13/16	1-1/8
3/4	3/4	12U-262	3/4-14	4.81	2.63	.61	1	1-3/8
1	1	16U-266	1-11-1/2	5.26	3.06	.80	1-1/4	1-5/8

Note:

Swivel for installation purposes only.
(Not for temperatures above 212°F.)

JIC 37° Female Swivel

(Exceptions Noted)

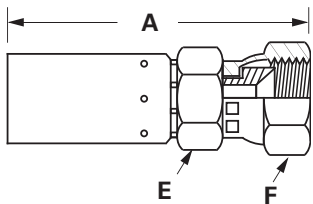

Hose I.D.	Pipe Size	Part Number	Thread Size	A	Hose Cut-Off Factor	Hole Dia.	Hex E	Hex F
1/4	1/4	04U-604 ^a	7/16-20	2.61	1.13	.16	9/16	9/16
1/4	5/16	04U-605 ^a	1/2-20	2.67	1.18	.16	9/16	5/8
1/4	3/8	04U-606	9/16-18	2.72	1.25	.16	9/16	11/16
3/8	1/4	06U-604 ^a	7/16-20	2.66	1.25	.16	11/16	9/16
3/8	3/8	06U-606	9/16-18	2.77	1.31	.25	11/16	11/16
3/8	1/2	06U-608 ^a	3/4-16	2.86	1.44	.25	11/16	7/8
3/8	5/8	06U-610 ^a	7/8-14	3.00	1.56	.25	7/8	1
3/8	3/4	06U-612	1-1/16-12	3.15	1.69	.25	1	1-1/4
1/2	3/8	08U-606	9/16-18	2.68	1.25	.30	13/16	11/16
1/2	1/2	08U-608 ^a	3/4-16	2.79	1.38	.36	13/16	7/8
1/2	5/8	08U-610 ^a	7/8-14	3.00	1.56	.36	13/16	1
1/2	3/4	08U-612	1-1/16-12	3.12	1.44	.36	1	1-1/4
1/2	1	08U-616	1-5/16-12	3.17	1.75	.36	1-1/4	1-1/2
5/8	1/2	10U-608 ^a	3/4-16	3.48	1.56	.39	15/16	7/8
5/8	5/8	10U-610 ^a	7/8-14	3.53	1.63	.48	15/16	1
5/8	3/4	10U-612	1-1/16-12	3.64	1.75	.48	1	1-1/4
3/4	5/8	12U-610 ^a	7/8-14	3.75	1.56	.48	1	1
3/4	3/4	12U-612	1-1/16-12	3.86	1.69	.61	1	1-1/4
3/4	7/8	12U-614	1-3/16-12	3.88	1.69	.61	1-1/8	1-3/8
3/4	1	12U-616	1-5/16-12	4.07	1.88	.61	1-1/4	1-1/2
1	3/4	16U-612	1-1/16-12	4.37	2.13	.61	1-1/4	1-1/4
1	7/8	16U-614	1-3/16-12	4.35	2.13	.72	1-1/4	1-3/8
1	1	16U-616	1-5/16-12	4.46	2.25	.81	1-1/4	1-1/2
1	1-1/4	16U-620	1-5/8-12	4.30	2.19	.81	1-5/8	2
1-1/4	1-1/4	20U-620	1-5/8-12	4.90	2.63	1.02	1-11/16	2

^a Swivel nuts are universal – both SAE 37° and 45° connections.

Female Straight Pipe Swivel (NPSM)

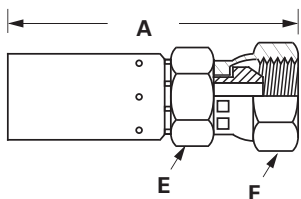

Hose I.D.	Pipe Size	Part Number	Thread Size	A	Hose Cut-Off Factor	Hole Dia.	Hex E	Hex F
1/4	1/4	04U-054	1/4-18	2.55	1.06	.16	1/2	11/16
3/8	3/8	06U-056	3/8-18	2.65	1.19	.27	11/16	7/8
1/2	1/2	08U-058	1/2-14	2.85	1.44	.36	13/16	1
3/4	3/4	12U-062	3/4-14	3.77	1.63	.61	1	1-1/4
1	1	16U-066	1-11-1/2	4.34	2.13	.81	1-1/4	1-1/2
1-1/4	1-1/4	20U-070	1-1/4-11-1/2	4.76	2.44	1.08	1-11/16	1-7/8

(Connects to male pipe fitting with internal seat.)

Coll-O-Crimp

'U' Series

To determine the correct length of hose, subtract the cut-off factor for each end fitting from the overall length of assembly.

SAE 45° Female Swivel

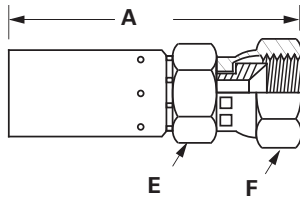

Hose I.D.	Tube Size	Part Number	Thread Size	A	Hose Cut-Off Factor	Hole Dia.	Hex E	Hex F
3/8	3/8	06U-406	5/8-18	2.68	1.25	.25	11/16	3/4
3/4	3/4	12U-412	1-1/16-14	3.86	1.69	.61	1	1-1/4

Female Swivel DIN Universal Seat

l. Rh. (Light)

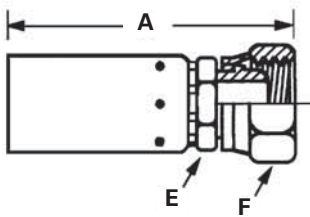

Hose I.D.	Tube Size (mm)	Part Number	Thread Size	A	Hose Cut-Off Factor	Hole Dia.	Hex E	Hex F
1/4	6	04U-06C	M12x1.5	2.73	1.25	.16	9/16	11/16
1/4	8	04U-08C	M14x1.5	2.76	1.25	.16	9/16	11/16
1/4	10	04U-10C	M16x1.5	2.82	1.38	.16	9/16	3/4
3/8	10	06U-10C	M16x1.5	2.78	1.38	.25	11/16	3/4
3/8	12	06U-12C	M18x1.5	2.93	1.50	.25	11/16	7/8
1/2	15	08U-15C	M22x1.5	2.98	1.56	.36	13/16	1-1/16
5/8	18	10U-18C	M26x1.5	3.61	1.69	.48	15/16	1-1/4
3/4	22	12U-22C	M30x2.0	4.03	1.88	.61	1-1/8	1-7/16
1	28	16U-28C	M36x2.0	4.47	2.25	.78	1-1/4	1-5/8
1-1/4	35	20U-35C	M45x2.0	4.61	2.25	1.02	1-3/4	2-1/8

Female Swivel DIN 24° Seat

s. Rh. DKO (Heavy)

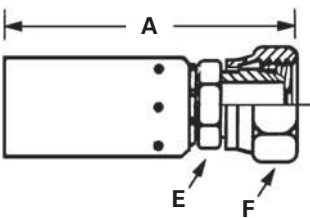

Hose I.D.	Tube Size (mm)	Part Number	Thread Size	A	Hose Cut-Off Factor	Hole Dia.	Hex E	Hex F
1/4	8	04U-58C	M16x1.5	2.88	1.40	.16	9/16	3/4
1/4	10	04U-60C	M18x1.5	2.78	1.31	.16	5/8	7/8
1/4	12	04U-62C	M20x1.5	2.67	1.19	.16	3/4	1
3/8	10	06U-60C	M18x1.5	2.78	1.38	.22	3/4	7/8
3/8	12	06U-62C	M20x1.5	2.87	1.44	.25	3/4	1
3/8	14	06U-64C	M22x1.5	2.92	1.50	.25	3/4	1-1/16
1/2	16	08U-66C	M24x1.5	3.06	1.63	.36	7/8	1-1/8
5/8	20	10U-70C	M30x2.0	3.46	1.69	.48	1-1/8	1-7/16
3/4	20	12U-70C	M30x2.0	3.91	1.75	.48	1-1/8	1-7/16
3/4	25	12U-75C	M36x2.0	4.24	2.06	.61	1-1/4	1-5/8
1	30	16U-80C	M42x2.0	4.34	2.13	.81	1-5/8	2
1-1/4	38	20U-88C*	M52x2.0	4.80	2.50	1.02	2	2-3/8

*20U-88C for use with H42520 only. Crimp on Super I, COC II or COC II Plus only. Contact Eaton for crimping instructions. (Includes o-ring.)

Female Swivel 30° Flare

(Komatsu, Linkbelt)

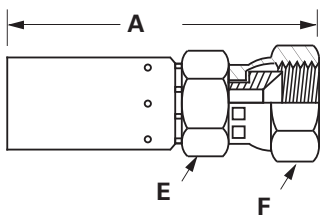

Hose I.D.	Part Number	Thread Size	A	Cut-Off Factor	Hole Dia.	Hex E	Hex F
1/4	04U-14K	M14x1.5	2.89	1.19	.18	9/16	3/4
3/8	06U-18K	M18x1.5	2.86	1.44	.31	11/16	7/8
1/2	08U-22K	M22x1.5	2.99	1.56	.39	13/16	1
5/8	10U-24K	M24x1.5	3.64	1.69	.50	1	1-1/4
3/4	12U-30K	M30x1.5	3.86	1.69	.61	1-1/8	1-3/8
1	16U-33K	M33x1.5	4.53	2.31	.81	1-1/4	1-5/8
1-1/4	20U-36K	M36x1.5	5.24	2.94	.92	1-5/8	1-3/4

J

Hose Ends - Crimp

Coll-O-Crimp

'U' Series

To determine the correct length of hose, subtract the cut-off factor for each end fitting from the overall length of assembly.

British Standard (BSPP) 60° Cone Female Pipe Swivel

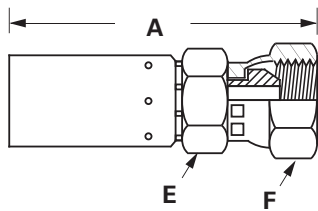

Hose I.D.	BSPP Pipe Size	Part Number	Thread Size	A	Hose Cut-Off Factor	Hole Dia.	Hex E	Hex F
1/4	1/4	04U-354	G-1/4-19*	2.75	1.25	.16	9/16	3/4
1/4	3/8	04U-356	G-3/8-19*	2.84	1.38	.16	3/4	7/8
3/8	3/8	06U-356	G-3/8-19*	2.84	1.44	.25	3/4	7/8
3/8	1/2	06U-358	G-1/2-14*	2.97	1.56	.25	7/8	1-1/16
1/2	1/2	08U-358	G-1/2-14*	3.05	1.63	.36	13/16	1-1/16
1/2	5/8	08U-360	G-5/8-14*	2.96	1.56	.36	13/16	1-3/16
5/8	5/8	10U-360	G-5/8-14*	3.71	1.75	.48	15/16	1-3/16
3/4	3/4	12U-362	G-3/4-14*	3.87	1.75	.61	1	1-1/4
1	1	16U-366	G-1-11*	4.47	2.25	.81	1-1/4	1-1/2
1-1/4	1-1/4	20U-370	G-1-1/4-11*	4.81	2.50	1.02	1-5/8	1-7/8

*G as part of thread size is ISO designation for parallel thread.

Female JIS 30° Flare Parallel Pipe Swivel

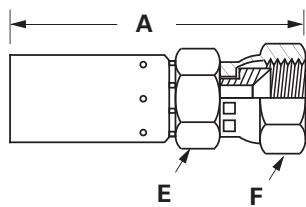

Hose I.D.	Tube Size	Part Number	Thread Size	A	Hose Cut-Off Factor	Hole Dia.	Hex E	Hex F
1/4	1/4	04U-04L	G-1/4-19	2.73	1.25	.16	9/16	3/4
3/8	3/8	06U-06L	G-3/8-19	2.84	1.38	.25	11/16	7/8
1/2	1/2	08U-08L	G-1/2-14	3.02	1.56	.36	13/16	1-1/16
5/8	3/4	10U-12L	G-3/4-14	3.52	1.56	.48	1	1-5/16
3/4	3/4	12U-12L	G-3/4-14	3.85	1.75	.61	1	1-1/4
1	1	16U-16L	G-1-11	4.13	1.94	.81	1-1/4	1-1/2

*G As Part of Thread Size is ISO Designation for Parallel Thread.

Female FOR-SEAL® Swivel Straight

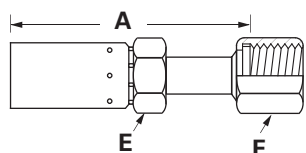

Hose I.D.	Tube Size	Part Number	Thread Size	A	Hose Cut-Off Factor	Hole Dia.	Hex E	Hex F
1/4	1/4	04U-S64	9/16-18	2.56	1.08	.16	9/16	11/16
1/4	3/8	04U-S66	11/16-16	2.85	1.37	.26	9/16	13/16
1/4	1/2	04U-S68	13/16-16	3.19	1.75	.36	11/16	15/16
3/8	1/4	06U-S64	9/16-18	2.81	1.38	.16	11/16	5/8
3/8	3/8	06U-S66	11/16-16	2.64	1.21	.26	11/16	13/16
3/8	1/2	06U-S68	13/16-16	2.80	1.37	.28	11/16	15/16
3/8	5/8	06U-S70*	1-14	3.03	1.60	.25	15/16	1-1/8
1/2	3/8	08U-S66	11/16-16	2.75	1.32	.26	13/16	13/16
1/2	1/2	08U-S68	13/16-16	2.80	1.37	.36	13/16	15/16
1/2	5/8	08U-S70	1-14	3.30	1.87	.46	13/16	1-1/8
1/2	3/4	08U-S72	1-3/16-12	3.38	1.94	.36	1	1-3/8
5/8	5/8	10U-S70	1-14	3.53	1.60	.48	15/16	1-1/8
5/8	3/4	10U-S72	1-3/16-12	3.84	1.94	.55	1	1-3/8
3/4	5/8	12U-S70	1-14	3.85	1.70	.46	1	1-1/8
3/4	3/4	12U-S72	1-3/16-12	3.95	1.80	.61	1-1/8	1-3/8
3/4	1	12U-S76	1-7/16-12	4.78	2.81	.61	1-1/4	1-5/8
1	3/4	16U-S72	1-3/16-12	4.36	2.16	.55	1-1/4	1-3/8
1	1	16U-S76	1-7/16-12	4.24	2.04	.78	1-1/4	1-5/8
1	1-1/4	16U-S80	1-11/16-12	4.20	2.00	.81	1-1/2	1-7/8
1-1/4	1-1/4	20U-S80	1-11/16-12	4.54	2.25	1.04	1-5/8	1-7/8

* Crimp nut design

Coll-O-Crimp

'U' Series

To determine the correct length of hose, subtract the cut-off factor for each end fitting from the overall length of assembly..

BSPP Flat Face Female Swivel

(HIAB Cranes-Swedish)

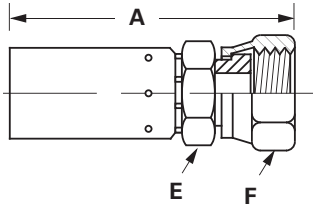

Hose I.D.	Tube Size	Part Number	Thread Size	A	Hose Cut-Off Factor	Hole Dia.	Hex E	Hex F
3/8	3/8	06U-06P	G-3/8-19*	2.90	1.50	.25	11/16	7/8
3/8	1/2	06U-08P	G-1/2-14*	2.96	1.50	.25	3/4	1-1/16
1/2	1/2	08U-08P	G-1/2-14*	3.02	1.56	.36	13/16	1-1/16
1/2	3/4	08U-12P	G-3/4-14*	3.06	1.63	.36	1	1-1/4
3/4	3/4	12U-12P	G-3/4-14*	3.92	1.75	.61	1	1-1/4

*G as part of thread size is ISO designation for parallel thread.

READY-LOK Male Connector

(For Deep Mining Markets)

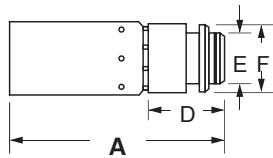

Hose I.D.	Connect. Size	Part Number	A	Hose Cut-Off Factor	Hole Dia.	Length D	Dia. E	Dia. F
1/4	1/4	04U-04S	2.82	1.31	.16	1.13	.39	.59
3/8	3/8	06U-06S	2.84	1.31	.26	1.13	.54	.78
1/2	1/2	08U-08S	2.82	1.31	.36	1.13	.70	.94
3/4	3/4	12U-12S	3.64	1.50	.61	1.13	.94	1.14
1	1	16U-16S	3.94	1.75	.81	1.34	1.22	1.53
1-1/4	1-1/4	20U-20S	4.06	1.75	1.02	1.34	1.49	1.80

(O-ring and backup ring included.)

Split Flange Straight

(SAE Code 61)

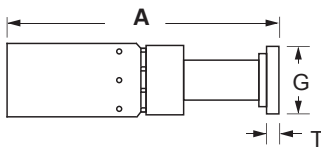

Hose I.D.	Nominal Tube Size	Part Number	Replacement O-Ring (Not Included)	A	Hose Cut-Off Factor	Hole Dia.	Dia. G	T
1/2	1/2	08U-G08	8x252	3.94	2.50	.33	1.19 (30mm)	.265
3/4	3/4	12U-G12	12x252	4.40	2.25	.58	1.50 (38mm)	.265
3/4	1	12U-G16	16x252	4.40	2.25	.58	1.75 (44mm)	.315
1	1	16U-G16	16x252	4.58	2.38	.77	1.75 (44mm)	.315
1	1-1/4	16U-G20	20x252	4.58	2.38	.77	2.00 (51mm)	.315
1-1/4	1-1/4	20U-G20	20x252	5.04	2.75	1.02	2.00 (51mm)	.315
1-1/4	1-1/2	20U-G24	24x252	5.12	2.81	1.02	2.38 (60mm)	.315

(See page L-90 for Code 61 Split Flange Kits.)

Split Flange Straight — Metric

(Komatsu, Linkbelt, etc.)

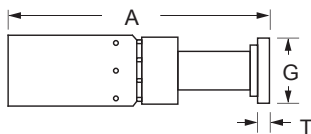

Hose I.D.	Nominal Tube Size	Part Number	Replacement O-Ring (Not Included)	A	Hose Cut-Off Factor	Hole Dia.	Dia. G	T
5/8	16mm (5/8")	10U-G09	10x252	4.18	2.25	.46	34mm (1.325")	.265

J

Hose Ends - Crimp

Coll-O-Crimp

'U' Series

To determine the correct length of hose, subtract the cut-off factor for each end fitting from the overall length of assembly.

Banjo (Ford Tractor)

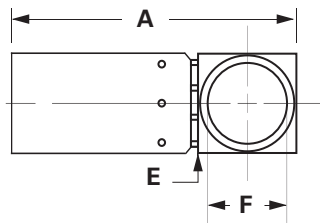

Hose I.D.	Part Number	A	Hose Cut-Off Factor	Hole Dia.	Hex E
3/8	06U-L06	2.56	.69	.62	7/8

Metric Standpipe Straight Tube

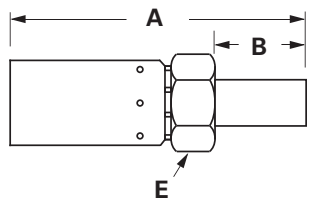

Hose I.D.	Tube O.D. (mm)	Part Number	A	B	Hose Cut-Off Factor	Hole Dia.	Hex E
1/4	8	04U-38T	3.06	1.00	1.56	.15	5/8
1/4	10	04U-40T	3.10	1.04	1.63	.15	5/8
3/8	10	06U-40T	3.10	1.04	1.63	.24	13/16
3/8	12	06U-42T	3.10	1.04	1.63	.24	13/16
3/8	14	06U-44T	3.28	1.22	1.81	.24	13/16
1/2	15	08U-45T	3.12	1.00	1.69	.35	7/8
1/2	16	08U-46T	3.34	1.22	1.91	.35	7/8
5/8	18	10U-48T	3.64	1.06	1.75	.48	1-15/16
5/8	20	10U-50T	4.00	1.42	2.06	.48	1-15/16
3/4	22	12U-52T	4.13	1.19	1.88	.61	1
3/4	25	12U-55T	4.53	1.59	2.25	.61	1
1	28	16U-58T	4.43	1.25	2.25	.81	1-1/2
1	30	16U-60T	4.89	1.71	2.69	.81	1-1/2

(See page L-66 for Metric Nuts and Sleeves.)

Standpipe Straight Tube

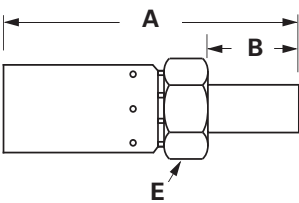

Hose I.D.	Tube O.D.	Part Number	A	B	Hose Cut-Off Factor	Hole Dia.	Hex E
1/4	1/4	04U-T04	3.16	1.10	1.69	.15	9/16
3/8	3/8	06U-T06	3.36	1.30	1.94	.25	11/16
1/2	1/2	08U-T08	3.70	1.58	2.25	.33	3/4
5/8	5/8	10U-T10	3.92	1.34	2.00	.46	15/16
3/4	3/4	12U-T12	4.11	1.17	1.94	.58	1
1	1	16U-T16	4.48	1.30	2.31	.76	1-1/4

(See pages L-80 for Ermeto nuts and sleeves.)

SAE 37° Female Swivel 30° Tube Elbow

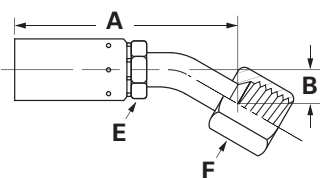

Hose I.D.	Tube Size	Part Number	Thread Size	A	B	Hose Cut-Off Factor	Hex E	Hex F
5/8	3/4	10U-L22	1-1/16-12	4.50	.46	2.56	15/16	1-1/4

J
Hose Ends - Crimp

Inverted Male Swivel 45° Tube Elbow

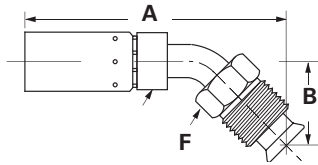

Hose I.D.	Tube Size	Part Number	Thread Size	A	B	Hose Cut-Off Factor	Hole Dia.	Hex F
1/4	3/16	04U-B43	3/8-24	3.48	.69	2.00	.12	3/8
1/4	1/4	04U-B44	7/16-24	3.61	.93	2.13	.15	7/16
1/4	5/16	04U-B45	1/2-20	3.98	1.14	2.50	.21	1/2
3/8	1/4	06U-B44	7/16-24	3.59	.93	2.19	.15	7/16
3/8	5/16	06U-B45	1/2-20	4.02	1.14	2.56	.21	1/2
3/8	3/8	06U-B46	5/8-18	4.05	1.34	2.63	.24	5/8
3/8	7/16	06U-B47	11/16-18	4.05	1.34	2.63	.24	11/16
1/2	1/2	08U-B48	3/4-18	4.85	1.58	3.44	.33	3/4

SAE 45° Female Swivel 45° Tube Elbow

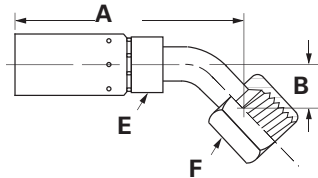

Hose I.D.	Tube Size	Part Number	Thread Size	A	B	Hose Cut-Off Factor	Hole Dia.	Hex Dia. F	Hex F
3/8	3/8	06U-486	5/8-18	3.18	.39	1.75	.21	11/16	3/4

Female Swivel DIN Universal Seat 45° Tube Elbow

I. Rh. (Light)

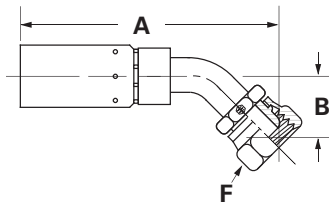

Hose I.D.	Tube Size	Part Number	Thread Size	A	B	Hose Cut-Off Factor	Hole Dia.	Hex F
1/4	8	04U-08D	M14x1.5	3.08	.73	1.63	.16	11/16
1/4	10	04U-10D	M16x1.5	3.21	.79	1.75	.16	3/4
3/8	10	06U-10D	M16x1.5	3.90	.96	2.47	.25	3/4
3/8	12	06U-12D	M18x1.5	3.93	.96	2.50	.25	7/8
1/2	15	08U-15D	M22x1.5	3.48	.91	2.06	.36	1-1/16
5/8	18	10U-18D	M26x1.5	4.40	1.08	2.50	.48	1-5/16
3/4	22	12U-22D	M30x2.0	4.62	1.19	2.44	.61	1-7/16
1	28	16U-28D	M36x2.0	5.52	1.59	3.32	.81	1-5/8

Flareless 45° Tube Elbow

7000 Ermeto Series

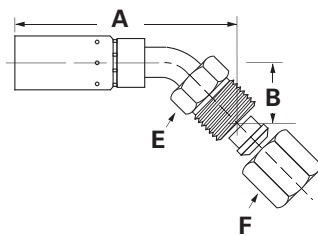

Hose I.D.	Tube Size	Part Number	Thread Size	A	B	Hose Cut-Off Factor	Hole Dia.	Hex Dia. F	Hex F
3/8	3/8	06U-956	9/16-18	4.08	.88	2.65	.28	11/16	11/16

(For replacement nuts and sleeves see pages L-80.)

J

Hose Ends - Crimp

Coll-O-Crimp

'U' Series

To determine the correct length of hose, subtract the cut-off factor for each end fitting from the overall length of assembly.

^a Swivel nuts are universal – both SAE 37° and 45° connections.

JIC 37° Female Swivel 45° Tube Elbow

(Exceptions Noted)

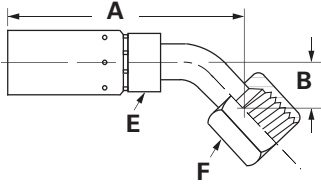

Hose I.D.	Tube Size	Part Number	Thread Size	A	B	Hose Cut-Off Factor	Hole Dia.	Hex Dia. E	Hex F
1/4	1/4	04U-684 ^a	7/16-20	2.98	.33	1.50	.15	9/16	9/16
1/4	5/16	04U-685 ^a	1/2-20	3.14	.36	1.69	.21	9/16	5/8
3/8	1/4	06U-684 ^a	7/16-20	3.08	.33	1.69	.15	11/16	9/16
3/8	3/8	06U-686	9/16-18	3.17	.39	1.75	.25	11/16	11/16
3/8	1/2	06U-688 ^a	3/4-16	3.51	.55	2.08	.25	3/4	7/8
1/2	1/2	08U-688 ^a	3/4-16	3.51	.55	2.08	.35	13/16	7/8
1/2	5/8	08U-690 ^a	7/8-14	3.76	.63	2.31	.36	13/16	1
5/8	5/8	10U-690 ^a	7/8-14	4.22	.63	2.22	.48	15/16	1
5/8	3/4	10U-692	1-1/16-12	4.37	.78	2.44	.48	15/16	1-1/4
3/4	3/4	12U-692	1-1/16-12	4.79	.78	2.64	.59	1	1-1/4
3/4	1	12U-696	1-5/16-12	5.18	1.10	3.00	.61	1-1/4	1-1/2
1	1	16U-696	1-5/16-12	5.28	1.10	3.06	.76	1-1/4	1-1/2

^a Swivel nuts are universal – both SAE 37° and 45° connections.

Male Swivel 45° Tube Elbow O-Ring Port

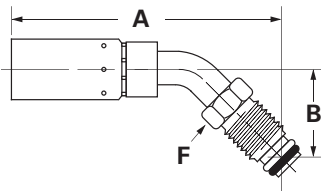

Hose I.D.	Tube O.D.	Part Number	O-Ring	Thread Size	A	B	Hose Cut-Off Factor	Hole Dia.	Hex F
1/2	5/8	08U-L50	7629x7	7/8-14	4.75	1.84	3.38	.36	7/8

Split Flange 45° Tube Elbow (SAE Code 61)

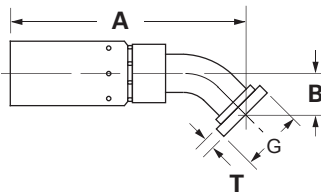

Hose I.D.	Nominal Flange Size	Part Number	Replacement O-Ring (Not Included)	A	B	Hose Cut-Off Factor	Hole Dia.	Dia. G	T Nominal
1/2	1/2	08U-G41	8x252	3.68	.78	2.25	.41	1.19 (30mm)	.265
3/4	3/4	12U-G42	12x252	5.00	1.00	2.88	.58	1.50 (38mm)	.265
3/4	1	12U-G46	16x252	5.00	1.00	2.88	.58	1.75 (44mm)	.315
1	1	16U-G46	16x252	4.82	.89	2.62	.77	1.75 (44mm)	.315
1	1-1/4	16U-G50	20x252	5.00	1.06	2.80	.77	2.00 (51mm)	.315
1-1/4	1-1/4	20U-G50	20x252	5.22	1.09	2.90	1.02	2.00 (51mm)	.315

(See page L-90 for Code 61 Split Flange Kits.)

J Hose Ends - Crimp

British Standard 60° Cone (BSPP) Female Swivel 45° Tube Elbow

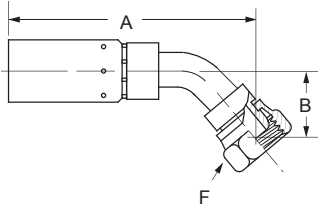

Hose I.D.	BSP Pipe Size	Part Number	Thread Size	A	B	Hose Cut-Off Factor	Hole Dia.	Hex F
1/4	1/4	04U-44P	G-1/4-19*	3.69	.91	2.25	.15	3/4
3/8	3/8	06U-46P	G-3/8-19*	3.85	.90	2.44	.25	7/8
1/2	1/2	08U-48P	G-1/2-14*	3.88	.87	2.44	.33	1-1/16
5/8	5/8	10U-50P	G-5/8-14*	4.38	.98	2.44	.46	1-3/16
3/4	3/4	12U-52P	G-3/4-14*	5.53	1.31	3.38	.61	1-1/4
1	1	16U-56P	G-1-11*	5.39	1.46	3.19	.76	1-1/2
1-1/4	1-1/4	20U-60P**	G-1 1/4-11*	5.89	1.76	3.57	1.02	1-7/8

*G as part of thread size is ISO designation for parallel thread.

**Part number will crimp in COC ET4000, T-410-1, T-420-1, and T-440-1 presses only.

Female FOR-SEAL® Swivel 45° Tube Elbow

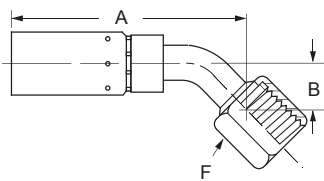

Hose I.D.	Tube Size	Part Number	Thread Size	A	B	Hose Cut-Off Factor	Hole Dia.	Hex F
1/4	1/4	04U-L64	9/16-18	3.14	.41	1.68	.16	11/16
1/4	3/8	04U-L66	11/16-16	3.24	.43	1.75	.16	13/16
3/8	3/8	06U-L66	11/16-16	3.26	.43	1.81	.26	13/16
3/8	1/2	06U-L68	13/16-16	3.58	.60	2.15	.26	15/16
1/2	3/8	08U-L66	11/16-16	3.32	.43	1.88	.26	13/16
1/2	1/2	08U-L68	13/16-16	3.56	.60	2.13	.36	15/16
1/2	5/8	08U-L70	1-14	3.67	.65	2.25	.36	1-1/8
5/8	5/8	10U-L70	1-14	4.13	.65	2.19	.46	1-1/8
5/8	3/4	10U-L72	1-3/16-12	4.53	.84	2.63	.48	1-3/8
3/4	5/8	12U-L70	1-14	4.49	.65	2.31	.46	1-1/8
3/4	3/4	12U-L72	1-3/16-12	4.96	.84	2.81	.59	1-3/8
3/4	1	12U-L76	1-7/16-12	5.29	.94	3.13	.76	1-5/8
1	3/4	16U-L72	1-3/16-12	4.99	.83	2.79	.56	1-3/8
1	1	16U-L76	1-7/16-12	5.29	.95	3.06	.76	1-5/8
1	1-1/4	16U-L80	1-11/16-12	5.00	1.07	2.79	.81	1-7/8
1-1/4	1-1/4	20U-L80	1-11/16-12	5.15	1.05	2.85	1.01	1-7/8

Split Flange 45° Tube Elbow - Metric (Komatsu, Linkbelt, etc.)

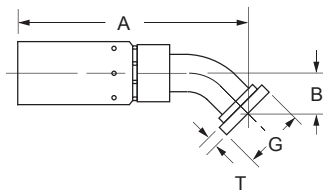

Hose I.D.	Nominal Flange Size	Part Number	Replacement O-Ring (Not Included)	A	B	Hose Cut-Off Factor	Hole Dia.	Dia. G	T Nominal
5/8	16mm (5/8)	10U-G69	10x252	4.21	.94	2.25	.46	34mm (1.335)	.265

(See page L-90 for Code 61 Split Flange Kits.)

Inverted Male Swivel 90° Tube Elbow

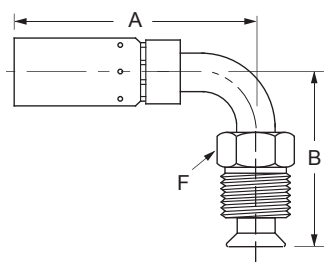

Hose I.D.	Tube Size	Part Number	Thread Size	A	B	Hose Cut-Off Factor	Hole Dia.	Hex F
1/4	3/16	04U-B63	3/8-24	2.85	1.06	1.38	.12	3/8
1/4	1/4	04U-B64	7/16-24	2.89	1.36	1.38	.15	7/16
1/4	5/16	04U-B65	1/2-20	3.08	1.61	1.63	.21	1/2
3/8	1/4	06U-B64	7/16-24	2.89	1.36	1.44	.15	7/16
3/8	5/16	06U-B65	1/2-20	3.08	1.61	1.50	.21	1/2
3/8	3/8	06U-B66	5/8-18	3.40	1.97	1.88	.24	5/8
3/8	7/16	06U-B67	11/16-18	3.40	1.97	2.00	.24	11/16
1/2	1/2	08U-B68	3/4-18	3.50	2.32	2.06	.35	3/4

Coll-O-Crimp

'U' Series

To determine the correct length of hose, subtract the cut-off factor for each end fitting from the overall length of assembly.

^a Swivel nuts are universal – both SAE 37° and 45° connections.

SAE 37° Male Rigid 90° Elbow

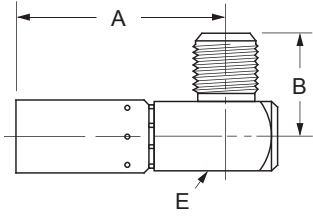

Hose I.D.	Tube Size	Part Number	Thread Size	A	B	Hose Cut-Off Factor	Hole Dia.	Square E
3/8	5/8	06U-X60	7/8-14	2.50	1.10	1.06	.36	11/16
1/2	5/8	08U-X60	7/8-14	2.75	1.13	1.31	.36	3/4
3/4	5/8	12U-X60	7/8-14	4.15	1.32	2.00	.48	1-1/8

Male Pipe Swivel 90° Elbow

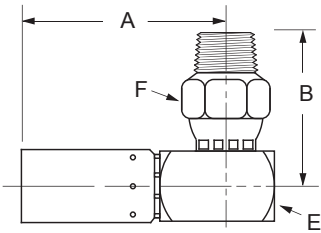

Hose I.D.	Pipe Size	Part Number	Thread Size	A	B	Hose Cut-Off Factor	Hole Dia.	Sqaure E	Hex F
1/4	1/4	04U-M04	1/4-18	2.43	1.79	1.00	.15	11/16	13/16
3/8	1/4	06U-M04	1/4-18	2.50	1.83	1.06	.24	11/16	13/16
3/8	3/8	06U-M06	3/8-18	2.50	1.84	1.06	.24	11/16	7/8
3/8	1/2	06U-M08	1/2-14	2.50	1.97	1.07	.24	11/16	7/8
1/2	1/2	08U-M08	1/2-14	2.75	1.96	1.31	.35	3/4	7/8
3/4	3/4	12U-M12	3/4-14	4.15	2.46	2.00	.61	1-1/8	1-1/4

Note:

Swivel for installation purposes only. (Not for temperatures above 212°F.)

JIC 37° Female Swivel Long Drop 90° Tube Elbow

(Exceptions Noted)

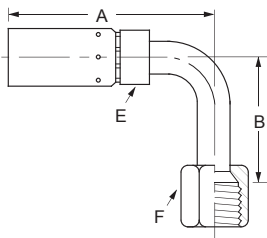

Hose I.D.	Tube Size	Part Number	Thread Size	A	B	Hose Cut-Off Factor	Hole Dia.	Hex F
1/4	1/4	04U-644 ^a	7/16-20	2.95	1.80	1.50	.15	9/16
3/8	1/4	06U-644 ^a	7/16-20	2.89	1.80	1.44	.15	9/16
3/8	3/8	06U-646	9/16-18	3.18	2.18	1.75	.24	11/16
3/8	1/2	06U-648 ^a	3/4-16	3.35	2.43	1.92	.24	7/8
1/2	1/2	08U-648 ^a	3/4-16	3.33	2.43	1.88	.35	7/8
1/2	5/8	08U-650 ^a	7/8-14	3.45	2.57	2.00	.36	1
5/8	5/8	10U-650 ^a	7/8-14	3.91	2.57	1.98	.48	1
3/4	3/4	12U-652	1-1/16-12	4.81	3.73	2.63	.58	1-1/4
1	1	16U-656L33	1-5/16-12	5.18	3.37	3.00	.76	1-1/2

^a Swivel nuts are universal – both SAE 37° and 45° connections.

SAE 45° Female Swivel Long Drop 90° Tube Elbow

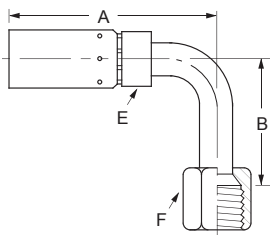

Hose I.D.	Tube Size	Part Number	Thread Size	A	B	Hose Cut-Off Factor	Hole Dia.	Hex F
3/8	3/8	06U-446	5/8-18	3.19	2.18	1.75	.24	3/4

J Hose Ends - Crimp

Coll-O-Crimp 'U' Series

To determine the correct length of hose, subtract the cut-off factor for each end fitting from the overall length of assembly.

^a Swivel nuts are universal – both SAE 37° and 45° connections.

Flareless 90° Tube 7000 Ermeto Series

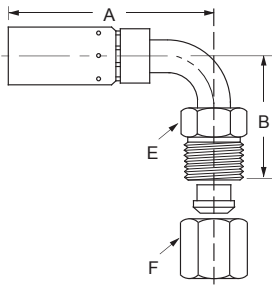

Hose I.D.	Tube Size	Part Number	Thread Size	A	B	Hose Cut-Off Factor	Hole Dia.	Hex E	Hex F
3/8	3/8	06U-976	9/16-18	3.14	1.54	1.69	.28	5/8	11/16

(For replacement nuts and sleeves, see pages L-80.)

JIC 37° Female Swivel 90° Tube Elbow

(Exceptions Noted,
Refer to Footnotes)

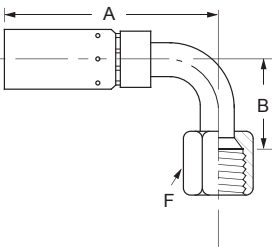

Hose I.D.	Tube Size	Part Number	Thread Size	A	B	Hose Cut-Off Factor	Hole Dia.	Hex F
1/4	1/4	04U-664 ^a	7/16-20	2.90	.68	1.44	.15	9/16
1/4	5/16	04U-665 ^a	1/2-20	3.09	.77	1.63	.21	5/8
1/4	3/8	04U-666	9/16-18	3.16	.85	1.63	.25	11/16
3/8	1/4	06U-664 ^a	7/16-20	2.85	.68	1.44	.15	9/16
3/8	3/8	06U-666	9/16-18	3.20	.85	1.75	.25	11/16
3/8	1/2	06U-668 ^a	3/4-16	3.27	1.09	1.75	.33	7/8
1/2	1/2	08U-668 ^a	3/4-16	3.33	1.09	1.88	.33	7/8
1/2	5/8	08U-670 ^a	7/8-14	3.92	1.23	2.50	.36	1
5/8	5/8	10U-670 ^a	7/8-14	4.36	1.23	2.44	.46	1
5/8	3/4	10U-672	1-1/16-12	4.96	1.82	3.00	.48	1-1/4
3/4	5/8	12U-670 ^a	7/8-14	4.29	1.23	2.14	.46	1
3/4	3/4	12U-672	1-1/16-12	4.76	1.82	2.63	.58	1-1/4
1	1	16U-676	1-5/16-12	5.03	2.14	2.81	.76	1-1/2
1	1-1/4	16U-677	1-5/8-12	5.06	3.31	2.86	.76	2
1-1/4	1-1/4	20U-677 [#]	1-5/8-12	5.29	3.34	2.99	1.01	2

^a Swivel nuts are universal – both SAE 37° and 45° connections.

Female Swivel Universal Seat DIN 90° Tube Elbow

l. Rh. (Light)

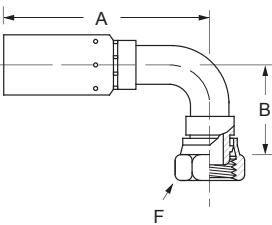

Hose I.D.	Tube Size (mm)	Part Number	Thread Size	A	B	Hose Cut-Off Factor	Hole Dia.	Hex F
1/4	8	04U-58D	M14x1.5	2.99	1.48	1.50	.16	11/16
1/4	10	04U-60D	M16x1.5	3.31	1.65	1.81	.16	3/4
3/8	10	06U-60D	M16x1.5	3.29	1.65	1.88	.25	3/4
3/8	12	06U-62D	M18x1.5	3.31	1.65	1.88	.25	7/8
1/2	15	08U-65D	M22x1.5	3.73	1.93	2.31	.36	1-1/16
5/8	18	10U-68D	M26x1.5	4.42	2.28	2.50	.48	1-1/4
3/4	22	12U-72D	M30x2.0	4.97	2.59	2.81	.61	1-7/16
1	28	16U-78D	M36x2.0	4.95	3.27	2.75	.81	1-5/8
1-1/4	35	20U-85D	M45x2.0	5.29	3.51	2.99	1.02	2-3/16

Female 24° Swivel DIN 90° Tube Elbow

s. Rh. DKO (Heavy)

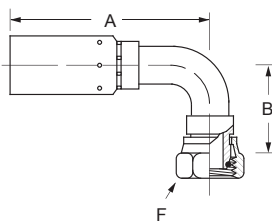

Hose I.D.	Tube Size (mm)	Part Number	Thread Size	A	B	Hose Cut-Off Factor	Hole Dia.	Hex F
3/8	12	06U-62E	M20x1.5	3.25	1.53	1.82	.25	1
3/8	14	06U-64E	M22x1.5	3.61	1.63	2.19	.25	1-1/16
1/2	16	08U-66E	M24x1.5	3.69	1.95	2.25	.33	1-1/8
5/8	20	10U-70E	M30x2.0	4.46	2.47	2.50	.48	1-7/16
3/4	25	12U-75E**	M36x2.0	5.27	2.90	3.13	.61	1-5/8
1	30	16U-80E**	M42x2.0	5.19	2.79	3.00	.77	2

**Part number will crimp in COC T-410, T-420, T-440, ET1000, and ET4000 presses only.
(Includes o-ring)

J

Hose Ends - Crimp

To determine the correct length of hose, subtract the cut-off factor for each end fitting from the overall length of assembly.

British Standard (BSPP) 60° Cone Female Pipe Swivel 90° Tube Elbow

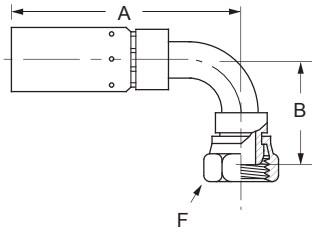

Hose I.D.	BSPP Pipe Size	Part Number	Thread Size	A	B	Hose Cut-Off Factor	Hole Dia.	Hex F
1/4	1/4	04U-74P	G-1/4-19*	2.99	1.50	1.50	.16	3/4
3/8	3/8	06U-76P	G-3/8-19*	3.26	1.60	1.83	.25	7/8
3/8	1/2	06U-78P	G-1/2-14*	3.06	1.67	1.63	.25	1-1/16
1/2	1/2	08U-78P	G-1/2-14*	3.96	1.89	2.56	.36	1-1/16
1/2	5/8	08U-80P	G-5/8-14*	3.55	1.44	2.13	.36	1-1/4
5/8	5/8	10U-80P	G-5/8-14*	4.15	1.83	2.25	.49	1-3/16
3/4	3/4	12U-82P	G-3/4-14*	5.02	2.49	2.88	.58	1-1/4
1	1	16U-86P**	G-1-11*	4.95	3.09	2.75	.77	1-1/2
1-1/4	1-1/4	20U-90P**	G-1-1/4-11*	5.37	3.57	2.99	1.51	1-7/8

*G as part of thread size is ISO designation for parallel thread.

**Part number will crimp in C-O-C ET4000, T-410, T-420, and T-440 presses only.

Female FOR-SEAL Swivel Short Drop 90° Elbow

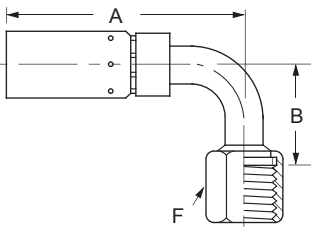

Hose I.D.	Tube Size	Part Number	Thread Size	A	B	Hose Cut-Off Factor	Hole Dia.	Hex F
1/4	1/4	04U-A24	9/16-18	3.00	.81	1.50	.16	11/16
1/4	3/8	04U-A26	11/16-16	3.13	.90	1.75	.16	13/16
3/8	1/4	06U-A24	9/16-18	3.00	.81	1.56	.16	11/16
3/8	3/8	06U-A26	11/16-16	3.13	.90	1.81	.26	13/16
3/8	1/2	06U-A28	13/16-16	3.33	1.15	1.88	.26	15/16
1/2	3/8	08U-A26	11/16-16	3.13	.90	1.75	.26	13/16
1/2	1/2	08U-A28	13/16-16	3.34	1.15	1.91	.36	15/16
1/2	5/8	08U-A30	1-14	3.46	1.27	2.03	.36	1-1/8
1/2	3/4	08U-A32	1-3/16-12	3.98	1.88	2.56	.36	1-3/8
5/8	5/8	10U-A30	1-14	3.92	1.27	2.00	.46	1-1/8
5/8	3/4	10U-A32	1-3/16-12	4.37	1.88	2.44	.46	1-3/8
3/4	5/8	12U-A30	1-14	4.26	1.27	2.13	.46	1-1/8
3/4	3/4	12U-A32	1-3/16-12	4.86	1.88	2.69	.59	1-3/8
3/4	1	12U-A36	1-7/16-12	5.14	2.21	2.98	.61	1-5/8
1	1	16U-A36	1-7/16-12	5.23	2.21	3.00	.76	1-5/8
1	1-1/4	16U-A40	1-11/16-12	5.06	2.59	2.86	.81	1-7/8
1-1/4	1-1/4	20U-A40	1-11/16-12	5.29	2.50	2.99	1.02	1-7/8
1-1/4	1-1/2	20U-A44	2-12	5.29	2.67	2.99	1.02	2-1/4

Female FOR-SEAL Swivel Medium Drop 90° Tube Elbow

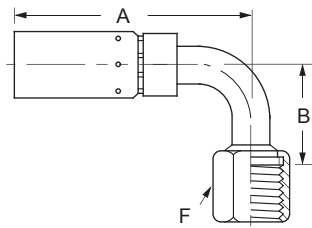

Hose I.D.	Tube Size	Part Number	Thread Size	A	B	Hose Cut-Off Factor	Hole Dia.	Hex F
1/4	1/4	04U-J34	9/16-18	3.07	1.26	1.59	.16	11/16
1/4	3/8	04U-J36	11/16-16	3.13	1.51	1.69	.16	13/16
1/4	1/2	04U-J38	13/16-16	3.37	1.62	1.88	.16	15/16
3/8	3/8	06U-J36	11/16-16	3.20	1.51	1.69	.24	13/16
3/8	1/2	06U-J38	13/16-16	3.36	1.62	1.93	.25	15/16
1/2	3/8	08U-J36	11/16-16	3.20	1.51	1.72	.24	13/16
1/2	1/2	08U-J38	13/16-16	3.37	1.62	1.94	.33	15/16
1/2	3/4	08U-J42	1-3/16-12	4.02	2.28	2.59	.36	1-3/8
5/8	5/8	10U-J40	1-14	4.29	1.85	2.13	.46	1-1/8
3/4	5/8	12U-J40	1-1/4	3.95	1.85	2.00	.46	1-1/8
3/4	3/4	12U-J42	1-3/16-12	4.83	2.28	2.69	.58	1-3/8
1	1	16U-J46	1-7/16-12	5.33	2.78	3.13	.76	1-5/8
1	1-1/4	16U-J50	1-11/16-12	5.11	3.22	3.04	.81	1-7/8
1-1/4	1-1/4	20U-J50	1-11/16-12	5.31	3.09	3.00	1.01	1-7/8

J

Hose Ends - Crimp

JIC 37° Female Swivel 90° Elbow

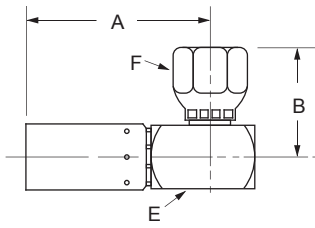

Hose I.D.	Tube Size	Part Number	Thread Size	A	B	Hose Cut-Off Factor	Hole Dia.	Sqaure E	Hex F
1/4	1/4	04U-554	7/16-20	2.43	1.06	.95	.16	11/16	9/16
3/8	3/8	06U-556	9/16-18	2.50	1.18	1.06	.25	11/16	11/16
1/2	1/2	08U-558	3/4-16	2.75	1.35	1.31	.36	3/4	7/8
1/2	5/8	08U-560	7/8-14	2.75	1.34	1.31	.36	3/4	1
3/4	5/8	12U-560	7/8-14	4.15	1.54	2.00	.61	1-1/8	1
3/4	3/4	12U-562	1-1/16-12	4.15	1.62	2.00	.61	1-1/8	1-1/4
3/4	7/8	12U-564	1-3/16-12	4.15	1.68	2.00	.61	1-1/8	1-3/8

Male Straight Thread O-Ring Swivel 90° Elbow

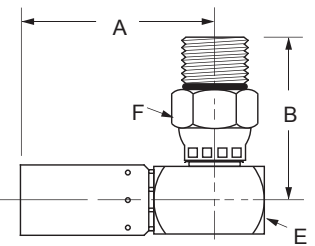

Hose I.D.	Tube Size	Part Number	Thread Size	A	B	Hose Cut-Off Factor	Hole Dia.	Sqaure E	Hex F
1/4	3/8	04U-R66	9/16-18	2.43	1.68	.94	.16	11/16	7/8
3/8	3/8	06U-R66	9/16-18	2.50	1.68	1.06	.25	11/16	7/8
3/8	1/2	06U-R68	3/4-16	2.50	1.64	1.06	.25	11/16	7/8
3/8	5/8	06U-R70	7/8-14	2.50	1.80	1.06	.25	11/16	1
1/2	1/2	08U-R68	3/4-16	2.75	1.64	1.31	.36	3/4	7/8
1/2	5/8	08U-R70	7/8-14	2.75	1.79	1.31	.36	3/4	1-1/8
1/2	3/4	08U-R72	1-1/16-12	2.75	1.89	1.31	.36	3/4	1-1/4
3/4	3/4	12U-R72	1-1/16-12	4.15	2.24	2.00	.61	1-1/8	1-7/16

(Includes o-ring. For replacement o-ring, see page L-64.)

Note: Swivel for installation purposes only. (Not for temperatures above 212°F.)

Female FOR-SEAL Swivel Long Drop 90° Tube Elbow

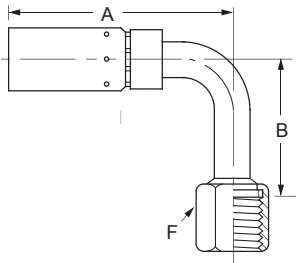

Hose I.D.	Tube Size (mm)	Part Number	Thread Size	A	B	Hose Cut-Off Factor	Hole Dia.	Hex F
1/4	1/4	04U-A64	9/16-18	3.14	1.80	1.63	.16	11/16
1/4	3/8	04U-A66	11/16-16	3.31	2.13	1.83	.16	13/16
3/8	3/8	06U-A66	11/16-16	3.34	2.13	1.91	.24	13/16
3/8	1/2	06U-A68	13/16-16	3.37	2.51	1.94	.25	15/16
1/2	1/2	08U-A68	13/16-16	3.28	2.51	1.85	.36	15/16
1/2	5/8	08U-A70	1-14	3.49	2.76	2.00	.36	1-1/8
5/8	5/8	10U-A70	1-14	3.95	2.76	2.06	.46	1-1/8
3/4	3/4	12U-A72	1-3/16-12	4.87	3.78	2.72	.59	1-3/8
1	1	16U-A76	1-7/16-12	5.34	4.50	3.13	.76	1-5/8
1-1/4	1-1/4	20U-A80	1-11/16-12	5.31	5.09	3.00	1.01	1-7/8
1-1/4	1-1/2	20U-A84	2-12	5.31	5.54	3.00	1.01	2-1/4

Split Flange 90° Tube Elbow (SAE Code 61)

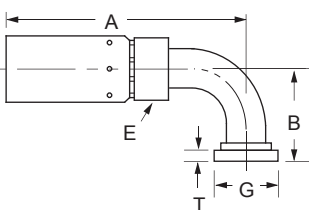

Hose I.D.	Tube Size	Part Number	Thread Size	A	B	Hose Cut-Off Factor	Hole Dia.	Sqaure E	Hex F
1/2	1/2	08U-G71	8x252	3.63	1.63	2.19	.41	1.19 (30mm)	.265
3/4	3/4	12U-G72	12x252	4.75	2.13	2.63	.58	1.50 (38mm)	.265
3/4	1	12U-G76	16x252	4.78	2.13	2.56	.58	1.75 (44mm)	.315
1	1	16U-G76	16x252	5.43	2.38	3.23	.77	1.75 (44mm)	.315
1	1-1/4	16U-G80	20x252	5.43	2.38	3.23	.77	2.00 (51mm)	.315
1-1/4	1-1/4	20U-G80	20x252	5.35	2.63	3.05	1.02	2.00 (51mm)	.315
1-1/4	1-1/2	20U-G84	24x252	5.37	2.63	3.05	1.02	2.38 (60mm)	.315

(For Split Flange Kits, see pages L-89 thru L-92.)

Coll-O-Crimp

430 'U' Series

To determine the correct length of hose, subtract the cut-off factor for each end fitting from the overall length of assembly.

Hose End 430 'U' Series

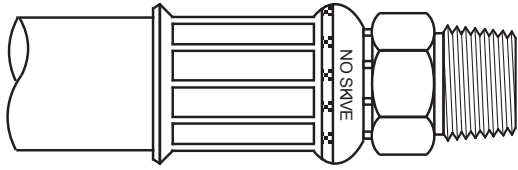

Note:

Refer to current price list for availability of cataloged items. Configurations and dimensions subject to change without notice.

Ordering Information: Order individually by part number. O-rings not supplied with split flange hose ends. Order o-rings by catalog number; reference individual hose end listings for details.

Refer to important safety information on pages A-2-3.

Application: Very high pressure hydraulic lines subjected to pressure surges and flexing. Some applications include mining, construction, farming, and high performance industrial equipment.

Compatible Hose: H039, H115, H145, H245, H425, H350, H430, H430R, H1812 (-24 only), H115 (-24 only),

H116 (-24 only), H6002 (-24 & -32 only), H6009, H1776 (-24 only), H9622, H6008

Pressure: Determined by maximum operating pressure for hose size and hose end configuration whichever is lesser. See pages A-15-16 for operating pressure ratings for hose end configurations.

Material: Low Carbon Steel

Plating: Zinc; Clear Trivalent Chromate

Advantages: Excellent selection of no-skive hose ends. Can be used with Caterpillar, John Deere, and many major manufacturers of heavy equipment.

Assemble With:

T-410-1, T-420-1, T-440-1, T-480, ET1000, ET4000, ET4001, ET4020 and ET4040

Label Set: FS-3100

Male Pipe (NPTF) Rigid

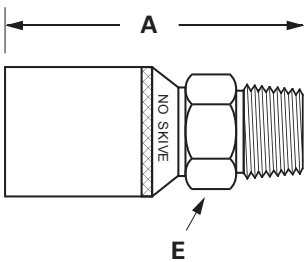

Hose I.D.	Pipe Size	Part Number	Thread Size	A	Hose Cut-Off Factor	Hole Dia.	Hex E
3/8	1/4	43006U-104	1/8-18	2.02	1.18	.26	11/16
3/8	3/8	43006U-106	3/8-18	2.11	1.28	.26	11/16
3/8	1/2	43006U-108	12-18	2.11	1.28	.26	7/8
1/2	1/2	43008U-108	1/2-14	3.56	1.69	.34	7/8
1/2	3/4	43008U-112	3/4-14	3.29	1.38	.34	1-1/16
5/8	1/2	43010U-108	1/2-18	2.61	1.58	.50	15/16
5/8	3/4	43010U-112	3/4-14	2.43	1.40	.50	1-1/16
3/4	3/4	43012U-112	3/4-14	3.68	1.69	.61	1-1/16
3/4	1	43012U-116	1-11-1/2	3.77	1.75	.61	1-3/8
1	3/4	43016U-112	3/4-14	3.86	1.81	.71	1-1/4
1	1	43016U-116	1-11-1/2	4.05	2.00	.81	1-3/8
1	1-1/4	43016U-120	1-1/4-11-1/2	4.08	2.06	.81	1-11/16
1-1/4	1-1/4	43020U-120	1-1/4-11-1/2	4.58	2.31	1.02	1-11/16
1-1/2	1-1/2	43024U-124	1-1/2-11-1/2	4.87	2.38	1.25	2
2	2	43032U-132	2-11-1/2	5.51	2.69	1.69	2-1/2

British Standard 60° Cone (BSPP) Male Pipe Rigid

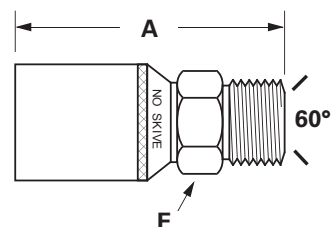

Hose I.D.	BSPP Pipe Size	Part Number	Thread Size	A	Hose Cut-Off Factor	Hole Dia.	Hex E
3/4	3/4	43012U-P62	G-3/4-14*	3.56	1.56	.61	1-1/8
1	1	43016U-P66	G-1-11*	3.73	1.69	.81	1-3/8
1-1/4	1-1/4	43020U-P67	G-1-1/4-11*	4.41	2.13	1.02	1-3/4

*G as part of thread size is ISO designation for parallel thread.

J Hose Ends - Crimp

FOR-SEAL Male Rigid

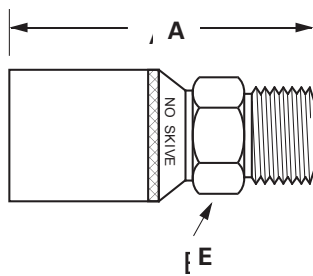

Hose I.D.	Tube Size	Part Number	Thread Size	A	Hose Cut-Off Factor	Hole Dia.	Hex E
3/8	3/8	43006U-E66	11/16-06	1.83	.99	.26	3/4
3/8	1/2	43006U-E68	13/16-16	1.79	.95	.26	7/8
1/2	1/2	43008U-E68	13/16-16	3.24	1.31	.34	7/8
3/4	3/4	43012U-E72	1-3/16-12	3.57	1.56	.61	1-1/4
1	1	43016U-E76	1-7/16-12	3.55	1.50	.81	1-1/2
1-1/4	1-1/4	43020U-E80	1-11/16-12	3.90	1.56	1.04	1-3/4

Does not include o-ring. For replacement o-ring, see page L-34.

Male Pipe Swivel

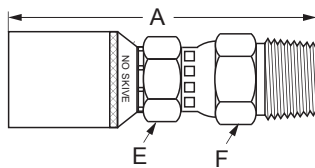

Hose I.D.	Tube Size	Part Number	Thread Size	A	Hose Cut-Off Factor	Hole Dia.	Hex E	Hex F
1	1	43016U-J16	1-11	5.02	3.00	.78	1-1/4	1-3/8

Note:

Swivel for installation purposes only. (Not for temperatures above 212°F.)

SAE 37° Male Rigid

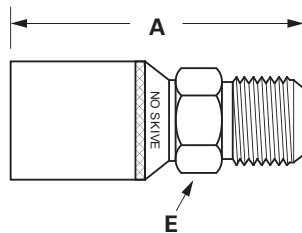

Hose I.D.	Tube Size	Part Number	Thread Size	A	Hose Cut-Off Factor	Hole Dia.	Hex E
3/8	3/8	43006U-506	9/16-18	2.00	1.17	.26	11/16
3/8	1/2	43006U-508	3/4-16	1.94	1.11	.26	13/16
1/2	1/2	43008U-508	3/4-16	3.50	1.63	.34	7/8
1/2	5/8	43008U-510	7/8-14	3.30	1.38	.34	1
5/8	5/8	43010U-510	7/8-14	2.60	1.57	.50	15/16
5/8	3/4	43010U-512	1-1/16-12	2.46	1.43	.50	1-1/8
3/4	3/4	43012U-512	1-1/16-12	3.74	1.75	.61	1-1/8
3/4	7/8	43012U-514	1-3/16-12	3.81	1.81	.61	1-1/4
3/4	1	43012U-516	1-5/16-12	4.02	2.06	.61	1-3/8
1	1	43016U-516	1-5/16-12	4.02	2	.81	1-3/8
1	1-1/4	43016U-520	1-5/8-12	3.84	1.81	.81	1-11/16
1-1/4	1-1/4	43020U-520	1-5/8-12	4.57	2.31	1.02	1-11/16
1-1/2	1-1/2	43024U-524	1-7/8-12	4.95	2.50	1.25	2
2	2	43032U-532	2-1/2-12	5.57	2.75	1.69	2-5/8

Male Straight Thread O-Ring Rigid

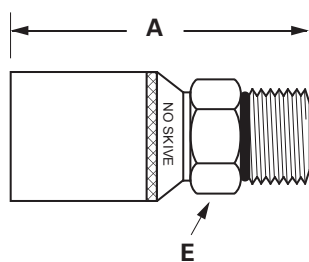

Hose I.D.	Tube Size	Part Number	Thread Size	A	Hose Cut-Off Factor	Hole Dia.	Hex E
3/8	3/8	43006U-P06	9/16-18	1.84	1.00	.26	11/16
3/8	1/2	43006U-P08	3/4-16	1.81	.98	.26	7/8
5/8	3/4	43010U-P12	1-1/16-12	2.26	1.23	.50	1-1/4
1	1	43016U-P16	1-5/16-12	3.45	1.44	.81	1-1/2

(Includes o-ring)

(Includes o-ring. For replacement o-ring, see page L-64.)

Coll-O-Crimp

430 'U' Series

To determine the correct length of hose, subtract the cut-off factor for each end fitting from the overall length of assembly.

^a Swivel nuts are universal — both SAE 37° and 45° connections.

JIC 37° Female Swivel

(Exceptions noted)

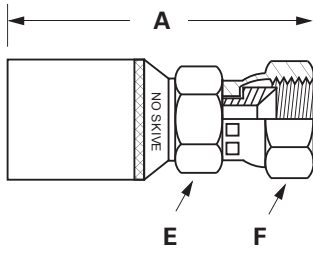

Hose I.D.	Tube Size	Part Number	Thread Size	A	Hose Cut-Off Factor	Hole Dia.	Hex E	Hex F
3/8	1/4	43006U-604	7/16-20	2.03	1.19	.17	11/16	9/16
3/8	3/8	43006U-606	9/16-18	2.12	1.28	.26	9/16	9/16
3/8	1/2	43006U-608	3/4-16	2.15	1.31	.26	11/16	7/8
1/2	3/8	43008U-606	9/16-18	3.56	1.69	.34	13/16	11/16
1/2	1/2	43008U-608 ^a	3/4-16	3.67	1.75	.34	13/16	7/8
1/2	5/8	43008U-610 ^a	7/8-14	3.72	1.81	.34	13/16	1
1/2	3/4	43008U-612	1-1/16-12	3.76	1.88	.34	1	1-1/4
5/8	5/8	43010U-610	7/8-14	2.64	1.61	.50	15/16	1
3/4	5/8	43012U-610	7/8-14	3.97	1.97	.61	1	1
5/8	3/4	43010U-612	1-1/16-12	2.59	1.57	.50	1	1-1/4
3/4	3/4	43012U-612	1-1/16-12	4.08	2.06	.61	1	1-1/4
3/4	7/8	43012U-614	1-3/16-12	3.90	1.88	.61	1-1/4	1-3/8
3/4	1	43012U-616	1-5/16-12	4.01	2.00	.61	1-1/4	1-1/2
1	3/4	43016U-612	1-1/16-12	4.19	2.19	.61	1-1/4	1-1/4
1	1	43016U-616	1-5/16-12	4.28	2.25	.81	1-1/4	1-1/2
1	1-1/4	43016U-620	1-5/8-12	4.12	2.06	.81	1-5/8	2
1-1/4	1-1/4	43020U-620	1-5/8-12	4.87	2.63	1.02	1-11/16	2
1-1/4	1-1/2	43020U-624	1-7/8-12	5.03	2.75	1.02	1-7/8	2-1/4
1-1/2	1-1/2	43024U-624	1-7/8-12	5.29	2.81	1.25	2	2-1/4
2	2	43032U-632	2-1/2-12	6.04	3.25	1.69	2-1/2	3

Female Swivel DIN Universal Seat

l. Rh. (Light) (DIN 3901/3902)

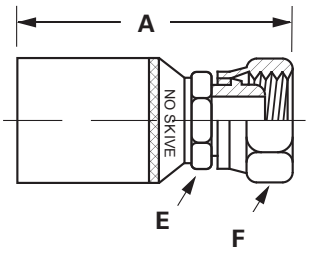

Hose I.D.	Tube Size (mm)	Part Number	Thread Size	A	Hose Cut-Off Factor	Hole Dia.	Hex E	Hex F
3/4	22	43012U-22C	M30x2.0	4.12	2.13	.61	1-1/8	1-7/16

Female Swivel DIN 24° Seat

s. Rh. DKO (Heavy)

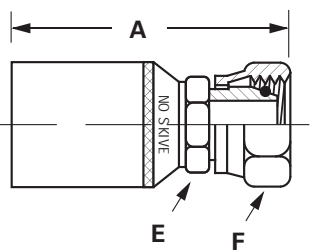

Hose I.D.	Tube Size (mm)	Part Number	Thread Size	A	Hose Cut-Off Factor	Hole Dia.	Hex E	Hex F
3/4	20	43012U-70C	M30x2.0	3.68	1.69	.61	1-1/8	1-7/16
3/4	25	43012U-75C	M36x2.0	4.14	2.13	.61	1-1/4	1-5/8
1	30	43016U-80C	M42x2.0	4.07	2.00	.81	1-5/8	2
1-1/4	30	43020U-80C	M42x2.0	4.32	2.00	1.02	1-5/8	2

(Includes o-ring)

Hose Ends - Crimp

Female Swivel 30° Flare Metric Thread

(Komatsu, Linkbelt, etc.)

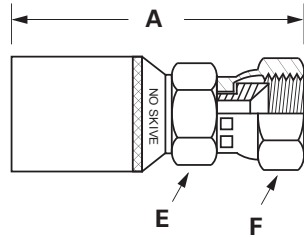

Hose I.D.	Part Number	Thread Size	A	Hose Cut-Off Factor	Hole Dia.	Hex E	Hex F
1/2	43008U-22K	M22x1.5	3.72	1.81	.34	7/8	1
3/4	43012U-30K	M30x1.5	3.96	1.94	.61	1-1/8	1-3/8
1	43016U-33K	M33x1.5	4.27	2.25	.81	1-1/4	1-1/2
1-1/4	43020U-36K	M36x1.5	5.19	2.88	.92	1-5/8	1-3/4

British Standard (BSPP) 60° Cone Female Pipe Swivel

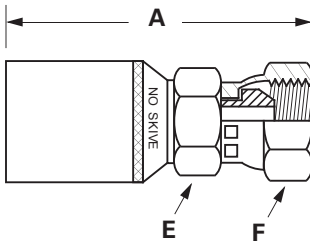

Hose I.D.	BSPP Pipe Size	Part Number	Thread Size	A	Hose Cut-Off Factor	Hole Dia.	Hex E	Hex F
1/2	1/2	43008U-358	G-1/2-14*	3.78	1.88	.34	7/8	1-1/16
3/4	3/4	43012U-362	G-3/4-14*	4.09	2.06	.61	1	1-1/4
1	1	43016U-366	G-1-11*	4.29	2.25	.81	1-1/4	1-1/2
1-1/4	1-1/4	43020U-370	G-1-1/4-11*	4.76	2.50	1.02	1-5/8	1-7/8

*G as part of thread size is ISO designation for parallel thread.

Female FOR-SEAL® Swivel Straight

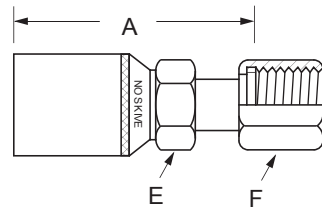

Hose I.D.	Tube Size	Part Number	Thread Size	A	Hose Cut-Off Factor	Hole Dia.	Hex E	Hex F
3/8	1/4	43006U-S64	9/16-18	1.98	1.15	.17	11/16	11/16
3/8	3/8	43006U-S66	11/16-16	2.07	1.24	.26	11/16	13/16
3/8	1/2	43006U-S68	13/16-16	2.16	1.32	.26	13/16	15/16
1/2	1/2	43008U-S68	13/16-16	3.30	1.42	.34	13/16	15/16
1/2	5/8	43008U-S70	1-14	3.40	1.52	.34	15/16	1-1/8
5/8	1/2	43010U-S68	13/16-16	2.54	1.51	.38	15/16	15/16
5/8	5/8	43010U-S70	1-14	2.63	1.61	.48	15/16	1-1/8
5/8	3/4	43010U-S72	1-3/16-12	2.66	1.63	.50	1-1/8	1-3/8
3/4	5/8	43012U-S70	1-14	4.06	2.06	.45	1	1-1/8
3/4	3/4	43012U-S72	1-3/16-12	3.85	2.09	.61	1-1/8	1-3/8
3/4	1	43012U-S76	1-7/16-12	4.15	2.13	.55	1	1-5/8
1	1	43016U-S76	1-7/16-12	4.68	2.69	.76	1-1/4	1-5/8
1	1-1/4	43016U-S80	1-11/16-12	4.33	2.31	.81	1-1/2	1-7/8
1-1/4	1-1/4	43020U-S80	1-11/16-12	4.51	2.25	1.02	1-5/8	1-7/8
1-1/2	1-1/2	43024U-S84	2-12	4.77	2.31	1.25	2	2-1/4

READY-LOK Male Connector

(For Deep Mining Markets)

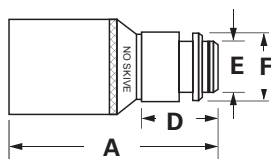

Hose I.D.	Connection Size	Part Number	A	Hose Cut-Off Factor	Hole Dia.	Length D	Dia. E	Dia. F
3/8	3/8	43006U-06S	2.14	1.30	.26	1.04	.55	.78
3/8	1/2	43006U-08S	2.14	1.30	.26	1.04	.71	.94
1/2	1/2	43008U-08S	3.31	1.43	.34	.94	.70	.94
3/4	3/4	43012U-12S	3.53	1.50	.61	1.14	.94	1.14
1	1	43016U-16S	3.76	1.75	.81	1.34	1.21	1.53
1-1/4	1-1/4	43020U-20S	4.01	1.75	1.02	1.34	1.49	1.80
1-1/2	1-1/2	43024U-24S	5.06	2.59	1.25	2.51	1.85	2.17

Hose Ends - Crimp

Coll-O-Crimp

430 'U' Series

To determine the correct length of hose, subtract the cut-off factor for each end fitting from the overall length of assembly.

Split Flange Straight (SAE Code 61)

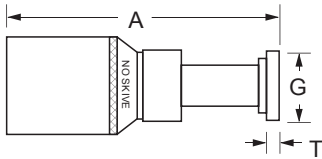

Hose I.D.	Nominal Flange Size	Part Number	Replacement O-Ring (Not Included)	A	Hose Cut-Off Factor	Hole Dia.	Dia. G	T Nominal
1/2	1/2	43008U-G08	8x252	4.18	2.25	.34	1.19 (30 mm)	.265
1/2	3/4	43008U-G12	12x252	4.24	2.31	.34	1.50 (38 mm)	.265
3/4	3/4	43012U-G12	12x252	4.16	2.13	.56	1.50 (38 mm)	.265
3/4	1	43012U-G16	16x252	4.16	2.13	.56	1.75 (44 mm)	.315
3/4	1-1/4	43012U-G20	20x252	4.16	2.13	.56	2.00 (51 mm)	.315
5/8	3/4	43010U-G12	12x252	3.13	2.10	.50	1.50 (38 mm)	.265
1	1	43016U-G16	16x252	4.40	2.38	.76	1.75 (44 mm)	.315
1	1-1/4	43016U-G20	20x252	4.40	2.38	.76	2.00 (51 mm)	.315
1	1-1/2	43016U-G24	24x252	4.46	2.44	.76	2.38 (60 mm)	.315
1-1/4	1-1/4	43020U-G20	20x252	5.01	2.75	1.02	2.00 (51 mm)	.315
1-1/4	1-1/2	43020U-G24	24x252	5.07	2.81	1.02	2.38 (60 mm)	.315
1-1/4	1-1/2	43020U-G24L64	24x252	9.60	7.31	1.01	2.38 (60 mm)	.315
1-1/4	2	43020U-G32	32x252	5.13	2.88	1.02	2.81 (71 mm)	.375
1-1/2	1-1/2	43024U-G24	24x252	5.63	3.13	1.25	2.38 (60 mm)	.315
1-1/2	2	43024U-G32	32x252	5.83	3.31	1.25	2.81 (71 mm)	.375
2	1-1/2	43032U-G24	24x252	6.23	3.38	1.56	2.38 (60 mm)	.315
2	2	43032U-G32	32x252	6.08	3.25	1.56	2.81 (71 mm)	.375

(For Split Flange Kits, see pages L-89 thru L-92.)

Split Flange Straight (SAE Code 62)

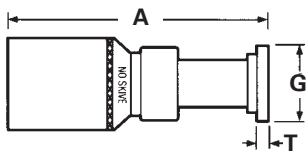

Hose I.D.	Nominal Flange Size	Part Number	Replacement O-Ring (Not Included)	A	Hose Cut-Off Factor	Hole Dia.	Dia. G	T Nominal
1/2	1/2	43008U-D08	8x252	4.25	2.38	.34	1.25 (32 mm)	.345
1/2	3/4	43008U-D12	12x252	4.27	2.38	.34	1.62 (41 mm)	.345
5/8	3/4	43010U-D12	12x252	3.13	2.11	.50	1.62 (41 mm)	.345
3/4	3/4	43012U-D12	12x252	4.19	2.19	.56	1.62 (41 mm)	.345
3/4	1	43012U-D16	16x252	4.22	2.19	.56	1.88 (48 mm)	.375
1	1	43016U-D16	16x252	4.46	2.44	.76	1.88 (48 mm)	.375
1	1-1/4	43016U-D20	20x252	4.49	2.44	.76	2.12 (54 mm)	.405
1-1/4	1-1/4	43020U-D20	20x252	5.10	2.81	1.02	2.12 (54 mm)	.405
1-1/4	1-1/2	43020U-D24	24x252	5.21	2.94	1.02	2.50 (64 mm)	.495
1-1/2	1-1/2	43024U-D24	24x252	5.63	3.13	1.25	2.50 (64 mm)	.495
2	2	43032U-D32	32x252	7.18	4.38	1.56	3.12 (79 mm)	.495

(For Split Flange Kits, see pages L-89 thru L-92.)

British Standard 60° Cone (BSPP) Female Swivel 45° Tube Elbow

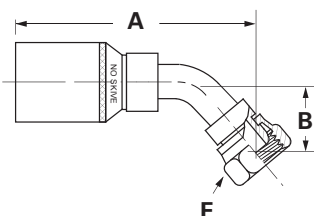

Hose I.D.	Tube Size	Part Number	Thread Size	A	B	Hose Cut-Off Factor	Hole Dia.	Hex F
3/4	3/4	43012U-52P	G-3/4-14*	5.33	1.24	3.31	.56	1-1/4
1	1	43016U-56P	G-1-11*	5.21	1.46	3.19	.76	1-1/2

*G as part of thread size is ISO designation for parallel thread.

Coll-O-Crimp

430 'U' Series

To determine the correct length of hose, subtract the cut-off factor for each end fitting from the overall length of assembly.

^a Swivel nuts are universal – both SAE 37° and 45° connections.

Split Flange 22-1/2° Tube Elbow

(SAE Code 61)

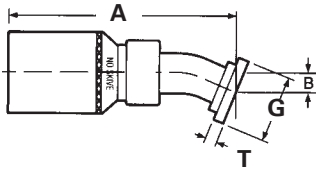

Hose I.D.	Nominal Flange Size	Part Number	Replacement O-Ring (Not Included)	A	B	Hose Cut-Off Factor	Hole Dia.	Dia. G	T Nominal
1/2	1/2	43008U-H01	8x252	4.45	.38	2.56	.34	1.19 (30mm)	.265
1/2	3/4	43008U-H02	12x252	4.50	.40	2.63	.34	1.50 (38mm)	.265
3/4	3/4	43012U-H02	12x252	4.81	.44	2.81	.56	1.50 (38mm)	.265
3/4	1	43012U-H03	16x252	4.81	.44	2.81	.56	1.75 (44mm)	.315
1	1	43016U-H03	16x252	5.09	.45	3.06	.76	1.75 (44mm)	.315
1	1-1/4	43016U-H04	20x252	6.15	.45	3.07	.76	2.00 (51mm)	.315
1-1/4	1-1/4	43020U-H04	20x252	5.21	.50	2.94	1.02	2.00 (51mm)	.315
1-1/4	1-1/2	43020U-H05	24x252	5.21	.50	2.94	1.02	2.38 (60mm)	.315
1-1/2	1-1/2	43024U-H05	24x252	6.16	.63	3.69	1.25	2.38 (60mm)	.315
1-1/2	2	43024U-H06	32x252	6.15	.63	3.69	1.25	2.81 (71mm)	.375
2	2	43032U-H06	32x252	7.67	.94	4.88	1.56	2.81 (71mm)	.375

(For Split Flange Kits, see pages L-89 thru L-92.)

JIC 37° Female Swivel 45° Tube Elbow

(Refer to Footnotes)

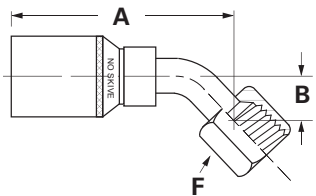

Hose I.D.	Tube Size	Part Number	Thread Size	A	B	Hose Cut-Off Factor	Hole Dia.	Hex F
3/8	3/8	43006U-686	9/16-18	2.82	.85	1.98	.24	11/16
3/8	1/2	43006U-688	3/4-16	2.98	.95	2.14	.26	7/8
1/2	1/2	43008U-688 ^a	3/4-16	4.08	.55	2.19	.34	7/8
1/2	5/8	43008U-690 ^a	7/8-14	4.28	.63	2.38	.34	1
3/4	3/4	43012U-692	1-1/16-12	4.70	.78	2.69	.56	1-1/4
1	1	43016U-696	1-5/16-12	5.67	1.53	3.84	.76	1-1/2
1-1/4	1-1/4	43020U-697	1-5/8-12	5.77	1.64	3.45	1.01	2

Split Flange 30° Tube Elbow

(SAE Code 61)

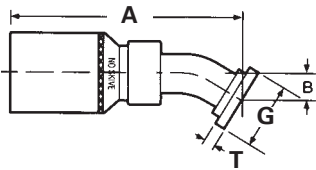

Hose I.D.	Nominal Flange Size	Part Number	Replacement O-Ring (Not Included)	A	B	Hose Cut-Off Factor	Hole Dia.	Dia. G	T Nominal
1/2	1/2	43008U-H21	8x252	4.40	.50	2.50	.34	1.19 (30mm)	.265
1/2	3/4	43008U-H22	12x252	4.45	.53	2.56	.34	1.50 (38mm)	.265
3/4	3/4	43012U-H22	12x252	4.75	.59	2.75	.56	1.50 (38mm)	.265
3/4	1	43012U-H23	16x252	4.75	.59	2.75	.56	1.75 (44mm)	.315
1	1	43016U-H23	16x252	5.09	.64	3.06	.76	1.75 (44mm)	.315
1	1-1/4	43016U-H24	20x252	5.01	.64	3.00	.76	2.00 (51mm)	.315
1-1/4	1-1/4	43020U-H24	20x252	5.33	.72	3.06	1.02	2.00 (51mm)	.315
1-1/4	1-1/2	43020U-H25	24x252	5.38	.75	3.13	1.02	2.38 (60mm)	.315
1-1/2	1-1/2	43024U-H25	24x252	6.33	.91	3.81	1.25	2.38 (60mm)	.315
1-1/2	2	43024U-H26	32x252	6.50	1.01	4.00	1.25	2.81 (71mm)	.375
2	2	43032U-H26	32x252	7.88	1.31	5.44	1.56	2.81 (71mm)	.375

(For Split Flange Kits, see pages L-89 thru L-92.)

Female FOR-SEAL Swivel 45° Tube Elbow

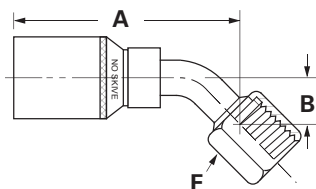

Hose I.D.	Tube Size	Part Number	Thread Size	A	B	Hose Cut-Off Factor	Hole Dia.	Hex F
3/8	3/8	43006U-L66	11/16-16	2.27	.43	1.43	.26	13/16
3/8	1/2	43006U-L68	13/16-16	2.58	.59	1.74	.26	15/16
1/2	1/2	43008U-L68	13/16-16	4.16	.59	2.25	.34	15/16
1/2	5/8	43008U-L70	1-14	4.48	.65	2.56	.34	1-1/8
5/8	5/8	43010U-L70	1-14	3.05	.65	2.02	.45	1-1/8
3/4	3/4	43012U-L72	1-3/16-12	4.80	.84	2.81	.56	1-3/8
1	1	43016U-L76	1-7/16-12	5.11	.95	3.06	.76	1-5/8
1-1/4	1-1/4	43020U-L80	1-11/16-12	5.07	1.05	2.85	1.01	1-7/8
1-1/2	1-1/2	43024U-L84	2-12	5.98	1.07	3.50	1.25	2-1/4

To determine the correct length of hose, subtract the cut-off factor for each end fitting from the overall length of assembly.

JIC 37° Female Swivel 60° Tube Elbow

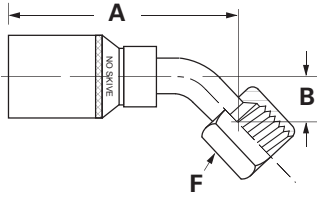

Hose I.D.	Tube Size	Part Number	Thread Size	A	B	Hose Cut-Off Factor	Hole Dia.	Hex F
1/2	5/8	43008U-C60	7/8-14	4.48	1.00	2.63	.34	1
3/4	3/4	43012U-C62	1-1/16-12	5.12	1.71	3.13	.56	1-1/4
1	1	43016U-C66	1-5/16-12	5.74	1.53	3.69	.76	1-1/2

Split Flange 45° Tube Elbow
(SAE Code 61)

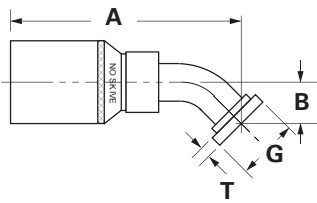

Hose I.D.	Nominal Flange Size	Part Number	Replacement O-Ring (Not Included)	A	B	Hose Cut-Off Factor	Hole Dia.	Dia. G	T Nominal
1/2	1/2	43008U-G41	8x252	4.51	.78	2.63	.34	1.19 (30 mm)	.265
1/2	3/4	43008U-G42	12x252	4.55	.82	2.63	.34	1.50 (38 mm)	.265
1/2	1	43008U-G46	16x252	4.86	.82	3.00	.34	1.75 (44 mm)	.315
5/8	3/4	43010U-G42	12x252	3.56	1.00	2.53	.50	1.50 (38 mm)	.265
3/4	3/4	43012U-G42	12x252	4.92	1.00	2.94	.56	1.50 (38 mm)	.265
3/4	1	43012U-G46	16x252	4.92	1.00	2.94	.56	1.75 (44 mm)	.315
1	1	43016U-G46	16x252	4.64	.89	2.62	.76	1.75 (44 mm)	.315
1	1-1/4	43016U-G50	20x252	4.82	1.06	2.81	.76	2.00 (51 mm)	.315
1-1/4	1-1/4	43020U-G50	20x252	5.22	1.09	2.90	1.01	2.00 (51 mm)	.315
1-1/4	1-1/2	43020U-G54	24x252	5.14	1.09	2.90	1.01	2.38 (60 mm)	.315
1-1/2	1-1/2	43024U-G54	24x252	6.39	1.41	3.93	1.25	2.38 (60 mm)	.315
1-1/2	2	43024U-G62	32x252	6.39	1.41	3.93	1.25	2.81 (71 mm)	.375
2	2	43032U-G62	32x252	8.04	2.00	5.23	1.56	2.81 (79 mm)	.375

(For Split Flange Kits, see pages L-89 thru L-92.)

Hose Ends - Crimp
Split Flange 45° Tube Elbow
(SAE Code 62)

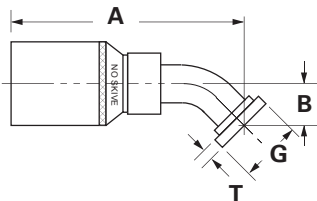

Hose I.D.	Nominal Flange Size	Part Number	Replacement O-Ring (Not Included)	A	B	Hose Cut-Off Factor	Hole Dia.	Dia. G	T Nominal
1/2	1/2	43008U-D41	8x252	4.82	.94	2.94	.34	1.25 (32 mm)	.345
1/2	3/4	43008U-D42	12x252	4.82	1.00	2.94	.34	1.62 (41 mm)	.345
3/4	3/4	43012U-D42	12x252	5.19	1.27	3.19	.56	1.62 (41 mm)	.345
3/4	1	43012U-D46	16x252	5.21	1.29	3.19	.56	1.88 (48 mm)	.375
1	1	43016U-D46	16x252	5.57	1.34	3.56	.76	1.88 (48 mm)	.375
1	1-1/4	43016U-D50	20x252	5.56	1.44	3.50	.76	2.12 (54 mm)	.405
1-1/4	1-1/4	43020U-D50	20x252	6.60	1.68	4.31	1.01	2.12 (54 mm)	.405
1-1/4	1-1/2	43020U-D54	24x252	6.67	1.75	4.38	1.01	2.50 (64 mm)	.495
1-1/2	1-1/2	43024U-D54	24x252	7.25	1.86	4.75	1.25	2.50 (64 mm)	.495
2	2	43032U-D62	32x252	8.74	2.25	5.94	1.56	3.12 (79 mm)	.495

(For Split Flange Kits, see pages L-89 thru L-92.)

Split Flange 60° Tube Elbow (SAE Code 61)

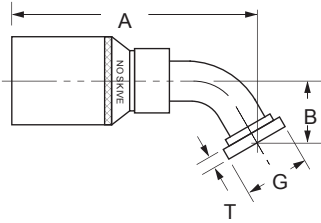

Hose I.D.	Nominal Flange Size	Part Number	Replacement O-Ring (Not Included)	A	B	Hose Cut-Off Factor	Hole Dia.	Dia. G	T Nominal
1/2	1/2	43008U-H51	8x252	4.59	1.05	2.69	.34	1.19 (30 mm)	.265
1/2	3/4	43008U-H52	12x252	4.62	1.10	2.75	.34	1.50 (38 mm)	.265
3/4	3/4	43012U-H52	12x252	4.98	1.38	2.94	.56	1.50 (38 mm)	.265
3/4	1	43012U-H53	16x252	4.98	1.38	2.94	.56	1.75 (44 mm)	.315
1	1	43016U-H53	16x252	5.47	1.51	3.44	.76	1.75 (44 mm)	.315
1	1-1/4	43016U-H54	20x252	5.58	1.51	3.56	.76	2.00 (51 mm)	.315
1-1/4	1-1/4	43020U-H54	20x252	5.57	1.69	3.31	1.01	2.00 (51 mm)	.315
1-1/4	1-1/2	43020U-H55	24x252	5.57	1.66	3.30	1.01	2.38 (60 mm)	.315
1-1/2	1-1/2	43024U-H55	24x252	6.51	2.08	4.00	1.25	2.38 (60 mm)	.315
1-1/2	2	43024U-H56	32x252	6.61	2.25	4.13	1.25	2.81 (71 mm)	.375
2	2	43032U-H56	32x252	8.19	2.87	5.38	1.56	2.81 (71 mm)	.375

(For Split Flange Kits, see pages L-89 thru L-92.)

Split Flange 67-1/2° Tube Elbow (SAE Code 61)

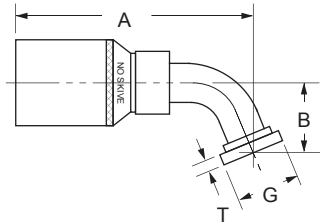

Hose I.D.	Nominal Flange Size	Part Number	Replacement O-Ring (Not Included)	A	B	Hose Cut-Off Factor	Hole Dia.	Dia. G	T Nominal
1/2	1/2	43008U-H61	8x252	4.40	1.25	2.50	.34	1.19 (30 mm)	.265
1/2	3/4	43008U-H62	12x252	4.46	1.25	2.56	.34	1.50 (38 mm)	.265
1/2	1	43008U-H63	16x252	4.69	1.25	2.81	.34	1.75 (44 mm)	.315
3/4	3/4	43012U-H62	12x252	4.99	1.59	3.00	.56	1.50 (38 mm)	.265
3/4	1	43012U-H63	16x252	4.99	1.59	3.00	.56	1.75 (44 mm)	.315
3/4	1-1/4	43012U-H64	20x252	4.99	1.59	3.00	.56	2.00 (51 mm)	.315
1	1	43016U-H63	16x252	5.25	1.76	3.19	.76	1.75 (44 mm)	.315
1	1-1/4	43016U-H64	20x252	5.25	1.76	3.19	.76	2.00 (51 mm)	.315
1-1/4	1-1/4	43020U-H64	20x252	5.55	1.94	3.25	1.01	2.00 (51 mm)	.315
1-1/4	1-1/2	43020U-H65	24x252	5.57	2.00	3.30	1.01	2.38 (60 mm)	.315
1-1/2	1-1/2	43024U-H65	24x252	6.53	2.37	4.07	1.25	2.38 (60 mm)	.315
1-1/2	2	43024U-H66	32x252	6.53	2.37	4.07	1.25	2.81 (71 mm)	.375
2	2	43032U-H66	32x252	8.39	3.40	5.56	1.56	2.81 (71 mm)	.375

(For Split Flange Kits, see pages L-89 thru L-92.)

British Standard (BSPP) 60° Cone Female Pipe Swivel 90° Elbow

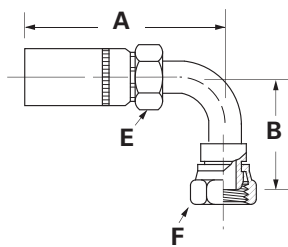

Hose I.D.	BSPP Size	Part Number	Thread Size	A	B	Hose Cut-Off Factor	Hole Dia.	Hex E	Hex F
3/4	3/4	43012U-82P	G-3/4-14*	4.58	2.46	2.97	.56	1-1/8	1-1/4
1	1	43016U-86P	G-1-11*	4.77	3.09	2.75	.76	1-1/4	1-1/2

*G as part of thread size is ISO designation for parallel thread.

Coll-O-Crimp

430 'U' Series

To determine the correct length of hose, subtract the cut-off factor for each end fitting from the overall length of assembly.

Swivel nuts are universal — both SAE 37° and 45° connections.

JIC 37° Female Swivel 90° Tube Elbow

(Refer to Footnotes)

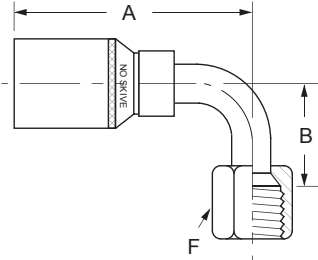

Hose I.D.	Tube Size	Part Number	Thread Size	A	B	Hose Cut-Off Factor	Hole Dia.	Hex F
3/8	3/8	43006U-666	9/16-18	2.26	1.50	1.42	.24	11/16
3/8	3/8	43006U-646	9/16-18	2.26	2.73	1.42	.24	11/16
3/8	1/2	43006U-668	3/4-16	2.55	1.87	1.71	.26	7/8
1/2	1/2	43008U-648L36 ^a	3/4-16	4.04	3.60	2.13	.34	7/8
1/2	1/2	43008U-648L45 ^a	3/4-16	4.04	4.50	2.13	.34	7/8
1/2	1/2	43008U-668 ^a	3/4-16	3.85	1.09	1.94	.34	7/8
1/2	5/8	43008U-650 ^a	7/8-14	4.14	2.57	2.25	.34	1
1/2	5/8	43008U-670 ^a	7/8-14	4.11	1.23	2.19	.34	1
5/8	5/8	43010U-670	7/8-14	2.94	1.52	1.91	.45	1
5/8	3/4	43010U-672	1-1/16-12	3.20	2.35	2.18	.50	1-1/4
3/4	3/4	43012U-652	1-1/16-12	4.65	3.62	2.63	.56	1-1/4
3/4	3/4	43012U-672	1-1/16-12	4.65	2.50	2.63	.56	1-1/4
1	1	43016U-656L33	1-5/16-12	5.00	3.37	3.00	.76	1-1/2
1	1	43016U-656L56	1-5/16-12	5.00	5.62	3.00	.76	1-1/2
1	1	43016U-676	1-5/16-12	5.27	3.00	3.25	.76	1-1/2
1	1	43016U-676L22	1-5/16-12	4.83	2.22	2.81	.76	1-1/2
1-1/4	1-1/4	43020U-677 ⁺	1-5/8-12	5.21	3.34	2.99	1.01	2
1-1/2	1-1/2	43024U-678 ⁺	1-7/8-12	6.11	3.95	3.62	1.19	2-1/4

+ Crimp style swivel nut.

Female FOR-SEAL® Swivel 90° Short Drop Tube Elbow

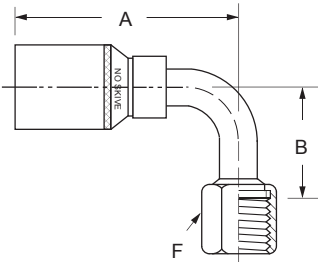

Hose I.D.	Tube Size	Part Number	Thread Size	A	B	Hose Cut-Off Factor	Hole Dia.	Hex F
3/8	3/8	43006U-A26	11/16-16	2.18	.90	1.34	.26	13/16
3/8	1/2	43006U-A28	13/16-16	2.46	1.15	1.62	.26	15/16
1/2	1/2	43008U-A28	13/16-16	3.90	1.15	2.00	.34	15/16
1/2	5/8	43008U-A30	1-14	4.21	1.27	2.31	.34	1-1/8
5/8	5/8	43010U-A30	1-14	2.94	1.27	1.91	.45	1-1/8
5/8	3/4	43010U-A32	1-3/16-12	3.31	1.88	2.29	.50	1-3/8
3/4	5/8	43012U-A30	1-14	4.24	1.27	2.25	.46	1-1/8
3/4	3/4	43012U-A32	1-3/16-12	4.78	1.88	2.75	.56	1-3/8
1	1	43016U-A36	1-7/16-12	4.95	2.21	2.93	.76	1-5/8
1-1/4	1-1/4	43020U-A40	1-11/16-12	5.26	2.51	3.00	1.02	1-7/8
1-1/4	1-1/2	43020U-A44	2-12	5.26	2.55	3.00	1.01	2-1/4
1-1/2	1-1/2	43024U-A44	2-12	6.11	2.70	3.63	1.25	2-1/4

Female FOR-SEAL® Swivel Long Drop 90° Tube Elbow

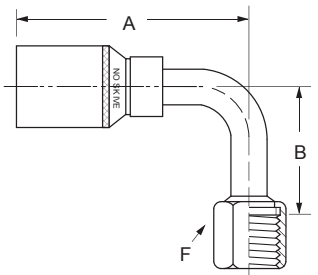

Hose I.D.	Tube Size	Part Number	Thread Size	A	B	Hose Cut-Off Factor	Hole Dia.	Hex F
3/8	3/8	43006U-A66	11/16-16	2.18	2.13	1.34	.26	13/16
3/8	1/2	43006U-A68	13/16-16	2.55	2.50	1.71	.26	15/16
1/2	1/2	43008U-A68	13/16-16	4.32	2.51	2.44	.34	15/16
1/2	5/8	43008U-A70	1-14	4.61	2.76	2.75	.34	1-1/8
3/4	3/4	43012U-A72	1-3/16-12	4.73	3.78	2.75	.56	1-3/8
1	1	43016U-A76	1-7/16-12	5.16	4.50	3.13	.76	1-5/8
1-1/4	1-1/4	43020U-A80	1-11/16-12	5.26	5.09	3.00	1.01	1-7/8
1-1/4	1-1/2	43020U-A84	2-12	5.26	5.54	3.00	1.01	2-1/4
1-1/2	1-1/2	43024U-A84	2-12	6.11	5.54	3.63	1.25	2-1/4

Hose Ends - Crimp

To determine the correct length of hose, subtract the cut-off factor for each end fitting from the overall length of assembly.

Split Flange 90° Tube Elbow (SAE Code 61)

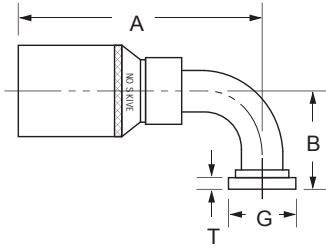

Hose I.D.	Nominal Flange Size	Part Number	Replacement O-Ring (Not Included)	A	B	Hose Cut-Off Factor	Hole Dia.	Dia. G	T Nominal
1/2	1/2	43008U-G71	8x252	4.18	1.63	2.25	.34	1.19 (30 mm)	.265
1/2	1/2	43008U-G71L32	8x252	4.04	3.20	2.13	.34	1.19 (30 mm)	.265
1/2	3/4	43008U-G72	12x252	4.53	1.68	2.63	.34	1.50 (38 mm)	.265
1/2	1	43008U-G76	16x252	4.63	1.68	2.75	.34	1.75 (44 mm)	.315
5/8	3/4	43010U-G72	12x252	3.31	2.13	2.29	.50	1.50 (38 mm)	.265
3/4	3/4	43012U-G72	12x252	4.65	2.12	2.63	.56	1.50 (38 mm)	.265
3/4	3/4	43012U-G72L37	12x252	4.65	3.75	2.63	.56	1.50 (38 mm)	.265
3/4	3/4	43012U-G72L50	12x252	4.74	5.00	2.75	.56	1.50 (38 mm)	.265
3/4	1	43012U-G76	16x252	4.65	2.12	2.63	.56	1.75 (44 mm)	.315
3/4	1	43012U-G76L31	16x252	4.65	3.12	2.63	.56	1.75 (44 mm)	.315
3/4	1-1/4	43012U-G80	20x252	5.65	2.12	3.63	.56	2.00 (51 mm)	.315
1	1	43016U-G76	16x252	5.25	2.38	3.23	.76	1.75 (44 mm)	.315
1	1	43016U-G76L21	16x252	5.06	2.12	3.06	.76	1.75 (44 mm)	.315
1	1	43016U-G76L46	16x252	5.15	4.62	3.13	.76	1.75 (44 mm)	.315
1	1-1/4	43016U-G80	20x252	5.21	2.38	2.94	.76	2.00 (51 mm)	.315
1	1-1/4	43016U-G80L46	20x252	5.12	4.62	3.13	.76	2.00 (51 mm)	.315
1	1-1/2	43016U-G84	24x252	5.15	2.44	3.13	.76	2.38 (60 mm)	.315
1-1/4	1-1/4	43020U-G80	20x252	5.32	2.63	3.05	1.01	2.00 (51 mm)	.315
1-1/4	1-1/4	43020U-G80L31	20x252	5.32	3.00	3.05	1.02	2.00 (51 mm)	.315
1-1/4	1-1/4	43020U-G80L40	20x252	5.26	4.00	3.00	1.02	2.00 (51 mm)	.315
1-1/4	1-1/4	43020U-G80L51	20x252	5.32	5.13	3.05	1.02	2.00 (51 mm)	.315
1-1/4	1-1/4	43020U-G80L66	20x252	5.26	6.62	3.00	1.02	2.00 (51 mm)	.315
1-1/4	1-1/2	43020U-G84	24x252	5.37	2.63	3.05	1.01	2.38 (60 mm)	.315
1-1/4	1-1/2	43020U-G84L46	24x252	5.26	4.68	3.00	1.02	2.38 (60 mm)	.315
1-1/2	1-1/2	43024U-G84	24x252	6.03	3.12	3.73	1.25	2.38 (60 mm)	.315
1-1/2	1-1/2	43024U-G84L58	24x252	6.11	5.80	3.63	1.21	2.38 (60 mm)	.315
1-1/2	1-1/2	43024U-G84L67	24x252	6.11	6.70	3.63	1.21	2.38 (60 mm)	.315
1-1/2	2	43024U-G92	32x252	6.11	3.13	3.65	1.25	2.81 (71 mm)	.375
1-1/2	2	43024U-G92L45	32x252	6.11	4.50	3.63	1.21	2.81 (71 mm)	.375
1-1/2	2	43024U-G92L67	32x252	6.11	6.70	3.63	1.21	2.81 (71 mm)	.375
2	1-1/2	43032U-G84	24x252	6.63	3.12	3.81	1.19	2.38 (60 mm)	.315
2	2	43032U-G92	32x252	7.83	4.50	4.91	1.56	2.81 (71 mm)	.375
2	2	43032U-G92L65	32x252	7.95	6.50	5.13	1.56	2.81 (71 mm)	.375
2	2	43032U-G92L80	32x252	7.98	8.00	5.14	1.56	2.81 (71 mm)	.375

(For Split Flange Kits, see pages L-89 thru L-92.)

Split Flange 90° Tube Elbow (SAE Code 62)

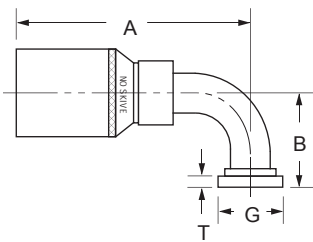

Hose I.D.	Nominal Flange Size	Part Number	Replacement O-Ring (Not Included)	A	B	Hose Cut-Off Factor	Hole Dia.	Dia. G	T Nominal
1/2	1/2	43008U-D71	8x252	4.49	1.72	2.56	.34	1.25 (32 mm)	.345
1/2	3/4	43008U-D72	12x252	4.53	1.90	2.63	.34	1.62 (41 mm)	.345
3/4	3/4	43012U-D72	12x252	4.84	2.41	2.81	.56	1.62 (41 mm)	.345
3/4	1	43012U-D76	16x252	4.84	2.70	2.81	.56	1.88 (48 mm)	.375
1	1	43016U-D76	16x252	5.42	2.75	3.38	.76	1.88 (48 mm)	.375
1	1-1/4	43016U-D80	20x252	5.31	2.90	3.25	.76	2.12 (54 mm)	.405
1-1/4	1-1/4	43020U-D80	20x252	5.79	3.24	3.50	1.01	2.12 (54 mm)	.405
1-1/4	1-1/2	43020U-D84	24x252	5.79	3.35	3.50	1.01	2.50 (64 mm)	.405
1-1/2	1-1/2	43024U-D84	24x252	6.11	3.70	3.63	1.25	2.50 (64 mm)	.495
1-1/2	2	43024U-D92	32x252	6.11	4.26	3.63	1.25	3.12 (79 mm)	.495
2	2	43032U-D92	32x252	7.81	4.84	5.00	1.56	3.12 (79 mm)	.495

(For Split Flange Kits, see pages L-89 thru L-92.)



Hose Ends - Crimp

To determine the correct length of hose, subtract the cut-off factor for each end fitting from the overall length of assembly.

Split Flange 100° Tube Elbow (SAE Code 61)

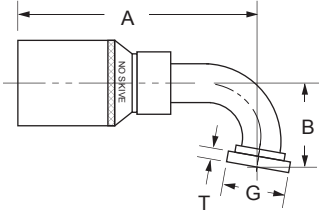

Hose I.D.	Nominal Flange Size	Part Number	Replacement O-Ring (Not Included)	A	B	Hose Cut-Off Factor	Hole Dia.	Dia. G	T Nominal
3/4	3/4	43012U-H72	12x252	4.78	2.33	2.81	.61	1.50 (38 mm)	.265
3/4	1	43012U-H73	16x252	4.94	2.33	2.81	.61	1.75 (44 mm)	.315

(For Split Flange Kits, see pages L-89 thru L-92.)

Split Flange 110° Tube Elbow (SAE Code 61)

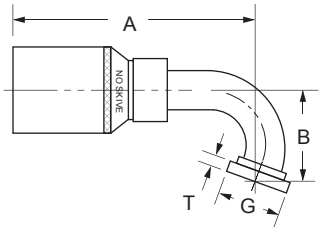

Hose I.D.	Nominal Flange Size	Part Number	Replacement O-Ring (Not Included)	A	B	Hose Cut-Off Factor	Hole Dia.	Dia. G	T Nominal
1	1	43016U-H83	16x252	4.48	2.84	2.46	.76	1.75 (44 mm)	.315
1-1/4	1-1/4	43020U-H84	20x252	4.82	3.12	2.56	1.01	2.00 (51 mm)	.315
1-1/4	1-1/2	43020U-H85	24x252	5.24	3.17	2.94	1.01	2.38 (60 mm)	.315
1-1/2	1-1/2	43024U-H85	24x252	5.49	3.69	3.00	1.25	2.38 (60 mm)	.315
2	2	43032U-H86	32x252	7.26	5.65	4.44	1.56	2.81 (71 mm)	.375

(For Split Flange Kits, see pages L-89 thru L-92.)

Split Flange 135° Tube Elbow (SAE Code 61)

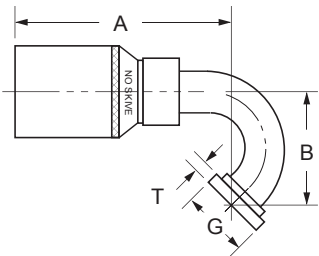

Hose I.D.	Nominal Flange Size	Part Number	Replacement O-Ring (Not Included)	A	B	Hose Cut-Off Factor	Hole Dia.	Dia. G	T Nominal
1/2	1/2	43008U-H91	8x252	4.06	2.12	2.19	.34	1.19 (30 mm)	.265
3/4	3/4	43012U-H92	12x252	4.04	3.00	2.06	.61	1.50 (38 mm)	.265

(For Split Flange Kits, see pages L-89 thru L-92.)

WeatherGRIP™ Z-Series Hose Ends

General Information

The next generation technology of Eaton's WeatherGRIP™ hose ends are compatible with the most Weatherhead standard and newer generation hose styles combining best-in-class technologies to meet and exceed the highest globally recognized standards for 1 and 2 wire braid hydraulic hose assemblies.

Now, with the addition of 168 new hose ends, the total array of over 550 WeatherGRIP hose ends meets virtually all customer needs for domestic and non-North American thread styles and configurations. The resulting hose assemblies provide superior performance in the demanding applications often encountered within mobile and industrial equipment.

Easy Assembly

WeatherGRIP® hose ends are assembled with Weatherhead hose using existing Coll-O-Crimp® machines.

The hose ends have a scribe line around the circumference of the socket to easily identify the location where the Coll-O-Crimp collets are positioned for crimping.



Bite-the-Wire Type Technology

WeatherGrip hose ends feature advanced "Bite-the-Wire" technology:

- Advanced "Bite-the-Wire" design provides higher operating and burst pressure
- Eliminates cool down leakage
- Flat crimp for easier routing
- Compatible with multiple hose styles to accommodate most application needs

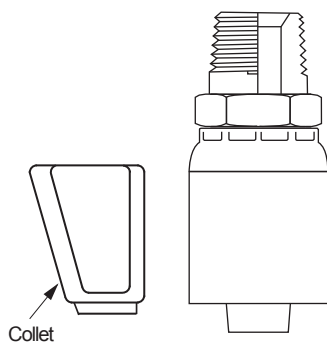

Ordering Information:

Order individually by catalog number. O-rings not supplied with flange hose ends. Order O-rings by catalog number; reference individual listings for details. For split flange kits and O-ring part numbers, refer to pages L89-92.

Note:

Refer to current price list for availability of cataloged items. Configurations and dimensions subject to change without notice.

Typical Application:

General purpose low, medium, and high pressure hydraulic.

Pressure: Determined by maximum working pressure for hose size and hose end configuration whichever is less. For working pressure ratings for hose end configurations, refer to pages A-15-16.

Material: Low Carbon Steel
Plating: Trivalent Zinc Plated

Advantages:

Wide selection of hose and end configurations allowing a diverse number of applications.

Assemble With:

T-400-1, T-410-1, T-420-1, T-440, T-460, T-462, T-465, T-480, ET1000, ET4000, ET4001, ET4020 and ET4040.

Label Set: FF90645

Compatible Hose Styles:

H104
H145
H145R
H190
H190H
H245
H245L
H280
H290
H290H
H290L
H345

H350
H400
H421
H425
H1777 (-04, -06, 08)
H1776 (-04 thru -20)
H1571 (-12 only)
H6002 (-08, -12, -16)
H6008 (-16 & -20)
H6009 (-20 only)
H9622 (-12, -16, -20)
H265 (-04, -06, -08, -12, -16)

H275 (-04 thru -16)
H1812 (-04 thru -20)
H0106 (-04 thru -10)
H0105 (-06 thru -12, -20)
H116 (-04, -06, -08)
H115 (-04 thru -20)
H1982 (-06 thru -16)
H1981 (-04, -06, -08)
H9949

Z Series Part Description	Part Number Example	Page Number
General Information		J-69
Male Pipe Rigid	08Z-108	J-71
Male Pipe Swivel	08Z-J08	J-71
Female Pipe Rigid	08Z-208	J-72
Female Pipe Swivel	08Z-258	J-72
Female Straight Pipe Swivel (NPSM)	08Z-058	J-72
Male Pipe Swivel 90° Elbow	08Z-M08	J-73
JIC/37° Female Swivel	08Z-608	J-73
JIC/37° Female Swivel 30° Tube Elbow	10Z-L22	J-74
JIC/37° Female Swivel 45° Tube Elbow	08Z-688	J-74
JIC/37° Female Swivel 90° Tube Elbow	08Z-668	J-75
JIC/37° Female Swivel 90° Long Drop Tube Elbow	08Z-648	J-75
JIC/37° Male Rigid	08Z-508	J-76
SAE 45° Female Swivel	08Z-408	J-76
SAE 45° Female Swivel 45° Tube Elbow	06Z-486	J-76
SAE 45° Female Swivel Long Drop 90° Tube Elbow	06Z-446	J-77
SAE 45° Flare Male Rigid	06Z-306	J-77
Female FOR-SEAL® Swivel	08Z-S68	J-77
Female FOR-SEAL® Swivel 45° Tube Elbow	08Z-L68	J-78
Female FOR-SEAL® Swivel Short Drop 90° Tube Elbow	08Z-A28	J-78
Female FOR-SEAL® Swivel Medium Drop 90° Tube Elbow	08Z-J38	J-79
Female FOR-SEAL® Swivel Long Drop 90° Tube Elbow	08Z-A68	J-79
FOR-SEAL® Male Rigid	08Z-E68	J-80
Male Straight Thread O-ring Rigid	08Z-P08	J-80
Male Straight Thread O-ring Swivel	08Z-R08	J-81
Male Straight Thread O-ring Swivel 90° Elbow	08Z-R68	J-81
Flareless Tube Rigid Ermeto 7000 Series	08Z-758	J-81
Flareless 45° Tube Elbow 7000 Ermeto Series	06Z-956	J-82
Flareless 90° Tube Elbow 7000 Ermeto Series	06Z-976	J-82
Inverted Male Swivel Straight	08Z-B08	J-82
Inverted Male Swivel 45° Tube Elbow	08Z-B48	J-83
Inverted Male Swivel 90° Tube Elbow	08Z-B68	J-83
Split Flange Straight (SAE Code 61)	12Z-G12	J-83
Split Flange 22.5° Tube Elbow (SAE Code 61)	16Z-H03	J-84
Split Flange 45° Tube Elbow (SAE Code 61)	12Z-G42	J-84
Split Flange 60° Tube Elbow (SAE Code 61)	16Z-H53	J-85
Split Flange 90° Tube Elbow (SAE Code 61)	12Z-G72	J-85
Metric Split Flange Straight (Komatsu, Linkbelt, etc.)	10Z-G09	J-86
Metric Split Flange 45° Tube Elbow (Komatsu, Linkbelt, etc.)	10Z-G69	J-86
Metric Split Flange 90° Tube Elbow (Komatsu, Linkbelt, etc.)	10Z-G99	J-86
READY-LOK® Male Connector	08Z-085	J-87
Standpipe Straight Tube	08Z-T08	J-87
Metric Standpipe Straight Tube	08Z-45T	J-87
Pressure Washer Connection	06Z-6PW	J-88
BSPP Flat Face Female Swivel	08Z-08PA	J-88
British Standard (BSPP) 60° Cone Female Swivel Straight	08Z-358	J-88
British Standard (BSPP) 60° Cone Female 45° Tube Elbow	08Z-48P	J-89
British Standard (BSPP) 60° Cone Female 90° Tube Elbow	08Z-78P	J-89
British Standard (BSPT) Tapered Male Rigid	08Z-158	J-89
British Standard (BSPP) 60° Cone Male Rigid	08Z-P58	J-90
Female JIS 30° Flare Swivel Straight	08Z-08L	J-90
Female Swivel 30° Flare (Komatsu, Linkbelt)	08Z-22K	J-90
Female Swivel DIN 24° Seat I.Rh DKO (Light)	08Z-15C	J-91
Female Swivel DIN Universal Seat 45° Tube Elbow (Light)	08Z-15D	J-91
Female Swivel DIN Universal Seat 90° Tube Elbow (Light)	08Z-65D	J-91
Male DIN 24° Seat I.Rh (Light)	08Z-15A	J-92
Female Swivel DIN 24° Seat s.Rh DKO (Heavy)	08Z-64C	J-92
Female Swivel DIN 24° Seat 45° Tube Elbow s.Rh (Heavy)	08Z-16E	J-92
Female Swivel DIN 24° Seat 90° Tube Elbow s.Rh DKO (Heavy)	08Z-66E	J-93
Male DIN 24° Seat s.Rh (Heavy)	08Z-16F	J-93
STC Male Straight	08Z-BC08	J-94
STC Male 45° Tube Elbow	08Z-BC48	J-94
STC Male 90° Tube Elbow	08Z-BC68	J-94
STC Male 90° Long Drop Tube Elbow	08Z-BC88	J-94

Male Pipe Rigid

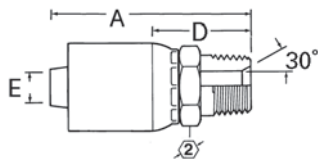

Note: 20ZA fittings should only be used with one wire braided hose. 20Z fittings should only be used with two wire braided hose.

* Stainless Steel

Z-Series Part #	Thd.	Hose Size	A		Hose Cut-Off Factor (D)		EØ		②
			mm	in	mm	in	mm	in	
04Z-102	1/8-27	-04	46,7	1.84	23,4	0.92	4,3	0.17	9/16
04Z-104	1/4-18	-04	52,3	2.06	29,0	1.14	4,3	0.17	9/16
04ZR-104*	1/4-18	-04	52,3	2.06	29,0	1.14	4,3	0.17	9/16
04Z-106	3/8-18	-04	48,3	1.90	24,9	0.98	4,3	0.17	11/16
04Z-108	1/2-14	-04	51,3	2.02	31,2	1.23	4,3	0.17	7/8
06Z-104	1/4-18	-06	55,4	2.18	30,0	1.18	6,6	0.26	11/16
06Z-106	3/8-18	-06	57,7	2.27	32,5	1.28	6,6	0.26	11/16
06ZR-106*	3/8-18	-06	57,7	2.27	32,5	1.28	6,6	0.26	11/16
06Z-108	1/2-14	-06	57,7	2.27	32,5	1.28	4,1	0.16	7/8
08Z-104	1/4-18	-08	61,0	2.40	31,2	1.23	7,6	0.30	13/16
08Z-106	3/8-18	-08	63,2	2.49	33,5	1.32	9,7	0.38	13/16
08Z-108	1/2-14	-08	69,6	2.74	39,6	1.56	9,7	0.38	7/8
08ZR-108*	1/2-14	-08	69,6	2.74	39,6	1.56	9,7	0.38	7/8
08Z-112	3/4-14	-08	65,0	2.56	35,3	1.39	9,7	0.38	1 1/16
10Z-106	3/8-18	-10	59,9	2.36	33,8	1.33	10,7	0.42	15/16
10Z-108	1/2-14	-10	69,6	2.74	40,1	1.58	12,7	0.50	15/16
10Z-112	3/4-14	-10	65,0	2.56	35,6	1.40	12,7	0.50	1 1/16
12Z-108	1/2-14	-12	70,6	2.78	40,6	1.60	14,2	0.56	1 1/8
12Z-112	3/4-14	-12	72,1	2.84	41,9	1.65	15,5	0.61	1 1/8
12ZR-112*	3/4-14	-12	72,1	2.84	41,9	1.65	15,5	0.61	1 1/8
12Z-116	1-11 1/2	-12	71,1	2.80	40,9	1.61	15,5	0.61	1 3/8
16Z-112	3/4-14	-16	76,7	3.02	42,4	1.67	19,3	0.76	1 3/8
16Z-116	1-11 1/2	-16	81,8	3.22	47,2	1.86	20,8	0.82	1 3/8
16ZR-116*	1-11 1/2	-16	81,8	3.22	47,2	1.86	20,8	0.82	1 3/8
16Z-120	1 1/4-11 1/2	-16	78,2	3.08	43,7	1.72	20,8	0.82	1 11/16
20Z-116	1-11 1/2	-20	93,0	3.66	49,0	1.93	24,1	0.95	1 3/4
20ZA-116	1-11 1/2	-20	93,0	3.66	49,0	1.93	24,1	0.95	1 3/4
20Z-120	1 1/4-11 1/2	-20	89,4	3.52	45,5	1.79	26,7	1.05	1 13/16
20ZA-120	1 1/4-11 1/2	-20	89,4	3.52	45,5	1.79	26,7	1.05	1 13/16
24Z-124	1 1/2-11 1/2	-24	106,2	4.18	59,9	2.36	32,0	1.26	2
32Z-132	2-11 1/2	-32	116,6	4.59	66,3	2.61	44,5	1.75	2 1/2

Male Pipe Swivel

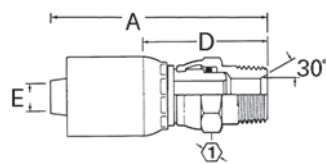

Z-Series Part #	Thd.	Hose Size	A		Hose Cut-Off Factor (D)		EØ		①
			mm	in	mm	in	mm	in	
04Z-J04	1/4-18	-04	64,5	2.54	41,4	1.62	4,3	0.17	3/4
06Z-J04	1/4-18	-06	63,5	2.54	42,4	1.67	6,6	0.26	3/4
06Z-J06	3/8-18	-06	67,6	2.66	42,4	1.67	6,6	0.26	7/8
06Z-J08	1/2-14	-06	72,4	2.85	47,0	1.85	6,6	0.26	7/8
08Z-J06	3/8-18	-08	73,2	2.88	43,4	1.71	9,7	0.38	7/8
08Z-J08	1/2-14	-08	79,5	3.13	49,8	1.96	9,7	0.38	15/16
12Z-J12	3/4-14	-12	82,3	3.24	52,1	2.05	15,5	0.61	1 3/8
16Z-J16	1-11 1/2	-16	98,6	3.88	64,3	2.53	20,6	0.81	1 1/2

Hose Ends - Crimp

Female Pipe Rigid
Dryseal NPTF

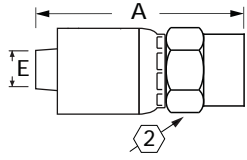

Z-Series Part #	Thd.	Hose Size	A		Hose Cut-Off Factor		EØ		⊠ 2
			mm	in	mm	in	mm	in	
04Z-202	1/8-27	-04	52,6	2.07	32,5	1.28	4,3	0.17	9/16
04Z-204	1/4-18	-04	58,4	2.30	38,4	1.51	4,3	0.17	3/4
06Z-204	1/4-18	-06	58,4	2.30	37,1	1.46	6,6	0.26	3/4
06Z-206	3/8-18	-06	61,2	2.41	39,9	1.57	6,6	0.26	7/8
08Z-208	1/2-14	-08	66,5	2.62	42,0	1.65	9,7	0.38	1 1/16
12Z-212	3/4-14	-12	90,9	3.58	64,0	2.52	15,5	0.61	1 5/16

* G as part of thread size is ISO Designation for parallel thread.

Female Pipe Swivel

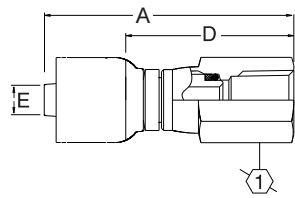

Z-Series Part #	Thd.	Hose Size	A		Hose Cut-Off Factor (D)		EØ		⊠ 1
			mm	in	mm	in	mm	in	
04Z-254	1/4-18	-04	72,9	2.87	49,5	1.95	4,3	0.17	3/4
06Z-256	3/8-18	-06	75,4	2.97	50,0	1.97	6,6	0.26	7/8
08Z-258	1/2-14	-08	90,9	3.58	61,2	2.41	9,7	0.38	1 1/16
12Z-262	3/4-14	-12	92,2	3.63	62,0	2.44	15,5	0.61	1 3/8
16Z-266	1-11 1/2	-16	111,0	4.37	77,5	3.05	20,6	0.81	1 5/8

J

Hose Ends - Crimp

Female Straight Pipe Swivel
(NPSM)

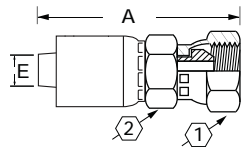

Z-Series Part #	Thd.	Hose Size	A		Hose Cut-Off Factor (D)		EØ		⊠ 2	⊠ 1
			mm	in	mm	in	mm	in		
04Z-054	1/4-18	-04	47,8	1.88	27,7	1.09	4,3	0.17	9/16	1 1/16
06Z-056	3/8-18	-06	51,8	2.04	30,5	1.20	6,6	0.26	1 1/16	7/8
08Z-058	1/2-14	-08	61,0	2.40	35,8	1.41	9,7	0.38	7/8	1
12Z-062	3/4-14	-12	66,5	2.62	39,6	1.56	15,5	0.61	1 1/8	1 1/4
16Z-066	1-11 1/2	-16	79,0	3.11	29,9	1.18	20,8	0.81	1 3/8	1 1/2
20Z-070	1 1/4-11 1/2	-20	92,7	3.65	53,3	2.10	26,7	1.05	1 3/4	1 7/8

Male Pipe Swivel
90° Elbow

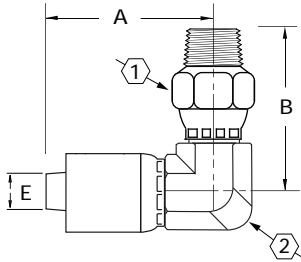

Z-Series Part #	Thd.	Hose Size	A		Hose Cut-Off Factor (D)		EØ		②	①	B
			mm	in	mm	in	mm	in			
04Z-M04	1/4-18	-04	54,6	2.15	31,2	1.23	4,3	0.17	3/4	3/4	1.81
06Z-M04	1/4-18	-06	54,9	2.16	33,7	1.33	6,6	0.26	3/4	7/8	1.96
06Z-M06	3/8-18	-06	59,2	2.33	33,7	1.33	6,6	0.26	3/4	7/8	1.80
08Z-M08	1/2-14	-08	68,1	2.68	38,3	1.51	9,6	0.38	3/4	15/16	2.05
12Z-M12	3/4-14	-12	94,5	3.72	64,2	2.53	15,4	0.61	1 1/4	1 3/8	2.72

JIC/37° Female Swivel

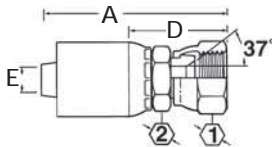

Z-Series Part #	Thd.	Hose Size	A		Hose Cut-Off Factor (D)		EØ		①	②
			mm	in	mm	in	mm	in		
04Z-603	3/8-24	-04	49,3	1.94	25,9	1.02	3,3	0.13	1/2	9/16
04Z-604	7/16-20	-04	50,8	2.00	27,2	1.07	4,3	0.17	9/16	9/16
04ZR-604*	7/16-20	-04	50,8	2.00	27,2	1.07	4,3	0.17	9/16	9/16
04Z-605	1/2-20	-04	50,3	1.98	26,9	1.06	4,3	0.17	5/8	9/16
04Z-606	9/16-18	-04	51,6	2.03	28,2	1.11	4,3	0.17	11/16	9/16
06Z-604	7/16-20	-06	55,6	2.19	30,2	1.19	4,3	0.17	9/16	11/16
06Z-605	1/2-20	-06	56,9	2.24	31,5	1.24	5,8	0.23	5/8	11/16
06Z-606	9/16-18	-06	57,9	2.28	32,5	1.28	6,6	0.26	11/16	11/16
06ZR-606*	9/16-18	-06	57,9	2.28	32,5	1.28	6,6	0.26	11/16	11/16
06Z-608	3/4-16	-06	58,7	2.31	33,3	1.31	6,6	0.26	7/8	11/16
06Z-610	7/8-14	-06	57,4	2.26	13,2	0.52	6,6	0.26	1	13/16
06Z-612	1 1/16-12	-06	59,5	2.34	38,4	1.51	6,7	0.26	1 1/4	1
08Z-606	9/16-18	-08	59,9	2.36	34,5	1.36	9,6	0.33	11/16	13/16
08Z-608	3/4-16	-08	66,8	2.63	37,1	1.46	9,7	0.38	7/8	13/16
08ZR-608*	3/4-16	-08	66,8	2.63	37,1	1.46	9,7	0.38	7/8	13/16
08Z-610	7/8-14	-08	67,1	2.64	37,3	1.47	9,7	0.38	1	13/16
08Z-612	1 1/16-12	-08	69,3	2.73	39,6	1.56	9,7	0.38	1 1/4	1
08Z-616	1 5/16-12	-08	77,7	3.06	48,0	1.89	9,7	0.38	1 1/2	1 1/4
10Z-608	3/4-16	-10	67,3	2.65	38,1	1.50	9,9	0.39	7/8	15/16
10Z-610	7/8-14	-10	70,4	2.77	40,9	1.61	12,7	0.50	1	15/16
10ZR-610*	7/8-14	-10	70,4	2.77	40,9	1.61	12,7	0.50	1	15/16
10Z-612	1 1/16-12	-10	69,1	2.72	39,9	1.57	12,7	0.50	1 1/4	1
12Z-608	3/4-16	-12	66,0	2.60	38,8	1.53	9,9	0.39	7/8	1 1/8
12Z-610	7/8-14	-12	71,4	2.81	41,4	1.63	12,2	0.48	1	1 1/8
12Z-612	1 1/16-12	-12	72,1	2.84	41,9	1.65	15,5	0.61	1 1/4	1 1/8
12ZR-612*	1 1/16-12	-12	72,1	2.84	41,9	1.65	15,5	0.61	1 1/4	1 1/8
12Z-614	1 3/16-12	-12	72,1	2.84	41,9	1.65	15,5	0.61	1 3/8	1 1/8
12Z-616	1 5/16-12	-12	73,9	2.91	43,7	1.72	15,5	0.61	1 1/2	1 1/4
16Z-612	1 1/16-12	-16	80,0	3.15	45,7	1.80	15,5	0.61	1 1/4	1 3/8
16Z-614	1 3/16-12	-16	80,0	3.15	46,5	1.83	20,6	0.81	1 3/8	1 3/8
16Z-616	1 5/16-12	-16	83,6	3.29	49,0	1.93	20,6	0.81	1 1/2	1 3/8
16ZR-616*	1 5/16-12	-16	83,6	3.29	49,0	1.93	20,6	0.81	1 1/2	1 3/8
16Z-620	1 5/8-12	-16	80,5	3.17	46,0	1.81	20,6	0.81	2	
20Z-616	1 5/16-12	-20	87,9	3.46	43,9	1.73	21,6	0.85	1 1/2	
20ZA-616	1 5/16-12	-20	87,9	3.46	43,9	1.73	21,6	0.85	1 1/2	
20Z-620	1 5/8-12	-20	91,7	3.61	47,8	1.88	26,7	1.05	2	
20ZA-620	1 5/8-12	-20	91,7	3.61	47,8	1.88	26,7	1.05	2	
24Z-624	1 7/8-12	-24	99,1	3.90	52,6	2.07	32,0	1.26	2 1/4	
32Z-632	2 1/2-12	-32	110,2	4.34	60,7	2.39	44,5	1.75	2 7/8	

Note: 20ZA fittings should only be used with one wire braided hose.
20Z fittings should only be used with two wire braided hose.

* Stainless Steel

Hose Ends - Crimp

^a Swivel nuts are universal – both SAE 37° and 45° connections.

JIC/37° Female Swivel
30° Tube Elbow

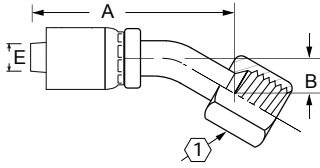

Z-Series Part #	Thd.	Hose Size	A		Hose Cut-Off Factor (D)		EØ		1	B
			mm	in	mm	in	mm	in		
10Z-L22	1 ¹ / ₁₆ -12	-10	86,1	3.39	60,5	2.38	12,7	0.51	1/4 Hex	0.69

JIC/37° Female Swivel
45° Tube Elbow
(Exceptions noted, refer to footnotes)

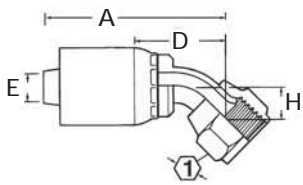

Z-Series Part #	Thd.	Hose Size	A		Hose Cut-Off Factor (D)		EØ		H		1
			mm	in	mm	in	mm	in	mm	in	
04Z-684 ^a	7/16-20	-04	49,8	1.96	26,4	1.04	3,8	0.15	8,4	0.33	9/16
04Z-685 ^a	1/2-20	-04	51,8	2.04	28,4	1.12	4,3	0.17	9,4	0.37	5/8
04Z-686	9/16-18	-04	53,1	2.09	29,7	1.17	4,3	0.17	9,9	0.39	11/16
06Z-684 ^a	7/16-20	-06	44,5	1.75	23,4	0.92	4,1	0.16	8,4	0.33	9/16
06Z-686	9/16-18	-06	58,7	2.31	33,3	1.31	6,1	0.24	9,9	0.39	11/16
06Z-688 ^a	3/4-16	-06	67,3	2.65	42,2	1.66	6,6	0.26	14,0	0.55	7/8
08Z-688 ^a	3/4-16	-08	71,6	2.82	41,9	1.65	9,4	0.37	14,0	0.55	7/8
08Z-690 ^a	7/8-14	-08	77,0	3.03	47,2	1.86	9,7	0.38	15,0	0.59	1
10Z-690 ^a	7/8-14	-10	74,7	2.94	45,5	1.79	11,7	0.46	15,0	0.59	1
10Z-692	1 ¹ / ₁₆ -12	-10	85,9	3.38	56,4	2.22	12,7	0.50	19,8	0.78	1 ¹ / ₄
12Z-696	1 ⁵ / ₁₆ -12	-12	87,1	3.43	60,2	2.37	15,5	0.61	26,9	1.06	1 ¹ / ₂
12Z-692	1 ¹ / ₁₆ -12	-12	87,1	3.43	56,9	2.24	14,7	0.58	19,8	0.78	1 ¹ / ₄
16Z-696	1 ⁵ / ₁₆ -12	-16	95,0	3.74	60,7	2.39	19,3	0.76	27,2	1.07	1 ¹ / ₂
20Z-697	1 ⁵ / ₈ -12	-20	112,8	4.44	68,8	2.71	25,7	1.01	31,0	1.22	2
20ZA-697	1 ⁵ / ₈ -12	-20	112,8	4.44	68,8	2.71	25,7	1.01	31,0	1.22	2

^a Swivel nuts are universal – both SAE 37° and 45° connections.

Note: 20ZA fittings should only be used with one wire braided hose. 20Z fittings should only be used with two wire braided hose.

^a Swivel nuts are universal – both SAE 37° and 45° connections.

JIC/37° Female Swivel
90° Elbow
(Exceptions noted, refer to footnotes)

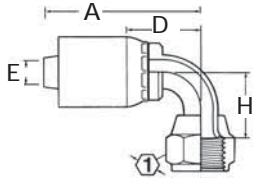

Note: 20ZA fittings should only be used with one wire braided hose.
20Z fittings should only be used with two wire braided hose

Z-Series Part #	Thd.	Hose Size	A		Hose Cut-Off Factor (D)		EØ		H		① in
			mm	in	mm	in	mm	in	mm	in	
04Z-664 ^a	7/16-20	-04	46,7	1.84	23,4	0.92	3,8	0.15	17,3	0.68	9/16
04Z-665 ^a	1/2-20	-04	48,8	1.92	25,4	1.00	4,3	0.17	19,3	0.76	5/8
04Z-666	9/16-18	-04	50,8	2.00	27,4	1.08	4,3	0.17	21,3	0.84	11/16
06Z-664 ^a	7/16-20	-06	46,0	1.81	24,9	0.98	4,1	0.16	17,3	0.68	9/16
06Z-666	9/16-18	-06	56,1	2.21	31,0	1.22	6,1	0.24	21,3	0.84	11/16
06Z-668 ^a	3/4-16	-06	61,5	2.42	36,1	1.42	6,6	0.26	27,7	1.09	7/8
08Z-666	9/16-18	-08	61,7	2.43	32,0	1.26	6,1	0.24	21,3	0.84	11/16
08Z-668 ^a	3/4-16	-08	65,8	2.59	36,1	1.42	9,4	0.37	27,7	1.09	7/8
08Z-670 ^a	7/8-14	-08	70,6	2.78	41,0	1.61	9,7	0.38	30,2	1.19	1
10Z-670 ^a	7/8-14	-10	68,6	2.70	39,4	1.55	11,4	0.45	30,2	1.19	1
10Z-672	1 1/16-12	-10	84,1	3.31	54,9	2.16	12,7	0.50	45,7	1.80	1 1/4
12Z-670 ^a	7/8-14	-12	65,3	2.57	39,6	1.56	11,7	0.46	30,2	1.19	1
12Z-672	1 1/16-12	-12	85,4	3.36	55,1	2.17	17,4	0.58	45,7	1.80	1 1/4
12Z-676	1 5/16-12	-12	85,6	3.37	55,4	2.18	15,5	0.61	60,7	2.39	1 1/2
16Z-676	1 5/16-12	-16	90,4	3.56	55,9	2.20	19,3	0.76	60,7	2.39	1 1/2
16Z-677	1 5/8-12	-16	95,8	3.77	62,2	2.45	20,8	0.82	69,9	2.75	2
20Z-677	1 5/8-12	-20	108,0	4.25	64,0	2.52	25,7	1.01	69,9	2.75	2
20ZA-677	1 5/8-12	-20	108,0	4.25	64,0	2.52	25,7	1.01	69,9	2.75	2
24Z-678	1 7/8-12	-24	117,6	4.63	71,4	2.81	32,0	1.26	80,5	3.17	2 1/4

^a Swivel nuts are universal – both SAE 37° and 45° connections.

JIC/37° Female Swivel
90° Long Drop Tube Elbow
(Exceptions noted, refer to footnotes)

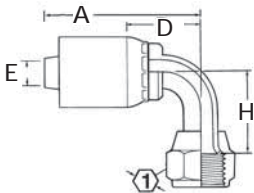

Note: 20ZA fittings should only be used with one wire braided hose.
20Z fittings should only be used with two wire braided hose.

Z-Series Part #	Thd.	Hose Size	A		Hose Cut-Off Factor (D)		EØ		H		① in
			mm	in	mm	in	mm	in	mm	in	
04Z-644 ^a	7/16-20	-04	46,7	1.84	23,4	0.92	3,8	0.15	45,7	1.80	9/16
04Z-645 ^a	1/2-20	-04	48,8	1.92	25,4	1.00	4,3	0.17	45,7	1.80	5/8
06Z-644 ^a	7/16-20	-06	46,0	1.81	24,9	0.98	4,3	0.17	45,7	1.80	9/16
06Z-646	9/16-18	-06	56,4	2.22	31,2	1.23	6,1	0.24	55,4	2.18	11/16
06Z-648 ^a	3/4-16	-06	64,5	2.54	39,1	1.54	6,6	0.26	62,2	2.45	7/8
08Z-648 ^a	3/4-16	-08	68,8	2.71	39,1	1.54	9,4	0.37	62,2	2.45	7/8
08Z-650 ^a	7/8-14	-08	70,6	2.78	40,9	1.61	9,7	0.38	65,3	2.57	1
10Z-650 ^a	7/8-14	-10	68,6	2.70	39,1	1.54	11,7	0.46	65,3	2.57	1
12Z-652	1 1/16-12	-12	85,3	3.36	55,1	2.17	14,7	0.58	94,0	3.70	1 1/4
16Z-656	1 5/16-12	-16	90,4	3.56	55,9	2.20	19,3	0.76	116,3	4.58	1 1/2
20Z-657	1 5/8-12	-20	108,0	4.25	64,0	2.52	25,7	1.01	140,5	5.53	2
20ZA-657	1 5/8-12	-20	108,0	4.25	64,0	2.52	25,7	1.01	140,5	5.53	2

^a Swivel nuts are universal – both SAE 37° and 45° connections.

JIC/37° Male Rigid

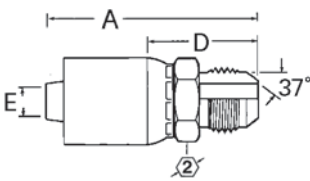

Note: 20ZA fittings should only be used with one wire braided hose.
20Z fittings should only be used with two wire braided hose.

Z-Series Part #	Thd.	Hose Size	A		Hose Cut-Off Factor (D)		EØ		②
			mm	in	mm	in	mm	in	
04Z-504	7/16-20	-04	50,8	2.00	27,2	1.07	4,3	0.17	9/16
04Z-505	1/2-20	-04	46,7	1.84	23,4	0.92	4,3	0.17	9/16
04Z-506	9/16-18	-04	47,0	1.85	23,6	0.93	4,3	0.17	5/8
06Z-506	9/16-18	-06	54,9	2.16	29,7	1.17	6,6	0.26	11/16
06Z-508	3/4-16	-06	53,3	2.10	28,2	1.11	6,6	0.26	13/16
06Z-510	7/8-14	-06	53,3	2.10	30,7	1.21	6,6	0.26	15/16
08Z-508	3/4-16	-08	65,3	2.57	35,8	1.41	9,7	0.38	13/16
08Z-510	7/8-14	-08	61,5	2.42	32,0	1.26	9,7	0.38	15/16
08Z-512	1 1/16-12	-08	65,8	2.59	36,1	1.42	9,7	0.38	1 1/8
10Z-508	3/4-16	-10	61,7	2.43	35,8	1.41	12,7	0.50	15/16
10Z-510	7/8-14	-10	69,3	2.73	39,9	1.57	12,2	0.48	15/16
10Z-512	1 1/16-12	-10	65,8	2.59	36,3	1.43	12,7	0.50	1 1/8
12Z-510	7/8-14	-12	70,6	2.78	40,4	1.59	12,2	0.48	1 1/8
12Z-512	1 1/16-12	-12	74,7	2.94	44,5	1.75	15,5	0.61	1 1/8
12Z-514	1 3/16-12	-12	69,3	2.73	39,1	1.54	15,5	0.61	1 1/4
12Z-516	1 5/16-12	-12	69,9	2.75	39,6	1.56	15,5	0.61	1 3/8
16Z-514	1 3/16-12	-16	79,0	3.11	45,7	1.80	18,3	0.72	1 3/8
16Z-516	1 5/16-12	-16	82,6	3.25	48,3	1.90	20,8	0.82	1 3/8
16Z-520	1 5/8-12	-16	77,0	3.03	43,4	1.71	20,6	0.81	1 11/16
20Z-520	1 5/8-12	-20	98,8	3.89	54,9	2.16	26,7	1.05	1 3/4
20ZA-520	1 5/8-12	-20	98,8	3.89	54,9	2.16	26,7	1.05	1 3/4
24Z-524	1 7/8-12	-24	109,5	4.31	63,2	2.49	32,0	1.26	2

SAE 45° Female Swivel

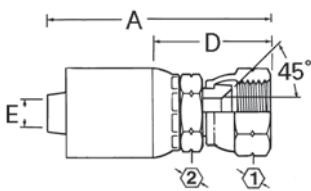

Z-Series Part #	Thd.	Hose Size	A		Hose Cut-Off Factor (D)		EØ		①	②
			mm	in	mm	in	mm	in		
04Z-404	7/16-20	-04	50,8	2.00	27,2	1.07	4,3	0.17	9/16	9/16
06Z-404	7/16-20	-06	55,6	2.19	30,2	1.19	4,8	0.19	9/16	11/16
06Z-406	5/8-18	-06	58,7	2.31	33,3	1.31	6,6	0.26	3/4	11/16
06Z-408	3/4-16	-06	58,7	2.31	33,3	1.31	6,6	0.26	7/8	11/16
08Z-408	3/4-16	-08	66,8	2.63	37,1	1.46	9,7	0.38	7/8	13/16
08Z-410	7/8-14	-08	67,1	2.64	37,3	1.47	9,7	0.38	1	13/16
12Z-412	1 1/16-14	-12	72,1	2.84	41,9	1.65	15,5	0.61	1 1/4	1 1/8

SAE 45° Female Swivel 45° Tube Elbow

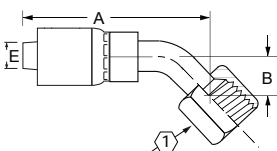

Z-Series Part #	Thd.	Hose Size	A		Hose Cut-Off Factor (D)		EØ		①	B
			mm	in	mm	in	mm	in		
06Z-486	5/8-18	-06	58,2	2.29	36,8	1.45	6,1	0.24	3/4	0.73

J
Hose Ends - Crimp

SAE 45° Female Swivel Long Drop 90° Tube Elbow

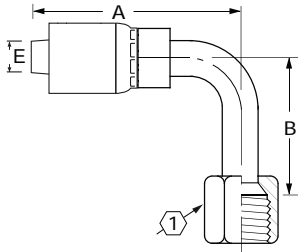

Z-Series Part #	Thd.	Hose Size	A		Hose Cut-Off Factor (D)		EØ		1	B
			mm	in	mm	in	mm	in		
06Z-446	5/8-18	-06	47,5	1.87	26,2	1.03	6.1	0.24	3/4	2.18

SAE 45° Flare Male Rigid

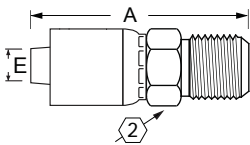

Z-Series Part #	Thd.	Hose Size	A		Hose Cut-Off Factor (D)		EØ		2
			mm	in	mm	in	mm	in	
06Z-306	5/8-18	-06	52,3	2.06	31,2	1.23	6,6	0.26	11/16
12Z-312	1 1/16-14	-12	74,7	2.94	47,8	1.88	15,5	0.61	1 1/8

Female FOR-SEAL® Swivel

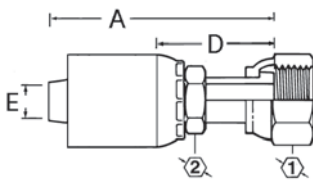

Z-Series Part #	Thd.	Hose Size	A		Hose Cut-Off Factor (D)		EØ		1	2
			mm	in	mm	in	mm	in		
04Z-S64	9/16-18	-04	49,5	1.95	26,2	1.03	4,3	0.17	11/16	9/16
04Z-S66	11/16-16	-04	51,8	2.04	28,4	1.12	4,3	0.17	13/16	5/8
04Z-S68	13/16-16	-04	52,3	2.06	32,5	1.28	4,1	0.16	13/16	15/16
06Z-S64	9/16-18	-06	54,4	2.14	29,2	1.15	4,3	0.17	11/16	11/16
06Z-S66	11/16-16	-06	56,6	2.23	31,5	1.24	6,6	0.26	13/16	11/16
06Z-S68	13/16-16	-06	58,9	2.32	33,5	1.32	6,6	0.26	15/16	13/16
08Z-S66	11/16-16	-08	63,8	2.51	34,0	1.34	6,6	0.26	13/16	7/8
08Z-S68	13/16-16	-08	67,8	2.67	38,1	1.50	9,7	0.38	15/16	7/8
08Z-S70	1-14	-08	67,1	2.64	37,3	1.47	9,7	0.38	1 1/8	15/16
08Z-S72	13/16-12	-08	71,1	2.80	41,4	1.63	9,7	0.38	1 3/8	1 1/8
10Z-S68	13/16-16	-10	67,8	2.67	38,4	1.51	9,7	0.38	15/16	15/16
10Z-S70	1-14	-10	70,1	2.76	40,9	1.61	12,2	0.48	1 1/8	15/16
10Z-S72	13/16-12	-10	70,9	2.79	41,4	1.63	12,7	0.50	1 3/8	1 1/8
12Z-S70	1-14	-12	71,4	2.81	41,4	1.62	12,2	0.48	1 1/8	1 1/8
12Z-S72	13/16-12	-12	73,9	2.91	43,7	1.72	15,5	0.61	1 3/8	1 1/8
12Z-S76	17/16-12	-12	75,7	2.98	45,5	1.79	15,5	0.61	1 5/8	1 3/8
16Z-S72	13/16-12	-16	81,8	3.22	47,2	1.86	15,5	0.61	1 3/8	1 3/8
16Z-S76	17/16-12	-16	83,6	3.29	49,3	1.94	20,6	0.81	1 5/8	1 3/8
16Z-S80	11/16-12	-16	82,6	3.25	48,3	1.90	20,6	0.81	1 7/8	1 5/8
20Z-S80	11/16-12	-20	98,8	3.89	59,2	2.33	25,9	1.02	1 7/8	1 3/4
20ZA-S80	11/16-12	-20	98,8	3.89	59,2	2.33	25,9	1.02	1 7/8	1 3/4
20Z-S84	2-12	-20	94,6	3.88	54,6	2.15	26,7	1.05	2 1/4	1 13/16
20ZA-S84	2-12	-20	94,6	3.88	54,6	2.15	26,7	1.05	2 1/4	1 13/16
24Z-S84	2-12	-24	102,1	4.02	55,6	2.19	32,0	1.26	2 1/4	2

Note: 20ZA fittings should only be used with one wire braided hose. 20Z fittings should only be used with two wire braided hose.

Female FOR-SEAL® Swivel
45° Tube Elbow

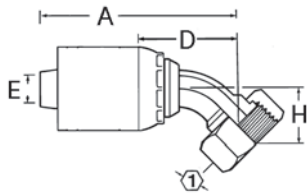

Z-Series Part #	Thd.	Hose Size	A		Hose Cut-Off Factor (D)		EØ		H		① in
			mm	in	mm	in	mm	in	mm	in	
04Z-L64	9/16-18	-04	53,8	2.12	30,5	1.20	4,3	0.17	10,2	0.40	11/16
04Z-L66	11/16-16	-04	58,4	2.30	35,1	1.38	4,3	0.17	10,9	0.43	13/16
06Z-L64	9/16-18	-06	58,4	2.30	33,0	1.30	4,3	0.17	10,4	0.41	11/16
06Z-L66	11/16-16	-06	61,7	2.43	36,3	1.43	6,6	0.26	10,9	0.43	13/16
06Z-L68	13/16-16	-06	69,6	2.74	44,2	1.74	6,6	0.26	15,0	0.59	15/16
08Z-L66	11/16-16	-08	67,3	2.65	37,6	1.48	6,6	0.26	10,9	0.43	13/16
08Z-L68	13/16-16	-08	75,2	2.96	45,5	1.79	9,1	0.36	15,0	0.59	15/16
08Z-L70	1-14	-08	80,8	3.18	51,1	2.01	9,7	0.38	16,5	0.65	1 1/8
08Z-L72	1 3/16-12	-08	89,2	3.51	59,4	2.34	9,7	0.38	21,1	0.83	1 3/8
10Z-L70	1-14	-10	77,5	3.05	51,1	2.01	11,4	0.45	16,5	0.65	1 1/8
10Z-L72	1 3/16-12	-10	89,4	3.52	59,9	2.36	12,7	0.50	21,1	0.83	1 3/8
12Z-L70	1-14	-12	78,5	3.09	51,8	2.04	11,4	0.45	16,5	0.65	1 1/8
12Z-L72	1 3/16-12	-12	90,7	3.57	60,5	2.38	14,0	0.55	21,1	0.83	1 3/8
12Z-L76	1 7/16-12	-12	102,6	4.04	72,4	2.85	15,5	0.61	23,9	0.94	1 5/8
16Z-L72	1 3/16-12	-16	94,5	3.72	60,9	2.40	14,0	0.55	21,1	0.83	1 3/8
16Z-L76	1 7/16-12	-16	107,4	4.23	73,2	2.88	19,8	0.78	23,9	0.94	1 5/8
16Z-L80	1 11/16-12	-16	117,3	4.62	83,8	3.30	20,7	0.81	25,4	1.00	1 7/8
20Z-L80	1 11/16-12	-20	129,5	5.10	85,6	3.37	25,9	1.02	25,4	1.00	1 7/8
20ZA-L80	1 11/16-12	-20	129,5	5.10	85,6	3.37	25,9	1.02	25,4	1.00	1 7/8
20Z-L84	2-12	-20	139,4	5.49	95,5	3.76	25,7	1.01	27,2	1.07	2 1/4
24Z-L84	2-12	-24	115,3	4.54	68,8	2.71	32,0	1.26	27,2	1.07	2 1/4

Female FOR-SEAL® Swivel
Short Drop
90° Tube Elbow

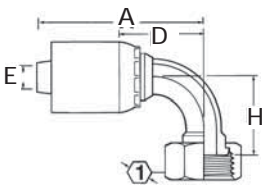

Z-Series Part #	Thd.	Hose Size	A		Hose Cut-Off Factor (D)		EØ		H		① in
			mm	in	mm	in	mm	in	mm	in	
04Z-A24	9/16-18	-04	53,1	2.09	29,7	1.17	4,3	0.17	20,8	0.82	11/16
04Z-A26	11/16-16	-04	56,4	2.22	33,0	1.30	4,3	0.17	22,9	0.90	13/16
06Z-A24	9/16-18	-06	56,1	2.21	30,7	1.21	4,3	0.17	20,8	0.82	11/16
06Z-A26	11/16-16	-06	59,4	2.34	34,0	1.34	6,6	0.26	22,9	0.90	13/16
06Z-A28	13/16-16	-06	66,5	2.62	41,4	1.62	6,6	0.26	29,2	1.15	15/16
08Z-A26	11/16-16	-08	65,0	2.56	35,3	1.39	6,6	0.26	22,9	0.90	13/16
08Z-A28	13/16-16	-08	72,1	2.84	42,4	1.67	9,1	0.36	29,2	1.15	15/16
08Z-A30	1-14	-08	78,0	3.07	48,5	1.91	9,7	0.38	32,3	1.27	1 1/8
08Z-A32	1 3/16-12	-08	87,6	3.45	57,9	2.28	9,7	0.38	47,8	1.88	1 3/8
10Z-A30	1-14	-10	78,0	3.07	48,5	1.91	11,4	0.45	32,3	1.27	1 1/8
10Z-A32	1 3/16-12	-10	87,4	3.44	58,2	2.29	12,7	0.50	47,8	1.88	1 3/8
12Z-A30	1-14	-12	79,0	3.11	49,0	1.93	11,4	0.45	32,3	1.27	1 1/8
12Z-A32	1 3/16-12	-12	88,6	3.49	58,4	2.30	14,0	0.55	47,8	1.88	1 3/8
12Z-A36	1 7/16-12	-12	102,6	4.04	72,4	2.85	15,5	0.61	56,1	2.21	1 5/8
16Z-A36	1 7/16-12	-16	107,2	4.22	72,9	2.87	20,6	0.81	56,1	2.21	1 5/8
16Z-A40	1 11/16-12	-16	123,2	4.85	89,0	3.50	20,6	0.81	63,8	2.51	1 7/8
20Z-A40	1 11/16-12	-20	134,6	5.30	90,7	3.57	25,9	1.02	63,8	2.51	1 7/8
20ZA-A40	1 11/16-12	-20	134,6	5.30	90,7	3.57	25,9	1.02	63,8	2.51	1 7/8
20Z-A44	2-12	-20	109,7	4.32	70,4	2.77	26,6	1.05	68,6	2.70	2 1/4
24Z-A40	1 11/16-12	-24	117,6	4.63	71,4	2.81	32,0	1.26	68,6	2.70	2 1/4
24Z-A44	2-12	-24	117,6	4.63	71,4	2.81	32,0	1.26	68,6	2.70	2 1/4

Note: 20ZA fittings should only be used with one wire braided hose.
20Z fittings should only be used with two wire braided hose.

Female FOR-SEAL® Swivel
Medium Drop
90° Tube Elbow

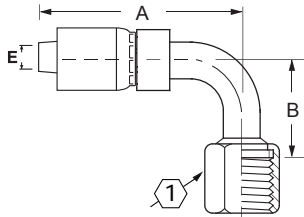

Z-Series Part #	Thd.	Hose Size	A		Hose Cut-Off Factor (D)		EØ		1	B
			mm	in	mm	in	mm	in		
04Z-J34	9/16-18	-04	49,5	1.95	29,7	1.17	4,3	0.17	11/16	1.26
04Z-J36	11/16-16	-04	55,1	2.17	32,8	1.29	4,3	0.17	13/16	1.51
04Z-J38	13/16-16	-04	55,9	2.20	35,8	1.41	4,3	0.17	15/16	1.67
06Z-J36	11/16-16	-06	55,1	2.17	34,0	1.34	6,6	0.26	13/16	1.51
06Z-J38	13/16-16	-06	57,4	2.26	36,1	1.42	6,6	0.26	15/16	1.67
08Z-J36	11/16-16	-08	63,0	2.48	37,6	1.48	6,1	0.24	13/16	1.51
08Z-J38	13/16-16	-08	67,6	2.66	42,4	1.67	9,1	0.36	15/16	1.62
08Z-J42	13/16-12	-08	98,3	3.87	72,9	2.87	9,7	0.38	13/8	2.13
10Z-J40	1-14	-10	74,4	2.93	48,5	1.91	11,4	0.45	11/8	1.85
12Z-J40	1-14	-12	67,6	2.66	40,6	1.60	11,4	0.45	11/8	1.78
12Z-J42	13/16-12	-12	85,3	3.36	58,4	2.30	13,9	0.55	13/8	2.28
16Z-J46	17/16-12	-16	106,2	4.18	72,6	2.86	19,8	0.78	15/8	2.78
16Z-J50	111/16-12	-16	141,2	5.56	107,7	4.24	20,6	0.81	17/8	3.06
20Z-J50	111/16-12	-20	148,8	5.86	109,5	4.31	23,6	0.93	17/8	3.06

Female FOR-SEAL® Swivel
Long Drop
90° Tube Elbow

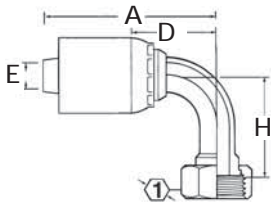

Z-Series Part #	Thd.	Hose Size	A		Hose Cut-Off Factor (D)		EØ		H		1
			mm	in	mm	in	mm	in	mm	in	
04Z-A64	9/16-18	-04	53,1	2.09	29,7	1.17	4,3	0.17	45,7	1.80	11/16
04Z-A66	11/16-16	-04	56,4	2.22	33,0	1.30	4,3	0.17	54,1	2.13	13/16
04Z-A68	13/16-16	-04	65,8	2.59	42,4	1.67	4,3	0.17	64,8	2.55	15/16
06Z-A66	11/16-16	-06	59,4	2.34	34,0	1.34	6,1	0.24	54,1	2.13	13/16
06Z-A68	13/16-16	-06	68,8	2.71	43,4	1.71	6,6	0.26	64,8	2.55	15/16
08Z-A68	13/16-16	-08	72,9	2.87	43,2	1.70	9,4	0.37	64,8	2.55	15/16
08Z-A70	1-14	-08	78,0	3.07	48,5	1.91	9,7	0.38	70,1	2.76	11/8
10Z-A70	1-14	-10	78,0	3.07	48,5	1.91	11,7	0.46	70,1	2.76	11/8
12Z-A72	13/16-12	-12	88,4	3.48	58,2	2.29	14,2	0.56	96,0	3.78	13/8
12Z-A76	17/16-12	-12	102,6	4.04	72,4	2.85	15,5	0.61	114,3	4.50	15/8
16Z-A76	17/16-12	-16	107,2	4.22	72,6	2.86	19,8	0.78	114,3	4.50	15/8
20Z-A80	111/16-12	-20	134,6	5.30	90,7	3.57	25,7	1.01	129,3	5.09	17/8
20Z-A84	2-12	-20	109,7	4.32	70,4	2.77	26,7	1.05	140,7	5.54	21/4
24Z-A84	2-12	-24	117,6	4.63	71,4	2.81	32,0	1.26	140,7	5.54	21/4



Hose Ends - Crimp

FOR-SEAL® Male Rigid

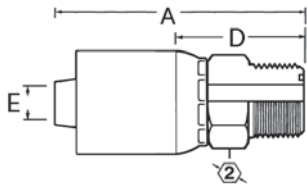

Z-Series Part #	Thd.	Hose Size	A		Hose Cut-Off Factor (D)		EØ		in
			mm	in	mm	in	mm	in	
04Z-E64	9/16-18	-04	45,2	1.78	21,8	0.86	4,3	0.17	5/8
06Z-E66	11/16-16	-06	50,5	1.99	25,1	0.99	6,6	0.26	3/4
06Z-E68	13/16-16	-06	49,5	1.95	24,1	0.95	6,6	0.26	7/8
08Z-E68	13/16-16	-08	58,4	2.30	28,7	1.13	9,7	0.38	7/8
08Z-E70	1-14	-08	55,1	2.17	29,7	1.17	9,7	0.38	1 1/16
08Z-E72	1 3/16-12	-08	57,7	2.27	32,3	1.27	9,7	0.38	1 1/4
10Z-E70	1-14	-10	57,4	2.26	31,5	1.24	12,2	0.48	1 1/16
10Z-E72	1 3/16-12	-10	57,4	2.26	31,5	1.24	12,7	0.50	1 1/4
12Z-E72	1 3/16-12	-12	66,8	2.63	36,6	1.44	15,5	0.61	1 1/4
12Z-E76	1 7/16-12	-12	64,3	2.53	34,0	1.34	15,5	0.61	1 1/2
16Z-E76	1 7/16-12	-16	75,2	2.96	41,7	1.64	20,7	0.81	1 1/2
20Z-E80	1 11/16-12	-20	85,1	3.35	45,7	1.80	26,2	1.03	1 3/4

Does not include o-ring. See page L-34 for o-ring part number.

Male Straight Thread
O-ring Rigid

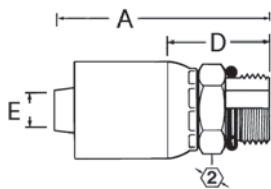

Z-Series Part #	Thd.	Hose Size	A		Hose Cut-Off Factor (D)		EØ		in
			mm	in	mm	in	mm	in	
04Z-P04	7/16-20	-04	46,7	1.84	23,4	0.92	4,3	0.17	9/16
04Z-P05	1/2-20	-04	46,7	1.84	23,4	0.92	4,3	0.17	5/8
04Z-P06	9/16-18	-04	45,2	1.78	21,8	0.86	4,3	0.17	11/16
06Z-P06	9/16-18	-06	50,8	2.00	25,4	1.00	6,6	0.26	11/16
06Z-P08	3/4-16	-06	50,0	1.97	24,9	0.98	6,6	0.26	7/8
06Z-P10	7/8-14	-06	47,8	1.88	26,7	1.05	6,6	0.26	1
08Z-P08	3/4-16	-08	59,9	2.36	30,2	1.19	9,7	0.38	7/8
08Z-P10	7/8-14	-08	57,4	2.26	27,7	1.09	9,7	0.38	1
08Z-P12	1 1/16-12	-08	60,7	2.39	31,0	1.22	9,7	0.38	1 1/4
10Z-P08	3/4-16	-10	56,1	2.21	30,2	1.19	12,7	0.50	15/16
10Z-P10	7/8-14	-10	59,4	2.34	33,5	1.32	12,7	0.50	1
10Z-P12	1 1/16-12	-10	60,7	2.39	31,2	1.23	12,7	0.50	1 1/4
12Z-P10	7/8-14	-12	64,3	2.53	37,1	1.46	12,2	0.48	1 1/8
12Z-P12	1 1/16-12	-12	62,0	2.44	31,8	1.25	15,5	0.61	1 1/4
12Z-P16	1 5/16-12	-12	65,0	2.56	34,8	1.37	15,5	0.61	1 1/2
16Z-P16	1 5/16-12	-16	69,6	2.74	35,3	1.39	20,8	0.82	1 1/2
20Z-P20	1 5/8-12	-20	92,2	3.63	48,3	1.90	26,7	1.05	1 7/8
20ZA-P20	1 5/8-12	-20	92,2	3.63	48,3	1.90	26,7	1.05	1 7/8
24Z-P24	1 7/8-12	-24	92,2	3.63	46,0	1.81	32,0	1.26	2 1/8

See page L-64 for replacement o-rings.

J
Hose Ends - Crimp

Note: 20ZA fittings should only be used with one wire braided hose. 20Z fittings should only be used with two wire braided hose.

Male Straight Thread O-ring Swivel

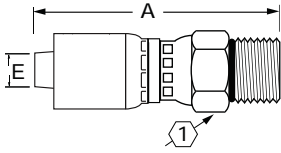

Z-Series Part #	Thd.	Hose Size	A		Hose Cut-Off Factor (D)		EØ		(1)
			mm	in	mm	in	mm	in	
04Z-R04	7/16-20	-04	64,0	2.52	40,3	1.59	4,3	0.17	3/4
06Z-R06	9/16-18	-06	69,1	2.72	43,9	1.73	6,6	0.26	7/8
06Z-R08	3/4-16	-08	67,6	2.66	42,4	1.67	6,6	0.26	7/8
08Z-R08	3/4-16	-08	76,5	3.01	46,7	1.84	9,6	0.38	1
08Z-R10	7/8-14	-08	77,0	3.03	47,2	1.86	9,6	0.38	1
08Z-R12	1 1/16-12	-08	88,6	3.49	58,9	2.32	9,6	0.38	1 7/16
10Z-R08	3/4-16	-10	76,7	3.02	47,2	1.86	12,7	0.5	1
12Z-R10	7/8-14	-12	87,1	3.43	56,9	2.24	15,5	0.61	1 7/16

Includes o-ring. See page L-64 for replacement o-rings.

Male Straight Thread O-ring Swivel 90° Elbow

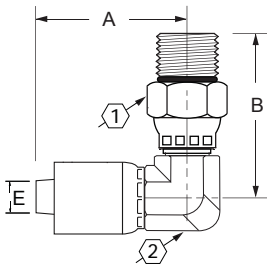

Z-Series Part #	Thd.	Hose Size	A		Hose Cut-Off Factor (D)		EØ		(2)	(1)	B
			mm	in	mm	in	mm	in			
04Z-R66	9/16-18	-04	55,4	2.18	32,0	1.26	4,3	0.17	3/4	7/8	1,87
06Z-R66	9/16-18	-06	59,2	2.33	33,7	1.33	6,6	0.26	3/4	7/8	1,87
06Z-R68	3/4-16	-06	59,2	2.33	33,7	1.33	6,6	0.26	3/4	1	1,93
06Z-R70	7/8-14	-06	59,2	2.33	33,7	1.33	6,6	0.26	3/4	1	1,95
08Z-R68	3/4-16	-08	68,1	2.68	38,3	1.51	9,7	0.38	3/4	1	1,93
08Z-R70	7/8-14	-08	68,1	2.68	38,3	1.51	9,7	0.38	3/4	1	1,97
08Z-R72	1 1/16-12	-08	79,2	3.12	49,5	1.95	9,7	0.38	1 1/16	1 7/16	2,43
12Z-R72	1 1/16-12	-12	94,5	3.72	64,2	2.53	15,5	0.61	32	1 7/16	2,65

Includes o-ring. See page L-64 for replacement o-rings.

Flareless Tube Rigid Ermeto 7000 Series

(With Nut and Sleeve)

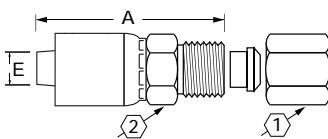

Z-Series Part #	Thd.	Tube O.D.	Hose Size	A		Hose Cut-Off Factor (D)		EØ		(2)	(1)
				mm	in	mm	in	mm	in		
04Z-754	7/16-20	1/4	-04	41,9	1.65	21,8	0.86	4,3	0.17	9/16	9/16
04Z-755	1/2-20	5/16	-04	40,1	1.58	20,3	0.80	4,3	0.17	9/16	5/8
06Z-754	7/16-20	1/4	-06	46,0	1.81	24,6	0.97	6,6	0.26	11/16	9/16
06Z-755	1/2-20	5/16	-06	46,0	1.81	24,6	0.97	5,8	0.23	11/16	5/8
06Z-756	9/16-18	3/8	-06	46,2	1.82	25,2	0.99	6,6	0.26	11/16	11/16
08Z-758	3/4-16	1/2	-08	54,6	2.15	29,5	1.16	9,7	0.38	13/16	7/8
08Z-760	7/8-14	5/8	-08	53,8	2.12	28,5	1.12	9,7	0.38	15/16	1
12Z-762	1 1/16-12	3/4	-12	61,0	2.40	34,0	1.34	15,5	0.61	1 1/8	1 1/4
16Z-766	1 5/16-12	1	-16	96,5	3.80	37,6	1.48	20,6	0.81	1 3/8	1 1/2
20Z-770	1 5/8-12	1 1/4	-20	85,1	3.35	45,7	1.80	26,7	1.05	1 3/4	2

See page L-80 for replacement nuts and sleeves.

Flareless 45° Tube Elbow 7000 Ermeto Series

(With Nut and Sleeve)

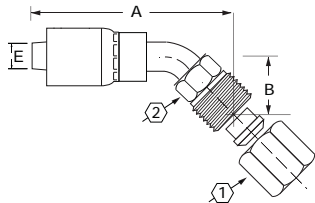

Z-Series Part #	Thd. T	Tube O.D.	Hose Size	A		Hose Cut-Off Factor (D)		EØ		1	2	B
				mm	in	mm	in	mm	in			
06Z-956	9/16-18	3/8	-06	62,0	2.44	39,6	1.56	6,6	.26	11/16	5/8	0.83

See page L-80 for replacement nuts and sleeves.

Flareless 90° Tube Elbow 7000 Ermeto Series

(With Nut and Sleeve)

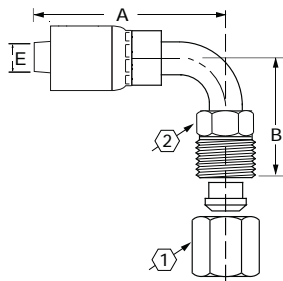

Z-Series Part #	Thd. T	Tube O.D.	Hose Size	A		Hose Cut-Off Factor (D)		EØ		2	1	B
				mm	in	mm	in	mm	in			
06Z-976	9/16-18	3/8	-06	52,1	2.05	30,9	1.22	6,6	0.26	5/8	11/16	1.46

See page L-80 for replacement nuts and sleeves.

J

Hose Ends - Crimp

Inverted Male Swivel Straight

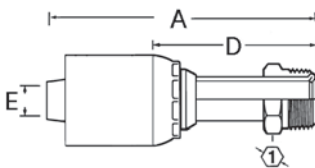

Z-Series Part #	Thd.	Hose Size	A		Hose Cut-Off Factor (D)		EØ		1
			mm	in	mm	in	mm	in	in
04Z-B03	3/8-24	-04	76,2	3.00	55,9	2.20	2,5	0.10	3/8
04Z-B04	7/16-24	-04	60,7	2.39	37,1	1.46	4,3	0.17	7/16
04Z-B05	1/2-20	-04	60,7	2.39	37,1	1.46	4,3	0.17	1/2
06Z-B04	7/16-24	-06	64,3	2.53	38,9	1.53	4,3	0.17	7/16
06Z-B05	1/2-20	-06	66,0	2.60	40,9	1.61	6,1	0.24	1/2
06Z-B06	5/8-18	-06	66,0	2.60	40,9	1.61	6,6	0.26	5/8
06Z-B07	11/16-18	-06	62,2	2.45	40,6	1.60	6,6	0.26	11/16
08Z-B08	3/4-18	-08	70,9	2.79	41,4	1.62	9,7	0.38	3/4
08Z-B10	7/8-18	-08	74,7	2.94	49,0	1.93	9,7	0.38	7/8

Inverted Male Swivel
45° Tube Elbow

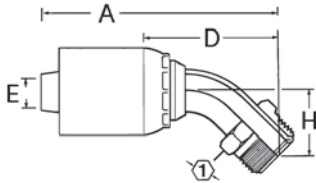

Z-Series Part #	Thd.	Hose Size	A		Hose Cut-Off Factor (D)		EØ		H		in
			mm	in	mm	in	mm	in	mm	in	
04Z-B43	3/8-24	-04	69,9	2.75	49,8	1.96	2,5	0.10	17,5	0.69	3/8
04Z-B44	7/16-24	-04	67,8	2.67	44,5	1.75	4,3	0.17	24,4	0.96	7/16
04Z-B45	1/2-20	-04	64,5	2.54	44,5	1.75	4,3	0.17	24,4	0.96	1/2
06Z-B45	1/2-20	-06	69,1	2.72	48,0	1.89	6,1	0.24	24,4	0.96	1/2
06Z-B46	5/8-18	-06	73,2	2.88	48,0	1.89	6,6	0.26	24,4	0.96	5/8
06Z-B47	11/16-18	-06	69,3	2.73	48,0	1.89	6,6	0.26	24,4	0.96	11/16
08Z-B48	3/4-18	-08	78,0	3.07	48,3	1.90	9,7	0.38	23,6	0.93	3/4

Inverted Male Swivel
90° Tube Elbow

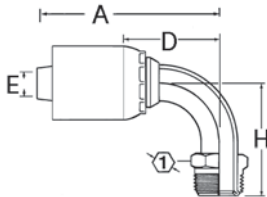

Z-Series Part #	Thd.	Hose Size	A		Hose Cut-Off Factor (D)		EØ		H		in
			mm	in	mm	in	mm	in	mm	in	
04Z-B63	3/8-24	-04	53,8	2.12	33,5	1.32	2,5	0.10	27,9	1.06	3/8
04Z-B64	7/16-24	-04	58,2	2.29	34,8	1.37	4,3	0.17	42,3	1.69	7/16
04Z-B65	1/2-20	-04	55,1	2.17	34,8	1.37	4,3	0.17	43,9	1.73	1/2
06Z-B64	7/16-24	-06	57,8	2.28	36,6	1.44	4,3	0.17	42,3	1.69	7/16
06Z-B65	1/2-20	-06	63,8	2.51	38,4	1.51	6,1	0.24	43,9	1.73	1/2
06Z-B66	5/8-18	-06	63,8	2.51	38,4	1.51	6,6	0.26	43,9	1.73	5/8
06Z-B67	11/16-18	-06	62,0	2.44	40,9	1.61	6,6	0.26	43,9	1.73	11/16
08Z-B68	3/4-18	-08	69,3	2.73	39,6	1.56	9,7	0.38	44,5	1.75	3/4

Split Flange Straight
(SAE Code 61)

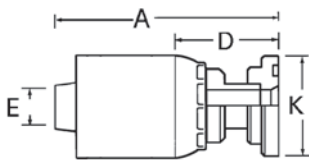

Z-Series Part #	Nominal Flange Size	Thd. Flange Head Dia. K Ø	Hose Size	A		Hose Cut-Off Factor (D)		EØ	
				mm	in	mm	in	mm	in
08Z-G08	1/2	1.19	-08	82,0	3.23	52,3	2.06	9,7	0.38
08Z-G12	3/4	1.50	-08	83,1	3.27	53,3	2.10	9,7	0.38
10Z-G12	3/4	1.50	-10	82,8	3.26	53,3	2.10	12,7	0.50
12Z-G12	3/4	1.50	-12	84,1	3.31	53,8	2.12	15,5	0.61
12Z-G16	1	1.75	-12	84,1	3.31	53,8	2.12	15,5	0.61
12Z-G20	1 1/4	2.00	-12	91,7	3.61	61,5	2.42	15,5	0.61
16Z-G16	1	1.75	-16	88,6	3.49	54,4	2.14	20,8	0.82
16Z-G20	1 1/4	2.00	-16	96,3	3.79	62,0	2.44	20,8	0.82
20Z-G16	1	1.75	-20	100,1	3.94	56,1	2.21	20,8	0.82
20ZA-G16	1	1.75	-20	100,1	3.94	56,1	2.21	20,8	0.82
20Z-G20	1 1/4	2.00	-20	107,7	4.24	63,8	2.51	26,7	1.05
20ZA-G20	1 1/4	2.00	-20	107,7	4.24	63,8	2.51	26,7	1.05
20Z-G24	1 1/2	2.38	-20	108,5	4.27	64,5	2.54	26,7	1.05
20ZA-G24	1 1/2	2.38	-20	108,5	4.27	64,5	2.54	26,7	1.05
20Z-G32	2	2.81	-20	108,5	4.27	64,5	2.54	25,7	1.01
24Z-G24	1 1/2	2.38	-24	111,8	4.40	65,5	2.58	32,0	1.26
24Z-G32	2	2.81	-24	111,8	4.40	65,5	2.58	30,2	1.19
32Z-G32	2	2.81	-32	117,1	4.61	66,8	2.63	44,5	1.75
32Z-G33	2 1/2	3.31	-32	116,8	4.60	66,8	2.63	44,5	1.75

Note: 20ZA fittings should only be used with one wire braided hose. 20Z fittings should only be used with two wire braided hose.

See pages L-90 thru L-92 for split flange kits.



Hose Ends - Crimp

Z-Series

Split Flange 22.5° Tube Elbow
(SAE Code 61)

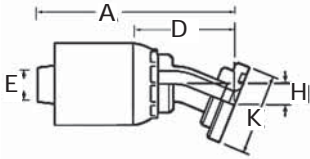

Z-Series Part #	Nominal Flange Size	Flange Head Dia. K Ø	Hose Size	A		Hose Cut-Off Factor (D)		EØ		H	
				mm	in	mm	in	mm	in	mm	in
16Z-H03	1	1.75	-16	117,9	4.64	83,6	3.29	19,3	0.76	11,4	0.45
16Z-H04	1 1/4	2.00	-16	130,0	5.12	95,8	3.77	19,3	0.76	11,7	0.46
20Z-H04	1 1/4	2.00	-20	141,5	5.57	97,3	3.83	25,7	1.01	11,7	0.46

See pages L-90 thru L-92 for split flange kits.

Split Flange 45° Tube Elbow
(SAE Code 61)

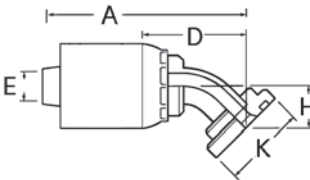

Z-Series Part #	Nominal Flange Size	Flange Head Dia. K Ø	Hose Size	A		Hose Cut-Off Factor (D)		EØ		H	
				mm	in	mm	in	mm	in	mm	in
08Z-G41	1/2	1.19	-08	79,0	3.11	49,3	1.94	9,4	0.37	19,8	0.78
08Z-G42	3/4	1.50	-08	92,5	3.64	62,7	2.47	9,4	0.37	25,4	1.00
10Z-G42	3/4	1.50	-10	93,5	3.68	64,3	2.53	11,7	0.46	25,4	1.00
12Z-G42	3/4	1.50	-12	93,2	3.67	63,0	2.48	14,7	0.58	25,7	1.01
12Z-G46	1	1.75	-12	105,7	4.16	75,4	2.97	14,7	0.58	26,9	1.06
16Z-G46	1	1.75	-16	110,5	4.35	76,2	3.00	19,3	0.76	26,9	1.06
16Z-G50	1 1/4	2.00	-16	122,2	4.81	87,6	3.45	19,3	0.76	29,2	1.15
20Z-G46	1	1.75	-20	121,9	4.80	77,7	3.06	19,3	0.76	26,9	1.06
20ZA-G46	1	1.75	-20	121,9	4.80	77,7	3.06	19,3	0.76	26,9	1.06
20Z-G50	1 1/4	2.00	-20	134,1	5.28	90,2	3.55	25,7	1.01	30,0	1.18
20ZA-G50	1 1/4	2.00	-20	134,1	5.28	90,2	3.55	25,7	1.01	30,0	1.18
20Z-G54	1 1/2	2.37	-20	146,2	5.76	106,7	4.20	25,7	1.01	35,8	1.41
20ZA-G54	1 1/2	2.37	-20	150,9	5.94	106,7	4.20	25,7	1.01	35,8	1.41
24Z-G54	1 1/2	2.37	-24	151,6	5.97	107,0	4.25	32,0	1.26	35,8	1.41
24Z-G62	2	2.81	-24	154,2	6.07	108,0	4.25	32,0	1.26	35,8	1.41
32Z-G54	1 1/2	2.37	-32	159,3	6.27	109,0	4.29	32,0	1.26	35,8	1.41
32Z-G62	2	2.81	-32	190,2	7.49	140,2	5.52	44,5	1.75	50,8	2.00

See pages L-90 thru L-92 for split flange kits.

Note: 20ZA fittings should only be used with one wire braided hose.
20Z fittings should only be used with two wire braided hose.

Hose Ends - Crimp

Split Flange 60° Tube Elbow
(SAE Code 61)

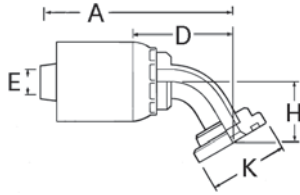

Z-Series Part #	Nominal Flange Size	Flange Head Dia. K Ø	Hose Size	A		Hose Cut-Off Factor (D)		EØ		H	
				mm	in	mm	in	mm	in	mm	in
16Z-H53	1	1.75	-16	132,5	5.22	98,7	3.89	19,9	0.78	38,3	1.51
24Z-H55	1-1/2	2.37	-24	187,1	7.37	143,4	5.65	32,0	1.26	46,1	1.81

See pages L-90 thru L-92 for split flange kits.

Split Flange 67° Tube Elbow
(SAE Code 61)

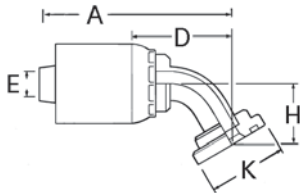

Z-Series Part #	Nominal Flange Size	Flange Head Dia. K Ø	Hose Size	A		Hose Cut-Off Factor (D)		EØ		H	
				mm	in	mm	in	mm	in	mm	in
20Z-H60	1-1/4	2.00	-20	157,0	6.18	112,8	4.44	25,7	1.01	46,5	1.83
20Z-H64	1-1/2	2.37	-24	189,7	7.47	143,5	5.65	30,2	1.19	46,0	1.81

Split Flange 90° Tube Elbow
(SAE Code 61)

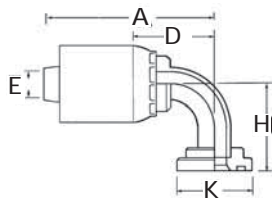

Z-Series Part #	Nominal Flange Size	Flange Head Dia. K Ø	Hose Size	A		Hose Cut-Off Factor (D)		EØ		H	
				mm	in	mm	in	mm	in	mm	in
08Z-G71	1/2	1.19	-08	72,6	2.86	42,3	1.69	9,4	0.37	41,4	1.63
08Z-G72	3/4	1.50	-08	87,6	3.45	57,9	2.28	9,4	0.37	54,1	2.13
10Z-G72	3/4	1.50	-10	87,4	3.44	58,2	2.29	12,7	0.50	54,1	2.13
12Z-G72	3/4	1.50	-12	88,6	3.49	58,4	2.30	14,7	0.58	54,1	2.13
12Z-G76	1	1.75	-12	102,4	4.03	72,1	2.84	14,7	0.58	60,5	2.38
12Z-G80	1 1/4	2.00	-12	118,6	4.67	88,4	3.48	14,7	0.58	66,5	2.62
16Z-G76	1	1.75	-16	107,2	4.22	72,6	2.86	19,3	0.76	60,5	2.38
16Z-G80	1 1/4	2.00	-16	123,2	4.85	89,0	3.50	19,3	0.76	66,5	2.62
16Z-G84	1 1/2	2.37	-16	142,0	5.59	107,7	4.24	19,3	0.76	79,2	3.12
20Z-G76	1	1.75	-20	118,4	4.66	74,4	2.93	19,3	0.76	60,5	2.38
20ZA-G76	1	1.75	-20	118,4	4.66	74,4	2.93	19,3	0.76	60,5	2.38
20Z-G80	1 1/4	2.00	-20	134,6	5.30	90,7	3.57	25,7	1.01	66,5	2.62
20ZA-G80	1 1/4	2.00	-20	134,6	5.30	90,7	3.57	25,7	1.01	66,5	2.62
20Z-G84	1 1/2	2.37	-20	153,4	6.04	109,4	4.31	26,6	1.05	79,3	3.12
20ZA-G84	1 1/2	2.37	-20	153,4	6.04	109,4	4.31	26,6	1.05	79,3	3.12
24Z-G80	1 1/4	2.00	-24	137,9	5.43	91,7	3.61	25,7	1.01	66,5	2.62
24Z-G84	1 1/2	2.37	-24	157,0	6.18	110,5	4.35	32,0	1.26	79,3	3.12
24Z-G92	2	2.81	-24	184,9	7.28	138,4	5.45	32,0	1.26	114,3	4.50
32Z-G92	2	2.81	-32	182,9	7.20	119,9	4.72	41,4	1.62	114,3	4.50
32Z-G93	2 1/2	3.31	-32	182,9	7.20	119,9	4.72	41,4	1.62	115,8	4.56

Note: 20ZA fittings should only be used with one wire braided hose. 20Z fittings should only be used with two wire braided hose.

See pages L-90 thru L-92 for split flange kits.



Hose Ends - Crimp

Metric Split Flange Straight
(Komatsu, Linkbelt, etc.)

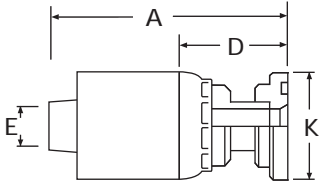

Z-Series Part #	Nominal Flange Size	Flange Head Dia. K Ø		Hose Size	A		Hose Cut-Off Factor (D)		E Ø	
		mm	in		mm	in	mm	in	mm	in
10Z-G09	5/8	34,2	1.35	-10	94,2	0.16	64,8	2.55	11,5	0.45

Metric Split Flange
45° Tube Elbow
(Komatsu, Linkbelt, etc.)

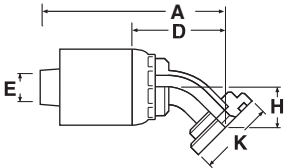

Z-Series Part #	Nominal Flange Size	Flange Head Dia. K Ø		Hose Size	A		Hose Cut-Off Factor (D)		E Ø		H
		mm	in		mm	in	mm	in	mm	in	
10Z-G69	5/8	34,2	1.35	-10	86,1	3.39	56,7	2.23	11,5	0.45	21,8 0.86

J

Hose Ends - Crimp

Metric Split Flange
90° Tube Elbow
(Komatsu, Linkbelt, etc.)

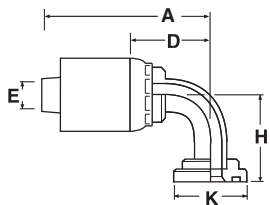

Z-Series Part #	Nominal Flange Size	Flange Head Dia. K Ø		Hose Size	A		Hose Cut-Off Factor (D)		E Ø		H
		mm	in		mm	in	mm	in	mm	in	
10Z-G69	5/8	34,2	1.35	-10	77,9	3.07	48,5	1.91	11,5	0.45	51,3 2.02

READY-LOK® Male Connector

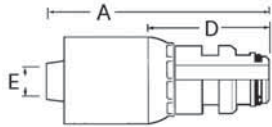

Note: 20ZA fittings should only be used with one wire braided hose.
20Z fittings should only be used with two wire braided hose.

Z-Series Part #	Connect. Size	Hose Size	A		Hose Cut-Off Factor (D)		EØ	
			mm	in	mm	in	mm	in
04Z-04S	1/4	-04	55,4	2.18	32,0	1.26	4,3	0.17
06Z-06S	3/8	-06	58,4	2.30	33,0	1.30	6,6	0.26
06Z-08S	1/2	-06	58,4	2.30	33,0	1.30	6,6	0.26
08Z-08S	1/2	-08	64,0	2.52	34,3	1.35	9,7	0.38
12Z-12S	3/4	-12	65,0	2.56	34,8	1.37	15,5	0.61
16Z-16S	1	-16	74,9	2.95	40,6	1.60	20,6	0.81
20ZA-20S	1 1/4	-20	86,4	3.40	42,4	1.67	26,7	1.05

(O-ring and backup ring included.)

Standpipe Straight Tube

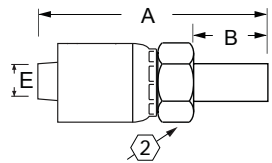

Z-Series Part #	Tube O.D.	Hose Size	A		Hose Cut-Off Factor (D)		EØ		2x	B	
			mm	in	mm	in	mm	in		mm	in
04Z-T04	1/4	-04	55,6	2.19	35,56	1.40	4,3	0.17	9/16	25,4	1.00
06Z-T06	3/8	-06	59,7	2.35	38,61	1.52	6,6	0.26	11/16	25,4	1.00
08Z-T08	1/2	-08	68,3	2.69	43,18	1.70	9,7	0.38	13/16	27,9	1.10
10Z-T10	5/8	-10	71,1	2.80	45,47	1.79	12,7	0.50	15/16	29,2	1.15
12Z-T12	3/4	-12	73,7	2.90	46,74	1.84	15,5	0.61	1 1/8	30,2	1.19
16Z-T16	1	-16	87,1	3.43	53,59	2.11	20,6	0.81	1 3/8	33,5	1.32

See page L-80 for Ermeto nuts and sleeves.

Metric Standpipe Straight Tube

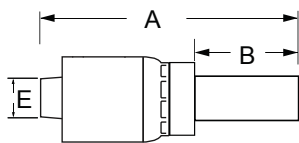

Z-Series Part #	Tube O.D.	Hose Size	A		Hose Cut-Off Factor (D)		EØ		B	
			mm	in	mm	in	mm	in	mm	in
04Z-38T	8	-04	56,4	2.22	33,0	1.30	4,1	0.16	23	0.91
04Z-40T	10	-04	56,4	2.22	33,0	1.30	4,3	0.17	23	0.91
06Z-40T	10	-06	59,4	2.34	34,3	1.35	6,6	0.26	23	0.91
06Z-42T	12	-06	60,5	2.38	35,0	1.38	6,6	0.26	24	0.95
06Z-44T	14	-06	61,5	2.42	36,1	1.42	6,6	0.26	25	0.98
08Z-45T	15	-08	66,8	2.63	37,1	1.46	9,7	0.38	25	0.98
08Z-46T	16	-08	68,1	2.68	38,4	1.51	9,7	0.38	26	1.02
10Z-48T	18	-10	69,1	2.72	39,6	1.56	12,7	0.05	27	1.06
10Z-50T	20	-10	69,1	2.72	39,6	1.56	12,7	0.50	27	1.06
12Z-52T	22	-12	71,1	2.80	40,9	1.61	15,5	0.61	28	1.10
12Z-55T	25	-12	70,1	2.76	39,9	1.57	15,5	0.61	27	1.06
16Z-58T	28	-16	75,7	2.98	41,4	1.63	20,6	0.81	28	1.10
16Z-60T	30	-16	75,9	2.99	41,7	1.64	20,6	0.81	28	1.10

See page L-66 for metric nuts and sleeves.

Pressure Washer Connection

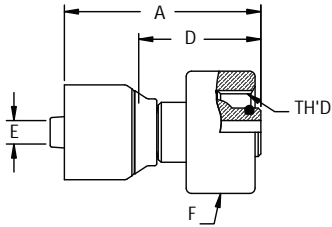

Z-Series Part #	Thd.	Hose Size	A		Hose Cut-Off Factor (D)		EØ		F Dia.	
			mm	in	mm	in	mm	in	mm	in
04Z-6PW	M22x1.5	-04	55,4	2.18	35,3	1.39	4,2	0.17	34,9	1.38
06Z-6PW	M22x1.5	-06	56,1	2.21	34,9	1.38	6,7	0.26	34,9	1.38

BSPP Flat Face Female Swivel

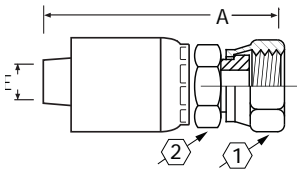

Z-Series Part #	Thd.	Hose Size	A		Hose Cut-Off Factor (D)		EØ		2	1
			mm	in	mm	in	mm	in	in	in
06Z-06PA	G 3/8-19	-06	57,2	2.25	36,7	1.42	6,6	0.26	11/16	3/4
06Z-08PA	G 1/2-14	-06	58,7	2.31	37,6	1.48	6,6	0.26	3/4	11/16
08Z-08PA	G 1/2-14	-08	66,8	2.63	41,7	1.64	9,2	0.36	13/16	11/16
08Z-12PA	G 3/4-14	-08	67,1	2.64	41,9	1.65	9,7	0.38	1	11/4
12Z-12PA	G 3/4-14	-12	71,1	2.80	44,2	1.74	15,5	0.61	11/8	11/4

* G as part of thread size is ISO Designation for parallel thread.

J

Hose Ends - Crimp

British Standard (BSPP) 60° Cone Female Swivel Straight

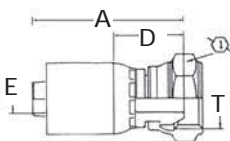

Z-Series Part #	Thd. T	Hose Size	A		Hose Cut-Off Factor (D)		EØ		1	
			mm	in	mm	in	mm	in	mm	in
04Z-354	G 1/4-19*	-04	42,3	1.66	18,9	0.74	4,2	0.16	19,0	0.75
04Z-356	G 3/8-19*	-04	45,5	1.79	22,1	0.87	4,3	0.17	22,0	0.87
06Z-356	G 3/8-19*	-06	46,4	1.83	21,1	0.83	6,7	0.26	22,0	0.87
06Z-358	G 1/2-14*	-06	47,9	1.88	22,6	0.89	6,7	0.26	27,0	1.06
08Z-358	G 1/2-14*	-08	53,5	2.11	23,8	0.94	9,6	0.38	27,0	1.06
08Z-360	G 5/8-14*	-08	56,4	2.22	26,7	1.05	9,6	0.38	30,0	1.18
10Z-360	G 5/8-14*	-10	54,1	2.13	24,7	0.97	12,7	0.50	30,0	1.18
12Z-362	G 3/4-14*	-12	55,5	2.18	25,3	1.00	15,5	0.61	32,0	1.26
16Z-366	G 1-11*	-16	62,0	2.44	27,6	1.09	20,7	0.81	41,0	1.61
20Z-370	G 1 1/4-11*	-20	73,6	2.90	29,6	1.16	26,6	1.05	50,0	1.97

* G as part of thread size is ISO Designation for parallel thread.

British Standard (BSPP)
60° Cone Female
45° Tube Elbow

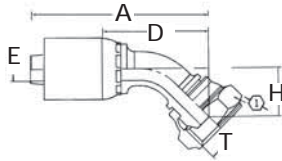

Z-Series Part #	Thd. T	Hose Size	A		Hose Cut-Off Factor (D)		EØ		H		①	
			mm	in	mm	in	mm	in	mm	in	mm	in
04Z-44P	G 1/4 -19*	-04	65,3	2.57	41,9	1.65	4,2	0.16	16,5	0.65	19,0	0.75
06Z-46P	G 3/8 -19*	-06	73,8	2.90	48,5	1.91	6,7	0.26	19,0	0.75	22,0	0.87
08Z-48P	G 1/2 -14*	-08	91,5	3.60	61,8	2.43	9,6	0.38	24,8	0.98	27,0	1.06
10Z-50P	G 5/8 -14*	-10	100,4	3.95	71,0	2.79	12,7	0.50	27,4	1.08	30,0	1.18
12Z-52P	G 3/4 -14*	-12	108,8	4.28	78,6	3.09	15,5	0.61	29,4	1.16	32,0	1.26
16Z-56P	G 1 -11*	-16	126,8	4.99	92,4	3.09	20,7	0.81	33,2	1.31	41,0	1.61
20Z-60P	G 1 1/4 -11*	-20	153,6	6.05	109,6	4.31	26,6	1.05	37,2	1.46	50,0	1.97

* G as part of thread size is ISO Designation for parallel thread.

British Standard (BSPP)
60° Cone Female
90° Tube Elbow

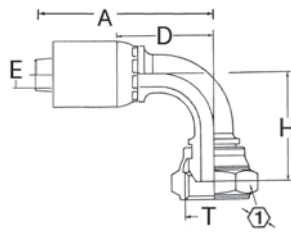

Z-Series Part #	Thd. T	Hose Size	A		Hose Cut-Off Factor (D)		EØ		H		①	
			mm	in	mm	in	mm	in	mm	in	mm	in
04Z-74P	G 1/4 -19*	-04	45,8	1.80	22,4	0.88	4,2	0.16	24,8	0.98	17,0	0.67
06Z-76P	G 3/8 -19*	-06	58,9	2.32	33,6	1.32	6,7	0.26	35,0	1.38	22,0	0.87
06Z-78P	G 1/2 -14*	-06	75,7	2.98	50,4	1.98	6,7	0.26	47,8	1.88	27,0	1.06
08Z-78P	G 1/2 -14*	-08	64,0	2.52	34,3	1.35	9,6	0.38	37,6	1.48	27,0	1.06
08Z-80P	G 5/8 -14*	-08	90,7	3.57	61,0	2.40	9,6	0.38	56,3	2.22	27,0	1.06
10Z-80P	G 5/8 -14*	-10	90,6	3.57	61,2	1.41	12,7	0.50	56,3	2.22	27,0	1.06
12Z-82P	G 3/4 -14*	-12	82,2	3.24	52,0	2.05	15,5	0.61	47,5	1.87	32,0	1.26
16Z-86P	G 1 -11*	-16	118,2	4.65	83,8	3.30	20,7	0.81	71,5	2.81	41,0	1.61
20Z-90P	G 1 1/4 -11*	-20	146,2	5.75	102,2	4.02	26,6	1.05	82,5	3.25	50,0	1.97

* G as part of thread size is ISO Designation for parallel thread.

British Standard (BSPT)
Tapered Male Rigid

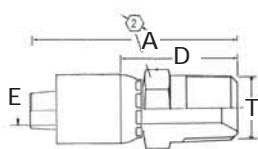

Z-Series Part #	Thd. T	Hose Size	A		Hose Cut-Off Factor (D)		EØ		②	
			mm	in	mm	in	mm	in	mm	in
04Z-154	R 1/4 -19*	-04	50,6	1.99	27,2	1.07	4,2	0.16	14,0	0.55
06Z-156	R 3/8 -19*	-06	54,9	2.16	29,6	1.16	6,7	0.26	19,0	0.75
08Z-158	R 1/2 -14*	-08	66,2	2.61	36,5	1.44	9,6	0.38	22,0	0.87
12Z-162	R 3/4 -14*	-12	71,1	2.80	40,9	1.61	15,5	0.61	30,0	1.18
16Z-166	R 1 -11*	-16	81,2	3.20	46,8	1.84	20,7	0.81	36,0	1.42
20Z-170	R 1 1/4 -11*	-20	96,2	3.79	52,2	2.05	26,6	1.05	46,0	1.81

* R as part of thread size is ISO Designation for tapered thread.



Z-Series

British Standard (BSPP)
60° Cone Male Rigid

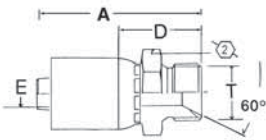

Z-Series Part #	Thd. T	Hose Size	A		Hose Cut-Off Factor (D)		EØ		⌀2	
			mm	in	mm	in	mm	in	mm	in
04Z-P54	G 1/4-19*	-04	44,3	1.74	20,9	0.82	4,2	0.16	19,0	0.75
06Z-P56	G 3/8-19*	-06	48,4	1.90	23,1	0.91	6,7	0.26	22,0	0.87
08Z-P56	G 3/8-19*	-08	55,9	2.20	26,4	1.04	9,6	0.38	22,0	0.87
06Z-P58	G 1/2-14*	-06	52,4	2.06	27,1	1.07	6,7	0.26	27,0	1.06
08Z-P58	G 1/2-14*	-08	58,0	2.28	28,3	1.11	9,6	0.38	27,0	1.06
10Z-P60	G 5/8-14*	-10	62,0	2.44	35,5	1.25	12,7	0.50	30,0	1.18
12Z-P62	G 3/4-14*	-12	63,1	2.48	32,9	1.29	15,5	0.61	32,0	1.26
16Z-P66	G 1-11*	-16	70,9	2.79	36,5	1.44	20,7	0.81	41,0	1.61
20Z-P67	G 1 1/4-11*	-20	86,1	3.39	42,2	1.66	26,6	1.50	50,0	1.97

* G as part of thread size is ISO Designation for parallel thread.

Female JIS 30° Flare
Swivel Straight

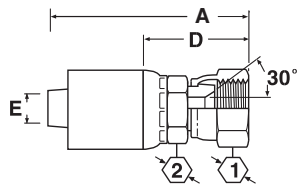

Z-Series Part #	Thd.	Hose Size	A		Hose Cut-Off Factor (D)		EØ		⌀1		⌀2	
			mm	in	mm	in	mm	in	mm	in	mm	in
04Z-04L	G 1/4-19*	-04	53,2	2.09	29,8	1.17	4,2	0.16	19,0	0.75	19,0	0.75
06Z-06L	G 3/8-19*	-06	59,2	2.33	33,9	1.33	6,7	0.26	22,0	0.87	22,0	0.87
08Z-08L	G 1/2-14*	-08	66,3	2.61	36,6	1.44	9,6	0.38	27,0	1.06	27,0	1.06
10Z-12L	G 3/4-14*	-10	70,6	2.78	45,2	1.78	12,7	0.50	32,0	1.26	36,0	1.42
12Z-12L	G 3/4-14*	-12	73,3	2.88	43,1	1.70	15,5	0.61	32,0	1.26	36,0	1.42
16Z-16L	G 1-11*	-16	83,6	3.29	49,2	1.94	20,7	0.81	41,0	1.61	41,0	1.61
20Z-20L	G 1 1/4-11*	-20	102,1	4.02	58,1	2.29	26,6	1.05	50,0	1.97	46,0	1.81

* G as part of thread size is ISO Designation for parallel thread.

J

Hose Ends - Crimp

Female Swivel
30° Flare
(Komatsu, Linkbelt)

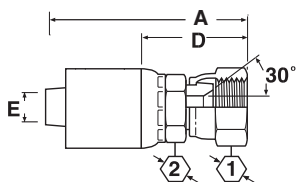

Z-Series Part #	Thd.	Hose Size	A		Hose Cut-Off Factor (D)		EØ		⌀1		⌀2	
			mm	in	mm	in	mm	in	mm	in	mm	in
04Z-14K	M14 x 1.5	-04	56,1	2.21	32,7	1.29	42,2	1.66	19,0	0.75	19,0	0.75
06Z-18K	M18 x 1.5	-06	60,4	2.38	35,1	1.38	6,7	0.26	24,0	0.94	22,0	0.87
08Z-22K	M22 x 1.5	-08	69,5	2.74	39,8	1.57	9,6	0.38	27,0	1.06	27,0	1.06
10Z-24K	M24 x 1.5	-10	75,4	2.97	46,0	1.81	12,4	0.49	32,0	1.26	30,0	1.18
12Z-30K	M30 x 1.5	-12	81,5	3.21	51,3	2.02	15,5	0.61	36,0	1.42	36,0	1.42
16Z-33K	M33 x 1.5	-16	91,4	3.60	57,0	2.24	20,7	0.81	41,0	1.61	41,0	1.61

Female Swivel DIN 24° Seat
I.Rh DKO (Light)

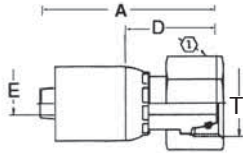

Z-Series Part #	Thd. T	Tube O.D.	Hose Size	A		Hose Cut-Off Factor (D)		EØ		①	
				mm	in	mm	in	mm	in	mm	in
04Z-06C	M12 x 1.5	6	-04	48,0	1.89	24,6	0.97	4,2	0.16	17,0	0.67
04Z-08C	M14 x 1.5	8	-04	46,0	1.81	22,6	0.89	4,2	0.16	17,0	0.67
04Z-10C	M16 x 1.5	10	-04	48,3	1.90	24,9	0.98	4,3	0.17	19,0	0.75
06Z-10C	M16 x 1.5	10	-06	56,9	2.24	31,6	1.24	6,7	0.26	19,0	0.75
06Z-12C	M18 x 1.5	12	-06	51,2	2.01	25,9	1.02	6,7	0.26	22,0	0.87
08Z-15C	M22 x 1.5	15	-08	58,3	2.29	28,6	1.12	9,6	0.38	27,0	1.06
10Z-18C	M26 x 1.5	18	-10	59,2	2.33	29,8	1.17	12,7	0.50	32,0	1.26
12Z-22C	M30 x 2.0	22	-12	62,5	2.46	32,3	1.27	15,5	0.61	36,0	1.42
16Z-28C	M36 x 2.0	28	-16	68,2	2.68	33,8	1.33	20,7	0.81	41,0	1.61
20Z-35C	M45 x 2.0	35	-20	83,7	3.29	39,7	1.56	26,6	1.05	50,0	1.97

Female Swivel DIN 24° Seat
45° Tube Elbow
I. Rh. (Light)

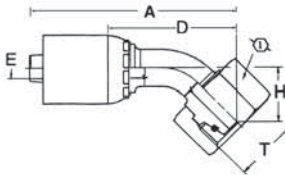

Z-Series Part #	Thd. T	Tube O.D.	Hose Size	A		Hose Cut-Off Factor (D)		EØ		H		①	
				mm	in	mm	in	mm	in	mm	in	mm	in
04Z-08D	M14 X 1.5	8	-04	6,2	2.46	3,9	1.54	0,4	0.17	17,5	0.69	17,0	0.67
04Z-10D	M16 X 1.5	10	-04	6,5	2.55	4,1	1.63	0,4	0.17	18,4	0.72	19,0	0.75
06Z-10D	M16 X 1.5	10	-06	6,7	2.63	4,1	1.63	0,7	0.26	19,0	0.75	19,0	0.75
06Z-12D	M18 X 1.5	12	-06	7,0	2.76	4,5	1.76	0,7	0.26	17,6	0.69	22,0	0.87
08Z-15D	M22 X 1.5	15	-08	8,3	3.27	5,3	2.10	1,0	0.38	20,5	0.81	27,0	1.06
10Z-18D	M26 X 1.5	18	-10	9,1	3.59	6,2	2.44	1,3	0.50	22,0	0.87	32,0	1.26
12Z-22D	M30 X 2.0	22	-12	10,1	3.97	7,1	2.78	1,5	0.61	24,3	0.96	36,0	1.42
16Z-28D	M36 X 2.0	28	-16	10,3	4.06	6,9	2.70	2,1	0.81	26,6	1.05	41,0	1.61

Female Swivel DIN 24° Seat
90° Tube Elbow
I. Rh. (Light)

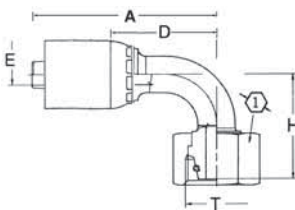

Z-Series Part #	Thd. T	Tube O.D.	Hose Size	A		Hose Cut-Off Factor (D)		EØ		H		①	
				mm	in	mm	in	mm	in	mm	in	mm	in
04Z-58D	M14 x 1.5	8	-04	51,1	2.01	27,7	1.09	4,3	0.17	31,5	1.24	17,0	0.67
04Z-60D	M16 x 1.5	10	-04	55,4	2.18	32,0	1.26	4,3	0.17	35,5	1.40	19,0	0.75
06Z-60D	M16 x 1.5	10	-06	58,4	2.30	33,5	1.32	6,6	0.26	33,5	1.32	19,0	0.75
06Z-62D	M18 x 1.5	12	-06	59,7	2.35	34,5	1.36	6,6	0.26	34,2	1.35	22,0	0.87
08Z-65D	M22 x 1.5	15	-08	75,2	2.96	45,7	1.80	9,7	0.38	40,0	1.57	27,0	1.06
10Z-68D	M26 x 1.5	18	-10	86,4	3.40	56,9	2.24	12,7	0.50	46,5	1.83	32,0	1.26
12Z-72D	M30 x 2.0	22	-12	92,5	3.64	62,2	2.45	15,5	0.61	50,7	2.00	36,0	1.42
16Z-78D	M36 x 2.0	28	-16	100,1	3.94	65,5	2.58	20,6	0.81	61,0	2.40	41,0	1.61
20Z-85D	M45 x 2.0	35	-20	130,0	5.12	86,1	3.39	26,7	1.05	79,0	3.11	50,0	1.97

Hose Ends - Crimp

Z-Series

Male DIN 24° Seat
I.Rh (Light)

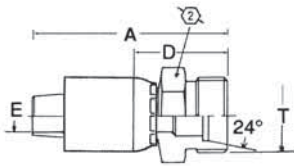

Z-Series Part #	Thd. T	Tube O.D.	Hose Size	A		Hose Cut-Off Factor (D)		EØ		⊕2	
				mm	in	mm	in	mm	in	mm	in
04Z-06A	M12 x 1.5	6	-04	44,7	1.76	21,3	0.84	4,2	0.16	12,0	0.47
04Z-08A	M14 x 1.5	8	-04	44,5	1.75	21,1	0.83	4,2	0.16	14,0	0.55
04Z-10A	M16 X 1.5	10	-04	46,0	1.81	22,6	0.89	4,3	0.17	17,0	0.67
06Z-10A	M16 x 1.5	10	-06	52,0	2.05	26,7	1.05	6,7	0.26	17,0	0.67
06Z-12A	M18 x 1.5	12	-06	49,0	1.93	23,7	0.93	6,7	0.26	19,0	0.75
08Z-15A	M22 x 1.5	15	-08	56,0	2.20	26,3	1.03	9,6	0.38	24,0	0.94
10Z-18A	M26 x 1.5	18	-10	56,0	2.20	26,6	1.05	12,7	0.50	27,0	1.06
12Z-22A	M30 x 2.0	22	-12	62,0	2.44	31,8	1.25	15,5	0.61	32,0	1.26
16Z-28A	M36 x 2.0	28	-16	66,0	2.60	31,6	1.24	20,7	0.81	41,0	1.61
20Z-35A	M45 x 2.0	35	-20	79,4	3.12	35,4	1.39	26,6	1.05	46,0	1.81

Female Swivel
DIN 24° Seat
s.Rh DKO (Heavy)

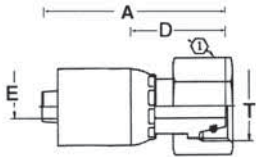

Z-Series Part #	Thd. T	Tube O.D.	Hose Size	A		Hose Cut-Off Factor (D)		EØ		⊕1	
				mm	in	mm	in	mm	in	mm	in
04Z-58C	M16 x 1.5	8	-04	49,6	1.95	26,2	1.03	4,2	0.16	19,0	0.75
04Z-60C	M18 x 1.5	10	-04	50,8	2.00	27,4	1.08	4,2	0.16	22,0	0.87
04Z-62C	M20 X 1.5	12	-04	50,8	2.00	27,4	1.08	4,3	0.17	24,0	0.94
06Z-60C	M18 X 1.5	10	-06	52,8	2.08	27,7	1.09	6,6	0.26	27,0	1.06
06Z-62C	M20 x 1.5	12	-06	53,8	2.12	28,5	1.12	6,7	0.26	24,0	0.94
06Z-64C	M22 x 1.5	14	-06	56,9	2.24	31,6	1.24	6,7	0.26	27,0	1.06
08Z-64C	M22 x 1.5	14	-08	55,2	2.17	25,5	1.00	9,6	0.38	27,0	1.06
08Z-66C	M24 x 1.5	16	-08	62,4	2.46	32,7	1.29	9,6	0.38	30,0	1.18
10Z-70C	M30 x 2.0	20	-10	66,9	2.63	37,5	1.48	12,7	0.50	36,0	1.42
12Z-75C	M36 x 2.0	25	-12	72,0	2.83	41,8	1.64	15,5	0.61	46,0	1.81
12Z-70C	M30 X 2.0	20	-12	60,2	2.37	30,2	1.19	14,0	0.55	36,0	1.42
16Z-80C	M42 x 2.0	30	-16	78,5	3.09	44,1	1.44	20,7	0.81	50,0	1.97
20Z-88C	M52 X 2.0	38	-20	93,7	3.69	49,8	1.96	26,6	1.05	60,0	2,36

Hose Ends - Crimp

Female Swivel
DIN 24° Seat 45° Tube Elbow
s.Rh (Heavy)

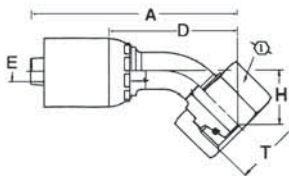

Z-Series Part #	Thd. T	Tube O.D.	Hose Size	A		Hose Cut-Off Factor (D)		EØ		H		⊕1	
				mm	in	mm	in	mm	in	mm	in	mm	in
04Z-10E	M18 x 1.5	10	-04	61,4	2.42	38,0	1.50	4,2	0.16	17,0	0.67	22,0	0.87
06Z-12E	M20 x 1.5	12	-06	68,3	2.69	43,0	1.69	6,7	0.26	19,0	0.75	24,0	0.94
06Z-14E	M22 x 1.5	14	-06	68,8	2.71	43,5	1.71	6,7	0.26	20,0	0.79	27,0	1.06
08Z-16E	M24 x 1.5	16	-08	79,7	3.14	50,0	1.97	9,6	0.38	23,0	0.90	30,0	1.18
10Z-20E	M30 x 2.0	20	-10	89,3	3.51	59,9	2.36	12,7	0.50	26,0	1.02	36,0	1.42
12Z-25E	M36 x 2.0	25	-12	107,4	4.23	77,2	3.04	15,5	0.61	32,5	1.28	46,0	1.81
16Z-30E	M42 x 2.0	30	-16	121,4	4.78	87,0	3.42	20,7	0.81	37,5	1.48	55,0	2.16

Female Swivel
DIN 24° Seat 90° Tube Elbow
s.Rh DKO (Heavy)

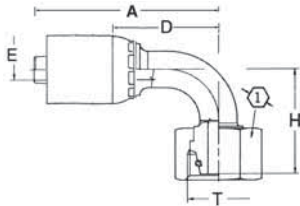

Z-Series Part #	Thd. T	Tube O.D.	Hose Size	A		Hose Cut-Off Factor (D)		EØ		H		Ⓛ1
				mm	in	mm	in	mm	in	mm	in	
04Z-58E	M16 x 1.5	10	-04	54,0	2.13	30,6	1.20	4,2	0.16	28,6	1.13	19,0 0.75
04Z-60E	M18 x 1.5	10	-04	54,5	2.14	31,0	1.22	4,2	0.16	33,5	1.32	22,0 0.87
06Z-62E	M20 x 1.5	12	-06	60,3	2.37	35,0	1.38	6,7	0.26	35,0	1.38	24,0 0.94
06Z-64E	M22 x 1.5	14	-06	63,8	2.51	38,5	1.51	6,7	0.26	42,0	1.65	27,0 1.06
08Z-66E	M24 x 1.5	16	-08	73,7	2.90	44,0	1.73	9,6	0.38	49,0	1.93	30,0 1.18
10Z-70E	M30 x 2.0	20	-10	82,0	3.23	52,6	2.07	12,7	0.50	53,5	2.11	36,0 1.42
12Z-75E	M36 x 2.0	25	-12	93,0	3.66	62,8	2.47	15,5	0.61	64,5	2.54	46,0 1.81
16Z-80E	M42 x 2.0	30	-16	104,0	4.09	69,6	2.74	20,7	0.81	74,0	2.91	50,0 1.97

Male DIN 24° Seat
s.Rh (Heavy)

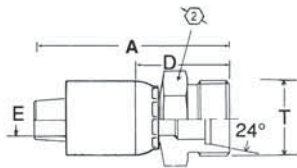

Z-Series Part #	Thd. T	Tube O.D.	Hose Size	A		Hose Cut-Off Factor (D)		EØ		Ⓛ2
				mm	in	mm	in	mm	in	
04Z-08F	M16 x 1.5	8	-04	47,5	1.87	24,1	0.95	4,2	0.16	17,0 0.67
04Z-10F	M18 x 1.5	10	-04	40,7	1.60	23,6	0.93	4,2	0.16	19,0 0.75
06Z-10F	M18 X 1.5	10	-06	49,5	1.95	24,1	0.95	6,7	0.26	19,0 0.75
06Z-12F	M20 x 1.5	12	-06	50,3	1.98	25,0	0.98	6,7	0.26	22,0 0.87
06Z-14F	M22 x 1.5	14	-06	52,6	2.07	27,3	1.07	6,7	0.26	24,0 0.94
08Z-16F	M24 x 1.5	16	-08	58,0	2.28	28,3	1.11	9,6	0.38	27,0 1.06
10Z-20F	M30 x 2.0	20	-10	62,0	2.44	32,6	1.28	12,7	0.50	32,0 1.26
12Z-20F	M30 X 2.0	20	-12	57,7	2.27	30,7	1.21	15,5	0.61	32,0 1.26
12Z-25F	M36 x 2.0	25	-12	65,5	2.58	35,3	1.39	15,5	0.61	41,0 1.61
16Z-30F	M42 x 2.0	30	-16	72,3	2.85	37,9	1.49	20,7	0.81	46,0 1.81

STC Male Straight

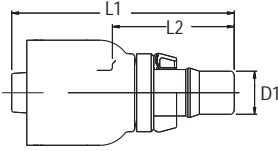

Z-Series Part #	D1		L1		L2	
	mm	in	mm	in	mm	in
04Z-BC04	4,2	0.17	49,9	1.97	26,5	1.04
04Z-BC06	4,2	0.17	52,4	2.06	29,0	1.14
06Z-BC06	6,7	0.26	55,5	2.19	30,2	1.19
06Z-BC08	6,7	0.26	60,6	2.39	35,4	1.39
08Z-BC08	9,6	0.38	66,3	2.61	36,6	1.44
10Z-BC10	12,8	0.50	69,0	2.72	39,6	1.56
12Z-BC12	15,5	0.61	74,6	2.94	44,4	1.75
16Z-BC16	0,7	0.82	83,7	3.30	49,3	1.94

STC Male 45° Tube Elbow

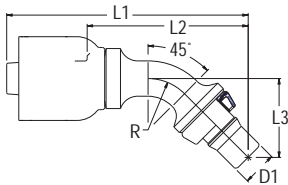

Z-Series Part #	D1		L1		L2		L3		R	
	mm	in	mm	in	mm	in	mm	in	mm	in
04Z-BC46	4,2	0.17	69,8	2.75	46,4	1.83	22,2	0.86	14,0	0.55
06Z-BC46	6,7	0.26	72,9	2.87	47,6	1.87	22,2	0.87	14,0	0.55
08Z-BC48	8,8	0.35	89,9	3.54	60,2	2.37	29,6	1.17	19,0	0.75
10Z-BC50	11,5	0.45	97,8	3.85	68,4	2.69	33,6	1.32	22,0	0.87
12Z-BC52	13,9	0.55	110,2	4.34	80,0	3.15	40,7	1.60	31,0	1.22

STC Male 90° Tube Elbow

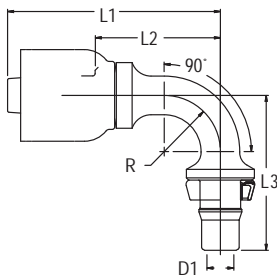

Z-Series Part #	D1		L1		L2		L3		R	
	mm	in	mm	in	mm	in	mm	in	mm	in
04Z-BC64	4,2	0.17	53,1	2.09	29,6	1.17	36,1	1.42	13,0	0.51
06Z-BC66	6,7	0.26	59,3	2.33	34,0	1.34	39,6	1.56	14,0	0.55
06Z-BC68	6,7	0.26	66,4	2.61	41,1	1.62	53,0	2.09	19,0	0.75
08Z-BC68	8,8	0.35	72,0	2.83	42,3	1.67	53,0	2.09	19,0	0.75
10Z-BC70	11,5	0.45	77,9	3.07	48,5	1.91	60,4	2.36	22,0	0.87
12Z-BC72	13,9	0.55	88,7	3.49	58,5	2.30	75,7	2.98	31,0	1.22
16Z-BC76	19,9	0.78	107,3	4.22	72,9	2.87	90,0	3.54	38,0	1.50

STC Male 90° Long Drop Elbow

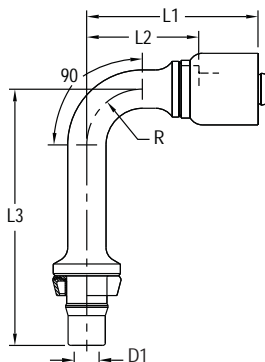

Z-Series Part #	D1		L1		L2		L3		R	
	mm	in	mm	in	mm	in	mm	in	mm	in
06Z-BC86	6,4	0.25	59,3	2.33	34,0	1.34	70,6	2.78	14,0	0.55
08Z-BC88	9,1	0.36	72,0	2.84	42,3	1.67	88,1	3.46	19,0	0.75
12Z-BC92	13,9	0.55	88,7	3.49	58,5	2.30	123,7	4.87	31,0	1.22

Hose Ends - Crimp

WeatherTIGHT™ 4SP/6SP Series Hose Ends

For use with H464, H470, H471, H485, H487

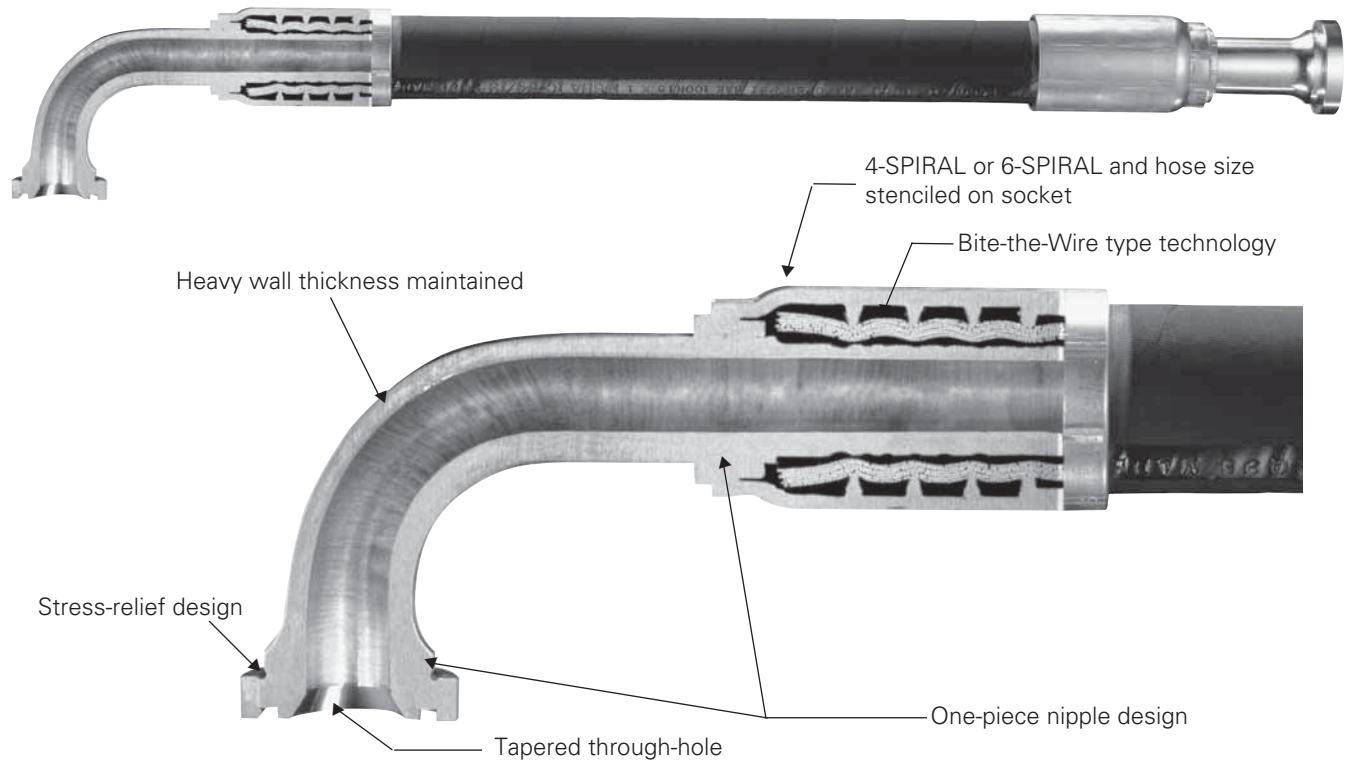

Features	Benefits
Bite the Wire type technology	Skiving not required, saves time in assembly
One-piece nipple design	Stronger design, no braze joints
One-piece hose end	Easier to assemble
Stress-relief design	Maximizes durability
Heavy wall thickness	Heavy-duty construction for heavy-duty applications
Modern micro-alloy steel	Maximizes fatigue life
Tapered through-hole	Improves flow characteristics
Global design	Global availability
Stenciled socket	Hose insertion depth
Operating pressure to 6000 psi	Perfect for hydrostatic drives and other demanding applications
Available in -12, -16, -20, -24 & -32	Multiple configurations and jump sizes to fit a wide array of applications

Label Set: FF90686

Assembly Instructions

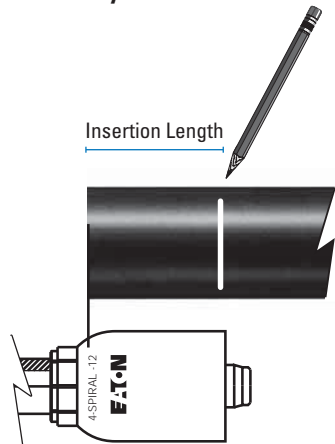

Figure 1

1. Cut hose to proper length by subtracting appropriate fitting "D" dimensions from overall assembly length.

- To determine hose insertion length (L), align end of hose to top of stenciled "4 SPIRAL" or "6 SPIRAL" (located on the socket taper) and mark hose where the socket ends (Figure 1).
- Install hose end onto hose until socket edge aligns with mark.

2. Select proper Collet and Spacer Ring, then crimp to specified diameter.

- To achieve full flat crimp locate back edge of socket approximately 1/8" (3mm) from back edge of crimp jaws as shown in Figure 2.

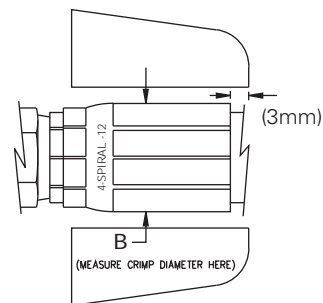

Figure 2

Hose End '4SP/6SP' Series

Ordering Information: Order individually by part number. O-rings not supplied with flange hose ends. Order o-rings by part number; reference individual listings for details. For split flange kits, refer to pages L-89-92.

Typical Application: General purpose high pressure hydraulic.

Pressure: Determined by the maximum working pressure for hose size and hose end configuration, whichever is lesser. See pages A15-16 for operating pressure ratings for hose end configurations.

Material:
Carbon Steel

Plating:
Clear silver hexavalent chromium-free plating

Advantages: Wide selection of hose and end configurations allowing a diverse number of applications.

Label Set:
FF90686

4SP Hose Ends

Compatible Hose:

H464: All sizes
H470*: -12 & -16 only
H471: -12 thru -24
H485: -16 only
H487: -12 & -16 only

* H470 with black cover only

Assemble With:

ET4000
ET4001
ET4040
T-440-1: -12 & -16 only

6SP Hose Ends

Compatible Hose:

H470*: -20 thru -32
H471: -32
H485: -20 & -24
H487: -20 & -24

* H470 with black cover only

Assemble With:

ET4000
ET4001
ET4040

4SP Hose Ends

For Use with Hose:
H464, H485 (-16 only),
H470 (-12 & -16 only)*
H471 (-12 thru -24),
H487 (-12 & -16 only)

Assembled with:
ET4000, ET4001, ET4040
T-440-1 (-12 & -16 only)

6SP Hose Ends

For Use with Hose:
H470 (-20, -24, -32 only)*
H485 (-20 & -24 only),
H471 (-32 only), H487 (-20 & -24)
*H470 with black cover only

Assembled with:
ET4000, ET4001, ET4040

Straight Split Flange

Code 61

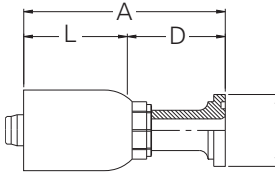

Fitting Part Number	Flange Head Dia. K		Hose Size	A		D		Insertion Length - L		H	
	inch	mm		inch	mm	inch	mm	inch	mm	inch	mm
Straight split flange - Code 61 (SAE J518)											
4SP12W-G12	1.50	38.1	-12	3.92	99.5	2.15	54.5	1.77	45.0	--	--
4SP12W-G16	1.75	44.4	-12	3.78	96.1	2.01	51.1	1.77	45.0	--	--
4SP16W-G16	1.75	44.4	-16	4.78	121.3	2.22	56.3	2.56	65.0	--	--
4SP16W-G20	2.00	50.8	-16	4.94	125.5	2.38	60.5	2.56	65.0	--	--
4SP20W-G20	2.00	50.8	-20	5.57	141.5	2.62	66.5	2.95	75.0	--	--
4SP20W-G24	2.38	60.3	-20	6.45	163.8	3.50	88.8	2.95	75.0	--	--
4SP24W-G24	2.38	60.3	-24	6.61	167.8	3.54	89.8	3.07	78.0	--	--
4SP24W-G32	2.81	71.4	-24	6.73	170.9	3.66	92.9	3.07	78.0	--	--
4SP32W-G32	2.81	71.4	-32	6.81	173.0	3.74	95.0	3.07	78.0	--	--
6SP20W-G20	2.00	50.8	-20	5.57	141.5	2.62	66.5	2.95	75.0	--	--
6SP24W-G24	2.38	60.3	-24	6.61	167.8	3.54	89.8	3.07	78.0	--	--
6SP32W-G32	2.81	71.4	-32	6.81	173.0	3.74	95.0	3.07	78.0	--	--

45° Elbow Split Flange

Code 61

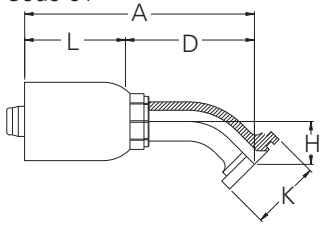

Fitting Part Number	Flange Head Dia. K		Hose Size	A		D		Insertion Length - L		H	
	inch	mm		inch	mm	inch	mm	inch	mm	inch	mm
45° split flange - Code 61 (SAE J518)											
4SP12W-G42	1.50	38.1	-12	4.93	125.3	3.16	80.3	1.77	45.0	1.06	27.0
4SP12W-G46	1.75	44.4	-12	5.37	136.5	3.60	91.5	1.77	45.0	1.26	32.0
4SP16W-G46	1.75	44.4	-16	6.37	161.7	3.81	96.7	2.56	65.0	1.26	32.0
4SP16W-G50	2.00	50.8	-16	6.99	177.4	4.43	112.4	2.56	65.0	1.54	39.0
4SP20W-G50	2.00	50.8	-20	7.61	193.4	4.66	118.4	2.95	75.0	1.54	39.0
4SP20W-G54	2.38	60.3	-20	8.12	206.3	5.17	131.3	2.95	75.0	1.77	45.0
4SP24W-G54	2.38	60.3	-24	8.28	210.3	5.21	132.3	3.07	78.0	1.77	45.0
4SP24W-G62	2.81	71.4	-24	9.73	247.2	6.66	169.2	3.07	78.0	2.26	57.5
4SP32W-G62	2.81	71.4	-32	9.81	249.3	6.74	171.3	3.07	78.0	2.26	57.5
6SP20W-G50	2.00	50.8	-20	7.61	193.4	4.66	118.4	2.95	75.0	1.54	39.0
6SP24W-G54	2.38	60.3	-24	8.28	210.3	5.21	132.3	3.07	78.0	1.77	45.0
6SP32W-G62	2.81	71.4	-32	9.81	249.3	6.74	171.3	3.07	78.0	2.26	57.5

90° Elbow Split Flange

Code 61

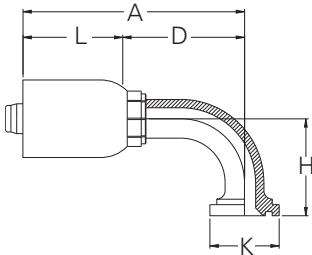

Fitting Part Number	Flange Head Dia. K		Hose Size	A		D		Insertion Length - L		H	
	inch	mm		inch	mm	inch	mm	inch	mm	inch	mm
90° split flange - Code 61 (SAE J518)											
4SP12W-G72	1.50	38.1	-12	4.72	120.0	2.95	75.0	1.77	45.0	2.32	59.0
4SP12W-G76	1.75	44.4	-12	5.17	131.4	3.40	86.4	1.77	45.0	2.80	71.0
4SP16W-G76	1.75	44.4	-16	6.17	156.6	3.61	91.6	2.56	65.0	2.80	71.0
4SP16W-G80	2.00	50.8	-16	6.79	172.4	4.23	107.4	2.56	65.0	3.50	89.0
4SP20W-G80	2.00	50.8	-20	7.41	188.4	4.46	113.4	2.95	75.0	3.50	89.0
4SP20W-G84	2.38	60.3	-20	7.92	201.1	4.96	126.1	2.95	75.0	4.09	104.0
4SP24W-G84	2.38	60.3	-24	8.07	205.1	5.00	127.1	3.07	78.0	4.09	104.0
4SP24W-G92	2.81	71.4	-24	9.59	243.6	6.52	165.6	3.07	78.0	5.43	138.0
4SP32W-G92	2.81	71.4	-32	9.67	245.7	6.60	167.7	3.07	78.0	5.43	138.0
6SP20W-G80	2.00	50.8	-20	7.41	188.4	4.46	113.4	2.95	75.0	3.50	89.0
6SP24W-G84	2.38	60.3	-24	8.07	205.1	5.00	127.1	3.07	78.0	4.09	104.0
6SP32W-G92	2.81	71.4	-32	9.67	245.7	6.60	167.7	3.07	78.0	5.43	138.0

(For Split Flange Kits, see pages L-89 thru L-92.)

4SP Hose Ends

For Use with Hose:

H464, H485 (-16 only),
H470 (-12 & -16 only)*
H471 (-12 thru -24),
H487 (-12 & -16 only)

Assembled with:

ET4000, ET4001, ET4040
T-440-1 (-12 & -16 only)**6SP Hose Ends**

For Use with Hose:

H470 (-20, -24, -32 only)*
H485 (-20 & -24 only),
H471 (-32 only), H487 (-20 & -24)
*H470 with black cover only

Assembled with:

ET4000, ET4001, ET4040

Straight Split Flange

Code 62

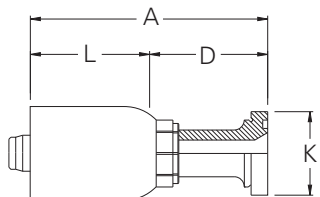

Fitting Part Number	Flange Head Dia. K		Hose Size	A		D		Insertion Length - L		H	
	inch	mm		inch	mm	inch	mm	inch	mm	inch	mm
Cat-flange - Code 62 (SAE J518)											
4SP12W-D12	1.62	41.3	-12	4.16	105.8	2.39	60.8	1.77	45.0	-	-
4SP12W-D16	1.88	47.6	-12	4.33	110.0	2.56	65.0	1.77	45.0	-	-
4SP16W-D16	1.88	47.6	-16	5.32	135.2	2.76	70.2	2.56	65.0	-	-
4SP16W-D20	2.12	54.0	-16	5.22	132.6	2.66	67.6	2.56	65.0	-	-
4SP20W-D20	2.12	54.0	-20	5.85	148.6	2.90	73.6	2.95	75.0	-	-
4SP20W-D24	2.50	63.5	-20	7.31	185.6	4.35	110.6	2.95	75.0	-	-
4SP24W-D24	2.50	63.5	-24	7.46	189.6	4.39	111.6	3.07	78.0	-	-
4SP24W-D32	3.13	79.4	-24	7.90	200.6	4.83	122.6	3.07	78.0	-	-
4SP32W-D32	3.13	79.4	-32	7.98	202.7	4.91	124.7	3.07	78.0	-	-
6SP20W-D20	2.12	54.0	-20	5.85	148.6	2.90	73.6	2.95	75.0	-	-
6SP20W-D24	2.50	63.5	-20	7.31	185.6	4.35	110.6	2.95	75.0	-	-
6SP24W-D24	2.50	63.5	-24	7.46	189.6	4.39	111.6	3.07	78.0	-	-
6SP24W-D32	3.13	79.4	-24	7.90	200.6	4.83	122.6	3.07	78.0	-	-
6SP32W-D32	3.13	79.4	-32	7.98	202.7	4.91	124.7	3.07	78.0	-	-

45° Elbow Split Flange

Code 62

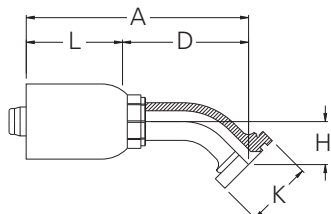

Fitting Part Number	Flange Head Dia. K		Hose Size	A		D		Insertion Length - L		H	
	inch	mm		inch	mm	inch	mm	inch	mm	inch	mm
45° split flange - Code 62 (SAE J518)											
4SP12W-D42	1.62	41.3	-12	4.93	125.3	3.16	80.3	1.77	45.0	1.06	27.0
4SP12W-D46	1.88	47.6	-12	5.37	136.5	3.60	91.5	1.77	45.0	1.26	32.0
4SP16W-D46	1.88	47.6	-16	6.37	161.7	3.81	96.7	2.56	65.0	1.26	32.0
4SP16W-D50	2.12	54.0	-16	6.99	177.4	4.43	112.4	2.56	65.0	1.54	39.0
4SP20W-D50	2.12	54.0	-20	7.61	193.4	4.66	118.4	2.95	75.0	1.54	39.0
4SP20W-D54	2.50	63.5	-20	8.12	206.3	5.17	131.3	2.95	75.0	1.77	45.0
4SP24W-D54	2.50	63.5	-24	8.28	210.3	5.21	132.3	3.07	78.0	1.77	45.0
4SP24W-D62	3.13	79.4	-24	9.73	247.2	6.66	169.2	3.07	78.0	2.26	57.5
4SP32W-D62	3.13	79.4	-32	9.81	249.3	6.74	171.3	3.07	78.0	2.26	57.5
6SP20W-D50	2.12	54.0	-20	7.61	193.4	4.66	118.4	2.95	75.0	1.54	39.0
6SP20W-D54	2.50	63.5	-20	8.12	206.3	5.17	131.3	2.95	75.0	1.77	45.0
6SP24W-D54	2.50	63.5	-24	8.28	210.3	5.21	132.3	3.07	78.0	1.77	45.0
6SP24W-D62	3.13	79.4	-24	9.73	247.2	6.66	169.2	3.07	78.0	2.26	57.5
6SP32W-D62	3.13	79.4	-32	9.81	249.3	6.74	171.3	3.07	78.0	2.26	57.5

90° Elbow Split Flange

Code 62

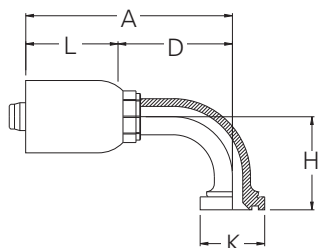

Fitting Part Number	Flange Head Dia. K		Hose Size	A		D		Insertion Length - L		H	
	inch	mm		inch	mm	inch	mm	inch	mm	inch	mm
90° split flange - Code 62 (SAE J518)											
4SP12W-D72	1.62	41.3	-12	4.72	120.0	2.95	75.0	1.77	45.0	2.32	59.0
4SP12W-D76	1.88	47.6	-12	5.17	131.4	3.40	86.4	1.77	45.0	2.80	71.0
4SP16W-D76	1.88	47.6	-16	6.17	156.6	3.61	91.6	2.56	65.0	2.80	71.0
4SP16W-D80	2.12	54.0	-16	6.79	172.4	4.23	107.4	2.56	65.0	3.50	89.0
4SP20W-D80	2.12	54.0	-20	7.41	188.4	4.46	113.4	2.95	75.0	3.50	89.0
4SP20W-D84	2.50	63.5	-20	7.92	201.1	4.96	126.1	2.95	75.0	4.09	104.0
4SP24W-D84	2.50	63.5	-24	8.07	205.1	5.00	127.1	3.07	78.0	4.09	104.0
4SP24W-D92	3.13	79.4	-24	9.59	243.6	6.52	165.6	3.07	78.0	5.43	138.0
4SP32W-D92	3.13	79.4	-32	9.67	245.7	6.60	167.7	3.07	78.0	5.43	138.0
6SP20W-D80	2.12	54.0	-20	7.41	188.4	4.46	113.4	2.95	75.0	3.50	89.0
6SP20W-D84	2.50	63.5	-20	7.92	201.1	4.96	126.1	2.95	75.0	4.09	104.0
6SP24W-D84	2.50	63.5	-24	8.07	205.1	5.00	127.1	3.07	78.0	4.09	104.0
6SP24W-D92	3.13	79.4	-24	9.59	243.6	6.52	165.6	3.07	78.0	5.43	138.0
6SP32W-D92	3.13	79.4	-32	9.67	245.7	6.60	167.7	3.07	78.0	5.43	138.0

(For Split Flange Kits,
see pages L-89 thru L-92.)

4SP Hose Ends

For Use with Hose:
H464, H485 (-16 only),
H470 (-12 & -16 only)*
H471 (-12 thru -24),
H487 (-12 & -16 only)

Assembled with:
ET4000, ET4001, ET4040
T-440-1 (-12 & -16 only)

6SP Hose Ends

For Use with Hose:
H470 (-20, -24, -32 only)*
H485 (-20 & -24 only),
H471 (-32 only), H487 (-20 & -24)
*H470 with black cover only

Assembled with:
ET4000, ET4001, ET4040

Cat-Flange Straight

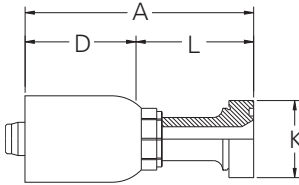

Fitting Part Number	Flange Head Dia. K inch	mm	Hose Size	A inch	mm	D inch	mm	Insertion Length - L inch	mm	H inch	mm
Cat-flange - Straight split flange											
4SP12W-K12	1.62	41.3	-12	4.38	111.3	2.61	66.3	1.77	45.0	–	–
4SP12W-K16	1.88	47.6	-12	4.51	114.7	2.74	69.7	1.77	45.0	–	–
4SP16W-K16	1.88	47.6	-16	5.51	139.9	2.95	74.9	2.56	65.0	–	–
4SP16W-K20	2.12	54.0	-16	5.37	136.5	2.81	71.5	2.56	65.0	–	–
4SP20W-K20	2.12	54.0	-20	6.00	152.5	3.05	77.5	2.95	75.0	–	–
6SP20W-K20	2.12	54.0	-20	6.00	152.5	3.05	77.5	2.95	75.0	–	–
6SP20W-K24	2.50	63.5	-20	7.37	187.3	4.42	112.3	2.95	75.0	–	–
6SP24W-K24	2.50	63.5	-24	7.53	191.3	4.46	113.3	3.07	78.0	–	–
6SP24W-K32	3.13	79.4	-24	7.96	202.3	4.89	124.3	3.07	78.0	–	–
6SP32W-K32	3.13	79.4	-32	8.05	204.4	4.98	126.4	3.07	78.0	–	–

Compatible only with D-Ring FF90319. See page J-100.

Cat-Flange - 22.5° Elbow

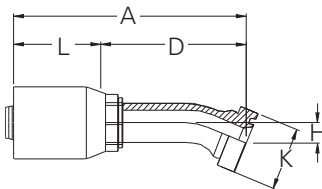

Fitting Part Number	Flange Head Dia. K inch	mm	Hose Size	A inch	mm	D inch	mm	Insertion Length - L inch	mm	H inch	mm
Cat-flange - 22.5°											
4SP12W-BD12	1.62	41.3	-12	5.43	137.9	3.66	92.9	1.77	45.0	0.54	13.7
4SP16W-BD16	1.88	47.6	-16	6.88	174.8	4.32	109.8	2.56	65.0	0.60	15.3
4SP16W-BD20	2.12	54.0	-16	7.56	191.9	5.00	126.9	2.56	65.0	0.70	17.8
6SP20W-BD20	2.12	54.0	-20	8.19	207.9	5.23	132.9	2.95	75.0	0.70	17.8
6SP20W-BD24	2.50	63.5	-20	8.67	220.1	5.71	145.1	2.95	75.0	0.76	19.4
6SP24W-BD24	2.50	63.5	-24	8.82	224.1	5.75	146.1	3.07	78.0	0.76	19.4

Compatible only with D-Ring FF90319. See page J-100.

Cat-Flange - 30° Elbow

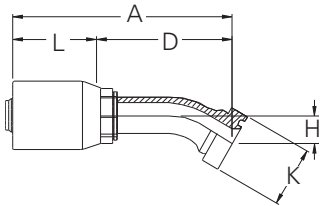

Fitting Part Number	Flange Head Dia. K inch	mm	Hose Size	A inch	mm	D inch	mm	Insertion Length - L inch	mm	H inch	mm
Cat-flange - 30°											
4SP12W-BD42	1.62	41.3	-12	5.34	135.7	3.57	90.7	1.77	45.0	0.75	19.1
4SP16W-BD46	1.88	47.6	-16	6.79	172.4	4.23	107.4	2.56	65.0	0.85	21.6
4SP16W-BD50	2.12	54.0	-16	7.45	189.1	4.89	124.1	2.56	65.0	1.00	25.3
6SP20W-BD50	2.12	54.0	-20	8.08	205.1	5.12	130.1	2.95	75.0	1.00	25.3
6SP20W-BD54	2.50	63.5	-20	8.55	217.1	5.59	142.1	2.95	75.0	1.09	27.7
6SP24W-BD54	2.50	63.5	-24	8.70	221.1	5.63	143.1	3.07	78.0	1.09	27.7
6SP24W-BD62	3.13	79.4	-24	10.26	260.5	7.19	182.5	3.07	78.0	1.37	34.8
6SP32W-BD62	3.13	79.4	-32	10.34	262.6	7.27	184.6	3.07	78.0	1.37	34.8

Compatible only with D-Ring FF90319. See page J-100.

Cat-Flange - 45° Elbow

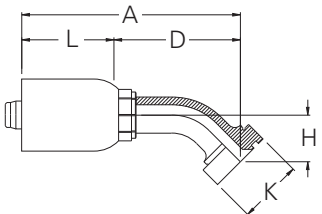

Fitting Part Number	Flange Head Dia. K inch	mm	Hose Size	A inch	mm	D inch	mm	Insertion Length - L inch	mm	H inch	mm
Cat-flange - 45° split flange											
4SP12W-K42	1.62	41.3	-12	5.08	129.2	3.31	84.2	1.77	45.0	1.22	30.9
4SP12W-K46	1.88	47.6	-12	5.50	139.8	3.73	94.8	1.77	45.0	1.39	35.3
4SP16W-K46	1.88	47.6	-16	6.50	165.0	3.94	100.0	2.56	65.0	1.39	35.3
4SP16W-K50	2.12	54.0	-16	7.10	180.2	4.54	115.2	2.56	65.0	1.65	41.8
4SP20W-K50	2.12	54.0	-20	7.72	196.2	4.77	121.2	2.95	75.0	1.65	41.8
6SP20W-K50	2.12	54.0	-20	7.72	196.2	4.77	121.2	2.95	75.0	1.65	41.8
6SP20W-K54	2.50	63.5	-20	8.17	207.5	5.22	132.5	2.95	75.0	1.82	46.2
6SP24W-K54	2.50	63.5	-24	8.33	211.5	5.26	133.5	3.07	78.0	1.82	46.2
6SP24W-K62	3.13	79.4	-24	9.78	248.4	6.71	170.4	3.07	78.0	2.31	58.7
6SP32W-K62	3.13	79.4	-32	9.86	250.5	6.79	172.5	3.07	78.0	2.31	58.7

4SP Hose Ends

For Use with Hose:

H464, H485 (-16 only),
H470 (-12 & -16 only)*
H471 (-12 thru -24),
H487 (-12 & -16 only)

Assembled with:

ET4000, ET4001, ET4040
T-440-1 (-12 & -16 only)

6SP Hose Ends

For Use with Hose:

H470 (-20, -24, -32 only)*
H485 (-20 & -24 only),
H471 (-32 only), H487 (-20 & -24)
*H470 with black cover only

Assembled with:

ET4000, ET4001, ET4040

Cat-Flange - 60° Elbow

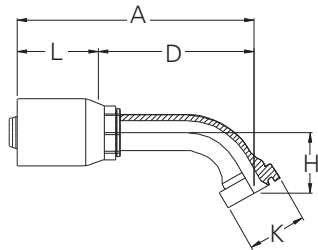

Fitting Part Number	Flange Head Dia. K		Hose Size	A	D	Insertion Length - L		H			
	inch	mm		inch	mm	inch	mm	inch	mm		
Cat-flange - 60°											
4SP12W-BD72	1.62	41.3	-12	5.83	148.1	4.06	103.1	1.77	45.0	1.66	42.3
4SP16W-BD76	1.88	47.6	-16	7.45	189.3	4.89	124.3	2.56	65.0	1.92	48.7
4SP16W-BD80	2.12	54.0	-16	8.36	212.4	5.80	147.4	2.56	65.0	2.33	59.3
6SP											
6SP20W-BD80	2.12	54.0	-20	8.99	228.4	6.04	153.4	2.95	75.0	2.33	59.3
6SP20W-BD84	2.50	63.5	-20	9.70	246.4	6.75	171.4	2.95	75.0	2.62	66.6
6SP24W-BD84	2.50	63.5	-24	9.86	250.4	6.79	172.4	3.07	78.0	2.62	66.6
6SP24W-BD92	3.13	79.4	-24	11.94	303.2	8.87	225.2	3.07	78.0	3.44	87.3

Compatible only with D-Ring FF90319. See below.

Cat-Flange - 67.5° Elbow

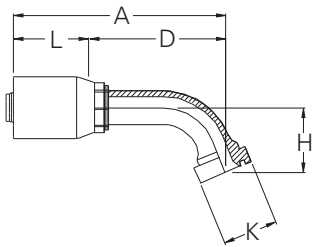

Fitting Part Number	Flange Head Dia. K		Hose Size	A	D	Insertion Length - L		H			
	inch	mm		inch	mm	inch	mm	inch	mm		
Cat-flange - 67.5°											
4SP12W-BE12	1.62	41.3	-12	5.60	142.2	3.83	97.2	1.77	45.0	1.90	48.2
4SP16W-BE16	1.88	47.6	-16	7.18	182.5	4.62	117.5	2.56	65.0	2.20	55.8
4SP16W-BE20	2.12	54.0	-16	8.04	204.1	5.48	139.1	2.56	65.0	2.68	68.1
6SP											
6SP20W-BE20	2.12	54.0	-20	8.67	220.1	5.71	145.1	2.95	75.0	2.68	68.1
6SP20W-BE24	2.50	63.5	-20	9.33	237.0	6.38	162.0	2.95	75.0	3.02	76.8

Compatible only with D-Ring FF90319. See below.

Cat-Flange - 90° Elbow

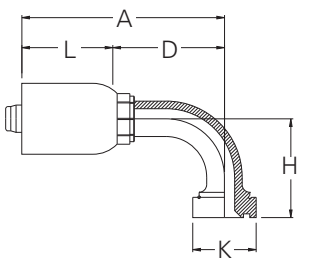

Fitting Part Number	Flange Head Dia. K		Hose Size	A	D	Insertion Length - L		H			
	inch	mm		inch	mm	inch	mm	inch	mm		
Cat-flange - 90° split flange											
4SP12W-K72	1.62	41.3	-12	4.72	120.0	2.95	75.0	1.77	45.0	2.54	64.5
4SP12W-K76	1.88	47.6	-12	5.17	131.4	3.40	86.4	1.77	45.0	2.98	75.7
4SP16W-K76	1.88	47.6	-16	6.17	156.6	3.61	91.6	2.56	65.0	2.98	75.7
4SP16W-K80	2.12	54.0	-16	6.79	172.4	4.23	107.4	2.56	65.0	3.66	92.9
4SP20W-K80	2.12	54.0	-20	7.41	188.4	4.46	113.4	2.95	75.0	3.66	92.9
6SP											
6SP20W-K80	2.12	54.0	-20	7.41	188.4	4.46	113.4	2.95	75.0	3.66	92.9
6SP20W-K84	2.50	63.5	-20	7.92	201.1	4.96	126.1	2.95	75.0	4.16	105.7
6SP24W-K84	2.50	63.5	-24	7.92	201.1	4.96	126.1	2.95	75.0	4.16	105.7
6SP24W-K92	3.13	79.4	-24	9.59	243.6	6.52	165.6	3.07	78.0	5.50	139.6
6SP32W-K92	3.13	79.4	-32	9.59	243.6	6.52	165.6	3.07	78.0	5.50	139.6

Compatible only with D-Ring FF90319. See below.

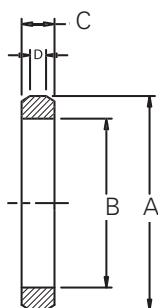
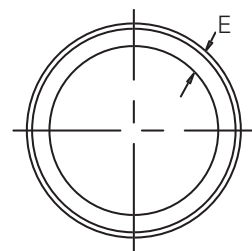

Cat-Flange D-Ring*

Part Number	A Ref		B Ref		C Ref		D Ref		E Ref	
	inch	mm	inch	mm	inch	mm	inch	mm	inch	mm
FF90319-12	1.27	32,3	1.00	25,4	.20	5,1	.10	2,5	.135	3,4
FF90319-16	1.52	36,6	1.25	31,8	.20	5,1	.10	2,5	.135	3,4
FF90319-20	1.77	45,0	1.50	38,1	.20	5,1	.10	2,5	.135	3,4
FF90319-24	2.03	51,6	1.76	44,7	.20	5,1	.10	2,5	.135	3,4
FF90319-32	2.78	70,6	2.52	64,0	.20	5,1	.10	2,5	.135	3,4

Temperature range: -40°F to +212°F.

Material: Nitrile (Buna-N).

*To be used only with Cat-Flange hose ends.

4SP Hose Ends

For Use with Hose:

H464, H485 (-16 only),
H470 (-12 & -16 only)*
H471 (-12 thru -24),
H487 (-12 & -16 only)

Assembled with:

ET4000, ET4001, ET4040
T-440-1 (-12 & -16 only)

6SP Hose Ends

For Use with Hose:

H470 (-20, -24, -32 only)*
H485 (-20 & -24 only),
H471 (-32 only), H487 (-20 & -24)
*H470 with black cover only

Assembled with:

ET4000, ET4001, ET4040

BSPP Swivel - Straight

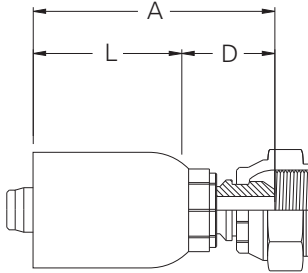

Fitting Part Number	Thread	Hose Size	A inch	mm	D inch	mm	Insertion Length - L inch	mm	H inch	mm
BSP/JIS Female Swivel										
4SP12W-362	G 3/4	-12	3.27	83.0	1.50	38.0	1.77	45.0	-	-
4SP12W-366	G 1	-12	3.22	81.7	1.44	36.7	1.77	45.0	-	-
4SP16W-366	G 1	-16	4.21	106.9	1.65	41.9	2.56	65.0	-	-
4SP16W-370	G 1 1/4	-16	4.13	104.9	1.57	39.9	2.56	65.0	-	-
4SP20W-370	G 1 1/4	-20	4.76	120.9	1.81	45.9	2.95	75.0	-	-
4SP24W-374	G 1 1/2	-24	6.04	153.5	2.97	75.5	3.07	78.0	-	-
4SP32W-375	G 2	-32	6.28	159.5	3.21	81.5	3.07	78.0	-	-
<hr/>										
6SP24W-374	G 1 1/2	-24	6.04	153.5	2.97	75.5	3.07	78.0	-	-
6SP32W-375	G 2	-32	6.28	159.5	3.21	81.5	3.07	78.0	-	-

BSPP Swivel - 45° Elbow

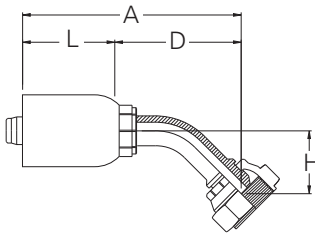

Fitting Part Number	Thread	Hose Size	A inch	mm	D inch	mm	Insertion Length - L inch	mm	H inch	mm
BSP/JIS Female Swivel, 45° elbow										
4SP12W-52P	G 3/4	-12	4.76	121.0	2.99	76.0	1.77	45.0	1.02	26.0
4SP12W-56P	G 1	-12	5.13	130.4	3.36	85.4	1.77	45.0	1.18	30.0
4SP16W-56P	G 1	-16	6.13	155.6	3.57	90.6	2.56	65.0	1.18	30.0
4SP16W-60P	G 1 1/4	-16	6.57	166.9	4.01	101.9	2.56	65.0	1.34	34.0
4SP20W-60P	G 1 1/4	-20	7.19	182.6	4.25	107.9	2.95	75.0	1.34	34.0
4SP24W-64P	G 1 1/2	-24	8.20	208.2	5.13	130.2	3.07	78.0	1.69	43.0
4SP32W-65P	G 2	-32	9.78	248.5	6.71	170.5	3.07	78.0	2.23	56.6
<hr/>										
6SP24W-64P	G 1 1/2	-24	8.20	208.2	5.13	130.2	3.07	78.0	1.69	43.0
6SP32W-65P	G 2-32		9.78	248.5	6.71	170.5	3.07	78.0	2.23	56.6

BSPP Swivel - 90° Elbow

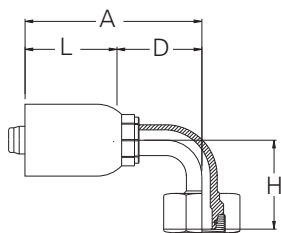

Fitting Part Number	Thread	Hose Size	A inch	mm	D inch	mm	Insertion Length - L inch	mm	H inch	mm
BSP/JIS Female Swivel, 90° elbow										
4SP12W-82P	G 3/4	-12	4.51	114.5	2.74	69.5	1.77	45.0	2.24	57.0
4SP12W-86P	G 1	-12	4.94	125.6	3.17	80.6	1.77	45.0	2.68	68.0
4SP16W-86P	G 1	-16	5.94	150.8	3.38	85.8	2.56	65.0	2.68	68.0
4SP16W-90P	G 1 1/4	-16	6.44	163.7	3.89	98.7	2.56	65.0	3.11	79.0
4SP20W-90P	G 1 1/4	-20	7.07	179.7	4.12	104.7	2.95	75.0	3.11	79.0
4SP24W-94P	G 1 1/2	-24	8.07	205.1	5.00	127.1	3.07	78.0	4.09	104.0
4SP32W-95P	G 2	-32	9.67	245.7	6.60	167.7	3.07	78.0	5.28	134.0
<hr/>										
6SP24W-94P	G 1 1/2	-24	8.07	205.1	5.00	127.1	3.07	78.0	4.09	104.0
6SP32W-95P	G 2	-32	9.67	245.7	6.60	167.7	3.07	78.0	5.28	134.0

NOTE: The JIS parallel thread and BSPP connection are interchangeable.

4SP Hose Ends

For Use with Hose:

H464, H485 (-16 only),
H470 (-12 & -16 only)*
H471 (-12 thru -24),
H487 (-12 & -16 only)

Assembled with:

ET4000, ET4001, ET4040
T-440-1 (-12 & -16 only)

6SP Hose Ends

For Use with Hose:

H470 (-20, -24, -32 only)*
H485 (-20 & -24 only),
H471 (-32 only), H487 (-20 & -24)
*H470 with black cover only

Assembled with:

ET4000, ET4001, ET4040

Male Pipe Rigid

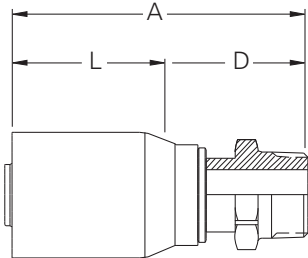

Fitting Part Number	Thread NPTF	Hose Size	A inch	mm	D inch	Insertion Length		H mm	inch
						L mm	inch		
Male Pipe Rigid									
4SP12W-112	3/4-14	-12	3.89	98.7	2.12	53.7	1.77	45	1 1/4
4SP16W-116	1-11 1/2	-16	4.94	125.4	2.38	60.4	2.56	65	1 1/2
4SP20W-120	1 1/4-11 1/2	-20	5.70	144.8	2.75	69.8	2.95	75	1 7/8
4SP24W-124	1 1/2-11 1/2	-24	5.93	150.6	2.86	72.6	3.07	78	2
4SP32W-132	2-11 1/2	-32	6.03	153.2	2.96	75.2	3.07	78	2 5/8
6SP20W-120	1 1/4-11 1/2	-20	5.70	144.8	2.75	69.8	2.95	75	1 7/8
6SP24W-124	1 1/2-11 1/2	-24	5.93	150.6	2.86	72.6	3.07	78	2
6SP32W-132	2-11 1/2	-32	6.03	153.2	2.96	75.2	3.07	78	2 5/8

4SP Hose Ends

For Use with Hose:
 H464, H485 (-16 only),
 H470 (-12 & -16 only)*
 H471 (-12 thru -24),
 H487 (-12 & -16 only)

Assembled with:
 ET4000, ET4001, ET4040
 T-440-1 (-12 & -16 only)

6SP Hose Ends

For Use with Hose:
 H470 (-20, -24, -32 only)*
 H485 (-20 & -24 only),
 H471 (-32 only), H487 (-20 & -24)
 *H470 with black cover only

Assembled with:
 ET4000, ET4001, ET4040

**Female Swivel DIN 24° Seat
 s.Rh. DKO (heavy)**

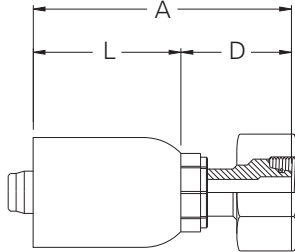

Fitting Part Number	Thread Size	Tube Size	Hose Size	A inch	mm	D inch	mm	Insertion Length - L inch	mm	H inch	mm
DKO Female Swivel, Heavy Duty											
4SP12W-75C	M36 x 2	25	-12	3.87	98.4	2.10	53.4	1.77	45.0	-	-
4SP12W-80C	M42 x 2	30	-12	3.80	96.6	2.03	51.6	1.77	45.0	-	-
4SP16W-80C	M42 x 2	30	-16	4.80	121.8	2.24	56.8	2.56	65.0	-	-
4SP16W-88C	M52 x 2	38	-16	4.82	122.3	2.26	57.3	2.56	65.0	-	-
4SP20W-88C	M52 x 2	38	-20	5.44	138.3	2.49	63.3	2.95	75.0	-	-
6SP20W-88C	M52 x 2	38	-20	5.44	138.3	2.49	63.3	2.95	75.0	-	-

**Female Swivel DIN 24° Seat
 45° Tube Elbow S.Rh. DKO
 (heavy)**

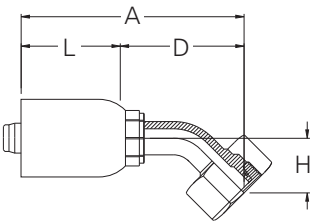

Fitting Part Number	Thread Size	Tube Size	Hose Size	A inch	mm	D inch	mm	Insertion Length - L inch	mm	H inch	mm
DKO Female Swivel, Heavy Duty, 45° Elbow											
4SP12W-25E	M36 x 2	25	-12	5.13	130.3	3.36	85.3	1.77	45.0	1.26	32.0
4SP12W-30E	M42 x 2	30	-12	5.49	139.4	3.72	94.4	1.77	45.0	1.38	35.0
4SP16W-30E	M42 x 2	30	-16	6.48	164.6	3.92	99.6	2.56	65.0	1.38	35.0
4SP16W-38E	M52 X 2	38	-16	6.98	177.3	4.42	112.3	2.56	65.0	1.54	39.0
4SP20W-38E	M52 x 2	38	-20	7.61	193.3	4.66	118.3	2.95	75.0	1.54	39.0
6SP20W-38E	M52 x 2	38	-20	7.61	193.3	4.66	118.3	2.95	75.0	1.54	39.0

**Female Swivel DIN 24° Seat
 90° Tube Elbow s.Rh. DKO
 (heavy)**

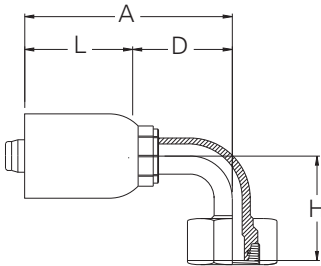

Fitting Part Number	Thread Size	Tube Size	Hose Size	A inch	mm	D inch	mm	Insertion Length - L inch	mm	H inch	mm
DKO Female Swivel, Heavy Duty, 90° elbow											
4SP12W-75E	M36 x 2	25	-12	4.72	120.0	2.95	75.0	1.77	45.0	2.56	65.0
4SP12W-80E	M42 X 2	30	-12	5.17	131.4	3.40	86.4	1.77	45.0	2.99	76.0
4SP16W-80E	M42 x 2	30	-16	6.17	156.8	3.61	91.8	2.56	65.0	2.99	76.0
4SP16W-88E	M52 X 2	38	-16	6.79	172.4	4.23	107.4	2.56	65.0	3.50	89.0
4SP20W-88E	M52 x 2	38	-20	7.41	188.4	4.46	113.4	2.95	75.0	3.50	89.0
6SP20W-88E	M52 x 2	38	-20	7.41	188.4	4.46	113.4	2.95	75.0	3.50	89.0

J

Hose Ends - Crimp

4SP Hose Ends

For Use with Hose:

H464, H485 (-16 only),
H470 (-12 & -16 only)*
H471 (-12 thru -24),
H487 (-12 & -16 only)

Assembled with:

ET4000, ET4001, ET4040
T-440-1 (-12 & -16 only)

6SP Hose Ends

For Use with Hose:

H470 (-20, -24, -32 only)*
H485 (-20 & -24 only),
H471 (-32 only), H487 (-20 & -24)
*H470 with black cover only

Assembled with:

ET4000, ET4001, ET4040

FOR-SEAL Swivel Straight

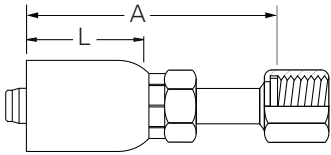

Fitting Part Number	Thread	Hose Size	A		D		Insertion Length - L		H	
			inch	mm	inch	mm	inch	mm	inch	mm
Female FOR-SEAL Swivel, Straight										
4SP12W-J72	1 3/16-12	-12	3.77	95.9	-	-	1.77	45.0	-	-
4SP12W-J76	1 7/16-12	-12	3.33	84.6	-	-	1.77	45.0	-	-
4SP16W-J76	1 7/16-12	-16	4.71	119.5	-	-	2.56	65.0	-	-
4SP16W-J80	1 11/16-12	-16	4.19	106.4	-	-	2.56	65.0	-	-
4SP20W-J80	1 11/16-12	-20	5.38	136.7	-	-	2.95	75.0	-	-
4SP24W-J84	2-12	-24	5.00	126.9	-	-	3.07	78.0	-	-
<hr/>										
6SP20W-J80	1 11/16-12	-20	5.38	136.7	-	-	2.95	75.0	-	-
6SP24W-J84	2-12	-24	5.00	126.9	-	-	3.07	78.0	-	-

FOR-SEAL Swivel 45° Elbow

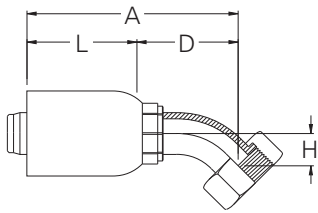

Fitting Part Number	Thread	Hose Size	A		D		Insertion Length - L		H	
			inch	mm	inch	mm	inch	mm	inch	mm
Female FOR-SEAL Swivel, 45° Elbow										
4SP12W-L72	1 3/16-12	-12	4.68	118.9	2.91	73.9	1.77	45.0	0.94	24.0
4SP12W-L76	1 7/16-12	-12	5.05	128.4	3.28	83.4	1.77	45.0	1.10	28.0
4SP16W-L76	1 7/16-12	-16	6.04	153.4	3.48	88.4	2.56	65.0	1.10	28.0
4SP16W-L80	1 11/16-12	-16	6.45	163.9	3.89	98.9	2.56	65.0	1.22	31.0
4SP20W-L80	1 11/16-12	-20	7.08	179.8	4.13	104.8	2.95	75.0	1.22	31.0
<hr/>										
6SP20W-L80	1 11/16-12	-20	7.08	179.8	4.13	104.8	2.95	75.0	1.22	31.0

FOR-SEAL Swivel 90° Elbow

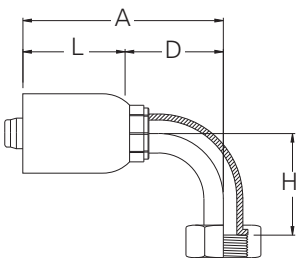

Fitting Part Number	Thread	Hose Size	A		D		Insertion Length - L		H	
			inch	mm	inch	mm	inch	mm	inch	mm
Female FOR-SEAL, 90° Elbow										
4SP12W-J42	1 3/16-12	-12	4.51	114.5	2.74	69.5	1.77	45.0	2.28	58.0
4SP12W-J46	1 7/16-12	-12	4.94	125.6	3.17	80.6	1.77	45.0	2.80	71.0
4SP16W-J46	1 7/16-12	-16	5.93	150.6	3.37	85.6	2.56	65.0	2.80	71.0
4SP16W-J50	1 11/16-12	-16	6.45	163.7	3.89	98.7	2.56	65.0	3.07	78.0
4SP20W-J50	1 11/16-12	-20	7.07	179.6	4.12	104.6	2.95	75.0	3.07	78.0
<hr/>										
6SP20W-J50	1 11/16-12	-20	7.07	179.6	4.12	104.6	2.95	75.0	3.07	78.0

4SP Hose Ends

For Use with Hose:

H464, H485 (-16 only),
H470 (-12 & -16 only)*
H471 (-12 thru -24),
H487 (-12 & -16 only)

Assembled with:

ET4000, ET4001, ET4040
T-440-1 (-12 & -16 only)

6SP Hose Ends

For Use with Hose:

H470 (-20, -24, -32 only)*
H485 (-20 & -24 only),
H471 (-32 only), H487 (-20 & -24)
*H470 with black cover only

Assembled with:

ET4000, ET4001, ET4040

SAE 37° (JIC) Swivel Straight

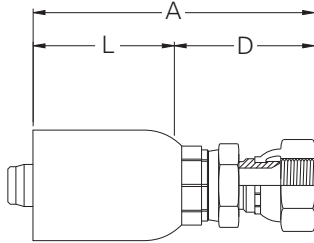

Fitting Part Number	Thread	Hose Size	A inch	mm	D inch	mm	Insertion Length - L inch	mm	H inch	mm
SAE 37° (JIC) Swivel, Straight										
4SP12W-612	1 1/16-12	-12	4.10	104.2	2.33	59.2	1.77	45.0	-	-
4SP12W-616	1 5/16-12	-12	4.20	106.6	2.43	61.6	1.77	45.0	-	-
4SP16W-616	1 5/16-12	-16	5.19	131.8	2.63	66.8	2.56	65.0	-	-
4SP16W-620	1 5/8-12	-16	5.26	133.7	2.70	68.7	2.56	65.0	-	-
4SP20W-620	1 5/8-12	-20	5.89	149.7	2.94	74.7	2.95	75.0	-	-
4SP20W-624	1 7/8-12	-20	6.59	167.5	3.64	92.5	2.95	75.0	-	-
4SP24W-624	1 7/8-12	-24	6.75	171.5	3.68	93.5	3.07	78.0	-	-
4SP32W-632	2 1/2-12	-32	7.32	186.0	4.25	108.0	3.07	78.0	-	-
<hr/>										
6SP20W-620	1 5/8-12	-20	5.89	149.7	2.94	74.7	2.95	75.0	-	-
6SP20W-624	1 7/8-12	-20	6.59	167.5	3.64	92.5	2.95	75.0	-	-
6SP24W-624	1 7/8-12	-24	6.75	171.5	3.68	93.5	3.07	78.0	-	-
6SP32W-632	2 1/2-12	-32	7.32	186.0	4.25	108.0	3.07	78.0	-	-

SAE 37° (JIC) Swivel 45° Elbow

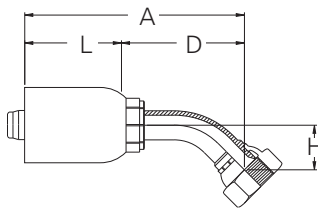

Fitting Part Number	Thread	Hose Size	A inch	mm	D inch	mm	Insertion Length - L inch	mm	H inch	mm
SAE 37° (JIC) Swivel, 45° Elbow										
4SP12W-692	1 1/16-12	-12	4.80	121.9	3.03	76.9	1.77	45.0	1.06	27.0
4SP12W-696	1 5/16-12	-12	5.25	133.4	3.48	88.4	1.77	45.0	1.30	33.0
4SP16W-696	1 5/16-12	-16	6.25	158.6	3.69	93.6	2.56	65.0	1.30	33.0
4SP16W-697	1 5/8-12	-16	6.70	170.2	4.14	105.2	2.56	65.0	1.46	37.0
4SP20W-697	1 5/8-12	-20	7.33	186.2	4.38	111.2	2.95	75.0	1.46	37.0
4SP24W-698	1 7/8-12	-24	8.20	208.2	5.13	130.2	3.07	78.0	1.69	43.0
<hr/>										
6SP20W-697	1 5/8-12	-20	7.33	186.2	4.38	111.2	2.95	75.0	1.46	37.0
6SP24W-698	1 7/8-12	-24	8.20	208.2	5.13	130.2	3.07	78.0	1.69	43.0

SAE 37° (JIC) Swivel 90° Elbow

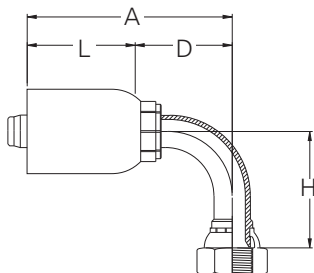

Fitting Part Number	Thread	Hose Size	A inch	mm	D inch	mm	Insertion Length - L inch	mm	H inch	mm
SAE 37° (JIC) Female Swivel, 90° Elbow										
4SP12W-672	1 1/16-12	-12	4.51	114.5	2.74	69.5	1.77	45.0	2.28	58.0
4SP12W-676	1 5/16-12	-12	4.94	125.6	3.17	80.6	1.77	45.0	2.80	71.0
4SP16W-676	1 5/16-12	-16	5.94	150.8	3.38	85.8	2.56	65.0	2.80	71.0
4SP16W-677	1 5/8-12	-16	6.45	163.9	3.89	98.9	2.56	65.0	3.23	82.0
4SP20W-677	1 5/8-12	-20	7.08	179.9	4.13	104.9	2.95	75.0	3.23	82.0
4SP24W-678	1 7/8-12	-24	8.07	205.1	5.00	127.1	3.07	78.0	4.09	104.0
<hr/>										
6SP20W-677	1 5/8-12	-20	7.08	179.9	4.13	104.9	2.95	75.0	3.23	82.0
6SP24W-678	1 7/8-12	-24	8.07	205.1	5.00	127.1	3.07	78.0	4.09	104.0

J
Hose Ends - Crimp



Hose Ends - Crimp

Hose Ends - Field Attachable

Table of Contents

009 'B' Series	K-2	425 'N' Series	K-27 thru K-29
057 'B' Series	K-3 thru K-4	436 'N' Series	K-30 thru K-31
100 'B' Series	K-5 thru K-7	E-Z Clip System	
105 'B' Series	K-8	End Connections & O-Rings	K-32 thru K-33
338 'B' Series	K-9 thru K-11	Hose Ends	K-34 thru K-58
069 'D' Series	K-12 thru K-13	Cages, Clips & Lifesavers	K-59
'K' Series	K-14	Aluminum Lifesaver	K-60
039 'K' Series	K-15	Tools	K-61
104 'N' Series	K-16 thru K-18	Ordering & Identifying	K-62
213 'N' Series	K-19 thru K-21	Assembly Instructions	K-63 thru K-64
247 'N' Series	K-22 thru K-26		



Field Attachable

009 'B' Series

Hose End 009 'B' Series

Ordering Information:

Order individually by catalog number.

 Refer to important safety information on pages A-2-3.

Application: Low pressure air, lube and oil lines.

Compatible Hose: H009

Pressure: Determined by maximum working pressure for hose size. See pages A-15-16 for working pressure ratings for hose end configurations.

Material: CA360 brass

Advantages: Reusable and easy to assemble. An excellent fitting where low pressure applications exist and a clamp may get in the way. Good selection of configurations at a reasonable cost.

Assembly Instructions:

1. Lubricate insert threads and I.D. of hose.
2. Push hose into socket until it bottoms.
3. Screw insert into socket until insert hex touches socket. When assembling swivel ends, leave 1/32" clearance between swivel nut and socket.

Label Set: FS-400

Note:

Refer to current price list for availability of cataloged items. Configurations and dimensions subject to change without notice.

To determine the correct length of hose, subtract the cut-off factor for each end fitting from the overall length of assembly.

Swivel nuts are universal – both SAE 37° and 45° connections.

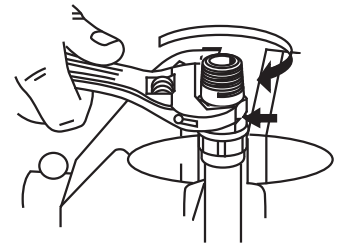
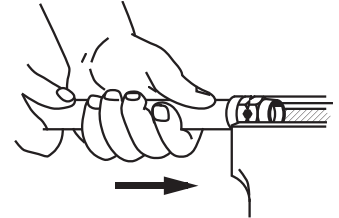

Male Pipe Rigid

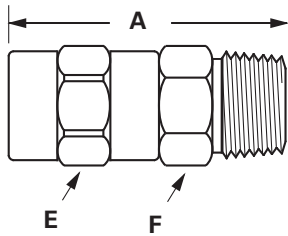

Hose I.D.	Pipe Size	Part Number	Thread Size	A	Hose Cut-Off Factor	Hole Dia.	Hex E	Hex F
1/4	1/8	00904B-102	1/8-27	1.20	.75	.172	5/8	7/16
1/4	1/4	00904B-104	1/4-18	1.39	.94	.172	5/8	9/16

K

JIC 37° Female Swivel

(Exceptions noted)

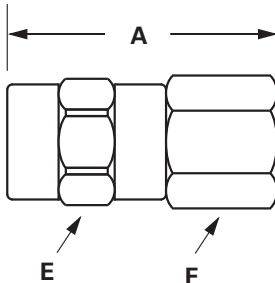

Hose I.D.	Pipe Size	Part Number	Thread Size	A	Hose Cut-Off Factor	Hole Dia.	Hex E	Hex F
1/4	1/4	00904B-604	7/16-20	1.31	.81	.172	5/8	9/16

Hose Ends - Field Attachable

Field Attachable

057 'B' Series

Hose End 057 'B' Series

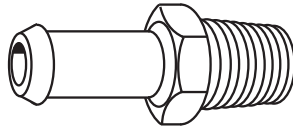
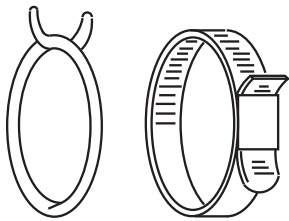

WARNING

Hose can be cut or damaged if over-tightened.

Ordering Information: Order individually by catalog number.

 Refer to important safety information on pages A-2-3.

Assembly Instructions:

1. Slide clamp over hose.
2. Insert barbed end of fitting into hose.
3. Locate band clamp in the middle of 057 'B' Series inserts and tighten.
4. Position wire clamp behind bump on 057 'B' Series insert with H057 hose only.

Application: Low pressure air, fuel and oil applications. Generally used for automotive, light truck, and small engine fuel lines.

Compatible Hose: H057, H0105*, H0106*, H115*, H116*, EH049, EH089.

*H0105, H0106, H115 and H116 for air applications only.

Pressure: Determined by maximum working pressure for hose size. See pages A-15-16 for working pressure ratings for hose end configurations.

Material: CA360 brass

Advantages: Easy to assemble — just push the fitting into the hose and clamp. Good selection of configurations at reasonable cost.

Note:

Refer to current price list for availability of cataloged items. Configurations and dimensions subject to change without notice.

Male Pipe Rigid

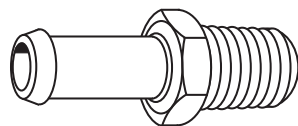

Hose I.D.	Pipe Size	Part Number
3/16	1/8	05703B-102
1/4	1/8	05704B-102
1/4	1/4	05704B-104
5/16	1/8	05705B-102
5/16	1/4	05705B-104
3/8	1/8	05706B-102
3/8	1/4	05706B-104
3/8	3/8	05706B-106
5/8	3/8	05710B-106
5/8	1/2	05710B-108
3/4	1/2	05712B-108

SAE 45° Flare Connector

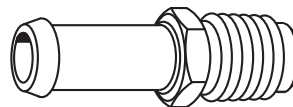

Hose I.D.	Tube Size	Part Number
3/8	5/16	05706B-305

Inverted Male Connector

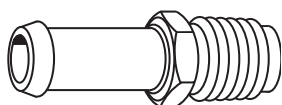

Hose I.D.	Tube Size	Part Number
5/16	1/4	05705B-1598
5/16	5/16	05705B-1560
5/16	3/8	05705B-1561
3/8	5/16	05706B-1568
3/8	3/8	05706B-1570

Male Straight Thread Connector

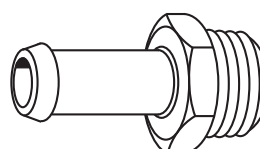

Hose I.D.	Thread Size	Part Number
3/8	9/16-24	05706B-1412
3/8	7/8-20	05706B-1413
3/8	5/8-20	05706B-1569

(Gasket included.)

K

Hose Ends - Field Attachable

Field Attachable

057 'B' Series

**Male Pipe Rigid
90° Elbow**

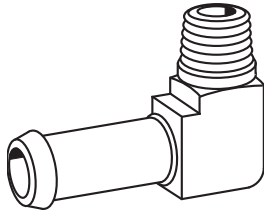

Hose I.D.	Pipe Size	Part Number
1/4	1/8	05704B-C02
5/16	1/8	05705B-C02
5/16	1/4	05705B-C04
3/8	1/8	05706B-C02
3/8	1/4	05706B-C04
3/8	3/8	05706B-C06
5/8	3/8	05710B-C06

Inverted Male Tee Swivel

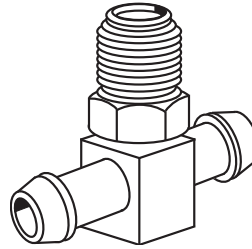

Hose I.D.	Tube Size	Part Number
3/8	5/16	05706B-1414#
3/8	3/8	05706B-1415#

(Chrome plated.)

**Inverted Male Swivel 90°
Elbow**

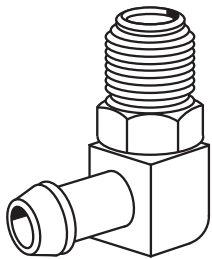

Hose I.D.	Tube Size	Part Number
1/4	1/4	05704B-B64
1/4	5/16	05704B-B65
5/16	5/16	05705B-B65
3/8	5/16	05706B-B65
3/8	3/8	05706B-B66
3/8	5/16	05706B-1416#
3/8	3/8	05706B-1417#

(# Chrome plated.)

Wire Hose Clamp
(For H057 Hose Only)



Hose I.D.	Part Number
3/16, 1/4	1538
5/16	1539
3/8	1540

Note: Zinc-Plated Carbon Steel Spring Wire

K

Hose Ends - Field Attachable

Field Attachable

100 'B' Series Barb-Tite™

Hose End 100 'B' Series

CAUTION Sealing integrity may be damaged by the use of clamps.

Ordering Information: Order individually by part number.

Refer to important safety information on pages A-2-3.

Application: Low pressure shop or service air lines. Often used for low pressure lube and oil lines.

Compatible Hose: H100, H101, H201, H332

Pressure: Determined by maximum working pressure for hose size. See pages A-15-16 for working pressure ratings for hose end configurations.

Material: CA360 brass

Advantages: Easy to assemble – just push the fitting into the hose. No clamps needed! Low cost and a wide selection of configurations and sizes.

Assembly Instructions:

1. Lubricate insert.
2. Hold hose at angle as shown and push on and up over first barb.
3. Continue to push straight on until hose is seated under protective plastic cap. (Keep hand back from hose end area so that hose can expand.)

To determine the correct length of hose, subtract the cut-off factor for each end fitting from the overall length of assembly.

Note: Drawings may differ from actual parts.

Disassembly Instructions:

1. Split hose as shown. Do not cut completely through hose. Sealing edge of barb could be damaged.
2. Bend hose and remove with quick pull.

Assembly Equipment:

See page N-72 for optional Assembly Tools.

Label Set: FS-500

Note: Refer to current price list for availability of cataloged items. Configurations and dimensions subject to change without notice.

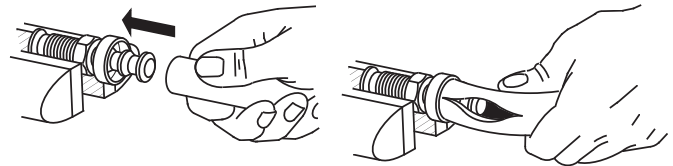

Male Pipe Rigid

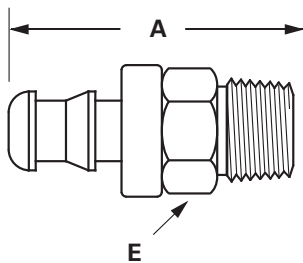

Hose I.D.	Pipe Size	Part Number	Thread Size	A	Hose Cut-Off Factor	Hole Dia.	Hex E
1/4	1/8	10004B-102	1/8-27	1.29	.65	.172	7/16
1/4	1/4	10004B-104	1/4-18	1.52	.88	.172	9/16
5/16	1/8	10005B-102	1/8-27	1.36	.69	.234	1/2
5/16	1/4	10005B-104	1/4-18	1.57	.87	.234	9/16
3/8	1/8	10006B-102	1/8-27	1.46	.69	.297	1/2
3/8	1/4	10006B-104	1/4-18	1.65	.88	.297	9/16
3/8	3/8	10006B-106	3/8-18	1.65	.88	.297	11/16
1/2	3/8	10008B-106	3/8-18	1.85	.94	.391	11/16
1/2	1/2	10008B-108	1/2-14	2.10	1.19	.391	7/8
5/8	1/2	10010B-108	1/2-14	2.60	1.19	.484	7/8
3/4	3/4	10012B-112	3/4-14	2.66	1.25	.609	1-1/16

SAE 45° Flare Male Rigid

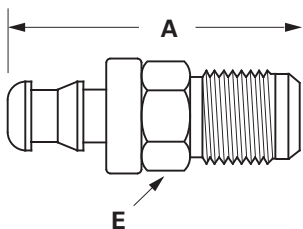

Hose I.D.	Tube Size	Part Number	Thread Size	A	Hose Cut-Off Factor	Hole Dia.	Hex E
1/4	1/4	10004B-304	7/16-20	1.45	.81	.172	7/16
1/4	5/16	10004B-305	1/2-20	1.54	.94	.172	1/2
5/16	5/16	10005B-305	1/2-20	1.60	.94	.220	1/2
3/8	3/8	10006B-306	5/8-18	1.73	1.00	.297	5/8

K

Hose Ends - Field Attachable

Field Attachable

100 'B' Series Barb-Tite™

To determine the correct length of hose, subtract the cut-off factor for each end fitting from the overall length of assembly.

Note:

Drawings may differ from actual parts.

Inverted Male Swivel

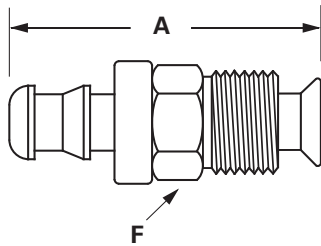

Hose I.D.	Tube Size	Part Number	Thread Size	A	Hose Cut-Off Factor	Hole Dia.	Hex F
1/4	3/16	10004B-B03	3/8-24	1.39	1.13	.109	3/8
1/4	1/4	10004B-B04	7/16-24	1.42	1.13	.172	7/16
1/4	5/16	10004B-B05	1/2-20	1.52	1.19	.188	1/2
5/16	1/4	10005B-B04	7/16-24	1.81	1.11	.184	7/16
5/16	5/16	10005B-B05	1/2-20	1.60	.80	.234	1/2
5/16	3/8	10005B-B06	5/8-18	1.60	1.19	.234	5/8
3/8	5/16	10006B-B05	1/2-20	1.64	1.19	.234	1/2
3/8	3/8	10006B-B06	5/8-18	1.70	.97	.297	5/8
1/2	1/2	10008B-B08	3/4-18	2.24	1.25	.391	3/4

Female Inverted Rigid

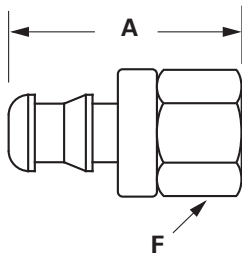

Hose I.D.	Tube Size	Part Number	Thread Size	A	Hose Cut-Off Factor	Hole Dia.	Hex F
1/4	3/16	10004B-A03	3/8-24	1.12	.48	.172	1/2
1/4	1/4	10004B-A04	7/16-24	1.14	.50	.172	9/16
1/4	5/16	10004B-A05	1/2-20	1.18	.56	.172	5/8
5/16	5/16	10005B-A05	1/2-20	1.25	.56	.220	5/8
3/8	5/16	10006B-A05	1/2-20	1.32	.55	.297	5/8
3/8	3/8	10006B-A06	5/8-18	1.35	.63	.297	3/4
1/2	1/2	10008B-A08	3/4-18	1.73	.75	.391	7/8

Female Pipe Swivel

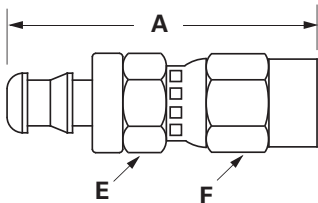

Hose I.D.	Tube Size	Part Number	Thread Size	A	Hose Cut-Off Factor	Hole Dia.	Hex E	Hex F
1/4	1/4	10004B-254	1/4-18	2.42	1.81	.172	3/4	5/8
3/8	3/8	10006B-256	3/8-18	2.77	2.00	.297	7/8	11/16
1/2	1/2	10008B-258	1/2-14	3.29	2.38	.391	1-1/8	7/8

K

JIC 37° Female Swivel

(Refer to Footnotes)

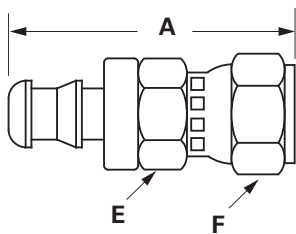

Hose I.D.	Tube Size	Part Number	Thread Size	A	Hose Cut-Off Factor	Hole Dia.	Hex E	Hex F
1/4	1/4	10004B-604 ^a	7/16-20	1.38	.74	.172	9/16	
1/4	5/16	10004B-605 ^a	1/2-20	1.42	.81	.172	5/8	
5/16	5/16	10005B-605 ^a	1/2-20	1.54	.83	.234	11/16	
3/8	5/16	10006B-605 ^a	1/2-20	1.60	.88	.297	11/16	
3/8	3/8	10006B-606	9/16-18	1.66	.88	.297	11/16	
1/2	1/2	10008B-608 ^a	3/4-16	2.06	1.06	.391	7/8	
5/8	5/8	10010B-610 ^a	7/8-14	2.67	1.19	.484	1	
3/4	5/8	10012B-610 ^a	7/8-14	2.69	1.25	.511	1	
3/4	3/4	10012B-612	1-1/16-12	2.69	1.19	.609	1-1/4	

^a Swivel nuts are universal — both SAE 37° and 45° connections.

Hose Ends - Field Attachable

Field Attachable

100 'B' Series Barb-Tite™

To determine the correct length of hose, subtract the cut-off factor for each end fitting from the overall length of assembly.

Note:
Drawings may differ from actual parts.

SAE 45° Flare Female Swivel

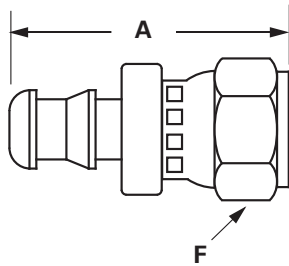

Hose I.D.	Tube Size	Part Number	Thread Size	A	Hose Cut-Off Factor	Hole Dia.	Hex F
3/8	3/8	10006B-406	5/8-18	1.73	.88	.297	3/4
3/4	3/4	10012B-412	1-1/16-14	2.66	1.25	.609	1-1/4

Straight Tube Rigid

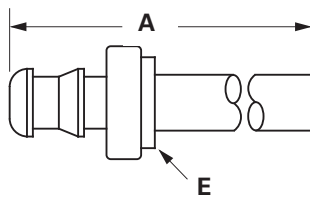

Hose I.D.	Tube Size	Part Number	Thread Size	A	Hose Cut-Off Factor	Hole Dia.	Hex F
1/4	3/16	10004B-X03	.188	1.53	0.78	.172	13/32
1/4	1/4	10004B-X04	.250	1.55	0.80	.172	13/32
1/4	5/16	10004B-X05	.312	1.65	0.90	.172	13/32
5/16	5/16	10005B-X05	.312	2.02	1.21	.228	7/16
3/8	3/8	10006B-X06	.375	2.13	1.26	.297	1/2

Hose Mender

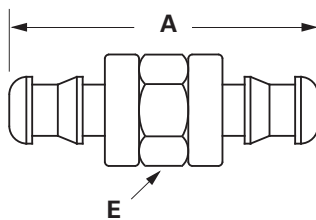

Hose I.D.	Part Number	A	Hose Cut-Off Factor	Hole Dia.	Hex E
1/4	10004B-Y04	1.86	.38	.172	1/2
5/16	10005B-Y05	2.04	.44	.234	9/16
3/8	10006B-Y06	2.14	.44	.297	5/8
1/2	10008B-Y08	2.46	.50	.391	3/4

Male Pipe Rigid 90° Elbow

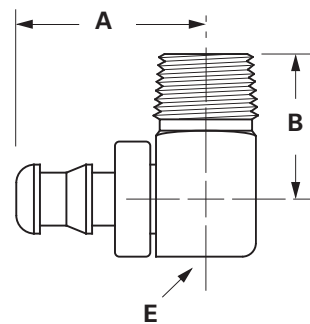

Hose I.D.	Pipe Size	Part Number	Thread Size	A	B	Hose Cut-Off Factor	Hole Dia.	Square E
5/16	1/8	10005B-C02	1/8-27	1.11	.94	.31	.228	1/2
5/16	1/4	10005B-C04	1/4-18	1.18	.94	.38	.228	9/16
3/8	1/8	10006B-C02	1/8-27	1.17	.94	.38	.297	1/2
3/8	1/4	10006B-C04	1/4-18	1.24	.94	.38	.297	9/16

K

Hose Ends - Field Attachable

Field Attachable

105 'B' Series

Hose End 105 'B' Series

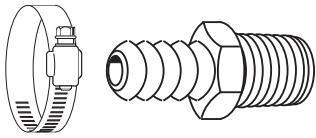

⚠ WARNING

Hose can be damaged if over-tightened.

Ordering Information: Order individually by part number.

⚠ Refer to important safety information on pages A-2-3.

Application: Low pressure shop or service air lines.

Compatible Hose: H0105; H0106; H115; H116.

Pressure: Determined by maximum working pressure for hose size. See pages A-15-16 for working pressure ratings for hose end configurations.

Material: CA360 brass

Advantages: Easy to assemble—just push the fitting into the hose and clamp. Low cost and a good selection of sizes.

To determine the correct length of hose, subtract the cut-off factor for each end fitting from the overall length of assembly.

Note:

Drawings may differ from actual parts.

Assembly Instructions:

1. Slide clamp over hose.
2. Insert barbed end of fitting into hose.
3. Locate clamp in middle of insert and tighten. Use 6203/6204 Series clamps only. See page M-26.

Label Set: FS-500

Note:

Refer to current price list for availability of cataloged items. Configurations and dimensions subject to change without notice.

Male Pipe (PTF Short)

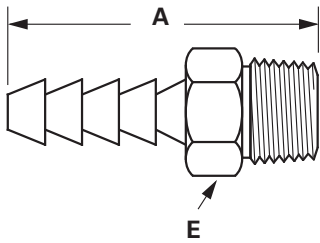

Hose I.D.	Pipe Size	Part Number	A	Hex F	Number of Barbs
1/8	1/8	10502B-102	1.00	7/16	4
3/16	1/8	10503B-102	1.16	7/16	3
3/16	1/4	10503B-104	1.43	9/16	3
1/4	1/8	10504B-102	1.54	7/16	4
1/4	1/4	10504B-104	1.61	9/16	4
1/4	3/8	10504B-106	1.72	11/16	4
5/16	1/8	10505B-102	1.60	7/16	4
5/16	1/4	10505B-104	1.77	9/16	4
3/8	1/8	10506B-102	1.53	7/16	4
3/8	1/4	10506B-104	1.70	9/16	4
3/8	3/8	10506B-106	1.72	11/16	4
3/8	1/2	10506B-108	1.95	7/8	4
1/2	1/4	10508B-104	1.71	9/16	4
1/2	3/8	10508B-106	1.72	11/16	4
1/2	1/2	10508B-108	1.94	7/8	4
1/2	3/4	10508B-112	1.95	1-1/8	4
5/8	3/8	10510B-106	1.72	3/4	4
5/8	1/2	10510B-108	1.95	7/8	4
5/8	3/4	10510B-112	1.91	1-1/8	4
3/4	1/2	10512B-108	1.86	7/8	4
3/4	3/4	10512B-112	1.92	1-1/8	4

Female Pipe (NPTF)

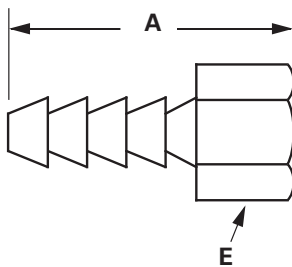

Hose I.D.	Pipe Size	Part Number	A	Hex F	Number of Barbs
1/8	1/8	10502B-202	.97	9/16	4
3/16	1/8	10503B-202	1.19	9/16	3
1/4	1/8	10504B-202	1.47	9/16	4
1/4	1/4	10504B-204	1.58	11/16	4
5/16	1/8	10505B-202	1.47	9/16	4
5/16	1/4	10505B-204	1.58	11/16	4
3/8	1/8	10506B-202	1.47	9/16	4
3/8	1/4	10506B-204	1.58	11/16	4
3/8	3/8	10506B-206	1.64	13/16	4
1/2	1/4	10508B-204	1.58	11/16	4
1/2	3/8	10508B-206	1.64	13/16	4
1/2	1/2	10508B-208	1.86	1	4

K

Hose Ends - Field Attachable

Field Attachable

338 'B' Series

To determine the correct length of hose, subtract the cut-off factor for each end fitting from the overall length of assembly.

Hose End 338 'B' Series
(Parts are stamped with DOT)

Ordering Information:
Order individually by part number. Complete air brake hose assemblies can be found in the Ready-Made Hose Assemblies section of this catalog. Refer to pages M-12-17.

 Refer to important safety information on pages A-2-3.

Application: Air brake hose lines.

Compatible Hose: H338

Pressure: Determined by maximum working pressure for hose size. See pages A-15-16 for working pressure ratings for hose end configurations.

Material: CA360 brass

Advantages: Can be used for nearly any air brake line. Easy to assemble with a good selection of hose end configurations. Brass material offers excellent resistance against corrosion.

Assembly Instructions:

1. Slide nut and sleeve onto hose. Make sure bevel edge of sleeve faces out toward fitting.

2. Push hose into fitting until it bottoms.
3. Screw nut until contact is made with body hex.

Label Set: FS-800

Note:
Refer to current price list for availability of cataloged items. Configurations and dimensions subject to change without notice.

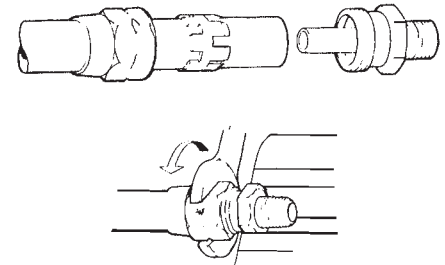

Male Connector

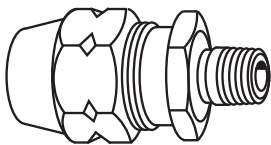

Hose I.D.	Pipe Size	Part Number	Overall Length	Hose Cut-Off Factor
3/8	1/4	33806B-Y24	2.26	.69
3/8	3/8	33806B-Y26	2.35	.81
3/8	1/2	33806B-Y28	2.45	.94
1/2	3/8	33808B-Y26	2.24	.75
1/2	1/2	33808B-Y28	2.40	.94

Male Connector with Spring Guard

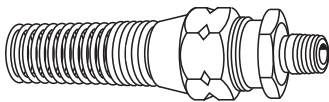

Hose I.D.	Pipe Size	Part Number	Overall Length	Hose Cut-Off Factor
3/8	1/4	33806B-Y34	4.72	.75
3/8	3/8	33806B-Y36	4.78	.81
3/8	1/2	33806B-Y38	4.88	.94
1/2	3/8	33808B-Y36	5.12	.75
1/2	1/2	33808B-Y38	4.88	.94

Female Connector

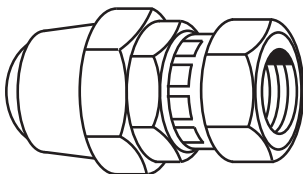

Hose I.D.	ABS Thread Size	Part Number	Overall Length	Hose Cut-Off Factor
3/8	3/4-20	33806B-Y76	2.40	.88
1/2	7/8-20	33808B-Y78	2.37	.88

(Steel Nut)

K

Hose Ends - Field Attachable

Field Attachable

338 'B' Series

To determine the correct length of hose, subtract the cut-off factor for each end fitting from the overall length of assembly.

Female Connector with Adapter

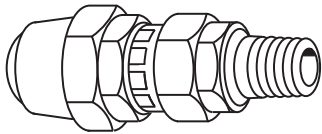

Hose I.D.	Pipe Size	Part Number	ABS Thread Size	Overall Length	Hose Cut-Off Factor
3/8	1/4	33806B-Y84	3/4-20	3.33	1.81
3/8	3/8	33806B-Y86	3/4-20	3.33	1.75
1/2	3/8	33808B-Y86	7/8-20	3.30	1.75

(Steel Nut)

Hose Mender

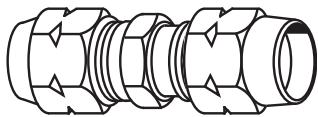

Hose I.D.	Part Number	Overall Length
3/8	33806B-Y06	3.28
1/2	33808B-Y08	3.25

Hose Mender (Body Only)

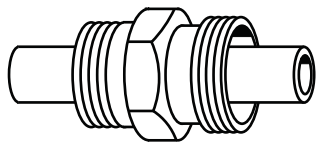

Hose I.D.	Part Number	Overall Length
3/8	33806-E	2.55

Adapter

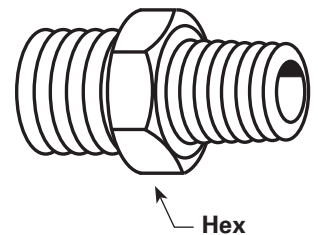

ABS Thread Size	Pipe Size	Part Number	Overall Length	ABS Thread Size	Hex
3/8	1/4	1390x6	1.18	3/4-20	3/4
3/8	3/8	1390x6x6	1.18	3/4-20	3/4
3/8	1/2	1390x6x8	1.37	3/4-20	7/8
1/2	3/8	1390x8	1.18	7/8-20	7/8
1/2	1/2	1390x8x8	1.37	7/8-20	7/8

Spring Guard

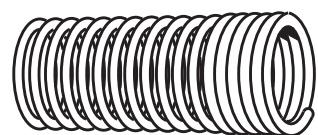

Hose I.D.	Part Number
3/8	33806-C
1/2	33808-C

(Steel Nut)

K

Hose Ends - Field Attachable

Field Attachable

338 'B' Series

To determine the correct length of hose, subtract the cut-off factor for each end fitting from the overall length of assembly.

Insert (Body Only)

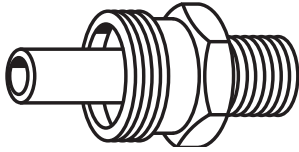

Hose I.D.	Pipe Size	Part Number	Hole Dia.
3/8	1/4	1391x6	.281
3/8	3/8	1391x6x6	.281
3/8	1/2	1391x6x8	.281
1/2	3/8	1391x8	.390
1/2	1/2	1391x8x8	.390

Sleeve

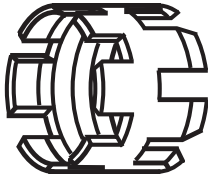

Hose I.D.	Part Number
3/8	33806-A
1/2	33808-A

Nut

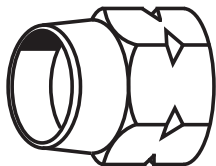

Hose I.D.	Part Number
3/8	33806-B
1/2	33808-B

Nut For Spring Guard

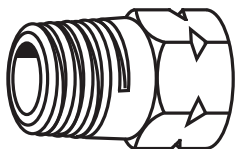

Hose I.D.	Part Number
3/8	33806-D
1/2	33808-D

K

Hose Ends - Field Attachable

Field Attachable

069 'D' Series

Hose End 069 'D' Series

Ordering Information: Order individually by part number. For mandrel, see page N-71.

 Refer to important safety information on pages A-2-3.

Application: Medium pressure and high temperature hose lines for a variety of applications including truck, industrial, and small engine where temperature may be a problem.

Compatible Hose: H069, H166, H169, H229, H366.

Pressure: Determined by hose burst pressure. See pages A-15-16 for working pressure ratings for hose end configurations.

Material: AISI/SAE 12L14 carbon steel

Plating: Zinc; clear trivalent chromate

Advantages: Very popular in heavy-duty truck markets. Can be used with a variety of hoses allowing for a diverse number of applications.

Assembly Instructions:

1. Lubricate mandrel, insert threads and I.D. of hose.
2. Screw hose into socket (left-hand thread) until hose bottoms. Back out 1/4 turn.
3. Place insert on mandrel. Screw insert into socket. When assembling swivel ends, leave 1/32" clearance between swivel nut and socket.

Label Set: FS-600

Note:

Refer to current price list for availability of cataloged items. Configurations and dimensions subject to change without notice.

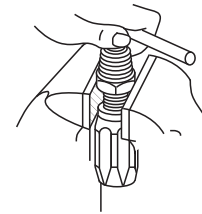
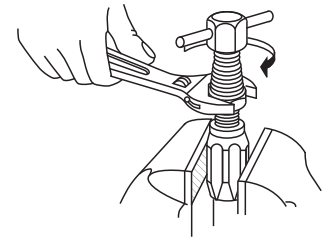
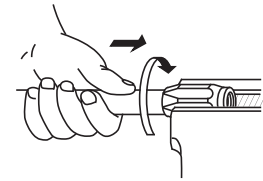

Male Pipe Rigid

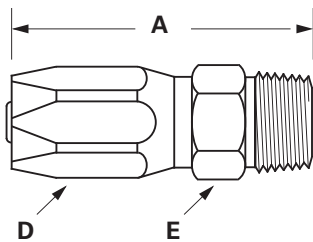

Hose I.D.	Pipe Size	Part Number	Thread Size	A	Hose Cut-Off Factor	Hole Dia.	Hex D	Hex E
3/16	1/8	06904D-102	1/8-27	1.72	1.00	.17	5/8	7/16
3/16	1/4	06904D-104	1/4-18	1.90	1.19	.17	5/8	9/16
1/4	1/4	06905D-104	1/4-18	1.96	1.18	.25	11/16	9/16
5/16	1/4	06906D-104	1/4-18	2.10	1.25	.30	13/16	5/8
13/32	3/8	06908D-106	3/8-18	2.48	1.38	.39	15/16	11/16
13/32	1/2	06908D-108	1/2-14	2.73	1.58	.39	15/16	7/8
1/2	1/2	06910D-108	1/2-14	2.88	1.59	.48	1-1/8	7/8
5/8	3/4	06912D-112	3/4-14	3.24	1.67	.61	1-1/4	1-1/16
7/8	3/4	06916D-112	3/4-14	2.80	1.53	.72	1-7/16	1-1/8
7/8	1	06916D-116	1-11-1/2	3.00	1.81	.81	1-7/16	1-3/8
1-1/8	1-1/4	06920D-120	1-1/4-11-1/2	3.18	1.88	1.05	1-3/4	1-11/16
1-3/8	1-1/2	06924D-124	1-1/2-11-1/2	3.48	2.03	1.28	1-15/16	2
1-13/16	2	06932D-132	2-11-1/2	4.06	2.21	1.75	2-1/2	2-1/2
2-3/8	2-1/2	06940T-140*	2-1/2-8	5.03	3.13	2.20	3-1/8	3

* Brass construction

K

Hose Ends - Field Attachable

To determine the correct length of hose, subtract the cut-off factor for each end fitting from the overall length of assembly.

Field Attachable

069 'D' Series

To determine the correct length of hose, subtract the cut-off factor for each end fitting from the overall length of assembly.

^a Swivel nuts are universal – both SAE 37° and 45° connections.

JIC 37° Female Swivel

(Exceptions Noted for 45° Flare)
(Refer to Footnotes)

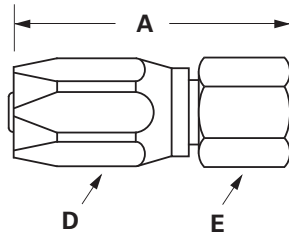

Hose I.D.	Tube Size	Part Number	Thread Size	A	Hose Cut-Off Factor	Hole Dia.	Hex D	Hex E
3/16	1/4	06904D-604 ^a	7/16-20	1.74	1.06	.17	5/8	9/16
1/4	5/16	06905D-605 ^a	1/2-20	1.90	1.19	.24	11/16	5/8
5/16	3/8	06906D-606	9/16-18	2.05	1.15	.30	13/16	11/16
13/32	1/2	06908D-608 ^a	3/4-16	2.52	1.38	.39	15/16	7/8
1/2	5/8	06910D-610 ^a	7/8-14	2.79	1.56	.49	1-1/8	1
5/8	3/4	06912D-612	1-1/16-12	3.15	1.63	.61	1-1/4	1-1/4
7/8	1	06916D-616	1-5/16-12	2.81	1.63	.82	1-7/16	1-1/2
1-1/8	1-1/4	06920D-620	1-5/8-12	3.00	1.64	1.05	1-3/4	2
1-3/8	1-1/2	06924D-624	1-7/8-12	3.28	1.88	1.28	1-15/16	2-1/4
1-13/16	2	06932D-632	2-1/2-12	4.02	2.18	1.75	2-1/2	2-7/8
2-3/8	2-1/2	06940T-640*	3-12	4.16	2.25	2.22	3-1/8	3-3/8

*Brass construction.

^a Swivel nuts are universal – both SAE 37° and 45° connections.

SAE 45° Female Swivel

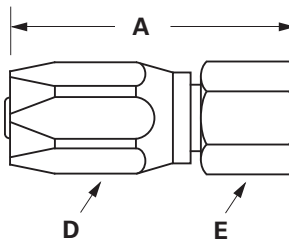

Hose I.D.	Tube Size	Part Number	Thread Size	A	Hose Cut-Off Factor	Hole Dia.	Hex D	Hex E
5/16	3/8	06906D-406	5/8-18	2.05	1.19	.29	13/16	3/4
5/8	3/4	06912D-412	1-1/16-14	3.02	1.44	.61	1-1/4	1-1/4

30° Flare Female Swivel

(PTT Thread for Diesel Applications)

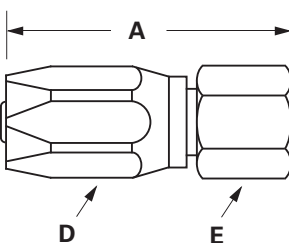

Hose I.D.	Tube Size	Part Number	Thread Size	A	Hose Cut-Off Factor	Hole Dia.	Hex D	Hex E
7/8	1	06916D-X26	1-5/16-14	2.60	1.33	.81	1-7/16	1-1/2

(See page L-77 for PTT Thread Adapter.)

Field Attachable

'K' Series

To determine the correct length of hose, subtract the cut-off factor for each end fitting from the overall length of assembly.

Hose End 'K' Series

Ordering Information: Order as a complete kit or order individual components by part number.

 Refer to important safety information on pages A-2-3.

Application: Low pressure hydraulic applications and suction lines.

Compatible Hose: H039

Pressure: Determined by maximum working pressure for hose size. See pages A-15-16 for working pressure ratings for hose end configurations.

Material: 12L14 carbon steel insert; malleable iron clamp

Plating: Zinc; clear trivalent chromate

Assembly Instructions:

1. Lubricate insert and hose I.D.
2. Push hose on barbed stand pipe. Be sure hose is bottomed to clamp retainer.
3. After making sure clamp shoulders will lock in recesses of insert, draw clamps together evenly.

Note: Refer to current price list for availability of cataloged items. Configurations and dimensions subject to change without notice.

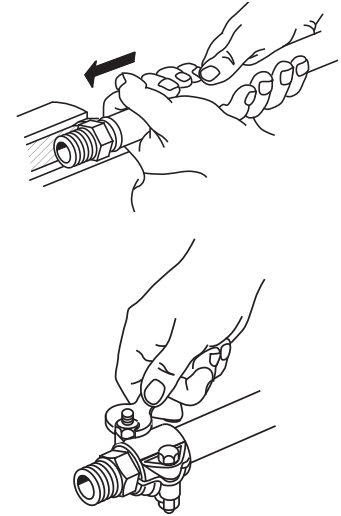

Male Pipe

Assembly Includes Insert, Clamps, Nuts and Bolts

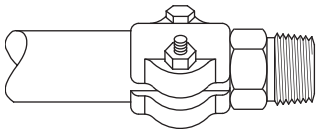

Hose I.D.	Pipe Size	Catalog Number Complete Assembly	Insert I.D.	Hose Cut-Off Factor†	Insert Only	Clamp Ass'y Less Insert	Clamp Only	Nut No.	Bolt No.
3/4	3/4	K12N-112	.66	1.44	IKE12N-112	K12	CK12	NK12	BK12
1	1	K16N-116	.91	1.63	IKE16N-116	K16	CK16	NK16	BK16
1-1/4	1-1/4	K20N-120	1.06	1.81	IKE20N-120	K20	CK20	NK20	BK20
2	2	K32N-132	1.75	2.19	IKE32N-132	K32	CK32	NK32	BK32

K

Male Connector Insert Only

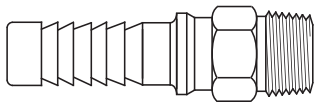

Hose I.D.	Pipe Size	Catalog Number	Pipe Thread	Overall Length	Hose Cut-Off Factor†	Insert I.D.
3/4	3/4	IKE12N-112	3/4-14	3.03	1.44	.66
1	1	IKE16N-116	1-11-1/2	3.72	1.63	.91
1-1/4	1-1/4	IKE20N-120	1-1/4-11-1/2	4.59	1.88	1.06
2	2	IKE32N-132	2-11-1/2	5.19	2.19	1.75

Use with H039 hose only. May be clamped with band or gear-type clamp. Used with suction hose for suction lines or return lines. For low pressure applications only.

Hose Ends - Field Attachable

Field Attachable

039 'K'

Hose End 039 'K' Series
(Used with H039 and H039H hose only.)

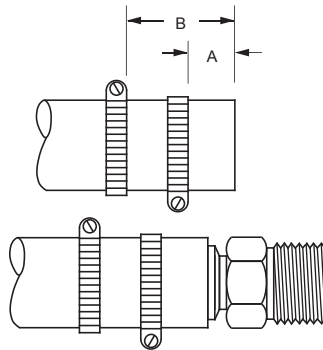

Ordering Information: Order individually by part number.

 Refer to important safety information on pages A-2-3.

Application: Suction and return lines; Used with suction hose for suction or return lines. For low pressure applications.

Compatible Hose: H039

Pressure: Refer to H039 listing on page B-2 when used with 039 'K' Series hose ends and 6203 Series clamps.

Material: AISI/SAE 12L14 carbon steel

Plating: Zinc; clear trivalent chromate

Assembly Instructions:

1. Cut hose to length. Be sure the cut is square and hose is clean. Trim sharp exposed wire to prevent injury.
2. Slide clamps onto hose.
3. Push fitting into hose. Be sure the hose is bottomed against the atop ring.
4. Position clamps as shown. Secure with a screwdriver or wrench.

Note:
Band-It Clamps may be used in place of worm gear clamps.
Not intended for SAE 100R4 applications.

Refer to current price list for availability of cataloged items. Configurations and dimensions subject to change without notice.

Hose Size	Clamp Part Number	A	B	T Minimum
-12	6203-012	5/8	1-1/4	25 in./lbs.
-16	6203-016	5/8	1-1/4	25 in./lbs.
-20	6203-024	5/8	1-1/4	25 in./lbs.

Male Pipe Rigid

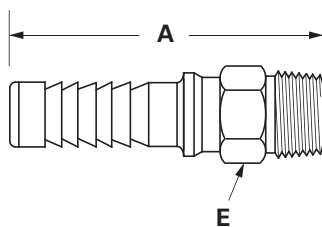

Hose I.D.	Pipe Size	Part Number	Thread Size	A	Hose Cut-Off Factor	Hex E
3/4	3/4	03912K-112	3/4-14	3.61	1.44	1-1/16
1	1	03916K-116	1-11-1/2	3.90	1.69	1-3/8
1-1/4	1-1/4	03920K-120	1-1/4-11-1/2	4.63	2.31	1-11/16

JIC 37° Female Swivel

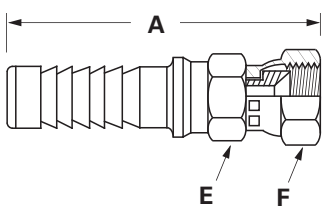

Hose I.D.	Tube Size	Part Number	Thread Size	A	Hose Cut-Off Factor	Hex E	Hex F
3/4	3/4	03912K-612	1-1/16-12	3.86	1.69	1	1-1/4
1	1	03916K-616	1-5/16-12	4.46	2.25	1-1/4	1-1/2
1-1/4	1-1/4	03920K-620	1-5/8-12	4.92	2.56	1-11/16	2

K

Hose Ends - Field Attachable

Field Attachable

104 'N' Series

Hose End 104 'N' Series

Ordering Information: Order individually by part number. Order o-rings by catalog number; reference individual hose listing for details. For split flange kits, refer to pages L-89-92.

Application: Medium pressure hydraulic applications such as construction, farm implement and industrial equipment.

Compatible Hose: H104

Pressure: Determined by maximum working pressure for hose size and hose end configuration whichever is lesser. See pages A-15-16 for working pressure ratings for hose end configurations.

Material: AISI/SAE 12L14 carbon steel

Plating: Zinc; clear trivalent chromate

Advantages: Good selection of hose ends. Non-mandrel assembly. Wide variety of applications because of its use with H104 hose.

Assembly Instructions:

Due to the high torque required to assemble larger sizes, it is recommended that 104 'N' Series hose ends be assembled with the T-300 (page N-71) assembly machine.

1. Lubricate insert threads and I.D. of hose.
2. Measure from end of hose and mark the socket depth. Use notch on socket or see insertion depth chart below.
3. Screw hose into socket (left-hand thread) to the depth marked on hose.
4. Screw insert into socket until insert touches socket.

To determine the correct length of hose, subtract the cut-off factor for each end fitting from the overall length of assembly.

Note:

Refer to current price list for availability of cataloged items. Configurations and dimensions subject to change without notice.

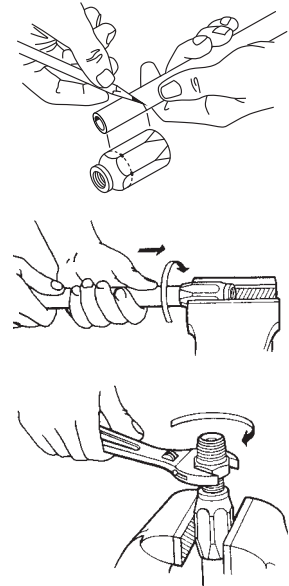

Insertion Depth

Hose I.D.	Screw Hose Into Socket
1/4	1"
3/8	1-5/32"
1/2	1-3/16"
3/4	1-5/16"
1	1-9/16"

Male Pipe Rigid

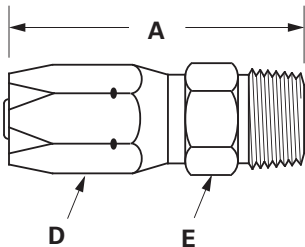

Hose I.D.	Pipe Size	Part Number	Thread Size	A	Hose Cut-Off Factor	Hole Dia.	Hex E	Hex F
1/4	1/8	10404N-102	1/8-27	2.18	1.19	.17	3/4	7/16
1/4	1/4	10404N-104	1/4-18	2.36	1.38	.17	3/4	9/16
3/8	1/4	10406N-104	1/4-18	2.50	1.31	.27	7/8	9/16
3/8	3/8	10406N-106	3/8-18	2.53	1.38	.27	7/8	11/16
1/2	3/8	10408N-106	3/8-18	2.58	1.38	.39	1	11/16
1/2	1/2	10408N-108	1/2-14	2.83	1.63	.39	1	7/8
1/2	3/4	10408N-112	3/4-14	2.86	1.69	.39	1	1-1/16
3/4	3/4	10412N-112	3/4-14	2.98	1.69	.61	1-3/8	1-1/16
1	1	10416N-116	1-11-1/2	3.59	2.00	.81	1-3/4	1-3/8

JIC 37° Male Rigid

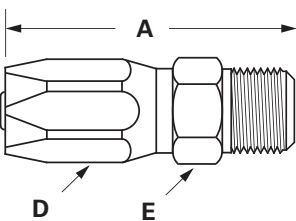

Hose I.D.	Pipe Size	Part Number	Thread Size	A	Hose Cut-Off Factor	Hole Dia.	Hex E	Hex F
1/4	1/4	10404N-504	7/16-20	2.35	1.38	.17	3/4	9/16
1/4	5/16	10404N-505	1/2-20	2.35	1.38	.17	3/4	9/16
1/4	3/8	10404N-506	9/16-18	2.39	1.38	.17	3/4	5/8
3/8	3/8	10406N-506	9/16-18	2.53	1.38	.27	7/8	5/8
3/8	1/2	10406N-508	3/4-16	2.69	1.50	.27	7/8	13/16
1/2	1/2	10408N-508	3/4-16	2.74	1.56	.39	1	13/16
1/2	5/8	10408N-510	7/8-14	2.87	1.69	.39	1	15/16
3/4	3/4	10412N-512	1-1/16-12	3.09	1.75	.61	1-3/8	1-1/8
1	1	10416N-516	1-5/16-12	3.56	2.00	.81	1-3/4	1-3/8

K

Hose Ends - Field Attachable

Field Attachable

104 'N' Series

To determine the correct length of hose, subtract the cut-off factor for each end fitting from the overall length of assembly.

^a Swivel nuts are universal – both SAE 37° and 45° connections.

JIC 37° Female Swivel

(Exceptions Noted for 45° Flare, Refer to Footnotes)

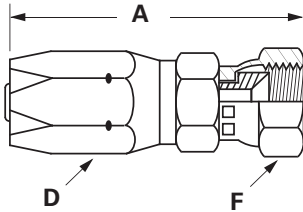

Hose I.D.	Tube Size	Part Number	Thread Size	A	Hose Cut-Off Factor	Hole Dia.	Hex E	Hex F
1/4	1/4	10404N-604 ^a	7/16-20	2.49	1.50	.17	3/4	9/16
1/4	5/16	10404N-605 ^a	1/2-20	2.59	1.56	.17	3/4	5/8
1/4	3/8	10404N-606	9/16-18	2.65	1.63	.17	3/4	11/16
3/8	3/8	10406N-606	9/16-18	2.79	1.63	.27	7/8	11/16
3/8	1/2	10406N-608 ^a	3/4-16	2.96	1.81	.27	7/8	7/8
1/2	1/2	10408N-608 ^a	3/4-16	3.01	1.81	.39	1	7/8
1/2	5/8	10408N-610 ^a	7/8-14	3.02	1.88	.39	1	1
3/4	5/8	10412N-610 ^a	7/8-14	3.14	1.88	.46	1-3/8	1
3/4	3/4	10412N-612	1-1/16-12	3.26	2.00	.61	1-3/8	1-1/4
3/4	7/8	10412N-614	1-3/16-12	3.39	2.06	.61	1-3/8	1-3/8
1	1	10416N-616	1-5/16-12	4.19	2.63	.81	1-3/4	1-1/2

^a Swivel nuts are universal – both SAE 37° and 45° connections.

SAE 45° Female Swivel

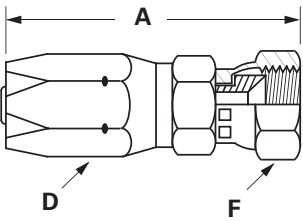

Hose I.D.	Tube Size	Part Number	Thread Size	A	Hose Cut-Off Factor	Hole Dia.	Hex E	Hex F
3/8	3/8	10406N-406	5/8-18	2.67	1.50	.27	7/8	3/4
3/4	3/4	10412N-412	1-1/16-14	3.27	2.00	.61	1-3/8	1-1/4

Split Flange Straight

(SAE Code 61)

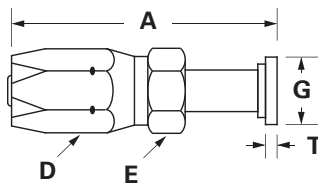

Hose I.D.	Nom. Flange Size	Part Number	Replacement O-Ring (Not Included)	A	Hose Cut-Off Factor	Hole Dia.	Hex D	Hex E	Flange Dia.	T
3/4	3/4	10412N-G12	12x252	3.79	2.44	.58	1-3/8	15/16	1.500 (38 mm)	.265
1	1	10416N-G16	16x252	4.21	2.63	.76	1-3/4	1-1/4	1.750 (44 mm)	.315

(For Split Flange Kits, see pages L-89 thru L92.)

JIC 37° Female Swivel 45° Tube Elbow

(Exceptions noted)

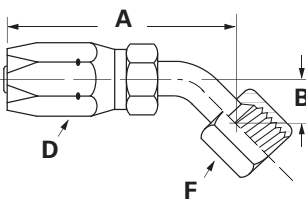

Hose I.D.	Tube Size	Part Number	Thread Size	A	B	Hose Cut-Off Factor	Hole Dia.	Hex E	Hex F
1/4	1/4	10404N-684 ^a	7/16-20	2.90	.33	1.88	.15	3/4	9/16
3/8	3/8	10406N-686	9/16-18	3.22	.39	2.00	.24	7/8	11/16
1/2	1/2	10408N-688 ^a	3/4-16	3.61	.55	2.44	.33	1	7/8
1/2	5/8	10408N-690 ^a	7/8-14	3.67	.63	2.50	.39	1	1
3/4	3/4	10412N-692	1-1/16-12	4.20	.78	2.81	.58	1-3/8	1-1/4
1	1	10416N-696	1-5/16-12	5.42	1.10	3.88	.81	1-3/4	1-1/2

^a Swivel nuts are universal – both SAE 37° and 45° connections.

K
Hose Ends - Field Attachable

Field Attachable

104 'N' Series

To determine the correct length of hose, subtract the cut-off factor for each end fitting from the overall length of assembly.

^a Swivel nuts are universal— both SAE 37° and 45° connections.

Split Flange 45° Tube Elbow (SAE Code 61)

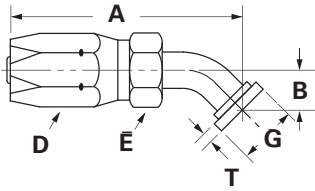

Hose I.D.	Nom. Flange Size	Part Number	Replacement O-Ring (Not Included)	A	B	Hose Cut-Off Factor	Hole Dia.	Hex D	Hex E	Flange Dia.	T
3/4	3/4	10412N-G42	12x252	4.43	.99	3.13	.58	1-3/8	15/16	1.500 (38mm)	.265
1	1	10416N-G46	16x252	4.99	1.06	3.44	.76	1-3/4	1-1/4	1.750 (44mm)	.315

(For Split Flange Kits, see pages L-89 thru L-92.)

JIC 37° Female Swivel 90° Tube Elbow (Refer to Footnotes)

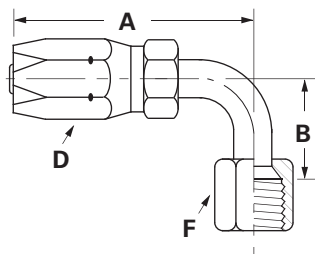

Hose I.D.	Tube Size	Part Number	Thread Size	A	B	Hose Cut-Off Factor	Hole Dia.	Hex D	Hex F
1/4	1/4	10404N-664 ^a	7/16-20	2.80	.68	1.81	.15	3/4	9/16
3/8	3/8	10406N-666	9/16-18	3.15	.85	2.00	.24	7/8	11/16
1/2	1/2	10408N-668 ^a	3/4-16	3.44	1.09	2.25	.33	1	7/8
1/2	5/8	10408N-670 ^a	7/8-14	3.75	1.23	2.56	.39	1	1
3/4	3/4	10412N-672	1-1/16-12	4.07	1.82	2.75	.58	1-3/8	1-1/4
1	1	10416N-676	1-5/16-12	5.27	2.14	3.75	.81	1-3/4	1-1/2

^a Swivel nuts are universal – both SAE 37° and 45° connections.

JIC 37° Female Swivel Long Drop 90° Tube Elbow (Refer to Footnotes)

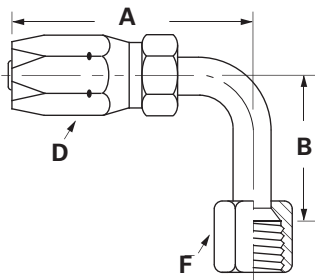

Hose I.D.	Tube Size	Part Number	Thread Size	A	B	Hose Cut-Off Factor	Hole Dia.	Hex D	Hex F
1/4	1/4	10404N-644 ^a	7/16-20	2.83	1.80	1.81	.15	3/4	9/16
3/8	3/8	10406N-646	9/16-18	3.20	2.18	2.00	.24	7/8	11/16
1/2	1/2	10408N-648 ^a	3/4-16	3.44	2.43	2.25	.33	1	7/8
3/4	3/4	10412N-652	1-1/16-12	4.10	3.73	2.75	.58	1-3/8	1-1/4

^a Swivel nuts are universal – both SAE 37° and 45° connections.

Split Flange 90° Tube Elbow (SAE Code 61)

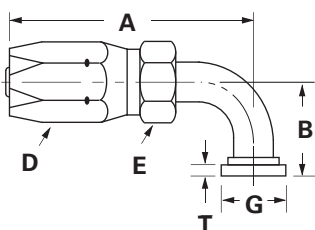

Hose I.D.	Nom. Flange Size	Part Number	Replacement O-Ring (Not Included)	A	B	Hose Cut-Off Factor	Hole Dia.	Hex D	Hex E	Flange Dia.	T
3/4	3/4	10412N-G72	12x252	4.08	2.13	2.75	.58	1-3/8	15/16	1.500 (38 mm)	.265
3/4	1	10412N-G76	16x252	4.08	2.13	2.75	.83	1-3/8	15/16	1.750 (44 mm)	.315
1	1	10416N-G76	16x252	4.81	2.38	3.25	.83	1-3/4	1-1/4	1.750 (44 mm)	.315

(For Split Flange Kits, see pages L-89 thru L-92.)

K

Hose Ends - Field Attachable

Field Attachable

213 'N' Series

To determine the correct length of hose, subtract the cut-off factor for each end fitting from the overall length of assembly.

Hose End 213 'N' Series

Ordering Information: Order individually by part number.

 Refer to important safety information on pages A-2-3.

Application: Medium pressure and high temperature hose lines for a variety of applications including truck, industrial, and small engines where high temperatures exist.

Compatible Hose: H213

Pressure: Determined by maximum working pressure for hose size and hose end configuration whichever is lesser. See pages A-15-16 for working pressure ratings for hose end configurations.

Material: AISI/SAE 12L14 carbon steel

Plating: Zinc; clear trivalent chromate

Advantages: Very popular in heavy-duty truck markets. Good selection of hose ends. Non-mandrel assembly.

Assembly Instructions:

1. Lubricate insert threads and I.D. of hose.
2. Screw hose into socket (left-hand thread) until hose bottoms. Back out 1/4 turn.
3. Screw insert into socket until insert touches socket.

Note: Refer to current price list for availability of cataloged items. Configurations and dimensions subject to change without notice.

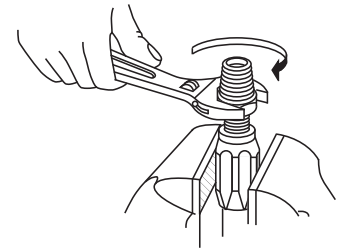
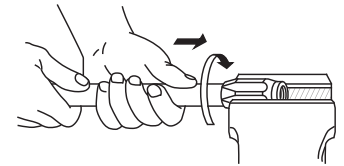

Male Pipe Rigid

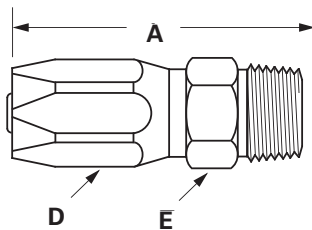

Hose I.D.	Pipe Size	Part Number	Thread Size	A	Hose Cut-Off Factor	Hole Dia.	Hex D	Hex F
3/16	1/8	21304N-102	1/8-27	1.59	.94	.12	9/16	7/16
3/16	1/4	21304N-104	1/4-18	1.78	1.13	.12	9/16	9/16
1/4	1/4	21305N-104	1/4-18	1.80	1.06	.17	5/8	9/16
5/16	3/8	21306N-106	3/8-18	1.96	1.19	.23	3/4	11/16
13/32	1/2	21308N-108	1/2-14	2.36	1.44	.33	7/8	7/8
1/2	1/2	21310N-108	1/2-14	2.45	1.44	.42	1	7/8
5/8	3/4	21312N-112	3/4-14	2.56	1.50	.55	1-1/8	1-1/16
7/8	1	21316N-116	1-11-1/2	2.71	1.69	.80	1-3/8	1-3/8

Inverted Male Swivel Straight

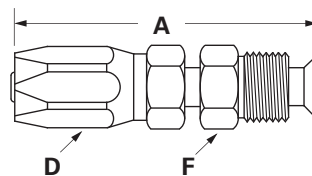

Hose I.D.	Tube Size	Part Number	Thread Size	A	Hose Cut-Off Factor	Hole Dia.	Hex D	Hex F
3/16	1/4	21304N-B04	7/16-24	2.43	1.69	.15	9/16	7/16
1/4	5/16	21305N-B05	1/2-20	2.47	1.75	.21	5/8	1/2
5/16	1/4	21306N-B04	7/16-24	2.50	1.63	.15	3/4	7/16
5/16	5/16	21306N-B05	1/2-20	2.57	1.75	.21	3/4	1/2
5/16	3/8	21306N-B06	5/8-18	2.74	1.88	.25	3/4	5/8
13/32	1/2	21308N-B08	3/4-18	3.26	2.25	.33	7/8	3/4

K

Hose Ends - Field Attachable

Field Attachable

213 'N' Series

To determine the correct length of hose, subtract the cut-off factor for each end fitting from the overall length of assembly.

^a Swivel nuts are universal—both SAE 37° and 45° connections.

JIC 37° Female Swivel

(Exceptions Noted for 45° Flare, Refer to Footnotes)

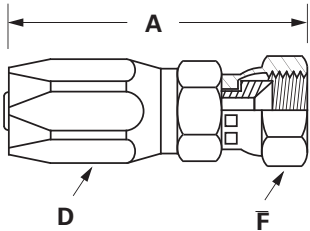

Hose I.D.	Tube Size	Part Number	Thread Size	A	Hose Cut-Off Factor	Hole Dia.	Hex D	Hex F
3/16	1/4	21304N-604 ^a	7/16-20	1.92	1.25	.15	9/16	9/16
1/4	5/16	21305N-605 ^a	1/2-20	2.01	1.25	.20	5/8	5/8
5/16	3/8	21306N-606	9/16-18	2.20	1.38	.26	3/4	11/16
13/32	1/2	21308N-608 ^a	3/4-16	2.49	1.50	.36	7/8	7/8
1/2	5/8	21310N-610 ^a	7/8-14	2.69	1.63	.45	1	1
5/8	3/4	21312N-612	1-1/16-12	2.91	1.75	.57	1-1/8	1-1/4
7/8	1	21316N-616	1-5/16-12	2.95	1.88	.82	1-3/8	1-1/2

^a Swivel nuts are universal – both SAE 37° and 45° connections.

SAE 45° Female Swivel

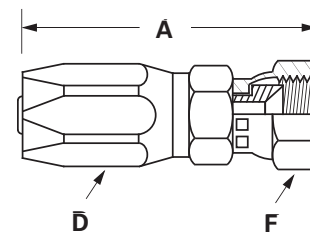

Hose I.D.	Tube Size	Part Number	Thread Size	A	Hose Cut-Off Factor	Hole Dia.	Hex D	Hex F
5/16	3/8	21306N-406	5/8-18	2.14	1.38	.26	3/4	3/4
5/8	3/4	21312N-412	1-1/16-14	2.85	1.75	.57	1-1/8	1-1/4

30° Flare Female Swivel

(PTT Thread For Diesel Applications)

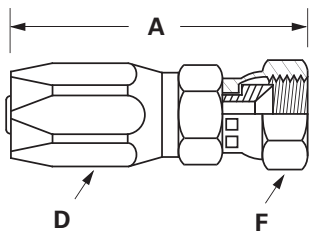

Hose I.D.	Tube Size	Part Number	Thread Size	A	Hose Cut-Off Factor	Hole Dia.	Hex D	Hex F
7/8	1	21316N-X26	1-5/16-14	2.78	1.69	.81	1-3/8	1-1/2

(See page L-77 for PTT Thread Adapter.)

K

Inverted Male Swivel 45° Tube Elbow

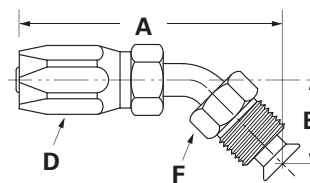

Hose I.D.	Tube Size	Part Number	Thread Size	A	B	Hose Cut-Off Factor	Hole Dia.	Hex D	Hex F
3/16	1/4	21304N-E44	7/16-24	2.91	.93	2.19	.15	9/16	7/16
1/4	5/16	21305N-E45	1/2-20	3.30	1.14	2.63	.21	5/8	1/2
5/16	1/4	21306N-E44	7/16-24	3.10	.93	2.25	.15	3/4	7/16
5/16	5/16	21306N-E45	1/2-20	3.40	1.14	2.63	.21	3/4	1/2
5/16	3/8	21306N-E46	5/8-18	3.26	.94	2.38	.25	3/4	5/8
13/32	1/2	21308N-E48	3/4-18	3.70	.94	2.69	.33	7/8	3/4

Hose Ends - Field Attachable

Field Attachable

213 'N' Series

To determine the correct length of hose, subtract the cut-off factor for each end fitting from the overall length of assembly.

^a Swivel nuts are universal—both SAE 37° and 45° connections.

SAE 37° Female Swivel 45° Tube Elbow

(Exceptions Noted for 45° Flare, Refer to Footnotes)

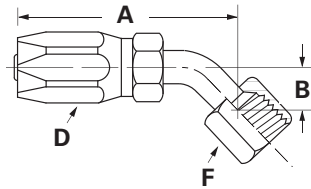

Hose I.D.	Tube Size	Part Number	Thread Size	A	B	Hose Cut-Off Factor	Hole Dia.	Hex D	Hex F
3/16	1/4	21304N-684 ^a	7/16-20	2.34	.33	1.63	.15	9/16	9/16
1/4	5/16	21305N-685 ^a	1/2-20	2.44	.36	1.69	.21	5/8	5/8
5/16	3/8	21306N-686	9/16-18	2.61	.39	1.75	.25	3/4	5/8
13/32	1/2	21308N-688 ^a	3/4-16	3.13	.55	2.13	.33	7/8	7/8

^a Swivel nuts are universal – both SAE 37° and 45° connections.

SAE 45° Female Swivel 45° Tube Elbow

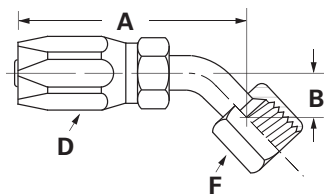

Hose I.D.	Tube Size	Part Number	Thread Size	A	B	Hose Cut-Off Factor	Hole Dia.	Hex D	Hex F
5/16	3/8	21306N-486	5/8-18	2.85	.39	1.81	.25	3/4	3/4

Inverted Male Swivel 90° Tube Elbow

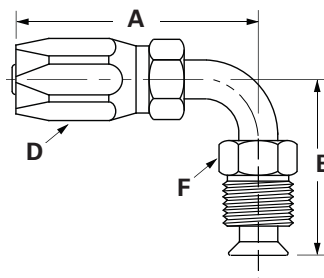

Hose I.D.	Tube Size	Part Number	Thread Size	A	B	Hose Cut-Off Factor	Hole Dia.	Hex D	Hex F
3/16	1/4	21304N-E04	7/16-24	1.69	1.36	1.50	.13	9/16	7/16
3/16	5/16	21304N-E05	1/2-20	2.30	1.61	1.56	.13	9/16	1/2
1/4	5/16	21305N-E05	1/2-20	2.49	1.61	1.75	.17	5/8	1/2
5/16	1/4	21306N-E04	7/16-24	2.58	1.65	1.75	.15	3/4	7/16
5/16	5/16	21306N-E05	1/2-20	2.50	1.61	1.63	.21	3/4	1/2
5/16	3/8	21306N-E06	5/8-18	2.82	1.97	2.00	.24	3/4	5/8
13/32	1/2	21308N-E08	3/4-18	2.78	1.69	1.81	.33	7/8	3/4

JIC 37° Female Swivel 90° Tube Elbow

(Exceptions Noted for 45° Flare, Refer to Footnotes)

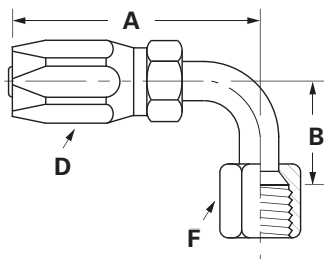

Hose I.D.	Tube Size	Part Number	Thread Size	A	B	Hose Cut-Off Factor	Hole Dia.	Hex D	Hex F
3/16	1/4	21304N-664 ^a	7/16-20	2.16	.68	1.44	.13	9/16	9/16
1/4	5/16	21305N-665 ^a	1/2-20	2.46	.77	1.75	.17	5/8	5/8
5/16	3/8	21306N-666	9/16-18	2.61	.85	1.81	.24	3/4	11/16
13/32	1/2	21308N-668 ^a	3/4-16	2.91	1.09	1.94	.33	7/8	7/8

^a Swivel nuts are universal – both SAE 37° and 45° connections.

SAE 45° Female Swivel 90° Tube Elbow

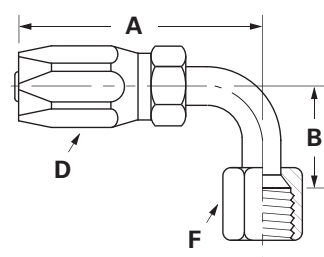

Hose I.D.	Tube Size	Part Number	Thread Size	A	B	Hose Cut-Off Factor	Hole Dia.	Hex D	Hex F
5/16	3/8	21306N-466	5/8-18	2.48	.85	1.63	.24	3/4	3/4

K

Hose Ends - Field Attachable

Field Attachable

247 'N' Series

To determine the correct length of hose, subtract the cut-off factor for each end fitting from the overall length of assembly.

Hose End 247 'N' Series

Ordering Information:
Order individually by catalog number.

 Refer to important safety information on pages A-2-3.

Application: Medium pressure and high temperature hose lines for a variety of applications including truck, industrial, and small engine where temperature may be a problem.

Compatible Hose: H059, H069, H166, H169, H229, H366, H569

Pressure: Determined by maximum working pressure for hose size and hose end configuration whichever is lesser. See pages A-15-16 for working pressure ratings for hose end configurations.

Material: AISI/SAE 12L14 carbon steel

Plating: Zinc; clear trivalent chromate

Advantages: Very popular in heavy-duty truck markets. Good selection of hose ends. Compatible with a wide variety of hose types allowing for a diverse number of applications. Non-mandrel assembly.

Assembly Instructions:

1. Lubricate insert threads and I.D. of hose.
2. Screw hose into socket (left-hand thread) until hose bottoms. Back out 1/4 turn.
3. Screw insert into socket until insert touches socket.

Label Set: FS-600

Note:

Refer to current price list for availability of cataloged items. Configurations and dimensions subject to change without notice.

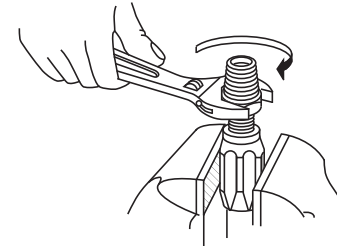
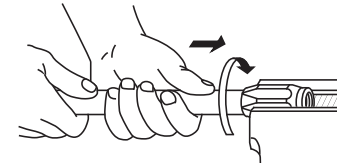

Male Pipe Rigid

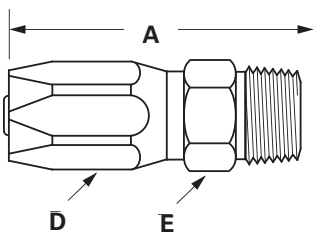

Hose I.D.	Pipe Size	Part Number	Thread Size	A	Hose Cut-Off Factor	Hole Dia.	Hex D	Hex E
3/16	1/8	24704N-102	1/8-27	1.71	1	.12	5/8	7/16
3/16	1/4	24704N-104	1/4-18	1.87	1.12	.12	5/8	9/16
1/4	1/4	24705N-104	1/4-18	1.96	1.25	.18	11/16	9/16
5/16	1/4	24706N-104	1/4-18	2.08	1.25	.25	13/16	9/16
5/16	3/8	24706N-106	3/8-18	2.11	1.25	.25	13/16	11/16
13/32	3/8	24708N-106	3/8-18	2.48	1.33	.36	15/16	11/16
13/32	1/2	24708N-108	1/2-14	2.73	1.58	.36	15/16	7/8
1/2	1/2	24710N-108	1/2-14	2.88	1.63	.45	1-1/8	7/8
1/2	3/4	24710N-112	3/4-14	2.94	1.69	.45	1-1/8	1-1/8
5/8	3/4	24712N-112	3/4-14	3.24	1.67	.55	1-1/4	1-1/4

JIC 37° Male Rigid

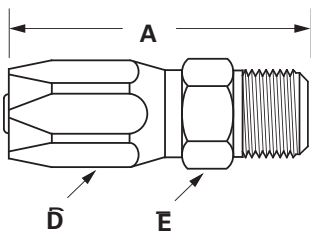

Hose I.D.	Pipe Size	Part Number	Thread Size	A	Hose Cut-Off Factor	Hole Dia.	Hex D	Hex E
3/16	1/4	24704N-504	7/16-20	1.85	1.10	.12	5/8	1/2
1/4	5/16	24705N-505	1/2-20	2.01	1.19	.18	11/16	9/16
5/16	3/8	24706N-506	9/16-18	2.13	1.25	.25	13/16	5/8
13/32	1/2	24708N-508	3/4-16	2.64	1.56	.36	15/16	13/16
1/2	5/8	24710N-510	7/8-14	2.92	1.69	.45	1-1/8	15/16
5/8	3/4	24712N-512	1-1/16-12	3.32	1.81	.55	1-1/4	1-1/8
7/8	1	24716N-516	1-5/16-12	2.97	1.81	.81	1-7/16	1-3/8

K

Hose Ends - Field Attachable

Field Attachable

247 'N' Series

To determine the correct length of hose, subtract the cut-off factor for each end fitting from the overall length of assembly.

SAE 45° Flare Male Rigid

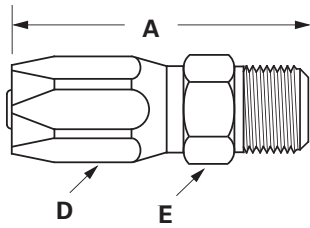

Hose I.D.	Pipe Size	Part Number	Thread Size	A	Hose Cut-Off Factor	Hole Dia.	Hex D	Hex E
3/16	1/4	24704N-304	7/16-20	1.84	1.13	.12	5/8	1/2
1/4	5/16	24705N-305	1/2-20	2.00	1.25	.18	11/16	9/16
5/16	3/8	24706N-306	5/8-18	2.18	1.28	.25	13/16	11/16
13/32	1/2	24708N-308	3/4-16	2.67	1.50	.36	15/16	13/16
1/2	5/8	24710N-310	7/8-14	3.00	1.72	.45	1-1/8	15/16
5/8	3/4	24712N-312	1-1/16-14	3.46	1.88	.55	1-1/4	1-1/8

Inverted Male Swivel Straight

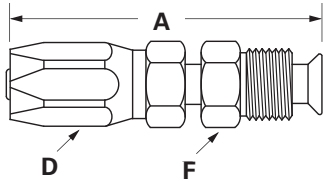

Hose I.D.	Pipe Size	Part Number	Thread Size	A	Hose Cut-Off Factor†	Hole Dia.	Hex D	Hex F
3/16	1/4	24704N-B04	7/16-24	2.54	1.81	.18	5/8	7/16
1/4	5/16	24705N-B05	1/2-20	2.75	2.00	.21	11/16	1/2
5/16	3/8	24706N-B06	5/8-18	2.91	2.00	.31	13/16	5/8
13/32	1/2	24708N-B08	3/4-18	3.63	2.50	.43	15/16	3/4

Inverted Male Swivel - Extended

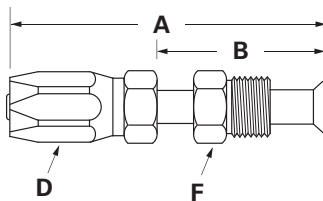

Hose I.D.	Tube Size	Part Number	Thread Size	A	B	Hose Cut-Off Factor	Hole Dia.	Hex D	Hex F
6	4	24 06N- 24	6 24	.62	6.00	6.	.	3 6	6
6	6	24 06N- 2	2 20	.62	6.00	6.	.2	3 6	2
6	3 8	24 06N- 26	8- 8	.62	6.00	6.	.24	3 6	8

K

Hose Ends - Field Attachable

Field Attachable

247 'N' Series

To determine the correct length of hose, subtract the cut-off factor for each end fitting from the overall length of assembly.

^a Swivel nuts are universal—both SAE 37° and 45° connections.

Flareless Tube Rigid Ermeto 7000 Series

(With Nut and Sleeve)

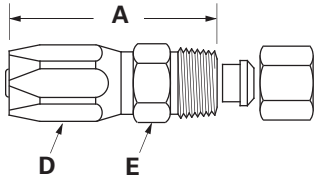

Hose I.D.	Pipe Size	Part Number	Thread Size	A	Hose Cut-Off Factor	Hole Dia.	Hex D	Hex E
5/16	1/4	24706N-754	7/16-20	2.02	1.13	.20	13/16	5/8
5/16	5/16	24706N-755	1/2-20	1.96	1.13	.23	13/16	5/8
5/16	3/8	24706N-756	9/16-18	1.98	1.13	.28	13/16	11/16
5/16	1/2	24706N-758	3/4-16	2.12	1.25	.28	13/16	13/16

JIC 37° Female Swivel

(Exceptions Noted)

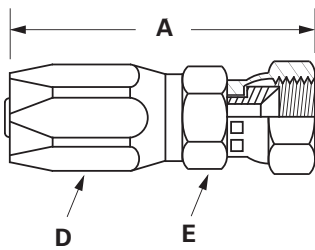

Hose I.D.	Pipe Size	Part Number	Thread Size	A	Hose Cut-Off Factor	Hole Dia.	Hex D	Hex E
3/16	1/4	24704N-604 ^a	7/16-20	2.01	1.31	.13	5/8	9/16
1/4	5/16	24705N-605 ^a	1/2-20	2.19	1.50	.18	11/16	5/8
5/16	1/4	24706N-604 ^a	7/16-20	2.19	1.31	.17	13/16	9/16
5/16	5/16	24706N-605 ^a	1/2-20	2.38	1.50	.25	13/16	5/8
5/16	3/8	24706N-606	9/16-18	2.35	1.50	.25	13/16	11/16
5/16	1/2	24706N-608 ^a	3/4-16	2.45	1.56	.39	13/16	7/8
13/32	1/2	24708N-608 ^a	3/4-16	2.82	1.75	.36	15/16	7/8
1/2	1/2	24710N-608 ^a	3/4-16	3.04	1.75	.39	1-1/8	7/8
1/2	5/8	24710N-610 ^a	7/8-14	3.04	1.75	.45	1-1/8	1
5/8	3/4	24712N-612	1-1/16-12	3.46	1.94	.55	1-1/4	1-1/4
7/8	1	24716N-616	1-5/16-12	3.21	2.00	.81	1-7/16	1-1/2

^a Swivel nuts are universal – both SAE 37° and 45° connections.

SAE 45° Flare Female Swivel

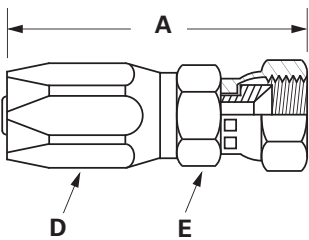

Hose I.D.	Pipe Size	Part Number	Thread Size	A	Hose Cut-Off Factor	Hole Dia.	Hex D	Hex E
5/16	3/8	24706N-406	5/8-18	2.36	1.46	.25	13/16	3/4
13/32	3/8	24708N-406	5/8-18	2.65	1.56	.28	15/16	3/4
5/8	3/4	24712N-412	1-1/16-14	3.49	1.92	.55	1-1/4	1-1/4

Straight Tube – Extended

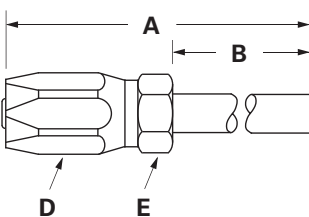

Hose I.D.	Pipe Size	Part Number	Thread Size	A	Hose Cut-Off Factor	Hole Dia.	Hex D	Hex E
3/16	1/4	24704N-T54	5.22	3.75	4.50	.12	5/8	1/2
1/4	5/16	24705N-T55	6.33	4.80	5.56	.18	11/16	1/2
5/16	3/8	24706N-T56	7.42	5.80	6.50	.25	13/16	1/2
13/32	1/2	24708N-T58	8.78	6.69	7.63	.36	15/16	3/4

K

Hose Ends - Field Attachable

Field Attachable

247 'N' Series

To determine the correct length of hose, subtract the cut-off factor for each end fitting from the overall length of assembly.

^a Swivel nuts are universal—both SAE 37° and 45° connections.

Inverted Male Swivel 45° Tube Elbow

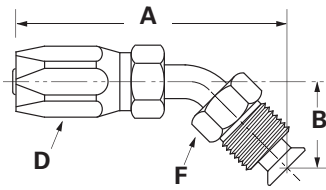

Hose I.D.	Pipe Size	Part Number	Thread Size	A	B	Hose Cut-Off Factor	Hole Dia.	Hex D	Hex F
5/16	1/4	24705N-E45	1/2-20	3.42	1.14	2.63	.18	11/16	1/2

JIC 37° Female Swivel 45° Tube Elbow

(Exceptions Noted for 45° Flare, Refer to Footnotes)

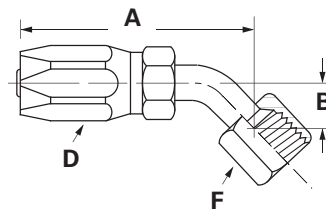

Hose I.D.	Pipe Size	Part Number	Thread Size	A	B	Hose Cut-Off Factor	Hole Dia.	Hex D	Hex F
3/16	1/4	24704N-684 ^a	7/16-20	1.85	.33	1.10	.12	5/8	9/16
1/4	5/16	24705N-685 ^a	1/2-20	2.07	.36	1.29	.18	11/16	5/8
5/16	3/8	24706N-686	9/16-18	2.29	.39	1.33	.25	13/16	11/16
13/32	1/2	24708N-688 ^a	3/4-16	2.99	.55	1.84	.33	15/16	7/8
1/2	5/8	24710N-690 ^a	7/8-14	3.24	.63	1.95	.45	1-1/8	1
5/8	3/4	24712N-692	1-1/16-12	3.778	.78	2.21	.55	1-1/4	1-1/4
7/8	1	24716N-696	1-5/16-12	4.21	1.07	2.85	.76	1-7/16	1-7/16

^a Swivel nuts are universal – both SAE 37° and 45° connections.

SAE 45° Female Swivel 45° Tube Elbow

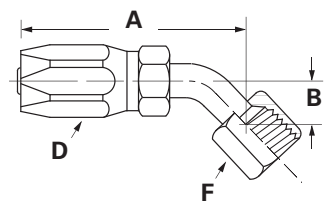

Hose I.D.	Pipe Size	Part Number	Thread Size	A	B	Hose Cut-Off Factor	Hole Dia.	Hex D	Hex F
5/16	1/4	24706N-484	7/16-20	2.61	.33	1.75	.25	13/16	5/8
5/16	3/8	24706N-486	5/8-18	2.23	.45	1.33	.25	13/16	3/4
5/8	3/4	24712N-492	1-1/16-14	3.78	.80	2.21	.55	1-1/4	1-1/4

Inverted Male Swivel 90° Tube Elbow

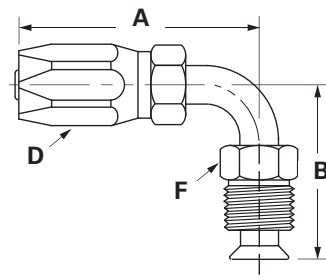

Hose I.D.	Pipe Size	Part Number	Thread Size	A	B	Hose Cut-Off Factor	Hole Dia.	Hex D	Hex F
3/16	1/4	24704N-E04	7/16-24	2.36	1.69	1.62	.18	5/8	7/16
1/4	5/16	24705N-E05	1/2-20	2.53	1.69	1.75	.24	11/16	1/2
5/16	1/4	24706N-E04	7/16-24	2.41	1.36	1.50	.18	7/8	7/16
5/16	5/16	24706N-E05	1/2-20	2.63	1.69	1.73	.24	7/8	1/2
5/16	3/8	24706N-E06	5/8-18	2.63	1.73	1.73	.30	7/8	5/8

K

Hose Ends - Field Attachable

Field Attachable

247 'N' Series

To determine the correct length of hose, subtract the cut-off factor for each end fitting from the overall length of assembly.

^a Swivel nuts are universal — both SAE 37° and 45° connections.

JIC 37° Female Swivel 90° Tube Elbow

(Exceptions Noted)

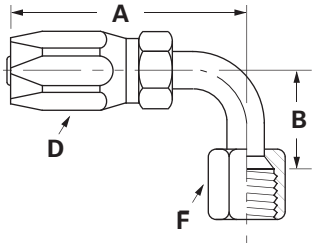

Hose I.D.	Pipe Size	Part Number	Thread Size	A	B	Hose Cut-Off Factor	Hole Dia.	Hex D	Hex F
3/16	1/4	24704N-664 ^a	7/16-20	1.74	.68	0.99	.12	5/8	9/16
1/4	5/16	24705N-665 ^a	1/2-20	1.96	.77	1.18	.18	11/16	5/8
5/16	3/8	24706N-666	9/16-18	2.13	.85	1.23	.25	13/16	11/16
13/32	1/2	24708N-668 ^a	3/4-16	2.76	1.09	1.61	.36	15/16	7/8
1/2	1/2	24710N-668 ^a	3/4-16	2.91	1.09	1.62	.45	15/16	7/8
1/2	5/8	24710N-670 ^a	7/8-14	2.94	1.23	1.65	.45	1-1/8	1
5/8	3/4	24712N-672	1-1/16-12	3.74	1.82	2.17	.55	1-1/4	1-1/4
7/8	1	24716N-676	1-5/16-12	3.55	2.39	2.28	.81	1-7/16	1-1/2

^a Swivel nuts are universal — both SAE 37° and 45° connections.

SAE 45° Female Swivel 90° Tube Elbow

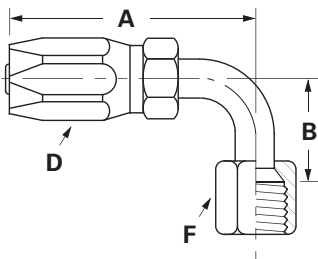

Hose I.D.	Pipe Size	Part Number	Thread Size	A	B	Hose Cut-Off Factor	Hole Dia.	Hex D	Hex F
5/16	3/8	24706N-466	5/8-18	2.13	.85	1.23	.25	13/16	3/4
5/8	3/4	24712N-472	1-1/16-14	3.74	1.82	2.17	.55	1-1/4	1-1/4

JIC 37° Female Swivel Long Drop 90° Tube Elbow

(Exceptions Noted)

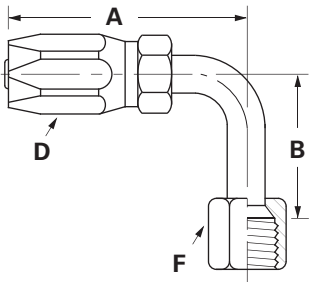

Hose I.D.	Pipe Size	Part Number	Thread Size	A	B	Hose Cut-Off Factor	Hole Dia.	Hex D	Hex F
3/16	1/4	24704N-644 ^a	7/16-20	1.74	1.80	0.99	.15	5/8	9/16
1/4	5/16	24705N-645 ^a	1/2-20	1.96	1.77	1.18	.21	11/16	5/8
5/16	3/8	24706N-646	9/16-18	2.13	2.18	1.23	.24	13/16	11/16
13/32	1/2	24708N-648 ^a	3/4-16	2.88	2.43	1.73	.33	15/16	7/8
1/2	5/8	24710N-650 ^a	7/8-14	3.19	2.57	1.90	.46	1-1/8	1
5/8	3/4	24712N-652	1-1/16-12	3.74	3.73	2.17	.58	1-1/4	1-1/4
7/8	1	24716N-656	1-5/16-12	3.55	4.58	2.28	.76	1-7/16	1-1/2

^a Swivel nuts are universal — both SAE 37° and 45° connections.

SAE 45° Female Swivel Long Drop 90° Tube Elbow

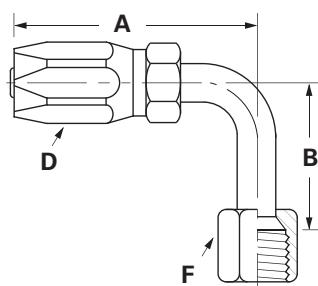

Hose I.D.	Pipe Size	Part Number	Thread Size	A	B	Hose Cut-Off Factor	Hole Dia.	Hex D	Hex F
5/16	1/4	24706N-444	7/16-20	2.54	1.80	1.63	.15	13/16	5/8
5/16	3/8	24706N-446	5/8-18	2.13	2.18	1.23	.24	13/16	3/4
5/8	3/4	24712N-452	1-1/16-14	3.74	3.73	2.17	.58	1-1/4	1-1/4

K

Hose Ends - Field Attachable

Field Attachable

425 'N' Series

Hose End 425 'N' Series

Ordering Information: Order individually by part number. Order o-rings by catalog number; reference individual hose listing for details. For split flange kits, reference pages L-89-92.

Application: High pressure hydraulic applications such as construction, farm implement and industrial equipment.

Compatible Hose: H425

Pressure: Determined by maximum working pressure for hose size. See pages A-15-16 for working pressure ratings for hose end configurations.

Material: AISI/SAE 12L14 carbon steel

Plating: Zinc; clear trivalent chromate

Advantages: Good selection of hose ends. Non-mandrel assembly. Wide variety of applications because of its use with H425 hose.

Assembly Instructions:

Due to the high torque required to assemble larger sizes, it is recommended that 425 'N' Series hose ends be assembled with the T-300 assembly machine (page N-71).

1. Lubricate insert threads and I.D. of hose.
2. Measure from end of hose and mark the socket depth. Use notch on socket or see insertion depth chart below.
3. Screw hose into socket (left-hand thread) to the depth marked on hose.
4. Screw insert into socket until insert touches socket.

Label Set: FS-700

Note:

Refer to current price list for availability of cataloged items. Configurations and dimensions subject to change without notice.

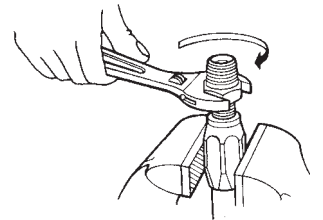
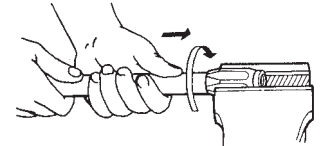
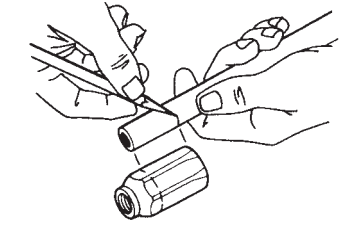

Insertion Depth

Hose I.D.	Screw Hose Into Socket
1/4	1"
3/8	1-5/32"
1/2	1-3/16"
3/4	1-5/16"
1	1-9/16"
1-1/4	1-7/8"
1-1/2	2"
2	1-15/16"

Male Pipe Rigid

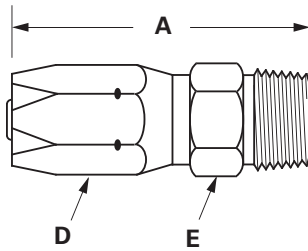

Hose I.D.	Pipe Size	Part Number	Thread Size	A	Hose Cut-Off Factor	Hole Dia.	Hex D	Hex E
1/4	1/8	42504N-102	1/8-27	2.18	1.19	0.17	13/16	7/16
1/4	1/4	42504N-104	1/4-18	2.36	1.38	.17	13/16	9/16
3/8	1/4	42506N-104	1/4-18	2.50	1.31	.27	15/16	9/16
3/8	3/8	42506N-106	3/8-18	2.53	1.38	.27	15/16	11/16
1/2	3/8	42508N-106	3/8-18	2.58	1.38	.39	1-1/16	11/16
1/2	1/2	42508N-108	1/2-14	2.83	1.63	.39	1-1/16	7/8
1/2	3/4	42508N-112	3/4-14	2.86	1.69	.39	1-1/16	1-1/16
3/4	3/4	42512N-112	3/4-14	2.98	1.69	.61	1-3/8	1-1/16
1	1	42516N-116	1-11-1/2	3.59	2.00	.81	1-3/4	1-3/8
1-1/4	1-1/4	42520N-120	1-1/4-11-1/2	4.37	2.44	1.05	2-1/4	1-11/16
1-1/2	1-1/2	42524N-124	1-1/2-11-1/2	4.71	2.69	1.28	2-1/2	2

JIC 37° Male Rigid

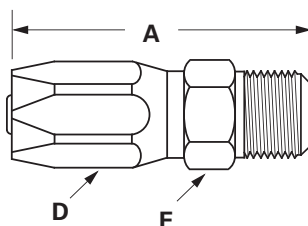

Hose I.D.	Pipe Size	Part Number	Thread Size	A	Hose Cut-Off Factor	Hole Dia.	Hex D	Hex E
1/4	1/4	42504N-504	7/16-20	2.35	1.38	.17	13/16	9/16
1/4	5/16	42504N-505	1/2-20	2.35	1.38	.17	13/16	9/16
1/4	3/8	42504N-506	9/16-18	2.39	1.38	.17	13/16	5/8
3/8	3/8	42506N-506	9/16-18	2.53	1.38	.27	15/16	5/8
3/8	1/2	42506N-508	3/4-16	2.69	1.50	.27	15/16	13/16
1/2	1/2	42508N-508	3/4-16	2.74	1.56	.39	1-1/16	13/16
1/2	5/8	42508N-510	7/8-14	2.87	1.69	.39	1-1/16	15/16
3/4	3/4	42512N-512	1-1/16-12	3.09	1.75	.61	1-3/8	1-1/8
1	1	42516N-516	1-5/16-12	3.56	1.94	.81	1-3/4	1-3/8

To determine the correct length of hose, subtract the cut-off factor for each end fitting from the overall length of assembly.

^a Swivel nuts are universal — both SAE 37° and 45° connections.

K

Hose Ends - Field Attachable

Field Attachable

425 'N' Series

To determine the correct length of hose, subtract the cut-off factor for each end fitting from the overall length of assembly.

^a Swivel nuts are universal — both SAE 37° and 45° connections.

Female Pipe Swivel

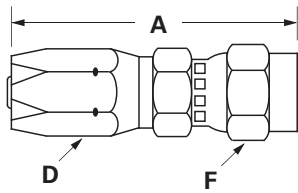

Hose I.D.	Pipe Size	Part Number	Thread Size	A	Hose Cut-Off Factor	Hole Dia.	Hex D	Hex F
1/2	1/2	42508N-258	1/2-14	3.89	2.75	.39	1-1/16	1-1/8
3/4	3/4	42512N-262	3/4-14	4.09	2.81	.61	1-3/8	1-3/8

Note:
Swivel for installation purposes only.
(Not for temperatures above 200°F.)

JIC 37° Female Swivel

(Exceptions Noted)

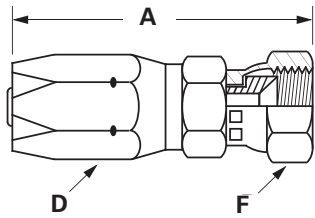

Hose I.D.	Pipe Size	Part Number	Thread Size	A	Hose Cut-Off Factor	Hole Dia.	Hex D	Hex F
1/4	1/4	42504N-604 ^a	7/16-20	2.49	1.50	.17	13/16	9/16
1/4	5/16	42504N-605 ^a	1/2-20	2.59	1.56	.17	13/16	5/8
1/4	3/8	42504N-606	9/16-18	2.65	1.63	.17	13/16	11/16
3/8	3/8	42506N-606	9/16-18	2.79	1.63	.27	15/16	11/16
3/8	1/2	42506N-608 ^a	3/4-16	2.96	1.81	.27	15/16	7/8
1/2	1/2	42508N-608 ^a	3/4-16	3.01	1.81	.39	1-1/16	7/8
1/2	5/8	42508N-610 ^a	7/8-14	3.02	1.88	.39	1-1/16	1
3/4	5/8	42512N-610 ^a	7/8-14	3.14	1.88	.48	1-3/8	1
3/4	3/4	42512N-612	1-1/16-12	3.26	2.00	.61	1-3/8	1-1/4
3/4	7/8	42512N-614	1-3/16-12	3.38	2.06	.61	1-3/8	1-3/8
1	1	42516N-616	1-5/16-12	4.19	2.63	.81	1-3/4	1-1/2
1-1/4	1-1/4	42520N-620	1-5/8-12	4.76	2.75	1.08	2-1/4	2
1-1/2	1-1/2	42524N-624	1-7/8-12	5.04	3.00	1.28	2-1/2	2-1/4

^a Swivel nuts are universal — both SAE 37° and 45° connections.

SAE 45° Female Swivel

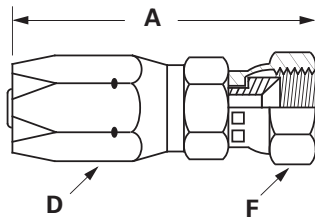

Hose I.D.	Pipe Size	Part Number	Thread Size	A	Hose Cut-Off Factor	Hole Dia.	Hex D	Hex F
3/8	3/8	42506N-406	5/8-18	2.67	1.50	.27	15/16	3/4
3/4	3/4	42512N-412	1-1/16-14	3.27	2.00	.61	1-3/8	1-1/4

Split Flange Straight

(SAE Code 61)

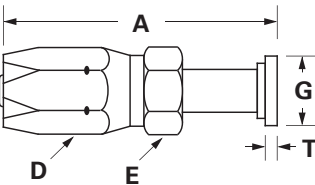

Hose I.D.	Nom. Pipe Size	Part Number	Replacement O-Ring (Not Included)	A	Hose Cut-Off Factor	Hole Dia.	Hex D	Hex E	G	T
3/4	3/4	42512N-G12	12x252	3.81	2.50	.58	1-3/8	1-15/16	1.50 (38 mm)	.265
1	1	42516N-G16	16x252	4.02	2.50	.76	1-3/4	1-1/4	1.75 (44 mm)	.315
1-1/4	1-1/4	42520N-G20	20x252	5.32	3.50	1.01	2-1/4	1-5/8	2.00 (51 mm)	.315

(For Split Flange Kits, see pages L-89 thru L-92.)

JIC 37° Female Swivel 45° Tube Elbow

(Refer to Footnotes)

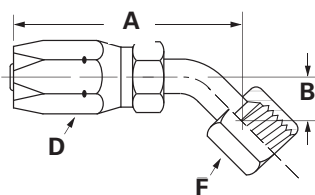

Hose I.D.	Pipe Size	Part Number	Thread Size	A	Hose Cut-Off Factor	Hole Dia.	Hex D	Hex E
1/4	1/4	42504N-684 ^a	7/16-20	2.86	.33	1.81	.15	13/16
3/8	3/8	42506N-686	9/16-18	3.15	.39	2.00	.25	15/16
1/2	1/2	42508N-688 ^a	3/4-16	3.46	.56	2.25	.36	1-1/16
1/2	5/8	42508N-690 ^a	7/8-14	3.92	.64	2.50	.36	1-1/16
3/4	3/4	42512N-692	1-1/16-12	4.17	.73	2.88	.55	1-3/8
1	1	42516N-696	1-5/16-12	5.42	1.10	3.75	.76	1-3/4

^a Swivel nuts are universal — both SAE 37° and 45° connections.

K

Hose Ends - Field Attachable

Field Attachable

425 'N' Series

To determine the correct length of hose, subtract the cut-off factor for each end fitting from the overall length of assembly.

^a Swivel nuts are universal — both SAE 37° and 45° connections.

Split Flange 45° Tube Elbow

(SAE Code 61)

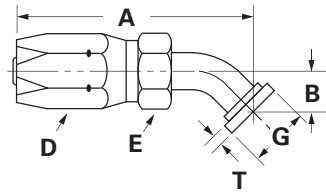

Hose I.D.	Nom. Pipe Size	Part Number	Replacement O-Ring (Not Included)	A	B	Hose Cut-Off Factor	Hex D	Hex E	G	T
3/4	3/4	42512N-G42	12x252	4.47	1.00	.58	1-3/8	15/16	1.50 (38 mm)	.265
1	1	42516N-G46	16x252	5.15	1.06	.76	1-3/4	1-1/4	1.75 (44 mm)	.315
1-1/4	1-1/4	42520N-G50	20x252	5.32	1.15	1.01	2-1/4	1-5/8	2.00 (51 mm)	.315

(For Split Flange Kits, see pages L-89 thru L-92.)

JIC 37° Female Swivel 90° Tube Elbow

(Refer to Footnotes)

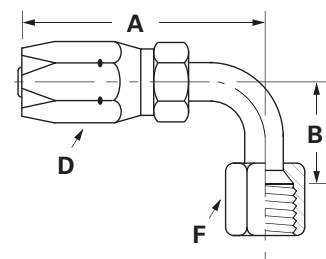

Hose I.D.	Nom. Pipe Size	Part Number	Thread Size	A	B	Hose Cut-Off Factor	Hole Dia.	Hex D	Hex E
1/4	1/4	42504N-664 ^a	7/16-20	2.71	.68	1.69	.15	13/16	9/16
3/8	3/8	42506N-666	9/16-18	3.12	.85	1.94	.24	15/16	11/16
1/2	1/2	42508N-668 ^a	3/4-16	3.33	1.09	2.13	.33	1-1/16	7/8
1/2	5/8	42508N-670 ^a	7/8-14	3.57	1.23	2.38	.39	1-1/16	1
3/4	3/4	42512N-672	1-1/16-12	4.26	1.85	2.94	.58	1-3/8	1-1/4
1	1	42516N-676	1-5/16-12	5.14	2.14	3.56	.81	1-3/4	1-1/2

^a Swivel nuts are universal — both SAE 37° and 45° connections.

JIC 37° Female Swivel Long Drop 90° Tube Elbow

(Refer to Footnotes)

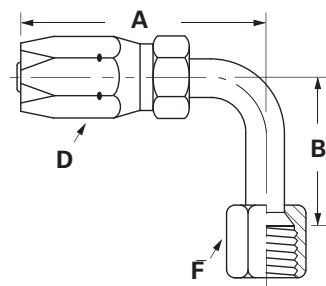

Hose I.D.	Nom. Pipe Size	Part Number	Thread Size	A	B	Hose Cut-Off Factor	Hole Dia.	Hex D	Hex E
1/4	1/4	42504N-644 ^a	7/16-20	2.76	1.80	1.75	.15	13/16	9/16
3/8	3/8	42506N-646	9/16-18	3.17	2.18	2.00	.24	15/16	11/16
1/2	1/2	42508N-648 ^a	3/4-16	3.40	2.45	2.19	.33	1-1/16	7/8
3/4	3/4	42512N-652	1-1/16-12	4.08	3.75	2.75	.58	1-3/8	1-1/4

^a Swivel nuts are universal — both SAE 37° and 45° connections.

Split Flange 90° Tube Elbow

(SAE Code 61)

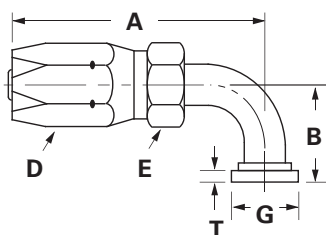

Hose I.D.	Nom. Pipe Size	Part Number	Replacement O-Ring (Not Included)	A	B	Hose Cut-Off Factor	Hole Dia.	Hex D	Hex E	G	T
3/4	3/4	42512N-G72	12x252	3.95	2.13	2.75	.58	1-3/8	15/16	1.50 (38 mm)	.265
3/4	1	42512N-G76	16x252	4.06	2.13	2.75	.58	1-3/8	15/16	1.75 (44 mm)	.315
1	1	42516N-G76	16x252	4.81	2.38	3.25	.88	1-3/4	1-1/4	1.75 (44 mm)	.315
1-1/4	1-1/4	42520N-G80	20x252	5.47	2.62	3.56	1.03	2-1/4	1-5/8	2.00 (51 mm)	.315
1-1/4	1-1/2	42520N-G84	24x252	5.49	2.75	3.63	1.05	2-1/4	1-7/8	2.37 (60 mm)	.315

(For Split Flange Kits, see pages L-89 thru L-92.)

K

Hose Ends - Field Attachable

Field Attachable

436 'N' Series

To determine the correct length of hose, subtract the cut-off factor for each end fitting from the overall length of assembly.

Hose End 436 'N' Series

Ordering Information:
Order individually by catalog number.

 Refer to important safety information on pages A-2-3.

Application: Medium pressure hydraulic applications where compatibility may be a problem or where shock hazards exist.

Compatible Hose: H435; H436; H435 and H436 Twinline.

Pressure: Determined by maximum working pressure for hose size and hose end configuration whichever is lesser. See pages A-15-16 for working pressure ratings for hose end configurations.

Material: AISI/SAE 12L14 carbon steel

Plating: Zinc; clear trivalent chromate

Advantages:
Good selection of hose ends. Non-mandrel assembly.

Assembly Instructions:

1. Lubricate insert threads and I.D. of hose.
2. Screw hose into socket (left-hand thread) until hose bottoms. Back out 1/4 turn.
3. Screw insert into socket until insert touches socket.

Note:
Refer to current price list for availability of cataloged items. Configurations and dimensions subject to change without notice.

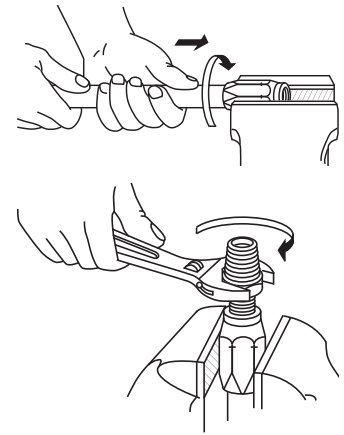

Male Pipe Rigid

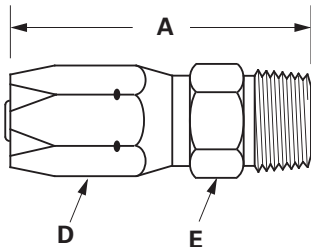

Hose I.D.	Pipe Size	Part Number	Thread Size	A	Hose Cut-Off Factor	Hole Dia.	Hex D	Hex E
1/4	1/4	43604N-104	1/4-18	1.96	1.13	.18	5/8	9/16
3/8	1/4	43604N-104	1/4-18	2.50	1.31	.27	7/8	9/16
3/8	3/8	43604N-106	3/8-18	2.53	1.38	.27	7/8	11/16
1/2	3/8	43604N-106	3/8-18	2.58	1.31	.39	1-1/16	11/16
1/2	1/2	43604N-108	1/2-14	2.83	1.56	.39	1-1/16	7/8
3/4	3/4	43604N-112	3/4-14	2.98	1.63	.61	1-3/8	1-1/16
1	1	43604N-116	1-11-1/2	3.59	1.94	.81	1-11/16	1-3/8

K

JIC 37° Male Rigid

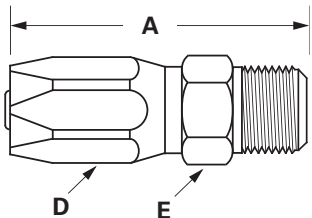

Hose I.D.	Pipe Size	Part Number	Thread Size	A	Hose Cut-Off Factor	Hole Dia.	Hex D	Hex E
1/4	1/4	43604N-504	7/16-20	1.99	1.19	.17	5/8	1/2
1/4	5/16	43604N-505	1/2-20	1.96	1.19	.18	5/8	9/16
3/8	3/8	43606N-506	9/16-18	2.53	1.38	.27	7/8	5/8
3/8	1/2	43606N-508	3/4-16	2.69	1.50	.27	7/8	13/16
1/2	1/2	43608N-508	3/4-16	2.74	1.50	.39	1-1/16	13/16
1/2	5/8	43608N-510	7/8-14	2.87	1.63	.39	1-1/16	15/16

Hose Ends - Field Attachable

Field Attachable

436 'N' Series

To determine the correct length of hose, subtract the cut-off factor for each end fitting from the overall length of assembly.

^a Swivel nuts are universal — both SAE 37° and 45° connections.

SAE 37° Female Swivel

(Exceptions Noted)

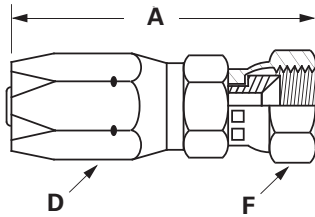

Hose I.D.	Pipe Size	Part Number	Thread Size	A	Hose Cut-Off Factor	Hole Dia.	Hex D	Hex E
1/4	1/4	43604N-604 ^a	7/16-20	2.13	1.31	.17	5/8	9/16
1/4	5/16	43604N-605 ^a	1/2-20	2.23	1.44	.18	5/8	5/8
1/4	3/8	43604N-606	9/16-18	2.24	1.44	.18	5/8	11/16
3/8	3/8	43606N-606	9/16-18	2.79	1.63	.27	7/8	11/16
3/8	1/2	43606N-608 ^a	3/4-16	2.96	1.81	.27	7/8	7/8
1/2	1/2	43608N-608 ^a	3/4-16	3.01	1.75	.39	1-1/16	7/8
1/2	5/8	43608N-610 ^a	7/8-14	3.02	1.75	.39	1-1/16	1
3/4	3/4	43612N-612	1-1/16-12	3.27	1.88	.61	1-3/8	1-1/4
1	1	43616N-616	1-5/16-12	3.83	2.19	.81	1-11/16	1-1/2

^a Swivel nuts are universal — both SAE 37° and 45° connections.

SAE 45° Female Swivel

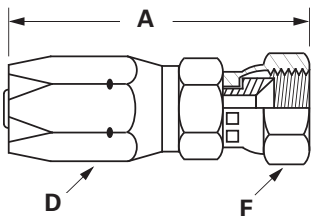

Hose I.D.	Pipe Size	Part Number	Thread Size	A	Hose Cut-Off Factor	Hole Dia.	Hex D	Hex E
3/8	3/8	43606N-406	5/8-18	2.67	1.50	.27	7/8	3/4

JIC 37° Female Swivel 45° Tube Elbow

(Refer to Footnotes)

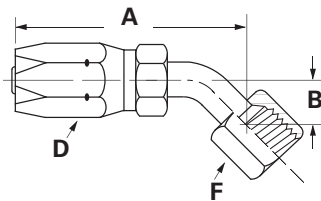

Hose I.D.	Pipe Size	Part Number	Thread Size	A	Hose Cut-Off Factor	Hole Dia.	Hex D	Hex E
1/4	1/4	43604N-684 ^a	7/16-20	2.49	0.33	1.69	5/8	9/16

^a Swivel nuts are universal — both SAE 37° and 45° connections.

JIC 37° Female Swivel 90° Tube Elbow

(Refer to Footnotes)

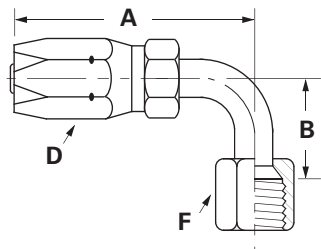

Hose I.D.	Nom. Pipe Size	Part Number	Thread Size	A	B	Hose Cut-Off Factor	Hole Dia.	Hex D	Hex F
1/4	1/4	43604N-664 ^a	7/16-20	2.42	.68	1.63	.18	5/8	9/16
3/8	3/8	43606N-666	9/16-18	3.02	.85	1.88	.24	7/8	11/16
1/2	1/2	43608N-668 ^a	3/4-16	3.28	1.09	2.00	.33	1-1/16	7/8

^a Swivel nuts are universal — both SAE 37° and 45° connections.

K

Hose Ends - Field Attachable

E-Z Clip System™ - End Connections & O-rings

How to Identify O-ring Pilot Thread Sizes

This connection is common to air conditioning systems, both in vehicle and commercial applications. Both the male and female halves of the connections have a pilot, either long or short. The seal

takes place by compressing an O-ring adjacent to the bead of the tube. The threads hold the connection together mechanically.

Label Set: FF90646

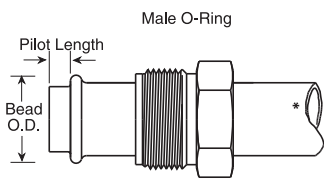

Nunch Size	Dash Size	Male Thread O.D. (in)			Female Thread O.D. (in)		
		Nominal Thread	Fraction	Decimal	Nominal Thread	Fraction	Decimal
3	0	5 1	5	2	5 1	91	5
12	0	34 1	34	5	34 1	111	9
5	10	1			14	131	1
34	12	1 11 1	1 11	10	1 11 1	1 11	99

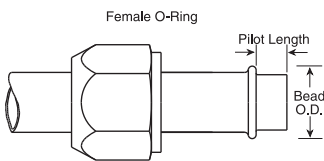

Nunch Size	Nominal Tube Size	Long Pilot		Short Pilot	
		O.D. (in)	Bead Pilot Length	O.D. (in)	Bead Pilot Length
3	0	52	2	52	19
12	0	4	39	4	19
5	10		39		19
34	12	91	39	91	19

K

Hose Ends - Field Attachable

Refrigerant Compatibility Chart

Refrigerant	Hose Style H13
R 12	
R 22	
R 134	
R 502	
39	
R404	

Lubricant Compatibility Chart

Lubricant	Hose Style H13
Mineral Oil	
SAE 52	
SAE 52	
SAE 52	
SAE 52	
SAE 525	
SAE 525	
SAE 525	
SAE 525	
SAE 525	

* Contact product support for application review

Tubing Identification

Size	Tubing Style	Wall Thickness
	SAE 52	0.035
0 0	SAE 52	0.035
	SAE 52	0.035
0 10	SAE 52	0.035
10	SAE 525	0.049
1012	SAE 525	0.049
12	SAE 525	0.049
1	SAE 525	0.025

E-Z Clip System™ - End Connections & O-rings

O-Rings for Bum Tube O-Ring Seal and O-Ring Pilot Fittings

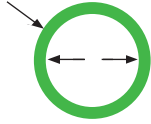

FF9017
 Material: H BR
 Durometer: 70
 Temperature Range: -25 F to 300 F
 Color: Green

O-ring Part Number	O-ring Pilot Dash Size	A	E
FF901 11	0	301	0 25
FF901 13	0	42	0 25
FF901 15	10	551	0 25
FF901 1	12		0 25

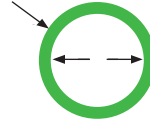

W74706
 Material: H BR
 Durometer: 70
 Temperature Range: -40 F to 250 F
 Color - Green

O-ring Part Number	O-ring Pilot Dash Size	A	E
4 0	0	301	0
4 0	0	42	0
4 10	10	551	0
4 12	12		0

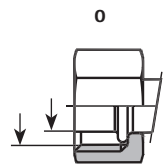
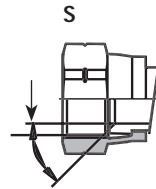
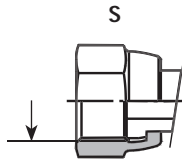
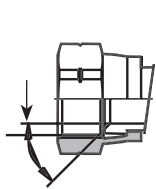

Size	C Thread	ORS Thread	ØE	SAE Thread	ØE	Tube Thread	ØE	ØT
4	1 20	9 1 1	12.9	1 20				
	9 1 1	11 1 1	15.9	5 1	14.5	5 1	14.5	4
	3 4 1	13 1 1	19.1	3 4 1	1 5	3 4 1	1 5	11
10	14	1 14	23	14	20.5	14	20.5	14.4
12	1 1 1 12	1 3 1 12	2 1	1 1 1 14	25.2	1 1 1 14	25.2	1 5
1	1 5 1 12	1 1 1 12	34.5					
20		1 11 1 12	40					
24								

K

Hose Ends - Field Attachable

E-Z Clip System™ - Hose Ends

FJ59 4

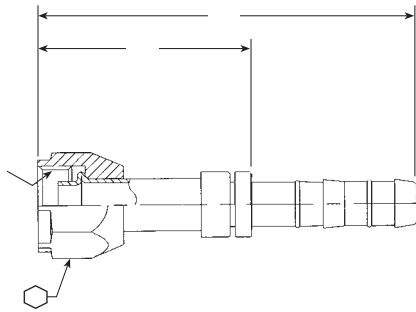

Straight Female O-ring (Short Pilot)

Part Number	TH D T	Hose Size	A Ref	D Ref	F Ref	H Ref	⊕ Ref
FJ5984-0606S	5/8-18	6	3.14	1.62			0.75
FJ5984-0608S	5/8-18	8	3.16	1.62			0.75
FJ5984-0808S	3/4-16	8	3.56	2.02			0.88
FJ5984-0810S	3/4-16	10	3.57	2.02			0.88
FJ5984-1008S	7/8-14	8	3.62	2.08			0.88
FJ5984-1010S	7/8-14	10	3.63	2.08			1.06
FJ5984-1012S	7/8-14	12	3.66	2.08			1.06
FJ5984-1210S	1-1/16-14	10	4.25	2.62			1.25
FJ5984-1212S	1-1/16-14	12	4.25	2.67			1.25
FJ5984-1016S	7/8-14	16	3.76	2.08			1.06
FJ5984-1216S	1-1/16-14	16	4.35	2.67			1.25

FJ3632/EJ3111

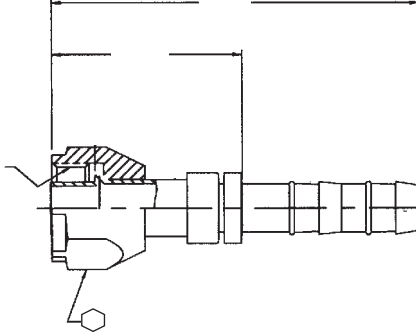

Straight Female O-ring, (Long Pilot)

Part Number	TH D T	Hose Size	A Ref	D Ref	F Ref	H Ref	⊕ Ref
FJ3632-0806S	3/4-16	6	2.91	1.36			0.88
EJ3111-1216S	1-1/16-14	16	4.35	2.67			1.25
EJ3111-1016S*	7/8-14	16	3.76	2.08			1.06

* 0 (made to order)

FJ340

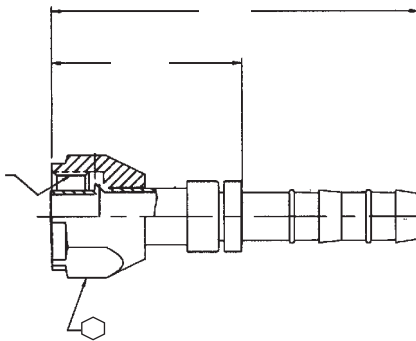

Straight Female O-ring, Metric Thread (Long Pilot)

Part Number	TH D T	Hose Size	A Ref	D Ref	F Ref	H Ref	⊕ Ref
FJ3408-0808S	M20 x 1.5	8	3.20	1.66			0.94
FJ3408-0810S	M20 x 1.5	10	3.21	1.66			0.94
FJ3408-1212S	M27 x 2	12	4.25	2.67			1.25

K

FJ3055

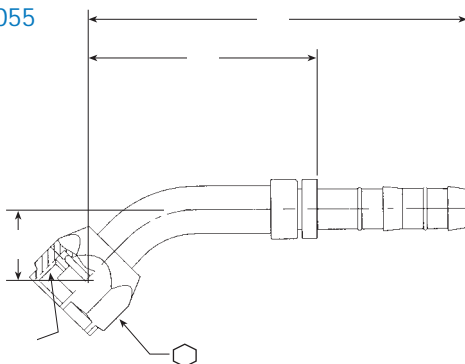

45° Elbow Female O-ring (Short Pilot)

Part Number	TH D T	Hose Size	A Ref	D Ref	F Ref	H Ref	⊕ Ref
FJ3055-01-0606S	5/8-18	6	3.60	2.08		0.67	0.75
FJ3055-02-0608S	5/8-18	8	3.62	2.08		0.67	0.75
FJ3055-03-0808S	3/4-16	8	3.94	2.40		0.73	0.88
FJ3055-04-0810S	3/4-16	10	3.95	2.40		0.73	0.88
FJ3055-05-1010S	7/8-14	10	4.37	2.81		1.19	1.06
FJ3055-06-1012S	7/8-14	12	4.46	2.88		1.25	1.06
FJ3055-07-1212S	1-1/16-14	12	5.33	3.75		1.47	1.25
FJ3055-09-1216S*	1-1/16-14	16	5.43	3.15		1.47	1.25
FJ3055-08-1016S	7/8-14	16	4.56	2.66		1.25	1.06

* 0 (made to order)

Hose Ends - Field Attachable

E-Z Clip System™ - Hose Ends

FJ59 5

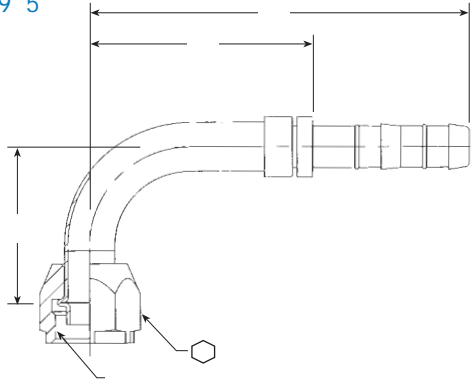

90° Elbow Female O-ring (Short Pilot)

Part Number	TH D T	Hose Size	A Ref	D Ref	F Ref	H Ref	⊕ Ref
FJ5985-0606S	5/8-18	6	3.32	1.79		1.38	0.75
FJ5985-0608S	5/8-18	8	3.33	1.79		1.38	0.75
FJ5985-0806S	3/4-16	6	3.86	2.33		1.62	0.88
FJ5985-0808S	3/4-16	8	3.77	2.23		1.62	0.88
FJ5985-0810S	3/4-16	10	3.78	2.23		1.62	0.88
FJ5985-1010S	7/8-14	10	4.22	2.67		1.89	1.06
FJ5985-1012S	7/8-14	12	4.24	2.67		1.89	1.06
FJ5985-1210S	1-1/16-14	10	4.76	3.31		2.56	1.25
FJ5985-1212S	1-1/16-14	12	4.74	3.16		2.56	1.25
FJ5985-1216S	1-1/16-14	16	4.84	3.16		2.56	1.25

FJ32

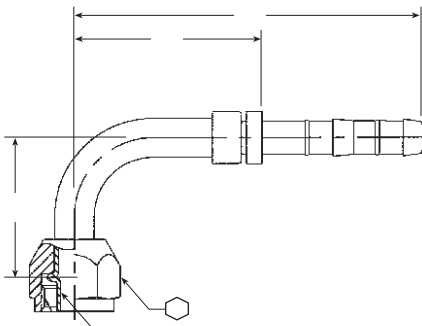

90° Female O-ring (Long Pilot)

Part Number	TH D T	Hose Size	A Ref	D Ref	F Ref	H Ref	⊕ Ref
FJ3288-01-0606S	5/8-18	6	3.32	1.79	-	1.38	0.75
FJ3288-02-0808S	3/4-16	8	3.77	2.23	-	1.62	0.88
FJ3288-03-0806S	3/4-16	6	3.75	2.33	-	1.62	0.88
FJ3288-04-0810S	3/4-16	10	3.78	2.23	-	1.62	0.88
FJ3288-06-1216S	1-1/16-14	16	4.84	3.16	-	2.56	1.25
FJ3288-05-1016S	7/8-14	16	4.40	2.72	-	1.89	1.06
FJ3288-07-1012S	7/8-14	12	4.24	2.67	-	1.89	1.06
FJ3288-08-1212S	1-1/16-14	12	4.74	3.16	-	2.56	1.25
FJ3288-11-1010S	7/8-14	16	4.22	2.67	-	1.89	1.06

FJ3054

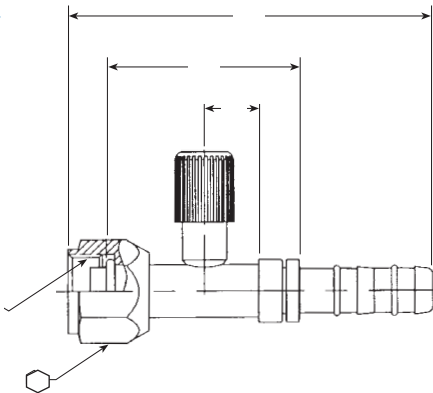

Straight Female O-ring (Short Pilot) with R134a Low Side Port

Part Number	TH D T	Hose Size	A Ref	D Ref	F Ref	H Ref	⊕ Ref
FJ3054-1010S	7/8-14	10	4.24	2.25	0.63		1.06
FJ3054-1012S	7/8-14	12	4.27	2.25	0.63		1.06
FJ3054-1212S	1-1/16-14	12	4.58	2.43	0.54		1.25
FJ3054-1216S*	1-1/16-14	16	4.68	2.43	0.54		1.25

* 0 (made to order)

FJ3053

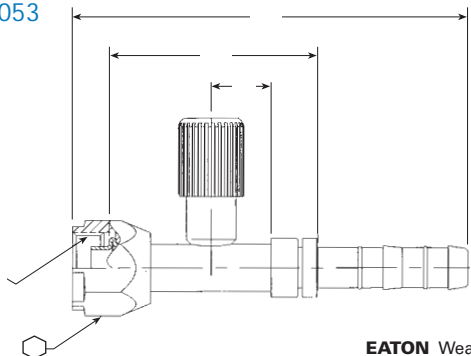

Straight Female O-ring (Short Pilot) with R134a High Side Port

Part Number	TH D T	Hose Size	A Ref	D Ref	F Ref	H Ref	⊕ Ref
FJ3053-0606S	5/8-18	6	3.91	2.10	0.63		0.75
FJ3053-0806S	3/4-16	6	4.06	2.26	0.63		0.88
FJ3053-0808S	3/4-16	8	4.09	2.16	0.63		0.88
FJ3053-0810S	3/4-16	10	4.09	2.16	0.63		0.88

K

Hose Ends - Field Attachable

E-Z Clip System™ - Hose Ends

FJ3162

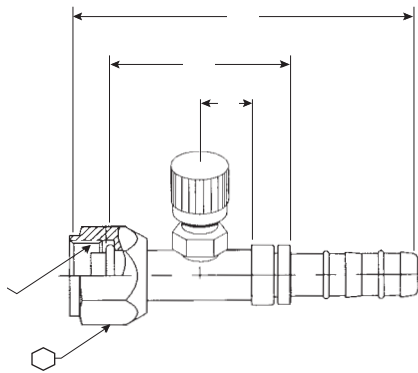

Straight Female O-ring (Long Pilot) with Switch Port (7/16-20 thd)

Part Number	TH D T	Hose Size	A Ref	D Ref	F Ref	H Ref	⊕ Ref
FJ3162-0808S	3/4-16	8	4.09	2.16	0.79		0.88
FJ3162-1010S	7/8-14	10	4.25	2.25	0.79		1.06
FJ3162-1012S	7/8-14	12	4.27	2.25	0.79		1.06
FJ3162-1212S	1-1/16-14	12	4.86	2.71	0.79		1.25
FJ3162-1016S	7/8-14	16	4.42	2.30	0.79		1.06

FJ3416

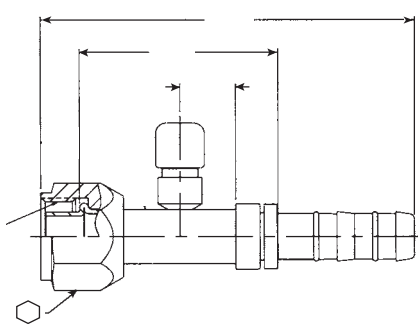

Straight Female O-ring (Long Pilot) with Switch Port (M10 1.25)

Part Number	TH D T	Hose Size	A Ref	D Ref	F Ref	H Ref	⊕ Ref
FJ3416-01-1010S	7/8-14	10	4.25	2.25	.63		1.06
FJ3416-02-0808S*	7/8-14	8	4.25	2.25	.63		1.06

* O (made to order)

FJ3461

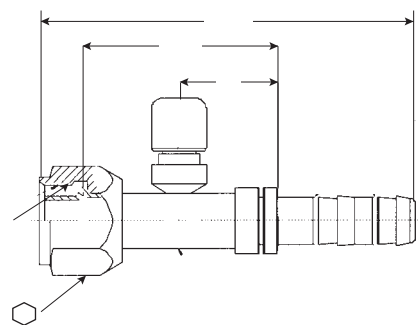

Straight Female O-ring (Long Pilot) with Switch Port (M12 1.25)

Part Number	TH D T	Hose Size	A Ref	D Ref	F Ref	H Ref	⊕ Ref
FJ3461-01-1010S	7/8-14	10	4.25	2.25	.63		1.06
FJ3461-02-1012S	7/8-14	12	4.27	2.25	.63		1.06
FJ3461-03-1212S	1-1/16-14	12	4.86	2.71	.54		1.25

EJ3299

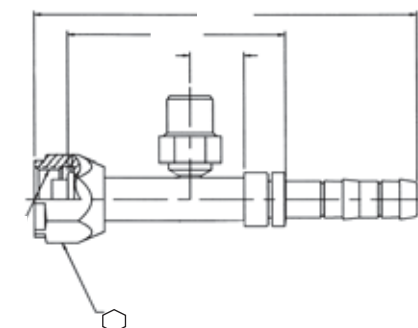

Straight - Female O-ring (Short Pilot) with Switch Port (M12 1.25)

Part Number	TH D T	Hose Size	A Ref	D Ref	F Ref	H Ref	⊕ Ref
EJ3299-01-0808S	3/4-16	8	4.46	2.53	.63		.88

* O (made to order)

K

Hose Ends - Field Attachable

E-Z Clip System™ - Hose Ends

FJ3363

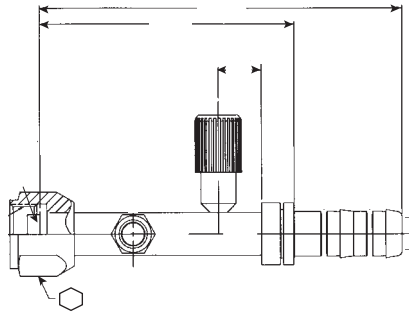

Straight Female O-ring (Short Pilot), with R134a High Side Port and Female Switch Connection, (1/ -27 Thread)

Part Number	TH D T	Hose Size	A Ref	D Ref	F Ref	H Ref	⊕ Ref
FJ3363-03-0808S*	3/4-16	8	5.16	3.62	.63		.88
FJ3363-02-0810S*	3/4-16	10	5.54	3.62	.63		.88

* 0 (made to order)

FJ3363

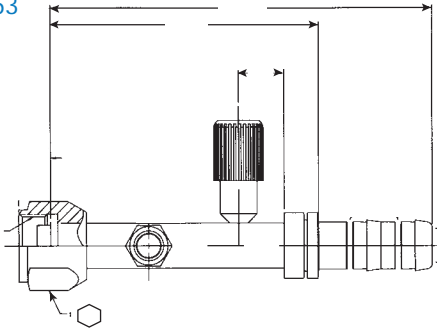

Straight Female O-ring (Short Pilot), with R134a Low Side Port and Female Switch Connection, (1/ -27 Thread)

Part Number	TH D T	Hose Size	A Ref	D Ref	F Ref	H Ref	⊕ Ref
FJ3363-01-1012S	7/8-14	12	5.30	3.72	.63		1.06

* 0 (made to order)

FJ3365

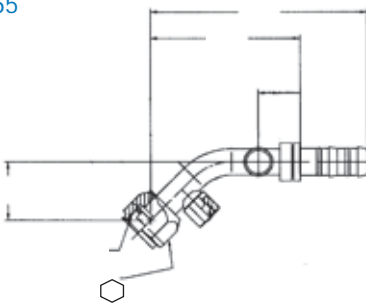

45° Female O-ring (Short Pilot) with R134a Low Side Port and Switch Port

Part Number	TH D T	Hose Size	A Ref	D Ref	F Ref	H Ref	⊕ Ref
FJ3365-01-1012S*	7/8-14	12	5.09	3.51	0.50	1.43	1.13

* 0 (made to order)

FJ3230

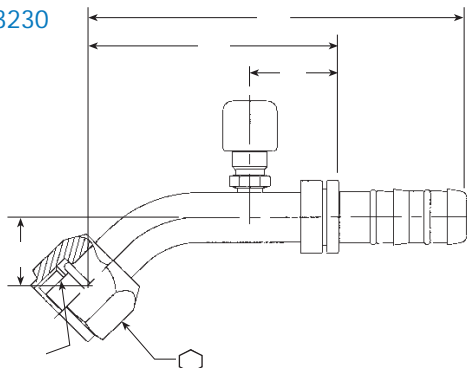

45° Female O-ring (Long Pilot) with Switch Port (7/16-20 thd)

Part Number	TH D T	Hose Size	A Ref	D Ref	F Ref	H Ref	⊕ Ref
FJ3230-01-0810S	3/4-16	10	4.61	2.58	0.63	0.80	0.88
FJ3230-02-1012S	7/8-14	12	4.73	2.67	0.63	0.89	1.06
FJ3230-03-0808S	3/4-16	8	4.43	2.40	0.63	0.73	0.88
FJ3230-04-1010S	7/8-14	10	5.00	2.97	0.63	1.19	1.06
FJ3230-05-1016S	7/8-14	16	4.88	2.67	0.63	0.89	1.06

K

Hose Ends - Field Attachable

E-Z Clip System™ - Hose Ends

EJ3410

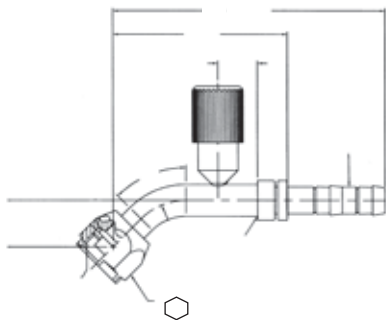

45° Female O-ring (Short Pilot) with R134a High Side Port

Part Number	TH D T	Hose Size	A Ref	D Ref	F Ref	H Ref	⊕ Ref
EJ3410-0808S	3/4-16	8	4.3	2.76	0.62	0.73	0.88

EJ3543

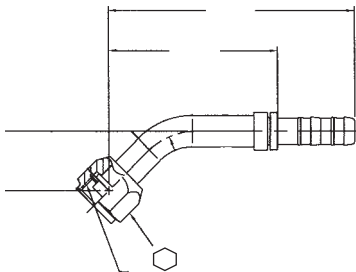

45° Female O-ring (Short Pilot) with R134a Low Side Port (Rotated 270°)

Part Number	TH D T	Hose Size	A Ref	D Ref	F Ref	H Ref	⊕ Ref
EJ3543-1010S	7/8-14	10	4.99	3.44	0.52	1.19	1.06

FJ3012

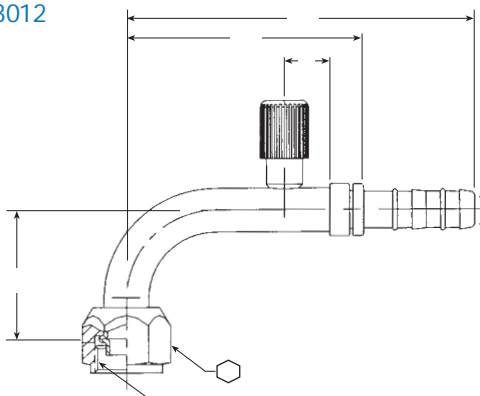

90° Female O-ring (Short Pilot) with R134a Low Side Port

Part Number	TH D T	Hose Size	A Ref	D Ref	F Ref	H Ref	⊕ Ref
FJ3012-02-1010S	7/8-14	10	4.88	3.33	0.63	1.89	1.06
FJ3012-01-1012S	7/8-14	12	4.83	3.25	0.63	1.89	1.06
FJ3012-03-1212S	1-1/16-14	12	5.10	3.52	0.63	2.56	1.25

FJ3013/
EJ3302

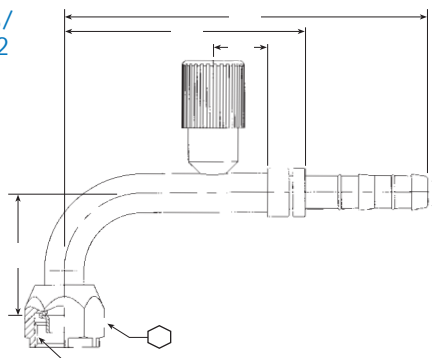

90° Female O-ring (Short Pilot) with R134a High Side Port

Part Number	TH D T	Hose Size	A Ref	D Ref	F Ref	H Ref	⊕ Ref
FJ3013-02-0606S	5/8-18	6	4.35	2.82	0.63	1.38	0.75
FJ3013-03-0808S	3/4-16	8	4.61	3.07	0.69	1.62	0.88
FJ3013-01-0810S	3/4-16	10	4.53	2.98	0.69	1.62	0.88
EJ3302-01-0608S	M18 x 1.5	8	4.36	2.82	0.94	1.38	0.88
EJ3302-02-0808S	M20 x 1.5	8	4.52	2.98	0.69	1.62	0.94

K

Hose Ends - Field Attachable

E-Z Clip System™ - Hose Ends

FJ32 9

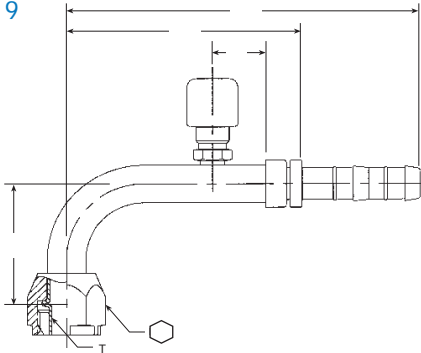

90° Female O-ring (Long Pilot) with Charge Port (7/16-20 thd)

Part Number	TH D T	Hose Size	A Ref	D Ref	F Ref	H Ref	⊕ Ref
FJ3289-01-0808S	3/4-16	8	4.61	2.59	0.69	1.62	0.88
FJ3289-02-1010S	7/8-14	10	4.80	2.77	0.63	1.93	1.06
FJ3289-03-0606S	5/8-18	6	4.35	2.82	0.69	1.35	0.75
FJ3289-04-0810S	3/4-16	10	4.62	2.59	0.69	1.62	0.88
FJ3289-05-1012S	7/8-14	12	4.82	2.77	0.63	1.93	1.06

FJ3163

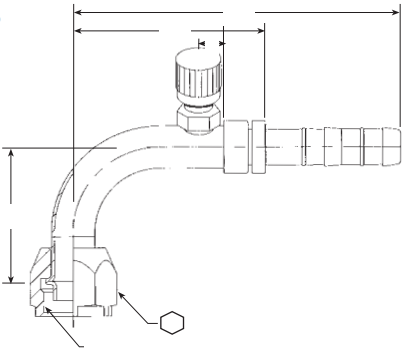

90° Elbow Female O-ring (Short Pilot) with Charge Port (7/16-20 thd)

Part Number	TH D T	Hose Size	A Ref	D Ref	F Ref	H Ref	⊕ Ref
FJ3163-01-1010S	7/8-14	10	4.80	3.25	0.79	1.89	1.06
FJ3163-02-1212S	1-1/16-14	12	5.08	3.50	0.79	2.56	1.25

FJ3047

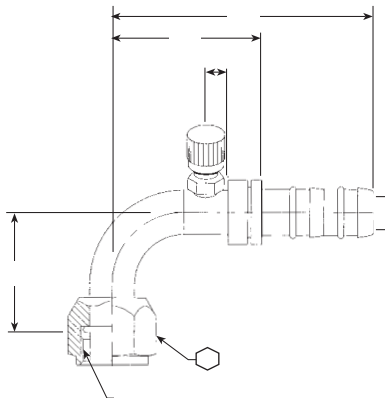

90° Female O-ring (Long Pilot) with Charge Port (7/16-20Thd)
45° Port Rotation

Part Number	TH D T	Hose Size	A Ref	D Ref	F Ref	H Ref	⊕ Ref
FJ3047-1012S	7/8-14	12	4.06	2.48	0.50	1.69	1.06
FJ3047-1016S	7/8-14	16	4.21	2.53	0.50	1.69	1.06

EJ329

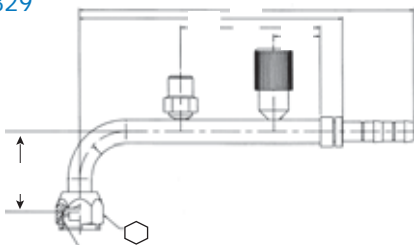

90° Female O-ring (Short Pilot) with R134a High Side Port
and a Switch Port

Part Number	TH D T	Hose Size	A Ref	D Ref	F Ref	H Ref	⊕ Ref
EJ3298-01-0808S	3/4-16	8	7.22	5.67	1	1.71	0.88

* 0 (made to order)

K

Hose Ends - Field Attachable

E-Z Clip System™ - Hose Ends

FJ3444

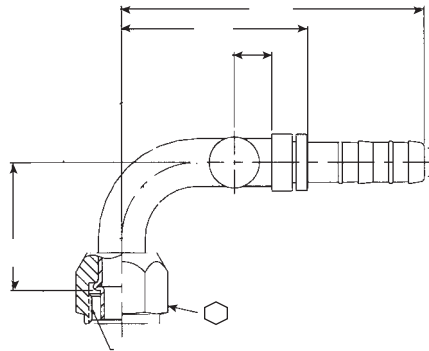

90° Female O-ring (long pilot) with Charge Port (7/16-20 thd)
90° Port Rotation

Part Number	TH D T	Hose Size	A Ref	D Ref	F Ref	H Ref	Ⓛ Ref
FJ3444-1010S	7/8-14	10	4.03	2.48	.50	1.69	1.06

FJ3460

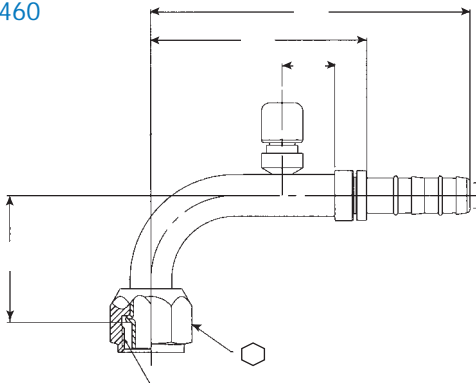

90° Female O-ring (Long Pilot) with Switch Port (M12 1.5)

Part Number	TH D T	Hose Size	A Ref	D Ref	F Ref	H Ref	Ⓛ Ref
FJ3460-01-1010S	7/8-14	10	4.80	3.25	0.79	1.89	1.06
FJ3460-02-1012S	7/8-14	12	4.83	3.25	0.79	1.89	1.06
FJ3460-03-1212S	1-1/16-14	12	5.08	3.50	.54	2.56	1.25

EJ3297

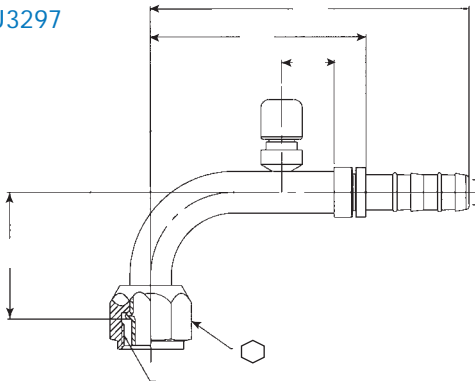

90° Female O-ring (Short Pilot) with Switch Port (M10 1.25)

Part Number	TH D T	Hose Size	A Ref	D Ref	F Ref	H Ref	Ⓛ Ref
EJ3297-01-0808S	3/4-16	8	4.16	2.62	0.87	1.68	0.88

FJ3052

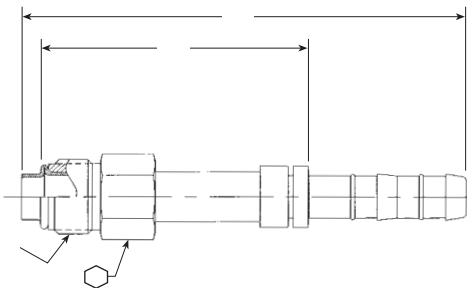

Straight Male O-ring (Short Pilot)

Part Number	TH D T	Hose Size	A Ref	D Ref	F Ref	H Ref	Ⓛ Ref
FJ3052-0606S	5/8-18	6	3.41	1.70			0.62
FJ3052-0608S	5/8-18	8	3.43	1.70			0.62
FJ3052-0808S	3/4-18	8	4.37	2.64			0.75
FJ3052-1010S	7/8-18	10	3.66	1.92			0.88
FJ3052-1012S	7/8-18	12	3.68	1.92			0.88
FJ3052-1212S	1-1/16-16	12	3.68	1.92			1.06
FJ3052-1016S	7/8-18	16	4.33	2.47			0.88
FJ3052-1216S	1 1/16 -16	16	4.28	2.42			1.06

K

Hose Ends - Field Attachable

E-Z Clip System™ - Hose Ends

FJ3116

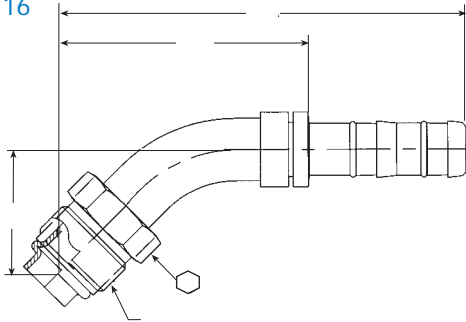

45° Male O-ring (Short Pilot)

Part Number	TH D T	Hose Size	A Ref	D Ref	F Ref	H Ref	Ⓛ Ref
FJ3116-01-0606S	5/8-18	6	3.99	2.47		0.94	0.62
FJ3116-03-0808S	3/4-18	8	4.59	2.83		1.20	0.75
FJ3116-02-1010S	7/8-18	10	4.65	3.10		1.46	0.88
FJ3116-04-0608S	5/8-18	8	4.01	2.47		0.94	0.62
FJ3116-05-1012S	7/8-18	12	4.68	3.10		1.47	0.88
FJ3116-06-1212S	1 1/16-16	12	4.90	3.32		1.53	1.06

FJ3019

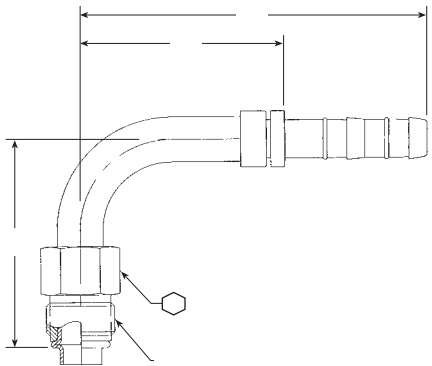

90° Male O-ring (Short Pilot)

Part Number	TH D T	Hose Size	A Ref	D Ref	F Ref	H Ref	Ⓛ Ref
FJ3019-03-0606S	5/8-18	6	3.33	1.80		1.77	0.62
FJ3019-02-0608S	5/8-18	8	3.34	1.80		1.77	0.62
FJ3019-04-0808S	3/4-18	8	3.77	2.23		2.31	0.75
FJ3019-06-0810S	3/4-18	10	3.78	2.23		2.31	0.75
FJ3019-01-1012S	7/8-18	12	4.24	2.67		2.45	0.88
FJ3019-05-1212S	1-1/16-16	12	4.22	2.64		2.79	1.06
FJ3019-07-1010S	7/8-18	10	4.22	2.67		2.45	0.88
FJ3019-08-1210S	1-1/16-16	10	4.19	2.64		2.79	1.06

FJ3132

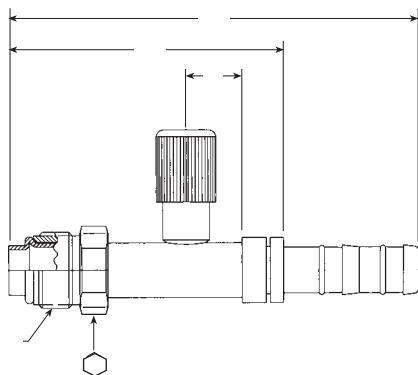

Straight Male O-ring (Short Pilot) with R134a Low Side Port

Part Number	TH D T	Hose Size	A Ref	D Ref	F Ref	H Ref	Ⓛ Ref
FJ3132-01-1010S	7/8-18	10	4.43	2.70	0.63		0.88
FJ3132-02-1012S	7/8-18	12	4.46	2.70	0.63		0.88

FJ3131

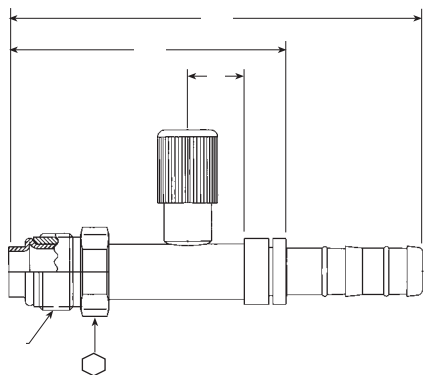

Straight Male O-ring (Short Pilot) with R134a High Side Port

Part Number	TH D T	Hose Size	A Ref	D Ref	F Ref	H Ref	Ⓛ Ref
FJ3131-01-0606S	5/8-18	6	4.18	2.47	0.63		0.62
FJ3131-02-0808S	3/4-18	8	4.58	2.85	0.63		0.75
FJ3131-03-1010S	7/8-18	10	4.34	2.61	0.63		0.88

K

Hose Ends - Field Attachable

E-Z Clip System™ - Hose Ends

FJ3134

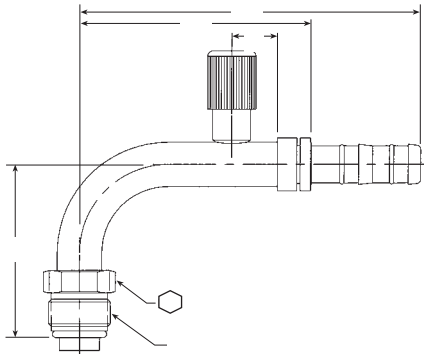

90° Elbow Male O-ring (Short Pilot) with R134a High Side Port

Part Number	TH D T	Hose Size	A Ref	D Ref	F Ref	H Ref	① Ref
FJ3134-01-0606S	5/8-18	6	4.34	2.82	0.63	1.75	0.62
FJ3134-02-0808S	3/4-18	8	4.61	3.07	0.63	2.31	0.75
FJ3134-03-1010S	7/8-18	10	4.81	3.25	0.63	2.34	0.88

FJ3611

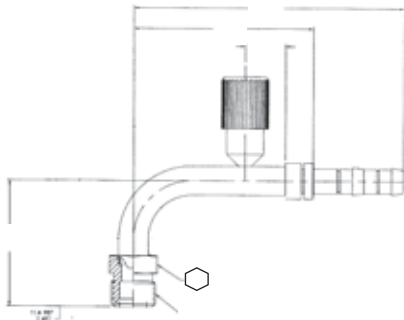

90° Elbow Male MIO with R134a High Side Port

Part Number	TH D T	Hose Size	A Ref	D Ref	F Ref	H Ref	① Ref
FJ3611-01-0808S	3/4-16	8	4.61	3.07	0.69	2.17	0.813

FJ3135

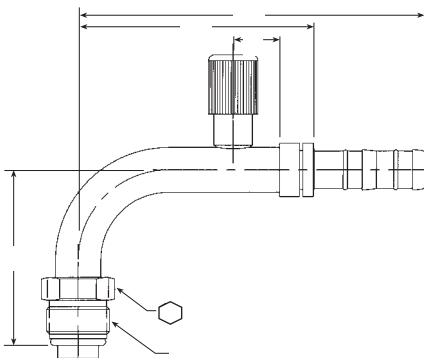

90° Elbow Male O-ring (Short Pilot) with R134a Low Side Port

Part Number	TH D T	Hose Size	A Ref	D Ref	F Ref	H Ref	① Ref
FJ3135-01-1010S	7/8-18	10	4.81	3.25	0.63	2.34	0.88
FJ3135-02-1012S	7/8-18	12	4.81	3.25	0.63	2.34	0.88

FJ3026

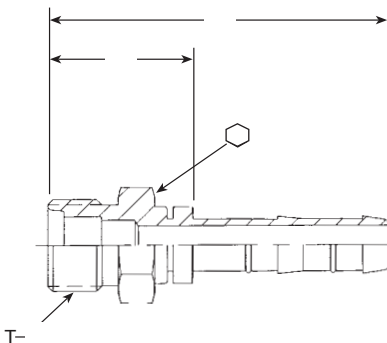

Male MIO (Male Insert O-ring) Straight

Part Number	TH D T	Hose Size	A Ref	D Ref	F Ref	H Ref	① Ref
FJ3026-0606S	5/8-18	6	3.36	1.83			0.690
FJ3026-0808S	3/4-16	8	2.69	1.15			0.810
FJ3026-1010S	7/8-14	10	2.90	1.35			0.940
FJ3026-1012S	7/8-14	12	4.11	2.50			0.940
FJ3026-1212S	1-1/16-14	12	4.29	2.71			1.125

K

Hose Ends - Field Attachable

E-Z Clip System™ - Hose Ends

FJ3056

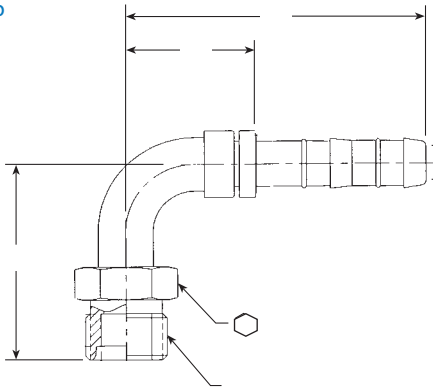

90° Male MIO (Male Insert O-ring)

Part Number	TH D T	Hose Size	A Ref	D Ref	F Ref	H Ref	① Ref
FJ3056-01-0606S	5/8-18	6	2.50	0.98		1.44	0.69
FJ3056-02-0808S	3/4-16	8	2.74	1.20		1.82	0.81
FJ3056-03-1010S	7/8-14	10	3.09	1.54		2.13	0.94
FJ3056-04-0810S	3/4-16	10	2.75	1.20		1.82	0.81
FJ3056-05-0608S	5/8-18	8	2.52	0.98		1.44	0.69

FJ3057

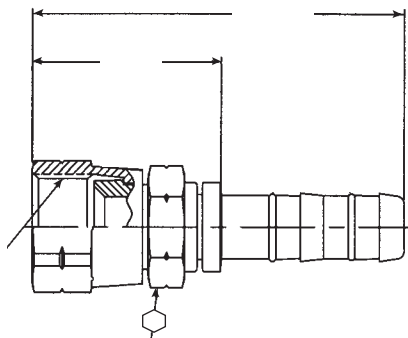

Female SAE 45° Flares

Part Number	TH D T	Hose Size	A Ref	D Ref	F Ref	H Ref	① Ref
FJ3057-01-0606S	5/8-18	6	2.88	1.35			0.56
FJ3057-02-0608S	5/8-18	8	3.14	1.62			0.75
FJ3057-03-0808S	3/4-16	8	2.96	1.42			0.69
FJ3057-04-0810S	3/4-16	10	3.56	2.02			0.88
FJ3057-05-1010S	7/8-14	10	3.63	2.08			1.00
FJ3057-06-1012S	7/8-14	12	3.66	2.08			1.00
FJ3057-07-1212S	1-1/16-14	12	3.20	1.62			1.25

FJ3731

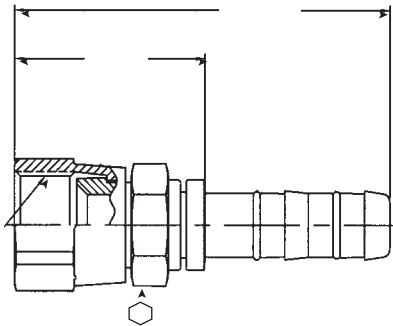

Straight Female 37° Flares

Part Number	TH D T	Hose Size	A Ref	D Ref	F Ref	H Ref	① Ref
FJ3731-1010S	7/8-14	10	4.21	2.66			1.00
FJ3731-0606S	9/16-18	6	3.66	2.13			0.68
FJ3731-0808S	3/4-16	8	4.35	2.81			0.88
FJ3731-1212S	1-1/16-12	12	4.62	3.04			1.25
FJ3731-1616S	1-5/16-12	16	5.99	4.31			1.50
FJ3731-0404S	7/16-20	4	2.75	2.08			0.56

EJ3534

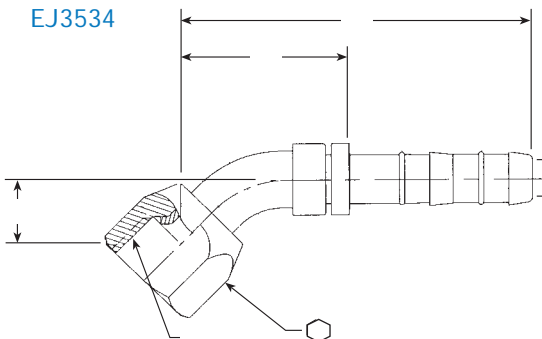

45° Female JIC 37° Flare

Part Number	TH D T	Hose Size	A Ref	D Ref	F Ref	H Ref	① Ref
EJ3534-02-0606S	9/16-18	6	3.31	1.79		0.74	1.00
EJ3534-03-0608S	9/16-18	8	3.76	3.32		1.10	0.68
EJ3534-04-0808S	3/4-16	8	4.04	2.49		1.10	0.88
EJ3534-05-1010S	7/8-14	10	4.21	2.66		1.27	1.25
EJ3534-06-1212S	1-1/16-12	12	4.30	2.73		1.33	1.50
EJ3534-07-1616S	1-5/16-12	16	5.46	3.79		1.92	1.50
EJ3534-01-0404S	7/16-20	4	2.37	1.70		0.63	0.56

K

Hose Ends - Field Attachable

E-Z Clip System™ - Hose Ends

FJ3059

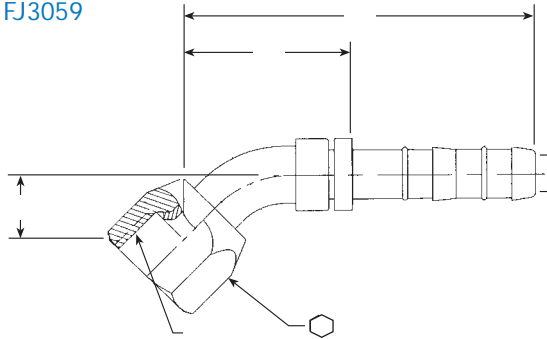

45° Female SAE 45° and Universal Flares

Part Number	TH D T	Hose Size	A Ref	D Ref	F Ref	H Ref	Ⓜ Ref
FJ3059-01-0606S	5/8-18	6	2.61	1.08		0.39	0.75
FJ3059-02-0608S	5/8-18	8	2.62	1.08		0.39	0.75
FJ3059-03-0808S*	3/4-16	8	2.97	1.43		0.55	0.88
FJ3059-04-0810S*	3/4-16	10	2.98	1.43		0.55	0.88
FJ3059-05-1010S*	7/8-14	10	3.08	1.53		0.63	1.00
FJ3059-06-1012S*	7/8-14	12	3.11	1.53		0.63	1.00

Double notch in nut for universal type identification
* universal flare

FJ3133

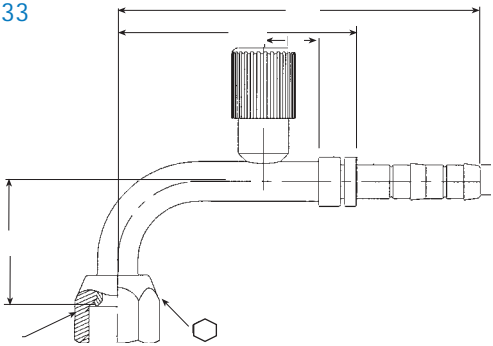

90° Female SAE 45° with High Side Charge Port (R134a)

Part Number	TH D T	Hose Size	A Ref	D Ref	F Ref	H Ref	Ⓜ Ref
FJ3133-01-0606S	5/8-18	6	4.35	2.82	0.63	1.28	0.75
FJ3133-02-0808S	3/4-16	8	4.61	3.07	0.63	1.53	0.88
FJ3133-03-1010S	7/8-14	10	4.80	3.25	0.63	1.84	0.88

FJ3366

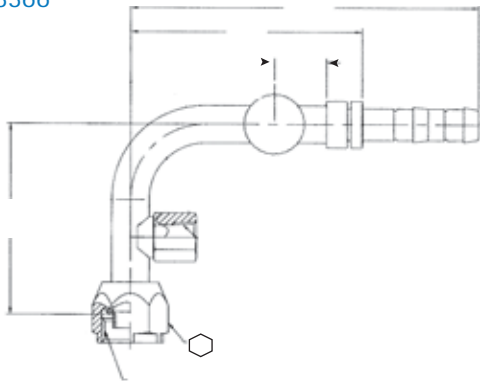

SAE 90° and with R134a C/Port and Switch Port

Part Number	TH D T	Hose Size	A Ref	D Ref	F Ref	H Ref	Ⓜ Ref
FJ3366-01-0810S*	3/4-16	10	4.62	3.07	0.69	2.53	0.875
FJ3366-02-0808S*	3/4-16	8	4.61	3.07	0.69	2.53	0.875

* 0 (made to order)

FJ3149

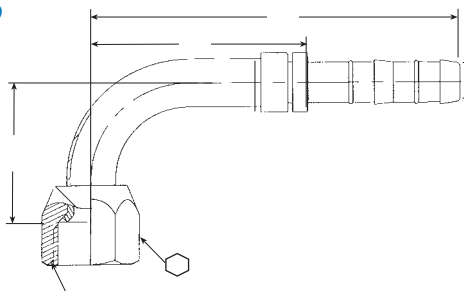

90° Female SAE 45° and Universal Flares

Part Number	TH D T	Hose Size	A Ref	D Ref	F Ref	H Ref	Ⓜ Ref
FJ3149-01-0606S	5/8-18	6	2.51	0.98		0.85	0.75
FJ3149-02-0608S	5/8-18	8	2.52	0.98		0.85	0.75
FJ3149-03-0808S*	3/4-16	8	2.74	1.20		1.09	0.88
FJ3149-04-1010S*	7/8-14	10	3.09	1.54		1.19	1.00
FJ3149-05-1012S*	7/8-14	12	3.09	1.54		1.19	1.00
FJ3149-06-1212S	1-1/16-14	12	3.68	2.11		1.80	1.25

Double notch in nut for universal type identification
* universal flare

K

Hose Ends - Field Attachable

E-Z Clip System™ - Hose Ends

EJ3533

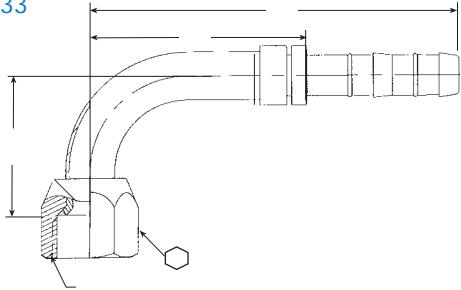

90° Female JIC 37° Flare

Part Number	TH D T	Hose Size	A Ref	D Ref	F Ref	H Ref	⊕ Ref
EJ3533-02-0606S	9/16-18	6	3.27	1.74		1.69	0.69
EJ3533-03-0608S	9/16-18	8	3.28	1.74		1.69	0.69
EJ3533-04-0808S	3/4-16	8	3.14	1.60		1.77	0.88
EJ3533-05-1010S	7/8-14	10	3.78	2.23		2.59	1.00
EJ3533-06-1212S	1 1/16-12	12	4.11	2.53		3.02	1.25
EJ3533-07-1616S	1 5/16-12	16	5.16	3.48		3.86	1.50
EJ3533-01-0404S	7/16-20	4	2.09	1.42		1.21	0.56

A23911

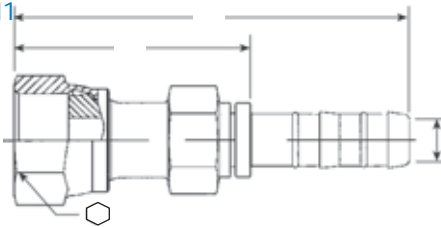

Straight ORS Female Swivel Metric Hex Nut

Part Number	TH D T	Hose Size	A Ref	D Ref	F Ref	H Ref	⊕ Ref
GA23911-6-6*	1-1/16-16	6	2.95	1.43	-	-	22mm
GA23911-8-8*	1-3/16-16	8	3.17	1.62	-	-	24mm
GA23911-10-12*	1-14	12	3.32	1.74	-	-	30mm
GA23911-10-10*	1-14	10	3.33	1.78	-	-	30mm
GA23911-12-12*	1-3/16-12	12	3.320	1.52	-	-	41mm

* GA Part numbers have a metric hex

FJ3161 A23912

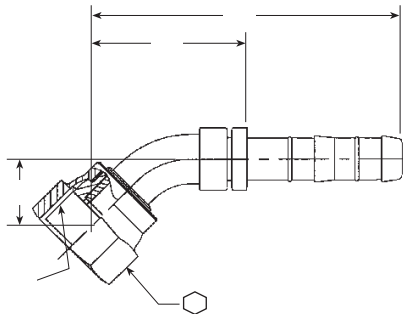

45° ORS Female Swivel

Part Number	TH D T	Hose Size	A Ref	D Ref	F Ref	H Ref	⊕ Ref
FJ3161-01-0606S	11/16-16	6	2.65	1.12		0.44	0.81
FJ3161-02-0808S	13/16-16	8	3.02	1.47		0.59	0.94
FJ3161-03-1010S	1-14	10	3.22	1.67		0.70	1.13
FJ3161-04-1008S	1-14	8	3.32	1.78		0.70	1.13
GA23912-10-8*	1-14	8	3.50	1.96		0.68	30mm
GA23912-12-12*	1-3/16-12	12	4.23	2.65		0.83	36mm
F3161-08-0810S	13/16-16	10	3.02	1.47		0.59	0.94
GA23912-10-10*	1-14	10	3.77	2.22		0.68	30mm
GA23912-8-8*	13-16-16	8	3.43	1.89		0.59	30mm

* GA Part numbers have a metric hex

FJ5994/ A23913

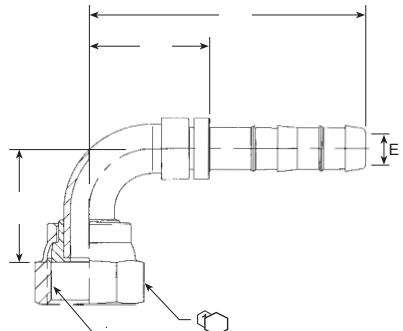

90° ORS Female Swivel

Part Number	TH D T	Hose Size	A Ref	D Ref	F Ref	H Ref	⊕ Ref
FJ5994-01-0606S	1-1/16-16	6	2.50	0.98		0.91	0.81
FJ5994-02-0808S	13/16-16	8	2.74	1.20		1.15	0.94
FJ5994-04-1010S	1-14	10	3.09	1.53		1.27	1.12
FJ5994-03-1212S	1-3/16-12	12	3.36	1.78		1.90	1.38
FJ5994-05-0406S	9/16-18	6	2.44	0.92		0.82	0.69
FJ5994-05-1012S	1-14	12	3.11	1.53		1.78	1.13
FJ5994-07-0806S	13/16-16	6	2.66	1.10		1.15	0.94
FJ5994-09-1016S	1-14	16	3.30	1.62		1.78	1.125
GA23913-10-12*	1-14	12	3.67	2.10		1.54	1.18

* GA Part numbers have a metric hex

K

Hose Ends - Field Attachable

E-Z Clip System™ - Hose Ends

FJ3319

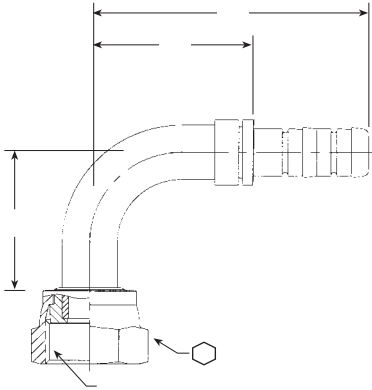

90° ORS Female Swivel (Long Drop)

Part Number	TH D T	Hose Size	A Ref	D Ref	F Ref	H Ref	Ⓜ Ref
FJ3319-1212S	1-3/16-12	12	3.82	2.24		2.38	1.13

FJ3136

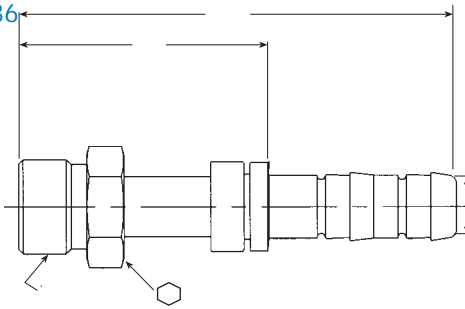

Straight Male O-ring (Rigid) Metric Thread

Part Number	TH D T	Hose Size	A Ref	D Ref	F Ref	H Ref	Ⓜ Ref
FJ3136-0810S	M20 x 1.5	10	3.62	2.07	0.69		0.88

FJ3192

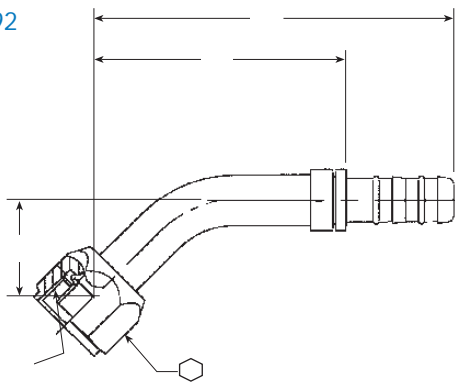

45° Female O-ring (long pilot, metric thread)

Part Number	TH D T	Hose Size	A Ref	D Ref	F Ref	H Ref	Ⓜ Ref
FJ3192-02-1212S	M27x2	12	4.74	3.17		1.47	1.25

K

Hose Ends - Field Attachable

FJ3111

FJ3409

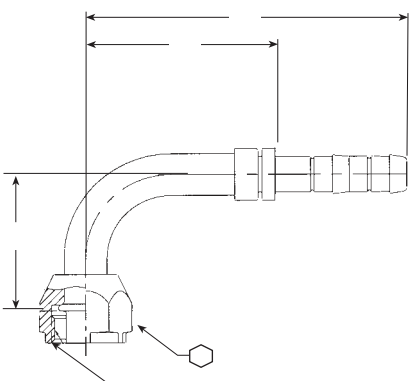

90° Female O-ring (Long Pilot) Metric Thread

Part Number	TH D T	Hose Size	A Ref	D Ref	F Ref	H Ref	Ⓜ Ref
FJ3111-01-0808S	M20 x 1.5	8	3.77	2.23		1.62	0.94
FJ3111-02-0810S	M20 x 1.5	10	3.78	2.23		1.62	0.94
FJ3111-03-0806S*	M20 x 1.5	6	3.75	2.23		1.62	0.94
FJ3409-1212S	M27 x 2	12	4.74	3.16		2.56	1.25

* 0 (made to order)

E-Z Clip System™ - Hose Ends

FJ3 92

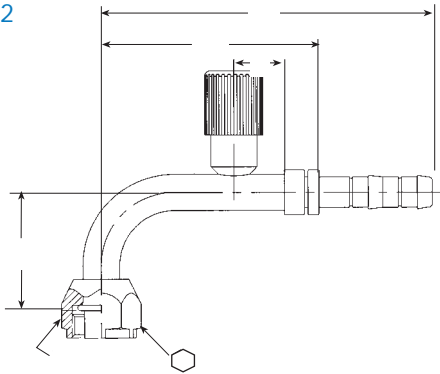

90° Female O-ring (Long Pilot)
with R134a Low Side Port (Metric Thread)

Part Number	TH D T	Hose Size	A Ref	D Ref	F Ref	H Ref	⊕ Ref
FJ3892-01-1010S	M24 x 1.5	10	4.88	3.33	.63	1.89	1.125

FJ3112

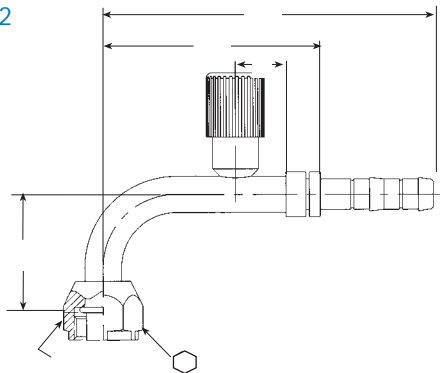

90° Female O-ring (Long Pilot) Metric Thread
with High Side Charge Port (R134a)

Part Number	TH D T	Hose Size	A Ref	D Ref	F Ref	H Ref	⊕ Ref
FJ3112-01-0808S	M20 x 1.5	8	4.52	2.98	0.69	1.62	0.94
FJ3112-02-0810S	M20 x 1.5	10	4.53	2.98	0.69	1.62	0.94
FJ3112-03-0806S	M20 x 1.5	6	4.50	2.98	0.69	1.62	0.94
FJ3112-03-1010S	M24 x 1.5	10	4.88	3.33	0.63	1.89	1.125

FJ3 90/
FJ3301

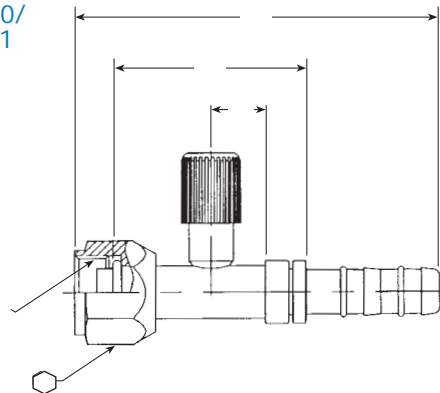

Straight Female O-ring (Long Pilot)
with R134a High Side Port (Metric Thread)

Part Number	TH D T	Hose Size	A Ref	D Ref	F Ref	H Ref	⊕ Ref
FJ3890-01-0806S	M20 x 1.5	6	4.06	2.16	0.63		0.94
FJ3301-01-0606S*	M18 x 1.5	6	3.91	2.10	0.63		0.94

* 0 (made to order)

FJ3 91

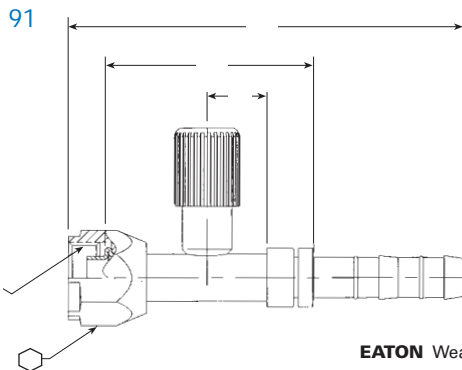

Straight Female O-ring (Long Pilot)
with R134a Low Side Port (Metric Thread)

Part Number	TH D T	Hose Size	A Ref	D Ref	F Ref	H Ref	⊕ Ref
FJ3891-01-1010S	M24 x 1.5	10	4.24	2.25	0.62	1.62	1.125

K

Hose Ends - Field Attachable

E-Z Clip System™ - Hose Ends

FJ3113

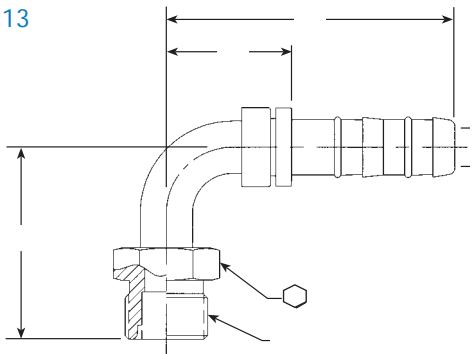

90° Male O-ring (Rigid) Metric Thread

Part Number	TH D T	Hose Size	A Ref	D Ref	F Ref	H Ref	⊕ Ref
FJ3113-0810S	M20 x 1.5	10	2.75	1.20		1.82	0.88

FJ3067
FJ3495

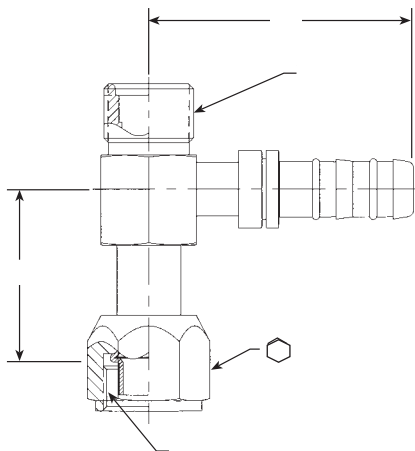

Part Number	TH D T	Hose Size	A Ref	D Ref	F Ref	H Ref	⊕ Ref
FJ3067-1212S*	M27 x 2	12	3.12			2.02	1.25
FJ3495-0808S	M20 x 1.5	8	2.71			1.68	0.94

* 0 (made to order)

EJ315

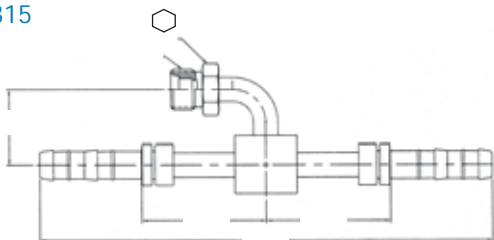

Tee Style Fitting with Male O-ring Connection

Part Number	TH D T	Hose Size	A Ref	D Ref	F Ref	H Ref	⊕ Ref
EJ3158-101212S	7/8-14	12	5.67	1.26		1.49	0.94
EJ3158-121616S	1-1/16-14	16	6.79	1.72		2.13	1.13
EJ3158-060808S	5/8-18	8	6.86	1.88		1.14	0.69
EJ3158-080808S	3/4-16	8	6.86	1.89		1.39	0.81

FJ3274

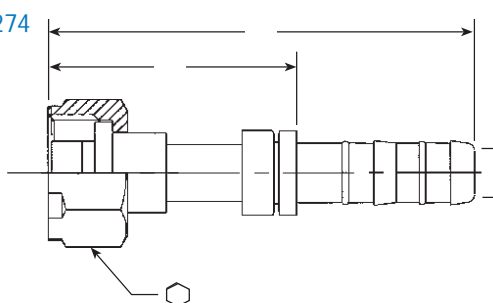

Straight Female Rotalok

Part Number	TH D T	Hose Size	A Ref	D Ref	F Ref	H Ref	⊕ Ref
FJ3274-1010S	1-14	10	3.69	2.14			1.13
FJ3274-1012S*	1-14	12	3.75	2.14			1.13

* 0 (made to order)

K

Hose Ends - Field Attachable

E-Z Clip System™ - Hose Ends

FJ3225

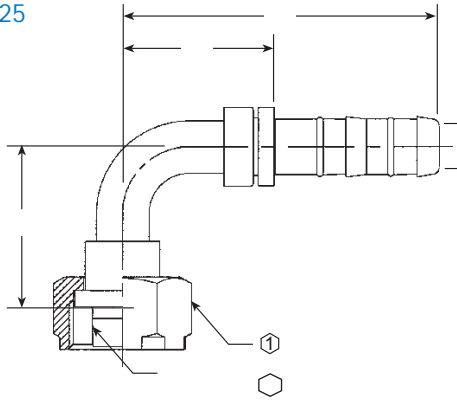

90° Female Rotalok

Part Number	TH D T	Hose Size	A Ref	D Ref	F Ref	H Ref	⊕ Ref
FJ3225-1010S	1-14	10	2.98	1.43		1.52	1.13
FJ3225-1008S	1-14	8	2.98	1.43		1.52	1.13
FJ3225-1012S	1-14	12	3.11	1.54		1.62	1.13

EJ3321

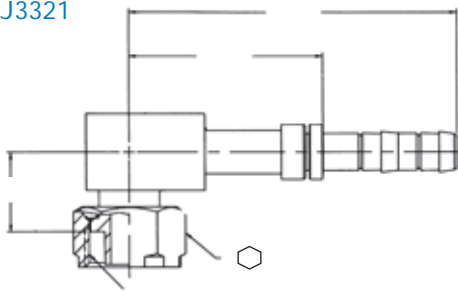

Short Drop 90° Female Rotalok

Part Number	TH D T	Hose Size	A Ref	D Ref	F Ref	H Ref	⊕ Ref
EJ3321-1008S	1-14	8	3.62	2.07		0.91	1.13
EJ3321-1012S	1-14	12	3.87	2.29		0.91	1.13

EJ3421/
EJ3422

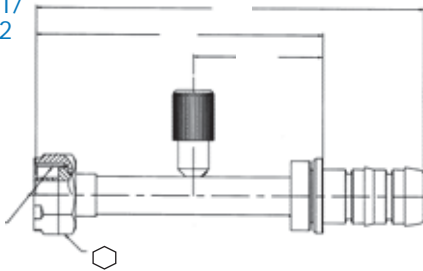

Female Rotalok with R134 Port

Part Number	TH D T	Hose Size	A Ref	D Ref	F Ref	H Ref	⊕ Ref
EJ3421-1012S	1-14	12	6.44	4.86	2.17	High	1.13
EJ3422-1016S	1-14	16	6.45	4.77	2.15	Low	1.13

K

Hose Ends - Field Attachable

E-Z Clip System™ - Hose Ends

FJ3510

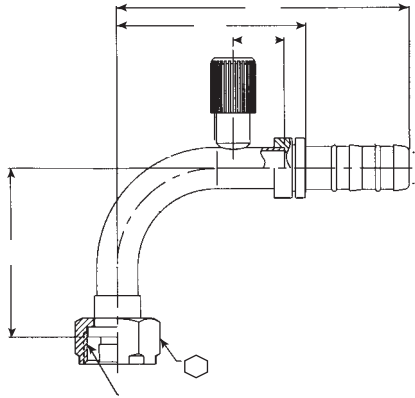

90° Female Rotalok with R134a Low Side Port

Part Number	TH D T	Hose Size	A Ref	D Ref	F Ref	H Ref	Ⓢ Ref
FJ3510-1012S	1-14	12	4.48	2.88	.79	2.58	1.13

FJ3511

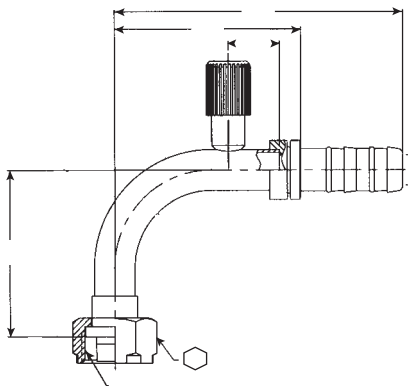

90° Female Rotalok with R134a High Side Port

Part Number	TH D T	Hose Size	A Ref	D Ref	F Ref	H Ref	Ⓢ Ref
FJ3511-1010S	1-14	10	4.43	2.88	.79	2.58	1.13

FJ3226

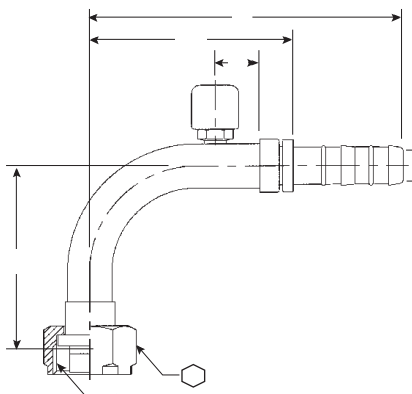

90° Female Rotalok with Switch Port (7/16-20 Thread)

Part Number	TH D T	Hose Size	A Ref	D Ref	F Ref	H Ref	Ⓢ Ref
FJ3226-1010S	1-14	10	4.43	2.88	0.63	2.56	1.13

K

Hose Ends - Field Attachable

E-Z Clip System™ - Hose Ends

FJ356

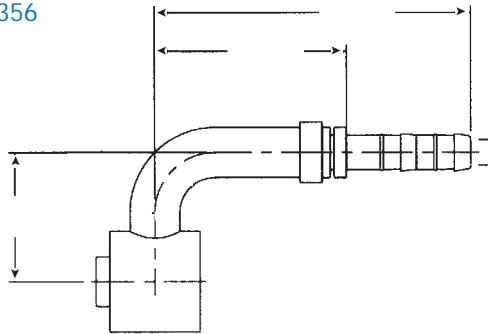

90° M Block Style

Part Number	TH D T	Hose Size	A Ref	D Ref	F Ref	H Ref	Ⓜ Ref
FJ3568-1008S*		8	3.92	2.38		1.60	
FJ3568-1010S*		10	3.83	2.28		2.31	
FJ3568-1012S*		12	3.86	2.28		2.38	

* 0 (made to order)

FJ3513

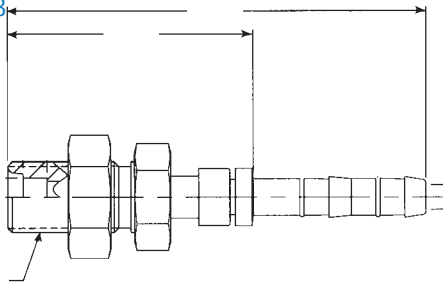

Straight Bulkhead

Part Number	TH D T	Hose Size	A Ref	D Ref	F Ref	H Ref	Ⓜ Ref
FJ3513-0606S	5/8-18	6	3.69	2.16			0.94
FJ3513-0808S	3/4-16	8	3.93	2.39			1.0
FJ3513-1010S	7/8-14	10	4.49	2.94			1.13
FJ3513-1212S	1-1/16-14	12	4.83	3.24			1.38
FJ3513-1216S	1-1/16-14	16	4.92	3.24			1.38

FJ3514

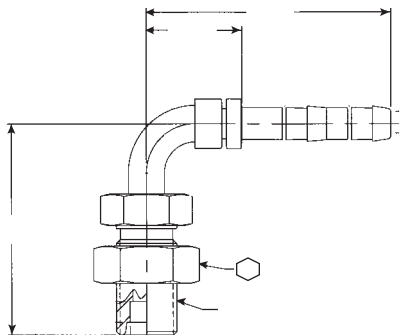

90° Male Bulkhead

Part Number	TH D T	Hose Size	A Ref	D Ref	F Ref	H Ref	Ⓜ Ref
FJ3514-0606S	5/8-18	6	2.50	.98		2.15	0.94
FJ3514-0808S	3/4-16	8	2.74	1.20		2.61	1.0
FJ3514-1010S	7/8-14	10	3.08	1.53		3.26	1.13
FJ3514-1012S	7/8-14	12	3.11	1.53		3.26	1.13
FJ3514-1212S	1-1/16-14	12	3.69	2.11		3.78	1.38

FJ3045

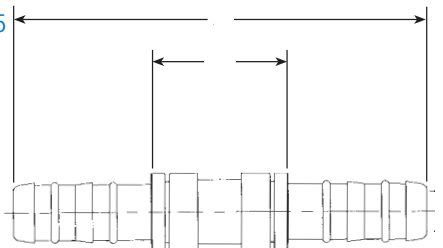

Straight Splicer

Part Number	TH D T	Hose Size	A Ref	D Ref	F Ref	H Ref	Ⓜ Ref
FJ3045-0606S		6	4.63	1.58			
FJ3045-0808S		8	4.76	1.68			
FJ3045-1010S		10	5.68	2.58			
FJ3045-1212S		12	4.72	1.57			
FJ3045-1008S		8	5.78	2.69			
FJ3045-1616S		16	5.18	1.82			

K

Hose Ends - Field Attachable

E-Z Clip System™ - Hose Ends

FJ305

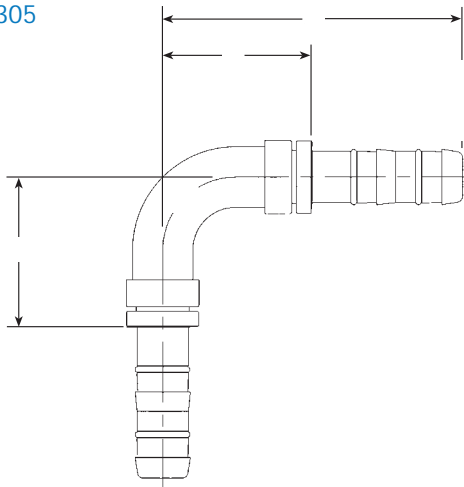

90° Splicer

Part Number	TH D T	Hose Size	A Ref	D Ref	F Ref	H Ref	Ⓜ Ref
FJ3058-01-0606S		6	2.71	1.18		2.71	
FJ3058-02-0808S		8	2.98	1.43		2.98	
FJ3058-03-1010S		10	3.08	1.53		3.08	
FJ3058-04-1212S		12	3.68	2.11		3.68	
FJ3058-05-1010S		10	6.86	5.61		6.86	
FJ3058-06-1212S		12	6.86	5.36		6.86	

FJ3496

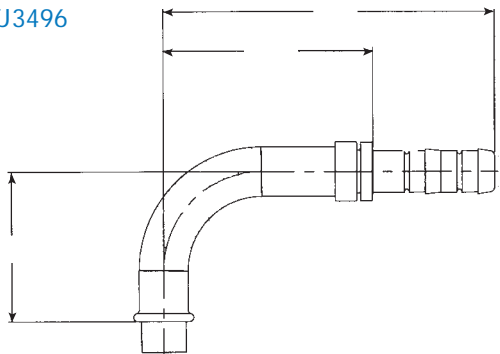

90° Pilot Connection (Long Pilot)

Part Number	TH D T	Hose Size	A Ref	D Ref	F Ref	H Ref	Ⓜ Ref
FJ3496-01-1010S		10	4.22	2.67		1.89	
FJ3496-02-0808S*		8	3.77	2.23		1.62	
FJ3496-03-1012S		12	4.25	2.67		1.89	

* 0 (made to order)

FJ3171

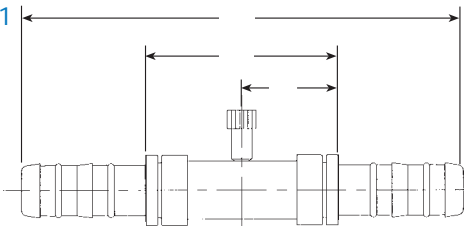

Splicer with Switch Port (7/16-20 Thd)

Part Number	TH D T	Hose Size	A Ref	D Ref	F Ref	H Ref	Ⓜ Ref
FJ3171-0606S		6	5.41	2.36	1.18		
FJ3171-0808S		8	5.61	2.52	1.26		
FJ3171-1010S		10	5.54	2.44	1.22		
FJ3171-1212S		12	5.60	2.44	1.22		
FJ3171-1616S		16	6.79	3.44	1.72		

FJ5995

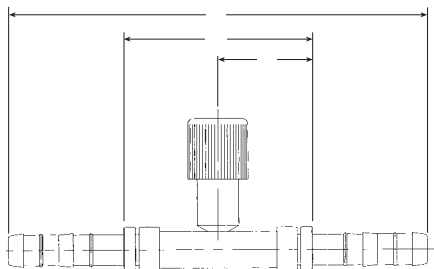

Splicer with High Side R134a Port

Part Number	TH D T	Hose Size	A Ref	D Ref	F Ref	H Ref	Ⓜ Ref
FJ5995-0606S		6	5.41	2.36	1.18		
FJ5995-0808S		8	5.61	2.52	1.26		
FJ5995-1010S		10	5.62	2.52	1.26		
FJ5995-1212S		12	5.67	2.52	1.26		

* 0 (made to order)

K

Hose Ends - Field Attachable

E-Z Clip System™ - Hose Ends

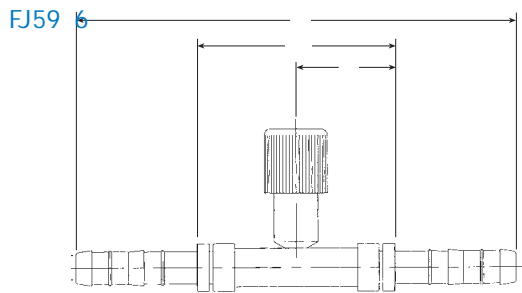

FJ596 Splicer with R134a Low Side Port

Part Number	TH D T	Hose Size	A Ref	D Ref	F Ref	H Ref	① Ref
FJ5986-1010S		10	5.54	2.44	1.22		
FJ5986-1212S		12	5.60	2.44	1.22		
FJ5986-1616S		16	6.79	3.44	1.72		

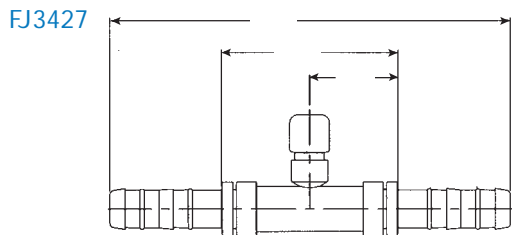

FJ3427 Splicer with High Side Switch Port (M10 1.25)

Part Number	TH D T	Hose Size	A Ref	D Ref	F Ref	H Ref	① Ref
FJ3427-0808S		8	5.61	2.52	1.26		
FJ3427-1010S		10	5.54	2.44	1.22		

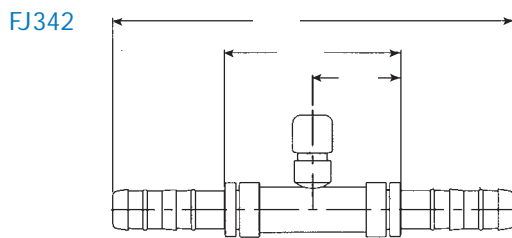

FJ342 Splicer with Low Side Switch Port (M12 1.25)

Part Number	TH D T	Hose Size	A Ref	D Ref	F Ref	H Ref	① Ref
FJ3428-1212S		12	5.59	2.44	1.22		

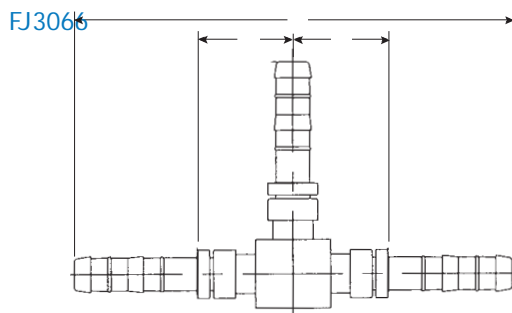

FJ3066 T Splicer 3 Hose Connector

Part Number	TH D T	Hose Size	A Ref	D Ref	F Ref	H Ref	① Ref
FJ3066-0808S		8	5.48	2.40			
FJ3066-1010S		10	5.62	2.52			
FJ3066-1212S		12	5.67	2.52			
FJ3066-101212S		10x12x12	5.67	2.52			
FJ3066-060808S		6x8x8	5.48	2.40			
FJ3066-060606S*		6x6x6	5.48	2.40			

* 0 (made to order)

K

Hose Ends - Field Attachable

E-Z Clip System™ - Hose Ends

FJ3623

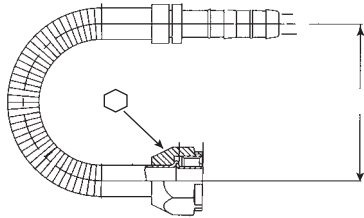

1 0° Female O-ring Pilot

Part Number	TH D T	Hose Size	A Ref	D Ref	F Ref	H Ref	⊕ Ref
FJ3623-0808S*	M20 x 1.5	8				2.50	.94

* 0 (made to order)

FJ3624

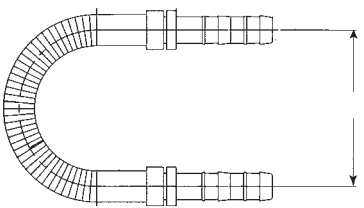

Part Number	TH D T	Hose Size	A Ref	D Ref	F Ref	H Ref	⊕ Ref
FJ3624-0808S*		8				2.50	

* 0 (made to order)

FJ3 04

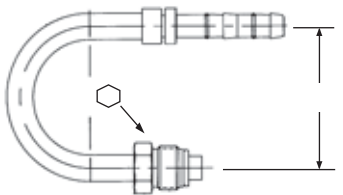

1 0° Male O-ring

Part Number	TH D T	Hose Size	A Ref	D Ref	F Ref	H Ref	⊕ Ref
FJ3804-0606S*	5/8-18	6				2.00	.625
FJ3804-1010S*	7/8-18	10				3.00	.88

* 0 (made to order)

K

Hose Ends - Field Attachable

FJ3914

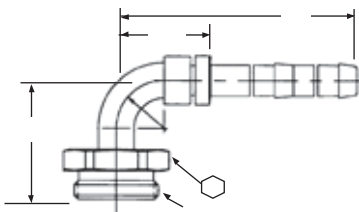

90° 5400 Coupling Thread

Part Number	TH D T	Hose Size	A Ref	D Ref	F Ref	H Ref	⊕ Ref
FJ3914-03-1210S*	1 1/4-18	10	3.08	1.53		1.23	1.375
FJ3914-03-0806S*	7/8-20	6	2.50	0.98		1.23	1.00

* 0 (made to order)

E-Z Clip System™ - Hose Ends

FJ3970

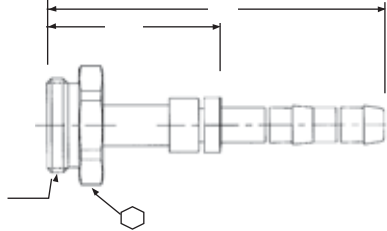

Straight 5400 Coupling Thread

Part Number	TH D T	Hose Size	A Ref	D Ref	F Ref	H Ref	⊕ Ref
FJ3970-0606S	7/8 x 20	6	3.14	1.82			1.00

FJ3734



Female O-ring (Long Pilot) Compound Tube

Part Number	TH D T	Hose Size	A Ref	D Ref	F Ref	H Ref	⊕ Ref
FJ3734-1212S*	1 1/16 x 14	12					1.25

* 0 (made to order)

FJ3 01

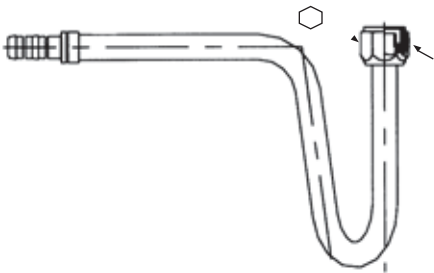

Female O-ring (Long Pilot) Compound Tube

Part Number	TH D T	Hose Size	A Ref	D Ref	F Ref	H Ref	⊕ Ref
FJ3801-1212S*	1 1/16 x 14	12					1.25

* 0 (made to order)

FJ3977

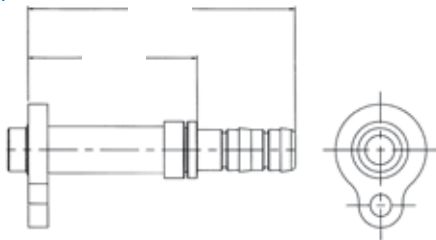

Pad Style Connection (olvo)

Part Number	TH D T	Hose Size	A Ref	D Ref	F Ref	H Ref	⊕ Ref
FJ3977-0806S		6	3.34	1.82			
FJ3977-0810S		10	3.74	2.19			
FJ3977-1012S		12	4.32	2.73			

K

Hose Ends - Field Attachable

E-Z Clip System™ - Hose Ends

FJ39 2

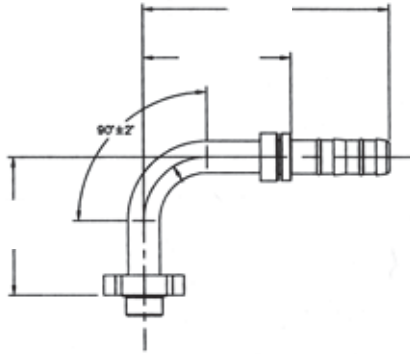

90° Pad Style Connection (olvo)

Part Number	TH D T	Hose Size	A Ref	D Ref	F Ref	H Ref	① Ref
FJ3982-0806S		6	3.86	2.33		2.18	
FJ3982-0810S		10	3.86	2.31		2.18	

FJ39 3

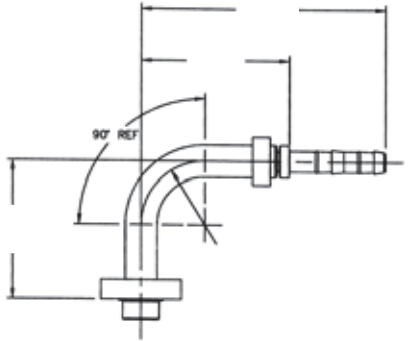

90° Pad Style Connection (olvo) (Pad Orientation 90°)

Part Number	TH D T	Hose Size	A Ref	D Ref	F Ref	H Ref	① Ref
FJ3983-0806S		6	3.86	2.33		2.18	

FJ39 0

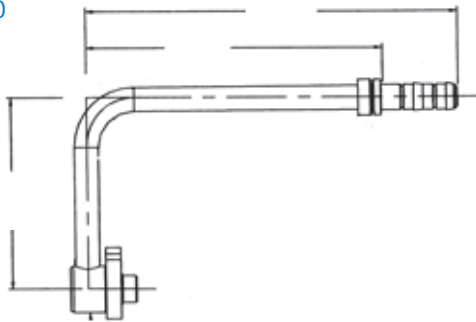

1 0° Pad Style Connection

Part Number	TH D T	Hose Size	A Ref	D Ref	F Ref	H Ref	① Ref
FJ3980-0810S*		10	6.04	4.48		3.92	

* 0 (made to order)

FJ397

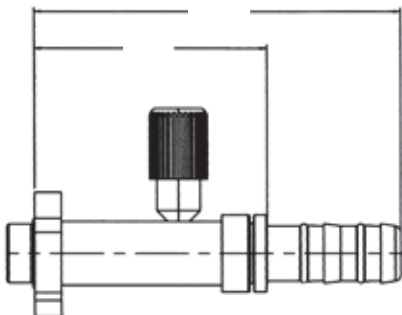

Straight Pad Style (olvo) with R134a Low Side Port

Part Number	TH D T	Hose Size	A Ref	D Ref	F Ref	H Ref	① Ref
FJ3978-1012S*		12	4.32	2.73			

* 0 (made to order)

K

Hose Ends - Field Attachable

E-Z Clip System™ - Hose Ends

FJ3979

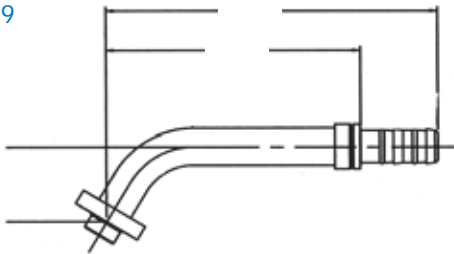

60° Elbow, Pad Style (olvo) with R134a Low Side Port

Part Number	TH D T	Hose Size	A Ref	D Ref	F Ref	H Ref	⊕ Ref
FJ3979-1012S		12	6.78	5.2		1.53	

FJ39 1

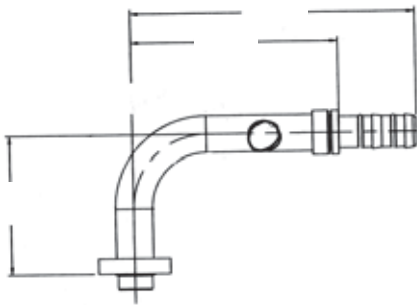

90° Elbow, Pad Style (olvo) with R134a Low Side Port

Part Number	TH D T	Hose Size	A Ref	D Ref	F Ref	H Ref	⊕ Ref
FJ3981-1012S		12	5.9	4.32		2.84	

IF20340

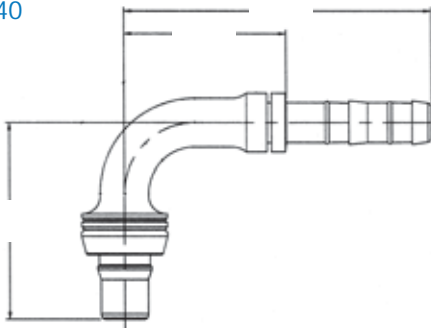

90° to STC

Part Number	TH D T	Hose Size	A Ref	D Ref	F Ref	H Ref	⊕ Ref
1F20340-0808-S		8	3.03	1.49		2.09	

EJ3 09

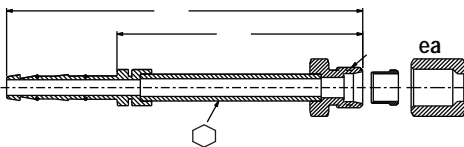

E- Clip Compression Fitting

Part Number	TH D T	Hose Size	A Ref	B Ref	F Ref	H Ref	⊕ Ref
EJ3809-01-0606S	9/16-18	6	4.92	3.40			0.69
EJ3809-02-0806S	2/4-16	6	4.93	2.40			0.88
EJ3809-03-0606S	9/16-18	6	4.94	3.40			0.69
EJ3809-04-0808S	3/4-16	8	4.84	3.30			0.88
EJ3809-05-1008S	7/8-14	8	4.73	3.19			1.00
EJ3809-06-0810S	3/4-16	10	4.85	3.30			0.88
EJ3809-07-1010S	7/8-14	10	4.64	3.09			1.00
EJ3809-08-1012S	7/8-14	12	4.66	3.09			1.00
EJ3809-09-1212S	1-1/16-12	12	4.98	3.40			1.25
EJ3809-10-1210S	1-1/16-12	10	5.05	3.50			1.25

K

Hose Ends - Field Attachable

E-Z Clip System™ - Hose Ends

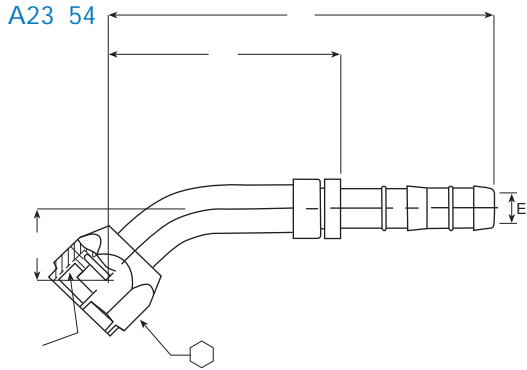

45° Female O-ring (Long Pilot)

Part Number	TH D T	Hose Size	A Ref	D Ref	F Ref	H Ref	① Ref
GA23854-12-16*	1 1/16-14	16	5.125	3.175		1.39	32mm
* 0 (made to order)							

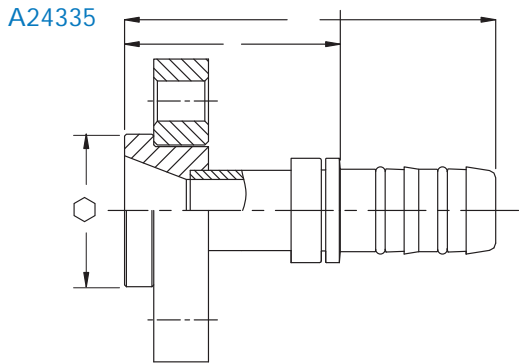

Straight Bock Compressor Fitting

Part Number	TH D T	Hose Size	A Ref	D Ref	F Ref	H Ref	① Ref
GA24335-22-16*		16	4.01	2.33			1.65
* 0 (made to order)							

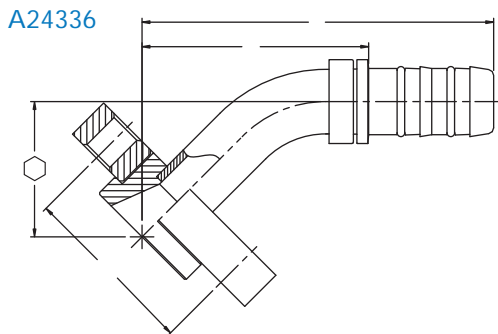

45° Bock Compressor Fitting

Part Number	TH D T	Hose Size	A Ref	D Ref	F Ref	H Ref	① Ref
GA24336-22-16*		16	4.72	3.04		1.81	1.65
* 0 (made to order)							

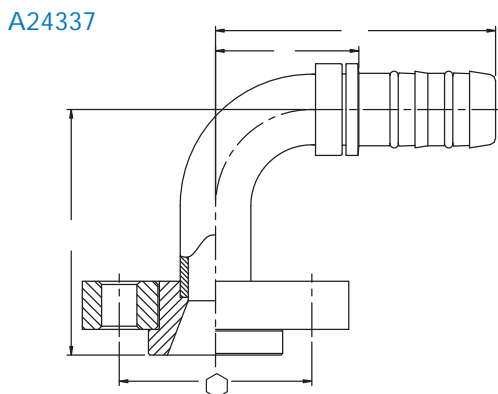

90° Bock Compressor Fitting

Part Number	TH D T	Hose Size	A Ref	D Ref	F Ref	H Ref	① Ref
GA24337-22-16*		16	3.44	1.76		3.01	1.65
* 0 (made to order)							

K

Hose Ends - Field Attachable

E-Z Clip System™ - Cages, Clips, and Lifesavers

Cages

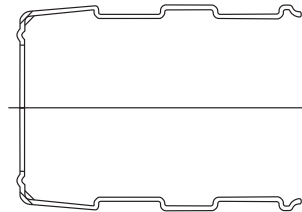

Part Number	Cage Size	Hose Description
1F40105-06C	0	erie 0 e
1F40105-08C	0	erie 0 e
1F40105-10C	10	erie 10 e
1F40105-12C	12	erie 12 e
1F40105-16C	1	erie 1 e

Clips

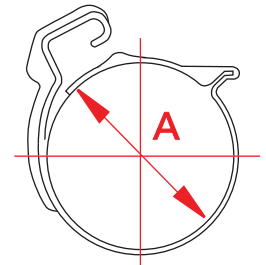

Part Number	A Ref	Description
1F40104-06C	18.0 mm	Clips for size -06 hose
1F40104-08C	20.5 mm	Clips for size -08 hose
1F40104-10C	23.0 mm	Clips for size -10 hose
1F40104-12C	27.5 mm	Clips for size -12 hose
1F40104-16C	33.0 mm	Clips for size -16 hose

Clip and Cage Kits

Kit Part Number	Hose Size	Number of Clips per Kit	Number of Cages per Kit
FF14171	6	2	1
FF14172	8	2	1
FF14173	10	2	1
FF14174	12	2	1
FF14401	16	2	1
FF13819	6	4	2
FF13820	8	4	2
FF13821	10	4	2
FF13822	12	4	2
FF14402	16	4	2

Lifesaver Bra e Nipple

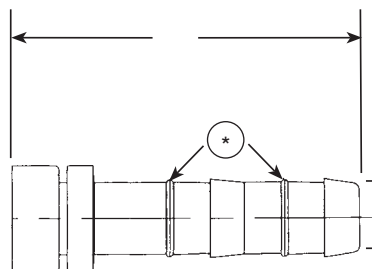

Part Number	TH D T	Hose Size	A Ref
FF12262-0606		6	2.01
FF12262-0608		8	2.02
FF12262-0808		8	2.02
FF12262-0810		10	2.03
FF12262-1010		10	2.03
FF12262-1012		12	2.06
FF12262-1212		12	2.21
FF12262-1616		16	2.21
FF12262-1016		16	2.21
FF12262-1216		16	2.21

* O-rings packaged separately

Lifesaver Bra e Rings

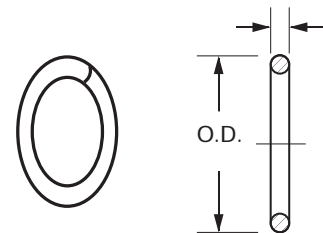

Part Number	Tube O.D.	ire Dia.	O.D.
4640 x 6	3/8	.046	.375
4640 x 8	1/2	.046	.500
4640 x 10	5/8	.046	.625
4640 x 12	3/4	.062	.750
4640 x 16	1	.062	1.000

K

Hose Ends - Field Attachable

E-Z Clip System™ - Aluminum Lifesaver

A/C Hose Repair System

The Aluminum Lifesaver braze fitting is designed to rework failed OEM aluminum air conditioning tubing and hose assemblies in sizes 10mm to 18mm (metric tubing only, -6 to -12). This repair system allows the installer to reuse unique OEM terminal connections, while replacing the failed OEM hose and nipple with the E-Z Clip attachment system.

Note: The E-Z Clip system can only be used with Weatherhead GH134W hose.



How to use

Each kit contains the correct components for replacement of a single hose assembly.

Weatherhead GH134W hose must be ordered or purchased separately.

Determine tube O.D. for Hose I.D. per chart below:

Standard Configurations

Size Nipple	Hose I.D. in	Hose O.D. in	Hose Part No.	Assembly Part No.
-6	10 (.39)	8 (.32)	GH134W-6	FF13727-1006
-8	12 (.47)	11 (.42)	GH134W-8	FF13727-1208
-10	16 (.63)	13 (.51)	GH134W-10	FF13727-1610
-12	18 (.71)	16 (.64)	GH134W-12	FF13727-1812

* This (-) size label will be referenced throughout the instructions

E-Z Clip Aluminum

Lifesaver Kits Part number ordering guide:

Order Kit No.	Kit Component	Description	Quantity
FF13727 -size	GW1172-size	Braze-on nipple	2
	1F40106-size	Nipple O-ring	5
	GA7000579-size	Silver Braze Ring	3
		Assembly Instructions	1

K

Hose Ends - Field Attachable

E-Z Clip System™ - Tools

Pliers/Connecting Tool



Part Number	Description
FT1357	nnec in T I
FT1421	nnec in T I r 1
re l ce FT141	

Hose Cutter



Part Number	Description
T-135	Hose Cutter
T-135B	Replacement Blade

Core Tool

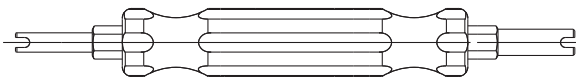

Part Number	Description
FT1406	Core Tool
FF90192-02	High Side Core*
FF90192-01	Low Side Core*
FF90193-02	High Side Cap
FF90193-01	Low Side Cap
FF9872-04	Cap for 7/16-20 Thd.port

* or Weatherhead high flow charge ports only.



90 92-02



90 92-0



90 93-02, 90 93-0



98 2-04

K
Hose Ends - Field Attachable

E-Z Clip Components - Ordering & Identifying



The E-Z Clip System is designed for assembly with Weatherhead GH134W Multi-Refrigerant hose. Its engineered connection exceeds SAE J2064 and has been vibration and impulse tested.

The benefits of E-Z Clip are virtually endless:

- No guess work
- No leaking crimps
- No power supply needed
- As easy to use as a pair of pliers
- Easy to use in confined areas

Assembly Materials Checklist

- Pliers (FT1357)
- Guillotine blade (T-135) or equivalent cutting tool
- Refrigerant oil compatible with refrigeration or A/C system
- GH134W Multi-Refrigerant hose
- Nipple assembly*
- Appropriately sized clips and cage

* The two black o-rings on the nipple assembly are of a specific rubber compound and size. They should NO be removed.



E-Z Clip System Components Are Simple to Identify - Order and Use

Ordering Information

Hose	Nipple	Clips	Cage	Clips
GH134-6W	FJ - 06S	1F40105-06C	1F40104-06C	
GH134-8W	FJ - 08S	1F40105-08C	1F40104-08C	
GH134-10W	FJ - 10S	1F40105-10C	1F40104-10C	
GH134-12W	FJ - 12S	1F40105-12C	1F40104-12C	
GH134-16W*	FJ - 16S	1F40105-16C	1F40104-16C	

Identification Guide

Hose	Clips	Nipple	Clips	N
GH134-6W	-6 and 150	150	1F40106-06	
GH134-8W	-8 and 175	175	1F40106-08	
GH134-10W	-10 and 200	200	1F40106-10	
GH134-12W	-12 and 245	245	1F40106-12	
GH134-16W	-16 and 285	285	1F40106-16	

* The o-ring shown must be used on the hose nipple. NO substitution can be made, without potential of failure.

For Example...



Hose



Nipple



Nipple



Clips

See the following in the Eaton HA S002 E

K

Hose Ends - Field Attachable

E-Z Clip System™ - Assembly Instructions

Step 1. Cut the Hose

Cut the hose to proper length with an appropriate cutting tool. The Weatherhead hand-held hose cutter (T-135) has been specifically designed for cutting all non-wire reinforced hose, such as GH134W Multi-Refrigerant hose. Be sure the cut is made square to the hose length.



Step 2. Slip on Two Clips

Install two proper-sized clips onto the cut end of the hose. Orientation of the clips does not affect the performance of the connection. However, for ease of assembly, both clips should have the same orientation.

NOTE: Failure to slide the clips over the hose at this time will require the clips to be stretched over the hose or fitting later. This may permanently damage the clip.



Step 3. Oil the Nipple

Lubricate the nipple with a generous amount of the refrigeration or A/C system's compressor lubricating oil. This MUST be done to lower the force of nipple insertion.



Step 4. Insert the Nipple into the Hose

To ensure that the nipple is fully inserted, check the gap between the cut end of the hose and the shoulder on the nipple. Care should be taken to avoid kinking or other damage to the hose during nipple insertion.

NOTE: Be sure to wipe excess oil from the nipple and hose.



Step 5. Snap on the Cage

Snap the cage into the groove on the nipple. The arms should extend over the hose length. When the cage has been correctly installed in the cage groove, the cage will be able to rotate in the groove. This step MUST be performed to ensure:

1. The clips will be located over the O-rings on the nipple.
2. The connection will be compatible with the connection's pressure rating.



K

Hose Ends - Field Attachable

E-Z Clip System™ - Assembly Instructions (cont.)

Step 6: Slide the Clips

Slide the clips over the cage arms and into the channels on each arm

Step 7: Close the Clips

Use the FT1357 pliers to close the clips. The pliers should be positioned squarely on the clip connection points and should remain square during the closing of the clip.

The nose of the pliers should be firmly seated under the assembly bump and lock latch.

For easiest assembly, the clasp should be closed between the cage arms. If the pliers are not kept square during closing of the clip, the clasp may have an offset. Use the pliers to correct the clasp alignment.

Notice: E-Z Clip components should not be reused.

⚠ CAUTION

Failure to follow these assembly instructions and/or the use of Weatherhead hose with Hose Ends supplied by other manufacturers may result in unreliable and unsafe hose assemblies, which may result in sudden or unintended escape of refrigerant gases. Personal injury and/or violations of EPA regulations may occur as a consequence.

Eaton recommends adherence to all guidelines, including EPA guidelines, concerning the service of refrigerant systems.



For easiest assembly, the clasp should be closed between the cage arms.



rrec



nc rrec



nc rrec

rrec

K

Hose Ends - Field Attachable

Adapters, Tube Fittings & Connectors

Table of Contents

Hose to Order & Size Designation	L-2	Special Adapters	L-77
Steel Adapters	L-3 thru 16	Steel Flareless Ermeto Connectors	L-78 thru 88
Swivel Adapters	L-17 thru 23	Split Flange Adapters and Kits	L-89 thru 92
For-Seal Adapters	L-24 thru 34	STC Connectors	
JIC 37° Flare-Twin Fittings	L-35 thru 64	How To Order, STC Overview	L-93 thru 95
Steel Din Fittings	L-65 thru 67	Assembly Method and Verification	L-96
Straight Thread O-Rings	L-68 thru 70	Female STC Cap and Male STC Plug	L-97
Din Connectors	L-71	STC Adapters	L-98 thru 106
Metric Connectors	L-72 thru 73	STC Repair Adapters	L-107
BSP Connectors	L-74 thru 76	Accessories and Sales Tools	L-108



Adapters

How to Order and Size Designation

Eaton Adapter Part Numbers

Adapter part numbers consist of a base number followed by a size designation. If the part number contains a "T" character between the base number and size designator, the first size designator signifies the tube size.

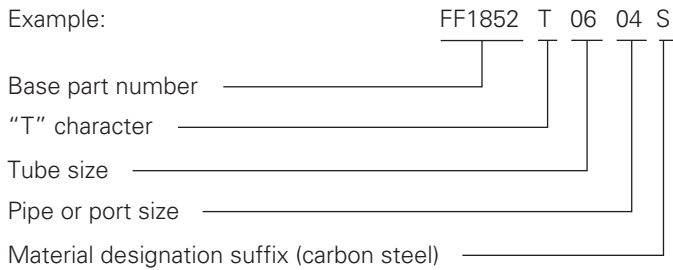

If the part number does not contain a "T" character between the base number and the size description, the first size designation signifies the port size.

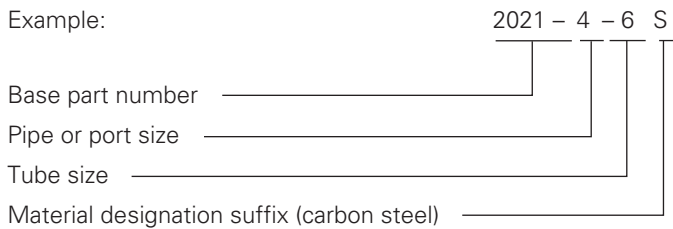

If the adapter part number contains an "X" character following the base number, the first size designation signifies the tube size.

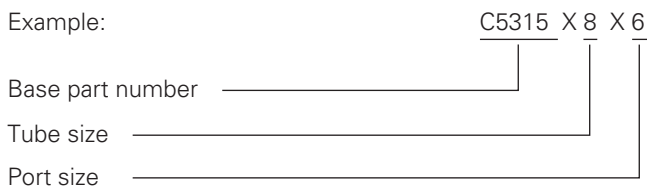

For-Seal® tube fitting body with o-ring, locknut and washer, where applicable.

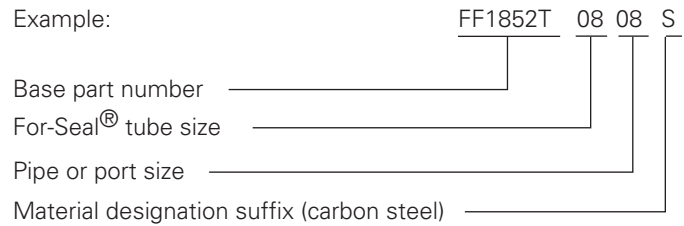

For-Seal® tube fitting body without o-ring

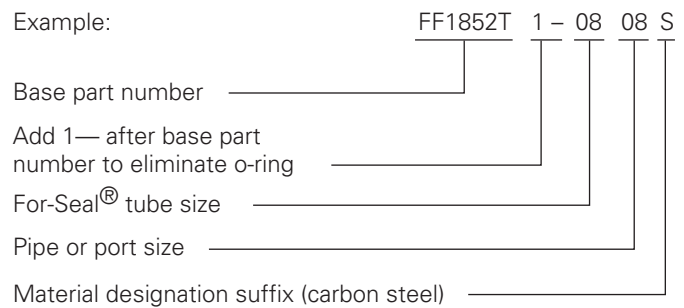

Steel Adapters

Introduction

Materials

Eaton connectors are available in a variety of alloys on special order.

Carbon Steel Adapters – are precision machined from AISI 12L14 carbon steel. Shaped Adapters such as elbows and tees with a “C” prefix are made from high-density forgings. Straight Adapters are made from bar stock.

Stainless Steel Adapters – are made from type 316 stainless. Standard Ermeto flareless sleeves are made from 17-4PH precipitation-hardened stainless.

Finishes

Weathercote™ – is an Eaton trademark for a protective coating that far exceeds the minimum requirements of the SAE specifications for a corrosion-resistant finish for use with petroleum-based, synthetic, and water-based hydraulic fluids. It is readily identified by its dark appearance. Weathercote is an amorphous phosphate coating covered with a soluble rust-proof film resulting in a coating .0002" thick. Weathercote provides full protection against electrolytic action, thread

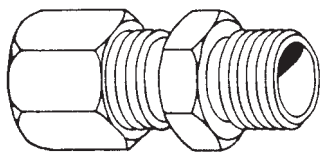

seizure or corrosive action of hydraulic fluids.

The lubricity of the rust-proof solvent film measurably reduces the amount of torque required to make leak-proof connections.

Zinc Plated – Eaton connectors are given a minimum coating .0002" thick.

Stainless Steel – Stainless Steel Adapters are supplied with natural surface finish, except tube nuts which are coated with a bonded dry-film lubricant (black) to reduce assembly torque and prevent galling of threads.

All Eaton Stainless Steel Adapters are passivated to remove microscopic foreign particles from the surface of stainless steel as required. The process also leaves a film of corrosion protection.

Hydraulic Fluids

Modern hydraulic systems in use today employ a wide variety of high-quality hydraulic fluids. There are three principle types in general use today – each best suited for particular conditions. They are discussed here briefly to clarify the fitting finishes compatible with each type.

Petroleum or Mineral Oil-Based

Hydraulic Fluids – are good general purpose fluids available in a full range of viscosity specified as SAE 10, 20, 30, etc. These fluids are not fire-resistant, making them unsuitable for use where there is a potential source of ignition. Eaton Connectors can be used with these fluids.

Straight Synthetic Hydraulic Fluids – is a general term applied to such products as Pydraul, Lindol, Cellulubes 90, 150, 180, 220, etc., where fire hazards are high. Weathercote-finish Connectors are recommended for this type of fluid. O-ring MUST be made of a “Butyl” compound, or they will “swell” when contacted by synthetic fluids.

Water-Based Hydraulic Fluids – consist generally of a mixture of water and polyglycols. They are non-flammable and serve the same purpose as the synthetic types. **Only Weathercote-finish Connectors are recommended for this type of fluid.** Zinc plate finishes will be dissolved by water-based fluids and damage to expensive components may result. These water-based fluids are usually less expensive than synthetic fluids and have little or no detrimental effects on Buna-N compounds used in o-ring.

O-ring Compound and Application Chart

O-ring Part Number	Base Material of Compound	Petroleum & Mineral Oil-Based Hydraulic Fluids	Straight Synthetic Hydraulic Fluids	Water-Based Hydraulic Fluids (Polyglycols)	Lubricating Oils			Durometer Hardness	Temp Range °F
					Air	Water			
_x252*	Buna-N	Excellent	Unsuitable	Good	Excellent	Good	Excellent	90	-40° to +250°
2018x*	Buna-N	Excellent	Unsuitable	Good	Excellent	Good	Excellent	90	-40° to +250°
4629x*	Buna-N	Excellent	Unsuitable	Good	Excellent	Good	Excellent	90	-40° to +250°
7629x*	Buna-N	Excellent	Unsuitable	Good	Excellent	Good	Excellent	90	-40° to +250°
MB7629x*	Buna-N	Excellent	Unsuitable	Good	Excellent	Good	Excellent	90	-40° to +250°
M7629x*	Buna-N	Excellent	Unsuitable	Good	Excellent	Good	Excellent	90	-40° to +250°
ZW747x*	Buna-N	Excellent	Unsuitable	Good	Excellent	Good	Excellent	70	-40° to +250°

*Standard o-ring complies with SAE J-515 Type CH and ASTM specifications D2000. All standard Eaton connectors are supplied with this type o-ring, unless otherwise specified. (Viton o-ring are available as special order items only).

Steel Adapters

Ordering Information

Each adapter is ordered individually by Part number.

Typical Application

Grease, instrumentation and most hydraulic systems.

Pressure See chart.

Vibration Rating

Fair resistance.

Material Carbon steel –
AISI/SAE 12L14
Stainless steel – Type 316.

Plating Zinc; clear trivalent chromate.

Temperature

-65°F to +400°F.

Advantages Dry seal pipe threads (NPTF), zinc plate, compact size, and broad selection of styles and sizes.

Conformance

Meets SAE specifications.

Note: See page N-53 for hydraulic o-ring assortment.

Label Set FS-2000 (Adhesive).

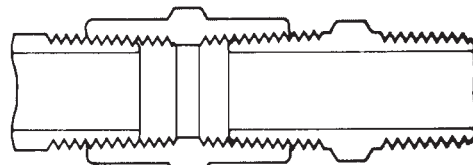

Pipe Size	1/16	1/8	1/4	3/8	1/2	3/4	1	1-1/4	1-1/2	2
Thread Size	1/16-27	1/8-27	1/4-18	3/8-18	1/2-14	3/4-14	1-11 1/2	1 1/4-11 1/2	1 1/2-11 1/2	2-11 1/2

Seal-Nut For Male Pipe Thread

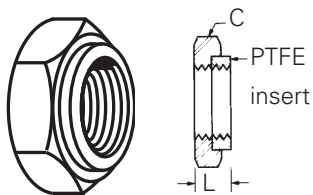

Pipe Thread	Part Number	Hex C	L
1/8	C3059x2	5/8	.15
1/4	C3059x4	3/4	.25
3/8	C3059x6	7/8	.25
1/2	C3059x8	1-1/8	.25
3/4	C3059x12	1-5/16	.25
1	C3059x16	1-5/8	.34

Hex Socket Plug

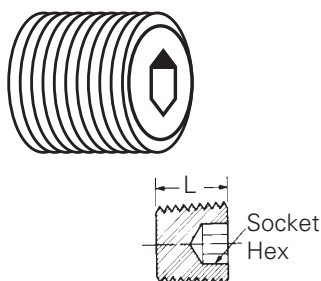

Male Pipe Thread	Part Number	Socket Hex	L
1/16	C3169x1	5/32	.31
1/8	C3169x2	3/16	.30
1/4	C3169x4	1/4	.46

Steel Adapters

Square Head Plug Thread

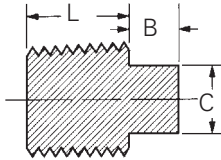
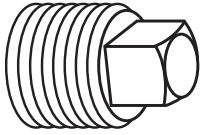

Male Pipe Thread	Part Number	B	C	L
1/8	C3179x2	.25	9/32	.34
1/4	C3179x4	.29	3/8	.51
3/8	C3179x6	.32	7/16	.51
1/2	C3179x8	.40	9/16	.68
3/4	C3179x12	.46	5/8	.69
1	C3179x16	.52	13/16	.85

Hex Head Plug Stainless Steel No. 3171x

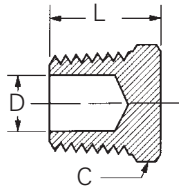
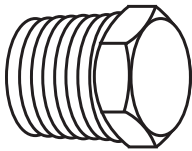

Male Pipe Thread	Part Number	Hex C	L	D Opt. Dia.
1/8	C3159x2•	7/16	.56	.156
1/4	C3159x4•	9/16	.68	.250
3/8	C3159x6•	11/16	.78	.375
1/2	C3159x8•	7/8	.98	.500
3/4	C3159x12	1-1/8	1.06	.690
1	C3159x16	1-3/8	1.25	.875
1-1/4	C3159x20	1-3/4	1.56	–
1-1/2	C3159x24	2	1.62	–
2	C3159x32	2-1/2	1.75	–

• Available in Stainless Steel

Bushing Stainless Steel No. 3121x (Ref. SAE No. 140140)

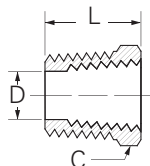
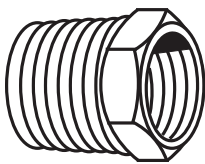

Male Pipe Thread	Female Pipe Thread	Part Number	Hex C	D	L
1/4	1/8	C3109x4x2•	5/8	.322	.85
3/8	1/8	C3109x6x2•	3/4	.332	.85
3/8	1/4	C3109x6x4	3/4	.438	.85
1/2	1/8	C3109x8x2	7/8	.332	1.10
1/2	1/4	C3109x8x4•	7/8	.438	1.10
1/2	3/8	C3109x8x6•	7/8	.562	1.10
3/4	1/4	C3109x12x4•	1-1/8	.438	1.17
3/4	3/8	C3109x12x6	1-1/8	.562	1.17
3/4	1/2	C3109x12x8	1-1/8	.703	1.17
1	3/8	C3109x16x6	1-3/8	.562	1.36
1	1/2	C3109x16x8•	1-3/8	.703	1.36
1	3/4	C3109x16x12•	1-3/8	.922	1.36
1-1/4	1/2	C3109x20x8	1-3/4	.703	1.47
1-1/4	3/4	C3109x20x12	1-3/4	.922	1.47
1-1/4	1	C3109x20x16	1-3/4	1.156	1.47
1-1/2	3/4	C3109x24x12	2	.906	1.58
1-1/2	1	C3109x24x16	2	1.141	1.58
1-1/2	1-1/4	C3109x24x20	2	1.500	1.57
2	1-1/4	C3109x32x20	2-1/2	1.484	1.75
2	1-1/2	C3109x32x24	2-1/2	1.719	1.75

• Available in Stainless Steel

Steel Adapters

Straight Thread O-ring to Female Pipe Adapter

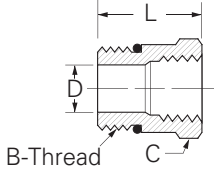
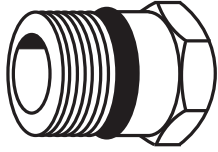

Male Port Size	Female Pipe Thread	Part Number	Straight Thread B	Hex C	D	L
1/4	1/8	C3269x4x2	7/16-20	9/16	.172	.97
1/4	1/4	C3269x4x4	7/16-20	3/4	.172	1.16
5/16	1/8	C3269x5x2	1/2-20	5/8	.234	.94
3/8	1/4	C3269x6x4	9/16-18	3/4	.297	1.09
3/8	3/8	C3269x6x6	9/16-18	7/8	.281	1.30
3/8	1/2	C3269x6x8	9/16-18	1-1/8	.281	1.44
1/2	1/4	C3269x8x4	3/4-16	7/8	.421	1.06
1/2	3/8	C3269x8x6	3/4-16	7/8	.421	1.22
1/2	1/2	C3269x8x8	3/4-16	1-1/16	.421	1.65
5/8	1/4	C3269x10x4	7/8-14	1	.422	.81
5/8	3/8	C3269x10x6	7/8-14	1	.500	1.25
5/8	1/2	C3269x10x8	7/8-14	1-1/8	.500	1.50
5/8	3/4	C3269x10x12	7/8-14	1-3/8	.500	1.62
3/4	1/2	C3269x12x8	1-1/16-12	1-1/4	.688	1.34
3/4	3/4	C3269x12x12	1-1/16-12	1-3/8	.656	1.66
7/8	3/4	C3269x14x12	1-3/16-12	1-3/8	.718	1.63
1	1/2	C3269x16x8	1-5/16-12	1-1/2	.688	1.00
1	3/4	C3269x16x12	1-5/16-12	1-1/2	.876	1.50
1	1	C3269x16x16	1-5/16-12	1-5/8	.876	1.88
1-1/4	1	C3269x20x16	1-5/8-12	1-7/8	1.080	1.00
1-1/4	1-1/4	C3269x20x20	1-5/8-12	2	1.080	2.00
1-1/2	1-1/2	C3269x24x24	1-7/8-12	2-3/8	1.344	2.00
2	2	C3269x32x32	2-1/2-12	2-7/8	1.781	2.10

Replacement o-ring page L-64.

Adapters, Tube Fittings & Connectors

Adapter

Stainless Steel No. 3221x
(Ref. SAE No. 140139)

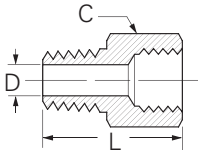
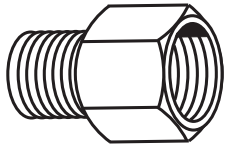

Female Pipe Thread	Male Pipe Thread	Part Number	Hex C	D	L
1/4	1/8	C3209x4x2•	3/4	.188	1.21
3/8	1/4	C3209x6x4	7/8	.281	1.44
1/2	1/8	C3209x8x2	1-1/8	.188	1.50
1/2	1/4	C3209x8x4	1-1/8	.281	1.68
1/2	3/8	C3209x8x6	1-1/8	.406	1.68
3/4	1/4	C3209x12x4	1-3/8	.281	1.78
3/4	1/2	C3209x12x8•	1-3/8	.531	1.93
1	1/2	C3209x16x8	1-5/8	.562	2.09
1	3/4	C3209x16x12	1-5/8	.719	2.18
1-1/4	1	C3209x20x16	2	.938	2.46
1-1/2	1-1/4	C3209x24x20	2-3/8	1.25	2.50
2	1-1/2	C3209x32x24	2-7/8	1.500	2.63

• Available in Stainless Steel

Female Straight Thread O-ring to Male Pipe Adapter

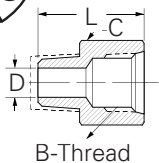
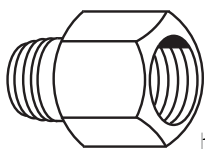

Female Port Size	Male Pipe Thread	Part Number	Straight Thread B	Hex C	D	L
3/8	3/8	C3239x6x6	9/16-18	13/16	.406	1.38
3/8	1/2	C3239x6x8	9/16-18	7/8	.500	1.61
1/2	3/8	C3239x8x6	3/4-16	1	.406	1.46
1/2	1/2	C3239x8x8	3/4-16	1	.562	1.69
5/8	1/2	C3239x10x8	7/8-14	1-1/4	.531	1.81

Steel Adapters

Male Straight Thread O-ring to Male Pipe Adapter

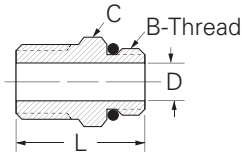
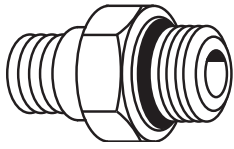

Male Port Size	Male Pipe Thread	Part Number	Straight Thread B	Hex C	D	L
1/4	1/8	C3249x4x2	7/16-20	9/16	.172	1.05
3/8	1/4	C3249x6x4	9/16-18	11/16	.281	1.30
1/2	3/8	C3249x8x6	3/4-16	7/8	.391	1.36
1/2	1/2	C3249x8x8	3/4-16	7/8	.391	1.55
5/8	1/2	C3249x10x8	7/8-14	1	.434	1.69
3/4	3/4	C3249x12x12	1-1/16-12	1-1/4	.609	1.73
1	1	C3249x16x16	1-5/16-12	1-1/2	.844	2.06
1-1/4	1-1/4	C3249x20x20	1-5/8-12	1-7/8	1.078	2.17
1-1/2	1-1/2	C3249x24x24	1-7/8-12	2-1/8	1.312	2.26
2	2	C3249x32x32	2-1/2-12	2-7/8	1.781	2.47

Replacement o-ring page L-64.

Coupling

Stainless Steel No. 3321x
(Ref. SAE No. 140138)

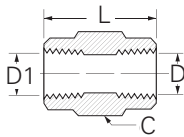
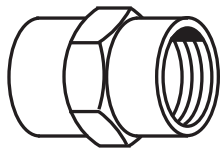

Female Pipe Thread	Female Pipe Thread	Part Number	Hex C	D	D1	L
1/8	1/8	C3309x2	5/8	.332	.332	.75
1/4	1/8	C3309x4x2•	3/4	.437	.332	1.13
1/4	1/4	C3309x4•	3/4	.437	.437	1.13
3/8	1/4	C3309x6x4•	7/8	.562	.437	1.13
3/8	3/8	C3309x6•	7/8	.562	.562	1.13
1/2	1/4	C3309x8x4•	1-1/8	.687	.437	1.50
1/2	3/8	C3309x8x6•	1-1/8	.687	.562	1.50
1/2	1/2	C3309x8	1-1/8	.687	.687	1.50
3/4	1/2	C3309x12x8	1-3/8	.906	.687	1.53
3/4	3/4	C3309x12•	1-3/8	.906	.906	1.53
1	3/4	C3309x16x12	1-5/8	1.125	.906	1.89
1	1	C3309x16	1-5/8	1.125	1.125	1.89
1-1/4	1-1/4	C3309x20	2	1.468	1.468	1.93
1-1/2	1-1/2	C3309x24	2-3/8	1.703	1.703	1.93
2	2	C3309x32	2-7/8	2.188	2.188	1.96

• Available in Stainless Steel

Male FOR-SEAL® to Male Pipe Adapter

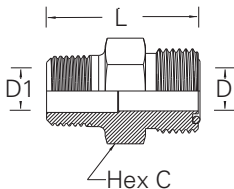

Tube O.D.	Male Pipe Thread	Part Number	Hex C	D	D1	L
3/8	3/8	4205x6x6	3/4	.264	.406	1.30
1/2	3/8	4205x8	7/8	.378	.406	1.45
1/2	1/2	4205x8x8	7/8	.378	.484	1.64
5/8	1/2	4205x10	1-1/16	.484	.531	1.82
3/4	1/2	4205x12x8	1-1/4	.406	.484	1.87
3/4	3/4	4205x12	1-1/4	.609	.719	1.94
3/4	1	4205x12x16	1-3/8	.609	.938	1.87
1	1	4205x16	1-1/2	.811	.938	2.19
1-1/4	1-1/4	4205x20	1-3/4	1.024	1.250	2.30

Replacement o-ring page L-34.

Steel Adapters

Hex Nipple

Stainless Steel No. 3081x
(Ref. SAE No. 140137)

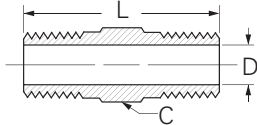
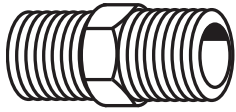

Male Pipe Thread	Male Pipe Thread	Part Number	Hex C	D	L
1/16	1/16	C3069x1	5/16	.141	.940
1/8	1/16	C3069x2x1	7/16	.141	.970
1/8	1/8	C3069x2•	7/16	.188	1.060
1/4	1/8	C3069x4x2•	5/8	.188	1.260
1/4	1/4	C3069x4•	5/8	.281	1.450
3/8	1/8	C3069x6x2	3/4	.188	1.260
3/8	1/4	C3069x6x4•	3/4	.281	1.450
3/8	3/8	C3069x6•	3/4	.406	1.450
1/2	1/4	C3069x8x4	7/8	.281	1.700
1/2	3/8	C3069x8x6	7/8	.406	1.700
1/2	1/2	C3069x8•	7/8	.531	1.890
3/4	1/2	C3069x12x8	1-1/8	.531	1.960
3/4	3/4	C3069x12•	1-1/8	.719	1.960
1	3/4	C3069x16x12	1-3/8	.719	2.160
1	1	C3069x16	1-3/8	.938	2.340
1-1/4	1-1/4	C3069x20	1-3/4	1.250	2.480
1-1/2	1-1/2	C3069x24	2	1.500	2.610
2	2	C3069x32	2-1/2	1.938	2.830

• Available in Stainless Steel

Part No. 2084- (Dash Size)

Dash Size	Thread P (NPTF)	A	
		mm	inches
2S - 3/4	1/8-27	19,0	.75
2S - 2	1/8-27	50,8	2.00
4S - 7/8	1/4-18	22,3	.88
6S - 1	3/8-18	25,4	1.00
6S - 2	3/8-18	50,8	2.00
6S - 3	3/8-18	76,2	3.00
8S - 1 1/8	1/2-14	28,5	1.12
8S - 2 1/2	1/2-14	63,5	2.50
12S - 1 3/8	3/4-14	35,1	1.38
16S - 1 1/2	1 - 11 1/2	38,1	1.50

Adapters, Tube Fittings & Connectors

Long Nipple

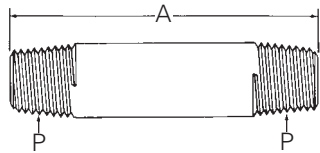

NPSM Adapter

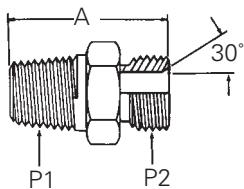

Part No. 2015- (Dash Size)

Dash Size	Thread P1 (NPTf)	Thread P2 (NPSM)	A	
			mm	inches
8 - 8S	1/2-14	1/2-14	38,1	1.50

Steel Adapters

Available in Stainless Steel

Bulkhead Coupling

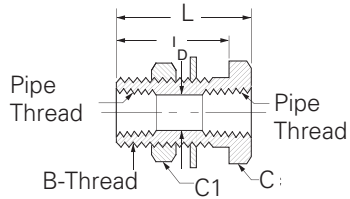
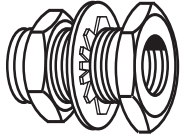

Female Pipe Thread	Part Number	Thread Size B	Hex C	Hex C1	D	I	L
1/4	W05465	3/4-16	1	1-1/16	.422	1.25	1.50
1/4	W21204	3/4-16	1	1-1/16	.422	.69	.94
3/8	W17709	1-14	1-1/8	1-3/8	.563	1.06	1.31

Bulkhead Coupling

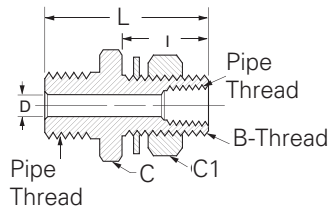
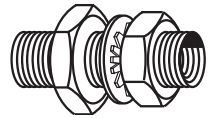

Male Pipe Thread	Female Pipe Thread	Part Number	Thread Size B	Hex C	Hex C1	D	I	L
1/2	1/4	W05498	3/4-16	1-1/4	1-1/16	.312	1.13	2.16
1/2	1/4	W05499	3/4-16	1-1/4	1-1/16	.312	1.53	2.53

Bulkhead Coupling

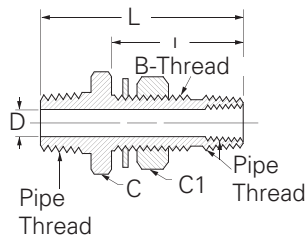
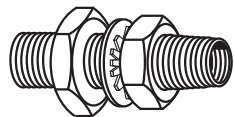

Male Pipe Thread	Female Pipe Thread	Part Number	Thread Size B	Hex C	Hex C1	D	I	L
1/2	1/4	W05730	1-14	1-1/4	1-3/8	.375	1.88	2.94
1/2	1/4	W23464	1-14	1-1/4	1-3/8	.375	2.88	3.94



Steel Adapters

45° Union Elbow

(Ref. SAE 140337)

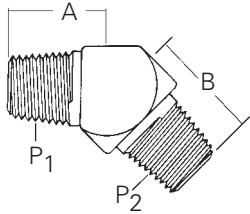

Part No. 2247- (Dash Size)

Dash Size	Thread		A		B	
	P1 (NPTF)	P2 (NPTF)	mm	inches	mm	inches
4-4S	1/4 - 18	1/4 - 18	21,8	.86	21,8	.86
6-6S	3/8 - 18	3/8 - 18	24,1	.95	24,1	.95
8-8S	1/2 - 14	1/2 - 14	28,7	1.13	29,7	1.17
12-12S	3/4 - 14	3/4 - 14	29,7	1.17	30,5	1.20
16-16S	1 - 11 1/2	1 - 11 1/2	30,5	1.20	37,6	1.48

45° Female Elbow

(Ref. SAE No. 140338)

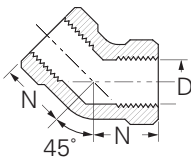
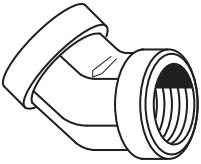

Female Pipe Thread	Part Number	D	N	Across Flats
1/4	C3559x4	.437	.69	3/4
3/8	C3559x6	.562	.750	7/8
1/2	C3559x8	.687	.940	1-1/16
3/4	C3559x12	.906	1.000	1-5/16
1	C3559x16	1.125	1.190	1-5/8

45° Street Elbow

Stainless Steel No. 3371x
(Ref. SAE No. 140339)

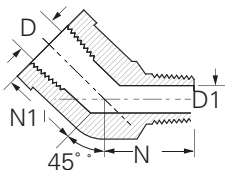
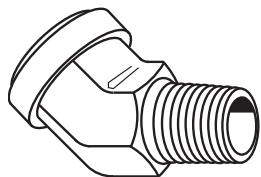

Female Pipe Thread	Male Pipe Thread	Part Number	D	D1	N1	N	Across Flats
1/8	1/8	C3359x2•	.332	.188	.47	.72	9/16
1/4	1/4	C3359x4•	.437	.281	.62	1.05	3/4
3/8	3/8	C3359x6	.562	.406	.72	1.10	7/8
1/2	1/2	C3359x8•	.687	.531	.91	1.34	1-1/16
3/4	3/4	C3359x12	.906	.719	.97	1.38	1-5/16
1	1	C3359x16	1.125	.938	1.12	1.72	1-5/8

Steel Adapters

90° Female Elbow

Stainless Steel No. 3521x
(Ref. SAE No. 140238)

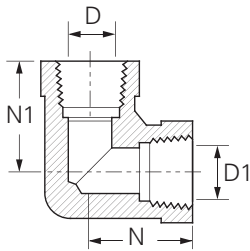
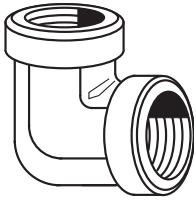

Female Pipe Thread	Female Pipe Thread	Part Number	D	N	Across Flats
1/8	1/8	C3509x2•	.332	.66	9/16
1/4	1/4	C3509x4•	.437	.88	3/4
1/4	1/8	C3509x4x2	.343	.88	3/4
3/8	3/8	C3509x6	.562	1.02	7/8
3/8	1/4	C3509x6x4	.437	1.02	7/8
1/2	1/2	C3509x8•	.687	1.23	1-1/16
1/2	3/8	C3509x8x6	.562	1.23	1-1/8
3/4	3/4	C3509x12•	.906	1.36	1-5/16
3/4	1/2	C3509x12x8	.687	1.23	1-3/8
1	1	C3509x16	1.125	1.62	1-5/8
1-1/4	1-1/4	C3509x20	1.468	1.70	1-7/8
2	2	C3509x32	2.188	2.39	2-3/16

90° Street Elbow

(Ref. SAE No. 140239)

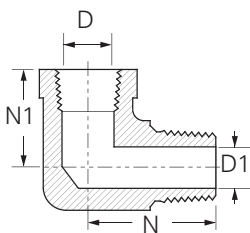
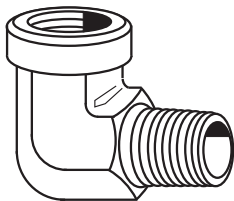

Male Pipe Thread	Female Pipe Thread	Part Number	D	D1	N	N1	Across Flats
1/8	1/8	C3409x2	.332	.188	.78	.66	9/16
1/8	1/4	C3409x2x4	.437	.188	.91	.88	3/4
1/4	1/4	C3409x4	.437	.281	1.09	.88	3/4
1/4	1/8	C3409x4x2	.332	.281	1.09	.67	5/8
1/4	3/8	C3409x4x6	.562	.281	1.22	1.02	7/8
3/8	3/8	C3409x6	.562	.406	1.22	1.02	7/8
3/8	1/4	C3409x6x4	.437	.406	1.22	.91	13/16
3/8	1/2	C3409x6x8	.687	.406	1.38	1.23	1-1/8
1/2	1/2	C3409x8	.687	.531	1.47	1.23	1-1/16
1/2	3/8	C3409x8x6	.562	.531	1.47	1.05	15/16
1/2	3/4	C3409x8x12	.906	.531	1.59	1.23	1-3/8
3/4	3/4	C3409x12	.906	.719	1.59	1.36	1-5/16
3/4	1/2	C3409x12x8	.687	.719	1.59	1.23	1-1/8
1	1	C3409x16	1.125	.938	1.97	1.62	1-5/8
1-1/4	1-1/4	C3409x20	1.468	1.250	2.38	1.70	1-7/8
2	2	C3409x32	2.188	1.930	3.00	2.39	2-13/16

Steel Adapters

90° Straight Thread O-ring Male Elbow

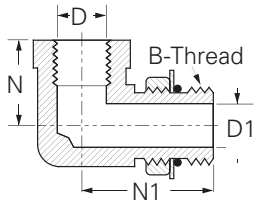
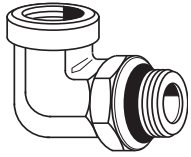

Male Port Size	Female Pipe Thread	Part Number	Straight Thread B	D	D1	N	N1	Across Flats
3/8	1/4	C3459x6	9/16-18	.44	.30	.88	1.31	3/4
1/2	3/8	C3459x8	3/4-16	.53	.39	1.02	1.62	7/8
5/8	1/2	C3459x10	7/8-14	.65	.48	1.23	1.89	1-1/16
3/4	3/4	C3459x12	1-1/16-12	.85	.61	1.36	2.17	1-1/4
1	1	C3459x16	1-5/16-12	1.06	.84	1.62	2.41	1-5/8
1-1/4	1-1/4	C3459x20	1-5/8-12	1.47	1.08	1.70	2.38	1-5/8

Replacement o-ring page L-64.

90° Straight Thread O-ring Female Elbow Long

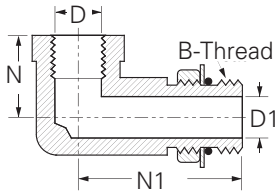
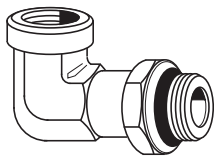

Male Port Size	Female Pipe Size	Part Number	Straight Thread B	D	D1	N	N1	Across Flats
1/2	3/8	C3469x8	3/4-16	.562	.422	.63	2.94	7/8
5/8	1/2	C3469x10	7/8-14	.687	.500	.75	3.56	1-1/16
3/4	3/4	C3469x12	1-1/16-12	.906	.656	.81	4.13	1-5/16
1	1	C3469x16	1-5/16-12	1.125	.876	1.00	4.63	1-5/8

Replacement o-ring page L-64.

90° Straight Thread O-ring Male Elbow To Male Pipe

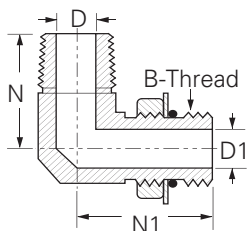
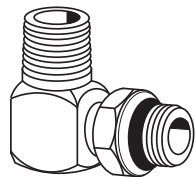

Male Port Size	Male Pipe Thread	Part Number	Straight Thread B	D	D1	N	N1	Across Flats
3/8	1/4	C3569x6	9/16-18	.297	.281	1.09	1.25	5/8
1/2	3/8	C3569x8	3/4-16	.391	.406	1.22	1.45	13/16
5/8	1/2	C3569x10	7/8-14	.484	.531	1.47	1.70	15/16
1	1	C3569x16	1-5/16-12	.844	.938	1.97	2.05	1-3/8

Replacement o-ring page L-64.

Steel Adapters

90° Elbow Hose Connector

(Ref. SAE 430260)

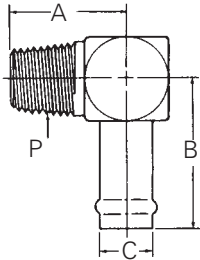

Part No. FF1162 – (Dash Size)

Dash Size	Hose Size		Thread P (NPTF)	A		B		C	
	mm	inches		mm	inches	mm	inches	mm	inches
1212S	19,0	.75	3/4 - 14	35,8	1.41	46,5	1.83	19,0	.75
1616S	25,4	1.00	1 - 11 1/2	43,4	1.71	49,3	1.94	25,4	1.00

90° Male Elbow

Stainless Steel No. 3541x

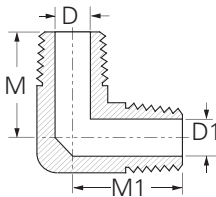
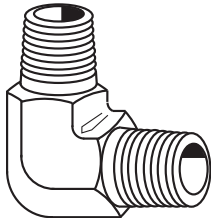

Male Pipe Thread	Male Pipe Thread	Part Number	D	D1	M	M1 Flats	Across
1/8	1/8	C3529x2	.188	.188	.78	.78	7/16
1/4	1/4	C3529x4•	.281	.281	1.09	1.09	9/16
3/8	3/8	C3529x6•	.406	.406	1.22	1.22	3/4
3/8	1/4	C3529x6x4	.406	.281	1.28	1.19	13/16
1/2	1/2	C3529x8	.531	.531	1.47	1.47	7/8
1/2	3/8	C3529x8x6	.531	.406	1.47	1.28	15/16
3/4	3/4	C3529x12	.719	.719	1.59	1.59	1-1/16
3/4	1/2	C3529x12x8	.719	.531	1.59	1.56	1-1/8
1	3/4	C3529x16x12	.938	.719	1.97	1.72	1-3/8
1	1	C3529x16	.938	.938	1.97	1.97	1-3/8
1-1/4	1-1/4	C3529x20	1.250	1.250	2.38	2.38	1-3/4

90° Male Pipe Swivel to Female Pipe Rigid

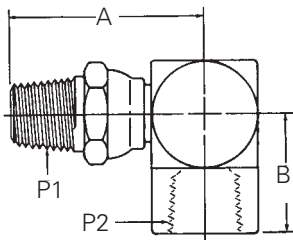

Part No. 2252- (Dash Size)

Dash Size	Thread P1 (NPTF)		Thread P2 (NPTF)		A		B	
	mm	inches	mm	inches	mm	inches	mm	inches
4-4S	1/4 - 18	1/4 - 18	43,7	1.72	22,3	.88		
6-6S	3/8 - 18	3/8 - 18	42,9	1.69	25,9	1.02		
8-8S	1/2 - 14	1/2 - 14	54,3	2.14	31,2	1.23		
12-12S	3/4 - 14	3/4 - 14	57,2	2.25	34,5	1.36		

Not for use in applications over +212°F. Not intended to be a live swivel.

Steel Adapters

Union Tee

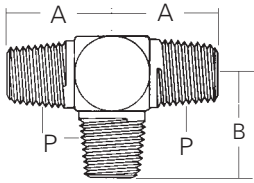

Part No. 2257- (Dash Size)

Dash Size	Thread P (NPTF)	A		B	
		mm	inches	mm	inches
4-4S	1/4 - 18	27,7	1.09	27,7	1.09
6-6S	3/8 - 18	31,0	1.22	31,0	1.22
8-8S	1/2 - 14	37,3	1.47	37,3	1.47
12-12S	3/4 - 14	40,4	1.59	40,4	1.59

Tee

Stainless Steel No. 3721x
(Ref. SAE No. 140438)

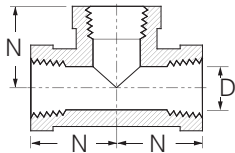
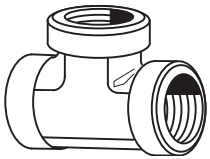

Female Pipe Thread	Part Number	D	N	Across Flats
1/8	C3709x2	.332	.66	9/16
1/4	C3709x4	.437	.88	3/4
3/8	C3709x6	.562	1.02	7/8
1/2	C3709x8	.687	1.23	1-1/16
3/4	C3709x12	.906	1.36	1-5/16
1	C3709x16	1.125	1.62	1-5/8
1-1/4	C3709x20	1.468	1.70	1-7/8
1-1/2	C3709x24	1.710	2.08	2-3/8

Male Branch Tee

(Ref. SAE No. 140425)

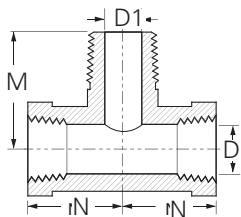
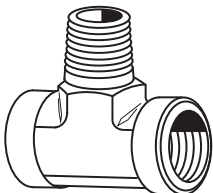

Male Pipe Thread	Female Pipe Thread	Part Number	D	D1	M	N	Across Flats
1/8	1/8	C3609x2	.332	.188	.78	.66	9/16
1/4	1/4	C3609x4	.437	.281	1.09	.88	3/4
3/8	3/8	C3609x6	.562	.406	1.22	1.02	7/8
1/2	1/2	C3609x8	.687	.531	1.47	1.23	1-1/8
1	1	C3609x16	1.125	.938	1.97	1.62	1-5/8
3/4	3/4	C3609x12	.906	.719	1.59	1.36	1-3/8

Steel Adapters

Male Run Tee

Stainless Steel No. 3771x
(Ref. SAE No. 140424)

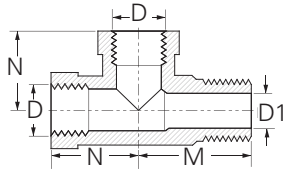
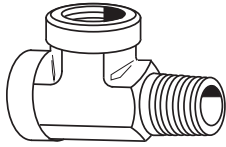

Female Pipe Thread	Male Pipe Thread	Part Number	D	D1	M	N	Across Flats
1/8	1/8	C3759x2	.332	.188	.78	.66	9/16
1/4	1/4	C3759x4	.437	.281	1.09	.88	3/4
3/8	3/8	C3759x6	.562	.406	1.22	1.02	7/8
1/2	1/2	C3759x8	.687	.531	1.47	1.23	1-1/16
3/4	3/4	C3759x12	.906	.719	1.59	1.36	1-5/16
1	1	C3759x16	1.125	.938	1.97	1.62	1-5/8
1-1/4	1-1/4	C3759x20	1.468	1.250	2.38	1.70	2

Female Run Tee

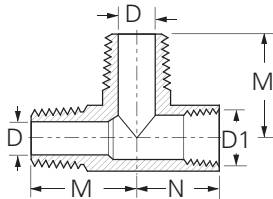
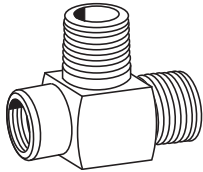

Female Pipe Thread	Male Pipe Thread	Part Number	D	D1	M	N	Across Flats
1/4	1/4	C3805x4	.281	.437	1.09	.88	3/4
3/8	3/8	C3805x6	.406	.562	1.22	1.02	7/8
1/2	1/2	C3805x8	.531	.687	1.47	1.23	1-1/8
3/4	3/4	C3805x12	.719	.906	1.59	1.36	1-3/8
1	1	C3805x16	.938	1.125	1.97	1.62	1-5/8

Female Branch Tee

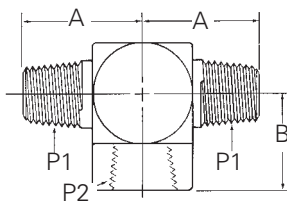

Part No. 2256- (Dash Size)

Dash Size	Thread P1 (NPTF)	Thread P2 (NPTF)	A		B	
			mm	inches	mm	inches
4-4S	1/4 - 18	1/4 - 18	27,7	1.09	22,3	.88
6-6S	3/8 - 18	3/8 - 18	31,0	1.22	25,9	1.02
8-8S	1/2 - 14	1/2 - 14	37,3	1.47	31,2	1.23
12-12S	3/4 - 14	3/4 - 14	40,4	1.59	34,5	1.36

Steel Adapters

Cross

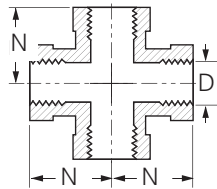
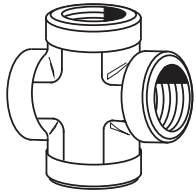

Female Pipe Thread	Part Number	D	N	Across Flats
1/8	C3959x2	.343	.66	5/8
1/4	C3959x4	.437	.88	3/4
3/8	C3959x6	.562	1.02	7/8
1/2	C3959x8	.687	1.23	1-1/16
3/4	C3959x12	.906	1.36	1-5/16
1	C3959x16	1.125	1.62	1-5/8

Adapters, Tube Fittings & Connectors

Cross

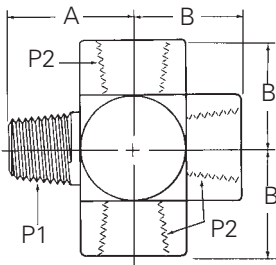

Part No.208007 –(Dash Size)

Dash Size	Thread P1 (NPTF)	Thread P2 (NPTF)	A		B	
			mm	inches	mm	inches
4-4S	1/4 - 18	1/4 - 18	29,5	1.16	22,3	.88
8-8S	1/2 - 14	1/2 - 14	41,4	1.63	31,2	1.23

Straight Thread O-ring

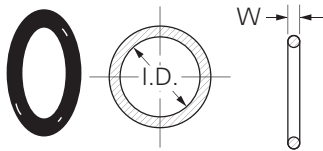

Material: Buna-N, 90 Durometer

Temperature Range:

-40°F to +250°F
(-40°C to +121°C)

Standard o-ring complies with SAE specification SAE J515 Type CH. (See page L-3 for o-ring compound and application chart.)

Tube O.D.	Part Number	W	I.D.
1/16	7629x1	.058	.185
1/8	7629x2	.064	.239
3/16	7629x3	.064	.301
1/4	7629x4	.072	.351
5/16	7629x5	.072	.414
3/8	7629x6	.078	.468
7/16	7629x7	.082	.530
1/2	7629x8	.087	.644
5/8	7629x10	.097	.755
3/4	7629x12	.116	.924
7/8	7629x14	.116	1.048
1	7629x16	.116	1.171
1-1/4	7629x20	.118	1.475
1-1/2	7629x24	.118	1.720
2	7629x32	.118	2.337

Steel Connectors

Swivel Adapters

9000 Pipe Connectors

Typical Application

Pressure hydraulic systems.

Pressure See chart.

Sealing Method Metal to metal, 30° cone-NPSM thread on pipe swivel end. Sealing methods vary depending on swivel adapter type.

Material Carbon steel

Plating Trivalent Zinc Plated

Pipe Hose Ends 9000 Series Pressure Rating Chart

Connection Type	End Size								
	1/8"	1/4"	3/8"	1/2"	3/4"	1"	1-1/4"	1-1/2"	2"
Male Pipe (NPTF)*	5,000	5,000	4,000	3,000	2,500	2,000	1,500	1,000	1,000
Female Pipe (NPTF)*	5,000	5,000	4,000	3,000	2,500	2,000	1,500	1,500	1,000

*Pressure ratings shown are the pressure ratings for the fitting and are not necessarily the pressure ratings applicable in an assembly with hydraulic hose. The applicable pressure rating for an assembly with hydraulic hose is the lower value specified for the hose and the fitting unless otherwise agreed to by the supplier and user.

Female Pipe Swivel to Male Pipe

(Ref. SAE No. 140130)

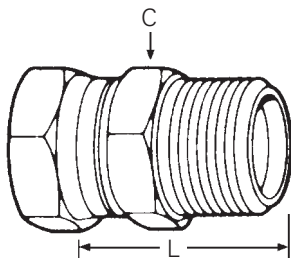

NPSM Swivel Nut	Male Pipe Thread	Part Number	Hex C	L
1/8-27	1/8-27	9205x2x2	9/16	.900
1/8-27	1/4-18	9205x2x4	11/16	1.187
1/4-18	1/8-27	9205x4x2	11/16	1.060
1/4-18	1/4-18	9205x4x4	11/16	1.200
1/4-18	3/8-18	9205x4x6	11/16	1.200
1/4-18	1/2-14	9205x4x8	7/8	1.500
3/8-18	1/4-18	9205x6x4	5/8	1.210
3/8-18	3/8-18	9205x6x6	3/4	1.240
3/8-18	1/2-14	9205x6x8	7/8	1.540
1/2-14	3/8-18	9205x8x6	7/8	1.330
1/2-14	1/2-14	9205x8x8	1	1.640
1/2-14	3/4-14	9205x8x12	1-1/4	1.620
3/4-14	1/2-14	9205x12x8	1	1.720
3/4-14	3/4-14	9205x12x12	1-1/4	1.680
3/4-14	1-11-1/2	9205x12x16	1-1/2	1.984
1-11-1/2	3/4-14	9205x16x12	1-1/2	1.800
1-11-1/2	1-11-1/2	9205x16x16	1-1/2	2.010
1-11-1/2	1-1/4-11-1/2	9205x16x20	1-11/16	2.080
1-1/4-11-1/2	1-11-1/2	9205x20x16	1-7/8	2.100
1-1/4-11-1/2	1-1/4-11-1/2	9205x20x20	1-7/8	2.140
1-1/4-11-1/2	1-1/2-11-1/2	9205x20x24	2-1/8	2.187
1-1/2-11-1/2	1-1/4-11-1/2	9205x24x20	2-1/8	2.093
1-1/2-11-1/2	1-1/2-11-1/2	9205x24x24	2-1/8	2.270
2-11-1/2	2-11-1/2	9205x32x32	2-5/8	2.420

Steel Connectors

Swivel Adapters

Female 37° JIC Swivel to Male Pipe Adapter

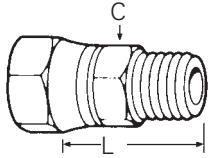

Tube O.D.	Male Pipe Thread	Part Number	Hex C	L
1/4	1/4	9100x4x4	9/16	1.130
5/16	1/4	9100x5x4	11/16	1.170
3/8	1/4	9100x6x4	11/16	1.290
3/8	3/8	9100x6x6	11/16	1.290
1/2	3/8	9100x8x6	7/8	1.430
1/2	1/2	9100x8x8	7/8	1.610
5/8	3/8	9100x10x6	1	1.400
5/8	1/2	9100x10x8	1	1.600
3/4	1/2	9100x12x8	1-1/8	1.650
3/4	3/4	9100x12x12	1-1/8	1.650
1	3/4	9100x16x12	1-3/8	1.750
1	1	9100x16x16	1-3/8	1.940
1-1/4	1 1/4	9100x20x20	1-7/8	2.090

Female Pipe Swivel to Female Pipe Straight

(Ref. SAE No. 140131)

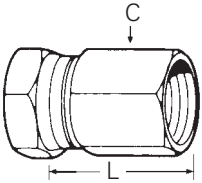

NPSM Swivel Nut	Female Pipe Thread	Part Number	Hex C	L
1/8-27	1/8-27	9255x2x2	9/16	.880
1/4-18	1/4-18	9255x4x4	11/16	1.170
1/4-18	3/8-18	9255x4x6	7/8	1.312
3/8-18	1/4-18	9255x6x4	11/16	1.250
3/8-18	3/8-18	9255x6x6	7/8	1.310
3/8-18	1/2-14	9255x6x8	1	1.453
1/2-14	3/8-18	9255x8x6	1	1.500
1/2-14	1/2-14	9255x8x8	1	1.500
3/4-14	3/4-14	9255x12x12	1-1/4	1.620
3/4-14	1-11-1/2	9255x12x16	1-1/2	1.906
1-11-1/2	1-11-1/2	9255x16x16	1-1/2	2.000
1-1/4-11-1/2	1-1/4-11-1/2	9255x20x20	1-7/8	2.000
1-1/2-11-1/2	1-1/2-11-1/2	9255x24x24	2-1/8	2.000
2-11-1/2	2-11-1/2	9255x32x32	2-5/8	2.120

Steel Connectors

Swivel Adapters

Male Straight Thread O-ring to Female Pipe Swivel

(Ref. SAE No. 140157)

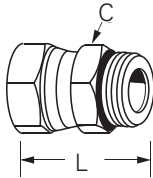

Straight Thread	NPSM Swivel Nut	Part Number	Hex C	L
7/16-20	1/4-18	9315x4x4	9/16	.970
7/16-20	3/8-18	9315x4x6	5/8	1.060
1/2-20	1/4-18	9315x5x4	5/8	1.109
9/16-18	1/4-18	9315x6x4	11/16	1.171
9/16-18	3/8-18	9315x6x6	11/16	1.090
9/16-18	1/2-14	9315x6x8	13/16	1.210
3/4-16	1/4-18	9315x8x4	7/8	1.234
3/4-16	3/8-18	9315x8x6	7/8	1.200
3/4-16	1/2-14	9315x8x8	7/8	1.260
3/4-16	3/4-14	9315x8x12	1	1.406
7/8-14	3/8-18	9315x10x6	1	1.375
7/8-14	1/2-14	9315x10x8	1	1.400
7/8-14	3/4-14	9315x10x12	1	1.546
1-1/16-12	1/2-14	9315x12x8	1-1/4	1.453
1-1/16-12	3/4-14	9315x12x12	1-1/4	1.600
1-3/16-12	3/4-14	9315x14x12	1-3/8	1.703
1-5/16-12	3/4-14	9315x16x12	1-1/2	1.734
1-5/16-12	1-11-1/2	9315x16x16	1-1/2	1.710
1-5/8-12	1-11-1/2	9315x20x16	1-7/8	1.828
1-5/8-12	1-1/4-11-1/2	9315x20x20	1-7/8	1.890
1-7/8-12	1-1/2-11-1/2	9315x24x24	2-1/8	1.953
2-1/2-12	2-11-1/2	9315x32x32	2-3/4	2.156

Replacement o-ring page L-64.

45° Swivel Elbow Female Pipe Swivel to Male Pipe

(Ref. SAE No. 140330)

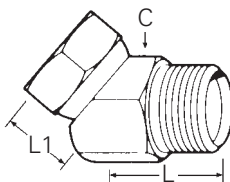

NPSM Swivel Nut	Male Pipe Thread	Part Number	Hex C	L	L1
1/8-27	1/8-27	9355x2x2	9/16	.620	.500
1/4-18	1/8-27	9355x4x2	11/16	.660	.470
1/4-18	1/4-18	9355x4x4	11/16	1.020	.670
1/4-18	3/8-18	9355x4x6	7/8	1.060	.620
1/4-18	1/2-14	9355x4x8	1	1.380	.730
3/8-18	1/4-18	9355x6x4	7/8	1.000	.750
3/8-18	3/8-18	9355x6x6	7/8	1.060	.750
3/8-18	1/2-14	9355x6x8	1	1.060	.750
1/2-14	3/8-18	9355x8x6	1	1.310	.910
1/2-14	1/2-14	9355x8x8	1	1.310	.910
1/2-14	3/4-14	9355x8x12	1-1/4	1.31	.910
3/4-14	1/2-14	9355x12x8	1-1/4	1.500	1.000
3/4-14	3/4-14	9355x12x12	1-1/4	1.500	1.000
3/4-14	1-11-1/2	9355x12x16	1-1/2	1.500	1.030
1-11-1/2	3/4-14	9355x16x12	1-1/2	1.310	1.050
1-11-1/2	1-11-1/2	9355x16x16	1-1/2	1.500	1.060
1-11-1/2	1-1/4-11-1/2	9355x16x20	1-7/8	1.800	1.300
1-1/4-11-1/2	1-1/4-11-1/2	9355x20x20	1-7/8	1.750	1.250
1-1/2-11-1/2	1-1/2-11-1/2	9355x24x24	2-1/8	1.940	1.380

Steel Connectors

Swivel Adapters

45° Swivel Elbow Female Pipe Swivel to Female Pipe

(Ref. SAE No. 140331)

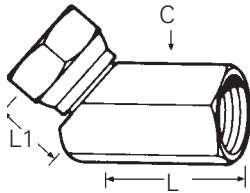

NPSM Swivel Nut	Fem. Pipe Thread	Part Number	Hex C	L	L1
1/8-27	1/8-27	9385x2x2	1/2	.620	.500
1/4-18	1/4-18	9385x4x4	11/16	1.020	.670
1/4-18	3/8-18	9385x4x6	7/8	1.062	.625
3/8-18	3/8-18	9385x6x6	7/8	1.060	.750
3/8-18	1/2-14	9385x6x8	1	1.310	.750
1/2-14	1/2-14	9385x8x8	1	1.310	1.270
3/4-14	3/4-14	9385x12x12	1-1/4	1.500	1.000
3/4-14	1-11-1/2	9385x12x16	1-1/2	1.500	1.031
1-11-1/2	1-11-1/2	9385x16x16	1-1/2	1.500	1.090
1-1/4-11-1/2	1-1/4-11-1/2	9385x20x20	1-7/8	1.790	1.250
1-1/2-11-1/2	1-1/2-11-1/2	9385x24x24	2-1/8	1.940	1.380
2-11-1/2	2-11-1/2	9385x32x32	2-5/8	2.000	1.500

45° Swivel Elbow Female 45° SAE to Male 45° SAE (Steel)

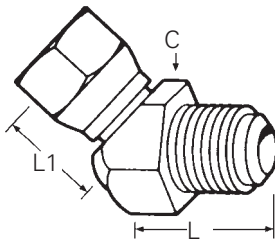

Tube O.D.	Part Number	Hex C	L	L1
3/8	9154x6x6	3/4	1.400	.429
1/2	9154x8x8	1	1.760	.598
5/8	9154x10x10	1-1/4	1.920	.645

45° Swivel Elbow Male Straight Thread O-ring to Female Pipe Swivel 45° Elbow

(Ref. SAE No. 140357)

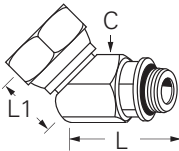

Straight Thread	NPSM Swivel Nut	Part Number	Hex C	L	L1
7/16-20	1/4-18	9365x4x4	11/16	1.062	.656
7/16-20	3/8-18	9365x4x6	7/8	1.062	.656
9/16-18	3/8-18	9365x6x6	7/8	1.062	.703
9/16-18	1/2-14	9365x6x8	1	1.062	.812
3/4-16	3/8-16	9365x8x6	1	1.125	.875
3/4-16	1/2-14	9365x8x8	1	1.125	.812
7/8-14	1/2-14	9365x10x8	1	1.500	.781
1-1/16-12	3/4-14	9365x12x12	1-1/4	1.500	1.046
1-5/16-12	1-11-1/2	9365x16x16	1-1/2	1.625	1.062
1-5/8-12	1-1/4-11 1/2	9365x20x20	1-7/8	1.281	1.171

Replacement o-ring page L-64.

Steel Connectors

Swivel Adapters

90° Elbow Female Pipe Swivel to Male Pipe

(Ref. SAE No. 140230)

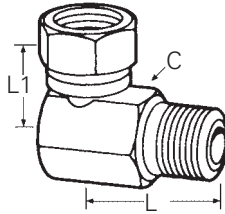

NPSM Swivel Nut	Male Pipe Thread	Part Number	Hex C	L	L1
1/8-27	1/8-27	9405x2x2	9/16	.940	.700
1/8-27	1/4-18	9405x2x4	11/16	1.190	.750
1/4-18	1/8-27	9405x4x2	11/16	1.060	.780
1/4-18	1/4-18	9405x4x4	11/16	1.190	.750
1/4-18	3/8-18	9405x4x6	11/16	1.500	.880
1/4-18	1/2-14	9405x4x8	1	1.810	.940
3/8-18	1/4-18	9405x6x4	13/16	1.500	.950
3/8-18	3/8-18	9405x6x6	7/8	1.500	.950
3/8-18	1/2-14	9405x6x8	1	1.810	1.010
3/8-18	3/4-14	9405x6x12	1-1/4	2.000	1.120
1/2-14	3/8-18	9405x8x6	1	1.000	1.560
1/2-14	1/2-14	9405x8x8	1	1.810	1.600
1/2-14	3/4-14	9405x8x12	1-1/4	2.000	1.130
1/2-14	1-11-1/2	9405x8x16	1-1/2	2.380	1.250
3/4-14	3/4-14	9405x12x12	1-1/4	2.000	1.260
3/4-14	1-11-1/2	9405x12x16	1-1/2	2.380	1.380
1-11-1/2	3/4-14	9405x16x12	1-1/2	2.190	1.390
1-11-1/2	1-11-1/2	9405x16x16	1-1/2	2.380	1.400
1-11-1/2	1-1/4-11-1/2	9405x16x20	1-7/8	1.590	2.630
1-1/4-11-1/2	1-11-1/2	9405x20x16	1-7/8	2.530	1.670
1-1/4-11-1/2	1-1/4-11-1/2	9405x20x20	1-7/8	2.630	1.670
1-1/4-11-1/2	1-1/2-11-1/2	9405x20x24	2-1/8	2.810	1.780
1-1/2-11-1/2	1-1/2-11-1/2	9405x24x24	2-1/8	2.810	1.750
2-11-1/2	2-11-1/2	9405x32x32	2-5/8	3.120	2.080

90° Elbow Long - Female Pipe Swivel to Male Pipe

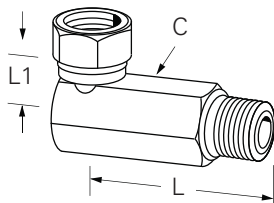

NPSM Swivel Nut	Male pipe Thread	Part Number	Hex C	L	L1
1/8-27	1/8-27	9405X2X2LL	9/16	1.90	.70
1/4-18	1/4-18	9405X4X4LL	11/16	2.57	.75
3/8-18	3/8-18	9405X6X6LL	13/16	3.16	.90
1/2-14	1/2-14	9405X8X8LL	1	3.67	1.02
3/4-14	3/4-14	9405X12X12LL	1-1/4	4.29	1.20
1-11-1/2	1-11-1/2	9405X16X16LL	1-1/2	5.06	1.46

Steel Connectors

Swivel Adapters

90° Elbow Female Pipe Swivel to Female Pipe

(Ref. SAE No. 140231)

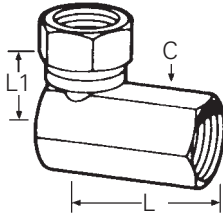

NPSM Swivel Nut	Fem. Pipe Thread	Part Number	Hex C	L	L1
1/8-27	1/8-27	9455x2x2	9/16	.640	.700
1/4-18	1/4-18	9455x4x4	11/16	.870	.750
1/4-18	3/8-18	9455x4x6	13/16	1.000	.810
1/4-18	1/2-14	9455x4x8	1	1.250	.940
3/8-18	1/4-18	9455x6x4	13/16	1.000	.900
3/8-18	3/8-18	9455x6x6	13/16	1.000	.900
3/8-18	1/2-14	9455x6x8	1	1.250	1.000
1/2-14	3/8-18	9455x8x6	1	1.220	1.020
1/2-14	1/2-14	9455x8x8	1	1.250	1.000
1/2-14	3/4-14	9455x8x12	1-1/4	1.440	1.120
3/4-14	1/2-14	9455x12x8	1-1/4	1.440	1.250
3/4-14	3/4-14	9455x12x12	1-1/4	1.490	1.200
3/4-14	1-11-1/2	9455x12x16	1-1/2	1.750	1.380
1-11-1/2	3/4-14	9455x16x12	1-1/2	1.750	1.380
1-11-1/2	1-11-1/2	9455x16x16	1-1/2	1.750	1.400
1-1/4-11-1/2	1-1/4-11-1/2	9455x20x20	1-7/8	1.850	1.630
1-1/2-11-1/2	1-1/2-11-1/2	9455x24x24	2-1/8	2.250	1.750
2-11-1/2	2-11 1/2	9455x32x32	2-5/8	2.500	2.310

90° Elbow 45° SAE Female Swivel to SAE 45° Male (Steel)

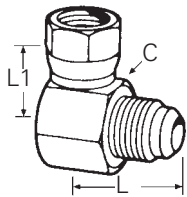

Tube O.D.	Part Number	Hex C	L	L1
3/8	9151x6x6	3/4	1.00	.69
1/2	9151x8x8	1	1.25	.99
5/8	9151x10x10	1-1/4	1.44	1.09

90° Elbow Male Straight Thread O-ring to Female Pipe Swivel

(Ref. SAE No. 140257)

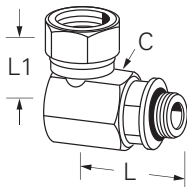

Straight Thread	NPSM Swivel Nut	Part Number	Hex C	L	L1
7/16-20	1/4-18	9515x4x4	11/16	1.090	.781
7/16-20	3/8-18	9515x4x6	7/8	1.100	.900
9/16-18	1/4-18	9515x6x4	11/16	1.187	.781
9/16-18	3/8-18	9515x6x6	7/8	1.296	.937
9/16-18	1/2-14	9515x6x8	1	1.484	1.000
3/4-16	3/8-18	9515x8x6	1	1.515	1.000
3/4-16	1/2-14	9515x8x8	1	1.515	1.000
3/4-16	3/4-14	9515x8x12	1-1/4	1.656	1.250
7/8-14	3/8-18	9515x10x6	1	1.640	1.000
7/8-14	1/2-14	9515x10x8	1	1.640	1.025
7/8-14	3/4-14	9515x10x12	1-1/4	1.781	1.250
1-1/16-12	1/2-14	9515x12x8	1-1/4	1.921	1.125
1-1/16-12	3/4-14	9515x12x12	1-1/4	1.921	1.250
1-3/16-12	3/4-14	9515x14x12	1-1/4	1.921	1.250
1-5/16-12	3/4-14	9515x16x12	1-1/2	2.093	1.375
1-5/16-12	1-11-1/2	9515x16x16	1-1/2	2.093	1.390
1-5/8-12	3/4-14	9515x20x12	1-7/8	2.484	1.562
1-5/8-12	1-1/4-11-1/2	9515x20x20	1-7/8	2.484	1.656
1-7/8-12	1-1/2-11-1/2	9515x24x24	2-1/8	2.609	1.734
2-1/2-12	2-11-12	9515x32x32	2-5/8	3.250	2.312

Replacement o-ring page L-64.

Steel Connectors

Swivel Adapters

90° Elbow Male Pipe Swivel to Male Pipe Rigid

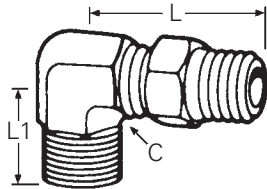

Male Pipe Swivel	Male Pipe Rigid	Part Number	Hex C	L	L1
1/4-18	1/4-18	9435x4x4	9/16	1.870	1.060
3/8-18	3/8-18	9435x6x6	3/4	1.950	1.220
1/2-14	1/2-14	9435x8x8	7/8	2.250	1.470

Not for use with liquids over 212°F.

Female Pipe Swivel Tee

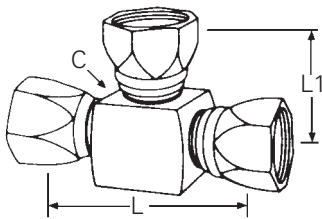

NPSM Swivel	Part Number	Hex C	L	L1
1/8-27	9705x2x2x2	1/2	1.406	.660
1/4-18	9705x4x4x4	11/16	1.720	.780
3/8-18	9705x6x6x6	7/8	1.720	.940
1/2-14	9705x8x8x8	1	2.200	1.000
3/4-14	9705x12x12x12	1-1/4	2.780	1.250
1-11-1/2	9705x16x16x16	1-1/2	3.060	1.390
1 1/4-11 1/2	9705x20x20x20	1-7/8	3.320	1.660

Female Pipe Swivel to Male Pipe Branch Tee

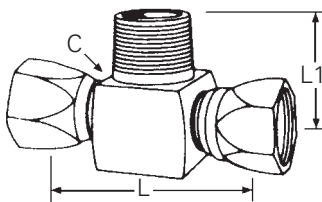

Swivel Thread	NPSM Male Pipe	Part Number	Hex C	L	L1
1/8-27	1/8-27	9406x2x2x2	9/16	1.380	.940
1/4-18	1/4-18	9406x4x4x4	11/16	1.500	1.190
1/4-18	3/8-18	9406x4x4x6	7/8	1.744	1.500
1/4-18	1/2-14	9406x4x4x8	7/8	1.880	1.500
3/8-18	3/8-18	9406x6x6x6	1	1.874	1.750
3/8-18	1/2-14	9406x6x6x8	1	2.000	1.750
1/2-14	1/2-14	9406x8x8x8	1	2.000	1.810
1/2-14	3/4-14	9406x8x8x12	1-1/4	2.250	2.000
3/4-14	3/4-14	9406x12	1-1/4	2.375	2.000
1-11-1/2	1-11-1/2	9406x16x16x16	1-1/2	2.880	2.380

Female Pipe Swivel to Female Pipe Branch Tee

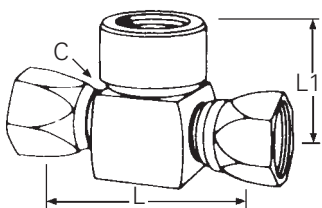

NPSM Swivel Thread	Female Pipe	Part Number	Hex C	L	L1
1/8-27	1/8-27	9456x2x2x2	1/2	1.312	.687
1/4-18	1/4-18	9456x4x4x4	11/16	1.625	.937
1/4-18	3/8-18	9456x4x4x6	7/8	1.744	1.062
3/8-18	3/8-18	9456x6x6x6	7/8	1.874	.937
3/8-18	1/2-14	9456x6x6x8	1	2.000	1.250
1/2-14	1/2-14	9456x8x8x8	1	2.000	1.250
3/4-14	3/4-14	9456x12x12x12	1-1/4	2.500	1.437



Ordering Information

Use Part number.

Typical Application

High pressure, hydraulic, pneumatic and chemical processing.

Pressure*

Working pressure to 6000 PSI (1-1/4" and 1-1/2"; maximum 4000 PSI).

Sealing Method

O-ring.

Vibration Rating

Excellent resistance.

Material

Generally 12L14 steel

Plating

Eaton Carbon Steel Connectors are zinc-plated, with clear trivalent chromatic.

Used With

Steel tubing (tubing for brazing must be non-coated).

Advantages

Tubing is brazed for permanent leakproof connection.

Conformance

An exclusive item with Eaton, meets SAE J1453.

Label Set FS-2400

Tube Preparation and Cleaning

Figure 1

1. Establish the length of tubing required allowing 1/16 cut-off factor for each connection.
2. Cut the tubing to proper length keeping ends reasonably square. A fine tooth hacksaw or cutoff saw works well for this job. The use of a tubing cutter is not recommended due to possible collapse of the tube end, retarding the capillary action required for proper braze flow.
3. Clean the end of the tube with an alkaline cleaner to remove all traces of oil or grease. Deburr the end of the tube with a file and polish the outside of the tube down to bare metal with clean emery paper. Oil and grease residue must be removed first to avoid working the oily residue into the tube surface.
4. After polishing, wipe off any metal particles using a clean solvent if necessary. Avoid touching the tube end after final cleaning as this may leave greasy spots which will braze poorly. Clean the tailpiece with an alkaline cleaner.

Note:

See page N-52 for hydraulic o-ring assortment.

* Pressure ratings shown are the pressure ratings for the fitting and are not necessarily the pressure rating applicable in an assembly with hydraulic hose. The applicable pressure rating for an assembly with hydraulic hose is the lower value specified for the hose and the fitting.

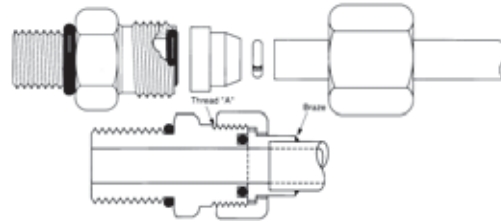

Tube O.D.	1/4	3/8	1/2	5/8	3/4
Thread	9/16-18	11/16-16	13/16-16	1-14	1 3/16-12

Tube O.D.	7/8	1	1-1/4	1-1/2
Thread	1 3/16-12	1 7/16-12	1 11/16-12	2-12

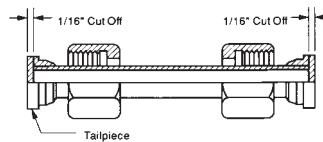

Note:

Subtract 1/16" from tube length for each connection.



Fluxing and Brazing Cleanup

Flux may be cleaned up using hot water and a wire brush, using care not to scratch the tailpiece sealing surface.

1. Assemble proper size braze ring into counterbore of tailpiece. The correct size brazing will be slightly smaller than the inside diameter of the counterbore.



2. Clamp the tube securely in a vise, slide nut on tube, with threads pointing outward. Coat the tube end with flux and several inches of the tube outside diameter.



3. Coat the tailpiece liberally with flux including the counterbore and braze ring.



4. In a well-ventilated area, apply heat uniformly to the tailpiece and the tube end. Watch the flux. The flux becomes completely clear when it is close to the proper brazing temperature. When ring melts, the tailpiece will settle down onto the end.



Note: General working knowledge of acetylene torch brazing techniques is recommended.

5. Remove tube assembly from vise and check braze joint.



6. The braze alloy will flow down through the joint and should form a continuous fillet at the tube to tailpiece joint.



Note: Do not overheat. Excessive heat will only cause scaling and charred flux and make the parts more difficult to clean up.

Torque Requirements

Tube O.D.	1/4	3/8	1/2	5/8	3/4	1	1-1/4	1-1/2
Torque Ft-Lb.	10-12	18-20	32-35	46-50	65-70	92	125	150
For-Seal® SW. Nut						100	140	165
Torque Ft-Lb O-ring	14-16	24-26	50-60	72-80	125	200	210	270
Boss Straight Thread					135	220	280	360
O-ring Locknut Torque								

Thread Chart

Rated pressures are for low surge, static type applications.

Tube O.D.	1/4	3/8	1/2	5/8	3/4	1	1-1/4	1-1/2
For-Seal Thread	9/16-18	11/16-16	13/16-16	1-14	1-3/16-12	1-7/16-12	1-11/16-12	2-12
Maximum PSI	6,000	6,000	6,000	6,000	6,000	6,000	4,000	4,000
Adjustable Hose Ends PSI	6,000	6,000	6,000	6,000	6,000	5,000	4,000	3,000



Tailpiece Silver Braze

(Ref. SAE No. 520115)

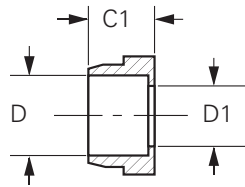
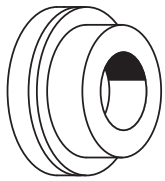

Tube O.D.	Part Number	D	D1	C1
1/4	4165x4	.256	.172	.374
3/8	4165x6	.381	.264	.374
1/2	4165x8	.506	.378	.374
3/4	4165x12	.757	.609	.551
1	4165x16	1.007	.811	.610
1-1/4	4165x20	1.257	1.024	.610
1-1/2	4165x24	1.507	1.260	.610

Oil Dipped

FOR-SEAL Braze Adapter

(Ref. SAE No. 520104)

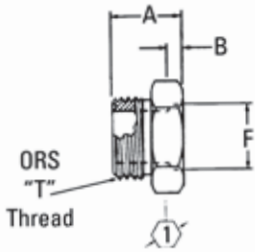

Part No. FF1851T (Size)*

Dash Size	Tube O.D. mm	inches	Thread T1	A mm	inches	B mm	inches	F mm	inches	
1212S	19,0	.75	1 ³ / ₁₆ -12	30,7	1.21	9,6	.38	19,0	.75	1.25

*Eaton counterbores are dimensioned for sizes or emerged tubing. If tubing is used as received, contact Eaton for appropriate part number.

Adapters, Tube Fittings & Connectors

FOR-SEAL Cadmium Free Braze Ring

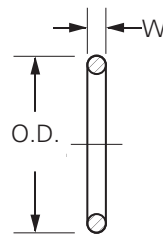

Tube O.D.	Part Number	Wire Dia.	O.D.
1/4	4640x4	.046	.250
3/8	4640x6	.046	.375
1/2	4640x8	.046	.500
5/8	4640x10	.046	.625
3/4	4640x12	.062	.750
1	4640x16	.062	1.000
1-1/4	4640x20	.062	1.250
1-1/2	4640x24	.062	1.500

Bulkhead Nut

(Ref. SAE No. 520118)

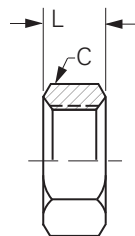

Tube O.D. A	Part Number	Hex C	L
3/8	4924x6	1	.31
1/2	4924x8	1-1/8	.35
3/4	4924x12	1-1/2	.41
1	4924x16	1-3/4	.41
1-1/4	4924x20	2	.41
1-1/2	4924x24	2-3/8	.41

Nut

(Ref. SAE No. 520110)

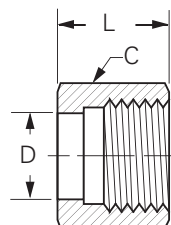
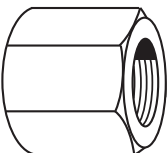

Tube O.D.	Part Number	Hex C	D	L
1/4	4105x4	11/16	.412	.58
3/8	4105x6	13/16	.531	.67
1/2	4105x8	15/16	.652	.83
5/8	4105x10	1-1/8	.829	.93
3/4	4105x12	1-3/8	.950	1.02
1	4105x16	1-5/8	1.144	1.10
1-1/4	4105x20	1-7/8	1.415	1.10
1-1/2	4105x24	2-1/4	1.727	1.10

Cap

(Ref. SAE No. 520112)

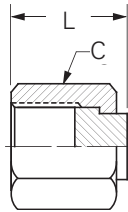
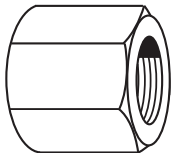

Tube O.D.	Part Number	Hex C	L
1/4	4129x4	11/16	.67
3/8	4129x6	13/16	.75
1/2	4129x8	15/16	.90
5/8	4129x10	1-1/8	1.00
3/4	4129x12	1-3/8	1.10
1	4129x16	1-5/8	1.17
1-1/4	4129x20	1-7/8	1.17
1-1/2	4129x24	2-1/4	1.17

Plug

(Ref. SAE No. 520109)

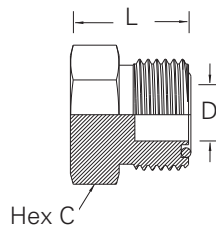
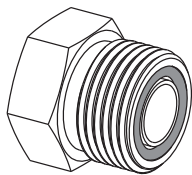

Tube O.D.	Part Number	Hex C	D	L
1/4	4229x4	5/8	.172	.659
3/8	4229x6	3/4	.264	.751
1/2	4229x8	7/8	.378	.854
5/8	4229x10	1-1/16	.484	1.020
3/4	4229x12	1-1/4	.609	1.080
1	4229x16	1-1/2	.811	1.100
1-1/4	4229x20	1-3/4	1.024	1.100
1-1/2	4229x24	2-1/8	1.260	1.100

FOR-SEAL O-ring included.

Union

(Ref. SAE No. 520101)

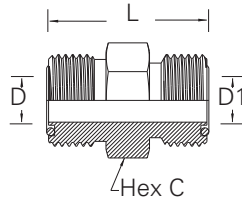
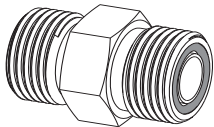

Tube O.D.	Tube O.D.	Part Number	Hex C	D	D1	L
1/4	1/4	4305x4	5/8	.172	.172	1.08
3/8	1/4	4305x6x4	3/4	.264	.172	1.17
3/8	3/8	4305x6	3/4	.264	.264	1.22
1/2	3/8	4305x8x6	7/8	.378	.264	1.33
1/2	1/2	4305x8	7/8	.378	.378	1.39
5/8	1/2	4305x10x8	1-1/16	.484	.378	1.57
5/8	5/8	4305x10	1-1/16	.484	.484	1.68
3/4	1/2	4305x12x8	1-1/4	.609	.378	1.69
3/4	5/8	4305x12x10	1-1/4	.609	.484	1.80
3/4	3/4	4305x12	1-1/4	.609	.609	1.86
1	3/4	4305x16x12	1-1/2	.812	.609	1.92
1	1	4305x16	1-1/2	.811	.811	1.94
1-1/4	1-1/4	4305x20	1-3/4	1.024	1.024	2.02
1-1/2	1-1/2	4305x24	2-1/8	1.260	1.260	2.09

Bulkhead Union

(Ref. SAE No. 520601)

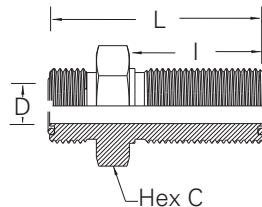
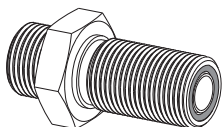

Tube O.D.	Part Number	Hex C	D	I	L
3/8	4325x6	1	.264	1.34	2.09
1/2	4325x8	1-1/8	.378	1.44	2.30
3/4	4325x12	1-1/2	.609	1.64	2.72
1	4325x16	1-3/4	.812	1.66	2.76

For bulkhead nut, see page L-26.



**FOR-SEAL
Reducer Adapter**

(Ref. SAE No. 520123)

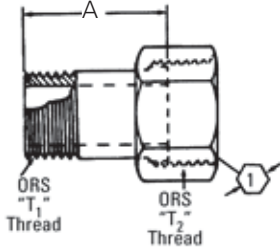

Part No. FF2281T (Size)

Dash Size	Tube O.D.		Thread T1	Thread T2	A		①
	mm	inches			mm	inches	
0406S	9,6	.38	9/16 - 18	11/16 - 16	19,5	.77	.81
0408S	12,7	.50	9/16 - 18	13/16 - 16	21,8	.86	.94
0608S	12,7	.50	11/16 - 16	13/16 - 16	22,3	.88	.94
0612S	19,0	.75	11/16 - 16	13/16 - 12	26,2	1.03	1.38
0812S	19,0	.75	13/16 - 16	13/16 - 12	27,9	1.10	1.38

**Straight Thread
O-ring Connector**

(Ref. SAE No. 520120)

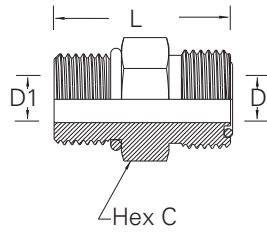
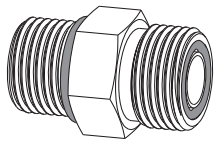

Male Tube O.D.	Male Port Size	Part Number	Hex C	D	D1	L
1/4	1/4	4315x4	5/8	.172	.172	1.133
1/4	3/8	4315x4x6	11/16	.172	.172	1.202
3/8	1/4	4315x6x4	3/4	.264	.172	1.343
3/8	3/8	4315x6	3/4	.264	.264	1.252
3/8	1/2	4315x6x8	7/8	.378	.264	1.378
3/8	5/8	4315x6x10	1-1/16	.264	.484	1.530
1/2	3/8	4315x8x6	7/8	.378	.264	1.472
1/2	1/2	4315x8	7/8	.378	.378	1.441
1/2	5/8	4315x8x10	1	.378	.484	1.590
1/2	3/4	4315x8x12	1-1/4	.378	.609	1.748
5/8	5/8	4315x10	1-1/16	.484	.484	1.700
3/4	3/4	4315x12	1-1/4	.609	.609	1.918
3/4	1	4315x12x16	1-1/2	.609	.609	1.960
1	3/4	4315x16x12	1-1/2	.812	.609	2.138
1	1	4315x16	1-1/2	.811	.811	1.978
1	1-1/4	4315x16x20	1-7/8	.812	1.709	2.058
1-1/4	1	4315x20x16	1-3/4	1.024	.843	2.278
1-1/4	1-1/4	4315x20	1-7/8	1.024	1.024	2.058
1-1/2	1-1/2	4315x24	2-1/8	1.260	1.260	2.125

**Straight Thread O-ring
Extended**

(Ref. SAE No. 520122)

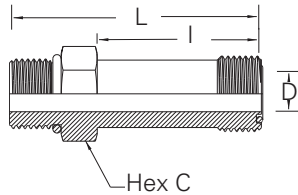
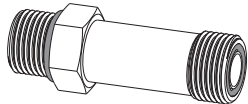

Male Tube O.D.	Male Port Size	Part Number	Hex C	D	I	L
3/8	3/8	4316x6	3/4	.264	1.46	2.27
1/2	1/2	4316x8	7/8	.378	1.75	2.67
3/4	3/4	4316x12	1-1/4	.609	2.52	3.76
1	1	4316x16	1-1/2	.811	2.87	4.14

For replacement Straight Thread o-ring, see page L-64.

Male 37° to Female FOR-SEAL

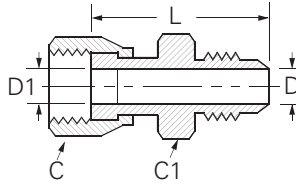
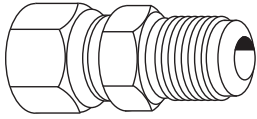

Female Tube O.D.	Male Tube Size	Part Number	Hex C	Hex C1	D	L
1/4	1/4	4213x4	11/16	5/8	.172	1.50
3/8	3/8	4213x6	13/16	3/4	.297	1.62
1/2	1/2	4213x8	15/16	7/8	.360	2.03
5/8	5/8	4213x10	1-1/8	1-1/16	.484	2.25
3/4	3/4	4213x12	1-3/8	1-1/4	.550	2.44
1	1	4213x16	1-5/8	1-1/2	.780	2.82

Male FOR-SEAL Male Pipe Adapter

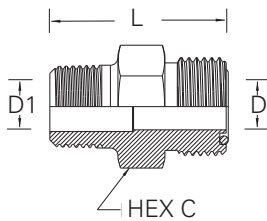
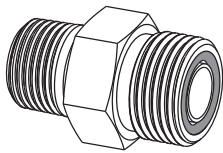

Tube O.D.	Male Pipe Size	Part Number	Hex C	D	D1	L
3/8	3/8	4205x6x6	3/4	.264	.406	1.30
1/2	3/8	4205x8	7/8	.378	.406	1.45
1/2	1/2	4205x8x8	7/8	.378	.484	1.64
5/8	1/2	4205x10	1-1/16	.484	.531	1.82
3/4	1/2	4205x12x8	1-1/4	.406	.484	1.87
3/4	3/4	4205x12	1-1/4	.609	.719	1.94
3/4	1	4205x12x16	1-3/8	.609	.938	1.87
1	1	4205x16	1-1/2	.811	.938	2.19
1-1/4	1-1/4	4205x20	1-3/4	1.024	1.250	2.30

45° Male Elbow

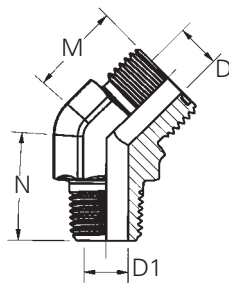

Male Tube O.D.	Male Pipe Thread	Part Number	D	D1	M	N	Across Flats
1/4	1/8	4355x4	.172	.188	.63	.64	9/16
3/8	1/4	4355x6	.264	.281	.74	.86	3/4
1/2	3/8	4355x8	.378	.406	.80	.95	7/8
3/4	3/4	4355x12	.609	.719	1.02	1.20	1-5/16

Straight Thread O-ring Connector 45° Elbow

(Ref. SAE No. 520320)

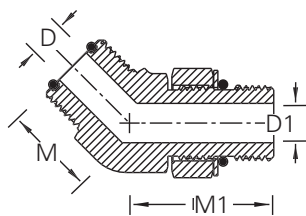
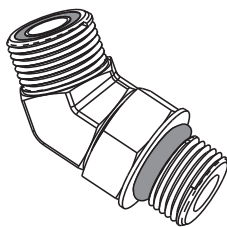

Male Tube O.D.	Male Port Size	Part Number	D	D1	M	M1	Across Flats
1/4	1/4	4365x4	.172	.172	.63	1.18	9/16
1/4	3/8	4365x4x6	.172	.264	.68	1.30	3/4
3/8	1/4	4365x6x4	.264	.172	.74	1.22	3/4
3/8	3/8	4365x6	.264	.264	.74	1.30	3/4
3/8	1/2	4365x6x8	.264	.390	.74	1.43	3/4
1/2	3/8	4365x8x6	.378	.264	.80	1.27	3/4
1/2	1/2	4365x8	.378	.390	.80	1.43	3/4
1/2	5/8	4365x8x10	.378	.484	.82	1.76	1-1/16
5/8	1/2	4365x10x8	.484	.390	.92	1.59	1-1/16
5/8	5/8	4365x10	.484	.484	.92	1.76	1-1/16
5/8	3/4	4365x10x12	.484	.609	.94	1.97	1-3/16
3/4	5/8	4365x12x10	.609	.484	1.02	1.81	1-3/16
3/4	3/4	4365x12	.609	.609	1.02	1.97	1-5/16
3/4	1	4365x12x16	.609	.811	1.16	2.06	1-5/16
1	3/4	4365x16x12	.811	.609	1.12	2.03	1-7/16
1	1	4365x16	.812	.811	1.18	2.06	1-1/2
1	1-1/4	4365x16x20	.811	1.081	1.26	2.11	1-5/8

For replacement straight thread o-ring, see page L-64.



45° Bulkhead Elbow

(Ref. SAE No. 520201)

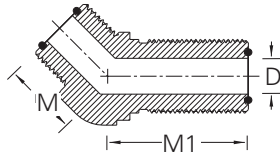
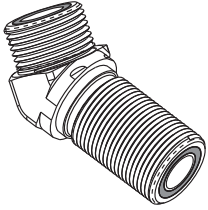

Male Tube O.D.	Part Number	D	M	M1	Across Flats
1/4	4375x4	.172	.63	1.73	9/16
3/8	4375x6	.264	.74	1.91	3/4
1/2	4375x8	.378	.80	2.01	3/4

For Bulkhead Nut, see page L-26.

Union 90° Elbow

(Ref. SAE No. 520201)

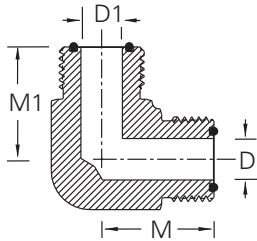
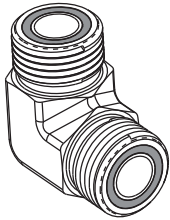

Male Tube O.D.	Part Number	D	M	Across Flats
1/4	4505x4	.172	.85	9/16
3/8	4505x6	.264	.98	3/4
1/2	4505x8	.378	1.10	3/4
5/8	4505x10	.484	1.31	1-1/16
3/4	4505x12	.609	1.47	1-3/16
1	4505x16	.811	1.64	1-7/16
1-1/4	4505x20	1.045	1.76	1-5/8
1-1/2	4505x24	1.312	1.92	1-7/8

90° Male Elbow

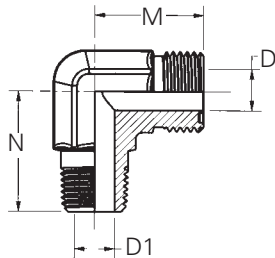

Male Tube O.D.	Pipe Size	Part Number	D	D1	M	N	Across Flats
1/4	1/8	4405x4	.172	.188	.85	.78	9/16
3/8	1/4	4405x6	.264	.281	.80	1.09	3/4
1/2	3/8	4405x8	.378	.406	1.10	1.22	3/4
5/8	1/2	4405x10	.484	.531	1.31	1.47	1-1/16
3/4	3/4	4405x12	.609	.719	1.47	1.59	1-5/16
1	1	4405x16	.812	.939	1.64	1.97	1-5/8

Bulkhead Union 90° Elbow

(Ref. SAE No. 520701)

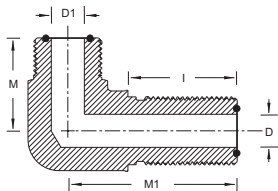
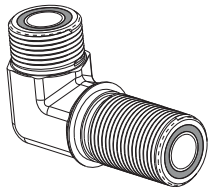

Male Tube O.D.	Port Size	Part Number	D	D1	M	M1	I	Across Flats
3/8	3/8	4525x6	.264	.264	1.02	2.05	1.34	3/4
1/2	1/2	4525x8	.378	.378	1.14	2.18	1.44	7/8
3/4	3/4	4525x12	.609	.609	1.52	2.64	1.60	1-5/16
1	1	4525x16	.811	.811	1.67	2.80	1.64	1-5/8

For Bulkhead Nut, see page L-26.

90° Swivel Elbow

(Ref. SAE No. 520221)

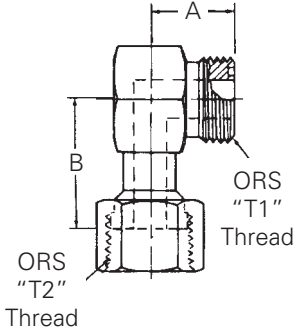

Male Tube O.D.	Female Tube O.D.	Part Number	Hex C	D	D1	M	M1	Across Flats
1/4	1/4	4506x4	11/16	.172	.165	.85	1.04	9/16
3/8	3/8	4506x6	13/16	.264	.264	.98	1.19	3/4
1/2	1/2	4506x8	15/16	.378	.358	1.10	1.46	3/4
5/8	5/8	4506x10	1-1/8	.484	.453	1.31	1.59	1-1/16
3/4	3/4	4506x12	1-3/8	.609	.547	1.47	1.79	1-5/16
1	1	4506x16	1-5/8	.811	.783	1.64	2.10	1-7/16

Straight Thread O-ring 90° Elbow

(Ref. SAE No. 520220)

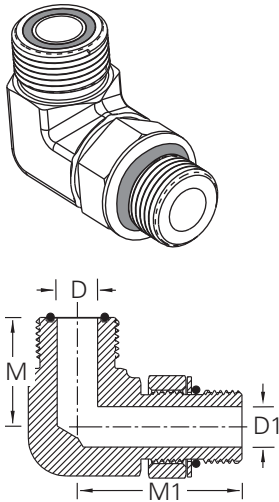

Male Tube O.D.	Port Size	Part Number	D	D1	M	M1	Across Flats
1/4	1/4	4515x4	.172	.172	.85	1.29	9/16
1/4	3/8	4515x4x6	.172	.264	.92	1.45	3/4
1/4	1/2	4515x4x8	.172	.390	.97	1.60	3/4
3/8	1/4	4515x6x4	.264	.172	.98	1.37	3/4
3/8	5/16	4515x6x5	.264	.234	.98	1.37	3/4
3/8	3/8	4515x6	.264	.264	.98	1.45	3/4
3/8	1/2	4515x6x8	.264	.390	1.04	1.60	3/4
3/8	5/8	4515x6x10	.264	.484	1.15	1.97	3/4
3/8	3/4	4515x6x12	.264	.609	1.25	2.17	1-3/16
1/2	5/8	4515x8x10	.378	.484	1.21	1.97	1-1/16
1/2	3/4	4515x8x12	.378	.484	1.32	2.17	1-1/16
1/2	3/8	4515x8x6	.378	.264	1.10	1.44	3/4
1/2	1/2	4515x8	.378	.390	1.10	1.60	3/4
5/8	5/8	4515x10	.484	.484	1.31	1.97	1-1/16
5/8	3/4	4515x10x12	.484	.609	1.41	2.17	1-3/16
5/8	1/2	4515x10x8	.484	.390	1.31	1.80	1-1/16
3/4	5/8	4515x12x10	.609	.484	1.47	2.01	1-5/16
3/4	3/4	4515x12	.609	.609	1.47	2.17	1-5/16
3/4	1	4515x12x16	.609	.811	1.62	2.35	1-5/16
3/4	1/2	4515x12x8	.609	.390	1.47	1.84	1-3/16
1	3/4	4515x16x12	.811	.609	1.64	2.32	1-5/8
1	1	4515x16	.811	.811	1.64	2.35	1-5/8
1	1-1/4	4515x16x20	.811	1.081	1.76	2.45	1-5/8
1-1/4	1	4515x20x16	1.024	.811	1.76	2.42	1-5/8
1-1/4	1-1/4	4515x20	1.024	1.081	1.76	2.45	1-7/8
1-1/2	1-1/2	4515x24	1.312	1.312	1.92	2.59	1-7/8

For replacement straight thread o-ring, see page L-64.



**Straight Thread O-ring
90° Elbow - Long**

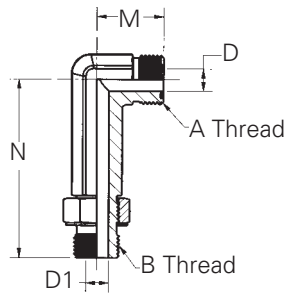

Male Tube O.D.	Male Port Size	Part Number	D	D1	M	N	Across Flats
1/2	1/2	4515x8L	.378	.398	1.10	2.95	3/4

90° Straight Thread Swivel

(Ref. SAE No. 520281)

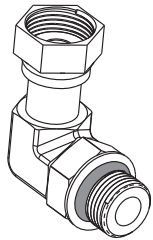

Female Tube O.D.	Port Size	Part Number	D	D1	M	M1	Hex C	Across Flats
1/4	1/4	4535x4	.165	.180	1.04	1.29	11/16	9/16
3/8	3/8	4535x6	.264	.300	1.15	1.45	13/16	3/4
1/2	1/2	4535x8	.258	.398	1.49	1.60	15/16	7/8
5/8	5/8	4535x10	.453	.498	1.62	1.97	1-1/8	1-1/16
3/4	3/4	4535x12	.547	.616	1.82	2.17	1-3/8	1-3/8
1	1	4535x16	.783	.852	2.10	2.35	1-5/8	1-5/8

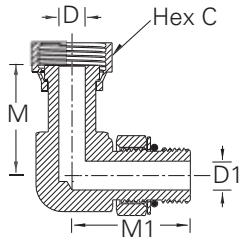

Union Tee

(Ref. SAE No. 520401)

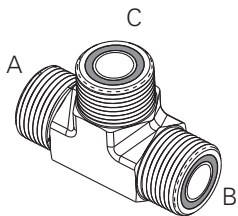

Male Tube O.D. A	Male Tube O.D. B	Male Tube O.D. C	Part Number	D	D1	M	M1	M2	Across Flats
1/4	1/4	1/4	4705x4	.172	.172	.85	.85	.85	9/16
3/8	3/8	3/8	4705x6	.264	.264	.98	.98	.98	3/4
3/8	3/8	1/2	4705x6x6x8	.264	.378	1.04	1.04	1.10	3/4
1/2	3/8	1/2	4705x8x6x8	.264	.378	.98	.98	1.10	3/4
1/2	1/2	1/2	4705x8	.378	.378	1.10	1.10	1.10	3/4
5/8	5/8	5/8	4705x10	.484	.484	1.31	1.31	1.31	1-1/16
3/4	3/4	3/4	4705x12	.609	.609	1.47	1.47	1.47	1-3/16

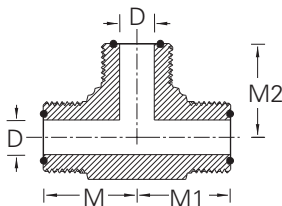

Straight Thread Branch Tee

(Ref. SAE No. 520429)

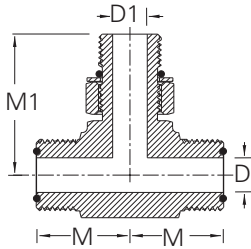
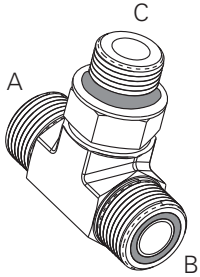

Tube O.D.	Port Size	Part Number	D	D1	M	M1	Across Flats
1/4	1/4	4715x4	.172	.172	.85	1.29	9/16
3/8	3/8	4715x6	.264	.264	.98	1.45	3/4
1/2	3/8	4715x8x6	.378	.264	1.10	1.44	3/4
1/2	1/2	4715x8	.378	.390	1.10	1.60	3/4
5/8	5/8	4715x10	.484	.484	1.31	1.97	1-1/16
3/4	3/4	4715x12	.609	.609	1.47	2.17	1-3/16
3/4	1	4715x12x16	.609	.812	1.62	2.35	1-5/8
1	1	4715x16	.811	.845	1.64	2.35	1-5/8

For replacement straight thread o-ring, see page L-64.

Female Branch Tee

(Ref. SAE No. 520433)

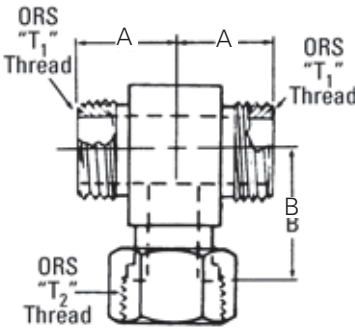

Part Number	Tube OD	Thread T1	Thread T2	A	B
4707x6	3/8	11/16-16	11/16-16	0.98	1.15
4707x8	1/2	13/16-16	13/16-16	1.10	1.49

Female Run Tee

(Ref. SAE No. 520432)

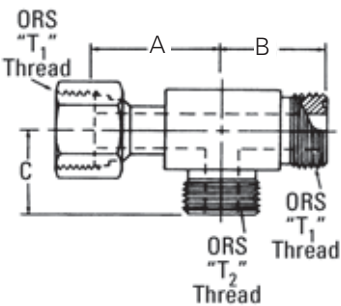

Part Number	Tube OD	Thread T1	Thread T2	A	B	C
4706x4	1/4	9/16-18	9/16-18	1.04	.85	.85
4706x6	3/8	11/16-16	11/16-16	1.15	.98	.98
4706x8	1/2	13/16-16	13/16-16	1.49	1.10	1.10
4706x10	5/8	1-14	1-14	1.62	1.31	1.31
4706x12	3/4	1 3/16-12	1 3/16-12	1.82	1.47	1.47
4706x16	1	1 7/16-12	1 7/16-12	2.10	1.64	1.64
4706x20	1-1/4	1 11/16-12	1 11/16-12	2.29	1.76	1.76



Straight Thread Run Tee

(Ref. SAE No. 520428)

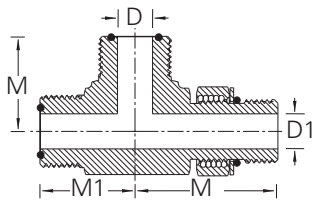
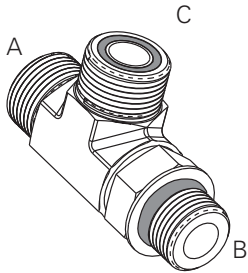

Male Tube O.D. A	Male Tube O.D. B	Male Tube O.D. C	Part Number	D	D1	M	M1	Across Flats
1/4	1/4	1/4	4716x4	.172	.172	.85	1.29	9/16
3/8	3/8	3/8	4716x6	.264	.264	.98	1.45	3/4
1/2	1/2	1/2	4716x8	.378	.391	1.10	1.60	7/8
3/4	3/4	3/4	4716x12	.609	.609	1.47	2.17	1-3/16

For replacement straight thread o-ring, see page L-64.

Bulkhead Run Tee

(Ref. SAE No. 520958)

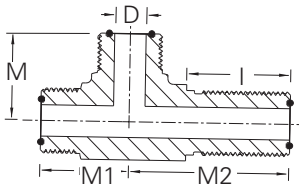
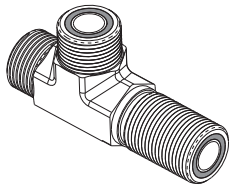

Tube O.D.	Part Number	D	I	M	M1	M2	Across Flats
3/8	4726x6	.264	1.34	1.02	1.02	2.05	3/4
1/2	4726x8	.378	1.44	1.14	1.14	2.18	3/4
3/4	4726x12	.609	1.64	1.52	1.52	2.65	1-3/16
1	4726x16	.812	1.66	1.67	1.67	2.80	1-7/16

For Bulkhead Nut, see page L-26.

O-ring, FOR-SEAL

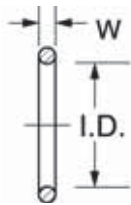

Material:
Buna N, 90 Durometer

Temperature:
-40°F to +250°F
(-40°C to +121°C)

Standard o-ring complies with SAE specification SAE J515 Type CH

Tube O.D.	Part Number	W	I.D.
1/4	4629x4	.070 ± .005	.301 ± .005
3/8	4629x6	.070 ± .005	.364 ± .005
1/2	4629x8	.070 ± .005	.489 ± .005
5/8	4629x10	.070 ± .005	.614 ± .005
3/4	4629x12	.070 ± .005	.739 ± .005
1	4629x16	.070 ± .006	.926 ± .006
1-1/4	4629x20	.070 ± .006	1.176 ± .006
1-1/2	4629x24	.070 ± .010	1.489 ± .010

JIC 37° - Flare-Twin®

Tube O.D.	1/8"	3/16"	1/4"	5/16"	3/8"	1/2"	5/8"	3/4"	7/8"	1"	1-1/4"	1-1/2"	2"
Thread Size-B	5/16-24	3/8-24	7/16-20	1/2-20	9/16-18	3/4-16	7/8-14	1-1/16-12	1-3/16-12	1-5/16-12	1-5/8-12	1-7/8-12	2-1/2-12

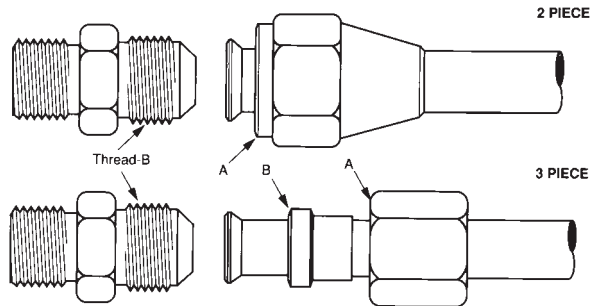

Typical Application

Hydraulic, instrumentation, and chemical processing systems.

Pressure

Refer to the pressure charts above. The maximum working pressure of an adapter is the lower working pressure of the end size. Ex: C3069x8x6, 8 = 4000 psi and 6 = 5000 psi.

Maximum working pressure is 4000 psi.

Vibration

Good resistance. Vibration resistance decreases with increase in tube size.

Use two-piece design when greater vibration resistance is required.

Temperature Range

-65°F to +400°F (-53°C to +204°C) at maximum operating pressures.

Material

Carbon Steel - AISI/SAE 12L14

Stainless Steel - Type 316

Plating - Trivalent Zinc Plated

Used With

Copper, brass, steel, aluminum, and other tubing that can be flared. See pages A-12-14 for material compatibility.

Advantages

Zinc Plate. Choice of two- or three-piece design. Broad selection of styles and sizes. Interchangeable with all sources.

Conformance

Meets specifications and standards of ASA, ASME, and SAE.

How to Order

To order a three-piece assembly, prefix the catalog number with a "3". Example: To order a male connector C5205x4 with nut and sleeve assembled, order C35205x4. To order a two-piece assembly, order nut and body separately.

Example: Order male connector C5205x4 and twopiece style nut C5115x4. Bodies, nuts and sleeves can be ordered separately by catalog number. Stainless steel bodies, nuts and sleeves are ordered separately by catalog number.

To order Weathercote finish (black phosphate coating) use "W" prefix in place of "C". Example: W5205x4 (special order only).

To order with pipe sealants (Seal-AThread), add a "Z" suffix to the catalog number. Example: C5205x4Z (special order only).

NOTE

Refer to current price list for availability of cataloged items. Quotations and delivery of non-stock items supplied on request. Configurations and dimensions subject to change without notice.

Additional information can be found in SAE J514.

Weatherhead fittings with a "C" prefix are made from a forged construction.

Label Set: FS-200 (adhesive)

Assembly Instructions

1. Cut tubing to desired length. Make sure all burrs are removed and ends are cut square.
2. Slide nut on tube. Threaded end of nut "A" must face toward fitting body. (See the drawing.)
3. Slide sleeve on tube (3-piece assembly only). Collar end "B" of sleeve must face toward fitting body. (See drawing.)
4. Flare end of tubing with 37° flaring tool.
5. Check flare diameter. For dimensional data on 37° flares, see page L-36.
6. Examine flare for excessive thinout.
7. On thin wall, welded or brazed tubing, use double flare to prevent pinch-off and cracked flares.
8. Lubricate threads and assemble to fitting body. Nut should be turned hand tight.
9. Tighten assembly until finger tight, then until a sharp torque rise is encountered. From that point, apply one-sixth turn with a wrench.

Dimensional Data

Dimensional Data Two-Piece Assemblies

Dimensional Data Three-Piece Assemblies

Note: H & H1 are dimensions of fittings assembled to hand-tight condition.

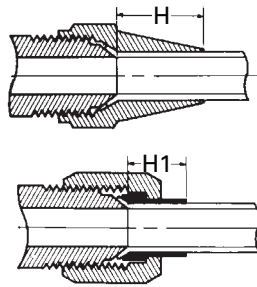

Tube O.D.	H	H1
1/8	—	.31
3/16	—	.38
1/4	.59	.36
5/16	.66	.41
3/8	.69	.47
1/2	.81	.50
5/8	.94	.64
3/4	—	.61
7/8	—	.69
1	—	.75
1-1/4	—	.73
1-1/2	—	1.05
2	—	1.08

Straight Thread O-ring Thread Sizes

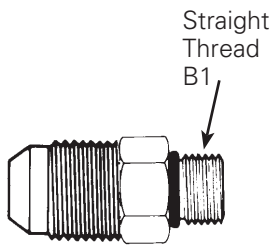

Port Size	Thread Size B1	Port Size	Thread Size B1
1/8	5/16-24	3/4	1-1/16-12
3/16	3/8-24	7/8	1-3/16-12
1/4	7/16-20	1	1-5/16-12
5/16	1/2-20	1-1/4	1-5/8-12
3/8	9/16-18	1-1/2	1-7/8-12
1/2	3/4-16	2	2-1/2-12
5/8	7/8-14		

Straight Thread O-ring Fitting

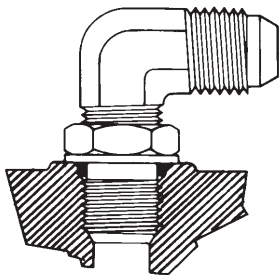

Adjustable Fittings

- Permit exact positioning of tees and elbows.
- Provide a leakproof joint.
- Eliminate distorted bosses from over-tightening.

1. Lubricate o-ring by coating with a light oil or petroleum and push back-up washer and o-ring to the extreme rear of the o-ring groove.
2. Turn the lock nut down until it just contacts the back-up washer.
3. Screw fitting by hand into straight thread boss until the back-up washer contacts the face of the boss.
4. Position the fitting by backing out (counter-clockwise) up to one full turn. Hold fitting in desired position and tighten lock nut with a wrench.
5. Assemble tube to fitting. Retighten lock nut.

NOTE: O-ring, lock nuts and back-up washers are preassembled on all straight thread fittings.

Swivel Fitting

(Used with Connector)

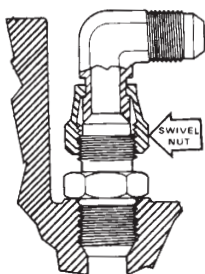

Weatherhead swivel end fittings can be used with a straight connector when space limitations will not permit full rotation of standard straight thread elbows and tees.

1. Screw connector into the o-ring boss and tighten.
2. Thread swivel nut onto connector.
3. Hold fitting in desired position and tighten swivel nut with a wrench.

JIC 37° - Flare-Twin®

Available in Stainless Steel

Sleeve 3-Piece

Stainless Steel No. 5177x
(Ref. SAE No. 070115)

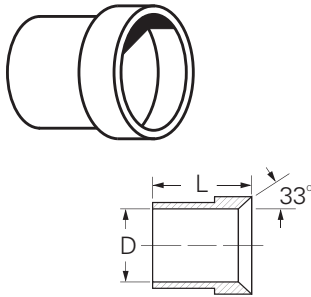

Tube O.D.	Part Number	D	L
1/8	C5165x2	.130	.34
3/16	C5165x3	.193	.34
1/4	C5165x4•	.255	.41
5/16	C5165x5•	.318	.44
3/8	C5165x6•	.380	.50
1/2	C5165x8•	.505	.56
5/8	C5165x10•	.631	.66
3/4	C5165x12	.756	.68
7/8	C5165x14	.881	.76
1	C5165x16•	1.006	.78
1-1/4	C5165x20	1.260	.91
1-1/2	C5165x24	1.510	1.12
2	C5165x32	2.014	1.19

Sleeve 3-Piece Metric

(Ref. SAE No. 070115)

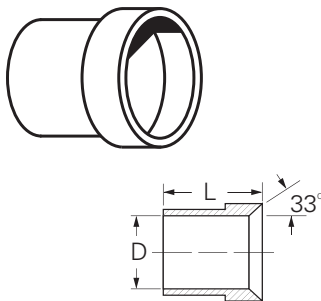

Tube O.D.	Part Number	D	L	
in	mm			
1/4	6	C5165x4x6MM	.241	.41
5/16	8	C5165x5x8MM	.320	.44
3/8	10	C5165x6x10MM	.399	.50
1/2	12	C5165x8x12MM	.478	.56
5/8	14	C5165x10x14MM	.556	.66
5/8	15	C5165x10x15MM	.596	.66
5/8	16	C5165x10x16MM	.636	.66
3/4	18	C5165x12x18MM	.717	.68
7/8	20	C5165x14x20MM	.793	.76
7/8	22	C5165x14x22MM	.866	.76
1	25	C5165x16x25MM	.990	.78
1-1/4	30	C5165x20x30MM	1.191	.91
1-1/4	32	C5165x20x32MM	1.270	.91
1-1/2	38	C5165x24x38MM	1.510	1.12

Adapts Standard SAE Flare-Twin® Hose Ends for use with metric tubing.

JIC 37° Braze Adapter

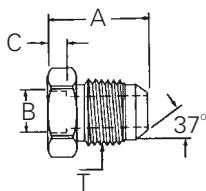

Part No. 73014 – (Dash Size)

Dash Size	Tube O.D.		Thread T	A		B		C	
	mm	inches		mm	inches	mm	inches	mm	inches
4S	6,3	.25	7/16 – 20	18,8	.74	6,3	.25	4,0	.16
5S	7,9	.31	1/2 – 20	20,3	.80	7,9	.31	4,0	.16
6S	9,6	.38	9/16 – 18	20,6	.81	9,6	.38	4,0	.16
8S	12,7	.50	3/4 – 16	23,9	.94	12,7	.50	4,0	.16
10S	16,0	.63	7/8 – 14	27,2	1.07	15,7	.62	4,0	.16
12S	19,0	.75	1 1/16 – 12	31,5	1.24	19,0	.75	6,3	.25
16S	25,4	1.00	1 5/16 – 12	32,8	1.29	25,4	1.00	6,3	.25
20S	31,7	1.25	1 5/8 – 12	35,6	1.40	31,7	1.25	6,3	.25
20-16S	31,7	1.25	1 5/16 – 12	32,8	1.29	31,7	1.25	6,3	.25
32S	50,8	2.00	2 1/2 – 12	49,8	1.96	50,8	2.00	6,3	.25

JIC 37° - Flare-Twin®

Available in Stainless Steel

Nut 3-Piece

Stainless Steel No. 5117x
(Ref. SAE No. 070110)

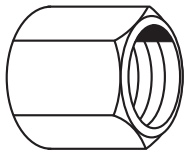

SAE Style B

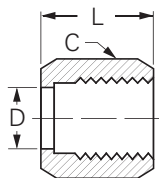

Tube O.D.	Part Number	Hex C	D	L
1/8	C5105x2	3/8	.181	.55
3/16	C5105x3	7/16	.243	.61
1/4	C5105x4•	9/16	.306	.62
5/16	C5105x5•	5/8	.375	.68
3/8	C5105x6•	11/16	.441	.73
1/2	C5105x8	7/8	.571	.85
5/8	C5105x10•	1	.698	.98
3/4	C5105x12•	1-1/4	.835	1.03
7/8	C5105x14	1-3/8	.961	1.09
1	C5105x16•	1-1/2	1.089	1.13
1-1/4	C5105x20	2	1.347	1.23
1-1/2	C5105x24	2-1/4	1.617	1.42
2	C5105x32	2-7/8	2.167	1.75

2-Piece Nut (Short)

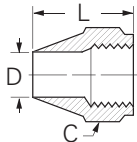
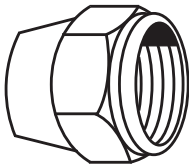

Tube O.D.	Part Number	Hex C	D	L
1/4	C5125x4	9/16	.255	.59
5/16	C5125x5	5/8	.318	.59
3/8	C5125x6	11/16	.380	.66
1/2	C5125x8	7/8	.505	.81
5/8	C5125x10	1	.631	.94
3/4	C5125x12	1-1/4	.756	1.14

2-Piece Nut

(Ref. SAE No. 070111 (Style A))

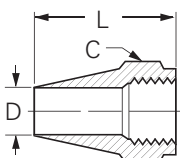
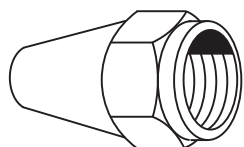

Tube O.D.	Part Number	Hex C	D	L
1/4	C5115x4	9/16	.255	1.00
5/16	C5115x5	5/8	.318	1.06
3/8	C5115x6	11/16	.380	1.09
1/2	C5115x8	7/8	.505	1.28
5/8	C5115x10	1	.631	1.48
3/4	C5115x12	1-1/4	.756	1.66
7/8	C5115x14	1-3/8	.881	1.81
1	C5115x16	1-1/2	1.006	1.94
1-1/4	C5115x20	2	1.260	2.19
1-1/2	C5115x24	2-1/4	1.510	2.31

JIC 37° - Flare-Twin®

Available in Stainless Steel

Bulkhead Nut

Stainless Steel No. 7936x
(Ref. SAE No. 070118)

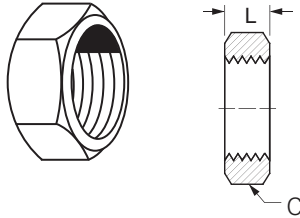

Tube O.D.	Part Number	Hex C	L
1/8	C5924x2	9/16	.22
3/16	C5924x3	5/8	.22
1/4	C5924x4	11/16	.25
5/16	C5924x5	3/4	.28
3/8	C5924x6•	13/16	.27
1/2	C5924x8•	1	.31
5/8	C5924x10	1-1/8	.36
3/4	C5924x12	1-3/8	.41
7/8	C5924x14	1-1/2	.41
1	C5924x16	1-5/8	.41
1-1/4	C5924x20	1-7/8	.41
1-1/2	C5924x24	2-1/8	.41
2	C5924x32	2-3/4	.41

Cap

Stainless Steel No. 5141x
(Ref. SAE No. 070112)

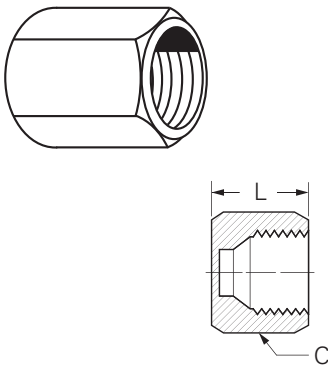

Tube O.D.	Part Number	Hex C	L
1/8	C5129x2	3/8	.50
3/16	C5129x3	7/16	.56
1/4	C5129x4•	9/16	.59
5/16	C5129x5	5/8	.61
3/8	C5129x6	11/16	.62
1/2	C5129x8•	7/8	.75
5/8	C5129x10	1	.84
3/4	C5129x12	1-1/4	.91
1	C5129x16	1-1/2	1.02
1-1/4	C5129x20	2	1.06
1-1/2	C5129x24	2-1/4	1.19
2	C5129x32	2-7/8	1.44

Plug

Stainless Steel No. 5241x
(Ref. SAE No. 070109)

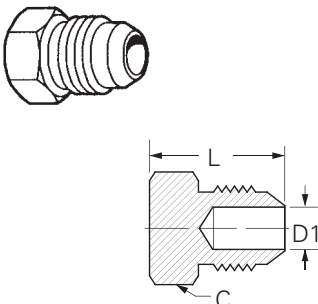

Tube O.D.	Part Number	Hex C	L	D1 Opt.
1/4	C5229x4	1/2	.80	.172
5/16	C5229x5	9/16	.80	.234
3/8	C5229x6	5/8	.84	.297
1/2	C5229x8	13/16	.94	.391
5/8	C5229x10•	15/16	1.10	.484
3/4	C5229x12•	1-1/8	1.28	.609
7/8	C5229x14	1-1/4	1.31	.719
1	C5229x16	1-3/8	1.33	.844
1-1/4	C5229x20	1-11/16	1.45	1.078
1-1/2	C5229x24	2	1.65	1.312
2	C5229x32	2-5/8	2.05	1.781



JIC 37° - Flare-Twin®

Available in Stainless Steel

Reducer

Stainless Steel No. 5027x
(Ref. SAE No. 070123)

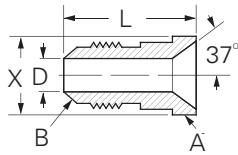
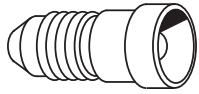

Female Reduction	Male Reduction A	Part Number	B	D	Dia. L	Hex XC
3/8	1/4	C5015x6x4	.172	.97	.502	—
1/2	1/4	C5015x8x4	.172	1.00	.682	—
1/2	3/8	C5015x8x6	.297	1.00	.682	—
5/8*	1/4	C5015x10x4	.172	1.47	—	1
5/8*	3/8	C5015x10x6	.297	1.41	—	1
5/8*	1/2	C5015x10x8●	.391	1.41	—	1
3/4	1/4	C5015x12x4	.172	1.09	.972	—
3/4	3/8	C5015x12x6	.297	1.09	.972	—
3/4	1/2	C5015x12x8	.391	1.19	.972	—
3/4*	5/8	C5015x12x10	.484	1.58	—	1-1/4
7/8*	3/8	C5015x14x6	.297	1.59	—	1-3/8
7/8*	1/2	C5015x14x8	.391	1.69	—	1-3/8
7/8*	3/4	C5015x14x12	.609	1.80	—	1-3/8
1*	1/2	C5015x16x8	.391	1.72	—	1-1/2
1*	5/8	C5015x16x10	.484	1.79	—	1-1/2
1	3/4	C5015x16x12	.609	1.47	1.222	—
1*	7/8	C5015x16x14	.719	1.87	—	1-1/2
1-1/4	3/4	C5015x20x12	.609	1.50	1.534	—
1-1/4*	1	C5015x20x16	.844	2.00	—	2
1-1/2*	1-1/4	C5015x24x20	1.078	2.15	—	2-1/4
2*	1-1/2	C5015x32x24	1.312	2.61	—	2-7/8

NOTE: Two-piece design does not include nut. Order nut C5105x to use reducer.
(*one-piece design)

Adapters, Tube Fittings & Connectors

Reducer

(Ref. SAE 070123)

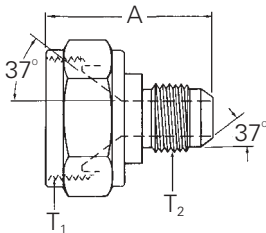

Part No. 221501- (Dash Size)

Dash Size	Tube O.D.		Thread T1	Thread T2	A	
	mm	inches			mm	inches
10-6S	9,6	.38	7/8 - 14	9/16 - 18	41,1	1.62
16-6S	9,6	.38	15/16 - 12	9/16 - 18	46,7	1.84
16-8S	12,7	.50	15/16 - 12	3/4 - 16	49,3	1.94
16-10S	16,0	.63	15/16 - 12	7/8 - 14	51,8	2.04
16-12S	19,0	.75	15/16 - 12	1 1/16 - 12	54,6	2.15
20-16S	25,4	1.00	1 5/8 - 12	1 5/16 - 12	56,6	2.23

Includes swivel nut

JIC 37° - Flare-Twin®

Available in Stainless Steel

Small Hex Union

Stainless Steel No. 5317x
(Ref. SAE No. 070101)

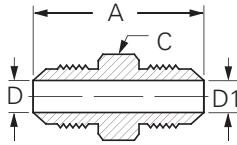
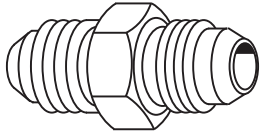

Tube O.D.	Tube O.D.	Part Number	Hex C	D	D1	L
1/8	1/8	C5305x2	7/16	.062	.062	1.17
3/16	3/16	C5305x3	7/16	.125	.125	1.23
1/4	1/4	C5305x4	1/2	.172	.172	1.37
5/16	1/4	C5305x5x4	9/16	.234	.172	1.37
5/16	5/16	C5305x5	9/16	.234	.234	1.37
3/8	1/4	C5305x6x4	5/8	.297	.172	1.40
3/8	5/16	C5305x6x5	5/8	.297	.234	1.40
3/8	3/8	C5305x6•	5/8	.297	.297	1.41
1/2	3/8	C5305x8x6	13/16	.391	.297	1.52
1/2	1/2	C5305x8•	13/16	.391	.391	1.62
5/8	1/2	C5305x10x8	15/16	.484	.391	1.78
5/8	5/8	C5305x10•	15/16	.484	.484	1.88
3/4	1/2	C5305x12x8	1-1/8	.609	.391	1.95
3/4	5/8	C5305x12x10	1-1/8	.609	.484	2.05
3/4	3/4	C5305x12	1-1/8	.609	.609	2.16
7/8	7/8	C5305x14	1-1/4	.719	.719	2.21
1	3/4	C5305x16x12	1-3/8	.844	.609	2.20
1	1	C5305x16•	1-3/8	.844	.844	2.25
1-1/4	1-1/4	C5305x20	1-11/16	1.078	1.078	2.43
1-1/2	1-1/2	C5305x24	2	1.312	1.312	2.75
2	2	C5305x32	2-5/8	1.781	1.781	3.40

Large Hex Union

Stainless Steel No. 5318x
(Ref. SAE No. 070119)

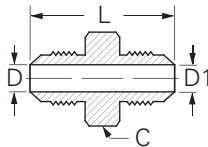
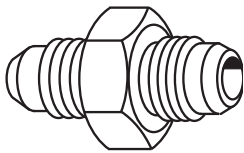

Tube O.D.	Part Number	Hex C	D	D1	L
1/4	C5306x4	11/16	.172	.172	1.37
5/16	C5306x5	3/4	.234	.234	1.37
3/8	C5306x6	13/16	.297	.297	1.41
1/2	C5306x8•	1	.391	.391	1.62
5/8	C5306x10	1-1/8	.484	.484	1.88
3/4	C5306x12	1-3/8	.609	.609	2.16
1	C5306x16	1-5/8	.844	.844	2.25
1-1/4	C5306x20	1-7/8	1.078	1.078	2.43

Bulkhead Union

Stainless Steel No. 5337x
(Ref. SAE No. 070601)

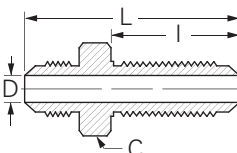
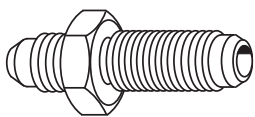

Tube O.D.	Part Number	Hex C	D	I	L
3/16	C5325x3	5/8	.125	1.14	1.90
1/4	C5325x4	11/16	.172	1.23	2.07
5/16	C5325x5	3/4	.234	1.23	2.07
3/8	C5325x6•	13/16	.297	1.31	2.18
1/2	C5325x8•	1	.391	1.47	2.44
5/8	C5325x10	1-1/8	.484	1.61	2.74
3/4	C5325x12	1-3/8	.609	1.78	3.09
1	C5325x16	1-5/8	.844	1.78	3.14
1-1/4	C5325x20	1-7/8	1.078	1.83	3.31

Bulkhead nut not included. Must be ordered separately. See page L-39 for bulkhead nut.

Male Connector

Stainless Steel No. 5217x
(Ref. SAE No. 070102)

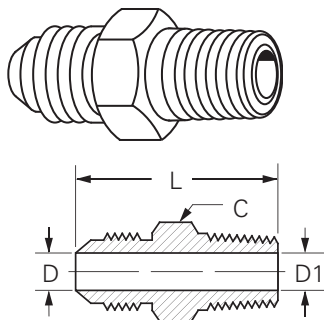

*Optional counterbore for D1

Tube O.D.	Male Pipe Thread	Part Number	Hex C	D	D1 Opt.	L
1/8	1/8	C5205x2•	7/16	.062	.188*	1.11
3/16	1/8	C5205x3	7/16	.125	.188*	1.14
1/4	1/8	C5205x4•	1/2	.172	.188*	1.22
1/4	1/4	C5205x4x4•	9/16	.172	.281*	1.42
1/4	3/8	C5205x4x6	3/4	.172	.406*	1.42
1/4	1/2	C5205x4x8	7/8	.172	.531*	1.68
5/16	1/8	C5205x5	9/16	.234	.188	1.22
5/16	1/4	C5205x5x4•	5/8	.234	.281*	1.42
5/16	3/8	C5205x5x6	13/16	.234	.406*	1.42
3/8	1/8	C5205x6x2•	5/8	.297	.188	1.24
3/8	1/4	C5205x6•	5/8	.297	.281	1.43
3/8	3/8	C5205x6x6•	3/4	.297	.297*	1.43
3/8	1/2	C5205x6x8•	7/8	.297	.531*	1.69
1/2	1/4	C5205x8x4	13/16	.391	.281	1.53
1/2	3/8	C5205x8•	13/16	.391	.406*	1.53
1/2	1/2	C5205x8x8•	15/16	.391	.531*	1.79
1/2	3/4	C5205x8x12	1-1/8	.391	.719*	1.85
5/8	3/8	C5205x10x6	15/16	.484	.406	1.70
5/8	1/2	C5205x10	15/16	.484	.531*	1.89
5/8	3/4	C5205x10x12	1-1/8	.484	.484*	1.95
3/4	1/2	C5205x12x8•	1-1/8	.531	.531	2.06
3/4	3/4	C5205x12•	1-1/8	.609	.719*	2.06
3/4	1	C5205x12x16	1-3/8	.609	.938*	2.25
7/8	3/4	C5205x14	1-1/4	.718	.718*	2.09
1	3/4	C5205x16x12	1-3/8	.844	.719	2.25
1	1	C5205x16•	1-3/8	.844	.938*	2.30
1	1-1/4	C5205x16x20	1-11/16	.844	1.250*	2.40
1-1/4	1	C5205x20x16	1-11/16	1.078	.938	2.42
1-1/4	1-1/4	C5205x20	1-11/16	1.078	1.250*	2.45
1-1/2	1-1/4	C5205x24x20	2	1.312	1.250*	2.65
1-1/2	1-1/2	C5205x24	2	1.312	1.500*	2.68
2	2	C5205x32	2-5/8	1.781	1.938*	3.11

• Available in Stainless Steel

Male Connector Long

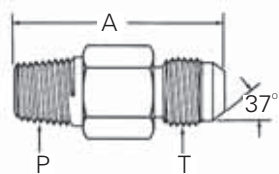

Part No. 202113 – (Dash Size)

Dash Size	Tube O.D.		Thread P (nptf)	Thread T	A	
	mm	inches			mm	inches
2-4S	6,3	.25	1/8 - 27	7/16 - 20	46,0	1.81
4-4S	6,3	.25	1/4 - 18	7/16 - 20	57,2	2.25
4-5S	7,9	.31	1/4 - 18	1/2 - 20	57,2	2.25
4-6S	9,6	.38	1/4 - 18	9/16 - 18	57,2	2.25
6-6S	9,6	.38	3/8 - 18	9/16 - 18	63,5	2.50
6-8S	12,7	.50	3/8 - 18	3/4 - 16	69,8	2.75
8-12S	19,0	.75	1/2 - 14	1 1/16 - 12	83,3	3.28
12-12S	19,0	.75	3/4 - 14	1 1/16 - 12	88,9	3.50
16-16S	25,4	1.00	1 - 11 1/2	1 5/16 - 12	101,6	4.00

Male Connector Extra Long

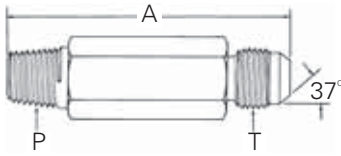

Part No. 202114- (Dash Size)

Dash Size	Tube O.D.		Thread P (nptf)	Thread T	A	
	mm	inches			mm	inches
2-4S	6,3	.25	1/8 - 27	7/16 - 20	65,0	2.56
4-4S	6,3	.25	1/4 - 18	7/16 - 20	82,5	3.25
4-6S	9,6	.38	1/4 - 18	9/16 - 18	82,5	3.25
6-8S	12,7	.50	3/8 - 18	3/4 - 16	101,6	4.00
12-12S	19,0	.75	3/4 - 14	1 1/16 - 12	127,0	5.00

Female Connector

Stainless Steel No. 5267x
(Ref. SAE No. 070103)

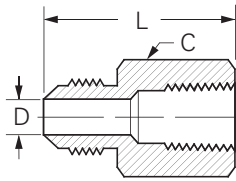
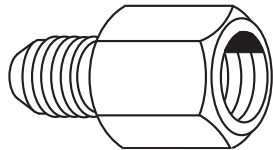

Tube O.D.	Fem. pipe Thread	Part Number	Hex C	D	L
1/8	1/8	C5255x2	9/16	.062	1.12
3/16	1/8	C5255x3	9/16	.125	1.13
1/4	1/8	C5255x4	9/16	.172	1.19
1/4	1/4	C5255x4x4	3/4	.172	1.39
5/16	1/8	C5255x5	9/16	.234	1.17
5/16	1/4	C5255x5x4	3/4	.234	1.39
3/8	1/4	C5255x6	3/4	.297	1.40
3/8	3/8	C5255x6x6	7/8	.297	1.46
1/2	3/8	C5255x8•	7/8	.391	1.56
1/2	1/2	C5255x8x8	1-1/8	.391	1.79
5/8	3/8	C5255x10x6	7/8	.484	1.89
5/8	1/2	C5255x10	1-1/8	.484	1.89
3/4	1/2	C5255x12x8	1-1/8	.609	2.05
3/4	3/4	C5255x12•	1-3/8	.609	2.06
7/8	3/4	C5255x14	1-3/8	.875	2.06
1	1	C5255x16	1-5/8	.844	2.35
1-1/4	1-1/4	C5255x20	2	1.078	2.49
1-1/2	1-1/2	C5255x24	2-3/8	1.312	2.62
2	2	C5255x32	2-7/8	1.781	2.97

• Available in Stainless Steel

Female Bulkhead Connector

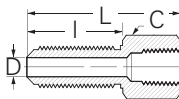
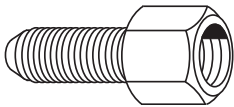

Tube O.D.	Fem. pipe Thread	Part Number	Hex C	D	I	L
1/4	1/8	C5275x4	11/16	.172	1.23	1.84
3/8	1/4	C5275x6	13/16	.297	1.31	2.06
1/2	3/8	C5275x8	1	.391	1.47	2.35
5/8	1/2	C5275x10	1-1/8	.484	1.61	2.66
3/4	3/4	C5275x12	1-3/8	.609	1.78	2.91
1	1	C5275x16	1-5/8	.844	1.78	3.09

Bulkhead nut not included. Must be ordered separately. See page L-39 for bulkhead nut.

Male Bulkhead Connector

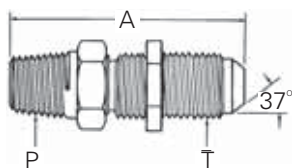

Part No. 2240 - (Dash Size)

Dash Size	Tube O.D.		Thread P (nptf)	Thread T	A	
	mm	inches			mm	inches
2-4S	6,3	.25	1/8 - 27	7/16 - 20	46,7	1.84
4-4S	6,3	.25	1/4 - 18	7/16 - 20	51,6	2.03
4-6S	9,6	.38	1/4 - 18	9/16 - 18	53,9	2.12
6-8S	12,7	.50	3/8 - 18	3/4 - 16	59,9	2.36
12-12S	19,0	.75	3/4 - 14	1 1/16 - 12	74,2	2.92
16-16S	25,4	1.00	1 - 11 1/2	5 5/16 - 12	79,0	3.11

JIC 37° - Flare-Twin®

Male JIC 37° SAE to Female FOR-SEAL®

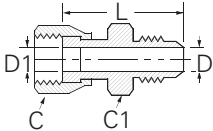
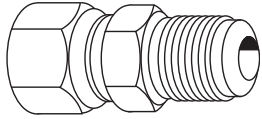

Female Tube O.D.	Male 37° Tube Size	Part Number	Hex C1	Hex C	D	D1	L
1/4	1/4	4213x4	11/16	5/8	.172	.165	1.50
3/8	3/8	4213x6	13/16	3/4	.297	.264	1.62
1/2	1/2	4213x8	15/16	7/8	.360	.360	2.03
5/8	5/8	4213x10	1-1/8	1-1/16	.484	.453	2.25
3/4	3/4	4213x12	1-3/16	1-1/4	.550	.550	2.44
1	1	4213x16	1-5/8	1-1/2	.780	.780	2.82

Straight Thread O-ring Extended Connector

(Ref. SAE No. 070122)

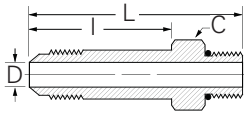
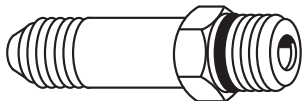

Tube O.D.	Port Size	Part Number	Hex C	D	I	L
1/4	1/4	C5316x4	9/16	.172	1.39	2.08
3/8	3/8	C5316x6	11/16	.297	1.56	2.31
1/2	3/8	C5316x8x6	7/8	.297	1.56	2.38
1/2	1/2	C5316x8	7/8	.391	1.88	2.70
5/8	5/8	C5316x10	1	.484	2.09	3.04
3/4	3/4	C5316x12	1-1/4	.609	2.50	3.61
1	1	C5316x16	1-1/2	.844	2.84	3.98

Replacement o-ring page L-64.

Adapter

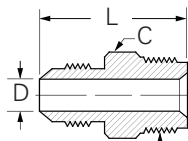
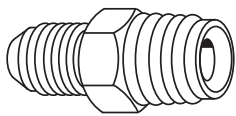

Inverted Thread

Tube O.D.	Inverted Thread	Part Number	Hex C	D	L
1/4	7/16-24	C5880x4	1/2	.172	1.08
5/16	1/2-20	C5880x5	9/16	.234	1.14
3/8	5/8-18	C5880x6	11/16	.297	1.22
1/2	3/4-18	C5880x8	13/16	.391	1.46

JIC 37° - Flare-Twin®

Straight Thread O-ring Connector

Stainless Steel No. 5327x
(Ref. SAE No. 070120)

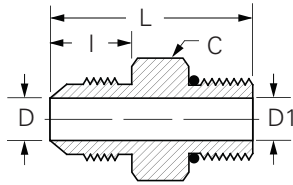
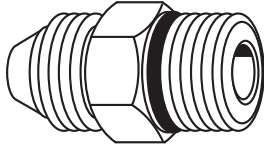

*Optional counterbore for D1.

Replacement o-ring page L-64.

Tube O.D.	Port Size	Part Number	Hex C	D	D1 Opt.	I	L
1/8	1/8	C5315x2	7/16	.062	.062*	.45	1.06
3/16	3/16	C5315x3	1/2	.125	.125*	.48	1.10
1/4	1/4	C5315x4•	9/16	.172	.172*	.55	1.23
1/4	5/16	C5315x4x5	5/8	.172	.234*	.55	1.23
1/4	3/8	C5315x4x6	11/16	.172	.297*	.55	1.29
1/4	1/2	C5315x4x8	7/8	.172	.391*	.55	1.37
5/16	1/4	C5315x5x4	5/8	.234	.172	.55	1.23
5/16	5/16	C5315x5	5/8	.234	.234*	.55	1.23
5/16	3/8	C5315x5x6	11/16	.234	.297*	.55	1.29
3/8	1/4	C5315x6x4	11/16	.297	.172	.56	1.27
3/8	5/16	C5315x6x5	11/16	.297	.234	.56	1.27
3/8	3/8	C5315x6•	11/16	.297	.297*	.56	1.30
3/8	1/2	C5315x6x8•	7/8	.297	.391*	.56	1.38
3/8	5/8	C5315x6x10	1	.297	.484*	.56	1.50
1/2	3/8	C5315x8x6	13/16	.391	.297	.66	1.44
1/2	1/2	C5315x8	7/8	.391	.391*	.66	1.48
1/2	5/8	C5315x8x10•	1	.391	.484*	.66	1.60
1/2	3/4	C5315x8x12•	1-1/4	.391	.609*	.66	1.76
5/8	1/2	C5315x10x8	1	.484	.391	.76	1.64
5/8	5/8	C5315x10	1	.484	.484*	.76	1.70
5/8	3/4	C5315x10x12	1-1/4	.484	.609*	.76	1.86
5/8	1	C5315x10x16	1-1/2	.484	.844*	.76	1.89
3/4	1/2	C5315x12x8	1-1/4	.609	.391	.86	1.94
3/4	5/8	C5315x12x10	1-1/8	.609	.484	.86	1.88
3/4	3/4	C5315x12•	1-1/4	.609	.609*	.86	1.97
3/4	7/8	C5315x12x14	1-3/8	.609	.718*	.86	1.96
3/4	1	C5315x12x16	1-1/2	.609	.844*	.86	1.99
3/4	1-1/4	C5315x12x20	1-7/8	.609	1.078*	.86	2.08
7/8	7/8	C5315x14	1-3/8	.719	.719*	.89	1.99
1	5/8	C5315x16x10	1-1/2	.844	.484	.91	2.07
1	3/4	C5315x16x12	1-1/2	.844	.609	.91	2.04
1	1	C5315x16	1-1/2	.844	.844*	.91	2.04
1	1-1/4	C5315x16x20	1-7/8	.844	1.078*	.91	2.12
1-1/4	1	C5315x20x16	1-7/8	1.078	.844	.96	2.33
1-1/4	1-1/4	C5315x20	1-7/8	1.078	1.078*	.96	2.17
1-1/4	1-1/2	C5315x20x24	2-1/8	1.078	1.312*	.96	2.24
1-1/2	1-1/4	C5315x24x20	2-1/8	1.312	1.078*	1.08	2.53
1-1/2	1-1/2	C5315x24	2-1/8	1.312	1.312*	1.08	2.37
1-1/2	2	C5315x24x32	2-3/4	1.312	1.781*	1.08	2.53
2	1-1/2	C5315x32x24	2-3/4	1.781	1.312*	1.33	2.81
2	2	C5315x32	2-3/4	1.781	1.781	1.33	2.78

• Available in Stainless Steel

Female JIC 37° Swivel to Female Pipe

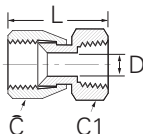
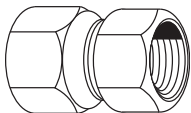

Tube O.D.	Female Pipe	Part Number	Hex C	Hex C1	L	D
1/4	1/4	C5256x4x4	9/16	3/4	1.32	.172
3/8	3/8	C5256x6x6	11/16	7/8	1.63	.297
1/2	1/2	C5256x8x8	7/8	1-1/8	1.81	.391
3/4	3/4	C5256x12	1-1/4	1-1/4	2.08	.609
1	1	C5256x16	1-1/2	1-1/2	2.62	.844

JIC 37° - Flare-Twin®

Available in Stainless Steel

Female JIC 37° Swivel to Male Pipe Adapter

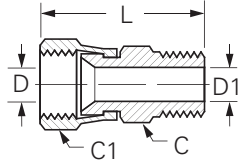
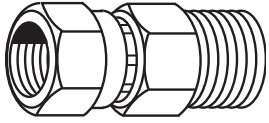

*Optional counterbore for D1

Tube O.D.	Male pipe size	Part Number	Hex C	Hex C1	D	D1	L
1/4	1/4	9100x4x4	9/16	9/16	.172	.281*	1.50
5/16	1/4	9100x5x4	11/16	5/8	.234	.281*	1.57
3/8	1/4	9100x6x4	11/16	11/16	.297	.281	1.69
3/8	3/8	9100x6x6	11/16	11/16	.297	.406*	1.69
1/2	3/8	9100x8x6	7/8	7/8	.391	.406*	1.87
1/2	1/2	9100x8x8	7/8	7/8	.391	.531*	2.05
5/8	3/8	9100x10x6	1	1	.484	.406	1.91
5/8	1/2	9100x10x8	1	1	.484	.531*	2.11
3/4	1/2	9100x12x8	1-1/8	1-1/4	.609	.531	2.21
3/4	3/4	9100x12x12	1-1/8	1-1/4	.609	.719*	2.21
1	3/4	9100x16x12	1-3/8	1-1/2	.844	.719	2.36
1	1	9100x16x16	1-3/8	1-1/2	.844	.938*	2.55
1-1/4	1-1/4	9100x20x20	1-7/8	2	1.078	1.250*	2.73

Male JIC 37° to Male Metric Standpipe

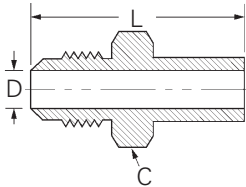
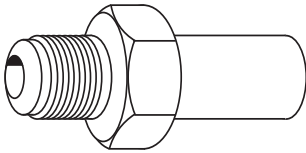

For metric flareless nuts and sleeves see page L-66.

Tube O.D.	Tube O.D. (mm)	Part Number	Hex C	L	D
1/4	6	MC5019x4x6	9/16	1.58	.16
1/4	8	MC5019x4x8	9/16	1.68	.17
3/8	10	MC5019x6x10	3/4	1.67	.28
1/2	12	MC5019x8x12	7/8	1.97	.32
1/2	14	MC5019x8x14	7/8	1.89	.39
5/8	16	MC5019x10x16	1	2.07	.47
3/4	16	MC5019x12x16	1-1/4	2.22	.47
3/4	20	MC5019x12x20	1-1/4	2.38	.61
1	22	MC5019x16x22	1-1/2	2.21	.67
1	25	MC5019x16x25	1-1/2	2.54	.79

Male JIC 37° to O-ring Port Adapter

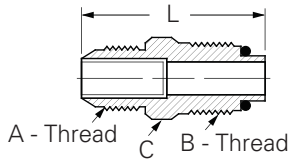
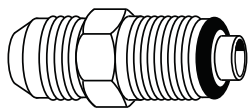

Tube Size	Port Size	Part Number	Replacement O-ring	Thread A	Thread B	Hex C	L
1/4	1/4	41157x4	7629x1	7/16-20	7/16-24	7/16	1.33
3/8	3/8	41157x6	7629x3	9/16-18	5/8-18	5/8	1.47
1/2	1/2	41157x8	7629x5	3/4-16	3/4-16	3/4	1.91
5/8	5/8	41157x10	7629x7	7/8-14	7/8-14	15/16	2.23
3/4	3/4	41157x12	7629x8	1-1/16-12	1-1/16-16	1-1/8	2.13

Adapters, Tube Fittings & Connectors

JIC 37° - Flare-Twin®

45° Male Elbow

Stainless Steel No. 5367x
(Ref. SAE No. 070302)

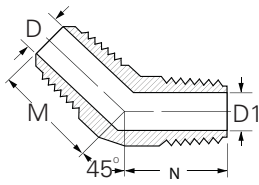
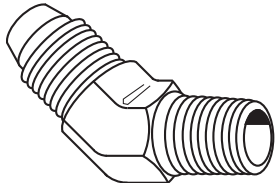

Tube O.D.	Male Pipe Thread	Part Number	D	D1	M	N	Across Flats
1/8	1/8	C5355x2	.062	.188	.66	.52	7/16
3/16	1/8	C5355x3	.125	.188	.66	.52	7/16
1/4	1/8	C5355x4•	.172	.188	.72	.64	7/16
1/4	1/4	C5355x4x4	.172	.281	.83	.86	9/16
5/16	1/8	C5355x5	.234	.188	.77	.67	9/16
5/16	1/4	C5355x5x4	.234	.281	.83	.86	9/16
3/8	1/8	C5355x6x2	.297	.188	.83	.69	9/16
3/8	1/4	C5355x6•	.297	.281	.83	.86	9/16
3/8	3/8	C5355x6x6	.297	.406	.98	.95	3/4
3/8	1/2	C5355x6x8	.297	.531	1.06	1.17	7/8
1/2	3/8	C5355x8	.391	.406	.98	.95	3/4
1/2	1/4	C5355x8x4	.391	.281	.98	.95	3/4
1/2	1/2	C5355x8x8	.391	.531	.99	1.17	7/8
5/8	1/2	C5355x10	.484	.531	1.11	1.17	7/8
5/8	3/8	C5355x10x6	.484	.406	1.11	1.00	7/8
5/8	3/4	C5355x10x12	.484	.719	1.26	1.20	1-1/8
3/4	3/4	C5355x12•	.609	.719	1.28	1.20	1-1/16
3/4	1/2	C5355x12x8	.609	.531	1.28	1.20	1-1/16
3/4	1	C5355x12x16	.609	.938	1.42	1.48	1-3/8
1	1	C5355x16	.844	.938	1.47	1.48	1-5/16
1	3/4	C5355x16x12	.844	.719	1.47	1.27	1-5/16
1-1/4	1-1/4	C5355x20	1.078	1.250	1.59	1.67	1-3/4
1-1/2	1-1/2	C5355x24	1.312	1.500	1.78	1.77	1-7/8
2	2	C5355x32	1.781	1.938	2.22	2.11	2-5/8

• Available in Stainless Steel

JIC 37° - Flare-Twin®

37° JIC Female Swivel to Male Straight Thread O-ring

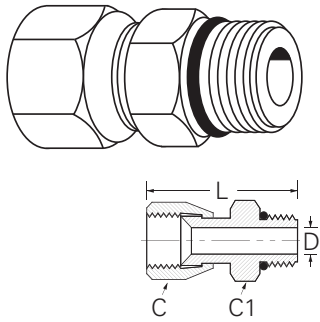

Tube O.D.	Port Size	Part Number	Hex C	Hex C1	L	D
1/4	1/4	C5216x4x4	9/16	9/16	1.32	.17
1/4	3/8	C5216x4x6	11/16	11/16	1.37	.17
3/8	3/8	C5216x6x6	11/16	11/16	1.51	.30
3/8	1/2	C5216x6x8	11/16	7/8	1.58	.30
1/2	3/8	C5216x8x6	7/8	3/4	1.62	.30
1/2	1/2	C5216x8x8	7/8	7/8	1.61	.39
5/8	5/8	C5216x10x10	1	1	1.96	.48
3/4	3/4	C5216x12x12	1-1/4	1-1/4	2.17	.61
1	1	C5216x16x16	1-1/2	1-1/2	2.30	.84
1-1/4	1-1/4	C5216x20x20	2	1-7/8	2.47	1.08
1-1/2	1-1/2	C5216x24x24	2-1/8	2-1/8	2.63	1.31
2	2	C5216x32x32	2-3/4	2-3/4	2.95	1.78

For replacement Straight Thread o-ring, see page L-64.

45° Elbow - Swivel Nut

Stainless Steel No. 5368x
(Ref. SAE No. 070321)

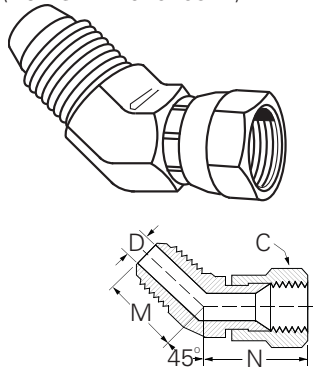

Tube O.D.	Part Number	Hex C	D	M	N	Across Flats
1/4	C5356x4	9/16	.172	.72	.94	7/16
5/16	C5356x5	5/8	.234	.77	1.00	9/16
3/8	C5356x6	11/16	.297	.83	1.12	9/16
1/2	C5356x8•	7/8	.391	.98	1.28	3/4
5/8	C5356x10	1	.484	1.11	1.44	7/8
3/4	C5356x12	1-1/4	.609	1.28	1.50	1-1/16
7/8	C5356x14	1-3/8	.718	1.39	1.62	1-5/16
1	C5356x16	1-1/2	.845	1.47	1.75	1-5/16
1-1/4	C5356x20	2	1.078	1.59	2.03	1-3/4

JIC 37° - Flare-Twin®

45° Bulkhead Union Elbow

(Ref. SAE No. 070801)

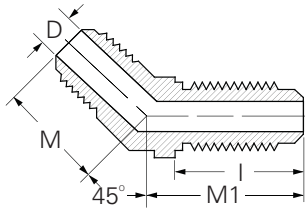
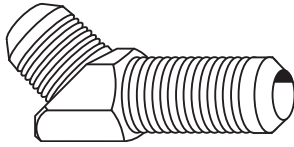

Tube O.D.	Part Number	D	M	M1	Across Flats	I
1/4	C5375x4	.172	.72	1.53	1/2	1.11
5/16	C5375x5	.234	.76	1.53	9/16	1.11
3/8	C5375x6	.297	.83	1.67	5/8	1.18
1/2	C5375x8	.391	.98	1.94	13/16	1.38
5/8	C5375x10	.484	1.11	2.17	15/16	1.52
3/4	C5375x12	.609	1.28	2.44	1-1/8	1.69
1	C5375x16	.844	1.47	2.56	1-3/8	1.69

Bulkhead nut not included. Must be ordered separately. See page L-39 for bulkhead nut.

45° Elbow - Straight Thread O-ring

(Ref. SAE No. 070320)

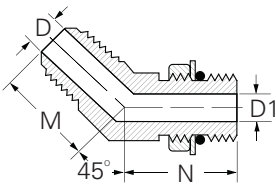
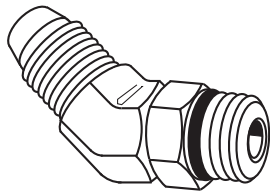

Tube O.D.	Port Size	Part Number	D	D1	M	N	Across Flats
1/4	1/4	C5365x4	.172	.172	.72	1.05	7/16
5/16	5/16	C5365x5	.234	.234	.77	1.05	9/16
3/8	3/8	C5365x6	.297	.297	.83	1.14	9/16
3/8	1/2	C5365x6x8	.297	.391	.87	1.30	13/16
1/2	1/2	C5365x8	.391	.391	.98	1.30	3/4
1/2	3/8	C5365x8x6	.391	.297	.98	1.17	13/16
1/2	5/8	C5365x8x10	.391	.484	.99	1.52	7/8
5/8	5/8	C5365x10	.484	.484	1.11	1.52	7/8
5/8	1/2	C5365x10x8	.484	.391	1.09	1.41	15/16
5/8	3/4	C5365x10x12	.484	.609	1.22	1.73	1-1/8
3/4	3/4	C5365x12	.609	.609	1.28	1.73	1-1/16
3/4	5/8	C5365x12x10	.609	.484	1.30	1.58	1-1/8
3/4	5/8	C5365x12x10	.609	.484	1.28	1.57	1-1/16
3/4	1	C5365x12x16	.609	.844	1.45	1.86	1-3/8
7/8	7/8	C5365x14	.718	.718	1.39	1.80	1-1/4
1	1	C5365x16	.844	.844	1.47	1.86	1-5/16
1	3/4	C5365x16x12	.844	.609	1.47	1.86	1-3/8
1-1/4	1-1/4	C5365x20	1.078	1.078	1.59	1.91	1-5/8

Replacement o-ring page L-64.



JIC 37° - Flare-Twin®

90° Union Elbow

Stainless Steel No. 5517x
(Ref. SAE No. 070201)

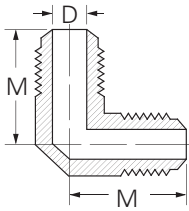
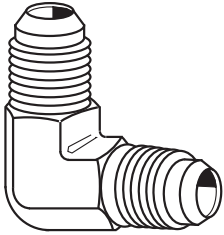

Tube O.D.	Part Number	D	M	Across Flats
1/4	C5505x4	.172	.89	7/16
5/16	C5505x5	.234	.95	1/2
3/8	C5505x6•	.297	1.06	9/16
1/2	C5505x8	.391	1.25	3/4
5/8	C5505x10	.484	1.45	7/8
3/4	C5505x12	.609	1.66	1-1/16
1	C5505x16	.844	1.81	1-5/16
1-1/4	C5505x20	1.078	2.06	1-3/4
1-1/2	C5505x24	1.312	2.33	2

• Available in Stainless Steel

90° Male Elbow Long

(Ref. SAE No. 071502)

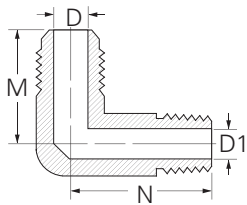
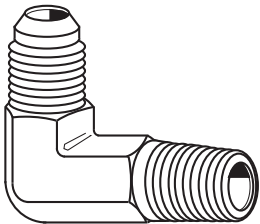

Tube O.D.	Male Pipe Thread	Part Number	D	D1	M	N	Across Flats
1/4	1/8	C5425x4	.172	.188	.89	1.17	1/2
1/4	1/4	C5425x4x4	.172	.281	.95	1.58	5/8
3/8	1/4	C5425x6	.297	.281	1.06	1.58	9/16
3/8	3/8	C5425x6x6	.297	.406	1.16	1.83	13/16
1/2	3/8	C5425x8	.391	.406	1.25	1.83	13/16
1/2	1/2	C5425x8x8	.391	.531	1.31	2.17	15/16
5/8	1/2	C5425x10	.484	.531	1.45	2.17	15/16
3/4	3/4	C5425x12	.609	.719	1.66	2.44	1-1/16
1	1	C5425x16	.844	.938	1.81	3.02	1-3/8
1-1/4	1-1/4	C5425x20	1.078	1.250	2.06	3.69	1-3/4
1-1/2	1-1/2	C5425x24	1.312	1.500	2.32	4.11	2

JIC 37° - Flare-Twin®

90° Male Elbow

Stainless Steel No. 5417x
(Ref. SAE No. 070202)

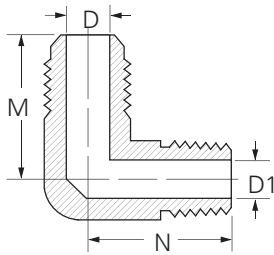
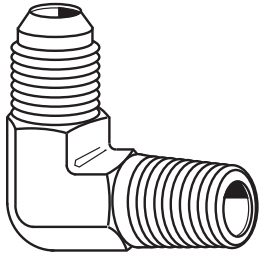

Tube O.D.	Male Pipe Thread	Part Number	D	D1	M	N	Across Flats
1/8	1/8	C5405x2	.062	.188	.77	.72	7/16
3/16	1/8	C5405x3	.125	.188	.83	.72	7/16
1/4	1/8	C5405x4•	.172	.188	.89	.78	7/16
1/4	1/4	C5405x4x4•	.172	.281	1.05	1.09	9/16
1/4	3/8	C5405x4x6	.172	.406	1.05	1.22	13/16
1/4	1/2	C5405x4x8	.172	.531	1.11	1.47	15/16
5/16	1/8	C5405x5	.234	.188	.95	.78	9/16
5/16	1/4	C5405x5x4	.234	.281	1.05	1.09	9/16
5/16	3/8	C5405x5x6	.234	.406	1.08	1.22	13/16
3/8	1/4	C5405x6	.297	.281	1.06	1.09	9/16
3/8	1/8	C5405x6x2	.297	.188	1.06	.90	9/16
3/8	3/8	C5405x6x6•	.297	.406	1.14	1.22	3/4
3/8	1/2	C5405x6x8	.297	.531	1.22	1.47	7/8
3/8	3/4	C5405x6x12	.297	.719	1.31	1.59	1-1/8
1/2	1/4	C5405x8x4•	.391	.281	1.25	1.22	3/4
1/2	3/8	C5405x8•	.391	.406	1.25	1.22	3/4
1/2	1/2	C5405x8x8	.391	.531	1.33	1.47	7/8
1/2	3/4	C5405x8x12•	.391	.719	1.42	1.59	1-1/16
5/8	3/8	C5405x10x6	.484	.406	1.45	1.28	7/8
5/8	1/2	C5405x10	.484	.531	1.45	1.47	7/8
5/8	3/4	C5405x10x12	.484	.719	1.54	1.59	1-1/16
3/4	3/4	C5405x12•	.609	.719	1.66	1.59	1-1/16
3/4	1/2	C5405x12x8	.609	.531	1.66	1.59	1-1/16
3/4	1	C5405x12x16	.609	.938	1.78	1.97	1-3/8
1	1	C5405x16	.844	.938	1.81	1.97	1-5/16
1	3/4	C5405x16x12	.844	.719	1.81	1.78	1-5/16
1	1-1/4	C5405x16x20	.844	1.250	2.00	2.37	1-3/4
1-1/4	1-1/4	C5405x20	1.078	1.250	2.06	2.38	1-5/8
1-1/4	1	C5405x20x16	1.078	.938	2.06	2.38	1-5/8
1-1/4	1-1/2	C5405x20x24	1.078	1.500	2.19	2.64	2
1-1/2	1-1/2	C5405x24	1.312	1.500	2.33	2.64	1-7/8
1-1/2	1-1/4	C5405x24x20	1.312	1.250	2.33	2.50	2
2	2	C5405x32	1.781	1.938	3.06	3.00	2-9/16

• Available in Stainless Steel

JIC 37° - Flare-Twin®

90° Male Elbow Extra Long

(Ref. SAE No. 071602)

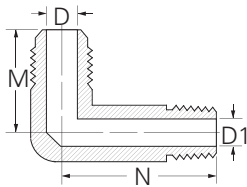
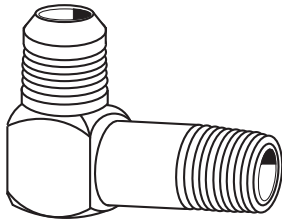

Tube O.D.	Male Pipe Thread	Part Number	D	D1	M	N	Across Flats
1/4	1/8	C5435x4	.172	.188	.89	1.56	1/2
1/4	1/4	C5435x4x4	.172	.281	.95	2.07	5/8
5/16	1/4	C5435x5x4	.234	.281	.95	2.04	9/16
3/8	1/4	C5435x6	.297	.281	1.06	2.08	5/8
3/8	3/8	C5435x6x6	.297	.406	1.06	2.42	13/16
1/2	3/8	C5435x8	.391	.406	1.25	2.42	13/16
1/2	1/2	C5435x8x8	.391	.531	1.31	2.88	15/16
5/8	1/2	C5435x10	.484	.531	1.45	2.88	15/16
3/4	3/4	C5435x12	.609	.719	1.66	3.28	1-1/8
1	1	C5435x16	.844	.938	1.81	4.05	1-3/8
1-1/4	1-1/4	C5435x20	1.078	1.250	2.06	5.00	1-3/4

Adapters, Tube Fittings & Connectors

90° Swivel Male Elbow

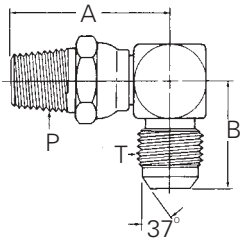

Part No. 2249 – (Dash Size)

Dash Size	Tube O.D.		Thread P (nptf)	Thread T	A		B	
	mm	inches			mm	inches	mm	inches
4-6S	9,6	.38	1/4 - 18	9/16 - 18	40,6	1.60	26,9	1.06
6-8S	12,7	.50	3/8 - 18	3/4 - 18	43,4	1.71	31,0	1.22
12-12S	19,0	.75	3/4 - 14	1 1/16 - 12	54,3	2.14	42,2	1.66

90° Bulkhead Union Elbow

Stainless Steel No. 5537x
(Ref. SAE No. 070701)

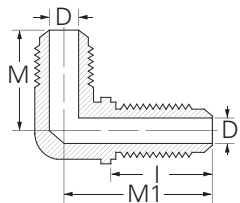
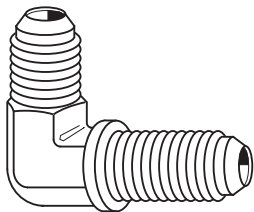

Tube O.D.	Part Number	D	I	M	M1	Across Flats
1/4	C5525x4	.172	1.11	.97	1.59	7/16
5/16	C5525x5	.234	1.11	1.03	1.62	9/16
3/8	C5525x6•	.297	1.18	1.09	1.81	9/16
1/2	C5525x8•	.391	1.38	1.36	2.11	3/4
5/8	C5525x10	.484	1.52	1.56	2.39	15/16
3/4	C5525x12	.609	1.69	1.78	2.67	1-1/16
1	C5525x16	.844	1.69	1.94	2.80	1-5/16
1-1/4	C5525x20	1.078	1.74	2.17	3.12	1-5/8

Bulkhead nut not included. Must be ordered separately.
See page L-39 for bulkhead nut.

- Available in Stainless Steel

JIC 37° - Flare-Twin®

90° Female Elbow

(Ref. SAE No. 070203)

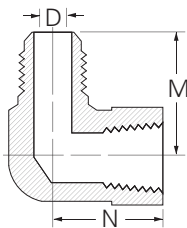
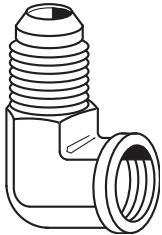

Tube O.D.	Fem. Pipe Thread	Part Number	D	M	N	Across Flats
1/4	1/8	C5455x4	.172	1.08	.66	9/16
1/4	1/4	C5455x4x4	.172	1.14	.88	3/4
5/16	1/8	C5455x5	.234	1.08	.66	5/8
5/16	1/4	C5455x5x4	.234	1.30	1.02	7/8
3/8	1/8	C5455x6x2	.297	1.06	.66	9/16
3/8	1/4	C5455x6	.297	1.23	.88	3/4
3/8	3/8	C5455x6x6	.297	1.31	1.02	7/8
1/2	1/4	C5455x8x4	.391	1.23	.88	3/4
1/2	3/8	C5455x8	.391	1.42	1.02	7/8
1/2	1/2	C5455x8x8	.391	1.52	1.23	1-1/16
5/8	1/2	C5455x10	.484	1.64	1.23	1-1/16
3/4	1/2	C5455x12x8	.609	1.66	1.23	1-1/16
3/4	3/4	C5455x12	.609	1.89	1.36	1-5/16
1	1	C5455x16	.844	2.17	1.62	1-5/8
1-1/4	1-1/4	C5455x20	1.078	2.33	1.70	2
1-1/2	1-1/2	C5455x24	1.312	2.89	2.08	2-3/8
2	2	C5455x32	1.781	3.30	2.39	2-7/8

90° Elbow - Swivel Nut

Stainless Steel No. 5518x
(Ref. SAE No. 070221)

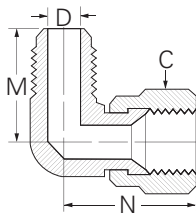
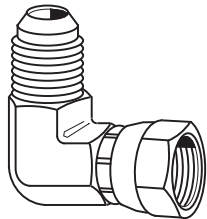

Tube O.D.	Part Number	Hex C	D	M	N	Across Flats
1/4	C5506x4	9/16	.172	.89	1.00	7/16
5/16	C5506x5	5/8	.234	.95	1.06	9/16
3/8	C5506x6•	11/16	.297	1.06	1.25	9/16
1/2	C5506x8•	7/8	.391	1.25	1.42	3/4
5/8	C5506x10	1	.484	1.43	1.62	7/8
3/4	C5506x12•	1-1/4	.609	1.66	1.75	1-1/16
7/8	C5506x14	1-3/8	.718	1.73	1.78	1-1/4
1	C5506x16	1-1/2	.844	1.81	2.00	1-5/16
1-1/4	C5506x20	2	1.078	2.06	2.31	1-5/8
1-1/2	C5506x24	2-1/4	1.312	2.33	2.59	2
2	C5506x32	2-7/8	1.781	3.06	3.38	2-5/8

• Available in Stainless Steel



90° Sweep Elbow

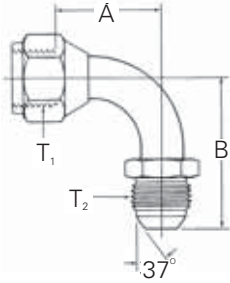

Part No. 500454 – (Dash Size)

Dash Size	Tube O.D.		Thread T1	Thread T2	A		B	
	mm	inches			mm	inches	mm	inches
4S	6,3	.25	7/16-20	7/16-20	17,3	.68	28,5	1.12
6S	9,6	.38	9/16-18	9/16-18	21,6	.85	33,3	1.31
8S	12,7	.50	3/4-16	3/4-16	27,7	1.09	42,2	1.66
10S	16,0	.63	7/8-14	7/8-14	31,2	1.23	46,2	1.82
12S	19,0	.75	1 1/16-12	1 1/16-12	46,2	1.82	63,2	2.49
16S	25,4	1.00	1 5/16-12	1 5/16-12	60,7	2.39	70,9	2.79
20S	31,7	1.25	1 5/8-12	1 5/8-12	69,8	2.75	79,7	3.14

(Suitable for pressures through 2-wire hose)

90° Sweep Elbow

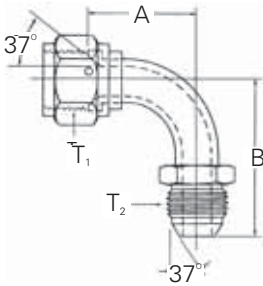

Part No. FF5163 – (Dash Size)

Dash Size	Tube O.D.		Thread T1	Thread T2	A		B	
	mm	inches			mm	inches	mm	inches
0808S	12,7	.50	3/4-16	3/4-16	47,5	1.87	54,9	2.16
1212S	19,0	.75	1 1/16-12	1 1/16-12	59,7	2.35	71,4	2.81
1616S	25,4	1.00	1 5/16-12	1 5/16-12	77,2	3.04	71,4	2.81
2020S	31,7	1.25	1 5/8-12	1 5/8-12	86,4	3.40	94,2	3.71
2424S	38,1	1.50	1 7/8-12	1 7/8-12	100,3	3.95	110,0	4.33

(Suitable for pressures through 4-wire hose)

90° Sweep Elbow Long

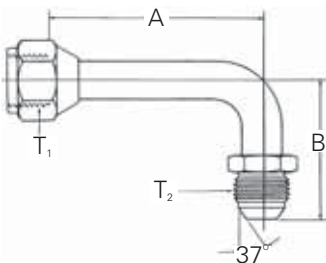

Part No. 504095 – (Dash Size)

Dash Size	Tube O.D.		Thread T1	Thread T2	A		B	
	mm	inches			mm	inches	mm	inches
4S	6,3	.25	7/16-20	7/16-20	45,7	1.80	28,5	1.12
6S	9,6	.38	9/16-18	9/16-18	55,4	2.18	33,3	1.31
8S	12,7	.50	3/4-16	3/4-16	61,7	2.43	45,2	1.78
10S	16,0	.63	7/8-14	7/8-14	65,3	2.57	52,6	2.07
12S	19,0	.75	1 1/16-12	1 1/16-12	94,7	3.73	63,2	2.49
16S	25,4	1.00	1 5/16-12	1 5/16-12	116,3	4.58	70,9	2.79
20S	31,7	1.25	1 5/8-12	1 5/8-12	140,5	5.53	79,7	3.14

(Suitable for pressures through 2-wire hose)

90° Sweep Elbow Long

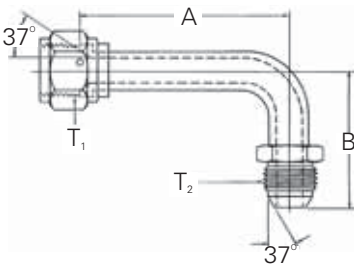

Part No. FF5164 – (Dash Size)

Dash Size	Tube O.D.		Thread T1	Thread T2	A		B	
	mm	inches			mm	inches	mm	inches
0808S	12,7	.50	3/4-16	3/4-16	84,8	3.34	54,9	2.16
1212S	19,0	.75	1 1/16-12	1 1/16-12	112,0	4.41	71,4	2.81
1616S	25,4	1.00	1 5/16-12	1 5/16-12	133,1	5.24	71,4	2.81

(Suitable for pressures through 4-wire hose)

JIC 37° - Flare-Twin®

90° Elbow - Straight Thread O-ring

Stainless Steel No. 5527x
(Ref. SAE No. 070220)

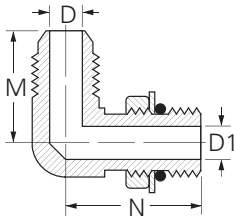
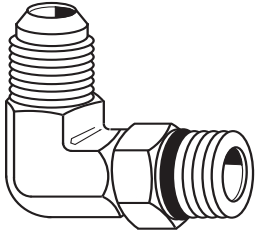

Tube O.D.	Port Size	Part Number	D	D1	M	N	Across Flats
1/4	1/4	C5515x4	.172	.172	.89	1.03	7/16
1/4	5/16	C5515x4x5	.172	.234	.95	1.12	5/8
1/4	3/8	C5515x4x6	.172	.297	.95	1.25	5/8
5/16	5/16	C5515x5	.234	.234	.95	1.13	9/16
5/16	1/4	C5515x5x4	.234	.172	.98	1.06	9/16
5/16	3/8	C5515x5x6	.234	.297	.98	1.25	5/8
3/8	3/8	C5515x6•	.297	.297	1.06	1.25	9/16
3/8	1/4	C5515x6x4	.297	.172	1.06	1.09	5/8
3/8	5/16	C5515x6x5	.297	.234	1.06	1.12	5/8
3/8	1/2	C5515x6x8	.297	.391	1.14	1.45	3/4
3/8	5/8	C5515x6x10	.297	.484	1.22	1.70	15/16
1/2	3/8	C5515x8x6	.391	.297	1.25	1.32	3/4
1/2	1/2	C5515x8•	.391	.391	1.25	1.45	3/4
1/2	5/8	C5515x8x10	.391	.484	1.33	1.70	7/8
1/2	3/4	C5515x8x12	.391	.609	1.41	1.94	1-1/8
5/8	5/8	C5515x10	.484	.484	1.45	1.70	7/8
5/8	1/2	C5515x10x8	.484	.391	1.45	1.52	15/16
5/8	3/4	C5515x10x12	.484	.609	1.55	1.94	1-1/8
3/4	3/4	C5515x12•	.609	.609	1.66	1.94	1-1/16
3/4	1/2	C5515x12x8	.609	.391	1.66	1.61	1-1/8
3/4	5/8	C5515x12x10	.609	.484	1.66	1.78	1-1/16
3/4	1	C5515x12x16	.609	.844	1.78	2.05	1-3/8
1	1	C5515x16	.844	.844	1.81	2.05	1-5/16
1	3/4	C5515x16x12	.844	.609	1.81	2.05	1-5/16
1	7/8	C5515x16x14	.844	.718	1.81	2.06	1-3/8
1	1-1/4	C5515x16x20	.844	1.078	2.00	2.25	1-3/4
1-1/4	1-1/4	C5515x20	1.078	1.078	2.06	2.25	1-5/8
1-1/4	1	C5515x20x16	1.078	.844	2.06	2.23	1-3/4
1-1/2	1-1/2	C5515x24	1.312	1.312	2.33	2.39	1-7/8
1-1/2	1-1/4	C5515x24x20	1.312	1.078	2.33	2.37	2

• Available in Stainless Steel

JIC 37° - Flare-Twin®

90° Elbow Long - Straight Thread O-ring

(Ref. SAE No. 071520)

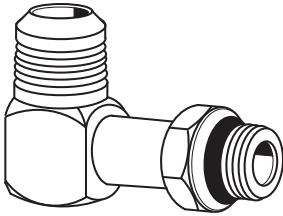

Tube O.D.	Port Size	Part Number	D	D1	M	N	Across Flats
3/8	3/8	C5515x6L	.297	.297	1.06	1.66	5/8
1/2	1/2	C5515x8L	.391	.391	1.25	1.81	13/16
3/4	3/4	C5515x12L	.609	.609	1.66	2.47	1-1/8

Replacement o-ring page L-64.

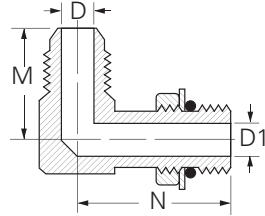

90° Elbow Extra Long - Straight Thread O-ring

(Ref. SAE No. 071620)

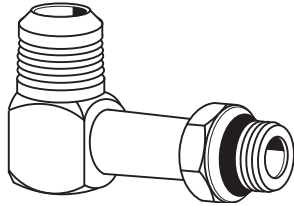

Tube O.D.	Port Size	Part Number	D	D1	M	N	Across Flats
3/8	3/8	C5515x6LL	.297	.297	1.06	2.08	5/8
1/2	1/2	C5515x8LL	.391	.391	1.25	2.50	13/16
5/8	5/8	C5515x10LL	.484	.484	1.45	3.25	15/16
3/4	3/4	C5515x12LL	.609	.609	1.66	3.34	1-1/8

Replacement o-ring page L-64.

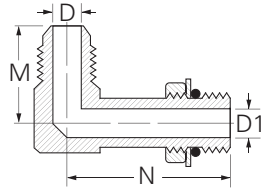

90° Male Pipe to 37° JIC Swivel

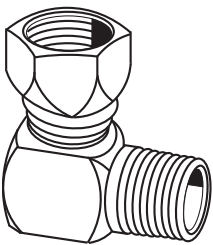

Tube O.D.	Male Pipe	Part Number	D	M	Across N	Hex Flats	C
1/4	1/8	C5406x4	.188	.78	1.00	1/2	9/16
3/8	1/4	C5406x6	.281	1.09	1.25	5/8	11/16
1/2	3/8	C5406x8	.406	1.22	1.38	13/16	7/8
5/8	1/2	C5406x10	.531	1.47	1.62	15/16	1
3/4	3/4	C5406x12	.719	1.59	1.75	1-1/8	1-1/4
1	1	C5406x16	.938	1.97	2.00	1-3/8	1-1/2
1-1/4	1-1/4	C5406x20	1.250	2.38	2.31	1-3/4	2

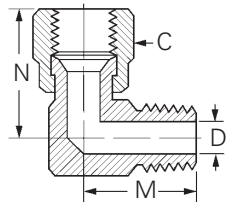

JIC 37° - Flare-Twin®

90° Female Pipe to 37° JIC Swivel

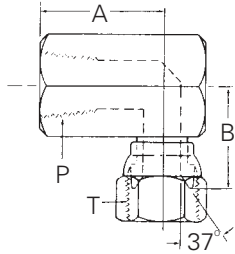

Part No. 2244 – (Dash Size)

Dash Size	Tube O.D.		Thread P (NPTF)	Thread T	A		B	
	mm	inches			mm	inches	mm	inches
8-8S	12,7	.50	1/2-14	3/4-16	31,2	1.23	27,4	1.08
8-10S	16,0	.63	1/2-14	7/8-14	31,2	1.23	28,5	1.12

Union Tee

Stainless Steel No. 55717x
(Ref. SAE No. 070401)

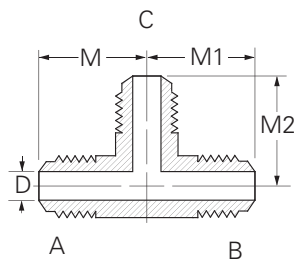
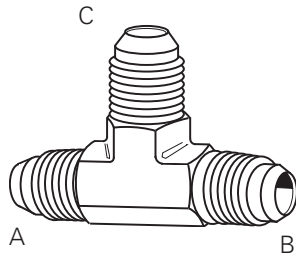

Tube O.D. A	Tube O.D. B	Tube O.D. C	Part Number	D	M	M1	M2	Across Flats
1/4	1/4	1/4	C5705x4	.172	.89	.89	.89	7/16
5/16	5/16	5/16	C5705x5	.234	.95	.95	.95	9/16
3/8	3/8	3/8	C5705x6•	.297	1.06	1.06	1.06	9/16
1/2	1/2	1/2	C5705x8•	.391	1.25	1.25	1.25	3/4
5/8	5/8	5/8	C5705x10	.484	1.45	1.45	1.45	7/8
3/4	3/4	3/4	C5705x12	.609	1.66	1.66	1.66	1-1/16
7/8	7/8	7/8	C5705x14	.718	1.73	1.73	1.73	1-5/16
1	1	1	C5705x16	.844	1.81	1.81	1.81	1-5/16
1-1/4	1-1/4	1-1/4	C5705x20	1.078	2.06	2.06	2.06	1-5/8
1-1/2	1-1/2	1-1/2	C5705x24	1.312	2.33	2.33	2.33	1-7/8

• Available in Stainless Steel

JIC 37° - Flare-Twin®

Male Run Tee

(Ref. SAE No. 070424)

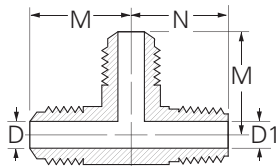
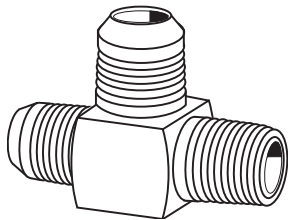
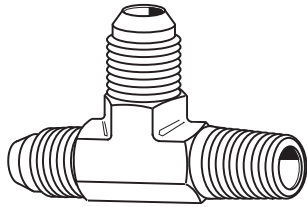

Tube O.D.	Male Pipe Thread	Part Number	D	D1	M	N	Across Flats
1/4	1/8	C5755x4	.172	.188	.89	.78	7/16
1/4	1/4	C5755x4x4x4	.172	.281	.95	1.09	9/16
3/8	1/4	C5755x6	.297	.281	1.06	1.09	9/16
3/8	3/8	C5755x6x6x6	.297	.406	1.16	1.22	9/16
1/2	3/8	C5755x8	.391	.406	1.25	1.22	3/4
1/2	1/2	C5755x8x8x8	.391	.531	1.31	1.47	7/8
5/8	1/2	C5755x10	.484	.531	1.45	1.47	7/8
3/4	3/4	C5755x12	.609	.719	1.66	1.59	1-1/16
1	1	C5755x16	.844	.938	1.81	1.97	1-5/16
1-1/4	1-1/4	C5755x20	1.078	1.250	2.06	2.38	1-3/4

Female Run Tee

(Ref. SAE No. 070426)

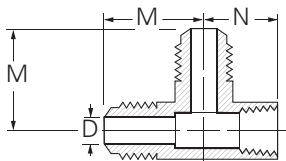
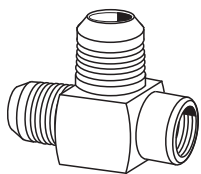

Tube O.D.	Fem. Pipe Thread	Part Number	D	M	N	Across Flats
1/4	1/8	C5805x4	.172	1.08	.66	5/8
3/8	1/4	C5805x6	.297	1.23	.88	3/4
3/4	3/4	C5805x12	.609	1.89	1.36	1-3/8
1	1	C5805x16	.844	2.17	1.62	1-5/8

Male Pipe/Female Pipe/37° Flare Tee

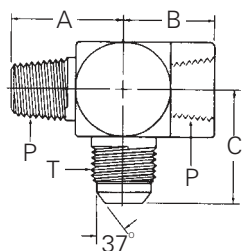

Part No. 203301 – (Dash Size)

Dash Size	Tube O.D.		Thread P (NPTF)	Thread T	A		B		C	
	mm	inches			mm	inches	mm	inches	mm	inches
2-4S	6,3	.25	1/8-27	7/16-20	19,8	.78	16,8	.66	27,4	1.08
4-6S	9,6	.38	1/4-18	9/16-18	27,7	1.09	22,3	.88	31,2	1.23
12-12S	19,0	.75	3/4-14	1 1/16-12	40,4	1.59	34,5	1.36	48,0	1.89
16-16S	25,4	1.00	1-11 1/2	1 5/16-12	50,0	1.97	41,1	1.62	55,1	2.17

JIC 37° - Flare-Twin®

Male Pipe/37° Flare/ Female Pipe

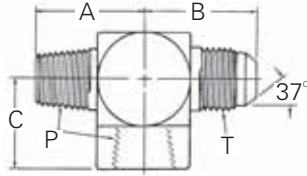

Part No. 203103 – (Dash Size)

Dash Size	Tube O.D.		Thread P (NPTF)	Thread T	A		B		C	
	mm	inches			mm	inches	mm	inches	mm	inches
2-4S	6,3	.25	1/8-27	7/16-20	19,8	.78	27,4	1.08	16,8	.66
4-6S	9,6	.38	1/4-18	9/16-18	27,7	1.09	31,2	1.23	22,3	.88
6-6S	9,6	.38	3/8-18	9/16-18	31,0	1.22	33,3	1.31	25,9	1.02
6-8S	12,7	.50	3/8-18	3/4-16	31,0	1.22	36,1	1.42	25,9	1.02
8-10S	16,0	.63	1/2-14	7/8-14	37,3	1.47	41,6	1.64	31,2	1.23
12-12S	19,0	.75	3/4-14	1 1/16-12	40,4	1.59	48,0	1.89	34,5	1.36

Male Pipe/Female Pipe 37° Flare Tee

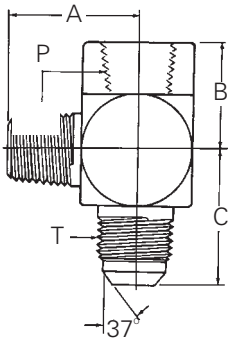

Part No. 203006 – (Dash Size)

Dash Size	Tube O.D.		Thread P	Thread T	A		B		C	
	mm	inches			mm	inches	mm	inches	mm	inches
12-12S	19,0	.75	3/4-14	1 1/16-12	40,4	1.59	34,5	1.36	48,0	1.89

Male JIC Run Tee

(Ref. SAE No. 070427)

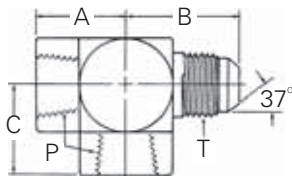

Part No. 203104 – (Dash Size)

Dash Size	Tube O.D.		Thread P	Thread T	A		B		C	
	mm	inches			mm	inches	mm	inches	mm	inches
4-6S	9,6	.38	1/4-18	9/16-18	22,3	.88	31,2	1.23	22,3	.88

JIC 37° - Flare-Twin®

Swivel Nut Run Tee

(Ref. SAE No. 070432)

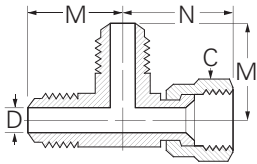
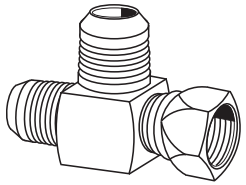
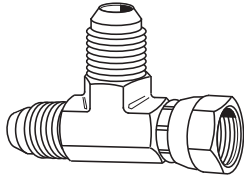

Tube O.D.	Part Number	Hex C	D	M	N	Across Flats
1/4	C5706x4	9/16	.172	.89	1.00	7/16
5/16	C5706x5	5/8	.234	.95	1.06	9/16
3/8	C5706x6	11/16	.297	1.06	1.25	9/16
1/2	C5706x8	7/8	.391	1.25	1.44	3/4
5/8	C5706x10	1	.484	1.45	1.62	7/8
3/4	C5706x12	1-1/4	.609	1.66	1.75	1-1/16
1	C5706x16	1-1/2	.844	1.81	2.00	1-5/16
1-1/4	C5706x20	2	1.078	2.06	2.36	1-5/8

Bulkhead Run Tee

(Ref. SAE No. 070958)

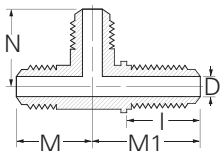
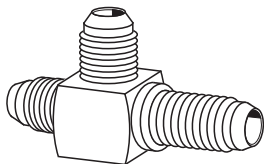
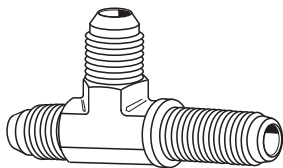

Tube O.D.	Part Number	D	I	N	M	M1	Across Flats
3/8	C5726x6	.297	1.18	1.09	1.06	1.81	9/16
1/2	C5726x8	.391	1.38	1.36	1.36	2.11	3/4

Bulkhead nut not included. Must be ordered separately.
See page L-39 for bulkhead nut.

Straight Thread O-ring Run Tee

(Ref. SAE No. 070428)

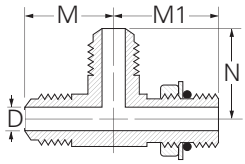
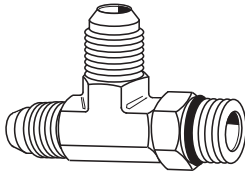

Tube O.D.	Port Size	Part Number	D	M	M1	Across Flats	N
1/4	1/4	C5716x4	.172	.89	1.03	7/16	.89
5/16	5/16	C5716x5	.234	.95	1.09	9/16	.95
3/8	3/8	C5716x6	.297	1.06	1.25	9/16	1.06
1/2	1/2	C5716x8	.391	1.25	1.45	3/4	1.25
5/8	5/8	C5716x10	.484	1.45	1.70	7/8	1.45
3/4	3/4	C5716x12	.609	1.66	1.94	1-1/16	1.66
1	1	C5716x16	.844	1.81	2.05	1-5/16	1.81
1-1/4	1-1/4	C5716x20	1.078	2.06	2.25	1-5/8	2.06

Replacement o-ring page L-64

Male Branch Tee

(Ref. SAE No. 070425)

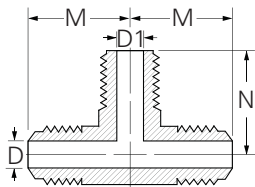
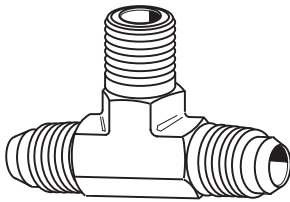

Tube O.D.	Male Pipe Thread	Part Number	D	D1	M	N	Across Flats
1/4	1/8	C5605x4	.172	.188	.89	.78	7/16
1/4	1/4	C5605x4x4x4	.172	.281	1.05	1.09	9/16
5/16	1/8	C5605x5	.234	.188	.95	.78	9/16
3/8	1/4	C5605x6	.297	.281	1.06	1.09	9/16
1/2	3/8	C5605x8	.391	.406	1.25	1.22	3/4
5/8	1/2	C5605x10	.484	.531	1.45	1.47	7/8
3/4	3/4	C5605x12	.609	.719	1.66	1.59	1-1/16
1	1	C5605x16	.844	.938	1.81	1.97	1-5/16

JIC 37° - Flare-Twin®

Female Branch Tee

(Ref. SAE No. 070427)

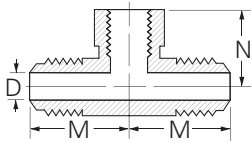
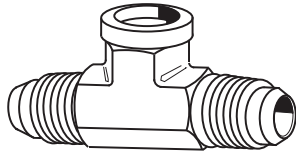

Tube O.D.	Fem. Pipe Thread	Part Number	D	M	N	Across Flats
1/4	1/4	C5655x4x4x4	.172	1.14	.88	3/4
1/4	1/8	C5655x4	.172	1.08	.66	9/16
3/8	1/4	C5655x6	.297	1.23	.88	3/4
3/8	3/8	C5655x6x6x6	.297	1.30	1.02	7/8
1/2	3/8	C5655x8	.391	1.42	1.02	7/8
1/2	1/2	C5655x8x8x8	.391	1.55	1.23	1-1/8
5/8	1/2	C5655x10	.484	1.64	1.23	1-1/16
3/4	3/4	C5655x12	.609	1.89	1.36	1-5/16
1	1	C5655x16	.844	2.17	1.62	1-5/8
2	2	C5655x32	1.781	3.30	2.39	2-7/8

Swivel Nut Branch Tee

(Ref. SAE No. 070433)

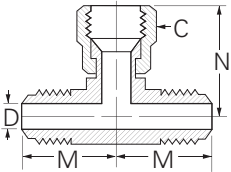
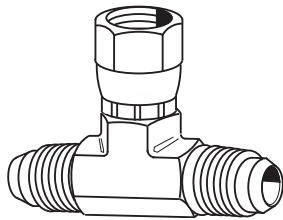

Tube O.D.	Part Number	Hex C	D	M	N	Across Flats
1/4	C5707x4	9/16	.172	.89	1.00	7/16
3/8	C5707x6	11/16	.297	1.06	1.25	9/16
1/2	C5707x8	7/8	.391	1.25	1.43	3/4
3/4	C5707x12	1-1/4	.609	1.66	1.75	1-1/16
1	C5707x16	1-1/2	.844	1.81	2.00	1-5/16
1/2	C5707x8	7/8	.391	1.25	1.38	13/16
5/8	C5707x10	1	.484	1.45	1.62	7/8
1-1/4	C5707x20	2	1.078	2.06	2.31	2

JIC 37° - Flare-Twin®

Bulkhead Branch Tee

(Ref. SAE No. 070959)

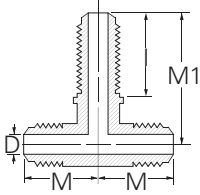
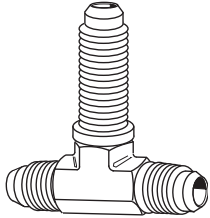

Tube O.D.	Part Number	I	D	M	M1	Across Flats
1/4	C5725x4	1.11	.172	.97	1.59	1/2
3/8	C5725x6	1.18	.297	1.06	1.81	5/8
1/2	C5725x8	1.38	.391	1.36	2.11	13/16
5/8	C5725x10	1.52	.484	1.56	2.39	15/16
3/4	C5725x12	1.69	.609	1.78	2.67	1-1/8
1	C5725x16	1.69	.844	1.94	2.80	1-3/8

Bulkhead nut not included. Must be ordered separately.
See page L-39 for bulkhead nut.

Straight Thread O-ring Branch Tee

(Ref. SAE No. 070429)

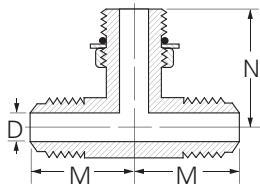
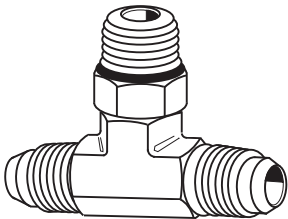

Tube O.D.	Port Size	Part Number	D	M	N	Across Flats
1/4	1/4	C5715x4	.172	.89	1.03	7/16
3/8	3/8	C5715x6	.297	1.06	1.25	9/16
1/2	1/2	C5715x8	.391	1.25	1.45	3/4
5/8	5/8	C5715x10	.484	1.45	1.70	7/8
3/4	3/4	C5715x12	.609	1.66	1.94	1-1/16
1	1	C5715x16	.844	1.81	2.05	1-5/16

Replacement o-ring listed on page L-64.

JIC 37° - Flare-Twin®

Cross

(Ref. SAE No. 070501)

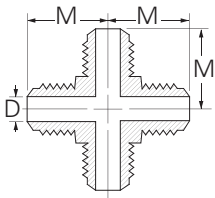
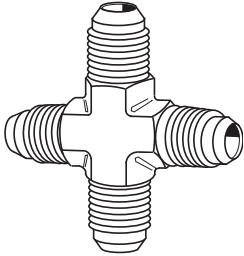

Tube O.D.	Part Number	D	M	Across Flats
3/8	C5955x6	.297	1.06	5/8
1/2	C5955x8	.391	1.25	13/16
5/8	C5955x10	.484	1.45	15/16
3/8	5967x6•	.297	1.06	9/16

• Available in Stainless Steel

Adapters, Tube Fittings & Connectors

Straight Thread O-ring

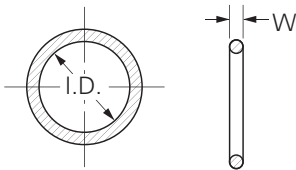

Material: Buna-N 90 Durometer-
Temperature Range:

-40°F to +250°F
(-40°C to +121°C)

Port Size	Part Number	W	I.D.
1/16	7629x1	.058	.185
1/8	7629x2	.064	.239
3/16	7629x3	.064	.301
1/4	7629x4	.072	.351
5/16	7629x5	.072	.414
3/8	7629x6	.078	.468
7/16	7629x7	.082	.530
1/2	7629x8	.087	.644
5/8	7629x10	.097	.755
3/4	7629x12	.116	.924
7/8	7629x14	.116	1.048
1	7629x16	.116	1.171
1-1/4	7629x20	.118	1.475
1-1/2	7629x24	.118	1.720
2	7629x32	.118	2.337

Standard O-ring complies with
SAE specification SAE J515
Type CH

Steel DIN Fittings

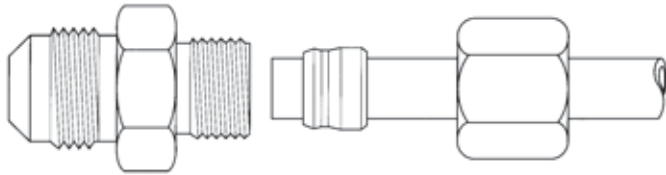

METRIC TUBE OD	6	8	10	12	14	15	16	18	20	22	25	28	30	38
Light	M12x1.5	M14x1.5	M16x1.5	M18x1.5	-	M22x1.5	-	M26x1.5	-	M30x2.0	-	M36x2.0	-	-
Heavy	M14x1.5	M16x1.5	M18x1.5	M20x1.5	M22x1.5	-	M24x1.5	-	M30x2.0	-	M36x2.0	-	M42x2.0	M52x2.0

• Typical Application

Used in applications to adapt connections made to DIN (Deutsche Industrie Norme) specifications to male 37° JIC Flare.

• Sealing Method

Three-Piece Flareless Bite Type or 60° or 24° Tube Seat, or 37° Flare.

• Vibration Rating

Three-Piece Flareless Bite Type or 60° or 24° Tube Seat. Fair Resistance.

• Material

Carbon Steel - SAE 12L14

• Plating

Bodies and Sleeves - Trivalent Zinc Plated Nuts - Phosphate Coating.

• Advantages

Provides an adapter to convert a metric hose assembly to JIC 37° allowing the use of standard hose and end fittings. Can also be used in the repair of metric tubing.

• Presetting Instructions

1. Preset with preset tool. All sleeves should be preset in tool prior to installation.
2. Cut the tubing squarely and lightly deburr the end of the tubing inside and out.
3. Lubricate the sleeve, nut and threads with a good grade of lubricant compatible with the system fluid.
4. Slide the nut and sleeve on the tubing. The thicker end of the sleeve should be toward the nut.
5. Insert the tube into the preset tool making sure it is bottomed on the tube stop. Tighten the nut by hand as much as possible.
6. On the tube sizes up to and including 18mm O.D., tighten the nut 1-1/2 turns past hand tight. For larger tube O.D.'s, tighten the nut 1-1/4 turns past hand-tight.
7. To inspect preset, mark the nut location and remove nut.
8. To reinstall, tighten the nut 1/6 turn (one hex flat) past the previous nut location.

• Ordering Information

Order individually by Part number. Preset tools found on page N-76.

Metric Flareless Sleeve

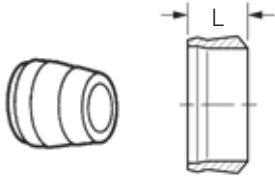

Tube O.D. (mm)	Part Number	L (mm)
6	7165x6MM	9.8
8	7165x8MM	9.5
10	7165x10MM	10.2
12	7165x12MM	9.7
14	7165x14MM	10.0
15	7165x15MM	9.8
16	7165x16MM	10.5
18	7165x18MM	9.8
20	7165x20MM	12.0
22	7165x22MM	10.5
25	7165x25MM	12.0
28	7165x28MM	11.0
30	7165x30MM	13.0

NOTE:
Multiply millimeters (mm) by 0.03937 to obtain inches.

Metric Flareless Nut Light Series

(DIN 3901/3902L)

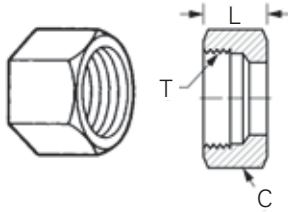

Tube O.D. (mm)	Part Number	T Thd.	Hex C (mm)	L (mm)
6	ML7105x6	M12x1.5	14	14.5
8	ML7105x8	M14x1.5	17	14.5
10	ML7105x10	M16x1.5	19	15.5
12	ML7105x12	M18x1.5	22	15.5
15	ML7105x15	M22x1.5	27	18.0
18	ML7105x18	M26x1.5	32	19.0
22	ML7105x22	M30x2.0	36	20.3
28	ML7105x28	M36x2.0	41	22.0

Metric Flareless Nut Heavy Series

(DIN /3902S)3901

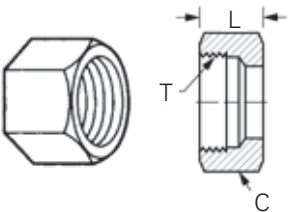

Tube O.D. (mm)	Part Number	T Thd.	Hex C (mm)	L (mm)
6	MH7105x6	M14x1.5	17	16.5
8	MH7105x8	M16x1.5	19	16.5
10	MH7105x10	M18x1.5	22	17.5
12	MH7105x12	M20x1.5	24	18.5
14	MH7105x14	M22x1.5	27	20.5
16	MH7105x16	M24x1.5	30	21.5
20	MH7105x20	M30x2.0	36	24.0
25	MH7105x25	M36x2.0	46	27.0
30	MH7105x30	M42x2.0	50	29.0
38	MH7105x38	M52x2.0	60	32.5

Male JIC 37° to 24° Metric Tube Seat (Light)

(DIN 3901/3902L)

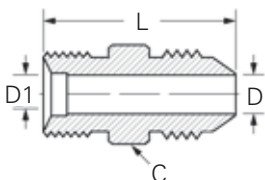
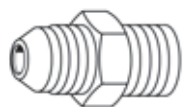

Tube O.D.	Tube O.D. (mm)	Part Number	Metric Thd.	Hex C	D	D1	L
1/4	6	MC5206x4x6	M12x1.5	5/8	.171	.171	1.22
3/8	8	MC5206x6x8	M14x1.5	3/4	.297	.240	1.22
1/2	10	MC5206x8x10	M16x1.5	7/8	.391	.322	1.41
1/2	12	MC5206x8x12	M18x1.5	15/16	.391	.398	1.48
5/8	15	MC5206x10x15	M22x1.5	1-1/16	.484	.478	1.70
3/4	18	MC5206x12x18	M26x1.5	1-3/4	.609	.596	1.91

Steel DIN Fittings

Male JIC 37° to 24° Metric Tube Seat (Heavy)

(DIN 3901/3902S)

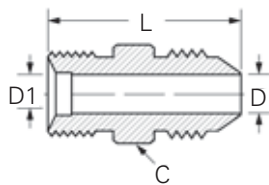

Tube O.D.	Tube O.D. (mm)	Part Number	Metric Thd.	Hex C	D	D1	L
3/8	6	MC5208x6x6	M14x1.5	3/4	.297	.167	1.22
1/2	10	MC5208x8x10	M18x1.5	15/16	.391	.283	1.48
5/8	14	MC5208x10x14	M22x1.5	1-1/16	.484	.397	1.70
3/4	16	MC5208x12x16	M24x1.5	1-1/8	.609	.476	1.77

Male JIC 37° to 60° Metric Tube Seat

(DIN 7631)

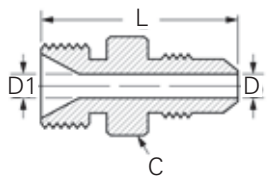

Tube O.D.	Tube O.D. (mm)	Part Number	Metric Thd.	Hex C	D	D1	L
1/4	6	MC5207x4x6	M12x1.5	1/2	.171	.157	1.22
3/8	8	MC5207x6x8	M14x1.5	5/8	.297	.242	1.22
3/8	10	MC5207x6x10	M16x1.5	7/8	.297	.321	1.32
1/2	12	MC5207x8x12	M18x1.5	15/16	.391	.394	1.48
5/8	15	MC5207x10x15	M22x1.5	1-1/16	.472	.472	1.52
3/4	18	MC5207x12x18	M26x1.5	1-1/8	.609	.596	1.91

Male JIC 37° to Male Metric Standpipe

(DIN 7631)

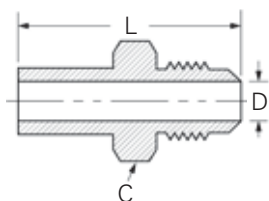
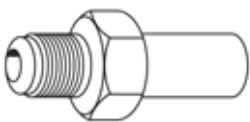

Tube O.D.	Tube O.D. (mm)	Part Number	Hex C	L	D
1/4	6MM	MC5019x4x6	9/16	1.58	.16
1/4	8MM	MC5019x4x8	9/16	1.68	.17
3/8	10MM	MC5019x6x10	3/4	1.67	.28
1/2	12MM	MC5019x8x12	7/8	1.97	.32
1/2	14MM	MC5019x8x14	7/8	1.89	.39
5/8	16MM	MC5019x10x16	1	2.07	.47
3/4	16MM	MC5019x12x16	1-1/4	2.22	.47
3/4	18MM	MC5019x12x18	1-1/4	2.12	.55
3/4	20MM	MC5019x12x20	1-1/4	2.38	.61
1	22MM	MC5019x16x22	1-1/2	2.21	.67
1	25MM	MC5019x16x25	1-1/2	2.54	.79

NOTE:

Multiply millimeters (mm) by 0.03937 to obtain inches.

Straight Thread O-ring

Straight Thread O-ring Hex Socket Plug

(Ref. SAE No. 090109B)

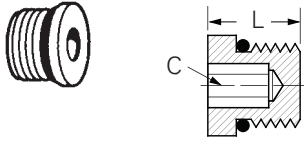

Port Size	Part Number	Hex C	L
1/8	7238x2	1/8	.40
3/16	7238x3	1/8	.40
1/4	7238x4	3/16	.47
5/16	7238x5	3/16	.47
3/8	7238x6	1/4	.50
1/2	7238x8	5/16	.58
5/8	7238x10	3/8	.65
3/4	7238x12	9/16	.77
7/8	7238x14	9/16	.77
1	7238x16	5/8	.77
1-1/4	7238x20	3/4	.78

Replacement o-ring page L-64.

Straight Thread O-ring Hex Head Plug

(Ref. SAE No. 090109A)

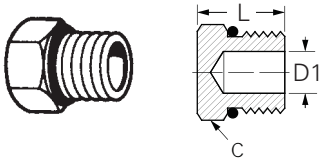

Port Size	Part Number	Hex C	L	D1 Opt.
1/8	7237x2	7/16	.60	.093
3/16	7237x3	1/2	.60	.125
1/4	7237x4	9/16	.67	.203
5/16	7237x5	5/8	.67	.234
3/8	7237x6	11/16	.73	.297
1/2	7237x8	7/8	.80	.422
5/8	7237x10	1	.93	.500
3/4	7237x12	1-1/4	1.09	.656
7/8	7237x14	1-3/8	1.09	.718
1	7237x16	1-1/2	1.12	.875
1-1/4	7237x20	1-7/8	1.20	1.093
1-1/2	7237x24	2-1/8	1.27	1.344
2	7237x32	2-3/4	1.42	1.815

Replacement o-ring page L-64.

Straight Thread O-ring

Male Straight Thread/Female Straight Thread O-ring Boss

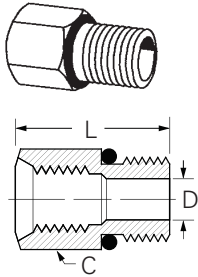

Male Port Size	Female Port Size	Part Number	Hex C	D	L
1/2	3/8	7033x8x6	7/8	.391	1.16
5/8	1/2	7033x10x8	1	.484	1.34
3/4	1/2	7033x12x8	1-1/4	.671	1.44
7/8	3/4	7033x14x12	1-3/8	.719	1.72
1	1/2	7033x16x8	1-1/2	.687	1.12
1	3/4	7033x16x12	1-1/2	.844	1.70
1-1/4	3/4	7033x20x12	1-7/8	.968	1.20
1-1/2	1-1/4	7033x24x20	2-1/8	1.312	1.75
2	1-1/2	7033x32x24	2-3/4	1.781	1.44

Replacement o-ring page L-64.

Straight Thread O-ring Union

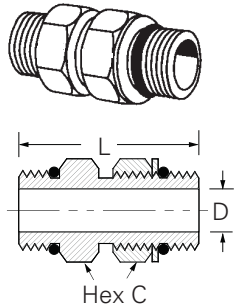

Port Size	Part Number	Hex C	D	L
1/4	C5314x4x4	9/16	.172	1.37
3/8	C5314x6x6	11/16	.297	1.50
1/2	C5314x8x8	7/8	.391	1.56
5/8	C5314x10x10	1	.484	1.80
3/4	C5314x12x12	1-1/4	.609	2.33
1	C5314x16x16	1-1/2	.844	2.28
1-1/4	C5314x20x20	1-7/8	1.078	2.13
1-1/2	C5314x24x24	2-1/8	1.312	2.13
2	C5314x32x32	2-3/4	1.781	2.13

Replacement o-ring page L-64.

Male Straight Thread O-ring to Male Pipe Adapter

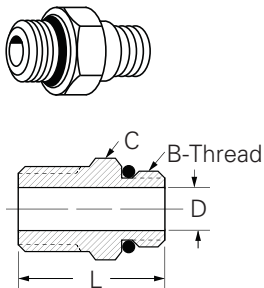

Port Size	Male Pipe Thd.	Part Number	Straight Thd B	Hex C	D	L
1/4	1/8	C3249x4x2	7/16-20	9/16	.172	1.05
3/8	1/4	C3249x6x4	9/16-18	11/16	.281	1.30
1/2	3/8	C3249x8x6	3/4-16	7/8	.391	1.36
1/2	1/2	C3249x8x8	3/4-16	7/8	.391	1.55
5/8	1/2	C3249x10x8	7/8-14	1	.484	1.69
3/4	3/4	C3249x12x12	1-1/16-12	1-1/4	.609	1.73
1	1	C3249x16x16	1-5/16-12	1-1/2	.844	2.06
1-1/4	1-1/4	C3249x20x20	1-5/8-12	1-7/8	1.078	2.17
1-1/2	1-1/2	C3249x24x24	1-7/8-12	2-1/8	1.312	2.26
2	2	C3249x32x32	2-1/2-12	2-3/4	1.781	2.47

Replacement o-ring page L-64.

Straight Thread O-ring

Straight Thread O-ring to Female Pipe Adapter

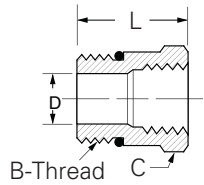
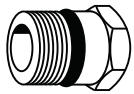

Port Size	Female Pipe Thd.	Part Number	Straight Thd B	Hex C	D	L
1/4	1/8	C3269x4x2	7/16-20	9/16	.172	.97
1/4	1/4	C3269x4x4	7/16-20	3/4	.172	1.16
5/16	1/8	C3269x5x2	1/2-20	5/8	.234	.94
3/8	1/4	C3269x6x4	9/16-18	3/4	.297	1.09
3/8	3/8	C3269x6x6	9/16-18	7/8	.281	1.30
3/8	1/2	C3269x6x8	9/16-18	1-1/8	.281	1.44
1/2	1/4	C3269x8x4	3/4-16	7/8	.421	1.06
1/2	3/8	C3269x8x6	3/4-16	7/8	.421	1.22
1/2	1/2	C3269x8x8	3/4-16	1-1/16	.421	1.65
5/8	1/4	C3269x10x4	7/8-14	1	.422	.81
5/8	3/8	C3269x10x6	7/8-14	1	.500	1.25
5/8	1/2	C3269x10x8	7/8-14	1-1/8	.500	1.50
5/8	3/4	C3269x10x12	7/8-14	1-3/8	.500	1.62
3/4	1/2	C3269x12x8	1-1/16-12	1-1/4	.688	1.34
3/4	3/4	C3269x12x12	1-1/16-12	1-3/8	.656	1.66
7/8	3/4	C3269x14x12	1-3/16-12	1-3/8	.718	1.63
1	1/2	C3269x16x8	1-5/16-12	1-1/2	.688	1.00
1	3/4	C3269x16x12	1-5/16-12	1-1/2	.876	1.50
1	1	C3269x16x16	1-5/16-12	1-5/8	.876	1.88
1-1/4	1	C3269x20x16	1-5/8-12	1-7/8	1.080	1.00
1-1/4	1-1/4	C3269x20x20	1-5/8-12	2	1.080	2.00
1-1/2	1-1/2	C3269x24x24	1-7/8-12	2-3/8	1.344	2.00
2	2	C3269x32x32	2-1/2-12	2-7/8	1.781	2.10

Replacement o-ring page L-64.

Adapters, Tube Fittings & Connectors

Straight Thread O-ring Connector to FOR-SEAL®

(Ref. SAE No. 520120)

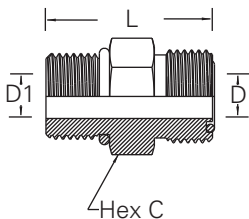
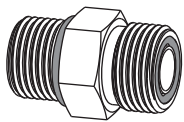

Male Tube O.D.	Port Size	Part Number	Hex C	D	D1	L
1/4	1/4	4315x4	5/8	.172	.172	1.133
1/4	3/8	4315x4x6	11/16	.172	.172	1.202
3/8	1/4	4315x6x4	3/4	.264	.172	1.343
3/8	3/8	4315x6	3/4	.264	.264	1.252
3/8	1/2	4315x6x8	7/8	.378	.264	1.378
3/8	5/8	4315x6x10	1-1/16	.264	.484	1.530
1/2	3/8	4315x8x6	7/8	.378	.264	1.472
1/2	1/2	4315x8	7/8	.378	.378	1.441
1/2	5/8	4315x8x10	1	.378	.484	1.590
1/2	3/4	4315x8x12	1-1/4	.378	.609	1.748
5/8	5/8	4315x10	1-1/16	.484	.484	1.700
3/4	3/4	4315x12	1-1/4	.609	.609	1.918
3/4	1	4315x12x16	1-1/2	.609	.609	1.960
1	3/4	4315x16x12	1-1/2	.812	.609	2.138
1	1	4315x16	1-1/2	.811	.811	1.978
1	1-1/4	4315x16x20	1-7/8	.812	1.709	2.058
1-1/4	1	4315x20x16	1-3/4	1.024	.843	2.278
1-1/4	1-1/4	4315x20	1-7/8	1.024	1.024	2.058
1-1/2	1-1/2	4315x24	2-1/8	1.260	1.260	2.125

Replacement straight o-ring page L-64.

DIN Connectors

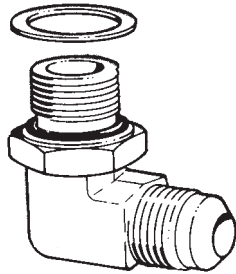
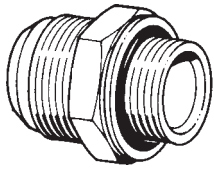

Typical Application

Used in applications to adapt connections and tubing to male and female swivel 37° JIC flare.

Material

Carbon steel – SAE 12L14.

Plating

Zinc Plated

Also metric tubing that can be flared can be adapted to a standard 37° JIC connection by the use of sleeves.

Sealing Method

Tapered pipe thread, or o-ring, or 37° flare.

Advantages

Provides an adapter to convert metric ports to 37° JIC allowing the use of standard hose and end fittings.

Ordering Information

Order individually by Part number.

Vibration Rating

Fair resistance.

Sleeve 3-Piece Metric

(Ref. SAE No. 070115)

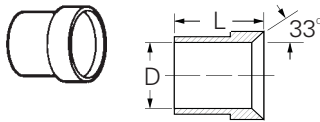

Adapts standard JIC Flare-Twin® fittings for use with metric tubing

Tube O.D. In. Size	Tube O.D. Metric	Part Number	D	L
1/4	6MM	C5165x4x6MM	.241	.41
5/16	8MM	C5165x5x8MM	.320	.44
3/8	10MM	C5165x6x10MM	.399	.50
1/2	12MM	C5165x8x12MM	.478	.56
5/8	14MM	C5165x10x14MM	.556	.66
5/8	15MM	C5165x10x15MM	.596	.66
5/8	16MM	C5165x10x16MM	.636	.66
3/4	18MM	C5165x12x18MM	.717	.68
7/8	20MM	C5165x14x20MM	.793	.76
7/8	22MM	C5165x14x22MM	.866	.76
1	25MM	C5165x16x25MM	.990	.78
1-1/4	30MM	C5165x20x30MM	1.191	.91
1-1/4	32MM	C5165x20x32MM	1.270	.91
1-1/2	38MM	C5165x24x38MM	1.500	1.12

Male JIC 37° to Male Metric Straight Thread Connector

(Port Per ISO 9974)

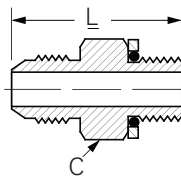
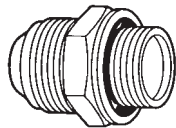

Tube O.D.	Male Thd. Metric	Part Number	L	Hex C
1/4	M10x1.0	MC5315x4x10	1.18	5/8
1/4	M12x1.5	MC5315x4x12	1.22	5/8
1/4	M14x1.5	MC5315x4x14	1.22	3/4
3/8	M14x1.5	MC5315x6x14	1.22	3/4
3/8	M16x1.5	MC5315x6x16	1.32	7/8
1/2	M18x1.5	MC5315x8x18	1.48	15/16
1/2	M22x1.5	MC5315x8x22	1.61	1-1/16
5/8	M20x1.5	MC5315x10x20	1.71	1
3/4	M22x1.5	MC5315x12x22	1.81	1-1/8
3/4	M27x2.0	MC5315x12x27	1.95	1-1/4
1	M33x2.0	MC5315x16x33	2.03	1-5/8
1-1/4	M42x2.0	MC5315x20x42	2.19	2

Replacement o-ring page L-73.



Metric Connectors

Female JIC 37° Swivel to Male Metric Taper Pipe Thread

(Pipe Thread Per DIN 3852)

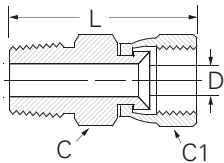
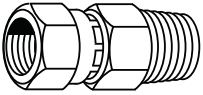

Tube O.D.	Taper Pipe Thd. Metric	Part Number	Hex C	Hex C1	D	L
1/4	M10 x 1.0	M9700x4x6	9/16	9/16	.172	1.25
5/16	M12 x 1.5	M9700x5x8	11/16	5/8	.234	1.54
3/8	M14 x 1.5	M9700x6x10	11/16	11/16	.297	1.60
1/2	M16 x 1.5	M9700x8x12	7/8	7/8	.391	1.78
5/8	M20 x 1.5	M9700x10x14	1	1	.484	1.91
3/4	M24 x 1.5	M9700x12x20	1-1/8	1-1/8	.609	2.04
1	M27 x 2.0	M9700x16x25	1-3/8	1-1/2	.845	2.30
1-1/4	M36 x 2.0	M9700x20x32	1-7/8	2	1.079	2.43

Adapters, Tube Fittings & Connectors

Metric 24° (DIN 3901/3902 I. Rh)/ 37° Flare

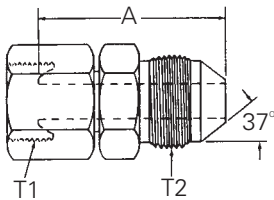

Part No. 15.163 – (Dash Size)

Dash Size	Tube O.D. mm	inches	Thread T1	Thread T2	A mm	inches
4-4T	6,3	.25	M12 x 1.5	7/16 – 20	34,5	1.36

90° Elbow - Male JIC 37° to Male Metric Straight Thread

(For ISO 9974 Port)

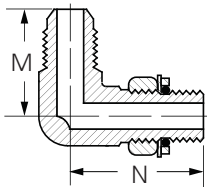
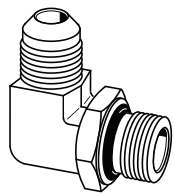

Tube O.D.	Male Thd. Metric	Part Number	M	N
1/4	M10x1.0	MC5515x4x10	.89	1.03
1/4	M12x1.5	MC5515x4x12	.95	1.09
3/8	M14x1.5	MC5515x6x14	1.06	1.25
3/8	M16x1.5	MC5515x6x16	1.14	1.45
1/2	M18x1.5	MC5515x8x18	1.26	1.47
1/2	M22x1.5	MC5515x8x22	1.33	1.70
5/8	M18x1.5	MC5515x10x18	1.41	1.60
5/8	M20x1.5	MC5515x10x20	1.45	1.70
5/8	M22x1.5	MC5515x10x22	1.45	1.70
3/4	M22x1.5	MC5515x12x22	1.66	1.78
3/4	M27x2.0	MC5515x12x27	1.66	1.94
1	M33x2.0	MC5515x16x33	1.81	2.05

Replacement retaining rings and o-ring see page L-73.

Metric Connectors

Metric Retaining Ring

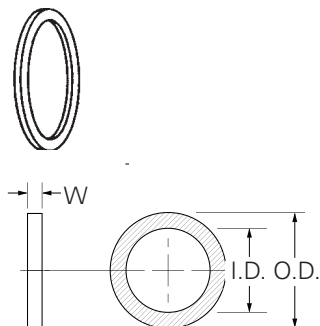

Tube O.D. (mm)	Part Number	Ring I.D. (mm)	Ring O.D. (mm)	W (mm)
10	M7630x10	11.33	14.85	1.00
12	M7630x12	13.72	17.85	1.42
14	M7630x14	15.73	19.85	1.42
16	M7630x16	17.73	21.85	1.42
18	M7630x18	19.73	23.80	1.42
20	M7630x20	21.73	25.85	1.42
22	M7630x22	23.73	27.85	1.42
27	M7630x27	29.44	32.85	1.90
33	M7630x33	35.44	39.85	1.90
42	M7630x42	44.44	49.85	1.90

Metric O-ring

(For ISO 9974 Port)

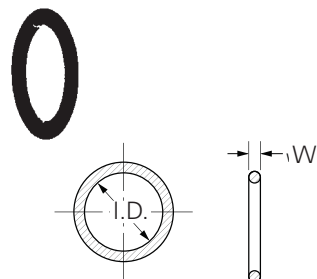

Tube O.D.	Part Number	W (mm)	I.D. (mm)
10	M7629x10	1.60	8.10
12	M7629x12	2.40	9.30
14	M7629x14	2.10	11.40
16	M7629x16	2.40	13.30
18	M7629x18	2.40	15.60
20	M7629x20	2.46	18.00
22	M7629x22	2.46	19.80
27	M7629x27	2.95	23.47
33	M7629x33	2.95	29.74
42	M7629x42	3.00	39.20

Material

Buna N 90 Durometer

Temperature Range

-40°F to +250°F
(-40°C to +121°C)

BSP Connectors

Typical Application:

Used in applications to adapt connections made to BSP (British Standard Pipe) specifications to male or female swivel SAE 37° flare.



Sealing Method

Tapered (BSPT) or Parallel Pipe Thread (BSPP), O-ring or JIC 37° flare.

Vibration Rating

Fair resistance.

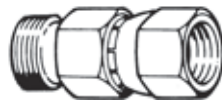

Pipe Size	1/8	1/4	3/8	1/2	5/8	3/4	1	1-1/4
Thread Size	1/8-28	1/4-19	3/8-19	1/2-14	5/8-14	3/4-14	1-11	1-1/4-11

Material

Carbon steel

Plating

Zinc, with clear trivalent chromate

Advantages

Provides an adapter to convert BSP ports to 37° allowing the use of standard connectors.

Hex Head Plug

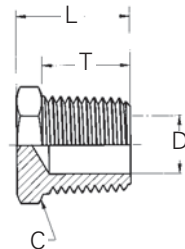

BSPT Pipe Size	Part Number	Hex C (Mm)	L	T	D Opt. Dia.
1/2	MC3159x8	22	.98	.765	.50

Male Connector

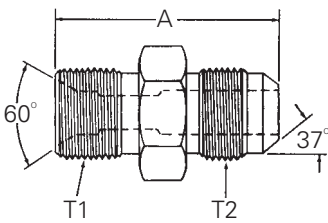

Part No. 2063 – (Dash Size)

Dash Size	Tube O.D. mm	inches	Thread T1 (BSPP)	Thread T2	A mm	inches
2-4S	6,3	.25	1/8-28	7/16-20	35,1	1.38
4-4S	6,3	.25	1/4-19	7/16-20	35,1	1.38
4-6S	9,6	.38	1/4-19	9/16-18	35,1	1.38
6-6S	9,6	.38	3/8-19	9/16-18	36,3	1.43
8-10S	16,0	.63	1/2-14	7/8-14	43,9	1.73
12-12S	19,0	.75	3/4-14	1 1/16-12	50,5	1.99
16-16S	25,4	1.00	1-11	1 5/16-12	53,1	2.09

Male British Standard Parallel Pipe to Male 37° SAE

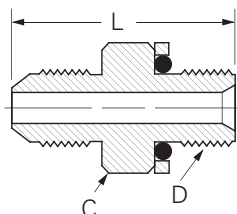
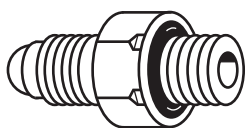

Tube O.D.	BSPP Pipe Size	Part Number	Thread B	BSPP L	Hex C
1/4	1/8	MB5315x4x2	1/8-28	1.10	5/8
1/4	1/4	MB5315x4x4	1/4-19	1.24	3/4
5/16	1/4	MB5315x5x4	1/4-19	1.24	3/4
3/8	1/4	MB5315x6x4	1/4-19	1.25	3/4
3/8	3/8	MB5315x6x6	3/8-19	1.31	7/8
1/2	3/8	MB5315x8x6	3/8-19	1.48	7/8
1/2	1/2	MB5315x8x8	1/2-14	1.67	1-1/8
5/8	3/4	MB5315x10x12	3/4-14	1.83	1-3/8
3/4	3/4	MB5315x12x12	3/4-14	1.93	1-3/8
1	1	MB5315x16x16	1-11	2.20	1-3/4
1-1/4	1-1/4	MB5315x20x20	1-1/4-11	2.32	2

Replacement retaining rings and o-ring page L-76.

BSP Connectors

Female 37° SAE Swivel to Male British Standard Tapered Pipe Thread

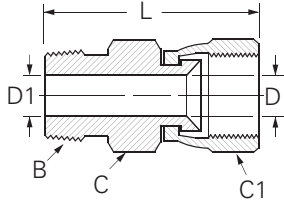
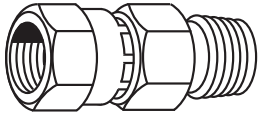

Tube O.D.	BSPT Pipe	Part Number Size	BSPT Pipe	Hex Size	Hex C1	D	D1	L
1/4	1/4	M9800x4x4	1/4	9/16	9/16	.172	.281*	1.56
5/16	1/4	M9800x5x4	1/4	11/16	5/8	.234	.281*	1.63
3/8	1/4	M9800x6x4	1/4	11/16	11/16	.297	.281	1.69
1/2	1/4	M9800x8x4	1/4	7/8	7/8	.391	.281	1.87
1/2	3/8	M9800x8x6	3/8	7/8	7/8	.391	.406*	1.87
1/2	1/2	M9800x8x8	1/2	7/8	7/8	.391	.531*	2.06
5/8	1/2	M9800x10x8	1/2	1	1	.484	.531*	2.11
3/4	1/2	M9800x12x8	1/2	1-1/8	1-1/4	.609	.531	2.21
3/4	3/4	M9800x12x12	3/4	1-1/8	1-1/4	.609	.719*	2.24
1	3/4	M9800x16x12	3/4	1-3/8	1-1/2	.845	.719	2.39
1	1	M9800x16x16	1	1-3/8	1-1/2	.845	.938*	2.55
1-1/4	1-1/4	M9800x20x20	1-14	1-7/8	2	1.079	1.125*	2.73

*Optional counterbore.

Female 37° SAE Swivel to Male British Standard Parallel Pipe Thread

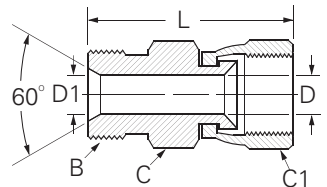
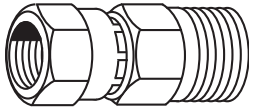

Tube O.D.	BSPP Pipe	Part Number Size	BSPT Pipe	Hex Size	Hex C1	D	D1	L
1/4	1/4	M9600x4x4	1/4	9/16	9/16	.172	.198*	1.43
5/16	1/4	M9600x5x4	1/4	5/8	11/16	.234	.198	1.50
3/8	1/4	M9600x6x4	1/4	11/16	11/16	.297	.198	1.56
3/8	3/8	M9600x6x6	3/8	11/16	11/16	.297	.322*	1.66
1/2	3/8	M9600x8x6	3/8	7/8	7/8	.391	.322	1.77
1/2	1/2	M9600x8x8	1/2	7/8	7/8	.391	.448*	1.92
5/8	1/2	M9600x10x8	1/2	1	1	.484	.448	1.97
3/4	3/4	M9600x12x12	3/4	1-1/4	1-1/8	.609	.666*	2.25
1	1	M9600x16x16	1	1-1/2	1-3/8	.845	.885*	2.48
1-1/4	1-1/4	M9600x20x20	1-1/4	2	1-7/8	1.078	1.125*	2.64

*Optional counterbore.

Male British Standard Tapered Pipe to Male SAE 37° SAE 90° Elbow

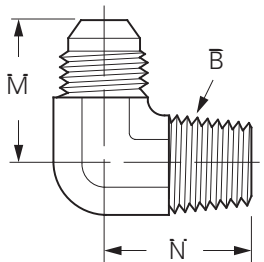
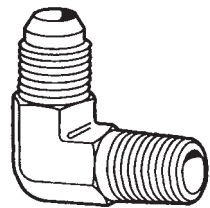

Tube O.D.	BSPT Pipe Size	Part Number	BSPT Thread B	M	N	Across Flats
1/4	1/4	MC5405x4x4	1/4-19	1.05	1.09	7/16
5/16	1/4	MC5405x5x4	1/4-19	1.05	1.09	1/2
3/8	1/4	MC5405x6x4	1/4-19	1.06	1.09	9/16
3/8	3/8	MC5405x6x6	3/8-19	1.14	1.22	3/4
1/2	3/8	MC5405x8x6	3/8-19	1.25	1.22	3/4
1/2	1/2	MC5405x8x8	1/2-14	1.33	1.47	7/8
5/8	3/4	MC5405x10x12	3/4-14	1.54	1.59	1-1/16
3/4	3/4	MC5405x12x12	3/4-14	1.66	1.59	1-1/16
1	1	MC5405x16x16	1-11	1.81	1.97	1-5/16
1-1/4	1-1/4	MC5405x20x20	1-1/4-11	2.06	2.38	1-5/8



BSP Connectors

Male British Standard Parallel Pipe to Male 37° SAE 90° Elbow

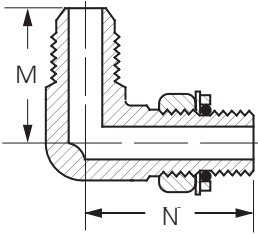
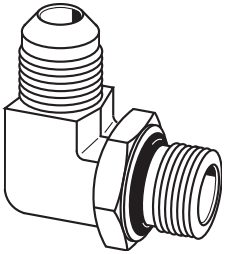

Tube O.D.	BSP Pipe Size	Part Number	BSP Thread	M	N	Across Flats
1/4	1/4	MB5515x4x4	1/4-19	1.05	1.25	9/16
5/16	1/4	MB5515x5x4	1/4-19	.95	1.25	9/16
3/8	1/4	MB5515x6x4	1/4-19	1.06	1.25	9/16
3/8	3/8	MB5515x6x6	3/8-19	1.14	1.45	3/4
1/2	3/8	MB5515x8x6	3/8-19	1.25	1.45	3/4
1/2	1/2	MB5515x8x8	1/2-14	1.33	1.70	7/8
5/8	3/4	MB5515x10x12	3/4-14	1.34	1.94	1-1/16
3/4	3/4	MB5515x12x12	3/4-14	1.66	1.94	1-1/16
1	1	MB5515x16x16	1-11	1.81	2.05	1-5/16
1-1/4	1-1/4	MB5515x20x20	1-14-11	2.06	2.25	1-5/8

Replacement retaining rings and o-ring see below.

Adapters, Tube Fittings & Connectors

British Retaining Ring

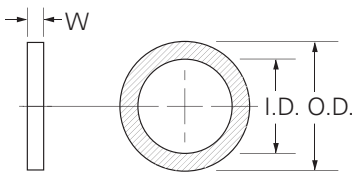

Tube O.D.	Part Number	Ring	Ring I.D.	W O.D.
1/8	MB7630x2	.45	.60	.044
1/4	MB7630x4	.63	.81	.067
3/8	MB7630x6	.77	.93	.067
1/2	MB7630x8	.91	1.12	.067
5/8	MB7630x10	1.00	1.24	.067
3/4	MB7630x12	1.12	1.37	.067
1	MB7630x16	1.44	1.74	.092
1-1/4	MB7630x20	1.76	2.18	.092
1-1/2	MB7630x24	2.02	2.43	.092

British O-ring

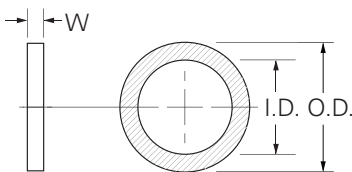

Tube O.D.	Part Number	W	I.D.
1/8	MB7629x2	.070	.239
1/4	MB7629x4	.103	.424
3/8	MB7629x6	.103	.549
1/2	MB7629x8	.103	.695
5/8	MB7629x10	.103	.818
3/4	MB7629x12	.103	.924
1	MB7629x16	.139	1.171
1-1/4	MB7629x20	.139	1.484

Material

Buna N 90 Durometer

Temperature Range

-40°F to +250°F
(-40°C to +121°C)

Special Adapters

AC8111 Connector (Steel)

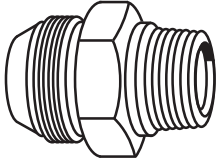

Tube Size	Male Pipe Thread	Part Number
1 (1-5/16-14)	3/4	C9240
1 (1-5/16-14)	1	C9200

APPLICATION: PTT Thread 30° tube to male pipe adapter for Diesel Engines.

Restriction Pipe Adapter (Brass)

With .0625 orifice

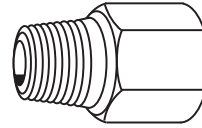

Male Pipe Size	Fem. Pipe Thread	Part Number
1/8	1/8	1512

JIC 37° Flare to O-ring Port (Steel)

Includes o-ring

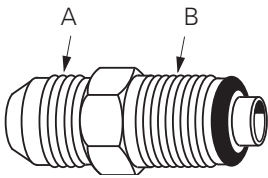

Tube Size	Thread A	Thread B	Part Number
1/4	7/16-20	7/16-24	41157x4
3/8	9/16-18	5/8-18	41157x6
1/2	3/4-16	3/4-16	41157x8
5/8	7/8-14	7/8-14	41157x10
3/4	1-1/16-12	1-1/16-16	41157x12

Includes o-ring.

JIC 37° Flare to Metric O-ring Port Adapter (Steel)

Includes o-ring

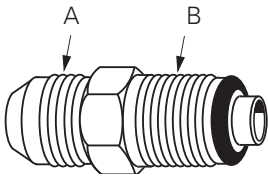

Tube Size	Thread A	Thread B	Part Number
3/8	9/16-18	M14x1.5	M41157x6x14
3/8	9/16-18	M16x1.5	M41157x6x16
3/8	9/16-18	M18x1.5	M41157x6x18

Includes o-ring.

Application: GM power steering with Saginaw steering and rack and pinion steering systems

Male Pipe to 30° Flare

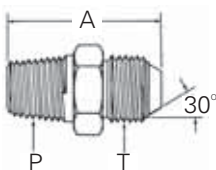

Part No. 2004 – (Dash Size)

Dash Size	Tube O.D.		Thread P (nptf)	Thread T	A	
	mm	inches			mm	inches
16-16S	25,4	1.00	1 – 11 ¹ / ₂	1 ⁵ / ₁₆ – 14	51,6	2.03

Steel Flareless

Ermeto Connectors

Typical Application:

Hydraulic, instrumentation, and chemical processing. Highly recommended for high pressure and high vibration applications.

Pressure

See chart below

Sealing Method

3-piece bite-type

Vibration Rating

Excellent resistance

Material

Carbon steel

Used With

Aluminum, hard or half-hard copper, steel, stainless steel, monel, titanium and heavy wall tubing that cannot be flared.

Advantages

No tube flaring. Used with extra heavy wall tubing. Broad selection of styles and sizes.

Conformance

Meets ASA, ASME, SAE, and MS specifications and standards.

Ordering Information

Connectors are ordered as complete assemblies. To order bodies only (less nut and sleeve), prefix Part number with the letter "B." Example: B7205x4. Order nuts and sleeves separately by Part number.

Label Set: FS-1600

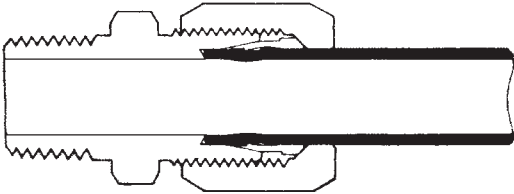

Tube O.D.	1/8	3/16	1/4	5/16	3/8	1/2	5/8	3/4	7/8	1	1-1/4	1-1/2	2
Thread	5/16-24	3/8-24	7/16-20	1/2-20	9/16-18	3/4-16	7/8-14	1-1/16-12	1-3/16-12	1-5/16-12	1-5/8-12	1-7/8-12	2-1/2-12

Preset with Preset Tool:

(Preset Tools are listed on page N-76.)

- Slide nut and then sleeve on tube. Shoulder of sleeve 'A' must be toward nut.
- Insert tube into presetting tool. Be sure that tube is bottomed on fitting tube stop at point 'B.' Lubricate threads, seat of fitting and shoulder of sleeve with good grade of lubricant.
- Turn nut slowly with wrench while turning tube with other hand. When the sleeve grips the tube, that is, when the tube can no longer be turned by hand – STOP – and note the position of the wrench. This is the "Ring Grip" point. Tighten nut an additional number of turns past the ring grip point as shown in Table 1, page N-80.

Preset in Fitting Body

- Follow same procedure as when presetting with preset tool. Once the fitting nut has been turned the proper number of turns past ring grip, the fitting assembly is complete and ready for use.

⚠ WARNING

Follow the installation procedures below with care to ensure proper installation of Ermeto Connectors.

Installation:

- After sleeve and nut have been preset on the tubing and checked as described, the assembly is ready for installation into the Ermeto connector seat.
- Lubricate threads, seat of fitting and shoulder of sleeve with a good grade of lubricant compatible with system fluid.
- Insert tube assembly into fitting and tighten nut until sharp rise in torque is felt.
- Starting at the position of sharp torque rise, tighten nut 1/4 turn to complete the assembly.

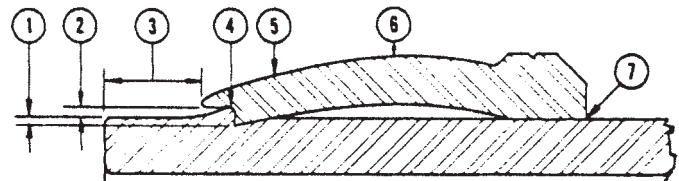
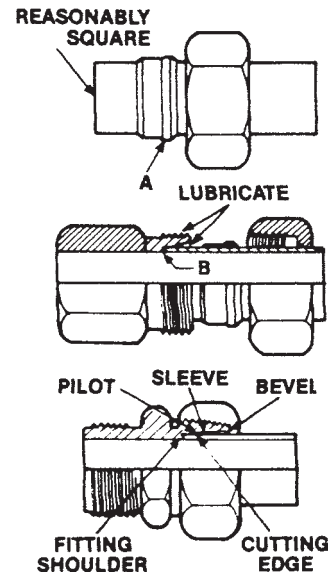

Steel Flareless

Ermeto Connectors

TABLE 1

Number of Additional Turns from “Ring Grip” for Hand Presetting Operation – Ermeto Sleeve

Tube Size	**Tube Material	.018	.022	.028	.035	.049	.065	.083	.095	.109	.120
2	C1010	1-1/6	1-1/6	1-1/6	1-1/6						
	MIL T 8504	1-1/6	1-1/6	1-1/6	1-1/6						
3	C1010	1-1/6	1-1/6	1-1/6	1						
	MIL T 8504	1-1/6	1-1/6	1-1/6	1						
4	C1010			1-1/6	1-1/6	1-1/6	1				
	MIL T 8504			1-1/6	1	1	5/6				
5	C1010			1-1/6	1-1/6	1-1/6	1				
	MIL T 8504			1-1/6	1-1/6	1	1				
6	C1010				1-1/6	1-1/6	1	1			
	MIL T 8504				1-1/6	1	5/6	5/6			
8	C1010				1-1/6	1-1/6	1	1	1		
	MIL T 8504				1-1/6	1	5/6	5/6	5/6		
10	C1010					1-1/6	1	5/6	5/6	5/6	5/6
	MIL T 8504					1-1/6	1	5/6	5/6		
12	C1010					1	1	5/6	5/6	5/6	5/6
	MIL T 8504					1-1/6	1	5/6	5/6	5/6	5/6
16	C1010					1-1/6	1-1/6	5/6	5/6	5/6	5/6
	MIL T 8504					1-1/6	1-1/6	5/6	5/6	5/6	5/6
20	C1010					1-1/6	1	1	1	5/6	5/6
	MIL T 8504					1	1	1	1	5/6	5/6
24	C1010										
	MIL T 8504								1	1	1
32	C1010										
	MIL T 8504								1	1	1

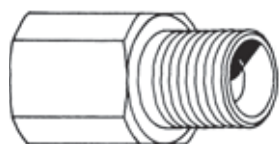

Presetting tools provide a more accurate and positive leakproof method of coupling flareless Connectors. Presetting steel Ermeto sleeves on tubing prior to the fitting assembly will permit the maximum high performance obtainable with flareless Connectors. Due to possible thread galling the use of presetting tools is required when stainless steel Connectors are to be assembled. See page N-76 for T-570-1 hydraulic preset machine.

Ermeto Hand-Presetting Tools 7000 Series

Part Number	Seat Size	Tube O.D. (Inches)	Thread Size
T-7002	2	1/8	5/16-24
T-7003	3	3/16	3/8-24
T-7004	4	1/4	7/16-20
T-7005	5	5/16	1/2-20
T-7006	6	3/8	9/16-18
T-7008	8	1/2	3/4-16
T-7010	10	5/8	7/8-14
T-7012	12	3/4	1-1/16-12
T-7016	16	1	-5/16-12
T-7020	20	1-1/4	1-5/8-12
T-7024	24	1-1/2	1-7/8-12
T-7032	32	2	2-1/2-12



Steel Connectors

Steel Flareless, Ermeto Connectors

Sleeve

(Ref. SAE No. 080115B)

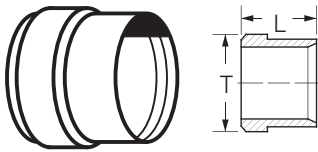

Tube O.D.	Part Number	L	Dia. T
1/8	7165x2	.28	.20
3/16	7165x3	.28	.31
1/4	7165x4	.34	.36
5/16	7165x5	.34	.42
3/8	7165x6	.38	.48
1/2	7165x8	.38	.63
5/8	7165x10	.42	.75
3/4	7165x12	.42	.88
7/8	7165x14	.42	1.00
1	7165x16	.42	1.13
1-1/4	7165x20	.42	1.41
1-1/2	7165x24	.42	1.66
2	7165x32	.45	2.19

Sleeve

(For use with diesel nuts only)

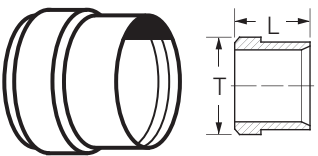

Tube O.D.	Part Number	L	Dia. T
1/4	8165x4	.34	.38
5/16	8165x5	.34	.44
3/8	8165x6	.38	.50

Nut

(Ref. SAE No. 080110)

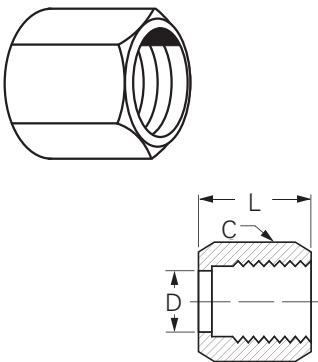

Tube O.D.	Part Number	Hex C	L	D Dia.
1/8	7105x2	3/8	.53	.132
3/16	7105x3	7/16	.61	.195
1/4	7105x4	9/16	.70	.257
5/16	7105x5	5/8	.72	.320
3/8	7105x6	11/16	.75	.382
1/2	7105x8	7/8	.84	.508
5/8	7105x10	1	.92	.634
3/4	7105x12	1-1/4	.97	.759
7/8	7105x14	1-3/8	1.00	.884
1	7105x16	1-1/2	1.05	1.009
1-1/4	7105x20	2	1.05	1.263
1-1/2	7105x24	2-1/4	1.03	1.513
2	7105x32	2-7/8	1.12	2.017

Diesel Nut

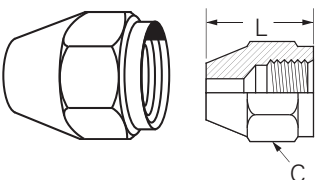

Tube O.D.	Thread Size	Part Number	Hex C	L
1/4	9/16-18	8112x4	3/4	.94
5/16	5/8-18	8112x5	13/16	1.00
3/8	3/4-16	8112x6	15/16	1.13

Steel Connectors

Steel Flareless, Ermeto Connectors

Bulkhead Nut

(Ref. SAE No. 080118)

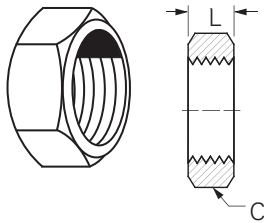

Tube O.D.	Part Number	Hex C	L
1/4	7924x4	11/16	.28
3/8	7924x6	13/16	.27
1/2	7924x8	1	.31
5/8	7924x10	1-1/8	.36
3/4	7924x12	1-3/8	.41
7/8	7924x14	1-1/2	.41
1	7924x16	1-5/8	.41
1-1/4	7924x20	1-7/8	.41

Cap

(Ref. SAE No. 080112)

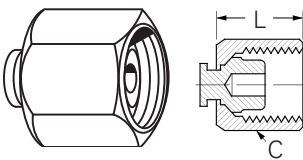

Tube O.D.	Part Number	Hex C	L
1/4	7129x4	9/16	.70
3/8	7129x6	11/16	.75
1/2	7129x8	7/8	.84
5/8	7129x10	1	.92
3/4	7129x12	1-1/4	.97
1	7129x16	1-1/2	1.05
1-1/4	7129x20	2	1.05

Plug

(Ref. SAE No. 080109)

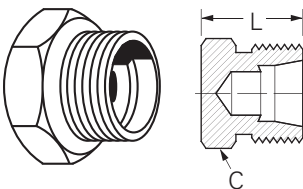

Tube O.D.	Part Number	Hex C	L
1/8	7229x2	7/16	.63
1/4	7229x4	1/2	.71
5/16	7229x5	9/16	.71
3/8	7229x6	5/8	.75
1/2	7229x8	13/16	.85
5/8	7229x10	15/16	.97
3/4	7229x12	1-1/8	1.10
1	7229x16	1-3/8	1.10

Reducer

(Ref. SAE No. 080123)

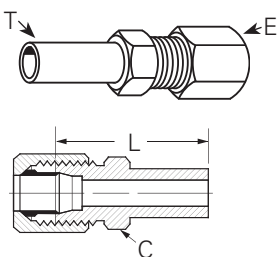

Body Size T	Tube Size E	Part Number	Hex C	L
3/8	1/4	7015x6x4	1/2	1.61
1/2	1/4	7015x8x4	9/16	1.73
1/2	3/8	7015x8x6	5/8	1.77
5/8	1/2	7015x10x8	13/16	1.96
3/4	3/8	7015x12x6	13/16	1.93
3/4	1/2	7015x12x8	13/16	2.03
1-1/4	1	7015x20x16	1-3/8	2.28



Steel Connectors

Steel Flareless, Ermeto Connectors

Small Hex Union

(Ref. SAE No. 080101)

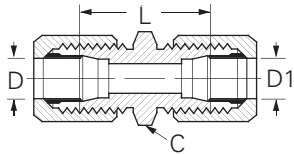
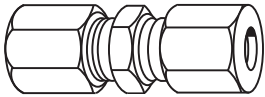

Tube O.D.	Tube O.D.	Part Number	Hex C	D	D1	L
1/8	1/8	7305x2	7/16	.093	.093	1.02
3/16	3/16	7305x3	7/16	.125	.125	1.11
1/4	1/4	7305x4	1/2	.203	.203	1.18
5/16	5/16	7305x5	9/16	.234	.234	1.18
3/8	1/4	7305x6x4	5/8	.281	.203	1.22
3/8	3/8	7305x6	5/8	.281	.281	1.24
1/2	3/8	7305x8x6	13/16	.422	.281	1.33
1/2	1/2	7305x8	13/16	.422	.422	1.42
5/8	5/8	7305x10	15/16	.500	.500	1.61
3/4	3/4	7305x12	1-1/8	.656	.656	1.81
7/8	7/8	7305x14	1-1/4	.718	.718	1.81
1	1	7305x16	1-3/8	.875	.875	1.81
1-1/4	1-1/4	7305x20	1-11/16	1.093	1.093	1.89
1-1/2	1-1/2	7305x24	2	1.344	1.344	1.96
2	2	7305x32	2-5/8	1.813	1.813	2.11

Large Hex Union

(Ref. SAE No. 080119)

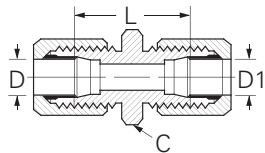
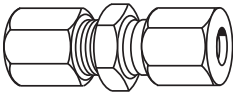

Tube O.D.	Tube O.D.	Part Number	Hex C	D	D1	L
1/4	1/4	7306x4	11/16	.203	.203	1.18
3/8	3/8	7306x6	13/16	.281	.281	1.24
1/2	3/8	7306x8x6	1	.422	.281	1.33
1/2	1/2	7306x8	1	.422	.422	1.42
3/4	3/4	7306x12	1-3/8	.656	.656	1.81
1	1	7306x16	1-5/8	.875	.875	1.81

Bulkhead Union

(Ref. SAE No. 080601)

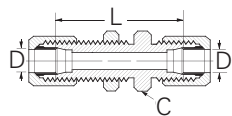
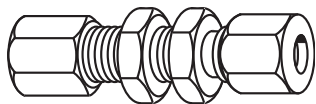

Tube O.D.	Part Number	Hex C	D	L
1/4	7325x4	11/16	.203	1.89
3/8	7325x6	13/16	.281	1.98
1/2	7325x8	1	.422	2.22
3/4	7325x12	1-3/8	.656	2.72
1	7325x16	1-5/8	.875	2.72

For bulkhead nuts see page L-81.

Steel Connectors

Steel Flareless, Ermeto Connectors

Male Connector

(Ref. SAE No. 080102)

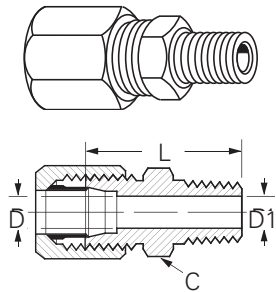

Tube O.D.	Male Pipe Thread	Part Number	Hex C	D	D1 Opt.	L
1/8	1/8	7205x2	7/16	.093	.188	1.04
1/8	1/4	7205x2x4	9/16	.093	.281	1.25
3/16	1/8	7205x3	7/16	.125	.188	1.09
1/4	1/8	7205x4	1/2	.203	.188	1.12
1/4	1/4	7205x4x4	9/16	.203	.281	1.32
1/4	3/8	7205x4x6	3/4	.203	.406	1.33
1/4	1/2	7205x4x8	7/8	.203	.531	1.58
5/16	1/8	7205x5	9/16	.234	.188	1.12
5/16	1/4	7205x5x4	9/16	.234	.281	1.32
3/8	1/8	7205x6x2	5/8	.281	.188	1.15
3/8	1/4	7205x6	5/8	.281	.281	1.34
3/8	3/8	7205x6x6	3/4	.281	.406	1.35
3/8	1/2	7205x6x8	7/8	.281	.531	1.60
1/2	1/4	7205x8x4	13/16	.422	.281	1.44
1/2	3/8	7205x8	13/16	.422	.406	1.44
1/2	1/2	7205x8x8	7/8	.422	.531	1.69
1/2	3/4	7205x8x12	1-1/8	.422	.719	1.76
5/8	3/8	7205x10x6	15/16	.500	.406	1.56
5/8	1/2	7205x10	15/16	.500	.531	1.75
3/4	1/2	7205x12x8	1-1/8	.656	.531	1.88
3/4	3/4	7205x12	1-1/8	.656	.719	1.88
7/8	3/4	7205x14	1-1/4	.718	.719	1.88
1	3/4	7205x16x12	1-3/8	.875	.719	1.88
1	1	7205x16	1-3/8	.875	.938	2.07
1-1/4	1-1/4	7205x20	1-11/16	1.093	1.250	2.18
1-1/2	1-1/2	7205x24	2	1.344	1.500	2.28
2	2	7205x32	2-5/8	1.813	1.938	2.46

Female Connector

(Ref. SAE No. 080103)

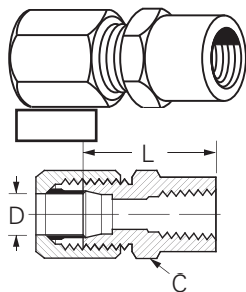

Tube O.D.	Fem. Pipe Thread	Part Number	Hex C	D	L
1/8	1/8	7255x2	9/16	.093	1.05
3/16	1/8	7255x3	9/16	.125	1.08
1/4	1/8	7255x4	9/16	.203	1.09
1/4	1/4	7255x4x4	3/4	.203	1.20
5/16	1/8	7255x5	9/16	.234	1.08
3/8	1/4	7255x6	3/4	.281	1.31
3/8	3/8	7255x6x6	7/8	.281	1.40
1/2	1/4	7255x8x4	7/8	.422	1.38
1/2	3/8	7255x8	7/8	.422	1.47
1/2	1/2	7255x8x8	1-1/8	.422	1.63
5/8	1/2	7255x10	1-1/8	.500	1.76
3/4	3/4	7255x12	1-3/8	.656	1.89
7/8	3/4	7255x14	1-3/8	.718	1.86
1	1	7255x16	1-5/8	.875	2.13
1-1/4	1-1/4	7255x20	2	1.093	2.22

Steel Connectors

Steel Flareless, Ermeto Connectors

Straight Thread O-Ring Connector

(Ref. SAE No. 080120)

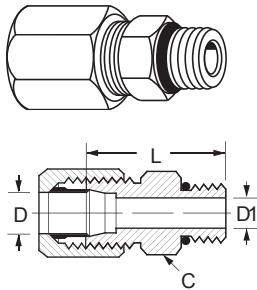

Replacement o-rings page L-64.

Tube O.D.	Port Size	Part Number	Hex C	D	L	D1 Opt.
3/16	3/16	7315x3	1/2	.125	1.04	—
1/4	1/4	7315x4	9/16	.203	1.13	—
1/4	5/16	7315x4x5	5/8	.203	1.13	—
1/4	3/8	7315x4x6	11/16	.203	1.19	.281
5/16	5/16	7315x5	5/8	.234	1.13	—
3/8	3/8	7315x6	11/16	.281	1.21	—
3/8	1/2	7315x6x8	7/8	.281	1.29	.422
1/2	1/2	7315x8	7/8	.422	1.38	—
1/2	5/8	7315x8x10	1	.422	1.51	.500
1/2	3/4	7315x8x12	1-1/4	.422	1.67	.656
5/8	5/8	7315x10	1	.500	1.57	—
3/4	3/4	7315x12	1-1/4	.656	1.79	—
3/4	1	7315x12x16	1-1/2	.656	1.82	.876
7/8	7/8	7315x14	1-3/8	.718	1.79	—
1	3/4	7315x16x12	1-1/2	.875	1.82	.656
1	1	7315x16	1-1/2	.875	1.82	—
1-1/4	1-1/4	7315x20	1-7/8	1.093	1.90	—
1-1/2	1-1/2	7315x24	2-1/8	1.344	1.97	—
2	2	7315x32	2-3/4	1.813	2.13	—

Adapters, Tube Fittings & Connectors

45° Male Elbow

(Ref. SAE No. 080302)

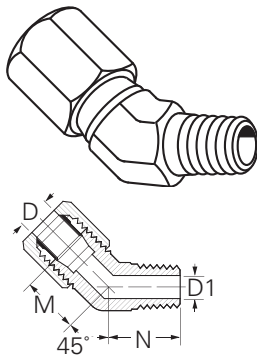

Tube O.D.	Male Pipe Thread	Part Number	D	D1	M	N	Across Flats
1/4	1/8	7355x4	.203	.188	.70	.64	7/16
1/4	1/4	7355x4x4	.203	.281	.83	.86	9/16
5/16	1/8	7355x5	.234	.188	.75	.64	9/16
3/8	1/4	7355x6	.281	.281	.83	.86	9/16
1/2	3/8	7355x8	.422	.406	.98	.95	3/4
5/8	1/2	7355x10	.500	.531	1.08	1.17	7/8
3/4	3/4	7355x12	.656	.719	1.27	1.20	1-1/16
1	1	7355x16	.875	.938	1.36	1.48	1-5/16

90° Union Elbow

(Ref. SAE No. 080201)

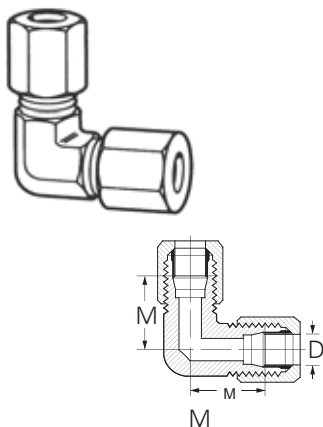

Tube O.D.	Part Number	D	M	Across Flats
1/4	7505x4	.203	.89	7/16
5/16	7505x5	.234	.95	1/2
3/8	7505x6	.281	1.05	9/16
1/2	7505x8	.422	1.25	3/4
5/8	7505x10	.500	1.42	7/8
3/4	7505x12	.656	1.58	1-1/16
7/8	7505x14	.718	1.66	1-5/16
1	7505x16	.875	1.73	1-5/16
1-1/4	7505x20	1.093	1.89	1-5/8
1-1/2	7505x24	1.346	2.02	1-7/8

Steel Connectors

Steel Flareless, Ermeto Connectors

90° Male Elbow

(Ref. SAE No. 080202)

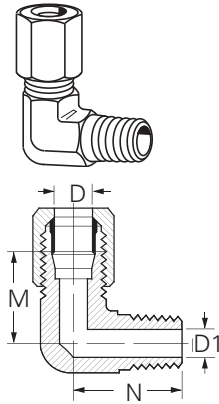

Tube O.D.	Male Pipe Thread	Part Number	D	D1	M	N	Across Flats
1/8	1/8	7405x2	.093	.188	.77	.72	7/16
3/16	1/8	7405x3	.125	.188	.83	.72	7/16
1/4	1/8	7405x4	.203	.188	.89	.78	7/16
1/4	1/4	7405x4x4	.203	.281	1.03	1.09	9/16
5/16	1/8	7405x5	.234	.188	.95	.81	1/2
5/16	1/4	7405x5x4	.234	.281	1.03	1.09	9/16
3/8	1/8	7405x6x2	.281	.188	1.05	.90	9/16
3/8	1/4	7405x6	.281	.281	1.05	1.09	9/16
3/8	3/8	7405x6x6	.281	.406	1.16	1.22	3/4
3/8	1/2	7405x6x8	.281	.531	1.24	1.47	7/8
1/2	1/4	7405x8x4	.422	.281	1.25	1.22	3/4
1/2	3/8	7405x8	.422	.406	1.25	1.22	3/4
1/2	1/2	7405x8x8	.422	.531	1.35	1.47	7/8
5/8	3/8	7405x10x6	.500	.406	1.42	1.28	7/8
5/8	1/2	7405x10	.500	.531	1.42	1.47	7/8
3/4	1/2	7405x12x8	.656	.531	1.58	1.59	1-1/16
3/4	3/4	7405x12	.656	.719	1.58	1.59	1-1/16
7/8	3/4	7405x14	.718	.719	1.62	1.69	1-5/16
1	3/4	7405x16x12	.875	.719	1.73	1.78	1-5/16
1	1	7405x16	.875	.938	1.73	1.97	1-5/16
1-1/4	1-1/4	7405x20	1.093	1.250	1.89	2.38	1-5/8
1-1/2	1-1/2	7405x24	1.344	1.500	2.02	2.64	1-7/8
2	2	7405x32	1.813	1.938	2.45	3.00	2-9/16

90° Female Elbow

(Ref. SAE No. 080203)

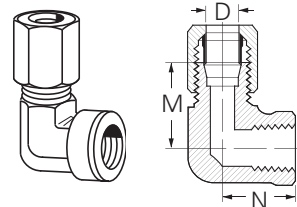

Tube O.D.	Fem. Pipe Thread	Part Number	D	M	N	Across Flats
1/4	1/8	7455x4	.203	.89	.66	9/16
1/4	1/4	7455x4x4	.203	1.03	.88	3/4
3/8	1/4	7455x6	.281	1.05	.88	3/4
3/8	3/8	7455x6x6	.281	1.14	1.02	7/8
1/2	3/8	7455x8	.422	1.23	1.02	7/8
1/2	1/2	7455x8x8	.422	1.35	1.23	1-1/16
5/8	1/2	7455x10	.500	1.42	1.23	1-1/16
3/4	3/4	7455x12	.656	1.58	1.36	1-5/16
7/8	3/4	7455x14	.718	1.66	1.42	1-5/16
1	1	7455x16	.875	1.73	1.62	1-5/8

90° Elbow - Straight Thread O-Ring

(Ref. SAE No. 080220)

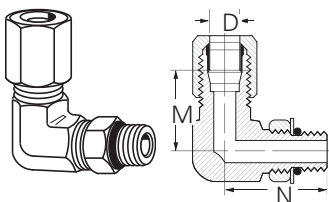

Tube O.D.	Port Size	Part Number	D	M	N	Across Flats
1/4	1/4	7515x4	.203	.89	1.03	7/16
5/16	5/16	7515x5	.234	.96	1.13	9/16
3/8	3/8	7515x6	.281	1.05	1.25	9/16
1/2	1/2	7515x8	.422	1.25	1.45	3/4
5/8	5/8	7515x10	.500	1.42	1.70	7/8
3/4	3/4	7515x12	.656	1.58	1.94	1-1/16
1	3/4	7515x16x12	.875	1.73	2.05	1-5/16
1	1	7515x16	.875	1.73	2.05	1-5/16
1-1/4	1-1/4	7515x20	1.093	1.89	2.25	1-5/8

Replacement o-rings page L-64.

Steel Connectors

Steel Flareless, Ermeto Connectors

Union Tee

(Ref. SAE No. 080401)

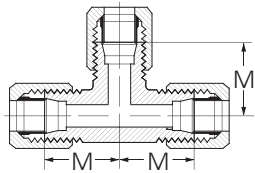
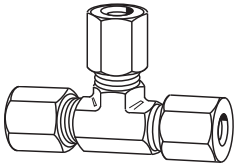

Tube O.D.	Part Number	D	M	Across Flats
3/16	7705x3	.125	.83	7/16
1/4	7705x4	.203	.89	7/16
5/16	7705x5	.234	.95	9/16
3/8	7705x6	.281	1.05	9/16
1/2	7705x8	.422	1.25	3/4
5/8	7705x10	.500	1.42	7/8
3/4	7705x12	.656	1.58	1-1/16
7/8	7705x14	.718	1.62	1-5/16
1	7705x16	.875	1.73	1-5/16

Adapters, Tube Fittings & Connectors

Male Run Tee

(Ref. SAE No. 080424)

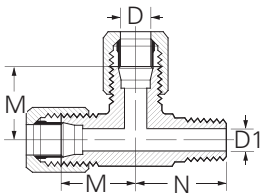
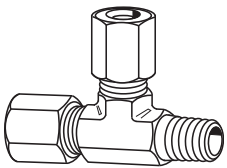

Tube O.D.	Male Pipe Thread	Part Number	D	D1	M	N	Across Flats
1/4	1/8	7755x4	.203	.188	.89	.78	7/16
1/4	1/4	7755x4x4x4	.203	.281	1.03	1.09	9/16
3/8	1/4	7755x6	.281	.281	1.05	1.09	9/16
1/2	3/8	7755x8	.422	.422	1.25	1.22	3/4
1/2	1/2	7755x8x8x8	.422	.531	1.35	1.47	7/8
5/8	1/2	7755x10	.500	.531	1.42	1.47	7/8
3/4	3/4	7755x12	.656	.719	1.58	1.59	1-1/16
1	1	7755x16	.875	.938	1.73	1.97	1-5/16

Female Run Tee

(Ref. SAE No. 080426)

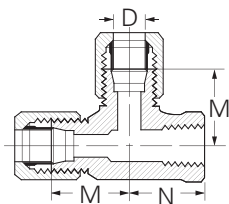
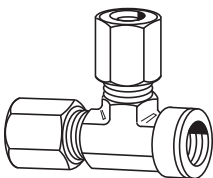

Tube O.D.	Fem. Pipe Thread	Part Number	D	M	N	Across Flats
1/4	1/8	7805x4	.203	.89	.66	9/16
1/4	1/4	7805x4x4x4	.203	1.03	.88	3/4
3/8	1/4	7805x6	.281	1.05	.88	3/4
1/2	3/8	7805x8	.422	1.23	1.02	7/8
5/8	1/2	7805x10	.500	1.42	1.23	1-1/16
3/4	3/4	7805x12	.656	1.58	1.36	1-5/16

Steel Connectors

Steel Flareless, Ermeto Connectors

Straight Thread O-Ring Run Tee

(Ref. SAE No. 080428)

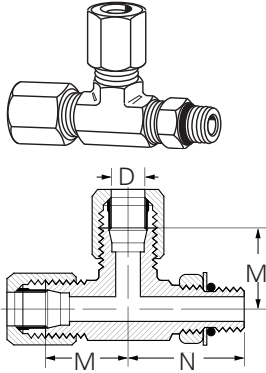

Tube O.D.	Port Size	Part Number	D	M	N	Across Flats
1/4	1/4	7716x4	.203	.89	1.03	7/16
3/8	3/8	7716x6	.281	1.05	1.25	9/16
1/2	1/2	7716x8	.422	1.25	1.45	3/4

Male Branch Tee

(Ref. SAE No. 080425)

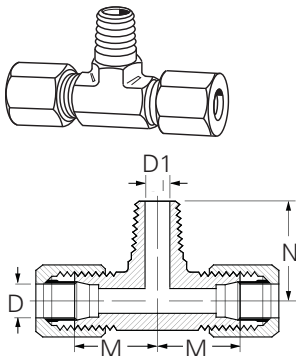

Tube O.D.	Male Pipe Thd.	Part Number	D	D1	M	N	Across Flats
1/4	1/8	7605x4	.203	.188	.89	.78	7/16
1/4	1/4	7605x4x4x4	.203	.281	1.03	1.09	9/16
5/16	1/8	7605x5	.234	.188	.95	.81	9/16
3/8	1/4	7605x6	.281	.281	1.05	1.09	9/16
1/2	3/8	7605x8	.422	.406	1.25	1.22	3/4
1/2	1/2	7605x8x8x8	.422	.531	1.35	1.47	7/8
5/8	1/2	7605x10	.500	.531	1.42	1.47	7/8
3/4	3/4	7605x12	.656	.719	1.58	1.59	1-1/16
1	1	7605x16	.875	.938	1.73	1.97	1-5/16

Female Branch Tee

(Ref. SAE No. 080427)

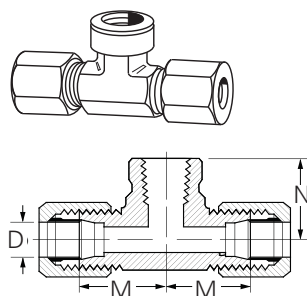

Tube O.D.	Female Pipe Thd.	Part Number	D	M	N	Across Flats
1/4	1/8	7655x4	.203	.89	.66	9/16
1/4	1/4	7655x4x4x4	.203	1.03	.88	3/4
3/8	1/4	7655x6	.281	1.05	.88	3/4
1/2	3/8	7655x8	.422	1.23	1.02	7/8
5/8	1/2	7655x10	.500	1.42	1.23	1-1/16
3/4	3/4	7655x12	.656	1.58	1.36	1-5/16
7/8	3/4	7655x14	.718	1.62	1.42	1-5/16
1	1	7655x16	.875	1.73	1.62	1-5/8
1-1/4	1-1/4	7655x20	1.093	2.08	1.70	1-7/8



Steel Connectors

Steel Flareless, Ermeto Connectors

Straight Thread O-Ring Branch Tee

(Ref. SAE No. 080429)

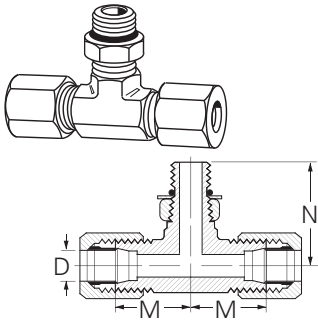

Tube O.D.	Port Size	Part Number	D	M	N	Across Flats
1/4	1/4	7715x4	.203	.89	1.03	7/16
3/8	3/8	7715x6	.281	1.05	1.25	9/16
1/2	1/2	7715x8	.422	1.25	1.45	3/4

Replacement o-rings see below.

Cross

(Ref. SAE No. 080501)

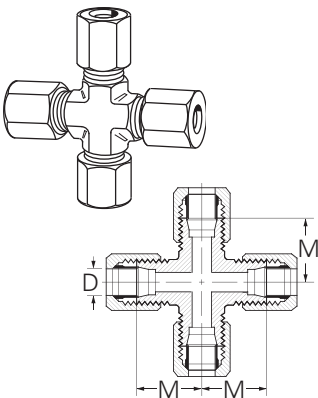

Tube O.D.	Part Number	D	M	Across Flats
1/4	7955x4*	.203	.89	9/16
3/8	7955x6*	.281	1.05	9/16
1/2	7955x8	.422	1.25	3/4

*Brazed construction.

Adapters, Tube Fittings & Connectors

Straight Thread O-Ring

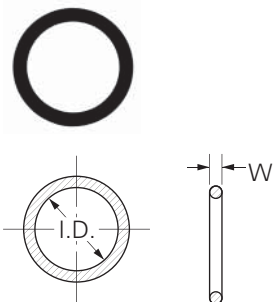

Material: Buna-N 90 Durometer

Temperature Range:
-40°F to +250°F
(-40°C to +121°C)

Standard o-ring complies with SAE J515 Type CH

Tube O.D.	Part Number	W	I.D.
1/16	7629x1	.058 ± .003	.185 ± .005
1/8	7629x2	.064 ± .003	.239 ± .005
3/16	7629x3	.064 ± .003	.301 ± .005
1/4	7629x4	.072 ± .003	.351 ± .005
5/16	7629x5	.072 ± .003	.414 ± .005
3/8	7629x6	.078 ± .003	.468 ± .005
7/16	7629x7	.082 ± .003	.530 ± .005
1/2	7629x8	.087 ± .003	.644 ± .005
5/8	7629x10	.097 ± .003	.755 ± .005
3/4	7629x12	.116 ± .004	.924 ± .006
7/8	7629x14	.116 ± .004	1.048 ± .006
1	7629x16	.116 ± .004	1.171 ± .006
1-1/4	7629x20	.118 ± .004	1.475 ± .010
1-1/2	7629x24	.118 ± .004	1.720 ± .010
2	7629x32	.118 ± .004	2.337 ± .010

Steel Connectors

Split Flange Adapters and Kits

Adapter Used With Standard Female Swivel End

(Ref. SAE Code 61)

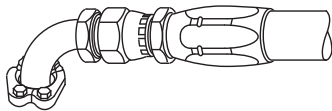

Weatherhead split flange adapter eliminates the need for special hose ends. Interconnect pumps and valves with SAE flange outlets using low-cost standard hose assemblies to replace equipment hose assembly.

Material

Low carbon steel

Plating

Zinc, with clear Trivalent Chromate

Pressure

Code 61 – 3000 PSI working pressure (32 sizes 2500 PSI W.P.).

Label Set

FS-300

Note:

See page N-53 for hydraulic o-ring assortment.

Straight

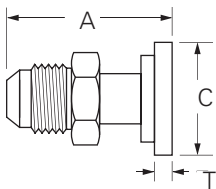

Tube Size	Code 61 Flange Size	Part Number	A	Dia. C	T	Thread Size
1/2	1/2	50008	2.66	1.188	.265	3/4-16
1/2	3/4	50008x12	2.72	1.500	.265	3/4-16
3/4	3/4	50012	2.62	1.500	.265	1-1/16-12
1	1	50016	2.74	1.750	.315	1-5/16-12
1	1-1/4	50016x20	2.74	2.000	.315	1-5/16-12
1-1/4	1	50020x16	2.80	1.750	.315	1-5/8-12
1-1/4	1-1/4	50020	3.27	2.000	.315	1-5/8-12
1-1/2	1-1/2	50024	3.42	2.375	.315	1-7/8-12
2	2	50032	4.24	2.812	.375	2-1/2-12

O-ring not included.

45° Elbow

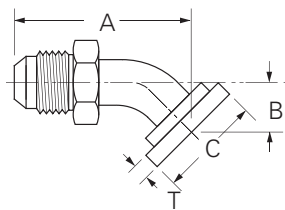

Tube Size	Code 61 Flange Size	Part Number	A	B	Dia. C	T	Thread Size
1/2	1/2	54508	2.91	.78	1.188	.265	3/4-16
1/2	3/4	54508x12	2.93	.84	1.500	.265	3/4-16
3/4	3/4	54512	3.28	1.03	1.500	.265	1-1/16-12
1	1	54516	3.61	1.06	1.750	.315	1-5/16-12
1	1-1/4	54516x20	3.61	1.06	2.000	.315	1-5/16-12
1-1/4	1	54520x16	3.67	1.06	1.750	.315	1-5/8-12
1-1/4	1-1/4	54520	3.86	1.15	2.000	.315	1-5/8-12
1-1/2	1-1/2	54524	4.61	1.41	2.375	.315	1-7/8-12
2	2	54532	6.04	2.00	2.812	.375	2-1/2-12

O-ring not included.

90° Elbow

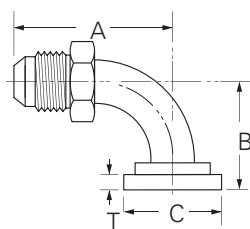

Tube Size	Code 61 Flange Size	Part Number	A	B	Dia. C	T	Thread Size
1/2	1/2	59008	2.54	1.63	1.188	.265	3/4-16
1/2	3/4	59008x12	2.54	1.69	1.500	.265	3/4-16
3/4	3/4	59012	2.81	2.13	1.500	.265	1-1/16-12
1	1	59016	3.41	2.38	1.750	.315	1-5/16-12
1	1-1/4	59016x20	3.41	2.38	2.000	.315	1-5/16-12
1-1/4	1	59020x16	3.46	2.38	1.750	.315	1-5/8-12
1-1/4	1-1/4	59020	3.71	2.62	2.000	.315	1-5/8-12
1-1/2	1-1/2	59024	4.33	3.12	2.375	.315	1-7/8-12
2	2	59032	5.71	4.50	2.812	.375	2-1/2-12

O-ring not included.

Steel Connectors

Split Flange Adapters and Kits

Split Flange Kits – SAE Standard

Pressure Series (Ref. SAE Code 61) SAE J518

O-Ring Material
Buna-N 90 Durometer

Temperature Range
-40°F to +250°F
(-40°C to + 121°C)

Standard o-ring complies with SAE specification SAE J515 Type CH (See page L-3 for o-ring compound and application chart).

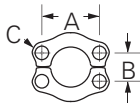
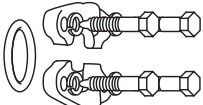

Included in kit

Nominal Flange Size	Part Number Complete Kit	Flange Halves 2 Req'd.	O-Ring	Bolts	Lock Washer	A	B	C	Bolt Torque Range Lb. - In.
1/2	SFK-08	8x251	8x252	8x853	8x254	1.50	.69	11/32	175-225
3/4	SFK-12	12x251	12x252	12x853	12x254	1.88	.88	13/32	250-350
1	SFK-16	16x251	16x252	12x853	12x254	2.06	1.03	13/32	325-425
1-1/4	SFK-20	20x251	20x252	20x853	20x254	2.31	1.19	15/32	425-550
1-1/2	SFK-24	24x251	24x252	24x853	24x254	2.75	1.41	17/32	550-700
2	SFK-32	32x251	32x252	24x853	24x254	3.06	1.69	17/32	650-800

Flanges conform to SAE J518.

Adapters, Tube Fittings & Connectors



Steel Connectors

Split Flange Adapters and Kits

Adapter Used With Standard Female Swivel End

(Ref. SAE Code 62)

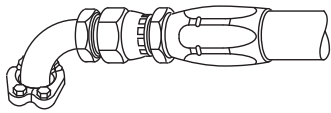

Eaton split flange adapter eliminates the need for special hose ends. Interconnect pumps and valves with SAE flange outlets using low-cost standard hose assemblies to replace original equipment hose assembly.

Material
Carbon steel

Plating
Zinc, with clear Trivalent Chromate

Pressure
Code 62 – 6000 PSI working pressure.

Label Set:
FS-300

Note:
See page N-53 for hydraulic o-ring assortment.

Straight

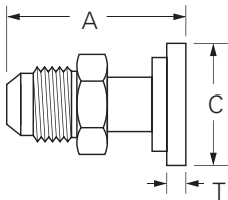

Tube Size	Code 62 Flange Size	Part Number	A	Dia. C	T	Thread Size
1/2	1/2	60008	2.32	1.25	.305	3/4-16
3/4	3/4	60012	2.64	1.62	.345	1-1/16-12
1	1	60016	3.44	1.88	.375	1-5/16-12
1-1/4	1-1/4	60020	3.97	2.12	.405	1-5/8-12
1-1/2	1-1/2	60024	4.97	2.50	.495	1-7/8-12
2	2	60032	5.22	3.12	.495	2-1/2-12

45° Elbow

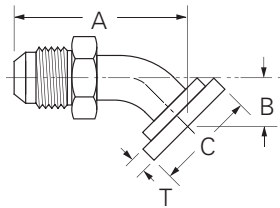

Tube Size	Code 62 Flange Size	Part Number	A	B	Dia. C	T	Thread Size
1/2	1/2	64508	2.12	1.10	1.25	.305	3/4-16
3/4	3/4	64512	2.56	1.32	1.62	.345	1-1/16-12
1	1	64516	3.34	1.43	1.88	.375	1-5/16-12
1-1/4	1-1/4	64520	3.49	1.87	2.12	.405	1-5/8-12
1-1/2	1-1/2	64524	6.31	3.07	2.50	.495	1-7/8-12
2	2	64532	8.19	3.74	3.12	.495	2-1/2-12

90° Elbow

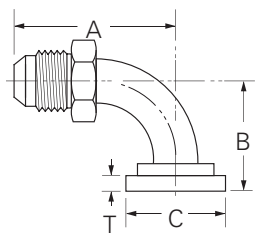

Tube Size	Code 62 Flange Size	Part Number	A	B	Dia. C	T	Thread Size
1/2	1/2	69008	1.57	2.11	1.25	.305	3/4-16
3/4	3/4	69012	1.93	2.56	1.62	.345	1-1/16-12
1	1	69016	2.35	2.90	1.88	.375	1-5/16-12
1-1/4	1-1/4	69020	2.91	3.46	2.12	.405	1-5/8-12
1-1/2	1-1/2	69024	5.44	6.53	2.50	.495	1-7/8-12
2	2	69032	7.38	8.22	3.12	.495	2-1/2-12

Steel Connectors

Split Flange Adapters and Kits

Split Flange Kits – SAE High Pressure Series

(Ref. SAE Code 62) SAE J518

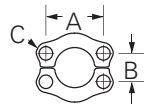
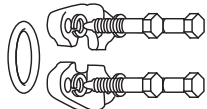

O-Ring Material

Buna-N 90 Durometer

Temperature Range

-40°F to +250°F
(-40°C to + 121°C)

Standard o-ring complies with SAE specifications SAE J515 Type CH (See page L-3 for o-ring compound and application chart).

Note:

Code 62 split flange kits cannot be used with Thick Flange™ Hose Ends. Use existing split flanges.

Included in kit

Nominal Flange Size	Part Number Complete Kit	Flange Halves 2 Req'd.	O-Ring	Bolts	Lock Washer	A	B	C	Bolt Torque Range Lb. - In.
1/2	SFK62-8	8x262	8x252	8x853	8x254	1.57	.72	5/16	175-225
3/4	SFK62-12	12x262	12x252	12x863	12x254	2.00	.94	13/32	300-400
1	SFK62-16	16x262	16x252	12x863	12x254	2.25	1.09	15/32	500-600
1-1/4	SFK62-20	20x262	20x252	20x863	20x254	2.63	1.25	17/32	750-900
1-1/2	SFK62-24	24x262	24x252	24x863	24x264	3.12	1.44	21/32	1400-1600
2	SFK62-32	32x262	32x252	24x863	24x264	3.81	1.75	25/32	2400-2600

Flanges conform to SAE J518.

How to Order STC® Adapters

STC® Adapters:

First, state the base part number, then thread size, then the nominal STC® interface size.

(For adapters add a "0" prefix to interface and port thread sizes 6 and 8.)

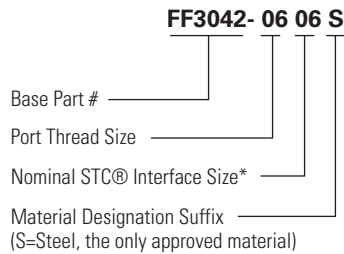

List o-ring material designation suffix; omit the "S" suffix if ordering alternate o-ring materials.

Buna-N (nitrile) is the standard o-ring in Female OTC Adapters; no suffix is needed for standard Buna-N.

EPR (Ethylene Propylene Rubber) = -212

Viton™ (Fluoroelastomer) = -213

Neoprene = -352

HNBR = -461

Polyurethane = -523

Example:

FF3042-0606-213

Viton is a registered trademark of E.I. DuPont.

Seal Elastomer Data

Seal Elastomer	Application Specification	Operating Temperature Range
Buna-N/Nitrile	None	-40°F to +250°F (-40°C to +121°C)
EPR (Ethylene Propylene Rubber)	None	-65°F to +300°F (-55°C to +150°C)
Viton	MIL-R-25897	-15°F to +400°F (-25°C to +205°C)
Neoprene	None	-65°F to +300°F (-55°C to +150°C)
HNBR (Hydrogenated Nitrile Rubber)	None	-40°F to +300°F (-40°C to +150°C)
Polyurethane*	None	-40°F to +250°F (-40°C to +121°C)

Note:

Even though the seal temperature range can go below -40°F (-40°C) and/or above +300°F (+150°C), the temperature range of STC® is -40°F to +300°F (-40°C to +150°C), due to the fact that the release sleeve is made out of HNBR.

* -04 STC® only comes with a polyurethane internal seal.

Leak-Free Connections in a Snap

Design Features

- Positive round-wire style latching mechanism
- Swivels for installation (in absence of pressure)
- Low profile; compact design
- Elastomeric o-ring seal – available in many materials
- Capable of direct porting into valve blocks or manifolds
- Dual purpose dust seal/ release sleeve
- Simple stamped release tool for disconnecting

Benefits

- Fast reliable one-hand connections requiring no assembly tools
- Eliminates cross-threading, over or undertorquing, and hose twisting
- Installs easily in confined areas
- Zero leak performance per SAE J1176
- Direct porting eliminates adapters to maximize cost savings
- Resists external contamination
- Allows easy disconnection with release tool

Operating Characteristics

Interface Size	Maximum Operating Pressure		Minimum Burst Pressure		Vacuum	
	psi	Bar	psi	Bar	in./Hg.	mm/Hg.
1/4"	6,000	414	24,000	1,655	29.5	750
3/8"	5,000	345	20,000	1,380	29.5	750
1/2"	4,250	295	17,000	1,175	29.5	750
5/8"	4,000	275	16,000	1,100	29.5	750
3/4"	4,000	275	16,000	1,100	29.5	750
1"	4,000	275	16,000	1,100	29.5	750

Technology Comparison

	Threaded fittings	STC connectors
Assembly tools required	•	
Torque sensitive	•	
Limited reusability	•	
Virtually zero leakage		•
Fast, reliable connections		•
Ease of installation in confined areas – improved ergonomics		•
Ease of orienting hose ends		•
Compact design, install and remove in limited access areas		•

What You Should Know About STC® Connectors

1. The STC® connection is not recommended for use in swivel applications. Rotation should be limited to assembly and disassembly when zero pressure is present.
 2. The o-ring seal determines the temperature range and fluid compatibility of the STC® connection except when exceeding the release sleeve operating temperature of 300°F.
 3. Disconnection of the STC® connection should be limited to situations where there is no pressure present.
 4. Installation of the male STC® connector must be made straight into the adapter and not at an angle. Misalignment during the connection results in a higher connect force.
- If the release sleeve is damaged during the connection or disconnection of the STC® connection, the male portion must be replaced – premature failure of the STC® connection may result if the replacement is not made.
- Do not use the rubber sleeve as leverage to push the male half into the female half of the STC® connection.
5. Applications that involve vibration should be analyzed with the aid of Eaton prior to utilization.
 6. After the STC® connection is made, pull on the connection to make sure the male STC® connector is properly inserted into the female STC® connector.
 7. The use of clamps is highly recommended for long hose assemblies that utilize STC® connections; the clamp should be positioned close to the STC® connection to prevent its rotation.
 8. STC® connection should not be used as a quick disconnect coupling.
 9. Do not hold sleeve during assembly.



For your own safety, do not hold the release sleeve during assembly.

WARNING:

Do NOT disconnect STC® connection when under pressure. Failure to observe the foregoing may result in property damage or personal injury.

STC® Connectors

STC® Assembly Method and Verification

Assembly Method

Align the STC® fitting on the hose assembly with the STC® connector. Push the hose fitting into the mating connector until you feel a definite snap and a solid stop.



Correct Method



Incorrect Method

Do not hold sleeve during assembly

Assembly Verification

Verify that the STC® connection has been made successfully by pulling on the connection to make sure that the male connector has been properly inserted into female connector. Be sure that the direction of pull is parallel to the axis of the STC® connection.

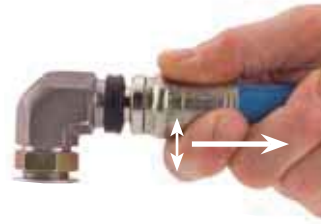

Correct Method

Pulling parallel to the connections axis

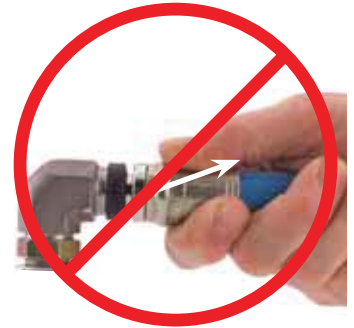

Incorrect Method

Pulling at an angle to connections axis



Correct Method

Pulling on the fitting such that the motion is parallel to the connections axis.



Incorrect Method

Subjecting the connection to a sideload by pulling on the hose.

Female STC Cap

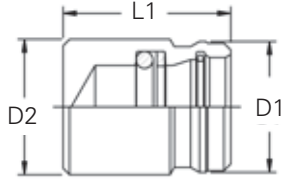

Part Number	D1		L1		D2	
	mm	in.	mm	in.	mm	in.
FF90202-06S	17,0	0.67	18,0	0.71	21,1	0.83
FF90202-08S	20,3	0.80	21,0	0.83	26,8	1.06
FF90202-10S	24,4	0.96	25,0	0.99	33,0	1.30
FF90202-12S	31,3	1.24	32,0	1.26	36,7	1.45
FF90202-16S	39,0	1.54	50,9	2.00	41,0	1.61

NOTE:

Female STC cap can hold pressure equal to the operating pressure of the particular STC size.

Male STC Plug

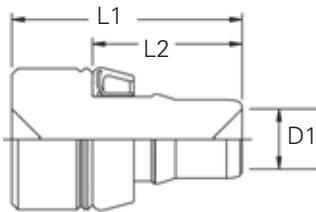

Part Number	D1		L1		L2	
	mm	in.	mm	in.	mm	in.
FF90384-06S	6,8	0.27	31,2	1.23	19,2	0.76
FF90384-08S	9,7	0.38	37,5	1.48	24,4	0.96
FF90384-10S	11,5	0.45	42,4	1.68	27,2	1.08
FF90384-12S	15,6	0.62	46,8	1.85	31,6	1.25
FF90384-16S	20,6	0.81	51,9	2.05	36,0	1.42

NOTE:

Male STC Plug can hold pressure equal to the operating pressure of the particular STC size.



STC® Adapters

Male SAE O-Ring to Female STC®

STC® adapters come standard with nitrile O-rings. See page L-108 for seal options.

Straight FF3042

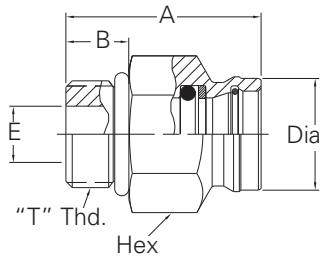

Straight Part Number

Part Number	A mm	in.	B mm	in.	Dia. mm	in.	E mm	in.	HEX mm	in.	"T" THD
FF3042-0404-523	26,8	1.06	9,1	0.36	14,6	0.51	4,4	0.17	16,0	0.633	7/16-20 2A
FF3042-0406S	30,0	1.18	9,1	0.36	17,0	0.67	4,4	0.17	19,0	0.75	7/16-20 2A
FF3042-0606S	28,7	1.13	9,9	0.39	17,0	0.67	7,5	0.30	19,0	0.75	9/16-18 2A
FF3042-0608S	33,7	1.33	9,9	0.39	20,3	0.80	7,5	0.30	21,0	0.83	9/16-18 2A
FF3042-0806S	29,9	1.18	11,1	0.44	17,0	0.67	9,9	0.39	25,0	0.98	3/4-162A
FF3042-0808S	34,5	1.36	11,1	0.44	20,3	0.80	9,9	0.39	24,0	0.94	3/4-162A
FF3042-0810S	36,5	1.44	11,1	0.44	24,4	0.96	10,0	0.39	25,4	1.00	3/4-162A
FF3042-1008S	35,0	1.38	12,7	0.50	20,3	0.80	12,3	0.48	27,0	1.06	7/8-142A
FF3042-1010S	38,0	1.50	12,7	0.50	24,4	0.96	12,3	0.48	27,0	1.06	7/8-142A
FF3042-1012S	44,6	1.76	12,7	0.50	31,3	1.23	12,3	0.48	32,0	1.26	7/8-142A
FF3042-1210S	40,4	1.59	15,1	0.59	24,4	0.96	15,5	0.61	32,0	1.26	1 1/16-12 2A
FF3042-1212S	47,0	1.85	15,1	0.59	31,2	1.23	15,5	0.61	32,0	1.26	1 1/16-12 2A
FF3042-1616S	50,9	2.00	15,1	0.59	41,0	1.61	21,4	0.84	41,0	1.62	1 5/16-12 2A

Adapters, Tube Fittings & Connectors

45° Adjustable FF3038

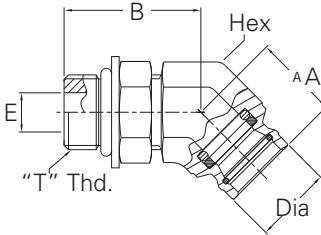

45° Part Number

Part Number	A mm	in.	B mm	in.	DIA mm	in.	E mm	in.	HEX mm	in.	"T" THD
FF3038-0406S	18,5	0.73	28,4	1.12	17,0	0.67	4,4	0.17	19,0	0.75	7/16-20 2A
FF3038-0606S	18,5	0.73	30,0	1.18	17,0	0.67	7,5	0.30	19,0	0.75	9/16-18 2A
FF3038-0808S	21,4	0.84	34,5	1.36	20,3	0.80	9,9	0.39	22,0	0.86	3/4-162A
FF3038-1010S	23,1	0.91	42,5	1.67	24,4	0.96	12,3	0.48	27,0	1.05	7/8-142A

90° Adjustable FF3046

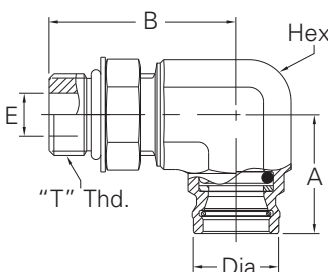

90° Part Number

Part Number	A mm	in.	B mm	in.	DIA mm	in.	E mm	in.	HEX mm	in.	"T" THD
FF3046-0404-523	24,9	0.98	32,8	1.29	14,6	0.57	4,4	0.17	17,0	0.69	7/16-20 2A
FF3046-0406S	27,7	1.09	32,8	1.29	17,0	0.67	4,4	0.17	19,0	0.75	7/16-20 2A
FF3046-0606S	27,7	1.09	35,6	1.40	17,0	0.67	7,5	0.30	19,0	0.75	9/16-18 2A
FF3046-0806S	27,5	1.08	43,2	1.70	17,0	0.67	9,9	0.39	22,0	0.86	3/4-162A
FF3046-0808S	27,5	1.08	43,2	1.70	20,3	0.80	9,9	0.39	22,0	0.86	3/4-162A
FF3046-1008S	30,9	1.22	50,0	1.97	20,3	0.80	12,3	0.48	22,0	0.86	7/8-142A
FF3046-1010S	31,8	1.25	48,2	1.90	24,4	0.96	12,3	0.48	27,0	1.05	7/8-142A
FF3046-1212S	38,1	1.50	55,5	2.18	31,2	1.23	15,5	0.61	32,0	1.25	1 1/16-12 2A
FF3046-1616S	46,4	1.83	63,5	2.50	41,0	1.61	21,5	0.85	41,0	1.62	1 5/16-12 2A

STC® Adapters

Male NPTF to Female STC®

STC® adapters come standard with nitrile O-rings. See page L-108 for seal options.

Straight FF3089

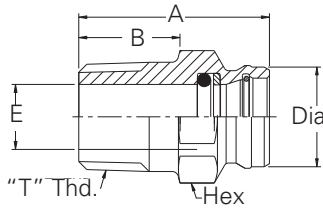

Straight Part Number	A		B		DIA		E		HEX		"T" THD
	mm	in.	mm	in.	mm	in.	mm	in.	mm	in.	
FF3089-0406S	36,8	1.45	14,6	0.57	17,0	0.67	7,1	0.28	19,0	0.75	1/4-18
FF3089-0606S	36,8	1.45	14,6	0.57	17,0	0.67	10,3	0.41	19,0	0.75	3/8-18
FF3089-0608S	38,8	1.53	14,6	0.57	20,3	0.80	10,3	0.41	21,0	0.83	3/8-18
FF3089-0806S	41,6	1.64	19,4	0.76	17,0	0.67	9,7	0.38	22,2	0.88	1/2-14
FF3089-0808S	37,8	1.49	19,4	0.76	20,3	0.80	12,3	0.48	24,0	0.94	1/2-14
FF3089-0810S	43,9	1.73	19,4	0.76	24,4	0.96	13,5	0.53	25,4	1.00	1/2-14
FF3089-1210S	43,9	1.73	19,4	0.76	24,4	0.96	16,2	0.64	27,0	1.06	3/4-14
FF3089-1212S	44,6	1.76	19,4	0.76	31,3	1.23	18,3	0.72	32,0	1.26	3/4-14

45° FF3093

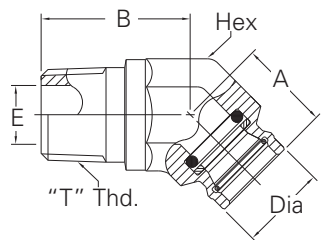

45° Part Number	A		B		DIA		E		HEX		"T" THD
	mm	in.	mm	in.	mm	in.	mm	in.	mm	in.	
FF3093-0406S	18,8	0.74	26,7	1.05	17,0	0.67	7,1	0.28	19,0	0.75	1/4-18
FF3093-0606S	20,4	0.80	26,9	1.06	17,0	0.67	10,3	0.41	19,0	0.75	3/8-18
FF3093-0808S	25,6	1.01	34,0	1.34	20,3	0.80	13,5	0.53	22,0	0.86	1/2-14
FF3093-0810S	26,2	1.03	34,0	1.34	24,4	0.96	13,5	0.53	27,0	1.06	1/2-14
FF3093-1212S	32,0	1.28	35,0	1.38	31,2	1.23	18,3	0.72	32,0	1.26	3/4-14

90° FF3056

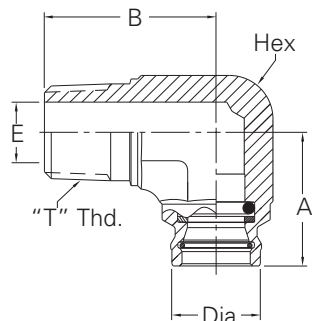

90° Part Number	A		B		DIA		E		HEX		"T" THD
	mm	in.	mm	in.	mm	in.	mm	in.	mm	in.	
FF3056-0606S	27,7	1.09	27,5	1.08	17,0	0.67	10,3	0.41	19,0	0.75	3/8-18
FF3056-0608S	28,2	1.11	27,7	1.09	20,3	0.80	10,3	0.41	22,0	0.86	3/8-18
FF3056-0808S	29,8	1.17	38,4	1.51	20,3	0.80	13,5	0.53	22,0	0.86	1/2-14
FF3056-1212S	37,3	1.47	41,9	1.65	31,2	1.23	18,3	0.72	32,0	1.26	3/4-14

STC® Adapters

Female FOR-SEAL® to Female STC®

STC® adapters come standard with nitrile O-rings. See page L-108 for seal options.

Straight FF3236

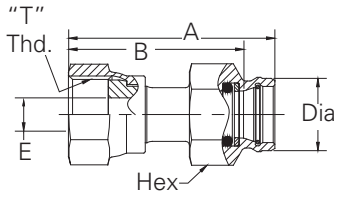

Straight Part Number

Part Number	A mm	in.	B mm	in.	DIA mm	in.	E mm	in.	HEX mm	in.	"T" THD
FF3236-0606S	50,8	2.00	18,2	0.72	19,0	0.75	6,7	0.26	19,0	0.75	11/16-16 2B
FF3236-0808S	45,5	1.79	22,1	0.87	20,3	0.80	9,1	0.36	24,0	0.95	1 3/16-16 2B

Adapters, Tube Fittings & Connectors

45° FF3362

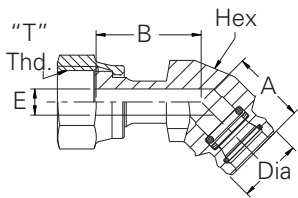

45° Part Number

Part Number	A mm	in.	B mm	in.	DIA mm	in.	E mm	in.	HEX mm	in.	"T" THD
FF3362-0606S	18,8	0.74	26,9	1.06	17,0	0.67	6,7	0.26	19,0	0.75	11/16-16 2B

90° FF3246

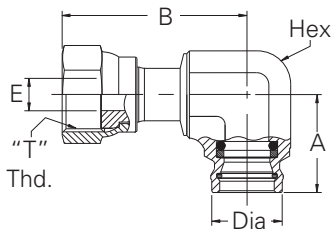

90° Part Number

Part Number	A mm	in.	B mm	in.	DIA mm	in.	E mm	in.	HEX mm	in.	"T" THD
FF3246-0606S	27,7	1.09	40,6	1.60	16,5	0.65	6,7	0.26	19,0	0.75	11/16-16 2B
FF3246-0808S	27,5	1.08	51,9	2.04	19,8	0.78	9,1	0.36	22,0	0.86	13/16-16 2B

STC® Adapters

Male FOR-SEAL® to Male STC®

STC® adapters come standard with nitrile O-rings. See page L-108 for seal options.

Straight FF3318T

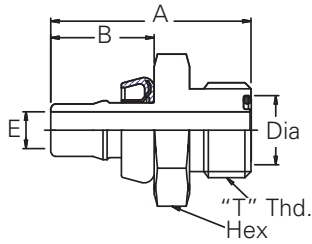

Straight Part Number	A		B		DIA		E		HEX		"T" THD
	mm	in.	mm	in.	mm	in.	mm	in.	mm	in.	
FF3318T0606S	36,5	1.44	18,8	0.74	12,6	0.50	6,7	0.26	24,0	0.95	11/16-16

STC Adapters

SAE 37° Male Flare to Female STC®, Bulkhead Adapters

Straight FF3412

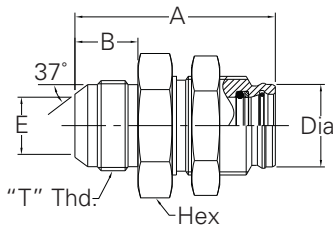

Straight Part Number	A		B		DIA		E		HEX		"T" THD
	mm	in.	mm	in.	mm	in.	mm	in.	mm	in.	
FF3412-1612S	73,7	2.90	23,1	0.91	31,2	1.23	20,6	0.81	46,0	1.79	15/16-12.2A

90° Elbow FF3044

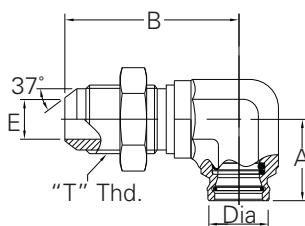

90° Part Number	A		B		DIA		E		HEX		"T" THD
	mm	in.	mm	in.	mm	in.	mm	in.	mm	in.	
FF3044-1210S	31,8	1.25	67,8	2.67	24,4	0.96	15,5	0.61	27,0	1.06	1-1/16-12.2A
FF3044-1616S	46,4	1.83	64,5	2.54	41,0	1.61	21,4	0.84	41,0	1.61	1-5/16-12.2A

STC® Adapters

Male ISO 6149 O-Ring Boss (S-Series) to Female STC®

STC® adapters come standard with nitrile O-rings. See page L-108 for seal options.

Straight FF3061

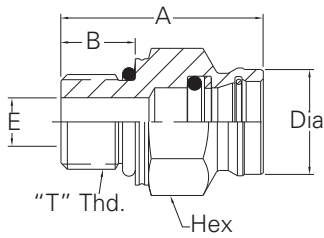

Straight Part Number	A		B		DIA		E		HEX		"T" THD
	mm	in.	mm	in.	mm	in.	mm	in.	mm	in.	
FF3061-1006S	29,0	1.14	9,5	0.37	17,0	0.67	3,1	0.12	19,0	0.75	M10x1 6g
FF3061-1206S	30,5	1.20	11,0	0.43	17,0	0.67	4,1	0.16	19,0	0.75	M12x1.5 6g
FF3061-1406S	30,5	1.20	11,0	0.43	17,0	0.67	6,1	0.24	19,0	0.75	M14x1.5 6g
FF3061-1408S	34,8	1.37	11,0	0.43	20,3	0.80	6,1	0.24	21,0	0.82	M14x1.5 6g
FF3061-1606S	32,0	1.26	12,5	0.49	17,0	0.67	7,1	0.28	22,0	0.86	M16x1.5 6g
FF3061-1608S	36,3	1.43	12,5	0.49	20,3	0.80	7,1	0.28	22,0	0.86	M16x1.5 6g
FF3061-1610S	39,5	1.56	12,5	0.49	24,4	0.96	7,1	0.28	25,0	0.98	M16-1.5 6g
FF3061-1806S	33,5	1.32	14,0	0.55	17,0	0.67	9,1	0.36	24,0	0.94	M18-1.5 6g
FF3061-1808S	38,1	1.50	14,0	0.55	20,3	0.80	9,1	0.36	24,0	0.94	M18-1.5 6g
FF3061-1810S	39,4	1.55	14,0	0.55	24,4	0.96	9,1	0.36	25,0	0.98	M18-1.5 6g
FF3061-1812S	50,0	1.97	14,0	0.55	31,3	1.23	9,1	0.36	32,0	1.26	M18-1.5 6g
FF3061-2210S	40,4	1.59	15,0	0.59	24,4	0.96	12,1	0.48	27,0	1.06	M22-1.5 6g
FF3061-2212S	51,0	2.01	15,0	0.59	31,3	1.23	12,1	0.48	32,0	1.26	M22-1.5 6g

Adapters, Tube Fittings & Connectors

45° Adjustable FF3065

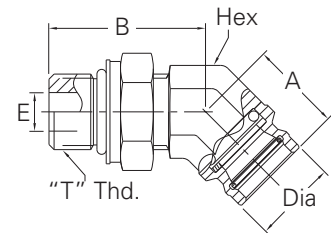

45° Part Number	A		B		DIA		E		HEX		"T" THD
	mm	in.	mm	in.	mm	in.	mm	in.	mm	in.	
FF3065-1406S	18,8	0.74	31,4	1.24	17,0	0.67	6,1	0.24	19,0	0.75	M14-1.5 6g
FF3065-1606S	18,8	0.74	33,5	1.32	17,0	0.67	7,1	0.28	19,0	0.75	M16-1.5 6g
FF3065-1808S	21,6	0.85	37,0	1.46	20,3	0.80	9,1	0.36	22,0	0.87	M18-1.5 6g
FF3065-1810S	25,9	1.02	42,5	1.67	24,4	0.96	9,1	0.36	27,0	1.06	M18-1.5 6g
FF3065-2212S	31,2	1.23	44,0	1.73	31,2	1.23	12,1	0.48	32,0	1.25	M22-1.5 6g
FF3065-2712S	30,3	1.19	52,6	2.07	31,0	1.21	15,1	0.60	36,0	1.40	M27-2 6g

90° Adjustable FF3067

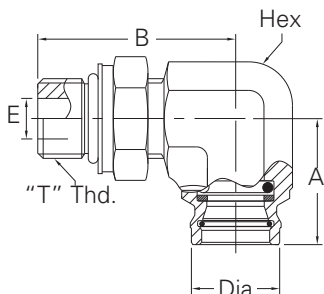

90° Part Number	A		B		DIA		E		HEX		"T" THD
	mm	in.	mm	in.	mm	in.	mm	in.	mm	in.	
FF3067-1406S	24,9	0.98	35,5	1.40	17,0	0.67	6,1	0.24	19,0	0.75	M14-1.5 6g
FF3067-1606S	27,7	1.09	42,9	1.69	17,0	0.67	7,1	0.28	19,0	0.75	M16-1.5 6g
FF3067-1808S	28,2	1.11	44,3	1.74	20,3	0.80	9,1	0.36	22,0	0.87	M18-1.5 6g
FF3067-1810S	33,3	1.31	47,5	1.87	24,4	0.96	9,1	0.36	27,0	1.06	M18-1.5 6g
FF3067-2210S	33,3	1.31	49,0	1.93	24,4	0.96	12,1	0.48	27,0	1.06	M22-1.5 6g
FF3067-2212S	37,6	1.48	50,8	2.00	31,2	1.23	12,1	0.48	32,0	1.25	M22-1.5 6g
FF3067-2712S	37,6	1.48	55,5	2.18	31,2	1.23	15,1	0.60	32,0	1.26	M27-2 6g

STC® Adapters

O-Ring Boss DIN 3852 Metric Male to Female STC®

STC® adapters come standard with nitrile O-rings. See page L-108 for seal options.

Straight FF3284

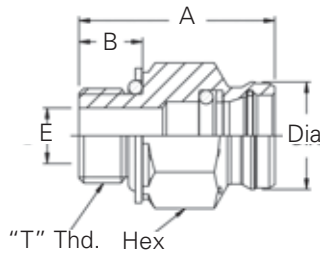

Straight Part Number	A		B		DIA		E		HEX		"T" THD
	mm	in.	mm	in.	mm	in.	mm	in.	mm	in.	
FF3284-1608S	37,5	1.48	12,0	0.47	20,3	0.80	8,5	0.34	22,1	0.88	M18-1.5 6g
FF3284-1808S	37,0	1.46	12,0	0.47	20,3	0.80	10,5	0.42	23,8	0.94	M18-1.5 6g
FF3284-2612S	48,4	1.91	15,4	0.61	31,3	1.24	15,0	0.60	36,0	1.42	M18-1.5 6g

90° FF3286

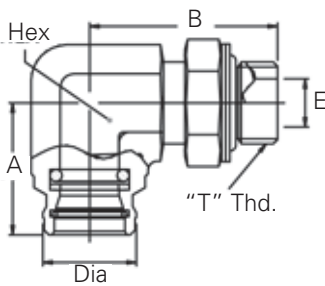

90° Part Number	A		B		DIA		E		HEX		"T" THD
	mm	in.	mm	in.	mm	in.	mm	in.	mm	in.	
FF3286-1808S	28.8	(1.14)	40.8	(1.61)	20.3	(0.80)	10.5	(0.42)	22.0	(0.87)	M18-1.5 6g

STC® Adapters

Male BSPT to Female STC®

STC® adapters come standard with nitrile O-rings. See page L-108 for seal options.

Straight FF3503

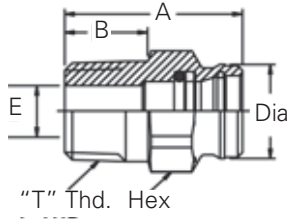

Straight Part Number	A		B		DIA		E		HEX		"T" THD
	mm	in.	mm	in.	mm	in.	mm	in.	mm	in.	
FF3503-0406S	37,1	1.47	13,0	0.51	17,0	0.67	5,0	0.20	19,0	0.75	R 1/4 - 19
FF3503-0606S	36,9	1.46	15,0	0.59	17,0	0.67	8,0	0.32	19,0	0.75	R 3/8 - 19
FF3503-0808S	38,3	1.51	18,0	0.71	20,3	0.80	11,0	0.43	24,0	0.95	R 1/2 - 14
FF3503-1212S	44,7	1.77	20,0	0.79	31,3	1.24	16,0	0.63	32,0	1.26	R 3/4 - 14

45° FF3505

Adapters, hose fittings & connectors

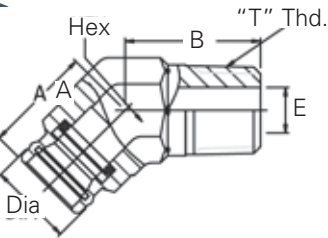

45° Part Number	A		B		DIA		E		HEX		"T" THD
	mm	in.	mm	in.	mm	in.	mm	in.	mm	in.	
FF3505-0406S	18,7	0.74	13,0	0.51	17,0	0.67	5,0	0.20	19,0	0.75	R 1/4 - 19
FF3505-0606S	20,5	0.81	24,4	0.96	17,0	0.67	8,0	0.32	19,0	0.75	R 3/8 - 18
FF3505-0808S	26,2	1.04	34,0	1.34	20,3	0.80	11,0	0.43	22,0	0.87	R 1/2 - 14
FF3505-1212S	32,6	1.29	36,0	1.42	31,3	1.24	16,0	0.63	32,0	1.26	R 3/4 - 14

90° FF3507

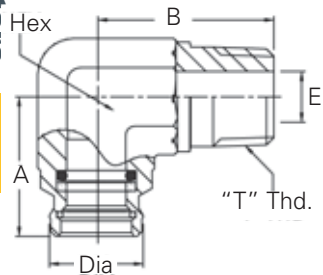

90° Part Number	A		B		DIA		E		HEX		"T" THD
	mm	in.	mm	in.	mm	in.	mm	in.	mm	in.	
FF3507-0406S	28,1	1.11	27,5	1.08	17,0	0.67	5,0	0.20	19,0	0.75	R 1/4 - 19
FF3507-0606S	28,1	1.11	27,5	1.08	17,0	0.67	5,0	0.20	19,0	0.75	R 3/8 - 19
FF3507-0808S	30,3	1.19	38,4	1.50	20,3	0.80	11,0	0.43	22,0	0.87	R 1/2 - 14
FF3507-1212S	37,3	1.47	41,9	1.65	31,3	1.24	16,0	0.63	32,0	1.26	R 3/4 - 14

STC® Adapters

Male BSPP (Special JIS) to Female STC®

STC® adapters come standard with nitrile O-rings. See page L-108 for seal options.

Straight FF3509

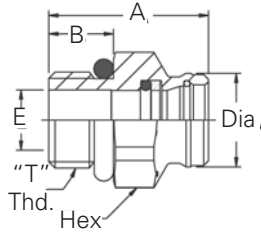

Straight Part Number	A		B		DIA		E		HEX		"T" THD
	mm	in.	mm	in.	mm	in.	mm	in.	mm	in.	
FF3509-0406S	30,1	1.19	12,0	0.47	17,0	0.67	6,1	0.24	19,0	0.75	G1/4 - 19
FF3509-0606S	28,9	1.14	12,0	0.47	17,0	0.67	9,6	0.38	22,0	0.87	G3/8 - 19
FF3509-0808S	34,6	1.37	14,0	0.55	20,3	0.80	13,1	0.52	27,0	1.07	G1/2 - 14
FF3509-1212S	47,6	1.88	16,0	0.24	31,3	1.24	18,1	0.72	32,0	1.26	G3/4 - 14

45° FF3511

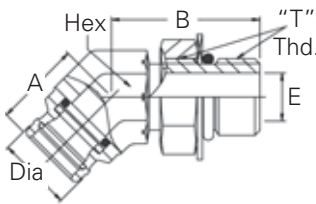

45° Part Number	A		B		DIA		E		HEX		"T" THD
	mm	in.	mm	in.	mm	in.	mm	in.	mm	in.	
FF3511-0406S	16,8	0.66	32,4	1.28	17,0	0.67	6,1	0.24	19,0	0.75	G1/4 - 19
FF3511-0606S	16,8	0.66	35,0	1.38	17,0	0.67	9,6	0.38	19,0	0.75	G3/8 - 19
FF3511-0808S	23,6	0.93	40,2	1.59	20,3	0.80	13,1	0.52	22,0	0.87	G1/2 - 14
FF3511-1212S	29,9	1.18	46,7	1.85	31,3	1.24	18,1	0.72	32,0	1.26	G3/4 - 14

90° FF3513

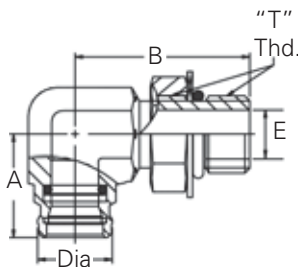

90° Part Number	A		B		DIA		E		HEX		"T" THD
	mm	in.	mm	in.	mm	in.	mm	in.	mm	in.	
FF3513-0406S	28.1	1.11	37.8	1.49	17.0	0.67	6.1	0.24	19.0	0.75	G1/4 - 19
FF3513-0606S	28.1	1.11	39.5	1.56	17.0	0.67	9.6	0.38	19.0	0.75	G3/8 - 19
FF3513-0808S	28.0	1.11	47.5	1.88	20.3	0.80	13.1	0.52	22.0	0.87	G1/2 - 14
FF3513-1212S	38.0	1.50	56.4	2.23	31.3	1.24	18.1	0.72	32.0	1.26	G3/4 - 14

STC® Adapters

Male BSPP to Female STC® -
Meets Standard 5005 DIN 3852 Form A

STC® adapters come standard with nitrile O-rings. See page L-108 for seal options.

Straight FF3218

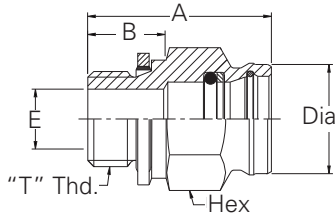

Straight Part Number	A		B		DIA		E		HEX		"T" THD
	mm	in.	mm	in.	mm	in.	mm	in.	mm	in.	
FF3218-0406S	31,8	1.25	14,2	0.56	17,0	0.67	6,1	0.24	19,0	0.75	G6 1/4-19A
FF3218-0606S	32,3	1.27	14,6	0.58	17,0	0.67	9,6	0.38	22,0	0.87	G6 3/8-19A
FF3218-0806S	37,0	1.46	17,2	0.68	17,0	0.67	9,1	0.36	27,0	1.06	G6 1/2-14A
FF3218-0608S	36,1	1.42	14,6	0.58	20,3	0.80	9,6	0.38	22,0	0.87	G6 3/8-19A
FF3218-0808S	38,6	1.52	17,2	0.68	20,3	0.80	12,3	0.48	27,0	1.06	G6 1/2-14A
FF3218-0810S	40,2	1.58	17,2	0.68	24,4	0.96	13,1	0.52	27,0	1.06	G6 1/2-14A
FF3218-1210S	42,2	1.66	19,2	0.75	24,4	0.96	15,5	0.61	32,0	1.26	G6 3/4-14A
FF3218-1212S	44,2	1.74	19,2	0.75	31,2	1.23	18,1	0.71	32,0	1.26	G6 3/4-14A

Adapters, Tube Fittings & Connectors

STC® Adapters

Tee Adapter Female STC®

FF3178

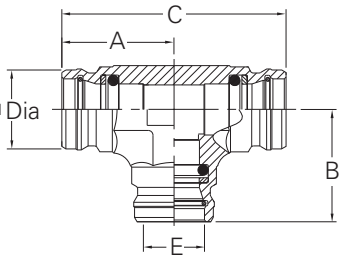

Part Number	A		B		C		DIA		E	
	mm	in.	mm	in.	mm	in.	mm	in.	mm	in.
FF3178-0808S	28,2	1.11	28,2	1.11	56,4	2.22	20,3	0.80	20,3	0.80

STC® Repair Adapters

Repair adapters can be used to convert a hose assembly with male pipe, female JIC, or female ORFS hose ends into a STC® female direct port or a STC® female adapter.

Female Pipe to Male STC®

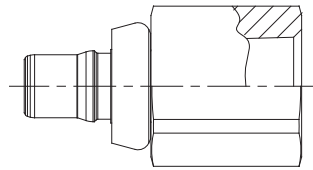

Part Number	Thread	Male STC Size
FF3233-0406S	1/4"-18	-06
FF3233-0606S	3/8"-18	-06
FF3233-0808S	1/2"-14	-08
FF3233-0810S	1/2"-14	-10
FF3233-1212S	3/4"-14	-12
FF3233-1616S	1"-11½	-16

Male JIC to Male STC®

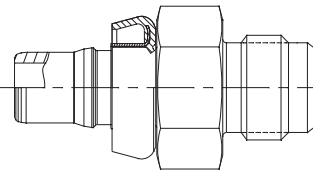

Part Number	Thread	Male STC Size
FF3227-0406S	7/16"-20	-06
FF3227-0606S	9/16"-18	-06
FF3227-0808S	3/4"-16	-08
FF3227-1010S	7/8"-14	-10
FF3227-1212S	1-1/16"-12	-12
FF3227-1616S	1-5/16"-16	-16

Male ORFS to Male STC®

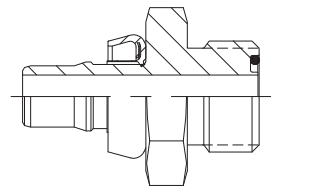

Part Number	Thread	Male STC Size
FF3318T0406-458	9/16"-18	-06
FF3318T0606-458	11/16"-16	-06
FF3318T0808-458	13/16"-16	-08
FF3318T1010-458	1"-14	-10
FF3318T1212-458	1-3/16"-12	-12
FF3318T1616-458	1-7/16"-12	-16

STC® Accessories and Sales Tools

Release Tools

- STC -04 = FF90213-01-04S
- STC -06 = FF90213-06
- STC -08 = FF90213-08
- STC -10 = FF90213-10
- STC -12 = FF90213-12
- STC -16 = FF90213-01-16S



STC® Repair Kits (Female Halves)

Includes

- Instructions on repairing STC® (Bulletin JA535)
- Back-up Ring
- Retaining Ring
- O-Ring

BUNA-N/Nitrile

Size	Part Number
-06	FF12228-06
-08	FF12228-08
-10	FF12228-10
-12	FF12228-12
-16	FF12228-16

Viton

Size	Part Number
-06	FF12230-06
-08	FF12230-08
-10	FF12230-10
-12	FF12230-12
-16	FF12230-16

HNBR

Size	Part Number
-06	FF12229-06
-08	FF12229-08
-10	FF12229-10
-12	FF12229-12
-16	FF12229-16

EPDM

Size	Part Number
-06	FF12231-06
-08	FF12231-08
-10	FF12231-10
-12	FF12231-12
-16	FF12231-16

STC® Instructional Video

Part number A-MEFI-ME001-E



Female Ring Part Numbers

Retaining Rings

Size	Part Number
-06	FF90277-06C
-08	FF90277-08C
-10	FF90277-10C
-12	FF90277-12C
-16	FF90277-16C

Nitrile O-rings

Size	Part Number
-06	22550-12
-08	22550-112
-10	22550-114
-12	22550-117
-16	22550-215

Back-up Rings

Size	Part Number
-06	FF90241-12
-08	FF90241-112
-10	FF90241-114
-12	FF90241-117
-16	FF90241-215

HNBR O-rings

Size	Part Number
-06	FF90467-12
-08	FF90467-112
-10	FF90467-114
-12	FF90467-117
-16	FF90467-215

Viton O-rings

Size	Part Number
-06	22566-12
-08	22566-112
-10	22566-114
-12	22566-117
-16	22566-215

Accessories

Table of Contents

Hose Abrasion Sleeves, Guards, Firesleeve	M-2 thru 11		
Ready-Made Hose Assemblies	M-12 thru 18	Guardian Sleeves	M-22
JetCleaner, Insertion Gauge, Pressure Gauge Kit	M-19	Bundling Sleeves	M-23
Hose Spacers, Protectors	M-20	Bundling Straps	M-24 thru 25
Flaretite Seals	M-21	Hose and Gear Clamps	M-26 thru 28



Hose Sleeves and Guards

Round-Wire Spring Guard

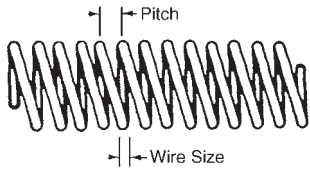
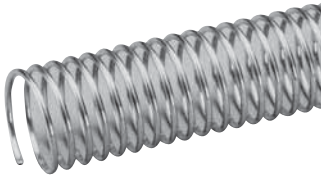

Spring guards should be considered for applications that call for tough, steel armor protection. They offer heavy-duty defense against cuts and abrasion, with the added benefit of kink resistance and the ability to mold hose assembly routing for applications requiring tight bends.

Construction

Hot dipped Galvanized steel, chemically treated and oiled

Guard I.D.	Part Number	Package Length (ft)	Wire Diameter	Pitch
0.532	A1900	100	0.063	0.188
0.532	A1900-20	20	0.063	0.188
0.532	A1901	100	0.063	0.188
0.532	A1901-20	20	0.063	0.188
0.610	A1902	100	0.063	0.188
0.610	A1902-20	20	0.063	0.188
0.660	A1903	100	0.080	0.188
0.660	A1903-20	20	0.080	0.188
0.750	A1904	100	0.080	0.188
0.750	A1904-20	20	0.080	0.188
0.840	A1905	100	0.080	0.188
0.840	A1905-20	20	0.080	0.188
0.910	A1906	100	0.080	0.188
0.910	A1906-20	20	0.080	0.188
0.990	A1907	100	0.080	0.188
0.990	A1907-20	20	0.080	0.188
1.048	A1908	100	0.080	0.188
1.048	A1908-20	20	0.080	0.188
1.340	A1912	60	0.105	0.375
1.642	A1913	60	0.120	0.375
1.880	A1916	60	0.120	0.375
2.125	A1917	40	0.120	0.375
2.300	A1919	40	0.120	0.375

Flat-Wire Spring Guard

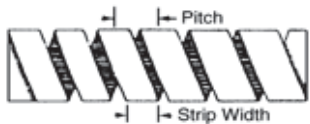

Spring guards should be considered for applications that call for tough, steel armor protection. They offer heavy-duty defense against cuts and abrasion, with the added benefit of kink resistance and the ability to mold hose assembly routing for applications requiring tight bends.

Guard I.D.	Part Number	Package Length (ft)	Strip Thickness	Strip Width	Pitch
0.500	A2900	100	0.028	0.250	0.37
0.570	A2901	100	0.028	0.250	0.37
0.625	A2902	100	0.028	0.250	0.37
0.750	A2904	100	0.028	0.250	0.37
0.875	A2905	100	0.028	0.250	0.37
0.900	A2906	100	0.028	0.500	0.69
0.990	A2907	100	0.028	0.500	0.69
1.031	A2908	100	0.028	0.500	0.69
1.110	A2909	100	0.028	0.500	0.69
1.219	A2910	100	0.028	0.500	0.69
1.300	A2911	60	0.028	0.500	0.69
1.380	A2912	60	0.028	0.500	0.81
1.630	A2913	60	0.028	0.500	0.81
2.130	A2917	40	0.028	0.500	0.81
2.300	A2919	40	0.028	0.500	0.81

Hose Sleeves and Guards

Heavy-Duty Poly Hose Guard



Poly Hose ID

A heavy-duty hose guard can be easily placed around a single or bundle of hydraulic and pneumatic hose. It protects against abrasion and also provides crush resistance, reducing or eliminating costly premature hose failures.

Benefits

Resists oils, lubricants, gasoline and most solvents.

Operating Temperature Range

-100°F to +220°F

Color

Black

Construction

High Density Polyethylene

Guard I.D.	Part Number	Wall Thickness	Guard O.D.	Roll Length(ft)
0.492	A9900	.069	.630	100
0.668	A9901	.086	.840	100
1.014	A9902	.118	1.250	100
1.600	A9903	.150	1.900	50
2.457	A9904	.209	2.875	50
3.065	A9905	.218	3.500	35

Abrasion Sleeve MSHA Accepted ISO 6945



Abrasion sleeve is used to help safeguard hose covers from abrasions and cuts. The sleeve is also useful for bundling two or more hose assemblies together, adding to its protective qualities. It is available in .045" thin-wall and .090" thick-wall sleeving.

Application

- Agriculture
- Logging
- Construction
- Mining

Construction

Bulk continuous filament nylon

Note:

Wall thickness is for single wall.

* Add side sleeve onto the hose before assembling the ends. After assembly, clamp the hose onto the fittings.

Sleeve I.D.	.045" Thin Wall Part No.	.090" Thick Wall Part No.	Package Length* (ft)	Flat I.D.
0.90	A4900	A3900	100	1.32-1.51
1.06	A4901	A3901	100	1.57-1.76
1.22	A4902	A3902	100	1.82-2.01
1.35	A4903	A3903	100	2.03-2.21
1.66	A4904	A3904	100	2.63-2.87
1.81	A4905	A3905	100	2.75-2.94
2.19	A4906	A3906	100	3.43-3.53
2.62	A4907	A3907	100	4.02-4.21
2.80	A4908	A3908	100	4.43-4.62

*Package contains two pieces that are not less than 30 feet long each.

Locator Clamp

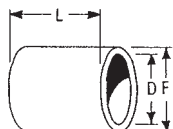

Locator clamps are designed for crimping to H14510 or H42510 hydraulic hose to provide a support for routing clamps. They are popular in Case equipment applications.

Note:

Crimp using collet T-400-5C and spacer ring T-400-62 (yellow), flat side up.

Hose I.D.	Part Number	L	D	F
5/8	A4910	1.60	1.084	1.25

Hose Sleeves and Guards

Hose Bend Restrictors



For use in protecting the last section of hose at the fitting connection, bend restrictors are designed to allow for an appropriate degree of "bend" without compromising the integrity of hose assemblies. They are also recommended for hose assemblies that receive substantial handling, such as in pressure washer, air, oil, and hydraulic fluid transfer applications.

Construction

Plastisol MR 436 gloss PVC

Note:

Colors Red, Blue, Green and Yellow available by special order.

Restrictor I.D.	Part Number	Restrictor Length (Inch)	Hose Type Application
0.530	A5953	6	H14504, H00904
0.625	A5962	6	H10404, H20906, H24504, H34504, H42504
0.690	A5969	6	H14506, H34506
0.750	A5975	7	H10406, H20908, H24506, H30006
0.840	A5984	7	H10408, H14508, H24508
0.875	A5987	7	H34508

Firesleeve



Firesleeve is a flame-resistant sheathing constructed of tightly woven fiberglass, which is coated with a specially compounded, highly temperature-resistant silicone rubber. Firesleeve offers protection in high temperature environments with heat extremes. It is not compatible with hydrocarbons.

Temperature Range

- Continuous exposure up to 500°F
- Up to 2000°F for 15 to 20 minutes
- Up to 3000°F for durations of 15 to 30 seconds

Color

Red-Orange

Note:

Refer to application chart on pages A-33-34 for Firesleeve part numbers for specific Weatherhead hose.

Sleeve I.D.	Part Number	Roll Length (ft)
0.50	A6908	100
0.63	A6910	100
0.75	A6912	100
0.88	A6914	100
1.00	A6916	100
1.25	A6920	100
1.50	A6924	100
1.75	A6928	100
2.00	A6932	50
2.25	A6936	50
3.00	A6948	50

Accessories

Firesleeve Tape



CAUTION

Tests should be conducted to determine the suitability of Firesleeve for each application.

Tape Coverage	Part Number	Roll Length
All sizes	A6900W	1x432

Firesleeve tape provides protection in high temperature environments. It acts as an end sealant in preventing moisture and hydraulic oils from wicking into the inner braids of Firesleeve.

Construction

High temperature-resistant, non-adhesive, silicone elastomer

Operating Temperature Range

+475° continuous.

M

Hose Sleeves and Guards

Hose Type	Dash Size	Hose Clamp	Round-Wire Spring Guard	Flat-Wire Spring Guard	Nylon (.45) Abrasion Sleeve	Nylon (.90) Abrasion Sleeve	Silicone Fiberglass Firesleeve	Poly Hose Guard
H009	04	HK0913	A1901	A2901	A4900	A3900	A6910	A9901
	05	HK1013	A1902	A2902	A4900	A4900	A6914	A9901
	06	HK1113	A1903	A2904	A4901	A3901	A6916	A9901
	08	HK1313	A1905	A2905	A4901	A3901	A6916	A9902
	12	HK1813	A1910	A2909	A4902	A3902	A6920	A9903
H017	04	HK1013	A1902	A2902	A4900	A3900	A6912	A9901
	06	HK1313	A1905	A2905	A4900	A3900	A6914	A9902
	08	HK1613	A1907	A2907	A4901	A3901	A6920	A9902
	12	HK2117	A1912	A2911	A4903	A3903	A6924	A9903
	16	HK2517	A1913	A2913	A4904	A3904	A6928	A9903
	20	HK2917	A1916	A2913	A4906	A3906	A6932	A9904
H039	12	HK2117	A1913	A2913	A4904	A3904	A6928	A9903
	16	HK2517	A1916	A2913	A4905	A3605	A6932	A9904
	20	HK2917	A1917	A2917	A4906	A3906	A6932	A9904
	24	HK3317	A1919	A2917	A4907	A3907	A693	6A9904
	32	HK3817	—	—	A4908	A3908	A6948	A9905
H039h	12	HK2117	A1913	A2913	A4904	A3904	A6928	A9903
	16	HK2517	A1916	A2913	A4905	A3605	A6932	A9904
	20	HK2917	A1916	A2913	A4906	A3906	A6932	A9904
	24	HK3317	A1919	A2917	A4907	A3907	A6936	A9904
	32	HK3817	—	—	A4908	A3908	A6948	A9905
H057	03	HK0709	A1900	A2900	A4900	A3900	A6910	A9900
	04	HK1013	A1901	A2901	A4900	A3900	A6912	A9901
	05	HK1013	A1902	A2902	A4900	A3900	A6914	A9901
	06	HK1113	A1903	A2904	A4900	A3900	A6914	A9901
	07	HK1213	A1904	A2904	A4901	A3901	A6916	A9902
	08	HK1313	A1905	A2905	A4901	A3901	A6916	A9902
H059	04	HK0913	A1901	A2901	A4900	A3900	A6912	A9901
	05	HK1013	A1902	A2902	A4900	A3900	A6912	A9901
	06	HK1213	A1904	A2904	A4901	A3901	A6916	A9902
	08	HK1313	A1905	A2905	A4901	A3901	A6916	A9902
	10	HK1613	A1907	A2907	A4902	A3902	A6916	A9902
	12	HK1813	A1910	A2909	A4904	A3904	A6924	A9903
	16	HK2117	A1912	A2911	A4905	A3905	A6928	A9903
	20	HK2517	A1913	A2913	A4906	A3906	A6928	A9903
H069	04	HK0913	A1902	A2901	A4900	A3900	A6912	A9901
	05	HK1013	A1903	A2902	A4900	A3900	A6912	A9901
	06	HK1213	A1904	A2904	A4901	A3901	A6912	A9902
	08	HK1413	A1905	A2905	A4901	A3901	A6916	A9902
	10	HK1613	A1907	A2907	A4902	A3902	A6916	A9902
	12	HK1913	A1910	A2909	A4903	A3903	A6920	A9903
	16	HK2117	A1912	A2910	A4904	A3904	A6924	A9903
	20	HK2517	A1913	A2913	A4906	A3906	A6928	A9903
	24	HK2117	A1916	A2917	A4907	A3907	A6932	A9904
	32	—	A1919	A2919	—	—	—	A9904
	40	—	—	—	—	—	A6948	A9905
	48	—	—	—	—	—	—	—
	H077	04	HK0913	A1901	A2901	A4900	A3900	A6912
05		HK1013	A1902	A2902	A4900	A3900	A6914	A9901
06		HK1113	—	A2904	A4901	A3901	A6914	A9901
H100	04	HK0913	A1900	A2900	A4900	A3900	A6912	A9901
	05	HK1013	A1902	A2902	A4900	A3900	A6912	A9901
	06	HK1113	A1903	A2904	A4900	A3900	A6912	A9902
	08	HK1313	A1905	A2905	A4901	A3901	A6916	A9902
	10	HK1613	A1907	A2907	A4902	A3902	A6920	A9902
	12	HK1813	A1908	A2909	A4903	A3903	A6924	A9903

Hose Sleeves and Guards

Hose Type	Dash Size	Hose Clamp	Round-Wire Spring Guard	Flat-Wire Spring Guard	Nylon (.45) Abrasion Sleeve	Nylon (.90) Abrasion Sleeve	Silicone Fiberglass Firesleeve	Poly Hose Guard
H101	04	HK0913	A1902	A2902	A4900	A3900	A6910	A9901
	05	HK1013	A1903	A2902	A4900	A3900	A6912	A9901
	06	HK1113	A1904	A2904	A4900	A3900	A6912	A9901
	08	HK1413	A1905	A2905	A4902	A3902	A6916	A9902
	10	HK1613	A1907	A2907	A4903	A3903	A6920	A9902
	12	HK1813	A1908	A2909	A4903	A3903	A6924	A9903
	16	HK2317	A1913	A2913	A4904	A3904	A6928	A9903
H104	04	HK1903	A1902	A2902	A4900	A3900	A6912	A9901
	06	HK1213	A1904	A2904	A4900	A3900	A6914	A9902
	08	HK1413	A1907	A2907	A4902	A3902	A6920	A9902
	10	HK1613	A1907	A2907	A4903	A3903	A6924	A9902
	12	HK1913	A1910	A2910	A4903	A3903	A6924	A9903
	16	HK2317	A1913	A2913	A4904	A3904	A6928	A9903
	20	HK2117	A1916	A2917	A4906	A3906	A6936	A9904
H0105	04	HK1113	A1903	A2904	A4900	A3900	A6914	A9901
	06	HK1313	A1905	A2905	A4903	A3903	A6914	A9902
	08	HK1513	A1907	A2907	A4904	A3904	A6924	A9902
	12	HK2017	A1910	A2909	A4904	A3904	A6924	A9903
	16	HK2517	A1913	A2913	A4906	A3906	A6932	A9903
H114	04	HK0913	A1902	A2902	A4900	A3900	A6912	A9901
	06	HK1113	A1904	A2904	A4900	A3900	A6914	A9901
	08	HK1413	A1906	A2906	A4902	A3902	A6920	A9902
H115	04	HK1113	A1902	A2902	A4900	A3900	A6912	A9901
	05	HK1113	A1904	A2904	A4900	A3900	A6912	A9901
	06	HK1213	A1905	A2905	A4900	A3900	A6914	A9902
	08	HK1513	A1907	A2907	A4901	A3901	A6920	A9902
	12	HK2017	A1910	A2910	A4903	A3903	A6924	A9903
	16	HK2317	A1913	A2913	A4904	A3904	A6928	A9903
	20	HK2117	A1916	A2917	A4906	A3906	A6936	A9904
H145	04	HK0913	A1902	A2902	A4900	A3900	A6912	A9900
	06	HK1113	A1904	A2904	A4901	A3901	A6916	A9901
	08	HK1413	A1906	A2906	A4901	A3901	A6916	A9902
	10	HK1613	A1908	A2908	A4903	A4903	A6924	A9902
	12	HK1813	A1910	A2910	A4903	A3903	A6924	A9902
	16	HK2317	A1913	A2913	A4904	A3904	A6928	A9903
	20	HK2117	A1916	A2917	A4906	A3906	A6936	A9904
H145R	04	HK0913	A1900	A2901	A4900	A3900	A6912	A9900
	06	HK1113	A1904	A2904	A4901	A3901	A6916	A9901
	08	HK1413	A1906	A2906	A4901	A3901	A6916	A9902
	10	HK1613	A1908	A2908	A4903	A4903	A6924	A9902
	12	HK1813	A1910	A2910	A4903	A3903	A6924	A9902
	16	HK2317	A1913	A2913	A4904	A3904	A6928	A9903
	20	HK2117	A1916	A2917	A4906	A3906	A6936	A9904
H146	04	HK0913	A1902	A2902	A4900	A3900	A6912	A9901
	06	HK1213	A1905	A2905	A4901	A3901	A6914	A9902
	08	HK1413	A1906	A2906	A4901	A3901	A6920	A9903
H166	04	HK0913	A1902	A2901	A4900	A3900	A6912	A9901
	05	HK1013	A1902	A2902	A4900	A3900	A6912	A9901
	06	HK1013	A1904	A2904	A4901	A3901	A6916	A9902
	08	HK1413	A1905	A2905	A4901	A3901	A6916	A9902
	10	HK1613	A1907	A2907	A4901	A3901	A6920	A9902
	12	HK1913	A1910	A2910	A4903	A3903	A6924	A9903
	16	HK2117	A1912	A2911	A4905	A3905	A6932	A9903
20	HK2517	A1913	A2913	A4905	A3905	—	A9903	

Hose Sleeves and Guards

Hose Type	Dash Size	Hose Clamp	Round-Wire Spring Guard	Flat-Wire Spring Guard	Nylon (.45) Abrasion Sleeve	Nylon (.90) Abrasion Sleeve	Silicone Fiberglass Firesleeve	Poly Hose Guard
H169	04	HK1013	A1902	A2901	A4900	A3900	A6914	A9901
	05	HK1113	A1902	A2902	A4900	A3900	A6914	A9901
	06	HK1213	A1904	A2904	A4901	A3901	A6916	A9902
	08	HK1413	A1905	A2905	A4901	A3901	A6916	A9902
	10	HK1613	A1907	A2907	A4901	A3901	A6920	A9902
	12	HK1913	A1910	A2910	A4903	A3903	A6924	A9903
	16	HK2117	A1912	A2912	A4905	A3905	A6932	A9903
	20	HK2517	A1913	A2913	A4904	A3904	—	A9903
	24	HK2917	A1916	A2917	A4907	A3907	A6948	A9904
	32	HK3417	A1919	A2919	—	—	—	A9904
H190	04	HK1013	A1902	A2902	A4900	A3900	A6914	A9901
	06	HK1213	A1904	A2904	A4901	A3901	A6916	A9902
	08	HK1413	A1906	A2906	A4901	A3901	A6916	A9902
	10	HK1613	A1908	A2908	A4901	A3901	A6920	A9902
	12	HK1913	A1910	A2910	A4903	A3903	A6924	A9903
	16	HK2517	A1913	A2913	A4905	A3905	A6932	A9903
H190H	04	HK1013	A1902	A2902	A4900	A3900	A6914	A9901
	06	HK1213	A1904	A2904	A4901	A3901	A6916	A9902
	08	HK1413	A1906	A2906	A4901	A3901	A6916	A9902
	10	HK1613	A1908	A2908	A4901	A3901	A6920	A9902
	12	HK1913	A1910	A2910	A4903	A3903	A6924	A9903
	16	HK2517	A1913	A2913	A4905	A3905	A6932	A9903
H201	04	HK0913	A1902	A2902	A4900	A3900	A3612	A9901
	06	HK1113	A1904	A2904	A4901	A3901	A6914	A9901
	08	HK1313	A1905	A2905	A4901	A3901	A6916	A9902
	10	HK1613	A1907	A2907	A4902	A3902	A6920	A9902
	12	HK1813	A1908	A2909	A4903	A3903	A6924	A9903
H209	04	HK0809	A1900	A2900	A4900	A3900	A6910	A9900
	05	HK0913	A1902	A2902	A4900	A3900	A6914	A9900
	06	HK1013	A1903	A2902	A4901	A3901	A6914	A9900
	08	HK1213	A1905	A2905	A4901	A3901	A6920	A9902
H213	04	HK0913	A1901	A2901	A4900	A3900	A6910	A9900
	05	HK1013	A1902	A2902	A4900	A3900	A6914	A9900
	06	HK1113	A1903	A2904	A4900	A3900	A6914	A9901
	08	HK1313	A1905	A2905	A4901	A3901	A6920	A9902
	10	HK1413	A1907	A2907	A4902	A3902	A6920	A9902
	12	HK1713	A1908	A2908	A4903	A3903	A6924	A9902
	16	HK2017	A1912	A2911	A4904	A3904	A6928	A9903
H229	04	HK0913	A1902	A2901	A4900	A3900	A6910	A9901
	06	HK1213	A1904	A2904	A4901	A3901	A6914	A9902
	08	HK1413	A1905	A2905	A4902	A3902	A6924	A9902
	10	HK1613	A1907	A2907	A4902	A3902	A6924	A9902
H229	12	HK2617	A1912	A2912	A4905	A3905	A6928	A9903
	16	HK2117	A1912	A2912	A4906	A3906	A6932	A9906
H239	04	HK0913	A1902	A2901	A4900	A3900	A6912	A9901
	06	HK1213	A1904	A2904	A4900	A3900	A6914	A9902
	08	HK1313	A1905	A2905	A4901	A3901	A6920	A9902
	10	HK1613	A1907	A2907	A4902	A3902	A6920	A9902
	12	HK1813	A1910	A2910	A4905	A3905	A6928	A9903
	16	HK2117	A1912	A2912	A4906	A3906	A6932	A9903
	20	HK2517	A1913	A2913	A4904	A3904	—	A9903

Hose Sleeves and Guards

Hose Type	Dash Size	Hose Clamp	Round-Wire Spring Guard	Flat-Wire Spring Guard	Nylon (.45) Abrasion Sleeve	Nylon (.90) Abrasion Sleeve	Silicone Fiberglass Firesleeve	Poly Hose Guard
H243	03	HK0709	A1900	A2900	A4900	A3900	A6910	A9900
	04	HK0709	A1900	A2900	A4900	A3900	A6914	A9900
	05	HK0809	A1902	A2902	A4900	A3900	A6914	A9901
	06	HK0913	A1904	A2904	A4901	A3901	A6920	A9901
	08	HK1113	A1905	A2905	A4902	A3902	A6920	A9902
	12	HK1513	A1910	A2910	A4904	A3904	A6924	A9903
	16	HK1913	A1912	A2912	A4905	A3905	A6928	A9904
H245	04	HK1013	A1902	A2902	A4900	A3900	A6914	A9901
	06	HK1013	A1904	A2904	A4903	A3903	A6920	A9902
	08	HK1213	A1906	A2906	A4904	A3904	A6924	A9902
	10	HK1413	A1908	A2908	A4904	A3904	A6924	A9902
	12	HK1613	A1910	A2910	A4905	A3905	A6928	A9903
	16	HK2317	A1913	A2913	A4906	A3906	A6932	A9903
	20	HK2917	A1916	A2917	A4907	A3907	—	A9904
H265	04	HK0913	A1902	A2902	A4900	A3900	A6914	A9901
	06	HK1213	A1904	A2904	A4901	A3901	A6916	A9901
	08	HK1413	A1905	A2905	A4902	A3902	A6920	A9902
	12	HK1813	A1910	A2910	A4904	A3904	A6928	A9903
	16	HK2217	A1913	A2913	A4905	A3905	A6932	A9903
H275	03	HK0809	A1900	A2900	A4900	A3900	A6912	A9900
	04	HK0913	A1902	A2902	A4900	A3900	A6914	A9901
	06	HK1113	A1903	A2904	A4901	A3901	A6916	A9901
	08	HK1413	A1905	A2905	A4902	A3902	A6920	A9902
	12	HK1813	A1910	A2909	A4904	A3904	A6924	A9902
	16	HK2217	A1913	A2913	A4905	A3905	A6928	A9903
	20	HK2917	A1916	A2916	A4907	A3907	A6936	A9904
	24	HK3217	A1917	A2917	A4908	A3908	A6940	A9904
	32	HK3817	—	—	—	—	A6948	A9904
H277	03	HK0709	A1900	A2900	A4900	A3900	A6910	A9900
	04	HK0709	A1900	A2900	A4900	A3900	A6914	A9900
	05	HK0809	A1900	A2900	A4901	A3901	A6920	A9902
	06	HK0913	A1903	A2902	A4902	A3902	A6920	A9902
	08	HK1113	A1904	A2904	A4901	A3901	A6920	A9902
	12	HK1513	A1907	A2907	A4904	A3904	A6928	A9903
	16	HK1913	A1912	A2912	A4905	A3905	A6932	A9903
H280	04	HK1013	A1902	A2902	A4900	A3900	A6914	A9901
	06	HK1213	A1904	A2904	A4901	A3901	A6920	A9902
	08	HK1413	A1906	A2906	A4901	A3901	A6920	A9902
	10	HK1613	A1908	A2908	A4904	A3904	A6928	A9903
	12	HK1913	A1910	A2910	A4904	A3904	A6928	A9903
	16	HK2517	A1913	A2913	A4905	A3905	A6932	A9903
H285	04	HK0913	A1900	A2900	A4900	A3900	A6914	A9900
	06	HK1213	A1903	A2902	A4901	A3901	A6916	A9901
	08	HK1413	A1905	A2905	A4901	A3901	A6920	A9902
	12	HK1813	A1910	A2909	A4904	A3904	A6924	A9903
	16	HK2217	A1912	A2912	A4905	A3905	A6928	A9903
H290	04	HK1113	A1903	A2904	A4900	A3900	A6914	A9901
	06	HK1313	A1905	A2905	A4901	A3901	A6916	A9902
	08	HK1513	A1907	A2907	A4902	A3902	A6920	A9902
	10	HK1713	A1910	A2910	A4904	A3904	A6924	A9903
	12	HK2017	A1912	A2912	A4904	A3904	A6928	A9903
	16	HK2517	A1913	A2913	A4904	A3904	A6932	A9903

Hose Sleeves and Guards

Hose Type	Dash Size	Hose Clamp	Round-Wire Spring Guard	Flat-Wire Spring Guard	Nylon (.45) Abrasion Sleeve	Nylon (.90) Abrasion Sleeve	Silicone Fiberglass Firesleeve	Poly Hose Guard
H290H	04	HK1113	A1903	A2904	A4900	A3900	A6914	A9901
	06	HK1313	A1905	A2905	A4901	A3901	A6916	A9902
	08	HK1513	A1907	A2907	A4902	A3902	A6920	A9902
	10	HK1713	A1910	A2910	A4904	A3904	A6924	A9903
	12	HK2017	A1912	A2912	A4904	A3904	A6928	A9903
	16	HK2517	A1913	A2913	A4904	A3904	A6932	A9903
H324	06	HK1313	A1905	A2905	A4900	A3900	A6924	A9902
H325	04	HK1013	A1902	A2902	A4900	A3900	A6914	A9901
	06	HK1313	A1905	A2905	A4900	A3900	A3616	A9902
	08	HK1513	A1907	A2907	A4901	A3901	A6920	A9902
	12	HK2017	A1912	A2912	A4904	A3904	A6928	A9903
	16	HK2517	A1913	A2913	A4904	A3904	A3932	A9903
H332	04	HK1013	A1903	A2902	A4900	A3900	A6914	A9901
	06	HK1313	A1905	A2905	A4900	A3900	A3616	A9902
	08	HK1513	A1907	A2907	A4901	A3901	A6920	A9902
	12	HK2017	A1910	A2910	A4904	A3904	A6928	A9903
H335	03	HK0913	A1901	A2901	A4900	A3900	A6916	A9901
	04	HK1113	A1903	A2904	A4901	A3901	A6916	A9902
	06	HK1313	A1905	A2905	A4902	A3902	A6920	A9902
	08	HK1513	A1907	A2907	A4902	A3902	A6924	A9902
	12	HK1913	A1910	A2910	A4903	A3903	A6924	A9903
	16	HK2517	A1913	A2913	A4905	A3905	A6928	A6603
H336	03	HK0913	A1901	A2901	A4900	A3900	A6916	A9901
	04	HK1113	A1903	A2904	A4901	A3901	A6916	A9902
	06	HK1313	A1905	A2905	A4902	A3902	A6920	A9902
	08	HK1513	A1907	A2907	A4902	A3902	A6924	A9903
	12	HK1913	A1910	A2910	A4903	A3903	A6924	A9903
	16	HK2517	A1913	A2913	A4905	A3905	A6928	A9902
H338	06	HK1313	A1905	A2905	A4900	A3900	A6920	A9902
	08	HK1513	A1907	A2907	A4901	A3901	A6920	A9902
H345	04	HK0913	A1900	A2900	A4900	A3900	A6916	A9901
	06	HK1113	A1904	A2904	A4900	A3900	A6920	A9902
	08	HK1313	A1906	A2906	A4901	A3901	A6924	A9902
H350	06	HK1313	A1904	A2904	A4901	A3901	A6916	A9902
	08	HK1513	A1906	A2906	A4901	A3901	A6916	A9902
	10	HK1813	A1908	A2908	A4904	A3904	A6924	A9903
	12	HK2017	A1910	A2910	A4905	A3905	A6928	A9903
	16	HK2517	A1913	A2913	A4906	A3906	A6936	A9903
H366	06	HK1213	A1904	A2904	A4901	A3901	A6916	A9902
	08	HK1413	A1905	A2905	A4901	A3901	A6916	A9902
H400	04	HK1013	A1903	A2904	A4901	A3901	A6916	A9902
	06	HK1313	A1905	A2905	A4901	A3901	A6920	A9903
	08	HK1413	A1907	A2907	A4901	A3901	A6920	A9903
	10	HK1713	A1909	A2909	A4903	A3903	A6920	A9903

Hose Sleeves and Guards

Hose Type	Dash Size	Hose Clamp	Round-Wire Spring Guard	Flat-Wire Spring Guard	Nylon (.45) Abrasion Sleeve	Nylon (.90) Abrasion Sleeve	Silicone Fiberglass Firesleeve	Poly Hose Guard	
H425	04	HK1113	A1903	A2904	A4900	A3900	A6916	A9902	
	06	HK1313	A1905	A2905	A4900	A3900	A6916	A9902	
	08	HK1513	A1907	A2907	A4902	A3902	A6920	A9902	
	10	HK1713	A1910	A2909	A4903	A3903	A6920	A9903	
	12	HK2017	A1912	A2911	A4903	A3903	A6924	A9903	
	16	HK2517	A1913	A2913	A4905	A3905	A6928	A9903	
	20	HK3117	A1917	A2917	A4906	A3906	A6936	A9904	
	24	HK3417	A1919	A2919	A4907	A3907	—	A9904	
	32	HK3817	—	—	—	—	—	A9905	
	H430	06	HK1413	A1906	A2906	A4901	A3901	A6916	A9902
08		HK1613	A1908	A2908	A4904	A3904	A6924	A9903	
10		HK1913	A1909	A2909	A4904	A3904	A6924	A9903	
12		HK2117	A1912	A2912	A4905	A3905	A6928	A9903	
16		HK2517	A1913	A2913	A4906	A3906	A6936	A9903	
20		HK3117	A1917	A2917	A4907	A3907	—	A9904	
24		—	A1919	A2919	A4907	A3907	—	A9904	
32		HK3817	—	—	—	—	—	A9905	
H430R		06	HK1413	A1906	A2907	A4901	A3901	A6916	A9902
		08	HK1613	A1908	A2908	A4904	A3904	A6924	A9903
	12	HK2117	A1912	A2912	A4905	A3905	A6928	A9903	
	16	HK2517	A1913	A2913	A4906	A3906	A6936	A9903	
	20	HK3117	A1917	A2917	A4907	A3907	—	A9904	
	24	—	A1919	A2919	A4907	A3907	—	A9904	
	32	HK3817	—	—	—	—	—	A9905	
	H435	04	HK0809	A1900	A2900	A4900	A3900	A6912	A9901
05		HK1013	A1902	A2902	A4900	A3900	A6912	A9901	
06		HK1113	A1904	A2904	A4900	A3900	A6916	A9901	
08		HK1413	A1906	A2906	A4902	A3902	A6920	A9902	
12		HK1813	A1910	A2910	A4903	A3903	A6924	A9903	
16		HK2317	A1913	A2913	A4904	A3904	A6928	A9903	
H436		04	HK0809	A1900	A2900	A4900	A3900	A6912	A9901
	05	HK1013	A1902	A2902	A4900	A3900	A6912	A9901	
	06	HK1113	A1904	A2904	A4901	A3901	A6916	A9901	
	08	HK1413	A1906	A2906	A4902	A3902	A6920	A9902	
	12	HK1813	A1910	A2910	A4903	A3903	A6924	A9903	
	16	HK2317	A1913	A2913	A4904	A3904	A6928	A9903	
	H464	12	HK2317	A1912	A2912	A4903	A3903	A6920	A9902
16		HK2517	A1913	A2913	A4904	A3904	A6924	A9902	
20		HK3117	A1916	—	A4905	A3905	A6928	A9903	
24		HK3417	A1919	A2919	A4906	A3906	A6936	A9903	
32		HK3817	—	—	A4908	A3908	A6948	A9904	
H470	08	HK1713	A1908	A2908	A4901	A3901	A6916	A9902	
	12	HK2117	A1912	A2912	A4904	A3904	A6928	A9903	
	16	HK2517	A1913	A2913	A4904	A3904	A6928	A9903	
	20	HK3217	A1917	A2917	A4906	A3906	A6936	A9904	
	24	HK3417	A1919	A2919	A4907	A3907	—	A9904	
	32	HK3817	—	—	—	—	—	A9905	

Hose Sleeves and Guards

Hose Type	Dash Size	Hose Clamp	Round-Wire Spring Guard	Flat-Wire Spring Guard	Nylon (.45) Abrasion Sleeve	Nylon (.90) Abrasion Sleeve	Silicone Fiberglass Firesleeve	Poly Hose Guard	
H545	04	HK1013	A1902	A2902	A4900	A3900	A6912	A9901	
	06	HK1113	A1904	A2904	A4901	A3901	A6916	A9901	
	08	HK1513	A1906	A2906	A4901	A3901	A6916	A9902	
	10	HK1713	A1907	A2907	A4903	A3903	A6924	A9902	
	12	HK2017	A1910	A2910	A4904	A3904	A6928	A9903	
	16	HK2517	A1913	A2913	A4906	A3906	A6936	A9903	
	H569	04	HK0913	A1901	A2901	A4900	A3900	A6912	A9901
05		HK1113	A1902	A2902	A4900	A3900	A6912	A9901	
06		HK1213	A1904	A2904	A4901	A3901	A6916	A9902	
08		HK1413	A1905	A2905	A4901	A3901	A6916	A9902	
10		HK1613	A1907	A2907	A4901	A3901	A6916	A9902	
12		HK1913	A1910	A2910	A4903	A3903	A6924	A9903	
16		HK2117	A1912	A2912	A4904	A3904	A6928	A9903	
20		HK2517	A1913	A2913	A4906	A3906	A6936	A9903	
H757		06	HK1013	A1902	A2902	A4900	A3900	A6916	A9901
		08	HK1213	A1904	A2904	A4900	A3900	A6920	A9902
	10	HK1313	A1905	A2905	A4901	A3901	A6920	A9902	
	12	HK1613	A1907	A2907	A4902	A3902	A6924	A9902	

Ready-Made Hose Assemblies

Coiled Air Brake Tube Assemblies

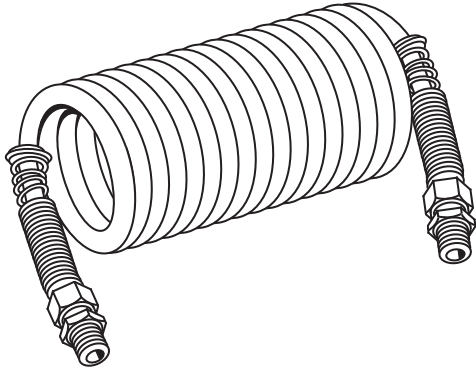

Part Number	Tube O.D.	Male Pipe	Working Length(ft)	Pigtail Length
12CA12-12*	1/2	1/2	12	12
12CAR12-12	1/2	1/2	12	12
12CAB12-12	1/2	1/2	12	12
15CA12-12*	1/2	1/2	12	12
15CA48-12*	1/2	1/2	15	48/12
15CAR48-12	1/2	1/2	15	48/12
15CAB48-12	1/2	1/2	15	48/12

* Each catalog number contains a coiled red assembly and a coiled blue assembly.

Features / Benefits

- Conform to SAE J844 Type B and SAE J1131
- Conform to DOT FMVSS 571.106

Construction

- Brass end fittings with spring guards and 1/2" male pipe connections
- Zinc plated spring guards for maximum corrosion resistance
- Preassembled for immediate installation

Maximum Operating pressure

150 psi

Minimum Burst Pressure

950 psi.

Operating Temperature Range

-54°C to +93°C
(-65°F to +200°F).

Color Coding

Red for emergency–blue for service.

Gladhand Couplings

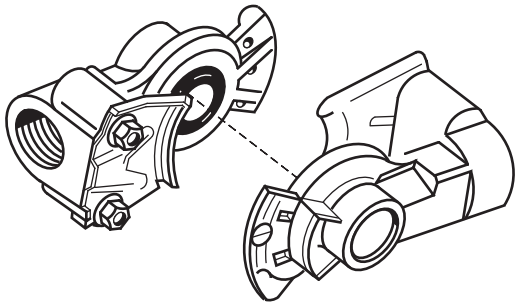

Description	Part Number
Service – Signal (Connects only to service)	W79850
Emergency – Supply line (Connects only to emergency)	W79851
Universal (Connects to all three styles)	W76150
Gladhand Seal	W14630**

** For use with W79850, W79851, and W76150 gladhands

Features / Benefits

- Conform to SAE J318
- Connect to 1/2" pipe

Construction

- Die cast aluminum body

Ready-Made Hose Assemblies

Air Compressor Discharge Teflon® Hose Assembly

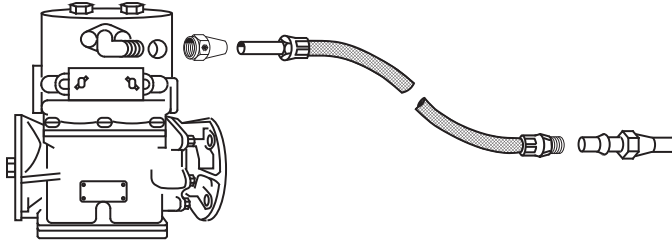

Ready-made hose Teflon® assemblies eliminate tubing failures caused by vibration and heat. They make excellent replacements for troublesome copper tubing running from the air compressor discharge to the reservoir. The assemblies are easy to install with standard air brake nuts and sleeves. No special fittings or adapters are needed.

Max. Working Pressure
1000 psi

Operating Temperature Range

-65°F to +450°F
(-18°C to +232°C)

Standpipe to Standpipe



Description	Length	Part Number
5/8" hose I.D. – 5/8" tube	24"	WTT024
	36"	WTT036
5/8" hose I.D. – 3/4" tube	36"	WTT236

SAE 45° Flare to SAE 45° Flare



Description	Length	Part Number
1/2" hose I.D. – 5/8" tube	34"	W44034
	38"	W44038
	40"	W44040
	42"	W44042
	48"	W44048
	50"	W44050
	52"	W44052
	54"	W44054
67"	W44067	

Teflon® is a registered trademark of DuPont used under license by Eaton.

Ready-Made Hose Assemblies

Grease Hose Whip Ends for High-Pressure Grease Applications

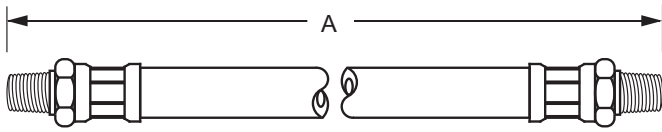

Part Number	Tube O.D.	Male Pipe	Working Length	Pigtail Length
11312	1/8-27	3/16"	12"	Rubber
11318	1/8-27	3/16"	18"	Rubber
11352	1/8-27	3/16"	12"	Nylon
11358	1/8-27	3/16"	18"	Nylon

Maximum Operating Pressure
3000 psi

Operating Temperature Range
-40°F to +200°F (-40°C to +93°C)

Note:
Use with hand-operated grease gun only!

Hose Part No. H993903

Power Trim Teflon® Hose Assembly

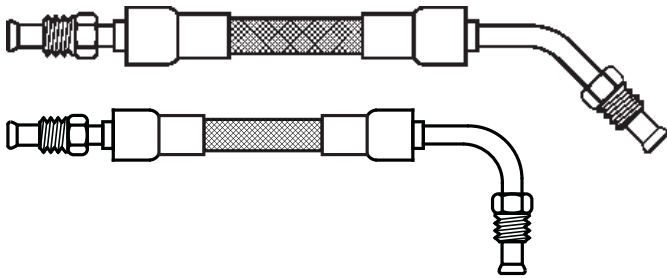

Part Number	Overall Length	Fiting Description
1909	14-1/2"	3/16" Inv. Nut Straight x 3/16" Inv. Nut 90° Elbow
1910	14-1/2"	3/16" Inv. Nut Straight x 3/16" Inv. Nut 45° Elbow

Expand service to marinas with the inboard/outboard power trim teflon hose assemblies, available in the most popular size, 3/16" I.D., 14-1/2" long, with inverted nut end styles. Marine applications will benefit from the non-aging and temperature resistant qualities of Teflon®, plus the

corrosion resistance of 300 Series stainless steel fittings and braid.

Maximum Operating Pressure
3000 psi

Operating Temperature Range
-65°F to +450°F

Teflon® is a registered trademark of DuPont used under license by Eaton.

Ready-Made Hose Assemblies

Air Brake Air Chamber Hose Lines

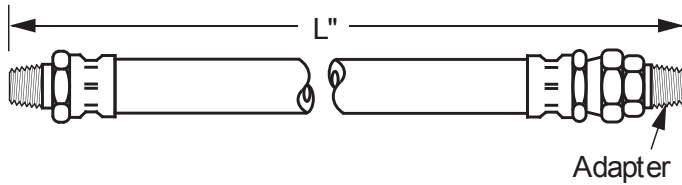

Features / Benefits

- Low cost
- Ready to install
- Available in both 3/8" and 1/2" I.D.
- H338 Weatherhead Air Brake Hose

Hose Assembly I.D.	Male Pipe	Air Brake Swivel*	Length L	Factory Made Assembly Part Number**
1/2"	3/8"	3/8"	15"	38353-01500
1/2"	3/8"	3/8"	16"	38353-01600
1/2"	3/8"	3/8"	18"	38353-01800
1/2"	3/8"	3/8"	19"	38353-01900
1/2"	3/8"	3/8"	20-3/8"	38353-02037
1/2"	3/8"	3/8"	22"	38353-02200
1/2"	3/8"	3/8"	23"	38353-02300
1/2"	3/8"	3/8"	24"	38353-02400
1/2"	3/8"	3/8"	26"	38353-02600
1/2"	3/8"	3/8"	28-3/8"	38353-02837
1/2"	3/8"	3/8"	30"	38353-03000
1/2"	3/8"	3/8"	32"	38353-03200
1/2"	3/8"	3/8"	34-3/8"	38353-03437
1/2"	3/8"	3/8"	36"	38353-03600
1/2"	3/8"	3/8"	41-1/8"	38353-04112
1/2"	3/8"	3/8"	44"	38353-04400
1/2"	3/8"	3/8"	46"	38353-04600
1/2"	3/8"	3/8"	48"	38353-04800
1/2"	3/8"	3/8"	60"	38353-06000
1/2"	3/8"	3/8"	72"	38353-07200

*Includes 3/8" A.B.S. to 3/8" male pipe adapter.

**Air chamber hose assemblies can also be made using Weatherhead H338 hose, 33808P-106 and 33808P-Y76 hose ends, and 1390x6x6 adapter with the Coll-O-Crimp field crimping system.

Ready-Made Hose Assemblies

Air Brake Air Chamber Hose Lines

Hose Assembly I.D.	Male Pipe	Air Brake Swivel*	Length L	Factory Made Assembly Part Number**
3/8"	1/4"	3/8"	18-1/8"	38166-01812
3/8"	1/4"	3/8"	20-3/8"	38166-02137
3/8"	1/4"	3/8"	22"	38166-02200
3/8"	1/4"	3/8"	24-1/8"	38166-02412
3/8"	1/4"	3/8"	24-7/8"	38166-02487
3/8"	1/4"	3/8"	26"	38166-02600
3/8"	1/4"	3/8"	27-5/8"	38166-02762
3/8"	1/4"	3/8"	28-3/8"	38166-02837
3/8"	1/4"	3/8"	29-1/8"	38166-02912
3/8"	1/4"	3/8"	30-1/8"	38166-03012
3/8"	1/4"	3/8"	32"	38166-03200
3/8"	1/4"	3/8"	34"	38166-03400
3/8"	1/4"	3/8"	34-3/8"	38166-03437
3/8"	1/4"	3/8"	36-1/8"	38166-03612
3/8"	1/4"	3/8"	38-1/8"	38166-03812
3/8"	1/4"	3/8"	40"	38166-04000
3/8"	1/4"	3/8"	41-1/8"	38166-04112
3/8"	1/4"	3/8"	42"	38166-04200
3/8"	1/4"	3/8"	48"	38166-04800
3/8"	1/4"	3/8"	60"	38166-06000
3/8"	1/4"	3/8"	72"	38166-07200

*Includes 3/8" A.B.S. to 3/8" male pipe adapter.

**Air chamber hose assemblies can also be made using Weatherhead H338 hose, 33808P-106 and 33808P-Y76 hose ends, and 1390x6x6 adapter with the Coll-O-Crimp field crimping system.

Hose Assembly I.D.	Male Pipe	Air Brake Swivel*	Length L	Factory Made Assembly Part Number**
3/8"	3/8"	3/8"	18"	38097-01800
3/8"	3/8"	3/8"	20"	38097-02000
3/8"	3/8"	3/8"	24"	38097-02400
3/8"	3/8"	3/8"	26"	38097-02600
3/8"	3/8"	3/8"	28"	38097-02800
3/8"	3/8"	3/8"	30"	38097-03000
3/8"	3/8"	3/8"	32"	38097-03200
3/8"	3/8"	3/8"	34"	38097-03400
3/8"	3/8"	3/8"	40"	38097-04000
3/8"	3/8"	3/8"	42"	38097-04200
3/8"	3/8"	3/8"	60"	38097-06000
3/8"	3/8"	3/8"	72"	38097-07200

*Includes 3/8" A.B.S. to 3/8" male pipe adapter.

**Air chamber hose assemblies can also be made using Weatherhead H338 hose, 33808P-106 and 33808P-Y76 hose ends, and 1390x6x6 adapter with the Coll-O-Crimp field crimping system.

Ready-Made Hose Assemblies

**Automobile, Light Truck
Gas/Oil Lines**

**Maximum Working
Pressure:**

50 PSI

Temperature Range

-40°F to +257°F

Weatherhead H057 Hose

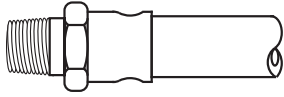

Male Pipe

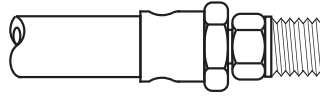

Inverted Male

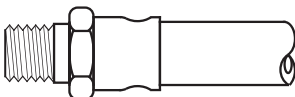

Male Pipe

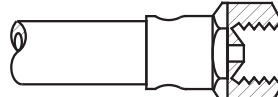

Inverted Female

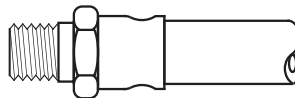

Male Pipe

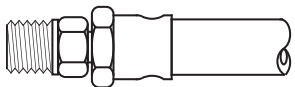

Inverted Male

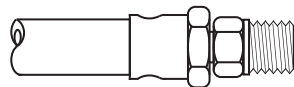

Inverted Male

Part Number	Overall Length	Fitting Description
11461	10"	1/8" Male Pipe x 1/4" Inv. Male
11462	12"	1/8" Male Pipe x 1/4" Inv. Male
11463	13"	1/8" Male Pipe x 1/4" Inv. Male
11464	15"	1/8" Male Pipe x 1/4" Inv. Male
11465	21"	1/8" Male Pipe x 1/4" Inv. Male
11466	28"	1/8" Male Pipe x 1/4" Inv. Male
11474	19"	1/8" Male Pipe x 1/4" Inv. Male
11477	17"	1/8" Male Pipe x 1/4" Inv. Male
11478	24"	1/8" Male Pipe x 1/4" Inv. Male

Part Number	Overall Length	Fitting Description
11079	6-5/8"	1/8" Male Pipe x 5/16" Inv. Female
11076	8-1/4"	1/8" Male Pipe x 5/16" Inv. Female
11205	8-7/8"	1/8" Male Pipe x 5/16" Inv. Female
11215	9-3/8"	1/8" Male Pipe x 5/16" Inv. Female
11093	18"	1/8" Male Pipe x 5/16" Inv. Female
11217	7-1/2"	1/4" Male Pipe x 3/8" Inv. Female
11216	9"	1/4" Male Pipe x 3/8" Inv. Female

Part Number	Overall Length	Fitting Description
11223	15-1/4"	1/4" Male Pipe (one end only, other end blank)

Part Number	Overall Length	Fitting Description
11486	10"	1/4" Inv. Male x 1/4" Inv. Male

Ready-Made Hose Assemblies

Automobile, Light Truck Gas/Oil Lines*

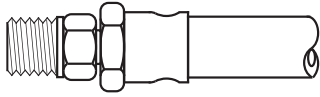

Inverted Male

Weatherhead H057 Hose

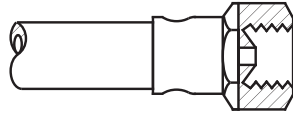

Inverted Female

Part Number	Overall Length	Fitting Inverted Description
11080	5"	1/4" Male x 1/4" Female
11224	7"	1/4" Male x 1/4" Female
11089	10-5/8"	1/4" Male x 1/4" Female
11078	7"	5/16" Male x 5/16" Female
11212	7-7/8"	5/16" Male x 5/16" Female
11041	9"	5/16" Male x 5/16" Female
11208	10-3/4"	5/16" Male x 5/16" Female

Maximum Operating Pressure
50 psi

Operating Temperature Range
-40°F to +257°F

Part Number	Overall Length	Fitting Inverted Description
11219	6-1/4"	5/16" Male x 5/16" Female

Automobile, Light Truck Universal-Type Filter Lines*

(1/4" SAE Swivel Nut to 1/8" Male Pipe)



Weatherhead H05804 Hose

Part Number	Overall Length	Part Number	Overall Length
81430-08	8"	81430-20	20"
81430-10	10"	81430-22	22"
81430-12	12"	81430-24	24"
81430-14	14"	81430-28	28"
81430-16	16"	81430-30	30"
81430-18	18"	81430-36	36"

Maximum Operating Pressure
400 psi

Operating Temperature Range
-40°F to +250°F

Note: Hose end material is brass.

*Hose assemblies listed are for automobile or light truck (up to 3/4-ton pickup truck) application only. Consult Eaton prior to any other use.

Accessories

Jetcleaner™



The Jetcleaner™ hose cleaning system offers a revolutionary solution for internal cleaning of bulk hose and finished hose assemblies. Using a low-pressure air gun, the Jetcleaner system routes a foam projectile through the hose to thoroughly remove debris remaining from cutting, skiving, and assembly operations. Available in kit form or as individual components, it is the system of choice for hose assembly professionals.

Hose Kit (Part Number FT1355-01)

Includes:

- Jetcleaner pistol
- Hose nozzles, 1/4" through 2" ID
- Adapter ring
- Aluminum case
- Bench stand

Note

Hose projectiles (Part number FT1355-3-size) not included in kit.

Small Jet Cleaner Kit (Part Number FT1355-02)

Includes:

- Jetcleaner pistol
- Hose nozzles 1/4" thru 1-1/4"
- Hose projectiles 1/4" thru 1-1/4"
- Adapter ring
- Aluminum case
- Bench stand

Hose Insertion Gauges



Part Number FF90308

For use with all hose with WeatherGRIP™ hose ends.

Improve hose assembly reliability with these easy-to-use aluminum gages that are designed to ensure proper hose end depth during pre-assembly.

Simply bottom the hose in the appropriately marked cavity and scribe a mark on the hose flush with the top surface of the gauge. Insert the hose end until the back of the socket is aligned with scribe line.

Part Number	Usage
FF90308-01	All hose styles that mate with -4 through -16 WeatherGRIP hose ends
FF90308-02	All hose styles that mate with -20 WeatherGRIP hose ends
FF90308-03	All hose styles that mate with -12, -16, -20 4SP/6SP hose ends

Pressure Gauge Kit



Complete Kit Number	Component Part Number	Description	Quantity Per Kit
FF14802	FF14783	1/8" NPT Test Coupling	2
	FF14784	1/4" NPT Test Coupling	2
	FF14787	7/16-20 UNF Test Coupling	1
	FF14788	9/16-20 UNF Test Coupling	1
	FF14794	1/4" NPT Gauge Adapter	3
	FF14796	Union Adapter	2
	FF14798	60" Test Hose Assembly	2
	FF14799	(-) 30 in/Hg - 30 psi Gauge	1
	FF14800	1,000 psi Gauge	1
	FF14801	7,500 psi Gauge	1

Hose Spacers



Part Number	Description
HSM-48	Case of 48 Mixed Hose Spacers

Features

- Prevent hose abrasion at points of contact
- Help keep hose organized
- Prevent damage from unrestrained hoses
- Easy to install
- Available in 3/4", 1", 1 1/8", 1 3/8" sizes
- Packed in colorful counter display box of 48, cable ties included
- Also available in mixed box of 48 (12 of each size) or refill bag of 12

Hose Protectors*



Part Number	Description
HP4	4" Hose Protector Case of 50
HP6	6" Hose Protector Case of 50
HP8	8" Hose Protector Case of 50
HP10	10" Hose Protector Case of 10
HP12	12" Hose Protector Case of 10
HPM	Mixed Hose Protectors Case of 60

*Available in black, orange and yellow.

Abrasion Protection For

- Hydraulic hose
- Battery cables
- Wiring harness
- Brake systems
- Fuel lines
- Air lines
- Radiator hose
- Oil lines

Features

- Extremely high-wear factor
- Formulated to resist solvents, oils, grease, gasoline, etc.
- 3 grooves protect cable ties and prevent slipping
- Operating temperature range -40° to 430°F
- Exceptionally cost effective
- Easy installation in minutes – no need to remove hose
- Packed in colorful easy-to-assemble, counter display box
- Available in 4", 6" and 8" sizes – cable ties included

Applications:

- Agriculture
- Industrial
- Trucking
- Mining
- Construction
- Aviation support
- Public transportation
- Road maintenance
- Waste management
- Original equipment manufacturer

Flaretite* Seals

Flaretite seals are the ideal product to enhance new installations of SAE connections, as well as seal off minor leaks and weeping connections.



Features

- Ribbed insert design
- Coated with Loctite** sealant
- Economical method to reduce minor leaks and weeping connections
- Built-in clip to attach the Flaretite seal to the nose of the SAE 37° connection
- -04 through -32 sizes

Benefits

- Multiple surface contact points
- Lock the joint and fill surface imperfections
- Save time and money associated with maintenance and rework
- Quick and easy assembly

Flaretite Seal
Joint Section of Applied Seal

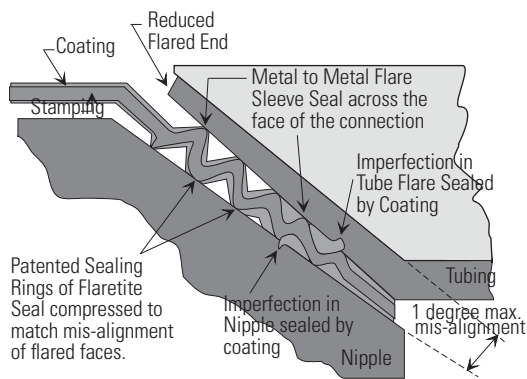

Standard Flared Connection (Section)

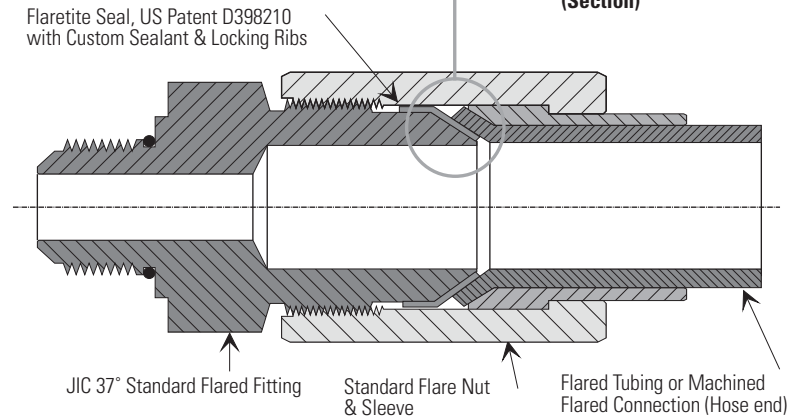

Assembly and Torque Requirements

To assemble an SAE 37° connection, simply push the Flaretite seal onto the male portion of the connection. The built-in clip will hold the Flaretite seal onto the male half.

- The seal is fitted squarely to the conical nose of the JIC fitting -37° flare
- The sealing faces of the flared connector part are clean and free of burrs
- The flared joint is correctly tightened with recommended torque settings noted below.

During assembly ensure:

* Flaretite is a registered trademark of Flaretite Inc.

** Loctite is a registered trademark of Henkel Loctite Corporation.

Note:

All photos and the name Flaretite are the property of Flaretite Inc.

Seal Size	Package Part Number	Number of Seals per Package
-04	FF13267	100
-06	FF13268	100
-08	FF13269	100
-10	FF13270	100
-12	FF13271	100
-16	FF13272	50
-20	FF13273	50
-24	FF13570	25
-32	FF13571	10
Variety Pack	FF14001	6 ea of sizes -04 to -16

Recommended Torque Settings

Tolerance: +10% -0%

-04 (1/4")	SAE 37°: 14lb-ft.	-10 (5/8")	SAE 37°: 80lb-ft.	-20 (1-1/4")	SAE 37°: 190lb-ft.
-06 (3/8")	SAE 37°: 26lb-ft.	-12 (3/4")	SAE 37°: 110lb-ft.	-24 (1-1/2")	SAE 37°: 220lb-ft.
-08 (1/2")	SAE 37°: 55lb-ft.	-16 (1")	SAE 37°: 140lb-ft.	-32 (2")	SAE 37°: 325lb-ft.



Guardian Sleeve



Eaton's new Guardian Sleeve is designed to provide protection against hydraulic hose failure by containing pressure and fluids that may escape during a hose burst or pinhole leak. With this new line of sight sleeving which meets industry standards, both equipment operators and the environment are guarded from the effects of hose failures.

Benefits

- Meets new line of sight operator specification EN982 ISO norm 833 EN414 and ISO 3457
- The ultra tight weave resists oil spillage from hose failure
- Meets ASTM D6770 for abrasion resistance of textile webbing
- Meets abrasion standard ISO 6945
- Meets Fed-STD191-Test Method 5309 for abrasion
- Densely twisted polyamide 6 yarn offers optimum UV and abrasion protection
- MSHA approved # IC-234/0 – Meets standard application procedures for acceptance of Flame Resistance Solid Products taken into mines
- Meets Conductivity Requirements of ISO 8031
- Tight, smooth surface resists wear

Chemical Compatibility Chart for Guardian Sleeving

Chemical	Compatibility
Gasoline	Very Good
Oil	Very Good
Mineral and Vegetable Oil	Very Good
Ionic Metallic Solutions	Very Good
Alcohols	Very Good
Diluted Bases	Very Good
Diluted acids	Good
Benzene	Very Good
Acetone	Very Good
Ether	Very Good
Carbon Tetrachloride	Very Good
Chlorine Based Solvent	Very Good
Mold, Bacteria, Moths	Very Good

* Strong and concentrated acids; ie. Hcl or Formic Acid may have some corrosive action.

Denier: 1260

Melting Point: 215°C/420°F

Material: Polyamide 6, made with pre-dyed yarn

Dim. Stability: Great resistance to sun, atmospheric agents and aging

Toxicity: Non-Toxic

Color: Black

Packing Requirements: Eaton Guardian Sleeve comes in a 300 foot roll with no more than 3 cuts per roll and no piece shorter than 30 feet.

* Slide sleeve onto the hose before assembling the ends. After assembly, clamp the hose onto the fitting using a metal banding product.

Properties	Specification	Description
Burst Pressure	16,000 psi	Capable to contain hose burst up to 16,000 psi
Pin Hole Leak Pressure	4,000 psi	Sustained 4,000 psi pin hole deflection from focused 1mm pin hole
Abrasion Cycles	250,000	Holds up to 250,000 Abrasion cycles per ISO 6945

General and Dimensional Information

Part Number	Nominal I.D. (in)	A – Flat Width (in) +/- 0.125	Weights in lbs per 300 ft Roll	Rolls per Box
FF90754-68	0.68	1.290	7.43	8
FF90754-79	0.79	1.400	8.50	7
FF90754-91	0.91	1.590	9.70	6
F90754-98	0.98	1.590	10.13	6
FF90754-106	1.06	1.825	11.10	5
FF90754-122	1.22	2.076	12.60	4
FF90754-142	1.42	2.390	14.50	4
FF90754-157	1.57	2.650	16.10	3
FF90754-173	1.73	2.910	17.70	3
FF90754-185	1.85	3.100	18.80	3
FF90754-209	2.09	3.470	21.10	2
FF90754-219	2.19	3.630	22.10	2
FF90754-238	2.38	3.925	23.90	2
FF90754-288	2.88	4.714	28.60	2
FF90754-366	3.66	5.938	36.10	1

Guardian Sleeve Selection Chart

Suggested Sleeve Part Number	Sleeve I.D. (in)	Max Hose OD that Sleeve can accept (in)	Hose Size as a Ref.
FF90754-68	0.68	0.52	-4
FF90754-79	0.79	0.61	-4
FF90754-91	0.91	0.70	-6
FF90754-98	0.98	0.76	-6
FF90754-106	1.06	0.80	-6
FF90754-122	1.22	0.92	-8
FF90754-142	1.42	1.02	-10
FF90754-157	1.57	1.13	-10
FF90754-173	1.73	1.24	-12
FF90754-185	1.85	1.34	-16
FF90754-209	2.09	1.50	-16
FF90754-219	2.19	1.54	-20
FF90754-238	2.38	1.70	-20
FF90754-288	2.88	2.00	-20
FF90754-366	3.66	2.40	-24

Bundling Sleeves

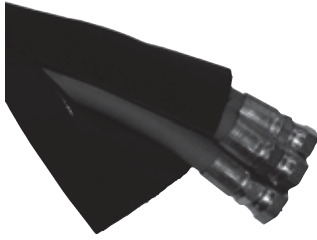

Hydraulic lines are often subjected to tremendous stress and wear during use. Lines that are allowed to move freely are easily abraded, crimped, or cut. Common methods for binding hydraulic lines, such as cable ties, can restrict movement too much as the lines expand and contract.

Bundling sleeves hold lines securely in place to protect them from damage, while providing enough flexibility for normal operation.

The sleeves can be removed and replaced quickly, allowing easy access for hose repair.

Specifications

Part Number	Fits Bundle Outer Diameter	Circumference of Bundle to be Covered (laid flat)	Sleeve Width	Bulk Roll Length (ft)	Length Tolerance
A4926	2	6.0	7-3/4	150	(+1 ft., - 0 ft)
A4927	3	9.4	11	150	(+1 ft., - 0 ft)
A4928	4	12.5	14	150	(+1 ft., - 0 ft)
A4929	5	15.7	17-1/4	150	(+1 ft., - 0 ft)
A4930	6	18.8	20-3/8	150	(+1 ft., - 0 ft)

Features

- Tight bundling and secure hose containment
- Resistant to heat, ozone, and abrasion
- Easy removal and replacement

Benefits

- Increase productivity in assembly and reassembly of hose bundles
- Reduce contamination of hose during bundle assembly
- Force routing of hydraulic lines for safety and efficiency
- Reduce risk of hose bursts, resulting in greater operator safety
- Reduce time spent on field repairs

- Replace inefficient bundling methods and line-damaging cable ties
- Eliminate cumbersome winding of spiral-formed products
- Reduce old-sock-syndrome-bunching at end of bundled lines
- Eliminate line contamination during hose replacement

Construction

- 1050 ballistit nylon, .71mm thickness
- Urethane coating

Color

Black

Operating Temperature Range

175° F

How to order

- Part numbers above are stocked in 150 foot shrink –wrapped bulk rolls, as rolled up and unfastened.
- Orders the number of rolls needed, not footage.
- 150 foot bulk rolls are one continuous length.
- Order per foot

Bundling Straps



Merchandising Kits for Straps

Standard Duty

Part Number FF13502

Heavy Duty

Part Number FF13503

Contains:

Each merchandising kit comes with a quantity of individually cellophane-wrapped bundling straps in both cinch and hanging styles for bundling diameters of 8", 12", 16", and 20 inches. Resupply the merchandising kit by ordering the individually wrapped straps listed on the next page.

The box has a pop-up lid that can be positioned upright, making an effective advertising backdrop. Attached to the merchandising box is a handy bundling strap for demonstration purposes.

Note:

Kit boxes are stocked with approximately half the available strap capacity to allow for lower kit pricing at startup.

Bundling straps hold hose, cables, pipes, tubes, and other items securely in place. They can be removed, adjusted, and put back in place easily.

Unlike cable ties, bundling straps allow hose and tubes to expand and contract in changing conditions. Cable ties cannot be reused. Bundling straps, however, can be used again and again, with no loss of strength. Their hook-and-loop fasteners, developed for industrial applications, the safety industry, and the military, have superior sheer strength and peel compared to those used in the garment industry.

Features

- Easy to remove and replace
- Adjustable to any size bundle
- Industrial strength strap fabric and fasteners
- Secure containment of hose, cables, and other items
- Clean professional appearance

Cinching strap (CS Series) bundling straps are designed for economical service applications, such as hose and cable bundling. All joints are ultrasonically welded and tested.

Hanging strap (HS Series) bundling straps are held in place by a 3/8" grommet. The straps can be mounted vertically or horizontally.

Both cinching and hanging straps are available in standard duty or heavy duty. Heavy-duty bundling straps are designed for severe industrial applications and ultrasonically welded to 1-1/2" hook-and-loop material. All heavy-duty hardware is nickel-plated steel.

Benefits

- Reduce cost of managing cables and hose
- Improve worker safety and productivity
- Reduce abrasion of bundles items
- Save money through reusability

Bundling straps are sold in packages of five, and discounts are offered for volume quantities of 50, 100, 250, 500, and 1,000. Special sizes, materials, colors, and configurations are available.

Construction

Standard Duty

- 1050 Ballistic nylon II webbing, .71 mm thickness with dense nylon backing
- Delrin plastic fastening loop on cinch and hanging straps
- Urethane coating

Heavy Duty

- 1000 Nylon webbing, 3.18 mm thickness with dense nylon backing
- Nickel-plated steel 12 L.14 fastening loop on cinch and hanging straps
- Urethane coating

Color

- Black

Operating Temperature Range

- -40° - 250° F



Accessories

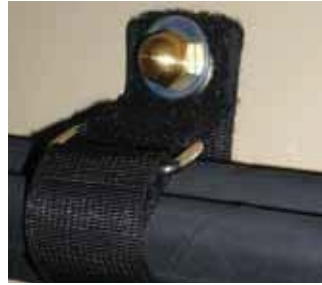

Bundling Straps

Cinch Straps Standard Duty

Standard Duty		Heavy Duty		Circumference of Hose Bundle	Strap Length (flat)	Ordering Measurement
Bulk Packed	Individually Cellophane Wrapped	Bulk Packed	Individually Cellophane Wrapped			
Part Number	Part Number	Part Number	Part Number			
FF90519-4	FF90520-4	FF90521-4	FF90522-4	4"	7-3/4"	Each
FF90519-6	FF90520-6	FF90521-6	FF90522-6	6"	11"	Each
FF90519-8	FF90520-8	FF90521-8	FF90522-8	8"	14"	Each
FF90519-10	FF90520-10	FF90521-10	FF90522-10	10"	17-1/4"	Each
FF90519-12	FF90520-12	FF90521-12	FF90522-12	12"	20-3/8"	Each
FF90519-14	FF90520-14	FF90521-14	FF90522-14	14"		Each
FF90519-16	FF90520-16	FF90521-16	FF90522-16	16"		Each
FF90519-18	FF90520-18	FF90521-18	FF90522-18	18"		Each
FF90519-20	FF90520-20	FF90521-20	FF90522-20	20"		Each
	FF90520-22	FF90521-22		22"		Each
	FF90520-24	FF90521-24		24"		Each
	FF90520-26	FF90521-26		26"		Each

Cinch Straps Standard Duty

Standard Duty		Heavy Duty		Circumference Of Hose Bundle	Strap Length (flat)	Ordering Measurement
Bulk Packed	Individually Cellophane Wrapped	Bulk Packed	Individually Cellophane Wrapped			
Part Number	Part Number	Part Number	Part Number			
FF90523-4	FF90524-4	FF90525-4	FF90526-4	4"	7-3/4"	Each
FF90523-6	FF90524-6	FF90525-6	FF90526-6	6"	11"	Each
FF90523-8	FF90524-8	FF90525-8	FF90526-8	8"	14"	Each
FF90523-10	FF90524-10	FF90525-10	FF90526-10	10"	17-1/4"	Each
FF90523-12	FF90524-12	FF90525-12	FF90526-12	12"	20-3/8"	Each
FF90523-14	FF90524-14	FF90525-14	FF90526-14	14"		Each
FF90523-16	FF90524-16	FF90525-16	FF90526-16	16"		Each
FF90523-18	FF90524-18	FF90525-18	FF90526-18	18"		Each
FF90523-20	FF90524-20	FF90525-20	FF90526-20	20"		Each
		FF90525-22	FF90526-22	22"		Each
		FF90525-24	FF90526-24	24"		Each
		FF90525-26	FF90526-26	26"		Each

Hose and Gear Clamps

Hose Support

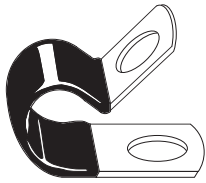

Application

- Support for long hose length
- Ensure proper hose routing in applications in which abrasion, moving parts, or heat are present

Construction

- C1010 steel with 1/32" thick black vinyl cushion.
- Zinc-plated

Clamping Diameter	Part Number	Bolt Hole
1/4	HK0509	13/32
3/8	HK0709	13/32
7/16	HK0809	13/32
1/2	HK0913	13/32
9/16	HK1013	13/32
5/8	HK1113	13/32
11/16	HK1213	13/32
3/4	HK1313	13/32
13/16	HK1413	13/32
7/8	HK1513	13/32
15/16	HK1613	13/32
1	HK1713	13/32
1-1/16	HK1813	13/32
1-1/8	HK1913	17/32
1-3/16	HK2017	17/32
1-1/4	HK2117	17/32
1-3/8	HK2317	17/32
1-1/2	HK2517	17/32
1-9/16	HK2617	17/32
1-3/4	HK2917	17/32
1-7/8	HK3117	17/32
1-15/16	HK3217	17/32
2	HK3317	17/32
2-1/8	HK3417	17/32
2-5/8	HK3817	17/32

E.F.I. Hose Clamps

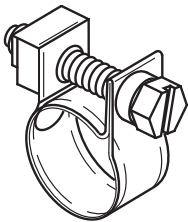

Application

Electronic fuel injection hose.

Construction

Plated carbon steel; 23/64" (9mm) band width.

Clamp Size	Part Number	Minimum Diameter	Maximum Diameter	Nominal Diameter
04	6207-004	.433	.551	.512
05	6207-005	.472	.590	.551
06	6207-006	.551	.669	.630

Hose and Gear Clamps

Round-Wire Clamps

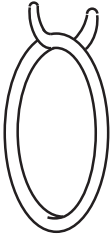

Application

- Industrial
- Automotive
- Agriculture
- General market applications.

Construction

- Carbon steel spring wire.
- Zinc-plated

Clamp Size	Hose Size	Part Number	Minimum Diameter	Maximum Diameter	Nominal Diameter
06	1/4	1538	.370	.380	.375
08	5/16	1539	.551	.573	.562
10	3/8	1540	.610	.640	.625

Heavy-Duty Hose Support Clamps

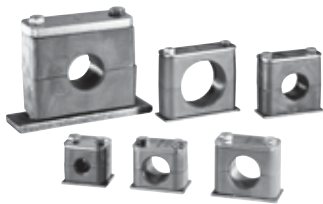

Heavy-duty weld-based clamps are designed to securely hold hose in applications subject to impulsing, flexing, and vibrating conditions. The clamps help prevent abrasion and extend hose life through proper routing. Clamps are rated to ambient temperature of +250°F.

Part Number FF90311

Clamp Part Number	Inside Diameter (mm)	(in)
FF90311-127	12.70	0.50
FF90311-137	13.70	0.54
FF90311-150	15.00	0.59
FF90311-160	16.00	0.63
FF90311-171	17.10	0.67
FF90311-174	17.40	0.69
FF90311-190	19.00	0.75
FF90311-205	20.50	0.81
FF90311-222	22.20	0.87
FF90311-239	23.90	0.94
FF90311-254	25.40	1.00
FF90311-266	26.60	1.05
FF90311-280	28.00	1.10
FF90311-300	30.00	1.18
FF90311-320	32.00	1.26
FF90311-334	33.40	1.31
FF90311-357	35.70	1.41
FF90311-381	38.10	1.50
FF90311-400	40.00	1.57
FF90311-422	42.20	1.66
FF90311-445	44.50	1.75
FF90311-483	48.30	1.90
FF90311-508	50.80	2.00
FF90311-572	57.20	2.25
FF90311-635	63.50	2.50
FF90311-700	70.00	2.76

Hose and Gear Clamps

Full- and Micro-Sized Partial Stainless Steel Clamps SAE J1508 Type F

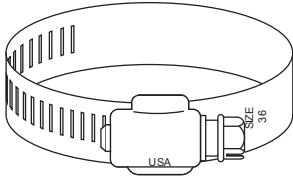

Partial stainless steel clamps utilize a 300 Series stainless steel band and housing with a steel case-hardened, zinc-plated screw. They feature a 14.3mm (9/16") band housing with a 8mm (5/16") hexagon and screwdriver slotted screw.

Application

- Heavy-duty equipment
- Agriculture
- General industry

Full- and Micro-Size All Stainless Steel Clamps SAE J1508 Type F

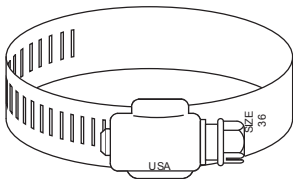

Clamps with an all stainless steel construction offers maximum protection against corrosion. Full-sized all stainless clamps are manufactured with 300 Series stainless steel. They feature a 14.3mm (9/16") band and housing with a 8mm (5/16") hexagon and screwdriver slotted screw.

Micro all stainless clamps have a 5/16" (8mm) band housing manufactured with 300 Series stainless steel.

The 6.35mm (1/4") hexagon and screwdriver slotted screw features 410 stainless steel.

Application

- Chemical
- Marine
- Food processing
- Dairy
- Automotive
- Electrical
- Plumbing

Clamp Size	Part Number	Minimum Diameter	Maximum Diameter	Nominal Diameter
*004	6205-004	7/32	5/8	1/4
*006	6205-006	5/16	7/8	1/2
006	6203-006	3/8	7/8	1/2
008	6203-008	7/16	1	9/16
010	6203-010	9/16	1-1/16	5/8
012	6203-012	9/16	1-1/4	3/4
016	6203-016	11/16	1-1/2	1
020	6203-020	3/4	1-3/4	1-1/4
024	6203-024	1-1/16	2	1-1/2
028	6203-028	1-5/16	2-1/4	1-3/4
032	6203-032	1-9/16	2-1/2	2
036	6203-036	1-13/16	2-3/4	2-1/4
040	6203-040	2-1/16	3	2-1/2
044	6203-044	2-5/16	3-1/4	2-3/4
048	6203-048	2-9/16	3-1/2	3
052	6203-052	2-13/16	3-3/4	3-1/4
056	6203-056	3-1/16	4	3-1/2
064	6203-064	3-9/16	4-1/2	4
072	6203-072	4-1/16	5	4-1/2
080	6203-080	4-5/8	5-1/2	5
088	6203-088	4-3/32	6	5-1/2
096	6203-096	4-1/2	6-1/2	6
104	6203-104	5	7	6-1/2

*Micro-sized clamps

Clamp Size	Part Number	Minimum Diameter	Maximum Diameter	Nominal Diameter
*004	6206-004	7/32	5/8	1/4
*006	6206-006	5/16	7/8	1/2
006	6204-006	3/8	7/8	1/2
008	6204-008	7/16	1	9/16
010	6204-010	9/16	1-1/16	5/8
012	6204-012	9/16	1-1/4	3/4
016	6204-016	11/16	1-1/2	1
020	6204-020	3/4	1-3/4	1-1/4
024	6204-024	1-1/16	2	1-1/2
028	6204-028	1-5/16	2-1/4	1-3/4
032	6204-032	1-9/16	2-1/2	2
036	6204-036	1-13/16	2-3/4	2-1/4
040	6204-040	2-1/16	3	2-1/2
044	6204-044	2-5/16	3-1/4	2-3/4
048	6204-048	2-9/16	3-1/2	3
052	6204-052	2-13/16	3-3/4	3-1/4
056	6204-056	3-1/16	4	3-1/2
064	6204-064	3-9/16	4-1/2	4
072	6204-072	4-1/16	5	4-1/2
080	6204-080	4-5/8	5-1/2	5
088	6204-088	4-3/32	6	5-1/2
096	6204-096	4-1/2	6-1/2	6
104	6204-104	5	7	6-1/2

*Micro-sized clamps

Assembly Equipment

Table of Contents

Index to Crimp Packages	N-2 thru N-3		
Crimping Machines - Portable			
Coll-O-Crimp Portable T-464 & T-466	N-4		
Coll-O-Crimp Portable T-465	N-5 thru N-6		
Coll-O-Crimp T-465 Crimping Procedures	N-7		
Air Conditioning Portable Crimper, T-477	N-8		
T-477 Crimping Procedures	N-9 thru N-12		
Coll-O-Crimp Portable T-480	N-13 thru N-15		
ET1000 Portable Crimp Machine	N-16		
ET1000 Crimp Procedures	N-17		
Crimping Machines - Stationary			
Coll-O-Crimp Shop Press Tooling, T-400-17	N-18		
Coll-O-Crimp I, T-400, T-407	N-19 thru N-20		
Coll-O-Crimp SUPER I, T-420	N-21		
Coll-O-Crimp ET4001	N-22		
T-440, ET4000 & ET4001 Repair Items	N-23		
Crimping Machines - Variable			
Coll-O-Crimp ET4020	N-24		
Coll-O-Crimp ET4040	N-25		
		Tooling and Accessories	
		Coll-O-Crimp Collet Kits	N-26 thru N-29
		WeatherGRIP Tooling	N-30 thru N-31
		Coll-O-Crimp Spacer Rings	N-32
		Coll-O-Crimp Air & Hydraulic Pumps	N-33 thru N-35
		Competitor Conversion Kits	N-36
		Tube Flaring Tools	N-37
		Hose Cutting Equipment	N-38 thru N-40
		Presetting Tools	N-41
		Hose Bore Cleaning Brushes	N-42
		Skiving Tools & Wrenches	N-43
		Power Steering Assembly	N-44 thru N-46
		Cable Controls	N-47 thru N-48
		Assortments	N-49 thru N-67
		Equipment	
		Cabinets, Tool Boxes, and Plastic Bags	N-68 thru N-70
		Label Sets & Mylar Hose Labels	N-71
		Field Attachable Assembly	N-72 thru 73



Index

Weatherhead Crimp Machine and Tooling Packages

Portable Crimpers

Base Machine #	Part Number	Package Contents *	Hose fitting sizes crimped**				Catalog Page
			U-Series	Z-Series	430U	4SP/6SP	
T-465	T-465-HPU	T-465 vice mounted press, hand pump	-4 to -8	—	—	—	N-5
T-460	T-460	T-460 press, hand pump	—	—	—	—	N-4
T-460	T-462	T-462 press, air/hydraulic pump	—	—	—	—	N-4
T-460	T-464	T-460, collets and spacers	-4 to -8	—	—	—	N-4
T-460	T-466	T-462, collets and spacers	-4 to -8	—	—	—	N-4
T-460	ET460TP-0001	Z tooling for -4 to -8	—	-4 to -8	—	—	N-30
T-480	T-480-AH	T-480 press, hand lever air/hydraulic pump	—	—	—	—	N-13
T-480	T-480-HP	T-480 press, hand pump	—	—	—	—	N-13
T-480	T-480-EP	T-480 press, 110v pump	—	—	—	—	N-14
T-480	T-480-TA	T-480 press, foot treadle air/hydraulic pump	—	—	—	—	N-14
T-480	T-480-80	U and 430U tooling for T-480 press	-4 to -16	—	-8 to -20	—	N-28
T-480	ET480-001	T-480-HP press, pump, Z tooling	—	-4 to -16	—	—	N-14
T-480	ET480-002	T-480-AH press, pump, Z tooling	—	-4 to -16	—	—	N-14
T-480	ET480-003	T-480-TA press, pump, Z tooling	—	-4 to -16	—	—	N-14
T-480	ET480-004	T-480-EP press, pump, Z tooling	—	-4 to -16	—	—	N-14
T-480	ET480TP-0001	Z tooling for -4 to -16	—	-4 to -16	—	—	N-30
ET1000	ET1000-001	ET1000 press only	—	—	—	—	N-16
ET1000	ET1000-002	ET1000 press, hand pump	—	—	—	—	N-16
ET1000	ET1000-003	ET1000 press, air/hydraulic pump	—	—	—	—	N-16
ET1000	ET1000-004	ET1000 press, 110v pump	—	—	—	—	N-16
ET1000	ET1000-005	ET1000 press, 12v DC pump	—	—	—	—	N-16
ET1000	ET1000-016	ET1000-002, hand pump, Z tooling	—	-4 to -16	—	—	N-16
ET1000	ET1000-017	ET1000-003, air/hydraulic, Z tooling	—	-4 to -16	—	—	N-16
ET1000	ET1000-018	ET1000-004, 110v pump, Z tooling	—	-4 to -16	—	—	N-16
ET1000	ET1000TP-0001	Z tooling for -4 to -16	—	-4 to -16	—	—	N-30

Stationary Crimpers: Coll-O-Crimp 1 Series (thru 1-1/4" 2-wire)

Base Machine #	Part Number	Package Contents *	Hose fitting sizes crimped**				Catalog Page
			U-Series	Z-Series	430U	4SP/6SP	
T-400	T-400	T-400-1 press, tooling, (no pump)	-4 to -16	—	—	—	N-19
T-400	T-400-1	T-400-1 press only	—	—	—	—	N-19
T-400	T-401	T-400, 220v 1 phase pump, U tooling	-4 to -16	—	—	—	N-19
T-400	T-401-110	T-400, 110v 1 phase pump, U tooling	-4 to -16	—	—	—	N-19
T-400	T-402	T-400, air/hydraulic pump, U tooling	-4 to -16	—	—	—	N-19
T-400	T-403	T-400, hand pump, U tooling	-4 to -16	—	—	—	N-19
T-400	T-407-1	T-407-1 press only	—	—	—	—	N-20
T-400	T-407	T-407-1, high-volume pump and foot switch	—	—	—	—	N-20
T-400	T-414	T-400, 12v DC pump	-4 to -16	—	—	—	N-19
T-400	ET400-001	T-400-1, 220v 1 phase pump, Z tooling	—	-4 to -16	—	—	N-19
T-400	ET400-002	T-400-1, 110v 1 phase pump, Z tooling	—	-4 to -16	—	—	N-19
T-400	ET400-003	T-400-1, air/hydraulic pump, Z tooling	—	-4 to -16	—	—	N-19
T-400	ET400TP-0001	Z tooling for -4 to -16	—	-4 to -16	—	—	N-30

* Hose assembly included if pump is included.

** Collets and spacers to crimp fitting size ranges noted are included in packages except -10 size collets/dies typically not included. Check catalog for details.

Index

Weatherhead Crimp Machine and Tooling Packages

Stationary Crimpers: Coll-O-Crimp Super 1 Series (thru 1-1/4" 6-wire)

Base Machine #	Part Number	Package Contents *	Hose fitting sizes crimped**				Catalog Page
			U-Series	Z-Series	430U	4SP/6SP	
T-420	T-420-1	T-420-1 press only	-	-	-	-	N-21
T-420	T-420-N	T-420-1, T-421U 220v pump, U & 430U tooling	-4 to -16	-	-8 to -20	-	N-21
T-420	T-420N-110	T-420-1, T-421U-110 110v pump, U & 430U tooling	-4 to -16	-	-8 to -20	-	N-21
T-420	ET420-002	T-420-1, T-421U 220v pump, Z tooling	-	-4 to -16	-	-	N-21
T-420	ET420-003	T-420-1, T-421U-110 110v pump, Z tooling	-	-4 to -16	-	-	N-21
T-420	ET420-004	T-420-1, T-421U 220v pump, Z & 430U tooling	-	-4 to -16	-8 to -20	-	N-21
T-420	ET420-005	T-420-1, T-421U-110 110v pump, Z & 430U tooling	-	-4 to -16	-8 to -20	-	N-21
T-420	ET420TP-0001	Z tooling for -4 to -16	-	-4 to -16	-	-	N-30

Stationary Crimpers: Coll-O-Crimp ET4001 (thru 2")

Base Machine #	Part Number	Package Contents *	Hose fitting sizes crimped**				Catalog Page
			U-Series	Z-Series	430U	4SP/6SP	
ET4001	ET4001-002	ET4001 press only (no pump or valve)	-	-	-	-	N-22
ET4001	ET4001-004	ET4001 press, ET4001P-001 220v 1 phase pump	-	-	-	-	N-22
ET4001	ET4001-006	ET4001-004 plus 430U collets	-	-	-8 to -32	-	N-22
ET4001	ET4001-010	ET4001-004 plus 4SP/6SP collets	-	-	-	-12 to -32	N-22
ET4001	ET440TP-0001	Z tooling for -4 to -16	-	-4 to -16	-	-	N-30
ET4001	FF91047	Coll-O-Cart	-	-	-	-	N-23

Variable Crimpers: ET4020 (thru 1 1/4") and ET4040 (thru 2")

Base Machine #	Part Number	Package Contents *	Hose fitting sizes crimped**				Catalog Page
			U-Series	Z-Series	430U	4SP/6SP	
ET4020	ET4020-115	ET4020 press, 115v pump	-	-	-	-	N-24
ET4020	ET4020-230	ET4020 press, 230v pump	-	-	-	-	N-24
ET4020	ET4020TP-0003	Tooling- full set of die cages	-	-4 to -20	-6 to -20	-	N-24
ET4020	ET4020-006	ET4020-115 plus ET4020TP-003 tooling	-	-4 to -20	-6 to -20	-	N-24
ET4040	ET4040-115	ET4040 press, 115v pump	-	-	-	-	N-25
ET4040	ET4040-230	ET4040 press, 230v pump	-	-	-	-	N-25
ET4040	ET4040TP-0004	Tooling- full set of die cages for Z & 430U	-	-4 to -32	-6 to -32	-	N-25
ET4040	ET4040TP-0005	Tooling- full set of die cages for 4SP/6SP	-	-	-	-12 to -32	N-25
ET4040	ET4040TP-0006	Tooling- full set of die cages for Z & 430U & 4SP/6SP	-	-4 to -32	-6 to -32	-12 to -32	N-25
ET4040	ET4040-007	ET4040-115, ET4040TP-0004, master cage & handle	-	-4 to -32	-6 to -32	-	N-25
ET4040	ET4040-008	ET4040-115, ET4040TP-0005, master cage & handle	-	-	-	-12 to -32	N-25
ET4040	ET4040-009	ET4040-115, ET4040TP-0006, master cage & handle	-	-4 to -32	-6 to -32	-12 to -32	N-25

* Hose assembly included if pump is included.

** Collets and spacers to crimp fitting size ranges noted are included in packages except -10 size collets/dies typically not included. Check catalog for details.

Crimping Machines - Portable

Coll-O-Crimp Portable T-464



Refer to pages A-2 and A-3 and machine operator's manuals for safety information.

T-464 • Portable Coll-O-Crimp w/Hand Pump



For T-460 Tool Box see page N-6.

Reference pages N-2 and N-3 for COC machine and tooling packages, and pages N-26 to N-30 for collet kits and spacer ring details.

Refer to pages A-2 and A-3 and machine operator's manuals for safety information.

The T-460 is a completely portable hose assembly system. Lightweight, hand pump-powered, and complete with a self-supporting base, this crimping press features layback positioning up to a 45° angle.

Capacity: 3/16" I.D. 1-fiber braid through 1-3/8" I.D. 1-wire hose and 1-1/4" 2-wire hose.

Mounting:
Free-standing base

Size: 15" high, 14" wide, 11-1/4" deep

Weight: 62 lbs

T-464 • Portable Coll-O-Crimp w/Hand Pump Package

Includes one each of the following:

Catalog Number	Description
T-460	Portable Coll-O-Crimp Press, Hand Pump & Hose Assembly Kit, W-EQCR-TM008-E Instructions
T-400-2C	"U" Series Collet – 1/4"
T-400-3C	"U" Series Collet – 3/8"
T-400-4C	"U" Series Collet – 1/2"
T-400-10	Black Spacer Ring
T-400-62	Yellow Spacer Ring

Repair and Replacement Items

Catalog Number	Description	Catalog Number	Description
W-EQCR-TM008-E	Instructions	T-460-P	Pusher
T-460-SPR	Slide Pull Rod	T-460-SF	Slide Flange
T-460-16	Hose Assembly	T-460-SP	Slide Plate
T-460-2	Hand Pump	T-460-SPK	Slide Pull Knob
W-EQCR-TE009-E	Shroud Decal	E-EQCR-ME002-E	Instructional Video

For replacement pump see page N-33.

T-466 • Portable Coll-O-Crimp w/Air Hydraulic Pump

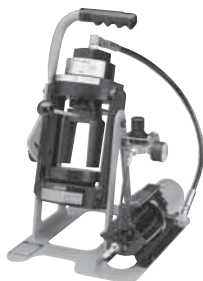

For T-462 Tool Box see page N-6.

Reference pages N-2 and N-3 for COC machine and tooling packages, and pages N-26 to N-30 for collet kits and spacer ring details.

Refer to pages A-2 and A-3 and machine operator's manuals for safety information.

This portable Coll-O-Crimp features an air/hydraulic pump making it the ideal system if you have the availability of compressed air in your shop or in the field via a portable compressor.

Capacity: 3/16" I.D. 1-fiber braid through 1-3/8" I.D. 1-wire hose and 1-1/4" 2-wire hose.

Mounting:
Free standing base

Size: 15" high, 14" wide, 11-1/4" deep

Weight: 62 lbs

T-466 • Portable Coll-O-Crimp w/Air Hydraulic Pump Package

Includes one each of the following:

Catalog Number	Description
T-462	Portable Coll-O-Crimp Press, Air/Hydraulic Pump & Hose Assembly Kit, W-EQCR-TM008-E Instructions
T-400-2C	"U" Series Collet – 1/4"
T-400-3C	"U" Series Collet – 3/8"
T-400-4C	"U" Series Collet – 1/2"
T-400-10	Black Spacer Ring
T-400-62	Yellow Spacer Ring

Repair and Replacement Items

Catalog Number	Description	Catalog Number	Description
W-EQCR-TM008-E	Instructions	T-460-SPK	Slide Pull Knob
T-460-P	Pusher	T-460-SPR	Slide Pull Rod
T-460-SF	Slide Flange	T-462-16	Hose Assembly
T-460-SP	Slide Plate	T-462-V	Regulator only
W-EQCR-TE010-E	Shroud Decal	T-462-2	Air/Hydraulic Pump
140-06675	Air Regulator Kit	E-EQCR-ME002-E	Instructional Video

For replacement pump see page N-33.

Crimping Machines - Portable

Coll-O-Crimp Portable T-465

 Refer to pages A-2 and A-3 and machine operator's manuals for safety information.

Portable Coll-O-Crimp



The Portable Coll-O-Crimp is a completely PORTABLE hose assembly system. NO ELECTRICAL POWER SOURCE IS NEEDED. Hand pump powered, lightweight, vise or stand mounted, this crimper is ideal for your portable crimping needs.

Capacity

3/16" I.D. 1-fiber braid through 1-3/8" I.D.
1-wire hose and 1-1/4" 2-wire hose

Mounting

Vise/Stand

Size

12-1/2" high, 8-1/2" wide, 5-1/2" deep

Weight

31 lbs

The vise bracket, die ring, pusher, decal and instruction kit are components of the T-465 Portable Coll-O-Crimp Press.

Pump Required

(sold separately): T-460-2

T-465

Portable Coll-O-Crimp Press ONLY

CAUTION

Use T-460-2 10,000 PSI hand pump only.

CAUTION

The Coll-O-Crimp power source has the pressure relief valve set at 10,000 PSI. Damage to the press will result if higher pressures are used and warranty will be voided.

Reference pages N-2 and N-3 for COC machine and tooling packages, and pages N-26 to N-30 for collet kits and spacer ring details.

Refer to pages A-2 and A-3 and machine operator's manuals for safety information.

T-465-HP • Portable Coll-O-Crimp Package

Includes one each of the following:

Catalog Number	Description
T-465	Portable Coll-O-Crimp Press
T-460-2	Hand Pump (10,000 PSI)
T-450-3	Quick Disconnect Hose Assembly

For replacement pump see pages N-33-35.

T-465 HPU • Portable Coll-O-Crimp Package

Includes one each of the following:

Catalog Number	Description
T-465-HP	Portable Coll-O-Crimp Package
T-400-2C	"U" Series Collet – 1/4"
T-400-3C	"U" Series Collet – 3/8"
T-400-4C	"U" Series Collet – 1/2"
T-400-10	Black Spacer Ring
T-400-62	Yellow Spacer Ring

Crimping Machines - Portable

Coll-O-Crimp Portable T-465



Refer to pages A-2 and A-3 and machine operator's manuals for safety information.

T-450-C • Portable Coll-O-Crimp Stand



The T-450-C Stand is designed specifically for your Portable Coll-O-Crimp T-465 Press. This stand allows you to use your press on a work bench or other flat surface without the need of a vise. Simply bolt the press onto the stand with the supplied bolts, and you're ready to make Coll-O-Crimp Hose Assemblies.

Refer below for repair and replacement items.

T-465-TB • Portable Coll-O-Crimp Tool Boxes



The T-465-TB tool boxes feature convenient press, pump and collet storage while offering easy mobility of your hose assembly equipment. Supplied as a set, the T-465-TB tool boxes are an excellent addition to the portable Coll-O-Crimp System.

Refer below for repair and replacement items.

Includes one each:

Catalog Number	Description
T-460-10B	Small Tool Box Stores the T-465 and spacer rings. 15" x 9" x 8".
T-460-10BB	Large Tool Box Stores the T-460-2 and collets. 25" x 10" x 8".

T-450/T-465 Portable Coll-O-Crimp Repair and Replacement Items

Catalog Number	Description
T-450-D1	Spacer Ring Selector Decal for Nylon Hose (H009, H209, H243, H435, and H436)
T-450-P	Pusher
T-450-Q	Quick Disconnect Coupling
T-450K	Pusher and Retainer Plate Repair Kit. Includes: T-450B Pusher bolt (1) T-450R Retainer plate (1) T-450S Retainer plate screw (2)
W-EQCR-TE011-E	Shroud Decal

Crimping Machines - Portable

T-465-1 Crimping Procedure

WARNING

You must hold the hose assembly in place from below throughout the crimping operation. Do not place fingers or hands at the crimping point during operation. Failure to follow this procedure could result in serious bodily injury.



- Clamp the crimper into a vise or mount to a work bench using the mounting bracket.

Note:

Lubricate the tapered cone seat with T-400-G grease or equivalent before any crimping is completed. Continued periodic lubrication is necessary.



- Select proper Coll-O-Crimp hose and end fitting. Insert hose into end fitting, hose is bottomed in end fitting.
- Remove pusher and insert proper size collet halves. Refer to crimp bulletin W-HOOV-TM001-E2.



- Insert hose assembly from below between the collet halves. Align the hose end with the top of the collet in the proper location.



- Refer to crimp bulletin W-HOOV-TM001-E2 for proper spacer ring. Place appropriate spacer ring, with the proper orientation, on top of collet. Hold uncrimped hose assembly in place throughout crimping operation.



1. Replace pusher by hanging it from ramplate with bolt on top. Slide it back for centering. Close valve on hand pump and start pumping to crimp.



- When spacer ring contacts die ring, the crimp is complete. Open valve on hand pump. Allow the ram and pusher to retract.
- Remove pusher and spacer ring. Remove crimped assembly from below through the collet halves. Visually inspect the crimped end.
- To ensure a proper crimp has been completed, measure the nominal crimp diameter and verify the proper crimp length and crimp location. Refer to crimp bulletin W-HOOV-TM001-E2.

Crimping Machines - Portable

Air Conditioning Portable T-477

 Refer to pages A-2 and A-3 and machine operator's manuals for safety information.

T-477-1 • Portable Air Conditioning Press



This hand operated, lightweight and easy-to-use air conditioning press is engineered and designed specifically for use with Weatherhead 757 "E" series hose end fittings. Perfect for bench mounting this portable press is made of heavy-duty construction for use with an air-impact wrench. Uses color-coded urethane-encased

dies and a removable die holder to accommodate complicated shapes. Uses four standard die sizes (#6, #8, #10, and #12) that produce an OE-style triple-bubble crimp. No electrical requirements necessary.

Capacity: Crimps 2-braid dimension nylon barrier or reduced-diameter hose.

Mounting:

Bench or mount in vise

Weight: 6 lbs.

Reference pages N-2 and N-3 for COC machine and tooling packages, and pages N-26 to N-30 for collet kits and spacer ring details.

Refer to pages A-2 and A-3 and machine operator's manuals for safety information.

T-477 • Portable Air Conditioning Package



Package includes:

Part Number	Description
T-477-1	Portable A/C Press
T-477-105C	#6 Die Set - Red
T-477-106C	#8 Die Set - Black
T-477-107C	#10 Die Set - Almond
T-477-108C	#12 Die Set - Green

Includes Bench Mount Flange, Die Set Lubricant and Steel Pipe Nipple Extension. Also includes a Custom Carrying Case with Instructions.

Crimping Machines - Portable

T-477-1 Crimping Procedure

 Refer to pages A-2 and A-3 and machine operator's manuals for safety information.

T-477-1 Crimp Die Sets

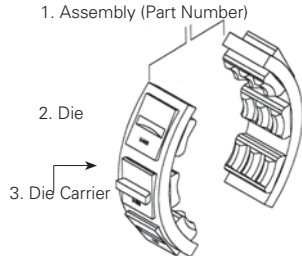

T-477-1 Die Set Information

Item	Description	Quantity	6	8	10	12
1	Assembly Part Number	1 set	T-477-105C	T-477-106C	T-477-107C	T-477-108C
2	Die Marking	-	6R556	8R655	10R742	12R897
3	Die Carrier Color	-	Red	Black	Almond	Green

For use with H757 Hose and 757 "E" Series Hose Ends.

T-477-1 Crimper Parts List

When ordering T-477-1 spare parts, contact: www.atcoproductsinc.com or Email: info@atcomail.com or call: 1-972-842-8178.

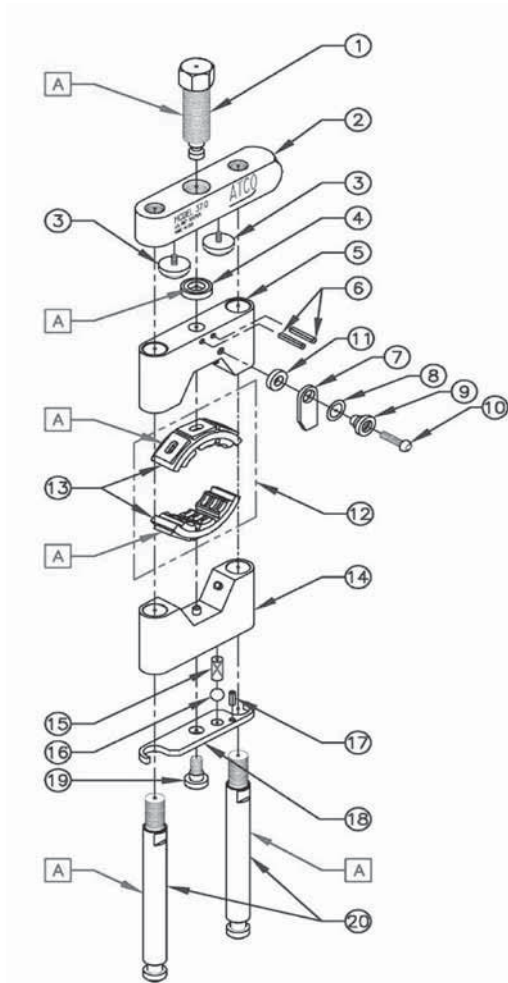

Parts List

Item	Description	Qty	Part No.
1	Actuator Screw	1	75013
2	Actuator Bar	1	75177
3	Rubber Bumper	2	75012
4	Thrust Bushing	1	75149
5	Movable Die Holder	1	75175
6	3/16 x 1 Roll Pin	2	75010
7	Locator Flag*	1	75086-Y
8	Curved Disc Spring	1	75088
9	Locator Bushing	1	75087-Y
10	1/4-20 x 1 Button Head Screw*	1	75113
11	Spacer Bushing	7	75176
12	See Crimp Die List	1	See Item 1 (top)‡
13	Crimp Die Carrier	1	See Item 1 (top)‡
14	Removable Die Holder**	1	75174
15	Spring-Compression**	1	75076
16	7/16 Diameter Ball**	1	75077
17	3/16 x 1/2 Roll Pin**	1	75009
18	Latch Plate	1	75074
19	Lock Screw**	1	75008
20	Strain Rod	2	75020

‡ References Item 1 in Die Set Chart at the top of the page.

Items Not Shown

Item	Description	Qty	Part No.
A	Grease	1	75015
B	3/8 x 4 Pipe Nipple	1	75016
C	3/8 Flooring Flange	1	90607
D	Carrying Case	1	75017

* Included in item 24 (Not assembled) / ** Included in item 25 (Assembled).

For use with H757 Hose and 757 "E" Series Hose Ends

Item	Description	Qty	6	8	10	12
-	Die Marking	-	6R556	8R655	10R742	12R897
26	Crimp Die No.	1 set	T-475-105C	T-475-106C	T-475-107C	T-475-108C
-	Color	-	Red	Black	Almond	Green
16	Die Carrier	2	75140	71688	75136	71690
15	Die Segment	6	71741	75119	71743	71744

Crimping Machines - Portable

T-477-1 Crimping Procedure

Model T-477 Portable Air Conditioning Hose Crimping Kit

Description of terms

The crimper can be operated with a 1/2" drive air impact wrench, ratchet or breaker bar. It takes approximately 100 foot pounds of torque to fully close the jaws and achieve a satisfactory crimp. The crimper can be bench mounted using the flange and pipe nipple provided or it can be mounted in a bench vise to stabilize the unit. If the unit is used in a service vehicle with a mounted vice, it will be necessary to use a 12" minimum extension to the pipe nipple to counteract the torque while closing the dies. This extension is not provided in the kit.

Bench mount: Bolt the flange to a bench top. Screw the pipe nipple and crimper to the flange plate.

Impact wrench (1/2" Drive @ 100 PSIG Max.): Use a 1" impact socket to drive the movable die holder.

⚠ CAUTION

Do not exceed 100 PSIG air pressure on the impact wrench as damage to the wrench and the crimper may result.

⚠ CAUTION

Do not continue impacting after the dies are closed. This can cause damage to the crimper.

⚠ CAUTION

Care should be taken when reversing the impact so that the die holder does not slam into the crimper body (actuator bar, Item 2). Bumpers are provided to minimize damage.

Ratchet or breaker bar:

Use a 1" socket to drive the movable die holder. It will take approximately 100 foot pounds of torque to achieve a full crimp.

Removable die holder:

The bottom of the crimper can be removed to accommodate special shapes or under-hood crimping. Push the latch plate (Item 21) open while holding the removable die holder. Pull the holder off the strain rods.

Die change: With the removable die holder removed, loosen two of the button head screws (Item 12) on one side of the die holder. The die will drop out of the holder. Apply grease (Item B) to the slide surfaces. Squeeze the outer segments of the die set together and insert the die into the holder making sure that the Woodruff Key (Item 14) in the center segment snaps fully into the groove in the holder (Refer to Fig. 1).

While holding the die securely in the slot, retighten the two button head screws. Check to make sure that the two outer segments on each half are free to move. If they do not move freely, remove and inspect for damaged guide block pad or dirt.

⚠ CAUTION

Retention of the Woodruff Key in the slot while tightening the screws is most important. Failure to do so will result in an irregular crimp and damage to the guide blocks and Woodruff Key (Refer to Fig. 2).

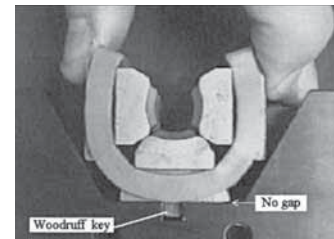
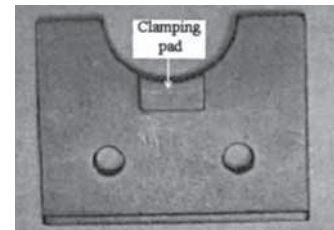

Figure 1

Die carrier properly inserted in holder.



Undamaged Pad

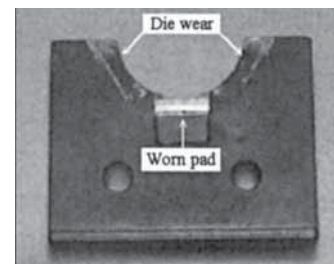

Figure 2

Damaged Pad

Crimping Machines - Portable

T-477-1 Crimping Procedure

! Refer to pages A-2 and A-3 and machine operator's manuals for safety information.

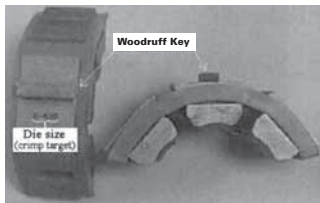
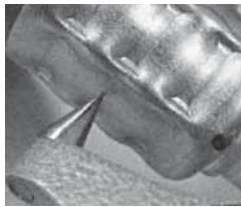

Figure 3

Dies with Woodruff Keys in place



Position of tip of micrometer

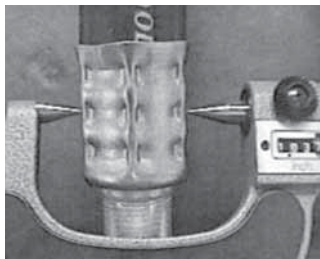

Figure 4

Measuring the crimp with a micrometer

! **CAUTION**

It is not necessary to over-tighten the screws. Always use the short hex key wrench provided in order to avoid damage.

Die Carrier

The die carriers will become worn and produce unacceptable crimps with time. To replace the color-coded die carriers, simply push the die segment out of the back of the carrier. Reverse the process to assemble die segments in the new carrier.

Woodruff Key

The Woodruff Key is bonded into the slot in the center die segment. It is used to align the dies in the die holders (Refer to Fig. 3).

! **CAUTION**

If the Woodruff Key is not in the center segment of each half of the die set, an irregular crimp will be formed increasing the probability of leakage.

! **CAUTION**

Never use dies without Woodruff Key engaged in the slot of the segment and holder.

To replace the Woodruff Key, use a screwdriver and hammer to remove the old key. Replace the key using a drop of adhesive such as Loctite® to hold the key securely.

Locator Flag

There is a locator flag on the crimper. It is spring loaded and movable to locate the end of the ferrule for proper crimp location. Swivel the flag to a position so that when the fitting is inserted into the crimper, the ferrule will stop in the proper location for crimping.

Crimp diameter measurement

The crimp diameter can be measured by using a set of point micrometers or calipers with a point accessory kit installed. Standard measuring instruments will not reach to the crimp impression because of the pinch of the crimp. When measuring the crimp diameter, take three measurements around the center crimp ring. Add the measurements, divide by three to get the average. The average should be the target crimp diameter (+.015/-.005). Example: The #6 size is .556 target crimp diameter. The crimp should measure between .571 and .551 (Refer to Fig 4).

Hose Wall Thickness

The hose wall thicknesses for one-braid dimension hoses are listed below. It is important to check the hose wall thickness to make sure that the crimp will be leak free.

Hose size	Hose O.D.
#6 - 5/16 I.D.	9/16
#8 - 13/32 I.D.	11/16
#10 - 1/2 I.D.	3/4
#12 - 5/8 I.D.	15/16

Operation

- Mount the crimper as described previously unless it is necessary to mount it in the vice on the service vehicle.
- Select the proper size dies. Check all segments to make sure that all of the segments have the same numbers on the back. Each segment will be marked identifying the hose size and crimp diameter. Example: 5/16 ID hose with a .556 diameter crimp will be marked "556" (Refer to Fig. 3).
- Lubricate the slides of the crimper die holders (Items 5 and 17) and the screw thread (Item 1) with an appropriate grease (Item B).
- Refer to die change outlined above for proper assembly of the dies into the crimper.
- Position the locator flag (Item 8) so the ferrule of the fitting bumps it on the side when inserted into the crimper.

! **CAUTION**

Do not locate from the bead on the fitting. This will result in the wrong crimp location.

- Insert the hose into the fitting making sure that the hose appears in the small inspection hole on the side or end of the ferrule.

! **CAUTION**

If the hose does not appear in the inspection hole, a poor crimp may result.

Loctite® is a registered trademark of Loctite Corporation.

Crimping Machines - Portable

T-477-1 Crimping Procedure



Refer to pages A-2 and A-3 and machine operator's manuals for safety information.

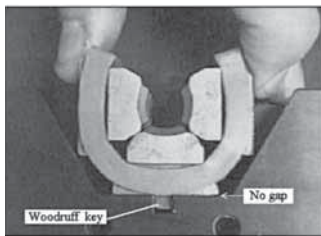

Figure 5

Crimp head completely closed.

*Refer to T-477-1 Crimper Parts List, page N-4.

- Place the assembly into the crimper and hold it against the locator flag. Only the ferrule should touch the flag. Operate the screw (Item 1) to close the dies to the full closed position. This will provide the proper compression to achieve a leak-free crimp. When the crimp dies are bottomed out, there will be a slight gap between the two die holders. This ensures that the dies are fully closed before the holders bottom out (Refer to Fig. 5).
- Reverse the screw (Item 1) to release the crimper from the hose assembly. Take care not to drive the die holder (Item 5) against the actuator bar (Item 2) as damage to the crimper may result. The bumpers (Item 3) are provided as a cushion to help prevent this from occurring.
- If the crimp is performed under-hood or the fitting is a complicated shape that requires disassembly of the crimper, open the latch plate (Item 18) and remove the die holder (Item 14).
- Inspect the first crimp to make sure that the correct dies were used, the crimp location is correct, the crimp is uniform and there is no internal deformation of the fitting.

Note:
See page N-9 for item references.

Note:
Some hose materials trap air in the hose layers during manufacture. When leak testing a newly pressurized hose using soap bubbles or water submersion, the air in the hose will bleed out at the fitting and hose interface indicating a false leaking condition. Leave the hose pressurized for one hour and retest. The residual air should completely bleed out and no leak will be visible.

Crimper Maintenance

- Clean and lubricate all moving parts. Use an appropriate grease (Item B) as needed when lubricating.
- Inspect the strain rods and latch plate for wear around the contact points.
- Make sure the actuator screw turns freely. Lubricate as noted above.
- Check for worn or torn die carriers. Replace when crimp appears to go out of round.
- Inspect Woodruff Keys. Replace if they are damaged or missing to ensure good crimps.

Troubleshooting

Problem	Cause	Action
1. Oblong or irregular crimp	<ul style="list-style-type: none"> • Worn carriers • One die segment in the set is the wrong size • Woodruff Key missing • Guide blocks installed backwards 	<ul style="list-style-type: none"> • Replace carriers • Check all segments for correct size on back of die • Replace key • Turn guide blocks around so raised pad clamps on die
2. Crimp diameter too large	<ul style="list-style-type: none"> • Crimper not fully closed – refer to instructions • Incorrect size dies 	<ul style="list-style-type: none"> • Recrimp until dies fully close • Replace with correct size
3. Crimp diameter too small	<ul style="list-style-type: none"> • Incorrect size dies 	<ul style="list-style-type: none"> • Replace with correct size
4. Crimp location too close to closed end of ferrule	<ul style="list-style-type: none"> • Ferrule not inserted far enough into crimper 	<ul style="list-style-type: none"> • Use locator flag to properly locate ferrule position
5. Crimp location too close to hose	<ul style="list-style-type: none"> • Ferrule inserted too far into crimper (past locator flag) 	<ul style="list-style-type: none"> • Use locator flag to properly locate ferrule position
6. Crimped fitting leaks when tested with soap bubbles	<ul style="list-style-type: none"> • Air trapped in the hose during manufacture • Insufficient crimp • Hose wall thickness is undersize (see chart) • Fitting is defective 	<ul style="list-style-type: none"> • Recheck after system has been charged for one hour – air will bleed out of the hose • Check crimp diameter • Recrimp with .030 undersize die • Replace fitting/recrimp
7. Crimped fitting leaks when tested with electronic leak detector	<ul style="list-style-type: none"> • Insufficient crimp • Hose wall thickness 	<ul style="list-style-type: none"> • Check crimp diameter • Recrimp with .030

Crimping Machines - Portable

Coll-O-Crimp Portable T-480



Refer to pages A-2 and A-3 and machine operator's manuals for safety information.

T-480-HP • Portable Coll-O-Crimp Press & Hand Pump Package



Reference pages N-2 and N-3 for COC machine and tooling packages, and pages N-26 to N-30 for collet kits and spacer ring details.

Refer to pages A-2 and A-3 and machine operator's manuals for safety information.

Make factory-type hose assemblies anywhere-anytime! Versatile and portable, this package offers the ease of use you are looking for in a Coll-O-Crimp hose assembly system. The T-480 Coll-O-Crimp Press packages are offered in four options. Listed below are press/power unit packages.

For cabinets see pages N-68-70 (not included).

Capacity

3/16" I.D. 1 fiber braid through 1-1/4" I.D. 6 spiral hose

Mounting

Free Standing Base

Size

22-1/2" high, 14" long, 10-1/2" wide

Total Weight

112 lbs.

T-480-2 Pump Specifications:

Dimensions

7-3/16" high, 21-1/64" long, 4-3/4" wide

Pressure

0-10,000 psi

Outlet Port Size

3/8" NPT

Hydraulic Oil

Enerpac

Reservoir Capacity

55 cu. in.

Includes **T-480-68** blue pusher extension ring to be used with **T-480** Portable Coll-O-Crimp and the **T-420** and **ET420** collets only.

For replacement pump see pages N-33-35.

T-480-AH • Portable Coll-O-Crimp Press & Air/Hydraulic Pump Package

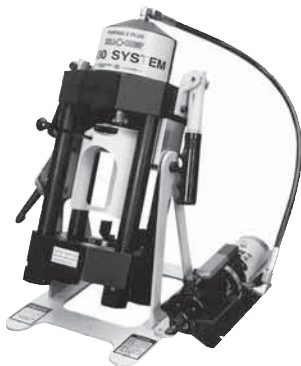

Reference pages N-2 and N-3 for COC machine and tooling packages, and pages N-26 to N-30 for collet kits and spacer ring details.

Refer to safety information regarding Coll-O-Crimp crimping procedures on pages N-4-17.

Capacity

3/16" I.D. 1 fiber braid through 1-1/4" I.D. 6 spiral hose

Mounting

Free Standing Base

Size

22-1/2" high, 14" long, 10-1/2" wide

Total Weight

124 lbs.

T-482-2 Pump Specifications:

Dimensions

5" high, 14-5/8" long, 5-5/8" wide

Pressure

0-10,000 psi

Outlet Port Size

3/8" NPT

Inlet Port

1/4" NPT

Pump Inlet Air Pressure

60-100 psi

Hydraulic Oil

Enerpac

Reservoir Capacity

36 cu. in.

Includes **T-480-68** blue pusher extension ring to be used with **T-480** Portable Coll-O-Crimp and the **T-420** and **ET420** collets only.

Note: It is recommended that a filter, regulator, lubricator, and air pressure gauge be installed upstream from the pump. Filter, regulator, and lubricator units are not included.

For replacement pump see pages N-33-35.

Crimping Machines - Portable

Coll-O-Crimp Portable T-480



Refer to pages A-2 and A-3 and machine operator's manuals for safety information.

T-480-TA Portable Coll-O-Crimp Press and Turbo Air/Hydraulic Pump Package



Reference pages N-2 and N-3 for COC machine and tooling packages, and pages N-26 to N-30 for collet kits and spacer ring details.

Refer to pages A-2 and A-3 and machine operator's manuals for safety information.

Capacity
3/16" I.D. 1 fiber braid through 1-1/4" I.D. 6 spiral hose

Mounting
Free Standing Base

Size
22-1/2" high, 14" long, 10-1/2" wide

Total Weight
116 lbs.

T-480-3 Pump Specifications:

Dimensions
8-1/4" high, 12-3/8" long, 8" wide

Pressure
0-10,000 psi

Outlet Port Size
3/8" NPT

Inlet Port
1/4" NPT

Pump Inlet Air Pressure:
40-150 psi

Hydraulic Oil
Enerpac

Reservoir Capacity
150 cu. in.

Includes **T-480-68** blue pusher extension ring to be used with **T-480** Portable Coll-O-Crimp and the **T-420** and **ET420** collets only.

Note: It is recommended that a filter, regulator, lubricator, and air pressure gauge be installed upstream from the pump. Filter, regulator, and lubricator units are not included.

For replacement pump see pages N-33-35.

T-480-EP Portable Coll-O-Crimp Press and 110v Electric Pump Package



Reference pages N-2 and N-3 for COC machine and tooling packages, and pages N-26 to N-30 for collet kits and spacer ring details.

Refer to pages A-2 and A-3 and machine operator's manuals for safety information.

Capacity
3/16" I.D. 1 fiber braid through 1-1/4" I.D. 6 spiral hose

Mounting
Free Standing Base

Size
22-1/2" high, 14" long, 10-1/2" wide

Total Weight
134 lbs.

T-481-110 Pump Specifications:

Electrical Power Source
15amp, 110v grounded 1Ph 50/60HZ

Dimensions
14-1/4" high, 9-5/8" long, 9-5/8" wide

Pressure
0-10,000 psi

Outlet Port Size
3/8" NPT

Hydraulic Oil
Enerpac

Reservoir Capacity
115.5 cu. in.

Flow
.5 to 1.0 gpm

Motor Rating
1/2 hp universal, 9 amps at 10,000 psi

Includes **T-480-68** blue pusher extension ring to be used with **T-480** Portable Coll-O-Crimp and the **T-420** and **ET420** collets only.

For replacement pump see pages N-33-35.

Package #	ET480-001	ET480-002	ET480-003	ET480-004
Power source	Hand pump	Air/Hydraulic (Hand Switch)	Turbo Air/Hydraulic (Foot Pedal)	110V
Contents				
Press, Pump and Hose Assembly	T-480-HP	T-480-AH	T-480-TA	T-480-EP
Adapter Ring	T-420-25	T-420-25	T-420-25	T-420-25
Z-series tooling for -4 thru -16 (no -10) one wire and two wire	ET480TP-0001	ET480TP-0001	ET480TP-0001	ET480TP-0001

See pages N-26-32 for a breakdown of collets and spacer rings included in these packages.

Crimping Machines - Portable

Coll-O-Crimp Portable T-480



Refer to pages A-2 and A-3 and machine operator's manuals for safety information.

T-480 • Portable Coll-O-Crimp Repair and Replacement Items

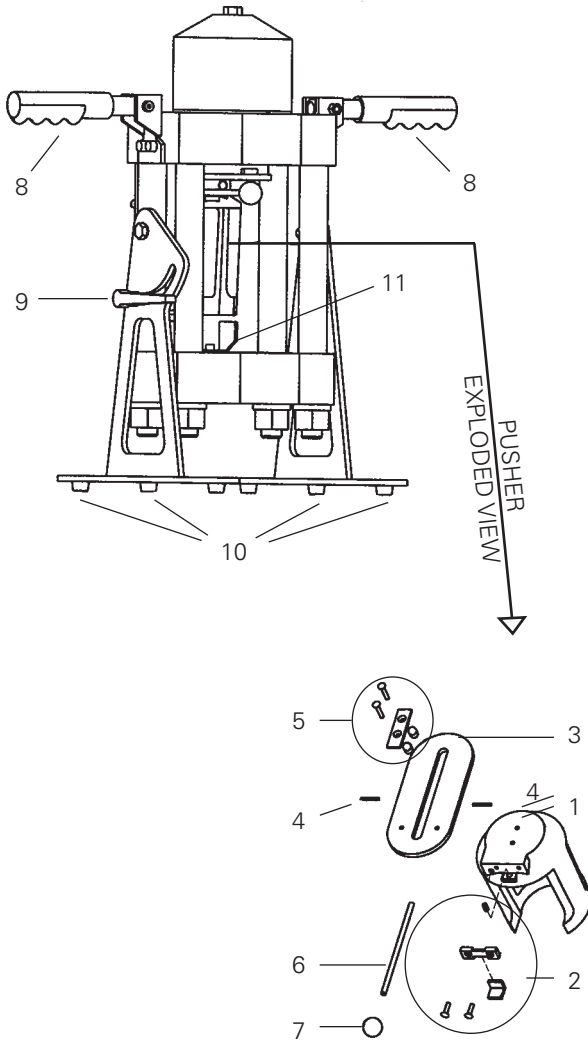

Item Number	Catalog Number	Description
1	T-480-P	Pusher
2	T-480-PSK	Pusher Stop Repair Kit (Includes pusher clip, 2 machine screws, pusher stop and spring)
3	T-480-SP	Slider Plate
4	140-05485-01	Roll Pin
5	T-480-SFK	Slide Flange Kit (Includes slide flange, 2 bushings and 2 machine screws)
6	T-480-SPR	Slide Pull Rod
7	T-480-SPK	Slide Pull Knob
8	140-06601	Vinyl Grip
9	T-480-TBK	Tilt Bracket Knob
10	140-06894	Foot Pad
11	T-480-69	Tool Locator Bracket
#	T-480-16	10,000 PSI replacement hose assembly for 480-HP
#	T-480-17	10,000 PSI replacement hose assembly for T-480-TA and T-480-EP
#	T-480-18	10,000 PSI replacement hose assembly for 480-AH
#	140-06906	Hydraulic Quick Coupler used with the T-480-TA and T-480-EP System
#	T-480-3	Turbo Air/Hydraulic replacement pump for T-480-TA System
#	T-481-110	Electric replacement pump for T-480-EP System
#	T-480-2	Hand replacement pump for T-480-HP System
#	T-482-2	Air/Hydraulic replacement pump for T-480-AH System
#	W-EQCR-TE012-E	Shroud Decal
#	W-EQCR-TM013-E	Set-up and Operating Guide for T-480 System
#	E-EQCR-ME002-E	Instructional Video

Item not illustrated in parts breakdown.

Crimping Machines - Portable

ET1000 Portable Crimp Machine

ET1000 • Portable Crimp Machine

CAUTION

Refer to pages A-2 and A-3 and machine operator's manuals for safety information.



The completely PORTABLE ET1000 crimp machine boasts a broad crimp capability with an ease-of-use that is sure to please hose assemblers. With three power source options - air/hydraulic, hand, and electric - this portable machine can travel to the worksite. The machine comes equipped with a stand pre-drilled for mounting to a workbench or table-top.

The ET1000 Portable Crimp Machine is a mid-size machine positioned between the other two popular portable crimp machines (the T-460 and T-480).

Capacity

Coll-O-Crimp U series hose ends and applicable hoses in sizes 1/4" through 1-1/4"

Coll-O-Crimp Z Series hose ends and applicable hoses in sizes 1/4" through 1-1/4"

Coll-O-Crimp 430U Series hose ends and applicable hoses in sizes 3/8" through 3/4"

Mounting

Work bench or table top

Weight

70 lbs. (less pump)

Tooling

Standard Coll-O-Crimp collets and spacer rings. Uses the same tooling as the T-420 machine.

Pump Kits

(pump kits contain hose assembly and fittings to attach pump to machine)

ET1000PK-001
Hand Pump

ET1000PK-002,
Air/Hydraulic Pump

ET1000PK-003
110 Volt Electric Pump

Pump Only

(does not include hose assembly or fittings)

T-480-2
Hand Pump

T-482-2
Air/Hydraulic Pump

T-481-110
110 Volt Electric Pump

Ordering Options

ET1000-001	Basic machine (no pump)
ET1000-002	Machine with hand pump*
ET1000-003	Machine with air/hydraulic pump*
ET1000-004	Machine with 110 volt electric pump*

* Includes hose assembly and fittings to attach pump to machine.

Note: Collets and spacers not included in kits. Must be ordered separately. See pages N-26-32 for part numbers.

Note: ET1000AR-001 adapter die ring required to Crimp T-400 and ET400 series collets. Not included in kits and must be ordered separately.

Repair and replacement items

ET1000C-0001	Stand
ET1000C-0006	Pusher
ET1000AR-001	Adapter Ring
T-400-G	1.5 oz. Tube High Efficiency Teflon® Grease

Additional repair and replacement items are available. Refer to the owner's manual or contact Eaton for information.

Teflon® is a registered trademark of DuPont used under license by Eaton.

ET1000 • Portable Coll-O-Crimp Packages for Z-Series

-4 thru -16 (no -10), one-wire and two-wire

Package Number	ET1000-016	ET1000-017	ET1000-018
Power Source	Hand Pump	Air/Hydraulic	110V
Contents Press, Pump and Hose Assembly	ET1000-002	ET1000-003	ET1000-004
Adapter Ring	ET1000AR-001	ET1000AR-001	ET1000AR-001
Z-Series Collets*	ET1000TP-0001	ET1000TP-0001	ET1000TP-0001

* See page N-30

Crimping Machines - Portable

ET1000 Crimping Procedures

Note:

See Crimp Bulletin #W-HOOV-TM001-E2 for tooling specifications.

Crimping Procedures



Step 1

Slide the pusher to the back position.

Using the Collet/Spacer Ring Selector Chart, select the proper collet assembly and spacer ring.

Step 2A (for T-420 and ET420 Series Collets)

Lubricate the inside cone of the die ring and external surfaces of the collet assembly with a high-efficiency Teflon-based lubricant (T-400-G).

Insert the collet assembly into the base die ring.

Step 2B (for T-400 and ET400 Series Collets)

Lubricate the inside cone of the base die ring and the outside cone of the die ring adapter plate.

Place the die ring adapter plate into the base die ring.

Lubricate the external surfaces of collet assembly halves with a high-efficiency Teflon-based lubricant.

Insert the collet assembly into the die ring adapter plate.



Step 3

Insert the hose assembly through the bottom of the base die ring and between the two collet assembly halves. Align the fitting with the top of the collet halves as referenced on the Collet/Spacer Ring Selector Chart.



Step 4

Place the spacer ring in the appropriate position on top of the collet assembly (either flat-side up or flat-side down as referenced in the Collet/Spacer Ring Selector Chart).



Step 5

Pull the pusher forward into the detent holding position with the pusher positioning handle.

Step 6

Begin crimping by actuating the pump. **When the spacer ring bottoms out against the base die ring,** the crimping is complete.

Note:

Visually inspect the crimp and verify the correct crimp diameter and length.

Teflon® is a registered trademark of DuPont used under license by Eaton.

Crimping Machines - Stationary

Coll-O-Crimp T-400-17

 Refer to pages A-2 and A-3 and machine operator's manuals for safety information.

Shop Press Tooling Packages

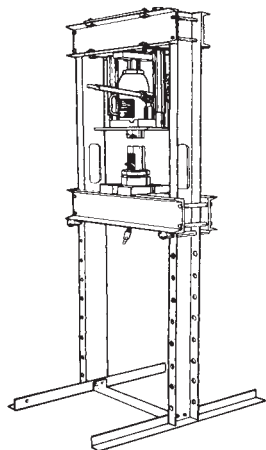

T-400-17 • Shop Press Tooling Package

The T-400-17 Shop Press Tooling Kit allows you to make factory-type hydraulic hose assemblies on your 25-ton shop press. With this minimum investment in equipment, and a nominal stock of packaged bulk hose and hose ends, you can begin to make Coll-O-Crimp hose assemblies in your own shop. This kit includes tooling to crimp 1/4" through 1" hose I.D. "U" Series hose ends. Additional tooling is available to crimp 5/8" and 1-1/4" I.D. sizes.

Included in kit:

Part Number	Description
T-400-2C	"U" Series Collet – 1/4"
T-400-3C	"U" Series Collet – 3/8"
T-400-4C	"U" Series Collet – 1/2"
T-400-5C	"U" Series Collet – 3/4"
T-400-6C	"U" Series Collet – 1"
T-400-8	Die Ring – 3/16" thru 1-1/4"
T-400-10	Spacer Ring – Black
T-400-11	Spacer Ring – Silver
T-400-17P	Pusher
W-EQCR-TD003-E	Shroud Decal
T-400-MSP	Instructions

WARNING

These kits are intended for use on shop presses not exceeding a 25-ton rating. Usage of presses exceeding this rating may result in damage to the pusher, causing metal fragments to spray which may result in serious bodily injury.

T-400-20A • Shop Press 757 "E" Series Tooling Package

The T-400-20A Shop Press 757 "E" Series Tooling Kit allows you to make factory-type air conditioning hose assemblies on your 25-ton shop press. With this minimum investment in equipment, and a nominal stock of packaged bulk hose and hose ends, you can begin to make Coll-O-Crimp hose assemblies in your own shop. This kit includes tooling to crimp all of the 757 'E' Series hose ends.

Included in kit:

Part Number	Description
T-400-114	757 "E" Series Collets
T-400-8	Die Ring Fits Collets 3/16" thru 1-1/4"
T-400-10	Spacer Ring – Black
T-400-17P	Pusher
W-EQCR-TD003-E	Shroud Decal
FS-3200	Label Set

Reference pages N-2 and N-3 for COC machine and tooling packages, and pages N-26 to N-30 for collet kits and spacer ring details.

Crimping Machines - Stationary

Coll-O-Crimp T-400



Refer to pages A-2 and A-3 and machine operator's manuals for safety information.

Coll-O-Crimp T-400

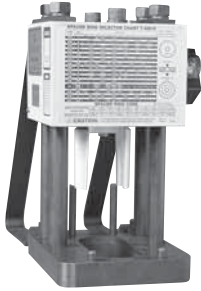

The Coll-O-Crimp I is the time-proven "Mini-Factory" that you can easily set up in your own shop. Fast, easy, compact, and various power sources available make this crimper versatile for even the smallest of workshops.

Capacity

3/16" I.D. 1-fiber braid through 1-3/8" I.D. 1 wire hose and 1-1/4" I.D. 2 wire hose

Mounting

Bench; FH-135X or C40X Cabinet

For cabinets see pages N-68-70

Size

16-1/4" high, 8" wide, 21-3/4" deep

Weight

113 lbs

Packages continued on next page.

Reference pages N-2 and N-3 for COC machine and tooling packages, and pages N-26 to N-30 for collet kits and spacer ring details.

Note:

25 ton (T-400-1 is C-O-C press only)

T-400 • Coll-O-Crimp I Packages for Z-Series

-4 thru -16 (no -10), one-wire and two-wire

Package Number	ET400-001	ET400-002	ET400-003
Power Source	220V	110V	Air/Hydraulic
Press	T-400-1	T-400-1	T-400-1
Hose Assembly	T-400-16	T-400-16	T-400-18
Pump	T-421U	T-421U-110	T-402-2
Die Ring	T-400-8	T-400-8	T-400-8
Z-Series Collets*	ET400TP-0001	ET400TP-0001	ET400TP-0001

* See page N-30 for details.

T-401 • C-O-C I and 220v Electric Pump Package

Includes one each of the following:

Catalog Number	Description
T-400	Press and tooling package
T-421U	Electric Pump (220v, 1 phase)

T-401-110 • C-O-C I and 110v Electric Pump Package

Includes one each of the following:

Catalog Number	Description
T-400	Press and tooling package
T-421U-110	Electric Pump (110v, 1 phase)

T-400 • Coll-O-Crimp I Package for U-Series*

Includes one each of the following:

Catalog Number	Description
T-400-1	Coll-O-Crimp Press, T-400-BB Switch, and T-400-M Instructions
T-400-2C	"U" Series Collet – 1/4"
T-400-3C	"U" Series Collet – 3/8"
T-400-4C	"U" Series Collet – 1/2"
T-400-5C	"U" Series Collet – 3/4"
T-400-6C	"U" Series Collet – 1"
T-400-10	Spacer Ring – Black
T-400-11	Spacer Ring – Silver
T-400-62	Spacer Ring – Yellow
T-400-16**	36" T-421U Pump to Press Hose Assembly
T-400-8	Die Ring

* Pump Required (sold separately): T-421U, T421U-110, T-402-2 or T-403-2 see pages N-33-35.

**Not supplied when ordering a T-402 or T-403 package.

T-402 • C-O-C I and Air/Hydraulic Pump Package

Includes one each of the following:

Catalog Number	Description
T-400	Press and tooling package/Less T-400-16
T-402-2	Air/Hydraulic Pump
T-400-18	108" Hose assembly and fittings

T-403 • C-O-C I and Hand Pump Package

Includes one each of the following:

Catalog Number	Description
T-400	Press and tooling package/Less T-400-16
T-403-2	Hand Pump
T-400-19	60" hose assembly and fittings

T-414 • C-O-C I and 12v Electric Pump Package

Includes one each of the following:

Catalog Number	Description
T-400	Press and tooling package
T-412	12-volt DC Electric Pump

Crimping Machines - Stationary

Coll-O-Crimp T-400 & T-407

T-400-9 • Crimp Locator

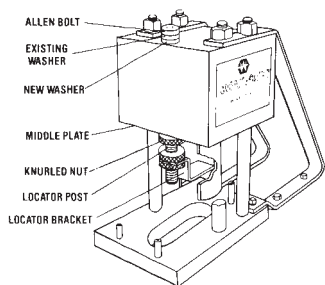

The T-400-9 allows you to make large volumes of hose assemblies by automatically aligning hose ends in proper crimp location.

Note:

Remove locator assembly when crimping bent tube ends.

Installation Procedure

- Remove the front Allen bolt using an Allen wrench or tool provided with kit.
- Add the washer provided with the kit to existing washer as shown and torque the bolt down to 75 ft.-lbs.
- Attach the locator post of the pre-assembled locator to the bottom of the middle plate and lock it in place with one of the knurled nuts.
- Align the dimples on the first assembly with top of collet to locate the crimp. Drop the locator bracket down to rest on top of the

hose end. Lock the bracket in position with remaining two knurled nuts. The locator now can be used, instead of dimples, to locate crimp accurately and consistently on the remaining hose ends of the same size and type.

T-400-1 Coll-O-Crimp I Repair and Replacement Items

Catalog Number	Description
T-400-B	Pusher Bolt
T-400-BB	Switch to interface T400-1 crimper to T421U pump or T-421U-110 pump
T-400-G	1.5 oz. Tube High Efficiency * Grease
T-400-K1	Seal Replacement Kit for T-400-1 press
W-EQCR-TD003-E	Shroud Decal
T-400-M	Instructions for T-400-1
T-400-S	Replacement press shroud with decals.
T-400-8	Die Ring
T-400-13	Replacement** collet cage for T-400 "U" Series collets, 1/4" and 3/8" sizes only, and 229 "P" Series
T-400-14	Replacement** collet cage for T-400 "U" Series collets with a "C" suffix, 1/2" through 1" only,
T-400-90	Replacement** collet cage for T-400 "E", 069 "E", and "E" Series collets with a "C" suffix.
T-432-15	Pusher
E-EQCR-ME002-E	Instructional Video

** 2 required for each collet

T-407-1 • Production Coll-O-Crimp Press



The T-407-1 Production Coll-O-Crimp, as its name implies, is at its best in the fast production of straight configuration hose end crimping. Taking advantage of the swiveling bracket which supports the crimper, tooling can be put in place and the press locked in at up to a 90° angle, facilitating quick hose end crimping. A crimp locator is included. When set to position, the crimp locator allows for a preset of the correct crimp location so hose assemblies can be built in volume, with accuracy and precision. The T-407-1 offers crimping capabilities of 3/16"-1-fiber braid through 1-3/8" I.D. 1-wire hose and 1-1/4" I.D. 2-wire hose.

Weight: (for press and pump) 198 lbs

Size Press: 16-1/4" high, 21-3/4" deep

Includes one each of the following:

Catalog Number	Description
T-400-M	Instructions
T-400-8	Die Ring
T-400-9	Crimp Locator
T-400-19	60" hose assembly and fittings

T-407 • Production Coll-O-Crimp Package

The T-407 comes with a high-volume pump and a foot switch.

Size Pump: 26" high, 18" wide (Pump is wired for 220v, 1 phase)

Includes one each of the following:

Catalog Number	Description
T-407-1	Production C-O-C Press
T-433	Two-Stage Piston Pump and foot switch

Note: The T-433 pump which is shipped as part of the T-407 Production Coll-O-Crimp System.

*Removal of crimp locator allows for crimping of 45° and 90° angle hose end configurations.

Reference pages N-2 and N-3 for COC machine and tooling packages, and pages N-26 to N-30 for collet kits and spacer ring details.

Crimping Machines - Stationary

Coll-O-Crimp Super I, T-420



Refer to pages A-2 and A-3 and machine operator's manuals for safety information.

T-420 • Coll-O-Crimp Super I Packages for Z-Series

-4 thru -16 (no -10), one-wire and two-wire

Package Number	ET420-002	ET420-003
Power Source	220V	110V
Contents Press	T-420-1	T-420-1
Hose Assembly	T-410-22	T-410-22
Pump	T-421U	T-421U-110
Adapter Ring	T-420-25	T-420-25
Z-Series Collets*	ET420TP-0001	ET420TP-0001

* See page N-30

T-420-N • Coll-O-Crimp Super I - 220V Package T-420N-110 • Coll-O-Crimp Super I - 110V Package

Includes one each of the following (with respective pump):

Catalog Number	Description
T-420-1	Coll-O-Crimp Super I Press and T-420-M Instructions
T-421U or T-421U-110	220v or 110V Electric Pump
T-400-2C	"U" Series Collet- 1/4"
T-400-3C	"U" Series Collet- 3/8"
T-400-4C	"U" Series Collet- 1/2"
T-400-5C	"U" Series Collet- 3/4"
T-400-6C	"U" Series Collet- 1"
T-400-10	Spacer Ring- Black
T-400-11	Spacer Ring- Silver
T-400-62	Spacer Ring Yellow
T-410-22	36" Pump to Press Hose Assembly
T-420-25	Adapter Ring for T-400 Series Collets
T-420-4CN	430 "U" Series Collet- 1/2"
T-420-5CN	430 "U" Series Collet- 3/4"
T-420-6CN	430 'U' Series Collet- 1"
T-420-7CN	430 'U' Series Collet- 1-1/4"



The Coll-O-Crimp Super I is a versatile machine ideal for your shop, factory, construction, and mine locations. Big capacity combined with lever-activated crimping gives you wide coverage and a quick and simple way to make factory-quality hose assemblies.

Capacity

3/16" I.D. 1 fiber braid through 1-1/4" 6 spiral hose*; for hose other than 4 and 6 spiral, conversion tooling is required. See page N-36 for details.

*Will not crimp 4SP/6SP ends

Mounting

Bench or C-40X cabinet.

See pages N-68-70 for cabinet (not included).

Size

22" high, 10" wide, 20-1/2" deep

Weight

210 lbs.



CAUTION

The Coll-O-Crimp power source has the pressure relief valve set at 4000 to 4200 PSI. Damage to the press will result if higher pressures are used and warranty will be voided.

ET420-004 Coll-O-Crimp I - 220V Package ET420-005 Coll-O-Crimp I - 110V Package

Both Packages include the following (with respective pump):

Catalog Number	Description
T-420-1	Coll-O-Crimp Super I
T-421U or T-421U-110	220v or 110V Electric Pump
ET400DC-M150S	'Z' Series Collet- 1/4"
ET400DC-M195S	'Z' Series Collet- 3/8"
ET400DC-M230S	'Z' Series Collet- 1/2"
T-420-85C	'Z' Series Collet- 5/8"
T-420-86C	'Z' Series Collet- 3/4"
ET420DC-M380S	'Z' Series Collet- 1"
T-400-10	Spacer Ring- Black
T-400-62	Spacer Ring- Yellow
T-420-80R	Spacer Ring- Black/White
ET1000SR-M190D	Spacer Ring- Light Green
ET420SR-M255A	Spacer Ring- Black/Grey
ET420SR-M495A	Spacer Ring- Brown
T-410-22	36" Pump to Press Hose Assembly
T-420-25	Adapter Ring for T-400 Series Collets
T-420-4CN	430 'U' Series Collet- 1/2"
T-420-5CN	430 'U' Series Collet- 3/4"
T-420-6CN	430 'U' Series Collet- 1"
T-420-7CN	430 'U' Series Collet- 1-1/4"

Crimping Machines - Stationary

Coll-O-Crimp ET4001



The ET4001 is ideal for factory, high performance machine operations, construction and mine locations. This machine offers the capabilities of crimping all of the crimp-style hose ends Weatherhead offers. With this coverage, this heavy-duty crimper can handle all of your crimping needs.

Capacity

3/16" I.D. 1-fiber braid through 2" 6-spiral hose.

Mounting

Bench or Coll-O-Cart (FF91042)

Size

29" high, 12" wide, 21" deep

Weight

550 lbs.

Reference pages N-2 and N-3 for COC machine and tooling packages, and pages N-26 to N-30 for collet kits and spacer ring details.

Note:

Seal kits for T-410, T-440, ET4000 and ET4001 are not sold separately. Crimpers must be sent in and torqued by Weatherhead.

Note:

ET4000AR-002 Adapter Die Ring required for -20, -24, and -32 size 4SP and 6SP series collets.

ET4001-004 • Coll-O-Crimp Package

Includes one each of the following:

Catalog Number	Description
ET4001-002	ET4001 Press, Operating Instructions and 140-06741 Switch
ET4001P-001	220v Single Phase Electric Pump
T-410-22	36" Pump to Press Hose Assembly

ET4001-006 • Coll-O-Crimp Package

Includes one each of the following:

Catalog Number	Description
ET4001-004	Press and Pump Package
T-410-4CN	430 'U' Series Collet – 1/2" I.D.
T-410-5CN	430 'U' Series Collet – 3/4" I.D.
T-410-6CN	430 'U' Series Collet – 1" I.D.
T-410-7CN	430 'U' Series Collet – 1-1/4" I.D.
T-410-8N	430 'U' Series Collet – 1-1/2" I.D.
T-410-9N	430 'U' Series Collet – 2" I.D.

ET4001-010 • Coll-O-Crimp Package

Includes one each of the following:

Catalog Number	Description
ET4001-004	Machine 220V Pump & Assembly
ET4000AR-002	Adapter Ring
ET4000SR-M215A	Black/Magenta Spacer Ring
ET4000SR-M180A	Black/Purple Spacer Ring
T-440-80R	Black/White Spacer Ring
ET4000DC-6S32	2" 6SP Series Collet
ET4000DC-6S24	1-1/2" 6SP Series Collet
ET4000DC-6S20	1-1/4" 6SP Series Collet
ET4000DC-4S16	1" 4SP Series Collet
ET4001DC-4S12	3/4" 4SP Series Collet

Crimping Machines - Stationary

Repair and Replacement Parts



Refer to pages A-2 and A-3 and machine operator's manuals for safety information.

Coll-O-Crimp Super I T-420 Repair and Replacement Items

Catalog Number	Description	Catalog Number	Description
T-420-1M	Micro-Switch for T-420-1 Press	T-420-G	Linkage Assembly
T-420-28	Tool Locator Bracket	T-420-2R	Rack
T-420-B	Pusher Bolt and Washers	T-420-2K	Pinion Shaft Assembly (incl'd T-420-2G, T-420-2R and T-420-2S)
W-EQCR-TE006-E	Shroud Decal	T-420-2S	Replacement Pinion Gear Shaft
T-420-H	Handle	T-420-2G	Replacement Pinion Gear
T-420-L	Light Bulb	T-400-G	1.5 oz. Tube High Efficiency Teflon® Grease
T-420-LA	Light Assembly	T-401-1BC	Threaded Breather Cap for T-421U Pump
T-420-LS	Light Switch	T-421U-BC	Twist Lock Breather Cap for T-421U Pump
W-EQCR-TM004-E	Instructions for T-420-1	140-06745	Pusher Wear Plates includes (1) Left and (1) Right
T-420-P	Pusher Set (2) with Wear Plates and Screws	140-06748	Pusher Wear Plates Screws (1)
T-420-S	Press Shroud with Decals		See pages N-33-35 for replacement pumps.
T-420-26	Insert – Base Plate		Reference pages N-2 and N-3 for COC machine and tooling packages, and pages N-26 to N-30 for collet kits and spacer ring details.
E-EQCR-ME002-E	Instructional Video		Refer to pages A-2 and A-3 and machine operator's manuals for safety information.

Teflon® is a registered trademark of DuPont used under license by Eaton.



T-420



ET4000



ET4001



FF91042
Coll-O-Cart

Repair and Replacement Items:

Catalog Number	Description
T-410-26	Base Plate Insert for T-410-1 Machine
T-410-26R	Base Plate Insert for T-440-1 Machine
ET4000AR-001	Base Plate Insert for ET4000 Machine
T-410-28	Tool Locator Bracket Kit for the T-410-1 and T-440-1 Machine
ET4000TP-0001	Tool Locator Bracket Kit for the ET4000 Machine
T-410-P	Pusher Set for T-410-1, T-440-1 and ET4000 Machines (includes wear plates)
T-410-1M	Microswitch for T-410-1, T-440-1 and ET400 Machine
T-421-FP	4 Prong Female Electrical Outlet
T-400-G	1.5 oz. Tube Teflon® Grease
T-410-BB	Pump Switch for T-410-1 Machine
140-06741	Pump Switch for the T-440-1 and ET4000 Machines
ET4000TP-002	Wear Plate Kit for T-410-1, T-440-1 and ET4000 Machines (Includes both halves plus screws)
W-EQCR-TE007-E	Shroud Decal for T-440-1 Machine
W-EQCR-TE014-E	Shroud Decal for ET4000 Machine
W-EQCR-TE010-E	Owner's Manual for T-440-1 Machine
W-EQCR-TE002-E	Owner's Manual for ET4000 Machine
W-EQCR-TM022-E	Owner's Manual for ET4001 Machine
E-EQCR-ME002-E	Instructional Video
ET4001-011	ET4000 Retrofit: Lengthen tie rods & install new valve & 3-way switch
ET4001-012	ET4000 Retrofit: Lengthen tie rods
ET4001-013	ET4000 Retrofit: Install new valve & 3-way switch
ET4001-014	ET4000 Retrofit: Kit for field installation of new valve & 3-way switch
ET4001C-0017	Gooseneck lamp, magnetic mount
FF91042	Coll-O-Cart for ET4001 or T-420

Teflon® is a registered trademark of DuPont used under license by Eaton.

Crimping Machines - Variable

ET4020

ET4020



The ET4020 is a benchtop crimp machine that crimps hydraulic hose assemblies up to 1-1/4" braided and four spiral wire hose. This machine has programmable electronic keypads with 10 presets. These keypads simplify the hose crimping operation by allowing the machine operator to enter a pre-determined setting for a specific hose type and size. The 10 most often used crimp settings can be stored for one-touch retrieval. The machine will automatically crimp to the exact crimp diameter required for that hose type and size. The electronic crimp machine settings eliminate the need

for spacers or shims in the crimping operation.

Features

- Electronic Programmable Keypad
- 10 Crimp Diameter Presets
- Individual die cages for each hose size

Benefits

- Easy to electronically enter crimp setting
- Can pre-program 10 most popular crimp settings
- Die cages easily slip in and out of machine

Dimensions

12.75" Wide x 25.75" Deep x 28.5" High

Electrical Requirements

115 volt standard, 230 volt available

Weight

238 lbs.

Hose Ends:

Z series and 430U series

Tooling and Crimp Machine Packages

Part Number	Description	Ends Crimped	430U Sizes Crimped	Tooling and Crimp Machine Packages	
				ET4020TP-0003 Z & 430U Tooling Only	ET4020-006 Z & 430U Tooling & Crimper
ET4020-115	Crimp Machine (115V)			0	1
W-EQCR-TM020-E	Operator's Manual			0	1
FT1380-200-M150	Die Cage	Z		1	1
FT1380-200-M180	Die Cage	Z		1	1
FT1380-200-M210	Die Cage	Z and 430U	-6	1	1
FT1380-200-M240	Die Cage	Z		1	1
FT1380-200-M280	Die Cage	Z and 430U	-8 and -10	1	1
FT1380-200-M320	Die Cage	Z and 430U	-12	1	1
FT1380-200-M370	Die Cage	Z		1	1
FT1380-200-M420	Die Cage	Z and 430U	-16	1	1
FT1381-200-M465	Die Cage	Z and 430U	-20	1	1

Note: Also available:

ET4020-230 (230V) machine.
ET1380-2-4 die holders. Consists of 4 plates that attach to the sides of the machine and can hold up to eight die cages. Mounting hardware is included.

Crimping Machines - Variable

ET4040



ET4040

The ET4040 crimp machine comes with a base so no benchtop is needed. The ET4040 will crimp up to 2" braided and six heavy-spiral hydraulic hose assemblies. This machine has programmable electronic keypads with 10 presets. These keypads simplify the hose crimping operation by allowing the machine operator to enter a pre-determined setting for a specific hose type and size. The 10 most often used crimp settings can be stored for one-touch retrieval. The machine will automatically crimp to the exact crimp diameter required for that hose type and size.

The electronic crimp machine settings eliminate the need for spacers or shims in the crimping operation.

Features

- Electronic Programmable Keypad
- 10 Crimp Diameter Presets
- 2-piece Master die cage
- Durable, lightweight and low cost die inserts for each size
- Magnetic handle

Benefits

- Easy to electronically enter crimp setting
- Can pre-program 10 most popular crimp settings
- Die sets easily mount into fixed master die cage

- Top half of master cage slips in and out to allow easy loading of elbows
- Tool mounted die inserts are safer and cleaner
- Magnetic handle firmly connects & releases die inserts with a quick twist

Dimensions

29" Wide x 28" Deep x 45" High

Electrical Requirements

115 volt standard, 230 volt available

Weight

825 lbs.

Hose Ends:

Z series, 430U series and 4SP/6SP series

ET4040 Tooling And Crimp Machine Packages (Qty per package)

Package Part Number	ET4040TP-0004	ET4040-007	ET4040TP-0005	ET4040-008	ET4040TP-0006	ET4040-009		
Part Number	Description	Ends Crimped	Z & 430U Tooling Only	Z & 430U Tooling & Crimper	4SP/6SP Tooling Only	4SP/6SP Tooling & Crimper	Z, 430U, & 4SP/6SP Tooling Only	Z, 430U, & 4SP/6SP Tooling & Crimper
ET4040-115	Crimp Machine (115V)			1		1		1
W-EQCR-TM021-E	Operator's Manual			1		1		1
ET1295-001	Master Die Cage (2-Piece)			1		1		1
ET1295TP-0001	Handle To Capture Die Inserts			1		1		1
ET1295C-0027	Hanging Rack for Die Inserts			2		2		2
ET1295DC-M150S	Die Inserts (8 Pieces)	Z	1	1			1	1
ET1295DC-M180S	Die Inserts (8 Pieces)	Z	1	1			1	1
ET4040DC-M210S	Die Inserts (8 Pieces)	Z and 430U	1	1			1	1
ET1295DC-M240S	Die Inserts (8 Pieces)	Z	1	1			1	1
ET4040DC-M280S	Die Inserts (8 Pieces)	Z and 430U	1	1			1	1
ET4040DC-M320S	Die Inserts (8 Pieces)	Z and 430U	1	1			1	1
ET1295DC-M370S	Die Inserts (8 Pieces)	Z	1	1			1	1
ET4040DC-M420S	Die Inserts (8 Pieces)	Z and 430U	1	1			1	1
ET4040DC-M465S	Die Inserts (8 Pieces)	Z and 430U	1	1			1	1
ET4040DC-M520S	Die Inserts (8 Pieces)	430U	1	1			1	1
ET1295DC-M550S	Die Inserts (8 Pieces)	Z	1	1			1	1
ET4040DC-M570S	Die Inserts (8 Pieces)	Z and 430U	1	1			1	1
ET4040DC-M690S	Die Inserts (8 Pieces)	Z and 430U	1	1			1	1
ET1295DC-82S	Die Inserts (8 Pieces)	4SP12			1	1	1	1
ET1295DC-46S	Die Inserts (8 Pieces)	4SP16			1	1	1	1
ET1295DC-14S	Die Inserts (8 Pieces)	4SP20			1	1	1	1
ET1295DC-20S	Die Inserts (8 Pieces)	4SP24			1	1	1	1
ET1295DC-23S	Die Inserts (8 Pieces)	4SP32			1	1	1	1
ET1295DC-15S	Die Inserts (8 Pieces)	6SP20			1	1	1	1
ET1295DC-16S	Die Inserts (8 Pieces)	6SP24			1	1	1	1
ET1295DC-21S	Die Inserts (8 Pieces)	6SP32			1	1	1	1
MSDS Sheet	Hydraulic Fluid			1		1		1
MSDS Sheet	Never Seez			1		1		1
FT1289-3-30	Shipping Crate			1		1		1
ET4040-230	Crimp Machine(230V, 50/60H) (optional)							

ET4040 Master Die Cage and Tooling



Master Die Cage

Die Inserts

Handle to capture die inserts

A - E 29 C-002 Machine Mounted Die Insert Holder Rack (standard)

B - E 29 C-0029 Machine Mounted Die Insert Holder Rack (optional)

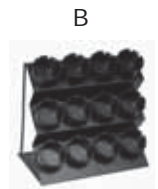
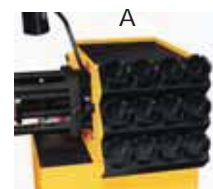

Coll-O-Crimp Collet Kits

Collet Kits



The Eaton tools listed are offered in kits for any given hose type, or collars and tools can be purchased individually by catalog number.

Refer to Crimp Bulletin # W-HOOV-TM001-E2 for proper spacer rings.



Refer to pages A-2 and A-3 and machine operator's manuals for safety information.

Note:

See Crimp Bulletin #W-HOOV-TM001-E2 for proper Collet selection for hose style and size desired.

Note:

Collars may be ordered individually.

T-400-30
'E' Series Collet Kit

This kit can be used with the following C-O-C systems: T-400-1, T-420-1, T-440-1, ET4000, T-460, T-462, T-465, and T-480.

Kit includes one each of the following:

Catalog Number	Description
T-400-113C	Collet – 3/16" (H243 only)
T-400-31C	Collet – 1/4"
T-400-32C	Collet – 5/16"
T-400-33C	Collet – 3/8"

Spacer Rings not included in T-400-30 kit.

Catalog Number	Description
T-400-34C	Collet – 1/2"
T-400-35C	Collet – 3/4"
T-400-36C	Collet – 1"
FS-1200	Label Set/Layout Guide

T-400-66
069 'E' Series Collet Kit

This kit can be used with the following C-O-C systems: T-400-1, T-420-1, T-440-1, ET4000, T-460, T-462, T-465, and T-480.

Kit includes one each of the following:

Catalog Number	Description
T-400-54C	Collet – 3/16"
T-400-55C	Collet – 1/4"
T-400-56C	Collet – 5/16"
T-400-57C	Collet – 13/32"
T-400-58C	Collet – 1/2"

Spacer Rings not included in T-400-66 kit.

Catalog Number	Description
T-400-59C	Collet – 5/8"
T-400-60C	Collet – 7/8"
T-400-61C	Collet – 1-1/8"
T-400-70	Collet – 1-3/8"
FS-1500	Label Set/Layout Guide

T-400-67
'U' Series Collet Kit

This kit can be used with the following C-O-C systems: ET1000, T-400-1, T-420-1, T-440-1, ET4000, T-460, T-462, T-465, T-480, and ET1000.

Kit includes one each of the following:

Catalog Number	Description
T-400-2C	Collet – 1/4"
T-400-3C	Collet – 3/8"
T-400-4C	Collet – 1/2"
T-400-64C	Collet – 5/8"

Spacer Rings not included in T-400-67 kit.

Catalog Number	Description
T-400-5C	Collet – 3/4"
T-400-6C	Collet – 1"
T-400-12	Collet – 1-1/4"
FS-1100	Label Set/Layout Guide

T-400-137
229 'P' Series Collet Kit

This kit can be used with the following C-O-C systems: T-400-1, T-420-1, T-440-1, ET4000, T-460, T-462, T-465, and T-480.

Kit includes one each of the following:

Catalog Number	Description
T-400-80C	Collet – 3/16"
T-400-82C	Collet – 13/32"

Spacer Rings not included in T-400-137 kit.

Catalog Number	Description
T-400-81C	Collet – 5/16"
T-400-83C	Collet – 1/2"

T-400-104
338 'P' Series Collet Kit

This kit can be used with the following C-O-C systems: T-400-1, T-420-1, T-440-1, ET4000, T-460, T-462, T-465, and T-480.

Kit includes one each of the following:

Catalog Number	Description
T-400-102C	Collet – 3/8"
T-400-103C	Collet – 1/2"

Spacer Rings not included in T-400-104 kit.

Catalog Number	Description
FS-2900	Label Set

Coll-O-Crimp Collet Kits

Collet Kits



Note:
See Crimp Bulletin # W-H00V-TM001-E2 for proper Collet selection for hose style and size desired.



Refer to pages A-2 and A-3 and machine operator's manuals for safety information.

Note:
Collets may be ordered individually.

T-400-114 757 'E' Series Collet Kit

This kit can be used with the following C-O-C systems: T-400-1, T-420-1, T-440-1, ET4000, T-460, T-462, T-465, and T-480.

Kit includes one each of the following:

Catalog Number	Description
T-400-105C	Collet – 5/16"
T-400-107C	Collet – 1/2"

Spacer Rings not included in T-400-114 kit.

Catalog Number	Description
T-400-106C	Collet – 13/32"
T-400-108C	Collet – 5/8"

T-400-129 336 'E' Series Collet Kit

This kit can be used with the following C-O-C systems: T-400-1, T-420-1, T-440-1, ET4000, T-460, T-462, and T-480.

Kit includes one each of the following:

Catalog Number	Description
T-400-120C	Collet – 3/16"
T-400-122C	Collet – 3/8"
T-400-121C	Collet – 1/4"

* For size 3/4" order T-420-15C. For 1" size order T-420-16C. For use with T-420-1 and T480-1 only.

Catalog Number	Description
T-400-123C	Collet – 1/2"
FS-3500	Label Set

T-410-70 470 'E' Series Collet Kit

This kit can be used with the following C-O-C systems: T-410-1, T-440-1, ET4000 ONLY.

Kit includes one each of the following:

Catalog Number	Description
T-470-8C	Collet – 1/2"
T-470-12C	Collet – 3/4"
T-470-16C	Collet – 1"
T-470-20	Collet – 1-1/4"

*-32 size requires T-440 or ET4000 system.

Catalog Number	Description
T-470-24	Collet – 1-1/2"
T-440-32*	Collet – 2"
FS-1800	Label Set/Layout Guide

T-410-80 430 'U' Series No Skive Collet Kit

This kit can be used with the following C-O-C systems: T-440-1, and ET4000 ONLY.

Kit includes one each of the following:

Catalog Number	Description
T-410-4CN	Collet – 1/2"
T-410-5CN	Collet – 3/4"
T-410-6CN	Collet – 1"
T-410-7CN	Collet – 1-1/4"

Catalog Number	Description
T-410-8N	Collet – 1-1/2"
T-410-9N	Collet – 2"
FS-3100	Label Set

T-420-70 470 'E' Series Collet Kit

This kit can be used with the following C-O-C systems: T-420-1, and T-480.

Kit includes one each of the following:

Catalog Number	Description
T-420-8C	Collet – 1/2"
T-420-9C	Collet – 3/4"
T-420-10C	Collet – 1"

Catalog Number	Description
T-420-11	Collet – 1-1/4"
FS-1800	Label Set

T-420-80 430 'U' Series No Skive Collet Kit

This kit can be used with the following C-O-C systems: T-420-1, and T-480

Kit includes one each of the following:

Catalog Number	Description
T-420-4CN	Collet – 1/2"
T-420-5CN	Collet – 3/4"
T-420-6CN	Collet – 1"

Catalog Number	Description
T-420-7CN	Collet – 1-1/4"
FS-3100	Label Set

Coll-O-Crimp Collet Kits

Collet Kits



Note:
See Crimp Bulletin # W-H00V-TM001-E2 for proper Collet selection for hose style and size desired.



Refer to pages A-2 and A-3 and machine operator's manuals for safety information.

Note:
Collets may be ordered individually.

T-480-80 'U' and 430 'U' Series Collet Kit

This kit can be used with the following C-O-C systems: T-420-1, and T-480 ONLY.

Kit includes one each of the following:

Catalog Number	Description
T-400-2C	Collet – 1/4" 'U' Series
T-400-3C	Collet – 3/8" 'U' Series
T-400-4C	Collet – 1/2" 'U' Series
T-400-5C	Collet – 3/4" 'U' Series
T-400-6C	Collet – 1" 'U' Series
T-400-10	Spacer Ring - Black
T-400-11	Spacer Ring - Silver

Catalog Number	Description
T-400-62	Spacer Ring - Yellow
T-420-25	Adapter Ring for T-400 Series Collets
T-420-4CN	Collet – 1/2" 430 'U' Series
T-420-5CN	Collet – 3/4" 430 'U' Series
T-420-6CN	Collet – 1" 430 'U' Series
T-420-7CN	Collet – 1-1/4" 430 'U' Series

Refer to Crimp Bulletin # W-H00V-TM001-E2 for proper spacer rings.

069 'E' Series Collet Size 32

For use with:
T-440, and ET4000 ONLY.

Catalog Number	Description
T-410-71C	Collet – 1-13/16"

265 'P' Series Collets

For use with: T-400, T-420, T-460, T-462, T-465, T-440, ET4000, T-480.

Kit includes one each of the following:

Catalog Number	Description
T-400-2C	Collet – 1/4" and 3/8"
T-400-3C	Collet – 1/2"

Catalog Number	Description
T-400-64C	Collet – 5/8"

4SP & 6SP Series Collets

For use with:
T-440. and ET4000 ONLY.

Kit includes one each of the following:

Catalog Number	Description
ET4000DC-4S12	Collet – 3/4"
ET4000DC-4S16	Collet – 1"
ET4000DC-4S20*	Collet – 1-1/4"
ET4000DC-4S24*	Collet – 1-1/2"
ET4000DC-4S32*	Collet – 2"

Catalog Number	Description
ET4000DC-6S20*	Collet – 1-1/4"
ET4000DC-6S24*	Collet – 1-1/2"
ET4000DC-6S32*	Collet – 2"

Qualified on ET4000 machine only.
*Requires ET4000AR-002 base adapter bowl.

Coll-O-Crimp Collet Kits

Collet Kits



Refer to pages A-2 and A-3 and machine operator's manuals for safety information.



Note:

See Crimp Bulletin # W-HOOV-TM001-E2 for proper Collet selection for hose style and size desired.

Note:

Collets may be ordered individually.

T-410-27 • Conversion Kit

For use if you have collets used on our smaller T-400 Coll-O-Crimp I and you are upgrading to an ET4000.

Example:

If you desire to crimp hose other than 4- or 6-spiral hose, you will need the T-410-25 Adapter Die Ring which is included in the conversion kit. This ring allows the use of standard Coll-O-Crimp I tooling, in the Coll-O-Crimp II Plus and ET4000 Press.

If you have a Coll-O-Crimp II Plus or ET4000 press and would like to be able to crimp 'U' Series hose ends, order T-410-27 conversion kit and T-400-67 for all the collets. Collets and tools may also be purchased individually by catalog number.

Kit includes one each of the following:

Catalog Number	Description
T-410-10	Spacer Ring Black
T-410-11	Spacer Ring Silver
T-410-25	Adapter Die Ring
T-410-41	Spacer Ring Yellow

Adapter Die Rings

Catalog Number	Description
T-400-8	Adapter Die Ring for T-400 Collets (T-400-1 Press)
T-410-25	Adapter Die Ring for T-400 Collets (ET4000, T-440-1 Presses)
T-420-25	Adapter Die Ring for T-400 Collets (T-420-1 Press and T-480 Packages)
ET1000AR-001	Adapter Die Ring for T-400 Collets (ET1000 Press)
ET4000AR-002	Adapter Die Ring for -20, -24 & -32 4SP/6SP Ends (ET4000 Press)

Collet Cage Replacements

Catalog Number	Description
T-400-13	Replacement collet cages for: T-400-2C, T-400-3C, T-400-80C, T-400-81C, T-400-82C, T-400-83C, T-400-100C, T-400-101C
T-400-14	Replacement collet cages for: T-400-4C, T-400-5C, T-400-6C, T-400-64C, T-400-105C, T-400-106C, T-400-107C, T-400-108C, T-400-109C, T-400-110C, T-400-111C, T-400-120C, T-400-121C, T-400-122C, T-400-123C
T-400-15	Replacement collet cages for: T-400-31C, T-400-32C, T-400-46C, T-400-47C, T-400-102C, T-400-103C, T-400-113C
T-400-90	Replacement collet cages for: T-400-33C, T-400-34C, T-400-35C, T-400-36C, T-400-48C, T-400-49C, T-400-54C, T-400-55C, T-400-56C, T-400-57C, T-400-58C, T-400-59C, T-400-60C, T-400-61C
T-420-14NS	Replacement collet cages for: T-410-4CN, T-410-5CN, T-410-6CN, T-410-7CN, T-410-72CN, T-410-73CN, T-420-4CN, T-420-5CN, T-420-6CN, T-420-7CN
T-420-14	Replacement collet cages for: T-410-4C, T-410-5C, T-410-6C, T-410-7C, T-410-8C, T-420-4C, T-420-5C, T-420-6C, T-420-7C, T-420-8C, T-420-9C, T-420-10C, T-420-30C, T-470-8C, T-470-12C, T-470-16C

Note:

These items are half cages. Order 2 for complete cage.

Die Ring Lubricant

Catalog Number	Description
T-400-G	1.5 oz. Tube High Efficiency Grease

Note:

See page N-31 for individual collet part numbers.



Refer to pages A-2 and A-3 and machine operator's manuals for safety information.

ET400TP-0001 Crimp Kit for T-400 Crimper

(For Braided Hose sizes -4 thru 16 (no -10) one-wire and two-wire)

Collet Color	Spacer Ring P/N	Spacer Ring
ET400DC-M150S	ET1000SR-M100A	Purple
ET400DC-M195S	T-400-62	Yellow
ET400DC-M230S	T-400-46R	Black/Tan
ET400DC-M245S	ET1000SR-M190D	Lt. Green
ET400DC-M295S	T-400-37	Green
ET400DC-M375S	T-400-10	Black
	ET400SR-002	Black/Green
	T-400-48R	Black/Orange
	ET400SR-003	Black/Purple
	T-400-49R	Black/Silver
	T-400-112	Tan

Note: Also includes 2 each of ET400AR-001 Adapter Ring.

ET420TP-0001 Crimp Kit for T-420 Crimper

(For Braided Hose sizes -4 thru 16 (no -10) for one-wire and two-wire)

Collet Color	Spacer Ring P/N	Spacer Ring
ET400DC-M150S	ET1000SR-M100A	Purple
ET400DC-M195S	T-400-62	Yellow
ET400DC-M230S	T-400-46R	Black/Tan
T-420-86C	ET1000SR-M190D	Lt. Green
ET420DC-M380S	T-400-37	Green
	T-400-10	Black
	T-400-112	Tan
	ET420SR-M495A	Gray
	ET420SR-M255A	Black/Silver
	T-420-29	Orange
	T-420-82R	Black/Blue

ET440TP-0001 Crimp Kit for T-440, ET4000 and ET4001 Crimpers

(For Braided Hose sizes -4 thru 16 (no -10) for one-wire and two-wire)

Collet Color	Spacer Ring P/N	Spacer Ring
ET400DC-M150S	ET4000SR-M100A	Purple
ET400DC-M195S	T-410-41	Yellow
ET400DC-M230S	T-440-78R	Black/Tan
T-440-86C	ET4000SR-M190D	Lt. Green
ET4000DC-M380S	T-410-39	Green
	T-410-10	Black
	T-410-42	Tan
	ET4000SR-M405A	Gray
	ET4000SR-M215A	Black/Magenta
	T-410-93	Orange
	T-440-82R	Black/Blue

ET460TP-0001 Crimp Kit for T-460 Series Crimper

(For Braided Hose sizes -4 thru 8 one-wire)

Collet Color	Spacer Ring P/N	Spacer Ring
ET400DC-M150S	ET1000SR-M100A	Purple
ET400DC-M195S	T-400-62	Yellow
ET400DC-M230S	T-400-46R	Black/Tan
	ET1000SR-M190D	Lt. Green
	T-400-37	Green
	T-400-10	Black
	T-400-112	Tan

ET1000TP-0001 Crimp Kit for ET1000 Crimper

(For Braided Hose sizes -4 thru 16 (no -10) for one-wire and two-wire)

Collet Color	Spacer Ring P/N	Spacer Ring
ET400DC-M150S	ET1000SR-M100A	Purple
ET400DC-M195S	T-400-62	Yellow
ET400DC-M230S	T-400-46R	Black/Tan
T-420-86C	ET1000SR-M190D	Lt. Green
ET420DC-M380S	T-400-37	Green
	T-400-10	Black
	T-400-112	Tan
PUSHER EXTENSION	ET420SR-M495A	Gray
ET1000C-0012	ET420SR-M255A	Black/Silver
	T-420-29	Orange
	T-420-82R	Black/Blue
	T-480-68	Blue

ET480TP-0001 Crimp Kit for T-480 Crimper

(For Braided Hose sizes -4 thru 16 (no -10) for one-wire and two-wire)

Collet Color	Spacer Ring P/N	Spacer Ring
ET400DC-M150S	ET1000SR-M100A	Purple
ET400DC-M195S	T-400-62	Yellow
ET400DC-M230S	T-400-46R	Black/Tan
T-420-86C	ET1000SR-M190D	Lt. Green
ET420DC-M380S	T-400-37	Green
	T-400-10	Black
	T-400-112	Tan
	ET420SR-M495A	Gray
	ET420SR-M255A	Black/Silver
	T-420-29	Orange
	T-420-82R	Black/Blue



Note:
See Crimp Bulletin #W-HOOV-TM001-E2 for proper Collet selection for hose style and size desired.

 Refer to pages A-2 and A-3 and machine operator's manuals for safety information.

'Z' Series Collets

For use with: T-400, T-410, T-420, T-460, T-462, T-465, T-440, T-480, ET1000, ET4000 and ET4001.

Part Number	Description
ET400DC-M150S	Collet – 1/4"
ET400DC-M195S	Collet – 3/8"
ET400DC-M230S	Collet – 1/2"

'Z' Series Collets

For use with: T-400.

Part Number	Description
ET400DC-M245S*	Collet – 5/8"
ET400DC-M295S*	Collet – 3/4"
ET400DC-M375S*	Collet – 1"

* Requires two ET400AR-001 base halves. Sold separately.

'Z' Series Collets

For use with:
T-420, T-480, and ET1000.

Part Number	Description
T-420-85C	Collet – 5/8"
T-420-86C	Collet – 3/4"
ET420DC-M380S	Collet – 1"
ET420DC-M480S	Collet – 1-1/4" 2-wire (20Z series)
ET420DC-M420S	Collet – 1-1/4" 1-wire (20ZA series)

'Z' Series Collets

For use with:
T-410, T-440, ET4000 and ET4001.

Part Number	Description
T-440-85C	Collet – 5/8"
T-440-86C	Collet – 3/4"
ET4000DC-M380S	Collet – 1"
ET4000DC-M480S	Collet – 1-1/4" 2-wire (20Z series)
ET4000DC-M420S	Collet – 1-1/4" 1-wire (20ZA series)
ET4000DC-M530S	Collet – 1-1/2" H190 hose
ET4000DC-M560S	Collet – 1-1/2" H280 hose
ET4000DC-M550S	Collet – 2" H190 & H280 Hose
ET4000DC-M580S	Collet – 2" H290 hose

Coll-O-Crimp Spacer Rings

Spacer Rings



Refer to pages A-2 and A-3 and machine operator's manuals for safety information.



Note:

See Crimp Bulletin # W-H00V-TM001-E2 for proper Spacer Ring selection for hose style and size desired.

Note:

Spacer rings may ONLY be ordered individually, no sets available.

For use with T-400, T-460, T-462, T-465.

* T-400 machine only

Catalog Number	Color 5" Diameter	Catalog Number	Color 5" Diameter	Catalog Number	Color 5" Diameter
T-400-10	Black	T-400-45R*	Black/Yellow	ET1000SR-M100A	Purple
T-400-11	Silver	T-400-46R	Black/Tan	ET1000SR-M190D	Lt. Green
T-400-112	Tan	T-400-47R	Black/Red	ET1000SR-M215A	Magenta
T-400-37	Green	T-400-48R*	Black/Orange	ET400SR-001*	Black/Red
T-400-38	Red	T-400-49R	Black/Silver	ET400SR-002*	Black/Green
		T-400-62	Yellow	ET400SR-003*	Black/Purple

For use with T-420.

Catalog Number	Color 5" Diameter	Catalog Number	Color 5" Diameter	Catalog Number	Color 5" Diameter
T-400-10	Black	T-400-47R	Black/Red	ET1000SR-M100A	Purple
T-400-11	Silver	T-400-62	Yellow	ET1000SR-M190D	Lt. Green
T-400-112	Tan	T-420-29	Orange	ET1000SR-M215A	Magenta
T-400-37	Green	T-420-80R	Black/White	ET420SR-M255A	Blk/Grey
T-400-38	Red	T-420-81R	Black/Orange	ET420SR-M495A	Brown
T-400-46R	Black/Tan	T-420-82R	Black/Blue	ET420SR-M660A	Pink

For use with T-480.

Catalog Number	Color 5" Diameter	Catalog Number	Color 5" Diameter	Catalog Number	Color 5" Diameter
T-400-10	Black	T-400-62	Yellow	ET1000SR-M100A	Purple
T-400-11	Silver	T-420-29	Orange	ET1000SR-M190D	Lt. Green
T-400-112	Tan	T-420-80R	Black/White	ET1000SR-M215A	Magenta
T-400-37	Green	T-420-81R	Black/Orange	ET420SR-M255A	Blk/Grey
T-400-38	Red	T-420-82R	Black/Blue	ET420SR-M495A	Brown
T-400-46R	Black/Tan	T-480-68	Blue	ET420SR-M660A	Pink
T-400-47R	Black/Red	ET1000C-0012	Blue		

For use with T-410, T-440, ET4000.

Catalog Number	Color 5" Diameter	Catalog Number	Color 5" Diameter	Catalog Number	Color 5" Diameter
T-410-10	Black	T-410-93	Orange	ET4000SR-M180A	Blk/Purple
T-410-11	Silver	T-440-78R	Black/Tan	ET4000SR-M050A	Blk/Green
T-410-12	White	T-440-79R	Black/Red	ET4000SR-M560A	Pink
T-410-39	Green	T-440-80R	Black/White	ET4000SR-M100A	Purple
T-410-40	Red	T-440-81R	Black/Orange	ET4000SR-M405A	Brown
T-410-41	Yellow	T-440-82R	Black/Blue	ET4000SR-M345A	Blk/Brown
T-410-42	Tan	ET4000SR-M215A	Blk/Magenta	ET4000SR-M190D	Lt. Green

For use with ET1000.

Catalog Number	Color 5" Diameter	Catalog Number	Color 5" Diameter	Catalog Number	Color 5" Diameter
T-400-10	Black	T-400-62	Yellow	ET1000SR-M100A	Purple
T-400-11	Silver	T-420-80R	Black/White	ET1000SR-M190D	Lt. Green
T-400-37	Green	T-420-81R	Black/Orange	ET1000SR-M215A	Magenta
T-400-46R	Black/Tan	T-420-82R	Black/Blue	ET420SR-M255A	Blk/Grey
T-400-47R	Black/Red	ET1000C-0012	Blue	ET420SR-M495A	Brown
				ET420SR-M660A	Pink

Coll-O-Crimp Pumps

T-481-110 Electric Pump (110 volt)

For use with
T-480-EP,
ET10000.



Pump Specifications

Dimensions

14-14" High x 9-5/8" long x
9-5/8" wide

Weight

32 lbs.

Operation Pressure

0-10,000 psi

Hydraulic Oil

Use Enerpac Oil ONLY

T-482-2 Air/Hydraulic Pump

For use with
T-480-AH,
ET1000

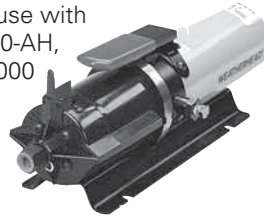

Pump Specifications

Dimensions

5" High, 14-5/8" long, 5-5/8"
wide

Weight

12 lbs.

Operation Pressure:

0-10,000 psi

Hydraulic Oil

Use Enerpac Oil ONLY

T-433 Two-Stage Piston Pump (220v)

For use with T-407 Production
Press, T-400-1
or T-420-1.

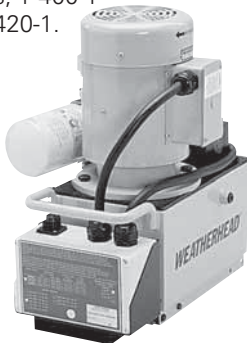

The Weatherhead T-433 two stage piston pump power unit is a high capacity pump especially suited for the T-407 Production crimper. It features a two stage piston pump providing high flow at low pressure for fast ram approach and low flow at high pressure for actual crimping. When used in conjunction with the T-433-2 connector cable, the T-433 can be used as an optional high capacity pump for the T-400-1 or T-420-1 Coll-O-Crimp presses.

Pump Specifications

Dimensions

22" high, 12" long, 15" long

Weight

127 lbs.

Operation Pressure

4,000 PSI

Reservoir Capacity

2 gallons

Outlet Port Size

3/8" Pipe Thread

Motor

1-1/2" H.P., 220 volts 60hz
single phase

Hydraulic Oil

Use Enerpac Oil ONLY

Flow

2.78 GPM @ 800 PSI, 0.52
GPM @ 4000 PSI

Replacement Parts

T-421-FP 220v 4 wire Female
electrical receptacle.

T-433-1 Foot Switch Assembly

T-402-2 Air/Hydraulic Pump

For use with T-400-1.

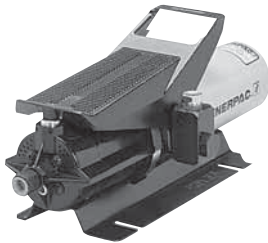

Pump Specifications:

Dimensions:

5-1/4" high, 12-1/2" long,
5" wide

Weight: 18 lbs.

Operation Pressure:

4000-4200 PSI

Reservoir Capacity: 1 pint

Hydraulic Oil

Use Enerpac Oil ONLY

Outlet Port Size

3/8" NPT

Inlet (Air) Port Size

1/4" NPT

Inlet Air Pressure Required

60 to 120 PSI

Note:

It is recommended that a filter, regulator, lubricator, and air pressure gauge be installed in the air line as close as possible to the pump. Filter, Regulator, and Lubricator units not included.

Some models have air port on right side.

T-403-2 Hand Pump

For use with T-400-1.



Pump Specifications:

Dimensions

7 high, 21" long, 4-3/4" wide

Weight

9 lbs.

Operation Pressure:

4000-4200 PSI

Reservoir Capacity

1 qt.

Outlet Port Size

3/8"

NPT Hydraulic Oil

Use Enerpac Oil ONLY

For repair and replacement items for the following pumps please contact an Enerpac Distributor at www.enerpac.com:
T-402-2, T-403-2, T-481-110 & T-482-2.

Coll-O-Crimp Pumps

T-412 • Mobile Electric Pump

For use with T-400-1.



Pump Specifications:

Dimensions: 7-1/2" high, 14-1/2" long, 9" wide

Weight: 65 lbs.

Operation Pressure: 4000-4200 PSI

Reservoir Capacity: 3 quarts

Outlet Port Size: 3/4"-16 straight thread

Motor: 2 volt D.C.

Replacement Parts:

Catalog Number	Description
T-401-1B	Replacement Gasket between motor and square reservoir
T-401-1BC	Breather Cap for Fenner-Stone pumps

Hydraulic Oil: SAE 10W hydraulic oil or (ATF) Automatic Transmission Fluid

Flow: 0.5 GPM

T-421U Electric Pump (220 Volt)

For use with T-400-1 and T-420-1.

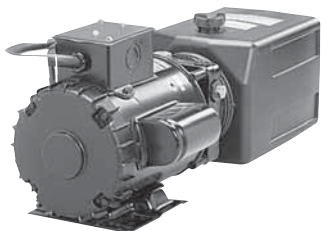

Pump Specifications:

Dimensions: 7-1/2" high, 22" long, 10" wide

Weight: 75 lbs.

Operation Pressure: 4000-4200 PSI

Reservoir Capacity: 6 quarts

Outlet Port Size: 3/4"-16 Straight Thread

Motor: 1 H.P., 3450 R.P.M., 220 volts, 60 cycle, single phase
At 50 Hertz, RPM = 2,850
At 60 Hertz, RPM = 3,450

Hydraulic Oil*: ISO 32 hydraulic oil or (ATF) automatic transmission fluid

*For low temperature applications automatic transmission fluid can be substituted.

Flow: 2.5 GPM @ 750 PSI, 0.5 GPM @ 4000 PSI

Note:

It is recommended that the electric pump be used on a 15 amp. fused circuit. Pump wired for 220 volts, single phase.

Replacement Parts:

Catalog Number	Description
140-06761	Relay for T-421U, T-441 and T-441 pumps only
T-421U-BC	Breather Cap - twist lock
T-421-FP	220v 4 wire Female electrical receptacle
T-401-1BC	Breather Cap → threaded

T-421U-110 Electric Pump (110 Volt)

For use with T-400-1 and T-420-1.

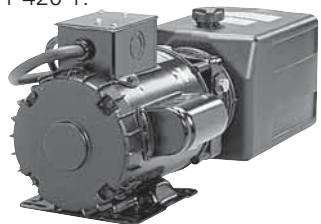

For dimensional data other than voltage information, refer to T-421U see above.

Note: It is recommended that the electric pump be used on an individual 30 amp. fused circuit.

Pump wired for 110 volts, single phase.

Assembly Equipment

T-441 Electric Pump (220 Volt)

For use with T-440-1 and ET4000 only.

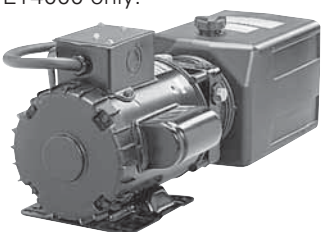

The Weatherhead T-441 power unit is designed for use with the latest Coll-O-Crimp II Plus press. It features a two-stage pump providing high flow at low pressure for fast ram approach and low flow at high pressure for actual crimping.

Pump Specifications:

Dimensions: 7-1/2" high, 22" long, 10" wide

Weight: 75 lbs.

Operation Pressure: 5,000 PSI

Reservoir Capacity: 6 quarts

Outlet Port Size: 3/4"-16 Straight Thread O-Ring

Motor: 1 H.P., 3450 R.P.M., 220 volts, 60 cycle, single phase

Hydraulic Oil: ISO 32 hydraulic oil automatic transmission fluid

Flow: 2.5 GPM @ 750 PSI, 0.5 GPM @ 5000 PSI

Replacement Parts:

T-421U-BC	Breather Cap
T-421-FP	220v 4 wire Female electrical receptacle.
140-06761	Relay for T-421U or T-421U-110 pumps

Note:

T441 pump is to be used with T440-1 and ET4000 press only. When replacing the pump on a standard T-410 Coll-O-Crimp II Press (without the black switchbox on the side of the press) refer to the repair and replacement items on page N-23.)

Coll-O-Crimp Pumps

T-460-2 Hand Pump

For use with T-450-1, T-460 and T-465



Pump Specifications

Dimensions
5-5/8" High, 13-1/4" long,
3-3/4" wide

Weight
4-1/2 lbs.

Operation Pressure
0-10,000 PSI

Reservoir Capacity
20 cu in.

Relief Valve Setting
10,000 PSI

Hydraulic Oil:
Use Enerpac Oil ONLY

Note:
For repair and replacement items for the following pumps please contact an Enerpac Distributor at www.enerpac.com:

T-402-2, T-403-2, T-433, T-460-2, T-462-2, T-480-2, T-480-3, T-481-110 & T-482-2.

T-462-2 Air/Hydraulic Pump

For use with T-462.

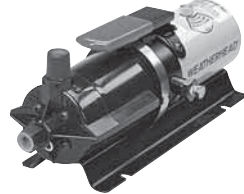

The Weatherhead T-462-2 power unit is a air/hydraulic pump designed for use with the T-462 portable system. Ideal if you have the availability of compressed air in your shop or in the field via a portable compressor.

Pump Specifications

Dimensions
4" high, 13" long

Weight
8 lbs.

Operation Pressure
0-10,000 PSI

Reservoir Capacity
10 cu in.

Relief Valve Setting
10,000 PSI

Hydraulic Oil
Use Enerpac Oil ONLY

Regulator to be set for 100-120 PSI inlet air.

Repair and Replacement Items for Discontinued T-401-1 Pump

Catalog Number	Description
T-401-1BC	Breather Cap for Fenner-Stone pumps
T-401-1S	Toggle Switch
T-401-SVF	Shuttle Valve for Fenner-Stone pump

T-480-2 Two-Stage Hand Pump

For use with T-480-HP, ET1000



Pump Specifications:

Dimensions
7-3/16" high x 21-1/64" long x 4-3/4" wide

Weight
9 lbs.

Operation Pressure
0-10,000 PSI

Hydraulic Oil
Use Enerpac Oil ONLY

T-480-3 Turbo Air/Hydraulic Pump

For use with T-480-TA.



Pump Specifications

Dimensions
8-1/4" High x 12-3/8" long x 8" wide

Weight
16-1/2 lbs.

Operation Pressure
0-10,000 PSI

Hydraulic Oil:
Use Enerpac Oil ONLY

For repair and replacement items for the following pumps please contact an Enerpac Distributor at www.enerpac.com:

T-402-2, T-403-2, T-460-2, T-462-2, T-480-2, T-480-3, T-481-110 & T-482-2.

T-421-FP 4-Prong Female Electrical Outlet

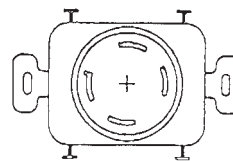

All Weatherhead 220v Coll-O-Crimp power pumps are equipped with a four prong electrical outlet as illustrated.

To obtain corresponding female wall receptacle order T-421-FP. For use with T-421U, T-441 & T-433 pumps.

Tooling - Competitor Conversion Kits

Conversion Tooling

 Refer to pages A-2 and A-3 and machine operator's manuals for safety information.

T-400-NP60 Dayco to Weatherhead Conversion Kit



The T-400-NP60 Conversion Kit is designed to allow the use of standard Weatherhead Coll-O-Crimp tooling, hose, and hose ends in the Dayco NP60, (2) tie rod, crimp machine. Everything is included to convert the crimper to accept Weatherhead tooling. This kit gives the crimper capacity to crimp up to and including 1-1/4" I.D. 4-spiral wire hose assemblies.

T-400-NP60 Kit Includes:

Part Description	Qty
Base Plate Assembly	1
Dayco Pusher Spacer	1
3/8-16 x 1.75 Cap Screw	1
Adapter Ring for T-400 Collets	1
Instruction Kit	1

T-400-DE60 Dayco to Weatherhead Conversion Kit



See pages N-26-32 for collets and spacer rings.

The T-400-DE60 Conversion Kit is designed to allow the use of standard Weatherhead Coll-O-Crimp tooling, hose and hose ends in the Dayco DE60, (4) tie rod, crimp machine. Everything is included to convert the crimper to accept Weatherhead tooling. This kit gives the crimper capacity to crimp up to and including 1-1/4" I.D. 4-spiral wire hose assemblies.

T-400-DE60 Kit Includes:

Part Description	Qty
Base Plate Assembly	1
Dayco Pusher Spacer	1
3/8-16 x 1.75 Cap Screw	1
Adapter Ring for T-400 Collets	1
Instruction Kit	1

T-400-GT Gates PC707 Conversion Kit



The T-400-GT Conversion Kit is designed to allow the use of standard Weatherhead Coll-O-Crimp tooling, hose, and hose ends in the Gates PC707 crimper. Everything is included to convert the crimper to accept Weatherhead tooling. This kit gives the crimper capacity to crimp up to and including 1-1/4" I.D. 2-wire hose factory-type hose assemblies.

This kit does not include the T-400-8 Die Ring which is required for crimping. If you do not already have the die ring or collets, you can order the kit to the right.

T-400-GT kit includes:

Pusher, 10-24 x 1/4 Set Screws (2), Spacer (2), Instructions

T-400-GTK • Gates PC707 Conversion Kit

Kit includes one each of the following:

Catalog Number	Description
T-400-GT	Conversion Kit
T-400-2C	'U' Series Collet – 1/4"
T-400-3C	'U' Series Collet – 3/8"
T-400-4C	'U' Series Collet – 1/2"
T-400-5C	'U' Series Collet – 3/4"
T-400-6C	'U' Series Collet – 1"
T-400-8	Die Ring – 3/16" thru 1-1/4"
T-400-10	Spacer Ring – Black
T-400-11	Spacer Ring – Silver

T-400-PH Parker 80c Conversion Kit

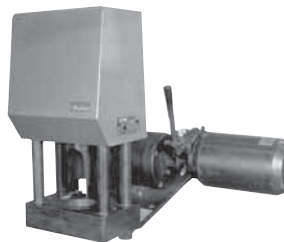

The T-400-PH Conversion Kit is designed to allow the use of standard Weatherhead Coll-O-Crimp tooling, hose, and hose ends in the Parker 80c crimper. Everything is included to convert the crimper to accept Weatherhead tooling. This kit gives the crimper capacity to crimp up to and including 1-1/4" I.D. 2-wire hose factory-type hose assemblies. If you do not already have the collets and spacer rings, you can order the kit to the right.

T-400-PH Kit includes:

1/4-20 x 1 Cap Screw (4), Dowel Pin Spacer (2), 1/4" Lockwasher (4), Spacer Bracket (4), Adapter Die Ring, Instructions

T-400-PHK • Parker 80c Conversion Kit

Kit includes one each of the following:

Catalog Number	Description
T-400-PH	Conversion Kit
T-400-2C	'U' Series Collet – 1/4"
T-400-3C	'U' Series Collet – 3/8"
T-400-4C	'U' Series Collet – 1/2"
T-400-5C	'U' Series Collet – 3/4"
T-400-6C	'U' Series Collet – 1"
T-400-10	Spacer Ring – Black
T-400-11	Spacer Ring – Silver

Tooling

Tube Flaring Tools

T-1290 • Segmented Flaring Tool (37°)

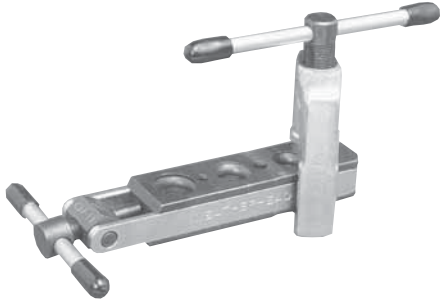

Hard chrome-finished cone makes exceptionally smooth flares and minimizes amount of effort needed. Forged steel yoke for maximum strength. Sliding die blocks lock in place by lever clamp action.

Flaring Capacity

3/16", 1/4", 5/16", 3/8", 1/2" and 5/8" O.D. Forms 37° SAE flares in soft copper, aluminum, brass, and Bundyweld tubing.

Weight

1 lb., 11 oz.

T-1295 • Heavy-Duty Segmented Flaring Tool (37°)

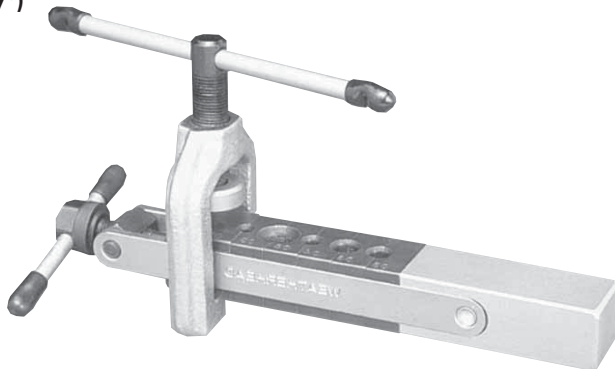

Ideal for use where considerable number of 37° flares in stainless steel tubing must be made. Built to withstand continuous rugged service. Ball thrust mechanism reduces effort required. Hardened tool steel die features non-slip grip of tubing – even after repetitive flaring. Bar has vise extension.

Flaring Capacity

1/8", 3/16", 1/4", 5/16", 3/8", and 1/2", O.D. tubing. Forms 37° SAE flares in annealed stainless steel (MIL-T-6845 or AMS-5566), cold drawn stainless steel, and annealed copper, brass, steel, or aluminum.

Weight

3 lbs.

Tooling

Hose Cutting Equipment

 Refer to safety information regarding Coll-O-Crimp hose, hose fittings and assembly equipment compatibility on pages A-2-3.

T-60A Portable Cutter



An excellent heavy-duty cutting machine. The T-60A is a portable power saw that can cut all hoses, including wire-reinforced. Includes three abrasive blades.

Replacement Blade T-1060A 14" diameter

Motor
3-1/2 H.P., 110/115 volts

Amps
15 amps

Weight
45 lbs.

RPM
3500

Note
Three blades are mounted on shaft for shipping purposes. Remove prior to use.

T-10B Hose Cutting Machine



The T-10B hose cutting machine assures quick, clean, right angle cuts, eliminating ragged and frayed cut ends which make hose assembly difficult and are a possible cause of premature hose failure. A powerful 1 H.P. motor and belt-driven blade cut all low, medium, and high pressure fabric and wire-braided hose from 3/16" through 1-1/4" I.D. 2 wire hose. Specifically designed for cutting hose, the T-10B is a natural companion to the T-400-1 Coll-O-Crimp and T-300 hose assembly machines.

Ordering Options
T-10B= saw with smooth edge blade for cutting up to 1-1/4" 1-wire hose

T-10B-1= saw with scalloped edge blade for cutting up to 1-1/4" 2-wire hose.

Replacement Blades
T-1047 (Smooth)

T-1047-1 (Scalloped)

Replacement Belt for T-10B & T-10C
T-10V-1 Belt

Motor
1 H.P., 3450 RPM, 115, 60 cycle, single phase

Size
13" wide, 24" long, 17" high

Weight
85 lbs.

Amps Drawn
115 volts – 15 amps

Replacement Parts
T-10-D Hose/Dowel
T-10-H Handle
T-10-P Pusher

Tooling

Hose Cutting Equipment

 Refer to safety information regarding Coll-O-Crimp hose, hose fittings and assembly equipment compatibility on pages A-2-3.

T-9-1 & T-9-3 Hose Cutting Machine



The T-9-1 and T-9-3 provide the capability for cutting multi-spiral and braided wire-reinforced hose through 2" I.D. Either machine is a perfect companion for the ET4000 press. Includes scalloped blade.

Note
The T-9-1 and T-9-3 are shipped less a line cord and plug. An electrician is recommended for direct electrical hook-up.

T-9-1

Motor
3 H.P., 230 volts, 60 cycle, single phase

Size
24" wide, 24" deep, 24" high

Weight
Approx. 255 lbs.

Amps Drawn
At 230 volts – 17

T-9-3

Motor
3 H.P., 230 volts, 60 cycle, 3 phase

Size and Weight
Same as T-9-1

Amps Drawn
At 230 volts – 8 amps

Replacement Blade:
T-75-14 Scalloped
T-75-17 Carborundum
T-75-11 Smooth

Guard
T-9-G

T-71 Hose Cutting Machine



This cutting machine easily handles all 1 and 2 braided wire hose through 4" I.D., up to 2" I.D. 4-spiral and up to 1-1/2" I.D. 6 multi-spiral reinforced hose. That makes this machine ideal for cutting most hydraulic and pneumatic hoses as well as a variety of industrial fluid transfer hoses. The T-71 uses a 14" cutting blade, T-1070, for cutting all 1 & 2 wire braid and through 2" 4 spiral hose. The scalloped toothed blade T-1071, is for cutting industrial transfer hoses through 4" and the smooth

beveled blade, T-1072, for cutting hose with a wire braid cover. T-71 includes a scalloped blade.

The T-71 is shipped with a scalloped blade, T-1070.

Replacement Blade

T-1070 Steel Scalloped

T-1071 Steel Scalloped Toothed

T-1072 Steel Smooth Beveled

Motor
4.5 H.P., 110/115 volts, single phase, 60 cycle

Size
22" wide, 19" deep, 25" high

Weight
Approx. 85 lbs.

Amps Drawn
115 volts – 20 amp

Hose Cutting and Skiving Wheels



Part Number	Type	Blade Dia.	Hole Dia.	Applicable Machinex
Cutting Wheels				
T-1042	Carborundum	8"	5/8"	T-10A
T-1047	Steel Smooth	7"	5/8"	T-10B & T-10C
T-1047-1	Steel Scalloped	7"	5/8"	T-10B & T-10C
T-1060	Carborundum	12"	1"	T-60
T-1060A	Carborundum	14"	1"	T-60A
T-1070	Steel Scalloped	14"	1"	T-70, T-71
T-1071	Steel Scalloped Toothed	14"	1"	T-70, T-71
T-1072	Steel Smooth Beveled	14"	1"	T-70, T-71
T-75-11	Steel Smooth	10"	3/4"	T-9/T-75
T-75-14	Steel Scalloped	10"	3/4"	T-9/T-75
T-75-17	Carborundum	10"	3/4"	T-9/T-75
Skiving Wheels				
T-75-12	Wire	8"	1"	T-75
Belts				
T-76-B	Reinforced	1"		Old T-76/T-76-1

Tooling

Hose Cutting Equipment

 Refer to safety information regarding Coll-O-Crimp hose, hose fittings and assembly equipment compatibility on pages A-2-3.

T-1037 Knife



An inexpensive, reliable knife useful in splitting twin-line and multiple-line hoses quickly and easily.

Replacement Blade T-1037B

Replacement Handle T-1037H

T-135 Plastic Tube and Hose Cutter



An economical alternative to quality tube and hose cutting. This versatile tool is lightweight and durable for long service life.

Replacement Blade T-135B

Capacity
Up to 1" hose I.D.

Note
Not for use with wire-reinforced hose.

T-191 Plastic Tube and Hose Cutter

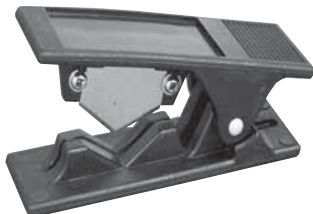

Only 2-7/8" long, the versatile T-191 offers quick and clean square cuts on 1/16" to 1/2" O.D. plastic tubing and non-wire reinforced hose. The T-191 can be either bench or wall mounted and offers the safety of closing automatically when not in use.

Spare Parts
T-191B Replacement Blade
(one per package)

Tooling

Presetting Tools

T-570-1 Ermeto-Quick Set™ Preset Machine

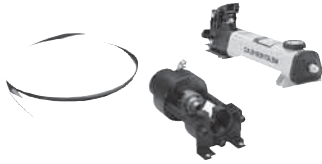

The Ermeto-Quick Set Machine is ideal for bulk assemblies. It has a positive-stop action, which guarantees uniform repeatability, and a hand pump operation which yields quick cycle time, reducing assembly time. The T-570 is an easy tool to use that will save you time and money.

T-570 Package includes:

Part Number	Description
T-460-2	Hand Pump (10,000 PSI)
T-450-3	Quick Disconnect Hose Assembly
T-570-1	Ermeto Preset Machine
T-570-4	Preset Die
T-570-6	Preset Die
T-570-8	Preset Die
T-570-12	Preset Die
T-570-16	Preset Die
T-571-4	Tube Support
T-571-6	Tube Support
T-571-8	Tube Support
T-571-12	Tube Support
T-571-16	Tube Support

-10, -20, -24, and -32 sizes also available.

Ermeto Hand Presetting Tools 7000 Series



Presetting tools provide a more accurate and positive leak-proof method of coupling flareless fittings. Presetting steel Ermeto sleeves on tubing prior to fitting assembly will permit the maximum high performance obtainable with flareless fittings. Due to possible thread galling, the use of presetting tools is required when assembling stainless steel fittings.

Part Number	Tube O.D. (Inches)	Thread Size
T-7002	1/8	5/16-24
T-7003	3/16	3/8-24
T-7004	1/4	7/16-20
T-7005	5/16	1/2-20
T-7006	3/8	9/16-18
T-7008	1/2	3/4-16
T-7010	5/8	7/8-14
T-7012	3/4	1 1/16-12
T-7016	1	1 5/16-12
T-7020	1-1/4	1 5/8-12
T-7024	1-1/2	1 7/8-12
T-7032	2	2 1/2-12

Metric Flareless Hand Presetting Tools

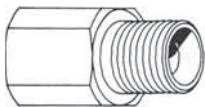

Presetting tools provide a more accurate and positive leak-proof method of coupling flareless fittings. Presetting the steel metric sleeves prior to fitting assembly will permit the maximum high performance obtainable with flareless fittings. These tools are available for both the Light (DIN 3901/3902L) flareless series.

Light Series 3901/3902L

Part Number	Tube O.D. (mm)	Thread Size
TL-7008	8	M14x1.5
TL-7010	10	M16x1.5
TL-7012	12	M18x1.5
TL-7015	15	M22x1.5
TL-7018	18	M26x1.5
TL-7022	22	M30x2.0
TL-7028	28	M36x2.0

Tooling

Hose Bore Cleaning Brushes

Individual Brushes



Hose I.D. (inch)	Part Number	Bristle O.D. (inch)	Bristle Length (inch)	Overall Length (inch)
3/16-3/8	T-1106	3/8	2	24
1/2-5/8	T-1110	1/2	3	24
3/4-1	T-1116	1	4	24
1-1/8-1-1/2	T-1124	1-1/2	4	24
2-3	T-1132	2	5	24

T-1100 3-Piece Kit



Hose I.D. (inch)	Part Number	Bristle O.D. (inch)	Bristle Length (inch)	Overall Length (inch)
3/16-3/8	T-1106	3/8	2	24
1/2-5/8	T-1110	1/2	3	24
3/4-1	T-1116	1	4	24

Tooling

Skiving Tools and Wrenches

Hand Skiving Tool

(For H470 Hose)



Order hand skiving tool components by the individual catalog numbers listed.

See page A-30 for skiving instructions.

T-410-36

Handle

T-410-37

Replacement cutting blades

Hose Size	Skiving Tool Cutting Head H470
1/2" I.D.	T-410-50
3/4" I.D.	T-410-52
1" I.D.	T-410-53
1-1/4" I.D.	T-410-54
1-1/2" I.D.	T-410-55
2" I.D.	T-410-56

Rapid Wrenches



The Rapid Wrench is a heavy-duty, high quality wrench that ratchets for quick installation and removal of tube fittings and hose ends. These wrenches have jaws that snap open and close completely around the fitting giving 6-point contact. Needing only 30° of rotation to ratchet, they allow easy access to tight locations. Available individually or in a set with pouch, these wrenches are a welcome addition to any tool box.

T-152

11-Piece Set with Pouch

T-152P

Pouch for 11-Piece Set

Catalog Number	Wrench Hex Size
T-140	3/8"
T-141	7/16"
T-143	9/16"
T-144	5/8"
T-145	11/16"
T-146	3/4"
T-147	13/16"
T-148	7/8"
T-151	15/16"
T-149	1"

Tooling

Power Steering Make-Up Information

H32406 Passenger Car Power Steering Hose



The Coll-O-Crimp System may be used to supplement the original equipment-type power steering hose assembly inventory by using hose ends listed below and tubing (from the old hose assembly) to duplicate out-of-stock or slow-moving hose assemblies.

Reinforcement

2 Fiber Braids

Cubical Expansion

8 to 17 cc ft. @ 1300 psi

Operating Temperature

-40°F to +250°F

SAE J188 Type 2

Hose I.D.	Hose O.D.	Catalog Number	Recom. Oper. Press.	Min. Burst Press.	Bend Radii
3/8	13/16	H32406	1500	6000	3-1/8

All dimensions in inches; pressure in psi

On many of late model cars the formed tubing from the old line with its complicated bends can be utilized to make up a new assembly. Just use a tube cutter to cut the old tube as close to the hose as possible, then make up a hose assembly with a flareless tube end (i.e., 06U-756) and attach to the old tubing. Reference flareless tube assembly instructions on page L-78.

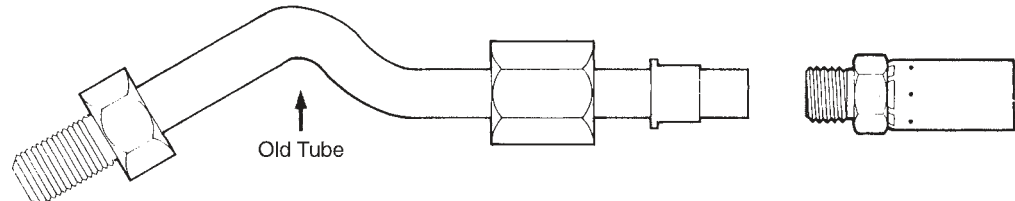

42x6
SAE 45° flare union

252x6, 252x7
Inverted flare to female pipe

1439, 1440, 41157x6
O-ring port to JIC 37° flare
M41157x6x14, M41157x6x16, M41157x6x18
Metric o-ring port to JIC 37° flare

1444, 1445, 1446, 1447
O-ring port to female inverted flare

1553, 1554, 1563
Inverted flare to SAE 45° flare

Tooling

Power Steering Make-Up Information

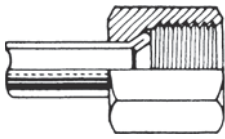

Original End

1/4" SAE Swivel 7/16-20

Configuration	Use Part Number
Straight	06U-604
45° Elbow	06U-684
90° Elbow (Short)	06U-664
90° Elbow (Long)	06U-644
Reuse old tube	06U-754

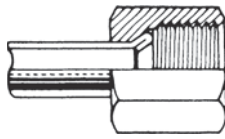

Original End

5/16" SAE Swivel 1/2-20

Configuration	Use Part Number
Reuse old tube	06U-755

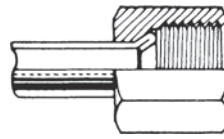

Original End

3/8" SAE Swivel 5/8-18

Configuration	Use Part Number
Straight	06U-406
45° Elbow	06U-486
90° Elbow	06U-446
Reuse old tube	06U-756

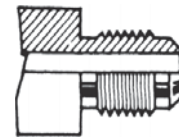

Original End

3/8" SAE 45° Rigid 5/8-18

Configuration	Use Part Number
Straight	06U-406 with 42x6
45° Elbow	06U-486 with 42x6
90° Elbow	06U-446 with 42x6
Reuse old tube	06U-756

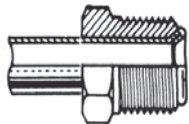

Original End

1/4" Inv. Swivel 7/16-24

Configuration	Use Part Number
Straight	06U-B04
45° Elbow	06U-B44
90° Elbow	06U-B64
Reuse old tube	06U-754

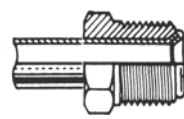

Original End

5/16" Inv. Swivel 1/2-20

Configuration	Use Part Number
Straight	06U-B05 or 06U-406 with 1553
45° Elbow	06U-B45 or 06U-486 with 1553
90° Elbow	06U-B65 or 06U-446 with 1553
Reuse old tube	06U-755

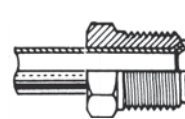

Original End

3/8" Inv. Swivel 5/8-18

Configuration	Use Part Number
Straight	06U-B06 or 06U-406 with 1563
45° Elbow	06U-B46 or 06U-486 with 1563
90° Elbow	06U-B66 or 06U-446 with 1563
Reuse old tube	06U-756

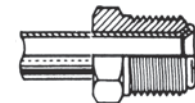

Original End

1/4" Inv. Swivel 7/16-24

Configuration	Use Part Number
Straight	06U-B04
45° Elbow	06U-B44
90° Elbow	06U-B64
Reuse old tube	06U-754

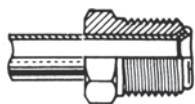

Original End

7/16" Inv. Swivel with 3/8" Tube Opening 11/16-18

Configuration	Use Part Number
Straight	06U-B07 or 06U-406 with 1554
45° Elbow	06U-B47 or 06U-486 with 1554
90° Elbow	06U-B67 or 06U-446 with 1554
Reuse old tube	06U-756
New tubing/nut	105x6x7



Original End

3/8" Inv. Seat 5/8-18

Configuration	Use Part Number
Straight	06U-104 with 252x6

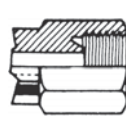

Original End

7/16" Inv. Seat 11/16-18

Configuration	Use Part Number
Straight	06U-104 with 252x6

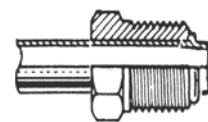

Original End

O-Ring Tube End 3/8" Tube – 5/8-18

Configuration	Use Part Number
Straight	06U-606 with 41157x6
45° Elbow	06U-686 with 41157x6
90° Elbow	06U-666 with 41157x6
Reuse old tube	06U-756

Tooling

Power Steering Make-Up Information

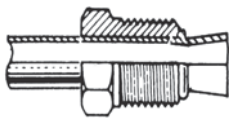

Original End

O-Ring Tube End (Chrysler)
5/16" Swivel 1/2-20

Configuration	Use Part Number
Reuse old tube	06U-755

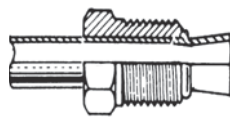

Original End

O-Ring Tube End (Ford) 1/4"
Tube –9/16-18 (Special)

Configuration	Use Part Number
Straight	06U-604 with 1440
45° Elbow	06U-684 with 1440
90° Elbow	06U-664 with 1440
Reuse old tube	06U-755

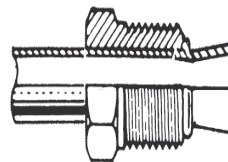

Original End

O-Ring Tube End 3/8"
Tube – 5/8-18 (Special)

Configuration	Use Part Number
Straight	06U-606 with 1439
45° Elbow	06U-686 with 1439
90° Elbow	06U-666 with 1439
Reuse old tube	06U-756

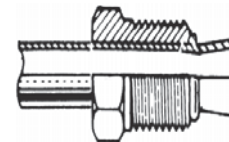

Original End

O-Ring Tube End (Ford) 7/16"
Tube –11/16-18 (Special)

Configuration	Use Part Number
Straight	06U-B06 with 1444
45° Elbow	06U-B46 with 1444
90° Elbow	06U-B66 with 1444
Reuse old tube	06U-756

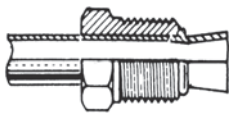

Original End

O-Ring Tube End 3/8"
Tube – M14x1.5

Configuration	Use Part Number
Straight	06U-B06 with 1445
45° Elbow	06U-B46 with 1445
90° Elbow	06U-B66 with 1445
Reuse old tube	06U-756

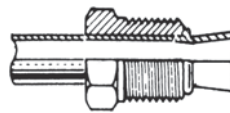

Original End

O-Ring Tube End 3/8"
Tube – M16x1.5

Configuration	Use Part Number
Straight	06U-B06 with 1446
45° Elbow	06U-B46 with 1446
90° Elbow	06U-B66 with 1446
Reuse old tube	06U-756

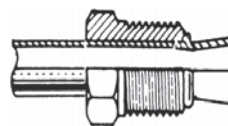

Original End

O-Ring Tube End 3/8"
Tube – M18x1.5

Configuration	Use Part Number
Straight	06U-B06 with 1447
45° Elbow	06U-B46 with 1447
90° Elbow	06U-B66 with 1447
Reuse old tube	06U-756

Tooling

Cable Controls

Vernier Controls

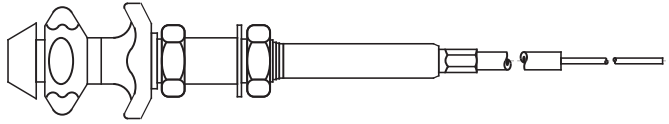

Catalog Number: 8374

Advanced styling. Meets or exceeds OEM specifications. Non-Corrosive aircraft aluminum body and stainless steel shaft assures 400-hour salt spray test without corrosion

A direct replacement for most "Remote Throttle

Controls"; Mack Truck 21QB-180 Series, Kenworth K068B Series, Peterbilt 05-1462 Series, Volvo-White 13401 Series, I.H. 34084 Series, Muncie COCL Series, BPC VCG Series. Also replaces most garage and service station wreckers remote control throttles; Earnest Holmes, Dover, etc.

Turn-To-Lock Controls (T-Locking)

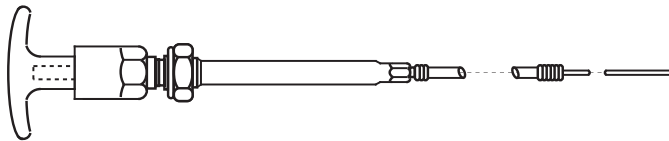

Catalog Numbers: 8370, 8371

Positive action control for small to mid-size engine throttles, governors, chokes, fuel shut-offs and more.

Aluminum body assures rust free performance. Acetal Locking bushing guarantees never before possible settings with one-third operator effort. Replaces Muncie COCL Series, and BPC R09 Series.

Power Take Off Controls (Ball Knob)

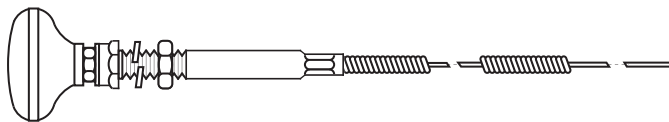

Catalog Numbers: 8372, 8373

Utility grade as exact replacement for most P.T.O. Controls.

Features 2" round knobs, galvanized steel, vinyl-covered casing and steel inner wire. All P.T.O. Controls meet or exceed OEM specifications. Replaces BPC R-38DS, R04, R38 and R38D Series, Muncie COKB Series.

Utility Light Load Controls (Dash)



Catalog Numbers: 8375, 8376, 8377, 8378

Universal light load choke, fuel-shutoff, throttle, hood, Trunk and more! Controls are designed for most engine applications. Stainless steel inner-wire resists corrosion and assures trouble-free operation. Vinyl coated.

Throttle Stop



Catalog Number	Description
1548	.081" dia. hole (#46)

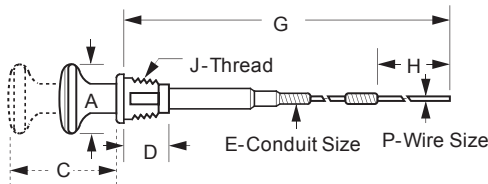

Specification Chart On Weatherhead "Push-Pull" Controls

Description	Dash				T-Hood	T-Locking	PTO Control		Vernier	Deluxe PTO Control		
Catalog Number	8375	8376	8377	8378	8367	8370	8371	8372	8373	8374	106370	106470
Length of "G"	84"	84"	84"	60"	180"	126"	186"	81"	165"	120"	192"	300"
Length of Wire "H"	9-3/8"	9-3/8"	9-3/8"	7"	5"	6"	6"	3"	3"	4-1/2"	12"	12"
Knob Type	Round				T-Handle	T-Handle	Round		Round	Round		
Knob Size "A"	1.06"				2"	2"		2"	2"	2"		
Knob Color	Black				Chrome	Chrome	Black		Black	Red		
Knob Material	Plastic				Cast Zinc	Nylon	Plastic		Plastic	Plastic		
Knob Lettering	Choke	Throttle	None	None	None	Lock	None		None	None		
Knob Travel "C"	2-1/2"				2-1/2"	3"	3-1/2"		3-3/8"	4-1/2"		
Thread Size "J"	3/8"-24				3/8"-24	7/16"-20	7/16"-20	3/4"-16	1/2"-20			
Thread Length "D"	1/2"				1/2"	3/4"	1-5/32"		2-1/2"	1-1/8"		
Conduit Size "E"	3/16"				3/16"	3/16"	1/4"		1/4"	3/8"		
Conduit Material & Style	Galvanized Steel				Steel	Galvanized Steel	Galvanized Steel		Galvanized Steel	High Carbon		
	Vinyl	Vinyl	Vinyl	Vinyl	Cover	Vinyl Covered	Vinyl Covered		Vinyl Covered	Polyethylene Lining & Cover		
Wire Size "P"	.054"				.054"	.054"	.088"		.0625"	.088"		

Assortments

AB-8 & AB-9 Air Brake Air Chamber Hose



Assembly Assortment of 3/8" and 1/2" I.D. Lines

Each selection of fourteen ready-made air chamber hose assemblies facilitate replacement of hoses. Eliminates time and cost of making special assemblies. Wall rack keeps assemblies handy and ready to use.

AB-8 • 1/2" I.D. Air Brake Air Chamber Lines

Length	Quantity	Part Number
18-1/2"	1	38353-01800
20-3/8"	2	38353-02037
24-1/8"	2	38353-02400
28-3/8"	2	38353-02837
30-1/8"	2	38353-03000
32"	1	38353-03200
34-3/8"	1	38353-03437
36-1/8"	2	38353-03600
41-1/8"	1	38353-04112
	1	AB-8X (rack only)

Replacement Labels: AB-8L

AB-9 • 3/8" I.D. Lines Air Brake Air Chamber Lines

Length	Quantity	Part Number
18-1/2"	1	38166-01812
20-3/8"	2	38166-02137
24-1/8"	2	38166-02412
28-3/8"	2	38166-02837
30-1/8"	2	38166-03012
32"	1	38166-03200
34-3/8"	1	38166-03437
36-1/8"	2	38166-03612
41-1/8"	1	38166-04112
	1	AB-9X (rack only)

Replacement Labels: AB-9L

CA-130 & CA-230 Clamp Assortments



You can now increase your all-stainless steel or part-stainless steel clamp sales with these all-purpose clamp assortments. These rugged assortments can be wall mounted or stand free using less than 2 sq. ft. of counter space. They load easily and organize your merchandise effectively.

CA-130 Part-Stainless Steel

Part Number	Quantity
6205-004	20
6205-006	10
6203-010	20
6203-016	20
6203-020	20
6203-024	10
6203-036	10
CA-10X (rack only)	1

CA-230 All-Stainless Steel

Part Number	Quantity
6206-004	20
6206-006	10
6204-010	20
6204-016	20
6204-020	20
6204-024	10
6204-036	10
CA-10X (rack only)	1

RG-24 Hydraulic O-Ring Assortment

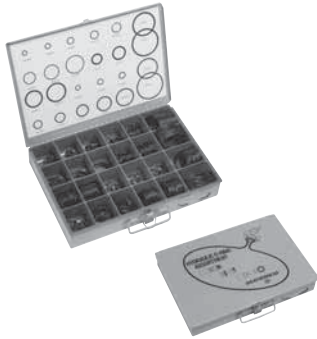

The Weatherhead RG-24 assortment is your solution to storing a useful inventory of hydraulic o-rings. This kit contains o-rings for Weatherhead straight thread and FOR-SEAL® tube fitting applications as well as popular split flange hydraulic applications. The RG-24 comes enclosed in a handy

steel case with a carrying handle. Consider an RG-24 for an over-the-counter sales merchandiser or keep one in your equipment shop or maintenance trailer to prepare for those critical “got-to-have-it” applications.

Twenty-four individual compartments keep your

hydraulic o-ring inventory separated by part number, and labeled illustrations on the inside of the assortment prevent the mix-up of o-rings. Compact, organized, and reasonably priced, if you specialize in hydraulic applications that call for o-rings — we’ve got your number — RG-24.

RG-24 • O-Ring Assortment Contents

Part Number	Split Flange Quantity	Part Number	FOR-SEAL Quantity	Part Number	Straight Thread Quantity
8x252	12	4629x4	12	7629x4	12
12x252	12	4629x6	12	7629x5	12
16x252	12	4629x8	12	7629x6	12
20x252	12	4629x10	12	7629x8	12
24x252	12	4629x12	12	7629x10	12
32x252	12	4629x16	12	7629x12	12
		4629x20	12	7629x16	12
		4629x24	12	7629x20	12
				7629x24	12
				7629x32	12

FL-310 Fuel Hose and Fittings Assortment

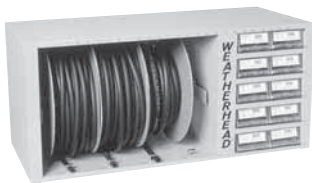

FL-310 contains 250' of Weatherhead fuel line hose, a variety of brass hose end fittings, and gear-type clamps for easy, instant service on fuel and oil line assemblies.

A well-designed cabinet keeps 1/4", 5/16", or 3/8" I.D. hose on reels free of kinks and tangles ready for instant

use. Ten clear plastic drawers with color-coded illustrated labels are provided for storing hose end fittings and clamps. H057 hose is compatible with unleaded gasolines and low pressure fuel systems.

Size

30" wide, 13-1/2" high, 13" deep

Part Number	Quantity	Part Number	Quantity
05704B-102	10	05706B-104	10
05704B-104	5	05706B-106	5
05704B-C02	5	05706B-1568	5
05705B-102	10	05706B-1570	5
05705B-104	10	05706B-C02	5
05705B-1560	5	05706B-C04	5
05705B-1561	5	6205-004	20
05705B-C02	5	CL-434	1
05705B-C04	5	FL-310X	1
05706B-102	10	H05704	100'
		H05705	100'
		H05706	50'

Assortments

SR3100W Weatherhead Air Conditioning Assortment



Air conditioning assortment kit; containing the most popular steel air conditioning hose ends for use with H757 air conditioning hose.

Included in Kit (various sizes)

- Bumped tube o-ring male swivels
- Bumped tube o-ring male swivel 90° tube elbows
- Bumped tube o-ring female swivels
- Bumped tube o-ring female swivel 90° tube elbows
- O-Ring Assortment
- Stackable sturdy steel case (18" x 12" x 3")

Part Number	Qty.	Part Number	Qty.	Part Number	Qty.	Part Number	Qty.
75706E-Z47	4	75706E-Z87	4	75708E-Z08	4	ZW74706	4
75708E-Z49	4	75708E-Z89	4	75710E-Z10	4	ZW74708	4
75710E-Z51	4	75710E-Z91	4	75712E-Z12	4	ZW74710	4
75712E-Z51	4	75712E-Z91	4	75706E-Z66	4	ZW74712	4
75712E-Z53	4	75712E-Z93	4	75708E-Z68	4		
		75706E-Z06	4	75710E-Z70	4		

FF12139 E-Z Clip System™



The E-Z Clip System is designed for assembly with weatherhead multi-Refrigerant hose GH134. It's engineered connection exceeds SAE J2064 and has been vibration and impulse tested.

Note:

The E-Z Clip System has been designed to work exclusively with Weatherhead GH134W Hose.

Kit Contents Components

Part Number	Description	Qty/Per Kit
1F40104-size	Clips	20 each size
1F40105-size	Cages	10 each size
FT1357	Assy. Tool	1
T-135	Hose Cutter	1
T-135B	Replacement Blade	1

BL-456 Barb-Tite Fittings and Hose Assortment



Making up an air line oil line transmission, or power steering return line? The BL-456 assortment puts Eaton Barb-Tite fittings and 1/4", 5/16", and 3/8" I.D. 350 psi maximum operating pressure H101 hose at your fingertips for quick and easy assembly. Simply push ends on hose, and you have a

hose assembly. No clamps required!

Measure the hose on top of the cabinet with the rule provided and then select the proper hose ends from the assortment in the two metal drawers. Within minutes the hose assembly is ready for installation.

Size

15" wide
16-1/2" high
13-3/16" deep
16 compartments in each drawer

Part Number	Qty.	Part Number	Qty.	Part Number	Qty.	Part Number	Qty.
10004B-102	4	10004B-B04	4	10005B-C02	4	10006B-606	4
10004B-104	4	10004B-B05	4	10005B-C04	4	10006B-B06	4
10004B-304	4	10004B-Y04	4	10005B-Y05	4	10006B-Y06	4
10004B-305	4	10005B-102	4	10006B-102	4	H10104	25'
10004B-605	4	10005B-104	4	10006B-104	4	H10105	25'
10004B-604	4	10005B-605	4	10006B-106	4	H10106	25'
10004B-A04	4	10005B-B05	4	10006B-306	4	FS-500	1
10004B-A05	4	10005B-B06	4	10006B-406	4	BL-456X	1
10004B-B03	4						

Fleet Hose and Fitting Assortment



These assortments are ideal for servicing fleet accounts. The DOT-approved hose and fittings will enable the user to make up chamber

lines, connect to gladhand couplings, and provide routing for air brake lines. The general purpose H069 provides for fuel, oil,

water, power steering, and transmission lines. A self-contained assortment in a super cabinet, all set up for easy serviceability!

FA-100 • Fleet Hose and Fitting Assortment (with Cabinet) FA-100-CO • Fleet Hose and Fitting Assortment (Contents Only)

Part Number	Quantity	Part Number	Quantity	Part Number	Quantity
H06904	50'	24706N-106	5	33806-A	20
H06906	50'	24706N-406	5	33806-B	5
H06908	50'	24706N-604	5	33806B-Y06	5
H06910	50'	24706N-605	5	33806B-Y24	5
H16606	50'	24706N-606	5	33806B-Y26	2
H16608	50'	24706N-608	5	33806B-Y28	5
H33806	50'	24706N-756	5	33806B-Y34	5
24704N-102	5	24706N-B06	5	33806B-Y36	5
24704N-104	5	24708N-106	5	33806B-Y38	5
24704N-604	5	24708N-108	5	FH-15X	1
24704N-B04	5	24708N-406	5	HD-1X	1
24705N-104	5	24708N-608	5		
24705N-605	5	24710N-108	5		
24705N-B05	5	24710N-608	5		
24706N-104	5	24710N-610	2		

HA-574 Fuel Hose Merchandiser

Now you can make those custom hose assemblies in minutes for instant service on fuel and oil line replacements. The attractive HA-574 includes H057 hose in all popular sizes for low

pressure fuel, EEC and PCV lines. Weatherhead H057 low pressure fuel line hose has Nitrile inner tube, fiber braid reinforcement, and Hypalon cover for long life compatibility with gasohol,

leaded, and unleaded fuels. The HC-574X rack can be easily installed on pegboard, wall, or metal shelving with the included hardware.

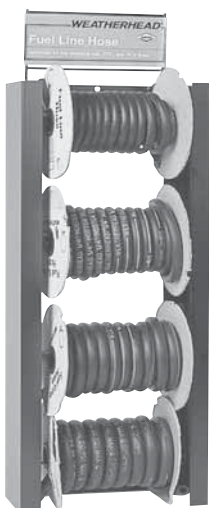

Part Number	Quantity	Description
H05703	25'	Hose
H05704	25'	Hose
H05705	25'	Hose
H05706	25'	Hose
HC-574X	1	Rack + 4 Dowels

Assortments

MA-100 • Metric Adapter Assortment

(with Cabinet)



The MA-100 is an ideal assortment to begin a metric adapter inventory. Offered are a variety of male British Standard Tapered Pipe (BSTP) and British Standard Parallel (BSPP) fittings in straight and 90° elbow configurations, sizes ranging from 1/8" through 1-1/4". Two male DIN (German metric) fittings adapt SAE fittings

and hose ends to metric size tubing, and a third DIN fitting connects SAE fittings with metric female swivel adapters, sizes ranging from 6mm through 42mm. The C5165X metric sleeves adapt metric tubing used with standard JIC fittings. The MA-100 is supplied with cabinet for accurate and easy access to your metric fittings.

Replacement Drawers PD-49 (one drawer)

Replacement Dividers PD-75 Set

MA-100 Contents

Part Number	Qty.	Part Number	Qty.	Part Number	Qty.	Part Number	Qty.	Part Number	Qty.
6 6		9600 8 8	2	3 20 20	2	C 3 4 2	2	L 0	
6 8	2	9600 0 8	2	4 4		C 3 6 4	2	L 0 8	
6 0		9600 2 2	2	6 4		C 3 6 6	2	L 0 22	
6 2		9600 6 6	2	6 6		C 3 8 8		L 0 28	
6 4		9600 20 20		8 6		C 40 4 4			
6		9 00 4 6	2	8 8		C 40 4			
6 6		9 00 8	2	0 2		C 40 6 4			
6 8		9 00 6 0	2	2 2		C 40 6 6			
6 20		9 00 8 2	2	6 6 2		C 40 8 6			
6 22		9 00 0 4	2	20 20 2		C 40 8 8			
6 2		9 00 2 20	2	C 20 0 8		C 40 0 2			
6 28		9 00 6 2	2	C 20 2 2		C 40 2 2			
6 30		9 00 20 32		C 20 8 8		C 40 6 6 2			
C 6 4 6		9800 4 4	2	C 206 4 6	2	C 40 20 20	2		
C 6 8		9800 4	2	C 206 6 8	2	C 0 20	2		
C 6 6 0		9800 6 4	2	C 206 8 0	2	C 2 22	2		
C 6 8 2		9800 8 4	2	C 206 8 2	2	C 2 2	2		
C 6 0 4		9800 8 6	2	C 206 0	2	C 6 33			
C 6 0		9800 8 8	2	C 206 2 8	2	C 4 2	2		
C 6 0 6		9800 0 8	2	C 20 4 6	2	C 6 4	2		
C 6 2 8		9800 2 2	2	C 20 6 0	2	C 6 6	2		
C 6 4 20		9800 2 8	2	C 20 6 8	2	C 8 8	2		
C 6 6 2		9800 6 2	2	C 20 8 2	2	0 6			
C 6 20 30		9800 6 6	2	C 20 0	2	0 8			
C 6 20 32		9800 20 20		C 20 2 8	2	0 0			
C-		3 4 2		C 208 0 4	2	0 2			
C-63		3 4 4		C 208 2 6	2	0 4			
CL- 02		3 4		C 208 6 6	2	0 6			
34		3 6 4		C 208 8 0	2	0 20			
4		3 6 6		C 3 0 20	2	0 2			
9600 4 4	2	3 8 8	2	C 3 2 22	2	0 30			
9600 4	2	3 8 6		C 3 2 2	2	L 0 6			
9600 6 4	2	3 0 2		C 3 6 33	2	L 0 8			
9600 6 6	2	3 2 2		C 3 20 42		L 0 0			
9600 8 6	2	3 6 6	2	C 3 4 0	2	L 0 2			

MA-200 • Metric Hose End Assortment

(with Cabinet)



The MA-200 hose end assortment offers an excellent introductory stock of metric hose ends. Coverage includes 'U' Series British Standard Tapered Pipe (BSPT) and British Standard Parallel Pipe (BSPP) in male straight, and female swivel in

straight and 90° tube elbow connections, swivels, and split flange ends for Komatsu and Link Belt applications and DIN standpipe hose ends in light and heavy series. One FH-15X stock cabinet is supplied for storage.

MA-200 Contents

Part Number	Qty.	Part Number	Qty.	Part Number	Qty.	Part Number	Qty.	Part Number	Qty.
04U-14K	2	06U-76P	2	12U-162	2	16U-P66	2	MH7105X14	2
04U-154	5	08U-158	5	12U-30K	2	7165X8MM	5	MH7105X16	2
04U-354	5	08U-22K	2	12U-362	2	7165X10MM	4	MH7105X20	2
04U-38T	2	08U-358	5	12U-52T	2	7165X12MM	2	MH7105X25	2
04U-40T	2	08U-360	5	12U-55T	2	7165X14MM	2	MH7105X30	1
04U-P54	5	08U-45T	2	12U-G12	2	7165X15MM	2	ML7105X8	2
04U-74P	2	08U-46T	2	12U-G42	2	7165X16MM	2	ML7105X10	2
06U-156	5	08U-P56	2	12U-P62	2	7165X18MM	2	ML7105X12	2
06U-18K	2	08U-P58	2	12U-82P	2	7165X20MM	2	ML7105X15	2
06U-356	5	08U-78P	2	16U-166	2	7165X22MM	2	ML7105X18	2
06U-358	2	08U-80P	5	16U-33K	2	7165X25MM	2	ML7105X22	2
06U-40T	2	10U-24K	2	16U-366	2	7165X28MM	2	ML7105X28	2
06U-42T	2	10U-48T	2	16U-58T	2	7165X30MM	1	FH-15X	2
06U-44T	2	10U-50T	2	16U-60T	1	MH7105X8	2	FS-2500	1
06U-P56	2	10U-G09	2	16U-G16	2	MH7105X10	2		
06U-P58	2	10U-G69	2	16U-G46	2	MH7105X12	2		

FA-15 Portable Coll-O-Crimp Assortment

(with Cabinet)



This portable assortment includes everything you need to service your hydraulic hose needs on the job site. Three sizes of 2 wire hose plus a variety of hose ends and adapters and a crimping system that requires no electrical power source makes this assortment the ultimate for field repairs. A 15-drawer cabinet is included for storage. Also available are

assortments with a cut-off saw or less the equipment.

FA-15

Includes contents listed below.

FA-15-CO

Includes contents listed below less equipment and cabinet.

FA-15-NH

Includes contents listed below less hose.

FA-15 Contents

Part Number	Qty.	Part Number	Qty.	Part Number	Qty.	Part Number	Qty.	Part Number	Qty.
04U-102	5	06U-406	5	06U-J06	5	08U-612	5	9405X8X8	5
04U-104	10	06U-506	5	06U-J08	5	08U-668	5	FH-15X	1
04U-106	5	06U-508	5	06U-P08	5	08U-J08	5	H42504	50'
04U-604	10	06U-606	10	08U-106	5	08U-P08	5	H42506	50'
04U-605	5	06U-608	5	08U-108	10	08U-P10	5	H42508	50'
04U-606	5	06U-666	5	08U-112	5	9205X2X2	5	T-465-HPU	1
04U-B04	5	06U-668	5	08U-508	5	9205X4X4	5	FS-1100	1
04U-J04	5	06U-755	5	08U-510	5	9205X6X6	5	FS-100	1
06U-104	10	06U-756	5	08U-512	5	9205X8X8	5		
06U-106	10	06U-B06	5	08U-608	10	9405X4X4	5		
06U-108	5	06U-B66	5	08U-610	5	9405X6X6	5		

Assortments

FA-135 Coll-O-Crimp I Assortment

(with Cabinet)



This assortment includes everything you need to start servicing hydraulic hose applications in your own shop. Five sizes of 2 wire hose along with a variety of hose ends and adapters gives you the versatility you need. In addition there is hose for power steering applications and a cabinet for storage. Also available are assortments with a cut-off saw or less the equipment.

FA-135
Includes contents listed below.

FA-135-CO
Includes contents listed below less equipment and cabinet.

FA-135-NH
Includes contents listed below less hose.

FA-135-10B
Includes contents listed below plus T-10B Saw.

FA-135 Contents

Part Number	Qty.	Part Number	Qty.	Part Number	Qty.
04U-102	5	06U-J08	5	12U-P12	5
04U-104	10	06U-P06	5	16U-116	5
04U-106	5	06U-P08	5	16U-516	2
04U-504	5	08U-058	5	16U-616	5
04U-505	5	08U-106	5	16U-676	1
04U-506	5	08U-108	10	16U-J16	1
04U-604	10	08U-112	5	41157X6	5
04U-605	5	08U-208	2	9205X2X2	5
04U-606	5	08U-508	5	9205X4X4	5
04U-664	5	08U-510	5	9205X6X6	5
04U-B04	5	08U-512	5	9205X6X8	5
04U-J04	5	08U-608	10	9205X8X6	5
06U-104	10	08U-610	5	9205X8X8	5
06U-106	10	08U-612	5	9405X4X4	5
06U-108	5	08U-668	5	9405X6X6	5
06U-206	5	08U-670	5	9405X8X8	5
06U-406	5	08U-758	5	9405X12X12	2
06U-446	5	08U-760	5	C5205X4X4	2
06U-506	5	08U-J08	5	C5205X6	4
06U-508	5	08U-P08	5	C5205X6X6	4
06U-606	10	08U-P10	5	C5205X8	4
06U-608	5	08U-R70	5	C5205X10	2
06U-610	5	12U-112	10	FH-135X	1
06U-666	5	12U-116	2	FS-1100	1
06U-668	5	12U-412	5	FS-100	1
06U-686	5	12U-512	5	FS-200	1
06U-755	5	12U-514	2	H32406	50'
06U-756	5	12U-516	2	H42504	50'
06U-B05	5	12U-610	5	H42506	50'
06U-B06	5	12U-612	10	H42508	50'
06U-B46	5	12U-614	5	H42512	50'
06U-B66	5	12U-616	2	H42516	50'
06U-J04	5	12U-672	2	T-401	1
06U-J06	5	12U-J12	5		

CA-50 Coll-O-Crimp Super I Assortment

(with Cabinet)

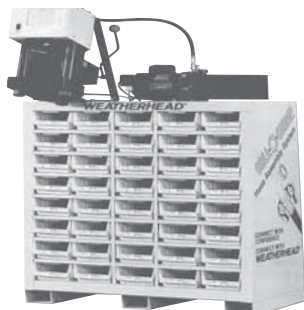

The CA-50 assortment includes everything you need to service your larger hydraulic applications. Five sizes of 2 wire hose and four sizes of 4 wire hose combined with a variety of hose ends and adapters gives you the coverage you need. Included with this assortment is a 40-drawer cabinet for mounting your press and storage. Also available are assortments with a cut-off saw or less the equipment.

CA-50

Includes contents listed below.

CA-50-CO

Includes contents listed below less equipment and cabinet.

CA-50-NH

Includes contents listed below less hose.

CA-50-60A

Includes contents listed below plus T-60A Saw.

CA-50 Contents

Catalog Number	Qty.	Catalog Number	Qty.	Catalog Number	Qty.	Catalog Number	Qty.
04U-102	5	08U-510	5	43012U-112	2	C5165X6	10
04U-104	10	08U-512	5	43012U-612	2	C5165X8	10
04U-106	5	08U-608	10	3012U-G12	1	C5165X12	5
04U-504	5	08U-610	5	43012U-G42	1	C5205X4	4
04U-506	5	08U-612	5	43012U-G72	1	C5205X4X4	2
04U-604	10	08U-668	5	43016U-116	2	C5205X6	4
04U-605	5	08U-670	5	43016U-616	2	C5205X6X6	4
04U-606	5	08U-688	5	43016U-G16	1	C5205X8	4
04U-664	5	08U-758	5	43016U-G46	1	C5205X8X8	4
04U-B04	5	08U-760	5	43016U-G76	1	C5205X10	2
04U-J04	5	08U-J08	5	43020U-120	1	C5205X12	2
06U-104	10	08U-P08	5	43020U-620	1	C5205X16	1
06U-106	10	08U-P10	5	43020U-G20	1	C5315X8	1
06U-108	5	12U-112	10	43020U-G50	1	C5405X6	2
06U-406	5	12U-116	2	43020U-G80	1	C5405X6X6	2
06U-506	5	12U-412	5	9205X2X2	5	C5405X8	2
06U-508	5	12U-512	5	9205X4X4	5	C5405X8X8	2
06U-604	5	12U-610	5	9205X6X6	5	C5405X10	1
06U-606	10	12U-612	10	9205X6X8	5	C5515X8	1
06U-608	5	12U-614	5	9205X8X6	5	H24504	50'
06U-610	5	12U-616	2	9205X8X8	5	H24506	50'
06U-666	5	12U-672	2	9205X12X12	2	H24508	50'
06U-668	5	12U-692	2	9205X16X16	1	H24512	50'
06U-755	5	12U-J12	5	9405X4X4	5	H24516	50'
06U-756	5	16U-116	5	9405X6X6	5	H43008	50'
06U-B06	5	16U-516	2	9405X8X8	5	H43012	50'
06U-B66	5	16U-616	5	9405X12X12	2	H43016	50'
06U-J06	5	16U-676	1	9405X16X16	1	H43020	50'
06U-J08	5	16U-J16	1	C-40X	1	T-420-N	1
06U-P08	5	43008U-108	2	C5105X4	2	FS-1100	1
08U-106	5	43008U-608	2	C5105X6	2	FS-100	1
08U-108	10	43008U-G08	1	C5105X8	2	FS-200	1
08U-112	5	43008U-G41	1	C5105X12	1	FS-3100	1
08U-508	5	43008U-G71	1	C5165X4	10		

Assortments

FT1341 Thread Measuring Kit

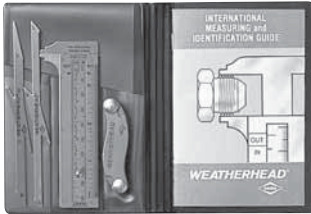

Measuring tube and pipe fitting threads can be a most difficult task if not completely understood. Tools needed include a thread pitch gauge, calipers and seat angle gauges. To aid you, Eaton has a kit to fit your needs; the FT1341 thread measuring kit.

This handy kit includes:

- Thread pitch gauge (Imperial and metric)
- Inside/outside caliper (inches and millimeters)
- 2 seat angle gauges (37°/45° and a 12°/30°)
- How to identify fluid ports and connectors bulletin
- Carrying case for easy convenient and storage

Weight: .5 lb.

TA-1004 Metric Thread Identification Kit



Contained in a durable steel carrying case, TA-1004 will help you with identification of metric, British pipe, and JIS thread configurations. Identification pieces are configured for 20 metric and 8 British pipe sizes.

This handy kit includes:

- Steel carrying case
- Stainless steel caliper
- Metric and british thread pitch gauges
- British thread measuring templates (4 measuring 8 sizes) made of durable aircraft grade aluminum
- Metric Thread Measuring Templates (10 measuring 20 sizes) made of durable aircraft grade aluminum
- Kit content identification chart

Assortments

SS-85 • Standard Brass Fittings Assortment



Instant service for service stations, car dealers, and repair shops. Contains 85 of the fastest moving Weatherhead brass fittings. Compact, lightweight plastic box stores easily in a drawer, shelf or service truck. Saves you time and money by having the right fitting when it is needed. Eliminates searching and make-shift repairs by giving you the right part when you need it most.

Size
11" wide, 1-3/4" high, 6-3/4" deep.

Weight
3-1/4 lbs.

Part Number	Qty.
105x3	5
105x4	5
105x5	10
202x4	5
202x5	5
3151x2	2
3220x4x2	5
3300x2	5
402x4	2
60x3	5
60x4	10

Part Number	Qty.
60x5	5
60x	5
62x3	2
62x4	5
62x5	5
62x6	2
68x4	2
BF-40X	1

SS-86 • Compression Fittings Assortment



Assortment contains 80 of the fastest moving compression fittings.

Size
11" wide, 1-3/4" high, 6-3/4" deep.

Weight
3-1/2 lbs.

Part Number	Qty.
60x3	5
60x4	10
60x5	5
60x6	5
61x3	5
61x4	5
61x5	5
61x6	5
62x3	5

Part Number	Qty.
62x4	5
62x5	5
62x6	2
68x3	2
68x4	5
68x5	2
69x3	2
69x4	5
69x5	2
BF-40X	1

SS-87 • Inverted Flare Assortment



Assortment contains 84 of the fastest moving inverted fittings.

Size
11" wide, 1-3/4" high, 6-3/4" deep.

Weight
3-1/2 lbs.

Part Number	Qty.
105x3	5
105x4	5
105x5	5
105x6	5
202x3	5
202x4	5
202x5	5
202x6	2
302x3	5

Part Number	Qty.
302x4	5
302x5	5
302x6	2
402x3	5
402x4	5
402x5	5
402x6	5
7896x3	5
7896x4	5
BF-40X	1

Assortments

SS-88 • Brass Pipe Assortment



Assortment contains 59 of the fastest moving brass pipe fittings.

Size
11" wide, 1-3/4" high, 6-3/4" deep.

Weight
3-1/2 lbs.

Part Number	Qty.
3152x2	5
3152x4	5
3152x6	2
3220x4x2	2
3220x6x4	2
3300x2	5
3300x4	2
3326x2	5
3326x4	5
3326x6	2
3350x2	5
3350x4	4
3350x6	2
3400x2	5
3400x4	2
3400x6	2
3500x2	2
3500x4	2
BF-40X	1

Part Number	Qty.
3326x6	2
3350x2	5
3350x4	4
3350x6	2
3400x2	5
3400x4	2
3400x6	2
3500x2	2
3500x4	2
BF-40X	1

BF-40 • Hydraulic Brake Fittings Assortment



The BF-40 assortment of fast moving hydraulic brake fittings is a must for any shop doing brake service work. Contains the adapters needed to convert large size ports in master cylinders to accept standard steel brake lines plus the brass tees used in the installation of electric towed trailer brakes.

Assortment is organized in a compact, handy plastic box for easy selection.

Size
1" wide, 1-3/4" high, 6-3/4" deep.

Weight
4 lbs. (approx.)

Part Number	Qty.
7818	2
7828	2
7829	2
7897	2
7898	2
7900	2
7901	2
7904	2
7905	2
7906	2
7908	2
7910	2
7911	2
7912	2
7913	2
7914	2
7917	2
7933	2
BF-40X	1

Part Number	Qty.
7906	2
7908	2
7910	2
7911	2
7912	2
7913	2
7914	2
7917	2
7933	2
BF-40X	1

BF-41 • Hydraulic Brake Line Adapter Assortment



The BF-41 assortment contains the adapters needed to convert the oversize master cylinder ports to accept the inverted flare nut used on standard replacement steel brake lines. The adapters eliminate the need to cut line, install oversize nut and double flare tubing as well as converting the port to standard size threads for the life of the car. Extra standard nuts and the unions needed to connect two steel brake lines when a non-standard length is required are also included in the assortment. The contents including the illustrations of parts are shown on the inside cover of the box.

Size
11" wide, 1-3/4" high, 6-3/4" deep.

Weight
4 lbs. (approx.)

Part Number	Qty.
105x3	10
105x4	10
105x5	10
105x6	5
105x6x7	2
302x3	5
302x4	5
302x5	5
302x6	2
7818	2
7828	2
7829	2
7896x3	5
7896x4	5
7897	2
7908	2
7917	2
BF-40X	1

Assortments

BF-42 • RV Brake Line Adapter Assortment



The BF-42 assortment contains the adapter tees required to install the control switch used to coordinate the electric trailer brakes with the hydraulic brakes on towing vehicle. The assortment also contains inverted brake line nuts and unions needed to make up non-standard steel brake line lengths.

Size

11" wide, 1-3/4" high, 6-3/4" deep.

Weight

4 lbs.

Part Number	Qty.
105x3	10
105x4	10
105x5	10
105x6	5
105x6x7	2
302x3	5
302x4	5
302x5	5
7898	1

Part Number	Qty.
7900	1
7901	1
7904	1
7905	1
7906	1
7914	1
7921	1
7933	1
BF-40X	1

BF-43 • Metric Adapter and Tee Assortment



The BF-43 assortment contains metric thread connectors to adapt the three port sizes in late model GM cars to use a steel brake line with metric threads (M10x1.0) and standard flare (Weatherhead J series). Included as well are metric adapters to convert European Bubble flare type ports to accept standard 3/16" U.S. steel brake lines, and metric towed trailer brake tees used in controls of electric trailer brakes. The 3/16" unions are used for joining metric and U.S. steel brake lines to make up non-standard lengths.

Size

11" wide, 1-3/4" high, 6-3/4" deep.

Weight

4 lbs. (approx.)

Part Number	Qty.
105x3	10
105x4	5
1442	5
1443	5
302x3	5
7921	1
7934A	5
7935	1
7936	1

Part Number	Qty.
7937	1
7940	5
7941	5
7896x3	5
7896x4	5
BF-40X	1

Assortments

DC-121 • Plastic Drain Cock Assortment



This kit can address all your plastic drain cock needs with a full assortment of Weatherhead domestic and offshore drain cocks. This kit comes complete with a plastic box and a label with part number and application information.

Part Number	Qty.
110	2
111	2
112	2
113	2
114	2
115	2
116	2
117	2
135	2
145	2

PC-48 • Push Connect Fittings Assortment



Weatherhead PUSH > CONNECT fittings are designed for quick assembly without the need for a wrench. Ideal for pneumatic applications where space is tight. Then fittings are also easily disconnected; simply depress the collet ring with two fingers and withdraw the tube. The PC-48 provides the 48 most popular PUSH > CONNECT fittings in a compact, handy plastic box to make your assortment organized and accessible.

Part Number	Qty.	Part Number	Qty.
1162x2	5	1168x6	5
1162x4	5	1168x6x6	5
1162x6	5	1168x6x8	2
1164x2.5	5	1168x8	5
1164x4	5	1168x8x8	2
1164x6	5	1169x2.5S	5
1164x8	2	1169x2S	5
1165x2.5	5	1169x2x4S	5
1165x4	5	1169x4S	5
1165x6	5	1169x4x4S	5
1165x8	2	1169x4x6S	5
1166x4	5	1169x6S	5
1166x4x4	5	1169x6x6S	5
1166x6	5	1169x8S	2
1166x6x6	2	1169x8x4S	2
1168x2	2	1171x4S	5
1168x2.5	5	1171x4x4S	5
1168x2.5A	5	1171x6S	5
1168x2.5x4	5	1172x4S	5
1168x2x4	5	1172x4x4S	5
1168x4	5	1174x2	5
1168x4A	5	1174x4	5
1168x4x4	5	CL-499	1
1168x4x6	5	FC-16X	1
1168x5	5		
1168x5x4	5		

Assortments

BA-84 • Steel Brake Line Assortment

The BA-84 attractive lobby merchandiser displays domestic as well as import car (British, European, and Japanese) steel brake lines. The BA-84 puts brake lines where users can make fast and easy selection from a complete inventory protected by sturdy cardboard color-coded tubes.

The corrosion- and vibration-resistant double wall steel brake lines are easily formed into the configurations you need without kinking. Longer or non-standard lengths can be made up by joining two lines with a Weatherhead union of the proper thread size.

The BA-84 includes all sizes of the 3/16", 1/4" and 5/16" Weatherhead steel brake lines for domestic cars and trucks plus a sturdy steel rack. Order the SB

series (Jaguar, M.G., Triumph), SC series (BMW, Mercedes, Peugeot, Porsche, Volkswagen), SJ series (Mazda, Nissan, Toyota) and Weatherhead import car steel brake lines and unions from listings in brake line section of this catalog. See page 431.

Increase your sales—
Organize your inventory—
Make selections easy—
Discover the results of putting this proven money maker to work for you—
Install a BA-84.

Part Length	Number	Qty.
3/16" LINES		
6"	S306	4
8"	S308	4
12"	S312	4
20"	S320	4
30"	S330	4
40"	S340	4
51"	S351	4
60"	S360	4
72"	S372	4
1/4" LINES		
12"	S412	4
20"	S420	4
30"	S430	4
40"	S440	4
51"	S451	4
60"	S460	4
5/16" LINES		
12"	S512	4
20"	S520	4
30"	S530	4
40"	S540	4
51"	S551	4
60"	S560	4
Rack	BA-84X	1



Assembly Equipment

N



BA-24 • Steel Brake Line Assortment

The BA-24 assortment includes an assortment of 5/16" steel brake lines and a rack for wall or bin installation. The multi-walled corrosion-resistant tubing can be easily formed for time saving installation.

All lines have color-coded label attached for easy identification. Non-standard lengths can be made up by joining two standard lengths with a 302x5 union.

Weight
6 lbs

Length	Part Number	Qty.
12"	S512	4
20"	S520	4
30"	S530	4
40"	S540	4
51"	S551	4
60"	S560	4
Rack	BA-24X	1

BA-28 • Steel Brake Line Assortment

BA-28 contains 3/16" easy to form, anti-corrosive, multi-walled steel brake lines for Japanese vehicles. The SJ lines with 10-1.0mm threads (standard flare) can be joined

to form longer lines by using the 7934A Japanese metric union. The handy wall rack is included.

Weight
6 lbs

Length	Part Number	Qty.
8"	SJ308	4
12"	SJ312	4
20"	SJ320	4
30"	SJ330	4
40"	SJ340	4
51"	SJ351	4
60"	SJ360	4
Rack	BA-28X	1

BA-38 • Steel Brake Line Assortment

BA-38 contains six different lengths made of 3/8" anti-corrosive non-standard multi-walled, easily formed, steel tubing with inverted flare nuts attached. All lines have color-coded label for

easy identification. Non-standard length lines may be fabricated by joining two 3/8" steel lines with a 302x6 union.

Weight
8 lbs.

Length	Part Number	Qty.
12"	S612	4
20"	S620	4
30"	S630	4
40"	S640	4
51"	S651	4
60"	S660	4
Rack	BA-38X	1

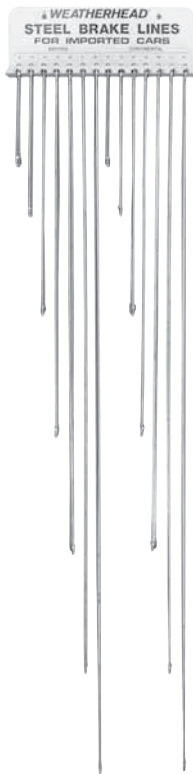

BA-48 • Steel Brake Line Assortment

BA-48 contains the most popular steel brake lines and an easy to install rack. The 3/16" and 1/4" steel brake lines are available in six different lengths. Each steel brake line has a standard inverted flare nut on one end and a long thread inverted flare nut on the other end for better sealing. Easy to

form, multi-walled steel tubing resists corrosion and vibration.

Non-standard length lines may be fabricated by joining two 3/16" lines with a 302x3 and two 1/4" lines with a 302x4.

Weight
10-1/2 lbs.

Length	Part Number	Qty.
3/16" LINES		
12"	S312	4
20"	S320	4
30"	S330	4
40"	S340	4
51"	S351	4
60"	S360	4
1/4" LINES		
12"	S412	4
20"	S420	4
30"	S430	4
40"	S440	4
51"	S451	4
60"	S460	4
Rack	BA-48X	1

BA-56 • Steel Brake Line Assortment

BA-56 contains 3/16" easy to form, anti-corrosive, multi-walled steel brake lines for British and European cars. The SB lines with 3/8-24 threads (Bubble Flare) can be joined to form longer lines by using the 7940 metric union. SC lines with 10X1.0mm threads (Bubble Flare) can be joined with the 7941 metric union. The handy wall rack is included.

Weight
10 lbs.

Length	Part Number	Qty.
British 3/8-24 Thread		
8"	SB308	4
12"	SB312	4
20"	SB320	4
30"	SB330	4
40"	SB340	4
51"	SB351	4
60"	SB360	4

Length	Part Number	Qty.
European 10-1.0mm Thread		
8"	SC308	4
12"	SC312	4
20"	SC320	4
30"	SC330	4
40"	SC340	4
51"	SC351	4
60"	SC360	4
Rack	BA-56X	1

Assortments

AB-1400 • Air Brake Fittings Assortment



The AB-1400 contains DOT approved brass air brake fittings for servicing nylon brake and secondary air lines. Selecting the proper fittings from the 63-drawer cabinet included with the assortment is easy. Clear, wide plastic drawers with color-coded labels make identification of shapes and sizes quick and simple. Order Weatherhead NT100 nylon air brake tubing to complete your nylon air brake line service center.

Part Number	Qty.
1460x4	10
1460x6	20
1460x8	10
1460x10	10
1460x12	10
1461x4	5
1461x6	10
1461x8	5
1461x10	5
1461x12	5
1462x4	5
1462x6	10
1462x8	5
1462x10	4
1462x12	2
1464x6	5
1464x8	5
1466x6	5
1466x6x6	5
1466x8	5
1468x4	5
1468x4x4	5
1468x6	10
1468x6x2	5
1468x8	5
1468x10	5
1468x12	4
1469x4	5

Part Number	Qty.
1469x4x4	5
1469x6	10
1469x6L	5
1469x6x2	5
1469x6x6	5
1469x8	5
1469x8x4	5
1469x10	5
1469x10x6	4
1469x12	4
1471x4	5
1471x6	5
1472x6	5
1472x8	5
1480x6	5
1480x6x6	5
1480x8	5
1480x10	4
1484x4	20
1484x6	20
1484x8	20
1484x10	10
1484x12	10
C-63X	1
CL-497	1

Assembly Equipment

AB-140 • 1400 Series Air Brake Fittings Assortment



This assortment of 1/4", 3/8", and 1/2" air brake fittings designed for use with NT100 nylon air brake tubing provides the coverage needed for service work by fleets, repair shops, and farm implement dealers. The DOT-approved air brake fittings are easily selected from the cabinet with 16 plastic drawers and color-coded labels included in the assortment.

Part Number	Qty.
1460x4	20
1460x6	20
1460x8	20
1461x4	10
1461x6	10
1461x8	5
1462x4	5
1462x6	10
1462x8	4
1468x4	10
1468x6	10
1468x8	5
1469x4	5
1469x6	5

Part Number	Qty.
1469x8	5
1484x4	20
1484x6	20
1484x8	20
145	10
CL-16-3	1
FC-16X	1
W15310	5

Assortments

QC-18



Designed as a glove box sized emergency repair kit, the QC-18 assortment contains Q-CAB® tube unions in 5/32", 1/4", 3/8", and 1/2" sizes, also included is a T-191 tubing cutter. The contents are contained in a convenient carrying case measuring 1-1/4" x 3-3/4" x 7".

Component Part No.	Qty.
1862x2.5	2
1862x4	2
1862x6	2
1862x8	2
T-191	1
QC-18X	1

QC-180



The QC180 contains tube unions, male connectors, swivel male 45° elbow, male 90° elbows, and repair kits in popular 1/4", 3/8", and 1/2" tube sizes designed for DOT Truck and Trailer Air Brake System needs (see complete listing at right in table). The Q-CAB® fittings are field proven with over millions of miles of leak free performance. Their design can save up to 75 percent of the assembly time over conventional compression fittings. These fittings are contained in a case measuring 1-3/4" x 6-3/4" x 1-3/4".

Component Part No.	Qty.
1869x6x6	2
1862x4	2
1869x8x8	1
1862x6	2
1880x4x4	2
1862x8	2
1880x6x6	2
1868x2.5	2
1880x8x8	1
1868x3	2
1800Kx4	2
1868x4x4	2
1800Kx6	2

Component Part No.	Qty.
1868x6x6	2
1800Kx8	2
1868x8x8	2
1800TRK	1
1869x4x4	2
BF-40X	1

QC-1800



This assortment contains a solid inventory of popular Weatherhead Q-CAB® fittings designed for DOT Truck and Trailer Air Brake System needs (see complete listing at right in table). The Q-CAB® fittings are field proven with over millions of of leak free performance. Their design can save up to 75 percent of the assembly time over conventional compression fittings.

Component Part No.	Qty.
1800Kx2.5	4
1862x10	2
1868x12	2
1874x6x6	1
1800Kx3	4
1868x2.5x1	5
1869x4	5
1874x8x8	1
1800Kx4	4
1868x2.5	5
1869x4x4	5
1880x4x4	5
1800Kx6	4
1868x3	5
1869x6	5
1880x6x6	5
1800Kx8	4
1868x4	5
1869x8	5
1880x8x8	5
1800Kx10	2
1868x4x4	5
1869x8x8	5
1880x10	2

Component Part No.	Qty.
1800Kx12	2
1868x6	5
1869x10	2
1880x12	2
1862x2.5	2
1868x6x6	5
1869x4S	5
1800T	1
1862x3	5
1868x8	5
1869x4x4S	5
CL-503	1
1862x4	5
1868x8x8	5
1869x6S	5
FC-16X	1
1862x6	5
1868x10x6	2
1869x8S	5
T-191	1
1862x8	5
1868x10	2
1874x4x4	1

Assortments

AB-45 • Air Brake Fittings Assortment

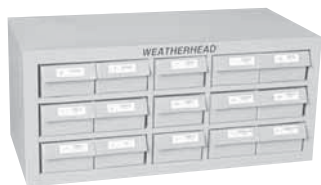

This assortment of draincocks, shutoffs, and air brake fittings for use with 1/4", 3/8", and 1/2" copper tubing is a must for jobbers and fleet service shops. Provides excellent coverage for air brake tube and hose service requirements. The large plastic drawers and the illustrated labels for the 15 drawer cabinet included in the assortment make positive part selection simple and quick.

Part Number	Qty.
1360x6	20
1360x8	20
1360x10	10
1360x12	10
1361x6	20
1361x8	5
1361x10	5
1362x4	5
1362x6	10
1362x8	5
1362x10	5
1368x6	10
1368x6x2	5
1368x6x6	5
1368x8	5
1368x10	5
1369x4x4	5
1369x6	10
1369x8	5
1380x6	5
1390x6	5
1391x6	5
145	10

Part Number	Qty.
33806-A	20
33806-B	5
33806B-Y06	2
33806B-Y24	5
33806B-Y28	5
33806B-Y34	5
33806B-Y38	5
6707	1
6708	1
6709	1
6747	1
6748	1
6749	1
FH-15X	1
FS-800	1
W05465	5
W14630	10
W15310	5
W76150	5
W79850	3
W79851	3

Assortments

SA-1 • Secondary Air Systems Kit



Ideal for fleet repair shops, truck dealers, garages and truck stops. SA-1 contains an assortment of popular 1/8" and 1/4" brass fittings plus 200' of Weatherhead NT100 SAE J844 Nylon tubing. The 1/8" fittings are Weatherhead SELFALIGN® and 1/4" fittings are Weatherhead 1400 series air brake. The sturdy box keeps the tubing and fittings together for quick and easy servicing of the tubing used on shifters, PTO's, wipers, horns, remote air, instrumentation, etc. All of the parts are organized at your finger tips. The SA-1 is a must for all vehicle air system maintenance facilities.

Size

15" wide, 3-1/2" high, 14-1/2" deep.

Part Number	Qty.
1460x4	10
1461x4	5
1462x4	2
1464x4	1
1468x4	2
1468x4x1	2
1468x4x4	2
1469x4	2
1469x4x4	2
1484x4	5
601x2	10

Part Number	Qty.
611x2	5
621x2	2
661x2	2
681x2	2
681x2x1	2
691x2	2
691x2x1	2
BF-40X	1
NT10002BK-100	100'
NT10004BK-100	100'

SA-2 • Secondary Air Systems Kit



The SA-2 assortment enables you to supply fleets and dealers with fittings and tubing for 1/4" and 3/8" O.D. air brake applications. 1/8" O.D. tubing and fittings are also supplied for applications such as transmission shifter, air horn, gauge and flat adjustment. A cabinet is also supplied for easy storage on shelves and bench tops.

Part Number	Qty.
1460x4	10
1460x6	20
1461x4	5
1461x6	10
1462x4	5
1462x6	10
1464x4	2
1464x6	2
1466x6	5
1468x4	5
1468x4x4	5
1468x4x6	2
1472x4	5
1472x6	5
1472x6x6x6	5
1484x4	10
1484x6	10
1485x4	10
1485x6	10
1468x6	10

Part Number	Qty.
1468x6x2	5
1468x6x6	5
1468x6x8	5
1469x4	5
1469x4x4	5
1469x6	10
1469x6x6	5
601x2	10
611x2	10
621x2	5
661x2	5
681x2	5
681x2x1	2
691x2	5
691x2x1	2
BL-456-X	1
FS-SA-2	1
NT10002BK-100	100'
NT10004BK-100	100'
NT10006BK-100	100'

Equipment - Cabinets

Cabinets

C-40X Stock Cabinet



Ideal for mounting the T-400-1 Coll-O-Crimp I Press and Pump or T-420-1 Coll-O-Crimp Super I. The sturdy C-40X Cabinet contains 40 heavy-duty plastic drawers that can be divided into one, two, three, or four compartments providing space for a large selection of Coll-O-Crimp hose ends and adapters.

Drawers
PD-40 (one drawer)

Dividers
PD-20 (individual)

Size
46-1/2" high, 40" wide, 26" deep at base, 18" deep at top

Weight
228 lbs.

FH-135X Stock Cabinet



The sturdy FH-135X Cabinet contains 50 heavy-duty plastic drawers that can be divided into one, two, or three compartments allowing you ample space for a large selection of Coll-O-Crimp hose ends and adapters. Ideal for mounting the Coll-O-Crimp I Press and Pump.

Drawers
PD-95 (one drawer)

Dividers
PD-15 (individual)

Size
46-1/2" high, 33" wide, 14-1/2" deep

Weight
115 lbs.

FH-15X Stock Cabinet



Here is the ideal way to organize your inventory of hose ends and adapters. The rugged FH-15X Cabinet contains 15 plastic drawers for stocking hose ends and adapters.

Drawers
PD-95 (one drawer)

Dividers (individual)
PD-15

Size
13-5/8" high, 14-3/8" deep, 30-1/4" wide

Weight
45 lbs.

FH-40X Stock Cabinet

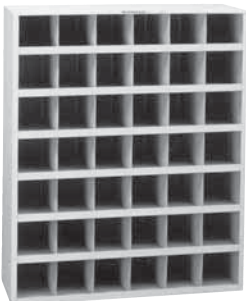

Provides convenient storage areas for those large size fittings and hose ends. This durable 20 gauge steel cabinet is made to handle abuse.

Size
35" wide, 42" high, 12" deep

Weight
200 lbs.

Note: Will not support Weatherhead Coll-O-Crimp equipment.

Equipment - Cabinets

Cabinets

FH-72X Stock Cabinet

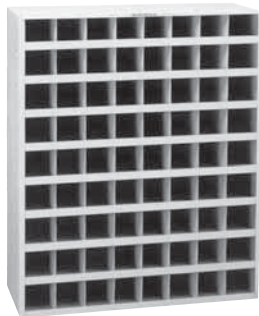

Large capacity all-welded cabinet provides 72 storage compartments. Fabricated from 20 gauge steel, the FH-72X will provide years of continued service.

Size
35" wide, 42" high, 12" deep

Weight
200 lbs.

Note: Will not support Weatherhead Coll-O-Crimp equipment.

C-5X Stock Cabinet



This mini-cabinet is designed to contain your oversized Weatherhead hose ends which may not currently have an organized home.

Size
30" wide, 5-7/8" high, 9-5/16" deep

Weight
10 lbs.

TC-20 Collet Cabinet



The TC-20 Cabinet provides you easy access to all of your tooling needs. There is ample space for collets, spacer rings, and related Coll-O-Crimp tooling.

Size
28-1/2" high, 26-1/2" wide, 12-3/4" deep

Weight
37-1/2 lbs.

HD-1X Hose Cabinet



The HD-1X Cabinet offers you the ideal solution for keeping 50 foot lengths of hose off your floor. Vertical slots in the cabinet keep your hoses organized and clean. Consider bolting an FH-15X Stacking Cabinet on top of the HD-1X to keep an inventory of hose ends readily available.

Size
36" high, 24" deep, 31" wide

Weight
83 lbs.

Equipment - Cabinets & Bags

Cabinets and Bags

HD-2X Hose Center Display

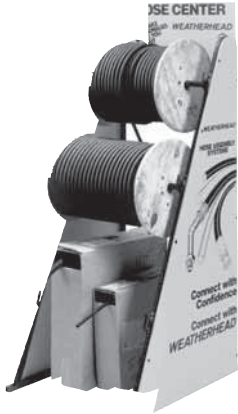

The HD-2X hose display is built with a heavy steel inner frame which supports the weight of the hose reels, while its tough wooden sides provide additional durability. It is designed to hold both Weatherhead bulk reels and boxed product. Handles are even provided to make loading the hose as safe and easy as possible.

Measurements
22" wide x 30" deep x 57" tall

Weight
54 lbs. (UPS Shipping)

Maximum Capabilities
(3) Reels or (2) Reels & (4) Boxes
(Hose not included)

T-460-10BB Coll-O-Crimp Tool Box



The T-460-10BB Tool Box complements our T-460 and T-462 portable crimpers by offering you storage for your collets, spacer rings, and perhaps an assortment of hose ends.

Measurements
25"x9"x8"

T-460-TR Tool Rack

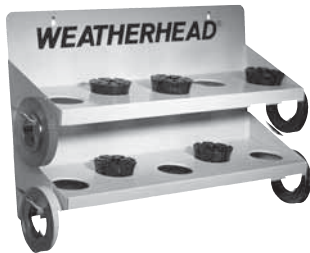

The T-460-TR wall-mounted tool rack is rugged and built to last! The perfect shop accessory for Coll-O-Crimp machines, the T-460-TR stores up to 10 collets and 4 spacer rings—organized and within easy reach.

(The T-460-TR rack does not include tooling)

Measurements
24 -1/2" Wide x 16" High x 7-1/2" Deep

Weight
16 lbs.

Plastic Bags



Weatherhead heavy duty plastic bags for Weatherhead fittings come in sizes 5"x6", 6"x10", and 8"x12". The bags include convenient spaces for labeling.

Catalog Number	Description	Qty
5x6 PB	Plastic Bag	100
6x10 PB	Plastic Bag	100
8x12 PB	Plastic Bag	100

Equipment - Labels

Label Sets

Self Adhesive Label Sets



For C-40X, FH-15X, and FH-135X Cabinets

Label Number	Description
FS-100	Swivel Adapters
FS-200	JIC Steel Adapters
FS-300	Split Flange Adapters
FS-400	Field Attachable Hose Ends – 009 'B' Series
FS-500	Barb-Tite® 100 'B' and 105 'B' Series Hose Ends
FS-600	Field Attachable Hose Ends – 069 'D' & 247 'N' Series
FS-700	Field Attachable Hose Ends – 425 'N' Series
FS-800	Field Attachable Hose Ends – 338 'B' Series & Brass
	Air Brake Fittings for Copper Tubing
FS-1100	Coll-O-Crimp Hose Ends – 'U' Series
FS-1200	Coll-O-Crimp Hose Ends – 'E' Series
FS-1500	Coll-O-Crimp Hose Ends – 069 'E' Series
FS-1600	7000 Series Flareless Fitting
FS-1800	Coll-O-Crimp Hose Ends – 470 'E' Series and 570 'S' Series
FS-2000	Steel Pipe
FS-2200	Ready-Lok Hose Ends and Adapters
FS-2300	Drain Cocks, Valves and Select 338 'B' Series Hose Ends
FS-2400	FOR-SEAL Adapters Label Set
FS-2500	Metric Hose Ends ('U' Series) and Metric Flareless Nuts/Sleeves
FS-2800	Field Attachable Hose Ends – 213 'N' Series
FS-2900	Coll-O-Crimp Hose Ends – 338 'P' Series
FS-3100	Coll-O-Crimp Hose Ends – 430 'U' Series No-Skive
FS-3200	Coll-O-Crimp Hose Ends – 757 'E' Series
FS-3300	Quick Connect Air Brake 1800 Series
FS-3500	Coll-O-Crimp Hose Ends – 336 'E' Series
FF90645	WeatherGRIP Hose Ends - 'Z' Series
FF90646	E-Z Clip Label Set
FF90686	4SP/6SP Hose Ends Label Set

A2103 Mylar Hose Labels



Eaton now offers Mylar labels for marking hose assemblies. They are self-adhesive Mylar strips, 1" wide by 3-3/4" long, with a 1" x 1" white area on one end for printed information. They are supplied on a roll of 2000 labels with each perforated page containing eight labels. The format is suitable for use in typewriters and tractor-feed or friction-drive printers.

Whether for compliance with federal hose assembly labeling requirements, or for simply meeting customer demands for labeling hose assemblies, we strongly recommend labeling become part of your hose assembly "manufacturing" procedure. The National Highway Traffic Safety Administration places responsibility for labeling an air brake hose assembly in the hands of the "manufacturer" of the hose assembly. (Not the manufacturer of the hose or hose ends.) For a summary

of air brake hose assembly labeling recommendations, see "Air Brake Hose Assembly Guidelines." For specific air brake hose assembly regulations, consult "Federal Motor Vehicle Safety Standard (FMVSS) 571.106," available from NHTSA, at the address listed below. For use other than air brake applications, customers may want additional information on the labels. Generally, the labels will accept 9-10 characters per row, on 4 or 5 rows. The information can be handwritten, typed, or printed on the labels. The main concern is resistance to the elements. Procedure for applying the labels is simple:

1. Print the appropriate information on the label.
2. Wrap the tag around the hose assembly; printed end first.
3. Cover the printed end with the clear mylar tail of the label.
4. The clear tail will protect the printed area from the elements.

Office Of Vehicle
Safety Standards
National Highway Traffic
Safety Administration
400 Seventh Street SW
Washington, DC 20590
Phone (202) 366-5317
www.nhtsa.dot.gov

Equipment - Field Attachable

Field Attachable Assembly Equipment

 Refer to safety information regarding Coll-O-Crimp hose, hose fittings and assembly equipment compatibility on pages A-2-3.

T-300 Field Attachable Hose End Assembly Machine



The Weatherhead T-300 machine eliminates lost time and hard work when making replacement hose assemblies with bulk hose and field attachable hose ends. Simple, effortless operation provides uniform, safe assemblies time after time. This heavy-duty machine assembles straight, swivel, elbow and flange-type ends on all medium and high pressure wire braid hose from 3/16" through 2" I.D.

Part Number	Description
T-300	Assembly Machine – complete with tripod stand, adjustable locator, chuck handle and foot switch
T-300X	Assembly Machine without tripod stand
T-301	Tripod Stand

Motor

Universal, reversible, 110-115 volts, 25-60 cycle, 1/2 H.P., 8 amps

Weight

167 lbs.

Mandrel Assembly Tools



These tools are required for assembling 069 'D' Series hose ends in sizes 4 through 12 to prevent cutting the hose inner tube. Size 16 through 32 mandrels are used as a holding device when assembling 069 'D' Series swivel ends. Mandrels can be ordered individually.

Hose I.D.	Part Number	Swivel End Application
3/16"	T-JS4	SAE 37° & 45°
1/4"	T-JS5	SAE 37° & 45°
5/16"	T-J6	SAE 37°
5/16"	T-S6	SAE 45°
13/32"	T-JS8	SAE 37° & 45°
1/2"	T-JS10	SAE 37° & 45°
5/8"	T-J12	SAE 37°
5/8"	T-S12	SAE 45°



Hose I.D.	Part Number	Swivel End Application
7/8"	T-J16	SAE 37°
1-3/8"	T-J24	SAE 37°
1-13/16"	T-J32	SAE 37°

Equipment - Field Attachable

Field Attachable Assembly Equipment

 Refer to safety information regarding Coll-O-Crimp hose, hose fittings and assembly equipment compatibility on pages A-2-3.

T-101A Barb-Tite End Assembly Tool



Assembly of Barb-Tite push-on hose ends is made easy with this handy tool. Easy and fast operation assures dependable, leak proof assemblies. Simply clamp hose in jaws, place hose end on push rod and pull the handle. Engineered for a lifetime of rugged service.

Weight

1 lb.

Capacity

1/4" to 1/2" I.D. hose only.

T-201 Barb-Tite End Assembly Tool



This bench-mounted tool is actually two tools in one. Not only does it assemble Barb-Tite hose ends, it is also a hose cutter. To cut your hose, simply retract the handle, place the hose in the cutter area and pull the handle. After cutting the hose to the desired length, place the hose under the cam handle locking it in place with the hose end aligned with the appropriate mark on the label. Place the barbed end of the fitting against the end of the hose and then pull the handle forward to complete the installation. The T-201 assembly tool is an easy-to-use tool that does everything you need to create a hose assembly.

Replacement Blade T-201B

Note

This tool is designed to cut fiber-reinforced rubber hose only.

Capacity

1/4" to 3/4" I.D. hose

Glossary & Index

Table of Contents

Glossary	O-2 thru O-6
Part Number Index	O-7 thru O-16



A

abrasion: external damage to a hose assembly caused by its being rubbed on a foreign object; a wearing away by friction.

ABS: Air-Brake Swivel absorption: regarding hose, the process of taking in fluid. Hose materials are often compared with regard to relative rates and total amounts of absorption as they pertain to specific fluids.

acid resistant: having the ability to withstand the action of identified acids within specified limits of concentration and temperature.

adapter, adaptor: 1) fittings of various sizes and materials used to change an end fitting from one type to another type or one size to another. (i.e., a male SAE to male pipe adapter is often attached to a female SAE to create a male end union fitting); **2)** the grooved portion of a cam & groove coupling.

adhesion: the strength of bond between cured rubber surfaces or between a cured rubber surface and a non-rubber surface.

adhesive: a material which, when applied, will cause two surfaces to adhere.

ambient temperature: the temperature of the atmosphere or medium surrounding an object under consideration.

ambient/atmospheric conditions: The surrounding conditions, such as temperature, pressure, and corrosion, to which a hose assembly is exposed.

amplitude of vibrations and/or lateral movement: the distance a hose assembly deflects laterally to one side from its normal position, when this deflection occurs on both sides of the normal hose centerline.

anchor: a restraint applied to eliminate motion and restrain forces.

annular: refers to the convolutions on a hose that are a series of complete circles or rings located at right angles to the longitudinal axis of the hose (sometimes referred to as “bellows”).

anodize, anodized: an electrolytic process used to deposit protective or cosmetic coatings in a variety of colors on metal; primarily used with aluminum.

ANSI: American National Standards Institute.

application working pressure: unique to customer’s application. See pressure, working.

application: the service conditions that determine how a hose assembly will be used.

armor: a protective cover slid over and affixed to a hose assembly; used to prevent over bending or for the purpose of protecting hose from severe external environmental conditions such as hot materials, abrasion, or traffic.

assembly: a general term referring to any hose coupled with end fittings of any style attached to one or both ends.

ASTM: American Society for Testing and Materials.

attachment: the method of securing an end fitting to a hose (e.g., banding, crimping, swaging, or screw-together 2 piece or 3 piece-style field attachable fittings).

axial movement: compression or elongation along the longitudinal axis.

B

backing: a soft rubber layer between a hose tube and/or cover and carcass to provide adhesion.

barb: the portion of a fitting (coupling) that is inserted into the hose, usually comprised of two or more radial serrations or ridges designed to form a redundant seal between the hose and fitting.

barbed and ferrule fitting: a two-piece hose fitting comprised of a barbed insert (nipple), normally with peripheral ridges or backward-slanted barbs, for inserting into a hose and a ferrule; usually crimped or swaged.

Barb-Tite: a line of low pressure push-on brass hose end fittings that is a trademark of Eaton Corporation.

bend radius: the radius of a bent section of hose measured to the innermost surface of the curved portion.

bend radius, minimum: the smallest radius at which a hose can be used. For metal hose: the radius of a bend measured to the hose centerline, as recommended by the manufacturer.

blister: a raised area on the surface or a separation between layers usually creating a void or air-filled space in a vulcanized article.

blow out force: the force generated from the internal pressure attempting to push the fitting from the hose.

body wire: normally a round or flat wire helix embedded in the hose wall to increase strength or to resist collapse.

bore: 1) an internal cylindrical passageway, as of a tube, hose or pipe; **2)** the internal diameter of a tube, hose, or pipe.

braid: the woven portion of a hose used as reinforcement to increase pressure rating and add hoop strength. Various materials such as polyester, cotton or metal wire are used. A hose may have one or more braids, outside or between layers of hose material.

braid wear: motion between the braid and corrugated hose, which normally causes wear on the outside diameter of the corrugation and the inside diameter of the braid.

braided ply: a layer of braided reinforcement.

braid-over-braid: multiple plies of braid having no separating layers.

brand: a mark or symbol identifying or describing a product and/or manufacturer, that is embossed, inlaid or printed.

brass: a family of copper/zinc alloys.

brazing: a process of joining metals using a non-ferrous filler metal having a melting point that is lower than the “parent metals” to be joined, typically over +800°F (+427°C).

bronze: an alloy of copper, tin and zinc.

BSPP/BSPT: British Standard Pipe Parallel / British Standard Pipe Tapered. See fitting/coupling — pipe thread fittings.

C

carcass: the fabric, cord and/or metal reinforcing section of a hose as distinguished from the hose tube or cover.

chalking: the formation of a powdery surface condition due to disintegration of surface binder or elastomer by weathering or other destructive environments.

checking: the short, shallow cracks on the surface of a rubber product resulting from damaging action of environmental conditions.

chemical compatibility: the relative degree to which a material may contact another without corrosion, degradation or adverse change of properties.

chemical resistance: the ability of a particular polymer, rubber compound, or metal to exhibit minimal physical and/or chemical property changes when in contact with one or more chemicals for a specified length of time, at specified concentrations, pressure, and temperature.

cold flexibility: relative ease of bending while being exposed to specified low temperature.

collar: 1) the portion of a fitting that is compressed by crimping to seal the hose onto the fitting barsbs and create a permanent attachment; also called a ferrule. (With field attachable fittings, the lock and seal are accomplished mechanically by the collar without crimping); **2)** a raised portion on the hose shank which functions as a connection for a ferrule or other locking device or functions as a hose stop.

collet: a tool or die-set used to crimp a hose end fitting onto a hose. A crimping die-set is typically six to eight "fingers" designed for infinite diameter settings within a range or preset to a specific diameter for a given hose type and size. Some may have a replaceable cage.

Coll-O-Crimp: a line of hydraulic and pneumatic hose, hose end fittings, and fabrication equipment that is a registered trademark of Eaton Corporation.

combustible liquid: a liquid having a flash point at or above +100°F (+37.8°C).

compound: the mixture of rubber or plastic and other materials, which are combined to give the desired properties when used in the manufacture of a product.

compression fitting: see fitting/coupling – compression

conductive: the ability to transfer electrical potential.

configuration: the combination of fittings on a particular assembly.

convoluted: description of hose or innercore having annular or helical ridges formed to enhance flexibility.

core: the inner portion of a hose, usually referring to the material in contact with the medium.

corrosion: the process of material degradation by chemical or electrochemical means.

corrosion resistance: ability of metal components to resist oxidation.

corrugated hose: hose with a carcass fluted, radially or helically, to enhance its flexibility or reduce its weight.

coupling: a frequently used alternative term for hose end fitting.

cover: the outer component usually intended to protect the carcass of a product.

CPE: chlorinated polyethylene, a rubber elastomer.

cracking: a sharp break or fissure in the surface, generally caused by strain and environmental conditions.

crimp diameter: the distance across opposite flats after crimping.

crimp/crimping: a hose end fitting attachment method utilizing a number of dies mounted in a radial configuration. The dies close perpendicular to the hose and fitting axis, compressing the collar, ferrule, or sleeve around the hose.

cure: the act of vulcanization. See vulcanization.

cut off factor: the hose length to be subtracted from the overall assembly length that allows for the hose coupling end connection extension beyond the end of the hose.

D

date code: any combination of numbers, letters, symbols or other methods used by a manufacturer to identify the time of manufacture of a product.

deburr: to remove ragged edges from the inside diameter of a hose end.

design factor: a ratio used to establish the working pressure of the hose, based on the burst strength of the hose.

displacement: the amount of motion applied to a hose defined as inches for parallel offset and degrees for angular misalignment.

DOT: Department of Transportation.

DIN: Deutsche Industrie Norme.

duplex assembly: an assembly consisting of two hose assemblies, one inside the other, and connected at the ends; also known as "jacketed assemblies."

durometer: an instrument for measuring the hardness of rubber and plastic compounds.

E

eccentricity: the condition resulting from the inside and outside diameters not having a common center.

effusion: the escape, usually of gases, through a material. See permeation.

elastic limit: the limiting extent to which a body may be deformed and yet return to its original shape after removal of the deforming force.

elastomer: any one of a group of polymeric materials, usually designated thermoset, such as natural rubber, or thermoplastic, which will soften with application of heat.

elongation: the increase in length expressed numerically as a percentage of the initial length.

EN: European Normes

ERMETO: a steel fitting product trademarked by Eaton Corporation.

endurance test: a service or laboratory test, conducted to product failure, usually under normal use conditions.

EPDM: Ethylene Propylene Diene Monomer; an elastomer.

extrude/extruded/extrusion: forced through the shaping die of an extruder; extrusion may have a solid or hollow cross section.

F

fabric impression: impression formed on the rubber surface during vulcanization by contact with fabric jacket or wrapper.

fabricator: the producer of hose assemblies.

fatigue: the weakening or deterioration of a material occurring when a repetitious or continuous application of stress causes strain, which could lead to failure.

FDA: United States Food and Drug Administration.

fire sleeve: slip-on or integrally extruded sleeve used to retard the effects of fire in certain applications; most often made with silicone and/or ceramic fiber.

fitting/coupling: a device attached to the end of the hose to facilitate connection.

The following is only a partial list of types of fittings available.

- **banjo fitting:** a through bolted designed featuring a hollow circle or "donut" attached to one end of the fitting barb so that the inner diameter is along the hose axis.
- **compression fitting:** a fitting style that seals on a mating tube by compressing an internal ferrule against the tube O.D.
- **field attachable fitting:** a fitting designed to be attached to hose without crimping or swaging. This fitting is not always a reusable type fitting.
- **flange style fittings:** pipe flanges and flanged fitting standards are listed under ANSI B16.5. Flanges are rated for pressure and listed as "American Class 150, 300, 400, 600, 900, 1,500 or 2,500." Pressure-

temperature ratings can be obtained by consulting the ANSI specification or ASME B16.5 (American Society of Mechanical Engineers). Designs vary by neck and face style, or other dimensional changes based on use. Various finishes or grooves may be applied to the face for sealing on a gasket or o-ring. Bolt holes and other dimensions are per the ANSI standard.

- **inverted flare fitting:** a fitting consisting of a male or female nut, trapped on a tube by flaring the end of the tube material to either 37° or 45°.
- **JIC fittings:** Joint Industrial Council (no longer in existence). An engineering group that established an industry standard fitting design incorporating a 37° mating surface, male and female styles. These standards are now governed by SAE.
- **o-ring fittings:** a fitting that seals by means of an elastomeric ring of a specified material.

pipe thread fittings:

- **NPT:** National Pipe Taper. Pipe thread per ANSI B1.20.1
- **NPTF:** National Pipe Tapered for Fuels. (Same as above except dry-seal per ANSI B1.20.3)
- **NPSH:** National Pipe Straight Hose per ANSI B1.20.7
- **NPSM:** National Pipe Straight Mechanical. Straight thread per ANSI B1.20.1
- **NPSL:** National Pipe Straight Loosefit per ANSI B1.20.1
- **BSPP, BSPT:** British Standard Pipe Parallel, British Standard Pipe Taper. BS21-

• **quick connect fitting:** a fitting designed to quickly connect and disconnect. These fittings come in many styles and types.

• **split flange fitting:** a fitting consisting of a flange retainer and a flange of two halves. This design allows the flanges to be installed after the retainer has been attached to the hose, making the flange reusable. SAE code 61 and 62.

• **tube fitting:** a hose fitting of which the mating end conforms to a tube diameter. The mate or male end of a compression fitting.

flammable gases/liquid/

media: a flammable gas, including liquefied gas, is one having a closed cup flash point below +100°F (+37.8°C) and a vapor pressure greater than 25 psi (174.2 KPa).

flex cracking: a surface cracking induced by repeated bending and straightening.

flow rate: a volume of media being conveyed in a given time period.

fluid: a gas or liquid medium.

fluorocarbon: an organic compound containing fluorine directly bonded to carbon. The ability of the carbon atom to form a large variety of structural chains gives rise to many fluorocarbons and fluorocarbon derivatives.

FOR-SEAL: a product name for a hose end configuration using an o-ring sealing method, trademarked by Eaton Corporation.

G

gpm: gallons per minute.

Glossary

Alpha/Numeric

H

heat resistance: the property or ability to resist the deteriorating effects of elevated temperatures.

helix: a shape formed by spiraling a wire or other reinforcement around the cylindrical body of a hose; typically used in suction hose.

hose: a flexible conduit consisting of a tube, reinforcement, and usually an outer cover.

hydrostatic testing: the use of liquid pressure to test a hose or hose assembly for leakage, twisting, and/or hose change-in-length.

Hytrel: registered trademark of DuPont.

I

I.D.: inside diameter.

identification yarn: a yarn of single or multiple colors, usually embedded in the hose wall, used to identify the manufacturer.

impression: a design formed during vulcanization in the surface of a hose by a method of transfer, such as fabric impression or molded impression.

impulse: an application of force in a manner to produce sudden strain or motion, such as hydraulic pressure applied in a hose.

innertube: the innermost layer of a hose; the hose material in contact with the medium.

insert: optional term for nipple. See nipple.

interlocking clamp: a clamp which engages the fitting in a manner which prevents the clamp from sliding off the fitting, typically a bolt or U-bolt style with interlocking fingers which engage an interlock ring on the fitting.

interlocking ferrule: a ferrule, which physically attaches to the fitting preventing the ferrule from sliding off the fitting.

ISO: International Organization for Standardization.

J

jacket: a seamless tubular braided or woven ply generally on the outside of a hose.

JIC: see fitting/coupling—JIC.

K

kinking: a temporary or permanent distortion of the hose induced by bending beyond the minimum bend radius.

L

layline: the line of printed information that runs parallel on the side of a manufactured hose giving details such as part number, psi rating, hose size, and manufacturing data.

layer: a single thickness of rubber or fabric between adjacent parts.

loop installation: the assembly is installed in a loop or "U" shape, and is most often used when frequent and/or large amounts of motion are involved.

LPG, LP Gas: liquefied petroleum gas.

M

MAWP: see pressure, maximum allowable working.

mandrel built: a hose fabricated and/or vulcanized on a mandrel.

manufacturer's identification: a code symbol used on or in some hose to indicate the manufacturer.

media, medium: the substance(s) being conveyed through a system.

N

NAHAD: National Association of Hose & Accessories Distributors.

Neoprene: a registered trademark of DuPont.

nipple: the internal member or portion of a hose fitting.

nitrile rubber (NB/Buna-N): a family of acrylonitrile elastomers used extensively for industrial hose.

nominal: a size indicator for reference only.

nomograph: a chart used to compare hose size to flow rate to recommended velocity.

non-conductive: the inability to transfer an electrical charge.

NPT/NPTF: national pipe threads. See fitting/coupling — pipe thread fittings.

nylon: a family of polyamide materials.

O

OAL: see overall length

O.D.: outside diameter.

OE/OEM: original equipment manufacturer.

oil resistance: the ability of the materials to withstand exposure to oil.

oil swell: the change in volume of a rubber article resulting from contact with oil.

operating conditions: the pressure, temperature, motion, and environment to which a hose assembly is subjected.

o-ring fitting: see fitting/coupling—o-ring.

overall length (OAL): the total length of a hose assembly, which consists of the free hose length plus the length of the coupling(s).

oxidation: the reaction of oxygen on a material, usually evidenced by a change in the appearance or feel of the surface or by a change in physical properties.

ozone cracking: the surface cracks, checks, or crazing caused by exposure to an atmosphere containing ozone.

ozone resistance: the ability to withstand the deteriorating effects of ozone (generally cracking).

P

permanent fitting: the type of fitting which, once installed, may not be removed for re-use.

permeation: the process of migration of a substance into and through another, usually the movement of a gas into and through a hose material; the rate of permeation is specific to the substance, temperature, pressure, and the material being permeated.

pin pricked: perforations through the cover of a hose to vent permeating gases.

pitch: **1)** the distance from one point on a helix to the corresponding point on the next turn of the helix, measured parallel to the axis; **2)** the distance between the two peaks of adjacent corrugation or convolution.

plating: a material, usually metal, applied to another metal by electroplating, for the purpose of reducing corrosion; typically a more noble metal such as zinc is applied to steel.

ply: an individual layer in hose construction.

polymer: a macromolecular material formed by the chemical combination of monomers, having either the same or different chemical compositions.

pressure: force ÷ unit area. For purposes of this document, refers to PSIG (pounds per square inch gauge).

pressure drop: the measure of pressure reduction or loss over a specific length of hose.

pressure, burst: the pressure at which rupture occurs.

pressure, maximum allowable working: the maximum pressure at which a hose or hose assembly is designed to be used. Abbreviated as MAWP.

pressure, working: the maximum pressure to which a hose will be subjected, including the momentary surges in pressure, which can occur during service. Abbreviated as WP.

psi: pounds per square inch.

PVC: polyvinyl chloride. A low cost thermoplastic material typically used in the manufacture of industrial hoses. The operating temperature range is -500°F to +1750°F (-295.5°C to +954.4°C).

R

reinforcement: the strengthening members, consisting of either fabric, cord, and/or metal, of a hose. See ply.

reusable fitting/coupling: see fitting/coupling—field attachable fittings.

RhinoHide: an abrasion resistant covered hydraulic hose that is a registered trademark of Eaton Corporation.

RMA: The Rubber Manufacturers Association, Inc.

S

SAE: Society of Automotive Engineers.

shank: that portion of a fitting, which is inserted into the bore of a hose.

skive: the removal of a short length of cover and/or tube to permit the attachment of a fitting directly over the hose reinforcement.

sleeve: a metal cylinder, which is not physically

attached to the fitting, for the purpose of forcing the hose into the serrations of the fitting.

smooth bore: a term used to describe the type of innercore in a hose.

specification: a document setting forth pertinent details of a product.

spiral: a method of applying reinforcement in which there is not interlacing between individual strands of the reinforcement.

spring guard: a helically wound component applied internally or externally to a hose assembly, used for strain relief, abrasion resistance, collapse resistance.

standard: a document, or an object for physical comparison, for defining product characteristics, products, or processes, prepared by a consensus of a properly constituted group of those substantially affected and having the qualifications to prepare the standard for use.

static wire: wire incorporated in a hose to conduct static electricity.

stem: see nipple.

Sub-Zero: a low temperature resistant hose that is a registered trademark of Eaton Corporation.

surge (spike): a rapid and transient rise in pressure.

swelling: an increase in volume or linear dimension of a specimen immersed in liquid or exposed to a vapor.

T

Thick-Flange: a hose end fitting that is trademarked by Eaton Corporation.

tube: the innermost continuous all-rubber or

plastic element of a hose.

tube fitting: see fitting/coupling—tube.

tubing: a non-reinforced, homogeneous conduit, generally of circular cross-section.

V

vacuum resistance: the measure of a hoses ability to resist negative gauge pressure.

vibration: amplitude motion occurring at a given frequency.

viscosity: the resistance of a material to flow.

vulcanization: a process during which a rubber compound, through a change in its chemical structure, improves or extends elastic properties over a greater range of temperature.

W

weathering: the surface deterioration of a hose cover during outdoor exposure, as shown by checking, cracking, crazing and chalking.

wire reinforced: a hose containing wires to give added strength, increased dimensional stability and crush resistance. See reinforcement.

working temperature: the temperature range of the application; may include the temperature of the fluid conveyed or the environmental conditions the assembly is exposed to in use.

WP: working pressure.

The preceding Glossary of Terms, as utilized in the hose industry, includes some definitions from The Hose Handbook, published by the Rubber Manufacturers Association.

Index

Alpha/Numeric

A190X.....	M-2, M-5-11	C3359.....	L-10	C5716.....	L-61	ET1000TP-0001.....	N-30
A191X.....	M-2, M-5-11	C3409.....	L-11	C5725.....	L-63	ET4001-OXX.....	N-22
A-2103.....	N-48	C3459.....	L-12	C5726.....	L-60	ET400-001.....	N-19
A290X.....	M-2, M-5-11	C3469.....	L-12	C5755.....	L-58	ET400-002.....	N-19
A291X.....	M-2, M-5-11	C3509.....	L-11	C5805.....	L-58	ET400-003.....	N-19
A361X.....	M-7, M-9	C3529.....	L-13	C5880.....	L-44	ET400-010.....	N-27
A390X.....	M-5-11	C3559.....	L-10	C5924.....	L-39	ET4000AR.....	N-28
A393X.....	M-9	C3569.....	L-12	C5955.....	L-64	ET4000AR-XXX.....	N-39
A490X.....	M-3, M-5-11	C3609.....	L-14	C-5X.....	N-46	ET4000DC-4SXX.....	N-38
A491X.....	M-3	C3709.....	L-14	C9200.....	L-77	ET4000DC-6SXX.....	N-38
A492X.....	M-21	C3759.....	L-15	C9240.....	L-77	ET4000DC-MXXXS.....	N-35
A493X.....	M-21	C3805.....	L-15	CA-130.....	N-52	ET4000SR-MXXXXA.....	N-40
A595X.....	M-4	C3959.....	L-16	CA-230.....	N-52	ET4000TP.....	N-28
A596X.....	M-4	C-40X.....	N-45	CA-50.....	N-59	ET4020-XXX.....	N-24
A597X.....	M-4	C5015.....	L-40	CA-50-60A.....	N-59	ET4020TP-0003.....	N-24
A598X.....	M-4	C5105.....	L-38	CA-50-CO.....	N-59	ET4040-XXX.....	N-25
A690X.....	M-4	C5115.....	L-38	CA-50-NH.....	N-59	ET4040-000X.....	N-25
A690XW.....	M-4	C5125.....	L-38	CL-434.....	N-53	ET400DC-MXXXS.....	N-35
A691X.....	M-4-11	C5129.....	L-39	DC-121.....	N-64	ET400SR-00X.....	N-40
A692X.....	M-4-11	C5165.....	L-37, L-71	E6X.....	J-77	ET400TP-001.....	N-22
A693X.....	M-4-11	C5165MM.....	L-37	EH049.....	A-8, E-2	ET400TP-0001.....	N-30
A694X.....	M-4-5, M-7-8, M-10	C5205.....	L-42	EH089.....	A-8, E-2	ET420-00X.....	N-21
A990X.....	M-3, M-5-11	C5216.....	L-48	EH225.....	A-8, F-2	ET420CD-MXXXS.....	N-35
AB-140.....	N-67	C5229.....	L-39	EH226.....	A-8, F-2	ET420TP-0001.....	N-30
AB-1400.....	N-67	C5255.....	L-43	EH227.....	A-8, F-3	ET420-XXR.....	N-40
AB-45.....	N-69	C5256.....	L-45	EJ3111.....	K-34	ET440TP-0001.....	N-30
AB-8.....	N-52	C5275.....	L-43	EJ3158.....	K-48	ET460TP-0001.....	N-30
AB-9.....	N-52	C5305.....	L-41	EJ3297.....	K-40	ET480-00X.....	N-14
AC8111.....	L-77	C5306.....	L-41	EJ3298.....	K-39	ET480TP-001.....	N-30
A-MEFI-ME001-E.....	L-108	C5314.....	L-69	EJ3299.....	K-36	FA-100.....	N-55
BA-24.....	N-66	C5315.....	L-45	EJ3302.....	K-38	FA-100-CO.....	N-55
BA-28.....	N-66	C5316.....	L-44	EJ3321.....	K-49	FA-135.....	N-58
BA-37.....	N-66	C5325.....	L-41	EJ3410.....	K-38	FA-135-10B.....	N-58
BA-48.....	N-66	C5355.....	L-47	EJ3421.....	K-49	FA-135-CO.....	N-58
BA-56.....	N-66	C5356.....	L-48	EJ3422.....	K-49	FA-135-NH.....	N-58
BA-84.....	N-65	C5365.....	L-49	EJ3533.....	K-45	FA-15.....	N-57
BF-40.....	N-62	C5405.....	L-51	EJ3534.....	K-43	FA-15-CO.....	N-57
BF-41.....	N-62	C5406.....	L-56	EJ3543.....	K-38	FA-15-NH.....	N-57
BF-42.....	N-63	C5425.....	L-50	EJ3809.....	K-57	FF1162.....	L-13
BF-43.....	N-63	C5435.....	L-52	ET1000.....	N-31-33	FF12139.....	N-54
BL-456.....	N-54	C5455.....	L-53	ET1000-00X.....	N-16	FF12228.....	L-108
C3059.....	L-4	C5505.....	L-50	ET1000-01X.....	N-16	FF12229.....	L-108
C3069.....	L-8	C5506.....	L-53	ET-1000-01X.....	N-32	FF12230.....	L-108
C3109.....	L-5	C5515.....	L-55-56	ET1000AR.....	N-31	FF12231.....	L-108
C3159.....	L-5	C5515LL.....	L-56	ET1000AR-XXX.....	N-39	FF12262.....	K-59
C3169.....	L-4	C5525.....	L-52	ET1000C.....	N-31	FF132XX.....	M-20
C3179.....	L-5	C5605.....	L-61	ET1000C-XXXX.....	N-40	FF1355-02.....	M-18
C3209.....	L-6	C5655.....	L-62	ET1000PK.....	N-31	FF135XX.....	M-20
C3239.....	L-6	C5705.....	L-57	ET-1000PK.....	N-32	FF135XX.....	M-22
C3249.....	L-7, L-69	C5706.....	L-60	ET1000SR-MXXXXA.....	N-40	FF13727.....	K-60
C3269.....	L-6, L-70	C5707.....	L-62	ET1000SR-MXXXD.....	N-40	FF13819.....	K-59
C3309.....	L-7	C5715.....	L-63	ET1000TP.....	N-31	FF13820.....	K-59

Index

Alpha/Numeric

FF13821	K-59	FF90467	L-108	FJ3408	K-34	FT1421	K-61
FF13822	K-59	FF9051X	M-23	FJ3409	K-46	GA23854	K-58
FF14171	K-59	FF9052X	M-23	FJ3416	K-36	GA23911	K-45
FF14172	K-59	FF906XX	N-48	FJ3427	K-53	GA23912	K-45
FF14173	K-59	FF91047	N-23	FJ3428	K-53	GA23913	K-45
FF14174	K-59	FF9872-04	K-61	FJ3444	K-40	GA24335	K-58
FF14401	K-59	FH-135X	N-45	FJ3460	K-40	GA24336	K-58
FF14402	K-59	FH-15X	N-45	FJ3461	K-36	GA24337	K-58
FF147XX	M-18	FH-40X	N-45	FJ3495	K-48	GA7000579	K-60
FF14802	M-18	FH-72X	N-46	FJ3496	K-52	GH100	E-2
FF148XX	M-18	FJ3012	K-38	FJ3510	K-50	GH134W	A-9, G-2, K-60, K-62
FF1851T	L-26	FJ3013	K-38	FJ3511	K-50	GW1172	K-60
FF2281T	L-28	FJ3019	K-41	FJ3513	K-51	H009	A-8, C-2, M-5
FF3038	L-98	FJ3026	K-42	FJ3514	K-51	H0105	A-7, D-2, M-6
FF3042	L-98	FJ3045	K-51	FJ3568	K-51	H0106	A-7, D-2
FF3044	L-101	FJ3047	K-39	FJ3611	K-42	H014	M-6
FF3046	L-98	FJ3052	K-40	FJ3623	K-54	H017	A-4, B-3, M-5
FF3056	L-99	FJ3053	K-35	FJ3624	K-54	H039	A-4, B-2, M-5
FF3061	L-102	FJ3054	K-35	FJ3632	K-34	H039H	M-5
FF3065	L-102	FJ3055	K-34	FJ3731	K-43	H057	A-8, E-3, M-5
FF3067	L-102	FJ3056	K-43	FJ3734	K-55	H0570X	N-53
FF3089	L-99	FJ3057	K-43	FJ3801	K-55	H059	A-8, E-3, M-5
FF3093	L-99	FJ3058	K-52	FJ3804	K-54	H069	A-9, H-6, M-5
FF3178	L-106	FJ3059	K-44	FJ3890	K-47	H077	A-8, E-4, M-5
FF3218	L-106	FJ3066	K-53	FJ3891	K-47	H100	A-6, C-2, M-5
FF3227	L-107	FJ3067	K-48	FJ3892	K-47	H101	A-6, C-3, M-6
FF3233	L-107	FJ3111	K-46	FJ3914	K-54	H104	A-4, B-3
FF3236	L-100	FJ3112	K-47	FJ3970	K-55	H114	A-4, B-6, M-6
FF3246	L-100	FJ3113	K-48	FJ3977	K-55	H1146	M-6
FF3284	L-103	FJ3116	K-41	FJ3978	K-56	H115	A-6, C-4, M-6
FF3286	L-103	FJ3131	K-41	FJ3979	K-57	H116	A-6, C-4
FF3318T	L-101, L-107	FJ3132	K-41	FJ3980	K-56	H145	A-4, B-6, M-6
FF3362	L-100	FJ3133	K-44	FJ3981	K-57	H145R	A-4, B-7, M-6
FF3412	L-101	FJ3134	K-42	FJ3982	K-56	H146	A-4, B-7
FF3503	L-104	FJ3135	K-42	FJ3983	K-56	H1571	A-7, C-7
FF3505	L-104	FJ3136	K-46	FJ5984	K-34	H160	A-7, D-3
FF3507	L-104	FJ3149	K-44	FJ5985	K-35	H166	A-9, H-4, M-6
FF3509	L-105	FJ3161	K-45	FJ5986	K-53	H169	A-9, H-3, M-7
FF3511	L-105	FJ3162	K-36	FJ5995	K-52	H1719	A-7, D-4
FF3513	L-105	FJ3163	K-39	FL-310	N-53	H1776/7	A-7, D-5
FF5163	L-54	FJ3171	K-52	FS-1XXX	N-48	H1812	A-7, D-5
FF5164	L-54	FJ3192	K-46	FS-2XXX	N-48	H190	A-4, B-4, M-7
FF90178	K-33	FJ3225	K-49	FS-3200	N-2	H190H	A-4, B-5, M-7
FF-90192-XX	K-61	FJ3226	K-50	FS-3XXX	N-48	H1981/2	A-7, D-6
FF-90193-XX	K-61	FJ3230	K-37	FS-85	N-61	H1987	A-8, D-7
FF90202	L-97	FJ3274	K-48	FS-86	N-61	H201	A-6, C-5, M-7
FF90213	L-108	FJ3288	K-35	FS-87	N-61	H209	A-7, C-5, M-7
FF90241	L-108	FJ3289	K-39	FS-X00	N-48	H213	A-9, H-4, M-7
FF90277	L-108	FJ3301	K-47	FT-1341	N-60	H229	A-9, H-2, M-7
FF90308	M-18	FJ3319	K-46	FT1355	M-18	H239	A-9, H-2, M-7
FF90311	M-25	FJ3363	K-37	FT1357	K-61	H243	A-9, I-2, M-8
FF90319	J-97	FJ3365	K-37	FT1357	N-54	H245	A-4, B-9, M-8
FF90384	L-97	FJ3366	K-44	FT-1406	K-61	H245L	A-4, B-10

Index

Alpha/Numeric

H265.....	A-7, C-6, M-8	M41157.....	L-77	T-1047.....	N-73	T-400-GT.....	N-44
H275.....	A-7, C-6, M-8	M41157X14.....	N-79	T-104X.....	N-74	T-400-GTK.....	N-44
H277.....	A-9, I-2, M-8	M41157X16.....	N-79	T-1060A.....	N-73	T-400-K1.....	N-23
H280.....	A-4, B-11, M-8	M41157X18.....	N-79	T-106X.....	N-74	T-400-M.....	N-23
H285.....	A-7, D-4, M-8	M41157X6.....	N-79	T-107X.....	N-74	T-400-MSP.....	N-2
H290.....	A-5, B-13, M-8	M7629.....	L-73	T-107X.....	N-74	T-400-NP60.....	N-44
H290H.....	A-5, B-13, M-9	M7629X.....	L-3	T-10B.....	N-73	T-400-PH.....	N-44
H324.....	A-5, B-2, M-9	M7630.....	L-73	T-10C.....	N-73	T-400-PHK.....	N-44
H32406.....	N-79	M9600.....	L-75	T-10-D.....	N-73	T-400-S.....	N-23
H325.....	A-5, B-10, M-9	M9700.....	L-72	T-10-H.....	N-73	T-400-X.....	N-25
H332.....	A-7, C-7, M-9	M9800.....	L-75	T-10-P.....	N-73	T-400-XC.....	N-2, N-13
H335.....	A-5, B-19, M-9	MA-100.....	N-56	T-10V-1.....	N-73	T-400-XX... N-2, N-13, N-21-23, N-26	
H336.....	A-5, B-19, M-9	MA-200.....	N-57	T-11XX.....	N-77	T-400-XXC.....	N-38
H338.....	A-9, H-3, M-9	MB5315.....	L-74	T-121.....	N-75	T-400-XXR.....	N-40
H345.....	A-5, B-5, M-9	MB5515.....	L-76	T-1290.....	N-51	T-400-XXX.....	N-2
H350.....	A-5, B-8, M-9	MB7629.....	L-76	T-1295.....	N-51	T-401-110.....	N-19
H366.....	A-8, E-4, M-9	MB7629X.....	L-3	T-135.....	K-61	T-401-1B.....	N-42
H400.....	A-5, B-9, M-9	MB7630.....	L-76	T-135.....	N-54	T-401-1BC.....	N-42
H421.....	A-5, B-18	MC3159.....	L-74	T-135.....	N-75	T-401.....	N-19
H425.....	A-5, B-12, M-10	MC5019.....	L-46	T-135B.....	K-61	T-402.....	N-19
H429.....	A-9, H-3	MC5019.....	L-67	T-135B.....	N-54	T-402-2.....	N-41
H430.....	A-5, B-14, M-10	MC5206.....	L-66	T-135B.....	N-75	T-403.....	N-19
H430R.....	A-5, B-15, M-10	MC5207.....	L-67	T-137B.....	N-75	T-403-2.....	N-41
H435.....	A-6, B-20, M-10	MC5208.....	L-67	T-137H.....	N-75	T-407.....	N-20
H436.....	A-6, B-21, M-10	MC5315.....	L-71	T-14X.....	N-78	T-407-1.....	N-20
H464.....	A-6, B-26, M-10	MC5405.....	L-75	T-152.....	N-78	T-410-27.....	N-39
H470.....	A-6, A-30, B-15, M-10	MC5515.....	L-72	T-152-P.....	N-78	T-410-36.....	N-78
H471.....	A-6, B-16	MH7105.....	L-66	T-191B.....	N-75	T-410-37.....	N-78
H485.....	A-6, B-17	ML7105.....	L-66	T-201.....	N-72	T-410-5X.....	N-78
H487.....	A-6, B-17	PB.....	N-47	T-201B.....	N-72	T-410-70.....	N-37
H545.....	A-6, B-8, M-11	PC-48.....	N-64	T-282-2.....	N-16	T-410-80.....	N-37
H569.....	A-9, H-6, M-11	PD-15.....	N-45	T-300.....	N-71	T-410-XX.....	N-260
H757.....	A-9, G-2, M-11	PD-20.....	N-45	T-400.....	N-19	T-410-XXC.....	N-38
H757XX.....	N-5	PD-40.....	N-45	T-400-1.....	N-19	T-412.....	N-22
H900.....	A-8	PD-49.....	N-56	T-400-104.....	N-36	T-414.....	N-19
H900.....	E-5	PD-75.....	N-56	T-400-10BB.....	N-47	T-420.....	N-26
H9949.....	A-8, D-7	PD-95.....	N-45	T-400-110.....	N-21	T-420-25.....	N-19
HA-574.....	N-55	PR014040-01.....	L-108	T-400-114.....	N-37	T-420-70.....	N-37
HD-1X.....	N-46	QC-18.....	N-68	T-400-129.....	N-37	T-420-80.....	N-37
HD-2X.....	N-47	QC-180.....	N-68	T-400-137.....	N-36	T-420N.....	N-21
HK0XXX.....	M-5-8, M-10-11, M-24	QC-1800.....	N-68	T-400-17.....	N-2	T-420N-001.....	N-21
HK1XXX.....	M-5-11, M-24	R12-Z5X.....	J-28	T-400-17P.....	N-2	T-420-X.....	N-21
HK2XXX.....	M-5-11, M-24	R12-Z6X.....	J-28	T-400-19.....	N-25	T-420-XCN.....	N-26
HK3XXX.....	M-5-6, M-8-10, M-24	R12-Z9X.....	J-28	T-400-20A.....	N-2	T-420-XX.....	N-26
HPM.....	M-19	RG-24.....	N-53	T-400-30.....	N-36	T-420-XXC.....	N-35
HPX.....	M-19	SA-1.....	N-70	T-400-66.....	N-36	T-420-XXNS.....	N-39
HSM-XX.....	M-19	SA-2.....	N-70	T-400-67.....	N-36	T-421-FP.....	N-41
IKEXXN-11X.....	K-14	SFK.....	L-90	T-400-8.....	N-24	T-421-FP.....	N-43
IKEXXN-12X.....	K-14	SFK62.....	L-92	T-400-9.....	N-23	T-421U.....	N-21
IKEXXN-13X.....	K-14	SR3100W.....	N-54	T-400-B.....	N-23	T-421U-001.....	N-42
KXXN-11X.....	K-14	SS-88.....	N-62	T-400-BB.....	N-23	T-432-15.....	N-23
KXXN-12X.....	K-14	T-101A.....	N-72	T-400-DE61.....	N-44	T-433.....	N-25
KXXN-13X.....	K-14	T-1037.....	N-75	T-400-G.....	N-19	T-433.....	N-41

Index

Alpha/Numeric

T-433-1	N-41	T-60A	N-73	XXE-36X	J-4	XXU-2XC	J-44
T-433-2	N-41	T-70	N-74	XXE-40X	J-4	XXU-2XD	J-48
T-440	N-29	T-7002	L-79	XXE-46X	J-7	XXU-2XF	J-39
T-440-XXC	N-35	T-7003	L-79	XXE-50X	J-3	XXU-2XK	J-44
T-440-XXR	N-40	T-7004	L-79	XXE-60X	J-4	XXU-30X	J-40
T-441	N-42	T-7005	L-79	XXE-64X	J-7	XXU-31X	J-40
T-450-C	N-11	T-7006	L-79	XXE-65X	J-7	XXU-36X	J-45
T-450-D1	N-11	T-7008	L-79	XXE-66X	J-6	XXU-3XF	J-39
T-450-K	N-11	T-700X	N-76	XXE-68X	J-6	XXU-3XK	J-44
T-450-P	N-11	T-7010	L-79	XXE-69X	J-6	XXU-3XT	J-47
T-450-Q	N-11	T-7012	L-79	XXE-75X	J-3	XXU-40X	J-44
T-460	N-4	T-7016	L-79	XXE-7XP	J-7	XXU-41X	J-44
T-460-2	N-4	T-701X	N-76	XXE-A2X	J-8	XXU-44X	J-51
T-460-P	N-13	T-7020	L-79	XXE-A6X	J-8	XXU-48X	J-48
T-460-SF	N-13	T-7024	L-79	XXE-B0X	J-3	XXU-4XP	J-50
T-460-SP	N-13	T-702X	N-76	XXE-B4X	J-5	XXU-4XT	J-47
T-460-SPK	N-13	T-7032	L-79	XXE-B6X	J-6	XXU-50X	J-40
T-460-SPR	N-13	T-703X	N-76	XXE-J0X	J-2	XXU-51X	J-40
T-460-TR	N-47	T-75-12	N-74	XXE-L6X	J-6	XXU-52X	J-40
T-460-X	N-10	T-75-XX	N-74	XXE-S6X	J-5	XXU-55X	J-54
T-460-XX	N-13	T-75-XX	N-74	XXE-S7X	J-5	XXU-56X	J-54
T-460-XXB	N-11	T-76-B	N-74	XXE-T5X	J-5	XXU-5XC	J-44
T-460-XXBB	N-11	T-9-1	N-74	XXE-T6X	J-5	XXU-5XD	J-52
T-462	N-4	T-9-3	N-74	XXE-X9X	J-5	XXU-5XP	J-50
T-462-2	N-43	T-9-G	N-74	XXE-XXL	J-4	XXU-5XT	J-47
T-462-V	N-13	TA-1002	A-18	XXE-Y6X	J-3	XXU-60X	J-43
T-462-XX	N-13	TA-1004	N-60	XXS-10X	J-36	XXU-61X	J-43
T-464	N-4	TC-20	N-46	XXS-11X	J-36	XXU-62X	J-43
T-465	N-10-11	TF5375	L-49	XXU035X	J-45	XXU-64X	J-51
T-465-1	N-12	TF5605	L-61	XXU-05X	J-43	XXU-65X	J-51
T-465-HP	N-10	TF5715	L-63	XXU-06X	J-43	XXU-66X	J-52
T-465-HPU	N-5	T-JSX	N-71	XXU-0XA	J-38	XXU-67X	J-52
T-465-TB	N-11	T-JX	N-71	XXU-0XC	J-44	XXU-68X	J-49
T-466	N-4	T-JXX	N-71	XXU-0XD	J-48	XXU-69X	J-49
T-475	N-3	TL-70XX	N-76	XXU-0XL	J-45	XXU-6XC	J-44
T-475-1	N-3-9	T-SX	N-71	XXU-0XP	J-46	XXU-6XD	J-52
T-475-XXXC	N-3-5	T-SXX	N-71	XXU-0XS	J-46	XXU-6XE	J-52
T-480	N-16-20	W05465	L-9	XXU-10X	J-37	XXU-6XP	J-50
T-480-2	N-16, N-31, N-43	W05498	L-9	XXU-11X	J-37	XXU-6XT	J-47
T-480-3	N-17, N-43	W05499	L-9	XXU-15X	J-38	XXU-75X	J-41
T-480-80	N-28	W05730	L-9	XXU-16X	J-38	XXU-76X	J-41
T-480-AH	N-13, N-17, N-19	W146XX	M-13	XXU-1XA	J-38	XXU-7XC	J-44
T-480-EP	N-14	W17709	L-9	XXU-1XC	J-44	XXU-7XD	J-52
T-480-HP	N-13	W21204	L-9	XXU-1XD	J-48	XXU-7XE	J-52
T-480-TA	N-14	W23464	L-9	XXU-1XF	J-39	XXU-7XP	J-53
T-480-XX	N-18	W440XX	M-12	XXU-1XK	J-44	XXU-8XC	J-44
T-480-XXX	N-18	W761XX	M-13	XXU-1XL	J-45	XXU-8XD	J-52
T-481-110	N-17, N-31, N-41	W798XX	M-13	XXU-1XP	J-46	XXU-8XE	J-52
T-481-XXX	N-18	WTT0XX	M-12	XXU-1XS	J-46	XXU-8XP	J-53
T-482-2	N-31, N-41	WTT2XX	M-12	XXU-20X	J-42	XXU-95X	J-48
T-482-X	N-18	X252	L-3	XXU-25X	J-43	XXU-97X	J-52
T-570	N-76	XXE-10X	J-2	XXU-26X	J-43	XXU-9XP	J-53
T-570-1	N-76	XXE-35X	J-4	XXU-2XA	J-38	XXU-A2X	J-53

Index

Alpha/Numeric

XXU-A3X.....	J-53	XXZ-0XPA.....	J-85	XXZ-5XT.....	J-84	XXZA-L8X.....	J-75
XXU-A4X.....	J-53	XXZ-0XS.....	J-84	XXZ-60X.....	J-70	XXZA-P2X.....	J-77
XXU-A6X.....	J-54	XXZ-10X.....	J-68	XXZ-61X.....	J-70	XXZA-S8X.....	J-74
XXU-A7X.....	J-54	XXZ-11X.....	J-68	XXZ-62X.....	J-70	XXZ-B0X.....	J-79
XXU-A8X.....	J-54	XXZ-12X.....	J-68	XXZ-63X.....	J-70	XXZ-B1X.....	J-79
XXU-B0X.....	J-40	XXZ-13X.....	J-68	XXZ-64X.....	J-72	XXZ-B4X.....	J-80
XXU-B4X.....	J-48	XXZ-15X.....	J-86	XXZ-65X.....	J-72	XXZ-B6X.....	J-80
XXU-B6X.....	J-50	XXZ-16X.....	J-86	XXZ-667X.....	J-72	XXZ-BC0X.....	J-91
XXU-C3X.....	J-42	XXZ-17X.....	J-86	XXZ-66X.....	J-72	XXZ-BC1X.....	J-91
XXU-E6X.....	J-39	XXZ-1XA.....	J-89	XXZ-68X.....	J-71	XXZ-BC4X.....	J-91
XXU-E7X.....	J-39	XXZ-1XC.....	J-88	XXZ-6PW.....	J-85	XXZ-BC5X.....	J-91
XXU-G0X.....	J-46	XXZ-1XD.....	J-88	XXZ-6XC.....	J-89	XXZ-BC6X.....	J-91
XXU-G1X.....	J-46	XXZ-1XE.....	J-89	XXZ-6XD.....	J-88	XXZ-BC7X.....	J-91
XXU-G2X.....	J-46	XXZ-1XF.....	J-90	XXZ-6XE.....	J-90	XXZ-BC8X.....	J-91
XXU-G4X.....	J-49	XXZ-1XK.....	J-87	XXZ-6XP.....	J-86	XXZ-BC9X.....	J-91
XXU-G5X.....	J-49	XXZ-1XL.....	J-87	XXZ-6XT.....	J-84	XXZ-E7X.....	J-77
XXU-G6X.....	J-50	XXZ-1XPA.....	J-85	XXZ-75X.....	J-78	XXZ-E8X.....	J-77
XXU-G7X.....	J-54	XXZ-1XS.....	J-84	XXZ-76X.....	J-78	XXZ-G0X.....	J-80
XXU-G8X.....	J-54	XXZ-20X.....	J-69	XXZ-77X.....	J-78	XXZ-G0X.....	J-83
XXU-J0X.....	J-39	XXZ-21X.....	J-69	XXZ-7XC.....	J-89	XXZ-G1X.....	J-80
XXU-J1X.....	J-39	XXZ-25X.....	J-69	XXZ-7XD.....	J-88	XXZ-G2X.....	J-80
XXU-J3X.....	J-53	XXZ-26X.....	J-69	XXZ-7XE.....	J-90	XXZ-G3X.....	J-80
XXU-J4X.....	J-53	XXZ-2XA.....	J-89	XXZ-7XP.....	J-86	XXZ-G4X.....	J-81
XXU-J5X.....	J-53	XXZ-2XC.....	J-88	XXZ-8XC.....	J-89	XXZ-G5X.....	J-81
XXU-L0X.....	J-47	XXZ-2XD.....	J-88	XXZ-8XD.....	J-88	XXZ-G6X.....	J-81
XXU-L2X.....	J-47	XXZ-2XE.....	J-89	XXZ-8XE.....	J-90	XXZ-G6X.....	J-83
XXU-L5X.....	J-49	XXZ-2XF.....	J-90	XXZ-8XP.....	J-86	XXZ-G7X.....	J-82
XXU-L6X.....	J-50	XXZ-2XK.....	J-87	XXZ-95X.....	J-79	XXZ-G8X.....	J-82
XXU-L7X.....	J-50	XXZ-2XL.....	J-87	XXZ-97X.....	J-79	XXZ-G9X.....	J-82
XXU-L8X.....	J-50	XXZ-30X.....	J-74	XXZ-9XP.....	J-86	XXZ-H0X.....	J-81
XXU-M0X.....	J-51	XXZ-31X.....	J-74	XXZA-11X.....	J-68	XXZ-H5X.....	J-82
XXU-M1X.....	J-51	XXZ-35X.....	J-85	XXZA-12X.....	J-68	XXZ-H6X.....	J-82
XXU-P0X.....	J-42	XXZ-36X.....	J-85	XXZ-A2X.....	J-75	XXZ-J0X.....	J-68
XXU-P1X.....	J-42	XXZ-37X.....	J-85	XXZA-2XS.....	J-84	XXZ-J1X.....	J-68
XXU-P5X.....	J-38	XXZ-3XA.....	J-89	XXZ-A3X.....	J-75	XXZ-J3X.....	J-76
XXU-P6X.....	J-38	XXZ-3XC.....	J-88	XXZ-A4X.....	J-75	XXZ-J4X.....	J-76
XXU-R0X.....	J-41	XXZ-3XE.....	J-89	XXZA-52X.....	J-73	XXZ-J5X.....	J-76
XXU-R1X.....	J-41	XXZ-3XF.....	J-90	XXZA-60X.....	J-70	XXZ-L2X.....	J-71
XXU-R6X.....	J-54	XXZ-3XK.....	J-87	XXZA-61X.....	J-70	XXZ-L6X.....	J-75
XXU-R7X.....	J-54	XXZ-3XT.....	J-84	XXZA-62X.....	J-70	XXZ-L7X.....	J-75
XXU-S6X.....	J-45	XXZ-40X.....	J-73	XXZA-65X.....	J-72	XXZ-L8X.....	J-75
XXU-S7X.....	J-45	XXZ-41X.....	J-73	XXZA67X.....	J-72	XXZ-M0X.....	J-70
XXU-S8X.....	J-45	XXZ-44X.....	J-74	XXZA-69X.....	J-71	XXZ-M1X.....	J-70
XXU-T1X.....	J-47	XXZ-48X.....	J-73	XXZ-A6X.....	J-76	XXZ-OXL.....	J-87
XXU-T0X.....	J-47	XXZ-4XP.....	J-86	XXZ-A7X.....	J-76	XXZ-P0X.....	J-77
XXU-X6X.....	J-51	XXZ-4XT.....	J-84	XXZ-A8X.....	J-76	XXZ-P1X.....	J-77
XXZ-05X.....	J-69	XXZ-50X.....	J-73	XXZA-A4X.....	J-75	XXZ-P2X.....	J-77
XXZ-06X.....	J-69	XXZ-51X.....	J-73	XXZA-G1X.....	J-80	XXZ-P2X.....	J-77
XXZ-07X.....	J-69	XXZ-52X.....	J-73	XXZA-G2X.....	J-80	XXZ-P5X.....	J-87
XXZ-0XA.....	J-89	XXZ-5XC.....	J-89	XXZA-G4X.....	J-81	XXZ-P6X.....	J-87
XXZ-0XC.....	J-88	XXZ-5XD.....	J-88	XXZA-G5X.....	J-81	XXZ-R0X.....	J-78
XXZ-0XD.....	J-88	XXZ-5XE.....	J-90	XXZA-G7X.....	J-82	XXZR-10X.....	J-68
XXZ-0XF.....	J-90	XXZ-5XP.....	J-86	XXZA-G8X.....	J-82	XXZR-11X.....	J-68

Index

Alpha/Numeric

XXZ-R1X	J-78	4165	L-26	7405	L-85	75702	J-27
XXZR-60X	J-70	4205	L-7	7455	L-85	75704	J-27
XXZ-R6X	J-78	4205	L-29	7505	L-84	75706	J-27
XXZ-R7X	J-78	4213	L-29	7515	L-85	75729	J-28
XXZ-S6X	J-74	4213	L-44	7605	L-87	75730	J-28
XXZ-S7X	J-74	4229	L-27	7629	L-16	75731	J-28
XXZ-S8X	J-74	4305	L-27	7629	L-46	75732	J-28
XXZ-T0X	J-84	4315	L-28	7629	L-64	75750	J-29
XXZ-T1X	J-84	4315	L-70	7629	L-88	75751	J-29
ZW747X	L-3	4316	L-28	7629	N-53	75760	J-29
ZW747XX	J-26	4325	L-27	7655	L-87	75761	J-29
ZW747XX	J-27	4355	L-29	7705	L-86	201113	L-42
ZW747XX	J-28	4365	L-29	7715	L-88	202114	L-43
ZW747XX	K-33	4375	L-30	7716	L-87	203006	L-59
ZW747XX	N-54	4405	L-30	7755	L-86	203103	L-59
15.163	L-72	4505	L-30	7805	L-86	203104	L-59
252	N-53	4506	L-31	7924	L-81	203301	L-58
1360	J-5	4515	L-31	7955	L-88	208007	L-16
1361	J-5	4515	L-32	8112	L-80	221501	L-40
1390	J-35	4525	L-30	8165	L-80	500454	L-54
1390	K-10	4535	L-32	8370	N-49	504095	L-54
1391	K-11	4629	L-34	8371	N-49	00904B-10X	K-2
1439	N-79	4629	N-53	8372	N-49	00904B-60X	K-2
1440	N-79	4640	K-59	8373	N-49	00X-60X	J-36
1444	N-79	4640	L-26	8374	N-49	00X-61X	J-36
1445	N-79	4705	L-32	8375	N-49	039XXK-11X	K-15
1446	N-79	4706	L-33	8376	N-49	039XXK-12X	K-15
1447	N-79	4707	L-33	8377	N-49	039XXK-61X	K-15
1512	L-77	4715	L-33	8378	N-49	039XXK-61X	K-15
1538	K-4	4716	L-34	9100	L-18	05704B	N-53
1538	M-25	4726	L-34	9100	L-46	05705B	N-53
1539	K-4	4924	L-26	9151	L-22	05706B	N-53
1539	M-25	5967	L-64	9154	L-20	057XXB-10X	K-3
1540	K-4	6203	N-52	9205	L-17	057XXB-14XX	K-3
1540	M-25	6204	N-52	9255	L-18	057XXB-14XX	K-4
1548	N-50	6205	N-52	9315	L-19	057XXB-15XX	K-3
1553	N-79	6206	N-52	9355	L-19	057XXB-30X	K-3
1554	N-79	7015	L-81	9365	L-20	057XXB-B6X	K-4
1563	N-79	7033	L-69	9385	L-20	057XXB-C0X	K-4
2004	L-77	7105	L-80	9405	L-21	057XXP-40X	J-30
2015	L-8	7129	L-81	9406	L-23	057XXP-41X	J-30
2063	L-74	7165	L-66	9435	L-23	060XXE-4XX	J-10
2084	L-8	7165	L-80	9455	L-22	069XXD-10X	K-12
2240	L-43	7205	L-83	9456	L-23	069XXD-11X	K-12
2244	L-57	7229	L-81	9515	L-22	069XXD-12X	K-12
2247	L-10	7237	L-68	9705	L-23	069XXD-13X	K-12
2249	L-52	7238	L-68	22550	L-108	069XXD-40X	K-13
2252	L-13	7255	L-83	22566	L-108	069XXD-41X	K-13
2256	L-15	7305	L-82	38166	N-52	069XXD-60X	K-13
2257	L-14	7306	L-82	38353	N-52	069XXD-61X	K-13
3901	N-76	7315	L-84	41157	L-77	069XXD-62X	K-13
4105	L-26	7325	L-82	73014	L-38	069XXD-63X	K-13
4129	L-27	7355	L-84	75701	J-27	069XXD-X2X	K-13

Index

Alpha/Numeric

069XXE-1XX	J-9	1104X	M-17	247XXN-10X	K-22	336XXE-67X	J-16
069XXE-48X	J-11	1107X	M-16	247XXN-112	K-22	336XXE-68X	J-15
069XXE-48X	J-11	1107X	M-17	247XXN-30X	K-23	336XXE-69X	J-15
069XXE-4XX	J-12	1108X	M-17	247XXN-31X	K-23	336XXE-A2X	J-16
069XXE-5XX	J-9	1109X	M-16	247XXN-40X	K-24	336XXE-B4X	J-15
069XXE-69X	J-11	1120X	M-16	247XXN-41X	K-24	336XXE-J0X	J-13
069XXE-6XX	J-10	1120X	M-17	247XXN-44X	K-26	336XXE-M0X	J-16
069XXE-6XX	J-12	1121X	M-16	247XXN-45X	K-26	336XXE-P0X	J-15
069XXE-B0X	J-10	1121X	M-17	247XXN-46X	K-26	336XXE-S6X	J-15
069XXE-E0X	J-12	1121X	M-17	247XXN-47X	K-26	336XXE-S7X	J-15
069XXE-E4X	J-11	1122X	M-16	247XXN-48X	K-25	3371X	L-10
069XXE-XXK	J-11	1122X	M-17	247XXN-49X	K-25	3380X-A	K-11
069XXE-XXX	J-10	113XX	M-13	247XXN-50X	K-22	3380X-B	K-11
069XXT-14X	K-12	1146X	M-16	247XXN-51X	K-22	3380X-C	K-10
069XXT-64X	K-13	1147X	M-16	247XXN-60X	K-24	3380X-D	K-11
10004B	N-54	1148X	M-16	247XXN-61X	K-24	3380X-E	K-10
10005B	N-54	12CABXX	M-12	247XXN-64X	K-26	338XXP-10X	J-34
10006B	N-54	12CARXX	M-12	247XXN-65X	K-26	338XXP-40X	J-34
100XB-10X	K-5	12CAXX	M-12	247XXN-66X	K-26	338XXP-JXX	J-34
100XB-11X	K-5	140-05485	N-18	247XXN-67X	K-26	338XXP-Y6X	J-34
100XB-25X	K-6	140-06601	N-18	247XXN-68X	K-25	338XXP-Y7X	J-35
100XB-30X	K-5	140-06675	N-13	247XXN-69X	K-25	3521X	L-11
100XB-40X	K-7	140-06761	N-42	247XXN-75X	K-24	3541X	L-13
100XB-41X	K-7	140-06894	N-18	247XXN-B0X	K-23	3700-1	N-4
100XB-60X	K-6	140-06906	N-18	247XXN-B2X	K-23	3721X	L-14
100XB-61X	K-6	140-1674X	N-28	247XXN-E0X	K-25	3771X	L-15
100XB-A0X	K-6	15CABXX	M-12	247XXN-E4X	K-25	38097-XXXXX	M-15
100XB-B0X	K-6	15CARXX	M-12	247XXN-T5X	K-24	38166-XXXXX	M-15
100XB-C0X	K-7	15CAXX	M-12	252X6	N-79	38353-XXXXX	M-14
100XB-X0X	K-7	19XX	M-13	252X7	N-79	3902L	N-76
100XB-Y0X	K-7	1F20340	K-57	265XXP-10X	J-32	41157X6	N-79
1018X	M-17	1F40104	K-59	265XXP-20X	J-32	425XXN-10X	K-27
104XXN-10X	K-16	1F40104	N-54	2818X	L-3	425XXN-11X	K-27
104XXN-11X	K-16	1F40105	K-59	3121X	L-5	425XXN-12X	K-27
104XXN-40X	K-17	1F40105	K-62	3171X	L-5	425XXN-13X	K-27
104XXN-41X	K-17	1F40105	N-54	3221X	L-6	425XXN-25X	K-28
104XXN-50X	K-16	1F40106	K-60	3321X	L-7	425XXN-26X	K-28
104XXN-51X	K-16	1F40106	K-62	336XXB-Y0X	K-10	425XXN-40X	K-28
104XXN-60X	K-17	213XXN-10X	K-19	336XXB-Y2X	K-9	425XXN-41X	K-28
104XXN-61X	K-17	213XXN-11X	K-19	336XXB-Y3X	K-9	425XXN-50X	K-27
104XXN-64X	K-18	213XXN-40X	K-20	336XXB-Y7X	K-9	425XXN-51X	K-27
104XXN-65X	K-18	213XXN-41X	K-20	336XXB-Y8X	K-10	425XXN-60X	K-28
104XXN-66X	K-18	213XXN-46X	K-21	336XXE-05X	J-15	425XXN-61X	K-28
104XXN-67X	K-18	213XXN-48X	K-21	336XXE-1XX	J-13	425XXN-62X	K-28
104XXN-68X	K-17	213XXN-60X	K-20	336XXE-2XX	J-15	425XXN-63X	K-28
104XXN-69X	K-17	213XXN-61X	K-20	336XXE-30X	J-15	425XXN-64X	K-29
104XXN-G1X	K-17	213XXN-66X	K-21	336XXE-40X	J-15	425XXN-65X	K-29
104XXN-G4X	K-18	213XXN-68X	K-21	336XXE-5XX	J-14	425XXN-66X	K-29
104XXN-G7X	K-18	213XXN-B0X	K-19	336XXE-60X	J-15	425XXN-67X	K-29
105XB-10X	K-8	213XXN-E0X	K-21	336XXE-61X	J-15	425XXN-68X	K-28
105XB-11X	K-8	213XXN-E4X	K-20	336XXE-64X	J-16	425XXN-69X	K-28
105XB-20X	K-8	213XXN-X2X	K-20	336XXE-65X	J-16	425XXN-G1X	K-28
106XXX	N-50	229XXP-40X	J-31	336XXE-66X	J-16	425XXN-G2X	K-28

Index

Alpha/Numeric

425XXN-G4X	K-29	430XXU-D1X	J-59	470XXE-D2X	J-19	4SPXXW-D7X	J-95
425XXN-G5X	K-29	430XXU-D2X	J-59	470XXE-D4X	J-20	4SPXXW-D8X	J-95
425XXN-G7X	K-29	430XXU-D3X	J-59	470XXE-D5X	J-20	4SPXXW-D9X	J-95
425XXN-G8X	K-29	430XXU-D4X	J-61	470XXE-D7X	J-21	4SPXXW-G1X	J-94
426XXN-10X	K-30	430XXU-D5X	J-61	470XXE-D8X	J-21	4SPXXW-G2X	J-94
426XXN-11X	K-30	430XXU-D6X	J-61	470XXE-G0X	J-18	4SPXXW-G3X	J-94
426XXN-40X	K-31	430XXU-D7X	J-64	470XXE-G1X	J-18	4SPXXW-G4X	J-94
426XXN-48X	K-31	430XXU-D8X	J-64	470XXE-G2X	J-18	4SPXXW-G5X	J-94
426XXN-50X	K-30	430XXU-D9X	J-64	470XXE-G4X	J-20	4SPXXW-G6X	J-94
426XXN-51X	K-30	430XXU-E6X	J-56	470XXE-G5X	J-20	4SPXXW-G7X	J-94
426XXN-60X	K-31	430XXU-E7X	J-56	470XXE-G7X	J-21	4SPXXW-G8X	J-94
426XXN-61X	K-31	430XXU-E8X	J-56	470XXE-G80	J-21	4SPXXW-G9X	J-94
426XXN-66X	K-31	430XXU-G0X	J-59	470XXE-N2X	J-19	4SPXXW-J4X	J-101
42X6	N-79	430XXU-G1X	J-59	470XXE-N5X	J-20	4SPXXW-J5X	J-101
430XXU-0XS	J-58	430XXU-G2X	J-59	470XXE-N6X	J-20	4SPXXW-J7X	J-101
430XXU-10X	J-55	430XXU-G3X	J-59	470XXE-S7X	J-18	4SPXXW-J8X	J-101
430XXU-11X	J-55	430XXU-G4X	J-61	470XXE-S8X	J-18	4SPXXW-K1X	J-96
430XXU-12X	J-55	430XXU-G5X	J-61	470XXE-XXC	J-18	4SPXXW-K2X	J-96
430XXU-13X	J-55	430XXU-G6X	J-61	470XXE-XXF	J-17	4SPXXW-K4X	J-96
430XXU-1XS	J-58	430XXU-G7X	J-64	4SPXXW-11X	J-99	4SPXXW-K5X	J-96
430XXU-2XC	J-57	430XXU-G8X	J-64	4SPXXW-12X	J-99	4SPXXW-K7X	J-97
430XXU-2XK	J-58	430XXU-G9X	J-64	4SPXXW-13X	J-99	4SPXXW-K8X	J-97
430XXU-2XS	J-58	430XXU-H0X	J-60	4SPXXW-2XE	J-100	4SPXXW-L7X	J-101
430XXU-35X	J-58	430XXU-H2X	J-60	4SPXXW-36X	J-98	4SPXXW-L8X	J-101
430XXU-36X	J-58	430XXU-H5X	J-62	4SPXXW-37X	J-98	500XX	L-89
430XXU-37X	J-58	430XXU-H6X	J-62	4SPXXW-3XE	J-100	5027X	L-40
430XXU-3XK	J-58	430XXU-H7X	J-65	4SPXXW-5XP	J-98	5117X	L-37
430XXU-50X	J-56	430XXU-H8X	J-65	4SPXXW-61X	J-102	5117X	L-38
430XXU-51X	J-56	430XXU-H9X	J-65	4SPXXW-62X	J-102	5141X	L-39
430XXU-52X	J-56	430XXU-J1X	J-56	4SPXXW-63X	J-102	5217X	L-42
430XXU-53X	J-56	430XXU-L6X	J-60	4SPXXW-67X	J-102	5241X	L-39
430XXU-5XP	J-59	430XXU-L7X	J-60	4SPXXW-69X	J-102	5267X	L-43
430XXU-60X	J-57	430XXU-L8X	J-60	4SPXXW-6XP	J-98	5317X	L-41
430XXU-61X	J-57	430XXU-P0X	J-56	4SPXXW-7XC	J-100	5318X	L-41
430XXU-62X	J-57	430XXU-P1X	J-56	4SPXXW-7XE	J-100	5327X	L-45
430XXU-63X	J-57	430XXU-P6X	J-55	4SPXXW-8XC	J-100	5337X	L-41
430XXU-64X	J-63	430XXU-S6X	J-58	4SPXXW-8XE	J-100	5367X	L-47
430XXU-65X	J-63	430XXU-S7X	J-58	4SPXXW-8XP	J-98	5368X	L-48
430XXU-66X	J-63	430XXU-S8X	J-58	4SPXXW-9XP	J-98	5417X	L-51
430XXU-67X	J-63	4629X	L-3	4SPXXW-BD1X	J-96	545XX	L-89
430XXU-68X	J-60	470XXE-1XX	J-17	4SPXXW-BD2X	J-96	5517X	L-50
430XXU-69X	J-60	470XXE-36X	J-18	4SPXXW-BD4X	J-96	5518X	L-53
430XXU-7XC	J-57	470XXE-37X	J-18	4SPXXW-BD5X	J-96	5527X	L-55
430XXU-8XC	J-57	470XXE-48X	J-19	4SPXXW-BD7X	J-97	5537X	L-52
430XXU-8XP	J-62	470XXE-5XP	J-19	4SPXXW-BD8X	J-97	55717X	L-57
430XXU-A2X	J-63	470XXE-61X	J-17	4SPXXW-BE1X	J-97	570XX	N-4
430XXU-A3X	J-63	470XXE-62X	J-17	4SPXXW-BE2X	J-97	590XX	L-89
430XXU-A4X	J-63	470XXE-66X	J-20	4SPXXW-D1X	J-95	600XX	L-91
430XXU-A6X	J-63	470XXE-67X	J-20	4SPXXW-D2X	J-95	6203-0XX	K-15
430XXU-A7X	J-63	470XXE-69X	J-19	4SPXXW-D3X	J-95	6203-XXX	M-26
430XXU-A8X	J-63	470XXE-8XP	J-21	4SPXXW-D4X	J-95	6204-XXX	M-26
430XXU-C6X	J-61	470XXE-A4X	J-21	4SPXXW-D5X	J-95	6205-XXX	M-26
430XXU-D0X	J-59	470XXE-D1X	J-19	4SPXXW-D6X	J-95	6206-XXX	M-26

Index

Alpha/Numeric

6207-XXX.....	M-24	757XXE-47X.....	J-27
645XX.....	L-91	757XXE-48X.....	J-26
690XX.....	L-91	757XXE-49X.....	J-26
6SPXXW-12X.....	J-99	757XXE-75X.....	J-23
6SPXXW-13X.....	J-99	757XXE-76X.....	J-23
6SPXXW-37X.....	J-98	757XXE-W0X.....	J-23
6SPXXW-3XE.....	J-100	757XXE-W1X.....	J-23
6SPXXW-62X.....	J-102	757XXE-W4X.....	J-25
6SPXXW-63X.....	J-102	757XXE-W5X.....	J-25
6SPXXW-67X.....	J-102	757XXE-W6X.....	J-26
6SPXXW-69X.....	J-102	757XXE-W7X.....	J-26
6SPXXW-6XP.....	J-98	757XXE-X0X.....	J-26
6SPXXW-8XC.....	J-100	757XXE-X1X.....	J-26
6SPXXW-8XE.....	J-100	757XXE-Y3X.....	J-24
6SPXXW-9XP.....	J-98	757XXE-Y4X.....	J-24
6SPXXW-BD2X.....	J-96	757XXE-Y4X.....	J-25
6SPXXW-BD5X.....	J-96	757XXE-Y5X.....	J-25
6SPXXW-BD6X.....	J-96	757XXE-YXX.....	N-9
6SPXXW-BD8X.....	J-97	757XXE-Z0X.....	J-23
6SPXXW-BD9X.....	J-97	757XXE-Z0X.....	J-27
6SPXXW-BE2X.....	J-97	757XXE-Z1X.....	J-23
6SPXXW-D2X.....	J-95	757XXE-Z2X.....	J-25
6SPXXW-D3X.....	J-95	757XXE-Z3X.....	J-25
6SPXXW-D5X.....	J-95	757XXE-Z4X.....	J-24
6SPXXW-D6X.....	J-95	757XXE-Z5X.....	J-24
6SPXXW-D8X.....	J-95	757XXE-Z6X.....	J-24
6SPXXW-D9X.....	J-95	757XXE-Z6X.....	J-26
6SPXXW-G2X.....	J-94	757XXE-Z7X.....	J-26
6SPXXW-G3X.....	J-94	757XXE-Z8X.....	J-27
6SPXXW-G5X.....	J-94	757XXE-Z9X.....	J-27
6SPXXW-G6X.....	J-94	757XXE-ZXX.....	N-9
6SPXXW-G8X.....	J-94	757XXE-ZXX.....	N-54
6SPXXW-G9X.....	J-94	7629X.....	L-3
6SPXXW-J5X.....	J-101	7936X.....	L-39
6SPXXW-J8X.....	J-101	81430-XX.....	M-17
6SPXXW-K2X.....	J-96	837X.....	N-50
6SPXXW-K3X.....	J-96	906XX.....	N-4
6SPXXW-K5X.....	J-96	9405LL.....	L-21
6SPXXW-K6X.....	J-96		
6SPXXW-K8X.....	J-97		
6SPXXW-K9X.....	J-97		
6SPXXW-L8X.....	J-101		
717XX.....	N-4		
750XX.....	N-4		
750XX.....	N-4		
751XX.....	N-4		
757XXE-30X.....	J-23		
757XXE-31X.....	J-23		
757XXE-38X.....	J-25		
757XXE-39X.....	J-25		
757XXE-40X.....	J-24		
757XXE-41X.....	J-24		
757XXE-46X.....	J-27		

Eaton
Hydraulics Group USA
14615 Lone Oak Road
Eden Prairie, MN 55344
USA
Tel: 952-937-9800
Fax: 952-294-7722
www.eaton.com/hydraulics

Eaton
Hydraulics Group Europe
Route de la Longeraie 7
1110 Morges
Switzerland
Tel: +41 (0) 21 811 4600
Fax: +41 (0) 21 811 4601

Eaton
Hydraulics Group Asia Pacific
Eaton Building
4th Floor, No. 3 Lane 280 Linhong Rd.
Changning District
Shanghai 200335
China
Tel: (+86 21) 5200 0099
Fax: (+86 21) 5200 0400



Powering Business Worldwide

© 2011 Eaton Corporation
All Rights Reserved
Printed in USA
Document No. W-HYOV-MC002-E3
Supersedes W-HYOV-MC002-E2
February 2011