

February 7, 1996

Mr. Donald A. Reid
Vice President, Operations
Vermont Yankee Nuclear Power Corporation
RD 5, Box 169
Ferry Road
Brattleboro, Vermont 05301

SUBJECT: PUBLIC WORKSHOP ON PRESSURE LOCKING AND THERMAL BINDING

Dear Mr. Reid:

This refers to the public workshop conducted in King of Prussia, Pennsylvania, on November 2, 1995. The meeting was held to discuss Generic Letter (GL) 95-07, "Pressure Locking and Thermal Binding of Safety-Related Power-Operated Gate Valves," with Region I licensees. Special emphasis was placed on the principal technical issues, experiences and analyses of pressure locking and thermal binding, recommendations in GL 95-07, and planned NRC actions to resolve this concern.

Copies of the meeting agenda, presentations, and a summary of the significant discussion topics from similar meetings held in each of the four NRC Regions are enclosed. In accordance with Section 2.790 of the NRC's "Rules of Practice," Part 2, Title 10, Code of Federal Regulations, a copy of this letter will be placed in the NRC's Public Document Room.

We appreciated the responsiveness and turnout for this meeting, and we will continue to communicate with you regarding this important safety topic. Should you have any questions concerning any of the topics raised, we will be pleased to discuss them further with you.

Sincerely,

(original signed by)

Eugene M. Kelly, Chief
Systems Engineering Branch
Division of Reactor Safety

Docket No. 50-271

Enclosures:

1. Agenda
2. Summary of Public Workshops
3. Region I Licensee Presentations

9602150348 960207
PDR ADDCK 05000271
P PDR

TEC/11
9056

Mr. Donald A. Reid

2

cc w/encls:

- R. Wanczyk, Plant Manager
- J. Thayer, Vice President, Yankee Atomic Electric Company
- J. Duffy, Licensing Engineer, Vermont Yankee Nuclear Power Corporation
- J. Gilroy, Director, Vermont Public Interest Research Group, Inc.
- D. Tefft, Administrator, Bureau of Radiological Health, State of New Hampshire
- Chief, Safety Unit, Office of the Attorney General, Commonwealth of Massachusetts
- W. D. Meinert, Nuclear Engineer
- R. Gad, Esquire
- G. Bisbee, Esquire
- R. Sedano, Vermont Department of Public Service
- T. Rapone, Massachusetts Executive Office of Public Safety
- NRC Resident Inspector
- State of New Hampshire, SLO Designee
- State of Vermont, SLO Designee
- Commonwealth of Massachusetts, SLO Designee

Distribution w/encls:

- Region I Docket Room (with concurrences)
- W. Dean, OEDO
- D. Dorman, NRR
- P. McKee, NRR
- R. Conte, DRP
- Inspection Program Branch, NRR (IPAS)
- PUBLIC
- Nuclear Safety Information Center (NSIC)

DOCUMENT NAME: A: THANKS.VY

To receive a copy of this document, indicate in the box: "C" = Copy without attachment/enclosure "E" = Copy with attachment/enclosure "N" = No copy

OFFICE	RI/DRS	RI/DRS					
NAME	FBower/dmg	EKelly					
DATE	02/06/96	02/7/96	02/ /96	02/ /96	02/ /96	02/ /96	

OFFICIAL RECORD COPY

ENCLOSURE 1

**PRESSURE LOCKING AND
THERMAL BINDING MEETING AGENDA**

**DOUBLETREE GUEST SUITES
VALLEY FORGE, PA**

"The Witherspoon Room"

November 2, 1995

- 8:00 - 8:15 a.m.** Welcome and Opening Remarks by James T. Wiggins,
Director, Division of Reactor Safety
- 8:15 - 8:45 a.m.** "Utility Perspective," by Robert Harris, Program Manager,
Northeast Utilities
- 8:45 - 9:00 a.m.** "The Headquarters Perspective," by Terence Chan, Chief,
Components and Testing Section, NRR, Division of
Engineering
- 9:00 - 9:30 a.m.** "Pressure Locking and Thermal Binding Experiences," by
Tom Scarbrough, Senior Mechanical Engineer, NRR, MEB
- 9:30 - 9:45 a.m.** Break
- 9:45 - 11:15 a.m.** Breakout Sessions (Meetinghouse and Millhouse)
- 11:15 - 11:30 a.m.** Breakout Session Results
- 11:30 - 1:00 p.m.** Lunch
- 1:00 - 1:30 p.m.** "Utility Perspective," by Mark Mjaatvedt and Michael Rose,
Senior Project Engineers, Pennsylvania Power & Light
Company
- 1:30 - 2:00 p.m.** "Examples of GL 95-07 Susceptibility And Evaluation
Methods," by Howard Rathbun, Mechanical Engineer, NRR,
MEB
- 2:00 - 2:15 a.m.** Break
- 2:15 - 4:15 p.m.** Questions and Answers Panel Session
- 4:15 - 4:30 p.m.** Closing Remarks by Eugene Kelly, Chief, Systems Branch,
Division of Reactor Safety



ENCLOSURE 2

UNITED STATES
NUCLEAR REGULATORY COMMISSION

WASHINGTON, D.C. 20555-0001

November 30, 1995

MEMORANDUM TO: James T. Wiggins, Director
Division of Reactor Safety, RI

Albert F. Gibson, Director
Division of Reactor Safety, RII

Geoffrey E. Grant, Director
Division of Reactor Safety, RIII

Thomas P. Gwynn, Director
Division of Reactor Safety, RIV

FROM: *[Signature]* Richard H. Wessman, Chief
Mechanical Engineering Branch
Division of Engineering

SUBJECT: SUMMARY OF PUBLIC WORKSHOPS TO DISCUSS GENERIC LETTER 95-07,
"PRESSURE LOCKING AND THERMAL BINDING OF SAFETY-RELATED POWER-
OPERATED GATE VALVES"

In October and November 1995, the NRC staff conducted one-day public workshops in each Region to discuss Generic Letter (GL) 95-07, "Pressure Locking and Thermal Binding of Safety-Related Power-Operated Gate Valves." The workshops were attended by representatives of nuclear power plant licensees in the applicable Regions. Attachment 1 is a list of meeting participants.

The Mechanical Engineering Branch of NRR, NRR Projects, the Office for the Analysis and Evaluation of Operational Data, the Mechanical Engineering Branch of the Office of Nuclear Regulatory Research, and Regional management and staff participated in the workshops. During each workshop, Regional and NRR management provided their perspectives on the issue of pressure locking and thermal binding, and expectations for licensee action in response to GL 95-07. NRC staff discussed past experience with pressure locking and thermal binding, and the recommendations in GL 95-07. Attachment 2 includes the handouts from the staff presentations.

Personnel from several nuclear power utilities made presentations on their activities in response to the pressure locking and thermal binding issue. Attachment 3 includes the handouts from the industry presentations.

At the conclusion of each meeting, the staff responded to questions from licensees regarding pressure locking and thermal binding. The most significant discussion topics are summarized below:

CONTACT: H. Rathbun, NRR
415-2787

9601020147

Actions, Schedules and Submittals

1. The 90-day requested screening action in GL 95-07 was intended for the licensee to identify any critical deficiencies in the past evaluations of potential pressure locking and thermal binding that may have been conducted in response to industry, vendor or NRC communications. The licensee should use best available information and assure that the subject valves are operable. The staff considered that more detailed review and evaluation, and corrective actions, would be included as part of the 180-day requested action.
2. The staff does not plan to extend the proposed schedule for completing the 180-day requested action of GL 95-07. If a licensee establishes corrective action plans as part of its 180-day response that are later determined to be unnecessary or inadequate based on ongoing industry testing and analyses, the licensee would be expected to notify the staff of the change to those plans and the basis for the change. As stated in GL 95-07, a licensee may consider risk significance and outage schedules in developing corrective action schedules. If an immediate operability concern does not exist and risk considerations are appropriate, a licensee might consider corrective action for one train at the next available outage and the other train at the following outage.
3. NRR staff will be conducting the principal review of licensee responses to GL 95-07 and detailed inspections at all facilities are not planned. The staff stated that information provided in response to the 180-day requested action would be most helpful if it briefly summarized the depth of the licensee's review, the susceptible valves by function and identification number, the corrective action completed and planned, and valves acceptable as installed and currently set. Detailed supporting data and calculations are not desired in the submittal but should be retained in plant records.

Identifying Susceptible Valves

4. As yet, licensees have not presented an analytical method for predicting the thrust required to overcome pressure locking or thermal binding as part of a long-term resolution of the susceptibility of a valve to these phenomena. Based on the preliminary test verification efforts to date, the staff has not objected to licensees using one of the several industry analytical methods for predicting thrust requirements as part of an operability decision until a long-term solution can be achieved. However, if a licensee intends to rely on these analytical methods as a long-term solution, test verification will need to be completed.
5. GL 95-07 does not include a specific recommendation for the minimum temperature differential that could be assumed in predicting the occurrence of thermal binding of a gate valve. The staff considers the susceptibility of a gate valve to thermal binding to be a function of several valve-specific parameters, including gate valve type (i.e., solid or flexible wedge), differential temperature, temperature gradient

across the valve and disk, the rate of change of temperatures, the valve size and rating, valve and disk material, and manufacturing tolerances. The staff does not believe that the presence of the same material for both the valve and disk would eliminate the need to consider the potential for thermal binding. The staff suggested that licensees contact their valve manufacturers for more-detailed information.

6. The staff believes that slow ambient temperature changes that normally occur in a nuclear power plant would not be a principal concern for pressure locking or thermal binding, provided the valve has not experienced such problems under these conditions and there are no potential significant heating or cooling sources near the valve.
7. The staff recognizes that conflicting industry test information exists regarding the potential increase in valve bonnet pressure as the temperature of the fluid in the bonnet increases. The industry and staff are both conducting additional tests in this area. The staff believes that, until the pressure versus temperature relationship can be resolved, the pressure rise can be assumed to be significant if the valve bonnet is water solid. However, if a licensee can demonstrate that a small amount of air is present in the valve bonnet, the pressure rise will be minimal except in the case of large temperature changes. A licensee might establish a program to monitor air in the valve bonnet as part of a long-term resolution plan.
8. One or more check valves might not prevent pressure increase in piping between the check valve and the gate valve being evaluated for potential pressure locking. A significant length of piping might mitigate the pressure increase over the time interval between gate valve stroking as part of IST or plant operations. Gate and globe valves with continuous seating force will minimize the potential for significant pressure increase in the piping between these valves and the valve being evaluated for pressure locking, provided inservice test results and methods (e.g., instrumentation) to reveal the pressure increase are considered.
9. The staff recognizes that leakage from the valve bonnet around the valve disk or packing can reduce pressure over time. The staff believes that licensees may be able to justify reliance on such leakage for valves that are first called upon to operate following a significant time interval after the event that might have caused a pressure locking situation to develop.

Responding to Susceptible Valves

10. The staff believes that valve-specific information could be useful in addressing whether any immediate concern exists regarding a valve found to be susceptible to pressure locking or thermal binding, provided the valve is normally operated under conditions that might cause these phenomena. The staff noted that the licensee would need to address capability of the actuator under degraded voltage conditions, if

applicable, and structural and electrical capability from accelerated wear or fatigue, over the long term.

11. If a licensee declares a valve inoperable when conducting surveillance testing and follows its plant technical specifications, the provisions of GL 95-07 to address pressure locking and thermal binding during surveillance testing would not apply. If the valve is to remain operable during surveillance testing, the licensee should address the possibility of pressure locking or thermal binding during the conduct of the surveillance. The staff believes that licensees may be able to more readily address the susceptibility of the valve to pressure locking and thermal binding during surveillance testing (e.g., low likelihood of thermally induced pressure locking or thermal binding during the surveillance test).

Regarding surveillance testing and operability of safety-related valves, the staff pointed out that if a system (train) is to be considered operable during the conduct of a surveillance test, then safety-related valves in the system (train) must be capable of repositioning as necessary in response to an engineered safeguards signal. If the licensee cannot assure the valve is capable of repositioning during surveillance, they should declare the system (train) inoperable during surveillance and apply the technical specification LCO. [In a safety evaluation dated October 16, 1995, addressing the scope of the GL 89-10 program at the Hatch nuclear plant, the staff stated that a motor-operated valve placed in a position that prevents the safety-related system (or train) from performing its safety function must be capable of returning to its safety position, or the system (or train) must be declared inoperable.]

12. The staff noted that licensees should address potential adverse effects of proposed corrective action to respond to the susceptibility of a gate valve to pressure locking or thermal binding. The staff discussed an example from one plant where a hole drilled in a valve disk had to be filled because check valve leakage resulted in a flow path from the refueling water storage tank to the reactor building sump.
13. The staff referred licensees to GL 91-18 regarding inappropriate reliance on risk assessments in determining the operability of a safety-related valve.
14. The staff referred licensees to GL 91-18 for the use of manual action to ensure the capability of equipment. The staff noted difficulties in implementing manual action with respect to operating valves that might be pressure locked or thermally bound. For example, high pressure fluid and adverse environments could cause manual action to be unsafe to maintenance personnel and to be difficult to implement.

Miscellaneous

15. The staff is conducting research on various aspects of the pressure locking and thermal binding phenomena. Results of the staff's research will be made available to the industry via generic communication or industry symposia.
16. The staff discussed a recent AEOD report alerting licensees to the potential for damaging valves under surveillance test conditions that exceed design-basis conditions. The AEOD report is included as Attachment 4 to this meeting summary. The staff also noted that preparation for maintenance or surveillance testing could initiate a pressure locking or thermal binding situation.

Comments from workshop participants indicated that the workshops were highly beneficial in increasing licensee understanding of staff expectations regarding GL 95-07 and in promoting the exchange of technical information on the pressure locking and thermal binding issue.

Attachments: As stated

GENERIC LETTER 95-07 PUBLIC WORKSHOP PARTICIPANTS

<u>NAME</u>	<u>ORGANIZATION</u>
<u>All 4 Workshops</u>	
T. Scarbrough	NRC/NRR
H. Rathbun	NRC/NRR
E. Brown	NRC/AEOD
<u>Region I Workshop</u>	
J. Wiggins	NRC/Region I
E. Kelly	NRC/Region I
F. Bower	NRC/Region I
D. Dempsey	NRC/Region I
R. Reyes	NRC/Region I
T. Chan	NRC/NRR
L. Dudes	NRC/NRR
R. Eaton	NRC/NRR
C. Poslusny	NRC/NRR
A. Wang	NRC/NRR
G. Weidenhamer	NRC/RES
T. Kenny	NRC/Region I
K. Kolaczyk	NRC/Region I
D. Moy	NRC/Region I
J. Osborne	BGE
K. Robinson	BGE
J. Szivos	BGE
J. Jerz	Boston Edison
J. Tucker	Boston Edison
J. Doyle	Boston Edison
W. Kline	Boston Edison
L. Cona	ConEd
J. Lomar	ConEd
N. Mah	ConEd
D. Shah	ConEd
S. Loehlein	Duquesne Light Company
P. Slifkin	Duquesne Light Company
E. Coholich	Duquesne Light Company
R. McGoey	GPU Nuclear
J. Correa	GPU Nuclear
J. Tabone	GPU Nuclear
J. Abramovici	GPU Nuclear
B. Knight	GPU Nuclear
T. Carroll	GPU Nuclear
J. Bashista	GPU Nuclear
S. Parsons	GPU Nuclear
B. Lord	MYAPC
S. Nichols	MYAPC
D. Whittier	MYAPC
F. Martsen	NYPA
P. Swinburne	NYPA

P. Grissom	Georgia Power
J. Dailey	Georgia Power
G. Williams	SC&G
R. Justice	SC&G
J. Pease	SC&G
D. Ray	Southern Company
G. Talton	Southern Nuclear
S. Gates	Southern Nuclear
J. Daniels	Southern Nuclear
O. Vidal	Southern Nuclear
R. Golub	TVA
J. Elmerick	TVA
R. Poole	TVA
T. Chan	TVA
H. Benninghoff	TVA
B. DeMars	Virginia Power
E. May	Virginia Power
A. Szczepaniec	INPO
M. Kalsi	Kalsi Engineering

Region III Workshop

R. Wessman	NRC/NRR
J. Jacobson	NRC/Region III (DRS)
S. Burgess	NRC/Region III
J. Guzman	NRC/Region III
M. Shuaibi	NRC/NRR
A. Setlur	AES Corp.
A. Widmer	CEI
S. Benesh	ComEd - Zion
C. Bedford	ComEd - Braidwood
B. Burte	ComEd - Corp.
M. Dowd	ComEd - LaSalle
I. Garza	ComEd - Corp.
B. Jelke	ComEd - Zion
R. Mika	ComEd - Zion
M. Melnicoff	ComEd - NES (PRA)
J. O'Neill	ComEd - Dresden
B. Westphal	ComEd - LaSalle
B. Smith	ComEd - Byron
P. Yost	ComEd
E. Evans	CPCO
P. Flenner	CPCO
R. Gambrill	CPCO
R. Scudder	CPCO
R. Swanson	CPCO
J. Toskey	CPCO
M. Jaworsky	DECO
A. Nayakwadi	DECO
L. Schuerman	DECO
L. Georgopoulos	EMS, Inc.
Y. Patel	EMS, Inc.
W. Miller	IES - Duane Arnold
D. Wiley	IES - Duane Arnold

M. Holbrook
A. Gort
N. Howey
J. Puzauskas
K. Peterson
R. Wirkkala
J. Vitellas
A. Meligi
D. Blakely
B. Gallatin
N. Peterson
P. Young
J. Roberts
T. Ruiz
B. Heida
E. Leinheiser

INEL
I&M Power
IONS
IPCO
NSP - Monticello
NSP - Prairie Island
PUCO
S&L
TECO
TECO - Davis Besse
TECO - Davis Besse
Vectra Tech.
WEPCO - Point Beach
WEPCO - Point Beach
WPSCO - Kewaunee
WPSCO - Kewaunee

Region IV Workshop

T. Gwynn
K. Brockman
C. VanDenburgh
M. Runyan
C. Myers
R. Wessman
S. Bauer
M. Hooshmand
M. Renfro
B. Matthew
K. Fitzsimmons
J. Burton
R. Jackson
D. Smith
K. Taplett
A. Aldridge
R. Thacker
J. Geschwender
R. Cahn
T. Raidy
E. David
T. Hoyle
J. Barker
B. Black
R. Cockrel
O. Bhatti
D. Dillinger
D. Weninger
E. Simbles
C. Sellers
D. Phillips
R. Stoddard
I. Ezekoye

NRC/Region IV
NRC/Region IV
NRC/Region IV
NRC/Region IV
NRC/Region IV
NRC/NRR
Arizona Public Service
Arizona Public Service
Arizona Public Service
Entergy Operations
Entergy Operations
Entergy - Grand Gulf
Entergy - Grand Gulf
Entergy - Grand Gulf
HP&L
HP&L
NPPD
OPPD
PG&E
Southern Cal. Edison
Southern Cal. Edison
Supply System
Texas Utilities
Texas Utilities
Texas Utilities
Texas Utilities
Texas Utilities
Texas Utilities
Wolf Creek
ERIN Engineering
ERIN Engineering
ERIN Engineering
Lincoln Electric Systems
Westinghouse Corp.

K. Eslinger
R. Plasse
G. Bruce
D. Cruz
M. McGinley
T. Pucko
P. Brown
R. Faix
B. Harris
S. Bobbyock
B. Carsky
J. Daise
J. Mitman
G. Stathes
S. Singh
S. Mangi
G. Miller
M. Mjaatvedt
M. Rose
C. Coddington
R. Lewis
S. Gallogly
M. Hoskins
D. LaMastra
J. Nichols
G. Overbeck
K. Muller
B. Buteau
J. Callaghan
T. Miller
J. Duffy
S. McConarty

NYPA
NYPA
NMPC
NMPC
NMPC
North Atlantic Energy Service Corp.
North Atlantic Energy Service Corp.
North Atlantic Energy Service Corp.
NU
PECO Energy
PECO Energy
PECO Energy
PECO Energy
PECO Energy
State of New Jersey
State of Pennsylvania
PP&L
PP&L
PP&L
PP&L
PSE&G
PSE&G
PSE&G
PSE&G
PSE&G
PSE&G
RG&E
VY Nuclear Power
VY Nuclear Power
VY Nuclear Power
Yankee Atomic Nuclear Power
Yankee Atomic Nuclear Power

Region II Workshop

J. Jaudon
M. Shymlock
E. Girard
T. Chan
M. Worth
M. Verrilli
W. McGoun
W. Wilton
G. Thearling
F. Setzer
K. Beasley
D. King
S. Hart
V. Haramis
O. Hanek
W. Bryan
K. Ledzian
S. Powell
B. Naumria

NRC/Region II
NRC/Region II
NRC/Region II
NRC/NRR
CP&L
CP&L
CP&L
CP&L
CP&L
Duke Power
Duke Power
Duke Power
Duke Power
Duke Power
FP&L
FP&L
Florida Power Corp.
Florida Power Corp.
Georgia Power

**PUBLIC WORKSHOP ON
GENERIC LETTER 95-07,
"PRESSURE LOCKING AND THERMAL BINDING
OF SAFETY-RELATED POWER-OPERATED
GATE VALVES"**

**REGION I November 2, 1995
REGION II October 24, 1995
REGION III November 7, 1995
REGION IV November 9, 1995**

**NRR MANAGEMENT PERSPECTIVE ON
PRESSURE LOCKING AND THERMAL BINDING**

**Richard H. Wessman/
Terence L. Chan**

**Mechanical Engineering Branch
Division of Engineering
Office of Nuclear Reactor Regulation
U.S. Nuclear Regulatory Commission**

NRR MANAGEMENT PERSPECTIVE

SAFETY SIGNIFICANCE

NRC CONSIDERS PRESSURE LOCKING AND THERMAL BINDING TO BE A SAFETY SIGNIFICANT ISSUE SINCE IT REPRESENTS A POTENTIAL COMMON FAILURE MODE OF A SYSTEM OR SYSTEMS

- VERMONT YANKEE [CORE SPRAY INJECTION VALVES]
- MILLSTONE 2 [CONTAINMENT SUMP RECIRCULATION VALVES]; IN 95-14 ISSUED
- HADDAM NECK [SAFETY INJECTION VALVES];
IN 95-18 ISSUED

NRR MANAGEMENT PERSPECTIVE

HISTORY

- NRC COMMUNICATIONS
 - IE CIRCULAR 77-05 (MARCH 29, 1977)
 - IN 81-31 (OCTOBER 8, 1981)
 - IN 92-26 (APRIL 2, 1992)
 - NUREG-1275, VOL. 9 (MARCH 1993)
 - GENERIC LETTER 89-10 (JUNE 28, 1989)
 - GL 89-10, SUPPLEMENT 6 (MARCH 8, 1994)
- INDUSTRY COMMUNICATIONS
 - GE SIL-368 (DECEMBER 1981)
 - INPO SOER 84-7 (DECEMBER 14, 1984)
- ACTIONS PERFORMED IN RESPONSE TO GL 89-10

NRR MANAGEMENT PERSPECTIVE

RESOLUTION

- **GL 95-07 SCHEDULE IS REASONABLE**
 - **INITIAL SCREENING - 90 DAYS**
 - **SUMMARY OF ACTIONS AND ANALYSES - 180 DAYS**
 - **ALLOWS FOR CONSIDERATION OF PLANT OUTAGE AND OPERATION SCHEDULES IN DEVELOPING CORRECTIVE ACTION SCHEDULES**

RECENT
PRESSURE LOCKING AND THERMAL BINDING
EXPERIENCE AND ANALYSES

Thomas G. Scarbrough

Mechanical Engineering Branch
Division of Engineering
Office of Nuclear Reactor Regulation
U.S. Nuclear Regulatory Commission

PRESSURE LOCKING AND THERMAL BINDING PHENOMENA

PRESSURE LOCKING OF FLEXIBLE WEDGE OR PARALLEL DISK GATE VALVES OCCURS WHEN FLUID IS PRESSURIZED WITHIN VALVE BONNET, AND ACTUATOR IS INCAPABLE OF OVERCOMING ADDITIONAL THRUST REQUIREMENT FROM DIFFERENTIAL PRESSURE ACROSS BOTH VALVE DISKS.

THERMAL BINDING RESULTS FROM MECHANICAL INTERFERENCE THAT OCCURS DUE TO DIFFERENT EXPANSION AND CONTRACTION CHARACTERISTICS OF VALVE BODY AND DISK MATERIALS. REOPENING OF A CLOSED VALVE MIGHT BE PREVENTED UNTIL VALVE AND DISK ARE RETURNED TO THEIR ORIGINAL TEMPERATURES.

PRESSURE LOCKING AND THERMAL BINDING REPRESENT POTENTIAL COMMON-CAUSE FAILURE MODES THAT CAN RENDER REDUNDANT TRAINS OF SAFETY-RELATED SYSTEMS OR MULTIPLE SAFETY SYSTEMS INCAPABLE OF PERFORMING THEIR SAFETY FUNCTIONS.

RELATED INDUSTRY DOCUMENTS

GE SIL 368, "RECIRCULATION DISCHARGE ISOLATION VALVE LOCKING," DECEMBER 1981

GE SIL 368, SUPPLEMENT 1, "GATE VALVE LOCKUP," AUGUST 14, 1989

INPO SOER 84-7, "PRESSURE LOCKING AND THERMAL BINDING OF GATE VALVES," DECEMBER 14, 1984

INPO SER 8-88, "PRESSURE LOCKING OF RESIDUAL HEAT REMOVAL GATE VALVES," MARCH 25, 1988

ASME SECTION III, DIVISION 1 - SUBSECTION NB-3511 - 1980

ANSI B31.1 - 1973

ANSI B16.5 - 1973

POWER ENGINEERING, "BONNET OVERPRESSURIZATION PROTECTION FOR DOUBLE-SEATED VALVES," JANUARY 1985

RELATED NRC DOCUMENTS

IE CIRCULAR 77-05, "FLUID ENTRAPMENT IN VALVE BONNETS,"
MARCH 29, 1977

IN 81-31, "FAILURE OF SAFETY INJECTION VALVES TO OPERATE
AGAINST DIFFERENTIAL PRESSURE," OCTOBER 8, 1981

IN 92-26, "PRESSURE LOCKING OF MOTOR-OPERATED FLEXIBLE
WEDGE GATE VALVES," APRIL 2, 1992

NUREG-1275, VOL. 9, "OPERATING EXPERIENCE FEEDBACK REPORT -
PRESSURE LOCKING AND THERMAL BINDING OF GATE VALVES,"
MARCH 1993

GENERIC LETTER 89-10, "SAFETY-RELATED MOTOR-OPERATED
VALVE TESTING AND SURVEILLANCE," JUNE 28, 1989

GL 89-10, SUPPLEMENT 6, "INFORMATION ON SCHEDULE AND
GROUPING, AND STAFF RESPONSES TO ADDITIONAL PUBLIC
QUESTIONS," MARCH 8, 1994

NUREG/CP-0146, "WORKSHOP (FEBRUARY 1994) ON GATE VALVE
PRESSURE LOCKING AND THERMAL BINDING," ISSUED JULY 1995

NUREG/CP-0137, VOLUME 2, "PROCEEDINGS OF THIRD NRC/ASME
SYMPOSIUM ON VALVE AND PUMP TESTING," JULY 1994

IN 95-14, "SUSCEPTIBILITY OF CONT. SUMP RECIRCULATION GATE
VALVES TO PRESSURE LOCKING," FEBRUARY 28, 1995

IN 95-18, "POTENTIAL PRESSURE-LOCKING OF SAFETY-RELATED
POWER-OPERATED GATE VALVES," MARCH 15, 1995

IN 95-18, SUPP. 1, "POTENTIAL PRESSURE-LOCKING OF SAFETY-
RELATED POWER-OPERATED GATE VALVES," MARCH 31, 1995

IN 95-30, "SUSCEPTIBILITY OF LOW-PRESSURE COOLANT INJECTION
AND CORE SPRAY INJECTION VALVES TO PRESSURE LOCKING,"
AUGUST 3, 1995

RECENT PRESSURE LOCKING AND THERMAL BINDING EXPERIENCE AND ANALYSES

LPCI SYSTEM INJECTION VALVE AT FITZPATRICK

IN JULY 1991, A LPCI SYSTEM INJECTION VALVE AT FITZPATRICK FAILED WHEN ATTEMPTED TO OPEN ABOUT 9 HOURS AFTER A HYDROSTATIC TEST OF THE PIPING.

CAUSE ATTRIBUTED TO HIGH PRESSURE IN THE VALVE BONNET RESULTING IN THRUST GREATER THAN MOTOR CAPABILITY.

LICENSEE INSTALLED VENT LINES ON 4 LPCI AND LPCS VALVES.

INFO NOTICE 92-26 DISCUSSES PRESSURE LOCKING EVENT.

RHR SUPPRESSION POOL SUCTION VALVE AT GRAND GULF

IN JANUARY 1992, RHR SUPPRESSION POOL SUCTION VALVE AT GRAND GULF FAILED TO OPEN DURING PLANT STARTUP.

CAUSE ATTRIBUTED TO HIGH REACTOR COOLANT TEMPERATURE EXPANDING WATER IN VALVE BONNET RESULTING IN THRUST GREATER THAN MOTOR CAPABILITY.

LICENSEE INSTALLED VENT LINES IN BOTH SUCTION VALVES.

RCIC STEAM LINE ISOLATION VALVE AT LASALLE

IN FEBRUARY 1993, A RCIC STEAM LINE ISOLATION VALVE AT LASALLE FAILED TO OPEN DURING TESTING.

FAILURE COULD HAVE BEEN CAUSED BY COLLECTION OF CONDENSATE IN THE VALVE BONNET WITH SUBSEQUENT EXPANSION RESULTING IN HIGH THRUST REQUIREMENTS.

LICENSEE DRILLED HOLE IN DISK TO PREVENT LOCKING.

**RECENT
PRESSURE LOCKING AND THERMAL BINDING
EXPERIENCE AND ANALYSES
(continued)**

PWR CONTAINMENT SUMP RECIRCULATION VALVES

IN JANUARY 1995, MILLSTONE UNIT 2 NOTIFIED NRC THAT BOTH CONTAINMENT SUMP RECIRCULATION VALVES MIGHT FAIL TO OPEN BECAUSE OF PRESSURE LOCKING DURING LOCA.

LICENSEE INITIALLY DRILLED SMALL HOLE IN CONTAINMENT-SIDE DISKS OF BOTH VALVES. BECAUSE CHECK VALVE LEAKAGE CAUSED INCREASING SUMP LEVEL, LICENSEE REFILLED HOLES AND JUSTIFIED MOV CAPABILITY FOR SHORT TERM UNTIL LONG-TERM SOLUTION CAN BE DEVELOPED.

IN 95-14 ISSUED ON POTENTIAL PRESSURE LOCKING OF PWR CONTAINMENT SUMP RECIRCULATION VALVES.

TI 2515/129 ADDRESSED SUMP VALVES ON A PRIORITY BASIS.

FOR SHORT TERM, APPLICABLE PWR LICENSEES VERIFIED CONTAINMENT SUMP RECIRCULATION VALVES NOT SUSCEPTIBLE TO PRESSURE LOCKING THROUGH MODIFICATION, WATER BARRIER IN SUMP, OR ANALYSIS BASED ON AIR IN VALVE BONNET.

SAFETY INJECTION VALVES AT HADDAM NECK

IN MARCH 1995, HADDAM NECK FOUND SEVERAL MOVs IN SAFETY INJECTION SYSTEMS WITH QUESTIONABLE OPERABILITY BECAUSE OF POTENTIAL FOR PRESSURE LOCKING.

IN 95-18 ISSUED.

LICENSEE INSTALLED BONNET VENTS TO RCS ON 4 MOVs AND DRILLED HOLE IN DISK OF 2 MOVs.

**RECENT
PRESSURE LOCKING AND THERMAL BINDING
EXPERIENCE AND ANALYSES
(continued)**

CORE SPRAY VALVE AT VERMONT YANKEE

IN MARCH 1995, NRC STAFF RAISED QUESTIONS REGARDING THE CAPABILITY OF 2 CORE SPRAY INJECTION MOVs TO OPEN BECAUSE OF SUSCEPTIBILITY TO PRESSURE LOCKING.

LEAKING CHECK VALVE INCREASED PRESSURE LOCKING POTENTIAL.

SIMULATED PRESSURE-LOCKING CONDITION REVEALED LESS PRESSURE-LOCKING THRUST THAN PREDICTED, BUT GREATER TOTAL THRUST REQUIREMENT AS A RESULT OF HIGHER-THAN-PREDICTED UNWEDGING LOAD.

LICENSEE DRILLED HOLE IN DISK OF BOTH MOVs.

HPSI MOVs AT MAINE YANKEE

IN MAY 1995 (LER 95-008), LICENSEE DETERMINED THAT TWO MOVs IN THE HPSI SYSTEM AT MAINE YANKEE WERE SUSCEPTIBLE TO PRESSURE LOCKING AS DESCRIBED IN INFO NOTICE 95-18.

FAILURE OF THESE MOVs TO OPEN UPON INITIATION OF RECIRCULATION COOLING COULD RESULT IN A LOSS OF HPSI CAPABILITY AND POSSIBLE PUMP DAMAGE DUE TO INSUFFICIENT NPSH.

FAILURE MIGHT BE CAUSED BY THERMALLY-INDUCED PRESSURE LOCKING OF VALVE BONNET DUE TO HIGH CONTAINMENT SPRAY BUILDING TEMPERATURE.

LICENSEE DRILLED HOLE IN DISK OF BOTH MOVs.

**RECENT
PRESSURE LOCKING AND THERMAL BINDING
EXPERIENCE AND ANALYSES
(continued)**

PORV BLOCK VALVES AT MILLSTONE

IN JUNE 1995, MILLSTONE UNIT 2 DETERMINED THAT THE PORV BLOCK VALVES ARE POTENTIALLY SUSCEPTIBLE TO THERMAL BINDING UNDER CERTAIN CIRCUMSTANCES.

IF THE PORV BLOCK VALVES WERE CLOSED AND A SUBSEQUENT COOLDOWN WERE PERFORMED, THE BLOCK VALVES MAY EXPERIENCE THERMAL BINDING.

LICENSEE INSTALLED LARGER ACTUATORS AND CYCLES VALVES PERIODICALLY DURING COOLDOWN.

LPCI AND CORE SPRAY INJECTION VALVES AT HATCH

ON JULY 21, HATCH DETERMINED THAT A LPCI VALVE IN UNIT 2 MIGHT NOT OPERATE UNDER PRESSURE-LOCKING CONDITIONS.

LICENSEE DECLARED LPCI VALVE INOPERABLE AND TOOK CORRECTIVE ACTION. ANOTHER LPCI VALVE BEING MODIFIED. OTHER LPCI AND CORE SPRAY INJECTION VALVES ALSO EVALUATED.

LICENSEE BELIEVES MANUFACTURER AND SURVEILLANCE TESTING SUPPORTED PAST MOV OPERABILITY.

LEAKING CHECK VALVE CAUSED SURVEILLANCE TEST OF LPCI VALVE TO BE MORE SEVERE THAN DESIGN-BASIS CONDITIONS.

LICENSEES SHOULD ENSURE THAT MOVs CAN ACCOMMODATE SURVEILLANCE TEST CONDITIONS OR MODIFY TEST INTERVALS AS ALLOWED BY OM-10 OR GL 89-04.

**RECENT
PRESSURE LOCKING AND THERMAL BINDING
EXPERIENCE AND ANALYSES
(continued)**

RECIRCULATION VALVE AT HOPE CREEK

IN JULY 1995, A RECIRCULATION VALVE AT HOPE CREEK EXPERIENCED THERMAL BINDING PREVENTING OPENING UNTIL TEMPERATURE EQUALIZED BETWEEN VALVE BODY AND DISK.

VALVE DAMAGED WHEN OPENED BY ROTATION OF CONTACT BAR IN TORQUE SWITCH THAT PREVENTED VALVE CLOSING CIRCUIT FROM ENERGIZING.

RECIRCULATION VALVE POSITIONED PARTIALLY OPEN TO PREVENT THERMAL BINDING RESULTED IN BYPASS OF COOLING WATER FROM REACTOR CORE AND UNEXPECTED MODE CHANGE.

**EXAMPLES OF GENERIC LETTER 95-07
SUSCEPTIBILITY AND EVALUATION METHODS**

Howard J. Rathbun

**Mechanical Engineering Branch
Division of Engineering
Office of Nuclear Reactor Regulation
U.S. Nuclear Regulatory Commission**

GL 95-07 REQUESTED ACTIONS

WITHIN 90 DAYS

1. PERFORM SCREENING EVALUATION OF OPERATIONAL CONFIGURATIONS OF ALL SAFETY-RELATED POWER-OPERATED GATE VALVES TO IDENTIFY VALVES POTENTIALLY SUSCEPTIBLE TO PRESSURE LOCKING OR THERMAL BINDING; AND
2. DOCUMENT BASIS FOR OPERABILITY OF POTENTIALLY SUSCEPTIBLE VALVES OR, WHERE OPERABILITY CANNOT BE SUPPORTED, TAKE ACTION IN ACCORDANCE WITH INDIVIDUAL PLANT TECH SPECS.

SCREENING EVALUATION PROVIDES CONFIDENCE THAT NO SHORT-TERM SAFETY CONCERNS EXIST.

WHERE PREVIOUS EVALUATIONS PERFORMED, LICENSEE ENSURES THAT NO CRITICAL DEFICIENCIES EXIST IN PAST EVALUATIONS IN LIGHT OF NEW INFORMATION.

WITHIN 180 DAYS

1. EVALUATE OPERATIONAL CONFIGURATIONS OF SAFETY-RELATED POWER-OPERATED GATE VALVES TO IDENTIFY VALVES SUSCEPTIBLE TO PRESSURE LOCKING AND THERMAL BINDING;
2. PERFORM FURTHER ANALYSES AS APPROPRIATE, AND TAKE NEEDED CORRECTIVE ACTIONS (OR JUSTIFY LONGER SCHEDULES), TO ENSURE THAT SUSCEPTIBLE VALVES ARE CAPABLE OF PERFORMING SAFETY FUNCTION(S) UNDER ALL MODES OF PLANT OPERATION, INCLUDING TEST CONFIGURATION.

IF ALREADY PERFORMED ACTION IN RESPONSE TO SUPPLEMENT 6 TO GL 89-10, LICENSEE NEED NOT PERFORM ANY ADDITIONAL ACTION UNDER 1 AND 2 FOR MOV_s.

90-DAY REQUESTED ACTION

AN EFFECTIVE SCREENING EVALUATION SHOULD CONSIDER (BASED ON CURRENT KNOWLEDGE) THE FOLLOWING ATTRIBUTES:

INCLUDE ALL SAFETY-RELATED POWER-OPERATED GATE VALVES

INITIAL ASSESSMENT OF SYSTEM OR PLANT CONFIGURATIONS THAT MAY RESULT IN PRESSURE LOCKING OR THERMAL BINDING

INITIAL ASSESSMENT OF VALVE'S CAPABILITY TO OVERCOME A PRESSURE LOCKING OR THERMAL BINDING SITUATION SHOULD THE VALVE BE SUSCEPTIBLE

DOCUMENT A BASIS FOR OPERABILITY OF THE VALVE

GL 95-07 REQUESTED INFORMATION

PROVIDE SUMMARY DESCRIPTION OF:

1. SUSCEPTIBILITY EVALUATION OF OPERATIONAL CONFIGURATIONS PERFORMED IN RESPONSE TO (OR CONSISTENT WITH) 180-DAY REQUESTED ACTION 1, AND FURTHER ANALYSES PERFORMED IN RESPONSE TO (OR CONSISTENT WITH) LONG-TERM REQUESTED ACTION 2, INCLUDING BASES OR CRITERIA FOR DETERMINING THAT VALVES ARE OR ARE NOT SUSCEPTIBLE TO PRESSURE LOCKING OR THERMAL BINDING;
2. RESULTS OF SUSCEPTIBILITY EVALUATION AND FURTHER ANALYSES, INCLUDING LISTING OF SUSCEPTIBLE VALVES;
3. CORRECTIVE ACTIONS, OR OTHER DISPOSITIONING, OF SUSCEPTIBLE VALVES, INCLUDING: (A) EQUIPMENT OR PROCEDURAL MODIFICATIONS COMPLETED AND PLANNED (WITH COMPLETION SCHEDULE FOR SUCH ACTIONS); AND (B) JUSTIFICATION FOR ANY DETERMINATION THAT PARTICULAR SUSCEPTIBLE VALVES ARE ACCEPTABLE AS IS.

CORRECTIVE ACTION SCHEDULE MAY BE BASED ON RISK SIGNIFICANCE, INCLUDING CONSIDERATION OF COMMON CAUSE FAILURE OF MULTIPLE VALVES.

PLANT OPERATION AND OUTAGE SCHEDULES MAY BE CONSIDERED IN DEVELOPING CORRECTIVE ACTION SCHEDULES.

TIME SCHEDULES FOR COMPLETING CORRECTIVE ACTION DO NOT SUPERSEDE NRC REGULATIONS AND TECHNICAL SPECIFICATIONS.

SCHEDULE FOR COMPLETING CORRECTIVE ACTION INDEPENDENT OF GL 89-10.

GL 95-07 REQUIRED RESPONSE

ALL ADDRESSEES REQUIRED TO SUBMIT:

- 1. WITHIN 60 DAYS FROM DATE OF GL 95-07, A WRITTEN RESPONSE INDICATING WHETHER OR NOT ADDRESSEE WILL IMPLEMENT REQUESTED ACTIONS.**

IF ADDRESSEE INTENDS TO IMPLEMENT THE REQUESTED ACTIONS, PROVIDE A SCHEDULE FOR COMPLETION IMPLEMENTATION.

IF ADDRESSEE CHOOSES NOT TO TAKE REQUESTED ACTIONS, PROVIDE DESCRIPTION OF ANY PROPOSED ALTERNATIVE COURSE OF ACTION, SCHEDULE FOR COMPLETING ALTERNATIVE COURSE OF ACTION (IF APPLICABLE), AND SAFETY BASIS FOR DETERMINING ACCEPTABILITY OF PLANNED ALTERNATIVE COURSE OF ACTION;

- 2. WITHIN 180 DAYS FROM DATE OF GL 95-07, A WRITTEN RESPONSE TO THE INFORMATION REQUEST SPECIFIED ABOVE.**

PRESSURE LOCKING AND THERMAL BINDING SCOPE

GL 95-07

ALL SAFETY-RELATED POWER-OPERATED GATE VALVES WITH A SAFETY FUNCTION IN THE OPEN POSITION.

INADVERTENT MISPOSITIONING EXCLUDED.

ELIMINATE VALVES BASED ON DISK CONFIGURATION (SOLID WEDGE NOT SUSCEPTIBLE TO PRESSURE LOCKING, PARALLEL DISK NOT SUSCEPTIBLE TO THERMAL BINDING).

GL 90-06

PORV BLOCK VALVES

EXAMPLES OF OTHER NRC REGULATIONS AND LICENSEE COMMITMENTS

APPENDIX R WITH REPOSITIONING BY SHORT CIRCUITING

ANTICIPATED TRANSIENT WITHOUT SCRAM

STATION BLACKOUT

EXAMPLE MATRIX FOR EVALUATING GL 95-07 SAFETY-RELATED POWER-OPERATED GATE VALVE SUSCEPTIBILITY

Valve Normal Position	Safety Position	Test or Surveillance Position	Evaluate Susceptibility Within Scope of GL 95-07
Normally Closed	Open	Closed	Yes
Normally Closed	Open	Open	Yes
Normally Closed	Closed	Closed	No *
Normally Closed	Closed	Open	No *
Normally Open	Open	Closed	Yes
Normally Open	Open	Open	No
Normally Open	Closed	Closed	No *
Normally Open	Closed	Open	No *

* LICENSEES SHOULD BE AWARE OF THE POTENTIAL FOR THERMALLY-INDUCED PRESSURE TRANSIENTS RESULTING IN BONNET OVERPRESSURIZATION

GATE VALVES CLOSED FOR SURVEILLANCE OR TESTING

NRC REGULATIONS AND LICENSEE SAFETY ANALYSES REQUIRE THAT SAFETY-RELATED SYSTEMS BE CAPABLE OF PERFORMING THEIR SAFETY FUNCTIONS.

IF CLOSING A SAFETY-RELATED POWER-OPERATED GATE VALVE FOR TEST OR SURVEILLANCE DEFEATS THE CAPABILITY OF THE SAFETY SYSTEM OR TRAIN, LICENSEE NEEDS TO PERFORM ONE OF THE FOLLOWING WITHIN THE SCOPE OF GL 95-07:

- 1. VERIFY THAT VALVE IS NOT SUSCEPTIBLE TO PRESSURE LOCKING OR THERMAL BINDING WHILE CLOSED,**
- 2. FOLLOW PLANT TECHNICAL SPECIFICATIONS FOR TRAIN/SYSTEM WHILE VALVE CLOSED,**
- 3. DEMONSTRATE THAT THE ACTUATOR HAS SUFFICIENT CAPACITY TO OVERCOME THESE PHENOMENA, OR**
- 4. MAKE APPROPRIATE HARDWARE AND/OR PROCEDURAL MODIFICATIONS TO PREVENT PRESSURE LOCKING AND THERMAL BINDING.**

THIS APPROACH IS ALSO APPROPRIATE FOR NON-SAFETY-RELATED VALVES IN SAFETY SYSTEMS.

OPERATIONAL CONFIGURATIONS IN SUSCEPTIBILITY EVALUATIONS

ABSENCE OF HEAT SOURCE ELIMINATES VALVES FROM
THERMALLY-INDUCED PRESSURE LOCKING.

EXTERNAL CONDITIONS DURING NORMAL, SURVEILLANCE OR
OPERATING CONDITIONS SUCH AS:

 PRESENCE OF INSULATION (BENEFIT NEEDS TO BE JUSTIFIED)

 POTENTIAL HEAT SOURCES: PUMP MOTORS, STEAM DRIVEN
 TURBINES, HIGH ENERGY PIPING, HIGH TEMPERATURE FLUID

SURVEILLANCE TESTING OR OTHER SPECIAL TEST CONDITIONS
SUCH AS HYDROSTATIC TESTING.

GENERIC STUDIES SUCH AS THERMAL EFFECTS AND DESIGN-BASIS
DEPRESSURIZATION.

EFFORTS TO IMPROVE LEAK-TIGHTNESS OF PRIMARY SYSTEM
VALVE PRESSURE BOUNDARIES.

POTENTIAL FOR WATER FILLING VALVE BONNET (FULL BONNET NOT
REQUIRED FOR FLUID-INDUCED PRESSURE LOCKING)

INTERNAL SYSTEM OPERATING CONDITIONS.

PRESSURE LOCKING AND THERMAL BINDING WHEN VALVE
REQUIRED TO OPEN.

VALVE CLOSED AT HIGH TEMPERATURE AND REQUIRED TO OPEN AT
LOWER TEMPERATURE

ADEQUATELY JUSTIFIED ASSERTIONS OF DIFFERENTIAL
TEMPERATURE FOR THERMAL BINDING

INAPPROPRIATE REASONS FOR ELIMINATING VALVES FROM SUSCEPTIBILITY

LEAKAGE RATE

ENGINEERING JUDGEMENT WITHOUT JUSTIFICATION

LACK OF EVENT OCCURRENCE

EXAMPLES OF VALVES SUSCEPTIBLE TO PRESSURE LOCKING

**LOW-PRESSURE COOLANT INJECTION (LPCI) AND LOW-PRESSURE
CORE SPRAY (LPCS) SYSTEM INJECTION VALVES**

**RESIDUAL HEAT REMOVAL (RHR) SYSTEM HOT-LEG CROSSOVER
ISOLATION VALVES**

**RHR CONTAINMENT SUMP AND SUPPRESSION POOL SUCTION
VALVES**

**HIGH-PRESSURE COOLANT INJECTION (HPCI) STEAM ADMISSION
VALVES**

RHR HEAT EXCHANGER OUTLET VALVES

EMERGENCY FEEDWATER ISOLATION VALVES

RCIC STEAMLINER ISOLATION VALVE

EXAMPLES OF VALVES SUSCEPTIBLE TO THERMAL BINDING

REACTOR DEPRESSURIZATION SYSTEM ISOLATION VALVES

RHR INBOARD SUCTION ISOLATION VALVES

POWER-OPERATED RELIEF VALVE (PORV) BLOCK VALVES

REACTOR COOLANT SYSTEM LETDOWN ISOLATION VALVES

RHR SUPPRESSION POOL SUCTION VALVES

CONTAINMENT ISOLATION VALVES (SAMPLE LINE, LETDOWN HEAT EXCHANGER INLET HEADER)

CONDENSATE DISCHARGE VALVES

REACTOR FEEDWATER PUMP DISCHARGE VALVES

SHORT-TERM ACTION FOR GATE VALVES FOUND SUSCEPTIBLE TO PRESSURE LOCKING OR THERMAL BINDING

**EVALUATE IMMEDIATE OPERABILITY USING BEST AVAILABLE
METHODS FOR PREDICTING REQUIRED AND AVAILABLE THRUST:**

**BEST AVAILABLE METHODS FOR PREDICTING THRUST
REQUIRED TO OVERCOME PRESSURE LOCKING INCLUDE
ENTERGY, ComEd AND HOPE CREEK METHODS AT THIS TIME.**

**METHOD FOR PREDICTING THRUST REQUIRED TO OVERCOME
THERMALLY INDUCED PRESSURE LOCKING SHOULD CONSIDER
HEAT TRANSFER, PRESSURE VERSUS TEMPERATURE
INCREASE, AND AIR VOLUME RELIABILITY.**

**BEST AVAILABLE METHOD FOR PREDICTING AVAILABLE
THRUST AND WEAK LINK CAPABILITY CONSISTENT WITH
GL 89-10 PROGRAM.**

**IF CANNOT DEMONSTRATE CAPABILITY TO OVERCOME PRESSURE
LOCKING AND THERMAL BINDING OF SUSCEPTIBLE VALVE AND
CANNOT ESTABLISH PROCEDURE CONTROLS TO PREVENT THE
PHENOMENA, TAKE ACTION IN ACCORDANCE WITH TECH SPECS.**

LONG-TERM OPTIONS FOR RESOLVING PRESSURE LOCKING AND THERMAL BINDING OF SUSCEPTIBLE VALVES

ANALYSIS ONLY

**CONSERVATIVE ACCOUNTING FOR UNCERTAINTIES IN
ANALYSIS**

TESTING ONLY

**ASSURANCE THAT TEST CONDITIONS BOUND ALL
OPERATIONAL CONDITIONS**

COMBINATION OF TESTING AND ANALYSIS

CORRELATION OF TEST RESULTS AND ANALYSIS

CONSERVATIVE APPLICATION OF TEST RESULTS

EQUIPMENT MODIFICATIONS

SEE FOLLOWING SLIDE.

PROCEDURE MODIFICATIONS

**MAY BE MOST APPROPRIATE RESOLUTION TO RESOLVE
THERMAL BINDING**

EXAMPLES OF VALVE MODIFICATIONS

PRESSURE LOCKING

DRILL HOLE IN HIGH PRESSURE SIDE OF THE DISK AND ACCOUNT FOR VALVE BEING UNIDIRECTIONAL.

INSTALL PRESSURE RELIEF OR VENT PATH -
MODIFY OPERATING PROCEDURES IF OPERATOR ACTION IS REQUIRED (SUCH AS REMOTELY OPERATED VALVE)

INSTALL EXTERNAL BYPASS LINE WITH MANUAL VALVE -
MODIFY OPERATING PROCEDURES

VALVE DISK TRAVEL PRIOR TO HARD SEAT CONTACT AND ACCOUNT FOR LEAKAGE PAST VALVE

THERMAL BINDING

REPLACE FLEX-WEDGE OR SOLID WEDGE WITH A PARALLEL DISK -
(1) INVESTIGATE NEW POSSIBILITY FOR PRESSURE LOCKING AND (2) APPROPRIATE TESTS BEFORE PLACING THE VALVE IN SERVICE

PERIODICALLY STROKE VALVE -
(1) ADEQUATE JUSTIFICATION FOR THE TEMPERATURE INTERVAL AND (2) CONSIDERATION FOR DIVERSION OF FLOW

STOP VALVE DISK TRAVEL PRIOR TO HARD SEAT CONTACT -
(1) ADEQUATE JUSTIFICATION FOR HIGH TEMPERATURE GRADIENTS AND (2) VALVE DOES NOT PROVIDE COMPLETE ISOLATION

INSTALL A COMPENSATING SPRING PACK WITH TEST VERIFICATION

IMPORTANCE OF TRAINING TO RESOLVE PRESSURE LOCKING AND THERMAL BINDING

EXAMPLES:

DRILLING A HOLE IN THE HIGH PRESSURE SIDE

TRAIN OPERATORS TO REPLACE DISK IN CORRECT
ORIENTATION

PERIODICALLY STROKING THE VALVE

TRAIN OPERATORS REGARDING POTENTIAL PLANT
TRANSIENTS

STAFF PLANS FOR REVIEWING LICENSEE RESPONSES TO GL 95-07

REVIEW 60-DAY RESPONSE

REVIEW 180-DAY SUBMITTALS

CLOSE STAFF REVIEW BY 1 OR MORE OF:

1. NRR REVIEW
2. NRR AUDIT
3. REGION INSPECTION

RESOLVE ANY CONCERNS WITH LICENSEE INVOLVING PRESSURE
LOCKING/THERMAL BINDING WITH ANY APPROPRIATE LICENSEE
ACTION

NRC SPONSORED RESEARCH

THRUST REQUIREMENT VS. BONNET PRESSURE

BONNET PRESSURE VS. TEMPERATURE INCREASE

INCLUDING THE EFFECTS OF AIR ENTRAPMENT

**UNCERTAINTY IN ABILITY TO CALCULATE LEAKAGE RATE AND
IMPACT ON PRESSURE LOCKING**

UNCERTAINTY IN ABILITY TO RELY ON ENTRAPPED AIR

THRUST REQUIREMENT VS. THERMAL BINDING



**Pressure Locking
and
Thermal Binding (PL/TB):
Experience at Northeast Utilities (NU)**

November 2, 1995

Bob Harris

Nuclear Engineering Services Division
Northeast Utilities
Rope Ferry Road
Waterford, CT 06385-0128

NRC Region I Conference on GL 95-07, Wayne, PA



Purpose

- ➔ Share NU's Experience with Pressure Locking & Thermal Binding (PL/TB) of Gate Valves based primarily on our actions taken for MOVs as part of GL 89-10 Closure.
- ➔ Discuss preliminary results of GL 95-07 Screening of Power Operated Valves (POVs).



PL/TB Overview: Vulnerabilities & Corrective Actions

➔ Gate Valve Susceptibility

VALVE DESIGN	PL	TB
Solid-Wedge	No	Yes
Flex-Wedge	Yes	Yes<
Parallel/Double Disc	Yes	No

➔ Generic Corrective Actions

	HARDWARE* MODS	ADMIN MODS	ANALYSIS
PL	Many	Limited	Cautiously
TB	None*	Primary	N/A

* Replacement of valve with a different design may be feasible

➔ NU has Developed a Detailed Evaluation Procedure (called PI-20)

- ↳ Part of GL 89-10 MOV Program
- ↳ Conservative
- ↳ Engineering Judgment
- ↳ Empirical Data



PL & TB are Real, but Rare Phenomenon

- ➔ The physical phenomena are real & easily understood once gate valve design is examined in this context.
- ➔ PL/TB occurrences pre-date commercial nuclear plants; are events for valves in fluid systems exposed to temperature and pressure.
- ➔ There have been numerous NRC communications dating back to 1977; INPO 84-7 provides a comprehensive summary.
- ➔ Significantly, Industry-accepted guidance on screening for PL/TB susceptibility has been missing.
- ➔ NRC NUREG-1275 reported **11** instances of PL and **14** of TB, in hundreds of reactor years.
- ➔ NU has experienced **~1/2 dozen** recognized TB events in **~80Ryr**; and no PL known events.
- ➔ Some PL/TB Events may not have been recognized.

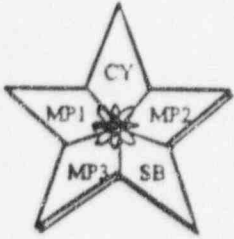

Actual Occurrence of PL Should be Rare

➔ Probability of Pressure Locking (P_{PL}):

$$P_{PL} = P_1 \times P_2 \times P_3 \times P_4 \times P_5 \times P_6 \times P_7$$

Causal/Mitigating Factors:

- ① System Condition/Upstream Leakage
- ② Seal Ring Condition/Packing Seal Leak Tight
- ③ Trapped Air in Bonnet
- ④ Process Fluid/External Heating
- ⑤ Insufficient Available Thrust
- ⑥ Temperature/Pressure Regime
- ⑦ Time Duration & Time History
- ⑧ The Unknowns, etc.

➔ Not Surprisingly *Actual* Occurrence of PL is Difficult to Predict



PL&TB are Situational & Complex: Two Examples

1 PL is highly Situational:

- ↳ Creare Inc. testing of MP2 Sump Recirculation Valves (see Fig. 1)
- ↳ Small Quantities of Air Mitigates PL
- ↳ Figure 1 shows Situational Nature

2 Unique Mechanisms can be Mistaken for PL or TB:

- ↳ Evaluation of MP1 Shutdown Cooling Valves
- ↳ Experienced multiple, recent "binding events
- ↳ Very PRELIMINARY cause attributed to **Pressure Induced Binding** (Kalsi Study)



Fig. 1: Millstone 2
1/4 Scale Tests at Creare

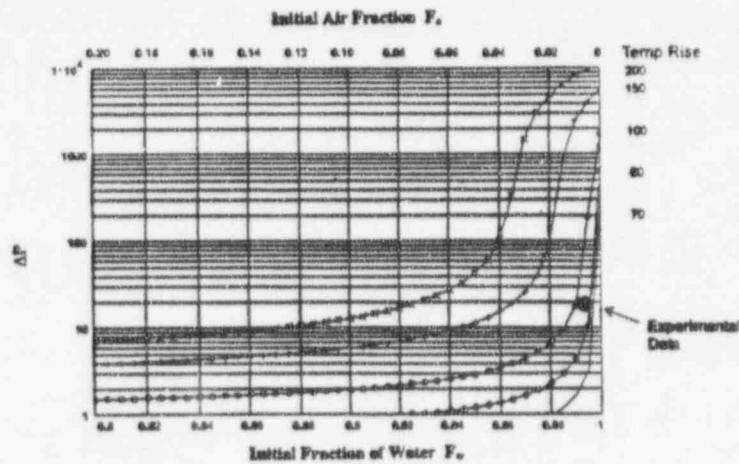
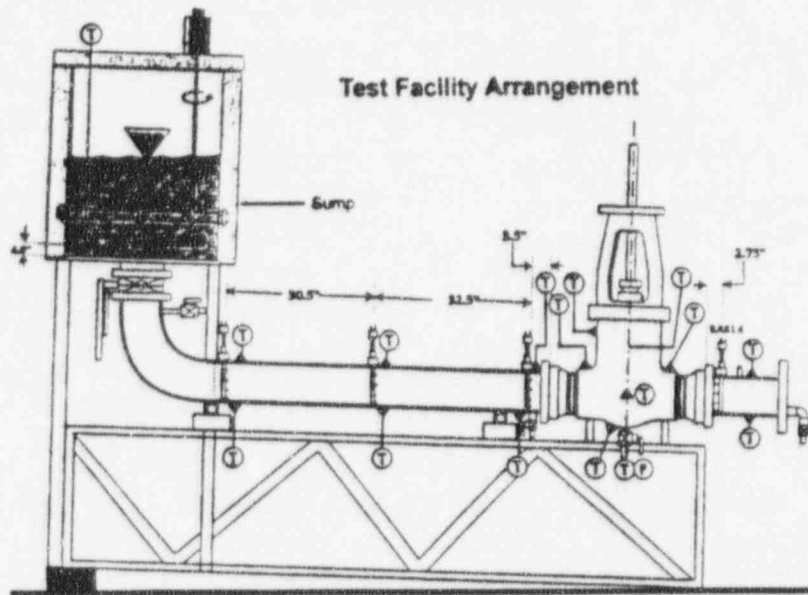



PL/TB & GL 95-07 Primarily Impact GL 89-10 MOVs

Preliminary

	CY	MP1	MP2	MP3	SB
All POVs (estimated)	504	~1000	~1200	~2000	~1000
S-R POWs	188	284	534	981	n/a
Less GL 89-10 Valves	(44)	(54)	(52)	(143)	(122)
S-R POV Gate Valves (non 89-10)	6	1	3	6	22
Open Safety Stroke	0	0	0	0	0
	0	0	0	0	0

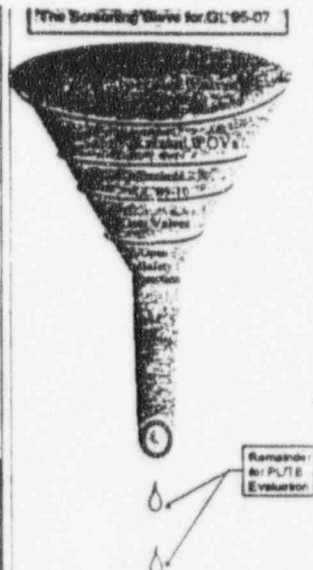



Modifications Required to Resolve PL/TB for GL 89-10 MOVs

- ➔ NU decided in Fall '94 to resolve PL/TB Issue for MOVs as a part of GL 89-10 Closure.
- ➔ This resulted in a substantial number of Modifications to NU Plants.
- ➔ Affected Systems Include:

TYPICAL SYSTEMS IMPACTED	
PWR	Shutdown Cooling Containment Sump Recirculation Main Steam Safety Injection
BWR	Feedwater Isolation Condenser LP Coolant Injection

➔ Summary of Changes

	CY	MP1	MP2	MP3	SB
Hardware Mods:					
Equilizing Line		2	1		
Drill Disc	8		1	2	
Packing Gland Leakoff	9			2	
Planned for next RFO		4		6	10
Admin Mods:					
Procedure Changes	2	6	6		2
Prototype Experiment			2		
Operability Space				2	



Conclusions

- ➔ PL/TB is real, but rare.
- ➔ Conceptually, PL&TB are reasonably simple phenomenon; however, predicting *actual* occurrences is complex and in many cases beyond State-of-the-Art.
- ➔ PL/TB is primarily a *GL 89-10 issue*, and required several modifications for NU Plants.
- ➔ GL 89-10 PL/TB Methodology is fully applicable to GL 95-07.
- ➔ At NU we had a bias toward hardware “fixes” vs. analysis.
- ➔ Further empirical data would be helpful
- ➔ Our conservative, systematic evaluation procedure (PI-20) provides the guidance to resolve GL 95-07. (some copies available)

Test Sequence

- **Static (Baseline) Tests**
- **LLRT of Test Valve**
- **Hydro-Pump DP Tests to determine seat to disk friction coefficient**
- **Bonnet Pressure Decay Tests**
- **Alternating Static (Baseline) Tests and Pressure Locking Tests at various bonnet/outlet pressure combinations**
- **Repeat of Test Sequence at different torque switch setting(s)**
- **Thermally Induced Bonnet Pressurization Tests**
- **Thermal Binding Test for Valve Cooldown Effect**

The logo for ComEd, featuring the word "ComEd" in a bold, sans-serif font. The letter "o" in "Com" is stylized with a starburst or spark-like graphic inside it. The logo is set against a dark, horizontal rectangular background.

Predicted Unseating Thrust Versus Measured Pressure Locking Unseating Force for Crane Valve

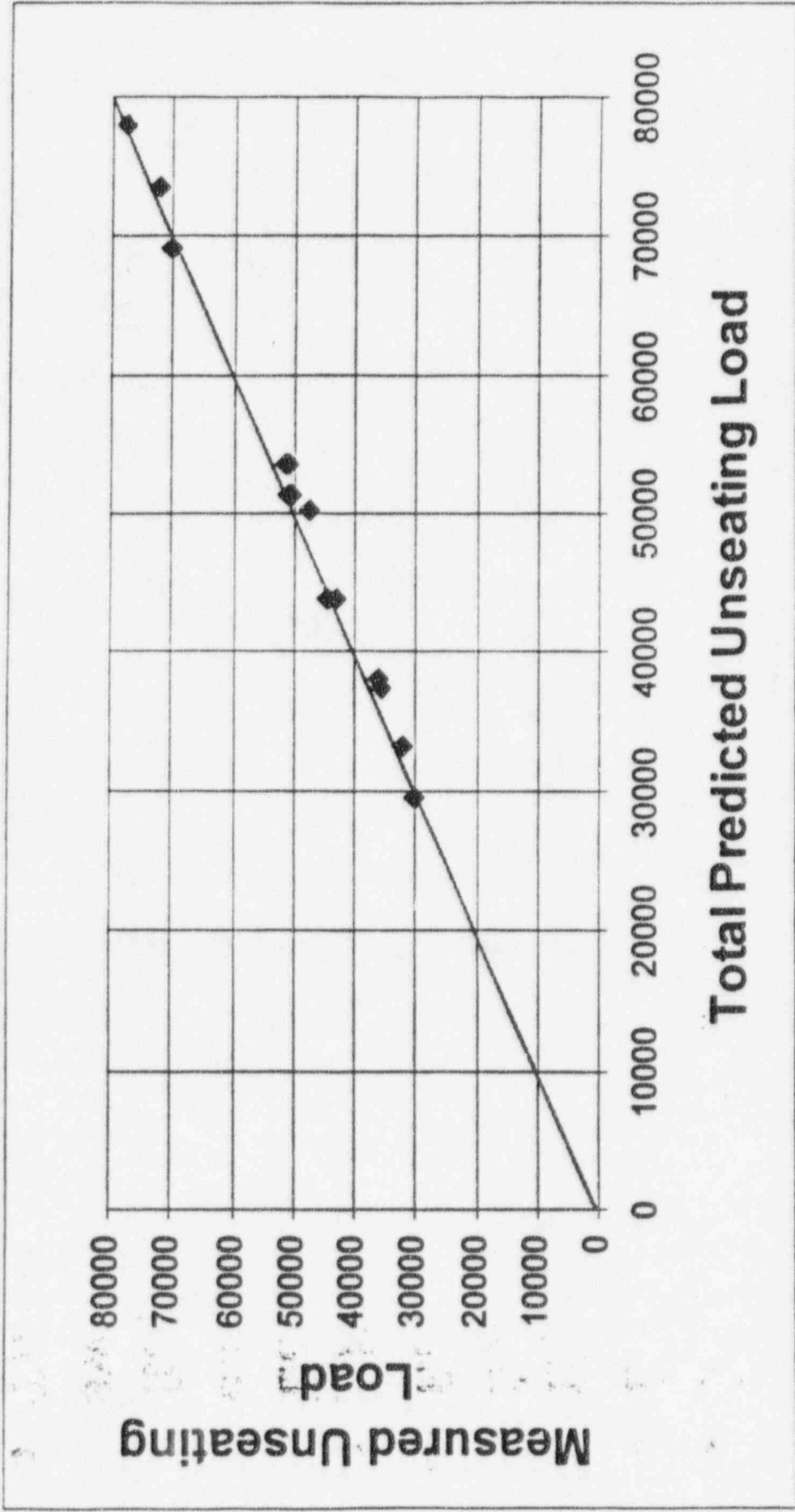

Predicted Versus Measured Portion of Pressure Thrust Due to Pressure Forces for Crane Valve

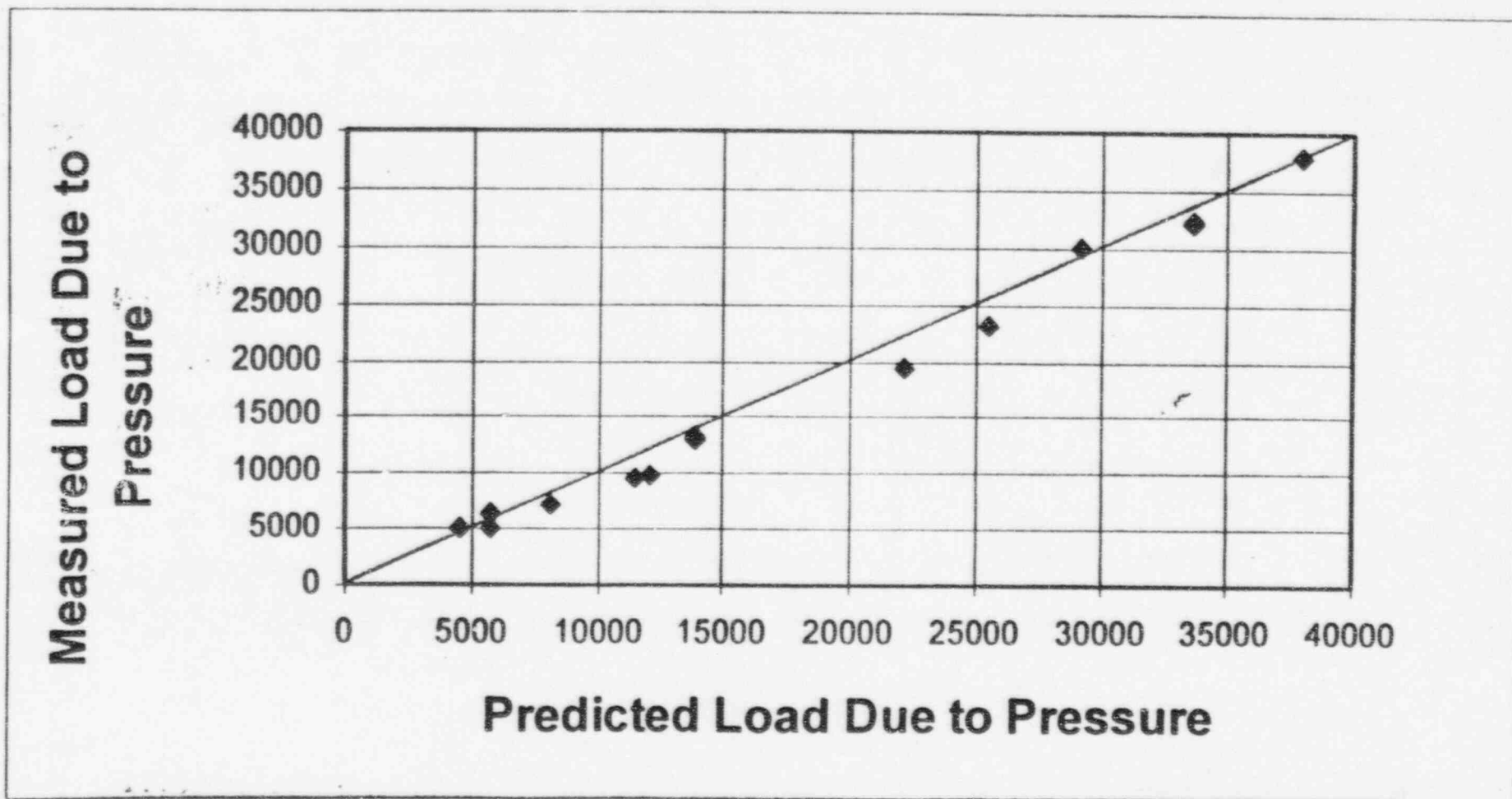

Predicted Unseating Thrust Versus Measured Pressure Locking Unseating Thrust for Westinghouse Valve

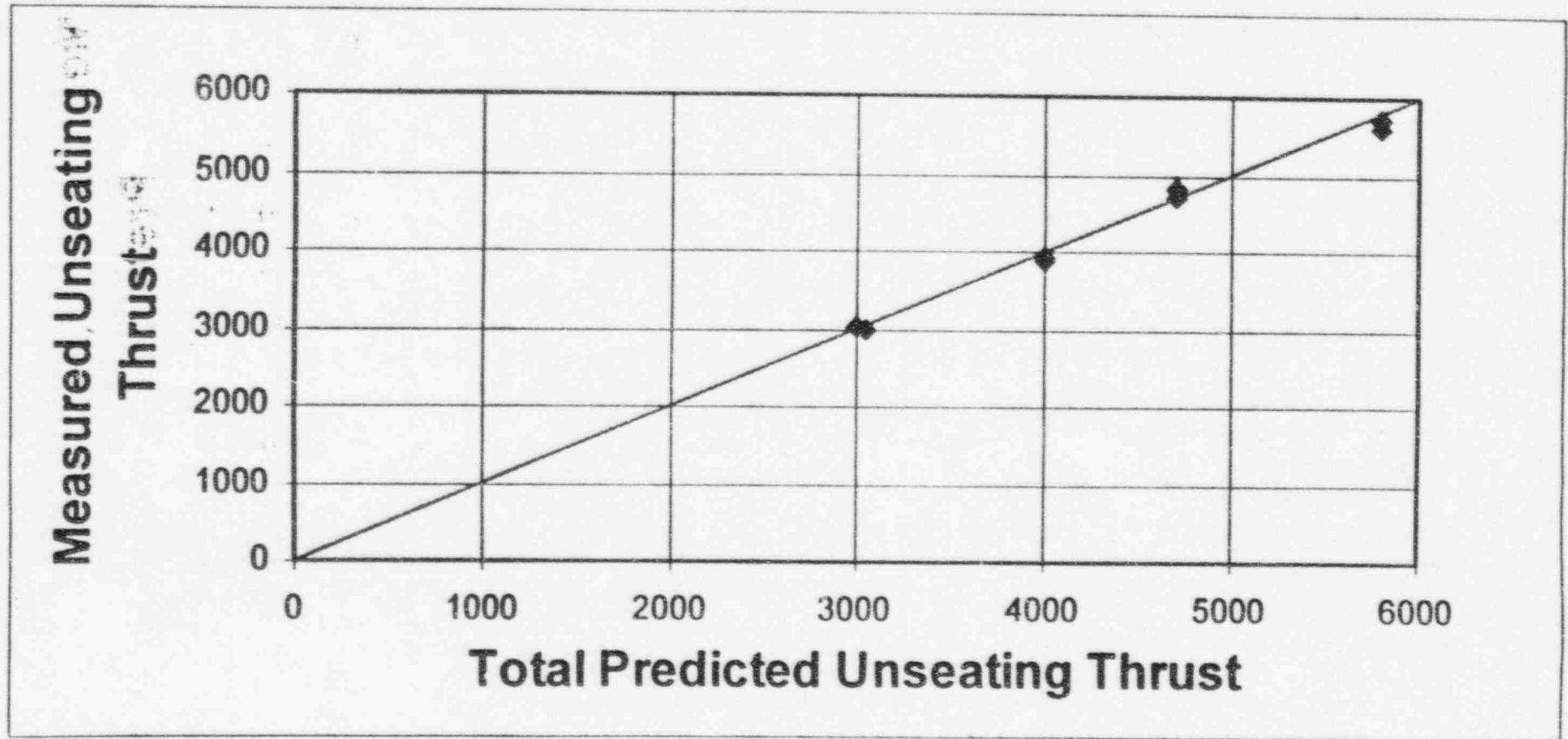

Predicted Versus Measured Portion of Unseating Thrust Due to Pressure Forces for Westinghouse Valve

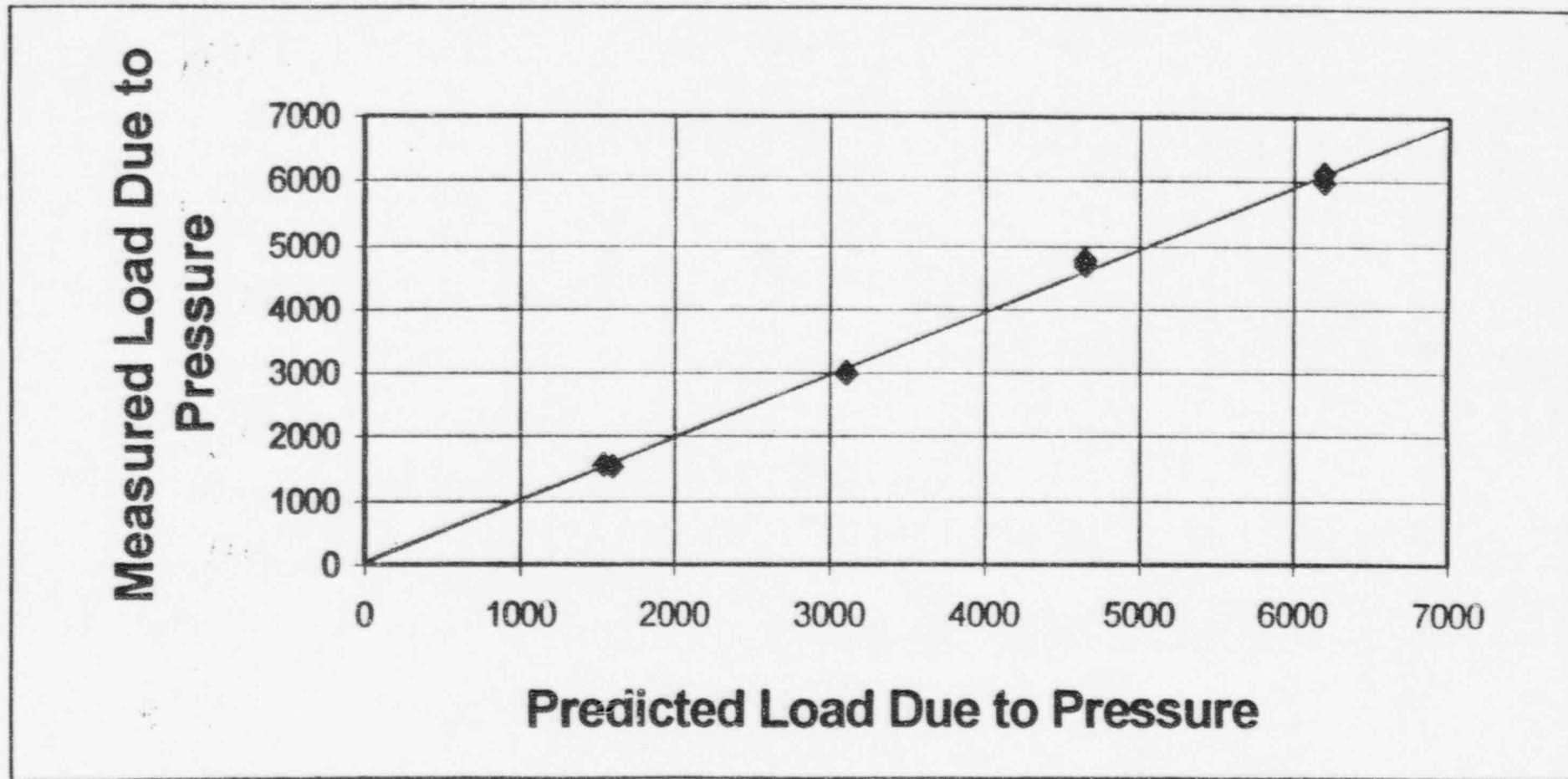

ComEd

Summary of Test Results

- **Accuracy of Roark's Equations for Predicting Pressure Locking Force:**

Initial data analysis indicates that the ComEd model for predicting pressure locking unseating thrust is accurate and conservative

- **Bonnet Depressurization Rates**

Crane Valve: 500 psi to 50 psi / min
(depending on TSS)

West. Valve: 300 psi to 1 psi / min
(depending on TSS)

The logo for ComEd, featuring the word "ComEd" in a bold, sans-serif font. The letter "E" is stylized with a starburst or spark-like graphic behind it. The logo is set against a dark, horizontal rectangular background.

Summary of Test Results (continued)

- **Thermally Induced Pressure Rise Data:**

Crane Valve: Test could not be performed due to high bonnet depressurization rate

West. Valve: Pressure rise rate of 0.4 psi per degree. Temperature was raised from 70 to 260 degrees F

- **Thermal Binding Test Results**

Crane Valve: (test is pending)

West. Valve: No increase in unseating thrust for 200 degree temperature drop (low seat mu makes this the expected result)

The logo for ComEd, featuring the word "ComEd" in a bold, sans-serif font with a stylized starburst or spark symbol integrated into the letter "d".

Future ComEd Testing Plans

- Thermal Binding Testing of Crane 10" Gate Valve
- Testing of Other Flex-Wedge Gate Valve Designs. The following valve designs are being considered:
 - 10" Borg-Warner Gate Valve (~11/27/95)
 - 6" Anchor/Darling Gate Valve (~11/27/95)
 - 10" Westinghouse Gate Valve (~12/?/95)
- Testing of 6" Anchor/Darling Double-Disk Gate Valve
- Comparison of Thermal Binding Test Data to Analytical Models Under Development
- Analysis of Data Collected by Other Utilities Using ComEd Pressure Locking Model



Comparison of Static Unseating to Pressure Locking Unseating Thrust for 10" Crane 900# Class Valve

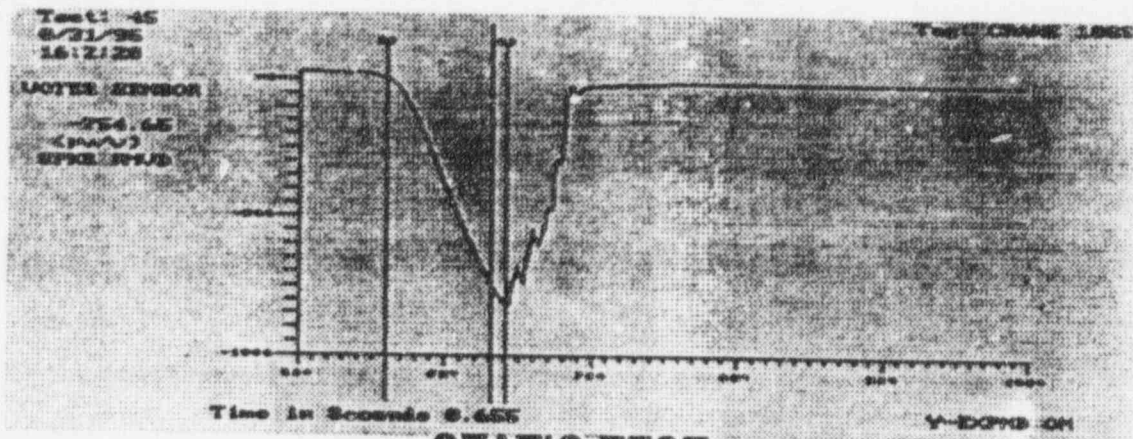

STATIC TEST

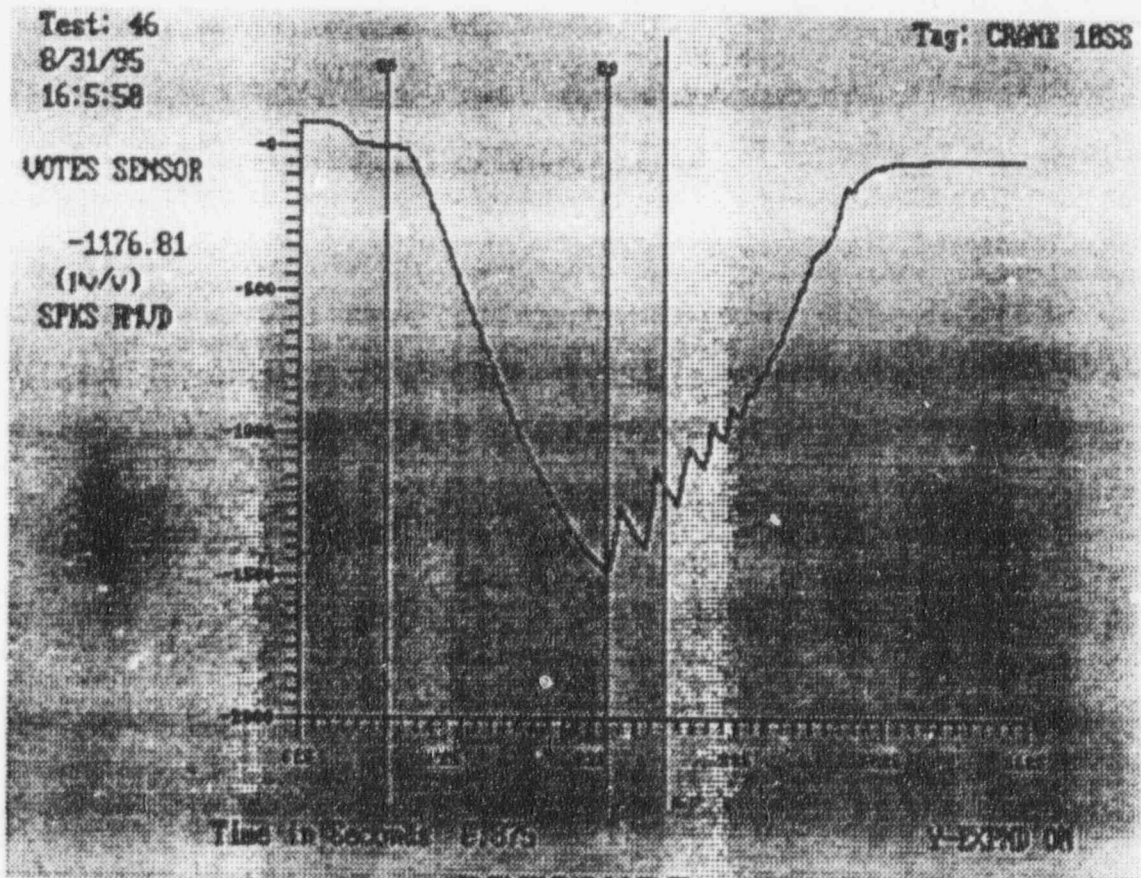

**PRESSURE
LOCKING TEST**

1 mV/v ≈ 50 lbf

Example of Hydro-Pump DP Test for Determining Seat Friction Coefficient (10" Crane 900# Class Valve)

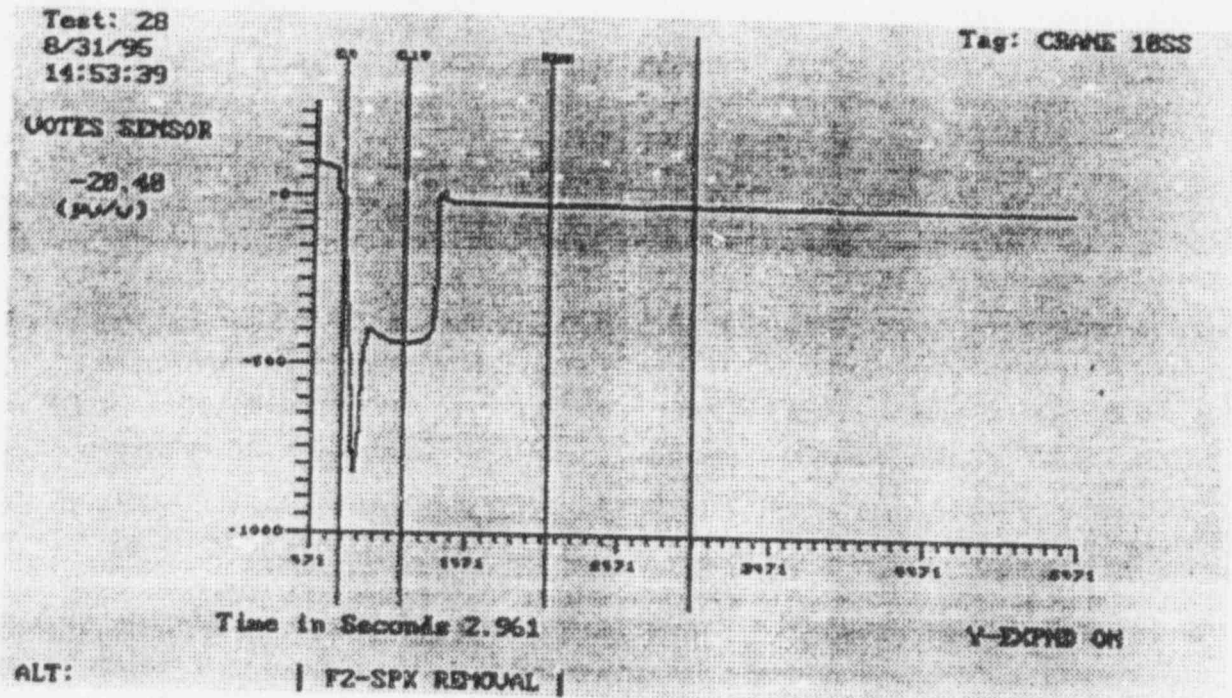

5 SECOND ZOOM

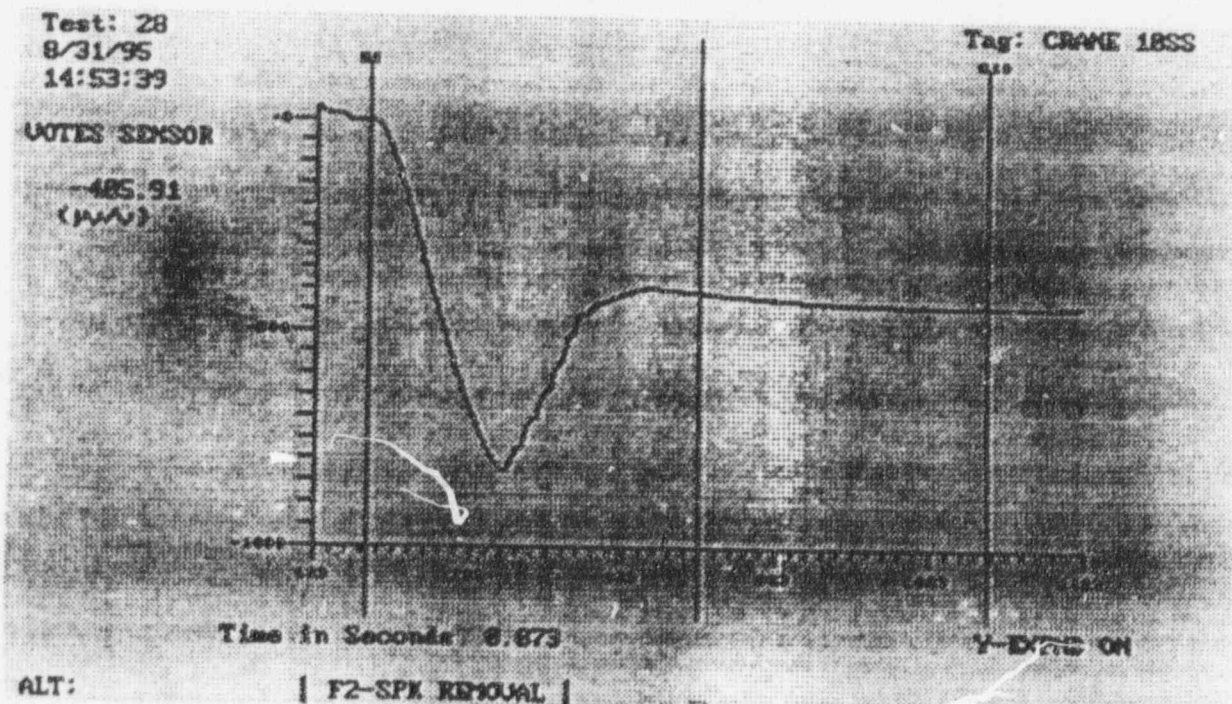

HALF SECOND ZOOM

Static Test for 4" Westinghouse 1500# Class Gate Valve

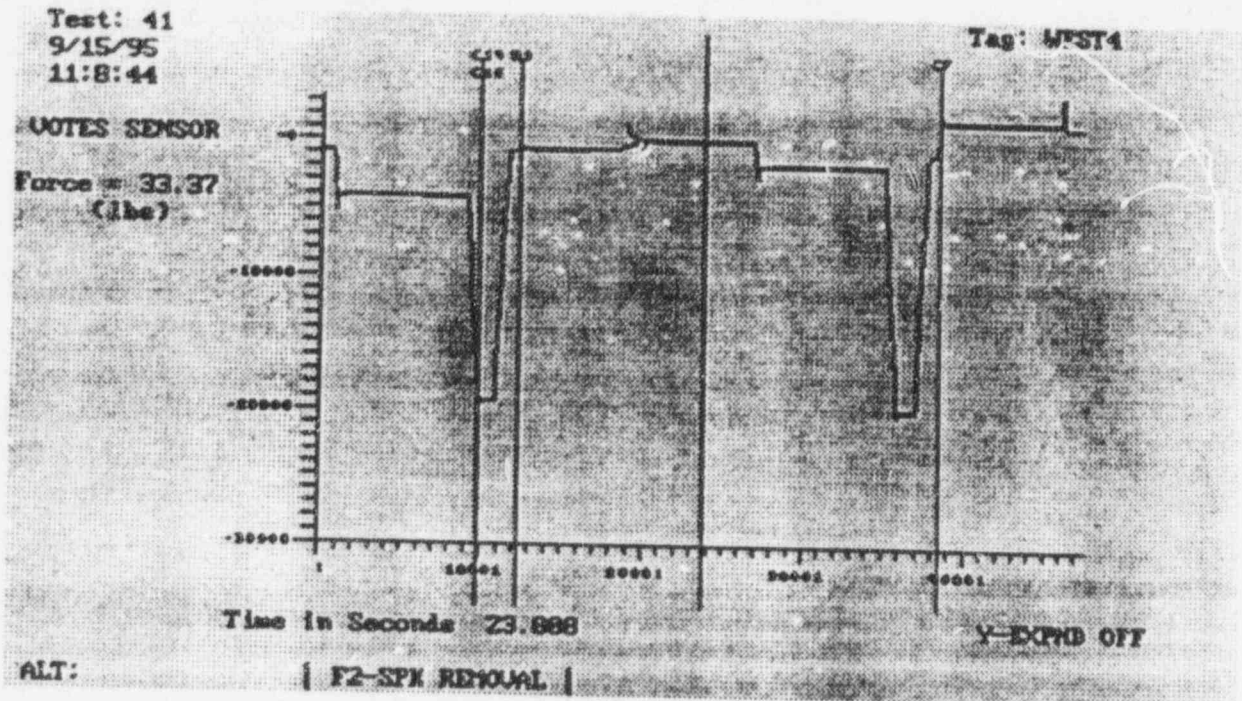

FULL VIEW OF TRACE

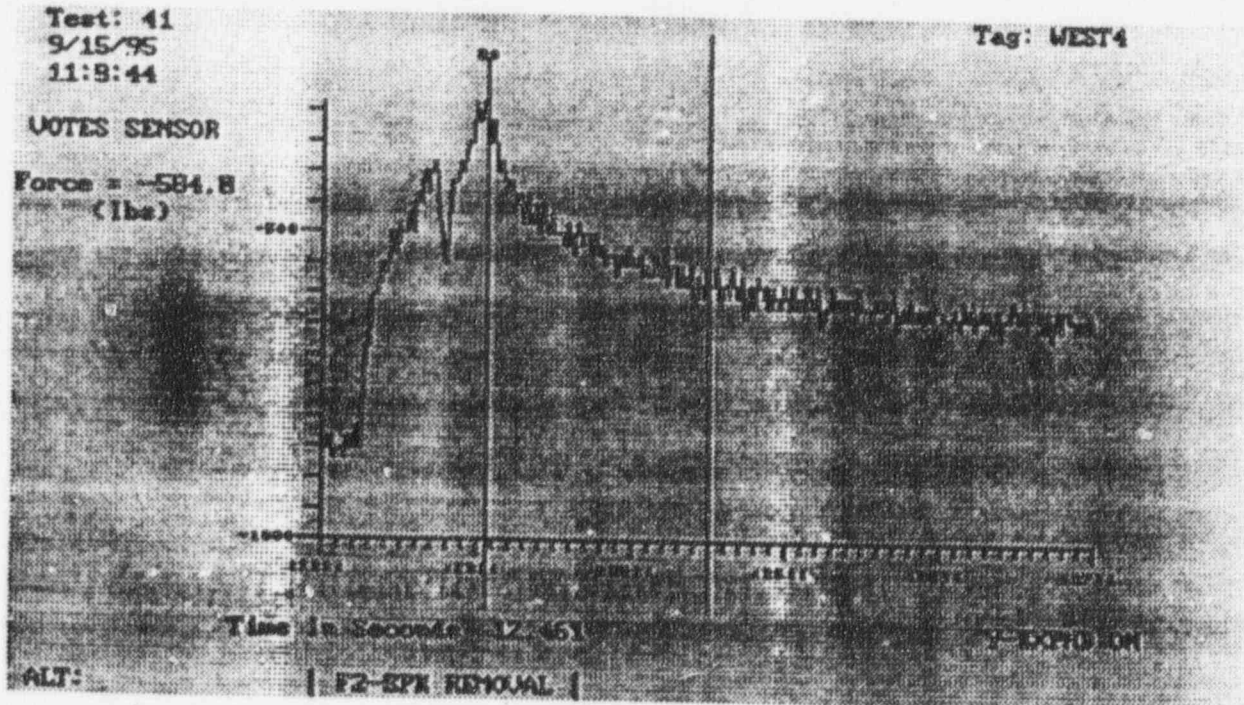

HALF SECOND VIEW OF TRACE

Comparison of Static Unseating to Pressure Locking Unseating Thrust for 4" Westinghouse 1500# Class Valve

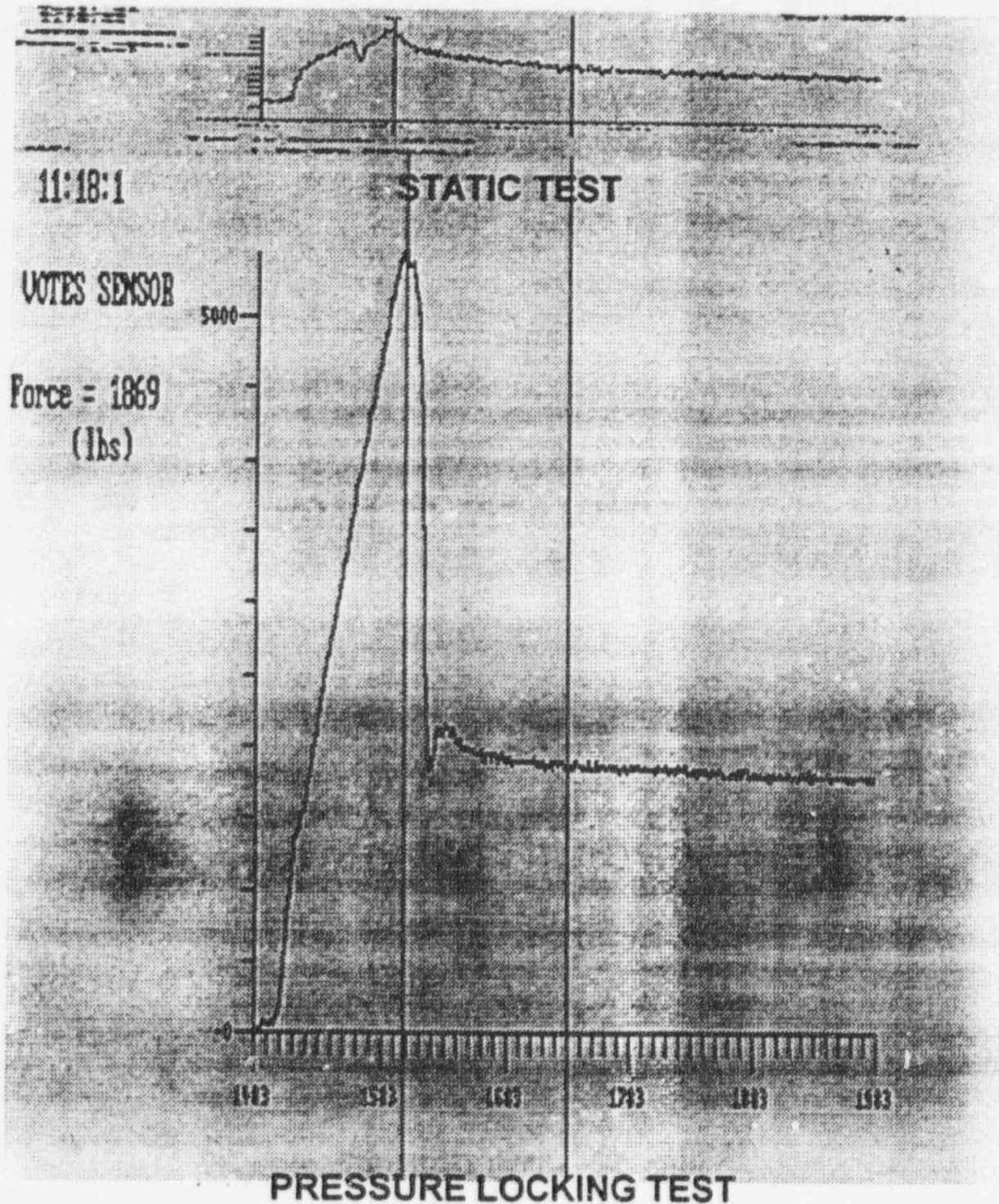

Example of Hydro-Pump DP Test for Determining Seat Friction Coefficient (4" Westinghouse 1500# Gate Valve)

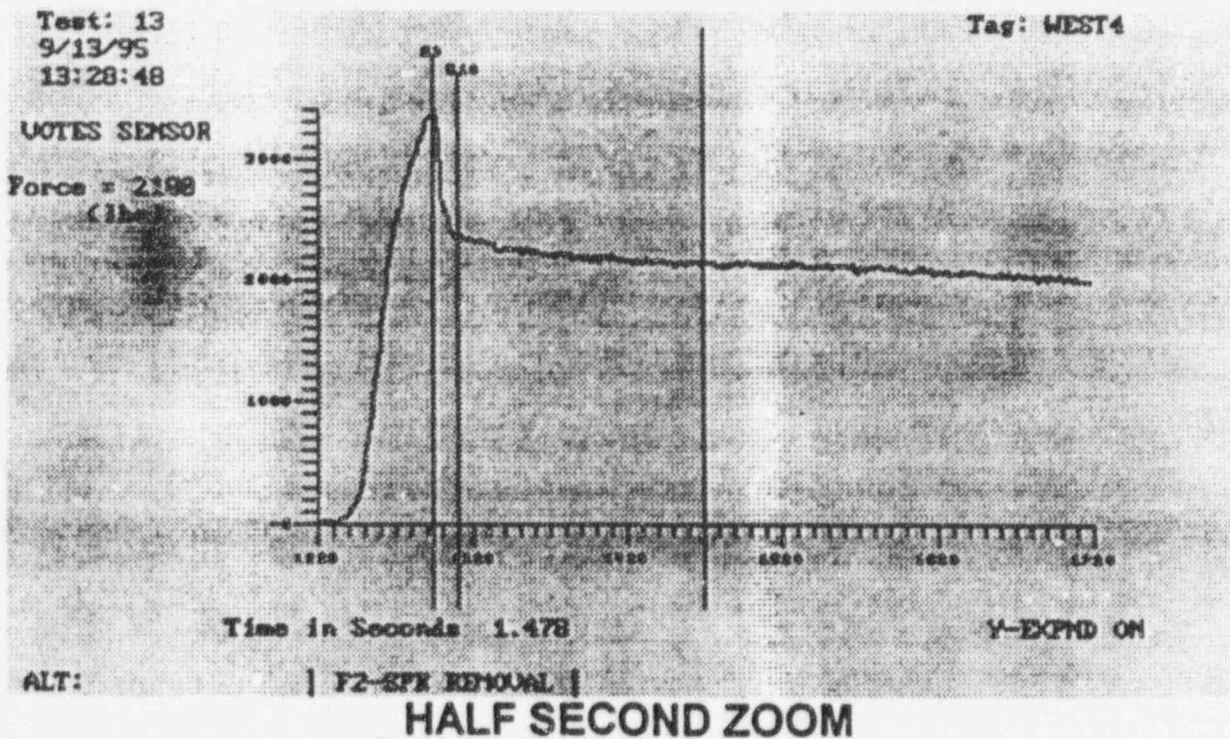
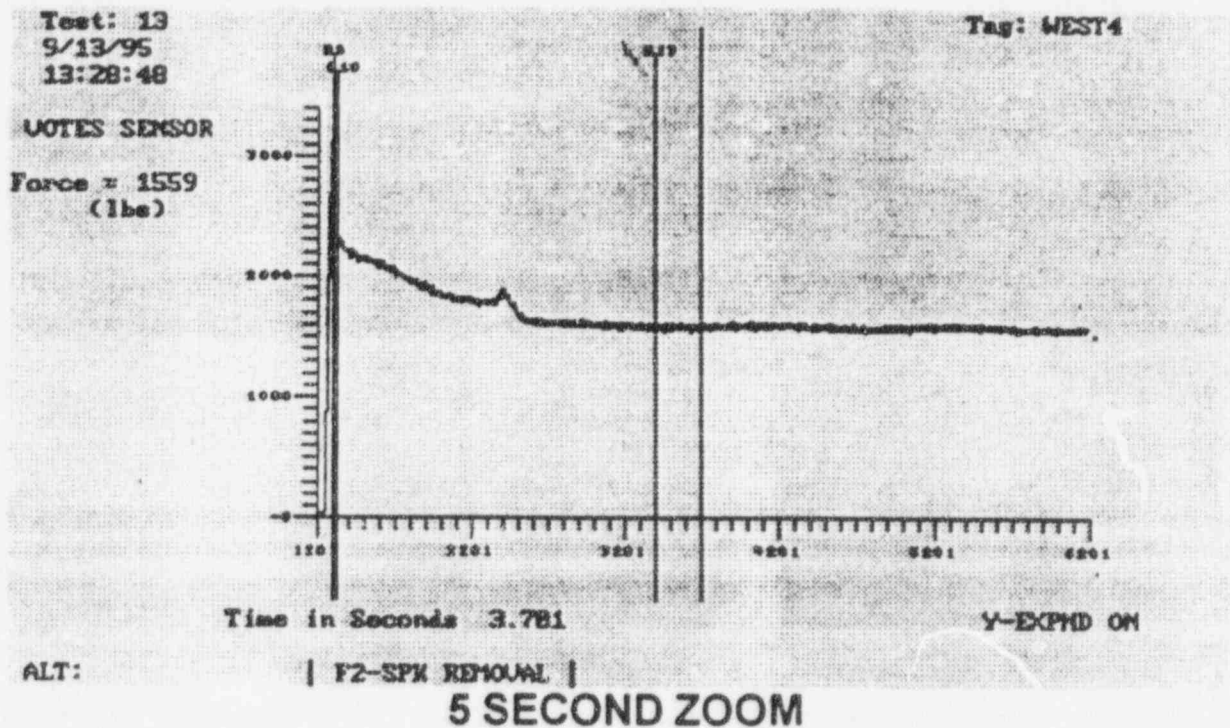

**PRESSURE LOCKING AND THERMAL BINDING
PROGRAM AT WNP-2**

**PRESENTED AT:
PRESSURE LOCKING AND
THERMAL BINDING WORKSHOP**

**ARLINGTON, TEXAS
NOVEMBER 9, 1995**

Presented by: Thomas F. Hoyle

MOV PROGRAM LEAD

SUPPLY SYSTEM

**PRESSURE LOCKING AND THERMAL BINDING
PROGRAM AT WNP-2**

Summary	1
GL 89-10 Actions	2
Contractor	2
Screening Criteria	2
PER & Operability Assessment	3
Modifications	4
Calculations & Enhanced Methodology	4
Testing Plans	4
NRC Inspection 95-24	5
GL 95-07	5
Operability	5
Future Actions	6
Calculational Methodology	Att 1

SUMMARY

The Washington Public Power Supply System took action as part of the GL 89-10 MOV Program to reassess pressure locking and thermal binding (PL/TB) of gate valves which must perform a safety function to open. Several studies have been conducted over the years at, but did not result in many physical changes to WNP-2 valves. GL 89-10 prompted yet another study. However, this study resulted in three valves being physically modified, the procedure for another valve being revised and extensive calculations performed on several other valves.

The NRC, in a recent MOV inspection, questioned the validity of one aspect on the screening criteria used in the PL/TB study. As a result of this concern and the issuance of GL 95-07, the WNP-2 PL/TB study completed in December, 1993 is being reassessed to determine if the screening criteria used and thus the study results remain valid.

Pressure Locking and Thermal Binding continue to be an industry concern as evidenced by the issuance of GL 95-07. The PL/TB phenomena is quite rare at any individual plant and thus has not been given high priority by most utilities. Non-quantifiable conditions such as seat and packing leakage and air pockets can have major impact on the effects of PL in the conditions exist. Additionally, emphasis is needed on this issue as PL/TB may occur and due to its inherent nature may not be repeatable. Thus, PL/TB may occur but is mis-diagnosed. There is enough industry experience to suggest more detailed review of the phenomena in general and at individual plants.

GL 89-10 ACTIONS

Supplement 6 of GL 89-10 contains the NRC's expectations with regard to Pressure locking/thermal binding. In Supplement 6, the NRC points out that GL 89-10 recommends that licensees review the design bases of their safety-related MOVs. Licensees are expected to have evaluated the potential for pressure locking or thermal binding of gate valves and take action to ensure that these phenomena do not affect the capability of these MOVs to perform their safety-related function. In Supplement 6, the Staff gives an acceptable approach to addressing PL/TB of gate valves in the GL 89-10 program. The evaluation would include:

- Document an evaluation of gate valves in the GL 89-10 program and: a) identify them as acceptable to pressure locking or thermal binding or b) eliminate them from further consideration.
- The evaluation should include those MOVs which could undergo PL/TB during surveillance testing as well as design basis conditions or normal operation.
- Licensees are given recommendations on acceptable and unacceptable resolutions to this issue.
- It is also stated in Supplement 6 that enforcement actions will depend on the safety significance of the issue.

CONTRACTOR

The Supply System decided to subcontract the effort to augment staff resources. As with most utilities, the issue of PL/TB was not new. Several other reviews had been conducted to determine if any corrective action was warranted. Minimal in-field work to mitigate PL/TB had been conducted in the past. As a result of the December, 1993 study, the most susceptible PL valves have been in-field worked to eliminate any PL potential. Other less susceptible valves are being re-evaluated for future modification, if required.

SCREENING CRITERIA

A screening criteria was established to determine susceptibility to PL/TB. The screening for Pressure-Hydraulic Locking consisted of all flexible wedge of parallel disc valves. PL susceptibility was based on the valve bonnet being pressurized with a subsequent depressurization of the upstream and/or downstream piping. This process potentially results in pressure locked between the discs which can cause an increased thrust to operate the valve OPEN. The screening process was in accordance with NRC Special Study, PL/TB of Gate Valves, December 1992, AEOD/S92-07. System operation was also reviewed to determine if open operation was required after PL and if the upstream valve seat would be repressurized before operation which eliminates PL.

The PL/TB report considers Hydraulic Locking to be a subset of PL which occurs when a solid fluid is trapped in the valve bonnet. Hydraulic locking is detrimental when the fluid temperature in the bonnet is increased resulting in a rapid pressure rise. Valve orientation influences the likelihood of vapor or gas pockets which prevent hydraulic lock. The likelihood of a vertically oriented valve bonnet being totally vented of all noncondensables is remote. This is being substantiated by Commonwealth Edison bench tests that induce and measure PL/HL forces. All valves were screened for orientation and temperature.

Thermal Binding (TB) was restricted to solid wedge valves that close at high temperature. The report evaluation found that there were no valves required to open that may have TB potential. As part of the re-evaluation of PL/TB at WNP-2, flex wedge gate valves will also be evaluated for thermal binding. A temperature criteria will be established to determine TB potential.

PER & OPERABILITY ASSESSMENT

The process used at WNP-2 to document conditions adverse to quality is called the Problem Evaluation Request or PER. The Pressure Locking/Thermal Binding identified eight gate valves susceptible to pressure locking. PER 294-0074 was initiated to document the issue and follow corrective action. The PL/TB report/PER identified the following MOVs as potentially susceptible to pressure locking:

LPCS-V-5	Low Pressure Core Spray injection valve
RCIC-V-13	Reactor Core Isolation Cooling injection valve
RHR-V-8,9	Residual Heat Removal shutdown cooling suction line containment isolation valves
RHR-V-42A,42B,42C	Low Pressure Coolant Injection injection valves
HPCS-V-4	High Pressure Core Spray injection Valve

As can be seen from inspection of the above valve functions, all Emergency Core Cooling injection valves were found susceptible to PL. The PER process drives a prompt operability assessment. This operability assessment found all susceptible valves operable. However, engineering judgement was used which needed more justification for long term resolution of the issue. Calculations were initially done to determine margin. These calculations used the best available information. Because the margin was low in some cases, stronger justification was needed.

MODIFICATIONS

Two valves, RHR-V-8 & 9, with the least margin were determined not to have a safety function in the open direction. However, since during their normal operation they could be subject to pressure locking, it was decided to perform a modification to the valves.

One other valve, LPCS-V-5, also had low margin and was modified at the next refueling outage.

Another valve, HPCS-V-4 is subject to pressure locking during surveillance testing. The surveillance procedures were modified to identify this potential PL condition to plant operators.

CALCULATIONS & ENHANCED METHODOLOGY

The remaining four valves, RCIC-V-13 and RHR-V-42A, 42B & 42C, as previously stated were all found to be operable by engineering calculation. RCIC-V-13 had significant margin and was not considered a concern. The LPCI injection valves, RHR-V-42A/42B/42C, were only marginally acceptable. A progressive verification approach was used where the initial calculations were later augmented with more indepth calculations. The calculational methodology used the Grand Gulf approach. After looking at this methodology, it was determined that it should be modified to also include the "wedge pressure effect". Due to the shape of a wedge gate valve a small force is created in the close direction due to the larger area that pressure has to act on in the bonnet. This force was added to the static unwedging load plus the running load. Compensation for the stem piston effect was included. Even after the wedge pressure effect was added, all of the valves were demonstrated by the calculation to be operable under the worst case scenario at degraded voltage. Attachment 1 contains an overview of the calculational methodology used at WNP-2.

To confirm the assumptions in the calculation and to provide additional justification, testing at simulated pressure locked conditions are planned.

TESTING PLANS

The Supply System's maintenance training organization has a 10", 900 lb flex wedge gate valve which is to be used for the confirmatory testing. The test setup will include welding one end of the valve and adding pressure connections to the closed end and to the bonnet. This way, one pressure can be put on one side of the valve and a different pressure can be put in the bonnet. This should simulate a pressure locked valve. In addition, this valve sticks in the closed direction which is similar to most of the flex wedge gate valves in the plant. The valve has an SMB-2 operator which is smaller than the LPCI injection valve's SMB-3 operator, but the technique is similar. A specific date has not been set for the testing at this time.

Commonwealth Edison has conducted testing of valves under pressure locked conditions. Also, valve 24 of the EPRI Performance Prediction Program was stroked under pressure locked conditions. The Supply System may opt to use the EPRI or CE test results in lieu of the testing described above.

NRC INSPECTION 95-24

During the WNP-2 MOV Closure Inspection, 95-24, pressure locking of GL 89-10 gate valves was reviewed in considerable detail. The calculational methodology was applauded since it went beyond the Grand Gulf methodology which was considered state of the art. The inspectors did take exception to the premise that hydraulic lock is a subset of pressure lock. We agreed to disagree. The inspection did point out that the basis of the screening criteria did not agree with most of the industry and that additional justification would be needed.

It is noted that the Commonwealth Edison PL testing has been unable to completely vent bonnets to get water solid conditions. The CE testing seems to demonstrate that under static conditions the previously published numbers for pressure rise may be very conservative.

GENERIC LETTER 95-07

At WNP-2, GL 95-07 does not appear to change the basic recommendations included in GL 89-10, Supplement 6. Recent NRC enforcement actions with respect to hydraulic lock and the inspection at WNP-2 have had an impact on how the previous report on PL/TB is viewed today.

OPERABILITY

One of the most important issues with PL/TB is identifying susceptible valves and then being able to continue operations. A conservative and timely call on operability may well declare a valve or valves inoperable. This, of course, is not very palatable with plant management. If one looks at the WNP-2 MOVs above, the LPCI injection valves, one quickly concludes that all valves are roughly the same. And if they were susceptible to PL/TB, then a plant shutdown would be warranted. Many times if enough time is allotted to perform a detailed analysis more margin exists than originally thought. Therefore, a conservative call on operability might unnecessarily shut the plant down.

FUTURE ACTIONS

The Supply System plans to re-evaluate its position on PL/TB. The screening criteria, particularly for hydraulic lock and thermal binding will be re-assessed. To date hydraulic lock has been viewed as a subset of PL. In other words if pressure locking (depressurization event) did not occur first than hydraulic lock would not occur. Another assumption is that horizontally installed valves will not experience hydraulic lock since there will always be some small air pocket. This may well be the case but justification for this position is not readily apparent. Thermal binding has been dispelled for all flex wedge gate valves. Again, this position may need additional justification or re-evaluation.

CALCULATIONAL METHODOLOGY

ATTACHMENT 1

Summation of Static Unwedging & Running Loads and Pressure Forces

- **Static Unwedging Load**
- **Running Load**
- **Piston Effect**
- **Wedge Pressure Effect**
- **Pressure Locking Load**

Static Unwedging Load

The unseating load measured during static testing consists of:

- The load required to overcome open packing load
- The force required to overcome the seat to disk contact load under static conditions

The Static Unwedging Loads (SUW) exist under pressure locking conditions.

Running Load

- The load measured under design basis dP conditions, or
- The calculated load for design basis dP based on the accepted valve factor.

The Running Load (RL) is conservatively included in the Required Thrust to Open (RTO) for pressure locking.

Piston Effect

- The difference between the bonnet pressure and ambient pressure outside the valve body results in a stem ejection force (or piston effect). This force is in the direction which assist valve opening. The magnitude of this force is calculated using the equation below:

$$F_{piston} = (\pi/4) \times D^2 \times (P_{bonnet} - P_{atm})$$

Vertical Downward Force on Disk

- Pressure exerts a downward force on the valve disk.
- This force is calculated for each side of the disk by multiplying the vertical projected area of the valve disk times the differential pressure across that disk face. The equation below is used:

$$F_{vert} = (\pi/4) \times D^2 \times \sin(\theta_{seat}) \times [2P_{bonnet} - P_{inlet} - P_{outlet}]$$

Pressure Locking Force

- Determine the force exerted on the seat ring by the disc due to internal pressure using Roark, Table 24, Case 2d.

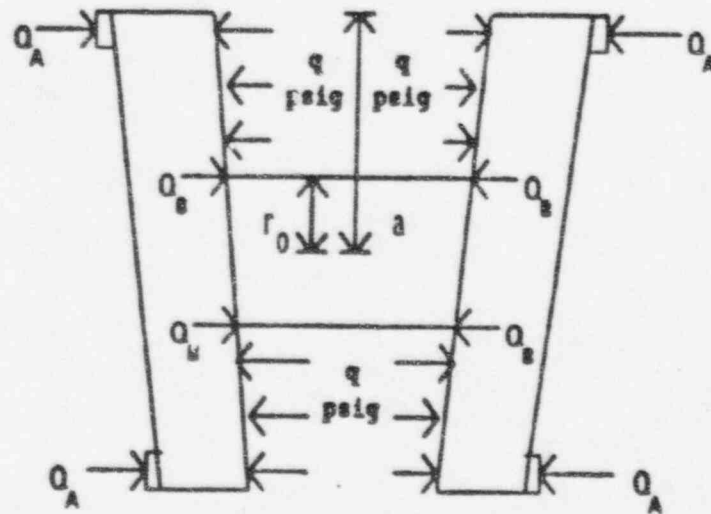

Pressure Locking Force (cont'd)

- Determine forces exerted by external pressures on the high and low pressure sides using Case 2d and 1b.

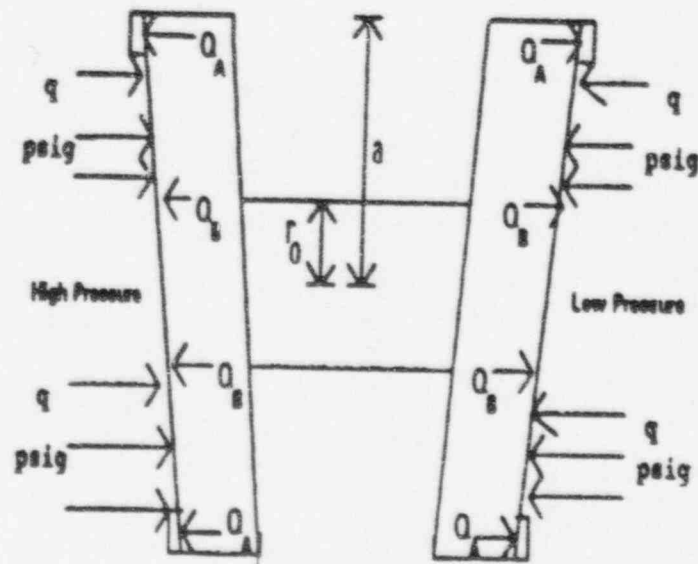

Pressure Locking Force (cont'd)

- Case 1b for increased force on the low pressure disc due to hub area that was left out of Case 2d equations.

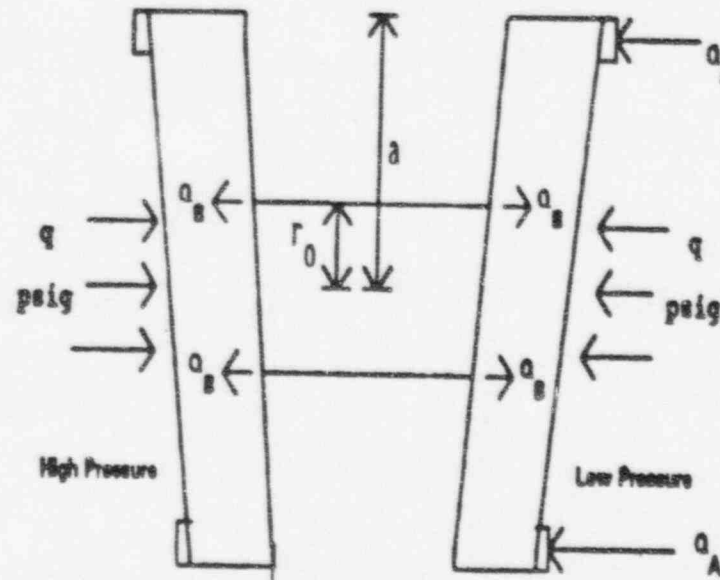

Pressure Locking Force (cont'd)

- The above analysis results in total disc force from pressure locking on the high pressure side and the low pressure side.
- The required thrust to overcome pressure locking only (RT_p) is the total disc force due to pressure locking times the valve factor.

Required Thrust To Open

- The RTO is indicated below:

$$RTO = SUW + RL - F_{piston} + F_{vert} + RT_p$$

NRC Region 4
Arlington, Texas

Workshop on Generic Letter 95-07
Pressure Locking and Thermal Binding
November 9, 1995

Thermal Binding Analysis

Bill R. Black, P.E.
TU Electric

THERMAL BINDING & PRESSURE LOCKING OF GATE VALVES

- Of COURSE it can be Analyzed!
- Do We Need To?
If so for Some MOVs,
at What Level of Sophistication?
- Challenge: Validate Analytical Method

DO WE NEED TO?

- If we can't justify operability on the basis of prior operation with conditions equal or greater than the design pressure/thermal conditions.

AT WHAT LEVEL OF SOPHISTICATION?

- as little as we can get by with!
- Formulas for Stress and Strain, Roark & Young

MODEL VALIDATION - WHAT TESTING?

- The Least Possible
- In the Lab

LOADS ON THE DISK AFFECTING UNSEATING THRUST ($T_{un,t}$)

- Design Basis Upstream & Downstream Pressure
- Residual Wedging from Prior Closing Stroke
- Loads due to Temperature Changes:
 - Bonnet Cavity Pressure
 - Stem Elongation/Body Shrinkage after closing
 - Piping Loads on Valve End
 - Different Rates of Thermal Growth/Shrinkage:
Disk, Seat Rings, Body

$$T_{un,t} = T_{un,d} + T_{un,bp} + T_{un,sg} + T_{un,ax}$$

CALCULATING GL 95-07 LOADS: **Tun,bp** & Tun,sg & Tun,ax

Tun,bp = additional unseating load required to overcome the effects of the bonnet cavity pressure

Being developed by Commonwealth Edison

- Similar simple analytical model
- Testing in progress to validate the model

CALCULATING GL 95-07 LOADS:

$T_{un,bp}$ & $T_{un,sg}$ & $T_{un,ax}$

DETERMINE: μ_{avg} = average seat friction coeff.

$$\frac{T_{un,s}}{TTOTc} < \frac{(\mu_{avg} \cos\theta - \sin\theta)(\cos\theta - \mu_{avg} \sin\theta)}{(\mu_{avg} \cos\theta + \sin\theta)(\cos\theta + \mu_{avg} \sin\theta)}$$

where θ = Seat angle

$T_{un,s}$ = Static Unseating Thrust

$TTOTc$ = Prior Static Total Closing Thrust

CALCULATING GL 95-07 LOADS:

$T_{un,bp}$ & $T_{un,sg}$ & $T_{un,ax}$

DETERMINE: K_m = MOV stiffness along stem axis, excluding the stem

$$K_m = \frac{\Delta T T O T c}{(\Delta \theta_{sn}/360^\circ)(L_{stem}) - (\Delta T T O T c)(K_{stem})}$$

where $K_{stem} = (K_{threaded}^{-1} + K_{threaded,inc}^{-1} + K_{solid}^{-1})^{-1}$

CALCULATING GL 95-07 LOADS:

Tun,bp & **Tun,sg** & Tun,ax

$$T_{un,sg} = (\Delta T_{sg})(A)$$

where

$$A = \frac{(\mu_{avg} \cos\theta - \sin\theta)(\cos\theta - \mu_{avg} \sin\theta)}{(\mu_{avg} \cos\theta + \sin\theta)(\cos\theta + \mu_{avg} \sin\theta)}$$

$$\Delta T_{sg} = (C_{ts})(L_{exp})(\Delta \text{temp,sg})(K_{mov})$$

$$K_{mov} = (K_m^{-1} + K_{threaded}^{-1} + K_{solid}^{-1} + K_{solid,inc}^{-1})^{-1}$$

CALCULATING GL 95-07 LOADS: $T_{un,bp}$ & $T_{un,sg}$ & $T_{un,ax}$

$$T_{un,ax} = (F_{body,therm}) \cdot (2) \cdot \frac{(\mu_{avg} \cos\theta - \sin\theta)}{(\cos\theta + \mu_{avg} \sin\theta)}$$

$$F_{body,therm} = \frac{(K_{ba})(K_{net,a})}{K_{ba} + K_{net,a}} \cdot (\sum C_i \cdot L_i \cdot \Delta temp_i)$$

K_{ba} = body stiffness between ends of seat rings

$K_{net,a}$ = net stiffness along pipe axis of the 2 seat rings, 2 wedge “plates” and wedge “hub”

THERMAL BINDING MODEL VALIDATION STATUS

Transmit to Commonwealth Edison	10-25-95
Transmit to Westinghouse Owner's Group	11-1-95

Commonwealth Edison presentation to Region 3 on
11-7-95: pursuing validation testing of model.

Copy of TU Electric transmittal to Commonwealth
Edison is available to any interested party.

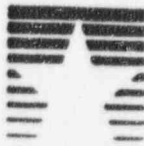

TU ELECTRIC

October 25, 1995

Mr. Brian Bunte
Commonwealth Edison
708-663-3824
708-663-7118 FAX

Dear Mr. Bunte:

TU Electric has created and is trying to validate an analytical model of gate valve body, seat ring, gate wedge, stem, and extended structure stiffnesses. It is intended that the model will be used to analyze the effects of differential pressure distributions on, and temperature changes in, the structural elements. If successful, the model will be a useful tool in responding to the recent NRC Generic Letter 95-07. Your on-going tests to assess these effects may provide data by which validation of the analytical model may be accomplished.

This letter is intended to solicit your cooperation in assessing the present analytical model developed by TU Electric. Our cooperative efforts may result in providing utilities with a less expensive way to resolve Generic Letter 95-07 concerns.

If you have insights which would beneficially refine TU Electric's efforts, you are cordially invited to share these with us. The methodology we are presently planning to use for modeling the stiffnesses of the various structural components (excluding the stem and the extended valve structure) is described below.

1. Use simple flat plate, and solid or hollow right cylinders, in combination to simulate the structures.
2. Model the hub of the wedge as a solid cylinder of radius r_{hub} , and length L_{hub} . The stiffness K_{hub} of the hub model relating axial deflection to an axial load uniformly applied over the end of the cylinder (along the pipe axis) is:

$$\begin{aligned} K_{hub} &= (\text{Area})(\text{Young's Modulus}) / (\text{Length}) \\ &= [(\pi)(r_{hub})^2] [E_{wedge} / L_{hub}] \end{aligned}$$

3. Model each of the two disks of the wedge as a flat plate of outer radius a_{disk} , thickness t_{disk} , and inner radius r_{hub} . Model the inner edge as rigidly fixed, and the outer edge as free. Model the applied load on the disk seat ring as a ring load of radius r_{load} equal to the mean valve body seat radius. The stiffness K_{plate} of each plate model relating bending

deflection of the plate at radius r_{load} to the ring load at that diameter is (Ref. 1, Table 24, Case 11):

$$K_{plate} = [2 \pi r_{load} D / (a_{disk})^3] / [(C_2 / C_8) \{ (r_{load} C_9 / r_{hub}) - L_9 \} - (r_{load} C_3 / r_{hub}) + L_3]$$

where $D = E_{wedge} (t_{disk})^3 / 12 (1 - \nu^2)$

4. The overall stiffness K_{wedge} of the wedge is the series combination of the stiffnesses of the hub and the two disks:

$$K_{wedge} = [(1 / K_{plate}) + (1 / K_{hub}) + (1 / K_{plate})]^{-1}$$

5. Given an compressive ring load of magnitude F_{seat} and radius r_{load} applied to the upstream wedge seat and reacted at the downstream wedge seat, the relative deflection y_{seat} of the upstream seat toward the downstream seat is:

$$y_{seat} = F_{seat} / K_{wedge}$$

It is important to select values for the hub radius and length, and the disk plate thickness and outer radius so that the model closely simulates the actual wedge's relative seat deflection under the same loading. TU Electric presently believes the plate thickness t_{disk} should be the average thickness of the actual wedge's plate from the bottom of the disk to the top of the wedge and from the inner radius r_{hub} to the outside radius a_{disk} .

Figures 1 through 3 provide illustrations of the dimensions which may be appropriate for the model described above. Note the following derived dimensions:

t_{disk} = thickness of wedge plate along the pipe centerline from the outer surface of the plate (point A) to the average thickness of the sloped inner surface of the plate (point B). Point B is the point on the axis of the pipe which intersects a plane perpendicular to the pipe axis and at a distance $((L_a + L_b)/2)$ from the stem centerline.

L_{hub} = $L_a + L_b$

r_{load} = $(D2 + E2) / 2$

6. Model each of the valve body seat ring inserts as hollow right cylinders of inside diameter $E3$ and outside diameter $D3$ and average length L_{sr} (in a plane perpendicular to the stem axis and containing the pipe axis). The stiffness K_{sr} of the seat ring model relating deflection along the pipe axis to an axial load F_{scat} uniformly applied over the end of the seat ring is:

$$K_{sr} = (\text{Cross-sectional Area})(\text{Young's Modulus}) / (\text{Length}) \\ = [(\pi)(D3^2 - E3^2)/4] [E_{sr} / L_{sr}]$$

7. Model the valve body between the outer ends of the seat ring inserts as a hollow right circular cylinder of inner diameter r_{body} and outer radius equal to the sum $(r_{body} + t_{body})$ and length L_{body} equal to the sum $(2 L_{sr} + 2 t_{disk} + L_{hub})$. The stiffness K_{body} of the valve body model relating deflection along the pipe axis to a load F_{scat} uniformly applied over the end of the seat ring along the pipe axis is:

$$K_{body} = (\text{Cross-sectional Area})(\text{Young's Modulus}) / (\text{Length}) \\ = [(\pi)((r_{body} + t_{body})^2 - r_{body}^2)] [E_{body} / L_{body}]$$

Other dimensions needed in order for TU Electric to perform the desired analyses are illustrated in Figure 4: the length L_{sc} of the stem from the bottom of the stem "T Head" to the bottom of the packing chamber in the valve bonnet when the valve is in the closed position with the disk pushed hard into the valve body seat by the stem, and the length L_{sn} of the stem from the bottom of the "T Head" to the start of the threaded section of the stem. Also required is the length L_{stem} of the stem from the bottom of the stem "T Head" to the bottom of the actuator stem nut when the stem is pushing the wedge hard into the valve body seat:

$$L_{stem} = L_{toy} + Y_{sn}$$

where L_{toy} = length of the stem from the bottom of the stem "T Head" to the top of the yoke-actuator mounting platform when the stem is pushing the wedge hard into the valve body seat

Y_{sn} = distance from the top of the yoke (the base of the actuator) to the bottom of the stem nut inside the actuator.

Note: TU Electric can obtain the value of the dimension Y_{sn} by inspection of an appropriate actuator sample. You are requested to provide the values of dimensions L_{sc} , L_{sn} , and L_{toy} .

Mr. Bunte : Valve Data for TU Electric

TU Electric will use the above dimensions to also quantify loads resulting from the thermal growth or contraction of the structural components. It is intended that confidence in the applicability of the analytical model will be gained by comparing test results with the results of the analytical model. As needed, the model will be refined.

Test data which is being collected by Commonwealth Edison can be used along with the needed dimensions and material properties to evaluate or verify the model. To accomplish this, **in addition to the data identified above, please provide the following test data and other information for use by TU Electric in evaluating the analytical model:**

- A. Static test data from pairs of closing and subsequent opening strokes. Data for several pairs of close and open strokes is desirable for addressing repeatability of valve performance. For the duration of these tests, the temperature of the valve body and internal components shall be maintained at room temperature.
- | | |
|---|--------------------|
| Thrust at control switch trip, | T _{cst,s} |
| Total thrust after control switch trip, | TTOTs |
| Peak unseating thrust, | T _{un,s} |
- B. With the valve fully closed, measure the amount of stem thrust increase resulting from further rotation of the stem nut. Small amounts of rotation, 10 to 15 degrees, are sufficient if measured accurately (within about 5% of reading) along with the resulting stem thrust changes that are also accurately measured. Provide the results of the measurements and the accuracies of the measurements.
- C. Stem geometry as follows:
- Stem unthreaded section diameter
 - Stem threaded section outside diameter, thread pitch, thread lead, and thread style: (ACME standard or stub)
- D. Materials of the valve body, valve body seat ring inserts, the wedge (obturator), and the stem. If available, also provide:
- the average thermal coefficients of expansion (in/in/degree F) for the ranges of temperature changes experienced by the wedge, the seat rings, the valve body, the stem inside the valve body, and the stem outside the valve body during testing of the valve assemblies for thermal binding effects.
 - Young's Modulus for each material

Mr. Bunte : Valve Data for TU Electric

- E. The sequence and values of temperature of the wedge upstream face, the hub, the wedge downstream face (if these are different), the upstream and downstream valve body seat ring inserts, and the valve body between the outer ends of the seat ring inserts.

Your interest in this effort as previously expressed to me is greatly encouraging to me. I look forward to our cooperation in evaluating the analytical model. If you have any questions, please contact Sid Chiu at 817-897-6510 or me at 817-897-6477. Our FAX number is 817-897-0868.

Sincerely,

Bill R. Black
Bill R. Black, P.E.

Attachments

(Figures 1-4)

(Hand-written development of analysis method, 5 pages)

cc: Sid Chiu

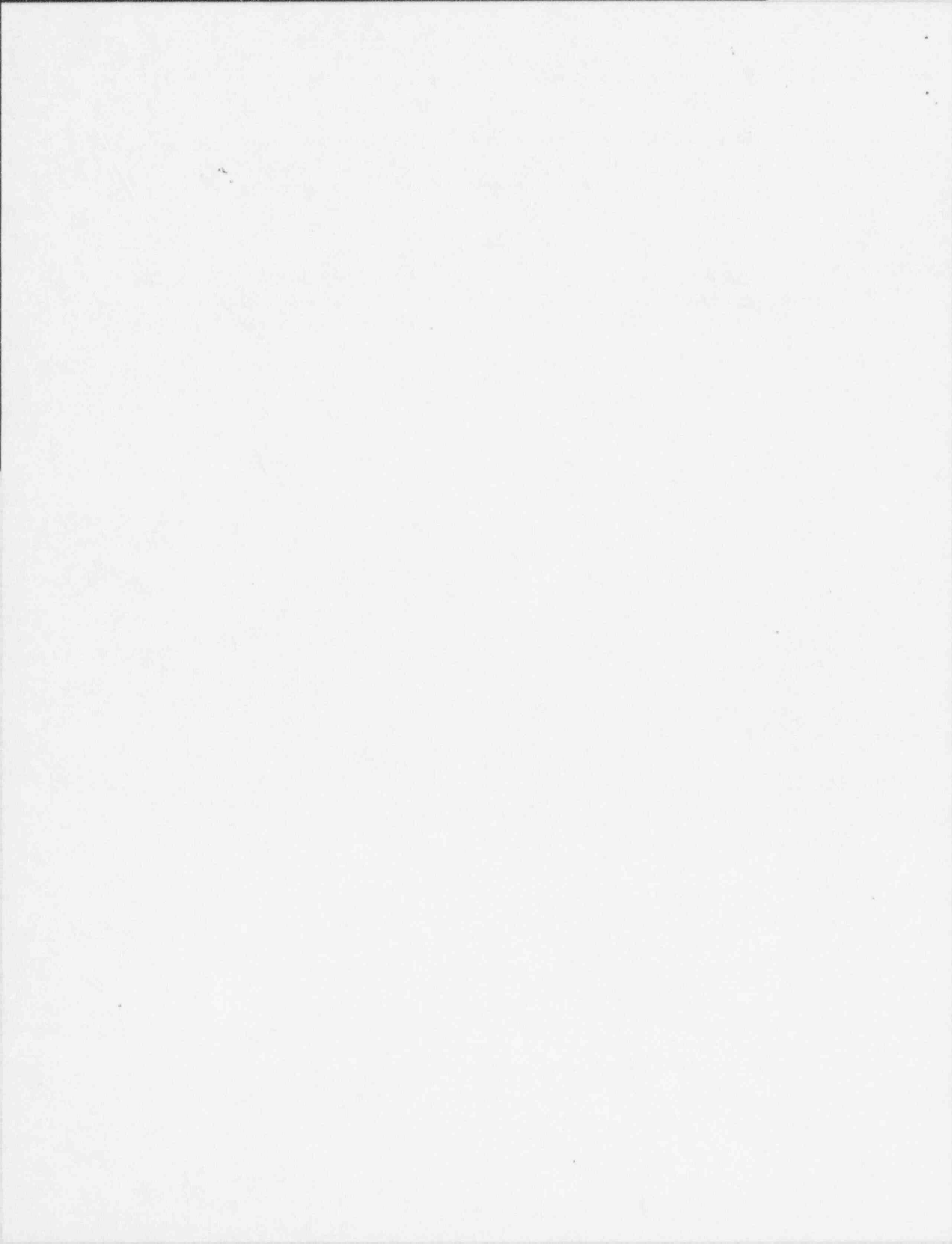

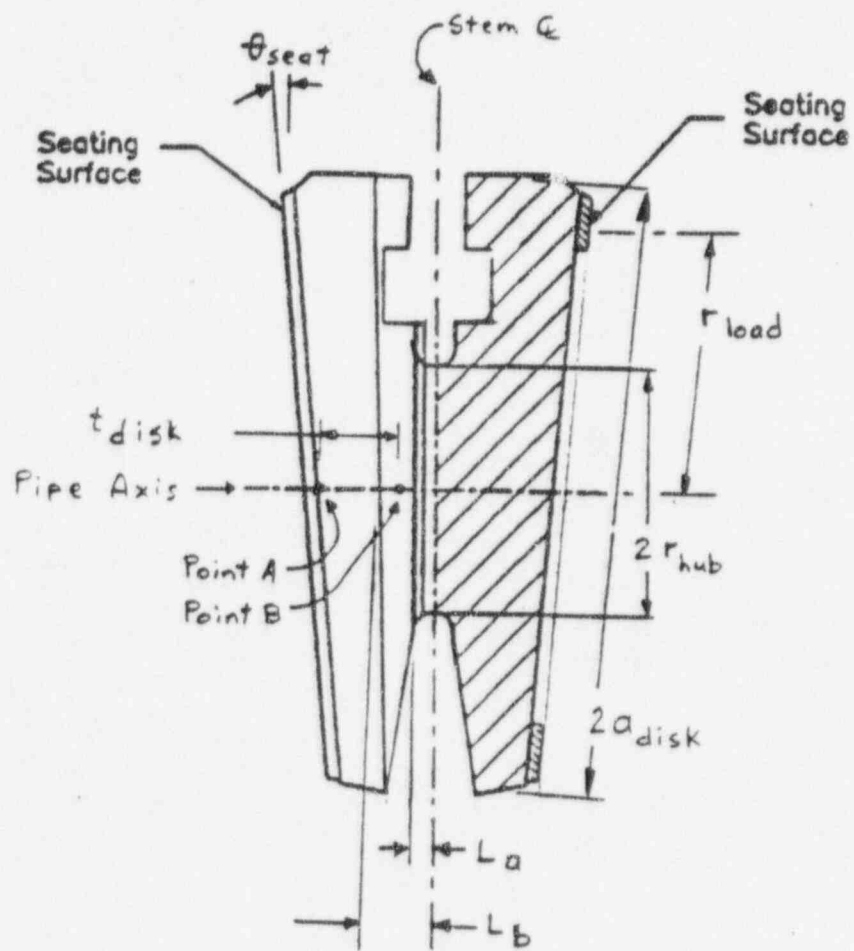

DIMENSIONS FOR FLEXIBLE WEDGE GATE VALVES

FIGURE 1

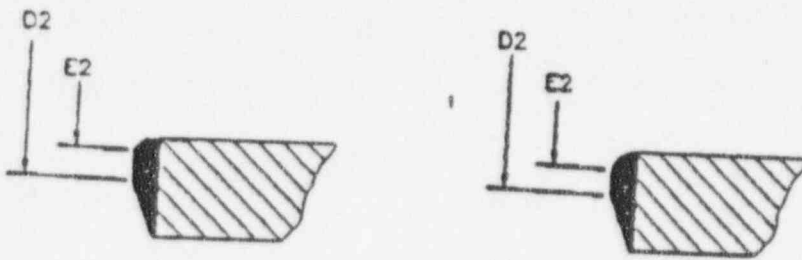
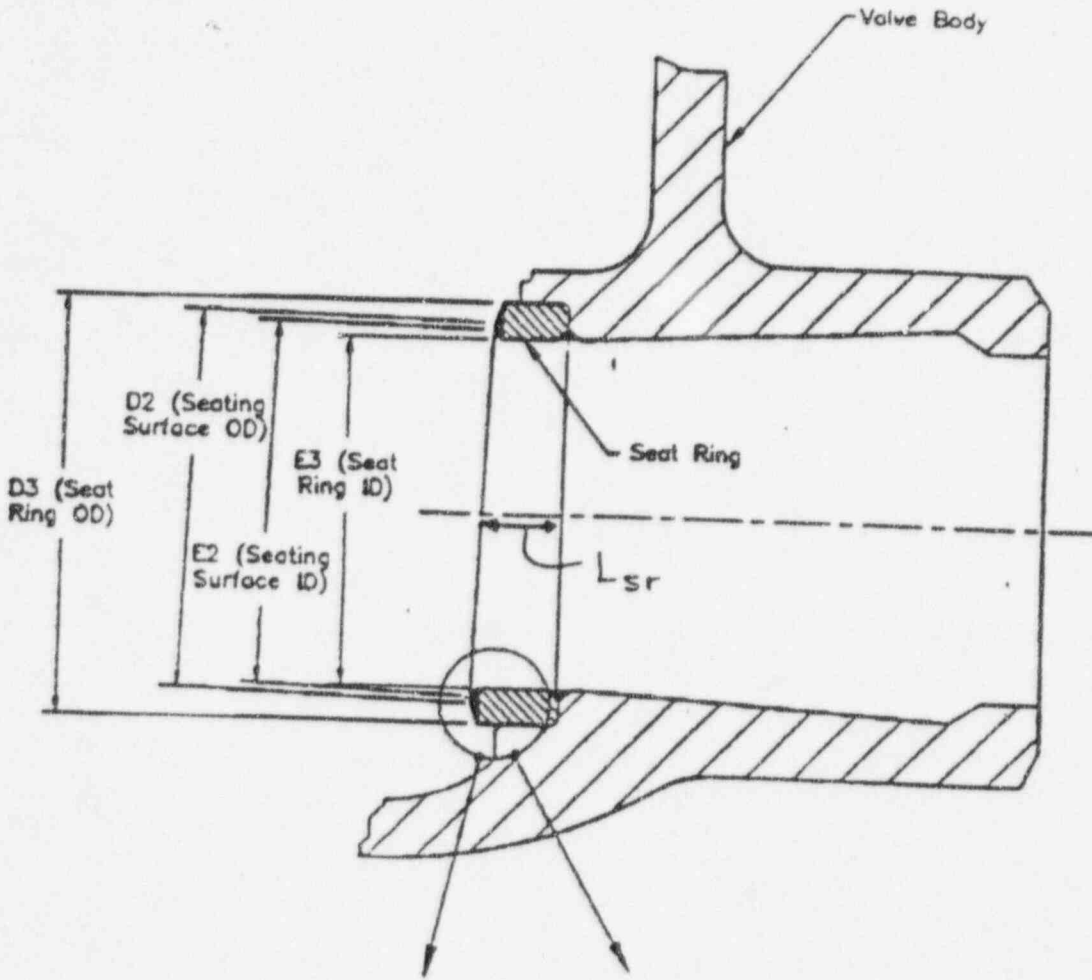

Chamfer

Radius

D2 and E2 are Diameters to the Edge of the Flat Seating Surface, Measured in the Plane of the Seat Ring.

SEAT RING DIAMETERS

FIGURE 2

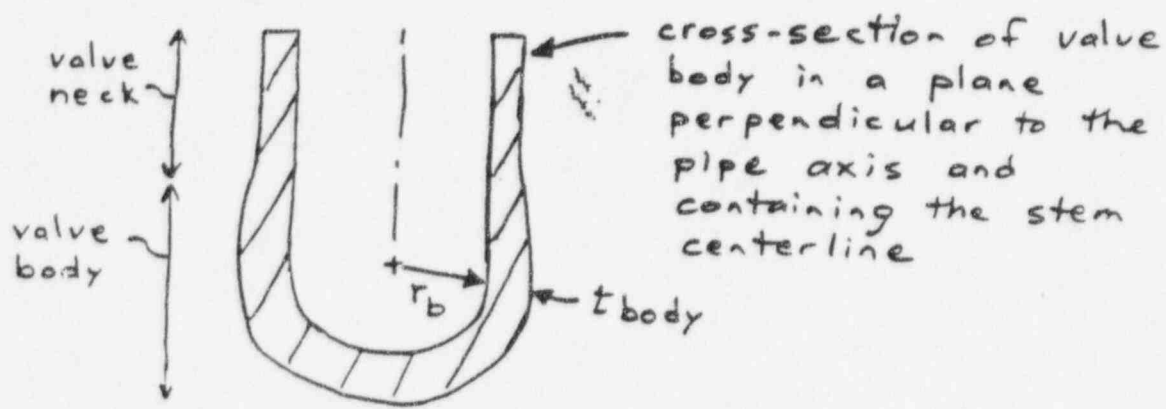

r_b = typical inside radius of valve body in the cross-section illustrated above.

t_{body} = typical valve body as-built wall thickness in the cross-section illustrated above.

Figure 3

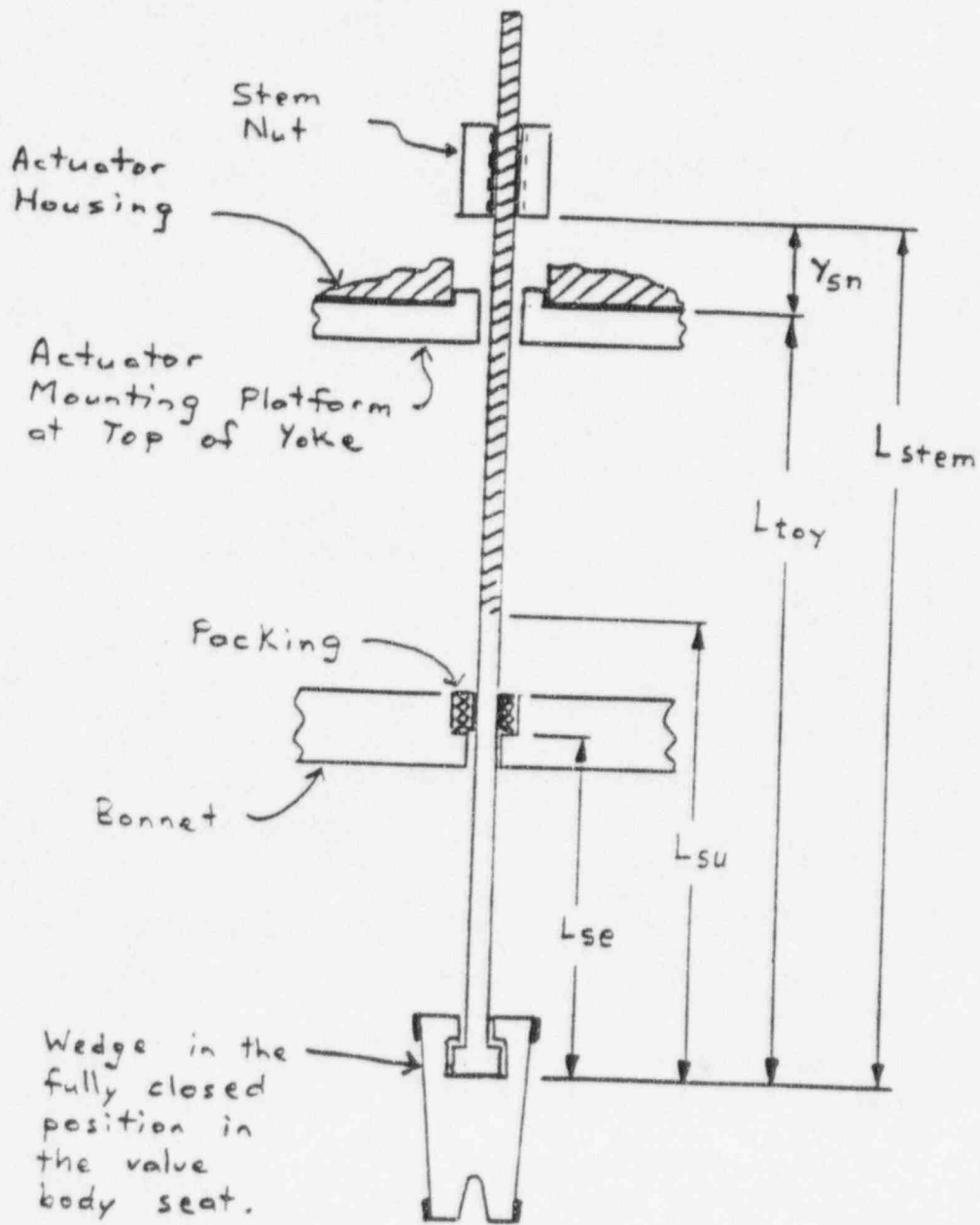
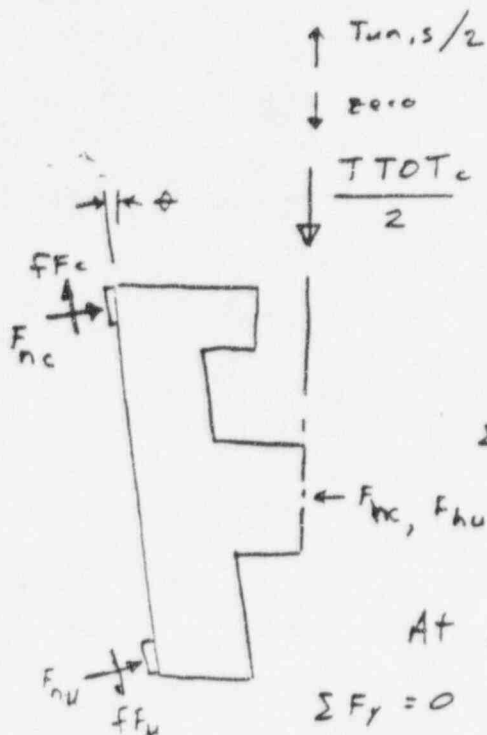

Figure 4

Determine average seat friction coefficient from test:



At peak seating, impending slip:

$$\sum F_y = 0, \quad f_{fc} = \mu F_{nc}$$

$$\frac{TTOT_c}{2} = F_{nc} \sin \theta + \mu F_{nc} \cos \theta$$

$$= F_{nc} [\sin \theta + \mu \cos \theta]$$

$$\therefore F_{nc} = \frac{TTOT_c}{2(\sin \theta + \mu \cos \theta)}$$

$$\sum F_x = 0: F_{nc} [\cos \theta - \mu \sin \theta] = F_{hc}$$

$$\therefore F_{hc} = \frac{TTOT_c (\cos \theta - \mu \sin \theta)}{2(\sin \theta + \mu \cos \theta)}$$

At peak unwedging, impending slip:

$$\sum F_y = 0, \quad f_{fu} = \mu F_{nu}$$

$$(T_{un,s}/2) + F_{nu} \sin \theta = \mu F_{nu} \cos \theta$$

$$\therefore T_{un,s} = 2 F_{nu} (\mu \cos \theta - \sin \theta)$$

$$\text{and } F_{nu} = T_{un,s} / [2(\mu \cos \theta - \sin \theta)]$$

$$\sum F_x = 0 \Rightarrow F_{nu} \cos \theta + \mu F_{nu} \sin \theta = F_{hu}$$

$$F_{nu} (\cos \theta + \mu \sin \theta) = F_{hu}$$

$$\therefore F_{hu} = \frac{T_{un,s} (\cos \theta + \mu \sin \theta)}{2(\mu \cos \theta - \sin \theta)}$$

Since

$$\frac{T_{un,s} (\cos \theta + \mu \sin \theta)}{2(\mu \cos \theta - \sin \theta)} < \frac{F_{hu}}{F_{hc}} < \frac{TTOT_c (\cos \theta - \mu \sin \theta)}{2(\sin \theta + \mu \cos \theta)}$$

$$\therefore \frac{T_{un,s}}{TTOT_c} < \frac{(\mu \cos \theta - \sin \theta)(\cos \theta - \mu \sin \theta)}{(\mu \cos \theta + \sin \theta)(\cos \theta + \mu \sin \theta)} = A$$

Example: assume $\theta = 7^\circ$; $\frac{T_{un,s}}{TTOT_c} = 0.50$:

Thus, given measured values of $T_{un,s}$ and $TTOT_c$, and given the seat angle θ , the average seat coefficient μ can be determined iteratively.

μ	$(T_{un,s}/TTOT_c)$	A	$[(T_{un,s}/TTOT_c) - A]$
0.40	0.5	0.4806	0.0194
0.50	0.5	0.5356	-0.0356
0.42	0.5	0.4939	0.0061
0.43	0.5	0.5000	-0.0000

$\mu_{max} = 0.43$

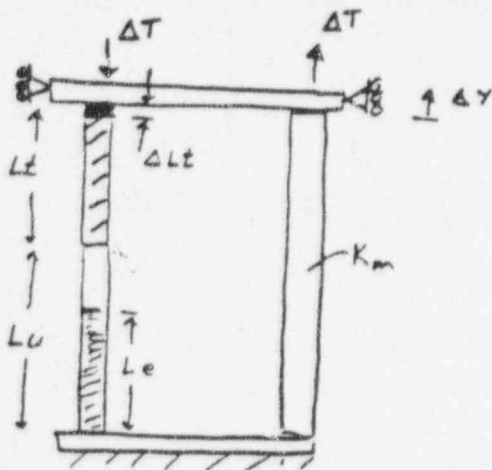

K_m = stiffness along stem axis of disk, body seats, body, all connections, yoke, actuator housing, drive sleeve, etc., but excluding the stem.

K_{ss} = stiffness of solid stem section

K_{st} = stiffness of threaded stem section

ΔT_{TOT} = increase in total thrust

$\Delta \theta_{sn}$ = degrees stem nut rotation for thrust increase ΔT_{TOT}

Testing: measure ΔT and $\Delta \theta_{sn}$

$$\Delta Y = \Delta T_{TOT} / K_m = \Delta L_t - (\Delta T_{TOT} / K_{st}) - (\Delta T_{TOT} / K_{ss}) - (\Delta T_{TOT} / K_{sti})$$

$$\frac{\Delta T_{TOT}}{K_m} = \left(\frac{\Delta \theta_{sn}}{360^\circ} \right) (L_{stem}) - \Delta T_{TOT} \left(\frac{1}{K_{st}} + \frac{1}{K_{ss}} + \frac{1}{K_{sti}} \right)$$

where L_{stem} = stem lead (inch/rev)

$$\therefore K_m = \frac{\Delta T_{TOT}}{\left(\frac{\Delta \theta_{sn}}{360^\circ} \right) (L_{stem}) - \Delta T_{TOT} \left(\frac{1}{K_{st}} + \frac{1}{K_{ss}} + \frac{1}{K_{sti}} \right)}$$

Thermal Stem Growth

$$\Delta Y = \Delta T_{tsg} / K_m = \Delta L_e - \Delta T_{tsg} / K_{st} - \Delta T_{tsg} / K_{ss} - \Delta T_{tsg} / K_{ssi}$$

$$\frac{\Delta T_{tsg}}{K_m} = (c_{ts} \cdot L_e \cdot \Delta T_{tsg}) - \Delta T_{tsg} \left(\frac{1}{K_{st}} + \frac{1}{K_{ss}} + \frac{1}{K_{ssi}} \right)$$

$$\therefore \frac{\Delta T_{tsg}}{K_m} + \Delta T_{tsg} \left(\frac{1}{K_{st}} + \frac{1}{K_{ss}} + \frac{1}{K_{ssi}} \right) = c_{ts} \cdot L_e \cdot \Delta T_{tsg}$$

$$\Delta T_{tsg} \left(\frac{1}{K_m} + \frac{1}{K_{st}} + \frac{1}{K_{ss}} + \frac{1}{K_{ssi}} \right) = c_{ts} \cdot L_e \cdot \Delta T_{tsg}$$

$$\Delta T_{tsg} = c_{ts} \cdot L_e \cdot \Delta T_{tsg} \left(\frac{1}{K_m} + \frac{1}{K_{st}} + \frac{1}{K_{ss}} + \frac{1}{K_{ssi}} \right)^{-1}$$

$$K_{ss} = \frac{\pi (D_u)^2}{4} \frac{E_s}{L_u}$$

$$K_{ssi} = \frac{\pi (D_u)^2 E_s}{4 (c_{ts} \cdot L_e \cdot \Delta T_{tsg})}$$

$$K_{st} = \frac{\pi (D_t)^2}{4} \frac{E_s}{L_t}$$

$$K_{sti} = \frac{\pi (D_t)^2 \cdot E_s}{4 \left(\frac{\Delta \theta_{sn}}{360^\circ} \right) (L_{stem})}$$

$$\Delta T_{tsg, un} = (\Delta T_{tsg}) (A), \text{ additional unseating thrust}$$

where c_{ts} = therm. exp. coeff. of stem matl.

L_e = length of stem undergoing temp increase ΔT_{tsg}

ΔT_{tsg} = closing thrust increase due to temperature increase ΔT_{tsg} .

L_t = threaded stem length up to base of stem nut

L_u = unthreaded stem length

ΔT_{tbs} = Increase in post-close stem thrust due to thermal shrink of body
 $\Delta T_{tbs} = \Delta L_{tbs} \cdot K_{net,b}$

where ΔL_{tbs} = reduction in body length along stem axis minus reduction in disk length along stem axis

$$\Delta L_{tbs} = c_{tb} \cdot L_{eb} \cdot |\Delta t_{bs}| - c_{td} \cdot L_{ed} \cdot |\Delta t_{ds}|$$

c_{tb} = therm. exp. coeff. for body matl.

c_{td} = therm. exp. coeff. for disk matl.

L_{eb} = length along stem axis from seat axis to top of valve neck which experiences temp change

L_{ed} = length along stem axis from seat axis to base of stem which experiences temp. change.

Δt_{bs} = temp. decrease affecting valve body

Δt_{ds} = temp. decrease affecting disk

$$K_{net,b} = \left[\frac{1}{K_s} + \frac{1}{K_m} \right]^{-1} = \frac{K_s K_m}{K_s + K_m}$$

$$\Delta T_{tbs,un} = (\Delta T_{tbs}) (A)$$

$$= \Delta L_{tbs} \cdot K_{net,b} \cdot A$$

$$\Delta T_{tbs,un} = [(c_{tb} \cdot L_{eb} \cdot |\Delta t_{bs}|) - (c_{td} \cdot L_{ed} \cdot |\Delta t_{ds}|)] \frac{K_s \cdot K_m \cdot A}{(K_s + K_m)}$$

Vertical text on the left margin, possibly a page number or reference.

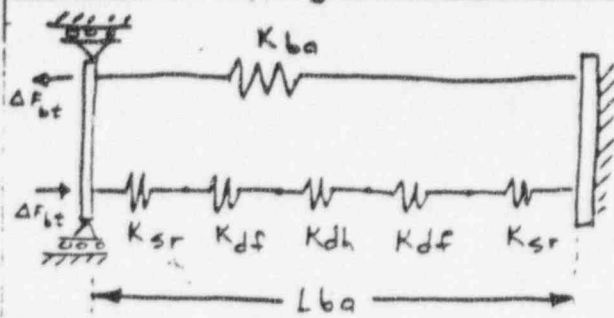

K_{ba} = valve body stiffness from seat ring to seat ring, approximated as pipe of ID = nominal pipe size
 $OD = ID + 4(t_{min,w})$
 $t_{min,w}$ = min wall thickness

$$K_{ba} = \frac{\pi (OD^2 - ID^2) / 4 \cdot (E_b)}{L_{ba}}$$

L_{ba} = distance between outer ends of seat rings, along pipe axis

K_{sr} = stiffness of downstream and upstream valve body seat rings along pipe axis

$$K_{sr} = \frac{\pi (OD_r^2 - ID_r^2) / 4 \cdot (E_r)}{L_{sr}}$$

where

OD_r = outside diameter of seat ring

ID_r = inside diameter of seat ring

E_r = Young's Modulus of seat ring matl.

L_{sr} = average length along pipe axis of seat ring.

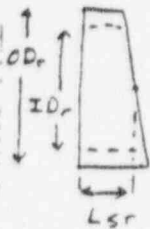

Model disk as solid circular hub with solid flat plate ends with uniform flange thickness.

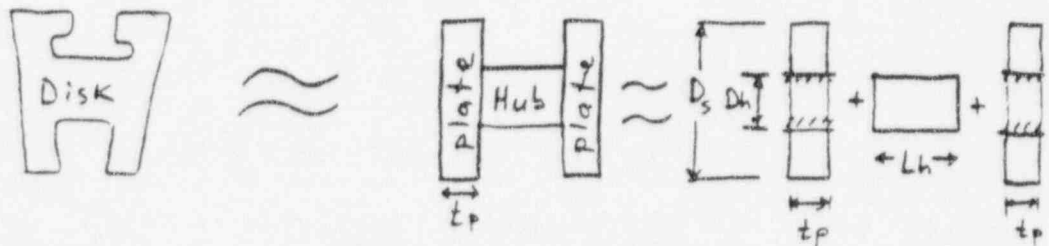

Model disk flexure by assuming the plate ends are fixed at the hub diameter D_h and free at the mean seat radius D_s :

$$D_s = (OD_r + ID_r) / 2$$

Change in length L_{ba} due to temperature change accompanies change in compressive load between body seat rings and disk, the compressive load in the disk hub.

K_{df} = stiffness of disk plate for ring load F_{bt} at free outer diameter (from Roark 5th ed. Table 24 Case 1L):

$$K_{df} = \frac{2\pi (D_h/2) D}{(D_s/2)^3} \left(\frac{C_3 C_7}{C_1 C_9 - C_3 C_7} \right), \quad D = \frac{E_d \cdot (t_p)^3}{12(1-\nu^2)}$$

where E_d = Young's Modulus of the disk material

ν = Poisson's ratio, assumed to be 0.30

t_p = disk plate average thickness

D_h = disk hub diameter

$C_1, C_3, C_7,$ and C_9 = Roark 5th ed Table 24

K_h = stiffness of disk hub for axial load F_{bt}

$$K_h = \frac{\pi(DH)^2(E_d)}{4 L_h}$$

Thermal Expansion or Contraction Loads :

$$e_{ba} = e_{sr1} + e_{df1} + e_{dh} + e_{df2} + e_{sr2}$$

$$e_{ba} = C_{tba} \cdot L_{ba} \cdot \Delta t_{ba} + \frac{F_{bt}}{K_{ba}}$$

$$\text{Also, } e_{ba} = C_{tsr} \cdot L_{sr} \cdot (\Delta t_{sr1} + \Delta t_{sr2}) + C_{td} \cdot t_p \cdot (\Delta t_{d1} + \Delta t_{d2}) + C_{td} \cdot L_h \cdot \Delta t_h - \frac{F_{bt}}{K_{net,a}}$$

$$K_{net,a} = \left[\frac{2}{K_{sr}} + \frac{2}{K_{df}} + \frac{1}{K_h} \right]^{-1}$$

$$\begin{aligned} \therefore \frac{F_{bt}}{K_{ba}} + \frac{F_{bt}}{K_{net,a}} &= \left[C_{tsr} \cdot L_{sr} \cdot (\Delta t_{sr1} + \Delta t_{sr2}) + C_{td} \cdot t_p \cdot (\Delta t_{d1} + \Delta t_{d2}) \right. \\ &\quad \left. + C_{td} \cdot L_h \cdot \Delta t_h - C_{tba} \cdot L_{ba} \cdot \Delta t_{ba} \right] \\ &= F_{bt} \frac{(K_{ba} + K_{net,a})}{K_{ba} \cdot K_{net,a}} \end{aligned}$$

$$\therefore F_{bt} = \frac{K_{ba} \cdot K_{net,a}}{(K_{ba} + K_{net,a})} \left[C_{tsr} \cdot L_{sr} \cdot (\Delta t_{sr1} + \Delta t_{sr2}) + C_{td} \cdot t_p \cdot (\Delta t_{d1} + \Delta t_{d2}) + C_{td} \cdot L_h \cdot \Delta t_h - C_{tba} \cdot L_{ba} \cdot \Delta t_{ba} \right]$$

where e_{ba} , e_{sr1} , e_{df1} , e_{dh} , e_{df2} , e_{sr2} are the elongations of the parts of corresponding stiffnesses K_{ba} , K_{sr} , K_{df} , K_{dh} , K_{df} , and K_{sr} ; and

- where
- C_{tba} = therm. exp. coeff. of body matl.
 - C_{tsr} = " " " " seat ring matl.
 - C_{td} = " " " " disk matl.
 - Δt_{ba} = increase (= if decrease) of temp. of body matl.
 - Δt_{sr1} = " " " " " ... downstream seat ring
 - Δt_{sr2} = " " " " " ... upstream seat ring
 - Δt_{d1} = " " " " " ... downstream disk plate
 - Δt_{d2} = " " " " " ... upstream disk plate
 - Δt_h = " " " " " ... disk hub matl.

From pg.1 : $F_{hu} = T_{un,s} (\cos \theta + \mu \sin \theta) / [2(\mu \cos \theta - \sin \theta)]$

$$\therefore \Delta T_{tax,un} = \frac{F_{bt} (2)(\mu \cos \theta - \sin \theta)}{(\cos \theta + \mu \sin \theta)}$$

95 DEC -4 16:38

RECEIVED-REGION 1

ENCLOSURE 3

“Utility Perspective”

Pennsylvania Power & Light Co.

Susquehanna SES

Units 1 & 2

PP&L Perspective

- Previous Experience at Susquehanna SES
- Plan for Addressing Generic Letter 95-07
- Susceptibility Evaluation Criteria
- Pressure Locking/Thermal Binding
Analytical Methodology

Previous PL/TB Experience

- Monitored industry activity via our Industry Events Review Program (IERP)
- Implemented corrective actions in response to these industry events
- Continue to monitor industry activity to improve overall plant safety

Previous PL/TB Experience

- In response to INPO SOER 84-7, all MOV/AOVs evaluated for PL/TB
 - 388 valves evaluated
 - 26 valves identified with PL/TB concerns
 - All valves handled thru our deficiency management program
 - Operability/Reportability
 - Corrective Actions

Previous PL/TB Experience

- Drilled holes in the discs of the following valves to prevent Pressure Locking:
 - LPCI & Core Spray injection valves
 - Feedwater Pump discharge valves
- Procedure changes made to the following valves:
 - HPCI & RCIC IB Steam Supply CIVs (PL)
 - RHR Heat Exchanger discharge valves (TB)

Plan for Addressing GL 95-07

- Develop Susceptibility Evaluation Criteria
- Develop PL/TB Analytical Methodology
- Perform Screening/Operability Evaluations
- Perform Detailed Analyses - Confirm Susceptibility
- Incorporate PL/TB into MOV Calculations
- Identify Corrective Actions as necessary

Risks Associated with GL 95-07

- 180 Day Completion Schedule
 - Concern: New issues arise during evaluation period
- Lack of Accepted Analytical Methodology
 - Concern: Developing methodologies in parallel with industry testing

Susceptibility Evaluation Criteria

- General Exclusion Criteria
- Thermal Binding Exclusion Criteria
- Pressure Locking Exclusion Criteria
- Specific Scenarios for PL/TB
 - Focus on specific conditions of concern
 - Supports detailed analyses to confirm susceptibility later

GENERIC LETTER 95-07

PRESSURE LOCKING/THERMAL BINDING

ANALYTICAL METHODOLOGY

CONSIDERATIONS

PP&L EXPERIENCE

VALVE	INITIATOR	ACTION	PREVENTS
RHR F015	84-07	MODIFICATION	PL
CS F005	84-07	MODIFICATION	PL
HPCI F002	INPO OE 5906	PROCED. REV.	TIPL
RCIC F007	INPO OE 5906	PROCED. REV.	TIPL
RHR F003	SSES TB	PROCED. REV.	TB
FW 0603	SSES TIPL	MODIFICATION	TIPL

ASSUMPTIONS

- PL / TB FORCES ADDITIVE TO STATIC UNSEATING
- MOV CAPABILITY BASED UPON G.L. 89-10 CRITERIA
- PL/TB MOV SCENARIO USED TO DEVELOP G.L.
89-10 ALLOWABLE THRUST

CONSIDER - TEMPERATURE

- PRESSURE

- VOLTAGE

- TIMELINE

THERMAL BINDING

- SPECIFIC THERMAL BINDING EXAMPLE
- CAUSE: DIFFERENTIAL EXPANSION/ CONTRACTION
- BINDING MECHANISMS: DISK/BODY
STEM/BODY
- THERMAL COEFFICIENTS: $\alpha_{\text{BODY}} = \alpha_{\text{DISK}}$
 $\alpha_{\text{BODY}} > \alpha_{\text{STEM}}$
- VALVE POSITION: CLOSED
- SAFETY FUNCTION: CLOSE

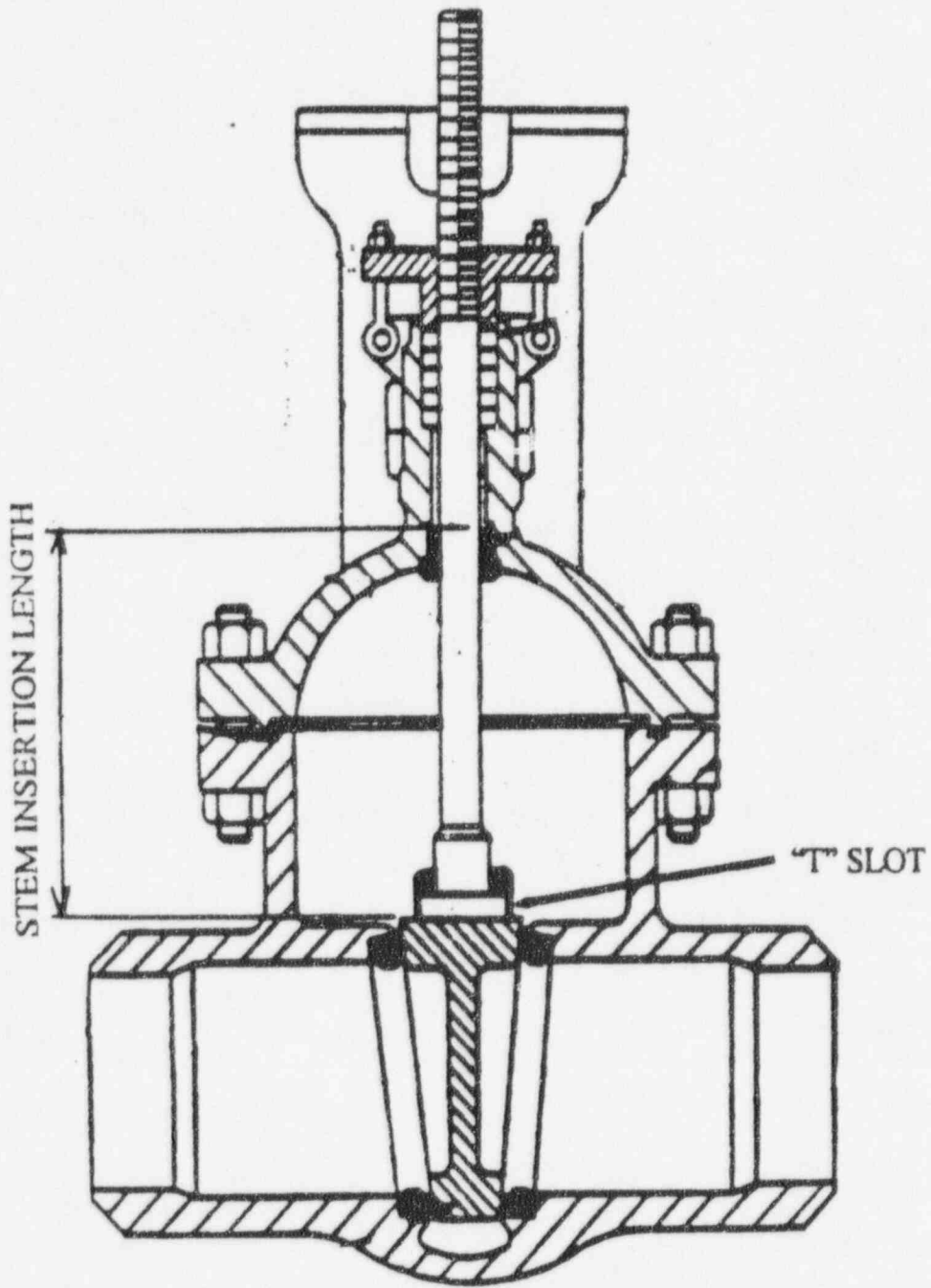

DETERMINE THERMAL GROWTH δL

VALVE CONDITION	THERMAL MOVEMENT	δL
HOT OPEN	NONE	0
CLOSED	STEM ELONGATION	$L_s \alpha_s \Delta T_1$
CYCLE VALVE	NEGATE STEM ELONGATION	$-L_s \alpha_s \Delta T_1$
COOLDOWN	STEM CONTRACTION BODY CONTRACTION	$L_s (\alpha_B - \alpha_s) \Delta T_2$

THERMAL GROWTH

$$\delta L = L_{TEE} (\alpha_{BODY} - \alpha_{STEM}) \Delta T_{BODY} + (L_{SI} - L_{TEE}) [(\alpha_{BODY}) \Delta T_{BODY} - (\alpha_{STEM}) \Delta T_{SR}]$$

δL = RELATIVE THERMAL GROWTH

L_{SI} = LENGTH OF STEM INSERTED INTO BODY

ΔT_{SR} = ΔT OF STEM INITIALLY RETRACTED FROM THE VALVE BODY

CONVERT THERMAL GROWTH TO FORCE

$$\frac{\Delta \text{THRUST}}{\delta L} = \frac{\Delta \text{THRUST/SEC}}{V_{ST}}$$

$\Delta \text{THRUST/SEC}$: FROM VOTES

$$V_{ST} = (\text{MOTOR RPM}) (\text{STEM LEAD}) (1/60)/\text{OAR}$$

$$\Delta \text{THRUST} = \frac{[\Delta \text{THRUST/SEC}] \delta L}{V_{ST}}$$

Test: 5
18/14/93
15:46:31

CALIBRATION/
A/E: SENSONE
-14814.5
(lbs)

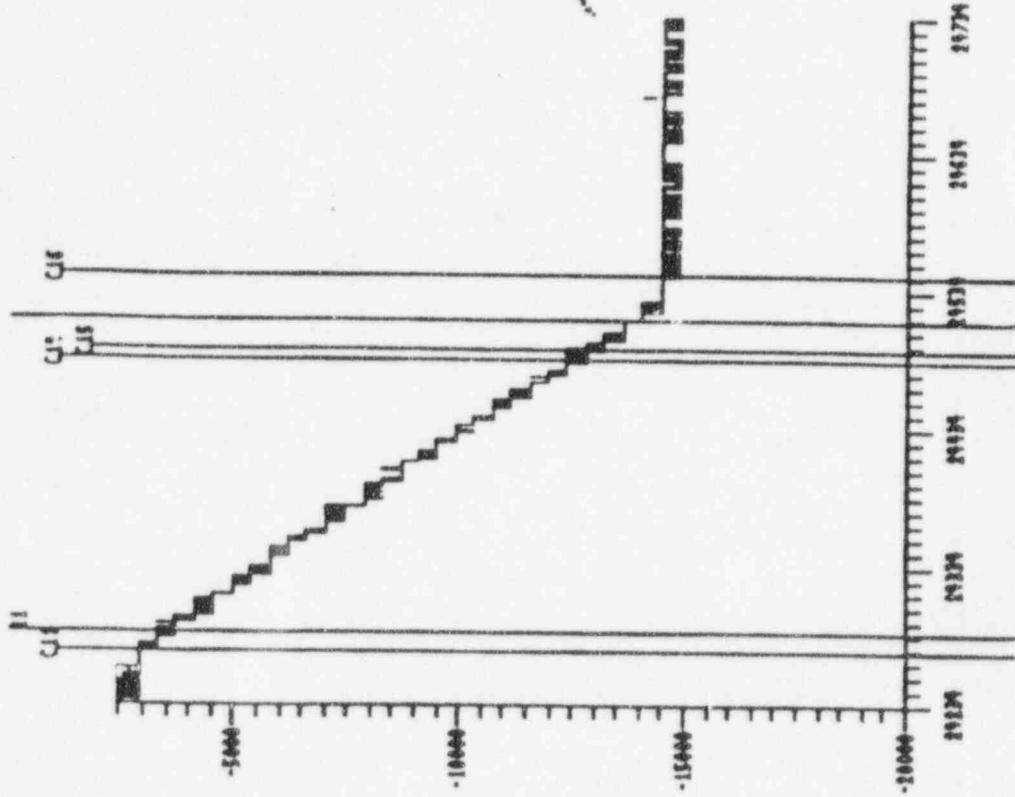

Time in Seconds 24.513 From 0.227

ASSUMPTIONS

- THRUST VS STEM POSITION IS LINEAR
- STEM SPEED IS CONSTANT
- ALL THERMAL GROWTH RESULTS IN WEDGING
- α_S & α_B ARE REASONABLE
- STEM OUTSIDE OF BODY IS COLD
- YOKE SHRINKAGE CANCELS OUT THAT OF EXTERNAL STEM
- ALL THERMAL FORCE ADDED TO UNSEATING

PHILOSOPHY

- ASSURE SAFE PLANT OPERATION
- USE BEST AVAILABLE INFORMATION
- CONSERVATISM FOR UNCERTAINTY

“Utility Perspective”

Pennsylvania Power & Light Co.

Susquehanna SES

Units 1 & 2

PP&L Perspective

- Previous Experience at Susquehanna SES
- Plan for Addressing Generic Letter 95-07
- Susceptibility Evaluation Criteria
- Pressure Locking/Thermal Binding
Analytical Methodology

Previous PL/TB Experience

- Monitored industry activity via our Industry Events Review Program (IERP)
- Implemented corrective actions in response to these industry events
- Continue to monitor industry activity to improve overall plant safety

Previous PL/TB Experience

- In response to INPO SOER 84-7, all MOV/AOVs evaluated for PL/TB
 - 388 valves evaluated
 - 26 valves identified with PL/TB concerns
 - All valves handled thru our deficiency management program
 - Operability/Reportability
 - Corrective Actions

Previous PL/TB Experience

- Drilled holes in the discs of the following valves to prevent Pressure Locking:
 - LPCI & Core Spray injection valves
 - Feedwater Pump discharge valves
- Procedure changes made to the following valves:
 - HPCI & RCIC IB Steam Supply CIVs (PL)
 - RHR Heat Exchanger discharge valves (TB)

Plan for Addressing GL 95-07

- Develop Susceptibility Evaluation Criteria
- Develop PL/TB Analytical Methodology
- Perform Screening/Operability Evaluations
- Perform Detailed Analyses - Confirm Susceptibility
- Incorporate PL/TB into MOV Calculations
- Identify Corrective Actions as necessary

Risks Associated with GL 95-07

- 180 Day Completion Schedule
 - Concern: New issues arise during evaluation period
- Lack of Accepted Analytical Methodology
 - Concern: Developing methodologies in parallel with industry testing