



# ARKANSAS POWER & LIGHT COMPANY

## Arkansas Nuclear One

TITLE: RECORD OF CHANGES AND REVISIONS

FORM NO. 1000.06A

OFFSITE DOSE PROJECTIONS PROCEDURE

REV. # 12 PC # /

Safety Related YES  NO

GERMS COMPUTER GRAPHICS METHOD  
1904.01 REV. 0

JN-

103

| PAGE | REV | PC# | PAGE | REV | PC# | PAGE | REV | PC# | PAGE | REV | PC# | PAGE | REV | PC# |
|------|-----|-----|------|-----|-----|------|-----|-----|------|-----|-----|------|-----|-----|
| 1    | 0   |     | 19   | 0   |     | 37   | 0   |     | 55   | 0   |     |      |     |     |
| 2    | 0   |     | 20   | 0   |     | 38   | 0   |     | 56   | 0   |     |      |     |     |
| 3    | 0   |     | 21   | 0   |     | 39   | 0   |     | 57   | 0   |     |      |     |     |
| 4    | 0   |     | 22   | 0   |     | 40   | 0   |     | 58   | 0   |     |      |     |     |
| 5    | 0   |     | 23   | 0   |     | 41   | 0   |     | 59   | 0   |     |      |     |     |
| 6    | 0   |     | 24   | 0   |     | 42   | 0   |     | 60   | 0   |     |      |     |     |
| 7    | 0   |     | 25   | 0   |     | 43   | 0   |     | 61   | 0   |     |      |     |     |
| 8    | 0   |     | 26   | 0   |     | 44   | 0   |     | 62   | 0   |     |      |     |     |
| 9    | 0   |     | 27   | 0   |     | 45   | 0   |     |      |     |     |      |     |     |
| 10   | 0   |     | 28   | 0   |     | 46   | 0   |     |      |     |     |      |     |     |
| 11   | 0   |     | 29   | 0   |     | 47   | 0   |     |      |     |     |      |     |     |
| 12   | 0   |     | 30   | 0   |     | 48   | 0   |     |      |     |     |      |     |     |
| 13   | 0   |     | 31   | 0   |     | 49   | 0   |     |      |     |     |      |     |     |
| 14   | 0   |     | 32   | 0   |     | 50   | 0   |     |      |     |     |      |     |     |
| 15   | 0   |     | 33   | 0   |     | 51   | 0   |     |      |     |     |      |     |     |
| 16   | 0   |     | 34   | 0   |     | 52   | 0   |     |      |     |     |      |     |     |
| 17   | 0   |     | 35   | 0   |     | 53   | 0   |     |      |     |     |      |     |     |
| 18   | 0   |     | 36   | 0   |     | 54   | 0   |     |      |     |     |      |     |     |

APPROVED BY:

*James M. Lewis*  
\_\_\_\_\_  
(General Manager)

APPROVAL DATE

*2/27/84*

REQUIRED EFFECTIVE DATE:

*3-1-84*



PLANT MANUAL SECTION:  
OFFSITE DOSE  
PROJECTIONS PROC.

PROCEDURE/WORK PLAN TITLE:  
OFFSITE DOSE PROJECTIONS - GERMS  
COMPUTER GRAPHICS METHOD

NO:  
1904.01

## ARKANSAS NUCLEAR ONE

|          |         |               |
|----------|---------|---------------|
| PAGE     | 1 of 62 |               |
| REVISION | 0       | DATE 02/08/84 |
| CHANGE   | DATE    |               |

### 1.0 PURPOSE

The purpose of this procedure is to determine the radiological release status, meteorology, and the offsite dose consequences in the vicinity of ANO by use of the Gaseous Effluent Radiation Monitoring System (GERMS) computers.

### 2.0 SCOPE

- 2.1 This procedure is applicable to airborne radioactive releases from ANO, Units One and Two as indicated by the ventilation system stack monitors (i.e. the SPING monitors of the GERM System).
- 2.2 If the monitors are off scale, determine the release rates from 1904.03, "Auxiliary Building Ventilation Exhaust Emergency Radiation Monitor".
- 2.3 This procedure does not take into account effects caused by precipitation.
- 2.4 To use the LFE Trapelo or Westinghouse effluent monitors, (normal range monitors) determine the release rates from procedure 1904.04, "Estimating Airborne Release Rates".
- 2.5 If releases are occurring from steam vents or from an unmonitored release point, determine the release rates by procedure 1904.04, "Estimating Airborne Release Rates".

### 3.0 REFERENCES

#### 3.1 References used to develop this procedure:

- 3.1.1 Operator's Manual, Emergency Dose Calculations, EDC/6600, Applied Physical Technology, Inc.; August 1982
- 3.1.2 Software Specification for APS.VENT, Applied Physical Technology, Inc.; August 1982
- 3.1.3 Report Generating Computers of the Extended Range Gaseous Effluent Radiation Monitoring system: System Manual, Nuclear Data - Nuclear Power Division
- 3.1.4 Operator's Manual, CG Series Color Graphics Computers, Chromatics, Inc.; 1981
- 3.1.5 Emergency Dose Calculations (EDC) Data Completion Software, Functional Requirement No. 80.1008.0001, Nuclear Data - Nuclear Power Division, December 1, 1982



PLANT MANUAL SECTION:  
OFFSITE DOSE  
PROJECTIONS PROC.

PROCEDURE WORK PLAN TITLE:  
OFFSITE DOSE PROJECTIONS - GERMS  
COMPUTER GRAPHICS METHOD

NO:  
1904.01

## ARKANSAS NUCLEAR ONE

|          |         |               |
|----------|---------|---------------|
| PAGE     | 2 of 62 |               |
| REVISION | 0       | DATE 02/08/84 |
| CHANGE   | DATE    |               |

- 3.1.6 Instruction sheets for Polaroid Type 809 and 891 instant film.
- 3.1.7 Methodology Manual, Emergency Dose Calculation Package, EDC/6600, Rev. 0, October 1982, Applied Physical Technology, Inc.
- 3.1.8 System Managers Manual, Automatic Data Acquisition and Processing for ANO-1 and 2, Applied Physical Technology, Inc., Rev. 0, November, 1982
- 3.2 References used to implement this procedure:
- None
- 3.3 References which complement this procedure:
- 3.3.1 Procedure 1903.10, "Emergency Action Level Response"
- 3.3.2 Procedure 1903.30, "Plant Evacuation"
- 3.3.3 Procedure 1903.31, "Exclusion Area Evacuation"
- 3.3.4 Procedure 1903.32, "Area Evacuation"
- 3.3.5 Procedure 1903.43, "Duties of the Emergency Radiation Team"
- 3.3.6 Procedure 1904.02, "Offsite Dose Projections - Pocket Computer Method"
- 3.3.7 Procedure 1904.03, "Aux. Bldg. Ventilation Exhaust Emer. Radiation Monitor"
- 3.3.8 Procedure 1904.04, "Estimating Airborne Release Rates"
- 3.3.9 Procedure 1904.07, "Protective Action Recommendations"
- 3.3.10 Procedure 1904.08, "Use of WSI Weather Information Service"

#### 4.0 DEFINITIONS

- 4.1  $\sigma\theta$  (sigma theta) - The standard deviation (net change) of the horizontal wind direction over time.
- 4.2  $\Delta t$  (delta t) - The vertical temperature differential between the upper and lower temperature sensors on the meteorological tower (in degrees Centigrade).



PLANT MANUAL SECTION:  
OFFSITE DOSE  
PROJECTIONS PROC.

PROCEDURE/WORK PLAN TITLE:  
OFFSITE DOSE PROJECTIONS - GERMS  
COMPUTER GRAPHICS METHOD

NO:  
1904.01

## ARKANSAS NUCLEAR ONE

|          |                 |
|----------|-----------------|
| PAGE     | 3 of 62         |
| REVISION | 0 DATE 02/08/84 |
| CHANGE   | DATE            |

- 4.3 X/O - The ratio of the concentration of radioactive material (at a specific location) to the release rate (at the origin) in units of  $\mu\text{Ci}/\text{cc}/\text{Ci}/\text{sec}$  which is equivalent to units of  $\text{secs}/\text{m}^3$ .
- 4.4 [] - Brackets represent a labeled computer button.
- 4.5 GERMS - Gaseous Effluent Radiation Monitoring System.
- 4.6 SPING-4 - Vendor designation for the ten Eberline radiological air monitoring detector systems connected to GERMS. Each SPING-4 monitors a single physical release point for airborne particulates, iodines, and noble gases.
- 4.7 Eberline Control Terminal - One of two redundant data concentrators located in the Control Rooms where SPING-4 data is collected and fed to the GERMS Computers or printed in response to operator requests.
- 4.8 GERMS Computers - One of two redundant Nuclear Data 6650 report-generating computers located in the PASS building which receive data from an Eberline Control Terminal and distribute it to the Chromatics Terminals.
- 4.9 Chromatics Terminals - Brand name for the desk-top systems with disk drive and color CRT, used as intelligent terminals for the GERMS Computers.
- 4.10 Light Pen - Metal pen-shaped device connected to the front of the Chromatics terminal by a spiral-wound cable.
- 4.11 USER Numbers - Integer numbers used by the GERMS computers and the system supervisor to identify the person or group of persons who are running programs on the GERMS computers. Different user numbers may have different pre-assigned data files for use with special programs, different priority levels, passwords, etc. and are generally not interchangeable.
- 4.12 Midas - "Operating system", or master program for the GERMS computers which executes user commands to manipulate files, run programs, etc. Midas will accept user commands when a carat (>) prompt is displayed on a terminal screen.
- 4.13 P.A.G - Protective Action Guideline: Cumulative radiological whole body or thyroid doses which the U.S. Environmental Protective Agency considers sufficiently hazardous to the health of the general public to warrant widespread protective actions, such as evacuation.
- 4.14 JOBSTREAM - Series of file definition commands, computer programs, etc. which can be run or scheduled to run on the GERMS Computers by a single command of the Form "Job Auto. ... [Return]"



PLANT MANUAL SECTION:  
OFFSITE DOSE  
PROJECTIONS PROC.

PROCEDURE/WORK PLAN TITLE:  
OFFSITE DOSE PROJECTIONS - GERMS  
COMPUTER GRAPHICS METHOD

NO:  
1904.01

## ARKANSAS NUCLEAR ONE

PAGE 4 of 62  
REVISION 0 DATE 02/08/84  
CHANGE DATE

4.15 CMF - Continuous Monitor File, the files which contain raw meteorological or release data. The GERMS system has four continuous monitor files; one for 2 minutes, one for 10 minutes, one for hourly averaged data, and one for daily averaged data.

### 5.0 RESPONSIBILITIES

- 5.1 The Shift Operations Supervisor is responsible for determining if an unplanned gaseous release to the environment is indicated by symptoms such as high stack monitor readings, area radiation monitor alarms or other indications.
- 5.2 The Duty Emergency Coordinator, or his designee, is responsible for performing the offsite dose projections until relieved and for supplying backup meteorological data and "unmonitored release" data to the GERMS computer as necessary throughout the incident.
- 5.3 The Shift Operations Supervisor/Duty Emergency Coordinator is responsible for notifying appropriate groups per 1903.10, "Emergency Action Level Response".
- 5.4 The Offsite Radiological Monitoring Section of the Emergency Radiation Team is responsible for measuring offsite radiological hazards per 1903.43, "Duties of the Emergency Radiation Team".
- 5.5 When the Technical Support Center is manned, responsibility for tracking offsite doses, gathering forecasts, and making protective action recommendations will transfer to the Technical Analysis Superintendent. At this time, the Shift Operations Supervisor/Duty Emergency Coordinator should turn over all paperwork generated under this procedure to the Technical Analysis Superintendent.
- 5.6 When the Emergency Control Center is manned, responsibility for tracking offsite doses, gathering forecasts, and making protective action recommendations will transfer to the ERO Dose Assessment Supervisor. At this time, the Technical Analysis Superintendent may turn over all paperwork generated under this procedure to the Dose Assessment Supervisor. The plant staff will continue to monitor the operation of GERMS computers and provide technical assistance to the ERO staff as needed (i.e. in case of computer malfunction).

### 6.0 LIMITS AND PRECAUTIONS

- 6.1 The Chromatics terminals in the ANO-1 and ANO-2 Control Rooms are connected to separate redundant report-generating computers. Data for the entire site is available from either computer. In addition, a malfunction on one computer will generally not affect operation of the other. This requires that to maintain redundancy, hand entries of "unmonitored" releases or missing met data must be made on both systems if they are both operating.



PLANT MANUAL SECTION:  
OFFSITE DOSE  
PROJECTIONS PROC.

PROCEDURE/WORK PLAN TITLE:  
OFFSITE DOSE PROJECTIONS - GERMS  
COMPUTER GRAPHICS METHOD

NO:  
1904.01

## ARKANSAS NUCLEAR ONE

|          |                 |
|----------|-----------------|
| PAGE     | 5 of 62         |
| REVISION | 0 DATE 02/08/84 |
| CHANGE   | DATE            |

- 6.2 This procedure describes only limited routine and emergency use of the GERMS computers. A wide range of additional capabilities are available. However, the occasional user should not attempt to use programs and commands which are not specifically described in this procedure.
- 6.3 This procedure provides a projection of the radiological conditions based upon measured release rates and meteorology; field monitoring is necessary to determine the actual conditions.
- 6.4 Actual terrain and weather conditions will generally limit the accuracy of the projected doses at a specific location.
- 6.5 The light pen attached to the Chromatics computer terminals may be damaged if dropped or subjected to rough use. Never press the end of the light pen hard against the face of the Chromatics screen. In most cases, no direct contact is required to select options. Never attempt to unscrew the light pen barrel. Operability of the light pen is required to complete this procedure.
- 6.6 The Chromatics color graphic terminals located in the ANO-1 and ANO-2 Control Rooms should normally be left with power on to both the terminal and its associated disk drive, an EDC processing diskette in the disk drive, and User 44 assigned.
- 6.7 If errors occur, or if the computers or terminals do not function properly, refer to section 17.0, "ERROR RECOVERY".
- 6.8 The occasional user should not attempt to sign-on user numbers which are not specifically authorized by this procedure. Disruption of automatic programs or the loss of important data may result.
- 6.9 Data shown on the GERMS offsite dose maps will typically be 30 minutes old when they are first produced. If high releases occur very suddenly, it would be advisable to calculate the first plume segment using Procedure 1904.02.
- 6.10 When releases have been in progress for more than 5½ hours, historical plume segments will be periodically "compressed". This may result in noticeable changes in the plume display and the tabulated data.
- 6.11 The Emergency Dose Calculation (EDC) jobstreams are assigned to GERMS computer user 44. This user must be signed on the Control Room Chromatics terminals to allow operator prompts, inputs, and automatic report generation.

NOTE: Each Control Room terminal will be addressing a different GERMS computer.



PLANT MANUAL SECTION:  
OFFSITE DOSE  
PROJECTIONS PROC.

PROCEDURE/WORK PLAN TITLE:  
OFFSITE DOSE PROJECTIONS - GERMS  
COMPUTER GRAPHICS METHOD

NO:  
1904 01

## ARKANSAS NUCLEAR ONE

|          |         |      |          |
|----------|---------|------|----------|
| PAGE     | 6 of 62 |      |          |
| REVISION | 0       | DATE | 02/08/84 |
| CHANGE   |         | DATE |          |

6.12 Upon receipt of a radiation alarm from any of the SPING-4 monitors, the EDC jobstreams will automatically start, using "instantaneous" data from the SPING-4 detectors. If a status change report has appeared on your Chromatics terminal, continue with Step 8.0; otherwise, continue with Step 7.0.

### 7.0 STARTING THE CHROMATICS TERMINALS

NOTE: Refer to Attachment 4 for a diagram of a flow pattern for the remainder of this procedure.

7.1 The square pushbuttons on the front of the display chassis and the disk drive should be lighted, indicating that power is "on". If not, press the buttons to turn on power.

NOTE: The disk drive is powered from the display chassis.

7.2 Squeeze together the wide and the narrow black bars on the front of the disk drive to open it.

7.3 Verify that a diskette with a label which includes the word "GERMS" or "EDC" is inside. If not, locate such a diskette, remove it from its dust jacket, verify that its read/write tape is correctly positioned, and insert it with the label facing up and toward the front until it locks into place. A spare diskette is included in the Emergency Kits for the TSC, ECC, and the two Control Rooms (see Attachment 5).

7.4 Close the disk drive door. Control Room users continue at Step 7.8.

7.5 Place the right-hand switch on the telephone modem in the "MA" position and dial either 6651 or 6653 on the attached telephone. After one or two rings, a high-pitched carrier tone should be heard.

7.6 Move the modem switch to the "DA" position. The CXR, DTR, DSR, CTS, and RTS lights should be lighted on the modem.

7.7. Hang up the telephone.

7.8 Depress the following keys sequentially: "[RESET], [BOOT], [ESC], L, [ROLL], [ESC], F, [RETURN]". A Midas prompt (carat mark) should appear. If not, report the problem to the Assistant Radiochemistry Supervisor in the OSC. Any error messages appearing at this time should be disregarded. Control Room users continue at Step 7.12.

7.9 Type "HELP.SEE[RETURN]" to determine which computer is being accessed.

7.10 If the terminal is not connected to the computer for the affected unit, type one of the following codes:

7.10.1 Simultaneous "[CTRL]G", then simultaneous "[CTRL]U"  
(Switches from computer #2 to computer #1).



PLANT MANUAL SECTION:  
OFFSITE DOSE  
PROJECTIONS PROC

PROCEDURE/WORK PLAN TITLE:  
OFFSITE DOSE PROJECTIONS - GERMS  
COMPUTER GRAPHICS METHOD

NO:  
1904.01

## ARKANSAS NUCLEAR ONE

PAGE 7 of 62  
REVISION 0 DATE 02/08/84  
CHANGE DATE

7.10.2 Simultaneous "[CTRL]G", then simultaneous "[CTRL]K"  
(Switches from computer #1 to computer #2).

7.11 Type "HELP.SEE[RETURN]" to verify that connection has been switched to the computer for the affected unit. If that computer is not operating, switch back to the computer for the unaffected unit. If neither computer is operating, refer to procedure 1904.02 for manual calculations.

7.12 Type "WHO[RETURN]" to determine which user, if any, is currently assigned to the computer port being accessed. Determine the correct user number from the list below. If the correct user is assigned, proceed to Section 8.0, otherwise, sign-off that user with the command "BYE XX[RETURN]", where XX is the current user number.

| <u>USER #</u> | <u>LOCATION</u>                                 | <u>APPLICATION</u>                           | <u>PASSWORD</u> |
|---------------|---|--|-----------------|
| 0             | TSC   | System Supervision                           | *****           |
| 8             | All   | Edit scale factors<br>for real-time updates  | EDITOR          |
| 9             | All   | Edit computer model<br>recirculation factors | RECIRC          |
| 11            | ANO-1<br>Control Room                           | General Display                              | USER11          |
| 12            | ANO-1<br>Control Room                           | General Display                              | USER12          |
| 21            | ANO-2<br>Control Room                           | General Display                              | USER21          |
| 22            | ANO-2<br>Control Room                           | General Display                              | USER22          |
| 31            | TSC   | General Display                              | USER31          |
| 32            | TSC   | General Display                              | USER32          |
| 40-43, 45-49  | Internal Scheduling of Automatic Functions***** |  |                 |
| 44            | ANO-1 / 2<br>Control Room                       | Input/Output for<br>Automatic Jobstreams     | U44             |
| 51            | ECC   | General Display                              | USER51          |
| 52            | ECC   | General Display                              | USER52          |
| 6i            | LR  | General Display                              | DATEAM          |
| 62            | Lx  | General Display                              | DATEAM          |

7.13 Sign on with the command "HEL XX[RETURN]" where XX is a proper user number. Enter the password and [RETURN] when requested. Type "WHO[RETURN]" to verify that the proper user number has been assigned.





PLANT MANUAL SECTION:  
OFFSITE DOSE  
PROJECTIONS PROC.

PROCEDURE WORK PLAN TITLE:  
OFFSITE DOSE PROJECTIONS - GERMS  
COMPUTER GRAPHICS METHOD

NO:  
1904.01

## ARKANSAS NUCLEAR ONE

|          |         |               |
|----------|---------|---------------|
| PAGE     | 8 of 62 |               |
| REVISION | 0       | DATE 02/08/84 |
| CHANGE   | DATE    |               |

### 8.0 EDC PROGRAM ACTUATION

- 8.1 A listing of the status of all vent flow rate and radiation monitoring channels will appear on the Chromatics screen. SPING-4 channels which do not currently have "normal" status are indicated by a series of question marks below their "current status" line. Note the data points which have abnormal status by marking an "M" on Form 1904.01A for currently missing data and "B" for currently bad data.
- 8.2 Fill in the summary data on the bottom of 1904.01A. The concentration data on the "current unmonitored path" line must all be zeros when processing begins. If they are not all zeros type:
- A. Simultaneously press [CTRL] and W, then WAIT [RETURN]
  - B. Simultaneously press [CTRL] and P, then TER [RETURN]
  - C. ABO [RETURN]
  - D. JOB AUTO.EDCEND
  - E. SCHED 0 + 0:01, AUTO.EAL

Processing will restart in about 5 minutes.

- 8.3 Check the status change report vs. the ventilation system status. If good data is present for the most significant release points, select option 1 (PROCEED) at the terminal keyboard. The "most significant" release points are those which the operator feels are ventilating the areas where the maximum leakage is occurring.
- 8.4 If good flow and radiation monitor data is not present for the most significant release point, select option 2 (SKIP) to postpone calculation of offsite dose rates until good data has been entered. Notify the Shift Supervisor of a malfunction in GERMS data collection.
- 8.4.1 Refer to procedure 1904.03 or 1904.04 to estimate the noble gas and iodine release rates.
- NOTE: The unmonitored release rates should be recalculated once per 30 minutes, or as time permits.
- 8.4.2 Spings monitoring non-operating release paths should be placed in the standby mode at this time. This may be done as follows:
- A. Locate panel C-498 in the Unit I Control Room or panel 2C-363 in the Unit II Control Room.
  - B. Turn the keyboard key switch on.
  - C. To place a SPING in standby, press the following keys: "STND-BY", "UNIT" (01-10), "CHANNEL" (0), "ENTER".



PLANT MANUAL SECTION:  
OFFSITE DOSE  
PROJECTIONS PROC.

PROCEDURE/WORK PLAN TITLE:  
OFFSITE DOSE PROJECTIONS - GERMS  
COMPUTER GRAPHICS METHOD

NO:  
1904 01

## ARKANSAS NUCLEAR ONE

|          |                 |
|----------|-----------------|
| PAGE     | 9 of 62         |
| REVISION | 0 DATE 02/08/84 |
| CHANGE   | DATE            |

- D. Repeat Step C above for each SPING of interest.
- E. Turn keyboard key switch off.
- F. If it becomes necessary to take a SPING out of stand-by mode, repeat Steps B through E above inserting "OFF" after "STND-BY" in Step C.

8.4.3 Record  $Q_{\text{gas}}$  and  $Q_{\text{iodine}}$  for each "unmonitored" release path on form 1904.01B. Sum the  $Q_{\text{gas}}$  column to produce a site total "unmonitored"  $Q_{\text{gas}}$ . Sum the  $Q_{\text{iodine}}$  column to produce a site total "unmonitored"  $Q_{\text{iodine}}$ .

8.4.4 Sign-off the current user by typing "WHO [RETURN]" and then "BYE XX [RETURN]" where XX is the current user number. When the computer responds with "SIGNED OFF", type "HEL 8 [RETURN]" to sign-on User 8. Enter the password "EDITOR [RETURN]" when requested.

NOTE: The Chromatics terminals in the two Control Rooms are hard-wired to two separate computers. Steps 8.4.4 through 8.4.5 must be completed in each Control Room if both computers are operating.

8.4.5 Edit the unmonitored pathway release rates as follows:

- A. Type "DEF 1,AUTO.UNMON;2,SCR.SØ[RETURN]" to define the logical units for editing.
- B. Type "RUN APS.EDITOR[RETURN]" to start the editing program. The current assignments of logical units 1 and 2 will appear. If they are incorrect, then type "EN [RETURN]" and restart from Step A above.
- C. When the "#" prompt appears, type "R[RETURN]". A prompt will appear again.
- D. Substitute the current unmonitored pathway release rate for one isotope class by typing the following character string:

"B2<G\*\*[ESC][ESC]-2CNNN.NNN[ESC][ESC]V>[RETURN]",

Where \*\* represents: PT for particulates,  
ID for radioiodines, or  
NG for noble gases,

and NNN.NNN represents the unmonitored pathway particulate, iodine, or noble gas release rate in Ci/sec. (This value is free-form and may be entered in scientific notation. However, a decimal should be included.)



PLANT MANUAL SECTION:  
OFFSITE DOSE  
PROJECTIONS PROC.

PROCEDURE/WORK PLAN TITLE:  
OFFSITE DOSE PROJECTIONS - GERMS  
COMPUTER GRAPHICS METHOD

NO:  
1904 01

## ARKANSAS NUCLEAR ONE

|          |                 |
|----------|-----------------|
| PAGE     | 10 of 62        |
| REVISION | 0 DATE 02/08/84 |
| CHANGE   | DATE            |

- E. Repeat Step D for all three classes of isotopes. If no data is available for one or more classes, use  $\emptyset.\emptyset$  in its character string.

The selected release rate should be echoed twice on the screen after typing the carriage return in Step 8.4.5.D. If it is incorrect, reenter the string.

- F. When data for all three isotope classes have been entered, type "EX[RETURN]" to conclude the editing.
- G. Type "JOB SCR.S $\emptyset$ , , TTY[RETURN]" to transfer the unmonitored release rates into the acquisition data dictionary and CMF. If any error messages result, contact the Assistant Radiochemistry Supervisor.

NOTE: To zero the unmonitored pathway release rates, type "JOB AUTO.UNMON $\emptyset$ , , TTY" [RETURN].

- H. Type "TIM[RETURN]" and note the current system time. The CMF data file will be updated with the new unmonitored release rates soon after the next 10-minute time boundary.

- I. Type "JOB AUTO.VENT, , TTY[RETURN]". When the listing appears, verify that the release rates for the unmonitored pathway (#11) are correct. If not, repeat all of 8.4.5.

NOTE: Once the unmonitored release rates are successfully entered in the most recent CMF data block, they will be automatically carried forward and used with subsequent data blocks until they are changed by operator command.

- 8.5 An "Emergency Action Level Report" will appear on the terminal screen within about 2 minutes. If this is the first GERMS output record, the data from the EAL display on Form 1904.01C and make initial notifications based upon this preliminary information.

NOTE: When the EAL Report appears on the screen, simultaneously hit "CTRL" and "T" on the keyboard. This will freeze the jobstream and screen display which will allow time to transcribe the numbers on Form 1904.01C. Quickly transcribe the numbers and release the jobstream by simultaneously striking "CTRL" and "T" a second time.

Offsite dose displays will appear on the terminal screen within about 15 minutes. Continue at Step 10.6.

### 9.0 EMERGENCY ACTION LEVEL (EAL) REPORTS

NOTE: This section describes a method of generating an EAL report which is usually not required when offsite dose maps are displayed.



PLANT MANUAL SECTION:  
OFFSITE DOSE  
PROJECTIONS PROC.

PROCEDURE/WORK PLAN TITLE:  
OFFSITE DOSE PROJECTIONS - GERMS  
COMPUTER GRAPHICS METHOD.

NO:  
1904.01

## ARKANSAS NUCLEAR ONE

|          |                 |
|----------|-----------------|
| PAGE     | 11 of 62        |
| REVISION | 0 DATE 02/08/84 |
| CHANGE   | DATE            |

- 9.1 An EAL Report can be generated at any printing or CRT terminal by a user which has no other programs running. However, reports displayed on the Control Room Chromatics terminal are subject to disruption if the computer encounters missing met data or changes in detector or flow sensor status. EAL reports are automatically produced at the terminal assigned to User 44.

NOTE: See procedure Section 22.0 to connect the LA12A Decwriter as a printing GERMS terminal.

- 9.2 Type "DIS[RETURN]" to display the current system status. If there is any entry other than "NONE" following "programs assigned" or "jobstreams assigned", sign-off the current user and sign-on as another "general display" user listed in 7.12 for your location, until a user with no programs or jobstreams assigned is found.
- 9.3 Type "JOB AUTO.EALRPT,,TTY[RETURN]" to define the appropriate logical units and run the report display program.
- 9.4 Copy the data from the EAL Report display to the corresponding blanks on Form 1904.01C. An additional carriage return is necessary to re-establish a midas prompt on the Chromatics screen.

### 10.0 OFFSITE DOSE DISPLAY

- 10.1 An Offsite Dose Display can be generated at any Chromatics terminal by a user which has no other programs running. However, displays drawn on the Control Room Chromatics terminals are subject to disruption if the computer encounters missing met data or changes in detector or flow sensor status. Offsite dose displays are automatically produced at the terminal assigned to User 44.
- 10.2 Type "DIS[RETURN]" to display current system status. If there is any entry other than "NONE" following "programs assigned" or "jobstreams assigned", sign-off the current user and sign-on as another appropriate "general display" user for your location.
- 10.3 Type "JOB AUTO.DRAW[RETURN]" to assign logical units and start the display program. Circle "Real Time" data on the top of each Form 1904.01D used.
- 10.4 Select option #1, NEAR-REAL TIME (EDC) FILES, when the option menu appears.
- 10.5 Enter a carriage return when prompted by "ENTER FIRST DATA INCREMENT TO READ(X) #" in order to obtain the most recent data. The X above refers to the number of plume segments currently in the data file.
- 10.6 When the dose map appears, copy the numerical information onto Form 1904.01D.



PLANT MANUAL SECTION:  
OFFSITE DOSE  
PROJECTIONS PROC.

PROCEDURE/WORK PLAN TITLE:  
OFFSITE DOSE PROJECTIONS - GERMS  
COMPUTER GRAPHICS METHOD

NO:  
1904.01

## ARKANSAS NUCLEAR ONE

|          |          |      |          |
|----------|----------|------|----------|
| PAGE     | 12 of 62 |      |          |
| REVISION | 0        | DATE | 02/08/84 |
| CHANGE   |          | DATE |          |

10.7 Sketch the green area where the dose rate exceeds 0.05 mR/hr on the map provided and list the affected sectors on line 1.0. If the message "Dose Rate  $\geq$  Centerline Dose Rate" appears; none of the sectors are affected.

10.8 Account for the uncertainty in the local wind near Mt. Nebo/Spring Mountain.

10.8.1 If the plume centerline lies in sector 10 and the plume boundary extends beyond 6 miles, the affected area should also include sectors 9, 10 and 11 (from subsector G to the projected extent of the plume).

10.8.2 If the plume centerline lies in sector 11 and the plume boundary extends beyond 6 miles, the affected area should also include sectors 10, 11 and 12 (from subsector G to the projected extent of the plume).

10.9 With the offsite dose map displayed, use the light pen to select the bottom menu circle, "C/L DOSE RATE". Operating instructions will appear at the top of the menu block, and a graphic cursor (blinking line) will appear on the map.

10.10 With the light pen pointed at the map area, touch the forward barrel of the pen to increment the cursor along the centerline of the downwind flow path. The interpolated centerline dose rate at the cursor location is shown next to the bottom menu circle.

NOTE: The cursor location is defined as the left end of the blinking line. The dose type is the same as that of the map.

10.11 The direction of movement of the cursor may be reversed by actuating the light pen on the yellow instruction block on the screen. Actuating the pen over the menu block will restore the usual menu functions.

10.12 Record the projected dose rate for the radii at which the field data was taken on the same line as the field data on Form 1904.01J. Also record the sector number of the cursor location for each radius. [Non-agreement of centerline sector locations may indicate offsite wind effects not included in the computer model.]

NOTE: It is advisable to record centerline dose rates for a variety of locations along the plume for general information. The rates at 0.62, 1.5, 3.56 and 7.25 miles are required for protective action calculations in 1904.07.

10.13 Select the "Plume Dose Type" circle. The dose type menu will appear.

10.14 Select the "Thyroid" circle with the light pen. The dose map will be redrawn as before, except based upon radiation exposure of the thyroid, rather than the whole body.



PLANT MANUAL SECTION:  
OFFSITE DOSE  
PROJECTIONS PROC.

PROCEDURE WORK PLAN TITLE:  
OFFSITE DOSE PROJECTIONS - GERMS  
COMPUTER GRAPHICS METHOD

NO:  
1904.01

## ARKANSAS NUCLEAR ONE

PAGE 13 OF 62  
REVISION 0 DATE 02/08/84  
CHANGE DATE

10.15 Account for the uncertainty in the local wind near Mt. Nebo/Spring Mountain.

10.15.1 If the plume centerline lies in sector 10 and the plume boundary extends beyond 6 miles, the affected area should also include sectors 9, 10 and 11 (from subsector G to the projected extent of the plume).

10.15.2 If the plume centerline lies in sector 11 and the plume boundary extends beyond 6 miles, the affected area should also include sectors 10, 11 and 12 (from subsector G to the projected extent of the plume).

10.16 Record the I-131 equivalent Ci/sec and  $\mu\text{Ci/cc}$  on Line 2.0 of Form 1904.01D. Also record the sectors which contain thyroid dose rates greater than 0.05 MREM/HR (i.e. green areas) on Line 3.0.

10.17 With the offsite dose map displayed, use the light pen to select the bottom menu circle, "C/L DOSE RATE". Operating instructions will appear at the top of the menu block, and a graphic cursor (blinking line) will appear on the map.

10.18 With the light pen pointed at the map area, touch the forward barrel of the pen to increment the cursor along the centerline of the downwind flow path. The interpolated centerline dose rate at the cursor location is shown next to the bottom menu circle.

NOTE: The cursor location is defined as the left end of the blinking line. The dose type is the same as that of the map.

10.19 The direction of movement of the cursor may be reversed by actuating the light pen on the yellow instruction block on the screen. Actuating the pen over the menu block will restore the usual menu functions.

10.20 Record the projected dose rate for the radii at which the field data was taken on the same line as the field data on Form 1904.01J. Also record the sector number of the cursor location for each radius. [Non-agreement of centerline sector locations may indicate offsite wind effects not included in the computer model.]

NOTE: It is advisable to record centerline dose rates for a variety of locations along the plume for general information. The rates at 0.62, 1.5, 3.56 and 7.25 miles are required for protective action calculations in 1904.07.

### 11.0 TABULATED DOSE RATES

NOTE: The data displayed in Sections 11.0 and 12.0 can also be directly printed at the Decwriter when it is connected as a GERMS terminal. Type "JOB AUTO.DOSLST,,AUTO.SCR[RETURN]". When the jobstream finishes, enter "TYP AUTO.SCR[RETURN]". Attach the printout to the other data sheets for this update. Check for exceedance of the protective action limits in Steps 11.4, 11.7, 12.3, and 12.5 before proceeding to 13.0.



PLANT MANUAL SECTION:  
OFFSITE DOSE  
PROJECTIONS PROC.

PROCEDURE WORK PLAN TITLE:  
OFFSITE DOSE PROJECTIONS - GERMS  
COMPUTER GRAPHICS METHOD

NO:  
1904.01

## ARKANSAS NUCLEAR ONE

|          |    |      |          |
|----------|----|------|----------|
| PAGE     | 14 | OF   | 62       |
| REVISION | 0  | DATE | 02/08/84 |
| CHANGE   |    | DATE |          |

11.1 If all offsite dose map is currently displayed on the Chromatics terminal, proceed with Step 11.2; otherwise, complete Steps 10.1 through 10.5 before proceeding.

11.2 Touch the forward housing of the light pen and select the "DISPLAY SECTOR ELEMENT DATA" circle from the function menu. Tabulated thyroid dose commitment rate data will appear.

11.3 Record all dose rates greater than 1 MREM/HR on page one of Form 1904.01E. The dose type (thyroid) is shown at the top of the dose rate table. Dose rates of less than 1 MREM per hour need not be recorded.

11.4 If real-time dose rates exceed 2.5 MREM/HR, review procedures 1903.30, 31, and 32 for appropriate protective action.

11.5 Select the "Sector Element Dose Type" circle. When the dose type menu appears, select the alternate dose type (whole body).

11.6 Record all dose rates greater than 1 MREM/HR on page two of Form 1904.01E.

11.7 If real-time dose rates exceed 2.5 MREM/HR, review procedures 1903.30, 31, and 32 for appropriate protective action.

### 12.0 ACCUMULATED OFFSITE DOSES

12.1 The dose map display program must be running with tabulated data displayed on the Chromatics screen (see Section 11).

12.2 Select the "Cumulative Sector Element Dose" menu circle with the light pen.

12.3 Record the cumulative whole body doses on page two of Form 1904.01F. The dose type (thyroid) appears on the screen at the top of the dose table.

NOTE: Cumulative doses of less than 1 MREM need not be recorded.

12.4 Select the "Sector Element Dose Type" circle. When the dose type menu appears, select the alternate dose type (thyroid).

12.5 Record the cumulative thyroid doses on page one of Form 1904.01F.

NOTE: Doses lower than 1 MREM need not be recorded.

12.6 Use the light pen to select the "Draw Plume" circle on the Chromatics display. The site area map will be redrawn.

12.7 Select the "Send Data" circle. An updated dose map will appear in about 2 minutes. This step may be repeated to display successive updates of offsite radiological conditions.



PLANT MANUAL SECTION:  
OFFSITE DOSE  
PROJECTIONS PROC.

PROCEDURE/WORK PLAN TITLE:  
OFFSITE DOSE PROJECTIONS - GERMS  
COMPUTER GRAPHICS METHOD

NO:  
1904.01

## ARKANSAS NUCLEAR ONE

|          |    |      |          |
|----------|----|------|----------|
| PAGE     | 15 | of   | 62       |
| REVISION | 0  | DATE | 02/08/84 |
| CHANGE   |    | DATE |          |

### 13.0 NOTIFICATIONS AND PROTECTIVE ACTION RECOMMENDATIONS

- 13.1 If an Unusual Event, Alert, or Site Emergency has been declared, proceed directly to Section 13.2. If a General Emergency has been declared, make the following recommendation to the Arkansas Department of Health:
- 13.1.1 As a minimum, recommend sheltering within a 2-mile radius of the plant and 5 miles in the downwind direction.
  - 13.1.2 In order to select the appropriate protective action, State officials should be given an estimate of the expected release duration. This is especially important if the release duration is expected to be less than 2 hours (puff releases).
  - 13.1.3 Upon activation of the TSC/ECC, additional protective action recommendations should be evaluated using procedure 1904.07, "Protective Action Recommendations". These evaluations, should be made under the supervision of the Technical Analysis Superintendent and/or the Dose Assessment Supervisor.
- 13.2 Provide radiological release information to appropriate groups per 1903.10, "Emergency Action Level Response".
- 13.3 If a photograph of current offsite conditions has been requested, the TSC/ECC staff should refer to Section 19.0 of this procedure.
- 13.4 The Emergency Radiation Team shall be dispatched to obtain field radiological data whenever any Emergency Action Level has been declared based on offsite radiological releases. When the field monitoring teams report maximum (centerline) dose rates at various downwind distances, the TSC/ECC staff should refer to Section 18.0.
- 13.5 Use the light pen to select the "Return to Midas" circle on the Chromatics screen, then type "QUIT[RETURN]" at the terminal keyboard.
- NOTE: Returning to Midas, then restarting the display program (Steps 10.1 through 10.5) is the fastest way to advance through several updates in order to observe current conditions.
- 13.6 Request that the plant Radiochemistry staff sample the air effluent from the plant vents and analyze the spectrum of radioactive isotopes being released. When this data becomes available, the TSC/ECC staff should complete Section 16.0 of this procedure.
- 13.7 A qualitative change in the data received from any of the meteorological, flow rate, or radiation monitoring sensors will result in the listing of a status change report on the control room Chromatics or a printing terminal. If this has occurred, refer to Section 23.0 of this procedure.





PLANT MANUAL SECTION:  
OFFSITE DOSE  
PROJECTIONS PROC

PROCEDURE/WORK PLAN TITLE:  
OFFSITE DOSE PROJECTIONS - GERMS  
COMPUTER GRAPHICS METHOD

NO:  
1904 01

## ARKANSAS NUCLEAR ONE

|          |          |      |          |
|----------|----------|------|----------|
| PAGE     | 16 of 62 |      |          |
| REVISION | 0        | DATE | 02/08/84 |
| CHANGE   |          | DATE |          |

- 13.8 If a plot of meteorological or release data has been requested, refer to Section 20.0 of this procedure.
- 13.9 If a detailed forecast of offsite dose rates has been requested, refer to Sections 14.0 and 15.0 of this procedure.
- 13.10 If there are significant releases from pathways which are not currently monitored by the GERMS SPING-4 detectors (i.e., unmonitored total Ci/sec exceeds 25% of monitored total Ci/sec), continue this procedure at Step 8.4.
- 13.11 If an emergency action level report is required, complete Section 9.0 of this procedure.
- 13.12 Continue this procedure from step 10.2 unless the incident or exercise has been officially terminated.

NOTE: This is an appropriate point in the procedure to transfer responsibility for offsite dose display and forecasting from the Control Room to the TSC, TSC to the ECC, etc.

- 13.13 At the end of an incident or exercise, terminate processing by typing the following sequence from User 44 after returning to Midas mode:

```
Simultaneous [CTRL] and W  
WAIT  
Simultaneous [CTRL] and P  
TER  
ABORT  
JOB AUTO.EDCEND
```

### 14.0 OBTAINING CURRENT METEOROLOGICAL AND RELEASE RATE DATA

- 14.1 Complete or terminate any ongoing programs. If an offsite dose map is being displayed at a Chromatics terminal, use the light pen to select "Return to Midas", and then type "Quit[RETURN]" at the terminal keyboard.

NOTE: Use of a printing terminal to execute these commands will result in a hard copy which may be used instead of the hand forms.

- 14.2 Type "WHO[RETURN]" to determine what user is signed on the terminal.
- 14.3 If the user number is 44, type "BYE 44[RETURN]". Repeat this step until "Signed Off" appears, then type "HEL XX[RETURN]" to sign on a general display user, where XX is the user number from the list in 7.12.
- 14.4 Type "JOB AUTO.MET,,,TTY[RETURN]". A listing which includes the most recent data date from the 10-minute CMF, and meteorological data for that time will then appear.
- 14.5 Obtain a summary of the current radiological release rates on any GERMS terminal:



PLANT MANUAL SECTION:  
OFFSITE DOSE  
PROJECTIONS PROC.

PROCEDURE/WORK PLAN TITLE:  
OFFSITE DOSE PROJECTIONS - GERMS  
COMPUTER GRAPHICS METHOD

NO:  
1904.01

## ARKANSAS NUCLEAR ONE

PAGE 17 of 62  
REVISION 0 DATE 02/08/84  
CHANGE DATE

- 14.5.1 If an offsite dose map is being displayed at a Chromatics terminal, use the light pen to select "Return to Midas", and then type "Quit[RETURN]" at the terminal keyboard.
- 14.5.2 A summary of the current site release rates will appear when you type "JOB AUTO. VENT,,,TTY[RETURN]".

NOTE: Typing simultaneous [CTRL] and [T] will temporarily stop the data from scrolling off the screen. A second [CTRL][T] will restart the scrolling.

- 14.5.3 Transcribe this data to Form 1904.01G.

### 15.0 DETAILED OFFSITE DOSE FORECASTING

NOTE: This portion of the procedure provides a graphic display of offsite dose rates caused by the forecast progression of the release. This process requires considerable time (and Chromatics terminal time) to complete. It will typically be performed only by the ERO Dose Assessment staff at the ECC, and only as time permits.

#### 15.1 Obtain a site release rate forecast:

- 15.1.1 Write the current hour in the first "Time Frame" block of Form 1904.01H. Write subsequent hours sequentially in the remaining "Time Frame" blocks out to 24 hours (use two forms).
- 15.1.2 Copy the most recent site total release rates from the Form 1904.01G summary section into the first "Release Rate" blocks on Form 1904.01H.
- 15.1.3 Show the vent status summary 1904.01G generated above along with any previous release rate forecasts to the Shift Technical Advisor and/or the ERO Technical Support Manager. Obtain forecasts of site total airborne radioactive release rates (particulate, iodine, and noble gas) for the duration of the incident or 24 hours, whichever is shorter. Record this information in the remaining "Release Rate" blocks of Forms 1904.01H for the appropriate hours.

#### 15.2 Meteorological Forecasting

- 15.2.1 Obtain the most recent meteorological forecast of the Russellville area (Arkansas Zone Five) from one of the following sources:
- A. Weather Services International (Procedure 1904.08)
  - B. MSS Dispatcher (4882)



PLANT MANUAL SECTION:  
OFFSITE DOSE  
PROJECTIONS PROC.

PROCEDURE/WORK PLAN TITLE:  
OFFSITE DOSE PROJECTIONS - GERMS  
COMPUTER GRAPHICS METHOD

NO:  
1904.01

## ARKANSAS NUCLEAR ONE

PAGE 18 of 62  
REVISION 0 DATE 02/08/84  
CHANGE DATE

- C. National Weather Service (Meteorologist-in-Charge)  
[834-0308 or •834-3955•]
- D. KARV Radio (968-1184)
- 15.2.2 Record the forecast on the lower portion of Form 1904.01H.
- 15.2.3 Complete the "Cloud Cover" blocks on Form 1904.01H with either "CLR", "P.C.", or "OVC" based upon the current weather forecast for the duration of the release. Use the following groupings of forecasting terms:
  - A. "CLR" ≡ Clear skies, fair, sunny, mostly clear or mostly sunny.
  - B. "P.C." ≡ Partly cloudy, partly sunny.
  - C. "OVC" ≡ Overcast, mostly cloudy, considerable cloudiness.
  - D. TODAY - 6 a.m. to 6 p.m. Standard (7-7 Daylight Saving Time)
  - E. TONIGHT - 6 p.m. to 6 a.m. Standard (7-7 Daylight Saving Time)
  - F. TOMORROW - 6 a.m. to 6 p.m. Standard (7-7 Daylight Saving Time)
  - G. TOMORROW NITE - 6 p.m. to 6 a.m. Standard (7-7 Daylight Saving Time)
- 15.2.4 Complete the "Forecast Stability Class" boxes on form 1904.01H with the appropriate stability classes from Table 1 based upon the current forecast cloud cover and times of occurrence.
- 15.2.5 Based upon the current weather forecast, complete the "Forecast Wind Speed" and "Forecast Wind Direction" boxes on Form 1904.01H for the duration of the release.
- 15.2.6 Group together into "Time Blocks" sequential hours during which the release rate and meteorological parameters all fall within the following tolerances of the first hour in the block: wind direction,  $\pm 10^\circ$ ; wind speed,  $\pm 1$  MPH under 5 MPH and  $\pm 20\%$  over 5 MPH; stability class, no change; and site total particulate, iodine, and noble gas release rates, all  $\pm 20\%$  of their values in the first hour of the time block.

The material contained within these symbols (•) is proprietary or private information.



PLANT MANUAL SECTION:  
OFFSITE DOSE  
PROJECTIONS PROC.

PROCEDURE/WORK PLAN TITLE:  
OFFSITE DOSE PROJECTIONS - GERMS  
COMPUTER GRAPHICS METHOD

NO:  
1904.01

## ARKANSAS NUCLEAR ONE

PAGE 19 of 62  
REVISION 0 DATE 02/08/84  
CHANGE DATE

15.2.7 Transcribe the data for these "Time Blocks" into the "Time Block Summary" on Form 1904.01H. The characteristics of each time block are those of the first hour in the block. The duration is the total number of minutes in the block.

### 15.3 Dose Forecast Processing

NOTE: To avoid tying up the GERMS Chromatics terminal, this section may be performed using a printing terminal, except Section 15.4.

- 15.3.1 At the same terminal used above, Type "JOB AUTO.FORCST[RETURN].
- 15.3.2 When the option menu appears, enter "1[RETURN]" to initialize the file.
- 15.3.3 When the option menu is again displayed, enter "2[RETURN]" to process a forecast time block.
- 15.3.4 The time selection menu will then appear. Enter "AI[RETURN]" followed by the number of minutes in the first time block.
- 15.3.5 The time selection menu will appear again. If the analysis interval is now correct, respond to the prompt with "EX[RETURN]".
- 15.3.6 The prompt "TO EDIT THE RELEASE POINT DISTRIBUTION SCALE FACTORS, ENTER RELEASE POINT (1-12)" will appear. Type "11 [RETURN]" to edit the "unmonitored pathway" release rates.

NOTE: For dose forecast processing, all release rates are entered manually. GERMS Sping-4 data is only available for historical and near-current time periods.

- 15.3.7 When the scale factor editing menu appears for release point #11, enter either 31, 32, or 33 and a carriage return to enter the particulate, iodine, or noble gas release rates respectively for the first time block.
- 15.3.8 A list of the individual isotopic release rates for the selected release rate distribution will appear followed by a prompt to enter a new scale factor.

NOTE: The isotopic release rate distributions are designed so that entry of 1.0 as a scale factor for the noble gas release rate distribution will result in a net noble gas release rate of 1.0 Ci/sec. Entering 2.8 as a scale factor for the iodine distribution is equivalent to a net iodine release rate of 2.8 Ci/sec. etc.

Enter the forecast release rate of the selected isotope type (particulate, iodine, or noble gas) for the first time block at the terminal keyboard in Ci/sec, followed by a carriage return.



PLANT MANUAL SECTION:  
OFFSITE DOSE  
PROJECTIONS PROC.

PROCEDURE/WORK PLAN TITLE:  
OFFSITE DOSE PROJECTIONS - GERMS  
COMPUTER GRAPHICS METHOD

NO:  
1904.01

## ARKANSAS NUCLEAR ONE

|          |          |      |          |
|----------|----------|------|----------|
| PAGE     | 20 of 62 |      |          |
| REVISION | 0        | DATE | 02/08/84 |
| CHANGE   |          | DATE |          |

- 15.3.9 The isotopic distribution will be listed again, followed by the scale factor. If the scale factor (i.e. release rate in Ci/sec) is correct, enter a carriage return; otherwise, redo Step 15.3.8.
- 15.3.10 Repeat Steps 15.3.7 to 15.3.9 until all 3 scale factors (release rates) have been correctly entered for the first time block. The scale factor editing menu will be displayed for the 11th pathway. Enter two carriage returns to continue processing.
- 15.3.11 The computer will then request meteorological data entry. When the prompt "Enter Option for Horizontal Stability Class Determination" appears, enter "3 [RETURN]" to select the direct entry option. Then enter the stability class for the first time block, followed by a carriage return.
- 15.3.12 When prompted for the vertical stability class option, again enter "3[RETURN]" and the stability class for the first time block, followed by a carriage return.
- 15.3.13 The windspeed for the first time block must then be entered in units of meters/sec. See the note on Form 1904.01H. Terminate the entry with a carriage return.
- 15.3.14 When prompted, enter the wind direction (from which the wind is blowing) for the first time block in degrees, followed by a carriage return.
- 15.3.15 All the assumed meteorology parameters will now be displayed. Corrections may be made by entering the two-letter code associated with the parameter. Ensure that the release height is set to zero and the mixing height is set to 500 meters, unless other values are forecast. Enter "EX [RETURN]" if all met data has been correctly entered.

NOTE: The "ANALYSIS DATE" for the forecast data is initially 1983:1:1:0:0, and then is incremented by the time duration of each subsequent time block.

### 15.4 Forecast Display

- 15.4.1 Perform Step 15.3.1 if jobstream AUTO.FORCST is not already running at the Chromatics color graphics terminal.
- 15.4.2 When the options menu is displayed, type "3[RETURN]" to select the dose map display.
- 15.4.3 The computer will prompt the user to enter the plume segment number with which the display should begin.



PLANT MANUAL SECTION:  
OFFSITE DOSE  
PROJECTIONS PROC.

PROCEDURE/WORK PLAN TITLE:  
OFFSITE DOSE PROJECTIONS - GERMS  
COMPUTER GRAPHICS METHOD

NO:  
1904.01

## ARKANSAS NUCLEAR ONE

|          |          |      |          |
|----------|----------|------|----------|
| PAGE     | 21 of 62 |      |          |
| REVISION | 0        | DATE | 02/08/84 |
| CHANGE   |          | DATE |          |

NOTE: A single carriage return defaults to the largest plume segment number (i.e. the latest update for the most complete offsite dose picture). If it is desired to view offsite doses projected for earlier time periods, enter a correspondingly lower plume segment number. Subsequent updates can be obtained later using the light pen, but the data for each update requires about 2 minutes to transfer.

Enter the plume segment number for the initial display.

15.4.4 Perform Steps 10.6 to 12.7 to record the forecast offsite radiological conditions for each time block of interest. Circle "forecast" data at the top of each Form 1904.01D used.

NOTE: The command "JOB AUTO.FORLST,,TTY[RETURN]" may be used from a printing terminal to obtain a hard copy of the most recent (i.e. final) offsite dose forecast.

15.4.5 Enter "4[RETURN]" to exit the AUTO.FORCST jobstream. No data is lost by a normal exit.

### 16.0 CHANGING THE RELEASE RATE DISTRIBUTIONS

NOTE: Each release path can be assigned individual iodine, particulate, and noble gas isotopic distributions. The gross iodine, particulate, and noble gas concentrations measured by the gross count detectors for each release path are used to scale these isotopic distributions, resulting in the isotopic release rates used in the offsite dose calculations.

NOTE: The calculated offsite doses can be modified substantially by changes to the release rate distributions which would appear to be slight.

NOTE: The mid-range and high-range noble gas channels of the SPING monitors indicate dose - equivalent Xe-133 concentrations. When the indicated noble gas activity in any duct monitored by a SPING exceeds approximately  $5E-2$   $\mu\text{Ci/cc}$  as Xe-133, then more accurate dose calculations will result if the noble gas distribution for this duct contains only Xe-133. For lower concentrations or for unmonitored pathways, use of the actual isotopic analysis is preferable.

16.1 The release rate distributions for a release pathway should be changed whenever new laboratory data is obtained detailing the relative concentrations of isotopes being discharged via that pathway.

If the Assistant Radiochemistry Supervisor is onsite, he should be asked to perform the editing as described below.



PLANT MANUAL SECTION:  
OFFSITE DOSE  
PROJECTIONS PROC.

PROCEDURE WORK PLAN TITLE:  
OFFSITE DOSE PROJECTIONS - GERMS  
COMPUTER GRAPHICS METHOD

NO:  
1904.01

## ARKANSAS NUCLEAR ONE

|          |    |      |          |
|----------|----|------|----------|
| PAGE     | 22 | of   | 62       |
| REVISION | 0  | DATE | 02/08/84 |
| CHANGE   |    | DATE |          |

- 16.2 Release rate distributions can be changed from any printing or CRT terminal by a user which has no other programs running. However, reports displayed on the Control Room Chromatics terminal are subject to disruption if the computer encounters missing met data or changes in detector or flow sensor status.
- 16.3 Type "DIS[RETURN]" to display the current system status. If there is any entry other than "NONE" following "programs assigned" or "jobstreams assigned", sign-off the current user and sign-on as another "general display" user listed in 7.12 for your location, until a user with no programs or jobstreams assigned is found.
- 16.4 Type "JOB AUTO.ISODIS[RETURN]" to define the appropriate logical units and run the editing program.
- 16.5 When the "Main Menu" appears, type "DS[RETURN]" to enter the data display routine.
- 16.6 When the "Display Data Menu" appears, type "DD[RETURN]" to obtain a listing of the currently-assigned distributions. Make a note of the distribution numbers (1-33) for the release paths and isotope types which you desire to change. The contents of any distribution can be examined by typing the distribution number followed by [RETURN]. A direct return to the main menu may be made by pressing [RETURN].
- 16.7 When the "Main Menu" again appears, type "MD[RETURN]" to enter the data modification routine.
- 16.8 When the "Modify Data Menu" appears, type "DI[RETURN]" to edit the distribution data.
- 16.9 Type the number of the distribution that you wish to edit, followed by "[RETURN]".
- 16.10 When prompted by the computer, enter the isotopic release rates or concentrations for the specified isotopes, followed by [RETURN]. To leave the prompted data unchanged, you may enter just a carriage return.
- NOTE: Since the computer uses the monitored distributions (1-30) only to subdivide the gross activity from the SPING-4 detectors, only the relative amounts of the isotopes are needed for any monitored release points, regardless of units. However, the total activity entered for any unmonitored release path distribution (31-33) must be normalized as follows: sum the individual activities together, divide 1.0 by the sum, and use this result to multiply each individual activity before entering it into the computer.
- 16.11 When the "Modify Data Menu" appears, you may change another distribution by returning to Step 16.8, or enter a single carriage return followed by "EX[RETURN]" to exit.



PLANT MANUAL SECTION:  
OFFSITE DOSE  
PROJECTIONS PROC.

PROCEDURE/WORK PLAN TITLE:  
OFFSITE DOSE PROJECTIONS - GERMS  
COMPUTER GRAPHICS METHOD

NO:  
1904.01

## ARKANSAS NUCLEAR ONE

PAGE 23 of 62  
REVISION 0 DATE 02/08/84  
CHANGE DATE

### 17.0 ERROR RECOVERY (FROM CHROMATICS TERMINAL)

NOTE: The following is a list of problems which may occasionally be encountered. Follow the instructions associated with the applicable symptoms below. More complex problems should be referred to the Assistant Radiochemistry Supervisor in the OSC when he arrives onsite. If insurmountable problems occur, use procedure 1904.02 to perform manual offsite dose calculations.

#### 17.1 Mis-Typed Keyboard Entry

- 17.1.1 If the Chromatics terminal is in color graphics mode (i.e. color display), the back-arrow key will back the cursor destructively over previously entered characters. All characters at or to the right of the cursor location are erased in memory, although they remain on the screen.
- 17.1.2 If the program is running on the GERMS computers, individual characters may be deleted by simultaneously pressing "[CTRL][SHIFT]O" or the entire line may be deleted by simultaneously pressing "[CTRL][SHIFT]/".

#### 17.2 Light-Pen Does Not Work

- 17.2.1 It is possible for the light pen to become overloaded by the strong electromagnetic fields near the Chromatics terminal screen. Waiting 30-60 seconds will usually restore operability.
- 17.2.2 Gently wiggling the black tip of the light pen from side to side will often restore operability (a flash of blue light should be seen on the screen).
- 17.2.3 If the program running in the Chromatics terminal halts, the light pen will stop responding. Hit the [BREAK] key. If a "Break in Line..." message appears where "... " represents one of the program line numbers, then the light pen is probably defective and should be replaced. Otherwise, the terminal program has halted (see Section 17.3.1 to restart the terminal).

#### 17.3 No Response to Keyboard Entries

NOTE: The automatic processing programs are designed to restart themselves, even if they are halted to clear other program/hardware errors.





PLANT MANUAL SECTION:  
OFFSITE DOSE  
PROJECTIONS PROC.

PROCEDURE/WORK PLAN TITLE:  
OFFSITE DOSE PROJECTIONS - GERMS  
COMPUTER GRAPHICS METHOD

NO:  
1904.01

## ARKANSAS NUCLEAR ONE

|          |    |      |          |
|----------|----|------|----------|
| PAGE     | 24 | of   | 62       |
| REVISION | 0  | DATE | 02/08/84 |
| CHANGE   |    | DATE |          |

17.3.1 If the Chromatics terminal becomes "lost" while executing a program, press the [RESET], [BOOT], [ESC], L, [ROLL], [ESC], F, E, and [RETURN] keys. Wait 10 seconds. If this does not produce a Midas prompt (carat mark) on the screen, type "[RETURN]" then type "R NORMAL [RETURN]".

17.3.2 If there is still no Midas prompt, type the following:

A. Simultaneous "[CTRL]P" followed by [RETURN]. (Request for prompt).

B. Simultaneous "[CTRL]W" followed by "WAIT[RETURN]", "TER[RETURN]", "ABORT[RETURN]". (Eliminates programs assigned by user).

NOTE: If an operator is using a Chromatics terminal in either Control Room, continue with Step 17.3.4.

C. Simultaneous "[CTRL]G" followed by "[CTRL]U"[RETURN]. (Switches to computer #1)

D. Simultaneous "[CTRL]G" followed by "[CTRL]K"[RETURN]. (Switches to computer #2)

If either C or D works, type "HELP.SEE[RETURN]" to identify the working computer. Request that the non-working computer be autoloaded as in Section 17.6.

17.3.3 If there is still no Midas prompt, and connection to the computer was established via the plant telephone system, verify that the RTS, CTS, DSR, DTR, and CXR lights on the modem are lighted. If not, switch the right-hand switch to MA, wait 3 seconds, and then attempt to reestablish telephone contact with the computer at extension 6651 or 6653 as in Steps 7.5 - 7.13. If contact cannot be re-established, power may be off to the PASS Building, the telephone system may be malfunctioning, or the modem at your location may be faulty.

17.3.4 Report the malfunction to the Assistant Radiochemistry Supervisor in the OSC.

17.3.5 If contact is reestablished, attempt to obtain a Midas prompt by repeating Steps 17.3.1 and 17.3.2. If a prompt is not then obtained, report the malfunction to the Assistant Radiochemistry Supervisor in the OSC.



PLANT MANUAL SECTION:  
OFFSITE DOSE  
PROJECTIONS PROC.

PROCEDURE/WORK PLAN TITLE:  
OFFSITE DOSE PROJECTIONS - GERMS  
COMPUTER GRAPHICS METHOD

NO:  
1904.01

## ARKANSAS NUCLEAR ONE

|          |          |      |          |
|----------|----------|------|----------|
| PAGE     | 25 of 62 |      |          |
| REVISION | 0        | DATE | 02/08/84 |
| CHANGE   |          | DATE |          |

### 17.4 Totally Missing Met Data

- 17.4.1 Check for the presence of met data on the ANO-1 Control Room strip charts. If data is present, record the information for entry into the GERMS system and request that the Assistant Radiochemistry Supervisor in the OSC attempt to reestablish communication.
- 17.4.2 If met data is not present, request repair of the met tower and obtain met data from a backup source listed in Step 15.2.1.

### 17.5 Totally Missing Radiation Monitor (RMS) Data

- 17.5.1 Check for the presence of RMS data at the Eberline control terminal associated with the computer which is not receiving data. If 10-minute averaged data is not available, contact I&C to reinitialize the Eberline control terminal.
- 17.5.2 If 10-minute averaged data is available at the control terminal but not at the Chromatics terminals, the data acquisition programs in the GERMS computers may have halted. Call the Assistant Radiochemistry Supervisor in the OSC.

### 17.6 Rebooting the Computers

- 17.6.1 If all else fails to make the GERMS computers respond, they may be restarted remotely from the Decwriter terminals in the TSC or the ECC. If the Assistant Radiochemistry Supervisor is in the OSC, he should be the one to reboot the system.
- 17.6.2 Establish contact with the affected computer via the Decwriter terminal in the TSC or ECC as in Section 22. If only one computer is to be rebooted, use the "HELP.SEE" command to be certain that you are accessing the non-working computer.
- 17.6.3 Type the following at the Decwriter keyboard: simultaneous "[CTRL]Z", simultaneous "[CTRL]A", followed by "L".
- 17.6.4 Sign-on the system as in Step 7.13.

### 17.7 Repeated Errors in the Chromatics Terminal

- 17.7.1 Errors generated within the Chromatics terminal usually result in error statements being displayed on the screen in red. They may, however, cause the terminal to cease functioning.



PLANT MANUAL SECTION:  
OFFSITE DOSE  
PROJECTIONS PROC.

PROCEDURE/WORK PLAN TITLE:  
OFFSITE DOSE PROJECTIONS - GERMS  
COMPUTER GRAPHICS METHOD

NO:  
1904.01

## ARKANSAS NUCLEAR ONE

|          |    |      |          |
|----------|----|------|----------|
| PAGE     | 26 | of   | 62       |
| REVISION | 0  | DATE | 02/08/84 |
| CHANGE   |    | DATE |          |

- 17.7.2 Replace the diskette from the disk drive with the spare from the Emergency Kit.
- 17.7.3 If errors continue, notify the Assistant Radiochemistry Supervisor in the OSC.
- 17.8 Requested User Number Already Signed On
- 17.8.1 Type "WHO[RETURN]" to confirm which user number is already assigned to your terminal.
- 17.8.2 Type "WHO ALL[RETURN]" to confirm that the desired user number is already assigned to another terminal.
- 17.8.3 If an Assistant Radiochemistry Supervisor is onsite in the OSC, refer the problem to him. If not, ask the operator(s) at the other Chromatics terminal(s) what user number they are using.
- 17.8.4 Sign-on as another user as in Step 7.13.
- 17.9 Hourly Dispersion Program not Running
- 17.9.1 A warning message to this effect is scheduled to occur hourly after an error exit from the AUTO.EDC60 jobstream. This warning will be cleared when the AUTO.EDC10 jobstream runs successfully, or when the AUTO.EDCEND or AUTO.HRINIT jobstreams are run. If an Assistant Radiochemistry Supervisor is onsite, he should be asked to correct this problem.
- 17.9.2 Sign-off the user currently assigned to your terminal.
- 17.9.3 Sign-on user 49. The password is "U49[RETURN]".
- 17.9.4 If it is not necessary to continue EDC (plume segment) processing, type "UNS SF=AUTO.HRWARN[RETURN]".
- 17.9.5 If EDC processing must continue, type "JOB AUTO.EDC60,,,TTY [RETURN]". This will clear the warning message, restart hourly-average processing, and display all commands and error messages as they occur.
- 17.9.6 Watch the jobstream command strings on the display terminal. If an error message occurs, type simultaneous "[CTRL]" and "T" characters to halt the scrolling of the messages off-screen. Copy the error message and as many of the preceding statements as possible onto a sheet of paper, then again type "[CTRL]T" to resume processing.



PLANT MANUAL SECTION:  
OFFSITE DOSE  
PROJECTIONS PROC.

PROCEDURE/WORK PLAN TITLE:  
OFFSITE DOSE PROJECTIONS - GERMS  
COMPUTER GRAPHICS METHOD

NO:  
1904.01

## ARKANSAS NUCLEAR ONE

|          |          |      |          |
|----------|----------|------|----------|
| PAGE     | 27 of 62 |      |          |
| REVISION | 0        | DATE | 02/08/84 |
| CHANGE   |          | DATE |          |

17.9.7 Call the Assistant Radiochemistry Supervisor and request help in correcting the problem.

NOTE: Failure to restart hourly-average data processing will eventually result in cessation of all plume segment processing when the 10-minute data file is filled.

17.9.8 If no error message occurs, wait for the jobstream to terminate (as signified by the word "ENDJOB"). Then sign-off user 49 by typing "BYE 49[RETURN]".

17.10 Computer responds to all keyboard commands with "#" prompt, only.

17.10.1 This is possible if an improper exit was taken from the trend plotting or map drawing programs.

17.10.2 Type "E[RETURN]" to make the computer echo the keyboard commands.

17.10.3 Type "R NORMAL[Return]" to reconfigure the port for interactive use. A message and carat prompt should appear within about 10 seconds.

17.11 Projected offsite dose consequences do not appear to be reasonable.

17.11.1 Type "JOB AUTO.VENT,,,TTY[RETURN]" to ensure that the release rates for each pathway (especially the "un-monitored" pathway #11) are reasonable.

17.11.2 Type "JOB AUTO.RECIRC,,,TTY[RETURN]" to verify that the appropriate recirculation factors are being used.

17.11.3 Type "JOB AUTO.MET,,,TTY[RETURN]" to verify that the meteorological parameters are reasonable.

17.11.4 Type "JOB AUTO.ISODIS[RETURN]" followed by "DS[RETURN]" to check the isotopic distributions currently assigned.

### 18.0 CENTERLINE DOSE RATES AND ADJUSTMENT FOR FIELD DATA

18.1 When the field monitoring teams report maximum (centerline) dose rates at various downwind distances, record these on Form 1904.01J.

18.2 As soon as possible after recording these field measurements, display a current offsite dose map as in Section 10.0.

18.3 With the offsite dose map displayed, use the light pen to select the bottom menu circle, "C/L DOSE RATE". Operating instructions will appear at the top of the menu block, and a graphic cursor (blinking line) will appear on the map.



PLANT MANUAL SECTION:  
OFFSITE DOSE  
PROJECTIONS PROC.

PROCEDURE WORK PLAN TITLE:  
OFFSITE DOSE PROJECTIONS - GERMS  
COMPUTER GRAPHICS METHOD

NO:  
1904.01

## ARKANSAS NUCLEAR ONE

|          |          |      |          |
|----------|----------|------|----------|
| PAGE     | 28 of 62 |      |          |
| REVISION | 0        | DATE | 02/08/84 |
| CHANGE   |          | DATE |          |

18.4 With the light pen pointed at the map area, touch the forward barrel of the pen to increment the cursor along the centerline of the downwind flow path. The interpolated centerline dose rate at the cursor location is shown next to the bottom menu circle.

NOTE: The cursor location is defined as the left end of the blinking line. The dose type is the same as that of the map.

18.5 The direction of movement of the cursor may be reversed by actuating the light pen on the yellow instruction block on the screen. Actuating the pen over the menu block will restore the usual menu functions.

18.6 Record the projected dose rate for the radii at which the field data was taken on the same line as the field data on Form 1904.01J. Also record the sector number of the cursor location for each radius. [Non-agreement of centerline sector locations may indicate offsite wind effects not included in the computer model.]

NOTE: It is advisable to record centerline dose rates for a variety of locations along the plume for general information. The rates at 0.62, 1.5, 3.56 and 7.25 miles are required for protective action calculations in 1904.07.

18.7 Divide the measured by the projected dose rates and record on Form 1904.01J under M/P ratio.

18.8 If the M/P ratio consistently is larger than 2.0 or smaller than 0.5 at three or more radii, the recirculation factors should be changed to compensate as described in Steps 18.10 to 18.15 below.

18.9 Multiply the current recirculation factor by the average M/P ratio from Form 1904.01J to obtain a new recirculation factor. Record this on a blank line on Form 1904.01J.

NOTE: The computer model can be adjusted to make the projected offsite dose rates agree with measured dose rates by changing the "recirculation factors" to values other than 1.0. These factors are used within the model to multiply the projected concentrations, doses, and dose rates before they are recorded and displayed. If the Assistant Radiochemistry Supervisor is onsite, he should be asked to perform these adjustments.

18.10 If a dose map is displayed, select the "Return to Midas" menu circle and type "QUIT[RETURN]". When the display menu appears, select option "(5) EXIT".



PLANT MANUAL SECTION:  
OFFSITE DOSE  
PROJECTIONS PROC

PROCEDURE/WORK PLAN TITLE:  
OFFSITE DOSE PROJECTIONS - GERMS  
COMPUTER GRAPHICS METHOD

NO:  
1904 01

## ARKANSAS NUCLEAR ONE

|          |          |      |          |
|----------|----------|------|----------|
| PAGE     | 29 of 62 |      |          |
| REVISION | 0        | DATE | 02/08/84 |
| CHANGE   |          | DATE |          |

- 18.11 From a terminal which is not otherwise occupied, you may check the current recirculation factors by typing the following command: "JOB AUTO.RECIRC,,,TTY[RETURN]". A tabulation of the recirculation factors which are currently in use will appear (they should all be identical). Record the recirculation factor on Form 1904.01J.
- 18.12 Type "WHO[RETURN]" to determine what user is signed-on, then "BYE XX[RETURN]" where XX is the current user number.
- 18.13 Type "HEL 9[RETURN]" to sign-on user 9. Enter password "RECIRC[RETURN]" when prompted.
- 18.14 Type the following sequence to create a jobstream for changing the recirculation factors:

```
DEF 1, AUTO.MASTER[RETURN]
DEF 2, SCR.SØ[RETURN]
RUN APS.EDITOR[RETURN]
R[RETURN]
```

NOTE: In the following command "N" should be replaced with the new recirculation factor.

```
96<GK[ESC][ESC]-1CN[ESC][ESC]>[RETURN]
B/L[RETURN]
```

NOTE: 96 instances of the new recirculation factor should now be listed.

```
EX[RETURN]
```

- 18.15 Change the recirculation factors in the "radioactive release" file by typing "JOB SCR.SØ,,,TTY[RETURN]". The modified factors may be reviewed by repeating Step 18.11.

- 18.16 Return to procedure Step 13.6.

### 19.0 GRAPHIC PHOTOGRAPHY

NOTE: The following instructions may be used to prepare either 8 x 10 color transparencies or prints. Both types of photograph require separate negative and positive films. The transparencies and prints are loaded, exposed, and processed identically, except for a longer development time for the transparencies. Do not intermix the print and transparency negatives and positives during processing!

- 19.1 Polaroid film is normally stored in the refrigerator in the Mechanical Equipment Room on the lower floor of the ECC. Remove a sufficient quantity from the refrigerator to allow it to reach room temperature prior to use.



PLANT MANUAL SECTION:  
OFFSITE DOSE  
PROJECTIONS PROC.

PROCEDURE/WORK PLAN TITLE:  
OFFSITE DOSE PROJECTIONS - GERMS  
COMPUTER GRAPHICS METHOD

NO:  
1904.01

## ARKANSAS NUCLEAR ONE

|          |          |      |          |
|----------|----------|------|----------|
| PAGE     | 30 of 62 |      |          |
| REVISION | 0        | DATE | 02/08/84 |
| CHANGE   |          | DATE |          |

19.2 Connect the Dunn Instruments model 631 camera to the Chromatics terminal:

- 19.2.1 Position the camera near the Chromatics terminal.
- 19.2.2 Find and separate the four coaxial cables stored with the camera.
- 19.2.3 Attach one coaxial cable to the "sync" connectors on the camera and the terminal.
- 19.2.4 Similarly attach cables for the "green", "blue", and "red" signals.
- 19.2.5 Plug the camera power cord into a 110 VAC wall outlet.
- 19.2.6 Depress the POWER button. When the power is on, the green indicator light on the button should be lit.
- 19.2.7 Plug the film processor power cord into a 110 VAC wall outlet.

19.3 Load the negative as follows:

- 19.3.1 Place the film cassette on a flat surface with the black "dark slide" facing upwards.
- 19.3.2 Open the cassette by pushing the two latch buttons and raising the lid.
- 19.3.3 Carefully lift the uppermost negative envelope from its tray. Do not press, fold or bend the negative envelope.
- 19.3.4 With the printed side up, place the negative between the two blue guide lines in the film cassette.
- 19.3.5 Hook the pocket on the underside of the negative firmly onto the orange tongue on the cassette. Push the negative over the tongue as far as it will go.
- 19.3.6 Close and latch the cassette.

19.4 Remove the negative envelope by pulling it straight out at the base of the cassette, where you see the three arrows. Do not pull the negative tab at the other end of the cassette. Do not squeeze or press the cassette.



PLANT MANUAL SECTION:  
OFFSITE DOSE  
PROJECTIONS PROC.

PROCEDURE/WORK PLAN TITLE:  
OFFSITE DOSE PROJECTIONS - GERMS  
COMPUTER GRAPHICS METHOD

NO:  
1904.01

## ARKANSAS NUCLEAR ONE

|          |          |      |          |
|----------|----------|------|----------|
| PAGE     | 31 of 62 |      |          |
| REVISION | 0        | DATE | 02/08/84 |
| CHANGE   |          | DATE |          |

19.5 Expose the negative as follows:

- 19.5.1 Insert the film cassette in the camera with the dark slide facing downward and the slide handle facing out.
- 19.5.2 Verify that the following controls are correctly set:
  - A. Mode select lever is set to 8 x 10. This may be verified by observing that the 8 x 10 LED on the front panel is lit.
  - B. Normal/Separate is on normal (pushed in).
  - C. Color - B/W is set to color.
  - D. The EXPOSE button LED must be green for a picture to be taken. If the button is not lit, press the reset button to light the expose button. If this does not help, reinsert the film cassette and repeat this step.
  - E. Verify that the SPDS switch is set to GERMS.
- 19.5.3 Carefully withdraw the dark slide, stopping when the blue line is visible.
- 19.5.4 Depress the EXPOSE button. The image on the Chromatics screen must not be changed during the exposure period.

NOTE: The full exposure consists of three cycles totaling an exposure time of just less than a minute. The SEQUENCE INDICATOR lights assure the operator of which cycle the camera is in. The red cycle lasts for about forty seconds, the green for about seven seconds and the blue three seconds.

- 19.5.5 After the camera beeps to signal completion of the exposure, the dark slide must be fully reinserted by pushing evenly on the blue bar until the bar touches the film cassette.
- 19.5.6 Remove the cassette from the camera by lifting the front corners of the cassette slightly and pulling it out.

19.6 Process the film as follows:

- 19.6.1 Load the positive sheet into the input tray on the processor as follows:
  - A. Carefully lift the uppermost positive sheet from its shipping tray.





PLANT MANUAL SECTION:  
OFFSITE DOSE  
PROJECTIONS PROC.

PROCEDURE/WORK PLAN TITLE:  
OFFSITE DOSE PROJECTIONS - GERMS  
COMPUTER GRAPHICS METHOD

NO:  
1904.01

## ARKANSAS NUCLEAR ONE

|          |          |      |          |
|----------|----------|------|----------|
| PAGE     | 32 of 62 |      |          |
| REVISION | 0        | DATE | 02/08/84 |
| CHANGE   |          | DATE |          |

NOTE: Do not touch the surface of the sheet. Do not press on the processing pod area.

B. Hold the sheet with the chemical pod facing up and toward the processor.

C. Slide the sheet into the processor. The sheet must go below the chrome plate and drop into the tray.

19.6.2 Load the film cassette into the input tray of the processor by inserting it above the chrome plate. The tab end must be inserted first. Be sure to push the cassette into the processor as far as it will go.

19.6.3 Remove the chrome plate above the white button and wipe the processing rollers with a paper towel.

19.6.4 Check the timer, located on the left side of the processor, to verify that it is set to 50 seconds.

19.6.5 Press the white button, on the right side of the processor, and hold it down for about one second. The processor will beep after 50 seconds

NOTE: The processing time extends from the time the process button is pressed to the moment the print is separated from the negative. Type 809 (color print) film should be removed from the processor and peeled from the negative as soon as the timer sounds. Type 891 (color transparency) film must remain in the processor with the lid closed for an additional three minutes after the timer sounds, and should then be promptly peeled from its negative.

19.6.6 At the end of the processing time, lift the lid at the rear of the processor, remove the film and peel the positive print from the negative. Peel with a smooth and continuous motion, starting at a corner near the tab end. To ensure a clean print, begin the peel diagonally and end it in such a way that the entire long edge of the print is released at the same moment. Fold the negative and dispose of it. Avoid all contact with the chemicals that remain on the negative.



PLANT MANUAL SECTION:  
OFFSITE DOSE  
PROJECTIONS PROC.

PROCEDURE/WORK PLAN TITLE:  
OFFSITE DOSE PROJECTIONS - GERMS  
COMPUTER GRAPHICS METHOD

NO:  
1904.01

## ARKANSAS NUCLEAR ONE

|          |                 |
|----------|-----------------|
| PAGE     | 33 of 62        |
| REVISION | 0 DATE 02/08/84 |
| CHANGE   | DATE            |

CAUTION: THE POLAROID LAND FILM PROCESS USES A CAUSTIC JELLY WHICH IS SAFELY PACKED INSIDE SEALED CONTAINERS ON EACH 8 x 10 POSITIVE SHEET. IF YOU SHOULD ACCIDENTALLY GET SOME OF THIS JELLY ON YOUR SKIN, WIPE IT OFF IMMEDIATELY. TO AVOID AN ALKALI BURN, WASH THE AREA WITH PLENTY OF WATER AS SOON AS POSSIBLE. IT IS PARTICULARLY IMPORTANT TO KEEP THE JELLY AWAY FROM EYES AND MOUTH. KEEP THE DISCARDED MATERIALS OUT OF THE REACH OF CHILDREN AND ANIMALS AND OUT OF CONTACT WITH CLOTHING AND FURNITURE, AS DISCARDED MATERIALS STILL CONTAIN SOME JELLY.

- 19.6.7 The positive print or transparency will be damp for a few minutes after processing. Until it is completely dry, do not touch the image surface or lay the photographs on top of each other.
- 19.6.8 Color transparencies should be attached to a cardboard mounting frame. Hold the transparency toward the light and turn it until you can read the lettering on the image correctly. Hold a mounting frame with the labeled side toward you. Place it over the transparency and staple or tape them together.
- 19.6.9 The film cassette can be removed from the processor by pulling straight back.

### 20.0 TREND PLOTTING

NOTE: This section of the procedure covers the production of a graph of meteorological or release data over time as an aid in understanding and reporting the radiological release status. Approximately ten minutes is required to produce each plot. Therefore, trend plotting will typically be performed only by the ERO Dose Assessment Staff in the ECC.

- 20.1 Terminate any programs or jobstreams currently running under your user (except for user 44).
- 20.2 Type "DIS[RETURN]" to display the current system status. If there is any entry other than "NONE" following "programs assigned" or "jobstreams assigned", sign-off the current user and sign-on as another "general display" user listed in 7.12 for your location, until a user with no programs or jobstreams assigned is found.
- 20.3 If 10-minute averaged data is to be plotted, type "JOB AUTO.PLOT10 [RETURN]". (Up to 28 hours of 10-minute data may be plotted on a single graph.) If hourly-averaged data is to be plotted, type "JOB AUTO.PLOT60[RETURN]". (Up to seven days of hourly averaged data may be plotted on a single graph.) The Chromatics screen will display a black-on-green product number for about 2 minutes while file initialization data is transferred from the GERMS computers.



PLANT MANUAL SECTION:  
OFFSITE DOSE  
PROJECTIONS PROC.

PROCEDURE WORK PLAN TITLE:  
OFFSITE DOSE PROJECTIONS - GERMS  
COMPUTER GRAPHICS METHOD

NO:  
1904.01

## ARKANSAS NUCLEAR ONE

|          |          |               |
|----------|----------|---------------|
| PAGE     | 34 of 62 |               |
| REVISION | 0        | DATE 02/08/84 |
| CHANGE   |          | DATE          |

20.4 When the key images appear on the display screen, select the variables to plot as follows:

20.4.1 Press the black colored key. The outline of the "select" key image will flash in red.

20.4.2 Answer the menu prompts in the displayed format to select one or two variables and a time period for plotting. Usually, weather (WE) and release rate (RR) data will be of interest.

NOTE: The ST10, RAIN, and SOLAR RADIATION variables are always missing and should not be selected.

20.4.3 When prompted with "OK TO SELECT?", examine the proposed variables and dates. If they are correct, type a carriage return; if not, type "N[RETURN]" and the selection routine will be terminated. The Chromatics will be inoperative for up to 3 minutes while it receives data from the GERMS computers.

20.5 When the outline of the "Select" key image is restored to white, scale the data as follows:

20.5.1 Press the dark blue colored key. The outline of the "Scale" key image will flash in red.

20.5.2 When prompted for an alternative title and units, type carriage returns.

20.5.3 Select maximum and minimum values for each variable to be plotted. If the actual range of the plotted data is not known, use the following values to plot the data so the actual ranges may be seen. The data can be rescaled and replotted later.

- a) Noble Gas Release Rate: 1E-6 to 1E6 Ci/sec
- b) Iodine Release Rate: 1E-11 to 10.0 Ci/sec
- c) Particulate Release Rate: 1E-11 to 10.0 Ci/sec
- d) Wind Speed: 0 to 80 MPH
- e) Wind Direction: 0 to 360 Degrees
- f) Sigma Theta: 0 to 40 Degrees
- g) Temperature: -30 to +50 Degrees C
- h) Temperature Change: -4 to +4 Degrees C
- i) Dew Point: -30 to +50 Degrees C
- j) Status Flags: 0 to 1.0
- k) Flow Rates: 0 to 1E6
- l) Noble Gas Concentration: 1E-7 to 1E5  $\mu$ Ci/cc
- m) Iodine Concentration: 1E-12 to 1.0  $\mu$ Ci/cc
- n) Particulate Concentration: 1E-12 to 1.0  $\mu$ Ci/cc



PLANT MANUAL SECTION:  
OFFSITE DOSE  
PROJECTIONS PROC.

PROCEDURE WORK PLAN TITLE:  
OFFSITE DOSE PROJECTIONS - GERMS  
COMPUTER GRAPHICS METHOD

NO:  
1904.01

## ARKANSAS NUCLEAR ONE

|          |          |      |          |
|----------|----------|------|----------|
| PAGE     | 35 of 62 |      |          |
| REVISION | 0        | DATE | 02/08/84 |
| CHANGE   |          | DATE |          |

20.6 When the outline of the "Scale" key image is restored to white, draw the trend plot as follows:

20.6.1 Press the dark green colored key. The outline of the "Draw" key image will flash in red.

20.6.2 When prompted for the desired plot type, type "1[Return]" to obtain a single-line plot. The other options can produce good visual effects but frequently will be harder to read. After scaling both variables, the plot will be drawn.

NOTE: The single-line ("concatenated vector") or the "dot" modes will result in a vertical dashed line being drawn at every sixth data point. This corresponds to hour boundaries for 10-minute data and quarter days for hourly averaged data.

20.6.3 If the plot is not satisfactory, it may be redrawn using a different plot mode by repeating 20.6. The axes may be rescaled and the axes redrawn by repeating 20.5 and 20.6. A different data set may be selected by repeating 20.4 through 20.6. You may terminate the plotting program by pressing the white colored key. You may photograph the plot by following the steps in Section 19.0. You may print the raw data on a printing terminal attached to the 300-band modem for this CPU by pressing the cyan (purple) print key. Finally, you may record the plot image on the flexible disk by continuing with Step 20.7 below.

20.7 When all the key images are outlined in white, you may store the plot image (not the raw data) on the flexible disk as follows:

20.7.1 Press the red colored key. The "Store" key image will be outlined in flashing red.

NOTE: If no additional storage space is available on the flexible disk, an error message will be shown. The spare flexible disk from the emergency kit may be substituted in the disk drive, or the Assistant Radio-chemistry Supervisor should be consulted regarding files which may be deleted.

20.7.2 When prompted, enter a file name of the form "XXZZDDHH" where:

XX is the first parameter displayed  
ZZ is the second parameter displayed  
DD is the day the first plotted data was collected  
HH is the hour the first plotted data was collected



PLANT MANUAL SECTION:  
OFFSITE DOSE  
PROJECTIONS PROC.

PROCEDURE WORK PLAN TITLE:  
OFFSITE DOSE PROJECTIONS - GERMS  
COMPUTER GRAPHICS METHOD

NO:  
1904.01

## ARKANSAS NUCLEAR ONE

|          |    |      |          |
|----------|----|------|----------|
| PAGE     | 36 | of   | 62       |
| REVISION | 0  | DATE | 02/08/84 |
| CHANGE   |    | DATE |          |

Therefore, "RRWS1310" would represent a plot of a release rate and wind speed starting at 10 a.m. on the 13th day of the month.

20.7.3 Return to Step 20.6.3 for other options, or press the white color key to terminate the program.

### 21.0 ROUTINE OPERABILITY CHECK

NOTE: This portion of the procedure should not be used during a radiological release incident. It is designed to repetitively display the most recent meteorological and RMS data in the Control Rooms during routine operations so that data collection failures may be quickly identified and reported. The "AUTO.OPCHEK" jobstream is automatically aborted if any of the SPING detectors registers a high radiation alarm.

- 21.1 From the Chromatics terminal in either Control Room, type "WHO [RETURN]". If any user other than User 44 is currently assigned, type "BYE NN[RETURN]", where NN is the current user. Then type "HEL 44[RETURN]", and "U44[RETURN]". The message "CAUTION - USER PROGRAM OR JOBSTREAM ACTIVE" should appear.
- 21.2 Type "JOB AUTO.OPCHEK, , TTY[RETURN]" to start the status-reporting jobstream. If the error, "USER ALREADY SIGNED ON" occurs, type "DIS[RETURN]" and copy down the name of the jobstreams and programs currently assigned. Request help from the Assistant Radiochemistry Supervisor as needed.
- 21.3 GERMS status information will begin scrolling up the screen. To stop the scrolling, hold down the [CTRL] key and type the letter "T". Repeat this to restore terminal operability and restart the scrolling.
- 21.4 When the "DIS" command is executed, a listing of the fundamental computer parameters, including the percentage of computer free time, the amount of free memory, and the status of the task processor will be displayed. The amount of free memory should be at least 100,000 words, and the number of disk errors should be zero.
- 21.5 When the "WHO ALL" command is executed, a listing of all users currently active on the computer will appear. User numbers 42 through 47 plus 49 should be present.
- 21.6 Two programs, APS.EDCTIM and APS.EDCDAT, will run primarily to select and format data for the remaining two, APS.EDCEMD and APS.VENT. APS.EDCTIM selects and displays the time ("DATA DATE") of the most recent entry in the continuous monitor, or raw data, file (CMF). APS.EDCDAT periodically checks this CMF entry and waits until all available data have been transferred to it, or a maximum of three minutes.



PLANT MANUAL SECTION:  
OFFSITE DOSE  
PROJECTIONS PROC.

PROCEDURE/WORK PLAN TITLE:  
OFFSITE DOSE PROJECTIONS - GERMS  
COMPUTER GRAPHICS METHOD

NO:  
1904.01

## ARKANSAS NUCLEAR ONE

|          |          |               |
|----------|----------|---------------|
| PAGE     | 37 of 62 |               |
| REVISION | 0        | DATE 02/08/84 |
| CHANGE   | DATE     |               |

21.7 When APS.VENT is run, a listing of the concentrations, flow rates, and total particulate, iodine, and noble gas release rates for each of the ten monitored gaseous discharge paths will appear. Release paths which are known to be "in service" should have reasonable flow rate and concentration data (i.e. not "BAD" or "MISSING"). The SPINGS which correspond to "out of service" release paths should be in the "STANDBY" mode, so their flow rates and concentrations should all be listed as "MISSING". "BAD" data indicates failed or misadjusted sensors, or channels which are undergoing maintenance or calibration.

21.8 The release rates for the "unmonitored pathway" will also be listed. These release rates should be zero and the "unmonitored" flow rate should be 2119 CFM. The flow rate functions as a units conversion factor in this case, and should not be changed.

21.9 When APS.EDCEMD is run, the current meteorological data should appear on the screen. If wind speed, wind direction, sigma theta, or temperature gradient information is not available, the operator will be warned and the program will request that correct data be entered. A single carriage return is sufficient at this time. If none of the meteorological data was received from the meteorological tower, the computer will display the message:

```
*****  
***** WARNING: INCOMPLETE MET DATA *****  
*****
```

21.10 To terminate the "AUTO.OPCHEK" jobstream, type:

```
[CTRL] and W  
WAIT[RETURN]  
[CTRL] and P  
TER[RETURN]  
ABO[RETURN]
```

21.11 If error messages were displayed during execution of the "AUTO.OPCHEK" jobstream, or if the status displayed is not as specified above, make a note of all errors and discrepancies and notify the Assistant Radiochemistry Supervisor.

### 22.0 PREPARING THE LA12A DECWRITER

22.1 Decwriters and paper are normally stored near the ECC and TSC emergency kits.

22.2 Remove the Decwriter completely from its cloth carrying case. In order to maintain proper cooling, the feet of the unit must rest directly on a smooth hard surface.



PLANT MANUAL SECTION:  
OFFSITE DOSE  
PROJECTIONS PROC.

PROCEDURE WORK PLAN TITLE:  
OFFSITE DOSE PROJECTIONS - GERMS  
COMPUTER GRAPHICS METHOD

NO:  
1904.01

## ARKANSAS NUCLEAR ONE

|          |          |               |
|----------|----------|---------------|
| PAGE     | 38 of 62 |               |
| REVISION | 0        | DATE 02/08/84 |
| CHANGE   | DATE     |               |

- 22.3 Connect the black power cord to the socket at the rear of the unit and a 110 VAC wall socket.
- 22.4 Push the power switch on the top right rear corner to the "1" (ON) position. In about two seconds the terminal should beep, indicating that the internal self-test was successful.

22.5 If the "Line" light is not lighted, press [LINE/LOC].

22.6 Install paper in the printer.

NOTE: The LA12A can use 9½ x 11" sprocket-feed z-fold paper such as Moore Forms #9510CJ (AP&L Stock #720-200), 8½"-wide roll-feed (Teletype) paper (AP&L Stock #720-438), or as a last resort, single sheets of letter-size or legal size paper. All papers are loaded similarly.

- 22.6.1 Move the two orange levers at the upper left fully forward.
- 22.6.2 Feed paper into rear paper slot with both hands.
- 22.6.3 Moving paper slightly from side to side, continue feeding into slot and under platen until paper edge appears at front.
- 22.6.4 Open the print compartment door by pulling up at the front.
- 22.6.5 Pull paper up until it catches on sprocket pins (plain roll paper should be aligned between the sprockets).
- 22.6.6 Line up paper perforations with the sprocket pins.
- 22.6.7 Move the left-hand orange lever to the rear (both orange levers for plain roll paper).
- 22.6.8 Close the print compartment door and press the [VIEW/FAULT RESET] key.
- 22.6.9 Press the [LOC FF/LOC LF] key to advance paper through front paper slot.
- 22.7 Check the option selections as follows:
- 22.7.1 Hold down the [CTRL] key and press [SET-UP]. The set-up status light should flash.



PLANT MANUAL SECTION:  
OFFSITE DOSE  
PROJECTIONS PROC.

PROCEDURE/WORK PLAN TITLE:  
OFFSITE DOSE PROJECTIONS - GERMS  
COMPUTER GRAPHICS METHOD

NO:  
1904.01

## ARKANSAS NUCLEAR ONE

|          |          |      |          |
|----------|----------|------|----------|
| PAGE     | 39 of 62 |      |          |
| REVISION | 0        | DATE | 02/08/84 |
| CHANGE   |          | DATE |          |

- 22.7.2 Type I[Return]. This initializes the keyboard, modem, and printer options.
- 22.7.3 Hold down the [CTRL] key and press [VIEW/FAULT RESET] to select automatic last-character viewing.
- 22.8 If the terminal is to be connected to a telephone which has a modular plug-in cable, proceed to Step 22.9. Otherwise, type CC=C[RETURN] [SET-UP], and proceed to Section 22.16.
- 22.9 Type CC=B[RETURN][SET-UP].
- 22.10 Disconnect a nearby telephone by unplugging the cable at its wall outlet.
- 22.11 Reconnect this cable to the socket marked "TELE" at the back of the Decwriter.
- 22.12 Connect the gray telephone cable stored with the Decwriter to the "LINE" socket at the back of the decwriter and the modular wall telephone outlet.
- 22.13 Depress the [DATA/TALK] key. With the [DATA/TALK] key on the decwriter in the (Down) "TALK" position, the telephone should operate normally.
- 22.14 Dial the extension number of one of the 300-baud GERMS modems (6652 for ANO-1 or 6650 for ANO-2). After one or two rings, a high-pitched carrier tone should be heard.
- 22.15 If the telephone has not already been connected to the printer with a modular plug, place the telephone handset in the acoustic couplers on the left of the unit, with the cord to the rear.
- 22.16 Place the [DATA/TALK] key in the (Up) "DATA" position. The DSR, CTS, and RLSD lights on the Decwriter should now be lighted.
- 22.17 Type [RETURN] at the keyboard. A Midas prompt (carat) should appear.
- 22.18 Type "HELP.SEE[RETURN]" to determine which computer is being accessed.
- 22.19 Type "WHO[RETURN]" to determine what user, if any, is currently assigned to the modem you have accessed.
- 22.20 See the table in Step 7.12 to determine whether an appropriate user number is currently signed-on. If not, type "BYE XX[RETURN]", where "XX" is the current user number. Then type "HEL YY[RETURN]", where "YY" is the desired user number. Enter the user password followed by [Return] when requested.





PLANT MANUAL SECTION:  
OFFSITE DOSE  
PROJECTIONS PROC.

PROCEDURE WORK PLAN TITLE:  
OFFSITE DOSE PROJECTIONS - GERMS  
COMPUTER GRAPHICS METHOD

NO:  
1904.01

## ARKANSAS NUCLEAR ONE

|          |    |      |          |
|----------|----|------|----------|
| PAGE     | 40 | of   | 62       |
| REVISION | 0  | DATE | 02/08/84 |
| CHANGE   |    | DATE |          |

### 23.0 ADJUSTMENTS TO THE UNMONITORED PATHWAY RELEASE RATES

NOTE: When any of the SPING radiation or flow channels changes status from "good" to "bad/missing", a release path which was previously monitored has potentially become unmonitored. By printing a status change report, the GERMS computer requests the operator to acknowledge the loss of data. If the loss of monitor data was not accompanied by the physical shutdown of the release point, the operator should add the release point data to the site total unmonitored release rates. Activity must be subtracted from the site total unmonitored release rates when a channel changes status from "bad/missing" to "good".

- 23.1 Record the "current" and "previous" data from the status change report for each channel which has changed state on Form 1904.01A. In case the screen has been cleared, typing "3[RETURN]" will relist the report.
- 23.2 Copy the summary information from the lower portion of the status change report to Form 1904.01A.
- 23.3 If the indicated status changes all correspond to the physical shutdown/startup of the associated release path, selection of option 1 (PROCEED) is the only response that is required. If any of the listed status changes are independent of the status of the associated release paths, proceed with Section 23.4.

NOTE: SPINGS monitoring non-operating release paths should be placed in the "standby" mode at this time. Refer to Step 8.4.2 for the procedure to do this.

- 23.4 If the absolute value of any of the "% CHANGE" values on Form 1904.01A exceeds 25%, select option 2 (SKIP) to postpone the calculation of offsite doses. Otherwise, enter option 1 (PROCEED).
- 23.5 Adjust the site total unmonitored release rates as follows:
  - A. If a channel has gone from "Good" status (i.e., some numerical value) to "Bad" or "Missing", use the "previous" flow or concentration to calculate a corresponding increase in the unmonitored release rates for this pathway on Form 1904.01B. Note the summary time as the "Time Last Measured" on the form.
  - B. For data which has gone from "Bad" or "Missing" status to "Good", record a zero in the appropriate line and column of Form 1904.01B. Note the summary time as the "Time Last Measured".
  - C. Transfer the remaining unmonitored release rates from the previous Form 1904.01B, along with their measurement times.



PLANT MANUAL SECTION:  
OFFSITE DOSE  
PROJECTIONS PROC.

PROCEDURE/WORK PLAN TITLE:  
OFFSITE DOSE PROJECTIONS - GERMS  
COMPUTER GRAPHICS METHOD

NO:  
1904.01

## ARKANSAS NUCLEAR ONE

|          |          |               |
|----------|----------|---------------|
| PAGE     | 41 of 62 |               |
| REVISION | 0        | DATE 02/08/84 |
| CHANGE   |          | DATE          |

NOTE: The remaining unmonitored releases need not be recalculated at this time. However, they should be recalculated using Procedures 1904.03 and 1904.04 once per 30 minutes or as time permits.

D. Compute the new  $Q_{\text{gas}}$  and  $Q_{\text{iodine}}$  totals.

E. Edit the unmonitored pathway release rates as in Section 8.4.5.

### 24.0 ATTACHMENTS AND FORMS

24.1 Attachment 1 - Typical Stability Classes by Date, Time and Cloud Cover

24.2 Attachment 2 - Jobstreams Used with Procedure 1904.01

24.3 Attachment 3 - Files Used with Procedure 1904.01

24.4 Attachment 4 - Principle Branches within 1904.01

24.5 Attachment 5 - Diagram of Floppy Disk Showing Write Protect Notch

24.6 Form 1904.01A - Status Change Report

24.7 Form 1904.01B - Unmonitored Release Summary

24.8 Form 1904.01C - EAL Report

24.9 Form 1904.01D - Offsite Dose Map

24.10 Form 1904.01E - Dose Rates

24.11 Form 1904.01F - Cumulative Doses

24.12 Form 1904.01G - Vent Status Summary

24.13 Form 1904.01H - Forecasting Worksheet

24.14 Form 1904.01I - Evacuation Start Time Worksheet

24.15 Form 1904.01J - Field Data Comparison



PLANT/MANUAL SECTION:  
OFFSITE DOSE  
PROJECTIONS PROC.

PROCEDURE/WORK PLAN TITLE:  
OFFSITE DOSE PROJECTIONS - GERMS  
COMPUTER GRAPHICS METHOD

NO:  
1904.01

# ARKANSAS NUCLEAR ONE

PAGE 42 of 62  
REVISION 0 DATE 02/08/84  
CHANGE DATE

## ATTACHMENT 1

### Typical Stability Classes by Date, Time, and Cloud Cover

| STANDARD<br>TIME FRAME | Feb. 16 - Apr. 22<br>and<br>Aug. 23 - Oct. 25 |                  | Apr. 23 - Aug. 22 |                  | Oct. 26 - Feb. 15 |                  |
|------------------------|---|------------------|-------------------|------------------|-------------------|------------------|
|                        | CLEAR   | PARTLY<br>CLOUDY | CLEAR             | PARTLY<br>CLOUDY | CLEAR             | PARTLY<br>CLOUDY |
|                        | Midnite - 1:00                                | F                | E                 | F                | E                 | F                |
| 1:00 - 2:00            | F   | E                | F                 | E                | F                 | E                |
| 2:00 - 3:00            | F   | E                | F                 | E                | F                 | E                |
| 3:00 - 4:00            | F   | E                | F                 | E                | F                 | E                |
| 4:00 - 5:00            | F   | E                | F                 | E                | F                 | E                |
| 5:00 - 6:00            | F   | E                | F                 | E                | F                 | E                |
| 6:00 - 7:00            | D   | D                | D                 | D                | F                 | E                |
| 7:00 - 8:00            | D   | D                | C                 | D                | D                 | D                |
| 8:00 - 9:00            | C   | D                | B                 | C                | D                 | D                |
| 9:00 - 10:00           | B   | C                | B                 | C                | C                 | D                |
| 10:00 - 11:00          | B   | C                | B                 | C                | C                 | D                |
| 11:00 - Noon           | B   | C                | B                 | B                | C                 | C                |
| Noon - 13:00           | B   | C                | B                 | B                | B                 | D                |
| 13:00 - 14:00          | B   | C                | B                 | B                | C                 | D                |
| 14:00 - 15:00          | B   | C                | B                 | C                | C                 | D                |
| 15:00 - 16:00          | C   | C                | B                 | C                | C                 | D                |
| 16:00 - 17:00          | D   | D                | B                 | C                | D                 | D                |
| 17:00 - 18:00          | D   | D                | C                 | D                | D                 | D                |
| 18:00 - 19:00          | D   | D                | D                 | D                | F                 | E                |
| 19:00 - 20:00          | F   | E                | F                 | E                | F                 | E                |
| 20:00 - 21:00          | F   | E                | F                 | E                | F                 | E                |
| 21:00 - 22:00          | F   | E                | F                 | E                | F                 | E                |
| 22:00 - 23:00          | F   | E                | F                 | E                | F                 | E                |
| 23:00 - Midnite        | F   | E                | F                 | E                | F                 | E                |

NOTE: For overcast (OVC.) conditions, the stability class typically is "D" at all hours and seasons.



PLANT MANUAL SECTION:  
OFFSITE DOSE  
PROJECTIONS PROC.

PROCEDURE/WORK PLAN TITLE:  
OFFSITE DOSE PROJECTIONS - GERMS  
COMPUTER GRAPHICS METHOD

NO:  
1904.01

## ARKANSAS NUCLEAR ONE

|          |          |               |
|----------|----------|---------------|
| PAGE     | 43 of 62 |               |
| REVISION | 0        | DATE 02/08/84 |
| CHANGE   |          | DATE          |

### ATTACHMENT 2

#### JOBSTREAMS USED WITH PROCEDURE 1904.01

- 1) AUTO.EAL
- 2) AUTO.UNMON
- 3) AUTO.UNMONØ
- 4) AUTO.RECIRC
- 5) AUTO.VENT
- 6) AUTO.EALRPT
- 7) AUTO.DRAW
- 8) AUTO.EDC1Ø
- 9) AUTO.EDC6Ø
- 10) AUTO.HRINIT
- 11) AUTO.HRPAC1
- 12) AUTO.HRPAC2
- 13) AUTO.HRPAC3
- 14) AUTO.HRPAC4
- 15) AUTO.HRPAC5
- 16) AUTO.HRPAC6
- 17) AUTO.HRPAC7
- 18) AUTO.HRPAC8
- 19) AUTO.HRWARN
- 20) AUTO.EDCEND
- 21) AUTO.OPCHEK
- 22) AUTO.MET
- 23) AUTO.VENT
- 24) AUTO.PLOT1Ø
- 25) AUTO.PLOT6Ø
- 26) AUTO.FORCST
- 27) AUTO.ISODIS
- 28) AUTO.MASTER
- 29) AUTO.MINNEW
- 30) AUTO.SCALE1
- 31) AUTO.HOUNEW
- 32) AUTO.DOSLST
- 33) AUTO.FORLST
- 34) AUTO.BOOT
- 35) AUTO.PLOTDA
- 36) AUTO.HRSTOP



PLANT MANUAL SECTION:  
OFFSITE DOSE  
PROJECTIONS PROC.

PROCEDURE WORK PLAN TITLE:  
OFFSITE DOSE PROJECTIONS - GERMS  
COMPUTER GRAPHICS METHOD

NO:  
1904.01

## ARKANSAS NUCLEAR ONE

|          |    |      |          |
|----------|----|------|----------|
| PAGE     | 44 | of   | 62       |
| REVISION | 0  | DATE | 02/08/84 |
| CHANGE   |    | DATE |          |

### ATTACHMENT 3

#### FILES USED WITH PROCEDURE 1904.01

- 1) SCR.SØ (OR AUTO.SCR)
- 2) D.MIN2
- 3) D.MIN1Ø
- 4) D.HOUR
- 5) D.EAL2
- 6) D.EDCRRF
- 7) D.EDCDD
- 8) D.EDCDDH
- 9) D.EBRACQ
- 10) D.TRANS
- 11) D.VENTDD
- 12) D.EAL1Ø
- 13) D.CONST
- 14) EDC
- 15) HOURLY
- 16) D.EAL6Ø
- 17) PROJ
- 18) D.EAL1ØP
- 19) D.EDCDDP
- 20) FORCST
- 21) D.EALFOR
- 22) D.EDCDDF
- 23) D.METDD
- 24) D.NODATA
- 25) D.DAILY



# ARKANSAS NUCLEAR ONE

## ATTACHMENT 4

### PRINCIPLE BRANCHES WITHIN 1904.01

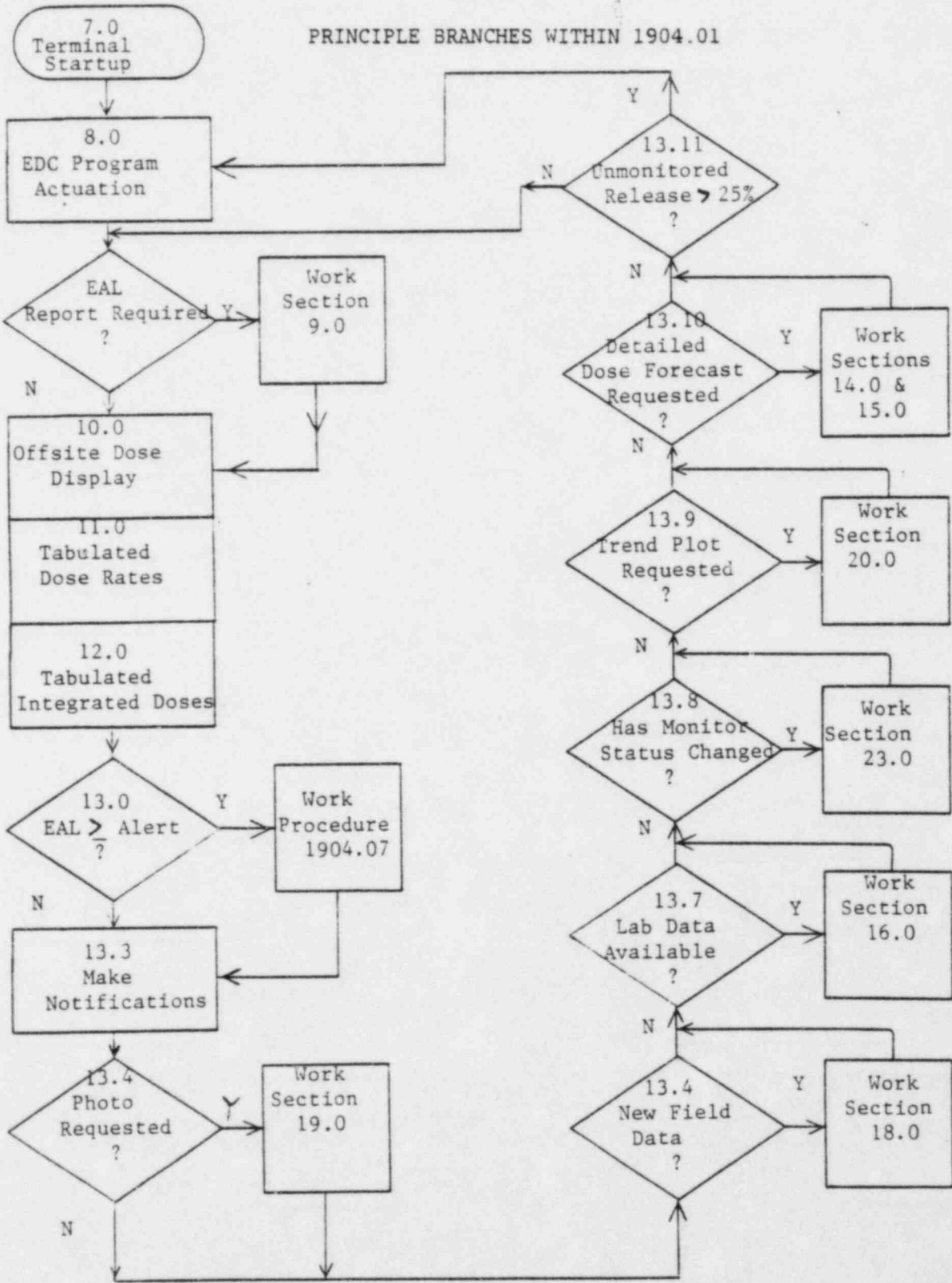



PLANT MANUAL SECTION:  
OFFSITE DOSE  
PROJECTIONS PROC.

PROCEDURE/WORK PLAN TITLE:  
OFFSITE DOSE PROJECTIONS - GERMS  
COMPUTER GRAPHICS METHOD

NO:  
1904.01

# ARKANSAS NUCLEAR ONE

PAGE 46 of 62  
REVISION 0 DATE 02/08/84  
CHANGE DATE

## ATTACHMENT 5

### DIAGRAM OF FLOPPY DISK SHOWING WRITE PROTECT NOTCH

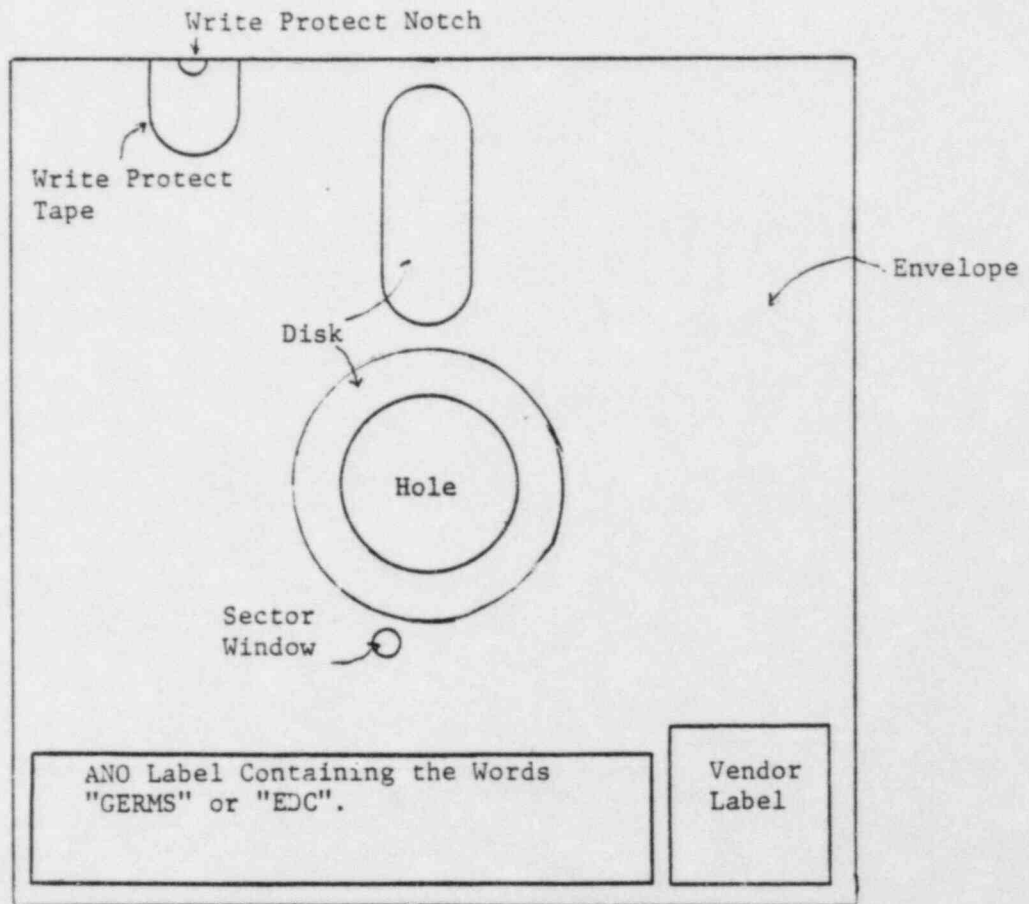



PLANT MANUAL SECTION:  
OFFSITE DOSE  
PROJECTIONS PROC.

PROCEDURE/WORK PLAN TITLE:  
OFFSITE DOSE PROJECTIONS - GERMS  
COMPUTER GRAPHICS METHOD

NO:  
1904.01

# ARKANSAS NUCLEAR ONE

PAGE 47 of 62  
REVISION 0 DATE 02/08/84  
CHANGE DATE



## ARKANSAS POWER & LIGHT COMPANY Arkansas Nuclear One

TITLE: STATUS CHANGE REPORT

FORM NO. 1904.01A

REV. # 0 PC #

| RELEASE POINT         | TIME FRAME | FLOW RATE (CFM) | PARTICULATE ( $\mu\text{Ci/cc}$ ) | IODINE ( $\mu\text{Ci/cc}$ ) | NOBLE GAS ( $\mu\text{Ci/cc}$ ) |
|-----------------------|------------|-----------------|-----------------------------------|------------------------------|---------------------------------|
| #001: ANO-1           | Previous   |                 |                                   |                              |                                 |
| CONT. PRG             | Current    |                 |                                   |                              |                                 |
| #002: ANO-1           | Previous   |                 |                                   |                              |                                 |
| RADWASTE              | Current    |                 |                                   |                              |                                 |
| #003: ANO-1           | Previous   |                 |                                   |                              |                                 |
| FUEL HD.              | Current    |                 |                                   |                              |                                 |
| #004: ANO-1           | Previous   |                 |                                   |                              |                                 |
| PEN/ $\text{H}_2$ PRG | Current    |                 |                                   |                              |                                 |
| #005: ANO-2           | Previous   |                 |                                   |                              |                                 |
| CONT. PRG             | Current    |                 |                                   |                              |                                 |
| #006: ANO-2           | Previous   |                 |                                   |                              |                                 |
| RADWASTE              | Current    |                 |                                   |                              |                                 |
| #007: ANO-2           | Previous   |                 |                                   |                              |                                 |
| FUEL HD.              | Current    |                 |                                   |                              |                                 |
| #008: ANO-2           | Previous   |                 |                                   |                              |                                 |
| PEN/ $\text{H}_2$ PRG | Current    |                 |                                   |                              |                                 |
| #009: ANO-C           | Previous   |                 |                                   |                              |                                 |
| PASS BLDG             | Current    |                 |                                   |                              |                                 |
| #010: ANO-2           | Previous   |                 |                                   |                              |                                 |
| AUX. BLDG. EXT        | Current    |                 |                                   |                              |                                 |
| UNMONITORED           |            |                 |                                   |                              |                                 |
| PATH                  | Current    | 2119            |                                   |                              |                                 |

Particulate (Ci/Sec)      Iodine (Ci/Sec)      Noble Gas (Ci/Sec)

Site Summary Data Date: \_\_\_\_\_

Current Monitored Totals: \_\_\_\_\_

Previous Monitored Totals: \_\_\_\_\_

Total Monitored Change: \_\_\_\_\_

% Change (+/-): \_\_\_\_\_

Circle One: Current Data Block (Is/Is Not) Complete

Performed By \_\_\_\_\_ /  
Initial/Date

Reviewed By \_\_\_\_\_





PLANT MANUAL SECTION:  
OFFSITE DOSE  
PROJECTIONS PROC.

PROCEDURE/WORK PLAN TITLE:  
OFFSITE DOSE PROJECTIONS - GERMS  
COMPUTER GRAPHICS METHOD

NO:  
1904.01

# ARKANSAS NUCLEAR ONE

PAGE 48 of 62  
REVISION 0 DATE 02/08/84  
CHANGE DATE



## ARKANSAS POWER & LIGHT COMPANY Arkansas Nuclear One

TITLE: "UNMONITORED" RELEASE SUMMARY

FORM NO. 1904.01B

REV. # 0 PC #

| Release Path                      | Qgas (1)<br>(Ci/sec) | Qiodine (2)<br>(Ci/sec) | Time Last<br>Measured |
|-----------------------------------|----------------------|-------------------------|-----------------------|
| 1/Containment Purge               |                      |                         |                       |
| 1/Radwaste Area                   |                      |                         |                       |
| 1/Fuel Hd. Area                   |                      |                         |                       |
| 1/Pen. Rm. & H <sub>2</sub> Purge |                      |                         |                       |
| 2/Containment Purge               |                      |                         |                       |
| 2/Radwaste                        |                      |                         |                       |
| 2/Fuel Hd. Area                   |                      |                         |                       |
| 2/Pen. Rm. & H <sub>2</sub> Purge |                      |                         |                       |
| PASS Bldg.                        |                      |                         |                       |
| 2/Aux. Bldg Ext.                  |                      |                         |                       |
| 1/Steam Releases                  |                      |                         |                       |
| 2/Steam Releases                  |                      |                         |                       |
| 1/Containment Leak                |                      |                         |                       |
| 2/Containment Leak                |                      |                         |                       |
| Other:                            |                      |                         |                       |
| Other:                            |                      |                         |                       |
| Other:                            |                      |                         |                       |
| Site Total                        | (Ci/sec)             | (Ci/sec)                |                       |

Updated GERMS CPU #1 \_\_\_\_\_  
Date/Time

Updated GERMS CPU #2 \_\_\_\_\_  
Date/Time

Performed By \_\_\_\_\_  
Initial/Date

Reviewed By \_\_\_\_\_

(1) Q<sub>gas</sub> (Ci/sec) = Noble Gas Concentration (µCi/cc) \* Flow Rate (CFM)/2119(CFM)  
(2) Q<sub>iodine</sub> (Ci/sec) = Iodine Concentration (µCi/cc) \* Flow Rate (CFM)/2119(CFM)



PLANT MANUAL SECTION:  
OFFSITE DOSE  
PROJECTIONS PROC.

PROCEDURE/WORK PLAN TITLE:  
OFFSITE DOSE PROJECTIONS - GERMS  
COMPUTER GRAPHICS METHOD

NO:  
1904.01

# ARKANSAS NUCLEAR ONE

PAGE 49 of 62  
REVISION 0 DATE 02/08/84  
CHANGE DATE



## ARKANSAS POWER & LIGHT COMPANY Arkansas Nuclear One

TITLE: CAL REPORT FORM NO. 1904.01C  
REV. # 0 PC #

| CALCULATED VALUES | UE | ALERT | SITE | GENERAL |
|-------------------|----|-------|------|---------|
|-------------------|----|-------|------|---------|

ASSUMING STANDARD X/Q = 4.00E-06

|                                      |       |       |       |       |
|--------------------------------------|-------|-------|-------|-------|
| MPC AT SITE BOUNDARY _____           | 1.0   | 10.0  | ***** | ***** |
| WHOLE BODY IMMERSION DOSE RATE _____ | ***** | ***** | ***** | ***** |
| CHILD THYROID DOSE RATE _____        | ***** | ***** | ***** | ***** |

ASSUMING CURRENT METEOROLOGICAL CONDITIONS

X/Q = \_\_\_\_\_  
X/Q DATE: \_\_\_\_\_

|                                      |       |       |       |       |
|--------------------------------------|-------|-------|-------|-------|
| MPC AT SITE BOUNDARY _____           | ***** | ***** | ***** | ***** |
| WHOLE BODY IMMERSION DOSE RATE _____ | ***** | ***** | 50.0  | 250.0 |
| CHILD THYROID DOSE RATE _____        | ***** | ***** | 150.0 | 500.0 |

HIGHEST LEVEL EXCEEDED USING RADIOLOGICAL CRITERIA: \_\_\_\_\_

Performed By \_\_\_\_\_ / \_\_\_\_\_  
Initial/Date

Reviewed By \_\_\_\_\_



PLANT MANUAL SECTION:  
OFFSITE DOSE  
PROJECTIONS PROC.

PROCEDURE/WORK PLAN TITLE:  
OFFSITE DOSE PROJECTIONS - GERMS  
COMPUTER GRAPHICS METHOD

NO:  
1904.01

# ARKANSAS NUCLEAR ONE

PAGE 50 OF 62  
REVISION 0 DATE 02/08/84  
CHANGE DATE



## ARKANSAS POWER & LIGHT COMPANY Arkansas Nuclear One

TITLE: OFFSITE DOSE MAP

FORM NO. 1904.01D

REV. # 0 PC #

Circle One: (Forecast/Real Time) Data

X/Q=4.0E-6

ACTUAL MET

Release Start: \_\_\_\_\_

EAL: \_\_\_\_\_

Plume Update: \_\_\_\_\_

MPC-Site-Bound: \_\_\_\_\_

Wind Speed: \_\_\_\_\_ Meters/Sec.

Whole Body: \_\_\_\_\_

Wind Direction: \_\_\_\_\_ Degrees

Thyroid (Child): \_\_\_\_\_

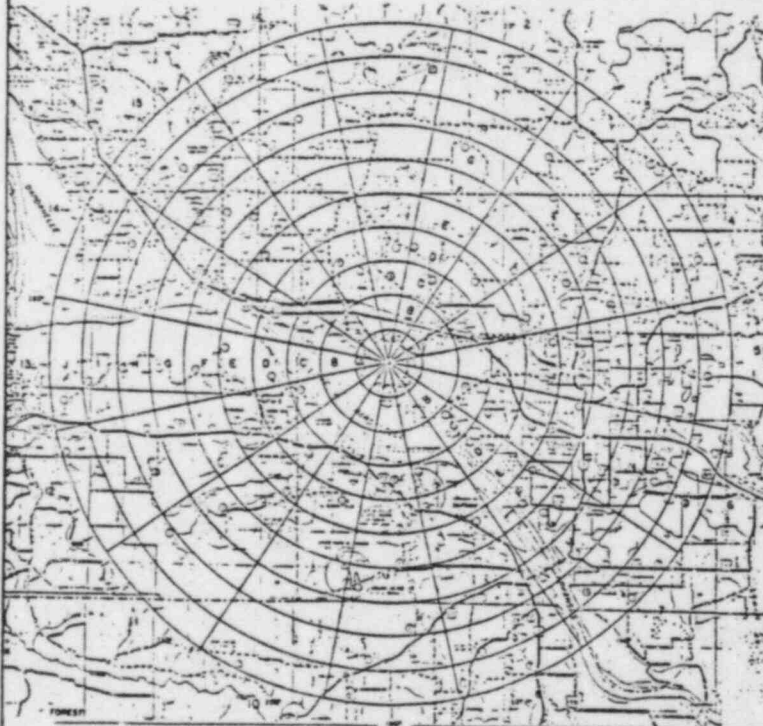

EDGE DOSE RATE:  
0.05  
MREM/HR

PLUME  
DOSE TYPE:  
IMMERSION

Xe-133 Equiv.:

Ci/Sec.

Xe-133 Equiv.:

µCi/cc

1.0 Affected Sectors (0.05 MREM/HR Immersion): \_\_\_\_\_

2.0 I-131 Equivalent Ci/sec: \_\_\_\_\_ µCi/cc: \_\_\_\_\_

3.0 Affected Sectors (0.05 MREM/HR Thyroid): \_\_\_\_\_

Performed By \_\_\_\_\_ /  
Initial/Date

Reviewed By \_\_\_\_\_



PLANT MANUAL SECTION:  
OFFSITE DOSE  
PROJECTIONS PROC.

PROCEDURE/WORK PLAN TITLE:  
OFFSITE DOSE PROJECTIONS - GERMS  
COMPUTER GRAPHICS METHOD

NO:  
1904.01

# ARKANSAS NUCLEAR ONE

PAGE 51 of 62  
REVISION 0 DATE 02/08/84  
CHANGE DATE



## ARKANSAS POWER & LIGHT COMPANY Arkansas Nuclear One

TITLE: DOSE RATES

FORM NO. 1904.01E

REV. # 0 PC #

PLUME UPDATE TIME: \_\_\_\_\_

Page 1 of 2

CIRCLE ONE: (FORECAST/REAL-TIME) DATA

### THYROID DOSE (COMMITMENT) RATES (MREM/HR)

| Sector # | 0.62 Miles | 1.45 Miles | 3.46 Miles | 7.25 Miles | 14.50 Miles | 34.60 Miles |
|----------|------------|------------|------------|------------|-------------|-------------|
| 1        |            |            |            |            |             |             |
| 2        |            |            |            |            |             |             |
| 3        |            |            |            |            |             |             |
| 4        |            |            |            |            |             |             |
| 5        |            |            |            |            |             |             |
| 6        |            |            |            |            |             |             |
| 7        |            |            |            |            |             |             |
| 8        |            |            |            |            |             |             |
| 9        |            |            |            |            |             |             |
| 10       |            |            |            |            |             |             |
| 11       |            |            |            |            |             |             |
| 12       |            |            |            |            |             |             |
| 13       |            |            |            |            |             |             |
| 14       |            |            |            |            |             |             |
| 15       |            |            |            |            |             |             |
| 16       |            |            |            |            |             |             |

Performed By \_\_\_\_\_ Initial/Date

Reviewed By \_\_\_\_\_



PLANT MANUAL SECTION:  
OFFSITE DOSE  
PROJECTIONS PROC.

PROCEDURE/WORK PLAN TITLE:  
OFFSITE DOSE PROJECTIONS - GERMS  
COMPUTER GRAPHICS METHOD

NO:  
1904.01

# ARKANSAS NUCLEAR ONE

PAGE 52 of 62  
REVISION 0 DATE 02/08/84  
CHANGE DATE



## ARKANSAS POWER & LIGHT COMPANY Arkansas Nuclear One

TITLE: DOSE RATES

FORM NO. 1904.01E

REV. # 0 PC #

PLUME UPDATE TIME: \_\_\_\_\_

Page 2 of 2

CIRCLE ONE: (FORECAST/REAL-TIME) DATA

### WHOLE BODY IMMERSION DOSE RATES (MREM/HR)

| Sector | 0.62<br>Miles | 1.45<br>Miles | 3.46<br>Miles | 7.25<br>Miles | 14.50<br>Miles | 34.60<br>Miles |
|--------|---------------|---------------|---------------|---------------|----------------|----------------|
| 1      |               |               |               |               |                |                |
| 2      |               |               |               |               |                |                |
| 3      |               |               |               |               |                |                |
| 4      |               |               |               |               |                |                |
| 5      |               |               |               |               |                |                |
| 6      |               |               |               |               |                |                |
| 7      |               |               |               |               |                |                |
| 8      |               |               |               |               |                |                |
| 9      |               |               |               |               |                |                |
| 10     |               |               |               |               |                |                |
| 11     |               |               |               |               |                |                |
| 12     |               |               |               |               |                |                |
| 13     |               |               |               |               |                |                |
| 14     |               |               |               |               |                |                |
| 15     |               |               |               |               |                |                |
| 16     |               |               |               |               |                |                |

Performed By \_\_\_\_\_ /  
Initial/Date

Reviewed By \_\_\_\_\_



PLANT MANUAL SECTION:  
OFFSITE DOSE  
PROJECTIONS PROC.

PROCEDURE/WORK PLAN TITLE:  
OFFSITE DOSE PROJECTIONS - GERMS  
COMPUTER GRAPHICS METHOD

NO:  
1904.01

# ARKANSAS NUCLEAR ONE

PAGE 53 of 62  
REVISION 0 DATE 02/08/84  
CHANGE DATE



## ARKANSAS POWER & LIGHT COMPANY Arkansas Nuclear One

TITLE: CUMULATIVE DOSES

FORM NO. 1904.01E

REV. # 0 PC #

PLUME UPDATE TIME: \_\_\_\_\_

Page 1 of 2

CIRCLE ONE: (FORECAST/REAL-TIME) DATA

### THYROID CUMULATIVE DOSE (MREM)

| Sector # | 0.62 Miles | 1.45 Miles | 3.46 Miles | 7.25 Miles | 14.50 Miles | 34.00 Miles |
|----------|------------|------------|------------|------------|-------------|-------------|
| 1        |            |            |            |            |             |             |
| 2        |            |            |            |            |             |             |
| 3        |            |            |            |            |             |             |
| 4        |            |            |            |            |             |             |
| 5        |            |            |            |            |             |             |
| 6        |            |            |            |            |             |             |
| 7        |            |            |            |            |             |             |
| 8        |            |            |            |            |             |             |
| 9        |            |            |            |            |             |             |
| 10       |            |            |            |            |             |             |
| 11       |            |            |            |            |             |             |
| 12       |            |            |            |            |             |             |
| 13       |            |            |            |            |             |             |
| 14       |            |            |            |            |             |             |
| 15       |            |            |            |            |             |             |
| 16       |            |            |            |            |             |             |

Performed By \_\_\_\_\_ /  
Initial/Date

Reviewed By \_\_\_\_\_



PLANT MANUAL SECTION:  
OFFSITE DOSE  
PROJECTIONS PROC.

PROCEDURE/WORK PLAN TITLE:  
OFFSITE DOSE PROJECTIONS - GERMS  
COMPUTER GRAPHICS METHOD

NO:  
1904.01

# ARKANSAS NUCLEAR ONE

PAGE 54 of 62  
REVISION 0 DATE 02/08/84  
CHANGE DATE



## ARKANSAS POWER & LIGHT COMPANY Arkansas Nuclear One

TITLE: CUMULATIVE DOSES

FORM NO. 1904.01F

REV. # 0 PC #

PLUME UPDATE TIME: \_\_\_\_\_

Page 2 of 2

CIRCLE ONE: (FORECAST/REAL-TIME) DATA

### WHOLE BODY IMMERSION CUMULATIVE DOSE (MREM)

| Sector # | 0.62 Miles | 1.45 Miles | 3.46 Miles | 7.25 Miles | 14.50 Miles | 34.00 Miles |
|----------|------------|------------|------------|------------|-------------|-------------|
| 1        |            |            |            |            |             |             |
| 2        |            |            |            |            |             |             |
| 3        |            |            |            |            |             |             |
| 4        |            |            |            |            |             |             |
| 5        |            |            |            |            |             |             |
| 6        |            |            |            |            |             |             |
| 7        |            |            |            |            |             |             |
| 8        |            |            |            |            |             |             |
| 9        |            |            |            |            |             |             |
| 10       |            |            |            |            |             |             |
| 11       |            |            |            |            |             |             |
| 12       |            |            |            |            |             |             |
| 13       |            |            |            |            |             |             |
| 14       |            |            |            |            |             |             |
| 15       |            |            |            |            |             |             |
| 16       |            |            |            |            |             |             |

Performed By \_\_\_\_\_ /  
Initial/Date

Reviewed By \_\_\_\_\_



PLANT MANUAL SECTION:  
OFFSITE DOSE  
PROJECTIONS PROC.

PROCEDURE/WORK PLAN TITLE:  
OFFSITE DOSE PROJECTIONS - GERMS  
COMPUTER GRAPHICS METHOD

NO:  
1904.01

# ARKANSAS NUCLEAR ONE

PAGE 55 of 62

REVISION 0 DATE 02/08/84

CHANGE DATE



## ARKANSAS POWER & LIGHT COMPANY Arkansas Nuclear One

TITLE TEST STATUS SUMMARY

FORM NO. 100-210

REV. # 0 PC #

Page 1 of 3

CMF DATA DATE/TIME:  
CMF NAME: TEN MINUTE CMF

RELEASE POINT #1  
UNIT 1 CONTAINMENT PURGE

| GROSS COUNT MONITORS | CONCENTRATION<br>MICROCURIES/CC | RELEASE RATE<br>CURIES/SEC |
|----------------------|---------------------------------|----------------------------|
| PARTICULATES         | _____                           | _____                      |
| IODINES              | _____                           | _____                      |
| NOBLE GASES          | _____                           | _____                      |
| FLOW RATE            | _____ CFM                       |                            |

RELEASE POINT #2  
UNIT 1 RADWASTE AREA

| GROSS COUNT MONITORS | CONCENTRATION<br>MICROCURIES/CC | RELEASE RATE<br>CURIES/SEC |
|----------------------|---------------------------------|----------------------------|
| PARTICULATES         | _____                           | _____                      |
| IODINES              | _____                           | _____                      |
| NOBLE GASES          | _____                           | _____                      |
| FLOW RATE            | _____ CFM                       |                            |

RELEASE POINT #3  
UNIT 1 FUEL HANDLING AREA

| GROSS COUNT MONITORS | CONCENTRATION<br>MICROCURIES/CC | RELEASE RATE<br>CURIES/SEC |
|----------------------|---------------------------------|----------------------------|
| PARTICULATES         | _____                           | _____                      |
| IODINES              | _____                           | _____                      |
| NOBLE GASES          | _____                           | _____                      |
| FLOW RATE            | _____ CFM                       |                            |

RELEASE POINT #4  
UNIT 1 EMERGENCY PENETRATION ROOM

| GROSS COUNT MONITORS | CONCENTRATION<br>MICROCURIES/CC | RELEASE RATE<br>CURIES/SEC |
|----------------------|---------------------------------|----------------------------|
| PARTICULATES         | _____                           | _____                      |
| IODINES              | _____                           | _____                      |
| NOBLE GASES          | _____                           | _____                      |
| FLOW RATE            | _____ CFM                       |                            |





PLANT MANUAL SECTION:  
OFFSITE DOSE  
PROJECTIONS PROC.

PROCEDURE WORK PLAN TITLE:  
OFFSITE DOSE PROJECTIONS - GERMS  
COMPUTER GRAPHICS METHOD

NO:  
1904.01

# ARKANSAS NUCLEAR ONE

PAGE 56 of 62

REVISION 0 DATE 02/08/84

CHANGE DATE



## ARKANSAS POWER & LIGHT COMPANY Arkansas Nuclear One

TITLE: UNIT STATUS SUMMARY

FORM NO. 1904.010

REV. # 0 PC #

Page 2 of 3

RELEASE POINT #5  
UNIT 2 CONTAINMENT PURGE

| GROSS COUNT MONITORS | CONCENTRATION<br>MICROCURIES/CC | RELEASE RATE<br>CURIES/SEC |
|----------------------|---------------------------------|----------------------------|
| PARTICULATES         | _____                           | _____                      |
| IODINES              | _____                           | _____                      |
| NOBLE GASES          | _____                           | _____                      |
| FLOW RATE            | _____ CFM                       |                            |

RELEASE POINT #6  
UNIT 2 RADWASTE AREA

| GROSS COUNT MONITORS | CONCENTRATION<br>MICROCURIES/CC | RELEASE RATE<br>CURIES/SEC |
|----------------------|---------------------------------|----------------------------|
| PARTICULATES         | _____                           | _____                      |
| IODINES              | _____                           | _____                      |
| NOBLE GASES          | _____                           | _____                      |
| FLOW RATE            | _____ CFM                       |                            |

RELEASE POINT #7  
UNIT 2 FUEL HANDLING AREA

| GROSS COUNT MONITORS | CONCENTRATION<br>MICROCURIES/CC | RELEASE RATE<br>CURIES/SEC |
|----------------------|---------------------------------|----------------------------|
| PARTICULATES         | _____                           | _____                      |
| IODINES              | _____                           | _____                      |
| NOBLE GASES          | _____                           | _____                      |
| FLOW RATE            | _____ CFM                       |                            |

RELEASE POINT #8  
UNIT 2 EMERGENCY PENETRATION ROOM

| GROSS COUNT MONITORS | CONCENTRATION<br>MICROCURIES/CC | RELEASE RATE<br>CURIES/SEC |
|----------------------|---------------------------------|----------------------------|
| PARTICULATES         | _____                           | _____                      |
| IODINES              | _____                           | _____                      |
| NOBLE GASES          | _____                           | _____                      |
| FLOW RATE            | _____ CFM                       |                            |



PLANT MANUAL SECTION:  
OFFSITE DOSE  
PROJECTIONS PROC.

PROCEDURE/WORK PLAN TITLE:  
OFFSITE DOSE PROJECTIONS - GERMS  
COMPUTER GRAPHICS METHOD

NO:  
1904.01

# ARKANSAS NUCLEAR ONE

PAGE 57 of 62  
REVISION 0 DATE 02/08/84  
CHANGE DATE



## ARKANSAS POWER & LIGHT COMPANY Arkansas Nuclear One

TITLE: VENT STATUS SUMMARY

FORM NO. 1904.010

REV. # 0 PC #

Page 3 of 3

RELEASE POINT #9  
UNIT 2 POST ACCIDENT SAMPLING BUILDING

| GROSS COUNT MONITORS | CONCENTRATION<br>MICROCURIES/CC | RELEASE RATE<br>CURIES/SEC |
|----------------------|---------------------------------|----------------------------|
| PARTICULATES         | _____                           | _____                      |
| IODINES              | _____                           | _____                      |
| NOBLE GASES          | _____                           | _____                      |
| FLOW RATE            | _____ CFM                       |                            |

RELEASE POINT #10  
UNIT 2 AUX BUILDING EXTENSION

| GROSS COUNT MONITORS | CONCENTRATION<br>MICROCURIES/CC | RELEASE RATE<br>CURIES/SEC |
|----------------------|---------------------------------|----------------------------|
| PARTICULATES         | _____                           | _____                      |
| IODINES              | _____                           | _____                      |
| NOBLE GASES          | _____                           | _____                      |
| FLOW RATE            | _____ CFM                       |                            |

RELEASE POINT #11  
SITE TOTAL UNMONITORED PATHWAYS

| GROSS COUNT MONITORS | CONCENTRATION<br>MICROCURIES/CC | RELEASE RATE<br>CURIES/SEC |
|----------------------|---------------------------------|----------------------------|
| PARTICULATES         | _____                           | _____                      |
| IODINES              | _____                           | _____                      |
| NOBLE GASES          | _____                           | _____                      |
| FLOW RATE            | _____ CFM                       |                            |

TOTAL SITE RELEASE

|              | RELEASE RATE<br>CURIES/SEC |
|--------------|----------------------------|
| PARTICULATES | _____                      |
| IODINES      | _____                      |
| NOBLE GASES  | _____                      |



PLANT MANUAL SECTION:  
OFFSITE DOSE  
PROJECTIONS PROC.

PROCEDURE WORK PLAN TITLE:  
OFFSITE DOSE PROJECTIONS - GERMS  
COMPUTER GRAPHICS METHOD

NO:  
1904.01

# ARKANSAS NUCLEAR ONE

PAGE 58 of 62  
REVISION 0 DATE 02/08/84  
CHANGE DATE



## ARKANSAS POWER & LIGHT COMPANY Arkansas Nuclear One

TITLE: FORECASTING WORKSHEET

FORM NO. 1904.01H

REV. # PC #

### HOURLY SUMMARY

|                                      |  |  |  |  |  |  |  |  |  |  |  |  |  |  |  |  |  |  |  |  |
|--------------------------------------|--|--|--|--|--|--|--|--|--|--|--|--|--|--|--|--|--|--|--|--|
| 1a. Time Frame: From                 |  |  |  |  |  |  |  |  |  |  |  |  |  |  |  |  |  |  |  |  |
| 1b. Time Frame: To                   |  |  |  |  |  |  |  |  |  |  |  |  |  |  |  |  |  |  |  |  |
| 2. Noble Gas Release Rate (Ci/sec)   |  |  |  |  |  |  |  |  |  |  |  |  |  |  |  |  |  |  |  |  |
| 3. Iodine Release Rate (Ci/sec)      |  |  |  |  |  |  |  |  |  |  |  |  |  |  |  |  |  |  |  |  |
| 4. Particulate Release Rate (Ci/sec) |  |  |  |  |  |  |  |  |  |  |  |  |  |  |  |  |  |  |  |  |
| 5. Cloud Cover                       |  |  |  |  |  |  |  |  |  |  |  |  |  |  |  |  |  |  |  |  |
| 6. Stability Class                   |  |  |  |  |  |  |  |  |  |  |  |  |  |  |  |  |  |  |  |  |
| 7. Wind Speed (MPH)                  |  |  |  |  |  |  |  |  |  |  |  |  |  |  |  |  |  |  |  |  |
| 8a. Wind Direction (from, Deg.)      |  |  |  |  |  |  |  |  |  |  |  |  |  |  |  |  |  |  |  |  |

### TIME BLOCK SUMMARY

|                                     |  |  |  |  |  |  |  |  |  |  |  |  |  |  |  |  |  |  |  |  |
|-------------------------------------|--|--|--|--|--|--|--|--|--|--|--|--|--|--|--|--|--|--|--|--|
| 9a. Time Frame: From                |  |  |  |  |  |  |  |  |  |  |  |  |  |  |  |  |  |  |  |  |
| 9b. Time Frame: To                  |  |  |  |  |  |  |  |  |  |  |  |  |  |  |  |  |  |  |  |  |
| 10. Duration (Minutes)              |  |  |  |  |  |  |  |  |  |  |  |  |  |  |  |  |  |  |  |  |
| 11. Noble Gas Release Rate (Ci/sec) |  |  |  |  |  |  |  |  |  |  |  |  |  |  |  |  |  |  |  |  |
| 12. Iodine Release Rate (Ci/sec)    |  |  |  |  |  |  |  |  |  |  |  |  |  |  |  |  |  |  |  |  |
| 13. Part. Release Rate (Ci/sec)     |  |  |  |  |  |  |  |  |  |  |  |  |  |  |  |  |  |  |  |  |
| 14. Stability Class                 |  |  |  |  |  |  |  |  |  |  |  |  |  |  |  |  |  |  |  |  |
| 15. Wind Speed (meters/sec.)*       |  |  |  |  |  |  |  |  |  |  |  |  |  |  |  |  |  |  |  |  |
| 16. Wind Direction (from, Deg.)     |  |  |  |  |  |  |  |  |  |  |  |  |  |  |  |  |  |  |  |  |

Current Weather Forecast: \_\_\_\_\_  
 \_\_\_\_\_  
 \_\_\_\_\_

\*NOTE: Windspeed in meters/sec = wind speed in MPH times 0.447.

Performed By \_\_\_\_\_ / \_\_\_\_\_  
 Initial/Date

Reviewed By \_\_\_\_\_



PLANT MANUAL SECTION:  
OFFSITE DOSE  
PROJECTIONS PROC.

PROCEDURE WORK PLAN TITLE:  
OFFSITE DOSE PROJECTIONS - GERMS  
COMPUTER GRAPHICS METHOD

NO:  
1904.01

# ARKANSAS NUCLEAR ONE

PAGE 59 of 62  
REVISION 0 DATE 02/08/84  
CHANGE DATE



## ARKANSAS POWER & LIGHT COMPANY Arkansas Nuclear One

TITLE: EVACUATION START TIME WORKSHEET

FORM NO. 1904.01F  
REV. # 0 PC #

Page 1 of 3

1.0 If any child thyroid cumulative dose for the forecast time block exceeds 5000 mRem on Form 1904.01F, use the child thyroid data from forms 1904.01E and F to complete the following table:

|  | <u>Child Thyroid</u>                         |
|--|--|
| 1.1 Worst Sector #                       | _____  |
| 1.2 Worst Radius (mi)                    | _____  |
| 1.3 Forecast Worst Dose (mRem)           | _____  |
| 1.4 Line 1.3 - 5000 (mRem)               | = _____                                      |
| 1.5 Forecast Dose Rate (mRem/hr)         | _____  |
| 1.6 Line 1.4 ÷ Line 1.5 (hours)          | = _____                                      |
| 1.7 Time Block end Time (hours from now) | _____  |
| 1.8 Line 1.7 - Line 1.6 (hours)          | = _____                                      |
|  | [time before exceedance<br>of Iodine P.A.G.] |

2.0 If any whole body cumulative dose for the forecast time block exceeds 1000 mRem on Form 1904.01F, use the whole body data from Forms 1904.01E and 1904.01F to complete the following table:

|  | <u>Whole Body</u>                                |
|--|--|
| 2.1 Worst Sector #                       | _____  |
| 2.2 Worst Radius (mi)                    | _____  |
| 2.3 Forecast Worst Dose (mRem)           | _____  |
| 2.4 Line 2.3 - 1000 (mRem)               | = _____  |
| 2.5 Forecast Dose Rate (mRem/hr)         | _____  |
| 2.6 Line 2.4 ÷ Line 2.5 (hours)          | = _____  |
| 2.7 Time Block end Time (hours from now) | _____  |
| 2.8 Line 2.7 - Line 2.6 (hours)          | = _____  |
|  | [time before exceedance<br>of Whole Body P.A.G.] |



PLANT MANUAL SECTION:  
OFFSITE DOSE  
PROJECTIONS PROC.

PROCEDURE WORK PLAN TITLE:  
OFFSITE DOSE PROJECTIONS - GERMS  
COMPUTER GRAPHICS METHOD

NO:  
1904.01

# ARKANSAS NUCLEAR ONE

PAGE 60 of 62  
REVISION 0 DATE 02/08/84  
CHANGE DATE



## ARKANSAS POWER & LIGHT COMPANY Arkansas Nuclear One

TITLE: EVACUATION START TIME WORKSHEET

FORM NO. 1904.01F

REV. # 0 PC #

Page 2 of 3

- 3.0 Record the smaller of Line 1.8 or Line 2.8 here: \_\_\_\_\_  
(PAG exceedance time in hours)
- 4.0 Based upon Form 1904.01F for the forecast time block, check the sectors in the following list which have cumulative doses greater than 5000 mRem child thyroid or 1000 mRem whole body. For each sector checked, list the largest radius with a dose rate above the limits.

| Affected Sector             | Maximum Radius (mi) | Evacuation Zone | Evacuation and Clear Times (Hours) |                      |                                |                                   |
|-----------------------------|---------------------|-----------------|------------------------------------|----------------------|--------------------------------|-----------------------------------|
|                             |                     |                 | (6AM-5PM) Weekday                  | (5PM-6AM) Week Night | (5PM Fri. to 6AM Mon.) Weekend | Adverse Road Conditions (Weekday) |
| <input type="checkbox"/> 1  |                     | London          | 5.7                                | 5.6                  | 5.7                            | 6.3                               |
| <input type="checkbox"/> 2  |                     | Russellville    | 6.8                                | 6.0                  | 8.4                            | 8.1                               |
| <input type="checkbox"/> 3  |                     | Russellville    | 6.8                                | 6.0                  | 8.4                            | 8.1                               |
| <input type="checkbox"/> 4  |                     | Russellville    | 6.8                                | 6.0                  | 8.4                            | 8.1                               |
| <input type="checkbox"/> 5  |                     | Russellville    | 6.8                                | 6.0                  | 8.4                            | 8.1                               |
| <input type="checkbox"/> 6  |                     | Russellville    | 6.8                                | 6.0                  | 8.4                            | 8.1                               |
| <input type="checkbox"/> 7  |                     | Russellville    | 6.8                                | 6.0                  | 8.4                            | 8.1                               |
| <input type="checkbox"/> 8  |                     | Dardanelle      | 5.1                                | 5.1                  | 5.6                            | 5.1                               |
| <input type="checkbox"/> 9  |                     | Dardanelle      | 5.1                                | 5.1                  | 5.6                            | 5.1                               |
| <input type="checkbox"/> 10 |                     | Dardanelle      | 5.1                                | 5.1                  | 5.6                            | 5.1                               |
| <input type="checkbox"/> 11 |                     | Delaware        | 5.1                                | 5.1                  | 5.1                            | 5.1                               |
| <input type="checkbox"/> 12 |                     | Delaware        | 5.1                                | 5.1                  | 5.1                            | 5.1                               |
| <input type="checkbox"/> 13 |                     | Delaware        | 5.1                                | 5.1                  | 5.1                            | 5.1                               |
| <input type="checkbox"/> 14 |                     | London          | 5.7                                | 5.6                  | 5.7                            | 6.3                               |
| <input type="checkbox"/> 15 |                     | London          | 5.7                                | 5.6                  | 5.7                            | 6.3                               |
| <input type="checkbox"/> 16 |                     | London          | 5.7                                | 5.6                  | 5.7                            | 6.3                               |



PLANT MANUAL SECTION:  
OFFSITE DOSE  
PROJECTIONS PROC.

PROCEDURE/WORK PLAN TITLE:  
OFFSITE DOSE PROJECTIONS - GERMS  
COMPUTER GRAPHICS METHOD

NO:  
1904.01

# ARKANSAS NUCLEAR ONE

|          |                 |
|----------|-----------------|
| PAGE     | 61 of 62        |
| REVISION | 0 DATE 02/08/84 |
| CHANGE   | DATE            |



## ARKANSAS POWER & LIGHT COMPANY Arkansas Nuclear One

|  |                   |
|--|-------------------|
| TITLE: EVACUATION START TIME WORKSHEET | FORM NO. 1904.011 |
|  | REV. # 0 PC #     |

Page 3 of 3

- 5.0 Circle the evacuation and clear time column in the table above which corresponds to forecast conditions at the PAG exceedance time [Line 3.0].
- 6.0 Record the highest evacuation and clear time from the circled column for the affected sectors checked in Part 4.0 above: \_\_\_\_\_ (hours).
- 7.0 Last evacuation start time = \_\_\_\_\_ hours from present.  
[Line 3.0 - Line 6.0]
- 8.0 Return to procedure step 16.3.

Performed By \_\_\_\_\_  
Initial/Date

Reviewed By \_\_\_\_\_



PROCEDURE #1904.02 REV. 2

Not Good Till

3/1/84





# ARKANSAS POWER & LIGHT COMPANY

## Arkansas Nuclear One

TITLE: RECORD OF CHANGES AND REVISIONS

FORM NO. 1000.06A

OFFSITE DOSE PROJECTIONS - POCKET COMPUTER METHOD

REV. #12 PC #

OFFSITE DOSE PROJECTIONS - POCKET COMPUTER METHOD  
1904.02 REV. 2

Safety Related YES  NO

Safety Related

UN-Controlled Copy # 103

| PAGE | REV | PC# | PAGE | REV | PC# | PAGE | REV | PC# | PAGE | REV | PC# |
|------|-----|-----|------|-----|-----|------|-----|-----|------|-----|-----|
| 1    | 2   |     |      |     |     |      |     |     |      |     |     |
| 2    | 2   |     |      |     |     |      |     |     |      |     |     |
| 3    | 2   |     |      |     |     |      |     |     |      |     |     |
| 4    | 2   |     |      |     |     |      |     |     |      |     |     |
| 5    | 2   |     |      |     |     |      |     |     |      |     |     |
| 6    | 2   |     |      |     |     |      |     |     |      |     |     |
| 7    | 2   |     |      |     |     |      |     |     |      |     |     |
| 8    | 2   |     |      |     |     |      |     |     |      |     |     |
| 9    | 2   |     |      |     |     |      |     |     |      |     |     |
| 10   | 2   |     |      |     |     |      |     |     |      |     |     |
| 11   | 2   |     |      |     |     |      |     |     |      |     |     |
| 12   | 2   |     |      |     |     |      |     |     |      |     |     |
| 13   | 2   |     |      |     |     |      |     |     |      |     |     |
| 14   | 2   |     |      |     |     |      |     |     |      |     |     |
| 15   | 2   |     |      |     |     |      |     |     |      |     |     |
| 16   | 2   |     |      |     |     |      |     |     |      |     |     |
| 17   | 2   |     |      |     |     |      |     |     |      |     |     |
| 18   | 2   |     |      |     |     |      |     |     |      |     |     |
| 19   | 2   |     |      |     |     |      |     |     |      |     |     |
| 20   | 2   |     |      |     |     |      |     |     |      |     |     |
| 21   | 2   |     |      |     |     |      |     |     |      |     |     |
| 22   | 2   |     |      |     |     |      |     |     |      |     |     |
| 23   | 2   |     |      |     |     |      |     |     |      |     |     |
| 24   | 2   |     |      |     |     |      |     |     |      |     |     |
| 25   | 2   |     |      |     |     |      |     |     |      |     |     |
| 26   | 2   |     |      |     |     |      |     |     |      |     |     |
| 27   | 2   |     |      |     |     |      |     |     |      |     |     |
| 28   | 2   |     |      |     |     |      |     |     |      |     |     |
| 29   | 2   |     |      |     |     |      |     |     |      |     |     |
| 30   | 2   |     |      |     |     |      |     |     |      |     |     |
| 31   | 2   |     |      |     |     |      |     |     |      |     |     |
| 32   | 2   |     |      |     |     |      |     |     |      |     |     |
| 33   | 2   |     |      |     |     |      |     |     |      |     |     |
| 34   | 2   |     |      |     |     |      |     |     |      |     |     |

APPROVED BY:

James M. Lewis

---

(General Manager)

APPROVAL DATE

2/27/84

REQUIRED/EFFECTIVE DATE:

3-1-84



PLANT MANUAL SECTION:  
OFFSITE DOSE  
PROJECTIONS

PROCEDURE/WORK PLAN TITLE:  
OFFSITE DOSE PROJECTIONS -  
POCKET COMPUTER METHOD

NO:  
1904.02

## ARKANSAS NUCLEAR ONE

|          |         |      |          |
|----------|---------|------|----------|
| PAGE     | 1 OF 34 |      |          |
| REVISION | 2       | DATE | 02/07/84 |
| CHANGE   |         | DATE |          |

### 1.0 PURPOSE

The purpose of this procedure is to provide an initial estimate of the radiological conditions at the ANO Exclusion Area Boundary, provide information to determine the Emergency Action Level, define the offsite area(s) potentially affected by an airborne radiological release, provide an estimate of the whole body and child thyroid dose rates and refine projections based on available field monitoring data, using a hand-held computer to perform the necessary calculations.

### 2.0 SCOPE

- 2.1 This procedure is applicable to airborne radioactive releases from ANO, Units One and Two as indicated by the ventilation system stack monitors (i.e. the SPING monitors of the GERM System).
- 2.2 If the monitors are off scale, refer to 1904.03, "Auxiliary Building Ventilation Exhaust Emergency Radiation Monitor".
- 2.3 This procedure does not take into account effects caused by precipitation.
- 2.4 To use the LFE Trapelo or Westinghouse effluent monitors, (normal range monitors) refer to procedure 1904.04 "Estimating Airborne Release Rates".
- 2.5 If releases are occurring from steam vents or from an unmonitored release point, determine the release rates by procedure 1904.04, "Estimating Airborne Release Rates".

### 3.0 REFERENCES

#### 3.1 References Used in Procedure Preparation:

- 3.1.1 Arkansas Nuclear One Emergency Plan
- 3.1.2 "Manual for Protective Actions, Appendix D", Environmental Protection Agency
- 3.1.3 "Workbook of Atmospheric Dispersion Estimates", U.S. Department of Health, Education and Welfare
- 3.1.4 Memoranda Numbers CL-1460, CL-1571, CL-1735, and CL-2115 (By A. L. Smith)
- 3.1.5 Radio Shack TRS-80 Pocket Computer User's Manual
- 3.1.6 Radio Shack Minisette-9 Owner's Manual

#### 3.2 References Used in Conjunction with this Procedure:

- 3.2.1 1903.10, "Emergency Action Level Response"



PLANT MANUAL SECTION:  
OFFSITE DOSE  
PROJECTIONS

PROCEDURE WORK PLAN TITLE:  
OFFSITE DOSE PROJECTIONS -  
POCKET COMPUTER METHOD

NO:  
1904.02

## ARKANSAS NUCLEAR ONE

|          |   |      |          |
|----------|---|------|----------|
| PAGE     | 2 | OF   | 34       |
| REVISION | 2 | DATE | 02/07/84 |
| CHANGE   |   | DATE |          |

- 3.2.2 1903.43, "Duties of the Emergency Radiation Team"
- 3.2.3 1904.01, "Offsite Dose Projections - GERMS Computer Graphics Method"
- 3.2.4 1904.03, "Auxiliary Building Ventilation Exhaust Emergency Radiation Monitor"
- 3.2.5 1904.04, "Estimating Airborne Release Rates"
- 3.2.6 1904.05, "Atmospheric Stability Class Determination"
- 3.2.7 1904.06, "Radiological Plume Tracking and Dose Intergration"
- 3.2.8 1904.07, "Protective Action Recommendations"
- 3.2.9 1904.08, "Use of the WSI Weather Information Service"

### 3.3 Related ANO References:

None

### 4.0 DEFINITIONS

- 4.1  $\sigma\theta$  (sigma theta) - The standard deviation (net change) of the horizontal wind direction over time.
- 4.2  $\Delta t$  (delta t) - The vertical temperature differential between the upper and lower temperature sensors on the meteorological tower (in degrees Centigrade).
- 4.3  $X/Q$  - The ratio of the concentration of radioactive material (at a specific location) to the release rate (at the origin) in units of  $\mu\text{Ci}/\text{cc}/\text{Ci}/\text{sec}$  which is equivalent to units of  $\text{secs}/\text{m}^3$ .
- 4.4 [] - Brackets represent a labeled computer button.
- 4.5 Abbreviations
  - 4.5.1 C.T. = Child Thyroid Dose Rate
  - 4.5.2 W.B. = Whole Body Dose Rate
  - 4.5.3 OK = "Non-radiological" Incident
  - 4.5.4 DEF = Define Mode
  - 4.5.5 PRO = Program Mode
  - 4.5.6 RES = Reserve Mode



PLANT MANUAL SECTION:  
OFFSITE DOSE  
PROJECTIONS

PROCEDURE/WORK PLAN TITLE:  
OFFSITE DOSE PROJECTIONS -  
POCKET COMPUTER METHOD

NO:  
1904.02

## ARKANSAS NUCLEAR ONE

PAGE 3 OF 34  
REVISION 2 DATE 02/07/84  
CHANGE DATE

### 5.0 RESPONSIBILITIES

- 5.1 The Shift Operations Supervisor is responsible for determining if an unplanned gaseous release to the environment is indicated by symptoms such as high stack monitor readings, area radiation monitor alarms or other indications.
- 5.2 The Duty Emergency Coordinator, or his designee, is responsible for performing the magnitude of release calculations.
- 5.3 The Shift Operations Supervisor/Duty Emergency Coordinator is responsible for notifying appropriate groups per 1903.10, "Emergency Action Level Response".
- 5.4 The Offsite Radiological Monitoring Section of the Emergency Radiation Team is responsible for measuring offsite radiological hazards per 1903.43, "Duties of the Emergency Radiation Team".

### 6.0 LIMITS AND PRECAUTIONS

- 6.1 This procedure provides an initial projection of the radiological conditions; field monitoring is necessary to determine the actual conditions.
- 6.2 Actual terrain and weather conditions will generally limit the accuracy of the projected doses at a specific location.
- 6.3 The diffusion overlays used in this procedure represent long-term average conditions for a ground level release.
- 6.4 When performing manual or programmed calculations, the computer should be in the RUN Mode.
- 6.5 When entering data in scientific notation (E-Format), be sure to use [EXP] key, rather than the [E] key. Otherwise, spurious data will result.

### 7.0 DETERMINATION OF EXISTING METEOROLOGICAL CONDITIONS

NOTE: Use Par. 7.1, 7.2 or 7.3 for the determination of meteorological conditions.

- 7.1 Site meteorological data may be obtained at the TSC, ECC, or other locations from GERMS (chromatics) terminals.
  - 7.1.1 Start the terminal, establish contact with a GERMS ND6650, and sign-on as a general display user as described in Procedure 1904.01, Section 7.0.
  - 7.1.2 Type "JOB AUTO.MET,,,TTY[Return]". A display of the most recent "data date" and the corresponding data will appear. If "INVALID DATA" messages occur, the data is not stored in the GERMS computers. In this case, exit the program with a series of carriage returns and resort to Step 7.2.



PLANT MANUAL SECTION:  
OFFSITE DOSE  
PROJECTIONS

PROCEDURE/WORK PLAN TITLE:  
OFFSITE DOSE PROJECTIONS -  
POCKET COMPUTER METHOD

NO:  
1904.02

## ARKANSAS NUCLEAR ONE

PAGE 4 OF 34  
REVISION 2 DATE 02/07/84  
CHANGE DATE

- 7.2 Recorders WDR 9300, WSR 9300, and AAR 9300 may also be used to obtain meteorological data from control room locations.
- 7.3 If the on-site meteorological system is out of service, limited meteorological data may be obtained from the following sources.
- 7.3.1 The WSI weather information service, Procedure 1904.08.
- 7.3.2 National Weather Service (Meteorologist-in-Charge) [834-0308 or •834-3955•]
- 7.3.3 KARV Radio (968-1184)
- 7.3.4 MSS Dispatcher •536-6935• - Request data for Arkansas Zone five.
- 7.3.5 The stability category may be calculated from causative factors (see procedure 1904.05, "Atmospheric Stability Class Determination").
- 7.4 Enter data on Form 1904.02A to record the current meteorological conditions.
- 7.4.1 If data is obtained from GERMS, convert wind speed from m/sec to mph ( $m/sec \times 2.238 = mph$ ), then enter on Form A.

### 8.0 DETERMINATION OF THE AIRBORNE RELEASE PATHS

NOTE: If the GERMS detectors are out of service for a normal release path which is discharging substantial amounts of radioactive material, refer to procedure 1904.04 "Estimating Airborne Release Rates".

#### 8.1 Normal Release Paths:

- 8.1.1 At the Eberline Control Terminal (CT), insert the key into the "keyboard" switch and activate the control terminal.
- 8.1.2 Set the History Format select knob to "Release Rate."
- 8.1.3 Depress the [PRINT], then the [FILE], then the [1] and then the [ENTER] pushbuttons. A printout with the "10-minute" averaged release rates for each SPING will appear followed by the Site Total Release Rates.
- 8.1.4 Record the radioactive iodine and noble gas release data as indicated on the Eberline CT-2 printout for each of the SPING monitors that are in service on Form 1904.02B. (For purposes of this procedure, disregard the particulate channel). Any negative values should be entered as zero. Record the noble gas data from the lowest range channel which gives valid, onscale data. Data is valid if either "NORMAL" or any of the following alarms are displayed beside each parameter. If other alarms are displayed, the channel should not be considered valid.



PLANT MANUAL SECTION:  
OFFSITE DOSE  
PROJECTIONS

PROCEDURE/WORK PLAN TITLE:  
OFFSITE DOSE PROJECTIONS -  
POCKET COMPUTER METHOD

NO:

1904.02

## ARKANSAS NUCLEAR ONE

PAGE 5 of 34

REVISION 2 DATE 02/07/84

CHANGE DATE

"TND ALM" (Trend Alarm)  
"ALT ALM" (Alert Alarm)  
"HI ALM" (High Radiation Alarm)

- 8.1.5 Record the site total release rates for noble gas (using the lowest numbered channel with valid data) and iodine that appears at the bottom of the CT-2 printout.

NOTE: If the sping noble gas data was not all taken using the same noble gas monitor range (i.e., low, med. or high), then the site total noble gas release rate must be calculated by hand.

### 8.2 Unmonitored Release Paths:

- 8.2.1 If a release is occurring from an unmonitored location and field monitoring data is not available, refer to procedure 1904.04 "Estimating Airborne Release Rates", and enter the estimated release rates on Form 1904.02B as "Other Releases".
- 8.2.2 If field monitoring data is available, complete sections 9.0, 10.0, and 12.0 using assumed initial release rates of 1.0 Ci/sec. for both iodines and noble gases. The scale factors determined in section 12.0 can then be used with the assumed release rates to produce relatively accurate offsite dose projections by repeating procedure sections 9.0 and 10.0.

### 9.0 DETERMINATION OF DOSE RATES AND MAXIMUM PERMISSIBLE CONCENTRATION

- 9.1 Obtain the computer, overlays and map from the appropriate emergency kit:
- 9.1.1 Control Room
  - 9.1.2 Technical Support Center
  - 9.1.3 Emergency Control Center
- 9.2 Complete Form 1904.02A through step 5.0 to determine the following information:
- 9.2.1 Whole body dose rate at the indicated distances.
  - 9.2.2 Child thyroid dose rate at the indicated distances.
  - 9.2.3 The ratio of the projected to the maximum permissible concentration of Xe-133 at the site boundary, assuming "annual average" meteorology.
- 9.3 If an Emergency Action Level is NOT indicated, return to Section 7.0. New data should be taken as specified by the Duty Emergency Coordinator or the Dose Assessment Supervisor.



PLANT MANUAL SECTION:  
OFFSITE DOSE  
PROJECTIONS

PROCEDURE/WORK PLAN TITLE:  
OFFSITE DOSE PROJECTIONS -  
POCKET COMPUTER METHOD

NO:  
1904.02

## ARKANSAS NUCLEAR ONE

|          |         |      |          |
|----------|---------|------|----------|
| PAGE     | 6 of 34 |      |          |
| REVISION | 2       | DATE | 02/07/84 |
| CHANGE   |         | DATE |          |

### 10.0 PLUME DEFINITION

NOTE: The attachments contained in this procedure are provided for ILLUSTRATION ONLY. The correctly scaled overlays and maps are located in the emergency kits.

- 10.1 Select the overlay (Attachments 1-7) which corresponds to the existing atmospheric stability category (Form 1904.02A).
- 10.2 Place the selected overlay on the ANO area map (Attachment 8) with the origin directly over the ANO site center and align the plume centerline with the downwind direction (from Form 1904.02A).
- 10.3 To locate the plume boundary line on the overlay, obtain the plume bounding X/Q from Form 1904.02A Section 4.0 and determine its location on the appropriate overlay. If the bounding X/Q falls between two existing X/Q lines on the overlay, select the outward of the two lines as the plume boundary. Any sub-sectors which are contained (or partially contained) with the plume boundary line should be designated as affected. Record this information on Section 6.0 of Form 1904.02A.
  - 10.3.1 Account for the uncertainty in the local wind near Mt. Nebo/Spring Mountain:
    - A. If the plume centerline lies in sector 10 and the plume boundary extends beyond 6 miles, the affected area should also include sectors 9, 10 and 11 (from sub-sector G to the projected extent of the plume).
    - B. If the plume centerline lies in sector 11 and the plume boundary extends beyond 6 miles, the affected area should also include sectors 10, 11 and 12 (from sub-sector G to the projected extent of the plume).

### 11.0 NOTIFICATIONS AND PROTECTIVE ACTION RECOMMENDATIONS

- 11.1 If an Unusual Event, Alert, or Site Emergency has been declared, proceed directly to Section 11.2. If a General Emergency has been declared, make the following recommendation to the Arkansas Department of Health:
  - 11.1.1 As a minimum, recommend sheltering within a 2-mile radius of the plant and 5 miles in the downwind direction.
  - 11.1.2 In order to select the appropriate protective action, State officials should be given an estimate of the expected release duration. This is especially important if the release duration is expected to be less than 2 hours (puff releases).



PLANT MANUAL SECTION:  
OFFSITE DOSE  
PROJECTIONS

PROCEDURE/WORK PLAN TITLE:  
OFFSITE DOSE PROJECTIONS -  
POCKET COMPUTER METHOD

NO:  
1904.02

## ARKANSAS NUCLEAR ONE

|          |         |      |          |
|----------|---------|------|----------|
| PAGE     | 7 of 34 |      |          |
| REVISION | 2       | DATE | 02/07/84 |
| CHANGE   |         | DATE |          |

11.1.3 Upon activation of the TSC/ECC, additional protective action recommendations should be evaluated using procedure 1904.07, "Protective Action Recommendations". These evaluations should be made under the supervision of the Technical Analysis Superintendent and/or the Dose Assessment Supervisor.

11.2 Provide radiological release information to appropriate groups per 1903.10, "Emergency Action Level Response".

11.3 The Emergency Radiation Team shall be dispatched to obtain field radiological data whenever an Emergency Action Level has been declared based on offsite radiological releases. If the Emergency Radiation Team is dispatched, refer to Section 12.0.

11.4 Return to Section 7.0 of this procedure. New data should be taken as specified by the Duty Emergency Coordinator/Dose Assessment Supervisor.

### 12.0 VERIFICATION OF PROJECTED DOSE RATES BY FIELD MEASUREMENT

12.1 Whenever an Emergency Action Level has been declared due to offsite radiological releases, the Duty Emergency Coordinator/Offsite Monitoring Supervisor shall, based on wind direction, dispatch offsite radiological monitoring teams to sample the plume to determine the magnitude and extent of the radiation fields.

12.1.1 Radiation surveys at specific locations should include a direct exposure rate measurement (mR/hr) and an air sample to determine iodine concentration ( $\mu\text{Ci/cc}$ ).

12.1.2 As the survey teams approach assigned survey locations, continuous measurements should be taken to identify the location of the highest radiation level for a particular downwind distance.

### 12.2 Scale Factor Determination

12.2.1 Accurate scale factors may be calculated only by comparing measured plume centerline conditions with projected plume centerline conditions for corresponding time periods and downwind distances.

12.2.2 When field monitoring data becomes available for a plume centerline location, select one set of data and complete Form 1904.02C to calculate whole body and child thyroid dose rate scale factors. The calculation on 1904.02C should be performed no more than once per run of the dose calculation program.

12.3 Return to section 7.0 of this procedure. New data should be taken as specified by the Duty Emergency Coordinator/Dose Assessment Supervisor.





PLANT MANUAL SECTION:  
OFFSITE DOSE  
PROJECTIONS

PROCEDURE/WORK PLAN TITLE:  
OFFSITE DOSE PROJECTIONS -  
POCKET COMPUTER METHOD

NO:  
1904.02

## ARKANSAS NUCLEAR ONE

|          |         |      |          |
|----------|---------|------|----------|
| PAGE     | 8 of 34 |      |          |
| REVISION | 2       | DATE | 02/07/84 |
| CHANGE   |         | DATE |          |

### 13.0 ATTACHMENTS AND FORMS

- 13.1 Form 1904.02A - EAL/Offsite Dose Projection Worksheet
- 13.2 Form 1904.02B - Airborne Release Rate Worksheet
- 13.3 Form 1904.02C - Scale Factor Worksheet
- 13.4 Attachment 1 - Diffusion Overlay (Atmospheric Stability Category A)
- 13.5 Attachment 2 - Diffusion Overlay (Atmospheric Stability Category B)
- 13.6 Attachment 3 - Diffusion Overlay (Atmospheric Stability Category C)
- 13.7 Attachment 4 - Diffusion Overlay (Atmospheric Stability Category D)
- 13.8 Attachment 5 - Diffusion Overlay (Atmospheric Stability Category E)
- 13.9 Attachment 6 - Diffusion Overlay (Atmospheric Stability Category F)
- 13.10 Attachment 7 - Diffusion Overlay (Atmospheric Stability Category G)
- 13.11 Attachment 8 - Area Map
- 13.12 Attachment 9 - Keyboard Layout
- 13.13 Attachment 10 - Battery Replacement
- 13.14 Attachment 11 - Program Loading/Verification
- 13.15 Attachment 12 - Program Listing
- 13.16 Attachment 13 - Memory Contents



PLANT MANUAL SECTION:  
OFFSITE DOSE  
PROJECTIONS

PROCEDURE/WORK PLAN TITLE:  
OFFSITE DOSE PROJECTIONS -  
POCKET COMPUTER METHOD

NO:  
1904.02

# ARKANSAS NUCLEAR ONE

PAGE 9 of 34  
REVISION 2 DATE 02/07/64  
CHANGE DATE



## ARKANSAS POWER & LIGHT COMPANY Arkansas Nuclear One

TITLE: EAL/OFFSITE DOSE PROJECTION WORKSHEET

FORM NO. 1904.02A

REV. # 2 PC #

Page 1 of 2

**INSTRUCTIONS**

- 1.0 Press the [ON] button.
    - 1.1 If a dot is not visible in the upper right hand corner of the display, replace the batteries per Attachment 10 - Battery Replacement.
  - 2.0 Press the [MODE] button repeatedly, as necessary, until the word "RUN" is indicated in the upper portion of the display.
- NOTE: At least one test case contained in Attachment 11 - Program Loading/ Verification should be performed prior to initial use. \_\_\_\_\_ Initials
- 3.0 Type RUN (followed by [ENTER])
  - 4.0 Enter data and record results in the appropriate space below:

| TIME | INPUT                            |  |  |  |
|------|----------------------------------|--|--|--|
|      | Wind Direction (10 min. average) |  |  |  |
|      | Wind Speed (10 min. average)     |  |  |  |
| *    | Stability Class                  |  |  |  |
|      | Q-Gas (From 1904.02B)            |  |  |  |
|      | Q-Iodine (From 1904.02B)         |  |  |  |
| **   | WB Scale Factor                  |  |  |  |
| **   | CT Scale Factor                  |  |  |  |
|      | OUTPUT                           |  |  |  |
|      | EAL                              |  |  |  |
|      | Downwind Direction               |  |  |  |
|      | X/Q: Plume Bdy.                  |  |  |  |
|      | .65 mi. Avg. MPC                 |  |  |  |
|      | .65 mi. WB (mrem/hr)             |  |  |  |
|      | .65 mi. CT (mrem/hr)             |  |  |  |
|      | 1 mi. WB (mrem/hr)               |  |  |  |
|      | 1 mi. CT (mrem/hr)               |  |  |  |
|      | 2 mi. WB (mrem/hr)               |  |  |  |
|      | 2 mi. CT (mrem/hr)               |  |  |  |
|      | 5 mi. WB (mrem/hr)               |  |  |  |
|      | 5 mi. CT (mrem/hr)               |  |  |  |
|      | 10 mi. WB (mrem/hr)              |  |  |  |
|      | 10 mi. CT (mrem/hr)              |  |  |  |
|      | Initials                         |  |  |  |

\* Atmospheric Stability Category

| Category | $\sigma\theta$ | $\Delta t$       |
|----------|----------------|------------------|
| A        | >22.5°         | <-0.87°          |
| B        | 17.5° to 22.5° | -0.87° to -0.78° |
| C        | 12.5° to 17.5° | -0.78° to -0.69° |
| D        | 7.5° to 12.5°  | -0.69° to -0.23° |
| E        | 3.8° to 7.5°   | -0.23° to -0.69° |
| F        | 2.1° to 3.8°   | +0.69° to +1.8°  |
| G        | <2.1°          | >1.8°            |

\*\*Enter 1.0 in the absence of useable field data.



PLANT MANUAL SECTION:  
OFFSITE DOSE  
PROJECTIONS

PROCEDURE/WORK PLAN TITLE:  
OFFSITE DOSE PROJECTIONS -  
POCKET COMPUTER METHOD

NO:  
1904.02

# ARKANSAS NUCLEAR ONE

PAGE 10 of 34  
REVISION 2 DATE 02/07/84  
CHANGE DATE



## ARKANSAS POWER & LIGHT COMPANY Arkansas Nuclear One

TITLE: EAL/OFFSITE DOSE PROJECTION WORKSHEET

FORM NO. 1904.02A

REV. # 2 PC #

Page 2 of 2

- 5.0 To facilitate review, record the program input variables as they are displayed on the calculator:

| TIME | INPUT                            |  |  |  |
|------|----------------------------------|--|--|--|
|      | Wind Direction (10 min. average) |  |  |  |
|      | Wind Speed (10 min. average)     |  |  |  |
|      | Stability Class                  |  |  |  |
|      | Q-Gas (From 1904.02B)            |  |  |  |
|      | Q-Iodine (From 1904.02B)         |  |  |  |
|      | WB Scale Factor                  |  |  |  |
|      | CT Scale Factor                  |  |  |  |
|      | Initials                         |  |  |  |

- 6.0 AFFECTED SUB-SECTORS (From Step 10.0 of this procedure):
- \_\_\_\_\_

- 7.0 The dose rates at any field location may be estimated if requested by the following method.

- 7.1 Interpolate the X/Q value from the appropriate overlay for the desired location. 1) \_\_\_\_\_ 2) \_\_\_\_\_ 3) \_\_\_\_\_ 4) \_\_\_\_\_
- 7.2 Type the value obtained in Step 6.1 followed by pressing the [SHIFT] B [ENTER] keys. The computer will display the projected whole body dose rate (mR/hr) for that location. 1) \_\_\_\_\_ 2) \_\_\_\_\_ 3) \_\_\_\_\_ 4) \_\_\_\_\_
- 7.3 Press [SHIFT] X [ENTER]. The computer will then display the projected child thyroid dose rate for the same location. 1) \_\_\_\_\_ 2) \_\_\_\_\_ 3) \_\_\_\_\_ 4) \_\_\_\_\_

NOTE: Data may be reviewed by the following:

### OTHER RESERVE KEY FUNCTIONS

| Key Sequence      | Function | Purpose                 |
|-------------------|----------|-------------------------|
| [SHIFT] V [ENTER] | Run 390  | Review Output Variables |
| [SHIFT] A [ENTER] | Run 560  | Review Input Variables  |

Performed By \_\_\_\_\_ / \_\_\_\_\_  
Initials Time

Reviewed By \_\_\_\_\_





OFFSITE DOSE SECTION:  
PROJECTIONS

PROCEDURE WORK PLAN TITLE -  
POCKET COMPUTER METHOD

NO:  
1904.02

# ARKANSAS NUCLEAR ONE

PAGE 12 of 34  
REVISION 2 DATE 02/07/84  
CHANGE DATE



## ARKANSAS POWER & LIGHT COMPANY Arkansas Nuclear One

TITLE: SCALE FACTOR WORKSHEET

FORM NO. 1904.02C

REV. # 2 PC #

- 1.0 Record the following raw data:
  - 1.1 Measurement Time \_\_\_\_\_
  - 1.2 Measurement Location (sub-sector) \_\_\_\_\_
  - 1.3 Downwind Distance \_\_\_\_\_ (mi)
  - 1.4 Measured Whole Body Dose Rate (record in column 1, line a) below)
  - 1.5 Measured Radioiodine Concentration \_\_\_\_\_ ( $\mu\text{Ci/cc}$ )
- 2.0 Multiply line 1.5 by 5.6E8 (mr/hr per  $\mu\text{Ci/cc}$ ) to convert the radioiodine concentration to the equivalent child thyroid dose commitment rate (record in column 1, line b) below).
- 3.0 Project the radiological conditions for the measurement location:
  - 3.1 X/Q at measurement location (from stability class overlay) = \_\_\_\_\_ ( $\text{sec/m}^3$ )
  - 3.2 Type the value obtained in step 3.1 followed by pressing the [SHIFT] B [ENTER] keys. The computer will display the projected whole body dose rate (mR/hr) for that location. Record in column 2a below.
  - 3.3 Press [SHIFT] X [ENTER]. The computer will then display the projected child thyroid dose rate for the same location. Record this value in column 2b below.
  - 3.4 Transcribe the previous scale factors used for these dose rate projections from form 1904.02A Section 4.0 to column 3 below.
- 4.0 Calculate the current scale factors:  
 Column 4 = (column 1  $\div$  column 2) x column 3

|                  | Column 1<br>Measured<br>mR/hr | Column 2<br>Projected<br>mR/hr | Column 3<br>Previous<br>Scale Factors | Column 4<br>Current<br>Scale Factors |
|------------------|-------------------------------|--------------------------------|---------------------------------------|--------------------------------------|
| a) Whole Body    |                               |                                |                                       | (WB)                                 |
| b) Child Thyroid |                               |                                |                                       | (CT)                                 |

Performed By \_\_\_\_\_ /  
Initials Time

Reviewed By \_\_\_\_\_



PLANT MANUAL SECTION:  
OFFSITE DOSE  
PROJECTIONS

PROCEDURE/WORK PLAN TITLE:  
OFFSITE DOSE PROJECTIONS  
POCKET COMPUTER METHOD

NO:  
1904.02

# ARKANSAS NUCLEAR ONE

PAGE 13 of 34  
REVISION 2 DATE 02/07/84  
CHANGE DATE

ATTACHMENT 1

"Not to Scale"

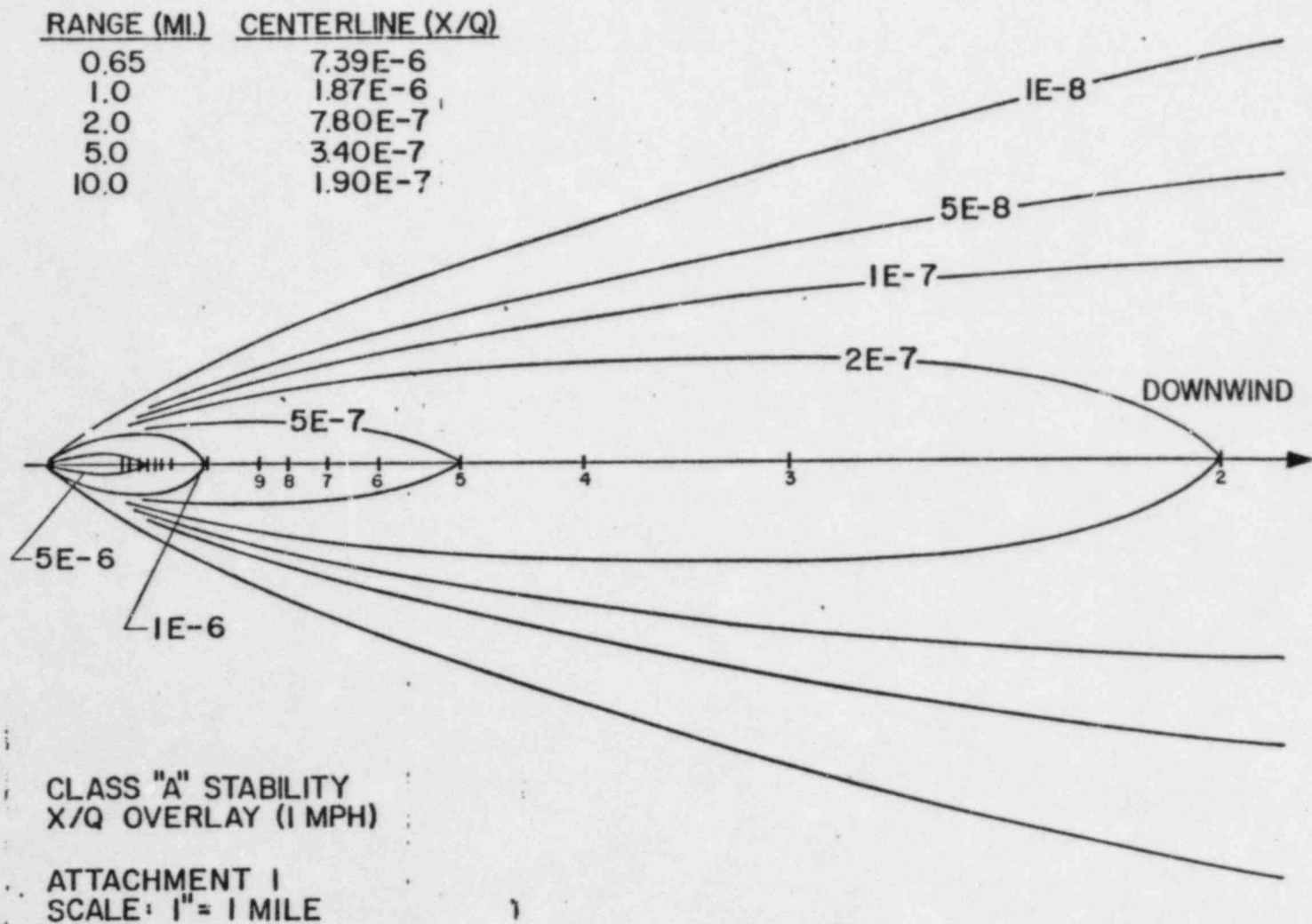



PLANT MANUAL SECTION:  
OFFSITE DOSE  
PROJECTIONS

PROCEDURE/WORK PLAN TITLE:  
OFFSITE DOSE PROJECTIONS  
POCKET COMPUTER METHOD

NO:  
1904.02

# ARKANSAS NUCLEAR ONE

ATTACHMENT 2

PAGE 14 of 34  
REVISION 2 DATE 02/07/84  
CHANGE DATE

| RANGE (MI.) | CENTERLINE (X/Q) |
|-------------|------------------|
| 0.65        | 4.10E-5          |
| 1.0         | 1.68E-5          |
| 2.0         | 4.18E-6          |
| 5.0         | 7.30E-7          |
| 10.0        | 2.51E-7          |

CLASS "B" STABILITY  
X/Q OVERLAY (1 MPH)

ATTACHMENT 2  
SCALE: 1" = 1 MILE

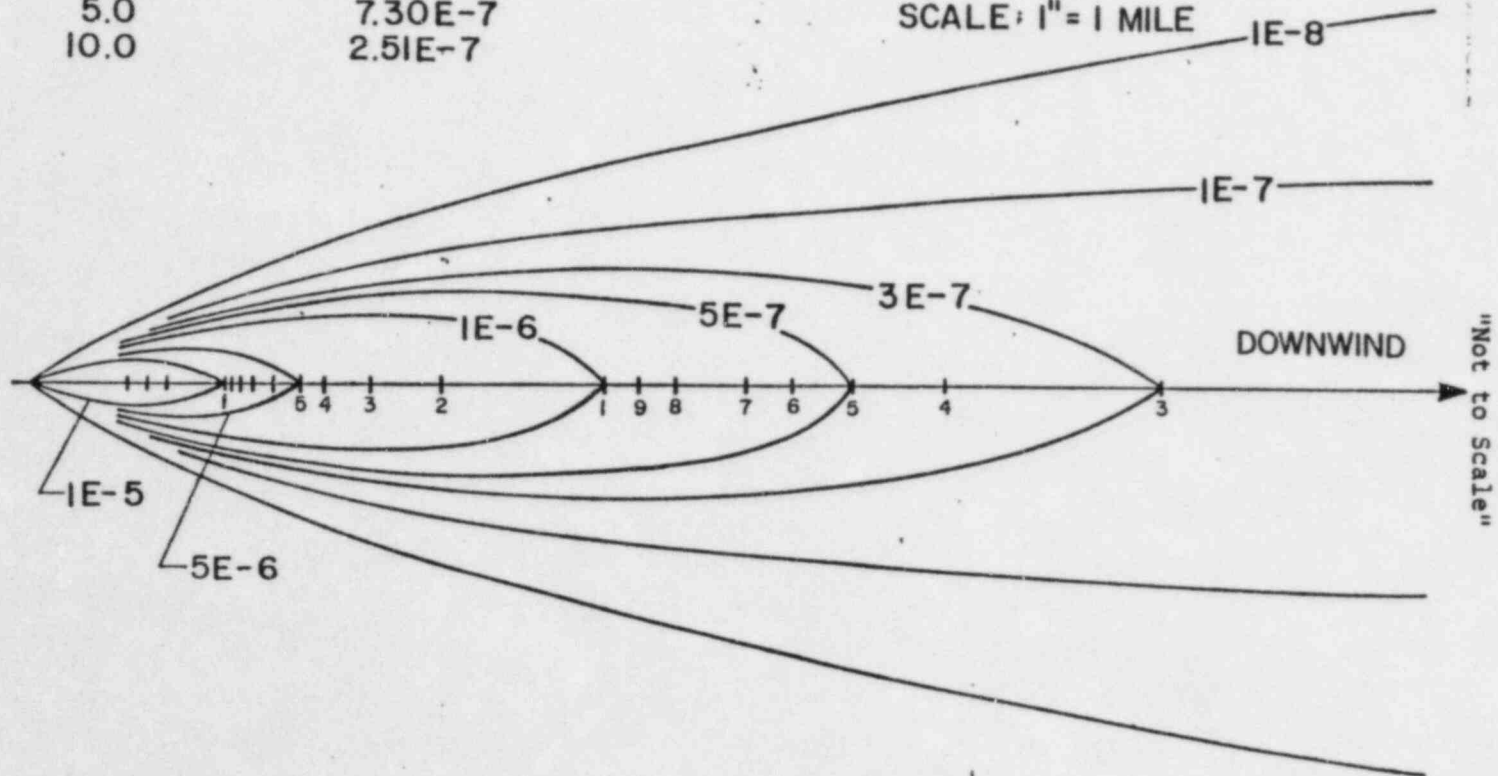



PLANT MANUAL SECTION:  
OFFSITE DOSE  
PROJECTIONS

PROCEDURE/WORK PLAN TITLE:  
OFFSITE DOSE PROJECTIONS  
POCKET COMPUTER METHOD

NO:  
1904.02

# ARKANSAS NUCLEAR ONE

PAGE 15 of 34  
REVISION 2 DATE 02/07/84  
CHANGE DATE

ATTACHMENT 3

CLASS "C" STABILITY  
X/Q OVERLAY (1 MPH)  
ATTACHMENT 3  
SCALE: 1" = 1 MILE

| RANGE (MI.) | CENTERLINE (X/Q) |
|-------------|------------------|
| 0.65        | 1.05E-4          |
| 1.0         | 4.64E-5          |
| 2.0         | 1.41E-5          |
| 5.0         | 2.63E-6          |
| 10.0        | 7.74E-7          |

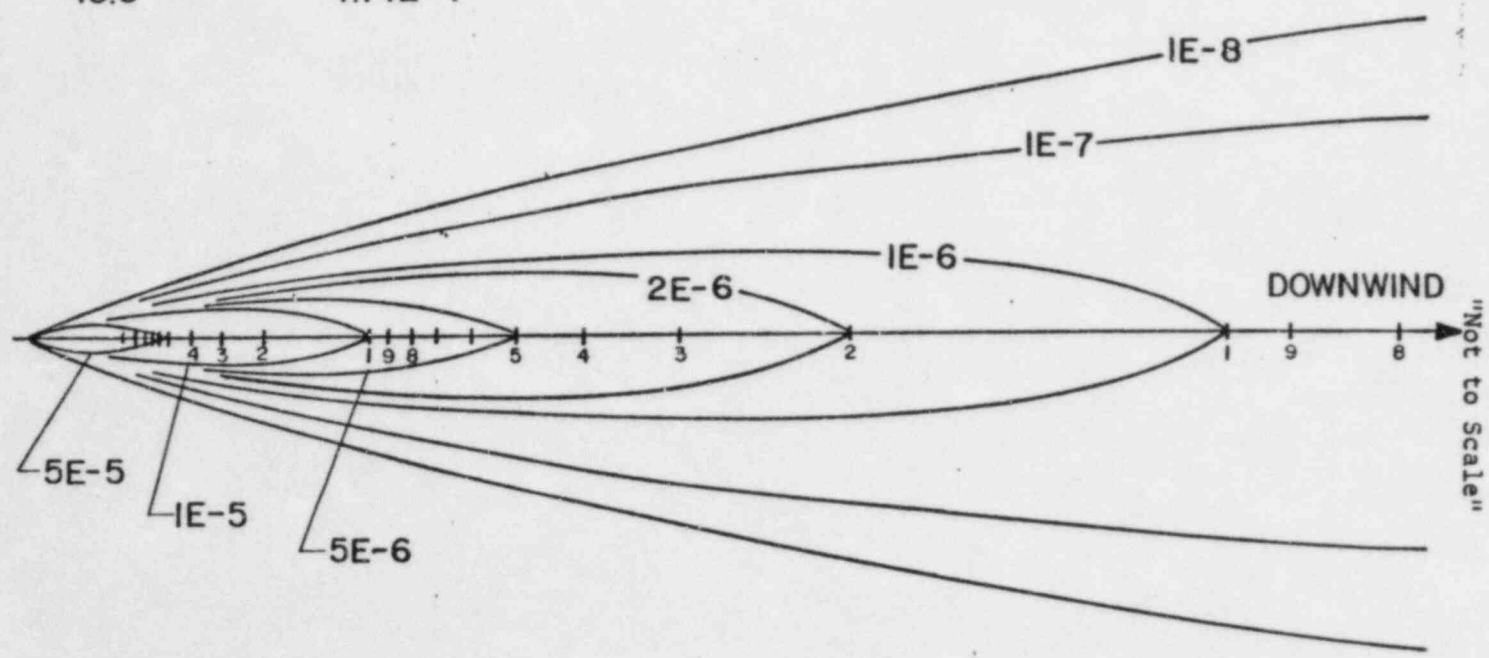





PLANT MANUAL SECTION:  
OFFSITE DOSE  
PROJECTIONS

PROCEDURE/WORK PLAN TITLE:  
OFFSITE DOSE PROJECTIONS -  
POCKET COMPUTER METHOD

NO:  
1904.02

# ARKANSAS NUCLEAR ONE

PAGE 16 OF 34  
REVISION 2 DATE 02/07/84  
CHANGE DATE

ATTACHMENT 4

"Not to Scale"

CLASS "D" STABILITY  
X/Q OVERLAY (1 MPH)

ATTACHMENT 4  
SCALE: 1" = 1 MILE

| RANGE (MI.) | CENTERLINE (X/Q) |
|-------------|------------------|
| 0.65        | 2.87E-4          |
| 1.0         | 1.38E-4          |
| 2.0         | 6.64E-5          |
| 5.0         | 1.31E-5          |
| 10.0        | 4.83E-6          |

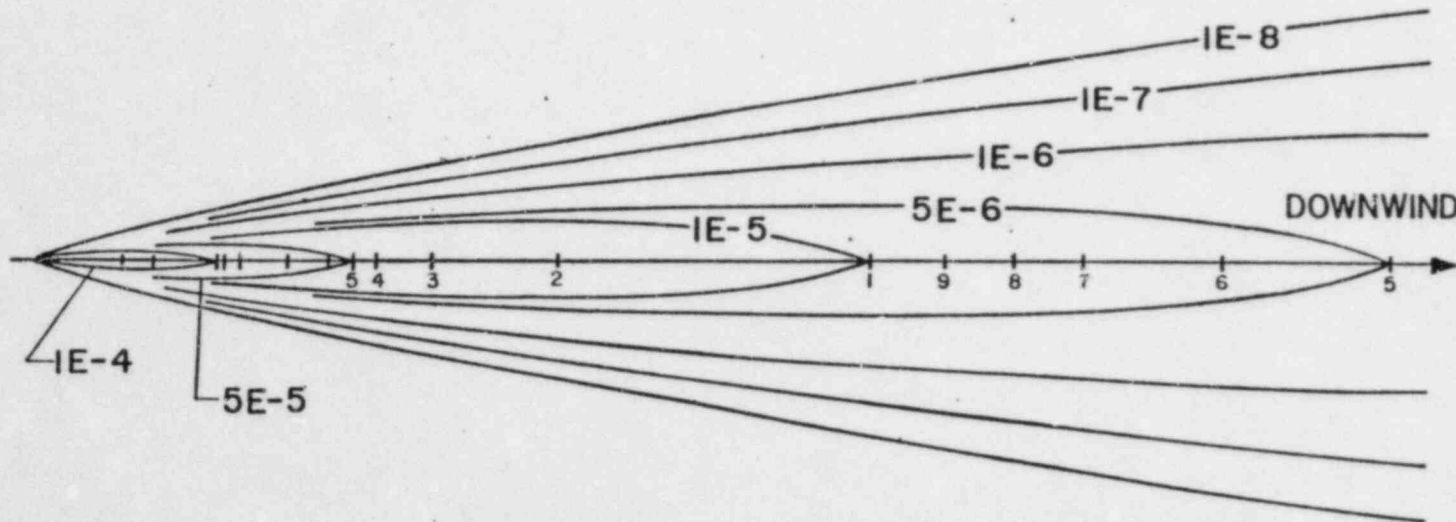



PLANT MANUAL SECTION:  
OFFSITE DOSE  
PROJECTIONS

PROCEDUREWORK PLAN TITLE:  
OFFSITE DOSE PROJECTIONS -  
POCKET COMPUTER METHOD

NO:  
1904.02

# ARKANSAS NUCLEAR ONE

PAGE 17 of 34  
REVISION 2 DATE 02/07/84  
CHANGE DATE

ATTACHMENT 5

| RANGE (MI.) | CENTERLINE (X/Q) |
|-------------|------------------|
| 0.65        | 4.84E-4          |
| 1.0         | 2.62E-4          |
| 2.0         | 1.02E-4          |
| 5.0         | 2.92E-5          |
| 10.0        | 1.14E-5          |

CLASS "E" STABILITY  
X/Q OVERLAY (1 MPH)

ATTACHMENT 5  
SCALE: 1" = 1 MILE

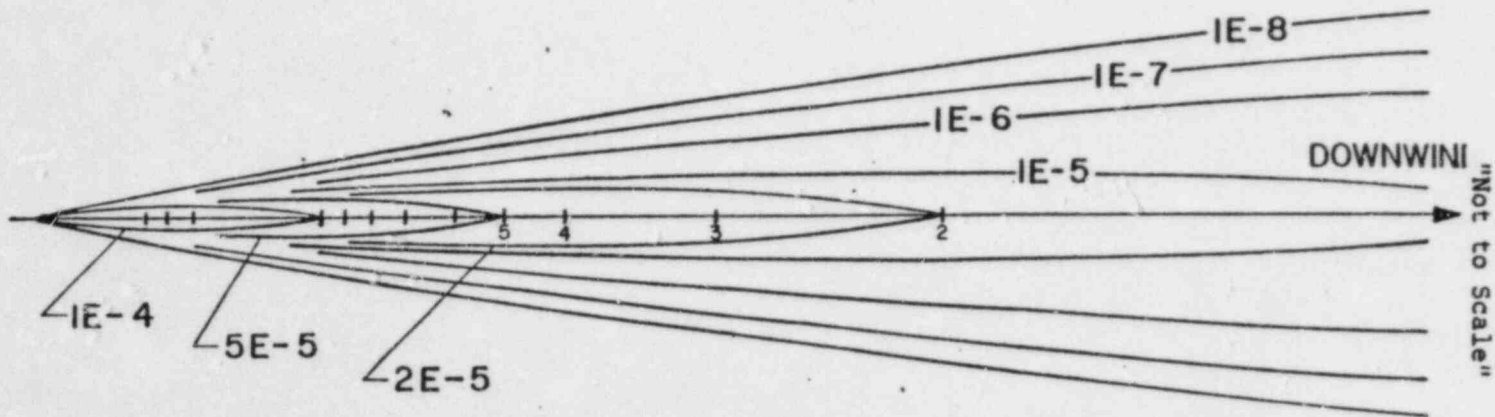



PLANT MANUAL SECTION:  
OFFSITE DOSE  
PROJECTIONS

PROCEDURE/WORK PLAN TITLE:  
OFFSITE DOSE PROJECTIONS  
POCKET COMPUTER METHOD

NO:  
1904.02

# ARKANSAS NUCLEAR ONE

PAGE 18 of 34  
REVISION 2 DATE 02/07/84  
CHANGE DATE

ATTACHMENT 6

| <u>RANGE (MI.)</u> | <u>CENTERLINE (X/Q)</u> |
|--------------------|-------------------------|
| 0.65               | 8.37E-4                 |
| 1.0                | 5.01E-4                 |
| 2.0                | 2.22E-4                 |
| 5.0                | 7.23E-5                 |
| 10.0               | 3.05E-5                 |

CLASS "F" STABILITY  
X/Q OVERLAY (1 MPH)

ATTACHMENT 6  
SCALE: 1" = 1 MILE

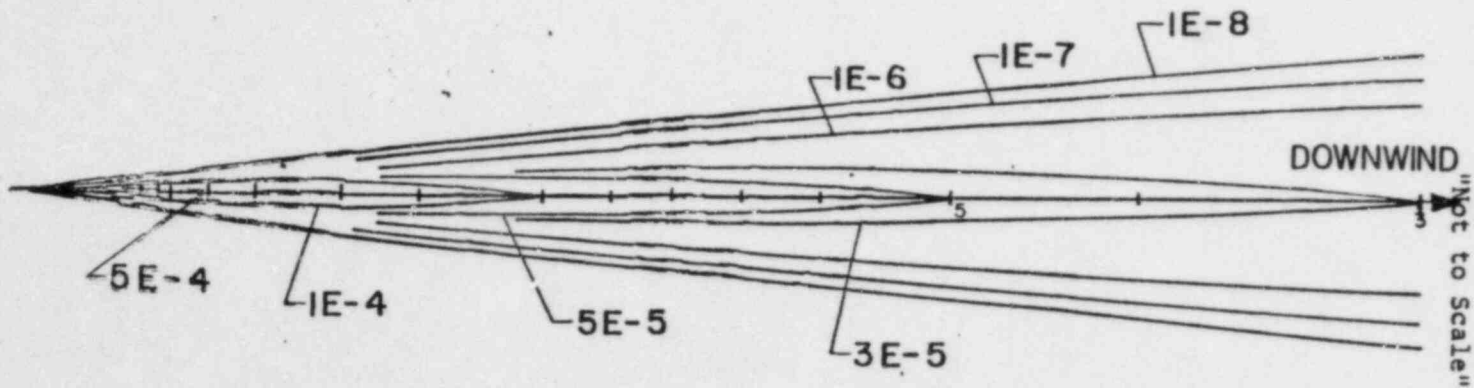



PLANT MANUAL SECTION:  
OFFSITE DOSE  
PROJECTIONS

PROCEDURE/WORK PLAN TITLE:  
OFFSITE DOSE PROJECTIONS -  
POCKET COMPUTER METHOD

NO:  
1904.02

# ARKANSAS NUCLEAR ONE

PAGE 19 of 34  
REVISION 2 DATE 02/07/84  
CHANGE DATE

ATTACHMENT 7

| RANGE (MI.) | CENTERLINE (X/Q) |
|-------------|------------------|
| 0.65        | 2.06E-3          |
| 1.0         | 9.61E-4          |
| 2.0         | 4.78E-4          |
| 5.0         | 1.72E-4          |
| 10.0        | 7.46E-5          |

CLASS "G" STABILITY  
X/Q OVERLAY (1 MPH)

ATTACHMENT 7  
SCALE: 1" = 1 MILE

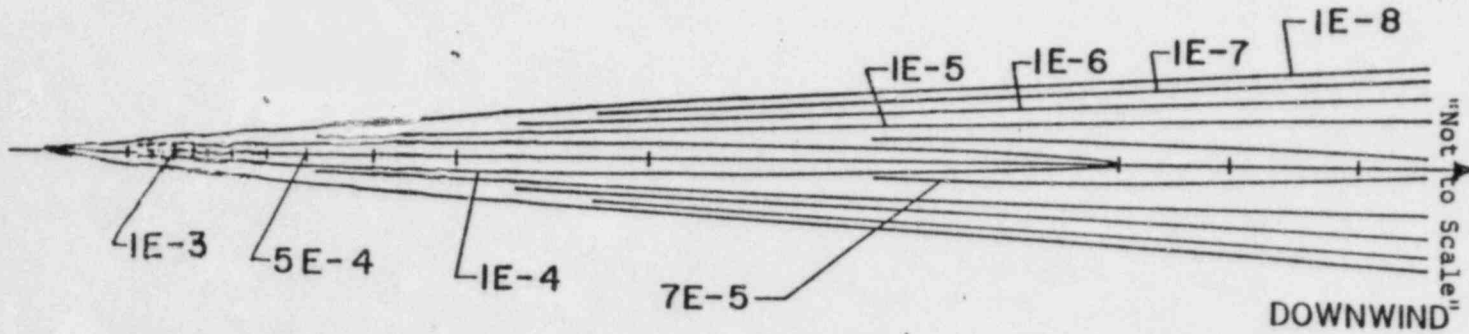



PLANT MANUAL SECTION:  
OFFSITE DOSE  
PROJECTIONS

PROCEDURE/WORK PLAN TITLE:  
OFFSITE DOSE PROJECTIONS -  
POCKET COMPUTER METHOD

NO:  
1904.02

# ARKANSAS NUCLEAR ONE

PAGE 20 of 34

REVISION 2 DATE 02/07/84

CHANGE DATE

ATTACHMENT 8

AREA MAP





PLANT MANUAL SECTION:  
OFFSITE DOSE  
PROJECTIONS

PROCEDURE/WORK PLAN TITLE:  
OFFSITE DOSE PROJECTIONS -  
POCKET COMPUTER METHOD

NO:  
1904.02

# ARKANSAS NUCLEAR ONE

PAGE 21 of 34  
REVISION 2 DATE 02/07/84  
CHANGE DATE

## ATTACHMENT 9 KEYBOARD LAYOUT

### KEYBOARD

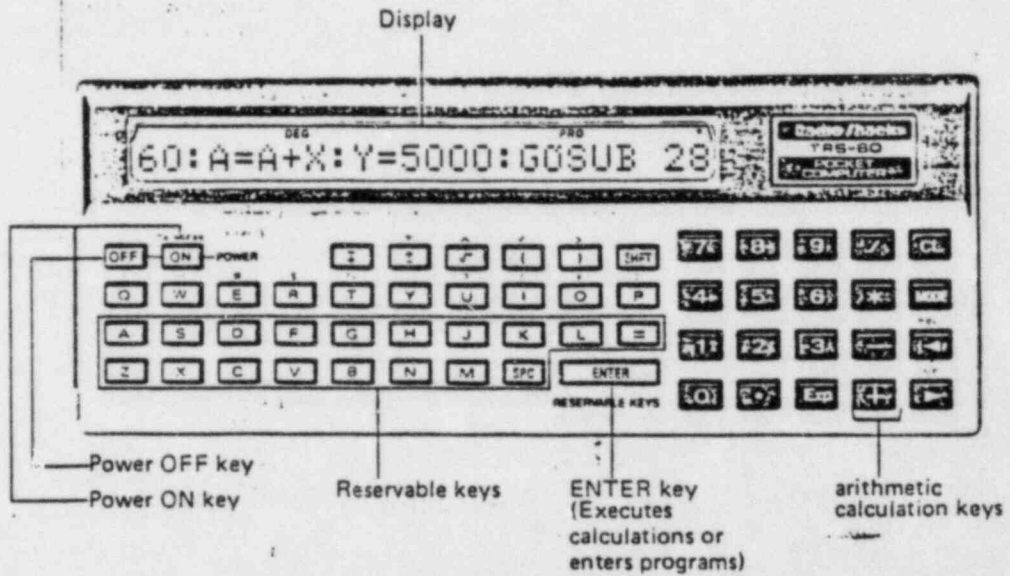



PLANT MANUAL SECTION:  
OFFSITE DOSE  
PROJECTIONS

PROCEDURE/WORK PLAN TITLE:  
OFFSITE DOSE PROJECTIONS -  
POCKET COMPUTER METHOD

NO:  
1904.02

## ARKANSAS NUCLEAR ONE

|          |          |      |          |
|----------|----------|------|----------|
| PAGE     | 22 of 34 |      |          |
| REVISION | 2        | DATE | 02/07/84 |
| CHANGE   |          | DATE |          |

ATTACHMENT 10

Page 1 of 2

### BATTERY REPLACEMENT

#### 1.0 COMPUTER

NOTE: This computer uses Type 675 batteries; mercury batteries should be used when possible.

1.1 Press the [OFF] button.

NOTE: Two (2) types of screws hold the back cover in place.

1.2 Remove the screws from the back cover.

NOTE: Use a dry cloth to wipe off the surface of the new batteries before installing.

1.3 Replace the batteries, placing the "+" side up.

1.4 Hook the tabs on the back cover into the slots on the computer.

1.5 Push the back cover in slightly while replacing the screws.

NOTE: Do not use a pencil.

1.6 Using a hard, pointed object, carefully push the Reset switch on the back cover to clear the computer.

1.7 Press the [OFF] and then [ON] button to clear the computer.

NOTE: When the batteries are correctly installed "> DEG (MODE) ." will be displayed.

#### 2.0 CASSETTE INTERFACE

NOTE: This device uses Type AA batteries; alkaline batteries should be used when possible.

2.1 Remove the sliding door located on the underside of the interface.

2.2 Replace the batteries as indicated on the interface.

#### 3.0 CASSETTE TAPE RECORDER

NOTE: An optional AC adapter may be used, as necessary, if battery replacement is not feasible.



PLANT MANUAL SECTION:  
OFFSITE DOSE  
PROJECTIONS

PROCEDURE/WORK PLAN TITLE:  
OFFSITE DOSE PROJECTIONS -  
POCKET COMPUTER METHOD

NO:  
1904.02

# ARKANSAS NUCLEAR ONE

|          |          |               |
|----------|----------|---------------|
| PAGE     | 23 of 34 |               |
| REVISION | 2        | DATE 02/07/84 |
| CHANGE   |          | DATE          |

ATTACHMENT 10

Page 2 of 2

- a) Press down on the battery compartment cover (on the back) and remove.
- b) Replace the batteries as indicated on the recorder.
- c) Replace the battery cover.





PLANT MANUAL SECTION:  
OFFSITE DOSE  
PROJECTIONS

PROCEDURE/WORK PLAN TITLE:  
OFFSITE DOSE PROJECTIONS -  
POCKET COMPUTER METHOD

NO:  
1904.02

## ARKANSAS NUCLEAR ONE

|          |          |      |          |
|----------|----------|------|----------|
| PAGE     | 24 of 34 |      |          |
| REVISION | 2        | DATE | 02/07/84 |
| CHANGE   |          | DATE |          |

ATTACHMENT 11

Page 1 of 5

### PROGRAM LOADING/VERIFICATION

#### 1.0 CONNECTING THE POCKET COMPUTER TO THE CASSETTE INTERFACE

NOTE: Before attaching or removing the Computer from the Interface, be sure to turn off the Computer with the [OFF] key. If the computer is connected or disconnected with power ON, all keys may become inoperative. In this case, press the ALL RESET switch on the back of the Computer. This will clear the entire Computer (including programs stored in memory).

1.1 Press the [OFF] button.

1.2 Remove the cover from the left side of the Computer. It may be snapped into place on the bottom of the Cassette Interface, if desired.

1.3 Fit the projecting parts on the Cassette Interface in the grooves of the Computer.

NOTE: If parts do not mate properly, do not force them. Carefully shift the Computer left or right to be sure the mating surfaces are correctly aligned.

1.4 Slide the Computer carefully to fit securely onto the Cassette Interface.

#### 2.0 CONNECTING THE CASSETTE INTERFACE TO A TAPE RECORDER

2.1 Connect red plug into the MIC jack on the Cassette Recorder.

2.2 Connect gray plug into the EAR phone jack on the Recorder.

#### 3.0 LOADING A PROGRAM FROM A MAGNETIC TAPE

3.1 Load tape in the tape recorder.

3.2 Rewind the tape completely; connect the black plug into the REMOTE jack on the Recorder.

3.3 Press the [ON] button.

3.4 Press the [MODE] button repeatedly, as necessary, until the word "Run" is indicated in the upper portion of the display.

3.5 Push the PLAY button on the tape recorder.

3.6 Set the VOLUME control to approximately 3/4 of its full scale value.



PLANT MANUAL SECTION:  
OFFSITE DOSE  
PROJECTIONS

PROCEDURE/WORK PLAN TITLE:  
OFFSITE DOSE PROJECTIONS -  
POCKET COMPUTER METHOD

NO:  
1904.02

## ARKANSAS NUCLEAR ONE

|          |          |      |          |
|----------|----------|------|----------|
| PAGE     | 25 of 34 |      |          |
| REVISION | 2        | DATE | 02/07/84 |
| CHANGE   |          | DATE |          |

ATTACHMENT 11

Page 2 of 5

- 3.7 Set Tone to maximum treble (if this option is available).
- 3.8 Type NEW [ENTER].
- 3.9 Press the [MODE] button repeatedly until the word "RESERVE" is indicated in the upper portion of the display.
- 3.10 Type NEW [ENTER].
- 3.11 Press the [MODE] button repeatedly until the word "RUN" is indicated in the upper portion of the display.

NOTE: When the program has been transferred, the Computer will automatically stop the tape motion and display the PROMPT (>) symbol.

3.12 Type CLOAD "PRO/ING" [ENTER]

- 3.12.1 If an error occurs (error code "5" is displayed), start over from the beginning. If the error continues, adjust volume up or down slightly and repeat steps 3.1 to 3.12.
- 3.12.2 If the error code is not displayed but tape motion continues, transferring is improper. Press [ON] key to stop the tape. Repeat steps 3.1 to 3.12.
- 3.12.3 If the error remains or the tape continues to run after several attempts to correct the problem, try cleaning or demagnetizing the Recorder's tape head.

3.13 Type INPUT # "MEM/ING" [ENTER].

3.14 Press the [MODE] button until the word "RESERVE" appears in the upper portion of the display.

3.15 Type CLOAD "RES/ING" [ENTER].

3.16 Stop the recorder.

3.17 Press the [MODE] button repeatedly, as necessary, until the word "RUN" appears in the upper portion of the display.

NOTE: The following methods may be used to indicate that the program has been loaded correctly. The first method causes the Computer to automatically search for the specified file name and compare the contents on tape with the contents in memory. The second method checks the general program operation by inputting given initial data and manually comparing the output data to the calculated results.



PLANT MANUAL SECTION:  
OFFSITE DOSE  
PROJECTIONS

PROCEDURE/WORK PLAN TITLE:  
OFFSITE DOSE PROJECTIONS -  
POCKET COMPUTER METHOD

NO:  
1904.02

## ARKANSAS NUCLEAR ONE

|          |          |               |
|----------|----------|---------------|
| PAGE     | 26 of 34 |               |
| REVISION | 2        | DATE 02/07/84 |
| CHANGE   | DATE     |               |

ATTACHMENT 11

Page 3 of 5

### 4.0 PROGRAM TESTS

#### 4.1 Comparison Method.

- 4.1.1 Disconnect the black plug from the REMote jack and completely rewind the tape.
- 4.1.2 Reconnect the black plug to the REMote jack.
- 4.1.3 Press the PLAY button of the recorder.
- 4.1.4 Type CLOAD? "PRO/ING" [ENTER]
  - A. If the programs are verified as being identical, the prompt symbol (>) will be displayed.
  - B. If the programs differ, execution will be interrupted and an Error Code 5 will be displayed. If this occurs, you may try again to either reload or re-verify the programs. A slight adjustment in the recorder volume level may improve the transfer.

NOTE: Ensure that the computer is turned OFF prior to removing it from the interface.

- C. Upon completion, the computer may be removed from the interface, as appropriate.

#### 4.2 Test Cases

- 4.2.1 Using the general operational method described in Sections 3.0 to 7.0 of 1904.02A, enter the appropriate input data from at least one of the following test cases. Compare the output data with the indicated results.



PLANT MANUAL SECTION:  
OFFSITE DOSE  
PROJECTIONS

PROCEDURE/WORK PLAN TITLE:  
OFFSITE DOSE PROJECTIONS -  
POCKET COMPUTER METHOD

NO:  
1904.02

# ARKANSAS NUCLEAR ONE

PAGE 27 of 34  
REVISION 2 DATE 02/07/84  
CHANGE DATE

ATTACHMENT 11

Page 4 of 5

| TEST CASE #     | 1        | 2                | 3        | 4                 | 5                    |
|-----------------|----------|------------------|----------|-------------------|----------------------|
| INPUT:          |          |                  |          |                   |                      |
| Wind Direction  | 17       | 215              | 100      | 360               | 180                  |
| Wind Speed      | 4.5      | 3                | 18       | 6                 | 1.5                  |
| Stability Class | A        | C                | D        | E                 | G                    |
| Q-Gas           | 5E-3     | 0.15             | 1.9      | 6.8               | 20                   |
| Q-Iodine        | 6E-6     | 5E-4             | 4E-3     | 5E-3              | 6E-3                 |
| WB Scale Factor | 0.9      | 1.1              | 0.6      | 0.99              | 1.9                  |
| CT Scale Factor | 0.7      | 1.5              | 0.3      | 0.88              | 1.7                  |
| RESULTS:        |          |                  |          |                   |                      |
| EAL             | O.K.     | Unusual<br>Event | Alert    | Site<br>Emergency | General<br>Emergency |
| Downwind Dir.   | 197      | 35               | 280      | 180               | 0                    |
| X/Q: Plume Bdy. | 3.68E-4  | 8.70E-6          | 9.65E-6  | 6.09E-7           | 4.93E-8              |
| .65 mi Avg. MPC | 5.98E-2  | 2.19E 0          | 1.51E 1  | 8.95E 1           | 5.05E 2              |
| .65 mi WB       | 1.00E-3  | 6.02E-1          | 1.48E 0  | 3.96E 1           | 2.08E 3              |
| .65 mi CT       | 3.86E-3  | 1.47E 1          | 1.07E 1  | 1.98E 2           | 7.84E 3              |
| 1 mi WB         | 2.53E-4  | 2.66E-1          | 7.14E-1  | 2.14E 1           | 9.74E 2              |
| 1 mi CT         | 9.77E-4  | 6.49E 0          | 5.15E 0  | 1.07E 2           | 3.65E 3              |
| 2 mi WB         | 1.05E-4  | 8.09E-2          | 3.43E-1  | 8.36E 0           | 4.84E 2              |
| 2 mi CT         | 4.07E-4  | 1.97E 0          | 2.47E 0  | 4.18E 1           | 1.82E 3              |
| 5 mi WB         | 4.61E-5  | 1.51E-2          | 6.78E-2  | 2.39E 0           | 1.74E 2              |
| 5 mi CT         | 1.77E-4  | 3.68E-1          | 4.89E-1  | 1.19E 1           | 6.54E 2              |
| 10 mi WB        | 2.57E-5  | 4.44E-3          | 2.50E-2  | 9.34E-1           | 7.56E 1              |
| 10 mi CT        | 9.93E-5  | 1.08E-1          | 1.80E-1  | 4.68E 0           | 2.84E 2              |
| INPUT:          |          |                  |          |                   |                      |
| Local X/Q       | 1E-7     | 1.9E-7           | 3.9E-7   | 1.2E-6            | 8.08E-9              |
| RESULTS:        |          |                  |          |                   |                      |
| Local WB        | ~1.22E-5 | ~0.0012          | ~1.21E-3 | ~9.74E-2          | ~1.56E-2             |
| Local CT        | ~3.66E-5 | ~0.0399          | ~4.37E-3 | ~4.34E-1          | ~0.0523              |



PLANT MANUAL SECTION:  
OFFSITE DOSE  
PROJECTIONS

PROCEDURE/WORK PLAN TITLE:  
OFFSITE DOSE PROJECTIONS -  
POCKET COMPUTER METHOD

NO:  
1904.02

## ARKANSAS NUCLEAR ONE

PAGE 28 of 34

REVISION 2 DATE 02/07/84

CHANGE DATE

ATTACHMENT 11

Page 5 of 5

- A. If the data compares favorably, then the overall program is operating properly.
- B. If the data does not compare, you may try to reload or reverify the program. A slight adjustment in the recorder volume level may improve the transfer.

NOTE: Ensure that the computer is turned OFF prior to removing it from the interface.

- C. Upon completion, the computer may be removed from the interface, as appropriate.



PLANT MANUAL SECTION:  
OFFSITE DOSE  
PROJECTIONS

PROCEDURE WORK PLAN TITLE:  
OFFSITE DOSE PROJECTIONS -  
POCKET COMPUTER METHOD

NO:  
1904.02

# ARKANSAS NUCLEAR ONE

|          |                 |
|----------|-----------------|
| PAGE     | 29 of 34        |
| REVISION | 2 DATE 02/07/84 |
| CHANGE   | DATE            |

ATTACHMENT 12

Page 1 of 2

## PROGRAM LISTING

```
110 Input "Wind Direction (From)?" ; C
120 Input "Windspeed (MPH)?" ; D
122 Input "Stability Class (A-G)?" ; Y$
123 B = 1: IF Y$ = "A" GOTO 140
124 B = 2: IF Y$ = "B" GOTO 140
125 B = 3: IF Y$ = "C" GOTO 140
126 B = 4: IF Y$ = "D" GOTO 140
127 B = 5: IF Y$ = "E" GOTO 140
128 B = 6: IF Y$ = "F" GOTO 140
129 B = 7: IF Y$ = "G" GOTO 140
130 GOTO 122
140 Input "Q-Gas (Ci/Sec)?" ; E
150 Input "Q-Iodine (Ci/Sec)?" ; C
170 Input "WB Scale Factor?" ; F
180 Input "CT Scale Factor?" ; A
200 H = C - 180
210 IF H<0 Let H = C + 180
215 K = E * 13.3 * F
225 X = A (B + 32)
230 M = A * G * 5.6E8 * X/D
245 L = 1.74E5 * E * F * A (B + 25) * X/D
294 IF ((M<= 500) * (L<= 250)) GOTO 298
296 Print "General Emergency": GOTO 314
298 IF ((M<= 150) * (L<= 50)) GOTO 302
300 Print "Site Emergency": GOTO 314
302 IF (K<= 10) GOTO 306
304 Print "Alert": GOTO 314
306 IF (K<= 1) GOTO 310
308 Print "Unusual Event": GOTO 314
310 Print "O.K."
314 W = X * .05/L
316 FOR N = 1 TO 4
318 A (14 + N) = A (7 * N + B + 32) * L/X
320 A (18 + N) = A (7 * N + B + 32) * M/X
330 Next N
390 Print Using; "Downwind Direction ="; H
400 Using "#.## ^"
405 Print "X/Q: Plume Bdy ="; W
430 Print ".65 mi Avg. MPC ="; K
440 Print ".65 mi WB ="; L
450 Print ".65 mi CT="; M
478 Print "1 mi WB ="; O
480 Print "1 mi CT ="; S
490 Print "2 mi WB ="; P
500 Print "2 mi CT ="; T
```



PLANT MANUAL SECTION:  
OFFSITE DOSE  
PROJECTIONS

PROCEDURE/WORK PLAN TITLE:  
OFFSITE DOSE PROJECTIONS -  
POCKET COMPUTER METHOD

NO:  
1904.02

# ARKANSAS NUCLEAR ONE

|          |          |      |          |
|----------|----------|------|----------|
| PAGE     | 30 of 34 |      |          |
| REVISION | 2        | DATE | 02/07/84 |
| CHANGE   |          | DATE |          |

ATTACHMENT 12

Page 2 of 2

## PROGRAM LISTING

```
510 Print "5 mi WB ="; Q
520 Print "5 mi CT ="; U
530 Print "10 mi WB ="; R
540 Print "10 mi CT ="; V
560 Print Using; "Wind Direction (From) ="; C
570 Print "Windspeed ="; D
580 Print "Stability ="; Y$
590 Using "#.## ^"
600 Print "Q-Gas ="; E
610 Print "Q-Iodine ="; G
620 Print "WB Factor ="; F
630 Print "CT Factor ="; A
999 END
```



PLANT MANUAL SECTION:  
OFFSITE DOSE  
PROJECTIONS

PROCEDURE/WORK PLAN TITLE:  
OFFSITE DOSE PROJECTIONS -  
POCKET COMPUTER METHOD

NO:  
1904.02

# ARKANSAS NUCLEAR ONE

PAGE 31 of 34  
REVISION 2 DATE 02/07/84  
CHANGE DATE

ATTACHMENT 13

Page 1 of 4

## MEMORY CONTENTS

| Memory Location | Variable Name | Description                | Value           |
|-----------------|---------------|----------------------------|-----------------|
| 1               | A             | Child Thyroid Scale Factor | (NOTE: The      |
| 2               | B             | Stability Class No.        | memory contents |
| 3               | C             | Wind Direction             | of locations    |
| 4               | D             | Wind Speed                 | 1-25 depend     |
| 5               | E             | Q-Gas                      | upon program    |
| 6               | F             | Whole Body Scale Factor    | input.)         |
| 7               | G             | Q-Iodine                   |                 |
| 8               | H             | Downwind Direction         |                 |
| 9               | I             | Not Used                   |                 |
| 10              | J             | Not Used                   |                 |
| 11              | K             | Line 10a) 0.65 MPC (ANN)   |                 |
| 12              | L             | " 10e) " W.B. (REAL)       |                 |
| 13              | M             | " 10c) " C.T. (REAL)       |                 |
| 14              | N             | Loop Counter               |                 |
| 15              | O             | 1 mi W.B.                  |                 |
| 16              | P             | 2 mi W.B.                  |                 |
| 17              | Q             | 5 mi W.B.                  |                 |
| 18              | R             | 10 mi W.B.                 |                 |
| 19              | S             | 1 mi C.T.                  |                 |
| 20              | T             | 2 mi C.T.                  |                 |
| 21              | U             | 5 mi C.T.                  |                 |
| 22              | V             | 10 mi C.T.                 |                 |





PLANT MANUAL SECTION:  
OFFSITE DOSE  
PROJECTIONS

PROCEDURE/WORK PLAN TITLE:  
OFFSITE DOSE PROJECTIONS -  
POCKET COMPUTER METHOD

NO:  
1904.02

# ARKANSAS NUCLEAR ONE

PAGE 32 of 34  
REVISION 2 DATE 02/07/84  
CHANGE DATE

ATTACHMENT 13

Page 2 of 4

## MEMORY CONTENTS

| Memory Location | Variable Name | Description                 | Value   |
|-----------------|---------------|-----------------------------|---------|
| 23              | W             | X/Q for .05 MR/hr           |         |
| 24              | X             | Current 1 MPH X/Q @ 0.65 mi |         |
| 25              | YS            | Literal Stability Class     |         |
| 26              |               | Fin. Plume C.F. (A)         | 0.78    |
| 27              |               | " " " (B)                   | 0.72    |
| 28              |               | " " " (C)                   | 0.60    |
| 29              |               | " " " (D)                   | 0.47    |
| 30              |               | " " " (E)                   | 0.42    |
| 31              |               | " " " (F)                   | 0.35    |
| 32              |               | " " " (G)                   | 0.23    |
| 33              |               | 0.65 mi X/Q (A)             | 7.39E-6 |
| 34              |               | " " " (B)                   | 4.10E-5 |
| 35              |               | " " " (C)                   | 1.05E-4 |
| 36              |               | " " " (D)                   | 2.87E-4 |
| 37              |               | " " " (E)                   | 4.84E-4 |
| 38              |               | " " " (F)                   | 8.37E-4 |
| 39              |               | " " " (G)                   | 2.06E-3 |
| 40              |               | 1.0 mi X/Q (A)              | 1.87E-6 |
| 41              |               | " " " (B)                   | 1.68E-5 |
| 42              |               | " " " (C)                   | 4.64E-5 |



PLANT MANUAL SECTION:  
OFFSITE DOSE  
PROJECTIONS

PROCEDURE/WORK PLAN TITLE:  
OFFSITE DOSE PROJECTIONS -  
POCKET COMPUTER METHOD

NO:  
1904.02

# ARKANSAS NUCLEAR ONE

PAGE 33 of 34  
REVISION 2 DATE 02/07/84  
CHANGE DATE

ATTACHMENT 13

Page 3 of 4

## MEMORY CONTENTS

| Location | Description     | Value   |
|----------|-----------------|---------|
| 43       | 1.0 mi X/Q (D)  | 1.38E-4 |
| 44       | " " " (E)       | 2.62E-4 |
| 45       | " " " (F)       | 5.01E-4 |
| 46       | " " " (G)       | 9.61E-4 |
| 47       | 2.0 mi X/Q (A)  | 7.80E-7 |
| 48       | " " " (B)       | 4.18E-6 |
| 49       | " " " (C)       | 1.41E-5 |
| 50       | " " " (D)       | 6.64E-4 |
| 51       | " " " (E)       | 1.02E-4 |
| 52       | " " " (F)       | 2.22E-4 |
| 53       | " " " (G)       | 4.78E-4 |
| 54       | 5.0 mi X/Q (A)  | 3.40E-7 |
| 55       | " " " (B)       | 7.30E-7 |
| 56       | " " " (C)       | 2.63E-6 |
| 57       | " " " (D)       | 1.31E-5 |
| 58       | " " " (E)       | 2.92E-5 |
| 59       | " " " (F)       | 7.23E-5 |
| 60       | " " " (G)       | 1.72E-4 |
| 61       | 10.0 mi X/Q (A) | 1.90E-7 |
| 62       | " " " (B)       | 2.51E-7 |
| 63       | " " " (C)       | 7.74E-7 |
| 64       | " " " (D)       | 4.83E-6 |



PLANT MANUAL SECTION:  
OFFSITE DOSE  
PROJECTIONS

PROCEDURE/WORK PLAN TITLE:  
OFFSITE DOSE PROJECTIONS -  
POCKET COMPUTER METHOD

NO:  
1904.02

# ARKANSAS NUCLEAR ONE

|          |          |      |          |
|----------|----------|------|----------|
| PAGE     | 34 of 34 |      |          |
| REVISION | 2        | DATE | 02/07/84 |
| CHANGE   |          | DATE |          |

ATTACHMENT 13

Page 4 of 4

## MEMORY CONTENTS

| Memory Location | Description     | Value   |
|-----------------|-----------------|---------|
| 65              | 10.0 mi X/Q (E) | 1.14E-5 |
| 66              | " " " (F)       | 3.05E-5 |
| 67              | " " " (G)       | 7.46E-5 |

Not Good Till

3 / 1 / 84



# ARKANSAS POWER & LIGHT COMPANY

## Arkansas Nuclear One

TITLE: RECORD OF CHANGES AND REVISIONS

FORM NO. 1000.06A

OFFSITE DOSE PROJECTIONS

REV. # 12 PC #

Safety Related YES  NO

AUX. BLDG. VENTILATION EXHAUST EMER. RADIATION MONITOR

1904.03 REV. 4

**UN-** Controlled Area # 103

| PAGE | REV | PC# | PAGE | REV | PC# | PAGE | REV | PC# | PAGE | REV | PC# |
|------|-----|-----|------|-----|-----|------|-----|-----|------|-----|-----|
| 1    | 4   |     |      |     |     |      |     |     |      |     |     |
| 2    | 4   |     |      |     |     |      |     |     |      |     |     |
| 3    | 4   |     |      |     |     |      |     |     |      |     |     |
| 4    | 4   |     |      |     |     |      |     |     |      |     |     |
| 5    | 4   |     |      |     |     |      |     |     |      |     |     |
| 6    | 4   |     |      |     |     |      |     |     |      |     |     |
| 7    | 4   |     |      |     |     |      |     |     |      |     |     |
| 8    | 4   |     |      |     |     |      |     |     |      |     |     |
| 9    | 4   |     |      |     |     |      |     |     |      |     |     |
| 10   | 4   |     |      |     |     |      |     |     |      |     |     |
| 11   | 4   |     |      |     |     |      |     |     |      |     |     |

APPROVED BY:

James M. Levine  
(General Manager)

APPROVAL DATE

2/27/84

REQUIRED EFFECTIVE DATE:

3-1-84



PLANT MANUAL SECTION:  
OFFSITE DOSE  
PROJECTIONS

PROCEDURE/WORK PLAN TITLE:  
AUX. BLDG. VENTILATION  
EXHAUST EMER. RADIATION MONITOR

NO:  
1904.03

## ARKANSAS NUCLEAR ONE

|          |         |               |
|----------|---------|---------------|
| PAGE     | 1 of 11 |               |
| REVISION | 4       | DATE 02/07/84 |
| CHANGE   |         | DATE          |

### 1.0 PURPOSE

The purpose of this procedure is to provide a method for quantifying radioactivity releases in the event the normal effluent instrumentation goes off-scale high.

### 2.0 SCOPE

This procedure is to be used if any of the normal effluent instrumentation for either Unit 1 or Unit 2 has gone off-scale high.

### 3.0 REFERENCES

#### 3.1 References Used in Procedure Preparation:

3.1.1 Arkansas Nuclear One Emergency Plan

#### 3.2 References Used in Conjunction with this Procedure:

3.2.1 1904.01 - "Offsite Dose Projections - GERMS Computer Graphics Method"

3.2.2 1904.02 - "Offsite Dose Projections - Pocket Computer Method"

#### 3.3 Related ANO Procedures:

3.3.1 1904.04 - "Estimating Airborne Release Rates"

### 4.0 DEFINITIONS

None

### 5.0 RESPONSIBILITIES

5.1 The Shift Operations Supervisor or the Duty Emergency Coordinator is responsible for initiating this procedure in the event normal effluent instrumentation has gone off-scale high.

### 6.0 PREREQUISITES

#### 6.1 The following systems must be secured:

6.1.1 If the affected Unit is Unit 1, secure:

A. Spent fuel area ventilation for Unit 1

B. Reactor Building purge system for Unit 1

C. Penetration Room ventilation system for Unit 1



PLANT MANUAL SECTION:  
OFFSITE DOSE  
PROJECTIONS

PROCEDURE/WORK PLAN TITLE:  
AUX. BLDG. VENTILATION  
EXHAUST EMER. RADIATION MONITOR

NO:  
1904.03

## ARKANSAS NUCLEAR ONE

|          |         |               |
|----------|---------|---------------|
| PAGE     | 2 OF 11 |               |
| REVISION | 4       | DATE 02/07/84 |
| CHANGE   |         | DATE          |

- D. Drumming station ventilation
- E. Systems capable of transferring material from Unit 1 to Unit 2 Auxiliary Building extension.

6.1.2 If the affected Unit is Unit 2, secure:

- A. Spent fuel area ventilation for Unit 2
- B. Reactor Building purge system for Unit 2
- C. Drumming station ventilation
- D. Auxiliary Building extension ventilation
- E. Systems capable of transferring material from Unit 2 to the Unit 2 Auxiliary Building extension.

### 7.0 PRECAUTIONS AND LIMITATIONS

7.1 Precautions must be taken to ensure that the exposure of individuals involved in implementing this procedure is in accordance with ALARA and that the necessary dosimetry is utilized to record and evaluate this exposure.

### 8.0 DESCRIPTION

8.1 The Auxiliary Building Ventilation Exhaust Stack Radiation Monitor System consists of an isokinetic probe installed in the exhaust stack (1 per unit), necessary piping (3/4") to the sampling station, valving, a silver zeolite cartridge (for iodine absorption) and a particulate filter, a sample bomb (for noble gas analysis), pump, flow indicator and a radiation monitor (Model RMS II, range of 0.1 to 10,000 mR/hr).

8.2 The radiation monitor (Model RMS II) consists of a detector which is located external to the sample piping on Elev. 404 between Unit I and Unit 2 in the Spent Fuel Pool (SFP) Area and a remote readout located in the Unit I Control Room. Normal power, 110 VAC, is supplied to the monitor and the pump from a wall outlet located in the Unit I Control Room next to the monitor. Backup power may be supplied by a vital buss in the Unit 2 Control Room. The use of an extension cord is necessary if power is to be provided from Unit 2. The extension cord consists of 100 feet of cable with 1 male plug on the end connecting to the vital buss connector in the Unit 2 Control Room and 2 female plugs to connect the monitor and the pump in the Unit 1 Control Room. This cord is located in the emergency kit located in front of the monitor located in the back of the Unit I Control Room.

NOTE: See Attachment 3 for locations of the above items.



PLANT MANUAL SECTION:  
OFFSITE DOSE  
PROJECTIONS

PROCEDURE/WORK PLAN TITLE:  
AUX. BLDG. VENTILATION  
EXHAUST EMER. RADIATION MONITOR

NO:  
1904.03

## ARKANSAS NUCLEAR ONE

|          |         |      |          |
|----------|---------|------|----------|
| PAGE     | 3 of 11 |      |          |
| REVISION | 4       | DATE | 02/07/84 |
| CHANGE   |         | DATE |          |

### 9.0 INSTRUCTIONS

#### 9.1 System Startup and Normal Operation (See Attachment 2)

- 9.1.1 Shut or verify shut all valves on pump skid and associated piping (V1A, V1B, V2, V3, V4, V5, V6, V7A, V7B, V8, V9, V10, V11, V12 and V13).

NOTE: Normal monitoring is accomplished by sending vent flow through an empty sample cartridge. Periodically vent flow is passed through a cartridge containing a particulate filter and a silver zeolite cartridge loaded in series in the cartridge.

- 9.1.2 Load particulate filter and silver zeolite cartridge into FA1 (filter assembly located between V3 and V5).
- 9.1.3 Select unit exhaust to be sampled and/or monitored.
- A. If Unit 1, open V1A and V7A.
- B. If Unit 2, open V1B and V7B.
- 9.1.4 Open inlet valve to empty filter assembly (V2). Open outlet valve to empty filter assembly (V4). Open V8, V6 and V9.
- 9.1.5 Start pump. Throttle V6 and, if necessary, V8 to maintain flow at ~2 CFM.
- 9.1.6 Log start time on Form 1904.03B.
- 9.1.7 Continue taking readings per Section 9.5.

#### 9.2 Sample Collection of Particulate Filter and Silver Zeolite Cartridge

- 9.2.1 Verify that the system is lined-up and operating per Section 9.1.
- 9.2.2 Verify that a particulate filter and silver zeolite cartridge are in the loaded filter assembly and open the outlet valve. If the assembly is not loaded, load the assembly and then open the outlet valve.
- 9.2.3 Simultaneously open the inlet valve on the loaded assembly while closing the inlet valve on the empty assembly (ex. V3 on FA1 should be open while V2 on FA2 should be closed).





PLANT MANUAL SECTION:  
OFFSITE DOSE  
PROJECTIONS

PROCEDURE/WORK PLAN TITLE:  
AUX. BLDG. VENTILATION  
EXHAUST EMER. RADIATION MONITOR

NO:  
1904.03

## ARKANSAS NUCLEAR ONE

PAGE 4 of 11  
REVISION 4 DATE 02/07/84  
CHANGE DATE

- 9.2.4 Log the start time on Form 1904.03A. Close the outlet valve on the empty filter assembly (ex. V4).
- 9.2.5 Adjust the flow rate to 2 CFM, if necessary, and log the flow on Form 1904.03A.
- 9.2.6 After sufficient sample flow has been collected, open the outlet and inlet valves to the empty sample cartridge (ex. V4 and V2).
- 9.2.7 Immediately close the inlet and outlet valve on the loaded cartridge (ex. V3 and V5).
- 9.2.8 Log the stop time for this sample on Form 1904.03A.
- 9.2.9 Readjust the flow rate to 2 CFM, if necessary.
- 9.2.10 Remove the sample assembly and replace it with a new assembly. Transport the sample to the count room for analysis.
- 9.2.11 Continue monitoring per Section 9.5.
- 9.3 Sample Collection of Noble Gases
- 9.3.1 Verify that the system is lined-up and operating as per Section 9.1.
- 9.3.2 Verify that valves V10 and V11 are shut.
- 9.3.3 Install the gas sampler between V10 and V11. Open the gas sampler inlet and outlet valves and then open V10 and V11.
- 9.3.4 Close V9 (sample bomb bypass) and readjust the flow rate to 2 CFM, if necessary.
- 9.3.5 Allow at least 7 volumes to pass through the sample container.
- 9.3.6 Open V9 slightly and immediately close the sample bomb outlet and inlet valves.
- 9.3.7 Close V10 and V11. Readjust the flow rate to 2 CFM, if necessary. Log the time of sample on Form 1904.03A.
- 9.3.8 Remove the sample bomb and transport it to the count room for analysis.
- 9.3.9 Continue monitoring per Section 9.5.



PLANT MANUAL SECTION:  
OFFSITE DOSE  
PROJECTIONS

PROCEDURE/WORK PLAN TITLE:  
AUX. BLDG. VENTILATION  
EXHAUST EMER. RADIATION MONITOR

NO:  
1904.03

## ARKANSAS NUCLEAR ONE

|          |         |      |          |
|----------|---------|------|----------|
| PAGE     | 5 of 11 |      |          |
| REVISION | 4       | DATE | 02/07/84 |
| CHANGE   |         | DATE |          |

### 9.4 System Shut-down

9.4.1 Turn off pump.

9.4.2 Shut or verify shut V1A, V1B, V7A and V7B.

### 9.5 Record the following information to determine the release rate from the affected Unit:

#### 9.5.1 Radiation Monitor (Model RMS II)

- A. The date and time of the incident and the current date should be entered each day in the heading of Form 1904.03B.
- B. When the Auxiliary Building exhaust system is in operation, readings should be taken every 15 minutes on the RMS II remote readout in the Unit 1 Control Room. The readings (in mR/hr) should be logged in Column 2 of Form 1904.03B. The corresponding time of each reading should be logged in Column 1.
- C. Enter the ventilation flow rate of the appropriate system for the affected unit in Column 3.
  1. Unit One: FR8001 (Total Stack Flow)
  2. Unit Two: 2FR8315 (Auxiliary Building Radwaste Flow)
- D. Enter the elapsed time from the time of the incident to the time of the reading in Column 4. Then enter in Column 5 the nomenclature of the diagonal line most closely corresponding to that elapsed time (see Attachment 1).
- E. The mR/hr readings from the RMS II are converted to  $\mu\text{Ci}/\text{cc}$  values by the use of the graph on Attachment 1 using the appropriate elapsed time diagonal line. Enter the corresponding value of  $\mu\text{Ci}/\text{cc}$  in Column 6 of Form 1904.03B.
- F. Noble gas sample bomb samples shall be taken to verify or correct the RMS II readings at intervals to be determined by the Shift Operations Supervisor or the Duty Emergency Coordinator. The total  $\mu\text{Ci}/\text{cc}$  results from the noble gas bomb sample analyzed should be logged in Column 7 (Form 1904.03B) on the line most closely corresponding to the sample time.



PLANT MANUAL SECTION:  
OFFSITE DOSE  
PROJECTIONS

PROCEDURE/WORK PLAN TITLE:  
AUX. BLDG. VENTILATION  
EXHAUST EMER. RADIATION MONITOR

NO:  
1904.03

## ARKANSAS NUCLEAR ONE

|          |         |      |          |
|----------|---------|------|----------|
| PAGE     | 6 of 11 |      |          |
| REVISION | 4       | DATE | 02/07/84 |
| CHANGE   |         | DATE |          |

G. When the noble gas sample is analyzed, the results should be compared to the RMS II readings of the same time. The obtained correction factor should be logged in Column 8 of Form 1904.03B for use in correcting RMS II readings until a new sample is analyzed.

NOTE: The correction factor (column 8) is initially 1.0 until laboratory analysis are available.

H. Determine the release rate and enter in Column 9 of Form 1904.03B. Copy the results to a line marked "other releases" on Form 1904.02B.

I. Notify the Duty Emergency Coordinator and the individuals performing Procedure 1904.02, "Offsite Dose Projections - Pocket Computer Method", of the value recorded in Column 9. They should record the value on a line marked "other releases" on Forms 1904.01B and 1904.02B.

NOTE: If lab analysis are available for both noble gas and iodine concentration on 1904.03A, then the iodine release rate (Q iodine) may be estimated by multiplying noble gas release rate (Ci/Sec) by the iodine concentration ( $\mu\text{Ci/cc}$ ) divided by noble gas conc. ( $\mu\text{Ci/cc}$ ).

J. Each entry shall be initialed (Column 10) by the individual making the entries.

### 10.0 ATTACHMENTS AND FORMS

- 10.1 Attachment 1, "Emergency Auxiliary Building Ventilation Monitor Reading
- 10.2 Attachment 2, "Schematic Arrangement"
- 10.3 Attachment 3, "Location of Monitor in the Control Room"
- 10.4 Form 1904.03A, "Aux. Bldg. Ventilation Exhaust Emergency Radiation Monitor Sample Report"
- 10.5 Form 1904.03B, "Emer. Aux. Bldg. Ventilation Monitor Readings"



PLANT MANUAL SECTION:  
OFFSITE DOSE  
PROJECTIONS

PROCEDURE/WORK PLAN TITLE:  
AUX. BLDG. VENTILATION  
EXHAUST EMER. RADIATION MONITOR

NO:  
1904.03

# ARKANSAS NUCLEAR ONE

PAGE 7 of 11  
REVISION 4 DATE 02/07/84  
CHANGE DATE

EMERGENCY AUXILIARY BUILDING VENTILATION MONITOR READING mR/hr vs.  $\mu\text{Ci/cc}$  (with time change)

ATTACHMENT 1

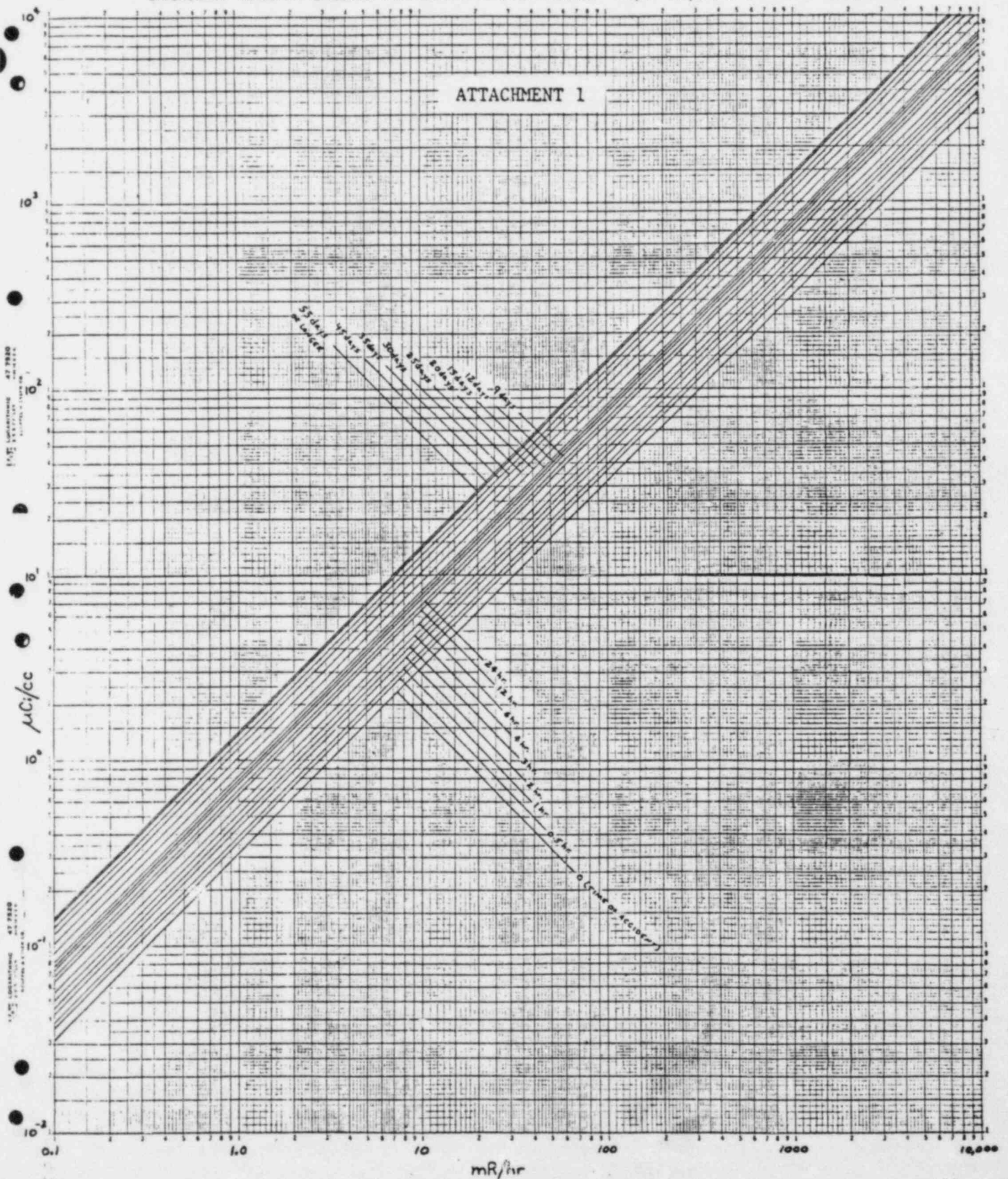

47 9820  
15% UNCORRECTED  
15% UNCORRECTED

47 9820  
15% UNCORRECTED  
15% UNCORRECTED



PLANT MANUAL SECTION:  
OFFSITE DOSE  
PROJECTIONS

PROCEDUREWORK PLAN TITLE:  
AUX. BLDG. VENTILATION  
EXHAUST EMER. RADIATION MONITOR

# ARKANSAS NUCLEAR ONE

PAGE 8 of 11  
REVISION 4 DATE 02/07/84  
CHANGE DATE

NO:  
1904.03

ATTACHMENT 2

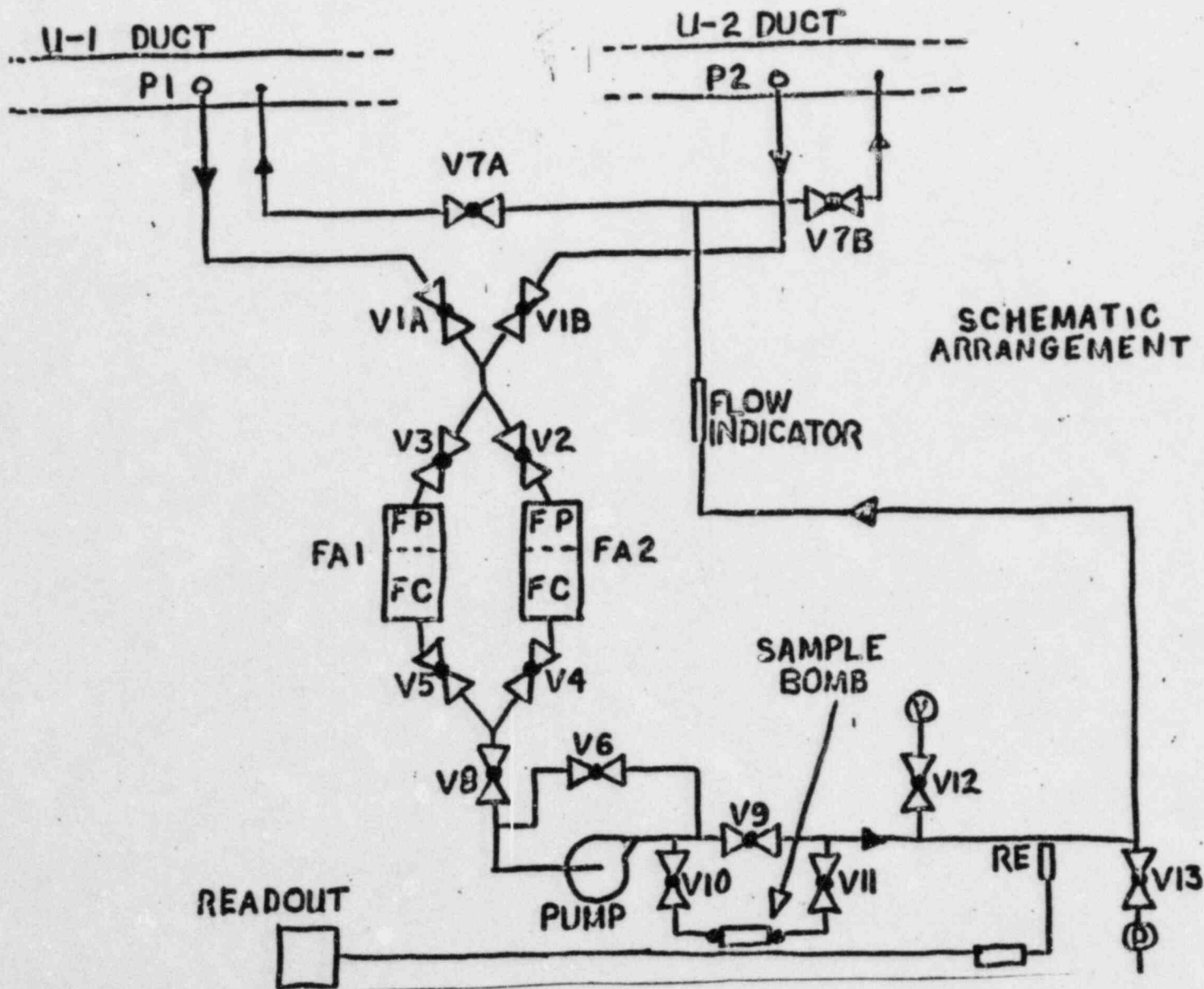









PROCEDURE #1904.06 REV. 4

Not Good Till

3/1/84



# ARKANSAS POWER & LIGHT COMPANY

## Arkansas Nuclear One

TITLE: RECORD OF CHANGES AND REVISIONS

FORM NO. 1000.06A

OFFSITE DOSE PROJECTIONS

REV. # 12 PC #

RADIOLOGICAL PLUME TRACKING AND DOSE INTEGRATION

Safety Related YES  NO

1904.06 REV. 4

UN - Controlled Copy



103

| PAGE | REV | PC# | PAGE | REV | PC# | PAGE | REV | PC# | PAGE | REV | PC# |
|------|-----|-----|------|-----|-----|------|-----|-----|------|-----|-----|
|------|-----|-----|------|-----|-----|------|-----|-----|------|-----|-----|

|    |   |  |  |  |  |  |  |  |  |  |  |
|----|---|--|--|--|--|--|--|--|--|--|--|
| 1  | 4 |  |  |  |  |  |  |  |  |  |  |
| 2  | 4 |  |  |  |  |  |  |  |  |  |  |
| 3  | 4 |  |  |  |  |  |  |  |  |  |  |
| 4  | 4 |  |  |  |  |  |  |  |  |  |  |
| 5  | 4 |  |  |  |  |  |  |  |  |  |  |
| 6  | 4 |  |  |  |  |  |  |  |  |  |  |
| 7  | 3 |  |  |  |  |  |  |  |  |  |  |
| 8  | 4 |  |  |  |  |  |  |  |  |  |  |
| 9  | 3 |  |  |  |  |  |  |  |  |  |  |
| 10 | 3 |  |  |  |  |  |  |  |  |  |  |
| 11 | 3 |  |  |  |  |  |  |  |  |  |  |
| 12 | 3 |  |  |  |  |  |  |  |  |  |  |

APPROVED BY:

*James M. Lewis*  
\_\_\_\_\_  
(General Manager)

APPROVAL DATE

*2/27/84*

REQUIRED EFFECTIVE DATE:

*3-1-84*



PLANT MANUAL SECTION:  
OFFSITE DOSE  
PROJECTIONS

PROCEDURE WORK PLAN TITLE:  
RADIOLOGICAL PLUME TRACKING  
AND DOSE INTEGRATION

NO:  
1904.06

## ARKANSAS NUCLEAR ONE

|          |         |             |
|----------|---------|-------------|
| PAGE     | 1 of 12 |             |
| REVISION | 4       | DATE 2/7/84 |
| CHANGE   |         | DATE        |

### 1.0 PURPOSE

This procedure provides a manual method for estimating the location of airborne radioactive materials offsite under changing release and meteorological conditions, and for estimating the maximum integrated dose commitments at 0.65, 2.0, 5.0, and 10.0 mile radii.

### 2.0 SCOPE

- 2.1 This procedure is applicable to airborne radioactive releases from either ANO-1 or ANO-2.
- 2.2 This procedure does not calculate the fine structure (actual distribution) of integrated doses offsite.
- 2.3 This procedure does not take into account effects caused by precipitation and terrain channelling.
- 2.4 The data generated from this procedure is used as input for procedure 1904.07, "Protective Action Recommendations" and no notifications are required.

### 3.0 REFERENCES

#### 3.1 References Used in Procedure Preparation

- 3.1.1 Emergency Dose Calculation Package Methodology Manual, Applied Physical Technology, July 1981

#### 3.2 References Used in Conjunction with this Procedure

- 3.2.1 1904.01, "Offsite Dose Projections - GERMS Computer Graphics Method"
- 3.2.2 1904.02, "Offsite Dose Projections - Pocket Computer Method"
- 3.2.3 1904.07, "Protective Action Recommendations"
- 3.2.4 1903.31, "Exclusion Area Evacuation"
- 3.2.5 1903.32, "Area Evacuation"

#### 3.3 Related ANO References

None

### 4.0 RESPONSIBILITIES

- 4.1 The Dose Assessment Supervisor in the Emergency Response Organization, or his designee, is responsible for long-term radiological plume tracking and dose integration.



PLANT MANUAL SECTION:  
OFFSITE DOSE  
PROJECTIONS

PROCEDURE/WORK PLAN TITLE:  
RADIOLOGICAL PLUME TRACKING  
AND DOSE INTEGRATION

NO:  
1904.06

## ARKANSAS NUCLEAR ONE

|          |         |      |        |
|----------|---------|------|--------|
| PAGE     | 2 of 12 |      |        |
| REVISION | 4       | DATE | 2/7/84 |
| CHANGE   |         | DATE |        |

- 4.2 The Duty Emergency Coordinator, or his designee, should initiate radiological plume tracking and dose integration as soon as possible after the TSC is activated and continue until relieved by the Dose Assessment Supervisor.

### 5.0 LIMITS AND PRECAUTIONS

- 5.1 Actual integrated doses will generally be lower than predicted by this procedure due to typical wind direction meander.
- 5.2 In order to be meaningful, the dose integration must cover the entire release period (i.e. all plume segments).
- 5.3 If dose calculations were made during the initial portion of a radioactive release incident using the GERMS computers, and these computers are no longer available, perform procedure Section 12.0 one time to convert the GERMS output into hand-calculation format.

### 6.0 DEFINITIONS

- 6.1 Plume Segment - An air parcel containing radioactive material emitted at a relatively uniform release rate and under relatively uniform meteorological conditions.

### 7.0 DOSE RATE PROJECTION SUMMARY

- 7.1 Transfer the dose projection input and output data from Form 1904.02A to Form 1904.06A for each dose projection as it is performed, i.e. therefore the oldest data will appear closer to the top of the form. Include all dose projections previously calculated by Control Room personnel since the beginning of the release. The time on Form 1904.06A refers to the time recorded on 1904.02A.
- 7.2 For each projection, compute the "segment length (miles)" by multiplying the then-current windspeed (mph) by the total elapsed time between the current and previous data collection times (hours). Record the "segment length" on Form 1904.06A for each dose projection (plume segment).

NOTE: The elapsed time for the first plume segment is the time period from the start of the release to the first data collection time.

- 7.3 Combine sequential dose projections which have similar meteorological and release rate characteristics into a single plume segment. This reduces subsequent plotting and integration tasks.



PLANT MANUAL SECTION:  
OFFSITE DOSE  
PROJECTIONS

PROCEDURE/WORK PLAN TITLE:  
RADIOLOGICAL PLUME TRACKING  
AND DOSE INTEGRATION

NO:  
1904.06

## ARKANSAS NUCLEAR ONE

|          |         |      |        |
|----------|---------|------|--------|
| PAGE     | 3 of 12 |      |        |
| REVISION | 4       | DATE | 2/7/84 |
| CHANGE   |         | DATE |        |

7.3.1 The criteria for grouping are:

Wind direction  $\pm 10^\circ$   
Wind speed  $\pm 1$  MPH under 5 MPH or  $\pm 20\%$  over 5 MPH  
Stability class no change  
Release rates  $\pm 20\%$

All tolerances are expressed as maximum deviation from the first segment in the group.

7.3.2 Draw brackets on the left hand margin of 1904.06A to indicate the grouping of segments.

7.3.3 The characteristics of the combined segment are those of the first segment of the group.

### 8.0 PLUME CENTERLINE PLOTTING

8.1 Obtain a  $360^\circ$  protractor, ruler, stability class overlays, map, calculator, and pad of tracing paper (11" x 17", ruled 10 x 10 to the inch) from the appropriate emergency kit:

8.1.1 Technical Support Center

8.1.2 Emergency Control Center

8.2 Select an origin and north-south axis on the tracing paper, taking into consideration the general direction of plume development.

8.3 Refer to Form 1904.06A to determine the downwind direction and segment length of the most recently emitted plume segment.

8.4 Center the protractor on the origin of the tracing paper.

8.5 Turn the protractor until the downwind direction angle (indicated on the outer ring) is aligned with either the north or the south direction on the tracing paper.

8.6 Draw the segment centerline along the indicated side of the protractor's central straightedge, depending on whether the downwind angle was aligned with north or south on the paper.

8.7 Use a ruler to draw the plume segment length to scale (1" = 1 mile).

8.8 Mark the segment endpoint. This is the starting point for the next (older) plume segment.



PLANT MANUAL SECTION:  
OFFSITE DOSE  
PROJECTIONS

PROCEDURE/WORK PLAN TITLE:  
RADIOLOGICAL PLUME TRACKING  
AND DOSE INTEGRATION

NO:  
1904.06

## ARKANSAS NUCLEAR ONE

|          |         |      |        |
|----------|---------|------|--------|
| PAGE     | 4 of 12 |      |        |
| REVISION | 4       | DATE | 2/7/84 |
| CHANGE   |         | DATE |        |

- 8.9 Label the segment centerline with its initial release time. Mark the segment endpoint with the total broken-path plume length at that point.
- 8.10 Center the protractor over the starting point for the next older segment.
- 8.11 Refer to Form 1904.06A to determine the downwind directions and lengths of successively older plume segments, repeating Steps 8.5 through 8.10 until all plume segments have been plotted which fall within a 10-mile radius of ANO.
- 8.12 If any radioactive material released during the time when the GERMS computers were being used for dose calculations is still within 10 miles of ANO:
- 8.12.1 Obtain the "GERMS" centerline tracing prepared in Step 12.0 of this procedure.
  - 8.12.2 Position the "GERMS" tracing over the centerline plot from 8.11.
  - 8.12.3 Align the origin of the "GERMS" tracing with the outermost (oldest) point of the plot from 8.11, and ensure that the "north" arrows on the two pages are parallel.
  - 8.12.4 Hold the plots together along one edge and slide a piece of carbon paper, inked side down, between the sheets.
  - 8.12.5 Trace the "GERMS" centerline on to the plot from 8.11. Portions of the "GERMS" centerline more than 10 miles from ANO need not be transferred.

### 9.0 PLUME OUTLINE DRAWING

NOTE: This section should normally be completed once every 30 minutes. It is not practical to draw the outline of portions of the plume which were previously tracked by the GERMS computers. For these portions, field data must be relied upon for plume width and dose rate information.

- 9.1 For each plume segment, beginning with the one emitted most recently:
- 9.1.1 Select the overlay corresponding to the atmospheric stability when that segment was released.



PLANT MANUAL SECTION:  
OFFSITE DOSE  
PROJECTIONS

PROCEDURE/WORK PLAN TITLE:  
RADIOLOGICAL PLUME TRACKING  
AND DOSE INTEGRATION

NO:  
1904.06

## ARKANSAS NUCLEAR ONE

|          |         |      |        |
|----------|---------|------|--------|
| PAGE     | 5 of 12 |      |        |
| REVISION | 4       | DATE | 2/7/84 |
| CHANGE   |         | DATE |        |

- 9.1.2 Using the total broken-path distance to the segment starting point (as recorded on the centerline plot), mark the segment starting point on the centerline of the stability overlay.
- 9.1.3 Place the overlay under the tracing paper bearing the centerline plot, aligning the segment starting points and centerlines.
- 9.1.4 Trace the bounding X/Q lines for the segment, connecting smoothly with the adjacent segment. (It is usually helpful to extend the boundary lines an inch or so beyond the segment endpoint).

9.2 Darken the plume outline.

9.3 Affix the tracing sheet to a 10-mile radius emergency planning map, aligning the north-south directions, and centering the starting point of the youngest plume segment over the plant site. Carbon paper may be used to transfer the plume centerline and outline to multiple emergency planning maps, if necessary.

### 10.0 DOSE COMMITMENT INTEGRATION

10.1 At the top, leftmost open column on each page of Form 1904.06B, list the starting and ending times for the earliest segment not previously listed.

10.2 Subtract the starting time from the ending time to determine the duration of this integration period in hours.

NOTE: A separate set of forms must be maintained for whole body and for child thyroid doses.

10.3 Compare the plume centerline plotted in Section 8.0 with the dose projection summary on Form 1904.06A. Determine which set of dose projection data on 1904.06A applies to the portion of the plume currently crossing the 0.65 mile map radius. Copy the mR/hr dose rates (child thyroid and whole body) to page 1 of Form 1904.06B. Each dose rate should be recorded on the line on 1904.06B which corresponds to the map sector where the intersection occurs.

NOTE: If portions of the plume were previously drawn by the GERMS computers, there will be no centerline data for them on Form 1904.06A. Interpolate among the field dose rates reported by the Offsite Monitoring Supervisor.

10.4 Multiply the dose rates obtained in Step 10.3 times the duration of the integration period to determine the incremental whole body and child thyroid integrated doses. Record these in the 'Δ' Dose column on the whole body and child thyroid worksheets (Form 1904.06B), on the appropriate sector/radius line.



PLANT/MANUAL SECTION:  
OFFSITE DOSE  
PROJECTIONS

PROCEDURE/WORK PLAN TITLE:  
RADIOLOGICAL PLUME TRACKING  
AND DOSE INTEGRATION

NO:  
1904.06

## ARKANSAS NUCLEAR ONE

PAGE 6 of 12  
REVISION 4 DATE 2/1/84  
CHANGE DATE

NOTE: When the plume centerline falls between two sectors, add the incremental doses to both sectors.

10.5 For each sector/radius line on Form 1904.06B, add the entry in the current ' $\Delta$ ' Dose column to the entry in the previous ' $\Sigma$ ' Dose column and record the new total integrated dose in the current ' $\Sigma$ ' Dose column. This will result in a running total being generated from left to right across the page.

NOTE: The integrated doses at all offsite locations are assumed to be zero prior to an incident; therefore, the first ' $\Sigma$ ' Dose column of an incident will equal the first ' $\Delta$ ' Dose column.

10.6 Circle the highest integrated exposure value for each major radius (0.65, 2.0, 5.0, and 10.0 miles) and for both dose types (whole body and child thyroid).

### 11.0 PROTECTIVE ACTION RECOMMENDATIONS

11.1 Recommend protective action in affected offsite subsectors when trends indicate that:

11.1.1 Whole body integrated dose may approach 1 R (1000 mR), or

11.1.2 Child thyroid integrated dose may approach 5 R (5000 mR) in accordance with procedure 1903.32.

11.2 Recommend protective action in affected onsite (exclusion area) subsectors when whole body dose rate exceeds 2.5 mR/hr in accordance with procedure 1903.31.

### 12.0 CONVERSION FROM GERMS TO MANUAL (TRS-80) CALCULATIONS

NOTE: This portion of the procedure should only be completed in case of failure of the GERMS computers during a radiological release incident. It is to be performed only once, immediately following the failure.

12.1 Transfer the "Release Start" and "Plume Update" times from the most recent Form 1904.01D to the "From (Time)" and "Until (Time)" lines in the leftmost column of each page of Form 1904.06B. Mark one set of Form 1904.06B's for "Whole Body", and one for "Child Thyroid".

12.2 Write "From GERMS" on the first-column "Duration (hr)" line.





PLANT MANUAL SECTION:  
OFFSITE DOSE  
PROJECTIONS

PROCEDURE/WORK PLAN TITLE:  
RADIOLOGICAL PLUME TRACKING  
AND DOSE INTEGRATION

NO:  
1904.06

# ARKANSAS NUCLEAR ONE

PAGE 8 of 12  
REVISION 4 DATE 2/7/84  
CHANGE DATE



## ARKANSAS POWER & LIGHT COMPANY Arkansas Nuclear One

TITLE: DOSE PROJECTION SUMMARY FORM NO. 1904.06A  
REV. # 4 PC #

|     | DOSE PROJECTION SUMMARY<br>(ACTUAL METEOROLOGY)   | RADIUS<br>(MILES) | WHOLE<br>BODY<br>(MR/HR) | CHILD<br>THYROID<br>(MR/HR) |
|-----|---|-------------------|--------------------------|-----------------------------|
| 1.0 | TIME: WINDSPEED: (MPH) 0.65<br>DOWNWIND DIRECTION: (DEG) ///////////////<br>STABILITY CLASS: 2.0<br>BOUNDING X/Q: (SEC/M <sup>3</sup> ) 5.0<br>SEGMENT LENGTH: (MILES) 10.0<br>Q-GAS: (Ci/Sec)<br>Q-I <sub>131</sub> : (Ci/Sec)<br>INITIAL: _____ |                   |                          |                             |
| 2.0 | TIME: WINDSPEED: (MPH) 0.65<br>DOWNWIND DIRECTION: (DEG) ///////////////<br>STABILITY CLASS: 2.0<br>BOUNDING X/Q: (SEC/M <sup>3</sup> ) 5.0<br>SEGMENT LENGTH: (MILES) 10.0<br>Q-GAS: (Ci/Sec)<br>Q-I <sub>131</sub> : (Ci/Sec)<br>INITIAL: _____ |                   |                          |                             |
| 3.0 | TIME: WINDSPEED: (MPH) 0.65<br>DOWNWIND DIRECTION: (DEG) ///////////////<br>STABILITY CLASS: 2.0<br>BOUNDING X/Q: (SEC/M <sup>3</sup> ) 5.0<br>SEGMENT LENGTH: (MILES) 10.0<br>Q-GAS: (Ci/Sec)<br>Q-I <sub>131</sub> : (Ci/Sec)<br>INITIAL: _____ |                   |                          |                             |
| 4.0 | TIME: WINDSPEED: (MPH) 0.65<br>DOWNWIND DIRECTION: (DEG) ///////////////<br>STABILITY CLASS: 2.0<br>BOUNDING X/Q: (SEC/M <sup>3</sup> ) 5.0<br>SEGMENT LENGTH: (MILES) 10.0<br>Q-GAS: (Ci/Sec)<br>Q-I <sub>131</sub> : (Ci/Sec)<br>INITIAL: _____ |                   |                          |                             |
| 5.0 | TIME: WINDSPEED: (MPH) 0.65<br>DOWNWIND DIRECTION: (DEG) ///////////////<br>STABILITY CLASS: 2.0<br>BOUNDING X/Q: (SEC/M <sup>3</sup> ) 5.0<br>SEGMENT LENGTH: (MILES) 10.0<br>Q-GAS: (Ci/Sec)<br>Q-I <sub>131</sub> : (Ci/Sec)<br>INITIAL: _____ |                   |                          |                             |

Reviewed By \_\_\_\_\_

PROCEDURE 1904.07 REV. 3

Not Good Till

3/1/84



# ARKANSAS POWER & LIGHT COMPANY

## Arkansas Nuclear One

TITLE: RECORD OF CHANGES AND REVISIONS

FORM NO. 1000.06A

OFFSITE DOSE PROJECTIONS PROCEDURE

REV. # 12 PC #

Safety Related YES  NO

PROTECTIVE ACTION RECOMMENDATIONS

1904.07 REV. 3

**UN-Controlled Copy # 103**

| PAGE | REV | PC# | PAGE | REV | PC# | PAGE | REV | PC# | PAGE | REV | PC# |
|------|-----|-----|------|-----|-----|------|-----|-----|------|-----|-----|
| 1    | 3   |     |      |     |     |      |     |     |      |     |     |
| 2    | 3   |     |      |     |     |      |     |     |      |     |     |
| 3    | 3   |     |      |     |     |      |     |     |      |     |     |
| 4    | 3   |     |      |     |     |      |     |     |      |     |     |
| 5    | 1   |     |      |     |     |      |     |     |      |     |     |
| 6    | 3   |     |      |     |     |      |     |     |      |     |     |
| 7    | 3   |     |      |     |     |      |     |     |      |     |     |
| 8    | 3   |     |      |     |     |      |     |     |      |     |     |
| 9    | 1   |     |      |     |     |      |     |     |      |     |     |
| 10   | 1   |     |      |     |     |      |     |     |      |     |     |
| 11   | 1   |     |      |     |     |      |     |     |      |     |     |
| 12   | 1   |     |      |     |     |      |     |     |      |     |     |

APPROVED BY:

James M. Lewis  
(General Manager)

APPROVAL DATE

2/27/84

REQUIRED EFFECTIVE DATE:

3-1-84



PLANT MANUAL SECTION:  
OFFSITE DOSE  
PROJECTIONS PROC.

PROCEDURE/WORK PLAN TITLE:  
PROTECTIVE ACTION RECOMMENDATIONS

NO:  
1904.07

## ARKANSAS NUCLEAR ONE

|          |         |      |          |
|----------|---------|------|----------|
| PAGE     | 1 of 12 |      |          |
| REVISION | 3       | DATE | 02/07/84 |
| CHANGE   |         | DATE |          |

### 1.0 PURPOSE

This procedure provides a rapid and reproducible method for generating offsite protective action recommendations due to airborne radiological releases based upon current best estimates of plant and meteorological trends.

### 2.0 SCOPE

- 2.1 This procedure is primarily a screening procedure which can be used to determine if immediate action is needed, or if additional time is available to wait for improved conditions which are reasonably certain to occur, but whose timing is unknown.
- 2.2 Some subjective factors are included, the importance of which must be evaluated at the time of the incident.

### 3.0 REFERENCES

#### 3.1 References used in procedure preparation:

- 3.1.1 "Manual of Protective Action Guides and Protective Actions for Nuclear Incidents", Environmental Protection Agency; Revised February 1980
- 3.1.2 "Workbook of Atmospheric Dispersion Estimates," U.S. Department of Health, Education, and Welfare, D. Bruce Turner, 1970
- 3.1.3 "Meteorology and Atomic Energy", U.S. Atomic Energy Commission, D. H. Slade, July 1968
- 3.1.4 "Arkansas Nuclear One Evacuation Time Study", ANO Emergency Plan Appendix I, March 1981
- 3.1.5 1904.05, "Atmospheric Stability Class Determination"

#### 3.2 References used in conjunction with this procedure:

- 3.2.1 1904.01, "Offsite Dose Projections - GERMS Computer Graphics Method"
- 3.2.2 1904.02, "Offsite Dose Projections - Pocket Computer Method"
- 3.2.3 1904.06, "Radiological Plume Tracking and Dose Integration"
- 3.2.4 1904.08, "Use of the WSI Weather Information Service"
- 3.2.5 1903.10, "Emergency Action Level Response"



SECTION:  
PROJECTIONS PROC.

PROCEDURE/WORK PLAN TITLE:  
PROTECTIVE ACTION RECOMMENDATIONS

NO:  
1904.07

## ARKANSAS NUCLEAR ONE

|          |         |      |          |
|----------|---------|------|----------|
| PAGE     | 2 of 12 |      |          |
| REVISION | 3       | DATE | 02/07/84 |
| CHANGE   |         | DATE |          |

### 3.3 Related ANO references:

None

### 4.0 RESPONSIBILITIES

- 4.1 The Shift Administrative Assistant is responsible for formulating protective action recommendations and communicating them to the Duty Emergency Coordinator for the initial notifications per procedure 1904.02, "Offsite Dose Projections - Pocket Computer Method".
- 4.2 The TSC staff as designated by the Duty Emergency Coordinator, or the ECC staff as directed, is responsible for formulating protective action recommendations for followup notifications as outlined by this procedure.
- 4.3 The ERO Technical Support Manager, or his designee, is responsible for preparing protective action recommendations for the remainder of a radiological incident.

### 5.0 LIMITS AND PRECAUTIONS

- 5.1 The "latest evacuation start time" calculated in this procedure allows one hour for preliminary governmental actions, sufficient time for evacuation, plus two hours for verification of evacuation.
- 5.2 If the current Emergency Action Level is "Unusual Event" or "None", this procedure need not be completed.
- 5.3 Calculations in this procedure are conservative; however, actual offsite doses and decision times may be higher or lower, and new recommendations should be considered whenever updated information becomes available.
- 5.4 Integrated offsite doses are required as input for this procedure. This data may be obtained from:
  - 5.4.1 Procedure 1904.06, "Radiological Plume Tracking and Dose Integration".
  - 5.4.2 Direct measurements (i.e. from portable ion chambers, TLD's, etc.).
  - 5.4.3 Integrated doses supplied by other computer models such as the NRC, state and GERMS.

### 6.0 EVACUATION RECOMMENDATIONS

- 6.1 Attach form 1904.07A to the most recent offsite dose projection forms (1904.02A-C or 1904.01A-F and J).



PLANT MANUAL SECTION:  
OFFSITE DOSE  
PROJECTIONS PROC.

PROCEDURE/WORK PLAN TITLE:  
PROTECTIVE ACTION RECOMMENDATIONS

NO:  
1904.07

## ARKANSAS NUCLEAR ONE

|          |   |      |          |
|----------|---|------|----------|
| PAGE     | 3 | of   | 12       |
| REVISION | 3 | DATE | 02/07/84 |
| CHANGE   |   | DATE |          |

- 6.2 Complete form 1904.07A to determine the appropriate evacuation recommendation.
- 6.3 If box d) is checked in section 18 of form 1904.07A, consider a recommendation of delaying evacuation due to the factors listed after the evacuation recommendation statements.
- 6.4 If evacuation is recommended for any radius, rerun this procedure to determine protective action recommendations for the next larger evacuation test radius.

### 7.0 NOTIFICATIONS

Make notifications and continue with offsite dose projections by re-starting procedure 1904.02, "Offsite Dose Projections - Pocket Computer Method" from Step 11.2, or procedure 1904.01, "Offsite Dose Projections - GERMS Computer Graphics Method" from Step 13.2.

### 8.0 ATTACHMENTS AND FORMS

- 8.1 Form 1904.07A - Protective Action Selection
- 8.2 Attachment 1 - X/Q Ratios



PLANT MANUAL SECTION:  
OFFSITE DOSE  
PROJECTIONS PROC.

PROCEDURE/WORK PLAN TITLE:  
PROTECTIVE ACTION RECOMMENDATIONS

NO:  
1904.07

# ARKANSAS NUCLEAR ONE

PAGE 4 OF 12  
REVISION 3 DATE 02/07/82  
CHANGE DATE



## ARKANSAS POWER & LIGHT COMPANY Arkansas Nuclear One

TITLE: PROTECTIVE ACTION SELECTION

FORM NO. 1904.07A

REV. # 3 PC #

Time Stamp of Dose Projection Data \_\_\_\_\_ Page 1 of 5

1.0 Check current Emergency Action level:

|                          |                          |                          |                          |                          |
|--------------------------|--------------------------|--------------------------|--------------------------|--------------------------|
| 1                        | 2                        | 3                        | 4                        | 5                        |
| <input type="checkbox"/> | <input type="checkbox"/> | <input type="checkbox"/> | <input type="checkbox"/> | <input type="checkbox"/> |
| O.K.                     | U.E.                     | ALERT                    | S.E.                     | G.E.                     |

If box 1 or 2 was checked, check box a) in section 18.0 and terminate the procedure.

2.0 Request the forecast average airborne radioactive release rate for the duration of the incident, based upon considerations of system temperature, pressure, planned remedial actions, probable failures, etc. (factor above current) from the Shift Operations Supervisor:

\_\_\_\_\_ (factor)

3.0 Request the forecast release continuation time in hours from the Shift Operations Supervisor and/or the Recovery Manager:

\_\_\_\_\_ (hours)

If a General Emergency has been declared, ensure the following recommendation has been made to the Arkansas Department of Health. As a minimum, recommend sheltering within a 2 mile radius of the plant and 5 miles in the downwind direction.

4.0 Refer to the table in Attachment 1 which applies to the current date and most closely approximates the current sky conditions. Select the predicted X/Q ratio which corresponds to the release continuation time from line 3.0.

NOTE: For overcast (i.e., 100% cloud cover) sky conditions, the predicted X/Q ratio is always 1.0. Predicted X/Q ratio: \_\_\_\_\_

5.0 Record the current windspeed and direction from Form 1904.02A or 1904.01D\*:

Wind direction (from) \_\_\_\_\_ Wind speed (MPH) \_\_\_\_\_

\*Windspeed (MPH) = Windspeed (Meters/Sec) x 2.24

6.0 Obtain a weather forecast using procedure 1904.08 and record the windspeeds (averages, not gusts) and directions forecast for the duration of the release period only:

|    |                             |                        |                   |
|----|-----------------------------|------------------------|-------------------|
| a. | Wind Direction (from) _____ | Wind Speed (MPH) _____ | Time Period _____ |
| b. | Wind Direction (from) _____ | Wind Speed (MPH) _____ | Time Period _____ |
| c. | Wind Direction (from) _____ | Wind Speed (MPH) _____ | Time Period _____ |
| d. | Wind Direction (from) _____ | Wind Speed (MPH) _____ | Time Period _____ |

THE MATERIAL CONTAINED WITHIN THESE SYMBOLS (\*) IS PROPRIETARY OR PRIVATE INFORMATION



PLANT MANUAL SECTION:  
OFFSITE DOSE  
PROJECTIONS PROC.

PROCEDURE/WORK PLAN TITLE:  
PROTECTIVE ACTION RECOMMENDATIONS

NO:  
1904.07

# ARKANSAS NUCLEAR ONE

PAGE 6 OF 12  
REVISION 3 DATE 02/07/84  
CHANGE DATE



## ARKANSAS POWER & LIGHT COMPANY Arkansas Nuclear One

TITLE PROTECTIVE ACTION SELECTION

FORM NO. 1904.07A

REV. B PC 9

Page 3 of 5

| Affected Sector             | Wind Direction (from) | Downwind Direction (degrees) | Evacuation Zone |
|-----------------------------|-----------------------|------------------------------|-----------------|
| <input type="checkbox"/> 9  | N                     | 168.8 - 191.3                | Dardanelle      |
| <input type="checkbox"/> 10 | NNE                   | 191.3 - 213.8                | Dardanelle      |
| <input type="checkbox"/> 11 | NE                    | 213.8 - 236.3                | Delaware        |
| <input type="checkbox"/> 12 | ENE                   | 236.3 - 258.8                | Delaware        |
| <input type="checkbox"/> 13 | E                     | 258.8 - 281.3                | Delaware        |
| <input type="checkbox"/> 14 | ESE                   | 281.3 - 303.8                | London          |
| <input type="checkbox"/> 15 | SE                    | 303.8 - 326.3                | London          |
| <input type="checkbox"/> 16 | SSE                   | 326.3 - 348.8                | London          |

NOTE: If Sector 10 was checked as an effected sector, also include Sectors 9 and 11. If Sector 11 was checked as an effected sector, also include Sectors 10 and 12.

10.0 Check the largest standard radius for which a protective action recommendation has been issued in the downwind directions checked above::

|                          |                          |                          |                          |
|--------------------------|--------------------------|--------------------------|--------------------------|
| (GERMS) None or 0.62 mi  | 1.45 mi                  | 3.46 mi                  | 7.25 mi.                 |
| <input type="checkbox"/> | <input type="checkbox"/> | <input type="checkbox"/> | <input type="checkbox"/> |
| (TRS-80) None or 0.65 mi | 2.0 mi                   | 5.0 mi                   | 10 mi.                   |

11.0 Complete the following table using data for the radius from 10.0 above and from the instructions in the note below:

|                  | Column 1                 | Column 2                          | Column 3                                   | Column 4                           | Yes No   |
|------------------|--------------------------|-----------------------------------|--|------------------------------------|--|
|                  | Current Doserate (mR/hr) | Forecast Average Doserate (mR/hr) | Current Max. Integrated Dose Downwind (mR) | Forecast Max. Integrated Dose (mR) |  |
| a) Whole Body    |                          |                                   |  |                                    | Exceeds 1000 mR? <input type="checkbox"/> <input type="checkbox"/> |
| b) Child Thyroid |                          |                                   |  |                                    | Exceeds 5000 mR? <input type="checkbox"/> <input type="checkbox"/> |

NOTE: Column 1 = Form 1904.02A, Section 4.0; or Form 1904.01J  
Calculations for columns 2, 3, and 4 are computed using the formulas below.

$$\text{Column 2a} = \text{Column 1a)} \times \text{Line 2.0} \times \text{Line 4.0} \times \text{Line 8.0}$$





PLANT MANUAL SECTION:  
OFFSITE DOSE  
PROJECTIONS PROC.

PROCEDURE/WORK PLAN TITLE:  
PROTECTIVE ACTION RECOMMENDATIONS

NO:  
1904.07

# ARKANSAS NUCLEAR ONE

PAGE 7 of 12  
REVISION 3 DATE 02/07/84  
CHANGE DATE



## ARKANSAS POWER & LIGHT COMPANY Arkansas Nuclear One

TITLE: PROTECTIVE ACTION SELECTION

FORM NO. 1904.07A

REV. #3 PC #

Page 4 of 5

(Note Continued)

$$\text{Column 2b} = \frac{\text{Column 1b}}{\text{Line 2.0}} \times \frac{\text{Line 4.0}}{\text{Line 3.0}}$$

Column 3 = Zero for initial recommendation; or use 1904.06B max. dose in an affected sector at the specified radius (1904.01F when using GERMS)

$$\text{Column 4a} = \frac{\text{Column 2a} \times \text{Line 3.0}}{\text{Line 3.0}} + \text{Column 3a}$$

$$\text{Column 4b} = \frac{\text{Column 2b} \times \text{Line 3.0}}{\text{Line 3.0}} + \text{Column 3b}$$

12.0 If both "no" boxes were checked in the table above, check box number b) in section 18.0 and terminate the procedure.

13.0 Calculate the PAG dose accumulation time:

$$13.1 \text{ [1000 (mR) - } \frac{\text{(mR)}}{\text{Column 3a}} \text{] + } \frac{\text{(mR/hr)}}{\text{Column 2a}} \text{ = } \frac{\text{(hr)}}{\text{Whole Body}}$$

$$13.2 \text{ [5000 (mR) - } \frac{\text{(mR)}}{\text{Column 3b}} \text{] + } \frac{\text{(mR/hr)}}{\text{Column 2b}} \text{ = } \frac{\text{(hr)}}{\text{Child Thyroid}}$$

13.3 Enter the lesser of line 13.1 or line 13.2:

\_\_\_\_\_ (hr)

14.0 Estimate the evacuation and clear time of potentially affected sectors. Based upon the road conditions forecast for the end of the PAG dose accumulation time in 13.3 above, circle the evacuation and clear time in the following table for each evacuation zone (from line 9.0).

| Evacuation Zone | (6AM-5PM) Weekday | (5PM-6AM) Week Night | (5PM Fri. 6AM Mon.) Weekend | Adverse Road Conditions (Weekday) |
|-----------------|-------------------|----------------------|-----------------------------|-----------------------------------|
| London          | 5.7 hrs.          | 5.6 hrs.             | 5.7 hrs.                    | 6.3 hrs.                          |
| Russellville    | 6.8 hrs.          | 6.0 hrs.             | 8.4 hrs.                    | 8.1 hrs.                          |
| Dardanelle      | 5.1 hrs.          | 5.1 hrs.             | 5.6 hrs.                    | 5.1 hrs.                          |
| Delaware        | 5.1 hrs.          | 5.1 hrs.             | 5.1 hrs.                    | 5.1 hrs.                          |

NOTE: These times include one hour for preliminary governmental action and two hours for clearance verification.



PROCEDURE 1904.08 REV. 0

Not Good Till

3/1/84



# ARKANSAS POWER & LIGHT COMPANY

## Arkansas Nuclear One

TITLE: RECORD OF CHANGES AND REVISIONS

FORM NO. 1000.06A

OFFSITE DOSE PROJECTIONS

REV. # 12 PC #

USE OF THE WSI WEATHER INFORMATION SERVICE  Safety Related YES  NO   
1904.08 REV. 0

UN-

103

| PAGE | REV | PC# | PAGE | REV | PC# | PAGE | REV | PC# | PAGE | REV | PC# |
|------|-----|-----|------|-----|-----|------|-----|-----|------|-----|-----|
| 1    | 0   |     |      |     |     |      |     |     |      |     |     |
| 2    | 0   |     |      |     |     |      |     |     |      |     |     |
| 3    | 0   |     |      |     |     |      |     |     |      |     |     |
| 4    | 0   |     |      |     |     |      |     |     |      |     |     |
| 5    | 0   |     |      |     |     |      |     |     |      |     |     |
| 6    | 0   |     |      |     |     |      |     |     |      |     |     |
| 7    | 0   |     |      |     |     |      |     |     |      |     |     |
| 8    | 0   |     |      |     |     |      |     |     |      |     |     |
| 9    | 0   |     |      |     |     |      |     |     |      |     |     |
| 10   | 0   |     |      |     |     |      |     |     |      |     |     |
| 11   | 0   |     |      |     |     |      |     |     |      |     |     |
| 12   | 0   |     |      |     |     |      |     |     |      |     |     |
| 13   | 0   |     |      |     |     |      |     |     |      |     |     |
| 14   | 0   |     |      |     |     |      |     |     |      |     |     |
| 15   | 0   |     |      |     |     |      |     |     |      |     |     |
| 16   | 0   |     |      |     |     |      |     |     |      |     |     |
| 17   | 0   |     |      |     |     |      |     |     |      |     |     |

APPROVED BY:

APPROVAL DATE

*[Signature]*  
\_\_\_\_\_  
(General Manager)

REQUIRED EFFECTIVE DATE:

3-1-24



PLANT MANUAL SECTION:  
OFFSITE DOSE  
PROJECTIONS

PROCEDURE WORK PLAN TITLE:  
USE OF THE WSI  
WEATHER INFORMATION SERVICE

NO:  
1904.08

## ARKANSAS NUCLEAR ONE

|          |         |               |
|----------|---------|---------------|
| PAGE     | 1 OF 17 |               |
| REVISION | 0       | DATE 02/07/84 |
| CHANGE   |         | DATE          |

### 1.0 PURPOSE

This procedure provides a backup method for obtaining an estimate of current meteorology in the unlikely event that the onsite meteorological measurements system fails completely. Forecasts are also available for a limited number of meteorology parameters.

### 2.0 SCOPE

- 2.1 The primary source of current meteorological data is the onsite meteorological measurements system.
- 2.2 The primary source of forecast meteorological data is the National Weather Service, Arkansas Zone 5 Forecast, available from the MSS Dispatcher, (4882), KARV Radio (968-1184), or from Weather Services International (WSI) via this procedure.
- 2.3 Supplemental meteorological data may be obtained from this procedure or from the National Weather Service (Meteorologist-in-Charge) [834-0308 or • 834-3955 •].
- 2.4 Storm warnings and current weather radar maps are available from WSI for general use during an emergency using this procedure.

### 3.0 REFERENCES

#### 3.1 References used in procedure preparation:

- 3.1.1 "Weather Information System User Manual", WSI Corporation; June 1, 1982.

#### 3.2 References used in conjunction with this procedure:

- 3.2.1 1904.01, "Offsite Dose Projections - GERMS Computer Graphics Method:
- 3.2.2 1904.02, "Offsite Dose Projections - Pocket Computer Method"

#### 3.3 Related ANO Procedures

None

### 4.0 DEFINITIONS

- 4.1 Greenwich Mean Time (GMT) - the standard time in Greenwich, England. Most international weather data is listed in GMT, and is designated by the suffix 'Z'. Convert Greenwich Mean Time to Central Standard Time by subtracting 6 hours (or add 6 hours to convert CST to GMT). Subtract 5 hours to convert from GMT to Central Daylight Saving Time.

---

The material contained within these symbols [•] is proprietary or private information.



PLANT MANUAL SECTION:  
OFFSITE DOSE  
PROJECTIONS

PROCEDURE/WORK PLAN TITLE:  
USE OF THE WSI  
WEATHER INFORMATION SERVICE

NO:

1904.08

## ARKANSAS NUCLEAR ONE

PAGE 2 of 17

REVISION 0 DATE 02/07/84

CHANGE DATE

4.2 Telenet, Tymnet - data transmission service companies which allow interconnection with distant computers (i.e. WSI, in Bedford, Mass.) from a local telephone number.

### 5.0 RESPONSIBILITIES

5.1 The Duty Emergency Coordinator, or his designee, is responsible for obtaining current meteorological data for use in completing offsite dose calculations until relieved by the Technical Analysis Superintendent or the Dose Assessment Supervisor.

5.2 The Technical Analysis Superintendent, Dose Assessment Supervisor, or their designees are responsible for obtaining forecast meteorological data for use in preparing offsite dose forecasts.

### 6.0 LIMITS AND PRECAUTIONS

6.1 The WSI Weather Information is billed on the basis of the number of minutes that a user is connected to the system. For this reason, users should know clearly what information is required before signing-on and should also sign-off promptly when the required information has been listed.

6.2 Weather Services International (WSI) collects weather information on a continuous, round-the-clock basis from weather stations located throughout the world. High-speed data links allow WSI to receive most of the U.S. hourly data within 10 minutes of the observation time.

6.3 A wide variety of additional data is available from the WSI service. However, the casual user is discouraged from experimenting with commands which are not explicitly described in this procedure.

6.4 Always wait until the "+" prompt appears before entering additional commands when you are logged in to the WSI service.

### 7.0 SPECIAL KEYBOARD COMMANDS

7.1 [CTRL] CC [CTRL] and C, then C again to "clear" the terminal. [CTRL] CC is the WSI panic button and will stop any program at any time. The + prompt will appear to indicate that you may enter a new command.

7.2 [DELETE] Press [DELETE] (on some terminals, this key is labeled [DEL] or [RUBOUT]. The [BACKSPACE] key will also perform the same function) to delete characters one at a time starting with the most recently typed character. For TELENET users, a backslash (\) will appear and the characters extinguished will show after the slash. For TYMNET, the characters deleted will be repeated, and the slash will not appear.



PLANT MANUAL SECTION:  
OFFSITE DOSE  
PROJECTIONS

PROCEDURE/WORK PLAN TITLE:  
USE OF THE WSI  
WEATHER INFORMATION SERVICE

NO:  
1904.08

## ARKANSAS NUCLEAR ONE

|          |         |      |          |
|----------|---------|------|----------|
| PAGE     | 3 of 17 |      |          |
| REVISION | 0       | DATE | 02/07/84 |
| CHANGE   |         | DATE |          |

- 7.3 [CTRL] R [CTRL] and R to show the characters that "remain" if there is some confusion after typing and deleting.
- 7.4 [CTRL] U [CTRL] and U to erase the current line and begin again. The + prompt will not appear again.
- 7.5 [RETURN] Press [RETURN]. [RETURN] must be pressed at the end of every line typed; this instructs the computer to begin processing your command.

### 8.0 PREPARING THE LA12A Decwriter

- 8.1 Decwriters and paper are normally stored near the ECC and TSC emergency kits in brown cloth carrying cases.
- 8.2 Remove the Decwriter completely from its carrying case. In order to maintain proper cooling, the feet of the unit must rest directly on a smooth hard surface.
- 8.3 Connect the black power cord to the socket at the rear of the unit and a 110 VAC wall socket.
- 8.4 Push the power switch on the top right rear corner to the "1" (on) position. In about two seconds the terminal should beep, indicating that the internal self-test was successful.
- 8.5 If the "line" light is not lighted, press [LINE/LOC].
- 8.6 Install paper in the printer.

NOTE: The LA12A can use 9½ x 11" sprocket-feed Z-fold paper such as Moore Forms #9510CJ (AP&L Stock #720-200), 8½"-wide roll-feed (teletype) paper (AP&L Stock #720-438), or as a last resort, single sheets of letter-size or 1-gal size paper. All papers are installed similarly.

- 8.6.1 Move the two orange levers at the upper left fully forward.
- 8.6.2 Feed paper into rear paper slot with both hands.
- 8.6.3 Moving paper slightly from side to side, continue feeding into slot and under platen until paper edge appears at front.
- 8.6.4 Open the print compartment door by pulling up at the front.
- 8.6.5 Pull paper up until it catches on sprocket pins (plain roll paper should be aligned between the sprockets).



PLANT MANUAL SECTION:  
OFFSITE DOSE  
PROJECTIONS

PROCEDURE/WORK PLAN TITLE:  
USE OF THE WSI  
WEATHER INFORMATION SERVICE

NO:  
1904.08

## ARKANSAS NUCLEAR ONE

|          |         |      |          |
|----------|---------|------|----------|
| PAGE     | 4 of 17 |      |          |
| REVISION | 0       | DATE | 02/07/84 |
| CHANGE   |         | DATE |          |

- 8.6.6 Line up paper perforations with the sprocket pins.
- 8.6.7 Move the left-hand orange lever to the rear (both orange levers for plain roll papers).
- 8.6.8 Close the print compartment door and press the [VIEW/FAULT RESET] key.
- 8.6.9 Press the [LOC FF/LOC LF] key to advance paper through front paper slot.
- 8.7 Check the option selections as follows:
  - 8.7.1 Hold down the [CTRL] key and press [SET-UP]. The set-up status light should flash.
  - 8.7.2 Type I[RETURN]. This initializes the keyboard, modem, and printer options.
  - 8.7.3 Hold down the [CTRL] key and press [VIEW/FAULT RESET] to select automatic last-character-view.
- 8.8 If the terminal is to be connected to a telephone which has a modular plug-in cable, proceed to Step 8.9. Otherwise, type CC = C [RETURN] [SET-UP], and proceed to Section 9.0.
- 8.9 If it is desired to operate at the highest speed using "TELENET", type CS = A[RETURN].
- 8.10 Type CC = B[RETURN] [SET-UP].
- 8.11 Disconnect a nearby telephone by unplugging the cable at its wall outlet.
- 8.12 Reconnect this cable to the socket marked "TELE" at the back of the Decwriter.
- 8.13 Connect the gray telephone cable stored with the decwriter to the "Line" socket at the back of the Decwriter and the modular wall telephone outlet.
- 8.14 With the [DATA/TALK] key on the Decwriter in the (down) "TALK" position, the telephone should operate normally.

### 9.0 ESTABLISHING TELEPHONE CONNECTION

NOTE: Any one of the following three methods may be used. However, they are listed in order of preference.

#### 9.1 Using Tymnet (for 300-Baud Modems Only)

- 9.1.1 Switch the modem or Decwriter to the "talk" or "voice" mode.





PLANT MANUAL SECTION:  
OFFSITE DOSE  
PROJECTIONS

PROCESS WORK PLAN TITLE:  
USE OF THE WSI  
WEATHER INFORMATION SERVICE

NO:  
1904.08

## ARKANSAS NUCLEAR ONE

|          |   |      |          |
|----------|---|------|----------|
| PAGE     | 5 | OF   | 17       |
| REVISION | 0 | DATE | 02/07/84 |
| CHANGE   |   | DATE |          |

- 9.1.2 Dial network access number (\*666-6886\*).
- 9.1.3 Listen for high pitched tone.
- 9.1.4 Switch the Decwriter or modem to "data" mode.
- 9.1.5 If the telephone is not connected via a modular plug, press the telephone handset into the acoustic coupler with the cord to the rear.
- 9.1.6 When the computer prints "PLEASE TYPE YOUR TERMINAL IDENTIFICATION", type "A" at the keyboard ("A" does not print).
- 9.1.7 When the computer prints "PLEASE LOG IN", type "WSI [Return]". The computer should respond with "WSI IS ON LINE", indicating that connection has been made.
- 9.1.8 Go to Section 10.0 "LOGGING IN".
- 9.2 Using Telenet (for 300/1200 Baud Modems)
  - 9.2.1 Switch the modem or decwriter to the "talk" or "voice" mode.
  - 9.2.2 Dial primary network access number. (\*372-4616\*.)
  - 9.2.3 Listen for high pitched tone.
  - 9.2.4 Switch the modem or Decwriter to the "data" mode.
  - 9.2.5 If the telephone is not connected via a modular plug, press the telephone handset into the acoustic coupler with the cord to the rear.
  - 9.2.6 Press the [RETURN] key two times. The computer should respond with "TELENET".
  - 9.2.7 When the computer prints "TERMINAL =", type "D1[Return]".
  - 9.2.8 When the computer prints an "@" sign, type "C[Space]617133 [Return][Return]". The computer should respond with "617 133X CONNECTED".
  - 9.2.9 Go to Section 10.0 "LOGGING IN".
- 9.3 Long-Distance Direct:
  - 9.3.1 Call WSI Customer Service at (\*617 275-5300\*), extension 172.
  - 9.3.2 Ask for assistance in establishing connection.

---

The material contained within these symbols (\*) is proprietary or private information.



PLANT MANUAL SECTION:  
OFFSITE DOSE  
PROJECTIONS

PROCEDURE WORK PLAN TITLE:  
USE OF THE WSI  
WEATHER INFORMATION SERVICE

NO:  
1904.08

## ARKANSAS NUCLEAR ONE

PAGE 6 OF 17  
REVISION 0 DATE 02/07/84  
CHANGE DATE

### 10.0 LOGGING-IN

10.1 After establishing a connection through one of the telecommunications networks in Section 9.0, the computer will prompt you with "PLEASE LOG IN". You should respond by typing "LOGIN[Space]APL[Return]".

10.2 When the computer requests your password, type "LIGHT[Return]". The computer should respond with:

```
***LOGGED INTO WEATHER SERVICES SYSTEM C***  
***ALL REPORTS COPYRIGHT WSI CORPORATION***
```

### 11.0 CURRENT DATA

NOTE: Data listed in Sections 11.0, 12.0, and 13.0 can be printed through the use of the following command: "ARKMET[RETURN]".

11.1 When the "+" prompt is present, type:

```
USINFO @AR NAWZGZQZKIDHPC [RETURN].
```

A listing of current data for 11 Arkansas reporting stations should appear (See Attachment 1 for an example).

11.2 The station names are encoded as follows:

| <u>STA</u> | <u>STATION NAME</u> |
|------------|---------------------|
| BYH        | BLYTHEVILLE, AR...  |
| ELD        | EL DORADO, AR.....  |
| FYV        | FAYETTEVILLE, AR..  |
| FSM        | FORT SMITH, AR....  |
| HRO        | HARRISON, AR.....   |
| HOT        | HOT SPRINGS, AR...  |
| LRF        | JACKSONVILLE, AR..  |
| JBR        | JONESBORO, AR.....  |
| LIT        | LITTLE ROCK, AR...  |
| PBF        | PINE BLUFF, AR....  |
| TXK        | TEXARKANA, AR.....  |

Underline the data for Fort Smith, Harrison, Hot Springs, and Little Rock. These will hereafter be referred to as the "adjacent reporting stations".

11.3 The first "wind" column of the report contains the compass direction from which the wind is blowing and the wind speed in MPH. The wind speeds at the adjacent reporting stations may be averaged for dose assessment work.



PLANT MANUAL SECTION:  
OFFSITE DOSE  
PROJECTIONS

PROCEDURE WORK PLAN TITLE:  
USE OF THE WSI  
WEATHER INFORMATION SERVICE

NO:  
1904.08

## ARKANSAS NUCLEAR ONE

|          |   |      |          |
|----------|---|------|----------|
| PAGE     | 7 | OF   | 17       |
| REVISION | 0 | DATE | 02/07/84 |
| CHANGE   |   | DATE |          |

11.4 The second "wind" column contains four-digit numbers. The first two digits represent the wind direction rounded to the nearest ten degrees and divided by ten. The second two digits are the windspeed in knots. The wind direction for the adjacent reporting stations may usually be averaged for dose assessment work, unless they are radically different, in which case selection should be based on estimated current conditions. (Remember that 0° and 360° both refer to north.)

11.5 The "GST" column is the maximum wind gusts reported, in MPH.

11.6 The "PS" column contains the Pasquill Stability Class at the reporting station. The stability class which exists at the largest number of the adjacent reporting stations may be used for dose assessment work.

11.7 The "sky" column contains a literal description of each cloud layer preceded by its height in hundreds of feet. When necessary for use in dose assessment procedures, onsite cloud conditions may be taken to be the most frequently occurring condition from the adjacent reporting stations. The letter "C" denotes the aviation ceiling, if any.

NOTE: The first column indicates the lowest cloud layer in hundreds of feet. Under stable dispersion conditions, this may be interpreted as the limit of vertical dispersion (mixing height).

11.8 The remaining columns are the surface temperature (°F), dew point (°F), relative humidity (%), barometric pressure (millibars times 10 minus 900 or 1000) and the three hour pressure change (millibars times 10).

NOTE: To convert the tabulated barometric pressure to millibars, divide by 10. If the resulting value is greater than 50.0, add 900. If it is less than 50.0, add 1000. (The normal surface pressure ranges between 960 and 1050 millibars.)

### 12.0 FORECAST DATA

12.1 Type "Zones AR [Return]". A listing of statewide weather forecasts will appear, by forecasting zone. (See Attachment 2 for an example - a map of Arkansas forecast zones is included as Figure 1).

12.2 The forecast for the counties west and east of Russellville are listed under "ZONE 4" and "Zone 5" respectively. If these zones are not specifically listed, type "Zones AR #2 [Return]" to list the previous forecast.

12.3 Type "STATE AR [RETURN]". A single statewide forecast will appear, followed by an extended (5-day) forecast. This extended forecast may contain information useful for longer-range emergency planning. (See Attachment 3 for an example.)



PLANT MANUAL SECTION:  
OFFSITE DOSE  
PROJECTIONS

PROCEDURE WORK PLAN TITLE:  
USE OF THE WSI  
WEATHER INFORMATION SERVICE

NO:  
1904.08

## ARKANSAS NUCLEAR ONE

PAGE 8 OF 17

REVISION 0 DATE 02/07/84

CHANGE DATE

12.4 An extended (5-day) forecast for the state can be obtained by typing "EXTEND AR[RETURN]".

12.5 Type "SATMKC[RETURN]". A summary of the latest satellite picture of the Central U.S. and Canada will appear. (See Attachment 4 for an example.)

12.5.1 This report uses a large percentage of abbreviated words, but is useful for locating the position and movement of fronts.

12.5.2 The maps in Figures 2 and 3 include the three-letter station names which appear in this report.

12.5.3 To convert knots to MPH, multiply by 1.15.

12.5.4 The three letter station names can be decoded by typing a command of the form "USNAME NNN[Return]", where NNN is the three-letter station name.

### 13.0 SEVERE WEATHER DATA

13.1 Type "SVRSTA AR [RETURN]" to obtain a list of all current weather watches and warnings.

13.2 Type "RADMAP LIT [RETURN]" to obtain a digitized radar map of Arkansas and surrounding states. (See Attachment 5 for an example.)

### 14.0 OTHER USEFUL MAPS

14.1 To obtain a map of the central United States (approximately 20 states), type "MAP US2 NN[RETURN]", where NN is a parameter code listed in 14.3 below.

14.2 To obtain a more detailed map of the Arkansas area (approximately 5 states), type "MAP OKC NN[Return]", where NN is a parameter code listed in 14.3 below.

14.3 Some of the more useful parameter codes are:

14.3.1 "A" - Cardinal wind direction and wind speed in MPH.

14.3.2 "W" - Wind direction in degrees and wind speed in knots.

14.3.3 "P" - Barometric pressure in millibars (see note in 11.8).

14.3.4 "C" - 3-hour barometric pressure change in millibars times 10.



PLANT MANUAL SECTION:  
OFFSITE DOSE  
PROJECTIONS

PROCEDURE/WORK PLAN TITLE:  
USE OF THE WSI  
WEATHER INFORMATION SERVICE

NO:  
1904.08

## ARKANSAS NUCLEAR ONE

|          |         |               |
|----------|---------|---------------|
| PAGE     | 9 of 17 |               |
| REVISION | 0       | DATE 02/07/84 |
| CHANGE   |         | DATE          |

- 14.3.5 "T" - Temperatures in degrees Fahrenheit.
- 14.3.6 "ZQ" - Pasquill stability class.
- 14.3.7 "ZR" - 6-hour precipitation.
- 14.3.8 "ZS" - Daily snowfall (inches).
- 14.3.9 "H" - Relative humidity.
- 14.3.10 "X" - Weather and sky.
- 14.3.11 "N" - Station names (reproduces Figures 2 and 3).
- 14.3.12 "YA" - Tomorrow's forecast weather.

### 15.0 LOGGING OUT

15.1 When all desired information has been obtained from the computer, type "LOGOUT[Return]" to disconnect from the WSI system. The "logout" will automatically end the billing time. If you forget to logout, the computer will automatically log you out within a few minutes.

The computer should respond with "\*\*\*LOGGED OUT FROM WSI\*\*\*".

15.2 Switch the modem to the "talk", "voice" or "MA" mode and hang up the receiver to complete the disconnect.

### 16.0 ATTACHMENTS AND FORMS

- 16.1 Attachment 1 - Example Printout for Current Data
- 16.2 Attachment 2 - Example Printout for Zone Forecast
- 16.3 Attachment 3 - Example Printout for Statewide Forecast
- 16.4 Attachment 4 - Example of Satellite Summary
- 16.5 Attachment 5 - Example Radar Map
- 16.6 Figure 1 - Arkansas Forecast Zone
- 16.7 Figure 2 - Map Oklahoma and Adjacent States
- 16.8 Figure 3 - Map Central US and Canada



PLANT MANUAL SECTION:  
OFFSITE DOSE  
PROJECTIONS

PROCEDURE/WORK PLAN TITLE:  
USE OF THE WSI  
WEATHER INFORMATION SERVICE

NO:  
1904.08

# ARKANSAS NUCLEAR ONE

PAGE 10 of 17  
REVISION 0 DATE 02/07/84  
CHANGE DATE

## ATTACHMENT 1

### EXAMPLE PRINTOUT FOR CURRENT DATA

ARKANSAS OBSERVATIONS FOR 3PM(21Z) 10-JAN-84

| STA | WIND | WIND | DIR | PR | SKY            | TEMP | DEW | HUM | PRP | P CHG |
|-----|------|------|-----|----|----------------|------|-----|-----|-----|-------|
| BYH | W 28 | 1621 | 33  | 0  | 30 SCT 250 SCT | 31   | 19  | 60  | 257 | -4    |
| SLB | W 11 | 2010 | 33  | 0  | 70 SCT         | 33   | 21  | 45  |     |       |
| FTY | W 17 | 2210 | 27  | 0  | 30 SCT         | 29   | 23  | 84  | 295 | -18   |
| PSB | W 14 | 1712 | 22  | 0  | 75 SCT         | 36   | 18  | 46  | 300 | -23   |
| HRB | W 13 | 2211 | 0   | 0  | 30 SKW         | 27   | 18  | 69  |     |       |
| WBT | W 17 | 2613 | 0   | 0  | 60 SCT         | 32   | 22  | 49  |     |       |
| LRB | W 14 | 2512 | 22  | 0  | 45 SCT         | 36   | 21  | 54  | 267 | -5    |
| BYR | W 15 | 1613 | 28  | 0  | 35 SCT 250 SCT | 35   | 27  | 70  | 241 | -6    |
| LIT | W 11 | 2813 | 22  | 0  | 40 SCT         | 40   | 22  | 47  | 370 | -5    |
| HRF | W 17 | 1615 | 26  | 0  | 35 SCT         | 40   | 23  | 49  |     |       |
| TRK | W 17 | 2015 | 23  | 0  | 20 SCT 30 SCT  | 44   | 24  | 44  |     |       |

OPH



PLANT MANUAL SECTION:  
OFFSITE DOSE  
PROJECTIONS

PROCEDURE/WORK PLAN TITLE:  
USE OF THE WSI  
WEATHER INFORMATION SERVICE

NO:  
1904.08

# ARKANSAS NUCLEAR ONE

|          |    |      |          |
|----------|----|------|----------|
| PAGE     | 11 | of   | 17       |
| REVISION | 0  | DATE | 02/07/84 |
| CHANGE   |    | DATE |          |

## ATTACHMENT 2

### EXAMPLE PRINTOUT FOR ZONE FORECASTS

\*\*\*\*\* XLIT 101900 AND

ARKANSAS ZONE FORECASTS UPDATED  
NATIONAL WEATHER SERVICE LITTLE ROCK AR  
1245 AM CST TUE JAN 10 1984

AR01-  
ARKANSAS ZONES 1  
1245 PM CST TUE JAN 10 1984

. THIS AFTERNOON PARTLY CLOUDY, WINDY AND COOL. HIGH NEAR 30.  
NORTH WIND 15 MPH AND GUSTY.  
. TONIGHT CLEAR AND COLDER WITH DIMINISHING WINDS. LOW FROM 15 TO 17.  
NORTHERLY WINDS DECREASING TO 5 TO 10 MPH.  
. WEDNESDAY SUNNY AND COOL WITH A HIGH NEAR 30.

##

AR04-AR05-AR07-  
ARKANSAS ZONES 4 5 7  
1245 PM CST TUE JAN 10 1984

. THIS AFTERNOON PARTLY CLOUDY, WINDY AND COOL. HIGH IN THE MID 30S.  
NORTH WIND 15 TO 20 MPH AND GUSTY.  
. TONIGHT CLEAR AND COLDER WITH DIMINISHING WINDS. LOW FROM 15 TO 18.  
NORTHERLY WINDS DECREASING TO 5 TO 10 MPH.  
. WEDNESDAY BUNNY AND COOL WITH A HIGH IN THE LOWER 30S.

##

AR08-AR10-AR15-  
ARKANSAS ZONES 8 10 15  
1245 PM CST TUE JAN 10 1984

. THIS AFTERNOON PARTLY CLOUDY, WINDY AND COOL. HIGH NEAR 30.  
NORTH WIND AROUND 20 MPH AND GUSTY.  
. TONIGHT BUNNY AND COLDER WITH DIMINISHING WINDS. LOW IN THE LOWER  
30S. NORTHERLY WINDS DECREASING TO 5 TO 10 MPH.  
. WEDNESDAY BUNNY AND COOL WITH A HIGH IN THE LOWER 30S.

##



PLANT MANUAL SECTION:  
OFFSITE DOSE  
PROJECTIONS

PROCEDURE/WORK PLAN TITLE:  
USE OF THE WSI  
WEATHER INFORMATION SERVICE

NO:  
1904.08

# ARKANSAS NUCLEAR ONE

|          |          |               |
|----------|----------|---------------|
| PAGE     | 13 of 17 |               |
| REVISION | 0        | DATE 02/07/84 |
| CHANGE   | DATE     |               |

## ATTACHMENT 4

### EXAMPLE OF SATELLITE SUMMARY

DATA FROM 001000  
 WSI WSI-APP-10N...BASED ON DATA THRU 11Z

THE PLAINS BEHIND FROM TRAILER ON NW HW THRU SW NE MOUNTY OF IWL  
 FROM SW TO NE END OF TRAILER SW BEHIND IS SLIDING SSE 30 KT..  
 THIS SW BEHIND MORE TO SW IN SW END OF TRAILER. ONLY JET  
 TO SW END OF TRAILER IS IN SW END OF THE OLD ROAD ACROSS  
 THE TRAILER FROM SW END APPROXIMATE.

THE SW BEHIND IS SLIDING OUT MOST PART OF SW CANADA LOOKS BEHIND  
 WITH A SLOW RATE SW SW TO SW END. LEADING EDGE OF MID/HI CLOS  
 TO MOUNTAIN BEHIND BEHIND INTO SW ALBERTA/MORN SASK. SW END OF  
 HI CLOS BEHIND BEHIND TO SW THE SW END OF NY IS BEING STRETCHED  
 OUT BEHIND SW TO SW END.

WAGGED SW END OF SW PLAINS LOW/HI CLOS IS SW A SLOW NW..  
 WSI-10S WSI-10S WSI-10S WSI-10S. CLOS HW SW PUSHING SSE 30 KT OUR  
 SW PART OF AREA. AND SLIDING MORE SSE 25 KT ACROSS THE SW DAKS.  
 CLOS BEHIND SUBTLE TWIST ON THKR MID CLOS PATCH CNTRD JUST SW ABR.

THE SW LOW/HI CLOS ARE RIGHT OF A 1SE TYR..FYV..HRO..JOW JDR..  
 WSI-10S WSI-10S WSI-10S WSI-10S. SW END HAS SLIPPED END 25 KT..  
 WHILE EXPANDING BEHIND SW THRU SW. BEHIND





PLANT MANUAL SECTION:  
OFFSITE DOSE  
PROJECTIONS

PROCEDURE/WORK PLAN TITLE:  
USE OF THE WSI  
WEATHER INFORMATION SERVICE

NO:  
1904.08

# ARKANSAS NUCLEAR ONE

|          |    |      |          |
|----------|----|------|----------|
| PAGE     | 14 | of   | 17       |
| REVISION | 0  | DATE | 02/07/84 |
| CHANGE   |    | DATE |          |

## ATTACHMENT 5

### EXAMPLE RADAR MAP



KEY TO RADAR MAP - SYMBOLS INDICATE RAINFALL INTENSITY:  
1=LIGHT 2=MODERATE 3=HEAVY 4=VERY HEAVY 5=INTENSE 6=EXTREME  
R=UNKNOWN, PROBABLY HEAVY 2=UNKNOWN, PROBABLY LIGHT TO MODERATE  
\*\*=INDICATES VALID REPORT HAS BEEN RECEIVED FROM THAT RADAR STATION  
\*\*=INDICATES STATION AT THAT LOCATION IS OUT OF SERVICE



PLANT MANUAL SECTION:  
OFFSITE DOSE  
PROJECTIONS

PROCEDURE/WORK PLAN TITLE:  
USE OF THE WSI  
WEATHER INFORMATION SERVICE

NO:  
1904.08

# ARKANSAS NUCLEAR ONE

PAGE 15 of 17

REVISION 0 DATE 02/07/84

CHANGE DATE

FIGURE 1

ARKANSAS FORECAST ZONES





PLANT MANUAL SECTION:  
OFFSITE DOSE  
PROJECTIONS

PROCEDURE/WORK PLAN TITLE:  
USE OF THE WSI  
WEATHER INFORMATION SERVICE

NO:  
1904.08

# ARKANSAS NUCLEAR ONE

|          |                 |
|----------|-----------------|
| PAGE     | 16 of 17        |
| REVISION | 0 DATE 02/07/84 |
| CHANGE   | DATE            |

FIGURE 2

MAP OKLAHOMA AND ADJACENT STATES



OKLAHOMA AREA MAP  
STATION NAMES  
1000 100  
1000 100



PLANT MANUAL SECTION:  
OFFSITE DOSE  
PROJECTIONS

PROCEDURE/WORK PLAN TITLE:  
USE OF THE WSI  
WEATHER INFORMATION SERVICE

NO:  
1904.08

# ARKANSAS NUCLEAR ONE

PAGE 17 of 17  
REVISION 0 DATE 02/07/84  
CHANGE DATE

FIGURE 3

MAP CENTRAL US AND CANADA

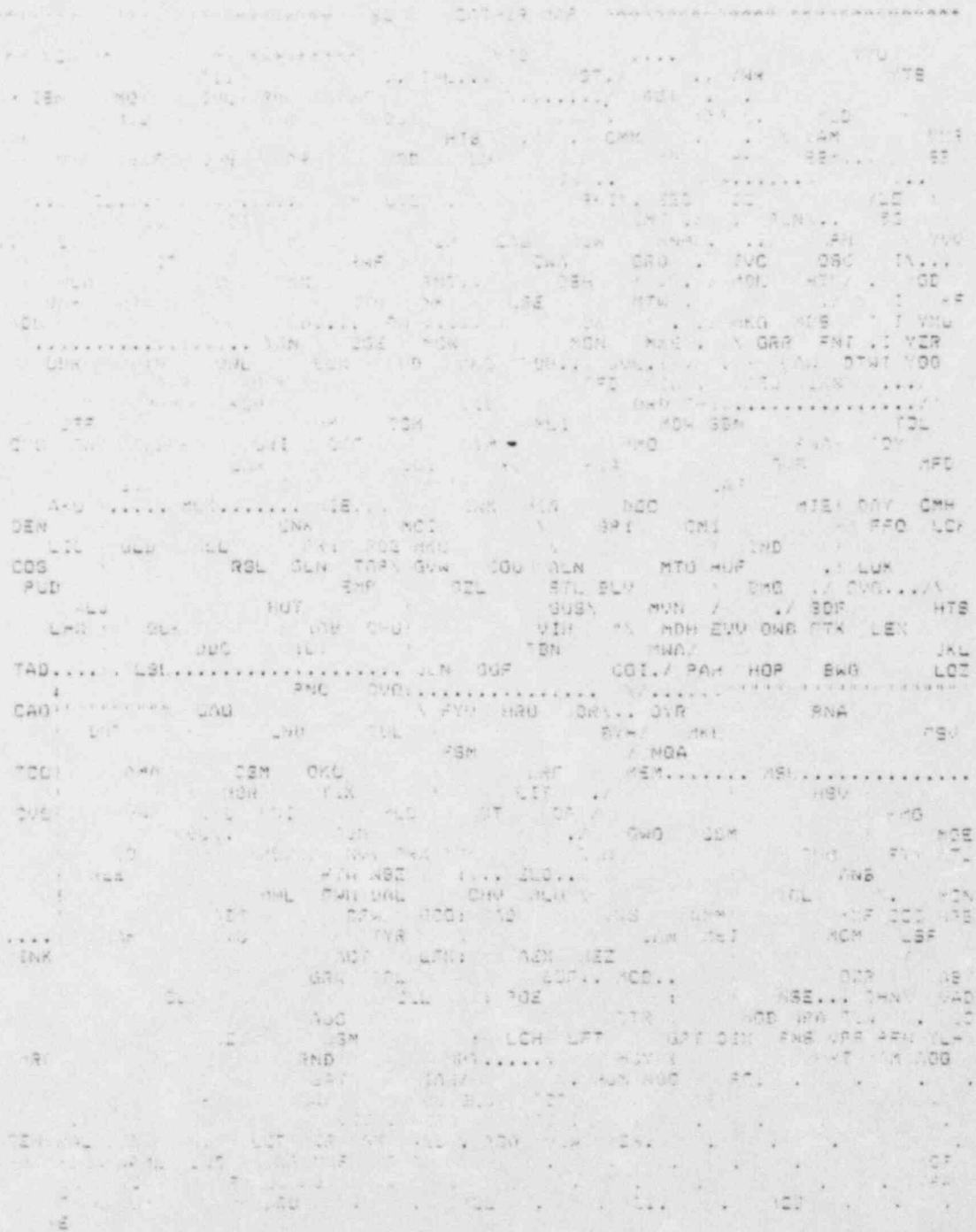



UNITED STATES  
NUCLEAR REGULATORY COMMISSION  
WASHINGTON, D. C. 20555

March 23, 1984

50-313/368 Arkansas Nuclear One

MEMORANDUM FOR: Chief, Document Management Branch, TIDC  
FROM: Director, Division of Rules and Records, ADM  
SUBJECT: REVIEW OF UTILITY EMERGENCY PLAN DOCUMENTATION

The submitter of the attached document has expressed no desire to withhold any information contained therein. Therefore, this material may now be made publicly available.

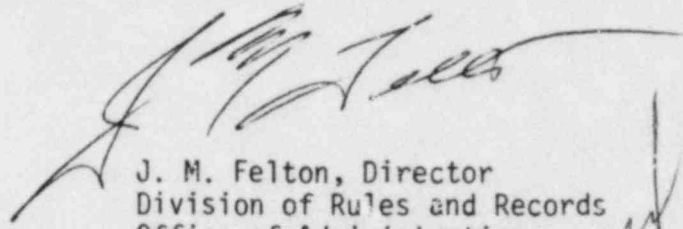
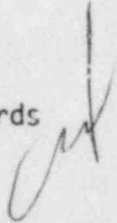
  
J. M. Felton, Director  
Division of Rules and Records  
Office of Administration 

Attachment: As stated



33

# ARKANSAS POWER & LIGHT COMPANY

## Arkansas Nuclear One

TITLE: TRANSMITTAL

FORM NO. 1013.02H

REV. # 12 PC #

Arkansas Nuclear One  
Russellville, Arkansas  
Date 2-28-84

MEMORANDUM

TO: 103-1486 Washington

FROM: ANO DOCUMENT CONTROL

SUBJECT: ANO MASTER PLANT MANUAL UPDATE

PROCEDURE NUMBER 1904.01 REV. # 0 PC # \_\_\_\_\_ TC # \_\_\_\_\_

PROCEDURE TITLE GERMS COMPUTER GRAPHICS METHOD

PROCEDURE NUMBER 1904.02 REV. # 2 PC # \_\_\_\_\_ TC # \_\_\_\_\_

PROCEDURE TITLE OFFSITE DOSE PROJECTIONS - POCKET COMPUTER METHOD

PROCEDURE NUMBER 1904.03 REV. # 4 PC # \_\_\_\_\_ TC # \_\_\_\_\_

PROCEDURE TITLE AUX. BLDG. VENTILATION EXHAUST EMER RADATION MONITOR

The following pages of the indicated procedure (s) contains items which involve personal privacy or proprietary material. PLEASE REMOVE THE INDICATED MATERIAL PRIOR TO DISTRIBUTION TO PUBLIC DOCUMENT ROOMS, ETC.

|                      |                 |
|----------------------|-----------------|
| <u>PROCEDURE (S)</u> | <u>PAGE (S)</u> |
|----------------------|-----------------|

PROCEDURE (S) HAS BEEN PLACED IN YOUR SET OF THE PLANT MANUAL.

PROCEDURE (S) SHOULD BE PLACED IN YOUR SET OF THE PLANT MANUAL.

NOTE: PLEASE RETURN SIGNED TRANSMITTAL TO DOCUMENT CONTROL - 4TH FLOOR:

SIGNATURE \_\_\_\_\_ DATE \_\_\_\_\_  
UPDATED

8403010280 840301  
 CF ADGCK 05000313  
 CF



*50-313*

*X005  
0/10*

PROCEDURE # 1904.01 REV. 0

Not Good Till

3/1/84