

CENTRAL FILE

MECHANICAL EQUIPMENT
QUALIFICATION PROGRAM

M-374

Reactor Building Spray System
Hydrazine Addition Positive Displacement Pump

1	2/2/83	See Revision Control Sheet	WA	WRK	PDR
0	1/22/83	Issued for use	WA	WRK	PDR
No.	DATE	REVISIONS	BY	CH'K	APPR
			JOB NO. CPC-09-12		
			SPEC/DES GUIDE No.		REV.
			Mechanical M-374		1

REVISION CONTROL SHEET

TITLE: Reactor Building Spray System REPORT NUMBER: M-374
 Hydrazine Addition Positive
 Displacement Pump

<i>C. W. Allen</i> / CONSULTANT NAME / TITLE	<i>CWA</i> INITIALS
<i>M. Rosa Lee</i> / consultant NAME / TITLE	<i>MRL</i> INITIALS
<i>W.K. Kelly</i> / PROJECT ENGINEER NAME / TITLE	<i>WKK</i> INITIALS
<i>Timothy J. ...</i> / PROJECT MANAGER NAME / TITLE	<i>TJF</i> INITIALS
<i>Philip A. ...</i> / ENGINEERING MANAGER NAME / TITLE	<i>PAB</i> INITIALS

PAGE(S)	REV	PREPARED BY / DATE	ACCURACY CHECK BY / DATE	CRITERIA CHECK BY / DATE	REMARKS
4	1				Added Program No. M-374 Added MFFCSS, Page 1 to Note (2)
6	1				Added Throat/Follower Bushings and information on EAES
7	1				Corrected REXNORD
8	1				Added Throat/Follower Bushings information and revised C/PSS Form to non-metallic part description
9	1				Revised to include forty (40) year upgrade for BUNA-N replacement interval
11-27	1				Revised MEEQRFs to include additional design data and requirement
30-33	1				Revised notes 4,5,7,9,10, 11, and 12 of Appendix A
34,35	1	<i>CWA 2/2/83</i>	<i>MRL 2/2/83</i>	<i>WKK 2/2/83</i>	Added References 14, 15, and 16

TABLE OF CONTENTS

I. QUALIFICATION PROGRAM

- A. Mechanical Equipment File Cover Summary Sheet (MEFCSS)
- B. Component Data and Environment Sheet (CDES)
- C. Mechanical Equipment Environmental Qualification Sheets (MEEQS)
- D. Equipment Applicability Evaluation Sheet (EAES)
- E. Component/Part Summary Sheet (C/PSS)
- F. Mechanical Equipment Environmental Qualification Review Form (MEEQRF)
- G. Maintenance and Surveillance Recommendations
- H. Appendix A
- I. References and Additional Data
- J. Generic Figures

II. REFERENCES

Mechanical Equipment File Cover Summary Sheet

Equipment Type: Positive Displacement Pump MEQ Prog No.: M-374

Manufacturer/Model No.: Hills-McCanna Co./McCannatrol P/D I Model
No. J1-15087-10 (See Appendix A No. 1)

Safety Function:

The Containment Spray System is an engineered safety featured system to remove fission products and to reduce pressure and temperature in the containment following a LOCA. Radioiodine in its various forms is the fission product of primary concern in the evaluation of a LOCA. The pump injects hydrazine into the Reactor Building Spray System to remove airborne iodine resulting from a LOCA.

Operation:

Hydrazine addition to the Reactor Building Chemical Spray Solution is accomplished via injection from the Hydrazine Positive Displacement Pump which takes suction from the Hydrazine Tank and discharges to the Containment Spray System Header. This operation ensures removal of iodine from the LOCA Containment atmosphere.

Qualification Status:

The Containment Spray System Hydrazine Addition Pump Packing must be replaced with a material which has greater radiation resistance properties than the presently installed Teflon TFE to maintain a forty (40) year qualified life including a two (2) hour post accident condition (See Appendix "A", No. 11).

**MIDLAND UNITS 1 AND 2
EQUIPMENT QUALIFICATION SUMMARY
COMPONENT DATA AND ENVIRONMENT SHEET**

EQUIPMENT ID NUMBER	PARAMETER	Normal	LOCA
EQUIPMENT ID NUMBER 1P-041A DESCRIPTION Positive Displacement Pump SERVICE Airborne Fission Product Removal MANUFACTURER Hills - McCanna MODEL NO. J1-15087-10P SYSTEM BKB PO NO. M-374 EEOS NO. M-374 ROOM NO. 027 BLDG. AX ELEVATION 568 OPERATING CYCLES. N/A NONSEISMIC VIBR. NO RESPONSE SPECTRUM FIG. Future use LOCA: Yes MSLB: NO SAFE SD: NO HEL B OUTSIDE RB: NO NOTES:	OPERABILITY PERIOD SAFETY FUNCTION A. TEMPERATURE (F) B. PRESSURE C. HUMIDITY (PERC RH) D. RADIATION (RADS) E. SPRAY F. SUBMERGENCE G. ACCURACY H. RESPONSE TIME	Normal 40 Years N/A 50-104 ATM 0-100 6.6E06 N/A N/A N/A N/A	LOCA 2 Hours Remove Iodine 104 ATM 100 1.7E05 N/A N/A N/A 1.15 sec
EQUIPMENT ID NUMBER 1P-041B DESCRIPTION Positive Displacement Pump SERVICE Airborne Fission Product Removal MANUFACTURER Hills-McCanna MODEL NO. J1-15087-10P SYSTEM BKB PO NO. M-374 EEOS NO. M-374 ROOM NO. 025 BLDG. AX ELEVATION 568 OPERATING CYCLES. N/A NONSEISMIC VIBR. NO RESPONSE SPECTRUM FIG. Future use LOCA: Yes MSLB: NO SAFE SD: NO HEL B OUTSIDE RB: NO NOTES:	OPERABILITY PERIOD SAFETY FUNCTION A. TEMPERATURE (F) B. PRESSURE C. HUMIDITY (PERC RH) D. RADIATION (RADS) E. SPRAY F. SUBMERGENCE G. ACCURACY H. RESPONSE TIME	Normal 40 Years N/A 50-104 ATM 0-100 6.6E06 N/A N/A N/A N/A	LOCA 2 Hours Remove Iodine 104 ATM 100 1.7E05 N/A N/A N/A 1.15 sec
EQUIPMENT ID NUMBER 2P-041A DESCRIPTION Positive Displacement Pump SERVICE Airborne Fission Product Removal MANUFACTURER Hills-McCanna MODEL NO. J1-15087-10P SYSTEM BKB PO NO. M-374 EEOS NO. M-374 ROOM NO. 028 BLDG. AX ELEVATION 568 OPERATING CYCLES. N/A NONSEISMIC VIBR. NO RESPONSE SPECTRUM FIG. Future use LOCA: Yes MSLB: NO SAFE SD: NO HEL B OUTSIDE RB: NO NOTES:	OPERABILITY PERIOD SAFETY FUNCTION A. TEMPERATURE (F) B. PRESSURE C. HUMIDITY (PERC RH) D. RADIATION (RADS) E. SPRAY F. SUBMERGENCE G. ACCURACY H. RESPONSE TIME	Normal 40 Years N/A 50-104 ATM 0-100 6.6E06 N/A N/A N/A N/A	LOCA 2 Hours Remove Iodine 104 ATM 100 1.7E05 N/A N/A N/A 1.15 sec

**MIDLAND UNITS 1 AND 2
EQUIPMENT QUALIFICATION SUMMARY
COMPONENT DATA AND ENVIRONMENT SHEET**

EQUIPMENT ID NUMBER 1P-041A	PARAMETER	Normal	LOCA		
<p>DESCRIPTION Positive Displacement Pump SERVICE: Airborne Fission Product Removal</p> <p>MANUFACTURER: Hills-McCanna MODEL NO: J1-15087-10P SYSTEM BKB PO NO: M-374 EEQS NO: M-374 ROOM NO: 026 BLDG: AX ELEVATION: 568 OPERATING CYCLES: N/A NONSEISMIC VIBR: NO RESPONSE SPECTRUM FIG: Future use LOCA: Yes MSLB: NO SAFE SD: NO HELB OUTSIDE RB: NO NOTES:</p>	<p>OPERABILITY PERIOD SAFETY FUNCTION</p> <p>A. TEMPERATURE (F) B. PRESSURE C. HUMIDITY (PERC RH) D. RADIATION (RADS) E. SPRAY F. SUBMERGENCE</p> <p>G. ACCURACY H. RESPONSE TIME</p>	<p>40 Years N/A</p> <p>50-104 ATM 0-100 6.6E06 N/A N/A</p> <p>N/A N/A</p>	<p>2 Hours Remove Iodine</p> <p>104 ATM 100 1.7E05 N/A N/A</p> <p>N/A 1.15 sec</p>		
<p>EQUIPMENT ID NUMBER</p> <p>DESCRIPTION SERVICE:</p> <p>MANUFACTURER: MODEL NO: SYSTEM PO NO: EEQS NO: ROOM NO: BLDG: ELEVATION: OPERATING CYCLES: NONSEISMIC VIBR: RESPONSE SPECTRUM FIG: LOCA: MSLB: SAFE SD: HELB OUTSIDE RB: NOTES:</p>	<p>PARAMETER</p> <p>OPERABILITY PERIOD SAFETY FUNCTION</p> <p>A. TEMPERATURE (F) B. PRESSURE C. HUMIDITY (PERC RH) D. RADIATION (RADS) E. SPRAY F. SUBMERGENCE</p> <p>G. ACCURACY H. RESPONSE TIME</p>				
<p>EQUIPMENT ID NUMBER</p> <p>DESCRIPTION SERVICE:</p> <p>MANUFACTURER: MODEL NO: SYSTEM PO NO: EEQS NO: ROOM NO: BLDG: ELEVATION: OPERATING CYCLES: NONSEISMIC VIBR: RESPONSE SPECTRUM FIG: LOCA: MSLB: SAFE SD: HELB OUTSIDE RB: NOTES:</p>	<p>PARAMETER</p> <p>OPERABILITY PERIOD SAFETY FUNCTION</p> <p>A. TEMPERATURE (F) B. PRESSURE C. HUMIDITY (PERC RH) D. RADIATION (RADS) E. SPRAY F. SUBMERGENCE</p> <p>G. ACCURACY H. RESPONSE TIME</p>				

MECHANICAL EQUIPMENT ENVIRONMENTAL QUALIFICATION SHEET (1)

TYPE OF EQUIPMENT: Positive Displacement Hydrazine Pump

MANUFACTURER: Hills-McCanna (See Appendix A, No. 1)

PROGRAM NO.: M-374

MODEL NO.: McCannatrol P/D I Model J1-15087-10

EQUIPMENT APPLICABILITY:

Model Qualified, Configuration and Interfaces Match Installation

ACCEPTANCE

Y

REF.

Apdx. A,
No. 13

PAGE(S)

-

EXTERNAL NORMAL OPERATING CONDITIONS

	REQUIRED	QUALIFIED	ACCEPT.	METHOD⁽¹⁾	REF.	PAGE(S)
QUALIFIED LIFE⁽²⁾	40 years	40 years ⁽²⁾	Y	AN	Apdx. A No. 14	-
RESPONSE TIME	N/A	N/A	N/A	N/A	N/A	-
ACCURACY	N/A	N/A	N/A	N/A	N/A	N/A
TEMPERATURE, MIN.	50 ^o F	50 ^o F	Y	AN	Apdx. A No. 9	-
TEMPERATURE, MAX.	104 ^o F	104 ^o F	Y	AN	Apdx. A No. 9	-
TEMPERATURE, AVE.	N/A	N/A	N/A	N/A	N/A	N/A
PRESSURE	ATM	ATM	Y	AN	Apdx. A No. 6	-
HUMIDITY, MAX.	100	100	Y	AN	Apdx. A No. 6	-
TID (RADS)	6.6E06	6.6E06	Y	AN	Apdx. A No. 7	-
OPERATING CYCLES	N/A	N/A	N/A	N/A	N/A	N/A

(1) Qualification Method Symbols: TT-Type Test, PT-Partial Type Test, TC-Test of Vital Components, OE-Operating Experience, AN-Analysis

(2) Qualified _____ without exception Y with exception (See MEFCSS, Page 1)

MECHANICAL EQUIPMENT ENVIRONMENTAL QUALIFICATION SHEET (2)

ACCIDENT ENVIRONMENT:		LOCA X	MSLB X	HELB OUTSIDE RB N/A	PROGRAM NO.: M-374	
	REQUIRED	QUALIFIED	ACCEPT- ANCE	METHOD (1)	REF.	PAGE(S)
OPERATING TIME	2 Hours	2 Hours	Y	AN	Apdx. A No. 15	-
RESPONSE TIME	72 sec	1.15 sec	Y	AN	Apdx. A No. 8	-
ACCURACY	N/A	N/A	N/A	N/A	N/A	N/A
TEMPERATURE	104 ^O F	104 ^O F	Y	AN	Apdx. A No. 4	-
PRESSURE	ATM	ATM	Y	AN	Apdx. A No. 4	-
TID (2) (RADS) δ/β	6.8E06 / N/A	6.8E06 / N/A	Y	AN	Apdx. A No. 7	-
SPRAY	N/A	N/A	N/A	N/A	N/A	N/A
SUBMERGENCE	N/A	N/A	N/A	N/A	N/A	N/A
LONG TERM FAILURE OF SHORT-TERM USE EQUIP. WAS ADDRESSED	N/A	N/A	N/A	N/A	N/A	N/A

ACCELERATED AGING TIME/TEMPERATURE N/A / N/A

(1) Qualification Method Symbols: TT-Type Test, PT-Partial Type Test, TC- Test of Vital Components, OE-Operating Experience, AN-Analysis

(2) Includes the dose acquired under normal operating conditions over the equipment qualified life.

EQUIPMENT APPLICABILITY EVALUATION SHEET

EQUIPMENT: Hydrazine Pump

PROGRAM NO.: M-374

SUBSYSTEM	COMPONENT	ESSENTIAL FOR FUNCTION	MFR./MODEL NO. DATA	C/PSS REF.	REMARKS
Positive Displacement Pump	N/A	Y	Hills-McCanna	N/A	
	Inlet Check Valve	Y	Hills-McCanna	N/A	
	Outlet Check Valve	Y	Hills-McCanna	N/A	
	Pump Seals	Y	Hills-McCanna John Crane C-06	A	
	Plunger Coupling	Y	Hills-McCanna	N/A	

EQUIPMENT APPLICABILITY EVALUATION SHEET

EQUIPMENT: Hydrazine Pump

PROGRAM NO.: M-374

SUBSYSTEM	COMPONENT	ESSENTIAL FOR FUNCTION	MFR./MODEL NO. DATA	C/PSS REF.	REMARKS
Drive System	N/A	Y	N/A	N/A	
	Pump/Motor Coupling	Y	Rexnord Inc. 101-DBZ	N/A	Appendix A, No. 2
	Drive Case	Y	Hills-McCanna	B	
	Drive Assembly	Y	Hills-McCanna	C	
	Motor	Y	Reliance PB-182T	N/A	Appendix A, No. 3
	Stroke Adjust- ment Assembly	Y	Hills-McCanna	N/A	Appendix A, No. 5
	Thermocouple	N	N/A	N/A	

COMPONENT/PART SUMMARY SHEET A

EQUIPMENT: Hydrazine Pump
 COMPONENT: Pump Seals & Throat/
 Follower Bushings

PROGRAM NO.: M-374

NON METALLIC PART DESCRIPTION	ESSENTIAL FOR FUNCTION	REF. DOC.	MATERIAL	REF. DOC.	REPLACE - MENT INTERVAL	BASIS (1)	REF. DOC.	REQUIRE - MENTS MET	REF. DOC.	REMARKS
O-Ring	N	N/A	N/A	N/A	N/A	N/A	N/A	N/A	N/A	
Gasket	N	N/A	N/A	N/A	N/A	N/A	N/A	N/A	N/A	
Packing	Y	3	Teflon Asbestos	12	1 Year	AN	12	N	12	Appendix A No. 10
Throat/Follower Bushings	Y	3.14	Graphitar, Gr. III	5.6	40 Years	AN	N/A	Y	N/A	Appendix A No. 17

(1) Replacement Interval Basis Abbreviations: OE-Operating Experience, AN-Analysis, MR-Manufacturers Recommendation

COMPONENT/PART SUMMARY SHEET B

EQUIPMENT: Hydrazine Pump

COMPONENT: O-Rings and Gaskets

PROGRAM NO.: M-374

NON-METALLIC PART DESCRIPTION	ESSENTIAL FOR FUNCTION	REF. DOC.	MATERIAL	REF. DOC.	REPLACE MENT INTERVAL	BASIS (1)	REF. DOC.	REQUIRE- MENTS MET	REF. DOC,	REMARKS
O-Ring	Y	3	BUNA-N	5	40 Years	AN	15	N/A	N/A	Apdx. A No. 7
O-Ring	Y	3	BUNA-N	5	40 Years	AN	15	N/A	N/A	Apdx. A No. 7
O-Ring	Y	3	BUNA-N	6	40 Years	AN	15	N/A	N/A	Apdx. A No. 7
Gasket	Y	3	CORK	5	1 Year	AN	16	N/A	N/A	Apdx. A No. 16
Gasket	Y	3	CORK	5	1 Year	AN	16	N/A	N/A	Apdx. A No. 16
Gasket	N	N/A	N/A	N/A	N/A	N/A	N/A	N/A	N/A	
Gasket	N	N/A	N/A	N/A	N/A	N/A	N/A	N/A	N/A	
Gasket	N	N/A	N/A	N/A	N/A	N/A	N/A	N/A	N/A	
Oil Seal	Y	3	BUNA-N	6	40 Years	AN	15	N/A	N/A	Apdx. A No. 7
Mylar Shim	N	N/A	N/A	N/A	N/A	N/A	N/A	N/A	N/A	

(1) Replacement Interval Basis Abbreviations: OE-Operating Experience, AN-Analysis, MR-Manufacturers Recommendation

COMPONENT/PART SUMMARY SHEET C

EQUIPMENT: Hydrazine Pump

COMPONENT: Drive Assembly

PROGRAM NO.: M-374

PART DESCRIPTION	ESSENTIAL FOR FUNCTION	REF. DOC.	MATERIAL	REF. DOC.	REPLACE MENT INTERVAL	BASIS (1)	REF. DOC.	REQUIREMENTS MET	REF. DOC.	REMARKS
Lubricating Oil	Y	2	Mobil Gear Oil 636	2	1 Year	AN	N/A	N/A	N/A	Apdx. A, No. 9, Ref 8

(1) Replacement Interval Basis Abbreviations: OE-Operating Experience, AN-Analysis, MR-Manufacturers Recommendation

MECHANICAL EQUIPMENT ENVIRONMENTAL QUALIFICATION REVIEW FORM

COMPONENT: Inlet Check Valve Assembly	PAGE <u>1</u> OF <u>17</u>
MFGR.: Hills-McCanna*	PROGRAM NO.: M-374
DWG./DOC. NO.: 5221-12, Sheet 1, (Ref. 3),	MODEL NO.: N/A
Item Nos.: 27, 28, 33, 34 & 35	LOCATION: Aux. Bldg., 568'

SAFETY RELATED: YES X NO _____

DISCUSSION:

The inlet check valve normally opens when the pump plunger is withdrawn to admit hydrazine from the storage tank into the plunger cylinder. The inlet check valve normally closes when the plunger is fully extended to prevent hydrazine from back flowing to the storage tank. There are no non-metallic parts whose failure could impact the safety function.

* The pump inlet check valve assembly is comprised of components supplied by various manufacturers other than Hills-McCanna. The only non-metallic parts of the pump inlet check valve assembly are the O-rings seals (Item Nos. 27 & 28).

PART DESCRIPTION: O-Ring (Item No. 27)

FUNCTION: The O-Ring seals between the inlet check valve and pump casing

SAFETY RELATED: YES _____ NO X

Seal failure provides an external leak path with no significant loss in discharge pressure or flow.

MFGR.: Parker

MODEL NO.: N/A

MATERIAL: Ethylene Propylene

REFERENCE (S): 3

DESIGN RATING (S)	REFER- ENCE (S)	REQUIREMENTS	DEMONSTRATED BY	ACCEPT- ABLE	REFER- ENCE (S)

MEEQRF (CONT.)

PAGE 2 OF 17

PROGRAM NO.: M-374

PART DESCRIPTION: O-Ring (Item No. 28)

FUNCTION: The O-Ring seals between the inlet check valve and flange

SAFETY RELATED: YES _____ NO X

The seal is subjected only to hydrazine tank head pressure and failure has no effect on the safety function.

MFGR.: Parker

MODEL NO.: N/A

MATERIAL: Ethylene Propylene

REFERENCE(S): 3

DESIGN RATING (S)	REFER- ENCE (S)	REQUIREMENTS	DEMONSTRATED BY	ACCEPT- ABLE	REFER- ENCE (S)

PART DESCRIPTION:

FUNCTION:

SAFETY RELATED: YES _____ NO _____

MFGR.:

MODEL NO.:

MATERIAL:

REFERENCE(S):

DESIGN RATING (S)	REFER- ENCE (S)	REQUIREMENTS	DEMONSTRATED BY	ACCEPT- ABLE	REFER- ENCE (S)

MECHANICAL EQUIPMENT ENVIRONMENTAL QUALIFICATION REVIEW FORM

COMPONENT: Outlet Check Valve Assembly	PAGE <u>3</u> OF <u>17</u>
MFGR.: Hills-McCanna*	PROGRAM NO.: M-374
DWG./DOC. NO.: 5221-12, Sheet 1, (Ref. 3)	MODEL NO.: N/A
Item Nos.: 25, 26, 27 & 28	LOCATION: Aux Bldg., 568'

SAFETY RELATED: YES NO

DISCUSSION:

The pump outlet check valve normally opens when the pump plunger fully extends to inject fluid into the discharge header. The outlet check valve must fully close to prevent reverse flow from the discharge header to the pump cylinder when the plunger is retracted. There are no non-metallic parts whose failure could impact the safety function.

* The pump outlet check valve assembly is comprised of components supplied by various manufacturers other than Hills-McCanna. The only non-metallic parts of the pump outlet check valve assembly are the O-Ring seals (Item Nos. 27 & 28).

PART DESCRIPTION: O-Ring (Item No. 27)

FUNCTION: The O-Ring seals between the outlet check valve and pump casing.

SAFETY RELATED: YES NO

Seal failure provides an external leak path with no significant reduction in discharge pressure or flow.

MFGR.: Parker MODEL NO.: N/A

MATERIAL: Ethylene Propylene REFERENCE(S): 3

DESIGN RATING (S)	REFER- ENCE (S)	REQUIREMENTS	DEMONSTRATED BY	ACCEPT- ABLE	REFER- ENCE (S)

PART DESCRIPTION: O-Ring (Item No. 28)

FUNCTION: The O-Ring provides a seal between the check valve and discharge header.

SAFETY RELATED: YES _____ NO X

Seal failure provides an external leak path with no significant reduction in fluid flow or discharge pressure.

MFGR.: Parker MODEL NO.: N/A

MATERIAL: Ethylene Propylene REFERENCE(S): 3

DESIGN RATING(S)	REFER- ENCE(S)	REQUIREMENTS	DEMONSTRATED BY	ACCEPT- ABLE	REFER- ENCE(S)

PART DESCRIPTION:

FUNCTION:

SAFETY RELATED: YES _____ NO _____

MFGR.: MODEL NO.:

MATERIAL: REFERENCE(S):

DESIGN RATING(S)	REFER- ENCE(S)	REQUIREMENTS	DEMONSTRATED BY	ACCEPT- ABLE	REFER- ENCE(S)

MECHANICAL EQUIPMENT ENVIRONMENTAL QUALIFICATION REVIEW FORM

COMPONENT: Pump Seals	PAGE <u>5</u> OF <u>17</u>
MFGR.: See Part Descriptions	PROGRAM NO.: M-374
DWG./DOC. NO.: 5221-12, Sheet 1, (Ref. 3),	MODEL NO.: N/A
Item Nos.: 31, 41, 45 & 46	LOCATION: Aux Bldg., 568'

SAFETY RELATED: YES x NO

DISCUSSION:
 Pump seals consist of the pump packing, vent plug seal and pump to sump gasket seal. Only pump packing (Item No. 45) failure will result in leakage which would significantly decrease pump output.

PART DESCRIPTION: Q-RING (Item NO. 31)

FUNCTION: The Q-Ring provides a seal between the vent plug and cylinder.

SAFETY RELATED: YES NO x

Seal failure does not significantly reduce pump output.

MFGR.: Parker MODEL NO.: N/A

MATERIAL: Ethylene Propylene REFERENCE(S): 3

DESIGN RATING (S)	REFER- ENCE (S)	REQUIREMENTS	DEMONSTRATED BY	ACCEPT- ABLE	REFER- ENCE (S)

MEEQRF (CONT.)		PAGE <u>6</u> OF <u>17</u>		PROGRAM NO.: M-374	
PART DESCRIPTION: Gasket L. E. to Sump (Item No. 46)					
FUNCTION:					
SAFETY RELATED: YES _____ NO <u>X</u>					
Gasket failure does not reduce pump capacity or impact the safety function.					
MFGR.: Hills-McCanna			MODEL NO.: N/A		
MATERIAL: Fiberoil			REFERENCE(S): 3		
DESIGN RATING(S)	REFER- ENCE(S)	REQUIREMENTS	DEMONSTRATED BY	ACCEPT- ABLE	REFER- ENCE(S)
PART DESCRIPTION: Pump Packing (Item No. 45)					
FUNCTION: The packing prevents leakage from the pump cylinder.					
SAFETY RELATED: YES <u>X</u> NO _____					
Packing failure decreases pump flowrate.					
MFGR.: John Crane			MODEL NO.: C-06		
MATERIAL: Teflon-Asbestos			REFERENCE(S): 3 and 12		
DESIGN RATING(S)	REFER- ENCE(S)	REQUIREMENTS	DEMONSTRATED BY	ACCEPT- ABLE	REFER- ENCE(S)
1.5E04 Rads	12	6.8E06 Rads	Requirement not met. To be replaced by Grafoil.	N	12 Apdx. A No. 11
180°F	UL Temp. Index	104°F	Design Rating	Y	UL Temp. Index

MECHANICAL EQUIPMENT ENVIRONMENTAL QUALIFICATION REVIEW FORM

COMPONENT: Plunger Coupling and Throat/ Follower Bushings	PAGE <u>7</u> OF <u>17</u>
MFGR.: Hills-McCanna	PROGRAM NO.: M-374
DWG./DOC. NO.: 5221-12, Sheet 1, (Ref. 3),	MODEL NO.: N/A
Item Nos.: 48 & 49	LOCATION: Aux. Bldg., 568'

SAFETY RELATED: YES NO

DISCUSSION:

The plunger coupling connects the driving mechanism to the pump plunger. The coupling contains no non-metallic parts. The LOCA induced environmental conditions will therefore not cause coupling failure within the required 2 hour operability period. A Component Part Summary Sheet is not required because there are no non-metallic components.

The Throat/Follower Bushings provide the bearing surface for the pump plunger (See Component Part Summary Sheet "A").

PART DESCRIPTION: Throat/Follower Bushings (Item Nos. 41 and 159)

FUNCTION: Provides veering surface for the pump plunger.

SAFETY RELATED: YES NO

Failure may result in scoring/binding of the pump plunger.

MFGR.: Hills-McCanna MODEL NO.: N/A

MATERIAL: Graphitar, Gr. III REFERENCE(S): 14

DESIGN RATING(S)	REFER- ENCE(S)	REQUIREMENTS	DEMONSTRATED BY	ACCEPT- ABLE	REFER- ENCE(S)
500°F	14	104°F	Analysis	Y	14
2E08Rads	Apdx. A, No. 17	6.8E06 Rads	Analysis	Y	Apdx. A, No. 17

MECHANICAL EQUIPMENT ENVIRONMENTAL QUALIFICATION REVIEW FORM

COMPONENT: Pump/Motor Coupling	PAGE <u>8</u> OF <u>17</u>
MFGR.: Rexnord Inc.	PROGRAM NO.: M-374
DWG./DOC. NO.: Reference 7	MODEL NO.: 101-DBZ
	LOCATION: Aux. Bldg., 568'

SAFETY RELATED: YES NO

DISCUSSION:

The Rexnord pump motor coupling mechanically connects the motor with the pump drive assembly. The coupling requires no lubrication and does not contain any non-metallic parts. Degradation of the coupling due to normal and post LOCA environmental service conditions is not applicable.

PART DESCRIPTION:

FUNCTION:

SAFETY RELATED: YES NO

MFGR. : MODEL NO. :

MATERIAL : REFERENCE(S) :

DESIGN RATING (S)	REFER- ENCE (S)	REQUIREMENTS	DEMONSTRATED BY	ACCEPT- ABLE	REFER- ENCE (S)

MECHANICAL EQUIPMENT ENVIRONMENTAL QUALIFICATION REVIEW FORM

COMPONENT: Drive Case Assembly	PAGE <u>9</u> OF <u>17</u>
MFGR.: Hills-McCanna	PROGRAM NO.: M-374
DWG./DOC. NO.: Dwg. 5221-12, Sheet 1, (Ref.3), Item No.: 74	MODEL NO.: 52-07-2000-2N
	LOCATION: Aux. Bldg., 568'

SAFETY RELATED: YES NO

DISCUSSION:
 The drive case provides the solid frame for conversion of the rotating motion of the motor shaft into a reciprocating motion to drive the pump plunger. In addition, the drive casing contains the lubricant required to minimize friction and wear which could cause mechanical binding resulting in pump failure. Various seals are used to retain the lubricant where casing penetrations are required for pump monitoring, operation or maintenance.

PART DESCRIPTION: O-Ring (Item No. 68)

FUNCTION: The O-Ring seals between the retaining plate and crank support

SAFETY RELATED: YES NO

Seal failure results in loss of lubricant and mechanical binding of the pump.

MFGR.: Parker MODEL NO.: N/A

MATERIAL: BUNA-N, 70 DURO REFERENCE(S): 3

DESIGN RATING(S)	REFERENCE(S)	REQUIREMENTS	DEMONSTRATED BY	ACCEPT-ABLE	REFERENCE(S)
2.038E08 Rads	15	6.8E06 Rads (40 yrs. plus two hour post accident condition)	Test & Analysis	Y	15

MEEQRF (CONT.)		PAGE <u>10</u> OF <u>17</u>	PROGRAM NO.: M-374		
PART DESCRIPTION: O-Ring (Item No. 64)					
FUNCTION: The O-rings (2) provide a seal between the retainer plate and cap screws.					
SAFETY RELATED: YES <u>x</u> NO _____					
Seal failure results in a loss of lubricant and mechanical binding of the pump.					
MFGR.: Parker			MODEL NO.: N/A		
MATERIAL: BUNA-N			REFERENCE(S): 3		
DESIGN RATING(S)	REFER- ENCE(S)	REQUIREMENTS	DEMONSTRATED BY	ACCEPT- ABLE	REFER- ENCE(S)
2.038E08	15	6.8E06 Rads	Test & Analysis	Y	15
Rads		(40 yrs. plus two hour post accident condition.)			

PART DESCRIPTION:					
FUNCTION:					
SAFETY RELATED: YES _____ NO _____					
MFGR.:					
			MODEL NO.:		
MATERIAL:					
REFERENCE(S):					
DESIGN RATING(S)	REFER- ENCE(S)	REQUIREMENTS	DEMONSTRATED BY	ACCEPT- ABLE	REFER- ENCE(S)

MEEQRF (CONT.)		PAGE <u>11</u> OF <u>17</u>		PROGRAM NO.: M-374	
PART DESCRIPTION: O-Ring (Item NO. 82)					
FUNCTION: The O-ring seal between end retainer guide block and drive casing.					
SAFETY RELATED: YES <u>X</u> NO <u> </u>					
Seal failure permits loss of lubricant to upper drive assembly bearing and cross-head.					
MFGR.: Parker			MODEL NO.: N/A		
MATERIAL: BUNA-N, 70 DURO			REFERENCE(S): 3		
DESIGN RATING(S)	REFER- ENCE(S)	REQUIREMENTS	DEMONSTRATED BY	ACCEPT- ABLE	REFER- ENCE(S)
2.038E08 Rads	15	6.8E06 Rads (40 yrs. plus two hour accident condition.)	Test & Analysis	Y	15
PART DESCRIPTION: Gasket-Sump (Item No. 12)					
FUNCTION: The gasket seals oil between the drive casing and sump.					
SAFETY RELATED: YES <u>X</u> NO <u> </u>					
Seal failure results in loss of lubricant to pump drive assembly.					
MFGR.: Hills-McCanna			MODEL NO.: N/A		
MATERIAL: Cork			REFERENCE(S): 3		
DESIGN RATING(S)	REFER- ENCE(S)	REQUIREMENTS	DEMONSTRATED BY	ACCEPT- ABLE	REFER- ENCE(S)
120°F		104°F	Design Rating	Y	2
1.0E06 Rads		3.05E05 Rads (one year normal plus two hour accident dose)	Decrease in breaking strength of 5 to 7%	Y	16

MEEQRF (CONT.)		PAGE <u>12</u> OF <u>17</u>	PROGRAM NO.: M-374		
PART DESCRIPTION: Gasket (Item 12)					
FUNCTION: The gasket seals oil between cover plate and drive casing.					
SAFETY RELATED: YES <input checked="" type="checkbox"/> NO <input type="checkbox"/>					
Seal failure results in loss of lubricant to pump drive assembly.					
MFGR.: Hills-McCanna			MODEL NO.: N/A		
MATERIAL: Cork			REFERENCE(S): 3		
DESIGN RATING(S)	REFER- ENCE(S)	REQUIREMENTS	DEMONSTRATED BY	ACCEPT- ABLE	REFER- ENCE(S)
120 ⁰ F		104 ⁰ F	Design Rating	Y	2
1.0E06 Rads		3.05E05 Rads (one year normal plus two hour accident dose)	Decrease in breaking strength of 5 to 7%	Y	16
PART DESCRIPTION: Gasket, stroke adjust cover. (Item No. 1)					
FUNCTION: Seals the stroke adjustment and the drive casing.					
SAFETY RELATED: YES <input type="checkbox"/> NO <input checked="" type="checkbox"/>					
Seal failure does not effect drive assembly.					
MFGR.: Hills-McCanna			MODEL NO.: N/A		
MATERIAL: Synthetic Rubber			REFERENCE(S): 3		
DESIGN RATING(S)	REFER- ENCE(S)	REQUIREMENTS	DEMONSTRATED BY	ACCEPT- ABLE	REFER- ENCE(S)

PART DESCRIPTION: Gasket-Drive Case Cover (Item No. 88)

FUNCTION: Seals the drive case cover to the drive case.

SAFETY RELATED: YES NO

Seal failure does not effect the drive assembly.

MFGR.: Hills-McCanna MODEL NO.: N/A

MATERIAL: Synthetic Rubber REFERENCE(S): 3

DESIGN RATING(S)	REFER- ENCE(S)	REQUIREMENTS	DEMONSTRATED BY	ACCEPT- ABLE	REFER- ENCE(S)

PART DESCRIPTION: Gasket-Sump cover (Item No. 23)

FUNCTION: Seals the sump cover to the sump.

SAFETY RELATED: YES NO

Seal failure does not effect the drive assembly.

MFGR.: Hills-McCanna MODEL NO.: N/A

MATERIAL: Synthetic Rubber REFERENCE(S): 3

DESIGN RATING(S)	REFER- ENCE(S)	REQUIREMENTS	DEMONSTRATED BY	ACCEPT- ABLE	REFER- ENCE(S)

MEEQRF (CONT.)

PAGE 14 OF 17

PROGRAM NO.: M-374

PART DESCRIPTION: Oil Seal (Item No. 115)

FUNCTION: The seal prevents oil leakage from the casing along the drive shaft.

SAFETY RELATED: YES NO

Seal failure results in loss of lubricant to the drive assembly.

MFGR.: Garlock

MODEL NO.: 63 x 141 3/4 soft

MATERIAL: Nitrile Rubber

REFERENCE(S): 3 & 9

DESIGN RATING(S)	REFER-ENCE(S)	REQUIREMENTS	DEMONSTRATED BY	ACCEPT-ABLE	REFER-ENCE(S)
2.038E08 Rads	15	6.8E06 Rads (40 yrs. plus two hour accident condition.)	Test & Analysis	Y	15

PART DESCRIPTION: Shim (Item No. 119)

FUNCTION: The shim adjusts bearing shaft tolerances.

SAFETY RELATED: YES NO

Failure of the Mylar Shim does not result in failure of the drive assembly.

MFGR.: Hills-McCanna

MODEL NO.: N/A

MATERIAL: Mylar

REFERENCE(S): 3

DESIGN RATING(S)	REFER-ENCE(S)	REQUIREMENTS	DEMONSTRATED BY	ACCEPT-ABLE	REFER-ENCE(S)

MECHANICAL EQUIPMENT ENVIRONMENTAL QUALIFICATION REVIEW FORM

COMPONENT: Drive Assembly	PAGE <u>15</u> OF <u>17</u>
MFGR.: Hills-McCanna	PROGRAM NO.: M-374
DWG./DOC. NO.: Dwg 5221-12, Sheet 1, (Ref. 3)	MODEL NO.: N/A
	LOCATION: Aux. Bldg., 568

SAFETY RELATED: YES NO

DISCUSSION:

The drive assembly provides the conversion of rotational motion of the pump shaft to reciprocating motion to move the pump plunger. The only non-metallic component in the drive assembly is the lubricant.

PART DESCRIPTION: Lubricant

FUNCTION: The lubricant prevents wear and binding of the drive assembly.

SAFETY RELATED: YES NO

Loss or breakdown of the lubricant causes overheating, binding and pump motor overload.

MFGR.: Mobil Oil MODEL NO.: Mobil gear oil 636

MATERIAL: REFERENCE(S): 2 and 8

DESIGN RATING(S)	REFER-ENCE(S)	REQUIREMENTS	DEMONSTRATED BY	ACCEPT-ABLE	REFER-ENCE(S)
1E08 Rads	8	6.8E06 Rads	Design Rating	Y	8
120°F	Apdx. A, No. 9	104°F	Design Rating	Y	Apdx. A, No. 9

MECHANICAL EQUIPMENT ENVIRONMENTAL QUALIFICATION REVIEW FORM

COMPONENT: Stroke Adjustment Assembly

PAGE 16 OF 17

MFGR.: Hills-McCanna

PROGRAM NO.: M-374

DWG./DOC. NO.: 5221-12, Sheet 1, (Ref. 3)

MODEL NO.: N/A

LOCATION: Aux. Bldg., 568

SAFETY RELATED: YES NO

DISCUSSION:

The manual stroke adjustment assembly provides for fine control of the stroke length traveled by the pump plunger and hence determines the pump output. The stroke assembly does not contain any non-metallic components and therefore degradation induced by normal and post LOCA environmental service conditions does not exist. The manual stroke adjustment is set quarterly, as required, during pump flowrate testing (See Maintenance and Surveillance Recommendations, pg. 28). As a result, manual stroke adjustment is not required during accident conditions.

PART DESCRIPTION:

FUNCTION:

SAFETY RELATED: YES NO

MFGR.:

MODEL NO.:

MATERIAL:

REFERENCE(S):

DESIGN RATING (S)	REFER- ENCE (S)	REQUIREMENTS	DEMONSTRATED BY	ACCEPT- ABLE	REFER- ENCE (S)

MECHANICAL EQUIPMENT ENVIRONMENTAL QUALIFICATION REVIEW FORM

COMPONENT: Thermocouple	PAGE <u>17</u> OF <u>17</u>
MFGR.: N/A	PROGRAM NO.: M-374
DWG./DOC. NO.: 5221-12, Sheet 1, (Ref. 3)	MODEL NO.: N/A
	LOCATION: Aux. Bldg., 568'

SAFETY RELATED: YES _____ NO X

DISCUSSION:

The thermocouple provides an indication of hydrazine pump lubricant temperature. Thermocouple failure does not effect the safety function of the pump.

PART DESCRIPTION: _____

FUNCTION: _____

SAFETY RELATED: YES _____ NO _____

MFGR.: _____ MODEL NO.: _____

MATERIAL: _____ REFERENCE(S): _____

DESIGN RATING(S)	REFER-ENCE(S)	REQUIREMENTS	DEMONSTRATED BY	ACCEPT-ABLE	REFER-ENCE(S)

Hydrazine Positive Displacement Pump
Maintenance and Surveillance Recommendations

M374

<u>Frequency</u>	<u>Requirement</u>	<u>Action</u>
Daily	Check pump head for hydrazine leakage.	Initiate corrective maintenance as appropriate.
	Check pump drive case for oil ⁽¹⁾	
Quarterly	Run hydrazine pumps to verify pump performance. Check pump head and drive case integrity.	Initiate corrective maintenance as appropriate.
	Check for abnormal pump vibrations and noise.	
	Check pump flow rate.	Adjust manual stroke assembly as required.
Annually	Disassemble and inspect inlet and outlet pump check valves for wear.	Replace check valve seats or ball check if required.
	Replace check valve seals.	
	Drain drive case lubricating oil.	Refill with fresh oil.
	Disassemble and inspect drive assembly.	

Hydrazine Positive Displacement Pump
Maintenance and Surveillance Recommendations
(Continued)

M374

<u>Frequency</u>	<u>Requirement</u>	<u>Action</u>
Annually	Check upper and lower bearings for wear.	
	Renew drive case oil seals.	
	Reassemble and test the pump.	

Note (1): Periodically check during pump operation.

APPENDIX A

1. The Hills-McCanna Positive Displacement Pump is now manufactured by the PPI Division of the Durion Co., Inc.
2. The pump/motor coupling manufactured by Rexnord Inc., requires no lubrication and contains no non-metallic parts (See Reference 7).
3. The pump/motor qualification analysis is covered under the Electrical Equipment Qualification Program, File Number M-374.
4. The Reactor Building Spray System Hydrazine Addition pumps are located in water tight rooms in the Auxiliary Building. Each pump is located in a separate room, therefore the pumps are unaffected by all post LOCA environmental service conditions except radiation. Radioactive fluid is transported by the Reactor Building Spray Pumps when the system is in the recirculatory mode. The Reactor Building Spray Pumps and Hydrazine Pumps are located in the same rooms.
5. The manual stroke adjustment assembly does not contain any non-metallic parts and is therefore not affected by radiation induced degradation. The manual stroke adjustment is set quarterly, as required, during pump flowrate testing (See Maintenance and Surveillance Recommendations, Page 28). As a result, manual stroke adjustment is not required during accident conditions.
6. The Hydrazine Pump is designed to function without auxiliary cooling water to cool the pump or drive assembly. The drive assembly lubricant is selected to provide lubrication with ambient temperature as high as 120°F which is greater than the maximum temperature listed as 104°F. Non-metallic components are internal to the pump and drive assembly and are therefore not exposed to an external 100% relative humidity environment.

7. The Hydrazine Pump is subjected to a total radiation field of $6.8E06$ Rads ($6.6E06$ Rads (40 Yr. Normal) plus $1.7E05$ Rads (2 hr. accident)). BUNA-N (Nitrile Rubber) O-Rings have been tested to $2.038E08$ Rads with no appreciable degradation observed. (See Reference 15).

8. The Hydrazine Pumps are positive displacement pumps activated by a run signal from the Reactor Building Spray Pumps. Due to the direct drive coupling of the pump and motor and characteristics of the positive displacement pumps rated flow is available in 1.15 seconds (Reference 10). A sufficient Response Time margin of approximately 70 seconds is inherent to system operation as the required time for RB Spray Pump full flow delivery is 72 seconds (See MFQ File M-054).

9. The hydrazine positive displacement pump was designed by Hills-McCanna to operate with ambient service temperatures as high as 120°F (See page 13 of Reference 8). Normal room temperature is between 50°F and 104°F . An average room temperature will be provided during actual plant operating conditions. Drive case gear lubricant should be selected based on average service temperature as follows:

Mobile gear oil 634	41°F to 90°F
Mobil gear oil 636	91°F to 120°F

10. The Hydrazine Pump packing is composed of asbestos impregnated Teflon TFE. The radiation resistance threshold for degradation of teflon is $1.5E04$ Rads (See Reference 12, Page 3-13). Degradation of the packing will occur in both the normal and accident environments where the annual normal dose is $1.65E05$ and the two (2) hour accident dose is $1.7E05$ Rads (See Reference 13). Therefore, replacement of the Teflon TFE ring packing with a material that has a higher tolerance to radiation is recommended. The recommended replacement packing material is Grafoil (See No. 11).

11. Grafoil pump packing, manufactured by Crane Packing Company can withstand pressure to 2000 psi and temperatures to 1200°F. The Grafoil packing has no resin binders or organic fillers and is therefore resistant to radiation degradation. Grafoil withstands exposure to corrosive fluids. The Crane Packing Company recommends Grafoil packing for this application. Grafoil is radiation resistant up to 1E09 Rads.
12. A Site Restriction Form designating the type of drive case gear lubricant (oil) and pump packing to be used in the Hydrazine Pump has been completed to insure that the manufacturer's lubrication requirements and the radiation resistance requirements are satisfied.
13. The Hydrazine Pumps subjected to analysis as described in this program is identical to the pumps installed at the Midland Plant, Units 1 and 2 as noted in References 3, 4, 5 and 6.
14. With appropriate maintenance and surveillance schedules, developed in the Maintenance and Surveillance Recommendation Section, the qualified life of the Hydrazine Pump is determined to be in excess of 40 years including a 2 hour post accident condition.
15. The addition of Hydrazine into the containment atmosphere through the RB Spray System has been assumed to be two (2) hours in duration in accordance with Section 1.4.3.2.3.2 of Reference 13. In addition, Table 1-15 of Reference 13 assumes maintenance of the Hydrazine solution for two (2) hours for the qualification program spray chemistry.
16. The Hydrazine Pump Cork Gaskets should be replaced as necessary as a result of normal annual maintenance activities.

17. The Throat/Follower Bushing are fabricated from Graphitar, Gr. III (See Reference 14). This is a carbon-graphite compound with a epoxy resin binding agent. Carbon and graphite are radiation insensitive at the radiation levels to which the Throat/Follower Bushings are subjected, i.e., $6.8E06$ Rads. The epoxy resin binding agent is radiation insensitive up to radiation levels of $2E08$ Rads. As a result it can be concluded that the Throat/Follower Bushings are radiation resistant with regards to their application within the Hydrazine Pump.

REFERENCES AND ADDITIONAL DATA

PAGE 1 OF 2

PROGRAM NO.: M-374

1. PPI-Durcometer, Bulletin 800G, Positive Displacement Pump Specifications
2. PPI-Durcometer P/DI Pump Instruction and Maintenance Manual
3. Hills-McCanna Co. DWG. 5221-12, Sheet 1, Rev. D, Parts Identification Section Assembly-Hydrazine Pump
4. Hills-McCanna Co. DWG. 5221-13, Sheet 2, Rev. D, Parts Identification Section Assembly-Hydrazine Pump
5. Hills-McCanna Co. DWG. 5221-14, Sheet 3, Rev. D, List of Materials
6. Hills-McCanna Co. DWG. 5221-15, Sheet 4, Rev. D, List of Materials
7. Telecommunication, Rexnord Inc., Manufacturer of pump/motor coupling
8. Telecommunication, Mobil Oil Co., Manufacturer of Mobil Gear Oil 636
9. Telecommunication, GARLOCK, INC., Manufacturer of Garlock Oil Seal
10. Telex, Gary L. Wheeler (Reliance) to W. DeJong, J. Payne (Béchtel), August 17, 1982, Subject: Hills-McCanna S.O.

1YF882844

REFERENCES AND ADDITIONAL DATA

PAGE 2 OF 2

PROGRAM NO.: M-374

11. Reference 11 deleted

12. Radiation Effects on Organic Materials in Nuclear Plants, EPRI
NP-2129, November 1981

13. Midland Plant, Units 1 & 2, Environmental Qualification Report,
Volume 1. Revision 1

14. Telecommunication, PPI Division of Durion Co., Inc., Manufacturer
of Hydrazine Pump

15. Rotork Qualification Test Report 7220-M123C-105-1, Wyle
Laboratories Test Report No. 43979, Rev. A, October 24, 1978
(Retained in CPCo Equipment Qualification Central File No.
M-123CC)

16. Radiation Chemistry of Monomers, Polymers, and Plastics by
J. E. Wilson, Publisher Marcell Dekker, Inc., 1974

Generic Figures

Generic Figures are not Required to
Support this Qualification Documentation

P

Bulletin No. 8006

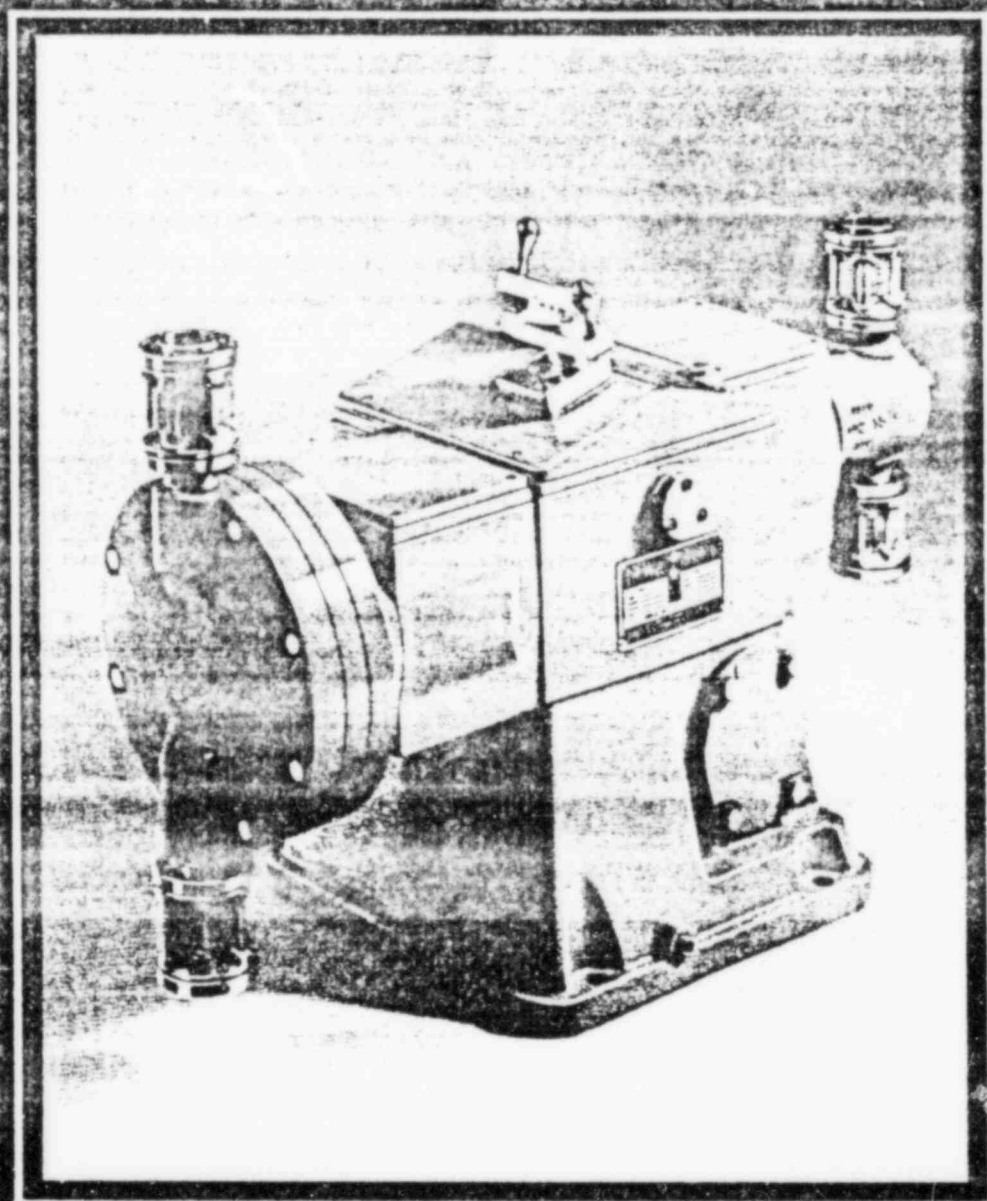

P/D Pumps

PPI-DURCOMETER

Plunger/Diaphragm Pump

*Patented

VANCE MCCA-4
1-215-675-1600 EXT 228 MAIN 1
270

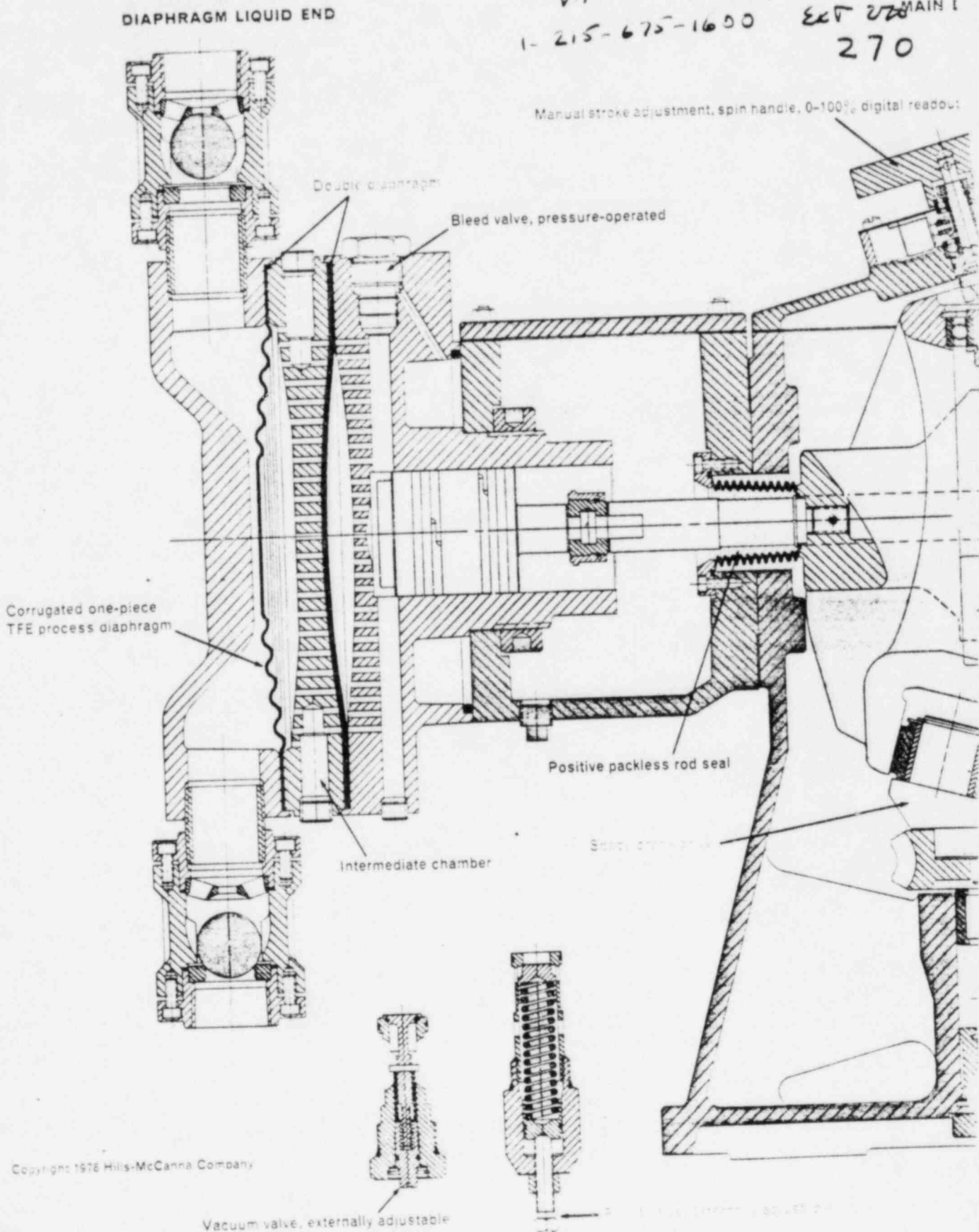

Copyright 1978 Hills-McCanna Company

Durcometer P D Pumps provide continuous, accurate, maintenance-free metering and proportioning of fluids under widely varying service conditions. Incorporating a host of new features these versatile pumps introduce new standards in industrial fluid processing.

Space crank drive provides for one or two feeds mounted on same drive case; multiple feeds can be provided by running drive cases in tandem. Manual or automatic stroke adjustment is independent for each feed; direct 0 - 100% digital readout is standard. Pumps may be provided with diaphragm heads, plunger heads, or a combination of diaphragm and plunger. Capacities per feed from 0.87 to 780 gph; discharge pressures up to 5,000 psig; pumping speeds up to 230 strokes per minute.

SECTION

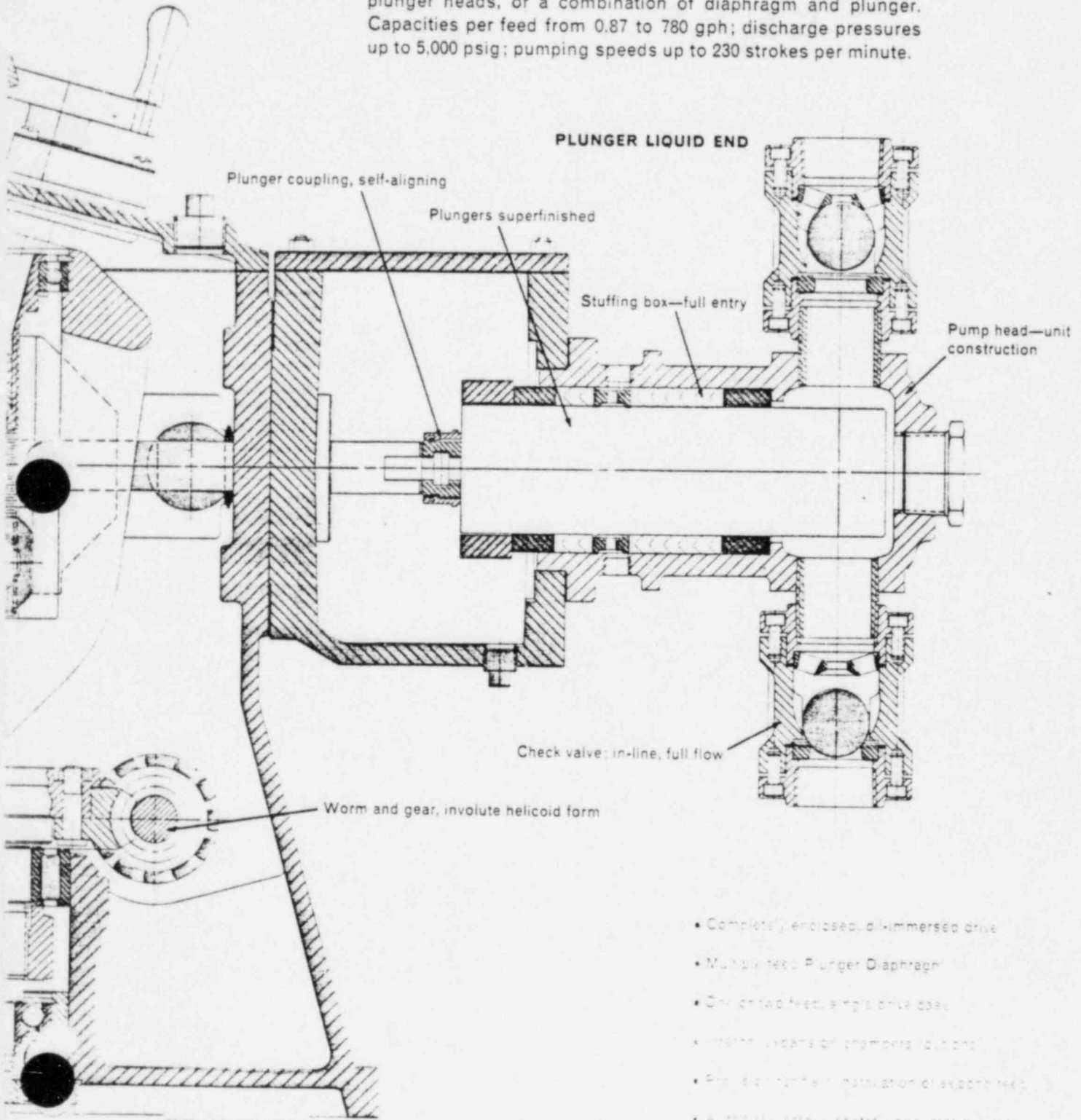

- Completely enclosed, oil-immersed drive
- Multiple feed Plunger Diaphragm
- One or two feeds, single drive case
- In-line, in-line or end-on connections
- Proven horizontal installation of all ports
- 4-100% stroke control (non-metric)

(See pages 8 and 9 for detailed specifications.)

Plunger Liquid End

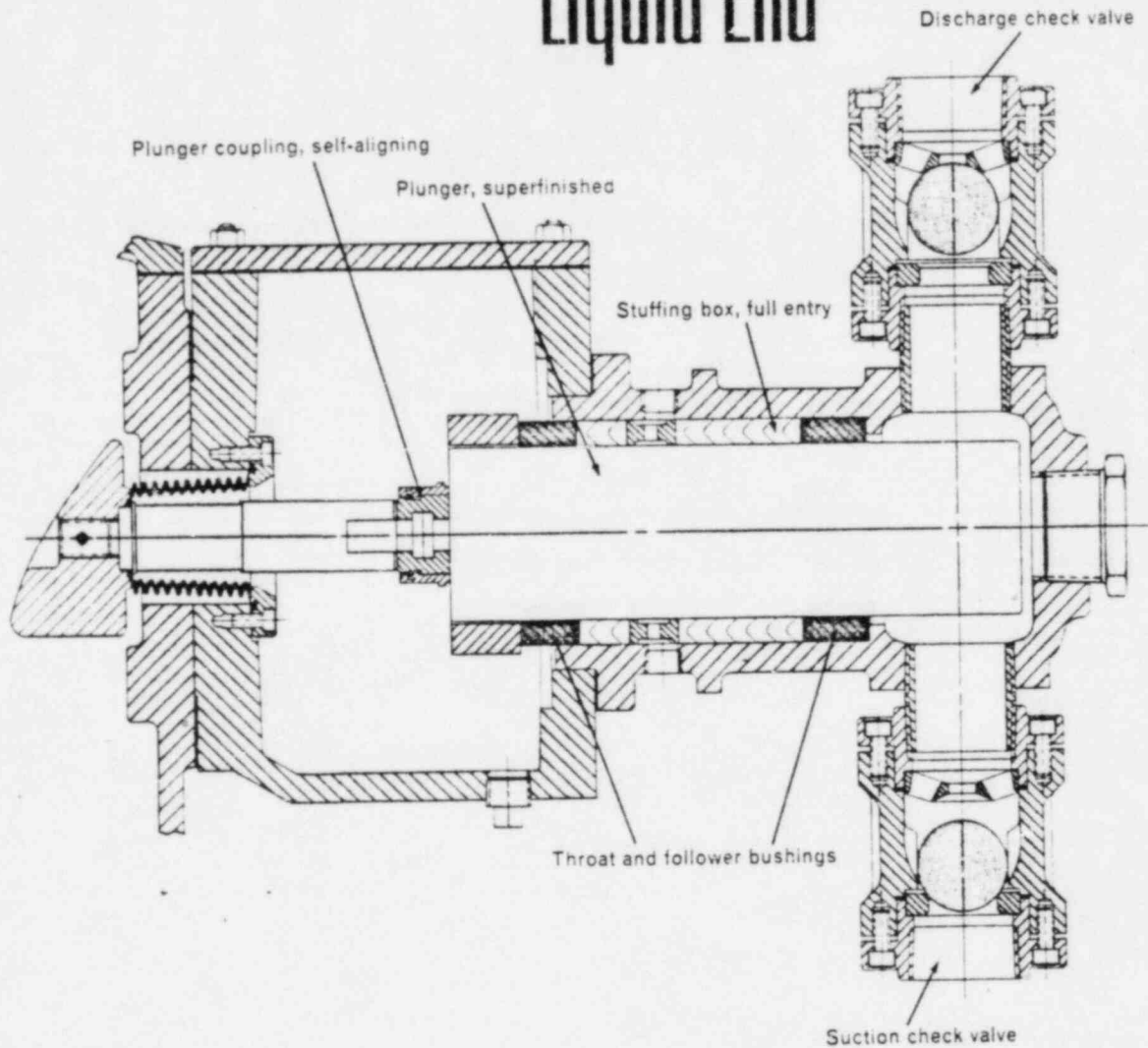

Plunger pumps are used in most all proportioning pump applications. Due to design features, plunger pumps are capable of handling much higher pressures than diaphragm type. Plunger pumps have stuffing boxes with packing rings. Stuffing box leakage and wear is a gradual progression. Properly designed, the plunger liquid end has a long life span before repacking is necessary. Gradual take-up on the gland will reduce or eliminate leakage as wear on the packing rings takes place. Plunger pumps can therefore be repacked on a planned maintenance schedule since immediate failure does not occur. The P/D Pump plunger liquid ends incorporate many features which greatly extend the life of the packing rings such as:

1. Longitudinally honed plunger surfaces to better than 8 microinch finish.
2. Hardened SS440 or alumina ceramic plunger materials available from stock.
3. True alignment of plunger to plunger driver is assured by a self-aligning plunger coupling.
4. Low-friction, nongalling throat and follower bushings assure smooth stroking cycles.
5. Plunger always travels to full forward position, regardless of stroke length setting, eliminating possibility of crystalline buildup on plunger surface, plus providing full purging of body.

Double-Diaphragm Liquid End

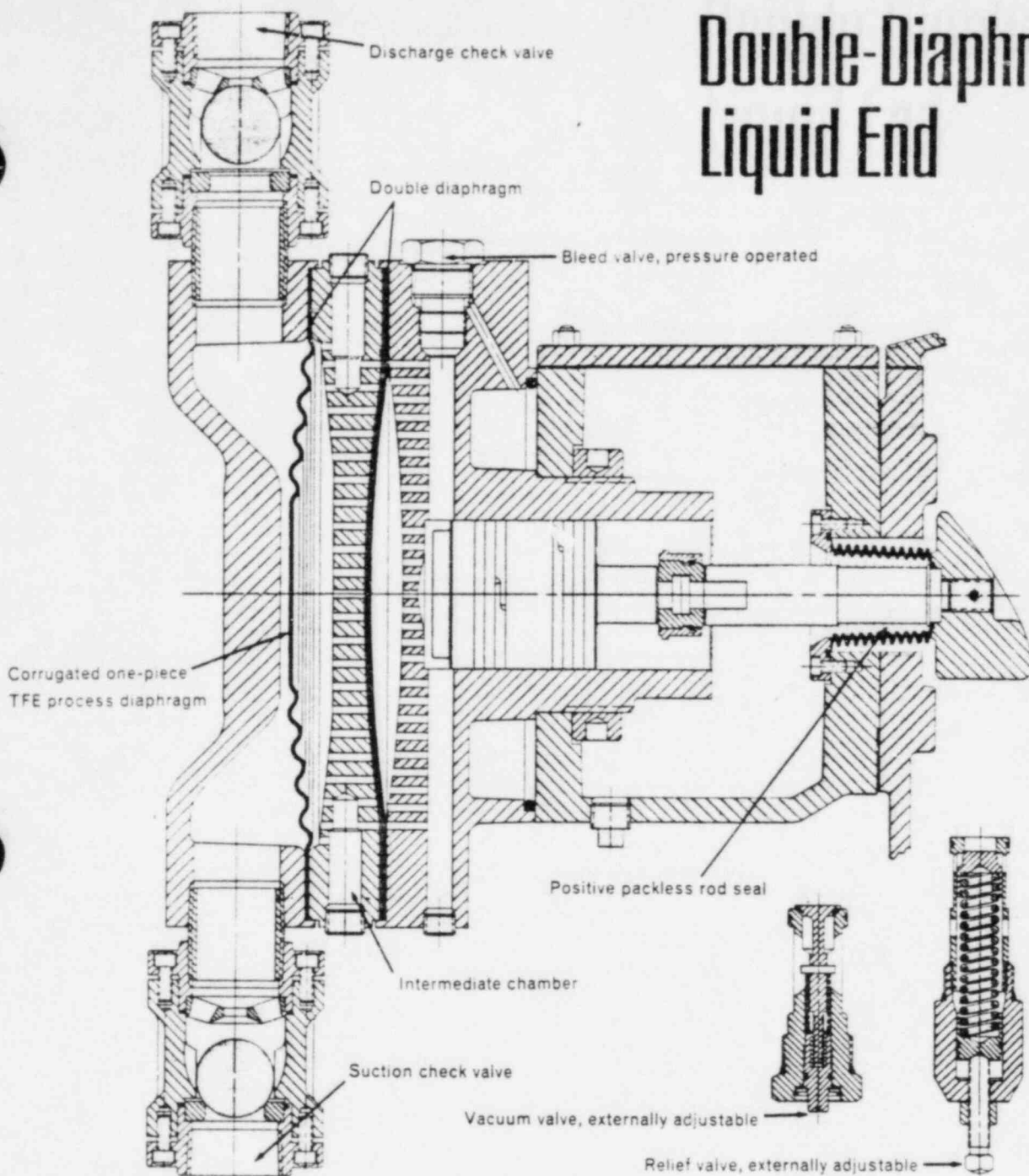

Diaphragm pumps are most widely used in applications where the nature of the material being pumped is:

1. Highly toxic
2. Highly corrosive
3. Radioactive
4. Of high purity (no contamination tolerated)
5. Of a high odorant content
6. Highly volatile

The packless design features of a diaphragm pump completely isolate the fluid being pumped from the atmosphere. However, in conventional diaphragm pump design, there is always the possibility of contaminating the process fluid in the event of a diaphragm rupture, since the hydraulic oil behind the

diaphragm can then become mixed with the fluid being pumped. For this reason, the P/D Pump design incorporates a *double* diaphragm which provides an intermediate chamber separating the hydraulic diaphragm from the process diaphragm. The chamber provides for a compatible liquid between the two diaphragms, giving 100% protection against contaminating the process fluid in the event of diaphragm failure. This chamber also provides for visual inspection or automatic detection of a diaphragm failure.

For services requiring a diaphragm pump, the double diaphragm feature of the P/D Pump insures against product contamination, loss of product and valuable downtime.

Space Crank Drive

The unique P D Pump drive is a variation of a three-dimensional space crank mechanism. The worm and worm gear revolve the space crank in a *conical path* with its origin at the *pivot point* of the hanger bracket. The conical revolution of the space crank is translated by the sliding block to the swinging path of the hanger bracket.

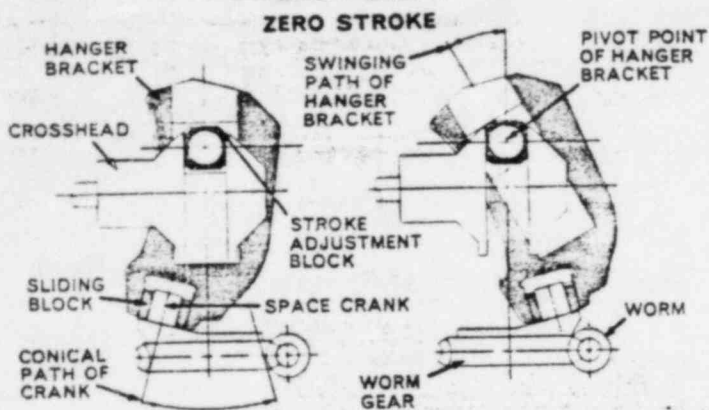

ZERO STROKE

When the stroke adjustment block position coincides with the pivot point of the hanger bracket, no motion is transmitted to the crosshead, and the pump is at zero stroke.

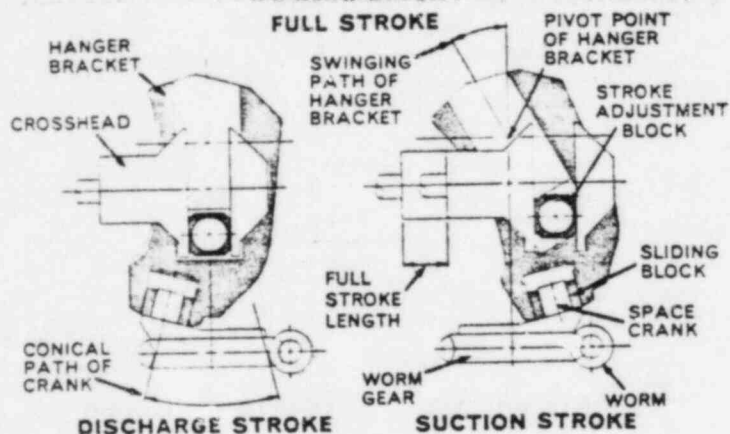

FULL STROKE

When the stroke adjustment block position is adjusted to the bottom of the hanger bracket slot, maximum motion is transmitted to the crosshead and the pump is at full stroke.



Stroke Adjustment

1. Stationary spin crank adjustment while the pump is in operation—or while stopped.
2. Zero to 100% digital readout, accurate to 1% of return setting, 50 turns from zero to full stroke.
3. Each feed independently adjustable.
4. Completely enclosed. Fully protected from atmospheric corrosion or mechanical damage.
5. Pneumatic- or electric-automated stroke controls available; may be field installed.

Approximate Dimensions for Multi-Feed Pumps

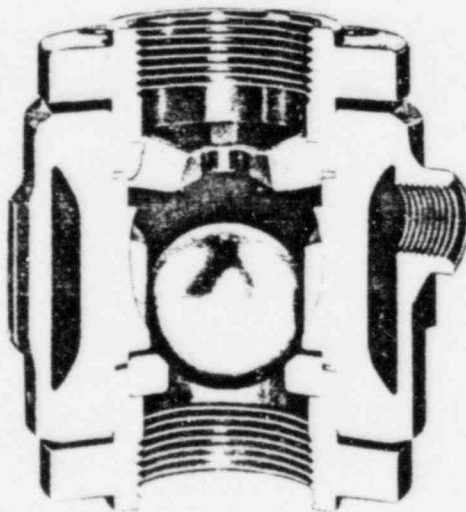
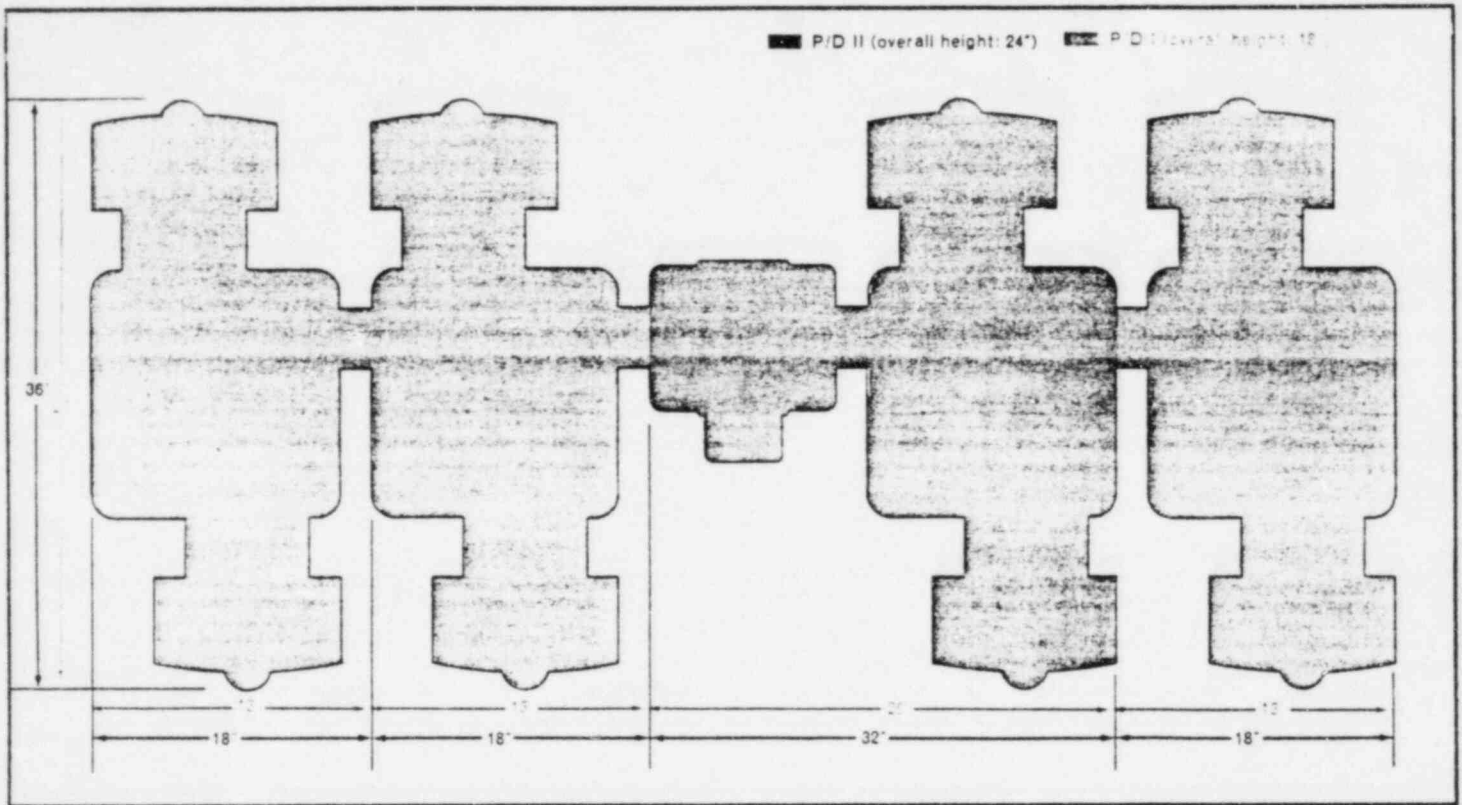

CHECK VALVE WITH JACKET

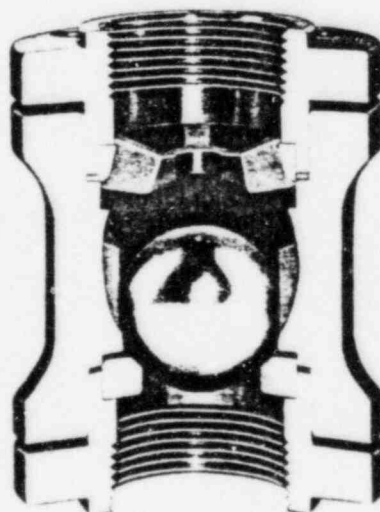

CHECK VALVE WITHOUT JACKET

Check Valves

Vertical check valves feature minimum velocity, clean-sweeping, straight-through flow. Accurately guided ball eliminates valve chatter, assuring metering accuracy and efficiency.

Valves are available with or without jacket, easily disassemble into four basic parts for minimal maintenance, time, and cost.

Specifications

MAIN DRIVE SECTION

MOTOR: Standard Four-Pole Squirrel Cage Induction
Nema Rate, flange-mounted, 230/460 volt, 3 phase, 60 cycle, 1750 rpm.

Motor options available include all current characteristics; any frame size and foot mounting; all enclosures including epoxy encapsulated chemical duty, U.L. and Buxton explosionproof. Variable speed drives: hydraulic, mechanical and electric with manual or automatic adjustment.

Engine, air motor, turbine, and sprocket or chain drives are also available.

COUPLING: Accessible without removing motor.

Standard motor coupling with resilient spider insert eliminates fretting corrosion between motor and worm shaft. Motor coupling halves are plated for atmospheric corrosion resistance. Coupling is accessible without removing the motor for manual turnover of the pump. The provision for manual turnover is valuable as a preliminary start-up precaution. Motor can be removed from the pump without disassembly of the coupling. Options available: All coupling types and manufacture including resilient center, gear and grid.

COUPLING GUARD: Snap-On Type

The standard coupling guard is a snap-on type that can be removed by hand. The guard is supported by the rigid cast sections of the motor bracket. Special coupling guards can be made to specification.

WORM & GEAR SET: Involute Helicoid Form

Standard gear sets are a nationally advertised catalog item. Single and double extended worm shafts are standard. The double extended worm shaft is used for multiple feed pumps or through drive for accessories such as a tachometer or tachometer generator. The worm gear sets use the advanced involute helicoid thread form with minimum selected backlash for maximum power transmission capacity and long life.

The worm mounting bearings are tapered steep-angle Timken roller bearings for maximum thrust and radial resultant loads. The worm gear mounting bearings are a combination of a pre-loaded double ball bearing for thrust and light radial loads and a roller bearing for the major radial loads.

SPACE CRANK DRIVE:

The P/D Pump Drive is a variation of a three-dimensional space crank mechanism. The drive minimizes the pump space envelope and allows for one or two feed options within the same drive case. Crank and crosshead sliding block size are proportioned for conservative pressure velocity values without need of pressure lubrication. All power transmission components are submerged in, and lubricated by, an oil bath.

The crosshead section of the P/D Pump drive is, by definition, "a connecting rod of infinite length" and is supported by four self-aligning bearings that run on hardened and ground track surfaces. The crosshead is completely load balanced and eliminates overhung loads that could cause force deflections in this critical section of the pump.

MANUAL STROKE ADJUSTMENT:

Spin Handle, 0-100% Digital Readout

The spin handle stroke adjustment mounted on antifriction bearings provides smooth stroke adjustment while the pump is in operation or stopped. The digital counter, geared to the stroke adjustment shaft, reads from 0 to 100 (can be read to 1/100) and is read in percent, a universal readout that does not need conversion to other units.

The stroke adjustment screw and knuckle thread is a fine pitch acme form to prevent creeping of the stroke adjustment when the pump is in operation and provides the exact 50-turn adjustment required for the digital 0-100% counter.

PNEUMATIC STROKE ADJUSTMENT:

Built-In Signal Trimming

Pneumatic stroke adjustment is available for all instrument signals, including standard linear 3-15 and 3-27 air, or special milliamp or millivolt to pneumatic conversion. The pneumatic stroke adjustment positioner has a provision for trimming the maximum and minimum output of the pump. This is a necessity for automated processes that otherwise would require an additional ratio controller or auxiliary trimming device.

POSITIVE PACKLESS ROD SEAL:

The P/D Pump mechanical drive section is completely submerged in, and lubricated by, a heavy worm and gear lubricant required for rated transmission capacity of the worm and gear set. This type of lubricant was developed by the industry for its properties of tenacious adhesion to wetted surfaces and lubricating quality over a wide temperature range. Because of these qualities the lubricant is extremely difficult to wipe clean from a reciprocating rod shaft with a conventional seal. For this reason, P/D Pump developed the packless rod seal to prevent carryover of lubricant or contamination of the main drive case.

PLUNGER COUPLING: Self-Aligning

The P/D Pump plunger coupling allows self-alignment of the plunger. This eliminates plunger side thrusts, binds or possible loosening of the drive rod. The coupling can be disconnected by hand without the use of special tools. The outer sleeve snaps back and the retainer separates into exactly machined halves.

PLUNGER LIQUID ENDS

PLUNGERS: Superfinished

The plungers for stuffing box type pumps are hard, wear resistant, and superfinished by longitudinally honing to a finish that is better than 8 microinch. Alumina ceramic and hard SS 440B are standard materials. Other materials can be furnished on application.

STUFFING BOX: Full Entry

Regardless of stroke setting, the full forward positioning of the pump plunger results in full entry of the plunger into the pump body and the same wetted plunger surface at all times. This feature eliminates the possibility of crystalline material build-

up on the plunger surface at reduced stroke setting and subsequent broaching of the packing when increasing the stroke length.

The combination of superfinished plungers, selection of bushing materials for their corrosion resistant and anti-galling properties, full forward entry of the plunger and standard TFE lubricated, reinforced "V" ring packing result in the longest possible minimum attention, servicefree stuffing box designed.

PUMP HEAD: Unit Construction

The pump head and check valves are separate components, allowing for maximum flexibility in the sizing of valves, selection of materials and component servicing.

All pump head components such as plunger, throat and follower bushings, lantern rings and packing can be easily removed for servicing without special tools.

DIAPHRAGM LIQUID ENDS

The P/D Diaphragm pump is the result of an extensive study of what is desired by the industry for optimum performance and reliability.

Double diaphragm construction with intermediate reference chamber is standard. There are many advantages to the double diaphragm construction that make it far superior to other type designs.

Visual indication of intermediate chamber contamination (optional): A pressure sight glass can be installed in one of the connection ports provided in the side of the intermediate chamber. A liquid of known pH reference color and process compatibility can be selected to fill the intermediate chamber. Should the process diaphragm fatigue after extensive service, the intermediate liquid pH reference color will change, providing visual indication of failure.

Automatic indication of intermediate chamber contamination (optional): An electric probe can be installed in one of the connection ports provided in the side of the intermediate chamber. A liquid of known reference conductivity and process compatibility can be selected to fill the intermediate chamber. Should the process diaphragm fatigue after extensive service, the intermediate fluid reference conductivity will change, causing an electric relay to operate and automatically indicate failure.

Superior diaphragm performance: Diaphragm pumps of conventional design rely on two contoured limit surfaces to keep the diaphragm within its maximum deflection limits. Single diaphragm pumps require one of the contoured limit surfaces to be located on the process side of the diaphragm. This is a poor condition for efficient diaphragm pump operation. Single diaphragm pumps must move the process liquid back and forth through small holes on every stroke of the pump. For aqueous process liquid, this condition is not detrimental but when process liquid viscosity, shear proper-

ties, separation or slurry suspension is a consideration, the many small holes will have a detrimental effect. Any particle fallout from the process liquid will eventually be compacted by the diaphragm in its forward limit position and inbed into or dent the diaphragm. This is probably the most frequent cause of diaphragm failure in single diaphragm pumps.

The standard double diaphragm P/D Pump isolates the diaphragm contour limit surface to the hydraulic side of the pump, thus eliminating the major cause of premature diaphragm failure.

CORRUGATED ONE-PIECE TFE PROCESS DIAPHRAGM:

The corrugated process diaphragm is a slave of the hydraulic diaphragm. The process and hydraulic diaphragm can, in motion, be considered one diaphragm with a liquid center. The corrugated shape of the process diaphragm is formed in the back position and results in a uniform rolling action throughout its entire movement.

VACUUM VALVE: Externally Adjustable

The diaphragm head vacuum valve is calibrated for external adjustments to obtain optimum pump performance at varying suction conditions.

RELIEF VALVE: Externally Adjustable

The P/D Diaphragm pump relief valve is externally adjustable for varying pump or process pressure requirements. With conventional diaphragm pumps using a pressure relief valve, the tendency is to set the relief valve for the maximum pressure potential of the pump without considering the advantage of selective settings for process system protection. The P/D Pump relief valve has been designed for minimum ΔP by providing generous flow areas through the valve and the use of an adjustment spring with the lowest possible spring rate. (This could eliminate a costly external relief valve.)

AIR BLEED VALVE: Pressure Operated

The air bleed valve purges the diaphragm head of entrained air. The valve operates as the pressure changes from positive to negative (above to below atmospheric) in value. The valve always expels a constant volume, resulting in the same slight volumetric loss regardless of discharge pressure fluctuations.

CHECK VALVES

In-Line, Full Flow

The P/D Pump check valves have been sized for minimum velocity, clean-sweeping flow. Positive uniform flow supported and accurately guided ball eliminates valve chatter, resulting in positive action and long seat life. Simple seat insert provides for unlimited economical selection of seat materials.

Standard NPT connections: Options available include flanged, socket weld or other end connections on application.

Jacketed components are also available for heat transfer requirements. The flow through the jackets is contained without gaskets permitting use of all heat transfer media such as steam, Dowtherm, Freon or ammonia.

Pump Application Characteristics in Process Design

In designing a process system requiring a proportioning pump, the following application characteristics should be considered.

1. Proportioning Pump Accuracy
 - a. The capacity of the pump is adjustable from zero to 100%.
 - b. The pump's highest metering accuracy is obtained in the 10% to 100% range.
 - c. In the 10% to 100% range, the pump's repeatable accuracy is within $\pm 1\%$ or better.
2. Positive Differential Pressure

To assure accurate pumping action, positive differential pressure must exist on the discharge side of the pump.
3. High Vapor Pressure

Materials with high vapor pressure will require N.P.S.H. (net positive suction head) consideration. Jacketed liquid ends and check valves are available to cool the material if additional N.P.S.H. is required.
4. High Viscosity

High-viscosity materials may require consideration of increased pipeline size, check valve design, or temperature control. Jacketed pump bodies and check valves should be considered for adding temperature control if high-viscosity conditions exist.
5. Suction Lift

If flooded suction conditions do not exist:

 - a. Maximum suction lift for plunger pumps should not exceed 15 feet of water.
 - b. Maximum suction lift for diaphragm pumps should not exceed 10 feet of water.
6. Pulsating Flow

The characteristic performance of a pro-

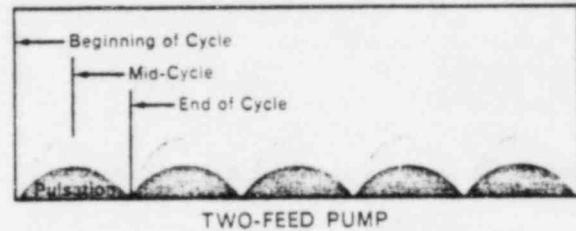
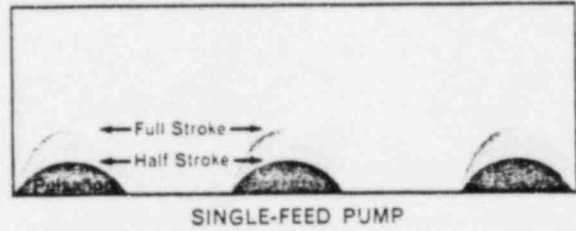

portioning pump results in a pulsating flow on each stroke of the pump as shown above.

Because of this pulsating characteristic:

- a. Pipeline size should be equal to or greater than the pump check valve size.
- b. Sudden restrictions in suction or discharge lines should be avoided. (Select valves and fittings with full pipeline capacity.)

7. Dampening Pulsations

The pulsating flow of a proportioning pump can be dampened by the installation of an accumulator in the discharge line.
8. Process System Protection
 - a. All plunger pumps will require the use of a relief valve in the discharge line for pump and system protection.
 - b. Diaphragm pumps have a built-in relief valve for pump and system protection.

Pump Selection

STANDARD* MATERIALS OF CONSTRUCTION

DIAPHRAGM PUMP				PLUNGER PUMP			
Basic Pump	Steel	SS316	Alloy 20	Basic Pump	Steel	SS316	Alloy 20
Reagent Head	Steel	SS316	Alloy 20	Pump Body	Steel	SS316	Alloy 20
Process Diaphragm	TFE	TFE	TFE	Plunger P/D I Plunger P/D II	MAC318 SS440	MAC318 Ceramic	SiC Carbide Ceramic
Hydraulic Diaphragm	TFE	TFE	TFE	Plunger Bushings	Carbon Graphite	Carbon Graphite	Carbon Graphite
				Lantern Ring	SS316	SS316	Alloy 20
Check Valve Body	Steel	SS316	Alloy 20	Check Valve Body	Steel	SS316	Alloy 20
Ball	Ceramic	Ceramic	Ceramic	Ball	Ceramic	Ceramic	Ceramic
Ball Stop	SS316	SS316	Alloy 20	Ball Stop	SS316	SS316	Alloy 20
Seat	SS316	SS316	Alloy 20	Seat	SS316	SS316	Alloy 20

*Other materials of construction — such as Hastelloy, Nickel, Monel, etc. — are available on special order.

Pump Selection

CAPACITIES AND PRESSURES MODEL P/D I PUMP

Capacity at Max Pres. GPH	ONE FEED						Plunger Dia. (Inches)	Speed Strokes Per Minute	Check Valve Size Inches	TWO FEED						
	3 4 hp		1 hp		1-1 2 hp					3 4 hp		1 hp		1-1 2 hp		
	Pres. PSIG	Code*	Pres. PSIG	Code*	Pres. PSIG	Code*				Pres. PSIG	Code*	Pres. PSIG	Code*	Pres. PSIG	Code*	
0.87	5000	J1-02058-06	J1-02058-10	J1-02058-14	1/4	58	1/4	7.0	5000	J2-02058-06	J2-02058-10	J2-02058-14				
1.35	5000	J1-02087-06	J1-02087-10	J1-02087-14	1/4	87	1/4	2.7	5000	J2-02087-06	J2-02087-10	J2-02087-14				
1.75	5000	J1-02116-06	J1-02116-10	J1-02116-14	1/4	116	1/4	3.5	5000	J2-02116-06	J2-02116-10	J2-02116-14				
2.1	5000	J1-02140-06	J1-02140-10	J1-02140-14	1/4	140	1/4	4.4	5000	J2-02140-06	J2-02140-10	J2-02140-14				
2.75	5000	J1-02175-06	J1-02175-10	J1-02175-14	1/4	175	1/4	5.5	5000	J2-02175-06	J2-02175-10	J2-02175-14				
3.5	5000	J1-02230-06	J1-02230-10	J1-02230-14	1/4	230	1/4	7.0	5000	J2-02230-06	J2-02230-10	J2-02230-14				
3.5	5000	J1-04058-06	5000	J1-04058-10	J1-04058-14	1/2	58	1/8	7.0	4500	J2-04058-06	4500	J2-04058-10	J2-04058-14		
5.4	3900	J1-04087-06	5000	J1-04087-10	5000	J1-04087-14	1/2	87	1/8	10.8	3500	J2-04087-06	4500	J2-04087-10	4500	J2-04087-14
7.0	2960	J1-04116-06	4100	J1-04116-10	5000	J1-04116-14	1/2	116	1/8	14.0	2650	J2-04116-06	3690	J2-04116-10	4500	J2-04116-14
8.8	2500	J1-04140-06	3360	J1-04140-10	5000	J1-04140-14	1/2	140	1/8	17.6	2250	J2-04140-06	3025	J2-04140-10	4500	J2-04140-14
11.0	2000	J1-04175-06	2690	J1-04175-10	4000	J1-04175-14	1/2	175	1/8	22.0	1800	J2-04175-06	2420	J2-04175-10	3650	J2-04175-14
14.0	1500	J1-04230-06	2200	J1-04230-10	3000	J1-04230-14	1/2	230	1/8	23.0	1350	J2-04230-06	1980	J2-04230-10	2700	J2-04230-14
8.0	2400	J1-06058-06	2400	J1-06058-10	J1-06058-14	3/4	58	3/8	16.0	2200	J2-06058-06	2200	J2-06058-10	J2-06058-14		
12.0	2340	J1-06087-06	2400	J1-06087-10	2480	J1-06087-14	3/4	87	3/8	21.0	2100	J2-06087-06	2200	J2-06087-10	2230	J2-06087-14
16.0	2200	J1-06116-06	1830	J1-06116-10	2480	J1-06116-14	3/4	116	3/8	28.0	1100	J2-06116-06	1650	J2-06116-10	2230	J2-06116-14
19.0	1110	J1-06140-06	1250	J1-06140-10	2230	J1-06140-14	3/4	140	3/8	35.0	1000	J2-06140-06	1125	J2-06140-10	2000	J2-06140-14
24.0	890	J1-06175-06	1000	J1-06175-10	1785	J1-06175-14	3/4	175	3/8	44.0	800	J2-06175-06	900	J2-06175-10	1600	J2-06175-14
32.0	670	J1-06230-06	900	J1-06230-10	1450	J1-06230-14	3/4	230	3/8	60.0	600	J2-06230-06	810	J2-06230-10	1300	J2-06230-14
14.0	1330	J1-10058-06	1340	J1-10058-10	J1-10058-14	1	58	1/2	28.0	1195	J2-10058-06	1200	J2-10058-10	J2-10058-14		
21.0	1000	J1-10087-06	1340	J1-10087-10	1390	J1-10087-14	1	87	1/2	42.0	900	J2-10087-06	1200	J2-10087-10	1250	J2-10087-14
29.0	750	J1-10116-06	1000	J1-10116-10	1390	J1-10116-14	1	116	1/2	58.0	680	J2-10116-06	900	J2-10116-10	1250	J2-10116-14
35.0	630	J1-10140-06	850	J1-10140-10	1250	J1-10140-14	1	140	1/2	70.0	560	J2-10140-06	770	J2-10140-10	1130	J2-10140-14
44.0	500	J1-10175-06	680	J1-10175-10	1000	J1-10175-14	1	175	1/2	88.0	450	J2-10175-06	610	J2-10175-10	900	J2-10175-14
57.0	375	J1-10230-06	510	J1-10230-10	870	J1-10230-14	1	230	1/2	114.0	340	J2-10230-06	460	J2-10230-10	780	J2-10230-14
22.0	850	J1-12058-06	870	J1-12058-10	J1-12058-14	1-1/4	58	1/2	44.0	770	J2-12058-06	780	J2-12058-10	J2-12058-14		
34.0	640	J1-12087-06	870	J1-12087-10	900	J1-12087-14	1-1/4	87	1/2	68.0	575	J2-12087-06	780	J2-12087-10	810	J2-12087-14
45.0	480	J1-12116-06	850	J1-12116-10	900	J1-12116-14	1-1/4	116	1/2	90.0	430	J2-12116-06	590	J2-12116-10	810	J2-12116-14
55.0	380	J1-12140-06	540	J1-12140-10	800	J1-12140-14	1-1/4	140	1/2	110.0	350	J2-12140-06	470	J2-12140-10	720	J2-12140-14
68.0	310	J1-12175-06	435	J1-12175-10	645	J1-12175-14	1-1/4	175	1/2	136.0	290	J2-12175-06	390	J2-12175-10	580	J2-12175-14
90.0	240	J1-12230-06	325	J1-12230-10	490	J1-12230-14	1-1/4	230	1/2	180.0	215	J2-12230-06	290	J2-12230-10	440	J2-12230-14
37.0	495	J1-15058-06	510	J1-15058-10	J1-15058-14	1-5/8	58	3/4	74.0	445	J2-15058-06	460	J2-15058-10	J2-15058-14		
47.0	375	J1-15087-06	525	J1-15087-10	525	J1-15087-14	1-5/8	87	3/4	114.0	340	J2-15087-06	460	J2-15087-10	470	J2-15087-14
61.0	280	J1-15116-06	380	J1-15116-10	525	J1-15116-14	1-5/8	116	3/4	152.0	250	J2-15116-06	340	J2-15116-10	470	J2-15116-14
81.0	230	J1-15140-06	320	J1-15140-10	480	J1-15140-14	1-5/8	140	3/4	182.0	210	J2-15140-06	280	J2-15140-10	430	J2-15140-14
115.0	185	J1-15175-06	250	J1-15175-10	380	J1-15175-14	1-5/8	175	3/4	230.0	165	J2-15175-06	225	J2-15175-10	340	J2-15175-14
150.0	141	J1-15230-06	190	J1-15230-10	280	J1-15230-14	1-5/8	230	3/4	303.0	125	J2-15230-06	170	J2-15230-10	250	J2-15230-14
58.0	320	J1-20058-06	340	J1-20058-10	J1-20058-14	2	58	1	116.0	310	J2-20058-06	310	J2-20058-10	J2-20058-14		
87.0	250	J1-20087-06	340	J1-20087-10	350	J1-20087-14	2	87	1	174.0	225	J2-20087-06	310	J2-20087-10	315	J2-20087-14
116.0	190	J1-20116-06	255	J1-20116-10	350	J1-20116-14	2	116	1	232.0	170	J2-20116-06	230	J2-20116-10	315	J2-20116-14
142.0	150	J1-20140-06	210	J1-20140-10	310	J1-20140-14	2	140	1	280.0	135	J2-20140-06	190	J2-20140-10	280	J2-20140-14
175.0	125	J1-20175-06	170	J1-20175-10	250	J1-20175-14	2	175	1	350.0	110	J2-20175-06	155	J2-20175-10	225	J2-20175-14
230.0	94	J1-20230-06	127	J1-20230-10	190	J1-20230-14	2	230	1	460.0	85	J2-20230-06	115	J2-20230-10	170	J2-20230-14

Note: Blue area indicates availability in both plunger and diaphragm styles. White area indicates only plunger construction available.
 *Indicate plunger or diaphragm configuration by using P or D after code number when ordering.

CAPACITIES AND PRESSURES MODEL P/D II PUMP

Capacity at Max Pres. GPH	ONE FEED				Plunger Dia. (Inches)	Speed Strokes Per Minute	Check Valve Size Inches	TWO FEED			
	2 hp		3 hp					2 hp		3 hp	
	Pres. PSIG	Code*	Pres. PSIG	Code*				Pres. PSIG	Code*	Pres. PSIG	Code*
11.0	4.600	L1-06058-20	L1-06058-30	3/4	58	1/2	22.0	3.900	L2-06058-20	L2-06058-30	
17.0	4.200	L1-06087-20	L1-06087-30	3/4	87	1/2	34.0	3.700	L2-06087-20	L2-06087-30	
23.0	3.100	L1-06116-20	L1-06116-30	3/4	116	1/2	46.0	2.800	L2-06116-20	L2-06116-30	
28.0	2.500	L1-06140-20	L1-06140-30	3/4	140	1/2	56.0	2.200	L2-06140-20	L2-06140-30	
35.0	2.000	L1-06175-20	L1-06175-30	3/4	175	1/2	70.0	1.800	L2-06175-20	L2-06175-30	
21.0	2.600	L1-10058-20	L1-10058-30	1	58	1/2	42.0	2.200	L2-10058-20	L2-10058-30	
32.0	2.310	L1-10087-20	L1-10087-30	1	87	1/2	64.0	2.100	L2-10087-20	L2-10087-30	
42.0	1.750	L1-10116-20	L1-10116-30	1	116	1/2	84.0	1.580	L2-10116-20	L2-10116-30	
51.0	1.300	L1-10140-20	L1-10140-30	1	140	1/2	102.0	1.250	L2-10140-20	L2-10140-30	
64.0	1.160	L1-10175-20	L1-10175-30	1	175	1/2	128.0	1.000	L2-10175-20	L2-10175-30	
40.0	1.300	L1-13058-20	L1-13058-30	1-3/8	58	3/4	80.0	1.150	L2-13058-20	L2-13058-30	
80.0	1.250	L1-13087-20	L1-13087-30	1-3/8	87	3/4	120.0	1.100	L2-13087-20	L2-13087-30	
80.0	930	L1-13116-20	L1-13116-30	1-3/8	116	3/4	160.0	830	L2-13116-20	L2-13116-30	
97.0	770	L1-13140-20	L1-13140-30	1-3/8	140	3/4	194.0	690	L2-13140-20	L2-13140-30	
121.0	610	L1-13175-20	L1-13175-30	1-3/8	175	3/4	242.0	550	L2-13175-20	L2-13175-30	
74.0	700	L1-17058-20	L1-17058-30	1-7/8	58	1	148.0	630	L2-17058-20	L2-17058-30	
112.0	670	L1-17087-20	L1-17087-30	1-7/8	87	1	224.0	600	L2-17087-20	L2-17087-30	
149.0	500	L1-17116-20	L1-17116-30	1-7/8	116	1	298.0	430	L2-17116-20	L2-17116-30	
180.0	410	L1-17140-20	L1-17140-30	1-7/8	140	1	360.0	375	L2-17140-20	L2-17140-30	
225.0	330	L1-17175-20	L1-17175-30	1-7/8	175	1	450.0	300	L2-17175-20	L2-17175-30	
146.0	370	L1-25058-20	L1-25058-30	2-5/8	58	1-1/4	292.0	330	L2-25058-20	L2-25058-30	
220.0	350	L1-25087-20	L1-25087-30	2-5/8	87	1-1/4	440.0	320	L2-25087-20	L2-25087-30	
293.0	260	L1-25116-20	L1-25116-30	2-5/8	116	1-1/4	586.0	240	L2-25116-20	L2-25116-30	
365.0	210	L1-25140-20									

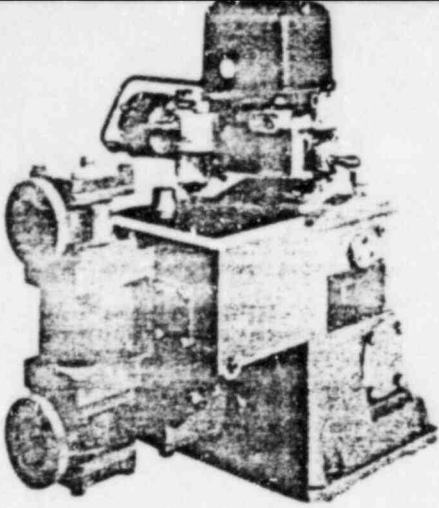

For metering highly corrosive materials most economically. Request Bulletin No. 804 for details.

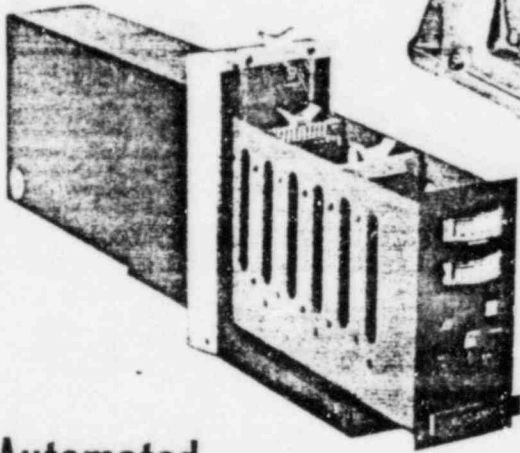
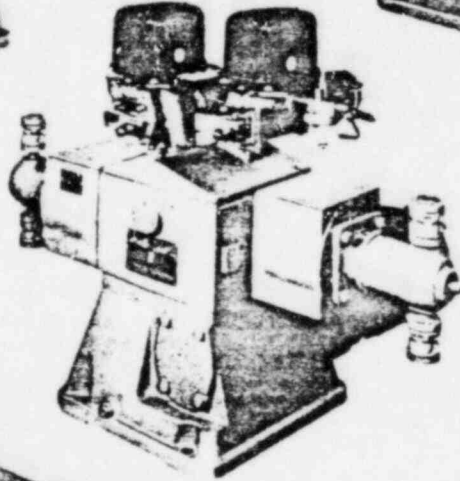
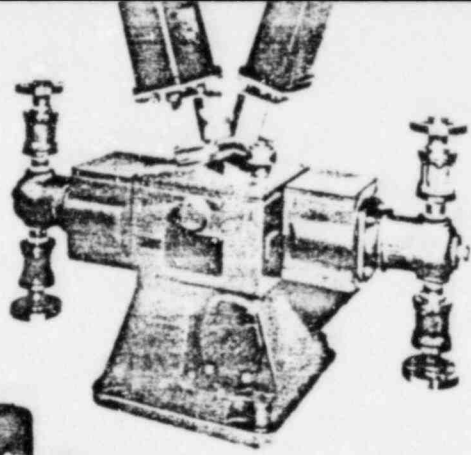

Automated metering pump control with single-source responsibility

P/D Pumps may be ordered with PPI actuation and control systems tailored to your process automation requirements, or pumps already installed may be field converted to automated controls. Packages range from pneumatic stroke adjustment through electronic control for either open or closed-loop systems.

For example, a package consisting of pump, electric actuators, and modular solid-state servo amplifier responds to any common electric process signal. Independent stroke positioners on each feed respond whenever the controller senses error between process and actuator position feedback signals.

Servo controls are easily mounted in control room consoles or can be supplied in NEMA IV or VII enclosures for installation near pumps.

Send us details of your application for a package designed to meet your specific requirements.

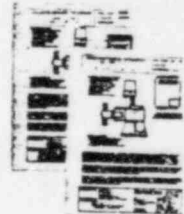

PPI Division

The Durrion Co., Inc.
900 Louis Drive • Phone 215/675-1600
Warrinoster, PA 18974 • Telex 84-5329



PRESSURE PRODUCTS INDUSTRIES

A DIVISION OF THE DURIRON COMPANY, INC.

WARMINSTER

PENNSYLVANIA 18974

INSTALLATION, OPERATION AND
MAINTENANCE MANUAL

WHEN COMMUNICATING OR ORDERING PARTS
FOR THIS EQUIPMENT PLEASE REFER TO

SERIAL NUMBER _____.

PRODUCT DESCRIPTION **DURCOMETER P/D I PUMP**

DO NOT ATTEMPT TO OPERATE THIS
UNIT WITHOUT THOROUGHLY READING
THESE INSTRUCTIONS

DurcoMeter P/D 1 PUMP INSTRUCTION MANUAL

- INDEX -

1.0 INSTALLATION

	<u>Page</u>
1.10 Mounting the Pump.....	2
1.20 Piping.....	2
1.21 Suction Piping.....	2
1.22 Discharge Piping.....	2
1.30 Electrical Installation.....	3
1.31 Voltage Variation.....	3
1.32 Frequency.....	3
1.33 Electrical Wiring.....	3

2.0 SPECIFIC SERVICES

2.10 Acid Service.....	3
2.20 Alkaline Service.....	3
2.30 Slurry Service.....	4

3.0 GENERAL START UP

3.10 Priming the Pump.....	4
3.20 Calibrating the Pump.....	4
3.30 Start Up.....	5
3.31 Drive.....	5
3.32 Plunger Head.....	5
3.33 Diaphragm Head.....	5

4.0 PUMP OPERATION

4.10 Description of Operation.....	6
4.11 Drive.....	6
4.12 Plunger Pump.....	6
4.13 Diaphragm Pump.....	7
4.20 Possible Operating Difficulties.....	8
4.21 Drive.....	8
4.22 Plunger Pump.....	9
4.23 Diaphragm Pump.....	10

5.0 GENERAL MAINTENANCE

	<u>Page</u>
5.10 Pump Lubrication.....	11
5.11 Diaphragm Head.....	11
5.12 Plunger Head.....	12
5.13 Drive.....	13
5.20 Worm Gear Assembly.....	13
5.30 Upper Drive Case Assembly.....	16
5.40 Digital Stroke Adjustment Assembly....	21
5.50 Plunger Head Assembly.....	22
5.60 Diaphragm Head Assembly.....	23
5.70 Check Valve Assembly.....	31

6.0 REFERENCE DRAWINGS

52-51-1000 Crank-Gear Assembly Drawing.....	32
52-51-1400 Worm Assembly Drawing.....	33
5212-01 Section Orientation Assembly....	34
5260-03 Plunger Head and Check Valves... 35	35
5260-01 Diaphragm, Head and Check Valves 36	36
5260-04 Diaphragm and Hydraulic Head.... 37	37
5270-04 Digital Stroke Adjustment..... 38	38
5270-03 Two Feed Cross Head..... 39	39
5270-02 One Feed Cross Head..... 40	40
5270-01 Single Extension Drive Case..... 41	41

1.0 INSTALLATION

1.10 MOUNTING THE PUMP

The pump must be firmly and evenly supported. A concrete foundation especially prepared to receive the pump is recommended. It is to be noted that the pump has no mounting base, but instead it is designed as an integral unit with the pads of the drive case serving as a mounting and support.

Locate the pump as near as possible to the source of supply (suction tank). Remember to leave enough space for maintenance personnel and for chemical liquid end removal, when necessary.

1.20 PIPING

All piping to and from the pump should be provided with a firm support in order to avoid any stress which might be detrimental to the pipe fittings. While the pump will support considerable weight, it is never recommended that the pipe hang on the pump. If crosses and tees, suitably plugged, are used in place of tees and ells, the piping will be accessible for cleaning. For convenience in dismantling the check valves or liquid end for inspection, cleaning or repair, unions or flanges are recommended to be installed in both the suction and discharge lines near the check valves. The pipe, supply tank, and fittings should be free of dirt, scale, or any foreign material before installation. If shut-off valves are to be used in the suction or discharge lines, they should be of the full flow type.

1.21 SUCTION PIPING

The suction piping should be kept as short and direct as possible. Preferably, the pipe should be one size larger than the check valve suction connection. The pipe should be arranged so that there are no places where air can be trapped. If possible, the suction piping should be sloped upwards uniformly from the supply tank to the pump, keeping the number of fittings to a minimum. If a high suction lift condition exists, a foot valve should be installed in the bottom of the line to prevent loss of prime during shutdown periods.

The maximum suction lift permissible is approximately 10 -15 feet for plunger pumps and 5 - 10 feet for diaphragm pumps (based on water at atmospheric pressure and 62F). When pumping with a suction lift, the fittings must be tight, otherwise the pump will draw in air on the suction stroke, resulting in loss of output. A strainer should be installed in the pump suction line as close as possible to the pump. The strainer will prevent suspended matter from settling in the check valve and causing improper seating of the ball on the check valve seat. The suction connection in the supply tank should be 3" to 8" above the bottom of the tank. Solid material can then settle to the bottom of the tank without being drawn into the pump. When low vapor pressure liquids are to be metered, sufficient net positive suction head (NPSH) must be provided to prevent vaporization of the liquid in the pump cylinder on the suction stroke of the pump.

1.22 DISCHARGE PIPING

Discharge piping from the pump should be the same size as the check valve or one size larger if the line is long or uses many fittings. On plunger pumps a relief valve must be installed in the discharge line to protect the pump and process equipment in case of a blocked discharge line. The relief valve must be installed as close as possible to the pump with a free line back to the supply tank. It is recommended that additional valves not be installed in the return line since they may be accidentally closed and obstruct the relief valve.

To reduce the pulsations of a proportioning pump, an accumulator may be installed in the discharge line of the pump as close as possible to the discharge check valve. This accumulator should have a volume of approximately ten times the full plunger stroke displacement. The accumulator will even out the pulsating flow of the pump. In most cases an accumulator will not be required, but when the pump causes high pressure surges in the discharge line, the installation of an accumulator is recommended. Accumulators may be purchased from the Greer Hydraulics Company (bladder type) or the Robertshaw Co. (bellows type).

For proper operation of the pump check valves, the discharge pressure must always exceed the suction pressure by 5 - 10 PSI.

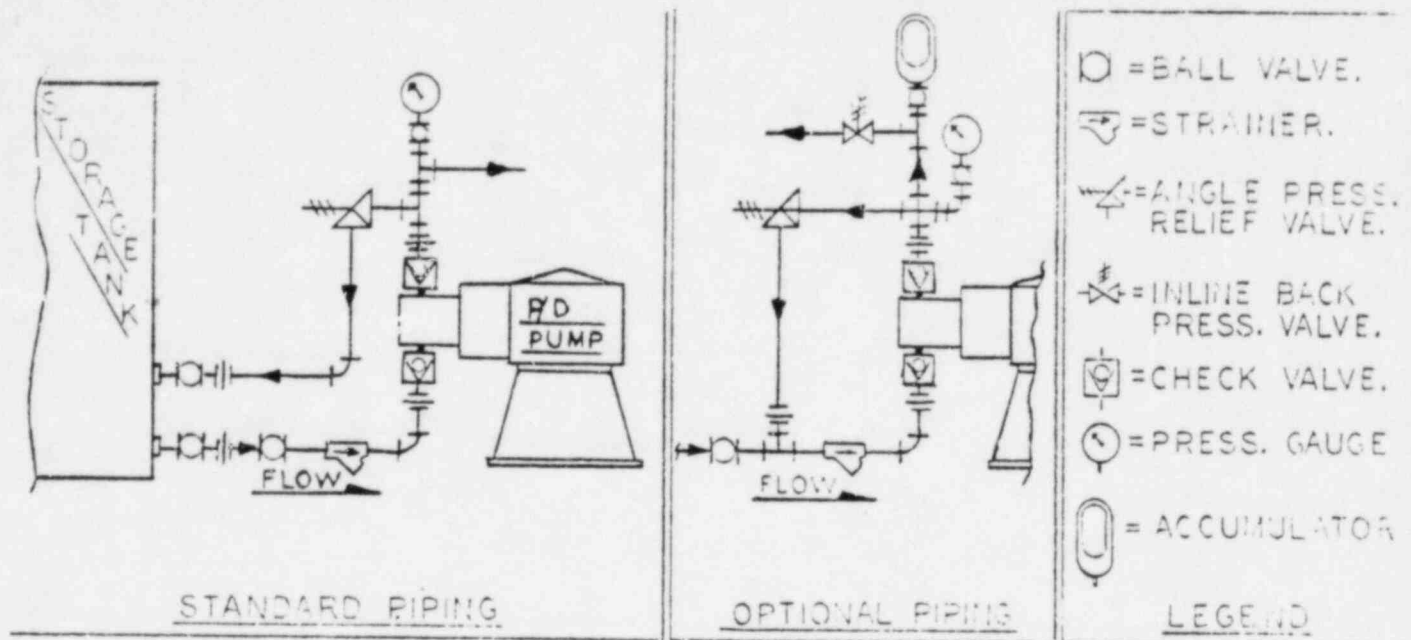

Fig.1

1.30 ELECTRICAL INSTALLATION

1.31 VOLTAGE VARIATION

All squirrel cage induction motors are designed to operate successfully at rated-load with a voltage variation of plus or minus 10 percent when rated frequency is supplied. They will also operate successfully when the sum of the voltage and frequency variation does not exceed 10 percent, provided the frequency variation does not exceed 5 percent above or below nominal ratings as stamped on the motor name-plate.

1.32 FREQUENCY

In addition to operating successfully with a voltage variation, squirrel cage induction motors will operate successfully with a frequency variation which does not exceed 5 percent above or below its rated frequency.

1.33 ELECTRICAL WIRING

1. Refer to the motor wiring diagram while making the installation.
2. Be sure that the electrical supply matches the pump motor nameplate characteristics.
3. Use an adequate wire size to prevent voltage drop.
4. Provide motor protection by fusing or by use of a thermal overload device or circuit breaker.

5. CAUTION: The motor starting current can exceed the full load running current by 200-300%. All motor protection devices, electrical wiring and starting switches should be selected accordingly.

2.0 SPECIFIC SERVICES

2.10 ACID SERVICE

In pumping acids with a plunger pump it should be remembered that the pump sump is cast iron and is not acid resistant. Always keep the pump sump clean, and where possible, paint with an acid resisting material to minimize corrosion on the sump walls.

It is also suggested that the components in the sump area be coated with a heavy grease (Flurolube Co.) to retard corrosion. Refer to Table #1 Page #12 for packing lubrication.

2.20 ALKALINE SERVICE

In pumping aqueous solution of salts and alkalis with a plunger pump, some solids will crystallize on the plunger unless steps have been taken to prevent this from happening. These abrasive crystals will score a metallic plunger as the plunger moves in and out of the packing, and will considerably reduce the plunger and/or packing life. All plunger pumps are provided with a stuffing box lantern ring to wash away any leakage, lubricate the packing, and prevent crystals from depositing on the plunger.

...with the discharge line with... material so that any... will not have... build up on the... The chemical resistance of... between the pump and the pump... be protected before the pump...

PLunger pump is a... forward... with the same walled... regardless of stroke length. Because of this characteristic, the material will not build up on the plunger at reduced stroke settings and then be forced into the stuffing box while increasing the stroke length. However, the precautionary procedure outlined above should be used when it is anticipated that the pump will be started and stopped frequently. Refer to Table 4-1, page 4-1 for packing lubrication.

...slurries is... kept thoroughly sus-... that it does not settle out in the... and fail their action. The first... step that can be taken... is that the pump suction must... in which the slurry is kept... The importance of this... since, in many cases, it... between suction and...

...the pump can handle slur-... particle size is... However, the success or... other factors such as... rate of solids, concentration of... arrangement, pump speed, abra-... of the slurry, etc. The above... is intended to give... the particle that can be handled... case. The only definite state-... is that... the lower the... the greater is the possibility...

...to control the particle... to the process requirements, but... important factor that can be con-... is the piping hook-up. In many cases... have failed, re-... of piping has eliminated recurrent troubles. Our recommendations for piping are as follows:

1. Keep the suction and discharge lines as short as possible.
2. Keep the number of fittings in the lines to a minimum. Fittings provide crevices and corners where solids can collect and cause trouble.

3. If the discharge line has to be relatively long, it is advisable to use an accumulator or some other surge dampening device in the discharge line. Without a surge dampening device, the fluid in the discharge line will be stationary on the suction stroke of the pump which greatly increases the possibility of solids settling out. Installation of a proper surge dampening device keeps the fluid in motion in the discharge line at all times, thus reducing this tendency.
4. If the suction line has to be relatively long, it is advisable to use a centrifugal pump to continuously circulate the slurry in the line from supply tank to pump suction and back to the supply tank. This will prevent settling of the slurry in the suction line during the otherwise stationary fluid flow period on the discharge stroke of the pump.
5. When using a plunger pump a relief valve must be installed in the discharge line as close to the pump as possible. Since it is possible that the relief valve will become fouled with solids, it is recommended that you take all possible steps to prevent closure or fouling of the discharge line.
6. In cases where it will be necessary to start and stop the pump frequently, we recommend that the pump be primed with clear fluid on start-up and flushed with clear fluid before shutdown.

3.0 GENERAL START UP

3.10 PRIMING THE PUMP

The pump must be properly primed before it will operate. To prime the pump, it is recommended that the pump be operated with the discharge lines open to the atmosphere. Operate the pump until liquid, free of air bubbles, flows from the discharge connection. If trouble is experienced in priming the pump, refer to Section 4.20 of this manual where possible operating difficulties are discussed.

When hazardous liquids are to be pumped, prime the pump by letting it circulate back to the supply tank until the lines are full and air free.

3.20 CALIBRATING THE PUMP

The stroke adjustment handle mounted on top of the drive case provides stroke adjustment while the pump is in or out of operation. The digital counter reads from 0-100 (can be read to 1/100) and is read in percent. Fifty turns of the handle will change the stroke length from zero to 100 percent.

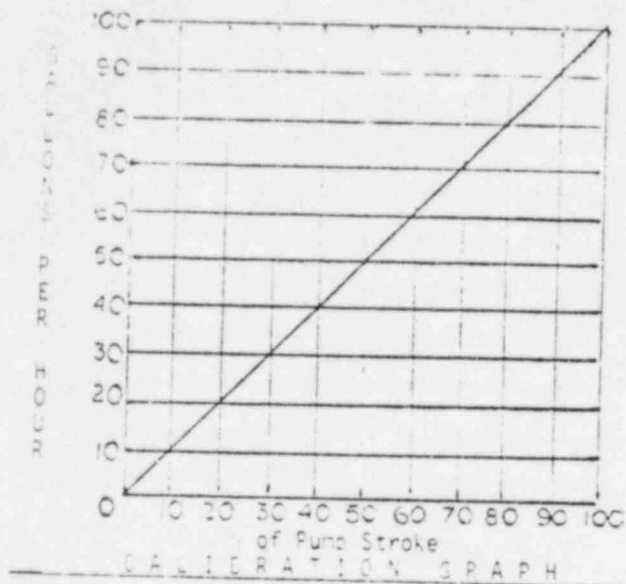

Fig. 2

The pump should be calibrated under actual operating conditions. Determine the capacities which correspond to the various digital settings on the stroke adjustment. Plot a graph of capacity versus percent stroke length. This graph (ref. Fig. #2) will show what digital setting should be used to obtain any desired capacity within the rated range of the pump. Keep this graph with the pump for future reference.

For occasional checking of the pump capacity, the following method may be used. The supply tank may be equipped with an auxiliary measuring tank which is normally kept at the same level of fluid as is in the supply tank. When it is necessary to measure the withdrawal of the pump suction, it is only necessary to switch the pump suction, by suitable valving, to the fluid in the measuring tank. Isolate the fluid in the supply tank and then note the quantity of fluid withdrawn per unit time. Be certain to switch the pump suction back to the supply tank before the fluid is exhausted in the auxiliary measuring tank, as air might inadvertently enter the pump.

3.30 START UP

3.31 DRIVE

Before start up, refer to the drive case lubrication plate located on the drive case cover. The correct lubricating oil properties are specified in Section #5.10 for your prevalent environmental conditions. Fill the drive case as specified with the correct tabulated lubricant. When filling the drive case, refer to the lubrication plate for filling instructions. After filling the drive

case, replace the plug with the air filter-vent attached to the pump.

Before starting the motor, remove the motor coupling guard and turn the pump over by hand until the pump has completed one stroke cycle. This is a necessary start up procedure to prevent possible damage to the pump. Replace the motor coupling guard and proceed with next step.

3.32 PLUNGER HEAD

1. CAUTION: Before starting make sure that all obstructions are removed from the discharge line. A new pump can be damaged in seconds if the relief valve is not operating.
2. Some model pumps are equipped with a bridge type packing gland that requires even take-up on two adjusting nuts. Most plunger pumps are supplied with carbon graphite follower bushings for smooth non-scratching or galling by plunger action. The carbon graphite material is fragile, and the gland bridge nuts must be taken up evenly. If the gland bridge is cocked, the carbon graphite bushing will fracture due to the uneven load.
3. CAUTION: The pump stuffing box take-up gland must not be tightened prior to start up. It is recommended that the pump be started with the take-up gland backed off slightly and then taken up gradually as the packing seats in. All new packings will generate friction heat because of uneven seating surfaces. As the packing seats in, the friction heat will drop noticeably. It may sometimes be necessary to fill the sump with water or some other suitable cooling media to help dissipate the stuffing box friction heat.
4. When it is desirable to flush through the lantern ring there should be sufficient flow to keep the lantern ring clean. The discharge water should be fairly clean. Flow rates will vary depending upon fluid solubility. A recommended rate is approximately 5% of the pump capacity but not less than 1/2 gallon per hour or more than 10 gallons per hour.
5. When it is desirable to lubricate the stuffing box through the lantern ring hole a Rockwell stick lubricant may be used. The recommended stick lubricants are listed in Table #1 on page #12.

NOTE: Refer to the Section "Specific Services" for additional installation recommendations.

3.33 DIAPHRAGM HEAD

The diaphragm head must be serviced by filling with the proper hydraulic oil prior to start up. The diaphragm pump is always shipped with

the intermediate chamber filled with the correct amount of a low viscosity technical grade mineral oil unless otherwise specified. The intermediate chamber fluid may be removed and replaced by some other non-corrosive fluid that is compatible with the process fluid. If this is done it must be in strict accordance with the service instructions given in the manual.

CAUTION: Under no circumstances should the intermediate chamber be opened while the pump is under pressure.

1. Filling the hydraulic reservoir and hydraulic diaphragm chamber. (Refer to Section 5.60 - Drawing No. 5260-04.)
 - a. Remove cap screws #11 and sump cover #12, exposing the sump interior.
 - b. Remove cap #7 and insert a 1/2" drive extension, female end, into the cavity and remove the air bleed valve.
 - c. Fill the sump with a good quality hydraulic oil with a viscosity of approximately 150 SSU (@ 70°F) until the round body hub is covered. (Refer to Section 5.11.)
 - d. Fill the hydraulic diaphragm chamber through the air bleed valve port until full.
 - e. Replace the air bleed valve and cap #7.
 - f. Replace the sump cover, cap screws and install the filter-breather attached to the pump.

The diaphragm head is now ready for start-up.

4.0 PUMP OPERATION

4.10 DESCRIPTION OF OPERATION

4.11 DRIVE

Refer to Fig. #3. The P/D I drive is a variation of a three-dimensional space crank mechanism. The worm and worm gear revolve the space crank in a conical path with its origin at the pivot point of the hanger bracket. The conical revolution of the space crank is translated by the sliding block to the swinging path of the hanger bracket.

ZERO STROKE

When the stroke adjustment block position coincides with the pivot point of the hanger bracket, no motion is transmitted to the crosshead, and the pump is at zero stroke.

FULL STROKE

When the stroke adjustment block position is adjusted to the bottom of the hanger bracket slot, maximum motion is transmitted to the crosshead and the pump is at full stroke.

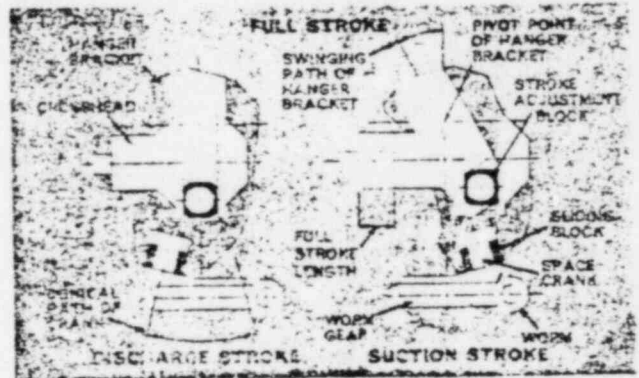
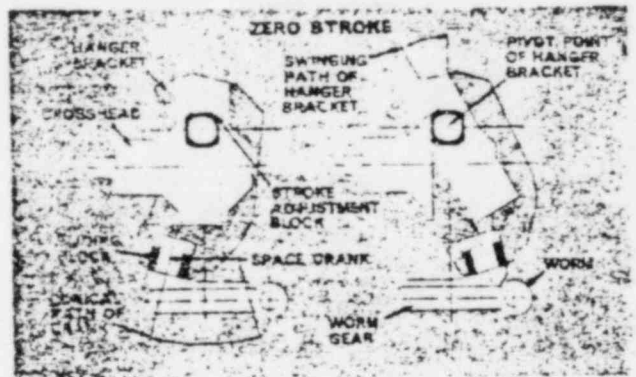

Figure #3.

The drive minimizes the pump space envelope and allows for one or two feed options within the same drive case. Crank and crosshead sliding block size are proportioned for conservative pressure velocity values without need of pressure lubrication. All power transmission components are submerged in, and lubricated by, an oil bath.

The crosshead is part of the P/D I drive is, by definition, "a connecting rod of infinite length" and is supported by four self-aligning bearings that run on hardened and ground shaft surfaces. The crosshead is completely load balanced and eliminates overhung loads that could cause force deflections in this critical section of the pump.

4.12 SEALING AREA

The stuffing box or hanger packing area (Fig. #4) of the plunger ring acts as a dynamic seal between the process pressure end of the pump and the atmosphere. The volumetric efficiency of this pump is dependent upon the effectiveness of this dynamic seal.

To achieve approximately even wear distribution and long service life of the packing, we have built in the following:

1. The plunger finish is better than 8 micro inch and has a longitudinal lay.

2. The plunger is supported by two bushings, one forward and one to the rear of the packing, maintaining the geometry of the stuffing box (see Fig. #4). The bushings are made of materials such as carbon graphite that will not scratch or otherwise damage the plunger surface.
3. The packing is selected for its bearing (PV) quality, low coefficient of friction, pressure rating, chemical resistance and temperature rating. TFE lubricated asbestos V ring or square section packings are the best choice for most services.
4. Regardless of stroke setting, the full forward positioning of the pump plunger results in full entry of the plunger into the pump body and the same wetted plunger surface at all times. This eliminates the possibility of crystalline material build-up on the plunger surface at reduced stroke setting and subsequent broaching of the packing when increasing the stroke length.

on the displacement side. The passage holes are small, minimizing the elastic deflection of the diaphragm into the holes should the diaphragm bottom into either contoured surface with pressure behind it. The head requires two valves, one that relieves at an over pressure condition, and one that relieves at a vacuum condition. When suction lift or starved suction conditions exist, the diaphragm will work forward until it bottoms into the front limit surface. The relief valve will expel any remaining portion of the hydraulic piston discharge cycle to the reservoir. When a high suction pressure (head) condition exists, the diaphragm will work rearward until it bottoms into the rear limit surface. The vacuum valve will intake any remaining portion of the hydraulic piston suction cycle from the reservoir. The pump is also equipped with an air bleed valve that is used for continuous entrained air elimination from the hydraulic oil.

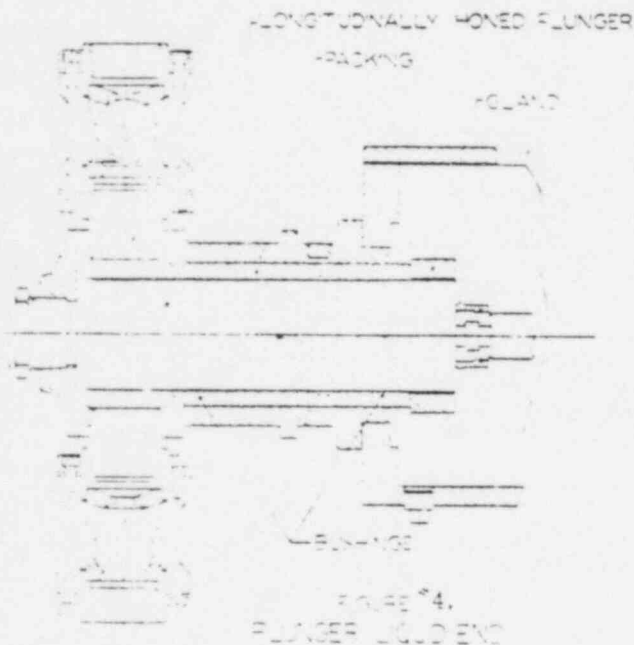

FIG. #4. PLUNGER LIQUID END

The hydraulically operated diaphragm head is shown in Fig. #5. The diaphragm is flexed back and forth by the hydraulic displacement of the reciprocating piston or plunger, resulting in a pumping displacement of the diaphragm.

The hydraulically operated diaphragm is kept within its deflection limits by two contoured limit surfaces. The contoured limit surfaces contain many small diameter holes that permit passage of hydraulic fluid from the piston chamber to the diaphragm chamber, and so forth

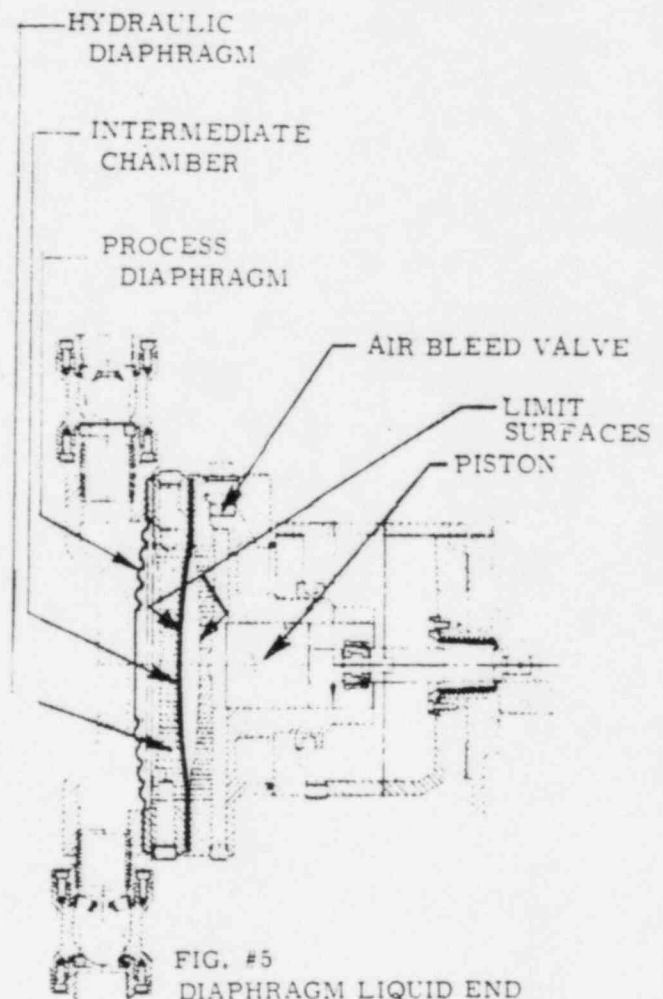

FIG. #5
DIAPHRAGM LIQUID END

4.10 POSSIBLE OPERATING DIFFICULTIES

Problem	Cause	Remedy
SYM	See 2.11	
Pump will not start	a. See 2.11 - 2.12 Plunger Pump. b. The FLS of the three phase circuit may be blown	Replace fuses
Pump will not start	a. Drive case oil is low (in hot and winter months) b. Drive case oil is too thick c. Drive case oil is too thin d. Drive case oil is too old e. Drive case oil is too dirty f. Drive case oil is too dark	Refer to the lubrication instruction plate on the drive case Select and observe for overload conditions refer to section 1.33 Replace fuses refer to Section 1.33
Gear case is hot	The normal gear case temperature can rise 50° - 75° above ambient temperature	See Section 1.31 thru 1.33
Motor runs hot	The maximum full load motor temperature can be quite high due to the new NEMA ratings and the subsequent use of Class insulation. In applications don't use the old "hand touch" method of determining operating temperature	
Drive case is noisy	a. Drive case oil is too thin (low summer temperatures) b. Obstruction in the suction line will cause a vacuum surge and backlash gear in the gearing	Refer to the lubrication plate on the drive case Remove the suction line obstruction; see 2.11 - 2.12 Plunger Pump
Stroke Adjustment is hesitant in operation	This is a normal characteristic of a three phase motor stroke adjustment Pump. The adjustment will be hesitant on the discharge stroke of the Pump when the motor is trying to move the internal components against the discharge pressure limit	

4.22 PLUNGER PUMP

SYMPTOM	CAUSE	REMEDY
Pump stalls	a. Over pressure due to blocked discharge line	Remove obstruction
	b. Excessive discharge	Place a pressure gauge in the line (200-300' above Pump rating) and record the reading. If it is over pressure, shut down the Pump and correct the problem. See Section 1.22 Discharge Piping
	c. Excessive packing friction	a. See Section 3.32 b. Loosen the stuffing box gland c. Lubricate as recommended in Section 5.10
Check valves rattle	a. All positive displacement reciprocating plunger Pumps will have some check valve noise. However, the "click-click" noise frequency of the suction or discharge balls should not exceed the stroke frequency of the Pump.	Normal as stated.
	b. Insufficient back pressure on the Pump. See Note 4.22-1 (Page #10)	See Section 1.22 (Increase back pressure)
Intermittent valve rattling	Insufficient back pressure on the Pump. See Notes 4.22 & 4.22-3 (Page #10).	See Section 1.22 (Increase back pressure)
Pump will not deliver	a. Pump is not primed See Note 4.22-4 (page #10).	See Section 3.10
	b. Pump has lost prime due to a high suction lift and/or leaky suction fittings	See Section 1.21
	c. Suction or discharge valve ball is hanging up	Clean check valve and inspect suction strainer for damaged screen or different mesh
	d. Obstruction in the suction line	Remove obstruction a. Closed valve b. Clogged strainer
Pump doesn't deliver rated capacity	a. Suction or discharge valve ball is hanging up	Clean check valve and inspect suction strainer for damaged screen or different mesh
	b. Obstruction in the suction line	Remove obstruction
	c. Excessive suction lift	See Section 1.21
	d. Leaky suction line drawing air in on suction lift applications	Inspect and repair suction line
	e. Air or gas pockets in the suction line	See Section 1.21
	f. Liquid is vaporizing in the suction line	
	g. Check valve components are worn or corroded	Replace components and review materials of construction
	h. Packing in the stuffing box is worn	Adjust or replace packing
	i. Relief valve is leaking	Inspect valve; replace worn components and review materials of construction
	j. Relief valve is blowing	Place a pressure gauge in the line (200-300' above Pump rating) and record the reading. If it is over pressure, shut down the Pump and correct the problem. See Section 1.22 Discharge Piping
	k. Viscosity of liquid too high	Consult factory
l. Clogged strainer	Clean strainer	

NOTES

4.22-1

The dynamic fluid acceleration characteristic of a positive displacement reciprocating plunger Pump requires sufficient back pressure on the discharge side of the Pump to prevent velocity head surges on the suction cycle from carrying over and through the Pump head on the discharge cycle. This characteristic is evidenced by rattling check valves, erratic pressure gauge action and an apparent excessive volumetric delivery of the Pump.

4.22-2

During normal cycling in a process system, the supply tank to the Pump may have a "high" or "low" limit. The Pump may operate well at levels half and below but evidence check valve rattle at higher levels. This may be caused by the condition stated in Note 4.22-1 due to the higher suction head on the Pump when the tank is full.

4.22-3

During normal cycling in a process system, the operating pressure in a reactor or pressure vessel may have "high" and "low" limits. The Pump may operate well at the normal process pressure but evidence check valve rattle while the pressure is building up during the system start up. If this condition is understood it is not usually objectionable during the short periods while the process pressure is building up.

4.22-4

After shut down periods the Pump may lose prime for the following reasons:

The process fluid may gas and cause vapor lock in the Pump or suction lines. This will occur in systems where we are pumping materials with a low vapor pressure, low supply pressure and high ambient temperature. Net positive suction head (NPSH) problems will also occur in this type of system.

4.23. HYDRAULIC PUMP

SYMPTOM	CAUSE	REMEDY
Pump does not deliver	a. Over pressure due to blocked discharge line	Remove obstruction
	b. Pump is not primed. See Note 4.22-4 Page 10	See Section 3.10
	c. Pump has lost prime due to a high suction lift and/or leaky suction fittings	See Section 1.21
	d. Suction or discharge ball is hanging up	Clean check valve and inspect strainer for damaged screen or large mesh
	e. Obstruction in the suction line	Remove obstruction a. Closed valve b. Clogged strainer
Pump doesn't deliver rated capacity	a. Same as "Pump does not deliver"	
	b. Excessive suction lift. See Note 4.23-1 (page 11)	Adjust vacuum valve. Locate pump closer to the supply tank. Remove line restrictions
	c. Leaky suction line drawing air in (on suction lift applications)	Inspect and repair suction line
	d. Air or gas pockets in the suction line	See Section 1.21
	e. Check valve components are worn or corroded	Replace components and review materials of construction
	f. Liquid is vaporizing in the suction line	
g. Process relief valve is leaking	Inspect valve; replace worn components and review materials of construction	
h. Diaphragm Hydraulic Relief Valve is blowing. See Note 4.23-1 (page 11)		

4.23 DIAPHRAGM PUMP - (Cont'd)

SYMPTOM	CAUSE	REMEDY
Pump doesn't deliver rated capacity	i. Viscosity of the liquid too high See Note 4.23-1 (page 11)	
	j. Clogged strainer	Clean strainer
	k. Hydraulic relief valve is leaking	
Check valves rattle	a. All positive displacement reciprocating plunger pumps will have some check valve noise. However, the "click-click" noise frequency of the suction or discharge balls should not exceed the stroke frequency of the pump	Normal as stated
	b. Insufficient back pressure on the pump See Note 4.22-2 & 4.22-3 (page 10)	See Section 1.22 (Increase back pressure)
Intermittent valve rattling	Insufficient back pressure on the pump See Note 4.22-2 & 4.22-3 (page 10)	See Section 1.22 (Increase back pressure)

4.23-1 NOTES

The Diaphragm pump requires two valves, as described in Section 4.13, for proper pump operation. The vacuum valve is normally factory set for approximately a ten foot suction lift including the internal hydraulic losses and dynamic fluid velocity line losses expected in a vertical line when pumping water at 70°F. The factory vacuum valve setting is approximately one half of one atmosphere. Should the application of the pump require pumping at a greater vacuum setting caused by an increased viscosity, longer than expected horizontal suction line length, etc., it may be necessary to adjust the vacuum valve for a greater vacuum. This may be accomplished by turning the valve's exposed screw driver slot plunger clockwise; one turn will increase the vacuum potential one psi, until the pump performs as required. The total turns available are approximately five, when the valve will be at the maximum setting of approximately two psia. The practical adjustment limit, clockwise beyond the factory setting, is approximately two turns. Beyond this adjustment the hydraulic oil in the diaphragm head will become spongy due to the alternate release and reabsorption of dissolved air and the vapor lock of the chamber. (See Section 5.67 for Valve Operation and Servicing.)

5.0 GENERAL MAINTENANCE

5.10 PUMP LUBRICATION

5.11 DIAPHRAGM HEAD LUBRICATION

Experience has shown that the 10W SAE viscosity "MS" automotive crankcase oils, as described by the API service classification and the ASTM engine sequence tests, are excellent for the diaphragm head hydraulic oil and lubricant. However, consideration must be given to the air humidity since the reciprocating action of the hydraulic piston will cause the hydraulic sump to breathe in and out on each stroke of the pump. With the combined effect of possible changing ambient temperatures and the breathing action described, water may precipitate and be emulsified in the oil. The detergent additives in the 10W SAE automotive oils will tend to hold water in a tight emulsion and prevent separation of water, even on long time standing. It should be noted that very few water problems have been experienced to date in the use of these crankcase oils in the hydraulic diaphragm head. Normal condensation has not been a problem. If normal maintenance precautions are observed by changing the oil once every six months, the pump will operate well without problems. Severe environmental conditions with extremes of low temperature, humidity, or oxidizing agents present in the atmosphere should be referred to our Engineering Dept. for selection of the proper hydraulic lubricant.

5.12 PLUNGER HEAD LUBRICATION

On a plunger pump a stick lubricator can be installed in the lantern ring hole. The hole, on the opposite side of the lantern ring, should be plugged with an acid resistant pipe plug. Various types of stick lubricants are available from Rockwell Manufacturing Company (see Table #1) to suit every particular application. After installation of the lubricator, the handle should be given a periodic turn (once or twice a day) to add lubricant to the stuffing box.

T A B L E #1
PLUNGER PUMP PACKING LUBRICATION

This list is made up for your information and convenience only. The lubricant stick numbers are Rockwell Mfg. Co. sealant numbers. PPI does not normally furnish these lubricant sticks. We recommend you contact your local Rockwell Mfg. Co. for availability or write to Rockwell Mfg. Co., Pittsburgh, PA.

Lub. stick number	Grades available	Temp. Range ° F.		Color	Principal Services	Unsuitable for
		From	To			
147	Stick	20	125	White	Acids (including nitrating), alcohols, alkalis, aqueous solutions, glycerine, dyes (alcohol soluble), water. Food and pharmaceutical applications as determined suitable by the user	Organic solvents
421	Stick	10	350	Cream	Acids, alkalis, alcohols, amines, asphalt, aqueous solutions, fats, glycerine, glycols, soap, water, steam. Food and pharmaceutical applications as determined suitable by the user	Hydrocarbon and aromatic solvents
555	Stick	10	500	Brown	General purpose sealant for hydrocarbon liquids and gases including gasoline, kerosene, fuel and lubricating oils, crude distillates, sweet or sour natural and manufactured gas with water or organic condensates, LPG systems, dilute acids and alkalis, glycols, textile plants, aqueous solutions, water	Aromatic solvents, strong chemicals, hot air
654	Stick	50	500	Brown	Solvent treating of lubricating oils, hot hydrocarbon vapors and gases, general hot oil service, asphalt	Liquid light hydrocarbons, aromatic solvents, strong acids and chemicals
755	Stick	30	300	Pink	Benzene, butane, solvent naphthas, toluene, gasoline containing benzene or large amount of aromatic hydrocarbons, carbon bisulfide, carbon tetrachloride, animal and vegetable oils	Strong acids, nitrating acids, alcohols, water, aqueous solutions
921	Stick	30	650	White	Acids, alkalis, alcohols, amines, asphalt, aqueous solutions, fats, glycerine, glycols, soap, water, steam. Food and pharmaceutical applications as determined suitable by the user Suitable for hot hydrocarbon gases and vapors, high temperature cracking and reforming to 1000° F. in conjunction with hard faced valves. Recommendations will be supplied on request	Liquid light hydrocarbons, aromatic solvents, nitrating acids

5.13 DRIVE LUBRICATION

The P/D I Pump Lubrication Plate shown to the right is located on top of the pump cover and specifies the correct oil to be installed in the Drive Case for varying ambient conditions.

AMOUNT OF OIL

P/D I Pump 1.75 Gal.

Listed below are several oil companies whose lubricants meet the specifications of our P/D Pumps as outlined on the Pump Lubrication Plates.

F/D I PUMP LUBRICATION INSTRUCTIONS
UNIT HAS BEEN SHIPPED DRY, FILL BEFORE OPERATING

HORSE POWER	REDUCTION	STROKES/MIN.	CASE CAPACITY GAL.

AMBIENT TEMP °F	AGMA OIL NO	VISCOSITY S.S.U RANGE @ 210 °F.
0-40°	5	
41-90°	7	125-150
91-120°	8	150-190

*POUR POINT OF THE OIL USED SHOULD BE LESS THAN THE MINIMUM AMBIENT TEMPERATURE EXPECTED. OIL SHOULD BE CHANGED EVERY 2500 HOURS OF OPERATION OR EVERY 6 MONTHS.

OIL LEVEL | **OIL FILL**

TABLE #2
DRIVE CASE LUBRICATION

Vendor	Brand Description	Service Temp °F.	Pour Point Temp °F.
1. Gulf Oil Co.	Gulf Senate 145D	41° - 90°	+10°
	Gulf Senate 155	91° - 120°	+ 5°
2. Humble Oil & Refining	Pen-O-Led EP 5	41° - 90°	+10°
	Pen-O-Led EP 6	91° - 120°	+15°
3. Mobile Oil Corp.	Mobile Cylinder Oil 660W	41° - 90°	+40°
	Mobilegear 634	41° - 90°	+20°
	Mobilegear 636	91° - 120°	+20°
4. Shell Oil Co.	Shell Macoma Code 65010	41° - 90°	+10°
	Shell Macoma Code 65013	91° - 120°	+10°
5. Standard Oil Div. American Oil Co.	Amogear Compound #5	41° - 90°	+20°
	Amogear Compound #6	91° - 120°	+30°
6. Standard Oil of California	Chevron Gear Compound #140	41° - 90°	+10°
	Chevron Gear Compound #160	91° - 120°	+10°
7. Standard Oil of Kentucky	(same as Standard Oil of Calif.)		
8. Union Oil Co. of California	Union PB Gear Lube #160	41° - 90°	+10°
	Union PB Gear Lube #140	91° - 120°	+10°

This oil is to be used in all P/D Pumps for operation at room temperatures from 41° to 90°F. For temperatures from 0° to 40°F., dilute this oil with very light oil of the same basic crude. The use of kerosene is not recommended.

5.20 DurcoMeter P/D I PUMP WORM GEAR DRIVE ASSEMBLY INSTRUCTIONS

5.21 REFERENCE DRAWINGS

- 5212-01 Section Orientation Assembly
- 5270-01 Single Extension Drive Case
- 52-51-1400 Worm Assembly
- 52-51-1000 Crank Assembly

5.22 REQUISITES AND PROCEDURES FOR ASSEMBLY

A clean surface area approximately 2' wide x 4' long is required. Cleanliness in assembly is essential, since any contamination of the assembly bearings will result in early failure of the pump drive.

5.23 REQUIRED ASSEMBLY EQUIPMENT AND TOOLS

1. An arbor press with approximately 8" throat depth and a capacity of 2-3 tons.
2. One sleeve 15/16" I.D. x 1-1/8" O.D. x 2" long with square and smooth ends.
3. One sleeve 7/8" I.D. x 1-1/8" O.D. x 4" long with square and smooth ends.
4. One 1/2" female drive to 3/8" male drive adapter.
5. One bar 7/16" dia. x 6" long with square and smooth ends.
6. One sleeve 3/4" I.D. x 1-1/16" O.D. x 5" long with square and smooth ends.
7. Snap ring tools, purchased from Waldes Truarc.

8. One oven (household or other) with temperature control to 500°F.
9. One 6 diameter drill.
10. One 0-1" dial depth gauge, depth micrometer or accurate vernier caliper.
11. One 7/16" hex. socket with 3/8" drive.
12. One 9/16" hex. socket with 1/2" drive.
13. One 3/16" hex. key 1-1/2" long.
14. One 1/4" hex. socket with 3/8" drive.
15. One 1/2" drive flexible head breaker bar 8-1/2" long.
16. One 1/8" hex. socket key.
17. One long nose plier 6" long.
18. One 1/2" hex. socket with 1/2" drive.
19. One sleeve 3" dia. O.D. x 1-3/8" dia. I.D. x 1" long with square and smooth ends.
20. One drift pin with a 3/16" dia. point and approximately 6" length.
21. One 17 ounce ball peen hammer.
22. One pair of asbestos gloves.
23. One 0-1" micrometer.
24. One torque wrench, 1/2" drive, 0-600 lb-in.
25. One dog suitable for a 11/16" diameter shaft.
26. One brass bar 1-1/2" O.D. x 8" long with square and smooth ends.

5.2- WORM AND GEAR SUB-ASSEMBLY

(Refer to Drawings #5212-01 & 5270-01)

1. The bronze gear drive #22 shall be placed in an oven (Ref. 5.23-8) at 400° for a period of 20 to 30 minutes.
2. Place the crank (#21) crank pin up and properly supported, and press on sleeve #23. (Use sleeve 5.23-3.)
3. Remove bearing #55 from its wrapper and insert into bearing retainer #35 (sleeve may be required).
4. Insert snap ring #34 angle side up into retainer #35 and seat the ring against the bearing by tapping around the inside of the ring. This ring must be seated so that all clearance between the bearing and snap ring is taken out.
5. Place the crank #21 shaft up on a bench. Remove bronze gear #22 from the oven, using asbestos gloves and place on the crank with the four holes in the closest possible alignment. Allow the gear to cool and "shrink fit" onto the crank without disturb.
6. Place worm #24 in the arbor press. Place bearing #25 on the end of the worm. Place a sleeve against the inner race of the bearing, noting that the assembly is square and press until the bearing bottoms against the worm shaft shoulder. Reverse the worm and first bearing assembly in the arbor press and repeat the foregoing steps. Place the assembly on the assembly bench in a clean area prior to assembly into the pump.

7. Place bearing and seal retainer #40, small end dia. down, on the arbor press. Place seal #48 by hand (noting lip surface down) in the center seal hole of the retainer. Place a bar against the seal, noting the assembly is square, and press until flush with the retainer. Place the assembly on the assembly bench in a clean area prior to assembly into the pump.

8. After cooling, place the gear and crank assembly on the bench and drill through the four holes. (Use drill 5.23-9.)
NOTE: The drilling should be accomplished by:

- a. Applying cutting oil to the hole and drill.
- b. Starting the drill, noting squareness to the hole.
- c. Turning the drill in, noting a free easy cutting action without binding or requiring excessive force.
- d. Turning the drill out, using the same direction of rotation as when turning in.
- e. Flushing the holes with solvent and blowing off with compressed air.

9. Place the crank and gear shaft up on the arbor press and press the retainer screws in the drilled holes until bottomed (use the arbor press and tool 5.23-5). Remove the assembly from the arbor press and screw down locknuts #16 until torqued firmly against the crank. (Use socket 5.23-11 and torque wrench 5.23-24.)
10. Place the crank and gear shaft up on the arbor press. Place a sleeve against the "inner race" surface, noting that the assembly is square and press until the bearing bottoms against the crank shaft.
11. Place the crank and gear sub-assembly in a vise, shaft up, with the vise jaws engaging the flat cast surfaces on the side of the crank. Place spacer against bearing and press outer bearing and retainer on shaft until it can't go any further. Spacer will be slightly loose. Keep spacer #33 in line with both bearings on shaft so it doesn't bind.
12. Place the crank and gear on flat plate, shaft up in the arbor press holding fixture. Place bearing and retainer sub-assembly as described in Steps #5.24-3 and #5.24-4 on the crank shaft. Place a sleeve against the bearing "inner race" surface, noting that the assembly is square and press until the bearing bottoms against the crank shaft.
13. Place the crank and gear assembly on the bench, shaft up. Set the retainer plate #37 in place and insert cap screw #38 (torque 100 lb-in.) using tools #5.23-4 and 5.23-24.

5.25 WORM AND GEAR ASSEMBLY INTO THE DRIVE CASE (Refer to Dwg. #5270-01)

1. Insert the crank, gear and bearing sub-assembly into the housing center bore. Be

careful not to cock the sub-assembly when starting, or the bearing retainer #35 will bind in the bore.

2. Insert the worm and bearing cone sub-assembly (Ref. 5.24-6) into the housing worm bore. Pass the forward bearing cone gently around the gear and into the opposite housing bore.
3. Insert bearing cups #50 into the housing worm bore and tap gently from both ends until the cups have seated with the bearing cones mounted on the worm. Note that the worm shaft is centered in the housing bore.
4. Place one gasket-shim #52 (.005 thick) onto the retainer seal sub-assembly (Ref. step #5.24-7).
5. Wipe the worm shaft diameter lightly with a coating of #2 cup grease. Insert bearing retainer, seal and gasket sub-assembly (Ref. step #5.25-4) over the worm shaft noting that the seal lip engages evenly. Slide the retainer assembly onto the worm shaft seal diameter, at the same time entering the housing until the shim and retainer bottom against the housing.
6. Fasten with four cap screws #46 and washers #47. Torque to 125 lb-in. using tools #5.23-13, #5.23-14, #5.23-4 and #5.23-24.

5.26 SHIMMING THE WORM-BEARING ASSEMBLY (Refer to Drawing #52-51-1000)

The shimming of the worm-bearing assembly will be a simple task if the procedures of this process specification are followed:

1. Paper and pencil will be required for addition and subtraction.
2. Using 0-1" micrometer (tool #5.23-23), measure the thickness of the bearing retainer flange (part #10, drawing #52-51-1400). The measurements should be taken at the two drilled and tapped 3/8-16 holes. Mark the bearing retainer holes one and two and record the measurements with paper and pencil accordingly.
3. Insert bearing retainer #10 into the housing worm bore, bottoming it against the bearing cup.
4. Insert four cap screws #4 into the housing and tighten evenly "x"ing the cap screws until the torque level has reached 50 lb-in., using tools #5.23-14, #5.23-4 and #5.23-24. Back off on the four cap screws, loosening evenly in an "x" pattern until the screws are 1/2" turn snug against the bearing retainer.
5. Fasten dog for 11/16" shaft on the worm shaft and rotate the worm. The worm should rotate without undue torque because of worm-gear fit or excessive seating torque on the bearing retainer fasteners.
6. Insert dial depth gauge (tool #5.23-10)

into the bearing retainer tapped holes #1 and #2 (Ref. step #5.26-2) and as shown on drawing #52-51-1400. Record the measurements with paper and pencil accordingly.

7. Subtract the measurements obtained in step #5.26-2 from those obtained in step #5.26-6 (Note: Dimension #1 should be subtracted from dimension #1, and dimension #2 from dimension #2.) The remainder should be the same for dimensions #1 and #2.
8. Add .005" to the dimension obtained in step #5.26-7 and select shims #8 that equal the total.
9. Remove the four fasteners #4 and bearing retainer #10 (use tools #5.23-13, #5.23-14, #5.23-4 and #5.23-15).
10. Place the shims obtained in step #5.26-8 onto the bearing retainer.
11. Repeat step #5.23-6.

5.27 SHIMMING THE CRANK GEAR-BEARING ASSEMBLY (Refer to Drawing #52-51-1000 and #5270-01)

1. By hand, push against the bearing retainer plate (dwg. #5270-01 - part #37), moving the crank-gear-bearing assembly until the gear bears against the worm. Hold the assembly firmly in this position and insert the dial depth gauge (tool #5.23-10) against the bearing retainer as shown on Drawing #52-51-1000 and record the dimension as letter "B" with pencil and paper.
2. By hand, reach into the drive case and push against the crank, moving the crank-bearing assembly until the gear bears against the worm. Hold the assembly firmly in this position and insert the dial depth gauge (tool #5.23-10) against the bearing retainer as shown on Drawing 52-51-1000 and record the dimension as letter "C" with pencil and paper.
3. Insert retaining ring (dwg. 5270-01 part #36) into the bearing bore using tool #5.23-7.
4. Wipe the "O" ring groove in the retainer plate (part #41) lightly with a #2 cup grease. Insert "O" ring #14 into the groove.
5. Place the retainer plate #41 and "O" ring against the housing counter bore. Insert seal washers #40 and cap screws #39 into the retainer plate and fasten to the bearing retainer #35, using tools #5.23-12 and #5.23-14 (torque 180 lb-in.).

5.28 COMPLETION OF THE WORM GEAR DRIVE ASSEMBLY

1. Turn the worm shaft using tool #5.23-25 and observe for free rotation of the worm and crank gear assembly. They should not be tight, bind, or evidence looseness in excess of .002" backlash.
2. Place sliding block #19 on the crank journal.

3. Place washer tool #5.33-7, insert snap ring #1
4. Cover the top of the drive case until the next internal assembly procedure begins.

5.30 DurcoMeter P/O I FLDG
UPPER DRIVE CASE ASSEMBLY

5.31 REFERENCE DRAWINGS:

- 5212-01 Section Orientation Assembly
- 5270-01 Single Extension Drive Case
- 5270-02 One Feed Crosshead
- 5270-04 Digital Stroke Adjustment
- Figures 6, 7, 8 & 9 - Upper Drive Case Assembly
- Figures 10, 11 & 12 - Upper Drive Case Assembly

5.32 REQUISITES AND PROCEDURES FOR ASSEMBLY

A clean surface area approximately 2' wide x 4' long is required. Cleanliness in Assembly is essential, since any contamination of the Assembly bearings will result in early failure of the Pump drive.

5.33 REQUIRED ASSEMBLY EQUIPMENT AND TOOLS

1. One Bar 2" dia. x 3" long with square and smooth ends
2. Three Crosshead Alignment Tools 3/4" x 3/4" sq. x 18" long Bar
3. One 15/16" Open End Wrench
4. One Feeler Gauge
5. One Drift Pin with a 3/16" dia. point and approximately 6" length
6. One 17 ounce Ball Peen Hammer
7. One Torque Wrench, 1/2" drive, 0-600 lb-in.
8. One Torque Wrench, 1/2" drive, 0-200 lb-ft.
9. One 9/16" Hex. socket with 1/2" drive
10. One 7/16" Hex. socket with 1/2" drive
11. One Ratchet Wrench with 1/2" drive
12. One Dog suitable for an 11/16" diameter shaft.
13. One 3/8" Blade Screw Driver 8" - 10" long
14. One 5/32" Hex. socket key 1-1/2" long
15. One 3/16" Hex. socket key 1-1/2" long
16. One 1/4" Hex. socket key 1-1/2" long
17. One 5/16" Hex. socket key 1-1/2" long
18. One 5/32" Hex. socket with 3/8" drive
19. One 3/16" Hex. socket with 3/8" drive
20. One 1/4" Hex. socket with 3/8" drive
21. One 5/16" Hex. socket with 3/8" drive
22. One 1/2" female drive to 3/8" male drive adapter
23. Snap Ring Tool, Waldes Truarc - Internal Plier
24. One plastic head mallet
25. One 6 ounce Ball Peen Hammer
26. One 2" dia. bar 9" long with square and smooth ends (brass)
27. One 0-1" Micrometer

5.34 HANGER BRACKET - CROSSHEAD SUB-ASSEMBLY INTO THE DRIVE CASE

Refer to Drawings 5270-03, 5270-02, 5270-01, 5212-01 and Figures 6 thru 9.

1. Place the bearings (Dwg. 5270-01-part #27) in the Hanger bracket and using tools #5.33-1 and #5.33-24, seat the bearings in the hanger bracket bearing bores.
2. Loosely assemble the hanger bracket sub-assembly and crosshead sub-assembly as shown in Figure 6.
3. Uncover the worm gear drive assembly previously assembled per Section 5.20.
4. Turn the worm shaft using tool #5.33-12 until the crank journal is in the position shown in Figure #8. The crank sliding block shall then be turned by hand until it is in the illustrated position.
5. Note the following hanger bracket-crosshead position shown in Figure #6 before assembly into the drive case.
 - a. The crossheads shall have the machined bottom slot surface down.
6. The loosely assembled hanger bracket-crosshead assembly shall be picked up by hand and installed in the drive case as shown in Fig. 8. The hanger bracket shall be gently maneuvered until the sliding block engages the hanger bracket slot as shown in Fig. 8.
7. Insert the extension shaft through the drive case, and screw into the crosshead until the extension shaft is engaged as far as possible by hand. (Figure #8)
8. Insert the hanger bracket pins (Dwg. 5270-01-part #26) into the drive case. Push against one pin, maneuvering the hanger bracket slightly until the pin begins to engage the bearing bore. Using tool #5.33-24, tap the pin into the bearing. Repeat this procedure with the second pin.
9. One feed installation of the guide blocks (Dwg. #5270-02 part #11) into the drive case.

ONE FEED PUMP

NOTE: Positions referred to are shown in Figure 9.

- a. Using the extension shaft, lift the forward end until the crosshead will accept the first crosshead tool.
- b. By hand, lift the rear until the crosshead will accept the second crosshead tool.
- c. Insert guide block Dwg. 5270-02 - part 11 into the drive case at position #2.

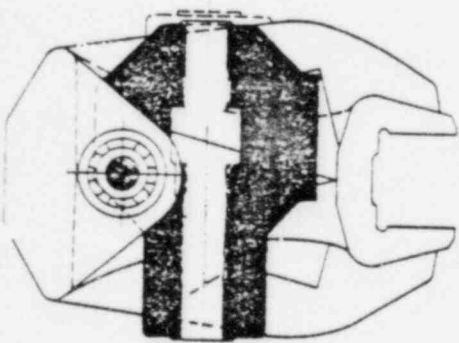

FIG. 6

HANDLE BRACKET

CROSS HEAD

EXTENSION SHAFT

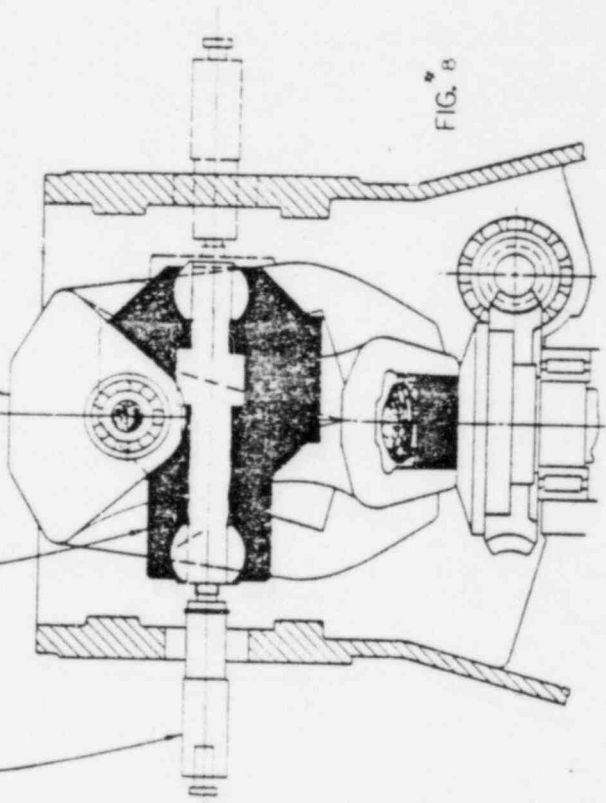

FIG. 8

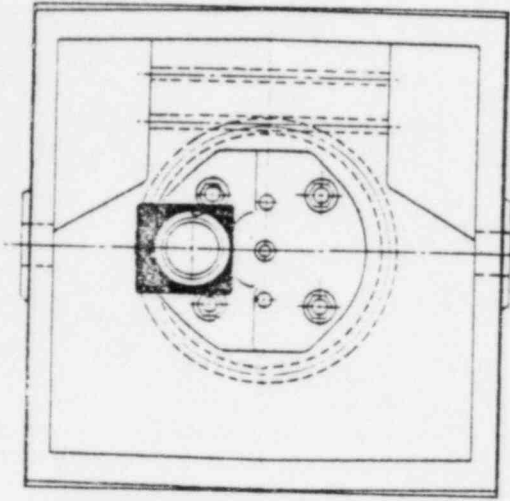

FIG. 7

POSITION NUMBERS

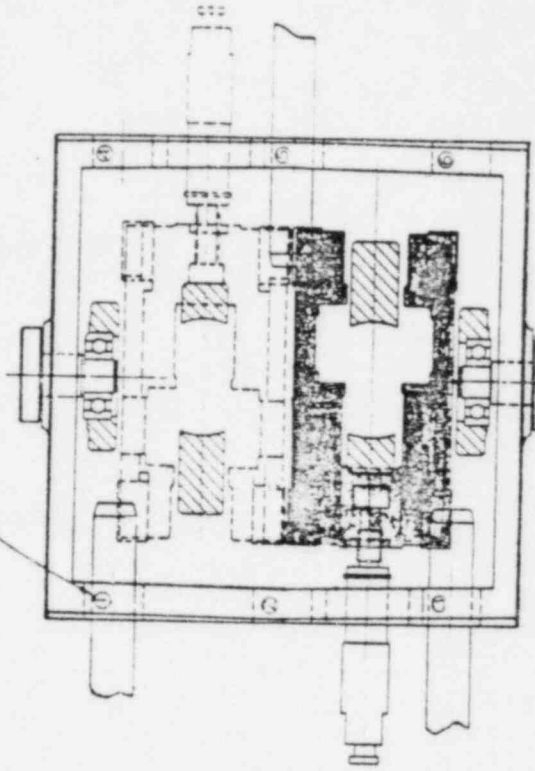

FIG. 9

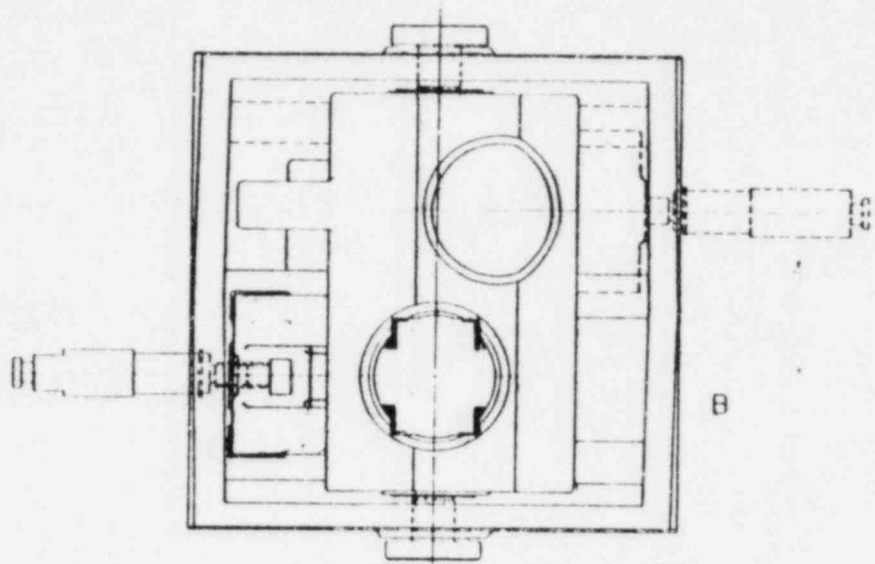

FIG. 10

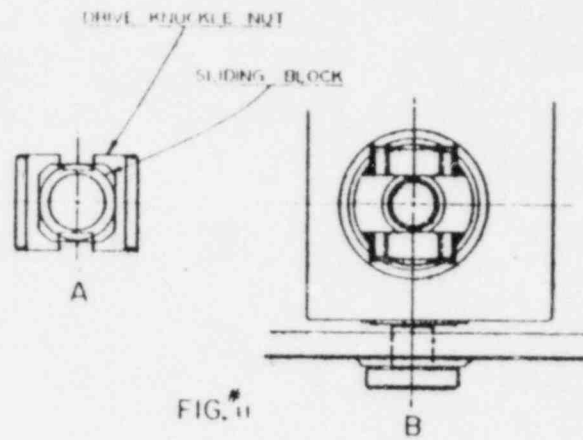
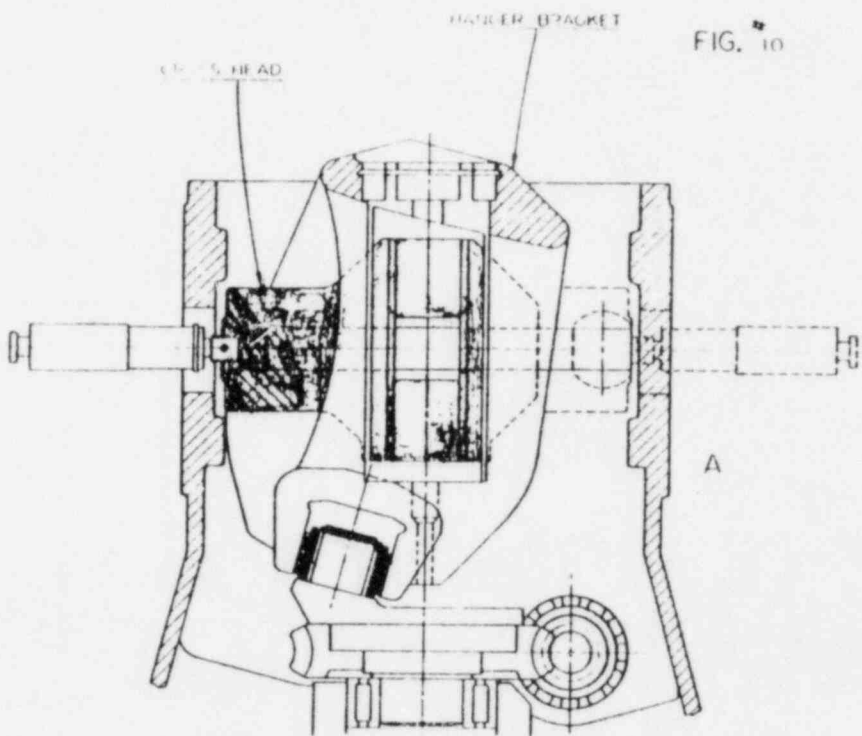

FIG. 11

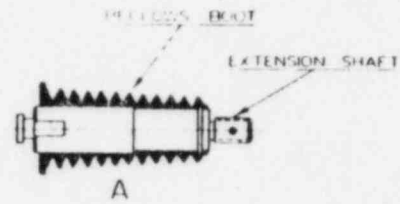
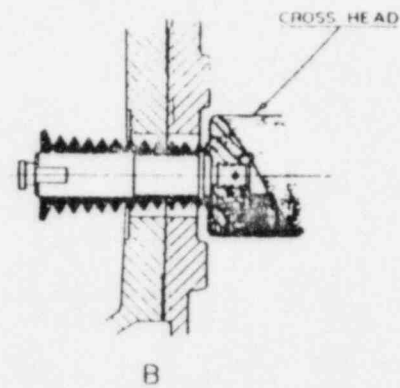

FIG. 12



- d. Push the guide block, withdrawing tool at the same time, until the block has engaged the drive case hole in position #5.
- e. Remove tool in position #3 and insert the second guide block into the drive case at position #3.
- f. Push the guide block through until the block has engaged the drive case hole in position #6.
- g. Apply #2 cup grease to the "O" ring groove in the end retainer #13 and insert "O" ring #12.
- h. Insert the end retainer #13 into hole position #3 and end retainer #13 with "O" ring #12 into hole position #6. Note that the protruding flat tangs of the end retainers engage the top and bottom of the square guide block.
- i. Insert the end retainers #13 into hole positions #2 and #5. Note that the protruding flat tangs of the end retainers engage the top and bottom of the square guide block.
- j. Insert two cap screws #15 across the corners of each end retainer (steps h + i) and draw down on the cap screws evenly until they are snug 1/2 turn tight.

10. Two Feed Installation of the Guide Blocks (Dwg. #5270-03 - part #7) into the drive case.

NOTE: Positions referred to are shown in Figure #9.

- a. Using the extension shaft, lift the forward end of the crosshead until it will accept the first crosshead tool.
- b. By hand, lift the rear of the second crosshead until it will accept the second crosshead tool.
- c. By hand, lift the rear and front of the first and second crossheads until the crosshead will accept the third crosshead tool.
- d. Insert guide block #7 into the drive case at position #2.
- e. Push the guide block #7 through, withdrawing tool at the same time until the guide block has engaged the drive case hole in position #5.
- f. Insert the end retainers #9 into the drive case holes in positions #2 and #5. Note that the protruding flat tangs of the end retainers engage the top and bottom of the square guide block.
- g. Insert two cap screws #10 across the corners of each end retainer #9, and using tools, draw down on the cap screws evenly until they are snug 1/2 turn tight.

- h. Insert guide block #7 into the drive case at position #4.
- i. Push the guide block through, withdrawing tool at the same time until the guide block has engaged the drive case hole in position #1.
- j. Apply #2 cup grease to the "O" ring groove in the end retainer #9 and insert "O" ring #8.
- k. Insert the end retainers #9 into hole positions #4 and #1 with "O" ring #8 into hole position #1. Note that the protruding flat tangs of the end retainers engage the top and bottom of the square guide block.
- l. Insert two cap screws #10 across the corners of each end retainer and using tool #5.33-15 draw down on the cap screws evenly until they are snug 1/2 turn tight.
- m. Remove tool #5.33-2 in position #3 and insert the third guide block #7 into the drive case at position #3.
- n. Push the guide block #7 through until it has engaged the drive case hole in position #6.
- o. Apply #2 cup grease to the "O" ring groove in the end retainer #9 and insert "O" ring #8.
- p. Insert the end retainer #9 into hole position #3 and end retainer #9 with "O" ring #8 into hole position #6. Note that the protruding flat tangs of the end retainer engage the top and bottom of the square guide block.
- q. Insert two cap screws #10 across the corners of each retainer #9 and draw down on the cap screws evenly until they are snug 1/2 turn tight.

11. Move the crosshead or crossheads back and forth by hand, noting that there are no binds that impair free movement. Should any binds be noticed, loosen cap screws #10, using tool 5.33-15 and tap the end retainers #9 with tool 5.33-24. When the crossheads move freely, retighten the cap screws #10.

12. Insert the remaining cap screws #10 and torque all fasteners evenly to 75 lb-in.

5.35 ADJUSTMENT SCREW AND KNUCKLE NUT ASSEMBLY INTO THE DRIVE CASE

1. Turn the worm shaft using tool 5.33-12 until the hanger bracket is in the position shown in Figure #10A.
2. Slide the crosshead into the position shown in Figure #A and B.
3. Align the hanger bracket-crosshead

- until the rectangular cavity is in the position shown in Figure #10B.
4. Align the sliding blocks on the drive knuckle nuts as shown in Fig. #11A. Insert the adjustment knuckle-sliding block assembly through the hanger bracket and into the rectangular cavity in the crosshead as shown in Fig. #11A and 11B. Gently push down on the sliding block assembly until it has passed through the hanger bracket and has engaged the crosshead completely. This procedure requires absolute alignment of the sliding blocks to the crosshead. The clearances are very close and patience may be required to obtain the absolute alignment of the sliding blocks, permitting entry of the assembly into the crosshead.
 5. Insert the adjustment screw sub-assembly (assembled per 5.40) through the hanger bracket and engage the adjustment knuckle by threading in with a counter clockwise rotation (left hand thread). Turn the screw assembly in approximately 18 turns and then push the adjustment screw down into the hanger bracket until the top ball bearing bottoms in the hanger bracket bearing cavity.
 6. Insert snap ring #26 (Ref. Dwg. 5270-04) into the snap ring cavity and seat the ring against the bearing by tapping around the inside of the ring.
 7. Insert the universal shaft-pin sub-assembly (assembled per 5.45) into the adjustment screw coupling guide as shown on Drawing 5270-04. Using the handle stroke adjustment shaft sub-assembly (assembled per 5.40) as a tool, engage the universal shaft-pin sub-assembly as shown on Drawing 5270-04 and turn clockwise until the adjustment knuckle bottoms in the hanger bracket. Disengage the handle-stroke adjustment shaft sub-assembly and place on the assembly bench until required in the further assembly of the Pump.
 8. Refer to Drawing #5270-01. Insert three cap screws #25 into the hanger bracket pins #25 and draw down evenly until they are snug 1/2 turn tight on both sides of the drive case. While drawing down and tightening the cap screws, observe that the adjustment screw assembly (#5.35-7) remains free and does not bind.
 9. Using feeler gauge #5.33-4, determine the gap between the hanger bracket pin and the housing on both sides.

10. Refer to Drawing #5270-01. Select the number of shims #57 (.014" thick) to fill the gaps determined in step #8. The cumulative shim thickness shall exceed the measured gap by the closest possible margin.
11. Remove cap screws #25 and #26 one at a time, and install the shims selected in step #6. Reinstall the pins per procedure #5.34-9. Insert cap screws #25 and torque to 110 lb-in. for a free fit before proceeding. Check that the adjustment screw assembly (#5.35-7) remains free and does not bind.
12. If this is a Two Feed Pump, repeat procedures #5.35-1 and #5.35-2 and follow steps #5.35-3 and #5.35-4 through #5.35-7 for the second feed.

5.36 Sump and Bellows Boot Assembly to the Drive Case

Refer to Drawings #5270-02, #5270-03 and Figure #12.

1. Apply a thin coating of #2 cup grease on the sump (part #5, Dwg. 5270-02) to drive case gasket surface. Place the gasket on the sump gasket surface and press firmly, noting that the gasket will remain in position due to the adhesive properties of the #2 cup grease.
2. By hand hold the sump #5 in position on the drive case and insert cap screws #8 into the two top sump mounting holes in the drive case. The One Feed sump mounting position is shown on Drawing #5270-02 and the Two Feed mounting positions are shown on Dwg. #5370-03.
3. Insert two cap screws #8 into the two lower sump holes and start by hand: using tool #5.33-11, run the screws in, and using tool #5.33-8 torque to 35 lb-ft.
4. If this is a Two Feed pump, repeat steps 1, 2 and 3 for the second feed.
5. Turn the worm shaft using tool 5.33-12 until the crosshead is in the position shown in Figure #12B.
6. Place the bellows boot #9 on the extension shaft #17 as shown in Figure #12A.
7. Insert the bellows boot-extension shaft into the drive case and screw the extension shaft by hand into the crosshead, as shown in Figure #12B. Using an open end wrench, engage the extension shaft through the sump bore and turn with the aid of a cross bar until the bellows boot-extension shaft is fully threaded into the crosshead.
8. Apply a thin coating of #2 cup grease on the circular groove of the bellows boot retainer plate #18 and engage the bellows boot, compressing it to the

position shown in view B5. Holding the plate #18 in position, insert screws #19 into the sump and tighten with tool #5.33-14.

4. If this is a Two Feed pump, repeat steps 5, 6, 7 and 8 for the second feed.

5.37 COMPLETION OF THE UPPER DRIVE CASE-ASSEMBLY

1. Turn the worm shaft, using tool 5.33-12, and observe that the upper drive components move freely and do not bind.
2. Cover the top of the drive case until the next assembly procedure begins.

5.38 INSTALLATION OF DRIVE CASE COVER

Refer to Drawing #5270-01, 5270-04

1. Place the cover gasket #12 on top of the drive case, being sure the holes in the gasket line up with the holes in the drive case.
2. Insert the flexible shaft into the coupling guide as shown on Drawing #5270-04. Place the drive case cover #11 on the drive case as shown on Drawing #5270-01.
3. Check to be sure the holes line up between the drive case #13, drive case gasket #12, and drive case cover #11. The drive case cover is secured by means of four cap screws #10.

5.40 DurcoMeter P/D I Pump Digital Stroke ADJUSTMENT ASSEMBLY

5.41 REFERENCE DRAWINGS

5270-04 Digital Stroke Adjustment
5270-01 Section Orientation Assembly

5.42 REQUISITES AND PROCEDURES FOR ASSEMBLY

A clean surface area approximately 2' wide x 4' long is required. Cleanliness in assembly is essential since any contamination of the stroke adjustment bearings will result in early failure.

5.43 REQUIRED ASSEMBLY EQUIPMENT AND TOOLS

1. An arbor press with approximately 8" throat depth and a capacity of 2-3 tons.
2. One 0.035 hex socket key.
3. One drift pin with a 1/8" diameter point and approximately 5" length.
4. One spanner wrench.
5. Snap ring tool Waldes Truarc - external drive end.
6. One 6 ounce ball peen hammer.

7. One plastic head mallet.
8. One sleeve 2" I.D. x 2-1/2" O.D. x 8" long with square smooth ends.
9. One bar 5/8" diameter x 3" long with square and smooth ends.
10. One sleeve 7/16" I.D. x 5/8" O.D. x 2-1/4" long with square and smooth ends.

5.44 DIGITAL STROKE ADJUSTMENT ASSEMBLY

Refer to Drawing 5270-04.

1. Turn worm shaft using tool until drive knuckle (#14) at 100% stroke.
2. Be sure counter (23A for 1FD & 23B for 2FD) reads 100% in mounting block.
3. Insert flexible shaft (#10) into shaft coupling (#13) inside of adjustment screw (#11).

The adjustment screw sub-assembly is now ready for installation in the drive case. Refer to 5.35-5 for installation instructions.

5.46 DIGITAL STROKE ADJUSTMENT HANDLE SUB-ASSEMBLY

Refer to Drawing 5270-04

1. Place the stroke adjustment shaft #9 in its holding fixture on the arbor press with the shaft end up.
2. Place the bearing #25 on the shaft and press until the bearing bottoms against the shaft shoulder.
3. Place gear #6 (teeth up), sleeve #5 and bearing #19 on the shaft and press until the gear bottoms against the lower bearing.
4. Place lock washer #16 on the shaft with the bottom tang engaging the slot in the shaft.
5. Turn bearing nut #18 on to the shaft using tool #5.43-4 until it bottoms against the washer-bearing-sleeve gear assembly. Torque the lock nut tightly against the assembly. Check gear #6, observing that the gear is locked tightly in place and will not rotate. Using tools #5.43-3 and #5.43-6, deflect one of the lock washer tangs into the closest matching lock washer tang slot.
6. Insert the shaft-bearing-gear assembly into the mounting block #22.
7. Insert set screw #20 into gear #24, noting that the set screw does not protrude into the gear bore.
8. Place the gear #24 on the counter shaft #23A or B. (Single feed pump is 23A; two feed pump uses 23A and 23B)
9. Place the counter-gear sub-assembly in the mounting block slot, engaging the bevel gear teeth by moving the counter

forward until the flange bottoms against the cross slot. (It may also be necessary to move the bevel gear forward on the counter shaft).

10. Remove the counter gear assembly in this position and tighten set screw #20 using tool #5.43-2 and repeat step #9.
11. Place the indicator plate #21 over the mounting block #22, engaging the rectangular protrusion window of the counter with the rectangular slot in the indicator plate. Push against the slotted diameter of the stroke adjustment shaft #9 and rotate by hand. Observe the bevel gear tooth engagement by looking at the bottom of the assembly through the mounting block slot while rotating the shaft. Observe the turning of the counter numerals while rotating the shaft.
12. Place handle #4 in the holding fixture on the arbor press. Start spin knob #2 in the handle by hand, noting that it is square to the handle. Insert pin #3 through spin knob into handle. Press against the pin until it bottoms against the handle.
13. Place the handle-knob assembly on the stroke adjustment sub-assembly shaft. Push the handle by hand onto the shaft until the roll pin hole in the handle is lined up with the one in the shaft. Hold the assembly in this position while starting roll pin #17 into the handle and using tool #5.43-6, tap the pin until it engages the shaft. Using tools #543.3 and #5.43-6, drive the roll pin into the handle until it is 1/8" below the handle surface.

5.50 PLUNGER HEAD ASSEMBLY

The instructions that follow are for the plunger head shown on drawing #5260-03 and are typical for other plunger head constructions.

The materials of construction used in the pump plunger head must be suitable for the intended service. The material recommendations are given in PPI's pump materials of construction Bulletin #725.

The plunger bushings #13, if they are carbon graphite, are fragile and should be handled with care. The pump plunger, if it is metal, is super finished and should be handled with care.

1. Slip each bushing #13 on the plunger and observe for a snug, free rotational fit.
2. The pump body bore should be clean and inspected for burrs or the presence of scale.
3. Place a bushing #13 in the pump body bore and push by hand until the bushing bottoms in the bore.

4. Unwrap and examine the packing set. There are two types of packing that may be used.

5.51 CHEVRON PACKING

Place a male adapter ring, flat side down, in the body bore and push by hand until the ring bottoms against the bushing. Place a pressure ring, with the Chevron pointing toward you, into the bore and push by hand until the ring bottoms against the male adapter ring. If the rings are cut, alternately stagger the cuts as they are placed in the bore. Continue installing the rings until there is room left for one more ring before it will overlap the lantern ring hole. Place a female adapter ring flat side up in the bore and push by hand until it bottoms on the pressure ring. Place the lantern ring #13 in the bore and push until it bottoms against the packing. Place a male adapter ring, flat side down, in the body bore and push by hand until the ring bottoms against the lantern ring. Install the pressure rings, as before, until there is room left for one more ring before it will protrude out of the bore. Install a female adapter ring, flat side up, in the bore and push by hand until it bottoms against the pressure ring. There should be a slight portion of the bore exposed for the follower bushing engagement. Place the follower bushing #13 in the bore. Place the plunger in the bushing and, while pushing, turn the plunger in a rotational motion back and forth as the plunger engages the packing until it has fully entered the stuffing box.

5.52 SQUARE SECTION PACKING

Place a ring in the bore and push by hand until the ring bottoms against the bushing. If the rings are cut, alternately stagger the cuts as they are placed in the bore. Continue installing the rings until there is room left for one more ring before it will overlap the lantern ring hole. Place the lantern ring #19 in the bore and push until it bottoms against the packing. Install the packing rings, as before, until there is a slight portion of the bore exposed for the follower bushing engagement. Place the follower bushing #13 in the bore. Place the plunger in the bushing and, while pushing, turn the plunger in a rotational motion back and forth as the plunger engages the packing until it has fully entered the stuffing box.

5.53 MOUNTING THE PLUNGER HEAD ASSEMBLY TO THE PUMP

1. Screw in studs #16 until they are fully engaged.
2. Using #2 cup grease, wipe the body gasket with a light coating and place it over the studs firmly against the body.

3. Lift the plunger head assembly and, engaging the studs in the sump holes, push the plunger head assembly until it bottoms against the sump.
4. Insert studs #19 into the pump body.
5. Tighten securely #20 hex nuts on #19 studs.
6. Turn the pump stroke adjustment by hand until the digital counter reads 100%.
7. Turn the pump motor coupling over by hand until the extension shaft, drawing #5270-02 Part #17 is fully retracted.
8. Place the gland #15 in the sump and slide it over the studs #16.
9. Screw the hex nuts #17 onto the studs until they loosely engage the gland.
10. Turn the pump stroke adjustment by hand until the digital counter reads 0%.
11. If the extension shaft and plunger buttons are not flush, place a screw driver or dry bar behind the plunger button and, using the gland as a fulcrum, pry the plunger towards the extension shaft until the buttons meet.
12. Place the split coupling, drawing #5270-03 part #2, over the extension shaft and plunger buttons, chamfered side towards the extension shaft, and snap the retaining rings #3 over the coupling firmly in place.
13. Refer to Section 3.32 for start up and break in procedures.

5.60 DIAPHRAGM HEAD ASSEMBLY

Reference Drawings:

5212-01	Section Orientation Assembly
5260-04	Diaphragm and Hydraulic Head
5260-01	Diaphragm Head and Check Valves
5270-02	One Feed Cross Head
5270-01	Two Feed Cross Head

5.61 REQUISITES AND PROCEDURES FOR ASSEMBLY

A clean surface area approximately 2' wide x 4' long is required. Cleanliness in assembly is essential, since any contamination of moving parts in the Diaphragm Liquid End Assembly can cause early failure or inefficient operation of the liquid end.

5.62 REQUIRED ASSEMBLY EQUIPMENT AND TOOLS

1. Drift Pin - 1/4" Diameter Point, approximately 6" long
2. Hammer - Ball Peen, 1#
3. Screwdriver - 1/4" Blade, 8"-10" long
4. Pliers - Needle Nose - 6" long
5. One 3/16" Hex Socket Key 1-1/2" long
6. One Torque Wrench with 1/2" Drive
0 - 150 lb-ft.
7. One Torque Wrench with 3/4" Drive
0 - 450 lb-ft.

8. One 12" Adjustable Wrench
9. One 10" Adjustable Wrench
10. Snap Ring Tool, Waldes Truarc - Internal Plier
11. Socket Wrench Set 3/8" thru 1" sockets
12. Channel Lock Pliers

5.63 ASSEMBLY OF DIAPHRAGM BODY TO THE SUMP AND DRIVE CASE

Reference: Drawing #5260-04, 5212-01 and 5270-02

1. Carefully inspect the Hydraulic Plunger #6 for burrs or any residue that may be present.
2. Holding the plunger by the button end, insert it into the bore of the diaphragm body to insure that the plunger is a free sliding fit in the bore.
3. Remove the plunger from the bore, and place on working surface with button end up. Using two small pieces of crocus cloth or fine emery paper (to avoid injury to fingers) spread one of the piston rings #5 just enough to slide it over the piston past the uppermost groove, and let it engage the second groove from the button end. Assemble another piston ring into the uppermost groove as just described. Turn the plunger over with the button end down and assemble the remaining two piston rings by the method described above.
4. Apply a thin coat of lubricating oil to both the bore of the diaphragm body #29 and the surface of the plunger #6 to assist in the assembly of the plunger into the diaphragm body.
5. Place the diaphragm body #29 face down on the work surface so that the open end of the bore is up. The body should be carefully and thoroughly cleaned. Inspect for burrs, sharp corners or any residue that might be present in the body.
6. Holding plunger #6 vertically, with button end up, carefully insert the plunger into the bore of the diaphragm body, letting it slide into the bore until it stops with the first piston ring resting against the hub of the diaphragm body. Using crocus cloth, fine emery paper or two pieces of wood to avoid injury to the fingers, compress the piston ring while manipulating the plunger until the piston ring enters the bore of the diaphragm body. Slide the plunger gently into the bore until it stops with the next piston ring resting against the hub of the diaphragm body. Repeat this procedure for each successive piston ring until the plunger is entered completely into

the bore of the diaphragm body.

As previously discussed in Section 5.36, the sump and bellows boot are mounted to the drive case.

7. With the diaphragm body and hydraulic plunger assembly still face down on the work surface, insert the O-ring #14 into the recess as shown on drawing #5260-0. A generous application of #2 cup grease to the O-ring before assembling will assist in keeping the O-ring in place during the next step in assembling the diaphragm body to the sump.
8. Refer to drawing #5270-02. Turn the digital stroke adjustment and/or the worm shaft (#28 Dwg. #5270-01) until the extension shaft #7 is withdrawn into the drive case.
9. With the diaphragm body still resting face down on the work surface, note that there is a locating pin #30 protruding from the surface of the body. Also note the location of the port for the air bleed valve #9. At this point have the ring nut #41 available within easy reach. With the air bleed valve port in the uppermost position, insert the plunger end of the diaphragm body thru the hole in the sump, watching carefully that the O-ring #14 remains in place. The locating pin #30 should line up and enter one of the bolt holes in the face of the sump. Hold the diaphragm body against the face of the sump and screw the ring nut #41 onto the threaded portion of the diaphragm body until it bears against the inner machined face of the sump. Using a drift pin and a hammer, or a spanner wrench, turn the ring nut #41 by means of the holes provided until the diaphragm body is solidly mounted against the sump effecting a tight seal of the O-ring #14 against the outer face of the sump.
10. Using a screwdriver or long nose pliers, reach into the bore of the diaphragm body and grasp or engage the button of the hydraulic plunger #5. Pull the plunger out so that the button is exposed outside of the body. Care must be exercised so that the bore surfaces will not be marred.
11. Turn the digital stroke control and/or the worm shaft by hand until the extension shaft #17 (Dwg. #5270-02) is moved outward from the drive case. Be sure that the snap ring #7 is at the end nearest the drive case. Continue moving the extension shaft outward until the button on the end is against the button on the hydraulic plunger. Take the two halves of the split coupling #2 (Dwg. 5270-03) and engage the two buttons so that they will be held

together by the groove in the split coupling. The external groove in the split coupling should be at the end facing the drive case. Holding the coupling halves together with one hand slide the retaining ring #7 into the internal groove in the sleeve. The connection is now complete.

5.64 ASSEMBLY OF CENTER DIAPHRAGM PLATE TO THE DIAPHRAGM BODY

Reference: Drawing #5260-0

1. Carefully examine the center diaphragm plate #3. See that all the holes and ports are clean and free of any chips or foreign particles.
2. Examine the hydraulic diaphragm #4. It must be clean with no particles of dirt or foreign matter present.
3. Note that there are eight bolt holes thru the plate, and four smaller holes on the same circular center line as the large holes. The four smaller holes are counter-bored on one side of the plate. This side will be referred to as the outer surface of the center diaphragm plate #3.
4. With the center diaphragm plate resting on edge on the work surface, insert two of the cap screws #28 thru two of the four counterbored holes with the heads of the screws on the same side of plate as the counterbores. Holding the center diaphragm plate on edge with one hand, place the hydraulic diaphragm #4 over the two cap screws with the diaphragm bearing against the inner face of the center diaphragm plate. Using both hands, place this assembly against the exposed face of the diaphragm body with one of the ports in the edge of the center diaphragm plate in the uppermost position. Line up the two cap screws with two corresponding tapped holes in the diaphragm body and screw them in by hand until the center diaphragm plate is held securely in position with the diaphragm located between the two surfaces.
5. Insert the remaining two cap screws #28 thru the appropriate holes and tighten all four cap screws securely, using a 3/16" Allen Wrench. Care should be taken to see that the diaphragm and center plate are positioned to slide into the recess of the diaphragm body before tightening the four cap screws.

5.65 ASSEMBLING REAGENT HEAD TO CENTER DIAPHRAGM PLATE AND DIAPHRAGM BODY

Reference: Drawing #5260-01 & #5260-04

1. Inspect the diaphragm head #10 carefully to see that it is free of burrs, loose particles or any residue that might be present. Also be sure that the diaphragm #9 is clean and free of dirt.

DIAPHRAGM HEAD TIGHTENING SPECIFICATIONS

TORQUE SPECIFICATIONS		
Diaphragm Head Size	Bolt Size	Tightening Torque - Ft. - Lbs.
1"	9/16 - 12 UNC	150
1-1/4"	9/16 - 12 UNC	150
2"	1/2 - 13 UNC	106

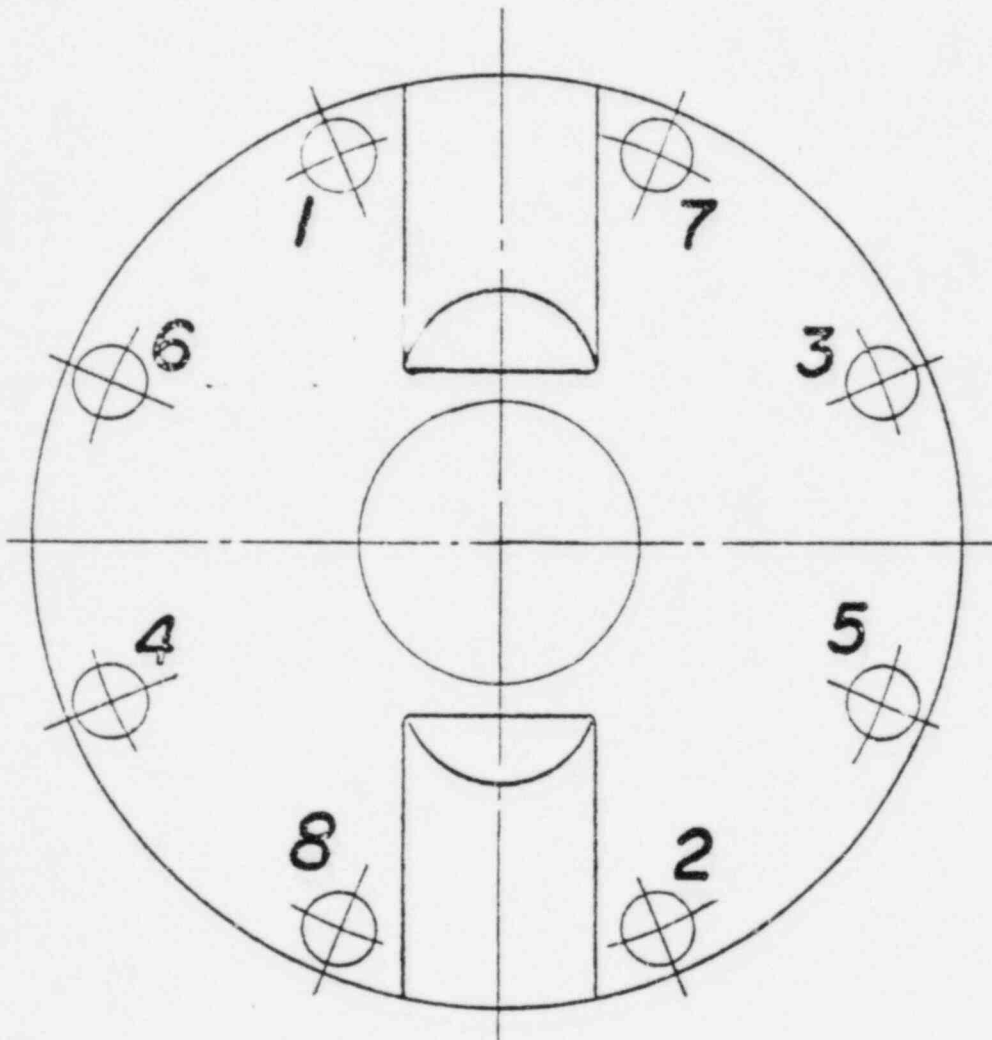

BOLT TIGHTENING SEQUENCE

FIGURE 13

2. Holding the diaphragm head #10 on edge with one hand, place the diaphragm into the recess in the diaphragm head with the concave face of the diaphragm positioned toward the diaphragm head.

Note that the corrugated surface of the diaphragm is in the position shown on Drawing #5260-01.

Twist the diaphragm in the head until the bolt holes are in alignment with the bolt holes in the diaphragm head. Also the holes corresponding to the smaller intermediate plate retainer screws should be coincident with their position. Insert two of the cap screws #11 thru the holes in the diaphragm head and the diaphragm. Now assemble the diaphragm head to the center plate lining up the two cap screws with corresponding holes in the center plate. Watch closely to see that the recess in the diaphragm head slides over the center plate, and that the ports in the diaphragm head are in the vertical position. Thread the two cap screws in as far as possible by hand. Insert the remaining six cap screws and screw them in as far as possible. Using a socket and torque wrench, tighten the eight bolts following the procedure shown in the diaphragm head tightening procedure, Table #3. Tighten bolts gradually, alternating from one to another following the sequence indicated until the recommended torque value is reached for each bolt. See Figure #13.

5.66 PRESSURE RELIEF VALVE ASSEMBLY AND INSTALLATION

Reference: Drawing #5260-04
1" & 1-1/4" Heads

The pressure relief valve consists of set screw #50 which bears against the spring follower #45 and can be locked in position by means of the locknut #49. When the set screw #50 is turned clockwise, it causes the spring follower #45 to move inward, compressing the spring #44, increasing the force against the element #43 which seats against the edge of an orifice machined in the end of the body #48 increasing the force required to move the element from the seat opening the valve. When the set screw #50 is turned counter-clockwise, it allows the spring #44 to move outward decreasing the force against the element #43 reducing the force required to move the element from the seat, opening the valve.

The innermost end of the relief valve is sealed into the diaphragm body #29 by means of an O-ring #42 so that when the valve is opened the hydraulic oil passes thru the orifice past the element #43 and out thru the holes provided in the

body #48, exhausting back into the reservoir (sump) thru holes provided in the diaphragm body.

Hydraulic oil is prevented from leaking to the outside by means of an O-ring #47 contained in the upper portion of the body #48 at the relief valve.

The relief valve is opened by an over-pressure condition as described in Section 4.13.

Assembly Instructions:

1. Carefully inspect the pressure relief valve parts to see that they are clean and free of any dirt or loose particles. All corners must be free of burrs.
2. Holding the body #48 in one hand, insert the element #43 into the bore of the body with the chamfer end of the element resting against the orifice end of the body.
3. Continuing to hold the above assembly in one hand, place the spring #44 into the bore of the element #43. Place the spring follower #45 into the bore of the body with the center recess area up.
4. The set screw #50 is now threaded into the body being sure the dog point of the set screw engages the center recess area of the spring follower.
5. Assemble the O-ring #42 into the groove area of the body #48 near the orifice area of the body.
6. Assemble the O-ring #47 onto the body #48 near the set screw #50.
7. Screw the locknut #49 onto the set screw #50.
8. After adjusting the relief valve to open 10% above the operating pressure of the pump, screw the locknut tightly against the body using one wrench to keep the set screw from turning and another to tighten the locknut.
9. Install the gasket #46 onto the body and thread on the cap #31.
10. The relief valve is normally installed in the lower right hand part provided in the diaphragm body. Right and left hand are determined from a position facing the outboard end of the diaphragm liquid end.
11. Insert the relief valve into the lower right hand part as shown on Dwg. 5260-04 and screw it firmly in place.
12. To adjust the pressure lower, loosen locknut #49 and turn the set screw #50 counter-clockwise. Observe the gauge pressure and continue to adjust the set screw until the desired setting is obtained.
13. After adjusting the relief valve to the desired setting, screw the locknut tightly against the body using one wrench to keep the set screw from turning and another to tighten the locknut.

2" Head

Reference: Drawing #5260-04

For operation of the pressure relief valve, see Section 4.13.

5. Fill the diaphragm head with oil, using the same grade oil removed, until the hydraulic chamber is full to the top of the air bleed valve port.
6. Replace the air bleed valve and plug #7, Figure #15.
7. Start the pump and observe the gauge pressure needle swing.
8. Shut off the strainer, tank supply, or isolation valve in the suction line. The pump will now behave as described in Section 4.13, "when suction lift or starved suction conditions exist".
9. Observe the gauge pressure needle swing and lightly depress the vacuum valve adjustment follower #27 until the maximum pressure has been obtained. The relief valve pressure, as set by the factory, should be 10% above the operating pressure stamped on the name plate. The snubbed gauge reading should not exceed this setting.
10. To adjust the pressure lower, loosen jam nut #38 and, turning the adjustment screw #39 counter-clockwise, lightly depress the vacuum valve adjustment follower and observe the gauge pressure until the desired setting is reached.

The methods outlined are not exact and are intended as a rough estimated relief valve adjustment. If closer settings are required, a hand-operated hydraulic pump can be connected to the bottom diaphragm head pipe thread connection and, while the pump is stopped, the hydraulic chamber can be pumped up until the relief valve setting is observed on the pressure gauge.

5.67 VACUUM VALVE ASSEMBLY AND INSTALLATION

Reference: Drawing 5260-04
1"- 1-1/4" Heads

The vacuum valve mechanism consists of an adjustment screw (#54) with ball seat insert (#59) pressed into the bore of the adjustment screw, and an O-ring inserted into the adjustment screw. A check valve ball (#52) seals against the O-ring. A spring (#56) is retained at one end by the shoulder in the body and at the other end by the check valve ball.

The above assembly is retained by means of the adjustment screw which threads into the body. A clockwise rotation of the adjustment screw #54 moves the ball #5 into compression against the spring #56, increasing the force necessary to open the valve. Conversely a counter-clockwise rotation of the adjustment screw allows the spring to extend, decreasing the force necessary to open the valve.

Assembly Instructions:

1. Carefully inspect the vacuum valve parts to see that they are clean and free of any dirt or any loose particles. All corners must be free of burrs.
2. Press the ball seat insert #59 into the bore of the adjustment screw #54 being sure the chamfer side is up.
3. Install the O-ring #58 in the recess groove of the O.D. of the adjustment screw. Insert O-ring #57 into the recessed area of the ball seat of the adjustment screw.
4. Place the check valve ball #52 on the ball seat O-ring #57. Press the ball firmly by hand against the O-ring and with a ground tester check to be sure the ball is not making contact with the metallic portion of the adjustment screw or the ball seat insert.
5. Install the spring #56 into the bore of the body #53 being sure it contacts the shoulder portion of the body orifice.
6. Place the ball #52 in the bore of the body so that it rests on the spring.
7. Thread the adjustment screw sub-assembly described in Item 3 into body being sure equal compression is made on the ball and spring. Thread the adjustment screw all the way into the body and then turn five full turns counter clockwise.
8. Insert O-ring #62 in groove area of body near the top and install O-ring #54 in the recess area of the body near the adjustment screw area.

2" Head

For operation of the valve, see Section 4.13

The vacuum valve mechanism consists of the adjustment follower (27) having a milled slot in one end that engages the adjustment nut (24) which in turn is threaded onto the stem portion of the poppet (15). The poppet seals, by means of an O-Ring (16) against a machined seat on the body (18) of the valve. A pin (21) press fitted thru the poppet stem rides in opposing slots in the body (18) and prevents rotation of the poppet when the adjustment follower (27) is being turned. The compression spring (22) is retained at one end by a shoulder in the body and at the other end by a washer (23) which bears against the adjustment nut (24).

The above assembly is held into the body (18) by means of a washer (19) and a retaining ring (20). A clockwise rotation of the adjustment follower (27) moves the adjustment nut (24) inward on the poppet stem, compressing the spring (22), increasing the force necessary to open the valve. Conversely, a counter-clockwise rotation of the adjustment follower moves the adjustment nut outward on the poppet stem, allowing the spring to extend, decreasing the force necessary to open the valve.

The pressure relief valve consists of an adjustment screw #39 which bears against the spring follower #37 and can be locked in position by means of the jam nut #38. When the adjustment screw is turned clockwise, it causes the spring follower to move inward, compressing the spring #33, increasing the force against the element #40 which seats against the edge of an orifice machined in the end of the lower body #32, increasing the force required to move the element from the seat opening the valve. When the adjustment screw #39 is turned counter-clockwise, it allows the spring #33 to move outward decreasing the force against the element reducing the force required to move the element from the seat, opening the valve.

The innermost end of the relief valve is sealed into the diaphragm body #29 by means of an O-Ring #31, so that when the valve is opened the hydraulic oil passes thru the orifice past the element #40 and out thru the holes provided in the lower body #32, exhausting back into the reservoir (sump) thru holes provided in the diaphragm body.

Hydraulic oil is prevented from leaking to the outside by means of an O-Ring #34 contained in a groove in the upper body #35 of the relief valve. Another O-Ring #36, contained in the spring follower #37, prevents leakage of the hydraulic oil past the adjustment screw to the outside.

The relief valve is opened by an over-pressure condition as described in Section 4.13.

Assembly Instructions:

1. Carefully inspect the pressure relief valve parts to see that they are clean and free of any dirt or loose particles. All corners must be free of burrs.
2. Assemble the O-Ring #36 into the groove in the spring follower #37. After the O-Ring is installed, apply a light coat of lubricating oil or #2 cup grease to the O-Ring. Holding the upper body #35 in one hand, insert the spring follower into the bore of the upper body with the hole end outward. Push the spring follower down into the upper body.
3. Still holding the upper body #35 in one hand, insert the spring #33 into the upper body, making sure that it enters the recess provided in the spring follower #37.
4. Holding the above assembly vertical, place the element #40 over the spring, being sure that the seating end of the element is smooth and clean.

5. Continuing to hold the above assembly in one hand, place the lower body #32 over the element and spring, entering the externally threaded end of the upper body into the internally threaded portion of the lower body. Now screw the two sections together by hand as tightly as possible. Using a wrench or vice, hold the hexagon-shaped portion of the valve and with a channel lock pliers (5.62-12) or a small pipe wrench grip the cylindrical portion of the upper body and screw the two sections tightly together.
6. Slide the O-Ring #34 over the cylindrical end of the assembled relief valve, carefully over the external threads on the lower body and into the groove provided against the face of the hexagon portion of the lower body. Masking tape may be wrapped around the threads to insure against damaging the O-Ring in assembly.
7. Assemble the O-Ring #31 into the groove provided in the end of the upper body.
8. Screw the jam nut #38 onto the adjustment screw #39 until it is nearest the head end of the screw. Screw this assembly into the threaded hole in the upper body until the rounded or threaded end of the screw contacts the spring follower #37.
9. After adjusting the relief valve to open at 10% above the operating pressure of the pump, screw the jam nut tightly against the lower body using one wrench to keep the adjustment screw from turning and another to tighten the jam nut. This will prevent the relief valve from losing its setting.
10. The relief valve is normally installed in the lower right hand port provided in the diaphragm body. Right and left hand are determined from a position facing the outboard end of the diaphragm liquid end.
11. Insert the relief valve into the lower right hand port as shown on Drawing #5260-04 and screw it firmly in place using an appropriate wrench.

Setting the Pressure Relief Valve - Refer to Drawing #5260-04.

The pressure relief valve is normally set at the factory to relieve at a pressure 10 per cent higher than the intended operating pressure of the pump.

Should it become necessary to change the setting of the pressure relief valve because of a change in pumping conditions, the following procedure should be followed:

1. Turn off the power to the pump.
2. Remove the plug #7 and air bleed valve body #1 shown in Figure #15.
3. Remove the outboard pipe plug in the side of diaphragm body #29.
4. Install a shut off valve and a snubbed pressure gauge with a maximum range well above the pump operating pressure stamped on the pump name plate, into the side of the diaphragm body.

As indicated on the graph, Figure #14, the vacuum valve is shipped from the factory with the setting at 5 turns counter-clockwise from the maximum inward adjustment. The valve is designed so that one complete turn of the adjustment screw in either direction will cause a change of approximately 1 P.S.I.A. required to open the valve.

If, during the operation of the pump, it appears that the vacuum valve is not allowing oil to flow from the reservoir (sump) to the hydraulic head, evidenced by a fall off in pumping capacity, slowly turn the adjustment screw out (counter-clockwise) and listen for increased pumping action in the check valves.

If the adjustment screw is turned out too far, the vacuum valve will allow too much oil to flow from the reservoir to the hydraulic head, causing the diaphragm to bottom against the forward limit surface creating a pressure condition that will blow the relief valve. If this condition occurs, slowly turn the adjustment screw inward until the relief valve ceases to open. Evidence of the relief valve blowing can be detected by a noticeable agitation in the hydraulic oil contained in the reservoir (sump).

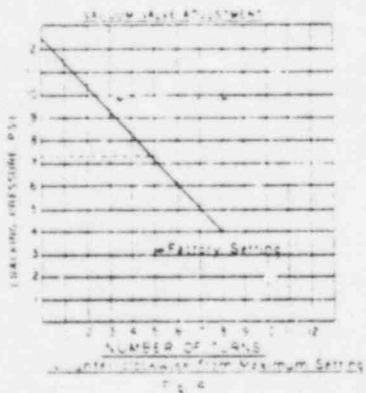

The vacuum valve is normally set at the factory as shown in Figure 14. The setting is based on a possible lift condition of approximately 10 feet, including the internal hydraulic losses and dynamic fluid velocity line losses expected in a vertical line when pumping water at 70° F.

If the adjustment screw is turned in too far a malfunction can occur, and a loss in pump volumetric efficiency will be evidenced. (See Section 4.23 Possible Operating Difficulties - Diaphragm Pumps).

Assembly Instructions:

1. Carefully inspect the vacuum valve parts to see that they are clean and free of any dirt or loose particles. All corners must be free of burrs.
2. Assemble O-Ring #16 into the groove in the conical or seat end of the poppet #15.
3. Insert the poppet #15 stem first into the body #18 from the end with the conically machined seat. Twist the poppet until the hole thru the stem is in alignment with the machined slots in the body.
4. With the body and poppet assembly horizontally supported, insert pin #21 thru the slot in the side of the body and into the hole in the poppet stem. Using a hammer and drift pin, tap the pin #21 thru the poppet stem until it is equally engaging both of the slots in the body. Check to be certain that the poppet moves freely in the body.
5. Stand the above assembly on the poppet end and drop the spring #22 into place.
6. Insert the washer #23 into the body, making sure that it passes over the poppet stem and down against the spring.
7. Assemble the O-Ring #26 into the groove in the adjustment follower #27. Insert the adjustment nut #24 into the body and using the adjustment follower #27, engage two flats on the adjustment nut with the slot in the adjustment follower, and screw the nut onto the poppet stem until it stops.
8. Drop the washer #19 over the protruding slotted end of the adjustment follower and into the recess in the body #18 of the valve.
9. Using a snap ring internal plier, insert the snap ring #20 over the protruding stem of the adjustment follower and into the recess in the body, sliding it down until it engages the internal groove in the body.
10. The vacuum valve is normally installed in the lower left hand port provided in the diaphragm body, right and left hand being determined from a position facing the out-board end of the diaphragm liquid end.
11. Insert the vacuum valve into the lower left hand port and screw it firmly in place, using an appropriate wrench.

5.6E AIR BLEED VALVE ASSEMBLY AND INSTALLATION

Reference: Figure #15 and Drawing #5260-04

1. Carefully inspect the air bleed valve parts to see that they are clean and free of any dirt or loose particles. All corners must be free of burrs.

2. Insert O-Ring #5 into the body #1; insert O-Ring #4 into the seat #2. Holding the body #1 in one hand with the threaded end up, drop the ball #3 into the opening, being sure that it drops into the hole as shown in Figure 15.

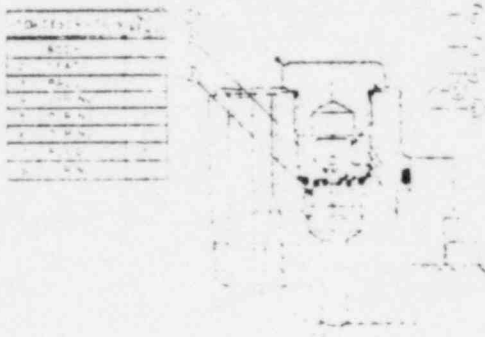

3. Screw seat #2 with O-Ring end first into the body using a screwdriver or the edge of a coin until it is tight. The slotted face of the seat will be very nearly flush with the end of the body.
4. Install O-Ring #6 into the groove in the body #1. Care should be exercised when passing the O-Ring over the threads in the body. A piece of masking tape can be wrapped around the threads so as to prevent the O-Ring from being cut or otherwise damaged.
5. Insert the air bleed valve into the port in the upper side of the diaphragm body #29. Using the connector-end of a 5/8" socket and a socket wrench with a 1/2" square connector, screw the air bleed valve assembly tightly into the port.
6. Assemble the O-Ring #8, Figure 15, into the groove in the plug #7, using care when passing the O-Ring over the threaded portion of the plug. Masking tape wrapped around the threads will prevent damage to the O-Ring.

5.69 REPLACEMENT OF DIAPHRAGM, AND FILLING THE INTERMEDIATE CHAMBER

Reference: Drawings #5212-01 and #5260-04

1. To remove either of the two diaphragms for replacement, first be sure the pump is turned off. Be sure that there is no pressure in any part of the diaphragm liquid end. Under no circumstances should any of the plugs be removed from the diaphragm liquid end when the pump is operating.
2. Remove the sump cover #12 by taking out the four cap screws #11. Take care that the gasket #13 is not damaged when removing the cover.

3. Place a container beneath the sump, and drain the sump by removing the pipe plug #11, Drawing #5270-03. Remove the plug #7, Figure 15, from the diaphragm body. Then, using the socket wrench as described in 5.65-5 above, remove the air bleed valve. Remove the plug from the bottom of the diaphragm body to completely drain the oil from the diaphragm body.
4. Refer to Drawing #5260-04. Remove pipe plug #1 from the center plate. Place a container beneath the center diaphragm plate #3. Remove the pipe plug from the bottom of the center plate to drain the oil from the intermediate chamber.
5. Refer to Drawing #5260-01. Remove the piping from the suction and discharge check valves. Remove the cap screws #11 from the liquid end, being sure to hold the diaphragm head #10 to prevent it from falling when the last cap screw is removed. Set the diaphragm head and check valve assembly aside. At this point, the process diaphragm #9 can be removed.
6. Refer to Drawing #5260-04. Remove the four cap screws #28 from the diaphragm hydraulic head being sure to hold on to the center diaphragm plate so that it does not fall when the four cap screws are removed. At this point the hydraulic diaphragm #4 can be removed.
7. Replace the damaged diaphragm with a new one, and re-assemble the diaphragm liquid end as outlined in 5.64 and 5.65 above.
8. Reconnect the suction and discharge check valves into the piping system.
9. Refill the hydraulic reservoir and the hydraulic chamber as described in Section 3.33-1.
10. Replace the plug in the bottom of the center diaphragm plate #3, Drawing #5260-04.
11. Withdraw the hydraulic plunger #6 to the rear limit of its stroke (toward the drive case). This can be done by turning the manual stroke control and/or the coupling connecting the motor to the worm shaft.
12. This chamber should be filled by the customer with non-corrosive solution compatible with the process fluid. However, unless otherwise specified by the customer, this chamber is shipped from the factory filled with mineral oil or commercial grade ethylene glycol base anti-freeze.

Fluid Capacity-Intermediate Chamber	
Diaph. Hd. Size	Quantity of Fluid cc's
1	57
1 1/4	57
2	127

13. Slowly move the hydraulic plunger forward (away from the drive case) by turning the manual stroke adjustment or the coupling connecting the motor and the worm shaft. Watch the hole thru which the intermediate chamber was filled for the liquid to rise. When the liquid has risen to the level just at the start of the threads in the port, replace the pipe plug #1.

Note: The above filling procedure should be done carefully, as any air that might not be expelled from the intermediate chamber can seriously affect the performance of the pump, and full pumping capacity cannot be obtained.

14. Replace the gasket #13 and the sump cover #12 and tighten the four cap screws #11. The pump is again ready for operation.

5.70 CHECK VALVE ASSEMBLY

The materials of construction used in the check valve must be suitable for the intended service. Material recommendations are given in Bulletin 725, Materials of Construction.

For 1" and 1-1/4" Head

Reference: Drawing 5260-01

The check valve seat #15 and ball #14 are the heart of the valve and should be in good condition or the pump will not operate properly.

The seat #15 is press fitted into the body #12. To remove the seat, thread the ball stop #13 out of body #12. Place a bar of suitable diameter with square ends through the internal threads/diameter until it bears squarely against the ball seat. Press the ball seat out of the body. Replace the ball seat with a new component in the same position as removed and press until it is firmly seated in the body. The press fit of the seat in the body acts as a metallic interference pressure seal and it is important for the proper operation of the pump that the components be clean, free from corrosion and/or other defects in the interference area.

Inspection of the ball should reveal good spherical geometry, within .0005", and the ball surface should be smooth and free from pits or etching caused by corrosion. Discoloration will not harm the check valve action and should not be considered cause for rejection. The ball may be seated in the seat by placing the ball on its seat in the arbor press. Bring the ram down on top of the ball and firmly bear down on the ball.

Thread the ball stop #13 into the body #12 until the ball stop bottoms the body threads.

For 1-5/8" and 2" Head

Reference: Drawing 5260-03

The check valve seat #7 and ball #6 are the heart of the valve and should be in good condition or the pump will not operate properly.

The seat #7 and ball stop #5 are press fitted into their respective caps #1. To remove the seat, or ball stop, the cap should be placed in an arbor press with the threaded end up. Place a bar of suitable diameter with square ends through the internal threaded diameter until it bears squarely against the ball seat/stop. Press the ball seat/stop from its cap. Replace the ball seat/stop with a new component in the same position as removed and press until it is seated firmly in the cap. The press fit of the seat in the cap acts as a metallic interference pressure seal, and it is important for the proper operation of the pump that the components be clean, free from corrosion and/or other defects in the interference area.

Inspection of the ball should reveal good spherical geometry, within .0005", and the ball surface should be smooth and free from pits or etching caused by corrosion. Discoloration will not harm the check valve action and should not be considered cause for rejection. The ball may be seated in the seat by placing the ball on its seat in the arbor press. Bring the ram down on top of the ball and firmly bear down on the ball.

Rap the top of the arbor press ram with a brass hammer, causing the ball to form its seat. (If ceramic balls are required, it is essential that a dummy steel ball be used for this operation). The ball may now be lapped in its seat until it is obvious that the ball is bearing evenly on the full seat perimeter evidenced by continuity of area on the seating surface.

Before assembly of the valve, the cap screws #3 should be examined for corrosion. If any corrosion is evidenced, they should be replaced.

When assembling the cap-ball stop and cap-seat sub-assemblies to the body #2, it should be observed that the cap-seat sub-assembly is inserted in the bottom side of the check valve coincident with the bottom of the cast arrow on the side of the body.

The remaining assembly procedures are obvious when referring to Drawing #5260-03.

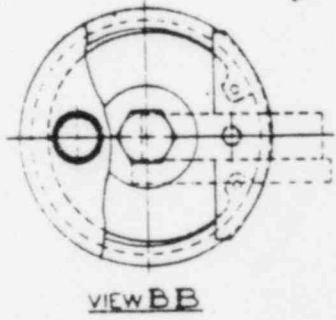
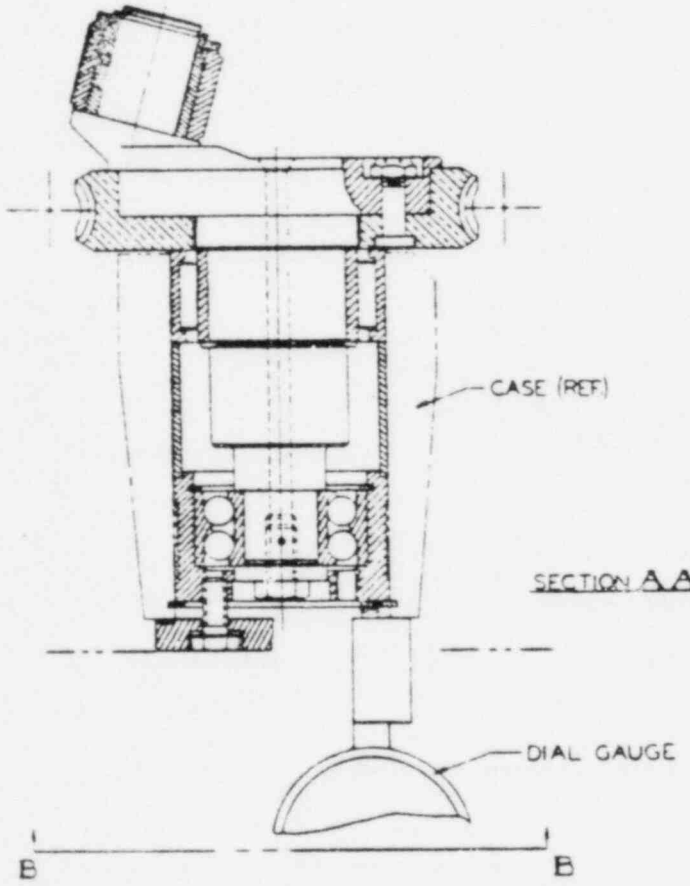
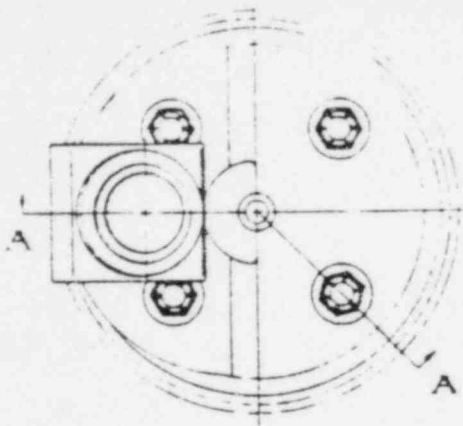

Drawing No. 52-51-1000

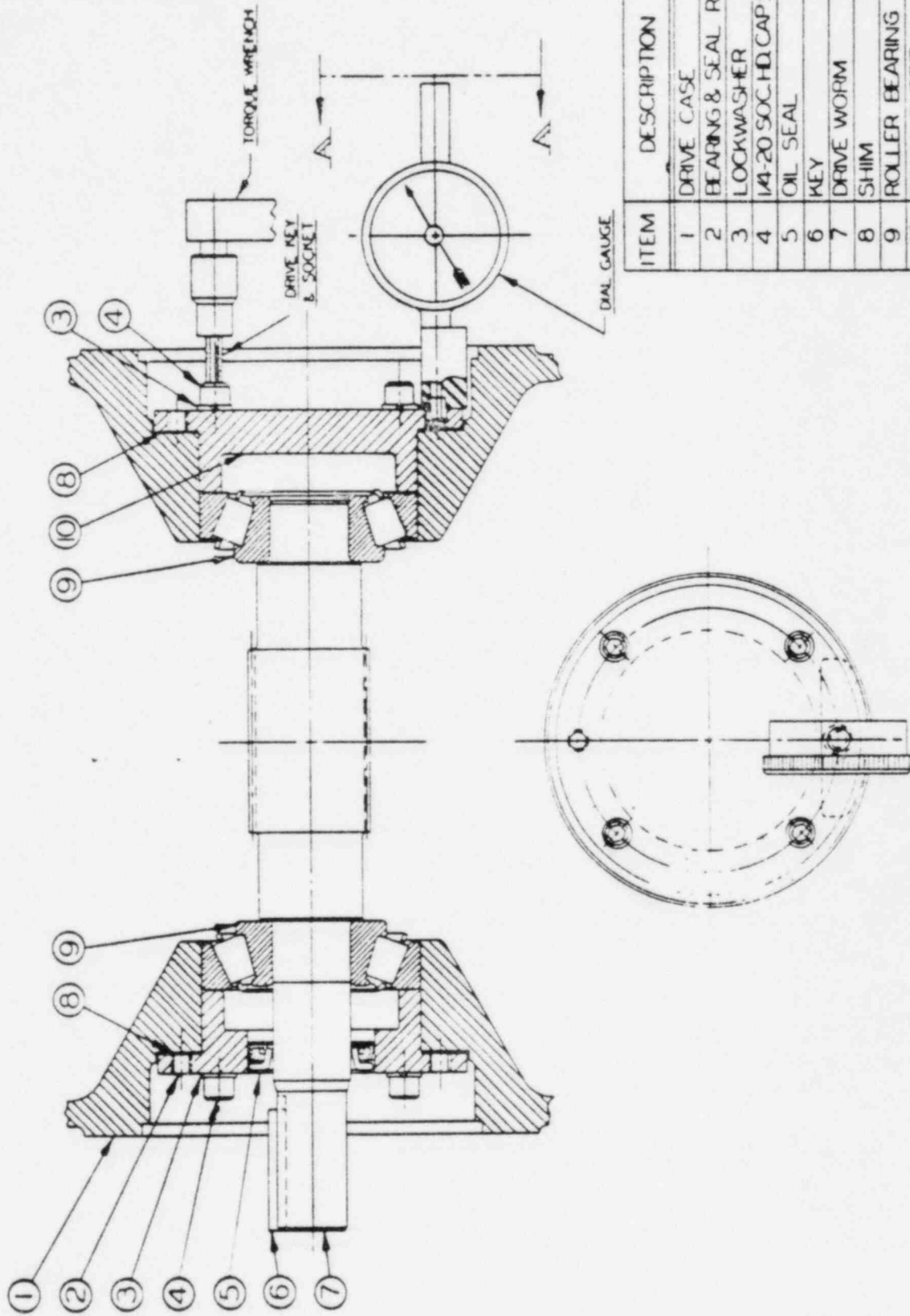

ITEM	DESCRIPTION
1	DRIVE CASE
2	BEARING & SEAL RET.
3	LOCKWASHER
4	1/4-20 SOC.H.D.CAP SCR.
5	OIL SEAL
6	KEY
7	DRIVE WORM
8	SHIM
9	ROLLER BEARING
10	BEARING RET.

Drawing No. 52-51-1400

TITLE

Durcometer P.O. : B.N.S. — PLUNGER DIAPHRAGM

SECTION ORIENTATION ASSEMBLY

SECTION	ASSEMBLY NO.	DESCRIPTION
A	5260-01	DIAPHRAGM HEAD & CHECK VALVES
B	5260-02	DIAPHRAGM & HYDRAULIC HEAD
C	5270-01	SINGLE EXTENSION DRIVE CASE
D-D	5270-02	ONE FEED CROSS HEAD
D-D	5270-03	TWO FEED CROSS HEAD
E	5270-04	DIGITAL STROKE ADJUSTMENT
F	5260-03	PLUNGER HEAD & CHECK VALVES

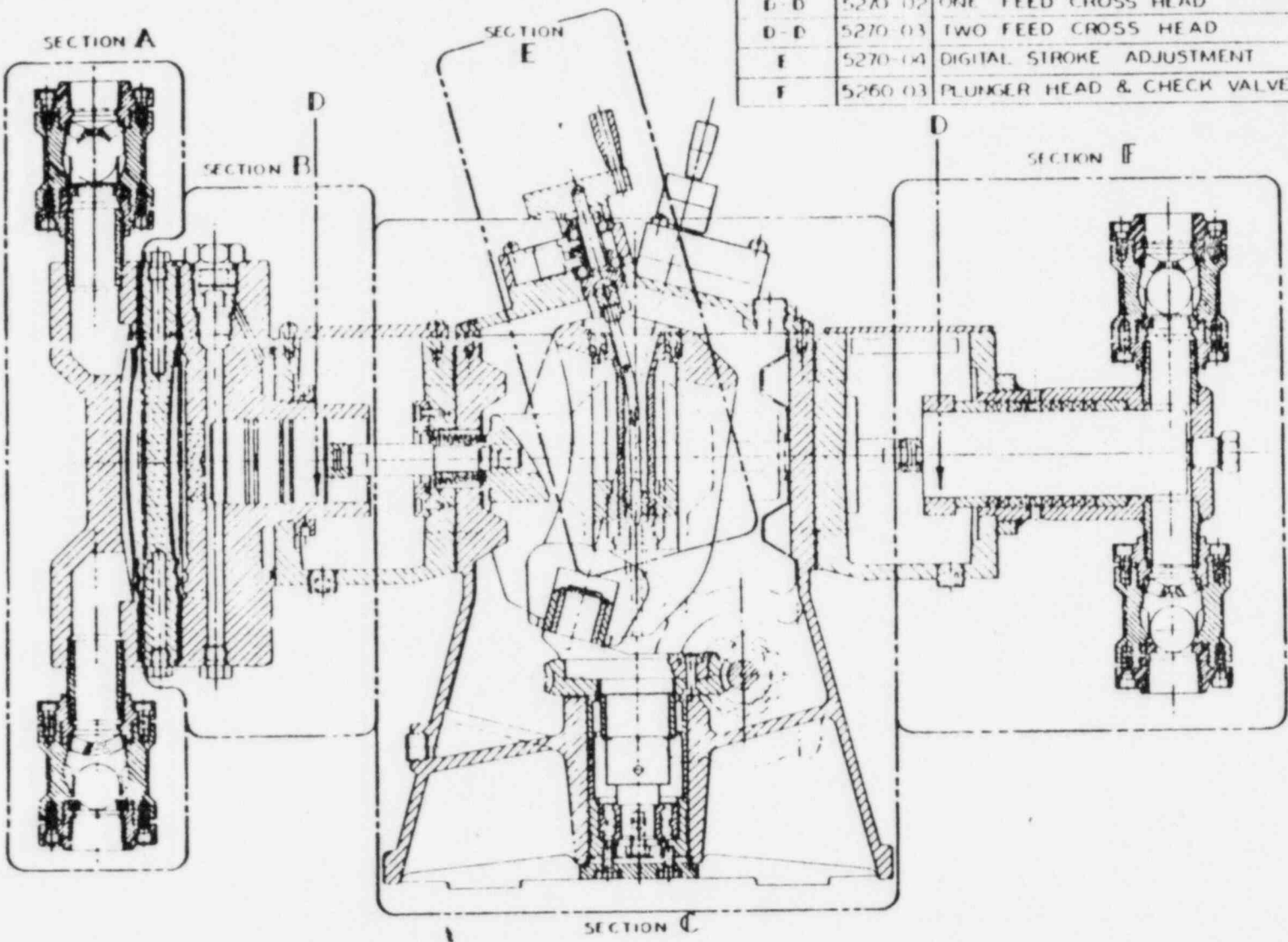

PUMP PRODUCT DRAWING

Drawn By: A.V.
Checked By: A.V.
DATE: 5/5/77
DWG. NO.: 5212.01
REV:

TITLE

DurcoMeter P/D 1 PUMP

PLUNGER, HEAD & CHECK VALVES

PARTS IDENTIFICATION ASSEMBLY (SECTION F OF 5212-01)

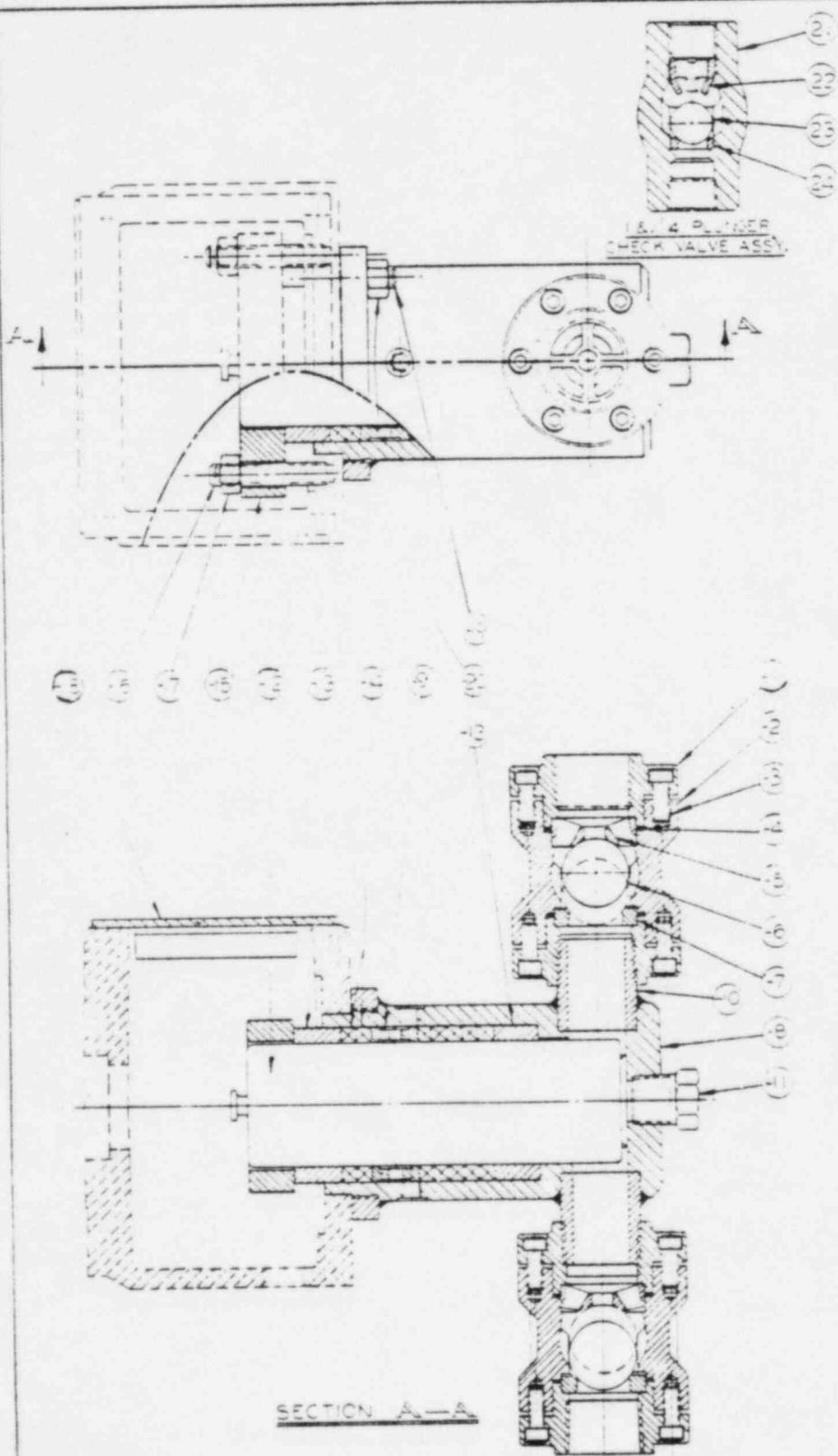

DESCRIPTION		QTY
4250-04 IN-LINE CV ASSY		2
-1	CAP	2
-2	BODY	1
-3	CAP SCREW	12
-4	GASKET	2
-5	BALL STOP	
-6	BALL	
-7	BALL SEAT	1
5260-03 PLGR & HEAD ASSY		1
-8	PUMP BODY	1
-9	LANTERN RING	
-10	PIPE NIPPLE	2
-11	PIPE PLUG	1
-12	PLUNGER	1
-13	PLUNGER BUSHING	2
-14	PACKING SET	1
-15	GLAND	1
-16	STUD	2
-17	HEX NUT	2
-18	COVER GUMP	1
-19	STUD	4
-20	HEX NUT	4
5000-01 IN-LINE CV ASSY		2
-21	BODY	1
-22	BALL STOP	1
-23	BALL	1
-24	BALL SEAT	1

SECTION A-A

FBI

PUMP PRODUCT DRAWING

DRN ELAY	
APPYD W/WR	
DATE 4-2-77	
DWG NO	REV
5260-03	A

QUANTITY	DESCRIPTION	REF.	DESCRIPTION	REF.
1	1250-01 IN-LINE CV HEAD	1	5200-01 IN-LINE CV ASSY	2
1	1250-02 IN-LINE CV HEAD	3	5200-02 IN-LINE CV ASSY	3
1	1250-03 IN-LINE CV HEAD	4	5200-03 IN-LINE CV ASSY	4
1	1250-04 IN-LINE CV HEAD	5	5200-04 IN-LINE CV ASSY	5
1	1250-05 IN-LINE CV HEAD	6	5200-05 IN-LINE CV ASSY	6
1	1250-06 IN-LINE CV HEAD	7	5200-06 IN-LINE CV ASSY	7
1	1250-07 IN-LINE CV HEAD	8	5200-07 IN-LINE CV ASSY	8
1	1250-08 IN-LINE CV HEAD	9	5200-08 IN-LINE CV ASSY	9
1	1250-09 IN-LINE CV HEAD	10	5200-09 IN-LINE CV ASSY	10
1	1250-10 IN-LINE CV HEAD	11	5200-10 IN-LINE CV ASSY	11

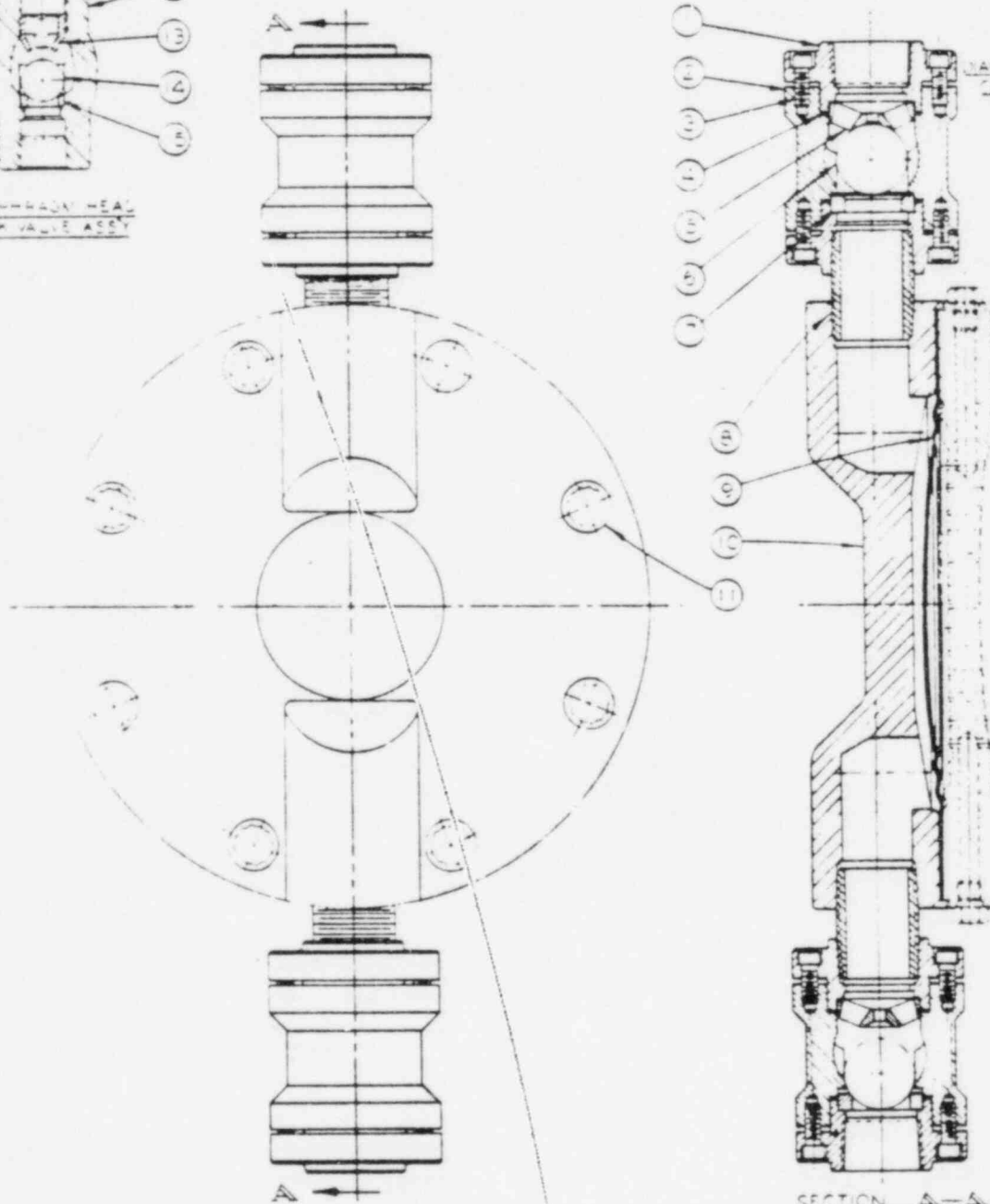
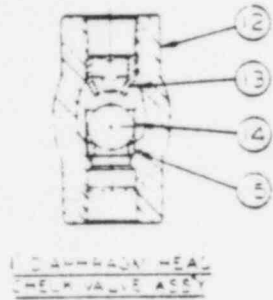

5/812
DIAPHRAGM HEAD
CHECK VALVE
ASSY

FPI

PUMP PRODUCT DRAWING

DRN B. LAY	REV.
APPVD [Signature]	A
DATE 11/23/70	
DWG NO. 15260-01	

TITLE

DurcoMeter P/D I PUMP

DAP-BAGM & HYDRAULIC HEAD

PARTS IDENTIFICATION ASSEMBLY SECTION B OF 5212-01

ITEM	DESCRIPTION	QTY	ITEM	DESCRIPTION	QTY	ITEM	DESCRIPTION	QTY
1	O-RING	1	22	SPRING	1	41	O-RING	1
2	O-RING	1	23	WASHER	1	42	ELEMENT	1
3	WASHER	1	24	ADJ. NUT	1	43	SPRING	1
4	WASHER	1	25	O-RING	1	44	SPRING FOLLOWER	1
5	O-RING	1	26	O-RING	1	45	WASHER	1
6	O-RING	1	27	ADJ. FOLLOWER	1	46	O-RING	1
7	O-RING	1	28	CAP SCREW	4	47	BODY	1
8	O-RING	1	29	DAPH. BODY	1	48	LOCKNUT	1
9	O-RING	1	30	LOCATING PIN	1	49	SET SCREW	1
10	O-RING	1	31	O-RING	1	50	CAP	1
11	O-RING	1	32	LOWER BODY	1	51	BALL	1
12	O-RING	1	33	SPRING	1	52	BODY	1
13	O-RING	1	34	O-RING	1	53	ADJ. SCREW	1
14	O-RING	1	35	UPPER BODY	1	54	GASKET	1
15	O-RING	1	36	O-RING	1	55	SPRING	1
16	O-RING	1	37	SPRING FOLLOWER	1	56	O-RING	1
17	O-RING	1	38	JAW NUT	1	57	O-RING	1
18	O-RING	1	39	ADJ. SCREW	1	58	BALL SEAT INSERT	1
19	O-RING	1	40	ELEMENT	1	59	WASHER	1
20	O-RING	1	41	O-RING	1	60	CAP	1

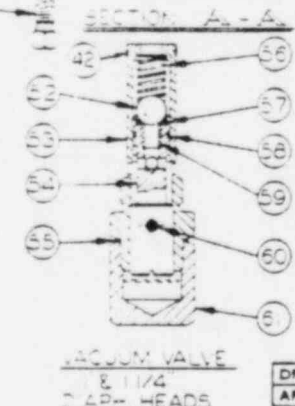
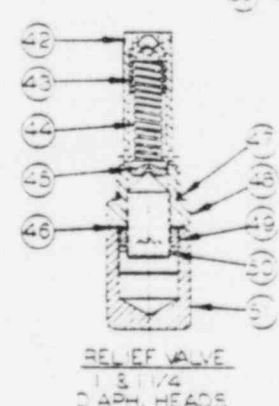
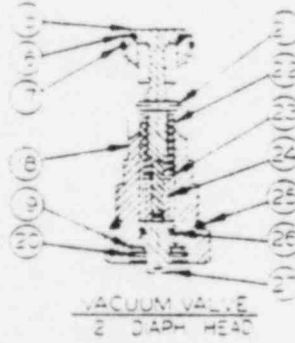
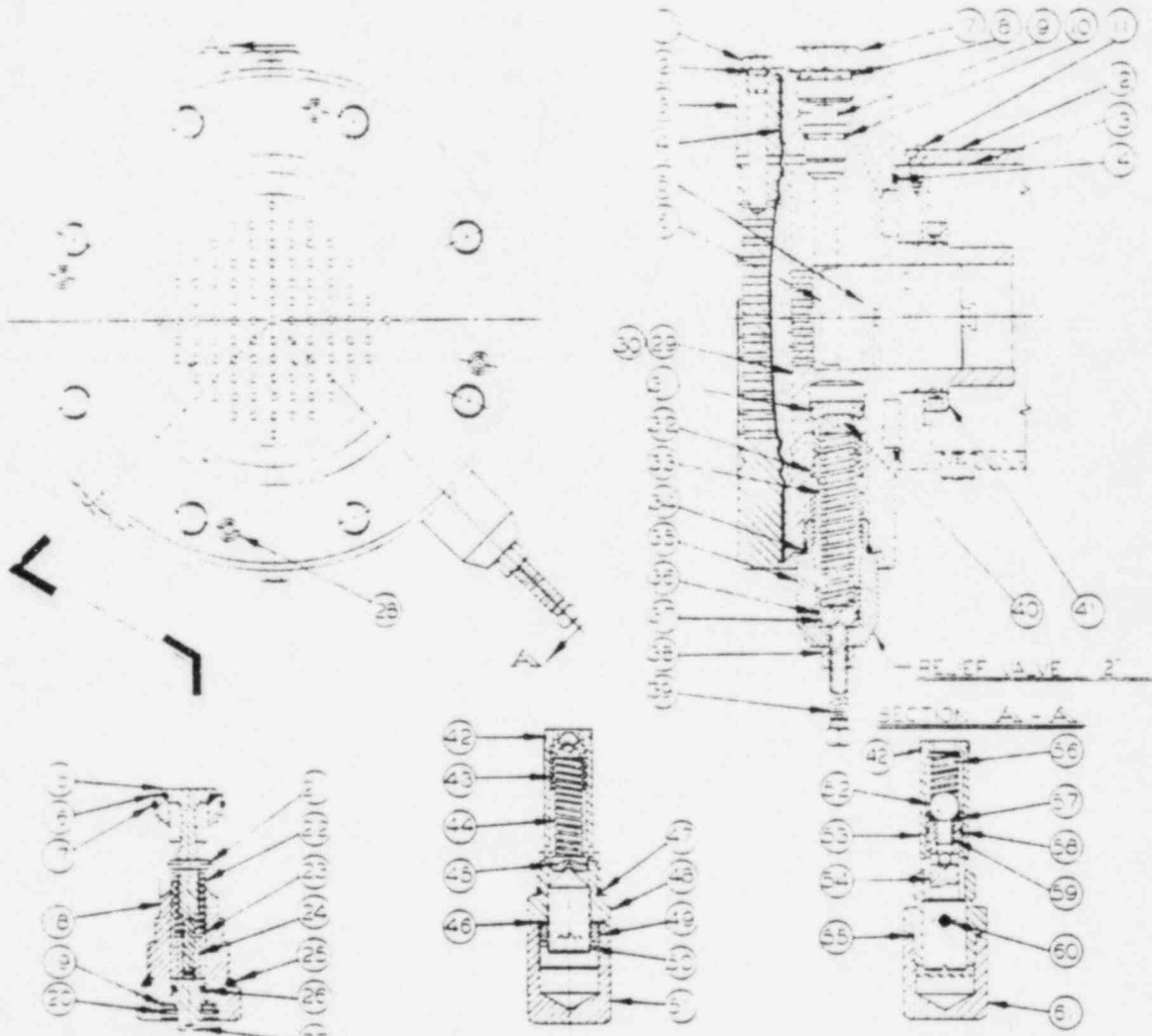

DRN	AW	CK	CCJ
APPVD.			
DATE	3-74		
DWG. NO.	15260-04		
REV.	A		

PUMP PRODUCT DRAWING

PPI

TITLE

DurcoMeter P/O I PUMP DIGITAL STROKE ADJUSTMENT

PARTS IDENTIFICATION ASSEMBLY (SECTION E OF 5212-01)

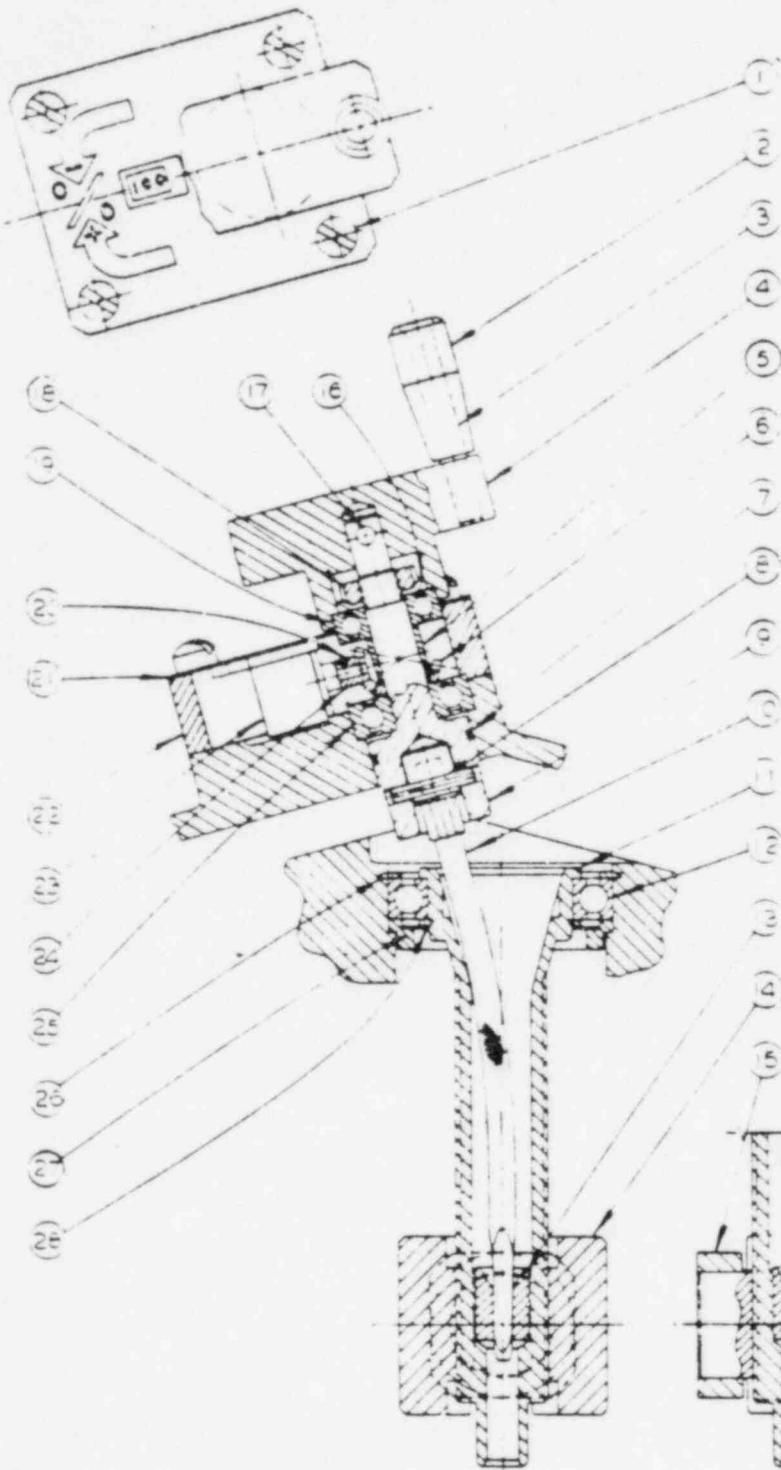

ITEM	DESCRIPTION	NO REQ
1	CAP SCREW	4
2	SPIN KNOB	
3	PIN	
4	HANDLE	
5	SPACER	
6	DRIVE GEAR	1
7	O-RING	
8	ROLL PIN	
9	STROKE ADJ SHAFT	
10	FLEXIBLE SHAFT	1
11	STROKE ADJ SCREW	1
12	BEARING	1
13	COUPLING-FLEX SHAFT	1
14	DRIVE KNUCKLE NUT	1
15	SLIDING BLOCK	2
16	LOCK WASHER	1
17	ROLL PIN	1
18	BEARING NUT	1
19	BEARING	
20	SET SCREW	
21	INDICATOR PLATE	1
22	MOUNTING BLOCK	
23	COUNTERS A OR B	1
24	PINION	1
25	BEARING	
26	RETAINING RING	1
27	SLEEVE	
28	RETAINING RING	

COUNTERS

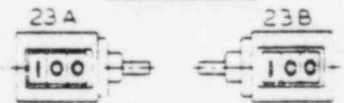

DRW: E. Ay
 APPVD: A. W. 44
 DATE: 5/30/74
 DWG. NO: 5270-04
 REV:

P01

PUMP PRODUCT DRAWING

TITLE

DurcoMeter 2 1/2" I.P.V. TWO FEET OF 10" HEAD

PARTS IDENTIFICATION ASSEMBLY SECTION (PART OF 5270-01)

ITEM	DESCRIPTION	QTY	DESCRIPTION	NO. REQ.
1	CAP SCREW	2	O-RING	2
2	SPACER COUPLING	2	END RETAINER	2
3	ADJUSTING SCREW	2	CAP SCREW	2
4	CAP SCREW	2	PIPE BLOC	2
5	SPACER BLOCK	2	EXTENSION GAUGE	2
6	SPACER BLOCK	2	GASKET	2
7	SPACER BLOCK	2	CAP SCREW	4
			GASKET	2

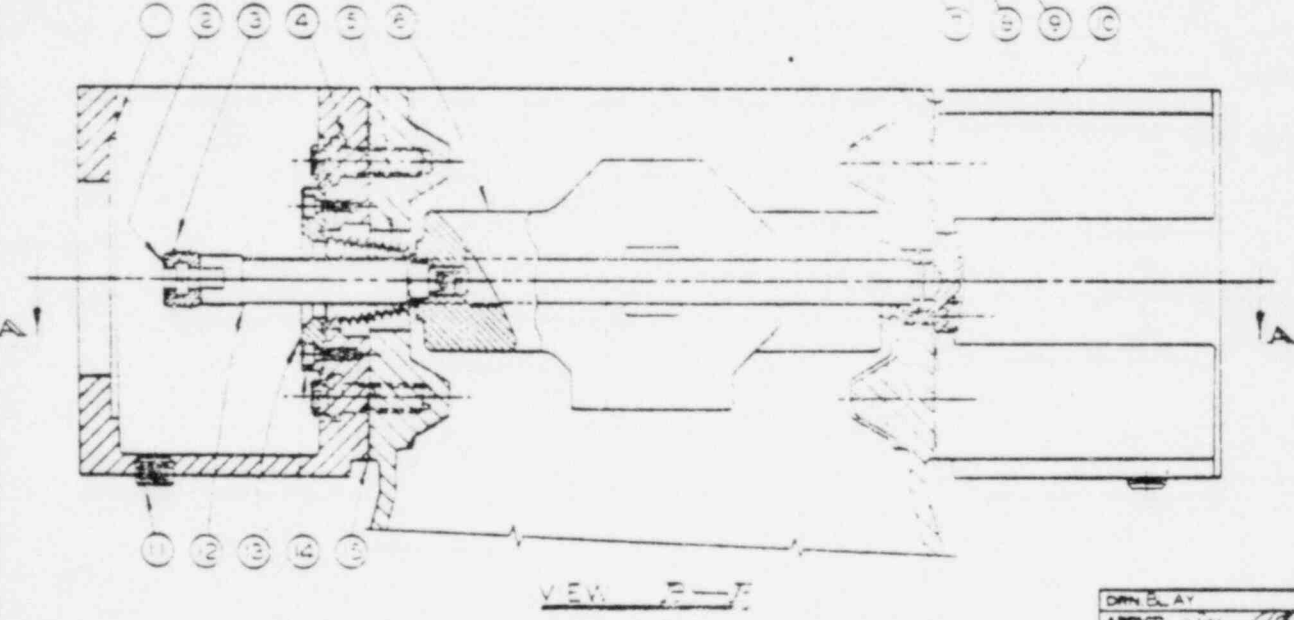
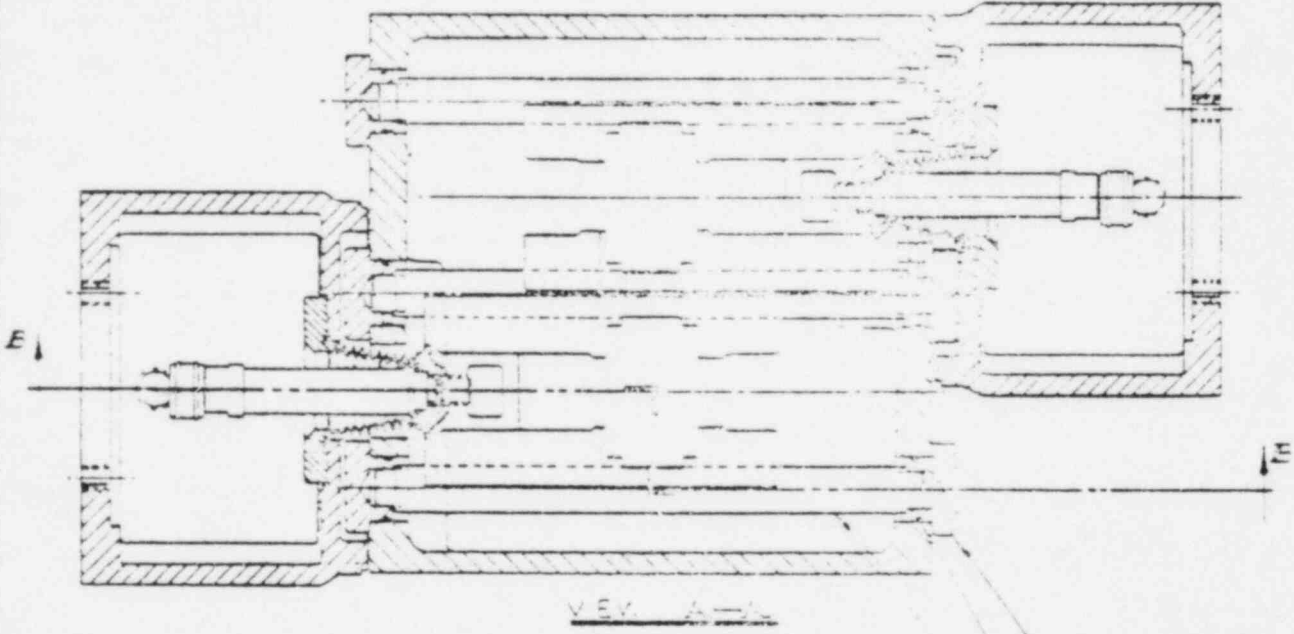

PEE

PUMP PRODUCT DRAWING

DRAWN BY
 APPROV. *[Signature]*
 DATE 9-25-53
 DWG NO. 5270-03
 REV.

TITLE

DurcoMeter F/D I PUMP ONE FEED CROSS-HEAD

PARTS IDENTIFICATION ASSEMBLY (SECTION D-D OF 5212-01)

ITEM	DESCRIPTION	NO. REQ.	ITEM	DESCRIPTION	NO. REQ.
	END PLATE	1	1	GUIDE BLOCK	2
2	GASKET	1	2	O RING	1
3	COVER	1	3	END RETAINER	4
4	GASKET	2	4	CAP SCREW	4
5	DRIP SUMP		5	CAP SCREW	10
6	SPLIT COUPLING	1	6	PIPE PLUG	1
7	RETAINING RING	2	7	EXTENSION SHAFT	1
8	CAP SCREW	4	8	PLATE	
9	BELLOWS BOOT	1	9	CAP SCREW	2
10	CROSS HEAD	1			

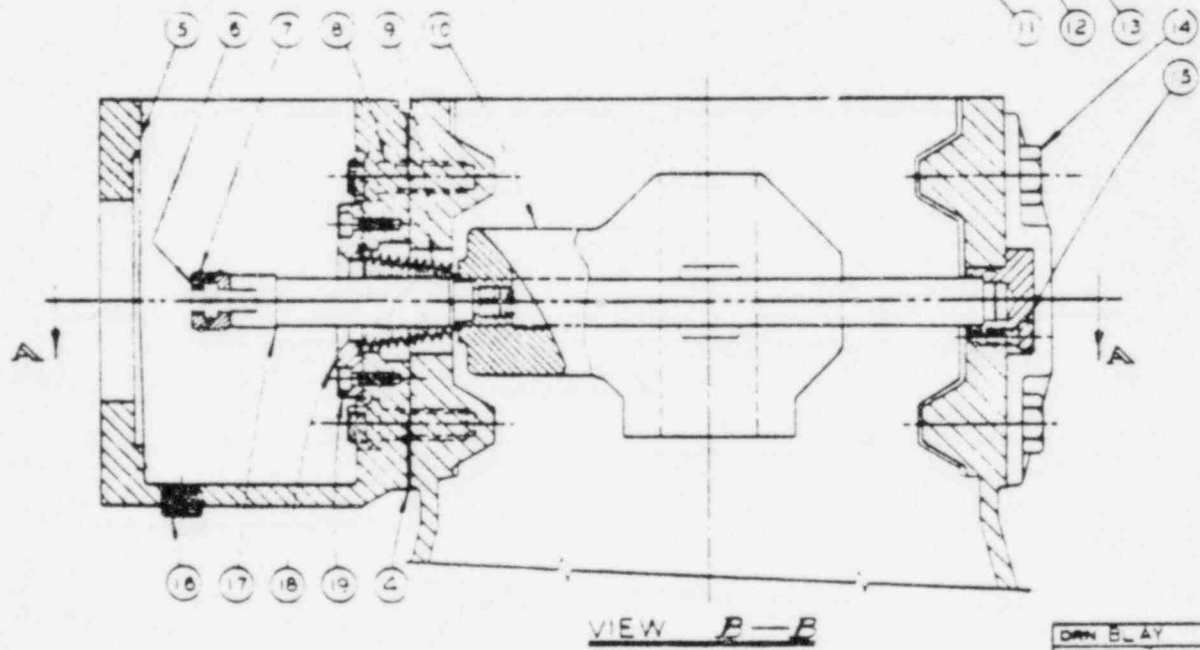
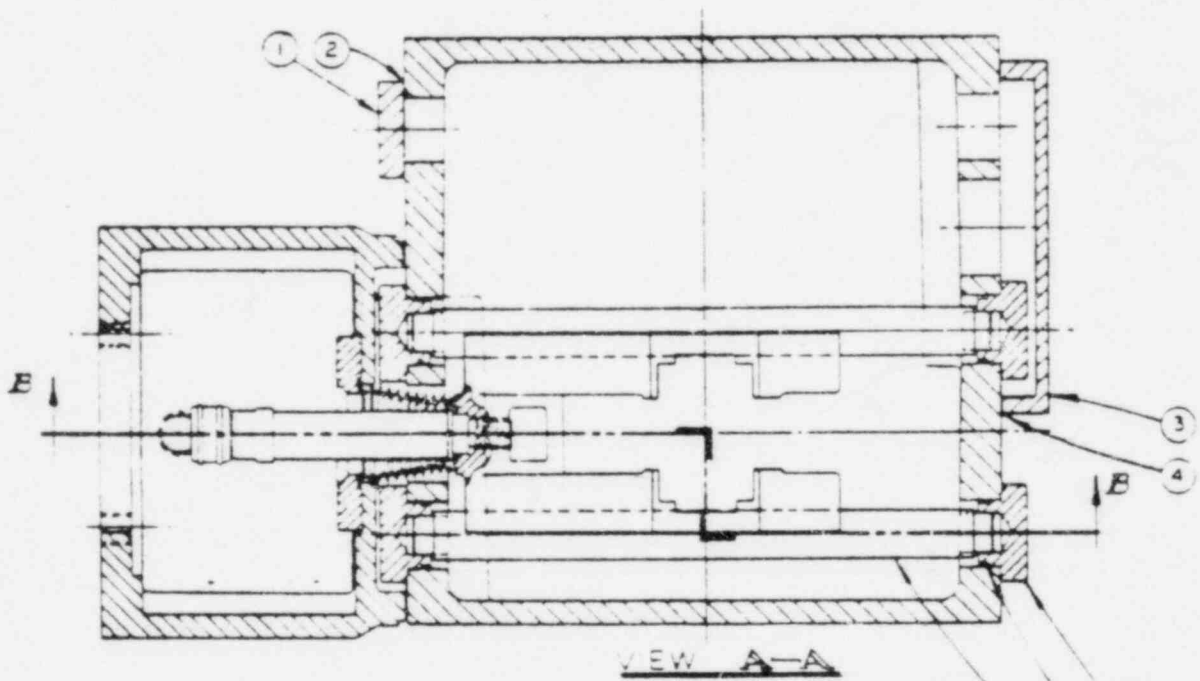

DRW B. LAY
 APPVD [Signature]
 DATE 9/23/70
 DWG NO 5270-02
 REV.

PUMP PRODUCT DRAWING

PDT

TITLE

DISCOMBURY P-1 PUMP - SINGLE EXTENSION DRIVE CASE

PARTS IDENTIFICATION ASSEMBLY (SECTION 1 OF 5270-01)

ITEM	DESCRIPTION	ITEM	DESCRIPTION	ITEM	DESCRIPTION	NO. REQ.
1	DRIVE CASE	1	RETAINING RING	1	DRIVE CASE	1
2	DRIVE CASE BRACKET	2	KEY	2	DRIVE CASE BRACKET	2
3	DRIVE CASE BRACKET	3	KEY	3	DRIVE CASE BRACKET	3
4	DRIVE CASE BRACKET	4	KEY	4	DRIVE CASE BRACKET	4
5	DRIVE CASE BRACKET	5	KEY	5	DRIVE CASE BRACKET	5
6	DRIVE CASE BRACKET	6	KEY	6	DRIVE CASE BRACKET	6
7	DRIVE CASE BRACKET	7	KEY	7	DRIVE CASE BRACKET	7
8	DRIVE CASE BRACKET	8	KEY	8	DRIVE CASE BRACKET	8
9	DRIVE CASE BRACKET	9	KEY	9	DRIVE CASE BRACKET	9
10	DRIVE CASE BRACKET	10	KEY	10	DRIVE CASE BRACKET	10
11	DRIVE CASE BRACKET	11	KEY	11	DRIVE CASE BRACKET	11
12	DRIVE CASE BRACKET	12	KEY	12	DRIVE CASE BRACKET	12
13	DRIVE CASE BRACKET	13	KEY	13	DRIVE CASE BRACKET	13
14	DRIVE CASE BRACKET	14	KEY	14	DRIVE CASE BRACKET	14
15	DRIVE CASE BRACKET	15	KEY	15	DRIVE CASE BRACKET	15
16	DRIVE CASE BRACKET	16	KEY	16	DRIVE CASE BRACKET	16
17	DRIVE CASE BRACKET	17	KEY	17	DRIVE CASE BRACKET	17
18	DRIVE CASE BRACKET	18	KEY	18	DRIVE CASE BRACKET	18
19	DRIVE CASE BRACKET	19	KEY	19	DRIVE CASE BRACKET	19
20	DRIVE CASE BRACKET	20	KEY	20	DRIVE CASE BRACKET	20
21	DRIVE CASE BRACKET	21	KEY	21	DRIVE CASE BRACKET	21
22	DRIVE CASE BRACKET	22	KEY	22	DRIVE CASE BRACKET	22
23	DRIVE CASE BRACKET	23	KEY	23	DRIVE CASE BRACKET	23
24	DRIVE CASE BRACKET	24	KEY	24	DRIVE CASE BRACKET	24
25	DRIVE CASE BRACKET	25	KEY	25	DRIVE CASE BRACKET	25
26	DRIVE CASE BRACKET	26	KEY	26	DRIVE CASE BRACKET	26
27	DRIVE CASE BRACKET	27	KEY	27	DRIVE CASE BRACKET	27
28	DRIVE CASE BRACKET	28	KEY	28	DRIVE CASE BRACKET	28
29	DRIVE CASE BRACKET	29	KEY	29	DRIVE CASE BRACKET	29
30	DRIVE CASE BRACKET	30	KEY	30	DRIVE CASE BRACKET	30
31	DRIVE CASE BRACKET	31	KEY	31	DRIVE CASE BRACKET	31
32	DRIVE CASE BRACKET	32	KEY	32	DRIVE CASE BRACKET	32
33	DRIVE CASE BRACKET	33	KEY	33	DRIVE CASE BRACKET	33
34	DRIVE CASE BRACKET	34	KEY	34	DRIVE CASE BRACKET	34
35	DRIVE CASE BRACKET	35	KEY	35	DRIVE CASE BRACKET	35
36	DRIVE CASE BRACKET	36	KEY	36	DRIVE CASE BRACKET	36
37	DRIVE CASE BRACKET	37	KEY	37	DRIVE CASE BRACKET	37
38	DRIVE CASE BRACKET	38	KEY	38	DRIVE CASE BRACKET	38
39	DRIVE CASE BRACKET	39	KEY	39	DRIVE CASE BRACKET	39
40	DRIVE CASE BRACKET	40	KEY	40	DRIVE CASE BRACKET	40
41	DRIVE CASE BRACKET	41	KEY	41	DRIVE CASE BRACKET	41
42	DRIVE CASE BRACKET	42	KEY	42	DRIVE CASE BRACKET	42
43	DRIVE CASE BRACKET	43	KEY	43	DRIVE CASE BRACKET	43
44	DRIVE CASE BRACKET	44	KEY	44	DRIVE CASE BRACKET	44
45	DRIVE CASE BRACKET	45	KEY	45	DRIVE CASE BRACKET	45
46	DRIVE CASE BRACKET	46	KEY	46	DRIVE CASE BRACKET	46
47	DRIVE CASE BRACKET	47	KEY	47	DRIVE CASE BRACKET	47
48	DRIVE CASE BRACKET	48	KEY	48	DRIVE CASE BRACKET	48
49	DRIVE CASE BRACKET	49	KEY	49	DRIVE CASE BRACKET	49
50	DRIVE CASE BRACKET	50	KEY	50	DRIVE CASE BRACKET	50
51	DRIVE CASE BRACKET	51	KEY	51	DRIVE CASE BRACKET	51
52	DRIVE CASE BRACKET	52	KEY	52	DRIVE CASE BRACKET	52
53	DRIVE CASE BRACKET	53	KEY	53	DRIVE CASE BRACKET	53
54	DRIVE CASE BRACKET	54	KEY	54	DRIVE CASE BRACKET	54
55	DRIVE CASE BRACKET	55	KEY	55	DRIVE CASE BRACKET	55
56	DRIVE CASE BRACKET	56	KEY	56	DRIVE CASE BRACKET	56
57	DRIVE CASE BRACKET	57	KEY	57	DRIVE CASE BRACKET	57
58	DRIVE CASE BRACKET	58	KEY	58	DRIVE CASE BRACKET	58
59	DRIVE CASE BRACKET	59	KEY	59	DRIVE CASE BRACKET	59
60	DRIVE CASE BRACKET	60	KEY	60	DRIVE CASE BRACKET	60
61	DRIVE CASE BRACKET	61	KEY	61	DRIVE CASE BRACKET	61
62	DRIVE CASE BRACKET	62	KEY	62	DRIVE CASE BRACKET	62
63	DRIVE CASE BRACKET	63	KEY	63	DRIVE CASE BRACKET	63
64	DRIVE CASE BRACKET	64	KEY	64	DRIVE CASE BRACKET	64
65	DRIVE CASE BRACKET	65	KEY	65	DRIVE CASE BRACKET	65
66	DRIVE CASE BRACKET	66	KEY	66	DRIVE CASE BRACKET	66
67	DRIVE CASE BRACKET	67	KEY	67	DRIVE CASE BRACKET	67
68	DRIVE CASE BRACKET	68	KEY	68	DRIVE CASE BRACKET	68
69	DRIVE CASE BRACKET	69	KEY	69	DRIVE CASE BRACKET	69
70	DRIVE CASE BRACKET	70	KEY	70	DRIVE CASE BRACKET	70
71	DRIVE CASE BRACKET	71	KEY	71	DRIVE CASE BRACKET	71
72	DRIVE CASE BRACKET	72	KEY	72	DRIVE CASE BRACKET	72
73	DRIVE CASE BRACKET	73	KEY	73	DRIVE CASE BRACKET	73
74	DRIVE CASE BRACKET	74	KEY	74	DRIVE CASE BRACKET	74
75	DRIVE CASE BRACKET	75	KEY	75	DRIVE CASE BRACKET	75
76	DRIVE CASE BRACKET	76	KEY	76	DRIVE CASE BRACKET	76
77	DRIVE CASE BRACKET	77	KEY	77	DRIVE CASE BRACKET	77
78	DRIVE CASE BRACKET	78	KEY	78	DRIVE CASE BRACKET	78
79	DRIVE CASE BRACKET	79	KEY	79	DRIVE CASE BRACKET	79
80	DRIVE CASE BRACKET	80	KEY	80	DRIVE CASE BRACKET	80
81	DRIVE CASE BRACKET	81	KEY	81	DRIVE CASE BRACKET	81
82	DRIVE CASE BRACKET	82	KEY	82	DRIVE CASE BRACKET	82
83	DRIVE CASE BRACKET	83	KEY	83	DRIVE CASE BRACKET	83
84	DRIVE CASE BRACKET	84	KEY	84	DRIVE CASE BRACKET	84
85	DRIVE CASE BRACKET	85	KEY	85	DRIVE CASE BRACKET	85
86	DRIVE CASE BRACKET	86	KEY	86	DRIVE CASE BRACKET	86
87	DRIVE CASE BRACKET	87	KEY	87	DRIVE CASE BRACKET	87
88	DRIVE CASE BRACKET	88	KEY	88	DRIVE CASE BRACKET	88
89	DRIVE CASE BRACKET	89	KEY	89	DRIVE CASE BRACKET	89
90	DRIVE CASE BRACKET	90	KEY	90	DRIVE CASE BRACKET	90
91	DRIVE CASE BRACKET	91	KEY	91	DRIVE CASE BRACKET	91
92	DRIVE CASE BRACKET	92	KEY	92	DRIVE CASE BRACKET	92
93	DRIVE CASE BRACKET	93	KEY	93	DRIVE CASE BRACKET	93
94	DRIVE CASE BRACKET	94	KEY	94	DRIVE CASE BRACKET	94
95	DRIVE CASE BRACKET	95	KEY	95	DRIVE CASE BRACKET	95
96	DRIVE CASE BRACKET	96	KEY	96	DRIVE CASE BRACKET	96
97	DRIVE CASE BRACKET	97	KEY	97	DRIVE CASE BRACKET	97
98	DRIVE CASE BRACKET	98	KEY	98	DRIVE CASE BRACKET	98
99	DRIVE CASE BRACKET	99	KEY	99	DRIVE CASE BRACKET	99
100	DRIVE CASE BRACKET	100	KEY	100	DRIVE CASE BRACKET	100

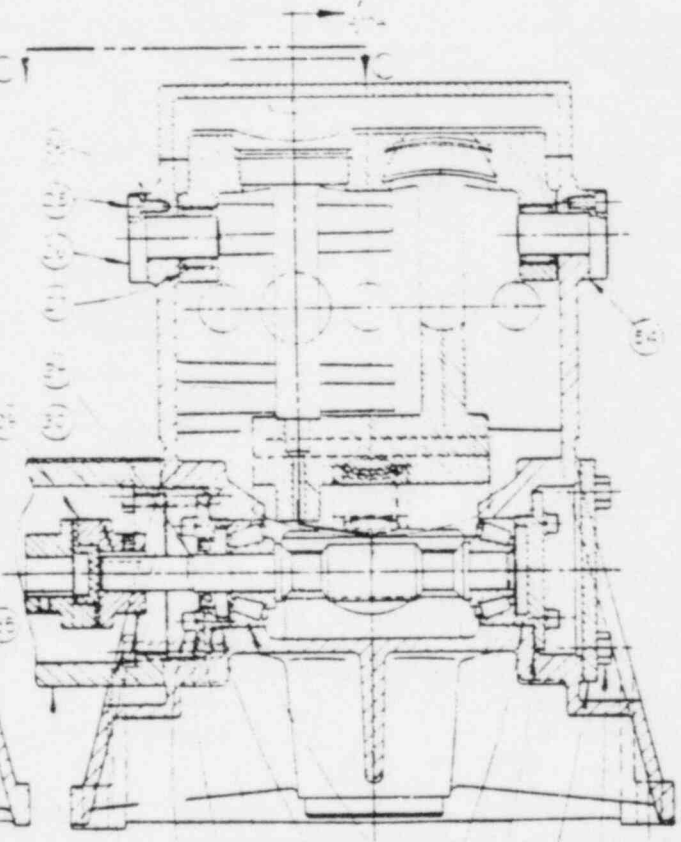
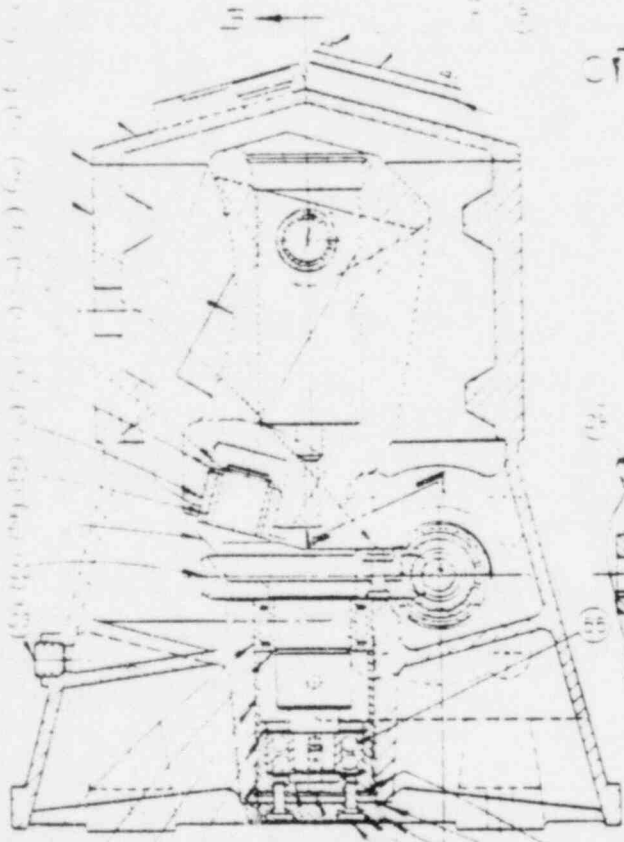
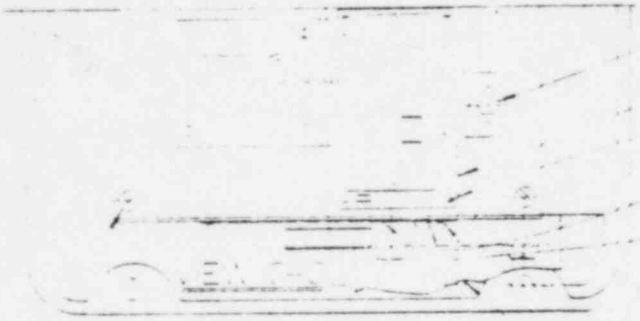

- (1)
- (2)
- (3)
- (4)
- (5)
- (6)
- (7)
- (8)
- (9)
- (10)
- (11)
- (12)
- (13)
- (14)
- (15)
- (16)
- (17)
- (18)
- (19)
- (20)
- (21)
- (22)
- (23)
- (24)
- (25)
- (26)
- (27)
- (28)
- (29)
- (30)
- (31)
- (32)
- (33)
- (34)
- (35)
- (36)
- (37)
- (38)
- (39)
- (40)
- (41)
- (42)
- (43)
- (44)
- (45)
- (46)
- (47)
- (48)
- (49)
- (50)
- (51)
- (52)
- (53)
- (54)
- (55)
- (56)
- (57)
- (58)
- (59)
- (60)
- (61)
- (62)
- (63)
- (64)
- (65)
- (66)
- (67)
- (68)
- (69)
- (70)
- (71)
- (72)
- (73)
- (74)
- (75)
- (76)
- (77)
- (78)
- (79)
- (80)
- (81)
- (82)
- (83)
- (84)
- (85)
- (86)
- (87)
- (88)
- (89)
- (90)
- (91)
- (92)
- (93)
- (94)
- (95)
- (96)
- (97)
- (98)
- (99)
- (100)

VIEW A-A

VIEW B-B

DRN BLAY
 APPVD 2/12/72
 DATE 2/16/72
 DWG NO 5270-0
 REV A

PUMP PRODUCT DRAWING

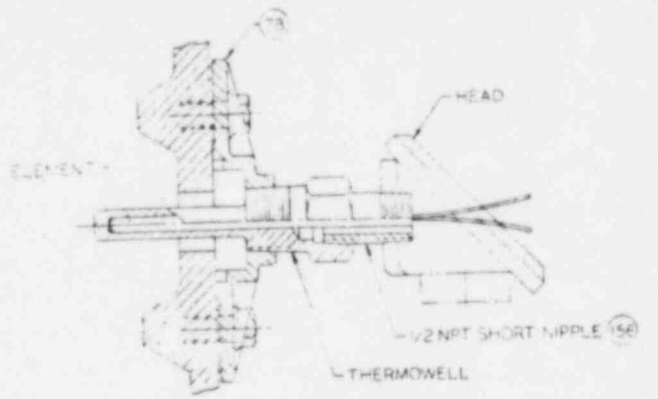

SECTIONAL VIEW
THERMOCOUPLE ASSEMBLY (157)

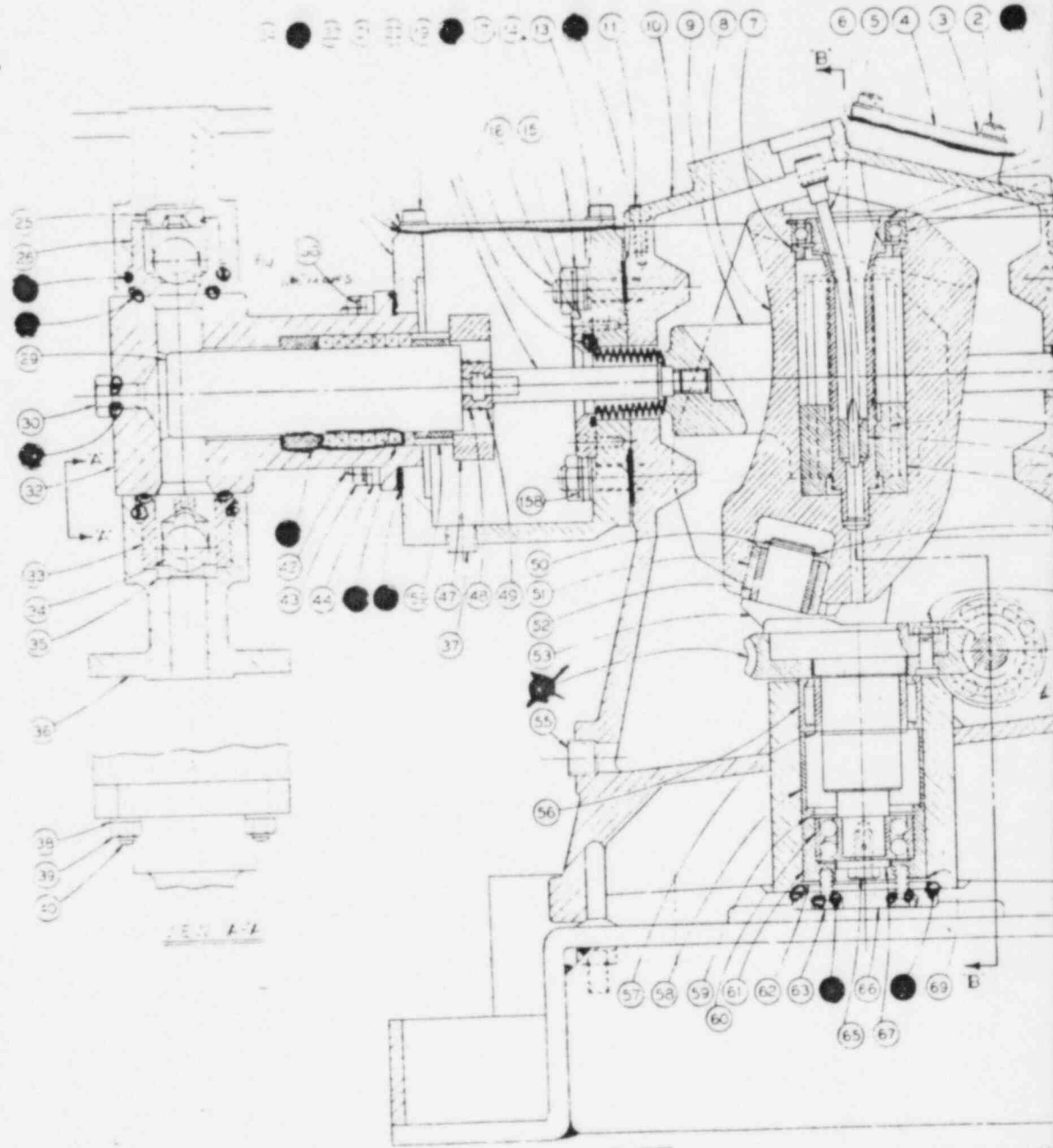

I certify that the design contained on this drawing was made in the normal and regular course of business at the date stated below and that it is an accurate reproduction of the drawings submitted to my agency.

30X

NOT
FOR
REPRODUCTION

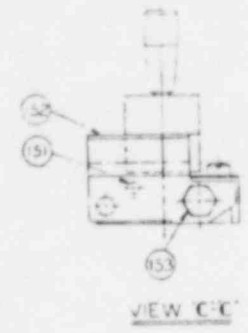
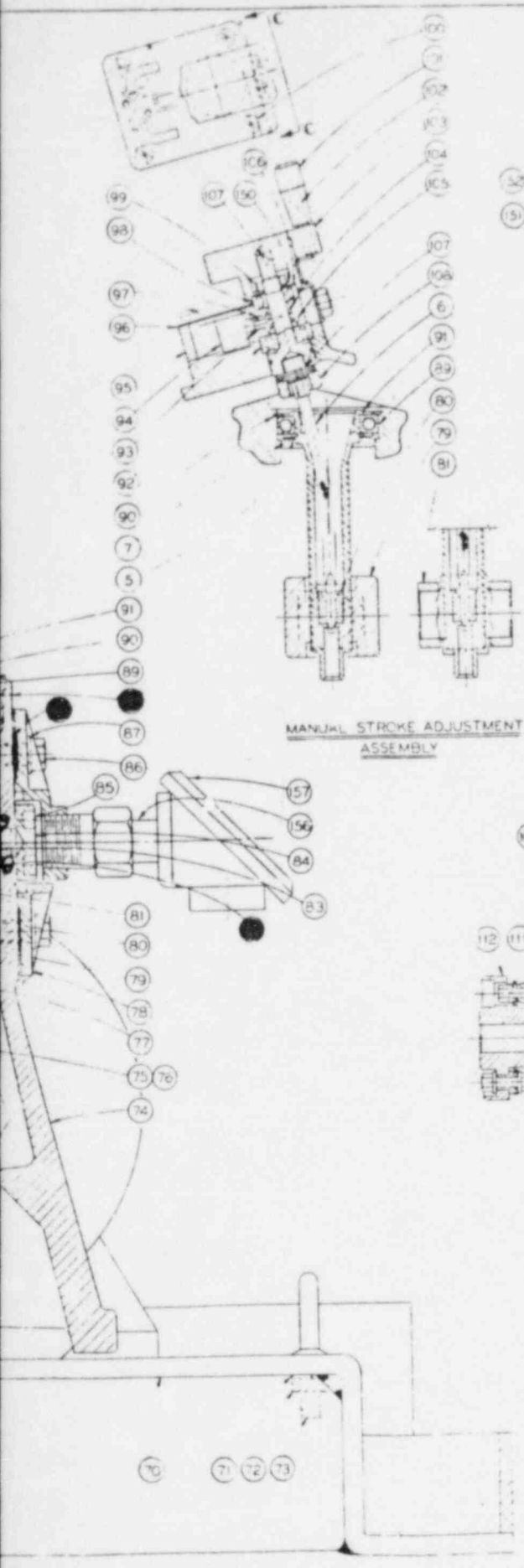

MANUAL STROKE ADJUSTMENT ASSEMBLY

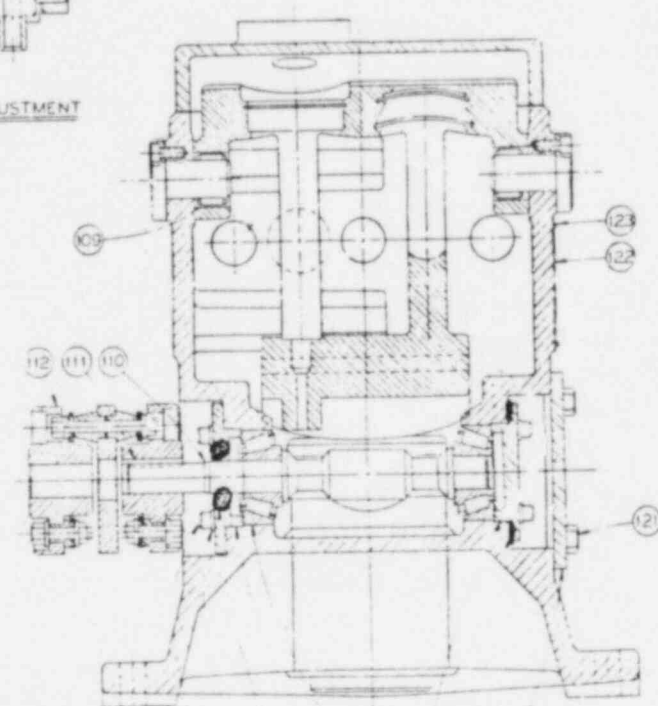

- 113
- 114
- 116
- 117
- 118
- 121

SECTION B-B

Pressure Release Control
 Manufactured by Hill's Maccanina
 Model J.C. Series

G-321-0
 Category J.C.A.A.

REV.	DESCRIPTION	DATE
1	ASSEMBLY	
2	REVISED TO SHOW THE CHANGE TO THE NEW DESIGN	
3	REVISED TO SHOW THE CHANGE TO THE NEW DESIGN	
4	REVISED TO SHOW THE CHANGE TO THE NEW DESIGN	

5221-12 D
 3-SHEET OF 4

NO.	DESCRIPTION	DATE
1	DESIGNED BY	
2	CHECKED BY	
3	APPROVED BY	
4	DATE	

REFERENCE DRAWINGS 5221-14 & 5221-15
 FOR PART NUMBERS, MATERIAL AND
 COMPLEMENTED SPARE PARTS

MOLAND PLANT, UNTS 1 & 2
 CONSUMERS POWER COMPANY
 POSITIVE RELEASEMENT
 HYDRAINE PLANS
 P.O. #7220-M-37-1-1

HILL'S-MACCANINA COMPANY	
DESIGNED BY	
CHECKED BY	
APPROVED BY	
DATE	
SCALE	
WORKING DRAWING	

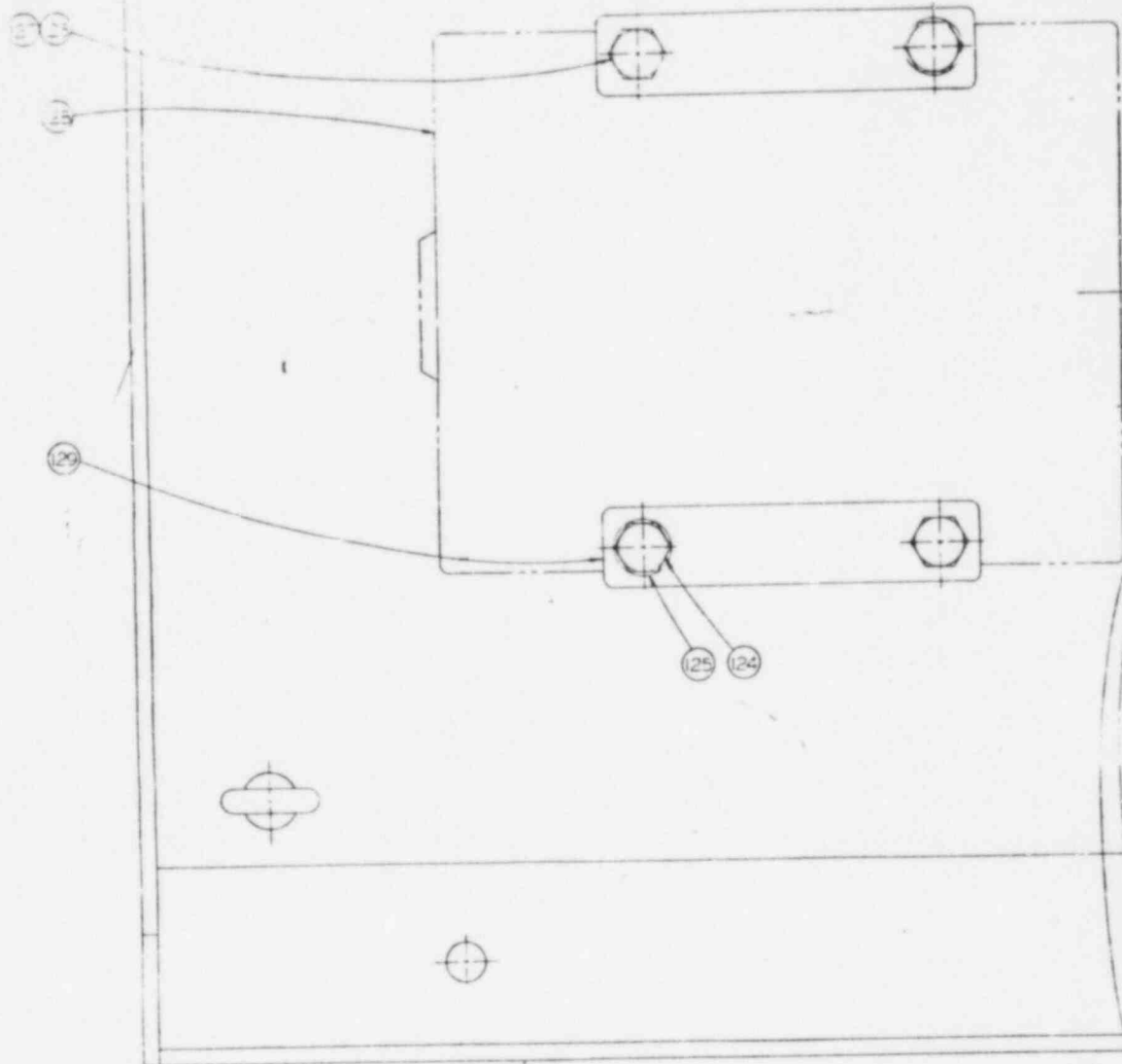

NOTE:
 REFERENCE DRAWINGS 5221-14 & 5221-
 FOR PART NUMBERS, MATERIAL AND
 RECOMMENDED SPARE PARTS.

I certify that the image contains
 was made in the normal and
 business, all the data stored
 an accurate reproduction of
 submitted to "microfilm".

127
 Date: _____
 12/1988

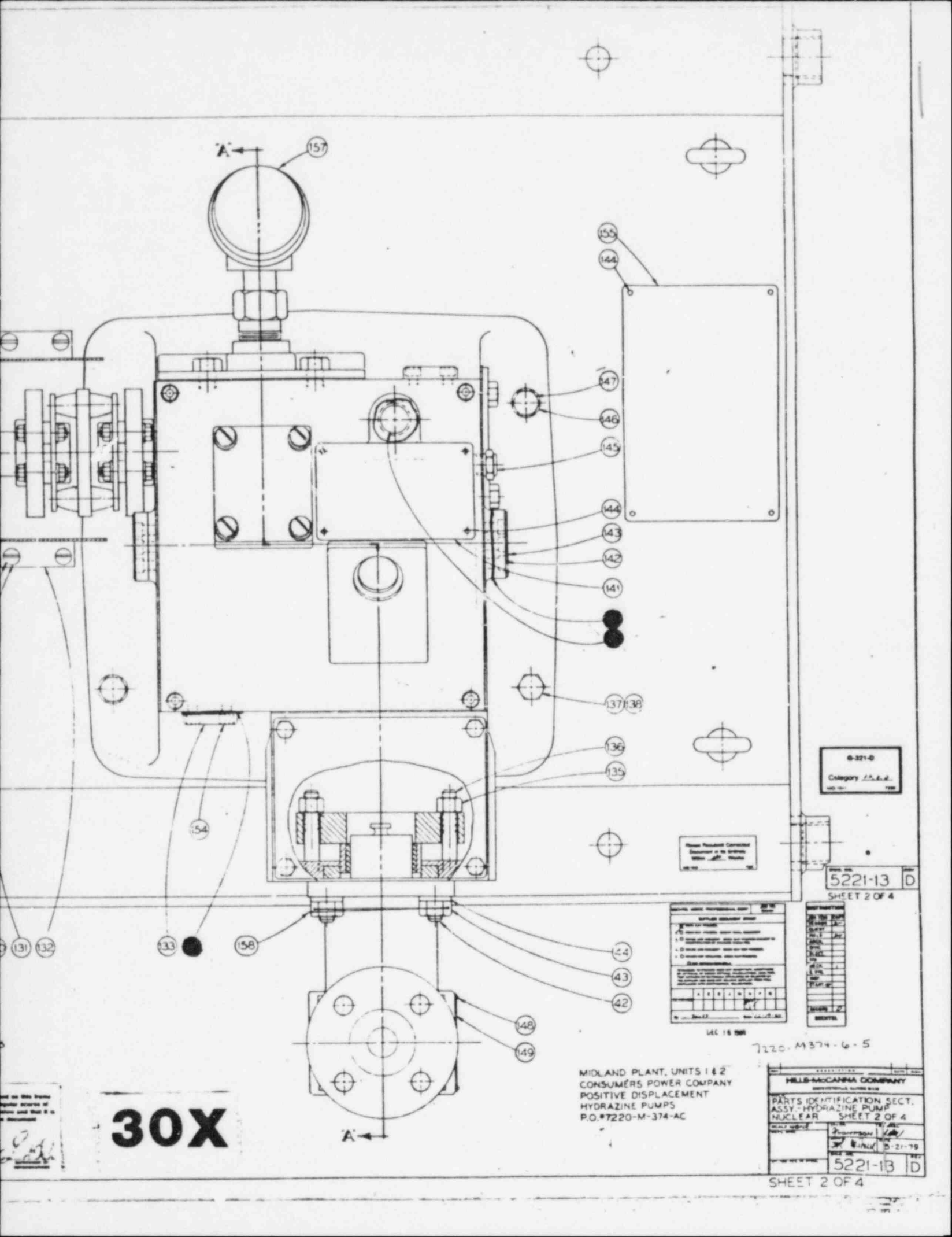

30X

MIDLAND PLANT, UNITS 1 & 2
 CONSUMERS POWER COMPANY
 POSITIVE DISPLACEMENT
 HYDRAZINE PUMPS
 P.O. #7220-M-374-AC

MILB-MCCANNIA COMPANY	
PARTS IDENTIFICATION SECT.	
ASSY - HYDRAZINE PUMP	
NUCLEAR SHEET 2 OF 4	
REV	DATE
1	10-21-79
5221-13 D	

SHEET 2 OF 4

0-321-0
 Category J.S.L.2

5221-13 D
 SHEET 2 OF 4

REV	DATE
1	10-21-79

DEC 16 1968

7220-M374-6-5

-LIST OF MATERIALS-

QTY	DESCRIPTION	PART NO	VENDOR NAME	VENDOR PART NO	UNIT	PRICE	TOTAL	MATERIAL
2	GASKET, STROKE ADJ. COVER	53-43-0400	HILLS-McCANNA	53-43-0400	2	2.15		SYNTHETIC RUBBER
4	CAP SCR. 1/4-20X 50F LL HD	902-2204-02E	VARIOUS	W/A				STEEL GR. 5
4	3/8 HI COLLAR LOCKWASHER	935-2201-11E	VARIOUS	W/A				STEEL GR. 87
1	COVER BLANK	53-19-0600-025	HILLS-McCANNA	53-19-0600-025				STEEL C1018
1	RETAINING RING	959-2805-74A	WALDES KOHINOOR	TRUARC MS102-137	1	1.90		SPRING STEEL HIGH C
1	FLEXIBLE SHAFT	52-15-0200	HILLS-McCANNA	52-15-0200				STEEL
1	SLEEVE ADJ. KNUCKLE	52-12-0200	HILLS-McCANNA	52-12-0200				LEDLOY 300
1	HANGER BRACKET	52-08-0300-001	HILLS-McCANNA	52-08-0300-001				CAST IRON
1	CROSS HEAD	52-11-0200	HILLS-McCANNA	52-11-0200				CAST IRON
1	COVER DRIVE CASE	52-19-0500-120	HILLS-McCANNA	52-19-0500-120				DUCTILE IRON NS-120
1	CAP SCR. 1/4-20X 43F LL HD	902-2221-02E	VARIOUS	W/A				STEEL GR. 5
1	GASKET - SUNP	52-43-0100	HILLS-McCANNA	52-43-0100	2	4.30		CORK COMPOSITION
1	3/8 HI COLLAR LOCKWASHER	935-2401-11P	VARIOUS	W/A				STEEL GR. 87
1	7/16-18 UNC HXY HEX NUT	52-81-0500-3P	VARIOUS	W/A	2	65.00		ASME SA-194 GR 2
1	1/2-20X 50 SOCKET HD	902-2221-11P	VARIOUS	W/A				STEEL GR. 87
1	3/8 HI COLLAR LOCKWASHER	935-2203-11E	VARIOUS	W/A				STEEL GR. 87
1	PLATE-BELLOWS ROOT	52-22-0200-024	HILLS-McCANNA	52-22-0200-024				STEEL LEDLOY AX
1	7/16-18UNCX2 12 LG. STUD	52-82-2100-7M	HILLS-McCANNA	52-82-2100-7M	2	127.10		ASME SA-984 GR. 830
1	BELLOWS ROOT	52-33-0100	HILLS-McCANNA	52-33-0100	2	83.80		SYNTHETIC RUBBER
1	EXTENSION SHAFT ASSY	52-72-2500	HILLS-McCANNA	52-72-2500				55416
1	CAP SCR. 1/4-20X 50 FEA	901-2203-02E	VARIOUS	W/A				STEEL GR. 5
1	25 HI COLLAR LOCKWASHER	935-2201-11E	VARIOUS	W/A				STEEL GR. 87
1	SUMP COVER	52-19-2500-024	HILLS-McCANNA	52-19-2500-024				STEEL C1018
1	SUMP COVER GASKET	52-43-0200	HILLS-McCANNA	52-43-0200	2	4.30		SYNTHETIC RUBBER
1	SUMP, FINISHED	52-07-2400-2M	HILLS-McCANNA	52-07-2400-2M				ASTM A216 GR PCB
1	BALL STOP INSERT	42-38-0208-15	HILLS-McCANNA	42-38-0208-15	2	693.30		ASME SA479 5530AL
1	BALL GUIDE SEAT	52-39-0500-15	HILLS-McCANNA	52-39-0500-15	2	231.10		ASME SA479 5530AL
1	40" RING	952-0131-770	PARKER	2-131 OR EQUIV.	4	80		ETHYLENE PRO. - PYLENE
1	40" RING	952-0131-770	PARKER	2-125 OR EQUIV.	4	80		ETHYLENE PRO. - PYLENE
1	40" RING	52-01-0215-15	HILLS-McCANNA	52-01-0215-15	2	228.60		ASME SA479 5530AL
1	PLUNGER	52-82-2000-15	HILLS-McCANNA	52-82-2000-15				ASME SA479 5530AL
1	40" RING PLUG	952-0808-770	PARKER	3-808 OR EQUIV.	2	2.00		ETHYLENE PRO. - PYLENE
1	40" RING	52-07-0515-15	HILLS-McCANNA	52-07-0515-15				ASME SA479 5530AL
1	PLUNGER BODY	52-39-0400-15	HILLS-McCANNA	52-39-0400-15	2	231.10		ASME SA479 5530AL
1	BALL GUIDE & STOP	969-2801-300	IND. TECHTOMICS	W/A	4	71.50		ALUMINA CERAMIC
1	BALL - 875 DIA.	42-27-0108-15	HILLS-McCANNA	42-27-0108-15	2	191.80		ASME SA479 5530AL
1	CHECK VALVE SEAT	52-41-0800-15	HILLS-McCANNA	52-41-0800-15				STEEL GR. 5
1	BODY SUCTION & DISCHARGE	970-2308-02P	VARIOUS	W/A				STEEL GR. 5
1	PIPE PLUG 3/8 NPT	935-2302-020	VARIOUS	W/A				STEEL GR. 5
1	3/16 HI COLLAR LOCKWASHER	919-2310-3P0	VARIOUS	W/A	2	65.00		ASME SA-194 GR 2
1	3/16-18 UNC HXY HEX NUT	52-82-1800-7M	HILLS-McCANNA	52-82-1800-7M	2	127.10		ASME SA-984 GR. 830
1	3/16-18 UNC X 1.81 LG. STUD	52-05-0115-11	HILLS-McCANNA	52-05-0115-11	1	71.80		GRAPHITAR GR111
1	THRUST BUSHING	52-82-2200-7M	HILLS-McCANNA	52-82-2200-7M	2	127.10		ASME SA-984 GR. 830
1	3/8-18 UNC X 1.81 LG. STUD	52-81-0700-3P	VARIOUS	W/A	2	65.00		ASME SA-194 GR 2
1	3/8-18 UNC HXY HEX NUT	955-2303-02E	VARIOUS	W/A				STEEL GR. 5
1	3/8 HI COLLAR LOCKWASHER	935-2303-02E	VARIOUS	W/A				STEEL GR. 5
1	PACKING SET	52-17-0115-415	JOHN CRANE	STYLE C-04	2SETS	46.80		NS-415
1	GASKET L.E. TO SUNP	52-43-1200	HILLS-McCANNA	52-43-1200	2	4.30		FIBERDIL
1	STUFFING BOX BLAND	52-03-0115-15	HILLS-McCANNA	52-03-0115-15	2	182.40		ASME SA479 5530AL
1	RETAINING RING COUPLING	52-35-0100	HILLS-McCANNA	52-35-0100	4	7.00		55304
1	SPLIT COUPLING	52-18-0100-007	HILLS-McCANNA	52-18-0100-007				55304
1	THRUST RACE	974-2603-000	TORRINGTON	TRC-1423				STEEL
1	SLIDING BLOCK	52-14-0100	HILLS-McCANNA	52-14-0100				SUPERDLITE
1	INNER RACE	974-2604-000	TORRINGTON	1R-1418				STEEL
1	CRANK SHAFT	52-16-0200-122	HILLS-McCANNA	52-16-0200-122				ASTM-A-149-60
1	DRIVE BEAR	52-88-1520	HILLS-McCANNA	52-88-1520				S. A. E. 85 PHOSPHOR
1	PIPE PLUG 1/4-18 NPT	970-2229-02E	VARIOUS	W/A				STEEL GR. 5
1	ROLLER BEARING	974-2908-000	TORRINGTON	WJ-263716				STEEL
1	INNER RACE	974-2904-000	TORRINGTON	1R-24218				STEEL
1	RETAINING RING	959-2803-74A	WALDES KOHINOOR	TRUARC S102-150				SPRING STEEL HIGH C
1	SPACER, CRANK	52-20-0100	HILLS-McCANNA	52-20-0100				STEEL TUBE
1	RETAINING RING	959-2901-74A	WALDES KOHINOOR	TRUARC MS002-187				SPRING STEEL HIGH C
1	BALL BEARING	974-2808-000	MFG	1907-5			24.00	STEEL
1	BEARINGS RETAINER CRANK	52-17-0800	HILLS-McCANNA	52-17-0800				STEEL LEDLOY AX
1	RETAINING RING	959-3001-74A	WALDES KOHINOOR	TRUARC 5000-231	1	2.00		SPRING STEEL HIGH C
1	CAP SCR. 1/4-20X 75 LG.	901-2228-02E	VARIOUS	W/A				STEEL GR. 5
1	SEAL WASHER	955-2203-020	PARKER	800-01-01				BUNA-N STEEL RETAIN
1	CAP SCR. 3/16-18X 42	901-2344-020	VARIOUS	T100-1/4				STEEL GR. 5
1	RETAINER PLATE CRANK	52-22-0100	HILLS-McCANNA	52-22-0100				STEEL LEDLOY AX
1	END RETAINER CRANK	52-17-0700	HILLS-McCANNA	52-17-0700				STEEL LEDLOY AX
1	40" RING	952-0037-410	PARKER	2-037 OR EQUIV.	2	2.30		BUNA-N10 DURO
1	SHIM CRANK BRG. RETAINER	52-43-0800	HILLS-McCANNA	52-43-0800				SHIM STEEL
1	SHIM BASE	57-43-1000	HILLS-McCANNA	52-43-1000				SHIM STEEL
1	38 HELICAL LOCKWASHER	40-06-A500-8P	HILLS-McCANNA	40-06-A500-8P				ASME SA516 GR70 CAP
1	3/8-18 HEAVY HEX NUT	935-2305-110	VARIOUS	W/A				STEEL GR. 87
1	3/8-18X1.25 EYE BOLT	919-2309-3P0	VARIOUS	W/A				ASME SA-194 GR 2
1	DRIVE CASE-FINISHED	52-07-2000-2M	HILLS-McCANNA	52-07-2000-2M				STEEL GR. 85
1	RETAINER SCREW, GEAR	52-82-0200	HILLS-McCANNA	52-82-0200				ASTM A216 GR PCB
1	LOCK NUT, 1/2-28X1.5XLOC	921-2203-02E	VARIOUS	21-FK-426				STEEL L-4142 H.T.
1	RETAINING RING	959-2803-74A	WALDES KOHINOOR	TRUARC S188-47				STEEL GR. 5
1	COVER PLATE, FEED B FOR THERMOCOUPLE	52-19-2200	HILLS-McCANNA	52-19-2200				SPR-NS STEEL HIGH C
1								DUCTILE IRON NS-120

NOTES:

1. RECOMMENDED QTY. FOR STOCK BASED ON NUMBER OF UNITS ON JOB SITE
 2. COST PER EACH PART. PRICES ARE SUBJECT TO CHANGE WITHOUT NOTICE
 3. WHEN ORDERING SPARE PARTS GIVE SERIAL OR PUMP NAME PLATE AND PARTS
 4. PRICES VARY. CONSULT FACTORY FOR LATEST PRICE ON SPECIAL MOTOR
 5. ALL RECOMMENDED SPARE PARTS ARE LONG LEAD TIME ITEMS, IN EXCESS OF 10 WEEKS.
- W.A. - NOT APPLICABLE
 N.S. - NOT SHOWN

6-221-0
 Category 2 #

Please Recycled Content
 Document or its Elements
 Where Applicable

ITEM NO.	DESCRIPTION	QTY.	UNIT
1
2
3
4
5

ITEM NO.	DESCRIPTION	QTY.	UNIT
1
2
3
4
5

5221-14 D
 SHEET 3 OF 4

DEC 16 1988

7220-M1874-7-5

I certify that the design contained on this drawing was made in the normal and regular course of business at the place stated below and that it is an accurate representation of the description submitted in reproduction.

[Signature]

30X

MOLAND PLANT, UNITS 1 & 2
 CONSUMERS POWER COMPANY
 POSITIVE DISPLACEMENT
 HYDRAZINE PUMPS
 P.O. #7220-M-374-AC

HILLBANCANNA COMPANY	
PARTS IDENTIFICATION SECT. ASSY. HYDRAZINE PUMP NUCLEAR	
DATE	5-17-79
NO.	5221-14 D

SHEET 3 OF 4

-LIST OF MATERIALS-

QTY	DESCRIPTION	PART NO	VENDOR NAME	VENDOR PART NO	SPARES QTY	EST COST EACH	MATERIAL
	...	52 81-0100-024	HILLS-McCANNA	52 81-0100-024			LEDOY
	...	52 14-0200	HILLS-McCANNA	52 14-0200			ES2100
	...	52 14-0300-071	HILLS-McCANNA	52 14-0300-071			SUPER 8
	...	52 019 410	PARKER	2-019 OR EQUIV	2	1.15	BUNA N.
	...	52 14-0200-024	HILLS-McCANNA	52 14-0200-024			STEEL C
	...	50-17-0200	HILLS-McCANNA	52-17-0200			STEEL C
	...	932-2201-71P	VARIOUS	N/A			STEEL C
	...	931-2478-32P	VARIOUS	N/A			STEEL C
	...	935-2401-11P	VARIOUS	N/A			STEEL C
	...	52 43-0300	HILLS-McCANNA	52 43-0300	2	4.30	SYNTH
	...	974-2409-000	NEW DEPARTURE	5204			STEEL
	...	958-3002-74E	RALDES KONHOOR	TPJARC NS002-218			SPRING
	...	52 82-0100-024	HILLS-McCANNA	52 82-0100-024			LEDOY
	...	974-2409-000	NEW DEPARTURE	Z89500			STEEL
	...	53 88-0200	HILLS-McCANNA	53 88-0200			BRASS
	...	9W9-0103-000	ENW	421-022			WFG. ST
	...	53 14-0400	HILLS-McCANNA	53 14-0400			ALUMIN
	...	53 24-0100	HILLS-McCANNA	53 24-0100			STAINL
	...	903-2105-02E	VARIOUS	N/A			STEEL
	...	974-2411-000	NEW DEPARTURE	Z893L00			WFG. ST
	...	922-2712-000	NEW DEPARTURE	N-00			STEEL
	...	902-2282-02E	VARIOUS	N/A			STEEL
	...	52 34-0200	HILLS-McCANNA	52 34-0200			SS416
	...	52 85-0100	HILLS-McCANNA	52 85-0100			SS416
	...	52 34-0100	HILLS-McCANNA	52 34-0100			ALUMIN
	...	53 20-0400	HILLS-McCANNA	53 20-0400			STEEL T
	...	53 88-0100	HILLS-McCANNA	53 88-0100			BRASS
	...	938-2305-740	BALLACE BARNES	976-89-501			SPRING
	...	943-2231-74E	VARIOUS	N/A			SPRING
	...	53 15-0200-028	HILLS-McCANNA	53 15-0200-028			SS416
	...	974-2405-000	TORRINGTON CO.	BH1312TY DC	2	8.90	STEEL
	...	52 88-1320	HILLS-McCANNA	52 88-1320			AISI 41
	...	52 85-0300	HILLS-McCANNA	52 85-0300			STEEL C
	...	9W4-2542-000	THOMAS	11-08Z			WFG. ST
	...	902-2202-11P	VARIOUS	N/A			STEEL C
	...	935-2201-11E	VARIOUS	N/A			STEEL C
	...	9MT-2510-00J	CARLOCK	63 X 141	2	2.95	WFG. ST
	...	52 17-0500-024	HILLS-McCANNA	52 17-0500-024			STEEL C
	...	974-2510-000	SINKER	2122(COME)	2 SETS	49.00	STD.
	...	974-2516-000	SINKER	2107S(CUP)	2 SETS	49.00	STD.
	...	52 17-0400	HILLS-McCANNA	52 17-0400			STEEL C
	...	52 43-0500	HILLS-McCANNA	52 43-0500	2 SETS	4.90	WFLAR
	...	52 43-0400	HILLS-McCANNA	52 43-0400	2 SETS	4.90	WFLAR
	...	52 43-0700	HILLS-McCANNA	52 43-0700			STEEL C
	...	52 19-0100	HILLS-McCANNA	52 19-0100			STEEL C
	...	901-2303-02P	VARIOUS	N/A			STEEL C
	...	53 24-0200	HILLS-McCANNA	53 24-0200			STAINL
	...	904-2105-02E	VARIOUS	N/A			STEEL C
	...	902-2441-7N0	VARIOUS	N/A			ASME SA
	...	935-2305-11P	VARIOUS	N/A			STEEL C
	...	919-2309-3P0	VARIOUS	N/A			ASME SA
	...	934-2403-020	VARIOUS	N/A			STEEL C
	...	901-2312-7N0	VARIOUS	N/A			ASME SA
	...	935-2305-110	VARIOUS	N/A			STEEL C
	...	919-2309-3P0	VARIOUS	N/A			ASME SA
	...	N/A	RELIANCE	SPECIAL	1		ASME SA
	...	52 20-1300-025	HILLS-McCANNA	52 20-1300-025			STEEL
	...	902-2285-020	VARIOUS	N/A			STEEL C
	...	935-2201-110	VARIOUS	N/A			STEEL C
	...	52 87-0400-025	HILLS-McCANNA	52 87-0400-025			C.W. STE
	...	52 22-0300	HILLS-McCANNA	52 22-0300			STEEL C
	...	52 43-0900	HILLS-McCANNA	52 43-0900	2	1.85	SYNTH
	...	919-2309-3P0	VARIOUS	N/A			ASME SA
	...	52 82-0400-7N	HILLS-McCANNA	52 82-0400-7N			ASME SA
	...	901-2405-7N0	VARIOUS	N/A			ASME SA
	...	935-2403-110	VARIOUS	N/A			STEEL C
	...	919-2409-3P0	VARIOUS	N/A			ASME SA
	...	970-2401-000	BENDIX	508699	2	16.60	WFG. ST
	...	52 43-1100	HILLS-McCANNA	52 43-1100	2	.98	WFLAR
	...	52 24-0100	HILLS-McCANNA	52 24-0100			STAINL
	...	902-2202-11P	VARIOUS	N/A			STEEL C
	...	52 85-0200-027	HILLS-McCANNA	52 85-0200-027			STEEL C
	...	904-2105-02E	VARIOUS	N/A			STEEL C
	...	970-2288-000	TEDECO	N-141C			WFG. ST
	...	934-2501-020	VARIOUS	N/A			STEEL C
	...	902-2441-7N0	VARIOUS	N/A			ASME SA
	...	919-2409-3P0	VARIOUS	N/A			ASME SA
	...	935-2403-110	VARIOUS	N/A			STEEL C
	...	904-2105-030	VARIOUS	N/A			STAINL
	...	52 24-0400	HILLS-McCANNA	52 24-0400			STAINL
	...	920-2114-110	NEW DEPARTURE	N-33			STEEL C
	...	943-2293-74E	VARIOUS	N/A			SPRING S
	...	53 35-0300	HILLS-McCANNA	53 35-0300			18 GAUG
	...	901-2844-02E	VARIOUS	N/A			STEEL C
	...	902-2202-11P	VARIOUS	N/A			STEEL C
	...	52 24-0500	HILLS-McCANNA	52 24-0500			STAINL
	...	N/A	HILLS-McCANNA	N/A	1	450.00	WFG. ST

NUTECH COMMUNICATION RECORD

Persons Involved: Levy Pearson	Date/Time: 11/1/82
Company: Mobil Oil Corporation	Recorded By: D.S. Rosenberg
<input type="checkbox"/> Telecon/Ph.No. 703-849-3000	Copy To:
<input type="checkbox"/> Meeting/Location	Route To:
File: CPC-09-T09	Page 1 of 1

SUBJECT: Mobil Gear Oil 636

Mobil Gear Oil 636 has been subjected to gamma radiation. Significant degradation of the oil does not occur until a total dose of 1E08 RADS is accumulated. Replacement of the oil is recommended before this exposure level occurs.

NUTECH COMMUNICATION RECORD

Persons Involved: David Walters	Date/Time: 11/1/82 3:30
Company: Garlock, Inc.	Recorded By: D.S. Rosenberg
<input type="checkbox"/> Telecon/Ph.No. 315-597-4811	Copy To:
<input type="checkbox"/> Meeting/Location	Route To:
File: CPC-09-T10	Page 1 1

SUBJECT: Garlock Oil Seal For Hydrating Valve Assembly

The Garlock Oil Seal is made of nitrile rubber which is held in place by stainless steel retainers.

RX TLX:
BECHTEL ARB

REL ELEC EUCD
ATTENTION: MR. BILL DEJONG
CC: JEFF PAYNG

RE: HILLS MCCANNA S.O. 1YF882844

BASED ON LOAD INERTIA OF 0.0044 LB-FT. LB AND ROTOR INERTIA OF 0.100
LB-FT 2. MOTOR ACCEL TIME AT 70 VOLTS SHOULD BE 1.15 SEC BASED ON
MTR PERFORMANCE CURVES AT 70 VOLTS.

REGARDS
MARY L. WHEELER RGO/JLM
NUCLEAR PRODUCT SPECIALIST RGO/JLM

ELEC EUCD
BECHTEL ARB

Line 171633 Disconnect
Connect 81 Secs Listed 16:34 EST 08/17/82S

Reference 11

(Deleted)

Reference 12

Radiation Effects on Organic Materials in
Nuclear Plants, EPRI NP-2129, November 1981

Reference 13

Midland Plant, Units 1 & 2, Environmental
Qualification Report, Volume 1, Revision 1

Reference 15

Rotork Qualification Test Report 7220-M123C-105-1, Wyle
Laboratories Test Report No. 43979, Rev. A, October 24, 1978

(Retained in CCo Equipment Qualification Central File No.
M-123CC)

Reference 16

Radiation Chemistry of Monomers, Polymers, and Plastics
by J. E. Wilson, Publisher Marcell Dekker, Inc., 1974