

INSERVICE INSPECTION
PROGRAM SUMMARY MANUAL

PALO VERDE
NUCLEAR GENERATING STATION
UNIT 1

ARIZONA PUBLIC SERVICE COMPANY
P.O. Box 52034
Phoenix, AZ 85072-2034

PVNGS
5801 S. Wintersburg Road
Buckeye, AZ 85326

PREPARED BY: *[Signature]* DATE: 3/2/93
REVIEWED BY: *[Signature]* DATE: 3/3/93
ANII CONCURRENCE: *[Signature]* DATE: 3-3-93
APPROVAL BY
ENGINEERING MANAGER: *[Signature]* DATE: 3/3/93

COMMERCIAL
SERVICE DATE: 01/28/86

PROGRAM NO: ISI-1
REVISION NO: 01.01

TABLE OF CONTENTS

	<u>PAGE</u>
1.0 Summary.....	1-1
2.0 Code Applicability.....	1-1
3.0 Description.....	1-2
3.1 Scope.....	1-2
3.2 System Boundaries.....	1-2
3.3 Accessibility.....	1-3
3.4 Examination Techniques.....	1-3
3.5 Inspection Intervals.....	1-3
3.6 Examination Categories.....	1-4
3.7 Evaluation and Repair.....	1-4
3.8 System Pressure Tests.....	1-4
3.9 Augmented High Energy Piping.....	1-4
3.10 Exemptions.....	1-5
3.11 Code Cases.....	1-5
3.12 Definition of Terms.....	1-6
4.0 ASME Class 1 Examination Summary.....	4-1
4.1 Index.....	4-2
5.0 ASME Class 2 Examination Summary.....	5-1
5.1 Index.....	5-2
6.0 ASME Class 3 Examination Summary.....	6-1
6.1 Index.....	6-2
7.0 Augmented High Energy Piping.....	7-1
8.0 RHR, ECCS, and CHR Piping.....	8-1
9.0 Requests for Relief.....	9-1
9.1 Index.....	9-2
10.0 ISI Boundary Drawings.....	10-1
11.0 Zone Drawings.....	11-1
11.1 Index.....	11-2

RECCRD OF REVISIONS

<u>PAGE NUMBER</u>	<u>REVISION</u>
Cover.....	1.01
i thru iii.....	1
1-1 thru 1-7.....	1
4-1 thru 4-2.....	0
TABLES:	
1-1 and 1-2.....	1
1-3 page 1 of 2.....	1
1-3 page 2 of 2.....	0
1-4.....	1
1-5 page 1 of 2.....	0
1-5 page 2 of 2.....	1
1-6 page 1 and 2 of 3.....	1
1-6 page 3 of 3.....	0
1-7 page 1 of 4.....	1
1-7 page 2 of 4.....	0
1-7 page 3 and 4 of 4.....	1
1-8.....	1
1-9 page 1 of 5.....	0
1-9 page 2 thru 4 of 5.....	1
1-9 page 5 of 5.....	0
1-10.....	0
1-12 page 1 of 2.....	0
1-12 page 2 of 2.....	1
1-13 and 1-14.....	1
1-15.....	1
1-16.....	0
1-IWF page 1 thru 3 of 3.....	1
1-RCP.....	0
5-1 and 5-2.....	0
TABLES:	
2-1.....	1
2-2.....	1
2-3 page 1 thru 3 of 4.....	1
2-3 page 4 of 4.....	0
2-4.....	0
2-5.....	1
2-6.....	1
2-7.....	0
2-IWF.....	1
6-1 and 6-2.....	0

TABLES:	
3-1 page 1 of 2.....	0
3-1 page 2 of 2.....	1
3-IWF.....	0
7-1.....	0
TABLES:	
2-AHE page 1 and 2 of 3.....	1
2-AHE page 3 of 3.....	0
8-1.....	0
TABLES:	
2-CFR.....	1
9-1.....	0
9-2.....	1
Relief Request 1 thru 8.....	1
10-1.....	0
10-2.....	1
11-1 thru 11-4.....	1
Zone Drawings.....	(see Dwg.)

**PALO VERDE
NUCLEAR GENERATING STATION
UNIT 1
INSERVICE INSPECTION - PROGRAM SUMMARY**

1.0 SUMMARY

- 1.1 This document contains a detailed description of the Inservice Inspection Program for Palo Verde Nuclear Generating Station (PVNGS), Unit 1. This program conforms to the requirements of 10 CFR 50.55a(g) and the PVNGS Technical Specifications. In addition, the information is presented in a form consistent with applicable requirements of Standard Review Plan Sections 5.2.4 and 6.6, and the recommendations contained in NRC letter dated July 17, 1981, from Mr. R.L. Tedesco, NRC, to E. E. Van Brunt, Jr., APS, "Guidance for Preparing Preservice and Inservice Inspection Programs and Relief Requests - Palo Verde Nuclear Generating Station Units 1, 2 and 3."
- 1.2 The revision is being prepared to include changes resulting from the NRC review and acceptance of Revision 0, see NRC letter dated October 21, 1987, from E. A. Licitra, NRC, to E. E. Van Brunt, Jr., ANPP, "Inservice Inspection Programs - Palo Verde Units 1, 2 & 3." The major changes in this revision are to establish a common interval date for all units, to update the Requests for Relief, to include the Zone Drawings, and to make small changes and corrections noted during the initial use of the program.

2.0 CODE APPLICABILITY

- 2.1 Based on paragraph 10 CFR 50.55a(b) (2) that was published 12 months prior to the date December 31, 1984 of issuance of the operating license, the 1980 Edition through and including the Winter 1981 Addenda of ASME Section XI was utilized to prepare this program. In addition, and in accordance with paragraph 10 CFR 50.55a(b) (2) (IV) (A), the extent of Class 2 piping welds for the PVNGS Safety Injection System: Residual Heat Removal (RHR), Emergency Core Cooling System (ECCS), and Containment Heat Removal (CHR) system was determined in accordance with the 1974 Edition through and including the Summer 1975 Addenda of ASME Section XI.
- 2.2 This program will be updated for each inspection interval to conform with the requirements of the latest edition and addenda of the ASME Section XI Code referenced in paragraph (b) of 10 CFR 50.55a. When a code required examination is considered to be impractical, because of plant design or other conditions, a request for relief from that requirement will be prepared and included in the program at the beginning of that inspection interval (Section 9.0). If a code required examination is identified to be impractical during the course of an inspection and the code required percentages are not met, a request for relief will be prepared and submitted with the next revision to the program.

3.0 DESCRIPTION

3.1 SCOPE

3.1.1 This Inservice Inspection Program Summary includes all applicable nondestructive examinations required by ASME Section XI and those identified in the PVNGS Technical Specifications as identified below:

1. Examination of ASME Class 1, 2, and 3 pressure retaining components and their supports.
2. Examination of the Reactor Coolant Pump Flywheels in accordance with PVNGS Technical Specifications Section 3/4.4.9.
3. Augmented high energy piping examination in accordance with PVNGS UFSAR Section 6.6.8.
4. Augmented examinations of CHR, RHR, and ECCS piping in accordance with 10 CFR 50.55a.
5. Special examinations to satisfy other commitments or concerns that are based on operating experiences, USNRC Circulars, Information Notices, Bulletins, Combustion Engineering Bulletins, INPO Reports, etc. These examinations are scheduled throughout this program and reference the applicable notification documents.

3.1.2 Those items that would generally be included in an Inservice Inspection Program, but are not included are identified below:

1. The inservice testing of snubbers will be performed in accordance with the PVNGS Technical Specifications Section 3/4.7.9.

Note: Request for Relief #1 in Section 9.0.

2. The pump and valve testing program is contained and submitted under a separate cover.

3.2 SYSTEM BOUNDARIES

3.2.1 A complete set of Inservice Boundary drawings was included in Section 10.0 of Revision 0 of the Unit 1 Program, see Letter ANPP-33266-EEVB/KLM, dated August 26, 1985, from E. E. Van Brunt, Jr., ANPP, to George W. Knighton, NRC, "Paio Verde Nuclear Generating Station (PVNGS) Unit 1 Docket Nos. STN 50-528 (License No. NPF-41) Initial Inservice Inspection Program-PVNGS Unit 1". There has not been any significant changes since those drawings were submitted; therefore, a new set is not being submitted with this revision. Please refer to these drawings for definition of the ASME Class 1, 2, and 3 systems; components; and boundaries scheduled for examinations and pressure testing. A set of zone drawings was requested to be submitted to the NRC for a thorough review of Revision 0. A copy of these are now included in Section 11.0.

3.3 ACCESSIBILITY

- 3.3.1 The preservice examinations were performed with examination techniques, both automated and manual, similar to those planned for use during Inservice Inspections. The examination limitations noted during the preservice examinations were documented in requests for relief submitted with the preservice examination program. There have been no additional code limitations noted during the formulation of this program other than those contained in the Request for Relief Section.
- 3.3.2 All items that are scheduled for examination will be examined to the extent practical. In addition, any code limitations that are noted during the examinations will be documented in the summary reports that are prepared after each outage.

3.4 EXAMINATION TECHNIQUES

- 3.4.1 The three types of examinations utilized to perform Inservice Inspections, along with the actual nondestructive examination technique, are identified in the legend below:

VT - Visual

- VT - 1 (General Condition)
- VT - 2 (Leakage)
- VT - 3 (Structural Condition)
- VT - 4 (Operability)

S - Surface

- PT - Liquid Penetrant
- MT - Magnetic Particle
- ET - Eddy Current

VOL - Volumetric

- UT - Ultrasonic
- RT - Radiography

- 3.4.2 All the above nondestructive examination techniques will be performed using specific techniques and procedures that are identified in ASME Section XI, or alternative examinations that are demonstrated to be equivalent or superior to those identified.

3.5 INSPECTION INTERVALS

- 3.5.1 The Inservice Inspection Program was prepared in accordance with Program B of ASME Section XI. The initial 10-year inspection interval and corresponding inspection periods are defined below:

First Inspection Interval:	01/28/86 to 07/17/98
Period One:	01/28/86 to 11/17/91
Period Two:	11/18/91 to 03/17/95
Period Three:	03/18/95 to 07/17/98

These dates have been modified to a common interval start date for all three PVNGS units. This is in accordance with NRC letter dated October 21, 1987, from E. A. Licitra, NRC, to E. E. Van Brunt, Jr., ANPP, "Inservice Inspection Programs - Palo Verde, Units 1, 2, and 3" to allow the three units to be under the same ASME Section XI edition and addenda. It should be noted that the intervals/periods may change between units to allow for extended outage durations per IWA-2400 of ASME Section XI. For Unit 1, a 16-month extension was also added to the interval due to the length of the second refueling outage.

3.6 EXAMINATION CATEGORIES

- 3.6.1 The examination categories of ASME Section XI were utilized to develop this program for all systems, components, and supports. The Program summary tables contained in Sections 4.0 and 5.0 are organized by examination category for ASME Class 1 and 2 systems, respectively. For each examination category, these tables identify the system, line number, nondestructive examination method, total number of items, required examination amount for each inspection period, and running percentage. For ASME Class 3 systems, the examinations categories are identified in Section 6.0.

3.7 EVALUATION AND REPAIR

- 3.7.1 The evaluation of all examination results will be performed in accordance with ASME Section XI Articles IWA and IWB-3000. In addition, all applicable repairs and replacements will be performed in accordance with ASME Section XI Articles IWA, IWB, IWC, IWD, and IWF-4000 and 7000. Pressure tests will be performed only on welded repairs or replacements, in accordance with IWA-4000 and 5000. Both the evaluations and repair or replacement will be performed in accordance with the 1980 Edition through and including the Winter 1981 Addenda of ASME Section XI, or later editions and addenda of ASME Section XI referenced in 10 CFR 50. All repairs and replacements will be documented in accordance with the Work Control program, and are maintained at Palo Verde for review.

3.8 SYSTEM PRESSURE TESTS

- 3.8.1 System pressure tests will be performed in accordance with ASME Section XI and as identified in Sections 4.0, 5.0, and 6.0 for ASME Class 1, 2, and 3, respectively. These tables also identify the type of pressure test, and test frequency, any applicable requests for relief, and references the appropriate ASME Section XI Article for each of the ASME Code Classes.

3.9 AUGMENTED HIGH ENERGY PIPING

- 3.9.1 Based on the PVNGS UFSAR, an augmented examination is required for protection against postulated pipe failures. This augmented examination program includes the following high energy piping systems located between the containment penetration and the main steam support structure wall:

Main Steam
Feedwater
Steam Generator Blowdown
Downcomer Feedwater

- 3.9.2 The summary tables in Section 7.0 identify each system, along with the required examination amounts and frequencies. As shown by these tables, a volumetric examination of all longitudinal and circumferential welds is scheduled. These welds will be examined to the maximum extent practical. Any limitations to the examination will be included and documented in the examination report prepared in accordance with ASME Section XI.

3.10 EXEMPTIONS

- 3.10.1 The exemption criteria identified in the 1980 Edition through and including the Winter 1981 Addenda of ASME Section XI was utilized for all ASME Class 1, 2, and 3 components and systems. This includes the PVNGS Safety Injection System (RHR, ECCS, and CHR systems) piping and components, even though 10 CFR 50.55a requires the 1974 Edition through and including the 1975 Summer Addenda be utilized. It was concluded after a detailed review that the exemption criteria identified in the Winter 1981 Addenda was more conservative in every case than those identified in the Summer 1975 Addenda, and more examinations would therefore be performed on safety injection systems piping and components.
- 3.10.2 A thorough review of all the systems and components was performed in accordance with the above exemptions and a complete set of color coded Inservice Inspection Boundary drawings was prepared. These drawings are maintained at the PVNGS site for review.

3.11 CODE CASES

- 3.11.1 ASME Section XI Code Case acceptability will be based on Regulatory Guide 1.147.

3.12 DEFINITION OF TERMS

AHE:	Augmented High Energy
ANII:	Authorized Nuclear Inservice Inspector
ANPP:	Arizona Nuclear Power Project
APS:	Arizona Public Service
ASME:	American Society of Mechanical Engineers
Aux:	Auxiliary
BWR:	Boiling Water Reactor
CE:	Combustion Engineering
CEDM:	Control Element Drive Mechanism
CFR:	Code of Federal Regulations
CH:	Charging
CHR:	Containment Heat Removal
Circ:	Circumferential
CL:	Cold Leg
CRD:	Control Rod Drive
CS:	Containment Spray
CSP:	Containment Spray Pump
DWG:	Drawing
ECCS:	Emergency Core Cooling System
FW:	Feedwater
HL:	Hot Leg
HPSI:	High Pressure Safety Injection
Hx:	Heat Exchanger
ICI:	In Core Instrumentation
IEB:	Inspection and Enforcement Bulletin
IEIN:	Inspection and Enforcement Information Notice
Inj:	Injection
INPO:	Institute for Nuclear Power Operations
ISI:	Inservice Inspection
LPSI:	Low Pressure Safety Injection
MSSS:	Main Steam Support Structure
NDE:	Nondestructive Examination
NRC:	Nuclear Regulatory Commission
PDV:	Pressure Differential Valve
PSV:	Pressurizer Safety Valve
PWR:	Pressurized Water Reactor

PVNGS:	Palo Verde Nuclear Generating Station
PZR:	Pressurizer
RC:	Reactor Coolant
RCP:	Reactor Coolant Pump
Reg.:	Regulatory
REV:	Revision
RHR:	Reactor Residual Heat Removal
Recirc:	Recirculation
RCS:	Reactor Coolant System
RPV:	Reactor Pressure Vessel
RVLMS:	Reactor Vessel Level Monitoring System
REM:	Roentgen Equivalent Man
SDCHX:	Shutdown Cooling Heat Exchanger
SD:	Shutdown
SER:	Significant Event Report
SG:	Steam Generator
SI:	Safety Injection
SN:	Serial Number
T:	Thickness
Tech. Spec:	Technical Specification
UFSAR:	Updated Final Safety Analysis Report
USNRC:	United States Nuclear Regulatory Commission
UV:	Multivariable Control Valve
V:	Valve

**SECTION 4.0
ASME CLASS 1
EXAMINATION SUMMARY**

INDEX

TABLE

EXAM CATEGORIES

1-1	E-A,	Pressure Retaining Welds in Reactor Vessel
1-2	B-B,	Pressure Retaining Welds in Vessels Other Than Reactor Vessels
1-3	B-D,	Full Penetration Welds of Nozzies In Vessels - Inspection Program B
1-4	B-E,	Pressure Retaining Partial Penetration Welds in Vessels
1-5	B-F,	Pressure Retaining Dissimilar Metal Welds
1-6	B-G-1,	Pressure Retaining Bolting, Greater Than 2 Inches in Diameter
1-7	B-G-2,	Pressure Retaining Bolting, 2 Inches and Less in Diameter
1-8	B-H,	Integral Attachments for Vessels
1-9	B-J,	Pressure Retaining Welds in Piping
1-10	B-K-1,	Integral Attachments for Piping, Pumps and Valves
1-12	B-L-1 & B-M-1,	Pressure Retaining Welds in Pump Casings and Valve Bodies and
	B-L-2 & B-M-2,	Pump Casings and Valve Bodies
1-13	B-N-1,	Interior of Reactor Vessel
	B-N-2,	Integrally Welded Core Support Structures and Interior Attachments to Reactor Vessels
	B-N-3,	Removable Core Support Structures
1-14	B-O,	Pressure Retaining Welds in Control Rod Housings
1-15	B-P,	All Pressure Retaining Components
1-16	B-Q,	Steam Generator Tubing
1-IWF	F-A,	Plate and Shell Type Supports
	F-B,	Linear Type Supports
	F-C,	Component Standard Support
1-RCP	N/A,	Reactor Coolant Pump Flywheel Examinations Reg. Guide 1.14

ASME ITEM NO.	ZONE-COMPONENT OR SYSTEM	IDENTIFICATION	DESCRIPTION LINE NO., OR SERIAL NO.	NDE METHOD	TOTAL ITEMS	EXAMINATION AMOUNT	INSPECTION PERIOD	RUNNING %	REMARKS AND RELIEF REQUESTS
B 100	EXAM CATEGORY B-A PRESSURE RETAINING WELDS IN REACTOR VESSEL								
110	SHELL WELDS CIRCUMFERENTIAL 1- Reactor Vessel	Butt Welds	SN 78173	Vol	3 **	0	One	0	
111						0	Two	0	
						3	Three	100	
112	LONGITUDINAL 1- Reactor Vessel	Butt Welds	SN 78173	Vol	9 **	0	One	0	
						0	Two	0	
						9	Three	100	
120	HEAD WELDS CIRCUMFERENTIAL	None							
121									
122	MERIDIONAL 1- Reactor Vessel Bottom Head	Butt Weld	SN 78173	Vol	1	0	One	0	AUTOMATED EXAM CORE BARREL REMOVED. EXAMINE ENTIRE ACCESSIBLE LENGTH
						0	Two	0	
						1	Three	100	
	2- Closure Head	Butt Weld	SN 78173	Vol	1	33%	One	33	EXAMINE ENTIRE ACCESSIBLE LENGTH
						33%	Two	66	
						34%	Three	100	
130	SHELL-TO-FLANGE WELD 1- Reactor Vessel	Butt Weld	SN 78173	Vol	1	50% *	One	50	* EXAM FROM FLANGE MATING SURFACE.
						0%	Two	50	
						100% **	Three	100	
140	HEAD-TO-FLANGE WELD 2- Closure Head	Butt Weld	SN 78173	Vol, S	1	33%	One	33	** AUTOMATED EXAM CORE BARREL REMOVED.
						33%	Two	66	
						34%	Three	100	

ASME ITEM NO.	ZONE-COMPONENT OR SYSTEM	IDENTIFICATION	DESCRIPTION LINE NO., OR SERIAL NO.	NDE METHOD	TOTAL ITEMS	EXAMINATION AMOUNT	INSPECTION PERIOD	RUNNING %	REMARKS AND RELIEF REQUESTS
150 151	REPAIR WELDS BELTLINE REGION	None							

ASME ITEM NO.	ZONE-COMPONENT OR SYSTEM	IDENTIFICATION	DESCRIPTION LINE NO., OR SERIAL NO.	NDE METHOD	TOTAL ITEMS	EXAMINATION AMOUNT	INSPECTION PERIOD	RUNNING %	REMARKS AND RELIEF REQUESTS
B 200	EXAM CATEGORY B-B, PRESSURE RETAINING WELDS IN VESSELS OTHER THAN REACTOR VESSELS								
210	PRESSURIZED SHELL TO HEAD WELDS								
211	CIRCUMFERENTIAL AND								
212	* LONGITUDINAL								
	5. Pressurizer Shell to bottom Head	Butt Weld	SN 78373	Vol	1	33% 33% 34%	One Two Three	33 66 100	*1 FOOT MINIMUM OF EACH LONGITUDINAL WELD THAT INTERSECTS THE SCHEDULED CIRCUMFERENTIAL WELDS WILL BE EXAMINED.
	5. Pressurizer Shell to Top Head	Butt Weld	SN 78373	Vol	1	33% 33% 34%	One Two Three	33 66 100	
220	HEAD WELDS	None							
221	CIRCUMFERENTIAL	None							
222	MERIDIONAL	None							
230	STEAM GENERATORS								
231	HEAD WELDS								
	CIRCUMFERENTIAL								
	3. Steam Generator 1	Butt Welds	SN 78273-1	Vol	4	1 1 2	One Two Three	25 50 100	**STAY CYLINDER EXAMS
	4. Steam Generator 2	Butt Welds	SN 78273-2	Vol	4	1 1 2	One Two Three	25 50 100	**STAY CYLINDER EXAMS

ASME ITEM NO.	ZONE-COMPONENT OR SYSTEM	IDENTIFICATION	DESCRIPTION LINE NO., OR SERIAL NO.	NDE METHOD	TOTAL ITEMS	EXAMINATION AMOUNT	INSPECTION PERIOD	RUNNING %	REMARKS AND RELIEF REQUESTS
232	MERIDIONAL 3. Steam Generator 1	Butt Welds	SN 78273-1	V61	6	4	One	66	
						1	Two	83	
						1	Three	100	
240	3. Steam Generator 2 TUBESHEET TO HEAD	Butt Welds	SN 78273-2	V61	6	0	One	-	
						2	Two	83	
						1	Three	100	
250	3. Steam Generator 1 TUBESHEET TO HEAD	Butt Welds	SN 78273-1	V61	2	1	One	50	*STAY CYLINDER EXAMS
						0	Two	50	
						1	Three	100	
252	4. Steam Generator 2 TUBESHEET TO SHELL	Butt Welds	SN 78273-2	V61	2	0	One	-	
						1	Two	50	
						1	Three	100	
253	HEAT EXCHANGERS HEAD WELDS	None		-	-	-	-	-	
						-	-	-	
						-	-	-	
260	CIRCUMFERENTIAL MERIDIONAL LONGITUDINAL TUBESHEET TO SHELL (OR HEAD) WELDS TUBESHEET TO SHELL	None		-	-	-	-	-	
						-	-	-	
						-	-	-	
261	TUBESHEET TO SHELL	None		-	-	-	-	-	
						-	-	-	
						-	-	-	

ASME ITEM NO.	ZONE-COMPONENT OR SYSTEM	IDENTIFICATION	DESCRIPTION LINE NO., OR SERIAL NO.	NDE METHOD	TOTAL ITEMS	EXAMINATION AMOUNT	INSPECTION PERIOD	RUNNING %	REMARKS AND RELIEF REQUESTS
B 300	EXAM CATEGORY B-D, FULL PENETRATION WELDS OF NOZZLES IN VESSELS INSPECTION PROGRAM B								
390 & 5100	REACTOR VESSEL NOZZLE-TO-VESSEL WELDS AND NOZZLE INSIDE RADIUS SECTION 1. Reactor (vessel)	Outlets - 2 Inlets - 4	SN 78173	MoI	6	2 0 4 *	One Two Three	33 33 100	* AUTOMATED EXAMS FROM SHELL SIDE WITH CORE BARREL REMOVED
3110 & 5120	PRESSURIZER NOZZLE-TO-VESSEL WELDS AND NOZZLE INSIDE RADIUS SECTION 3. Pressurizer	Surge - 1 Spray - 1 Safeties - 4	SN 78373	MoI	6	2 2 2	One Two Three	33 66 100	
3140 & 3140	STEAM GENERATORS NOZZLE-TO-VESSEL WELDS AND NOZZLE INSIDE RADIUS SECTION 3. Steam Generator 1 4. Steam Generator 2	Inlet - 1 Outlet - 2 Inlet - 1 Outlet - 2	SN 78273-1 SN 78273-2	MoI	3 3	1 1 1 1 1 1	One Two Three One Two Three	33 66 100 33 66 100	

APS

PALO VERDE NUCLEAR GENERATING STATION 10 YEAR INTERVAL - EXAMINATION SUMMARY

ASME CLASS I

ASME ITEM NO.	ZONE-COMPONENT OR SYSTEM	IDENTIFICATION	DESCRIPTION LINE NO., OR SERIAL NO.	NDE METHOD	TOTAL ITEMS	EXAMINATION AMOUNT	INSPECTION PERIOD	RUNNING %	REMARKS AND RELIEF REQUESTS
3180	HEAT EXCHANGERS NOZZLE-TO-VESSEL WELDS	None							
* 3190	AND NOZZLE INSIDE RADIUS SECTION	None							

ASME ITEM NO.	ZONE-COMPONENT OR SYSTEM	IDENTIFICATION	DESCRIPTION LINE NO., OR SERIAL NO.	NDE METHOD	TOTAL ITEMS	EXAMINATION AMOUNT	INSPECTION PERIOD	RUNNING %	REMARKS AND RELIEF REQUESTS
B 400	EXAM CATEGORY B-E, PRESSURE RETAINING PARTIAL PENETRATION WELDS IN VESSELS								ALL EXAMS PERFORMED IN CONJUNCTION WITH EXAM CATEGORY B-F
410	PARTIAL PENETRATION WELDS	None							
411	VESSEL NOZZLES								
412	CONTROL ROD DRIVE NOZZLES								
	Reactor Vessel Closure Head	CEDM Nozzles	SN 78173	VT-2	97	8 8 9	One Two Three	8 16 26	
413	INSTRUMENT NOZZLES								
	Reactor Vessel	Bottom Head	SN 78173	VT-2	61	5 5 6	One Two Three	8 16 26	
420	PRESSURIZER HEATER PENETRATION WELDS								
		Bottom Head	SN 78373	VT-2*	36	3 3 3	One Two Three	8 17 26	* A SUPPLEMENTAL VT-2 EXAM WILL BE PERFORMED ON ALL STANDPIPE AND HEATER NOZZLES EACH REFUELING OUTAGE. (SEE CE INFO BULLETIN 89-06)

ASME ITEM NO.	ZONE-COMPONENT OR SYSTEM	IDENTIFICATION	DESCRIPTION LINE NO., OR SERIAL NO.	NDE METHOD	TOTAL ITEMS	EXAMINATION AMOUNT	INSPECTION PERIOD	RUNNING %	REMARKS AND RELIEF REQUESTS
B 500	EXAM CATEGORY B-F PRESSURE RETAINING DISSIMILAR METAL WELDS								
510	REACTOR VESSEL NOMINAL PIPE SIZE ≥ 4 INCH NOZZLE TO SAFE END BUTT WELDS	None							
520	NOMINAL PIPE SIZE < 4 INCH NOZZLE TO SAFE END BUTT WELDS	None							
530	NOZZLE TO SAFE END SOCKET WELDS	None							
540	PRESSURIZER NOMINAL PIPE SIZE ≥ 4 INCH NOZZLE TO SAFE END BUTT WELDS								
	20-Surge 29-Spray* 31-Subcooled (4)	Butt Welds Butt Welds Butt Welds	RC-28-12" RC-18-4" RC-1-6" RC-3-6" RC-5-6" RC-7-6"	5, Vol	6	2 2 2	One Two Three	33 66 99	* RT SUPPLEMENTAL EXAM FOR THERMAL SLEEVE INTEGRITY (NOTE IEN 82-09)
550	NOMINAL PIPE SIZE < 4 INCH NOZZLE TO SAFE END BUTT WELDS	None							
560	NOZZLE TO SAFE END SOCKET WELDS	None							
570	STEAM GENERATOR NOMINAL PIPE SIZE ≥ 4 INCH NOZZLE TO SAFE END BUTT WELDS	None							
580	NOMINAL PIPE SIZE < 4 INCH NOZZLE TO SAFE END BUTT WELDS	None							

APS PALO VERDE NUCLEAR GENERATING STATION

10 YEAR INTERVAL - EXAMINATION SUMMARY

ASME CLASS 1

TABLE 1.5
PAGE 2 OF 2

ASME ITEM NO.	ZONE-COMPONENT OR SYSTEM	IDENTIFICATION	DESCRIPTION LINE NO., OR SERIAL NO.	NDE METHOD	TOTAL ITEMS	EXAMINATION AMOUNT	INSPECTION PERIOD	RUNNING %	REMARKS AND RELIEF REQUESTS
590	NOZZLE TO SAFE END SOCKET WELDS	None							
5100	HEAT EXCHANGERS NOMINAL PIPE SIZE ≥ 4 INCH NOZZLE TO SAFE END BUTT WELDS	None							
5110	NOMINAL PIPE SIZE < 4 INCH NOZZLE TO SAFE END BUTT WELDS	None							
5120	NOZZLE TO SAFE END SOCKET WELDS	None							
5130	PIPING NOMINAL PIPE SIZE ≥ 4 INCH DISSIMILAR METAL BUTT WELDS								ITEMS B5.133 & B5.140 SYSTEMS COMBINED FOR PERCENTAGE
	20-Pressurizer Surge	Butt Weld	RC-28-12"	S, Vol	1	1	Three		
	21-Shutdown Cooling Loop 1	Butt Weld	RC-31-16"	S, Vol	1	1	One		
	22-Shutdown Cooling Loop 2	Butt Weld	RC-68-16"	S, Vol	1	1	Two		
	23-Safety Injection 1A	Butt Weld	SI-207-14"	S, Vol	1	1	One		
	24-Safety Injection 1B	Butt Weld	SI-223-14"	S, Vol	1	1	Three		
	25-Safety Injection 2A	Butt Weld	SI-160-14"	S, Vol	1	1	Two		
	26-Safety Injection 2B	Butt Weld	SI-179-14"	S, Vol	1	1	Three		
5140	NOMINAL PIPE SIZE < 4 INCH DISSIMILAR METAL BUTT WELDS								
	27-Pressurizer Spray 1A	Butt Weld	RC-62-3"	S	1	1	One		
	28-Pressurizer Spray 1B	Butt Weld	RC-17-3"	S	1	1	Two		
	32-Drain Line 1A	Butt Weld	RC-60-2"	S	1	1	One	29	
	33-Drain Line 1B	Butt Weld	RC-38-2"	S	1	1	Two		
	34-Drain Line 2A	Butt Weld	RC-96-2"	S	1	1	Three		
	24-Letdown Line	Butt Weld	RC-91-2"	S	1	1	Three	100	
	37-Charging Line*	Butt Weld	CH-5-3"	S	1	1	Two	64	
5150	DISSIMILAR METAL SOCKET WELDS	None							*RT SUPPLEMENTAL EXAM FOR THERMAL SLEEVE INTEGRITY (NOTE BEEN #1-09)

REV 1
12-23-91

ASME ITEM NO.	ZONE-COMPONENT OR SYSTEM	IDENTIFICATION	DESCRIPTION LINE NO., OR SERIAL NO.	NDE METHOD	TOTAL ITEMS	EXAMINATION AMOUNT	INSPECTION PERIOD	RUNNING %	REMARKS AND RELIEF REQUESTS
B 600	EXAM CATEGORY B-G-1, PRESSURE RETAINING BOLTING GREATER THAN 2 IN. IN DIAMETER								
610	REACTOR VESSEL CLOSURE HEAD NUTS 2- Closure Head	Nuts	7.237" x 7.91"	5	54	18 18 18	One Two Three	33 66 100	
620	CLOSURE STUDS, IN PLACE	None*							*STUDS WILL BE REMOVED FOR EXAMINATION
630	CLOSURE STUDS, WHEN REMOVED 2- Closure Head	Studs	7.380" x 76.37"	S, Vol	54	18 18 18	One Two Three	33 66 100	
640	THREADS IN FLANGE 1- Reactor Vessel	Flange Ligaments	SN 78173	Vol	54	0 0 54	One Two Three	0 0 100	
650	CLOSURE WASHERS, BUSHINGS 1- Reactor Vessel	Washers	7.50" x 1.27"	VT-1	54	18 18 18	One Two Three	33 66 100	
660	PRESSURIZER	None							
670	BOLTS AND STUDS FLANGE SURFACE, WHEN CONNECTION DISASSEMBLED	None							
680	NUTS, BUSHINGS, AND WASHERS	None							

ASME ITEM NO.	ZONE-COMPONENT OR SYSTEM	IDENTIFICATION	DESCRIPTION LINE NO., OR SERIAL NO.	NDE METHOD	TOTAL ITEMS	EXAMINATION AMOUNT	INSPECTION PERIOD	RUNNING %	REMARKS AND RELIEF REQUESTS
600	STEAM GENERATORS BOLTS AND STUDS FLANGE SURFACE, WHEN CONNECTION DISAS- SEMBLED	None None	- -	- -	- -	- -	- -	- -	
6110	NUTS, BUSHINGS, AND WASHERS	None None	- -	- -	- -	- -	- -	- -	
6120	HEAT EXCHANGERS BOLTS AND STUDS FLANGE SURFACE, WHEN CONNECTION DISAS- SEMBLED	None None	- -	- -	- -	- -	- -	- -	
6140	NUTS, BUSHINGS, AND WASHERS	None	-	-	-	-	-	-	
6150	PIPING BOLTS AND STUDS FLANGE SURFACE, WHEN CONNECTION DISAS- SEMBLED	None None	- -	- -	- -	- -	- -	- -	
6170	NUTS, BUSHINGS, AND WASHERS	None	-	-	-	-	-	-	
6180	PUMPS BOLTS AND STUDS**								
	16- Reactor Coolant Pump 1A	Flange Studs	4.33" x 32.87"	Vol*	16	5 5 6	One Two Three	31 62 100	* A SUPPLEMENTAL VT-1 EXAM WILL BE PERFORMED 100% PER REFUELING OUTAGE (SEE BEB 80-27)
	17- Reactor Coolant Pump 1B	Flange Studs	4.33" x 32.87"	Vol*	16	5 5 6	One Two Three	31 62 100	** SUPPLEMENTED BY VISL VI (EACH REMOVAL AND SURFACE (A " 5 YR. INTERVALS) EXAMS WHEN REMOVED (SEE BEB 80-02)
	18- Reactor Coolant Pump 2A	Flange Studs	4.33" x 32.87"	Vol*	16	5 5 6	One Two Three	31 62 100	
	19- Reactor Coolant Pump 2B	Flange Studs	4.33" x 32.87"	Vol*	16	5 5 6	One Two Three	31 62 100	

ASME ITEM NO.	ZONE-COMPONENT OR SYSTEM	IDENTIFICATION	DESCRIPTION LINE NO., OR SERIAL NO.	NDE METHOD	TOTAL ITEMS	EXAMINATION AMOUNT	INSPECTION PERIOD	RUNNING %	REMARKS AND RELIEF REQUESTS
6100	FLANGE SURFACE, WHEN CONNECTION DISASSEMBLED 16, 17, 18 and 19, Reactor Coolant Pumps 1A, 1B, 2A & 2B	Flange Surface	CASING SN 1A - 1247 1B - 1249 2A - 1248 2B - 1250	VT-1	16 per pump	*	One	*	*100% EXAM WHEN DISASSEMBLED (THERE ARE NO BUSHINGS IN THE PUMP FLANGES) **THE CLAMPING RING WILL BE EXAMINED (THERE ARE NO WASHERS)
							Two	*	
							Three	*	
6300	NUTS, BUSHINGS AND WASHERS** 16-Reactor Coolant Pump 1A 17-Reactor Coolant Pump 1B 18-Reactor Coolant Pump 2A 19-Reactor Coolant Pump 2B	Nuts & Clamping Ring	4.538" x 7.283"	VT-1	16	5	One	31	
							Two	62	
		Three	100						
		Nuts & Clamping Ring	4.538" x 7.283"	VT-1	16	5	One	31	
							Two	62	
		Three	100						
Nuts & Clamping Ring	4.538" x 7.283"	VT-1	16	5	One	31			
					Two	62			
Three	100								
6210	VALVES BOLTS AND STUDS FLANGE SURFACE, WHEN CONNECTION DISASSEMBLED	None None	-	-	-	-	One	-	
							Two	-	
							Three	-	
6230	NUTS, BUSHINGS, AND WASHERS	None	-	-	-	-	One	-	
							Two	-	
							Three	-	

ASME ITEM NO.	ZONE-COMPONENT OR SYSTEM	IDENTIFICATION	DESCRIPTION LINE NO., OR SERIAL NO.	NDE METHOD	TOTAL ITEMS	EXAMINATION AMOUNT	INSPECTION PERIOD	RUNNING %	REMARKS AND RELIEF REQUESTS
B-700	EXAM. CATEGORY B-G-2, PRESSURE RETAINING BOLTING 2 IN. AND LESS IN DIAMETER								
710	REACTOR VESSEL BOLTS, STUDS AND NUTS	None							
720	PRESSURIZER BOLTS, STUDS AND NUTS	Studs & Nuts	1.5" x 14.5"	VT-1	* 20 Pairs	20 20 20	One Two Three	100 100 100	* SUPPLEMENTED BY VISUAL (EACH REMOVAL) AND SURFACE (AT 5 YR. INTERVALS) EXAMS WHEN REMOVED (SEE BEB 82-02)
730	3. Pressurizer Manway								
	STEAM GENERATORS BOLTS, STUDS AND NUTS	Studs & Nuts	1.5" x 14.5"	VT-1	* 40 Pairs	40 40 40	One Two Three	100 100 100	
	3. Steam Generator 1 Cold Leg and Hot Leg Manways								
	4. Steam Generator 2 Cold Leg and Hot Leg Manways	Studs & Nuts	1.5" x 14.5"	VT-1	* 40 Pairs	40 40 40	One Two Three	100 100 100	
740	HEAT EXCHANGERS	None							
750	PIPING BOLTS, STUDS AND NUTS	Flange Flange Flange Flange	RC-1.6" RC-3.6" RC-5.6" RC-7.6"	VT-1	* 4	1 1 1 1	One Two Three	25 50 100	
	31-Pressurizer Satisfier								
	37-Charging Line	Flange	CH-3.3"	VT-1	1	1 0 0	One Two Three	100 100 100	

ASME ITEM NO.	ZONE-COMPONENT OR SYSTEM	IDENTIFICATION	DESCRIPTION LINE #, A, OR SERIAL NO.	NDE METHOD	TOTAL ITEMS	EXAMINATION AMOUNT	INSPECTION PERIOD	RUNNING %	REMARKS AND RELIEF REQUESTS														
760	PUMPS BOLTS, STUDS AND NUTS 16- Reactor Coolant Pump 1A Seal Cover Bolting 17- Reactor Coolant Pump 1B Seal Cover Bolting 18- Reactor Coolant Pump 2A Seal Cover Bolting 19- Reactor Coolant Pump 2B Seal Cover Bolting	Seal Cover Studs & Nuts	1.5" x 8.27"	VT-1	16	5 5 6	One Two Three	31 62 100															
										Seal Cover Studs & Nuts	1.5" x 8.27"	VT-1	16	5 5 6	One Two Three	31 62 100							
																	Seal Cover Studs & Nuts	1.5" x 8.27"	VT-1	16	5 5 6	One Two Three	31 62 100
		VALVES BOLTS, STUDS AND NUTS 21- Shutdown Cooling Looping 1 22- Shutdown Cooling Loop 2 23- Safety Injection Loop 1A 24- Safety Injection Loop 1B 25- Safety Injection Loop 2A	UV-651 UV-653	R.C.051-16" SI-240-16"	VT-1	2	1 0 1	One Two Three	50 50 100														
											UV-652 UV-654	R.C.068-16" SI-193-16"	VT-1	2	1 1 0	One Two Three	50 100 100						
			V-235 UV-634 V-237 V-542	SI-207-14" SI-207-14" SI-207-14" SI-203-12"	VT-1	4	1 2 1	One Two Three	25 75 100														
										V-245 UV-644 V-247 V-543	SI-223-14" SI-223-14" SI-223-14" SI-221-12"	VT-1	4	1 2 1	One Two Three	25 75 100							
			V-215 UV-614 V-217 V-540	SI-160-14" SI-160-14" SI-156-14" SI-156-12"	VT-1	4	1 1 2	One Two Three	25 50 100														

ASME ITEM NO.	ZONE-COMPONENT OR SYSTEM	IDENTIFICATION	DESCRIPTION LINE NO., OR SERIAL NO.	NDE METHOD	TOTAL ITEMS	EXAMINATION AMOUNT	INSPECTION PERIOD	RUNNING %	REMARKS AND RELIEF REQUESTS
770	CONTINUED								
	36-Safety Injection Loop 2B	V-225 UV-624 V-227 V-581	SI-179-14" SI-179-14" SI-179-14" SI-175-12"	VT-1	4	1 2 1	One Two Three	25 75 100	
	27-Pressurizer Spray Loop 1A	V-240 PV-100E V-243	RC-62-3" RC-62-3" RC-16-3"	VT-1	3	0 3 2	One Two Three	0 33 100	
	28-Pressurizer Spray Loop 1B	V-241 PV-100F V-242	RC-17-3" RC-17-3" RC-18-3"	VT-1	3	2 1 0	One Two Three	66 100 100	
	29-Combined Pressurizer Spray	V-244	RC-14-4"	VT-1	1	0 0 1	One Two Three	0 0 100	
	31-Pressurizer Safeties	PSV-200 PSV-201 PSV-202 PSV-203	RC-1-6" RC-3-6" RC-5-6" RC-7-6"	VT-1	4	1 1 2	One Two Three	25 50 100	
	32-Drain Line Loop 1A	V-334 V-234	RC-60-2" RC-60-2"	VT-1	2	2 0	One Two Three	100 100 100	
	33-Drain Line Loop 1B	V-335 V-235	RC-38-2" RC-38-2"	VT-1	2	0 2	One Two Three	0 100 100	
	34-Drain Line Loop 2A	V-333 V-233	RC-96-2" RC-96-2"	VT-1	2	0 2 0	One Two Three	0 100 100	
	35-Drain Line Loop 2B	V-332 V-232	RC-89-2" RC-89-2"	VT-1	2	0 0 2	One Two Three	0 0 100	
	36-Letdown Line	UV-515 UV-516	RC-91-2" CH-1-2"	VT-1	2	0 0 2	One Two Three	0 0 100	
	37-Charging Line	PDV-240	CH-5-3"	VT-1	1	1 0 0	One Two Three	100 100 100	

ASME ITEM NO.	ZONE-COMPONENT OR SYSTEM	IDENTIFICATION	DESCRIPTION LINE NO., OR SERIAL NO.	NDE METHOD	TOTAL ITEMS	EXAMINATION AMOUNT	INSPECTION PERIOD	RUNNING %	REMARKS AND RELIEF REQUESTS
770	CONTINUED 38-Drain Line Loop 1	V-215 V-216	RC-70-2" RC-70-2"	VT-1	2	1 0 1	One Two Three	50 50 100	
	39-HPSI Long Term Rectirculation Loop 1	V-523 V-522 V-957	SI-248-3" SI-248-3" SI-248-3"	VT-1	3	1 2 0	One Two Three	33 100 100	
	40-HPSI Long Term Rectirculation Loop 2	V-533 V-532 V-958	SI-199-3" SI-199-3" SI-199-3"	VT-1	3	0 1 2	One Two Three	0 33 100	
780	CRD HOUSINGS BOLTS, STUDS, AND NUTS 2- RVLMS Locations	Marrison Clamps	CEIM 92 CEIM 96	VT-1	2	1 0 1	One Two Three	50 50 100	

ASME ITEM NO.	ZONE-COMPONENT OR SYSTEM	IDENTIFICATION	DESCRIPTION LINE NO., OR SERIAL NO.	NDE METHOD	TOTAL ITEMS	EXAMINATION AMOUNT	INSPECTION PERIOD	RUNNING %	REMARKS AND RELIEF REQUESTS
B 800	EXAM CATEGORY B-4: INTEGRAL ATTACHMENTS FOR VESSELS								
810	REACTOR VESSEL INTEGRALLY WELDED ATTACHMENTS	None							
820	PRESSURIZER INTEGRALLY WELDED ATTACHMENTS								
	5. Pressurizer	Support Skirt	SN 78273	5, Vol	1	33% 33% 34%	One Two Three	33 66 100	
830	STEAM GENERATORS INTEGRALLY WELDED ATTACHMENTS								
	3. Steam Generator 1	Support Skirt	SN 78273-1	Vol	1	33% 34%	One Two Three	33* * 100*	* MULTIPLE VESSELS. EXAMINATIONS TOTAL 100% SUPPORT SKIRT WELD IN 1 STEAM GENERATOR.
	4. Steam Generator 2	Support Skirt	SN 78273-2	Vol	1	* 33% *	One Two Three	* 66 *	
840	HEAT EXCHANGERS INTEGRALLY WELDED ATTACHMENTS	None							

APS PALO VERDE NUCLEAR GENERATING STATION

10 YEAR INTERVAL - EXAMINATION SUMMARY

ASME CLASS 1

TABLE 1.9
PAGE 1 OF 5

ASME ITEM NO.	ZONE-COMPONENT OR SYSTEM	IDENTIFICATION	DESCRIPTION LINE NO., OR SERIAL NO.	NDE METHOD	TOTAL ITEMS	EXAMINATION AMOUNT	INSPECTION PERIOD	RUNNING %	REMARKS AND RELIEF REQUESTS
B 900	EXAM CATEGORY B-F, PRESSURE RETAINING WELDS IN PIPING								
910	NOMINAL PIPE SIZE ≥ 4 IN.								
911 912	CIRCUMFERENTIAL AND LONGITUDINAL WELDS								* THE LESSER OF 12" OR ONE PIPE DIAMETER LENGTH FROM SCHEDULED CIRC WELD INTERSECTION WILL BE EXAMINED
	6- RCS Primary Piping	HL 1 HL 2 CL 1A to RCP CL 1B to RCP CL 2A to RCP CL 2B to RCP CL 1A to RPV CL 1B to RPV CL 2A to RPV CL 2B to RPV	RC-32-42" ID RC-63-42" ID RC-33-30" ID RC-30-30" ID RC-73-30" ID RC-84-30" ID RC-34-30" ID RC-31-30" ID RC-79-30" ID RC-93-30" ID	S, Vol	66	7 6 13	One Two Three	11 20 39	AUTOMATED EXAM OF NOZZLE TO EXTENSION AND EXTENSION TO PIPE WELDS
	20-Pressurizer Surge Line	Butt Welds	RC-28-12"	S, Vol	11	1 0 2	One Two Three	9 9 27	
	21-Shutdown Cooling Loop 1	Butt Welds	RC-51-16" SI-240-16"	S, Vol	22	2 2 2	One Two Three	9 18 27	
	22-Shutdown Cooling Loop 2	Butt Welds	RC-68-16" SI-193-16	S, Vol	27	2 2 3	One Two Three	7 15 25	
	23-Safety Injection 1A	Butt Welds	SI-207-14" SI-203-12"	S, Vol	19	3 0 2	One Two Three	16 16 26	

ASME ITEM NO.	ZONE/COMPONENT OR SYSTEM	IDENTIFICATION	DESCRIPTION LINE NO., OR SERIAL NO.	NDE METHOD	TOTAL ITEMS	EXAMINATION AMOUNT	INSPECTION PERIOD	RUNNING %	REMARKS AND RELIEF REQUESTS
911 & 912	CONTINUED 24-Safety Injection 1B 25-Safety Injection 2A 26-Safety Injection 2B	Butt Welds Butt Welds Butt Welds	SI-223-14" SI-221-12" SI-160-14" SI-156-12" SI-179-14" SI-175-12"	S, Vol S, Vol S, Vol	18 22 20	0 3 2 2 3 1 2 1 2	One Two Three One Two Three One Two Three	0 16 28 9 23 27 10 15 25	
	28 & 29-Pressurizer Spray Loop 1B and Combined Pressurizer Spray 31-Pressurizer Saturator	Butt Welds Butt Welds	RC-18-4" RC-1-6" RC-3-6" RC-5-6" RC-7-6"	S, Vol S, Vol	17 12	2 1 2 1 1 2	One Two Three One Two Three	12 18 29 8 25 42	
920	36-Leadwire Line Delay Coil NOMINAL PIPE SIZE IN.	Butt Welds	RC-91-16"	S, Vol	4	0 1 0	One Two Three	0 25 25	
921 & 922	CIRCUMFERENTIAL AND LONGITUDINAL WELDS 27-Pressurizer Spray 1A 28-Pressurizer Spray 1B	Butt Welds Butt Welds	RC-62-3" RC-16-3" RC-17-3" RC-18-3"	S S	40 37	3 3 4 4 3 3	One Two Three One Two Three	8 15 25 11 19 27	* THE LESSER OF 12" OR 1 PIPE DIA-METER LENGTH FROM SCHEDULED CIRC WELD INTER-SECTION WILL BE EXAMINED

ASME ITEM NO.	ZONE-COMPONENT OR SYSTEM	IDENTIFICATION	DESCRIPTION LINE NO., OR SERIAL NO.	NDE METHOD	TOTAL ITEMS	EXAMINATION AMOUNT	INSPECTION PERIOD	RUNNING %	REMARKS AND RELIEF REQUESTS
921 & 922	<u>CONTINUED</u>								
	30-Aux Pressurizer Spray	Butt Welds	CH-009-2" CH-520-2" CH-521-2"	S	11	2 2 0	One* Two Three	18 36 36	* VOL. EXAM OF 2 WELDS AND BASE METAL DOWN STREAM OF V431 PER IEB 88-08.
	32-Drain Line Loop 1A	Butt Welds	RC-60-2"	S	5	3 0 0	One Two Three	40 40 40	
	33-Drain Line Loop 1B	Butt Welds	RC-98-2"	S	5	0 2 0	One Two Three	0 40 40	
	34-Drain Line Loop 2A	Butt Welds	RC-96-2"	S	5	0 0 2	One Two Three	0 0 40	
	35-Drain Line Loop 2B	Butt Welds	RC-89-2"	S	5	0 0 2	One Two Three	0 0 40	
	36-Letdown Line	Butt Welds	RC-91-2"	S	70	4 6 8	One Two Three	6 14 26	
	37-Charging Line	Butt Welds	CH-5-3"	S	63	5 6 6	One Two Three	8 17 27	
	38-Drain Line Loop 1	Butt Welds	RC-76-2"	S	4	0 1 0	One Two Three	0 25 25	
	39-HPSI Long Term Recirculation 1	Butt Welds	SI-248-3"	S	36	2 3 4	One Two Three	6 14 25	
	40-HPSI Long Term Recirculation 2	Butt Welds	SI-198-3"	S	27	3 2 2	One Two Three	11 19 26	

APS PALO VERDE NUCLEAR GENERATING STATION 10 YEAR INTERVAL - EXAMINATION SUMMARY

ASME CLASS 1

TABLE 1-9
PAGE 4 OF 5

ASME ITEM NO.	ZONE-COMPONENT OR SYSTEM	IDENTIFICATION	DESCRIPTION LINE NO., OR SERIAL NO.	NDE METHOD	TOTAL ITEMS	EXAMINATION AMOUNT	INSPECTION PERIOD	RUNNING %	REMARKS AND RELIEF REQUESTS
930	BRANCH PIPE CONNECTION WELDS								
931	NOMINAL PIPE SIZE ≥ 4 IN.								ITEM B9.31, SYSTEMS COMBINED FOR PERCENTAGE
	6- RCS Primary Piping	Surge	RC-32-42" ID	S, Vol	1	1	Three	-	
		SD Cooling 1	RC-32-42" ID	S, Vol	1	0	-	-	
		SD Cooling 2	RC-63-42" ID	S, Vol	1	0	-	-	
		SI 1A	RC-34-30" ID	S, Vol	1	1	One	14	
		SI 1B	RC-31-30" ID	S, Vol	1	1	Three	-	
		SI 1C	RC-79-30" ID	S, Vol	1	1	Two	29	
		SI 1D	RC-93-30" ID	S, Vol	1	1	Three	71	
932	NOMINAL PIPE SIZE < 4 IN.								ITEM B9.32, SYSTEMS COMBINED FOR PERCENTAGE
	6- RCS Primary Piping	Drain 1A	RC-33-30" ID	S	1	1	One	-	
		PZR Spray 1A	RC-34-30" ID	S	1	0	-	-	
		Drain 1B	RC-30-30" ID	S	1	0	-	-	
		PZR Spray 1B	RC-31-30" ID	S	1	0	-	-	
		Drain 2A	RC-73-30" ID	S	1	0	-	-	
		Charging	RC-79-30" ID	S	1	1	Two	-	
		Letdown	RC-84-30" ID	S	1	1	Three	42	
	21-Shutdown Cooling Loop 1	2" Drain	RC-051-16"	S	2	0	One	-	
		3" HPSI				0	Two	-	
						0	Three	-	
	22-Shutdown Cooling Loop 2	3" HPSI	RC-068-16"	S	1	1	One	14	
						0	Two	-	
						0	Three	-	
	36-Letdown Line	2" Delay Coil	RC-091-16"	S	4	0	One	-	
						2	Two	36	
						0	Three	-	
940	SOCKET WELDS								
	32-Drain Line Loop 1A	Socket Welds	RC-060-2"	S	3	1	One	33	
						0	Two	33	
						0	Three	33	
	33-Drain Line Loop 1B	Socket Welds	RC-058-2"	S	3	0	One	0	
						1	Two	33	
						0	Three	33	

REV. 1
12-23-91

ASME ITEM NO.	ZONE-COMPONENT OR SYSTEM	IDENTIFICATION	DESCRIPTION LINE NO., OR SERIAL NO.	NDE METHOD	TOTAL ITEMS	EXAMINATION AMOUNT	INSPECTION PERIOD	RUNNING %	REMARKS AND RELIEF REQUESTS
940	CONTINUED 34-Drain Line Loop 2A	Socket Welds	RC-096-2"	S	3	0	One	0	
						1	Two	33	
						0	Three	33	
	35-Drain Line Loop 2B	Socket Welds	RC-089-2"	S	3	0	One	0	
						0	Two	0	
						3	Three	33	
	38-Drain Line Loop 1	Socket Welds	RC-070-3"	S	3	1	One	33	
						0	Two	33	
						0	Three	33	

ASME ITEM NO.	ZONE-COMPONENT OR SYSTEM	IDENTIFICATION	DESCRIPTION LINE NO. OR SERIAL NO.	NDE METHOD	TOTAL ITEMS	EXAMINATION AMOUNT	INSPECTION PERIOD	RUNNING %	REMARKS AND RELIEF REQUESTS
B .000	EXAM CATEGORY B-K-1. INTEGRAL ATTACHMENTS FOR PIPING, PUMPS, AND VALVES								
1010	PIPING INTEGRALLY WELDED ATTACHMENTS								
	22-Shutdown Cooling Loop 2	Large	SI-193-16"	S	1	1	Two	-	
	24-Safety Injection 1B	Stanchion	SI-223-14"	S	1	1	Three	-	
	25-Safety Injection 2A	Stanchion	SI-160-14"	S	1	1	Three	100	
	26-Safety Injection 2B	Stanchion	SI-179-14"	S	1	1	One	-	
	36-Lowdown Line	Large	RC-091-16"	S	2	1	One Two	33 66	ITEM B10.10 COMBINED FOR PERCENTAGE
1020	PUMPS INTEGRALLY WELDED ATTACHMENTS	None							
1030	VALVES INTEGRALLY WELDED ATTACHMENTS	None							

ASME ITEM NO.	ZONE-COMPONENT OR SYSTEM	IDENTIFICATION	DESCRIPTION LINE NO., OR SERIAL NO.	NDE METHOD	TOTAL ITEMS	EXAMINATION AMOUNT	INSPECTION PERIOD	RUNNING %	REMARKS AND RELIEF REQUESTS
B 1200	EXAM CATEGORY B-L-1, B-M-1, PRESSURE RETAINING WELDS IN PUMP CASINGS AND VALVE BODIES. EXAM CATEGORY B-L-2, B-M-2, PUMP CASINGS AND VALVE BODIES								
1210	<u>PUMPS</u> <u>PUMP CASING WELDS</u> 16- Reactor Coolant Pump 1A 17- Reactor Coolant Pump 1B 18- Reactor Coolant Pump 2A 19- Reactor Coolant Pump 2B	Circumferential Casing Welds	1247 1249 1248 1250	Vol	4	Examine the Weld in 1 Pump	*	100	
	16- Reactor Coolant Pump 1A 17- Reactor Coolant Pump 1B 18- Reactor Coolant Pump 2A 19- Reactor Coolant Pump 2B	Outlet Nozzle To Casing Welds	1247 1249 1248 1250	Vol	4	Examine the Weld in 1 Pump	*	100	* BY THE END OF THE INTERVAL.
1220	<u>PUMP CASINGS</u> 16- Reactor Coolant Pump 1A 17- Reactor Coolant Pump 1B 18- Reactor Coolant Pump 2A 19- Reactor Coolant Pump 2B	Internal Surfaces	1247 1249 1248 1250	VT-3	4	Examine the Internal surfaces in 1 Pump	*	100	* BY THE END OF THE INTERVAL.
1230	<u>VALVES</u> <u>VALVES, NOMINAL PIPE SIZE < 4 INCH VALVE BODY WELDS</u>	None							
1240	<u>VALVES, NOMINAL PIPE SIZE ≥ 4 INCH VALVE BODY WELDS</u> Borg Warner Gate Valves Utilizing Forged Construction	UV-651 UV-653 UV-652 UV-654 UV-634 UV-644 UV-614 UV-624	RC-51-16" SI-240-16" RC-68-16" SI-193-16" SI-207-14" SI-223-14" SI-190-14" SI-179-14"	Vol	8	Examine the Weld in 1 Valve	*	100	* BY THE END OF THE INTERVAL.

APS PALO VERDE NUCLEAR GENERATING STATION 10 YEAR INTERVAL - EXAMINATION SUMMARY

ASME CLASS 1

TABLE 1-12
PAGE 2 OF 2

ASME ITEM NO.	ZONE-COMPONENT OR SYSTEM	IDENTIFICATION	DESCRIPTION LINE NO., OR SERIAL NO.	NDE METHOD	TOTAL ITEMS	EXAMINATION AMOUNT	INSPECTION PERIOD	RUNNING %	REMARKS AND RELIEF REQUESTS
1240	<u>CONTINUED</u>								
	Borg Warner Check Valve Utilizing Forged Construction	V-344	RC-18-4"	Vol	1	1	*	100	* BY THE END OF THE INTERVAL
	Dresser Pressure Safety Valves Utilizing Forged Construction	PSV-200 PSV-201 PSV-202 PSV-203	RC-1-6" RC-3-6" RC-5-6" RC-7-6"	Vol	4	Examine the Weld in 1 Valve	*	100	
1250	<u>VALVE BODY, EXCEEDING 4 IN. NOMINAL PIPE SIZE</u>								
	Borg Warner Gate Valves Utilizing Forged Construction	UV-651 UV-653 UV-652 UV-654 UV-634 UV-644 UV-614 UV-624	RC-51-16" SI-240-16" RC-68-16" SI-193-16" SI-207-14" SI-223-14" SI-160-14" SI-179-14"	VT-3	8	Examine the Internal Surfaces of 1 Valve	*	100	
	Borg Warner Check Valves Utilizing Forged Construction	V-235 V-237 V-542 V-343 V-247 V-543 V-215 V-217 V-540 V-225 V-227 V-541	SI-207-14" SI-207-14" SI-203-12" SI-223-14" SI-223-14" SI-221-12" SI-160-14" SI-160-14" SI-136-12" SI-179-14" SI-179-14" SI-175-12"	VT-3	12	Examine the Internal Surfaces of 1 Valve	*	100	
	Dresser Pressure Safety Valves Utilizing Forged Construction	PSV-200 PSV-201 PSV-202 PSV-203	RC-1-6" RC-3-6" RC-5-6" RC-7-6"	VT-3	4	Examine the Internal Surfaces of 1 Valve	*	100	

REV 1
12-23-91

ASME ITEM NO.	ZONE-C COMPONENT OR SYSTEM	IDENTIFICATION	DESCRIPTION LINE NO., OR SERIAL NO.	NDE METHOD	TOTAL ITEMS	EXAMINATION AMOUNT	INSPECTION PERIOD	RUNNING %	REMARKS AND RELIEF REQUESTS
B 1300	EXAM CATEGORY B-N-1, INTERIOR OF REACTOR VESSEL, B-N-2, INTEGRALLY WELDED CORE SUPPORT STRUCTURES AND INTERIOR ATTACHMENTS TO REACTOR VESSELS, B-N-3, REMOVABLE CORE SUPPORT STRUCTURES								
1310	REACTOR VESSEL VESSEL INTERIOR 1. Reactor Vessel	Examine the areas above and below the reactor core that are made accessible for examination by removal of components during normal refueling outages.		VT-3	Accessible Areas	13% 33% 34%	*One *Two *Three	33 66 100	*EXAMINE AT 1st REFUELING OUTAGE AND SUBSEQUENTLY AT 3-YEAR INTERVALS
1320	REACTOR VESSEL (BWR) INTERIOR ATTACHMENTS CORE SUPPORT STRUCTURE	N/A N/A							
1330	INTERIOR ATTACHMENTS WITHIN BELT-LINE REGION	N/A							
1331	INTERIOR ATTACHMENTS BEYOND BELT-LINE REGION	Examine the accessible welds and the surrounding area.		VT-3	Accessible Welds	100%	**	100	** BY THE END OF THE INTERVAL
1332	CORE SUPPORT STRUCTURE	Examine the accessible core support structure		VT-3	Accessible Surfaces	100%	**	100	

ASME ITEM NO.	ZONE-COMPONENT OR SYSTEM	IDENTIFICATION	DESCRIPTION LINE NO., OR SERIAL NO.	NDE METHOD	TOTAL ITEMS	EXAMINATION AMOUNT	INSPECTION PERIOD	RUNNING %	REMARKS AND RELIEF REQUESTS
B 1400	EXAM CATEGORY B-0; PRESSURE RETAINING WELDS IN CONTROL ROD HOUSINGS								
1410	REACTOR VESSEL WELDS IN CRD HOUSING								
	2- Reactor Vessel Closure Head CEDM Housings	Lower Housing Welds	Housings #66 - #97	Vol	97 *	0 0 0	One Two Three	- - -	ITEM B14.10 COMBINED FOR PERCENTAGE
	2- Reactor Vessel Closure Heads CEDM Housings	Upper Housing Welds	Housings #66 - #97	Vol	97 *	2 2 3	One Two Three	- - -	*32 PERIPHERAL (126 TOTAL WELDS)
	2- Reactor Vessel Closure Heads CEDM Housings	Tube Housing Lower Weld	Housings ** #66 - #97	Vol	97 *	2 2 3	One Two Three	3 6 11	**INCLUDES 2 RVLMS TRANSITION HUBS.
	2- Reactor Vessel Closure Heads CEDM Housings	Tube Housing Upper Weld	Housings #66 - #97	Vol	97 *	0 0 0	One Two Three	- - -	

ASME ITEM NO.	ZONE-COMPONENT OR SYSTEM	IDENTIFICATION	DESCRIPTION LINE NO. OR SERIAL NO.	NDE METHOD	TOTAL ITEMS	EXAMINATION AMOUNT	INSPECTION PERIOD	RUNNING %	REMARKS AND RELIEF REQUESTS
B 1500	EXAMINATION CATEGORY B-F, ALL PRESSURE RETAINING COMPONENTS								
1510	SYSTEM LEAKAGE TEST								
1520	Reactor Vessel	Pressure Retaining Boundary		VT-2		Entire Pressure Retaining Boundary TWA-5000 TWB-5000	*	100	* EACH REFUELING OUTAGE
1530	Pressurizer						***		
1540	Steam Generators								
1550	Heat Exchangers								
1560	Piping								
1570	Pumps								
1570	Valves								
	SYSTEM HYDRO-TEST								
1511	Reactor Vessel	Pressure Retaining Boundary		VT-2		Entire Pressure Retaining Boundary TWA-5000 TWB-5000	**	100	** BY THE END OF THE INTERVAL *** PERFORM WALKDOWN AT THE BEGINNING OF EACH REFUELING OUTAGE FOR GEN. ERIC LETTER 98-05. IN ADDITION, WALKDOWNS SHOULD ALSO BE PERFORMED FOR SHUTDOWNS FOLLOWING OPERATION LONGER THAN APPROXIMATELY 6 MONTHS IN MODE 1 OR 2.
1521	Pressurizer								
1531	Steam Generators								
1541	Heat Exchangers								
1551	Piping								
1561	Pumps								
1571	Valves								

APS PALO VERDE NUCLEAR GENERATING STATION

10 YEAR INTERVAL - EXAMINATION SUMMARY

ASME CLASS 1

TABLE 1-IWF
PAGE 1 OF 3

ASME ITEM NO.	ZONE-COMPONENT OR SYSTEM	IDENTIFICATION	DESCRIPTION LINE NO., OR SERIAL NO.	NDE METHOD	TOTAL ITEMS	EXAMINATION AMOUNT	INSPECTION PERIOD	RUNNING %	REMARKS AND RELIEF REQUESTS
* F 110 F 120 F 130 F 140 F 210 F 220 F 230 F 240 F 310 F 320 F 330 F 340 F 350	EXAM CATEGORY F-A, PLATE AND SHELL TYPE SUPPORTS and EXAM CATEGORY F-B, LINEAR TYPE SUPPORTS and EXAM CATEGORY F-C, COMPONENT STANDARD SUPPORTS								REQUEST FOR RELIEF #1 & #3 * INCLUDES EXAM ITEMS IDENTIFIED AS APPLICABLE. * NDE METHOD INCLUDES VT-4 EXAMS, WHERE APPLICABLE.
	1- Reactor Vessel	Support Columns	SN 78173	** VT-3	4	0 *** 0 0	One Two Three	0 0 0	*** REQUEST FOR RELIEF #6.
	3- Steam Generator 1	Support Skirt	SN 78273-1	VT-3	1	1 0 0	One Two Three	100 100 100	
	4- Steam Generator-2	Support Skirt	SN 78273-2	VT-3	1	0 1 0	One Two Three	- 100 100	
	5- Pressurizer	Support Skirt	SN 78373	VT-3	1	0 0 1	One Two Three	- - 100	
	15- Reactor Coolant Pump 1A	Vertical and Lateral Supports	SN 1109-1A	VT-3	10	2 4 4	One Two Three	20 60 100	
	17- Reactor Coolant Pump 1B	Vertical and Lateral Supports	SN 1109-1B	VT-3	10	2 4 4	One Two Three	20 60 100	
	18- Reactor Coolant Pump 2A	Vertical and Lateral Supports	SN 1109-2A	VT-3	10	4 2 4	One Two Three	40 60 100	
	19- Reactor Coolant Pump 2B	Vertical and Lateral Supports	SN 1109-2B	VT-3	10	4 2 4	One Two Three	40 60 100	

REV 1
12-23-91

ASME ITEM NO.	ZONE-COMPONENT OR SYSTEM	IDENTIFICATION	DESCRIPTION LINE NO., OR SERIAL NO.	NDE METHOD	TOTAL ITEMS	EXAMINATION AMOUNT	INSPECTION PERIOD	RUNNING %	REMARKS AND RELIEF REQUESTS
F 110	CONTINUED								
F 120	20-Pressurizer Surge Line	Supports	RC-28-12"	VT-3	7	2	One	29	
F 130						2	Two	57	
F 140						3	Three	100	
F 210									
F 220									
F 230									
F 240	21-Shutdown Cooling Loop 1	Supports	RC-51-16" SI-240-16"	VT-3	22	7	One	32	
F 310						7	Two	64	
F 320						8	Three	100	
F 330									
F 340									
F 350									
F 360	22-Shutdown Cooling Loop 2	Supports (1-B10,10)	RC-68-16" SI-193-16"	VT-3	13	4	One	31	
F 370						5	Two	69	
F 380						4	Three	100	
F 390									
F 400	23-Safety Injection 1A	Supports	SI-207-14" SI-203-12"	VT-3	6	1	One	17	
F 410						2	Two	50	
F 420						3	Three	100	
F 430									
F 440	24-Safety Injection 1B	Supports (1-B10,10)	SI-223-14" SI-221-12"	VT-3	8	2	One	25	
F 450						2	Two	50	
F 460						4	Three	100	
F 470									
F 480	25-Safety Injection 2A	Supports (1-B10,10)	SI-160-14" SI-156-12"	VT-3	7	2	One	29	
F 490						3	Two	71	
F 500						2	Three	100	
F 510									
F 520	26-Safety Injection 2B	Supports (1-B10,10)	SI-179-14" SI-173-12"	VT-3	8	3	One	38	
F 530						3	Two	75	
F 540						2	Three	100	
F 550									
F 560	27-Pressurizer Spray Loop 1A	Supports	RC-62-3" RC-16-3"	VT-3	26	9	One	35	
F 570						9	Two	69	
F 580						8	Three	100	
F 590									
F 600	28-Pressurizer Spray Loop 1B	Supports	RC-17-3" RC-18-3" RC-18-4"	VT-3	28	9	One	52	
F 610						8	Two	61	
F 620						11	Three	100	
F 630									
F 640	29-Pressurizer Spray Loop 1B and Combined	Supports	RC-18-4"	VT-3	3	2	One	67	
F 650						1	Two	100	
F 660						0	Three	100	
F 670									
F 680	30-Aux Pressurizer Spray	Supports	CH-521-2"	VT-3	2	0	One	-	
F 690						0	Two	-	
F 700						2	Three	100	

ASME ITEM NO.	ZONE-COMPONENT OR SYSTEM	IDENTIFICATION	DESCRIPTION LINE NO., OR SERIAL NO.	NDE METHOD	TOTAL ITEMS	EXAMINATION AMOUNT	INSPECTION PERIOD	RUNNING %	REMARKS AND RELIEF REQUESTS
F 110	CONTINUED								
F 120	32-Drain Line	Supports	RC-60-2"	VT-3	2	2	One	100	
F 130	Loop 1A					0	Two	100	
F 140						0	Three	100	
F 210									
F 250	33-Drain Line	Supports	RC-58-2"	VT-3	2	0	One	-	
F 230	Loop 1B					2	Two	100	
F 240						0	Three	100	
F 310									
F 320	34-Drain Line	Supports	RC-96-2"	VT-3	2	0	One	-	
F 330	Loop 2A					2	Two	100	
F 340						0	Three	100	
F 350									
	35-Drain Line	Supports	RC-89-2"	VT-3	2	0	One	-	
	Loop 2B					0	Two	-	
						2	Three	100	
	36-Letdown Line	Supports	RC-91-2" CH-001-2"	VT-3	30	9	One	30	
						10	Two	63	
						11	Three	100	
	37-Charging Line	Supports	CH-5-3"	VT-3	43	14	One	33	
						14	Two	65	
						15	Three	100	
	38-Drain Line	Supports	RC-70-2"	VT-3	2	0	One	0	
	Loop 1					0	Two	0	
						2	Three	100	
	39-HPSI Long Term Recirculation	Supports	SI-248-3"	VT-3	14	4	One	29	
	Loop 1					5	Two	62	
						5	Three	100	
	40-HPSI Long Term Recirculation	Supports	SI-199-3"	VT-3	9	3	One	33	
	Loop 2					4	Two	78	
						2	Three	100	
N/A	Scrubbers: PWF-5000								REQUEST FOR RELIEF #1.
	All in-service testing requirements will be performed in accordance with PVNGS Technical Specifications.								

ASME ITEM NO.	ZONE/COMPONENT OR SYSTEM	IDENTIFICATION	DESCRIPTION LINE NO., OR SERIAL NO.	NDE METHOD	TOTAL ITEMS	EXAMINATION AMOUNT	INSPECTION PERIOD	RUNNING %	REMARKS AND RELIEF REQUESTS
N/A	<p>REACTOR COOLANT PUMP FLYWHEEL EXAMINATIONS REG. GUIDE 1.1.4.</p> <p>16- Reactor Coolant Pump 1A, 17 Reactor Coolant Pumps 1B, 18- Reactor Coolant Pump 2A, 19- Reactor Coolant Pump 2B</p> <p>Flywheels</p>	Flywheels		Vol**	4	4	One Two	100 100	<p>REFERENCE PVNGS TECHNICAL SPECIFICATION 4.4.9</p> <p>* AN ULTRASONIC EXAMINATION WILL BE PERFORMED OF THE AREAS OF HIGHER STRESS CONCENTRATION AT THE BORE AND KEYWAYS.</p> <p>** A SURFACE EXAM OF ALL EXPOSED SURFACES AND A COMPLETE ULTRASONIC EXAM TO THE EXTENT PRACTICAL WILL BE PERFORMED.</p>
				S, VOL**	4	4	Three	ED 100	

SECTION 5.0
ASME CLASS 2
EXAMINATION SUMMARY

INDEX

TABLE

EXAM CATEGORY

2-1	C-A,	Pressure Retaining Welds in Pressure Vessels
2-2	C-B,	Pressure Retaining Nozzle Welds in Vessels
2-3	C-C,	Integral Attachments for Vessels, Piping, Pumps, and Valves
2-4	C-D,	Pressure Retaining Bolting Exceeding 2 Inch in Diameter
2-5	C-F,	Pressure Retaining Welds in Piping
2-6	C-G,	Pressure Retaining Welds in Pumps and Valves
2-7	C-H,	All Pressure Retaining Components
2-IWF	F-A,	Plate to Shell Type Supports
	F-B,	Linear Type Supports
	F-C,	Component Standard Supports

ASME ITEM NO.	ZONE-COMPONENT OR SYSTEM	IDENTIFICATION	DESCRIPTION LINE NO. OR SERIAL NO.	NDE METHOD	TOTAL ITEMS	EXAMINATION AMOUNT	INSPECTION PERIOD	RUNNING %	REMARKS AND RELIEF REQUESTS
C100	EXAM. CATEGORY C-A PRESSURE RETAINING WELDS IN PRESSURIZABLE VESSELS STEAM GENERATORS SHELL CIRCUMFEREN- TIAL WELDS								
110	41-Steams Generator 1	Shell to Conical Welds	SN-78273-1	Vol	2	1* 0 0	One Two Three	50	MULTIPLE VESSELS PERCENTAGE COMBINED **50% EACH WELD
	42-Steams Generator 1	Shell to Conical Welds	SN-78273-2	Vol	2	0 0 1**	One Two Three	100	**50% EACH WELD
120	HEAD CIRCUMFEREN- TIAL WELDS								
	41-Steams Generator 1	Head to Shell Weld	SN-78273-1	Vol	1	50% 0 0	One Two Three	50	
	42-Steams Generator 2	Head to Shell Weld	SN-78273-2	Vol	1	0 0 50%	One Two Three	100	
130	TUBESHEET TO SHELL WELD								
	41-Steams Generator 1	Outside Shell and Stay Cylinder	SN-78273-1	Vol	2	50%* 0 0	One Two Three	25	*OUTSIDE SHELL WELDS
	42-Steams Generator 2	Outside Shell and Stay Cylinder	SN-78273-2	Vol	2	0 50%* 1**	One Two Three	50 100	**STAY CYLINDER EXAM

ASME ITEM NO.	ZONE-COMPONENT OR SYSTEM	IDENTIFICATION	DESCRIPTION LINE NO., OR SERIAL NO.	NDE METHOD	TOTAL ITEMS	EXAMINATION AMOUNT	INSPECTION PERIOD	RUNNING %	REMARKS AND RELIEF REQUESTS
110	REGENERATIVE HEAT EXCHANGER								
	SHELL CIRCUMFERENTIAL WELDS	Butt Welds	SN-79119	Vol	3	1 1 1	One Two Three	33 66 100	SINGLE VESSEL
	68 Regenerative Heat Exchanger								
120	HEAD CIRCUMFERENTIAL WELDS								
	68-R regenerative Heat Exchanger	Head to Shell	SN-79119	Vol	2	1 0 1	One Two Three	50 50 100	
	TUBESHEET-TO-SHELL WELDS								
130	68-R regenerative Heat Exchanger	Butt Welds	SN-79119	Vol	4	0 2 2	One Two Three	0 50 100	SINGLE VESSEL
	LETDOWN HEAT EXCHANGER								
	SHELL CIRCUMFERENTIAL WELDS								
140	69 Letdown Heat Exchanger	Shell to Flange	SN-N2370	Vol	1	50% 0 50%	One Two Three	50 50 100	
	HEAD CIRCUMFERENTIAL WELDS	None							
	TUBESHEET-TO-SHELL WELD	Butt Weld	SN-N2370	Vol	1	50% 0 50%	One Two Three	50 50 100	

ASME ITEM NO.	ZONE-COMPONENT OR SYSTEM	IDENTIFICATION	DESCRIPTION LINE NO., OR SERIAL NO.	NDE METHOD	TOTAL ITEMS	EXAMINATION AMOUNT	INSPECTION PERIOD	RUNNING %	REMARKS AND RELIEF REQUESTS
110	SHUTDOWN COOLING HEAT EXCHANGERS	Shell to Flange	SN-18341	Vol	1	0	One	50	MULTIPLE VESSELS PERCENTAGE COMBINED
						50%	Two	50	
						0	Three		
120	SHELL CIRCUMFERENTIAL WELDS 84-Shutdown Cooling Heat Exchanger Room A	Shell to Flange	SN-18342	Vol	1	0	One	50	
						0	Two		
						50%	Three	100	
130	HEAD CIRCUMFERENTIAL WELDS TUBESHEET-TO-SHELL WELD 84-SD Cooling Heat Exchanger Room A	None	SN-18341	Vol	1	0	One	50	
						50%	Two	50	
						0	Three		
130	87-SD Cooling Heat Exchanger B	Butt Weld	SN-18342	Vol	1	0	One	50	
						0	Two	100	
						50%	Three		

ASME ITEM NO.	ZONE-COMPONENT OR SYSTEM	IDENTIFICATION	DESCRIPTION LINE NO. OR SERIAL NO.	NDE METHOD	TOTAL ITEMS	EXAMINATION AMOUNT	INSPECTION PERIOD	RUNNING %	REMARKS AND RELIEF REQUESTS
C200	EXAM CATEGORY C-B PRESSURE RETAINING NOZZLE WELDS IN VESSELS								
210	NOZZLE IN VESSELS 5/2 IN NOMINAL THICKNESS	None							
220	NOZZLES WITHOUT REINFORCING PLATE IN VESSELS ≥ 1/2 IN NOMINAL THICKNESS								
221 & 222	NOZZLE TO-SHELL (OR HEAD) WELDS AND NOZZLE INSIDE RADIUS SECTION								
	41- Steam Generator 1	Nozzle to Vessel Welds	SN-78273-1	S, Vol	7	1 0 2	One Two Three	29 - 100	INSIDE R.A. PLUS ON PIPING ONLY GREATER THAN 12" DIAMETER MULTIPLE VESSELS PERCENTAGE COMBINED
	43- Steam Generator 2	Nozzle to Vessel Welds	SN-78273-2	S, Vol	7	1 2 1	One Two Three	5 57 -	
	84-SD Cooling Heat Exchanger Room A	Nozzle to Shell Welds	SN-18341	S, Vol	2	0 1 0	One Two Three	- 50 -	
	87-SD Cooling Heat Exchanger B	Nozzle to Shell Welds	SN-18342	S, Vol	2	0 0 1	One Two Three	- - 100	

ASME ITEM NO.	ZONE-COMPONENT OR SYSTEM	IDENTIFICATION	DESCRIPTION LINE NO. OR SERIAL NO.	NDE METHOD	TOTAL ITEMS	EXAMINATION AMOUNT	INSPECTION PERIOD	RUNNING %	REMARKS AND RELIEF REQUESTS
230	NOZZLES WITH REINFORCING PLATE IN VESSELS > 1/2 IN. NOMINAL THICKNESS	None							
231 & 232	REINFORCING PLATE WELDS TO NOZZLE AND VESSEL NOZZLE-TO-SHELL OR HEAD WELDS INSIDE OF VESSEL ACCESSIBLE INSIDE OF VESSEL INACCESSIBLE	None None None							

APS PALO VERDE NUCLEAR GENERATING STATION

10 YEAR INTERVAL - EXAMINATION SUMMARY

ASME CLASS 2

TABLE 2-3
PAGE 1 OF 4

ASME ITEM NO.	ZONE-COMPONENT OR SYSTEM	IDENTIFICATION	DESCRIPTION LINE NO., OR SERIAL NO.	NDE METHOD	TOTAL ITEMS	EXAMINATION AMOUNT	INSPECTION PERIOD	RUNNING %	REMARKS AND RELIEF REQUESTS
C300	EXAM CATEGORY C-C INTEGRAL ATTACHMENTS FOR VESSELS, PIPING PUMPS AND VALVES								
310	PRESSURE VESSELS INTEGRALLY WELDED ATTACHMENTS								
	41-Steam Generator 1	2-Scrubber Lugs	SN-78273-1	S	2	1 0 0	One Two Three	50 - -	MULTIPLE VESSELS PERCENTAGE COMBINED
	42-Steam Generator 2	2-Scrubber Lugs	SN-78273-2	S	2	0 1 0	One Two Three	- 100 -	
	68-Regenerative Heat Exchanger	2-Supports	SN-79119	S	2	0 1 1	One Two Three	- 50 100	SINGLE VESSEL
320	PIPING INTEGRALLY WELDED ATTACHMENTS								
	43-Main Steam SG 1 East 90° Inside Containment	Attachments	SG-36	S	6	1 1 4	One Two Three	17 33 100	
	44-Main Steam SG 1 West 270° Inside Containment	Attachments	SG-33	S	5	0 3 2	One Two Three	- 60 100	
	45-Main Steam SG 2 East 270° Inside Containment	Attachments	SG-42	S	5	3 1 1	One Two Three	60 80 100	
	46-Main Steam SG 2 West 90° Inside Containment	Attachments	SG-45	S	5	0 2 3	One Two Three	- 40 100	

REV. 1
12-23-91

ASME ITEM NO.	ZONE-COMPONENT OR SYSTEM	IDENTIFICATION	DESCRIPTION LINE NO., OR SERIAL NO.	NDE METHOD	TOTAL ITEMS	EXAMINATION ⁴ AMOUNT	INSPECTION PERIOD	RUNNING %	REMARKS AND RELIEF REQUESTS
330	CONTINUED								
	54 Feedwater SG No. 1 Inside Containment	Attachments	SG-002	S	1	0 0 1	One Two Three	- - 100	
	53 Feedwater SG No. 2 Inside Containment	Attachments	SG-005	S	2	1 0 1	One Two Three	50 50 100	
	82-Auxiliary Feedwater SG 1	Attachments	AF-018	S	1	0 1 0	One Two Three	- 100 100	
	64-Blowdown SG 1 Inside Containment	Attachments	SG-39 SG-53	S	5	1 1 1 1 1	One Two Three	10 80 100	
	63-Blowdown SG 2 Inside Containment	Attachments	SG-48 SG-52	S	7	2 3 2	One Two Three	29 71 100	
	71-A PSI Pump Room A Discharge	Attachments	SI-87	S	1	1	One	-	SI SYSTEM 4% COMBINED
	76-Containment Spray Pump Room A Suction	Attachments	SI-9	S	1	1	One	-	
	77-Containment Spray Pump Room A Discharge	Attachments	SI-79	S	1	1	Three	-	
	80-Containment Spray Pump Room B Discharge	Attachments	SI-119	S	1	1	Three	-	
	82-Shutdown Cooling Heat Exchanger Room A	Attachments	SI-78	S	1	1	Three	-	
	83-Shutdown Cooling Heat Exchanger Room A	Attachments	SI-70 SI-87 SI-90	S	4	2 2	Two Three	-	
	86-Shutdown Cooling Heat Exchanger Room B	Attachments	SI-72	S	2	2	Three	-	
	88-East Wrap	Attachments	SI-72	S	1	1	One	-	
	89-East Wrap	Attachments	SI-194	S	1	1	One	-	

ASME ITEM NO.	ZONE-COMPONENT OR SYSTEM	IDENTIFICATION	DESCRIPTION LINE NO., OR SERIAL NO.	NDE METHOD	TOTAL ITEMS	EXAMINATION AMOUNT	INSPECTION PERIOD	RUNNING %	REMARKS AND RELIEF REQUESTS
520	CONTINUED								
	91-West Wrap	Attachments	SI-70	S	4	4	One	-	
	92-West Wrap	Attachments	SI-239 SI-241	S	2	2	One Two	-	
	93-West Wrap	Attachments	SI-89	S	1	1	Two	-	
	94-A Train Misc. Pipe Chases & 80' Pipe Tunnel	Attachments	SI-70	S	2	2	Two	-	
	95-B Train Misc. Pipe Chases & 88' Pipe Tunnel	Attachments	SI-194	S	1	1	Three	-	
	96-Containment LPSI Header to Loop 1A	Attachments	SI-202	S	1	1	Three	-	
	99-Containment LPSI Header to Loop 2B	Attachments	SI-174	S	1	1	Two	-	
	100-Containment LPSI Train A Suction	Attachments	SI-7 SI-369	S	2	2	One Two	-	
	101-Containment LPSI Train B Suction	Attachments	SI-30	S	1	1	Three	-	
	Total Safety Injection			S	29	10 9 10	One Two Three	34 66 100	
730	PUMPS INTEGRALLY WELDED ATTACHMENTS								
	72-1-PSI Pump A	Attachment Lugs	SN 0876-36	S	3	2 1 0	One Two Three	66 100 100	
	73-1-PSI Pump B	Attachment Lugs	SN 0876-37	S	3	0 1 2	One Two Three	- 33 100	
	78-Containment Spray Pump A	Attachment Lugs	SN 0876-38	S	3	2 1 0	One Two Three	66 100 100	

ASME ITEM NO.	ZONE-COMPONENT OR SYSTEM	IDENTIFICATION	DESCRIPTION LINE NO. OR SERIAL NO.	NDE METHOD	TOTAL ITEMS	EXAMINATION AMOUNT	INSPECTION PERIOD	RUNNING %	REMARKS AND RELIEF REQUESTS
330	CONTINUED 8) Containment Spray Pump B	Attachment Lugs	SN 0876-39	5	3	0 1 2	One Two Three	33 100	
340	VALVES INTEGRALLY WELDED ATTACHMENTS	None							



**PALO VERDE NUCLEAR GENERATING STATION
10 YEAR INTERVAL - EXAMINATION SUMMARY**

ASME CLASS 2

ASME ITEM NO.	ZONE-COMPONENT OR SYSTEM	IDENTIFICATION	DESCRIPTION LINE NO., OR SERIAL NO.	NDE METHOD	TOTAL ITEMS	EXAMINATION AMOUNT	INSPECTION PERIOD	RUNNING %	REMARKS AND RELIEF REQUESTS
C400	EXAM CATEGORY C-D; PRESSURE RETAINING BOLTING EXCEEDING 2 IN. IN DIAMETER								
410	PRESSURE VESSELS BOLTS AND STUDS	None	-	-	-	-	-	-	
420	PIPING BOLTS AND STUDS	None	-	-	-	-	-	-	
430	PUMPS BOLTS AND STUDS	None	-	-	-	-	-	-	
440	VALVES BOLTS AND STUDS								
	47-Main Steam SG 1 West 270° MSSS	Bonnet Bolts	UV-170	Vol	20	20	One	(25)	ITEM C400 COMBINED FOR PERCENTAGE
	48-Main Steam SG 1 East 90° MSSS	Bonnet Bolts	UV-180	Vol	20	20	One	(25)	
	49-Main Steam SG 2 East 270° MSSS	Bonnet Bolts	UV-171	Vol	20	20	Three	(100)	
	50-Main Steam SG 2 West 90° MSSS	Bonnet Bolts	UV-181	Vol	20	20	Three	(100)	
	56-Feedwater SG No. 1 MSSS	Bonnet Bolts	UV-132 UV-174	Vol Vol	20 20	20 20	Two Two	(50) (50)	
	57-Feedwater SG No. 2 MSSS	Bonnet Bolts	UV-137 UV-177	Vol Vol	20 20	20 20	Three Three	(100) (100)	

APS

PALO VERDE NUCLEAR GENERATING STATION 10 YEAR INTERVAL - EXAMINATION SUMMARY

ASME CLASS 2

TABLE 2-5
PAGE 1 OF 4

ASME ITEM NO.	ZONE-COMPONENT OR SYSTEM	IDENTIFICATION	DESCRIPTION LINE NO., OR SERIAL NO.	NDE METHOD	TOTAL ITEMS	EXAMINATION AMOUNT	INSPECTION PERIOD	RUNNING %	REMARKS AND RELIEF REQUESTS
C-300	EXAMINATION CATEGORY C-F PRESSURE RETAINING WELDS IN PIPING								RHR, CHR, & ECCS SYSTEMS ARE SCHEDULED PER 10 CFR 50 REQUIREMENTS AND ARE IDENTIFIED IN TABLE 2-CFR
510	PIPING WELDS ≤ 1/2 IN. OR LESS NOMINAL WALL THICKNESS								*2.5T MIN. FROM EACH SCHEDULED CIRC. WELD INTERSECTION WILL BE EXAMINED
511 & 512	CIRCUMFERENTIAL AND *LONGITUDINAL WELDS								
	53-Steam to Aux Feedwater System	Butt Welds	SG-81-6" SG-83-6"	S S	14 14	** **			
	58-Aux & Downcomer Feedwater SG-1 Inside Containment	Butt Welds	SG-8-6" SG-8-8"	S*** S	3 23	1 2(5) 0(5)	One Two Three	4 12 12	**REQUIREMENTS IDENTIFIED IN TABLE 2-AHE
	59-Aux & Downcomer Feedwater SG-2 Inside Containment	Butt Welds	SG-11-6" SG-11-8"	S*** S	3 22	1(1) 3(5) 1(5)	One Two Three	4 15 19	***AN AUGMENTED (w/3) VOL EXAMINATION WILL BE PERFORMED EACH PERIOD (SEE IEB 79-13 AND SER 83-07)
520	PIPING WELDS > 1/2 IN. NOMINAL WALL THICKNESS								
521 & 522	CIRCUMFERENTIAL AND *LONGITUDINAL WELDS								
	43-Main Steam SG 1 East	Butt Welds	SG-36-28"	S, VOL	23	3 0 2	One Two Three	13 13 22	*2.5T MIN. FROM EACH SCHEDULED CIRC. WELD INTERSECTION WILL BE EXAMINED
	44-Main Steam SG 1 West	Butt Welds	SG-33-28"	S, VOL	20	3 1 2	One Two Three	15 20 30	

REV. 1
12-23-91

APS PALO VERDE NUCLEAR GENERATING STATION

10 YEAR INTERVAL - EXAMINATION SUMMARY

ASME CLASS 2

TABLE 2-5
PAGE 2 OF 4

ASME ITEM NO.	ZONE-COMPONENT OR SYSTEM	IDENTIFICATION	DESCRIPTION LINE NO., OR SERIAL NO.	NDE METHOD	TOTAL ITEMS	EXAMINATION AMOUNT	INSPECTION PERIOD	RUNNING %	REMARKS AND RELIEF REQUESTS	
521 522	CONTINUED									
	45-Main Steam SG 2 East 270° Inside Containment	Butt Welds	SG-42-28"	S. Vol	18	0	One	-		
					2	Two	11			
					3	Three	28			
	46-Main Steam SG 2 West 90° Inside Containment	Butt Welds	SG-43-28"	S. Vol	20	2	One	10		
					2	Two	20			
					1	Three	25			
	47-Main Steam SG 1 West 270° MSSS	Butt Welds	SG-206-28"	S. Vol	5	*	-	-		
					S. Vol	2	*	-		-
					S. Vol	5	*	-		-
	48-Main Steam SG 1 East 90° MSSS	Butt Welds	SG-207-28"	S. Vol	5	*	-	-		
					S. Vol	2	*	-		-
					S. Vol	5	*	-		-
	49-Main Steam SG 2 East 270° MSSS	Butt Welds	SG-208-28"	S. Vol	5	*	-	-	*REQUIREMENTS IDENTIFIED IN TABLE 2-AHE	
					S. Vol	2	*	-		-
					S. Vol	5	*	-		-
	50-Main Steam SG 2 West 90° MSSS	Butt Welds	SG-209-28"	S. Vol	5	*	-	-		
					S. Vol	2	*	-		-
					S. Vol	5	*	-		-
	51-Atmospheric Dump No. 1	Butt Welds	SG-59-12"	S. Vol	13	*	-	-		
					S. Vol	16	*	-		-
	52-Atmospheric Dump No. 2	Butt Welds	SG-84-12"	S. Vol	16	*	-	-		
					S. Vol	13	*	-		-
	54-Feedwater SG No. 1 Inside Containment	Butt Welds	SG-2-24"	S. Vol	33	5	One	8		
					S. Vol	4	5	Two		16
					S. Vol	11	6	Three		25
					S. Vol	4				
					S. Vol	11				
	55-Feedwater SG No. 2 Inside Containment	Butt Welds	SG-5-24"	S. Vol	31	5	One	9		
					S. Vol	3	5	Two		17
					S. Vol	10	5	Three		26
					S. Vol	4				
					S. Vol	10				

REV. 1
12-23-91

ASME ITEM NO.	ZONE-COMPONENT OR SYSTEM	IDENTIFICATION	DESCRIPTION LINE NO., OR SERIAL NO.	NDE METHOD	TOTAL ITEMS	EXAMINATION AMOUNT	INSPECTION PERIOD	RUNNING %	REMARKS AND RELIEF REQUESTS
521 522	CONTINUED								
	56-Feedwater SG No. 1 MESS	Butt Welds	SG-201-24" SG-202-24"	S, Vol S, Vol	2 3	*			
	57-Feedwater SG No. 2 MESS	Butt Welds	SG-204-24" SG-205-24"	S, Vol S, Vol	2 3	*			*REQUIREMENTS IDENTIFIED BY TABLE 2-AHE
	58-Aux & Downcomer Feedwater SG 1 Inside Containment	Butt Welds	SG-8-6" AF-4-6"	S, Vol S, Vol	1 13**	3	One Two Three	21 21 36	**INCLUDES 1 DISSIMILAR WELD
	59-Aux & Downcomer Feedwater SG 2 Inside Containment	Butt Welds	SG-11-6" AF-6-6"	S, Vol S, Vol	1 12**	2 2 1	One Two Three	15 31 38	
	60-Downcomer Feedwater SG 1 MESS	Butt Welds	SG-206-8" SG-008-8"	S, Vol	2 4	*			
	61-Downcomer Feedwater SG 2 MESS	Butt Welds	SG-203-8" SG-11-8"	S, Vol	2 4	*			
	62-Auxiliary Feedwater SG 1 MESS	Butt Welds	AF-4-6" AF-18-6"	S, Vol S, Vol	7 11	1 2 2	One Two Three	6 17 28	
	63-Auxiliary Feedwater SG 2 MESS	Butt Welds	AF-6-6" AF-16-6"	S, Vol S, Vol	13 3	1 3 2	One Two Three	6 19 31	
	64-B Isolation SG 1 Inside Containment	Butt Welds	SG-39-6" SG-53-6"	S, Vol S, Vol	37 14	2 4 4	One Two Three	4 12 20	
	65-B Isolation SG 2 Inside Containment	Butt Welds	SG-48-6" SG-52-6"	S, Vol S, Vol	34 14	4 3 4	One Two Three	8 15 22	

ASME ITEM NO.	ZONE-COMPONENT OR SYSTEM	IDENTIFICATION	DESCRIPTION LINE NO., OR SERIAL NO.	NDE METHOD	TOTAL ITEMS	EXAMINATION AMOUNT	INSPECTION PERIOD	RUNNING %	REMARKS AND RELIEF REQUESTS
521	CONTINUED 66-Blowdown SG 1 MSSS	Butt Welds	SG-39-6"	S, Vol	3	*	-	-	*REQUIREMENTS IDENTIFIED IN TABLE 2-AHE
522									
530	67-Blowdown SG 2 PIPE BRANCH CONNECTIONS > 4 IN NOMINAL PIPE SIZE CIRCUMFERENTIAL AND LONGITUDINAL WELDS	Butt Welds	SG-48-6"	S, Vol	3	*	-	-	**2.5T MIN FROM EACH SCHEDULED BRANCH WELD INTERSECTION WILL BE EXAMINED
531									
532	47 Main Steam SG 1 West 270° MSSS 48 Main Steam SG 1 East 90° MSSS 49 Main Steam SG 2 East 270° MSSS 50 Main Steam SG 2 West 90° MSSS	Sweepoints	SG-206-28	S	7	*	-	-	*REQUIREMENTS IDENTIFIED IN TABLE 2-AHE
		Sweepoints	SG-207-28	S	8	*	-	-	
		Sweepoints	SG-208-28	S	8	*	-	-	
		Sweepoints	SG-209-28	S	7	*	-	-	

ASME ITEM NO.	ZONE-COMPONENT OR SYSTEM	IDENTIFICATION	DESCRIPTION LINE NO., OR SERIAL NO.	NDE METHOD	TOTAL ITEMS	EXAMINATION AMOUNT	INSPECTION PERIOD	RUNNING %	REMARKS AND RELIEF REQUESTS
600	EXAM CATEGORY C-G PRESSURE RETAINING WELDS IN PUMPS AND VALVES								
610	PUMPS PUMP CASING WELDS	None							
620	VALVES VALVE BODY WELDS								
	Devices: 6" x 10" Pressure Safety Main Steam Valves	Zone 47 Zone 48 Zone 49 Zone 50	SG-206-28" SG-207-28" SG-208-28" SG-209-28"	S S S S	5 5 5 5	Examine the weld in 1 valve	*	100	*BY THE END OF THE INTERVAL
	Borg Warner, 16" Gate Valves LPSI Pump Suction	Zone 02 Zone 89	SI-241-16" SI-194-16"	S S	1 1	Examine the weld in 1 valve	*	100	
	Borg Warner, 6" Gate Valves SDCTUX Outlet	Zone 83 Zone 86	SI-131-6" SI-131-6"	S S	1 1	Examine the weld in 1 valve	*	100	

APS

PALO VERDE NUCLEAR GENERATING STATION 10 YEAR INTERVAL - EXAMINATION SUMMARY

ASME CLASS 2

TABLE 2-IWF
PAGE 1 OF 6

ASME ITEM NO.	ZONE-COMPONENT OR SYSTEM	IDENTIFICATION	DESCRIPTION LINE NO., OR SERIAL NO.	NDE METHOD	TOTAL ITEMS	EXAMINATION AMOUNT	INSPECTION PERIOD	RUNNING %	REMARKS AND RELIEF REQUESTS
* F110 F120 F130 F140 F210 F220 F230 F240 F310 F320 F330 F340 F350	EXAM CATEGORY F-A: PLATE AND SHELL TYPE SUPPORTS and EXAM CATEGORY F-B: LINEAR TYPE SUPPORTS and EXAM CATEGORY F-C: COMPONENT STANDARD SUPPORTS			**					REQUEST FOR RELIEF #1&3 *INCLUDES EXAM ITEMS IDENTIFIED AS APPLICABLE **NDE METHOD INCLUDES VT-4 EXAMS WHERE APPLICABLE
	41- Steam Generator 1	2-Subbers	SN-78273-1	VT-3	2	2 0 0	One Two Three	100 100 100	
	42- Steam Generator 2	2-Subbers	SN-78273-2	VT-3	2	0 2 0	One Two Three	- 100 100	
	43- Main Steam SG 1 East 90° Inside Containment	Supports	SG-36	VT-3	9	5 2 4	One Two Three	33 56 100	
	44- Main Steam SG 1 West 270° Inside Containment	Supports	SG-33	VT-3	10	2 5 3	One Two Three	20 70 100	
	45- Main Steam SG 2 East 270° Inside Containment	Supports	SG-42	VT-3	9	3 3 3	One Two Three	33 67 100	
	46- Main Steam SG 2 West 90° Inside Containment	Supports	SG-45	VT-3	10	2 5 3	One Two Three	20 70 100	
	47- Main Steam SG 1 West 270° MSSS	Supports	SG-206	VT-3	1	1 0 0	One Two Three	100 100 100	
	48- Main Steam SG 1 East 90° MSSS	Supports	SG-207	VT-3	1	0 1 0	One Two Three	- 100 100	
	49- Main Steam SG 2 East 270° MSSS	Supports	SG-208	VT-3	1	0 0 1	One Two Three	- - 100	

REV 1
12-23-91

ASME ITEM NO.	ZONE-COMPONENT OR SYSTEM	IDENTIFICATION	DESCRIPTION LINE NO., OR SERIAL NO.	NDE METHOD	TOTAL ITEMS	EXAMINATION AMOUNT	INSPECTION PERIOD	RUNNING %	REMARKS AND RELIEF REQUESTS
F110	CONTINUED								
F120	50-Main Steam SG 1 West	Supports	SG-309	VT-3	1	0	One	-	
F130	90" MSSS					0	Two		
F140						1	Three	100	
F210									
F220	51-Atmospheric Dump No. 1	Supports	SG-59 SG-70	VT-3	2	1	One	50	
F230						1	Two	100	
F240						0	Three	100	
F310									
F320	52-Atmospheric Dump No. 2	Supports	SG-44 SG-103	VT-3	2	0	One	-	
F330	SG-2					0	Two		
F340						2	Three	100	
F350									
	53-Steam to Aux Feedwater System	Supports	SG-81 SG-83	VT-3	8	4	One	50	
						2	Two	75	
						2	Three	100	
	54-Feedwater SG No. 1 Inside Containment	Supports	SG-2 SG-13	VT-3	20	7	One	35	
						7	Two	70	
						6	Three	100	
	55-Feedwater SG No. 2 Inside Containment	Supports	SG-5 SG-14	VT-3	20	9	One	45	
						7	Two	80	
						4	Three	100	
	56-Feedwater SG No. 1 MSSS	Supports	SG-202	VT-3	1	0	One	-	
						1	Two	100	
						0	Three	100	
	57-Feedwater SG No. 2 MSSS	Supports	SG-205	VT-3	1	0	One	-	
						0	Two		
						1	Three	100	
	58-Aux. & Downcomer Feedwater SG 1 Inside Containment	Supports	SG-8 AF-4	VT-3	22	7	One	32	
						7	Two	64	
						8	Three	100	
	59-Aux. & Downcomer Feedwater SG 2 Inside Containment	Supports	SG-11 AF-6	VT-3	22	6	One	27	
						6	Two	25	
						10	Three	100	
	60-Downcomer Feedwater SG 1 MSSS	Supports	SG-200	VT-3	3	1	One	33	
						0	Two	33	
						2	Three	100	
	61-Downcomer Feedwater SG 2 MSSS	Supports	SG-203	VT-3	3	0	One	-	
						2	Two	66	
						1	Three	100	

ASME ITEM NO.	ZONE-COMPONENT OR SYSTEM	IDENTIFICATION	DESCRIPTION LINE NO., OR SERIAL NO.	NDE METHOD	TOTAL ITEMS	EXAMINATION AMOUNT	INSPECTION PERIOD	RUNNING %	REMARKS AND RELIEF REQUESTS
F110	<u>CONTINUED</u>								
F120		Supports	AF-4	VT-3	4	1	One	25	
F130	62-Auxiliary Feedwater SG 1 MESS		AF-18			1	Two	50	
F140						2	Three	100	
F210		Supports	AF-6	VT-3	5	2	One	40	
F220	63-Auxiliary Feedwater SG 2 MESS		AF-16			2	Two	80	
F230						1	Three	100	
F240		Supports	SG-39	VT-3	37	12	One	32	
F310	64-Blowdown SG 1 Inside Containment		SG-53			13	Two	68	
F320						12	Three	100	
F330		Supports	SG-48	VT-3	36	12	One	33	
F340	65-Blowdown SG 2 Inside Containment		SG-52			11	Two	64	
F350						13	Three	100	
F400		Supports	SN-79119	VT-3	2	0	One	-	
F410	66-Representative Heat Exchanger					1	Two	50	
F420						1	Three	100	
F510		Supports	SI-67	VT-3	5	1	One	-	ALL SI (ZONES 70 THRU 101) COM- BINED FOR PER- CENTAGE.
F520	70-LPSI Pump Room A Suction		SI-241			4	Three	-	
F530			SI-307						
F610		Supports	SI-78	VT-3	6	1	One	-	
F620	71-LPSI Pump Room A Discharge		SI-87			5	Two	-	
F630			SN-0876-36	VT-3	3**	2	One	-	**3 PUMP SUPPORTS
F640						1	Two	-	
F650		Supports	SI-34	VT-3	5	1	Two	-	
F660	73-LPSI Pump Room B Suction		SI-194			4	Three	-	
F670			SI-308						
F680		Supports	SI-129	VT-3	6	6	Three	-	

ASME ITEM NO.	ZONE-COMPONENT OR SYSTEM	IDENTIFICATION	DESCRIPTION LINE NO., OR SERIAL NO.	NDE METHOD	TOTAL ITEMS	EXAMINATION AMOUNT	INSPECTION PERIOD	RUNNING %	REMARKS AND RELIEF REQUESTS
F110	CONTINUED								
F120									
F130									
F140	73-LPSI Pump B	Supports	SN-0876-37	VT-3	3**	1 2	Two Three	- -	
F210									
F220									
F230	76-Containment Spray Pump A Suction	Supports	SI-9 SI-67 SI-78	VT-3	5	1 4	One Three	- -	** 1 PUMP SUPPORTS
F240									
F310									
F320									
F330	77-Containment Spray Pump A Discharge	Supports	SI-79 SI-82	VT-3	10	4 3 3	One Two Three	- - -	
F340									
F350									
F40	78-Containment Spray Pump A	Supports	SN-0876-38	VT-3	3**	2 1	One Two	- -	
F50									
F60									
F70	79-Containment Spray Pump B Suction	Supports	SI-33 SI-34 SI-123	VT-3	8	3 2 3	One Two Three	- - -	
F80									
F90	80-Containment Spray Pump B Discharge	Supports	SI-119 SI-147	VT-3	10	3 4 3	One Two Three	- - -	
F100									
F110	81-Containment Spray Pump B	Supports	SN-0876-39	VT-3	3**	1 2	Two Three	- -	
F120									
F130	82-Shutdown Cooling A	Supports	SI-79 SI-78	VT-3	3	3 1	One Two	- -	
F140									
F150	83-Shutdown Cooling A	Supports	SI-79 SI-87 SI-90 SI-89 SI-82	VT-3	19	4 3 12	One Two Three	- - -	
F160									
F170									
F180	85-Shutdown Cooling B	Supports	SI-119 SI-123	VT-3	9	3 6	One Two	- -	
F190									
F200	86-Shutdown Cooling B	Supports	SI-72 SI-134 SI-147 SI-135 SI-129	VT-3	26	3 7 16	One Two Three	- - -	

APS PALO VERDE NUCLEAR GENERATING STATION 10 YEAR INTERVAL - EXAMINATION SUMMARY

ASME CLASS 2

TABLE 2-IWF
PAGE 5 OF 6

ASME ITEM NO.	ZONE-COMPONENT OR SYSTEM	IDENTIFICATION	DESCRIPTION LINE NO., OR SERIAL NO.	NDE METHOD	TOTAL ITEMS	EXAMINATION AMOUNT	INSPECTION PERIOD	RUNNING %	REMARKS AND RELIEF REQUESTS
F110									
F120									
F130	98-East Wrap	Supports	SI-72	VT-3	14	8	One	-	
F140			SI-73			6	Three	-	
F210									
F220									
F230	89-East Wrap	Supports	SI-173	VT-3	5	4	One	-	
F240			SI-194			1	Three	-	
F310									
F320									
F330	90-East Wrap	Supports	SI-134	VT-3	2	2	Two	-	
F340									
F350	91-West Wrap	Supports	SI-70	VT-3	10	7	One	-	
			SI-71			2	Two	-	
						1	Three	-	
	92-West Wrap	Supports	SI-2	VT-3	12	5	One	-	
			SI-239			5	Two	-	
			SI-241			2	Three	-	
	93-West Wrap	Supports	SI-89	VT-3	4	2	Two	-	
						2	Three	-	
	94-A Train Misc. Pipe Chases & 88' Pipe Tunnel	Supports	SI-70	VT-3	15	3	One	-	
			SI-89			7	Two	-	
			SI-241			5	Three	-	
	95-B Train Misc. Pipe Chases & 88' Pipe Tunnel	Supports	SI-72	VT-3	18	6	One	-	
			SI-134			10	Two	-	
			SI-194			2	Three	-	
	96-Containment LPSI Header to Loop 1A	Supports	SI-202	VT-3	18	3	One	-	
						8	Two	-	
						7	Three	-	
	97-Containment LPSI Header to Loop 1B	Supports	SI-220	VT-3	27	10	One	-	
						7	Two	-	
						10	Three	-	
	98-Containment LPSI Header to Loop 2A	Supports	SI-155	VT-3	7	2	One	-	
						5	Two	-	
	99-Containment LPSI Header to Loop 2B	Supports	SI-174	VT-3	10	5	Two	-	
						5	Three	-	

REV 1
12-23-91

ASME ITEM NO.	ZONE-COMPONENT OR SYSTEM	IDENTIFICATION	DESCRIPTION LINE NO., OR SERIAL NO.	NDE METHOD	TOTAL ITEMS	EXAMINATION AMOUNT	INSPECTION PERIOD	RUNNING %	REMARKS AND RELIEF REQUESTS
F110	CONTINUED 100-Containment LPSI Train A Section	Supports	SI-7 SI-241 SI-369	VT-3	3	2	One	-	
F130						1	Two	-	
F140									
F210	101-Containment LPSI Train B Section	Supports	SI-30 SI-194 SI-368	VT-3	8	8	Three	-	
F230									
F240									
F310	SI SYSTEMS ZONES (70-101) TOTALS				277	79 89 199	One Two Three	29 61 100	
F330									
F340									
F350									

SECTION 6.0
ASME CLASS 3
EXAMINATION SUMMARY

INDEX

<u>TABLE</u>		<u>EXAM CATEGORY</u>
3-1	D-A,	Systems in Support of Reactor Shutdown Function
	D-B,	Systems in Support of Emergency Core Cooling, Containment Heat Removal, Atmosphere Cleanup, and Reactor Heat Removal
	D-C,	Systems in Support of Residual Heat Removal from Spent Fuel Storage Pool
3-IWF	F-A,	Plate and Shell Type Supports
	F-B,	Linear Type Supports
	F-C,	Component Standard Supports

ASME ITEM NO.	ZONE-COMPONENT OR SYSTEM	IDENTIFICATION	DESCRIPTION LINE NO., OR SERIAL NO.	NDE METHOD	TOTAL ITEMS	EXAMINATION AMOUNT	INSPECTION PERIOD	RUNNING %	REMARKS AND RELIEF REQUESTS
D120 D160 D220 D260 D320 D360	EXAMINATION CATEGORY D-A. SYSTEMS IN SUP- PORT OF REACTOR SHUTDOWN FUNCTION AND EXAMINATION CATEGORY D-B. SYSTEMS IN SUP- PORT OF EMERGENCY CORE COOLING CON- TAINMENT HEAT RE- MOVAL, ATMOSPHERE CLEANUP, AND REAC- TOR RESIDUAL HEAT REMOVAL. AND EXAMINATION CATEGORY D-C. SYSTEMS IN SUP- PORT OF RESIDUAL HEAT REMOVAL FROM SPENT FUEL STORAGE POOL.					ASME CLASS 3 SYSTEMS ARE IDENTIFIED ON THE ISI BOUNDARY DRAWINGS CONTAINED IN SECTION 10.0.			
	All Class 3 Systems (Except Auxiliary Feedwater)	Integrally Welded Attachments	All lines greater than 4" nominal pipe size	VT-3	All	100%	Each In- spection interval	100%	
	Auxiliary Feedwater Systems	Integrally Welded Attachments	All lines	VT-3	All	100%	Each In- spection interval	100%	REQUEST FOR RELIEF #1883

ASME ITEM NO.	ZONE-COMPONENT OR SYSTEM	IDENTIFICATION	DESCRIPTION LINE NO., OR SERIAL NO.	NDE METHOD	TOTAL ITEMS	EXAMINATION AMOUNT	INSPECTION PERIOD	RUNNING %	REMARKS AND RELIEF REQUESTS
D110 D210 D310	<p>EXAMINATION CATEGORY D-A. SYSTEMS IN SUP- PORT OF REACTOR SHUTDOWN FUNCTION AND EXAMINATION CATEGORY D-B. SYSTEMS IN SUP- PORT OF EMERGENCY CORE COOLING, CON- TAINMENT HEAT RE- MOVAL, ATMOSPHERE CLEANUP, AND REAC- TOR RESIDUAL HEAT REMOVAL</p> <p>AND EXAMINATION CATEGORY D-C. SYSTEMS IN SUP- PORT OF RESIDUAL HEAT REMOVAL FROM SPENT FUEL STORAGE POOL</p> <p>SYSTEM INSERVICE TESTS OR FUNCTIONAL TESTS***</p> <p>Pressure Retaining Components</p>			VT-2		<p>Entire Pres- sure Retain- ing Boundary TWA-5000 TWD-5000</p>	*	100	*EACH INSPECTION PERIOD.
D110 D210 D310	<p>SYSTEM HYDRO-TESTS</p> <p>Pressure Retaining Components</p>			VT-2		<p>Entire Pres- sure Retain- ing Boundary TWA-5000 TWD-5000</p>	**	100	**EACH INSPECTION INTERVAL.
***REQUEST FOR RELIEF #7 AND #8									

ASME ITEM NO.	ZONE-COMPONENT OR SYSTEM	IDENTIFICATION	DESCRIPTION LINE NO. OR SERIAL NO.	NDE METHOD	TOTAL ITEMS	EXAMINATION AMOUNT	INSPECTION PERIOD	RUNNING %	REMARKS AND RELIEF REQUESTS
F110 F120 F130 F140 F210 F220 F230 F240 F310 F320 F330 F340 F350	EXAM CATEGORY E-A, PLATE AND SHELL TYPE SUPPORTS AND EXAM CATEGORY E-B, LINEAR TYPE SUPPORTS AND EXAM CATEGORY E-C, COMPONENT STANDARD SUPPORTS All Class 3 Systems (Except Auxiliary Feedwater) Auxiliary Feedwater Systems	Support Components Support Components	All lines greater than 4" nominal pipe size All lines	** VT-3 VT-3	All All	100% 100%	Each In- spection Interval Each In- spection Interval	100% 100%	*INCLUDES EXAM ITEMS IDENTIFIED AS APPL. CABLE. **NDE METHOD INCLUDES VT-4 EXAMS, WHERE APP. LICABLE. REQUEST FOR RELIEF #1 AND #3

**SECTION 7.0
AUGMENTED HIGH
ENERGY PIPING**

ASME ITEM NO.	ZONE-COMPONENT OR SYSTEM	IDENTIFICATION	DESCRIPTION LINE NO., OR SERIAL NO.	NDE METHOD	TOTAL ITEMS	EXAMINATION AMOUNT	INSPECTION PERIOD	RUNNING %	REMARKS AND RELIEF REQUESTS
510	AUGMENTED EXAMINATION OF HIGH ENERGY PIPING				(*)				(*ADJENT)- PIPES THE NUMBER OF WELDS THAT ARE NOT ASME CLASSIFIED
511	PIPING WELDS 5/2 IN. NOMINAL WALL THICKNESS	Butt Welds 4" x .337"	SG-83-4"	S, Vol	(20)	0 20 0	One Two Three	100 100	
512	CIRCUMFERENTIAL AND **LONGITUDINAL WELDS 51-Atmospheric Dump No. 1 Bypass UV-180	Butt Welds 4" x .337"	SG-100-4"	S, Vol	(20)	0 0 20	One Two Three	100	**NONE
520	52-Steam to AUA Feedwater	Butt Welds 4" x .432"	SG-81-6" SG-83-6"	S, Vol S, Vol	14 14	10 9 9	One Two Three	35 68 100	
521	PIPING WELDS > 1/2 IN. NOMINAL WALL THICKNESS								
522	CIRCUMFERENTIAL AND *LONGITUDINAL WELDS 47 Main Steam SG 1 West 270P MSSS	Butt Welds	SG-208-28" SG-206-12" SG-208-6"	S, Vol S, Vol S, Vol	5(1) 2 5	13 0 0	One Two Three	100 100 100	*100% OF ALL INTERSECTING LONGITUDINAL WELDS WILL BE EXAMINED
	48 Main Steam SG 1 East 90P MSSS	Butt Welds	SG-207-28" SG-207-12" SG-207-6"	S, Vol S, Vol S, Vol	5(1) 2 5	0 13 0	One Two Three	100 100 100	
	49 Main Steam SG 2 East 270P MSSS	Butt Welds	SG-208-28" SG-208-12" SG-208-6"	S, Vol S, Vol S, Vol	5(1) 2 5	0 0 13	One Two Three	100 100 100	

ASME ITEM NO.	ZONE-COMPONENT OR SYSTEM	IDENTIFICATION	DESCRIPTION LINE NO., OR SERIAL NO.	NDE METHOD	TOTAL ITEMS	EXAMINATION AMOUNT	INSPECTION PERIOD	RUNNING %	REMARKS AND RELIEF REQUESTS	
521	CONTINUED 50-Main Steam SG 3 West 90° MSSS	Butt Welds	SG-209-28"	S, Vol	5(1)	0	One	-		
522				SG-209-12"	S, Vol	2	0	Two	-	
				SG-209-6"	S, Vol	5	13	100	Three	
	51-Atmospheric Dump No. 1	Butt Welds 12" x 8.44"	SG-59-12" SG-70-12"	S, Vol	13	13	One	46		
				S, Vol	16	16	Two	100		
					0	100	Three			
	52-Atmospheric Dump No. 2	Butt Welds 12" x 8.44"	SG-84-12" SG-103-12"	S, Vol	16	0	One	-		
				S, Vol	13	0	Two	-		
					29	100	Three			
	56-Feedwater SG No. 1 MSSS	Butt Welds	SG-201-24" SG-202-24" SG-224-24"	S, Vol	2	5	One	63		
				S, Vol	3	2	Two	100		
				S, Vol	(2)	0	100	Three		
	57-Feedwater SG No. 2 MSSS	Butt Welds	SG-204-24" SG-205-24" SG-225-24"	S, Vol	2	0	One	-		
				S, Vol	3	0	Two	-		
				S, Vol	(2)	7	100	Three		
	60-Downcomer Feedwater SG 1 MSSS	Butt Welds 8" x 7.19"	SG-200-8" SG-8-8"	S, Vol	2(8)	9	One	64		
				S, Vol	4	5	Two	100		
					0	100	Three			
	61-Downcomer Feedwater SG 2 MSSS	Butt Welds 8" x 7.19"	SG-205-8" SG-11-8"	S, Vol	2(8)	0	One	-		
				S, Vol	4	5	Two	36		
					9	100	Three			
	66-Blowdown SG 1 MSSS	Butt Welds	SG-39-6"	S, Vol	3(12)	9	One	69		
					6	6	Two	100		
					0	100	Three			
	67-Blowdown SG 2 MSSS	Butt Welds	SG-48-6"	S, Vol	3(9)	0	One	-		
					6	6	Two	50		
					6	100	Three			
530	Pipe Branch Connectors									
	531									
	532									
	87-Main Steam SG 1 West 270° MSSS	Sweeps/ports	SG-206-28"	S, Vol	7	7	One	100		
					0	0	Two	100		
					0	0	Three	100		

*SCHEDULED
UNDER CS.21
AND CS.22

ASME ITEM NO.	ZONE/COMPONENT OR SYSTEM	IDENTIFICATION	DESCRIPTION LINE NO., OR SERIAL NO.	NDE METHOD	TOTAL ITEMS	EXAMINATION AMOUNT	INSPECTION PERIOD	RUNNING %	REMARKS AND RELIEF REQUESTS
531	48. Main Steam SG 1 East 90° MSSS	Sweepoints	SG-207-28"	S. Vol	8(1)	0	One	-	
0						Two	100		
0						Three	100		
532	49. Main Steam SG 2 East 270° MSSS	Sweepoints	SG-208-28"	S. Vol	8(1)	0	One	-	
0						Two	-		
9						Three	100		
	50. Main Steam SG 2 West 90° MSSS	Sweepoints	SG-209-28"	S. Vol	7	0	One	-	
0						Two	-		
7						Three	100		

SECTION 8.0
RHR, ECCS, AND CHR PIPING

ASME ITEM NO.	ZONE-COMPONENT OR SYSTEM	IDENTIFICATION	DESCRIPTION LINE NO., OR SERIAL NO.	NDE METHOD	TOTAL ITEMS	EXAM AMOUNT		INSPECTION PERIOD	(40 YR.) 10 YR. %	REMARKS AND RELIEF REQUESTS
						40 YR.	10 YR.			
C500	Exam Category C-P* Pressure Retaining Welds in Piping	Note 2		Note 1				Note 3		
510	Piping Welds ≤ 1/2" nominal wall thickness	Butt Welds 14" x 0.312"	SI-307 SI-308	S, Vol S, Vol	(48) 5 6	(24) 3 3	3 4 1	One Two Three	***	***Category C5.10 systems are combined for percentages
511	Circumferential and	16" x 0.312"	SI-67	S, Vol	3	3				
512	** Longitudinal welds (75 category C-F)	18" x 0.312"	SI-341 SI-194	S, Vol S, Vol	5 3	2 1				
	70-LPSI Pump Room A Suction 73-LPSI Pump Room B Suction	20" x 0.375"	SI-307 SI-308	S, Vol S, Vol	10 10	5 5				
	71-LPSI Pump Room A Discharge 74-LPSI Pump Room B Discharge	Butt Welds 8" x 0.322"	SI-87 SI-129	S, Vol S, Vol	(56) 2 2	(28) 1 1	3 3 2	One Two Three		
	76-Containment Spray Pump Room A Suction 79-Containment Spray Pump Room B Suction	10" x 0.365"	SI-78 SI-123 SI-87 SI-129	S, Vol S, Vol S, Vol S, Vol	3 3 24 22	1 2 12 11				
		Butt Welds 10" x 0.365"	SI-78 SI-123	S, Vol S, Vol	(47) 2 2	(24) 1 1	2 2 2	One Two Three		
		14" x 0.312"	SI-409 SI-33	S, Vol S, Vol	4 4	2 2				
		14" x 0.312"	SI-67 SI-34	S, Vol S, Vol	7 7	4 3				
		16" x 0.312"	SI-67 SI-34	S, Vol S, Vol	2 2	1 1				
		18" x 0.312"	SI-9 SI-33	S, Vol S, Vol	9 8	5 4				

ASME ITEM NO.	ZONE-COMPONENT OR SYSTEM	IDENTIFICATION	DESCRIPTION LINE NO., OR SERIAL NO.	NDE METHOD	TOTAL ITEMS	EXAM AMOUNT		INSPECTION PERIOD	(40 YR.) 10 YR. %	REMARKS AND RELIEF REQUESTS
						40 YR.	10 YR.			
511	CONTINUED									
512	77-Containment Spray Pump Room A Discharge. 80-Containment Spray Pump Room B Discharge.	Butt Welds 8" x 0.312" 10" x 0.365" 10" x 0.365"	SI-79 SI-119 SI-79 SI-119 SI-82 SI-147	S, Vol S, Vol S, Vol S, Vol S, Vol S, Vol	(67) 1 1 27 27 5 6	(34) 1 0 14 14 3 2	3 4 4	One Two Three		
	82-Shutdown Cooling Heat Exchanger Room A. 83-Shutdown Cooling Heat Exchanger Room B	Butt Welds 10" x 0.365" 10" X 0.365" 20" x 0.500"	SI-078 SI-123 SI-79 SI-119 SI-078 SI-123	S, Vol S, Vol S, Vol S, Vol S, Vol S, Vol	(45) 9 10 9 9 3 5	(24) 5 5 4 5 2 3	2 4 1	One Two Three		
	83-Shutdown Cooling Heat Exchanger Room A. 86-Shutdown Cooling Heat Exchanger Room B	Butt Welds 6" x 0.280" 10" X 0.365" 10" X 0.365" 10" X 0.365" 14" x 0.375" 16" x 0.375"	SI-131 SI-134 SI-82 SI-147 SI-87 SI-129 SI-89 SI-134 SI-90 SI-135 SI-70 SI-72	S, Vol S, Vol S, Vol S, Vol S, Vol S, Vol S, Vol S, Vol S, Vol S, Vol S, Vol S, Vol	(115) 4 4 3 3 12 7 14 14 10 13 4 4	(60) 2 2 2 1 6 4 6 7 6 5 2 2	6 3 3 3	One Two Three		

ASME ITEM NO.	ZONE-COMPONENT OR SYSTEM	IDENTIFICATION	DESCRIPTION LINE NO., OR SERIAL NO.	NDE METHOD	TOTAL ITEMS	EXAM AMOUNT		INSPECTION PERIOD	(40 YR.) 10 YR. %	REMARKS AND RELIEF REQUESTS
						40 YR.	10 YR.			
511	CONTINUED	20" x 0.500"	SI-70	S, Vol	14	8				
512				S, Vol	12	6				
	88-East Wmp, 89-East Wmp SI	Butt Welds 10" x 0.265"	SI-172	S, Vol	(52)					
				S, Vol	4	2	2	One		
			SI-71	S, Vol	2	1				Two
				S, Vol						Three
			SI-72	S, Vol	15	4				
			SI-73	S, Vol	6	2				
			SI-70	S, Vol	11	2				
			SI-71	S, Vol	8	2				
			SI-72	S, Vol	3	1				
			SI-70	S, Vol	3	2				
					(63)					
	89-East Wmp, 92-West Wmp Shutdown Cooling Section	Butt Welds 10" x 0.250" **10" x 0.265"	SI-173	S, Vol	11	6				
				SI-239	S, Vol	10	5		5	One
				S, Vol	4	2				
			SI-36	S, Vol	10	5				
			SI-2	S, Vol	8	4				
			SI-194	S, Vol	10	6				
			SI-241	S, Vol	2	1				
			SI-173	S, Vol	3	1				
			SI-194	S, Vol	3	1				
			SI-241	S, Vol	3	3				

ASME CLASS 2

ASME ITEM NO.	ZONE-COMPONENT OR SYSTEM	IDENTIFICATION	DESCRIPTION LINE NO., OR SERIAL NO.	NDE METHOD	TOTAL ITEMS	EXAM AMOUNT		INSPECTION PERIOD	(40 YR.) 10 YR. %	REMARKS AND RELIEF REQUESTS
						40 YR.	10 YR.			
511	CONTINUED									
512	90-East Wrap, 93-West Wrap SI	Butt Welds 8" x 0.312"	SI-134 SI-489	S, Vol S, Vol	(24) 2 2	(12) 1 1	0 3 0	One Two Three		
		10" x 0.365"	SI-134 SI-489	S, Vol S, Vol	7 11	3 5				
		24" x 0.375"	SI-30 SI-7	S, Vol S, Vol	2 2	1 1				
	94-A Toxin Misc. Pipe Chases & 88' Pipe Tunnel.	Butt Welds 10" x 0.365"	SI-489 SI-134	S, Vol S, Vol	(67) 10 9	(34) 3 5	7 0 2	One Two Three		
	95-B Toxin Misc. Pipe Chases & 88' Pipe Tunnel SI	18" x 0.312"	SI-194 SI-241	S, Vol S, Vol	18 15	9 8				
		20" x 0.500"	SI-70 SI-72	S, Vol S, Vol	10 5	5 2				
	100-Containment LPSI Train A Section. 101-Containment LPSI Train B Section Inside Containment	Butt Welds 10" x 0.250" **6" x 0.280"	SI-369 SI-368	S, Vol S, Vol	(43) 10 17	(22) 5 9	1 2 4	One Two Three		**One Weld per line.
		16" x 0.312"	SI-241 SI-194	S, Vol S, Vol	3 9	2 4				
		24" x 0.375"	SI-7 SI-30	S, Vol S, Vol	2 2	1 1				
	Category CS10 Systems Total				(627)	(310)	29 28 29	One Two Three	(100) 10 19 28	

APS PALO VERDE NUCLEAR GENERATING STATION

10 YEAR INTERVAL - EXAMINATION SUMMARY

(RHR, ECCS, and CHR SYSTEMS)

ASME CLASS 2

TABLE 2-CTR
PAGE 5 OF 6

ASME ITEM NO.	ZONE-COMPONENT OR SYSTEM	IDENTIFICATION	DESCRIPTION LINE NO., OR SERIAL NO.	NDE METHOD	TOTAL ITEMS	EXAM AMOUNT		INSPECTION PERIOD	(40 YR.) 10 YR. %	REMARKS AND RELIEF REQUESTS
						40 YR.	10 YR.			
520	Piping Welds Over 1/2" Nominal Wall Thickness									
521	Circumferential and									**2.5T min. from each scheduled circ. weld intersection will be examined.
522	**Longitudinal Welds (*75 category C-F)									
	88-East Wrap, 91-West Wrap LPSI Header To Loop-West Wrap	12" x 1.125"	SI-72 & 155 SI-73 & 174 SI-70 & 202 SI-71 & 220	S, Vol S, Vol S, Vol S, Vol	(33) 8 8 9 9	(8) 2 2 2 2	1 0 0 0	One Two Three	***	***Category C720 systems are combined for percentages.
	90-East Wrap, 91-West Wrap SI	Butt Welds 24" x 0.562"	SI-308 SI-307	S, Vol S, Vol	(4) 2 2	(2) 1 1	0 1 0	One Two Three		
	96-Containment LPSI Header to Loop 1A, 97-Containment LPSI Header to Loop 1B, 98-Containment LPSI Header to Loop 2A, 99-Containment LPSI Header to Loop 2B	Butt Welds 12" x 1.125" 12" x 1.312"	SI-202 SI-220 SI-155 SI-174 SI-202 SI-220 SI-155 SI-174	S, Vol S, Vol S, Vol S, Vol S, Vol S, Vol S, Vol S, Vol	(108) 4 4 4 2 36 21 13	(27) 1 1 1 1 6 8 5 4	2 3 3	One Two Three		
	100-Containment LPSI Train A Suction, 101-Containment LPSI Train B Suction	Butt Welds 16" x 1.594"	SI-241 SI-194	S, Vol S, Vol	(4) 2 2	(2) 1 1	0 0 0	One Two Three		
	Category C520 Systems Total				(149)	(39)	3 4 3	One Two Three	(100) 8 18 25	
530	Pipe Branch Connections									*2.5T min. from each weld intersection will be examined.
531	Circumferential and									
532	*Longitudinal Welded									
	83-Shutdown Cooling Heat Exchanger Room A, 85-Shutdown Cooling Heat Exchanger Room B Inlets	Sweepolet 20" x 10"	SI-78 SI-123	S S	(4) 2 2	(2) 1 1	1 0 0	One Two Three	**	**Category C530 systems are combined for percentages.

REV 1
12-23-91

ASME ITEM NO.	ZONE-COMPONENT OR SYSTEM	IDENTIFICATION	DESCRIPTION LINE NO., OR SERIAL NO.	NDE METHOD	TOTAL ITEMS	EXAM AMOUNT		INSPECTION PERIOD	(.40 YR.) 10 YR. %	REMARKS AND RELIEF REQUESTS
						40 YR.	10 YR.			
530	CONTINUED									
531	83-Shutdown Cooling Heat Exchanger Racem A.	Sweepolets 20" x 6"	SI-70	S	(8)	(4)	0	One		
532	86-Shutdown Cooling Heat Exchanger Racem B outlet	20" x 10" 20" x 14"	SI-72	S	4	2	0	Two		
	88-East Wrap, 91-West Wrap SI	S sweepolets 20" x 12"	SI-70 SI-72	S S	(2) 1 1	(1) 1 0	1 0 0	One Two Three		
	89-East Wrap, 92-West Wrap SI	Sweepolets 18" x 12"	SI-194 SI-241	S S	(2) 1 1	(1) 1 0	0 0 0	One Two Three		
	Category C530 Systems Total				(16)	(8)	2 0 1	One Two Three	(100) 25 25 50	

SECTION 9.0
REQUESTS FOR RELIEF

**RELIEF REQUESTS
INDEX**

<u>NUMBER</u>	<u>DESCRIPTION</u>
1.	Hydraulic and Mechanical Snubbers will be tested in accordance with PVNGS Technical Specifications.
2.	Withdrawn
3.	Insulation will not be removed for visual examinations or welded or mechanical attachments.
4.	Level III Personnel will be recertified by examination every 5 years.
5.	Withdrawn
6.	Reactor Vessel Support Visual Examination.
7.	Class 2 and 3 Systems Pressure Test.
8.	Class 3 System Pressure Test.

RELIEF REQUEST NO. 1

COMPONENT OR ITEM	CODE CLASS	PROGRAM TABLE	CODE ITEM	EXAM CATEGORY
HYDRAULIC AND MECHANICAL SNUBBERS	1	1-IWF	N/A	N/A
	2	2-IWF	N/A	N/A
	3	3-IWF	N/A	N/A

CODE REQUIREMENT

Perform inservice functional testing of hydraulic and mechanical snubbers in accordance with IWF-5000

BASIS

A detailed and comprehensive testing program for snubbers is contained in the PVNGS Technical Specifications.

0.3 ALTERNATE EXAMINATION

The requirements for testing snubbers will be in accordance with the PVNGS Technical Specifications, Section 4.7.9

SCHEDULE FOR IMPLEMENTATION

First Ten Year Inspection Interval

APPROVAL

NRC letter dated October 21, 1987, from E. A. Licitra, NRC, to E.E. Van Brunt, Jr., "Inservice Inspection Programs Palo Verde, Unit 1, 2, & 3".

RELIEF REQUEST NO. 2

COMPONENT OR ITEM	CODE CLASS	PROGRAM TABLE	CODE ITEM	EXAM CATEGORY
NOZZLE INSIDE RADIUS SECTIONS	1	1-3	B3.120	B-D
PRESSURIZER	1	1-3	B3.140	B-D
STEAM GENERATOR	2	2-2	C2.22	C-B
SHUT DOWN COOLING HEAT EXCHANGERS	2	2-2	C2.22	C-B

WITHDRAWN

RELIEF REQUEST NO. 3

COMPONENT OR ITEM	CODE CLASS	PROGRAM TABLE	CODE ITEM:	EXAM CATEGORY
SUPPORT COMPONENTS	1	1-IWF	ALL	F-A, F-B & F-C
	2	2-IWF	ITEMS	F-A, F-B & F-C
	3	3-IWF		F-A, F-B & F-C
INTEGRAL ATTACHMENTS	3	3-1		D-A, D-B & D-C

CODE REQUIREMENT

Perform visual examinations (VT-3) of the mechanical or welded attachments to the pressure retaining component on insulated systems.

9.5 BASIS

The visual examinations of the mechanical or welded attachments will be performed to the extent practical. The insulation will not be removed to perform these examinations. It has been our experience that any loss of support capability or adequate restraint can usually be detected through the examination of uninsulated portions of the support, the accessible portions of the attachments through the insulation gaps, and/or the surrounding insulation.

ALTERNATE EXAMINATION

The mechanical and welded attachments will be visually examined to the extent practical. The insulation will be removed from around the support attachment for further examinations whenever an abnormality is detected.

SCHEDULE FOR IMPLEMENTATION

First Ten Year Inspection Interval

APPROVAL

NRC letter dated October 21, 1987, from E. A. Licita, NRC, to E.E. Van Brunt, Jr., "Inservice Inspection Programs Palo Verde, Unit 1, 2, & 3".

REV 1
12-23-91

RELIEF REQUEST NO. 4

COMPONENT OR ITEM	CODE CLASS	PROGRAM TABLE	CODE ITEM	EXAM CATEGORY
N/A	N/A	N/A	N/A	N/A

CODE REQUIREMENT

All Level III personnel shall be recertified by examination on a triennial basis (IWA-2300(a)(1)).

BASIS

The 1986 Edition of Section XI and the 1983 Edition thru Summer 1983 Addenda of ASME III (Latest Edition and Addenda referenced in 10 CFR 55.55a) requires Level III personnel to be recertified every 5 years.

9-6

ALTERNATE EXAMINATION

All Level III personnel shall be recertified by examination every 5 years.

SCHEDULE FOR IMPLEMENTATION

First Ten Year Inspection Interval

APPROVAL

NRC letter dated October 21, 1987, from E. A. Licitra, NRC, to E.E. Van Brunt, Jr., "Inservice Inspection Programs Palo Verde, Unit 1, 2, & 3".

RELIEF REQUEST NO. 5

COMPONENT OR ITEM	CODE CLASS	PROGRAM TABLE	CODE ITEM	EXAM CATEGORY
N/A	N/A	N/A	N/A	N/A

WITHDRAWN

RELIEF REQUEST NO. 6

COMPONENT OR ITEM	CODE CLASS	PROGRAM TABLE	CODE ITEM	EXAM CATEGORY
Reactor Vessel Supports	1	1-IWF	F2.10 F2.20 F2.30 F2.40	F-B

CODE REQUIREMENT

Perform visual examination (VT-3) of the Reactor Vessel Supports

BASIS

The visual examination of the reactor vessel supports will not be performed. The supports are inaccessible from the refueling cavity seal ring area for either direct or remote visual examination. Examination from the ICI chase below the vessel would require extensive scaffolding to be erected in order to get up to the support pedestal and the exam would still be severely limited due to accessibility between the reactor vessel and the cavity. The performance of this visual would require extremely large amounts of time, effort, expense, and radiation exposure (expected to be 3 man rem per support based on surveys taken in Unit 3 during first refueling outage).

ALTERNATE EXAMINATION

No alternate examination is proposed.

SCHEDULE FOR IMPLEMENTATION

First Ten Year Inspection Interval.

APPROVAL

Pending NRC approval.

0-8

REV 1
12-23-91

RELIEF REQUEST NO. 7

COMPONENT OR ITEM	CODE CLASS	PROGRAM TABLE	CODE ITEM	EXAM CATEGORY
PRESSURE RETAINING COMPONENTS	2	2-7	C710	C-H
	3	3-1	C730	D-A
			C750	D-B
			C770	D-C
			D110	
			D210	
			D310	

CODE REQUIREMENT

Perform System Functional (class 2) and System Inservice (class 3) pressure test in accordance with IWA-5000, IWC-5000, IWD-5000.

9.9 BASIS

This relief is applicable only to portions of piping systems that are classified ASME due to penetration of containment building liner plate. For the applicable class 2 systems the piping upstream and downstream of containment isolation is classified non-ASME. The class 3 system is applicable to the fuel transfer tube (containment to fuel bldg.).

ALTERNATE EXAMINATION

The applicable containment piping penetrations and fuel transfer tube are routinely subjected to surveillance testing. This testing consists of integrated leak rate testing and/or local leak rate testing.

SCHEDULE FOR IMPLEMENTATION

First Ten Year Inspection Interval.

APPROVAL

Pending NRC approval.

RELIEF REQUEST NO. 8

COMPONENT OR ITEM	CODE CLASS	PROGRAM TABLE	CODE ITEM	EXAM CATEGORY
PRESSURE RETAINING COMPONENTS	3	3-1	D2.10	D-B

CODE REQUIREMENT

Perform System Inservice Pressure Test in accordance with IWA-5000 and IWD-5000

BASIS

The 1986 Edition of Section XI Code (which is included in the latest Edition referenced in the current 10 CFR 50.55a) requires a Functional Pressure Test be performed on systems in support of Emergency Core Cooling, Containment Heat Removal, Atmospheric Cleanup, and Reactor Residual Heat Removal.

9-10

ALTERNATE EXAMINATION

Perform a Functional Pressure Test on Class 3 Pressure Retaining Components within systems not normally operating while the Unit is Inservice.

SCHEDULE FOR IMPLEMENTATION

First Ten Year Inspection Interval.

APPROVAL

Pending NRC Approval.

REV 1
12-23-91

SECTION 10.0
ISI
BOUNDARY DRAWINGS

NOTE: See ISI Drawings for Unit 1 ISI Program, Letter ANPP-33266-EEVB/KLM, dated August 26, 1985, from E. E. Van Brunt, Jr., ANPP, to George W. Knighton, NRC, "Palo Verde Nuclear Generating Station (PVNGS) Unit 1 Docket Nos. STN 50-528 (License No. NPF-41) Initial Inservice Inspection Program-PVNGS Unit 1".

SECTION 11.0
ZONE DRAWINGS

ZONE DRAWING INDEX

<u>Drawing No.</u>	<u>Revision</u>	<u>Drawing Title</u>	<u>Code Class</u>
Zone 1	0	Reactor Vessel	1
Zone 2	0	Closure Head	1
Zone 3	0	Steam Generator 1	1
Zone 4	0	Steam Generator 2	1
Zone 5	0	Pressurizer	1
Zone 6	0	RCS Primary Piping	1
Zone 7-15	0	(NOT USED)	1
Zone 16	0	Reactor Coolant Pump 1A	1
Zone 17	0	Reactor Coolant Pump 1B	1
Zone 18	0	Reactor Coolant Pump 2A	1
Zone 19	0	Reactor Coolant Pump 2B	1
Zone 20	0	Pressurizer Surge Line	1
Zone 21	0	Shutdown Cooling Loop 1	1
Zone 22	0	Shutdown Cooling Loop 2	1
Zone 23	0	Safety Injection 1A	1
Zone 24	0	Safety Injection 1B	1
Zone 25	0	Safety Injection 2A	1
Zone 26	0	Safety Injection 2B	1
Zone 27	0	Pressurizer Spray 1A	1
Zone 28	0	Pressurizer Spray 1B	1
Zone 29	0	Combined Pressurizer Spray	1
Zone 30	0	Aux. Pressurizer Spray	1
Zone 31	0	Pressurizer Safeties	1
Zone 32	0	Drain Line 1A	1
Zone 33	0	Drain Line 1B	1
Zone 34	0	Drain Line 2A	1
Zone 35	0	Drain Line 2B	1
Zone 36	0	Letdown Line	1
Zone 37	0	Charging Line	1
Zone 38	0	Drain Line Loop 1	1
Zone 39	0	HPSI Long Term Recirc 1	1
Zone 40	0	HPSI Long Term Recirc 2	1
Zone 41	0	Steam Generator 1	2
Zone 42	0	Steam Generator 2	2
Zone 43	0	Main Steam SG1 East	2
Zone 44	0	Main Steam SG1 West	2
Zone 45	0	Main Steam SG2 East	2
Zone 46	0	Main Steam SG2 West	2
Zone 47	0	Main Steam SG1 West	2
Zone 48	0	Main Steam SG1 East	2
Zone 49	0	Main Steam SG2 East	2
Zone 50	0	Main Steam SG2 West	2
Zone 51	0	Atmospheric Dump No. 1	2
Zone 52	0	Atmospheric Dump No. 2	2

ZONE DRAWING INDEX (Cont'd)

<u>Drawing No.</u>	<u>Revision</u>	<u>Drawing Title</u>	<u>Code Class</u>
Zone 53	0	Steam to Aux Feedwater System	2
Zone 54	0	Feedwater SG No. 1	2
Zone 55	0	Feedwater SG No. 2	2
Zone 56	0	Feedwater SG No. 1	2
Zone 57	0	Feedwater SG No. 2	2
Zone 58	0	Aux & Downcomer Feedwater SG 1	2
Zone 59	0	Aux & Downcomer Feedwater SG 2	2
Zone 60	0	Downcomer Feedwater SG 1	2
Zone 61	0	Downcomer Feedwater SG 2	2
Zone 62	0	Aux Feedwater SG 1	2
Zone 63	0	Aux Feedwater SG 2	2
Zone 64	0	Blowdown SG 1	2
Zone 65	0	Blowdown SG 2	2
Zone 66	0	Blowdown SG 1	2
Zone 67	0	Blowdown SG 2	2
Zone 68	0	Regenerative Heat Exchanger	2
Zone 69	0	Letdown Heat Exchanger	2
Zone 70	0	LPSI Pump Room A Suction	2
Zone 71	0	LPSI Pump Room A Discharge	2
Zone 72	0	LPSI Pump A	2
Zone 73	0	LPSI Pump Room B Suction	2
Zone 74	0	LPSI Pump Room B Discharge	2
Zone 75	0	LPSI Pump B	2
Zone 76	0	Containment Spray Pump Room A Suction	2
Zone 77	0	Containment Spray Pump Room A Discharge	2
Zone 78	0	Containment Spray Pump A	2
Zone 79	0	Containment Spray Pump Room B Suction	2
Zone 80	0	Containment Spray Pump Room B Discharge	2
Zone 81	0	Containment Spray Pump B	2
Zone 82	0	Shutdown Cooling Heat Exchanger Room A	2
Zone 83	0	Shutdown Cooling Heat Exchanger Room A	2
Zone 84	0	Shutdown Cooling Heat Exchanger	2
Zone 85	0	Shutdown Cooling Heat Exchanger Room B	2
Zone 86	0	Shutdown Cooling Heat Exchanger Room B	2
Zone 87	0	Shutdown Cooling Heat Exchanger B	2
Zone 88	0	East Wrap	2

ZONE DRAWING INDEX (Cont'd)

Drawing Number	Revision	Drawing Title	Code Class
Zone 89	0	East Wrap	2
Zone 90	0	East Wrap	2
Zone 91	0	West Wrap	2
Zone 92	0	West Wrap	2
Zone 93	0	West Wrap	2
Zone 94	0	A Train Misc. Pipe Chases & 88' Pipe Tunnel	2
Zone 95	0	B Train Misc. Pipe Chases & 88' Pipe Tunnel	2
Zone 96	0	Containment LPSI Header to Loop 1A	2
Zone 97	0	Containment LPSI Header to Loop 1B	2
Zone 98	0	Containment LPSI Header to Loop 2A	2
Zone 99	0	Containment LPSI Header to Loop 2B	2
Zone 100	0	Containment LPSI Train A Suction	2
Zone 101	0	Containment LPSI Train B Suction	2

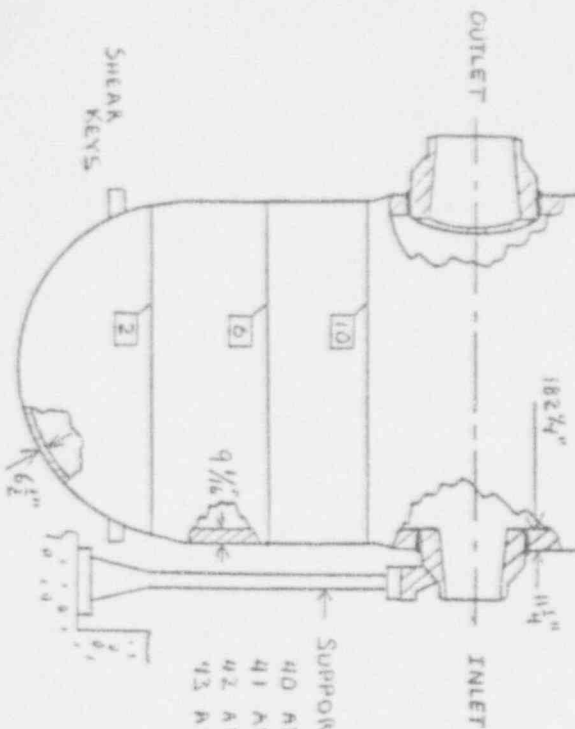
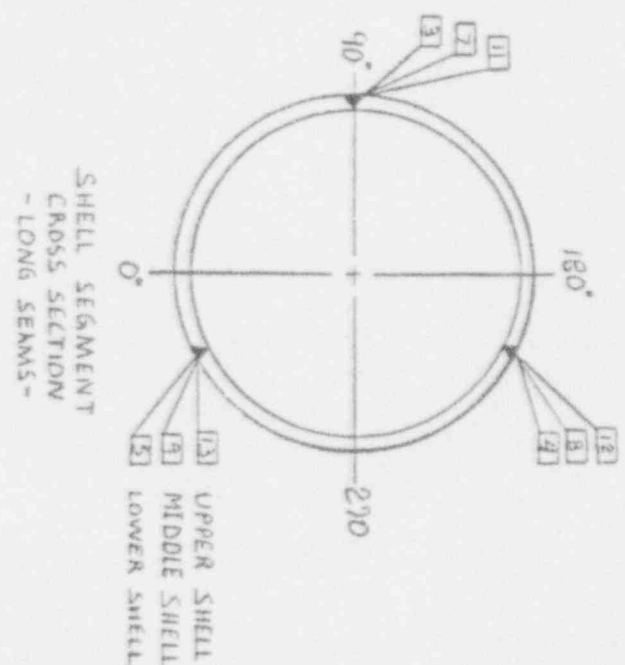
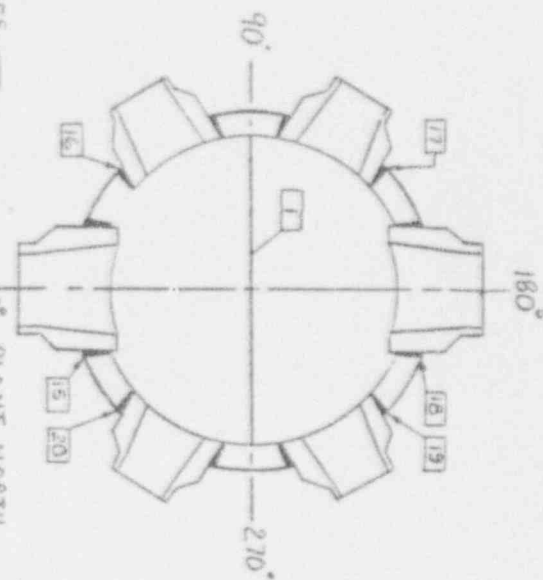

SUPPORT COLUMNS

40 AT 1A
41 AT 1B
42 AT 2A
43 AT 2B

NOTES:

TAG NO. IMRCEND1
SERIAL NO. 78173 (CE)
N.D. NO. 22253

REFERENCE DWG:

N001-3-01-15 AND 17
N001-3-01-41 AND 61
N001-3-01-72

REV D	DWG
UNIT #1 ZONE 1	
REACTOR VESSEL	
DRAWN BY D. B. HANSEN	
CHECKED BY T. STRICKER	

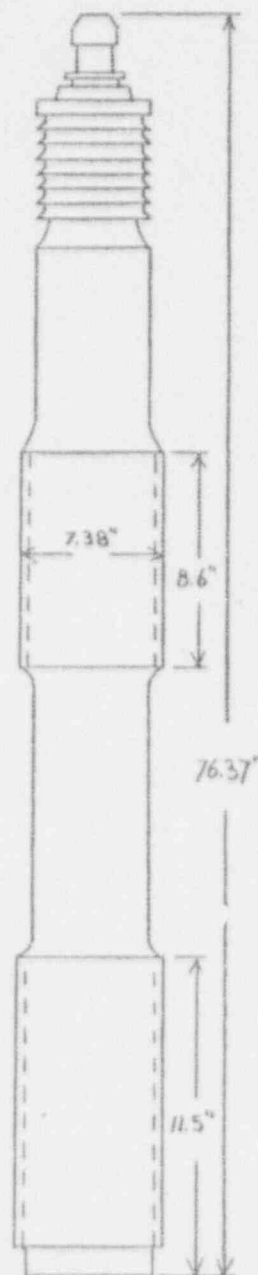
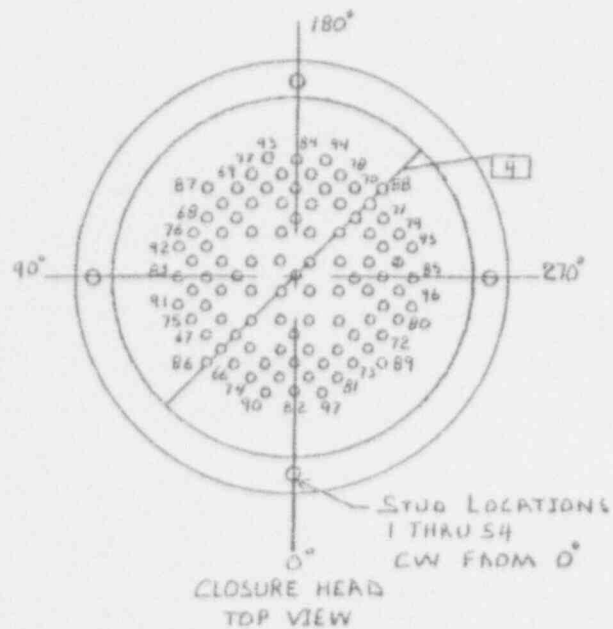
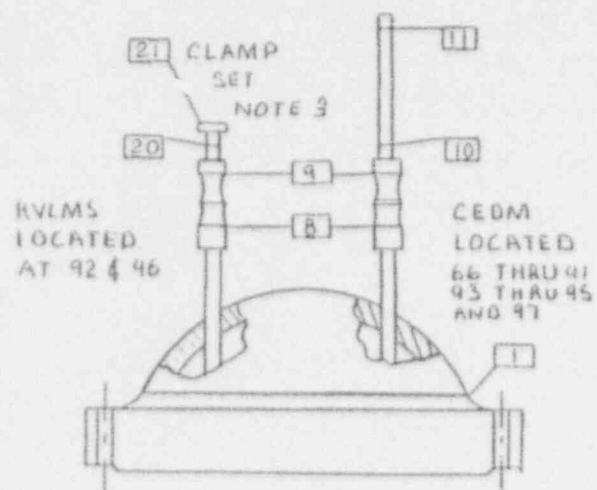

NOTES:

- 1) CEDM'S: ITEM NO. - CEDM NO.
- 2) TAG NO. 1MRCEX03
SERIAL NO. 78173 (E-E)
N. B. NO. 22253
- 3) ITEM 21 CONTAINS 9 SINGLE MITED STUDS IN A GRAYLOC CLAMP

REFERENCE DWGS:

- N001-3.01-24 AND 25
N001-3.01-121 AND 213

CLOSURE HEAD STUDS
#1 THRU #54

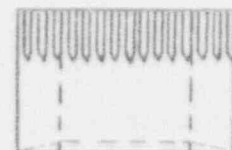

NUTS

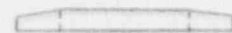

WASHERS

REV. D	DWG UNIT #1 ZONE 2
DRAWN BY D.B. HANSEN CHECKED BY J. STRICKLER	TITLE: CLOSURE HEAD

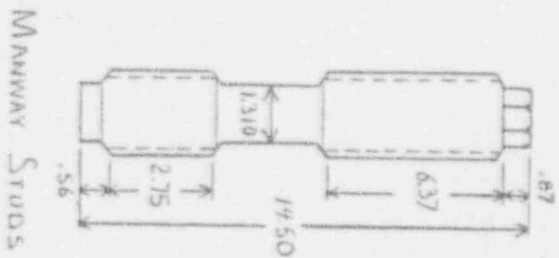
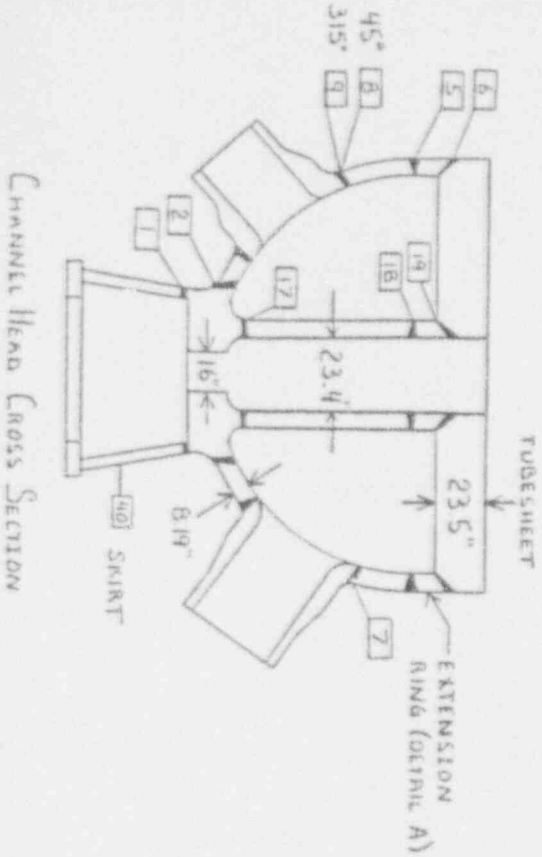
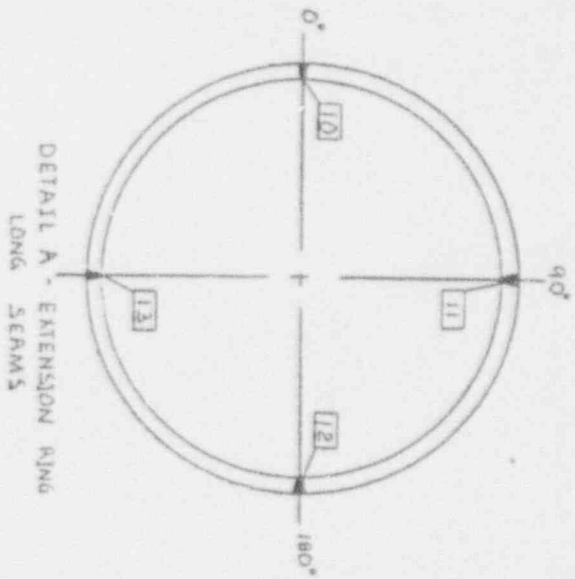
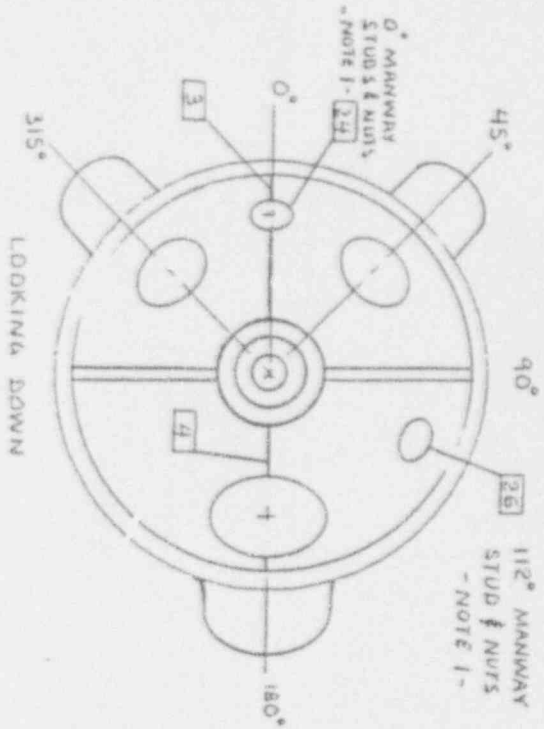

NOTES:

- 1) STUD LOCATION IS # 1 TDL
- 60JMG CW TO # 20
- 2) TRG NO. IMRCEEDIA
- SERIAL NO. 78273-1((C))
- N.D. NO. 22499

REFERENCE DWGS.

- N001-6.03-9 AND 10
- N001-6.03-53
- N001-6.03-219 AND 213

Channel Head Cross Section

REV D	DWG	UNIT '1 ZONE 3
DESIGNED BY D. B. HANSEN	TITLE:	STEAM GENERATOR # 1
CHECKED BY TGS		

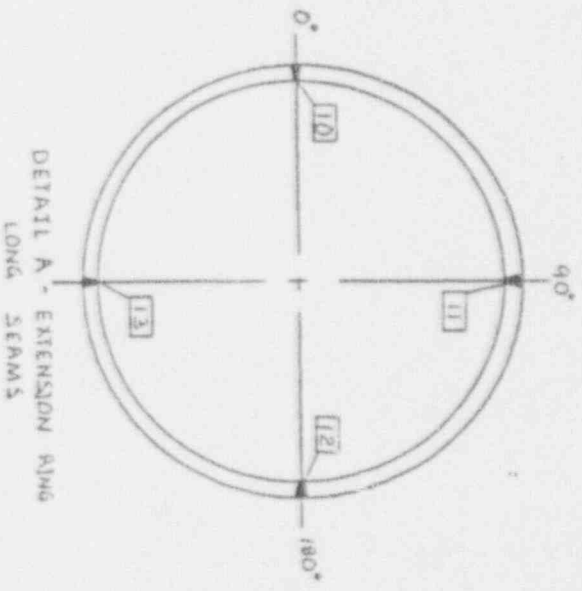
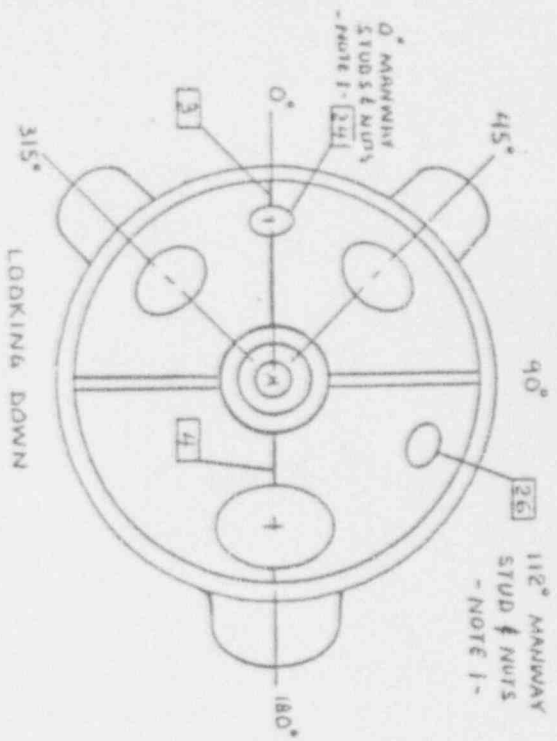

LOOKING DOWN

DETAIL A - EXTENSION RING LONG SEAMS

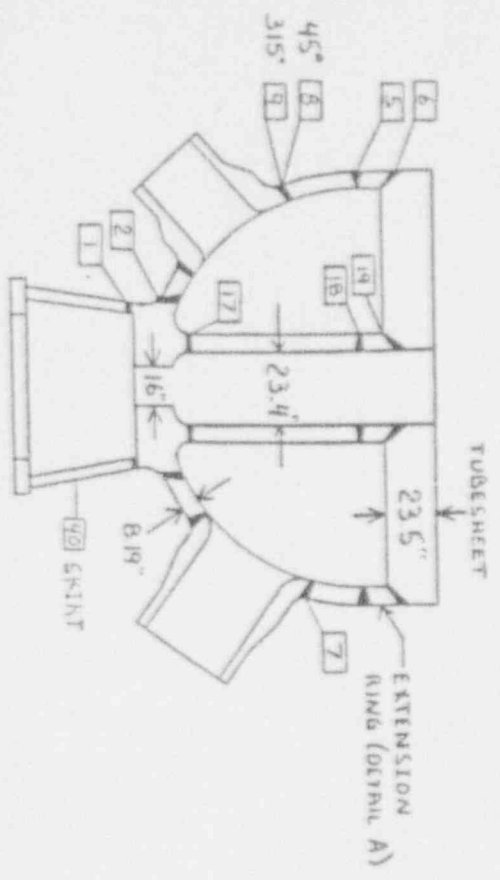

CHANNEL HEAD CROSS SECTION

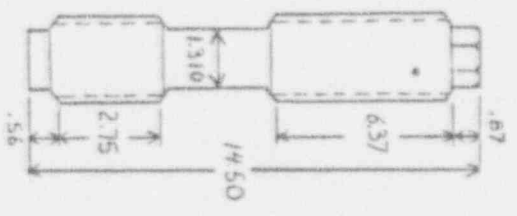

MANWAY STUDS

NOTES:

- 1) STUD LOCATION IS #1 TDC GOING CW TO #20
- 2) TAG NO. IMRCE01B SERIAL NO. 78273-2 (6) N.B. NO. 22500

REFERENCE DWGS:

- N001-6.03-9 AND 10
- N001-6.03-53
- N001-6.03-259 AND 313

DRAWN BY O. B. HANSEN CHECKED BY J. B. S.	REV D UNIT #1 ZONE 4 STEAM GENERATOR #2
--	---

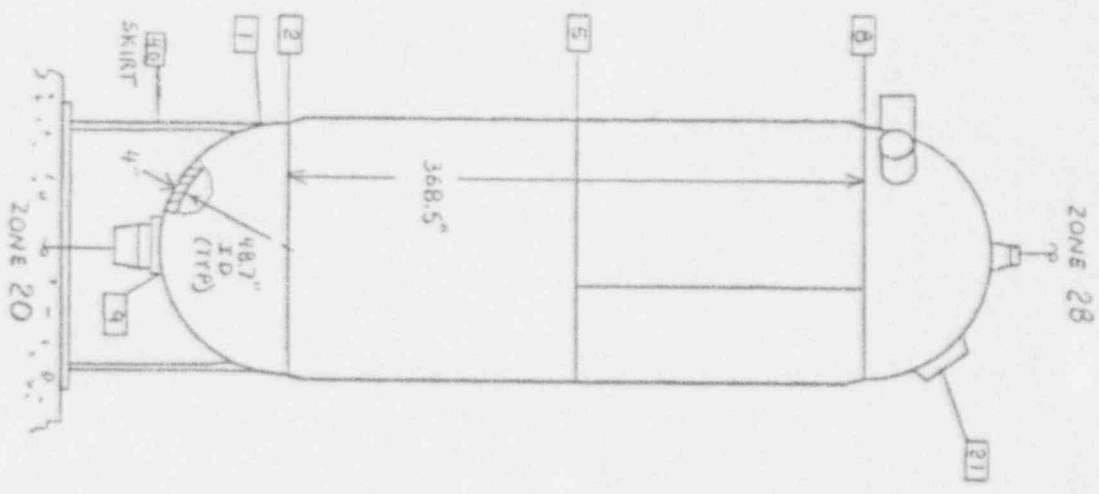
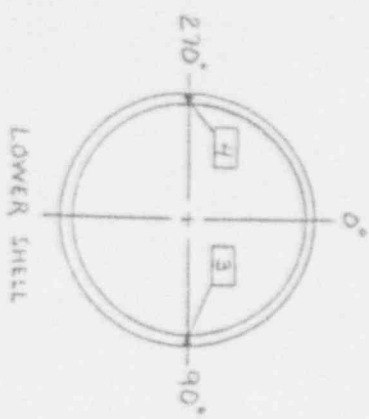
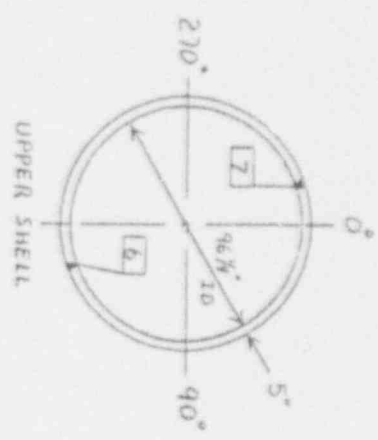
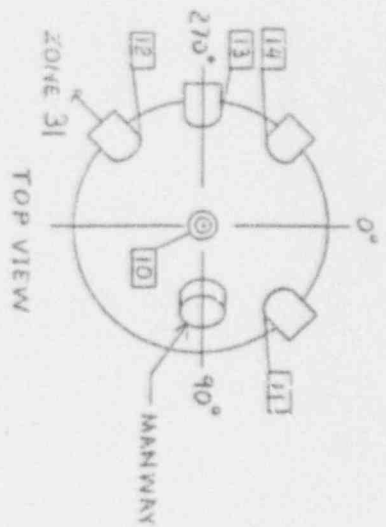

NOTE 1 -
MANWAY STUDS & NUTS

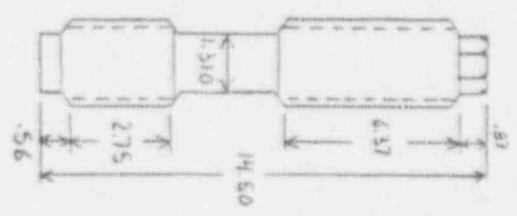

MANWAY STUDS

NOTES:

- 1) STUD LOCATION IS #1 TDC GOING CW TO #20
- 2) TAG NO. IMRCEK02 SERIAL NO. 78373 (CE)
- N. D. NO. 22234

REFERENCE DWGS:

ND01-604-6, 31 AND 40

REV 0	DWG
DRAWN BY D. B. HENSEN	UNIT #1 ZONE 5
CHECKED BY JRS	TITLE: PRESSURIZER

NOTES:

- 1 PIPE LONGSEAMS AT 3:00 AND 9:00 POSITIONS
- 2 ELBOW LONGSEAMS AT LONG AND SHORT RADII.

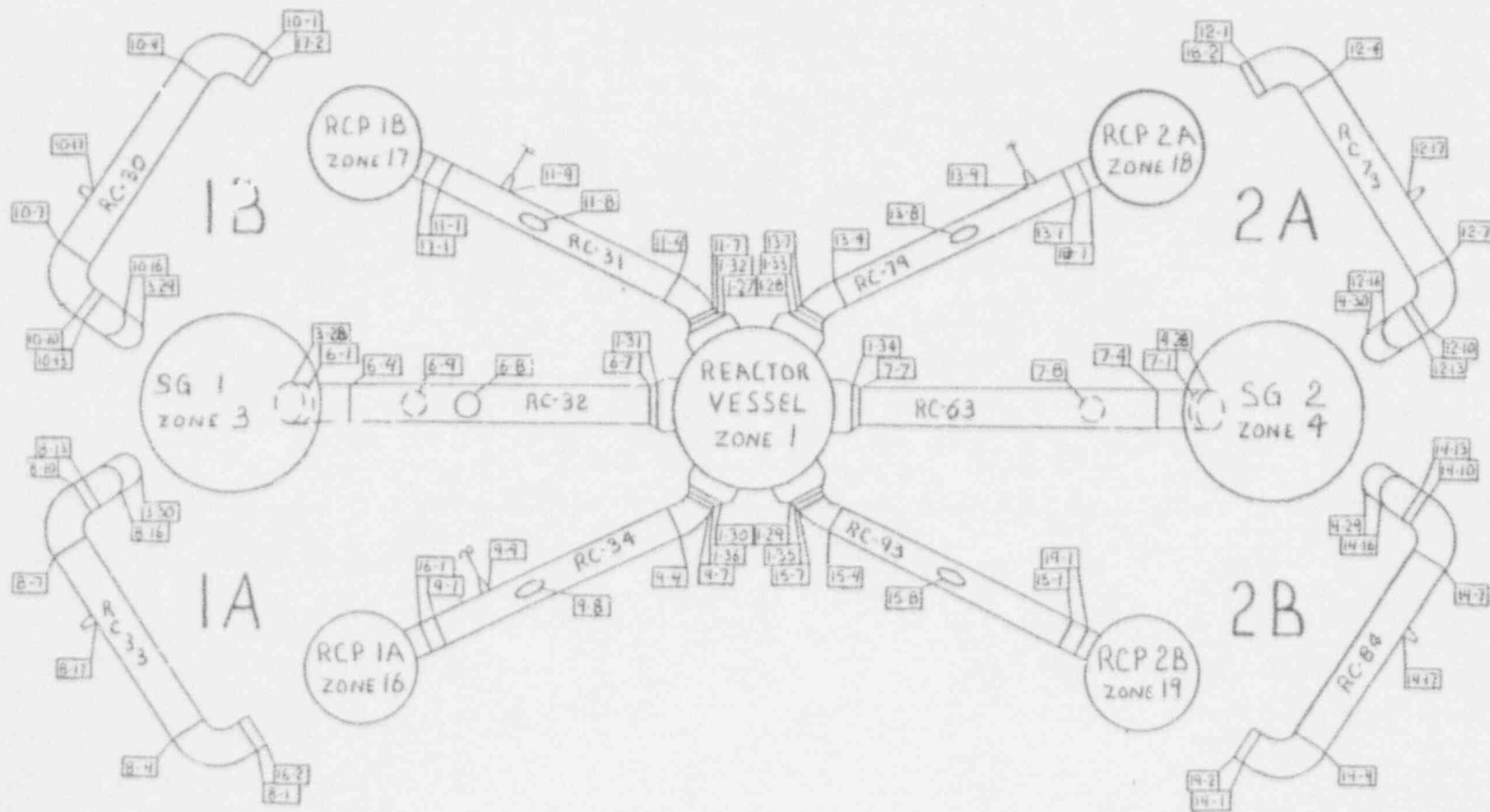

REFERENCE DRAWINGS:

- 13-P-266-103
- NDDI-6.07-83 AND 112
- NDDI-6.07-90 THRU 99
- NDDI-6.07-96 THRU 100

REV. 0	DWG UNIT #1 ZONE 6
DRAWN BY DB HANSEN	TITLE: RCS
CHECKED BY JBS	PRIMARY PIPING

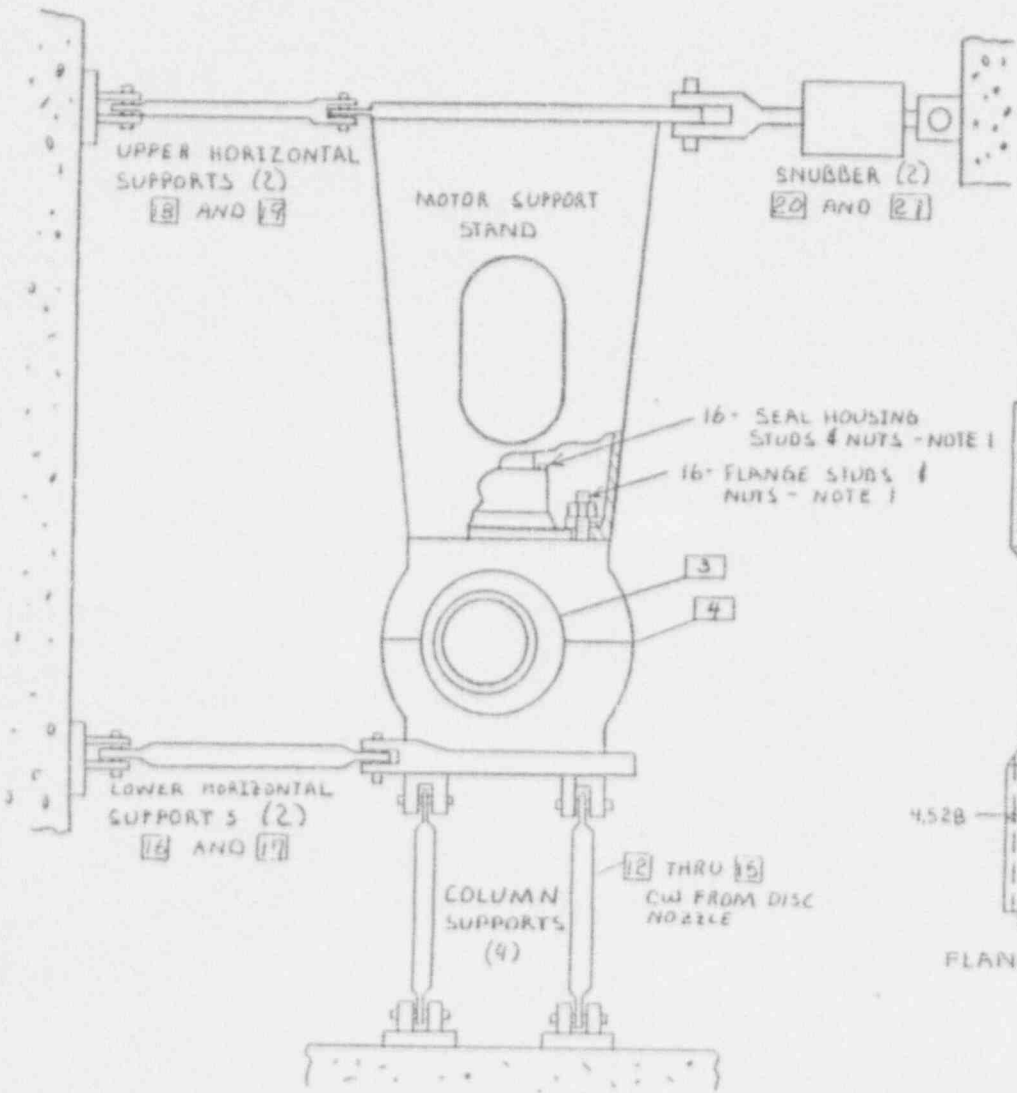

NOTES:

- 1) STUD LOCATIONS CW FROM DISCHARGE ϕ
- 2) TAG NO. 1MRCEPDIA
SERIAL NO. 1109-1A (C-E)
N.B. NO. 23434

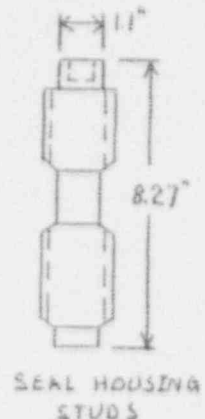
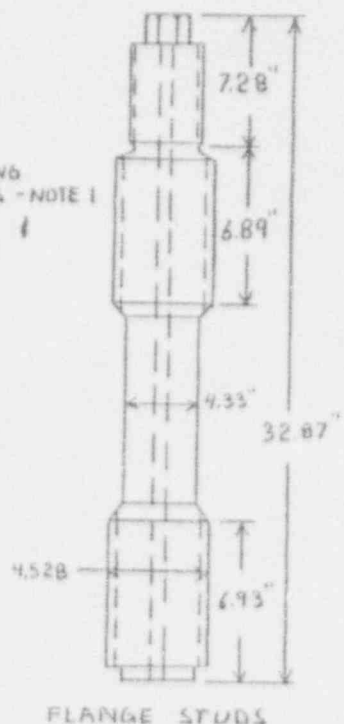

REFERENCE DWGS:

- N001- 6.02-41B
- N001- 6.02-42D THRU 423
- N001- 6.02-107 & 108

REV 0	DWG UNIT #1 ZONE 16
DRAWN BY D. S. HANSEN CHECKED BY JBS	TITLE: REACTOR COOLANT PUMP 1A

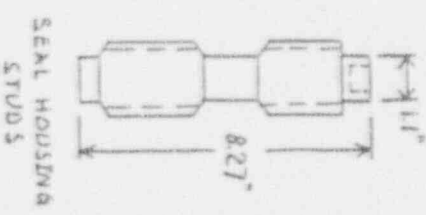
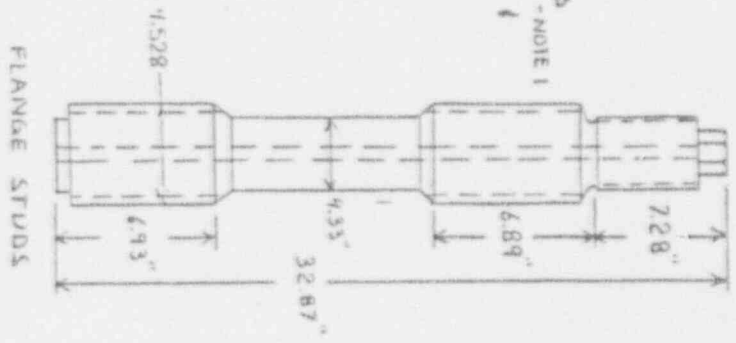
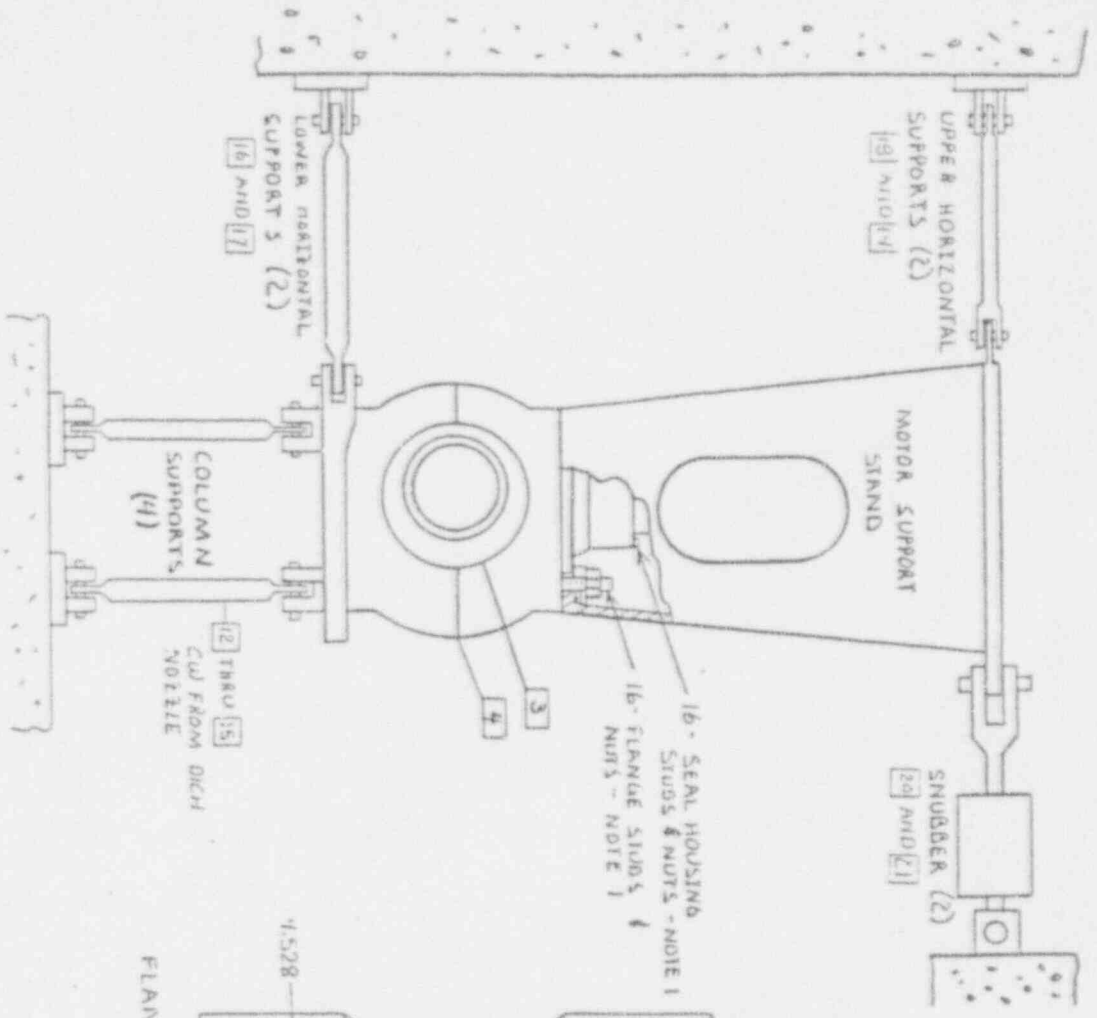

REFERENCE DWGS:
 N001 - 6.02-418
 N001 - 6.02-420 THRU 423
 N001 - 6.02-107 & 108

- NOTES:**
- STUD LOCATION S CW FROM DISTANCE Φ
 - TRG NO. MARCEHOIS SERIAL NO. 109-15 (C-E) N.A. NO. 23410

REV 0	DWG
DRAWN BY D. D. HENSEN CHECKED BY JES	TITLE: UNIT #1 ZONE 17 REACTOR COOLANT PUMP 1B

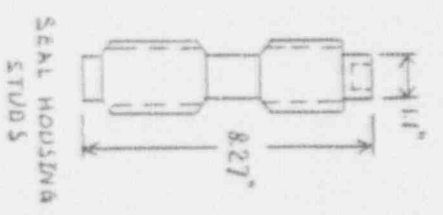
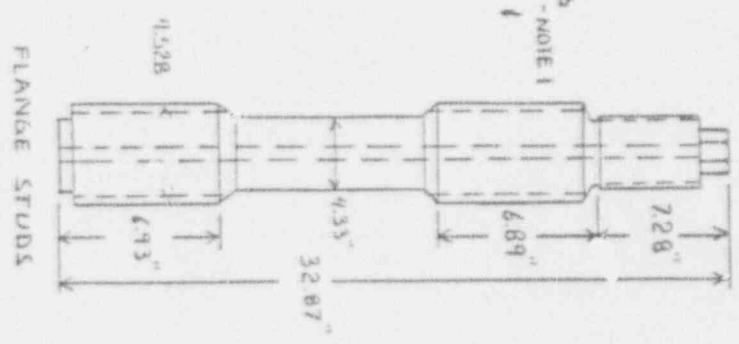
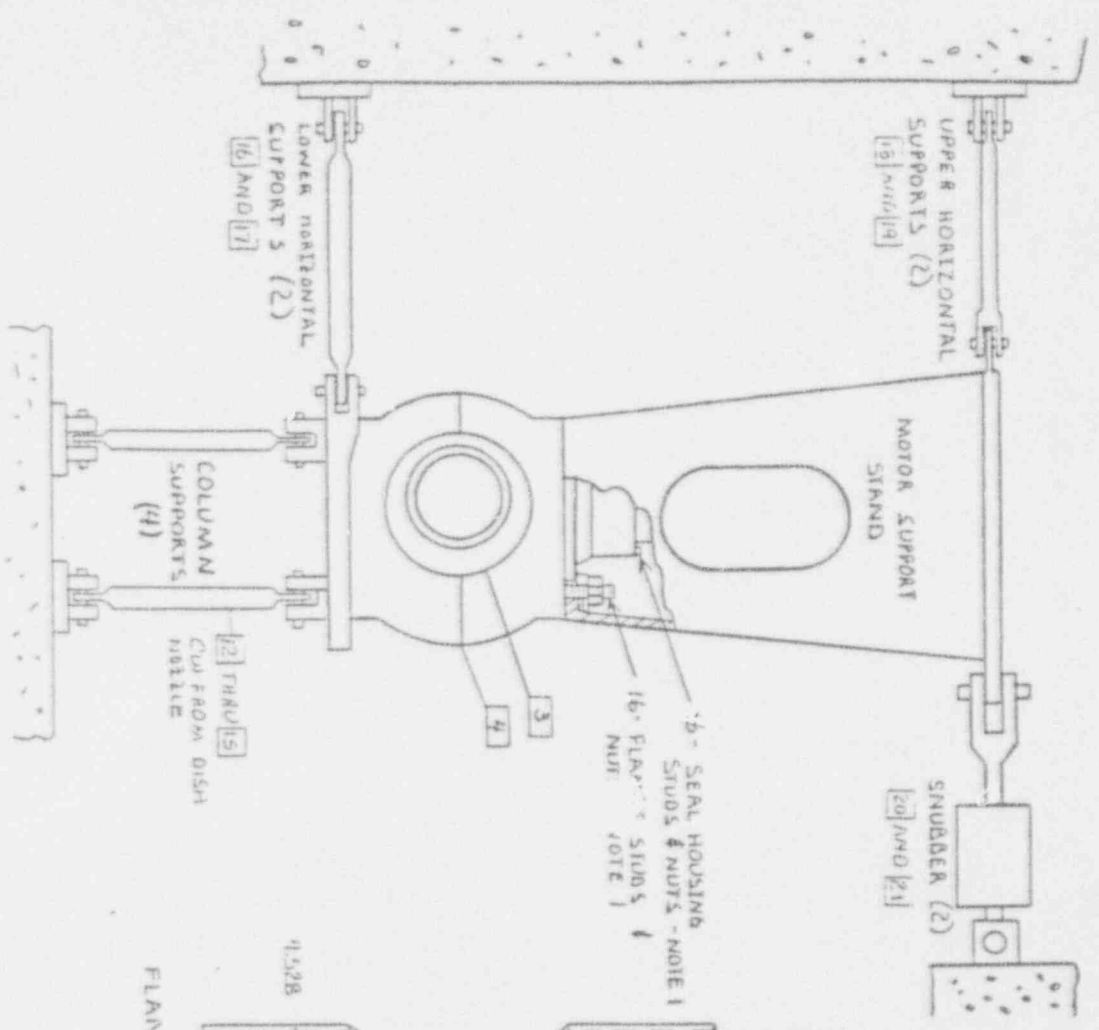

NOTES:
 1) STUD LOCATIONS COOL FROM DISCHARGE &
 2) TAG NO. IMRCEN01C
 SERIAL NO. 1107-2A (C-E)
 N.D. NO. 23441

REFERENCE DWGS:
 N001 - 6.02-41B
 N001 - 6.02-42D THRU 423
 N001 - 6.02-107 & 108

REV 0	DWG UNIT #1 ZONE 18
DRAWN BY D. O. HANSEN	TITLE REACTOR COOLANT PUMP 2A
CHECKED BY JBS	

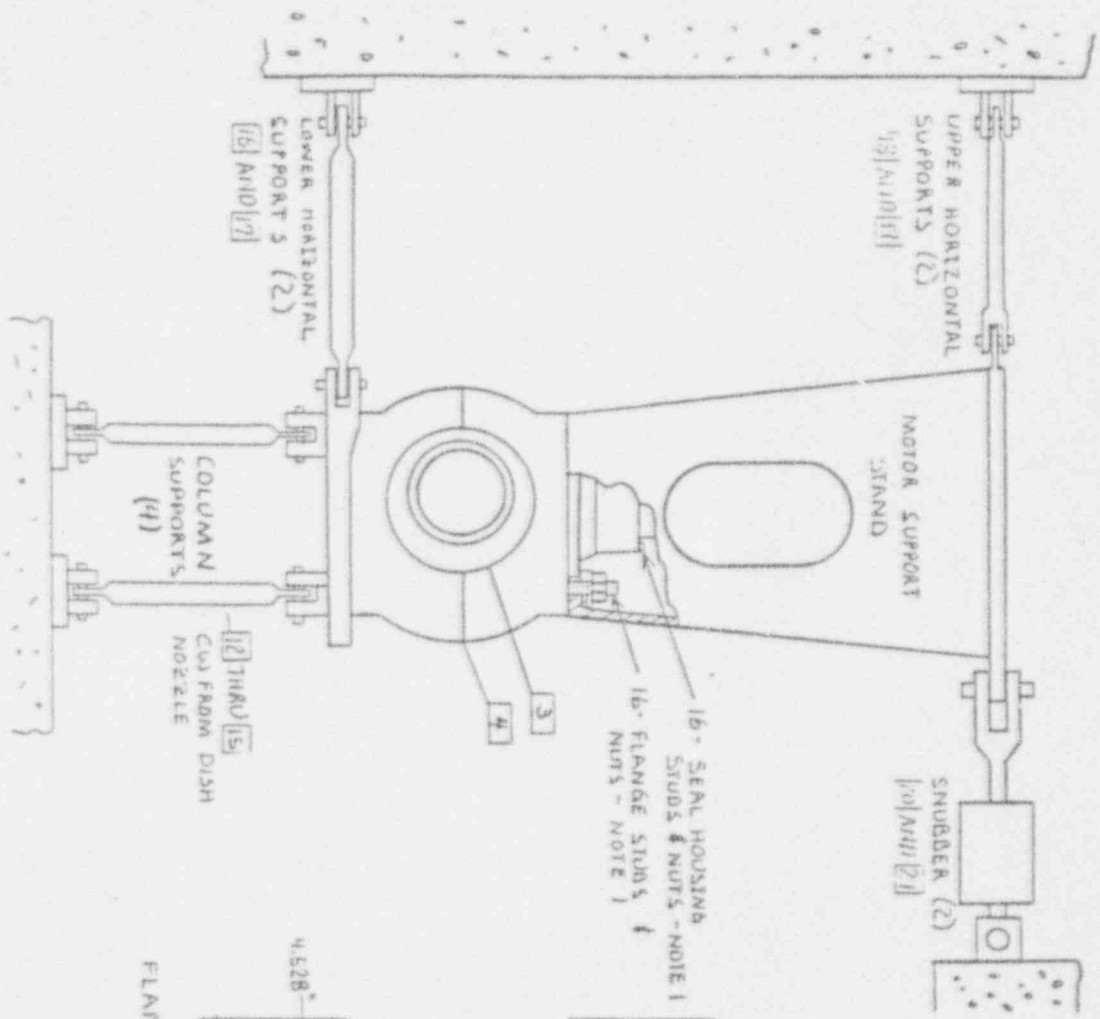

16" SEAL HOUSING STUDS & NUTS - NOTE 1
 16" FLANGE STUDS - NOTE 1

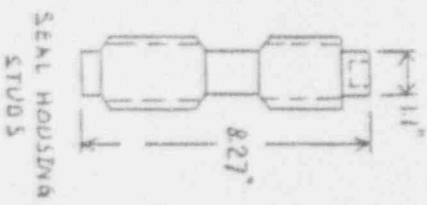
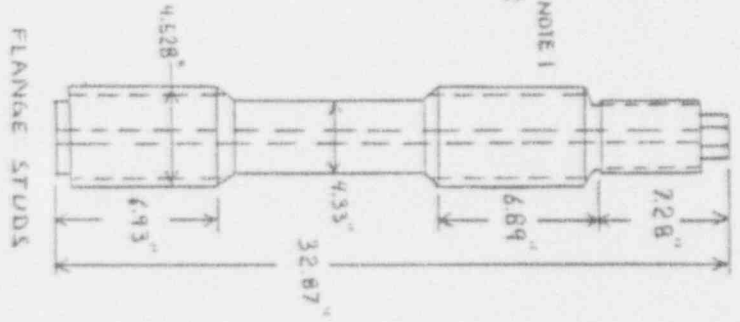

REFERENCE DWGS:
 N001 - 6.02-418
 N001 - 6.02-42D THRU 423
 N001 - 6.02-107 & 108

NOTES:
 1) STUD LOCATIONS C-112 FROM DISCHARGE Q
 2) TAG NO. 1MREPOID SERIAL NO. 11072B(C-E) N.D. NO. 23442

REV 0	DWG	UNIT #1 ZONE 19
DRAWN BY D. O. HANSEN	TITLE: REACTOR COOLANT PUMP 2B	
CHECKED BY C.B.S.		

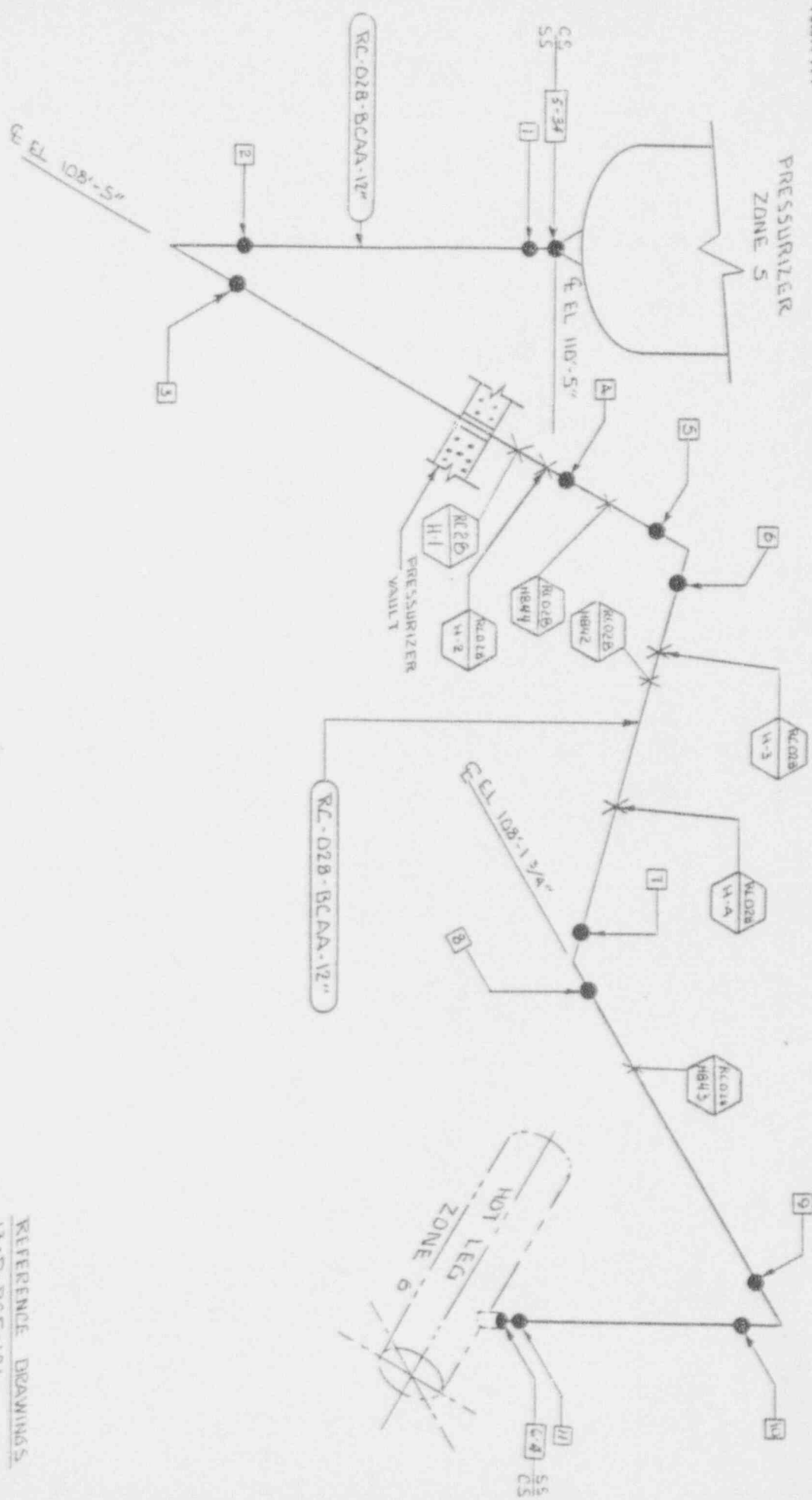

REFERENCE DRAWINGS
 15-P-KCF-101

REV	Q	DWG
DATE		UNIT 1 ZONE 20
BY		PRESSURIZER SURGE
CHECKED		
DATE		

REFERENCE DRAWINGS:

01-P-SIF-105

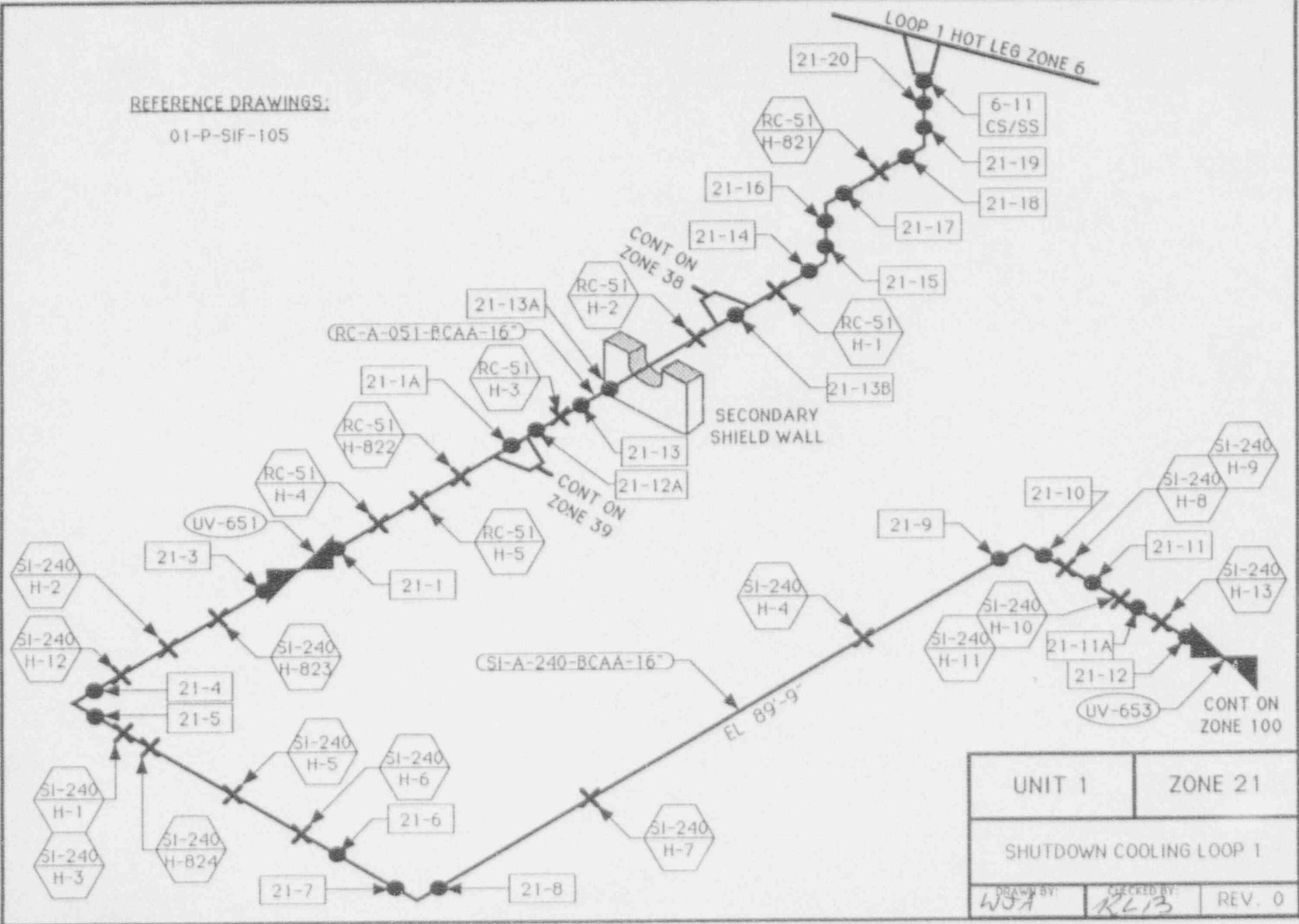

UNIT 1	ZONE 21
SHUTDOWN COOLING LOOP 1	
DRAWN BY WJA	CHECKED BY RLB
REV. 0	

REFERENCE DRAWINGS:

01-P-SIF-105

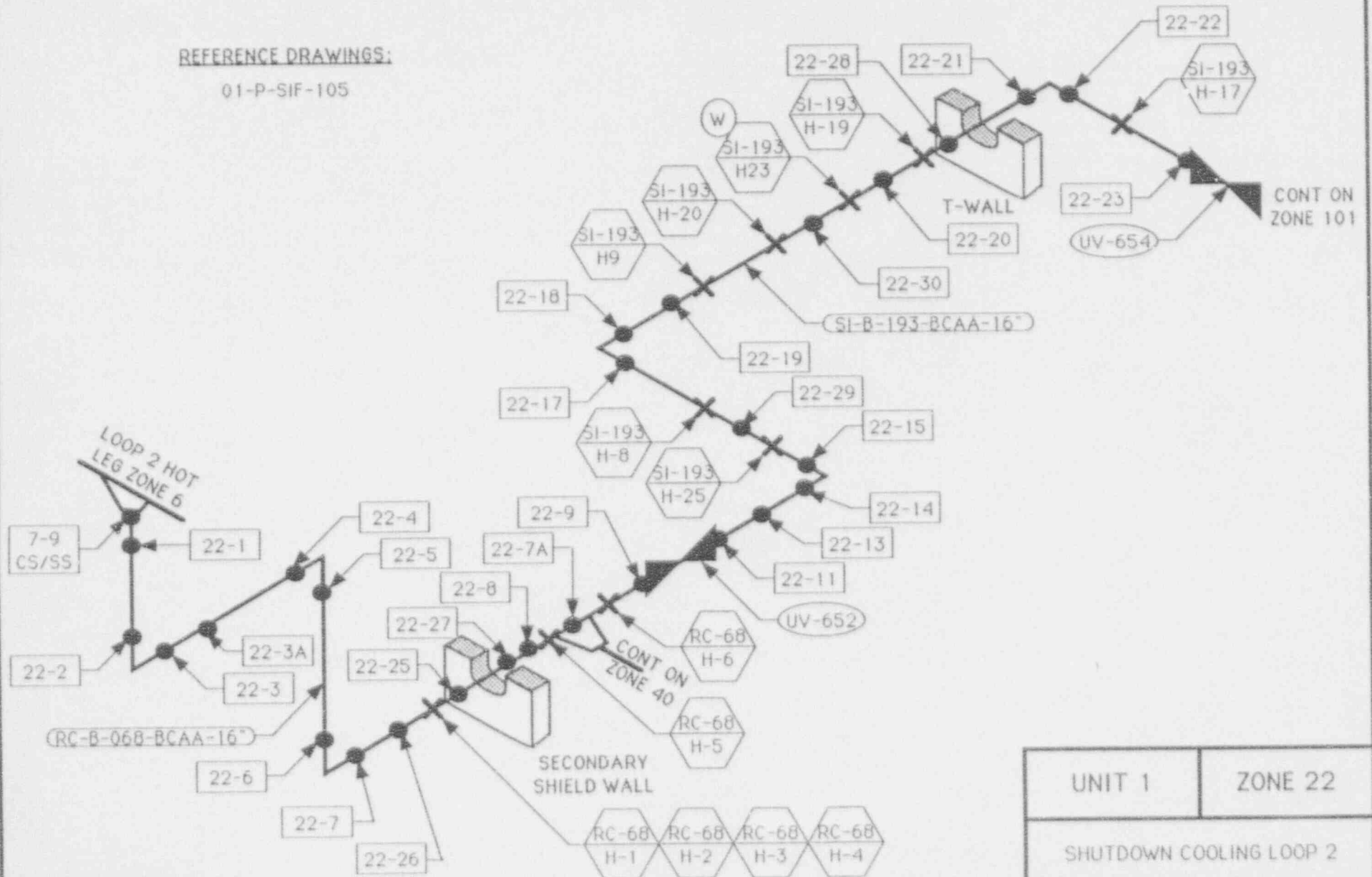

UNIT 1	ZONE 22
SHUTDOWN COOLING LOOP 2	
DRAWN BY: WJA	CHECKED BY: RLB
REV. 0	

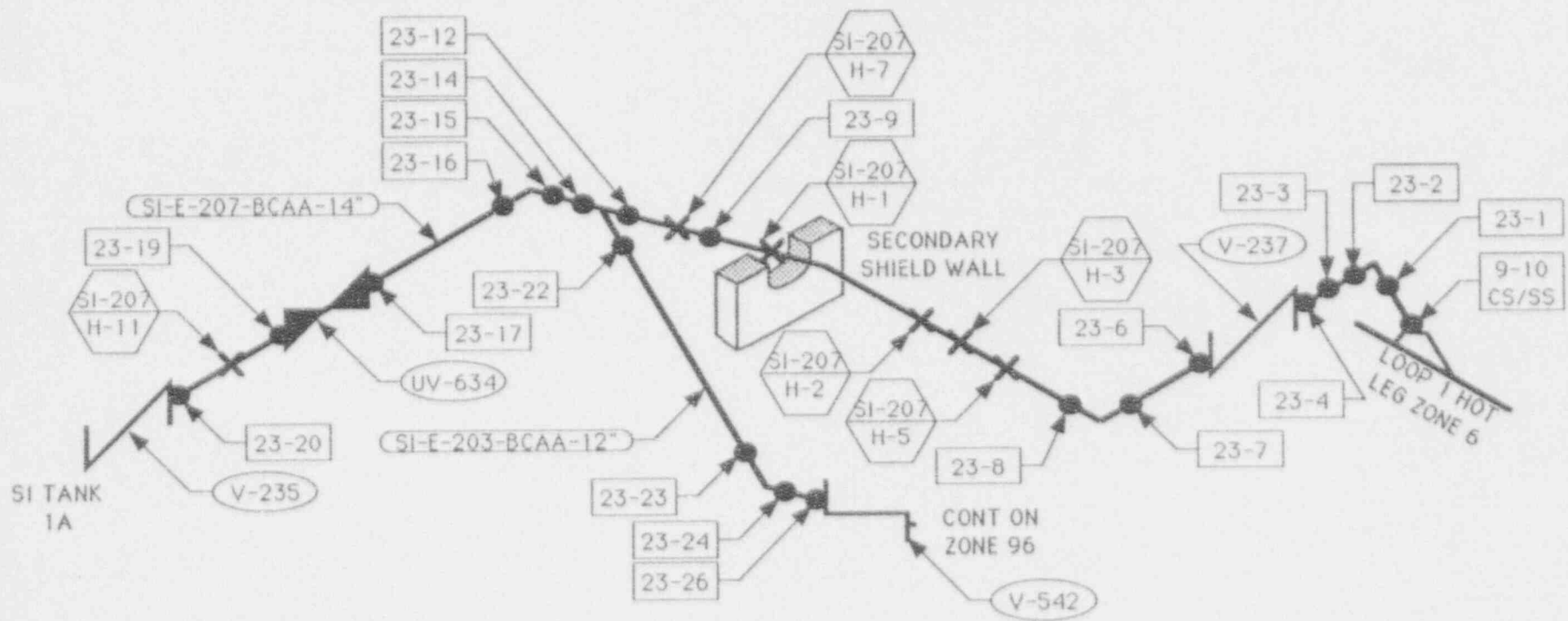

REFERENCE DRAWINGS:

13-P-SIF-103

UNIT 1	ZONE 23
SAFETY INJECTION 1A	
DRAWN BY: NJA	CHECKED BY: RLB
REV. 0	

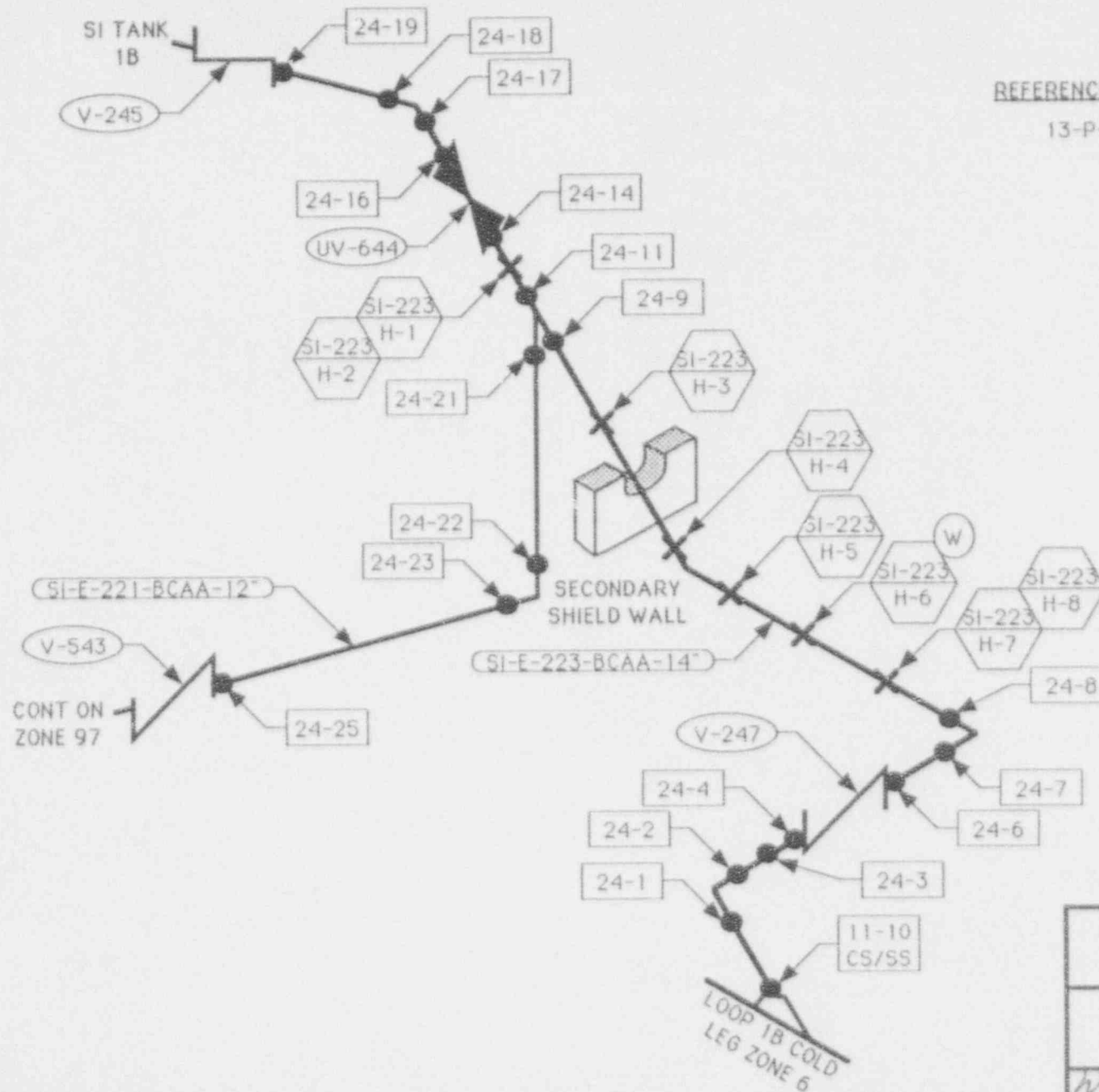

REFERENCE DRAWINGS:

13-P-SIF-103

UNIT 1	ZONE 24
SAFETY INJECTION 1B	
DRAWN BY: WJA	CHECKED BY: RLB
REV. 0	

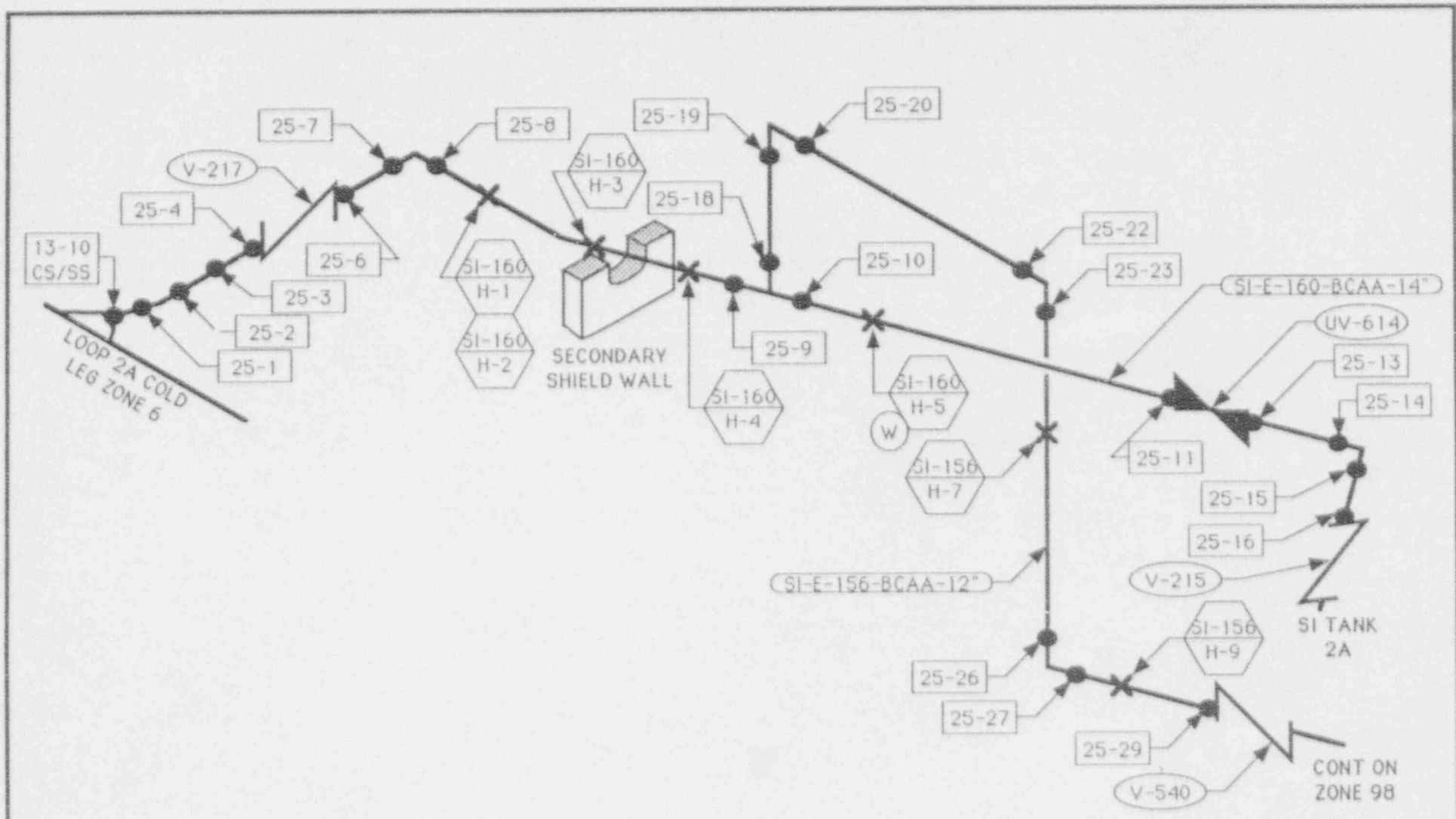

REFERENCE DRAWINGS:

13-P-SIF-136

UNIT 1	ZONE 25	
SAFETY INJECTION 2A		
DRAWN BY: WJA	CHECKED BY: RLB	REV. 0

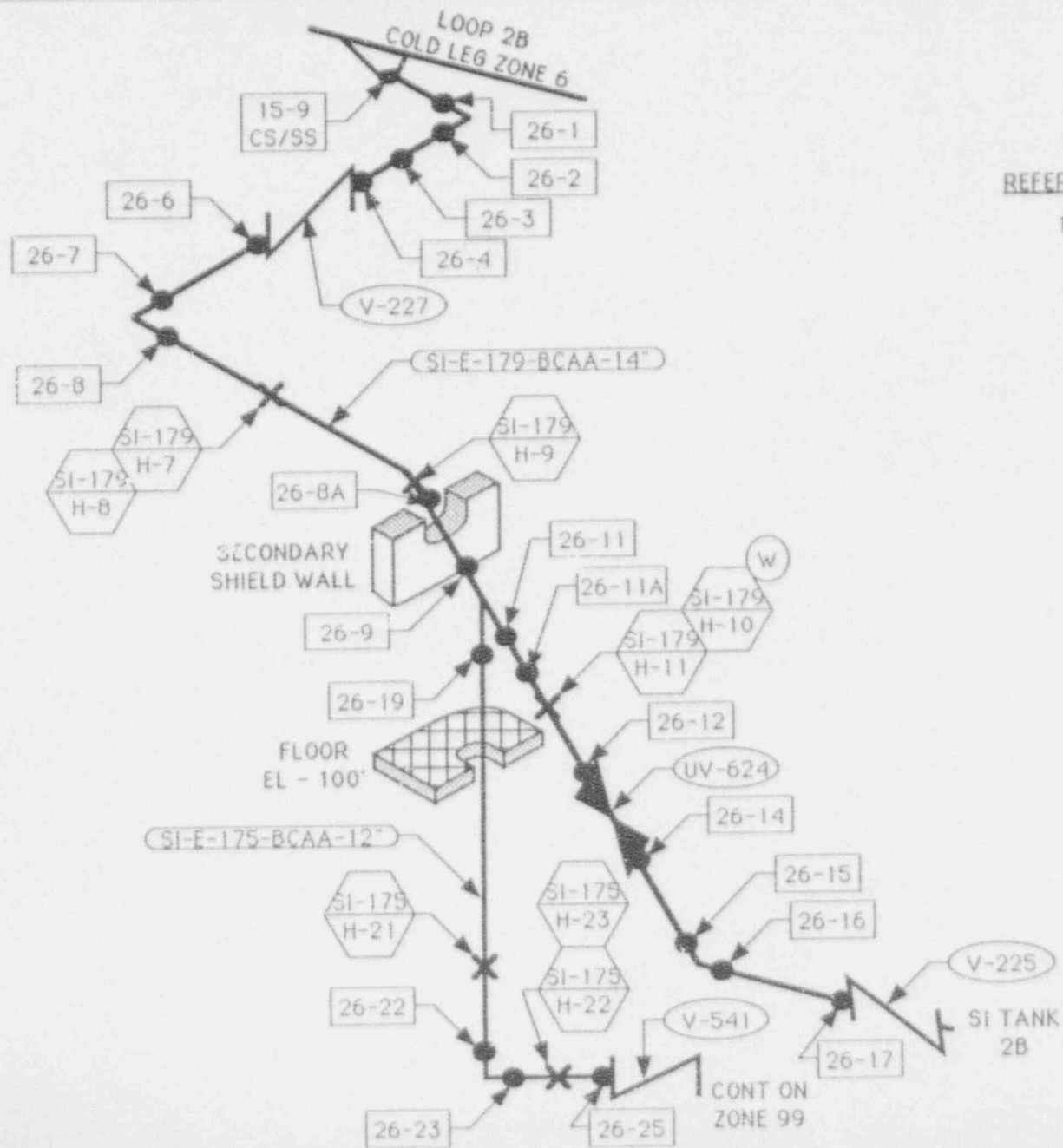

REFERENCE DRAWINGS:

13-P-SIF-136

UNIT 1	ZONE 26
SAFETY INJECTION 2B	
DRAWN BY: WJF	CHECKED BY: RLB
REV. 0	

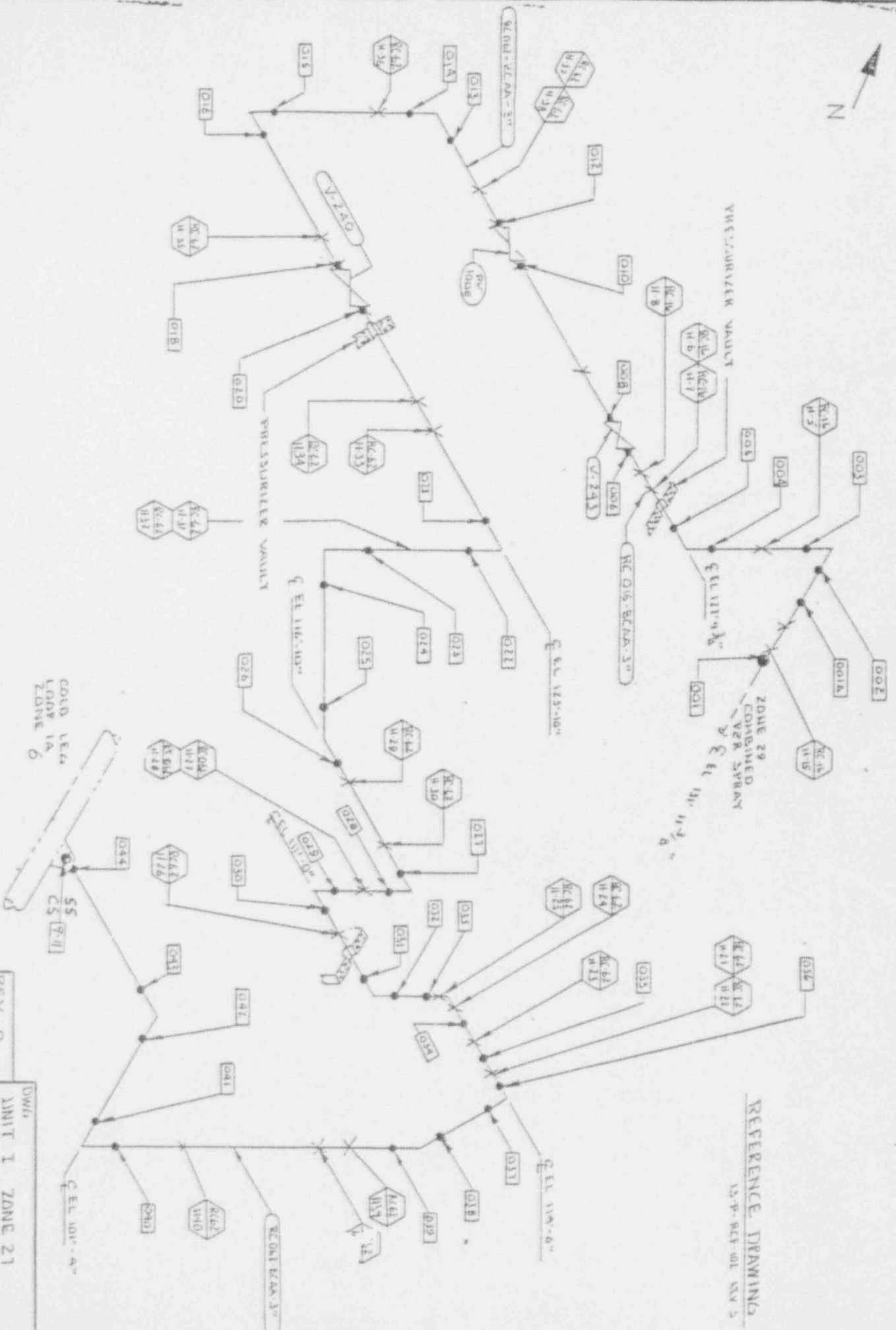

REFERENCE DRAWING
 15-P-957-01 NOV 5

REV. 0	DW/
DRAWN BY: J. HOLLER	TITLE UNIT I ZONE 21
CHECKED BY: JHS	PRESSURIZER SPRAY /A

COLD LEG
 LOOP 1A
 ZONE 6

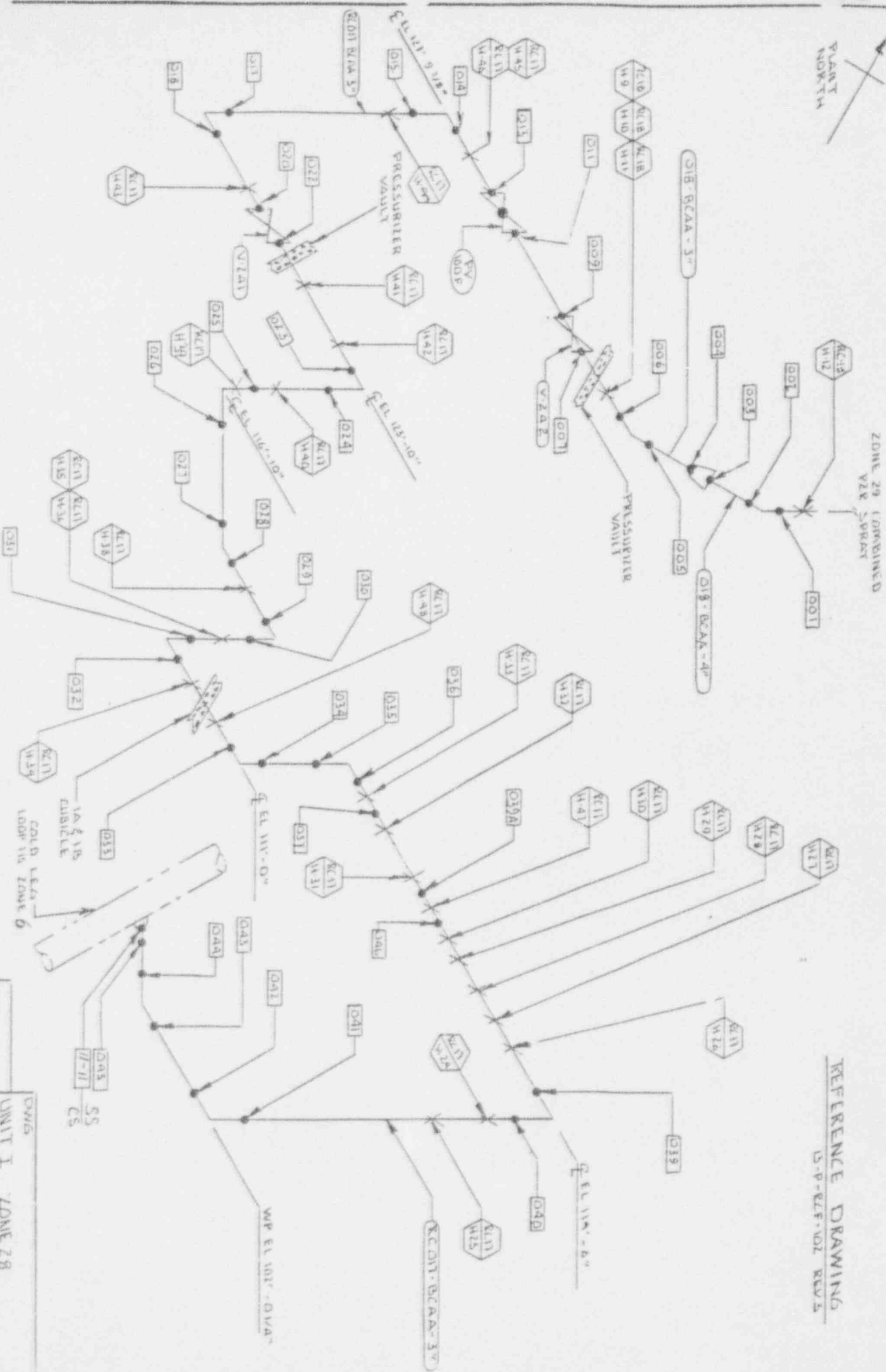

ZONE 29 COMBINED
VTR SPRAY

REFERENCE DRAWING
D-P-825-02 REV 2

REV. 0	DWG
DRAWN BY: J. MOILER	TITLE UNIT I ZONE 28
CHECKED BY: JRS	PRESSURIZER SPRAY IB

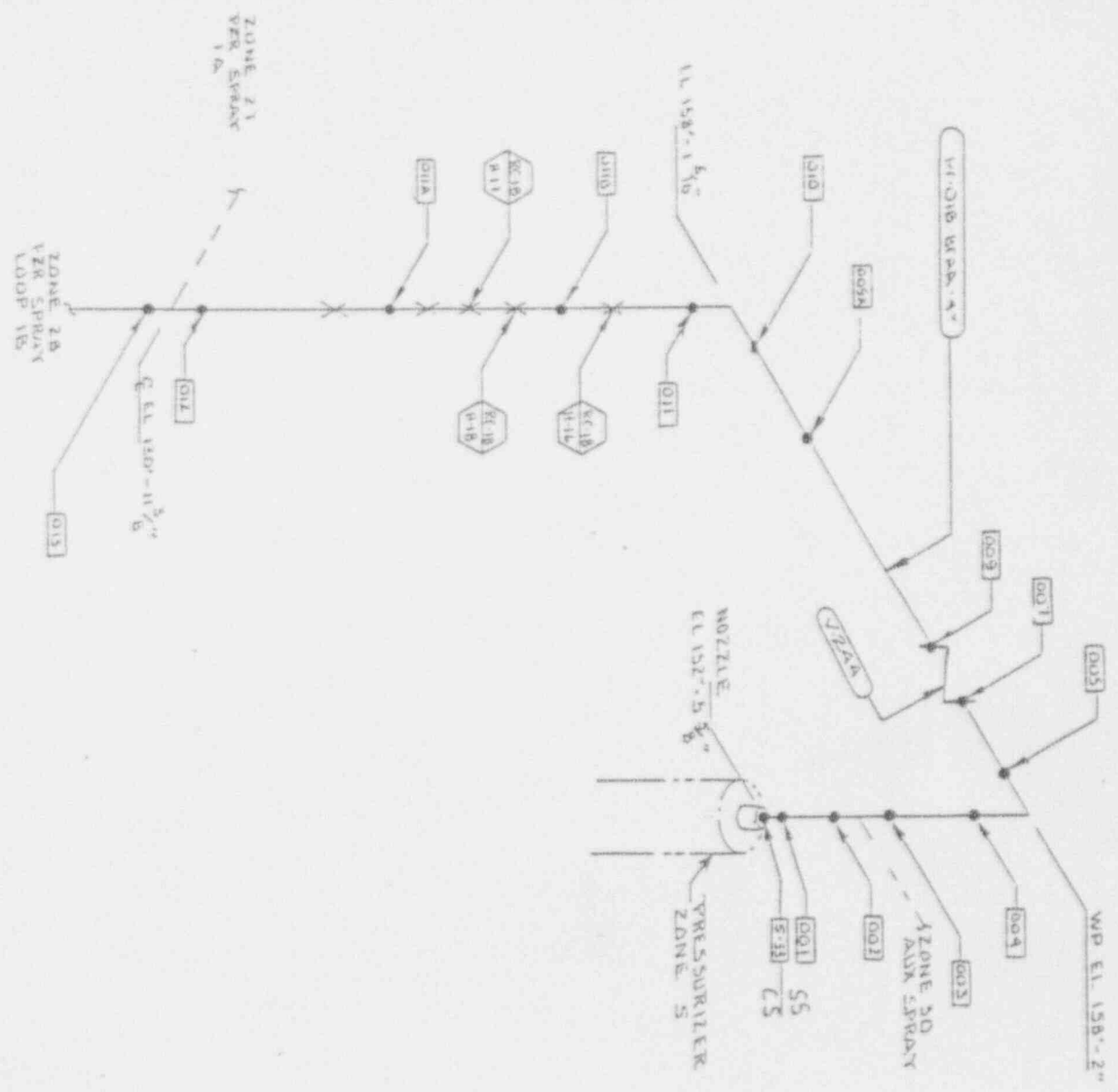

REFERENCE DRAWING

15-P-WCF-102-RLV 5

REV: 0	DWG:
DRAWN BY: J. HOLLER	UNIT 1 ZONE 2 9
CHECKED BY: TRS	TITLE
	COMBINED PRESSURIZER
	SPRAY

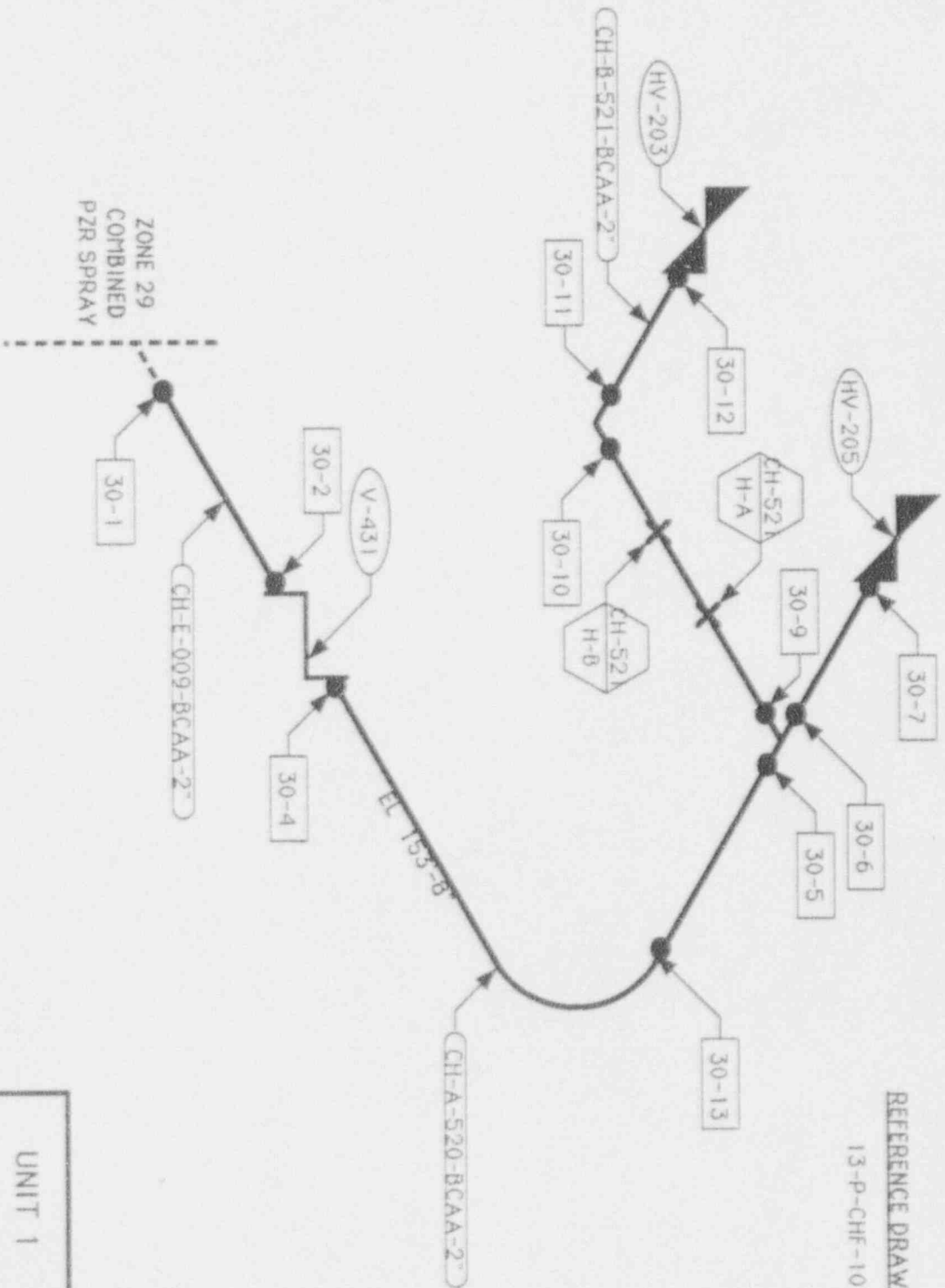

REFERENCE DRAWINGS:
13-P-CHF-107

UNIT 1	ZONE 30
AUX PRESSURIZER SPRAY	
DESIGNED BY <i>WJF</i>	CHECKED BY <i>RLB</i>
REV. 0	

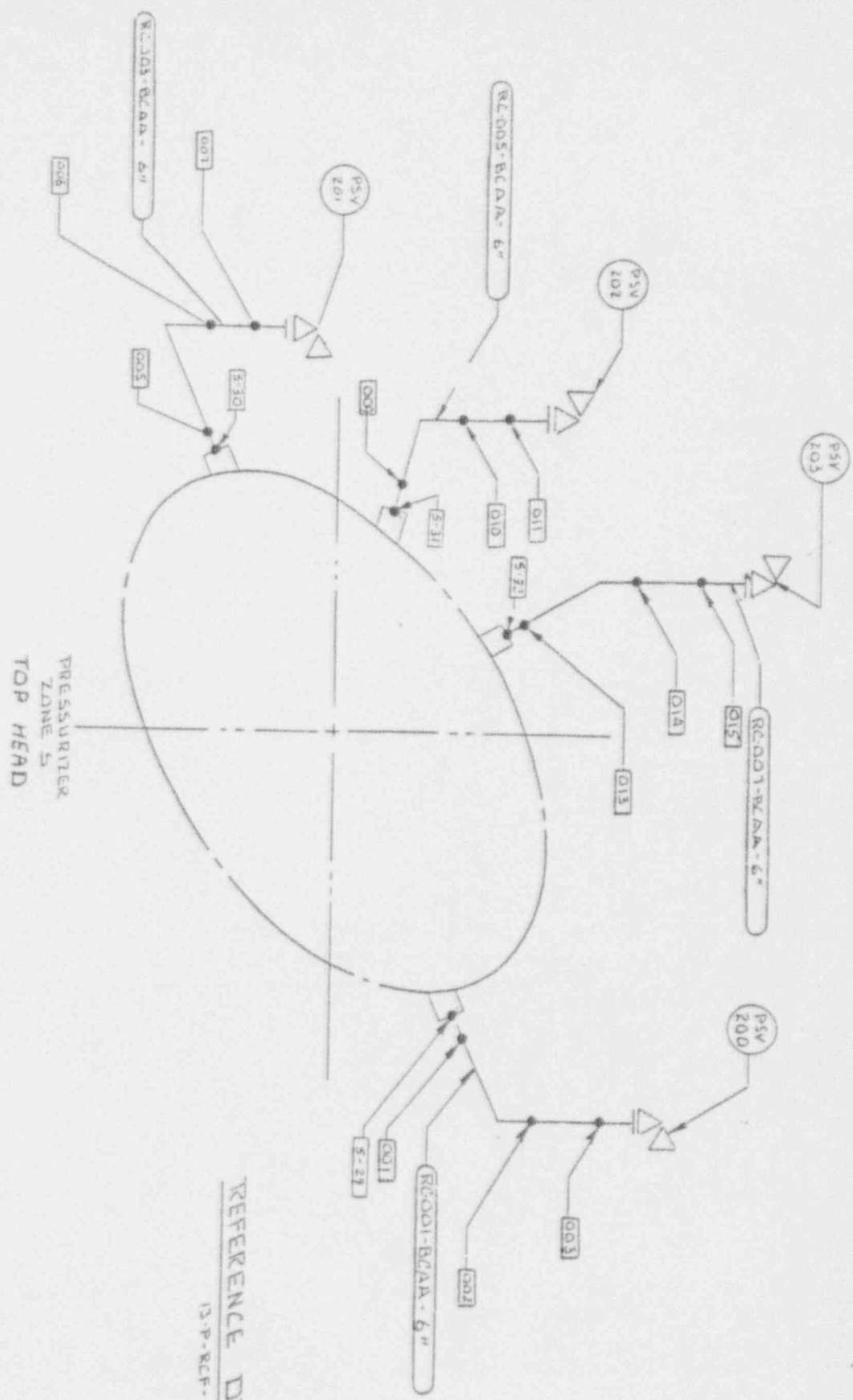

NOTE:
 B-2" X 1 1/2" STUDS / FLANGE

REFERENCE DRAWING
 13-P-RCF-114 REV 4

REV. 0	DATE	UNIT 1	ZONE 31
DRAWN BY:		TITLE	
CHECKED BY:		PRESSURIZER	SAFETIES
JBS			

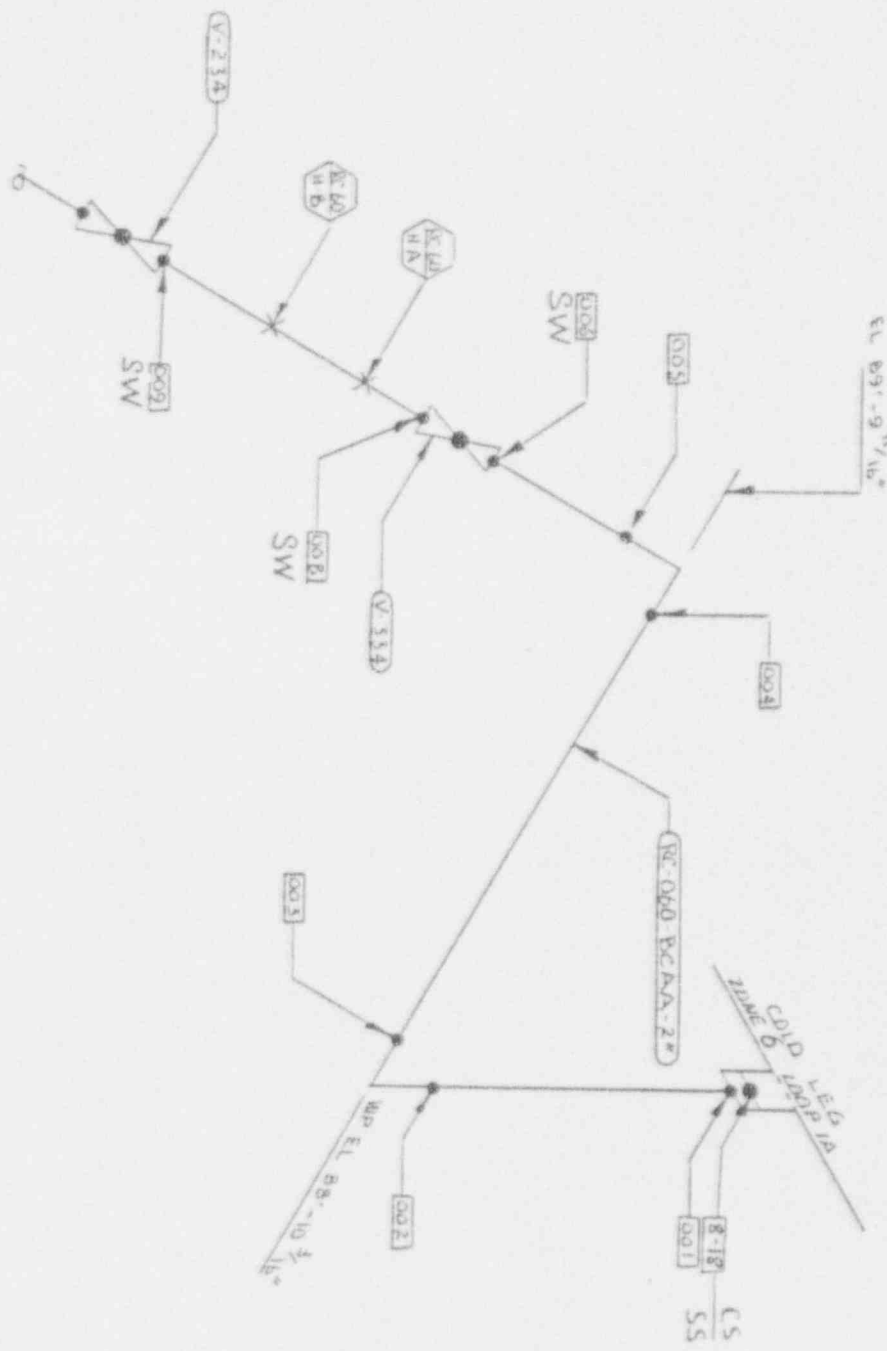

REFERENCE DRAWING

13-P-CHE-110 REV 5

NOTE:
 SW = SOCKET WELD

DWG. NO.	UNIT 1 ZONE 52
REV. 0	TITLE
DRAWN BY:	DRAIN LINE 1A
CHECKED BY:	
TBS	

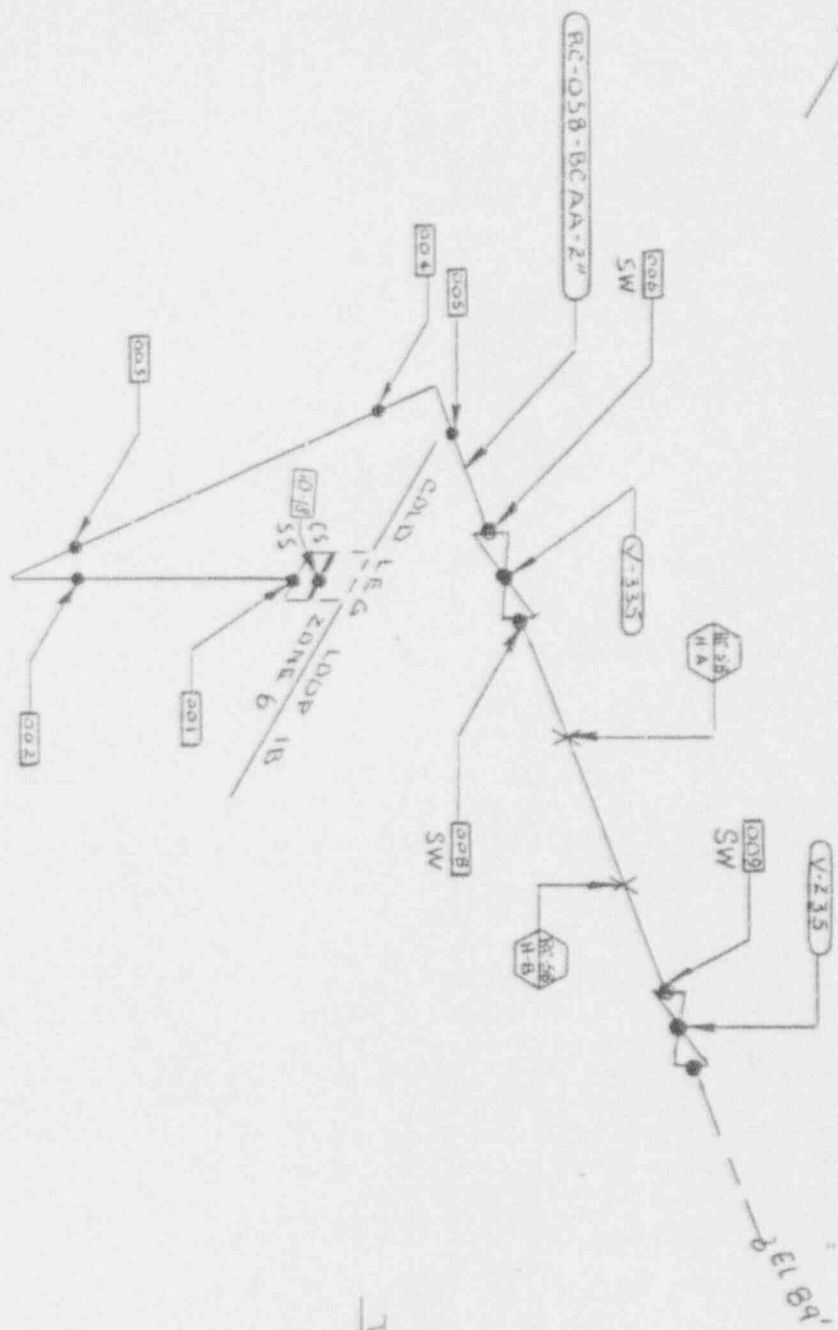

REFERENCE DRAWING
15-P-CIF-110 REV 3

NOTE:
SW : SOCKET WELD

REV: 0	DWG
DRAWN BY: J. HOLLER	UNIT 1 ZONE 33
CHECKED BY: JRS	TITLE DRAIN LINE 1B

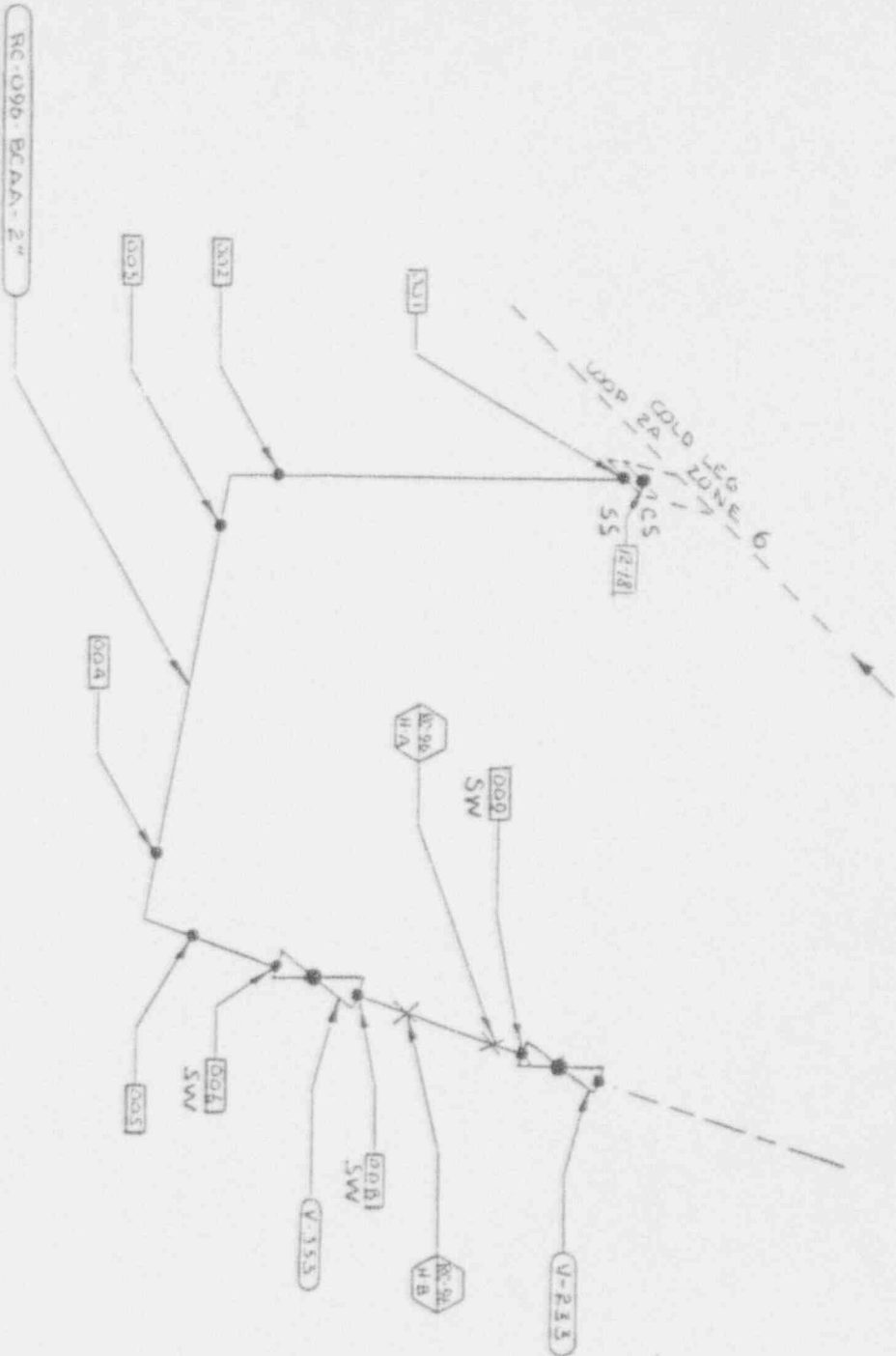

REFERENCE DRAWING

15-P-110 REV 5

REV. 0	UNIT 1 ZONE 34
DRAWN BY L. HINDLER	TITLE DRAIN LINE 2A
CHECKED BY JBS	

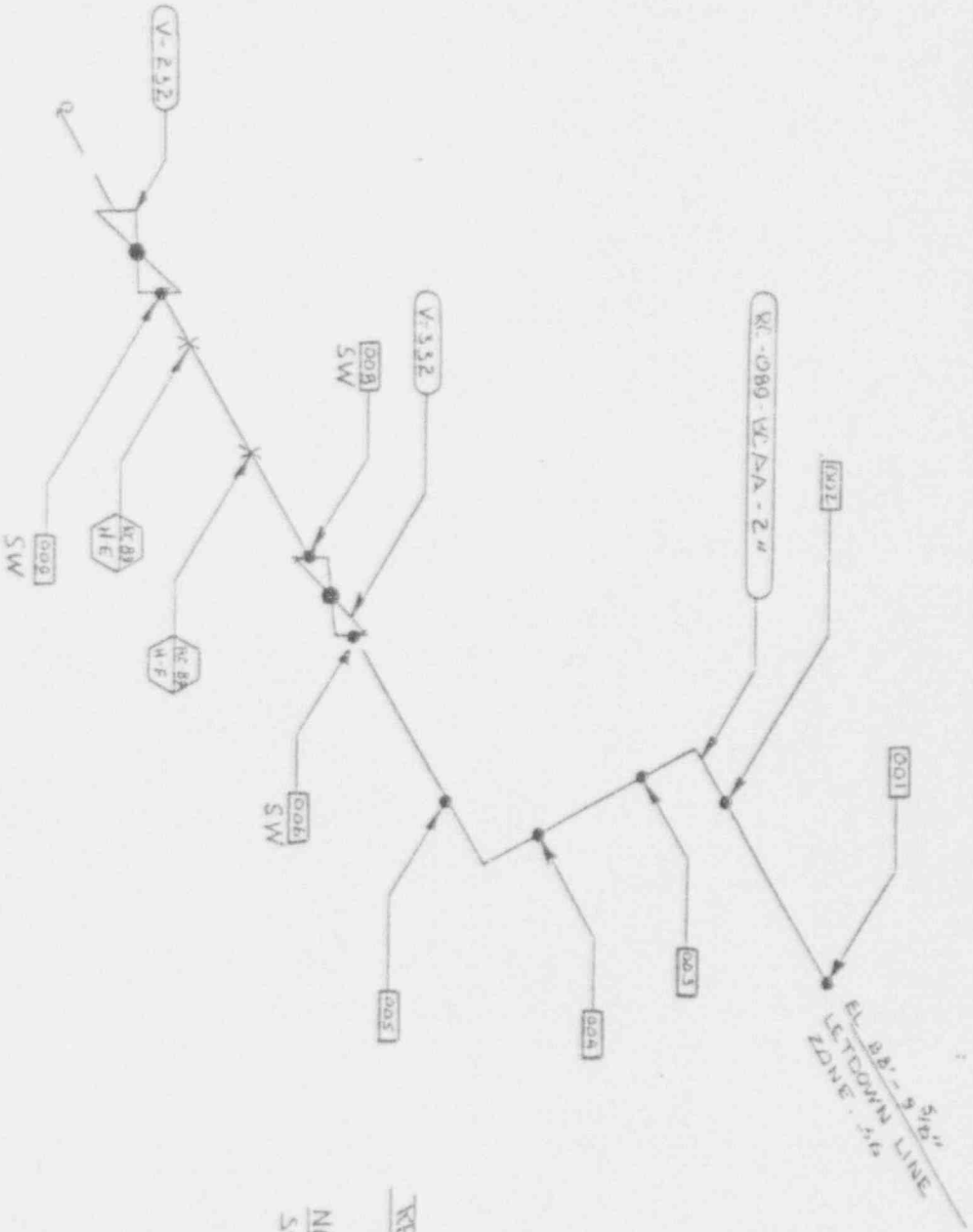

REFERENCE DRAWING

15 P-CHV-110 REV 3

NOTE:

SW = SOCKET WELD

REV 0	DWG
DRAWN BY T. MOHIER	UNIT 1 ZONE 35
CHECKED BY JRS	TITLE
	DRAIN LINE 2B

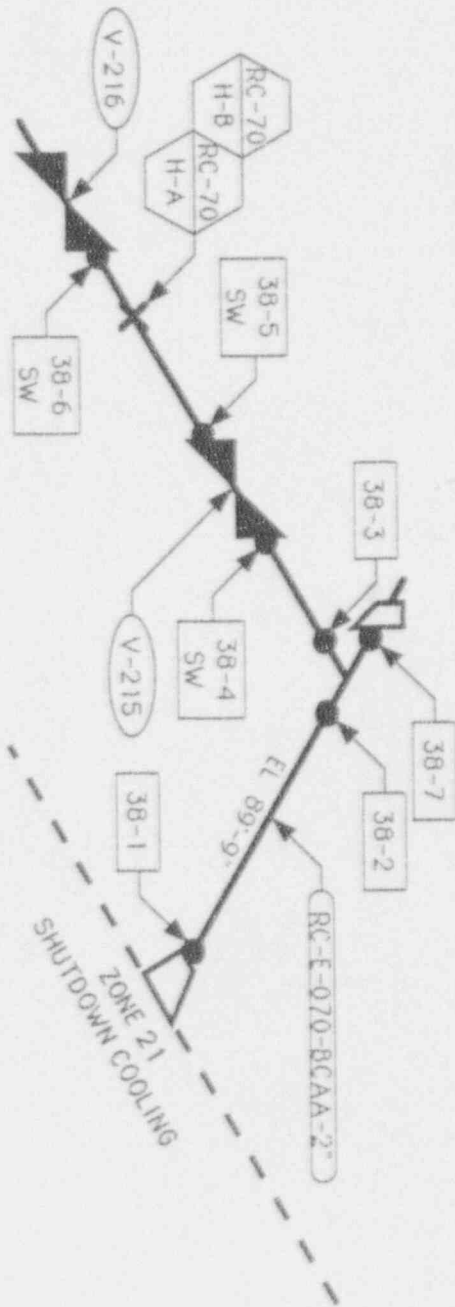

REFERENCE DRAWINGS:
 01-P-SIF-105

NOTE:
 SW = SOCKET WELD

UNIT 1	ZONE 38
DRAIN LINE LOOP 1	
DESIGNED BY AJS	CHECKED BY RLB
REV. 0	



SHUTDOWN COOLING
ZONE 22

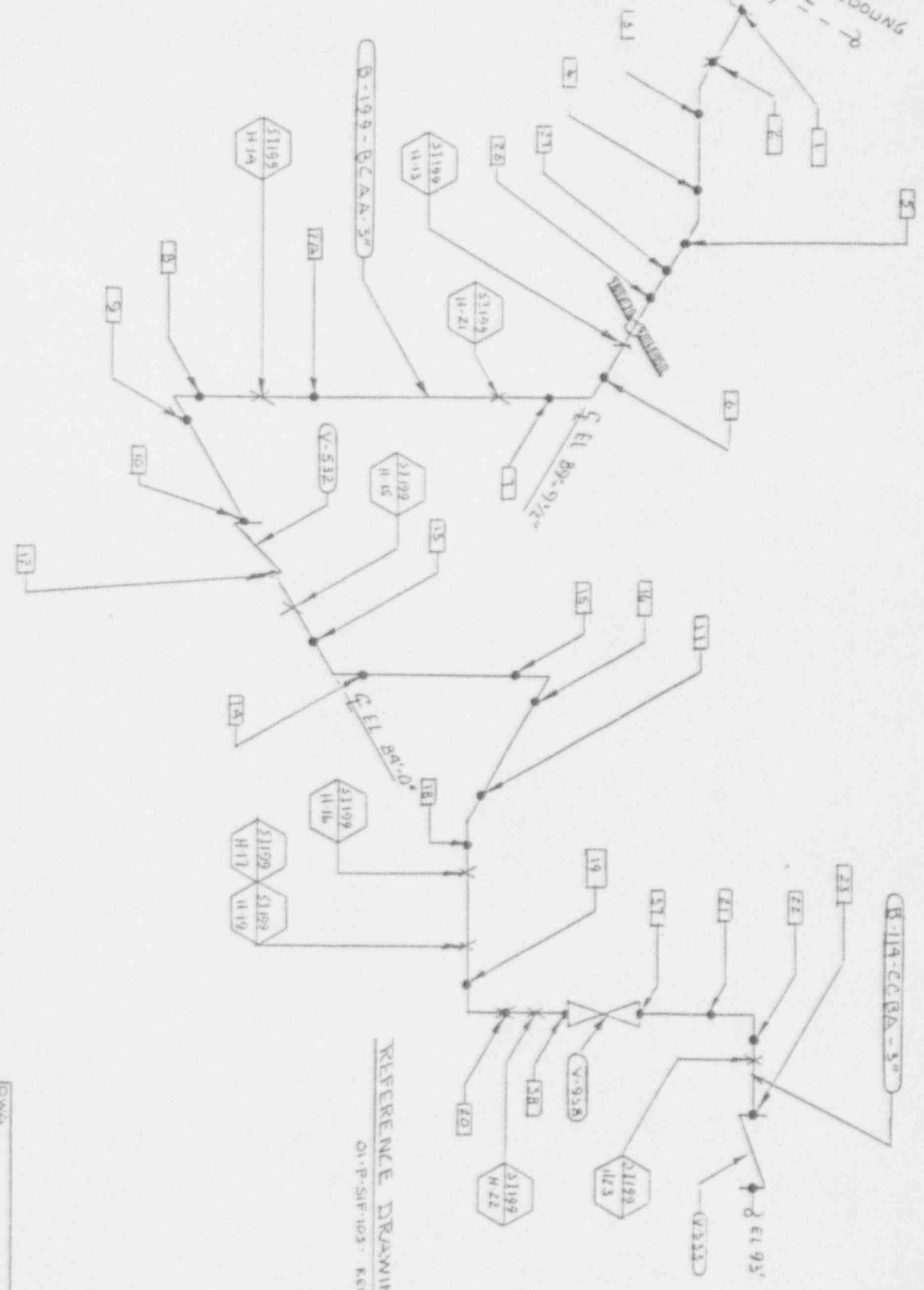

REFERENCE DRAWING
01-P-SIF-105 - KCV3

REV. 0	DWG. UNIT I ZONE 40
DRAWN BY A. HOLLER	TITLE
CHECKED BY J. B. S.	WPSI LONG TERM RELIANCE

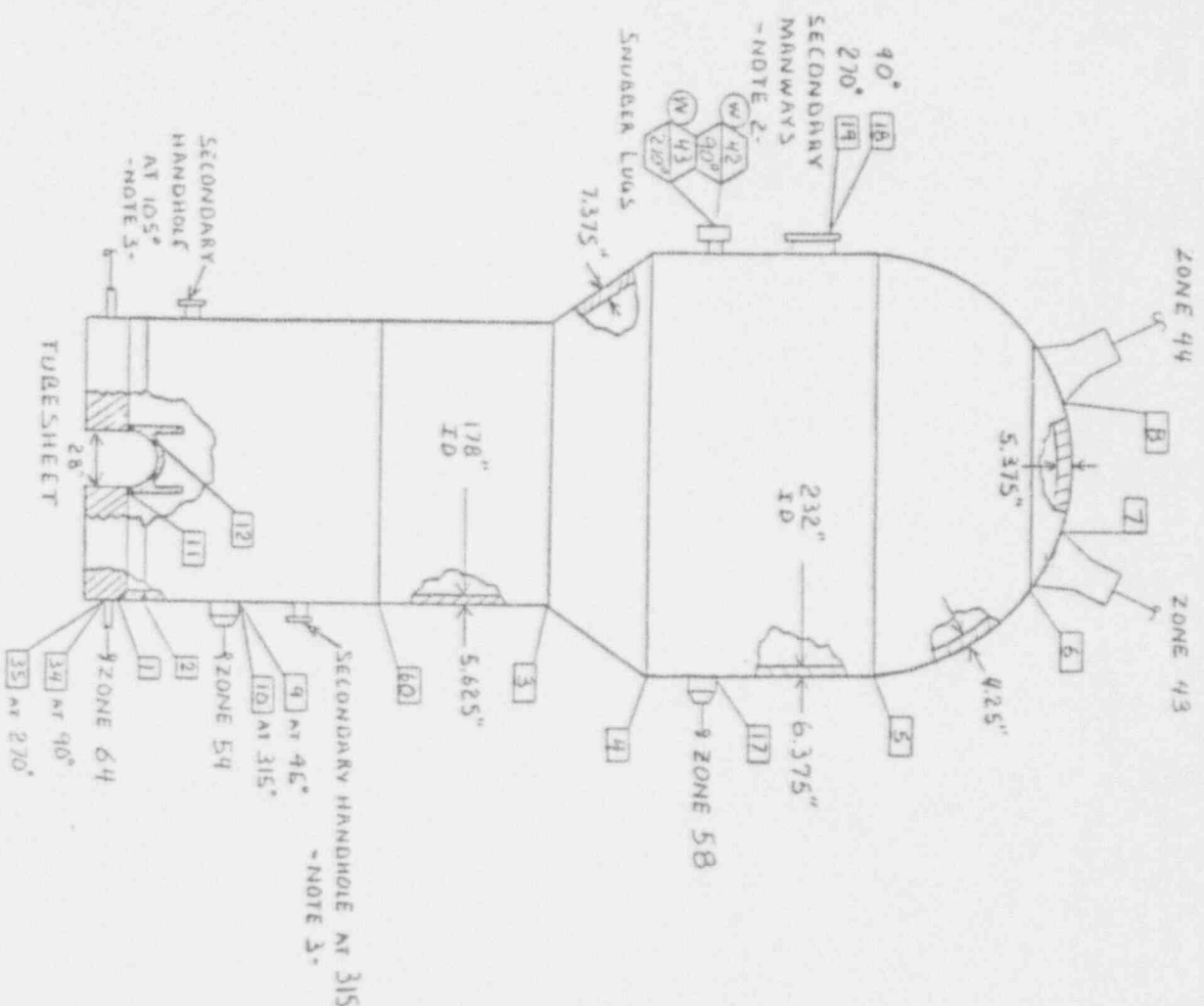

NOTES:

- 1) 0" IS AT 1/4 OF HOT LEG
 - 2) STUDS ARE 16- 1.5" X 9"
 - 3) STUDS ARE 16- 1" X 6"
 - 4) TAG NO. IMRCE01A
- SERIAL NO. 78273-1 (CE)
 N.B. NO. 22499

REFERENCE DWGS:

- N001- 6-03-9 AND 10
- N001- 6-03-103
- N001- 6-03-239

REV 0	DWG
DRAWN BY D. D. HANSEN	TITLE: UNIT "1" ZONE 41
CHECKED BY JRS	STEAM GENERATOR 1

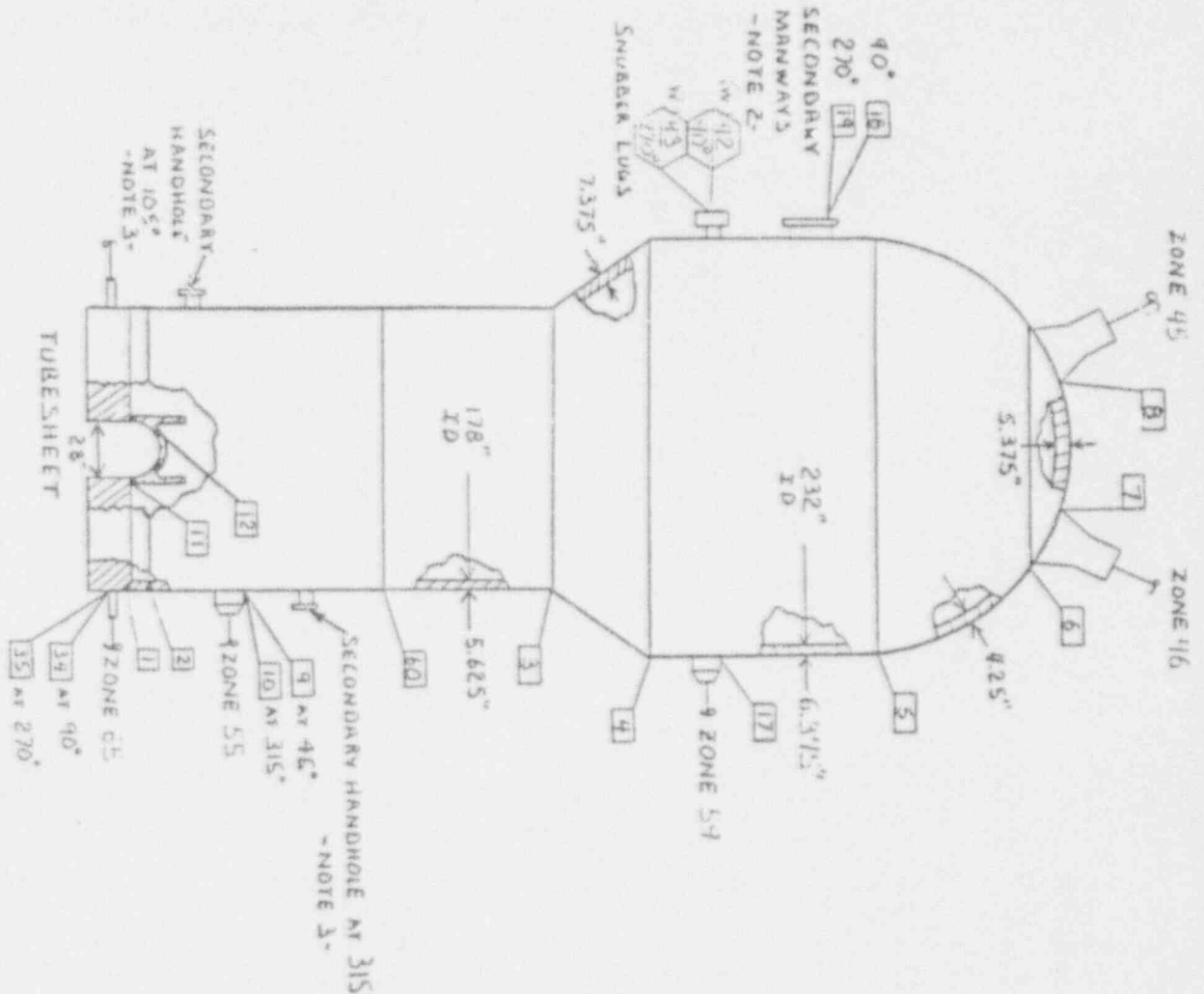

NOTES:

- 1) 0" IS AT 1/4 OF HOT LEG
- 2) STUDS ARE 16-1.5" X 9"
- 3) STUDS ARE 16-1" X 6"
- 4) TAG NO. 1MRLK1101B
- 5) SERIAL NO. 78273-2 (16)
- 6) N.B. NO. 22500

REFERENCE DWGS:

- N001-6.03-9 AND 10
- N001-6.03-103
- N001-6.03-139

REV D	DWG
DRAWN BY D. G. HANSEN	TITLE: UNIT #1 ZONE 42
CHECKED BY JBS	STEAM GENERATOR 2



LINE	UNITS	FROM	TO
35	27' X 2"	1	2
36	60" X 1.25"	2	30

REFERENCE DRAWING
15-P-56P-118 REV A

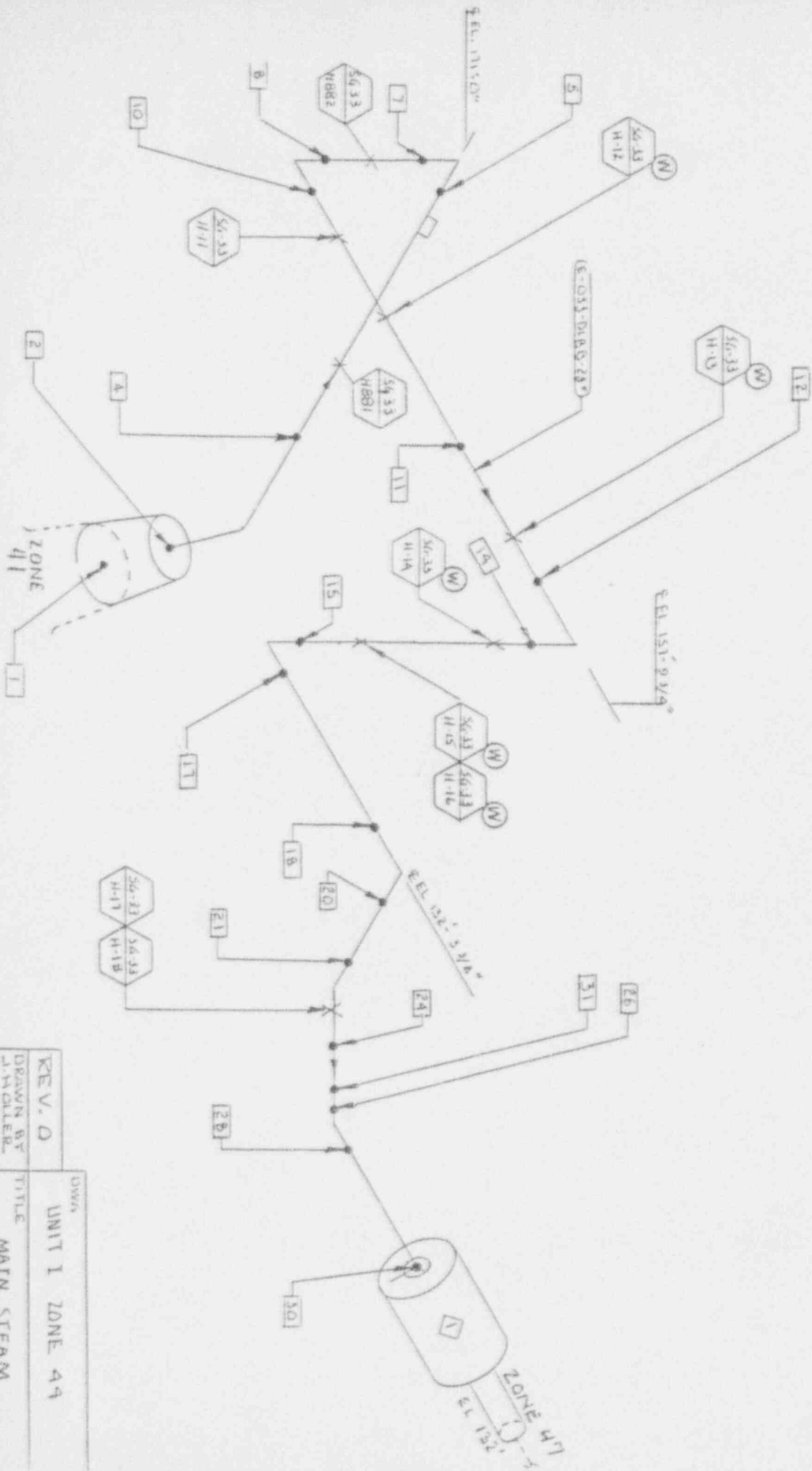

REV. 0	UNIT 1 ZONE 49
DRAWN BY A. HOLLER	TITLE MAIN STEAM
CHECKED BY JBS	



LINE #	DN/SLN	FROM	TO
42	3/2" X 2"	1	2
42	28" X 1.25"	2	25

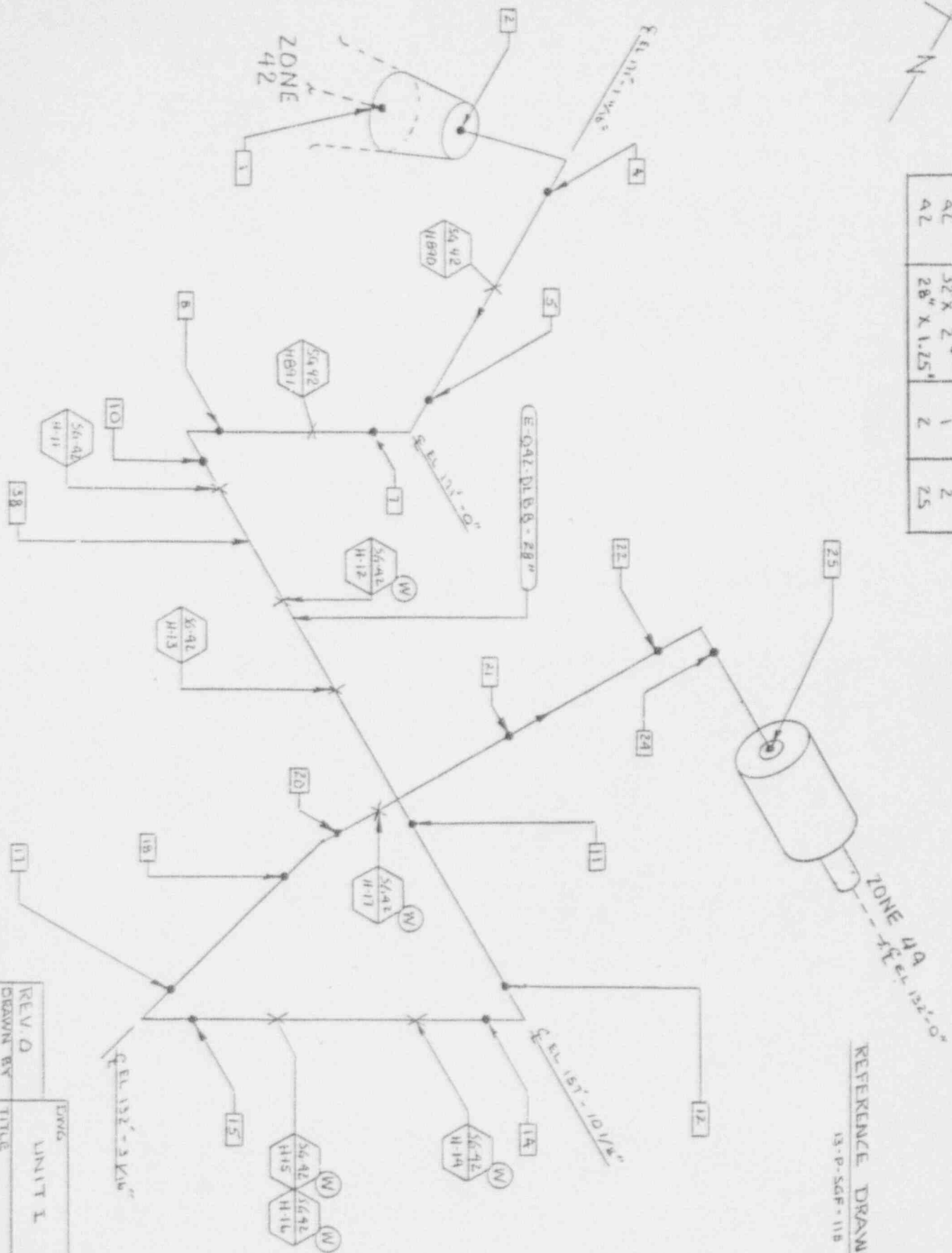

REFERENCE DRAWING
13-P-SGF-118 REV 4

REV 0	ENGINEER
DRAWN BY	TITLE
A. HOLLER	UNIT 1 ZONE 45
CHECKED BY	MAIN STEAM
TGS	56 2 EAST



LINE #	DIA/SLH	FROM	TO
45	32" X 2"	1	2
45	28" X 1.25"	2	28

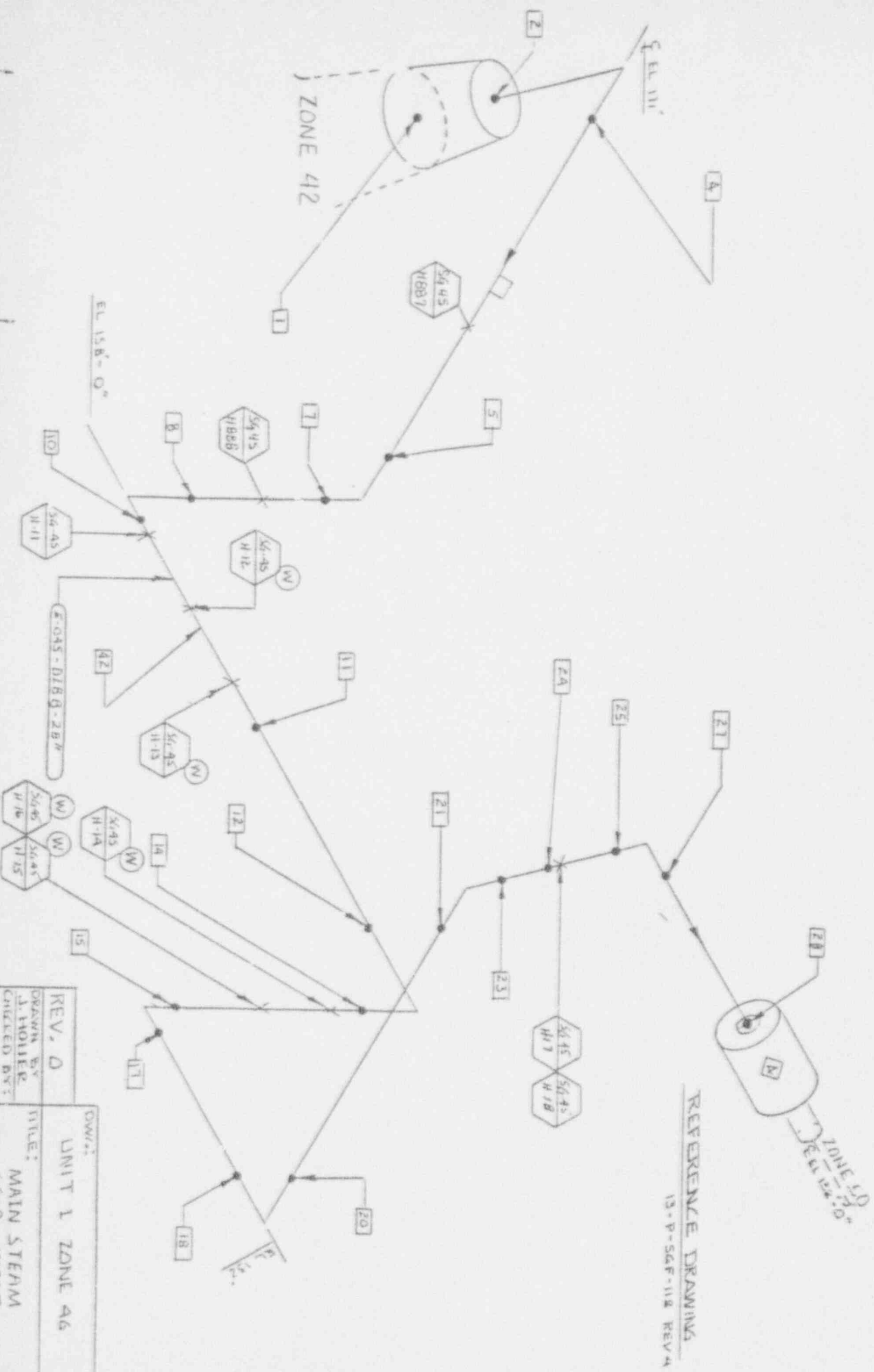

REV. 0
 DRAWN BY
 J. HOLLER
 CHECKED BY
 TRS

UNIT 1 ZONE 4G
 MAIN STEAM
 56 2 WEST

REFERENCE DRAWING
 13-P-56-F-112 REV. 4

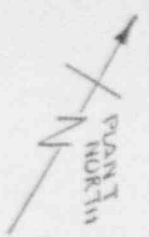

LINE #	DIA/SCH	F ROOM	TO
206	28" X 1.15"	1	30
206	6" X 1.5"	A	20
206	12" X .844	28	29

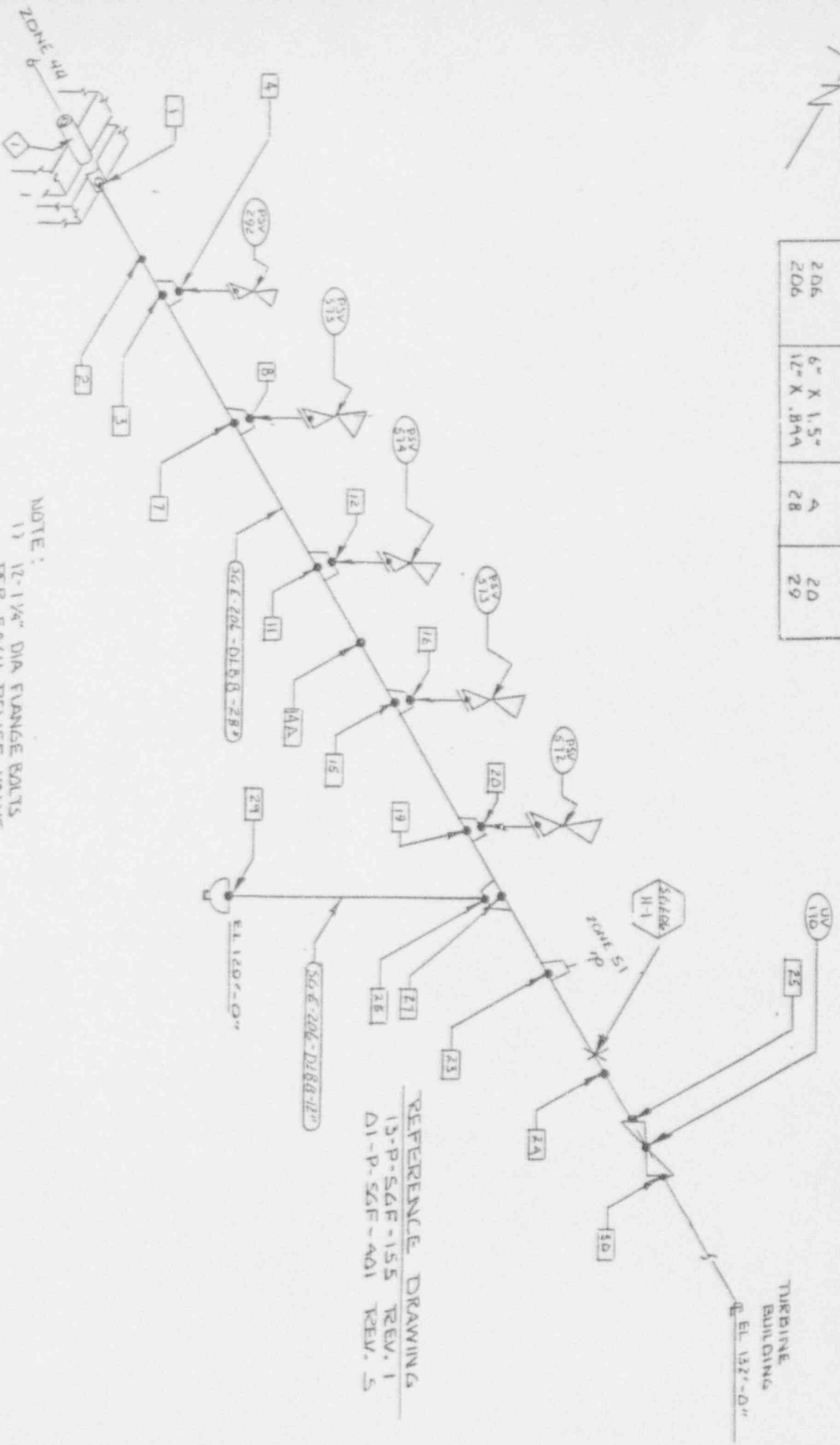

NOTE:
 1) 1/2-1 1/4" DIA FLANGE BOLTS
 PER EACH RELIEF VALVE.
 2) MSIV 20" 2 1/4" BODY TO
 BONNET BOLTS

REFERENCE DRAWING
 13-P-54E-155 REV. 1
 D1-P-54E-401 REV. 5

REV. 0	DWG
DRAWN BY J. HOLLER	UNIT 1 ZONE 41
CHECKED BY JGS	TITLE MAIN STEAM S/G #1 (WEST)

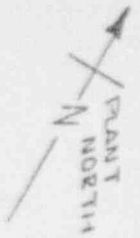

LINE #	DIA/SCH	FROM	TO
201	28" X 1.15"	1	30
201	6" X 1.5"	4	20
201	12" X .849"	28	29

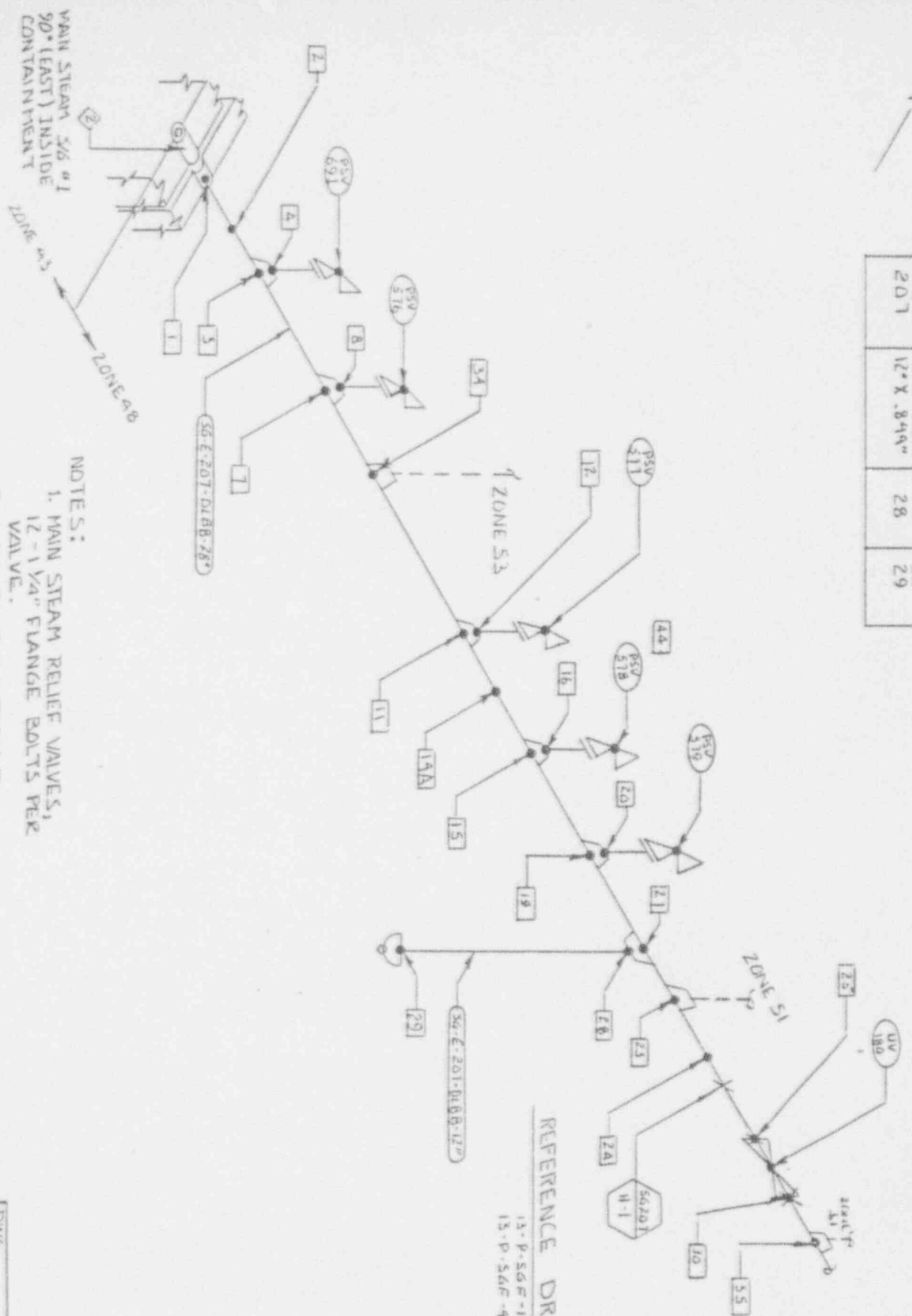

TURBINE BUILDING
E L 132'-0"

REFERENCE DRAWING

13-P-SGR-155 REV 1
13-P-SGR-401 REV 5

NOTES:

1. MAIN STEAM RELIEF VALVES, 12-1 1/4" FLANGE BOLTS PER VALVE.
2. MSIV, ZD-2 1/4" BODY TO CONNET BOLTS.

REV. 0	DWG
DRAWN BY: A. HOLLER	UNIT 1 ZONE 4B
CHECKED BY: TGS	TITLE MAIN STEAM
	S/6 / EAST

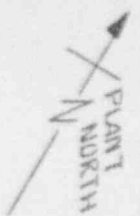

LINE #	DIA / SCH	FROM	TO
208	28" X 1.75"	1	30
208	6" X 1.5"	4	20
208	12" X .894"	28	29

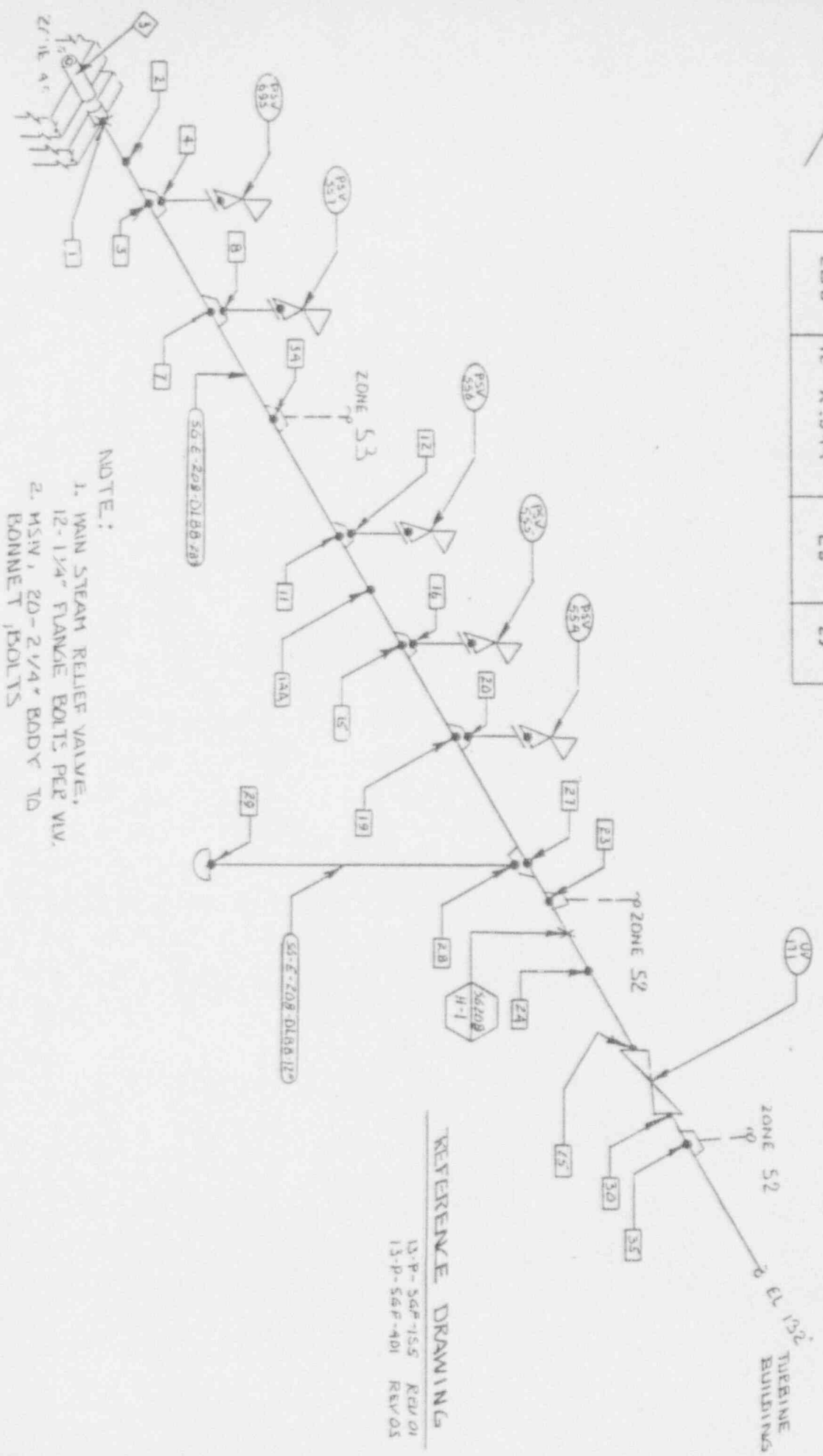

NOTE:
 1. MAIN STEAM RELIEF VALVE,
 12-1 1/4" FLANGE BOLTS PER VLV.
 2. MSIV, 20-2 1/4" BODY &
 BONNET BOLTS TO

REFERENCE DRAWING

13-P-56P-155 REV 01
 13-P-56P-401 REV 05

REV. 0	UNIT 1 ZONE 49
DRAWN BY J. MILLER	FILE: MAIN STEAM S/16 2 (EAST)
CHECKED BY: JRS	

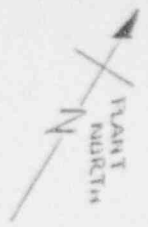

LINE	DWA/ S&H	FROM	TO
209	28" X 1.75"	1	50
209	6" X 1.5"	4	20
209	12" X .894"	28	29

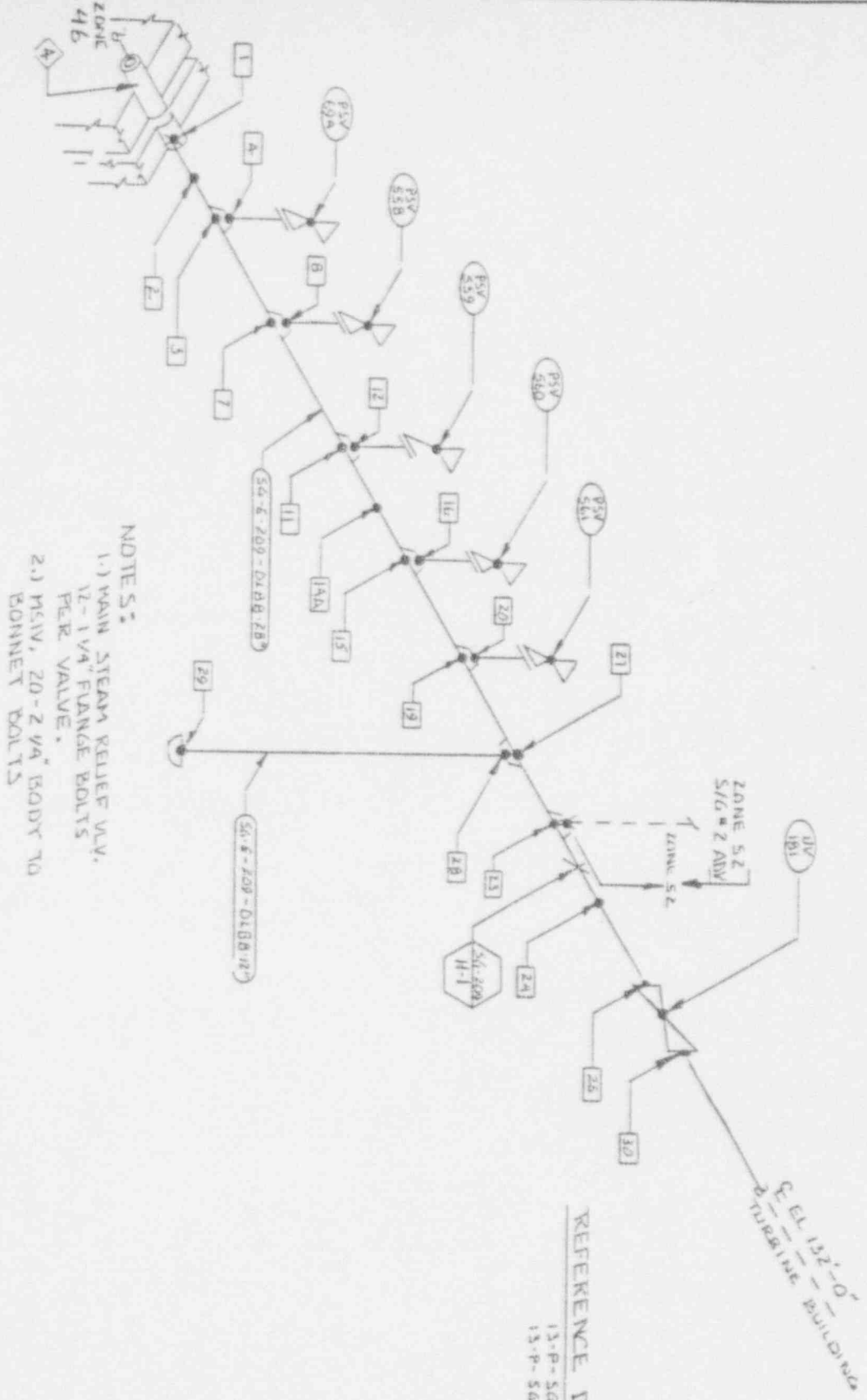

NOTE 5.2:
 1.) MAIN STEAM RELIEF VLV.
 12-1/4" FLANGE BOLTS
 PER VALVE.
 2.) MSIV, 20-2 1/4" BODY TO
 BONNET BOLTS

REFERENCE DRAWING
 13-P-50F-55 REV 1
 13-P-50F-01 REV 5

REV 0	DWG	UNIT 1	ZONE 50
DRAWN BY: J. HOLLER			
CHECKED BY: JBS			
TITLE MAIN STEAM S/G # 2 (WEST)			

REFERENCE DRAWINGS:

13-P-SGF-158

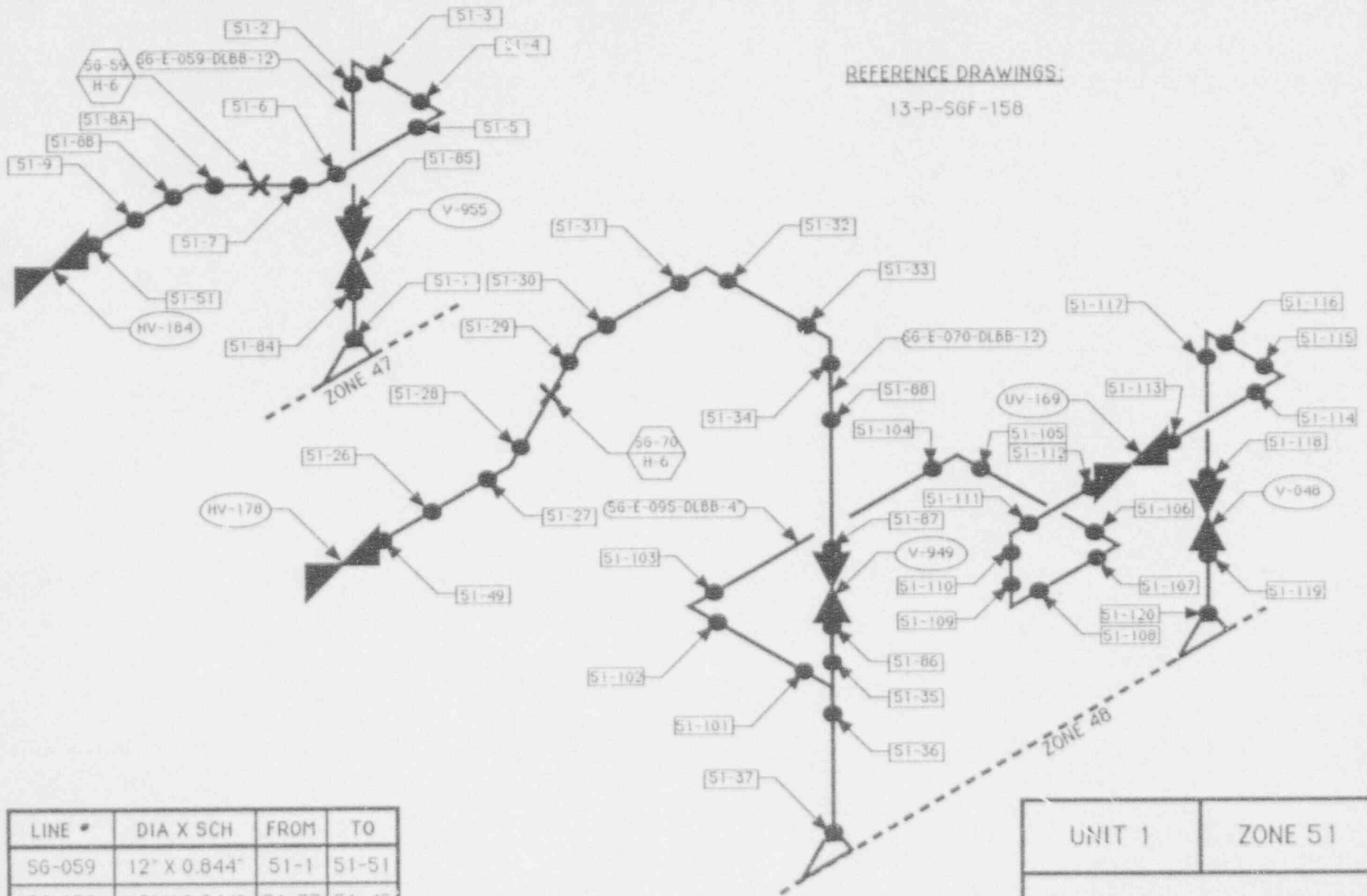

LINE #	DIA X SCH	FROM	TO
SG-059	12" X 0.844"	51-1	51-51
SG-070	12" X 0.844"	51-37	51-49
SG-095	4" X 0.377"	51-101	51-120

UNIT 1	ZONE 51
ATMOSPHERIC DUMP NO 1	
DESIGNED BY: <i>WJA</i>	CHECKED BY: <i>SB</i>
	REV. 0

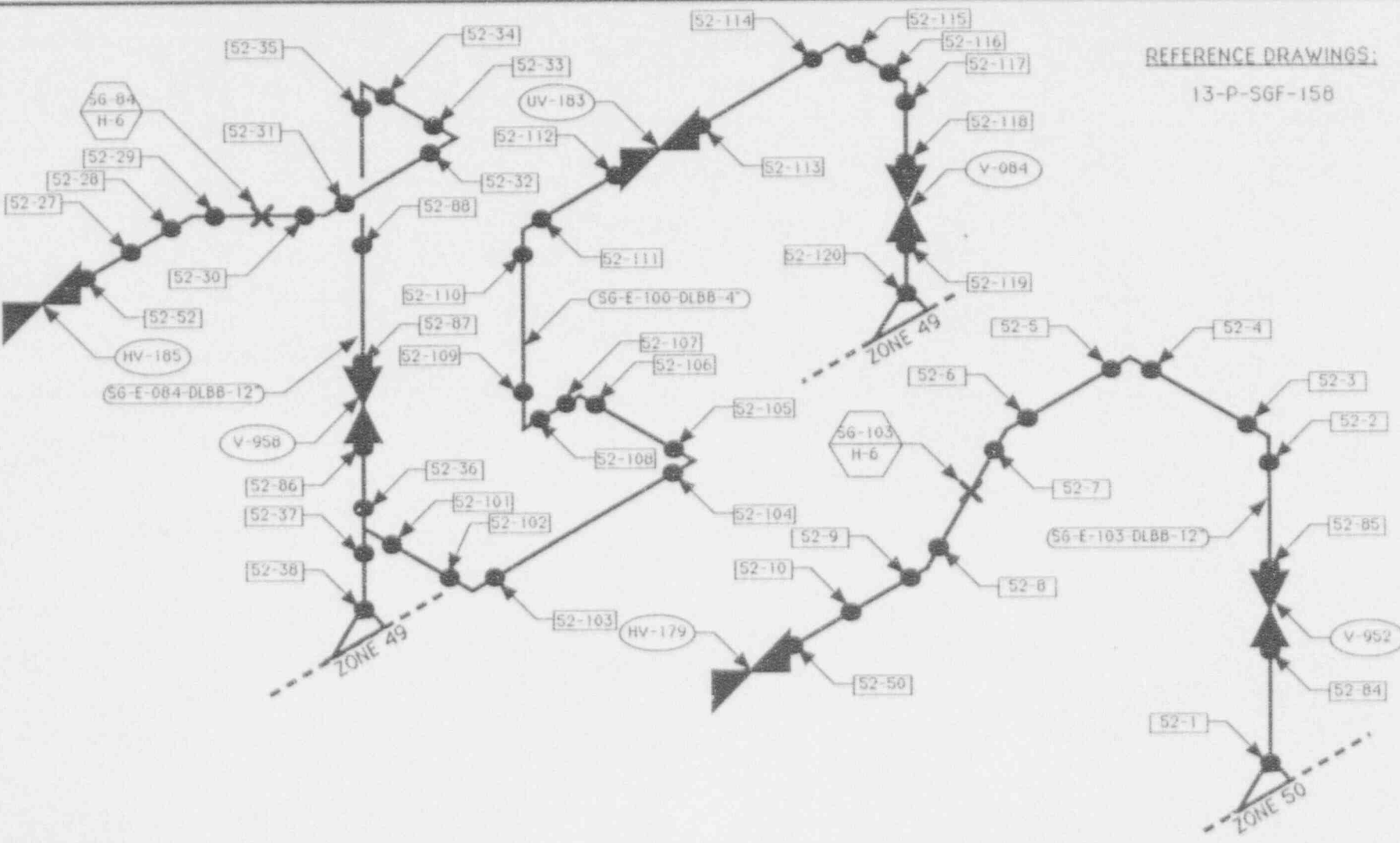

REFERENCE DRAWINGS:
13-P-SGF-158

LINE #	DIA X SCH	FROM	TO
SG-103	12" X 0.844"	52-1	52-50
SG-084	12" X 0.844"	52-38	52-52
SG-100	4" X 0.377"	52-101	52-120

UNIT 1	ZONE 52
ATMOSPHERIC DUMP NO 2	
DRAWN BY <i>[Signature]</i>	CREATED BY <i>[Signature]</i>
	REV 0

REFERENCE DRAWINGS:

13-P-AFF-131

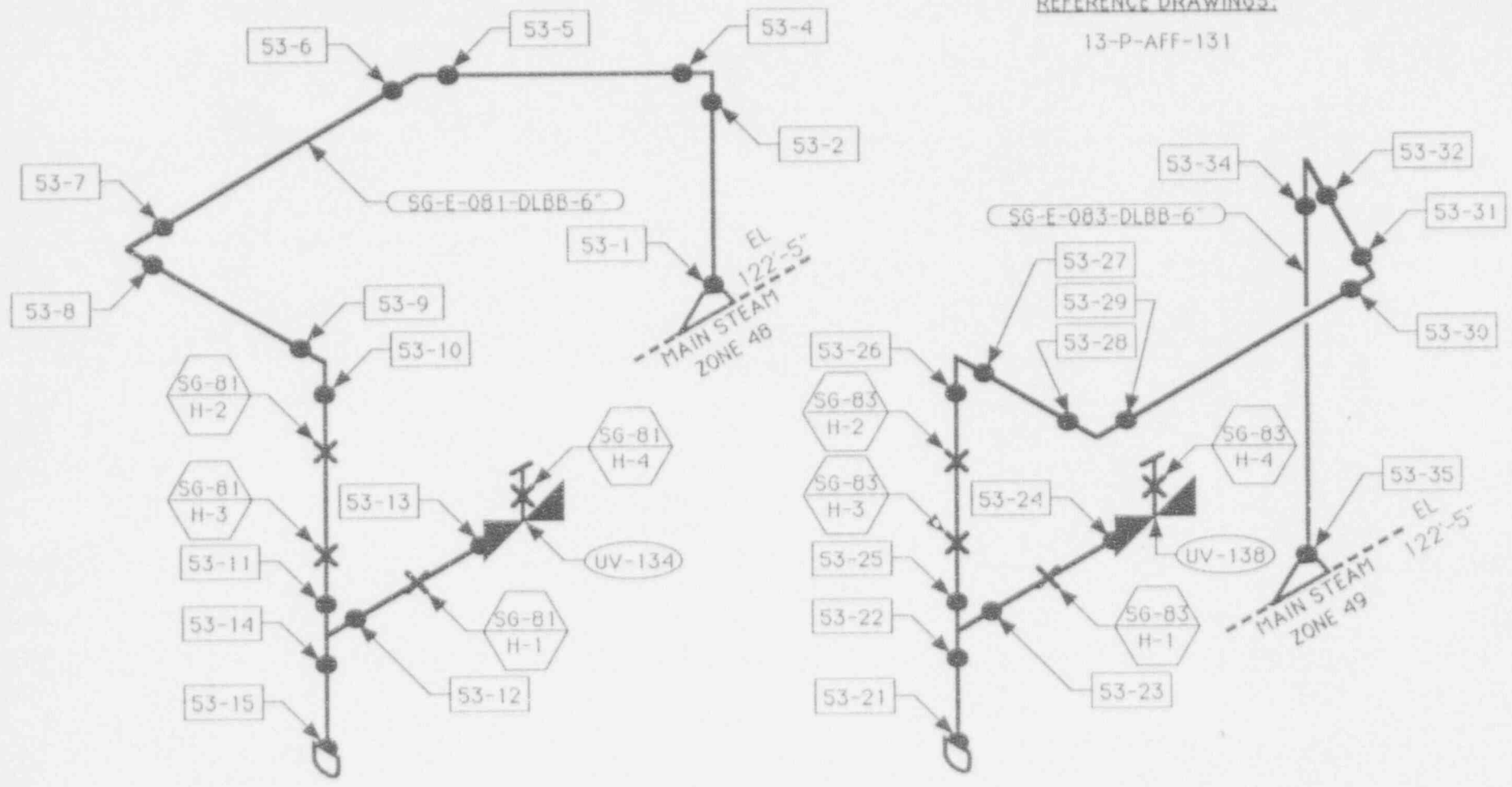

LINE #	DIA X SCH	FROM	TO
SG-081	6" X 0.432"	53-1	53-15
SG-083	6" X 0.432"	53-21	53-35

UNIT 1	ZONE 53	
STEAM TO AUX FEEDWATER SYSTEM		
DRAWN BY <i>WOA</i>	CHECKED BY <i>RLB</i>	REV. 0

LINE	EA/VA/SC/H	FROM	TD
2	14" x 1.38"	15	24
2	16" x .894"	25A	26
2	16" x 1.75"	41-45	-
2	24" x 1.216"	13, 27	40
13	14" x .938"	1	10
13	16" x .894"	11A	12
13	16" x 1.75"	41-44	-

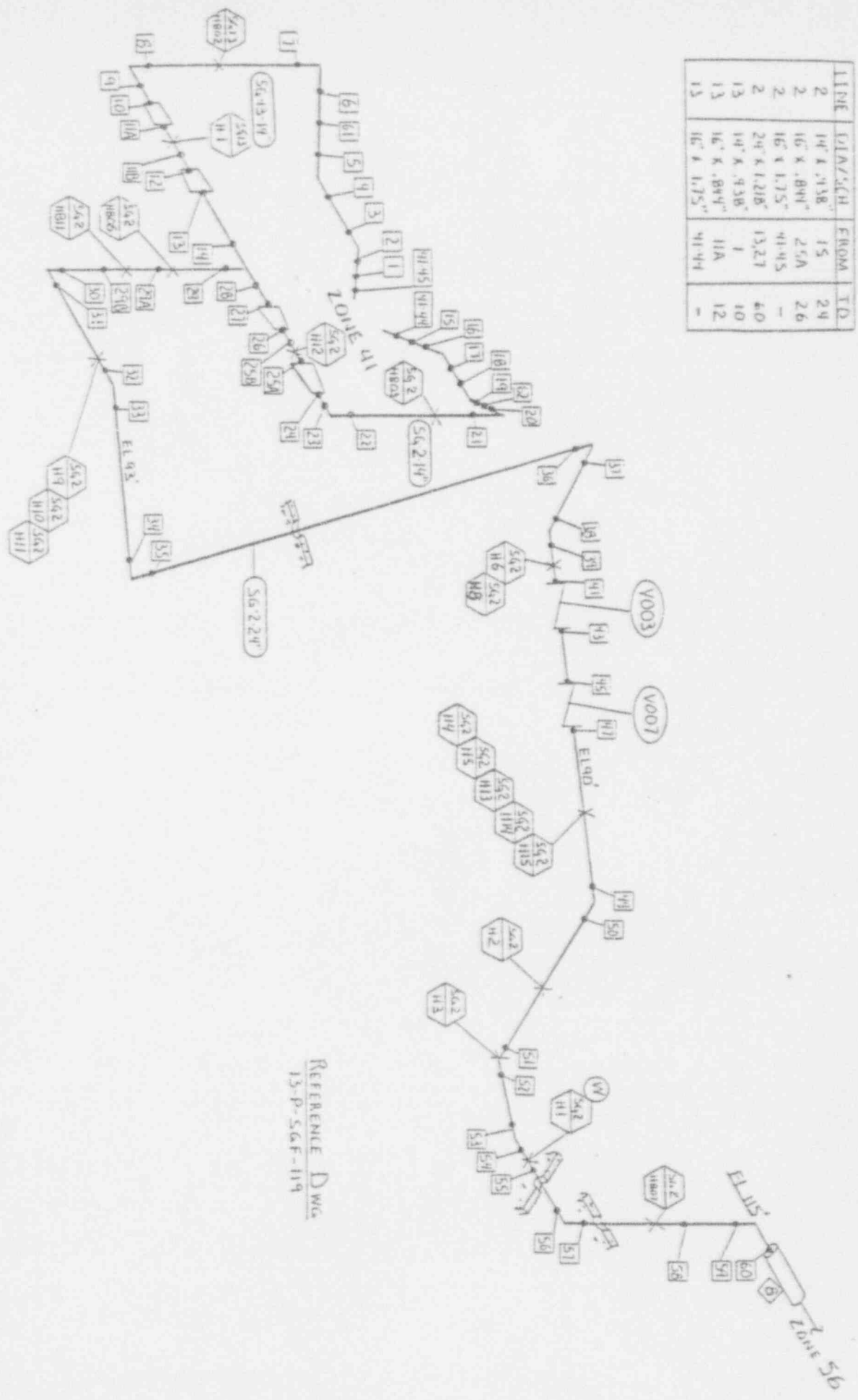

REFERENCE DWG
15-P-S6F-119

REV. 0	DWG
DRAWN BY OIS HANSEN	UNIT 1 ZONE 54
CHECKED BY JBS	FEDWATER S6 NO. 1

LINE	DIR / SCH	FROM	TO
5	14" x 1.58"	15	24
5	16" x .844"	25	26
5	16" x 1.75"	42-45	-
5	24" x 1.218"	13, 27	60
14	14" x .938"	1	10
14	16" x .844"	11	12
16	16" x 1.75"	42-44	-

REFERENCE DWG
13-P-56F-119

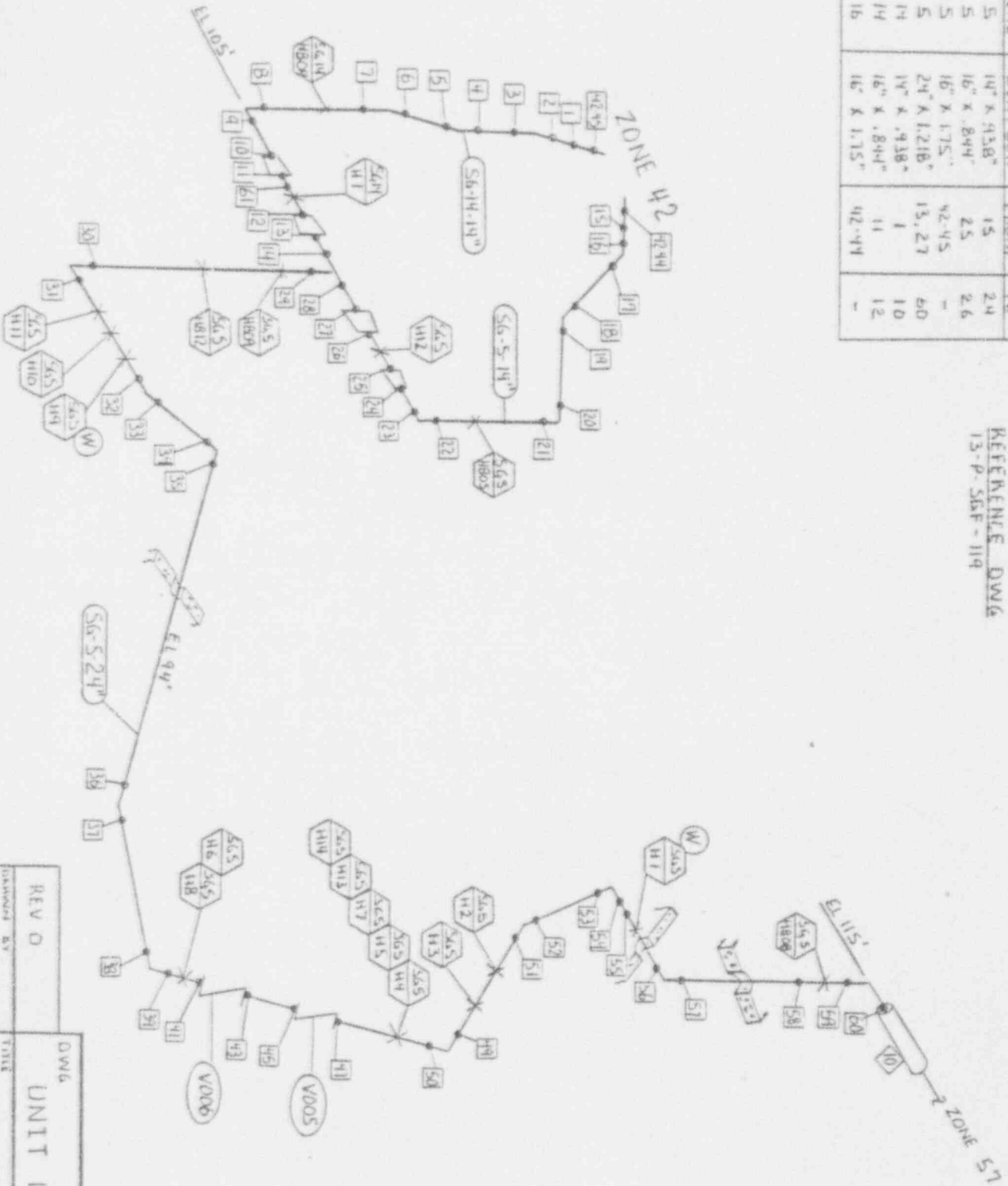

REV D	DWG
DESIGNED BY D. B. HINSHEN	UNIT 1 ZONE 55
CHECKED BY JPS	FEEDWATER SG ND 2

LINE #	DIA/SCH	FROM	TO
202	24"x1.531"	1	4
201	24"x1.812"	6	7
224	24"x1.812"	9	11

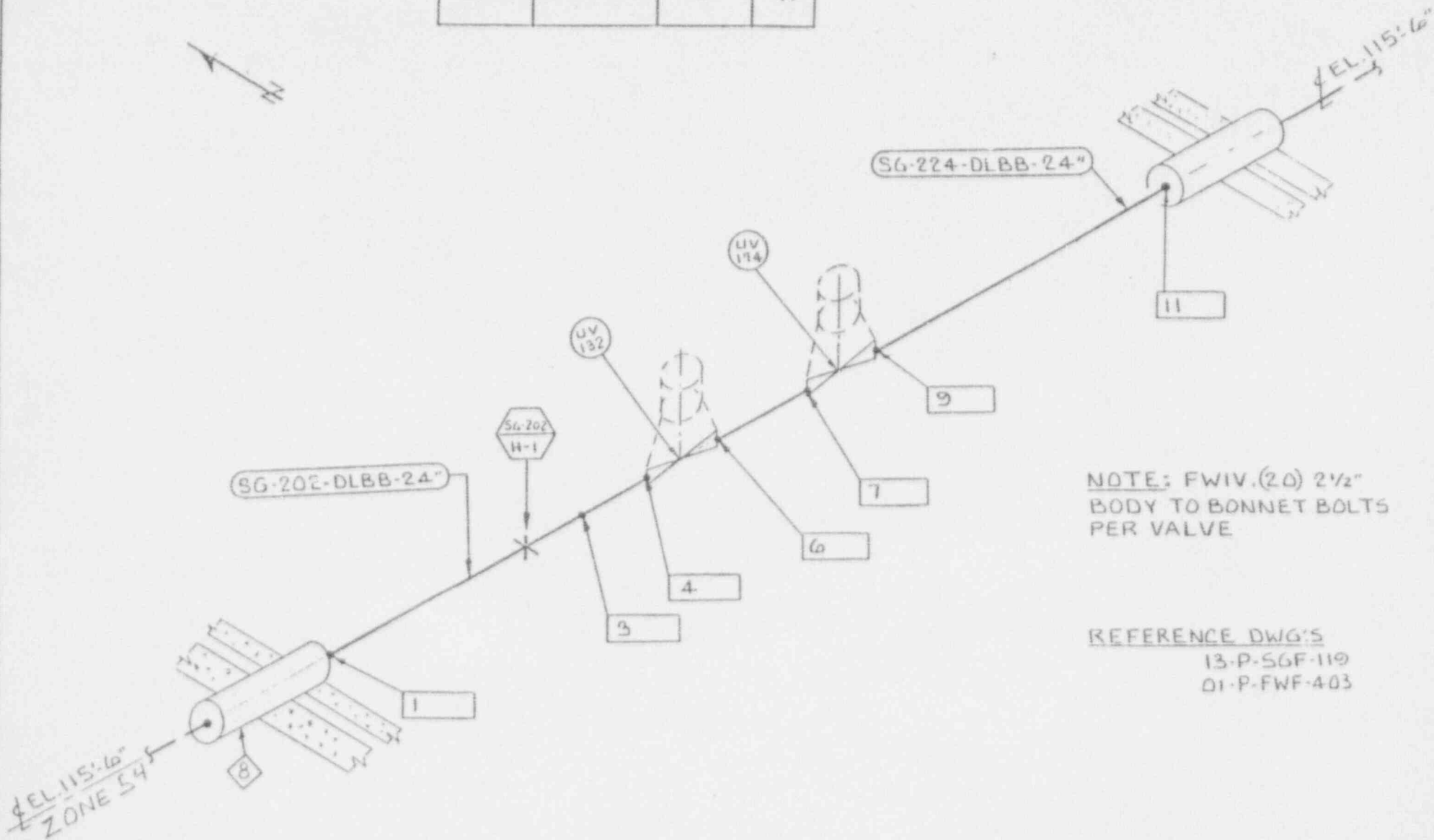

NOTE: FWIV.(20) 2 1/2" BODY TO BONNET BOLTS PER VALVE

REFERENCE DWG'S
13-P-SGF-119
01-P-FWF-403

REV. 0	DWG
	UNIT #1 ZONE 56
DRAWN BY R. CURCIO	TITLE: FEEDWATER
CHECKED BY JBS	STEAM GENERATOR # 1

LINE #	DIA/SCH	FROM	TO
205	24" x 1.531"	1	4
204	24" x 1.812"	6	7
225	24" x 1.812"	9	11

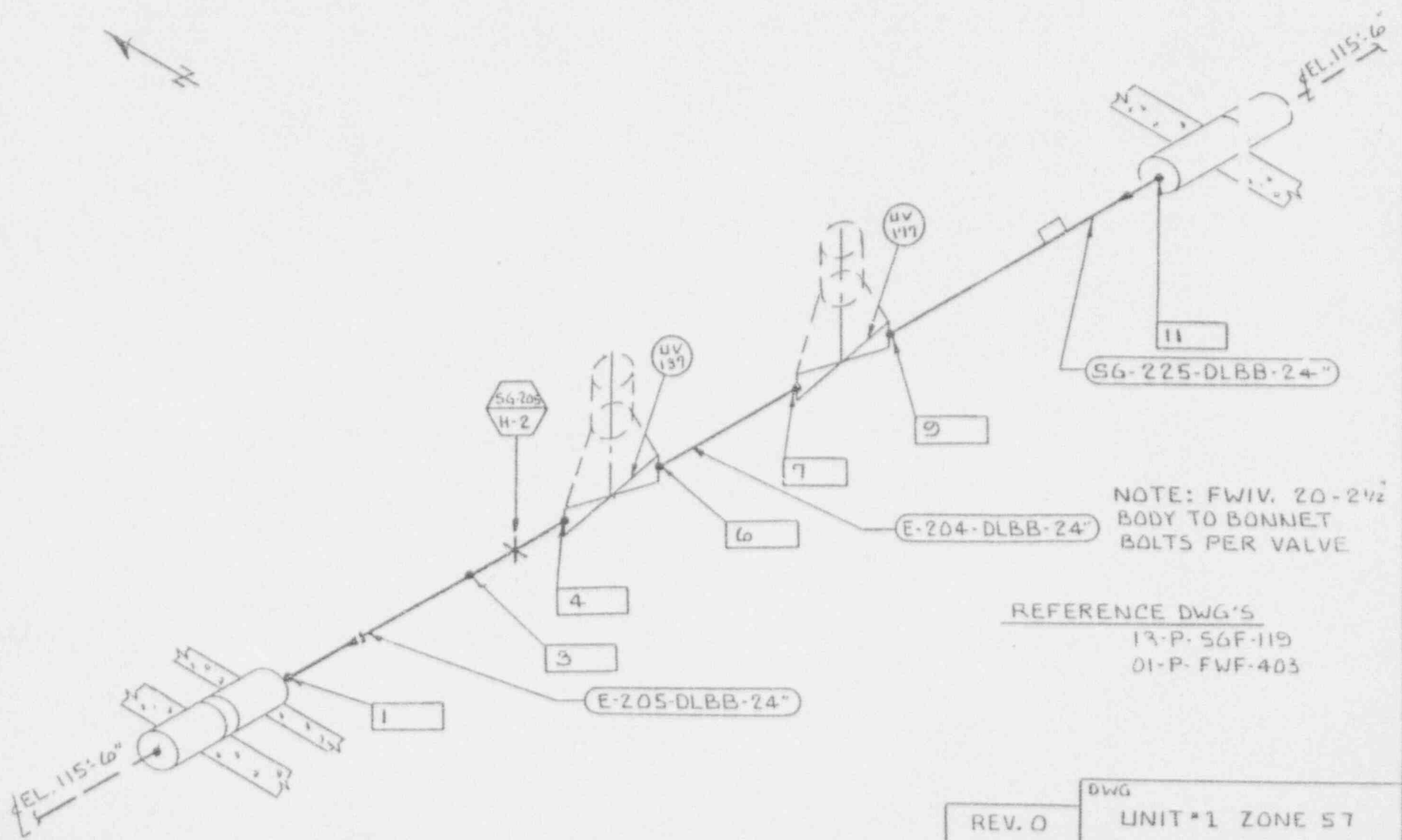

NOTE: FWIV, 20-2 1/2"
 BODY TO BONNET
 BOLTS PER VALVE

REFERENCE DWG'S
 13-P-56F-119
 01-P-FWF-403

REV. 0	DWG
DRAWN BY R. CURCIO	UNIT #1 ZONE 57
CHECKED BY JBS	TITLE FEEDWATER STEAM GENERATOR #2

LINE#	DIA/SCH	FROM	TO
56-B	6" x .432"	1	3
56-B	8" x .500"	4	25
AF-A	6" x .562"	19	34
56-B	6" x 1.8"	41-39	-

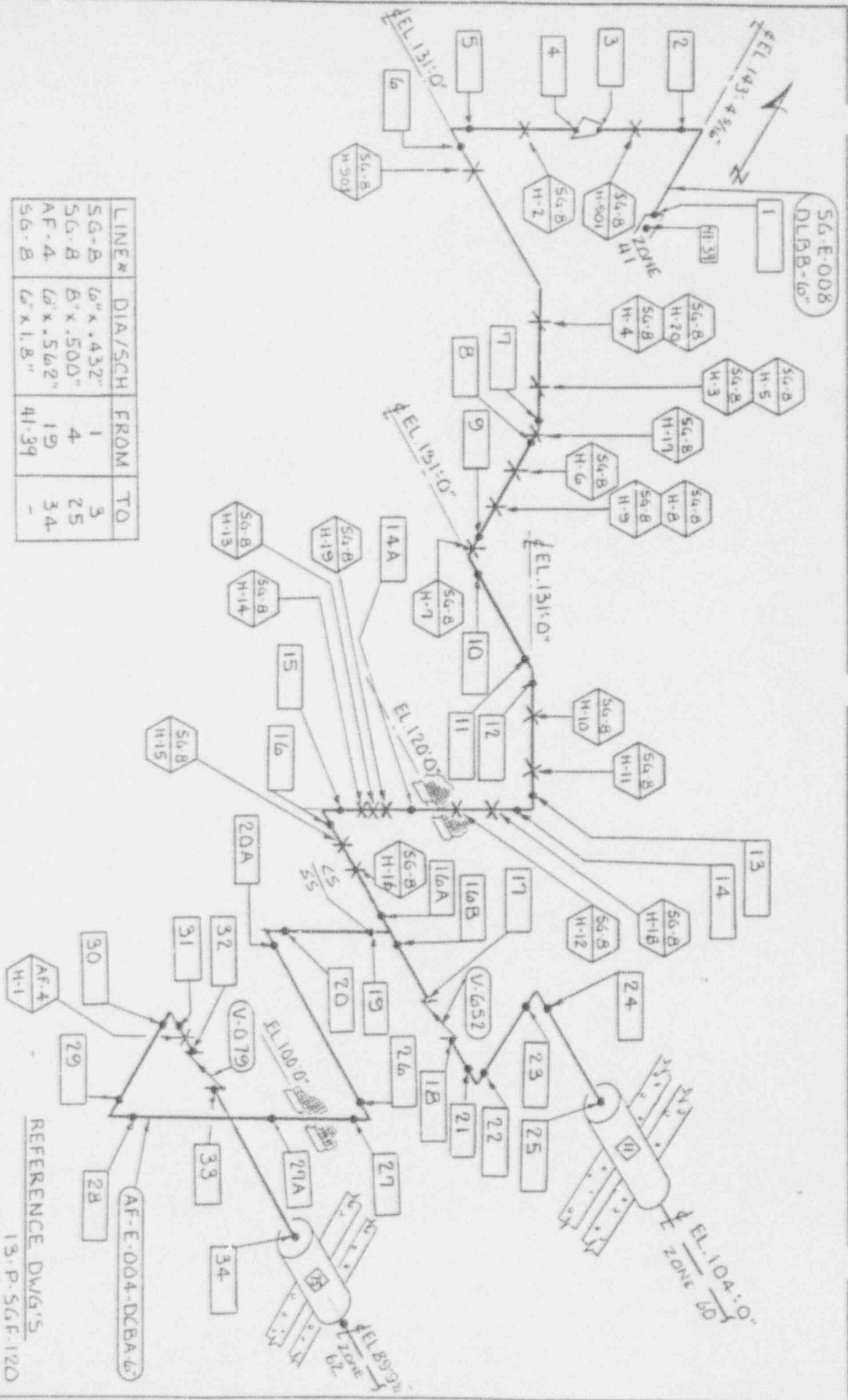

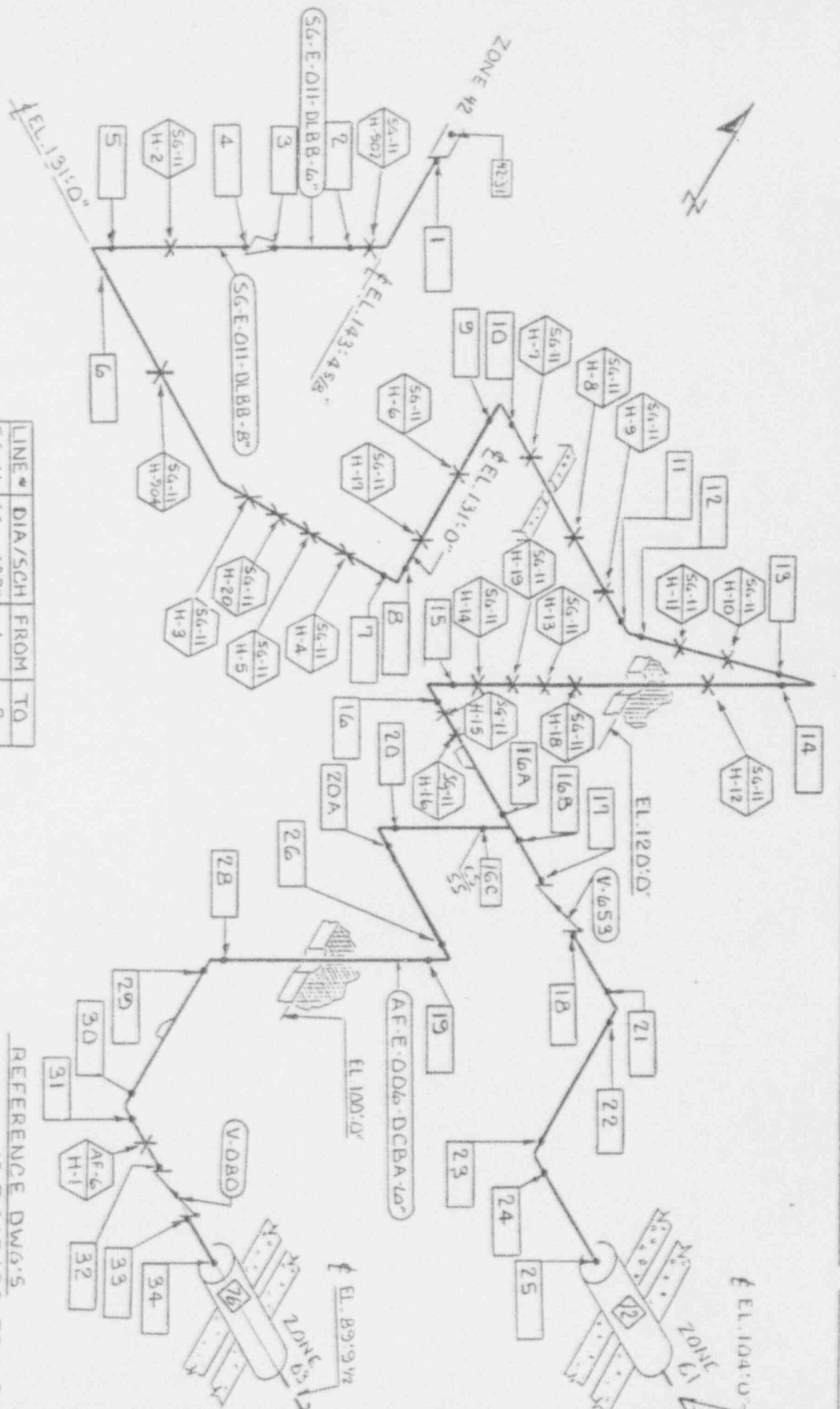

LINE #	DIA/SGH	FROM	TO
SG-11	6" x .432"	1	3
SG-11	8" x .500"	4	25
AF-6	6" x .562"	16	34
SG-11	6" x 1.8"	1/2-3/4	-

REFERENCE DWG. 5
13-P. 56F. 120 REV. 2

REV. 0	DWG	UNIT # 1	ZONE 59
DRAWN BY R. CLIRCIO		TITLE: AUX & DOWNCOMER	
CHECKED BY JBS		FEEDWATER, STEAM GEN # 2	

LINE #	DIA/SCH	FROM	TO
SG-200	8" X 719"	2	12
SG-8	8" X 719"	1 +	17

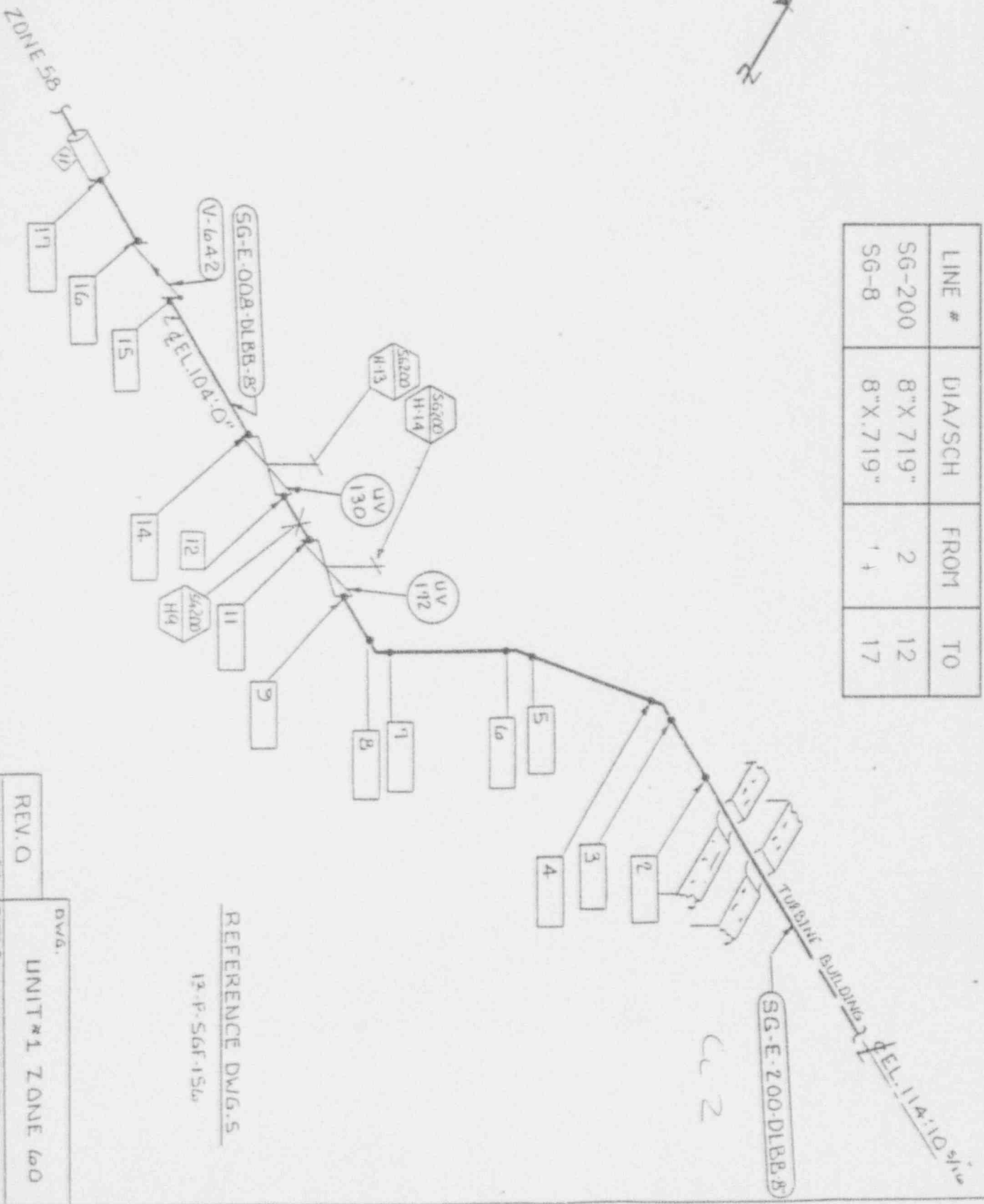

REFERENCE DWG. 5

13-F-SGF-156

REV. 0	DWG. UNIT #1 ZONE 600
DRAWN BY R. CURCIO	TITLE: DOWNCOMER
CHECKED BY JES	FEDWATER STA GEN #1

LINE #	DIA/SCH	FROM	TO
AF-18	6" x .562"	4	14
AF-4	6" x .562"	15	24

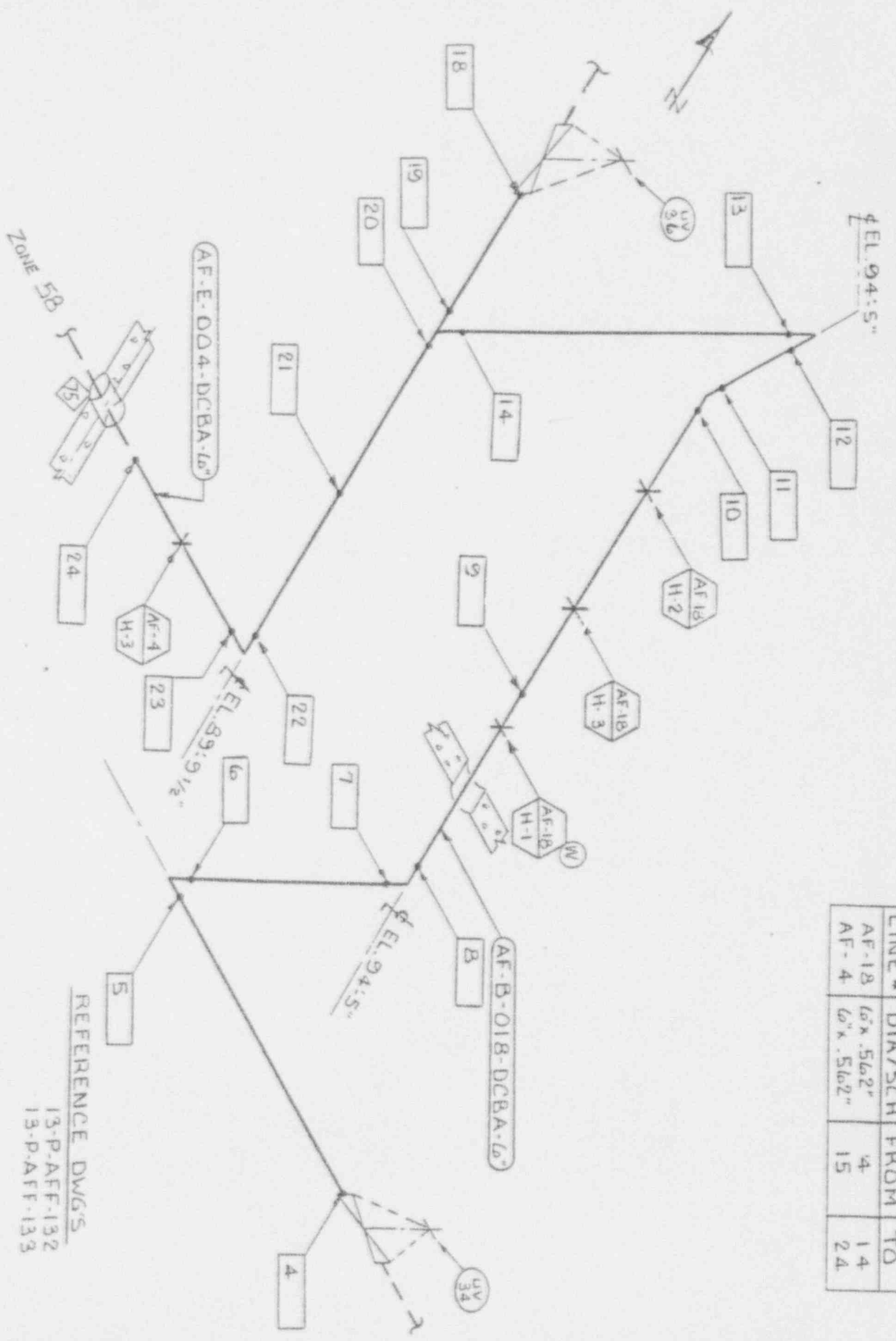

REFERENCE DWGS
 13-P-AFF-132
 13-P-AFF-133

REV. 0	DWG.	UNIT # 1	ZONE 62
DRAWN BY R. GURCIO	TITLE: AUXILIARY FEEDWATER STEAM GENERATOR # 1		
CHECKED BY JRS			

LINE #	DIA/SCH	FROM	TO
AF-16	6" x 562"	1B	19
AF-6	6" x 562"	4	31

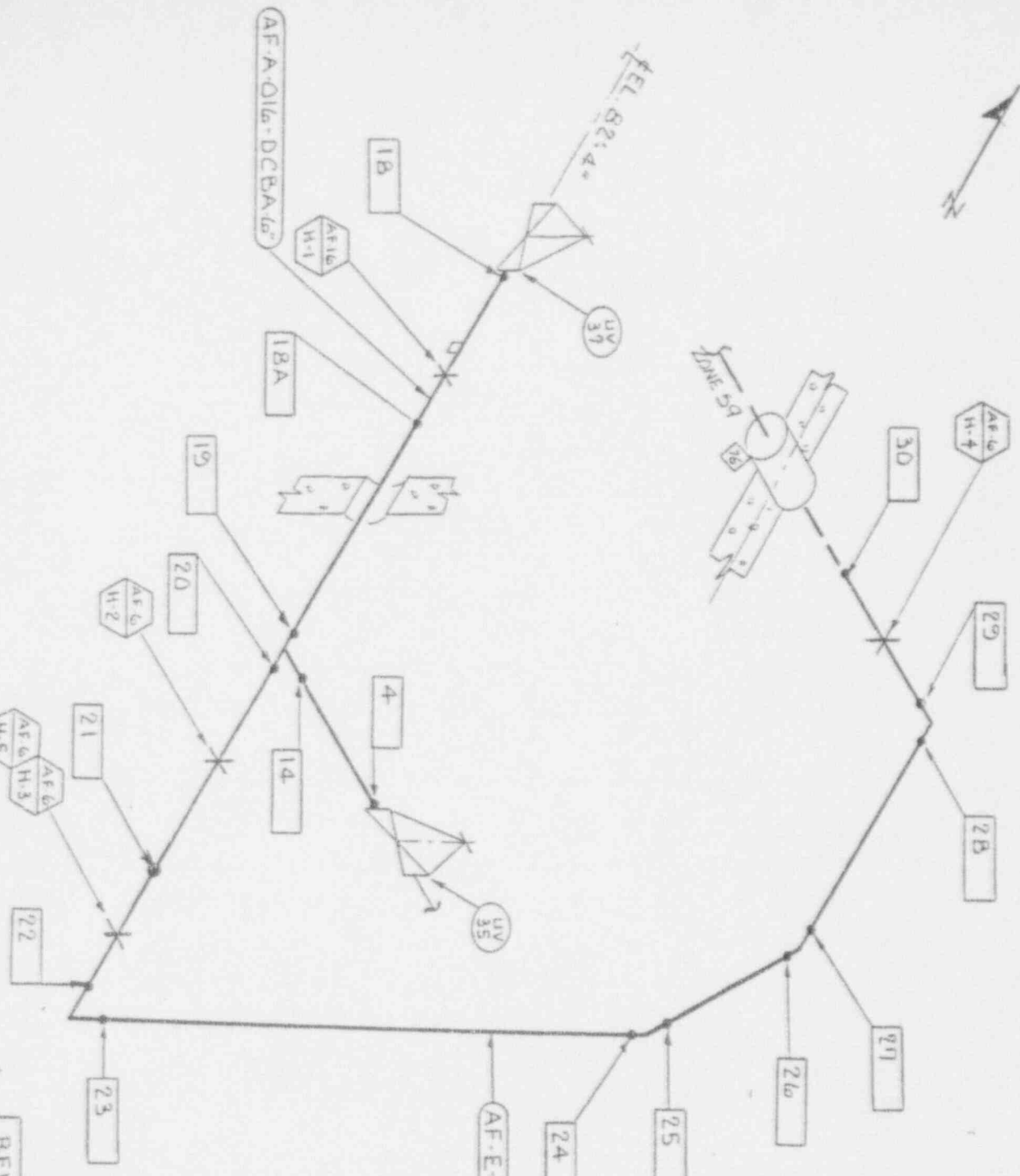

REFERENCE DWG'S

- 13-P-AFF-132
- 13-P-AFF-133

REV. D	DWG.
0	UNIT # 1 ZONE 63
DRAWING BY R. CURTIS	
TITLE: AUXILIARY FEEDWATER	
CHECKED BY JBS	
STEAM GENERATOR # 2	

LINE #	DIA X SCH	FROM	TO
S6-053	6" X 0.562"	64-1	64-14
S6-039	6" X 0.562"	64-15	64-53

REFERENCE DRAWINGS:

13-P-S6F-122

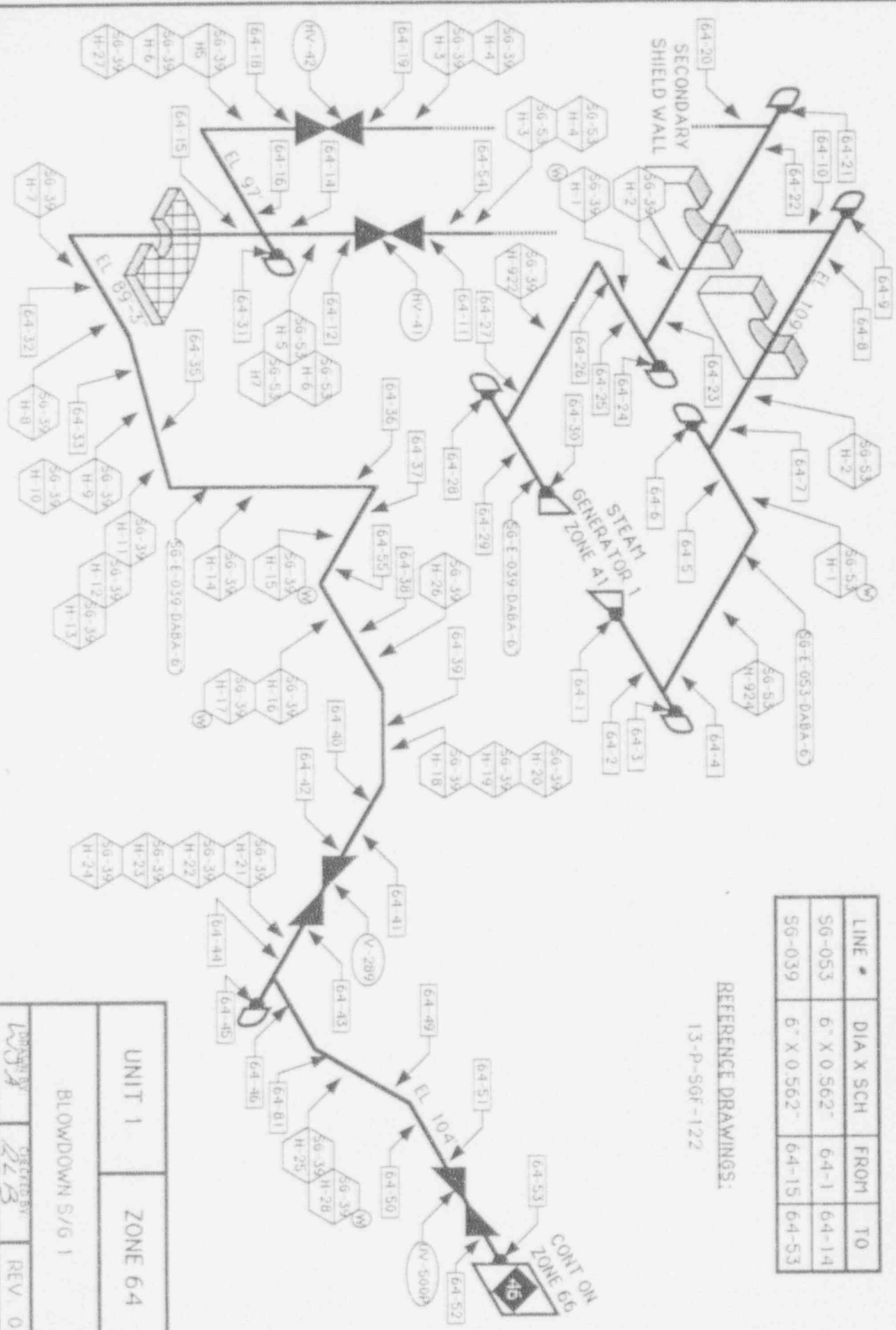

UNIT 1		ZONE 64
BLOWDOWN S/G 1		
DATE: 11/27/84	DESIGNED BY: [Signature]	REV. 0

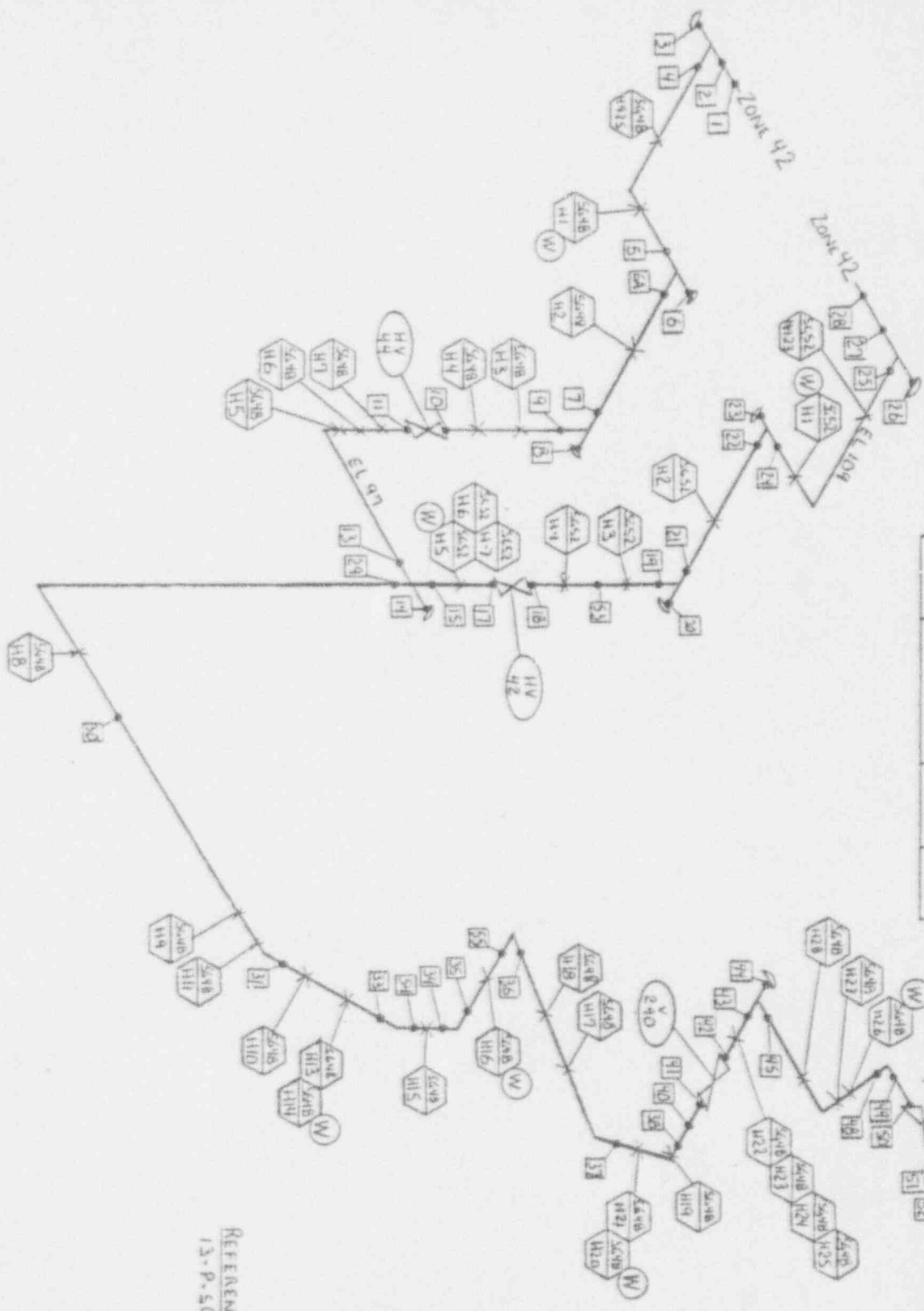

LINE	DIA/SCII	FROM	TO
18	6" x 562"	1	14
18	6" x 562"	29	55
52	6" x 562"	15	28

REFERENCE DWG
13-P-56F-140

REV 0	DATE
DRAWN BY D. B. STINEBAUGH	7/11/8
CHECKED BY JBS	
UNIT 1 ZONE 65	
BLOWDOWN 5/4 2	

ZONE 6A 15' 10"

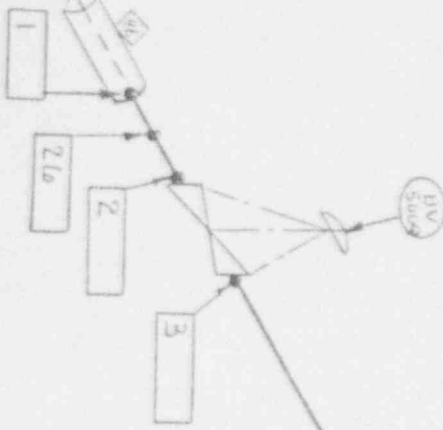

EL. 106'-0"

EL. 108'-8"

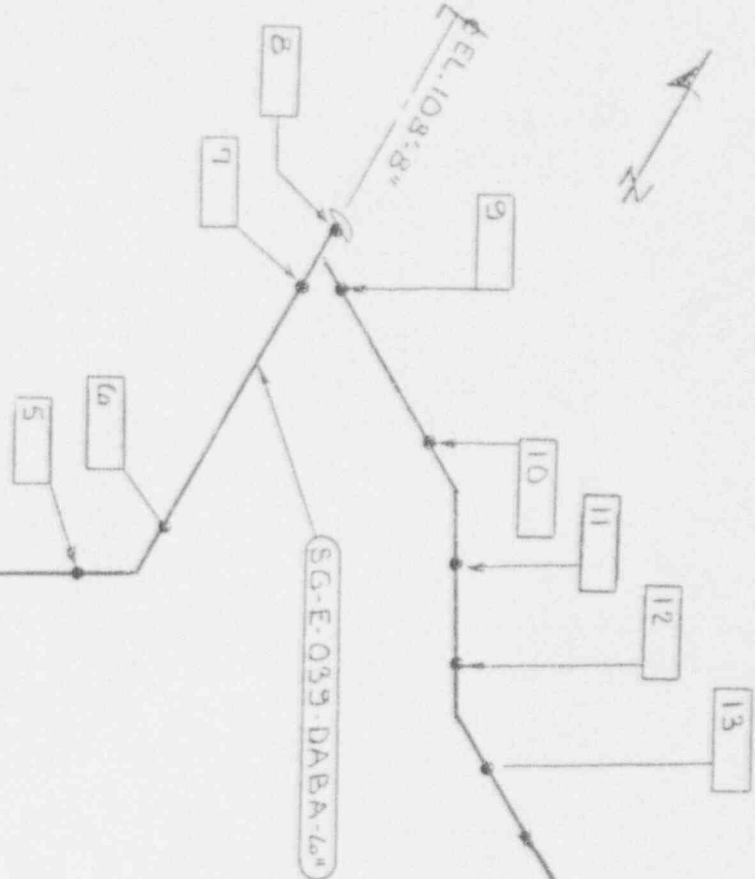

SG-E-039-DABA-6"

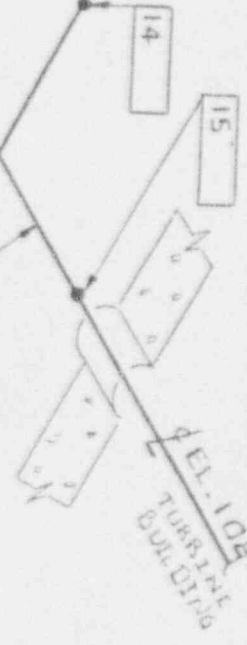

EL. 108'-8"
TURBINE BUILDING

LINE #	DIA/SCH	FROM	TO
SG-39	6" x 56.2"	1	15

REFERENCE DWG'S
13-P-SGF-151

REV.	DWG
0	UNIT # 1 ZONE 6A
DRAWN BY R. CURCIO	
CHECKED BY TBS	
TITLE: BLOWDOWN STEAM GENERATOR # 1	

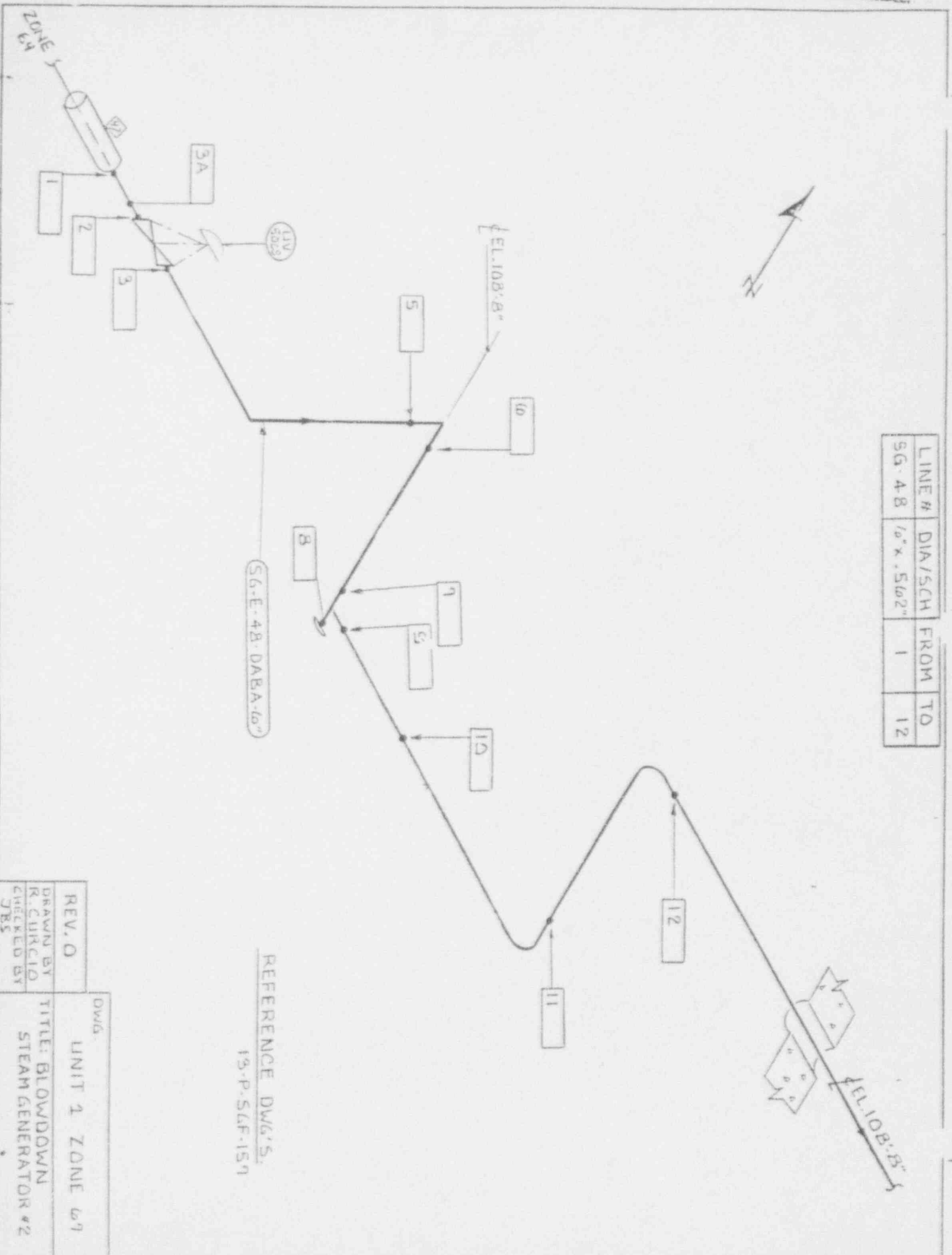

LINE #	DIA/SCH	FROM	TO
SG-48	10" x .5602"	1	12

REFERENCE DWG'S.
13-P-56F-157

REV. 0	DWG.
DRAWN BY R. CURCIO	UNIT 2 ZONE 4A
CHECKED BY JRS	TITLE: BLOWDOWN STEAM GENERATOR #2

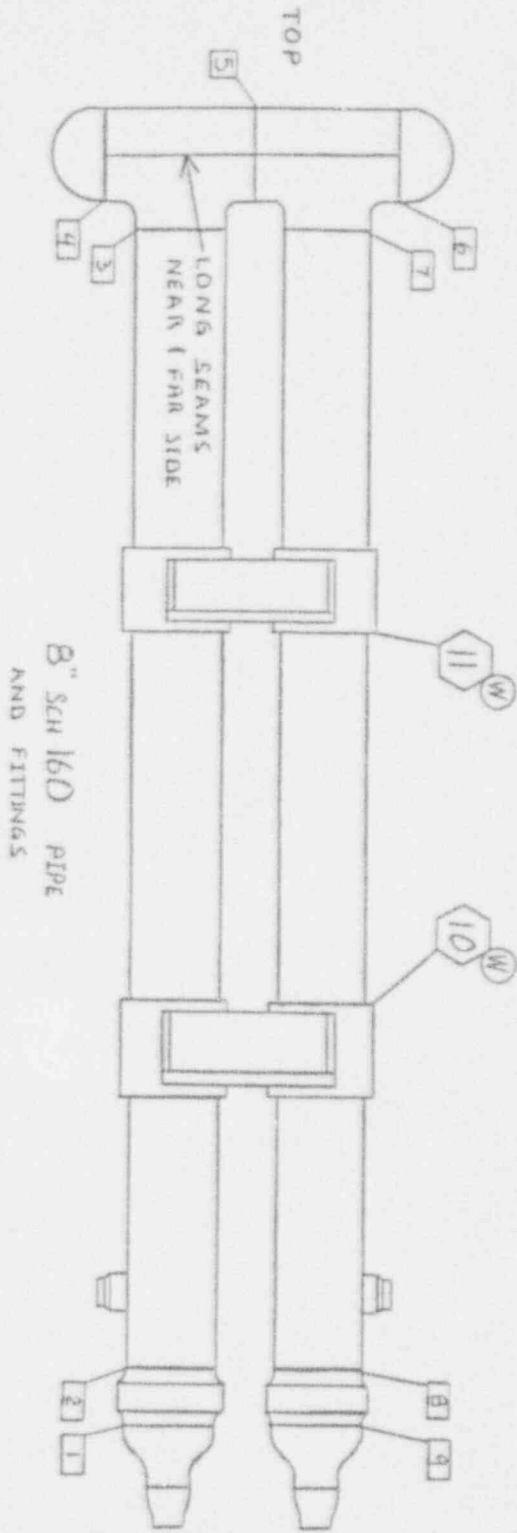

NOTES:

TAG NO. IMCHEE01
 SERIAL NO. 79119 AMETER
 N.D. NO. 437

REFERENCE DWGS:

NO01-7.03-1
 NO01-7.03-48 THRU 50

REV 0	DWG UNIT #1 ZONE 68
DRAWN BY D G HANSEN	TITLE: REGENERATIVE HEAT EXCHANGER
CHECKED BY TBS	

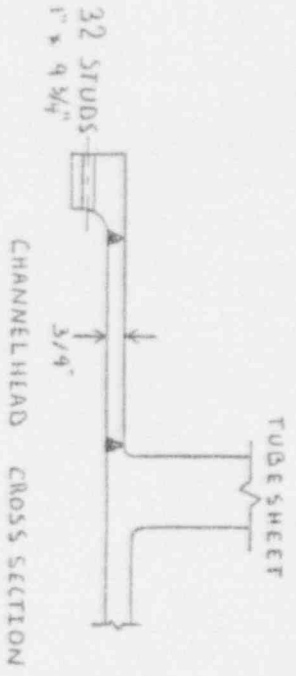

NOTES:
 TAG NO. IMLHNE02
 SERIAL NO. N2370 (RICHMOND ENGR)
 N.D. NO. 76129

REFERENCE DRAWINGS:
 N001-7.03-26
 N001-7.03-27
 N001-7.03-28
 N001-7.03-29

REV. 0	DWG. NO.
UNIT #1 ZONE 69	
TITLE:	
LETDOWN	
HEAT EXCHANGER	
DESIGNED BY	
D.B. HANSEN	
CHECKED BY	
VRS	

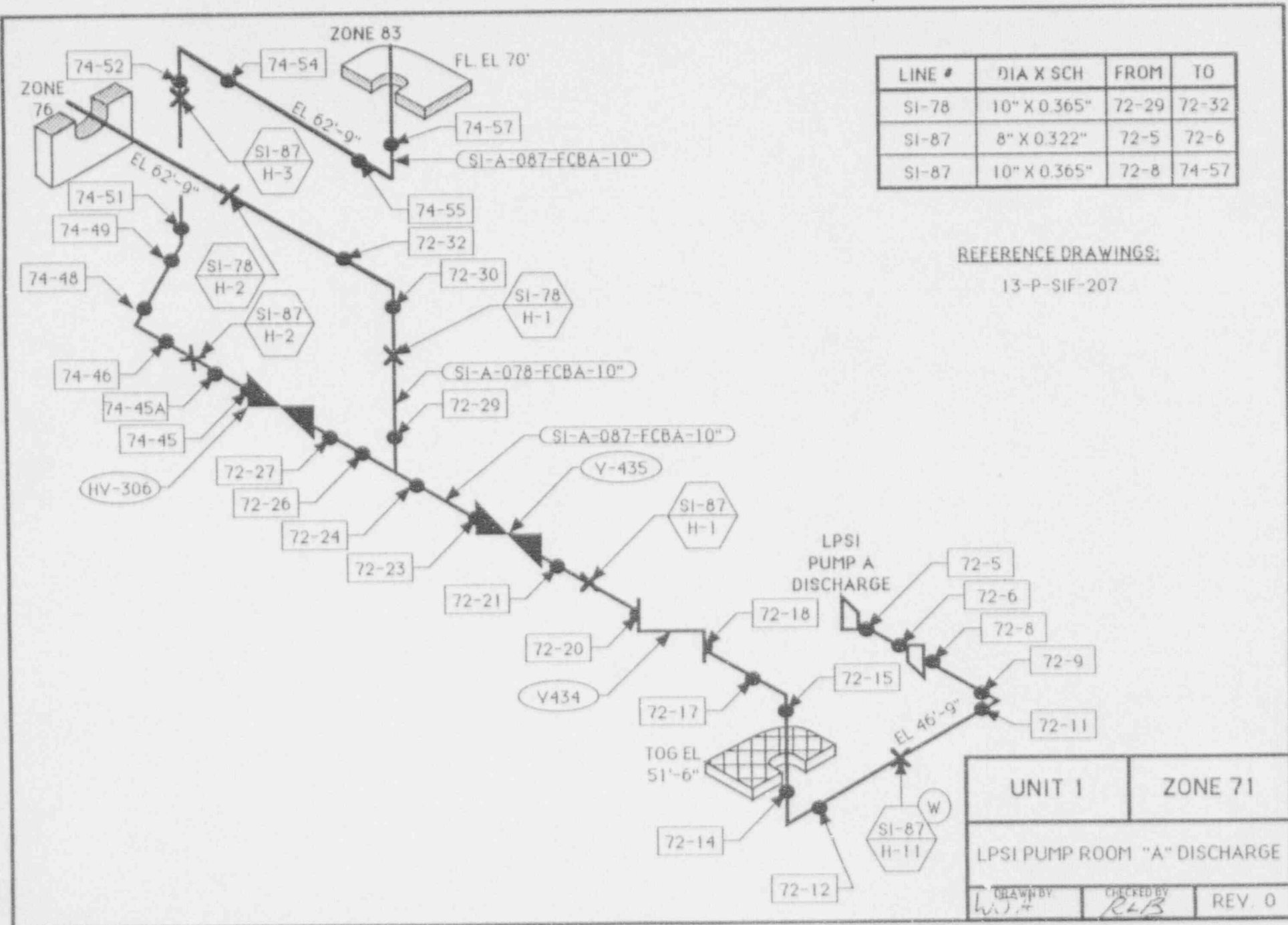

LINE #	DIA X SCH	FROM	TO
SI-78	10" X 0.365"	72-29	72-32
SI-87	8" X 0.322"	72-5	72-6
SI-87	10" X 0.365"	72-8	74-57

REFERENCE DRAWINGS:

13-P-SIF-207

UNIT 1	ZONE 71
LPSI PUMP ROOM "A" DISCHARGE	
DRAWN BY <i>WJ</i>	CHECKED BY <i>RLB</i>
REV. 0	

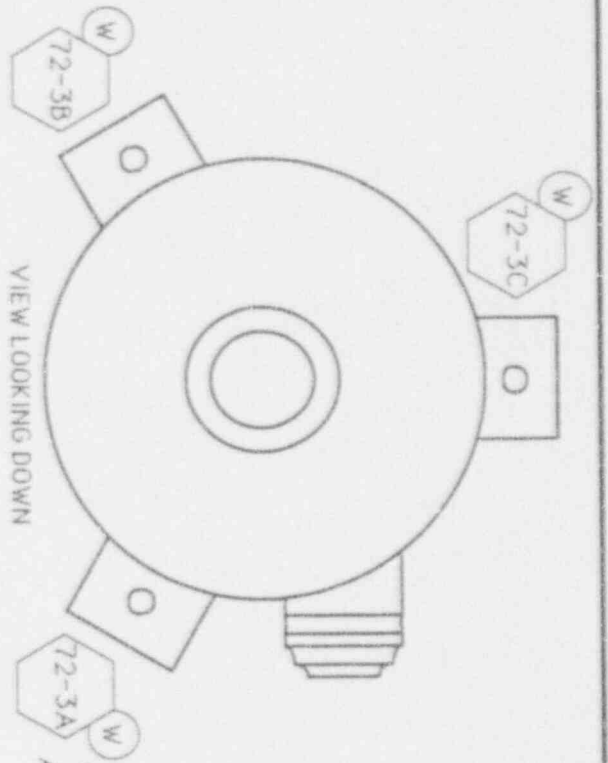

VIEW LOOKING DOWN

72-3A W
72-3B W
72-3C W
72-3D W
WELDED SUPPORT FEET AND SUPPORT COLUMNS

NOTES:

- 1) TAG NUMBER: 1H51AP01
- 2) SERIAL NUMBER: 0876-36 INGERSOLL RAND
- 3) NATIONAL BOARD NUMBER: 523

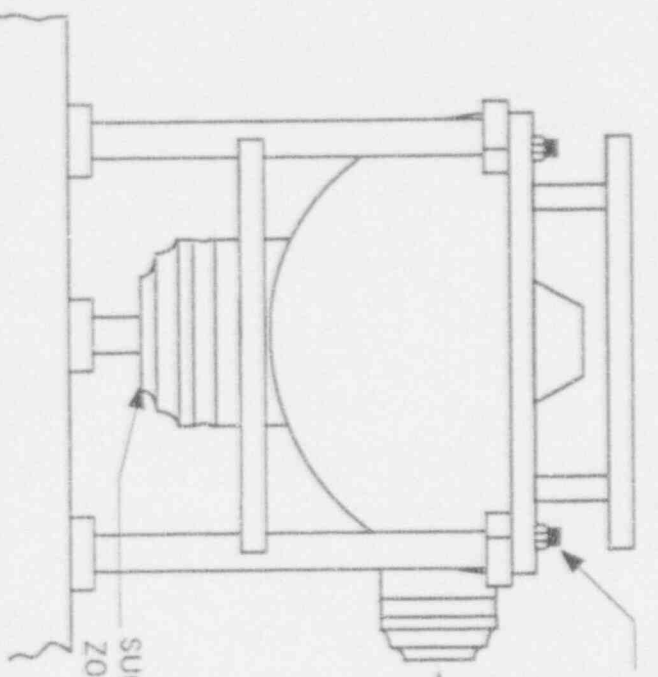

TWENTY-FOUR 2" DIAMETER STUDS
(21 @ 9.5" LONG AND 3 @ 8.88" LONG)

DISCHARGE
ZONE 71

SUCTION
ZONE 70

REFERENCE DRAWINGS:

- NO01-1101-36
- NO01-1101-50

UNIT 1	ZONE 72
LPSI PUMP A	
DESIGNED BY MUT	CHECKED BY KLS
REV. 0	

LINE #	DIA X SCH	FROM	TO
SI-308	14" X 0.312"	71-63	71-69
SI-308	20" X 0.375"	71-49	71-61
SI-194	18" X 0.312"	71-44	71-47
SI-34	16" X 0.312"	71-105	71-111

REFERENCE DRAWINGS:

13-P-SIF-202

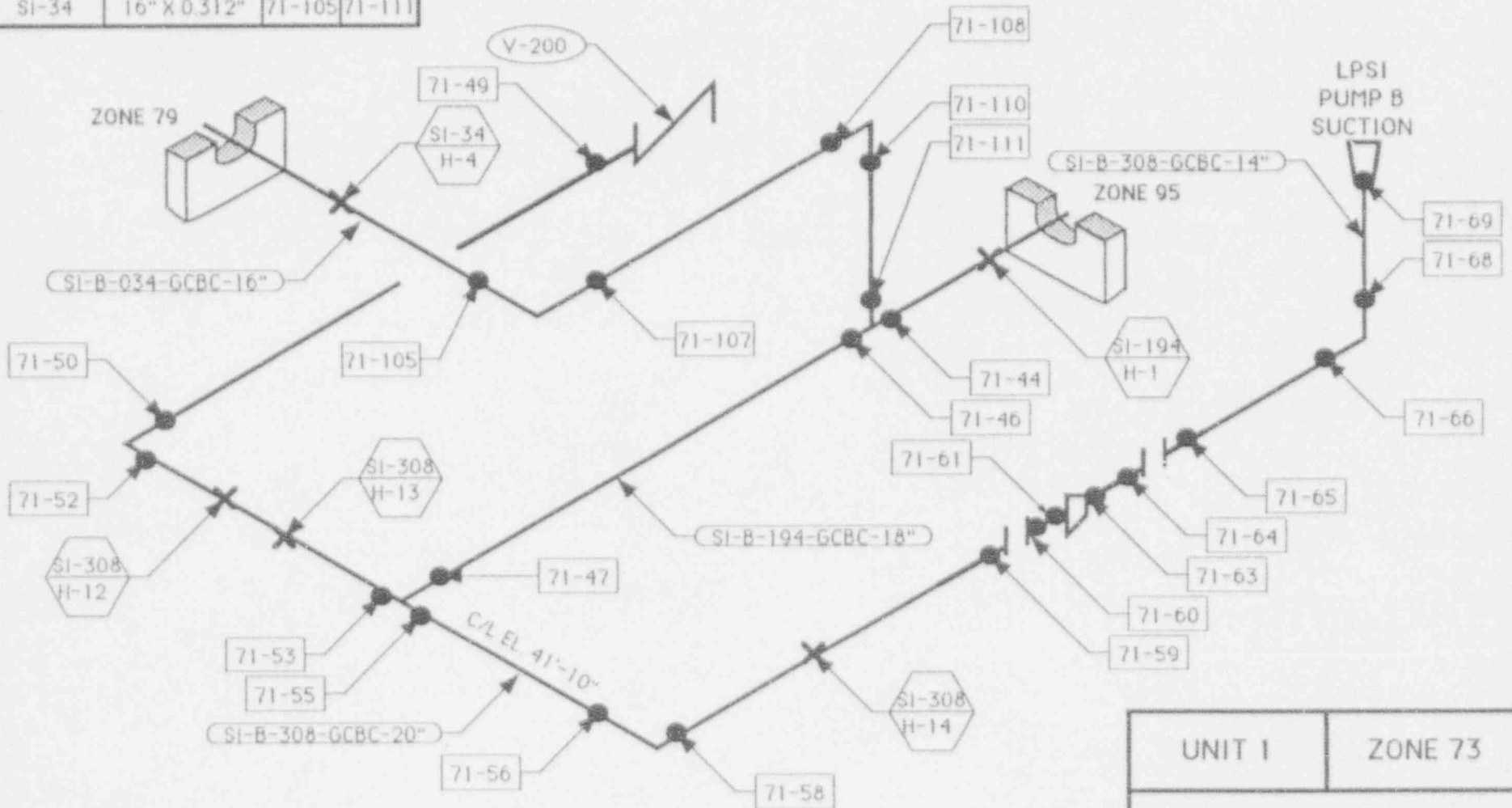

UNIT 1	ZONE 73
LPSI PUMP ROOM "B" SUCTION	
DRAWN BY WJF	CHECKED BY RLB
REV. 0	

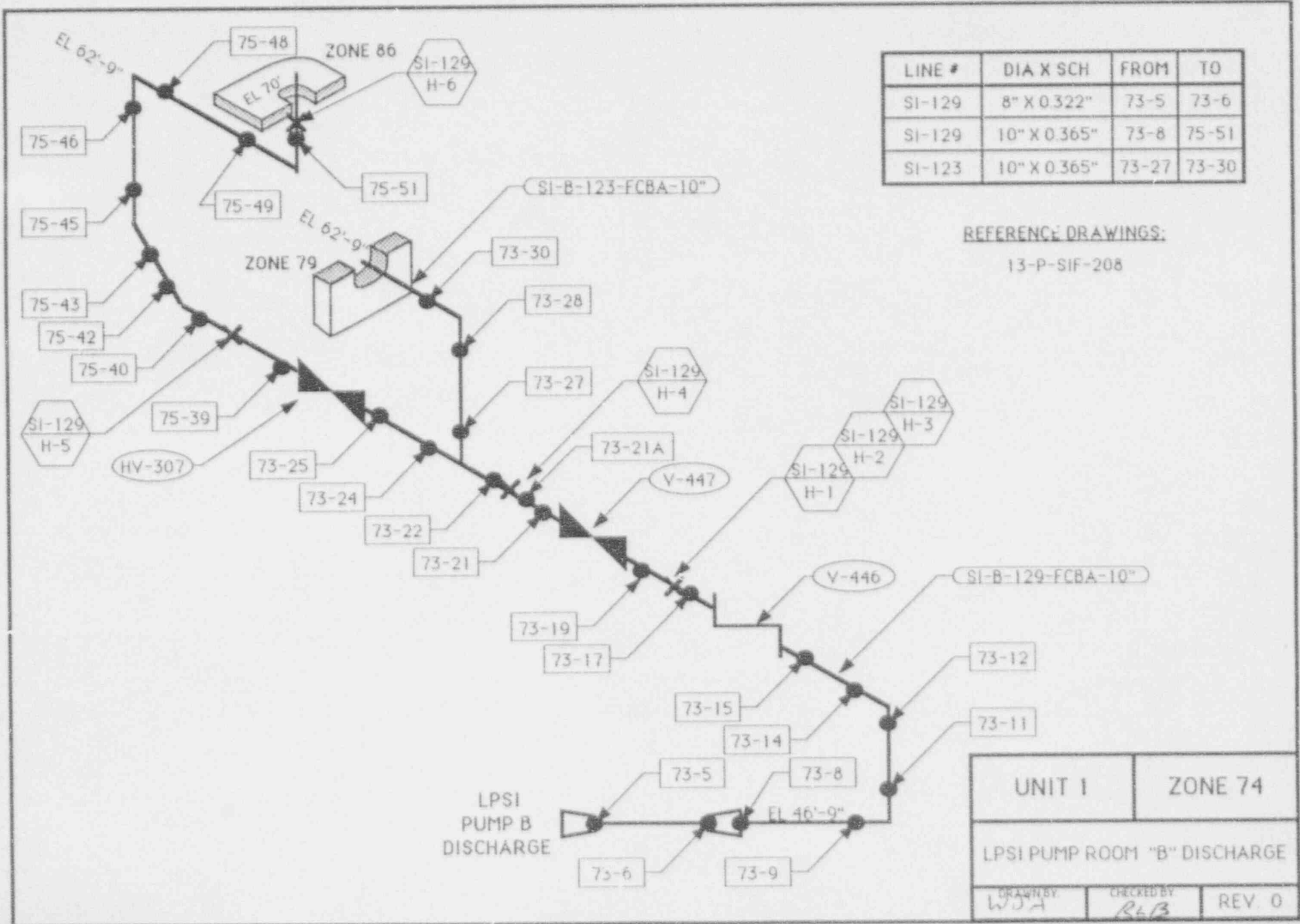

LINE #	DIA X SCH	FROM	TO
SI-129	8" X 0.322"	73-5	73-6
SI-129	10" X 0.365"	73-8	75-51
SI-123	10" X 0.365"	73-27	73-30

REFERENCE DRAWINGS:
13-P-SIF-208

UNIT 1	ZONE 74
LPSI PUMP ROOM "B" DISCHARGE	
DRAWN BY WDA	CHECKED BY RLB
REV. 0	

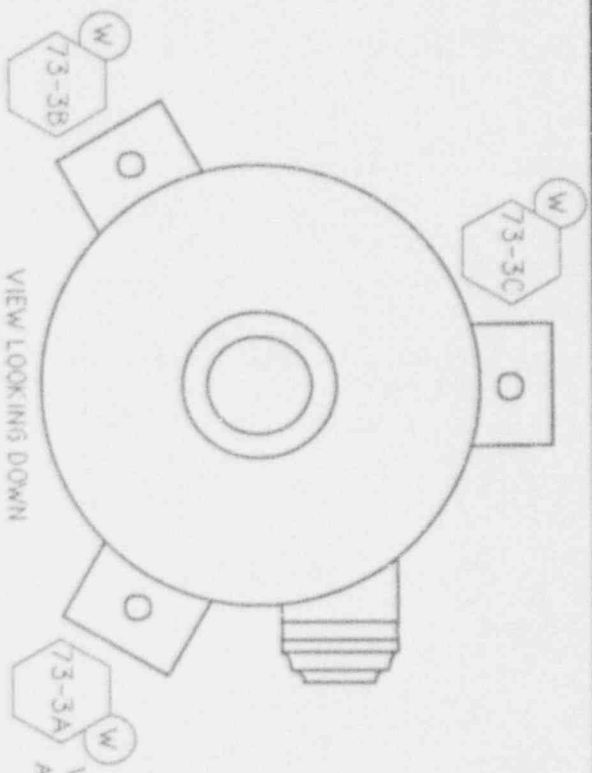

WELDED SUPPORT FEET
AND SUPPORT COLUMNS

NOTES:

- 1) TAG NUMBER: 1MSIBP02
- 2) SERIAL NUMBER: 0876-37 INGERSOLL RAND
- 3) NATIONAL BOARD NUMBER: 524

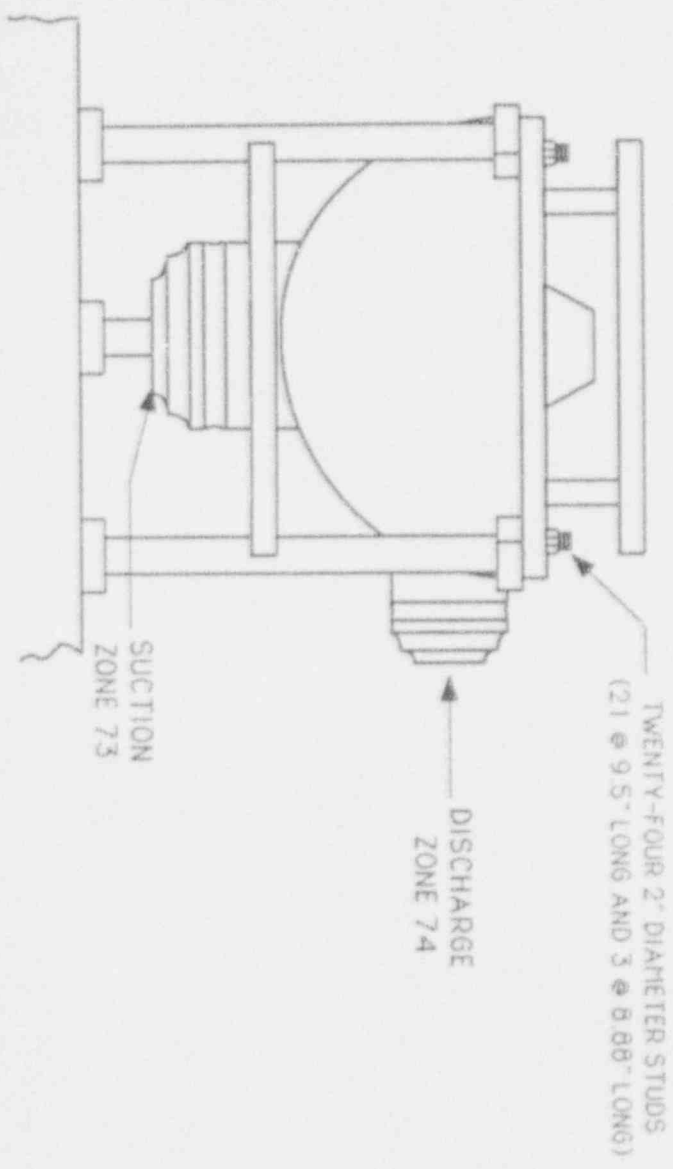

TWENTY-FOUR 2" DIAMETER STUDS
(21 @ 9.5" LONG AND 3 @ 8.88" LONG)

REFERENCE DRAWINGS:

- N001-11.01-36
- N001-11.01-50

UNIT 1	ZONE 75
LPSI PUMP B	
DESIGNED BY MCS	CHECKED BY RLB
REV. 0	

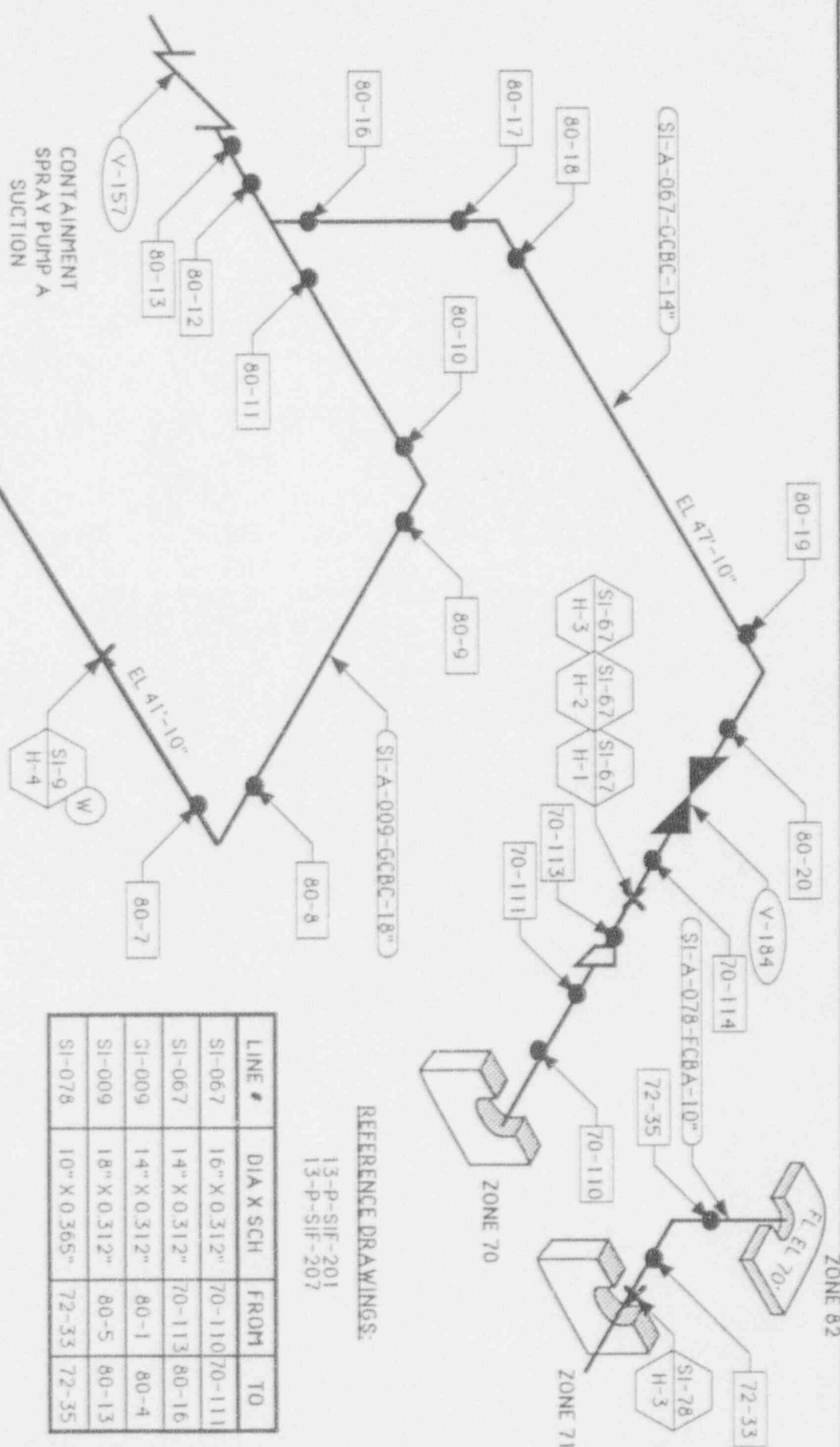

REFERENCE DRAWINGS:
 13-P-SIF-201
 13-P-SIF-207

LINE #	DIA X SCH	FROM	TO
SI-067	16" X 0.312"	70-110/70-111	
SI-067	14" X 0.312"	70-113	80-16
SI-009	14" X 0.312"	80-1	80-4
SI-009	18" X 0.312"	80-5	80-13
SI-078	10" X 0.365"	72-33	72-35

UNIT 1		ZONE 76	
CONTAINMENT SPRAY PUMP			
ROOM "A" SUCTION			
DRAWN BY	DESIGNED BY	REV	0
NSJ	278		

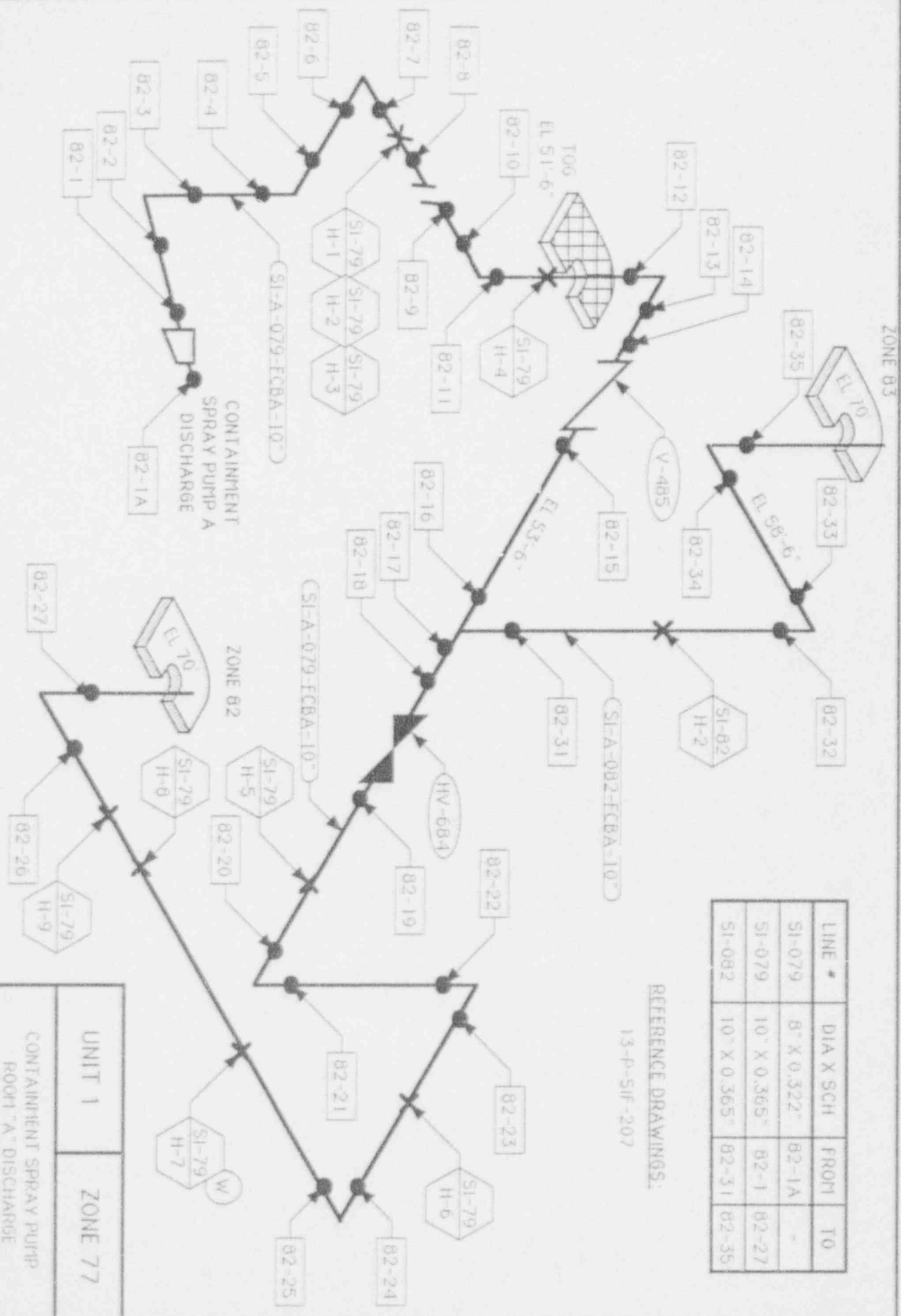

LINE #	DIA X SCH	FROM	TO
SI-079	8" X 0.322"	82-1A	-
SI-079	10" X 0.365"	82-1	82-27
SI-082	10" X 0.365"	82-31	82-35

REFERENCE DRAWINGS:

13-P-SIF-207

UNIT 1	ZONE 77
CONTAINMENT SPRAY PUMP	
ROOM "A" DISCHARGE	
DESIGNED BY	CHECKED BY
REV 0	

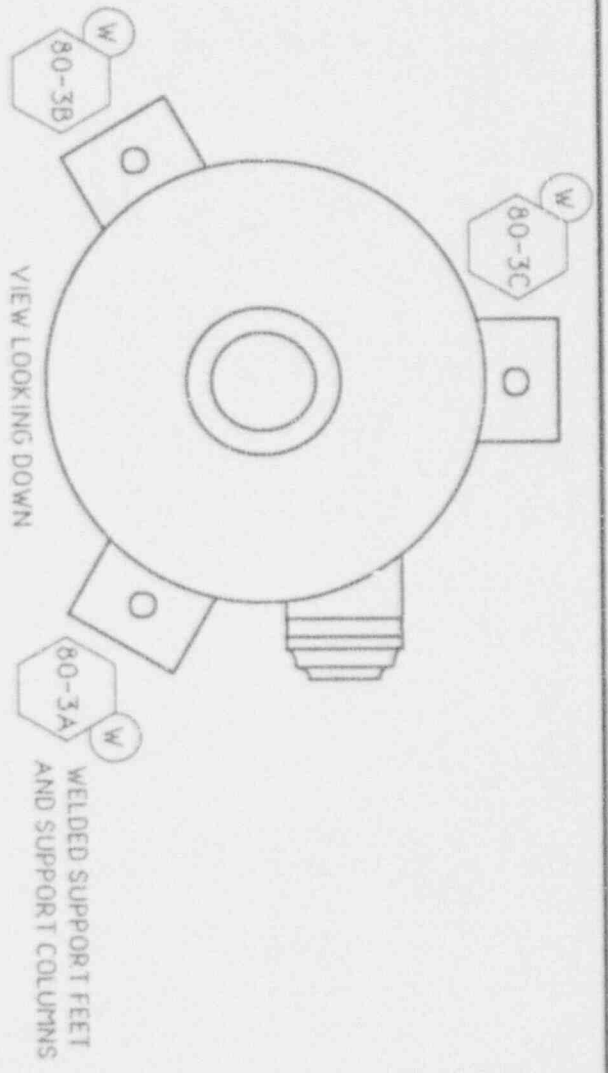

NOTES:

- 1) TAG NUMBER: IMSIAP03
- 2) SERIAL NUMBER: 0876-38 INGERSOLL RAND
- 3) NATIONAL BOARD NUMBER: 521

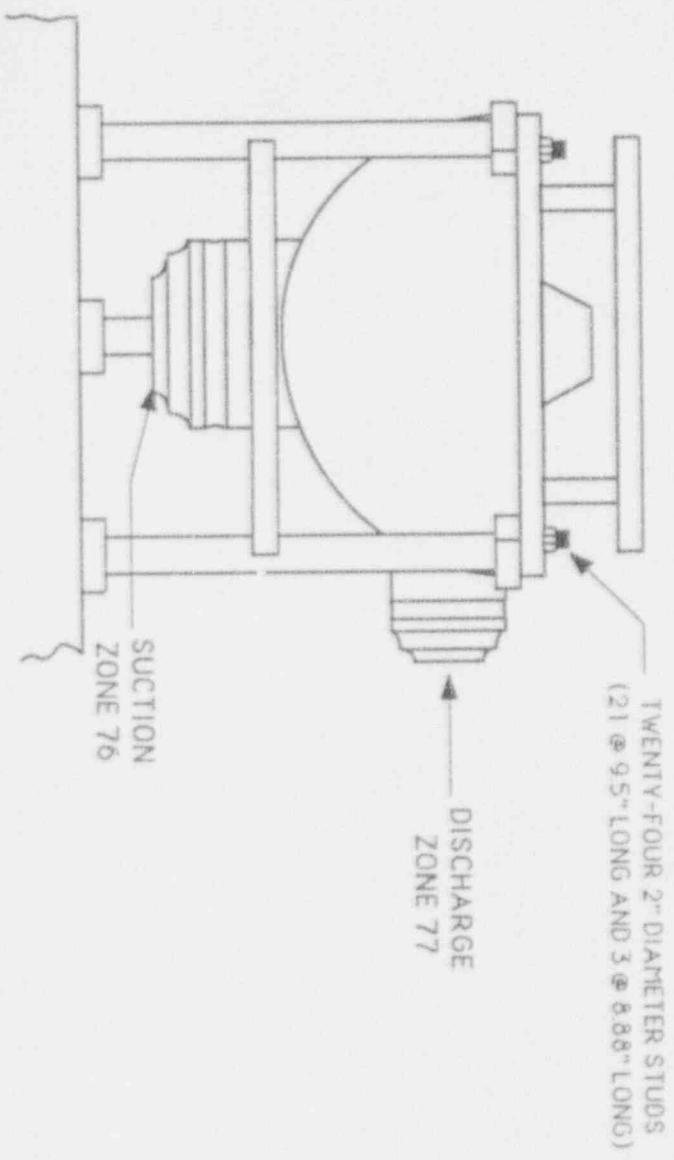

REFERENCE DRAWINGS:
 ND01-1101-36

UNIT 1	ZONE 78
CONTAINMENT SPRAY PUMP A	
DESIGNED BY L.V. J.	CHECKED BY R.C.B.
REV. 0	

LINE #	DIA X SCH	FROM	TO
SI-033	14" X 0.312"	81-1	81-4
SI-033	18" X 0.312"	81-5	81-12
SI-034	14" X 0.312"	81-15	71-101
SI-034	16" X 0.312"	71-103	71-104
SI-123	10" X 0.365"	73-31	73-33

REFERENCE DRAWINGS:
 13-P-SIF-202
 13-P-SIF-208

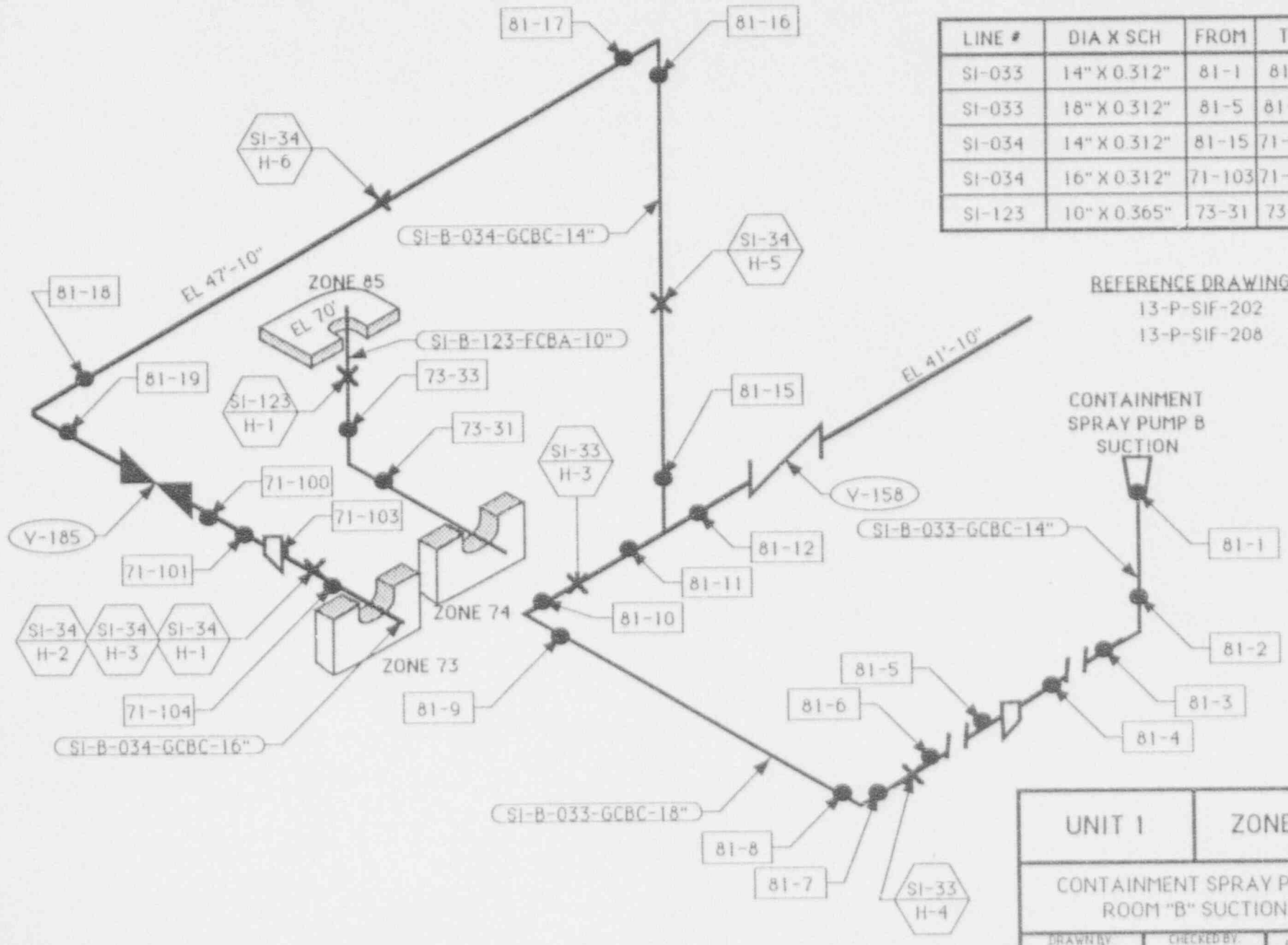

UNIT 1	ZONE 79
CONTAINMENT SPRAY PUMP ROOM "B" SUCTION	
DRAWN BY WJF	CHECKED BY RLB
	REV. 0

ZONE 86

LINE #	DIA X SCH	FROM	TO
SI-119	8" X 0.322"	83-1A	-
SI-119	10" X 0.365"	83-1	83-26
SI-147	10" X 0.365"	83-30	83-34

REFERENCE DRAWINGS:

13-P-SIF-208

ZONE 85

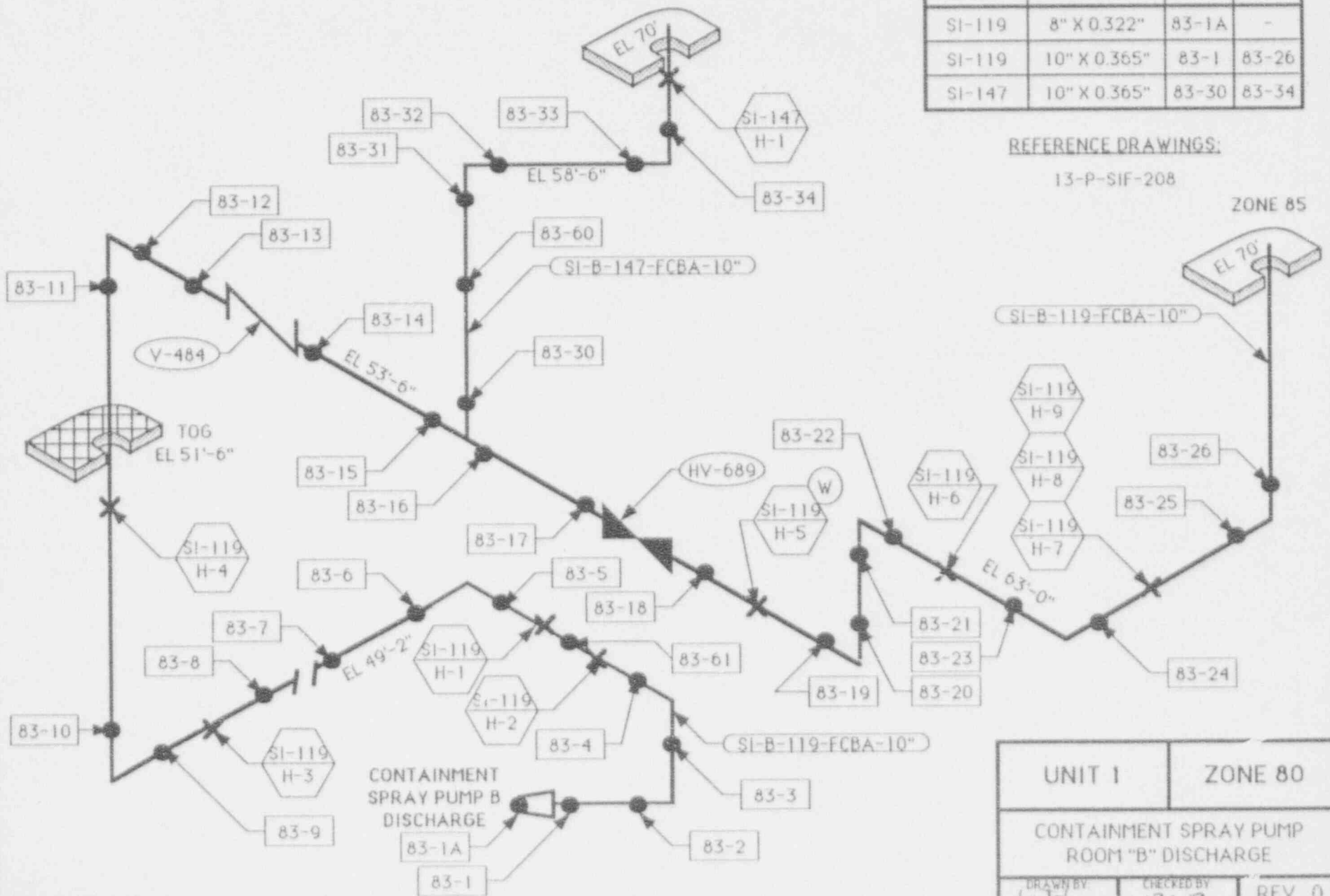

UNIT 1	ZONE 80
CONTAINMENT SPRAY PUMP ROOM "B" DISCHARGE	
DRAWN BY LVJ	CHECKED BY JCL/B
	REV. 0

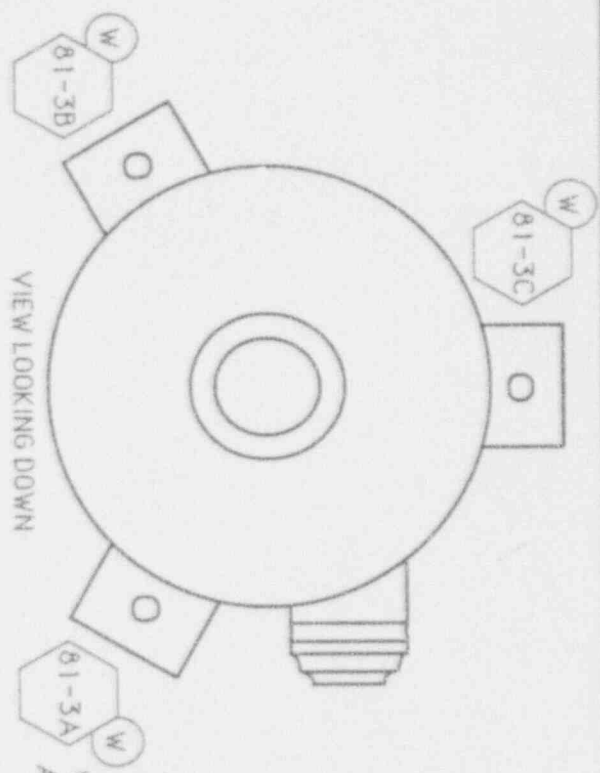

WELDED SUPPORT FEET
AND SUPPORT COLUMNS

- NOTES:**
- 1) TAG NUMBER: IMSIBP03
 - 2) SERIAL NUMBER: 0876-39 INGERSOL RAND
 - 3) NATIONAL BOARD NUMBER: 522

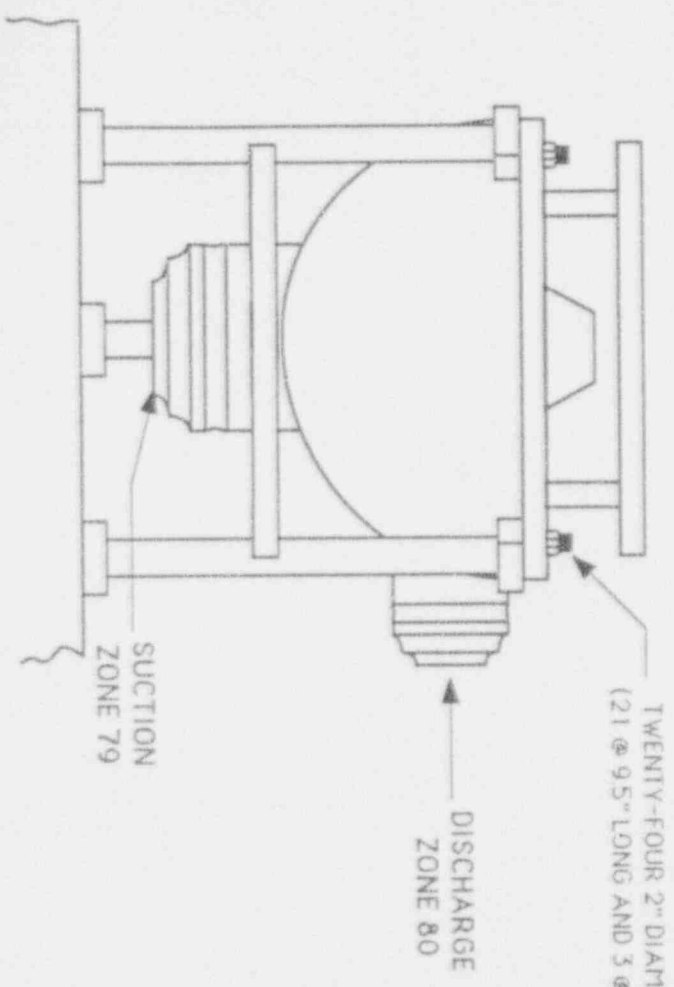

REFERENCE DRAWINGS:
N001-1101-36

UNIT 1	ZONE 81
CONTAINMENT SPRAY PUMP B	
DRAWN BY L.V.T.J.	CHECKED BY /24/3
REV. 0	

LINE #	DIA X SCH	FROM	TO
SI-078	10" X 0.365"	72-36	72-48
SI-078	20" X 0.500"	72-49	72-52
SI-079	10" X 0.365"	82-28	72-61

REFERENCE DRAWINGS:

13-P-SIF-207

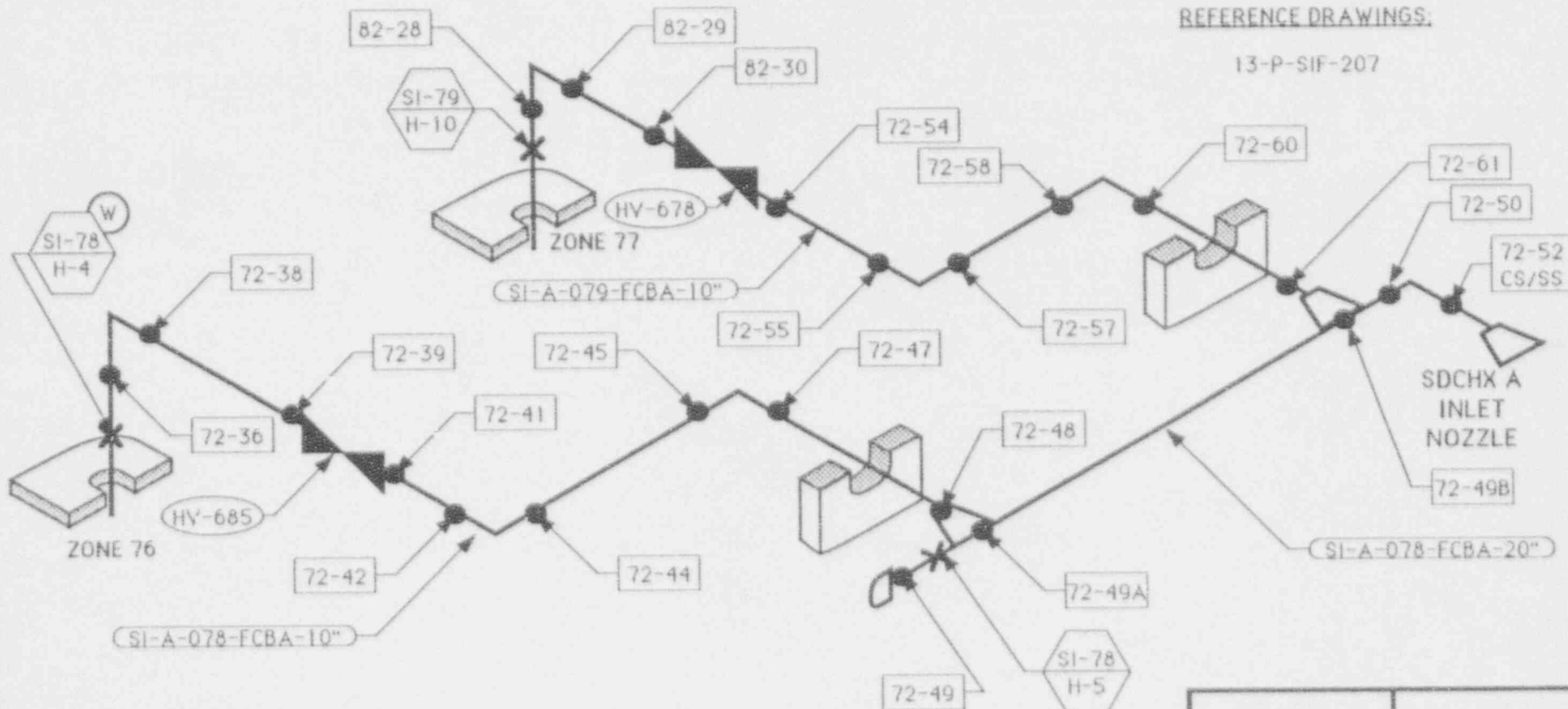

UNIT 1	ZONE 82
SHUTDOWN COOLING HEAT EXCHANGER ROOM A	
DRAWN BY WJA	CHECKED BY RJB
REV. 0	

REFERENCE DRAWINGS:
 13-P-SIF-201
 13-P-SIF-203
 13-P-SIF-207

LINE #	DIA X SCH	FROM	TO
SI-070	20" X 0.500"	74-1	74-19
SI-070	16" X 0.375"	74-21	74-25
SI-070	20" X 0.500"	74-27	74-27
SI-082	10" X 0.365"	82-36	82-38
SI-087	10" X 0.365"	74-58	74-74
SI-089	10" X 0.365"	74-77	74-87
SI-089	10" X 0.365"	82-39	82-44
SI-090	14" X 0.375"	74-105	74-118
SI-131	6" X 0.280"	74-97	74-100

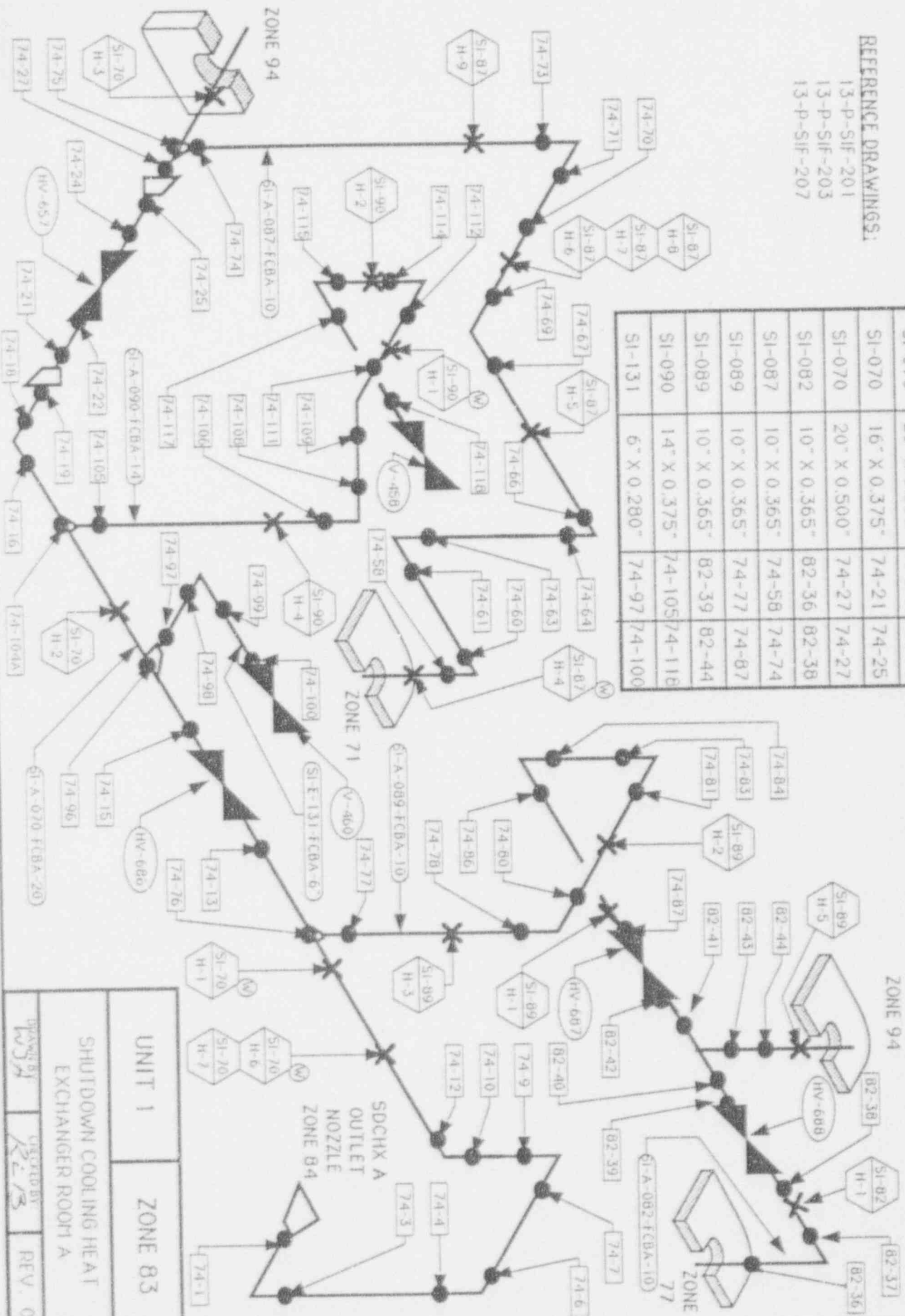

UNIT 1 ZONE 83

SHUTDOWN COOLING HEAT EXCHANGER ROOM A

DRAWING BY: *WJH* CHECKED BY: *RCS* REV. 0

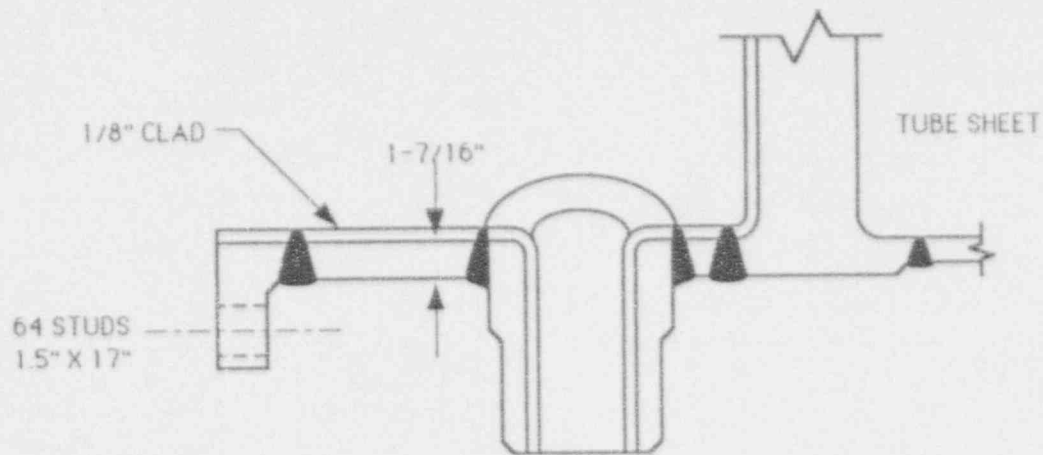

CHANNEL HEAD CROSS SECTION

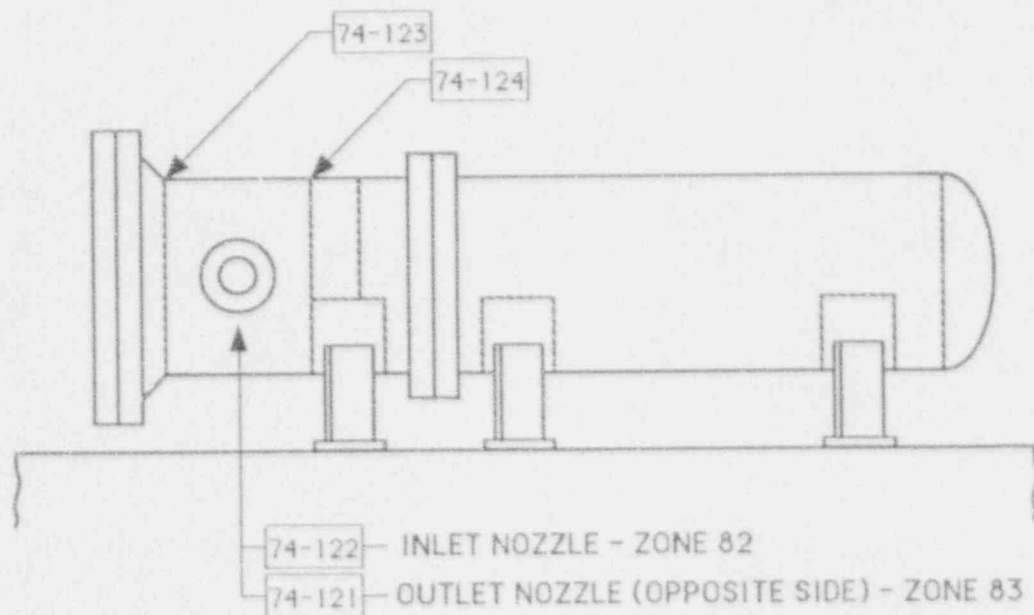

NOTES:

- 1) TAG NUMBER: IMSIAE01
- 2) SERIAL NUMBER: S-18341
(ENGR & FABRICATORS)
- 3) NATIONAL BOARD NUMBER: 1708

REFERENCE DRAWINGS:

- N001-7.03-20
N001-7.03-25

UNIT 1	ZONE 84
SHUTDOWN COOLING HEAT EXCHANGER A	
DRAWN BY WJA	CHECKED BY RLB
REV. 0	

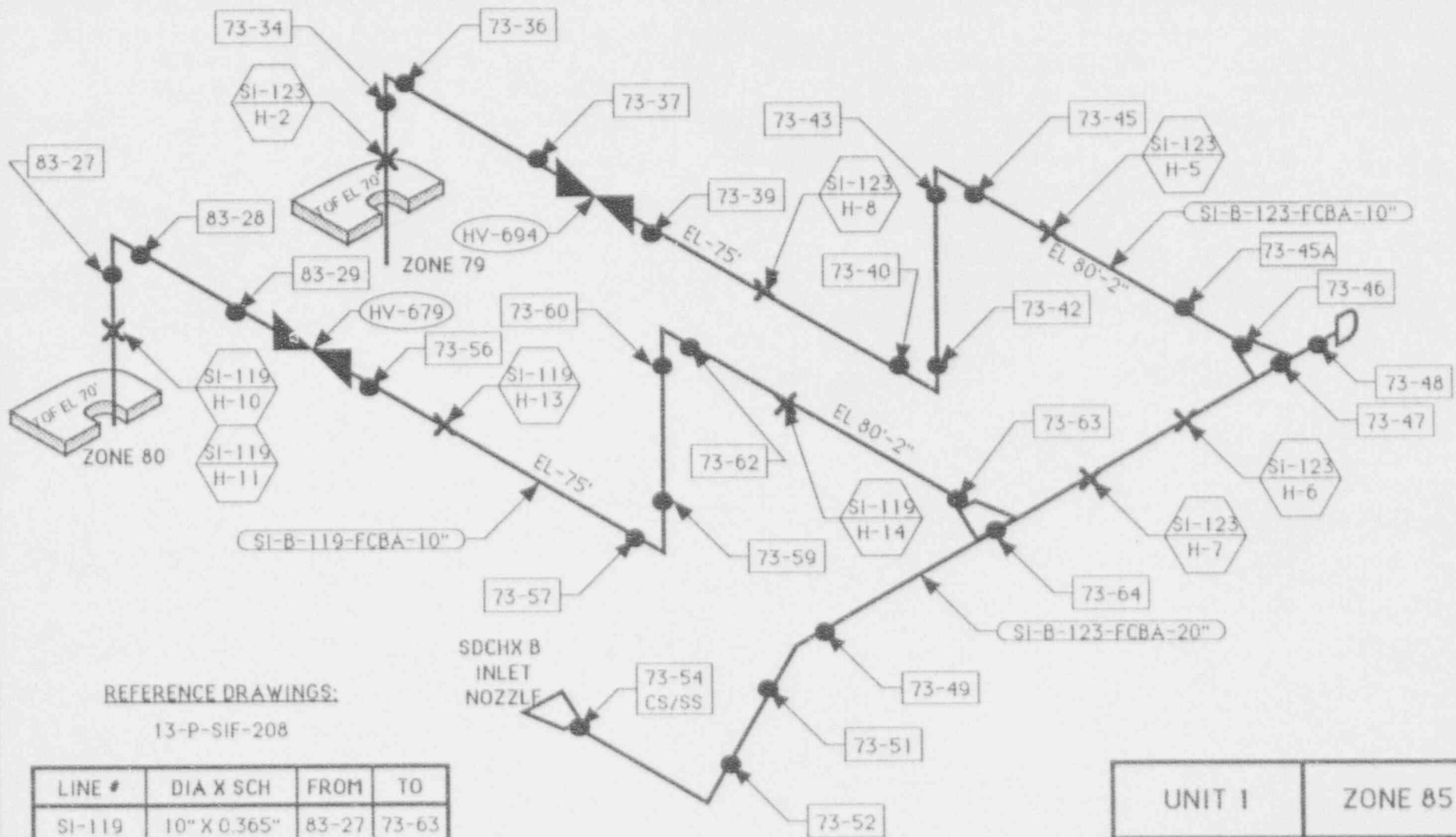

REFERENCE DRAWINGS:

13-P-SIF-208

LINE #	DIA X SCH	FROM	TO
SI-119	10" X 0.365"	83-27	73-63
SI-123	10" X 0.365"	73-34	73-46
SI-123	20" X 0.500"	73-48	73-54

UNIT 1	ZONE 85
SHUTDOWN COOLING HEAT EXCHANGER ROOM B	
DRAWN BY WJA	CHECKED BY RJB
REV. 0	

LINE #	DIA X SCH	FROM	TO
SI-072	20" X 0.500"	75-1	75-17
SI-072	16" X 0.375"	75-19	75-23
SI-072	20" X 0.500"	75-25	75-25
SI-129	10" X 0.365"	75-53	75-61
SI-131	6" X 0.280"	75-81	75-84
SI-134	10" X 0.365"	75-62	83-43
SI-135	14" X 0.375"	75-87	75-100
SI-147	10" X 0.365"	83-35	83-37

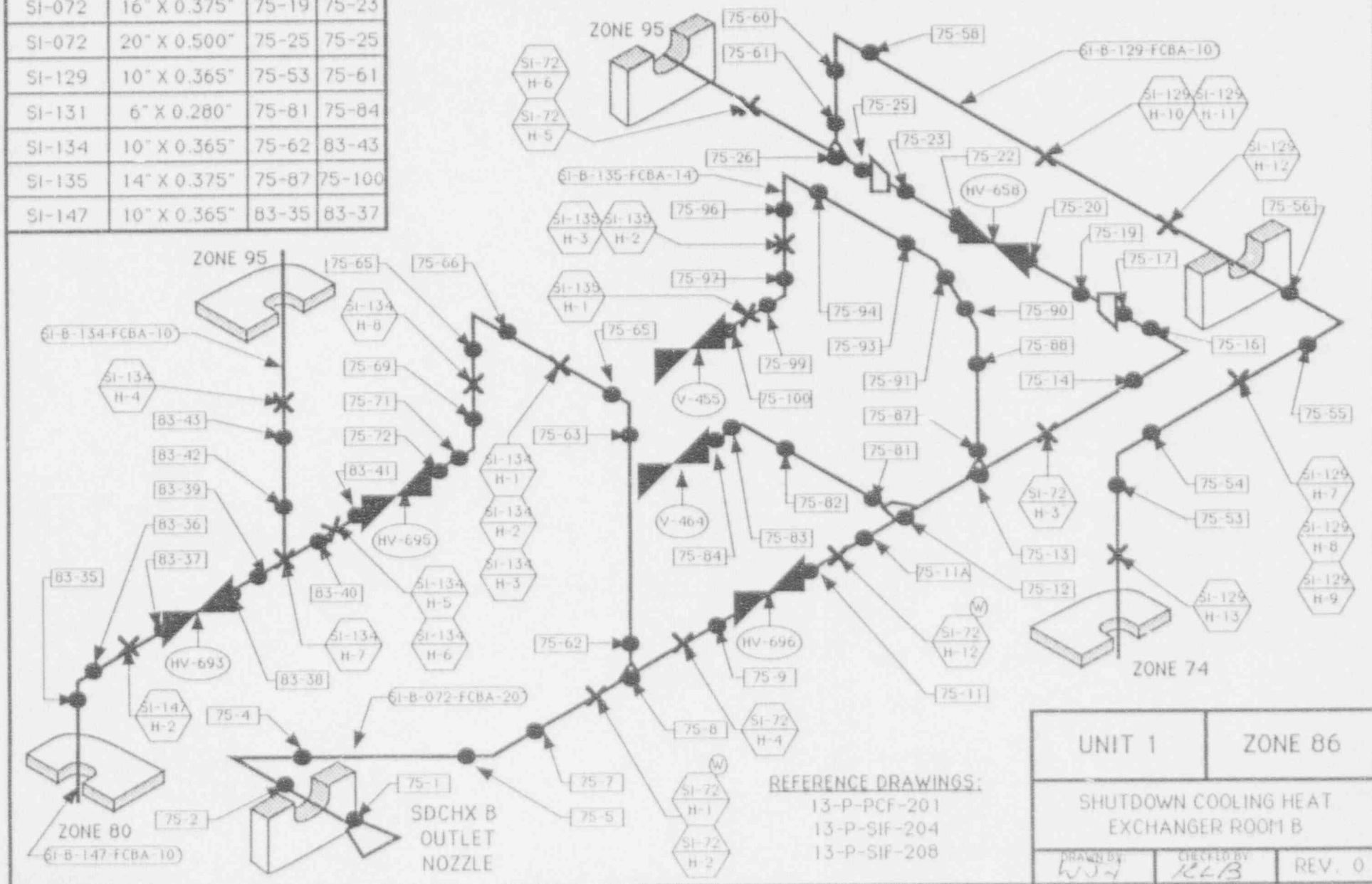

UNIT 1	ZONE 86	
SHUTDOWN COOLING HEAT EXCHANGER ROOM B		
DRAWN BY WJW	CHECKED BY KLB	REV. 0

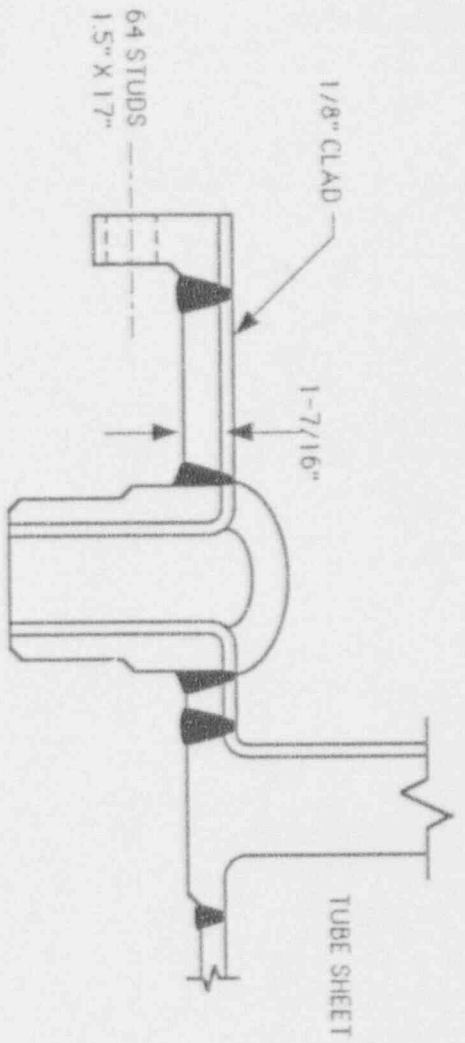

CHANNEL HEAD CROSS SECTION

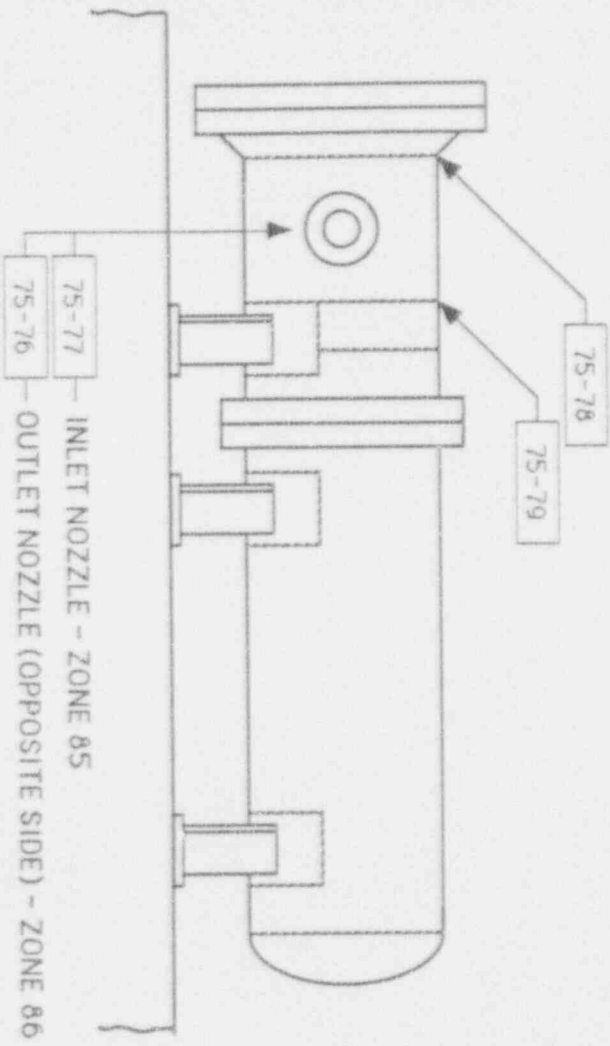

NOTES:

- 1) TAG NUMBER: 1MSIBED01
- 2) SERIAL NUMBER: 1-18342 (ENGR & FABRICATORS)
- 3) NATIONAL BOARD NUMBER: 1709

REFERENCE DRAWINGS:

- NO01-7.03-20
- NO01-7.03-25

UNIT 1	ZONE 87
SHUTDOWN COOLING HEAT EXCHANGER B	
DRAWN BY <i>WJ</i>	CHECKED BY <i>RCS</i>
REV. 0	

LINE #	DIA X SCH	FROM	TO
SI-072	12" X 0.375"	78-2	78-11
SI-072	12" X 1.125"	78-13	78-14
SI-072	20" X 0.500"	75-35	75-38
SI-073	12" X 0.375"	79-1	79-11
SI-073	12" X 1.125"	79-13	79-14
SI-155	12" X 1.125"	78-16	78-21
SI-172	10" X 0.365"	78-10C	78-10D
SI-174	12" X 1.125"	79-16	79-21

REFERENCE DRAWINGS:

13-P-SIF-208

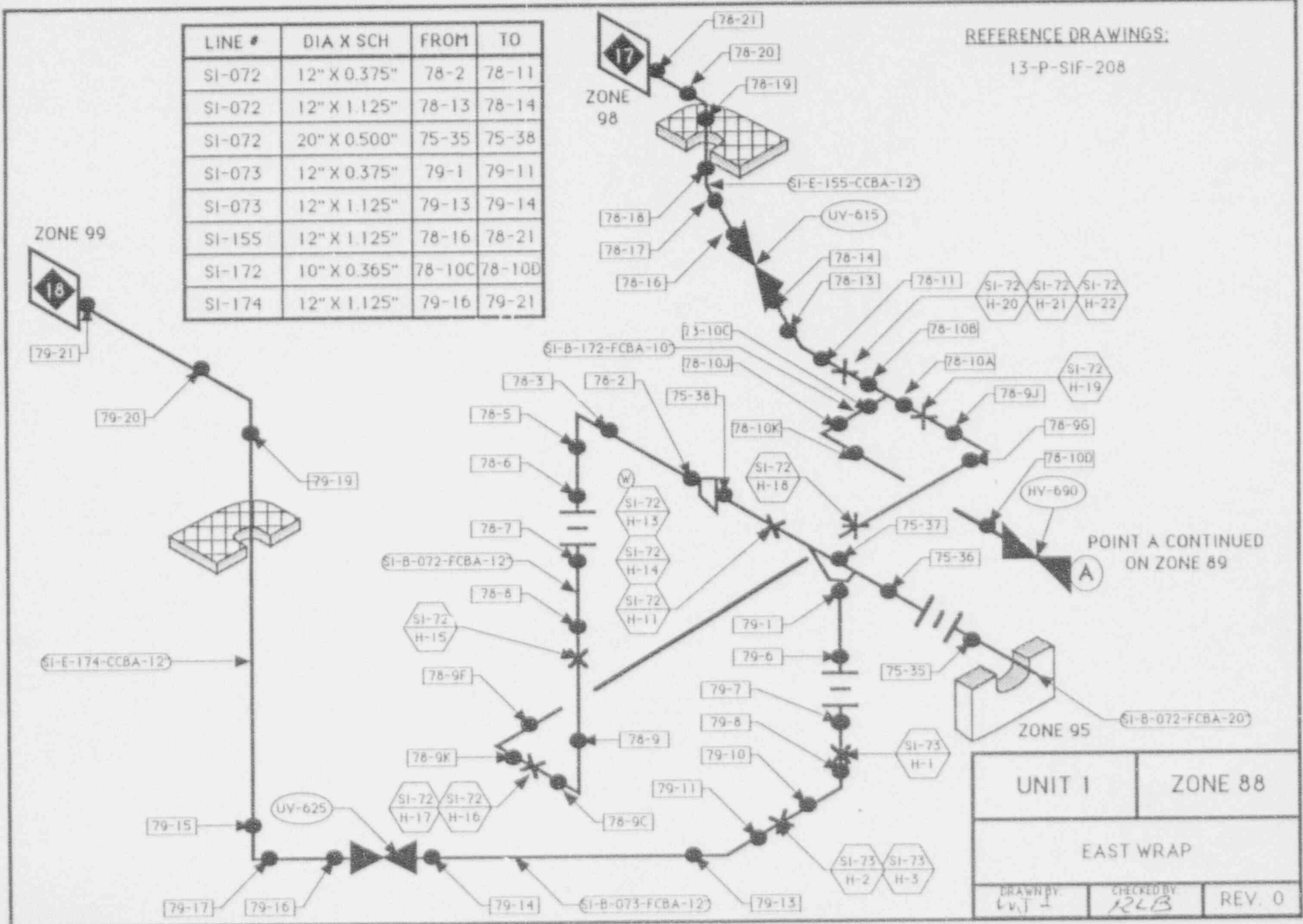

UNIT 1	ZONE 88
EAST WRAP	
DRAWN BY: L.V.J.	CHECKED BY: R.L.B.
REV. 0	

REFERENCE DRAWINGS:

13-P-SIF-202
13-P-SIF-208

ZONE 101

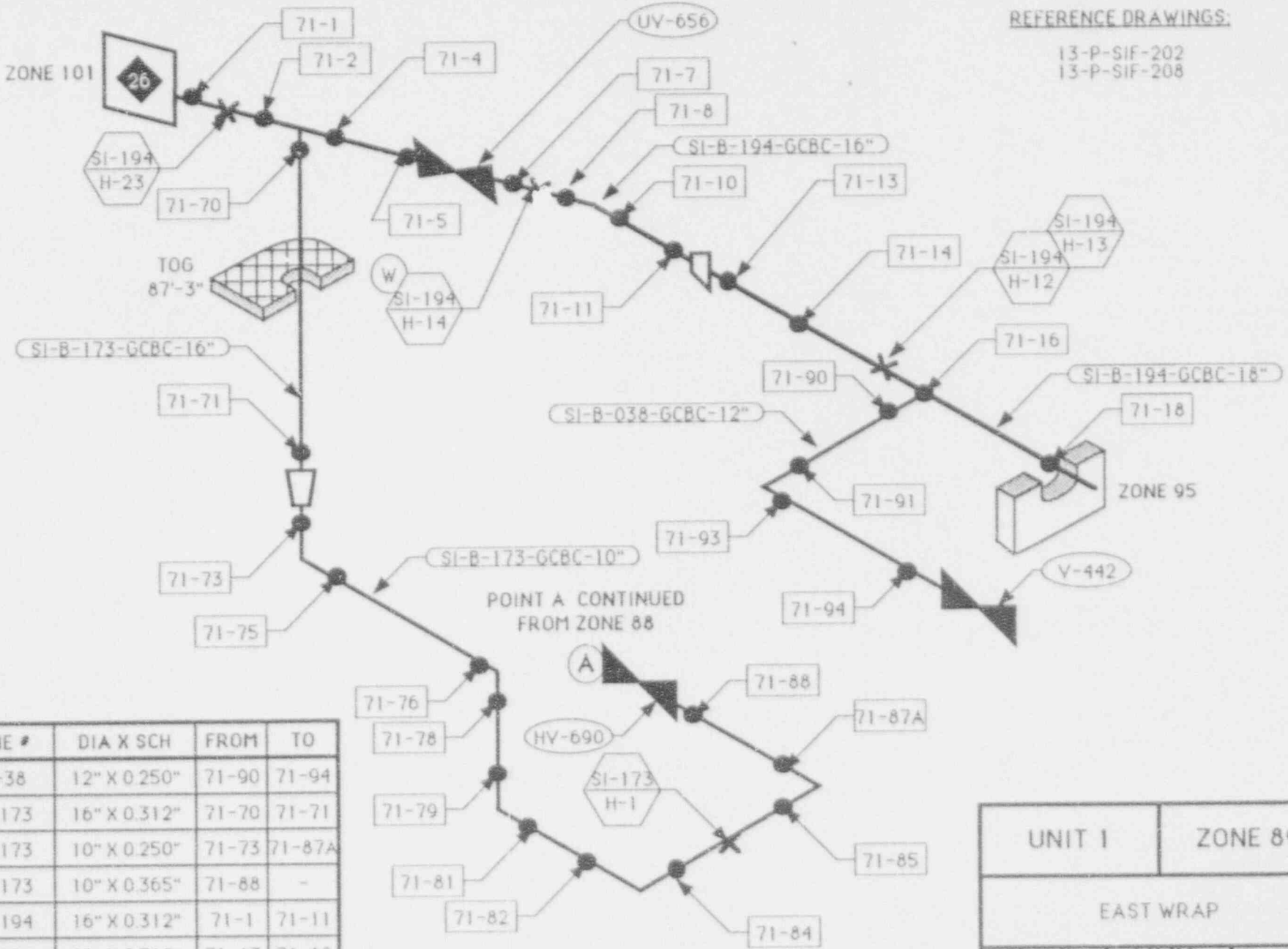

POINT A CONTINUED FROM ZONE 88

LINE #	DIA X SCH	FROM	TO
SI-38	12" X 0.250"	71-90	71-94
SI-173	16" X 0.312"	71-70	71-71
SI-173	10" X 0.250"	71-73	71-87A
SI-173	10" X 0.365"	71-88	-
SI-194	16" X 0.312"	71-1	71-11
SI-194	18" X 0.312"	71-13	71-18

UNIT 1	ZONE 89	
EAST WRAP		
DRAWN BY W. J.	CHECKED BY RLB	REV. 0

LINE #	DIA X SCH	FROM	TO
SI-030	24" X 0.375"	85-6	85-8
SI-134	10" X 0.365"	83-53	83-57
SI-134	8" X 0.322"	83-58	83-59
SI-308	24" X 0.562"	85-9	85-11

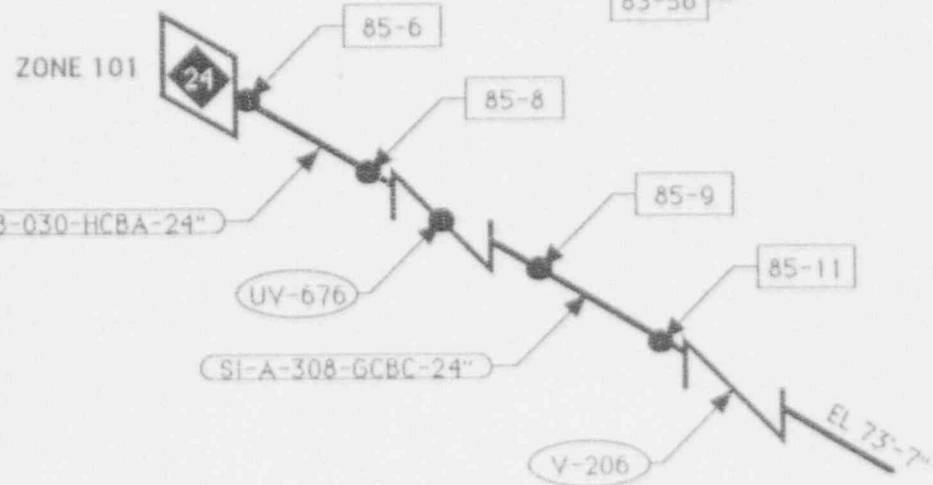
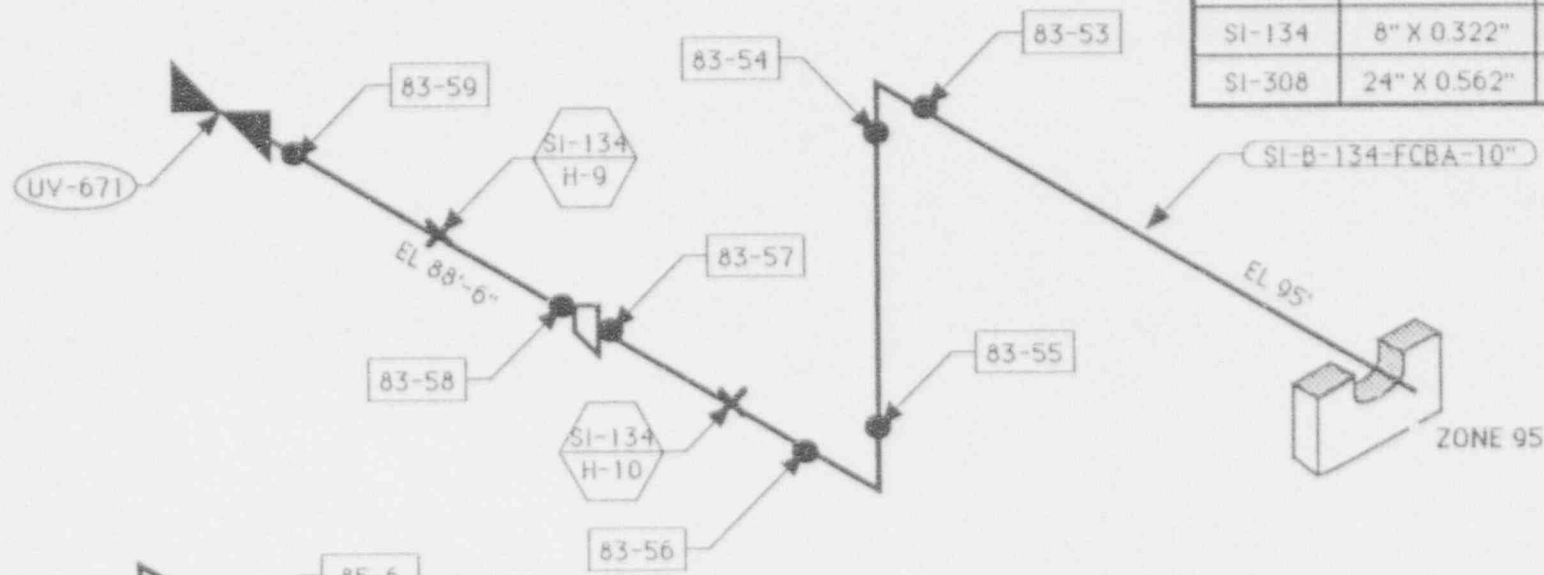

REFERENCE DRAWINGS:
 13-P-SIF-202
 13-P-SIF-208

UNIT 1	ZONE 90
EAST WRAP	
DRAWN BY VJA	CHECKED BY RJB
REV. 0	

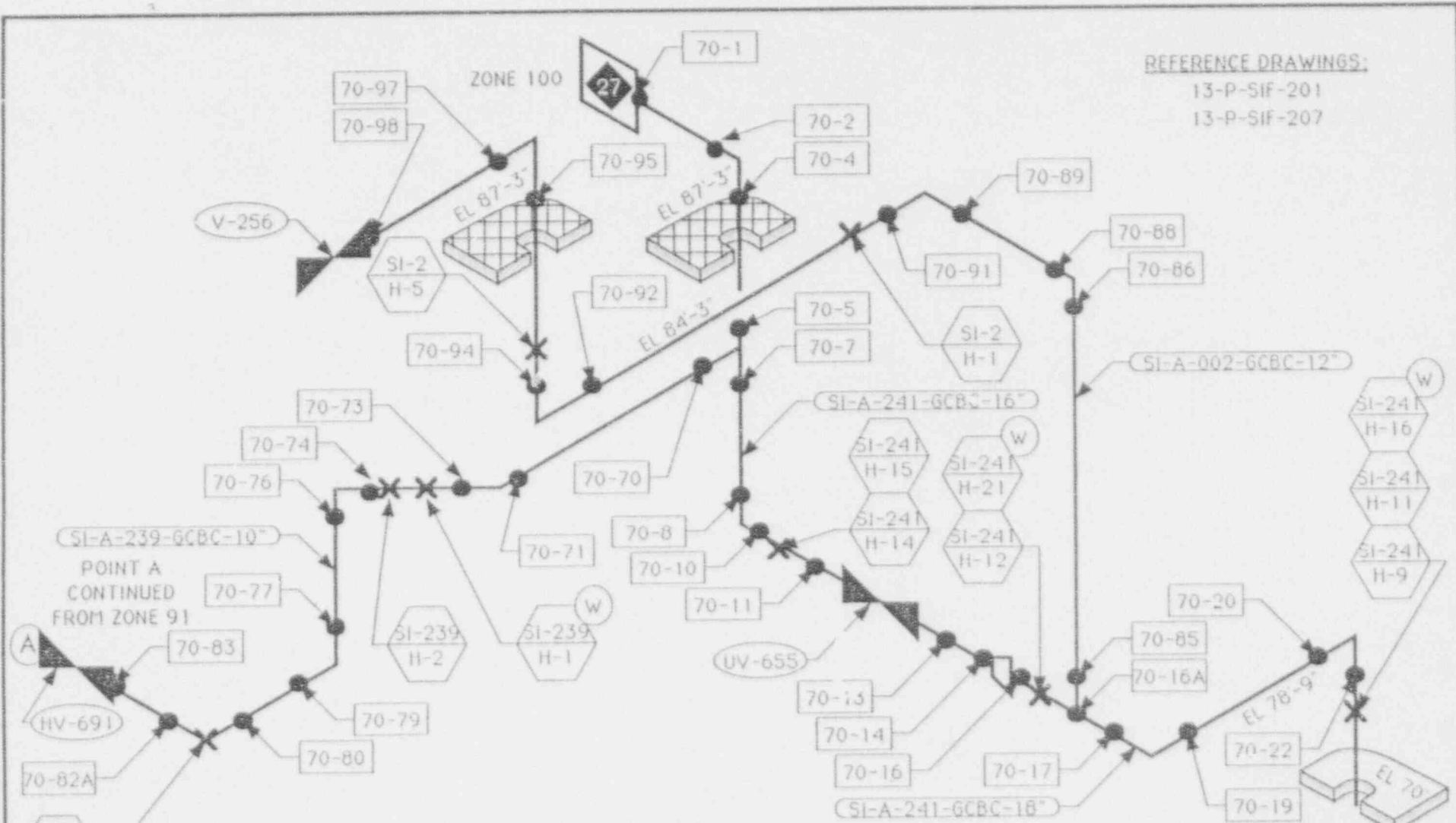

REFERENCE DRAWINGS:
 13-P-SIF-201
 13-P-SIF-207

POINT A
 CONTINUED
 FROM ZONE 91

LINE #	DIA X SCH	FROM	TO
SI-002	12" X 0.250"	70-85	70-98
SI-239	10" X 0.250"	70-70	70-82A
SI-239	10" X 0.365"	70-83	-
SI-241	16" X 0.312"	70-1	70-14
SI-241	18" X 0.312"	70-16	70-22

UNIT 1	ZONE 92
WEST WRAP	
DRAWN BY LJH	CHECKED BY RLB
REV. 0	

LINE #	DIA X SCH	FROM	TO
SI-007	8" X 0.322"	82-66	82-67
SI-089	10" X 0.365"	82-55	82-65
SI-089	24" X 0.375"	84-6	84-8
SI-307	24" X 0.562"	84-9	84-11

REFERENCE DRAWINGS:

13-P-SIF-201
13-P-SIF-207

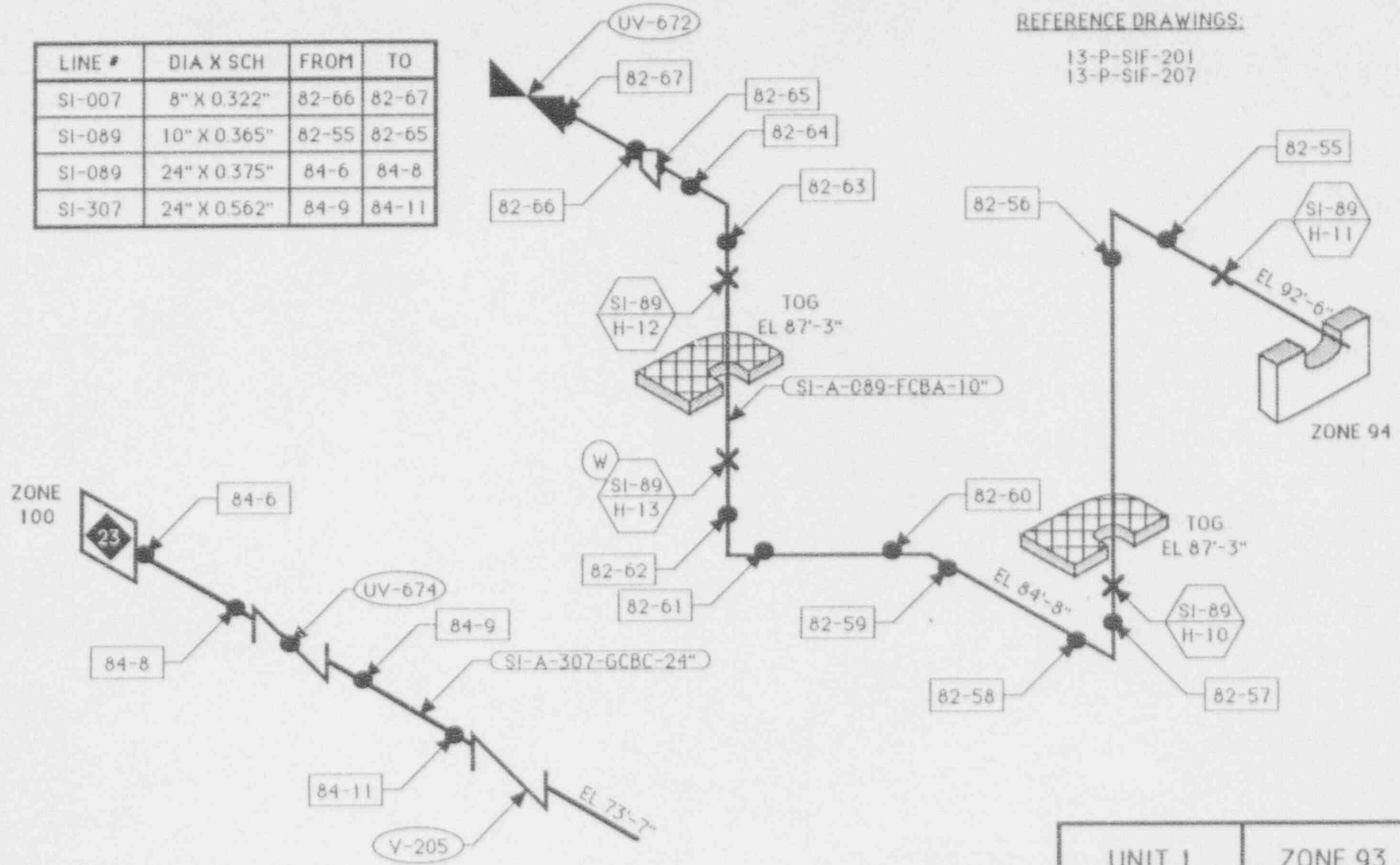

UNIT 1	ZONE 93	
WEST WRAP		
DRAWN BY WJS-7	CHECKED BY RLB	REV. 0

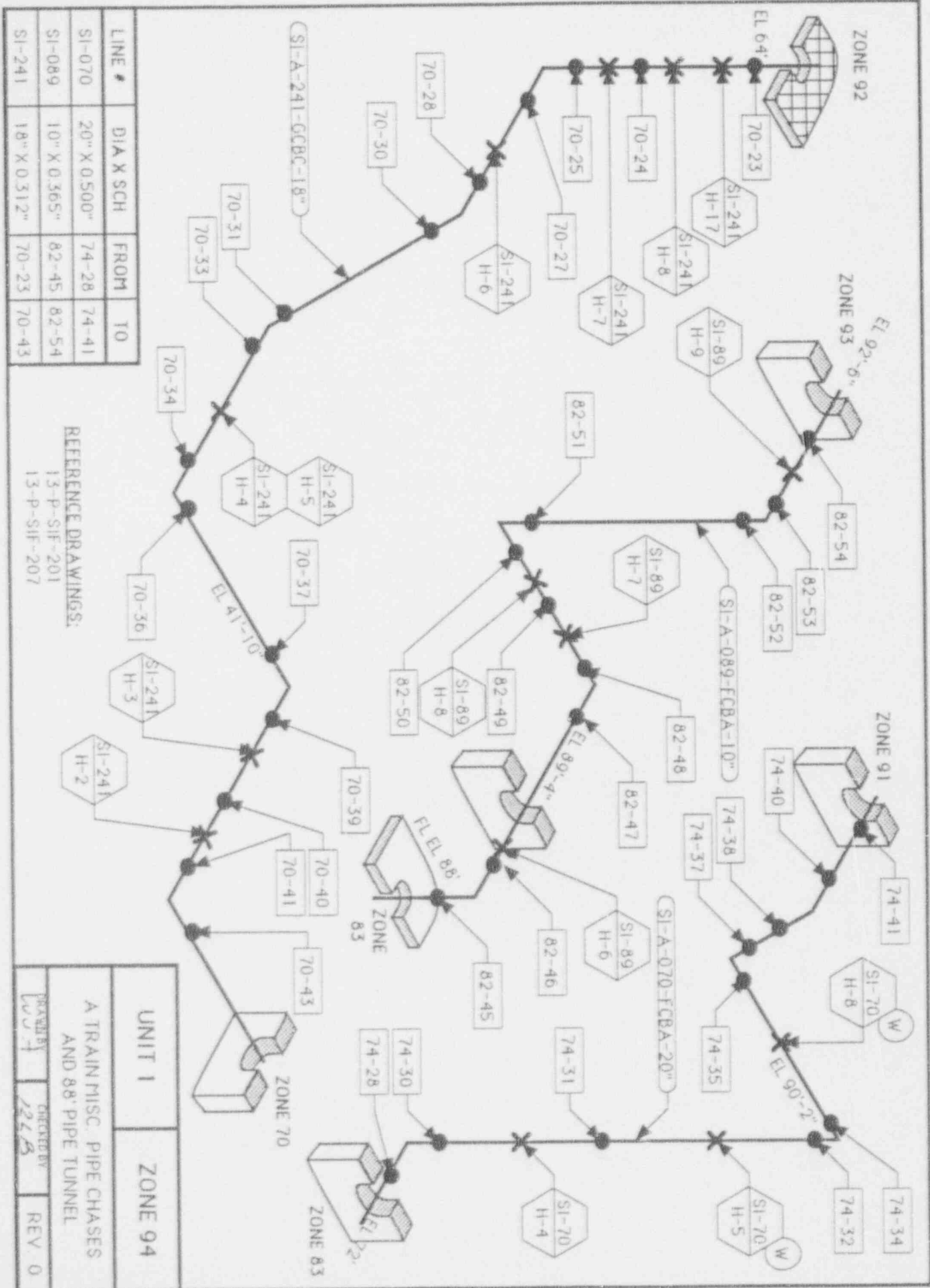

LINE #	DIA X SCH	FROM	TO
SI-070	20" X 0.500"	74-28	74-41
SI-089	10" X 0.365"	82-45	82-54
SI-241	18" X 0.312"	70-23	70-43

REFERENCE DRAWINGS:
 13-P-SIF-201
 13-P-SIF-207

UNIT 1		ZONE 94	
A TRAIN MISC PIPE CHASES AND 88' PIPE TUNNEL			
DRAWN BY	CHECKED BY	REV	
WJF	JCB	0	

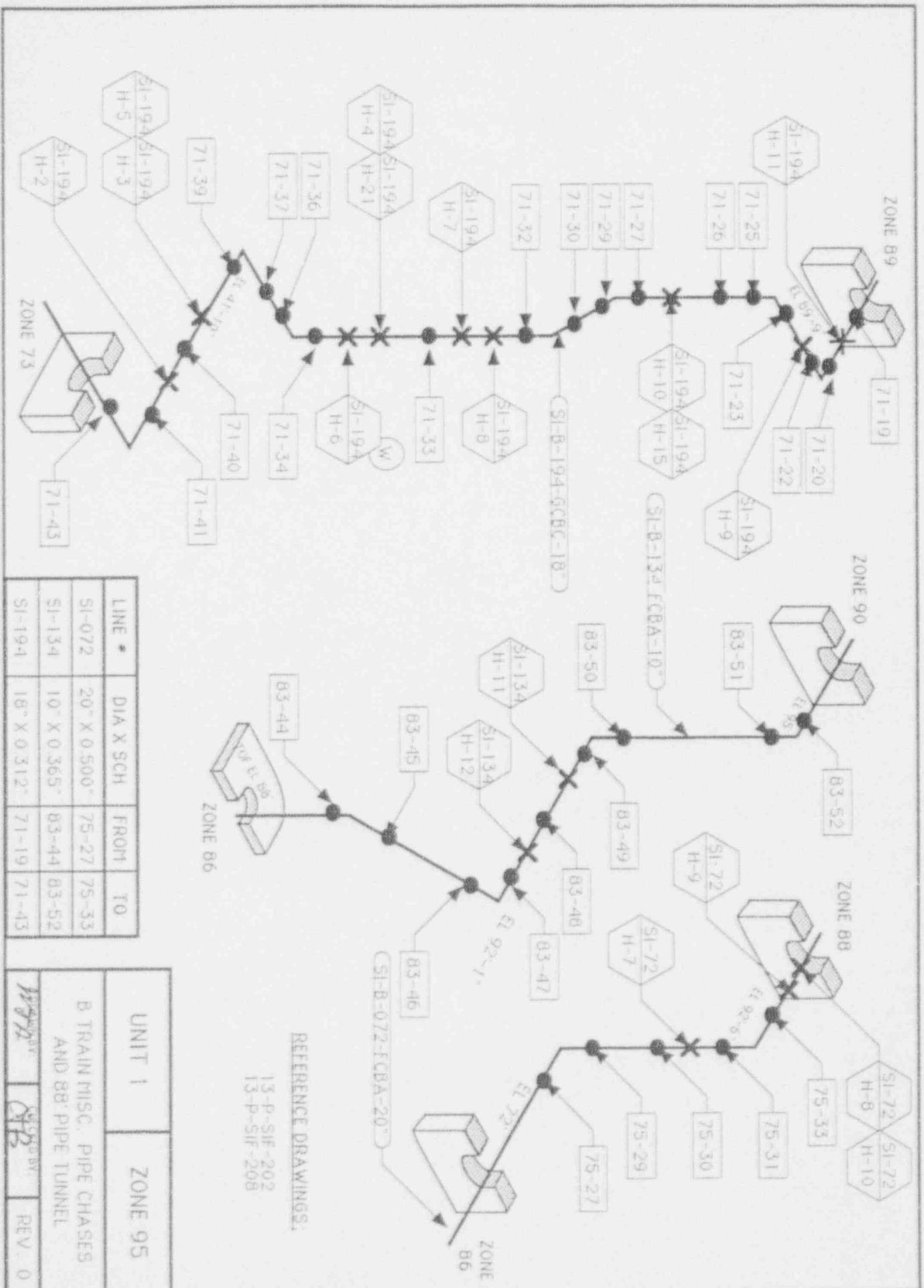

REFERENCE DRAWINGS:
 13-P-SIF-202
 13-P-SIF-208

LINE #	DIA X SCH	FROM	TO
SI-072	20" X 0.500"	75-27	75-33
SI-134	10" X 0.365"	83-44	83-52
SI-194	18" X 0.312"	71-19	71-43

UNIT 1		ZONE 95	
B TRAIN MISC. PIPE CHASES AND 88 PIPE TUNNEL			
DESIGNED BY	WPH	CHECKED BY	CR
REV.	0		

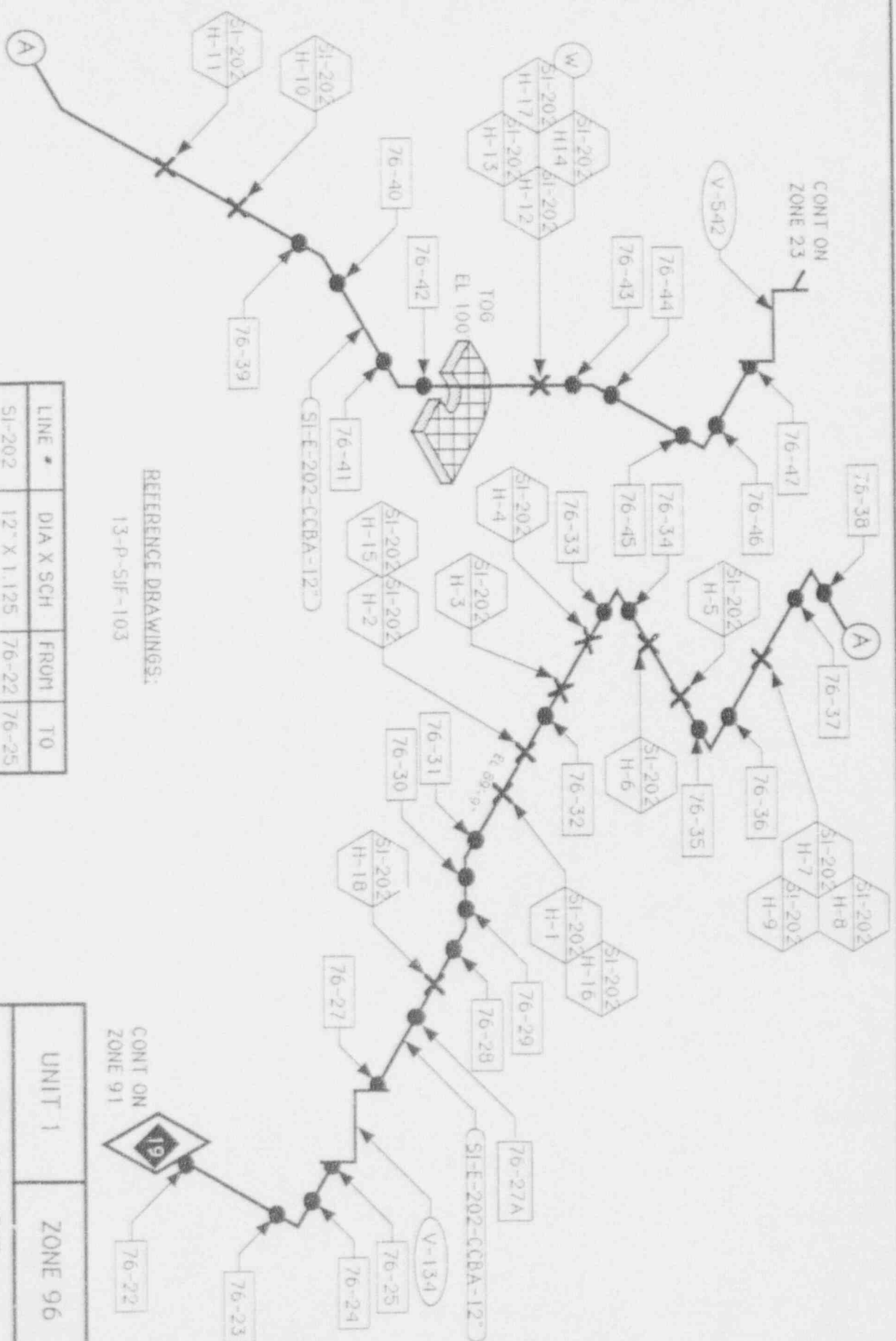

REFERENCE DRAWINGS:
13-P-SIF-103

LINE #	DIA X SCH	FROM	TO
SI-202	12" X 1.125	76-22	76-25
SI-202	12" X 1.312"	76-27	76-47

UNIT 1	ZONE 96
--------	---------

CONTAINMENT
LPSI HEADER TO LOOP 1A

DESIGNED BY: *hph*
CHECKED BY: *DR*
REV. 0

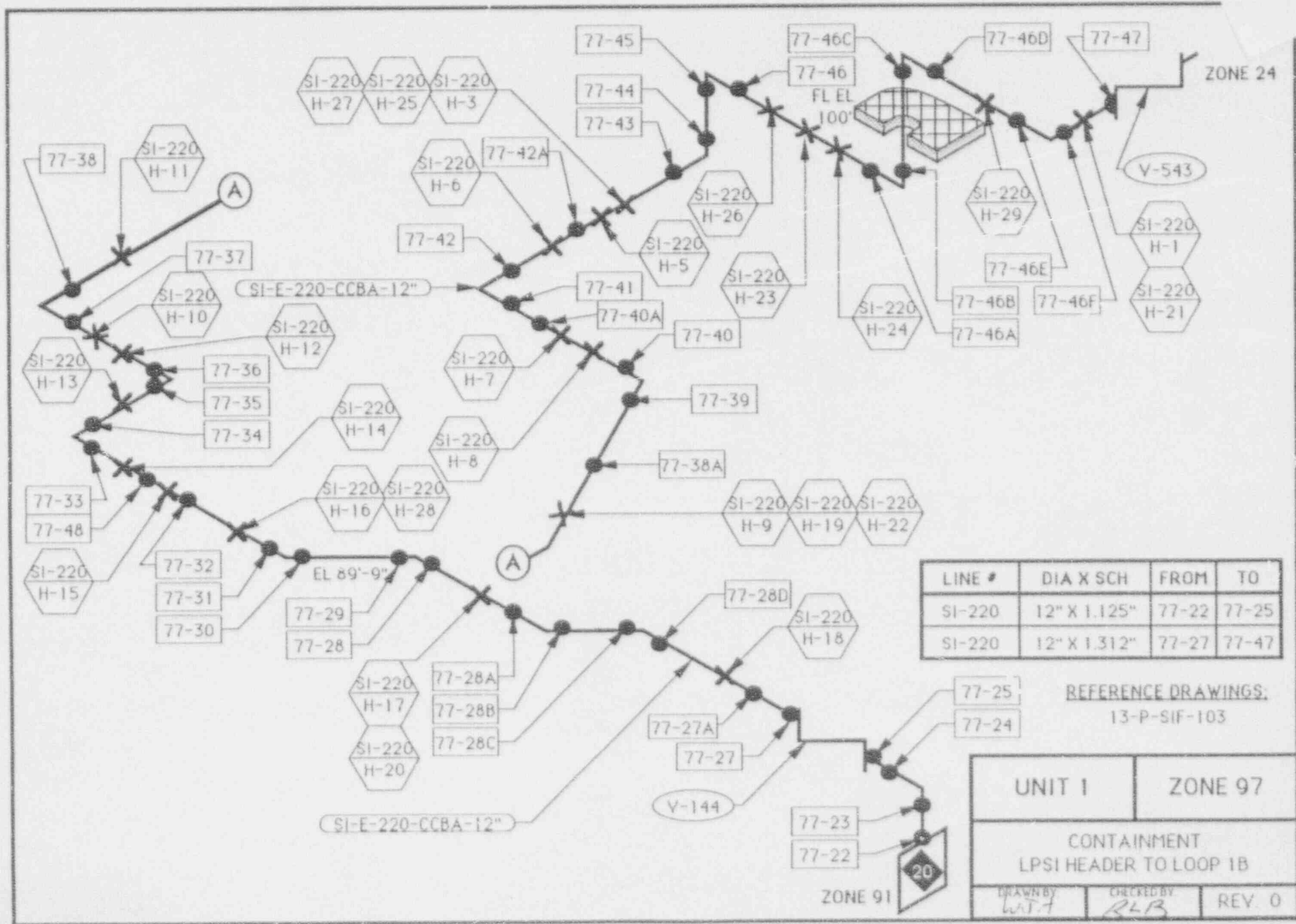

LINE #	DIA X SCH	FROM	TO
SI-220	12" X 1.125"	77-22	77-25
SI-220	12" X 1.312"	77-27	77-47

REFERENCE DRAWINGS:
13-P-SIF-103

UNIT 1	ZONE 97
CONTAINMENT LPSI HEADER TO LOOP 1B	
DRAWN BY LWT	CHECKED BY RLB
REV 0	

ZONE 91



LINE #	DIA X SCH	FROM	TO
SI-155	12" X 1.125"	78-22	78-25
SI-155	12" X 1.312"	78-27	78-47

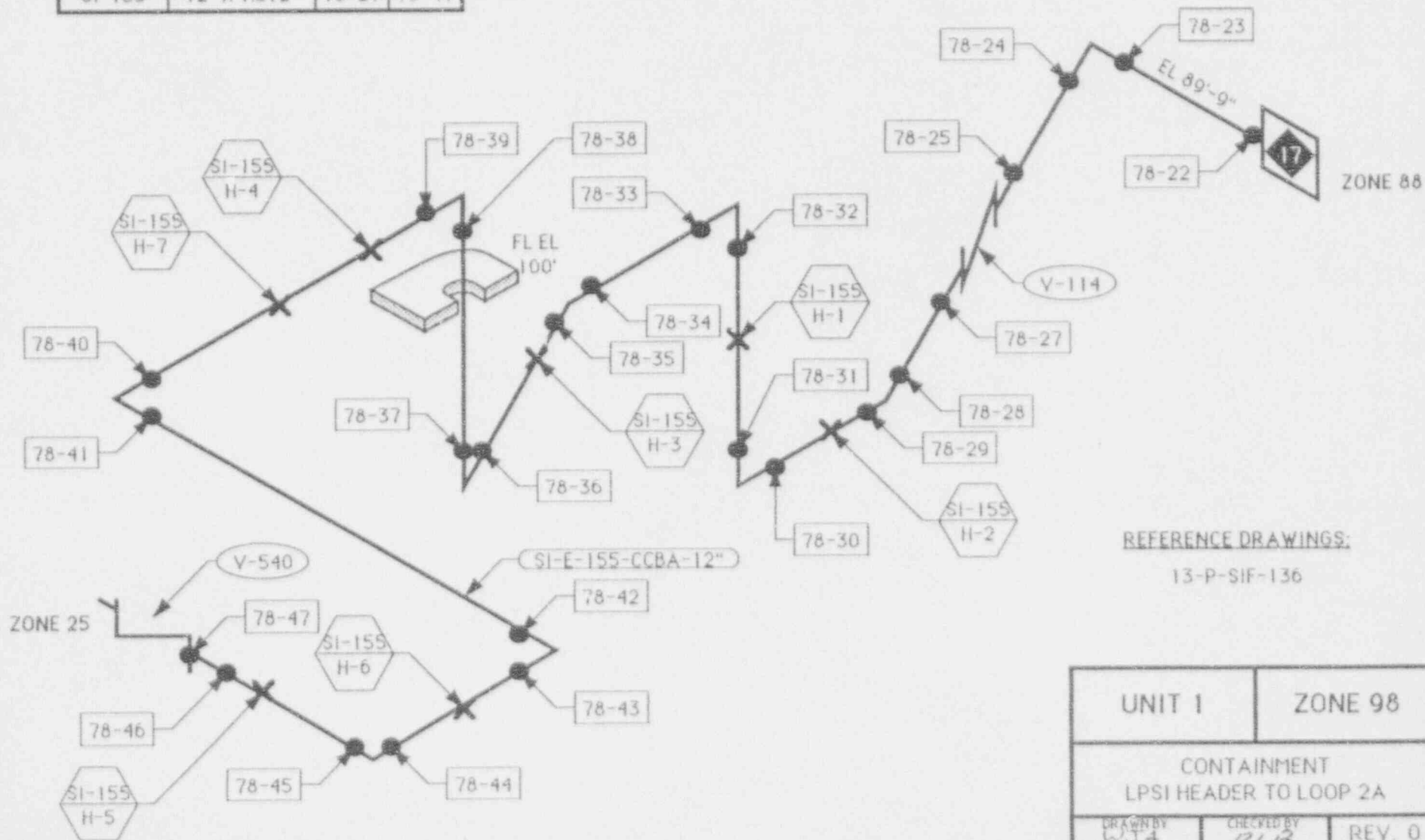

REFERENCE DRAWINGS:
13-P-SIF-136

UNIT 1	ZONE 98
CONTAINMENT LPSI HEADER TO LOOP 2A	
DRAWN BY WJA	CHECKED BY RLB
REV. 0	

LINE #	DIA X SCH	FROM	TO
SI-174	12" X 1.125"	79-23	79-25
SI-174	12" X 1.312"	79-27	79-47

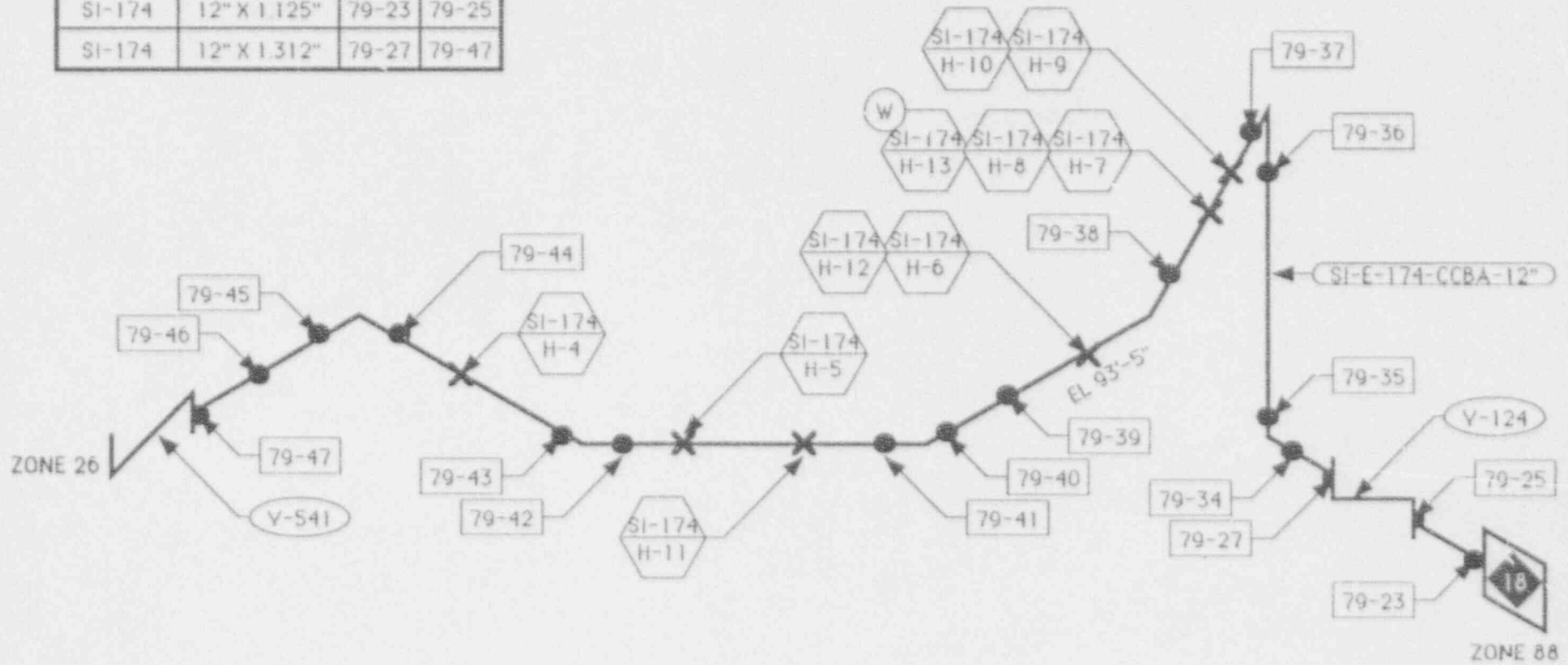

REFERENCE DRAWINGS:

13-P-SIF-136

UNIT 1	ZONE 99
CONTAINMENT LPSI HEADER TO LOOP 2B	
DRAWN BY WJH	CHECKED BY RLB
	REV. 0

LINE #	DIA X SCH	FROM	TO
SI-007	24" X 0.375"	84-2	84-3
SI-241	16" X 0.312"	70-116	70-119
SI-241	16" X 1.594"	70-120	70-121
SI-369	10" X 0.250"	70-122	70-132
SI-369	6" X 0.280"	70-134	-

REFERENCE DRAWINGS:

- 23-P-SIF-105
- 13-P-SIF-151
- 13-P-2CG-112

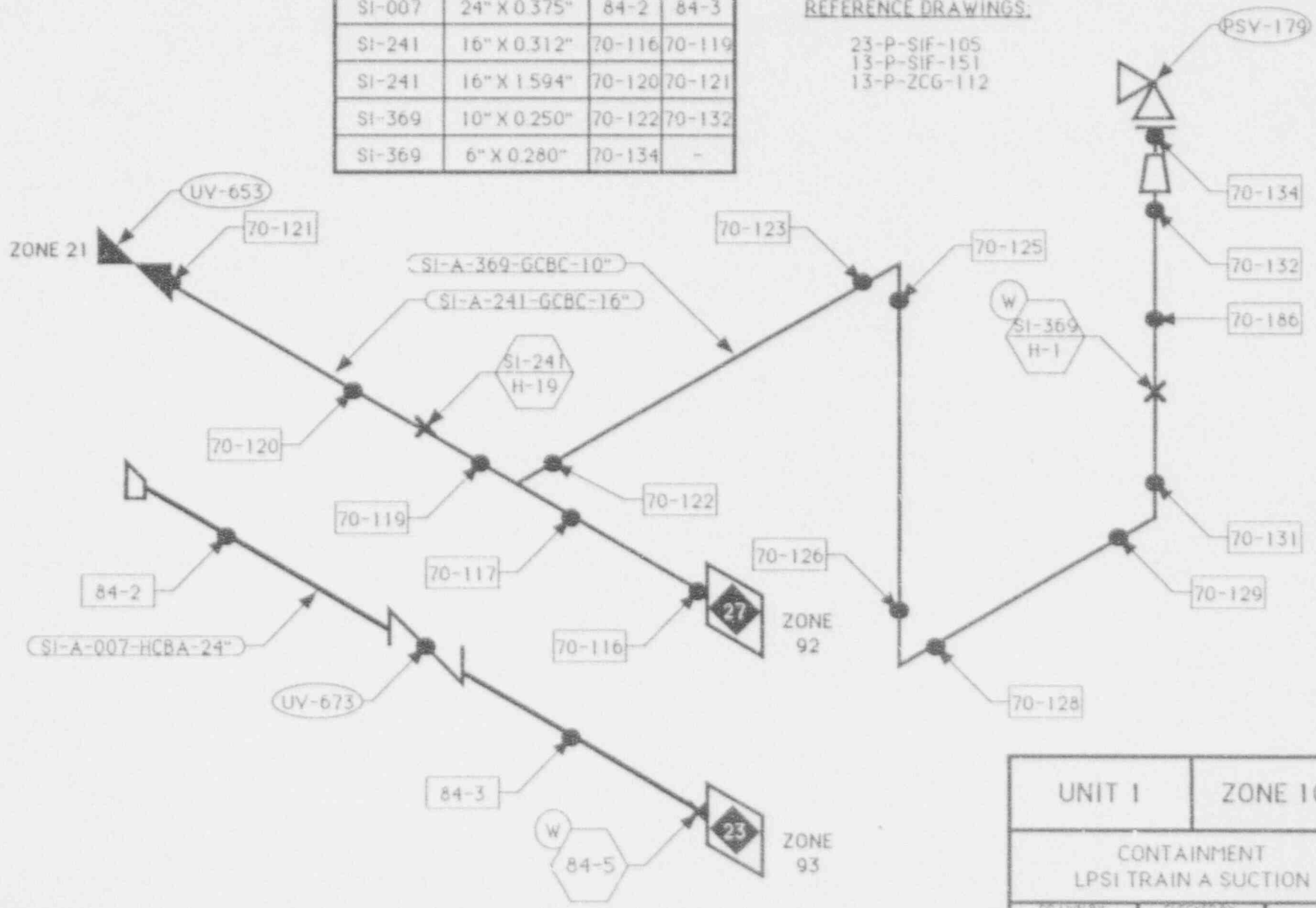

UNIT 1	ZONE 100
CONTAINMENT LPSI TRAIN A SUCTION	
DRAWN BY WJA	CHECKED BY RGA
	REV. 0

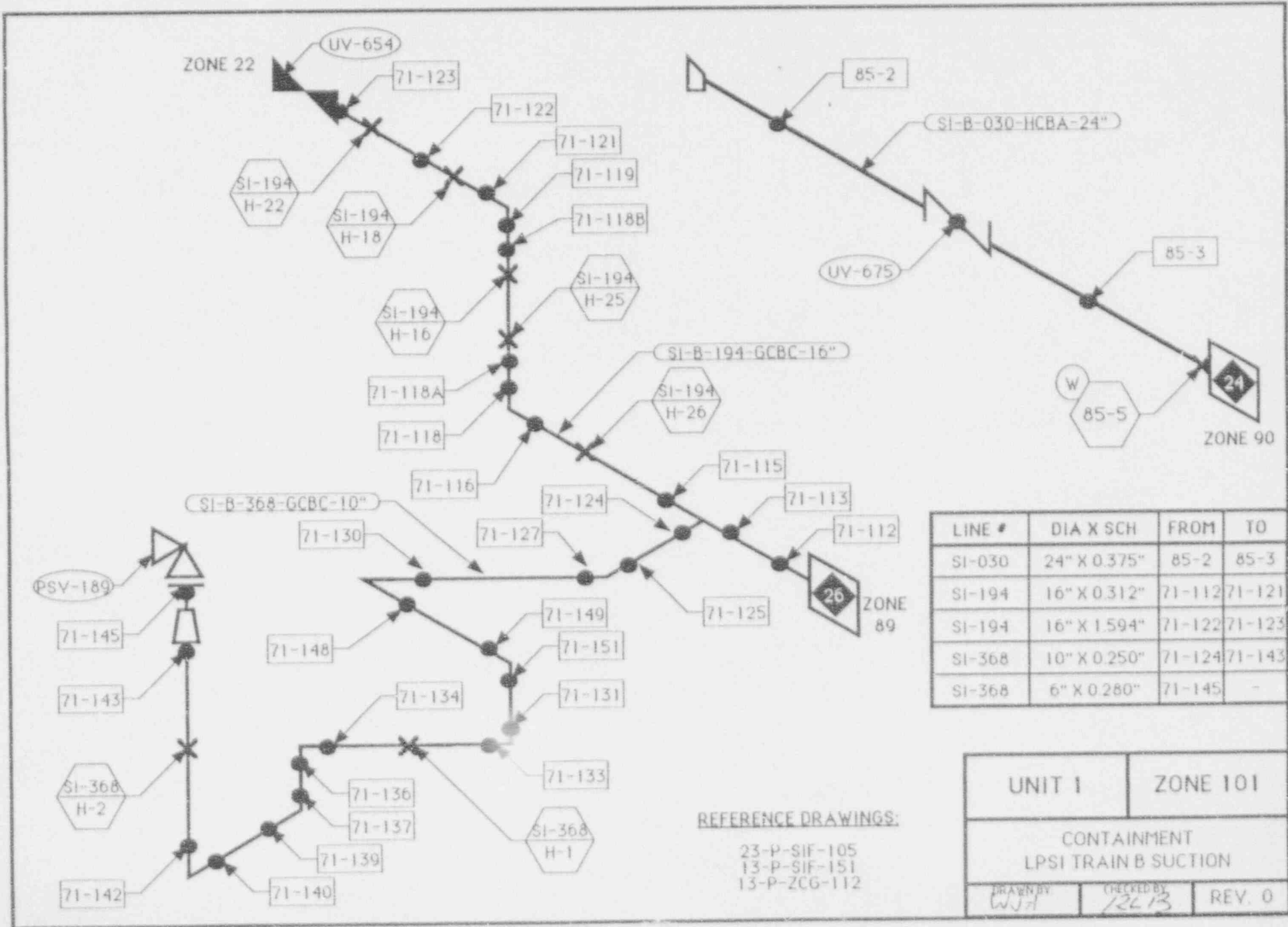

LINE #	DIA X SCH	FROM	TO
SI-030	24" X 0.375"	85-2	85-3
SI-194	16" X 0.312"	71-112	71-121
SI-194	16" X 1.594"	71-122	71-123
SI-368	10" X 0.250"	71-124	71-143
SI-368	6" X 0.280"	71-145	-

UNIT 1	ZONE 101
CONTAINMENT LPSI TRAIN B SUCTION	
DRAWN BY WJH	CHECKED BY RLB
REV. 0	

REFERENCE DRAWINGS:
 23-P-SIF-105
 13-P-SIF-151
 13-P-ZCG-112