

2018 MONTICELLO ILT NRC EXAM - KEY

1. The plant was in Mode 1 with the OPRM Upscale Scram OPERABLE when a trip of #11 Recirc Pump occurred. Plant conditions are stable as follows:

- Total Recirc Drive flow is 47%
- Recirc Loop A indicates a total jet pump flow of 9 Mlbm/hr
- Recirc Loop B indicates a total jet pump flow of 36 Mlbm/hr
- APRM recorders indicate approximately 65% reactor power
- SPDS Screen 228 (APRM POWER/DRIVE FLOW MAP) and C.2-06 Figure 1 (POWER/FLOW MAP) are provided on next page

Which of the following identifies a correct action to take, if any?

- A. NO action required.
- B. INSERT a manual reactor scram.
- C. INSERT control rods to a reactor power level of 40-45%.
- D. RAISE #12 Recirc pump speed to return to the allowable region.

CORRECT ANSWER: C

JUSTIFICATION: The examinee must determine that "A" jet pump flow must be subtracted from "B" jet pump flow. This results in a total core flow of 27 Mlbm/hr. With the current power of 65% this is an entry into the unanalyzed region. If plant is operating in unanalyzed region, THEN promptly insert control rods to within the analyzed region. Reducing power to 40-45% with RMCS would be in the analyzed region, through and out of Region 2.

A is incorrect: Plausible if examinee adds loop flows instead of subtracting them

B is incorrect: Inserting a scram would be required if OPRMs were inop and Region 1 was entered.

D is incorrect: Raising Recirc pump speed is no longer allowed for exiting the unanalyzed region.

REFERENCE: C.4-B.05.01.02.A **10 CFR** 55.41b(10)
ADDITIONAL REFERENCE PROVIDED DURING EXAM: None
QUESTION SOURCE: LOR Bank
TIER: 1 **GROUP:** 1 **CATEGORY:** 295001 Partial or Complete Loss of Forced Core Flow Circulation
K/A: AA1.03 **IMPORTANCE:** RO 2.6 **COG LEVEL:** 3 SPK
K/A DESCRIPTION: Ability to operate and/or monitor the following as they apply to PARTIAL OR COMPLETE LOSS OF FORCED CORE FLOW CIRCULATION: RMCS
DIFFICULTY 2 **LESSON PL:** MT-ILT-AOP-002L **OBJECTIVE:** 2

2018 MONTICELLO ILT NRC EXAM - KEY

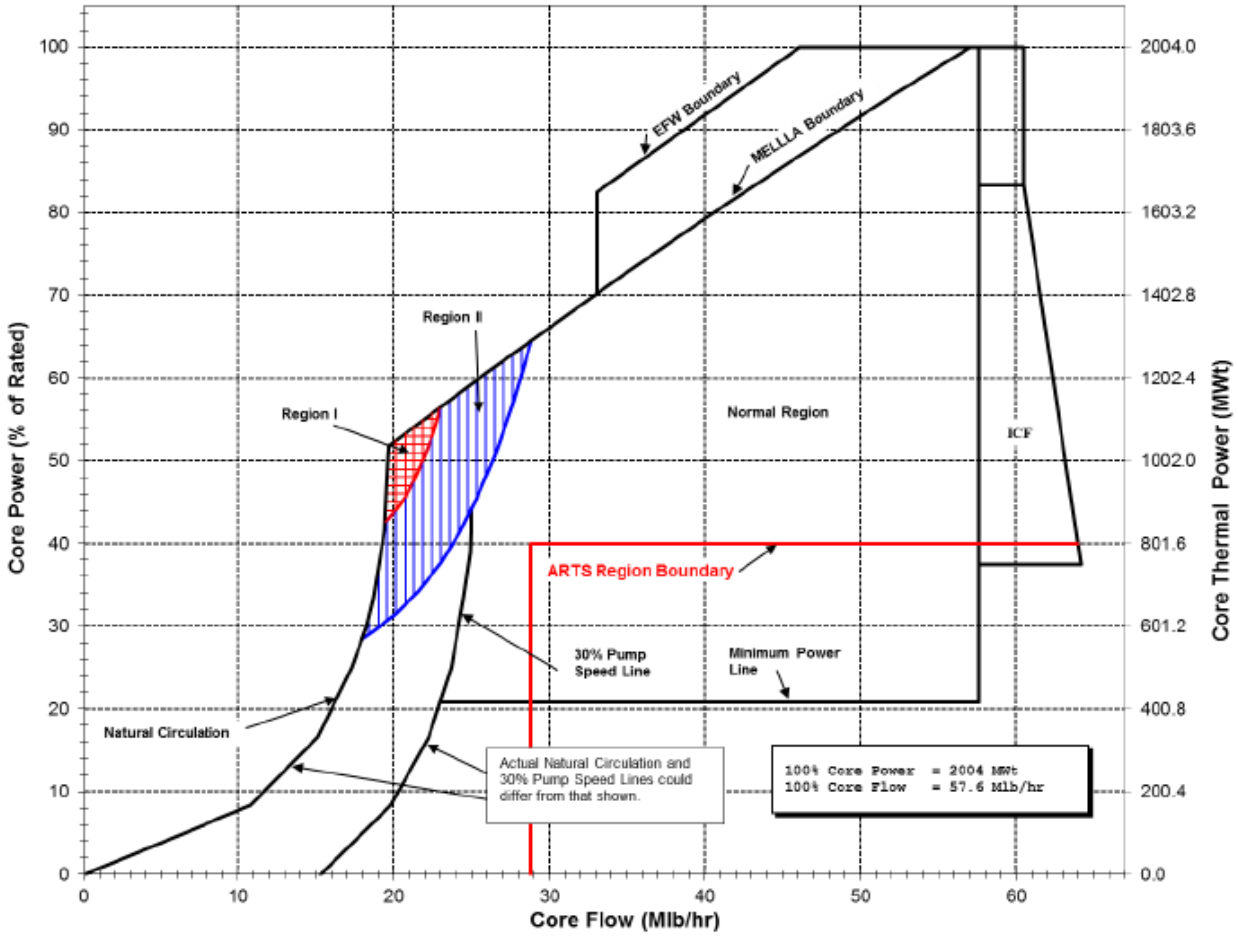
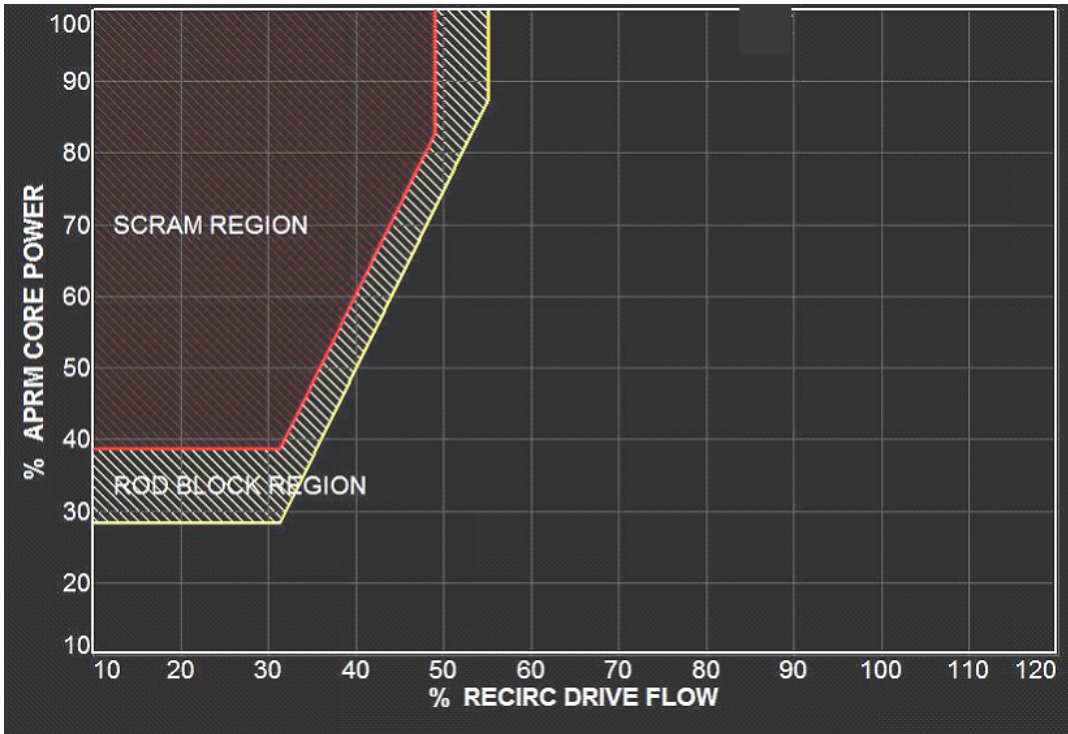

Figure 1 Power/Flow Map



2018 MONTICELLO ILT NRC EXAM - KEY

2. The plant was at rated conditions when a STATION BLACKOUT occurred. Shortly after the transient, one half of the Control Room lighting is restored.

For the above conditions, determine which of the following is the expected power availability to the Service Water Pumps (SWP)?

	<u>POWER to 11 SWP</u>	<u>POWER to 12 SWP</u>	<u>POWER to 13 SWP</u>
A.	UNAVAILABLE	UNAVAILABLE	UNAVAILABLE
B.	AVAILABLE	UNAVAILABLE	UNAVAILABLE
C.	AVAILABLE	AVAILABLE	UNAVAILABLE
D.	UNAVAILABLE	UNAVAILABLE	AVAILABLE

CORRECT ANSWER: B

JUSTIFICATION: Pump power is as follows:
 11 SWP – LC-107 via 13 Bus or 13 DG
 12 SWP – LC-104 via 16 Bus via 14 Bus
 13 SWP – LC-102 via 14 Bus

During a Station Blackout the 13 DG may or may not start and load. The candidate must determine if this is a SBO with 13 DG or an SBO without 13 DG. With one half of CR lighting restored this is an indication that 13 DG has started and loaded; therefore, power would be available to 11 SWP from LC-107 via 13 DG. The pump can be manually started once power is restored to LC-107. This is a change from a modification performed in the 2007 RFO. 11 SWP used to be powered from LC-103 via 15 Bus and wouldn't have had power during a Station Blackout. Candidates must interpret the SWP lineups and determine the extent of the Station Blackout or if a Loss of All Offsite power has occurred.

A is incorrect: Power would still be available to 11 SWP but would not auto start since 13 DG has auto loaded. This would have been the correct configuration on a Loss of All Offsite Power prior to the Mod.

C is incorrect: 12 SWP would not have power in a SBO. This lineup could be true in a Loss of ALL Offsite Power.

D is incorrect: 13 SWP would not have power, but 13 SWP is commonly misconceived as being powered by 13 DG.

REFERENCE: C.4-B.09.02.A B.08.01.01-05 **10 CFR** 55.41b(7)
ADDITIONAL REFERENCE PROVIDED DURING EXAM: None
QUESTION SOURCE: ILT Bank – 2009 NRC Exam
TIER: 1 **GROUP:** 1 **CATEGORY:** 295003 Partial or Complete Loss of AC
K/A: AA2.05 **IMPORTANCE:** RO 3.9 **COG LEVEL:** 2 DR
K/A DESCRIPTION: Ability to determine and/or interpret the following as they apply to PARTIAL OR COMPLETE LOSS OF A.C. POWER: Whether a partial or complete loss of A.C. power has occurred.
DIFFICULTY 3 **LESSON PL:** M8107L-016 **OBJECTIVE:** 4

2018 MONTICELLO ILT NRC EXAM - KEY

3. The plant was at rated conditions when an event occurred including the complete loss of Division 1 250 VDC. The following conditions are present:

- RCIC is NOT injecting
- HPCI automatically initiated and is injecting
- RHR and Core Spray pumps are NOT running
- Reactor Building Vent Exhaust Plenum radiation is 29 mrem/hr
- No operator action has been taken to this point

Using ONLY the information above, which EOPs should the crew enter at this time?

- (1) C.5-1100 RPV Control
- (2) C.5-1200 Primary Containment Control
- (3) C.5-1300 Secondary Containment Control

	<u>(1)</u>	<u>(2)</u>	<u>(3)</u>
A.	YES	NO	NO
B.	YES	NO	YES
C.	YES	YES	NO
D.	YES	YES	YES

CORRECT ANSWER: B

JUSTIFICATION: If HPCI is injecting with RHR and Core Spray pumps off then RPV water level fell below -47 inches, thus exceeding the +9 inch **EOP-1100** entry condition. **EOP-1300** is required because Reactor Building Vent Exhaust Plenum radiation is >20 mrem/hr.

A and C are incorrect: Plausible if examinee doesn't recall the EOP-1300 entry conditions.

C and D are incorrect: Plausible if examinee believes that since RCIC isn't running, HPCI initiated on high DW pressure which would require entry into C.5-1200. In this case, however, RCIC isn't running because of the loss of Division 1 250 VDC.

REFERENCE:	C.5-1100	C.5-1200	C.5-1300	10 CFR	55.41b(10)
ADDITIONAL REFERENCE PROVIDED DURING EXAM:			None		
QUESTION SOURCE:	New				
TIER:	1	GROUP:	1	CATEGORY:	295003 Partial or Complete Loss of DC Power
K/A:	2.4.2	IMPORTANCE:	RO 4.5	COG LEVEL:	1 P
K/A DESCRIPTION:	Knowledge of system set points, interlocks, and automatic actions associated with EOP entry conditions.				
DIFFICULTY	2	LESSON PL:	MT-ILT-EOP-002L/003L/004L	OBJECTIVE:	1

2018 MONTICELLO ILT NRC EXAM - KEY

4. The plant is operating in Mode 1 during a plant startup. Given the following:

- One Reactor Feed Pump is in service
- The Low Flow FW Reg. valve is in service in AUTO

Which is correct if a Turbine Trip occurs AND the Bypass Valves fail CLOSED?

- A. RPV water level will initially lower due to the collapse in core voids.
- B. PCIS will initiate a Group I isolation due to lowering main steam line pressure.
- C. DFLCS will shift to single element control due to the reduction in steam flow.
- D. A scram will occur due to the turbine control oil pressure lowering to <172.5 psig.

CORRECT ANSWER: A

JUSTIFICATION: The increase in pressure will cause voids to collapse and a reduction of indicated level. This will result in a rapid power increase and a full RPS trip from APRM high flux or RPV high pressure which will cause level to lower even more due to the collapse in voids following the scram

B is incorrect: With the Bypass valves failing to open, steam line pressure will rise. The candidate must recall that the Group 1 isolation signal is on lowering pressure <840 psig.

C is incorrect: With the Low flow FW reg. valve in service the loss of the steam flow input will have no effect on water level since DFCS is already in single element.

D is incorrect: The low control oil pressure scram in this case will be bypassed when < 30% power.

REFERENCE: C.4-A

10 CFR 55.41b(5)

ADDITIONAL REFERENCE PROVIDED DURING EXAM: None

QUESTION SOURCE: ILT Bank – 2009 NRC Exam

TIER: 1 **GROUP:** 1 **CATEGORY:** 295005 Main Turbine Generator Trip

K/A: AK1.03 **IMPORTANCE:** RO 3.5 **COG LEVEL:** 2 DR

K/A DESCRIPTION: Knowledge of the operational implications of the following concepts as they apply to MAIN TURBINE GENERATOR TRIP: Pressure effects on reactor level.

DIFFICULTY 2 **LESSON PL:** MT-ILT-AOP-001L **OBJECTIVE:** 8

2018 MONTICELLO ILT NRC EXAM - KEY

5. The plant was at rated conditions when Moisture Separator high level caused Main Turbine Lockout and a Reactor Scram. Given the following:

- EPR Setpoint is at 905 psig
- RPV Pressure is 1025 psig and rising
- RPV Water Level is 20 inches and stable
- The lowest RPV Water Level was -12 inches
- The Reactor Scram has been RESET
- Main Turbine Stop Valves have CLOSED
- Main Generator Field Breaker has OPENED
- Main Generator Output Breakers 8N7 and 8N8 have OPENED

Assuming NO operator actions; which of the following is correct for the conditions above?

- A. The Pressure Control System has failed as RPV pressure should be ~905 psig.
- B. The Lo Lo-SET System is expected to control RPV pressure ~900-1056 psig.
- C. The Main Generator Output Breakers should have remained CLOSED.
- D. The Main Generator Field Breaker should have remained CLOSED.

CORRECT ANSWER: A

JUSTIFICATION: The examinee must realize that given the above conditions, the MSIVs will remain open since a Group 1 isolation has not occurred. Since all of the Turbine Stop Valves are closed, pressure should be controlled via the Bypass Valves on the Electronic Pressure Regulator (EPR) at its previous setpoint. This value is typically around 900 psig following a reactor scram from full power.

B is incorrect: Low-Low Set System would maintain pressure 900-1056 psig but it is not expected since the MSIVs have not closed and bypass valve operation will maintain pressure. Additionally, LL-Set will not function with the scram reset.

C is incorrect: The Main Generator Output Breakers will immediately open and remain open on a Turbine Lockout.

D is incorrect: The Main Generator Field Breaker will immediately open on a turbine lockout.

REFERENCE:	C.4-A	C.5-3302	ARP 7-B-25	10 CFR	55.41b(7)
ADDITIONAL REFERENCE PROVIDED DURING EXAM:			None		
QUESTION SOURCE:	ILT Bank				
TIER:	1	GROUP:	1	CATEGORY:	295006 Scram
K/A:	AK2.07	IMPORTANCE:	RO 4.0	COG LEVEL:	2 DR
K/A DESCRIPTION:	Knowledge of the interrelations between SCRAM and the following: Reactor pressure control.				
DIFFICULTY	3	LESSON PL:	MT-ILT-AOP-001L	OBJECTIVE:	7

2018 MONTICELLO ILT NRC EXAM - KEY

6. The plant was at rated conditions when a Cable Spreading Room fire required an immediate evacuation of the Control Room. C.4-C (SHUTDOWN OUTSIDE CONTROL ROOM) Immediate Actions have been performed.

Complete the statement below concerning the performance of these Immediate Actions?

The plant is Scrammed and the Reactor Mode Switch is ...

- A. left in RUN to ensure the CONTAINMENT VENT RUN MODE INTLK remains in effect.
- B. left in RUN to maintain the MSIVs open and allow for plant cooldown from the ASDS panel.
- C. left in RUN to prevent an inadvertent depressurization of the vessel if a pressure regulator failure were to occur.
- D. placed in SHUTDOWN to ensure the reactor has a positive shutdown signal while the Control Room is unoccupied.

CORRECT ANSWER: C

JUSTIFICATION: If immediate evacuation is required the plant is scrammed and the Mode Switch is left in RUN to allow for a Group 1 Isolation if RPV pressure lowers to <840 psig. This may occur because there is a chance of a pressure regulator failure occurring within the assumed 10 minutes required to establish ASDS control.

A is incorrect: Although this interlock would remain in effect, this is not the reason for performing this step.

B is incorrect: It is left in this position to ensure the MSIVs close.

D is incorrect: Plausible for control room evacuation but not correct.

REFERENCE: C.4-C & Bases

10 CFR 55.41b(10)

ADDITIONAL REFERENCE PROVIDED DURING EXAM: None

QUESTION SOURCE: ILT Bank – Edits to stem and choices

TIER: 1 **GROUP:** 1 **CATEGORY:** 295016 Control Room Abandonment

K/A: AK3.01 **IMPORTANCE:** RO 4.1 **COG LEVEL:** 1 B

K/A DESCRIPTION: Knowledge of the reasons for the following responses as they apply to CONTROL ROOM ABANDONMENT: Reactor SCRAM.

DIFFICULTY 2 **LESSON PL:** MT-ILT-AOP-025L

OBJECTIVE: 2

2018 MONTICELLO ILT NRC EXAM - KEY

7. The plant is at rated conditions when the following alarms are received in the Control Room:

- 4-B-05 (RECIRC PUMP A LOW COOL WATER FLOW)
- 4-B-10 (RECIRC PUMP B LOW COOL WATER FLOW)
- 6-B-32 (RCT BLDG CLG WTR LOW DISCH PRESS)

Which of the following is an Immediate Operator Action if RBCCW System pressure can NOT be restored within 60 seconds?

- A. Trip the CRD Pumps.
- B. Verify RWCU system isolates.
- C. Close RBCCW Drywell Isolation Valves MO-1426, MO-4229, and MO-4230.
- D. Remove FPCC System from service before heat exchanger outlet temperature exceeds 120°F.

CORRECT ANSWER: C

JUSTIFICATION:

Immediate actions

Verify a RBCCW pump is running.

IF RBCCW System pressure cannot be restored within 60 seconds, THEN perform the following:

- a) Trip the Recirc pumps
- b) CLOSE RBCCW drywell isolation valves MO-1426, MO-4229, and MO-4230.
- c) If in Mode 1 or 2 scram
- d) Execute C.4-B.01.04.B (Trip of Two Recirc Pumps)

A is incorrect: Subsequent action requires monitoring of CRD pumps and keep one running if possible.

B is incorrect: This is a subsequent action.

D is incorrect: This is a subsequent action.

REFERENCE: C.4-B.02.05.A

10 CFR 55.41b(10)

ADDITIONAL REFERENCE PROVIDED DURING EXAM: None

QUESTION SOURCE: ILT Bank – Edits to stem and choices.

TIER: 1 **GROUP:** 1 **CATEGORY:** 295018 Partial of Complete Loss of CCW

K/A: AA1.02 **IMPORTANCE:** RO 3.3 **COG LEVEL:** 1 P

K/A DESCRIPTION: Ability to operate and/or monitor the following as they apply to PARTIAL OR COMPLETE LOSS OF COMPONENT COOLING WATER: System loads.

DIFFICULTY 2 **LESSON PL:** MT-ILT-AOP-004L **OBJECTIVE:** 1

2018 MONTICELLO ILT NRC EXAM - KEY

8. On a complete loss of Instrument Air, which of the following components will fail **OPEN**?
- A. V-D-25 (V-EF-28 ISOLATION DAMPER)
 - B. AO-1740 (COND DEMIN BYPASS)
 - C. CV-2104 (RCIC PUMP MIN FLOW)
 - D. CV-1474 (SERV AIR ISOL CV)

CORRECT ANSWER: C

JUSTIFICATION: RCIC Pump minimum flow valve will fail open resulting is CST water draining to the torus.

A is incorrect: All secondary containment isolation dampers will fail closed.

C is incorrect: The Cond Demin Bypass Valve will fail as-is.

D is incorrect: This valve will fail closed.

REFERENCE: C.4-B.08.04.01.A **10 CFR** 55.41b(7)
ADDITIONAL REFERENCE PROVIDED DURING EXAM: None
QUESTION SOURCE: New
TIER: 1 **GROUP:** 1 **CATEGORY:** 295019 Partial or Complete Loss of IA
K/A: AA2.02 **IMPORTANCE:** RO 3.6 **COG LEVEL:** 1 F
K/A DESCRIPTION: Ability to determine and/or interpret the following as they apply to PARTIAL OR COMPLETE LOSS OF INSTRUMENT AIR: Status of safety-related instrument air system loads.
DIFFICULTY 3 **LESSON PL:** MT-ILT-AOP-017L **OBJECTIVE:** 4

2018 MONTICELLO ILT NRC EXAM - KEY

9. The reactor is shutdown for a refueling outage. The following conditions exist:
- RPV water level is 57 inches
 - Reactor Coolant Temperature is 149°F
 - The Reactor Mode switch is in SHUTDOWN
 - ALL Reactor Vessel Head closure bolts are fully tensioned
 - Division 2 RHR/RHRSW pumps are in Shutdown Cooling (SDC)
 - Division 1 AC Busses are deenergized for a scheduled maintenance window

Electricians are performing a pre-maintenance walkdown and wish to open the Bus 16 POT drawer for visual inspection.

Which of the following SDC Technical Specification LCOs, if any, would be NOT MET if this drawer is opened?

- A. NONE; this maintenance will NOT affect SDC.
- B. LCO 3.4.7 (RHR Shutdown Cooling System – Hot Shutdown).
- C. LCO 3.4.8 (RHR Shutdown Cooling System – Cold Shutdown).
- D. LCO 3.9.8 (RHR – Low Water Level).

CORRECT ANSWER: C

JUSTIFICATION: Opening a Bus POT causes metering and relaying for the associated Bus to become de-energized. This will cause the main feeder breaker for Bus 16 to open resulting in loss of Bus 16 and all related loads. With this loss of power along with the Division 1 maintenance window, the examinee must determine that both shutdown cooling subsystems are inoperable. Then the examinee must determine that the plant is in Mode 4 and LCO 3.4.8 will be not met. This event occurred during the MNGP Loss of Bus 16 event during RFO-24.

A is incorrect: The examinee must recognize that bus pot removal will result in the loss of Bus 16 and a loss of SDC.

B is incorrect: This would be the correct answer if the plant was in Mode 3.

D is incorrect: 3.9.8 requires RHR SDC Mode to be operable and could be correct answer if the plant was in Mode 5 since water level is below 21'7" above the RPV flange. The water level given is normal level during shutdown cooling operations in Mode 4.

REFERENCE: TS 3.4.8 TS Table 1.1-1 Steam Tables **10 CFR** 55.41b(7)

REFERENCE PROVIDED DURING EXAM: Steam Tables

QUESTION SOURCE: ILT Bank – 2013 NRC Exam

TIER: 1 **GROUP:** 1 **CATEGORY:** 295021 Loss of Shutdown Cooling

K/A: 2.2.44 **IMPORTANCE:** RO 4.2 **COG LEVEL:** 2 RI

K/A DESCRIPTION: Ability to interpret control room indications to verify the status and operation of a system, and understand how operator actions and directives affect plant and system conditions.

DIFFICULTY 2 **LESSON PL:** MT-ILT-AOP-007L **OBJECTIVE:** 4

2018 MONTICELLO ILT NRC EXAM - KEY

10. During fuel movement from the core to the Fuel Pool, a fuel assembly becomes ungrappled and drops 20 ft. onto the top of the remaining fuel in the core. All refueling operations are stopped. Given the following timeline:

1000: The Fuel assembly is dropped

1001: Bubbles start to rise from the fuel assembly that was dropped

1002: The Refueling Bridge radiation monitor begins to alarm

1003: The Refuel Floor Area Radiation Monitor alarm has sounded

IMMEDIATE evacuation of the Refuel Floor is FIRST required when...

- A. the fuel assembly is dropped.
- B. bubbles start to rise from the fuel assembly.
- C. the Refueling Bridge radiation monitor begins to alarm.
- D. the Refuel Floor Area Radiation Monitor alarm has sounded.

CORRECT ANSWER: A

JUSTIFICATION: Ops Manual D.2 "Reactor Components Handling Equipment, Section 05 A.26.b.1)a.: "If it occurs that a fuel assembly or bundle is dropped, either in the fuel storage pool or the reactor vessel, the action below are to be taken: (1) Immediately clear the Refueling Floor of all personnel, even if the local radiation alarm siren has not sounded."

B is incorrect: Damaged fuel will release fission gasses and the bubbles will rise. This is a common BWR criterion for stoppage of fuel movement and evacuation.

C & D are incorrect: Ops Manual D.2 section 5.11 directs evacuation "at once" for high radiation alarms or high airborne radiation alarms. The high radiation would probably alarm before the airborne alarm, but both of these options occur after the first requirement to evacuate.

REFERENCE: D.2-05

10 CFR 55.41b(10)

ADDITIONAL REFERENCE PROVIDED DURING EXAM: None

QUESTION SOURCE: ILT Bank – 2009 NRC Exam – Minor edits to stem and choices

TIER: 1 **GROUP:** 1 **CATEGORY:** Refueling Accidents

K/A: AK1.01 **IMPORTANCE:** RO 3.6 **COG LEVEL:** 1P

K/A DESCRIPTION: Knowledge of the operational implications of the following concepts as they apply to REFUELING ACCIDENTS: Radiation exposure hazards.

DIFFICULTY 4 **LESSON PL:** M8107L-019 **OBJECTIVE:** 7

2018 MONTICELLO ILT NRC EXAM - KEY

11. The plant was at rated conditions with 11 & 12 RHR/RHR SW pumps in the Torus Cooling Mode when a Drywell steam leak and Group I isolation occurred. Conditions are as follows:
- Drywell pressure has risen to 3 psig.
 - Torus water temperature is 115°F and rising.
 - RPV level dropped to -35" and is slowly lowering.
 - RPV pressure is 600 psig.

Which of the following is correct concerning the current status of Torus cooling, and why?

- A. Torus cooling is no longer in operation because of the Low RPV water level.
- B. Torus cooling is no longer in operation because of the high Drywell pressure.
- C. Torus cooling is still in operation until the LPCI injection valves open at reduced RPV pressure.
- D. Torus cooling is still in operation; however, when RPV water level drops below Low-Low Level, torus cooling will no longer be in operation.

CORRECT ANSWER: B

JUSTIFICATION: The drywell pressure signal (1.84 psig) would have caused a LPCI initiation signal, which causes the Torus cooling isolation valves to close on interlock.

A is incorrect: LPCI initiation signal would not have been generated from RPV level until -47", NOT +9".

C is incorrect: There is no interlock associated with the 420 psig RPV pressure for the Torus cooling isolation valves.

D is incorrect: RPV Low-Low level is a LPCI initiation signal; however Torus cooling is not in service.

REFERENCE: B.03.04-02 **10 CFR** 55.41b(7)
ADDITIONAL REFERENCE PROVIDED DURING EXAM: None
QUESTION SOURCE: ILT Bank – Edits to stem and choices
TIER: 1 **GROUP:** 1 **CATEGORY:** 295024 High Drywell Pressure
K/A: EK2.12 **IMPORTANCE:** RO 3.5 **COG LEVEL:** 1I
K/A DESCRIPTION: Knowledge of the interrelations between HIGH DRYWELL PRESSURE and the following: Suppression pool cooling.
DIFFICULTY 2 **LESSON PL:** M8107L-023 **OBJECTIVE:** 7

2018 MONTICELLO ILT NRC EXAM - KEY

12. Which of the following is the ATWS System designed to maintain/prevent?
- A. Maintain RPV pressure < 1500 psig.
 - B. Prevent Torus water temperature from exceeding 110°F.
 - C. Maintain Containment pressure within the Pressure Suppression Limit.
 - D. Prevent the release of radioactive materials in excess of 10CFR100 guidelines.

CORRECT ANSWER: A

JUSTIFICATION: The ATWS (ARI) system initiation setpoint of 1135 psig is designed to limit the peak RPV pressure to less than the ASME Section III Code Service Level C limits (1500 psig).

B is incorrect: The ATWS system is designed to maintain Torus water temperature <170°F. Plausible scram required setpoint and SBLC initiation temperature.

C is incorrect: The ATWS system is designed to maintain containment pressure < 56 psig. The pressure suppression pressure limit for Containment pressure will be < 37 psig depending on Torus water level.

D is incorrect: Plausible design, however, this is the design of the PCIS system.

REFERENCE:	B.05.06-01	10 CFR	55.41b(7)
ADDITIONAL REFERENCE PROVIDED DURING EXAM:	None		
QUESTION SOURCE:	New		
TIER:	1	GROUP:	1
		CATEGORY:	295025 High Reactor Pressure
K/A:	EK3.06	IMPORTANCE:	RO 4.2
		COG LEVEL:	1 B
K/A DESCRIPTION:	Knowledge of the reasons for the following responses as they apply to HIGH REACTOR PRESSURE: Alternate rod insertion.		
DIFFICULTY	2	LESSON PL:	M8107L-071
		OBJECTIVE:	2

2018 MONTICELLO ILT NRC EXAM - KEY

13. The plant was at rated conditions when a severe ATWS condition occurred. The following indications were noted at **0800**:

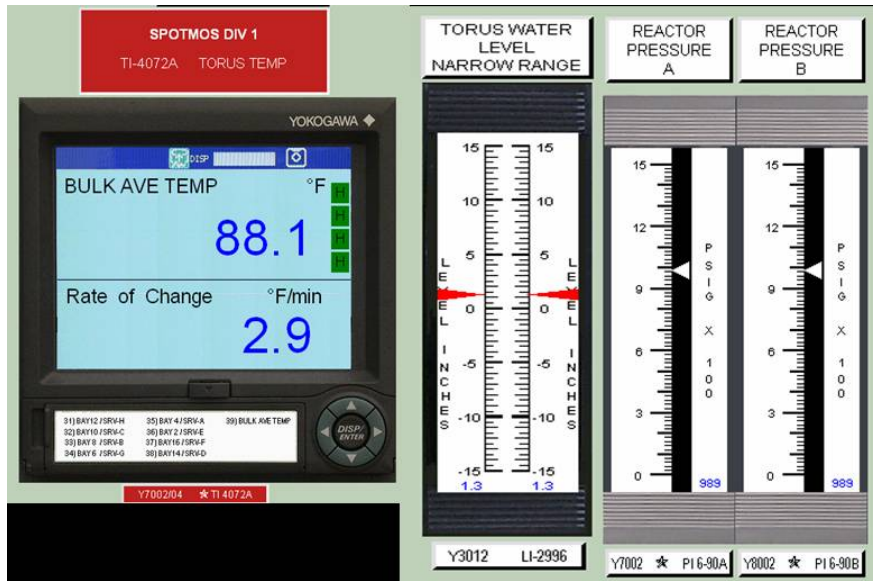

Of the times below, when will the Torus Heat Capacity (Detail M) be exceeded **FIRST?** (Assume Torus temperature rate of change, Torus water level and Reactor pressure remain constant. Detail M is on the following page).

- A. 0828
- B. 0835
- C. 0837
- D. 0839

CORRECT ANSWER: C

JUSTIFICATION: At 0837 Torus temperature will have risen to $(37 \text{ min} \times 2.9\text{F/min} + 88.1\text{F} = \mathbf{195.4\text{F}})$ With Rx Pressure at approximately 1000 psig and using the solid (-4" to +3.5") Torus level curve, Detail M will be exceeded.

A is incorrect: After 28 minutes Torus water temperature will be 169.3F. This would be the first to exceed Detail M only if using the dotted Torus Water level curve.

B is incorrect: After 35 minutes Torus water temperature will be 189.6F. This would exceed Detail M only if using the 1100 psig axis.

D is incorrect: After 39 minutes Torus water temperature will be 201.2F. This exceeds Detail M but wouldn't be first.

REFERENCE: C-5-1200 Detail M

10 CFR 55.41b(7)

REFERENCE PROVIDED DURING EXAM: None

QUESTION SOURCE: 2013 NRC Exam – Significantly Modified for new Detail M

TIER: 1 **GROUP:** 1 **CATEGORY:** 295026 Supp Pool High Water Temp

K/A: EA1.03 **IMPORTANCE:** RO 3.9 **COG LEVEL:** 3 SPK

K/A DESCRIPTION: Ability to operate and/or monitor the following as they apply to SUPPRESSION POOL HIGH WATER TEMPERATURE: Temperature monitoring

DIFFICULTY 3

LESSON PL: MT-ILT-EOP-003L

OBJECTIVE: 7.b

M

Heat Capacity Limit (SPDS 78)

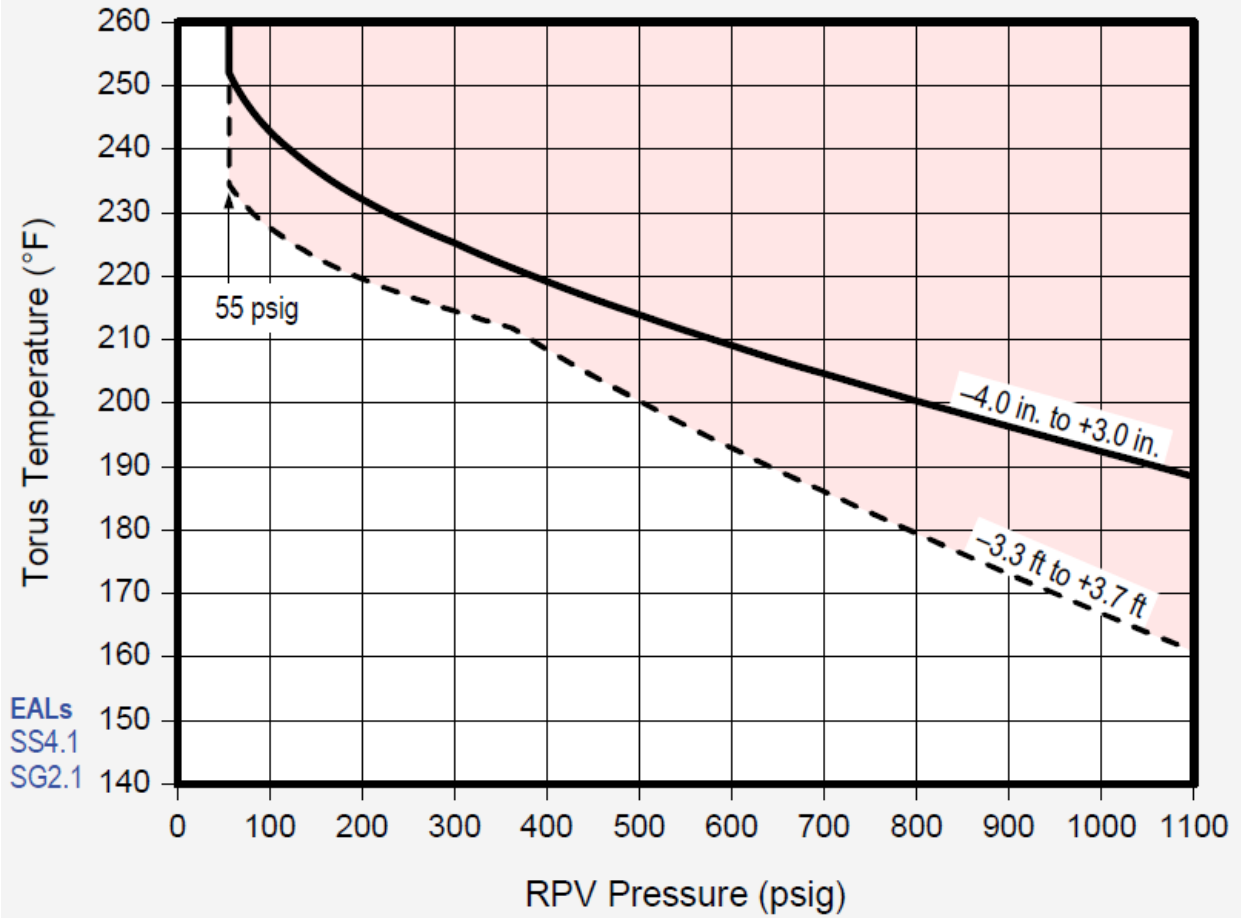

2018 MONTICELLO ILT NRC EXAM - KEY

14. The plant was at rated conditions when a Steam Line Rupture in the Drywell occurred. Given the following:

- Drywell sprays are in service to lower Drywell temperature
- Due to a logic failure, the "A" Loop Drywell Spray valves (MO-2020 and MO-2022) have been opened manually using the local handwheels

If a complete loss of Instrument Air (including Alternate Nitrogen) occurs, which of the following is correct?

- A. Reactor Building - Torus Vacuum Breakers will fail OPEN. Design Negative Containment Pressure will NOT be exceeded.
- B. Reactor Building - Torus Vacuum Breakers will fail CLOSED. Design Negative Containment Pressure MAY be exceeded.
- C. Reactor Building - Torus Vacuum Breakers will fail OPEN. Design Negative Containment Pressure MAY be exceeded.
- D. Reactor Building - Torus Vacuum Breakers will fail CLOSED. Design Negative Containment Pressure will NOT be exceeded.

CORRECT ANSWER: A

JUSTIFICATION: Reactor Building to suppression chamber vacuum relief is provided by two vacuum breaker valves in series in each of two parallel lines which are joined into one line attached to the suppression chamber. The first valve in each line is an air-operated, solenoid-controlled, 20" butterfly valve (AO-2379 and AO-2380). The butterfly valves fail open on loss of pneumatic supply and have an elastomer T-ring which requires pneumatic pressure to ensure a leak tight seat. The second valve in each line is a self-actuating check valve (DWV-8-1 and DWV-8-2).

B is incorrect: The vacuum breakers fail open and design negative pressure will not be exceeded.

C is incorrect: The design negative pressure will not be exceeded.

D is incorrect: The vacuum breakers fail open.

REFERENCE:	B.04.01-02	10 CFR	55.41b(7)
ADDITIONAL REFERENCE PROVIDED DURING EXAM:		None	
QUESTION SOURCE:	New		
TIER:	1	GROUP:	1
K/A:	EA2.05	IMPORTANCE:	RO 3.6
K/A DESCRIPTION:	Ability to determine and/or interpret the following as they apply to HIGH DRYWELL TEMPERATURE: Torus/suppression chamber pressure.		
DIFFICULTY	3	LESSON PL:	M8107L-044
		OBJECTIVE:	8

2018 MONTICELLO ILT NRC EXAM - KEY

15. Which of the following lists the torus water level at which HPCI is tripped and the reason for tripping HPCI at this level?
- A. -3.3 feet
prevents direct over pressurization of primary containment
 - B. -3.3 feet
prevents damage to HPCI exhaust piping due to pipe whip
 - C. -3.7 feet
prevents direct over pressurization of primary containment
 - D. -3.7 feet
prevents damage to HPCI exhaust piping due to pipe whip

CORRECT ANSWER: C

JUSTIFICATION: EOP-1200 Caution: Operating HPCI with torus level below -3.7 ft. may damage primary containment. Operation of the HPCI turbine with its exhaust unsubmerged will tend to directly pressurize the torus. If torus level cannot be maintained above the elevation of the top of the HPCI exhaust (-3.7 feet), HPCI is therefore secured if not needed for core cooling.

A and B are incorrect: This is a plausible level at which a Blowdown is required, but HPCI can remain running.

B and D are incorrect: Plausible consequence of uncovering the HPCI exhaust line with high pressure steam exiting.

REFERENCE:	C.5-1200	C.5.1-1200	10 CFR	55.41b(7,10)
ADDITIONAL REFERENCE PROVIDED DURING EXAM:		None		
QUESTION SOURCE:	ILT Bank			
TIER:	1	GROUP:	1	CATEGORY: 295030 Low Suppression Pool Water Level
K/A:	2.1.32	IMPORTANCE:	RO 3.8	COG LEVEL: 1 P
K/A DESCRIPTION:	Ability to explain and apply system limits and precautions.			
DIFFICULTY	2	LESSON PL:	MT-ILT-EOP-003L	OBJECTIVE: 4

2018 MONTICELLO ILT NRC EXAM - KEY

16. The plant was at rated conditions when a Main Turbine Trip and ATWS occurred. Given the following:

- SBLC is being injected
- Reactor power is 25% and slowly lowering
- RPV water level is -40" and intentionally being lowered
- Lo Lo-SET SRVs are lifting and Torus temperature is 112°F and rising

For the conditions above; which of the following is a valid reason for continuing to lower RPV water level?

- A. To further reduce reactor power.
- B. To prevent thermal-hydraulic instabilities.
- C. To further reduce feedwater inlet subcooling.
- D. To lower the amount of voids (void fraction) within the core.

CORRECT ANSWER: A

JUSTIFICATION: As RPV water level decreases, the height of the fluid columns is reduced, thereby reducing the natural circulation driving head. This lowers the natural circulation flow which raises the void fraction, thereby adding negative reactivity and lowering reactor power.

B is incorrect: Subcooling is minimized below -33", therefore, thermal-hydraulic instabilities will be prevented.

C is incorrect: With RPV level already below -33", the feedwater spargers will be uncovered and further reduction in subcooling will not occur. .

D is incorrect: Lowering RPV level will lower natural circulation which will raise the amount of voids in the core causing void fraction to rise.

REFERENCE: C.5.1-2007

10 CFR 55.41b(1)

REFERENCE PROVIDED DURING EXAM: None

QUESTION SOURCE: 2015 ILT Exam – Previous two exams

TIER: 1 **GROUP:** 1 **CATEGORY:** 295031 Reactor Low Water Level

K/A: EK1.03 **IMPORTANCE:** RO 3.7 **COG LEVEL:** 1 B

K/A DESCRIPTION: Knowledge of the operational implications of the following concepts as they apply to REACTOR LOW WATER LEVEL: Water level effects on reactor power

DIFFICULTY 2 **LESSON PL:** MT-ILT-EOP-007L **OBJECTIVE:** 4

2018 MONTICELLO ILT NRC EXAM - KEY

17. The plant was at rated conditions when an ATWS occurred. The OATC is unaware that the piping at Point A (Picture on the following page) is completely obstructed. The following actions are taken by the OATC:

- The SBLC control switch on C-05 is taken to the SYS 1 position, then through OFF to the SYS 2 position, then back through OFF and returned to the SYS 1 position.

Based on conditions above, complete the following statement describing the #11 SBLC Pumps ability to inject to the RPV? (Assume no other malfunctions have occurred.)

The #11 SBLC Pump...

- A. DID NOT inject to the RPV when the control switch was placed in SYS 1 the first time, but DID inject to the RPV when the control switch was placed in SYS 1 the second time.
- B. DID inject to the RPV when the control switch was placed in SYS 2, but DID NOT inject to the RPV when the control switch was returned to SYS 1.
- C. DID inject to the RPV when the control switch was in SYS 1 both times.
- D. NEVER injected to the RPV.

CORRECT ANSWER: A

JUSTIFICATION: The picture on the following page points to the immediate discharge piping of the #11 Squib Valve. The SBLC injection piping is separated at the squib valves so this blockage will prevent injection through the #11 Squib Valve. #11 SBLC Pump did not inject the first time the switch was taken to SYS 1 since the "A" squib valve line is obstructed. When the control switch is taken to SYS 2 the "B" squib valve will fire. Since the #11 SBLC pump can discharge through the "B" squib valve, the #11 SBLC pump will inject when the control switch is returned to SYS 1.

B is incorrect: SBLC will inject through SYS 2 and also when switch is returned to SYS 1.

C and D are incorrect: Plausible misunderstandings of how the system is constructed and operates.

REFERENCE: B.03.05-02 NH-36253 **10 CFR** 55.41b(7)

ADDITIONAL REFERENCE PROVIDED DURING EXAM: None

QUESTION SOURCE: ILT Bank – 2015 NRC Exam – Edits to stem and choices
From previous two NRC Exams

TIER: 1 **GROUP:** 1 **CATEGORY:** 295037 Scram Condition Present and Reactor Power Above APRM Downscale or Unknown

K/A: EK2.04 **IMPORTANCE:** RO 4.4 **COG LEVEL:** 3 PEO

K/A DESCRIPTION: Knowledge of the interrelations between SCRAM CONDITION PRESENT AND REACTOR POWER ABOVE APRM DOWNSCALE OR UNKNOWN and the following: SBLC system.

DIFFICULTY 3 **LESSON PL:** M8107L-004 **OBJECTIVE:** 7

2018 MONTICELLO ILT NRC EXAM - KEY

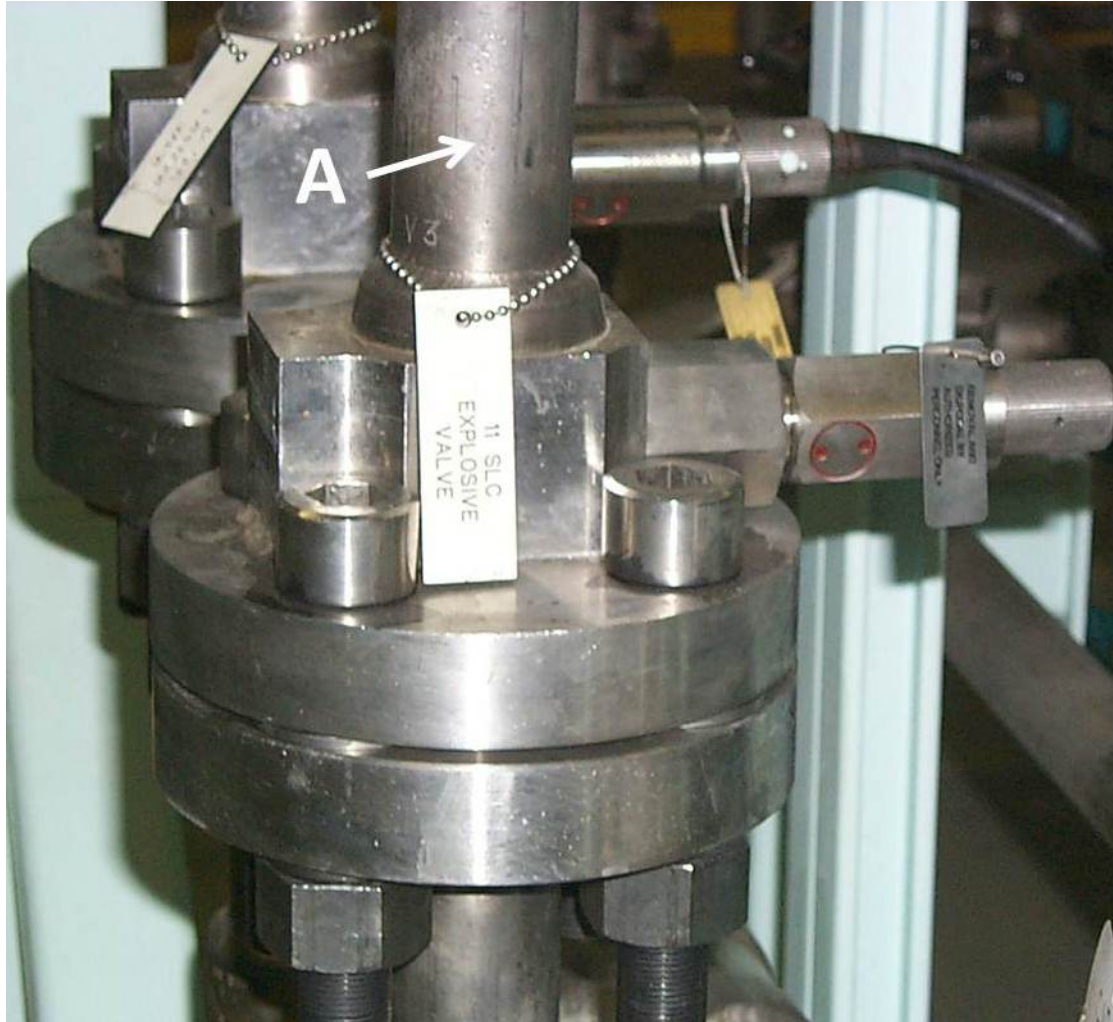

2018 MONTICELLO ILT NRC EXAM - KEY

18. The plant is at rated conditions when an event occurs resulting in a High Off-Site Release. Given the following:

- Refueling Floor Radiation Monitors – 60 mrem/hr

Complete the following statement that describes the CRV/EFT system response to the above condition and why?

The CRV/EFT system will...

- A. remain in Normal Mode because CRV/EFT is **NOT** affected by the above conditions.
- B. shift to Recirculation Mode **isolating** outside contaminated air from entering the Control Room atmosphere.
- C. shift to High Radiation Mode providing pressurized air to the Control Room preventing in-leakage from adjacent spaces.
- D. shift to High Radiation Mode **isolating** the Control Room and requiring the crew to utilize the Control Room Breathing Air Supply.

CORRECT ANSWER: C

JUSTIFICATION: CRV/EFT will shift to the High Rad mode when either Refueling Floor Radiation Monitors reach 50 mrem/hr or RB Exhaust Plenum Radiation Monitors reach 26 mrem/hr or Control Room Air Intake Radiation Monitors reach 1 mrem/hr. The CRV-EFT System will automatically shift into the High Radiation Mode to provide HEPA/charcoal filtered outside air to the Control Room and EFT Building 1st and 2nd floors to pressurize them. This will prevent any leakage into the Control Room from adjacent spaces.

A is incorrect: Prior to the modification during the 2007 RFO this would have been correct because the only signal that would cause entry into this mode was the 1 mrem/hr at the CR intake.

B is incorrect: The Recirc Mode is initiated manually and is used for total isolation during a toxic gas event.

D is incorrect: This is the correct mode but the control room won't be isolated. When isolated in the recirc mode control room breathing air may be required during a toxic gas event.

REFERENCE: B.08.13-01 **10 CFR** 55.41b(11)

ADDITIONAL REFERENCE PROVIDED DURING EXAM: None

QUESTION SOURCE: ILT Bank – Edits to stem and choices

TIER: 1 **GROUP:** 1 **CATEGORY:** 295038 High Offsite Rad Release Rate

K/A: EK3.02 **IMPORTANCE:** RO 3.9 **COG LEVEL:** 3 PEO

K/A DESCRIPTION: Knowledge of the reasons for the following responses as they apply to HIGH OFF-SITE RELEASE RATE: System isolations.

DIFFICULTY 3 **LESSON PL:** M8107L-049 **OBJECTIVE:** 7

2018 MONTICELLO ILT NRC EXAM - KEY

19. Given the picture below:



Which of the following would be consistent with the indications shown?

- A. Annunciator 20-A-8 (FIRE) is in alarm.
- B. The Deluge was manually initiated on the 2R Transformer.
- C. The Deluge automatically initiated spray on the 2R Transformer.
- D. Annunciator 20-A-15 (FIRE PROTECTION SYSTEM OPERATED) is in alarm.

CORRECT ANSWER: A

JUSTIFICATION: When the 2R HAD is activated or 190°F is reached at the LHD, and alarm will be received at panel C-522. This will actuate the Trouble alarm light above and initiate the fire alarm (20-A-8).

B is incorrect: The examinee must determine from the picture that this hasn't occurred. Plausible action to cause the trouble light, but no indication initiates when the arming collar is rotated. This is unlike the ATWS arming collars that alarm when rotated.

C is incorrect: The deluge valve is normally open, however, spray will not commence until the arming collar is rotated and the trip pushbutton depressed.

D is incorrect: This alarm will not come in until the manual trip pushbutton is armed and depressed. Plausible, however, because the Turbine Building Siding Deluge will automatically initiate when the detector operated light is on.

REFERENCE:	ARP 20-A-8	ARP 20-A-15	10 CFR	55.41b(8)
ADDITIONAL REFERENCE PROVIDED DURING EXAM:	None			
QUESTION SOURCE:	New			
TIER:	1	GROUP:	1	CATEGORY: 600000 Plant Fire on Site
K/A:	AA1.06	IMPORTANCE:	RO 3.0	COG LEVEL: 2 DR
K/A DESCRIPTION:	Ability to operate and/or monitor the following as they apply to PLANT FIRE ON SITE: Fire alarm.			
DIFFICULTY	3	LESSON PL:	MT-ILT-AOP-016L	OBJECTIVE: 12

2018 MONTICELLO ILT NRC EXAM - KEY

20. The plant was at rated conditions with the following Main Generator conditions:

- 600 MWe with 0 MVARs
- H2 pressure is 30 psig
- The Voltage Regulator is in automatic

If a malfunction results in the continuous rise in Main Generator **field current**, Which of the following is correct? (The REACTIVE CAPABILITY VS MEGAWATT LOAD curve is on the following page.)

- A. Delivered VARs OUT will rise exceeding the generators reactive capability.
- B. Received VARs IN will rise exceeding the generators reactive capability.
- C. Delivered VARs OUT will rise until the under excitation limit is reached.
- D. Received VARs IN will rise until the under excitation limit is reached.

CORRECT ANSWER: A

JUSTIFICATION: The examinee must determine that a rise in field current results in over-exciting a generator. VARs OUT occurs in over-excited machines (also known as a lagging power factor or delivered +VARs). With generator H2 pressure at 30 psig, the capability curve will eventually be exceeded.

B is incorrect: VARs IN would occur in an under-excited machine.

C is incorrect: Plausible for if examinee believes that since the voltage regulator is in automatic, it will counter the malfunction and attempt to receive VARs.

D is incorrect: In the case of an under excited machine, VARs IN would lower to the under excitation limit and stop.

REFERENCE:	B.09.02-02	B.09.02-06 Fig 1	10 CFR	55.41b(5)
ADDITIONAL REFERENCE PROVIDED DURING EXAM:	None			
QUESTION SOURCE:	New			
TIER:	1	GROUP:	1	CATEGORY: 700000 Generator Voltage and Electric Grid Disturbances
K/A:	AA2.03	IMPORTANCE:	RO 3.5	COG LEVEL: 3 SPK/SPR
K/A DESCRIPTION:	Ability to determine and/or interpret the following as they apply to GENERATOR VOLTAGE AND ELECTRIC GRID DISTURBANCES: Generator current outside the capability curve.			
DIFFICULTY	3	LESSON PL:	M8107L-015	OBJECTIVE: 7

2018 MONTICELLO ILT NRC EXAM - KEY

REACTIVE CAPABILITY VS MEGAWATT LOAD – TURBINE GENERATOR

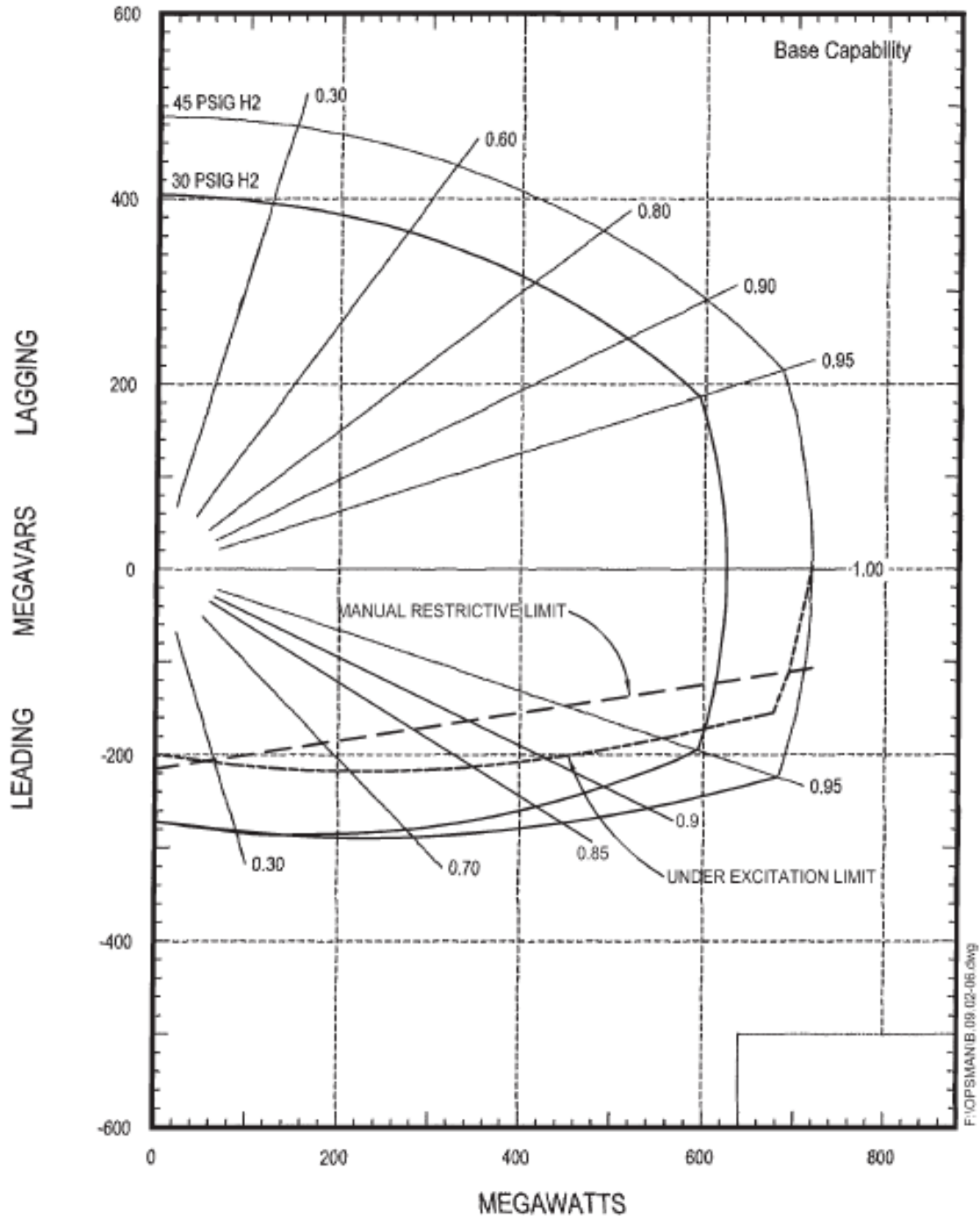

2018 MONTICELLO ILT NRC EXAM - KEY

21. The plant was at rated conditions when a steam line rupture in the Drywell resulted in the following conditions:

- Drywell pressure is 33 psig
- Drywell temperature is 340°F
- RPV pressure is 200 psig and slowly lowering
- Attempts to spray the drywell have been unsuccessful
- Total indicated Steam Flow peaked at 125% of rated steam flow
- The CRS has entered C.5-2002 (EMERGENCY DEPRESSURIZATION)

Based on the conditions above, which of the following is correct?

- A. Main Turbine Bypass Valves can be used for Alternate Depressurization; ONLY Drywell Design Temperature has been exceeded.
- B. Main Turbine Bypass Valves can be used for Alternate Depressurization; RPV-to-Drywell differential pressure is above Decay Heat Removal Pressure.
- C. ADS valves may NOT open; RPV-to-Drywell differential pressure is below Decay Heat Removal Pressure.
- D. ADS valves may NOT open; Drywell Design Temperature and ADS EQ Temperature Limit have been exceeded.

CORRECT ANSWER: D

JUSTIFICATION: The ADS valve EQ Qualification maximum temperature is 338°F. This temperature is bounded by the maximum analyzed DW accident temperature of 340°F. Reactor pressure relief functions are included in the scope of the EQ program which ensures that the portions of the equipment located in the Drywell are qualified. Since this has been exceeded the ADS valves may fail to open on an ADS initiation or if manually opening the valve. The high drywell temperature and humidity conditions can cause the solenoid valve to short resulting in blow power supply fuses resulting in the solenoid becoming deenergized.

A is incorrect: Drywell design temperature is 281°F. This has been exceeded, but it is not the only temperature limit that has been exceeded. The ADS valves would still be directed. Main Turbine Bypass valves would be unavailable because a Group 1 isolation has occurred from total steam flow being greater than 116.9% of rated.

B is incorrect: Main Turbine Bypass valves would be unavailable because a Group 1 isolation has occurred from total steam flow being greater than 116.9% of rated. Decay heat removal press is the lowest pressure at which an SRV will fully open and remain fully opened (55 psid) When its control switch is placed in open. The given differential pressure is 167 psid.

C is incorrect: Decay heat removal press is the lowest pressure at which an SRV will fully open and remain fully opened (55 psid) When its control switch is placed in open. The given differential pressure is 167 psid.

REFERENCE: C.5.1-1200 NX-7831-143-1 NX-7831-143-2 **10 CFR** 55.41b(7)

ADDITIONAL REFERENCE PROVIDED DURING EXAM: None

QUESTION SOURCE: New

TIER: 1 **GROUP:** 2 **CATEGORY:** 295010 High Drywell Pressure

K/A: AK1.03 **IMPORTANCE:** RO 3.2 **COG LEVEL:** 1 F

K/A DESCRIPTION: Knowledge of the operational implications of the following concepts as they apply to HIGH DRYWELL PRESSURE: Temperature increases.

DIFFICULTY 3 **LESSON PL:** MT-ILT-EOP-003L **OBJECTIVE:** 6.b

2018 MONTICELLO ILT NRC EXAM - KEY

22. A reactor startup is in progress when a Control Rod Drop Accident occurred resulting in the following conditions:

- Recirc flow is 12% core flow
- Reactor Pressure is 550 psig
- Reactor Power is 28% of rated power

Which one of the following actions is required?

- A. No actions are required.
- B. Raise reactor pressure to > 686 psig ONLY.
- C. Insert all insertable control rods within 2 hours.
- D. Lower Recirculation flowrate to <10% core flow.

CORRECT ANSWER: C

JUSTIFICATION: Reactor Core Safety Limits

With the reactor steam dome pressure <686 psig (GE) <586 (Areva) or core flow <10% rated core flow:

Thermal power shall be \leq 25% Rated Thermal Power

Required Actions:

With any Safety Limit violation, the following actions shall be completed within 2 hours:

Restore compliance with all Safety Limits; and

Insert all insertable control rods.

Inserting all insertable control rods will reduce power to less than 28% and restore compliance with Safety limits.

A is incorrect: Plausible if the examinee believes that pressure AND flow must be outside the limit.

B is incorrect: This would be correct action but not the only action.

D is incorrect: Plausible for misconception that lowering flow to lower power would mitigate this accident.

REFERENCE:	TS 2.1.1.1	TS 2.2	10 CFR	55.41b(2)
ADDITIONAL REFERENCE PROVIDED DURING EXAM:	None			
QUESTION SOURCE:	ILT Bank – Edits to stem and choices			
TIER:	1	GROUP:	2	CATEGORY: 295014 Inadvertent Reactivity Addition
K/A:	AK2.10	IMPORTANCE:	RO 4.1	COG LEVEL: 1 P, B
K/A DESCRIPTION:	Knowledge of the interrelations between INADVERTENT REACTIVITY ADDITION and the following: Safety limits.			
DIFFICULTY	2	LESSON PL:	MT-ILT-ITS-003L	OBJECTIVE: 2

2018 MONTICELLO ILT NRC EXAM - KEY

23. The plant was at rated conditions. A transient occurred resulting in an elevated fission product release and automatic initiation of the SBTG System.

With the conditions above, why should V-EF-20/21/22 (RB PLENUM EXHAUST FANS) be verified in the OFF position, and what would be the effect if these fans were NOT secured?

<u>WHY</u>	<u>WHAT EFFECT</u>
A. To prevent Turbine Building pressure becoming more negative than the Reactor Building.	Could cause some radioactivity to bypass the SBTG filtration.
B. To prevent Turbine Building pressure becoming more negative than the Reactor Building.	Could cause backflow through the SBTG train and reduce its effectiveness.
C. To prevent the Main Exhaust Plenum Room being at a lower pressure than SCTMT.	Could cause some radioactivity to bypass the SBTG filtration.
D. To prevent the Main Exhaust Plenum Room being at a lower pressure than SCTMT.	Could cause backflow through the SBTG train and reduce its effectiveness.

CORRECT ANSWER: C

JUSTIFICATION: With the Main Plenum Exhaust fans running, the Plenum Room could be at a lower pressure which would allow leakage from secondary containment that would not be treated by the SBTG System.

A is incorrect: If these fans remain on the TB supply fans will not trip. The Turbine Building pressure could become more negative but would not become more negative than the Reactor Building.

B is incorrect: The Turbine Building pressure could become more negative but would not become more negative than the Reactor Building. Backflow through SBTG would not be caused by continued operation of the exhaust fans.

D is incorrect: Backflow through SBTG would not be caused by continued operation of the exhaust fans.

REFERENCE:	B.04.02-05	10 CFR	55.41b(9)
ADDITIONAL REFERENCE PROVIDED DURING EXAM:	None		
QUESTION SOURCE:	ILT Bank – Edits to stem and choices		
TIER:	1	GROUP:	2
		CATEGORY:	295017 Abnormal Offsite Release Rate
K/A:	AK3.02	IMPORTANCE:	RO 3.3
		COG LEVEL:	1 P/B
K/A DESCRIPTION:	Knowledge of the reasons for the following responses as they apply to HIGH OFF-SITE RELEASE RATE: Plant ventilation.		
DIFFICULTY	3	LESSON PL:	M8107L-008
		OBJECTIVE:	7

2018 MONTICELLO ILT NRC EXAM - KEY

24. A plant startup is in progress with the Rx Mode Switch in START TO HOT STANDBY and the following conditions:

- RPV water level is +34" and stable
- 11 CRD Pump is in service
- RWCU Dump flow is 40 gpm
- MO-2399 (RWCU RETURN) is 50% open

If the in-service CV-3-19A (CRD FLOW CV) valve fails closed, how will RWCU Dump flow need to be adjusted in order to maintain RPV level relatively stable?

- A. Open MO-2399 only, RWCU Dump flow can NOT be reduced.
- B. Close MO-2399 and maximize RWCU Dump flow.
- C. Raise RWCU Dump flow to ~80 gpm.
- D. Secure RWCU Dump flow.

CORRECT ANSWER: D

JUSTIFICATION: With the reactor scram reset, the CRDH system will provide approximately 40 gpm to the RPV via the cooling water header. With the loss of CRD pump flow to the cooling water header, this flow will go away and RWCU dump flow will need to be lowered otherwise RPV level will start trending lower.

A is incorrect: Plausible for the 40 gpm interlock that will trip the RWCU pumps if dump flow is less than 40 gpm with MO-2399 closed.

B is incorrect: Plausible misconception with the 100 gpm that CRDH injects to the vessel post scram.

C is incorrect: Plausible for opposite compensation of the malfunction.

REFERENCE:	C.4-A	10 CFR	55.41b(10)
ADDITIONAL REFERENCE PROVIDED DURING EXAM:		None	
QUESTION SOURCE:	New		
TIER:	1	GROUP:	2
		CATEGORY:	295022 Loss of CRD Pumps
K/A:	AA1.04	IMPORTANCE:	RO 2.5
		COG LEVEL:	2 RI
K/A DESCRIPTION:	Ability to operate and/or monitor the following as they apply to LOSS OF CRD PUMPS: Reactor water cleanup system.		
DIFFICULTY	2	LESSON PL:	MT-ILT-AOP-001L
		OBJECTIVE:	4

2018 MONTICELLO ILT NRC EXAM - KEY

25. The plant was at rated conditions when an event occurred resulting in the following:

- Drywell pressure is 1.6 psig
- Reactor water level is 7 inches
- Reactor Building Vent radiation monitors indicate 31 mrem/hr

Which one of the following identifies an expected response to current plant conditions?

- A. RCIC will automatically initiate.
- B. RWCU will automatically isolate.
- C. LPCI Loop Select Logic will energize.
- D. Secondary Containment will automatically isolate.

CORRECT ANSWER: D

JUSTIFICATION: The Reactor Building vent plenum monitors have a high trip of 26 mrem/hr. This is also the Partial Group 2 isolation which will automatically isolate Secondary Containment and start SBTG.

A is incorrect: Although a 9" Low level Group 2 isolation and reactor scram signal is present, RCIC does not automatically initiate until Low-Low Level (-47") is reached.

B is incorrect: RWCU doesn't automatically isolate until -47" RPV water level. Plausible, however, because prior to a plant modification, RWCU did automatically isolate at 9".

C is incorrect: LPCI loop select logic will not energize until 1.84 psig in the drywell or -47" RPV water level.

REFERENCE: ARP 5-A-1

10 CFR 55.41b(7)

REFERENCE PROVIDED DURING EXAM: None

QUESTION SOURCE: 2013 NRC Exam – Significantly Modified

TIER: 1 **GROUP:** 2 **CATEGORY:** 295033 High Secondary Containment Area Radiation Levels

K/A: EA2.01 **IMPORTANCE:** RO 3.8 **COG LEVEL:** 1I

K/A DESCRIPTION: Ability to determine and/or interpret the following as they apply to HIGH SECONDARY CONTAINMENT AREA RADIATION LIMITS: Area radiation levels.

DIFFICULTY 2 **LESSON PL:** M8107L-008 **OBJECTIVE:** 7

2018 MONTICELLO ILT NRC EXAM - KEY

26. The plant is at rated conditions. A plant worker calls the control room and reports that it is difficult to pull OPEN Door-63 (MAIN ACCESS TO RX BLDG - INNER DOOR). The manometer on C-24 is reading -1.30 inches of H₂O.

Which of the following is a correct action to normalize the C-24 manometer reading?

- A. Manually place SBGT in service.
- B. Manually isolate Secondary Containment.
- C. Adjust the variable inlet vanes V-EF-20/21/22 (MAIN EXHAUST PLENUM FANS).
- D. Adjust the variable inlet vanes on V-EF-24A or V-EF-24B (RX BLDG EXHAUST FAN).

CORRECT ANSWER: D

JUSTIFICATION: Abnormally low pressure will cause airlock doors to be more difficult to open and cause the doors to close with more force. If the manometer is reading -1.25 inches of H₂O, then the Reactor Building Operator would be directed to adjust the variable inlet vanes (VIVs) on V-EF-24A or V-EF-24B in accordance with the applicable B-manual procedure.

A is incorrect: Manually starting SBGT will not isolate secondary containment, which will not correct the problem.

B is incorrect: Procedural direction to perform this procedure is only allowed when the RB is inaccessible. Since the RB is accessible, this procedure would not be performed.

C is incorrect: V-EF-20/21/22 have variable inlet vanes but are not adjusted for low pressure in the RB.

REFERENCE: B.04.02-05

10 CFR 55.41b(7)

REFERENCE PROVIDED DURING EXAM: None

QUESTION SOURCE: ILT Bank – 2013 NRC Exam

TIER: 1 **GROUP:** 2 **CATEGORY:** 295035 Secondary Containment High Differential Pressure

K/A: 2.4.35 **IMPORTANCE:** RO 4.2 **COG LEVEL:** 1 I

K/A DESCRIPTION: Knowledge of local auxiliary operator tasks during an emergency and the resultant operational effects.

DIFFICULTY 2 **LESSON PL:** M-8107L-027 **OBJECTIVE:** 8

2018 MONTICELLO ILT NRC EXAM - KEY

27. The plant has experienced a severe accident from rated power. Given the following:

- Drywell pressure is 47 psig
- Torus water level is +0.5 feet
- Both SBT systems are unavailable
- High hydrogen levels exist in Primary Containment
- Operators are executing C.5-3505 (VENTING PRIMARY CONTAINMENT)

Based on the given conditions; what location(s) can Primary Containment Venting be performed from?

- A. Control Room ONLY
- B. Turbine Building ONLY
- C. Alternate Shutdown Panel OR Turbine Building ONLY
- D. Control Room OR Turbine Building OR Alternate Shutdown Panel

CORRECT ANSWER: C

JUSTIFICATION: C.5-3505 has four parts (A-B-C-D). Parts B and C require the use of SBT to vent the containment. Part A uses the Hard Pipe Vent and this method can be used for the given conditions. Part D vents via the Hard Pipe Vent from the turbine building and could be used if Part A can't be used.

A and D are incorrect: Venting could only be performed from the control room if SBT is available.

B is incorrect: Venting operations can also be performed from the ASDS panel.

REFERENCE:	C.5-3505	10 CFR	55.41b(10)
ADDITIONAL REFERENCE PROVIDED DURING EXAM:	None		
QUESTION SOURCE:	LOR Bank		
TIER:	1	GROUP:	2
		CATEGORY:	500000 High Containment Hydrogen Concentration
K/A:	EK2.07	IMPORTANCE:	RO 3.2
		COG LEVEL:	2 RI
K/A DESCRIPTION:	Knowledge of the interrelations between HIGH CONTAINMENT HYDROGEN CONCENTRATIONS and the following: Drywell Vent System.		
DIFFICULTY	3	LESSON PL:	MT-ILT-EOP-003L
		OBJECTIVE:	4

2018 MONTICELLO ILT NRC EXAM - KEY

28. The plant is at rated conditions with the Service Water (SW) system functional and the RHRSW System operable.

Which of the following describes the effect on RHR/LPCI pump operability if it is discovered that both 13 & 14 EFT-ESW pumps are INOPERABLE?

- A. RHR/LPCI pump operability is NOT dependent on SW or EFT-ESW.
- B. RHR/LPCI pump operability is NOT dependent on EFT-ESW if SW is available.
- C. RHR/LPCI pump operability is NOT dependent on EFT-ESW if RHRSW is available.
- D. RHR/LPCI pump operability is affected based on backup cooling water needs.

CORRECT ANSWER: D

JUSTIFICATION: 13 and 14 RHR Pumps receive backup motor cooling from the EFT-ESW pumps. Additionally, both RHR rooms receive backup room cooler cooling from ESW. The ESW system must be available to provide the backup cooling needs of the RHR pumps' motor upper bearings and the RHR Room coolers. The EFT-EST Operations manual states "If a component, such as a pump, valve, or piping in the ESW system is inoperable and its ability to supply cooling water to safety related loads is compromised, then V-AC-4 and V-AC-5 are NOT required to be considered inoperable. In this case, Tech Spec 3.7.2 applies. However, Tech Spec LCO 3.0.6 SHALL be invoked and a safety function determination should be performed for the supplied loads that have their own Tech Spec section." An SFDP would determine with both divisions of EFT-ESW inoperable that there would be a loss of safety function for the RHR/LPCI pumps rendering them inoperable.

A is incorrect: Plausible if examinee believes Service Water and ESW don't affect LPCI injection.

B is incorrect: Plausible if examinee believes only normal Service Water is required for pump operability.

C is incorrect: Plausible if examinee believes only RHRSW is required for LPCI operability

REFERENCE: B.03.04-05 **10 CFR** 55.41b(7)

REFERENCE PROVIDED DURING EXAM: None

QUESTION SOURCE: ILT Bank

TIER: 2 **GROUP:** 1 **CATEGORY:** 203000 RHR/LPCI: Injection Mode

K/A: K6.10 **IMPORTANCE:** RO 3.0 **COG LEVEL:** 1 P

K/A DESCRIPTION: Knowledge of the effect that loss or malfunction of the following will have on the RHR/LPCI: INJECTION MODE: Component cooling water systems

DIFFICULTY 3 **LESSON PL:** M8107L-023 **OBJECTIVE:** 9

2018 MONTICELLO ILT NRC EXAM - KEY

29. The 11 RHR Pump is operating in a Normal Shutdown Cooling Mode. Given the following:

- 11 RHRSW Pump flow is 2000 gpm
- 11 RHR Pump flow is 3800 gpm
- RHR HX dP is 50 psid

Which of the following actions would BOTH raise the cooldown rate AND be allowed by procedure?

Throttle...

- A. CLOSED RHR-4-1 (11 RHR HX INLET).
- B. OPEN MO-2002 (11 RHR HX BYPASS).
- C. OPEN RHR-5-1 (11 RHR HX DISCHARGE).
- D. OPEN CV-1728 (11 RHR HX RHRSW OUTLET).

CORRECT ANSWER: D

JUSTIFICATION: If increased cooldown rate is desired, then perform one or more of the following actions as required to achieve the desired cooldown rate:

- Throttle open RHR-4-1
- Throttle closed MO-2002
- Increase RHRSW flow while maintaining RHR HX dP > 20 psid

Operating the RHRSW controller in manual from the control room in the open direction will raise RHRSW flow which is allowed as long as dP remains > 20 psid. With the given conditions there is plenty of room to adjust.

A, B are incorrect: Adjusting these valves is allowed per procedure but the wrong direction is given and both adjustments will cause cooldown rate to lower.

C is incorrect: This adjustment would raise cooldown rate but the valve is normally full open and this adjustment isn't IAW the procedure.

REFERENCE: B.03.04-05

10 CFR 55.41(7)

REFERENCE PROVIDED DURING EXAM: None

QUESTION SOURCE: ILT Bank – 2010 NRC Exam

TIER: 2 **GROUP:** 1 **CATEGORY:** 205000 Shutdown Cooling

K/A: K5.02 **IMPORTANCE:** RO 2.8 **COG LEVEL:** 2 DR

K/A DESCRIPTION: Knowledge of the operational implications of the following concepts as they apply to SHUTDOWN COOLING SYSTEM (RHR SHUTDOWN COOLING MODE): Valve operation.

DIFFICULTY 2

LESSON PL: M8107L-023

OBJECTIVE: 9

2018 MONTICELLO ILT NRC EXAM - KEY

30. The Reactor is being cooled down for RHR to be placed in the Shutdown Cooling Mode of operation for the first time prior to a refueling outage.

Given B.03.04-06 Figure 11 on the following page, what is the MAXIMUM reactor pressure that would allow an RHR pump start if measured pump casing temperature is 110°F?

- A. 30 psig
- B. 32 psig
- C. 37 psig
- D. 39 psig

CORRECT ANSWER: B

JUSTIFICATION: 32 psig and 110°F intersect above the forbidden zone and in the RHR pump start region. Reactor (suction) pressure must be checked before starting the RHR pump in SDC mode.

A is incorrect: This pressure would allow a pump start but it isn't the highest allowed.

C and D are incorrect: Plausible options for misapplication of Figure 1.

REFERENCE:	B.03.04-06 Fig 1	10 CFR	55.41b(3)
ADDITIONAL REFERENCE PROVIDED DURING EXAM:	None		
QUESTION SOURCE:	ILT Bank		
TIER:	2	GROUP:	1
		CATEGORY:	205000 Shutdown Cooling
K/A:	A1.04	IMPORTANCE:	RO 2.7
		COG LEVEL:	2 DR
K/A DESCRIPTION:	Ability to predict and/or monitor changes in parameters associated with operating the SHUTDOWN COOLING SYSTEM (RHR SHUTDOWN COOLING MODE) controls including: SDC/RHR pump suction pressure.		
DIFFICULTY	2	LESSON PL:	M8107L-023
		OBJECTIVE:	9

2018 MONTICELLO ILT NRC EXAM - KEY

Figure 11 Shutdown Cooling Differential Temperature Pump Start Requirements

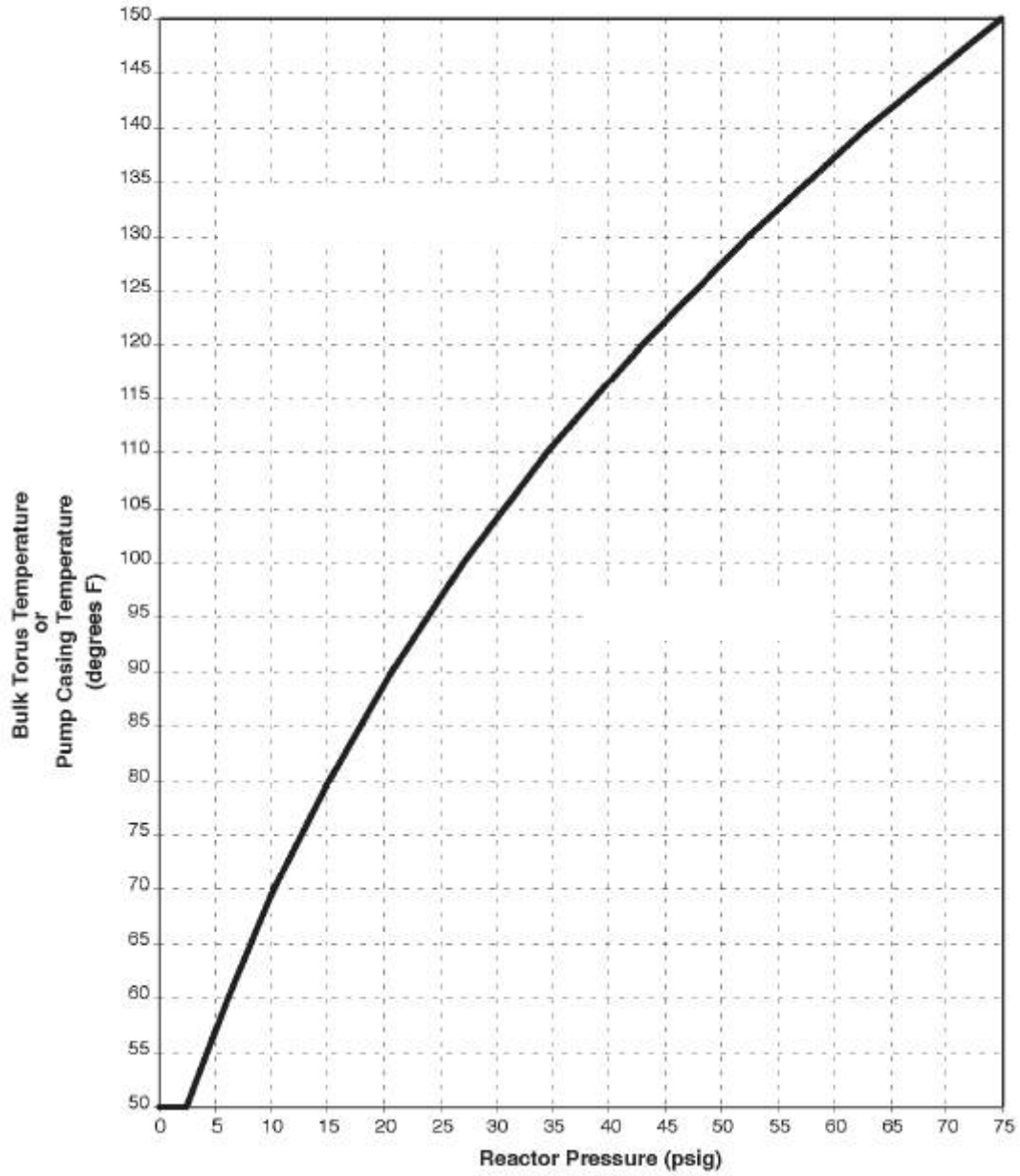

2018 MONTICELLO ILT NRC EXAM - KEY

31. The plant is at rated conditions when an event occurs resulting the loss of Division 2 250V DC Battery #16 and the receipt of the following annunciators:

- 8-C-24 (NO. 104 TRANS 4.16 BKR TRIP)
- 20-B-09 (DIVISION II – 125 & 250V DC TROUBLE).

What effect will this have on plant systems AND what action must be taken to mitigate the condition above?

- A. RCIC would be unavailable to inject.
Place the 250 VDC Swing Charger in service.
- B. HPCI would be unavailable to inject.
Place the 250 VDC Swing Charger in service.
- C. RCIC would be unavailable to inject.
Verify or establish Primary Containment Operability for loss of power to MO-2076 (STEAM LINE ISOLATION – OUTBOARD).
- D. HPCI would be unavailable to inject.
Verify or establish Primary Containment Operability for loss of power to MO-2035 (STEAM LINE ISOLATION – OUTBOARD).

CORRECT ANSWER: D

JUSTIFICATION: With the loss of 16 battery and LC-104; LC-104 feeds the battery chargers and the alarm to indicate low voltage on the Div II 250V DC bus). The HPCI Aux. Oil Pump is powered from this source and without the Aux Oil Pump, HPCI will not start. The abnormal procedure directs that if Division 2 250 VDC is lost, then verify primary containment operability of the HPCI system.

A is incorrect: RCIC is powered from Div I 250V DC. The swing charger is also supplied from LC-104 and would not be available.

B is incorrect: The swing charger is also supplied from LC-104 and would not be available.

C is incorrect: RCIC is powered from Div I 250V DC but this would be a correct action if power was lost to Div 1.

REFERENCE: C.4-B.09.09.A **10 CFR** 55.41b(7,10)
ADDITIONAL REFERENCE PROVIDED DURING EXAM: None
QUESTION SOURCE: New
TIER: 2 **GROUP:** 1 **CATEGORY:** 206000 HPCI
K/A: A2.05 **IMPORTANCE:** RO 3.5 **COG LEVEL:** 2 RI
K/A DESCRIPTION: Ability to (a) predict the impacts of the following on the HPCI SYSTEM and (b) based on those predictions, use procedures to correct, control, or mitigate the consequences of those abnormal operations: DC failures.
DIFFICULTY 2 **LESSON PL:** MT-ILT-AOP-019L **OBJECTIVE:** 4

2018 MONTICELLO ILT NRC EXAM - KEY

32. The plant is operating at rated conditions when the following occurs:

- Alarm 3-B-46 (CORE SPRAY SUCT VLV 1742 CLOSED) is received
- The BOP Operator confirms that the lights for MO-1742 indicate CLOSED
- The Reactor Building operator has locally confirmed that MO-1742 is CLOSED.

Complete the following statement based on the above conditions.

12 Core Spray Pump will...

- A. NOT start automatically or manually.
- B. auto start on a valid ECCS start signal but will immediately trip.
- C. NOT auto start on a valid ECCS start signal but will start manually.
- D. auto start on a valid ECCS start signal and will require action to prevent equipment damage.

CORRECT ANSWER: D

JUSTIFICATION: There is no interlock between core spray suction valves and the core spray pumps. This means that the core spray pumps will start on an ECCS start signal and will cause pump damage due to no suction path.

A is incorrect: There is no start permissive for Core Spray pumps relative to suction valve position or suction pressure.

B is incorrect: There is no immediate trip based on lack of suction pressure. Any plausible failure mechanism as a result of no suction path (pump overheating and eventually binding...bound pump results in overcurrent trip) would not be immediate.

C is incorrect: There is no start permissive for Core Spray pumps relative to suction valve position or suction pressure that is specific to automatic starts (auto vs. all is how this distracter differs from A).

REFERENCE: B.03.01-05

10 CFR 55.41(7)

REFERENCE PROVIDED DURING EXAM: None

QUESTION SOURCE: ILT Bank

TIER: 2 **GROUP:** 1 **CATEGORY:** 209001 LPCS

K/A: A3.06 **IMPORTANCE:** RO 3.6 **COG LEVEL:** 1 I

K/A DESCRIPTION: Ability to monitor automatic operations of the LPCS System including: Light and Alarms

DIFFICULTY 3 **LESSON PL:** M8107L-005 **OBJECTIVE:** 7

2018 MONTICELLO ILT NRC EXAM - KEY

33. The plant was at rated conditions when a Group 1 Isolation, Scram and ATWS condition occurred. The following conditions are present:

- Reactor power 40% and lowering
- RPV pressure is cycling on Low-Low Set
- RPV water level is -20" and intentionally being lowered
- Standby Liquid Control (SBLC) System 1 has been initiated
- Standby Liquid Control (SBLC) tank level is 1200 gallons and lowering

The CRS directs the OATC to report when reactor power is less than 4%.

Which of the following describes the reason for reporting this power level?

- A. This will allow a normal RPV depressurization to begin.
- B. This will verify that SBLC is injecting into the Rx vessel.
- C. This will allow SBLC injection from System 1 to be secured.
- D. This will allow the CRS to establish the required RPV water level band.

CORRECT ANSWER: D

JUSTIFICATION: During an ATWS event when RPV water level is intentionally being lowered the OATC is directed to report when reactor power is < 4%. Below this power level, RPV water level is recorded and this establishes the upper end of the water level band.

A is incorrect: In an ATWS, depressurization wouldn't be allowed until Cold Shutdown Boron is injected which is when tank level lowers to 475 gallons.

B is incorrect: In an ATWS, SBLC injection is verified by observing the pump discharge pressure, squib valve status and tank level lowering.

C is incorrect: C.5-2007 doesn't allow for SBLC injection to be secured until all control rods are inserted.

REFERENCE: C.5.1-2007

10 CFR 55.41b(1)

REFERENCE PROVIDED DURING EXAM: None

QUESTION SOURCE: New

TIER: 2 **GROUP:** 1 **CATEGORY:** 211000 Standby Liquid Control

K/A: A4.04 **IMPORTANCE:** RO 4.5 **COG LEVEL:** 1 B

K/A DESCRIPTION: Ability to manually operate and/or monitor in the control room: Reactor power.

DIFFICULTY 2 **LESSON PL:** MT-ILT-EOP-007L **OBJECTIVE:** 4

2018 MONTICELLO ILT NRC EXAM - KEY

34. A plant shutdown is in progress with Main Turbine 1st stage pressure at 90 psig.
Given the following:

- 5-B-37 (TURBINE PRESS GEN REJECTION BYPASS) is IN alarm
- Relays 5A-K9B, 5A-K9C and 5A-K9D are ENERGIZED
- Relay 5A-K9A is DE-ENERGIZED

Given NX-7834-67/8/9/10; how will RPS be affected if the Main Turbine is tripped?

- A. NO RPS actuation will occur.
- B. RPS A half scram ONLY.
- C. RPS B half scram ONLY.
- D. A Full Scram will occur.

CORRECT ANSWER: B

JUSTIFICATION: Alarm 5-B-37 is designed to alarm at 95 psig (Setpoint change for EPU). This bypasses the RPS trip associated with a turbine trip signal. The alarm is actuated if ANY turbine first stage pressure switch reaches the pressure equivalent of < 25% power. These pressure switches then energize relays 5A-K9A-D bypassing the scram. In the above situation since 5A-K9A is still de-energized, a half scram signal can still be generated from the A1 RPS logic.

A, C and D are incorrect: Plausible for confusion of the one out of two taken twice logic and whether or not the relays are supposed to energize or de-energize below 25%.

REFERENCE:	B.05.06-02	NX-7834-67/8/9/10	10 CFR	55.41b(7)
REFERENCE PROVIDED DURING EXAM:		NX-7834-67/8/9/10		
QUESTION SOURCE:	2016 NRC Exam – Significantly modified.			
TIER:	2	GROUP:	1	CATEGORY: 212000 RPS
K/A:	2.4.46	IMPORTANCE:	RO 4.2	COG LEVEL: 3 SPK
K/A DESCRIPTION:	Ability to verify that the alarms are consistent with the plant conditions.			
DIFFICULTY	2	LESSON PL:	M8107L-072	OBJECTIVE: 7

2018 MONTICELLO ILT NRC EXAM - KEY

35. The Reactor Mode Switch is in STARTUP TO HOT STANDBY. IRM 17 is BYPASSED on **Range 1** and ALL other IRM Range Switches are on **Range 4**. A rod withdrawal results in the following IRM readings:

<u>IRM 11</u>	<u>IRM 12</u>	<u>IRM 13</u>	<u>IRM 14</u>	<u>IRM 15</u>	<u>IRM 16</u>	<u>IRM 17</u>	<u>IRM 18</u>
102	122	101	103	112	101	125	105

Based on conditions above; which of the following is the status of RPS and/or RMCS?

- A. A Full Scram has occurred.
- B. An RMCS rod block ONLY has occurred.
- C. An RMCS rod block and a RPS A half scram ONLY have occurred.
- D. An RMCS rod block and a RPS B half scram ONLY have occurred.

CORRECT ANSWER: C

JUSTIFICATION: RMCS Rod Block is inserted if one IRM reaches 108. An RPS half scram signal is generated if one RPS A (IRM 11-14) or if one RPS B (IRM15-18) reaches 119.375. For the conditions above an RMCS Rod Block signal will be generated from IRMs 12 and 15. An RPS A half scram signal will be generated from IRM 12.

A is incorrect: A full scram will only occur if a half scram signal is generated in both RPS A & B.

B is incorrect: A half scram signal exists in RPS A.

D is incorrect: IRM 17 is above the rod block and RPS setpoint but since it is bypassed, and RPS B signal will NOT be generated.

REFERENCE:	B.05.06-02	ARP 5-A-13	10 CFR	55.41b(7)
REFERENCE PROVIDED DURING EXAM:	None			
QUESTION SOURCE:	ILT Bank			
TIER:	2	GROUP:	1	CATEGORY: 215003 IRM
K/A:	K1.01	IMPORTANCE:	RO 3.9	COG LEVEL: 3 PEO
K/A DESCRIPTION:	Knowledge of the physical connections and/or cause-effect relationships between INTERMEDIATE RANGE MONITOR (IRM) SYSTEM and the following: RPS.			
DIFFICULTY	2	LESSON PL:	M8107L-072	OBJECTIVE: 7

2018 MONTICELLO ILT NRC EXAM - KEY

36. The plant was at rated conditions when a complete loss of 24 VDC Battery 14 occurs.

Based on the condition above, will the following components be ENERGIZED or DE-ENERGIZED?

- 1) SRM 23 Channel Circuitry
- 2) SRM 23 Detector Drive Motor

- A. 1) ENERGIZED
2) ENERGIZED
- B. 1) ENERGIZED
2) DE-ENERGIZED
- C. 1) DE-ENERGIZED
2) ENERGIZED
- D. 1) DE-ENERGIZED
2) DE-ENERGIZED

CORRECT ANSWER: C

JUSTIFICATION: Power to the SRM components are as follows:
SRMs 21 & 22 Detectors and Trip Units – Battery 15 via D-15
SRMs 23 & 24 Detectors and Trip Units – Battery 14 via D-25
SRM & IRM Detector Drive control – L-38

A, B and D are incorrect: Plausible combinations of Battery 15 and SRM component power supplies.

REFERENCE: B.05.01.01-05 **10 CFR** 55.41b(6)
ADDITIONAL REFERENCE PROVIDED DURING EXAM: None
QUESTION SOURCE: ILT Bank – Significantly Modified.
TIER: 2 **GROUP:** 1 **CATEGORY:** 215004 SRM
K/A: K2.01 **IMPORTANCE:** RO **COG LEVEL:** 1F
K/A DESCRIPTION: Knowledge of electrical power supplies to the following: SRM channels/detectors.
DIFFICULTY 2 **LESSON PL:** M8107L-054 **OBJECTIVE:** 4

2018 MONTICELLO ILT NRC EXAM - KEY

37. The plant is at rated conditions when the following occurs:

- 5-A-22 (APRM UPSC/INOP TRIP) alarms
- APRM 3 indicates a Critical Self-Test Fault

With NO other plant changes, which of the following will also be in alarm?

- 5-A-3 (ROD WITHDRAW BLOCK)
- 5-A-6 (APRM DOWNSCALE / TROUBLE)
- 5-B-4 (REACTOR AUTO SCRAM CHANNEL A)

- A. 5-A-3 ONLY
- B. 5-A-6 ONLY
- C. 5-A-3 and 5-A-6 ONLY
- D. 5-A-3, 5-A-6 and 5-B-4

CORRECT ANSWER: C

JUSTIFICATION: 5-A-3 will be received from the INOP trip and 5-A-6 will be received from the self-test fault.

A is incorrect: 5-A-6 will also be received.

B is incorrect: 5-A-3 will also be received.

D is incorrect: 5-B-4 would not be received because with a single failure a half scram from an APRM fault is not possible, only a half vote.

REFERENCE:	ARP 5-A-6	ARP 5-A-3	ARP 5-A-22	10 CFR	55.41b(7)
REFERENCE PROVIDED DURING EXAM:		None			
QUESTION SOURCE:	ILT Bank				
TIER:	2	GROUP:	1	CATEGORY:	215005 APRM/LPRM
K/A:	K3.03	IMPORTANCE:	RO 3.3	COG LEVEL:	1 I
K/A DESCRIPTION:	Knowledge of the effect that a loss or malfunction of the AVERAGE POWER RANGE MONITOR/LOCAL POWER RANGE MONITOR SYSTEM will have on the following: Reactor Manual Control System.				
DIFFICULTY	3	LESSON PL:	M8107L-066	OBJECTIVE:	7

2018 MONTICELLO ILT NRC EXAM - KEY

38. The plant is at rated conditions with the RCIC turbine at rated speed for quarterly testing. RCIC-70 (EXH LINE ISOLATION) experiences a stem failure resulting in a complete blockage of the RCIC exhaust line.

Using P&ID NH-36251(RCIC – Steam Side); how would this blockage affect the RCIC system if the turbine FAILED TO TRIP on high exhaust pressure?

- A. The RCIC system is NOT protected; RCIC-70 is upstream of the rupture discs.
- B. Rupture discs will burst relieving steam via an 8 inch line directly to the Torus water space.
- C. Rupture discs will burst relieving steam directly to the RCIC room causing a Group 5 Isolation on high RCIC room temperature.
- D. Rupture discs will burst relieving steam directly to the Torus catwalk area causing a Group 5 Isolation on high RCIC room temperature.

CORRECT ANSWER: C

JUSTIFICATION: When RCIC turbine exhaust pressure rises to 125 psig or 50 psig for 5 seconds, the turbine should trip. If this doesn't occur two in-line rupture discs will fail at 150 psig relieving the exhaust steam directly to the RCIC Room air space. This will rapidly heat up the RCIC room and cause a Group 5 isolation when room temperature reaches 187.5°F thus preventing any further radioactive release to the Reactor Building.

A is incorrect: RCIC-70 is downstream, the rupture discs will protect the system in this instance.

B is incorrect: The rupture discs do not relieve to the torus water space.

D is incorrect: 8 of the 16 RCIC Group 5 high temperature switches are located in the torus room up near the catwalk area. The rupture discs do not relieve to this room therefore these switches would not activate the Group 5 isolation.

Note: BWR 4, 5 and 6 will receive an isolation and turbine trip on high pressure between the rupture disks which additionally justifies the plausibility of C and D. MNGP does not have this feature.

REFERENCE:	B.02.03-02	10 CFR	55.41b(7)
ADDITIONAL REFERENCE PROVIDED DURING EXAM:		P&ID NH-36251	
QUESTION SOURCE:	New		
TIER:	2	GROUP:	1
		CATEGORY:	217000 RCIC
K/A:	K4.05	IMPORTANCE:	RO 3.2
		COG LEVEL:	3 PEO
K/A DESCRIPTION:	Knowledge of REACTOR CORE ISOLATION COOLING SYSTEM (RCIC) design feature(s) and/or interlocks which provide for the following: Prevents radioactivity release to auxiliary/reactor building.		
DIFFICULTY	2	LESSON PL:	M8107L-002
		OBJECTIVE:	7

2018 MONTICELLO ILT NRC EXAM - KEY

39. The plant was operating at rated conditions when the following events occurred:

0800:00 A LOCA & Loss of ALL Offsite Power occurs
0800:10 BOTH Essential AC Busses are re-energized
0800:15 3-A-41 (AC INTERLOCK) is received
0800:45 3-A-38 (REACTOR LOW LOW LEVEL) is received
0801:15 8-B-18 (NO. 15 4160V BUS LOCKOUT) is received
0802:00 3-A-38 (REACTOR LOW LOW LEVEL) clears.

Based on the above timeline, which one of the following describes the expected response of the ADS valves, and why?

- A. At 0801:52 the ADS valves will OPEN due to the ADS timer having timed out.
- B. At 0802:32 the ADS valves will OPEN due to the ADS timer having timed out.
- C. The ADS valves will REMAIN CLOSED due to the receipt of a 15 Bus LOCKOUT.
- D. The ADS valves will REMAIN CLOSED due to the RPV Low-Low level condition clearing.

CORRECT ANSWER: D

JUSTIFICATION: In order for the ADS System to initiate, the following two signals are required.

- 100 psig discharge pressure from a low pressure ECCS pump (This causes the AC Interlock alarm) AND
- RPV level below -47" (This causes the Reactor Low-Low Level alarm).

The above conditions are present at time 0800:45. If the AC interlock clears at any time the ADS timer stops or the valves will close. However, the Low-Low level signal clearing can only stop the timer (107 seconds or 1 minute 47 seconds). Since the timer had not timed out (75 seconds) before the Reactor Low-Low Level cleared, the ADS SRVs will not get an open signal and thus prevent an inadvertent initiation.

A is incorrect: This only would be 67 seconds on the timer. Commonly performed calculation error to incorrectly transpose 107 seconds with 1 minute 7 seconds.

B is incorrect: This would be the full 107 seconds, but since the low level condition cleared the valves won't open.

C is incorrect: This would keep the valves close if it were the only source of power left. However, 16 Bus is still energized and the Division 2 low pressure ECCS pumps will be running.

REFERENCE: B.03.03-01

10 CFR 55.41b(7)

REFERENCE PROVIDED DURING EXAM: None

QUESTION SOURCE: ILT Bank – 2013 NRC Exam

TIER: 2 **GROUP:** 1 **CATEGORY:** 218000 ADS

K/A: K5.01 **IMPORTANCE:** RO 3.8 **COG LEVEL:** 3 PEO

K/A DESCRIPTION: Knowledge of the operational implications of the following concepts as they apply to AUTOMATIC DEPRESSURIZATION SYSTEM: ADS logic operation

DIFFICULTY 3 **LESSON PL:** M8107L-025 **OBJECTIVE:** 7

2018 MONTICELLO ILT NRC EXAM - KEY

40. The plant is in Mode 4 for a maintenance outage. Given the following plant conditions:

- Shutdown Cooling is in service on "A" Loop of RHR
- A loss of power occurs to RM-17-452A, (REACTOR BUILDING VENTILATION EXHAUST PLENUM MONITOR CHANNEL A)
- Annunciator 5-A-1 (REAC BLDG VENT & F P RAD CH A-HI/LO) is in alarm

Which of the following will receive a close signal as a result of this equipment malfunction?

1. AO-2378 (Torus Air Purge)
2. AO-2387 (Drywell Main Exhaust Vent)
3. MO-2029 (Shutdown Cooling Isolation)
4. AO-2541A/B (Drywell Floor Drain Isolation Valves)

- A. 3 ONLY
- B. 1 and 2 ONLY
- C. 2 and 4 ONLY
- D. 1, 2 and 4

CORRECT ANSWER: B

JUSTIFICATION: RM-17-452A & B will fail high on a loss of power. The examinee must recall that one high signal will cause a Partial Group 2 isolation. The containment isolation valves AO-2378 and AO-2387 will close on a Partial Group 2 Isolation.

A is incorrect: Plausible for reversing the isolations that occur as a result of a Full or Partial Group 2 isolation. MO-2029 only closes on a full group 2 isolation.

C is incorrect: Plausible to think only Drywell components close on an isolation signal. AO-2541 A/B only close on a full group 2 isolation.

D is incorrect: Plausible if it's believed only air operated valve close on a partial group 2 isolation. AO-2541 A/B only close on a full group 2 isolation.

REFERENCE: C.4-B.04.01.B ARP 5-A-1 **10 CFR** 55.41b(7)

REFERENCE PROVIDED DURING EXAM: None

QUESTION SOURCE: 2015 NRC Exam #65 – Significantly Modified.

TIER: 2 **GROUP:** 1 **CATEGORY:** 223022 PCIS

K/A: K6.03 **IMPORTANCE:** RO 2.9 **COG LEVEL:** 2 RI

K/A DESCRIPTION: Knowledge of the effect that a loss or malfunction of the following will have on the PCIS System: Process radiation monitoring system.

DIFFICULTY 3 **LESSON PL:** MT-ILT-AOP-008 **OBJECTIVE:** 4

2018 MONTICELLO ILT NRC EXAM - KEY

41. The plant was operating at rated conditions when an event occurred resulting in the receipt of 5-B-28 (DRYWELL HI PRESS SCRAM TRIP) and the following indications:



Which PCIS Group Isolation has caused the panel indications above?

- A. Group 1
- B. Group 2
- C. Group 3
- D. Group 4

CORRECT ANSWER: C

JUSTIFICATION: A Group 3 isolation can be cause by high drywell pressure scram signal (1.84 psig). Additionally, a Group 3 isolation will cause the Recirc Sample Isolation valves (CV-2790/91) to close. Based on the picture showing the valve control switches in Auto Open and the valves are closed a Group 3 isolation must have occurred.

A is incorrect: The Recirc sample valves will close but a Group 1 can't be cause by high drywell pressure.

B is incorrect: A Group 2 isolation can be caused by high drywell pressure but will not cause the Recirc Sample valves to close.

D is incorrect: High drywell pressure will initiate HPCI but will not isolate it.

REFERENCE: B.05.06-01/02 **10 CFR** 55.41b(7)

ADDITIONAL REFERENCE PROVIDED DURING EXAM: None

QUESTION SOURCE: ILT Bank

TIER: 2 **GROUP:** 1 **CATEGORY:** 223002 PCIS

K/A: A4.04 **IMPORTANCE:** RO 3.5 **COG LEVEL:** 3 PEO

K/A DESCRIPTION: Ability to manually operate and/or monitor in the control room: System indicating lights and alarms.

DIFFICULTY 3 **LESSON PL:** M8107L-070 **OBJECTIVE:** 7

2018 MONTICELLO ILT NRC EXAM - KEY

42. The plant was at rated conditions when the following annunciator was received:

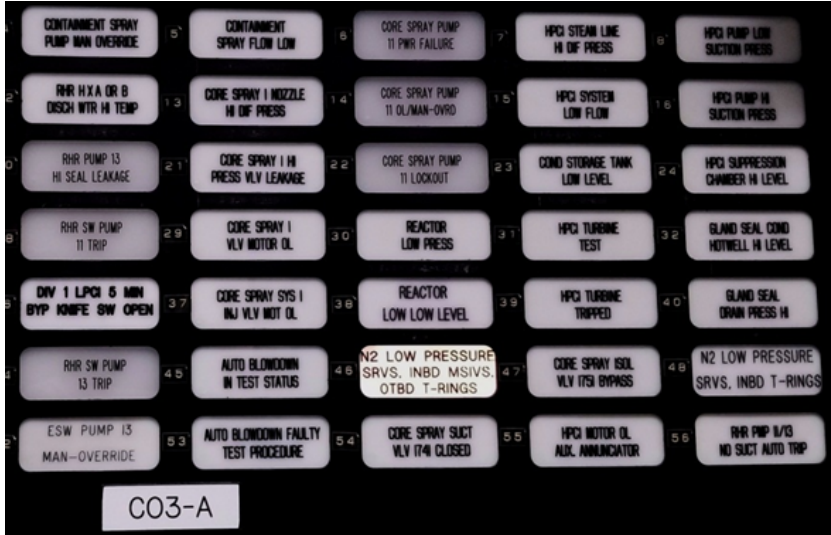

The Out Plant Operator reports that Alternate N2 Train B pressure is 195 psig and lowering.

Which of the following combinations of Safety Relief Valves (SRVs) will be affected by current plant conditions?

- A. A, B & G
- B. A, B & E
- C. C, H & F
- D. C, D & H

CORRECT ANSWER: C

JUSTIFICATION: 3-A-46, alarms setpoint is at 200 psig from PS-4237 on Alt Nitrogen System Train B bottle rack.

- Train A supplies one ADS SRV (A), one Lo-Lo Set SRV (E), and B SRV. It also supplies the INBD T-Rings.
- Train B supplies one ADS SRV (C) one Lo-Lo Set SRV (H) and F SRV. It also supplies the INBD MSIVs, OTBD T-rings and the HPV.

The candidate must recognize which train is affected by systems affected on the annunciator. Additionally losing the Alt N2 supply to SRVs renders them inoperable.

A is incorrect: SRV A is supplied by Train A and SRV G doesn't have Alt N2 backup.

B is incorrect: These are supplied by Train A.

D is incorrect: SRV H doesn't have Alt N2 backup.

REFERENCE: B.8.4.3-05

10 CFR

55.41 (7)

REFERENCE PROVIDED DURING EXAM: None

QUESTION SOURCE: ILT Bank – 2013 NRC Exam

TIER: 2 **GROUP:** 1 **CATEGORY:** 239002 SRVs

K/A: A1.03 **IMPORTANCE:** RO 2.8 **COG LEVEL:** 2RI

K/A DESCRIPTION: Ability to predict and/or monitor changes in parameters associated with operating the RELIEF/SAFETY VALVES controls including: Air supply:

DIFFICULTY 3 **LESSON PL:** M8107L-025 **OBJECTIVE:** 6

2018 MONTICELLO ILT NRC EXAM - KEY

43. The plant was operating at rated conditions when a scram occurred due to an RPS fault. The following conditions now exist:

- RPV Pressure is 900 psig and stable
- RPV water level lowered to -20 inches
- RPV water level is now +2 inches and slowly rising
- The DFWLC System status is shown pictorially on the next page

Using the given conditions, at what level will RPV water level stabilize? (Assume the Reactor Feed Pumps remain running)

- A. 5 inches.
- B. 15 inches.
- C. 35 inches.
- D. 38 inches.

CORRECT ANSWER: B

JUSTIFICATION: The picture shows both Main Feedwater Regulating valves (MFRV) in manual and closed which is a required action IAW the scram procedure. The Low Flow Regulating valve (LFRV) is in AUTO set at 5 inches. However, when the LFRV is in AUTO the setpoint is clamped between 15-40 inches. Therefore RPV water level should stabilize out at approximately 15 inches.

A is incorrect: Plausible for the current setting of the LFRV.

C is incorrect: Plausible for the current setting of the Master controller plus taking into account DFWLC programming which automatically lowers the setting by 3 inches. This programming is only in effect at high power.

D is incorrect: Plausible for the current setting of the Master controller.

REFERENCE: B.05.07-02

10 CFR 55.41(7)

REFERENCE PROVIDED DURING EXAM: None

QUESTION SOURCE: ILT Bank – 2013 NRC Exam

TIER: 2 **GROUP:** 1 **CATEGORY:** 259002 Reactor Water Level Control System

K/A: K5.01 **IMPORTANCE:** RO 2.6 **COG LEVEL:** 3 PEO/SPK/SPR

K/A DESCRIPTION: Knowledge of the operational implications of the following concepts as they apply to REACTOR WATER LEVEL CONTROL SYSTEM: GEMAC/Foxboro/Bailey controller operation.

DIFFICULTY 3

LESSON PL: M8107L-046

OBJECTIVE: 7

2018 MONTICELLO ILT NRC EXAM - KEY

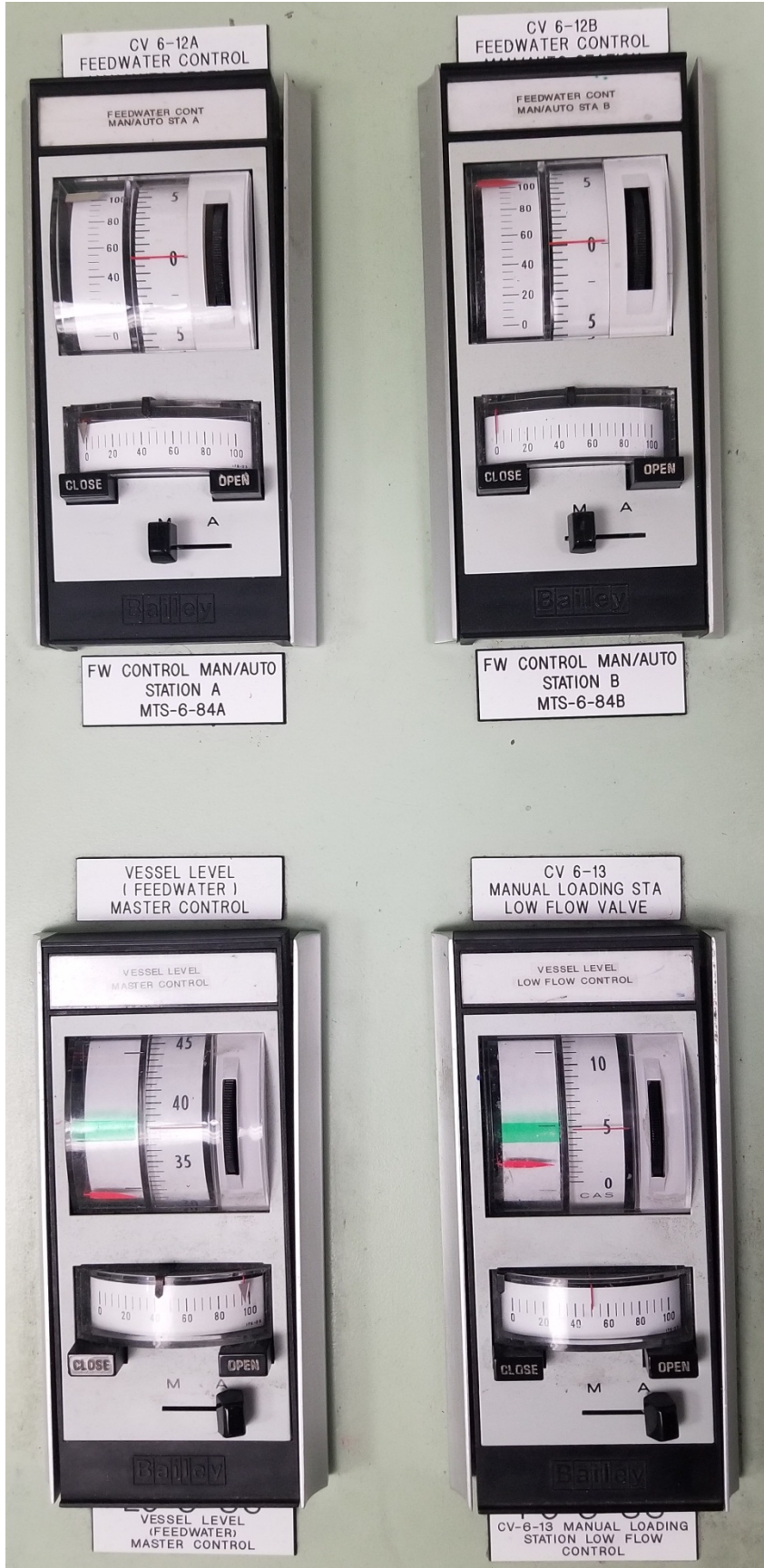

2018 MONTICELLO ILT NRC EXAM - KEY

44. The plant was at rated conditions when a 12 Bus Lockout occurred. Immediate Actions have been taken for the trip of 12 Reactor Feed Pump (RFP). Given the following:

- CV-3490 (12 RFP FW RECIRC TO CDSR) failed open
- 11 RFP suction pressure is 92 psig and stable
- RPV water level is +20 inches and stable
- Reactor power is 64% and stable

What action should be taken to mitigate the conditions above?

- A. Insert control rods IAW C.4-F (RAPID POWER REDUCTION).
- B. Scram the reactor IAW C.4-K (IMMEDIATE REACTOR SHUTDOWN).
- C. Raise the setpoint of LC-6-83 (FW MASTER CONTROLLER) back to normal.
- D. Lower the setpoint of FC-1095 (11/12 COND PMP RECIRC FLOW) to 4100 gpm.

CORRECT ANSWER: A

JUSTIFICATION: The conditions provided indicate that 11 RFP is operating at or near runout conditions. The procedure directs a power reduction if RFP suction pressure is <100 psig. Reducing power will lower the FW demand and allow RPV level to be restored.

B is incorrect: If reactor power remained above 69% or if reaching +9" were imminent, then the reactor would be scrammed.

C is incorrect: The immediate actions for a RFP trip will lower the setpoint of LC-6-83 to 30". Putting it back to normal (~38") will not mitigate the situation because the RFP is at max.

D is incorrect: This is an action taken for a trip of a RFP, but this will not mitigate the conditions.

REFERENCE:	C.4-B.06.05.A	10 CFR	55.41b(10)
ADDITIONAL REFERENCE PROVIDED DURING EXAM:		None	
QUESTION SOURCE:	New		
TIER:	2	GROUP:	1
K/A:	A2.04	IMPORTANCE:	RO 3.0
K/A DESCRIPTION:	Ability to (a) predict the impacts of the following on the REACTOR WATER LEVEL CONTROL SYSTEM; and (b) based on those predictions, use procedures to correct, control, or mitigate the consequences of those abnormal conditions or operations: RFP runout condition.		
DIFFICULTY	3	LESSON PL:	MT-ILT-AOP-015L
		OBJECTIVE:	4

2018 MONTICELLO ILT NRC EXAM - KEY

45. "A" SBGT has automatically initiated on a valid signal. After running for 15 minutes, V-EF-17A ("A" Standby Gas System Exhaust Fan) trips due to an electrical fault.

Which one of the following completes the statement below?

As SBGT system flow lowers, the "A" SBGT low flow annunciator will alarm at _____ (1) and the "B" SBGT train will auto-start when flow lowers to _____ (2) .

- | | (1) | (2) |
|----|----------|-------------------------|
| A. | 4000 CFM | 2800 CFM |
| B. | 4000 CFM | 2800 CFM for 10 seconds |
| C. | 3000 CFM | 2800 CFM for 10 seconds |
| D. | 3000 CFM | 2800 CFM |

CORRECT ANSWER: D

JUSTIFICATION: Low flow alarm is at 3000 CFM and the auto-start setpoint is at 2800 CFM.

A and B are incorrect: Plausible setpoint (4000 cfm) for low flow alarm on CRV-EFT.

B and C are incorrect: On an immediate failure of A SBGT to auto start; a 10 second time delay was used previously. However, that time delay no longer applies.

REFERENCE: B.04.02-01 **10 CFR** 55.41b(7)

ADDITIONAL REFERENCE PROVIDED DURING EXAM: None

QUESTION SOURCE: ILT Bank – Edits to stem and choices

TIER: 2 **GROUP:** 1 **CATEGORY:** 261000 SBGT

K/A: A3.01 **IMPORTANCE:** RO 3.2 **COG LEVEL:** 1I

K/A DESCRIPTION: Ability to monitor automatic operation of the STANDBY GAS TREATMENT SYSTEM including: System flow.

DIFFICULTY 4 **LESSON PL:** M8107L-008 **OBJECTIVE:** 7

2018 MONTICELLO ILT NRC EXAM - KEY

46. The plant is at rated conditions. During a C-05 panel walkdown, the OATC notices the red light for the in-service CRD pump is extinguished. Further investigation reveals the following:

- The local CRD pump breaker red light is also extinguished
- Both red light bulbs are functional and NOT burnt out

Based on the information above, which of the following is correct concerning this breaker?

- A. ALL electrical breaker trips remain functional for the in-service CRD pump.
- B. The breaker can ONLY be tripped by placing the local Control Switch in stop.
- C. The breaker can ONLY be tripped by placing the C-05 Control Switch in stop.
- D. The breaker can ONLY be tripped by depressing the local mechanical trip pushbutton.

CORRECT ANSWER: D

JUSTIFICATION: The red indicating lights in the control room and locally at the 4 KV breakers monitor continuity of the trip coil circuit while the breaker is closed. Loss of red light indication at both locations, and not due to burnt out lamps, is indicative of a malfunction of the breaker trip circuit. All electrical trips of the breaker are disabled. Losing both the red indicating lights would be indicative of losing 125 VDC control power to the breaker. Only the mechanical trip pushbutton on the lower portion of the breaker will trip the breaker.

A is incorrect: With both red lights out, all electrical trips of the breaker are disabled

B and C are incorrect: The remote switch on C-05 and the local control switch on the upper portion of the breaker would not work due to the loss of 125 VDC.

REFERENCE: B.09.06-05

10 CFR 55.41(7)

REFERENCE PROVIDED DURING EXAM: None

QUESTION SOURCE: ILT Bank – 2010 NRC Exam

TIER: 2

GROUP: 1

CATEGORY: 262001 AC Electrical Distribution

K/A: A4.03

IMPORTANCE: RO 3.2

COG LEVEL: 2 RI

K/A DESCRIPTION: Ability to manually operate and/or monitor in the control room: Local operation of breakers.

DIFFICULTY 3

LESSON PL: M8107L-039

OBJECTIVE: 5

2018 MONTICELLO ILT NRC EXAM - KEY

47. The plant is at rated conditions. Surveillance Tests 1292-01/02 (OPERABILITY TESTING OF THE UNINTERRUPTIBLE POWER SUPPLY) will be performed. The test requires that Y-80 be supplied from MCC-144.

What action, if any, must be taken prior to performing the test?

- A. Declare RCIC inoperable.
- B. Declare HPCI inoperable.
- C. Restore Y-80 to its normal supply within 7 days.
- D. None, Y-80 will remain energized from its normal supply.

CORRECT ANSWER: B

JUSTIFICATION: Y-80 supplies power to the HPCI flow controller. In Modes 1, 2 or 3, System Operational requirements state both UPS trains (Y-71 and Y-81) shall be supplied by their inverter outputs. If this is not the case for Y-80, the following administrative requirements are established: Declare HPCI inoperable immediately. In this situation, HPCI would be declared inoperable prior to the performance of the test.

A is incorrect: RCIC is supplied from Y-70, this action isn't required.

C is incorrect: System Operational requirements state that it must be placed back on the inverter within 3 days.

D is incorrect: Plausible if the examinee believes that Essential MCC-144 is the normal supply but it's the alternate supply. The normal supply is from the inverter Y-81 via 250 VDC.

REFERENCE:	B.09.13-05	1292-01/02	10 CFR	55.41b(10)
ADDITIONAL REFERENCE PROVIDED DURING EXAM:		None		
QUESTION SOURCE:	New			
TIER:	2	GROUP:	1	CATEGORY: 262002 UPS
K/A:	2.2.12	IMPORTANCE:	RO 3.7	COG LEVEL: 1 P
K/A DESCRIPTION:	Knowledge of surveillance procedures.			
DIFFICULTY	4	LESSON PL:	M8107L-063	OBJECTIVE: 9

2018 MONTICELLO ILT NRC EXAM - KEY

48. The plant is at rated conditions with D-20 (DIV II 125 VDC CHARGER) out of service. Given the following:

- D-10 (DIV I 125 VDC CHARGER) is in service supplying the Division I loads
- D-40 (SPARE 125 VDC CHARGER) is in service supplying the Division II loads

With the conditions above; what would be the impact over an extended period of time if a LOCKOUT occurred on LC-103?

- A. Battery 11 would deplete, resulting in a loss of Division I 125 VDC ONLY.
- B. Battery 12 would deplete, resulting in a loss of Division II 125 VDC ONLY.
- C. Batteries 11 & 12 would deplete, resulting in a COMPLETE loss of 125 VDC.
- D. Batteries 11 & 12 would be unaffected as they BOTH would be charging from LC-104.

CORRECT ANSWER: A

JUSTIFICATION: LC-103 supplies power to MCC-133 which supplies power to D-10 (DIV I 125 VDC CHARGER). A loss of LC-103 would eventually result in the depletion of Battery 11 and a loss of Div I 125 VDC because the spare charger is not allowed to be connected to both divisions. The examinee must recognize that D-40 is powered from LC-104 and not affected by the given power loss.

B and C are incorrect: The spare charger (D-40) will not lose power. It receives power from MCC-142 which is fed from LC-104. Therefore Battery 12 will remain charging.

D is incorrect: Plausible misconception if examinee believes the spare charger is powered from LC-103.

REFERENCE: B.09.10-02 B.09.10-06 **10 CFR** 55.41b(7)
REFERENCE PROVIDED DURING EXAM: None
QUESTION SOURCE: ILT Bank – 2013 NRC Exam
TIER: 2 **GROUP:** 1 **CATEGORY:** 263000 DC Distribution
K/A: K1.01 **IMPORTANCE:** RO 3.3 **COG LEVEL:** 2 RI
K/A DESCRIPTION: Knowledge of the physical connections and/or cause-effect relationships between D.C. ELECTRICAL DISTRIBUTION and the following: A.C electrical distribution.
DIFFICULTY 3 **LESSON PL:** M8107L-041 **OBJECTIVE:** 8.a

2018 MONTICELLO ILT NRC EXAM - KEY

49. The plant was at rated conditions when a grid disturbance resulted in an ATWS condition and the following electric plant conditions:

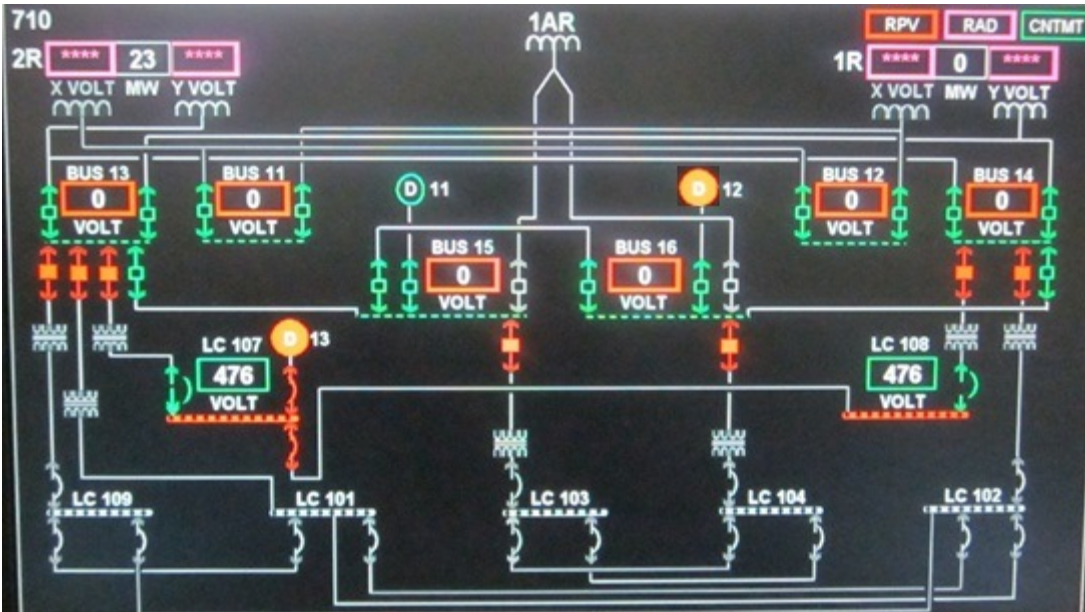

Which of the following describes the availability of #11 and #12 SBLC Squib Valves based on available plant electrical power?

- A. ONLY #11 would actuate.
- B. ONLY #12 would actuate.
- C. BOTH #11 and #12 would actuate.
- D. NEITHER #11 nor #12 would actuate.

CORRECT ANSWER: D

JUSTIFICATION: The electrical distribution picture above depicts a complete loss of offsite power with a failure of the EDG to re-energize the essential Busses (15 & 16)

SBLC Pump #11 and its explosive Squib valve are powered from MCC-133 via LC-103 via 15 Bus which in this case would be unavailable. Therefore, #11 Squib valve would not actuate.

SBLC Pump #12 and its explosive Squib valve are powered from MCC-142 via LC-104 via 16 Bus which in this case would be unavailable. Therefore #12 Squib valve would not actuate.

A, B and C incorrect: Plausible combinations for misinterpretation of the given conditions and/or failure to recall the SBLC Squib power supplies.

REFERENCE: B.03.05-02 B.03.05-05 MNGP USAR 6.6 **10 CFR** 55.41b(6)

REFERENCE PROVIDED DURING EXAM: None

QUESTION SOURCE: ILT Bank

TIER: 2 **GROUP:** 1 **CATEGORY:** 264000 EDGs

K/A: K3.03 **IMPORTANCE:** RO 4.1 **COG LEVEL:** 2 RI

K/A DESCRIPTION: Knowledge of the effect that a loss or malfunction of the EMERGENCY GENERATORS (DIESEL/JET) will have on the following: Major loads powered from electrical buses fed by the emergency generators.

DIFFICULTY 3 **LESSON PL:** M8107L-004 **OBJECTIVE:** 4

2018 MONTICELLO ILT NRC EXAM - KEY

50. #11 EDG was operating in parallel with Off-Site power when the following occurs:

- Voltage is lost on Buses 11-15
- Bus 16 is being powered from #12 EDG
- 8-B-30 (NO 11 DIESEL ENG TROUBLE) Alarms
- 8-B-35 (NO 11 DIESEL ENG MAINTENANCE LOCKOUT) Alarms

Which of the following action(s) should be taken to restore power to Bus 15 from #11 EDG?

- A. Depress and release both Engine Stop Pushbuttons ONLY.
- B. Valve in Service Water AND reset the #11 EDG Maintenance Lockout.
- C. Verify the overspeed trip is reset, set speed droop to zero AND depress and release both Engine Stop Pushbuttons.
- D. Place the #11 EDG control switch to pull to lock, depress and release both Engine Stop Pushbuttons, and place #11 EDG control switch to Start.

CORRECT ANSWER: C

JUSTIFICATION: Since 11 EDG is operating in parallel with offsite power when offsite power is lost, this may result in the EDG tripping on overspeed. B.09.08-05 D.1 states that if offsite power is lost and the EDG trips on overspeed, then reset the overspeed trip, place speed droop knob to zero, and depress and release both engine stop pushbuttons.

A is incorrect: the EDG tripped on overspeed.

B is incorrect: the EDG tripped on overspeed and service water is not required to be valved in.

D is incorrect: Plausible action to take with the exception of 8-B-35. The overspeed must be reset.

REFERENCE:	B.09.08-05	10 CFR	55.41b(7)
ADDITIONAL REFERENCE PROVIDED DURING EXAM:	None		
QUESTION SOURCE:	New		
TIER:	2	GROUP:	1
		CATEGORY:	264000 EDGs
K/A:	A2.09	IMPORTANCE:	RO 3.5
		COG LEVEL:	3 SPK
K/A DESCRIPTION:	Ability to (a) predict the impacts of the following on the EMERGENCY GENERATORS (DIESEL/JET); and (b) based on those predictions, use procedures to correct, control, or mitigate the consequences of those abnormal conditions or operations: Loss of offsite power during full-load testing.		
DIFFICULTY	3	LESSON PL:	M8107L-042
		OBJECTIVE:	9

2018 MONTICELLO ILT NRC EXAM - KEY

51. The plant was operating at rated conditions when a Loss of ALL Offsite Power occurred. Given the following conditions:

- 11 EDG Failed to start
- 12 EDG started and properly loaded
- 13 Diesel Generator started and properly loaded

For the above conditions, which of the following is the expected **power availability** to the Instrument Air Compressors (A/C)?

	<u>POWER to 15 A/C</u>	<u>POWER to 16 A/C</u>	<u>POWER to 17 A/C</u>
A.	UNAVAILABLE	UNAVAILABLE	UNAVAILABLE
B.	AVAILABLE	UNAVAILABLE	AVAILABLE
C.	AVAILABLE	AVAILABLE	UNAVAILABLE
D.	UNAVAILABLE	AVAILABLE	AVAILABLE

CORRECT ANSWER: D

JUSTIFICATION:

15 A/C Power - LC-103 via 15 Bus from 13 bus or 1AR or 11 EDG

15 A/C load sheds on a loss of power. It does require operator actions to restart the compressor but in this case where 11 EDG failed to start LC-103 will be without power.

16 A/C Power - LC-107 via 13 Bus or from 13 DG

No 16 A/C does not load shed and does not automatically restart but power will be available since 13 DG started and loaded on to LC-107.

17 A/C Power - LC-108 via 14 Bus

No 17 A/C does not load shed and automatically restarts either to run as the lead to supply plant loads or should another compressor supply plant loads, it will go to standby. In this case LC-108 will cross connect with LC-107 and be supplied by 13 DG.

A, B and C Incorrect: Plausible IA Compressor power availability for Pre-Modification of the IA System and for the above conditions.

REFERENCE: B.08.04.01-05

10 CFR 55.41b(7)

REFERENCE PROVIDED DURING EXAM: None

QUESTION SOURCE: ILT Bank – 2013 NRC Exam

TIER: 2 **GROUP:** 1 **CATEGORY:** 300000 Instrument Air

K/A: K2.01 **IMPORTANCE:** RO 2.8 **COG LEVEL:** 3 PEO

K/A DESCRIPTION: Knowledge of electrical power supplies to the following: Instrument air compressor.

DIFFICULTY 3 **LESSON PL:** MT-ILT-AOP-023L **OBJECTIVE:** 4

2018 MONTICELLO ILT NRC EXAM - KEY

52. The plant is at rated conditions when the following valid alarms are received:

- 4-A-23 (LIQUID PROCESS HI RADIATION) confirmed to be **HIGH** on Panel C-10
- 6-B-27 (RBCCW SURGE TK T-3 HIGH-LOW LEVEL) confirmed to be **HIGH** locally

Which system(s), if leaking, would cause BOTH alarms above?

1. RWCU
2. Service Water
3. Reactor Recirc
4. Drywell Coolers

- A. 1, 2 & 3 only.
- B. 1 & 3 only.
- C. 1 only.
- D. 4 only.

CORRECT ANSWER: B

JUSTIFICATION: All of the systems listed above interact physically with RBCCW. However in-leakage from RWCU or the Reactor Recirc system are the only ones that would cause both rising surge tank levels and rising radiation levels.

A is incorrect: A leak in the SW/RBCCW HX would cause a rise in surge tank level, but not rising radiation readings.

C is incorrect: Plausible to think that RWCU would be the only system that could cause a rise in radiation levels.

D is incorrect: Leakage from the Primary Containment Drywell Coolers would be leakage out of the RBCCW System. Plausible for backwards logic.

REFERENCE: C.4-B.02.05.B **10 CFR** 55.41b(3)

ADDITIONAL REFERENCE PROVIDED DURING EXAM: None

QUESTION SOURCE: ILT Bank – Significantly Modified from 2009 NRC Exam

TIER: 2 **GROUP:** 1 **CATEGORY:** 400000 Component Cooling Water

K/A: K1.04 **IMPORTANCE:** RO 2.9 **COG LEVEL:** 2 RI

K/A DESCRIPTION: Knowledge of the physical connections and/or cause-effect relationships between CCWS and the following: Reactor coolant system, in order to determine source(s) of RCS leakage into CCWS.

DIFFICULTY 2 **LESSON PL:** MT-ILT-AOP-004L **OBJECTIVE:** 4

2018 MONTICELLO ILT NRC EXAM - KEY

53. The plant is in Mode 1 when 6-B-32 (RBCCW LOW DISCH PRESS) is received.

Complete the following statement for the above conditions:

If RBCCW system pressure lowers to (1) psig, the (2).

- A. (1)
30 (2)
Standby RBCCW pump automatically starts
- B. 30 RBCCW system isolation valves automatically close
- C. 40 Standby RBCCW pump automatically starts
- D. 40 RBCCW system isolation valves automatically close

CORRECT ANSWER: A

JUSTIFICATION: At 30 psig, PS-1398, located on the pump discharge header, will start the standby pump and 6-B-32, RCT BLDG CLG WTR LOW DISCH PRESS, will alarm.

B is incorrect: The RBCCW system isolation valves are manually closed as part of the immediate actions for a loss of RBCCW.

C and D are incorrect: Plausible pressure as the Service Water Pumps auto start on low discharge pressure of 40 psig.

REFERENCE: C.4-B.02.05.A **10 CFR** 55.41b(7)
ADDITIONAL REFERENCE PROVIDED DURING EXAM: None
QUESTION SOURCE: ILT Bank – Edits to choices
TIER: 2 **GROUP:** 1 **CATEGORY:** 400000 Component Cooling Water
K/A: K4.01 **IMPORTANCE:** RO 3.4 **COG LEVEL:** 1I
K/A DESCRIPTION: Knowledge of CCWS design feature(s) and/or interlocks which provide for the following:
Automatic start of standby pump
DIFFICULTY 2 **LESSON PL:** M8107L-026 **OBJECTIVE:** 7

2018 MONTICELLO ILT NRC EXAM - KEY

54. The plant was at rated conditions when a complete loss of Y-30 occurs.

Which of the following describes the impact of this power loss on the plant?

- A. Control rods can NOT be selected at C-05.
- B. 11 Recirc MG Set scoop tube will LOCK up.
- C. Heat tracing will be LOST for the SBLC system.
- D. In-service CRD Flow Control Valve will go full OPEN.

CORRECT ANSWER: D

JUSTIFICATION: Y-30 supplies power to the flow element for the CRDH system. Loss of power to this flow detector will tell the flow control valve that there is zero flow and the flow control valve will respond by going full open.

A is incorrect: This will occur on a loss of Y-10.

B is incorrect: This will occur on a loss of Y-20.

C is incorrect: This will occur on a loss of Essential Lighting panel L-43.

REFERENCE:	C.4-B.09.13.E	10 CFR	55.41b(6)
REFERENCE PROVIDED DURING EXAM:	None		
QUESTION SOURCE:	New		
TIER:	2	GROUP:	2
K/A:	K6.05	IMPORTANCE:	RO 3.3
K/A DESCRIPTION:	Knowledge of the effect that a loss or malfunction of the following will have on the CONTROL ROD DRIVE HYDRAULIC System: AC Power		
DIFFICULTY	2	LESSON PL:	M8107L-020
		OBJECTIVE:	7

2018 MONTICELLO ILT NRC EXAM - KEY

55. A reactor startup is in progress with the plant in Mode 2. Given the following:

- Control Rod (CR) 22-31 has been single-notch withdrawn to position 10
- The OATC attempts to withdraw CR 22-31 to its withdraw limit, position 12
- CR 22-31 is double-notched to position 14 causing a RWM Withdraw Error

Which of the following identifies the RMCS control rod movement, if any, which will be allowed for the above conditions?

- A. The INSERTION of CR 22-31 **only**.
- B. The INSERTION of **any** withdrawn control rod.
- C. The INSERTION and WITHDRAWAL of CR 22-31 **only**.
- D. None, the RWM must be **bypassed** to allow control rod movement.

CORRECT ANSWER: A

JUSTIFICATION: The RWM should not allow errors under normal drive speeds. The physics calculations allow a tolerance of 1 notch for these conditions. The only Reactor Manual Control (RMCS) rod movement the RWM will allow is to correct the Withdraw Error that was created when rod 22-31 went past its Withdraw Limit. The Operator must insert rod 22-31 to its Withdraw Limit, position 12, before any other rod movements are permitted by the RWM.

B is incorrect: Plausible if examinee believes these conditions will only result in a withdrawal block.

C is incorrect: Plausible for correction of the error, but a withdraw error will only allow the rod to be inserted.

D is incorrect: Plausible required action with a control rod out of sequence because anything other than a one notch error would require this.

REFERENCE: B.05.02-02

10 CFR 55.41b(6)

REFERENCE PROVIDED DURING EXAM: None

QUESTION SOURCE: ILT Bank – 2013 NRC Exam

TIER: 2 **GROUP:** 2 **CATEGORY:** 201006 RWM

K/A: A1.02 **IMPORTANCE:** RO 3.4 **COG LEVEL:** 1 I

K/A DESCRIPTION: Ability to predict and/or monitor changes in parameters associated with operating the ROD WORTH MINIMIZER SYSTEM (RWM) controls including: Status of control rod movement blocks.

DIFFICULTY 4

LESSON PL: M8107L-001

OBJECTIVE: 7.a

2018 MONTICELLO ILT NRC EXAM - KEY

56. The plant was at rated conditions with Traversing In-core Probe (TIP) scans in progress when a spurious scram occurred due to an instrument relay malfunction. During the scram, RPV water level lowered to -10" and is now +20" and stable.

Which of the following is correct if the TIP detector didn't automatically retract from the core with the above conditions?

- A. The TIP Shear Valve must be manually actuated from panel C-13.
- B. The TIP Ball Valve will automatically close from the Group 2 isolation.
- C. The TIP Shear Valve will automatically actuate from the Group 2 isolation.
- D. The TIP detector must be manually retracted THEN the Ball Valve will automatically close.

CORRECT ANSWER: D

JUSTIFICATION: When a Group 2 isolation is received (+9"), the PCIS logic should retract the cable in fast speed and close the TIP Ball Valve. If the PCIS logic failed to retract the detector then it can be manually retracted from panel C-13 or locally using the hand crank to manually retract the probe,

A is incorrect: This would be a correct action to take if containment isolation was imperative due to an actual Group 2 isolation with elevated fission product releases.

B is incorrect: With no scans in progress the Ball Valve does receive a close signal. However, in this case, the ball valve won't close until the cable retracts. The cable is supposed to auto retract if a Group 2 isolation is received.

C is incorrect: The TIP shear valve doesn't auto actuate; it must be manually fired from the control room.

REFERENCE: B.05.03-05.H.1

10 CFR 55.41b(7)

REFERENCE PROVIDED DURING EXAM: None

QUESTION SOURCE: ILT Bank – 2013 NRC Exam – Edits to stem

TIER: 2 **GROUP:** 2 **CATEGORY:** 215001 Traversing In-core Probe

K/A: A2.01 **IMPORTANCE:** RO 2.7 **COG LEVEL:** 1 P/B

K/A DESCRIPTION: Ability to (a) predict the impacts of the following on TRAVERSING IN-CORE PROBE; and (b) based on those predictions, use procedures to correct, control, or mitigate the consequences of those abnormal conditions or operations: Low reactor water level.

DIFFICULTY 3

LESSON PL: M8107L-059

OBJECTIVE: 7.b

2018 MONTICELLO ILT NRC EXAM - KEY

57. The plant is at rated conditions with 88% Total Recirc Drive flow when an event results in the following indications on Control Room Panel C-37:

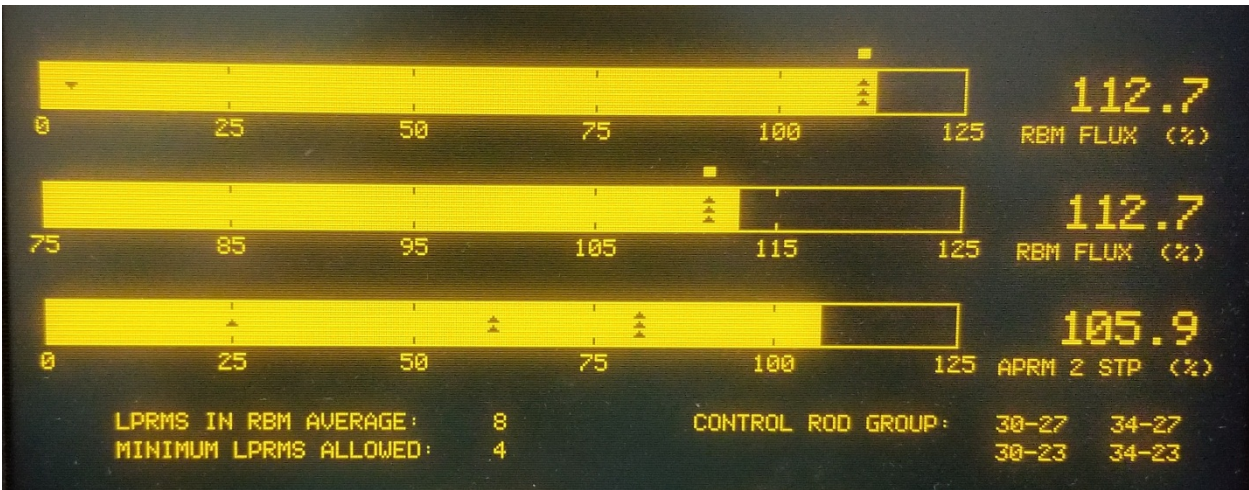

Which of the following is correct for the indications above?

- A. NO rod block is currently present.
- B. ONLY an RBM HI rod block is present.
- C. ONLY an APRM STP HI rod block is present.
- D. BOTH an RBM HI and APRM STP HI rod block are present.

CORRECT ANSWER: B

JUSTIFICATION: With the plant at 100% the RBM rod block setpoint is 111.2%. This value is currently being exceeded as shown from the C-37 back panel display (112.7%).

A is incorrect: RBM rod block setpoints vary with initial power level. 116.2 % (61%-81%) and 121.2 % (24.9- 61%). Plausible option for the current RBM and APRM STP values.

C and D are incorrect: For the current Recirc flow the APRM STP rod block would be calculated: $0.61(88\%) + 59.2\% = 112.8$. However, this Rod Block setpoint is clamped at 108% so no APRM STP rod block is present.

REFERENCE:	ARP 5-A-51	ARP 5-A-14	10 CFR	55.41b(7)
ADDITIONAL REFERENCE PROVIDED DURING EXAM:	None			
QUESTION SOURCE:	New			
TIER:	2	GROUP:	2	CATEGORY: 215002 Rod Block Monitor
K/A:	A3.05	IMPORTANCE:	RO 3.2	COG LEVEL: 2 DR
K/A DESCRIPTION:	Ability to monitor automatic operations of the ROD BLOCK MONITOR SYSTEM including: Back panel meters and indicating lights.			
DIFFICULTY	3	LESSON PL:	M8107L-066	OBJECTIVE: 7

2018 MONTICELLO ILT NRC EXAM - KEY

58. The plant is at rated conditions when 4-B-32 (DRYWELL EQUIP SUMP HI TEMP) alarms during pumping of the Drywell Equipment Drain Sump.

Which one of the following identifies expected system response?

AO-2560A (Drywell Equipment Drain Sump Pump Discharge To WCT) (1).
AO-2560B (Drywell Equipment Drain Sump Pump Discharge To HX) (2).

- | | | |
|----|----------------------|------------------------------|
| A. | <u>(1)</u>
CLOSES | <u>(2)</u>
REMAINS CLOSED |
| B. | REMAINS OPEN | OPENS |
| C. | CLOSES | OPENS |
| D. | REMAINS OPEN | REMAINS CLOSED |

CORRECT ANSWER: C

JUSTIFICATION: Annunciator 4-B-32 alarms at 140°F. This temperature starts Drywell Equipment Drain Sump Pumps, closes Drywell Equipment Drain Sump Pump Discharge To WCT, and opens Drywell Equipment Drain Sump Pump Discharge To HX. The operator is directed to verify panel indications are correct.

A, B and D are incorrect: Plausible combinations for misunderstanding of Primary Containment Auxiliaries component operations and/or confusion of component response between high temperature conditions and Group 2 isolation conditions.

REFERENCE: ARP 4-B-32 **10 CFR** 55.41b(7)
ADDITIONAL REFERENCE PROVIDED DURING EXAM: None
QUESTION SOURCE: ILT Bank – Edits to stem and choices.
TIER: 2 **GROUP:** 2 **CATEGORY:** 223001 Primary Containment and Auxiliaries
K/A: A4.08 **IMPORTANCE:** RO 3.4 **COG LEVEL:** 1I
K/A DESCRIPTION: Ability to manually operate and/or monitor in the control room: System indicating lights and alarms.
DIFFICULTY 3 **LESSON PL:** M8107L-044 **OBJECTIVE:** 7

2018 MONTICELLO ILT NRC EXAM - KEY

59. The plant was at rated conditions when an event occurred. Given the following:

- A Station Blackout and LOCA have occurred
- 13 Diesel Generator is supplying LC-107 and LC-108 (Back feed NOT available)
- C.5-1200 (PRIMARY CONTAINMENT CONTROL) has been entered

Which of the following actions from C.5-1200 can be accomplished (assume manual operation of MOTOR OPERATED valves is performed when required)?

- A. Establish H₂/O₂ Drywell sampling IAW C.5-3501 (H₂/O₂ ANALYZER OPERATION).
- B. Reduce Drywell air temperature IAW C.5-3503 (DEFEAT DRYWELL COOLER TRIPS).
- C. Lower Torus water level IAW C.5-3402 (DRAINING TORUS WATER TO RADWASTE).
- D. Use Fire Water System to initiate Torus sprays IAW C.5-3502 (CONTAINMENT SPRAY).

CORRECT ANSWER: D

JUSTIFICATION: IF a RHR pump is not available, THEN several options (PARTs) to spray containment are available, but, given the conditions, PART H of C.5-3502, USE FIRE WATER SYSTEM FOR CONTAINMENT SPRAY is the only viable option. All MOVs are in the Reactor Building and are accessible for manual operation.

A is incorrect: H₂/O₂ Analyzers are NOT available as they are powered from MCC-133A and MCC-143A (LC-103 and LC-104) via Power Panels P-73A and P-73B.

B is incorrect: DW Cooling Fans are NOT available as they are powered from MC-133A and MCC-143A (LC-103 and LC-104)

C is incorrect: a prerequisite to perform C.5-3402, Draining Torus Water to Radwaste, is having RHR available for service; however, with a SBO, and only the non-essential 13 Diesel Generator available and only powering to LC-107 and LC-108, RHR is NOT available.

REFERENCE:	C.5-3502	C.4-B.09.02.A	10 CFR	55.41b(10)
ADDITIONAL REFERENCE PROVIDED DURING EXAM:	None			
QUESTION SOURCE:	ILT Bank – 2016 NRC Exam – Edits to choices – From previous two NRC Exams			
TIER:	2	GROUP:	2	CATEGORY: 230000 RHR/LPCI Torus Spray Mode
K/A:	2.4.6	IMPORTANCE:	RO 3.7	COG LEVEL: 2 RI
K/A DESCRIPTION:	Knowledge of EOP mitigation strategies.			
DIFFICULTY	3	LESSON PL:	M8107L-023	OBJECTIVE: 9

2018 MONTICELLO ILT NRC EXAM - KEY

60. The plant is in an ELAP (Extended Loss of AC Power) with the following conditions:

- RPV level is +30" and stable
- The Diesel Fire Pump has failed
- The PDP (Portable Diesel Pump) is providing RPV injection
- RHRSW-14 (EMERG INJ VIA A RHRSW LOOP) is throttled open

Which of the following is correct concerning SFP (Spent Fuel Pool) makeup?
[P&IDs NH-36664 (M-112), NH-36247 (M-121) and NH-36256 (M-135) are provided]

- A. SFP makeup is NOT allowed when the PDP is lined up for RPV injection.
- B. SFP makeup can ONLY be provided by temporary hoses routed from RB 935' to the Refuel Floor.
- C. Opening PC-18 (FPCC RETURN FROM RHR HX) will directly supply water to the SFP in the current lineup.
- D. Opening RHRSW-68 (RHRSW EMERG FLEX INJECTION VALVE) will directly supply water to the SFP in the current lineup.

CORRECT ANSWER: C

JUSTIFICATION: For filling the SFP using the RHR to Fuel Pool Emergency Return Line the PDP must be supplying RHR for RPV injection with PDP or Diesel Fire Pump. If that lineup is in place (RHRSW-68 is open and RHRSW-14 is open) then throttling open PC-18 will directly supply water to the SFP.

A is incorrect: Provided sufficient flow is available for core cooling, it is allowed. Core cooling is sufficient with RPV level at +30 inches.

B is incorrect: This is an option, but not the only option.

D is incorrect: The examinee must recognize that this valve would be opened for RPV injection, and won't directly supply water to the SFP without PC-18 opened.

REFERENCE: C.5-4301 Part C

10 CFR 55.41b(10)

ADDITIONAL REFERENCE PROVIDED DURING EXAM:

NH-36664, NH-36247 & NH-36256

QUESTION SOURCE: New

TIER: 2 **GROUP:** 2 **CATEGORY:** 233000 Fuel Pool Cooling/Cleanup

K/A: K1.02 **IMPORTANCE:** RO 2.9 **COG LEVEL:** 2 RI

K/A DESCRIPTION: Knowledge of the physical connections and/or cause-effect relationships between FUEL POOL COOLING AND CLEAN-UP and the following: Residual heat removal system:

DIFFICULTY 4 **LESSON PL:** MT-ILT-FLX-001L **OBJECTIVE:** 12

2018 MONTICELLO ILT NRC EXAM - KEY

61. The plant is at rated conditions in a normal electric plant lineup. Given the following:

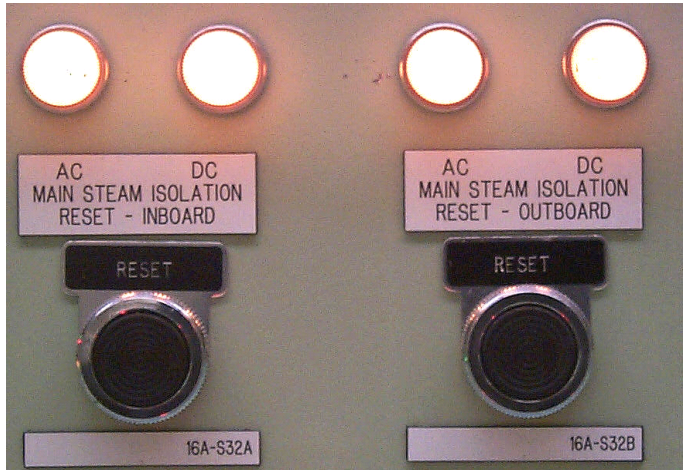

Which of the following describes the effect on the lights shown above and the MSIVs upon a complete loss of **Panel Y-70**?

- A. The INBOARD AC light will extinguish **and** the INBOARD MSIVs will CLOSE.
- B. The INBOARD AC light will extinguish **but** there will be NO effect on the MSIVs.
- C. The OUTBOARD AC light will extinguish **but** there will be NO effect on the MSIVs.
- D. The OUTBOARD AC light will extinguish **and** the OUTBOARD MSIVs will CLOSE.

CORRECT ANSWER: B

JUSTIFICATION: The MSIVs have two solenoid valves, both have to de-energize for the valves to go shut. The INBOARD MSIV solenoid valves are powered from Y70 and 125 Vdc Div I. The OUTBOARD MSIV solenoid valves are powered from Y80 and 125 Vdc Div II. The white lights shown provide indication to the solenoid valves. With a loss of Y70 INBOARD AC light would extinguish, but because the DC solenoid is still energized, the INBOARD MSIVs would remain open.

A, C and D are incorrect: Plausible choices for not understanding the PCIS Group 1 logic power.

REFERENCE:	B.05.06-02	B.02.04-05	10 CFR	55.41b(7)
REFERENCE PROVIDED DURING EXAM:	None			
QUESTION SOURCE:	ILT Bank – Significantly Modified from 2015 NRC Exam			
TIER:	2	GROUP:	2	CATEGORY: 239001 Main and Reheat Steam
K/A:	K2.01	IMPORTANCE:	RO 3.2	COG LEVEL: 2 DR
K/A DESCRIPTION:	Knowledge of electrical power supplies to the following: Main steam isolation valve solenoids.			
DIFFICULTY	2	LESSON PL:	M8107L-070	OBJECTIVE: 4

2018 MONTICELLO ILT NRC EXAM - KEY

62. The plant is at rated conditions with the Electrical Pressure Regulator (EPR) in service. Given the following:

- The EPR Control Position is set at 910 PSI
- The MPR Handwheel Position indicates 920 PSI

An overcurrent condition has caused the running EPR oil pump supply breaker to trip open and the Standby EPR oil pump failed to start.

Given the above information, which of the following is correct?

- A. Control valve closure will result in a reactor scram.
- B. Control valves will open, Main Steam pressure will lower; a reactor scram will occur.
- C. Control valves will initially throttle open, and then throttle close; RPV pressure will stabilize slightly lower.
- D. Control valves will initially throttle close, and then throttle open; RPV pressure will stabilize slightly higher.

CORRECT ANSWER: D

JUSTIFICATION: General precautions; during power operation, changing the controlling pressure regulator setpoint will have a small but noticeable effect on core thermal power (approximately 3MWt per 10 psig change). Both EPR oil pumps A & B are powered by MCC-142A, so loss will cause the MPR to be in control, reactor pressure will rise and reactor power would be expected to increase ~ 3 MWt, resulting in increased steam flow to the turbine.

A is incorrect: Plausible if the applicant believes that the EPR remains in control; MPR takes control when EPR output falls below MPR output.

B is incorrect: Plausible if examinee believes that the pressure set point fails to 0 psi upon loss of the EPR oil pumps; set point fails high on loss the oil pumps.

C is incorrect: this is the opposite effect of the correct answer and is plausible if examinee believes that the pressure set point fails to a slightly lower value (e.g. failed to 900 psi).

REFERENCE: B.05.09-05

10 CFR 55.41b(7)

ADDITIONAL REFERENCE PROVIDED DURING EXAM: None

QUESTION SOURCE: 2016 NRC Exam – Rearranged choices- From last two NRC Exams

TIER: 2 **GROUP:** 2 **CATEGORY:** 241000 Reactor/Turbine Pressure Regulating

K/A: K3.08 **IMPORTANCE:** RO 3.7 **COG LEVEL:** 3 PEO

K/A DESCRIPTION: Knowledge of the effect that a loss or malfunction of the REACTOR/TURBINE PRESSURE REGULATING SYSTEM will have on following: Control/governor valves.

DIFFICULTY 3 **LESSON PL:** M8107L-048 **OBJECTIVE:** 9

2018 MONTICELLO ILT NRC EXAM - KEY

63. The plant is at 10% power with the Low Flow FRV in AUTO and 11 RFP in service when the following occur concurrently:

- CV-3489 (11 RFP RECIRC VALVE) handswitch is in AUTO
- CV-3489 (11 RFP RECIRC VALVE) fails fully CLOSED
- The Low Flow FRV loses its electric control signal

Complete the following statement.

The Low Flow FRV will fail...

- A. OPEN and RPV water level will rise.
- B. CLOSED and 11 RFP will trip on low flow.
- C. CLOSED and damage may occur to 11 RFP.
- D. AS-IS and RPV water level will remain relatively stable.

CORRECT ANSWER: B

JUSTIFICATION: With CV-3489 failing CLOSED, RFP recirc flow will be 0 gpm. The Low Flow FRV closing will cause total feed flow to go to 0 gpm and with CV-3489 in AUTO, the RFP will trip on low flow less than 1200 gpm for 10 seconds.

A is incorrect: The valve fails closed.

C is incorrect: This would only occur at flows between 1200 gpm and 4500 gpm or CV-3489 Handswitch in CLOSE.

D is incorrect: The valve fails closed. Plausible for Main FWRV in service which will not be in service until 17% power.

REFERENCE:	B.05.07-01	B.06.05-02	10 CFR	55.41b(7)
ADDITIONAL REFERENCE PROVIDED DURING EXAM:	None			
QUESTION SOURCE:	ILT Bank – Edits to stem			
TIER:	2	GROUP:	2	CATEGORY: 259001 Feedwater
K/A:	K4.03	IMPORTANCE:	RO 2.7	COG LEVEL: 3 PEO
K/A DESCRIPTION:	Knowledge of REACTOR FEEDWATER SYSTEM design feature(s) and/or interlocks which provide for the following: RFP minimum flow.			
DIFFICULTY	4	LESSON PL:	M8107L-068	OBJECTIVE: 7

2018 MONTICELLO ILT NRC EXAM - KEY

64. A task needs to be performed that involves the movement of Radwaste. The RWP indicates a job dose estimate of 66 mrem.

Which of the following approaches to performing the task will maintain the total dose within the RWP job dose estimate AND result in the best ALARA practice?

- A. One individual performing the job in a 90 mrem/hr field for 45 minutes.
- B. Two individuals performing the job in a 90 mrem/hr field for 20 minutes.
- C. One individual installing/removing temporary shielding in a 90 mrem/hr field for 30 minutes and then performing the job in a 25 mrem/hr field for 60 minutes.
- D. Two individuals installing/removing temporary shielding in a 90 mrem/hr field for 10 minutes and then both individuals performing the job in a 35 mrem/hr field for 30 minutes.

CORRECT ANSWER: B

JUSTIFICATION: Total Dose = $2 \times 30 \text{ mrem} = 60 \text{ mrem}$

As part of Operations Shift briefs, the operators are required to evaluate upcoming work items and look for opportunities to reduce exposure. In this case it is within the RWP and is the lowest dose resulting in the best ALARA practice.

A is incorrect: Total Dose = $90 \text{ mrem/hr} \times .75 = 67.5 \text{ mrem}$ (Outside RWP and not the lowest dose).

C is incorrect: Total Dose = $90 \text{ mrem/hr} \times .5 + 25 \text{ mrem} = 70 \text{ mrem}$ (Outside RWP and not the lowest dose).

D is incorrect: Total Dose = $2 \times 15 \text{ mrem} + 2 \times 17.5 \text{ mrem} = 65 \text{ mrem}$ (within the RWP but not the lowest dose).

REFERENCE: 4AWI-08.04.08

10 CFR 55.41(12)

REFERENCE PROVIDED DURING EXAM: None

QUESTION SOURCE: ILT Bank

TIER: 2 **GROUP:** 2 **CATEGORY:** 268000 Radwaste

K/A: K5.02 **IMPORTANCE:** RO 3.1 **COG LEVEL:** 3 SPK

K/A DESCRIPTION: Knowledge of the operational implications of the following concepts as they apply to the RADWASTE System: Radiation hazards and ALARA concept.

DIFFICULTY 3 **LESSON PL:** M8108L-039 **OBJECTIVE:** 1

2018 MONTICELLO ILT NRC EXAM - KEY

65. The plant was at rated conditions when a scram occurred. RPV pressure was stable at 845 psig for one hour when an SRV partially stuck open.

Which of the pressures below will **FIRST** exceed the TS LCO limit for RPV Cooldown?

- A. 365 psig
- B. 325 psig
- C. 285 psig
- D. 275 psig

CORRECT ANSWER: C

JUSTIFICATION: The maximum allowed cooldown is 100°F/hr when averaged over a one hour period. Exceeding this limit will likely risk damage to the RPV and internal components. See data below:

Pressure (PSIG)	Pressure (PSIA)	Saturation Temp (°F)	Delta Temp (°F)
845	860	526.7	
365	380	439.6	87.1
325	340	429.0	97.7
285	300	417.4	109.3
275	290	414.3	112.4

A, B and D are incorrect: Plausible options for incorrect application of steam tables, psig vs psia, or knowledge of the TS requirements for cooldown rate. Additionally, the MNGP administrative limit is 97°F/hr.

REFERENCE: TS 3.4.9 **10 CFR** 55.41b(3)
ADDITIONAL REFERENCE PROVIDED DURING EXAM: Steam Tables
QUESTION SOURCE: New
TIER: 2 **GROUP:** 2 **CATEGORY:** 290002 Reactor Vessel Internals
K/A: K6.06 **IMPORTANCE:** RO 3.0 **COG LEVEL:** 3 SPR
K/A DESCRIPTION: Knowledge of the effect that a loss or malfunction of the following will have on the REACTOR VESSEL INTERNALS: Relief/safety valves.
DIFFICULTY 3 **LESSON PL:** M8107L-028 **OBJECTIVE:** 8

2018 MONTICELLO ILT NRC EXAM - KEY

66. The plant is stable in Mode 4 with no abnormal conditions present and no abnormal evolutions in progress.

IAW the Technical Requirements Manual (TRM), which of the following is the minimum number of active licenses required for Shift Crew Composition?

- A. Two
- B. Three
- C. Four
- D. Five

CORRECT ANSWER: A

JUSTIFICATION: This is the requirement in Modes 4 and 5. Also it's the minimum number of licenses required in the control room at all times IAW the AWI.

B is incorrect: Management expectation is that 3 actives licenses are in the control room at all times.

C is incorrect: In Modes 1, 2 and 3; the TRM requires 2 SROs and 2 RO for minimum shift composition.

D is incorrect: Five to Six is the normal crew composition but it's not required by the TRM.

REFERENCE: TRM 5.2-1

10 CFR: 55.41b(10)

ADDITIONAL REFERENCE PROVIDED DURING EXAM: None

QUESTION SOURCE: ILT Bank

TIER: 3 **GROUP:** 1 **CATEGORY:** Conduct of Operations

K/A: 2.1.1 **IMPORTANCE:** RO 3.8 **COG LEVEL:** 1P

K/A DESCRIPTION: Knowledge of conduct of operations requirements.

DIFFICULTY: 3 **LESSON PL:** M8107L-039 **OBJECTIVE:** 2

2018 MONTICELLO ILT NRC EXAM - KEY

68. Refer to B.05.05-06 Figure 1 on the next page and the following scenario timeline:

Scenario Timeline:

- The Mode Switch is in REFUEL.
- ALL control rods are fully inserted.
- ONE Control Rod is currently selected.
- The “Rod Out Permissive” white light is ON.
- The ONLY hoist in use is the Main Grapple Hoist.
- The Refuel Bridge is UNLOADED and driven over the core.
- The Main Grapple Hoist is LOWERED into the core to retrieve a fuel assembly
- The OATC attempts to WITHDRAW the selected Control Rod.

At which point in the scenario above would a Rod Block **FIRST** be initiated?

- A. When the Refuel Bridge is driven over the core.
- B. When the Main Grapple Hoist starts to lower into the core.
- C. When the OATC attempts to withdraw the selected control rod.
- D. When the loaded Main Grapple Hoist reaches Full-Up over the core.

CORRECT ANSWER: B

JUSTIFICATION: To prevent a refueling accident, interlocks are in place that will initiate rod blocks under certain refueling conditions. With the Refuel platform unloaded a rod block will occur when the Grapple is no longer full up.

A is incorrect: This would only occur if the Refuel platform was loaded.

C is incorrect: This could not occur because the rod block will have already occurred.

D is incorrect: If the hoist is loaded, a rod block will occur but this is not the first initiator.

REFERENCE:	B.05.05-06 Fig 1	10 CFR	55.41b(7)
ADDITIONAL REFERENCE PROVIDED DURING EXAM:	None		
QUESTION SOURCE:	ILT Bank		
TIER:	3	GROUP:	1
		CATEGORY:	Conduct of Operations
K/A:	2.1.44	IMPORTANCE:	RO 3.9
		COG LEVEL:	2 DR
K/A DESCRIPTION:	Knowledge of RO duties in the control room during fuel handling, such as responding to alarms from the fuel handling area, communication with the fuel storage facility, systems operated from the control room in support of fueling operations, and supporting instrumentation.		
DIFFICULTY	3	LESSON PL:	M8107L-019
		OBJECTIVE:	7

2018 MONTICELLO ILT NRC EXAM - KEY

Figure 1 Refuel Interlock-Rod Blocks

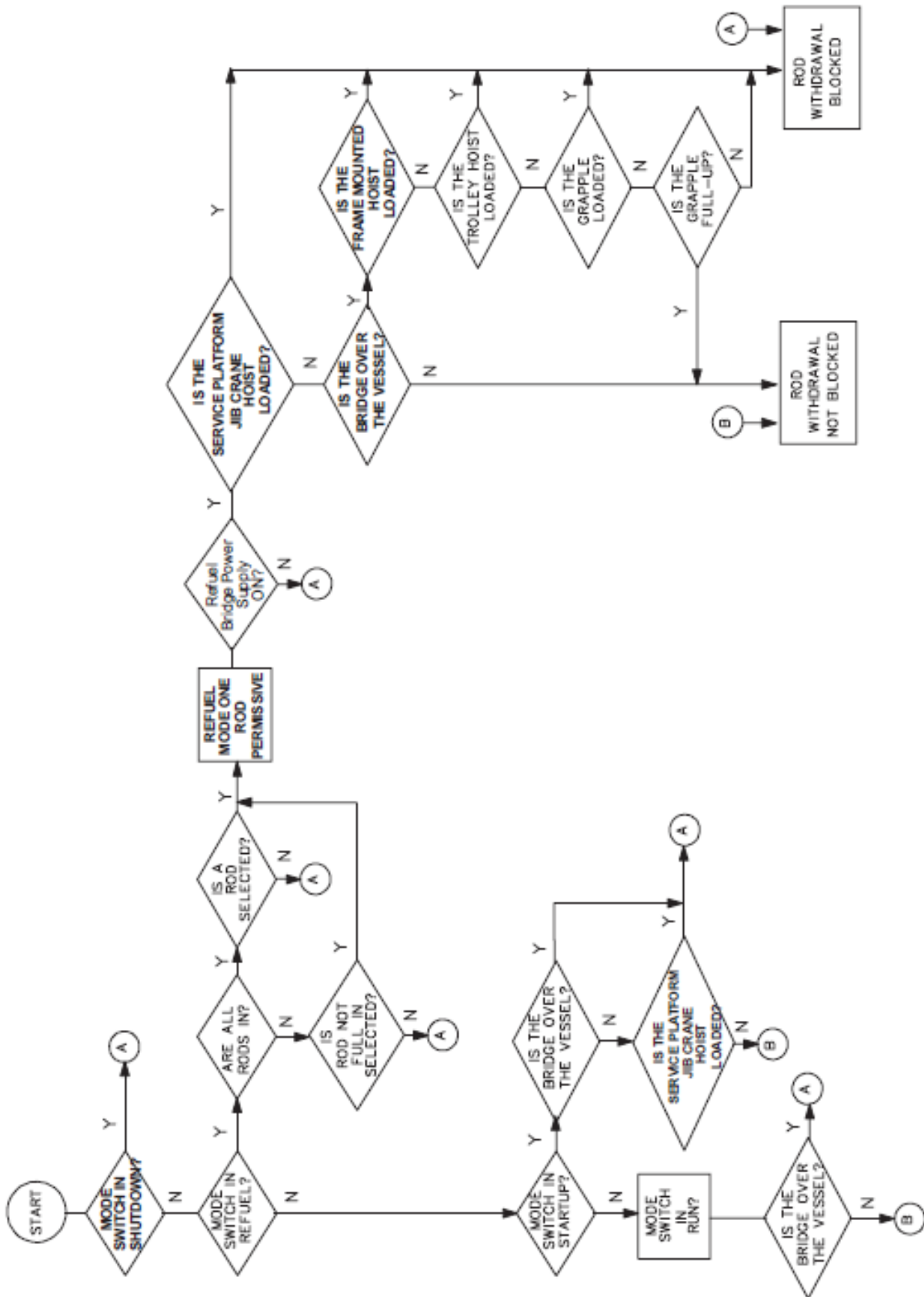

2018 MONTICELLO ILT NRC EXAM - KEY

69. A plant startup is in progress and the crew is about to transfer RPV water level control from the LOW FLOW FW REG VALVE to the A MAIN FW REG VALVE.

Which of the following is correct concerning these valves?

(Note: logarithmic = valve responds faster the longer the pushbutton is depressed)

- A. The LOW FLOW **and** MAIN FW Reg Valves controller pushbuttons are two-speed.
- B. The LOW FLOW **and** MAIN FW Reg Valves controller pushbuttons are single-speed.
- C. The LOW FLOW **and** MAIN FW Reg Valve controller pushbuttons are logarithmic speed.
- D. The LOW FLOW Reg Valve controller pushbuttons are two-speed **and** the MAIN FW Reg Valves controller pushbuttons are logarithmic speed.

CORRECT ANSWER: A

JUSTIFICATION: Feedwater controllers have a two speed controlling function, depressing the open or close pushbuttons halfway will cause slower response than depressing the buttons fully.

B, C and D are incorrect: These represent plausible but incorrect variations on the operation of these controllers during operation from shutdown and designated power levels.

REFERENCE: B.05.07-05.D.1

10 CFR

55.41b (7)

REFERENCE PROVIDED DURING EXAM: None

QUESTION SOURCE: ILT Bank – 2013 NRC Exam

TIER: 3

GROUP: 2.2

CATEGORY: Equipment Control

K/A: 2.2.2

IMPORTANCE: RO 4.6

COG LEVEL: 1F

K/A DESCRIPTION: Ability to manipulate the console controls as required to operate the facility between shutdown and designated power levels.

DIFFICULTY 2

LESSON PL: M8107L-046

OBJECTIVE: 7

2018 MONTICELLO ILT NRC EXAM - KEY

70. Which of the following combinations of plant conditions meet the definition of **MODE 4**?
- A. Reactor water temperature is 180°F
Mode switch is in SHUTDOWN
RPV head is removed
 - B. Reactor water temperature is 200°F
Mode switch is in REFUEL
ALL RPV closure head bolts fully tensioned
 - C. Reactor water temperature is 221°F
Mode switch is in SHUTDOWN
ALL RPV closure head bolts fully tensioned
 - D. Reactor water temperature is 100°F
Mode switch is in SHUTDOWN
ALL RPV closure head bolts fully tensioned

CORRECT ANSWER: D

JUSTIFICATION: It is the only answer that meets the definition of Mode 4.

MODE	TITLE	REACTOR MODE SWITCH POSITION	AVERAGE REACTOR COOLANT TEMPERATURE (°F)
1	Power Operation	Run	NA
2	Startup	Refuel ^(a) or Startup/Hot Standby	NA
3	Hot Shutdown ^(a)	Shutdown	> 212
4	Cold Shutdown ^(a)	Shutdown	≤ 212
5	Refueling ^(b)	Shutdown or Refuel	NA

(a) All reactor vessel head closure bolts fully tensioned.

(b) One or more reactor vessel head closure bolts less than fully tensioned.

A is incorrect: This would be Mode 5.

B is incorrect: This would be Mode 2.

C is incorrect: This would be Mode 3.

REFERENCE: TS Table 1.1-1

10 CFR 55.41b(10)

ADDITIONAL REFERENCE PROVIDED DURING EXAM:

None

QUESTION SOURCE: ILT Bank

TIER: 3 **GROUP:** 2 **CATEGORY:** Equipment Control

K/A: 2.2.35 **IMPORTANCE:** RO 3.6 **COG LEVEL:** 1 D

K/A DESCRIPTION: Ability to determine Technical Specification Mode of operation.

DIFFICULTY 2 **LESSON PL:** MT-OPS-ITS-002L **OBJECTIVE:** 2

2018 MONTICELLO ILT NRC EXAM - KEY

71. The plant is at rated conditions with all electrical buses on their normal supply and the Subyard aligned as follows for maintenance:

- 10 Bank Transformer is isolated
- Breaker 1N6 (13.8 KV OCB) is closed

If a 1R Transformer lockout occurs with the conditions above, which of the following TS/TRM Required Actions, if any, must be taken?

- A. NO TS/TRM action(s) is/are required.
- B. Verify both EDGs are operable IMMEDIATELY.
- C. Perform SR 3.8.1.1 for the 2R Transformer within 1 hour.
- D. Perform SR 3.8.1.1 for the 1AR Transformer within 1 hour.

CORRECT ANSWER: A

JUSTIFICATION: 2R Transformer is the normal supply to plant busses.

Qualified Offsite Circuits required by TS 3.8.1 are as follows (two of the four are required):

- 1) 2R Transformer
- 2) 1R Transformer
- 3) 1AR Transformer fed from 10 Bank via 1N2(normally) or
- 4) 1AR Transformer fed from 1ARS via 1N6

Number 4) above did not used to be a qualified circuit but now is. TSs requires that 2 qualified sources remain available to satisfy LCO 3.8.1. In the alignment above, Number 1) and 4) are available so no action is required.

Qualified NSP Transmission Lines (two of the six are required) are as follows:

- 345 KV – Elm Creek Substation, Sherburne County Substation and Quarry Substation.
- 115 KV – Hassan, Dickenson/Lake Pulaski, and Liberty Subyard.

All of the 345 KV transmission lines are available, 3 of 6 are available so TLCO 3.8.1 is met.

B is incorrect: Plausible TRM action if the required transmission lines were not met.

C is incorrect: Prior to the substation modification, this would have been the correct answer.

D is incorrect: Plausible action to take for the abnormal 1AR lineup.

REFERENCE: TS 3.8.1 and TRM 3.8.1 **10 CFR** 55.41(7, 10)

REFERENCE PROVIDED DURING EXAM: None

QUESTION SOURCE: New

TIER: 3 **GROUP:** 2 **CATEGORY:** Equipment Control

K/A: 2.2.36 **IMPORTANCE:** RO 3.1 **COG LEVEL:** 2RI

K/A DESCRIPTION: Ability to analyze the effect of maintenance activities, such as degraded power sources, on the status of limiting conditions for operations.

DIFFICULTY 3 **LESSON PL:** M8114L-003 **OBJECTIVE:** 2

2018 MONTICELLO ILT NRC EXAM - KEY

72. The plant was at rated conditions with “B” CRV/EFT in Normal Mode B. An event occurs resulting in the following conditions:

- Annunciators 242-A-05/07 (CR AIR INTAKE HI RAD CH A/B) are alarming
- Annunciators 242-A-04/06 (CR AIR INTAKE HI-HI RAD CH A/B) are alarming
- RM-9021A & B (AIR INTAKE RAD MONs) are reading 1.2 mrem/hr and slowly rising
- “A” CRV/EFT remains in Standby
- “B” CRV/EFT remains in Normal Mode B

Which of the following actions is correct for the above conditions?

- A. Align “A” CRV/EFT to supply fresh air to the control room.
- B. Place HS-9000A (A EFT SYSTEM MASTER SW) to RECIRC MODE.
- C. Place RM-9021A/B (AIR INTAKE RAD MONs) in CHECK for 5 seconds.
- D. Verify that the Control Room shifts to High Rad Mode once RM-9021A & B reach 2 mrem/hr.

CORRECT ANSWER: C

JUSTIFICATION: Annunciator 20-B-04 automatic actions are that CRV-EFT initiates into the high rad mode at 1 mrem/hr. Since this has not occurred, the system should be manually placed in the high rad mode by placing the radiation monitors in check for 5 seconds. The following annunciators would also be in alarm but were left out of stem to minimize unnecessary information.

- Annunciator 20-B-08 (CR AIR INTAKE HI RAD)
- Annunciator 20-B-04 (CR AIR INTAKE HI-HI RAD)

A is incorrect: Plausible option but in this case, the source of the radiation is from the outside air.

B is incorrect: Plausible to transfer the other train to the Recirc Mode.

D is incorrect: Plausible action for not recalling the High Rad Mode setpoint of 1 mrem/hr

REFERENCE:	ARP 242-A-04	B.08.13-05.H.1	10 CFR	55.41b(7)
ADDITIONAL REFERENCE PROVIDED DURING EXAM:	None			
QUESTION SOURCE:	New			
TIER:	3	GROUP:	3	CATEGORY: Radiation Control
K/A:	2.3.5	IMPORTANCE:	RO 2.9	COG LEVEL: 2 RI
K/A DESCRIPTION:	Ability to use radiation monitoring systems, such as fixed radiation monitors and alarms, portable survey instruments, personnel monitoring equipment, etc.			
DIFFICULTY	3	LESSON PL:	M8107L-049	OBJECTIVE: 7

2018 MONTICELLO ILT NRC EXAM - KEY

73. Following an inadvertent instrument actuation, a reactor scram occurred and plant conditions were stabilized. The OATC took actions to reset the scram per C.4-A and due to these actions, the following annunciator conditions are present:

- 5-B-6 (DISCH VOLUME HI WATER LEVEL BYPASS) **IN ALARM**
- 5-B-21 (DISCH VOLUME WATER LEVEL SCRAM TRIP) **RESET**
- 4-A-11 (REACTOR BUILDING HI RADIATION) **IN ALARM**

Based on the above information, which of the below is the source of the Reactor Building radiation condition?

- A. Waste Collector Tank.
- B. Reactor Building Floor Drain Sump.
- C. Reactor Building Equipment Drain Tank.
- D. Reactor Building Equipment Drain Sump.

CORRECT ANSWER: C

JUSTIFICATION: The annunciator status demonstrates that the SDV level has lowered due to the actions to reset the scram, personnel are evacuated per C.4-A from the 896' Floor and Equipment Drain Tank Room because the SDV is drained to these tanks. This may cause area radiation levels and area airborne activity to increase.

A is incorrect: The High Radiation annunciator came in due to the actions of the OATC, if not, the alarm would have already been in if these valves fail to close upon the scram.

B and D are incorrect: Although they are in the same location, this is not where the SDV dumps water.

REFERENCE: C.4-A **10 CFR** 55.41(10)

REFERENCE PROVIDED DURING EXAM: None

QUESTION SOURCE: ILT Bank

TIER: 3 **GROUP:** 3 **CATEGORY:** Radiation Control

K/A: 2.3.14 **IMPORTANCE:** RO 3.4 **COG LEVEL:** 2 RI

K/A DESCRIPTION: Knowledge of radiation or contamination hazards that may arise during normal, abnormal, or emergency conditions or activities.

DIFFICULTY 3 **LESSON PL:** MT-ILT-AOP-001L **OBJECTIVE:** 8

2018 MONTICELLO ILT NRC EXAM - KEY

74. Complete the statement below:

A Fire Brigade of _____ (1) _____ members must be on site at all times.
These Fire Brigade members _____ (2) _____ be the same personnel that are necessary for implementing C.4-C (SHUTDOWN OUTSIDE CONTROL ROOM).

- A. (1) four
(2) may
- B. (1) four
(2) may NOT
- C. (1) five
(2) may
- D. (1) five
(2) may NOT

CORRECT ANSWER: D

JUSTIFICATION: On-shift collateral duties require the following staffing during emergency and abnormal conditions: Five duty crew members normally filled by the following individuals: BOP, two NAPEOs, Shift Chemist, Shift Rad Prot Spec. These individuals are required to be respirator qualified.

Three duty crew members are required to effectively implement C.4-C (SHUTDOWN OUTSIDE CONTROL ROOM). Normally four individuals are available to implement this procedure. These individuals cannot simultaneously have Fire Brigade duties.

A, B and C are incorrect: Plausible misconceptions for required numbers and responsibilities.

REFERENCE:	OWI-01.06	10 CFR	55.41b(10)
ADDITIONAL REFERENCE PROVIDED DURING EXAM:	None		
QUESTION SOURCE:	ILT Bank		
TIER:	3	GROUP:	4
		CATEGORY:	Emergency Procedures / Plan
K/A:	2.4.12	IMPORTANCE:	RO 4.0
		COG LEVEL:	1 P
K/A DESCRIPTION:	Knowledge of general operating crew responsibilities during emergency operations.		
DIFFICULTY	2	LESSON PL:	M8108L-038
		OBJECTIVE:	2

2018 MONTICELLO ILT NRC EXAM - KEY

75. The plant was at rated conditions when a LOCA occurred. An "Emergency Depressurization" (ED) is being performed due to the inability to maintain RPV level with high pressure systems.

Which of the following RPV injection line-ups & level indications would be appropriate in this situation to maintain "adequate core cooling"?

- A. One Core Spray pump injecting at 2500 gpm, RPV level at -152" and lowering.
- B. Two Core Spray pumps injecting at 2500 gpm each, RPV level at -178" and steady.
- C. One Core Spray pump injecting at 3100 gpm, one RHR pump injecting at 4000 gpm, and RPV level at -165" and steady.
- D. One Core Spray pump injecting at 2500 gpm, three RHR pumps injecting at 4000 gpm each, and RPV level at -152" and steady.

CORRECT ANSWER: C

JUSTIFICATION: Adequate Core Cooling is defined as follows: Heat removal from the reactor sufficient to prevent rupturing the fuel clad. Three viable mechanisms of adequate core cooling exist. In order of preference:

Core submergence (>-126"),

2/3 Core height (>-174") with rated Core Spray injection (3020 gpm),

Steam cooling (>-149") with injection of makeup water to the RPV.

A, B and D are incorrect: Plausible injection methods and amounts but RPV levels are too low to meet the definition of adequate core cooling.

REFERENCE: C.5-1-1000

10 CFR 55.41b(10)

REFERENCE PROVIDED DURING EXAM: None

QUESTION SOURCE: ILT Bank

TIER: 3 **GROUP:** 4 **CATEGORY:** Emergency Procedures / Plan

K/A: 2.4.17 **IMPORTANCE:** RO 3.9 **COG LEVEL:** 1 D

K/A DESCRIPTION: Knowledge of EOP terms and definitions.

DIFFICULTY 2 **LESSON PL:** MT-ILT-EOP-001L **OBJECTIVE:** 1

2018 MONTICELLO ILT NRC EXAM - KEY

76. The plant is at rated conditions when an electrical transient occurs. While the panel operators are investigating the cause, you observe the following indications on the C-03 Mimic Bus (See Picture on following page).

Based on the indications, determine the extent of the electrical transient AND what Technical Specification Action is required as the CRS?

- A. **ONLY** a loss of D312 (Div 2 250V DC MCC) has occurred.
Direct the isolation of ONE penetration flow path within 4 hours.
- B. **ONLY** a loss of D312 (Div 2 250V DC MCC) has occurred.
Direct the Isolation of ONE penetration flow path within 8 hours.
- C. A loss of D313 (Div 1 250V DC MCC) **AND** D312 (Div 2 250V DC MCC) has occurred.
Direct the Isolation of ONE penetration flow path within 4 hours.
- D. A loss of D313 (Div 1 250V DC MCC) **AND** D312 (Div 2 250V DC MCC) has occurred.
Direct the Isolation of THREE penetration flow paths within 4 hours.

CORRECT ANSWER: A

JUSTIFICATION: The following valves are shown with no power:

MO-2035 HPCI Outboard which is powered by D312

MO-2029 RHR S/D Cooling Inboard which is AC powered and normally de-energized at power

MO-2032 RHR/Radwaste Drain Inboard which is AC powered and normally de-energized at power.

The picture only depicts a loss of power to the HPCI Outboard therefore the electrical transient has only affected ONE (HPCI) penetration flow path. This affected flow path must be isolated within 4 hours IAW TS 3.6.1.3 Condition A

B is incorrect: This is the correct transient but the 8 hour completion time only applies to MSIVs

C is incorrect: If D313 was lost, there would be no power to MO-2030.

D is incorrect: Only one penetration flow path is affected.

REFERENCE: C.4-B.09.09.A TS 3.6.1.3 **10 CFR:** 55.43b(2)

ADDITIONAL REFERENCE PROVIDED DURING EXAM: TS 3.6.1.3

SRO ONLY JUSTIFICATION: Technical Specification ACTION & COMPLETION TIME determination.

QUESTION SOURCE: ILT Bank – 2013 NRC Exam

TIER: 1 **GROUP:** 1 **CATEGORY:** 295004

K/A: AA2.01 **IMPORTANCE:** SRO 3.6 **COG LEVEL:** 3 SPR/SPK

K/A DESCRIPTION: Ability to determine and/or interpret the following as they apply to PARTIAL OR COMPLETE LOSS OF D.C. POWER: Cause of partial or complete loss of D.C. power.

DIFFICULTY: 4 **LESSON PL:** MT-ILT-AOP-019L **OBJECTIVE:** 4

2018 MONTICELLO ILT NRC EXAM - KEY

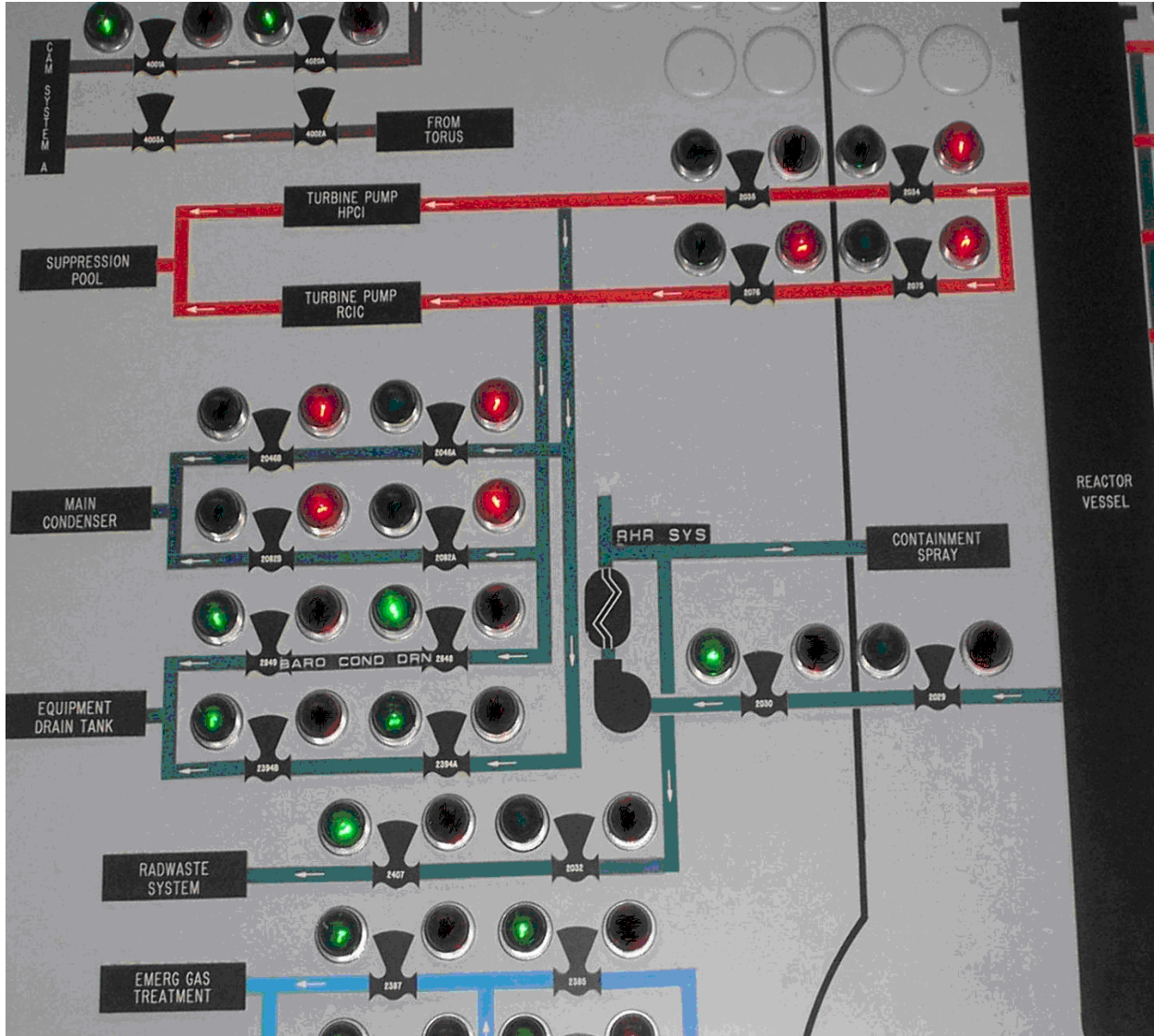

2018 MONTICELLO ILT NRC EXAM - KEY

77. The plant is at rated conditions. Test 0081 (Control Rod Drive Scram Insertion Test) is being performed. Given the following data:

Control Rod (CR) scram times to notch position 06:

- CR 30-27 - 6.8 seconds
- CR 30-31 - 6.5 seconds
- CR 34-27 - 7.1 seconds

Which of the following is a correct action to be taken at this time?
(A map of Control Rod positions is provided on the following page)

- A. Be in Mode 3 within 12 hours.
- B. Declare all three CRs operable but slow.
- C. Fully insert CR 34-27 within 3 hours and locally disarm it within 4 hours.
- D. Fully insert all three CRs within 3 hours and locally disarm them within 4 hours.

CORRECT ANSWER: C

JUSTIFICATION: For the 3 adjacent control rods above, two are slow and one in inop. TS 3.1.4.1 Note 2 requires entry into TS 3.1.3 for any rod with a scram time >7 sec. TS 3.1.3 will require the control rod to be fully inserted within 3 hours and locally disarmed within 4 hours. CR 34-27 is considered inop and not Slow. Two adjacent slow control rod are allowed IAW TS 3.1.4.

A is incorrect: Being in Mode 3 within 12 hours is wrong due to meeting Part b of LCO 3.1.4 with rod 34-27 inop rods 30-31 and 26-35 are the only rods considered slow and are not adjacent.

B is incorrect: Declaring all 3 rods operable but slow is wrong per Note 2 of 3.1.4.1.

D is incorrect: Control rod 34-27 is the only one required to be declared inop. The other 2 rods meet the LCO statement.

REFERENCE: TS 3.1.4.1 TS 3.1.3 **10 CFR:** 55.43b(2)

ADDITIONAL REFERENCE PROVIDED DURING EXAM: TS 3.1.3 & TS 3.1.4

SRO ONLY JUSTIFICATION: TS Condition and Required Action determination.

QUESTION SOURCE: New

TIER: 1 **GROUP:** 1 **CATEGORY:** 295006 Scram

K/A: 2.1.30 **IMPORTANCE:** SRO 4.0 **COG LEVEL:** 3 SPK

K/A DESCRIPTION: Ability to locate and operate components, including local controls.

DIFFICULTY: 4 **LESSON PL:** M8107L-020 **OBJECTIVE:** 10

2018 MONTICELLO ILT NRC EXAM - KEY

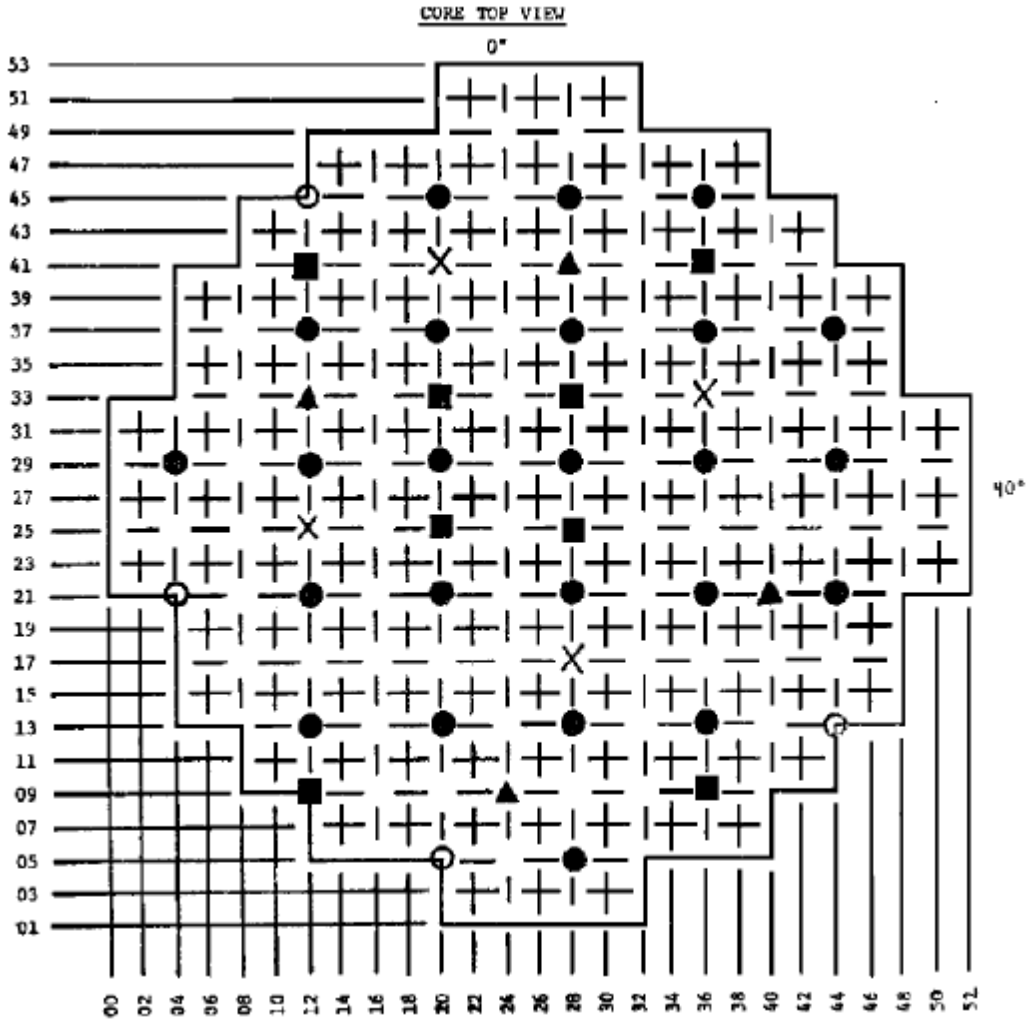

2018 MONTICELLO ILT NRC EXAM - KEY

78. The plant is at rated conditions. A Loss of Instrument Air occurs resulting in the receipt of alarm 5-B-22 (SCRAM PILOT AIR HEADER HI/LO PRESS).

Based on the conditions above; which procedure must be entered/directed, and why?

- A. C.4-A (REACTOR SCRAM); the backup scram valves will open at this pressure and an AUTOMATIC reactor scram will occur.
- B. C.4-B.01.03.C (CONTROL ROD DRIFTING); the CRD flow control valve will fail OPEN causing multiple control rods to drift in.
- C. C.5-2007 (FAILURE TO SCRAM); the potential exists for an ATWS condition due to a hydraulic lock in the Scram Discharge Volume.
- D. C.4-K (IMMEDIATE REACTOR SHUTDOWN); random control rods could begin inserting into the core resulting in uneven flux distribution.

CORRECT ANSWER: D

JUSTIFICATION: When air pressure lowers to 60 psig, the CRD HCU scram valves may begin to open causing controls to insert into the core. If the rods begin to insert or alarm 5-B-22 is received, the reactor should be scrammed. The scram prevents uneven flux distribution from random control rod insertion and minimizes the challenges to the CRD system through flooding of the SDV.

A is incorrect: Following a manual scram this procedure will be entered, but an automatic scram will not occur.

B is incorrect: This procedure is plausible as control rods will initially appear to drift in due to the lowering scram air header pressure. The CRD flow control valve fails closed on a loss of air and if multiple rods drift though the operators are instructed to execute C.4-K.

C is incorrect: SDV challenges may exist under these conditions; however this procedure wouldn't be entered preemptively.

REFERENCE: C.4-B.08.04.01

10 CFR: 55.43b(5)

ADDITIONAL REFERENCE PROVIDED DURING EXAM: None

SRO ONLY JUSTIFICATION: Assessment of plant conditions and selection of abnormal procedure.

QUESTION SOURCE: ILT Bank – 2013 NRC Exam

TIER: 1 **GROUP:** 1 **CATEGORY:** 295019 Partial or Complete Loss of IA

K/A: AA2.02 **IMPORTANCE:** SRO 3.7 **COG LEVEL:** 3 SPK

K/A DESCRIPTION: AA2.02 – Ability to determine and/or interpret the following as they apply to PARTIAL OR COMPLETE LOSS OF INSTRUMENT AIR: Status of safety-related instrument air system loads

DIFFICULTY: 3 **LESSON PL:** MT-ILT-AOP-017 **OBJECTIVE:** 4

2018 MONTICELLO ILT NRC EXAM - KEY

79. The plant is in a refueling outage with the following conditions present:

- The RPV head is removed
- RPV water level is two-feet (2') above the reactor vessel flange
- 1027' elevation radiation levels are 2 mrem/hr
- Secondary containment is NOT established

A leak occurs in the East Shutdown Cooling room that's confirmed by the Reactor Building Operator and plant conditions changed as follows:

- RPV water level lowered BY 224 inches
- 1027' elevation radiation levels rises to 18 mrem/hr
- 12 minutes after the start of the leak, it was isolated and RPV water level was restored to the flange

Which of the following E-plan classifications, if any, should be declared?
(B.01.01-06 Figure 28 is on the following page.)

- A. NUE
- B. Alert
- C. Site Area Emergency
- D. No Classification required

CORRECT ANSWER: A

JUSTIFICATION: The plant is in Mode 5 and a VALID water level lowering is observed. Reactor water level lowers by 224" resulting in indicated water level reading of approximately -25" (applicant must view Figure 28 below, note an original level of approximately $655''+2''=679''$, then subtract 224" from that to arrive at 455", which is approximately 25" above the Low-Low Level trip (-47") = -22". An UNPLANNED VALID Area Radiation Monitor rises as indicated by the 1027' elevation rad monitors (however, the rise is not enough to trip an alarm or in an area where continuous occupancy is required). These observations would meet the requirement of RU2.1 in the EAL Matrix.

B is incorrect: Radiation levels on the 1027' elevation would have to reach the alarm setpoint of 20 mrem to meet the requirements of RA2.1, in this case the rad monitors stay <20 mrem at 18mrem.

C is incorrect: Plausible as secondary containment is NOT established however water level has not gone below - 53" in order to meet CS2.1.

D is incorrect: Plausible if Hot EALs are used or if CU2.1 is used and less than 15 minutes is not recognized.

REFERENCE: EAL Matrix B.01.01-06 **10 CFR:** 55.43b(5)

ADDITIONAL REFERENCE PROVIDED DURING EXAM: EAL Matrix

SRO ONLY JUSTIFICATION: E-Plan classification determination

QUESTION SOURCE: 2016 NRC Exam – From previous two exams

TIER: 1 **GROUP:** 1 **CATEGORY:** 295023 Refueling Accidents

K/A: 2.4.30 **IMPORTANCE:** SRO 4.1 **COG LEVEL:** 3 SPR

K/A DESCRIPTION: Knowledge of events related to system operation/status that must be reported to internal organizations or external agencies, such as the State, the NRC, or the transmission system operator.

DIFFICULTY: 4 **LESSON PL:** MT-BEP-OPS-001L **OBJECTIVE:** 3

Figure 28 Reactor Vessel Level Instrumentation

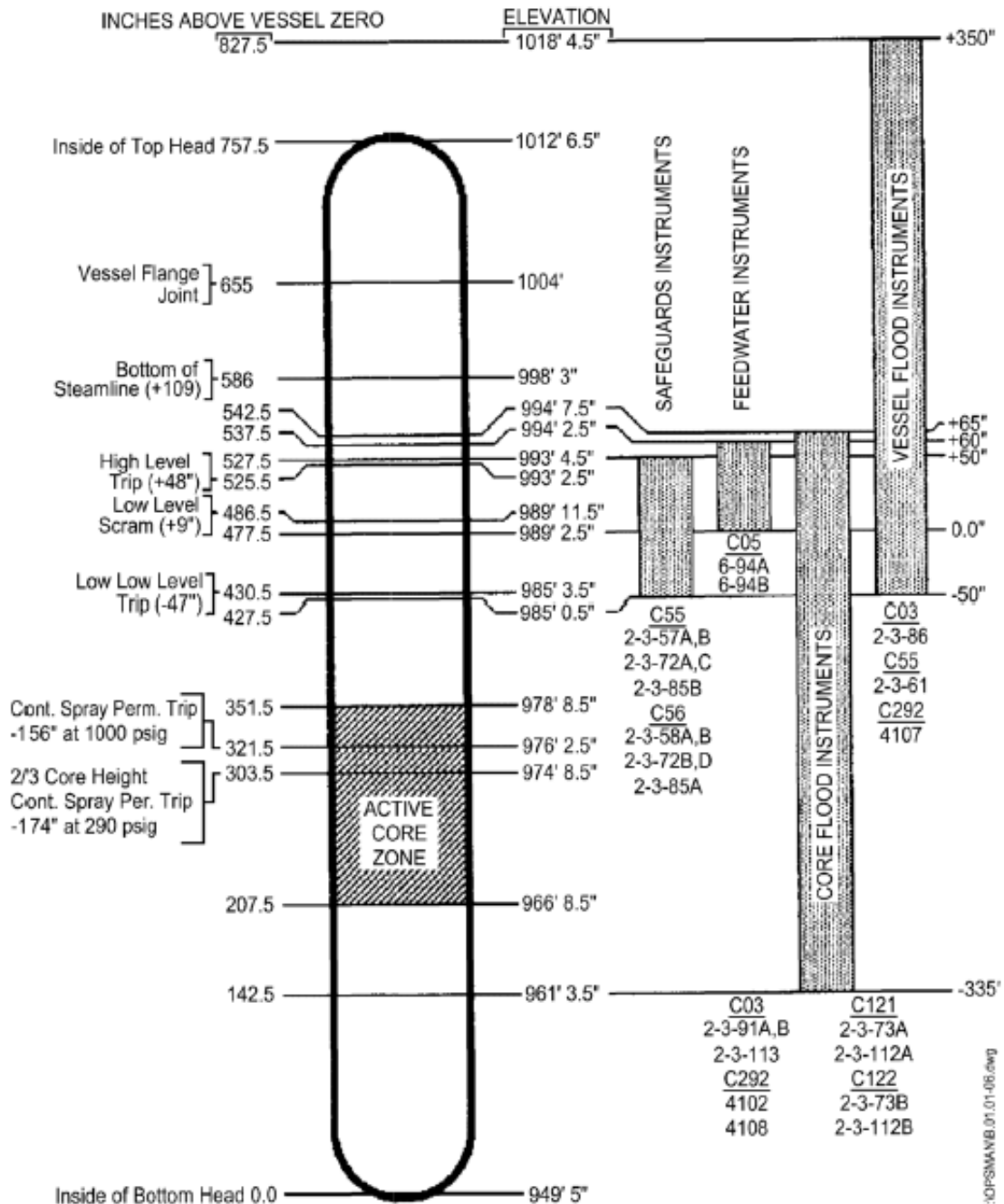

2018 MONTICELLO ILT NRC EXAM - KEY

80. LCO 3.4.10 (REACTOR STEAM DOME PRESSURE) requires that reactor steam dome pressure be maintained ≤ 1025.3 psig.

- (1) What is the bases for this pressure limit?
- (2) If this pressure is exceeded; what is the TS Completion Time for restoration?

- A. (1) This pressure limits the peak RPV pressure to less than the ASME Section III Code Service Level C limits.
(2) 15 minutes
- B. (1) This pressure ensures the plant is operated within the assumptions of the reactor overpressure protection analysis.
(2) 15 minutes
- C. (1) This pressure limits the peak RPV pressure to less than the ASME Section III Code Service Level C limits.
(2) 30 minutes
- D. (1) This pressure ensures the plant is operated within the assumptions of the reactor overpressure protection analysis.
(2) 30 minutes

CORRECT ANSWER: B

JUSTIFICATION: The specified reactor steam dome pressure limit ensures the plant is operated within the assumptions off the reactor overpressure protection analysis. Operation above the limit may result in a transient response more severe than analyzed. If this pressure is exceeded, it must be restored within 15 minutes.

A is incorrect: The ASME Section III Code Service Level C limits are associated with the ATWS high pressure trip setpoint of 1135 psig which ensures 1500 psig is not exceeded.

C is incorrect: The ASME Section III Code Service Level C limits are associated with the ATWS high pressure trip setpoint of 1135 psig which ensures 1500 psig is not exceeded. The required completion time is not 30 minutes.

D is incorrect: The required completion time is not 30 minutes.

REFERENCE: TS 3.4.10 & Bases

10 CFR: 55.43b(2)

ADDITIONAL REFERENCE PROVIDED DURING EXAM: None

SRO ONLY JUSTIFICATION: Knowledge of TS Bases

QUESTION SOURCE: New

TIER: 1 **GROUP:** 1 **CATEGORY:** 295025 High Reactor Pressure

K/A: 2.2.39 **IMPORTANCE:** SRO 4.5 **COG LEVEL:** 1B

K/A DESCRIPTION: Knowledge of less than or equal to one hour Technical Specification action statements for system

DIFFICULTY: 3 **LESSON PL:** M8170L-028 **OBJECTIVE:** 10

2018 MONTICELLO ILT NRC EXAM - KEY

81. Given the following plant conditions:

- The unit is operating at rated power
- 4-B-4 (SUPPRESSION WATER LEVEL HI/LOW) is received
- You observe the indications on the following page

Complete the statements below:

(1) IAW the Technical Specification Bases, are the DBA LOCA assumed initial conditions satisfied for Torus water level?

(2) If the Torus Downcomer lines become uncovered, which capability will be lost?

- A. (1) satisfied
(2) pressure suppression function
- B. (1) satisfied
(2) Torus cooling capability
- C. (1) NOT satisfied
(2) pressure suppression function
- D. (1) NOT satisfied
(2) Torus cooling capability

CORRECT ANSWER: A

JUSTIFICATION: DBA LOCA conditions assume that Torus water level is above -4.0". The analysis in C.5-1-1200 states that when the downcomers are uncovered then pressure suppression capability is lost and primary containment pressure could exceed structural limits. The picture provided shows Tours level to be - 0.2 feet which correlates to -2.4", therefore the initial conditions are satisfied.

B is incorrect: Plausible if the trainee believes that Torus cooling capability is the limiting factor for uncovering the downcomers.

C is incorrect: Plausible if the trainee does not understand the basis for staying above -4.0" in the Torus.

D is incorrect: Plausible if the trainee both doesn't understand the basis for -4.0" and believes that loss of Torus cooling capability is the limiting factor for uncovering the downcomers.

REFERENCE: TS 3.6.2.2 Bases

10 CFR: 55.43b(2)

ADDITIONAL REFERENCE PROVIDED DURING EXAM: None

SRO ONLY JUSTIFICATION: Knowledge of Tech Spec Bases

QUESTION SOURCE: ILT Bank – Significantly modified.

TIER: 1 **GROUP:** 1 **CATEGORY:** 295030 Low Suppression Pool Water Level

K/A: 2.1.19 **IMPORTANCE:** SRO 3.8 **COG LEVEL:** 3 SPR

K/A DESCRIPTION: Ability to use plant computers to evaluate system or component status.

DIFFICULTY: 2 **LESSON PL:** MT-ILT-EOP-003L **OBJECTIVE:** 5

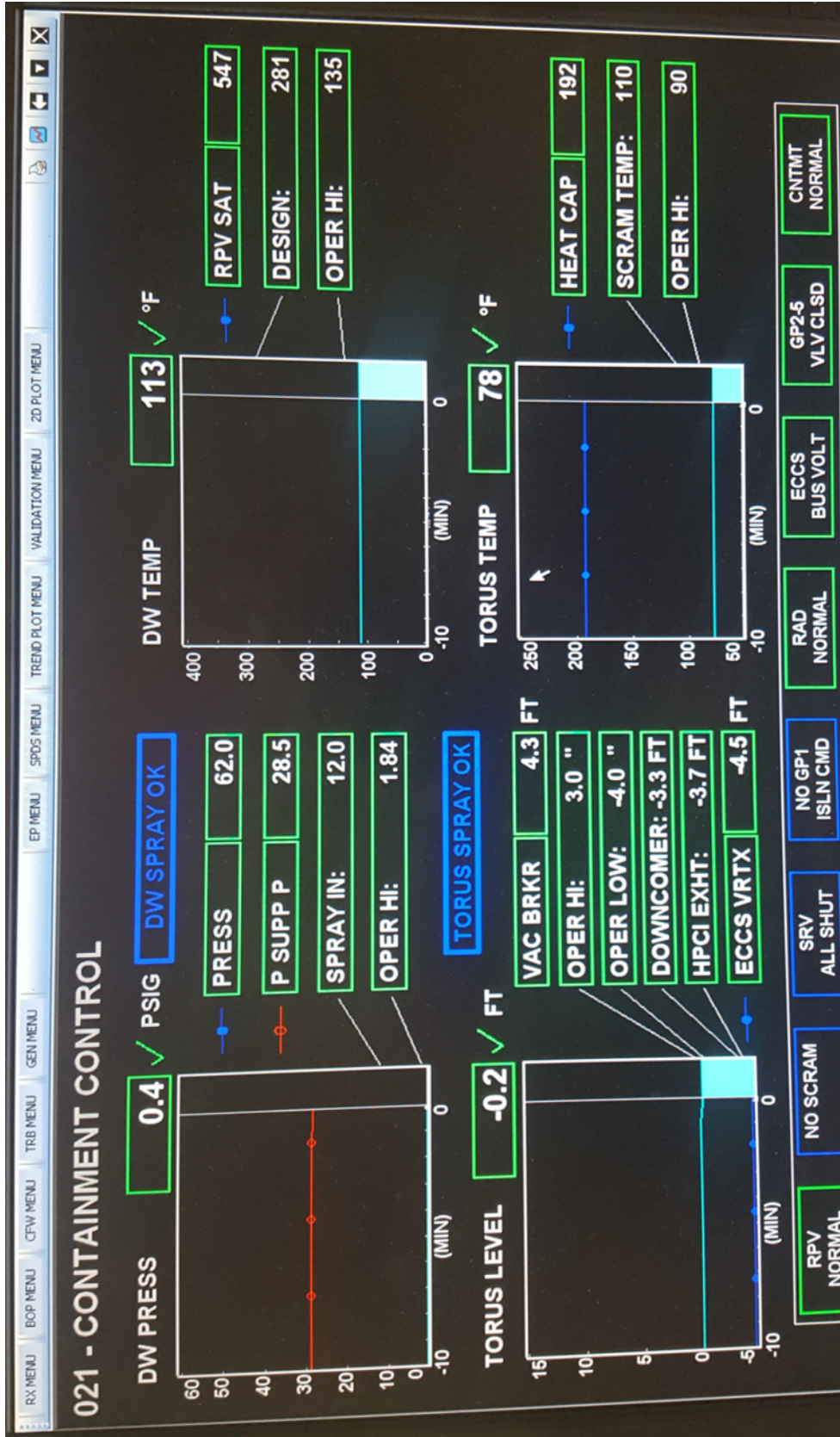

2018 MONTICELLO ILT NRC EXAM - KEY

82. The plant was at rated conditions when a steam line rupture occurred in the Steam Chase. Turbine Building ventilation has been restarted and Reactor Building Vent (RBV) Effluent monitor readings are as follows:

1700 – 5×10^2 uCi/sec
1715 – 6×10^3 uCi/sec
1730 – 7×10^4 uCi/sec
1745 – 8×10^5 uCi/sec
1800 – 9×10^6 uCi/sec

Based ONLY on the conditions above:

- (1) What is the source of the rising RBV Effluent monitor readings?
- (2) Which E-Plan Emergency Classification is required?

- A. (1) SBTG discharging to the RB Plenum
(2) Alert
- B. (1) Turbine Floor fans discharging to the RB Plenum
(2) NUE
- C. (1) SBTG discharging to the RB Plenum
(2) NUE
- D. (1) Turbine Floor fans discharging to the RB Plenum
(2) Alert

CORRECT ANSWER: D

JUSTIFICATION: The SRO examinee must recognize that the blowout panels have ruptured and with Turbine building ventilation restored the leakage from the steam chase is being directed to the RB Plenum. The SRO Examinee must further determine that the RBV Alert level of 6×10^5 has been exceeded for >15 minutes.

A is incorrect: SBTG does not draw from the Steam Chase or the Turbine building. Plausible if the examinee does not understand the SBTG flow path.

B is incorrect: Reactor Building plenum radiation level exceeds the Alert level an NUE would be incorrect. Plausible if the examinee incorrectly interprets the EAL Matrix

C is incorrect: SBTG does not pull from the Steam Chase and Reactor Building plenum radiation level exceeds the Alert level. Plausible if the examinee misreads the EALs and does not understand the SBTG flow path.

REFERENCE: EAL Matrix

10 CFR: 55.43b(5)

ADDITIONAL REFERENCE PROVIDED DURING EXAM: EAL Matrix

SRO ONLY JUSTIFICATION: Assessment of conditions and procedure direction & EAL matrix interpretation

QUESTION SOURCE: New

TIER: 1 **GROUP:** 1 **CATEGORY:** 295038 High Offsite Radioactivity Release Rate.

K/A: EA2.04 **IMPORTANCE:** SRO 4.5 **COG LEVEL:** 3 SPK

K/A DESCRIPTION: Ability to determine and/or interpret the following as they apply to HIGH OFF-SITE RELEASE RATE: Source of off-site release.

DIFFICULTY: 2 **LESSON PL:** M8107L-008 **OBJECTIVE:** 6.f

2018 MONTICELLO ILT NRC EXAM - KEY

83. The plant was at rated conditions when an Off-Gas System isolation occurred. C.4-F (RAPID POWER REDUCTION) was entered and the following conditions exist:
- Main Turbine exhaust pressure is 4.0" Hga and degrading 0.1" Hga/minute
 - Main Generator output is 400 MWe and lowering 10 MWe/minute
 - C.4-B.06.03.A (DECREASING CONDENSER VACUUM) Figure 1 is provided on the following page

Assuming the above trends remain constant, in how many minutes will the CRS be **FIRST REQUIRED** to direct a reactor scram IAW C.4.K (IMMEDIATE REACTOR SHUTDOWN)?

- A. 10 minutes
- B. 20 minutes
- C. 30 minutes
- D. 35 minutes

CORRECT ANSWER: C

JUSTIFICATION: The examinee must know the requirements of the 3 regions of Figure 1 (Allowable Operation, Alert and Scram required). Starting in the Allowable region and plotting pressure vs Power output, the Alert region will be reached in 10 minutes. Operation in the Alert region is allowed for 20 minutes before a scram is required. Therefore, a scram is required after 30 minutes.

A is incorrect: This is the entry point to the Alert region and a scram isn't required yet.

B is incorrect: Plausible if examinee can't recall the allowed time requirement in the Alert region.

D is incorrect: This is the entry point to the Scram Required region but a scram should have already been inserted.

REFERENCE: C.4-B.06.03.A

10 CFR: 55.43b(5)

ADDITIONAL REFERENCE PROVIDED DURING EXAM: None

SRO ONLY JUSTIFICATION: Assessment of conditions and direction of Abnormal procedures.

QUESTION SOURCE: 2015 NRC Exam – Previous two NRC Exams

TIER: 1 **GROUP:** 2 **CATEGORY:** 295002 Loss of Main Condenser Vac

K/A: AA2.02 **IMPORTANCE:** SRO 3.3 **COG LEVEL:** 3 SPR/SPK

K/A DESCRIPTION: Ability to determine or interpret the following as they apply to LOSS OF MAIN CONDENSER VAC: Reactor power

DIFFICULTY: 3 **LESSON PL:** MT-ILT-AOP-014L **OBJECTIVE:** 4

2018 MONTICELLO ILT NRC EXAM - KEY

MONTICELLO TURBINE EXHAUST PRESSURE LIMITS

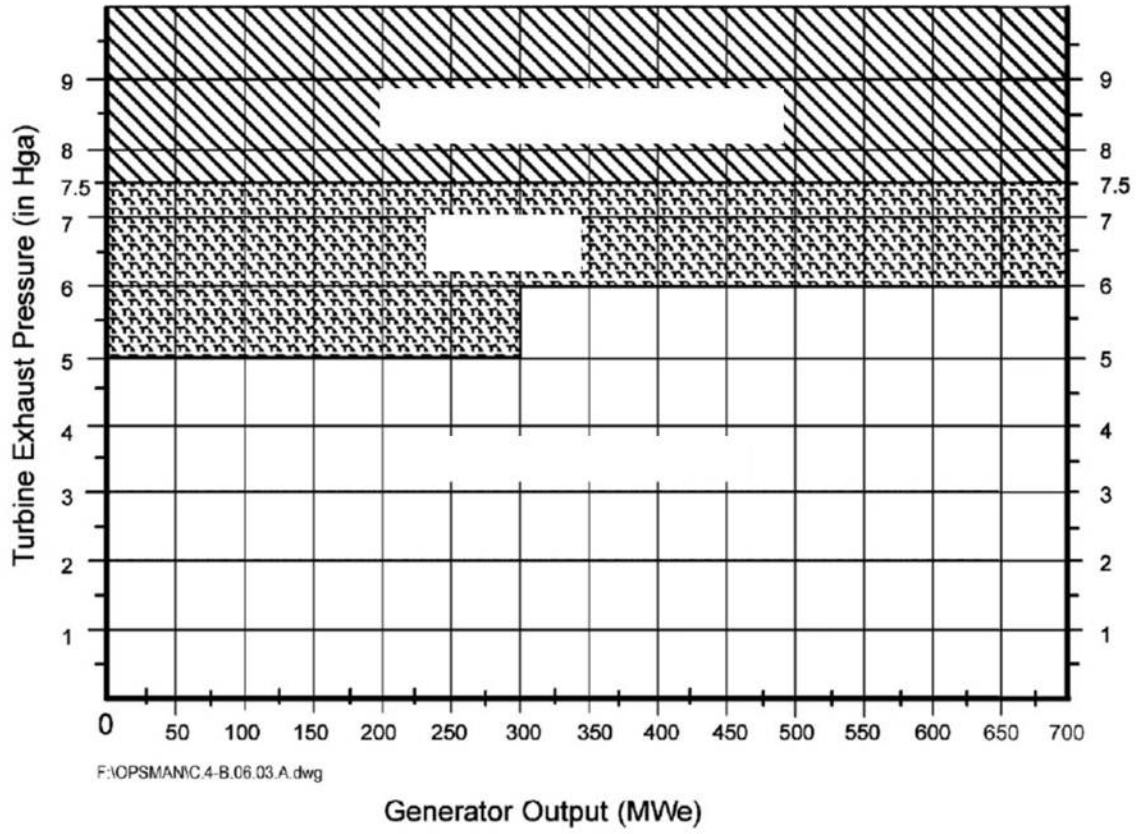

Figure 1 Turbine Exhaust Pressure Limits

2018 MONTICELLO ILT NRC EXAM - KEY

84. The plant was at rated conditions when the following valid annunciators were received:
- 5-A-44 (GROUP 1 ISOL CHAN A TRIP)
 - 5-A-52 (GROUP 1 ISOL CHAN B TRIP)
 - The cause of the annunciators was inadvertent
 - The annunciators are now CLEAR
 - The Group 1 Isolation signal is **NOT** reset

Which procedure(s) must be directed by the CRS to allow the Main Steam Line Drains to be opened for pressure control?

- A. C.5-3302 (ALTERNATE PRESSURE CONTROL) **only**.
- B. C.4-B.04.01.A (PRIMARY CONTAINMENT ISOLATION – GROUP 1) **only**.
- C. B.02.04-05 H.1 (OPENING MSIVS FOLLOWING A GROUP 1 ISOLATION) **only**.
- D. C.5-3302 (ALTERNATE PRESSURE CONTROL) **and**
B.02.04-05 H.1 (OPENING MSIVS FOLLOWING A GROUP 1 ISOLATION)

CORRECT ANSWER: B

JUSTIFICATION: C.5-3302 lists Group 1 signals being reset as a pre-requisite for use of the Main Steam Line Drains as an alternate pressure control method. Procedure hierarchy dictates that the guidance in C.4-B.04.01.A Primary Containment Isolation – Group 1 be used to reset the Group 1 isolation signal.

A is incorrect: C.5-3302 Alternate Pressure Control provides procedural guidance to use the Main Steam Line Drains for pressure control but no procedural guidance for resetting Group 1 isolation.

C and D are incorrect: B.02.04-05 H.1 does not contain guidance to reset the Group 1 isolation.

REFERENCE: C.5-1100 C.5-3302 C.4-B.04.01.A **10 CFR:** 55.43b(5)

ADDITIONAL REFERENCE PROVIDED DURING EXAM: None

SRO ONLY JUSTIFICATION: Assessment of facility conditions and selection of appropriate procedure

QUESTION SOURCE: New

TIER: 1 **GROUP:** 2 **CATEGORY:** 295020 Inadvertent Cont. Isolation

K/A: G2.4.8 **IMPORTANCE:** SRO 4.5 **COG LEVEL:** 2 DR

K/A DESCRIPTION: Knowledge of how abnormal operating procedures are used in conjunction with EOPs

DIFFICULTY: 3 **LESSON PL:** MT-ILT-EOP-002L **OBJECTIVE:** 7

2018 MONTICELLO ILT NRC EXAM - KEY

85. The plant was at rated conditions when an unisolable steam line rupture occurred in the HPCI Room: Given the following:

- HPCI Turbine Area temperature is 225°F
- West CRD HCU Area temperature is 122°F

Which procedure should be directed by the CRS for the above conditions?

- A. C.3 (PLANT SHUTDOWN)
- B. C.4-F (RAPID POWER REDUCTION)
- C. C.4-K (IMMEDIATE REACTOR SHUTDOWN)
- D. C.5-2002 (EMERGENCY DEPRESSURIZATION)

CORRECT ANSWER: C

JUSTIFICATION: The direction of a Scram in this case is because of Environmental Qualification concerns in accident mitigation equipment in the affected area. The operability of accident mitigation equipment is in question above the boiling point of water or 212°F which requires the CRS to direct a Reactor Scram based on an Area Temperature from Detail W being above the Max Safe Value.

A is incorrect: Plausible if the examinee misinterprets the stem of the question and believes the steam leak not to be a primary system.

B is incorrect: Plausible if the examinee believes that the problem can be mitigated by reducing reactor power and incorrectly interprets Detail W.

D is incorrect: Plausible if the examinee incorrectly determines that two areas are above Max Safe Value. However, West CRD HCU area is only above max normal.

REFERENCE: C.5-1300 C.5.1-1300 **10 CFR:** 55.43b(5)

ADDITIONAL REFERENCE PROVIDED DURING EXAM: EOP-1300 Flowchart

SRO ONLY JUSTIFICATION: Assessment of facility conditions and selection of appropriate procedures during emergency conditions.

QUESTION SOURCE: New

TIER: 1 **GROUP:** 2 **CATEGORY:** 295032 High Secondary Containment Area Temperature

K/A: EA2.02 **IMPORTANCE:** SRO 3.5 **COG LEVEL:** 3 SPR

K/A DESCRIPTION: Ability to determine and/or interpret the following as they apply to HIGH SECONDARY CONTAINMENT AREA TEMPERATURE: Equipment operability.

DIFFICULTY: 2 **LESSON PL:** MT-ILT-EOP-004L **OBJECTIVE:** 4

2018 MONTICELLO ILT NRC EXAM - KEY

86. Complete the following statement:

At rated conditions, a Main Turbine trip initiates a Reactor Scram to ensure the...

- A. APLHGR LCO is met.
- B. MCPR safety limit is NOT exceeded.
- C. Peak Fuel Enthalpy is NOT exceeded.
- D. RPV pressure safety limit is NOT exceeded.

CORRECT ANSWER: B

JUSTIFICATION The turbine stop valve closure scram function is the primary scram signal for the turbine trip event analyzed in the UFSAR. For this event, the reactor scram reduces the amount of energy required to be absorbed this ensures that the MCPR safety limit is not exceeded.

A is incorrect: APLHGR is a thermal limit as is MCPR; it is not the reason for this trip.

C is incorrect: The RWM rod block ensures peak fuel enthalpy (280cal/gm) is not exceeded and that fuel damage does not occur during a control rod drop accident.

D is incorrect: The scram anticipates reactor high pressure conditions; it is not based on exceeding this safety limit.

REFERENCE: TS 3.3.1.1 Bases

10 CFR: 55.43b(2)

ADDITIONAL REFERENCE PROVIDED DURING EXAM: None

SRO ONLY JUSTIFICATION: Knowledge of TS Bases

QUESTION SOURCE: Bank – Edits to choices

TIER: 2 **GROUP:** 1 **CATEGORY:** 212000 Reactor Protection

K/A: 2.2.25 **IMPORTANCE:** SRO 4.2 **COG LEVEL:** 1B

K/A DESCRIPTION: Knowledge of the bases in Technical Specifications for limiting conditions for operations and safety limits.

DIFFICULTY: 3 **LESSON PL:** M8107L-005 **OBJECTIVE:** 10

2018 MONTICELLO ILT NRC EXAM - KEY

87. The plant is at rated conditions. During Test 0255-02-III (SBLC QUARTERLY PUMP AND VALVE TESTS) the following data is collected:

#11 SBLC pump:

- Discharge Pressure: 1297 psig
- Pump Flow Rate: 28.5 gpm
- Stabilization time: 2 minutes 35 seconds

#12 SBLC pump:

- Discharge Pressure: 1295 psig
- Pump Flow Rate: 22.7 gpm
- Stabilization time: 2 minutes 25 seconds

What TS Actions, if any, are required for these conditions?

- A. None, both SBLC pumps are operable.
- B. Place the plant in MODE 3 within 12 hours.
- C. Restore #12 SLC subsystem to OPERABLE status within 7 days.
- D. Restore #11 or #12 SLC subsystem to OPERABLE status within 8 hours.

CORRECT ANSWER: C

JUSTIFICATION: TS 3.7.1 action B states One SLC subsystem inoperable for reasons other than Condition A, Condition A being Low Boron Concentration. SR 3.1.7.7 requires a flow rate ≥ 24 gpm for operability.

A is incorrect: #12 SBLC pump is inoperable due to low flow rate.

B is incorrect: No TS required completion time has been violated, this action is not required.

D is incorrect: Only #12 SBLC pump is inoperable, this action is required for both SBLC subsystems inoperable.

REFERENCE: TS 3.1.7 Test 0255-02-III **10 CFR:** 55.43b(2)

ADDITIONAL REFERENCE PROVIDED DURING EXAM: TS 3.1.7

SRO ONLY JUSTIFICATION: Facility operating limitations in the Technical Specifications and their bases

QUESTION SOURCE: New

TIER: 2 **GROUP:** 1 **CATEGORY:** 211000 Standby Liquid Control

K/A: A2.04 **IMPORTANCE:** SRO 3.4 **COG LEVEL:** 3 SPR

K/A DESCRIPTION: Ability to (a) predict the impacts of the following on the STANDBY LIQUID CONTROL SYSTEM; and (b) based on those predictions, use procedures to correct, control or mitigate the consequences of those abnormal conditions or operations; inadequate system flow.

DIFFICULTY: 2 **LESSON PL:** M8107L-004 **OBJECTIVE:** 10.b

2018 MONTICELLO ILT NRC EXAM - KEY

88. The plant was operating at rated conditions when an inadvertent ADS initiation signal was received. The BOP operator placed the ADS Inhibit Switches to INHIBIT but the ADS SRVs still OPENED after 107 seconds. Given the following:

- C.4-B.03.03.A (STUCK OPEN RELIEF VALVE) has been completed
- Reactor power is currently stable at 60%
- The ADS SRVs are verified CLOSED and indicate as follows:

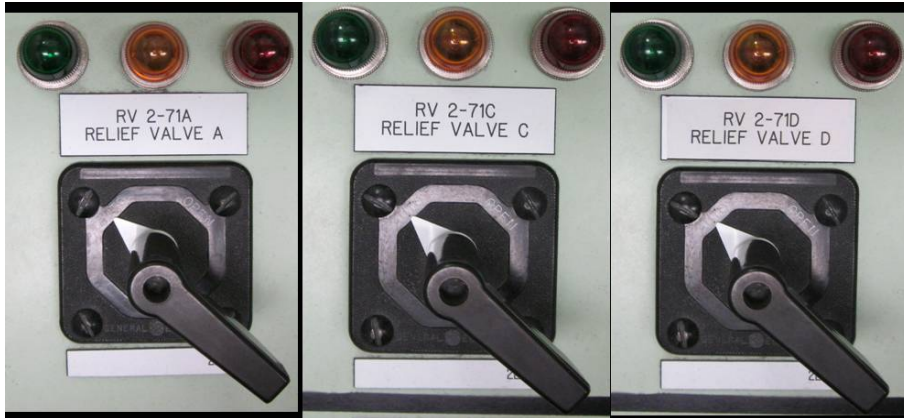

Which of the following is a correct Technical Specification ACTION to take?

- A. Enter LCO 3.0.3 IMMEDIATELY.
- B. Place the plant in Mode 3 within 12 HOURS.
- C. Place the plant in Mode 3 within 13 HOURS.
- D. Restore 2 of the 3 SRVs to operable within 14 DAYS.

CORRECT ANSWER: B

JUSTIFICATION: The SRO examinee must determine that the fuses were removed (Green light off) IAW the stuck open relief valve procedure. Then the examinee must determine that all 3 ADS valves are now inoperable because with the fuses removed, the ADS function is lost.

A is incorrect: Plausible for confusion with TLCO 3.0.3 as it would be entered for the failed Inhibit switches.

C is incorrect: If there was an ADS timer malfunction, TSs would allow an additionally hour to declare the ADS valves inoperable but not for inhibit switches and the fuses removed.

D is incorrect: This would only apply if the Safety Function of the SRVs was inoperable

REFERENCE: TRM TLCO 3.5.1 TS LCO 3.5.1 B.03.03-01 **10 CFR:** 55.43b(5)

ADDITIONAL REFERENCE PROVIDED DURING EXAM: TRM TLCO 3.5.1, TS 3.3.5.1, TS 3.4.3, TS 3.5.1 **SRO**

ONLY JUSTIFICATION: Tech Spec Action Determination

QUESTION SOURCE: ILT Bank – 2013 NRC Exam

TIER: 2 **GROUP:** 1 **CATEGORY:** 218000 ADS

K/A: 2.2.22 **IMPORTANCE:** SRO 4.7 **COG LEVEL:** 3 SPK/SPR

K/A DESCRIPTION: Knowledge of limiting conditions for operations and safety limits.

DIFFICULTY: 3 **LESSON PL:** M8107L-025 **OBJECTIVE:** 10

2018 MONTICELLO ILT NRC EXAM - KEY

89. The plant is at rated conditions. An extent of condition evaluation was conducted on the level switches used to initiate SBGT and the following AS-LEFT trip values were noted on November 8th at 0000:

- Trip CH A1 - LS-2-3-657C: -47"
- Trip CH A2 - LS-2-3-657D: -48"
- Trip CH B1 - LS-2-3-658C: -49"
- Trip CH B2 - LS-2-3-658D: -50"

Assuming NO operator action is taken, when is the latest LCO 3.0.3 must be entered as required by LCO 3.6.4.3 (Standby Gas Treatment System)?

- A. November 8th at 0100
- B. November 8th at 0200
- C. November 8th at 1300
- D. November 9th at 0200

CORRECT ANSWER: B

JUSTIFICATION: The examinee must first determine that channels B1 and B2 are outside the allowable TS value (≥ 48 "). Then the examinee must determine that a loss of initiation capability has occurred (TS LCO Action B.1). This action allows 1 hour to restore. After one hour, the associated SBGT train must be declared inoperable within 1 hour. These level switches initiate both SBGT trains which would require Both trains to be declared inoperable. With both SBGT trains inoperable, LCO 3.6.4.3 requires that LCO 3.0.3 be entered immediately. A total of 2 hours is allowed.

A is incorrect: Plausible for misapplication of the 1 hour requirements.

C is incorrect: Plausible for misapplication of the 1 hour requirements and not recognizing that a loss of initiation capability exists.

D is incorrect: Plausible for not recognizing that a loss of initiation capability exists.

REFERENCE: TS 3.3.6.2 & 3.6.4.3 B.04.02-01 NH-36242 **10 CFR:** 55.43b(2)

ADDITIONAL REFERENCE PROVIDED DURING EXAM: TS 3.3.6.2 & 3.6.4.3

SRO ONLY JUSTIFICATION: TS Required Action and Completion Time determination.

QUESTION SOURCE: New

TIER: 2 **GROUP:** 1 **CATEGORY:** 261000 SBGT

K/A: A2.19 **IMPORTANCE:** SRO 3.2 **COG LEVEL:** 3 SPR

K/A DESCRIPTION: Ability to (a) predict the impacts of the following on the STANDBY GAS TREATMENT SYSTEM; and (b) based on those predictions, use procedures to correct, control, or mitigate the consequences of those abnormal conditions or operations: Low reactor water level.

DIFFICULTY: 4 **LESSON PL:** M8107L-008 **OBJECTIVE:** 10

2018 MONTICELLO ILT NRC EXAM - KEY

90. The plant was at rated conditions when a complete Loss of Instrument Air occurred.

- The plant was successfully scrammed
- HPCI is required for Pressure/Level Control
- You have directed B.03.02-05.G.1 (REACTOR VESSEL PRESS/LEVEL CONTROL)

As the CRS, which additional procedure, if any, must be used to control reactor pressure and level with HPCI for the conditions above?

- A. B.03.02-05.D.1 (HPCI MANUAL INITIATION).
- B. C.4-B.08.04.01.A (LOSS OF INSTRUMENT AIR).
- C. B.03.02-05.H.1 (ALTERNATE N2 SUPPLY FOR OPERATING CV-3503 AND CV-2065).
- D. None, only B.03.02-05.G.1 (REACTOR VESSEL PRESS/LEVEL CONTROL) is required.

CORRECT ANSWER: C

JUSTIFICATION: B.03.02-05.H.1 gives instructions for connecting an alternate N2 supply to CV-3503 (HPCI FULL FLOW TEST RETURN TO CST) and CV-2065 (HPCI MIN FLOW TO TORUS) for operating the valves during loss of normal pneumatic supply. CV-2065 is equipped with an installed backup accumulator; however, CV-3503 would need the N2 to open for pressure and level control.

A is incorrect: Plausible procedure to direct to start HPCI and inject to the vessel but this procedure doesn't give guidance for loss of instrument air and pressure control.

B is incorrect: This procedure would be performed at this time; however, it doesn't provide specific guidance to use HPCI for the above conditions.

D is incorrect: Plausible if examinee believes that both valves have backup accumulators and do not need the N2.

REFERENCE: C.4-B.08.04.01.A B.03.02-05.H.1 **10 CFR:** 55.43b(5)

ADDITIONAL REFERENCE PROVIDED DURING EXAM: None

SRO ONLY JUSTIFICATION: Assessment of facility conditions and selection of appropriate procedures.

QUESTION SOURCE: New

TIER: 2 **GROUP:** 1 **CATEGORY:** 300000 Instrument Air

K/A: 2.1.23 **IMPORTANCE:** SRO 4.4 **COG LEVEL:** 2 DR

K/A DESCRIPTION: Ability to perform specific system and integrated plant procedures during all modes of plant operation.

DIFFICULTY: 3 **LESSON PL:** M8107L-002 **OBJECTIVE:** 9

2018 MONTICELLO ILT NRC EXAM - KEY

91. The plant is in REFUEL with a core shuffle in progress and two SRMs operable.
- The quadrant where fuel moves are in progress contains 4 fuel assemblies
 - The SRM in the quadrant where fuel is being moved indicates 2 cps
 - The adjacent quadrant contains 5 fuel assemblies
 - The SRM in the adjacent quadrant indicates 10 cps

What actions need to be taken for the above conditions AND why?

- A. Immediately suspend fuel moves and make FP-OP-REP-01 Event Notifications. Refueling interlocks should have prevented fuel moves with an SRM < 3 CPS.
- B. Immediately notify the Nuclear Engineer and continue fuel moves with caution. Refueling interlocks should have prevented fuel moves with an SRM < 3 CPS.
- C. Immediately suspend fuel moves and make FP-OP-REP-01 Event Notifications. With < 3 cps, assurance of neutron flux monitoring is no longer provided to prevent inadvertent criticality.
- D. Immediately notify the Nuclear Engineer and continue fuel moves with caution. With < 3 cps, assurance of neutron flux monitoring may no longer be provided to prevent inadvertent criticality.

CORRECT ANSWER: C

JUSTIFICATION: If SRM count rate decreases below 3 CPS, in a core quadrant with 3 or more bundles, HALT fuel handling operations and immediately notify personnel according to 4 AWI-04.08.01 (EVENT NOTIFICATIONS).

A, B and D are incorrect: SRM count rate will insert rod blocks but will not prevent fuel movement. Event Notifications must be made.

REFERENCE: D.2-05

10 CFR: 55.43b(6)

ADDITIONAL REFERENCE PROVIDED DURING EXAM: None

SRO ONLY JUSTIFICATION: Procedures and limitations involved with core alterations.

QUESTION SOURCE: Bank – Edits to stem and choices

TIER: 2 **GROUP:** 2 **CATEGORY:** 234000 Fuel Handling Equipment

K/A: A1.03 **IMPORTANCE:** SRO 3.9 **COG LEVEL:** 3 SPR

K/A DESCRIPTION: Ability to predict and/or monitor changes in parameters associated with operating the FUEL HANDLING EQUIPMENT controls including: core reactivity level.

DIFFICULTY: 3 **LESSON PL:** MT-OPS-ITS-013L **OBJECTIVE:** 7

2018 MONTICELLO ILT NRC EXAM - KEY

92. The plant is operating at 60% power. At 1100 you are performing your Shift Supervision completion review of a surveillance that documents the AS LEFT trip settings for the Turbine Control Valve Fast Closure instruments. Trip settings are as follows:

- PS-7110: 166.4 psig
- PS-7111: 169.4 psig
- PS-7112: 167.4 psig
- PS-7113: 168.9 psig

Given NX-7834-67-7, 8, 9 & 10; which one of the following is the most restrictive REQUIRED ACTION and COMPLETION TIME for the above conditions?

- A. Restore RPS trip capability by 1200.
- B. Place either RPS channel in trip by 1700.
- C. Place RPS Channel A in trip by 2300.
- D. Place RPS Channel B in trip by 2300.

CORRECT ANSWER: B

JUSTIFICATION: RPS A (PS-7112 & PS-7113); RPS B (PS-7110 & PS-7111). All pressure switches are required to be operable (≥ 167.8 psig) when $\geq 40\%$ RTP. With the given conditions one channel in each RPS trip system is inoperable. This will require entry into TS 3.3.1.1 conditions B. This requires one channel to be placed in trip within 6 hours.

A is incorrect: Plausible action to take if the switches are thought to both be on RPS B

C and D are incorrect: Plausible action to take for one or more required channels inop, 12 hour action.

REFERENCE: TS 3.3.1.1 NX-7834-67-7,8,9 & 10 **10 CFR:** 55.43b(2)

REFERENCE PROVIDED DURING EXAM: TS 3.3.1.1, NX-7834-67-7, 8, 9 & 10

SRO ONLY JUSTIFICATION: Technical Specification ACTION & COMPLETION TIME determination.

QUESTION SOURCE: 2015 NRC Exam – Significantly Modified

TIER: 1 **GROUP:** 1 **CATEGORY:** 245000 Main Turbine / Aux

K/A: 2.1.20 **IMPORTANCE:** SRO 4.6 **COG LEVEL:** 3 SPR

K/A DESCRIPTION: Ability to interpret and execute procedure steps.

DIFFICULTY: 3 **LESSON PL:** M8107L-072 **OBJECTIVE:** 10

2018 MONTICELLO ILT NRC EXAM - KEY

93. The plant is at rated conditions. Maintenance has just completed Procedure 0461 (CONTROL ROOM AIR INTAKE MONITOR CALIBRATION) to satisfy TSR 3.3.7.1.3. During your review, you note the following AS LEFT CRV/EFT HI-HI Trip values:

- RM-9021A – 2.1 mr/hr
- RM-9021B – 2.3 mr/hr

Which of the following Tech Spec/TRM Required Actions, if any, must be taken allowing for the **maximum** completion time?

- A. NO action is required; the AS LEFT setpoints are within the allowable range.
- B. Declare both CREF subsystems INOPERABLE immediately AND enter LCO 3.0.3.
- C. Place one CREF subsystem in the pressurization mode within 1 hour AND declare the other CREF subsystem INOPERABLE within 1 hour.
- D. Place one CREF subsystem in the pressurization mode within 1 hour OR declare one CREF subsystem INOPERABLE within 1 hour AND restore to OPERABLE status within 7 days.

CORRECT ANSWER: C

JUSTIFICATION: One channel per trip system is required for CREF operability (TRM 3.3.7.1). The radiation monitors are typically set to initiate CRV/EFT in the Hi Rad Mode at 1 mr/hr. The TS allowable value for this initiation is 2 mrem/hr which makes both of them inoperable. With both radiation monitors inoperable, then CREF (one subsystem) must be placed in the pressurization mode within one hour AND the other subsystems must be declared inoperable within one hour.

A is incorrect: Plausible if examinee believes the initiation setpoint is typically set to 2 mr/hr.

B is incorrect: Although LCO 3.0.3 would be entered if both were declared inoperable for this reason, both CREF subsystems are NOT required to be declared inoperable immediately. This would not allow for maximum completion time.

D is incorrect: TRM requirements are to place both subsystems in the pressurization mode or declare both inoperable within 1 hour. The SRO candidate must have system and TS bases knowledge of how each radiation monitor supplies a trip signal to each CREF subsystem.

REFERENCE: TRM 3.3.7.1 TS 3.7.4 0461 **10 CFR:** 55.43b(2)

ADDITIONAL REFERENCE PROVIDED DURING EXAM: TRM 3.3.7.1 & TS 3.7.4

SRO ONLY JUSTIFICATION: TS Action and Completion Time determination

QUESTION SOURCE: New

TIER: 2 **GROUP:** 2 **CATEGORY:** 290003 Control Room Ventilation

K/A: A2.03 **IMPORTANCE:** SRO 3.6 **COG LEVEL:** 3 SPK/SPR

K/A DESCRIPTION: Ability to (a) predict the impacts of the following on the CONTROL ROOM HVAC; and (b) based on those predictions, use procedures to correct, control, or mitigate the consequences of those abnormal conditions or operations: Initiation/reconfiguration failure.

DIFFICULTY: 3 **LESSON PL:** M8107L-049 **OBJECTIVE:** 10

2018 MONTICELLO ILT NRC EXAM - KEY

94. The plant is in MODE 5 with a core offload in progress. Complete the following statement:

The basis of the Control Rod OPERABILITY – Refueling Technical Specification is to...

- A. ensure ALL control rods remain fully inserted.
- B. prevent AND mitigate prompt reactivity excursion events.
- C. ensure ALL control rod scram accumulators are OPERABLE.
- D. prevent movement of ANY control rod while in Refueling Mode.

CORRECT ANSWER: B

JUSTIFICATION: The Applicable safety analyses of TS 3.9.5 are the prevention and mitigation of prompt reactivity excursions during refueling.

A is incorrect: One control rod may be withdrawn in Mode 5.

C is incorrect: Scram accumulators are covered in a different LCO.

D is incorrect: Movement of one control rod may be performed.

REFERENCE: TS 3.9.5 Bases

10 CFR: 55.43b(2)

ADDITIONAL REFERENCE PROVIDED DURING EXAM: None

SRO ONLY JUSTIFICATION: Knowledge of TS Bases

QUESTION SOURCE: ILT Bank

TIER: 3 **GROUP:** 1 **CATEGORY:** Conduct of Operations

K/A: 2.1.41 **IMPORTANCE:** SRO 3.7 **COG LEVEL:** 1B

K/A DESCRIPTION: Knowledge of the refueling process.

DIFFICULTY: 3 **LESSON PL:** M8107L-019 **OBJECTIVE:** 10

2018 MONTICELLO ILT NRC EXAM - KEY

95. The plant is in Mode 1 when annunciator 5-A-46 (SRV OPEN) is received along with the following stable indications:

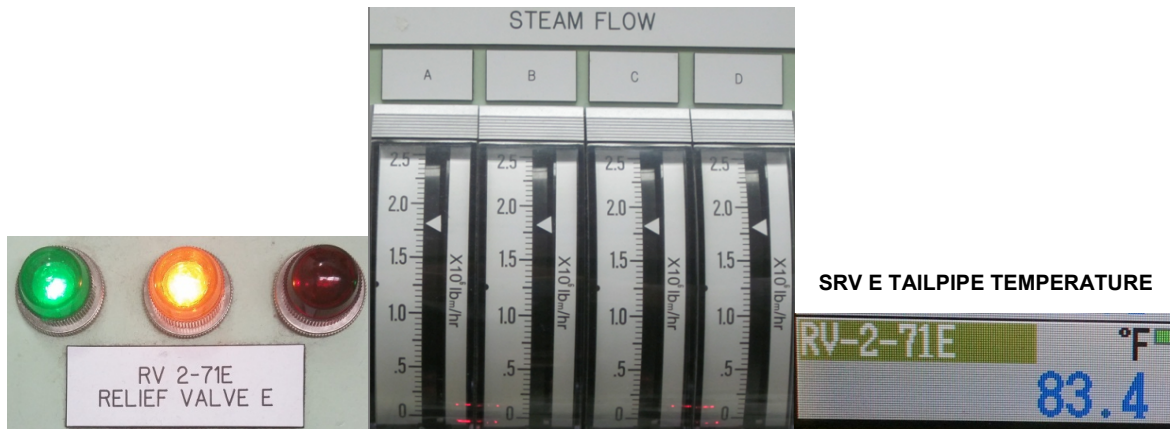

Which of the following is a correct action to be taken by the CRS for the above conditions?

- A. Restore the SRV to OPERABLE status within the LCO completion time.
- B. Restore the failed instrument(s) to OPERABLE status within the LCO completion time.
- C. Direct C.4-B.03.03.A (STUCK OPEN RELIEF VALVE) for an open ADS valve.
- D. Direct C.4-B.03.03.A (STUCK OPEN RELIEF VALVE) for an open LL-SET valve.

CORRECT ANSWER: B

JUSTIFICATION: The SRO examinee must determine if the SRV OPEN alarm is consistent with conditions shown in the pictures. The amber light lit means pressure switch has activated (30#), which would indicate that an S/RV is open; however, the associated MSL flow and tailpipe temperature do not reflect that the S/RV is open. This is indicative of a pressure switch instrument failure which requires entry into LCO 3.3.6.3 Condition A since it's a LLS valve.

A is incorrect: Plausible TS action for an inoperable LL-SET Valve.

C is incorrect: Plausible for believing the SRV is open and that it's an ADS valve.

D is incorrect: Plausible for believing the SRV is open.

REFERENCE: TS 3.3.6.3 TRM 3.3 C.4-B.03.03-A **10 CFR:** 55.43b(2)

ADDITIONAL REFERENCE PROVIDED DURING EXAM: None

SRO ONLY JUSTIFICATION: TS Action determination

QUESTION SOURCE: LOR Bank

TIER: 3 **GROUP:** 1 **CATEGORY:** Conduct of Operations

K/A: 2.1.45 **IMPORTANCE:** 4.3 **COG LEVEL:** 3 SPR/SPK

K/A DESCRIPTION: Ability to identify and interpret diverse indications to validate the response of another indication.

DIFFICULTY: 3 **LESSON PL:** M8107L-025 **OBJECTIVE:** 10

2018 MONTICELLO ILT NRC EXAM - KEY

96. The plant is at rated conditions at 0100. A planned 7 day LCO action for continuous maintenance is scheduled to begin at 0800 on #11 EDG. Additionally, system dispatch has just requested removal of the 115 KV Busses from service at 0800 for maintenance.

For the conditions above, which of the following Work Management Practices is correct?

- A. The off going night crew should enter the EDG action statement and isolate the 11 EDG by 0400.
- B. Both activities should be performed together to avoid multiple electrical maintenance windows.
- C. Removal of the 115KV Busses should be avoided until work is complete on the #11 EDG and it is operable.
- D. The planned work on #11 EDG can be scheduled for the full LCO completion time without Operations Manager approval.

CORRECT ANSWER: C

JUSTIFICATION:

IAW General Plant Operating Activities - The plant should be maintained in a stable condition. Other testing or maintenance that increases the likelihood of challenging the operating train or redundant equipment should be avoided. For example, while in a Tech Spec Action on an emergency diesel generator, work/testing in the substation, on electrical buses, High Pressure Coolant Injection (HPCI), Reactor Core Isolation Cooling (RCIC), or on the redundant low pressure systems should be avoided.

A is incorrect. Example: An EDG should not be isolated on the night shift at 0400 hours with scheduled maintenance set to begin at 0800 hours.

B is incorrect. These activities should not be performed together.

D is incorrect. Removing an EDG will place the plant in a 7 day Action IAW TS 3.8.1 Condition B.

REFERENCE: 4AWI-04.01.01

10 CFR: 55.43b(1)

ADDITIONAL REFERENCE PROVIDED DURING EXAM: None

SRO ONLY JUSTIFICATION: Knowledge of Work Management practices

QUESTION SOURCE: ILT Bank – 2009 NRC Exam

TIER: 3 **GROUP:** 2 **CATEGORY:** Equipment Control

K/A: 2.2.17 **IMPORTANCE:** SRO 3.8 **COG LEVEL:** 1P

K/A DESCRIPTION: Knowledge of the process for managing maintenance activities during power operations, such as risk assessments, work prioritization, and coordination with the transmission system operator.

DIFFICULTY: 2 **LESSON PL:** M8108L-039 **OBJECTIVE:** 2

2018 MONTICELLO ILT NRC EXAM - KEY

97. The plant is at rated conditions. Online maintenance had been performed on the #13 RHRSW Pump. Post-maintenance testing has just been completed satisfactorily and operability verification is planned for your shift.

All of the following activities should be performed as part of the Shift Supervisions Operability Verification **EXCEPT**:

- A. Visual check at the ASDS Panel to ensure proper positioning of controls.
- B. Review active work orders and procedures associated with DIV I RHRSW.
- C. Ensure all components are properly aligned per the DIV I RHRSW system checklist.
- D. Visual check at Panel C-03 in the Control Room to ensure proper positioning of controls.

CORRECT ANSWER: A

JUSTIFICATION: If the maintenance was associated with #12 RHRSW Pump then a visual check would be required at the ASDS panel. #13 RHRSW pump is not controlled from the ASDS Panel.

B, C and D are Incorrect: OWI-03.02, Section 4.2.2 provides a number of activities that would be acceptable to verify component operability. These activities listed are acceptable.

REFERENCE: OWI-03.02

10 CFR: 55.43b(1)

ADDITIONAL REFERENCE PROVIDED DURING EXAM: None

SRO ONLY JUSTIFICATION: SRO Only Task to perform Operability Verifications

QUESTION SOURCE: ILT Bank – Edits to stem and choices

TIER: 3 **GROUP:** 2 **CATEGORY:** Equipment Control

K/A: 2.2.21 **IMPORTANCE:** SRO 4.1 **COG LEVEL:** 1P

K/A DESCRIPTION: Knowledge of pre- and post-maintenance operability requirements.

DIFFICULTY: 2 **LESSON PL:** M8108L-038 **OBJECTIVE:** 2

2018 MONTICELLO ILT NRC EXAM - KEY

100. The plant is in a refueling outage with the following conditions:

- 1R Transformer is supplying plant loads
- 2R Transformer is OOS
- 11 EDG is OOS

An electrical fault occurs resulting in a 1R Lockout and the following conditions:

- Busses 15 and 16 are de-energized
- 12 EDG failed to start
- 15 minutes have elapsed
- Power restoration will take at least 6 hours

Classify the event for the conditions above?

- A. Unusual Event
- B. Alert
- C. Site Area Emergency
- D. General Emergency

CORRECT ANSWER: B

JUSTIFICATION: All offsite and onsite power to 15 and 16 bus has been lost in this condition. This requires an Alert classification per CA2.1.

A is incorrect: Plausible if the candidate incorrectly believes they still have a single power source to 15 or 16 bus.

C and D are incorrect: Plausible if the candidate reads the Hot EAL Classification for this condition.

REFERENCE: EAL Chart

10 CFR: 55.43b(5)

ADDITIONAL REFERENCE PROVIDED DURING EXAM: EAL Matrix

SRO ONLY JUSTIFICATION: EAL classification

QUESTION SOURCE: New

TIER: 3 **GROUP:** 4 **CATEGORY:** Emergency Procedures/Plan

K/A: 2.4.41 **IMPORTANCE:** 4.6 **COG LEVEL:** 3 SPR

K/A DESCRIPTION: Knowledge of the emergency action level thresholds and classifications.

DIFFICULTY: 3 **LESSON PL:** MT-BEP-EAL-001L **OBJECTIVE:** 7