

ENVIRONMENTAL ZONE DESCRIPTION  
SURRY POWER STATION - UNITS 1 AND 2  
AUGUST 24, 1981  
VIRGINIA ELECTRIC AND POWER COMPANY

8108270550 810824  
PDR ADOCK 05000280  
P PDR

**VEPCO  
SURRY POWER STATION  
UNITS 1 & 2**

**ENVIRONMENTAL  
ZONE DESCRIPTION**

**VOLUME 1**

**VIRGINIA ELECTRIC AND POWER COMPANY**

## TABLE OF CONTENTS

<u>Title</u>	<u>Page</u>	<u>Volume</u>
Introduction	1	1
Index to Environmental Zone Sheets	2	1
Environmental Zone Sheets	3-23	1
Reference List	24-25	1
Zone Key Plan	-	1
Equipment Qualification Diagrams	-	1
References	-	2-4

## INTRODUCTION

The Environmental Zone Description (EZD) documents the specification of parameters for environmentally harsh areas of the Surry Power Station Units 1 & 2 which contain safety-related equipment (IE Bulletin 79-01B). These areas have been ascribed environmental zones which possess more or less uniform environments relating to temperature, pressure, relative humidity, chemical spray, radiation, and submergence. As applicable for each environmental zone, these environmental parameters are specified for normal operation as well as LOCA, MSLB, and HELB conditions.

In certain instances, it was desirable to determine for specific plant components and environmental parameters a specification for an area contained within an environmental zone (i.e., temperature stratification and radiation zones).

Each environmental zone is described on a zone sheet (EZD pages 3 through 23). Reference numbers appearing on the zone sheets are identified by the reference list (EZD pages 24 through 25). The reference list also identifies secondary references which support/supplement the primary references. A copy of each of both types of references is provided in the succeeding volumes of the EZD.

Primary references have numerical tabs which correspond to their respective reference numbers, whereas secondary references have alphabetical tabs. Immediately preceding each primary reference is one or more pages of the user's guide; the user's guide identifies the specific pages of each primary reference where information from the zone sheet can be located.

INDEX TO ZONE SHEETS

<u>Environmental Zone</u>	<u>Page</u>
AB-2B	3
AB-2C	4
AB-13A	5
AB-13B	6
AB-27	7
AB-45	8
CSPH-11	9
CSPH-27	10
MSVH-11	11
MSVH-27	12
RC-3A	13
RC-3B	14
RC-18B	15
RC-27A	16
RC-27B	17
RC-47A	18
RC-47B	19
SB-9B	20
SFGD-1	21
TB-9	22
TB-35	23

ENVIRONMENTAL ZONE DESCRIPTION SHEET

Facility: VEPCO, SURRY  
 Units: 1 and 2  
 Dockets: 50-280 and 50-281

ZONE: AB-2B  
 DESCRIPTION: Auxiliary Building Penetration Area, Elev. 2'0"

<u>PARAMETER</u>	<u>NORMAL ENVIRONMENT</u>	<u>REFERENCE</u>	<u>LOCA ENVIRONMENT</u>	<u>REFERENCE</u>	<u>MSLB ENVIRONMENT</u>	<u>REFERENCE</u>	<u>HELB ENVIRONMENT</u>	<u>REFERENCE</u>
TEMPERATURE (°F)	Occupied spaces, 100F Normally un-occupied machinery spaces, 120F	14	NA	_____	NA	_____	120-205F, 0-30 secs 205F, 30-40 secs 205-190F, 40-1000 secs 190-145F, 1000-2000 secs 145-120F, 2000 secs-1 hr	4
PRESSURE (psia)	NA	_____	NA	_____	NA	_____	15.2, 0-1 min 14.9, 1-60 min	4
RELATIVE HUMIDITY (%)	NC	_____	NA	_____	NA	_____	100	4
CHEMICAL SPRAY	NA	_____	NA	_____	NA	_____	NA	_____
RADIATION (rads)	2.5 x 10 <sup>6</sup>	7	2.5 x 10 <sup>6</sup>	7	NA	_____	NA	_____
SUBMERGENCE (elev)	NA	_____	NA	_____	NA	_____	Note	_____

NA = Not applicable. NC = Not calculated. Numbers appearing in Reference columns are identified at the end of this section.

NOTE: Not applicable. No safety-related electrical equipment will be affected by the submergence level at the 2'0" elevation of the Auxiliary Building.

ENVIRONMENTAL ZONE DESCRIPTION SHEET

Facility: VEPCO, SURRY  
 Units: 1 and 2  
 Dockets: 50-280 and 50-281

ZONE: AB-2C  
 DESCRIPTION: Auxiliary Building Charging Pump Cubicles, Elev. 2'0"

<u>PARAMETER</u>	<u>NORMAL ENVIRONMENT</u>	<u>REFERENCE</u>	<u>LOCA ENVIRONMENT</u>	<u>REFERENCE</u>	<u>MSLB ENVIRONMENT</u>	<u>REFERENCE</u>	<u>HELB ENVIRONMENT</u>	<u>REFERENCE</u>
TEMPERATURE (°F)	Normally un-occupied machinery spaces, 120F	14	NA	_____	NA	_____	120-140F, 0-30 secs 140F, 30-1000 secs 140-125F, 1000-2000 secs 125-120F, 2000 secs-1 hr	4
PRESSURE (psia)	NA	_____	NA	_____	NA	_____	15.2, 0-1 min 14.9, 1-60 min	4
RELATIVE HUMIDITY (%)	NC	_____	NA	_____	NA	_____	100	4
CHEMICAL SPRAY	NA	_____	NA	_____	NA	_____	NA	_____
RADIATION (rads)	2.8 x 10 <sup>6</sup>	7	8.0 x 10 <sup>6</sup>	7	NA	_____	NA	_____
SUBMERGENCE (elev)	NA	_____	NA	_____	NA	_____	NOTE	_____

NA = Not applicable. NC = Not calculated. Numbers appearing in Reference columns are identified at the end of this section.

NOTE: Not applicable. No safety related electrical equipment will be affected by the submergence level at the 2'0" elevation of the Auxiliary Building.

ENVIRONMENTAL ZONE DESCRIPTION SHEET

Facility: VEPCO, SURRY  
 Units: 1 and 2  
 Dockets: 50-280 and 50-281

ZONE: AB-13A  
 DESCRIPTION: Auxiliary Building, General, Elev. 13'0"

<u>PARAMETER</u>	<u>NORMAL ENVIRONMENT</u>	<u>REFERENCE</u>	<u>LOCA ENVIRONMENT</u>	<u>REFERENCE</u>	<u>MSLB ENVIRONMENT</u>	<u>REFERENCE</u>	<u>HELB ENVIRONMENT</u>	<u>REFERENCE</u>
TEMPERATURE (°F)	Occupied spaces, 100F Normally un-occupied machinery spaces, 120F	14	NA	_____	NA	_____	120-205F, 0-30 secs 205F, 30-40 secs 205-190F, 40-1000 secs 190-145F, 1000-2000 secs 145-120F, 2000 secs-1hr	4
PRESSURE (psia)	NA	_____	NA	_____	NA	_____	15.2, 0-1 min 14.9, 1-60 min	4
RELATIVE HUMIDITY (%)	NC	_____	NA	_____	NA	_____	100	4
CHEMICAL SPRAY	NA	_____	NA	_____	NA	_____	NA	_____
RADIATION (rads)	NOTE	10	9.3 x 10 <sup>5</sup>	10	NA	_____	NA	_____
SUBMERGENCE (elev)	NA	_____	NA	_____	NA	_____	NA	_____

NA = Not applicable. NC = Not calculated. Numbers appearing in Reference columns are identified at the end of this section.

NOTE: The radiation dose of  $2.66 \times 10^7$  for the 40-yr normal operation in zone AB-13A is caused by the primary drain tank and gas stripper located in radiation zone Q (Units 1 & 2). The radiation dose is calculated to be  $4.87 \times 10^3$  in radiation zones O (Unit 1) and N (Unit 2) and  $1.40 \times 10^5$  in radiation zones T (Unit 1) and S (Unit 2).



ENVIRONMENTAL ZONE DESCRIPTION SHEET

Facility: VEPCO, SURRY  
 Units: 1 and 2  
 Dockets: 50-280 and 50-281

ZONE: AB-13B  
 DESCRIPTION: Auxiliary Building Cable Vault, Elev. 13'0"

<u>PARAMETER</u>	<u>NORMAL ENVIRONMENT</u>	<u>REFERENCE</u>	<u>LOCA ENVIRONMENT</u>	<u>REFERENCE</u>	<u>MSLB ENVIRONMENT</u>	<u>REFERENCE</u>	<u>HELB ENVIRONMENT</u>	<u>REFERENCE</u>
TEMPERATURE (°F)	Normally un-occupied machinery spaces, 120F	74	NA	_____	NA	_____	NA	_____
PRESSURE (psia)	NA	_____	NA	_____	NA	_____	NA	_____
RELATIVE HUMIDITY (%)	NC	_____	NA	_____	NA	_____	NA	_____
CHEMICAL SPRAY	NA	_____	NA	_____	NA	_____	NA	_____
RADIATION (rads)	1.96 x 10 <sup>4</sup>	10	3.2 x 10 <sup>4</sup>	10	NA	_____	NA	_____
SUBMERGENCE (elev)	NA	_____	NA	_____	NA	_____	NA	_____

NA = Not applicable. NC = Not calculated. Numbers appearing in Reference columns are identified at the end of this section.

ENVIRONMENTAL ZONE DESCRIPTION SHEET

Facility: VEPCO, SURRY  
 Units: 1 and 2  
 Dockets: 50-280 and 50-281

ZONE: AB-27

DESCRIPTION: Auxiliary Building, General Elev. 27'6" [excluding cont. vacuum pump cubicles]

<u>PARAMETER</u>	<u>NORMAL ENVIRONMENT</u>	<u>REFERENCE</u>	<u>LOCA ENVIRONMENT</u>	<u>REFERENCE</u>	<u>MSLB ENVIRONMENT</u>	<u>REFERENCE</u>	<u>HELB ENVIRONMENT</u>	<u>REFERENCE</u>
TEMPERATURE (°F)	Occupied spaces, 100F Normally un-occupied machinery spaces, 120F	14	NA		NA		120-205F, 0- 30 secs 205F, 30-40 secs 205-190F, 40-1000 secs 190-145F, 1000-2000 secs 145-120F, 2000 secs-1 hr	4
PRESSURE (psia)	NA		NA		NA		15.2, 0-1 min 14.9, 1-60 min	4
RELATIVE HUMIDITY (%)	NC		NA		NA		100	4
CHEMICAL SPRAY	NA		NA		NA		NA	
RADIATION (rads)	1.3 x 10 <sup>6</sup>	10	6.8 x 10 <sup>2</sup>	10	NA		NA	
SUBMERGENCE (elev)	NA		NA		NA		NA	

NA = Not applicable. NC = Not calculated. Numbers appearing in Reference columns are identified at the end of this section.

ENVIRONMENTAL ZONE DESCRIPTION SHEET

Facility: VEPCO, SURRY  
 Units: 1 and 2  
 Dockets: 50-280 and 50-281

ZONE: AB-45  
 DESCRIPTION: Auxiliary Building, General, Elev. 45'10"

<u>PARAMETER</u>	<u>NORMAL ENVIRONMENT</u>	<u>REFERENCE</u>	<u>LOCA ENVIRONMENT</u>	<u>REFERENCE</u>	<u>MSLB ENVIRONMENT</u>	<u>REFERENCE</u>	<u>HELB ENVIRONMENT</u>	<u>REFERENCE</u>
TEMPERATURE (°F)	Occupied spaces, 100F Normally un-occupied machinery spaces, 120F	14	NA		NA		120-125F, 0-300 secs 125-122F, 300-2000 secs 122-120F, 2000 secs-1 hr	4
OPRESSURE (psia)	NA		NA		NA		15.2, 0-1 min 14.9, 1-60 min	4
RELATIVE HUMIDITY (%)	NC		NA		NA		100	4
CHEMICAL SPRAY	NA		NA		NA		NA	
RADIATION (rads)	1.1 x 10 <sup>5</sup>	10	2.7 x 10 <sup>5</sup>	10	NA		NA	
SUBMERGENCE (elev)	NA		NA		NA		NA	

NA = Not applicable. NC = Not calculated. Numbers appearing in Reference columns are identified at the end of this section.

ENVIRONMENTAL ZONE DESCRIPTION SHEET

Facility: VEPCO, SURRY  
 Units: 1 and 2  
 Dockets: 50-280 and 50-281

ZONE: CSPH-11  
 DESCRIPTION: Containment Spray Pump House, Elev. 11'6"

<u>PARAMETER</u>	<u>NORMAL ENVIRONMENT</u>	<u>REFERENCE</u>	<u>LOCA ENVIRONMENT</u>	<u>REFERENCE</u>	<u>MSLB ENVIRONMENT</u>	<u>REFERENCE</u>	<u>HELB ENVIRONMENT</u>	<u>REFERENCE</u>
TEMPERATURE (°F)	Occupied spaces, 100F Normally un-occupied machinery spaces, 120F	14	NA		NA		NA	
PRESSURE (psia)	NA		NA		NA		NA	
RELATIVE HUMIDITY (%)	NC		NA		NA		NA	
CHEMICAL SPRAY	NA		NA		NA		NA	
RADIATION (rads)	8.8 x 10 <sup>2</sup>	11	5.9 x 10 <sup>6</sup>	11	NA		NA	
SUBMERGENCE (elev)	NA		NA		NA		NA	

NA = Not applicable. NC = Not calculated. Numbers appearing in Reference columns are identified at the end of this section.

ENVIRONMENTAL ZONE DESCRIPTION SHEET

Facility: VEPCO, SURRY  
 Units: 1 and 2  
 Dockets: 50-280 and 50-281

ZONE: CSPH-27  
 DESCRIPTION: Containment Spray Pump House, Elev. 27'6"

<u>PARAMETER</u>	<u>NORMAL ENVIRONMENT</u>	<u>REFERENCE</u>	<u>LOCA ENVIRONMENT</u>	<u>REFERENCE</u>	<u>MSLB ENVIRONMENT</u>	<u>REFERENCE</u>	<u>HELB ENVIRONMENT</u>	<u>REFERENCE</u>
TEMPERATURE (°F)	Occupied spaces, 100F Normally un-occupied machinery spaces, 120F	14	NA		NA		NA	
PRESSURE (psia)	NA		NA		NA		NA	
RELATIVE HUMIDITY (%)	NC		NA		NA		NA	
CHEMICAL SPRAY	NA		NA		NA		NA	
RADIATION (rads)	8.8 x 10 <sup>2</sup>	11	5.3 x 10 <sup>2</sup>	11	NA		NA	
SUBMERGENCE (elev)	NA		NA		NA		NA	

NA = Not applicable. NC = Not calculated. Numbers appearing in Reference columns are identified at the end of this section.

ENVIRONMENTAL ZONE DESCRIPTION SHEET

Facility: VEPCO, SURRY  
 Units: 1 and 2  
 Dockets: 50-280 and 50-281

ZONE: MSVH-11  
 DESCRIPTION: Main Steam Valve House, General, Elev. 11'6"

<u>PARAMETER</u>	<u>NORMAL ENVIRONMENT</u>	<u>REFERENCE</u>	<u>LOCA ENVIRONMENT</u>	<u>REFERENCE</u>	<u>MSLB ENVIRONMENT</u>	<u>REFERENCE</u>	<u>HELB ENVIRONMENT</u>	<u>REFERENCE</u>
TEMPERATURE (°F)	Normally un-occupied machinery spaces, 120F	14	NA		NA		NA	
PRESSURE (psia)	NA		NA		NA		NA	
RELATIVE HUMIDITY (%)	NC		NA		NA		NA	
CHEMICAL SPRAY	NA		NA		NA		NA	
RADIATION (rads)	8.8 x 10 <sup>2</sup>	11	5.9 x 10 <sup>6</sup>	11	NA		NA	
SUBMERGENCE (elev)	NA		NA		NA		NA	

NA = Not applicable. NC = Not calculated. Numbers appearing in Reference columns are identified at the end of this section.

ENVIRONMENTAL ZONE DESCRIPTION SHEET

Facility: VEPCO, SURRY  
 Units: 1 and 2  
 Dockets: 50-280 and 50-281

ZONE: MSVH-27  
 DESCRIPTION: Main Steam Valve House, General, Elev. 27'6"

<u>PARAMETER</u>	<u>NORMAL ENVIRONMENT</u>	<u>REFERENCE</u>	<u>LOCA ENVIRONMENT</u>	<u>REFERENCE</u>	<u>MSLB ENVIRONMENT</u>	<u>REFERENCE</u>	<u>HELB ENVIRONMENT</u>	<u>REFERENCE</u>
TEMPERATURE (°F)	Normally un-occupied machinery spaces, 120F	14	NA		NA		Note	12
PRESSURE (psia)	NA		NA		NA		16.5, 0-10 sec 16.2, 10 sec- 1 hr	12
RELATIVE HUMIDITY (%)	NC		NA		NA		100	12
CHEMICAL SPRAY	NA		NA		NA		NA	
RADIATION (rads)	8.8 x 10 <sup>2</sup>	11	1.7 x 10 <sup>4</sup>	11	NA		NA	
SUBMERGENCE (elev)	NA		NA		NA		NA	

NA = Not applicable. NC = Not calculated. Numbers appearing in Reference columns are identified at the end of this section.

NOTE: The HELB temperature of 300°F (0-1 hr) was calculated for environmental zone MSVH-27 which extends from elevation 27'6" to the roof. The HELB temperature for equipment located between elevations 27'6" and 38'0" is calculated to be 250°F (0-1 hr).

ENVIRONMENTAL ZONE DESCRIPTION SHEET

Facility: VEPCO, SURRY  
 Units: 1 and 2  
 Dockets: 50-280 and 50-281

ZONE: RC-3A  
 DESCRIPTION: Containment Inside Cranewall, Elev. (-)3'6"

<u>PARAMETER</u>	<u>NORMAL ENVIRONMENT</u>	<u>REFERENCE</u>	<u>LOCA ENVIRONMENT</u>	<u>REFERENCE</u>	<u>MSLB ENVIRONMENT</u>	<u>REFERENCE</u>	<u>HELB ENVIRONMENT</u>	<u>REFERENCE</u>
TEMPERATURE (°F)	Design, 105F Maximum, 125F	15 1	280F, 0-30 min 2 280-150F, 30-60 min 150-120F, 1-48 hr 120F, 2-120 days		280F, 0-30 min 2 280-150F, 30-60 min 150-120F, 1-48 hr 120F, 2-120 days		NA	
PRESSURE (psia)	9.0-11.1	1	59.7, 0-30 min 2 59.7-14.7, 30-60 min 14.7-12.7, 1-48 hr 12.7, 2-120 days		59.7, 0-30 min 2 59.7-14.7, 30-60 min 14.7-12.7, 1-48 hr 12.7, 2-120 days		NA	
RELATIVE HUMIDITY (%)	NC		100, 0-120 days 2		100, 0-120 days 2		NA	
CHEMICAL SPRAY	NA		Solution of 2 2000-2200 ppm H <sub>3</sub> BO <sub>3</sub> buffered with NaOH to pH of 8.5-11, 0-4 hr Same solution with pH of between 8.0 and 9.5, 4 hr-120 days		Solution of 2 2000-2200 ppm H <sub>3</sub> BO <sub>3</sub> buffered with NaOH to pH of 8.5-11, 0-4 hr Same solution with pH of between 8.0 and 9.5, 4 hr-120 days		NA	
RADIATION (rads)	1.3 x 10 <sup>7</sup>	3	≤2.4 x 10 <sup>7</sup>	3	<2.4 x 10 <sup>7</sup>	3,5	NA	
SUBMERGENCE (elev)	NA		NA		NA		NA	

NA = Not applicable. NC = Not calculated. Numbers appearing in reference columns are identified at the end of this section.



ENVIRONMENTAL ZONE DESCRIPTION SHEET

Facility: VEPCO, SURRY  
 Units: 1 and 2  
 Dockets: 50-280 and 50-281

ZONE: RC-3B  
 DESCRIPTION: Containment Outside Cranewall, Elev. (-)3'6"

<u>PARAMETER</u>	<u>NORMAL ENVIRONMENT</u>	<u>REFERENCE</u>	<u>LOCA ENVIRONMENT</u>	<u>REFERENCE</u>	<u>MSLB ENVIRONMENT</u>	<u>REFERENCE</u>	<u>HELB ENVIRONMENT</u>	<u>REFERENCE</u>
TEMPERATURE (°F)	Design, 105F Maximum, 125F	15 1	280F, 0-30 min 2 280-150F, 30-60 min 150-120F, 1-48 hr 120F, 2-120 days		280F, 0-30 min 2 280-150F, 30-60 min 150-120F, 1-48 hr 120F, 2-120 days		NA	
PRESSURE (psia)	9.0-11.1	1	59.7, 0-30 min 2 59.7-14.7, 30-60 min 14.7-12.7, 1-48 hr 12.7, 2-120 days		59.7, 0-30 min 2 59.7-14.7, 30-60 min 14.7-12.7, 1-48 hr 12.7, 2-120 days		NA	
RELATIVE HUMIDITY (%)	NC		100, 0-120 days 2		100, 0-120 days 2		NA	
CHEMICAL SPRAY	NA		Solution of 2 2000-2200 ppm H <sub>3</sub> BO <sub>3</sub> buffered with NaOH to pH of 8.5-11, 0-4 hr Same solution with pH of between 8.0 and 9.5, 4 hr-120 days		Solution of 2 2000-2200 ppm H <sub>3</sub> BO <sub>3</sub> buffered with NaOH to pH of 8.5-11, 0-4 hr Same solution with pH of between 8.0 and 9.5, 4 hr-120 days		NA	
RADIATION (rads)	3.5 x 10 <sup>4</sup>	3	7.4 x 10 <sup>6</sup>	3	<7.4 x 10 <sup>6</sup>	3,5	NA	
SUBMERGENCE (elev)	NA		NA		NA		NA	

NA = Not applicable. NC = Not calculated. Numbers appearing in Reference columns are identified at the end of this section.

ENVIRONMENTAL ZONE DESCRIPTION SHEET

Facility: VEPCO, SURRY  
 Units: 1 and 2  
 Dockets: 50-280 and 50-281

ZONE: RC-18B  
 DESCRIPTION: Containment Outside Cranewall, Elev. 18'4"

<u>PARAMETER</u>	<u>NORMAL ENVIRONMENT</u>	<u>REFERENCE</u>	<u>LOCA ENVIRONMENT</u>	<u>REFERENCE</u>	<u>MSLB ENVIRONMENT</u>	<u>REFERENCE</u>	<u>HELB ENVIRONMENT</u>	<u>REFERENCE</u>
TEMPERATURE (°F)	Design, 105F Maximum, 125F	15 1	280F, 0-30 min 2 280-150F, 30-60 min 150-120F, 1-48 hr 120F, 2-120 days		280F, 0-30 min 2 280-150F, 30-60 min 150-120F, 1-48 hr 120F, 2-120 days		NA	
PRESSURE (psia)	9.0-11.1	1	59.7, 0-30 min 2 59.7-14.7, 30-60 min 14.7-12.7, 1-48 hr 12.7, 2-120 days		59.7, 0-30 min 2 59.7-14.7, 30-60 min 14.7-12.7, 1-48 hr 12.7, 2-120 days		NA	
RELATIVE HUMIDITY (%)	NC		100, 0-120 days 2		100, 0-120 days 2		NA	
CHEMICAL SPRAY	NA		Solution of 2 2000-2200 ppm H <sub>3</sub> BO <sub>3</sub> buffered with NaOH to pH of 8.5-11, 0-4 hr Same solution with pH of between 8.0 and 9.5, 4 hr-120 days		Solution of 2 2000-2200 ppm H <sub>3</sub> BO <sub>3</sub> buffered with NaOH to pH of 8.5-11, 0-4 hr Same solution with pH of between 8.0 and 9.5, 4 hr-120 days		NA	
RADIATION (rads)	3.5 x 10 <sup>4</sup>	3	7.4 x 10 <sup>6</sup>	3	<7.4 x 10 <sup>6</sup>	3,5	NA	
SUBMERGENCE (elev)	NA		NA		NA		NA	

NA = Not applicable. NC = Not calculated. Numbers appearing in Reference columns are identified at the end of this section.

ENVIRONMENTAL ZONE DESCRIPTION SHEET

Facility: VEPCO, SURRY  
 Units: 1 and 2  
 Dockets: 50-280 and 50-281

ZONE: RC-27A  
 DESCRIPTION: Containment General, Elev. (-)27'7"

<u>PARAMETER</u>	<u>NORMAL ENVIRONMENT</u>	<u>REFERENCE</u>	<u>LOCA ENVIRONMENT</u>	<u>REFERENCE</u>	<u>MSLB ENVIRONMENT</u>	<u>REFERENCE</u>	<u>HELB ENVIRONMENT</u>	<u>REFERENCE</u>
TEMPERATURE (°F)	Design, 105F Maximum, 125F	15 1	280F, 0-30 min 2 280-150F, 30-60 min 150-120F, 1-48 hr 120F, 2-120 days		280F, 0-30 min 2 280-150F, 30-60 min 150-120F, 1-48 hr 120F, 2-120 days		NA	
PRESSURE (psia)	9.0-11.1	1	59.7, 0-30 min 2 59.7-14.7, 30-60 min 14.7-12.7, 1-48 hr 12.7, 2-120 days		59.7, 0-30 min 2 59.7-14.7, 30-60 min 14.7-12.7, 1-48 hr 12.7, 2-120 days		NA	
RELATIVE HUMIDITY (%)	NC		100, 0-120 days 2		100, 0-120 days 2		NA	
CHEMICAL SPRAY	NA		Solution of 2 2000-2200 ppm H <sub>3</sub> BO <sub>3</sub> buffered with NaOH to pH of 8.5-11, 0-4 hr Same solution with pH of between 8.0 and 9.5, 4 hr-120 days		Solution of 2 2000-2200 ppm H <sub>3</sub> BO <sub>3</sub> buffered with NaOH to pH of 8.5-11, 0-4 hr Same solution with pH of between 8.0 and 9.5, 4 hr-120 days		NA	
RADIATION (rads)	3.5 x 10 <sup>4</sup>	3	3.5 x 10 <sup>7</sup>	3	<3.5 x 10 <sup>7</sup>	3,5	NA	
SUBMERGENCE (elev)	NA		NA		NA		NA	

NA = Not applicable. NC = Not calculated. Numbers appearing in Reference columns are identified at the end of this section.

ENVIRONMENTAL ZONE DESCRIPTION SHEET

Facility: VEPCO, SURRY  
 Units: 1 and 2  
 Dockets: 50-280 and 50-281

ZONE: RC-27B\*  
 DESCRIPTION: Containment, Elev. (-)27'7" Submerged (Below (-)21'11")

<u>PARAMETER</u>	<u>NORMAL ENVIRONMENT</u>	<u>REFERENCE</u>	<u>LOCA ENVIRONMENT</u>	<u>REFERENCE</u>	<u>MSLB ENVIRONMENT</u>	<u>REFERENCE</u>	<u>HELB ENVIRONMENT</u>	<u>REFERENCE</u>
TEMPERATURE (°F)	Design, 105F Maximum, 125F	15 1	280F, 0-30 min 280-150F, 30-60 min 150-120F, 1-48 hr 120F, 2-120 days	2 2	280F, 0-30 min 280-150F, 30-60 min 150-120F, 1-48 hr 120F, 2-120 days	2 2	NA	
PRESSURE (psia)	9.0-11.1	1	59.7, 0-30 min 59.7-14.7, 30-60 min 14.7-12.7, 1-48 hr 12.7, 2-120 days	2 2	59.7, 0-30 min 59.7-14.7, 30-60 min 14.7-12.7, 1-48 hr 12.7, 2-120 days	2 2	NA	
RELATIVE HUMIDITY (%)	NC		100, 0-120 days	2	100, 0-120 days	2	NA	
CHEMICAL SPRAY	NA		Solution of 2000-2200 ppm H <sub>3</sub> BO <sub>3</sub> buffered with NaOH to pH of 8.5-11, 0-4 hr Same solution with pH of between 8.0 and 9.5, 4 hr-120 days	2	Solution of 2000-2200 ppm H <sub>3</sub> BO <sub>3</sub> buffered with NaOH to pH of 8.5-11, 0-4 hr Same solution with pH of between 8.0 and 9.5, 4 hr-120 days	2	NA	
RADIATION (rads)	3.5 x 10 <sup>4</sup>	3	3.8 x 10 <sup>7</sup>	3	<3.8 x 10 <sup>7</sup>	3,5	NA	
SUBMERGENCE (elev)	NA		(-)21'11"	6	(-)21'11"	6	NA	

NA = Not applicable. NC = Not calculated. Numbers appearing in Reference columns are identified at the end of this section.

\* No safety-related electrical equipment is contained in environmental zone RC-27B.

ENVIRONMENTAL ZONE DESCRIPTION SHEET

Facility: VEPCO, SURRY  
 Units: 1 and 2  
 Dockets: 50-280 and 50-281

ZONE: RC-47A

DESCRIPTION: Containment Inside Cranewall, Elev. 47'4"

<u>PARAMETER</u>	<u>NORMAL ENVIRONMENT</u>	<u>REFERENCE</u>	<u>LOCA ENVIRONMENT</u>	<u>REFERENCE</u>	<u>MSLB ENVIRONMENT</u>	<u>REFERENCE</u>	<u>HELB ENVIRONMENT</u>	<u>REFERENCE</u>
TEMPERATURE (°F)	Design, 105F Maximum, 125F	15 1	280F, 0-30 min 2 280-150F, 30-60 min 150-120F, 1-48 hr 120F, 2-120 days		280F, 0-30 min 2 280-150F, 30-60 min 150-120F, 1-48 hr 120F, 2-120 days		NA	
PRESSURE (psia)	9.0-11.1	1	59.7, 0-30 min 2 59.7-14.7, 30-60 min 14.7-12.7, 1-48 hr 12.7, 2-120 days		59.7, 0-30 min 2 59.7-14.7, 30-60 min 14.7-12.7, 1-48 hr 12.7, 2-120 days		NA	
RELATIVE HUMIDITY (%)	NC		100, 0-120 days 2		100, 0-120 days 2		NA	
CHEMICAL SPRAY	NA		Solution of 2 2000-2200 ppm H <sub>3</sub> BO <sub>3</sub> buffered with NaOH to pH of 8.5-11, 0-4 hr Same solution with pH of between 8.0 and 9.5, 4 hr-120 days		Solution of 2 2000-2200 ppm H <sub>3</sub> BO <sub>3</sub> buffered with NaOH to pH of 8.5-11, 0-4 hr Same solution with pH of between 8.0 and 9.5, 4 hr-120 days		NA	
RADIATION (rads)	<1.3 x 10 <sup>7</sup>	3	2.4 x 10 <sup>7</sup>	3	<2.4 x 10 <sup>7</sup>	3,5	NA	
SUBMERGENCE (elev)	NA		NA		NA		NA	

NA = Not applicable. NC = Not calculated. Numbers appearing in Reference columns are identified at the end of this section.

ENVIRONMENTAL ZONE DESCRIPTION SHEET

Facility: VEPCO, SURRY  
 Units: 1 and 2  
 Dockets: 50-280 and 50-281

ZONE: RC-47B  
 DESCRIPTION: Containment Outside Cranewall, Elev. 47'4"

<u>PARAMETER</u>	<u>NORMAL ENVIRONMENT</u>	<u>REFERENCE</u>	<u>LOCA ENVIRONMENT</u>	<u>REFERENCE</u>	<u>MSLB ENVIRONMENT</u>	<u>REFERENCE</u>	<u>HELE ENVIRONMENT</u>	<u>REFERENCE</u>
TEMPERATURE (°F)	Design, 105F Maximum, 125F	15 1	280F, 0-30 min 2 280-150F, 30-60 min 150-120F, 1-48 hr 120F, 2-120 days		280F, 0-30 min 2 280-150F, 30-60 min 150-120F, 1-48 hr 120F, 2-120 days		NA	
PRESSURE (psia)	9.0-11.1	1	59.7, 0-30 min 2 59.7-14.7, 30-60 min 14.7-12.7, 1-48 hr 12.7, 2-120 days		59.7, 0-30 min 2 59.7-14.7, 30-60 min 14.7-12.7, 1-48 hr 12.7, 2-120 days		NA	
RELATIVE HUMIDITY (%)	NC		100, 0-120 days 2		100, 0-120 days 2		NA	
CHEMICAL SPRAY	NA		Solution of 2 2000-2200 ppm H <sub>3</sub> BO <sub>3</sub> buffered with NaOH to pH of 8.5-11, 0-4 hr Same solution with pH of between 8.0 and 9.5, 4 hr-120 days		Solution of 2 2000-2200 ppm H <sub>3</sub> BO <sub>3</sub> buffered with NaOH to pH of 8.5-11, 0-4 hr Same solution with pH of between 8.0 and 9.5, 4 hr-120 days		NA	
RADIATION (rads)	3.5 x 10 <sup>4</sup>	3	7.4 x 10 <sup>6</sup>	3	<7.4 x 10 <sup>6</sup>	3,5	NA	
SUBMERGENCE (elev)	NA		NA		NA		NA	

NA = Not applicable. NC = Not calculated. Numbers appearing in Reference columns are identified at the end of this section.

ENVIRONMENTAL ZONE DESCRIPTION SHEET

Facility: VEPCO, SURRY  
 Units: 1 and 2  
 Dockets: 50-280 and 50-281

ZONE: SB-9B  
 DESCRIPTION: Mechanical Equipment Room 3

<u>PARAMETER</u>	<u>NORMAL ENVIRONMENT</u>	<u>REFERENCE</u>	<u>LOCA ENVIRONMENT</u>	<u>REFERENCE</u>	<u>MSLB ENVIRONMENT</u>	<u>REFERENCE</u>	<u>HELB ENVIRONMENT</u>	<u>REFERENCE</u>
TEMPERATURE (°F)	Occupied spaces, 100F Normally un-occupied machinery spaces, 120F	14	NA		NA		310F, 0-30 min 310-130F, 30-60 min	8
PRESSURE (psia)	NA		NA		NA		15.0	8
RELATIVE HUMIDITY (%)	NC		NA		NA		100	8
CHEMICAL SPRAY	NA		NA		NA		NA	
RADIATION (rads)	<2500	11	<2500	13	NA		NA	
SUBMERGENCE (elev)	NA		NA		NA		NA	

NA = Not applicable. NC = Not calculated. Numbers appearing in Reference columns are identified at the end of this section.

ENVIRONMENTAL ZONE DESCRIPTION SHEET

Facility: VEPCO, SURRY  
 Units: 1 and 2  
 Dockets: 50-280 and 50-281

ZONE: SFGD-1  
 DESCRIPTION: Safeguards Area

<u>PARAMETER</u>	<u>NORMAL ENVIRONMENT</u>	<u>REFERENCE</u>	<u>LOCA ENVIRONMENT</u>	<u>REFERENCE</u>	<u>MSLB ENVIRONMENT</u>	<u>REFERENCE</u>	<u>HELB ENVIRONMENT</u>	<u>REFERENCE</u>
TEMPERATURE (°F)	Occupied spaces, 100F Normally un-occupied machinery spaces, 120F	14	NA		NA		NA	
PRESSURE (psia)	NA		NA		NA		NA	
RELATIVE HUMIDITY (%)	NC		NA		NA		NA	
CHEMICAL SPRAY	NA		NA		NA		NA	
RADIATION (rads)	8.8 x 10 <sup>2</sup>	7	8.0 x 10 <sup>6</sup>	9	NA		NA	
SUBMERGENCE (elev)	NA		NA		NA		NA	

NA = Not applicable. NC = Not calculated. Numbers appearing in Reference columns are identified at the end of this section.



ENVIRONMENTAL ZONE DESCRIPTION SHEET

Facility: VEPCO, SURRY  
 Units: 1 and 2  
 Dockets: 50-280 and 50-281

ZONE: TB-9  
 DESCRIPTION: Turbine Building, General, Elev. 9'6"

<u>PARAMETER</u>	<u>NORMAL ENVIRONMENT</u>	<u>REFERENCE</u>	<u>LOCA ENVIRONMENT</u>	<u>REFERENCE</u>	<u>MSLB ENVIRONMENT</u>	<u>REFERENCE</u>	<u>HELB ENVIRONMENT</u>	<u>REFERENCE</u>
TEMPERATURE (°F)	Occupied spaces, 100F Normally un-occupied machinery spaces, 120F	14	NA		NA		310F, 0-30 min 310-130F, 30-60 min	8
PRESSURE (psia)	NA		NA		NA		15.0	8
RELATIVE HUMIDITY (%)	NC		NA		NA		100	8
CHEMICAL SPRAY	NA		NA		NA		NA	
RADIATION (rads)	<2500	11	<2500	13	NA		NA	
SUBMERGENCE (elev)	NA		NA		NA		NA	

NA = Not applicable. NC = Not calculated. Numbers appearing in Reference columns are identified at the end of this section.

ENVIRONMENTAL ZONE DESCRIPTION SHEET

Facility: VEPCO, SURRY  
 Units: 1 and 2  
 Dockets: 50-280 and 50-281

ZONE: TB-35  
 DESCRIPTION: Turbine Building, Mezzanine Level

<u>PARAMETER</u>	<u>NORMAL ENVIRONMENT</u>	<u>REFERENCE</u>	<u>LOCA ENVIRONMENT</u>	<u>REFERENCE</u>	<u>MSLB ENVIRONMENT</u>	<u>REFERENCE</u>	<u>HELB ENVIRONMENT</u>	<u>REFERENCE</u>
TEMPERATURE (°F)	Occupied spaces, 100F Normally un-occupied machinery spaces, 120F	14	NA	_____	NA	_____	310F, 0-30 min 310-130F, 30-60 min	8
PRESSURE (psia)	NA	_____	NA	_____	NA	_____	15.0	8
RELATIVE HUMIDITY (%)	NC	_____	NA	_____	NA	_____	100	8
CHEMICAL SPRAY	NA	_____	NA	_____	NA	_____	NA	_____
RADIATION (rads)	<2500	11	<2500	13	NA	_____	NA	_____
SUBMERGENCE (elev)	NA	_____	NA	_____	NA	_____	NA	_____

NA = Not applicable. NC = Not calculated. Numbers appearing in Reference columns are identified at the end of this section.

## REFERENCE LIST

1. Distribution Memorandum (from D.W. Speidell, Jr. of VEPCO dated August 21, 1978). Technical Specifications, Surry Power Station Units 1 & 2, Conditions of the License, August 14, 1978. Service Water Temperature Limit.
  2. Stone & Webster Calculation No. 12846.44-US(B)-052-1.\*
  3. Stone & Webster Calculation No. 12846.54-RP-038-1.
  4. Stone & Webster Calculation No. 12846.44-PE-050-0.\*
  5. IE Bulletin 79-01B, Surry Power Station Unit 1, Section 2.3.
  6. Stone & Webster Calculation No. 12846.01-PE-036-0.\*
  7. Stone & Webster Calculation No. 12846.38-RP-024-1.
  8. Stone & Webster Calculation No. 12846.44-PE-049-0.
  9. Stone & Webster Calculation No. 12846.54-RP-037-0.
  10. Stone & Webster Calculation No. 12846.44-UR(B)-043-0.\*
  11. Stone & Webster Calculation No. 12846.38-RP-031-0.\*
  12. Stone & Webster Calculation No. 12846.44-PE-044-0.
  13. Stone & Webster Calculation No. 12846.54-RP-039-0.
  14. FSAR Section 9.13.2 (Pg. 9.13.2-1); Surry Power Station Units 1 and 2, December 1, 1969.
  15. FSAR Section 5.3 (pg. 5.3-1); Surry Power Station Units 1 and 2, December 1, 1969.
- \* The following calculations support the methodology approach provided in the above referenced calculations:

Stone & Webster Calculation No.

Input to Reference No.

12846.07-57	2
12846.01-PE-030-0	6
12846.19-PE-038-0	2
12846.44-PE-041-0	4
12846.44-PE-042-1	4
12846.19-PE-045-0	2
12846.44-PE-046-0	4
12846.38-RP-026-0	10
12846.54-RP-035-0	10
12050-RP-095-0	11

12846-1SQ-FY-1D-1

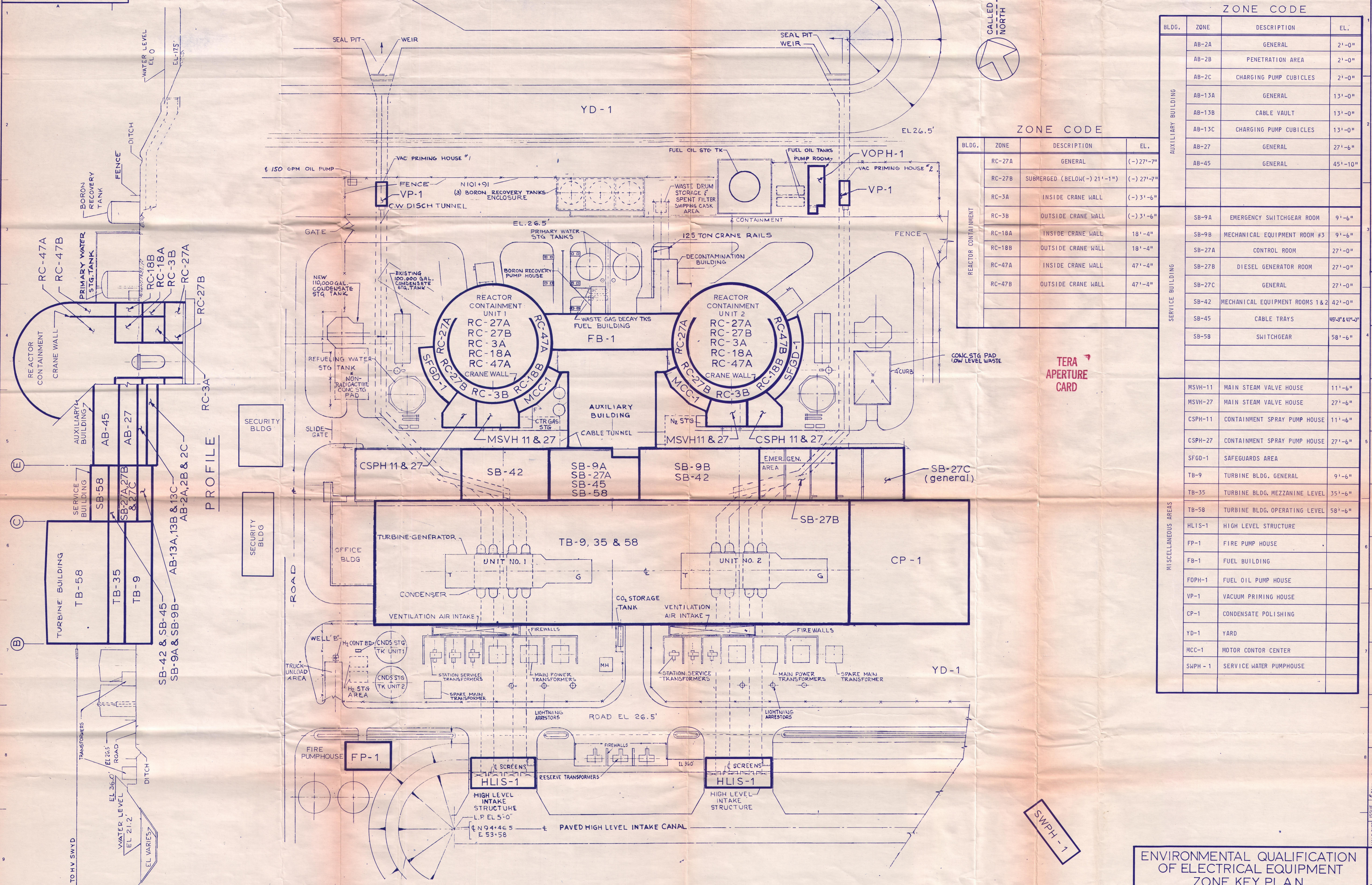

**ZONE CODE**

BLDG.	ZONE	DESCRIPTION	EL.
REACTOR CONTAINMENT	RC-27A	GENERAL	(-) 27'-7"
	RC-27B	SUBMERGED (BELOW (-) 21'-1")	(-) 27'-7"
	RC-3A	INSIDE CRANE WALL	(-) 3'-6"
	RC-3B	OUTSIDE CRANE WALL	(-) 3'-6"
	RC-18A	INSIDE CRANE WALL	18'-4"
	RC-18B	OUTSIDE CRANE WALL	18'-4"
SERVICE BUILDING	SB-9A	EMERGENCY SWITCHGEAR ROOM	9'-6"
	SB-9B	MECHANICAL EQUIPMENT ROOM #3	9'-6"
	SB-27A	CONTROL ROOM	27'-0"
	SB-27B	DIESEL GENERATOR ROOM	27'-0"
	SB-27C	GENERAL	27'-0"
	SB-42	MECHANICAL EQUIPMENT ROOMS 1 & 2	42'-0"
SB-45	CABLE TRAYS	45'-0" & 47'-0"	
SB-58	SWITCHGEAR	58'-6"	

**ZONE CODE**

BLDG.	ZONE	DESCRIPTION	EL.
AUXILIARY BUILDING	AB-2A	GENERAL	2'-0"
	AB-2B	PENETRATION AREA	2'-0"
	AB-2C	CHARGING PUMP CUBICLES	2'-0"
	AB-13A	GENERAL	13'-0"
	AB-13B	CABLE VAULT	13'-0"
	AB-13C	CHARGING PUMP CUBICLES	13'-0"
	AB-27	GENERAL	27'-6"
	AB-45	GENERAL	45'-10"
MISCELLANEOUS AREAS	MSVH-11	MAIN STEAM VALVE HOUSE	11'-6"
	MSVH-27	MAIN STEAM VALVE HOUSE	27'-6"
	CSPH-11	CONTAINMENT SPRAY PUMP HOUSE	11'-6"
	CSPH-27	CONTAINMENT SPRAY PUMP HOUSE	27'-6"
	SFGD-1	SAFEGUARDS AREA	
	TB-9	TURBINE BLDG. GENERAL	9'-6"
	TB-35	TURBINE BLDG. MEZZANINE LEVEL	35'-6"
	TB-58	TURBINE BLDG. OPERATING LEVEL	58'-6"
	HLIS-1	HIGH LEVEL STRUCTURE	
	FP-1	FIRE PUMP HOUSE	
	FB-1	FUEL BUILDING	
FOPH-1	FUEL OIL PUMP HOUSE		
VP-1	VACUUM PRIMING HOUSE		
CP-1	CONDENSATE POLISHING		
YD-1	YARD		
MCC-1	MOTOR CONTROL CENTER		
SWPH-1	SERVICE WATER PUMPHOUSE		

TERA APERTURE CARD

SWPH-1

ISSUE	DESCRIPTION	CHKD	CORRECT	APPR DATE	ISSUE	DESCRIPTION	CHKD	CORRECT	APPR DATE	ISSUE	DESCRIPTION	CHKD	CORRECT	APPR DATE	ISSUE	DESCRIPTION	CHKD	CORRECT	APPR DATE	
5					4					3					2					

ENVIRONMENTAL QUALIFICATION OF ELECTRICAL EQUIPMENT ZONE KEY PLAN

SURRY POWER STATION

VIRGINIA ELECTRIC AND POWER COMPANY

STONE & WEBSTER ENGINEERING CORPORATION  
BOSTON, MASS.

DRAWING NUMBER 12846-1SQ-FY-1D-1

DESIGNED BY: DSON CHKD BY: C.WIERZBICKI

DATE: 1/2/81

THE INFORMATION ON THIS DRAWING MAY NOT BE COPIED OR USED FOR OTHER THAN THE CONSTRUCTION, MAINTENANCE OR REPAIR OF THE PLANT FACILITY DESCRIBED IN THE TITLE BLOCK.

INDEX TO EQUIPMENT QUALIFICATION DIAGRAMS

12846-1SQ-FB-27B-1  
12846-1SQ-FK-3A-1  
12846-1SQ-FK-3B-1  
12846-1SQ-FK-10A-1  
12846-1SQ-FM-14A-1  
12846-1SQ-FM-16A-1  
12846-1SQ-FM-18A-1  
12846-1SQ-FM-21A-1  
12846-1SQ-FM-21B-1  
12846-1SQ-FM-22A-1  
12846-1SQ-FM-22B-1  
12846-1SQ-FM-32B-1  
12846-1SQ-FM-100A-1  
12846-1SQ-FM-100B-1  
12846-1SQ-FM-101A-1  
12846-1SQ-FM-102A-1  
12846-1SQ-FM-103A-1  
12846-1SQ-FM-103B-1  
12846-1SQ-FM-105B-1  
12846-1SQ-FM-105C-1  
12846-1SQ-FM-106A-1  
12846-1SQ-FM-106B-1  
12846-1SQ-FM-107A-1  
12846-1SQ-FM-122A-1  
12846-1SQ-FM-126A-1

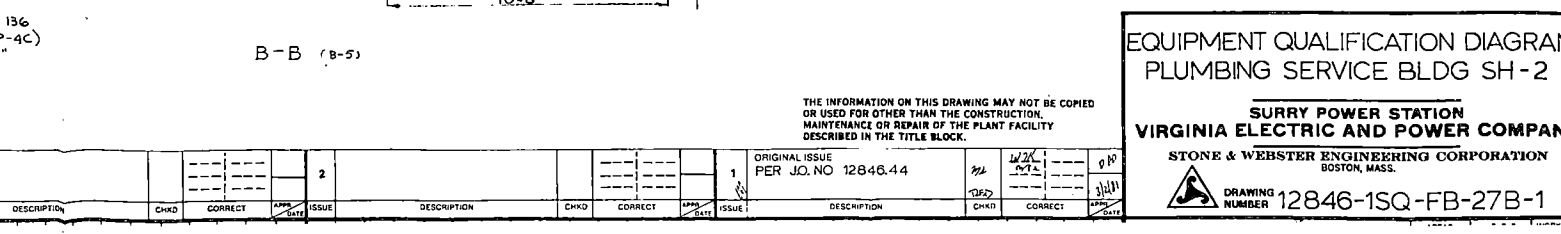
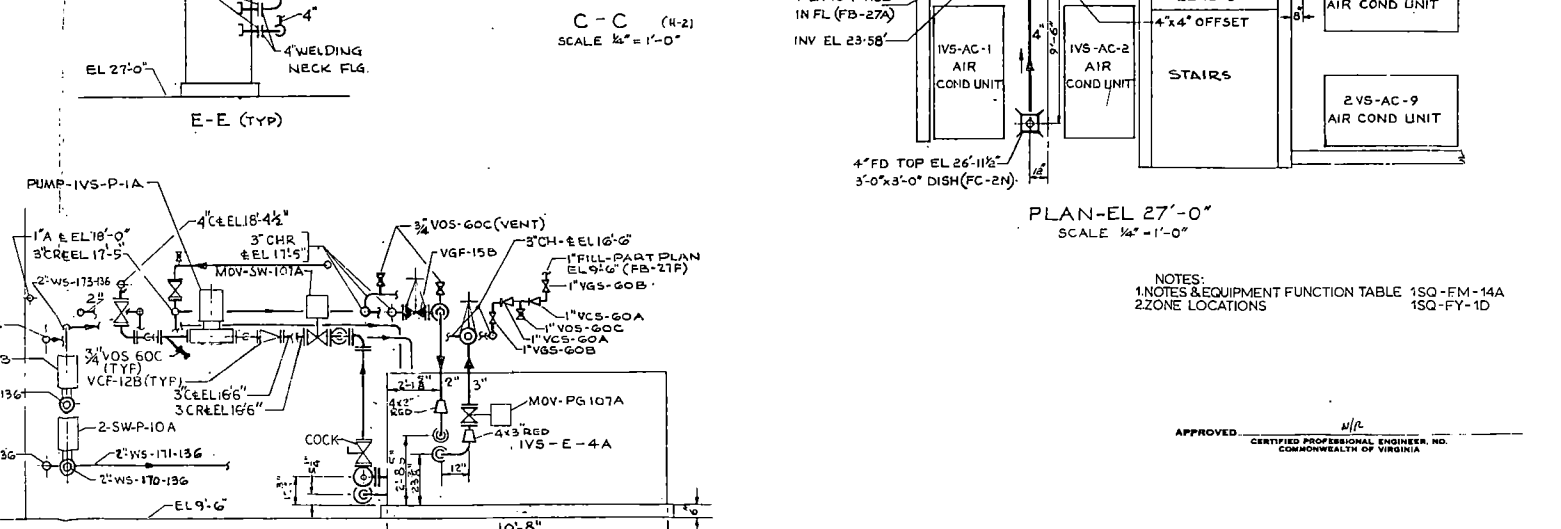
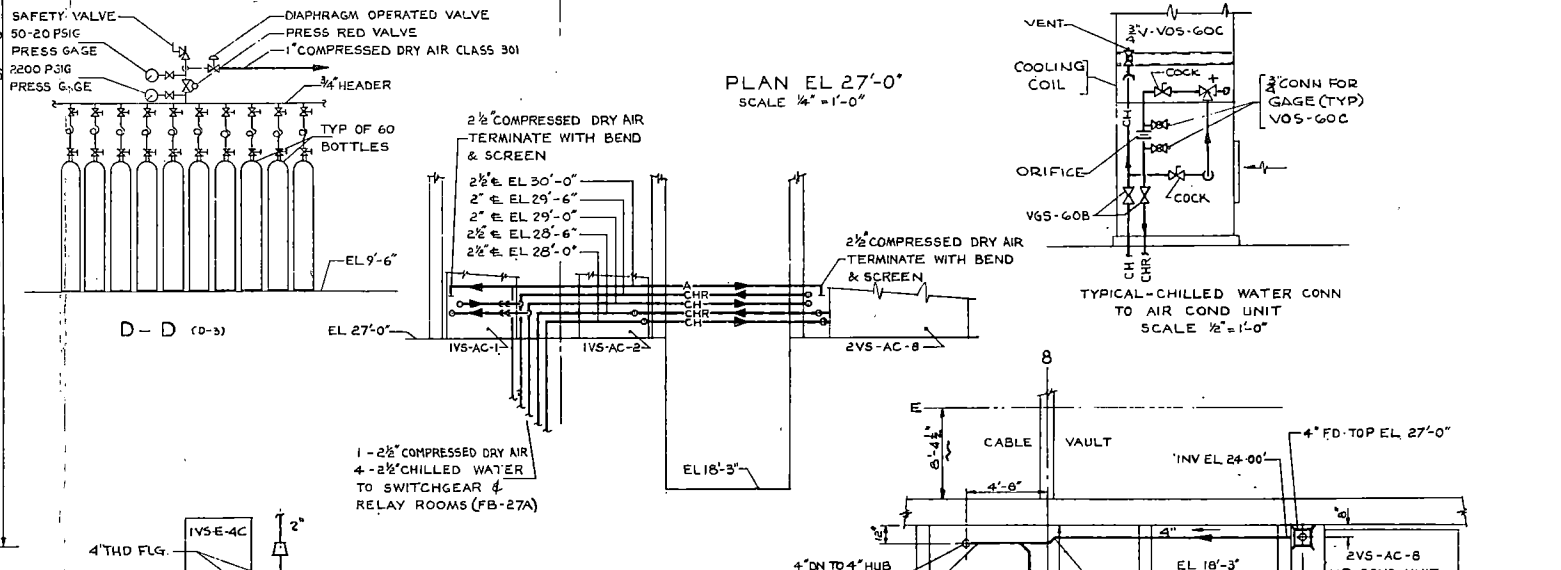
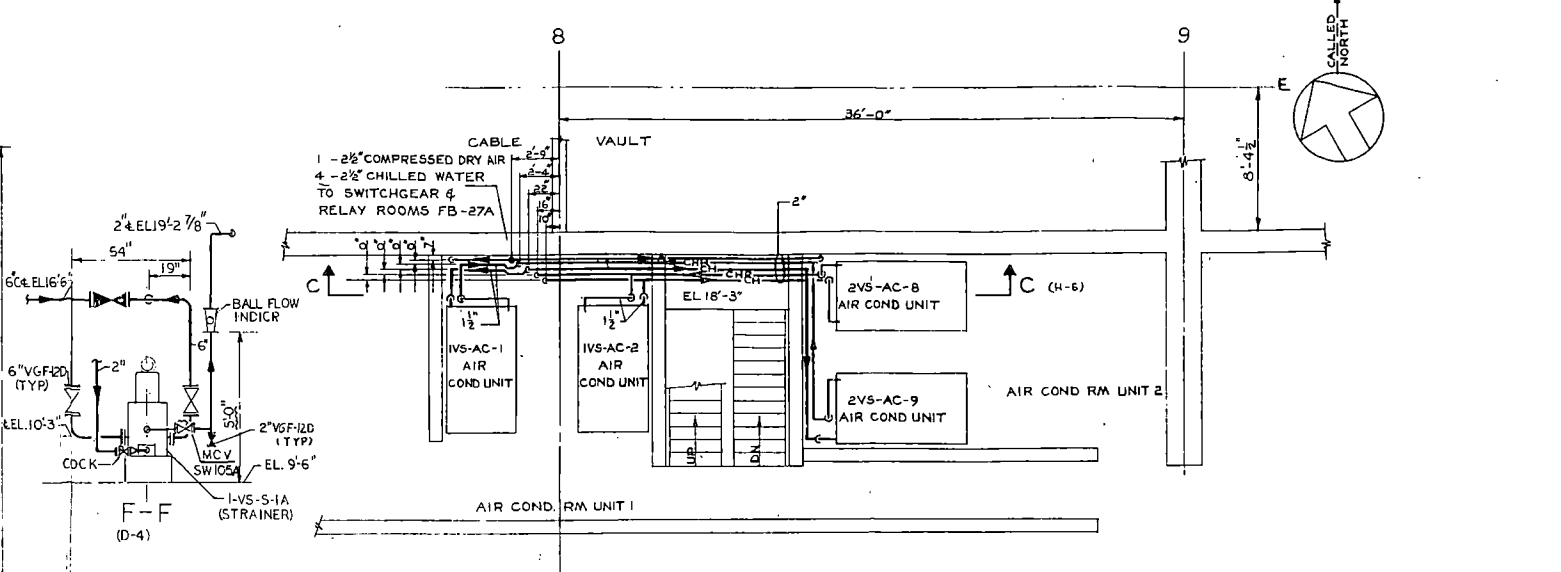
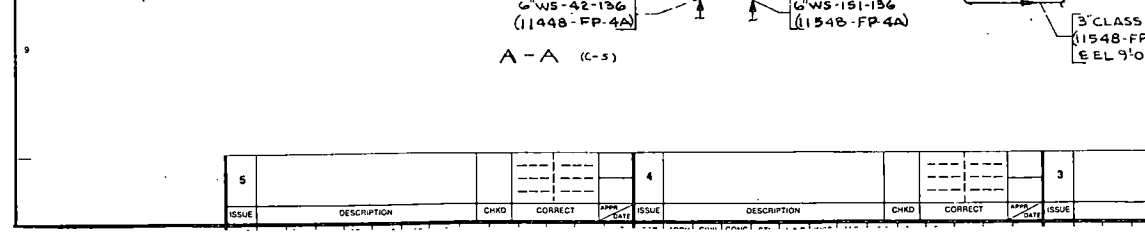
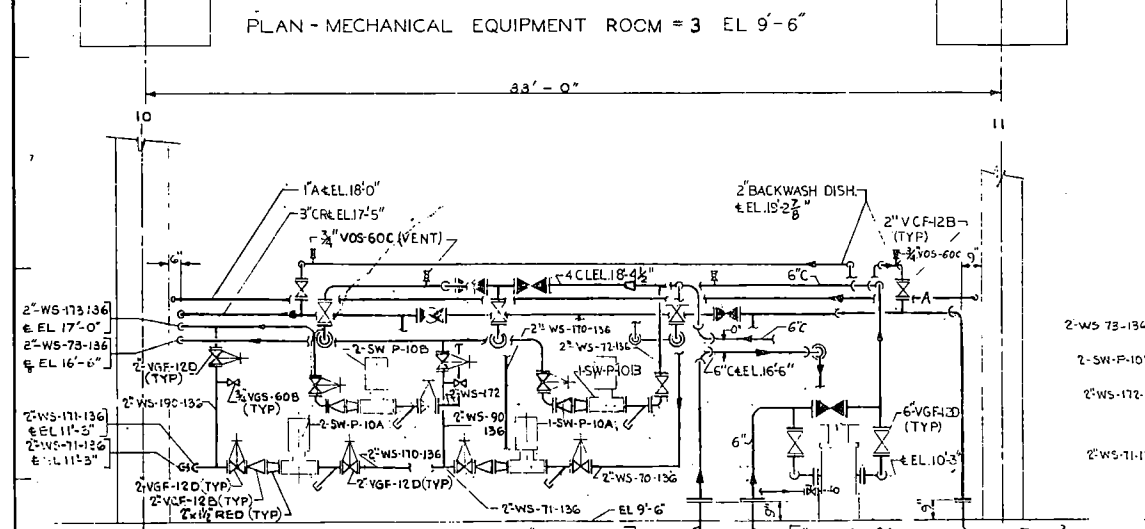
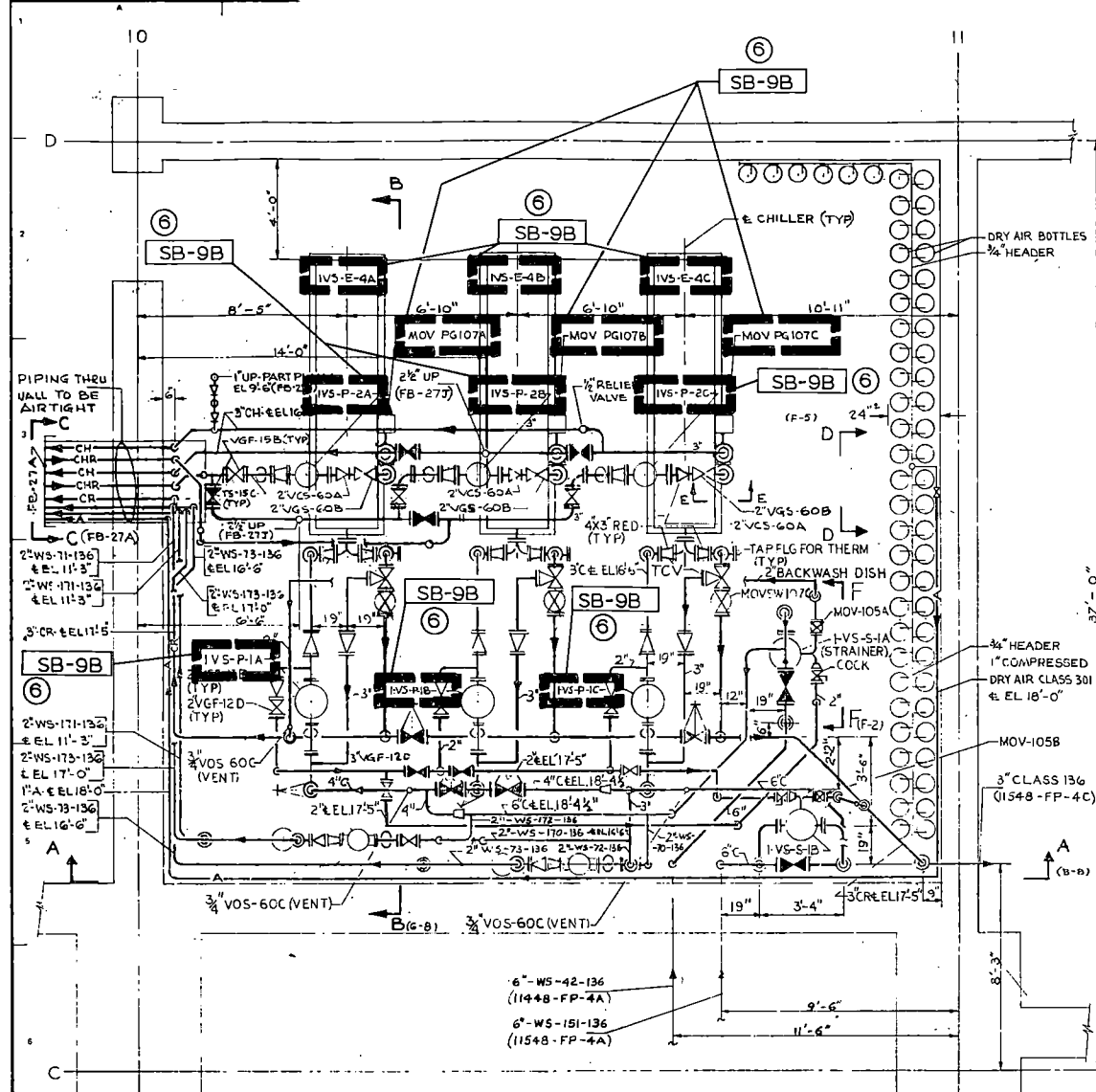

NOTES:  
1. NOTES & EQUIPMENT FUNCTION TABLE 1SQ-FM-14A  
2. ZONE LOCATIONS

APPROVED: [Signature]  
CERTIFIED PROFESSIONAL ENGINEER, NO. [Number]  
COMMONWEALTH OF VIRGINIA

**EQUIPMENT QUALIFICATION DIAGRAM**  
PLUMBING SERVICE BLDG SH-2

**SURRY POWER STATION**  
**VIRGINIA ELECTRIC AND POWER COMPANY**

STONE & WEBSTER ENGINEERING CORPORATION  
BOSTON, MASS.

DRAWING NUMBER 12846-1SQ-FB-27B-1

ISSUE	DESCRIPTION	CHKD	CORRECT	DATE	ISSUE	DESCRIPTION	CHKD	CORRECT	DATE	ISSUE	DESCRIPTION	CHKD	CORRECT	DATE
1	ORIGINAL ISSUE PER JO. NO 12846.44				2					3				

THE INFORMATION ON THIS DRAWING MAY NOT BE COPIED OR USED FOR OTHER THAN THE CONSTRUCTION MAINTENANCE OR REPAIR OF THE PLANT FACILITY DESCRIBED IN THE TITLE BLOCK.

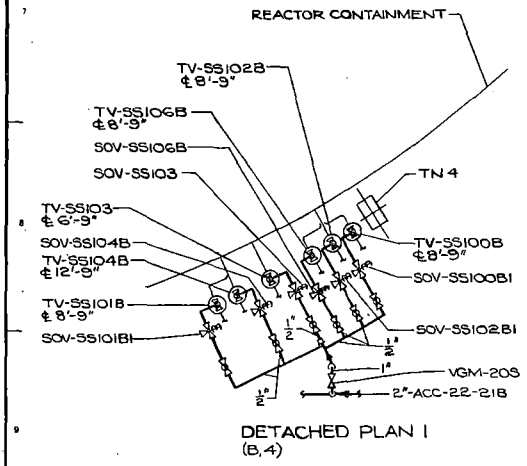
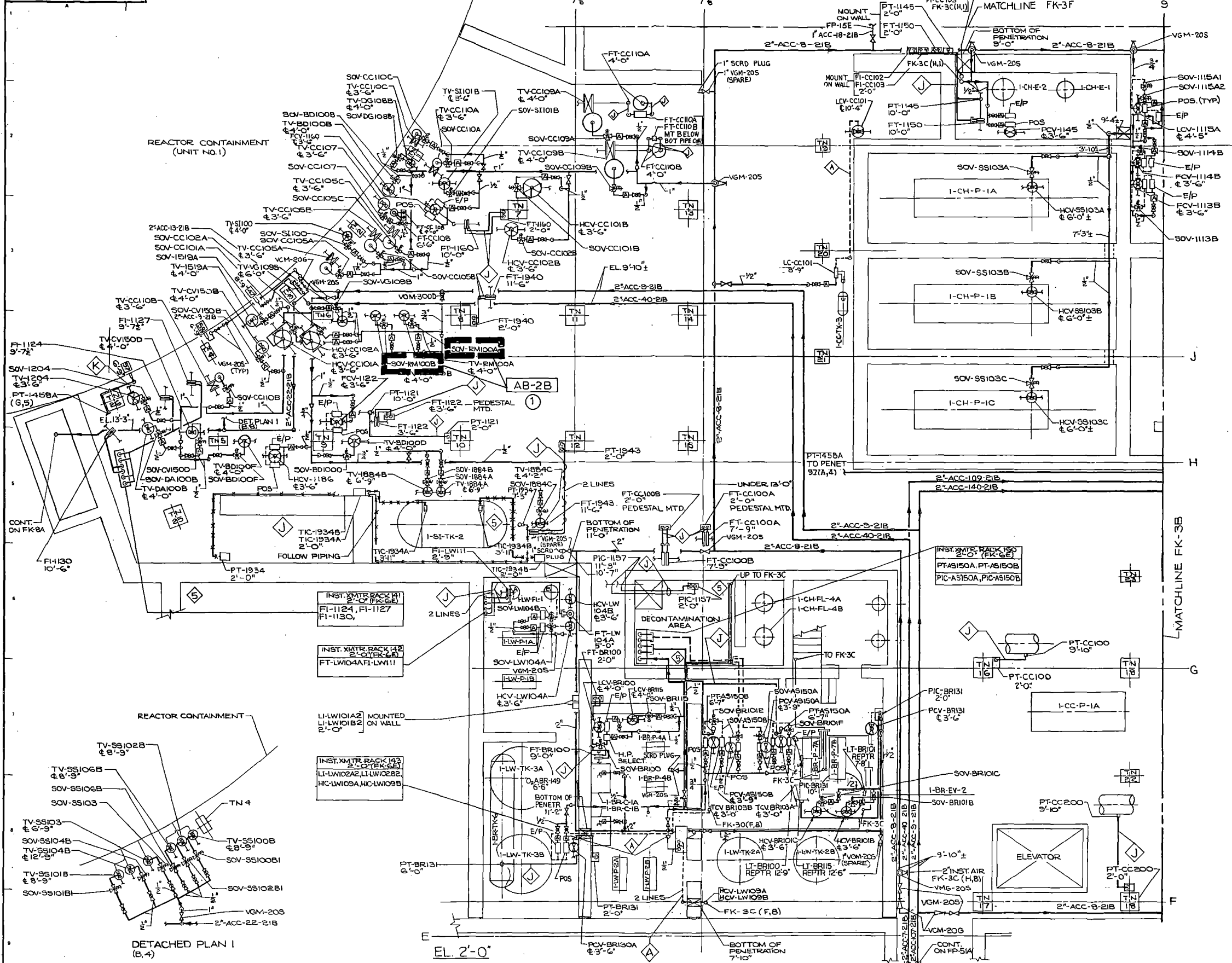

NOTES:  
 1. NOTES & EQUIPMENT FUNCTION TABLE 1SQ-FM-14A  
 2. ZONE LOCATIONS  
 1SQ-FY-1D

APPROVED: *[Signature]*  
 CERTIFIED PROFESSIONAL ENGINEER, NO. [Number]  
 COMMONWEALTH OF VIRGINIA

EQUIPMENT QUALIFICATION DIAGRAM  
 INSTRUMENT PPG AUX BLDG SH-1

**SURRY POWER STATION**  
**VIRGINIA ELECTRIC AND POWER COMPANY**

STONE & WEBSTER ENGINEERING CORPORATION  
 BOSTON, MASS.

DRAWING NUMBER 12846-1SQ-FK-3A-1

ISSUE	DESCRIPTION	CHNG	CORRECT	DATE	ISSUE	DESCRIPTION	CHNG	CORRECT	DATE	ISSUE	DESCRIPTION	CHNG	CORRECT	DATE
5					4					3				
										2				
										1	ORIGINAL ISSUE PER J.O. NO 12846.44			

THE INFORMATION ON THIS DRAWING MAY NOT BE COPIED  
 OR USED FOR OTHER THAN THE CONSTRUCTION,  
 MAINTENANCE OR REPAIR OF THE PLANT FACILITY  
 DESCRIBED IN THE TITLE BLOCK.







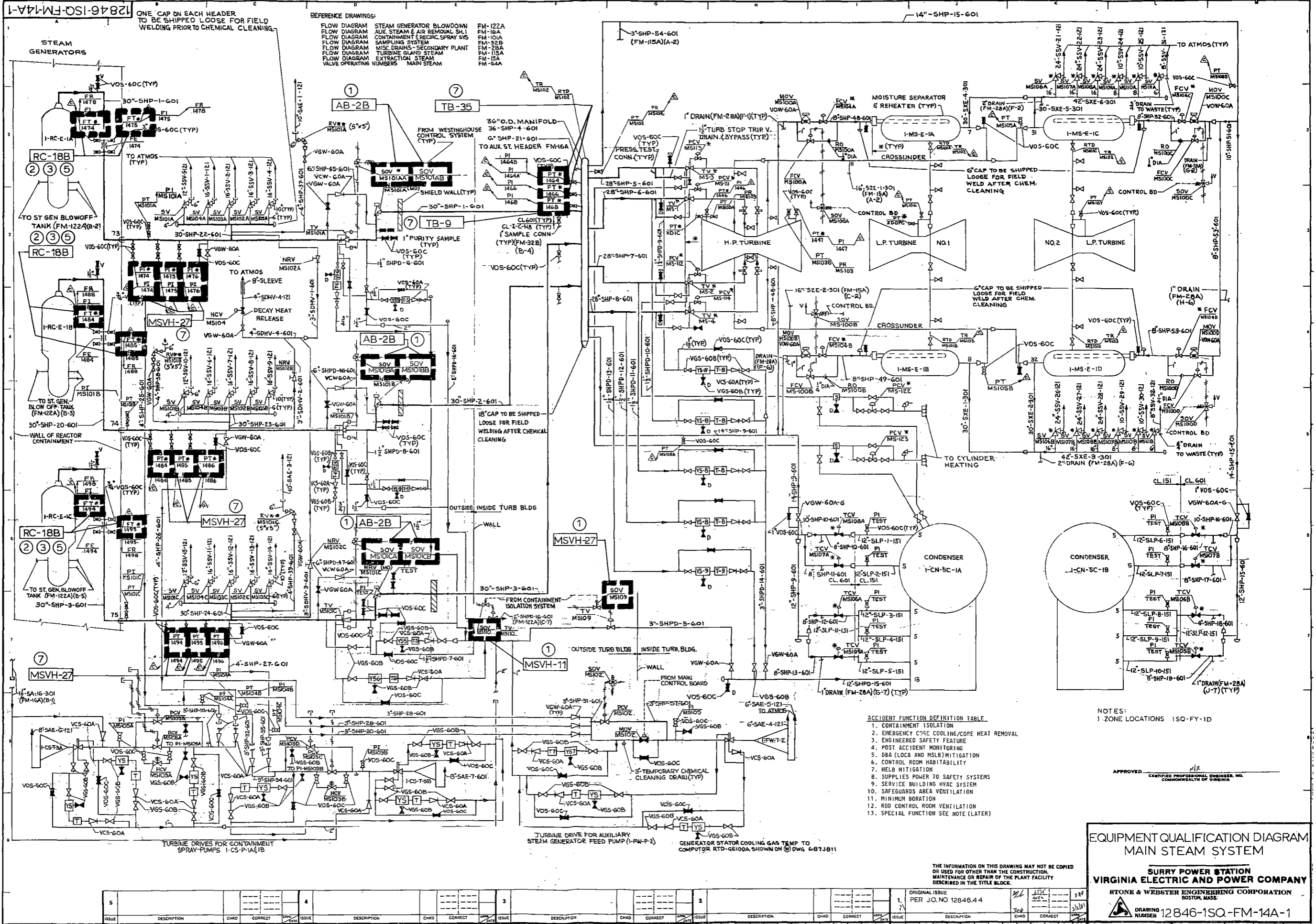

REFERENCE DRAWINGS:  
 FLOW DIAGRAM STEAM GENERATOR BLOWDOWN FM-122A  
 FLOW DIAGRAM AUX. STEAM & AIR REMOVAL SH-1 FM-16A  
 FLOW DIAGRAM CONTAINMENT RECIRC. SPRAY SYS FM-101A  
 FLOW DIAGRAM SAMPLING SYSTEM FM-32B  
 FLOW DIAGRAM MISC. DRAINS - SECONDARY PLANT FM-28A  
 FLOW DIAGRAM TURBINE GUAND STEAM FM-115A  
 FLOW DIAGRAM EXTRACTION STEAM FM-15A  
 VALVE OPERATING NUMBERS MAIN STEAM FM-64A

- ACCIDENT FUNCTION DEFINITION TABLE
1. CONTAINMENT ISOLATION
  2. EMERGENCY CORE COOLING/COPE HEAT REMOVAL
  3. ENGINEERED SAFETY FEATURE
  4. POST ACCIDENT MONITORING
  5. DBA (LOCA AND MSLB) MITIGATION
  6. CONTROL ROOM HABITABILITY
  7. HELP MITIGATION
  8. SUPPLIES POWER TO SAFETY SYSTEMS
  9. SERVICE BUILDING HVAC SYSTEM
  10. SAFEGUARDS AREA VENTILATION
  11. MINIMUM BORATION
  12. ROD CONTROL ROOM VENTILATION
  13. SPECIAL FUNCTION SEE NOTE (LATER)

NOTES:  
 1. ZONE LOCATIONS ISO-FY-ID

APPROVED: [Signature]  
 CERTIFIED PROFESSIONAL ENGINEER, NO. [Number]  
 COMMONWEALTH OF VIRGINIA

EQUIPMENT QUALIFICATION DIAGRAM  
 MAIN STEAM SYSTEM

SURRY POWER STATION  
 VIRGINIA ELECTRIC AND POWER COMPANY

STONE & WEBSTER ENGINEERING CORPORATION  
 BOSTON, MASS.

DRAWING NUMBER 12846-1SQ-FM-14A-1

ISSUE	DESCRIPTION	CHNG	CORRECT	DATE	ISSUE	DESCRIPTION	CHNG	CORRECT	DATE	ISSUE	DESCRIPTION	CHNG	CORRECT	DATE
1	ORIGINAL ISSUE				2	PER J.O. NO 12846.4.4								

THE INFORMATION ON THIS DRAWING MAY NOT BE COPIED OR USED FOR OTHER THAN THE CONSTRUCTION, MAINTENANCE OR REPAIR OF THE PLANT FACILITY DESCRIBED IN THE TITLE BLOCK.





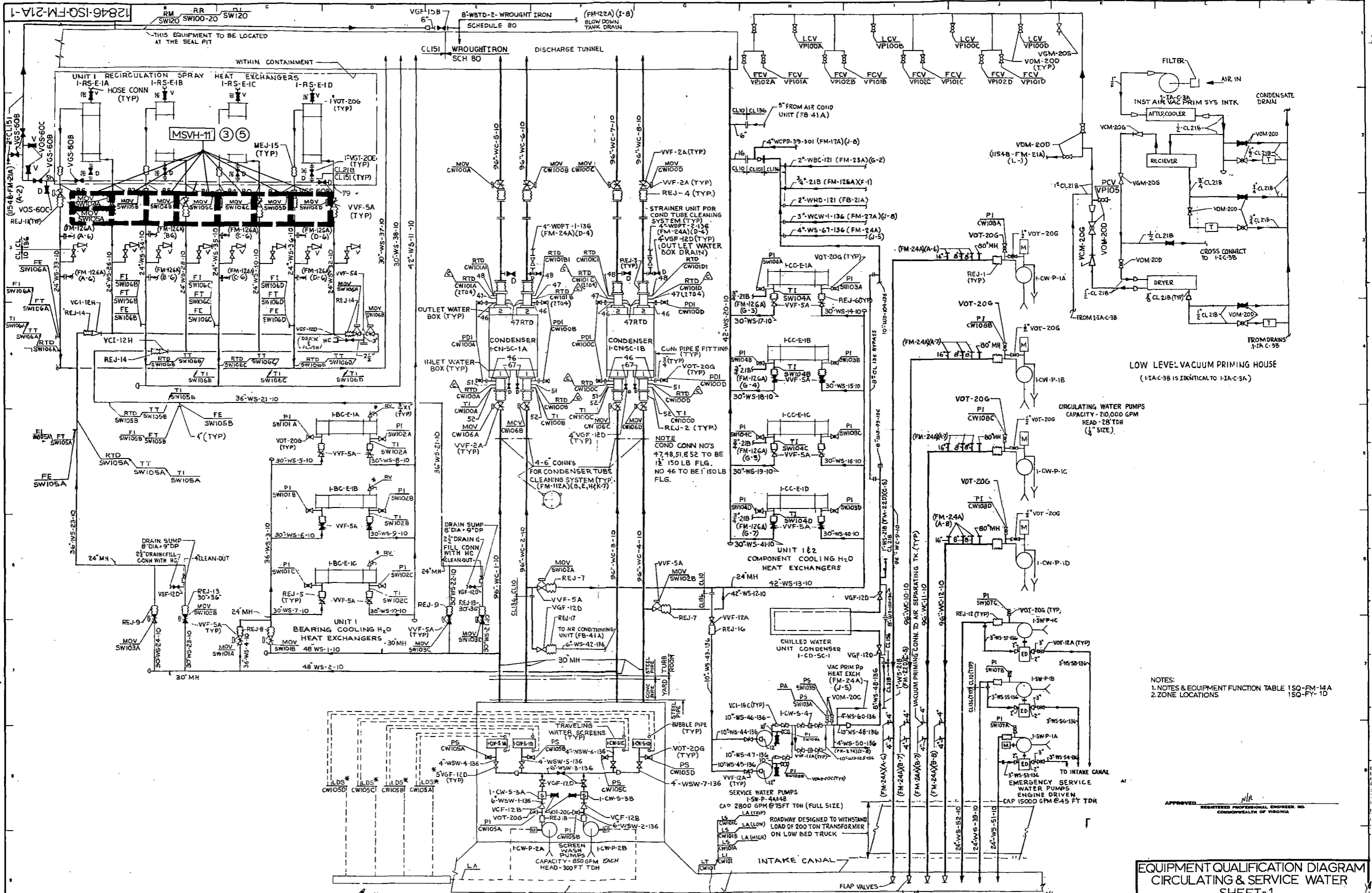

**EQUIPMENT QUALIFICATION DIAGRAM  
CIRCULATING & SERVICE WATER  
SHEET-1**

**ORIGINAL ISSUE**  
PER JO. NO 12846.4.4

**VIRGINIA ELECTRIC AND POWER COMPANY**  
STONE & WEBSTER ENGINEERING CORPORATION  
BOSTON, MASS.

**DRAWING NUMBER 12846-1 SQ-FM-21A-1**

THE INFORMATION ON THIS DRAWING MAY NOT BE COPIED OR USED FOR OTHER THAN THE CONSTRUCTION, MAINTENANCE OR REPAIR OF THE PLANT FACILITY DESCRIBED IN THE TITLE BLOCK.

- NOTES:  
1. NOTES & EQUIPMENT FUNCTION TABLE 1 SQ-FM-14A  
2. ZONE LOCATIONS 1SQ-FM-1D

5	4	3	2	1
ISSUE	DESCRIPTION	CHGD	CORRECT	DATE

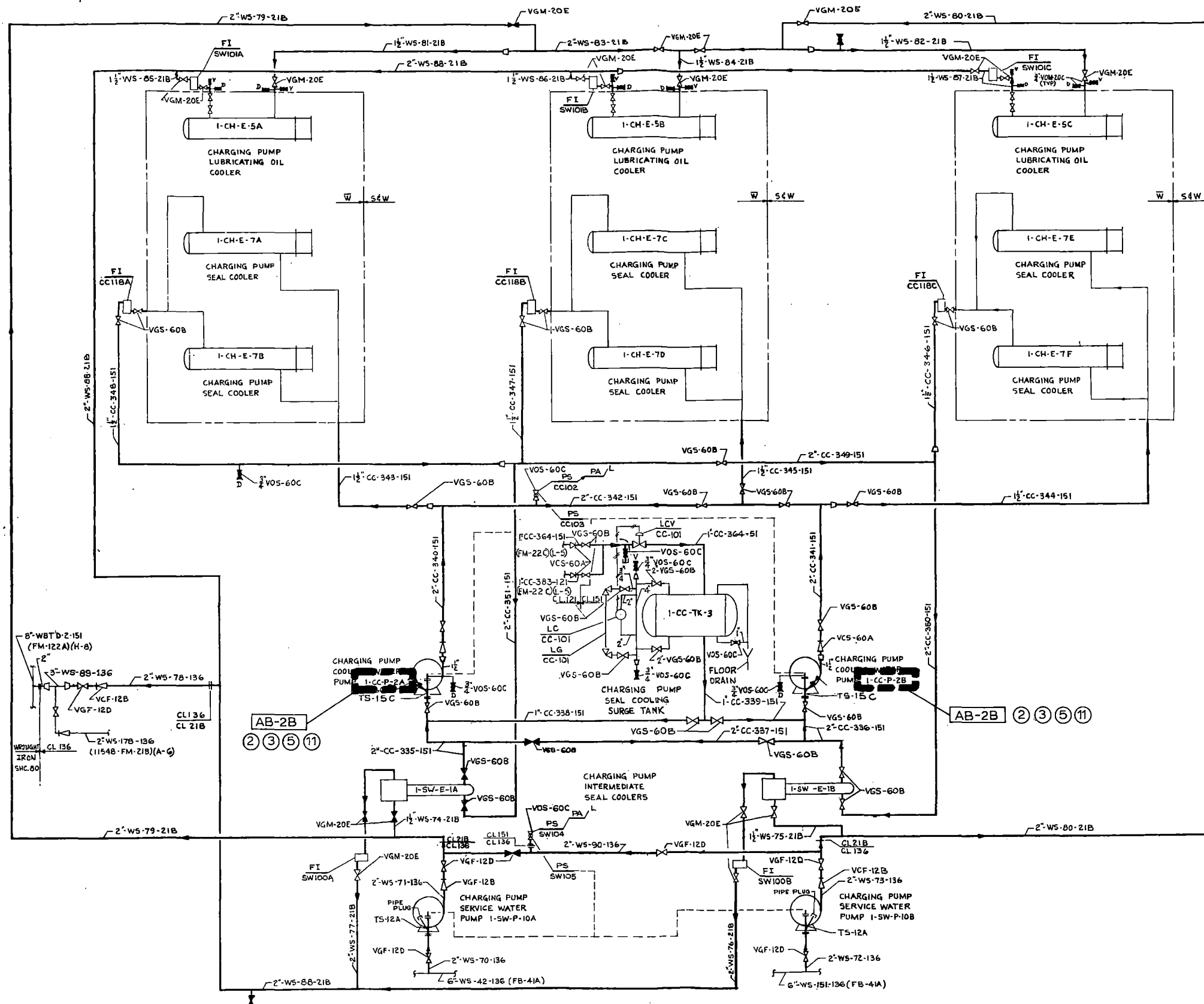

NOTES:  
 1. NOTES & EQUIPMENT FUNCTION TABLE 1SQ-FM-14A  
 2. ZONE LOCATIONS

APPROVED \_\_\_\_\_  
 CERTIFIED PROFESSIONAL ENGINEER, NO. \_\_\_\_\_  
 COMMONWEALTH OF VIRGINIA

**EQUIPMENT QUALIFICATION DIAGRAM  
 CIRCULATING & SERVICE WATER  
 SHEET-2**

**SURRY POWER STATION  
 VIRGINIA ELECTRIC AND POWER COMPANY**

STONE & WEBSTER ENGINEERING CORPORATION  
 BOSTON, MASS.

DRAWING NUMBER 12846-1SQ-FM-21B-1

ISSUE	DESCRIPTION	CHKD	CORRECT	DATE	ISSUE	DESCRIPTION	CHKD	CORRECT	DATE	ISSUE	DESCRIPTION	CHKD	CORRECT	DATE	ISSUE	DESCRIPTION	CHKD	CORRECT	DATE	
5					4					3					2					

THE INFORMATION ON THIS DRAWING MAY NOT BE COPIED OR USED FOR OTHER THAN THE CONSTRUCTION, MAINTENANCE OR REPAIR OF THE PLANT FACILITY DESCRIBED IN THE TITLE BLOCK.

ORIGINAL ISSUE  
 PER J.O. NO 12846.44

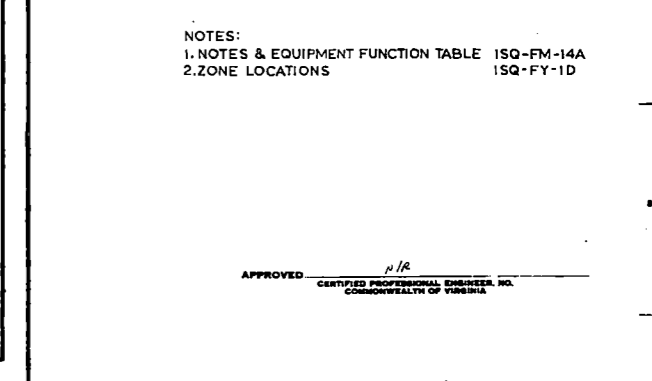
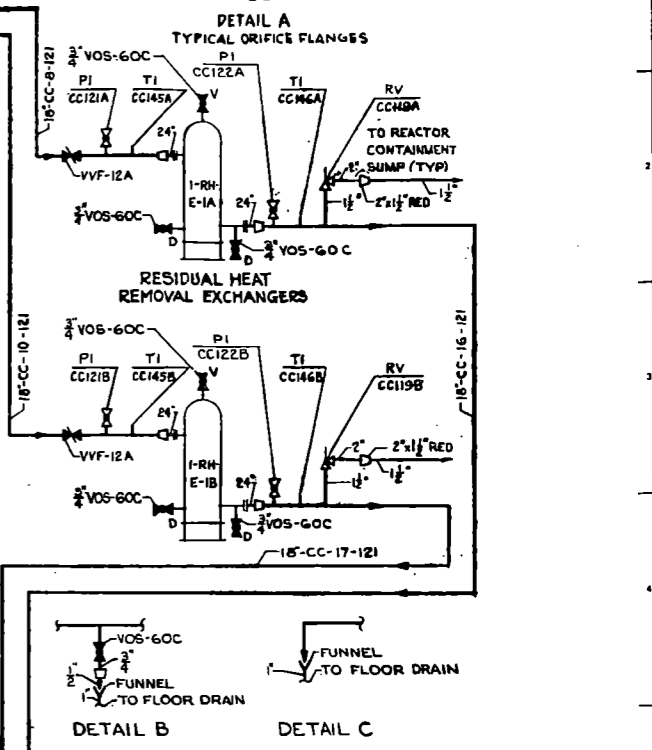
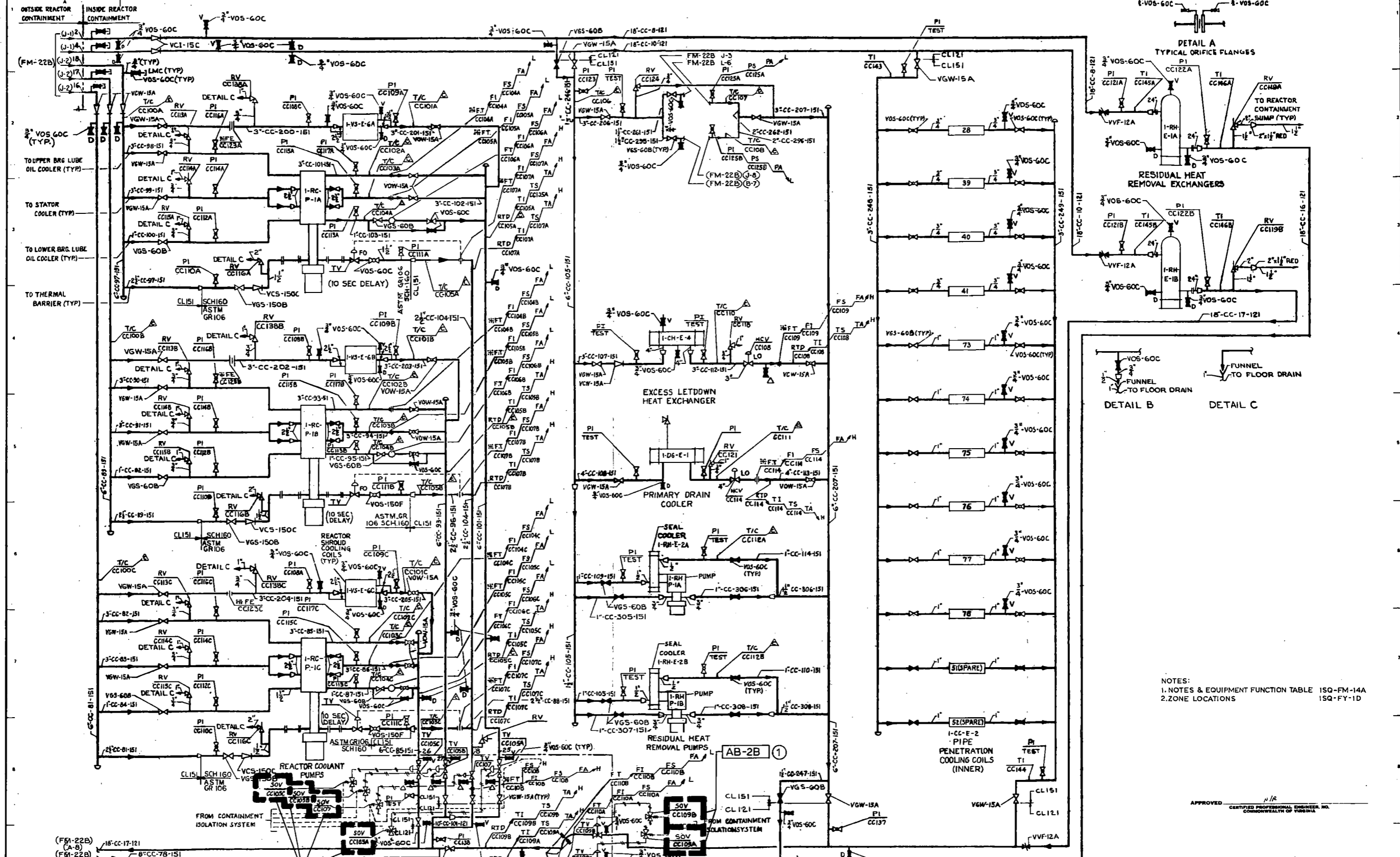

NOTES:  
 1. NOTES & EQUIPMENT FUNCTION TABLE ISQ-FM-14A  
 2. ZONE LOCATIONS ISQ-FY-1D

APPROVED  
 CERTIFIED PROFESSIONAL ENGINEER, INC.  
 COMMONWEALTH OF VIRGINIA

**EQUIPMENT QUALIFICATION DIAGRAM**  
**COMPONENT COOLING WTR SYS SH-1**  
**SURRY POWER STATION**  
**VIRGINIA ELECTRIC AND POWER COMPANY**  
 STONE & WEBSTER ENGINEERING CORPORATION  
 BOSTON, MASS.  
 DRAWING NUMBER **12846-ISQ-FM-22A-1**

THE INFORMATION ON THIS DRAWING MAY NOT BE COPIED OR USED FOR OTHER THAN THE CONSTRUCTION, MAINTENANCE OR REPAIR OF THE PLANT FACILITY DESCRIBED IN THE TITLE BLOCK.

ISSUE	DESCRIPTION	CHNG	CORRECT	DATE	ISSUE	DESCRIPTION	CHNG	CORRECT	DATE	ISSUE	DESCRIPTION	CHNG	CORRECT	DATE	ISSUE	DESCRIPTION	CHNG	CORRECT	DATE
1	ISSUE				2	ISSUE				3	ISSUE				4	ISSUE			



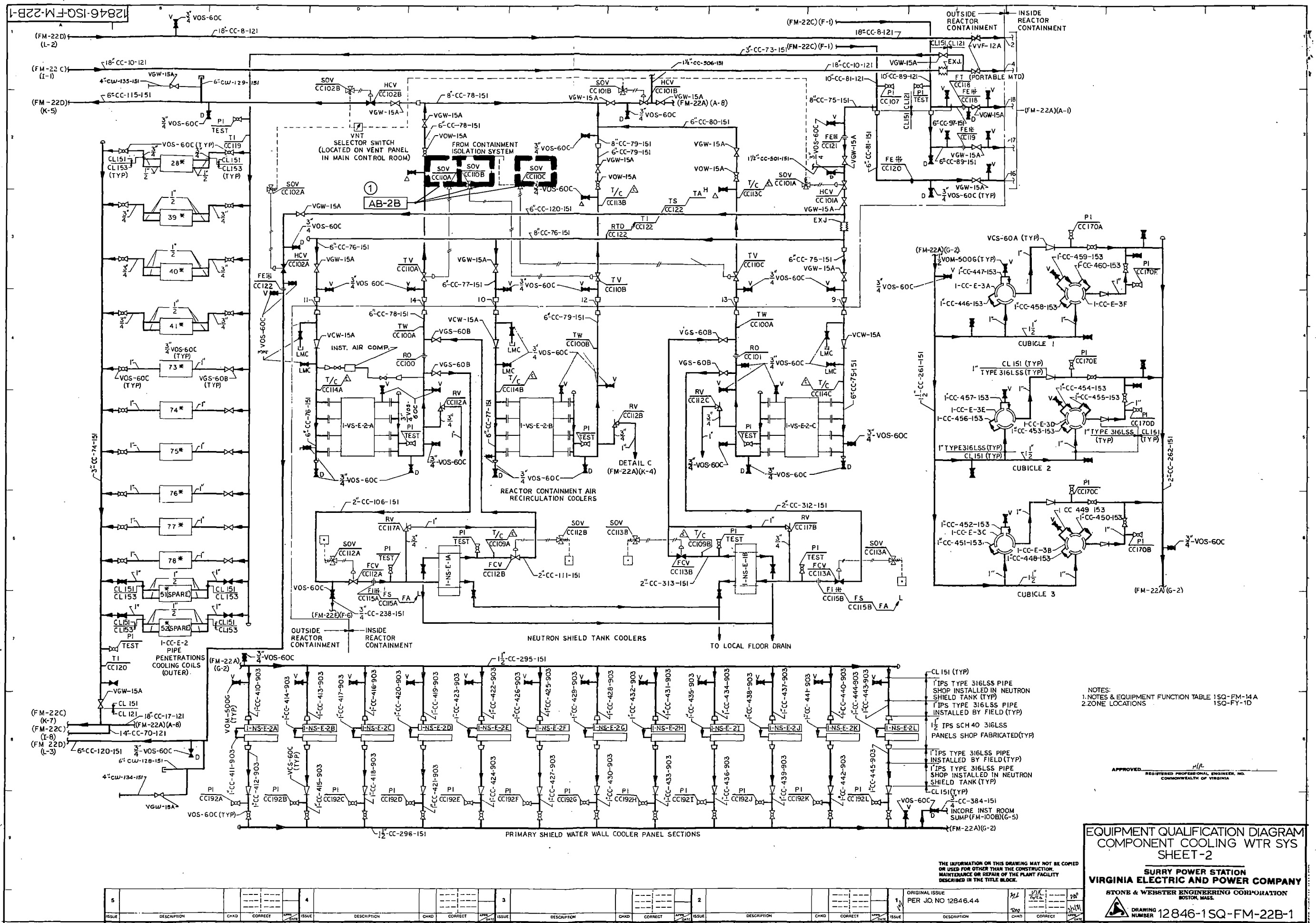

NOTES:  
 1. NOTES & EQUIPMENT FUNCTION TABLE 1SQ-FM-14A  
 2. ZONE LOCATIONS

APPROVED: *[Signature]*  
 REGISTERED PROFESSIONAL ENGINEER, INC.  
 COMMONWEALTH OF VIRGINIA

**EQUIPMENT QUALIFICATION DIAGRAM**  
**COMPONENT COOLING WTR SYS**  
**SHEET-2**

SURRY POWER STATION  
**VIRGINIA ELECTRIC AND POWER COMPANY**  
 STONE & WEBSTER ENGINEERING CORPORATION  
 BOSTON, MASS.

DRAWING NUMBER 12846-1SQ-FM-22B-1

THE INFORMATION ON THIS DRAWING MAY NOT BE COPIED OR USED FOR OTHER THAN THE CONSTRUCTION, MAINTENANCE OR REPAIR OF THE PLANT FACILITY DESCRIBED IN THE TITLE BLOCK.

ISSUE	DESCRIPTION	CHNG	CORRECT	DATE	ISSUE	DESCRIPTION	CHNG	CORRECT	DATE	ISSUE	DESCRIPTION	CHNG	CORRECT	DATE	ISSUE	DESCRIPTION	CHNG	CORRECT	DATE	
5					4					3					2					

ORIGINAL ISSUE  
 PER JO. NO 12846.44

12846-ISQ-FM-23B-1

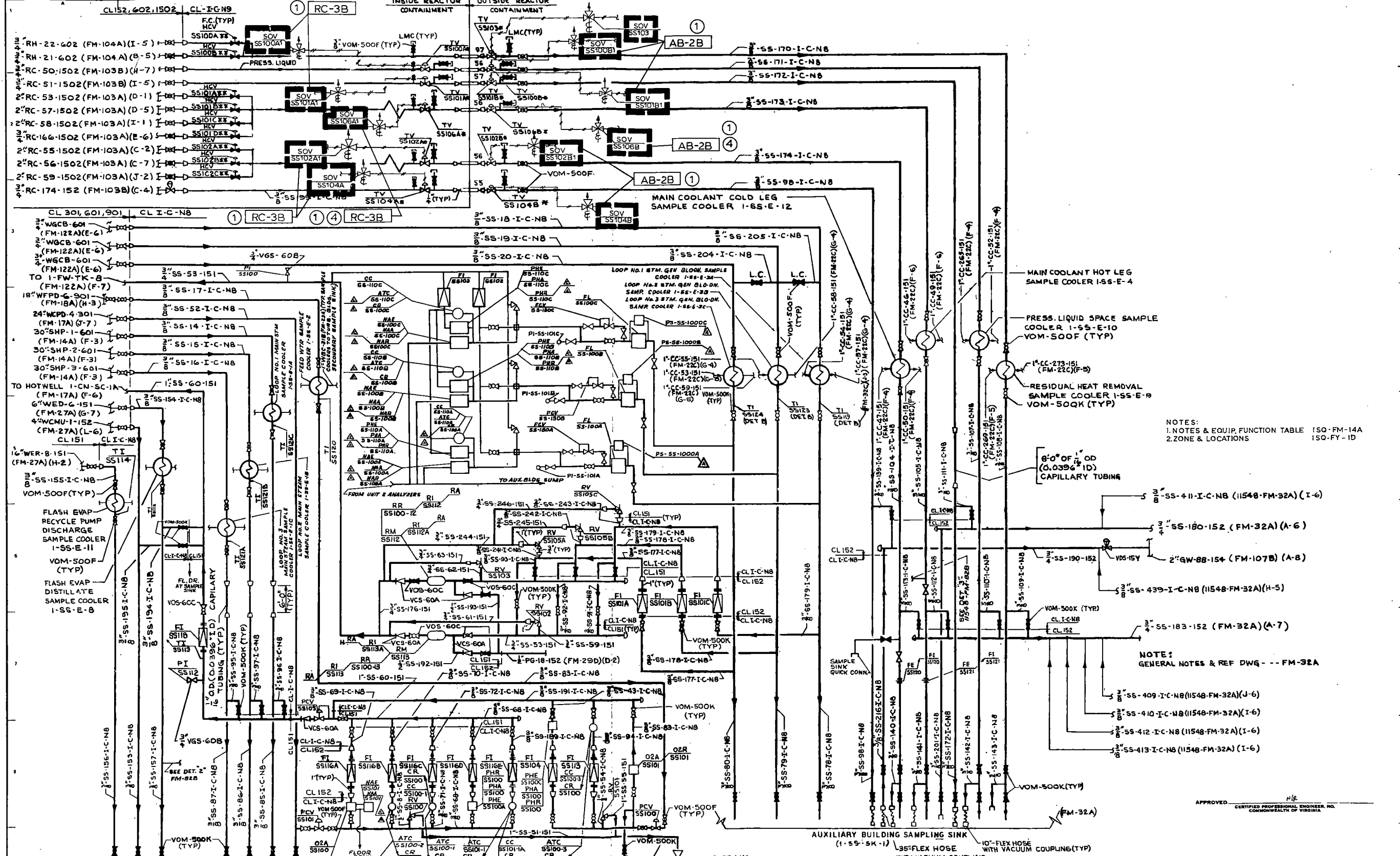

NOTES:  
 1. NOTES & EQUIP FUNCTION TABLE 150-FM-14A  
 2. ZONE & LOCATIONS 150-FY-1D

NOTE:  
 GENERAL NOTES & REF DWG -- FM-32A

APPROVED  
 CERTIFIED PROFESSIONAL ENGINEER, NO. \_\_\_\_\_  
 COMMONWEALTH OF VIRGINIA

**EQUIPMENT QUALIFICATION DIAGRAM**  
**SAMPLING SYSTEM SH-2**

SURRY POWER STATION  
 VIRGINIA ELECTRIC AND POWER COMPANY

STONE & WEBSTER ENGINEERING CORPORATION  
 BOSTON, MASS.

DRAWING NUMBER 12846-ISQ-FM-32B-1

THE INFORMATION ON THIS DRAWING MAY NOT BE COPIED OR USED FOR OTHER THAN THE CONSTRUCTION, MAINTENANCE OR REPAIR OF THE PLANT FACILITY DESCRIBED IN THE TITLE BLOCK.

ISSUE	DESCRIPTION	CHKD	CORRECT	DATE	ISSUE	DESCRIPTION	CHKD	CORRECT	DATE	ISSUE	DESCRIPTION	CHKD	CORRECT	DATE
1	ORIGINAL ISSUE				2	PER I.O. NO 12846.4				3				

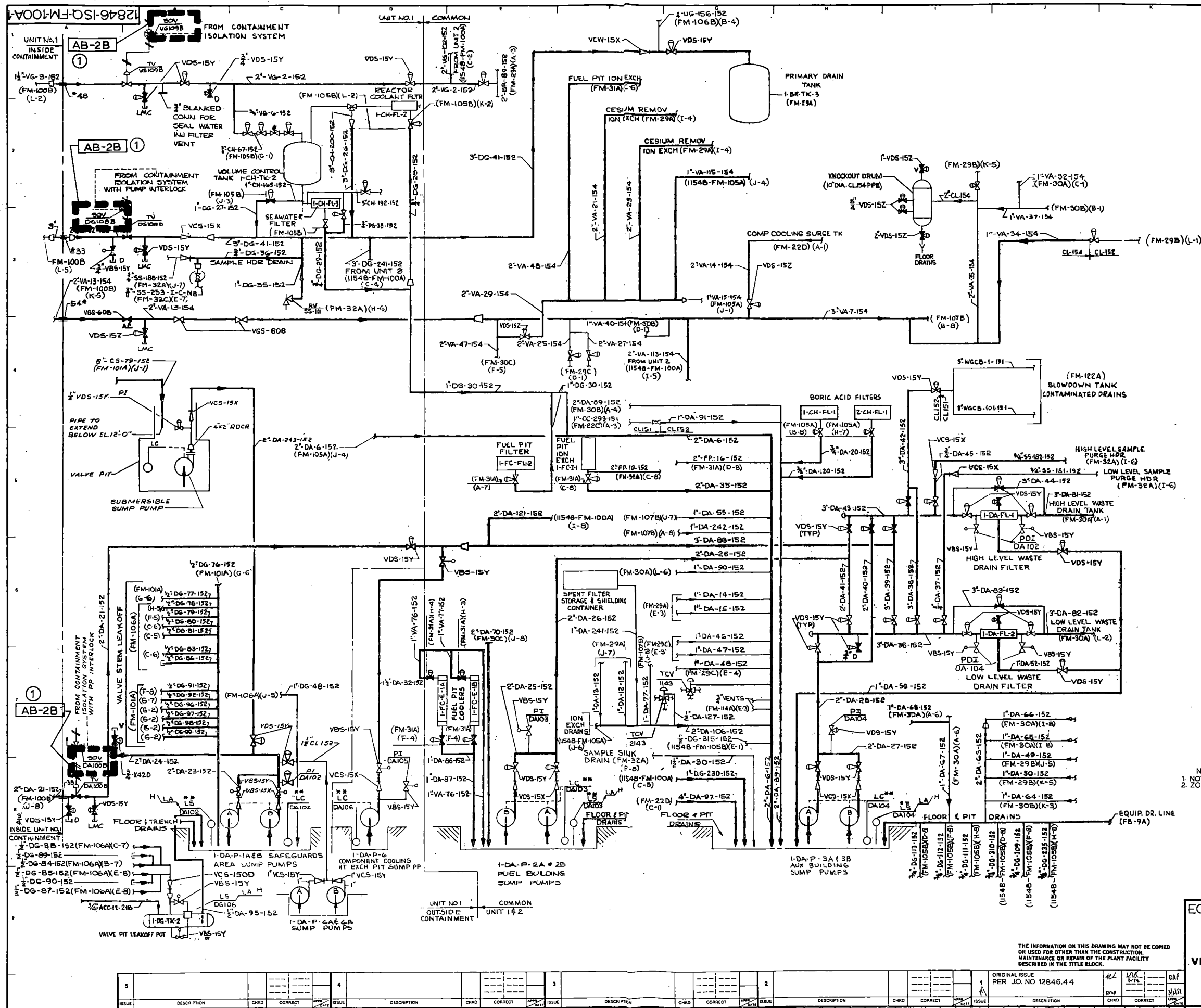

NOTES:  
 1. NOTES & EQUIPMENT FUNCTION TABLE 15Q-FM-14A  
 2. ZONE LOCATIONS

APPROVED: *[Signature]*  
 CERTIFIED PROFESSIONAL ENGINEER, NO. \_\_\_\_\_  
 COMMONWEALTH OF VIRGINIA

**EQUIPMENT QUALIFICATION DIAGRAM**  
**VENT & DRAIN SYSTEM**  
**SHEET-1**  
**SURRY POWER STATION**  
**VIRGINIA ELECTRIC AND POWER COMPANY**  
 STONE & WEBSTER ENGINEERING CORPORATION  
 BOSTON, MASS.  
 DRAWING NUMBER 12846-1SQ-FM-100A-1

THE INFORMATION ON THIS DRAWING MAY NOT BE COPIED OR USED FOR OTHER THAN THE CONSTRUCTION, MAINTENANCE OR REPAIR OF THE PLANT FACILITY DESCRIBED IN THE TITLE BLOCK.

ISSUE	DESCRIPTION	CHKD	CORRECT	DATE	ISSUE	DESCRIPTION	CHKD	CORRECT	DATE	ISSUE	DESCRIPTION	CHKD	CORRECT	DATE
1	ORIGINAL ISSUE				2					3				

ORIGINAL ISSUE  
 PER JO. NO 12846.44

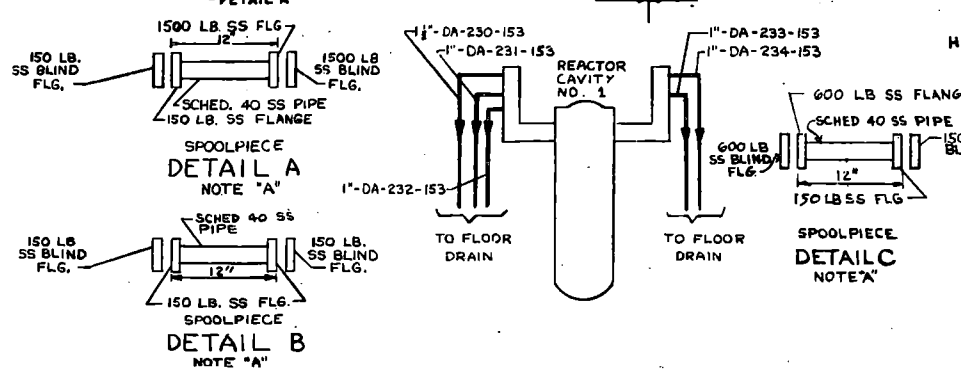
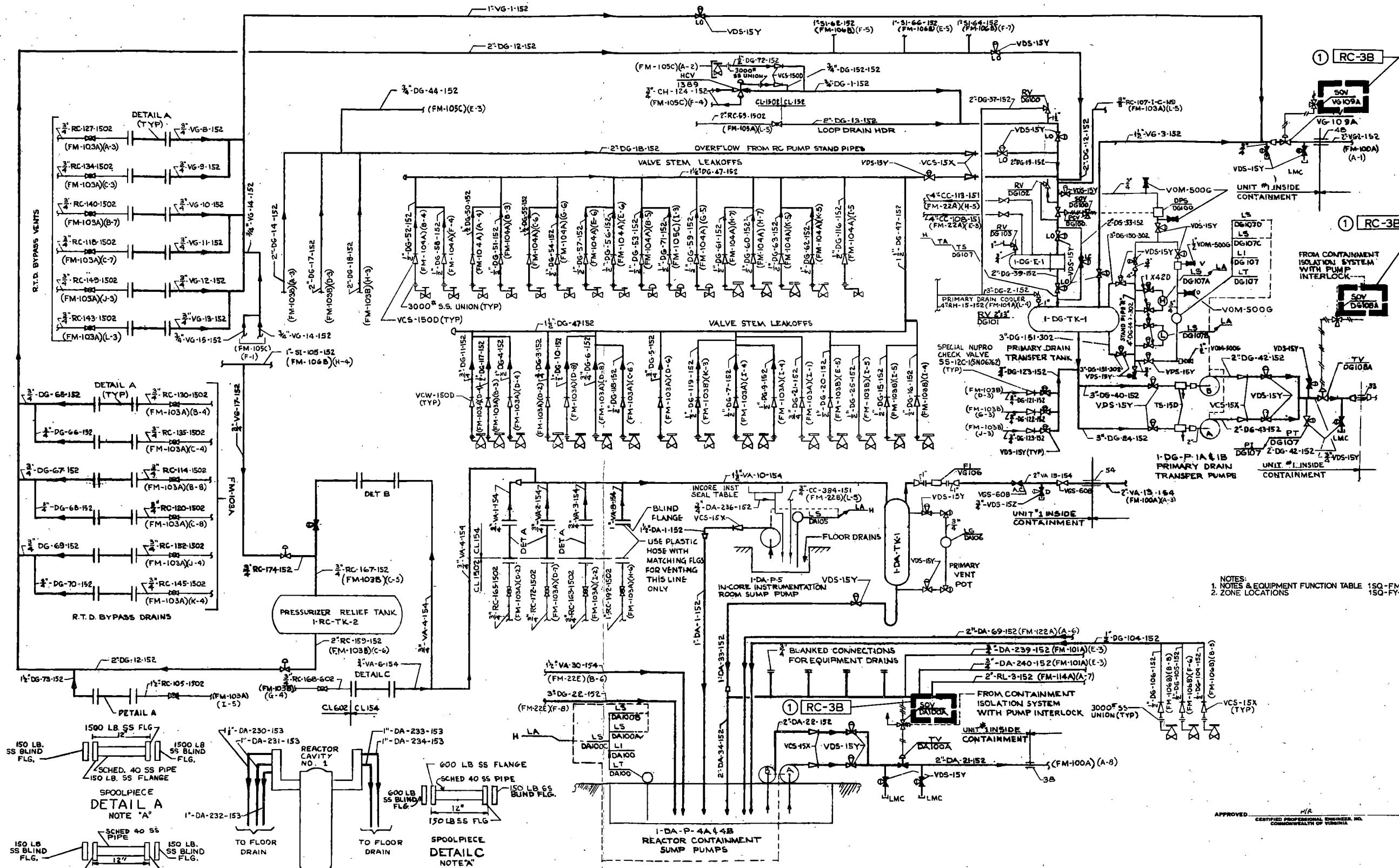

NOTES:  
 1. NOTES & EQUIPMENT FUNCTION TABLE 1SQ-FM-14A  
 2. ZONE LOCATIONS 1SQ-FY-1D

APPROVED: [Signature] CERTIFIED PROFESSIONAL ENGINEER, INC. COMMONWEALTH OF VIRGINIA

**EQUIPMENT QUALIFICATION DIAGRAM**  
**VENT & DRAIN SYSTEM SH-2**  
**SURRY POWER STATION**  
**VIRGINIA ELECTRIC AND POWER COMPANY**  
 STONE & WEBSTER ENGINEERING CORPORATION  
 BOSTON, MASS.  
**DRAWING NUMBER 12846-ISQ-FM-100B-1**

ISSUE	DESCRIPTION	CHD	CORRECT	DATE	ISSUE	DESCRIPTION	CHD	CORRECT	DATE	ISSUE	DESCRIPTION	CHD	CORRECT	DATE	ISSUE	DESCRIPTION	CHD	CORRECT	DATE
1	ORIGINAL ISSUE PER J.O. NO 12846.44				2					3					4				

THE INFORMATION ON THIS DRAWING MAY NOT BE COPIED OR USED FOR OTHER THAN THE CONSTRUCTION, MAINTENANCE OR REPAIR OF THE PLANT FACILITY DESCRIBED IN THE TITLE BLOCK.

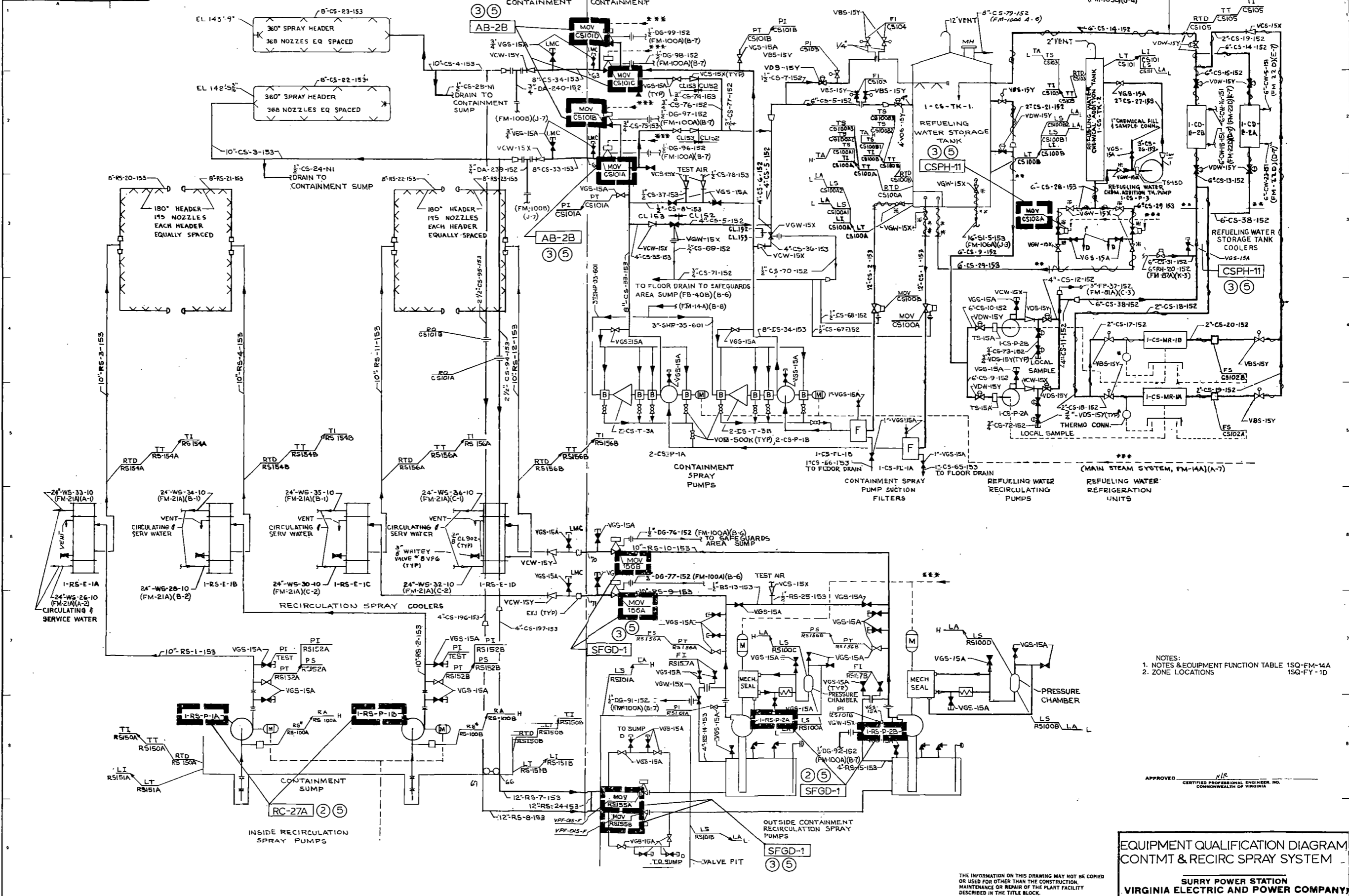

NOTES:  
 1. NOTES & EQUIPMENT FUNCTION TABLE 1SQ-FM-14A  
 2. ZONE LOCATIONS 1SQ-FY-1D

APPROVED: [Signature]  
 CERTIFIED PROFESSIONAL ENGINEER, NO. [Number]  
 COMMONWEALTH OF VIRGINIA

**EQUIPMENT QUALIFICATION DIAGRAM**  
**CONTMT & RECIRC SPRAY SYSTEM**

**SURRY POWER STATION**  
**VIRGINIA ELECTRIC AND POWER COMPANY**

STONE & WEBSTER ENGINEERING CORPORATION  
 BOSTON, MASS.

DRAWING NUMBER 12846-1SQ-FM-101A-1

ISSUE	DESCRIPTION	CHNG	CORRECT	DATE	ISSUE	DESCRIPTION	CHNG	CORRECT	DATE	ISSUE	DESCRIPTION	CHNG	CORRECT	DATE	ISSUE	DESCRIPTION	CHNG	CORRECT	DATE	
1	ORIGINAL ISSUE				2					3					4					

THE INFORMATION ON THIS DRAWING MAY NOT BE COPIED OR USED FOR OTHER THAN THE CONSTRUCTION, MAINTENANCE OR REPAIR OF THE PLANT FACILITY DESCRIBED IN THE TITLE BLOCK.



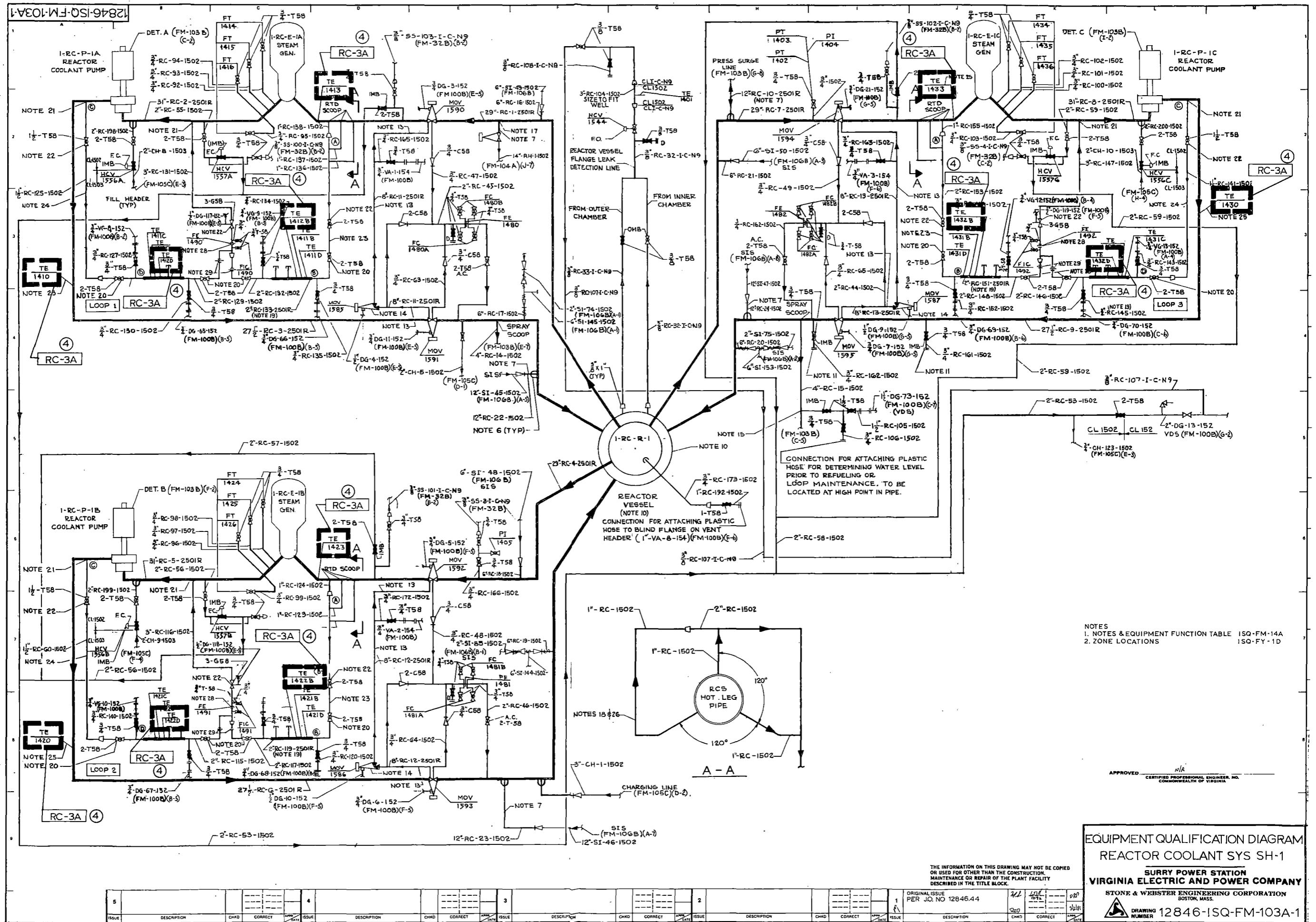

CONNECTION FOR ATTACHING PLASTIC HOSE FOR DETERMINING WATER LEVEL PRIOR TO REFUELING OR LOOP MAINTENANCE. TO BE LOCATED AT HIGH POINT IN PIPE.

REACTOR VESSEL (NOTE 10)  
CONNECTION FOR ATTACHING PLASTIC HOSE TO BLIND FLANGE ON VENT HEADER (1-VA-8-154) (FM-100B)(E-8)

- NOTES  
1. NOTES & EQUIPMENT FUNCTION TABLE ISQ-FM-14A  
2. ZONE LOCATIONS ISQ-FY-1D

APPROVED: [Signature]  
CERTIFIED PROFESSIONAL ENGINEER, NO. [Number]  
COMMONWEALTH OF VIRGINIA

**EQUIPMENT QUALIFICATION DIAGRAM**  
**REACTOR COOLANT SYS SH-1**  
**SURRY POWER STATION**  
**VIRGINIA ELECTRIC AND POWER COMPANY**  
STONE & WEBSTER ENGINEERING CORPORATION  
BOSTON, MASS.  
DRAWING NUMBER **12846-ISQ-FM-103A-1**

THE INFORMATION ON THIS DRAWING MAY NOT BE COPIED OR USED FOR OTHER THAN THE CONSTRUCTION, MAINTENANCE OR REPAIR OF THE PLANT FACILITY DESCRIBED IN THE TITLE BLOCK.

ISSUE	DESCRIPTION	CHNG	CORRECT	DATE	ISSUE	DESCRIPTION	CHNG	CORRECT	DATE	ISSUE	DESCRIPTION	CHNG	CORRECT	DATE
5					4					3				
										2				
										1				

ORIGINAL ISSUE PER JO. NO 12846.44  
DATE: 10/12/64  
BY: [Signature]

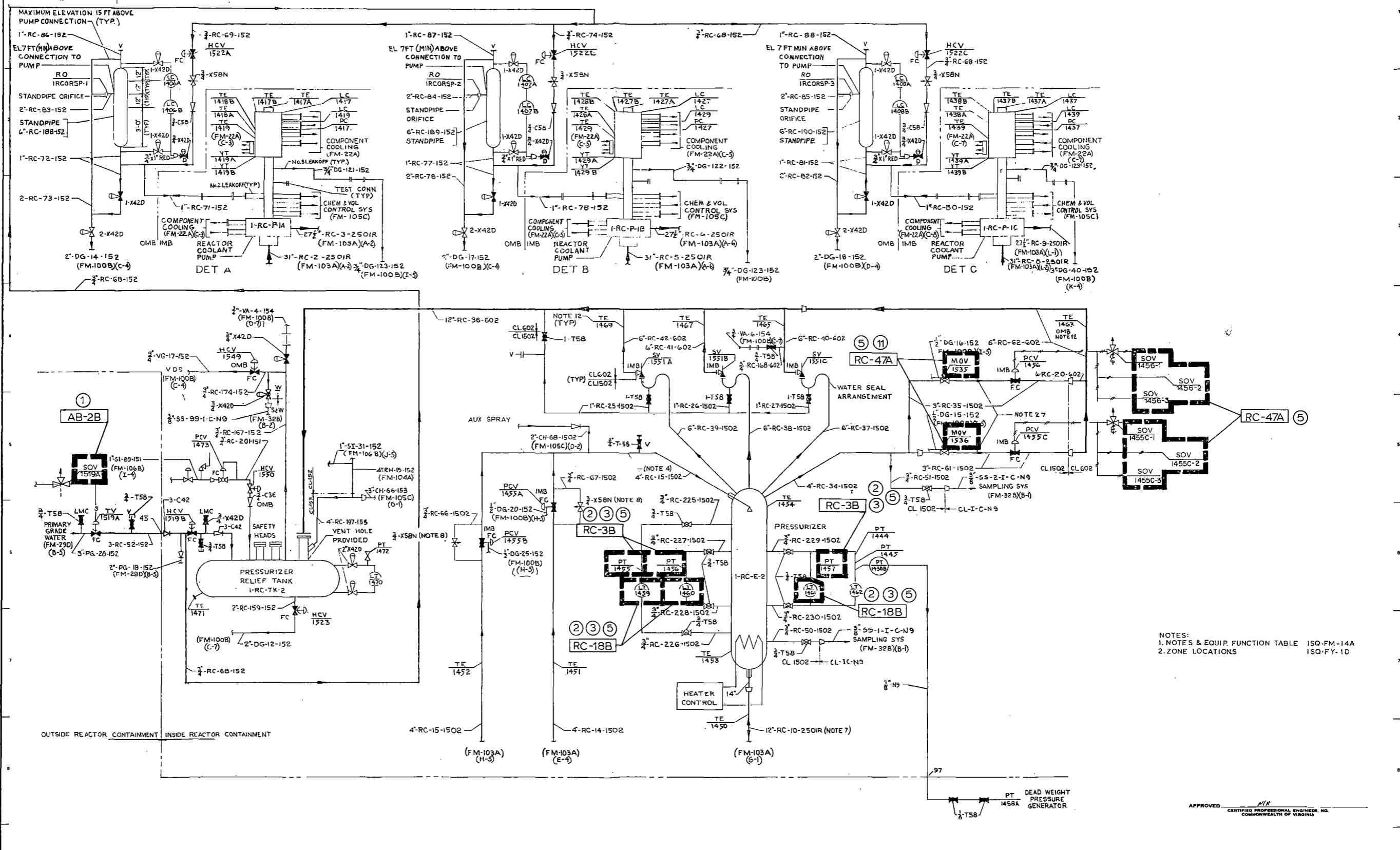

NOTES:  
 1. NOTES & EQUIP. FUNCTION TABLE ISQ-FM-14A  
 2. ZONE LOCATIONS ISQ-FY-1D

APPROVED: *M/R*  
 CERTIFIED PROFESSIONAL ENGINEER, INC.  
 COMMONWEALTH OF VIRGINIA

EQUIPMENT QUALIFICATION DIAGRAM  
 REACTOR COOLANT SYS SH-2

SURRY POWER STATION  
 VIRGINIA ELECTRIC AND POWER COMPANY

STONE & WEBSTER ENGINEERING CORPORATION  
 BOSTON, MASS.

DRAWING NUMBER 12846-1SQ-FM-103B-1

THE INFORMATION ON THIS DRAWING MAY NOT BE COPIED OR USED FOR OTHER THAN THE CONSTRUCTION, MAINTENANCE OR REPAIR OF THE PLANT FACILITY DESCRIBED IN THE TITLE BLOCK.

ISSUE	DESCRIPTION	CHKD	CORRECT	DATE	ISSUE	DESCRIPTION	CHKD	CORRECT	DATE	ISSUE	DESCRIPTION	CHKD	CORRECT	DATE	ISSUE	DESCRIPTION	CHKD	CORRECT	DATE	
1	ORIGINAL ISSUE				2					3					4					















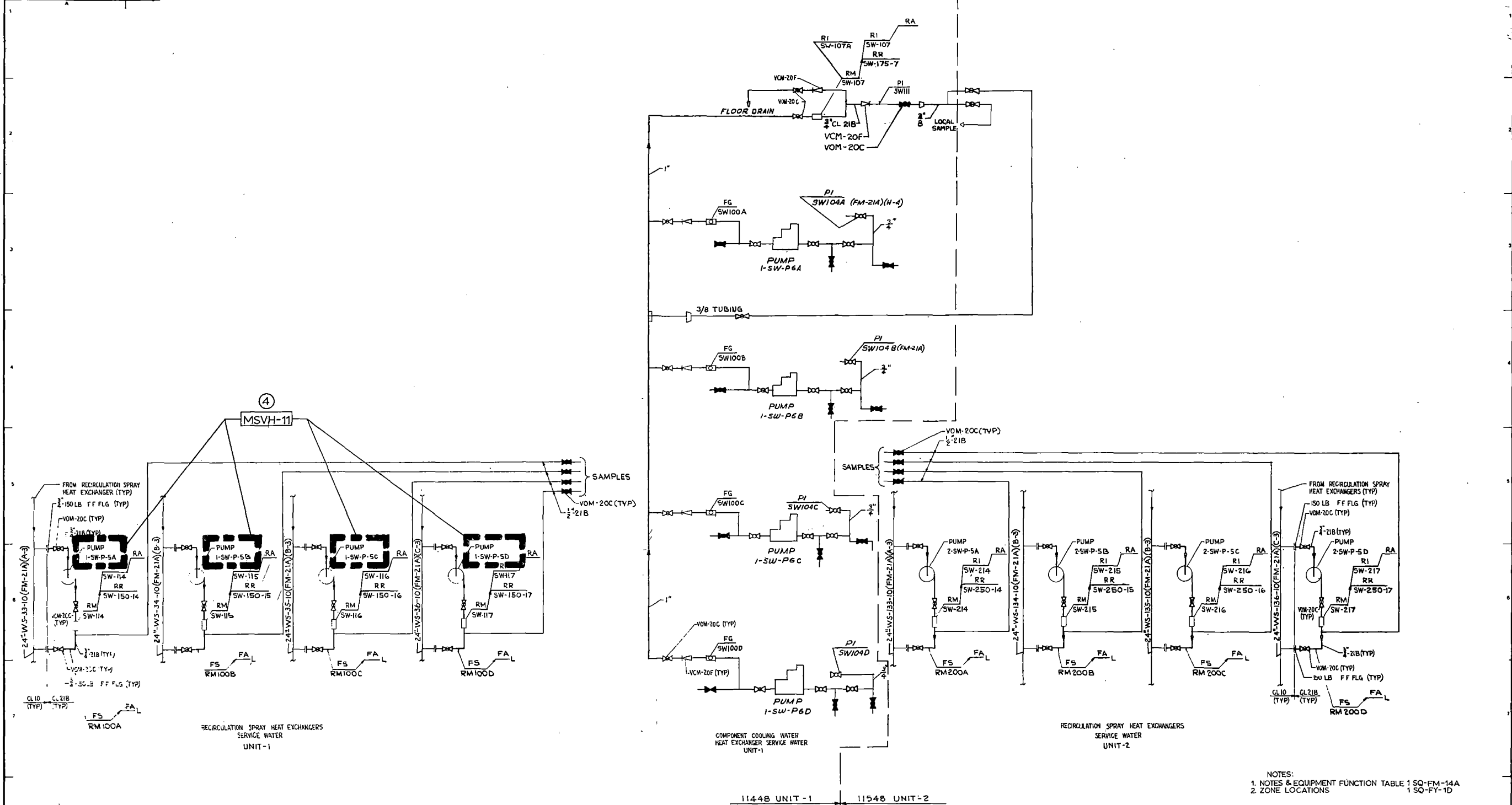

NOTES:  
 1. NOTES & EQUIPMENT FUNCTION TABLE 1 SQ-FM-14A  
 2. ZONE LOCATIONS 1 SQ-FY-1D

APPROVED \_\_\_\_\_  
 CERTIFIED PROFESSIONAL ENGINEER, NO. \_\_\_\_\_  
 COMMONWEALTH OF VIRGINIA

**EQUIPMENT QUALIFICATION DIAGRAM  
 RAD MONITORING SYSTEMS  
 CIRC. & SERVICE WTR.**

**SURRY POWER STATION  
 VIRGINIA ELECTRIC AND POWER COMPANY**

STONE & WEBSTER ENGINEERING CORPORATION  
 BOSTON, MASS.

DRAWING NUMBER 12846-1SQ-FM-126A-1

THE INFORMATION ON THIS DRAWING MAY NOT BE COPIED  
 OR USED FOR OTHER THAN THE CONSTRUCTION,  
 MAINTENANCE OR REPAIR OF THE PLANT FACILITY  
 DESCRIBED IN THE TITLE BLOCK.

ISSUE	DESCRIPTION	CHKD	CORRECT	DATE	ISSUE	DESCRIPTION	CHKD	CORRECT	DATE	ISSUE	DESCRIPTION	CHKD	CORRECT	DATE	ISSUE	DESCRIPTION	CHKD	CORRECT	DATE	
5					4					3					2					

ORIGINAL ISSUE  
 PER JO. NO 12846.44

**VEPCO  
SURRY POWER STATION  
UNITS 1 & 2**

**ENVIRONMENTAL  
ZONE DESCRIPTION**

**VOLUME 2**

**VIRGINIA ELECTRIC AND POWER COMPANY**



## INDEX TO REFERENCES

<u>Tab</u>	<u>Description</u>
1.	Distribution Memorandum Technical Specifications Surry Power Station Units 1 & 2, Conditions of the License, August 14, 1978. Service Water Temperature Limit (From D.W. Speidell, Jr. of VEPCO dated August 21, 1978).
2.	Stone & Webster Calculation No. 12846.44-US(B)-052-1.
3.	Stone & Webster Calculation No. 12846.54-RP-038-1.
4.	Stone & Webster Calculation No. 12846.44-PE-050-0.
5.	IE Bulletin 79-01B, Surry Power Station Unit 1, Section 2.3.
6.	Stone & Webster Calculation No. 12846.01-PE-036-0.
7.	Stone & Webster Calculation No. 12846.38-RP-024-1.
8.	Stone & Webster Calculation No. 12846.44-PE-049-0.
9.	Stone & Webster Calculation No. 12846.54-RP-037-0.
10.	Stone & Webster Calculation No. 12846.44-UR(B)-043-0.
11.	Stone & Webster Calculation No. 12846.38-RP-031-0.
12.	Stone & Webster Calculation No. 12846.44-PE-044-0.
13.	Stone & Webster Calculation No. 12846.54-RP-039-0.
14.	FSAR Section 9.13.2 (Pg. 9.13.2-1); Surry Power Station Units 1 and 2, December 1, 1969.
15.	FSAR Section 5.3 (pg. 5.3-1); Surry Power Station Units 1 and 2, December 1, 1969.

INDEX TO REFERENCES (Cont)

<u>Tab</u>	<u>Description</u>	<u>Input to Reference No.</u>
	Stone & Webster Calculation No.	
A.	12846.07-5.7	2
B.	12846.01-PE-030-0	6
C.	12846.19-PE-038-0	2
D.	12846.44-PE-041-0	4
E.	12846.44-PE-042-1	4
F.	12846.44-PE-045-0	2
G.	12846.44-PE-046-0	4
H.	12846.38-RP-026-0	10
I.	12846.54-RP-035-0	10
J.	12050-RP-095-0	11

USER'S GUIDE TO E2D REFERENCES

Facility: VEPSCO, SURRY  
 Units: 1 and 2  
 Dockets: 50-280 and 50-281

E2D REFERENCE NO. 1

E2D REFERENCE DESCRIPTION: Distribution Memorandum (from D.W. Speidell, Jr. of V&PCO dated August 21, 1978). Technical Specifications, Surry Power Station Units 1 & 2, Conditions of the License, August 14, 1978. Service Water Temperature Limit.

ENVIRONMENTAL ZONE(S): RC-3A, RC-3B, RC-18B, RC-27A, RC-27B, RC-47A, RC-47B

<u>PARAMETER</u>	<u>NORMAL ENVIRONMENT</u>	<u>PAGE</u>	<u>LOCA ENVIRONMENT</u>	<u>PAGE</u>	<u>MSLB ENVIRONMENT</u>	<u>PAGE</u>	<u>HELE ENVIRONMENT</u>	<u>PAGE</u>
TEMPERATURE (°F)	125 (maximum)	1						
PRESSURE (psia)	9.0-11.1	3						
RELATIVE HUMIDITY (%)								
CHEMICAL SPRAY								



Since the order constitutes limiting conditions for operation, please place your copy of this memo in the front of your Technical Specifications and delete the previous distribution memo for the June 29, 1978 Order. Once you have inserted your copy, please sign and date the acknowledgement sheet and forward it to my office.

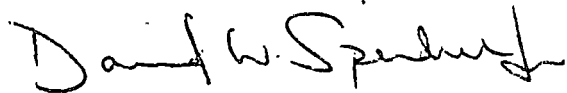

David W. Speidell, Jr.

Attachment

DWSjr:jal

8-14-78

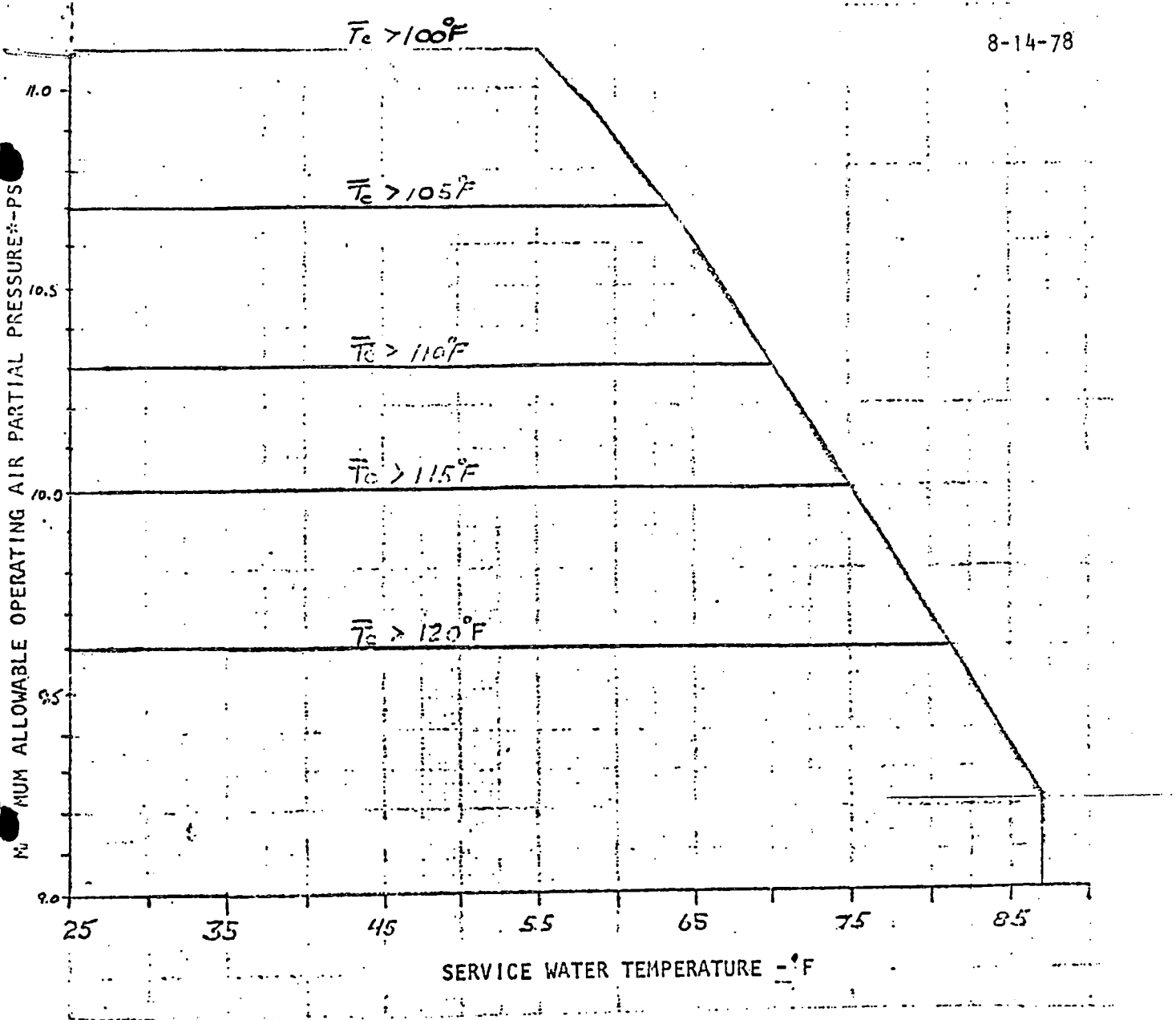

NOTES

Maximum allowable operating air partial pressure in the containment as a function of service water temperature and refueling water storage tank temperature.

\*Set point value in containment vacuum system instrumentation

$\bar{T}_c$  = Average containment temperature

Refueling Water Storage Tank Temperature  $\leq 45^\circ\text{F}$

FIG 3.F.2

MAXIMUM ALLOWABLE OPERATING  
AIR PARTIAL PRESSURE  
SURRY POWER STATION

Unit 1 Amend No. 43

Unit 2 Amend No. 42

FIGURE 3.F.1  
ALLOWABLE OPERATING PARAMETERS  
FOR HIGH SERVICE WATER TEMPERATURES  
SURRY POWER STATION UNITS 1 & 2

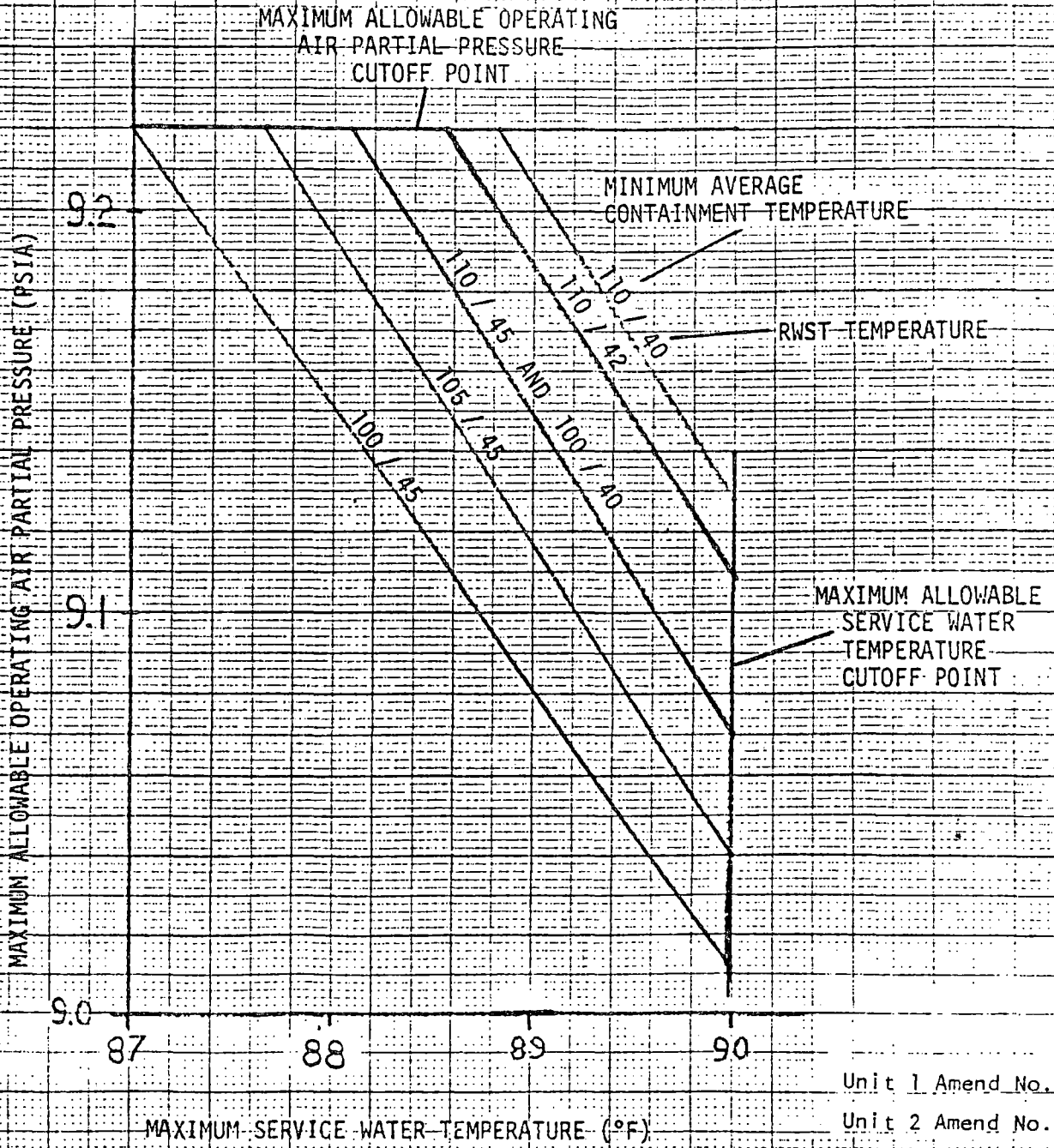

46 1320

K&E 10 X 10 TO 14 INCH 7 X 10 INCHES  
KEUFFEL & ESSER CO. MADE IN U.S.A.

Unit 1 Amend No. 43  
Unit 2 Amend No. 42

USER'S GUIDE TO E2D REFERENCES

Facility: VEPCO, SURRY  
 Units: 1 and 2  
 Dockets: 50-280 and 50-281

E2D REFERENCE NO. 2  
 E2D REFERENCE DESCRIPTION: 12846.44-US (B) -052-1  
 ENVIRONMENTAL ZONE(S): RC-3A, RC-3B, RC-18B, RC-27A, RC-27B, RC-47A, RC-47B

<u>PARAMETER</u>	<u>NORMAL ENVIRONMENT</u>	<u>PAGE</u>	<u>LOCA ENVIRONMENT</u>	<u>PAGE</u>	<u>MSLB ENVIRONMENT</u>	<u>PAGE</u>	<u>HELB ENVIRONMENT</u>	<u>PAGE</u>
TEMPERATURE (°F)			280 F, 0-30 min 280-150 F, 30-60 min 150-120 F, 1-48 hr 120 F, 2-120 days	7	280 F, 0-30 min 280-150 F 30-60 min 160-120 F, 1-48 hr 120 F, 2-120 days	7		
PRESSURE (psia)			59.7, 0-30 min 59.7-14.7 30-60 min 147.7-12.7, 1-48 hr 12.7, 2-120 days	6	59.7, 0-30 min 59.7-14.7 30-60 min 14.7-12.7, 1-48 hr 12.7, 2-120 days	6		
RELATIVE HUMIDITY (%)			100, 0-120 days	8	100, 0-120 days	8		
CHEMICAL SPRAY			Solution of 2000-2200 ppm H <sub>3</sub> BO <sub>3</sub> buffered with NaOH to pH of 8.5-11, 0-4 hr. Same solution with pH of between 8.0 and 9.5, 4 hr-120 days	9	Solution of 2000-2200 ppm H <sub>3</sub> BO <sub>3</sub> buffered with NaOH to pH of 8.5-11, 0-4 hr. Same solution with pH of between 8.0 and 9.5 4 hr-120 days	9		



**CALCULATION TITLE PAGE**

\*SEE INSTRUCTIONS ON REVERSE SIDE

▲ 5010.64 (FRONT)

CLIENT & PROJECT <i>VEPCO / Sunny 142</i>				PAGE 1 OF <i>21</i>		
CALCULATION TITLE (Indicative of the Objective): <i>Containment Post - accident environmental conditions for equipment qualification.</i>				QA CATEGORY (✓) <input checked="" type="checkbox"/> I - NUCLEAR SAFETY RELATED <input type="checkbox"/> II <input type="checkbox"/> III <input type="checkbox"/> OTHER		
CALCULATION IDENTIFICATION NUMBER						
J. O. OR W. O. NO.	DIVISION & GROUP	CURRENT CALC. NO.	OPTIONAL TASK CODE	OPTIONAL WORK PACKAGE NO.		
<i>12826.44</i>	<i>US</i>	<i>052</i>	<i>—</i>	<i>ETA 0004</i>		
* APPROVALS - SIGNATURE & DATE				REV. NO. OR NEW CALC NO.	SUPERSEDES * CALC. NO. OR REV. NO.	CONFIRMATION * REQUIRED (✓) YES NO
PREPARER(S)/DATE(S)	REVIEWER(S)/DATE(S)	INDEPENDENT REVIEWER(S)/DATE(S)				
<i>Edwin Sum 6-4-81</i>	<i>D. Post 6-10-81</i>	<i>D. Post / I 6-10-81</i>	<i>0</i>	<i>—</i>	<i>✓</i>	<i>LOGIC Rev. 22 L. 01</i>
	<b>NOTED JUN 11 1981 R.F. MILLER RPA</b>					
<i>Edwin Sum 7-7-81</i>	<i>D. Post 7-8-81</i>	<i>D. Post / I 7-8-81</i>	<i>1</i>	<i>0</i>	<i>"</i>	
	<b>NOTED JUL 9 1981 R.F. MILLER RPA</b>					

**DISTRIBUTION \***

GROUP	NAME & LOCATION	COPY SENT (✓)	GROUP	NAME & LOCATION	COPY SENT (✓)
RECORDS MGT. FILES (OR FIRE FILE IF NONE)	<i>M. Cliffe 245/14</i>	<i>2</i>			
	<i>J. Barnhart 245/14</i>	<i>5</i>			

CALCULATION SHEET

12846.44

US(B)

Preliminary

Item 052-1

1 Client VEPCO Location Sunny 1/2 Est. No. J.O. No.

2 Subject Date By

3 Checked By

4 Based on Revised By

T.O.C.

		page
I.	Title	3
II.	Purpose	3
III.	Reference	4
IV.	Assumption	5
V.	Method	6
VI.	Result + Conclusion	10

figures 1-10 11-21

[ figures 1-4, 7-10 of Rev. 0 has been replaced by Rev. 1. There were inconsistencies in envelopes in Rev. 0. New envelopes are used in Rev. 1 which is less conservative. This page 2 is also revised to reflect the changes. All replaced pages are given in Appendix A. ]

Rev. 1

VII Appendix A 9 pages

CALCULATION SHEET

12846.44

US(B)

052

1 Client \_\_\_\_\_ Location \_\_\_\_\_ Est. No. \_\_\_\_\_ J.O. No. \_\_\_\_\_

2 Subject \_\_\_\_\_ Date \_\_\_\_\_ By \_\_\_\_\_

3 \_\_\_\_\_ Checked \_\_\_\_\_ By \_\_\_\_\_

4 Based on \_\_\_\_\_ Revised \_\_\_\_\_ By \_\_\_\_\_

5

6 I. Title

7

8 Containment Post-accident environmental conditions for

9 equipment qualification.

10

11

12

13

14 II. Purpose

15

16 To document Surry 1 & 2 containment <sup>worst</sup> post-accident

17 environmental conditions for equipment qualification <sup>(EQ)</sup>

18 under the directive of IE Bulletin 79-01 B &

19 its supplements (ref. 1). Ref. 1 specifies

20 that operating plants <sup>with automatic spray actuation</sup> are allowed to use LOCA

21 temperature envelopes in lieu of Main Steam Line

22 Break which is more severe. Pressure envelopes are

23 more severe in LOCA than MSLB. This calc therefore

24 addresses only post-LOCA conditions (MSLB has

25 not been analysed for Surry). that are applicable

26 to MSLB conditions.

27

28

29

30

31

32

33

34

35

36

37

38

39

40

41

42

43

44

45

46

47

48

49

50

CALCULATION SHEET

12846.44

US(B)

052

1	Client	Location	Est. No.	J.O. No.
2	Subject		Date	By
3			Checked	By
4	Based on		Revised	By

5	<u>III Reference</u>			
6				
7				
8				
9	1.	NRC I+E Bulletin 79-01 B + Supplements		
10	2.	DC 77-9 Cont. Spray System Modification		
11	3.	DC 78-537 RS + RHSI Modification		
12	4.	NU-100, LOCTIC manual		
13	5.	ESSA calc 12846.19 - PE - 038 - 0		(Tech Spec)
14	6.	Proj. " 12846.07 - 35 - 0		(pH)
15	7.	ESSA " 12846.07 - PE - 035 - 0		(pH input)
16	8.	" " 12846.19 - PE - 045 - 0		(long term P)
17	9.	Proj. " 12846.07 - 57		(pH)
18	10.	NRC SRP 6.5.2		
19	11.	ESSA calc. 12846.07 - PE - 037 - 0		(Sump pH)
20	12.	Proj. calc. 12846.07 - 26 - 0		( " )
21	13.	Sew dwg 11448 - FP - 5E - 11		(RUST)
22	14.	ESSA calc. 12846.07 - PE - 025 - 1		(QS flow)
23	15.	" " 12846.07 - PE - 029 - 1		(Spray cover)
24	16.	Proj. calc. 12846.19 - 9		(K/S)
25	17.	" " 12846.19 - 24		(O/S)
26				
27				
28				
29				
30				
31				
32				
33				
34				
35				
36				
37				
38				
39				
40				
41				
42				
43				
44				
45				
46				
47				
48				
49				
50				

CALCULATION SHEET

12846.44

US(B)

052

1	Client	Location	Est. No.	J.O. No.
2	Subject		Date	By
3			Checked	By
4	Based on		Revised	By

IV Assumptions

1. PSDER is worst case for max pressure and temperature profiles in containment
2. Final NPSH fix (FF) configuration is in effect (for FF description, see ref. 2 & 3)
3. SeW (DOCTIC Rev. 22 Lev. 01, ref. 4) calculated blowdown & reflux release rates with old Westinghouse froth releases (generated for North Anna 1 & 2).

1	Client	Location	Est. No.	J.O. No.
2	Subject		Date	By
3			Checked	By
4	Based on		Revised	By

## V Method

Temperature and pressure profiles for post-LOCA conditions are taken from Tech Spec calc (ref. 5 + 8) LOCTIC runs. pH values are taken from ref. 6 (which in turn utilized input from ref. 7). Relative humidity is simply max value of 100%. LOCTIC (ref. 4) Rev. 22 Lev. 01 is used in the above calc's to generate pressure-temperature profiles and is also used to generate input for pH calc.

### V-a Pressures:

Maximum post-LOCA pressure profile is generated by peak pressure (2<sup>nd</sup> peak) LOCTIC runs in ref. 5. Maximum long-term pressure is generated by subatmospheric peak pressure (3<sup>rd</sup> peak) LOCTIC runs in ref. 5 + 8. Peak pressure is 44.71 psig. As shown on p. 8 of Ref. 5, max 2<sup>nd</sup> peak is from run # 58. Figure 1 is the pressure profile for the transient. For comparison purpose, a 3<sup>rd</sup> peak profile for run # 56 is shown in fig. 2. Long term pressure is calculated in ref. 8<sup>^</sup> & the profile is shown in fig. 3. Comparing fig. 1 + 2, pressure envelope

CALCULATION SHEET  
12846.44

US(B)

Item \_\_\_\_\_

052

1	Client	Location	Est. No.	J.O. No.
2	Subject		Date	By
3			Checked	By
4	Based on		Revised	By

5  
6 (Fig. 1)  
7 right after 2<sup>nd</sup> peak should be taken from 3<sup>rd</sup>  
8 peak run (fig. 2 or 3). Pressure envelope is drawn  
9 in fig. 1-3 & redrawn on fig. 6 by itself. Note that  
10 from 2 days to 120 days, maximum pressure is 0 psig  
11 (14.7 psia) since containment must be subatmospheric  
12 after 1 hr. The value of 12.7 is only an arbitrary estimate  
13 ~~which was used previously~~  
14 Max pressure of 45 psig is chosen since it is design pressure.

21 V-b. Temperature:-  
22  
23 Temperature is directly related to pressure. Thus maximum  
24 pressure runs in section V-a give maximum temperature  
25 as well. Maximum post-LOCA Temp is generated by  
26 2<sup>nd</sup> peak run (#58) from ref. 5 and is 277.1 °F @ 188 sec  
27 The design value of 280 °F is chosen to be max  
28 temp. from 0 to 1/2 hr. Long term max temp  
29 envelope after reaching peak temp is based on  
30 3<sup>rd</sup> peak runs (#56 in ref. 5 and #88 in ref. 8).  
31 The containment average temperature profile for  
32 run # 58, 56, and 88 are plotted in fig. 5, 6, and 7  
33 respectively. For comparison purpose, temp profile of  
34 two other runs are given on fig. 8 & 9.

47 Run # 53 = fig. 8 = 3<sup>rd</sup> peak run with different initial  
48 conditions as run # 53  
49 Run # 67 = fig. 9 = 2<sup>nd</sup> peak run with different initial  
50 conditions as run # 58.

## CALCULATION SHEET

12846.44

US(B)

052

1	Client	Location	Est. No.	J.O. No.
2	Subject		Date	By
3			Checked	By
4	Based on		Revised	By

Fig 5 gives the max peak temp. Fig 6 and 7 are very close and give max long term temp.

The maximum containment temperature envelope is drawn on fig. 5, 6 & 7 and redrawn separately on fig. 10. Note that the values of 150°F (@ 1 hr.) and 120°F (@ 2 days) are arbitrarily chosen to cover the actual temp profile.

V - c Relative Humidity:-

Maximum value of 100% is chosen for EQ since containment can be expected to be saturated most of the time after a LOCA.

V - d Spray (quench spray [QS] and resin spray [RS]) pH values:-

Ref. 9 shows that quench spray pH is between 8.5 to 11.0 as allowed in SRP 6.5.2 (ref. 10). Maximum time before quench spray terminates from continuous operation is 4300 sec (from pH plots in ref. 9)

Ref. 11 shows that sump pH rises from 4.7 to 8 in



CALCULATION SHEET

12846.44

US(B)

052

1	Client	Est. No.	J.O. No.
2	Subject	Date	By
3		Checked	By
4	Based on	Revised	By

less than 1 hr., then stabilizes at pH 8.19. Thus the following pH envelopes are chosen for quench spray and combined (quench & resin) spray:

quench spray { 0 to 4 hr. → pH 8.5 to 11.0

[for 1 train AS (≈ 2000 ppm, ref. 14), time to empty RWSI w/o SE is about 366,000/2000 ≈ 3 hrs. (366,000 see any runs)]

combined spray { 0 to 1 hr. → pH 5.0 to 11.0  
 1 to 4 hrs. → pH 8.0 to 11.0  
 4 hrs. to 120 days → pH 8.0 to 9.5

The combined spray envelope should be used for EQ.

Note that in the first hour, we can assume a little mixing of quench & resin spray such that the lowest spray pH is 5.0 instead of 6.7.

For completeness, RWSI boron conc. is 2000-2200 ppm (ref. 12).

However, if equipment operation is not hindered by low pH, the quench spray pH can be used for EQ.

CALCULATION SHEET

Preliminary

Item

12846.44

US(B)

052

1	Client	Location	Date	By
2	Subject		Checked	By
3			Revised	By
4	Based on			

V-a. Spray density (maximum) estimate:

Quench Spray: max RWST water (it is from overflow to bottom  $\approx 48$  ft. (ref. 13)  $\equiv L$  ( $\approx 36$  psia)  
 min containment pressure  $\approx -4$  psia  $\equiv C$   
 (typical subatmospheric containment value)

$(C - L)_{min} \approx -40$  psia

max. QS flow  $\approx 5300$  gpm (p. 15 of ref. 14)

Area of operating floor level covered  
 $\approx \pi (63 \text{ ft})^2 (0.92)$  (p. 2, ref. 15)  
 $\approx 11470$  ft<sup>2</sup>

(QS density)<sub>max</sub>  $\approx \frac{5300}{11470}$   
 $= 0.46$  gpm/ft<sup>2</sup>

Recirc Spray: IRS flow = 3500 gpm x 2 ref. 16  
 $= 7000$  gpm  
 ORS flow = 3000 gpm x 2 ref. 17  
 $= 6000$  gpm  
 Total C = 13000 gpm

(RS density)<sub>max</sub> =  $13000 / 11470$   
 assuming it sprays to annular area  
 $= 1.13$  gpm/ft<sup>2</sup>

QS + RS: Assume QS + RS sprays same area,

(Total Spray density)<sub>max</sub>  $\approx 1.13 + 0.46$   
 $\approx 1.6$  gpm/ft<sup>2</sup>

12846.44

US(B)

052

1	Client	Location	Est. No.	J.O. No.
2	Subject		Date	By
3			Checked	By
4	Based on		Revised	By

VI Result & Conclusion

Containment post-accident environmental conditions for equipment qualification are derived from post-LOCA conditions. They are:

1. Pressure — fig 4 (p.15)

2. Temperature — fig 10 (p.21)

3. Relative Humidity — 100% (p.7)

4. Spray pH: — time pH (p.9)

0 — 1 hr.	5.0 — 11.0
1 — 4 hrs.	8.0 — 11.0
4 hrs. — 120 days.	8.0 — 9.5

5. (Average spray density)  $\leq$  1.6  $\frac{gpm}{ft^2}$  <sub>max</sub> (p.10)

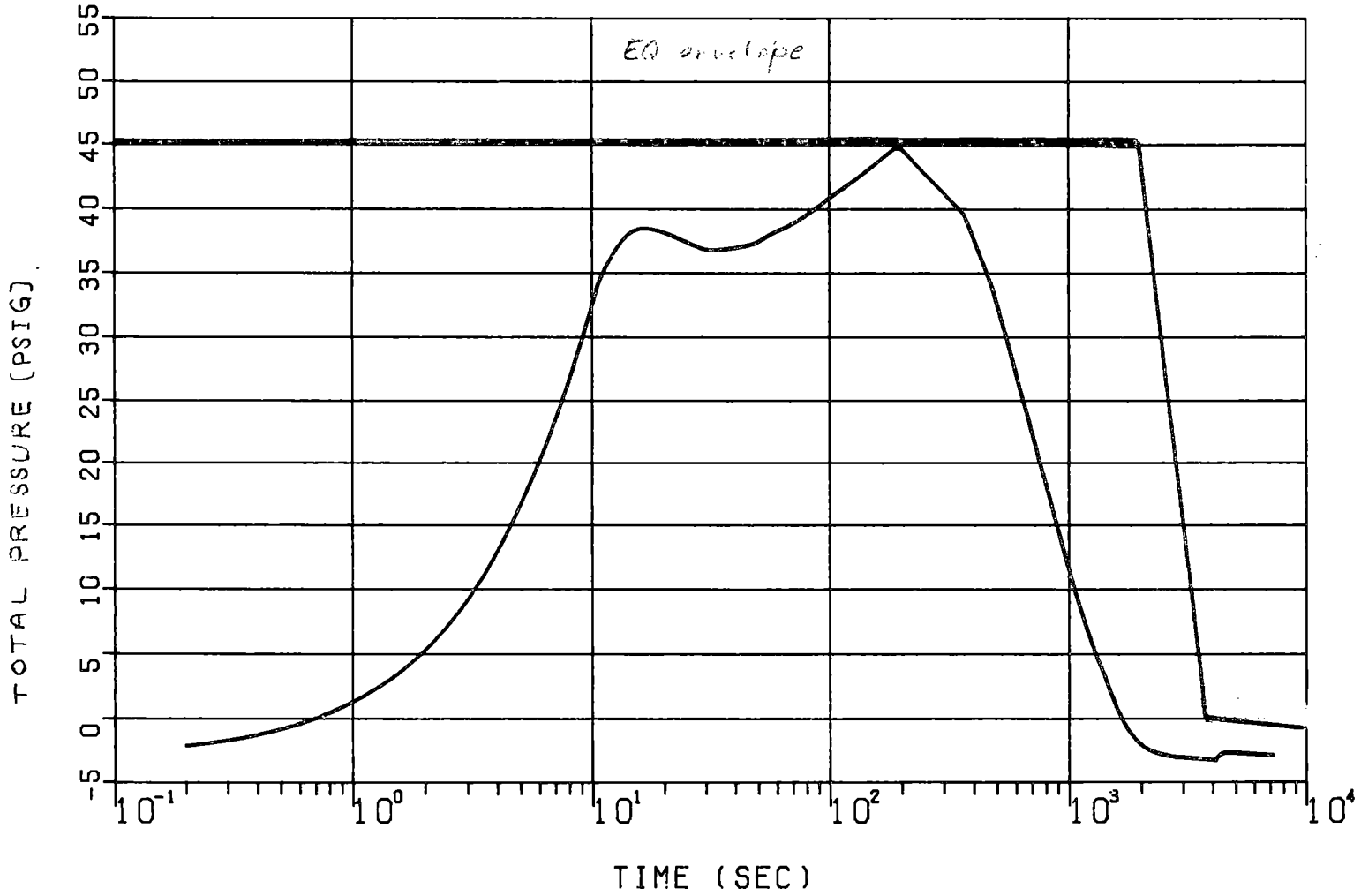

SURRY 142 TECH SPEC FINAL NPSH FIX  
TOTAL PRESSURE VERSUS TIME  
CONTAINMENT PRESSURE PROFILE  
PLOT OF RUN # 2479058

Fig. 1  
12846.44  
US(B)

052-1

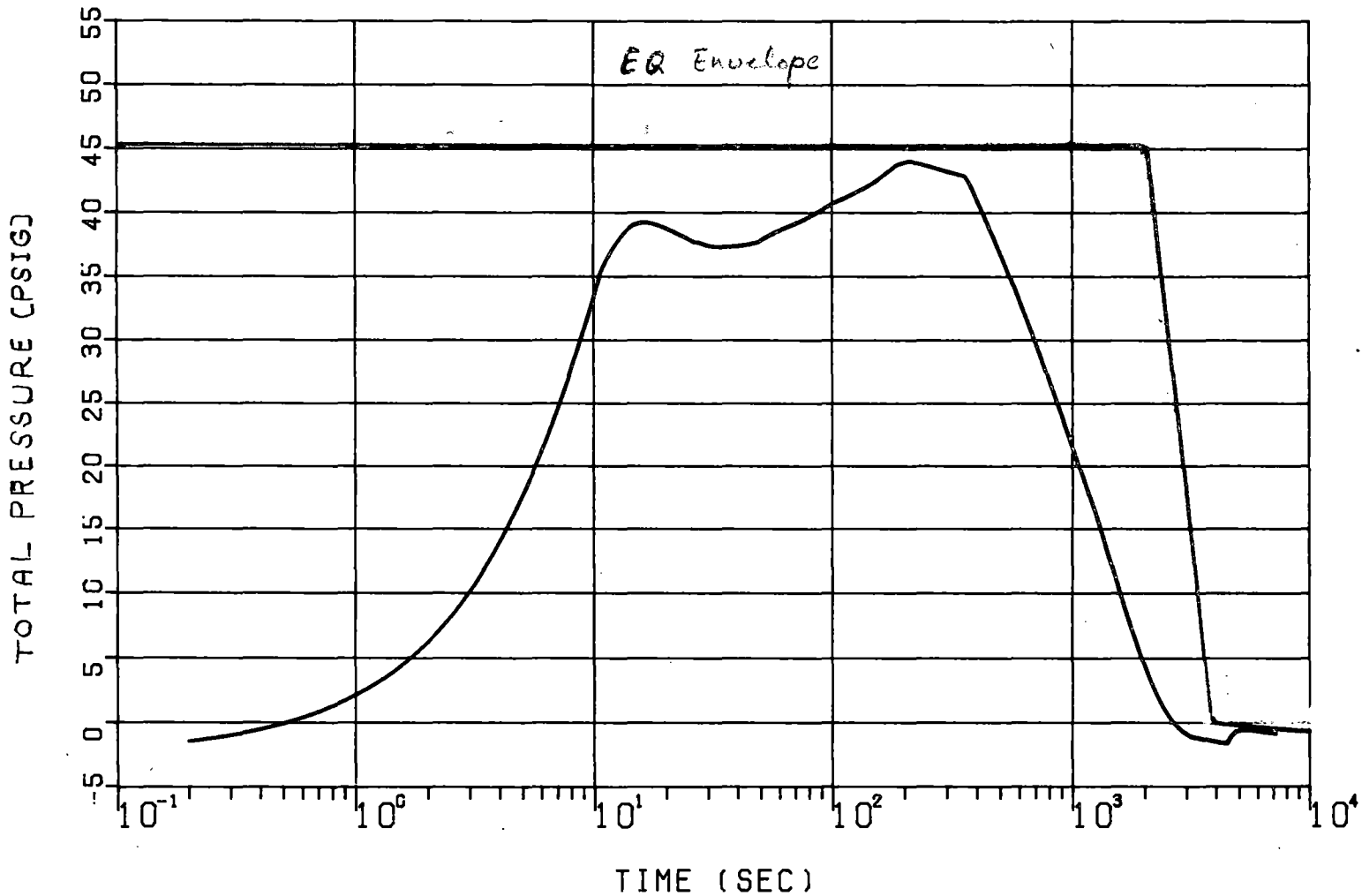

SURRY 142 TECH SPEC FINAL NPSH FIX  
TOTAL PRESSURE VERSUS TIME  
CONTAINMENT PRESSURE PROFILE  
PLOT OF RUN # 2479056

12846.44 US(B)

052-1

Fig 2

p13

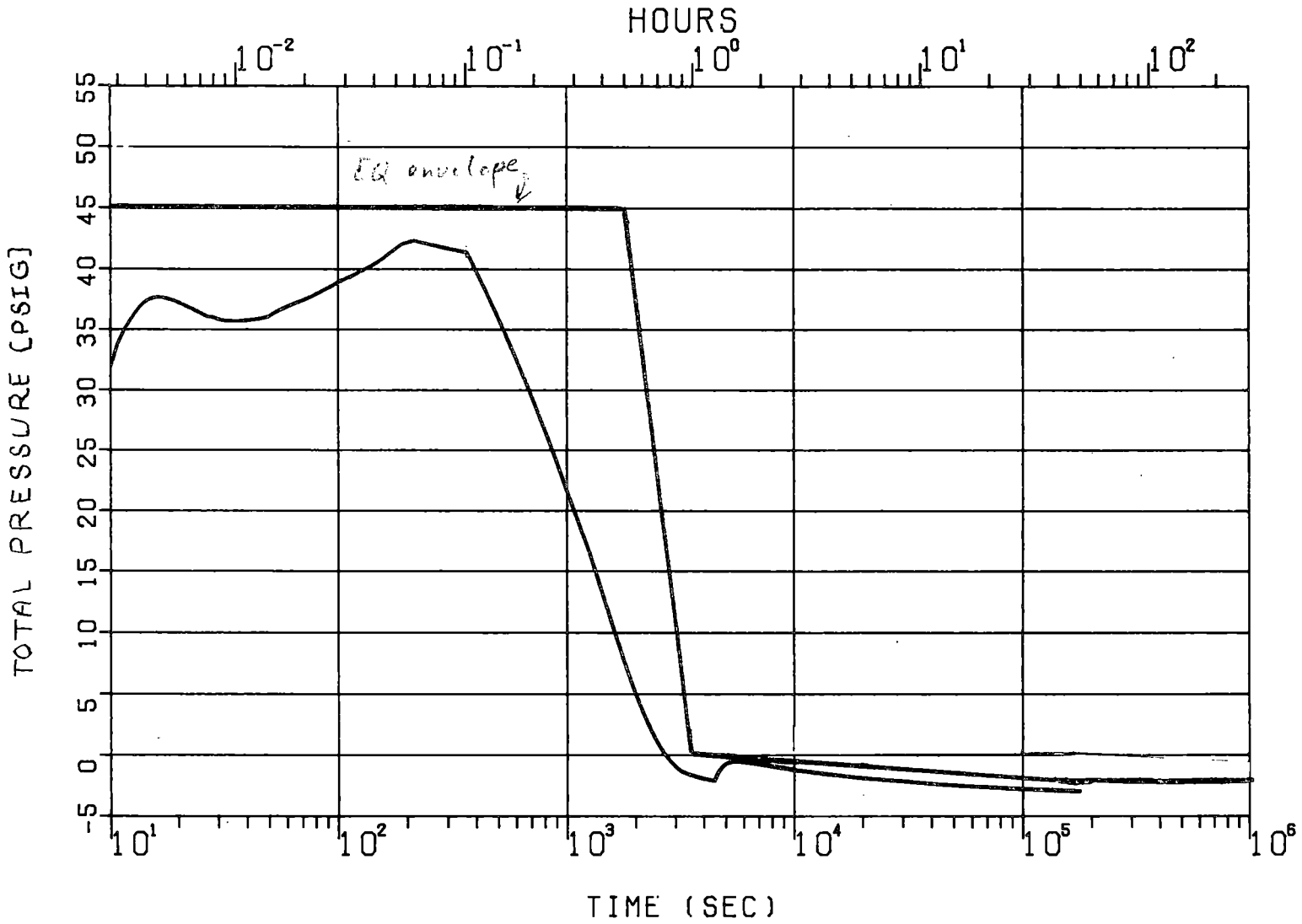

SURRY 142 TECH SPEC FINAL NPSH FIX  
TOTAL PRESSURE VERSUS TIME  
CONTAINMENT PRESSURE PROFILE  
PLOT OF RUN # 2479088

12846.44 US(B) 052 - 1

Fig. 3

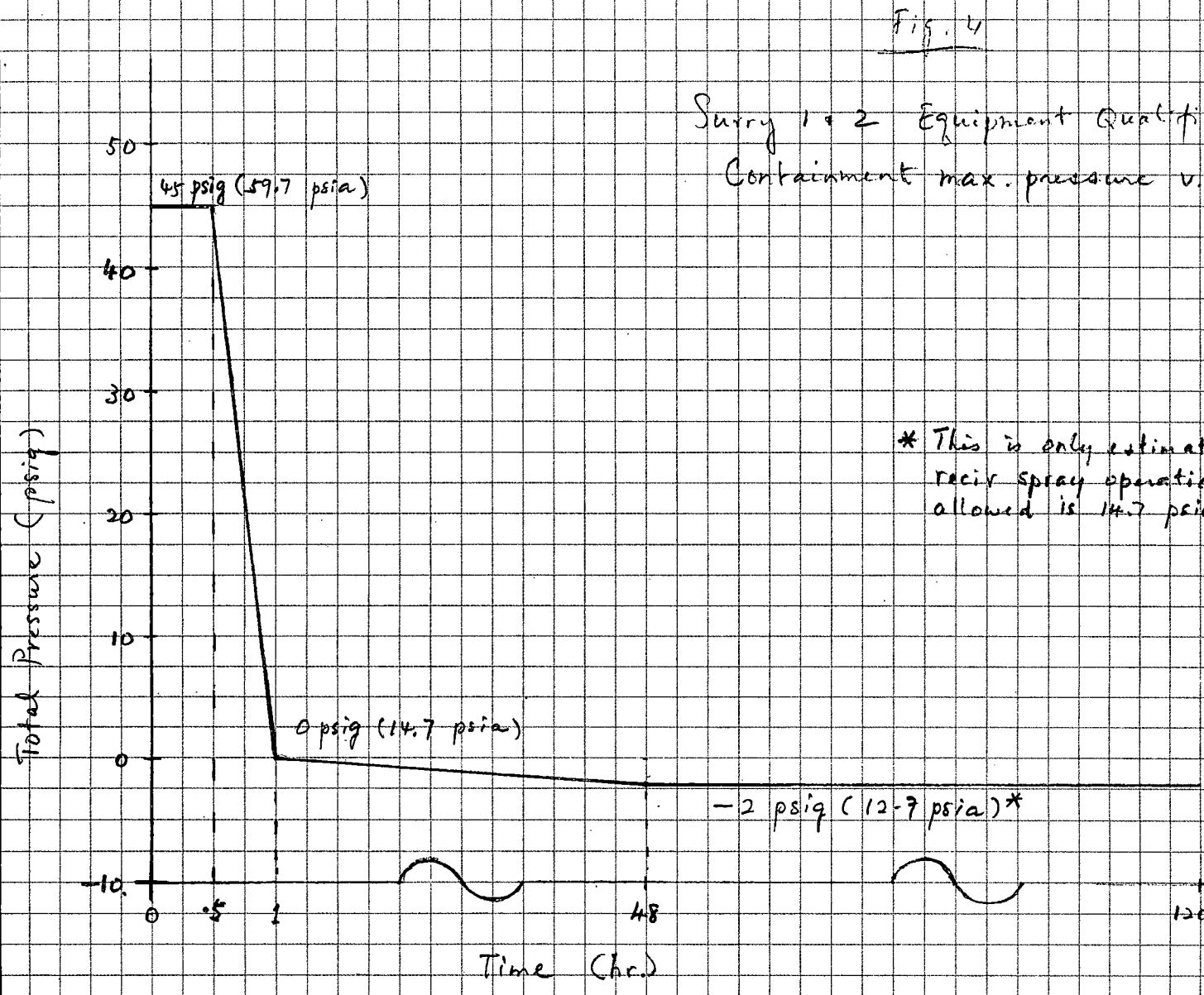
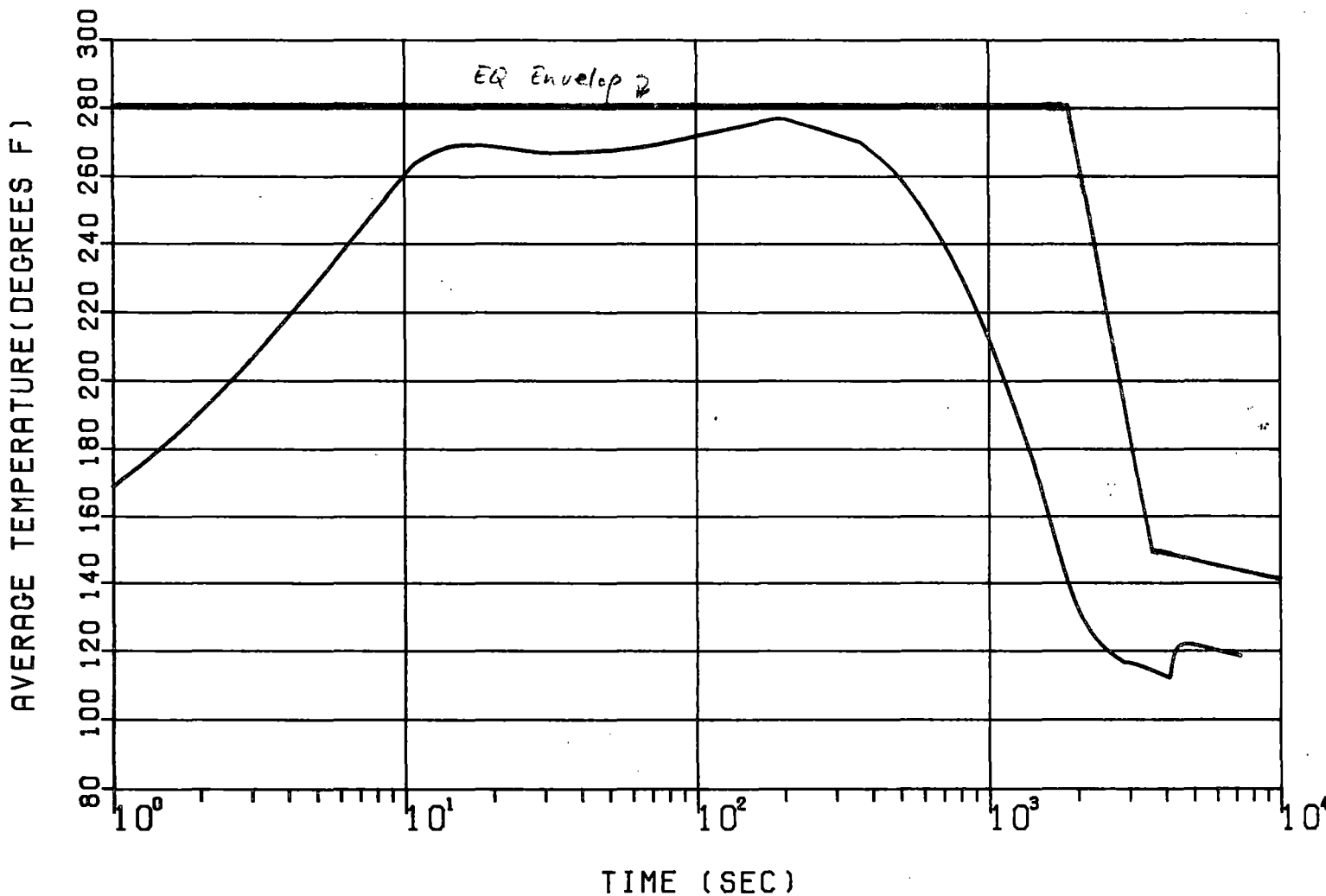

Fig. 4

Surry 1 & 2 Equipment Qualification.  
 Containment max. pressure v. time

\* This is only estimate for continuous  
 recir spray operation. Max pressure  
 allowed is 14.7 psia.



SURRY 142 TECH SPEC FINAL NPSH FIX  
AVERAGE TEMPERATURE VERSUS TIME  
CONTAINMENT TEMPERATURE PROFILES  
PLOT OF RUN # 2479058

12846.44 US(B) 052

Fig-5

p-16



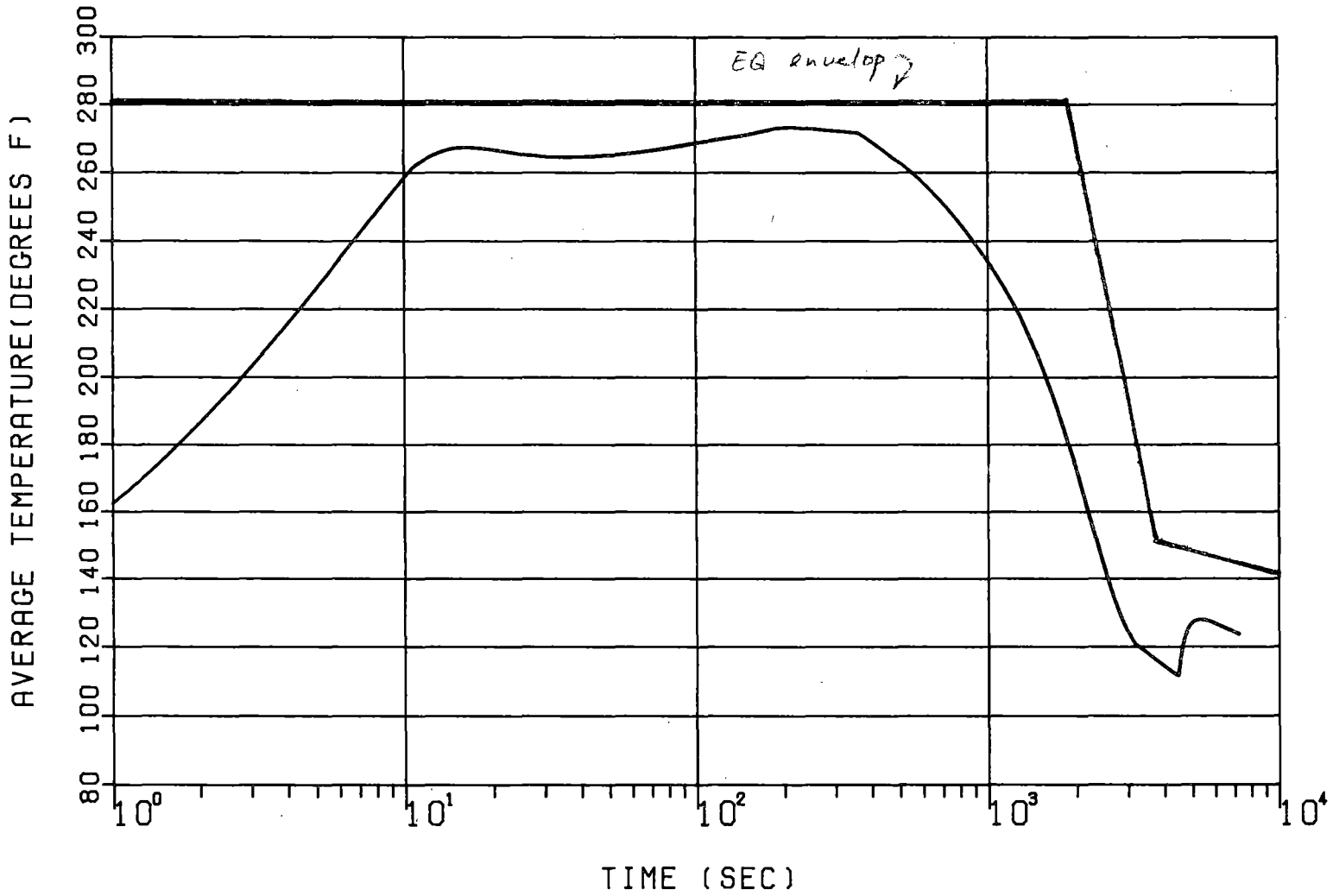

SURRY 1&2 TECH SPEC FINAL NPSH FIX  
AVERAGE TEMPERATURE VERSUS TIME  
CONTAINMENT TEMPERATURE PROFILES  
PLOT OF RUN # 2479056

12846.44 US(B)

052

Fig. 6

P17

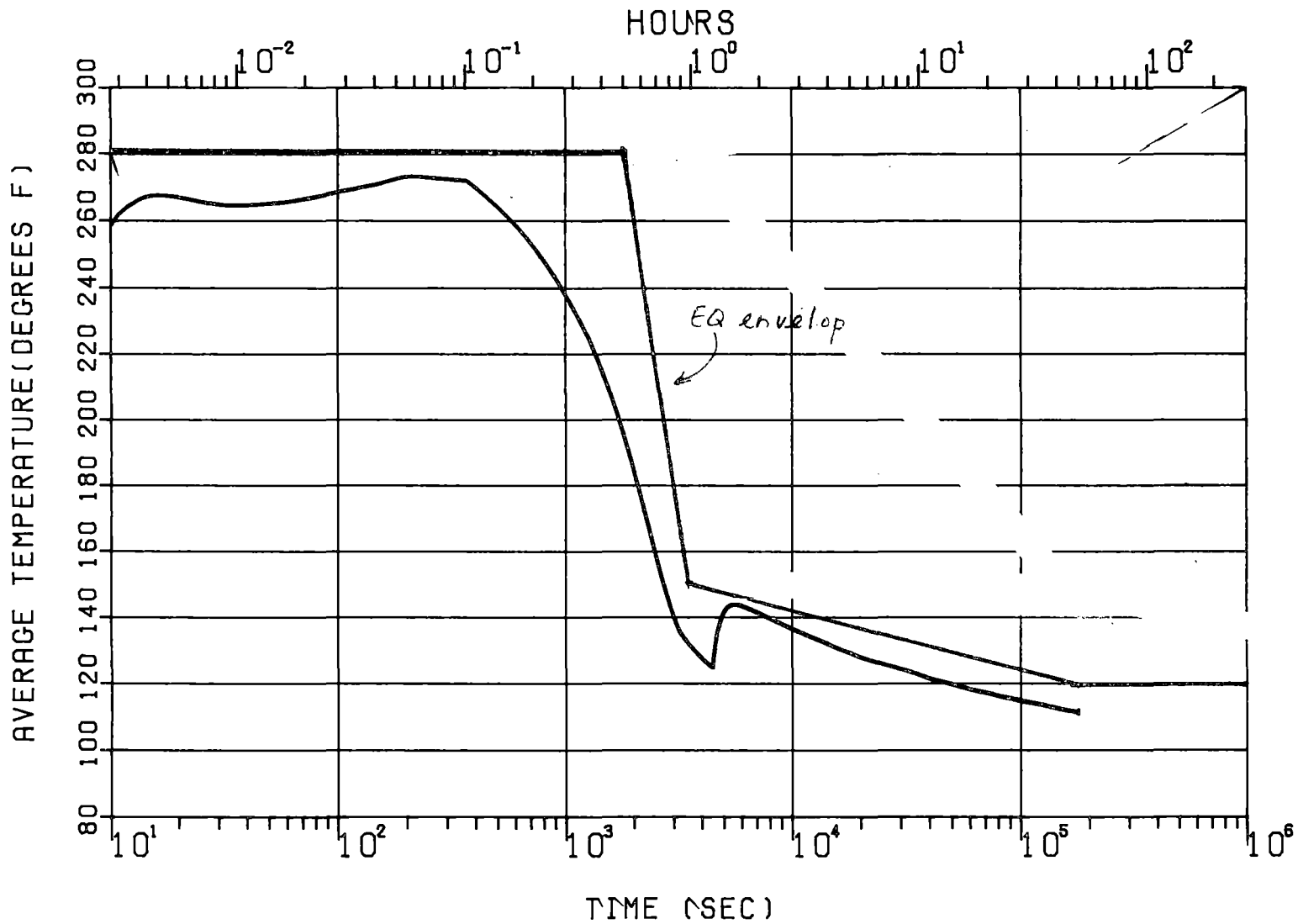

SURRY 1&2 TECH SPEC FINAL NPSH FIX  
AVERAGE TEMPERATURE VERSUS TIME  
CONTAINMENT TEMPERATURE PROFILES  
PLOT OF RUN # 2479068

Fig 7  
12846.44  
US(B)  
052 - 1

61-3-1

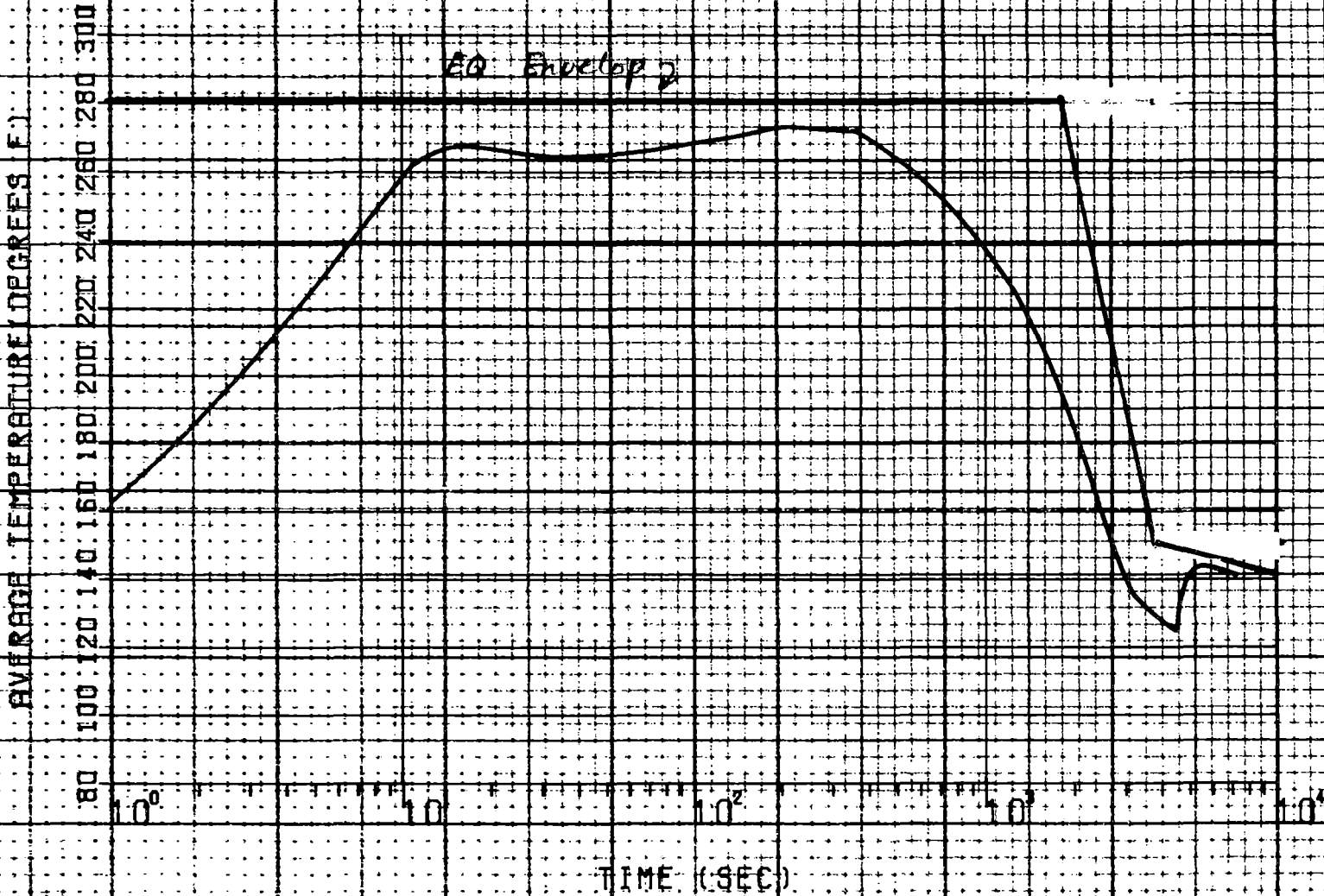
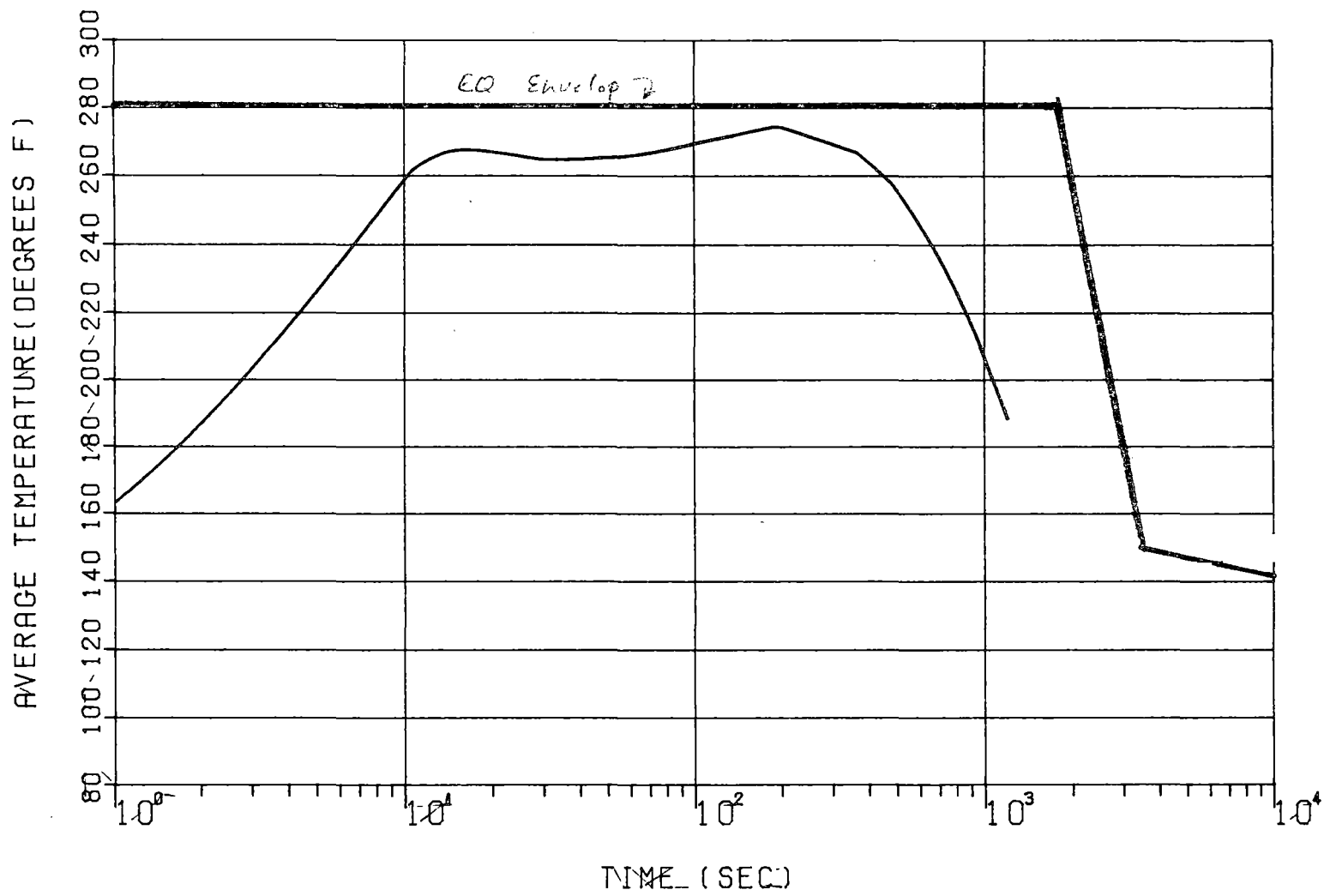

Fig 8  
12846.44 US(B)

BURRY 142 TECH SPEC FINAL NPBA.FIX  
 AVERAGE TEMPERATURE VERSUS TIME  
 CONTAINMENT TEMPERATURE PROFILES  
 PLOT OF RUN # 2479067

052



SURRY 1&2 TECH SPEC FINAL NPSH FIX  
AVERAGE TEMPERATURE VERSUS TIME  
CONTAINMENT TEMPERATURE PROFILES  
PLOT OF RUN # 2479067

Fig. 9  
12846.44  
US(B)  
052-1

12846.44-US-052-0

Page No. 21 12-2-1

STONE & WEBSTER ENGINEERING CORPORATION

ALCULATION SHEET

12846.44 US(B)

Item 052-1

Preliminary

Est. No.

J.O. No.

▲ 5010.10

Client

Subject

Date

By

Based on

Checked

By

Revised

By

Temperature (°F)

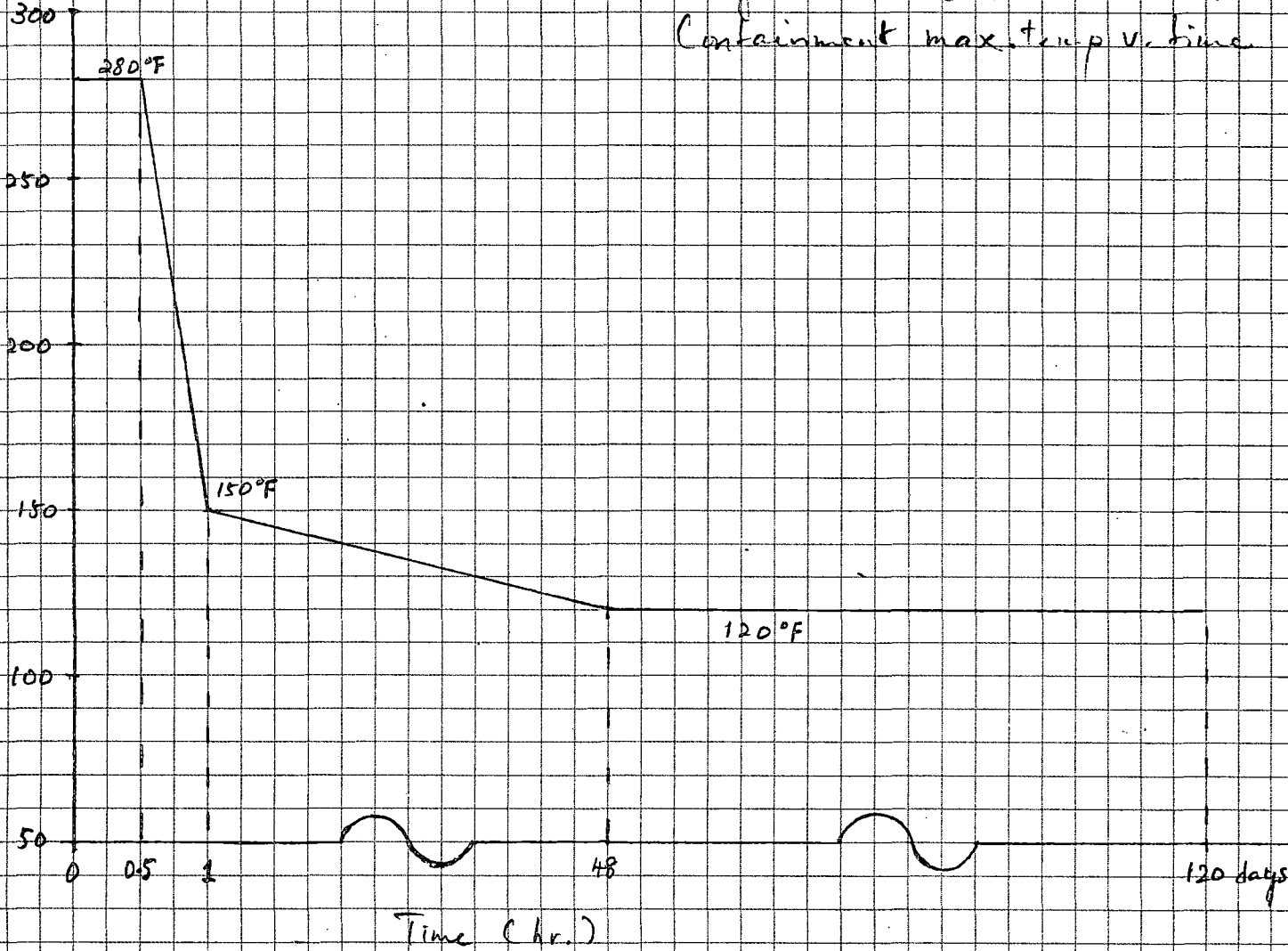

Fig. 10

Surry 1 & 2 Equipment Qualification  
Containment max. temp. vs. time

1 2 3 4 5 6 7 8 9 10 11 12 13 14 15 16 17 18 19 20 21 22 23 24 25 26 27 28 29 30 31 32 33 34 35 36 37 38 39 40 41 42 43 44 45 46 47 48 49 50

Appendix A - (see p. 2 for VEP CO explanation)

CALCULATION SHEET

12846.44

US(B)

1	Client	Location	Est. No.	J.O. No.
2	Subject	Date	By	
3		Checked	By	
4	Based on	Revised	By	

T.O.C.

7		page
8	I. Title	3
9		
10	II. Purpose	3
11		
12	III. Reference	4
13		
14	IV. Assumption	5
15		
16	V. Method	6
17		
18	VI. Result + Conclusion	10
19		
20	figures 1-10	11-20
21		
22		
23		
24		
25		
26		
27		
28		
29		
30		
31		
32		
33		
34		
35		
36		
37		
38		
39		
40		
41		
42		
43		
44		
45		
46		
47		
48		
49		
50		

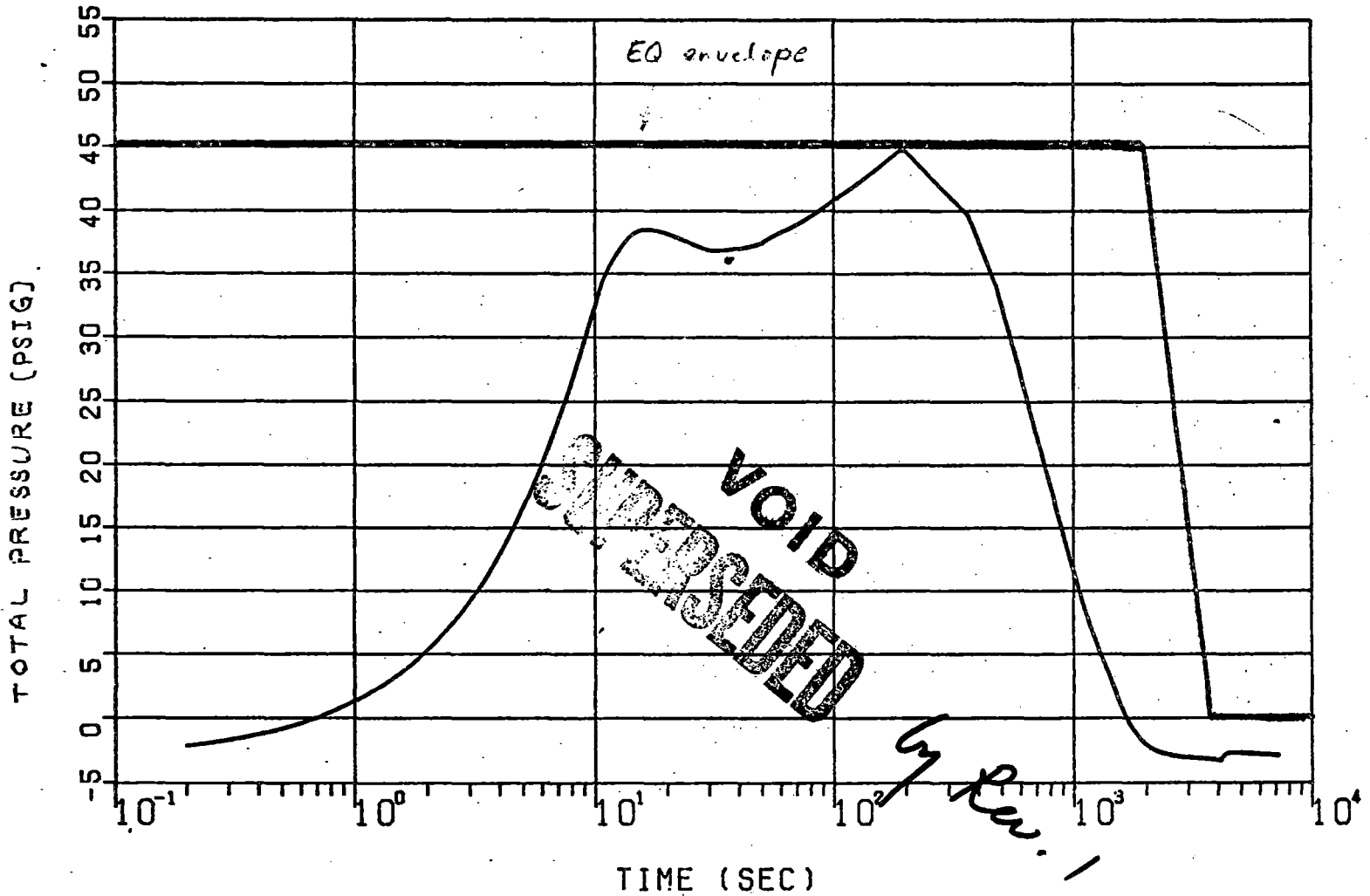

SURRY 142 TECH SPEC FINAL NPSH FIX  
 TOTAL PRESSURE VERSUS TIME  
 CONTAINMENT PRESSURE PROFILE  
 PLOT OF RUN # 2479068

Appendix A  
 Fig. 1  
 D2846.44  
 US(B)  
 052  
 (A. 2019)  
 p. 127

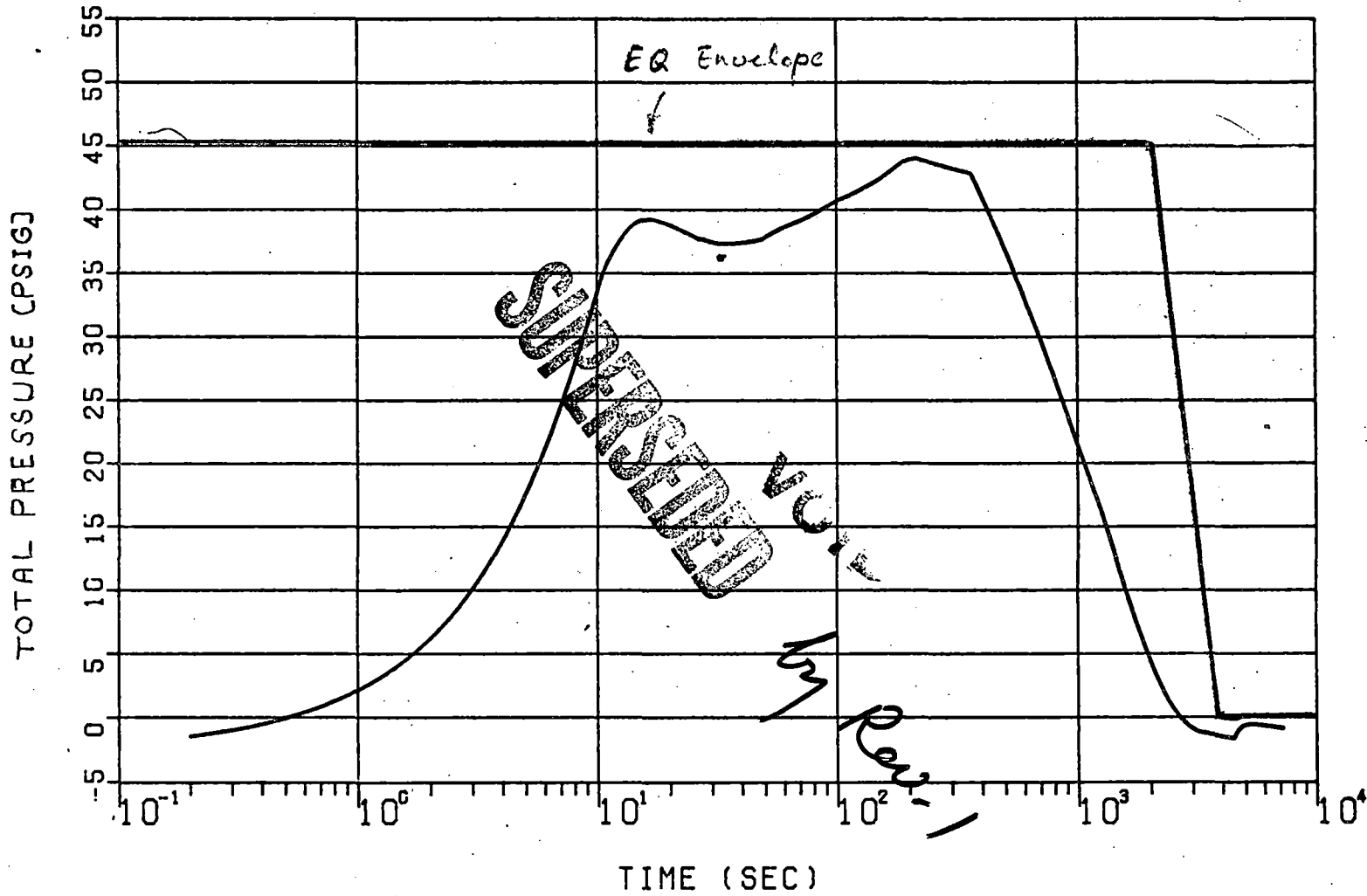

SURRY 142 TECH SPEC FINAL NPSH FIX  
 TOTAL PRESSURE VERSUS TIME  
 CONTAINMENT PRESSURE PROFILE  
 PLOT OF RUN # 2479056

12846.44 US(B) 052

Fig. 2  
 (Page 1)



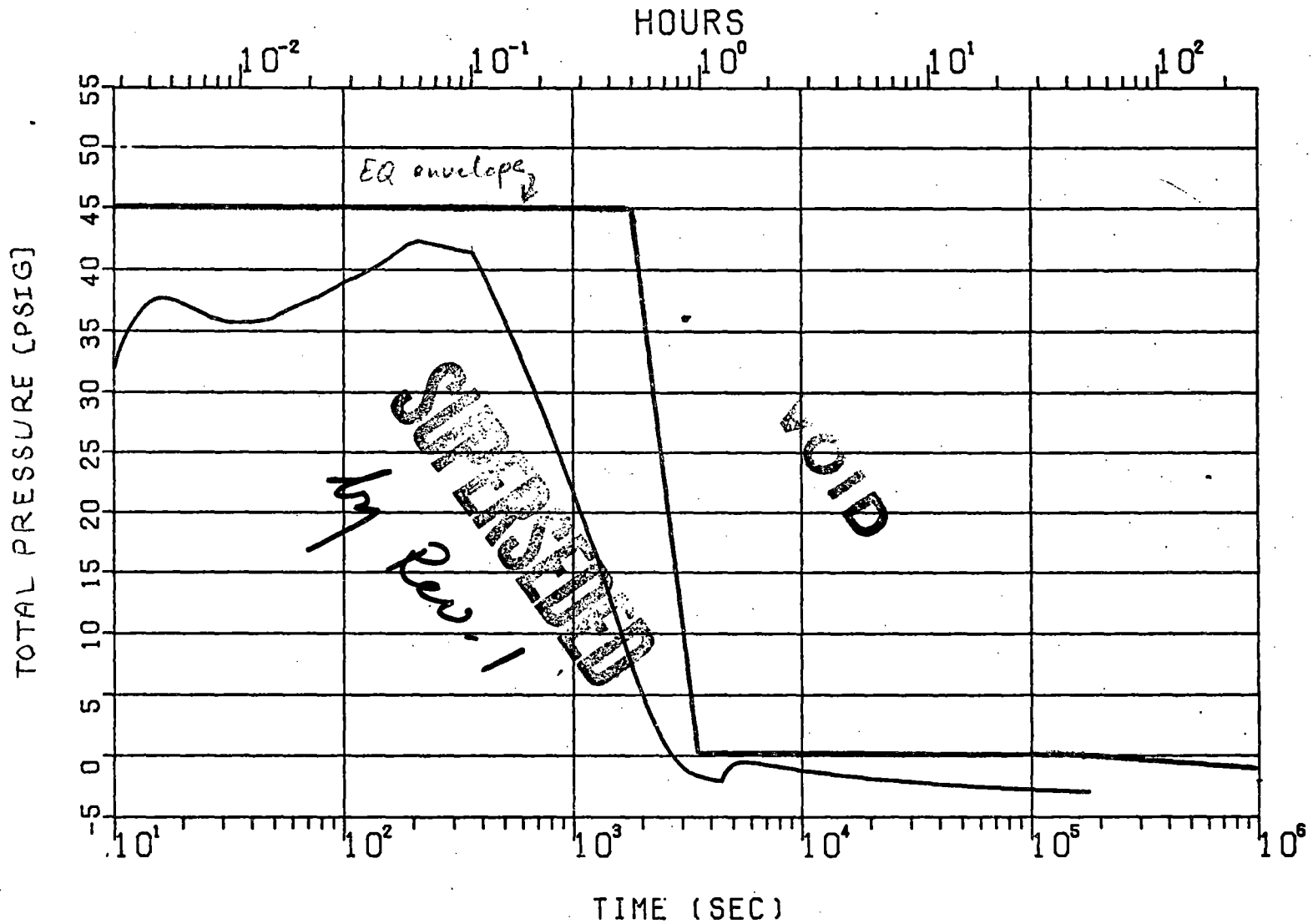

12846.44

US(B)

052

Fig. 3

(p. 6 of 9)

SURRY 142 TECH SPEC FINAL NPSH FIX  
TOTAL PRESSURE VERSUS TIME  
CONTAINMENT PRESSURE PROFILE  
PLOT OF RUN # 2479088

STONE & WEBSTER ENGINEERING CORPORATION

Preliminary

CALCULATION SHEET  
110(B)

BY CSM (6/5/79)

1701.6 h. h.

A 2010.10

Est. No. J.O. No.

Date

Checked By

Revised By

Client

Subject

Based on

Total Pressure (psig)

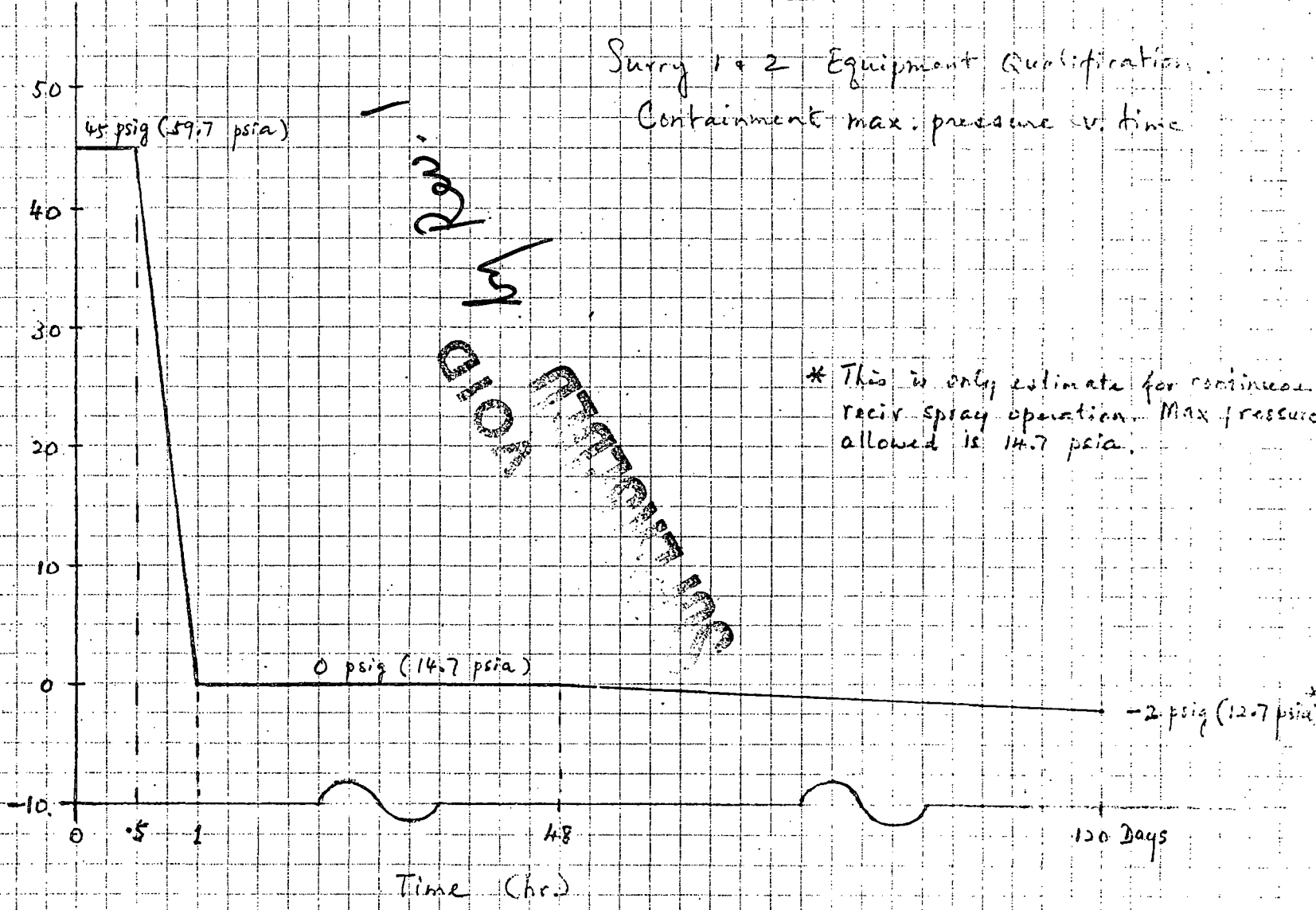

- 1
- 2
- 3
- 4
- 5
- 6
- 7
- 8
- 9
- 10
- 11
- 12
- 13
- 14
- 15
- 16
- 17
- 18
- 19
- 20
- 21
- 22
- 23
- 24
- 25
- 26
- 27
- 28
- 29
- 30
- 31
- 32
- 33
- 34
- 35
- 36
- 37
- 38
- 39
- 40
- 41
- 42
- 43
- 44
- 45
- 46
- 47
- 48
- 49
- 50

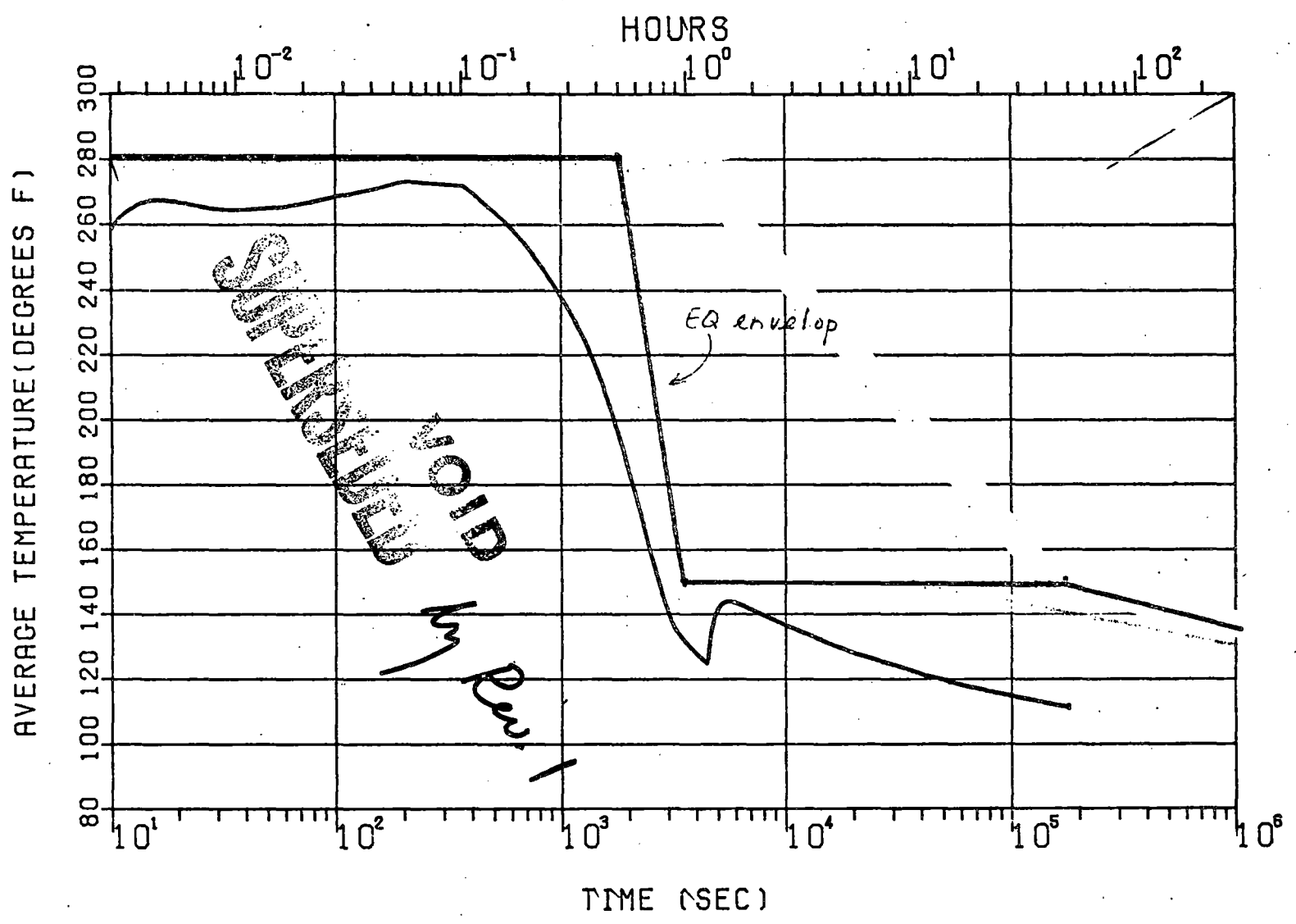

SURRY 142 TECH SPEC FINAL NPSH FIX  
 AVERAGE TEMPERATURE VERSUS TIME  
 CONTAINMENT TEMPERATURE PROFILES  
 PLOT OF RUN # 2479088

Fig. 7  
 12846.44 US(B) 052  
 (9.6.8-1)  
 P.18

1-C-28

AVERAGE TEMPERATURE (DEGREES F)

80 100 120 140 160 180 200 220 240 260 280 300

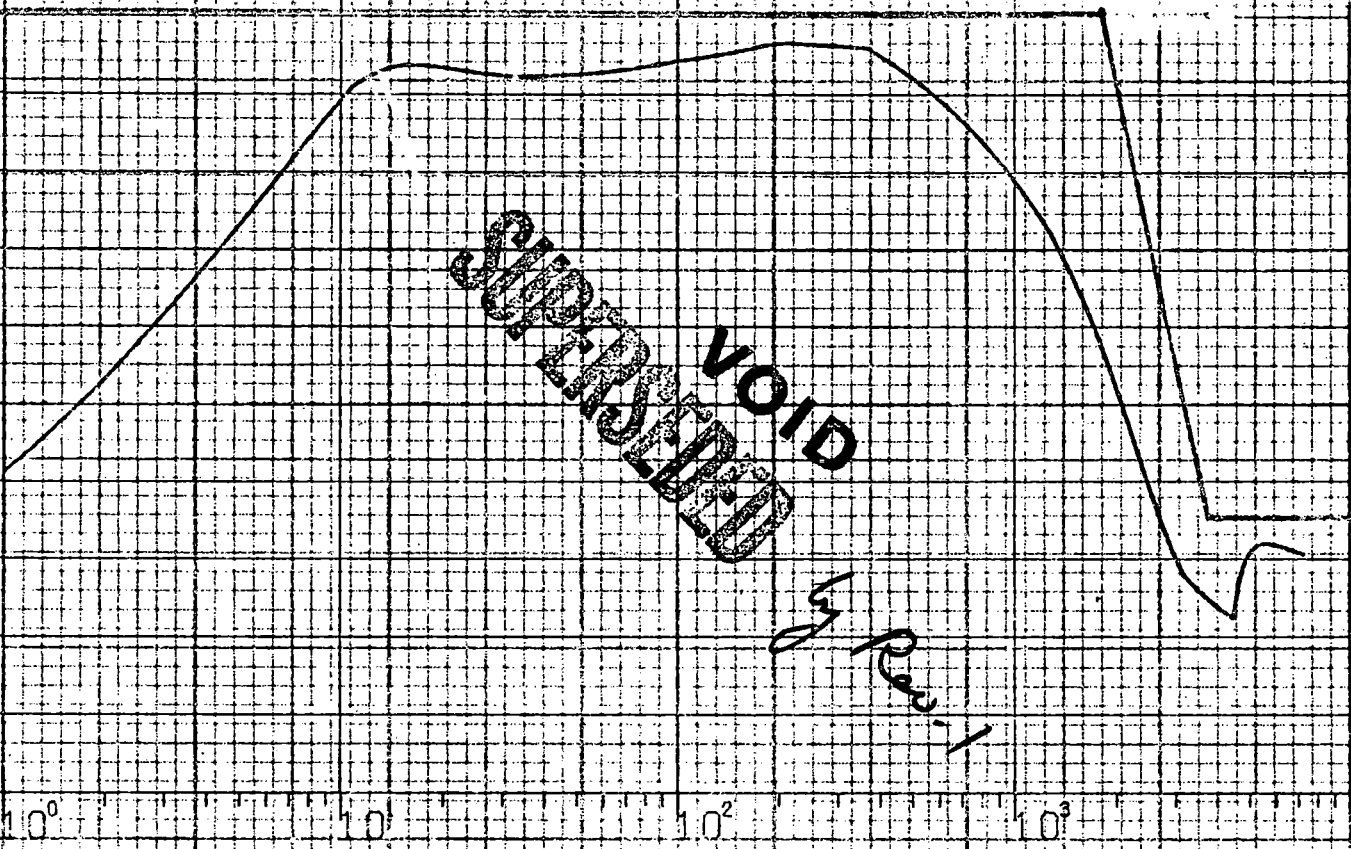

**REMOVED VOID**

*1.2*

TIME (SEC)

SURRY 1&2 TECH SPEC FINAL NPSH FIX  
AVERAGE TEMPERATURE VERSUS TIME  
CONTAINMENT TEMPERATURE PROFILES  
PLOT OF RUN # 2479063

12846.14 BSL

8

10

1/19

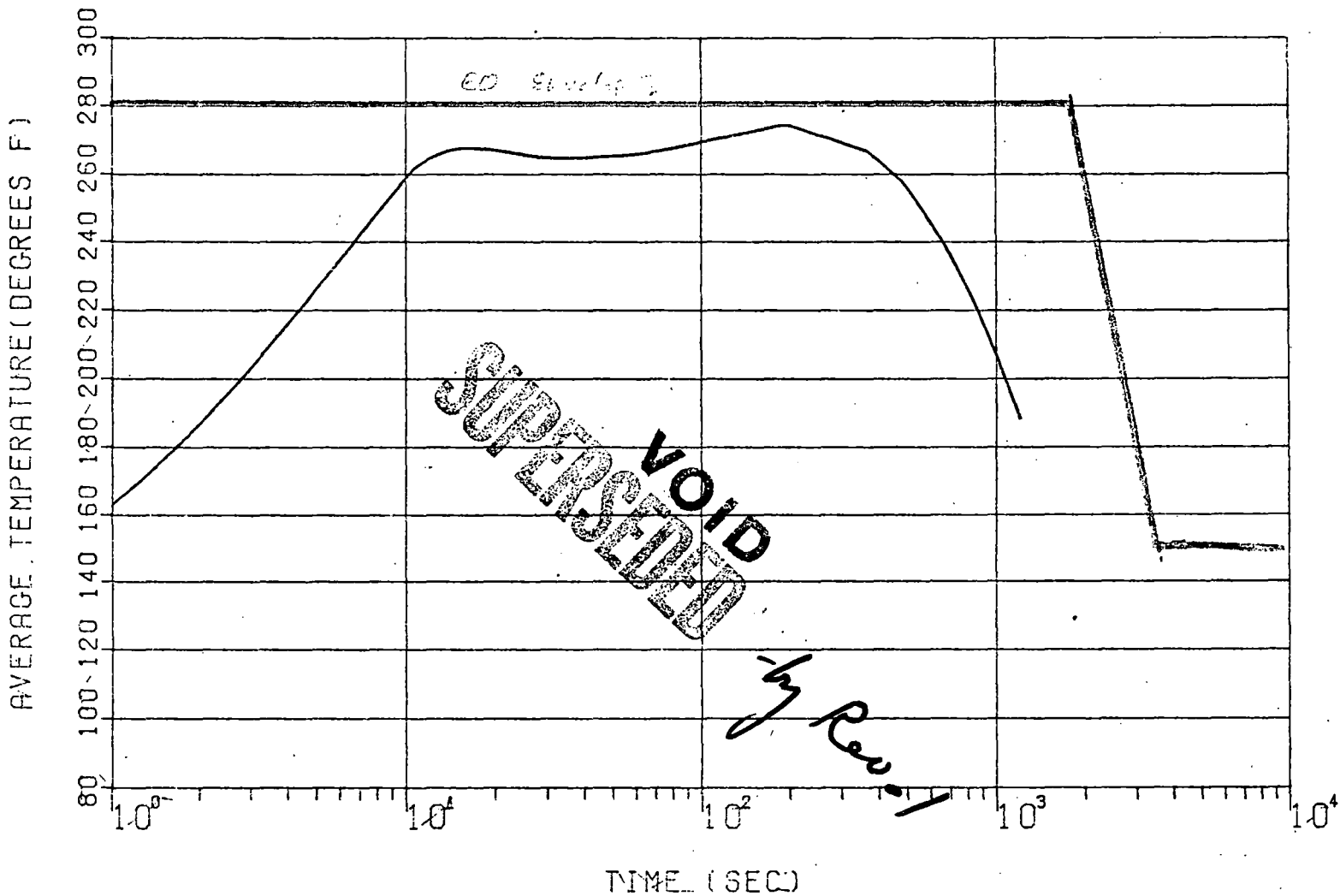

SURRY 1&2. TECH. SPEC. FINAL NPSH FIX  
 AVERAGE TEMPERATURE VERSUS TIME  
 CONFINEMENT TEMPERATURE PROFILES  
 PLOT OF RUN # 2479067

FIG. 9  
 12846.44  
 18(B)  
 052

1	Client	Date	By
2	Subject	Checked	By
3		Revised	By
4	Based on		

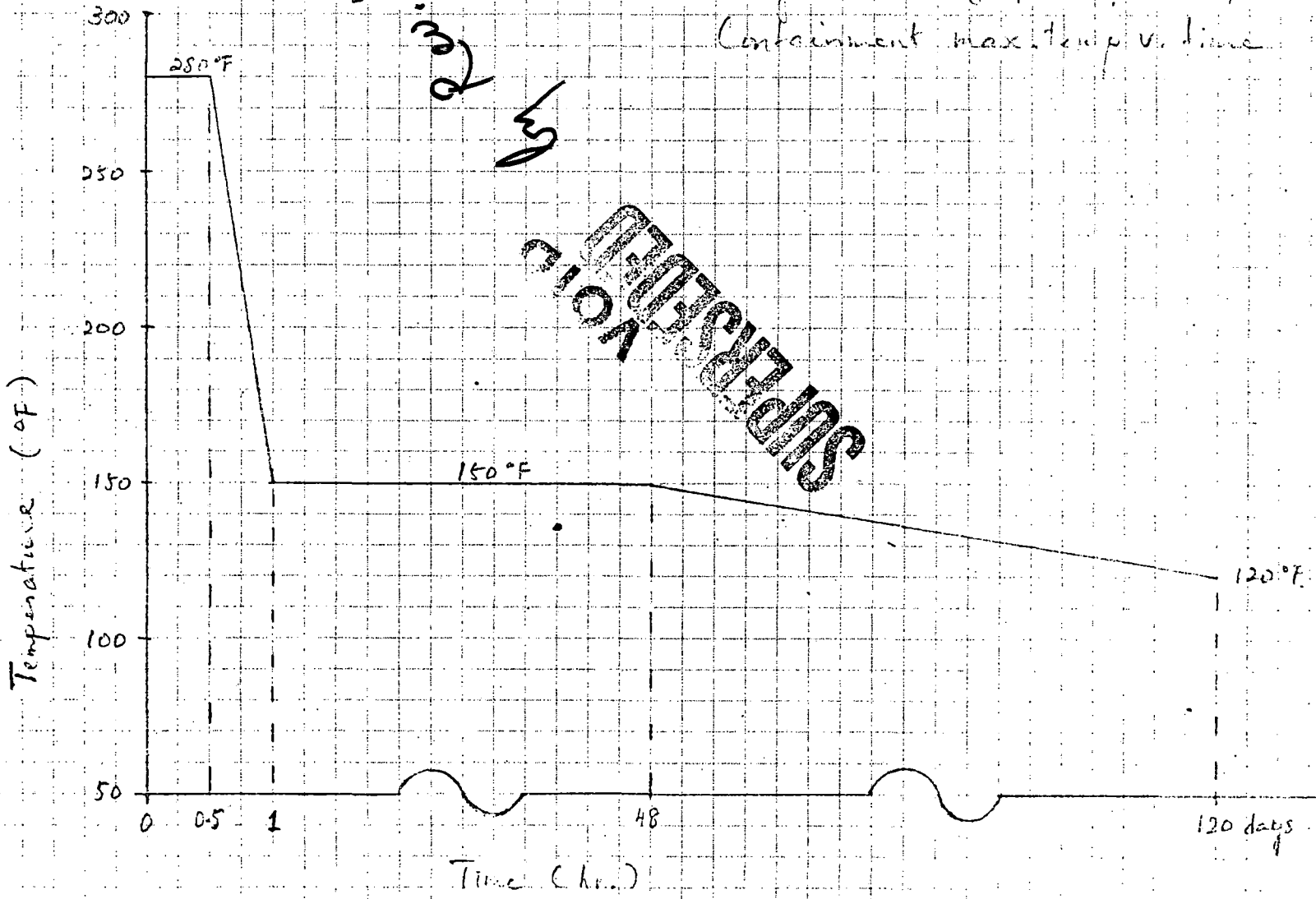

▲ 5010.1D

USER'S GUIDE TO EZD REFERENCES

Facility: VEPCO, SURRY  
 Units: 1 and 2  
 Dockets: 50-280 and 50-281

EZD REFERENCE NO. 3  
 EZD REFERENCE DESCRIPTION: 12846.54-RP-038-1  
 ENVIRONMENTAL ZONE(S): RC-3A

<u>PARAMETER</u>	<u>NORMAL ENVIRONMENT</u>	<u>PAGE</u>	<u>LOCA ENVIRONMENT</u>	<u>PAGE</u>	<u>MSLB ENVIRONMENT</u>	<u>PAGE</u>	<u>HELB ENVIRONMENT</u>	<u>PAGE</u>
RADIATION (rads)	1.3 x 10 <sup>7</sup>	6	≤2.4 x 10 <sup>7</sup>	6				

USER'S GUIDE TO EZD REFERENCES

Facility: VEPCO, SURRY  
 Units: 1 and 2  
 Dockets: 50-280 and 50-281

EZD REFERENCE NO. 3  
 EZD REFERENCE DESCRIPTION: 12846.54-RP-038-1  
 ENVIRONMENTAL ZONE(S): RC-3B, RC-18B, RC-47B

<u>PARAMETER</u>	<u>NORMAL ENVIRONMENT</u>	<u>PAGE</u>	<u>LOCA ENVIRONMENT</u>	<u>PAGE</u>	<u>MSLB ENVIRONMENT</u>	<u>PAGE</u>	<u>HELB ENVIRONMENT</u>	<u>PAGE</u>
RADIATION (rads)	3.5 x 10 <sup>6</sup>	6	7.4 x 10 <sup>6</sup>	6				



USER'S GUIDE TO EZD REFERENCES

Facility: VEPCO, SURRY  
 Units: 1 and 2  
 Dockets: 50-280 and 50-281

EZD REFERENCE NO. 3  
 EZD REFERENCE DESCRIPTION: 12846154-RP-038-1  
 ENVIRONMENTAL ZONE (S): RC-27A

<u>PARAMETER</u>	<u>NORMAL ENVIRONMENT</u>	<u>PAGE</u>	<u>LOCA ENVIRONMENT</u>	<u>PAGE</u>	<u>MSLB ENVIRONMENT</u>	<u>PAGE</u>	<u>HELB ENVIRONMENT</u>	<u>PAGE</u>
RADIATION (rads)	3.5 x 10 <sup>4</sup>	6	3.5 x 10 <sup>7</sup>	6				

USER'S GUIDE TO EZD REFERENCES

Facility: VEPCO, SURRY  
 Units: 1 and 2  
 Dockets: 50-280 and 50-281

EZD REFERENCE NO. 3  
 EZD REFERENCE DESCRIPTION: 12846.54-RP-038-1  
 ENVIRONMENTAL ZONE(S): RC-27B

<u>PARAMETER</u>	<u>NORMAL ENVIRONMENT</u>	<u>PAGE</u>	<u>LOCA ENVIRONMENT</u>	<u>PAGE</u>	<u>MSLB ENVIRONMENT</u>	<u>PAGE</u>	<u>HELB ENVIRONMENT</u>	<u>PAGE</u>
RADIATION (rads)	$3.5 \times 10^4$	6	$3.8 \times 10^7$	6				

USER'S GUIDE TO EZD REFERENCES

Facility: VEPCO, SURRY  
 Units: 1 and 2  
 Dockets: 50-280 and 50-281

EZD REFERENCE NO. 3  
 EZD REFERENCE DESCRIPTION: 12846.54-RP-038-1  
 ENVIRONMENTAL ZONE(S): RC-47A

<u>PARAMETER</u>	<u>NORMAL ENVIRONMENT</u>	<u>PAGE</u>	<u>LOCA ENVIRONMENT</u>	<u>PAGE</u>	<u>MSLB ENVIRONMENT</u>	<u>PAGE</u>	<u>HELB ENVIRONMENT</u>	<u>PAGE</u>
RADIATION (rads)	<1.3 x 10 <sup>7</sup>	6	2.4 x 10 <sup>7</sup>	6				

**CALCULATION TITLE PAGE**

\*SEE INSTRUCTIONS ON REVERSE SIDE

▲ 5010.64 (FRONT)

CLIENT & PROJECT <b>VEPCO</b> <i>Surry 1&amp;2</i>				PAGE 1 OF <b>16</b>	
CALCULATION TITLE (Indicative of the Objective): <i>Dose Rates and Integrated Doses Inside Containment following a LOCA</i>				QA CATEGORY (✓) <input checked="" type="checkbox"/> I - NUCLEAR SAFETY RELATED <input type="checkbox"/> II <input type="checkbox"/> III <input type="checkbox"/> OTHER	
CALCULATION IDENTIFICATION NUMBER					
J. O. OR W.O. NO.	DIVISION & GROUP	CURRENT CALC. NO.	OPTIONAL TASK CODE	OPTIONAL WORK PACKAGE NO.	
<i>12846.54</i>	<i>power RP</i>	<i>RP-038-1</i>			
* APPROVALS - SIGNATURE & DATE			REV. NO. OR NEW CALC NO.	SUPERSEDES * CALC. NO. OR REV. NO.	CONFIRMATION * REQUIRED (✓) YES NO
PREPARER(S)/DATE(S)	REVIEWER(S)/DATE(S)	INDEPENDENT REVIEWER(S)/DATE(S)			
<i>Wahung peng</i> <i>7/8/81</i>	<i>Shuway Lin</i> <i>7/8/81</i>	<i>Shuway Lin</i> <i>7/8/81</i>		<i>-RP-038-0</i>	✓ <i>ref.</i> <i>QADMD</i> <i>DRAGON</i> <i>(Activity)</i> <i>...</i>
<b>DISTRIBUTION *</b>					
GROUP	NAME & LOCATION	COPY SENT (✓)	GROUP	NAME & LOCATION	COPY SENT (✓)
RECORDS MGT. FILES (OR FIRE FILE IF NONE) <i>OR SERV. project</i>	<i>J. BARNHART 14</i> <i>M. O'NEARA 14</i>	✓ ✓			

STONE & WEBSTER ENGINEERING CORPORATION  
CALCULATION SHEET

▲ 5010.65

CALCULATION IDENTIFICATION NUMBER				PAGE <u>2</u>
J.O. OR W.O. NO. 12846.54	DIVISION & GROUP POWER RP	CALCULATION NO. RP-038-1	OPTIONAL TASK CODE	

1  
2  
3  
4  
5  
6  
7  
8  
9  
10  
11  
12  
13  
14  
15  
16  
17  
18  
19  
20  
21  
22  
23  
24  
25  
26  
27  
28  
29  
30  
31  
32  
33  
34  
35  
36  
37  
38  
39  
40  
41  
42  
43  
44  
45  
46

Table of Contents

	page
Title page	1
Table of Contents	2
I. Purpose	3
II Approach	3
III References	4
IV Data / Assumptions	5
V Results and Conclusions	6
VI Calculation	7
1. Dose Rate and Integrated Dose at Containment Centerline	7
2. Dose Rate and Dose Outside the Crane Wall	9
3. Dose Rate and Dose Outside the Personnel Hatch at the Existing High Range Radiation Monitor	11
4. Dose Rate and Integrated Dose in an Infinite Medium of Sump Water	14
5. 40 year normal operating dose	16

Note: This calc. supersedes calc. 12846.54-RP-038-0.

- ① Dose build-up<sub>in sump water</sub> has been taken into account.
- ② Dose above sump water is estimated.

STONE & WEBSTER ENGINEERING CORPORATION  
CALCULATION SHEET

▲ 5010.65

CALCULATION IDENTIFICATION NUMBER				PAGE <u>3</u>
J.O. OR W.O. NO.	DIVISION & GROUP	CALCULATION NO.	OPTIONAL TASK CODE	
12846.54	power RP	RP-038-1		

1  
2  
3 I. Purpose: The purpose of this calc. is to determine, following a LOCA,  
4 (1). dose rate and integrated dose at the containment centerline,  
5 (2). integrated dose behind crane wall,  
6 (3). integrated dose outside personnel hatch at high range  
7 radiation monitor, and  
8 (4). dose rate and integrated dose for an equipment totally  
9 submerged in the containment sump water;  
10 also, to determine 40 year normal operating dose inside containment.  
11  
12  
13  
14  
15  
16  
17  
18

19 II. Approach.

20  
21 (1) In N.A. Calc. # 12050-RP-106-0, "LOCA Doses in the containment  
22 for equipment qualification," (ref. 1) dose rates and integrated doses  
23 at the containment centerline, behind the crane wall and outside  
24 personnel hatch have been calculated. In N.A. calc. # 12050 -  
25 RP-108-0, "Worst 6 month P LOCA Integrated dose Inside  
26 an infinite medium of containment sump water," <sup>ref.(2)</sup> dose rates  
27 and integrated dose inside the sump water were given.  
28  
29  
30  
31  
32  
33  
34

35 (2) Due to the congruence of the reactor core and containment  
36 structure between North Anna and Surry plants, results  
37 mentioned in (1) will be used for Surry plant with a proper  
38 adjustment factor for the source strength. The difference in the  
39 door thickness of the personnel hatch was also adjusted.  
40  
41  
42  
43  
44  
45  
46

STONE & WEBSTER ENGINEERING CORPORATION  
 CALCULATION SHEET

▲ 5010.65

CALCULATION IDENTIFICATION NUMBER				PAGE <u>4</u>
J.O. OR W.O. NO.	DIVISION & GROUP	CALCULATION NO.	OPTIONAL TASK CODE	
12846.54	power RP	RP-038-1		

III References

- (1). S & W North Anna Calc. # 12050-RP-106-0, "LOCA Doses in the Containment for Equipment Qualification," 7/19/80.
- (2). S & W North Anna Calc. # 12050-RP-108-~~0~~<sup>2</sup> "Worst 6 month & LOCA integrated dose inside an infinite medium of Containment Sump water," Calc. # 12050-RP-108-1.
- (3) S & W Surry Calc. # 12846.38-RP-026-0, "NUREG-0578 Shielding Review - Aux. Bldg Radiation Zone maps following a LOCA."
- (4) S & W Drawings - 11448-FM-1A, B, C, D, E, F, G.
- (5) S & W Calc. 12846.38-RP-023-1, "Dose Rates to Containment High range Monitors, 0-8 hrs following release to containment of 100% Primary Coolant Inventory, 100% of Gap Inventory, 100%, 10% and 1% LOCA Activity." (12/21/79) (10/2/80)
- (6) S&W DWG = 11448.3.13-20 A (project).
- (7) "Shielding Design Summary for Surry power station, VEPCO" by S&W, Radiation Protection Group, J.O. No. 11448, 12/70.

STONE & WEBSTER ENGINEERING CORPORATION  
CALCULATION SHEET

▲ 5010.65

CALCULATION IDENTIFICATION NUMBER				PAGE <u>5</u>
J.O. OR W.O. NO.	DIVISION & GROUP	CALCULATION NO.	OPTIONAL TASK CODE	
12846.54	Power RP	-038-1		

1  
2  
3  
4  
5  
6  
7  
8  
9  
10  
11  
12  
13  
14  
15  
16  
17  
18  
19  
20  
21  
22  
23  
24  
25  
26  
27  
28  
29  
30  
31  
32  
33  
34  
35  
36  
37  
38  
39  
40  
41  
42  
43  
44  
45  
46

IV DATA / Assumptions

- Source terms in containment atmosphere = 100% Noble gas  
50% halogens  
(no spray removal and plate out for halogens) (NUR36.0588)
- in Sump water : 50% of halogens  
1% of remaining fission products
- power level 2546 MW  
Containment free volume =  $1.8 \times 10^6 \text{ ft}^3$  (ref. 3)  
primary coolant =  $9235 \text{ ft}^3$   
RWST dumped = 250000 gal.  
(Total sump water volume =  $1.2 \times 10^9 \text{ cm}^3$ )
- The primary containment atmosphere volume contributed to centerline dose is the same as North Anna, i.e.  $1.15 \times 10^6 \text{ ft}^3$ .  
This is the volume above the operating floor. (ref (4))
- Containment wall IR = 63 ft  
crane wall IR = 51 ft (ref. (4))  
OR = 53 ft
- The distance from the high range monitor outside personnel hatch to the containment center line is 99 ft (ref 5)
- Personnel hatch door thickness is  $\frac{1}{2}$ " (ref (6))



STONE & WEBSTER ENGINEERING CORPORATION  
CALCULATION SHEET

▲ 5010.65

CALCULATION IDENTIFICATION NUMBER				PAGE <u>6</u>
J.O. OR W.O. NO.	DIVISION & GROUP	CALCULATION NO.	OPTIONAL TASK CODE	
12846.54	power RP	RP-038-1		

II Results and Conclusions

(1). Dose rates and cumulative doses are shown in tables and figures on pages 7, 8, 9, 10, 12, 13, 14, 15.

(2) The 6 Month LOCA & doses are

- Containment centerline (center of Containment space):  $2.4 \times 10^7$  rads  
(On the operating floor :  $1.6 \times 10^7$  rads)
- Outside crane wall =  $7.4 \times 10^6$  rads
- Outside personnel hatch at existing HRRM =  $3.8 \times 10^4$  rads
- Totally submerged in the sump water \*  
(  ~~$1.2 \times 10^7$~~  rads for 120 day LOCA dose )  
 $3.6 \times 10^7$

~~$1.3 \times 10^7$  rads~~  
 $3.8 \times 10^7$  rads  
W.P. 3/6/81  
Including dose  
& build-up

(3) 40 year normal operating doses are

- Inside the crane wall (S.G. cubicles) =  $1.3 \times 10^7$  rads
- Outside the crane wall =  $3.5 \times 10^4$  rads

\* For an equipment hung in the air above the sump water surface, conservatively the estimated 6 month LOCA dose is  $\frac{1}{2} (3.8 \times 10^7) + 1.6 \times 10^7$   
 $= 3.5 \times 10^7$  rads

(dose build-up is included)

W.P. 7/2/81

S.L. 7/6/81

CALCULATION SHEET

▲ 5010.65

CALCULATION IDENTIFICATION NUMBER				PAGE <u>7</u>
J.O. OR W.O. NO. 12846.54	DIVISION & GROUP Power RP	CALCULATION NO. RP-038-1	OPTIONAL TASK CODE	

VI. Calculations

1. Dose Rate and Integrated Dose at Containment centerline

In ref. (1), dose rates and integrated doses were calculated for N.A. plant on the operating floor at containment center line.

As pointed out in Attachment A of ref. (1), a more conservative dose point will be the center of the centerline, at which the dose rate is 1.51 times that on the operating floor. This dose rate will be further adjusted by the source strength factor  $f_1$ :

$$f_1 = \frac{(\text{Surry's power level}) \times (\text{N.A. containment free volume})}{(\text{N.A. power level}) \times (\text{Surry's containment free volume})}$$

$$= \frac{(2546 \text{ MW}) \times (1.84 \times 10^6 \text{ ft}^3)}{(2900 \text{ MW}) \times (1.8 \times 10^6 \text{ ft}^3)} = 0.90$$

Therefore, the overall correction factor is  $1.51 \times 0.90 = 1.36$ .

The dose rates and cumulative doses at the center of containment space are listed in the following table

Time (hr)	Dose Rate (Rem/hr)	Cum. Dose (Rem)	Time (hr)	Dose Rate (Rem/hr)	Cum. Dose (Rem)
0	3.13+6	0.0	48	7.52+4	1.21+7
0.083	2.23+6	2.12+5	96	4.18+4	1.47+7
0.25	1.82+6	5.44+5	168	2.75+4	1.71+7
0.50	1.58+6	9.67+5	336	1.36+4	2.04+7
0.75	1.41+6	1.34+6	720	3.01+3	2.31+7
1.0	1.28+6	1.67+6	1440	2.09+2	2.38+7
2.0	9.37+5	2.76+6	2160	2.03+1	2.39+7
4.0	6.15+5	4.27+6	2880	6.23+0	2.39+7
8.0	3.66+5	6.15+6	4380	5.02+0	2.39+7
24.0	1.43+5	9.66+6	8760	4.86+0	2.39+7

⇒ 6 Month integrated dose at Center of Containment space =  $2.4 \times 10^7$  rads

1-D-8

Integrated Dose (REM) VS. Time (HRS)  
@ Center of Containment Space

TIME (HRS)

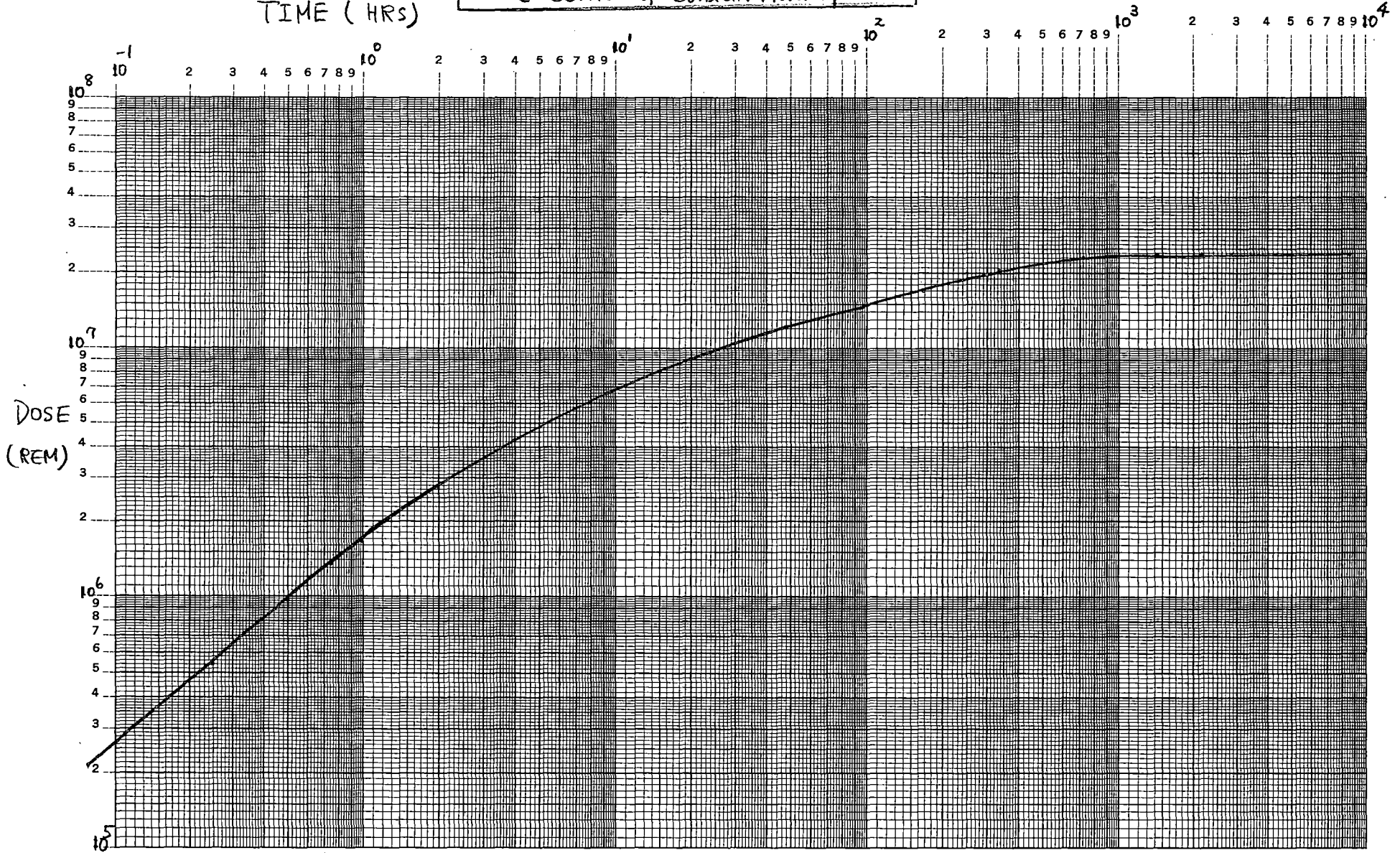

12846.54 RP-038-1

p.8

STONE & WEBSTER ENGINEERING CORPORATION  
CALCULATION SHEET

▲ 5010.65

CALCULATION IDENTIFICATION NUMBER				PAGE <u>9</u>
J.O. OR W.O. NO. 12 84 6. 54	DIVISION & GROUP Power RP	CALCULATION NO. RP-038-1	OPTIONAL TASK CODE	

2. Dose rates and dose outside the crane wall

The dose rate at  $t=0$  after LOCA outside the crane wall for North Anna plant has been calculated in ref. (1) to be  $1.08 \times 10^6$  Rem/hr (see attachment A, pg A-3, ref (1)). This value will be adjusted by the source strength factor  $f_1 = 0.90$ . Consequently, the dose rate at  $t=0$  for the Surry plant will be  $9.72 \times 10^5$  Rem/hr. The dose rate at  $t=0$  at containment centerline is  $3.13 \times 10^6$  Rem/hr. The ratio is  $9.72 \times 10^5 / 3.13 \times 10^6 = 0.3105$ . Since in both cases the major dose contributions are from unscattered  $\gamma$ 's (the attenuation of build-up in the air is insignificant), dose rates at  $t > 0$  will have the same ratio. Dose rates and integrated dose outside the crane wall are listed in the following:

Time (hr)	$\gamma$ Dose Rate (rem/hr)	Cum. $\gamma$ Dose (rem)	Time (hr)	$\gamma$ Dose Rate (rem/hr)	Cum. $\gamma$ Dose (rem)
0	$9.72 + 5$	0	48	$2.33 + 4$	$3.76 + 6$
0.083	$6.92 + 5$	$6.58 + 4$	96	$1.30 + 4$	$4.56 + 6$
0.25	$5.65 + 5$	$1.69 + 5$	168	$8.54 + 3$	$5.31 + 6$
0.50	$4.91 + 5$	$3.00 + 5$	336	$4.22 + 3$	$6.33 + 6$
0.75	$4.38 + 5$	$4.16 + 5$	720	$9.35 + 2$	$7.17 + 6$
1.0	$3.97 + 5$	$5.19 + 5$	1440	$6.49 + 1$	$7.39 + 6$
2.0	$2.91 + 5$	$8.57 + 5$	2160	$6.30 + 0$	$7.42 + 6$
4.0	$1.91 + 5$	$1.33 + 6$	2880	$1.93 + 0$	$7.42 + 6$
8.0	$1.14 + 5$	$1.91 + 6$	4380	$1.56 + 0$	$7.42 + 6$
24.0	$4.44 + 4$	$3.00 + 6$	8760	$1.51 + 0$	$7.42 + 6$

⇒ 6-month integrated dose outside the crane wall =  $7.4 \times 10^6$  rads

1-D-10

Integrated Dose (REM) vs. Time (HRS)  
Outside the Crane Wall

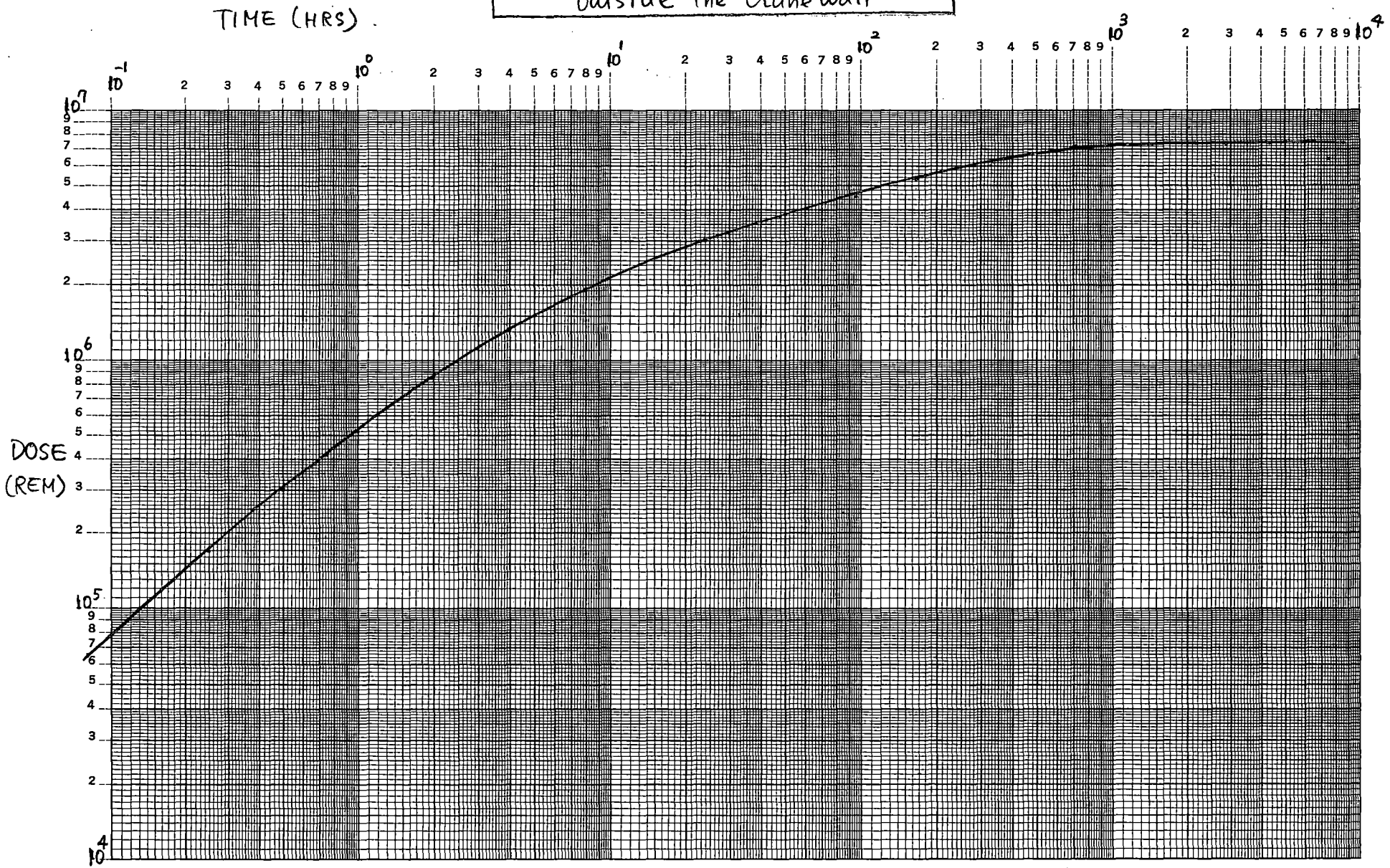

12846.54 RP-038-1

P.10

STONE & WEBSTER ENGINEERING CORPORATION  
CALCULATION SHEET

▲ 5010.65

CALCULATION IDENTIFICATION NUMBER				PAGE <u>11</u>
J.O. OR W.O. NO.	DIVISION & GROUP	CALCULATION NO.	OPTIONAL TASK CODE	
12846.54	Power RP	RP-038-1		

3. Dose Rate: and Dose Outside the personnel hatch at the existing high range radiation monitor

The dose rate at  $t=0$  for North Anna has been calculated to be  $4.76 \times 10^6$  mR/hr (p. 30 of ref. (12)). The door thickness for North Anna is  $\frac{3}{4}$ " and that of Surry is  $\frac{1}{2}$ " (ref. (15) and ref. (6)). There is a difference of  $\frac{1}{2}$ " of steel shielding because of two doors. Dose rate increase due to reduction of  $\frac{1}{2}$ " steel shield can be calculated as follows: (All parameters are from QADMOD user's manual)

Take an "average" energy of 1.3 MeV for the source photons.

$$\frac{\mu}{\rho} = 0.0521 \text{ cm}^2/\text{g} \quad ; \quad b = \mu t = 0.0521 \times 7.8 \times \frac{1}{2} \times 2.54 = 0.516$$

$$B(\mu t) = 1 + 0.8691 \cdot b + 0.02534 \cdot b^2 + 0.001239 \cdot b^3 = 1.455$$

The shielding adjustment factor is  $\frac{1}{B} e^{\mu t} = 1.15$ .

The source strength adjustment factor is  $f_1 = 0.90$ . Therefore, surry dose rate at  $t=0$  is  $4.93 \times 10^6$  mR/hr. The ratio of dose rate outside personnel hatch to that at containment centerline is  $(4.93 \times 10^6 \text{ mR/hr}) / (3.13 \times 10^9 \text{ mR/hr}) = 1.58 \times 10^{-3}$ . We use this ratio to determine dose rates outside personnel hatch for  $t > 0$ . This approach is conservative because source spectrum is softer for  $t > 0$ . The dose rates and integrated doses are listed in the following page.

STONE & WEBSTER ENGINEERING CORPORATION  
CALCULATION SHEET

▲ 5010.65

CALCULATION IDENTIFICATION NUMBER				PAGE <u>12</u>
J.O. OR W.O. NO.	DIVISION & GROUP	CALCULATION NO.	OPTIONAL TASK CODE	
12846.54	Power RP	RP-038-1		

Dose Rates & Integrated Doses Outside Personnel Hatch

<u>Time (hr)</u>	<u><math>\gamma</math> Dose Rate (mrem/hr)</u>	<u>Cum. <math>\gamma</math> Dose (mrem)</u>
0	4.95 + 6	0.0
0.083	3.52 + 6	3.35 + 5
0.25	2.88 + 6	8.60 + 5
0.50	2.50 + 6	1.53 + 6
0.75	2.23 + 6	2.12 + 6
1	2.02 + 6	2.64 + 6
2	1.48 + 6	4.36 + 6
4	9.72 + 5	6.75 + 6
8	5.78 + 5	9.72 + 6
24	2.26 + 5	1.53 + 7
48	1.19 + 5	1.91 + 7
96	6.60 + 4	2.32 + 7
168	4.35 + 4	2.70 + 7
336	2.15 + 4	3.22 + 7
720	4.76 + 3	3.65 + 7
1440	3.30 + 2	3.76 + 7
2160	3.21 + 1	3.78 + 7
2880	9.84 + 0	3.78 + 7
4380	7.93 + 0	3.78 + 7
8760	7.68 + 0	3.78 + 7

⇒ 6 Month LOCA integrated Dose outside personnel hatch is  $3.8 \times 10^4$  rads.

1-D-13

LOGARITHMIC  
3 X 5 CYCLES  
KEUFFEL & ESSER CO.

46 7520  
MADE IN U.S.A.

Integrated Dose (REM) vs. Time (hrs)  
Outside Personnel Hatch

TIME (HRS)

DOSE  
(REM)

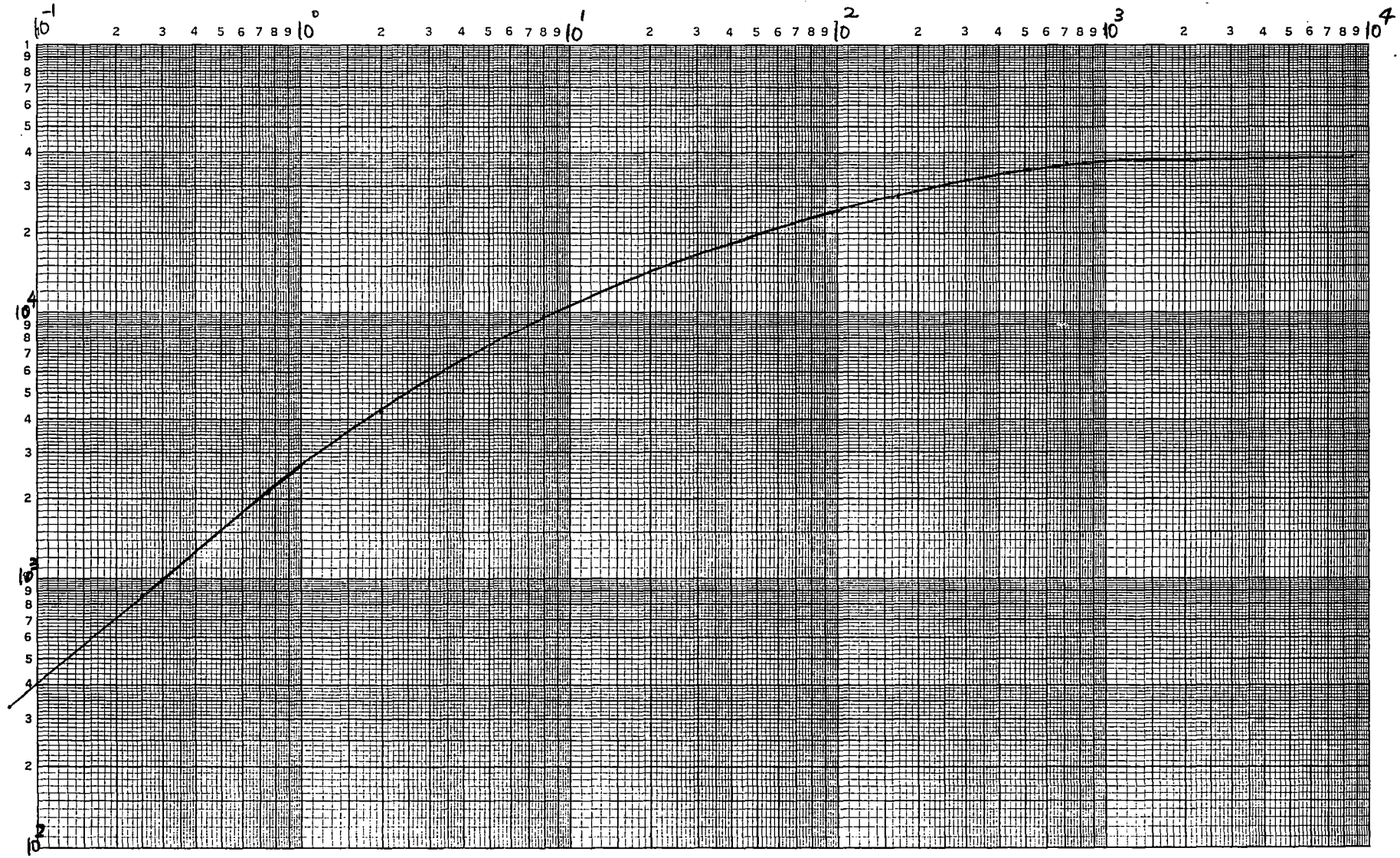

12846.54 RP-038-1



STONE & WEBSTER ENGINEERING CORPORATION  
**CALCULATION SHEET**

▲ 5010.65

CALCULATION IDENTIFICATION NUMBER				PAGE <u>14</u>
J.O. OR W.O. NO. <u>12846.54</u>	DIVISION & GROUP <u>POWER RP</u>	CALCULATION NO. <u>RP-038-1</u>	OPTIONAL TASK CODE	

4. Dose rate and integrated dose in an infinite medium of sump water.

In ref. (2), the dose rate and integrated dose in an infinite medium of sump water were given for North Anna plant. The source strength adjustment factor  $f_2$  is

$$f_2 = \frac{\text{Surry Power Level}}{\text{N.A. Power Level}} \times \frac{\text{N.A. Total Sump Water}}{\text{Surry Total Sump Water}}$$

$$= \frac{2546 \text{ MW}}{2900 \text{ MW}} \times \frac{1.5 \times 10^9 \text{ cm}^3}{1.2 \times 10^9 \text{ cm}^3} = 1.1 \quad \text{ref. (3)}$$

The dose rates and integrated doses as a function of time after LOCA are given in the following:

Time (hr)	without dose build-up		with dose build-up factors**	
	$\gamma$ Dose Rate* (rem/hr)	Cum. $\gamma$ Dose* (rem)	$\gamma$ Dose rate (rem/hr)	Cum. $\gamma$ Dose (rem)
0	6.41 + 5	0	1.55 + 6	0
1	3.70 + 5	5.05 + 5	9.26 + 5	1.24 + 6
2	2.56 + 5	8.18 + 5	6.49 + 5	2.03 + 6
8	1.03 + 5	1.89 + 6	2.70 + 5	4.78 + 6
24	4.06 + 4	3.04 + 6	1.17 + 5	7.88 + 6
96	1.34 + 4	4.98 + 6	4.24 + 4	1.36 + 7
192	9.08 + 3	6.06 + 6	2.85 + 4	1.70 + 7
360	5.85 + 3	7.32 + 6	1.80 + 4	2.09 + 7
720	2.88 + 3	8.89 + 6	8.61 + 3	2.57 + 7
2160	9.59 + 2	1.17 + 7	2.83 + 3	3.39 + 7
2880	7.79 + 2	1.23 + 7	2.30 + 3	3.58 + 7
4320	4.17 + 2	1.32 + 7	1.23 + 3	3.83 + 7

⇒ The 6 month integrated dose for an equipment totally submerged in the sump water is  $3.8 \times 10^7$  rads  
 ( $1.3 \times 10^7$  rads without including dose build-up)

\* Those numbers are dose rates without taking into account the build up factors  
 \*\* Taken from revision 1 of ref (2) with build-up considered. 3/6/81

1-D-15

Integrated Dose (REM) vs. Time (HRS)  
In Infinite Medium of Sump Water

TIME (HRS)

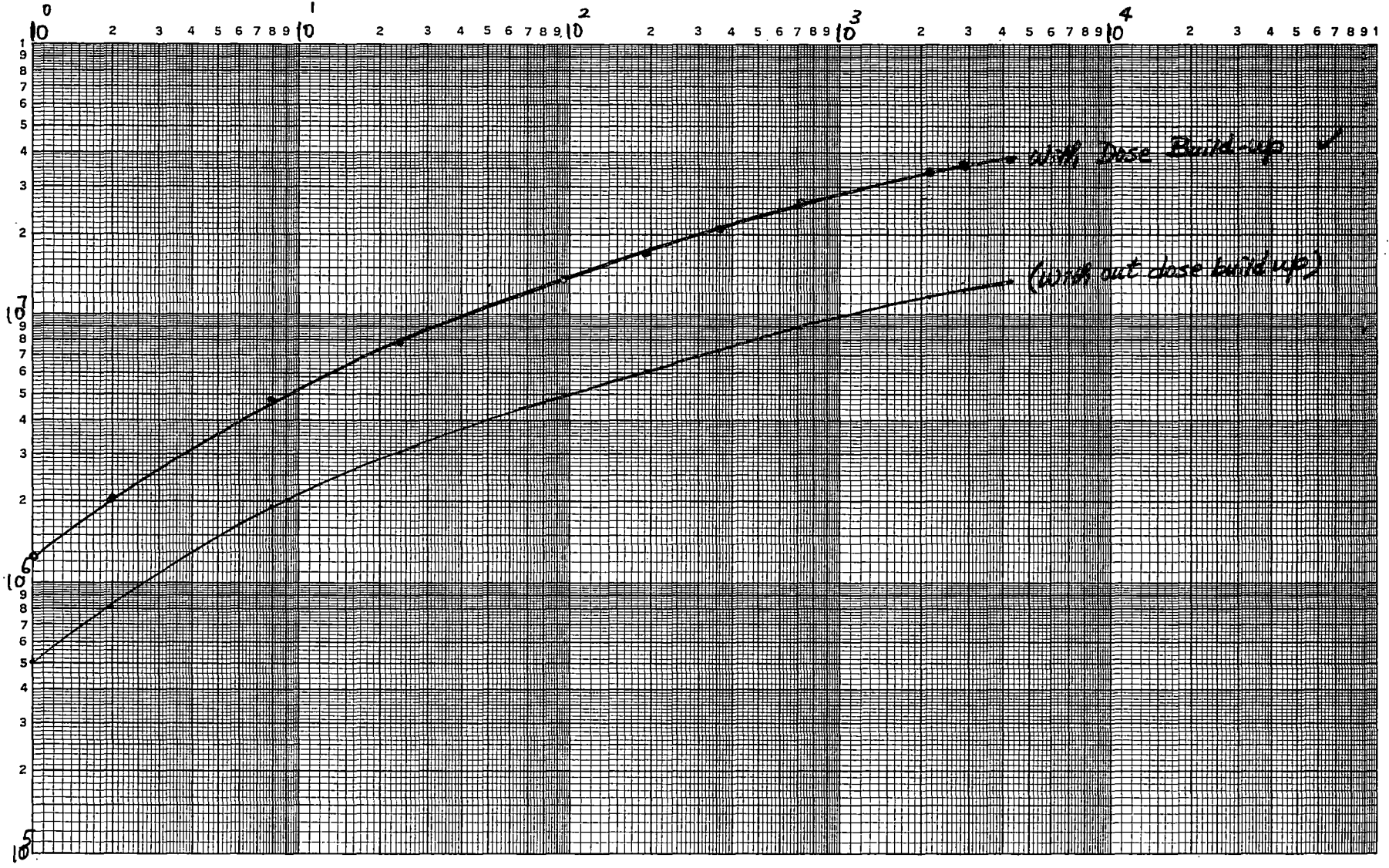

12846.54 RP-038-1

P. 15

# CALCULATION SHEET

▲ 5010.65

CALCULATION IDENTIFICATION NUMBER				PAGE <u>16</u>
J.O. OR W.O. NO.	DIVISION & GROUP	CALCULATION NO.	OPTIONAL TASK CODE	
12846.54	Power RP	RP-038-1		

5. 40 year normal operating dose

(1). Inside the crane wall

According to ref. (7), "Shielding design summary for Surry power station, VEPCO", the maximum dose rate inside the containment during normal operation is 37 rads/hr, which occurs inside the steam generator cubicles.

The maximum 40 year dose is

$$37 \frac{\text{rads}}{\text{hr}} \times 24 \times 365 \times 40 \text{ hrs} = 1.3 \times 10^7 \text{ rads}$$

(2). Outside the crane wall

The design basis maximum dose rate outside the crane wall is 100 mR/hr and the 40 year dose will be

$$0.1 \text{ rads/hr} \times 24 \times 365 \times 40 \text{ hrs} = 3.5 \times 10^4 \text{ rads}.$$

USER'S GUIDE TO E2D REFERENCES

Facility: VEPCO, SURRY  
 Units: 1 and 2  
 Dockets: 50-280 and 50-281

E2D REFERENCE NO. 4  
 E2D REFERENCE DESCRIPTION: 12846.44-PE-050-0  
 ENVIRONMENTAL ZONE(S): AB-2B, AB-13A, AB-27

<u>PARAMETER</u>	<u>NORMAL ENVIRONMENT</u>	<u>PAGE</u>	<u>LOCA ENVIRONMENT</u>	<u>PAGE</u>	<u>MSLB ENVIRONMENT</u>	<u>PAGE</u>	<u>HELB ENVIRONMENT</u>	<u>PAGE</u>
TEMPERATURE (°F)							120-205, 0-30 sec 205, 30-40 secs 205-190, 40-1000 secs 190-145, 1000-2000 secs 145-120, 2000 secs-1 hr	24
PRESSURE (psia)							15.2, 0-1 min 14.9, 1-60 min	24
RELATIVE HUMIDITY (%)							100	24
CHEMICAL SPRAY								

USER'S GUIDE TO EZD REFERENCES

Facility: VEPCO, SURRY  
 Units: 1 and 2  
 Dockets: 50-280 and 50-281

EZD REFERENCE NO. 4  
 EZD REFERENCE DESCRIPTION: 12846.44-PE-050-0  
 ENVIRONMENTAL ZONE (S): AB-2C

<u>PARAMETER</u>	<u>NORMAL ENVIRONMENT</u>	<u>PAGE</u>	<u>LOCA ENVIRONMENT</u>	<u>PAGE</u>	<u>MSLB ENVIRONMENT</u>	<u>PAGE</u>	<u>HELB ENVIRONMENT</u>	<u>PAGE</u>
TEMPERATURE (°F)							120-140, 0-30 sec 140, 30-1000 secs 140-125, 1000-2000 secs 125-120, 2000 secs-1 hr	24
PRESSURE (psia)							15.2, 0-1 min 14.9, 1-60 min	24
RELATIVE HUMIDITY (%)							100	24
CHEMICAL SPRAY								

USER'S GUIDE TO E2D REFERENCES

Facility: VEPCO, SURRY  
 Units: 1 and 2  
 Dockets: 50-280 and 50-281

E2D REFERENCE NO. 4  
 E2D REFERENCE DESCRIPTION: 12846.44-PE-050-0  
 ENVIRONMENTAL ZONE(S): AB-45

<u>PARAMETER</u>	<u>NORMAL ENVIRONMENT</u>	<u>PAGE</u>	<u>LOCA ENVIRONMENT</u>	<u>PAGE</u>	<u>MSLB ENVIRONMENT</u>	<u>PAGE</u>	<u>H&amp;LB ENVIRONMENT</u>	<u>PAGE</u>
TEMPERATURE (°F)							120-125, 0-300 secs 125-122, 300-2000 secs 122-120, 2000 secs-1 hr	24
PRESSURE (psia)							15.2, 0-1 min 14.9, 1-60 min	24
RELATIVE HUMIDITY (%)							100	24
CHEMICAL SPRAY								

STONE & WEBSTER ENGINEERING CORPORATION

CALCULATION TITLE PAGE

\*SEE INSTRUCTIONS ON REVERSE SIDE

▲ 5010.64 (FRONT)

CLIENT & PROJECT VEPCD, SURRY UNIT 1 & 2 AUX. BLDG. ENVIRONMENTAL QUALIFICATION				PAGE 1 OF 94	
CALCULATION TITLE (Indicative of the Objective): AUX. BUILDING HELB TEMPERATURE ANALYSIS WITH PROPOSED MODIFICATIONS				QA CATEGORY (✓) <input checked="" type="checkbox"/> I - NUCLEAR SAFETY RELATED <input type="checkbox"/> II <input type="checkbox"/> III <input type="checkbox"/> _____ OTHER	
CALCULATION IDENTIFICATION NUMBER					
J. O. OR W.O. NO.	DIVISION & GROUP	CURRENT CALC. NO.	OPTIONAL TASK CODE	OPTIONAL WORK PACKAGE NO.	
12844.44	NTD-ESSAG	PE-050	00004		
* APPROVALS - SIGNATURE & DATE			REV. NO. OR NEW CALC NO.	SUPERSEDES * CALC. NO. OR REV. NO.	CONFIRMATION * REQUIRED (✓) YES NO
PREPARER(S)/DATE(S)	REVIEWER(S)/DATE(S)	INDEPENDENT REVIEWER(S)/DATE(S)			
W. Donahue 12/1/80	J. Roman 1/13/81 NOTED FEB 2 1981 R.F.MILLER/RFM	J. Roman 1/13/81	0		✓ (See p. 2)
DISTRIBUTION *					
GROUP	NAME & LOCATION	COPY SENT (✓)	GROUP	NAME & LOCATION	COPY SENT (✓)
RECORDS MGT. FILES (OR FIRE FILE IF NONE)	M. Cliffe 245/14	2			
Project	HWDarlin 245/14 CHWilbur 245/14 WESchulz 245/14 WT Knapp 245/14 MEO'Meara 245/14	Results only by 2/4/81 IOM			

STONE & WEBSTER ENGINEERING CORPORATION  
CALCULATION SHEET

▲ 5010.65

CALCULATION IDENTIFICATION NUMBER			
J.O. OR W.O. NO. 12846.44.	DIVISION & GROUP	CALCULATION NO. PE-050-	OPTIONAL TASK CODE
			PAGE <u>2</u>

TABLE OF CONTENTS

	PAGE
TITLE PAGE	1
TABLE OF CONTENTS	2
OBJECTIVE	3
METHOD AND ASSUMPTIONS	2, 4
CALCULATION	4 - 19
CONCLUSION	19
SUMMARY	19-91
REFERENCES	92
ATTACHMENT 1, IOR. TO A. BOGHOSIAN FROM M. DONAHUE, DATED 11/24/80	1 PAGE

NOTES: CONFIRMATION OF THE CONTINUED OPERABILITY OF THE CENTRAL EXHAUST SYSTEM UNDER THE INCREASED ATMOSPHERIC DENSITY RESULTING FROM THE HIGH ENERGY LINE FAILURES ANALYZED IS REQUIRED.  
Verification of the information provided in Attach 1 is required.



STONE & WEBSTER ENGINEERING CORPORATION  
CALCULATION SHEET

▲ 5010.65

CALCULATION IDENTIFICATION NUMBER			
J.O. OR W.O. NO.	DIVISION & GROUP	CALCULATION NO.	OPTIONAL TASK CODE
12846.4A		PE-050	

PAGE 3

1  
2  
3  
4  
5  
6  
7  
8  
9  
10  
11  
12  
13  
14  
15  
16  
17  
18  
19  
20  
21  
22  
23  
24  
25  
26  
27  
28

OBJECTIVE: TO EVALUATE THE TEMPERATURE EFFECTS OF HIGH ENERGY LINE BREAKS IN THE CURRY UNIT 1 AND 2 AUXILIARY BUILDINGS AS A RESULT OF THE INSTALLATION OF PROPOSED MODIFICATIONS, BASED ON THE RESULTS OF THE REF. 2 CALCULATION PERFORMED IN RESPONSE TO THE I.E. JULLITEN 79-010 FOR THIS STRUCTURE.

METHOD: UTILIZING THE DATA OBTAINED IN THE REF. 2 CALCULATION WITH REGARDS TO TEMPERATURE PROFILE, MODIFICATIONS ARE POSTULATED AND ANALYZED FOR EFFECTIVENESS IN REDUCING THE SEVERITY OF THE TRANSIENTS WHICH RESULTED IN THAT CALCULATION. ADDITIONALLY THE MODEL DEVELOPED IN THE REF. 1 CALCULATION FOR THIS STRUCTURE IS REVISED TO INCLUDE THE USE OF ADDITIONAL PASSIVE HEAT SINKS AND AN ACTIVE EXHAUST VENTILATION SYSTEM FOR PURPOSES OF PROVIDING A REFINED EVALUATION OF THE POTENTIAL TEMPERATURE EFFECTS OF HIGH ENERGY LINE BREAKS WITH RESPECT TO THE AREAS OF THE AUXILIARY BUILDINGS WHICH CONTAIN IDENTIFIED CLASS 1E ELECTRICAL COMPONENTS. INPUT DATA OF THE NODAL MODEL AND MASS-ENERGY RELEASE RATES FROM EACH IDENTIFIED FAILURE ARE USED IN THE S.P.W. ENR. CORP. NU-92 THREE SUBCOMPARTMENT ANALYSIS COMPUTER PROGRAM, VERSION 12, LEVEL 1 TO EVALUATE THE RESULTANT AVERAGE TEMPERATURE PROFILE FOR EACH NODE. AN 'ENVELOPE' CURVE FROM THIS DATA IS DEVELOPED THAT DESCRIBES THE DURATION AND PEAK VALUES OF TEMPERATURE FOR EACH AREA OF CONCERN AS CONSERVATIVE WORSE CASE ENVIRONMENTALS RESULTING FROM ALL ANALYZED FAILURES. PIPE BREAK SIZE AND LOCATION ARE SELECTED ON THE BASIS OF THE INFORMATION CONTAINED IN REF 10, SECT. P.12.2-1 AND PROXIMITY TO THE AREAS OF CONCERN. THE METHODS OF DEVELOPING NODAL AND JUNCTION DATA CARDS ARE SIMILAR TO THOSE UTILIZED IN THE REF. 1 CALCULATION AND IN THE GUIDELINES OF REF. 14

29  
30  
31  
32  
33  
34  
35  
36  
37  
38  
39  
40  
41  
42  
43  
44  
45  
46

ASSUMPTIONS: THE FOLLOWING GENERAL ASSUMPTIONS ARE MADE FOR THIS ANALYSIS

- 1) CIRCUMFERENTIAL PIPE BREAK OF THE STEAMGENERATOR BLOWDOWN LINE WILL AUTOMATICALLY ISOLATE SUCH THAT THE RELEASE OF ENERGY TO THE NODE IS EFFECTIVELY 0.0 AT 30 SECS AFTER THE FAILURE OCCURS. THIS ASSUMES THAT HARDWARE MODIFICATIONS ARE MADE TO PROVIDE ADEQUATE DUAL PROTECTION CAPABILITIES SUCH THAT A SINGLE ACTIVE FAILURE WILL NOT PRECLUDE AUTOMATIC ISOLATION OF THIS LINE UPON ACTUATION OF HIGH FLOW SIGNAL.
- 2) PROVISIONS ARE ESTABLISHED TO ENSURE THAT THE LOUVERED OPENINGS IN THE SIDE WALLS OF THE VENTILATION EQUIPMENT ROOM, ELEV 45'12" ARE AT ALL TIMES OPEN AND FREE OF OBSTRUCTIONS.
- 3) IT IS ASSUMED THAT THE CENTRAL EXHAUST SYSTEM (1-EH-14) IS IN OPERATION AT THE TIME OF THE FAILURES OCCURENCE AND WILL REMAIN IN OPERATION THROUGHOUT THE DURATION OF THE ACCIDENT. PASSIVE HEAT SINKS WERE ALSO UTILIZED IN THIS CALCULATION

STONE & WEBSTER ENGINEERING CORPORATION  
 CALCULATION SHEET

▲5010.65

CALCULATION IDENTIFICATION NUMBER				PAGE <u>4</u>
J.O. OR W.O. NO. 10846.44	DIVISION & GROUP	CALCULATION NO. PE-050	OPTIONAL TASK CODE	

4) THE PIPE WALL PENETRATIONS BETWEEN CHARGING PUMP CUBICLE 1CH-P-1A AND THE UNIT 1 PIPE TUNNEL AND THE CORRESPONDING PENETRATIONS FOR THE UNIT 2 PIPE TUNNEL AND CHARGING PUMP CUBICLE FOR EVALUATION PURPOSES ARE ASSUMED TO BE CAPABLE OF BEING EFFECTIVELY SEALED IN A MANNER THAT WOULD ELIMINATE AIR FLOW BETWEEN THE ADJACENT AREAS AND WOULD WITHSTAND ANY CONCEIVABLE PRESSURE DIFFERENTIAL THAT MAY DEVELOPE AS A RESULT THROUGHOUT THE COURSE OF A FAILURE ANALYSIS.

5) AMBIENT AIR TEMPERATURE MONITORS ARE INSTALLED IN STRATEGIC LOCATIONS THROUGHOUT THE AUXILIARY BUILDING WITH REMOTE ALARM AND MONITORING CAPABILITIES IN THE MAIN CONTROL ROOM ALONG WITH IMPLEMENTATION OF EMERGENCY PROCEDURES THAT WOULD RESULT IN THE IMMEDIATE ISOLATION OF ALL NON-ESSENTIAL HIGH ENERGY LINES UPON INDICATION OF A RISE IN AMBIENT AIR TEMPERATURE GREATER THAN 1200F TO PROVIDE THE BASIS FOR AN ASSUMPTION THAT A FAILURE TERMINATED BY OPERATOR ACTION COULD BE ACCOMPLISHED WITHIN 900 SECS OF THE FAILURE'S OCCURENCE.

6) ADDITIONAL ASSUMPTIONS ARE NOTED AS APPROPRIATE THROUGHOUT THE CALCULATION.

CALCULATION: THE RESULTS OF THE REF. 2 CALCULATION LED TO THE DETERMINATION THAT THE COMPONENTS MOST SENSITIVE TO THE TEMPERATURE PROFILES OBTAINED WERE THOSE LOCATED IN THE 210" ELEVATION OF THE CHARGING PUMP CUBICLES. (NODES 2 AND 3 OF REF 1). IT IS POSTULATED THAT MODIFICATIONS WHICH WOULD REDUCE THE DURATION OF THE FAILURES ANALYZED THAT REQUIRE OPERATOR ACTION FOR TERMINATION MAY RESULT IN SIGNIFICANTLY LESS SEVERE TEMPERATURES THAN THOSE OBTAINED IN THE REF 2 CALCULATION. FURTHERMORE, IT IS POSTULATED THAT ELIMINATING THE DIRECT FLOWPATH FROM THE CH-P-1A CHARGING PUMP CUBICLE AND ITS RESPECTIVE PIPE TUNNEL (FOR UNIT 1 OR UNIT 2) AS REPRESENTED BY JUNCTION #3 OF REFERENCE 1 BY SEALING OFF THIS PIPE WALL PENETRATION MAY PROVIDE SOME ADDITIONAL TEMPERATURE PROTECTION FROM HIGH ENERGY LINE FAILURES. A COMPARITIVE CALCULATION IS MADE TO EVALUATE THE EFFECTIVENESS, IF ANY, OF THIS MODIFICATION

TO ACCOMPLISH REDUCTION OF THE BLOWDOWN DURATION, THE MODIFICATION PROPOSED IN ASSUMPTION 5 GIVEN ON THIS PAGE IS UTILIZED. THE USE OF 900SECS FOR TERMINATING THE FAILURE IS ARBITRARY IN NATURE, HOWEVER IT IS CONSIDERED TO BE CONSERVATIVE. TO PROVIDE A MORE REFINED EVALUATION OF THE FAILURES ANALYZED CERTAIN CHANGES TO THE MODEL DEVELOPED IN THE REF 1 CALCULATION IS MADE IN ADDITION TO THOSE BROUGHT ABOUT BY THE PROPOSED MODIFICATION, THESE CHANGES LISTED BELOW. AS A RESULT, THE POTENTIALLY INITIAL FAILURES FOR THIS REVISED MODEL ARE SLIGHTLY DIFFERENT THAN THOSE ANALYZED IN THE REF. 2 CALCULATION, THESE IDENTIFIED IN THE SUMMARY SECTION, PAGES 20-22 OF THIS CALCULATION. TO PROVIDE SOME INDICATION OF THE BENEFIT OBTAINED FROM SEALING THE WALL PIPE PENETRATIONS TO THE CHARGING PUMP CUBICLE, AS PREVIOUSLY NOTED, A COMPARITIVE ANALYSIS OF THE CIRCUMFERENTIAL STEAM GENERATOR BLOWDOWN LINE BREAK IN NODE 4 IS MADE KEEPING ALL FACTORS EQUAL IN BOTH EXCEPT IN ONE, THIS PENETRATION IS SEALED.

STONE & WEBSTER ENGINEERING CORPORATION  
 CALCULATION SHEET

▲ 5010.85

CALCULATION IDENTIFICATION NUMBER				PAGE <u>5</u>
J.O. OR W.O. NO. 12046.44	DIVISION & GROUP	CALCULATION NO. <u>28.050</u>	OPTIONAL TASK CODE	

IN GENERAL, THE FOLLOWING CHANGES TO THE MODEL DEVELOPED IN REF 1, SHOWN BY THE DIAGRAM ON PAGE 8 OF THAT CALCULATION, ARE MADE FOR THE REASONS LISTED.

1. NODE 30 AND THE ASSOCIATED JUNCTION # 46 IS DELETED. THIS NODE IS "DEAD ENDED", OF RELATIVELY SMALL VOLUME AND CONTAINS NO ELECTRICAL COMPONENTS OF CONCERN, CONSEQUENTLY IS OF INSIGNIFICANT CONTRIBUTION TO THE CALCULATION.
2. NODES 26, 27, 28 AND 29 ARE COMBINED INTO THE SINGLE NODE # 26 TO ELIMINATE THE COMPUTATIONAL INSTABILITIES THAT RESULTED FROM THE ARTIFICIALLY HIGH FLOW RESISTANCES BETWEEN THESE NODES EVIDENCED IN THE REF. 2 CALCULATIONS UTILIZING THE ORIGINAL DATA.
3. AN "ATMOSPHERIC" NODE WITH TWO ASSOCIATED JUNCTIONS FROM NODE 26 OF THIS MODEL IS ADDED TO INCLUDE THE EFFECTS OF THE LOUVERED INTAKES ON THE 45'10" ELEVATION AS DESCRIBED ON PAGES 6-9 OF REF 2.
4. THE REMAINING CHARGING PUMP CURICLES 1-CH-P-1A, 2CH-P-1A, 1B AND 1C ARE ADDED TO THE MODEL TO EVALUATE THE INDIVIDUAL TEMPERATURE PROFILES THAT EACH CURICLE OBTAINS.
5. JUNCTION #3, THE OPENING BETWEEN NODES 5 AND 3 IS REMOVED FROM THE MODEL TO EVALUATE THE EFFECTS ON THE TEMPERATURE PROFILE OF THE CHARGING PUMP CURICLE OBTAINED BY SEALING OFF THIS WALL PENETRATION.
6. 7 ADDITIONAL HEAT SINIKS ARE INCLUDED ON THE 2'0" AND 13'0" ELEVATIONS TO THE MODEL TO PROVIDE INCREASED HEAT REMOVAL CAPACITY FROM THE MODEL.
7. A SIMULATED MODEL OF THE CENTRAL EXHAUST SYSTEM IS, IN PART, INCLUDED TO APPROXIMATE THE EFFECTS OF THIS SYSTEM ON THE TEMPERATURE PROFILE OF THE CHARGING PUMP CURICLES.

A CROSS-REFERENCE GUIDE TO LOCATING THE SOURCE OF DATA FOR THE MODEL USED IN THIS CALCULATION IS PROVIDED ON PAGES 15A-15B WITH A FLOW DIAGRAM BY DESIGNATION NUMBER PROVIDED ON PAGE 14 OF THIS CALCULATION. DATA UTILIZED IN THIS CALCULATION WHICH IS RETAINED UNCHANGED FROM THE DATA GIVEN ON PAGES 153 TO 156 OF REF 1 IS NOT REPEATED HERE, AND IS SO INDICATED ON THE CROSS-REFERENCE SUMMARY BELOW. IS GIVEN THE NODAL AND JUNCTION <sup>DATA</sup> OBTAINED FOR THE MODEL USED IN THIS CALCULATION WHICH ARE DIFFERENT FROM THAT GIVEN BY THE MODEL DEVELOPED IN REF 1

NODAL DATA CARDS

NODE 26 : NET VOLUME WILL EQUAL SUM OF VOLUMES OF NODE 26, 27, 28 AND 29 AS GIVEN ON PAGE 153 OF REF 1

$$35998.5 \text{ ft}^3 + 25881.7 \text{ ft}^3 + 68204.7 \text{ ft}^3 + 19206.2 \text{ ft}^3 = 149291.1 \text{ ft}^3$$

AT ELEVATION 45.83 ft WITH A HEIGHT OF 18.5 ft

NODE 30 : ATMOSPHERIC NODE WITH AN ASSUMED VOLUME OF  $1.0 \times 10^{20} \text{ ft}^3$  AN ELEVATION OF 27.5' WITH A HEIGHT OF 50.0' IS ARBITRARILY USED

NODE 39 : THIS NODE IS USED TO SIMULATE THE EFFECTS OF COMBINING ALL VENTILATION INTAKES INTO A COMMON VOLUME WHICH IS SUBSEQUENTLY EVACUATED BY A SINGLE EXHAUST FAN. THE VOLUME IS ARBITRARILY SET

STONE & WEBSTER ENGINEERING CORPORATION  
CALCULATION SHEET

A 5010.65

CALCULATION IDENTIFICATION NUMBER				PAGE <u>6</u>
J.O. OR W.O. NO. 12846.44	DIVISION & GROUP	CALCULATION NO. PE-050	OPTIONAL TASK CODE	

TO EQUAL 2,000 FT<sup>3</sup> AS ADEQUATELY LARGE ENOUGH TO HANDLE THE EXPECTED MASS FLOW INTO THE NODE YET NOT SO LARGE AS TO BE RELATIVELY INSENSITIVE TO THE OPERATION OF THE FAN. ELEV. 2.0' AND HEIGHT OF 70' IS USED. NODE 10 - THIS NODE PROVIDES THE VOLUME TO WHICH THE FAN EXHAUST IS DIRECTED, THE 'ATMOSPHERE' WITH AN ASSUMED VOLUME OF  $1.0 \times 10^{20}$  FT<sup>3</sup>. THE PRESSURE OF 15.0 PSIA IS UTILIZED HERE TO ENSURE THAT ANY EXPECTED PRESSURE THAT MAY DEVELOPE IN NODE 39, THE VOLUME FROM WHICH THE FAN TAKES SUCTION, WILL NOT EXCEED THE PRESSURE OF THIS NODE WHERE THE FAN EXHAUSTS, A CONDITION WHICH WOULD ABORT THE COMPUTER ANALYSIS.

FOR PURPOSES OF CLARIFICATION, THE NOODAL DATA CARDS ADDED FOR THE INCLUSION OF ALL CHARGING PUMPS ORIGINATES FROM THE CALCULATION OF THE VOLUMES ASSOCIATED WITH 1-CH-P-1C AND 1-CH-P-1B, PERFORMED IN REFERENCE 1 CALCULATION AS FOLLOWS. (REFER TO ATTACH. 1 AND 2 OF REF 1 CALCULATION)

1-CH-P-1C AT 2.0" ELEV IS NODE 3 IN THE REF 1 CALCULATION

1-CH-P-1C AT 13.0" ELEV IS NODE 15 IN THE REF 1 CALCULATION

IT IS ASSUMED THAT THE VOLUMES AND DIMENSIONS OF THE ADDED CUBICLE 2-CH-P-1C IS THE SAME AS THOSE DEVELOPED FOR 1-CH-P-1C SUCH THAT NODE 34 IS THE SAME AS NODE 2 AND NODE 37 IS THE SAME AS NODE 15. SIMILARLY FOR THE REMAINING CUBICLES, IT IS ASSUMED THAT FOR THE NODES AT THE 2.0" ELEVATION FOR EACH CUBICLE IS THE SAME AS NODE 2 OF THE REFERENCE 1 CALCULATION, WHICH IS THE 2.0" ELEVATION OF CUBICLE 1-CH-P-1B AND THE 13.0" ELEVATION OF EACH CUBICLE IS THE SAME AS NODE 14 OF THE REFERENCE 1 CALCULATION, WHICH IS THE 13.0" ELEVATION OF CUBICLE 1-CH-P-1B, THUS, THE ADDED CUBICLE 1-CH-P-1A, 2-CH-P-1B AND 2-CH-P-1A AT THE 2.0" ELEVATION WHICH ARE NODES 31, 33 AND 35 RESPECTIVELY ARE THE SAME AS NODE 2 OF REF 1 GIVEN ON PAGE 153 AND THE 13.0" ELEVATION OF THOSE CUBICLES, NODES 32, 34 AND 38 RESPECTIVELY ARE THE SAME AS NODE 14 OF THAT CALCULATION, DATA GIVEN ON THE SAME PAGE. IT IS ASSUMED THAT ANY DIFFERENCE BETWEEN THE VOLUMES OF THESE NODES OBTAINED IN THIS MANNER AND THE ACTUAL VOLUME IS INSIGNIFICANT.

JUNCTION DATA CARDS: THE FOLLOWING IS THE CALCULATION OF DATA FOR THE JUNCTIONS WHICH ARE, WITH THE EXCEPTION OF THE DESIGNATION NUMBER, NOT IDENTICAL TO THAT GIVEN ON PAGES 154 AND 155 OF REF. 1.

THE SYMBOLS USED TO IDENTIFY THE PARAMETERS ANALYZED, FOR CLARIFICATION PURPOSES, ARE AS FOLLOWS.

$K$  IS THE FORWARD LOSS COEFFICIENT, NET. (FORWARD FLOW DIRECTION IS DEFINED IN THE JUNCTION DESCRIPTION BY THE STATEMENT "NODE (a) TO NODE (b)" WHICH IMPLIES FORWARD FLOW FROM NODE (a) TO NODE (b) THROUGH THE JUNCTION.  $K$  IS THE SAME COEFFICIENT IN THE REVERSE DIRECTION.

$I$  IS THE INERTIA

$K_m$  IS THE MOMENTUM FLUX TERM IN THE FORWARD DIRECTION,  $\bar{K}_m$  IS THE SAME TERM IN THE REVERSE DIRECTION.

$F$  IS THE CROSS-SECTIONAL FLOW AREA, SUBSCRIPT (j) REFERS TO THE JUNCTION FLOW AREA, NUMERICAL SUBSCRIPT IS THE FLOW AREA OF THE NODE OF THAT NUMBER.

STONE & WEBSTER ENGINEERING CORPORATION  
CALCULATION SHEET

▲ 5010.65

CALCULATION IDENTIFICATION NUMBER				PAGE <u>7</u>
J.O. OR W.O. NO. 12B46.44.	DIVISION & GROUP	CALCULATION NO. PE-650	OPTIONAL TASK CODE	

L IS THE FLOW LENGTH, BASED ON THE DISTANCE FROM THE CENTROID OF THE NODE TO THE JUNCTION WHEN USED IN ASSOCIATION WITH A NODE AND THE LENGTH OF THE RESTRICTION WHEN USED IN ASSOCIATION WITH A JUNCTION, SUBSCRIPTS UTILIZED IN THE SAME MANNER AS EMPLOYED IN IDENTIFYING F TO DENOTE WHICH NODE IS DISCUSSED OR IF THE VALUE RELATES TO THE JUNCTION IN QUESTION.

THE REMAINING SYMBOLS USED WILL BE THE SAME AS THE SYMBOLS EMPLOYED IN THE RESPECTIVE SOURCE FROM WHICH THE RELATIONSHIP OR FORMULA IS OBTAINED, THAT SOURCE REFERENCED AS APPROPRIATE.

JUNCTION #36, NODE 23 to NODE 26

NOTE THE JUNCTIONS CONNECTING NODES WHICH WERE UNCHANGED FROM THE REF. 1 CALCULATION TO THE REVISED NODE 26 OF THIS CALCULATION ARE RE-ANALYZED TO EVALUATE THE EFFECTS ON THE VALUES OF LOSS COEFFICIENTS AND INERTIA WHICH MAY OCCUR FROM THIS CHANGE. THE PHYSICAL QUANTITIES OF JUNCTION AREA, ELEVATION ETC ARE LEFT THE SAME AS THAT GIVEN BY THE REF. 1 CALCULATION.

1) AS SHOWN BY THE COMPARATIVE CALCULATION PERFORMED FOR JUNCTION #38 GIVEN BELOW, THE VALUES OF  $K_1, K_2$  ARE NOT SIGNIFICANTLY AFFECTED AS A RESULT OF REVISING THE SIZE OF NODE 26, THEREFORE IT IS ASSUMED THAT RETAINING THESE VALUES UNCHANGED WILL HAVE NEGLIGIBLE EFFECT ON RESULTS.

∴ FROM REF. 1, p. 42, JUNCTION #37

$$F_j = 60.0 \text{ ft}^2$$

$$K = 2.553$$

$$K = 2.6071 \text{ AT ELEV. 44.25' (p. 154 OF REF. 1)}$$

NODE 26 IS DIMENSIONED IN THE FOLLOWING MANNER

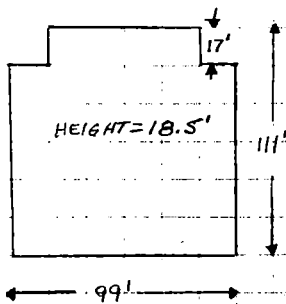

THE OVERALL DIMENSIONS ARE TAKEN FROM THOSE CALCULATED FOR NODES 26 THRU 29 OF REF. 1 ON PAGES 86, 88 AND 90 OF THAT CALCULATION, HERE COMBINED TO PROVIDE THE TOTAL LENGTH AND WIDTH. FLOW THROUGH THIS JUNCTION IS CONSIDERED TO BE VERTICAL RELATIVE TO THE DIMENSIONS GIVEN AT THE LEFT, THUS, THE FLOW LENGTH,  $L_{26}$  IS APPROXIMATELY  $\frac{1}{2}$  THE HEIGHT OF THE NODE, AND THE FLOW AREA,  $F_{26}$  WILL BE TAKEN AS THE PRODUCT OF THE OVERALL LENGTH 111 FT AND GREATEST WIDTH, 99 FT. WHILE THIS IS NOT STRICTLY CORRECT, THE VALUE OBTAINED IN THIS MANNER WILL NOT SIGNIFICANTLY DEVIATE FROM ACTUAL VALUES AND ITS EFFECTS ON RESULTS ARE NEGLIGIBLE.

THE CONTRIBUTION OF NODE 26 TO THE TOTAL INERTIA TERM IS CALCULATED AND SUMMED WITH THE VALUES OBTAINED FOR THE JUNCTION AND NODE 23 INERTIA TERMS, WHICH ARE UNCHANGED, FOUND ON PAGES 78 AND 79 OF REF. 1, FOR JUNCT. #37

AND

$$L_{N26} = \frac{1}{2}(18.5') = 9.25 \text{ ft}$$

$$F_{26} = (111')(99') = 10989 \text{ ft}^2$$

$$I = \frac{9.25 \text{ ft}}{10989 \text{ ft}^2} + .03571 \text{ ft}^{-1} + .00301 \text{ ft}^{-1} = 0.0396 \text{ ft}^{-1} = .040 \text{ ft}^{-1}$$

STONE & WEBSTER ENGINEERING CORPORATION  
CALCULATION SHEET

▲ 5010.65

CALCULATION IDENTIFICATION NUMBER				PAGE <u>8</u>
J.O. OR W.O. NO. 12B 461 44.	DIVISION & GROUP	CALCULATION NO. <u>VE-050</u>	OPTIONAL TASK CODE	

JUNCTION #38 NODE 24 TO NODE 26 (STAIRWELL)

THE DATA FOR THIS JUNCTION IS OBTAINED AS FOLLOWS

- 1)  $L_{24} = 1/2 (17')$ ; THE LENGTH AND WIDTH OF NODE 24  $\approx 34' \times 79'$ ; PAGE 31 OF REF 1
- 2)  $L_{26} = 9.25'$ ;  $F_{26} = 10989 \text{ ft}^2$ ; FROM JUNCTION #36 OF THIS CALCULATION
- 3)  $L_j = 1.5'$ ;  $F_j = 63 \text{ ft}^2$ ;  $D_H = 6'$ ;  $L_j/D_H = 0.25$  (OR  $l/D_H$ );  $\tau = 1.20$ ;  $F_{24} = 2053.1 \text{ ft}^2$   
FROM PAGE 143 OF REF 1 FOR JUNCTION #39

TO EVALUATE THE FRICTION LOSS OF THE JUNCTION AS A THICK EDGED ORIFACE THE FOLLOWING CALCULATION IS MADE IN THE MANNER GIVEN ON PAGE 137 OF REF. 3.

$$2 \left( \frac{L_j}{D_H} \right) \text{ where } 2 = \frac{1}{\left( 2 \log \frac{3.7}{\Delta} \right)^2} \text{ where } \Delta = \frac{\Delta}{D_H} \text{ IN MM.}$$

FROM TABLE 2-1, PAGE 65 OF REF. 3 FOR AVERAGE CONDITION CONCRETE  
 $\Delta = 2.5 \text{ mm.}$

$$2 \left( \frac{L_j}{D_H} \right) = \left[ \frac{2 \log \frac{3.7}{(2.5 \text{ mm})(0.3937 \text{ mm/in})}}{(6 \text{ ft})(12 \text{ in/ft})} \right]^{-2} (0.25) = 0.0053$$

FROM PAGE 137 OF REF. 3, THE RESISTANCE TO FLOW (IN THE FORWARD DIRECTION) OF THE JUNCTION AS A THICK-EDGED ORIFACE IS:

$$\phi = 0.5 \left( 1 - \frac{F_j}{F_{24}} \right) + \left( 1 - \frac{F_j}{F_{24}} \right)^2 + \tau \sqrt{\left( 1 - \frac{F_j}{F_{24}} \right) \left( 1 - \frac{F_j}{F_{26}} \right)} + 2 \left( \frac{L_j}{D_H} \right)$$

$$= 0.5 \left( 1 - \frac{63 \text{ ft}^2}{2053.1 \text{ ft}^2} \right) + \left( 1 - \frac{63 \text{ ft}^2}{2053.1 \text{ ft}^2} \right)^2 + 1.2 \sqrt{\left( 1 - \frac{63 \text{ ft}^2}{2053.1 \text{ ft}^2} \right) \left( 1 - \frac{63 \text{ ft}^2}{10989 \text{ ft}^2} \right)} + 0.0053 = 2.165$$

$$K_m = \left( \frac{63 \text{ ft}^2}{10989 \text{ ft}^2} \right)^2 - \left( \frac{63 \text{ ft}^2}{2053.1 \text{ ft}^2} \right)^2 = -0.0005173 \text{ WHICH IS NEGLIGIBLE}$$

THE DIFFERENCE BETWEEN  $\phi = 2.165$  OBTAINED HERE AND 2.163 OBTAINED FOR KTED ON PAGE 143 OF REF 1 FOR JUNCTION #39 IS INSIGNIFICANT, THUS THE LOSS COEFFICIENT OF  $K = 2.6733$  AND  $K = 2.6718$  ARE RETAINED AS CALCULATED IN REF 1. THE INERTIA TERM IS EVALUATED AS FOLLOWS, WHERE THE CONTRIBUTIONS TO THE TOTAL FROM THE JUNCTION AND NODE 24 IS OBTAINED FROM PAGES 83 AND 84 OF REF. 1.

$$I = \frac{9.25 \text{ ft}}{10989 \text{ ft}^2} + 0.0312 \text{ ft}^{-1} + 0.0414 \text{ ft}^{-1} = 0.035 \text{ ft}^{-1}$$

AT ELEV 29.25' (P 154, REF 1)

STONE & WEBSTER ENGINEERING CORPORATION  
CALCULATION SHEET

▲ 5010.65

CALCULATION IDENTIFICATION NUMBER				PAGE <u>9</u>
J.O. OR W.O. NO.	DIVISION & GROUP	CALCULATION NO.	OPTIONAL TASK CODE	
12846.44		7E-050		

1 JUNCTION # 39, NODE 24 TO NODE 26 (GRATINA)

2 THE VALUES OF  $F_j$ ,  $\bar{K}$ ,  $\bar{K}$  ARE RETAINED UNCHANGED AS GIVEN ON PAGE 154  
3 OF REF. 1, THE EFFECTS ON THE LOSS COEFFICIENT FROM REVISING NODE 26  
4 ARE CONSIDERED NEGLIGIBLE AS SHOWN IN THE JUNCTION #38 PORTION OF  
5 THIS CALCULATION. THE INERTIA IS EVALUATED AS FOLLOWS, THE DATA OBTAINED  
6 FROM THE VALUES GIVEN IN JUNCTION #38 OF THIS CALCULATION, AND  $L_j = 1.5'$ ,  $F_j =$   
7  $83.2 \text{ ft}^2$  FROM PAGE 143 OF REF. 1, JUNCTION # 40.

$$8 \quad I = \frac{L_{24}}{F_{24}} + \frac{L_{26}}{F_{26}} + \frac{L_j}{F_j} = \frac{8.5'}{2053.1 \text{ ft}^2} + \frac{9.25'}{10989 \text{ ft}^2} + \frac{1.5'}{83.2 \text{ ft}^2} = 0.22 \text{ ft}^{-1}$$

12 JUNCTION # 44, NODE 26 TO 30 AND JUNCTION # 45, NODE 26 TO 30

13 VALUES OF  $F_j$ ,  $\bar{K}$ ,  $\bar{K}$  AND  $I$  WERE CALCULATED ON PAGES 11 & 12 OF REF. 2  
14 AND ARE RETAINED HERE UNCHANGED.

17 JUNCTION # 46, NODE 2 TO NODE 31

18 FROM REF. 4 AND 5, THE DIMENSIONS OF THIS JUNCTION ARE

$$19 \quad L_j = 18''$$

$$20 \quad \text{PERIMETER (II)} = 2'3'' \times 14'' = 6.833'$$

21 THE DIMENSIONS OF NODE 31 IS IDENTICAL TO THAT OF NODE 2, SEEN ON PAGE  
22 124 OF REF. 1, SUCH THAT

$$23 \quad L_2 = L_{31} = 4.75'$$

$$24 \quad F_2 = F_{31} = 245.7'$$

25 PAGE 101 OF REF. 1 ASSUMES A 50% REDUCTION IN JUNCTION AREA FROM  
26 PIPING FOR JUNCTION #2 OF THAT CALCULATION, THIS ASSUMPTION WILL BE USED  
27 FOR THIS JUNCTION AS WELL, WHERE

$$28 \quad F_j = (2'3'')(14'')(0.5) = 1.31 \text{ ft}^2$$

30 EVALUATED AS A THICK EDGED ORIFICE IN A MANHOLE SIMILAR TO THAT USED  
31 FOR JUNCTION #2 OF REF. 1, P. 126, UTILIZING THE RELATIONSHIPS  
32 ESTABLISHED ON P. 137 OF REF. 3, THE LOSS COEFFICIENT ( $K$ ) IS EVALUATED  
33 AS FOLLOWS

$$34 \quad \frac{K_j}{D_k} = \frac{1.5'}{\left(\frac{4(1.31 \text{ ft}^2)}{6.833'}\right)} = 1.956 \quad \text{WHERE } D_k = \frac{4(F_j)}{II}$$

37  $K_j/D_k$  PROVIDES THE VALUE  $\tau = 0.0799$  BY INTERPOLATION FROM DIAG. 4-11, P. 137 OF REF. 3

$$38 \quad \tau \left(\frac{L_j}{D_k}\right) = \frac{1}{\left(2 \log \frac{3.7}{\Delta}\right)^2} \quad \text{WHERE } \Delta = \frac{\Delta}{10 \text{ mm}} \quad \Delta = 2.5 \text{ mm FOR AVERAGE}$$

39  $D_k$  CONDITION CONCRETE, FROM P. 65  
40 OF REF. 3,

$$42 \quad \therefore \tau \left(\frac{L_j}{D_k}\right) = \left[ \left( 2 \log \frac{(2.5 \text{ mm})(10393714 \text{ mm})}{\left(\frac{4(1.31 \text{ ft}^2)}{6.833'}\right)(12 \text{ in/ft})} \right)^2 \right]^{-1} (1.956) = 0.0763$$

STONE & WEBSTER ENGINEERING CORPORATION  
 CALCULATION SHEET

▲ 5010.65

CALCULATION IDENTIFICATION NUMBER			
J.O. OR W.O. NO.	DIVISION & GROUP	CALCULATION NO.	OPTIONAL TASK CODE
12B46.44		PE-050	
			PAGE 10

$$C = 0.5 \left( 1 - \frac{F_2}{F_2} \right) + \left( 1 - \frac{F_1}{F_1} \right)^2 + \frac{\tau}{N} \left( 1 - \frac{F_1}{F_2} \right) \left( 1 - \frac{F_1}{F_1} \right) + \frac{1}{2} \left( \frac{L_1}{D_k} \right)$$

$$= 0.5 \left( 1 - \frac{1.31 \text{ ft}^2}{245.7 \text{ ft}^2} \right) + \left( 1 - \frac{1.31 \text{ ft}^2}{245.7 \text{ ft}^2} \right)^2 + 0.0799 \left( 1 - \frac{1.31 \text{ ft}^2}{245.7 \text{ ft}^2} \right) \left( 1 - \frac{1.31 \text{ ft}^2}{245.7 \text{ ft}^2} \right) + 0.0763 = 1.64$$

$C$  IS THE SAME VALUE IN EITHER DIRECTION SINCE  $F_2 = F_{21}$   
 $F_m$  AND  $F_{m1}$  ARE CONSIDERED NEGLIGIBLE AND THUS ARE NOT INCLUDED  
 THE RESISTANCE TO FLOW FROM NOZAL FRICTION ( $C_{pf}$ ) = 0.0236, GIVEN ON PAGE 115 OF REF 1

$$K = C + C_{pf} = 1.64 + 0.0236 = 1.66$$

$$K = C + C_{pf} = 1.64 + 0.0236 = 1.66$$

INERTIA (I) IS EVALUATED AS  $I = \frac{L_2}{F_2} + \frac{L_{21}}{F_{21}} + \frac{L_j}{F_j}$

$$I = \frac{1.5'}{1.31 \text{ ft}^2} + \frac{9.75'}{245.7 \text{ ft}^2} + \frac{4.75'}{245.7 \text{ ft}^2} = 1.182$$

UTILIZE SAME ELEV AS JUNCT 2 ELEVATION = 9.2', p 15+ of REF 1

JUNCTION 57 TO 65 MAKE UP THE PORTION OF THIS MODEL INTENDED TO APPROXIMATE THE EFFECTS OF THE CENTRAL EXHAUST SYSTEM. FROM THE DRAWINGS OF REF. 6, 7, & 8 THE PORTIONS OF THIS SYSTEM, DESIGNATED 1-EH-14, THAT WERE USED INCLUDE THE INTAKE POINTS OF EACH CHARGING PUMP CUBICLE, ONE FROM THE NARROW CORRIDOR BETWEEN THE UNIT 1 & 2 CHARGING PUMP CUBICLES ON THE 2'0" ELEVATION, WHICH, FOR ORIENTATION PURPOSES, CORRESPONDS TO NODE 1 OF THE MODEL AND A SINGLE INTAKE ON THE 13'0" ELEVATION BETWEEN THE UNIT 1 AND UNIT 2 CHARGING PUMP CUBICLES CALLED THE PURIFICATION AREA. THIS LAST AREA INTAKE IS DESIGNATED TO BE LOCATED IN NODE 21 OF THE MODEL. THE INTENT OF THIS MODEL IS DIRECTED PRIMARILY TO ANALYZE THE EFFECTS ON THE TEMPERATURE PROFILE OF THE CHARGING PUMP CUBICLE, THUS MODELING ONLY THE PORTION OF THE SYSTEM AS INDICATED ABOVE IS CONSIDERED ADEQUATE. THE REFERENCED DRAWINGS INDICATE THE DESIGN FLOWRATE OF EACH INTAKE IN CFM, HOWEVER, AS INDICATED BY ATTACHMENT 1 OF THIS CALCULATION THOSE INTAKES PROVIDED IN THE CHARGING PUMP CUBICLES ARE CURRENTLY UNDERGOING DESIGN CHANGES WHICH WOULD ESTABLISH AT FLOW RATE OF 6500 CFM FOR EACH INTAKE VICE THE 8000 CFM THAT IT IS CURRENTLY RATED AT. THE DESIGN CHANGE WILL NOT AFFECT THE RATED FLOW OF THE OTHER INTAKES UTILIZED. EACH INTAKE WILL BE INPUTED AS A SINGLE JUNCTION CONNECTING THE NODE FROM WHICH IT DRAWS AIR TO THE SIMULATED "VENT" NODE, #39, TO APPROXIMATE THE DESIRED FLOW RATE THROUGH EACH OF THESE JUNCTIONS. A RATIO IS ESTABLISHED SUCH THAT, KEEPING ALL OTHER FACTORS EQUAL, THE NET FLOW OUT THE VENT NODE, BY WAY OF A CONSTANT FLOW FAN CURVE, WILL ESTABLISH APPROXIMATELY THE NET FLOW INTO THE



STONE & WEBSTER ENGINEERING CORPORATION  
 CALCULATION SHEET

▲ 5010.65

CALCULATION IDENTIFICATION NUMBER				PAGE <u>11</u>
J.O. OR W.O. NO.	DIVISION & GROUP	CALCULATION NO.	OPTIONAL TASK CODE	
12846-44		FE-050		

1 VENT NODE, THE COMPONENTS OF WHICH ARE DIVIDED AMONG EACH JUNCTION  
 2 PRIMARILY DEPENDENT ON THE RELATIVE SIZE OF EACH. THIS THEN IS ACCOMPLISHED  
 3 BY SUMMING THE RATED FLOWS OF ALL INTAKE JUNCTIONS AND UTILIZING THAT  
 4 TOTAL FOR THE FAN TABLE DATA CARDS, ALONG WITH SELECTING A CORRESPONDING  
 5 HEAD SUCH THAT ANY DIFFERENTIAL PRESSURE DEVELOPED ACROSS THIS FAN  
 6 JUNCTION WOULD NOT RESULT IN A CALCULATED HEAD THAT EXCEEDS THE VALUE  
 7 USED IN THE FAN TABLE CARD. EACH JUNCTION REPRESENTING AN INTAKE  
 8 IS THEN ASSIGNED A RATIO FLOW AREA TO BALANCE INTAKE FLOWS ACCORDINGLY,  
 9 RELATIVE TO THE DESIRED FLOW RATE OF EACH. BY USING THE LOWEST FLOW RATE  
 10 INTAKE AS ARBITRARILY EQUAL TO 1.0 FT<sup>2</sup>, THIS RATIO IS ESTABLISHED. ALL OTHER  
 11 COMPONENTS OF JUNCTION LOSS COEFFICIENT AND INERTIA ARE INITIALLY SET  
 12 EQUAL FOR ALL JUNCTIONS AT ARBITRARY VALUES WHOSE SELECTION WILL HAVE  
 13 THE PRIMARY EFFECT OF DETERMINING THE RESPONSIVENESS OF THIS SIMULATED  
 14 EXHAUST VENTILATION SYSTEM TO CHANGES IN DIFFERENTIAL PRESSURE. THE VALUES CHOSEN  
 15 WERE ORIGINALLY  $I = 0.1$ ,  $K = 1.0$  AND  $R_c = 30.0$  (A HIGH RESISTANCE TO REVERSE  
 16 FLOW THROUGH THESE JUNCTIONS IS CHOSEN TO PRECLUDE THIS EFFECT FROM OCCURRING)  
 17 BASED ON THE FLOW TO AREA RATIO, THE JUNCTION AREAS UTILIZED WOULD BE AS  
 18 FOLLOWS, FOR THE INTAKE FROM NODE 1, AT 400 CFM = 1.0 FT<sup>2</sup> (THE SIMPLEST  
 19 FLOWRATE, ESTABLISHING THE RATIO)  
 20 from the charging pump cubicles, AT 6500 CFM = 16.25 FT<sup>2</sup>  
 21 from NODE 21, AT 900 CFM = 2.25 FT<sup>2</sup>  
 22 JUNCTION #39, WHICH REPRESENTS THE FAN, UTILIZES THE FAN TABLE TO DETERMINE  
 23 FLOW THROUGH THE JUNCTION, TOTAL CFM OF ALL INTAKE JUNCTIONS = 40,300 CFM,  
 24 THE VALUES OF JUNCTION AREA, INERTIA AND LOSS COEFFICIENTS MUST STILL BE INPUT  
 25 ON THE JUNCTION DATA CARD, HOWEVER THEY ARE NOT UTILIZED IN CALCULATING  
 26 FLOW THROUGH THE JUNCTION. THEREFORE THE VALUES INPUT HERE ARE IRRELEVANT.  
 27 USING THESE VALUES, A TEST RUN WAS MADE TO DETERMINE THE ACCURACY OF THE SIMULATED  
 28 MODEL IN OBTAINING THE DESIRED FLOWRATES. FROM THE RESULTS OF THIS TEST, IT  
 29 WAS NECESSARY TO ADJUST THE VALUES TO BALANCE THE FLOW THROUGH  
 30 INDIVIDUAL JUNCTIONS TO OBTAIN ACCEPTABLE APPROXIMATIONS OF VOLUMETRIC  
 31 FLOW RATE ATTRIBUTABLE TO EACH, PRIMARILY DUE TO THE LARGE DIFFERENCE  
 32 IN JUNCTION AREA BETWEEN THAT OF THE CHARGING PUMP CUBICLES AND THOSE  
 33 OF THE JUNCTIONS FROM NODE 1 AND NODE 21. 0.2 SECS OF ANALYSIS TO ESTABLISH  
 34 FLOW PATTERNS DEVELOPED BY DIFFERENCES IN NOODAL ELEVATION WAS PERFORMED  
 35 PRIOR TO INITIATING FLOW ESTABLISHED BY THE FAN OPERATION AND 1.8 SECS  
 36 OF THIS ANALYSIS WAS REQUIRED TO ATTAIN RELATIVELY STABLE FLOW RATES  
 37 THROUGH EACH JUNCTION THEREAFTER. CONSEQUENTLY, ALL FAILURE ANALYSIS  
 38 WILL UTILIZE A 2.0 SEC DELAY PRIOR TO INITIATING A FAILURE FROM THE  
 39 START OF THE ANALYSIS TO ALLOW FOR A STABILIZATION OF THE BUILDING  
 40 FLOW PATTERNS ATTRIBUTABLE TO THE EXHAUST FAN SYSTEM OPERATION.  
 41 BELOW IS A SUMMARY OF THE RESULTANT JUNCTION INPUT DATA WHICH  
 42 RESULTED IN ACCEPTABLE APPROXIMATIONS OF VOLUMETRIC FLOW RATE  
 43 THROUGH EACH JUNCTION. NOTE THAT THE JUNCTIONS FROM NODE 1 AND 21  
 44 RESULT IN SLIGHTLY HIGHER THAN DESIGN FLOW RATES, HOWEVER THE FLOWS  
 45 OBTAINED ARE ADEQUATE AS AN APPROXIMATION AND WILL NOT ADVERSELY AFFECT  
 46 THE OVERALL CONSERVATISM OF THIS CALCULATION.



STONE & WEBSTER ENGINEERING CORPORATION  
CALCULATION SHEET

▲ 5010.65

CALCULATION IDENTIFICATION NUMBER				PAGE <u>13</u>
J.O. OR W.O. NO. <u>12846.44</u>	DIVISION & GROUP	CALCULATION NO. <u>PE-050</u>	OPTIONAL TASK CODE	

- 1 SINK # 1, NODE 4; DATA SAME AS GIVEN ON PAGE 156, REF 1
- 2 SINK # 2, NODE 5; " " " " " " " "
- 3 SINK # 3, NODE 6; " " " " " " " "
- 4 SINK # 4, NODE 7; " " " " " " " "
- 5 SINK # 5, NODE 8; " " " " " " " "
- 6 SINK # 6, NODE 9; " " " " " " " "
- 7 SINK # 7, NODE 10; " " " " " " " "
- 8 SINK # 8, NODE 11; " " " " " " " "
- 9 SINK # 9, NODE 21; " " " " " " " "
- 10 SINK # 10, NODE 22; " " " " " " " "
- 11 SINK # 11, NODE 12; (2) SIDE WALLS, 20' X 9', 18" THICK, PAGE 12, REF 1
- 12 (1) FLOOR 7 1/2' X 20', 4" THICK " " "
- 13 (1) END WALL ≈ 7 1/2' X 7', 18" THICK, ESTIMATED FROM REF 4
- 14 TOTAL AREA 562.5 ft<sup>2</sup>, 9" THICKNESS USED
- 15 SINK # 12, NODE 13; (2) SIDEWALLS, (22' X 3 1/2') + (13.75' X 9'), 18" THICK, PAGE 25, REF 1
- 16 (1) CEILING, 22' X 7.5', 18" THICK, " " "
- 17 (1) ENDWALL ≈ 22 1/2' X 7.5', 18" THICK " " "
- 18 TOTAL AREA = 660.25 ft<sup>2</sup>, 9" THICKNESS USED
- 19 SINK # 13, NODE 16; (1) SIDE WALL 34' X 13 1/2', 18" THICK, PAGE 24, REF 1
- 20 (1) CEILING 12' X 34', 12" THICK, " "
- 21 (1) FLOOR 12' X 34', 18" THICK, " "
- 22 TOTAL AREA 1075.0 ft<sup>2</sup>, 6" THICKNESS USED
- 23 SINK # 14, NODE 17; (1) SIDE WALL, 12' X 13 1/2', 2' THICK, PAGE 24, REF 1
- 24 (1) SIDE WALL, 7' X 12 1/2', 18" THICK, " " "
- 25 (1) END WALL, 12 3/4' X 13 1/2', 18" THICK, " " "
- 26 (1) END WALL, (28 1/2' X 13 1/2'), 3' THICK, " " "
- 27 (1) CEILING ≈ (28 1/2' X 12') + (7' X 15 3/4'), 12" THICK, P 24, REF 1
- 28 (1) FLOOR ≈ (28 1/2' X 12') + (7' X 15 3/4'), 18" THICK, " "
- 29 TOTAL AREA = 1717.875', 6" THICKNESS USED
- 30 SINK # 15, NODE 18; (2) END WALLS ≈ 64' X 13 1/2', 3' AND 18" THICK, P 24, REF 1
- 31 (1) CEILING ≈ 64' X 10', 12" THICK " "
- 32 (1) FLOOR ≈ 64' X 10', 2' THICK " "
- 33 TOTAL AREA = 3008 ft<sup>2</sup>, 12" THICKNESS IS USED, THE CEILING
- 34 THOUGH 12" THICK, IS NOT USED BY ANOTHER NODE AS A
- 35 HEAT SINK, THEREFORE THE FULL THICKNESS IS AVAILABLE
- 36 FOR USE IN THIS NODE WITHOUT COMPROMISING THE
- 37 CONSERVATISM OF THIS TECHNIQUE FOR DEVELOPING HEAT SINKS
- 38 SINK # 16, NODE 19; SAME AS SINK # 14
- 39 SINK # 17, NODE 20, SAME AS SINK # 13
- 40
- 41
- 42
- 43
- 44
- 45

STONE & WEBSTER ENGINEERING CORPORATION  
CALCULATION SHEET

▲ 5010.65

CALCULATION IDENTIFICATION NUMBER				PAGE <u>14</u>
J.O. OR W.O. NO. <u>12B46.44</u>	DIVISION & GROUP	CALCULATION NO. <u>PE-050</u>	OPTIONAL TASK CODE	

FILL TABLE DATA CARDS.

1. CIRCUMFERENTIAL STEAM GENERATOR BLOWDOWN LINE BREAK DATA IS TAKEN FROM REF. 9, PAGE 7, CASE 1
2. STEAM GENERATOR BLOWDOWN LINE CRACK DATA UTILIZED PRELIMINARY VALUES WHICH DIFFER SLIGHTLY FROM THE FINAL VALUES GIVEN BY REF 9, PAGE 7, CASE 2(B). THE DIFFERENCE IN THESE VALUES WILL NOT SIGNIFICANTLY AFFECT THE RESULTS OF THE CALCULATION
3. LETDOWN LINE CIRCUMFERENTIAL BREAK DATA WAS TAKEN FROM PRELIMINARY VALUES WHICH AFTER 2.16 SECS IS SLIGHTLY HIGHER THAN THE FINAL VALUES GIVEN BY REF 9, PAGES 10 AND 11, CASE 2. THUS, THE ANALYSIS PERFORMED UTILIZING THE PRELIMINARY DATA IS MORE CONSERVATIVE THAN THAT OF AN ANALYSIS USING THE FINAL DATA, FURTHERMORE THIS FAILURE DOES NOT PROVE TO BE LIMITING FOR COMPONENTS OF CONCERN, THUS RE-ANALYSIS UTILIZING THE FINAL VALUES FOR MASS-ENERGY RELEASE RATES IS NOT NECESSARY.
4. 6" AUXILIARY STEAM LINE CRACKS.  
THE MASS FLOW RATE ( $\dot{m}$ ) FROM A CRACK FAILURE IS EVALUATED AS FOLLOWS

$\dot{m} = GA$  WHERE  $G$  IS THE MOODY CRITICAL FLOW RATE INTERPOLATED FROM TABLE WB-2 OF REF 12 AT AN ASSUMED  $f_{110} = 0.10$ , QUALITY FACTOR = 1.0  
IN  $10^3 \text{ lbm/sec-ft}^2$

WHERE  $A$  IS THE CRACK SIZE, DETERMINED FROM THE INFORMATION CONTAINED IN REF 7, PAGE 510.1 AS  $A = (d/2)(t/2)$  IN  $\text{ft}^2$   
 $d =$  PIPE DIAMETER IN INCHES, TAKEN TO BE, CONSERVATIVELY, AS THE OUTSIDE DIAMETER FOR 6" NOMINAL PIPE SIZE AS GIVEN BY APPENDIX B OF REF. 11 WHICH = 6.625"  
 $t =$  WALL THICKNESS IN INCHES AS GIVEN FOR NOMINAL 6" SA, 40S PIPE OF THE SAME REF, WHICH = 0.280"

IF A SINGLE ACTIVE FAILURE OF THE AUXILIARY STEAM SYSTEM PRESSURE REGULATING VALVE IS POSTULATED SUCH THAT STEAM PRESSURE IS MAXIMIZED, THE RESULTANT SYSTEM PRESSURE IS ASSUMED TO BE A CONSTANT 2147 PSIA, LIMITED BY THE ACTUATION OF THE SYSTEM PRESSURE RELIEF VALVE AS GIVEN BY REF. 13. THEN MASS FLOW RATE FOR THIS FAILURE, THEN, IS AS FOLLOWS:

$$\dot{m} = \left[ \frac{0.47 \times 10^3 \text{ lbm}}{\text{sec-ft}^2} + \left( \frac{0.68 \times 10^3 \text{ lbm}}{\text{sec-ft}^2} - \frac{0.47 \times 10^3 \text{ lbm}}{\text{sec-ft}^2} \right) \left( \frac{2147 \text{ psia} - 200 \text{ psia}}{300 \text{ psia} - 200 \text{ psia}} \right) \right] \left( \frac{6.625''}{2} \right) \left( \frac{0.28''}{2} \right) \left( \frac{10^{-2}}{144 \text{ in}^2} \right) = 1.613 \frac{\text{lbm}}{\text{SEC}}$$

THE ENERGY RELEASE RATE ( $\dot{Q}$ ) IS EVALUATED AS  $\dot{m} h_u$  WHERE  $h_u$  IS THE ENTHALPY OF THE SYSTEM,  $\approx 1197 \text{ BTU/lbm}$  FROM THE STEAM TABLES, THUS

$$\dot{Q} = 1.613 \text{ lbm/sec} (1197 \text{ BTU/lbm}) = 1930.52 \text{ BTU/SEC}$$

STONE & WEBSTER ENGINEERING CORPORATION  
CALCULATION SHEET

▲ 5010.65

CALCULATION IDENTIFICATION NUMBER					
J.O. OR W.O. NO.	DIVISION & GROUP	CALCULATION NO.	OPTIONAL TASK CODE	PAGE <u>15</u>	
10846.44.		PE-050			
<p>1 <u>NODAL DATA CARDS</u> : THE INPUT VALUES OF PRESSURE = 14.7 psia, TEMPERATURE = 120.0°F</p> <p>2 RELATIVE HUMIDITY = 1.0 ARE THE SAME FOR ALL NODES.</p>					
NODE DESIG.	VOLUME (FT <sup>3</sup> )	ELEV. (FT)	HEIGHT (FT)	DATA SOURCE	
4	1	1137.7	2.0	9.50	NODE 1, P153 of REF 1
5	2	2011.2	2.0	10.0	NODE 2 " " "
6	3	2011.2	2.0	10.0	NODE 3, " " "
7	4	26611.5	2.0	12.0	NODE 4, " " "
8	5	5150.7	2.0	9.5	NODE 5 " " "
9	6	18697.8	2.0	10.10	NODE 6 " " "
10	7	5150.7	2.0	9.5	NODE 7 " " "
11	8	26611.5	2.0	12.0	NODE 8 " " "
12	9	4050.0	2.0	9.0	NODE 9 " " "
13	10	5820.0	2.0	9.0	NODE 10 " " "
14	11	4050.0	2.0	9.0	NODE 11 " " "
15	12	1255.5	2.0	9.0	NODE 12 " " "
16	13	1400.2	13.0	12.5	NODE 13 " " "
17	14	2799.8	13.0	12.5	NODE 14 " " "
18	15	2696.6	13.0	12.5	NODE 15 " " "
19	16	5122.4	13.0	13.5	NODE 16 " " "
20	17	5678.0	13.0	13.5	NODE 17 " " "
21	18	8035.2	13.0	13.5	NODE 18 " " "
22	19	5678.0	13.0	13.5	NODE 19 " " "
23	20	5122.4	13.0	13.5	NODE 20 " " "
24	21	17220.2	13.0	12.5	NODE 21 " " "
25	22	17593.5	13.0	12.5	NODE 22 " " "
26	23	47234.0	27.5	17.0	NODE 23 " " "
27	24	31900.5	27.5	17.0	NODE 24 " " "
28	25	29622.1	27.5	17.0	NODE 25, " " "
29	26	149291.1	45.83	18.5	P. 5 OF THIS CALC.
30	27	893025.0	9.0	79.0	NODE 31, P153, REF 1
31	28	13235.0	11.5	15.15	NODE 32, " "
32	29	13235.0	11.5	15.15	NODE 33, " "
33	30	1.0 x 10 <sup>20</sup>	27.5	50.0	P. 5 OF THIS CALC
34	31	2011.2	2.0	10.0	NODE 2, P153, REF 1
35	32	2799.8	13.0	12.5	NODE 14, " "
36	33	2011.2	2.0	10.0	NODE 2, P153, REF 1
37	34	2011.2	2.0	10.0	NODE 3, P153, REF 1
38	35	2011.2	2.0	10.0	NODE 2, " "
39	36	2799.8	13.0	12.5	NODE 14, " "
40	37	2696.6	13.0	12.5	NODE 15, " "
41	38	2799.6	13.0	12.5	NODE 14, " "
42	39	2000	2.0	70.0	PAGE 5 OF THIS CALC
43	40	1.0 x 10 <sup>20</sup>	27.5	50.0	PAGE 6 OF THIS CALC

STONE & WEBSTER ENGINEERING CORPORATION  
CALCULATION SHEET

▲ 5010.65

CALCULATION IDENTIFICATION NUMBER				PAGE 15A
J.O. OR W.O. NO. 12846.44	DIVISION & GROUP	CALCULATION NO. PE-050	OPTIONAL TASK CODE	

JUNCTION DATA CARDS. 3									
#	VOL. # AT JUNCT.	VOL. # AT EXIT	FLOW AREA (SQ FT)	INFECTION (FT-1)	FWD FLOW COEFF.	REV FLOW COEFF.	ELEV. (FT)	DATA SOURCE	
1	1	6	32.5	0.2888	2.219	1.176	7.58	JUNCT. 1, P. 154, REF 1	
2	2	3	1.75	0.894	1.61	1.61	9.2	JUNCT. 2, " "	
3	4	5	246.7	1.062	1.062	.216	6.5	JUNCT. 4, " "	
4	5	6	78.6	1.127	1.844	1.672	6.63	JUNCT. 5, " "	
5	7	6	78.6	1.127	1.844	1.672	6.63	JUNCT. 6, " "	
6	8	7	246.7	1.062	1.062	0.216	6.5	JUNCT. 7, " "	
7	1	12	3.75	0.473	1.161	1.161	9.75	JUNCT. 8, " "	
8	1	12	1.13	0.940	1.549	1.549	2.75	JUNCT. 9, " "	
9	7	11	20.25	0.401	1.716	1.272	4.75	JUNCT. 10, " "	
10	8	11	56.7	0.062	1.047	1.094	6.5	JUNCT. 11, " "	
11	4	9	56.7	1.062	1.047	1.094	6.5	JUNCT. 12, " "	
12	5	9	20.25	1.401	1.716	1.272	4.75	JUNCT. 13, " "	
13	10	12	60.75	1.149	1.491	-0.123	4.75	JUNCT. 14, " "	
14	9	10	90.0	0.434	1.004	-0.45	4.5	JUNCT. 15, " "	
15	11	10	90.0	0.434	1.004	-0.45	4.5	JUNCT. 16, " "	
16	9	17	24.5	0.337	2.088	2.048	4.5	JUNCT. 17, " "	
17	12	13	84.0	0.102	0.558	0.012	11.0	JUNCT. 18, " "	
18	11	19	24.5	0.337	2.088	2.048	11.0	JUNCT. 19, " "	
19	3	15	311.1	0.077	0.264	0.264	12.50	JUNCT. 20, " "	
20	2	14	208.7	1.060	0.264	0.264	12.50	JUNCT. 21, " "	
21	17	18	135.0	0.288	1.007	-0.451	19.75	JUNCT. 22, " "	
22	18	19	135.0	1.288	-0.451	1.007	19.75	JUNCT. 23, " "	
23	19	20	162.0	0.142	0.1696	-0.369	19.75	JUNCT. 24, " "	
24	14	16	47.5	1.164	1.027	1.718	19.25	JUNCT. 25, " "	
25	15	16	47.5	1.164	1.027	1.718	19.25	JUNCT. 26, " "	
26	16	21	162.0	.111	-0.197	1.456	19.75	JUNCT. 27, " "	
27	17	23	210	1.328	1.893	1.886	18.43	JUNCT. 28, " "	
28	19	23	210	1.328	1.893	1.886	18.43	JUNCT. 29, " "	
29	20	21	162.0	.111	-0.197	1.456	19.75	JUNCT. 30, " "	
30	18	13	210	1.329	2.125	2.1497	19.25	JUNCT. 31, " "	
31	16	17	162.0	1.142	-0.369	1.696	19.75	JUNCT. 32, " "	
32	21	22	496.5	1.029	1.831	7.418	19.25	JUNCT. 33, " "	
33	22	24	661.5	1.032	2.552	2.552	26.5	JUNCT. 34, " "	
34	25	23	195.0	.112	1.197	1.180	35.0	JUNCT. 35, " "	
35	25	23	153.0	.117	1.225	1.189	35.0	JUNCT. 36, " "	
36	23	26	60.0	1.040	2.553	2.1607	44.25	p. 7 of THIS CALC	
37	24	25	483.6	1.030	1.234	-0.181	35.0	JUNCT. 38, P. 154, REF 1	
38	24	26	63.0	1.035	2.1673	2.1672	44.25	p. 8 of THIS CALC	
39	24	26	831.2	1.022	1.636	1.634	44.25	p. 8 " " " "	
40	6	22	792.0	1.01	1.253	1.180	12.0	JUNCT. 47, P. 155, REF 1	
41	6	27	27.1	2.83	2.05	2.05	5.0	JUNCT. 48, " "	
42	4	28	5.69	1.723	2.809	2.822	19.08	JUNCT. 49, " "	
43	8	29	5.69	1.723	2.809	2.822	19.08	JUNCT. 50, " "	
44	26	30	42.24	1.072	2.653	2.104	50.0	p. 9 of THIS CALC	

1-E-16

STONE & WEBSTER ENGINEERING CORPORATION  
CALCULATION SHEET

▲ 5010.65

CALCULATION IDENTIFICATION NUMBER				PAGE <u>1513</u>
J.O. OR W.O. NO. <u>15846.44</u>	DIVISION & GROUP	CALCULATION NO. <u>PE-050</u>	OPTIONAL TASK CODE	

1  
2  
3  
4  
5  
6  
7  
8  
9  
10  
11  
12  
13  
14  
15  
16  
17  
18  
19  
20  
21  
22  
23  
24  
25  
26  
27  
28  
29  
30  
31  
32  
33  
34  
35  
36  
37  
38  
39  
40  
41  
42  
43  
44  
45  
46

JUNCTION DATA CARDS (CONTD)

#	VOL# AT INLET	VOL# AT EXIT	FLOW AREA (FT <sup>2</sup> )	INVERT (FT)	FLOOD FLOW COEF.	REV. FLOW COEF.	ELEV (FT)	DATA SOURCE
45	36	30	42.29	1072	21653	2.104	50.0	P. 9 OF THIS CALC
46	3	31	1.31	1182	1166	1166	9.2	P. 9. OF THIS CALC
47	31	32	208.7	106	1264	1264	12.5	JUNCT. 21, P154, REF. 1
48	32	16	47.5	1164	11027	11718	19.25	JUNCT. 25, " "
49	33	34	1175	1894	1161	1161	9.2	JUNCT. 2, " "
50	34	37	211.1	1077	1264	1264	12.5	JUNCT. 20, " "
51	33	36	208.7	1060	1264	1264	12.5	JUNCT. 21 " "
52	36	20	47.5	1164	11027	11718	19.25	JUNCT. 25 " "
53	37	20	47.5	1164	11027	11718	19.25	JUNCT. 26 " "
54	33	35	1.31	1182	1166	1166	9.2	SAME AS JUNCT 46 OF THIS CALC
55	35	38	208.7	106	1264	1264	12.5	JUNCT. 21, P154, REF. 1
56	38	20	47.5	1164	11027	11718	19.25	JUNCT. 25, " "
57	1	39	1.0	10.0	1.0	30.0	9.0	PAGES 10-12 OF THIS CALC
58	2	39	16.25	1.0	1.0	30.0	9.0	" " " "
59	3	39	16.25	1.0	1.0	30.0	9.0	" " " "
60	31	39	16.25	1.0	1.0	30.0	9.0	" " " "
61	31	39	3.25	10.0	1.0	30.0	15.0	" " " "
62	33	39	16.25	1.0	1.0	30.0	9.0	" " " "
63	34	39	16.25	1.0	1.0	30.0	9.0	" " " "
64	35	39	16.25	1.0	1.0	30.0	9.0	" " " "
65	39	40	1.0	0.1	1.0	30.0	50.0	" " " "

ALL REGULAR JUNCTIONS UTILIZE HOMOGENEOUS EQUILIBRIUM CHOKING INDEX AND A CHOKED FLOW MODEL MULTIPLIER OF 1.0. JUNCTION 65 UTILIZES THE FRICTION

STONE & WEBSTER ENGINEERING CORPORATION  
 CALCULATION SHEET

▲ 5010.65

CALCULATION IDENTIFICATION NUMBER				PAGE <u>16</u>
J.O. OR W.O. NO. <u>12846.44</u>	DIVISION & GROUP	CALCULATION NO. <u>AE-050</u>	OPTIONAL TASK CODE	

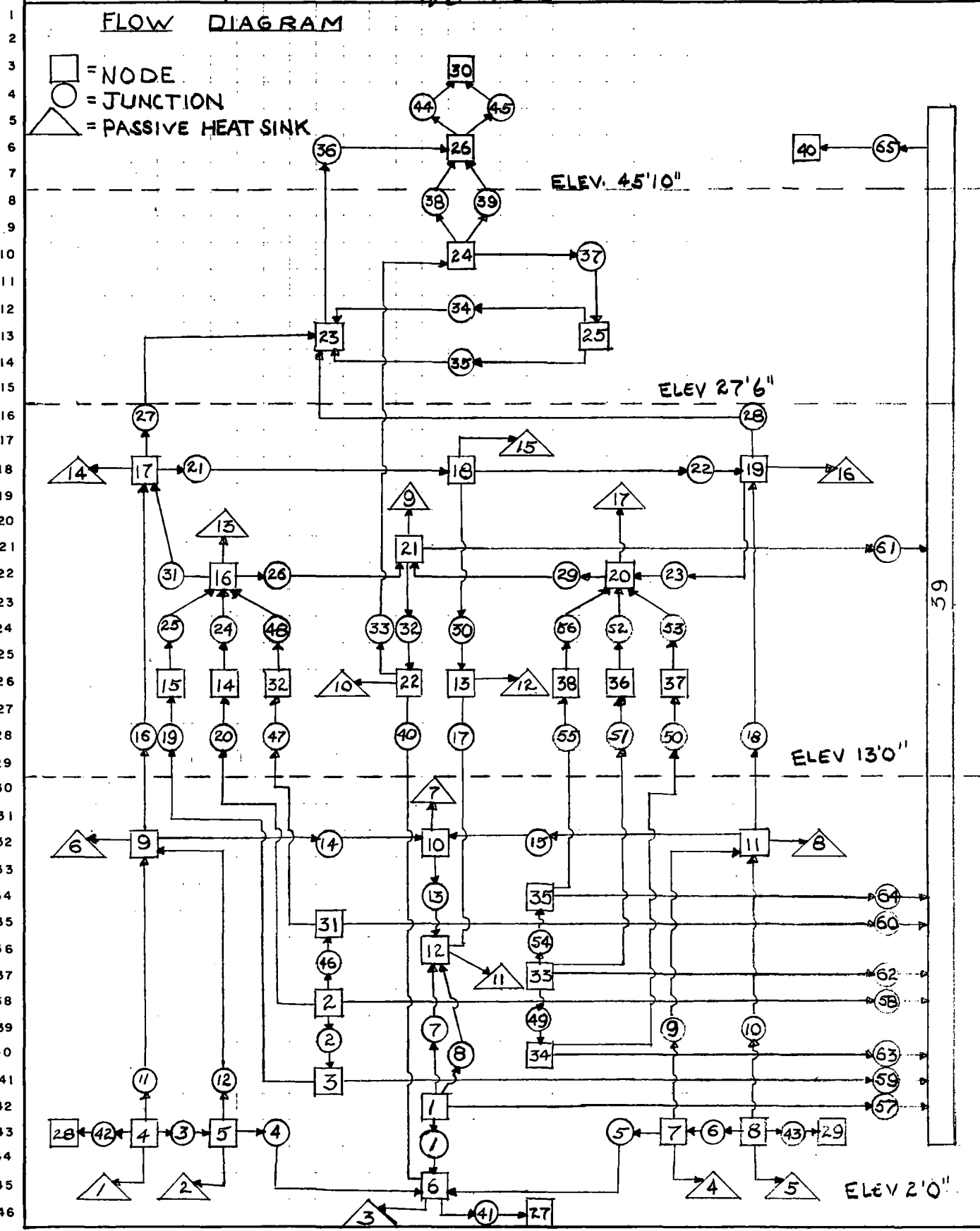

1-E-18



STONE & WEBSTER ENGINEERING CORPORATION  
 CALCULATION SHEET

▲ 5010.85

CALCULATION IDENTIFICATION NUMBER				PAGE <u>17</u>
J.O. OR W.O. NO.	DIVISION & GROUP	CALCULATION NO.	OPTIONAL TASK CODE	
12846.44		PE-050		

1  
2  
3  
4  
5  
6  
7  
8  
9  
10  
11  
12  
13  
14  
15  
16  
17  
18  
19  
20  
21  
22  
23  
24  
25  
26  
27  
28  
29  
30  
31  
32  
33  
34  
35  
36  
37  
38  
39  
40  
41  
42  
43  
44  
45  
46

THE FOLLOWING TWO PAGES CONTAIN A PLAN VIEW DIAGRAM OF THE NODAL ARRANGEMENT IN THE AUXILIARY BUILDING FOR PURPOSES OF RELATING THE AREAS OF CONCERN TO THE CORRESPONDING NODES OF THE MODEL AS IDENTIFIED IN ATTACHMENT 2 OF REF. 2. ONLY THOSE AREAS SO IDENTIFIED ARE Hatched, AS OPPOSED TO THE LABELING OF ALL AREAS AS WAS PERFORMED IN THE REFERENCED ATTACHMENT. NOTE THAT THE AREAS LABELED AS (C), (A) AND (Z) ON PAGES 2 AND 4 OF THE ATTACHMENT ARE NOTED AS AREAS OF INTEREST, HOWEVER p 14 OF REF. 2 INDICATES THAT THESE AREAS ARE NOT OF INTEREST AT THE PRESENT TIME, THUS FAILURE ANALYSIS FOR TEMPERATURE PROFILES IN THOSE AREAS IS NOT PERFORMED.

THE LETTER DESIGNATIONS IN THE ○ ARE THE AREAS OF CONCERN IDENTIFIED BY THE REFERENCED ATTACHMENT.  
 THE NUMERIC DESIGNATIONS ARE THE NODE NUMBERS USED IN THIS CALCULATION.  
 THE / / / / INDICATE AREAS OF THE AUXILIARY BUILDING NOT INCLUDED IN THE NODAL MODEL.

THE ENVELOPE CURVES, FOR SUMMARY PURPOSES, ARE DEVELOPED FROM GRAPHS OF THE NODES THAT CORRESPOND TO THE IDENTIFIED AREAS OF CONCERN, THAT RELATIONSHIP SUMMARIZED ON PAGE 20 OF THIS CALCULATION, NOTE THAT CURVE "D" REPRESENTING AREAS (C) AND (A) IS DEVELOPED FROM THE PROFILES OF 3 NODES, #16, 20, 21 AS THOSE AREAS ALSO INCLUDE A PORTION OF NODE 21.

STONE & WEBSTER ENGINEERING CORPORATION  
 CALCULATION SHEET

▲ 5010.65

CALCULATION IDENTIFICATION NUMBER			
J.O. OR W.O. NO. 12846.44.	DIVISION & GROUP	CALCULATION NO. PE-050	OPTIONAL TASK CODE
			PAGE 18

1  
2  
3  
4  
5  
6  
7  
8  
9  
10  
11  
12  
13  
14  
15  
16  
17  
18  
19  
20  
21  
22  
23  
24  
25  
26  
27  
28  
29  
30  
31  
32  
33  
34  
35  
36  
37  
38  
39  
40  
41  
42  
43  
44  
45  
46

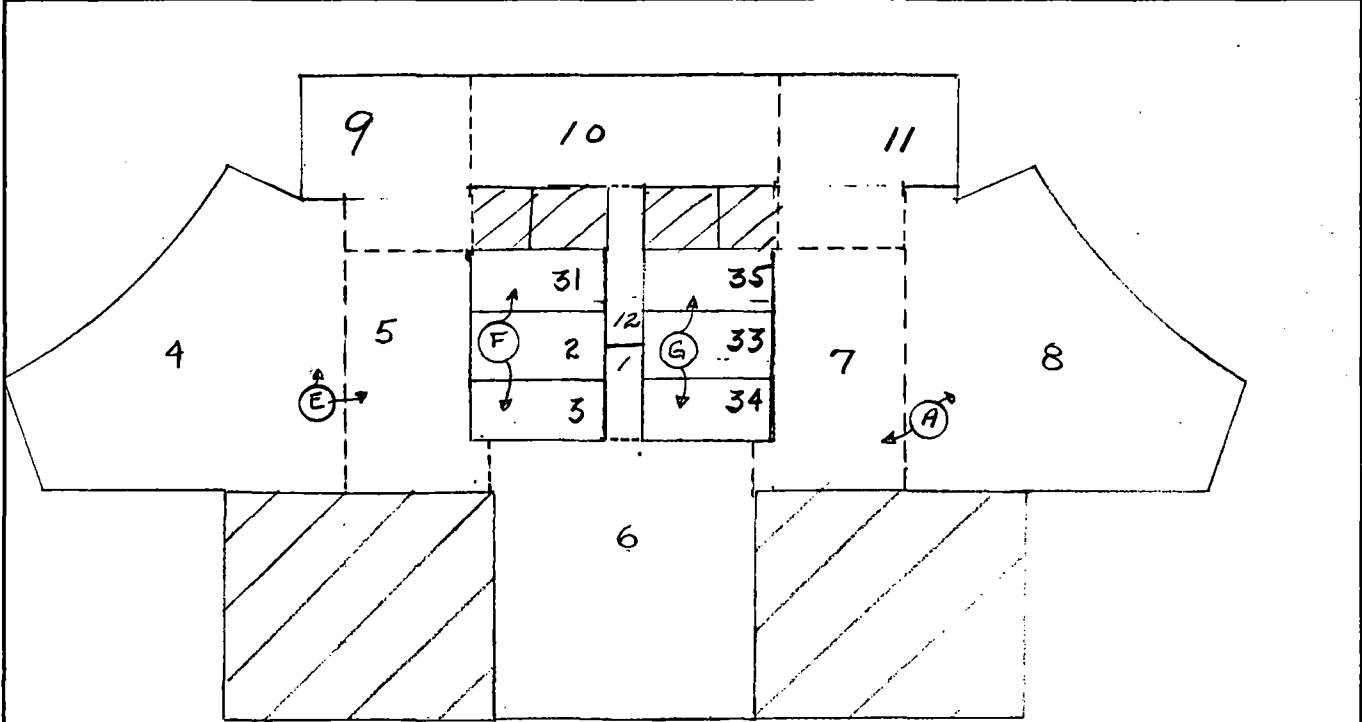

ELEV. 2'0"

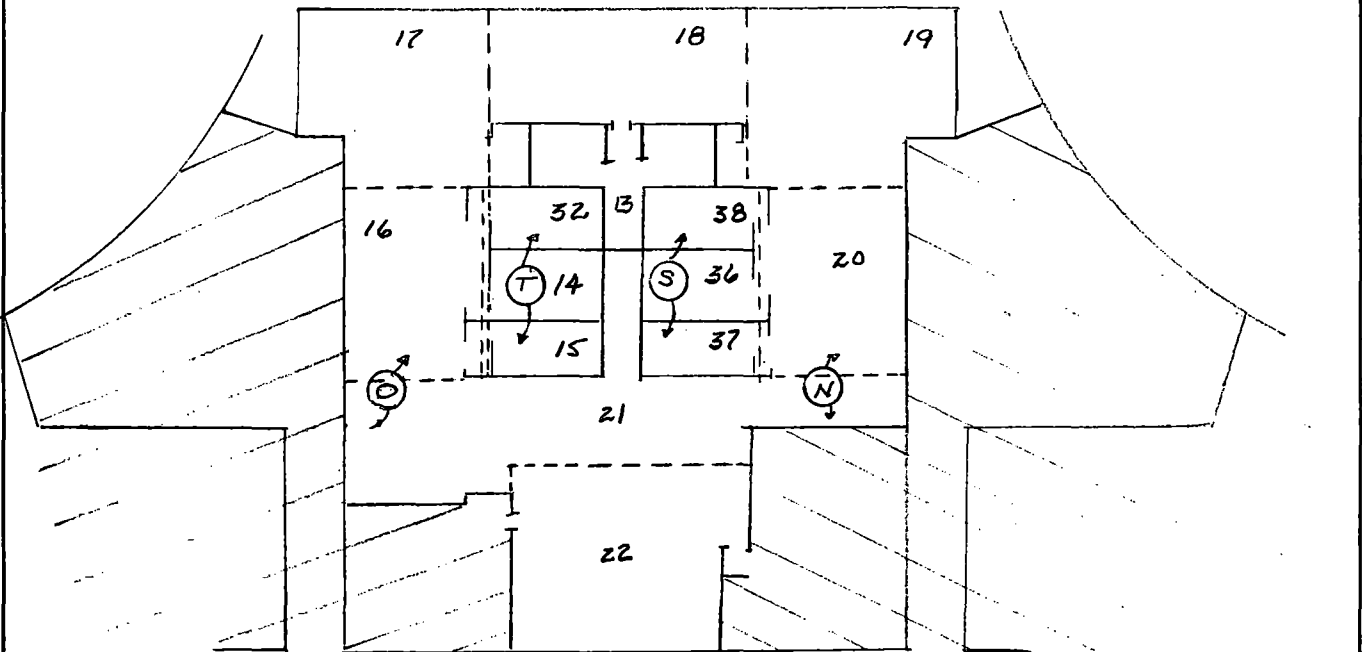

ELEV 13'0"

STONE & WEBSTER ENGINEERING CORPORATION  
 CALCULATION SHEET

▲ 5010.65

CALCULATION IDENTIFICATION NUMBER			
J.O. OR W.O. NO. 10846.44.	DIVISION & GROUP	CALCULATION NO. PE-050	OPTIONAL TASK CODE
			PAGE 19

1  
2  
3  
4  
5  
6  
7  
8  
9  
10  
11  
12  
13  
14  
15  
16  
17  
18  
19  
20  
21  
22  
23  
24  
25  
26  
27  
28  
29  
30  
31  
32  
33  
34  
35  
36  
37  
38  
39  
40  
41  
42  
43  
44  
45  
46

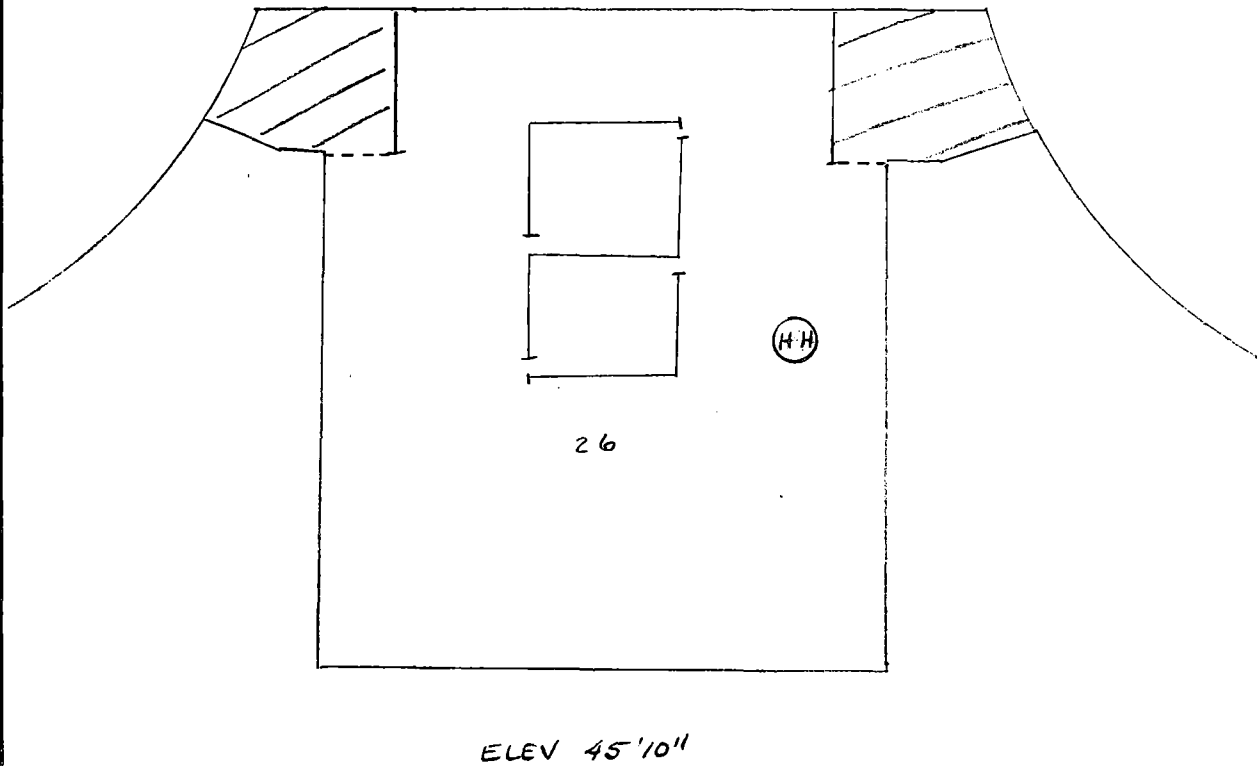
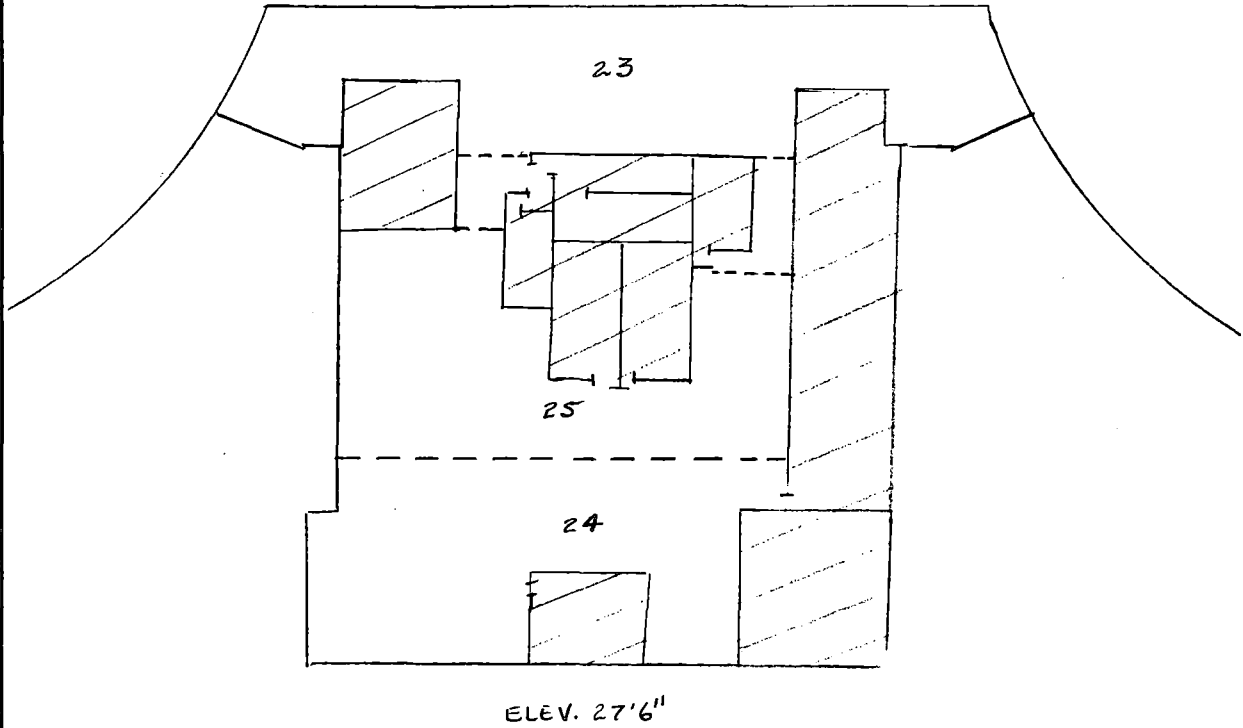

STONE & WEBSTER ENGINEERING CORPORATION  
CALCULATION SHEET

▲ 5010.85

CALCULATION IDENTIFICATION NUMBER				PAGE <u>20</u>
J.O. OR W.O. NO.	DIVISION & GROUP	CALCULATION NO.	OPTIONAL TASK CODE	
12846.44.		PE-050		

1 CONCLUSION: EVALUATION OF THE TEMPERATURE PROFILE OBTAINED IN THE  
 2 IDENTIFIED AREAS WHICH CONTAIN CLASS 1E ELECTRICAL COMPONENTS OF THE  
 3 SURRY UNIT 1 & 2 AUXILIARY BUILDING AS A RESULT OF THE INSTALLATION OF  
 4 PROPOSED MODIFICATIONS OUTLINED IN THIS CALCULATION IN RESPONSE TO THE I.E.  
 5 BULLETIN 79-018 IS COMPLETE AND SUMMARIZED THROUGH THE USE OF TEMPERATURE  
 6 "ENVELOPE" CURVES GIVEN ON PAGE 24.  
 7

8  
 9 SUMMARY  
 10 ATTACH. 2 OF THE REF. 2 CALCULATION PROVIDES THE GENERAL LOCATION  
 11 WITHIN THE AUXILIARY BUILDING OF THE IDENTIFIED AREAS WHICH CONTAIN  
 12 COMPONENTS OF CONCERN. FOR EACH AREA, AN 'ENVELOPE' CURVE IS DEVELOPED  
 13 FROM THE RESULTANT PROFILES OBTAINED IN THIS CALCULATION, SIMILAR AREA  
 14 PROFILES OR THOSE OF WHICH THE TRANSIENT OF ONE AREA IS CONSIDERED TO  
 15 REPRESENTATIVE OF ANOTHER ARE COMBINED TO FORM A SINGLE 'ENVELOPE' CURVE  
 16 IN THE FOLLOWING MANNER, THE CURVES SHOWN ON PAGE 24 OF THIS CALCULATION  
 17

- |    |    |                                |   |                   |
|----|----|--------------------------------|---|-------------------|
| 18 | 1) | - NODES 4, 5, 7, 8             | - | AREAS (A) (E) (E) |
| 19 | 2) | - NODES 2, 3, 31, 33, 34, 35   | - | AREAS (F) (E) (G) |
| 20 | 3) | - NODES 14, 15, 32, 36, 37, 38 | - | AREAS (T) (E) (S) |
| 21 | 4) | - NODES 16, 20, 21             | - | AREAS (O) (E) (N) |
| 22 | 5) | - NODE 26                      | - | AREA (HM)         |

23  
 24 THE REF. 2 CALCULATION ANALYZED A 4" AUX. STEAM LINE CRACK FAILURE  
 25 IN THE VENTILATION EQUIPMENT ROOM. TO EVALUATE THE TEMPERATURE EFFECTS  
 26 IN THIS AREA, INFORMATION OBTAINED SUBSEQUENT TO THAT ANALYSIS INDICATES  
 27 THAT THIS PARTICULAR LINE IS NOT NORMALLY PRESSURIZED DURING POWER OPERATIONS.  
 28 FOR THIS REASON A CRACK FAILURE OF A 6" AUX. STEAM LINE IN NODE 23 (FROM  
 29 THE REF. 17 DRAWING) WAS ANALYZED IN THIS CALCULATION INSTEAD AS POTENTIALLY  
 30 LIMITING FOR THE COMPONENTS IN THIS AREA. WITH THE USE OF THE PROPOSED  
 31 MODIFICATION OF SEALING THE WALL PIPING PENETRATION BETWEEN THE CHARGING  
 32 PUMP CUBICLE AND THE PIPE TUNNEL, IT WAS DETERMINED THAT A CRACK FAILURE  
 33 OF A 6" AUX. STEAM LINE IN NODE 22 (FROM REF 16) WOULD RESULT IN A MORE SEVERE TEMP.  
 34 TRANSIENT FOR THE CHARGING PUMP CUBICLES THAN THE 8" AUX. STEAM LINE FAILURE  
 35 IN NODE 6 ANALYZED IN REF. 2, WITHOUT THIS MODIFICATION DUE TO ITS CLOSER  
 36 PROXIMITY TO THE AREAS IN QUESTION. THIS SAME MODIFICATION LED TO THE POSSIBILITY  
 37 THAT A LETDOWN LINE CIRCUMFERENTIAL BREAK IN NODE 6 (REF 15) MAY BE A LIMITING  
 38 CONSIDERATION FOR THE CHARGING PUMP CUBICLES, CONSEQUENTLY THAT ANALYSIS  
 39 WAS MADE IN THIS CALCULATION.  
 40

41 GRAPHS OF REPRESENTATIVE TEMPERATURE PROFILES FOR EACH AREA OF  
 42 CONCERN WERE UTILIZED TO DEVELOPE THE FINAL 'ENVELOPE' CURVES. THOSE  
 43 FAILURES WHICH WERE NOT OF LIMITING CONSIDERATION IN A PARTICULAR AREA  
 44 WERE NOT PLOTTED FOR THE TRANSIENT, IF ANY, OBTAINED AND THIS ARE  
 45 NOT INCLUDED IN THE CALCULATION. THE FOLLOWING IS A SUMMARY OF THE TYPES  
 46 OF FAILURES ANALYZED AND THE LOCATION BY PAGE NUMBER OF THE INPUT AND  
 RUN SUMMARY DATA SHEETS AS WELL AS THE RESULTANT REPRESENTATIVE TEMPERATURE

STONE & WEBSTER ENGINEERING CORPORATION  
CALCULATION SHEET

▲ 5010.65

CALCULATION IDENTIFICATION NUMBER				PAGE <u>21</u>
J.O. OR W.O. NO.	DIVISION & GROUP	CALCULATION NO.	OPTIONAL TASK CODE	
12846.44		PE-050		

1  
2  
3  
4  
5  
6  
7  
8  
9  
10  
11  
12  
13  
14  
15  
16  
17  
18  
19  
20  
21  
22  
23  
24  
25  
26  
27  
28  
29  
30  
31  
32  
33  
34  
35  
36  
37  
38  
39  
40  
41  
42  
43  
44  
45  
46

PROFILE OBTAINED IN NODES FOR WHICH THE FAILURE WAS LIMITING AND AS A CONSEQUENCE UTILIZED IN THE DEVELOPEMENT OF THE FINAL 'ENVELOPE' CURVE.

FAILURE ANALYSIS SUMMARY.

1. CIRCUMFERENTIAL STEAM GENERATOR BLOWDOWN LINE BREAK IN NODE 4 (REPRESENTATIVE OF AN IDENTICAL FAILURE IN NODE 8). TERMINATED BY AUTOMATIC ISOLATION 30.0 SECS AFTER THE OCCURENCE OF THE FAILURE, WITH ALL POSTULATED MODIFICATIONS INCLUDED. RUN # 3800128

INPUT & RUN SUMMARY DATA SHEETS, PAGES 44 to 71

- TEMP. PROFILE NODE 2 - PAGE 72
- TEMP. PROFILE NODE 14 - PAGE 73    PLOT SYMBOL
- TEMP. PROFILE NODE 4 - PAGE 73    PLOT SYMBOL
- TEMP. PROFILE NODE 5 - PAGE 73    PLOT SYMBOL
- TEMP. PROFILE NODE 16 - PAGE 73    PLOT SYMBOL

2. CRACK FAILURE STEAM GENERATOR BLOWDOWN LINE IN NODE 4 (REPRESENTATIVE OF AN IDENTICAL FAILURE IN NODE 8), TERMINATED BY ASSUMED OPERATOR ACTION 900 SECS AFTER THE FAILURE OCCURS WITH ALL POSTULATED MODIFICATIONS INCLUDED. RUN # 3800127

INPUT AND RUN SUMMARY DATA SHEETS, PAGES 25-32

- TEMP. PROFILE NODE 2 - PAGE 33
- TEMP. PROFILE NODE 4 - PAGE 34    PLOT SYMBOL
- TEMP. PROFILE NODE 5 - PAGE 34    PLOT SYMBOL
- TEMP. PROFILE NODE 14 - PAGE 34    PLOT SYMBOL
- TEMP. PROFILE NODE 16 - PAGE 34    PLOT SYMBOL

3. CIRCUMFERENTIAL LETDOWN LINE BREAK IN NODE 6, TERMINATED BY ASSUMED OPERATOR ACTION 900 SECS AFTER THE FAILURE OCCURS WITH ALL POSTULATED MODIFICATIONS INCLUDED. RUN # 3800125

INPUT AND RUN SUMMARY DATA SHEETS, PAGES 35-42

- TEMP. PROFILE NODE 2, PAGE 43
- TEMP. PROFILE NODE 4, PAGE 44    PLOT SYMBOL
- TEMP. PROFILE NODE 5, PAGE 44    PLOT SYMBOL
- TEMP. PROFILE NODE 14, PAGE 44    PLOT SYMBOL
- TEMP. PROFILE NODE 16, PAGE 44    PLOT SYMBOL

4. CRACK FAILURE OF 6" AUX. STEAM LINE IN NODE 22, TERMINATED BY ASSUMED OPERATOR ACTION 900 SECS. AFTER THE FAILURE OCCURS WITH ALL POSTULATED MODIFICATIONS INCLUDED. RUN # 3800126

INPUT AND RUN SUMMARY DATA SHEETS, PAGES 45-52

- TEMP. PROFILE NODE 2, PAGE 53
- TEMP. PROFILE NODE 14, PAGE 54    PLOT SYMBOL

STONE & WEBSTER ENGINEERING CORPORATION  
CALCULATION SHEET

▲ 5010.65

CALCULATION IDENTIFICATION NUMBER				PAGE <u>22</u>
J.O. OR W.O. NO. <u>12846.44</u>	DIVISION & GROUP	CALCULATION NO. <u>PE-050</u>	OPTIONAL TASK CODE	

1  
2  
3  
4  
5  
6  
7  
8  
9  
10  
11  
12  
13  
14  
15  
16  
17  
18  
19  
20  
21  
22  
23  
24  
25  
26  
27  
28  
29  
30  
31  
32  
33  
34  
35  
36  
37  
38  
39  
40  
41  
42  
43  
44  
45  
46

TEMP. PROFILE NODE 16, PAGE 54, PLOT SYMBOL  $\Phi$   
TEMP. PROFILE NODE 21, PAGE 54, PLOT SYMBOL  $\Xi$

5. CRACK FAILURE 6" AUX STEAM LINE NODE 23 TERMINATED BY AN ASSUMED OPERATOR ACTION 900 SECS AFTER THE FAILURE OCCURS WITH ALL POSTULATED MODIFICATIONS INCLUDED RUN # 3P00127 ; INPUT AND RUN SUMMARY DATA SHEETS, PAGES 55-62  
TEMP. PROFILE NODE 14, PAGE 63, PLOT SYMBOL  $\Delta$   
TEMP. PROFILE NODE 20, PAGE 63, PLOT SYMBOL X  
TEMP. PROFILE NODE 26, PAGE 63, PLOT SYMBOL +

6. COMPARITIVE CIRCUMFERENTIAL STEAM GENERATOR BLOWDOWN LINE BREAK IN NODE 4 TERMINATED BY AUTOMATIC ISOLATION 30 SECS. AFTER THE FAILURE OCCURS WITH ALL POSTULATED MODIFICATIONS INCLUDED EXCEPT THE PIPING PENETRATIONS IN THE WALL BETWEEN THE 2'0" ELEVATION OF THE CHARGING PUMP CUBICLES AND ITS ASSOCIATED PIPE TUNNEL FOR BOTH 1CH-P-1C AND 2CH-P-1C ARE NOT SEALED, RUN # 3P00130 ; INPUT AND RUN SUMMARY DATA SHEETS, PAGES 74-81  
TEMP. PROFILE NODE 3, PAGE 82, PLOT SYMBOL  $\nabla$   
TEMP. PROFILE NODE 15, PAGE 82, PLOT SYMBOL  $\triangle$

7. COMPARITIVE CRACK FAILURE STEAM GENERATOR BLOWDOWN LINE IN NODE 4 TERMINATED BY AN ASSUMED OPERATOR ACTION 900 SECS AFTER THE FAILURE OCCURS WITH ALL POSTULATED MODIFICATIONS INCLUDED EXCEPT THE PIPING PENETRATIONS IN THE WALL BETWEEN THE 2'0" ELEVATION OF THE CHARGING PUMP CUBICLES AND ITS ASSOCIATED PIPE TUNNEL FOR BOTH 1CH-P-1C AND 2CH-P-1C ARE NOT SEALED. RUN # 3P00130-A ; INPUT AND RUN SUMMARY DATA SHEETS, PAGES 83-90  
TEMP. PROFILE NODE 3, PAGE 91, PLOT SYMBOL X  
TEMP. PROFILE NODE 15, PAGE 91, PLOT SYMBOL  $\Xi$

DISCUSSION: THE SINGLE MOST EFFECTIVE MODIFICATION IN REDUCING THE SEVERITY OF THE TEMPERATURE PROFILES OBTAINED IS A RESULT OF LIMITING THE DURATION OF FAILURES REQUIRING OPERATOR ACTION FOR ACCIDENT TERMINATION. THE PRINCIPLE EFFECT OF INCLUDING AN APPROXIMATION MODEL OF THE CENTRAL EXHAUST SYSTEM AND PASSIVE HEAT SINKS WAS REALIZED AS LIMITING THE TEMPERATURE RISE IN HYDRAULICALLY REMOTE AREAS FROM THE BREAK LOCATION AND PROVIDING A RAPID RATE OF TEMPERATURE DECREASE ONCE THE FAILURE WAS TERMINATED. FROM THE COMPARITIVE CALCULATIONS IT WAS DEMONSTRATED THAT FLOW PATTERNS WERE ESTABLISHED SUCH THAT EXCEPT DURING A SHORT INTERVAL DURING THE FAILURE INITIATION THE PRINCIPLE DIRECTION OF FLOW THROUGH THE WALL PIPING PENETRATION IS FROM THE CUBICLE TO THE PIPE TUNNEL WHILE IT MUST BE NOTED THAT THIS ANALYSIS TECHNIQUE PROVIDES ONLY AN APPROXIMATION OF ACTUAL FLOW PATTERNS ESTABLISHED, UNDER THESE CONDITIONS, NO CALCULATED BENEFIT IN REDUCING THE RESULTING PEAK TEMPERATURE OF THE CHARGING PUMP CUBICLES IN EITHER COMPARITIVE ANALYSIS PERFORMED WAS OBTAINED. A COMPARISON OF THE CIRCUMFERENTIAL STEAM GENERATOR BLOWDOWN LINE BREAK ANALYSIS, SHOWN BY THE PROFILES OBTAINED FOR NODES 2 (SIMILAR TO NODE 3) AND 7 AND 3 AND 15 ON PAGE 82 DEMONSTRATES THAT FOR THIS FAILURE THE PRINCIPLE EFFECT OF THE MODIFICATION WAS TO DELAY THE OCCURRENCE OF THE PEAK TEMPERATURE BY APPROXIMATELY 100 SECS AND EFFECT A MORE RAPID TEMP.

STONE & WEBSTER ENGINEERING CORPORATION  
CALCULATION SHEET

▲ 5010.65

CALCULATION IDENTIFICATION NUMBER			
J.O. OR W.O. NO. 12846.44	DIVISION & GROUP	CALCULATION NO. PE-050	OPTIONAL TASK CODE
			PAGE 23

1  
2  
3  
4  
5  
6  
7  
8  
9  
10  
11  
12  
13  
14  
15  
16  
17  
18  
19  
20  
21  
22  
23  
24  
25  
26  
27  
28  
29  
30  
31  
32  
33  
34  
35  
36  
37  
38  
39  
40  
41  
42  
43  
44  
45  
46

DECREASE ONCE BLOWDOWN WAS TERMINATED. FOR THE CRACK FAILURE COMPARISONS, SHOWN BY THE PROFILES OF THE SAME AREAS ON PAGE 83 AND PAGE 91, THE MODIFICATION RESULTED IN VIRTUALLY NO EFFECT ON THE PEAK TEMPERATURE OR PROFILES OBTAINED, PRINCIPALLY DUE TO THE RESULTANT FLOW PATTERNS ESTABLISHED BY THE CENTRAL EXHAUST SYSTEM PREVIOUSLY DISCUSSED WHICH THE MASS RELEASE RATE FROM THIS FAILURE COULD NOT OVERCOME. FROM THESE PROFILES IT IS CONCLUDED THAT NO CALCULATED BENEFIT IN LIMITING THE PEAK TEMPERATURE IS OBTAINED FROM THIS MODIFICATION AND THE PRINCIPLE EFFECT LIES IN SHIFTING THE PROFILE OF THE TRANSIENT SUCH THAT WITHOUT THE MODIFICATION THE INITIAL TEMPERATURE RISE IS GREATER AND THE RATE OF TEMPERATURE DECREASE IS LESS AFTER THE PEAK VALUE IS OBTAINED. THE "ENVELOPE" CURVE DEVELOPED FOR THE CHARGING PUMP CUBICLES UTILIZES THE MODIFICATION WHILE THE CURVE SHOWN BY --- LINES REPRESENTS THE PROFILE FOR THE INDICATED AREAS THAT RESULTS FROM NOT INCLUDING THIS MODIFICATION.

THE 8" DIA. STEAM LINE CRACK FAILURE IN NODE 6 ANALYZED IN THE REF. 2 CALCULATION IS NOT CONSIDERED LIMITING IN THIS CALCULATION DUE TO THE MODIFICATIONS UTILIZED AND AS A CONSEQUENCE IS NOT RE-ANALYZED.

THE STEAM GENERATOR BLOWDOWN LINE BREAK IN NODE 4 AS CALCULATED IN REF. 2 OBTAINED A PEAK VALUE OF 511.41°F IN THAT NODE AS SHOWN BY THE GRAPH ON PAGE 49 OF THAT CALCULATION WHEREAS IN THIS CALCULATION A PEAK VALUE OF 503°F WAS OBTAINED FOR THE SAME FAILURE. THIS IS ATTRIBUTABLE TO THE DIFFERENCE IN THE MASS-ENERGY RELEASE RATES USED, WHICH IN THE REF. 2 CALCULATION WERE CONSIDERABLY HIGHER. FOR THIS REASON, NOTWITHSTANDING THIS CALCULATION IS PRINCIPALLY CONCERNED WITH ANALYZING MODIFICATIONS TO REDUCE THE SEVERITY OF THE TRANSIENTS IN THE CHARGING PUMP CUBICLES, REVISED PROFILES OF ALL THE "ENVELOPES" DEVELOPED IN REF. 2 WERE MADE. AS NOTED PREVIOUSLY, THE DIAGRAMS GIVEN IN ATTACHMENT 2 OF REF. 2 PROVIDES A VISUAL REFERENCE FOR LOCATING THE RELATIVE POSITIONS OF THE AREAS OF INTEREST IN RELATION TO NODAL DESIGNATIONS. FOR PURPOSES OF CORRELATION THIS INFORMATION IS DUPLICATED ON PAGES 17 THROUGH 19 OF THIS CALCULATION WITH APPROPRIATE MODIFICATIONS TO REFLECT THE MODEL USED IN THIS CALCULATION. BASED ON THE RATE OF TEMPERATURE DECREASE IN ALL AREAS OF CONCERN AT THE TERMINATION OF THE ANALYSIS OF EACH FAILURE IT IS CONSERVATIVE TO PROJECT THAT AT 3600 SECS THE AVERAGE TEMPERATURE IN THESE AREAS IS 1200°F AS SHOWN BY THE ENVELOPE CURVES. FOR INFORMATION PURPOSES ONLY, AIR MASS DENSITY AT THE "FAN JUNCTION" RESULTED IN A VALUE AS HIGH AS 0.087 lbm/ft<sup>3</sup> FROM THE LETDOWN LINE FAILURE ANALYSIS WHICH MAY BE A FACTOR IN EVALUATING THE CONTINUED OPERABILITY OF THE CENTRAL EXHAUST SYSTEM IN TERMS OF POWER REQUIREMENTS.

P24 0926  
5.0 12846.44

SURRY UNIT 122 AUX BUILDING HELIX 'ENVELOPE' TEMP. PROFILES

AVERAGE TEMPERATURE (DEGREES F) PE-050

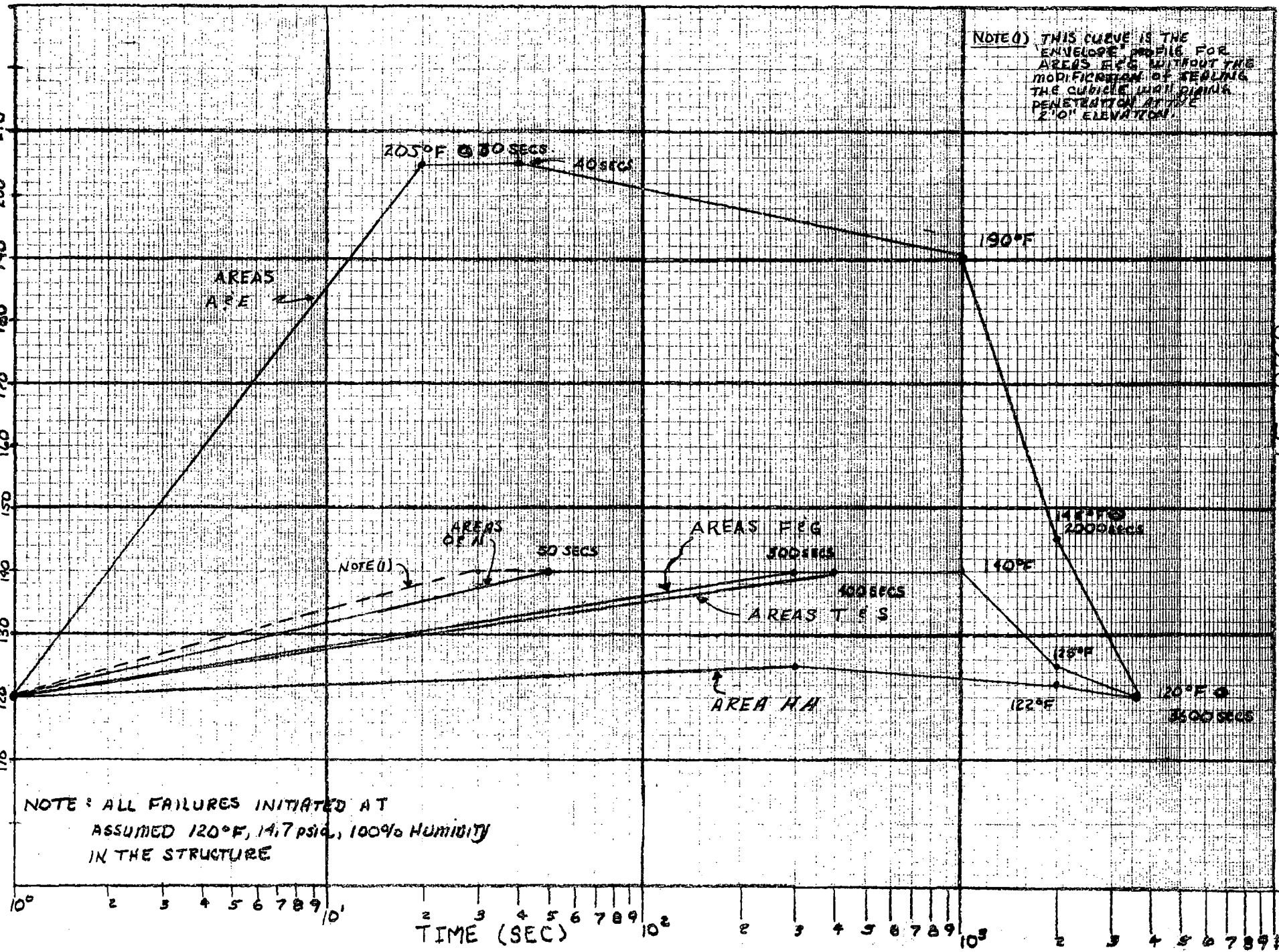

NOTE: ALL FAILURES INITIATED AT ASSUMED 120°F, 14.7 psia, 100% HUMIDITY IN THE STRUCTURE

070-34



1-E-27

R3800124 SURRY 1&2:AUX BLDG,SGBD-CRACK NODE4 WITH HEAT SINKS  
S & W ENGR CORP NU-92 << SUBCOMPARTMENT ANALYSIS PROGRAM >>

THREED 18 NOV 1980 10:49:25 PAGE 1  
THREED.VER12.LEV01 CREATED 80.106 11:35:02 UNIT 10

UNIT 55 (SEQ 1) INPUT ECHO 1 2 3 4 5 6 7 8  
1234567890123456789012345678901234567890123456789012345678901234567890

```

1 SURRY 1&2:AUX BLDG,SGBD-CRACK NODE4 WITH HEAT SINKS
2 *
3 *
4 *PROBLEM DIMENSION CARD
5 *
6 *
7 1 11 3 40 66 1 1 0 0 17
8 *
9 *
10 *IMPLICIT/EXPLICIT COEFFICIENT CARD
11 *
12 *
13 1.0
14 *
15 *
16 *TIME STEP CONTROL DATA CARDS
17 *
18 *
19 50 10 0 0 0.001 0.00001 2.2
20 2 10 0 0 0.01 0.0001 3.0
21 5 14 0 0 0.05 0.0001 10.0
22 5 15 0 0 0.1 0.0001 30.0
23 2 15 0 0 0.5 0.001 80.0
24 10 20 0 0 1.0 0.001 901.0
25 5 10 0 0 0.01 0.0001 903.0
26 5 14 0 0 0.05 0.0001 910.0
27 10 10 0 0 0.1 0.0001 930.0
28 2 25 0 0 0.5 0.001 980.0
29 10 20 0 0 1.0 0.001 1850.0
30 *
31 *
32 *TRIP CONTROL DATA CARDS
33 *
34 *
35 1 0 0 1800.0 0.0
36 1 0 0 0.0 2.0
37 1 0 0 0.0 0.2
38 *
39 *
40 *NODAL DATA CARDS
41 *
42 *
43 14.70 120. 1.0 1137.7 2.00 9.50 0.0 0
44 14.70 120. 1.0 2011.2 2.00 10.00 0.0 0
45 14.70 120. 1.0 2011.2 2.00 10.00 0.0 0
46 14.70 120. 1.0 26611.5 2.00 12.00 0.0 0
47 14.70 120. 1.0 5150.7 2.00 9.50 0.0 0
48 14.70 120. 1.0 18697.8 2.00 10.10 0.0 0
49 14.70 120. 1.0 5150.7 2.00 9.50 0.0 0
50 14.70 120. 1.0 26611.5 2.00 12.00 0.0 0

```

1  
2  
3  
4  
5  
6  
7  
8  
9  
10  
11  
12  
13  
14  
15  
16  
17  
18  
19  
20  
21  
22  
23  
24  
25  
26  
27  
28  
29  
30  
31  
32  
33  
34  
35  
36  
37  
38  
39  
40  
41  
42  
43  
44  
45  
46  
47  
48  
49  
50

1234567890123456789012345678901234567890123456789012345678901234567890

PC-05-0

J.O.12846.49

P25



1-E-29

R3800124 SURRY 1&2:AUX BLDG,SGBD-CRACK NODE4 WITH HEAT SINKS  
S & W ENGR CORP NU-92 << SUBCOMPARTMENT ANALYSIS PROGRAM >>

THREED 18 NOV 1980 10:49:25 PAGE 3  
THREED.VER12.LEV01 CREATED 80.106 11:35:02 UNIT 10

UNIT 55 (SEQ 1) INPUT ECHO

	1	2	3	4	5	6	7	8							
101	9	10	0	0	90.	.434	1.004	-0.45	2	1.0	0	0.0	4.5	1.0	101
102	11	10	0	0	90.	.434	1.004	-0.45	2	1.0	0	0.0	4.5	1.0	102
103	9	17	0	0	24.5	.337	2.088	2.048	2	1.0	0	0.0	4.5	1.0	103
104	12	13	0	0	84.0	.102	.558	0.012	2	1.0	0	0.0	11.00	1.0	104
105	11	19	0	0	24.5	.337	2.088	2.048	2	1.0	0	0.0	11.00	1.0	105
106	3	15	0	0	211.1	.077	.264	.264	2	1.0	0	0.0	12.50	1.0	106
107	2	14	0	0	208.7	.060	.264	.264	2	1.0	0	0.0	12.50	1.0	107
108	17	18	0	0	135.	.288	1.007	-0.451	2	1.0	0	0.0	19.75	1.0	108
109	18	19	0	0	135.	.288	-0.451	1.007	2	1.0	0	0.0	19.75	1.0	109
110	19	20	0	0	162.	.142	.696	-0.369	2	1.0	0	0.0	19.75	1.0	110
111	14	16	0	0	47.5	.164	1.027	1.718	2	1.0	0	0.0	19.25	1.0	111
112	15	16	0	0	47.5	.164	1.027	1.718	2	1.0	0	0.0	19.25	1.0	112
113	16	21	0	0	162.	.111	-0.197	1.456	2	1.0	0	0.0	19.75	1.0	113
114	17	23	0	0	21.0	.328	1.893	1.886	2	1.0	0	0.0	18.43	1.0	114
115	19	23	0	0	21.0	.328	1.893	1.886	2	1.0	0	0.0	18.43	1.0	115
116	20	21	0	0	162.0	-.111	-0.197	1.456	2	1.0	0	0.0	19.75	1.0	116
117	18	13	0	0	21.	.329	2.250	2.497	2	1.0	0	0.0	19.25	1.0	117
118	16	17	0	0	162.	.142	-0.369	.696	2	1.0	0	0.0	19.75	1.0	118
119	21	22	0	0	496.5	.029	.831	-.418	2	1.0	0	0.0	19.25	1.0	119
120	22	24	0	0	66.5	.032	2.552	2.552	2	1.0	0	0.0	26.5	1.0	120
121	25	23	0	0	195.	.112	1.197	1.180	2	1.0	0	0.0	35.0	1.0	121
122	25	23	0	0	155.	.17	1.225	1.189	2	1.0	0	0.0	35.0	1.0	122
123	23	26	0	0	60.	.040	2.553	2.607	2	1.0	0	0.0	44.25	1.0	123
124	24	25	0	0	983.6	.030	.284	-0.131	2	1.0	0	0.0	35.0	1.0	124
125	24	26	0	0	63.	.035	2.673	2.672	2	1.0	0	0.0	44.25	1.0	125
126	24	26	0	0	83.2	.022	1.636	1.634	2	1.0	0	0.0	44.25	1.0	126
127	6	22	0	0	792.	.01	1.253	1.130	2	1.0	0	0.0	12.	1.0	127
128	6	27	0	0	27.1	2.83	3.05	3.05	2	1.0	0	0.0	5.0	1.0	128
129	4	28	0	0	5.69	1.723	2.809	2.822	2	1.0	0	0.0	19.08	1.0	129
130	8	29	0	0	5.69	1.723	2.809	2.822	2	1.0	0	0.0	19.08	1.0	130
131	26	30	0	0	42.24	.072	2.653	2.104	2	1.0	0	0.0	50.0	1.0	131
132	26	30	0	0	42.24	.072	2.653	2.104	2	1.0	0	0.0	50.0	1.0	132
133	2	31	0	0	1.31	1.182	1.66	1.66	2	1.0	0	0.0	9.2	1.0	133
134	31	32	0	0	208.7	.06	.264	.264	2	1.0	0	0.0	12.5	1.0	134
135	32	16	0	0	47.5	.164	1.027	1.718	2	1.0	0	0.0	19.25	1.0	135
136	33	34	0	0	1.75	.894	1.61	1.61	2	1.0	0	0.0	9.2	1.0	136
137	34	37	0	0	211.1	.077	.264	.264	2	1.0	0	0.0	12.5	1.0	137
138	33	36	0	0	208.7	.060	.264	.264	2	1.0	0	0.0	12.5	1.0	138
139	36	20	0	0	47.5	.164	1.027	1.718	2	1.0	0	0.0	19.25	1.0	139
140	37	20	0	0	47.5	.164	1.027	1.718	2	1.0	0	0.0	19.25	1.0	140
141	33	35	0	0	1.31	1.182	1.66	1.66	2	1.0	0	0.0	9.2	1.0	141
142	35	38	0	0	208.7	.06	.264	.264	2	1.0	0	0.0	12.5	1.0	142
143	38	20	0	0	47.5	.164	1.027	1.718	2	1.0	0	0.0	19.25	1.0	143
144	1	39	0	0	1.0	10.0	1.0	30.0	2	1.0	0	0.0	9.0	1.0	144
145	2	39	0	0	16.25	1.0	1.0	30.0	2	1.0	0	0.0	9.0	1.0	145
146	3	39	0	0	16.25	1.0	1.0	30.0	2	1.0	0	0.0	9.0	1.0	146
147	31	39	0	0	16.25	1.0	1.0	30.0	2	1.0	0	0.0	9.0	1.0	147
148	21	39	0	0	3.25	10.0	1.0	30.0	2	1.0	0	0.0	15.0	1.0	148
149	33	39	0	0	16.25	1.0	1.0	30.0	2	1.0	0	0.0	9.0	1.0	149
150	34	39	0	0	16.25	1.0	1.0	30.0	2	1.0	0	0.0	9.0	1.0	150

1234567890123456789012345678901234567890123456789012345678901234567890

PS-050

J.O. 12846.44  
127

1-E-30

R3800124 SURRY 1&2:AUX BLDG,SGBD-CRACK NODE4 WITH HEAT SINKS  
S & W ENGR CORP NU-92 << SUBCOMPARTMENT ANALYSIS PROGRAM >>

THREED 18 NOV 1980 10:49:25 PAGE 4  
THREED.VER12.LEV01 CREATED 80.106 11:35:02 UNIT 10

UNIT 55 (SEQ 1) INPUT ECHO	1	2	3	4	5	6	7	8							
1234567890123456789012345678901234567890123456789012345678901234567890															
151	35	39	0	0	16.25	1.0	1.0	30.0	2	1.0	0	0.0	9.0	1.0	151
152	39	40	0	0	1.0	0.1	1.0	30.0	2	1.0	1	0.0	50.0	1.0	152
153	0	4	1	0	1.0	0.0	0.0	0.0	0	1.0	0	0.0	9.7	1.0	153
154	*														154
155	*														155
156	*FILL TABLE DATA CARDS:SGBD-CRACK NODE4														156
157	*														157
158	*														158
159	4	2													159
160		0.0			10.71		5418.2								160
161		900.0			10.71		5418.2								161
162		900.000001			0.0		0.0								162
163		1850.0			0.0		0.0								163
164	*														164
165	*														165
166	*FAN TABLE DATA CARDS														166
167	*														167
168	*														168
169	2	3													169
170		40300.0			0.0										170
171		40300.0			3000.0										171
172	*														172
173	*														173
174	*PASSIVE HEAT SINK DATA CARDS														174
175	*														175
176	*														176
177	SINK1,NODE4														177
178	12	1	0	0.0	7073.1	4	0								178
179	12	1.0													179
180	1														180
181	T														181
182	1	1	1	.08	0	0	0	1.0							182
183	SINK2,NODE5														183
184	12	1	0	0.0	1768.0	5	0								184
185	12	1.0													185
186	1														186
187	T														187
188	1	1	1	.08	0	0	0	1.0							188
189	SINK3,NODE6														189
190	12	1	0	0.0	5635.9	6	0								190
191	12	1.0													191
192	1														192
193	T														193
194	1	1	1	.08	0	0	0	1.0							194
195	SINK4,NODE7														195
196	12	1	0	0.0	1768.0	7	0								196
197	12	1.0													197
198	1														198
199	T														199
200	1	1	1	.08	0	0	0	1.0							200

1234567890123456789012345678901234567890123456789012345678901234567890

050-32  
P28  
5.0.12846.44



1-E-32

R3800124 SURRY 1&2:AUX BLDG,SGBD-CRACK NODE4 WITH HEAT SINKS  
S & W ENGR CORP NU-92 << SUBCOMPARTMENT ANALYSIS PROGRAM >>

THREED 18 NOV 1980 10:49:25 PAGE 6  
THREED.VER12.LEV01 CREATED 80.106 11:35:02 UNIT 10

UNIT 55 (SEQ 1) INPUT ECHO 1 2 3 4 5 6 7 8  
1234567890123456789012345678901234567890123456789012345678901234567890

251 6 0.5  
252 1  
253 T  
254 1 1 1 .08 0 0 0 1.0  
255 SINK14,NODE17  
256 6 1 0 0.0 1717.875 17 0  
257 6 0.5  
258 1  
259 T  
260 1 1 1 .08 0 0 0 1.0  
261 SINK15,NODE18  
262 12 1 0 0.0 3008.0 18 0  
263 12 1.0  
264 1  
265 T  
266 1 1 1 .08 0 0 0 1.0  
267 SINK16,NODE19  
268 6 1 0 0.0 1717.875 19 0  
269 6 0.5  
270 1  
271 T  
272 1 1 1 .08 0 0 0 1.0  
273 SINK17,NODE20  
274 6 1 0 0.0 1275.0 20 0  
275 6 0.5  
276 1  
277 T  
278 1 1 1 .08 0 0 0 1.0  
279 \*  
280 \*  
281 \*DATA COMMON TO HEAT SINKS  
282 \*  
283 \*  
284 120.0 T  
285 0.79 24.93 'CONCRETE'/  
286 END OF HEAT SLAB DATA

251  
252  
253  
254  
255  
256  
257  
258  
259  
260  
261  
262  
263  
264  
265  
266  
267  
268  
269  
270  
271  
272  
273  
274  
275  
276  
277  
278  
279  
280  
281  
282  
283  
284  
285  
286

1234567890123456789012345678901234567890123456789012345678901234567890 <EOF> COPIED TO UNIT 5  
W/O CMTS

PE-150

P30  
J.O. 12846.44

1-E-33

R3800124 SURRY 1&2:AUX BLDG,SGBD-CRACK NODE4 WITH HEAT SINKS  
S & W ENGR CORP NU-92 << SUBCOMPARTMENT ANALYSIS PROGRAM >>

THREED 18 NOV 1980 10:49:25 PAGE 7  
THREED.VER12.LEV01 CREATED 80.106 11:35:02 UNIT 10

RUN SUMMARY SHEET

MISCELLANEOUS PROBLEM CONTROL DATA:

OUTPUT FLAG.....	1	TOTAL TIME OF RUN.....	1801.000 SEC
NUMBER OF TIME STEP CARDS...	11	NUMBER OF STANDARD TIME STEPS.....	5002
NUMBER OF TRIP CONTROLS.....	3	NUMBER OF ACTUAL TIME STEPS.....	5013
NUMBER OF VOLUMES.....	40	NUMBER OF TIMES GAUSSIAN ELIMINATION USED..	2370
NUMBER OF JUNCTIONS.....	66	NUMBER OF TIMES GAUSS-SEIDEL USED.....	2643
NUMBER OF FILL TABLES.....	1	NUMBER OF TRANSIENTS STORED FOR PLOTENUP...	146
NUMBER OF FAN TABLES.....	1	NUMBER OF SELECTED NODAL DIFF. PRESS.....	0
NUMBER OF HT SOURCE CURVES..	0	NUMBER OF HEAT SINKS.....	17
IMPLICIT/EXPLICIT COEFF.....	1.000	NUMBER OF INTERNAL JUNCTIONS.....	65

STEAM TABLES USED (FT15) VOLUME SERIAL NO. = SHARE0 DATA SET NAME = HEATBAL.ME190.STH20G.OUTPUT1

OUTPUT: TRANSIENTS TAPE (FT08) = 016308 FILE NUMBER = 20 DATA SET NAME = FE.GUARDS.PLOTTER  
TRANSMITTAL FILE (FT09) WAS NOT USED

PEAK PRESSURE DIFFERENTIAL

JUNCTION NUMBER	CONNECTING VOLUMES	PRESSURE PSID	TIME SEC	JUNCTION NUMBER	CONNECTING VOLUMES	PRESSURE PSID	TIME SEC
1	1 TO 6	0.01	0.489	34	25 TO 23	0.00	0.546
2	2 TO 3	0.00	0.236	35	25 TO 23	0.00	0.546
3	4 TO 5	-0.01	0.394	36	23 TO 26	-0.01	0.000
4	5 TO 6	-0.01	0.396	37	24 TO 25	-0.01	0.080
5	7 TO 6	-0.01	0.396	38	24 TO 26	-0.01	0.000
6	8 TO 7	-0.01	0.394	39	24 TO 26	-0.01	0.000
7	1 TO 12	0.01	0.392	40	6 TO 22	-0.01	0.000
8	1 TO 12	0.01	0.392	41	6 TO 27	0.01	0.394
9	7 TO 11	0.01	0.394	42	4 TO 28	-0.02	0.408
10	8 TO 11	0.00	0.590	43	8 TO 29	-0.02	0.408
11	4 TO 9	0.00	0.590	44	26 TO 30	-0.01	0.098
12	5 TO 9	0.01	0.394	45	26 TO 30	-0.01	0.098
13	10 TO 12	-0.01	0.400	46	2 TO 31	-0.00	0.501
14	9 TO 10	-0.01	0.446	47	31 TO 32	-0.01	0.000
15	11 TO 10	-0.01	0.446	48	32 TO 16	-0.01	0.248
16	9 TO 17	0.01	0.593	49	33 TO 34	0.00	0.236
17	12 TO 13	-0.01	0.000	50	34 TO 37	-0.01	0.234
18	11 TO 19	0.01	0.593	51	33 TO 36	-0.01	0.000
19	3 TO 15	-0.01	0.234	52	36 TO 20	-0.01	0.249
20	2 TO 14	-0.01	0.000	53	37 TO 20	-0.01	0.251
21	17 TO 18	0.02	0.744	54	33 TO 35	-0.00	0.501
22	18 TO 19	-0.02	0.744	55	35 TO 38	-0.01	0.000
23	19 TO 20	0.01	0.271	56	38 TO 20	-0.01	0.248
24	14 TO 16	-0.01	0.249	57	1 TO 39	0.10	0.227
25	15 TO 16	-0.01	0.251	58	2 TO 39	0.09	0.225
26	16 TO 21	-0.02	0.268	59	3 TO 39	0.09	0.225
27	17 TO 23	-0.01	0.596	60	31 TO 39	0.09	0.225
28	19 TO 23	-0.01	0.596	61	21 TO 39	0.09	0.227
29	20 TO 21	-0.02	0.268	62	33 TO 39	0.09	0.225
30	18 TO 13	-0.01	0.321	63	34 TO 39	0.09	0.225
31	16 TO 17	-0.01	0.271	64	35 TO 39	0.09	0.225
32	21 TO 22	0.01	0.443	65	39 TO 40	-0.39	0.227
33	22 TO 24	-0.01	0.023				

PC-25-D

5012844.44

231

1-E-34

PEAK PRESSURES AND TEMPERATURES									
NODE NUMBER	PRESSURE (PSIA)	TIME (SEC)	TEMPERATURE (DEG F)	TIME (SEC)	NODE NUMBER	PRESSURE (PSIA)	TIME (SEC)	TEMPERATURE (DEG F)	TIME (SEC)
1	14.73	0.584	136.20	908.300	21	14.72	0.724	121.20	720.000
2	14.73	0.691	135.69	956.500	22	14.72	0.393	121.35	675.000
3	14.73	0.691	135.70	956.000	23	14.71	0.283	120.11	0.283
4	14.73	0.541	185.08	902.000	24	14.71	0.395	120.09	0.394
5	14.73	0.576	155.69	902.000	25	14.71	0.264	120.11	0.264
6	14.73	0.578	133.49	902.040	26	14.70	0.326	120.04	0.326
7	14.73	0.576	142.25	915.000	27	14.71	4.650	120.13	4.650
8	14.73	0.541	135.84	1128.000	28	14.72	0.447	120.25	0.446
9	14.73	0.545	183.41	902.310	29	14.72	0.446	120.25	0.446
10	14.73	0.206	172.60	902.030	30	14.70	1801.000	120.00	1801.000
11	14.73	0.545	153.25	902.080	31	14.73	0.691	135.69	956.500
12	14.73	0.234	137.38	902.030	32	14.72	0.414	135.78	942.000
13	14.72	0.490	127.13	824.000	33	14.73	0.691	121.08	676.000
14	14.72	0.691	135.78	942.000	34	14.73	0.691	121.08	676.000
15	14.73	0.413	135.79	941.500	35	14.73	0.691	121.08	677.000
16	14.72	0.429	136.05	923.500	36	14.72	0.691	121.08	655.000
17	14.73	0.646	149.30	902.010	37	14.73	0.413	121.08	654.000
18	14.72	0.686	130.79	738.000	38	14.72	0.414	121.08	655.000
19	14.73	0.646	121.32	528.000	39	14.76	0.274	130.27	957.000
20	14.72	0.429	121.09	626.000	40	15.00	1801.000	120.00	1801.000

PC-050

P32  
J.G. 12846.44



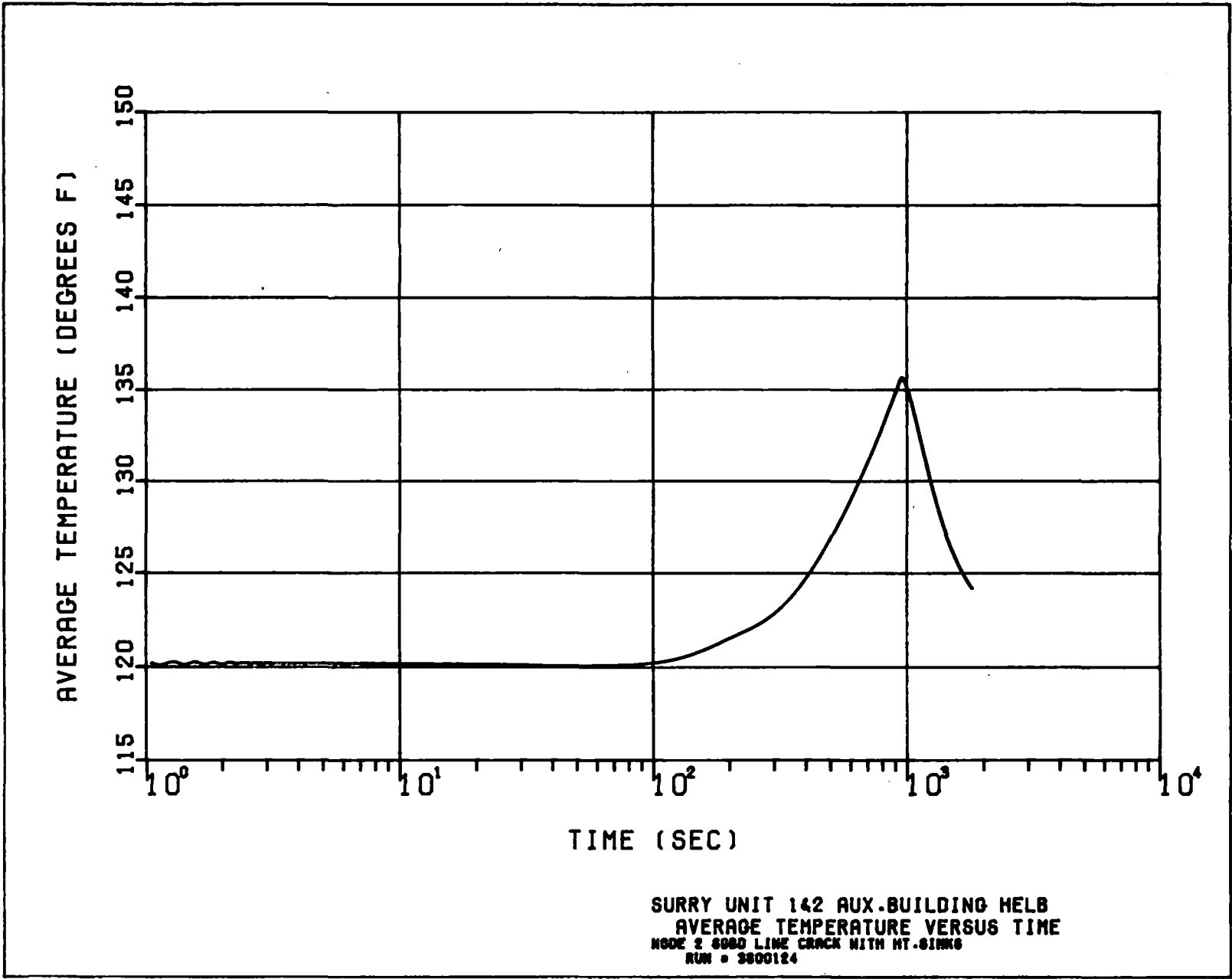

SURRY UNIT 142 AUX. BUILDING HELB  
AVERAGE TEMPERATURE VERSUS TIME  
NODE 2 6680 LINE CRACK WITH HT. 61116  
RUN # 3800124

28-050 P33

NO. 12846.44

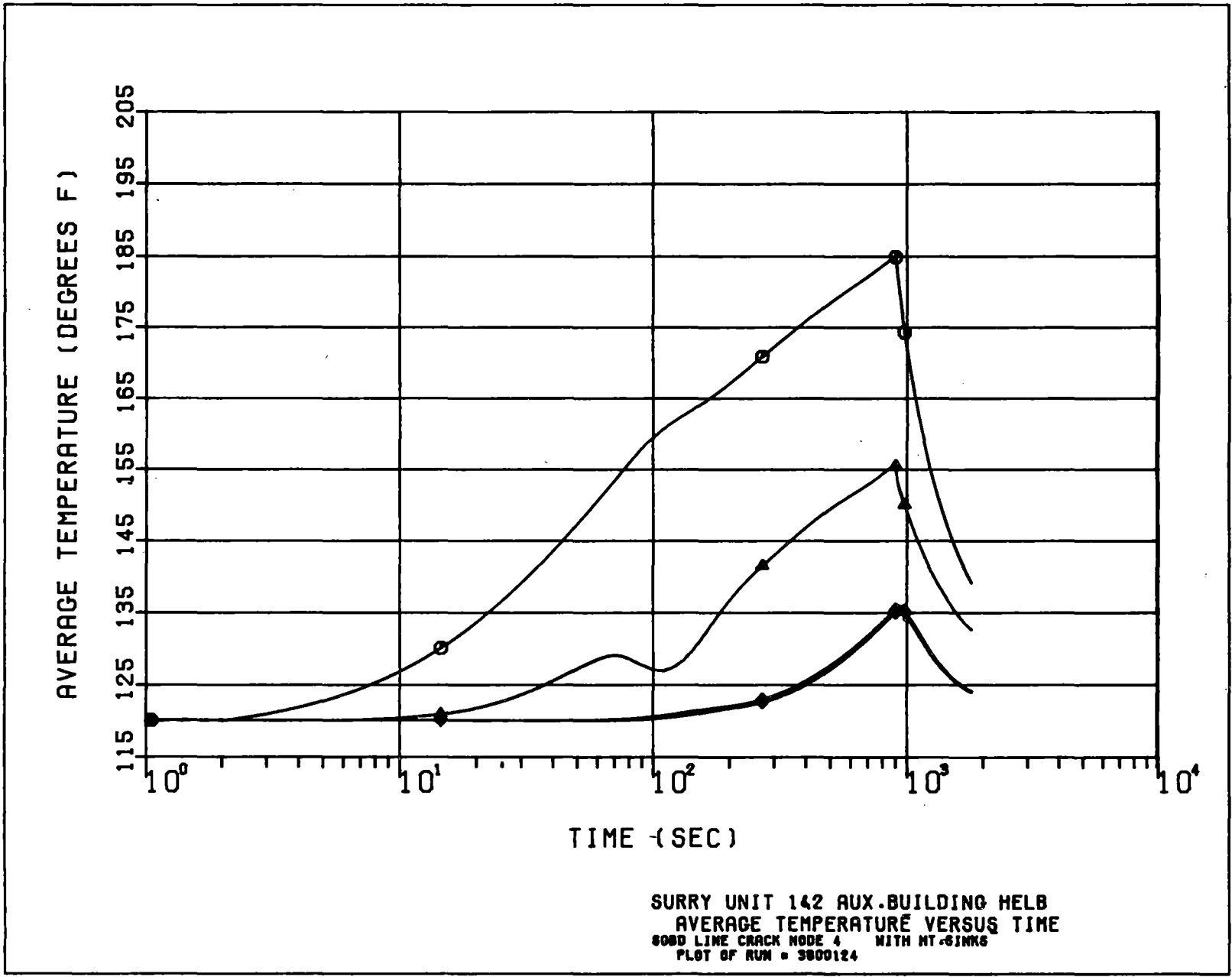

SURRY UNIT 142 AUX. BUILDING HELB  
AVERAGE TEMPERATURE VERSUS TIME  
GOOD LINE CRACK NODE 4 WITH HT-SINKS  
PLOT OF RUN # 3800124

PE-050

1-E-37

R3800125 SURRY 1&2:AUX BLDG,LETDOWN LINE CRACK NODE 6 WITH HT. SINKS  
S & H ENGR CORP NU-92 << SUBCOMPARTMENT ANALYSIS PROGRAM >>

THREED 18 NOV 1980 15:04:18 PAGE 1  
THREED.VER12.LEV01 CREATED 80.106 11:35:02 UNIT 10

UNIT 55 (SEQ 1) INPUT ECHO 1 2 3 4 5 6 7 8  
1234567890123456789012345678901234567890123456789012345678901234567890

1	SURRY 1&2:AUX BLDG,LETDOWN LINE CRACK NODE 6 WITH HT. SINKS	1
2	*	2
3	*	3
4	*PROBLEM DIMENSION CARD	4
5	*	5
6	*	6
7	1 11 3 40 66 1 1 0 0 17	7
8	*	8
9	*	9
10	*IMPLICIT/EXPLICIT COEFICIENT CARD	10
11	*	11
12	*	12
13	1.0	13
14	*	14
15	*	15
16	*TIME STEP CONTROL DATA CARDS	16
17	*	17
18	*	18
19	50 10 0 0 0.001 0.00001 2.2	19
20	2 10 0 0 0.01 0.0001 3.0	20
21	5 14 0 0 0.05 0.0001 10.0	21
22	5 15 0 0 0.1 0.0001 30.0	22
23	2 15 0 0 0.5 0.001 80.0	23
24	10 20 0 0 1.0 0.001 901.0	24
25	5 10 0 0 0.01 0.0001 903.0	25
26	5 14 0 0 0.05 0.0001 910.0	26
27	10 10 0 0 0.1 0.0001 930.0	27
28	2 25 0 0 0.5 0.001 980.0	28
29	10 20 0 0 1.0 0.001 1850.0	29
30	*	30
31	*	31
32	*TRIP CONTROL DATA CARDS	32
33	*	33
34	*	34
35	1 0 0 1800.0 0.0	35
36	1 0 0 0.0 2.0	36
37	1 0 0 0.0 0.2	37
38	*	38
39	*	39
40	*NODAL DATA CARDS	40
41	*	41
42	*	42
43	14.70 120. 1.0 1137.7 2.00 9.50 0.0 0	43
44	14.70 120. 1.0 2011.2 2.00 10.00 0.0 0	44
45	14.70 120. 1.0 2011.2 2.00 10.00 0.0 0	45
46	14.70 120. 1.0 26611.5 2.00 12.00 0.0 0	46
47	14.70 120. 1.0 5150.7 2.00 9.50 0.0 0	47
48	14.70 120. 1.0 18697.8 2.00 10.10 0.0 0	48
49	14.70 120. 1.0 5150.7 2.00 9.50 0.0 0	49
50	14.70 120. 1.0 26611.5 2.00 12.00 0.0 0	50

1234567890123456789012345678901234567890123456789012345678901234567890

PC-050

P 35-  
J.O. 12846.44



1-E-39

R3800125 SURRY 1&2:AUX BLDG,LETDOWN LINE CRACK NODE 6 WITH HT. SINKS  
S & W ENGR CORP NU-92 << SUBCOMPARTMENT ANALYSIS PROGRAM >>

THREED 18 NOV 1980 15:04:18 PAGE 3  
THREED.VER12.LEV01 CREATED 80.106 11:35:02 UNIT 10

UNIT 55 (SEQ 1) INPUT ECHO  
1 2 3 4 5 6 7 8  
1234567890123456789012345678901234567890123456789012345678901234567890

101	9	10	0	0	90.	.434	1.004	-0.45	2	1.0	0	0.0	4.5	1.0	101
102	11	10	0	0	90.	.434	1.004	-0.45	2	1.0	0	0.0	4.5	1.0	102
103	9	17	0	0	24.5	.337	2.088	2.048	2	1.0	0	0.0	4.5	1.0	103
104	12	13	0	0	84.0	.102	.558	0.012	2	1.0	0	0.0	11.00	1.0	104
105	11	19	0	0	24.5	.337	2.088	2.048	2	1.0	0	0.0	11.00	1.0	105
106	3	15	0	0	211.1	.077	.264	.264	2	1.0	0	0.0	12.50	1.0	106
107	2	14	0	0	208.7	.060	.264	.264	2	1.0	0	0.0	12.50	1.0	107
108	17	18	0	0	135.	.288	1.007	-0.451	2	1.0	0	0.0	19.75	1.0	108
109	18	19	0	0	135.	.288	-0.451	1.007	2	1.0	0	0.0	19.75	1.0	109
110	19	20	0	0	162.	.142	.696	-0.369	2	1.0	0	0.0	19.75	1.0	110
111	14	16	0	0	47.5	.164	1.027	1.718	2	1.0	0	0.0	19.25	1.0	111
112	15	16	0	0	47.5	.164	1.027	1.718	2	1.0	0	0.0	19.25	1.0	112
113	16	21	0	0	162.	.111	-0.197	1.456	2	1.0	0	0.0	19.75	1.0	113
114	17	23	0	0	21.0	.328	1.893	1.886	2	1.0	0	0.0	18.43	1.0	114
115	19	23	0	0	21.0	.328	1.893	1.886	2	1.0	0	0.0	18.43	1.0	115
116	20	21	0	0	162.0	.111	-0.197	1.456	2	1.0	0	0.0	19.75	1.0	116
117	18	13	0	0	21.	.329	2.250	2.497	2	1.0	0	0.0	19.25	1.0	117
118	16	17	0	0	162.	.142	-0.369	.696	2	1.0	0	0.0	19.75	1.0	118
119	21	22	0	0	496.5	.029	.831	-.418	2	1.0	0	0.0	19.25	1.0	119
120	22	24	0	0	66.5	.032	2.552	2.552	2	1.0	0	0.0	26.5	1.0	120
121	25	23	0	0	195.	.112	1.197	1.180	2	1.0	0	0.0	35.0	1.0	121
122	25	23	0	0	155.	.17	1.225	1.189	2	1.0	0	0.0	35.0	1.0	122
123	23	26	0	0	60.	.040	2.553	2.607	2	1.0	0	0.0	44.25	1.0	123
124	24	25	0	0	983.6	.030	.284	-0.131	2	1.0	0	0.0	35.0	1.0	124
125	24	26	0	0	63.	.035	2.673	2.672	2	1.0	0	0.0	44.25	1.0	125
126	24	26	0	0	83.2	.022	1.636	1.634	2	1.0	0	0.0	44.25	1.0	126
127	6	22	0	0	792.	.01	1.253	1.130	2	1.0	0	0.0	12.	1.0	127
128	6	27	0	0	27.1	2.83	3.05	3.05	2	1.0	0	0.0	5.0	1.0	128
129	4	28	0	0	5.69	1.723	2.809	2.822	2	1.0	0	0.0	19.08	1.0	129
130	8	29	0	0	5.69	1.723	2.809	2.822	2	1.0	0	0.0	19.08	1.0	130
131	26	30	0	0	42.24	.072	2.653	2.104	2	1.0	0	0.0	50.0	1.0	131
132	26	30	0	0	42.24	.072	2.653	2.104	2	1.0	0	0.0	50.0	1.0	132
133	2	31	0	0	1.31	1.182	1.66	1.66	2	1.0	0	0.0	9.2	1.0	133
134	31	32	0	0	208.7	.06	.264	.264	2	1.0	0	0.0	12.5	1.0	134
135	32	16	0	0	47.5	.164	1.027	1.718	2	1.0	0	0.0	19.25	1.0	135
136	33	34	0	0	1.75	.894	1.61	1.61	2	1.0	0	0.0	9.2	1.0	136
137	34	37	0	0	211.1	.077	.264	.264	2	1.0	0	0.0	12.5	1.0	137
138	33	36	0	0	208.7	.060	.264	.264	2	1.0	0	0.0	12.5	1.0	138
139	36	20	0	0	47.5	.164	1.027	1.718	2	1.0	0	0.0	19.25	1.0	139
140	37	20	0	0	47.5	.164	1.027	1.718	2	1.0	0	0.0	19.25	1.0	140
141	33	35	0	0	1.31	1.182	1.66	1.66	2	1.0	0	0.0	9.2	1.0	141
142	35	38	0	0	208.7	.06	.264	.264	2	1.0	0	0.0	12.5	1.0	142
143	38	20	0	0	47.5	.164	1.027	1.718	2	1.0	0	0.0	19.25	1.0	143
144	1	39	0	0	1.0	10.0	1.0	30.0	2	1.0	0	0.0	9.0	1.0	144
145	2	39	0	0	16.25	1.0	1.0	30.0	2	1.0	0	0.0	9.0	1.0	145
146	3	39	0	0	16.25	1.0	1.0	30.0	2	1.0	0	0.0	9.0	1.0	146
147	31	39	0	0	16.25	1.0	1.0	30.0	2	1.0	0	0.0	9.0	1.0	147
148	21	39	0	0	3.25	10.0	1.0	30.0	2	1.0	0	0.0	15.0	1.0	148
149	33	39	0	0	16.25	1.0	1.0	30.0	2	1.0	0	0.0	9.0	1.0	149
150	34	39	0	0	16.25	1.0	1.0	30.0	2	1.0	0	0.0	9.0	1.0	150

1234567890123456789012345678901234567890123456789012345678901234567890

PC-050

P37  
J.O. 12846

1-E-40

UNIT 55 (SEQ 1) INPUT ECHO	1	2	3	4	5	6	7	8							
1234567890123456789012345678901234567890123456789012345678901234567890															
151	35	39	0	0	16.25	1.0	1.0	30.0	2	1.0	0	0.0	9.0	1.0	151
152	39	40	0	0	1.0	0.1	1.0	30.0	2	1.0	1	0.0	50.0	1.0	152
153	0	6	1	0	1.0	0.0	0.0	0.0	0	1.0	0	0.0	9.7	1.0	153
154	*														154
155	*														155
156	*FILL TABLE DATA CARDS:LETDOWN LINE CRACK NODE 6 WITH HT.SINKS														156
157	*														157
158	*														158
159	8	2													159
160	0.0				563.0			146380.0							160
161	0.71				563.0			146380.0							161
162		0.710001			281.5			73190.0							162
163		2.16			281.5			73190.0							163
164		2.160001			25.5			6630.0							164
165		900.0			25.5			6630.0							165
166		900.000001			0.0			0.0							166
167		1850.0			0.0			0.0							167
168	*														168
169	*														169
170	*FAN TABLE DATA CARDS														170
171	*														171
172	*														172
173	2	3													173
174		40300.0			0.0										174
175		40300.0			3000.0										175
176	*														176
177	*														177
178	*PASSIVE HEAT SINK DATA CARDS														178
179	*														179
180	*														180
181	SINK1,NODE4														181
182	12	1	0	0.0	7073.1	4	0								182
183	12	1.0													183
184	1														184
185	T														185
186	1	1	1	.08	0	0	0	1.0							186
187	SINK2,NODE5														187
188	12	1	0	0.0	1768.0	5	0								188
189	12	1.0													189
190	1														190
191	T														191
192	1	1	1	.08	0	0	0	1.0							192
193	SINK3,NODE6														193
194	12	1	0	0.0	5635.9	6	0								194
195	12	1.0													195
196	1														196
197	T														197
198	1	1	1	.08	0	0	0	1.0							198
199	SINK4,NODE7														199
200	12	1	0	0.0	1768.0	7	0								200

1234567890123456789012345678901234567890123456789012345678901234567890

PC-050

5.0.12846.44  
P88







1-E-43

RUN SUMMARY SHEET

MISCELLANEOUS PROBLEM CONTROL DATA:

OUTPUT FLAG.....	1	TOTAL TIME OF RUN.....	1801.000 SEC
NUMBER OF TIME STEP CARDS...	11	NUMBER OF STANDARD TIME STEPS.....	5002
NUMBER OF TRIP CONTROLS.....	3	NUMBER OF ACTUAL TIME STEPS.....	5013
NUMBER OF VOLUMES.....	40	NUMBER OF TIMES GAUSSIAN ELIMINATION USED..	2295
NUMBER OF JUNCTIONS.....	66	NUMBER OF TIMES GAUSS-SEIDEL USED.....	2718
NUMBER OF FILL TABLES.....	1	NUMBER OF TRANSIENTS STORED FOR PLOTENUP...	146
NUMBER OF FAN TABLES.....	1	NUMBER OF SELECTED NODAL DIFF. PRESS.....	0
NUMBER OF HT SOURCE CURVES..	0	NUMBER OF HEAT SINKS.....	17
IMPLICIT/EXPLICIT COEFF.....	1.000	NUMBER OF INTERNAL JUNCTIONS.....	65

STEAM TABLES USED (FT15) VOLUME SERIAL NO. = SHARE0 DATA SET NAME = HEATBAL.ME190.STH20G.OUTPUT1

OUTPUT: TRANSIENTS TAPE (FT08) = 016308 FILE NUMBER = 21 DATA SET NAME = FE.GUARDS.PLOTTER  
TRANSMITTAL FILE (FT09) WAS NOT USED

PEAK PRESSURE DIFFERENTIAL

JUNCTION NUMBER	CONNECTING VOLUMES	PRESSURE PSID	TIME SEC	JUNCTION NUMBER	CONNECTING VOLUMES	PRESSURE PSID	TIME SEC
1	1 TO 6	-0.03	2.016	34	25 TO 23	-0.01	2.142
2	2 TO 3	0.00	0.236	35	29 TO 23	-0.01	2.142
3	4 TO 5	-0.01	2.041	36	23 TO 26	-0.01	0.000
4	5 TO 6	-0.03	2.019	37	24 TO 25	0.01	2.051
5	7 TO 6	-0.03	2.019	38	24 TO 26	0.01	2.054
6	8 TO 7	-0.01	2.041	39	24 TO 26	0.01	2.054
7	1 TO 12	0.02	2.041	40	6 TO 22	0.02	2.014
8	1 TO 12	0.02	2.041	41	6 TO 27	0.04	2.220
9	7 TO 11	0.01	2.041	42	4 TO 28	-0.02	2.450
10	8 TO 11	-0.00	2.192	43	8 TO 29	-0.02	2.450
11	4 TO 9	-0.00	2.192	44	26 TO 30	0.01	2.290
12	5 TO 9	0.01	2.041	45	26 TO 30	0.01	2.290
13	10 TO 12	-0.01	0.400	46	2 TO 31	-0.00	0.501
14	9 TO 10	-0.01	0.446	47	31 TO 32	-0.01	0.000
15	11 TO 10	-0.01	0.446	48	32 TO 16	0.01	2.117
16	9 TO 17	0.01	0.593	49	33 TO 34	0.00	0.238
17	12 TO 13	-0.01	0.000	50	34 TO 37	-0.01	0.234
18	11 TO 19	0.01	0.593	51	33 TO 36	-0.01	0.000
19	3 TO 15	-0.01	0.234	52	36 TO 20	0.01	2.117
20	2 TO 14	-0.01	0.000	53	37 TO 20	0.01	2.117
21	17 TO 18	0.02	0.744	54	33 TO 35	-0.00	0.501
22	18 TO 19	-0.02	0.744	55	35 TO 38	-0.01	0.000
23	19 TO 20	0.01	0.271	56	38 TO 20	0.01	2.117
24	14 TO 16	0.01	2.117	57	1 TO 39	0.10	0.227
25	15 TO 16	0.01	2.117	58	2 TO 39	0.09	0.225
26	16 TO 21	-0.03	2.056	59	3 TO 39	0.09	0.225
27	17 TO 23	0.02	2.195	60	31 TO 39	0.09	0.225
28	19 TO 23	0.02	2.195	61	21 TO 39	0.09	0.227
29	20 TO 21	-0.03	2.056	62	33 TO 39	0.09	0.225
30	18 TO 13	-0.01	2.060	63	34 TO 39	0.09	0.225
31	16 TO 17	-0.01	0.271	64	35 TO 39	0.09	0.225
32	21 TO 22	-0.03	2.032	65	39 TO 40	-0.39	0.227
33	22 TO 24	0.03	2.034				

PC-050

PA1  
5.0.17846.49

1-E-44

PEAK PRESSURES AND TEMPERATURES									
NODE NUMBER	PRESSURE (PSIA)	TIME (SEC)	TEMPERATURE (DEG F)	TIME (SEC)	NODE NUMBER	PRESSURE (PSIA)	TIME (SEC)	TEMPERATURE (DEG F)	TIME (SEC)
1	14.76	2.220	136.96	910.600	21	14.75	2.062	120.54	2.062
2	14.75	2.127	131.55	918.800	22	14.75	2.035	121.97	4.150
3	14.75	2.125	131.55	918.700	23	14.72	2.150	120.27	2.150
4	14.75	2.290	147.77	1083.000	24	14.72	2.210	120.26	2.200
5	14.75	2.200	168.58	904.150	25	14.72	2.220	120.26	2.220
6	14.76	2.210	171.60	902.000	26	14.71	2.280	120.12	2.280
7	14.75	2.200	168.65	903.750	27	14.72	5.100	120.10	902.080
8	14.75	2.290	145.51	906.850	28	14.75	2.440	120.55	2.440
9	14.75	2.290	153.18	926.300	29	14.75	2.440	120.55	2.440
10	14.75	2.185	144.36	922.600	30	14.70	1801.000	120.00	1801.000
11	14.75	2.290	156.44	911.500	31	14.75	2.127	131.55	918.900
12	14.75	2.220	137.72	902.020	32	14.75	2.129	131.57	912.700
13	14.74	2.220	126.98	210.000	33	14.75	2.127	126.66	673.000
14	14.75	2.129	131.57	912.700	34	14.75	2.125	126.66	671.000
15	14.75	2.130	131.58	912.600	35	14.75	2.127	126.66	673.000
16	14.74	2.179	131.68	907.400	36	14.75	2.129	126.66	642.000
17	14.74	2.188	139.37	902.030	37	14.75	2.130	126.66	640.000
18	14.74	2.158	126.07	910.500	38	14.75	2.129	126.66	642.000
19	14.74	2.188	130.09	681.000	39	14.76	0.274	130.16	918.700
20	14.74	2.179	126.67	599.000	40	15.00	1801.000	120.00	1801.000

PE-050

P42  
J.O. 12896.74

1-E-45

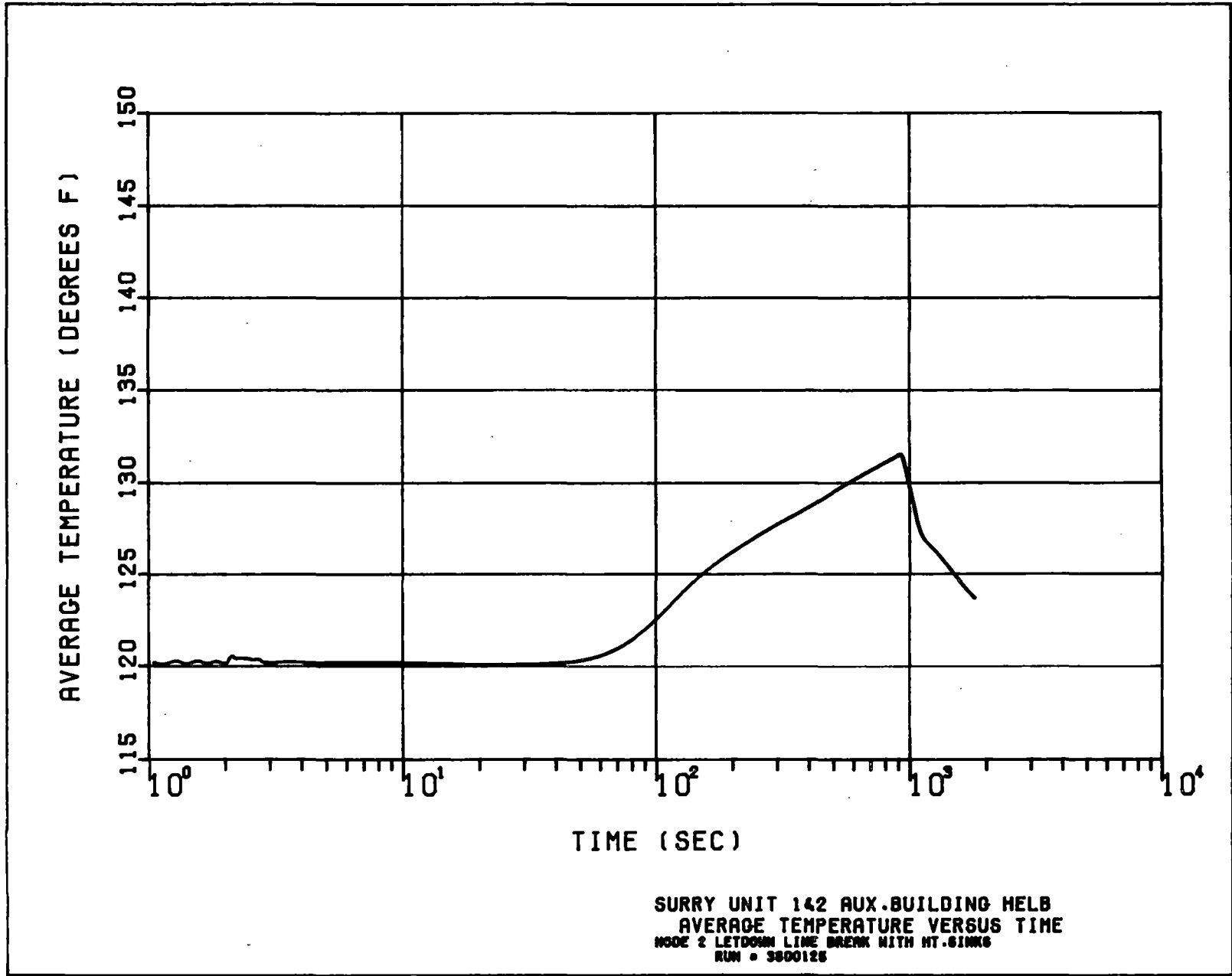

PC-050

P 43  
J10.17846.44

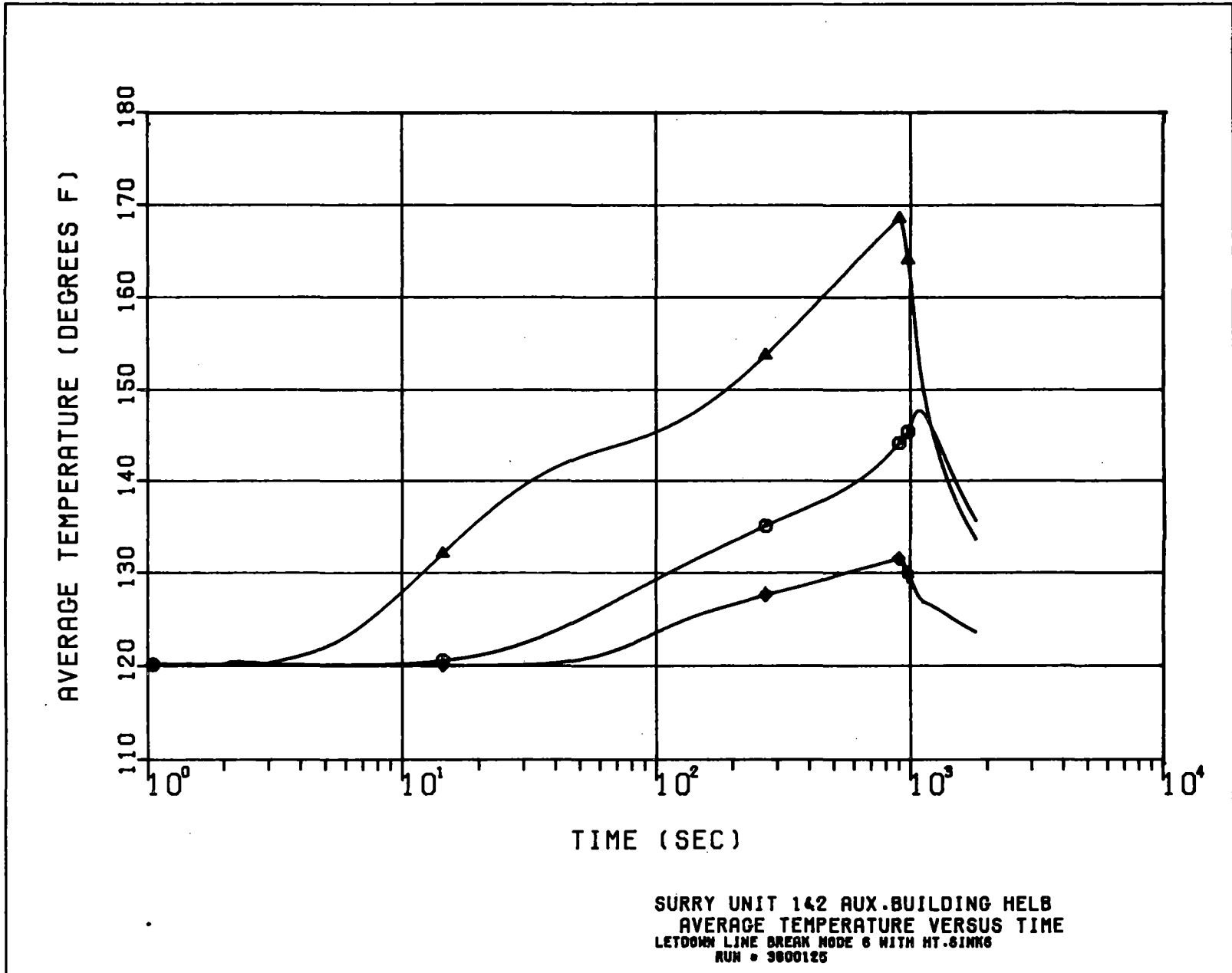

PE-050

1-E-47

UNIT 55 (SEQ 1) INPUT ECHO 1 2 3 4 5 6 7 8  
1234567890123456789012345678901234567890123456789012345678901234567890

1	SURRY 1&2:AUX BLDG,6"AUX STM LINE CRACK NODE22 WITH HT. SINKS								1		
2	*								2		
3	*								3		
4	*PROBLEM DIMENSION CARD								4		
5	*								5		
6	*								6		
7	1	11	3	40	66	1	1	0	0	17	7
8	*										8
9	*										9
10	*IMPLICIT/EXPLICIT COEFFICIENT CARD								10		
11	*										11
12	*										12
13	1.0										13
14	*										14
15	*										15
16	*TIME STEP CONTROL DATA CARDS								16		
17	*										17
18	*										18
19	50	10	0	0	0.001	0.00001	2.2				19
20	2	10	0	0	0.01	0.0001	3.0				20
21	5	14	0	0	0.05	0.0001	10.0				21
22	5	15	0	0	0.1	0.0001	30.0				22
23	2	15	0	0	0.5	0.001	80.0				23
24	10	20	0	0	1.0	0.001	901.0				24
25	5	10	0	0	0.01	0.0001	903.0				25
26	5	14	0	0	0.05	0.0001	910.0				26
27	10	10	0	0	0.1	0.0001	930.0				27
28	2	25	0	0	0.5	0.001	980.0				28
29	10	20	0	0	1.0	0.001	1850.0				29
30	*										30
31	*										31
32	*TRIP CONTROL DATA CARDS								32		
33	*										33
34	*										34
35	1	0	0	1800.0	0.0						35
36	1	0	0	0.0	2.0						36
37	1	0	0	0.0	0.2						37
38	*										38
39	*										39
40	*NODAL DATA CARDS								40		
41	*										41
42	*										42
43	14.70	120.	1.0	1137.7	2.00	9.50	0.0	0			43
44	14.70	120.	1.0	2011.2	2.00	10.00	0.0	0			44
45	14.70	120.	1.0	2011.2	2.00	10.00	0.0	0			45
46	14.70	120.	1.0	26611.5	2.00	12.00	0.0	0			46
47	14.70	120.	1.0	5150.7	2.00	9.50	0.0	0			47
48	14.70	120.	1.0	18397.8	2.00	10.10	0.0	0			48
49	14.70	120.	1.0	5150.7	2.00	9.50	0.0	0			49
50	14.70	120.	1.0	26611.5	2.00	12.00	0.0	0			50

1234567890123456789012345678901234567890123456789012345678901234567890

PC-050  
P45  
J. J. 12846.44



1-E-44

UNIT 55 (SEQ 1) INPUT ECHO  
1 2 3 4 5 6 7 8  
1234567890123456789012345678901234567890123456789012345678901234567890

101	9	10	0	0	90.	.434	1.004	-0.45	2	1.0	0	0.0	4.5	1.0	101
102	11	10	0	0	90.	.434	1.004	-0.45	2	1.0	0	0.0	4.5	1.0	102
103	9	17	0	0	24.5	.337	2.088	2.048	2	1.0	0	0.0	4.5	1.0	103
104	12	13	0	0	84.0	.102	.558	0.012	2	1.0	0	0.0	11.00	1.0	104
105	11	19	0	0	24.5	.337	2.088	2.048	2	1.0	0	0.0	11.00	1.0	105
106	3	15	0	0	211.1	.077	.264	.264	2	1.0	0	0.0	12.50	1.0	106
107	2	14	0	0	208.7	.060	.264	.264	2	1.0	0	0.0	12.50	1.0	107
108	17	18	0	0	135.	.288	1.007	-0.451	2	1.0	0	0.0	19.75	1.0	108
109	18	19	0	0	135.	.288	-0.451	1.007	2	1.0	0	0.0	19.75	1.0	109
110	19	20	0	0	162.	.142	.696	-0.369	2	1.0	0	0.0	19.75	1.0	110
111	14	16	0	0	47.5	.164	1.027	1.718	2	1.0	0	0.0	19.25	1.0	111
112	15	16	0	0	47.5	.164	1.027	1.718	2	1.0	0	0.0	19.25	1.0	112
113	16	21	0	0	162.	.111	-0.197	1.456	2	1.0	0	0.0	19.75	1.0	113
114	17	23	0	0	21.0	.328	1.893	1.886	2	1.0	0	0.0	18.43	1.0	114
115	19	23	0	0	21.0	.328	1.893	1.886	2	1.0	0	0.0	18.43	1.0	115
116	20	21	0	0	162.0	.111	-0.197	1.456	2	1.0	0	0.0	19.75	1.0	116
117	18	13	0	0	21.	.329	2.250	2.497	2	1.0	0	0.0	19.25	1.0	117
118	16	17	0	0	162.	.142	-0.369	.696	2	1.0	0	0.0	19.75	1.0	118
119	21	22	0	0	496.5	.029	.831	-.418	2	1.0	0	0.0	19.25	1.0	119
120	22	24	0	0	66.5	.032	2.552	2.552	2	1.0	0	0.0	26.5	1.0	120
121	25	23	0	0	195.	.112	1.197	1.180	2	1.0	0	0.0	35.0	1.0	121
122	25	23	0	0	155.	.17	1.225	1.189	2	1.0	0	0.0	35.0	1.0	122
123	23	26	0	0	60.	.040	2.553	2.607	2	1.0	0	0.0	44.25	1.0	123
124	24	25	0	0	983.6	.030	.284	-0.131	2	1.0	0	0.0	35.0	1.0	124
125	24	26	0	0	63.	.035	2.673	2.672	2	1.0	0	0.0	44.25	1.0	125
126	24	26	0	0	83.2	.022	1.636	1.634	2	1.0	0	0.0	44.25	1.0	126
127	6	22	0	0	792.	.01	1.253	1.130	2	1.0	0	0.0	12.	1.0	127
128	6	27	0	0	27.1	2.83	3.05	3.05	2	1.0	0	0.0	5.0	1.0	128
129	4	28	0	0	5.69	1.723	2.809	2.822	2	1.0	0	0.0	19.08	1.0	129
130	8	29	0	0	5.69	1.723	2.809	2.822	2	1.0	0	0.0	19.08	1.0	130
131	26	30	0	0	42.24	.072	2.653	2.104	2	1.0	0	0.0	50.0	1.0	131
132	26	30	0	0	42.24	.072	2.653	2.104	2	1.0	0	0.0	50.0	1.0	132
133	2	31	0	0	1.31	1.182	1.66	1.66	2	1.0	0	0.0	9.2	1.0	133
134	31	32	0	0	208.7	.06	.264	.264	2	1.0	0	0.0	12.5	1.0	134
135	32	16	0	0	47.5	.164	1.027	1.718	2	1.0	0	0.0	19.25	1.0	135
136	33	34	0	0	1.75	.894	1.61	1.61	2	1.0	0	0.0	9.2	1.0	136
137	34	37	0	0	211.1	.077	.264	.264	2	1.0	0	0.0	12.5	1.0	137
138	33	36	0	0	208.7	.060	.264	.264	2	1.0	0	0.0	12.5	1.0	138
139	36	20	0	0	47.5	.164	1.027	1.718	2	1.0	0	0.0	19.25	1.0	139
140	37	20	0	0	47.5	.164	1.027	1.718	2	1.0	0	0.0	19.25	1.0	140
141	33	35	0	0	1.31	1.182	1.66	1.66	2	1.0	0	0.0	9.2	1.0	141
142	35	38	0	0	208.7	.06	.264	.264	2	1.0	0	0.0	12.5	1.0	142
143	38	20	0	0	47.5	.164	1.027	1.718	2	1.0	0	0.0	19.25	1.0	143
144	1	39	0	0	1.0	10.0	1.0	30.0	2	1.0	0	0.0	9.0	1.0	144
145	2	39	0	0	16.25	1.0	1.0	30.0	2	1.0	0	0.0	9.0	1.0	145
146	3	39	0	0	16.25	1.0	1.0	30.0	2	1.0	0	0.0	9.0	1.0	146
147	31	39	0	0	16.25	1.0	1.0	30.0	2	1.0	0	0.0	9.0	1.0	147
148	21	39	0	0	3.25	10.0	1.0	30.0	2	1.0	0	0.0	15.0	1.0	148
149	33	39	0	0	16.25	1.0	1.0	30.0	2	1.0	0	0.0	9.0	1.0	149
150	34	39	0	0	16.25	1.0	1.0	30.0	2	1.0	0	0.0	9.0	1.0	150

1234567890123456789012345678901234567890123456789012345678901234567890

PC-050  
P. 47  
J.E. / 26 Feb. 84

1-E-50

R3800126 SURRY 1&2:AUX BLDG,6"AUX STM LINE CRACK NODE22 WITH HT. SINKS  
S & W ENGR CORP NU-92 << SUBCOMPARTMENT ANALYSIS PROGRAM >>

THREED 18 NOV 1980 18:59:27  
THREED.VER12.LEV01 CREATED 80.106 11:35:02

PAGE 4  
UNIT 10

UNIT 55 (SEQ 1) INPUT ECHO 1 2 3 4 5 6 7 8  
1234567890123456789012345678901234567890123456789012345678901234567890

151	35	39	0	0	16.25	1.0	1.0	30.0	2	1.0	0	0.0	9.0	1.0	151
152	39	40	0	0	1.0	0.1	1.0	30.0	2	1.0	1	0.0	50.0	1.0	152
153	0	22	1	0	1.0	0.0	0.0	0.0	0	1.0	0	0.0	9.7	1.0	153
154	*														154
155	*														155
156	*FILL TABLE DATA CARDS:LETDOWN LINE CRACK NODE 6 WITH HT.SINKS														156
157	*														157
158	*														158
159	4	2													159
160	0.0				1.613		1930.52								160
161	900.0				1.613		1930.52								161
162		900.000001			0.0		0.0								162
163		1850.0			0.0		0.0								163
164	*														164
165	*														165
166	*FAN TABLE DATA CARDS														166
167	*														167
168	*														168
169	2	3													169
170		40300.0			0.0										170
171		40300.0			3000.0										171
172	*														172
173	*														173
174	*PASSIVE HEAT SINK DATA CARDS														174
175	*														175
176	*														176
177	SINK1,NODE4														177
178	12	1	0	0.0	7073.1	4	0								178
179	12	1.0													179
180	1														180
181	F														181
182	1	1	1	.08	0	0	0	1.0							182
183	SINK2,NODE5														183
184	12	1	0	0.0	1768.0	5	0								184
185	12	1.0													185
186	1														186
187	F														187
188	1	1	1	.08	0	0	0	1.0							188
189	SINK3,NODE6														189
190	12	1	0	0.0	5635.9	6	0								190
191	12	1.0													191
192	1														192
193	F														193
194	1	1	1	.08	0	0	0	1.0							194
195	SINK4,NODE7														195
196	12	1	0	0.0	1768.0	7	0								196
197	12	1.0													197
198	1														198
199	F														199
200	1	1	1	.08	0	0	0	1.0							200

1234567890123456789012345678901234567890123456789012345678901234567890

PC-050  
P 48  
5.0.12846.94







1-E-53

R U N S U M M A R Y S H E E T

MISCELLANEOUS PROBLEM CONTROL DATA:

OUTPUT FLAG.....	1	TOTAL TIME OF RUN.....	1801.000 SEC
NUMBER OF TIME STEP CARDS...	11	NUMBER OF STANDARD TIME STEPS.....	5002
NUMBER OF TRIP CONTROLS.....	3	NUMBER OF ACTUAL TIME STEPS.....	5013
NUMBER OF VOLUMES.....	40	NUMBER OF TIMES GAUSSIAN ELIMINATION USED..	2381
NUMBER OF JUNCTIONS.....	66	NUMBER OF TIMES GAUSS-SEIDEL USED.....	2632
NUMBER OF FILL TABLES.....	1	NUMBER OF TRANSIENTS STORED FOR PLOTEUP...	146
NUMBER OF FAN TABLES.....	1	NUMBER OF SELECTED NODAL DIFF. PRESS.....	0
NUMBER OF HT SOURCE CURVES..	0	NUMBER OF HEAT SINKS.....	17
IMPLICIT/EXPLICIT COEFF.....	1.000	NUMBER OF INTERNAL JUNCTIONS.....	65

STEAM TABLES USED (FT15) VOLUME SERIAL NO. = SHARE0 DATA SET NAME = HEATBAL.NE190.STH20G.OUTPUT1

OUTPUT: TRANSIENTS TAPE (FT08) = 016308 FILE NUMBER = 22 DATA SET NAME = FE.GUARDS.PLOTTER  
TRANSMITTAL FILE (FT09) WAS NOT USED

PEAK PRESSURE DIFFERENTIAL

JUNCTION NUMBER	CONNECTING VOLUMES	PRESSURE PSID	TIME SEC	JUNCTION NUMBER	CONNECTING VOLUMES	PRESSURE PSID	TIME SEC
1	1 TO 6	0.01	0.489	34	25 TO 23	0.00	0.546
2	2 TO 3	0.00	0.236	35	25 TO 23	0.00	0.546
3	4 TO 5	-0.01	0.394	36	23 TO 26	-0.01	0.000
4	5 TO 6	-0.01	0.396	37	24 TO 25	-0.01	0.080
5	7 TO 6	-0.01	0.396	38	24 TO 26	-0.01	0.000
6	8 TO 7	-0.01	0.394	39	24 TO 26	-0.01	0.000
7	1 TO 12	0.01	0.392	40	6 TO 22	-0.01	0.000
8	1 TO 12	0.01	0.392	41	6 TO 27	0.01	0.394
9	7 TO 11	0.01	0.394	42	4 TO 28	-0.02	0.408
10	8 TO 11	0.00	0.590	43	8 TO 29	-0.02	0.408
11	4 TO 9	0.00	0.590	44	26 TO 30	-0.01	0.098
12	5 TO 9	0.01	0.394	45	26 TO 30	-0.01	0.098
13	10 TO 12	-0.01	0.400	46	2 TO 31	-0.00	0.501
14	9 TO 10	-0.01	0.446	47	31 TO 32	-0.01	0.000
15	11 TO 10	-0.01	0.446	48	32 TO 16	-0.01	0.248
16	9 TO 17	0.01	0.593	49	33 TO 34	0.00	0.236
17	12 TO 13	-0.01	0.000	50	34 TO 37	-0.01	0.234
18	11 TO 19	0.01	0.593	51	33 TO 36	-0.01	0.000
19	3 TO 15	-0.01	0.234	52	36 TO 20	-0.01	0.249
20	2 TO 14	-0.01	0.000	53	37 TO 20	-0.01	0.251
21	17 TO 18	0.02	0.744	54	33 TO 35	-0.00	0.501
22	18 TO 19	-0.02	0.744	55	35 TO 38	-0.01	0.000
23	19 TO 20	0.01	0.271	56	38 TO 20	-0.01	0.248
24	14 TO 16	-0.01	0.249	57	1 TO 39	0.10	0.227
25	15 TO 16	-0.01	0.251	58	2 TO 39	0.09	0.225
26	16 TO 21	-0.02	0.268	59	3 TO 39	0.09	0.225
27	17 TO 23	-0.01	0.596	60	31 TO 39	0.09	0.225
28	19 TO 23	-0.01	0.596	61	21 TO 39	0.09	0.227
29	20 TO 21	-0.02	0.268	62	33 TO 39	0.09	0.225
30	18 TO 13	-0.01	0.321	63	34 TO 39	0.09	0.225
31	16 TO 17	-0.01	0.271	64	35 TO 39	0.09	0.225
32	21 TO 22	0.01	0.443	65	39 TO 40	-0.39	0.227
33	22 TO 24	-0.01	0.023				

PE-050  
510.12846.44  
P51

1-E-54

PEAK PRESSURES AND TEMPERATURES									
NODE NUMBER	PRESSURE (PSIA)	TIME (SEC)	TEMPERATURE (DEG F)	TIME (SEC)	NODE NUMBER	PRESSURE (PSIA)	TIME (SEC)	TEMPERATURE (DEG F)	TIME (SEC)
1	14.73	0.584	120.31	0.584	21	14.72	0.724	134.33	902.000
2	14.73	0.691	132.08	909.400	22	14.72	0.393	135.00	902.000
3	14.73	0.691	132.08	909.400	23	14.71	0.283	120.11	0.283
4	14.73	0.541	120.30	0.541	24	14.71	0.395	120.09	0.394
5	14.73	0.576	120.30	0.576	25	14.71	0.264	120.11	0.264
6	14.73	0.578	120.28	0.578	26	14.70	0.326	120.04	0.326
7	14.73	0.576	120.30	0.576	27	14.71	4.550	120.12	4.550
8	14.73	0.541	120.30	0.541	28	14.72	0.447	120.25	0.446
9	14.73	0.545	120.31	0.545	29	14.72	0.446	120.25	0.446
10	14.73	0.206	120.29	0.206	30	14.70	1801.000	120.00	1801.000
11	14.73	0.545	120.31	0.545	31	14.73	0.691	132.08	909.400
12	14.73	0.234	120.29	0.234	32	14.72	0.414	132.08	903.200
13	14.72	0.490	120.24	0.490	33	14.73	0.691	132.08	909.450
14	14.72	0.691	132.08	903.200	34	14.73	0.691	132.08	909.200
15	14.73	0.413	132.08	903.200	35	14.73	0.691	132.08	909.450
16	14.72	0.429	132.10	902.000	36	14.72	0.691	132.08	903.200
17	14.73	0.646	120.28	0.646	37	14.73	0.413	132.08	903.200
18	14.72	0.686	120.24	0.686	38	14.72	0.414	132.08	903.200
19	14.73	0.646	120.28	0.646	39	14.76	0.274	131.99	904.900
20	14.72	0.429	132.10	902.000	40	15.00	1801.000	120.00	1801.000

PS2  
T=0.12846.44  
PE-050

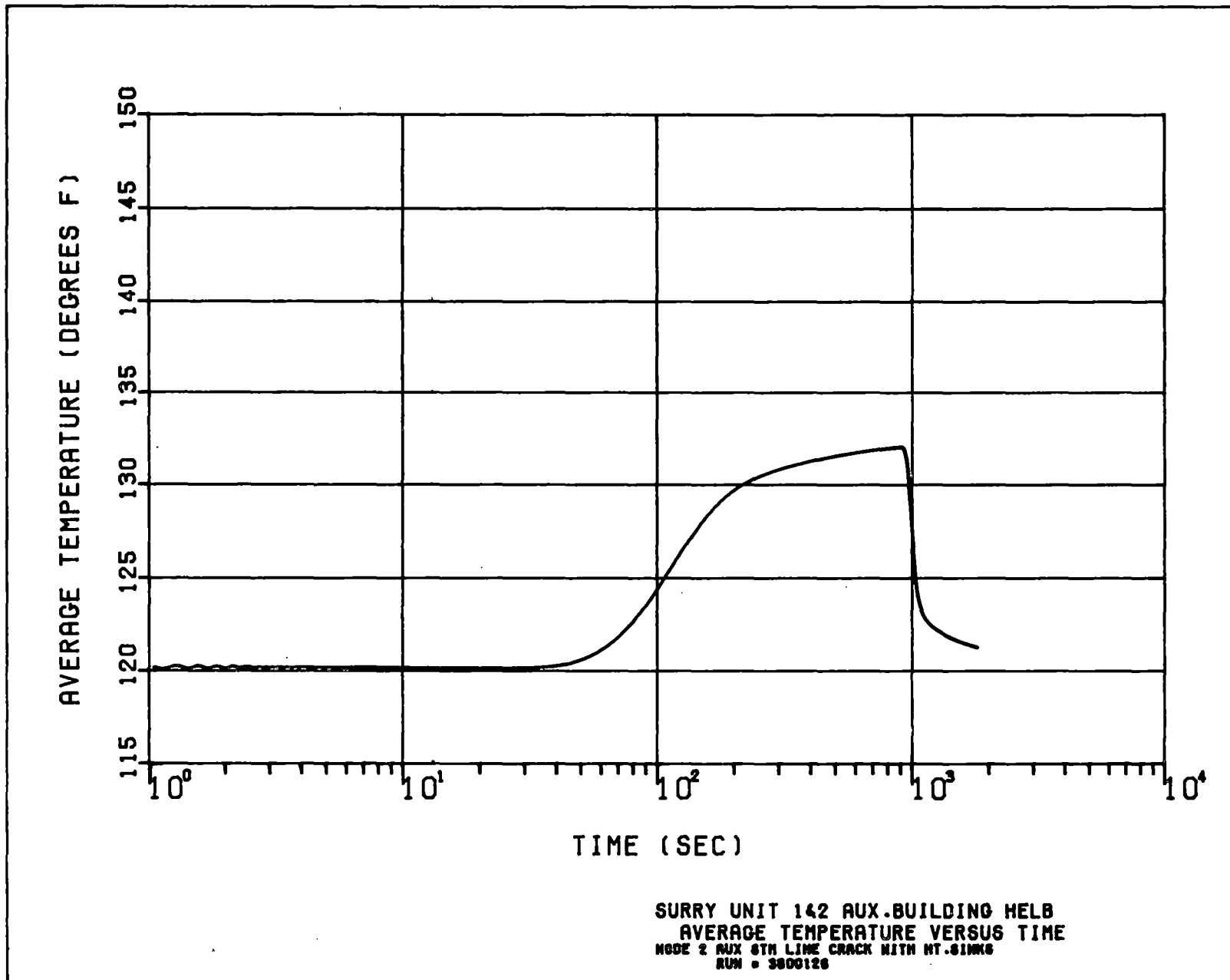

PC-050

5.0.12046.44

P53

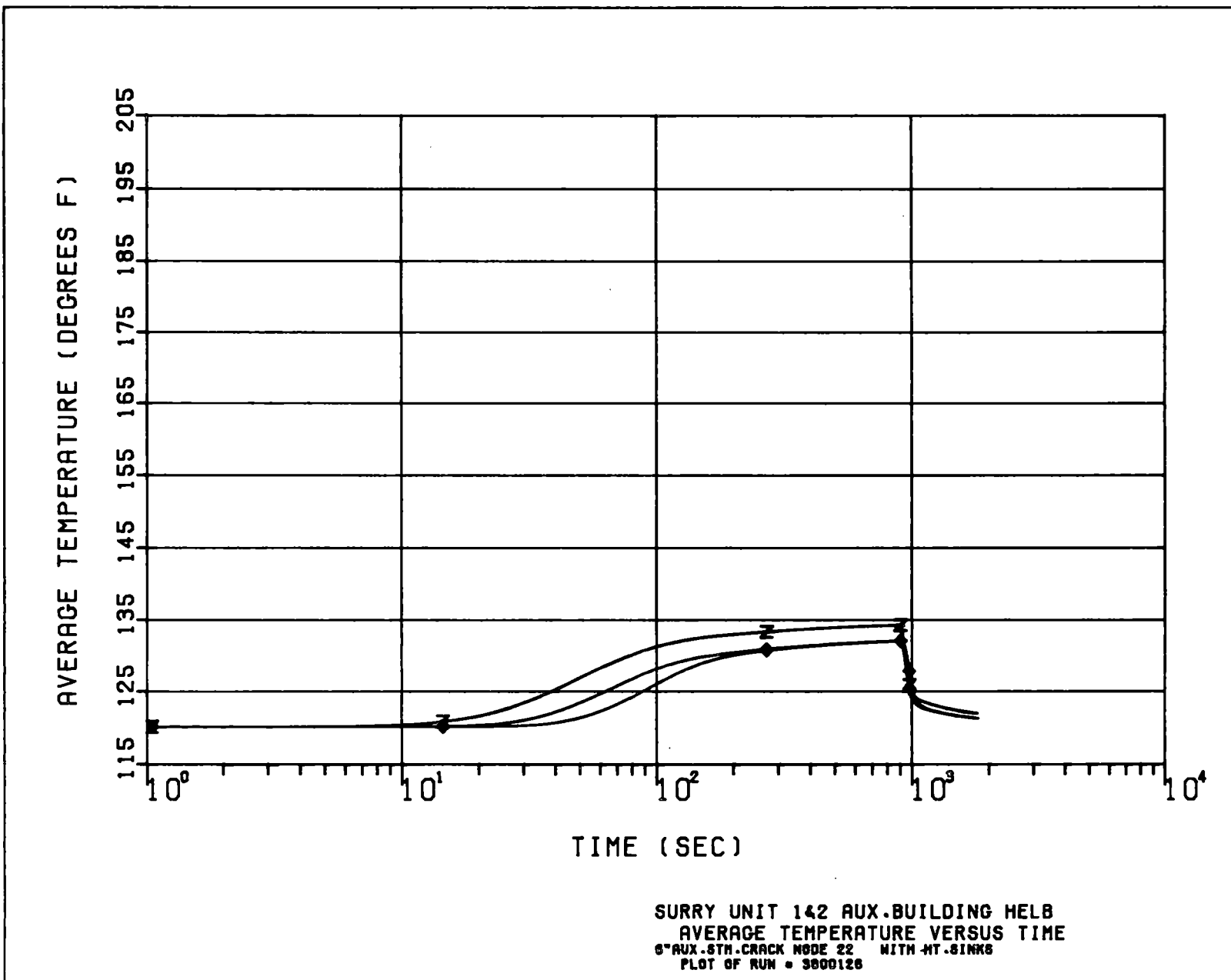

0-050-0

P54  
5.0.12846.44

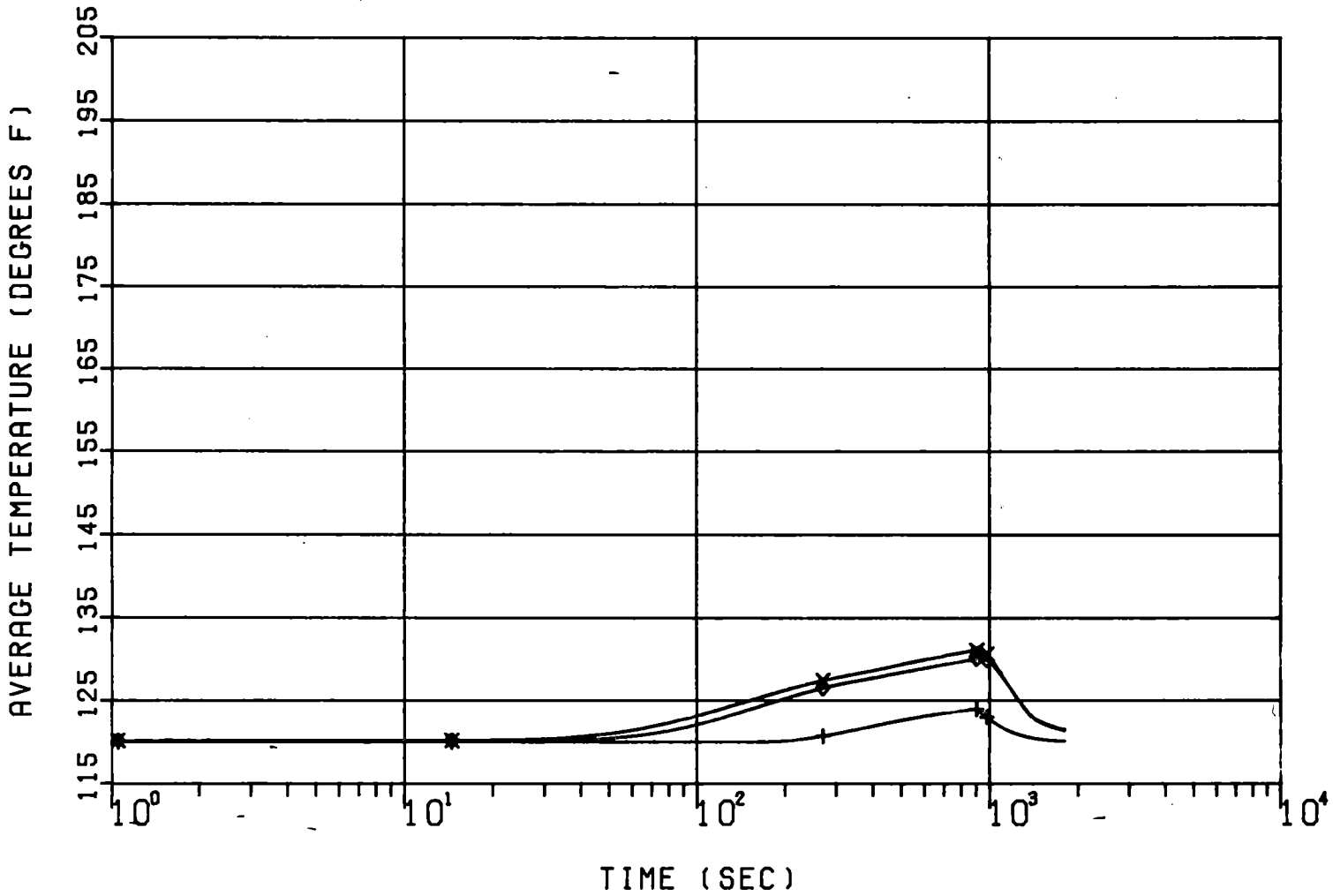

SURRY UNIT 142 AUX. BUILDING HELB  
AVERAGE TEMPERATURE VERSUS TIME  
8" AUX. STM. CRACK NODE 23 WITH HT. SINKS  
PLOT OF RUN # 3800127

P 63  
J.O. 12846.44  
Pc-050

1-E-58

UNIT 55 (SEQ 1) INPUT ECHO 1 2 3 4 5 6 7 8  
1234567890123456789012345678901234567890123456789012345678901234567890

1	SURRY 1&2:AUX BLDG,6"AUX STM LINE CRACK NODE23 WITH HT. SINKS							1			
2	*						2				
3	*						3				
4	*PROBLEM DIMENSION CARD							4			
5	*						5				
6	*						6				
7	1	11	3	40	66	1	1	0	0	17	7
8	*						8				
9	*						9				
10	*IMPLICIT/EXPLICIT COEFICIENT CARD							10			
11	*						11				
12	*						12				
13	1.0						13				
14	*						14				
15	*						15				
16	*TIME STEP CONTROL DATA CARDS							16			
17	*						17				
18	*						18				
19	50	10	0	0	0.001	0.00001	2.2	19			
20	2	10	0	0	0.01	0.0001	3.0	20			
21	5	14	0	0	0.05	0.0001	10.0	21			
22	5	15	0	0	0.1	0.0001	30.0	22			
23	2	15	0	0	0.5	0.001	80.0	23			
24	10	20	0	0	1.0	0.001	901.0	24			
25	5	10	0	0	0.01	0.0001	903.0	25			
26	5	14	0	0	0.05	0.0001	910.0	26			
27	10	10	0	0	0.1	0.0001	930.0	27			
28	2	25	0	0	0.5	0.001	980.0	28			
29	10	20	0	0	1.0	0.001	1850.0	29			
30	*						30				
31	*						31				
32	*TRIP CONTROL DATA CARDS							32			
33	*						33				
34	*						34				
35	1	0	0	1800.0	0.0		35				
36	1	0	0	0.0	2.0		36				
37	1	0	0	0.0	0.2		37				
38	*						38				
39	*						39				
40	*NODAL DATA CARDS							40			
41	*						41				
42	*						42				
43	14.70	120.	1.0	1137.7	2.00	9.50	0.0	0	43		
44	14.70	120.	1.0	2011.2	2.00	10.00	0.0	0	44		
45	14.70	120.	1.0	2011.2	2.00	10.00	0.0	0	45		
46	14.70	120.	1.0	26611.5	2.00	12.00	0.0	0	46		
47	14.70	120.	1.0	5150.7	2.00	9.50	0.0	0	47		
48	14.70	120.	1.0	18697.8	2.00	10.10	0.0	0	48		
49	14.70	120.	1.0	5150.7	2.00	9.50	0.0	0	49		
50	14.70	120.	1.0	26611.5	2.00	12.00	0.0	0	50		

1234567890123456789012345678901234567890123456789012345678901234567890

PC-650  
J.O. 12846.44  
P55





1-E-60

UNIT 55 (SEQ 1) INPUT ECHO

	1	2	3	4	5	6	7	8							
101	9	10	0	0	90.	.434	1.004	-0.45	2	1.0	0	0.0	4.5	1.0	101
102	11	10	0	0	90.	.434	1.004	-0.45	2	1.0	0	0.0	4.5	1.0	102
103	9	17	0	0	24.5	.337	2.088	2.048	2	1.0	0	0.0	4.5	1.0	103
104	12	13	0	0	84.0	.102	.558	0.012	2	1.0	0	0.0	11.00	1.0	104
105	11	19	0	0	24.5	.337	2.088	2.048	2	1.0	0	0.0	11.00	1.0	105
106	3	15	0	0	211.1	.077	.264	.264	2	1.0	0	0.0	12.50	1.0	106
107	2	14	0	0	208.7	.060	.264	.264	2	1.0	0	0.0	12.50	1.0	107
108	17	18	0	0	135.	.288	1.007	-0.451	2	1.0	0	0.0	19.75	1.0	108
109	18	19	0	0	135.	.288	-0.451	1.007	2	1.0	0	0.0	19.75	1.0	109
110	19	20	0	0	162.	.142	.696	-0.369	2	1.0	0	0.0	19.75	1.0	110
111	14	16	0	0	47.5	.164	1.027	1.718	2	1.0	0	0.0	19.25	1.0	111
112	15	16	0	0	47.5	.164	1.027	1.718	2	1.0	0	0.0	19.25	1.0	112
113	16	21	0	0	162.	.111	-0.197	1.456	2	1.0	0	0.0	19.75	1.0	113
114	17	23	0	0	21.0	.328	1.893	1.886	2	1.0	0	0.0	18.43	1.0	114
115	19	23	0	0	21.0	.328	1.893	1.886	2	1.0	0	0.0	18.43	1.0	115
116	20	21	0	0	162.0	.111	-0.197	1.456	2	1.0	0	0.0	19.75	1.0	116
117	18	13	0	0	21.	.329	2.250	2.497	2	1.0	0	0.0	19.25	1.0	117
118	16	17	0	0	162.	.142	-0.369	.696	2	1.0	0	0.0	19.75	1.0	118
119	21	22	0	0	496.5	.029	.831	-.418	2	1.0	0	0.0	19.25	1.0	119
120	22	24	0	0	66.5	.032	2.552	2.552	2	1.0	0	0.0	26.5	1.0	120
121	25	23	0	0	195.	.112	1.197	1.180	2	1.0	0	0.0	35.0	1.0	121
122	25	23	0	0	155.	.17	1.225	1.189	2	1.0	0	0.0	35.0	1.0	122
123	23	26	0	0	60.	.040	2.553	2.607	2	1.0	0	0.0	44.25	1.0	123
124	24	25	0	0	983.6	.030	.284	-0.131	2	1.0	0	0.0	35.0	1.0	124
125	24	26	0	0	63.	.035	2.673	2.672	2	1.0	0	0.0	44.25	1.0	125
126	24	26	0	0	83.2	.022	1.636	1.634	2	1.0	0	0.0	44.25	1.0	126
127	6	22	0	0	792.	.01	1.253	1.130	2	1.0	0	0.0	12.	1.0	127
128	6	27	0	0	27.1	2.83	3.05	3.05	2	1.0	0	0.0	5.0	1.0	128
129	4	28	0	0	5.69	1.723	2.809	2.822	2	1.0	0	0.0	19.08	1.0	129
130	8	29	0	0	5.69	1.723	2.809	2.822	2	1.0	0	0.0	19.08	1.0	130
131	26	30	0	0	42.24	.072	2.653	2.104	2	1.0	0	0.0	50.0	1.0	131
132	26	30	0	0	42.24	.072	2.653	2.104	2	1.0	0	0.0	50.0	1.0	132
133	2	31	0	0	1.31	1.182	1.66	1.66	2	1.0	0	0.0	9.2	1.0	133
134	31	32	0	0	208.7	.06	.264	.264	2	1.0	0	0.0	12.5	1.0	134
135	32	16	0	0	47.5	.164	1.027	1.718	2	1.0	0	0.0	19.25	1.0	135
136	33	34	0	0	1.75	.894	1.61	1.61	2	1.0	0	0.0	9.2	1.0	136
137	34	37	0	0	211.1	.077	.264	.264	2	1.0	0	0.0	12.5	1.0	137
138	33	36	0	0	208.7	.060	.264	.264	2	1.0	0	0.0	12.5	1.0	138
139	36	20	0	0	47.5	.164	1.027	1.718	2	1.0	0	0.0	19.25	1.0	139
140	37	20	0	0	47.5	.164	1.027	1.718	2	1.0	0	0.0	19.25	1.0	140
141	33	35	0	0	1.31	1.182	1.66	1.66	2	1.0	0	0.0	9.2	1.0	141
142	35	38	0	0	208.7	.06	.264	.264	2	1.0	0	0.0	12.5	1.0	142
143	38	20	0	0	47.5	.164	1.027	1.718	2	1.0	0	0.0	19.25	1.0	143
144	1	39	0	0	1.0	10.0	1.0	30.0	2	1.0	0	0.0	9.0	1.0	144
145	2	39	0	0	16.25	1.0	1.0	30.0	2	1.0	0	0.0	9.0	1.0	145
146	3	39	0	0	16.25	1.0	1.0	30.0	2	1.0	0	0.0	9.0	1.0	146
147	31	39	0	0	16.25	1.0	1.0	30.0	2	1.0	0	0.0	9.0	1.0	147
148	21	39	0	0	3.25	10.0	1.0	30.0	2	1.0	0	0.0	15.0	1.0	148
149	33	39	0	0	16.25	1.0	1.0	30.0	2	1.0	0	0.0	9.0	1.0	149
150	34	39	0	0	16.25	1.0	1.0	30.0	2	1.0	0	0.0	9.0	1.0	150

1234567890123456789012345678901234567890123456789012345678901234567890

050-32  
50.17846.44  
P57

1-E-61

R3800127 SURRY 1&2:AUX BLDG,6"AUX STM LINE CRACK NODE23 WITH HT. SINKS  
S & W ENGR CORP NU-92 << SUBCOMPARTMENT ANALYSIS PROGRAM >>

THREED 19 NOV 1980 17:23:59  
THREED.VER12.LEV01 CREATED 80.106 11:35:02

PAGE 4  
UNIT 10

UNIT 55 (SEQ 1) INPUT ECHO  
1 2 3 4 5 6 7 8  
123456789012345678901234567890123456789012345678901234567890

151	35	39	0	0	16.25	1.0	1.0	30.0	2	1.0	0	0.0	9.0	1.0	151
152	39	40	0	0	1.0	0.1	1.0	30.0	2	1.0	1	0.0	50.0	1.0	152
153	0	23	1	0	1.0	0.0	0.0	0.0	0	1.0	0	0.0	9.7	1.0	153
154	*														154
155	*														155
156	*FILL TABLE DATA CARDS:6"AUX.STM LINE CRACK NODE 23 WITH HT.SINKS														156
157	*														157
158	*														158
159	4	2													159
160	0.0				1.613		1930.52								160
161	900.0				1.613		1930.52								161
162		900.0000001			0.0		0.0								162
163		1850.0			0.0		0.0								163
164	*														164
165	*														165
166	*FAN TABLE DATA CARDS														166
167	*														167
168	*														168
169	2	3													169
170		40300.0			0.0										170
171		40300.0			3000.0										171
172	*														172
173	*														173
174	*PASSIVE HEAT SINK DATA CARDS														174
175	*														175
176	*														176
177	SINK1,NODE4														177
178	12	1	0	0.0	7073.1	4	0								178
179	12	1.0													179
180	1														180
181	F														181
182	1	1	1	.08	0	0	0	1.0							182
183	SINK2,NODES														183
184	12	1	0	0.0	1768.0	5	0								184
185	12	1.0													185
186	1														186
187	F														187
188	1	1	1	.08	0	0	0	1.0							188
189	SINK3,NODE6														189
190	12	1	0	0.0	5635.9	6	0								190
191	12	1.0													191
192	1														192
193	F														193
194	1	1	1	.08	0	0	0	1.0							194
195	SINK4,NODE7														195
196	12	1	0	0.0	1768.0	7	0								196
197	12	1.0													197
198	1														198
199	F														199
200	1	1	1	.08	0	0	0	1.0							200

1234567890123456789012345678901234567890123456789012345678901234567890

050-34  
PSB  
50.12846.44





1-E-64

RUN SUMMARY SHEET

MISCELLANEOUS PROBLEM CONTROL DATA:

OUTPUT FLAG.....	1	TOTAL TIME OF RUN.....	1801.000 SEC
NUMBER OF TIME STEP CARDS...	11	NUMBER OF STANDARD TIME STEPS.....	5002
NUMBER OF TRIP CONTROLS.....	3	NUMBER OF ACTUAL TIME STEPS.....	5013
NUMBER OF VOLUMES.....	40	NUMBER OF TIMES GAUSSIAN ELIMINATION USED..	2358
NUMBER OF JUNCTIONS.....	66	NUMBER OF TIMES GAUSS-SEIDEL USED.....	2655
NUMBER OF FILL TABLES.....	1	NUMBER OF TRANSIENTS STORED FOR PLOTEMUP...	146
NUMBER OF FAN TABLES.....	1	NUMBER OF SELECTED NODAL DIFF. PRESS.....	0
NUMBER OF HT SOURCE CURVES..	0	NUMBER OF HEAT SINKS.....	17
IMPLICIT/EXPLICIT COEFF.....	1.000	NUMBER OF INTERNAL JUNCTIONS.....	65

STEAM TABLES USED (FT15) VOLUME SERIAL NO. = SHARE0 DATA SET NAME = HEATBAL.ME190.STH20G.OUTPUT1

OUTPUT: TRANSIENTS TAPE (FT08) = 016308 FILE NUMBER = 23 DATA SET NAME = FE.GUARDS.PLOTTER  
TRANSMITTAL FILE (FT09) WAS NOT USED

PEAK PRESSURE DIFFERENTIAL

JUNCTION NUMBER	CONNECTING VOLUMES	PRESSURE PSID	TIME SEC	JUNCTION NUMBER	CONNECTING VOLUMES	PRESSURE PSID	TIME SEC
1	1 TO 6	0.01	0.489	34	25 TO 23	0.00	0.546
2	2 TO 3	0.00	0.236	35	25 TO 23	0.00	0.546
3	4 TO 5	-0.01	0.394	36	23 TO 26	-0.01	0.000
4	5 TO 6	-0.01	0.396	37	24 TO 25	-0.01	0.080
5	7 TO 6	-0.01	0.396	38	24 TO 26	-0.01	0.000
6	8 TO 7	-0.01	0.394	39	24 TO 26	-0.01	0.000
7	1 TO 12	0.01	0.392	40	6 TO 22	-0.01	0.000
8	1 TO 12	0.01	0.392	41	6 TO 27	0.01	0.394
9	7 TO 11	0.01	0.394	42	4 TO 28	-0.02	0.408
10	8 TO 11	0.00	0.590	43	8 TO 29	-0.02	0.408
11	4 TO 9	0.00	0.590	44	26 TO 30	-0.01	0.098
12	5 TO 9	0.01	0.394	45	26 TO 30	-0.01	0.098
13	10 TO 12	-0.01	0.400	46	2 TO 31	-0.00	0.501
14	9 TO 10	-0.01	0.446	47	31 TO 32	-0.01	0.000
15	11 TO 10	-0.01	0.446	48	32 TO 16	-0.01	0.248
16	9 TO 17	0.01	0.593	49	33 TO 34	0.00	0.236
17	12 TO 13	-0.01	0.000	50	34 TO 37	-0.01	0.234
18	11 TO 19	0.01	0.593	51	33 TO 36	-0.01	0.000
19	3 TO 15	-0.01	0.234	52	36 TO 20	-0.01	0.249
20	2 TO 14	-0.01	0.000	53	37 TO 20	-0.01	0.251
21	17 TO 18	0.02	0.744	54	33 TO 35	-0.00	0.501
22	18 TO 19	-0.02	0.744	55	35 TO 38	-0.01	0.000
23	19 TO 20	0.01	0.271	56	38 TO 20	-0.01	0.248
24	14 TO 16	-0.01	0.249	57	1 TO 39	0.10	0.227
25	15 TO 16	-0.01	0.251	58	2 TO 39	0.09	0.225
26	16 TO 21	-0.02	0.268	59	3 TO 39	0.09	0.225
27	17 TO 23	-0.01	0.596	60	31 TO 39	0.09	0.225
28	19 TO 23	-0.01	0.596	61	21 TO 39	0.09	0.227
29	20 TO 21	-0.02	0.268	62	33 TO 39	0.09	0.225
30	18 TO 13	-0.01	0.321	63	34 TO 39	0.09	0.225
31	16 TO 17	-0.01	0.271	64	35 TO 39	0.09	0.225
32	21 TO 22	0.01	0.443	65	39 TO 40	-0.39	0.227
33	22 TO 24	-0.01	0.023				

PE-050  
5.0.12846.4x  
P(6)

1-E-65

PEAK PRESSURES AND TEMPERATURES									
NODE NUMBER	PRESSURE (PSIA)	TIME (SEC)	TEMPERATURE (DEG F)	TIME (SEC)	NODE NUMBER	PRESSURE (PSIA)	TIME (SEC)	TEMPERATURE (DEG F)	TIME (SEC)
1	14.73	0.584	122.55	1053.000	21	14.72	0.724	123.08	970.000
2	14.73	0.691	130.16	951.000	22	14.72	0.393	123.65	934.500
3	14.73	0.691	130.16	950.500	23	14.71	0.283	151.14	902.000
4	14.73	0.541	120.81	1190.000	24	14.71	0.395	123.92	912.800
5	14.73	0.576	122.11	1034.000	25	14.71	0.264	123.65	967.000
6	14.73	0.578	122.65	986.000	26	14.70	0.326	123.99	902.010
7	14.73	0.576	122.11	1034.000	27	14.71	4.550	120.12	4.550
8	14.73	0.541	120.81	1190.000	28	14.72	0.447	120.25	0.446
9	14.73	0.545	120.73	1125.000	29	14.72	0.446	120.25	0.446
10	14.73	0.206	120.68	974.500	30	14.70	1801.000	120.00	1801.000
11	14.73	0.545	120.75	1158.000	31	14.73	0.691	130.16	951.000
12	14.73	0.234	122.83	972.500	32	14.72	0.414	130.17	937.500
13	14.72	0.490	124.32	964.000	33	14.73	0.691	131.15	953.000
14	14.72	0.691	130.17	937.500	34	14.73	0.691	131.15	953.000
15	14.73	0.413	130.17	937.000	35	14.73	0.691	131.15	953.000
16	14.72	0.429	130.21	921.900	36	14.72	0.691	131.17	939.500
17	14.73	0.646	135.52	902.000	37	14.73	0.413	131.17	939.500
18	14.72	0.686	126.39	954.000	38	14.72	0.414	131.17	939.500
19	14.73	0.646	137.21	902.000	39	14.76	0.274	130.25	955.500
20	14.72	0.429	131.22	925.300	40	15.00	1801.000	120.00	1801.000

PL 2  
J.O. 12898.44  
7E-056

99-3-1

R3800128 SURRY 1&2:AUX BLDG,SGBD LINE BREAK NODE 4 WITH HT. SINKS  
S & W ENGR CORP NU-92 << SUBCOMPARTMENT ANALYSIS PROGRAM >>

THREED 20 NOV 1980 10:52:00  
THREED.VER12.LEV01 CREATED 80.106 11:35:02

PAGE 1  
UNIT 10

UNIT 55 (SEQ 1) INPUT ECHO  
1 2 3 4 5 6 7 8  
123456789012345678901234567890123456789012345678901234567890

1	SURRY 1&2:AUX BLDG,SGBD LINE BREAK NODE 4 WITH HT. SINKS	1
2	*	2
3	*	3
4	*PROBLEM DIMENSION CARD	4
5	*	5
6	*	6
7	1 10.3 40 66 1 1 0 0 17	7
8	*	8
9	*	9
10	*IMPLICIT/EXPLICIT COEFICIENT CARD	10
11	*	11
12	*	12
13	1.0	13
14	*	14
15	*	15
16	*TIME STEP CONTROL DATA CARDS	16
17	*	17
18	*	18
19	50 10 0 0 0.001 0.00001 2.2	19
20	2 10 0 0 0.01 0.0001 3.0	20
21	5 14 0 0 0.05 0.0001 10.0	21
22	5 15 0 0 0.1 0.0001 31.9	22
23	5 11 0 0 0.01 0.0001 33.0	23
24	5 5 0 0 0.02 0.0001 34.0	24
25	5 12 0 0 0.05 0.0001 40.0	25
26	5 10 0 0 0.1 0.0001 50.0	26
27	2 15 0 0 0.5 0.001 80.0	27
28	10 20 0 0 1.0 0.001 950.0	28
29	*	29
30	*	30
31	*TRIP CONTROL DATA CARDS	31
32	*	32
33	*	33
34	1 0 0 900.0 0.0	34
35	1 0 0 0.0 2.0	35
36	1 0 0 0.0 0.2	36
37	*	37
38	*	38
39	*NODAL DATA CARDS	39
40	*	40
41	*	41
42	14.70 120. 1.0 1137.7 2.00 9.50 0.0 0	42
43	14.70 120. 1.0 2011.2 2.00 10.00 0.0 0	43
44	14.70 120. 1.0 2011.2 2.00 10.00 0.0 0	44
45	14.70 120. 1.0 26611.5 2.00 12.00 0.0 0	45
46	14.70 120. 1.0 5150.7 2.00 9.50 0.0 0	46
47	14.70 120. 1.0 18697.8 2.00 10.10 0.0 0	47
48	14.70 120. 1.0 5150.7 2.00 9.50 0.0 0	48
49	14.70 120. 1.0 26611.5 2.00 12.00 0.0 0	49
50	14.70 120. 1.0 4050.0 2.00 9.00 0.0 0	50

1234567890123456789012345678901234567890123456789012345678901234567890

PL4  
50. 1784644  
PS-050





1-5-89

R3800128 SURRY 1&2:AUX BLDG,SGBD LINE BREAK NODE 4 WITH HT. SINKS  
S & W ENGR CORP NU-92 << SUBCOMPARTMENT ANALYSIS PROGRAM >>

THREED 20 NOV 1980 10:52:00 PAGE 3  
THREED.VER12.LEV01 CREATED 80.106 11:35:02 UNIT 10

UNIT 55 (SEQ 1) INPUT ECHO 1 2 3 4 5 6 7 8  
1234567890123456789012345678901234567890123456789012345678901234567890

101	11	10	0	0	90.	.434	1.004	-0.45	2	1.0	0	0.0	4.5	1.0	101
102	9	17	0	0	24.5	.337	2.088	2.048	2	1.0	0	0.0	4.5	1.0	102
103	12	13	0	0	84.0	.102	.558	0.012	2	1.0	0	0.0	11.00	1.0	103
104	11	19	0	0	24.5	.337	2.088	2.048	2	1.0	0	0.0	11.00	1.0	104
105	3	15	0	0	211.1	.077	.264	.264	2	1.0	0	0.0	12.50	1.0	105
106	2	14	0	0	208.7	.060	.264	.264	2	1.0	0	0.0	12.50	1.0	106
107	17	18	0	0	135.	.288	1.007	-0.451	2	1.0	0	0.0	19.75	1.0	107
108	18	19	0	0	135.	.288	-0.451	1.007	2	1.0	0	0.0	19.75	1.0	108
109	19	20	0	0	162.	.142	.696	-0.369	2	1.0	0	0.0	19.75	1.0	109
110	14	16	0	0	47.5	.164	1.027	1.718	2	1.0	0	0.0	19.25	1.0	110
111	15	16	0	0	47.5	.164	1.027	1.718	2	1.0	0	0.0	19.25	1.0	111
112	16	21	0	0	162.	.111	-0.197	1.456	2	1.0	0	0.0	19.75	1.0	112
113	17	23	0	0	21.0	.328	1.893	1.886	2	1.0	0	0.0	18.43	1.0	113
114	19	23	0	0	21.0	.328	1.893	1.886	2	1.0	0	0.0	18.43	1.0	114
115	20	21	0	0	162.0	.111	-0.197	1.456	2	1.0	0	0.0	19.75	1.0	115
116	18	13	0	0	21.	.329	2.250	2.497	2	1.0	0	0.0	19.25	1.0	116
117	16	17	0	0	162.	.142	-0.369	.696	2	1.0	0	0.0	19.75	1.0	117
118	21	22	0	0	496.5	.029	.831	-.418	2	1.0	0	0.0	19.25	1.0	118
119	22	24	0	0	66.5	.032	2.552	2.552	2	1.0	0	0.0	26.5	1.0	119
120	25	23	0	0	195.	.112	1.197	1.180	2	1.0	0	0.0	35.0	1.0	120
121	25	23	0	0	155.	.17	1.225	1.189	2	1.0	0	0.0	35.0	1.0	121
122	23	26	0	0	60.	.040	2.553	2.607	2	1.0	0	0.0	44.25	1.0	122
123	24	25	0	0	983.6	.030	.284	-0.131	2	1.0	0	0.0	35.0	1.0	123
124	24	26	0	0	63.	.035	2.673	2.672	2	1.0	0	0.0	44.25	1.0	124
125	24	26	0	0	83.2	.022	1.636	1.634	2	1.0	0	0.0	44.25	1.0	125
126	6	22	0	0	792.	.01	1.253	1.130	2	1.0	0	0.0	12.	1.0	126
127	6	27	0	0	27.1	2.83	3.05	3.05	2	1.0	0	0.0	5.0	1.0	127
128	4	28	0	0	5.69	1.723	2.809	2.822	2	1.0	0	0.0	19.08	1.0	128
129	8	29	0	0	5.69	1.723	2.809	2.822	2	1.0	0	0.0	19.08	1.0	129
130	26	30	0	0	42.24	.072	2.653	2.104	2	1.0	0	0.0	50.0	1.0	130
131	26	30	0	0	42.24	.072	2.653	2.104	2	1.0	0	0.0	50.0	1.0	131
132	2	31	0	0	1.31	1.182	1.66	1.66	2	1.0	0	0.0	9.2	1.0	132
133	31	32	0	0	208.7	.06	.264	.264	2	1.0	0	0.0	12.5	1.0	133
134	32	16	0	0	47.5	.164	1.027	1.718	2	1.0	0	0.0	19.25	1.0	134
135	33	34	0	0	1.75	.894	1.61	1.61	2	1.0	0	0.0	9.2	1.0	135
136	34	37	0	0	211.1	.077	.264	.264	2	1.0	0	0.0	12.5	1.0	136
137	33	36	0	0	208.7	.060	.264	.264	2	1.0	0	0.0	12.5	1.0	137
138	36	20	0	0	47.5	.164	1.027	1.718	2	1.0	0	0.0	19.25	1.0	138
139	37	20	0	0	47.5	.164	1.027	1.718	2	1.0	0	0.0	19.25	1.0	139
140	33	35	0	0	1.31	1.182	1.66	1.66	2	1.0	0	0.0	9.2	1.0	140
141	35	38	0	0	208.7	.06	.264	.264	2	1.0	0	0.0	12.5	1.0	141
142	38	20	0	0	47.5	.164	1.027	1.718	2	1.0	0	0.0	19.25	1.0	142
143	1	39	0	0	1.0	10.0	1.0	30.0	2	1.0	0	0.0	9.0	1.0	143
144	2	39	0	0	16.25	1.0	1.0	30.0	2	1.0	0	0.0	9.0	1.0	144
145	3	39	0	0	16.25	1.0	1.0	30.0	2	1.0	0	0.0	9.0	1.0	145
146	31	39	0	0	16.25	1.0	1.0	30.0	2	1.0	0	0.0	9.0	1.0	146
147	21	39	0	0	3.25	10.0	1.0	30.0	2	1.0	0	0.0	15.0	1.0	147
148	33	39	0	0	16.25	1.0	1.0	30.0	2	1.0	0	0.0	9.0	1.0	148
149	34	39	0	0	16.25	1.0	1.0	30.0	2	1.0	0	0.0	9.0	1.0	149
150	35	39	0	0	16.25	1.0	1.0	30.0	2	1.0	0	0.0	9.0	1.0	150

1234567890123456789012345678901234567890123456789012345678901234567890

PC-OSO  
J.O. 12846.44  
P 46

1-E-69

R3800128 SURRY 1&2:AUX BLDG,SGBD LINE BREAK NODE 4 WITH HT. SINKS  
S & W ENGR CORP NU-92 << SUBCOMPARTMENT ANALYSIS PROGRAM >>

THREED 20 NOV 1980 10:52:00 PAGE 4  
THREED.VER12.LEV01 CREATED 80.106 11:35:02 UNIT 10

UNIT 55 (SEQ 1) INPUT ECHO  
1 2 3 4 5 6 7 8  
123456789012345678901234567890123456789012345678901234567890

151	39	40	0	0	1.0	0.1	1.0	30.0	2	1.0	1	0.0	50.0	1.0	151
152	0	4	1	0	1.0	0.0	0.0	0.0	0	1.0	0	0.0	9.7	1.0	152
153	*														153
154	*														154
155	*FILL TABLE DATA CARDS:SGBDLINE BREAK NODE 4 WITH HT.SINKS														155
156	*														156
157	*														157
158	8	2													158
159	0.0				656.2		333350.0								159
160	0.18				656.2		333350.0								160
161	0.180001				328.1		166675.0								161
162	0.27				328.1		166675.0								162
163	0.270001				189.6		96317.0								163
164	30.0				189.6		96317.0								164
165	30.000001				0.0		0.0								165
166	950.0				0.0		0.0								166
167	*														167
168	*														168
169	*FAN TABLE DATA CARDS														169
170	*														170
171	*														171
172	2	3													172
173	40300.0				0.0										173
174	40300.0				3000.0										174
175	*														175
176	*														176
177	*PASSIVE HEAT SINK DATA CARDS														177
178	*														178
179	*														179
180	SINK1,NODE4														180
181	12	1	0	0.0	7073.1	4	0								181
182	12	1.0													182
183	1														183
184	T														184
185	1	1	1	.08	0	0	0	1.0							185
186	SINK2,NODE5														186
187	12	1	0	0.0	1768.0	5	0								187
188	12	1.0													188
189	1														189
190	T														190
191	1	1	1	.08	0	0	0	1.0							191
192	SINK3,NODE6														192
193	12	1	0	0.0	5635.9	6	0								193
194	12	1.0													194
195	1														195
196	T														196
197	1	1	1	.08	0	0	0	1.0							197
198	SINK4,NODE7														198
199	12	1	0	0.0	1768.0	7	0								199
200	12	1.0													200

1234567890123456789012345678901234567890123456789012345678901234567890

PE-050-  
J.0.12846.114  
1267

1-E-70

R3800128 SURRY 1&2:AUX BLDG,SGBD LINE BREAK NODE 4 WITH HT. SINKS  
S & W ENGR CORP NU-92 << SUBCOMPARTMENT ANALYSIS PROGRAM >>

THREED 20 NOV 1980 10:52:00  
THREED.VER12.LEV01 CREATED 80.106 11:35:02

PAGE 5  
UNIT 10

UNIT 55 (SEQ 1) INPUT ECHO

	1	2	3	4	5	6	7	8	
	12345678901	2345678901	2345678901	2345678901	2345678901	2345678901	2345678901	2345678901	2345678901
201	1								201
202	T								202
203	1 1 1 .08 0 0 0 1.0								203
204	SINK5,NODE8								204
205	12 1 0 0.0 7073.1 8 0								205
206	12 1.0								206
207	1								207
208	T								208
209	1 1 1 .08 0 0 0 1.0								209
210	SINK6,NODE9								210
211	12 1 0 0.0 2273.5 9 0								211
212	12 1.0								212
213	1								213
214	T								214
215	1 1 1 .08 0 0 0 1.0								215
216	SINK7,NODE10								216
217	12 1 0 0.0 5167.5 10 0								217
218	12 1.0								218
219	1								219
220	T								220
221	1 1 1 .08 0 0 0 1.0								221
222	SINK8,NODE11								222
223	12 1 0 0.0 2273.5 11 0								223
224	12 1.0								224
225	1								225
226	T								226
227	1 1 1 .08 0 0 0 1.0								227
228	SINK9,NODE21								228
229	12 1 0 0.0 4974.0 21 0								229
230	12 1.0								230
231	1								231
232	T								232
233	1 1 1 .08 0 0 0 1.0								233
234	SINK10,NODE22								234
235	12 1 0 0.0 3335.0 22 0								235
236	12 1.0								236
237	1								237
238	T								238
239	1 1 1 .08 0 0 0 1.0								239
240	SINK11,NODE12								240
241	9 1 0 0.0 562.5 12 0								241
242	9 0.75								242
243	1								243
244	T								244
245	1 1 1 .08 0 0 0 1.0								245
246	SINK12,NODE13								246
247	9 1 0 0.0 660.25 13 0								247
248	9 0.75								248
249	1								249
250	T								250

12345678901234567890123456789012345678901234567890123456789012345678901234567890

PE-050

70.12846.44

P48

1-3-71

R3800128 HURRY 1&2:AUX BLDG,SGBD LINE BREAK NODE 4 WITH HT. SINKS  
S & W ENGR CORP NU-92 << SUBCOMPARTMENT ANALYSIS PROGRAM >>

THREED 20 NOV 1980 10:52:00 PAGE 6  
THREED.VER12.LEV01 CREATED 80.106 11:35:02 UNIT 10

UNIT 55 (SEQ 1) INPUT ECHO  
1 2 3 4 5 6 7 8  
123456789012345678901234567890123456789012345678901234567890

251	1 1 1 .08 0 0 0 1.0	251
252	SINK13,NODE16	252
253	6 1 0 0.0 1275.0 16 0	253
254	6 0.5	254
255	1	255
256	T	256
257	1 1 1 .08 0 0 0 1.0	257
258	SINK14,NODE17	258
259	6 1 0 0.0 1717.875 17 0	259
260	6 0.5	260
261	1	261
262	T	262
263	1 1 1 .08 0 0 0 1.0	263
264	SINK15,NODE18	264
265	12 1 0 0.0 3008.0 18 0	265
266	12 1.0	266
267	1	267
268	T	268
269	1 1 1 .08 0 0 0 1.0	269
270	SINK16,NODE19	270
271	6 1 0 0.0 1717.875 19 0	271
272	6 0.5	272
273	1	273
274	T	274
275	1 1 1 .08 0 0 0 1.0	275
276	SINK17,NODE20	276
277	6 1 0 0.0 1275.0 20 0	277
278	6 0.5	278
279	1	279
280	T	280
281	1 1 1 .08 0 0 0 1.0	281
282	*	282
283	*	283
284	*DATA COMMON TO HEAT SINKS	284
285	*	285
286	*	286
287	120.0 T	287
288	0.79 24.93 'CONCRETE'/	288
289	END OF HEAT SLAB DATA	289

1234567890123456789012345678901234567890123456789012345678901234567890 <EOF> COPIED TO UNIT 5  
W/O CMTS

PC-050  
P69  
T.O. 17846.44

1-E-72

R U N S U M M A R Y S H E E T

MISCELLANEOUS PROBLEM CONTROL DATA:

OUTPUT FLAG.....	1	TOTAL TIME OF RUN.....	901.000 SEC
NUMBER OF TIME STEP CARDS...	10	NUMBER OF STANDARD TIME STEPS.....	3900
NUMBER OF TRIP CONTROLS.....	3	NUMBER OF ACTUAL TIME STEPS.....	3910
NUMBER OF VOLUMES.....	40	NUMBER OF TIMES GAUSSIAN ELIMINATION USED..	1287
NUMBER OF JUNCTIONS.....	66	NUMBER OF TIMES GAUSS-SEIDEL USED.....	2623
NUMBER OF FILL TABLES.....	1	NUMBER OF TRANSIENTS STORED FOR PLOTEMUP...	146
NUMBER OF FAN TABLES.....	1	NUMBER OF SELECTED NODAL DIFF. PRESS.....	0
NUMBER OF HT SOURCE CURVES..	0	NUMBER OF HEAT SINKS.....	17
IMPLICIT/EXPLICIT COEFF.....	1.000	NUMBER OF INTERNAL JUNCTIONS.....	65

STEAM TABLES USED (FT15) VOLUME SERIAL NO. = SHARE0 DATA SET NAME = HEATBAL.ME190.STH20G.OUTPUT1

OUTPUT: TRANSIENTS TAPE (FT08) = 016308 FILE NUMBER = 24 DATA SET NAME = FE.GUARDS.PLOTTER  
TRANSMITTAL FILE (FT09) WAS NOT USED

PEAK PRESSURE DIFFERENTIAL

JUNCTION NUMBER	CONNECTING VOLUMES	PRESSURE PSID	TIME SEC	JUNCTION NUMBER	CONNECTING VOLUMES	PRESSURE PSID	TIME SEC
1	1 TO 6	0.03	2.110	34	25 TO 23	-0.01	2.210
2	2 TO 3	0.00	0.236	35	25 TO 23	-0.01	2.210
3	4 TO 5	0.07	2.083	36	23 TO 26	0.02	2.230
4	5 TO 6	0.16	2.059	37	24 TO 25	0.01	2.096
5	7 TO 6	0.04	2.250	38	24 TO 26	0.01	2.104
6	8 TO 7	0.02	2.210	39	24 TO 26	0.01	2.104
7	1 TO 12	-0.04	2.148	40	6 TO 22	0.01	2.067
8	1 TO 12	-0.04	2.148	41	6 TO 27	0.08	2.250
9	7 TO 11	-0.01	2.210	42	4 TO 28	0.21	2.083
10	8 TO 11	-0.01	2.143	43	8 TO 29	0.11	2.230
11	4 TO 9	0.07	2.083	44	26 TO 30	0.04	2.350
12	5 TO 9	0.03	2.220	45	26 TO 30	0.04	2.350
13	10 TO 12	0.02	2.073	46	2 TO 31	-0.00	0.501
14	9 TO 10	0.15	2.053	47	31 TO 32	-0.01	0.000
15	11 TO 10	-0.09	2.118	48	32 TO 16	-0.01	2.086
16	9 TO 17	0.16	2.113	49	33 TO 34	0.00	0.236
17	12 TO 13	0.01	2.080	50	34 TO 37	-0.01	0.234
18	11 TO 19	0.02	2.220	51	33 TO 36	-0.01	0.000
19	3 TO 15	-0.01	0.234	52	36 TO 20	-0.01	2.120
20	2 TO 14	-0.01	0.000	53	37 TO 20	-0.01	2.119
21	17 TO 18	0.04	2.073	54	33 TO 35	-0.00	0.501
22	18 TO 19	0.03	2.121	55	35 TO 38	-0.01	0.000
23	19 TO 20	-0.02	2.210	56	38 TO 20	-0.01	2.119
24	14 TO 16	-0.01	2.086	57	1 TO 39	0.10	0.227
25	15 TO 16	-0.01	2.085	58	2 TO 39	0.09	0.225
26	16 TO 21	-0.02	0.268	59	3 TO 39	0.09	0.225
27	17 TO 23	0.05	2.080	60	31 TO 39	0.09	0.225
28	19 TO 23	0.06	2.240	61	21 TO 39	0.09	0.227
29	20 TO 21	-0.03	2.108	62	33 TO 39	0.09	0.225
30	18 TO 13	-0.05	2.110	63	34 TO 39	0.09	0.225
31	16 TO 17	-0.04	2.072	64	35 TO 39	0.09	0.225
32	21 TO 22	0.01	2.210	65	39 TO 40	-0.39	0.227
33	22 TO 24	0.05	2.230				

950-34  
J.R. 12846.44  
P20

PEAK PRESSURES AND TEMPERATURES

NODE NUMBER	PRESSURE (PSIA)	TIME (SEC)	TEMPERATURE (DEG F)	TIME (SEC)	NODE NUMBER	PRESSURE (PSIA)	TIME (SEC)	TEMPERATURE (DEG F)	TIME (SEC)
1	14.80	2.116	139.70	102.000	21	14.81	2.240	129.16	52.000
2	14.82	2.230	131.81	119.000	22	14.80	2.250	140.95	32.080
3	14.83	2.230	131.90	117.000	23	14.76	2.310	121.62	32.080
4	14.95	2.088	202.72	32.000	24	14.76	2.310	122.03	32.060
5	14.92	2.119	196.08	32.010	25	14.76	2.290	120.64	2.290
6	14.80	2.240	159.92	32.050	26	14.74	2.340	120.47	2.340
7	14.84	2.240	137.63	65.500	27	14.73	4.650	120.31	4.650
8	14.85	2.240	131.33	187.000	28	14.82	2.270	120.69	901.000
9	14.92	2.110	194.13	32.010	29	14.81	2.410	121.19	2.410
10	14.85	2.136	176.13	32.060	30	14.70	901.000	120.00	901.000
11	14.84	2.240	161.40	36.100	31	14.82	2.230	131.81	119.000
12	14.84	2.138	155.53	32.060	32	14.82	2.230	132.37	95.000
13	14.83	2.161	136.92	32.080	33	14.85	2.230	125.22	124.000
14	14.82	2.230	132.37	96.000	34	14.85	2.230	125.26	123.000
15	14.82	2.230	132.48	94.000	35	14.85	2.230	125.22	124.000
16	14.81	2.210	134.68	64.000	36	14.84	2.230	125.54	101.000
17	14.79	2.182	151.82	32.040	37	14.84	2.230	125.59	100.000
18	14.81	2.170	129.56	276.000	38	14.84	2.230	125.54	101.000
19	14.82	2.240	129.68	32.330	39	14.83	2.230	129.00	122.000
20	14.83	2.230	126.40	69.000	40	15.00	901.000	120.00	901.000

PC-050

Sta. 12846.44

P71

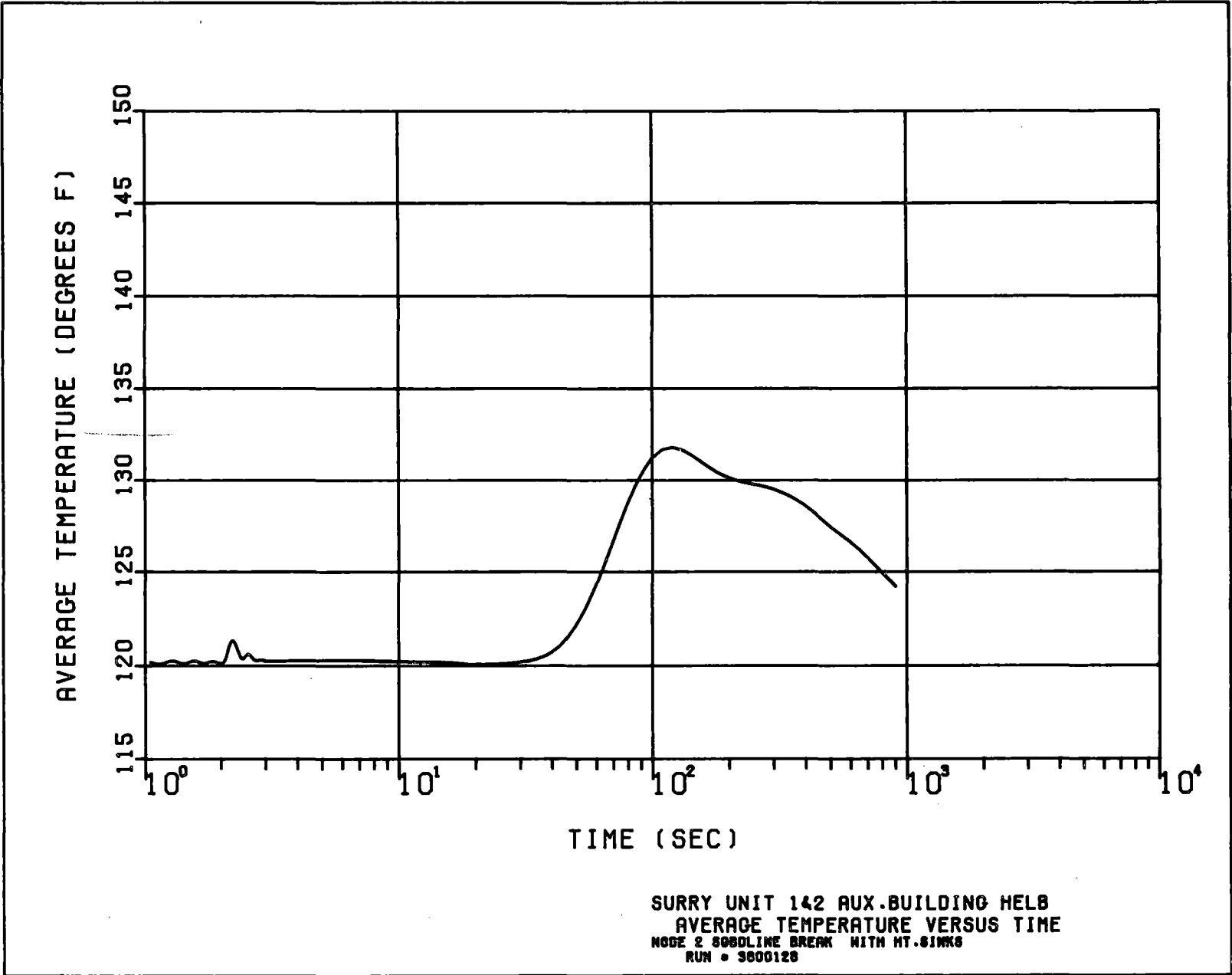

SURRY UNIT 142 AUX. BUILDING HELB  
AVERAGE TEMPERATURE VERSUS TIME  
NODE 2 SADDLINE BREAK WITH HT. SINKS  
RUN # 3800128

PE-050  
P72  
J.O. 12846.48



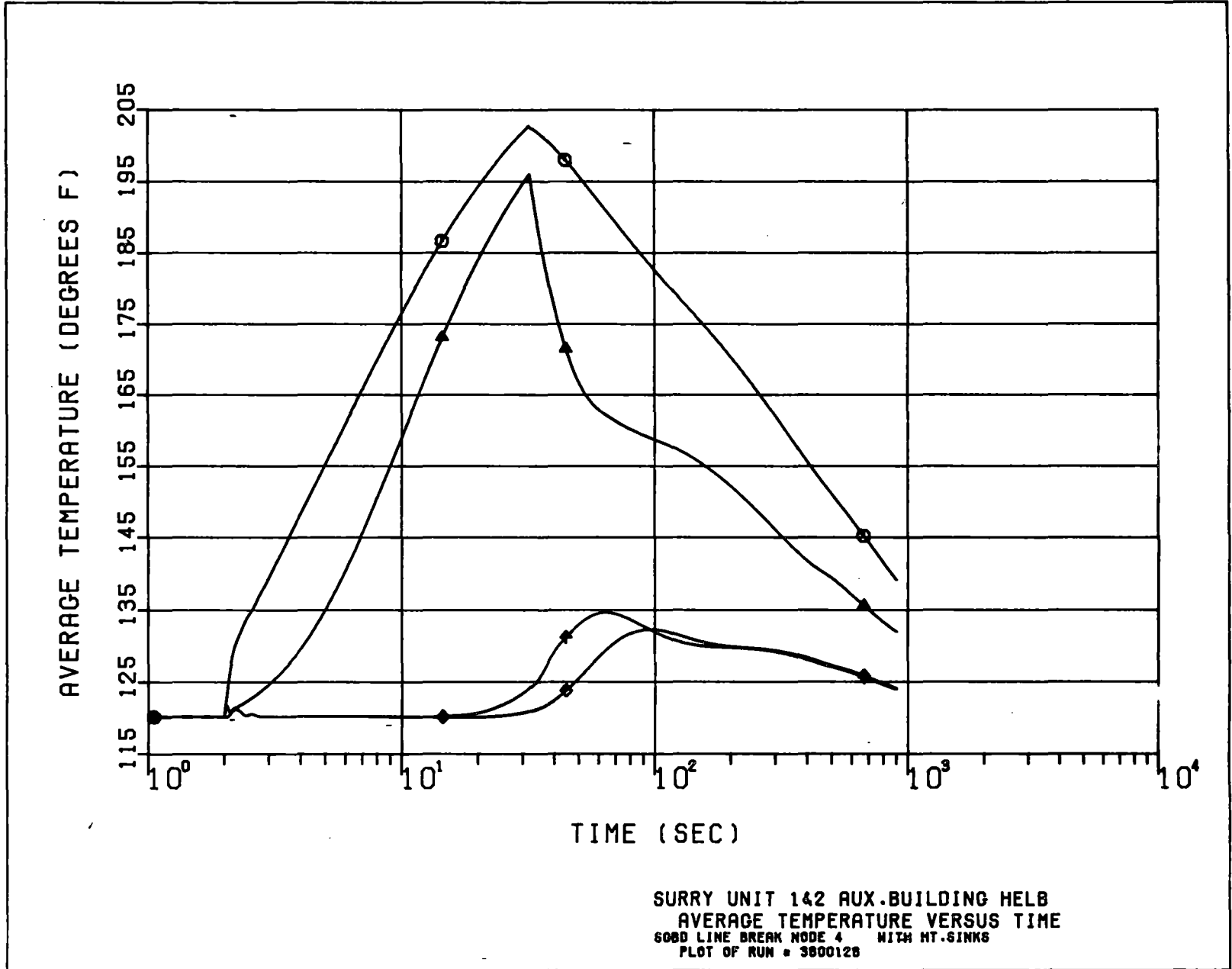

PE-050

510.17846.4

P73

1-E-76

R3800130 SURRY 1&2:SGBDLIN BREAK NODE4,COMPARITIVE: WITH HT. SINKS  
S & W ENGR CORP NU-92 << SUBCOMPARTMENT ANALYSIS PROGRAM >>

THREED 25 NOV 1980 10:56:16 PAGE 1  
THREED.VER12.LEV01 CREATED 80.106 11:35:02 UNIT 10

UNIT 55 (SEQ 1) INPUT ECHO 1 2 3 4 5 6 7 8  
1234567890123456789012345678901234567890123456789012345678901234567890

1	SURRY 1&2:SGBDLIN BREAK NODE4,COMPARITIVE: WITH HT. SINKS	1
2	*	2
3	*	3
4	*PROBLEM DIMENSION CARD	4
5	*	5
6	*	6
7	1 10 3 40 68 1 1 0 0 17	7
8	*	8
9	*	9
10	*IMPLICIT/EXPLICIT COEFICIENT CARD	10
11	*	11
12	*	12
13	1.0	13
14	*	14
15	*	15
16	*TIME STEP CONTROL DATA CARDS	16
17	*	17
18	*	18
19	50 10 0 0 0.001 0.00001 2.2	19
20	2 10 0 0 0.01 0.0001 3.0	20
21	5 14 0 0 0.05 0.0001 10.0	21
22	5 15 0 0 0.1 0.0001 31.9	22
23	5 11 0 0 0.01 0.0001 33.0	23
24	5 5 0 0 0.02 0.0001 34.0	24
25	5 12 0 0 0.05 0.0001 40.0	25
26	5 10 0 0 0.1 0.0001 50.0	26
27	2 15 0 0 0.5 0.001 80.0	27
28	10 20 0 0 1.0 0.001 950.0	28
29	*	29
30	*	30
31	*TRIP CONTROL DATA CARDS	31
32	*	32
33	*	33
34	1 0 0 900.0 0.0	34
35	1 0 0 0.0 2.0	35
36	1 0 0 0.0 0.2	36
37	*	37
38	*	38
39	*NODAL DATA CARDS	39
40	*	40
41	*	41
42	14.70 120. 1.0 1137.7 2.00 9.50 0.0 0	42
43	14.70 120. 1.0 2011.2 2.00 10.00 0.0 0	43
44	14.70 120. 1.0 2011.2 2.00 10.00 0.0 0	44
45	14.70 120. 1.0 26611.5 2.00 12.00 0.0 0	45
46	14.70 120. 1.0 5150.7 2.00 9.50 0.0 0	46
47	14.70 120. 1.0 18697.8 2.00 10.10 0.0 0	47
48	14.70 120. 1.0 5150.7 2.00 9.50 0.0 0	48
49	14.70 120. 1.0 26611.5 2.00 12.00 0.0 0	49
50	14.70 120. 1.0 4050.0 2.00 9.00 0.0 0	50

1234567890123456789012345678901234567890123456789012345678901234567890

PE-050

50.12846.44

P 74



1-E-78

R3800130 SURRY 1&2:SGBDLINE BREAK NODE4,COMPARITIVE: WITH HT. SINKS  
S & W ENGR CORP NU-92 << SUBCOMPARTMENT ANALYSIS PROGRAM >>

THREED 25 NOV 1980 10:56:16  
THREED.VER12.LEV01 CREATED 80.106 11:35:02

PAGE 3  
UNIT 10

UNIT 55 (SEQ 1) INPUT ECHO

	1	2	3	4	5	6	7	8							
	1234567890123456789012345678901234567890123456789012345678901234567890														
101	11	10	0	0	90.	.434	1.004	-0.45	2	1.0	0	0.0	4.5	1.0	101
102	9	17	0	0	24.5	.337	2.088	2.048	2	1.0	0	0.0	4.5	1.0	102
103	12	13	0	0	84.0	.102	.558	0.012	2	1.0	0	0.0	11.00	1.0	103
104	11	19	0	0	24.5	.337	2.088	2.048	2	1.0	0	0.0	11.00	1.0	104
105	3	15	0	0	211.1	.077	.264	.264	2	1.0	0	0.0	12.50	1.0	105
106	2	14	0	0	208.7	.060	.264	.264	2	1.0	0	0.0	12.50	1.0	106
107	17	18	0	0	135.	.288	1.007	-0.451	2	1.0	0	0.0	19.75	1.0	107
108	18	19	0	0	135.	.288	-0.451	1.007	2	1.0	0	0.0	19.75	1.0	108
109	19	20	0	0	162.	.142	.696	-0.369	2	1.0	0	0.0	19.75	1.0	109
110	14	16	0	0	47.5	.164	1.027	1.718	2	1.0	0	0.0	19.25	1.0	110
111	15	16	0	0	47.5	.164	1.027	1.718	2	1.0	0	0.0	19.25	1.0	111
112	16	21	0	0	162.	.111	-0.197	1.456	2	1.0	0	0.0	19.75	1.0	112
113	17	23	0	0	21.0	.328	1.893	1.886	2	1.0	0	0.0	18.43	1.0	113
114	19	23	0	0	21.0	.328	1.893	1.886	2	1.0	0	0.0	18.43	1.0	114
115	20	21	0	0	162.0	.111	-0.197	1.456	2	1.0	0	0.0	19.75	1.0	115
116	18	13	0	0	21.	.329	2.250	2.497	2	1.0	0	0.0	19.25	1.0	116
117	16	17	0	0	162.	.142	-0.369	.696	2	1.0	0	0.0	19.75	1.0	117
118	21	22	0	0	496.5	.029	.831	-.418	2	1.0	0	0.0	19.25	1.0	118
119	22	24	0	0	66.5	.032	2.552	2.552	2	1.0	0	0.0	26.5	1.0	119
120	25	23	0	0	195.	.112	1.197	1.180	2	1.0	0	0.0	35.0	1.0	120
121	25	23	0	0	155.	.17	1.225	1.189	2	1.0	0	0.0	35.0	1.0	121
122	23	26	0	0	60.	.040	2.553	2.607	2	1.0	0	0.0	44.25	1.0	122
123	24	25	0	0	983.6	.030	.284	-0.131	2	1.0	0	0.0	35.0	1.0	123
124	24	26	0	0	63.	.035	2.673	2.672	2	1.0	0	0.0	44.25	1.0	124
125	24	26	0	0	83.2	.022	1.636	1.634	2	1.0	0	0.0	44.25	1.0	125
126	6	22	0	0	792.	.01	1.253	1.130	2	1.0	0	0.0	12.	1.0	126
127	6	27	0	0	27.1	2.83	3.05	3.05	2	1.0	0	0.0	5.0	1.0	127
128	4	28	0	0	5.69	1.723	2.809	2.822	2	1.0	0	0.0	19.08	1.0	128
129	8	29	0	0	5.69	1.723	2.809	2.822	2	1.0	0	0.0	19.08	1.0	129
130	26	30	0	0	42.24	.072	2.653	2.104	2	1.0	0	0.0	50.0	1.0	130
131	26	30	0	0	42.24	.072	2.653	2.104	2	1.0	0	0.0	50.0	1.0	131
132	2	31	0	0	1.31	1.182	1.66	1.66	2	1.0	0	0.0	9.2	1.0	132
133	31	32	0	0	208.7	.06	.264	.264	2	1.0	0	0.0	12.5	1.0	133
134	32	16	0	0	47.5	.164	1.027	1.718	2	1.0	0	0.0	19.25	1.0	134
135	33	34	0	0	1.75	.894	1.61	1.61	2	1.0	0	0.0	9.2	1.0	135
136	34	37	0	0	211.1	.077	.264	.264	2	1.0	0	0.0	12.5	1.0	136
137	33	36	0	0	208.7	.060	.264	.264	2	1.0	0	0.0	12.5	1.0	137
138	36	20	0	0	47.5	.164	1.027	1.718	2	1.0	0	0.0	19.25	1.0	138
139	37	20	0	0	47.5	.164	1.027	1.718	2	1.0	0	0.0	19.25	1.0	139
140	33	35	0	0	1.31	1.182	1.66	1.66	2	1.0	0	0.0	9.2	1.0	140
141	35	33	0	0	209.7	.06	.264	.264	2	1.0	0	0.0	12.5	1.0	141
142	38	20	0	0	47.5	.164	1.027	1.718	2	1.0	0	0.0	19.25	1.0	142
143	1	39	0	0	1.0	10.0	1.0	30.0	2	1.0	0	0.0	9.0	1.0	143
144	2	39	0	0	16.25	1.0	1.0	30.0	2	1.0	0	0.0	9.0	1.0	144
145	3	39	0	0	16.25	1.0	1.0	30.0	2	1.0	0	0.0	9.0	1.0	145
146	31	39	0	0	16.25	1.0	1.0	30.0	2	1.0	0	0.0	9.0	1.0	146
147	21	39	0	0	3.25	10.0	1.0	30.0	2	1.0	0	0.0	15.0	1.0	147
148	33	39	0	0	16.25	1.0	1.0	30.0	2	1.0	0	0.0	9.0	1.0	148
149	34	39	0	0	16.25	1.0	1.0	30.0	2	1.0	0	0.0	9.0	1.0	149
150	35	39	0	0	16.25	1.0	1.0	30.0	2	1.0	0	0.0	9.0	1.0	150

1234567890123456789012345678901234567890123456789012345678901234567890

PC-050  
P76  
570.12846.44

1-E-79

R3800130 SURRY 1&2:SGBDLINE BREAK NODE4,COMPARITIVE: WITH HT. SINKS  
S & W ENGR CORP NU-92 << SUBCOMPARTMENT ANALYSIS PROGRAM >>

THREED 25 NOV 1980 10:56:16 PAGE 4  
THREED.VER12.LEV01 CREATED 80.106 11:35:02 UNIT 10

UNIT 55 (SEQ 1) INPUT ECHO 1 2 3 4 5 6 7 8  
1234567890123456789012345678901234567890123456789012345678901234567890

151	39	40	0	0	1.0	0.1	1.0	30.0	2	1.0	1	0.0	50.0	1.0	151
152	5	3	0	0	3.0	0.683	1.592	1.631	2	1.0	0	0.0	10.25	1.0	152
153	7	34	0	0	3.0	0.683	1.592	1.631	2	1.0	0	0.0	10.25	1.0	153
154	0	4	1	0	1.0	0.0	0.0	0.0	0	1.0	0	0.0	9.7	1.0	154
155	*														155
156	*														156
157	*FILL TABLE DATA CARDS: LETDOWN LINE BREAK NODE 5 WITH HT.SINKS														157
158	*														158
159	*														159
160	8	2													160
161		0.0			656.2	333350.0									161
162		0.18			656.2	333350.0									162
163		0.180001			328.1	166675.0									163
164		0.27			328.1	166675.0									164
165		0.270001			189.6	96317.0									165
166		30.0			189.6	96317.0									166
167		30.000001			0.0	0.0									167
168		950.0			0.0	0.0									168
169	*														169
170	*														170
171	*FAN TABLE DATA CARDS														171
172	*														172
173	*														173
174	2	3													174
175		40300.0			0.0										175
176		40300.0			3000.0										176
177	*														177
178	*														178
179	*PASSIVE HEAT SINK DATA CARDS														179
180	*														180
181	*														181
182	SINK1,NODE4														182
183	12	1	0	0.0	7073.1	4	0								183
184	12	1.0													184
185	1														185
186	F														186
187	1	1	1	.08	0	0	0	1.0							187
188	SINK2,NODE5														188
189	12	1	0	0.0	1768.0	5	0								189
190	12	1.0													190
191	1														191
192	F														192
193	1	1	1	.08	0	0	0	1.0							193
194	SINK3,NODE6														194
195	12	1	0	0.0	5635.9	6	0								195
196	12	1.0													196
197	1														197
198	F														198
199	1	1	1	.08	0	0	0	1.0							199
200	SINK4,NODE7														200

*mis-labeled - numbers OK*  
*248*

1234567890123456789012345678901234567890123456789012345678901234567890

73-050  
J.O.12846.44  
P77

08-3-1

UNIT 55 (SEQ 1) INPUT ECHO

	1	2	3	4	5	6	7	8	
201	12	1	0	0.0	1768.0	7	0		201
202	12	1.0							202
203	1								203
204	F								204
205	1	1	1	.08	0	0	0	1.0	205
206	SINK5,NODE8								206
207	12	1	0	0.0	7073.1	8	0		207
208	12	1.0							208
209	1								209
210	F								210
211	1	1	1	.08	0	0	0	1.0	211
212	SINK6,NODE9								212
213	12	1	0	0.0	2273.5	9	0		213
214	12	1.0							214
215	1								215
216	F								216
217	1	1	1	.08	0	0	0	1.0	217
218	SINK7,NODE10								218
219	12	1	0	0.0	5167.5	10	0		219
220	12	1.0							220
221	1								221
222	F								222
223	1	1	1	.08	0	0	0	1.0	223
224	SINK8,NODE11								224
225	12	1	0	0.0	2273.5	11	0		225
226	12	1.0							226
227	1								227
228	F								228
229	1	1	1	.08	0	0	0	1.0	229
230	SINK9,NODE21								230
231	12	1	0	0.0	4974.0	21	0		231
232	12	1.0							232
233	1								233
234	F								234
235	1	1	1	.08	0	0	0	1.0	235
236	SINK10,NODE22								236
237	12	1	0	0.0	3335.0	22	0		237
238	12	1.0							238
239	1								239
240	F								240
241	1	1	1	.08	0	0	0	1.0	241
242	SINK11,NODE12								242
243	9	1	0	0.0	562.5	12	0		243
244	9	0.75							244
245	1								245
246	F								246
247	1	1	1	.08	0	0	0	1.0	247
248	SINK12,NODE13								248
249	9	1	0	0.0	660.25	13	0		249
250	9	0.75							250

1234567890123456789012345678901234567890123456789012345678901234567890

TE-050  
J.O. 12846.44  
P 28



1-E-82

R3800130 SURRY 1&2:SGBDLINE BREAK NODE4,COMPARITIVE: WITH HT. SINKS  
S & W ENGR CORP NU-92 << SUBCOMPARTMENT ANALYSIS PROGRAM >>

THREED 25 NOV 1980 10:56:16 PAGE 7  
THREED.VER12.LEV01 CREATED 80.106 11:35:02 UNIT 10

R U N S U M M A R Y S H E E T

MISCELLANEOUS PROBLEM CONTROL DATA:

OUTPUT FLAG.....	1	TOTAL TIME OF RUN.....	901.000 SEC
NUMBER OF TIME STEP CARDS...	10	NUMBER OF STANDARD TIME STEPS.....	3900
NUMBER OF TRIP CONTROLS.....	3	NUMBER OF ACTUAL TIME STEPS.....	3910
NUMBER OF VOLUMES.....	40	NUMBER OF TIMES GAUSSIAN ELIMINATION USED..	1296
NUMBER OF JUNCTIONS.....	68	NUMBER OF TIMES GAUSS-SEIDEL USED.....	2614
NUMBER OF FILL TABLES.....	1	NUMBER OF TRANSIENTS STORED FOR PLOTEMUP...	148
NUMBER OF FAN TABLES.....	1	NUMBER OF SELECTED NODAL DIFF. PRESS.....	0
NUMBER OF HT SOURCE CURVES..	0	NUMBER OF HEAT SINKS.....	17
IMPLICIT/EXPLICIT COEFF.....	1.000	NUMBER OF INTERNAL JUNCTIONS.....	67

STEAM TABLES USED (FT15) VOLUME SERIAL NO. = SHAREO DATA SET NAME = HEATBAL.ME190.STH20G.OUTPUT1

OUTPUT: TRANSIENTS TAPE (FT08) = 016308 FILE NUMBER = 26 DATA SET NAME = FE.GUARDS.PLOTTER  
TRANSHITTAL FILE (FT09) WAS NOT USED

PEAK PRESSURE DIFFERENTIAL

JUNCTION NUMBER	CONNECTING VOLUMES	PRESSURE PSID	TIME SEC	JUNCTION NUMBER	CONNECTING VOLUMES	PRESSURE PSID	TIME SEC
1	1 TO 6	0.03	2.109	35	25 TO 23	-0.01	2.210
2	2 TO 3	-0.02	2.068	36	23 TO 26	0.02	2.230
3	4 TO 5	0.07	2.080	37	24 TO 25	0.01	2.095
4	5 TO 6	0.15	2.058	38	24 TO 26	0.01	2.103
5	7 TO 6	0.04	2.250	39	24 TO 26	0.01	2.103
6	8 TO 7	0.01	2.210	40	6 TO 22	0.01	2.067
7	1 TO 12	-0.04	2.148	41	6 TO 27	0.08	2.250
8	1 TO 12	-0.04	2.148	42	4 TO 28	0.21	2.081
9	7 TO 11	-0.01	2.197	43	8 TO 29	0.11	2.230
10	8 TO 11	-0.01	2.145	44	26 TO 30	0.04	2.340
11	4 TO 9	0.07	2.083	45	26 TO 30	0.04	2.340
12	5 TO 9	0.03	2.220	46	2 TO 31	-0.01	2.156
13	10 TO 12	0.02	2.074	47	31 TO 32	-0.01	0.000
14	9 TO 10	0.15	2.053	48	32 TO 16	-0.02	2.085
15	11 TO 10	-0.09	2.117	49	33 TO 34	0.00	0.353
16	9 TO 17	0.15	2.112	50	34 TO 37	-0.01	0.232
17	12 TO 13	0.01	2.080	51	33 TO 36	-0.01	0.000
18	11 TO 19	0.02	2.270	52	36 TO 20	-0.01	2.119
19	3 TO 15	0.01	2.049	53	37 TO 20	0.01	2.240
20	2 TO 14	-0.01	0.000	54	33 TO 35	0.00	0.545
21	17 TO 18	0.04	2.074	55	35 TO 38	-0.01	0.000
22	18 TO 19	0.03	2.122	56	38 TO 20	-0.01	2.119
23	19 TO 20	-0.02	2.210	57	1 TO 39	0.10	0.227
24	14 TO 16	-0.02	2.084	58	2 TO 39	0.09	0.225
25	15 TO 16	0.01	2.067	59	3 TO 39	0.09	0.225
26	16 TO 21	-0.02	0.267	60	31 TO 39	0.09	0.225
27	17 TO 23	0.05	2.081	61	21 TO 39	0.09	0.227
28	19 TO 23	0.06	2.240	62	33 TO 39	0.09	0.225
29	20 TO 21	-0.03	2.107	63	34 TO 39	0.09	0.225
30	19 TO 13	-0.05	2.108	64	35 TO 39	0.09	0.225
31	16 TO 17	-0.03	2.070	65	39 TO 40	-0.39	0.227
32	21 TO 22	-0.01	2.073	66	5 TO 3	0.16	2.113
33	22 TO 24	0.05	2.230	67	7 TO 34	0.02	2.098

PC-050

J.D. 12886.44

P80



1-E-83

34 25 TO 23 -0.01 2.210

PEAK PRESSURES AND TEMPERATURES

NODE NUMBER	PRESSURE (PSIA)	TIME (SEC)	TEMPERATURE		NODE NUMBER	PRESSURE (PSIA)	TIME (SEC)	TEMPERATURE	
			(DEG F)	TIME (SEC)				(DEG F)	TIME (SEC)
1	14.80	2.117	139.60	103.000	21	14.81	2.230	128.73	53.000
2	14.82	2.230	131.65	120.000	22	14.80	2.240	140.43	32.080
3	14.81	2.210	135.48	32.020	23	14.76	2.310	121.58	32.080
4	14.95	2.087	202.72	32.000	24	14.76	2.300	121.99	32.060
5	14.92	2.116	196.13	32.010	25	14.76	2.290	120.64	2.290
6	14.80	2.240	159.80	32.060	26	14.74	2.330	120.47	2.330
7	14.84	2.240	137.57	70.500	27	14.73	4.650	120.31	4.650
8	14.85	2.240	131.53	180.000	28	14.81	2.270	120.68	901.000
9	14.91	2.110	194.06	32.010	29	14.81	2.410	121.18	2.410
10	14.85	2.136	175.91	32.060	30	14.70	901.000	120.00	901.000
11	14.85	2.240	161.18	36.300	31	14.82	2.240	131.65	120.000
12	14.84	2.138	154.79	32.060	32	14.81	2.240	132.19	96.000
13	14.83	2.162	136.25	32.080	33	14.85	2.220	125.00	127.000
14	14.81	2.230	132.18	96.000	34	14.85	2.230	126.35	118.000
15	14.81	2.210	132.57	91.000	35	14.85	2.220	124.98	127.000
16	14.80	2.210	134.50	64.000	36	14.84	2.220	125.27	103.000
17	14.79	2.181	151.42	32.040	37	14.84	2.230	125.23	104.000
18	14.81	2.170	128.70	273.000	38	14.84	2.220	125.28	103.000
19	14.82	2.230	129.18	32.330	39	14.82	2.230	129.02	121.000
20	14.83	2.230	126.09	71.500	40	15.00	901.000	120.00	901.000

PE - 050  
5/0.12046.44  
P81

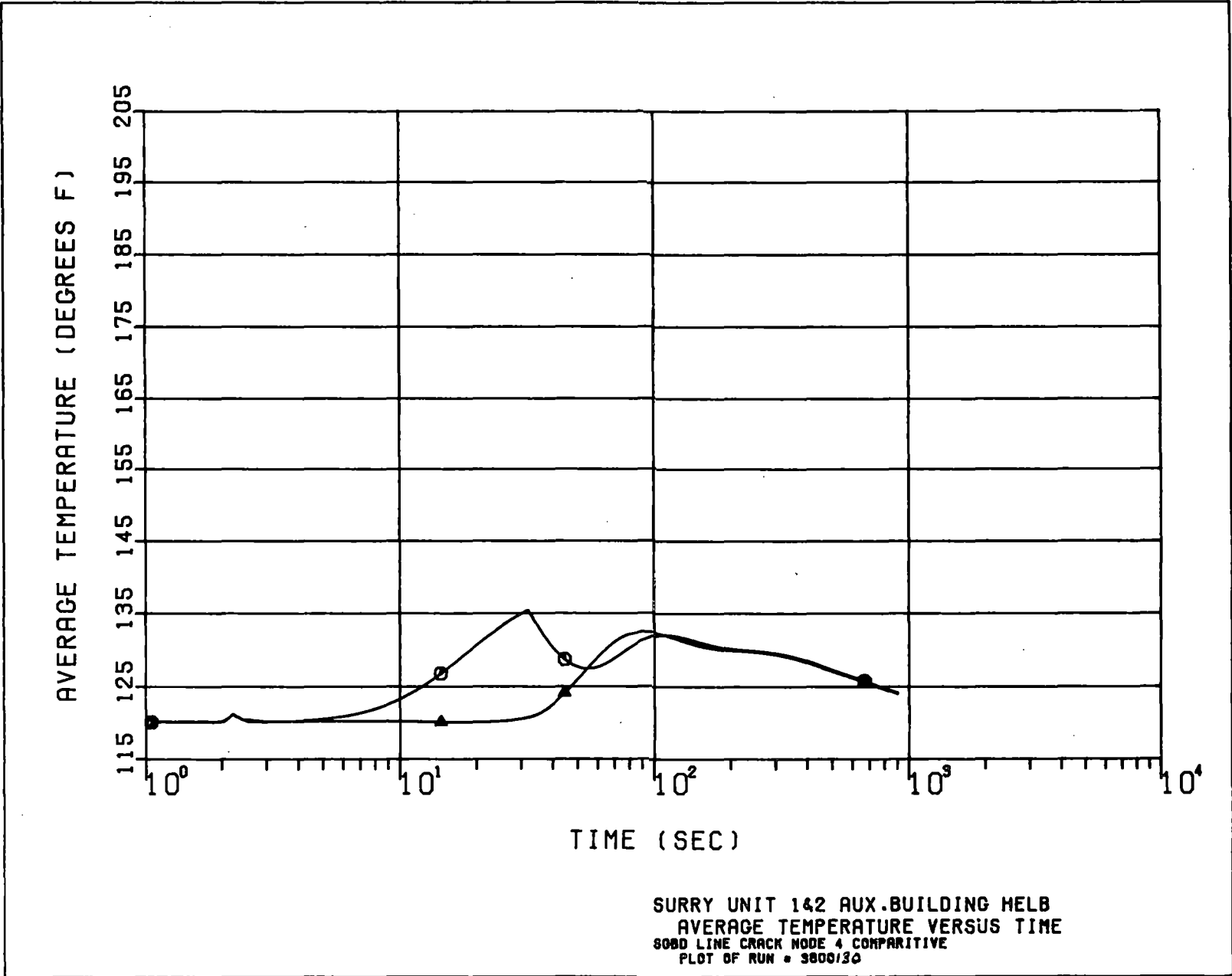

282  
J.O. 12046.44  
7E-050

1-E-85

R3800130-ASURRY 1&2:SGBDLINE CRACK NODE4,COMPARITIVE: WITH HT. SINKS  
S & W ENGR CORP NU-92 << SUBCOMPARTMENT ANALYSIS PROGRAM >>

THREED 29 JAN 1981 14:36:07 PAGE 1  
THREED.VER12.LEV01 CREATED 80.106 11:35:02 UNIT 10

UNIT 55 (SEQ 1) INPUT ECHO 1 2 3 4 5 6 7 8  
1234567890123456789012345678901234567890123456789012345678901234567890

1	SURRY 1&2:SGBDLINE CRACK NODE4,COMPARITIVE: WITH HT. SINKS	1
2	*	2
3	*	3
4	*PROBLEM DIMENSION CARD	4
5	*	5
6	*	6
7	1 10 3 40 68 1 1 0 0 17	7
8	*	8
9	*	9
10	*IMPLICIT/EXPLICIT COEFICIENT CARD	10
11	*	11
12	*	12
13	1.0	13
14	*	14
15	*	15
16	*TIME STEP CONTROL DATA CARDS	16
17	*	17
18	*	18
19	50 10 0 0 0.001 0.00001 2.2	19
20	2 10 0 0 0.01 0.0001 3.0	20
21	5 14 0 0 0.05 0.0001 10.0	21
22	5 15 0 0 0.1 0.0001 31.9	22
23	5 11 0 0 0.01 0.0001 33.0	23
24	5 5 0 0 0.02 0.0001 34.0	24
25	5 12 0 0 0.05 0.0001 40.0	25
26	5 10 0 0 0.1 0.0001 50.0	26
27	2 15 0 0 0.5 0.001 80.0	27
28	10 20 0 0 1.0 0.001 1250.0	28
29	*	29
30	*	30
31	*TRIP CONTROL DATA CARDS	31
32	*	32
33	*	33
34	1 0 0 1200.0 0.0	34
35	1 0 0 0.0 2.0	35
36	1 0 0 0.0 0.2	36
37	*	37
38	*	38
39	*NODAL DATA CARDS	39
40	*	40
41	*	41
42	14.70 120. 1.0 1137.7 2.00 9.50 0.0 0	42
43	14.70 120. 1.0 2011.2 2.00 10.00 0.0 0	43
44	14.70 120. 1.0 2011.2 2.00 10.00 0.0 0	44
45	14.70 120. 1.0 26611.5 2.00 12.00 0.0 0	45
46	14.70 120. 1.0 5150.7 2.00 9.50 0.0 0	46
47	14.70 120. 1.0 18697.8 2.00 10.10 0.0 0	47
48	14.70 120. 1.0 5150.7 2.00 9.50 0.0 0	48
49	14.70 120. 1.0 26611.5 2.00 12.00 0.0 0	49
50	14.70 120. 1.0 4050.0 2.00 9.00 0.0 0	50

1234567890123456789012345678901234567890123456789012345678901234567890

PC-050  
510.18846.44  
P 98



1-3-7

R3800130-ASURRY 1&2:SGBDLINE CRACK NODE4,COMPARITIVE: WITH HT. SINKS  
S & W ENGR CORP NU-92 << SUBCOMPARTMENT ANALYSIS PROGRAM >>

THREED 29 JAN 1981 14:36:07 PAGE 3  
THREED.VER12.LEV01 CREATED 80.106 11:35:02 UNIT 10

UNIT 55 (SEQ 1) INPUT ECHO  
1 2 3 4 5 6 7 8  
1234567890123456789012345678901234567890123456789012345678901234567890

101	11	10	0	0	90.	.434	1.004	-0.45	2	1.0	0	0.0	4.5	1.0	101
102	9	17	0	0	24.5	.337	2.088	2.048	2	1.0	0	0.0	4.5	1.0	102
103	12	13	0	0	84.0	.102	.558	0.012	2	1.0	0	0.0	11.00	1.0	103
104	11	19	0	0	24.5	.337	2.088	2.048	2	1.0	0	0.0	11.00	1.0	104
105	3	15	0	0	211.1	.077	.264	.264	2	1.0	0	0.0	12.50	1.0	105
106	2	14	0	0	208.7	.060	.264	.264	2	1.0	0	0.0	12.50	1.0	106
107	17	18	0	0	135.	.288	1.007	-0.451	2	1.0	0	0.0	19.75	1.0	107
108	18	19	0	0	135.	.288	-0.451	1.007	2	1.0	0	0.0	19.75	1.0	108
109	19	20	0	0	162.	.142	.696	-0.369	2	1.0	0	0.0	19.75	1.0	109
110	14	16	0	0	47.5	.164	1.027	1.718	2	1.0	0	0.0	19.25	1.0	110
111	15	16	0	0	47.5	.164	1.027	1.718	2	1.0	0	0.0	19.25	1.0	111
112	16	21	0	0	162.	.111	-0.197	1.456	2	1.0	0	0.0	19.75	1.0	112
113	17	23	0	0	21.0	.328	1.893	1.886	2	1.0	0	0.0	18.43	1.0	113
114	19	23	0	0	21.0	.328	1.893	1.886	2	1.0	0	0.0	18.43	1.0	114
115	20	21	0	0	162.0	.111	-0.197	1.456	2	1.0	0	0.0	19.75	1.0	115
116	18	13	0	0	21.	.329	2.250	2.497	2	1.0	0	0.0	19.25	1.0	116
117	16	17	0	0	162.	.142	-0.369	.696	2	1.0	0	0.0	19.75	1.0	117
118	21	22	0	0	496.5	.029	.831	-.418	2	1.0	0	0.0	19.25	1.0	118
119	22	24	0	0	66.5	.032	2.552	2.552	2	1.0	0	0.0	26.5	1.0	119
120	25	23	0	0	195.	.112	1.197	1.180	2	1.0	0	0.0	35.0	1.0	120
121	25	23	0	0	155.	.17	1.225	1.189	2	1.0	0	0.0	35.0	1.0	121
122	23	26	0	0	60.	.040	2.553	2.607	2	1.0	0	0.0	44.25	1.0	122
123	24	25	0	0	983.6	.030	.284	-0.131	2	1.0	0	0.0	35.0	1.0	123
124	24	26	0	0	63.	.035	2.673	2.672	2	1.0	0	0.0	44.25	1.0	124
125	24	26	0	0	83.2	.022	1.636	1.634	2	1.0	0	0.0	44.25	1.0	125
126	6	22	0	0	792.	.01	1.253	1.130	2	1.0	0	0.0	12.	1.0	126
127	6	27	0	0	27.1	2.83	3.05	3.05	2	1.0	0	0.0	5.0	1.0	127
128	4	28	0	0	5.69	1.723	2.809	2.822	2	1.0	0	0.0	19.08	1.0	128
129	8	29	0	0	5.69	1.723	2.809	2.822	2	1.0	0	0.0	19.08	1.0	129
130	26	30	0	0	42.24	.072	2.653	2.104	2	1.0	0	0.0	50.0	1.0	130
131	26	30	0	0	42.24	.072	2.653	2.104	2	1.0	0	0.0	50.0	1.0	131
132	2	31	0	0	1.31	1.182	1.66	1.66	2	1.0	0	0.0	9.2	1.0	132
133	31	32	0	0	208.7	.06	.264	.264	2	1.0	0	0.0	12.5	1.0	133
134	32	16	0	0	47.5	.164	1.027	1.718	2	1.0	0	0.0	19.25	1.0	134
135	33	34	0	0	1.75	.894	1.61	1.61	2	1.0	0	0.0	9.2	1.0	135
136	34	37	0	0	211.1	.077	.264	.264	2	1.0	0	0.0	12.5	1.0	136
137	33	36	0	0	208.7	.060	.264	.264	2	1.0	0	0.0	12.5	1.0	137
138	36	20	0	0	47.5	.164	1.027	1.718	2	1.0	0	0.0	19.25	1.0	138
139	37	20	0	0	47.5	.164	1.027	1.718	2	1.0	0	0.0	19.25	1.0	139
140	33	35	0	0	1.31	1.182	1.66	1.66	2	1.0	0	0.0	9.2	1.0	140
141	35	38	0	0	208.7	.06	.264	.264	2	1.0	0	0.0	12.5	1.0	141
142	38	20	0	0	47.5	.164	1.027	1.718	2	1.0	0	0.0	19.25	1.0	142
143	1	39	0	0	1.0	10.0	1.0	30.0	2	1.0	0	0.0	9.0	1.0	143
144	2	39	0	0	16.25	1.0	1.0	30.0	2	1.0	0	0.0	9.0	1.0	144
145	3	39	0	0	16.25	1.0	1.0	30.0	2	1.0	0	0.0	9.0	1.0	145
146	31	39	0	0	16.25	1.0	1.0	30.0	2	1.0	0	0.0	9.0	1.0	146
147	21	39	0	0	3.25	10.0	1.0	30.0	2	1.0	0	0.0	15.0	1.0	147
148	33	39	0	0	16.25	1.0	1.0	30.0	2	1.0	0	0.0	9.0	1.0	148
149	34	39	0	0	16.25	1.0	1.0	30.0	2	1.0	0	0.0	9.0	1.0	149
150	35	39	0	0	16.25	1.0	1.0	30.0	2	1.0	0	0.0	9.0	1.0	150

1234567890123456789012345678901234567890123456789012345678901234567890

PC-058  
50.12846.44  
P85

1-E-88

R3800130-ASURRY 1&2:SGBDLINE CRACK NODE4,COMPARITIVE: WITH HT. SINKS  
S & W ENGR CORP NU-92 << SUBCOMPARTMENT ANALYSIS PROGRAM >>

THREED 29 JAN 1981 14:36:07 PAGE 4  
THREED.VER12.LEV01 CREATED 80.106 11:35:02 UNIT 10

UNIT 55 (SEQ 1) INPUT ECHO 1 2 3 4 5 6 7 8  
1234567890123456789012345678901234567890123456789012345678901234567890

151	39	40	0	0	1.0	0.1	1.0	30.0	2	1.0	1	0.0	50.0	1.0	151
152	5	3	0	0	3.0	0.683	1.592	1.631	2	1.0	0	0.0	10.25	1.0	152
153	7	34	0	0	3.0	0.683	1.592	1.631	2	1.0	0	0.0	10.25	1.0	153
154	0	4	1	0	1.0	0.0	0.0	0.0	0	1.0	0	0.0	9.7	1.0	154
155	*														155
156	*														156
157	*FILL TABLE DATA CARDS														157
158	*														158
159	*														159
160	4	2													160
161	0.0				10.71		5418.2								161
162	900.0				10.71		5418.2								162
163	900.000001				0.0		0.0								163
164	1250.0				0.0		0.0								164
165	*														165
166	*														166
167	*FAN TABLE DATA CARDS														167
168	*														168
169	*														169
170	2	3													170
171	40300.0				0.0										171
172	40300.0				3000.0										172
173	*														173
174	*														174
175	*PASSIVE HEAT SINK DATA CARDS														175
176	*														176
177	*														177
178	SINK1,NODE4														178
179	12	1	0	0.0	7073.1	4	0								179
180	12	1.0													180
181	1														181
182	T														182
183	1	1	1	.08	0	0	0	1.0							183
184	SINK2,NODE5														184
185	12	1	0	0.0	1768.0	5	0								185
186	12	1.0													186
187	1														187
188	T														188
189	1	1	1	.08	0	0	0	1.0							189
190	SINK3,NODE6														190
191	12	1	0	0.0	5635.9	6	0								191
192	12	1.0													192
193	1														193
194	T														194
195	1	1	1	.08	0	0	0	1.0							195
196	SINK4,NODE7														196
197	12	1	0	0.0	1768.0	7	0								197
198	12	1.0													198
199	1														199
200	T														200

1234567890123456789012345678901234567890123456789012345678901234567890

13-050  
S.O. 1/28/81  
P86

1-E-87

R3800130-#SURRY 1&2:SGBDLINE CRACK NODE4,COMPARITIVE: WITH HT. SINKS  
S & W ENGR CORP NU-92 << SUBCOMPARTMENT ANALYSIS PROGRAM >>

THREED 29 JAN 1981 14:36:07 PAGE 5  
THREED.VER12.LEV01 CREATED 80.106 11:35:02 UNIT 10

UNIT 55 (SEQ 1) INPUT ECHO 1 2 3 4 5 6 7 8  
1234567890123456789012345678901234567890123456789012345678901234567890

201	1 1 1 .08 0 0 0 1.0	201
202	SINK5,NODE8	202
203	12 1 0 0.0 7073.1 8 0	203
204	12 1.0	204
205	1	205
206	T	206
207	1 1 1 .08 0 0 0 1.0	207
208	SINK6,NODE9	208
209	12 1 0 0.0 2273.5 9 0	209
210	12 1.0	210
211	1	211
212	T	212
213	1 1 1 .08 0 0 0 1.0	213
214	SINK7,NODE10	214
215	12 1 0 0.0 5167.5 10 0	215
216	12 1.0	216
217	1	217
218	T	218
219	1 1 1 .08 0 0 0 1.0	219
220	SINK8,NODE11	220
221	12 1 0 0.0 2273.5 11 0	221
222	12 1.0	222
223	1	223
224	T	224
225	1 1 1 .08 0 0 0 1.0	225
226	SINK9,NODE21	226
227	12 1 0 0.0 4974.0 21 0	227
228	12 1.0	228
229	1	229
230	T	230
231	1 1 1 .08 0 0 0 1.0	231
232	SINK10,NODE22	232
233	12 1 0 0.0 3335.0 22 0	233
234	12 1.0	234
235	1	235
236	T	236
237	1 1 1 .08 0 0 0 1.0	237
238	SINK11,NODE12	238
239	9 1 0 0.0 562.5 12 0	239
240	9 0.75	240
241	1	241
242	T	242
243	1 1 1 .08 0 0 0 1.0	243
244	SINK12,NODE13	244
245	9 1 0 0.0 660.25 13 0	245
246	9 0.75	246
247	1	247
248	T	248
249	1 1 1 .08 0 0 0 1.0	249
250	SINK13,NODE16	250

1234567890123456789012345678901234567890123456789012345678901234567890

78E-050

5.0-13846.24

P87

06-3-1

R3800130-ASURRY I&2:SGBDLINE CRACK NODE4,COMPARITIVE: WITH HT. SINKS  
S & W ENGR CORP NU-92 << SUBCOMPARTMENT ANALYSIS PROGRAM >>

THREED 29 JAN 1981 14:36:07 PAGE 6  
THREED.VER12.LEV01 CREATED 80.106 11:35:02 UNIT 10

UNIT 55 (SEQ 1) INPUT ECHO 1 2 3 4 5 6 7 8  
1234567890123456789012345678901234567890123456789012345678901234567890

251	6	1	0	0.0	1275.0	16	0	251
252	6	0.5						252
253	1							253
254	T							254
255	1	1	1	.08	0	0	0 1.0	255
256	SINK14,NODE17							256
257	6	1	0	0.0	1717.875	17	0	257
258	6	0.5						258
259	1							259
260	T							260
261	1	1	1	.08	0	0	0 1.0	261
262	SINK15,NODE18							262
263	12	1	0	0.0	3008.0	18	0	263
264	12	1.0						264
265	1							265
266	T							266
267	1	1	1	.08	0	0	0 1.0	267
268	SINK16,NODE19							268
269	6	1	0	0.0	1717.875	19	0	269
270	6	0.5						270
271	1							271
272	T							272
273	1	1	1	.08	0	0	0 1.0	273
274	SINK17,NODE20							274
275	6	1	0	0.0	1275.0	20	0	275
276	6	0.5						276
277	1							277
278	T							278
279	1	1	1	.08	0	0	0 1.0	279
280	*							280
281	*							281
282	*DATA COMMON TO HEAT SINKS							282
283	*							283
284	*							284
285	120.0	T						285
286	0.79	24.93	'CONCRETE'/					286
287	END OF HEAT SLAB DATA							287
288								288

1234567890123456789012345678901234567890123456789012345678901234567890 <EOF> COPIED TO UNIT 5  
H/O CMTS

PC-050  
5.0.12846.44  
P 88



1-E-91

R U N S U M M A R Y S H E E T

MISCELLANEOUS PROBLEM CONTROL DATA:

OUTPUT FLAG.....	1	TOTAL TIME OF RUN.....	1201.000 SEC
NUMBER OF TIME STEP CARDS...	10	NUMBER OF STANDARD TIME STEPS.....	4200
NUMBER OF TRIP CONTROLS.....	3	NUMBER OF ACTUAL TIME STEPS.....	4210
NUMBER OF VOLUMES.....	40	NUMBER OF TIMES GAUSSIAN ELIMINATION USED..	1641
NUMBER OF JUNCTIONS.....	68	NUMBER OF TIMES GAUSS-SEIDEL USED.....	2569
NUMBER OF FILL TABLES.....	1	NUMBER OF TRANSIENTS STORED FOR PLOTEHUP...	148
NUMBER OF FAN TABLES.....	1	NUMBER OF SELECTED NODAL DIFF. PRESS.....	0
NUMBER OF HT SOURCE CURVES..	0	NUMBER OF HEAT SINKS.....	17
IMPLICIT/EXPLICIT COEFF.....	1.000	NUMBER OF INTERNAL JUNCTIONS.....	67

STEAM TABLES USED (FT15) VOLUME SERIAL NO. = SHARED DATA SET NAME = HEATBAL.ME190.STH20G.OUTPUT1

OUTPUT: TRANSIENTS TAPE (FT08) = 016308 FILE NUMBER = 27 DATA SET NAME = FE.GUARDS.PLOTTER  
TRANSMITTAL FILE (FT09) HAS NOT USED

PEAK PRESSURE DIFFERENTIAL

JUNCTION NUMBER	CONNECTING VOLUMES	PRESSURE PSID	TIME SEC	JUNCTION NUMBER	CONNECTING VOLUMES	PRESSURE PSID	TIME SEC
1	1 TO 6	0.01	0.488	35	25 TO 23	0.01	0.545
2	2 TO 3	0.00	0.353	36	23 TO 26	-0.01	0.000
3	4 TO 5	-0.01	0.394	37	24 TO 25	-0.01	0.080
4	5 TO 6	-0.01	0.391	38	24 TO 26	-0.01	0.000
5	7 TO 6	-0.01	0.391	39	24 TO 26	-0.01	0.000
6	8 TO 7	-0.01	0.394	40	6 TO 22	-0.01	0.000
7	1 TO 12	0.01	0.390	41	6 TO 27	0.01	0.393
8	1 TO 12	0.01	0.390	42	4 TO 28	0.02	0.179
9	7 TO 11	0.01	0.394	43	8 TO 29	0.02	0.179
10	8 TO 11	0.00	0.505	44	26 TO 30	-0.01	0.098
11	4 TO 9	0.00	0.504	45	26 TO 30	-0.01	0.098
12	5 TO 9	0.01	0.394	46	2 TO 31	0.00	0.545
13	10 TO 12	-0.01	0.399	47	31 TO 32	-0.01	0.000
14	9 TO 10	-0.01	0.444	48	32 TO 16	-0.01	0.248
15	11 TO 10	-0.01	0.444	49	33 TO 34	0.00	0.353
16	9 TO 17	0.01	0.500	50	34 TO 37	-0.01	0.232
17	12 TO 13	-0.01	0.000	51	33 TO 36	-0.01	0.000
18	11 TO 19	0.01	0.501	52	36 TO 20	-0.01	0.249
19	3 TO 15	-0.01	0.232	53	37 TO 20	-0.01	0.251
20	2 TO 14	-0.01	0.000	54	33 TO 35	0.00	0.545
21	17 TO 18	0.02	0.744	55	35 TO 38	-0.01	0.000
22	18 TO 19	-0.02	0.745	56	38 TO 20	-0.01	0.248
23	19 TO 20	0.01	0.270	57	1 TO 39	0.10	0.227
24	14 TO 16	-0.01	0.249	58	2 TO 39	0.09	0.225
25	15 TO 16	-0.01	0.251	59	3 TO 39	0.09	0.225
26	16 TO 21	-0.02	0.267	60	31 TO 39	0.09	0.225
27	17 TO 23	0.01	0.645	61	21 TO 39	0.09	0.227
28	19 TO 23	-0.01	0.298	62	33 TO 39	0.09	0.225
29	20 TO 21	-0.02	0.267	63	34 TO 39	0.09	0.225
30	18 TO 13	0.01	0.370	64	35 TO 39	0.09	0.225
31	16 TO 17	-0.01	0.270	65	39 TO 40	-0.39	0.227
32	21 TO 22	0.01	0.442	66	5 TO 3	0.02	0.257
33	22 TO 24	-0.01	0.023	67	7 TO 34	0.02	0.257

72-050  
J.O. 1284644  
P89

1-E-92

34 25 TO 23 0.01 0.545

PEAK PRESSURES AND TEMPERATURES

NODE NUMBER	PRESSURE (PSIA)	TIME (SEC)	PEAK PRESSURES AND TEMPERATURES		NODE NUMBER	PRESSURE (PSIA)	TIME (SEC)	PEAK PRESSURES AND TEMPERATURES	
			TEMPERATURE (DEG F)	TIME (SEC)				TEMPERATURE (DEG F)	TIME (SEC)
1	14.73	0.584	137.04	909.000	21	14.72	0.543	121.13	696.000
2	14.73	0.672	135.63	956.000	22	14.72	0.392	121.28	650.000
3	14.73	0.404	135.66	954.000	23	14.71	0.284	120.11	0.284
4	14.73	0.519	184.94	902.000	24	14.71	0.395	120.10	0.395
5	14.73	0.504	156.17	902.000	25	14.71	0.407	120.11	0.407
6	14.73	0.392	132.99	903.000	26	14.70	0.325	120.03	0.326
7	14.73	0.504	142.04	915.000	27	14.71	4.650	120.13	4.650
8	14.73	0.519	136.05	1101.000	28	14.72	0.451	120.25	0.452
9	14.73	0.540	183.31	903.000	29	14.72	0.452	120.25	0.452
10	14.73	0.454	172.64	902.000	30	14.70	1201.000	120.00	1201.000
11	14.73	0.540	153.15	902.000	31	14.73	0.610	135.63	956.000
12	14.73	0.488	138.39	902.000	32	14.72	0.612	135.72	941.000
13	14.72	0.490	125.63	806.000	33	14.73	0.672	121.02	678.000
14	14.72	0.672	135.72	941.000	34	14.73	0.404	123.63	902.000
15	14.72	0.408	135.74	940.000	35	14.73	0.611	120.96	663.000
16	14.72	0.426	135.99	923.000	36	14.72	0.672	120.96	642.000
17	14.73	0.644	148.95	902.000	37	14.72	0.408	120.96	640.000
18	14.72	0.682	129.24	708.000	38	14.72	0.612	120.96	642.000
19	14.73	0.646	121.00	509.000	39	14.77	0.274	130.36	954.000
20	14.72	0.426	120.97	611.000	40	15.00	1201.000	120.00	1201.000

P90  
J.O. 12846.44  
PE-050

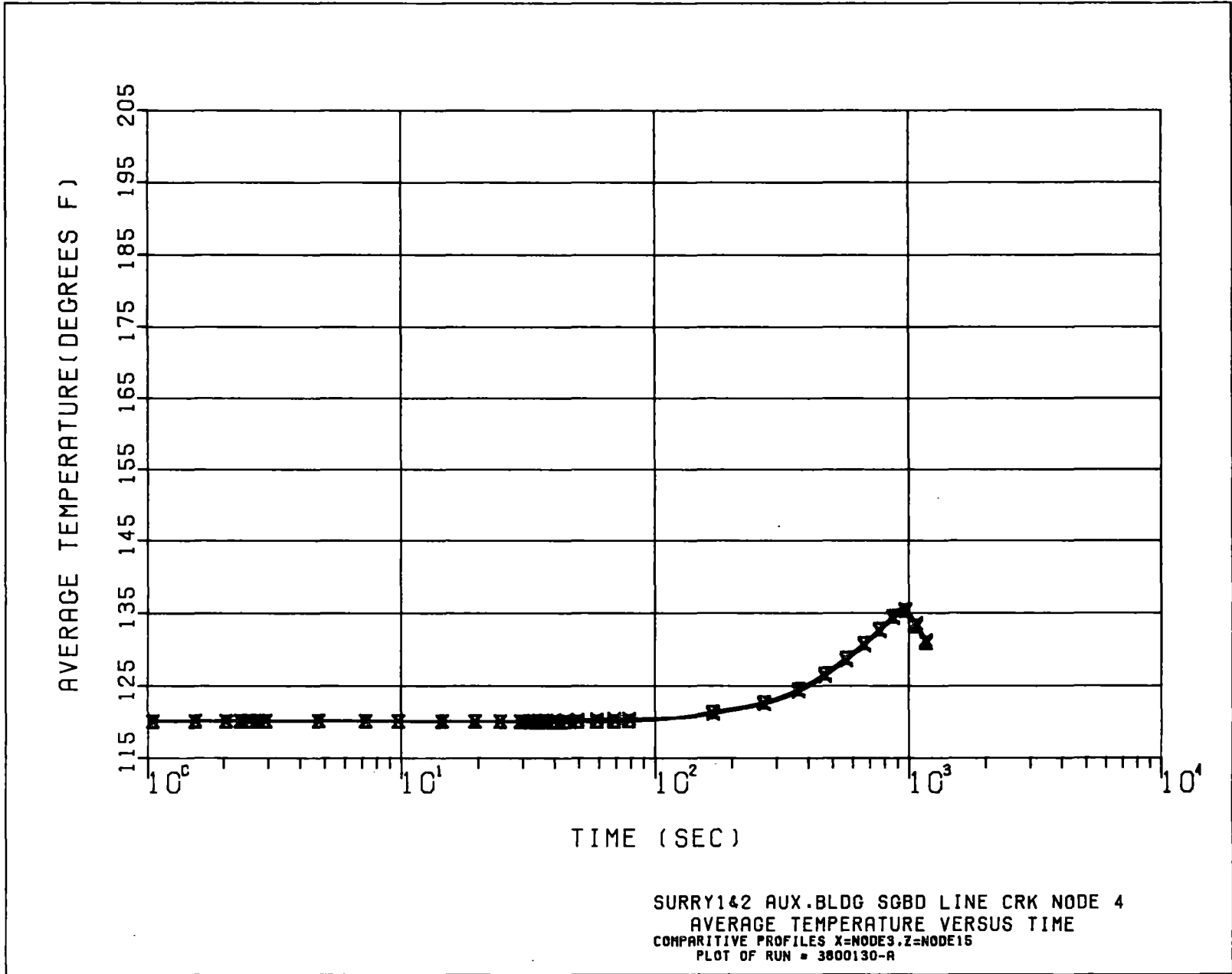

050 R

P. 91  
510.12846.44

STONE & WEBSTER ENGINEERING CORPORATION  
CALCULATION SHEET

▲ 5010.65

CALCULATION IDENTIFICATION NUMBER			
J.O. OR W.O. NO.	DIVISION & GROUP	CALCULATION NO.	OPTIONAL TASK CODE
12846.44		PE-050	

PAGE 92

1  
2  
3  
4  
5  
6  
7  
8  
9  
10  
11  
12  
13  
14  
15  
16  
17  
18  
19  
20  
21  
22  
23  
24  
25  
26  
27  
28  
29  
30  
31  
32  
33  
34  
35  
36  
37  
38  
39  
40  
41  
42  
43  
44  
45  
46

REFERENCES:

1. S&W CALCULATION ES-12846.44-PE-041-0
2. S&W CALCULATION ES-12846.44-PE-046-0
3. HANDBOOK OF HYDRAULIC RESISTANCE by I.L. ECKHART, 1966
4. S&W DRAWING 11448FB-24A, ISSUE 4
5. S&W DRAWING 11448FB-24A, ISSUE 7
6. S&W DRAWING 11448FB-11D, ISSUE 4
7. S&W DRAWING 11448FB-11C, ISSUE 5
8. S&W DRAWING 11448FB-11B, ISSUE 5
9. S&W CALCULATION ES-12846.44, PE-042, REV. 1
10. SURRY UNIT 1 & 2 FSAR, APPENDIX D.
11. CRANE TECHNICAL PAPER 410, 1979
12. "CESSAR, APPENDIX 6B - DESCRIPTION OF SGA III DIGITAL COMP. CODE", AMEND.#1, JAN. 1974
13. SURRY UNIT 1 & 2 VALVE SPEC. # NUS-80-3
14. ESG-19-1, MAR. 3, 1980
15. S&W DRAWING 11448-FP-10C, ISSUE 4
16. S&W DRAWING 11448-FP-19G, ISSUE 5
17. S&W DRAWING 11448-FP-19J, ISSUE 7
18. HEAT TRANSFER by J.P. HOLMAN © 1976, TABLE A-3

## INTEROFFICE CORRESPONDENCE

PE-050

TO: BOGHOSSIAN, A.	LOCATION 14	SUBJECT / REFERENCE / J.O. NO. ENVIRONMENTAL ANALYSIS SURRY 1&2 AUX. BUILDING 12846.44, VENT. SYSTEM MODIFICATIONS
FROM: DONAHUE, M.	LOCATION 9	

## MESSAGE: —

IN LIGHT OF THE INFORMATION THAT THE CENTRAL EXHAUST SYSTEM, 1-HEF-14 OF THE SURRY UNIT 1&2 AUXILIARY BUILDING IS CURRENTLY UNDERGOING DESIGN MODIFICATIONS, PLEASE INDICATE ~~THE~~ THE INTENDED FINAL VOLUMETRIC ~~DESIGN~~ FLOW RATE OF THE FOLLOWING INTAKE DUCTS OF THE AREAS NOTED.

1. CHARGING PUMP CUBICLES, CURRENTLY RATED AT 8000 CFM
2. 2'0" ELEV. BETWEEN CHARGING PUMP CUBICLES, NEAR GRID LINES 9 AND J, CURRENTLY RATED AT 400 CFM
3. 13'0" ELEV., PURIFICATION AREA, NEAR GRID LINES 9 AND J CURRENTLY RATED AT 900 CFM.

THANK YOU FOR YOUR ASSISTANCE.

10/24/80

DATE

M. Donahue

SIGNATURE

8041

TELEPHONE

## REPLY:

1. CHANGED FROM 8000 TO 6500 CFM
2. Same
3. Same

11/24/80

DATE

Cheri K. B. J.

SIGNATURE

7192

TELEPHONE

▲ 040.13B

USER'S GUIDE TO EZD REFERENCES

Facility: VEPCO, SURRY  
Units: 1 and 2  
Dockets: 50-280 and 50-281

EZD REFERENCE NO. 5  
EZD REFERENCE DESCRIPTION: IE Bulletin 79-01B, Surry Power Station Unit, Section 2.3  
ENVIRONMENTAL ZONE (S): RC-3A, RC-47A

<u>PARAMETER</u>	<u>NORMAL ENVIRONMENT</u>	<u>PAGE</u>	<u>LOCA ENVIRONMENT</u>	<u>PAGE</u>	<u>MSLB ENVIRONMENT</u>	<u>PAGE</u>	<u>HELB ENVIRONMENT</u>	<u>PAGE</u>
RADIATION (rads)					<2.4 x 10 <sup>7</sup>	2-5		

REMARKS: Also refer to EZD Reference No. 3 (LOCA Environment).

USER'S GUIDE TO EZD REFERENCES

Facility: VEPCO, SURRY  
 Units: 1 and 2  
 Dockets: 50-280 and 50-281

EZD REFERENCE NO. 5  
 EZD REFERENCE DESCRIPTION: IE Bulletin 79-01B, Surry Power Station Unit, Section 2.3  
 ENVIRONMENTAL ZONE(S): RC-3B, RC-18B, RC-47B

<u>PARAMETER</u>	<u>NORMAL ENVIRONMENT</u>	<u>PAGE</u>	<u>LOCA ENVIRONMENT</u>	<u>PAGE</u>	<u>MSLB ENVIRONMENT</u>	<u>PAGE</u>	<u>HELB ENVIRONMENT</u>	<u>PAGE</u>
RADIATION (rads)					<7.4 x 10 <sup>6</sup>	2-5		

REMARKS: Also refer to EZD Reference No. 3 (LOCA Environment).

USER'S GUIDE TO EZD REFERENCES

Facility: VEPCO, SURRY  
 Units: 1 and 2  
 Dockets: 50-280 and 50-281

EZD REFERENCE NO. 5  
 EZD REFERENCE DESCRIPTION: IE Bulletin 79-01B, Surry Power Station Unit 1, Section 2.3.  
 ENVIRONMENTAL ZONE(S): RC-27A

<u>PARAMETER</u>	<u>NORMAL ENVIRONMENT</u>	<u>PAGE</u>	<u>LOCA ENVIRONMENT</u>	<u>PAGE</u>	<u>MSLB ENVIRONMENT</u>	<u>PAGE</u>	<u>HELB ENVIRONMENT</u>	<u>PAGE</u>
RADIATION (rads)					<3.5 x 10 <sup>7</sup>	2-5		

REMARKS: Also refer to EZD Reference No. 3 (LOCA Environment).



USER'S GUIDE TO EZD REFERENCES

Facility: VEPCO, SURRY  
Units: 1 and 2  
Dockets: 50-280 and 50-281

EZD REFERENCE NO. 5  
EZD REFERENCE DESCRIPTION: IE Bulletin 79-01B, Surry Power Station Unit 1, Section 2.3  
ENVIRONMENTAL ZONE(S): RC-27B

<u>PARAMETER</u>	<u>NORMAL ENVIRONMENT</u>	<u>PAGE</u>	<u>LOCA ENVIRONMENT</u>	<u>PAGE</u>	<u>MSLB ENVIRONMENT</u>	<u>PAGE</u>	<u>HELB ENVIRONMENT</u>	<u>PAGE</u>
RADIATION (rads)					<3.8 x 10 <sup>7</sup>	2-5		

REMARKS: Also refer to EZD Reference No. 3 (LOCA Environment).

## 2.2 EQUIPMENT IDENTIFICATION

Equipment addressed in this report includes all Class IE equipment affected by and required to mitigate an accident and/or safely shut down the plant, as defined by the guidelines of Enclosure 4 to IE Bulletin 79-01B, and as clarified by Answers 1 and 2 of NRC letter dated February 29, 1980. This encompasses equipment exposed to harsh environments including those where fluids are being recirculated from inside containment to accomplish long-term cooling following a loss-of-coolant accident (LOCA). Equipment required to maintain minimum boration capability has been addressed as to the effect of any high energy line break (HELB) to which it may be subjected, even though it is not required to mitigate the HELB accident. Equipment necessary to bring the plant from hot to cold shutdown, however, is not included, as it is not a licensing requirement to achieve cold shutdown for this plant. (Refer to NRC letter dated February 29, 1980, Generic Questions and Answers to IE Bulletin 79-01B, Answer 3, page 1.)

## 2.3 SERVICE CONDITIONS AS ADDRESSED IN ENCLOSURE 4 OF IE BULLETIN 79-01B

The remainder of this discussion is based on guidelines provided by Enclosure 4 of IE Bulletin 79-01B. The specific paragraphs of Enclosure 4 which concern each of the following sections are referenced in parentheses after the headings.

### 2.3.1 Service Conditions Inside Containment for a Loss of Coolant Accident (LOCA) (4.1)

#### Temperature and Pressure Steam Conditions (4.1.1)

The time dependent temperature and pressure established as a result of the low head safety injection and recirculation spray pumps net positive suction head modification are described in the attachments to VEPCO letter to NRC Serial No. 382A dated November 22, 1977.

#### Radiation (4.1.2)

The radiation environment for qualification of equipment and components is based on the design basis given in Section 11.3 of the FSAR over the life of the plant (40 years), plus that associated with the LOCA. Consideration was given to source strength, shielding source volume, and structural shielding arrangements.

The analysis to determine the LOCA radiation environment at Surry is based on the instantaneous release from the fuel to the containment atmosphere of 100 percent of the noble gases and 50 percent of the halogens.

Using the above LOCA source terms, the containment centerline 120-day integrated dose for LOCA is calculated to be  $2.4 \times 10^7$  rads. When added to the 40-year normal operating dose of  $1.3 \times 10^7$  rads, the total dose is  $3.7 \times 10^7$  rads, which is the figure used in our review for components inside the cranewall. The analysis for the radiation environment assumed a release uniformly distributed in the containment, which is consistent with NUREG-0588, Appendix D, Page D-5, for a PWR.

The analysis for the LOCA radiation environment does not take into account the removal of airborne activity in the containment by the ESF systems or leakage. It does account for radioactivity decay. No plate-out for the iodines is assumed in the present analysis and the calculated dose is therefore conservative.

The present LOCA radiation environment is based on the dose and dose rate at the center point of the containment, and those values are used for unshielded equipment qualification. The dose rate for unshielded equipment is evaluated with respect to dose contribution of location dependent sources, such as the sump water. Integrated dose calculated for equipment qualification is based on a gamma source only.

Shielded components were reviewed based on a gamma source in accordance with NUREG-0588. IE Bulletin 79-01B, Section 4.1-2 states that "the conservative beta surface dose of  $1.40 \times 10^8$  rads reported in Appendix D of NUREG-0588 would be reduced by approximately a factor of ten within 30 mils of the surface of electrical cable insulation of unit density. An additional 40 mils insulation (total of 70 mils) results in another factor of 10 reduction in dose. Any structures or other equipment in the vicinity of the equipment of interest would act as shielding to further reduce beta doses. If it can be shown, by assuming a conservative unshielded beta surface dose of  $2.0 \times 10^8$  rads and considering the shielding factors discussed here, the beta dose to radiation sensitive equipment or component internals would be less than or equal to 10 percent of the total gamma dose to which an item of equipment has been qualified, then that equipment may be considered qualified for the total radiation environment (gamma plus beta)."

During the evaluation of NRC IE Bulletin 79-01B, a radiation "threshold" of 2,500 rads was used and all equipment exposed to less radiation was considered to be exempt from specific qualification requirements. This threshold value was based on an engineering review of material susceptibility to radiation damage as presented in existing literature<sup>(1,2)</sup>. We believe this threshold of 2,500 rads is reasonable and acceptable.

1. J. F. Kircher and R. E. Bowan, "Effects of Radiation on Materials and Components," Reinhold, 1964.

2. REIC Report No. 21, "The Effect of Nuclear Radiation in Elastomeric and Plastic Components and Materials," Battelle Memorial Institute, 1964.

#### Submergence (4.1.3)

The maximum water level on the containment floor following a LOCA is at elevation -21 feet 11 inches. This was determined by assuming that all water sources have been pumped into the containment and have drained to the floor.

Equipment located below this level is identified on the System Component Evaluation Work Sheets and has been reviewed for qualification in the submerged condition.

#### Chemical Sprays (4.1.4)

The caustic spray characteristics were addressed in VEPCO letter to NRC Serial No. 535 dated June 18, 1980. The most severe caustic spray environment was addressed and is reflected on the System Component Evaluation Work Sheets.

#### 2.3.2 Service Conditions Inside Containment for a PWR Main Steam Line Break (MSLB) (4.2.1, 4.2.2, 4.2.3, 4.2.4)

The pressure and temperature transients for a main steam line break (MSLB), referenced in the Surry Units 1 and 2 45-Day Report, were taken from the plant specific analysis for North Anna Units 1 and 2. A plant specific MSLB analysis has not been performed for Surry Units 1 and 2. The North Anna transients are more severe than those that would result from a Surry plant specific analysis, due to a smaller break size and use of partial revaporization to model condensate behavior.

The main steam line flow restrictors for Surry Unit 2 are located in the steam generator (SG) nozzles; therefore the effective break diameter is 16 inches. These restrictors are located outside the steam generator in the main steam line at North Anna. Thus, at North Anna, a MSLB between the SG and the flow restrictor would have an effective break diameter of 30 inches. The smaller break size at Surry reduces the rate of steam release and would give lower containment pressure and temperature transients. The main steam flow restrictor modification is to be performed on Surry Unit 1 steam generator during the Surry Unit 1 steam generator replacement outage which started September 1980.

The North Anna MSLB analysis was performed with the then required conservative assumption of no condensate revaporization. As described in NUREG-0588, Section 1.2(2), a partial revaporization treatment of condensate is now acceptable. This effect significantly decreases the calculated containment temperature transient. Therefore, a Surry plant specific analysis performed

with current methods would yield a lower temperature transient than the North Anna transient.

After analyzing the thermal response of equipment inside containment to a MSLB temperature transient, the NRC staff developed the "best estimate" evaluation method for predicting the containment transients and the equipment temperature transient. This method is described in Appendix B to NUREG-0458. It recognizes the significant conservatisms in the analytical methods used to predict the containment temperature following a MSLB, and it considers the thermal capability of equipment exposed to the MSLB environment.

NUREG-0458, Section 4.1.2, describes a "best estimate" evaluation which indicates that the calculated MSLB thermal response of typical components will remain within the actual LOCA qualification temperature envelope. Based on this evaluation, Enclosure 4 to IE Bulletin 79-01B states that for a PWR MSLB inside containment, "equipment qualified for a LOCA environment is considered qualified for a MSLB accident environment in plants with automatic spray systems not subject to disabling single component failures." The Surry units meet this last condition.

The 45-Day Report included reference to the North Anna MSLB temperature and pressure profiles as conservative envelopes for equipment qualification in lieu of a plant specific Surry MSLB analysis. The 90-Day Report requires an evaluation of equipment qualification against the guidelines provided in Enclosure 4. The containment spray system is initiated automatically and is designed to meet single failure criteria. Therefore, the Surry 90-Day Report will use the guidelines of Enclosure 4, and the "best estimate" approach for MSLB service conditions. Therefore, equipment qualification for a MSLB inside containment will be based on the LOCA environment envelopes.

#### Radiation (4.2.2)

LOCA doses described in Paragraph 2.3.1 were used for MSLB equipment qualification within the containment. Using LOCA doses for radiation qualification for MSLB results in conservative doses for MSLB radiation qualification.

#### Submergence (4.2.3)

The maximum water level associated with an MSLB has been conservatively assumed to equal the LOCA level, as described in Paragraph 2.3.1.

#### Chemical Sprays (4.2.4)

The caustic spray characteristics for a LOCA, as specified in Paragraph 2.3.1, were used for MSLB equipment qualification. Using LOCA caustic spray characteristics is conservative for a MSLB accident. The most severe caustic spray environment was addressed and is reflected on the System Component Evaluation Work Sheets.

#### 2.3.3 Service Conditions Outside Containment (4.3)

##### Areas Subject to a Severe Environment as a Result of a High Energy Line Break (HELB) (4.3.1)

HELB outside containment is addressed in FSAR Appendix D. Review of the postulated high energy line breaks has determined that electrical equipment required to mitigate each break is not physically affected by pipe whip or jet impingement. As part of the 90-Day Review this equipment has been reviewed against the environmental parameters listed in the System Component Evaluation Work Sheets.

An additional review was performed to identify equipment required to maintain a minimum charging and boration capability, to assure capability of adding borated water to the primary system. Therefore, portions of the Chemical and Volume Control Systems (CVCS) and supporting systems have been included in the qualification program and have been reviewed to the environmental parameters listed in the System Component Evaluation Work Sheets. The environmental qualification conditions within the auxiliary building, where the referenced CVCS equipment is located, are based on the worst case environment induced by potential HELBs in the area.

The breaks listed in Appendix D of the FSAR have been reanalyzed to produce temperature/pressure envelopes for equipment qualification review.

##### Areas Where Fluids are Recirculated from Inside Containment to Accomplish Long-Term Cooling Following a LOCA (4.3.2)

The areas through which fluids are recirculated from inside the containment following a LOCA for long-term cooling have been identified as the safeguards area, lower elevation of the containment spray pump area and main steam valve house, and the Auxiliary Building, particularly pipe penetration area and charging pump cubicles.

##### Temperature, Pressure, and Relative Humidity (4.3.2.1)

The systems recirculating fluids outside the containment have been designed to seismic Class I requirements. System components

have been selected to minimize or eliminate leakage. An augmented leak reduction program, as required in Paragraph 2.1.6a of NUREG-0578, is described in submittals made by VEPCO to the NRC dated January 10, 1980 and April 1, 1980.

The areas through which recirculation piping is routed are all ventilated by equipment that is remotely located with respect to the piping and its environmental effects. Therefore, harsh temperature, pressure, and relative humidity conditions are not assumed to result from the recirculation of fluids from inside the containment.

#### Radiation (4.3.2.2)

Post-LOCA radiation dose rates for areas outside the containment have been determined based upon TID-14844 and RG 1.4 source terms as required from the NUREG-0578 Review as follows:

1. Release from the fuel to the containment atmosphere of 100 percent of the noble gases, 25 percent of the halogens and 0 percent of the remaining solid fission products.
2. Release from the fuel to the reactor coolant system (RCS) and RCS sample lines of 100 percent of the noble gases, 50 percent of the halogens, and 1 percent of the remaining solid fission products.
3. Release from the fuel to the containment sump (and recirculation spray and recirculation portion of the high and low head safety injection system) of 0 percent of the noble gases, 50 percent of the halogens and 1 percent of the remaining fission products.

Consideration was given to source strength, source volume, structural shielding arrangements, and piping locations. These dose rates are given on the System Component Evaluation Work Sheets for equipment which must operate after a LOCA.

#### Submergence (4.3.2.3)

There has been no mechanism identified that would produce a significant amount of flooding near safety-related equipment in the Auxiliary Building.

#### Chemical Sprays (4.3.2.4)

Not Applicable

Areas Normally Maintained at Room Conditions (4.3.3)

As noted in the answer to Question 1 of the Supplemental Information to IE Bulletin 79-01B, dated February 29, 1980 (reference NRC letter to VEPCO dated February 29, 1980), these areas need not be addressed as part of the IE Bulletin 79-01B review.



USER'S GUIDE TO EZD REFERENCES

Facility: VEPCO, SURRY  
 Units: 1 and 2  
 Dockets: 50-280 and 50-281

EZD REFERENCE NO. 6  
 EZD REFERENCE DESCRIPTION: 12846.01-PE-036-0  
 ENVIRONMENTAL ZONE(S): RC-27B

<u>PARAMETER</u>	<u>NORMAL ENVIRONMENT</u>	<u>PAGE</u>	<u>LOCA ENVIRONMENT</u>	<u>PAGE</u>	<u>MSLB ENVIRONMENT</u>	<u>PAGE</u>	<u>HELB ENVIRONMENT</u>	<u>PAGE</u>
SUBMERGENCE (elev)			(-) 21'11"	8	(-) 21'11"	8		

CALCULATION TITLE PAGE

\*SEE INSTRUCTIONS ON REVERSE SIDE

▲ 5010.64 (FRONT)

CLIENT & PROJECT <i>VEPCO / Surry 182</i>				PAGE 1 OF 8	
CALCULATION TITLE (Indicative of the Objective): <i>Flooding elevation of Surry 142 Containment</i>				QA CATEGORY (✓) <input checked="" type="checkbox"/> I - NUCLEAR SAFETY RELATED <input type="checkbox"/> II <input type="checkbox"/> III <input type="checkbox"/> OTHER	
CALCULATION IDENTIFICATION NUMBER					
J. O. OR W. O. NO.	DIVISION & GROUP	CURRENT CALC. NO.	OPTIONAL TASK CODE	OPTIONAL WORK PACKAGE NO.	
<i>12846.01</i>	<i>POWER/EGG</i>	<i>36</i>	<i>00086</i>		
* APPROVALS - SIGNATURE & DATE			REV. NO. OR NEW CALC NO.	SUPERSEDES * CALC. NO. OR REV. NO.	CONFIRMATION * REQUIRED (✓)
PREPARER(S)/DATE(S)	REVIEWER(S)/DATE(S)	INDEPENDENT REVIEWER(S)/DATE(S)			YES NO
<i>K. Chin 5/7/80</i>	<i>W.C. Lynch 5-16-80 See note</i>	<i>W.C. Lynch 5-16-80 see note</i>			✓
		<b>NOTED</b>	<b>MAY 16 1980</b>	<b>R.F. MILLER</b>	
<b>DISTRIBUTION *</b>					
GROUP	NAME & LOCATION	COPY SENT (✓)	GROUP	NAME & LOCATION	COPY SENT (✓)
RECORDS MGT. FILES (OR FIRE FILE IF NONE)	<i>m. Cliffe 245/14</i>	<i>2</i>			
	<i>H. Rosebrock 245/14</i>	<i>1</i>			

CALCULATION SHEET

12846.01-PE-36-0

1	Client	Location	Est. No.	J.O. No.
2	Subject		Date	By
3			Checked	By
4	Based on		Revised	By

5				
6				
7				
8	Table of Contents			
9				
10				
11	Items			page
12				
13				
14	Objective and Method			3
15				
16	Assumption			3
17				
18	References			3
19				
20	Calculations			5
21				
22	Results			8
23				
24	Conclusions			8
25				
26	Attachment 1			1 page
27				
28	Attachment 2			1 page
29				
30	Attachment 3			1 page
31				
32	Attachment 4			1 page
33				
34				
35				
36				
37				
38				
39				
40				
41				
42				
43				
44				
45				
46				
47				
48				
49				
50				

CALCULATION SHEET

12846.19-PE-36-0

1	Client	Location	Est. No.	J.O. No.
2	Subject		Date	By
3			Checked	By
4	Based on		Revised	By

Objective and Method

This calculation is to assess the absolute elevation, inside the containment, at which all the water sources are exhausted. Amount of water from various sources are maximized because we are interested in maximum flooding level. The corresponding flooding elevation is determined by the graph from reference 1

Assumptions: noted in the body of calculation

References:

- 1) Sand W calculation 1284601-PE-030-0 4/3/80
- 2) Telecom (see Attachment 1) from Westinghouse to V.A. Suziedelis May 22, 1969
- 3) ASME Steam Table, 2<sup>nd</sup> Edition 1967
- 4) Telecom (see Attachment 2) from Westinghouse to G.J. Burrough Sept 19, 1972
- 5) S+W calc. 12846.07-14-0
- 6) S+W calc. 12846.07-21-1
- 7) IOC (see Attachment 3)
- 8) Surry 1&2 FSAR
- 9) IOC (see attachment 4)

CALCULATION SHEET

Preliminary \_\_\_\_\_

Item \_\_\_\_\_

12846.01-PE-36-0

1  
2  
3  
4  
5  
6  
7  
8  
9  
10  
11  
12  
13  
14  
15  
16  
17  
18  
19  
20  
21  
22  
23  
24  
25  
26  
27  
28  
29  
30  
31  
32  
33  
34  
35  
36  
37  
38  
39  
40  
41  
42  
43  
44  
45  
46  
47  
48  
49  
50

Client	Location	Est. No.	J.O. No.
Subject		Date	By
		Checked	By
Based on		Revised	By

10) S+W calc. 12846.01-4-0  
 11) S+W calc. 12846.01-38-0

12846.01-PE-36-0

1	Client	Location	Est. No.	J.O. No.
2	Subject		Date	By
3			Checked	By
4	Based on		Revised	By

Water SourcesA. Reactor Coolant System

Mass inventory in the RCS (with 3% expansion)

$$= 4.232 \times 10^5 \text{ lbm} \quad (\text{ref 2}) \checkmark$$

Assuming that the ultimate temp is 140F at 1 atm,  
the volume occupied by this mass is

$$4.232 \times 10^5 \text{ lbm} \left( 0.01629 \frac{\text{ft}^3}{\text{lbm}} \right) \quad (\text{ref 3})$$

$$= 6894 \text{ ft}^3 \checkmark$$

Since we'd like to maximize the water vol rejected onto  
the floor, we assume

$$\text{water on floor} /_{\text{RCS}} = 6894 - \text{vol below the top of core}$$

Furthermore, since North Anna and Surry are similar,

$$\text{we assume } (\text{vol below top of core})_{\text{NA}} = (\text{vol below top of core})_{\text{Surry}}$$

water on floor from RCS

$$= 6894 - 1947 \text{ ft}^3 \quad (\text{ref 4})$$

$$= 4947 \text{ ft}^3$$

$$= 37000 \text{ gal} \checkmark$$

## CALCULATION SHEET

Preliminary

Item

12846.01-PE-36-0

1	Client	Location	Est. No.	J.O. No.
2	Subject		Date	By
3			Checked	By
4	Based on		Revised	By

## B. RWST and related pipings

From calc. 12846.07-14-0 (ref 5), the total volume of piping connecting (12" dia) RWST up to the isolation valves (for both trains) = 324 ft<sup>3</sup> \*

From RWST:

top max level El: 72'8" + 6" (ref 6,7)

bottom El: 27'0" (ref 6)

diameter 38'0" (ref 6)

$$\therefore \text{vol} = (72'8" + 6" - 27'0") \left( \frac{38'}{2} \right)^2 \pi$$

$$= 52362 \text{ ft}^3$$

$$\therefore \text{total vol} = 52362 + 324 \text{ ft}^3$$

$$= 52686 \text{ ft}^3$$

$$= 394091 \text{ gal} \checkmark$$

## C. Accumulators

$$\text{Qty} = 3 \quad (\text{ref 8}) \checkmark$$

$$\text{max vol} = 989 \text{ ft}^3 \quad (\text{ref 9}) \checkmark$$

$$\therefore \text{total vol} = 3 \times 989 \times 7.48 = 22193 \text{ gal} \checkmark$$

\* Checkers comment: This means the length of each train is ~200 FT. Compared to reference 5, this length seems long. Although this results in great conservatism, it would be better to take the actual length and add 20% for the conservatism.

W. Lynch

## CALCULATION SHEET

Item  
12846.01-PE-36-0

1	Client	Location	Est. No.	J.O. No.
2	Subject		Date	By
3			Checked	By
4	Based on		Revised	By

## D. Boron Injection Tank

$$\text{max vol} = 1000 \text{ gal} \quad (\text{ref 10}) \quad \checkmark$$

## E. Chemical Addition Tank

From ref 11, we can assume that the CAT is a right circular tank with total height =

$$= 36' - 5'' + 2(Y_D)$$

$$= 36' - 5'' + 2(9.05'')$$

$$= 37.93' \quad \checkmark$$

$$\therefore \text{total vol} = (37.93') \left( \frac{\pi}{4} \right) \left( 54'' - 2 \cdot \frac{3''}{16} \right)^2$$

$$= 595 \text{ ft}^3 \quad \checkmark$$

taken out the vol below nozzle

$$= \left[ (6'' - 1.25'') + 9.05'' \right] \left( \frac{\pi}{4} \right) \left( 54'' - 2 \cdot \frac{3''}{16} \right)^2$$

$$= 18 \text{ ft}^3 \quad \checkmark$$

$\therefore$  total vol contribute by CAT

$$= 595 - 18 \text{ ft}^3$$

$$= 577 \text{ ft}^3$$

$$= 4316 \text{ gal} \quad \checkmark$$



CALCULATION SHEET

Preliminary

Item

12846.01-PE-36-0

1	Client	Location	Est. No.	J.O. No.
2	Subject		Date	By
3			Checked	By
4	Based on		Revised	By

F Final Result

$$\begin{aligned}
 \text{Total vol} &= 37000 + 394091 + 22193 + 1000 \\
 &+ 4316 \text{ gal} \\
 &= 458600 \text{ gal}
 \end{aligned}$$

From ref <sup>Fig 1</sup> 1<sup>A</sup>, the corresponding flooding elevation is  
 -21' 11"

Conclusion

The most conservative estimate for flooding with all water sources appropriately emptied is at elevation -21' 11"

12. Weight of secondary water in steam generator, at nominal power (one)
- Steam - 7,150 lb
  - Water - 113,300 lb — 81,600 lbs
13. Heat transfer area in one steam generator - 51,500 ft<sup>2</sup>
14. Internal energy of entire reactor coolant system at full nominal power (using properties at 2280 psia and T + 4°F)
- Without 3% volume expansion - 2.397 (10<sup>8</sup>) Btu
  - With 3% volume expansion - 2.469 (10<sup>8</sup>) Btu
15. Weight of reactor coolant system water (using properties at 2280 psia and T + 4°F)
- Without 3% volume expansion - 4.108 (10<sup>5</sup>) lb
  - With 3% volume expansion - 4.232 (10<sup>5</sup>) lb
16. Mass ratio (metal/water) of all metals, including fuel, to water within the confines of the thermal shield at 450°F.
- Volume water = 922 ft<sup>3</sup> (Inside thermal shield bottom to top)  
 Mass fuel = 176,300 lbs ✓  
 Mass clad = 36,300 lbs ✓  
 Mass metal (See 6)
- ≈ (8.65) → using 8.25 metal/water  
 ← 5570.0
17. Primary system piping diameters (ID)
- Hot leg - 29 in ✓
  - Pump suction - 31 in —
  - Cold leg - 27.5 in —
18. Core heat transfer coefficient (average at full power) - 5420 Btu/hr-ft<sup>2</sup>-°F (steady-state film coefficient)
- ← 5570.0
19. Curves of the reactor power output as a function of time. (All curves less fission product decay heat)
- Double-ended primary pipe break - attached
  - Surge line break - attached
  - 4 in. line break - attached

Note that the detailed core kinetic calculations for the LOCA have not as yet been completed so that the best estimate curves are presented.

ATTACHMENT, 1

- |    |  |   |
|----|--|---|
| 1. | Maximum calculated thermal power<br>(including pump heat)  | 2910 MWt  |
| 2. | Reactor coolant system volumes<br>(excluding pressurizer and surge line)                             |   |
|    | a. Total primary system  | 8394 ft <sup>3</sup>  |
|    | b. Vessel Vol below nozzle centerline  | 2448 ft <sup>3</sup>  |
|    | → c. Vessel Vol below top of core  | 1947 ft <sup>3</sup>  |
|    | d. Vessel Vol below bottom of core   | 900 ft <sup>3</sup>   |
| 3. | Primary system maximum operating pressure  | 2280 PSIA   |
| 4. | Coolant average temperature during full<br>power operation<br>(excluding pressurizer and surge line) |   |
|    | a. Algebraic average   | 586.8 °F  |
|    | b. Mass average  | 574.5 °F  |
| 5. | Reactor coolant system internal energy<br>at full power (includes pressurizer)                       | 241.8 x 10 <sup>6</sup> Btu   |
| 6. | Reactor coolant system mass at full power<br>(includes pressurizer)                                  | 414,700 lbs   |
| 7. | Flow information (total)   |   |
|    | a. Coolant flow at full power  | 105.1 x 10 <sup>6</sup> LB/hr   |
|    | b. Steam flow at full power/unit   | 4.04 x 10 <sup>6</sup> LB/hr  |
| 8. | Reactor core   |   |
|    | a. Average temperature   | 1940.0 °F   |
|    | b. Heat in core above algebraic average<br>temperature   | 22.08 x 10 <sup>6</sup> Btu   |
|    | c. Core heat transfer area   | 42,460 Ft <sup>2</sup>  |
|    | d. Core average full power heat<br>transfer coefficient  | 5700 Btu/hr-Ft <sup>2</sup> -°F   |
| 9. | Pressurizer (including surge line)   |   |
|    | a. Liquid Volume   | 932.9 ft <sup>3</sup>   |
|    | b. Steam Volume  | 547.0 ft <sup>3</sup>   |
|    | c. Surge Line minimum area   | 98.31 in <sup>2</sup> (89.71 in <sup>2</sup> through thermal<br>sleeve) |

# INTEROFFICE CORRESPONDENCE *Attachment*

12846,01-PE-38-01 of 1

TO: <i>H. CARLBERG</i>	LOCATION <i>14</i>	SUBJECT / REFERENCE / J.O. NO. <i>12846.07</i>
FROM: <i>R. REED</i>	LOCATION <i>14</i>	<i>SURRY 112 VEPco - Cont. Spray</i>

MESSAGE: *PER OUR CONVERSATION THE MAXIMUM TIME DELAY FROM THE SENSING OF CRITICAL LEVEL IN THE RWST UNTIL THE CHANGE OVER VALVES ARE SIGNALLED TO MOVE WILL NOT EXCEED 10 SECONDS, AND IN FACT WILL BE SOMEWHAT LESS*

*THE MAXIMUM ERROR IN THE CHANGE OVER SIGNAL SET POINT WILL REQUIRE A CALCULATION (CAT I)*

*ED - use 6" error for now*  
*H. E. Carlberg*  
*4/24/80*

NOTED, APR 24 1980 C. Woodworth

NOTED APR 21 1980 E.J. Adams

NOTED APR 24 1980 R. REED

*4/24/80*  
DATE

*[Signature]*  
SIGNATURE

*0405*  
TELEPHONE

REPLY:

*THX*

*4/24/80*  
DATE

*H. Carlberg*  
SIGNATURE *5068*  
TELEPHONE

▲ 040 188



USER'S GUIDE TO EZD REFERENCES

Facility: VEPCO, SURRY  
 Units: 1 and 2  
 Dockets: 50-280 and 50-281

EZD REFERENCE NO. 7  
 EZD REFERENCE DESCRIPTION: 12846.38-RP-024-1  
 ENVIRONMENTAL ZONE(S): AB-2B

<u>PARAMETER</u>	<u>NORMAL ENVIRONMENT</u>	<u>PAGE</u>	<u>LOCA ENVIRONMENT</u>	<u>PAGE</u>	<u>MSLB ENVIRONMENT</u>	<u>PAGE</u>	<u>HELB ENVIRONMENT</u>	<u>PAGE</u>
RADIATION (rads)	2.5 x 10 <sup>6</sup>	10	2.5 x 10 <sup>6</sup>	10				

USER'S GUIDE TO EZD REFERENCES

Facility: VEPCO, SURRY  
 Units: 1 and 2  
 Dockets: 50-280 and 50-281

EZD REFERENCE NO. 7  
 EZD REFERENCE DESCRIPTION: 12846.38-RP-024-1  
 ENVIRONMENTAL ZONE(S): AB-2C

<u>PARAMETER</u>	<u>NORMAL ENVIRONMENT</u>	<u>PAGE</u>	<u>LOCA ENVIRONMENT</u>	<u>PAGE</u>	<u>MSLB ENVIRONMENT</u>	<u>PAGE</u>	<u>HELB ENVIRONMENT</u>	<u>PAGE</u>
RADIATION (rads)	2.8 x 10 <sup>6</sup>	11	8.0 x 10 <sup>6</sup>	11				

USER'S GUIDE TO EZD REFERENCES

Facility: VEPCO, SURRY  
Units: 1 and 2  
Dockets: 50-280 and 50-281

EZD REFERENCE NO. 7  
EZD REFERENCE DESCRIPTION: 12846.38-RP-024-1  
ENVIRONMENTAL ZONE (S): SFGD-1

<u>PARAMETER</u>	<u>NORMAL ENVIRONMENT</u>	<u>PAGE</u>	<u>LOCA ENVIRONMENT</u>	<u>PAGE</u>	<u>MSLB ENVIRONMENT</u>	<u>PAGE</u>	<u>HELB ENVIRONMENT</u>	<u>PAGE</u>
RADIATION (rads)	8.8 x 10 <sup>2</sup>	13						



CALCULATION TITLE PAGE

\*SEE INSTRUCTIONS ON REVERSE SIDE

▲ 5010.64 (FRONT)

CLIENT & PROJECT <i>VEPCO - SURRY 1 &amp; 2</i>				PAGE 1 OF <i>13</i>		
CALCULATION TITLE (Indicative of the Objective): <i>EQUIPMENT QUALIFICATION IN AUX. &amp; SAFEGUARDS BLDGS.</i>				QA CATEGORY (✓) <input checked="" type="checkbox"/> I - NUCLEAR SAFETY RELATED <input type="checkbox"/> II <input type="checkbox"/> III <input type="checkbox"/> OTHER		
CALCULATION IDENTIFICATION NUMBER						
J. O. OR W.O. NO.	DIVISION & GROUP	CURRENT CALC. NO.	OPTIONAL TASK CODE	OPTIONAL WORK PACKAGE NO.		
<i>12846.38</i>	<i>power - RP</i>	<i>-RP-024-1</i>				
* APPROVALS - SIGNATURE & DATE			REV. NO. OR NEW CALC NO.	SUPERSEDES * CALC. NO. OR REV. NO.	CONFIRMATION * REQUIRED (✓)	
PREPARER(S)/DATE(S)	REVIEWER(S)/DATE(S)	INDEPENDENT REVIEWER(S)/DATE(S)			YES	NO
<i>Wu-hung peng 7/8/81</i>	<i>Shuwan Lin 7/8/81</i>	<i>Shuwan Lin 7/8/81</i>		<i>Super sedes RP-024-0</i>	<input checked="" type="checkbox"/>	
DISTRIBUTION *						
GROUP	NAME & LOCATION	COPY SENT (✓)	GROUP	NAME & LOCATION	COPY SENT (✓)	
RECORDS MGT. FILES (OR FIRE FILE IF NONE)	<i>Barnhart (4) - 14</i>	<i>(✓)</i>				

1-H-1

STONE & WEBSTER ENGINEERING CORPORATION  
CALCULATION SHEET

▲ 5010.65

CALCULATION IDENTIFICATION NUMBER				PAGE <u>2</u>
J.O. OR W.O. NO. 12846.38	DIVISION & GROUP Power RP	CALCULATION NO. - 024 - 1	OPTIONAL TASK CODE	

Table of Contents

	Page
Title page	1
Table of Contents	2
Objective	3
Method and Approach	3
Conclusions	4
References	5
Calculations	6
1. Source strength	6
2. Auxiliary Bldg - Outside Cubicles	7
3. Auxiliary Bldg - Inside Charging Pump Cubicles	
4. Safeguards Bldg	

This calc. supersedes calc. 12846.38-RP-024-0 to

- ① include 40 year normal dose in safeguard area
- ② explicitly state 40 year and LOCA doses outside the charging pump cubicles in the aux. bldg

1  
2  
3  
4  
5  
6  
7  
8  
9  
10  
11  
12  
13  
14  
15  
16  
17  
18  
19  
20  
21  
22  
23  
24  
25  
26  
27  
28  
29  
30  
31  
32  
33  
34  
35  
36  
37  
38  
39  
40  
41  
42  
43  
44  
45  
46

STONE & WEBSTER ENGINEERING CORPORATION  
CALCULATION SHEET

▲ 5010.65

CALCULATION IDENTIFICATION NUMBER				PAGE <u>3</u>
J.O. OR W.O. NO.	DIVISION & GROUP	CALCULATION NO.	OPTIONAL TASK CODE	
12846.38	Power RP	024 - 1		

1  
2  
3 OBJECTIVE:  
4

5 The objective of this calculation is to determine the  
6 integrated radiation dose (40 year normal operation plus  
7 6 month LOCA) to the equipments located inside the  
8 auxiliary bldg and those equipments inside the safeguards bldg.  
9  
10  
11  
12  
13  
14  
15

16 METHOD AND APPROACH  
17

- 18  
19  
20 1. This calculation is based on the detailed equipment  
21 Qualification calc. performed for North Anna plant Ref.(2),  
22 Ref.(6). The equipment arrangements, flow diagrams, piping  
23 layouts of North Anna units and Surry units are compared.  
24  
25  
26  
27  
28 2. The North Anna's results are taken as reference values,  
29 which are then adjusted for the Surry units with the following  
30 adjustment factors: ① source strength - taking into  
31 account of the difference of power level and dilution  
32 water volume; ② source geometry - taking into account  
33 the diameter of the <sup>line</sup> source, the distance of the equipment  
34 to the source etc.  
35  
36  
37  
38  
39  
40  
41  
42  
43 3. This calc. applies both to unit 1 and unit 2.  
44  
45  
46

STONE & WEBSTER ENGINEERING CORPORATION  
CALCULATION SHEET

▲ 5010.65

CALCULATION IDENTIFICATION NUMBER				PAGE <u>4</u>
J.O. OR W.O. NO.	DIVISION & GROUP	CALCULATION NO.	OPTIONAL TASK CODE	
12846-38	Power RP	024-1		

1  
2  
3  
4  
5  
6  
7  
8  
9  
10  
11  
12  
13  
14  
15  
16  
17  
18  
19  
20  
21  
22  
23  
24  
25  
26  
27  
28  
29  
30  
31  
32  
33  
34  
35  
36  
37  
38  
39  
40  
41  
42  
43  
44  
45  
46

CONCLUSIONS

1. Aux. bldg - outside cubicles : 6 Mo LOCA + 40 years normal operation  $5 \times 10^6$  rads  
- Inside cubicles : " " "  $1.1 \times 10^7$  rads

2. Safeguards bldg : 6 Mo LOCA dose -  $8 \times 10^6$  rads

See also calc. # 12846-RP-037-0 "Direct & dose rates and Integrated dose to electrical components in the safeguards area after a LOCA" in which a detailed mock-up for the pipes and walls was performed and the same conclusion was reached.

1-H-4

STONE & WEBSTER ENGINEERING CORPORATION  
 CALCULATION SHEET

▲ 5010.65

CALCULATION IDENTIFICATION NUMBER				PAGE <u>5</u>
J.O. OR W.O. NO.	DIVISION & GROUP	CALCULATION NO.	OPTIONAL TASK CODE	
12846.38	power RP	024-1		

REFERENCES

- (1). NA2 Calc # 12050-RP-078-0, QA Cat. I, 11/10/79;  
 "Integrated Doses In Aux. Bldg. el. 244'6" for Mitigation"
- (2). Stone and Webster, "shielding Design Summary for  
 Surry Power Station, VEPCO", 12/70; JO # 11448
- (3). NA2 Calc. # 12050-RP-077-0, QA Cat. I, 10/11/79;  
 "6 Month LOCA Doses from Various Sizes of 10 ft Long  
 Pipe"
- (4). IDC from M. Omeara to R. Vanasse / P. Karatzas; 11/27/79  
 "NUREG-0578 Surry Shielding Review", J.O. 12846.38
- (5). VEPCO Surry piping drawings as provided by the project  
 marked up showing lines of systems used for mitigation:  

11448 - FM - 105B	11448 - FM - 101A
- FM - 106A	FP - 5D
- FP - 10R	FP - 60A
FP - 10C	FP - 60B
FP - 10E	FP - 60C
FP - 10F	FP - 60D
FP - 10S	
MSK - 2A	
- (6) NA2 Calc. # 12050-RP-091-0, QA Cat. I, 11/17/79;  
 "6 Mo. LOCA Integrated P doses in the NA 1 & 2 Safeguards  
 Bldg, to components used for mitigation"

STONE & WEBSTER ENGINEERING CORPORATION  
CALCULATION SHEET

▲ 5010.65

CALCULATION IDENTIFICATION NUMBER			
J.O. OR W.O. NO. 12846.38	DIVISION & GROUP power RP	CALCULATION NO. 024-1	OPTIONAL TASK CODE
			PAGE 6

CALCULATIONS

1. Source strength

(1) The source strength is based on North-Anna's calculation<sup>(1)\*</sup> and adjusted to the power level and the volume of sump water for the Surry. During the LOCA, 50% halogens and 1% fission product particulates of the equilibrium core inventories are assumed mixed up uniformly with the reactor coolant and water from RWST which are dumped to the containment sump during a LOCA. It is assumed 1% FF for the normal operation.<sup>(2)</sup>

$$\begin{aligned}
 (2) \quad P_{N.A.} &= 2900 \text{ MW}^{(3)} & P_{\text{surry}} &= 2546 \text{ MW}^{(2)} \\
 P.C._{N.A.} &= 9380 \text{ ft}^3 & P.C._{\text{surry}} &= 9235 \text{ ft}^3^{(2)} \\
 RWST_{N.A.} &= 326000 \text{ gal.}^{(3)} & RWST_{\text{surry}} &= 250,000 \text{ gal.}^{(4)}
 \end{aligned}$$

$$\text{Total sump water}_{N.A.} = 1.5 \times 10^9 \text{ cm}^3 \quad \text{Total sump water}_{\text{surry}} = 1.2 \times 10^9 \text{ cm}^3$$

$$\begin{aligned}
 (3) \text{ Adjustment factor for LOCA source } f_1 &= \frac{2546}{2900} \times \frac{1.5 \times 10^9}{1.2 \times 10^9} \\
 &= 1.10
 \end{aligned}$$

$$\begin{aligned}
 \text{Adjustment factor for normal operation } f_2 &= \frac{2546}{2900} \times \frac{9380}{9235} \\
 &= 0.89
 \end{aligned}$$

\* Numbers inside the parentheses are the reference numbers.

STONE & WEBSTER ENGINEERING CORPORATION  
CALCULATION SHEET

▲ 5010.65

CALCULATION IDENTIFICATION NUMBER				PAGE <u>7</u>
J.O. OR W.O. NO.	DIVISION & GROUP	CALCULATION NO.	OPTIONAL TASK CODE	
12846.38	power RP	024-1		

2. Auxiliary Bldg - Outside Cubicles

(1) We only consider low head & high head safety injection system used during the recirculation mode for mitigation of LOCA consequences. The systems had been made up by the project. <sup>(5)</sup>

(2) The general arrangement dwgs show that the components used for mitigation purpose between NA-2 and surry are similar except that

- The 6 charging pumps (3 for each unit) of NA are located in 6 parallel cubicles, each in N-S direction. For the surry, there are two bands of cubicles. 3 charging pumps are arranged in a band in E-W direction.
- The chemical mixing tank is at the west of control volume tanks for NA-2 and it is at the south for the Surry.

(3) The flow diagrams between the two plants show that their mitigation systems are similar. In NA-2, a lot more piping are considered <sup>contaminated</sup>, including boron injection tank and its piping, piping for the seal water injection filters. In Surry, these pipings are isolated. <sup>(5)</sup>

STONE & WEBSTER ENGINEERING CORPORATION  
CALCULATION SHEET

▲ 5010.65

CALCULATION IDENTIFICATION NUMBER				PAGE <u>8</u>
J.O. OR W.O. NO. 12846.38	DIVISION & GROUP Power RP	CALCULATION NO. 024-1	OPTIONAL TASK CODE	

- continued -

The piping arrangement between these two units (NA-2 & Surry 1) are different. For the space outside the cubicles, Surry's piping is less congested than North Anna's piping.

(4) The radiation sensitive equipments outside the cubicles are identified as the following: MOV 1289B, MOV 1867A, MOV 1867B, FE 1943, FE 1160, FCV 1160, MOV 1370, MOV 1869A, MOV 1869B, MOV 1842 and FE 1940. The integrated dose of some of <sup>the</sup> corresponding equipments of NA-2 has been calculated. As a reference, they are listed in the following:

NA-2 Equipment	6 month LOCA Dose	40yrs operation	NA-2 total
MOV 289B	$6.9 \times 10^5$ rads	+ $5.4 \times 10^5$ rads	= $1.2 \times 10^6$ rads
MOV 2867A	$1.3 \times 10^6$ "	+ $1.1 \times 10^6$ "	= $2.4 \times 10^6$ "
MOV 2867B	$1.2 \times 10^6$ "	+ $1.1 \times 10^6$ "	= $2.3 \times 10^6$ "
FE 2943	$1.1 \times 10^6$ "	+ $9.1 \times 10^5$ "	= $2.0 \times 10^6$ "
FE 2160	$1.7 \times 10^6$ "	+ $2.0 \times 10^6$ "	= $3.7 \times 10^6$ "
FCV 2160	$5.9 \times 10^5$ "	+ $6.1 \times 10^5$ "	= $1.2 \times 10^6$ "

Since the dose contributions from LOCA and normal operation are comparable, the source strength adjustment factors <sup>are</sup> cancelled out. Surry's equipments have less piping around them and no contribution from boron injection tank; therefore, their doses can not be more than those listed above. It should be noted that the radiation from two 8" pipes (8"-SI-92 & 8"-SI-14) to MOV 1289B are essentially shielded by the concrete pole TN-10.



STONE & WEBSTER ENGINEERING CORPORATION  
CALCULATION SHEET

▲ 5010.65

CALCULATION IDENTIFICATION NUMBER				PAGE <u>9</u>
J.O. OR W.O. NO. <u>12846.38</u>	DIVISION & GROUP <u>Power RP</u>	CALCULATION NO. <u>026-1</u>	OPTIONAL TASK CODE	

- continued -

(5) MOV-1869A, 1869B, 1842 of Surry-1 are adjacent to many 3" pipes. NA-2's calculation does not include these element. Comparison of the piping layout suggests that the doses at these equipments not more than that of NA-2 MOV-2867C, which has total integrated dose of  $3.2 \times 10^6$  rads ( $1.7 \times 10^6$  rads for LOCA and  $1.5 \times 10^6$  rads for 40 yrs operation.)

(6) MOV-1370 is only 4.5' to pipe 8" SI-92 and 5' to 8" SI-14. MOV-2289B of NA-2 is 12.3' away from 8" SI-440 and 12.7' away from 8" SI-449. The total integrated dose of MOV-2289B is  $1.2 \times 10^6$  rads. Since the dose rate from a <sup>long</sup> line source is inversely proportional to the normal distance, the integrated dose of MOV-1370 of Surry-1 is estimated to be

$$1.2 \times 10^6 \times \frac{12.6'}{4.8'} \approx 3 \times 10^6 \text{ rads.}$$

Judged from the doses of MOV-2863A, 2863B, 2115B, 2115D of NA-2, which are also near many pieces of 8" pipe, the above value is believed to be correct for MOV-1370 of Surry-1.

(7) FE-1940 of Surry-1 encloses a 4" pipe and adjacent to a number of 3" pipes. Comparison with flow elements of NA-2 suggests that its dose should not

STONE & WEBSTER ENGINEERING CORPORATION  
 CALCULATION SHEET

▲ 5010.65

CALCULATION IDENTIFICATION NUMBER				PAGE <u>10</u>
J.O. OR W.O. NO.	DIVISION & GROUP	CALCULATION NO.	OPTIONAL TASK CODE	
12846.38	power RP	024 -1		

1  
2 - continued -  
3

4 exceed  $4.7 \times 10^6$  rads, which is the maximum total dose  
5 among flow elements of NA-2.  
6  
7

8  
9 (8) In conclusion, the total integrated dose to MDU's and  
10 FE's of mitigation system outside of cubicles in the aux.  
11 building is estimated, based upon comparison with  
12 NA-2, not more than  $5 \times 10^6$  rads. (The LOCA  
13 contribution and 40 year contribution are comparable;  
14  
15 that is,  $\sim 2.5 \times 10^6$  rads for 40 year normal operation dose,  
16 and  $\sim 2.5 \times 10^6$  rads for 6 month LOCA dose )  
17  
18  
19  
20  
21  
22  
23  
24  
25  
26  
27  
28  
29  
30  
31  
32  
33  
34  
35  
36  
37  
38  
39  
40  
41  
42  
43  
44  
45  
46

STONE & WEBSTER ENGINEERING CORPORATION  
CALCULATION SHEET

▲ 5010.65

CALCULATION IDENTIFICATION NUMBER				PAGE <u>11</u>
J.O. OR W.O. NO.	DIVISION & GROUP	CALCULATION NO.	OPTIONAL TASK CODE	
12846.38	power RP	024 - 1		

3. Auxiliary Bldg - Inside charging pump Cubicles

(1) According to Shielding Design Summary for Surry power station, VEPCO<sup>(2)</sup>, p.19, the dose rate at pump surface due to pump and lines > 2" in diameter is 10000 mR/hr (1% FF).

40 year integrated dose at 80% operation fraction is

$$10 \times 40 \times 365 \times 0.8 \times 24 = 2.8 \times 10^6 \text{ rads}$$

(2) In NA-2 Calculation<sup>(1)</sup>, the maximum equipment dose occurs at MOV-2863B and is  $3.6 \times 10^6$  rads in 6 months after LOCA. MOV-2863B is located outside the cubicle for NA-2; this piece of equipment is inside the cubicle for Surry-1. Apply

source strength adjustment factor,  $D_1 = 3.6 \times 10^6 \times 1.1 = 4.0 \times 10^6$  rads.

Based on engineering judgment, it is conservatively assumed <sup>the</sup> pump will contribute as much as the piping. The total LOCA dose is then  $\sim 4.0 \times 10^6 \times 2 = 8 \times 10^6$  rads.

(3) Therefore, it is estimated that the total integrated dose of equipment inside the charging cubicles of Aux. Bldg is not more than  $1.1 \times 10^7$  rads.

STONE & WEBSTER ENGINEERING CORPORATION  
CALCULATION SHEET

▲ 5010.65

CALCULATION IDENTIFICATION NUMBER				PAGE <u>12</u>
J.O. OR W.O. NO.	DIVISION & GROUP	CALCULATION NO.	OPTIONAL TASK CODE	
<u>12846.38</u>	<u>power RP</u>	<u>024 - 1</u>		

4. Safeguards Bldg

(1) Two systems are considered in safeguards bldg: low head safety injection system and containment-recirculation spray system. Equipments we consider critical to radiation damage are MCV's and FE's associated with these systems.

(2) The flow diagrams of SI and RS systems inside the safeguards bldg of NA and Surry are very similar. Three levels are considered in NA calculation: under ground level at 210'11", where we have two 12" pipes to the suction of the low head pump; "ground level" at 256'11", where we have most of the pipes of the system; and upper level at 267'6", where we have less number of pipes and they are generally of smaller size. For the Surry, as they were marked up by the project, only underground level at -32'7" and "ground level" at 12' are considered.

(3) The piping layout of RS system, and SI system at -32'7" level, of Surry-1 is very similar to those of NA-2. The SI piping of Surry-1 at el. 12' level is different from North Anna-2. However, the difference is minor, in my opinion for the equipment qualification, between Surry-1 and NA-2.

STONE & WEBSTER ENGINEERING CORPORATION  
CALCULATION SHEET

▲ 5010.65

CALCULATION IDENTIFICATION NUMBER				PAGE <u>13</u>
J.O. OR W.O. NO.	DIVISION & GROUP	CALCULATION NO.	OPTIONAL TASK CODE	
12846.38	Power RP	024-1		

1  
2  
3  
4  
5  
6  
7  
8  
9  
10  
11  
12  
13  
14  
15  
16  
17  
18  
19  
20  
21  
22  
23  
24  
25  
26  
27  
28  
29  
30  
31  
32  
33  
34  
35  
36  
37  
38  
39  
40  
41  
42  
43  
44  
45  
46

(4) The SI and RS piping layouts at ground level (256'6") between NA-1 and NA-2 are also different. The calculated integrated doses are listed below for reference. (Ref 16)

	NA-1		NA-2	
FE1945	$6.8 \times 10^6$	rads	$6.6 \times 10^6$	rads
FE1946	$5.7 \times 10^6$	"	$5.7 \times 10^6$	"
MOV1864A	$4.7 \times 10^6$	"	$5.6 \times 10^6$	"
MOV1864B	$5.3 \times 10^6$	"	$3.8 \times 10^6$	"
MOV1890A	$5.3 \times 10^6$	"	$5.3 \times 10^6$	"
MOV1890B	$4.9 \times 10^6$	"	$3.9 \times 10^6$	"
MOV1890C	$5.8 \times 10^6$	"	$4.4 \times 10^6$	"

( at el. 210'11" : MOV 1860 A  $4.6 \times 10^6$  rads  
MOV 1860 B  $4.4 \times 10^6$  " )

It can be seen that although the detail piping layouts between NA-1 and NA-2 are different, the integrated doses do not differ much. Therefore, it is judged that doses to Surry equipments should also <sup>be</sup> of the same order, adjusted by the source strength. The maximum dose above is  $6.8 \times 10^6$  rads.

LOCA source strength adjustment factor,  $f_1 = 1.10$ .

$$6.8 \times 1.1 = 7.5 \times 10^6 \text{ rads.}$$

5. In conclusion, it is expected that the <sup>6 month</sup> integrated doses to Surry-1 safeguard equipments after a ~~LOCA~~ LOCA are not more than  $8 \times 10^6$  rads.

6. 40 year normal dose is estimated to be  $2.5 \times 10^{-3} \frac{\text{rads}}{\text{hr}} \times 40 \times 365 \times 24 \text{ hrs} = 880 \text{ rads}$  (Assuming radiation zone II with max. dose rate  $2.5 \text{ mR/hr}$ ).

# INTEROFFICE CORRESPONDENCE

TO: R. VANASSE / P. KARATZAS

LOCATION  
916

SUBJECT / REFERENCE / J.O. NO. 12846.38  
NUREG-0578 EIA 00006  
SURRY SHIELDING REVIEW

FROM: MIKE OMEARA

LOCATION  
14

MESSAGE: —

The minimum amount of water injected into the reactor coolant systems after a LOCA is about 250,000 gal. This assumes that water will be drawn from a full RWST until the level at which automatic switchover to the reserve mode occurs. It is also assumed that switchover is immediate (conservative) and that Containment Spray is not initiated. Instrument error is also considered.

11/27/79  
DATE

Michael S. Omeara 6836  
SIGNATURE APR 11-27-79 TELEPHONE

REPLY:

DATE

SIGNATURE

TELEPHONE

▲ 040.13B

USER'S GUIDE TO EZD REFERENCES

Facility: VEPCO, SURRY  
 Units: 1 and 2  
 Dockets: 50-280 and 50-281

EZD REFERENCE NO. 8  
 EZD REFERENCE DESCRIPTION: 12846.44-PE-049-0  
 ENVIRONMENTAL ZONE (S): SB-9B, TB-9, TB-35

<u>PARAMETER</u>	<u>NORMAL ENVIRONMENT</u>	<u>PAGE</u>	<u>LOCA ENVIRONMENT</u>	<u>PAGE</u>	<u>MSLB ENVIRONMENT</u>	<u>PAGE</u>	<u>HELB ENVIRONMENT</u>	<u>PAGE</u>
TEMPERATURE (°F)							310, 0-30 min 130, 30-60 min	42
PRESSURE (psia)							15.0, 0-3500 sec 15.0-14.7, 3500-3600 sec	47*
RELATIVE HUMIDITY (%)							100	**
CHEMICAL SPRAY								

REMARKS: \* Profile is based on bounding the results of the computer analysis as referenced in calculation.

\*\* Relative humidity bounds are results of computer analysis referenced in calculation, but not included.

CALCULATION TITLE PAGE

\*SEE INSTRUCTIONS ON REVERSE SIDE

▲ 5010.64 (FRONT)

CLIENT & PROJECT VEPCO SURRY UNIT 1 & 2				PAGE 1 OF 50	
CALCULATION TITLE (Indicative of the Objective):  HIGH ENERGY LINE BREAK IN TURBINE BUILDING				QA CATEGORY (✓) <input checked="" type="checkbox"/> I - NUCLEAR SAFETY RELATED <input type="checkbox"/> II <input type="checkbox"/> III <input type="checkbox"/> OTHER	
CALCULATION IDENTIFICATION NUMBER					
J. O. OR W.O. NO.	DIVISION & GROUP	CURRENT CALC. NO.	OPTIONAL TASK CODE	OPTIONAL WORK PACKAGE NO.	
12846.44	POWER /ESG	PE-049-0	00006		
* APPROVALS - SIGNATURE & DATE			REV. NO. OR NEW CALC NO.	SUPERSEDES * CALC. NO. OR REV. NO.	CONFIRMATION * REQUIRED (✓)
PREPARER(S)/DATE(S)	REVIEWER(S)/DATE(S)	INDEPENDENT REVIEWER(S)/DATE(S)			YES NO
G.M. Donahue 10/15/80	D.M. Wallen 11/12/80 NOTED	D.M. Wallen 11/12/80 DEC 9 1980 R.F.MILLER/PM	0		✓
DISTRIBUTION*					
GROUP	NAME & LOCATION	COPY SENT (✓)	GROUP	NAME & LOCATION	COPY SENT (✓)
RECORDS MGT. FILES (OR FIRE FILE IF NONE)	M. Cliffe 245/14	2			
Project	J. Barnhart	1			



STONE & WEBSTER ENGINEERING CORPORATION  
CALCULATION SHEET

▲ 5010.65

CALCULATION IDENTIFICATION NUMBER				PAGE <u>2</u>
J.O. OR W.O. NO. 12846.44	DIVISION & GROUP	CALCULATION NO. PE-049-0	OPTIONAL TASK CODE	

1  
2  
3  
4  
5  
6  
7  
8  
9  
10  
11  
12  
13  
14  
15  
16  
17  
18  
19  
20  
21  
22  
23  
24  
25  
26  
27  
28  
29  
30  
31  
32  
33  
34  
35  
36  
37  
38  
39  
40  
41  
42  
43  
44  
45  
46

TABLE OF CONTENTS.

	PAGE #
TITLE PAGE	1
TABLE OF CONTENTS	2
OBJECTIVE	3
CALCULATION	3-40
LIST OF ATTACHMENT	41
CONCLUSION	41
SUMMARY	41-47
REFERENCES	48-50
ATTACHMENT 1	PAGE 1 of 1

STONE & WEBSTER ENGINEERING CORPORATION  
CALCULATION SHEET

▲ 5010.65

CALCULATION IDENTIFICATION NUMBER				PAGE <u>3</u>
J.O. OR W.O. NO. 12846.44	DIVISION & GROUP	CALCULATION NO. PE-049-0	OPTIONAL TASK CODE	

1  
2  
3 OBJECTIVE: TO EVALUATE THE EFFECTS OF A HIGH ENERGY LINE BREAK WITH  
4 RESPECT TO TEMPERATURE ON IDENTIFIED CLASS 1E ELECTRICAL COMPONENTS, LOCATED  
5 WITHIN THE SUPPLY UNIT 1 & MECHANICAL EQUIPMENT ROOM #3 IN RESPONSE TO  
6 THE I.E. BULLITEN 79-D18.

7  
8 METHOD: THE S&W ENG. CORP. NU-92 'THREE' SUBCOMPARTMENT ANALYSIS  
9 COMPUTER PROGRAM, VERSION 12, LEVEL 1 IS UTILIZED TO EVALUATE THE TEMPERATURE  
10 AND PRESSURE TRANSIENT THAT WOULD RESULT FROM A POSTULATED FAILURE  
11 OF A HIGH ENERGY PIPING SYSTEM. TO PROVIDE THE NECESSARY INPUT DATA  
12 OF THE STRUCTURE'S GEOMETRY, VOLUME, RESISTANCE TO FLOW AND TO CHANGES  
13 IN FLOW RATE, A 'NODALIZATION' OR SUBCOMPARTMENTATION OF THE STRUCTURE  
14 IS MODELED, USING THE GUIDELINES OF REFERENCE 32.

15  
16 CALCULATION: REF. 43 LOCATES THE MECHANICAL EQUIPMENT #3 IN THE SERVICE  
17 BUILDING AT THE 9'6" ELEVATION, WHICH IS CONNECTED TO THE TURBINE  
18 BUILDING UNIT #2 9'6" ELEVATION BY TWO WALL OPENINGS FOR VENTILATION  
19 PURPOSES, ONE OF WHICH CONTAINS A FAN FOR CONTINUOUS AIR CIRCULATION.  
20 SINCE THIS AREA IS MOST DIRECTLY CONNECTED TO A WORST CASE HIGH ENERGY  
21 LINE, THAT BEING A MAIN STEAM PIPING SYSTEM, IN THE TURBINE BUILDING,  
22 IT IS CONSERVATIVE AND REASONABLE TO EXPECT THAT THE TEMPERATURE  
23 TRANSIENT FOR THE TURBINE BUILDING 9'6" ELEVATION FOR UNIT #2 THAT WOULD  
24 RESULT FROM A FAILURE OF THE MAIN STEAM PIPE IN THAT AREA WOULD BE  
25 ALREADY THE SAME TRANSIENT THAT THE MECHANICAL EQUIPMENT ROOM WOULD  
26 EXPERIENCE. FOR THIS REASON, THE NODALIZATION MODEL DEVELOPED IS USED  
27 TO ANALYZE THE WORST CASE HELEB TEMPERATURE TRANSIENT FOR THE  
28 UNIT #2 TURBINE BUILDING LOWER ELEVATION. THE RESULTS OF THIS TRANSIENT  
29 ARE THEN ASSUMED TO BE THE TRANSIENT THAT THE MECHANICAL EQUIP-  
30 MENT ROOM WOULD UNDERGO. THE MODEL, THEREFORE, DOES NOT INCLUDE  
31 SPECIFICALLY THE MECHANICAL EQUIPMENT ROOM AND THE VALUES OF TEMPERATURE  
32 FOR NODE 1, AS SHOWN ON THE DIAGRAMS ON PAGE 4, IS THE TRANSIENT  
33 NODE OF INTEREST. PAGES 5 AND 11 PROVIDE THE NODAL NET VOLUME CALCULATION  
34 AND PAGES 12 AND 38 PROVIDE THE JUNCTION AREA AND FLOW RESISTANCE CALCULATION.  
35 THE MASS ENERGY RELEASE RATES UTILIZED ARE SHOWN ON PAGES 39 TO 40  
36 FOR PURPOSES OF CONSERVATISM, THE LOUVERED OPENINGS FOR THE SUPPLY FAN  
37 OPENINGS FOR THE SUPPLY FAN ARE ASSUMED TO BE SHUT.

38  
39 THE FOLLOWING PAGE PROVIDES THE SKETCHES OF THE NODAL SCHEME  
40 CHOSEN, BY ELEVATION VIEW AND PLAN VIEW OF THE OPENINGS THROUGH  
41 THE OPERATING FLOOR AS WELL AS A SINGLE LINE DIAGRAM OF THE  
42 NODE TO NODE RELATIONSHIPS. ALL ASSUMPTIONS CONCERNING THE  
43 CALCULATION OF VOLUMES, RESISTANCE TO FLOW AND INERTIA'S ARE  
44 CONTAINED IN THE TEXT WHERE APPLICABLE.  
45  
46

Client	VEPCO SURBYUNIT 1 & 2	Location		Est. No.		J.O. No.	12846.001
Subject or Apparatus	TURBINE BUILDING NODAL DIAGRAM	Date		Checked		By	
Based on		Revised		By			

1  
2  
3  
4  
5  
6  
7  
8  
9  
10  
11  
12  
13  
14  
15  
16  
17  
18  
19  
20  
21  
22  
23  
24  
25  
26  
27  
28  
29  
30  
31  
32  
33  
34  
35  
36  
37  
38  
39  
40  
41  
42  
43  
44  
45  
46  
47  
48  
49  
50  
51  
52  
53  
54

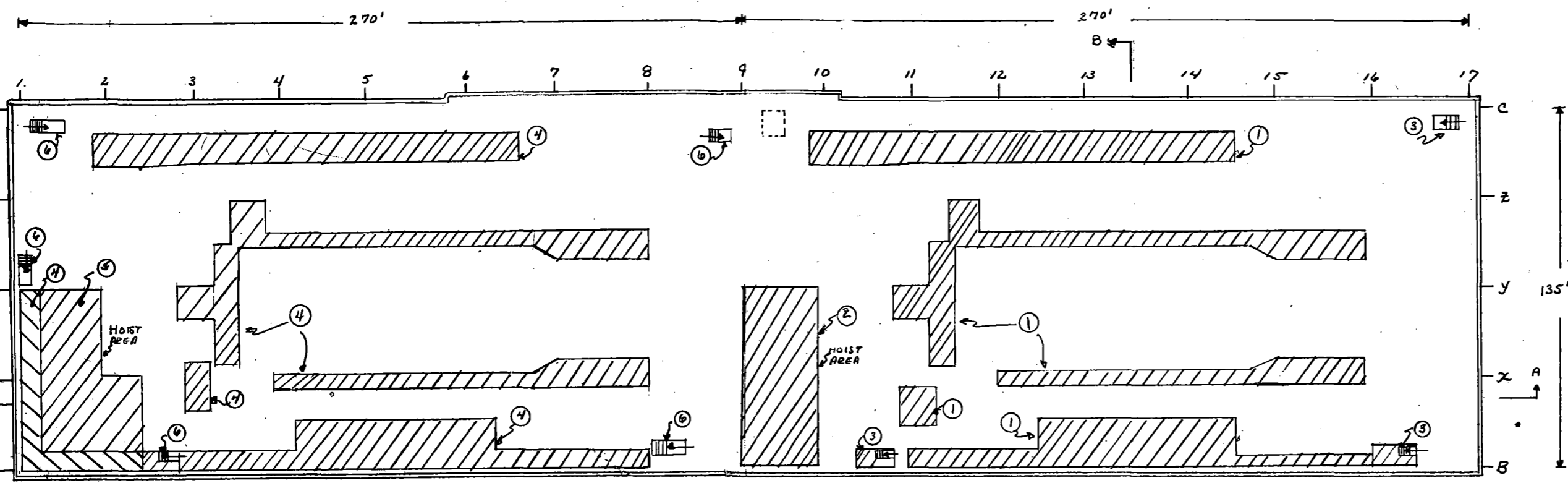

PLAN VIEW VERTICAL FLOW AREAS  
AT OPERATING PLATFORM.  
○ = JUNCTION DESIGNATION (ABOVE)  
□ = NODE DESIGNATION (BELOW)

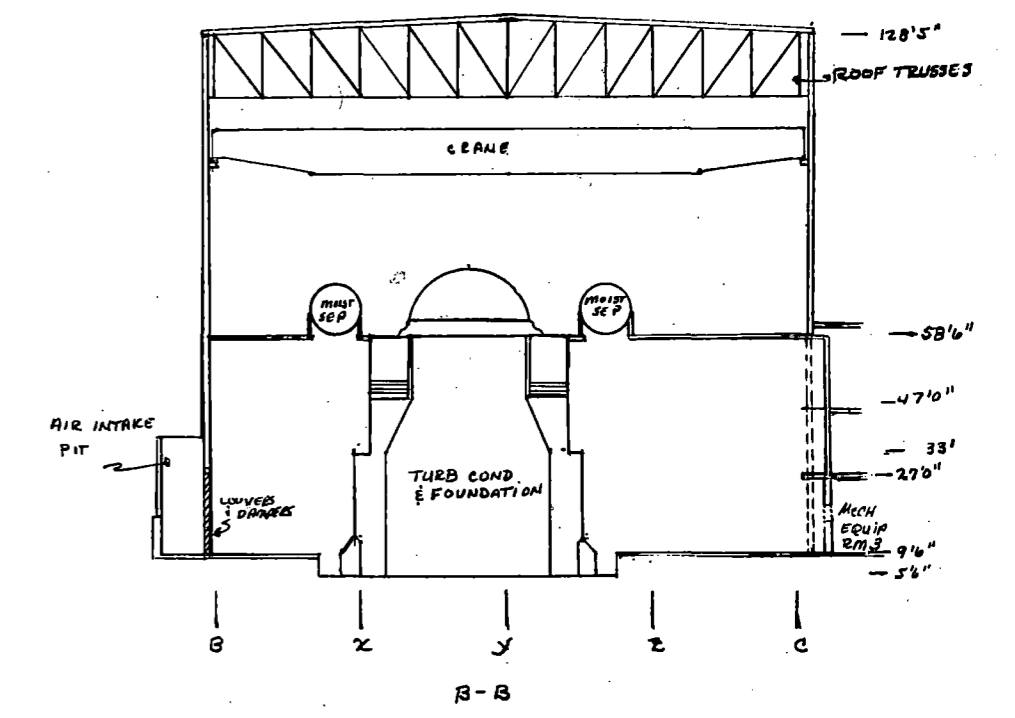
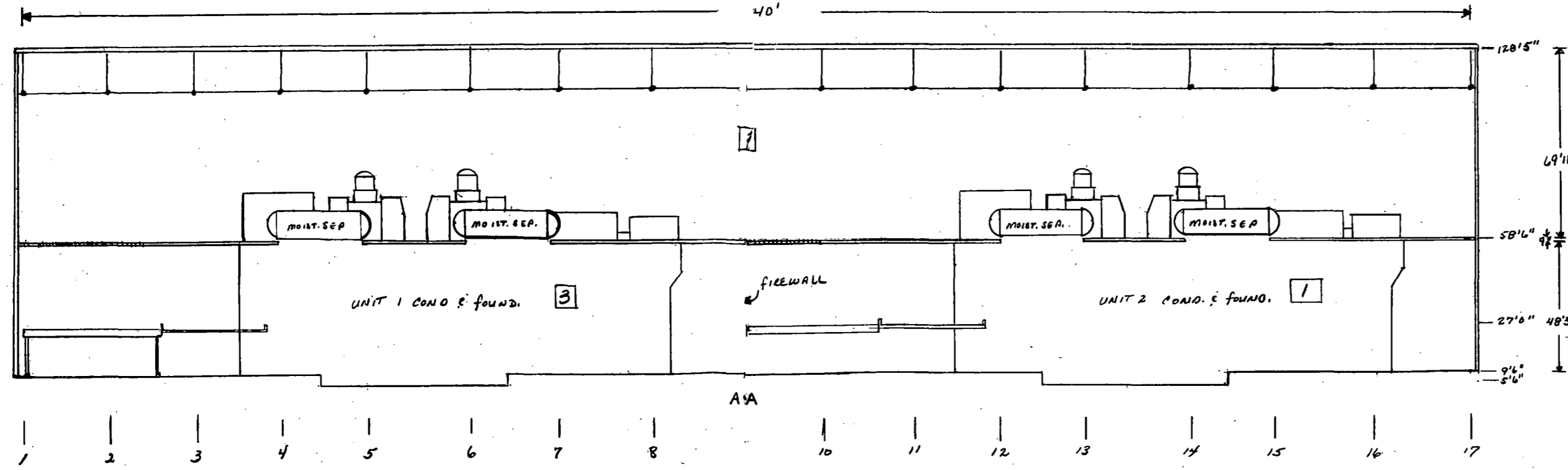

NODE DIAGRAM □ = NODE DESIGNATION ○ = JUNCTION DESIGNATION

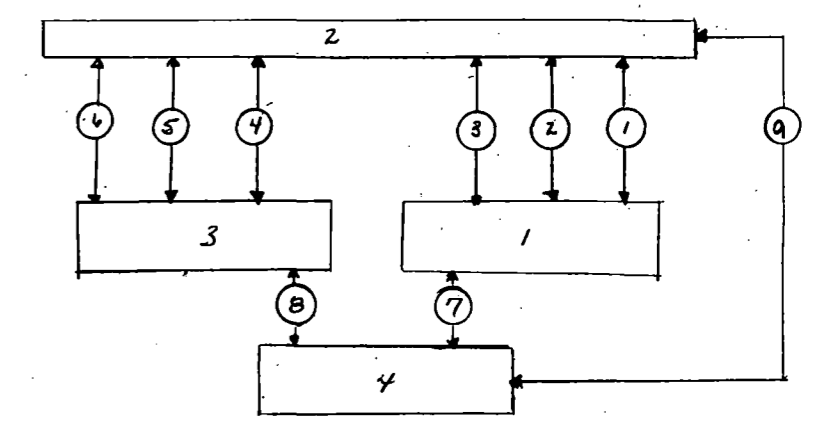

STONE & WEBSTER ENGINEERING CORPORATION  
CALCULATION SHEET

▲ 5010.65

CALCULATION IDENTIFICATION NUMBER			
J.O. OR W.O. NO. 12846-44	DIVISION & GROUP	CALCULATION NO. <b>PE-049-0</b>	OPTIONAL TASK CODE
			PAGE <u>5</u>

\* CHECKERS NOTE: NET VOLUMES ARE NOT EXACT CALCULATIONS BUT ARE WITHIN AN ACCEPTABLE TOLERANCE.

VOLUMES:

THE TURBINE BUILDING FOR THIS ANALYSIS IS DIVIDED INTO 3 AREAS OR NODES, TWO OF WHICH ARE BELOW THE OPERATING FLOOR SEPARATED BY A FIRE WALL WHICH DIVIDES THE BUILDING EVENLY AT LINE 9 ACROSS ITS WIDTH AS SHOWN ON REF 27. THE THIRD AREA IS THAT AT AND ABOVE THE OPERATING FLOOR FOR THE ENTIRE LENGTH OF STRUCTURE. REF 24 THRU 26 PROVIDES THE OVERALL DIMENSIONS FOR THE BUILDING. FOR CALCULATION PURPOSES, THE DIMENSION LENGTHS USED FOR EVALUATING NET VOLUMES ARE TAKEN FROM THE "B" LINE TO THE "C" FOR WIDTH, FROM LINE 1 TO LINE 17 FOR THE LENGTH OF THE ABOVE MENTIONED 3RD AREA (NODE 2), FROM LINE 1 TO LINE 9 FOR ONE OF THE LOWER AREAS (NODE 3), LINE 9 TO 17 FOR THE OTHER (NODE 1). FOR HEIGHT, FOR THE LOWER NODES THE ELEVATION USED IS FROM THE 9'6" LEVEL TO AN ELEVATION OF 57'9" AND FOR THE UPPER AREA FROM THE 58'6" LEVEL TO AN ELEVATION OF 128'5". THE STRUCTURE IS ACTUALLY SLIGHTLY LARGER THAN THIS, HOWEVER THE DIFFERENCE IS VERY SMALL AND WOULD NOT HAVE A SIGNIFICANT EFFECT ON RESULTS.

COMPONENTS UTILIZED IN THE UNIT 2 AREA ARE FOR THE MOST PART DUPLICATED IN THE UNIT 1 AREA FOR THAT UNIT. EQUIPMENT AND PIPING VOLUMES, THEREFORE, THAT ARE OBTAINED FOR ONE OF THE UNITS IS ASSUMED TO BE THE SAME FOR THE OTHER UNIT, EXCEPT WHERE NOTED. COMPONENT VOLUMES ARE ESTIMATED FROM THE MACHINERY ARRANGEMENT DRAWINGS AND PIPING ARRANGEMENT DRAWINGS FOR THOSE ARBITRARILY CONSIDERED TO BE OF SIGNIFICANT SIZE, THE ESTIMATES CONSIDERED TO BE CONSERVATIVELY LARGE. REMAINING EQUIPMENT, FOUNDATIONS, PIPING, & SUPPORTS ETC. NOT SPECIFICALLY ADDRESSED WILL BE ACCOUNTED FOR BY A GENERAL ASSUMPTION THAT THESE COMPONENTS WILL NOT OCCUPY MORE THAN 10% OF THE GROSS VOLUME OF NODE 2 AND 5% OF THE GROSS VOLUMES OF NODES 1 & 3, WHICH IS CONSERVATIVE.

PAGE 4 OF THIS CALCULATION SUMMARIZES THE NODAL ARRANGEMENT AND DIMENSIONING USED FOR THE TURBINE BUILDING.

NET VOLUMES:  $V_g$  = GROSS VOLUME ;  $V_c$  = VOLUME OF COMP. PIPING ;  $V_N$  = NET VOL.

NODE 1:  $V_g = (270')(135')(48'3") = 1758712.5 \text{ ft}^3$   
 $V_c = 418009 \text{ ft}^3$  (LINE 28, PAGE 9) +  $15109 \text{ ft}^3$  (LINE 44, PAGE 11)  
 $+ V_g(5\%) = 521053.6 \text{ ft}^3 = 521054 \text{ ft}^3$   
 $V_N = V_g - V_c = 1237658 \text{ ft}^3$  1237658

NODE 2:  $V_g = (540')(135')(69'11") = 5096925 \text{ ft}^3$   
 $V_c = 506668 \text{ ft}^3 + V_g(10\%) = 660360.5 \text{ ft}^3$  (LINE 36, P 6)  
 $V_N = V_g - V_c = 4436565 \text{ ft}^3$  4436565

NODE 3:  $V_g = (270')(135')(48'3") = 1758712.5 \text{ ft}^3$   
 $V_c = 15109 \text{ ft}^3$  (LINE 44, PAGE 11) +  $441457 \text{ ft}^3$  (LINE 36, PAGE 9)  
 $+ V_g(5\%) = 544501.6 \text{ ft}^3$   
 $V_N = V_g - V_c = 1214211 \text{ ft}^3$  1214211

NODE 4:  $V_N$  IS ASSUMED TO =  $1020 \text{ ft}^3$



STONE & WEBSTER ENGINEERING CORPORATION  
CALCULATION SHEET

▲ 5010.65

CALCULATION IDENTIFICATION NUMBER				PAGE <u>7</u>
J.O. OR W.O. NO. 12846.44	DIVISION & GROUP	CALCULATION NO. <u>PE-049-0</u>	OPTIONAL TASK CODE	

EQUIPMENT VOLUMES. ELEV. 9'6" TO EL 58'6"

NOTE: UNLESS NOTED OTHERWISE THE VOLUMES ESTIMATED BELOW ARE ASSUMED TO BE THE SAME FOR BOTH UNIT 1 & UNIT 2 AREAS. (NOTES 1 & 3)

1.) TURBINE CONDENSER AND FOUNDATION (REF 4 & 7)

IT IS CONSERVATIVE TO EVALUATE THESE COMPONENTS AS A SINGLE UNIT WHICH WOULD ALSO ACCOUNT FOR THE PLATFORM AT ELEVATION 33' & 35' AND MISCELLANEOUS SERVICE UNITS WITHIN THE BOUNDARIES OF THIS AREA

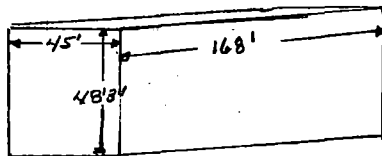

Volume =  $168' \times 48'3'' \times 45' = 364770 \text{ ft}^3$

2.) FEED WATER HEATERS (REF 3, 4 & 5)

(1) EST. 5.5' DIA X 40' =  $950 \text{ ft}^3$  EA = 5702 ft<sup>3</sup>

(2) EST. 6.5' DIA X 33.5' =  $1112 \text{ ft}^3$  EA = 2224 ft<sup>3</sup>

TOTAL 7926 ft<sup>3</sup>

3.) STEAM GENERATOR FEED PUMPS (REF 3, 4) (2)

APPROX. AS 8' X 7' X 20' =  $1120 \text{ ft}^3$  EA X 2 = 2240 ft<sup>3</sup>

4.) ELEVATOR SHAFT (UNIT 2 ONLY) (REF 4)

APPROX. AS 8' X 8' X 49' = 3136 ft<sup>3</sup>

5.) BRG WATER COOLING PUMPS (2) (REF 3, 5)

APPROX. AS 9' X 4' X 6' =  $216 \text{ ft}^3$  EA X 2 = 432 ft<sup>3</sup>

6.) HIGH PRESSURE DRAIN HEATER (REF 3)

APPROX. AS 9' DIA X 23' =  $1463 \text{ ft}^3$   
8' dia  $1156 \text{ ft}^3$

7.) BEARING COOLING WATER HEAT EXCH. (3) (REF 3, 5)

APPROX. AS 4' DIA X 25' =  $314 \text{ ft}^3$  EA X 3 = 942 ft<sup>3</sup>

8.) SERVICE AIR & CONTROL AIR COOLERS (2 SETS OF 2) (REF 3 & 4) UNIT 2 ONLY

APPROX. AS 6' X 13.5' X 4' =  $324 \text{ ft}^3$  EA X 4 = 1296 ft<sup>3</sup>

9.) SERVICE AIR & CONTROL AIR RECEIVERS (4) (REF 3 & 4) UNIT 2 ONLY

APPROX. AS 4' DIA X 10' =  $126 \text{ ft}^3$  EA X 4 = 503 ft<sup>3</sup>

10.) TURB. L.O. RESEVOIR (REF 2)

APPROX. AS 10' DIA X 37' = 2906 ft<sup>3</sup>

11.) L.O. COOLERS (2) (REF 2 & 5)

APPROX. AS 3' DIA X 30' =  $212 \text{ ft}^3$  EA X 2 = 424 ft<sup>3</sup>

STONE & WEBSTER ENGINEERING CORPORATION  
CALCULATION SHEET

▲ 5010.65

CALCULATION IDENTIFICATION NUMBER				PAGE <u>8</u>
J.O. OR W.O. NO. 12846 44	DIVISION & GROUP	CALCULATION NO. <u>PE-049-0</u>	OPTIONAL TASK CODE	
1	12) BEARING COOLING WATER HEAD TANK (REF 2:8)	APPROX AS 6' DIA X 15' = 424 ft <sup>3</sup>		
2	13) DEHYDRATORS (2) (REF 3:8)			
3		APPROX AS 3.5' X 3.5' X 6' = 74 ft <sup>3</sup> EA X 2 = 148 ft <sup>3</sup>		
4				
5	14) REHEATER DRAIN RECEIVERS (4) (REF 2:8)			
6		APPROX AS 7' DIA X 11' = 216 ft <sup>3</sup> EA X 4 = 864 ft <sup>3</sup>		Total 786 ft <sup>3</sup>
7		3 @ 5' dia and 1 @ 4' dia.		
8	15) FLASH EVAPORATOR (REF 2:8)			
9		APPROX AS 30' X 2' X 13' = 2730 ft <sup>3</sup>		
10				
11	16) 6" PT. HEATER DRAIN RECEIVER (2) (REF 3:6)			
12		APPROX AS 5' DIA X 22' = 138 ft <sup>3</sup> EA X 2 = 276 ft <sup>3</sup>		
13		482 ft <sup>3</sup> EA X 2 = 864 ft <sup>3</sup>		
14	17) SERVICE WATER PUMPS (2) (REF 3:6)			
15		APPROX AS 6.5' X 3' X 4' = 78 ft <sup>3</sup> EA X 2 = 156 ft <sup>3</sup>		
16				
17	18) CONDENSATE PUMPS (3) (REF 3:6)			
18		APPROX AS 4' DIA X 13' = 163 ft <sup>3</sup> EA, X 3 = 490 ft <sup>3</sup>		
19				
20	19) CHILLED WATER TANK (REF 2:6)			
21		APPROX AS 8' DIA X 13' = 654 ft <sup>3</sup>		
22		120 ft <sup>3</sup> should be included for connections between tank & condenser.		
23	20) CHILLED WATER CONDENSER (REF 2:6)			
24		APPROX AS 6' DIA X 20' = 566 ft <sup>3</sup>		
25		4' dia 251 ft <sup>3</sup>		
26	21) RECYCLE PUMPS (2) (REF 3:8)			Not included since below 75' level.
27		APPROX AS 9' X 5.5' X 5.5' = 272 ft <sup>3</sup> EA X 2 = 544 ft <sup>3</sup>		
28				
29	22) FUTURE FILTERS (3) (REF 3:8)			
30		APPROX AS 9' DIA X 11' = 670 ft <sup>3</sup> EA X 3 = 2010 ft <sup>3</sup>		
31		700 ft <sup>3</sup> EA. 2100 ft <sup>3</sup>		
32	23) MAKEUP PUMP HEAD TANK (REF 3:7)			
33		APPROX AS 6' DIA X 11' = 104 ft <sup>3</sup>		
34		311 ft <sup>3</sup>		
35	24) CHILLED WATER CIRC. PUMPS (2) (REF 3:7)			
36		APPROX AS 2.5' X 4' X 6' = 60 ft <sup>3</sup> EA X 2 = 120 ft <sup>3</sup>		
37				
38	25) FLASH EVAPORATOR DEMINERIZER (REF 3:6)			
39		APPROX AS 5' DIA X 10' = 196 ft <sup>3</sup>		
40				
41	26) AIR EJECTORS AND CONDENSORS (2) (REF 2:6)			
42		APPROX AS 3' DIA X 8' = 57 ft <sup>3</sup> EA X 2 = 114 ft <sup>3</sup>		
43				
44				
45				
46				





STONE & WEBSTER ENGINEERING CORPORATION  
**CALCULATION SHEET**

▲ 5010.65

CALCULATION IDENTIFICATION NUMBER				PAGE <u>10</u>
J.O. OR W.O. NO. <u>12846.44</u>	DIVISION & GROUP	CALCULATION NO. <u>PE-044-0</u>	OPTIONAL TASK CODE	

PIPING VOLUMES:

NOTE: DUE TO THE SIMILARITY OF PIPING SYSTEMS AND ARRANGEMENTS IN BOTH UNIT #1 & 2 TURBINE BUILDING AREAS AND THE USE OF APPROXIMATIONS FOR THESE VALUES IT IS ASSUMED THE ESTIMATED PIPING VOLUME CALCULATED BELOW IS THE SAME FOR BOTH AREAS UNLESS OTHERWISE NOTED, THOUGH NOT STRICTLY CORRECT THIS ASSUMPTION WILL HAVE INSIGNIFICANT EFFECTS ON THE RESULTS OBTAINED.

AREA BELOW OPERATING LEVEL (NODES 1 & 3)

1. STEAM GENERATOR FEEDWATER LINES (REF 20, 21)

a) 18" DIA PIPE WITH ASSUMED 4" LAGGING = 26" DIA  
 ESTIMATED 235' LENGTH

VOLUME =  $(1.08')^2 \pi (235')$  = 866 ft<sup>3</sup>

b) 14" DIA PIPE WITH ASSUMED 4" LAGGING = 22" DIA  
 ESTIMATED 50' LENGTH

VOLUME =  $(0.917')^2 \pi (50')$  = 132 ft<sup>3</sup>

c) 12" DIA PIPE WITH ASSUMED 4" LAGGING = 20" DIA  
 ESTIMATED 197' LENGTH

VOLUME =  $(0.83')^2 \pi (197')$  = 430 ft<sup>3</sup>

2. MAIN STEAM LINES (REF 22)

a) 36" DIA MANIFOLD WITH ASSUMED 4" LAGGING = 44" DIA  
 ESTIMATED 26.5' LENGTH

VOLUME =  $(1.83')^2 \pi (26.5')$  = 280 ft<sup>3</sup>

b) 30" DIA PIPE WITH ASSUMED 4" LAGGING = 38" DIA  
 ESTIMATED 130.5' LENGTH

VOLUME =  $(1.58')^2 \pi (130.5')$  = 1024 ft<sup>3</sup>

c) 28" PIPE WITH ASSUMED 4" LAGGING = 36" DIA  
 ESTIMATED 452' LENGTH

VOLUME =  $(1.5')^2 \pi (452')$  = 3195 ft<sup>3</sup>

d) 14" PIPE WITH ASSUMED 4" LAGGING = 22" DIA (REF 46)  
 ESTIMATED 203' LENGTH

VOLUME =  $(0.917')^2 \pi (203')$  = 536 ft<sup>3</sup>

e) 12" PIPE WITH ASSUMED 4" LAGGING = 20" DIA (REF 46)  
 ESTIMATED 133'

VOLUME =  $(0.83')^2 \pi (133')$  = 290 ft<sup>3</sup>

Checker's Note: Piping Lengths + Volumes are not exact calculations but since they are a small contribution to the overall volume the estimates are acceptable.

STONE & WEBSTER ENGINEERING CORPORATION  
CALCULATION SHEET

▲ 5010.65

CALCULATION IDENTIFICATION NUMBER				PAGE <u>11</u>
J.O. OR W.O. NO.	DIVISION & GROUP	CALCULATION NO.	OPTIONAL TASK CODE	
12846.44		PE-049-0		
1 2 3 4 5 6 7 8 9 10 11 12 13 14 15 16 17 18 19 20 21 22 23 24 25 26 27 28 29 30 31 32 33 34 35 36 37 38 39 40 41 42 43 44 45 46	<p>3. <u>COOLING WATER SYSTEM</u> (REF 33)</p> <p>a) 20" DIA PIPING WITH EST. 722' LENGTH  <math>VOLUME = (0.83')^2 \pi (722') = 1575 ft^3</math></p> <p>b) 16" DIA PIPING WITH EST. 75' LENGTH  <math>VOLUME = (0.66')^2 \pi (75') = 105 ft^3</math></p> <p>4. <u>1ST &amp; 2ND POINT EXTRACTION STEAM LINES</u> (REF 34)</p> <p>a) 18" DIA PIPING WITH ASSUMED 3" LAGGING AND EST. 156' LENGTH  <math>VOLUME = (1')^2 \pi (156') = 490 ft^3</math></p> <p>b) 20" DIA PIPING WITH ASSUMED 3" LAGGING AND EST 45' LENGTH  <math>VOLUME = (1.08')^2 \pi (45') = 166 ft^3</math></p> <p>5. <u>3RD &amp; 4TH POINT EXTRACTION STEAM LINES</u> (REF 35)</p> <p>a) 24" DIA PIPING WITH ASSUMED 3" LAGGING AND EST. 113' LENGTH  <math>VOLUME = (1.25')^2 \pi (113') = 653 ft^3</math></p> <p>b) 18" DIA PIPING WITH ASSUMED 3" LAGGING AND EST. 219' LENGTH  <math>VOLUME = (1')^2 \pi (219') = 688 ft^3</math></p> <p>c) 20" DIA PIPING WITH ASSUMED 3" LAGGING AND EST 70' LENGTH  <math>VOLUME = (1.08')^2 \pi (70') = 258 ft^3</math></p> <p>6. <u>5TH &amp; 6TH POINT EXTRACTION STEAM LINES</u> (REF 36)</p> <p>a) 24" PIPING WITH ASSUMED 3" LAGGING AND EST. 176' LENGTH  <math>VOLUME = (1.25')^2 \pi (176') = 864 ft^3</math></p> <p>b) 30" PIPING WITH ASSUMED 3" LAGGING AND EST 20' LENGTH  <math>VOLUME = (1.5')^2 \pi (20') = 141 ft^3</math></p> <p>c) 26" PIPING WITH ASSUMED 3" LAGGING AND EST 46' LENGTH  <math>VOLUME = (1.33')^2 \pi (46') = 240 ft^3</math></p> <p>d) 36" PIPING WITH ASSUME 3" LAGGING AND EST 26' LENGTH  <math>VOLUME = (1.75')^2 \pi (26') = 250 ft^3</math></p> <p>7. <u>AUXILIARY STEAM LINES</u> (REF 37)</p> <p>a) 12" PIPING WITH ASSUMED 2" LAGGING AND EST. 368' LENGTH  <math>VOLUME = (0.66')^2 \pi (368') = 514 ft^3</math></p> <p>8. <u>CONDENSATE PIPING</u> (REF 38)</p> <p>a) 30" PIPING WITH EST. 176' LENGTH, VOL. = <math>(1.25')^2 \pi (176') = 864 ft^3</math></p> <p>b) 18" PIPING WITH EST. 670' LENGTH, VOL. = <math>(0.75')^2 \pi (670') = 1184 ft^3</math></p> <p>c) 24" PIPING WITH EST. 335' LENGTH, VOL. = <math>(1')^2 \pi (335') = 1052 ft^3</math></p> <p><u>TOTAL PIPING VOLUME</u> = <math>864 ft^3 + 132 ft^3 + 430 ft^3 + 280 ft^3 + 1024 ft^3 + 3195 ft^3</math>  <math>+ 536 ft^3 + 290 ft^3 + 1575 ft^3 + 105 ft^3 + 490 ft^3 + 166 ft^3 + 653 ft^3 + 258 ft^3</math>  <math>+ 864 ft^3 + 141 ft^3 + 240 ft^3 + 250 ft^3 + 514 ft^3 + 864 ft^3 + 1184 ft^3 + 1052 ft^3</math>  <math>= 15109 ft^3</math>  <math>15414 ft^3</math></p>			

STONE & WEBSTER ENGINEERING CORPORATION  
CALCULATION SHEET

▲ 5010.65

CALCULATION IDENTIFICATION NUMBER				PAGE <u>12</u>
J.O. OR W.O. NO.	DIVISION & GROUP	CALCULATION NO.	OPTIONAL TASK CODE	
<u>12846.44</u>		<u>PEC44-0</u>		

JUNCTIONS:

PAGE 4 OF THIS CALCULATION DENOTES BY DIAGRAM THE JUNCTIONS USED AND DEPICTS THE LOCATION OF VERTICAL JUNCTIONS THROUGH THE OPERATING FLOOR TO NODES 1 & 3 FROM NODE 2 BY THE CROSS-HATCHED AREAS. IT IS NOTED THAT OPENINGS IN THE FLOOR BENEATH THE MOISTURE SEPARATORS EXIST, HOWEVER REF. 19 SHOWS THAT THESE OPENINGS ARE ESSENTIALLY BLOCKED BY THE COMPONENT AND ITS FOUNDATION AND SO IS NOT CONSIDERED AS SIGNIFICANT. THE CONSERVATIVE ASSUMPTION IS MADE THAT ALL OPENINGS, ACCESSES AND DOORS THROUGH THE FIRE WALL AS WELL AS TO THE SERVICE BUILDING OR EXITS FROM THE STRUCTURE ARE CLOSED OR SEALED SUCH THAT THERE ARE NO EFFECTIVE VENT PATHS FROM THE BUILDING VIA THESE MEANS. IT IS FURTHER ASSUMED THAT THE SASHES DEPICTED ON REF. 24, 25 & 30 ARE INTACT AND CLOSED AS WELL. THE LOUVERED OPENINGS WITH DAMPERS SHOWN ON REF 25 ARE CONSIDERED TO BE OPEN FULLY AND ALL LOUVERS ARE ASSUMED TO BE INTACT AND NOT BLOCKED AS SHOWN ON REF 24, 25 AND 30. THE AREA OPENINGS DESIGNATED AS "HOIST AREA" AT THE OPERATING PLATFORM ARE ASSUMED TO BE CLEAR, ALL OTHER AREAS, WITH THE EXCEPTION OF STAIRWELLS, HAVE 1 1/2" GRATING AS SHOWN ON REF 28 & 29.

THE VERTICAL VENT AREAS THROUGH THE OPERATING FLOOR ARE DIVIDED INTO 6 JUNCTIONS BY "TYPE", SIMILAR TYPE OPENINGS BEING TREATED AS THE SAME JUNCTION IN THE MANNER OF PARALLEL NETWORK FLOW PATHS DESCRIBED BY FIG. 19.3 OF REF. 32. THERE ARE 3 "TYPES" CONSIDERED, OPENINGS WITH 1 1/2" GRATING, CLEAR OPENINGS AND STAIRWELLS, THE JUNCTION DESIGNATION FOR EACH OPENING DEPICTED ON PAGE 4, COMBINING THESE AREAS IN THIS MANNER WHILE NOT STRICTLY CORRECT WILL HAVE INSIGNIFICANT EFFECT ON THE RESULTS

THE LOUVERED OPENINGS SHOWN ON REF 25 FROM THE AIR INTAKE PIT TO NODES 1 & 3 ARE COMBINED IN THE SAME MANNER FOR A SINGLE JUNCTION TO EACH NODE. THE LOUVERED OPENING WITH DIMENSIONS OF 7'0" X 2.5' SHOWN ON REF 24 IS CONSIDERED INSIGNIFICANT DUE TO ITS SMALL SIZE AND REMOTE LOCATION FROM THE BREAK AND IS NOT CONSIDERED.

CALCULATIONS OF INERTIA AND MOMENTUM UTILIZE THE NODAL CROSS SECTIONAL FLOW AREA AS THE GROSS AREA PERPENDICULAR TO FLOW DIRECTION, THAT IS COMPONENT AREAS ARE NOT DEDUCTED FROM THIS VALUE. THIS METHOD WOULD NOT SIGNIFICANTLY AFFECT RESULTS AND IT IS CONSERVATIVE FOR TEMPERATURE CONCERNS IN THE BREAK NODE.

THE USE OF THE TERM NODE (a) TO NODE (b) WHEN EVALUATING A JUNCTION DESCRIBES THE ARBITRARILY DETERMINED DIRECTION OF FORWARD FLOW LOSS COEFFICIENT.

STONE & WEBSTER ENGINEERING CORPORATION  
**CALCULATION SHEET**

▲ 5010.65

CALCULATION IDENTIFICATION NUMBER			
J.O. OR W.O. NO. 12846.44	DIVISION & GROUP	CALCULATION NO. <b>PE-049-0</b>	OPTIONAL TASK CODE
			PAGE <u>13</u>

NODAL GEOMETRY

THE FOLLOWING DIMENSIONS ARE USED AS THE VALUES OF LENGTH (L), WIDTH (W) AND HEIGHT (h) FOR THE NODES.

NODE 1 : L = 270' ; W = 135' ; h = 48'3"

NODE 2 : L = 540' ; W = 135' ; h = 69'11"

NODE 3 : L = 270' ; W = 135' ; h = 48'3"

JUNCTION #1 NODE 1 TO NODE 2 (REF 9 & 28)

THE AREAS COMPOSING THIS JUNCTION ARE DIMENSIONED AS FOLLOWS :

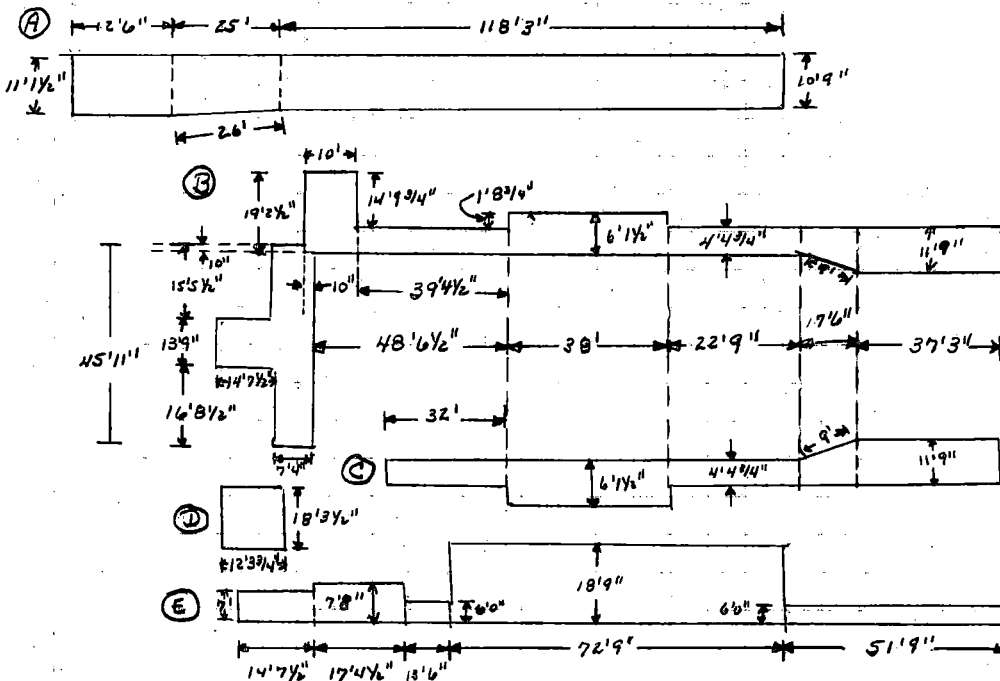

AREA A =  $(11'1 1/2" \times 12'6") + (118'3" \times 10'9") + [(25' \times 10'9") + \frac{1}{2}(4'5")(25')] = 1684 \text{ ft}^2$

AREA B =  $(13'9" \times 14'7 1/2") + (7'4" \times 45'11") + (10'1" \times 14'9 3/4") + (48'6 1/2" \times 4'4 3/4") + (6'1 1/2" \times 38') + (22'9" \times 4'4 3/4") + (7'6" \times 4'4 3/4") + [\frac{1}{2}(7'6')(7'4 1/4")] + (11'9" \times 37'3") = 1758 \text{ ft}^2$

AREA C =  $(11'9" \times 37'3") + [\frac{1}{2}(7'6')(7'4 1/4")] + (7'6" \times 4'4 3/4") + (22'9" \times 4'4 3/4") + (6'1 1/2" \times 38') + (32' \times 4'4 3/4") = 999 \text{ ft}^2$

AREA D =  $(18'3 1/2") \times (12'3 3/4") = 225 \text{ ft}^2$

AREA E =  $(7'8" \times 17'4 1/2") + (7'8" \times 17'4 1/2") + (6' \times 13'6") + (18'9" \times 72'9") + (6'0" \times 51'9") = 2012 \text{ ft}^2$

(NOTE: THE AREA OF THIS OPENING ACTUALLY EXTENDS SLIGHTLY BEYOND THE "B" LINE, HOWEVER THIS DIFFERENCE IS CONSIDERED INSIGNIFICANT AND THIS SMALLER AREA IN ANY EVENT IS CONSERVATIVE.)

THE EFFECTIVE OPENING AREA IS REDUCED BY THE PRESENCE OF THE GRATING, DISCUSSED BELOW.

THE GRATING ACROSS ALL OPENINGS IS ASSUMED TO BE BAR TYPE WITH CELL DIMENSIONS AS FOLLOWS (NOTE: THE GRATING THICKNESS OF 1 1/2" OF REF 28 IS TYPICAL OF ALL GRATING ON THE OPERATING FLOOR) REF 27, PAGE 5

STONE & WEBSTER ENGINEERING CORPORATION  
CALCULATION SHEET

▲ 5010.65

CALCULATION IDENTIFICATION NUMBER				PAGE <u>14</u>
J.O. OR W.O. NO. 12844.44	DIVISION & GROUP	CALCULATION NO. PE-049-0	OPTIONAL TASK CODE	

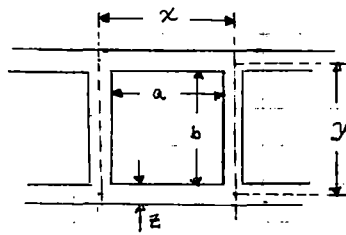

$z = 3/16''$   
 $a = 1''$   
 $b = 3 3/16''$

$\Pi$  (WETTED PERIMETER) =  $2x + 2y = 10.375$   
 $l = 1.5''$  (GRATING THICKNESS)

$\therefore x = a + z = 1 1/16''$   
 $y = b + z = 4''$

$\bar{f} = \frac{(ab)}{(xy)} = 0.80263$  FOR A GRATING NETWORK WITH THIS CELL DIMENSIONS

from p 330 REF 39 FOR BAR GRATING OF TYPE 1, 90° ANGLE TO STREAM FOR ANY  $\frac{l}{d_n}$  (EQUAT. 6)

$C = \rho_2 C' \sin \theta$  where  $\rho_2 = 1.0$  for bar type 1 and  $\sin 90^\circ = 1$

then  $C = C'$

$d_h = \frac{4f_0}{\Pi}$  (REF 39, P 324) where  $f_0 = \text{ORIFICE AREA} = ab = 3.8125$   
 $= \frac{4(3.8125)}{10.375} = 1.47$

$\frac{l}{d_h} = \frac{1.5}{1.47} = 1.02$

$C$  from diagram 8-4 of SAME REF (P 325) for  $l/d_h$  of 1.0 and  $\bar{f}$  of 0.8 IS 0.29 WHICH CLOSELY APPROXIMATES THE VALUES OF  $l/d_h$  &  $\bar{f}$  OBTAINED HERE. THIS IS EVALUATED IN TERMS OF UPSTREAM FLOW ( $w_1$ ) HOWEVER AND MUST BE CONVERTED AS FOLLOWS TO THE FLOW AREA OF THE GRATING FOR PURPOSES OF CONSISTENCY.

$C_{gr} = C(\bar{f})^2$  (REF 40, P. 2-10, EQUAT. 2-5)

$C_{gr} = 0.29(0.80263)^2$

$C_{gr} = 0.188$  WHICH WILL BE ROUNDED TO  $= 0.2$

$(C_{gr}$  WILL BE USED TO IDENTIFY THE LOSS COEFFICIENT ATTRIBUTED TO THE GRATING NETWORK THROUGHOUT THIS CALCULATION). FURTHER IT IS ASKED THAT THE GRATING OCCUPIES  $\approx 20\%$  OF THE OPENING AREA, THUS EACH OPENING IS REDUCED BY THIS AMOUNT.

THE EFFECTS OF THE FRICTION COEFFICIENT FOR FLOW ACROSS THE NODES IS DETERMINED BY EVALUATING THE LOSS IMPOSED BY WALL FRICTION ONLY FROM THE CENTROID OF THE NODE TO THE JUNCTION UTILIZING THE EXPRESSION FOUND ON PAGE 30 OF REF 39, PARAGRAPH 10.0.0.0.0.

$K_{fr} = 2 \frac{l}{d_n}$

BECAUSE ALL NODES ARE OF REGULAR GEOMETRIC SHAPE, THE CENTROID OF EACH NODE WILL  $= 1/2$  THE VALUE OF THE DIMENSION OF THE NODE IN THE DIRECTION OF FLOW, THAT IS THE CENTROID OF NODE 1 RELATIVE TO FLOW THEN JUNCTION #1  $= 1/2 h$  OF NODE 1 AND THE CENTROID OF NODE 2 RELATIVE TO FLOW THROUGH JUNCTION 1 IS  $1/2 h$  OF NODE 2, ETC. THE CROSS SECTIONAL AREA OF FLOW IS TAKEN AT A PLANE

STONE & WEBSTER ENGINEERING CORPORATION  
CALCULATION SHEET

▲ 5010.65

CALCULATION IDENTIFICATION NUMBER				PAGE <u>15</u>
J.O. OR W.O. NO.	DIVISION & GROUP	CALCULATION NO.	OPTIONAL TASK CODE	
12846, 44		PE-049-0		

PERPENDICULAR TO THE DIRECTION OF FLOW AT THE CENTROID, WHICH FOR FLOW THROUGH JUNCTION 1 IN NODE 1 WILL BE W X L OF NODE 1, ETC  
THUS  $D_h$  OF THE EXPRESSION FOR FLOW FROM NODE 1 THROUGH JUNCTION 1 WILL =  $\frac{4 \times \text{HYDRAULIC DIAMETER}}{\text{PERIMETER OF THE FLOW AREA}}$  OR

$$D_h = \frac{4(W)(L)}{(2W) + (2L)} = \frac{4(135')(270')}{(2(135') + 2(270'))} = 180 \text{ ft} \quad (\text{LINE 4, P 13})$$

$l$  OF THE EXPRESSION IS THE FLOW LENGTH, OR THE LENGTH FROM THE CENTROID TO THE JUNCTION. FOR THIS NODE

$$l = \frac{1}{2} h \text{ of NODE 1} \\ = \frac{1}{2} (48' 3") \quad (\text{LINE 4, P 13}) \\ = 24.125'$$

$\lambda$  (THE FRICTION COEFFICIENT) IS EVALUATED AS SHOWN ON P 72 OF REF 39 FORMULA 1. WHERE  $\lambda = \frac{1}{(2.3 \log \frac{3.7}{\frac{\Delta}{D}})^2}$

$$\frac{\Delta}{D_h} = \frac{\Delta}{D_h} \text{ IN MM (P 54, REF 39), WHICH WHEN CONVERTED TO INCHES}$$

WOULD =  $\frac{\Delta(0.03937)}{D_h(12)}$  WHERE  $\Delta$  IS THE MEAN ROUGHNESS PEAKS FOR THE MATERIAL SURFACE. IT IS ASSUMED THAT THE MATERIAL ROUGHNESS PEAKS OF ALL WALLS WOULD BE NO GREATER THAN THE ESTIMATE GIVEN FOR AVERAGE CONDITION CONCRETE ON P 63 OF REF 39 WHICH = 2.5 MM. THIS MATERIAL IS CHOSEN AS MOST OF THE FINE WALL IN NODE 1 IS CONCRETE, AND THOUGH THE OUTSIDE WALLS ARE OF METAL, THE USE OF 2.5 FOR ROUGHNESS WOULD BE CONSERVATIVE AS APPLIED TO ALL SURFACES.

$$\text{thus, } \frac{\Delta}{D_h} = \frac{2.5(0.03937)}{180(12)} = 0.00045$$

$$\lambda = \frac{1}{(2.3 \log \frac{3.7}{\frac{\Delta}{D}})^2} = 0.01$$

$$\therefore f_{fr} = \lambda \frac{l}{D_h} = \frac{0.01(24.125')}{180 \text{ ft}} = 0.0014 \quad \text{FOR NODE 1 FLOW THROUGH JUNCTION 1}$$

THE VALUE THEN USED WILL = 0.002

SIMILARLY THE NODAL FRICTION LOSS FROM NODE 2 THROUGH JUNCTION 1 IS EVALUATED, WHERE  $l = \frac{1}{2} h$  OF NODE 2 (LINE 5, P 13) =  $\frac{1}{2} (69' 11") = 34.96 \text{ ft}$

$$D_h = \frac{4(W)(L)}{(2W) + (2L)} = \frac{4(540')(135')}{(2(540') + 2(135'))} = 216 \text{ ft}$$

STONE & WEBSTER ENGINEERING CORPORATION  
CALCULATION SHEET

▲ 5010.85

CALCULATION IDENTIFICATION NUMBER				PAGE <u>16</u>
J.O. OR W.O. NO. 12846.44	DIVISION & GROUP	CALCULATION NO. PE-049-0	OPTIONAL TASK CODE	

$$\bar{\Delta} = \frac{\Delta (0.03937 \text{ in/mm})}{D_h (12 \text{ in/ft})} = \frac{2.5 (0.03937)}{216 (12)} = 0.000088 \text{ (THE VALUE OF } \Delta = 2.5 \text{ IS RETAINED FOR CONSERVATISM)}$$

$$\lambda = \frac{1}{(2 \log \frac{3.7}{\bar{\Delta}})^2} = 0.01005$$

$$P_{off} = 2 \left( \frac{f}{D_h} \right) = \frac{0.01 (34.96')}{216'} = 0.0016 \text{ for flow from NODE 2 TO JUNCT. \#1} \\ = 0.002$$

SINCE NODE 3 HAS THE SAME GEOMETRY AS NODE 1 AND FLOW THROUGH JUNCTIONS 2 THROUGH 6 ARE IN THE SAME DIRECTION AS THROUGH JUNCTION 1, THEN  $P_{off}$  FOR THOSE JUNCTIONS WOULD ALSO BE 0.002

EACH AREA THAT COMPOSES THIS JUNCTION WILL NOW BE EVALUATED FOR INDIVIDUAL LOSS COEFFICIENTS (K) AND INERTIA (I) AS A THICK-EDGED ORIFACE IN THE MANNER DESCRIBED ON P.137 OF REF 39, THE SLAB THICKNESS, THUS THE OPENING LENGTH ( $L_j$ ) IS 9" FOR ALL AREAS AS SHOWN ON REF 28. THE SYMBOL F IS UTILIZED TO DENOTE THE CROSS-SECTIONAL FLOW AREA AND THE SUBSCRIPTS j = JUNCTION, N(i) = NODE DESIGNATION. II IS USED TO SIGNIFY FLOW PERIMETER OF THE INLET TO THE CONTRACTING STRETCH AND SUBSCRIPTS F & R REFER TO FLOW DIRECTION THROUGH THE OPENING, RESPECTIVELY, FORWARD AND REVERSE.

AREA ①

$$L_j = 9" \text{ OR } (0.75')$$

$$F_j = 1684 \text{ ft}^2 (80\%) = 1347.2 \text{ ft}^2 \text{ (FROM LINE 30, P13)}$$

$$II = 25'11" + 12'6" + 118'3" + 10'9" + 118'3" + 26' + 12'6" = 334.375' (L12, P13)$$

$$D_h = \frac{4 F_j}{II} = \frac{4 (1347.2 \text{ ft}^2)}{334.375'} = 16.12'$$

$$\tau = f \left( \frac{L_j}{D_h} \right) = \frac{0.75'}{16.12'} = 0.0465 = 1.32 \text{ BY INTERPOLATION FROM DIAG 4-11 P137, REF 39}$$

$$\bar{\Delta} = \frac{\Delta (0.03937 \text{ in/mm})}{D_h (12 \text{ in/ft})} = \frac{2.5 (0.03937)}{16.12 (12)} = 0.000509 \text{ WHERE } \Delta = 2.5 \text{ FOR AVE. CONCRETE (P 63, REF 39)}$$

$$\lambda = \frac{1}{(2 \log \frac{3.7}{\bar{\Delta}})^2} = 0.017$$

$$F_{N1} = W \times L \text{ OF NODE 1} = 135' \times 220' = 36450 \text{ ft}^2$$

$$F_{N2} = W \times L \text{ OF NODE 2} = 135' \times 540' = 72900 \text{ ft}^2$$

FOR FORWARD FLOW

$$P_F = 0.5 \left( 1 - \frac{F_j}{F_{N1}} \right) + \left( 1 - \frac{F_j}{F_{N2}} \right)^2 + \tau \sqrt{\left( 1 - \frac{F_j}{F_{N1}} \right) \left( 1 - \frac{F_j}{F_{N2}} \right)} + \lambda \left( \frac{L_j}{D_h} \right)$$

$$P_F = 0.5 \left( 1 - \frac{1347.2 \text{ ft}^2}{36450 \text{ ft}^2} \right) + \left( 1 - \frac{1347.2 \text{ ft}^2}{72900 \text{ ft}^2} \right)^2 + 1.32 \sqrt{\left( 1 - \frac{1347.2 \text{ ft}^2}{36450 \text{ ft}^2} \right) \left( 1 - \frac{1347.2 \text{ ft}^2}{72900 \text{ ft}^2} \right)} + 0.017 \left( \frac{0.75'}{16.12'} \right) = 2.72$$

## CALCULATION SHEET

▲ 5010.65

CALCULATION IDENTIFICATION NUMBER				PAGE <u>17</u>
J.O. OR W.O. NO. 12846.44	DIVISION & GROUP	CALCULATION NO. PE-049-0	OPTIONAL TASK CODE	

1 for REVERSE flow

$$2 \quad C_{R2} = 0.5 \left( 1 - \frac{F_j}{F_{N2}} \right) + \left( 1 - \frac{F_j}{F_{N1}} \right)^2 + \sqrt{\left( 1 - \frac{F_j}{F_{N2}} \right) \left( 1 - \frac{F_j}{F_{N1}} \right)} + 2 \left( \frac{L_j}{D_k} \right)$$

$$3 \quad = 0.5 \left( 1 - \frac{1347.2 \text{ ft}^2}{72900 \text{ ft}^2} \right) + \left( 1 - \frac{1347.2 \text{ ft}^2}{36450 \text{ ft}^2} \right)^2 + 1.32 \sqrt{\left( 1 - \frac{1347.2 \text{ ft}^2}{72900 \text{ ft}^2} \right) \left( 1 - \frac{1347.2 \text{ ft}^2}{36450 \text{ ft}^2} \right)} + 0.017 \left( \frac{6.75'}{16.12'} \right) = \underline{2.68}$$

8 THE MOMENTUM FLUX TERM ( $K'$ ) IS EVALUATED AS DESCRIBED IN REF. 32.

9 FOR FORWARD FLOW

$$10 \quad K'_F = \left( \frac{F_j}{F_{N2}} \right)^2 - \left( \frac{F_j}{F_{N1}} \right)^2 = \left( \frac{1347.2 \text{ ft}^2}{72900 \text{ ft}^2} \right)^2 - \left( \frac{1347.2 \text{ ft}^2}{36450 \text{ ft}^2} \right)^2 = -0.001$$

12 FOR REVERSE FLOW

$$13 \quad K'_R = \left( \frac{F_j}{F_{N1}} \right)^2 - \left( \frac{F_j}{F_{N2}} \right)^2 = \left( \frac{1347.2 \text{ ft}^2}{36450 \text{ ft}^2} \right)^2 - \left( \frac{1347.2 \text{ ft}^2}{72900 \text{ ft}^2} \right)^2 = 0.001$$

15 THUS THE TOTAL LOSS COEFFICIENT ( $K$ ) FOR AREA ④ IS

16 FOR FORWARD FLOW

$$17 \quad K_F = C_{F2} + C_{F1} + C_{FN} + K'_F = 2.172 + 0.002 + 0.2 + (-0.001) = \underline{2.92}$$

18 FOR REVERSE FLOW

$$19 \quad K_R = C_{R2} + C_{R1} + C_{FN} + K'_R = 2.68 + 0.002 + 0.2 + 0.001 = \underline{2.88}$$

21 THE INERTIA TERM ( $I$ ) IS EVALUATED AS DESCRIBED IN REF 32.

$$22 \quad I = L_j \left( \frac{1}{F_j} \right) + L_{N1} \left( \frac{1}{F_{N1}} \right) + L_{N2} \left( \frac{1}{F_{N2}} \right) \quad \text{WHERE } L_{N1}, \text{ AND } L_{N2} \text{ IS THE}$$

25 flow length from the centroid of the node to the inlet of the junction, assumed  
26 to be  $\frac{1}{2} R$  in this case for those nodes, thus.

$$27 \quad L_{N1} = \frac{1}{2} (R_{N1}) = \frac{1}{2} (48'3") = 24.125'$$

$$28 \quad L_{N2} = \frac{1}{2} (R_{N2}) = \frac{1}{2} (69'11") = 34.958'$$

$$30 \quad \therefore I = 0.75' \left( \frac{1}{1347.2 \text{ ft}^2} \right) + 24.125' \left( \frac{1}{36450 \text{ ft}^2} \right) + 34.958' \left( \frac{1}{72900 \text{ ft}^2} \right) = 0.001698 \text{ ft}^{-1}$$

33 THE MINIMUM VALUE OF  $I$  THAT MAY BE USED AS INPUT TO THE 'THREE'  
34 SUBCOMPARTMENT ANALYSIS IS  $0.01 \text{ ft}^{-1}$ . AS DEMONSTRATED BY THIS CALCULATION  
35 FOR FLOWS THROUGH OPENINGS IN THE OPERATING DUE TO THE LARGE NORMAL  
36 FLOW AREAS AS COMPARED TO FLOW LENGTHS AND THE RELATIVELY SHORT FLOW  
37 LENGTH THROUGH THE OPENINGS AS COMPARED TO THE OPENING AREA, IT IS  
38 EVIDENT THAT ALL VALUES OF  $I$  FOR THESE OPENINGS WILL DEFAULT TO THE  
39 MINIMUM INPUT VALUE. FROM THIS OBSERVATION, NO FURTHER CALCULATION  
40 FOR THE INERTIA TERM WILL BE PERFORMED FOR THE OTHER OPENINGS IN  
41 THIS AREA AND THE VALUE OF  $I$  FOR THIS JUNCTION IS SET TO EQUAL  $0.01 \text{ ft}^{-1}$



STONE & WEBSTER ENGINEERING CORPORATION  
CALCULATION SHEET

▲ 5010.65

CALCULATION IDENTIFICATION NUMBER				PAGE <u>18</u>
J.O. OR W.O. NO. 12846.44	DIVISION & GROUP	CALCULATION NO. <b>PE-044-0</b>	OPTIONAL TASK CODE	

1 THE REMAINING AREAS ARE EVALUATED IN THE SAME MANNER AS USED FOR  
2 AREA A. AS NOTED BEFORE, THE VALUES OF  $C_{gr}$ ,  $C_{fr}$  AND  $I$  ARE THE  
3 SAME FOR ALL AREAS. SIMILARLY, THE VALUES OF  $L_j$ ,  $F_{N1}$ ,  $F_{N2}$  AND  $\Delta$   
4 ARE THE SAME AS THAT USED IN AREA A FOR THE REMAINING AREAS

5  
6 AREA B.  $L_j = 0.75'$   
7  $E_j = 1758 \text{ ft}^2 (80\%) = 1406.4 \text{ ft}^2$  (LINE 32, p 13)  
8  $\Pi = 14'7\frac{1}{2}" + 15'5\frac{1}{2}" + 6'6" + 19'2\frac{1}{2}" + 10' + 14'9\frac{3}{4}" + 39'4\frac{1}{2}" + 1'8\frac{3}{4}" + 38'$   
9  $+ 1'8\frac{3}{4}" + 22'9" + 7'6" + 37'3" + 11'9" + 37'3" + 9' + 22'9" + 38' +$   
10  $48'6\frac{1}{2}" + 45'11" + 7'4" + 16'8\frac{1}{2}" + 14'7\frac{1}{2}" + 13'9" = 494.56'$  (LINE 17, p 13)

11  $DK = \frac{4E_j}{\Pi} = \frac{4(1406.4 \text{ ft}^2)}{494.56'} = 11.38'$

12  
13  $r = f\left(\frac{L_j}{DK}\right) = \frac{0.75'}{11.38'} = 0.066 = 1.31$  by INTERPOLATION DIAG 4-11, p 137, REF 39

14  
15  $\bar{\Delta} = \frac{\Delta(0.03937 \text{ in/mm})}{DK (12 \text{ in/ft})} = \frac{0.5(0.03937)}{11.38(12)} = 0.006721$

16  
17  
18  $a = \frac{1}{(2 \log \frac{3.7}{\bar{\Delta}})^2} = 0.018$

19  
20  
21  $C_{PF} = 0.5 \left(1 - \frac{E_j}{F_{N1}}\right) + \left(1 - \frac{E_j}{F_{N2}}\right)^2 + r \sqrt{\left(1 - \frac{E_j}{F_{N1}}\right) \left(1 - \frac{E_j}{F_{N2}}\right)} + a \left(\frac{L_j}{DK}\right)$   
22  
23  
24  $= 0.5 \left(1 - \frac{1406.4 \text{ ft}^2}{36450 \text{ ft}^2}\right) + \left(1 - \frac{1406.4 \text{ ft}^2}{72900 \text{ ft}^2}\right)^2 + 1.31 \sqrt{\left(1 - \frac{1406.4 \text{ ft}^2}{36450 \text{ ft}^2}\right) \left(1 - \frac{1406.4 \text{ ft}^2}{72900 \text{ ft}^2}\right)} + 0.018 \left(\frac{0.75'}{11.38'}\right) = 2.70$

25  
26  
27  $C_{PR} = 0.5 \left(1 - \frac{E_j}{F_{N2}}\right) + \left(1 - \frac{E_j}{F_{N1}}\right)^2 + r \sqrt{\left(1 - \frac{E_j}{F_{N2}}\right) \left(1 - \frac{E_j}{F_{N1}}\right)} + a \left(\frac{L_j}{DK}\right)$   
28  
29  
30  $= 0.5 \left(1 - \frac{1406.4 \text{ ft}^2}{72900 \text{ ft}^2}\right) + \left(1 - \frac{1406.4 \text{ ft}^2}{36450 \text{ ft}^2}\right)^2 + 1.31 \sqrt{\left(1 - \frac{1406.4 \text{ ft}^2}{72900 \text{ ft}^2}\right) \left(1 - \frac{1406.4 \text{ ft}^2}{36450 \text{ ft}^2}\right)} + 0.018 \left(\frac{0.75'}{11.38'}\right) = 2.66$

31  
32  
33  $K'_F = \left(\frac{E_j}{F_{N2}}\right)^2 - \left(\frac{E_j}{F_{N1}}\right)^2 = \left(\frac{1406.4 \text{ ft}^2}{72900 \text{ ft}^2}\right)^2 - \left(\frac{1406.4 \text{ ft}^2}{36450 \text{ ft}^2}\right)^2 = -0.00112$

34  
35  
36  $K'_R = \left(\frac{E_j}{F_{N1}}\right)^2 - \left(\frac{E_j}{F_{N2}}\right)^2 = \left(\frac{1406.4 \text{ ft}^2}{36450 \text{ ft}^2}\right)^2 - \left(\frac{1406.4 \text{ ft}^2}{72900 \text{ ft}^2}\right)^2 = +0.00112$

37  
38  $C_{gr} = 0.2$   
39  $C_{fr} = 0.002$   
40

41  $K_F = K'_F + C_{PF} + C_{fr} + C_{gr} = (-0.00112) + 2.70 + 0.002 + 0.2 = 2.90$

42  
43  $K_R = K'_R + C_{PR} + C_{fr} + C_{gr} = 0.00112 + 2.66 + 0.002 + 0.2 = 2.86$

44  
45  $I = 0.01 \text{ ft}^{-1}$   
46

STONE & WEBSTER ENGINEERING CORPORATION  
CALCULATION SHEET

▲ 5010.65

CALCULATION IDENTIFICATION NUMBER				PAGE <u>19</u>
J.O. OR W.O. NO. 12846.44	DIVISION & GROUP	CALCULATION NO. <u>PE-049-0</u>	OPTIONAL TASK CODE	

1  
2  
3  
4  
5  
6  
7  
8  
9  
10  
11  
12  
13  
14  
15  
16  
17  
18  
19  
20  
21  
22  
23  
24  
25  
26  
27  
28  
29  
30  
31  
32  
33  
34  
35  
36  
37  
38  
39  
40  
41  
42  
43  
44  
45  
46

AREA C

$$L_j = 0.75'$$

$$F_j = 999 \text{ ft}^2 (80\%) = 799.2 \text{ ft}^2 \quad (\text{LINE 34, P 13})$$

$$II = 32' + 38' + 22'9'' + 9' + 37'3'' + 11'9'' + 37'3'' + 7'6'' + 22'9'' + 38' + 1'8\frac{3}{4}'' + 1'8\frac{3}{4}'' + 32' + 4'4\frac{3}{4}'' = 296.104' \quad (\text{LINE 23, P 13})$$

$$D_k = \frac{4K_j}{II} = \frac{4(799.2 \text{ ft}^2)}{296.104'} = 10.8'$$

$$\tau = f\left(\frac{L_j}{D_k}\right) = \frac{0.75'}{10.8'} = 0.069 = 1.31 \text{ by INTERP. from DIAG H-11, P 137, REF 39}$$

$$\bar{\Delta} = \frac{\Delta (1.03937 \text{ in/mm})}{D_k (12 \text{ in/ft})} = \frac{2.5(1.03937)}{10.8'(12)} = 0.00076$$

$$z = \frac{1}{(2.3 \log \frac{3.7}{\bar{\Delta}})^2} = 0.018$$

$$C_{PF} = 0.5 \left(1 - \frac{F_{j1}}{F_{N1}}\right) + \left(1 - \frac{F_{j2}}{F_{N2}}\right)^2 + \tau \sqrt{\left(1 - \frac{F_{j1}}{F_{N1}}\right) \left(1 - \frac{F_{j2}}{F_{N2}}\right)} + z \left(\frac{L_j}{D_k}\right)$$

$$= 0.5 \left(1 - \frac{799.2 \text{ ft}^2}{36450 \text{ ft}^2}\right) + \left(1 - \frac{799.2 \text{ ft}^2}{72900 \text{ ft}^2}\right)^2 + 1.31 \sqrt{\left(1 - \frac{799.2 \text{ ft}^2}{36450 \text{ ft}^2}\right) \left(1 - \frac{799.2 \text{ ft}^2}{72900 \text{ ft}^2}\right)} + 0.018 \left(\frac{0.75'}{10.8'}\right) = \underline{2.75}$$

$$C_{PR} = 0.5 \left(1 - \frac{F_j}{F_{N2}}\right) + \left(1 - \frac{F_j}{F_{N1}}\right)^2 + \tau \sqrt{\left(1 - \frac{F_j}{F_{N2}}\right) \left(1 - \frac{F_j}{F_{N1}}\right)} + z \left(\frac{L_j}{D_k}\right)$$

$$= 0.5 \left(1 - \frac{799.2 \text{ ft}^2}{72900 \text{ ft}^2}\right) + \left(1 - \frac{799.2 \text{ ft}^2}{36450 \text{ ft}^2}\right)^2 + 1.31 \sqrt{\left(1 - \frac{799.2 \text{ ft}^2}{72900 \text{ ft}^2}\right) \left(1 - \frac{799.2 \text{ ft}^2}{36450 \text{ ft}^2}\right)} + 0.018 \left(\frac{0.75'}{10.8'}\right) = \underline{2.73}$$

$$K'_F = \left(\frac{F_j}{F_{N2}}\right)^2 - \left(\frac{F_j}{F_{N1}}\right)^2 = \left(\frac{799.2 \text{ ft}^2}{72900 \text{ ft}^2}\right)^2 - \left(\frac{799.2 \text{ ft}^2}{36450 \text{ ft}^2}\right)^2 = -0.00036$$

$$K'_R = \left(\frac{F_j}{F_{N1}}\right)^2 - \left(\frac{F_j}{F_{N2}}\right)^2 = \left(\frac{799.2 \text{ ft}^2}{36450 \text{ ft}^2}\right)^2 - \left(\frac{799.2 \text{ ft}^2}{72900 \text{ ft}^2}\right)^2 = 0.00036$$

$$C_{gr} = 0.2$$

$$C_{fr} = 0.002$$

$$K_F = C_{PF} + C_{gr} + C_{fr} + K'_F = 2.75 + 0.2 + 0.002 + (-0.00036) = \underline{2.95}$$

$$K_R = C_{PR} + C_{gr} + C_{fr} + K'_R = 2.73 + 0.2 + 0.002 + (0.00036) = \underline{2.93}$$

$$I = 0.01 \text{ ft}^{-1}$$

CALCULATION SHEET

▲ 5010.65

CALCULATION IDENTIFICATION NUMBER				PAGE <u>20</u>
J.O. OR W.O. NO.	DIVISION & GROUP	CALCULATION NO.	OPTIONAL TASK CODE	
1284644		PE-049-0		

1  
2  
3  
4  
5  
6  
7  
8  
9  
10  
11  
12  
13  
14  
15  
16  
17  
18  
19  
20  
21  
22  
23  
24  
25  
26  
27  
28  
29  
30  
31  
32  
33  
34  
35  
36  
37  
38  
39  
40  
41  
42  
43  
44  
45  
46

AREA D

$$L_j = 0.75'$$

$$F_j = 225 \text{ ft}^2 (80\%) = 180 \text{ ft}^2 \quad (\text{LINE 35, p. 13})$$

$$II = 18'3\frac{1}{2}'' + 18'3\frac{1}{2}'' + 12'3\frac{3}{4}'' + 12'3\frac{3}{4}'' = 61.21' \quad (\text{LINE 25, p. 13})$$

$$D_h = \frac{4F_j}{II} = \frac{4(180 \text{ ft}^2)}{61.21'} = 11.76'$$

$$\tau = f\left(\frac{L_j}{D_h}\right) = \left(\frac{0.75'}{11.76'}\right) = 0.0638 = 1.31 \text{ by INTERP. DIAG 4-11, P137, REF 39}$$

$$\bar{\Delta} = \frac{\Delta(0.03937 \text{ IN/MM})}{D_h(12 \text{ IN/FT})} = \frac{2.5(0.03937)}{11.76(12)} = 0.0006975$$

$$\lambda = \frac{1}{\left(2 \log \frac{3.7}{\lambda}\right)^2} = 0.018$$

$$C_F = 0.5\left(1 - \frac{F_j}{F_{N1}}\right) + \left(1 - \frac{F_j}{F_{N2}}\right)^2 + \tau \sqrt{\left(1 - \frac{F_j}{F_{N1}}\right)\left(1 - \frac{F_j}{F_{N2}}\right)} + \lambda \left(\frac{L_j}{D_h}\right)$$

$$= 0.5\left(1 - \frac{180 \text{ ft}^2}{36450 \text{ ft}^2}\right) + \left(1 - \frac{180 \text{ ft}^2}{72900 \text{ ft}^2}\right)^2 + 1.31 \sqrt{\left(1 - \frac{180 \text{ ft}^2}{36450 \text{ ft}^2}\right)\left(1 - \frac{180 \text{ ft}^2}{72900 \text{ ft}^2}\right)} + 0.018\left(\frac{0.75'}{11.76'}\right) = 2.80$$

$$C_R = 0.5\left(1 - \frac{F_j}{F_{N2}}\right) + \left(1 - \frac{F_j}{F_{N1}}\right)^2 + \tau \sqrt{\left(1 - \frac{F_j}{F_{N2}}\right)\left(1 - \frac{F_j}{F_{N1}}\right)} + \lambda \left(\frac{L_j}{D_h}\right)$$

$$0.5\left(1 - \frac{180 \text{ ft}^2}{72900 \text{ ft}^2}\right) + \left(1 - \frac{180 \text{ ft}^2}{36450 \text{ ft}^2}\right)^2 + 1.31 \sqrt{\left(1 - \frac{180 \text{ ft}^2}{72900 \text{ ft}^2}\right)\left(1 - \frac{180 \text{ ft}^2}{36450 \text{ ft}^2}\right)} + 0.018\left(\frac{0.75'}{11.76'}\right) = 2.80$$

$$K'_F = \left(\frac{F_j}{F_{N2}}\right)^2 - \left(\frac{F_j}{F_{N1}}\right)^2 = \left(\frac{180 \text{ ft}^2}{72900 \text{ ft}^2}\right)^2 - \left(\frac{180 \text{ ft}^2}{36450 \text{ ft}^2}\right)^2 = -0.000018$$

$$K'_R = \left(\frac{F_j}{F_{N1}}\right)^2 - \left(\frac{F_j}{F_{N2}}\right)^2 = \left(\frac{180 \text{ ft}^2}{36450 \text{ ft}^2}\right)^2 - \left(\frac{180 \text{ ft}^2}{72900 \text{ ft}^2}\right)^2 = 0.000018$$

$$C_{gr} = 0.2$$

$$C_{fr} = 0.002$$

$$K_F = C_F + C_{gr} + C_{fr} + K'_F = 2.80 + 0.2 + 0.002 + (-0.000018) = 3.00$$

$$K_R = C_R + C_{gr} + C_{fr} + K'_R = 2.80 + 0.2 + 0.002 + 0.000018 = 3.00$$

$$I = 0.01 \text{ ft}^{-1}$$

STONE & WEBSTER ENGINEERING CORPORATION  
CALCULATION SHEET

▲ 5010.65

CALCULATION IDENTIFICATION NUMBER				PAGE 21
J.O. OR W.O. NO.	DIVISION & GROUP	CALCULATION NO.	OPTIONAL TASK CODE	
12846.44		PE-049-0		

AREA E

$L_j = 0.75'$

$F_j = 2012 \text{ ft}^2 (80\%) = 1609.6 \text{ ft}^2$  (LINE 36, P13)

$II = 14'7\frac{1}{2}'' + 8'' + 17'4\frac{1}{2}'' + 8'' + 13'6'' + 12'9'' + 72'9'' + 12'9'' + 51'9'' + 4'0'' + 51'9'' + 72'9'' + 13'6'' + 17'4\frac{1}{2}'' + 14'7\frac{1}{2}'' + 7' = 394.5'$  (LINE 27, P13)

$D_k = \frac{4(L_j)}{II} = \frac{4(1609.6 \text{ ft}^2)}{394.5'} = 16.32'$  378.54

$\tau = f\left(\frac{L_j}{D_k}\right) = \frac{0.75'}{16.32'} = 0.046 = 1.32$  by INTER. from DIAG N-11, P137, REF 39

$\bar{\Delta} = \frac{\Delta (0.3937 \text{ in/mm})}{D_k (12 \text{ in/ft})} = \frac{2.5 (0.3937)}{16.32' (12)} = 0.0005$

$\lambda = \frac{1}{(2.609 \frac{3.7}{\Delta})^2} = 0.017$

$\rho_{FF} = 0.5 \left(1 - \frac{F_j}{F_{N2}}\right) + \left(1 - \frac{F_j}{F_{N2}}\right)^2 + \tau \sqrt{\left(1 - \frac{F_j}{F_{N1}}\right) \left(1 - \frac{F_j}{F_{N2}}\right)} + \lambda \left(\frac{L_j}{D_k}\right)$

$= 0.5 \left(1 - \frac{1609.6 \text{ ft}^2}{36450 \text{ ft}^2}\right) + \left(1 - \frac{1609.6 \text{ ft}^2}{72900 \text{ ft}^2}\right)^2 + 1.32 \sqrt{\left(1 - \frac{1609.6 \text{ ft}^2}{36450 \text{ ft}^2}\right) \left(1 - \frac{1609.6 \text{ ft}^2}{72900 \text{ ft}^2}\right)} + 0.017 \left(\frac{0.75'}{16.32'}\right) = 2.70$

$\rho_{RR} = 0.5 \left(1 - \frac{F_j}{F_{N2}}\right) + \left(1 - \frac{F_j}{F_{N1}}\right)^2 + \tau \sqrt{\left(1 - \frac{F_j}{F_{N2}}\right) \left(1 - \frac{F_j}{F_{N1}}\right)} + \lambda \left(\frac{L_j}{D_k}\right)$

$= 0.5 \left(1 - \frac{1609.6 \text{ ft}^2}{72900 \text{ ft}^2}\right) + \left(1 - \frac{1609.6 \text{ ft}^2}{36450 \text{ ft}^2}\right)^2 + 1.32 \sqrt{\left(1 - \frac{1609.6 \text{ ft}^2}{72900 \text{ ft}^2}\right) \left(1 - \frac{1609.6 \text{ ft}^2}{36450 \text{ ft}^2}\right)} + 0.017 \left(\frac{0.75'}{16.32'}\right) = 2.65$

$k'_F = \left(\frac{F_j}{F_{N2}}\right)^2 - \left(\frac{F_j}{F_{N1}}\right)^2 = \left(\frac{1609.6 \text{ ft}^2}{72900 \text{ ft}^2}\right)^2 - \left(\frac{1609.6 \text{ ft}^2}{36450 \text{ ft}^2}\right)^2 = -0.0015$

$k'_R = \left(\frac{F_j}{F_{N1}}\right)^2 - \left(\frac{F_j}{F_{N2}}\right)^2 = \left(\frac{1609.6 \text{ ft}^2}{36450 \text{ ft}^2}\right)^2 - \left(\frac{1609.6 \text{ ft}^2}{72900 \text{ ft}^2}\right)^2 = 0.0015$

$\rho_{gr} = 0.2$

$\rho_{fr} = 0.002$

$K_F = \rho_{FF} + \rho_{fr} + \rho_{gr} + k'_F = 2.70 + 0.002 + 0.2 + (-0.0015) = 2.90$

$K_R = \rho_{RR} + \rho_{fr} + \rho_{gr} + k'_R = 2.65 + 0.002 + 0.2 + 0.0015 = 2.85$

$I = 0.01 \text{ ft}^{-1}$

STONE & WEBSTER ENGINEERING CORPORATION  
CALCULATION SHEET

▲ 5010.85

CALCULATION IDENTIFICATION NUMBER				PAGE <u>22</u>
J.O. OR W.O. NO.	DIVISION & GROUP	CALCULATION NO.	OPTIONAL TASK CODE	
12846.44		PE-049-0		

1 THE REFERENCE 32 DISCUSSION ON COMBINING PARALLEL NETWORK FLOW PATHS IS USED  
 2 AS THE BASIS FOR EVALUATING THE EFFECTIVE LOSS COEFFICIENT RESULTING FROM  
 3 COMBINING AREAS A THROUGH E INTO ONE JUNCTION. SINCE THE RATE OF CHANGE OF  
 4 THE MASS FLOW RATE IS UNKNOWN FOR THE INERTIA VALUES THE DISCUSSION  
 5 STIPULATES THAT THE PARALLEL FLOW PATHS BE IDENTICAL, AND THEREFORE EVALUATES  
 6 THE EFFECTIVE INERTIAS AND LOSS COEFFICIENTS IN THAT MANNER. IN THIS CASE, HOWEVER,  
 7 THE INERTIA VALUES ARE DEFAULTED TO 0.01 ft<sup>-1</sup> AND THUS AN ARITHMETIC COMBINATION  
 8 OF THOSE VALUES IS MEANINGLESS, THEREFORE IT REMAINS VALID THAT A COMBINATION  
 9 OF THESE AREAS INTO ONE JUNCTION, THOUGH NOT IDENTICAL, IS PERFORMED. SINCE  
 10 THE FLOW AREAS ARE NOT SAME IT WILL BE NECESSARY TO EVALUATE THE EFFECTIVE  
 11 LOSS COEFFICIENT THROUGH THE SUMMATION AS GIVEN BY FORMULA (19-19) OF  
 12 THE DISCUSSION AS SHOWN BELOW

$$K_{eff} = \frac{A_{REF}^2}{\left( \sum_i \left( \frac{A_i^2}{K_i} \right)^{1/2} \right)^2} \quad \text{WHERE } A_{REF} \text{ IS THE SUM OF ALL AREAS } (F_j) \text{ TO BE COMBINED}$$

18 TO SUMMARIZE THE VALUES OF  $F_j$  AND  $K$  FOR EACH AREA, DENOTED BY SUBSCRIPT  $\odot$  FOR ITS DESIGNATION.

19  $F_{j\odot A} = 1347.2 \text{ ft}^2$  ;  $F_{j\odot B} = 1406.4 \text{ ft}^2$  ;  $F_{j\odot C} = 799.2 \text{ ft}^2$  ;  $F_{j\odot D} = 180 \text{ ft}^2$  ;  $F_{j\odot E} = 1609.6 \text{ ft}^2$   
 20  $K_{F\odot A} = 2.92$  ;  $K_{F\odot B} = 2.90$  ;  $K_{F\odot C} = 2.95$  ;  $K_{F\odot D} = 3.00$  ;  $K_{F\odot E} = 2.90$   
 21  $K_{R\odot A} = 2.88$  ;  $K_{R\odot B} = 2.86$  ;  $K_{R\odot C} = 2.93$  ;  $K_{R\odot D} = 3.00$  ;  $K_{R\odot E} = 2.85$

23 FOR FORWARD FLOW

$$K_{eff} = \frac{(F_{j\odot A} + F_{j\odot B} + F_{j\odot C} + F_{j\odot D} + F_{j\odot E})^2}{\left( \frac{F_{j\odot A}}{(K_{F\odot A})^{1/2}} + \frac{F_{j\odot B}}{(K_{F\odot B})^{1/2}} + \frac{F_{j\odot C}}{(K_{F\odot C})^{1/2}} + \frac{F_{j\odot D}}{(K_{F\odot D})^{1/2}} + \frac{F_{j\odot E}}{(K_{F\odot E})^{1/2}} \right)^2}$$

$$= \frac{(1347.2 \text{ ft}^2 + 1406.4 \text{ ft}^2 + 799.2 \text{ ft}^2 + 180 \text{ ft}^2 + 1609.6 \text{ ft}^2)^2}{\left( \frac{1347.2 \text{ ft}^2}{(2.92)^{1/2}} + \frac{1406.4 \text{ ft}^2}{(2.90)^{1/2}} + \frac{799.2 \text{ ft}^2}{(2.95)^{1/2}} + \frac{180 \text{ ft}^2}{(3.0)^{1/2}} + \frac{1609.6 \text{ ft}^2}{(2.90)^{1/2}} \right)^2} = 2.92$$

33 FOR REVERSE FLOW

$$K_{eff} = \frac{(F_{j\odot A} + F_{j\odot B} + F_{j\odot C} + F_{j\odot D} + F_{j\odot E})^2}{\left( \frac{F_{j\odot A}}{(K_{R\odot A})^{1/2}} + \frac{F_{j\odot B}}{(K_{R\odot B})^{1/2}} + \frac{F_{j\odot C}}{(K_{R\odot C})^{1/2}} + \frac{F_{j\odot D}}{(K_{R\odot D})^{1/2}} + \frac{F_{j\odot E}}{(K_{R\odot E})^{1/2}} \right)^2}$$

$$= \frac{(1347.2 \text{ ft}^2 + 1406.4 \text{ ft}^2 + 799.2 \text{ ft}^2 + 180 \text{ ft}^2 + 1609.6 \text{ ft}^2)^2}{\left( \frac{1347.2 \text{ ft}^2}{(2.88)^{1/2}} + \frac{1406.4 \text{ ft}^2}{(2.86)^{1/2}} + \frac{799.2 \text{ ft}^2}{(2.93)^{1/2}} + \frac{180 \text{ ft}^2}{(3.0)^{1/2}} + \frac{1609.6 \text{ ft}^2}{(2.85)^{1/2}} \right)^2} = 2.88$$

43 IN SUMMARY

44 JUNCTION AREA = SUM OF  $F_{j\odot} \rightarrow F_{j\odot} = 5342.4 \text{ ft}^2$  AT ELEVATION 58'6"  
 45 INERTIA = 0.01 ft<sup>-1</sup> ;  $K_F = 2.92$  ;  $K_R = 2.88$

CALCULATION SHEET

▲ 5010.65

CALCULATION IDENTIFICATION NUMBER				PAGE <u>23</u>
J.O. OR W.O. NO.	DIVISION & GROUP	CALCULATION NO.	OPTIONAL TASK CODE	
12846.44		PE-049-0		

JUNCTION #2. (NODE 1 to NODE 2)

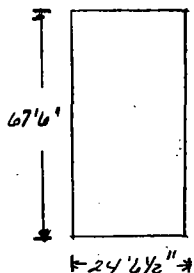

DIMENSIONS FROM REF. 28

0.75' THICK =  $L_j$

$F_j = (67'6") (24'6 1/2") = 1656.56 \text{ ft}^2$

$\Pi = (67'6") + 24'6 1/2" + 67'6" + 24'6 1/2" = 184.08 \text{ ft}$

$D_h = \frac{4F_j}{\Pi} = \frac{4(1656.56 \text{ ft}^2)}{184.08 \text{ ft}} = 35.996$

$\gamma = f\left(\frac{L_j}{D_h}\right) = 0.0208 = 1.34 \text{ by INTERPOLATION DIAG. 4-11 P 137, REF 39}$

$\bar{\Delta} = \frac{\Delta(0.03937 \text{ in/mm})}{D_h(12 \text{ in/ft})} = \frac{2.5(0.03937)}{35.996(12)} = 0.000228$

where  $\Delta = 2.5$  for AVE. CONCRETE  
P 48, REF. 89

$\alpha = \frac{1}{(2 \log 3.7)^2} = 0.014$

FROM AREA A OF JUNCTION 1,  $F_{N1} = 36450 \text{ ft}^2$  ?  $\text{I} = 0.01$   
 $F_{N2} = 72900 \text{ ft}^2$

AND  $\rho_{fr} = 0.002$

$\rho_F = 0.5 \left(1 - \frac{F_j}{F_{N1}}\right) + \left(1 - \frac{F_j}{F_{N2}}\right)^2 + \gamma \sqrt{\left(1 - \frac{F_j}{F_{N1}}\right) \left(1 - \frac{F_j}{F_{N2}}\right)} + \alpha \left(\frac{L_j}{D_h}\right)$

$= 0.5 \left(1 - \frac{1656.56 \text{ ft}^2}{36450 \text{ ft}^2}\right) + \left(1 - \frac{1656.56 \text{ ft}^2}{72900 \text{ ft}^2}\right)^2 + 1.34 \sqrt{\left(1 - \frac{1656.56 \text{ ft}^2}{36450 \text{ ft}^2}\right) \left(1 - \frac{1656.56 \text{ ft}^2}{72900 \text{ ft}^2}\right)} + 0.014 \left(\frac{0.75'}{35.996'}\right)$   
 $= 2.71$

$\rho_R = 0.5 \left(1 - \frac{F_j}{F_{N2}}\right) + \left(1 - \frac{F_j}{F_{N1}}\right)^2 + \gamma \sqrt{\left(1 - \frac{F_j}{F_{N2}}\right) \left(1 - \frac{F_j}{F_{N1}}\right)} + \alpha \left(\frac{L_j}{D_h}\right)$

$= 0.5 \left(1 - \frac{1656.56 \text{ ft}^2}{72900 \text{ ft}^2}\right) + \left(1 - \frac{1656.56 \text{ ft}^2}{36450 \text{ ft}^2}\right)^2 + 1.34 \sqrt{\left(1 - \frac{1656.56 \text{ ft}^2}{72900 \text{ ft}^2}\right) \left(1 - \frac{1656.56 \text{ ft}^2}{36450 \text{ ft}^2}\right)} + 0.014 \left(\frac{0.75'}{35.996'}\right)$   
 $= 2.67$

$K'_F = \left(\frac{F_j}{F_{N2}}\right)^2 - \left(\frac{F_j}{F_{N1}}\right)^2 = \left(\frac{1656.56 \text{ ft}^2}{72900 \text{ ft}^2}\right)^2 - \left(\frac{1656.56 \text{ ft}^2}{36450 \text{ ft}^2}\right)^2 = -0.00155$

$K'_R = \left(\frac{F_j}{F_{N1}}\right)^2 - \left(\frac{F_j}{F_{N2}}\right)^2 = \left(\frac{1656.56 \text{ ft}^2}{36450 \text{ ft}^2}\right)^2 - \left(\frac{1656.56 \text{ ft}^2}{72900 \text{ ft}^2}\right)^2 = 0.00155$

$K_F = \rho_F + K'_F + \rho_{fr} = 2.71 + 0.002 + (-0.00155) = 2.71$

$K_R = \rho_R + K'_R + \rho_{fr} = 2.67 + 0.002 + (0.00155) = 2.67$

STONE & WEBSTER ENGINEERING CORPORATION  
CALCULATION SHEET

▲ 5010.65

CALCULATION IDENTIFICATION NUMBER			
J.O. OR W.O. NO. 12846.44	DIVISION & GROUP	CALCULATION NO. PE-049-0	OPTIONAL TASK CODE
			PAGE 24

JUNCTION #3 (NODE 1 TO NODE 2)

THIS JUNCTION IS COMPOSED OF 3 STAIRWELL OPENINGS AS SHOWN ON REF 9 E 28. THE STAIRS ASSUMED TO OCCUPY, CONSERVATIVELY, 50% OF THE OPENING LENGTH X THEIR WIDTH, THE NET EFFECT TO SIMPLY REDUCE FLOW AREA, FROM WHICH THE OPENINGS AS EVALUATED AS ATTACK EDGED ORIFACE. THE OPENINGS WILL THEN BE COMBINED IN THE SAME MANNER AS WAS PERFORMED FOR JUNCTION #1, SAVE THAT AN APPROXIMATION OF THE INERTIA TERM WILL BE UTILIZED AS DISCUSSED BELOW. FROM REF 9 E 28 THE OPENINGS ARE DIMENSIONED AS INDICATED.

AREA (A) LOCATED ALONG SOUTH WALL NEAR LINE (1)

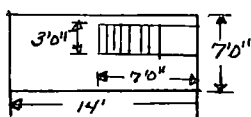

$$L_j = 0.75' \text{ (REF 28)}$$

$$F_j = (7' \times 14') - (3' \times 7') = 77 \text{ ft}^2$$

$$II = 2(14') + 0(7') = 42 \text{ ft}$$

$$D_h = \frac{4(F_j)}{II} = \frac{4(77)}{42} = 7.33'$$

$$\gamma = f\left(\frac{L_j}{D_h}\right) = \frac{0.75'}{7.33'} = 0.102 = 1.28 \text{ by INTER. FROM DIAG 4-11, P137, REF 39}$$

$$\bar{\Delta} = \frac{\Delta(1.03937 \text{ in/mm})}{D_h(12 \text{ in/ft})} = \frac{2.5(1.03937)}{7.33'(12)} = .001119 \text{ where } \Delta = 2.5 \text{ for AVE. COND. CONCRETE P 43, REF 39}$$

$$\alpha = \frac{1}{\left(2.169 \frac{3.7}{\bar{\Delta}}\right)^2} = 0.02$$

from JUNCTION #1  $F_{N1} = 36450 \text{ ft}^2$  ;  $LN1 = 24.125'$   
 $F_{N2} = 72900 \text{ ft}^2$  ;  $LN2 = 34.958'$

$$C_F = 0.5 \left(1 - \frac{F_j}{F_{N1}}\right) + \left(1 - \frac{F_j}{F_{N2}}\right)^2 + \gamma \sqrt{\left(1 - \frac{F_j}{F_{N1}}\right)\left(1 - \frac{F_j}{F_{N2}}\right)} + \alpha \left(\frac{L_j}{D_h}\right)$$

$$= 0.5 \left(1 - \frac{77 \text{ ft}^2}{36450 \text{ ft}^2}\right) + \left(1 - \frac{77 \text{ ft}^2}{72900 \text{ ft}^2}\right)^2 + 1.28 \sqrt{\left(1 - \frac{77 \text{ ft}^2}{36450 \text{ ft}^2}\right)\left(1 - \frac{77 \text{ ft}^2}{72900 \text{ ft}^2}\right)} + 0.02 \left(\frac{.75'}{7.33'}\right) = 2.78$$

$$C_R = 0.5 \left(1 - \frac{F_j}{F_{N2}}\right) + \left(1 - \frac{F_j}{F_{N1}}\right)^2 + \gamma \sqrt{\left(1 - \frac{F_j}{F_{N2}}\right)\left(1 - \frac{F_j}{F_{N1}}\right)} + \alpha \left(\frac{L_j}{D_h}\right)$$

$$= 0.5 \left(1 - \frac{77 \text{ ft}^2}{72900 \text{ ft}^2}\right) + \left(1 - \frac{77 \text{ ft}^2}{36450 \text{ ft}^2}\right)^2 + 1.28 \sqrt{\left(1 - \frac{77 \text{ ft}^2}{72900 \text{ ft}^2}\right)\left(1 - \frac{77 \text{ ft}^2}{36450 \text{ ft}^2}\right)} + 0.02 \left(\frac{.75'}{7.33'}\right) = 2.77$$

$$K_F = \left(\frac{F_j}{F_{N2}}\right)^2 - \left(\frac{F_j}{F_{N1}}\right)^2 = \left(\frac{77 \text{ ft}^2}{72900 \text{ ft}^2}\right)^2 - \left(\frac{77 \text{ ft}^2}{36450 \text{ ft}^2}\right)^2 = -0.0000035$$

$$K'_R = \left(\frac{F_j}{F_{N1}}\right)^2 - \left(\frac{F_j}{F_{N2}}\right)^2 = \left(\frac{77 \text{ ft}^2}{36450 \text{ ft}^2}\right)^2 - \left(\frac{77 \text{ ft}^2}{72900 \text{ ft}^2}\right)^2 = 0.0000035$$

from JUNCTION #1  $C_{F1} = 0.002$

$$K_F = C_F + C_{F1} + K'_F = 2.78 + 0.002 + (-0.0000035) = 2.78$$

$$K_R = C_R + C_{R1} + K'_R = 2.77 + 0.002 + 0.0000035 = 2.77$$

$$I = L_j \left(\frac{1}{F_j}\right) + LN1 \left(\frac{1}{F_{N1}}\right) + LN2 \left(\frac{1}{F_{N2}}\right)$$

$$= 0.75' \left(\frac{1}{77 \text{ ft}^2}\right) + 24.125' \left(\frac{1}{36450 \text{ ft}^2}\right) + 34.958' \left(\frac{1}{72900 \text{ ft}^2}\right) = 0.0108 \text{ ft}^{-1}$$

STONE & WEBSTER ENGINEERING CORPORATION  
CALCULATION SHEET

▲ 5010.85

CALCULATION IDENTIFICATION NUMBER				PAGE <u>25</u>
J.O. OR W.O. NO. 12846.44	DIVISION & GROUP	CALCULATION NO. <u>PE-049-0</u>	OPTIONAL TASK CODE	

AREA B, LOCATED ALONG SOUTH WALL NEAR LINE (16)

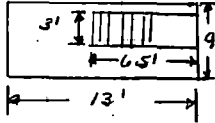

$$L_j = 0.75'$$

$$F_j = (13' \times 9') - (3' \times 6.5') = 97.5 \text{ ft}^2$$

$$II = 2(13') + 2(9') = 44 \text{ ft}$$

$$D_h = \frac{4F_j}{II} = \frac{4(97.5 \text{ ft}^2)}{44'} = 8.86'$$

$$\tau = f\left(\frac{L_j}{D_h}\right) = \left(\frac{0.75'}{8.86'}\right) = 0.0846 = 1.3 \text{ by INTERP. DIAG 4-11, P137, REF 39}$$

$$\bar{\Delta} = \frac{\Delta(0.03937 \text{ in/mm})}{D_h(12 \text{ in/ft})} = \frac{2.5(0.03937)}{8.86'(12)} = 0.000926 \text{ where } \Delta = 2.5 \text{ for AVE. COND. CONCRETE}$$

P 63, REF 39

$$\lambda = \frac{1}{(2.109 \frac{3.7}{\lambda})^2} = 0.0193$$

$$\rho_F = 0.5 \left(1 - \frac{F_{j1}}{F_{N1}}\right) + \left(1 - \frac{F_{j2}}{F_{N2}}\right)^2 + \tau \sqrt{\left(1 - \frac{F_{j1}}{F_{N1}}\right)\left(1 - \frac{F_{j2}}{F_{N2}}\right)} + \lambda \left(\frac{L_j}{D_h}\right)$$

$$= 0.5 \left(1 - \frac{97.5 \text{ ft}^2}{36450 \text{ ft}^2}\right) + \left(1 - \frac{97.5 \text{ ft}^2}{72900 \text{ ft}^2}\right)^2 + 1.3 \sqrt{\left(1 - \frac{97.5 \text{ ft}^2}{36450 \text{ ft}^2}\right)\left(1 - \frac{97.5 \text{ ft}^2}{72900 \text{ ft}^2}\right)} + 0.0193 \left(\frac{0.75'}{8.86'}\right) = 2.79$$

$$\rho_R = 0.5 \left(1 - \frac{F_{j2}}{F_{N2}}\right) + \left(1 - \frac{F_{j1}}{F_{N1}}\right)^2 + \tau \sqrt{\left(1 - \frac{F_{j1}}{F_{N1}}\right)\left(1 - \frac{F_{j2}}{F_{N2}}\right)} + \lambda \left(\frac{L_j}{D_h}\right)$$

$$= 0.5 \left(1 - \frac{97.5 \text{ ft}^2}{72900 \text{ ft}^2}\right) + \left(1 - \frac{97.5 \text{ ft}^2}{36450 \text{ ft}^2}\right)^2 + 1.3 \sqrt{\left(1 - \frac{97.5 \text{ ft}^2}{72900 \text{ ft}^2}\right)\left(1 - \frac{97.5 \text{ ft}^2}{36450 \text{ ft}^2}\right)} + 0.0193 \left(\frac{0.75'}{8.86'}\right) = 2.79$$

$$k'_F = \left(\frac{F_j}{F_{N2}}\right)^2 - \left(\frac{F_j}{F_{N1}}\right)^2 = \left(\frac{97.5 \text{ ft}^2}{72900 \text{ ft}^2}\right)^2 - \left(\frac{97.5 \text{ ft}^2}{36450 \text{ ft}^2}\right)^2 = -0.000054$$

$$k'_R = \left(\frac{F_j}{F_{N1}}\right)^2 - \left(\frac{F_j}{F_{N2}}\right)^2 = \left(\frac{97.5 \text{ ft}^2}{36450 \text{ ft}^2}\right)^2 - \left(\frac{97.5 \text{ ft}^2}{72900 \text{ ft}^2}\right)^2 = 0.000054$$

FROM JUNCTION #1  $\rho_{fr} = 0.002$

$$K_F = \rho_F + \rho_{fr} + k'_F = 2.79 + 0.002 + (-0.000054) = 2.79$$

$$K_R = \rho_R + \rho_{fr} + k'_R = 2.79 + 0.002 + 0.000054 = 2.79$$

$$I = L_j \left(\frac{1}{F_j}\right) + L_{N1} \left(\frac{1}{F_{N1}}\right) + L_{N2} \left(\frac{1}{F_{N2}}\right)$$

$$= 0.75 \left(\frac{1}{97.5 \text{ ft}^2}\right) + 34.125' \left(\frac{1}{36450 \text{ ft}^2}\right) + 34.958' \left(\frac{1}{72900 \text{ ft}^2}\right) = 0.0088$$

AREA C, LOCATED ALONG NORTH WALL NEAR LINE (17)

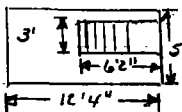

$$L_j = 0.75'$$

$$F_j = (12'4'' \times 5') - (6'2'' \times 3') = 43 \text{ ft}^2$$

$$II = 12'4'' + 5' + 12'4'' + 5' = 34.6 \text{ ft}$$

$$D_h = \frac{4F_j}{II} = \frac{4(43 \text{ ft}^2)}{34.6 \text{ ft}} = 4.97 \text{ ft}$$

$$\tau = f\left(\frac{L_j}{D_h}\right) = \left(\frac{0.75'}{4.97'}\right) = 0.1509 = 1.25 \text{ by INTERP. FROM DIAG 4-11, P137 REF 39}$$

$$\bar{\Delta} = \frac{\Delta(0.03937 \text{ in/mm})}{D_h(12 \text{ in/ft})} = \frac{2.5(0.03937)}{4.97'(12)} = 0.00165 \text{ where } \Delta = 2.5 \text{ for AVE. COND. CONCRETE}$$

P 63, REF 39

$$\lambda = \frac{1}{(2.109 \frac{3.7}{\lambda})^2} = 0.022$$



STONE & WEBSTER ENGINEERING CORPORATION  
CALCULATION SHEET

▲ 5010.65

CALCULATION IDENTIFICATION NUMBER			
J.O. OR W.O. NO. 12846.44	DIVISION & GROUP	CALCULATION NO. PE-049-0	OPTIONAL TASK CODE
			PAGE 26

$$C_F = 0.5 \left(1 - \frac{F_V}{F_{N1}}\right) + \left(1 - \frac{F_V}{F_{N2}}\right)^2 + T \sqrt{\left(1 - \frac{F_V}{F_{N1}}\right) \left(1 - \frac{F_V}{F_{N2}}\right)} + 2 \left(\frac{L}{Dh}\right)$$

$$= 0.5 \left(1 - \frac{43ft^2}{36450ft^2}\right) + \left(1 - \frac{43ft^2}{72900ft^2}\right)^2 + 1.25 \sqrt{\left(1 - \frac{43ft^2}{36450ft^2}\right) \left(1 - \frac{43ft^2}{72900ft^2}\right)} + 0.022 \left(\frac{0.75'}{4.97'}\right) = 0.75$$

$$C_R = 0.5 \left(1 - \frac{F_V}{F_{N2}}\right) + \left(1 - \frac{F_V}{F_{N1}}\right)^2 + T \sqrt{\left(1 - \frac{F_V}{F_{N2}}\right) \left(1 - \frac{F_V}{F_{N1}}\right)} + 2 \left(\frac{L}{Dh}\right)$$

$$= 0.5 \left(1 - \frac{43ft^2}{72900ft^2}\right) + \left(1 - \frac{43ft^2}{36450ft^2}\right)^2 + 1.25 \sqrt{\left(1 - \frac{43ft^2}{72900ft^2}\right) \left(1 - \frac{43ft^2}{36450ft^2}\right)} + 0.022 \left(\frac{0.75'}{4.97'}\right) = 0.75$$

$$K'_F = \left(\frac{F_j}{F_{N2}}\right)^2 - \left(\frac{F_V}{F_{N1}}\right)^2 = \left(\frac{43ft^2}{72900ft^2}\right)^2 - \left(\frac{43ft^2}{36450ft^2}\right)^2 = -0.000001$$

$$K'_R = \left(\frac{F_j}{F_{N1}}\right)^2 - \left(\frac{F_j}{F_{N2}}\right)^2 = \left(\frac{43ft^2}{36450ft^2}\right)^2 - \left(\frac{43ft^2}{72900ft^2}\right)^2 = 0.000001$$

from JUNCTION #1:  $C_{fr} = 0.002$

$$K_F = C_F + C_{fr} + K'_F = 0.75 + 0.002 + (-0.000001) = 0.75$$

$$K_R = C_R + C_{fr} + K'_R = 0.75 + 0.002 + 0.000001 = 0.75$$

$$I = L \left(\frac{1}{F_j}\right) + L_{N1} \left(\frac{1}{F_{N1}}\right) + L_{N2} \left(\frac{1}{F_{N2}}\right)$$

$$= 0.75' \left(\frac{1}{43ft^2}\right) + 24.125' \left(\frac{1}{36450ft^2}\right) + 34.958' \left(\frac{1}{72900ft^2}\right) = 0.0186$$

TO COMBINE LOSS COEFFICIENTS (K), USING SAME TECHNIQUE AS FOR JUNCTION #1

$$K_{eff} = \frac{A^2_{ref}}{\left(\sum \frac{A_i^2}{K_i}\right) V_0^2} \quad \text{where } A_{ref} = \text{sum of } F_j \text{ (A), (B), (C)}$$

$$F_j \text{ (A)} = 77ft^2 \quad ; \quad F_j \text{ (B)} = 97.5ft^2 \quad ; \quad F_j \text{ (C)} = 43ft^2$$

$$K_F \text{ (A)} = 0.78 \quad ; \quad K_F \text{ (B)} = 0.79 \quad ; \quad K_F \text{ (C)} = 0.75$$

$$K_R \text{ (A)} = 0.77 \quad ; \quad K_R \text{ (B)} = 0.79 \quad ; \quad K_R \text{ (C)} = 0.75$$

for FORWARD FLOW

$$K_{eff} = \frac{(F_j \text{ (A)} + F_j \text{ (B)} + F_j \text{ (C)})^2}{\left(\frac{F_j \text{ (A)}}{K_F \text{ (A)}} + \frac{F_j \text{ (B)}}{K_F \text{ (B)}} + \frac{F_j \text{ (C)}}{K_F \text{ (C)}}\right) V_0^2} = \frac{(77ft^2 + 97.5ft^2 + 43ft^2)^2}{\left(\frac{77ft^2}{(0.78)V_0^2} + \frac{97.5ft^2}{(0.79)V_0^2} + \frac{43ft^2}{(0.75)V_0^2}\right) V_0^2} = 0.78$$

for REVERSE FLOW

$$K_{eff} = \frac{(F_j \text{ (A)} + F_j \text{ (B)} + F_j \text{ (C)})^2}{\left(\frac{F_j \text{ (A)}}{K_R \text{ (A)}} + \frac{F_j \text{ (B)}}{K_R \text{ (B)}} + \frac{F_j \text{ (C)}}{K_R \text{ (C)}}\right) V_0^2} = \frac{(77ft^2 + 97.5ft^2 + 43ft^2)^2}{\left(\frac{77ft^2}{(0.77)V_0^2} + \frac{97.5ft^2}{(0.79)V_0^2} + \frac{43ft^2}{(0.75)V_0^2}\right) V_0^2} = 0.78$$

STONE & WEBSTER ENGINEERING CORPORATION  
CALCULATION SHEET

▲ 5010.65

CALCULATION IDENTIFICATION NUMBER			
J.O. OR W.O. NO. 1284644	DIVISION & GROUP	CALCULATION NO. PE-049-0	OPTIONAL TASK CODE
			PAGE 27

TO EVALUATE THE EFFECTIVE INERTIA FOR DISSIMILAR PARALLEL FLOW PATHS THE ASSUMPTION THAT FOR VALUES OF INERTIA'S THIS SMALL CAN BE AVERAGED AND THAT APPROXIMATION WOULD BE REASONABLE, AND ANY DIFFERENCE BETWEEN THE CALCULATED COEFFICIENT AND THE ACTUAL WOULD HAVE INSIGNIFICANT EFFECTS ON THE RESULTS. FOR THIS APPROXIMATION, THE ASSUMPTION IS MADE THAT THE RATE OF MASS FLOW RATE CHANGE IS PROPORTIONAL TO THE AREA OF THE JUNCTION, WHICH WHILE NOT STRICTLY CORRECT, DOES APPROXIMATE THE ACTUAL EFFECTS. FROM REF 32, FORMULA (19-26)  $I_{EFF}$  CAN THUS BE EVALUATED BY USING A SUMMATION WHICH TRANSPOSES THE RATE OF FLOW CHANGE TERMS WITH A RATIO OF INERTIA & AREA, AS FOLLOWS, WHEN THE EXPRESSION  $(\frac{dw}{dt})$  IS REPLACED BY  $F_j$  OF THE OPENING

$$I_{eff} = \frac{1}{K(\sum \frac{F_j}{A_j})} \sum I_i F_{ji}$$

$$which = \frac{I_{(A)} F_{j(A)} + I_{(B)} F_{j(B)} + I_{(C)} F_{j(C)}}{3(F_{j(A)} + F_{j(B)} + F_{j(C)})}$$

$$= \frac{(0.0108 ft^{-1})(77 ft^2) + (0.0038 ft^{-1})(97.5 ft^2) + (0.0186 ft^{-1})(43 ft^2)}{3(77 ft^2 + 97.5 ft^2 + 43 ft^2)}$$

$$= 0.0038 \text{ which defaults to } 0.01 \text{ AS PREVIOUSLY DISCUSSED}$$

IN SUMMARY JUNCTION #3 AREA = SUM OF  $F_{j(A)} \rightarrow F_{j(C)} = 217.5 ft^2$   
 $I = 0.01 ft^{-1}$ ;  $K_F = 2.78$ ;  $K_R = 3.78$  AT ELEVATION 58'6"

JUNCTION #4 NODE 2 TO NODE 3. (REF 41)

THIS JUNCTION IS NEARLY IDENTICAL TO JUNCTION #1 WITH THE EXCEPTION THAT A GRATING AREA IS ADJACENT TO THE HOIST AREA AS SEEN ON REF. 41. ALL OTHER OPENINGS HAVE NEARLY IDENTICAL DIMENSIONS, THUS IT IS ASSUMED THAT THE JUNCTION AREAS AND LOSS COEFFICIENTS FOR CORRESPONDING OPENINGS IN THIS JUNCTION ARE THE SAME. THE ADDITIONAL AREA, THEN, WILL BE DESIGNATED AS AREA (E) AND EVALUATED IN THE SAME MANNER AS WAS USED FOR JUNCTION #1, THEN COMBINED WITH THE OPENINGS (A) THRU (C) OF THAT JUNCTION TO EVALUATE THE  $K_{eff}$  FOR THIS JUNCTION

FROM REF 41, THE OPENING IS DIMENSIONED AS FOLLOWS FROM THE (A) LINE & (B) LINE OF THE DRAWING

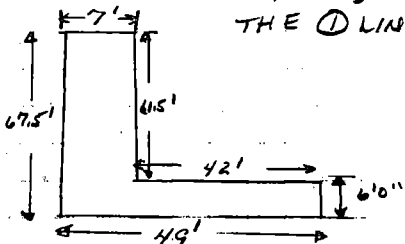

$$L_j = 0.75' \text{ (REF 28)}$$

$$F_j = [(67.5')(7') + (6')(42')] (80\%) = 579.6 ft^2$$

$$II = 67.5' + 7' + 61.5' + 42' + 6' + 49' = 233'$$

$$DK = 4 F_j = 4(579.6 ft^2) = 9.95'$$

$$II = 233'$$

CALCULATION SHEET

▲ 5010.65

CALCULATION IDENTIFICATION NUMBER			
J.O. OR W.O. NO. 12846.44	DIVISION & GROUP	CALCULATION NO. PE-049-0	OPTIONAL TASK CODE
			PAGE 28

$\tau = f \left( \frac{L_v}{D_h} \right) = \frac{0.75'}{9.95'} = 0.0754 = 1.30$  by INTERP. DIAG 4-11, P137, REF 39

$\bar{\Delta} = \frac{\Delta (0.03937 \text{ in/mm})}{D_h (D_h \text{ in/ft})} = \frac{2.5 (0.03937)}{9.95' (12)} = 0.000824$  where  $\Delta = 2.5$  for AVE COND CONCRETE, P43 REF 39

$\lambda = \frac{1}{(2 \log \frac{3.7}{\bar{\Delta}})^2} = 0.019$

FROM JUNCTION 1,  $F_{N1} = 36450 \text{ ft}^2 = F_{N3}$   
 $F_{N2} = 72900 \text{ ft}^2$

$C_{FR} = 0.5 \left( 1 - \frac{F_j}{F_{N3}} \right) + \left( 1 - \frac{F_j}{F_{N2}} \right)^2 + \tau \sqrt{\left( 1 - \frac{F_j}{F_{N3}} \right) \left( 1 - \frac{F_j}{F_{N2}} \right)} + \lambda \left( \frac{L_v}{D_h} \right)$

$= 0.5 \left( 1 - \frac{579.6 \text{ ft}^2}{36450 \text{ ft}^2} \right) + \left( 1 - \frac{579.6 \text{ ft}^2}{72900 \text{ ft}^2} \right)^2 + 1.3 \sqrt{\left( 1 - \frac{579.6 \text{ ft}^2}{36450 \text{ ft}^2} \right) \left( 1 - \frac{579.6 \text{ ft}^2}{72900 \text{ ft}^2} \right)} + 0.019 \left( \frac{0.75'}{9.95'} \right) = 2.76$

$C_{FF} = 0.5 \left( 1 - \frac{F_j}{F_{N2}} \right) + \left( 1 - \frac{F_j}{F_{N3}} \right)^2 + \tau \sqrt{\left( 1 - \frac{F_j}{F_{N2}} \right) \left( 1 - \frac{F_j}{F_{N3}} \right)} + \lambda \left( \frac{L_v}{D_h} \right)$

$= 0.5 \left( 1 - \frac{579.6 \text{ ft}^2}{72900 \text{ ft}^2} \right) + \left( 1 - \frac{579.6 \text{ ft}^2}{36450 \text{ ft}^2} \right)^2 + 1.3 \sqrt{\left( 1 - \frac{579.6 \text{ ft}^2}{72900 \text{ ft}^2} \right) \left( 1 - \frac{579.6 \text{ ft}^2}{36450 \text{ ft}^2} \right)} + 0.019 \left( \frac{0.75'}{9.95'} \right) = 2.74$

$K'_R = \left( \frac{F_j}{F_{N2}} \right)^2 - \left( \frac{F_j}{F_{N3}} \right)^2 = \left( \frac{579.6 \text{ ft}^2}{72900 \text{ ft}^2} \right)^2 - \left( \frac{579.6 \text{ ft}^2}{36450 \text{ ft}^2} \right)^2 = -0.000019$

$K'_F = \left( \frac{F_j}{F_{N3}} \right)^2 - \left( \frac{F_j}{F_{N2}} \right)^2 = \left( \frac{579.6 \text{ ft}^2}{36450 \text{ ft}^2} \right)^2 - \left( \frac{579.6 \text{ ft}^2}{72900 \text{ ft}^2} \right)^2 = 0.000019$

FROM JUNCTION 1  $C_{FR} = 0.002$  ;  $C_{FR} = 0.2$

$K_R = K'_R + C_{FR} + C_{FR} + C_{FR} = (-0.000019) + 2.76 + 0.002 + 0.2 = 2.86$  2.96

$K_F = K'_F + C_{FR} + C_{FR} + C_{FR} = 0.000019 + 2.74 + 0.002 + 0.2 = 2.84$  2.94

from junction 1  $I = 0.01 \text{ ft}^{-1}$

SUMMED USING THE VALUES OF  $F_j \text{ @ } \rightarrow F_j \text{ @ } ? K_{\text{ @ }} \rightarrow K_{\text{ @ }} \text{ OF JUNCTION 1 FOR REVERSE FLOW}$

$K_{\text{eff}} = \frac{(1347.2 \text{ ft}^2 + 1406.4 \text{ ft}^2 + 799.2 \text{ ft}^2 + 180 \text{ ft}^2 + 1609.6 \text{ ft}^2 + 579.6 \text{ ft}^2)^2}{\left( \frac{1347.2 \text{ ft}^2}{(2.92) \sqrt{2}} + \frac{1406.4 \text{ ft}^2}{(2.90) \sqrt{2}} + \frac{799.2 \text{ ft}^2}{(2.85) \sqrt{2}} + \frac{180 \text{ ft}^2}{(3.0) \sqrt{2}} + \frac{1609.6 \text{ ft}^2}{(2.90) \sqrt{2}} + \frac{579.6 \text{ ft}^2}{(2.86) \sqrt{2}} \right)^2} = 2.91$

FOR FORWARD FLOW

$K_{\text{eff}} = \frac{(1347.2 \text{ ft}^2 + 1406.4 \text{ ft}^2 + 799.2 \text{ ft}^2 + 180 \text{ ft}^2 + 1609.6 \text{ ft}^2 + 579.6 \text{ ft}^2)^2}{\left( \frac{1347.2 \text{ ft}^2}{(2.88) \sqrt{2}} + \frac{1406.4 \text{ ft}^2}{(2.86) \sqrt{2}} + \frac{799.2 \text{ ft}^2}{(2.93) \sqrt{2}} + \frac{180 \text{ ft}^2}{(3.0) \sqrt{2}} + \frac{1609.6 \text{ ft}^2}{(2.85) \sqrt{2}} + \frac{579.6 \text{ ft}^2}{(2.84) \sqrt{2}} \right)^2} = 2.87$

2.88

STONE & WEBSTER ENGINEERING CORPORATION  
CALCULATION SHEET

▲ 5010.65

CALCULATION IDENTIFICATION NUMBER			
J.O. OR W.O. NO. 12846.44	DIVISION & GROUP	CALCULATION NO. PE-049-0	OPTIONAL TASK CODE
			PAGE 29

IN SUMMARY, JUNCTION AREA =  $F_{J@} \rightarrow F_{J\oplus} = 5922 \text{ ft}^2$ ,  $K_F = 2.87$   
 $K_R = 2.91$   $I = 0.01 \text{ ft}^{-1}$  AT ELEVATION 58'6"

JUNCTION #5 NODE 2 TO NODE 3 (REF 41)

DIMENSIONED AS follows.

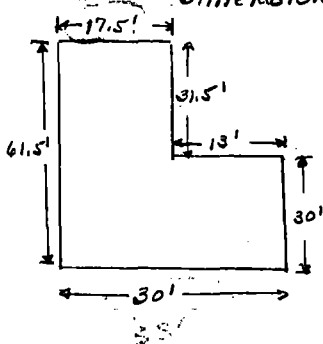

$$L_j = 0.75'$$

$$F_j = (17.5')(61.5') + (30')(13') = 1466.25 \text{ ft}^2$$

$$P = 61.5' + 17.5' + 31.5' + 13' + 30' + 30' = 183.5'$$

$$D_h = \frac{4 F_j}{P} = \frac{4(1466.25 \text{ ft}^2)}{183.5'} = 31.96' \approx 32'$$

$$\gamma = f\left(\frac{L_j}{D_h}\right) = \frac{0.75}{32} = 0.0235 = 1.34 \text{ by INTERPOLATION FROM DIAG 4-11, p137, REF 39.}$$

$$\Delta = \frac{\Delta(1.03937 \text{ in/mm})}{D_h(12 \text{ in/ft})} = \frac{2.5(1.03937)}{32(12)} = 0.00054$$

$$\lambda = \frac{1}{(\log \frac{3.7}{\Delta})^2} = 0.015$$

from JUNCTION #1,  $F_{N1} = F_{N3} = 36450 \text{ ft}^2$   
 $F_{N2} = 72900 \text{ ft}^2$

$$C_F = 0.5 \left(1 - \frac{F_j}{F_{N2}}\right) + \left(1 - \frac{F_j}{F_{N3}}\right)^2 + \gamma \sqrt{\left(1 - \frac{F_j}{F_{N2}}\right) \left(1 - \frac{F_j}{F_{N3}}\right)} + \lambda \left(\frac{L_j}{D_h}\right)$$

$$= 0.5 \left(1 - \frac{1466 \text{ ft}^2}{72900 \text{ ft}^2}\right) + \left(1 - \frac{1466 \text{ ft}^2}{36450 \text{ ft}^2}\right)^2 + 1.34 \sqrt{\left(1 - \frac{1466 \text{ ft}^2}{72900 \text{ ft}^2}\right) \left(1 - \frac{1466 \text{ ft}^2}{36450 \text{ ft}^2}\right)} + 0.015 \left(\frac{0.75'}{32'}\right) = 2.69$$

$$C_R = 0.5 \left(1 - \frac{F_j}{F_{N3}}\right) + \left(1 - \frac{F_j}{F_{N2}}\right)^2 + \gamma \sqrt{\left(1 - \frac{F_j}{F_{N3}}\right) \left(1 - \frac{F_j}{F_{N2}}\right)} + \lambda \left(\frac{L_j}{D_h}\right)$$

$$= 0.5 \left(1 - \frac{1466 \text{ ft}^2}{36450 \text{ ft}^2}\right) + \left(1 - \frac{1466 \text{ ft}^2}{72900 \text{ ft}^2}\right)^2 + 1.34 \sqrt{\left(1 - \frac{1466 \text{ ft}^2}{36450 \text{ ft}^2}\right) \left(1 - \frac{1466 \text{ ft}^2}{72900 \text{ ft}^2}\right)} + 0.015 \left(\frac{0.75'}{32'}\right) = 2.73$$

$$K'_F = \left(\frac{F_j}{F_{N3}}\right)^2 - \left(\frac{F_j}{F_{N2}}\right)^2 = \left(\frac{1466 \text{ ft}^2}{36450 \text{ ft}^2}\right)^2 - \left(\frac{1466 \text{ ft}^2}{72900 \text{ ft}^2}\right)^2 = 0.0012$$

$$K'_R = \left(\frac{F_j}{F_{N2}}\right)^2 - \left(\frac{F_j}{F_{N3}}\right)^2 = \left(\frac{1466 \text{ ft}^2}{72900 \text{ ft}^2}\right)^2 - \left(\frac{1466 \text{ ft}^2}{36450 \text{ ft}^2}\right)^2 = -0.0012$$

$$C_{fr} = 0.002 \text{ (from junction #1)}$$

$$K_F = C_F + C_{fr} + K'_F = 2.69 + 0.002 + 0.0012 = 2.69 \quad 2.69$$

$$K_R = C_R + C_{fr} + K'_R = 2.73 + 0.002 + (-0.0012) = 2.73 \quad 2.73$$

$I = 0.01$  from junction 1

STONE & WEBSTER ENGINEERING CORPORATION  
CALCULATION SHEET

▲ 5010.65

CALCULATION IDENTIFICATION NUMBER				PAGE <u>30</u>
J.O. OR W.O. NO. 12846.44	DIVISION & GROUP	CALCULATION NO. PG-049-0	OPTIONAL TASK CODE	

JUNCTION #6. (NODE 2 TO NODE 3)

THIS JUNCTION CONSISTS OF 5 STAIRWAY OPENINGS AS SHOWN ON REF. 41 AND IS EVALUATED IN THE SAME MANNER AS WAS PERFORMED FOR JUNCTION #3 THE OPENINGS ARE DIMENSIONED AS FOLLOWS:

AREA A LOCATED ALONG SOUTH WALL NEAR LINE 3.

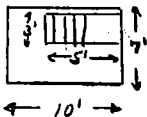

$$L_j = 0.75'$$

$$F_j = (7')(10') - (3')(5) = 55 \text{ ft}^2$$

$$I = 2(10') + 2(7') = 34 \text{ ft}$$

$$D_h = \frac{4F_j}{I} = \frac{4(55 \text{ ft}^2)}{34 \text{ ft}} = 6.47'$$

$$\gamma = f\left(\frac{L_j}{D_h}\right) = \left(\frac{0.75'}{6.47'}\right) = 0.116 = 1.28 \text{ by INTERPOLATION DIAG 4-11, P139, REF 39}$$

$$\bar{\Delta} = \frac{\Delta(0.03937 \text{ in/mm})}{D_h(127 \text{ in/ft})} = \frac{2.5(0.03937)}{6.47'(12)} = 0.00127 \text{ where } \Delta = 2.5 \text{ FOR AVE. CONCR. CONCRETE, P43 REF 39}$$

$$\lambda = \frac{1}{(2.306 \frac{3.7}{\bar{\Delta}})^2} = 0.0021 \quad ; \text{ from JUNCTION \#1 } F_{N2} = 72900 \text{ ft}^2$$

$$F_{N1} = F_{N3} = 36450 \text{ ft}^2$$

$$\rho_F = 0.5 \left(1 - \frac{F_j}{F_{N2}}\right) + \left(1 - \frac{F_j}{F_{N3}}\right)^2 + \gamma \sqrt{\left(1 - \frac{F_j}{F_{N2}}\right) \left(1 - \frac{F_j}{F_{N3}}\right)} + \lambda \left(\frac{L_j}{D_h}\right)$$

$$= 0.5 \left(1 - \frac{55 \text{ ft}^2}{72900 \text{ ft}^2}\right) + \left(1 - \frac{55 \text{ ft}^2}{36450 \text{ ft}^2}\right)^2 + 1.28 \sqrt{\left(1 - \frac{55 \text{ ft}^2}{72900 \text{ ft}^2}\right) \left(1 - \frac{55 \text{ ft}^2}{36450 \text{ ft}^2}\right)} + 0.0021 \left(\frac{0.75'}{6.47'}\right) = 2.78$$

$$\rho_R = 0.5 \left(1 - \frac{F_j}{F_{N3}}\right) + \left(1 - \frac{F_j}{F_{N2}}\right)^2 + \gamma \sqrt{\left(1 - \frac{F_j}{F_{N3}}\right) \left(1 - \frac{F_j}{F_{N2}}\right)} + \lambda \left(\frac{L_j}{D_h}\right)$$

$$= 0.5 \left(1 - \frac{55 \text{ ft}^2}{36450 \text{ ft}^2}\right) + \left(1 - \frac{55 \text{ ft}^2}{72900 \text{ ft}^2}\right)^2 + 1.28 \sqrt{\left(1 - \frac{55 \text{ ft}^2}{36450 \text{ ft}^2}\right) \left(1 - \frac{55 \text{ ft}^2}{72900 \text{ ft}^2}\right)} + 0.0021 \left(\frac{0.75'}{6.47'}\right) = 2.78$$

$$K'_F = \left(\frac{F_j}{F_{N3}}\right)^2 - \left(\frac{F_j}{F_{N2}}\right)^2 = \left(\frac{55 \text{ ft}^2}{36450 \text{ ft}^2}\right)^2 - \left(\frac{55 \text{ ft}^2}{72900 \text{ ft}^2}\right)^2 = 0.0000017$$

$$K'_R = \left(\frac{F_j}{F_{N2}}\right)^2 - \left(\frac{F_j}{F_{N3}}\right)^2 = \left(\frac{55 \text{ ft}^2}{72900 \text{ ft}^2}\right)^2 - \left(\frac{55 \text{ ft}^2}{36450 \text{ ft}^2}\right)^2 = -0.0000017$$

FROM JUNCTION #1,  $\rho_{fr} = 0.002$

$$K_F = \rho_F + \rho_{fr} + K'_F = 2.78 + 0.002 + 0.0000017 = 2.78$$

$$K_R = \rho_R + \rho_{fr} + K'_R = 2.78 + 0.002 + (-0.0000017) = 2.78$$

FROM JUNCTION #1  $LN_1 = 24.125'$  ;  $LN_2 = 34.958'$

$$I = L_j \left(\frac{1}{F_j}\right) + LN_3 \left(\frac{1}{F_{N3}}\right) + LN_2 \left(\frac{1}{F_{N2}}\right) \quad (LN_1 = LN_3)$$

$$= 0.75 \left(\frac{1}{55 \text{ ft}^2}\right) + 24.125' \left(\frac{1}{36450 \text{ ft}^2}\right) + 34.958' \left(\frac{1}{72900 \text{ ft}^2}\right) = 0.0148$$

STONE & WEBSTER ENGINEERING CORPORATION  
CALCULATION SHEET

▲ 5010.65

CALCULATION IDENTIFICATION NUMBER				PAGE <u>31</u>
J.O. OR W.O. NO. 12846.44	DIVISION & GROUP	CALCULATION NO. PE-049-0	OPTIONAL TASK CODE	

AREA (B) LOCATED ALONG SOUTH WALL NEAR LINE (B)

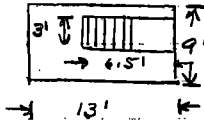

THIS OPENING IS NEARLY IDENTICAL TO THAT OF AREA B IN JUNCTION #3, THUS THE VALUES OF  $F_j$ ,  $K_F$ ,  $K_R$  &  $I$  ARE CONSIDERED TO BE THE SAME.

$$F_j = 97.5 \text{ ft}^2$$

$$K_F = 0.79$$

$$K_R = 0.79$$

$$I = 0.0088$$

AREA (C) LOCATED ALONG NORTH WALL NEAR LINE (C)

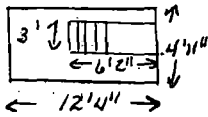

THIS OPENING IS NEARLY IDENTICAL TO THAT OF AREA C IN JUNCTION #3, THUS THE VALUES OF  $F_j$ ,  $K_F$ ,  $K_R$  &  $I$  ARE CONSIDERED TO BE THE SAME.

$$F_j = 43.0 \text{ ft}^2$$

$$K_F = 0.75$$

$$K_R = 0.75$$

$$I = 0.0186$$

AREA (D) LOCATED ALONG NORTH WALL NEAR LINE (D) FROM REF 41, THIS IS THE SAME SIZE AS AREA (C), THUS

$$F_j = 43.0 \text{ ft}^2$$

$$K_F = 0.75$$

$$K_R = 0.75$$

$$I = 0.0186$$

AREA (E) LOCATED ALONG WEST WALL NEAR LINE (E)

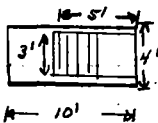

$$L_j = 0.75'$$

$$F_j = 4'(10') - (3')(5') = 25 \text{ ft}^2$$

$$P = 2(10') + 2(4') = 28'$$

$$D_h = \frac{4(F_j)}{P} = \frac{4(25 \text{ ft}^2)}{28'} = 3.57$$

$$\tau = f\left(\frac{L_j}{D_h}\right) = \frac{0.75'}{3.57'} = 0.21 = 1.21 \text{ by INTERPOLATION from DIAG 4-11, p137, R39}$$

$$\Delta = \frac{\Delta(1.03937 \text{ in/mm})}{D_h(12 \text{ in/ft})} = \frac{0.5(1.03937)}{3.57(12)} = 0.002298 \text{ where } \Delta = 0.5 \text{ for AVE. COND. CONCRETE, p.63, REF.39}$$

$$\lambda = \left( (2 \log \frac{\tau}{\Delta})^2 - 1 \right)^{-1} = 0.004$$

FROM JUNCTION #1  $F_{N2} = 72900 \text{ ft}^2$ ;  $F_{N1} = F_{N3} = 36450 \text{ ft}^2$

$$C_F = 0.5 \left( 1 - \frac{F_j}{F_{N2}} \right) + \left( 1 - \frac{F_j}{F_{N3}} \right)^2 + \tau \sqrt{\left( 1 - \frac{F_j}{F_{N2}} \right) \left( 1 - \frac{F_j}{F_{N3}} \right)} + \lambda \left( \frac{L_j}{D_h} \right)$$

$$= 0.5 \left( 1 - \frac{25 \text{ ft}^2}{72900 \text{ ft}^2} \right) + \left( 1 - \frac{25 \text{ ft}^2}{36450 \text{ ft}^2} \right)^2 + 1.21 \sqrt{\left( 1 - \frac{25 \text{ ft}^2}{72900 \text{ ft}^2} \right) \left( 1 - \frac{25 \text{ ft}^2}{36450 \text{ ft}^2} \right)} + 0.004 \left( \frac{0.75'}{3.57'} \right) = 0.73$$

STONE & WEBSTER ENGINEERING CORPORATION  
CALCULATION SHEET

▲ 5010.65

CALCULATION IDENTIFICATION NUMBER				PAGE <u>32</u>
J.O. OR W.O. NO. 12846.44	DIVISION & GROUP	CALCULATION NO. PE-049-0	OPTIONAL TASK CODE	

1  
2  
3  
4  
5  
6  
7  
8  
9  
10  
11  
12  
13  
14  
15  
16  
17  
18  
19  
20  
21  
22  
23  
24  
25  
26  
27  
28  
29  
30  
31  
32  
33  
34  
35  
36  
37  
38  
39  
40  
41  
42  
43  
44  
45  
46

$$C_{PR} = 0.5 \left(1 - \frac{F_j}{F_{N3}}\right) + \left(1 - \frac{F_j}{F_{N2}}\right)^2 + \sqrt{1 - \frac{F_j}{F_{N3}}} \left(1 - \frac{F_j}{F_{N2}}\right) + 2 \left(\frac{L_j}{D_k}\right)$$

$$C_{PR} = 0.5 \left(1 - \frac{25 \text{ft}^2}{36450 \text{ft}^2}\right) + \left(1 - \frac{25 \text{ft}^2}{72900 \text{ft}^2}\right)^2 + \sqrt{1 - \frac{25 \text{ft}^2}{36450 \text{ft}^2}} \left(1 - \frac{25 \text{ft}^2}{72900 \text{ft}^2}\right) + 6.024 \left(\frac{0.75'}{3.57'}\right) = 2.73$$

$$K'_F = \left(\frac{F_j}{F_{N3}}\right)^2 - \left(\frac{F_j}{F_{N2}}\right)^2 = \left(\frac{25 \text{ft}^2}{36450 \text{ft}^2}\right)^2 - \left(\frac{25 \text{ft}^2}{72900 \text{ft}^2}\right)^2 = 0.0000004$$

$$K'_R = \left(\frac{F_j}{F_{N2}}\right)^2 - \left(\frac{F_j}{F_{N3}}\right)^2 = \left(\frac{25 \text{ft}^2}{72900 \text{ft}^2}\right)^2 - \left(\frac{25 \text{ft}^2}{36450 \text{ft}^2}\right)^2 = -0.0000004$$

from junction #1,  $C_{FR} = 0.002$ ;  $LN_1 = 24.125' = LN_3$ ;  $LN_2 = 34.958'$

$$K_F = C_{PF} + C_{PR} + K'_F = 2.73$$

$$K_R = C_{PR} + C_{FR} + K'_R = 2.73$$

$$I = L_j \left(\frac{1}{F_j}\right) + LN_3 \left(\frac{1}{F_{N3}}\right) + LN_2 \left(\frac{1}{F_{N2}}\right) = 0.75' \left(\frac{1}{25 \text{ft}^2}\right) + 24.125' \left(\frac{1}{36450 \text{ft}^2}\right) + 34.958' \left(\frac{1}{72900 \text{ft}^2}\right) = 0.0311$$

THE EFFECTIVE COMBINED VALUES OF (K) AND I FOR THIS JUNCTION IS CALCULATED IN THE SAME MANNER AS WAS FOR JUNCTION #3 WHERE

- $F_A = 55 \text{ft}^2$ ;  $F_B = 97.5 \text{ft}^2$ ;  $F_C = 34.6 \text{ft}^2$ ;  $F_D = 34.6 \text{ft}^2$ ;  $F_E = 25 \text{ft}^2$   
 $K_{FA} = 2.78$ ;  $K_{FB} = 2.79$ ;  $K_{FC} = 2.75$ ;  $K_{FD} = 2.75$ ;  $K_{FE} = 2.73$   
 $K_{RA} = 2.78$ ;  $K_{RB} = 2.79$ ;  $K_{RC} = 2.75$ ;  $K_{RD} = 2.75$ ;  $K_{RE} = 2.73$   
 $I_A = 0.0148$ ;  $I_B = 0.0088$ ;  $I_C = 0.0186$ ;  $I_D = 0.0186$ ;  $I_E = 0.0311$

FOR FORWARD & REVERSE FLOW (K<sub>F</sub> & K<sub>R</sub> OF EACH COMPONENT ARE THE SAME VALUE)

$$K_{eff} = \frac{(K_A F_A + K_B F_B + K_C F_C + K_D F_D + K_E F_E)^2}{\left(\frac{K_A}{K_A^{1/2}} + \frac{K_B}{K_B^{1/2}} + \frac{K_C}{K_C^{1/2}} + \frac{K_D}{K_D^{1/2}} + \frac{K_E}{K_E^{1/2}}\right)^2} = \frac{(55 \text{ft}^2 + 97.5 \text{ft}^2 + 34.6 \text{ft}^2 + 34.6 \text{ft}^2 + 25 \text{ft}^2)^2}{\left(\frac{55 \text{ft}^2}{(2.78)^{1/2}} + \frac{97.5 \text{ft}^2}{(2.79)^{1/2}} + \frac{34.6 \text{ft}^2}{(2.75)^{1/2}} + \frac{34.6 \text{ft}^2}{(2.75)^{1/2}} + \frac{25 \text{ft}^2}{(2.73)^{1/2}}\right)^2} = 2.77$$

$$I_{eff} = \frac{I_A F_A + I_B F_B + I_C F_C + I_D F_D + I_E F_E}{R (F_A + F_B + F_C + F_D + F_E)} = \frac{0.0148(55 \text{ft}^2) + 0.0088(97.5 \text{ft}^2) + (0.0186)(34.6 \text{ft}^2) + (0.0186)(34.6 \text{ft}^2) + (0.0311)(25 \text{ft}^2)}{5 (55 \text{ft}^2 + 97.5 \text{ft}^2 + 34.6 \text{ft}^2 + 34.6 \text{ft}^2 + 25 \text{ft}^2)} = 0.003 \text{ which defaults to } 0.01$$

JUNCTION AREA = SUM  $F_{JA} \rightarrow F_{JE} = 246.7 \text{ft}^2$ ;  $K_F = 2.77$ ,  $K_R = 2.77$  & IS AT ELEVATION 58'6"

STONE & WEBSTER ENGINEERING CORPORATION  
CALCULATION SHEET

▲ 5010.65

CALCULATION IDENTIFICATION NUMBER				PAGE <u>33</u>
J.O. OR W.O. NO. 12826.44	DIVISION & GROUP	CALCULATION NO. PE-044-0	OPTIONAL TASK CODE	

JUNCTION # 7 NODE 1 TO NODE 4

FROM REF. 25, 3 & 4 THIS JUNCTION CONSISTS OF THE FOLLOWING:

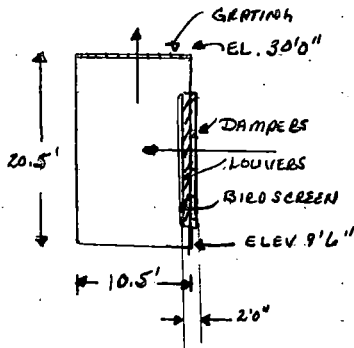
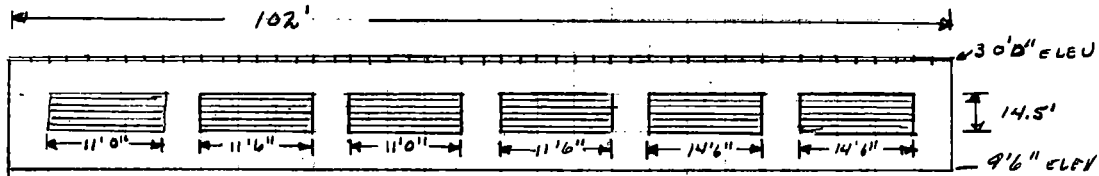

THE LOUVERS ARE DETAINED ON REF 31 AND ARE DIMENSIONED AS SHOWN ABOVE. MANUFACTURERS DRAWING S&W 1144B/1154B-9-55C INDICATES THAT THE LOUVERS ARE CONSTRUCTION SPECIALTY CORPORATION MODEL 4830 WITH #2 1/2" MESH BIRD SCREEN, WHICH, ACCORDING TO THAT VENDORS CATALOG, CONSISTS OF STRENGTHENED BLADING IN A 4" DEEP FRAME, VERY SIMILAR TO THE LOUVER MODEL 4110 ANALYZED IN THE REF. 43, JUNCTION 51 CALCULATION. THE DAMPERS ARE ASSUMED TO BE OF THE SAME

CONSTRUCTION AS THAT ANALYZED IN REF. 42. FROM THIS, THEN IT IS ASSUMED THAT THE VALUES OF COMPONENT RESISTANCE TO FLOW FOR THE BIRD SCREEN, LOUVER AND DAMPER ARE SIMILAR TO THOSE VALUES OF THE NETWORK ANALYZED HERE AND THAT ANY DIFFERENCE BETWEEN THOSE OF REF 42 AND ACTUAL WOULD BE INSIGNIFICANT. THUS, FROM PP 7-9 REF 42 WHERE  $K_{SCREEN} = 0.1372 = 0.14$ ,  $K_{LOUVER} = 1.2$  AND  $\bar{f}$  OF 0.8 FOR THE DAMPER IS USED HERE. ADDITIONALLY, WHILE THESE LOUVERS ARE PNEUMATIC, THE APPROXIMATION OF NET FREE AREA OF 44% OF THE GROSS USED IN REF. 42 IS HIGHLY CONSERVATIVE AND WILL BE RETAINED HERE AS VALID EVEN THOUGH THE COMPONENTS ARE NOT IN FACT IDENTICAL. REF 42 INDICATES  $\bar{f} = 0.88$  FOR THE BIRD SCREEN ALSO.

THE GRATING COEFFICIENT IS ASSUMED TO BE THE SAME AS THAT IDENTIFIED FOR JUNCTION # 1 OF THIS CALCULATION. THE AIR INTAKE PIT WILL BE MODELED AS A SHARP 90° ELBOW IN THE MANNER UTILIZED ON P 215 OF REF 39. AND THE ENTIRE JUNCTION COMBINED FOR THE EFFECTIVE LOSS COEFFICIENT AND INERTIA IN THE MANNER UTILIZED IN REF. 42.

FOR PURPOSES OF SIMPLIFICATION, THE LOUVERED NETWORK WILL BE TREATED AS A SINGLE CONTINUOUS COMPONENT WITH THE COMBINED DIMENSIONS GIVEN ABOVE. THOUGH THIS APPROACH IS NOT TECHNICALLY CORRECT, THE RESULTS WILL NOT SIGNIFICANTLY DIFFER FROM ACTUAL VALUES. THUS THE GROSS OPENING AREA OF THIS NETWORK WILL BE

$$14.5' (11' + 11.5' + 11' + 11.5' + 14.5' + 14.5') = 1073 \text{ ft}^2$$

THE NET FREE AREA OF EACH COMPONENT (F) WILL EQUAL GROSS AREA  $\times \bar{f}$  OF THAT COMPONENT (THE SUBSCRIPTS S = SCREEN, L = LOUVER & D = DAMPER), THUS:

$$F_s = 1073 \text{ ft}^2 (0.88) = 944.24 \text{ ft}^2 \quad (K_s = 0.14)$$

$$F_l = 1073 \text{ ft}^2 (0.44) = 472.12 \text{ ft}^2 \quad (K_l = 1.2)$$

$$F_d = 1073 \text{ ft}^2 (0.8) = 858.4 \text{ ft}^2$$

THE PERIMETER (II) OF THIS OPENING, THEN, IS TAKEN TO BE THE AS FOLLOWS

$$II = 2(11' + 11.5' + 11' + 11.5' + 14.5' + 14.5') + 2(14.5') = 177 \text{ ft}$$



STONE & WEBSTER ENGINEERING CORPORATION  
CALCULATION SHEET

▲ 5010.65

CALCULATION IDENTIFICATION NUMBER				PAGE <u>34</u>
J.O. OR W.O. NO. <u>12846.44</u>	DIVISION & GROUP	CALCULATION NO. <u>PE-044-0</u>	OPTIONAL TASK CODE	

$C_{pf}$  FOR NODE 2 IS EVALUATED IN THE SAME MANNER AS USED IN JUNCTION #1 OF THIS CALCULATION, WHERE  $L_{N1} = \frac{1}{2} W$  OF NODE 1  
 $= \frac{1}{2} (135') = \underline{67.5'}$

AND  $F_{N1} = R(L)$  OF NODE 1  
 $= 48'3" \times 0.70' = 37627.5 \text{ ft}^2 = \underline{37028 \text{ ft}^2}$

II OF NODE 2 =  $2(R) + 2(L)$  OF NODE 1  
 $= 2(48'3") + 2(0.70') = 636.5 \text{ ft}$

THUS,  $D_h = \frac{4(F_{N2})}{II} = \frac{4(37028 \text{ ft}^2)}{636.5 \text{ ft}} = \underline{81.87}$

$\bar{A} = \frac{\Delta (0.03937 \text{ IN/MM})}{D_h (12 \text{ IN/FT})} = \frac{0.5 (0.03937)}{81.87 (12)} = 0.0001$  WHERE  $\Delta = 0.5$  FOR AVE. COND. CONCRETE, P63, REF 39

$R = \frac{1}{(2.47 \frac{0.7}{\bar{A}})^2} = 0.012$

$\therefore C_{pf} = R \left( \frac{L_{N1}}{D_h} \right) = 0.012 \left( \frac{67.5'}{81.87'} \right) = 0.0099 = \underline{0.01}$

THE LOSS COEFFICIENT REALIZED BY THE DAMPER IS EVALUATED AS A SHARP ORIFICE AS PERFORMED IN REF 42, WHERE THE VALUE OF THE OUTLET AREA ( $A_0$ ) IS THE AREA BETWEEN THE DAMPER AND THE LOUVER =  $1073 \text{ ft}^2$ , SUCH THAT, FROM P. 135 OF REF 39

FOR FORWARD FLOW  $K'_{DF} = \left( 1 + 1.707 \sqrt{\left( 1 - \frac{F_D}{F_{N1}} \right) - \frac{F_D}{A_0}} \right)^2$   
 $= \left( 1 + 1.707 \sqrt{\left( 1 - \frac{858.4 \text{ ft}^2}{37028 \text{ ft}^2} \right) - \frac{858.4 \text{ ft}^2}{1073 \text{ ft}^2}} \right)^2 = 0.81$

FOR REVERSE FLOW  $K'_{DR} = \left( 1 + 1.707 \sqrt{\left( 1 - \frac{F_D}{A_0} \right) - \frac{F_D}{F_{N1}}} \right)^2$   
 $= \left( 1 + 1.707 \sqrt{\left( 1 - \frac{858.4 \text{ ft}^2}{1073 \text{ ft}^2} \right) - \frac{858.4 \text{ ft}^2}{37028 \text{ ft}^2}} \right)^2 = 1.67 \quad 1.56$

THE EFFECTIVE RESISTANCE OF THESE COMPONENTS CAN BE SUMMED, USING THE SAME TECHNIQUE EMPLOYED IN REF 42, THIS VALUE SYMBOLICALLY AS  $C_{PA}$ . THE REFERENCE AREA USED IS THE MOST RESTRICTIVE VALUE IMPOSED BY THE LOUVERS,  $F_L = 472.12 \text{ ft}^2$

FOR FORWARD FLOW  $C_{PAF} = (F_L)^2 \left( \frac{K'_S}{F_S^2} + \frac{K'_L}{F_L^2} + \frac{K'_{DF}}{F_D^2} \right)$   
 $= (472.12 \text{ ft}^2)^2 \left( \frac{0.14}{(944.24 \text{ ft}^2)^2} + \frac{1.2}{(472.12 \text{ ft}^2)^2} + \frac{0.81}{(858.4 \text{ ft}^2)^2} \right) = \frac{1.48}{1.47}$

FOR REVERSE FLOW  $C_{PAR} = (F_L)^2 \left( \frac{K'_S}{F_S^2} + \frac{K'_L}{F_L^2} + \frac{K'_{DR}}{F_D^2} \right)$   
 $= (472.12 \text{ ft}^2)^2 \left( \frac{0.14}{(944.24 \text{ ft}^2)^2} + \frac{1.2}{(472.12 \text{ ft}^2)^2} + \frac{1.67}{(858.4 \text{ ft}^2)^2} \right) = \underline{1.74}$

STONE & WEBSTER ENGINEERING CORPORATION  
CALCULATION SHEET

▲ 5010.65

CALCULATION IDENTIFICATION NUMBER			
J.O. OR W.O. NO.	DIVISION & GROUP	CALCULATION NO.	OPTIONAL TASK CODE
12846.44		PE-049-0	

PAGE 35

UPON EXITING THE BIRD SCREEN FOR FLOW IN THE FORWARD DIRECTION, AN EXPANSION OF THE STREAM OCCURS, THIS VALUE THEN WOULD BE (P128, REF 39)

$K_{EXPA} = \left(1 - \frac{F_L}{A_1}\right)^2$  WHERE  $A_1$  IS THE CROSS SECTIONAL FLOW AREA OF THE AIR INTAKE PIT,  $(20.5')(102') = 2091 \text{ ft}^2$

$$K_{EXPA} = \left(1 - \frac{472.12 \text{ ft}^2}{2091 \text{ ft}^2}\right)^2 = 0.6$$

FOR REVERSE FLOW (P98, REF 39)

$$K_{CONT A} = 0.5 \left(1 - \frac{F_L}{A_1}\right)$$

$$= 0.5 \left(1 - \frac{472.12 \text{ ft}^2}{2091 \text{ ft}^2}\right) = 0.39$$

THE AIR INTAKE PIT, THEN, IS EVALUATED AS A 90° ELBOW AS DESCRIBED BY P. 215 & 214 OF REFERENCE 39, THE RESISTANCE DENOTED AS  $\phi_B$

WHERE, FOR ROUGH WALLS ( $\Delta > 0$ )

$$\phi_B = k_A k_{RE} C_1 A \phi_1 \text{ (+ friction coefficient for this stretch)}$$

WHERE  $k_A$  &  $k_{RE}$  ARE A FUNCTION OF  $\bar{\Delta}$

TO DETERMINE  $\bar{\Delta}$  FOR THIS AREA, THE VALUE OF  $D_h$  MUST BE OBTAINED.

FOR ALL PRACTICAL PURPOSES, THE STREAM FLOW ENTERS THE PIT ALONG NEARLY 70% OF ITS HEIGHT, NOT THROUGH A NARROW CHANNEL AT ONE END OF THE FLOW STRETCH AS IS NORMALLY THE CASE, AND THE FLOW DIRECTION CHANGE OCCURS HYDRAULICALLY NEARLY IMMEDIATELY AFTER THE EXPANSION INTO THE AREA. FROM THIS OBSERVATION, THE HYDRAULIC AREA,  $D_h$ , IS TAKEN TO BE AN  $H$  PARALLEL PLANE WITH THE FLOOR OF THE PIT, THE  $II$  THEN WOULD BE THE LENGTH + WIDTH OF THE PIT BY DIMENSION.

$$A_B = (102')(10.5') = 1071 \text{ ft}^2$$

$$II = 2(102') + 2(10.5') = 225'$$

$$D_h = \frac{4A}{II} = \frac{4(1071 \text{ ft}^2)}{225} = 19.1$$

$$\bar{\Delta} = \frac{\Delta (0.03937 \text{ m/in})}{D_h (12 \text{ in/ft})} = \frac{2.5 (0.03937)}{19.1 (12)} = 0.00043 \text{ WHERE } \Delta = 2.5 \text{ FOR AVE. COND. CONCRETE P 63, REF 39}$$

FROM TABLE 6-11, REF 39  $\bar{\Delta} = 0 - 0.001$  &  $Re \geq 4 \cdot 10^4$

$$k_{RE} = 1.0$$

$$k_A = 1 + 0.5 \times 10^3 \bar{\Delta} = 1 + 0.5 \times 10^3 (0.00043) = 1.22$$

$C_1$  IS A FUNCTION OF THE INLET PERIMETER OF  $\frac{L}{W} = \frac{102'}{20.5'}$  AS THE MOST CONSERVATIVE APPROXIMATION  $\frac{102'}{20.5'} = 4.97 = 5$

FROM DIAG 6-7, P. 215  $C_1 = 0.75$  FOR  $\frac{L}{W} = 5$

$\phi_1$  &  $A$  IS DETERMINED FROM GRAPH (b) P. 216 AS A FUNCTION OF  $\theta$  WHICH IS 90°  
THUS  $\phi_1 = 0.99$  AND  $A = 1.2$

$$\therefore \phi_B = 1.22(1.0)(0.75)(0.99)(1.2) + \phi_{fr} = 1.09 + \phi_{fr}$$

STONE & WEBSTER ENGINEERING CORPORATION  
CALCULATION SHEET

▲ 5010.65

CALCULATION IDENTIFICATION NUMBER			
J.O. OR W.O. NO. 12846.44	DIVISION & GROUP	CALCULATION NO. PE-049-0	OPTIONAL TASK CODE
			PAGE 34

$C_{fr}$  FOR THIS AREA IS APPROXIMATED BY USING THE  $\Delta$  OBTAINED FOR THE  $D_k = 19.1$ , THE FLOW LENGTH IS TAKEN TO BE 10.5' AS A CONSERVATIVE ESTIMATE.

$$a = \frac{1}{(2.6 \log \frac{3.7}{\Delta})^2} = 0.016$$

$$C_{fr} = a \left( \frac{L}{D_k} \right) = 0.016 \left( \frac{10.5}{19.1} \right) = 0.0089$$

$$\therefore C_B = 1.09 + 0.0089 = \underline{1.1}$$

THE LOSS COEFFICIENT ATTRIBUTABLE TO THE GRATINGS IS ASSUMED TO BE THAT DETERMINED FOR 1 1/2" GRATINGS IN JUNCTION #1

$$C_{gr} = 0.2 \quad \& \quad F_{gr} = (102')(10.5')(0.8) = \underline{856.8 \text{ ft}^2}$$

FINALLY AN EXPANSION TERM TO ATMOSPHERE FOR FORWARD FLOW FROM THE JUNCTION (AND A CONTRACTION TERM FOR REVERSE FLOW) MUST BE INCLUDED.  $F_{N4}$  (THE ATMOSPHERE) WILL REDUCE THE EXPRESSION  $\frac{F_j}{F_{N4}}$  TO A VALUE SO SMALL AS TO BE INSIGNIFICANT, THUS,

$$\begin{aligned} \text{for FORWARD flow } K_{EXPB} &= \left( 1 - \frac{F_j}{F_{N4}} \right)^2 = \underline{1.0} \\ \text{for REVERSE flow } K_{CONTB} &= 0.5 \left( 1 - \frac{F_j}{F_{N4}} \right)^2 = \underline{0.5} \end{aligned}$$

THE EFFECTIVE JUNCTION LENGTH IS CONSIDERED TO BE THE WIDTH OF THE AIR INTAKE PIT (10.5') + THE LENGTH OF THE LOUVER/DAMPER NETWORK (2')

$$L_j = (10.5') + (2') = 12.5'$$

THE MOMENTUM FLUX TERM THEN IS EVALUATED AS A THICK ORIFACE FOR THIS JUNCTION WHERE  $F_j$  IS THE MOST RESTRICTIVE FLOW AREA OF THE NETWORK =  $F_2 = 472.12 \text{ ft}^2$

$$K'_F = \left( \frac{F_j}{F_{N4}} \right)^2 - \left( \frac{F_j}{F_{N1}} \right)^2 = \left( \frac{472.12 \text{ ft}^2}{F_{N4}} \right)^2 - \left( \frac{472.12 \text{ ft}^2}{37028 \text{ ft}^2} \right)^2 = -0.00016$$

$$K'_R = \left( \frac{F_j}{F_{N1}} \right)^2 - \left( \frac{F_j}{F_{N4}} \right)^2 = \left( \frac{472.12 \text{ ft}^2}{37028 \text{ ft}^2} \right)^2 = 0.00016$$

THE SUMMATION OF THESE RESISTANCES THEN IS

for FORWARD flow

$$K_{EFF} = (F_2)^2 \left( \frac{C_{AF}}{(F_2)^2} + \frac{C_0}{(A_0)^2} + \frac{C_{gr}}{(F_{gr})^2} \right) + K'_F + K_{EXPA} + K_{EXPB} + C_{fr}$$

$$= (472.12 \text{ ft}^2)^2 \left( \frac{1.48}{(472.12 \text{ ft}^2)^2} + \frac{1.1}{(107 \text{ ft}^2)^2} + \frac{0.2}{(856.8 \text{ ft}^2)^2} \right) + (-0.00016) + 0.6 + 1.0 + 0.01 = \underline{3.37}$$

for REVERSE flow

$$K_{EFF} = (F_2)^2 \left( \frac{C_{AR}}{(F_2)^2} + \frac{C_0}{(A_0)^2} + \frac{C_{gr}}{(F_{gr})^2} \right) + K'_R + K_{CONTA} + K_{CONTB} + C_{fr}$$

$$= (472.12 \text{ ft}^2)^2 \left( \frac{1.74}{(472.12 \text{ ft}^2)^2} + \frac{1.1}{(107 \text{ ft}^2)^2} + \frac{0.2}{(856.8 \text{ ft}^2)^2} \right) + 0.00016 + 0.39 + 0.5 + 0.01 = \underline{2.18}$$

STONE & WEBSTER ENGINEERING CORPORATION  
**CALCULATION SHEET**

▲ 5010.65

CALCULATION IDENTIFICATION NUMBER			
J.O. OR W.O. NO. 12846.44.	DIVISION & GROUP	CALCULATION NO. <b>PE-049-0</b>	OPTIONAL TASK CODE
			PAGE <u>37</u>

1  
2  
3  
4  
5  
6  
7  
8  
9  
10  
11  
12  
13  
14  
15  
16  
17  
18  
19  
20  
21  
22  
23  
24  
25  
26  
27  
28  
29  
30  
31  
32  
33  
34  
35  
36  
37  
38  
39  
40  
41  
42  
43  
44  
45  
46

THE INERTIA TERM IS EVALUATED AS FOLLOWS.

$$I = L \left( \frac{1}{E_f} \right) + L N_1 \left( \frac{1}{E_{N1}} \right) + L N_4 \left( \frac{1}{E_{N4}} \right)$$

$$I = 12.5' \left( \frac{1}{472.12 \text{ ft}^2} \right) + 67.5' \left( \frac{1}{\frac{37028 \text{ ft}^2}{13025}} \right) = 0.028 \quad , \quad 0.32$$

THIS JUNCTION IS CONSIDERED TO BE AT ELEVATION 15'0"

JUNCTION # 8 (NODE 3 TO NODE 4)

THIS JUNCTION IS IDENTICAL TO JUNCTION #7, THEREFORE

$$E_f = 472.12 \text{ ft}^2$$

$$K_f = 3.37 \quad 3.35$$

$$K_R = 0.18 \quad 2.91$$

$$I = 0.028 \quad , \quad 0.32$$

AT ELEVATION 15'0"

JUNCTION # 9 NODE 2 TO NODE 4

THIS JUNCTION IS COMPOSED OF 4 OPENINGS IN THE ROOF OF THE BUILDING FOR THE STRUCTURE EXHAUST FANS. IT IS ASSUMED THAT THE OPENINGS ARE IDENTICAL AND WILL BE TREATED AS ONLY CLEAR OPENINGS, ANY BENEFIT OF EXHAUSTING THE MASS-ENERGY FROM THE BUILDING TO THE ATMOSPHERE BY THE OPERATION OF THE FANS IS NOT CONSIDERED. THE OPENINGS ARE CONSIDERED CIRCULAR AND ARE COMBINED INTO ONE JUNCTION USING THE METHOD DESCRIBED IN THE REFERENCE 32 DISCUSSION ON PARALLEL NETWORK FLOW PATHS.

FROM REF 14, THE DIAMETER OF THE OPENING IS APPROXIMATED AS 6'0" AND THE LENGTH, TAKEN AS THE APPROXIMATE HEIGHT OF THE FAN HOUSING, IS ESTIMATED TO BE 5'0". THIS, THEN, WILL BE ANALYZED AS A THICK EDGED ORIFICE

$$L_j = 5'$$

$$F_j = \pi d^2 = \pi (6')^2 = 28.27 \text{ ft}^2$$

$$A = \frac{4}{\pi} L_j d = \frac{4}{\pi} (5') (6') = 18.85 \text{ ft}$$

$$D_h = \frac{4 F_j}{A} = \frac{4 (28.27 \text{ ft}^2)}{18.85 \text{ ft}} = 6'$$

$$\bar{A} = \frac{A (0.03937 / \text{IN/FT})}{D_h (12 \text{ IN/FT})} = \frac{0.18 (6.03937)}{6' (12)} = 0.000098 \text{ FOR USED GALVANIZED SHEET STEEL, p 63, REF 39}$$

$$Z = \frac{1}{\left( 0.69 \frac{3.17}{A} \right)^2} = 0.012$$

$$Z = 1.39$$

$$L_{N2} = \frac{1}{2} K_{N2} = \frac{1}{2} (69'11") = 34.96 \text{ ft}$$

$$E_{N2} = L_{N2} W_{N2} = 370' (135') = 36.450 \text{ ft}^2$$

$$C_{PF} = 0.5 \left( 1 - \frac{E_f}{E_{N2}} \right) + \left( 1 - \frac{E_f}{E_{N4}} \right)^2 + \sqrt{\left( 1 - \frac{E_f}{E_{N2}} \right) \left( 1 - \frac{E_f}{E_{N4}} \right)} + 2 \left( \frac{L_j}{D_h} \right)$$

$$C_{PF} = 0.5 \left( 1 - \frac{28.27 \text{ ft}^2}{36.450 \text{ ft}^2} \right) + (1)^2 + 0.012 \left( \frac{5'}{6'} \right) + 1.39 \sqrt{1 - \frac{28.27}{36.450}} = 1.51 \quad 1.9$$

STONE & WEBSTER ENGINEERING CORPORATION  
CALCULATION SHEET

▲ 5010.65

CALCULATION IDENTIFICATION NUMBER				PAGE <u>38</u>
J.O. OR W.O. NO. 12846.44	DIVISION & GROUP	CALCULATION NO. PE-049-0	OPTIONAL TASK CODE	

1  
2  
3  
4  
5  
6  
7  
8  
9  
10  
11  
12  
13  
14  
15  
16  
17  
18  
19  
20  
21  
22  
23  
24  
25  
26  
27  
28  
29  
30  
31  
32  
33  
34  
35  
36  
37  
38  
39  
40  
41  
42  
43  
44  
45  
46

$$C_R = 0.5 \left(1 - \frac{F_j}{F_{N4}}\right) + \left(1 - \frac{F_j}{F_{N2}}\right)^2 + 2 \sqrt{\left(1 - \frac{F_j}{F_{N4}}\right) \left(1 - \frac{F_j}{F_{N2}}\right)} + 2 \frac{L_j}{D_j} \left(1 - \frac{28.27}{26.45}\right)$$

$$= 0.5(1) + \left(1 - \frac{28.27 \text{ ft}^2}{36450 \text{ ft}^2}\right)^2 + 0.012 \left(\frac{5'}{6'}\right) + 3.9 \sqrt{1} \left(1 - \frac{28.27}{26.45}\right) = 1.51 \quad 1.90$$

$$K'_F = \left(\frac{F_j}{F_{N4}}\right)^2 - \left(\frac{F_j}{F_{N2}}\right)^2 = \left(\frac{28.27 \text{ ft}^2}{36450 \text{ ft}^2}\right)^2 - \left(\frac{28.27 \text{ ft}^2}{36450 \text{ ft}^2}\right)^2 = -0.00078$$

$$K'_R = \left(\frac{F_j}{F_{N2}}\right)^2 - \left(\frac{F_j}{F_{N4}}\right)^2 = \left(\frac{28.27 \text{ ft}^2}{36450 \text{ ft}^2}\right)^2 - \left(\frac{28.27 \text{ ft}^2}{36450 \text{ ft}^2}\right)^2 = 0.00078$$

$C_{fr} = 0.002$  from junction #1

$$K_F = C_F + C_{fr} + K'_F = 1.51 + 0.002 + (-0.00078) = 1.51 \quad 1.90$$

$$K_R = C_R + C_{fr} + K'_R = 1.51 + 0.002 + 0.00078 = 1.51 \quad 1.90$$

$K_{eff}$  for  $n$  IDENTICAL PARALLEL FLOW PATHS IS EQUAL TO  $K_i$

$$I_{eff} = \frac{1}{n} I_i = \frac{1}{4} \left[ L_j \left(\frac{1}{F_j}\right) + L_{N2} \left(\frac{1}{F_{N2}}\right) + L_{N4} \left(\frac{1}{F_{N4}}\right) \right]$$

$$= \frac{1}{4} \left[ 5' \left(\frac{1}{28.27 \text{ ft}^2}\right) + 34.96 \text{ ft} \left(\frac{1}{36450 \text{ ft}^2}\right) \right] = 0.04445 = 0.045$$

THE JUNCTION AREA =  $28.27 \text{ ft}^2 (4) = 113.1 \text{ ft}^2$  at elevation 128.42'  
 =  $44.18 \text{ ft}^2 (4) = 176.72 \text{ ft}^2$   
 $K_F = 1.9$        $K_R = 1.9$

THE INITIAL CONDITIONS OF 120°F AND 14.7 PSIA ARE UTILIZED AS APPROXIMATIONS. THE TEMPERATURE BASED ON THE VALUE GIVEN FOR UNOCCUPIED MACHINERY SPACES TAKEN FROM RCF 45, PAGE 9.13.2-1 TO MAXIMIZE RESULTS.

NOTE: The vent area assumed out of Node 2 is less than what exists. When a larger vent area and different  $K_F$  &  $K_R$  values are applied to the model, the peak temp. in Node 1 did not change but occurred earlier in time. A computer run was made with the different area. The temperature of Node 1 occurs at  $t = 11.1$ , which is the same as the peak. The peak temp. is therefore limited by the enthalpies.

STONE & WEBSTER ENGINEERING CORPORATION  
**CALCULATION SHEET**

▲ 5010.85

CALCULATION IDENTIFICATION NUMBER				PAGE <u>39</u>
J.O. OR W.O. NO. 12846.44	DIVISION & GROUP	CALCULATION NO. <u>PE-049-0</u>	OPTIONAL TASK CODE	

THE FOLLOWING TABLES SUMMARIZE THE NODAL AND JUNCTION DATA TO BE USED AS INPUT TO THE "THREED" SUBCOMPARTMENT ANALYSIS COMPUTER PROGRAM.

A. NODAL DATA

#	TEMP (°F)	PRESS (PSIA)	VOLUME (ft <sup>3</sup> )	ELEVATION (ft)	HEIGHT (ft)
1	120	14.7	1237658.0	9.5	48.25
2	120	14.7	4436565.0	58.5	69.92
3	120	14.7	1214211.0	9.5	48.25
4	120	14.7	1.0e <sup>20</sup>	9.5	70.0

B. JUNCTION DATA

#	Node TO	Node	F <sub>j</sub> (ft <sup>2</sup> )	I (ft <sup>-1</sup> )	K <sub>F</sub>	K <sub>R</sub>	ELEVATION (ft)
1	1	2	5342.4	0.01	2.92	2.88	58.5
2	1	2	1656.6	0.01	2.71	2.67	58.5
3	1	2	217.5	0.01	2.78	2.78	58.5
4	2	3	5922.0	0.01	2.87	2.91	2.88 2.92 58.5
5	2	3	<u>1466.3</u> 18045	0.01	2.69	2.73	2.65 2.7 58.5
6	2	3	<u>246.7</u> 2435	0.01	2.77	2.77	58.5
7	1	4	472.1	0.028, 1032	3.37	2.18	3.35 2.91 15.0
8	3	4	472.1	0.028	3.37	2.18	15.0
9	2	4	<u>113.1</u> 176.7	0.045	<u>1.51</u> 1.51	1.9 1.9	128.42

MASS-ENERGY RELEASE RATES FROM A CRACK FAILURE OF THE MAIN STEAM LINE.

IT IS CONSERVATIVE FOR TEMPERATURE CONSIDERATIONS THAT THE MOST LIMITING FAILURE WOULD BE SUCH THAT THE RESULTANT FLOW RATE WOULD NOT ACTUATE AN AUTOMATIC ISOLATION SEQUENCE. REF 44 INDICATES THAT THE LARGEST SIZE FAILURE THAT DOES NOT RESULT IN A FLOW RATE OF ADEQUATE MAGNITUDE TO ACTUATE AUTOMATIC ISOLATION WOULD BE A 0.7065 ft<sup>2</sup> SPILT RUPTURE AT 30% POWER FOR A FLOOD PLANT GIVEN ON TABLE IV-12, P. 48. ANY FAILURE, THEREFORE, WHICH RESULTS IN A FLOW RATE SLIGHTLY LESS THAN THOSE GIVEN BY THE TABLE IS ASSUMED TO REQUIRE OPERATOR ACTION FOR ISOLATION. IT IS FURTHER ASSUMED THAT A FAILURE OF THIS SIZE WOULD NOT, IN A SHORT TIME PERIOD, ADVERSELY AFFECT THE OPERATION OF THE SECONDARY STEAM SYSTEM SUCH THAT AN AUTOMATIC ACTUATION OF A RELATED SAFETY FUNCTION WOULD TAKE PLACE PRIOR TO AT LEAST 20 MINUTES AFTER THE FAILURE OCCURS. THIS ASSUMPTION IS BASED ON THE OBSERVATION THAT THE NORMAL OPERATING INVENTORY OF CONDENSATE IN THE TURBINE HOTWELL, AS INDICATED BY REF 45, P. 10.3.5-1, IS DESIGNED TO PROVIDE ABOUT 4 MINUTES OF CONDENSATE FLOW (65,000 gpm), SUCH THAT, EVEN IF NO MAKE-UP CAPABILITIES WERE CONSIDERED AND THE FEED REQUIREMENTS WERE OF THAT FLOW, IT WOULD TAKE APPROXIMATELY 26 MINUTES TO DEplete THAT INVENTORY WITH AN ESTIMATED 10,000 gpm LOSS OF MASS FROM THE SYSTEM. IT IS CONSERVATIVE THEN, TO ESTABLISH A MASS-ENERGY RELEASE RATE BASED ON THE FLOW RATES GIVEN BY THE ABOVE MENTIONED TABLE. ADDITIONALLY IT IS ASSUMED THAT

CALCULATION SHEET

▲ 5010.65

CALCULATION IDENTIFICATION NUMBER			
J.O. OR W.O. NO. 12846.44	DIVISION & GROUP	CALCULATION NO. PE-049-0	OPTIONAL TASK CODE
			PAGE 40

ALL BLOWDOWN INTO THE STRUCTURE IS EFFECTIVELY TERMINATED AT 1800 SECS AFTER THE FAILURE OCCURS, WHICH IS CONSIDERED REASONABLE AND INCLUDES POST ISOLATION EVACUATION OF ONE GENERATOR ASSUMING A SINGLE STEAM GENERATOR STEAM ISOLATION VALVE FAILS TO OPERATE. THE FOLLOWING TABLE IS USED AS THE MASS-ENERGY RELEASE RATE FOR THE 'THREE' SUBCOMPARTMENT ANALYSIS

TIME (SECS)	$\dot{M}$ (LBM/SEC) (FOR 3 GEN.)	ENTHALPY (BTU/LBM)	$\dot{Q}$ (BTU/SEC)
0.0	1617.0	1188.1	1921157.7
1.0	1602.0	1188.7	1904297.4
2.0	1581.0	1189.3	1880283.3
3.0	1560.0	1189.8	1856088.0
4.0	1539.0	1190.3	1831871.7
5.0	1521.0	1190.8	1811206.8
6.0	1506.0	1191.2	1793947.2
7.0	1488.0	1191.6	1773100.8
8.0	1473.0	1192.0	1755816.0
9.0	1461.0	1192.3	1741950.3
10.0	1449.0	1192.6	1728077.4
11.0	1473.0 14370	1192.9	1714197.3
12.0	1425.0	1193.2	1700310.0
13.0	1413.0	1193.4	1686274.2
14.0	1404.0	1193.7	1675954.8
15.0	1392.0	1193.9	1661908.8
17.5	1371.0	1194.4	1637522.4
20.0	1350.0	1194.9	1613115.0
22.5	1332.0	1195.3	1592139.6
25.0	1314.0	1195.7	1573777.8
27.5	1299.0	1196.0	1553604.0
30.0	1287.0	1196.3	1539638.1
35.0	1266.0	1196.7	1515022.2
40.0	1254.0	1196.9	1500912.6
45.0	1248.0	1197.1	1493980.8
50.0	1242.0	1197.2	1486922.4
60.0	1239.0	1197.2	1483330.8
70.0	1242.0	1197.2	1486922.4
80.0	1242.0	1197.2	1486922.4
90.0	1245.0	1197.1	1490389.5
100.0	1245.0	1197.1	1490389.5
1800.0	1245.0	1197.1	1490389.5

STONE & WEBSTER ENGINEERING CORPORATION  
CALCULATION SHEET

▲ 5010.65

CALCULATION IDENTIFICATION NUMBER				PAGE <u>41</u>
J.O. OR W.O. NO. <u>12846.44</u>	DIVISION & GROUP	CALCULATION NO. <u>PE-049-0</u>	OPTIONAL TASK CODE	

LIST OF ATTACHMENT

1. ATTACHMENT 1, 1 PAGE; I.O.C. TO BOB MILLER FROM MIKE O'MEARA  
DATED 9/23/80

CONCLUSIONS. THE ANALYSIS OF THE EFFECTS OF A HIGH ENERGY LINE BREAK OUTSIDE CONTAINMENT WITH RESPECT TO TEMPERATURE FOR EQUIPMENT LOCATED IN THE SURRY UNIT 1%2 MECHANICAL EQUIPMENT ROOM #3 IS COMPLETE AND SUMMARIZED BY THE GRAPH OF TEMPERATURE VS TIME ON PAGE 42 OF THIS CALCULATION.

SUMMARY: THE GRAPH ON P 42 OF THE TEMPERATURE TRANSIENT FOR NODE 1 OF THE TURBINE BUILDING, AS DISCUSSED PREVIOUSLY, IS ASSUMED TO BE THE TRANSIENT EXPERIENCED BY THE MECHANICAL EQUIPMENT ROOM #3 FOR THE FAILURE ANALYZED. THE FAILURE MODE AND DURATION IS CONSIDERED TO BE REASONABLE AND CONSERVATIVE, ALTHOUGH SOME APPROXIMATIONS OF DURATION ARE ARBITRARY. HOWEVER, REVIEW OF THE RESULTANT TRANSIENT INDICATES THAT THE STRUCTURE TENDS TO REACH AN EQUILIBRIUM TEMPERATURE CONDITION OF 309°F TO 310°F IN THE NODE OF INTEREST AFTER ABOUT 330 SEC. FROM THIS IT IS REASONABLE TO POSTULATE THAT THE MAXIMUM TEMPERATURE FROM THIS SIZE FAILURE IS 310°F REGARDLESS OF DURATION, FOR ANY CONTINUED RELEASE OF ENERGY AFTER 330 SECS. IT IS ALSO EVIDENT THAT AFTER TERMINATION OF THE FAILURE, THE TEMPERATURE DECREASE IS RELATIVELY RAPID FOR THIS AREA, SUCH THAT AT 30 MINUTES AFTER THE FAILURE IS ISOLATED, TEMPERATURES IN THE NODE OF INTEREST WILL BE BELOW 130°F. THIS ANALYSIS DOES NOT CONSIDER THE EFFECTS OF AN ACTIVE VENTILATION SYSTEM, WITH THE EXCEPTION OF EQUATING TEMPERATURES IN NODE 1 TO THAT OF THE MECHANICAL EQUIPMENT ROOM #3, NOR THAT OF PASSIVE HEAT SINKS. A SUMMARY OF THE INPUT DATA FOR THE ANALYSIS AND RESULTANT PEAK TEMPERATURES AND PRESSURES ARE CONTAINED IN PAGES 43 TO 47.



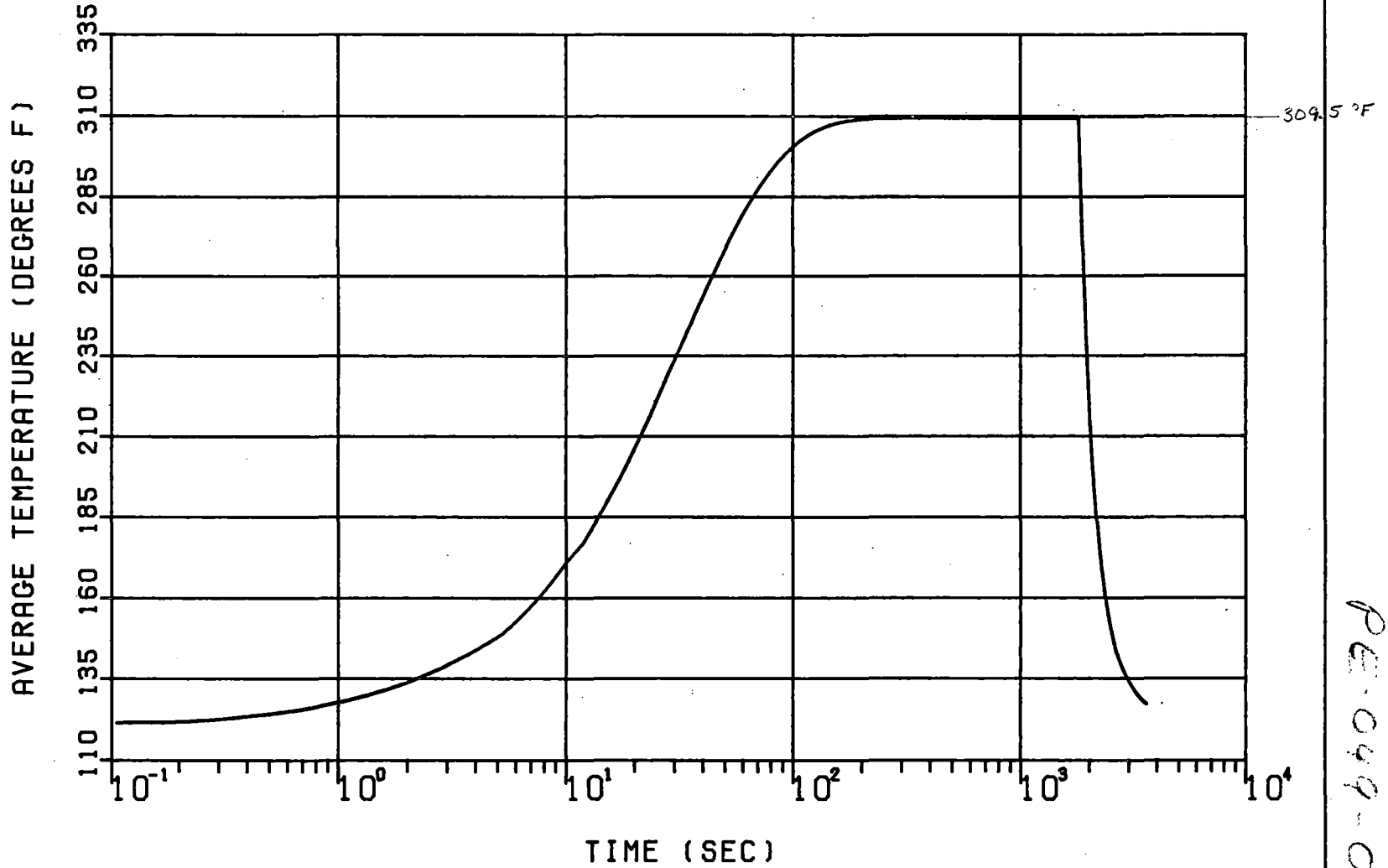

SURRY UNIT 142 TURBINE BLDG HELB  
AVERAGE TEMPERATURE VERSUS TIME  
4 NODE MAIN STEAM LINE CRACK IN NODE1  
RUN = 3600802

PE-049-0

1-5-43

UNIT 55 (SEQ 1) INPUT ECHO 1 2 3 4 5 6 7 8  
1234567890123456789012345678901234567890123456789012345678901234567890

1	SURRY UNIT 2 TURBINE BLDG HELB	1
2	*	2
3	*	3
4	*PROBLEM DIMENSION DATA CARD	4
5	*	5
6	*	6
7	1 12 2 4 10 1 0 0 0 0	7
8	*	8
9	*	9
10	*IMPLICIT/EXPLICIT COEFFICIENT DATA CARD	10
11	*	11
12	*	12
13	1.0	13
14	*	14
15	*	15
16	*TIME STEP CONTROL DATA CARDS	16
17	*	17
18	*	18
19	5 20 0 0 0.001 0.0001 .2	19
20	2 20 0 0 0.01 0.001 1.0	20
21	2 10 0 0 0.02 0.001 2.0	21
22	8 10 0 0 0.05 0.001 10.0	22
23	9 20 0 0 0.1 0.001 100.0	23
24	10 20 0 0 0.2 0.001 200.0	24
25	15 15 0 0 0.5 0.001 1799.0	25
26	2 20 0 0 0.05 0.001 1805.0	26
27	5 20 0 0 0.1 0.001 1850.0	27
28	5 10 0 0 0.2 0.001 1900.0	28
29	2 10 0 0 0.5 0.001 2000.0	29
30	10 5 0 0 1.0 0.01 3650.0	30
31	*	31
32	*	32
33	*TRIP CONTROL DATA CARDS	33
34	*	34
35	*	35
36	1 0 0 3600.0 0.00	36
37	1 0 0 0.0 0.0	37
38	*	38
39	*	39
40	*NODAL DATA CARDS	40
41	*	41
42	*	42
43	14.7 120. 1.0 1237658.0 9.5 48.25 0.0 0	43
44	14.7 120. 1.0 4436565.0 58.5 69.92 0.0 0	44
45	14.7 120. 1.0 1214211.0 9.5 48.25 0.0 0	45
46	14.7 120. 1.0 1.0E20 9.5 70.00 0.0 0	46
47	*	47
48	*	48
49	*JUNCTION DATA CARDS	49
50	*	50

1234567890123456789012345678901234567890123456789012345678901234567890

PE 047900

1234567890

PAGE 43





9h-Z-I-1

R U N S U M M A R Y S H E E T

MISCELLANEOUS PROBLEM CONTROL DATA:

OUTPUT FLAG.....	1	TOTAL TIME OF RUN.....	3601.000 SEC
NUMBER OF TIME STEP CARDS...	12	NUMBER OF STANDARD TIME STEPS.....	7709
NUMBER OF TRIP CONTROLS.....	2	NUMBER OF ACTUAL TIME STEPS.....	7721
NUMBER OF VOLUMES.....	4	NUMBER OF TIMES GAUSSIAN ELIMINATION USED..	7721
NUMBER OF JUNCTIONS.....	10	NUMBER OF TIMES GAUSS-SEIDEL USED.....	0
NUMBER OF FILL TABLES.....	1	NUMBER OF TRANSIENTS STORED FOR PLOTENUP...	18
NUMBER OF FAN TABLES.....	0	NUMBER OF SELECTED NODAL DIFF. PRESS.....	0
NUMBER OF HT SOURCE CURVES..	0	NUMBER OF HEAT SINKS.....	0
IMPLICIT/EXPLICIT COEFF.....	1.000	NUMBER OF INTERNAL JUNCTIONS.....	9

STEAM TABLES USED (FT15) VOLUME SERIAL NO. = SHARE0 DATA SET NAME = HEATBAL.ME190.STH20G.OUTPUT1

OUTPUT: TRANSIENTS TAPE (FT08) = 016308 FILE NUMBER = \_\_\_\_\_ DATA SET NAME = FE.GUARDS.PLOTTER  
TRANSMITTAL FILE (FT09) WAS NOT USED

PEAK PRESSURE DIFFERENTIAL

JUNCTION NUMBER	CONNECTING VOLUMES	PRESSURE PSID	TIME SEC
1	1 TO 2	0.05	0.104
2	1 TO 2	0.05	0.104
3	1 TO 2	0.05	0.104
4	2 TO 3	0.03	0.000
5	2 TO 3	0.03	0.000
6	2 TO 3	0.03	0.000
7	1 TO 4	0.07	0.108
8	3 TO 4	0.05	0.680
9	2 TO 4	0.05	1.120

PE-049-0

PAGE 4/6  
J.O. 12846.44

64-2-1

R3800902 SURRY UNIT 2 TURBINE BLDG HELB  
S & W ENGR CORP NU-92 << SUBCOMPARTMENT ANALYSIS PROGRAM >>

THREED 14 OCT 1980 17:05:26 PAGE 5  
THREED.VER12.LEV01 CREATED 80.106 11:35:02 UNIT 10

NODE NUMBER	PEAK PRESSURES AND TEMPERATURES			
	PRESSURE (PSIA)	TIME (SEC)	TEMPERATURE (DEG F)	TIME (SEC)
1	14.77	0.107	309.50	806.500
2	14.73	1.100	309.40	1800.000
3	14.76	0.670	309.51	1800.000
4	14.70	3601.000	120.00	3601.000

PE-049-0

PAGE 4/7  
J.O. 12846.44

STONE & WEBSTER ENGINEERING CORPORATION  
CALCULATION SHEET

▲ 5010.65

CALCULATION IDENTIFICATION NUMBER				PAGE <u>48</u>
J.O. OR W.O. NO.	DIVISION & GROUP	CALCULATION NO.	OPTIONAL TASK CODE	
1284644		<b>PE-049-0</b>		
1	REFERENCES			
2				
3	1. S.F.W. DRAWING 11548-FM-6A, ISSUE 5			
4				
5	2. S.F.W. DRAWING 11548-FM-6B, ISSUE 6			
6				
7	3. S.F.W. DRAWING 11548-FM-6C, ISSUE 4			
8				
9	4. S.F.W. DRAWING 11548-FM-6D, ISSUE 5			
10				
11	5. S.F.W. DRAWING 11548-FM-6E, ISSUE 5			
12				
13	6. S.F.W. DRAWING 11548-FM-6F, ISSUE 6			
14				
15	7. S.F.W. DRAWING 11548-FM-6G, ISSUE 6			
16				
17	8. S.F.W. DRAWING 11548-FM-6H, ISSUE 6			
18				
19	9. S.F.W. DRAWING 11548-FA-7A, ISSUE 2			
20				
21	10. S.F.W. DRAWING 11548-FC-7B, ISSUE 1			
22				
23	11. S.F.W. DRAWING 11448-FM-6A, ISSUE 6			
24				
25	12. S.F.W. DRAWING 11448-FM-6B, ISSUE 7			
26				
27	13. S.F.W. DRAWING 11448-FM-6C, ISSUE 10			
28				
29	14. S.F.W. DRAWING 11448-FM-6D, ISSUE 4			
30				
31	15. S.F.W. DRAWING 11448-FM-6E, ISSUE 4			
32				
33	16. S.F.W. DRAWING 11448-FM-6F, ISSUE 7			
34				
35	17. S.F.W. DRAWING 11448-FM-6G, ISSUE 7			
36				
37	18. S.F.W. DRAWING 11448-FM-6H, ISSUE 7			
38				
39	19. S.F.W. DRAWING 11548-FS-3C, ISSUE 4			
40				
41	20. S.F.W. DRAWING 11548-FP-2D, ISSUE 6			
42				
43	21. S.F.W. DRAWING 11548-FP-2E, ISSUE 5			
44				
45	22. S.F.W. DRAWING 11448-FP-1C, ISSUE 7			
46				

STONE & WEBSTER ENGINEERING CORPORATION  
CALCULATION SHEET

▲ 5010.65

CALCULATION IDENTIFICATION NUMBER				PAGE <u>49</u>
J.O. OR W.O. NO.	DIVISION & GROUP	CALCULATION NO.	OPTIONAL TASK CODE	
12846.44		<b>PE-049-D</b>		
1				
2		23. S&W DRAWING 11548 - FS-4D, ISSUE 3		
3				
4		24. S&W DRAWING 11448 - FA-2A, ISSUE 6		
5				
6		25. S&W DRAWING 11448 - FA-2B, ISSUE 7		
7				
8		26. S&W DRAWING 11448 - FA-2C, ISSUE 7		
9				
10		27. S&W DRAWING 11448 - FA-11A, ISSUE 3		
11				
12		28. S&W DRAWING 11548 - FS-3A, ISSUE 6		
13				
14		29. S&W DRAWING 11448 - FS-3A, ISSUE 9		
15				
16		30. S&W DRAWING 11548 - FA-2A, ISSUE 5		
17				
18		31. S&W DRAWING 11448 - FA-7B, ISSUE 7		
19				
20		32. ENGINEERED SAFEGUARDS GUIDELINES 19-1, MARCH 3, 1980		
21				
22		33. S&W DRAWING 11448 - FP-44A, ISSUE 7		
23		FP-44B, ISSUE 6		
24		FP-44C, ISSUE 7		
25				
26		34. S&W DRAWING 11548 - FP-29A, ISSUE 6		
27		29B, ISSUE 4		
28				
29		35. S&W DRAWING 11548 - FP-30A, ISSUE 3		
30				
31		36. S&W DRAWING 11548 - FP-31A, ISSUE 2		
32		31B, ISSUE 1		
33				
34		37. S&W DRAWING 11548 - FP-32A, ISSUE 5		
35		32B, ISSUE 5		
36				
37		38. S&W DRAWING 11548 - FP-33A, ISSUE 8		
38		33B, ISSUE 4		
39		33C, ISSUE 5		
40		33D, ISSUE 6		
41		33E, ISSUE 7		
42		33F, ISSUE 6		
43		33G, ISSUE 7		
44		33H, ISSUE 8		
45				
46				



STONE & WEBSTER ENGINEERING CORPORATION  
CALCULATION SHEET

▲ 5010.65

CALCULATION IDENTIFICATION NUMBER				PAGE <u>50</u>
J.O. OR W.O. NO.	DIVISION & GROUP	CALCULATION NO.	OPTIONAL TASK CODE	
12846.44		PE-044-0		
1				
2				
3				
4				
5				
6				
7				
8				
9				
10				
11				
12				
13				
14				
15				
16				
17				
18				
19				
20				
21				
22				
23				
24				
25				
26				
27				
28				
29				
30				
31				
32				
33				
34				
35				
36				
37				
38				
39				
40				
41				
42				
43				
44				
45				
46				

- 39. HAND BOOK of HYDRAULIC RESISTANCE, I.E. IDEL'CHIK, 1960
- 40. CRANE TECHNICAL PAPER # 410, 1979
- 41. S&W DRAWING - 11448 FC-7A, ISSUE 2
- 42. S&W CALCULATION 12846.44 - PE-046-0
- 43. S&W DRAWING - 11448 - FB-24A, ISSUE 5
- 44. WESTINGHOUSE ELECTRIC CORP. ANALYSIS 12.2, REV. 1, 12/11/75
- 45. SURRY POWER STATION UNIT 1 & 2 FSAR
- 46. S&W DRAWING 11448 - FP-10, ISSUE 8
- 47. S&W CALCULATION ES-13075.44 - ES-224-0

SENDER — RETAIN YELLOW COPY.  
FORWARD WHITE AND PINK COPIES.

REPLIER — RETURN WHITE COPY.  
RETAIN PINK COPY FOR FILE.

F-01-12846.44  
ATTACHMENT 1, P 1 of 1

# INTEROFFICE CORRESPONDENCE

PC-0470

TO: BOB MILLER	LOCATION 9	SUBJECT / REFERENCE / J.O. NO. 12846.44 SURRY 1 & 2 ENVIRONMENTAL QUALIFICATION OF SAFETY GRADE EQUIPMENT.
FROM: MIKE SHEARA	LOCATION 14	

MESSAGE: —

REQUEST YOU PERFORM AN ANALYSIS OF A STEAM LINE BREAK (SLB) IN THE SURRY UNIT #2 TURBINE BLDG. (UNIT #2 IS MORE CONSERVATIVE AS IT COULD AFFECT MECH. EQUIP. ROOM #3). DETERMINE THE ENVIRONMENTAL CONDITIONS (TEMP. - PRESS - HUMIDITY) FOR BREAKS/CRACKS POSTULATED IN FSAR APPENDIX D. PER OUR DISCUSSION THE BREAKS TO BE ANALYZED SHOULD BE BOUND BY A "CRITICAL CRACK SIZE" AS DEFINED IN APP. D SECTION D.2.2.1, AND A BREAK WHICH RESULTS IN TOTAL STEAM FLOW FROM ~~ALL THREE~~ EACH STEAM GENERATORS UP TO THE HIGH STEAM FLOW TRIP SETPOINT.

DATE 9/23/80	SIGNATURE [Signature]	TELEPHONE 6836
--------------	-----------------------	----------------

- \* PLEASE CALL IF YOU HAVE ANY QUESTIONS
- \* PLEASE PROVIDE AN ESTIMATED COMPLETION DATE FOR THIS ANALYSIS
- \* CHARGE TIME TO J.O. 12846.44 ETA -00006

DATE 9/23/80	SIGNATURE [Signature]	TELEPHONE 6836
--------------	-----------------------	----------------

ATTACH 2, p 1 of 1

# INTEROFFICE CORRESPONDENCE

ES-230-0

TO: R Miller	LOCATION 9	SUBJECT / REFERENCE / J.O. NO. 13075 HELB ANALYSIS NORTH ANNA - UNITS 142
FROM: J McCumber	LOCATION 14	

MESSAGE: Reference attached memo, w. Emerson to W Dodson dated 6-24-80.

The attached sheet provides additional information related to a let down line break.

The time to break isolation (automatic) or operator action to isolate break is difficult to determine based on system instrumentation.

Based on our discussion it would be best to assume that operator action would be required to isolate break and to use the 1/2 hour time for that action to occur (as provided by VEPCO). A maximum letdown flow of 120 gpm prior to break should be assumed.

I also understand that you do not require my input on item 2 of the referenced memo.

7/3/80  
DATE

Joe McCumber  
SIGNATURE

2313  
TELEPHONE

REPLY:

Thank you.

7/22/80  
DATE

R F Miller  
SIGNATURE

6016  
TELEPHONE

▲ 040.13B

USER'S GUIDE TO EZD REFERENCES

Facility: VEPCO, SURRY  
 Units: 1 and 2  
 Dockets: 50-280 and 50-281

EZD REFERENCE NO. 9  
 EZD REFERENCE DESCRIPTION: 12846.54-RP-037-0  
 ENVIRONMENTAL ZONE(S): SFGD-1

<u>PARAMETER</u>	<u>NORMAL ENVIRONMENT</u>	<u>PAGE</u>	<u>LOCA ENVIRONMENT</u>	<u>PAGE</u>	<u>MSLB ENVIRONMENT</u>	<u>PAGE</u>	<u>HELB ENVIRONMENT</u>	<u>PAGE</u>
RADIATION (rads)			8.0 x 10 <sup>6</sup>	25				

CALCULATION TITLE PAGE

\*SEE INSTRUCTIONS ON REVERSE SIDE

▲5010.84 (FRONT)

CLIENT & PROJECT <i>NEPCO - SURRY 1 &amp; 2</i>				PAGE 1 OF <i>25</i>	
CALCULATION TITLE (Indicative of the Objective): <i>Direct &amp; dose rates and integrated dose to electrical components in the Safeguards Area after a LOCA.</i>				QA CATEGORY (✓) <input checked="" type="checkbox"/> I - NUCLEAR SAFETY RELATED <input type="checkbox"/> II <input type="checkbox"/> III <input type="checkbox"/> OTHER	
CALCULATION IDENTIFICATION NUMBER					
J. O. OR W.O. NO.	DIVISION & GROUP	CURRENT CALC. NO.	OPTIONAL TASK CODE	OPTIONAL WORK PACKAGE NO.	
<i>12846.54</i>	<i>Power RP</i>	<i>037-0</i>			
* APPROVALS - SIGNATURE & DATE			REV. NO. OR NEW CALC NO.	SUPERSEDES * CALC. NO. OR REV. NO.	CONFIRMATION * REQUIRED (✓) YES NO
PREPARER(S)/DATE(S)	REVIEWER(S)/DATE(S)	INDEPENDENT REVIEWER(S)/DATE(S)			
<i>J. Cahill 8/11/80</i> <i>8/11/80</i>	<i>Shuwaylin</i> <i>9-5-80</i>	<i>Shuwaylin</i> <i>9-5-80</i>			<i>✓</i> <i>GAMTRAN</i> <i>(Activity 2)</i> <i>(radiometers)</i>
DISTRIBUTION*					
GROUP	NAME & LOCATION	COPY SENT (✓)	GROUP	NAME & LOCATION	COPY SENT (✓)
RECORDS MGT. FILES (OR FIRE FILE IF NONE)					
<i>Op. Serv. project</i>	<i>J. BARNHART - 14</i> <i>M. OMEARA - 14</i>	<i>✓</i> <i>✓</i>			

STONE & WEBSTER ENGINEERING CORPORATION  
CALCULATION SHEET

▲ 5010.65

CALCULATION IDENTIFICATION NUMBER				PAGE <u>2</u>
J.O. OR W.O. NO.	DIVISION & GROUP	CALCULATION NO.	OPTIONAL TASK CODE	
12846	Power RP	037-0		

1  
2  
3  
4  
5  
6  
7  
8  
9  
10  
11  
12  
13  
14  
15  
16  
17  
18  
19  
20  
21  
22  
23  
24  
25  
26  
27  
28  
29  
30  
31  
32  
33  
34  
35  
36  
37  
38  
39  
40  
41  
42  
43  
44  
45  
46

Contents

<u>Section</u>	<u>page</u>
Title page	1
contents	2
Objective	3
DATA	4
References	6
Approach	7
Model Diagrams	8
Calculation	12
Conclusion	25

STONE & WEBSTER ENGINEERING CORPORATION  
CALCULATION SHEET

▲ 5010.65

CALCULATION IDENTIFICATION NUMBER				PAGE <u>3</u>
J.O. OR W.O. NO.	DIVISION & GROUP	CALCULATION NO.	OPTIONAL TASK CODE	
12846	Power RP	037-0		

1  
2  
3  
4  
5  
6  
7  
8  
9  
10  
11  
12  
13  
14  
15  
16  
17  
18  
19  
20  
21  
22  
23  
24  
25  
26  
27  
28  
29  
30  
31  
32  
33  
34  
35  
36  
37  
38  
39  
40  
41  
42  
43  
44  
45  
46

Objective

This calculation will estimate the exposure to the following components in the event of a LOCA for Surry power station: from low head safety injection (LHSE) and recirculatory spray (RS) lines in the safeguards area:

- MOV1862A
- MOV1862B
- MOV-RS156A
- MOV-RS156B
- MOV1864A
- MOV1864B
- MOV1840A
- MOV1840B
- MOV1840C
- MOV1860A
- MOV1860B
- FE1945
- FE1946

} The doses to the motors which operate these values are calculated.

STONE & WEBSTER ENGINEERING CORPORATION  
CALCULATION SHEET

▲ 5010.65

CALCULATION IDENTIFICATION NUMBER				PAGE <u>4</u>
J.O. OR W.O. NO. <u>12846</u>	DIVISION & GROUP <u>Power RP</u>	CALCULATION NO. <u>037-0</u>	OPTIONAL TASK CODE	

DATA

Source Terms (ref. 3) (MeV/cm<sup>2</sup>.sec)

Time (hrs)	Group Energy (MeV)						
	0.4	0.8	1.3	1.7	2.2	2.5	3.5
0.0	5.16+8	6.40+9	5.69+9	2.86+9	5.65+8	6.14+8	2.93+9
1.0	3.64+8	5.38+9	3.26+9	2.64+9	3.19+8	2.98+8	4.62+8
2.0	3.49+8	3.74+9	2.44+9	1.73+9	2.51+8	4.89+7	2.76+8
8.0	3.30+8	1.51+9	4.64+8	6.68+8	1.04+8	4.21+6	4.68+7
24.0	3.08+8	7.98+8	1.79+8	1.85+8	1.96+7	4.13+6	8.78+5
96.0	2.34+8	2.12+8	8.55+6	6.06+7	1.24+6	3.74+6	1.50-2
192.0	1.64+8	1.30+8	5.13+6	4.81+7	5.21+5	3.08* 2.75+6	-
360.0	9.09+7	4.48+7	2.83+6	3.28+7	1.17+5	2.12+6	-
720.0	2.68+7	6.51+7	1.24+6	1.44+7	4.68+3	4.42+5	-
2160.0	1.11+6	3.36+7	1.55+5	5.95+5	-	3.67+5	-
4320.0	3.44+5	1.52+7	5.34+4	3.23+4	-	2.83+2	-

Density of concrete = 145 lb/ft<sup>3</sup> (ref 2)

Density of water = 62.4 lbm/ft<sup>3</sup>

The value of

\* 3.08+6 was corrected in Ref. 3 calculation.

However, this will not introduce significant difference in the results.

SL



STONE & WEBSTER ENGINEERING CORPORATION  
CALCULATION SHEET

▲ 5010.65

CALCULATION IDENTIFICATION NUMBER			
J.O. OR W.O. NO. <i>12846</i>	DIVISION & GROUP <i>Power RP</i>	CALCULATION NO. <i>037-0</i>	OPTIONAL TASK CODE  
			PAGE <i>5</i>

1  
2  
3  
4  
5  
6  
7  
8  
9  
10  
11  
12  
13  
14  
15  
16  
17  
18  
19  
20  
21  
22  
23  
24  
25  
26  
27  
28  
29  
30  
31  
32  
33  
34  
35  
36  
37  
38  
39  
40  
41  
42  
43  
44  
45  
46

*Pipe Data (ref. 5):*

<u>Nominal Size</u>	<u>Inside Dia.</u>	<u>Wall Thickness</u>
<i>4"</i>	<i>4.026"</i>	<i>0.237"</i>
<i>6"</i>	<i>6.065"</i>	<i>0.280"</i>
<i>8"</i>	<i>7.981"</i>	<i>0.322"</i>
<i>10"</i>	<i>10.020"</i>	<i>0.365"</i>
<i>12"</i>	<i>12.000"</i>	<i>0.375"</i>
<i>24"</i>	<i>23.250"</i>	<i>0.375"</i>

STONE & WEBSTER ENGINEERING CORPORATION  
CALCULATION SHEET

▲ 5010.65

CALCULATION IDENTIFICATION NUMBER				PAGE <u>6</u>
J.O. OR W.O. NO.	DIVISION & GROUP	CALCULATION NO.	OPTIONAL TASK CODE	
12845	Power RP	037-0		

References

- ① Surry drawings: 11448-FP-60A } marked up by  
11448-FP-60B } project to show  
11448-FP-60C } pertinent piping  
11448-FP-60D }
- ② "Shielding Design Summary for Surry Power Station, VEPCO",  
Stone and Webster, J.O. #11448; 12/70
- ③ Calculation 12846-46-RP-025-0,  
"Dose Rates From Aux. Bldg. Sump" 1/10/80
- ④ "Gamma transport by Point Kernel Technique (GAMTRAN)"  
by J.A. Mayer, Jr. and E.A. Brown, Users Manual  
NU-3, 4/77
- ⑤ Crane Technical Paper #410, "Flow of Fluids  
Through Valves, Fittings, and Pipes", Crane Co.,  
1979
- ⑥ StW Computer Code, NU-3, GAMTRAN1,  
2/77, version 1, level 3

STONE & WEBSTER ENGINEERING CORPORATION  
CALCULATION SHEET

▲ 5010.65

CALCULATION IDENTIFICATION NUMBER				PAGE <u>2</u>
J.O. OR W.O. NO.	DIVISION & GROUP	CALCULATION NO.	OPTIONAL TASK CODE	
<u>12846</u>	<u>Power RP</u>	<u>0370</u>		

Approach

The piping and shield walls shown in Figures 1 Thru 4 were modeled and used in GAMTRAN1. Successive runs were made to obtain dose rates for various components for times up to 6 months, however only the higher doses were considered post time = 0 hrs in order to conserve computer expense.

It was assumed that the RS and LHSI lines contained undiluted sump water containing 50% of the halogens and 10% of the remainder uniformly mixed. The source strengths as given in calc. 12846-RP-025-0 (ref. 3) for various times were then input into GAMTRAN1.

Finally, the integrated doses were calculated using exponential interpolation as follows:

$$D(t) = \alpha e^{-\beta t} \quad ; \quad \beta = \frac{\ln \frac{D(t_1)}{D(t_2)}}{t_2 - t_1} \quad , \quad \alpha = D(t_1) e^{\beta t_1} \quad ; \quad D = \text{dose rate}$$

$$\Delta D = \int_{T_1}^{T_2} D(t) dt = \frac{\alpha}{\beta} [e^{-\beta t_1} - e^{-\beta t_2}] = \text{integrated dose between } T_1 \text{ and } T_2$$

$$\text{accumulated dose} = \sum_{i=1}^n (\Delta D)_i \quad ; \quad \text{where } n = \# \text{ time intervals}$$



12846 Power RP 037-0 99.9

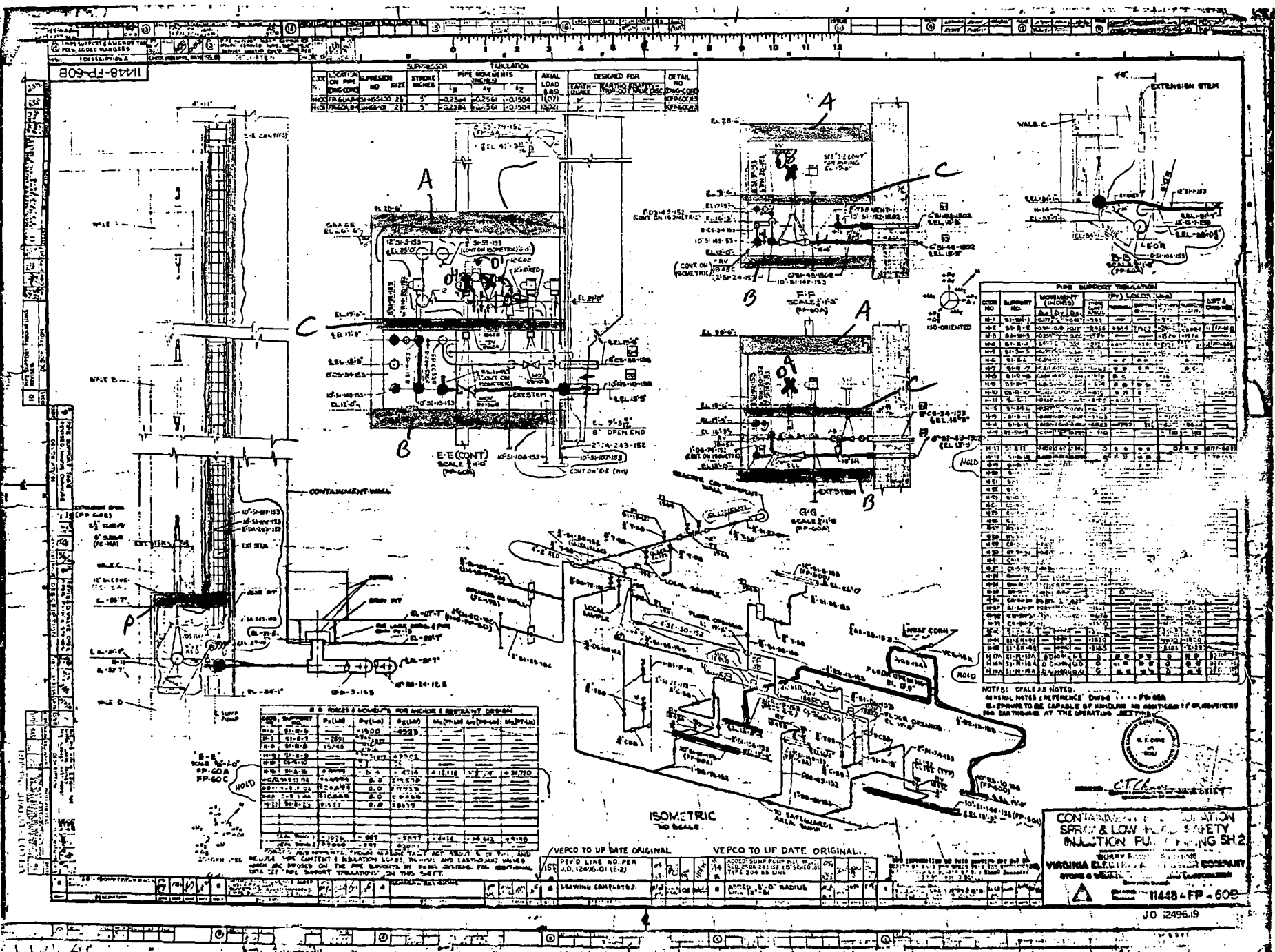

LOCATION	SUPPLIER	INSULATION	PIPE	DESIGNED FOR	DETAIL
ON PIPE	NO. 1	NO. 1	NO. 1	NO. 1	NO. 1
ON PIPE	NO. 2	NO. 2	NO. 2	NO. 2	NO. 2
ON PIPE	NO. 3	NO. 3	NO. 3	NO. 3	NO. 3

NO.	SUPPLY	MONUMENT	DATE	BY	CHKD.	APP'D.
01	...	...	...	...	...	...
02	...	...	...	...	...	...
03	...	...	...	...	...	...
04	...	...	...	...	...	...
05	...	...	...	...	...	...
06	...	...	...	...	...	...
07	...	...	...	...	...	...
08	...	...	...	...	...	...
09	...	...	...	...	...	...
10	...	...	...	...	...	...
11	...	...	...	...	...	...
12	...	...	...	...	...	...
13	...	...	...	...	...	...
14	...	...	...	...	...	...
15	...	...	...	...	...	...
16	...	...	...	...	...	...
17	...	...	...	...	...	...
18	...	...	...	...	...	...
19	...	...	...	...	...	...
20	...	...	...	...	...	...
21	...	...	...	...	...	...
22	...	...	...	...	...	...
23	...	...	...	...	...	...
24	...	...	...	...	...	...
25	...	...	...	...	...	...
26	...	...	...	...	...	...
27	...	...	...	...	...	...
28	...	...	...	...	...	...
29	...	...	...	...	...	...
30	...	...	...	...	...	...
31	...	...	...	...	...	...
32	...	...	...	...	...	...
33	...	...	...	...	...	...
34	...	...	...	...	...	...
35	...	...	...	...	...	...
36	...	...	...	...	...	...
37	...	...	...	...	...	...
38	...	...	...	...	...	...
39	...	...	...	...	...	...
40	...	...	...	...	...	...
41	...	...	...	...	...	...
42	...	...	...	...	...	...
43	...	...	...	...	...	...
44	...	...	...	...	...	...
45	...	...	...	...	...	...
46	...	...	...	...	...	...
47	...	...	...	...	...	...
48	...	...	...	...	...	...
49	...	...	...	...	...	...
50	...	...	...	...	...	...

NO.	DESCRIPTION	QTY	UNIT	REMARKS
1	...	...	...	...
2	...	...	...	...
3	...	...	...	...
4	...	...	...	...
5	...	...	...	...
6	...	...	...	...
7	...	...	...	...
8	...	...	...	...
9	...	...	...	...
10	...	...	...	...
11	...	...	...	...
12	...	...	...	...
13	...	...	...	...
14	...	...	...	...
15	...	...	...	...
16	...	...	...	...
17	...	...	...	...
18	...	...	...	...
19	...	...	...	...
20	...	...	...	...
21	...	...	...	...
22	...	...	...	...
23	...	...	...	...
24	...	...	...	...
25	...	...	...	...
26	...	...	...	...
27	...	...	...	...
28	...	...	...	...
29	...	...	...	...
30	...	...	...	...
31	...	...	...	...
32	...	...	...	...
33	...	...	...	...
34	...	...	...	...
35	...	...	...	...
36	...	...	...	...
37	...	...	...	...
38	...	...	...	...
39	...	...	...	...
40	...	...	...	...
41	...	...	...	...
42	...	...	...	...
43	...	...	...	...
44	...	...	...	...
45	...	...	...	...
46	...	...	...	...
47	...	...	...	...
48	...	...	...	...
49	...	...	...	...
50	...	...	...	...

VERCO TO UP DATE ORIGINAL  
 VERCO TO UP DATE ORIGINAL

CONTAINMENT SYSTEM  
 SAFETY & LOW PRESSURE  
 INJECTION PUMP SYSTEM SH.2  
 VIRGINIA ELECTRIC & POWER COMPANY  
 11448-FP-608

X-dotted copy  
 modeled valves  
 shields  
 RS lines  
 I lines

Fig. 2

1-3-9



12846 - Power RP 037-0

8811

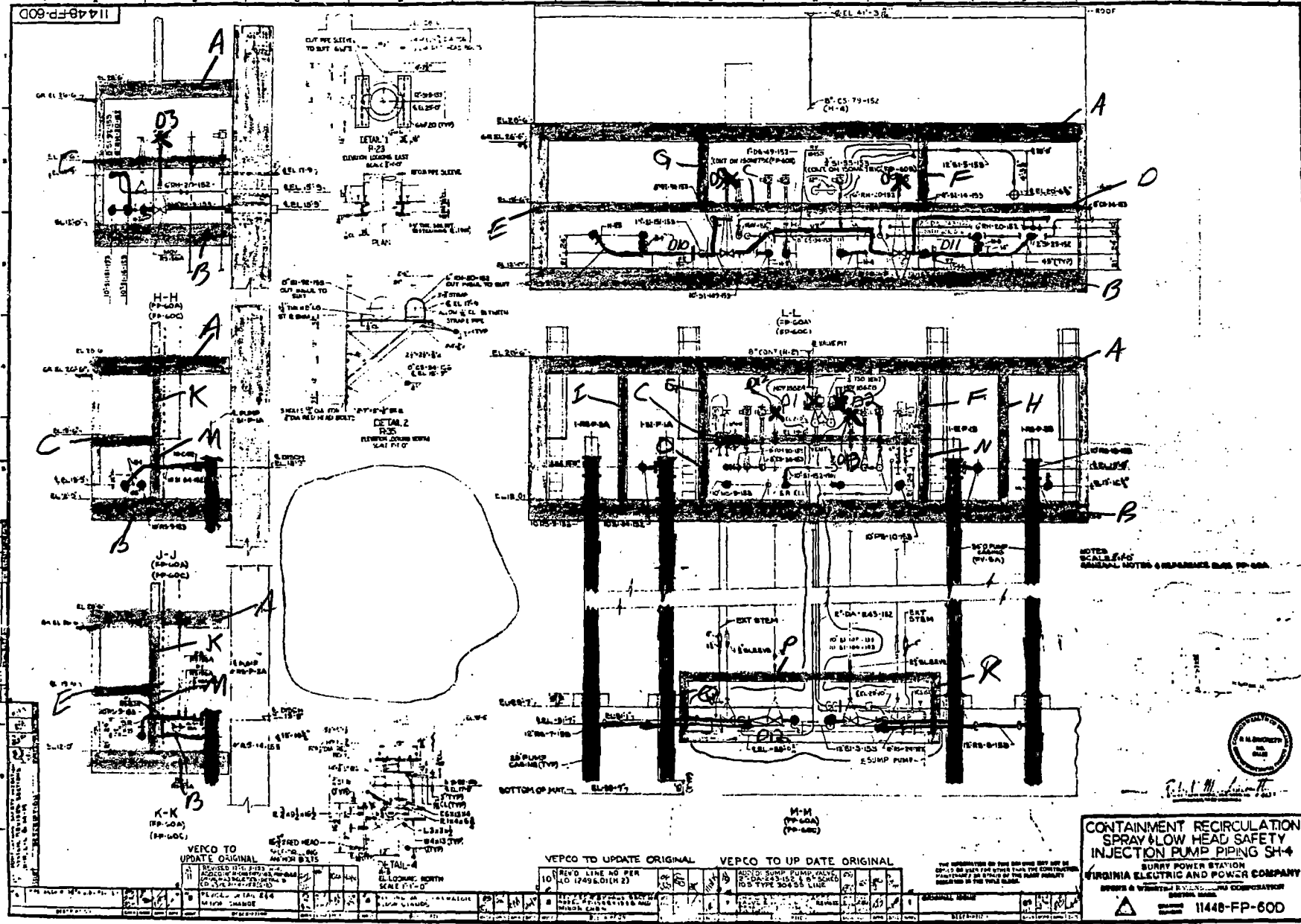

X - detector of locations

moderated valves

- shields

AS Lines  
H&SI Lines

Fig. 4

1-5-11

STONE & WEBSTER ENGINEERING CORPORATION  
CALCULATION SHEET

▲ 5010.65

CALCULATION IDENTIFICATION NUMBER				PAGE <u>12</u>
J.O. OR W.O. NO.	DIVISION & GROUP	CALCULATION NO.	OPTIONAL TASK CODE	
<u>12846</u>	<u>Power RP</u>	<u>037-0</u>		

Calculation

The SI and RS lines shown in figures 1 thru 4 (red for SI, blue for RS) were modeled so as to be used in computer code GAMTRANII. The reference origin is at the point of intersection of the valve pit center line and the containment wall (67.75' from center) at sea level (e.l. 0.00'), as shown in fig. 1. The pipes which were modeled are listed in Table I with their corresponding model sections. The coordinates of the model sections as input into GAMTRANII are given in Table II.

Detector points were located at the components listed in the Objective Section of this Calculation. The coordinates of the detector pts. are listed in Table III. The detector pts. were generally located at the base of the motor drives except of D12 and D13 which were located at the top of the motor drives, but only for time = 0 hrs. In order to conserve computer time, the number of dose pts. were reduced by choosing



STONE & WEBSTER ENGINEERING CORPORATION  
CALCULATION SHEET

▲ 5010.65

CALCULATION IDENTIFICATION NUMBER				PAGE 13
J.O. OR W.O. NO.	DIVISION & GROUP	CALCULATION NO.	OPTIONAL TASK CODE	
12846	Power RP	037-0		

1  
2 The higher dose rate of a pair of symmetric  
3 components. After Time = 0 hrs, only dose  
4 points 02, 04, 06, 08, 010, 011, 013 were  
5 considered.  
6  
7  
8

9  
10 The walls of the safeguards areas  
11 shown in figs. 1-4 were modeled in  
12 the input to GAMTRAN1. The coordinates  
13 of the modeled walls are given in  
14 Table II. Walls 01, 02, 03 and E1, E2, E3  
15 constitute the floor at el. 19.5' in front  
16 of walls K and J, respectively. Each floor  
17 was modeled in three parts due to the  
18 curvature of the building.  
19  
20  
21  
22  
23  
24  
25  
26  
27

28 The modeled data was input in  
29 two parts for each time after T = 0 hrs  
30 (at 0 hrs the data was input in 4 runs).  
31  
32 Table II contains a list of the computer  
33 runs made in this calculation for the  
34 various time intervals. The outputs of the  
35 GAMTRAN1 runs are given in Table VI. These  
36 dose rates were then used to find the integrated  
37 doses (using exponential interpolation) which  
38  
39  
40  
41  
42  
43  
44  
45  
46

STONE & WEBSTER ENGINEERING CORPORATION  
CALCULATION SHEET

▲ 5010.65

CALCULATION IDENTIFICATION NUMBER				PAGE 14
J.O. OR W.O. NO.	DIVISION & GROUP	CALCULATION NO.	OPTIONAL TASK CODE	
12846	Power RP	037-0		

are given in Table VIII

There was some question as to whether or not pipes 10"-SZ-106-153 and 10"-SZ-107-153 would be contaminated after a LOCA. Computer runs were made for dose points D1 and D2 without these lines modeled (sections 55-59). However these pts. are at el. 20.5' in these runs, and the motors are at el. 22.5' but this 2' difference shouldn't introduce significant error in the calculation of the dose rates at D1 and D2 since there are no pipes near these dose points.

The following method was used to find dose rates at times greater than 0 hrs.:

$$D.R. \text{ w/o } (t=T) = D.R. \text{ w/o } (t=0) \times \frac{D.R. \text{ w } (t=T)}{D.R. \text{ w } (t=0)} \text{ ----- (Eq. A)}$$

Where w/o signifies a value without lines 10"-SZ-106-153 and 10"-SZ-107-153 modeled. Since these lines are very close to D1 and D2 with no shielding separating them, the dose rates calculated are conservative

STONE & WEBSTER ENGINEERING CORPORATION  
CALCULATION SHEET

▲ 5010.65

CALCULATION IDENTIFICATION NUMBER				PAGE 15
J.O. OR W.O. NO.	DIVISION & GROUP	CALCULATION NO.	OPTIONAL TASK CODE	
12846	lower RP	037-0		

1  
2 Since There is proportionately less shielding  
3 between The radioactive pipes and D2 (and D1)  
4 Than what has been calculated. This occurs  
5 because in the case with The pipes modeled  
6 The dose points see a harder  $\gamma$ -spectrum  
7 from The pipes than from  $\gamma$ 's penetrating  
8 concrete.  
9  
10  
11  
12  
13  
14  
15  
16

17 \*Note\*

18 Eq. (A) can be used to estimate dose rates at D1 & D2 for  $t > 0$   
19 for the case without pipes 10" SI-106 & 10" SI-107 because:

- 20  
21  
22 ① source spectrum for  $t > 0$  is softer and  
23  
24 ② there is at least 1' concrete floor between the detector and  
25  
26 other live sources.  
27

28 The calculated results by eq. (A) are conservative.

30 w. peng 9/17/80  
31  
32  
33  
34  
35  
36  
37  
38  
39  
40  
41  
42  
43  
44  
45  
46

STONE & WEBSTER ENGINEERING CORPORATION  
 CALCULATION SHEET

▲ 5010.65

CALCULATION IDENTIFICATION NUMBER				PAGE 16
J.O. OR W.O. NO.	DIVISION & GROUP	CALCULATION NO.	OPTIONAL TASK CODE	
12846	Power RP	037-0		

1  
2  
3  
4  
5  
6  
7  
8  
9  
10  
11  
12  
13  
14  
15  
16  
17  
18  
19  
20  
21  
22  
23  
24  
25  
26  
27  
28  
29  
30  
31  
32  
33  
34  
35  
36  
37  
38  
39  
40  
41  
42  
43  
44  
45  
46

Modeled Pipe                      Model Section #'s

10"-SI-84-152 (with 10"-SI-16-153)	1, 2, 3
10"-SI-151-153	4, 5, 6
6"-SI-49-1502	7
8"-SI-92-153	8, 9, 10, 11, 12, 13
10"-SI-149-153	14, 15, 16, 17
10"-SI-83-152 (with 10"-SI-13-153)	18, 19, 20
8"-SI-14-153	21, 22
10"-SI-148-153	23, 24, 25
10"-SI-152-1502	26, 27, 28, 29
10"-SI-150-153	30, 31
10"-RS-9-153	32, 33, 34
10"-RS-10-153	35, 36, 37
12"-SI-1-153	38, 39
12"-RS-7-153	40, 41
12"-SI-2-153	42, 43
12"-RS-8-153	44, 45
1-SI-P-1B	46
1-RS-P-2B	47
1-SI-P-1A	48
1-RS-P-2A	49

Table I

1-5-16

STONE & WEBSTER ENGINEERING CORPORATION  
 CALCULATION SHEET

▲ 5010.65

CALCULATION IDENTIFICATION NUMBER				PAGE <u>17</u>
J.O. OR W.O. NO. <u>12846</u>	DIVISION & GROUP <u>Power RP</u>	CALCULATION NO. <u>037-0</u>	OPTIONAL TASK CODE	

1  
2  
3  
4  
5  
6  
7  
8  
9  
10  
11  
12  
13  
14  
15  
16  
17  
18  
19  
20  
21  
22  
23  
24  
25  
26  
27  
28  
29  
30  
31  
32  
33  
34  
35  
36  
37  
38  
39  
40  
41  
42  
43  
44  
45  
46

Table I (continued)

Modeled Pipe	Model Section #'s
6"-SI-4B-1502	50
4"-RS-14-153	51, 53
4"-RS-15-153	52, 54
10"-SI-106-153	55, 56, 57*
10"-SI-107-153	57, 58, 59*

\* note: Lines 10"-SI-106-153 and 10"-SI-107-153 share section 57. This is because both lines have a section of pipe around el. -32'. As can be seen in Figure 1, the two sections of pipe can apparently be modeled as one pipe since the closest detector point is at el. 14.25'.

CALCULATION SHEET

▲ 5010.65

CALCULATION IDENTIFICATION NUMBER				PAGE <u>18</u>
J.O. OR W.O. NO. <u>12846</u>	DIVISION & GROUP <u>Power RP</u>	CALCULATION NO. <u>037-0</u>	OPTIONAL TASK CODE	

Computer Pipe Data for GAMTRAN I

1  
2  
3  
4  
5  
6  
7  
8  
9  
10  
11  
12  
13  
14  
15  
16  
17  
18  
19  
20  
21  
22  
23  
24  
25  
26  
27  
28  
29  
30  
31  
32  
33  
34  
35  
36  
37  
38  
39  
40  
41  
42  
43  
44  
45  
46

Section number	Section End Point Coordinates						D.O. (in)	Thick (wall) (in)	
	X <sub>1</sub>	Y <sub>1</sub>	Z <sub>1</sub>	(Ft.)	X <sub>2</sub>	Y <sub>2</sub>			Z <sub>2</sub>
1	17.0	0.5	15.75		18.50	8.5	15.75	10.02	0.365
2	18.5	8.5	15.75		18.75	9.25	13.75	10.02	0.365
3	18.75	9.25	13.75		9.50	11.50	13.75	10.02	0.365
4	12.50	11.00	13.75		12.50	13.00	13.75	10.02	0.365
5	12.50	13.00	13.75		5.50	14.00	13.75	10.02	0.365
6	5.50	14.00	13.75		5.50	9.50	13.75	10.02	0.365
7	5.50	9.50	13.75		5.00	0.00	13.75	6.065	0.280
8	11.50	11.00	13.75		11.50	11.00	17.75	7.981	0.322
9	11.50	11.00	17.75		11.50	13.00	17.75	7.981	0.322
10	11.50	13.00	17.75		-14.00	13.00	17.75	7.981	0.322
11	-14.00	13.00	17.75		-27.00	8.50	17.75	7.981	0.322
12	-27.00	8.50	17.75		-28.00	7.00	17.75	7.981	0.322
13	-28.00	7.00	17.75		-33.00	5.00	17.75	7.981	0.322
14	9.50	11.50	13.75		5.50	11.50	16.00	10.020	0.365
15	5.50	11.50	16.00		-6.00	11.50	16.00	10.020	0.365
16	-6.00	11.50	16.00		-6.00	11.50	13.75	10.020	0.365
17	-6.00	11.50	13.75		-10.00	11.00	13.75	10.020	0.365
18	-10.00	11.00	13.75		-19.50	9.00	13.75	10.020	0.365
19	-19.50	9.00	13.75		-19.00	8.00	15.75	10.020	0.365
20	-19.00	8.00	15.75		-16.50	0.00	15.75	10.020	0.365
21	-11.00	11.75	13.75		-11.00	11.75	17.75	7.981	0.322
22	-11.00	11.75	17.75		-32.00	4.50	17.75	7.981	0.322
23	-12.50	10.50	13.75		-12.50	12.50	13.75	10.020	0.365
24	-12.50	12.50	13.75		-3.50	13.50	13.75	10.020	0.365
25	-3.50	13.50	13.75		-3.50	9.50	13.75	10.020	0.365
26	-2.50	3.50	15.75		-2.50	0.00	15.75	10.020	0.365
27	3.50	3.50	15.75		-2.50	3.50	15.75	10.020	0.365
28	3.50	3.50	13.75		3.50	3.50	15.75	10.020	0.365
29	3.50	9.50	13.75		3.50	3.50	13.75	10.020	0.365
30	3.50	12.00	13.75		3.50	9.50	13.75	10.020	0.365
31	3.50	12.00	16.00		3.50	12.00	13.75	10.020	0.365
32	8.50	0.00	13.75		9.50	9.00	13.75	10.020	0.365
33	9.50	9.00	13.75		26.00	6.00	13.75	10.020	0.365
34	25.00	6.00	15.75		23.00	-0.50	15.75	10.020	0.365
35	-8.50	-1.00	13.75		-10.00	9.00	13.75	10.020	0.365
36	-10.00	9.00	13.75		-26.00	5.00	13.75	10.020	0.365
37	-25.00	5.00	15.75		-23.00	-1.50	15.75	10.020	0.365
38	2.00	-4.50	-31.00		2.00	4.00	-31.00	12.000	0.375
39	2.00	4.00	-31.00		16.00	3.50	-31.00	12.000	0.375
40	* 6.00	-7.00	-31.00		6.00	0.00	-31.00	12.000	0.375
41	* 6.00	0.00	-31.00		14.00	-1.00	-31.00	12.000	0.375
42	-2.00	-4.50	-31.00		-2.00	4.00	-31.00	12.000	0.375
43	* -2.00	4.00	-31.00		-16.00	3.50	-31.00	12.000	0.375
44	-6.00	-7.00	-31.00		-6.00	0.00	-31.00	12.000	0.375
45	-6.00	0.00	-31.00		-14.00	-1.00	-31.00	12.000	0.375
46	-14.50	0.00	16.75		-14.50	0.00	-37.00	23.250	0.375
47	-22.50	-2.50	16.75		-22.50	-2.50	-37.00	23.250	0.375
48	14.00	0.50	16.75		14.00	0.50	-37.00	23.250	0.375
49	22.50	-1.50	16.75		22.50	-1.50	-37.00	23.250	0.375
50	-3.50	9.50	13.75		-2.50	0.00	13.75	6.065	0.290
51	25.00	3.00	15.75		26.50	-2.00	15.75	4.026	0.237
52	-24.00	-2.00	15.75		-26.50	3.00	15.75	4.026	0.237
53	26.50	3.00	15.75		24.00	3.50	15.75	4.026	0.237
54	-26.50	3.00	15.75		-24.00	3.50	15.75	4.026	0.237
55	-0.50	1.00	21.00		-0.50	1.00	-33.00	10.020	0.365
56	-0.50	1.00	21.00		-0.50	6.50	21.00	10.020	0.365
57	13.00	2.00	-31.00		-12.00	2.00	-31.00	10.020	0.365
58	-1.00	0.00	-30.00		-1.00	0.00	21.00	10.020	0.365
59	-1.00	0.00	21.00		-2.00	6.00	21.00	10.020	0.365

\* Coordinates for these sections vary (as shown above) from the Drawings. However, due to the large distances from these points, this should not produce significant errors. SLW

1-5-18

Table II

STONE & WEBSTER ENGINEERING CORPORATION  
CALCULATION SHEET

▲ 5010.65

CALCULATION IDENTIFICATION NUMBER				PAGE <u>19</u>
J.O. OR W.O. NO. <u>12846</u>	DIVISION & GROUP <u>Power RP</u>	CALCULATION NO. <u>037-0</u>	OPTIONAL TASK CODE	

Detector Point Coordinates

1  
2  
3  
4  
5  
6  
7  
8  
9  
10  
11  
12  
13  
14  
15  
16  
17  
18  
19  
20  
21  
22  
23  
24  
25  
26  
27  
28  
29  
30  
31  
32  
33  
34  
35  
36  
37  
38  
39  
40  
41  
42  
43  
44  
45  
46

Component	Detector point	X	Y	Z (ft.)
MOV 1862 A	01	-0.50	6.50	22.50
MOV 1862 B	02	-2.00	6.00	22.50
MOV-RS156A	03	4.50	7.50	21.70
MOV-RS156B	04	-4.50	7.50	21.70
MOV 1864 A	05	4.50	11.50	21.70
MOV 1864 B	06	-4.50	11.50	21.70
MOV 1890 A	07	5.50	9.50	21.70
MOV 1890 B	08	-3.50	9.50	21.70
MOV 1890 C	04	3.50	4.50	21.70
FE 1945	010	13.50	10.50	14.25
FE 1946	011	-13.50	10.50	14.25
MOV 1860 A	012	4.50	4.50	22.50
MOV 1860 B	013	-4.50	4.50	22.50*

\* note: in runs for times greater than 0 hrs, the Z coordinate for 013 was changed to 21.70 as the value of 22.50 was slightly higher than desirable.

Table III

STONE & WEBSTER ENGINEERING CORPORATION  
 CALCULATION SHEET

A 5010 65

J.O. OR W.O. NO. <i>12846</i>	DIVISION & GROUP <i>Power PP</i>	CALCULATION NO. <i>037-D</i>	OPTIONAL TASK CODE
CALCULATION IDENTIFICATION NUMBER			PAGE <i>20</i>

RECTANGULAR SHIELD DATA

NO.	.....CORNER NO.1.....			.....CORNER NO.2.....			.....CORNER NO.3.....			.....HALL.....		
	X1 (FT.)	Y1 (FT.)	Z1 (FT.)	X2 (FT.)	Y2 (FT.)	Z2 (FT.)	X3 (FT.)	Y3 (FT.)	Z3 (FT.)	THICK (FT.)	MAT	DENSITY (LB/CUFT)
A	-32.00	16.00	26.50	32.00	16.00	26.50	32.00	-7.00	26.50	2.000	2	145.000
B	-32.00	16.00	9.50	32.00	16.00	9.50	32.00	-7.00	9.50	2.500	2	145.000
C	12.50	16.00	18.50	12.50	-1.00	18.50	-12.50	-1.00	18.50	1.000	2	145.000
D1	-32.00	14.00	18.50	-12.50	14.00	18.50	-12.50	7.00	18.50	1.000	2	145.000
D2	-32.00	7.00	18.50	-17.00	7.00	18.50	-17.00	5.00	18.50	1.000	2	145.000
D3	-32.00	5.00	18.50	-22.00	5.00	18.50	-22.00	3.00	18.50	1.000	2	145.000
E1	12.50	7.00	18.50	12.50	14.00	18.50	32.00	14.00	18.50	1.000	2	145.000
E2	17.00	5.00	18.50	17.00	7.00	18.50	32.00	7.00	18.50	1.000	2	145.000
E3	22.00	3.00	18.50	22.00	5.00	18.50	32.00	5.00	18.50	1.000	2	145.000
F	-13.00	16.00	26.50	-10.00	-1.00	26.50	-10.00	-1.00	19.50	1.000	2	145.000
G	10.00	-1.00	19.50	10.00	-1.00	26.50	13.00	16.00	26.50	1.000	2	145.000
H	-19.00	-3.00	12.00	-19.00	-3.00	26.50	-21.00	5.00	26.50	1.000	2	145.000
I	19.00	-3.00	12.00	21.00	5.00	12.00	21.00	5.00	26.50	1.000	2	145.000
J	-13.00	7.50	19.50	-13.00	7.50	26.50	-31.00	2.00	26.50	1.000	2	145.000
K	31.00	2.00	26.50	13.00	7.50	26.50	13.00	7.50	19.50	1.000	2	145.000
L	-12.50	6.50	12.00	-12.50	6.50	18.50	-31.00	2.00	18.50	1.000	2	145.000
M	31.00	2.00	18.50	13.0	7.5	18.50	13.0	7.5	12.00	1.000	2	145.000
N	-11.50	8.00	18.50	-10.0	-1.0	18.50	-10.0	-1.0	12.00	1.000	2	145.000
O	10.00	-1.00	12.00	10.0	-1.00	18.50	11.5	8.00	18.50	1.000	2	145.000
P	-11.0	7.00	-25.00	11.0	7.00	-25.00	11.0	-5.00	-25.00	1.000	2	145.000
Q	11.0	7.00	-25.00	11.0	-5.00	-25.00	11.0	-5.00	-34.00	1.000	2	145.000
R	-11.0	-5.00	-34.00	-11.0	-5.00	-25.00	-11.0	7.00	-25.00	1.000	2	145.000

Table IV

1-5-20 46



STONE & WEBSTER ENGINEERING CORPORATION  
CALCULATION SHEET

▲ 5010.65

CALCULATION IDENTIFICATION NUMBER				PAGE <u>21</u>
J.O. OR W.O. NO.	DIVISION & GROUP	CALCULATION NO.	OPTIONAL TASK CODE	
12846	Power RP	037-0		

1  
2  
3  
4  
5  
6  
7  
8  
9  
10  
11  
12  
13  
14  
15  
16  
17  
18  
19  
20  
21  
22  
23  
24  
25  
26  
27  
28  
29  
30  
31  
32  
33  
34  
35  
36  
37  
38  
39  
40  
41  
42  
43  
44  
45  
46

<u>Time</u>	<u>Run #'s</u>	<u>Job #'s</u>	<u>Date</u>
0	R2819301	2378	7/2/80
	302	2539	7/2/80
	303	2361	8/6/80
	304	2544	8/6/80
1 hr	R2819305	557	8/7/80
	306	528	8/7/80
2 hrs	R2819305	573	8/7/80
	308	819	8/7/80
8 hrs	R2819304	540	8/7/80
	310	833	8/7/80
24 hrs	R2819311	605	8/7/80
	312	849	8/7/80
96 hrs	R2819313	626	8/7/80
	314	866	8/7/80
192 hrs	R2819315	640	8/7/80
	316	879	8/7/80
360 hrs	R2819317	649	8/7/80
	318	892	8/7/80
720 hrs	R2819319	662	8/7/80
	320	901	8/7/80
2160 hrs	R2819321	784	8/7/80
	322	911	8/7/80
4320 hrs	R2819323	798	8/7/80
	324	924	8/7/80
0 hrs	R2819301	1462	8/5/80
	303	766	8/6/80

Table V

5010.65

CALCULATION IDENTIFICATION NUMBER

J.O. OR W.O. NO.  
12846

DIVISION & GROUP  
Power RP

CALCULATION NO.  
037-0

OPTIONAL TASK CODE

PAGE 22

Dose Rates to various Valve Motors in The Safeguards Area

Dose Point Component Time (hr)	01	02	03	04	05	06	07	08	09	010	011	012	013
	MOV1862A	MOV1862B	MOV-RS186A	MOV-RS186B	MOV1864A	MOV1864B	MOV1890A	MOV1890B	MOV1890C	FE1945	FE1946	MOV1860A	MOV1860B
0	4.96+7	5.66+7	5.49+6	6.72+6	5.02+6	5.26+6	7.77+6	1.01+7	9.55+6	3.21+8	3.24+8	1.60+7	3.05+7
1	*	3.43+7	*	3.97+6	*	3.02+6	*	5.94+6	*	1.95+8	1.97+8	*	2.07+7
2		2.41+7		2.78+6		2.10+6		4.15+6		1.37+8	1.37+8		1.45+7
8		1.01+7		1.06+6		8.46+5		1.71+6		5.75+7	5.82+7		6.11+6
24		4.46+6		4.89+5		3.37+5		7.21+5		2.54+7	2.57+7		2.70+6
48		1.66+6		1.79+5		1.16+5		2.61+5		9.47+6	9.62+6		1.02+6
192		1.12+6		1.21+5		7.85+4		1.76+5		6.38+6	6.48+6		6.87+5
360		7.04+5		7.62+4		5.01+4		1.11+5		4.01+6	4.07+6		4.31+5
720		3.31+5		3.60+4		2.42+4		5.29+4		1.89+6	1.91+6		2.02+5
2160		1.07+5		1.15+4		7.80+3		1.70+4		6.09+5	6.17+5		6.46+4
4320		4.67+4		5.03+3		3.38+3		7.40+3		2.67+5	2.70+5		2.83+4

Table VII

1-5-22

46 45 44 43 42 41 40 39 38 37 36 35 34 33 32 31 30 29 28 27 26 25 24 23 22 21 20 19 18 17 16 15 14 13 12 11 10 9 8 7 6 5 4 3 2 1

STONE & WEBSTER ENGINEERING CORPORATION  
 CALCULATION SHEET

▲ 5010.65

CALCULATION IDENTIFICATION NUMBER				PAGE <u>23</u>
J.O. OR W.O. NO. <u>12846</u>	DIVISION & GROUP <u>Power RP</u>	CALCULATION NO. <u>0370</u>	OPTIONAL TASK CODE	

Integrated Doses to Valve Motors in Safeguards Area

Time (hrs)	Cumulative Dose (Rads)						
	MOV1862B	MOV-RS156B	MOV1864B	MOV1890B	MOV1860B	FE1945	FE1946
0	0.0	0.0	0.0	0.0	0.0	0.0	0.0
1	4.45+4	5.22+3	4.04+3	7.84+3	2.53+4	2.53+5	2.55+5
2	7.34+4	8.56+3	6.57+3	1.28+4	4.27+4	4.17+5	4.20+5
8	1.70+5	1.93+4	1.48+4	2.93+4	1.01+5	9.66+5	4.73+5
24	2.80+5	3.11+4	2.37+4	4.77+4	1.68+5	1.60+6	1.61+6
46	4.84+5	5.33+4	3.86+4	8.03+4	2.92+5	2.76+6	2.79+6
192	6.16+5	6.75+4	4.78+4	1.01+5	3.73+5	3.51+6	3.55+6
360	7.67+5	8.38+4	5.85+4	1.25+5	4.65+5	4.38+6	4.42+6
720	9.45+5	1.03+5	2.13+4	1.53+5	5.74+5	5.39+6	5.45+6
2160	1.23+6	1.34+5	4.21+4	1.98+5	7.47+5	7.02+6	7.10+6
4320	1.39+6	1.51+5	1.04+5	2.24+5	8.45+5	7.94+6	8.03+6

Table III

STONE & WEBSTER ENGINEERING CORPORATION  
CALCULATION SHEET

▲ 5010.65

CALCULATION IDENTIFICATION NUMBER				PAGE <u>24</u>
J.O. OR W.O. NO. <u>12846</u>	DIVISION & GROUP <u>Power RP</u>	CALCULATION NO. <u>037-0</u>	OPTIONAL TASK CODE	

1  
2  
3  
4  
5  
6  
7  
8  
9  
10  
11  
12  
13  
14  
15  
16  
17  
18  
19  
20  
21  
22  
23  
24  
25  
26  
27  
28  
29  
30  
31  
32  
33  
34  
35  
36  
37  
38  
39  
40  
41  
42  
43  
44  
45  
46

Dose to MOV1862 B without Lines

10"-SI-106-153 and 10"-SI-107-153 modeled

Time (hrs)	Dose Rate (mR/hr)	$\Delta$ Dose (R)	Cumulative Dose (R)
0	1.14 + 6	0.0	0.0
1	6.91 + 5	8.97 + 2	8.97 + 2
2	4.85 + 5	1.48 + 3	1.48 + 3
8	2.03 + 5	3.42 + 3	3.42 + 3
24	8.98 + 4	5.64 + 3	5.64 + 3
96	3.34 + 4	9.75 + 3	9.75 + 3
192	2.26 + 4	1.24 + 4	1.24 + 4
360	1.42 + 4	1.54 + 4	1.54 + 4
720	6.67 + 3	1.90 + 4	1.90 + 4
2160	2.16 + 3	2.48 + 4	2.48 + 4
4320	9.41 + 2	2.80 + 4	2.80 + 4

Table VIII

STONE & WEBSTER ENGINEERING CORPORATION  
 CALCULATION SHEET

▲ 5010.65

CALCULATION IDENTIFICATION NUMBER				PAGE <u>25</u>
J.O. OR W.O. NO. <u>12846</u>	DIVISION & GROUP <u>Power RP</u>	CALCULATION NO. <u>0370</u>	OPTIONAL TASK CODE	

Conclusion

The six month integrated dose to the components studied are:

<u>Component</u>	<u>6 mo. dose (Rads)</u>	
MOV1862B	1.39+6	} motors which operate these values
MOV-RS-156B	1.51+6	
MOV1864B	1.04+5	
MOV1890B	2.24+5	
MOV1860B	8.45+5	
FE1945	7.94+6	
FE1946	8.03+6	
* MOV1862B	2.80+4	} →

\* note: This value was arrived at without lines 10"-SI-106-153 and 10"-SI-107-153 modeled and with the detector point (D2) located 2' below the motor (in center of valve, but this should be an acceptable location to render and estimate of the dose to the component under question).

It is noted that the maximum 6 month LOCA dose is  $8 \times 10^6$  rads, the same as the number in calc. # 12846.38-RP-024-0.

USER'S GUIDE TO EZD REFERENCES

Facility: VEPCO, SURRY  
 Units: 1 and 2  
 Dockets: 50-280 and 50-281

EZD REFERENCE NO. 10  
 EZD REFERENCE DESCRIPTION: 12846.44-UR(B)-043-0  
 ENVIRONMENTAL ZONE(S): AB-13A

<u>PARAMETER</u>	<u>NORMAL ENVIRONMENT</u>	<u>PAGE</u>	<u>LOCA ENVIRONMENT</u>	<u>PAGE</u>	<u>MSLB ENVIRONMENT</u>	<u>PAGE</u>	<u>HELB ENVIRONMENT</u>	<u>PAGE</u>
RADIATION (rads)	2.66 x 10 <sup>7</sup>	6	9.3 x 10 <sup>5</sup>	6				

USER'S GUIDE TO EZD REFERENCES

Facility: VEPCO, SURRY  
 Units: 1 and 2  
 Dockets: 50-280 and 50-281

EZD REFERENCE NO. 10  
 EZD REFERENCE DESCRIPTION: 12846.44-UR(B)-043-0  
 ENVIRONMENTAL ZONE(S): AB-13B

<u>PARAMETER</u>	<u>NORMAL ENVIRONMENT</u>	<u>PAGE</u>	<u>LOCA ENVIRONMENT</u>	<u>PAGE</u>	<u>MSLB ENVIRONMENT</u>	<u>PAGE</u>	<u>HELB ENVIRONMENT</u>	<u>PAGE</u>
RADIATION (rads)	1.96 x 10 <sup>4</sup>	6	3.2 x 10 <sup>4</sup>	6				

USER'S GUIDE TO EZD REFERENCES

Facility: VEPCO, SURRY  
 Units: 1 and 2  
 Dockets: 50-280 and 50-281

EZD REFERENCE NO. 10  
 EZD REFERENCE DESCRIPTION: 12846.44-UR(B)-043-0  
 ENVIRONMENTAL ZONE(S): AB-27

<u>PARAMETER</u>	<u>NORMAL ENVIRONMENT</u>	<u>PAGE</u>	<u>LOCA ENVIRONMENT</u>	<u>PAGE</u>	<u>MSLB ENVIRONMENT</u>	<u>PAGE</u>	<u>HELB ENVIRONMENT</u>	<u>PAGE</u>
RADIATION (rads)	1.26 x 10 <sup>6</sup>	6	6.8 x 10 <sup>2</sup>	6				



USER'S GUIDE TO EZD REFERENCES

Facility: VEPCO, SURRY  
 Units: 1 and 2  
 Dockets: 50-280 and 50-281

EZD REFERENCE NO. 10  
 EZD REFERENCE DESCRIPTION: 12846.44-UR(B)-043-0  
 ENVIRONMENTAL ZONE(S): AB-45

<u>PARAMETER</u>	<u>NORMAL ENVIRONMENT</u>	<u>PAGE</u>	<u>LOCA ENVIRONMENT</u>	<u>PAGE</u>	<u>MSLB ENVIRONMENT</u>	<u>PAGE</u>	<u>HELE ENVIRONMENT</u>	<u>PAGE</u>
RADIATION (rads)	1.1 x 10 <sup>5</sup>	6	2.7 x 10 <sup>5</sup>	6				

CALCULATION TITLE PAGE

\*SEE INSTRUCTIONS ON REVERSE SIDE

▲ 5010.64 (FRONT)

CLIENT & PROJECT VEPCO      Surry 1 & 2				PAGE 1 OF 6	
CALCULATION TITLE (Indicative of the Objective): 6 Month LOCA Dose and 40 year Normal Dose Inside the Aux. Bldg According to Environmental zone Designations				QA CATEGORY (✓) <input checked="" type="checkbox"/> I - NUCLEAR SAFETY RELATED <input type="checkbox"/> II <input type="checkbox"/> III <input type="checkbox"/> OTHER	
CALCULATION IDENTIFICATION NUMBER					
J. O. OR W.O. NO.	DIVISION & GROUP	CURRENT CALC. NO.	OPTIONAL TASK CODE	OPTIONAL WORK PACKAGE NO.	
12846.44	NT      RP	UR(B)-043-0			
* APPROVALS - SIGNATURE & DATE			REV. NO. OR NEW CALC NO.	SUPERSEDES * CALC. NO. OR REV. NO.	CONFIRMATION * REQUIRED (✓)
PREPARER(S)/DATE(S)	REVIEWER(S)/DATE(S)	INDEPENDENT REVIEWER(S)/DATE(S)			YES    NO
Wahung peng 6/29/81	Juan Lin 7/6/81	Joseph Lin 7/6/81			GIMTRAM QADND RADIOISOTOPE ACTIVITY
DISTRIBUTION *					
GROUP	NAME & LOCATION	COPY SENT (✓)	GROUP	NAME & LOCATION	COPY SENT (✓)
RECORDS MGT. FILES (OR FIRE FILE IF NONE)	J. Barnhart (14)	✓			

## CALCULATION SHEET

▲ 5010.65

CALCULATION IDENTIFICATION NUMBER				PAGE <u>2</u>
J.O. OR W.O. NO. 12846.44	DIVISION & GROUP NT RP	CALCULATION NO. UR(B)-043-0	OPTIONAL TASK CODE	

Objective

The objective of this calc. is to list the 40 year normal and 6 Month LOCA dose inside the auxiliary bldg according to Environmental zone designation.

Approach

- Aux bldg has been divided in 8 zones according to Environmental conditions following a LOCA and 38 zones according to Radiation Level. Each environmental zone includes several Radiation zones.
- The 6 Month LOCA dose and 40 year normal dose of each radiation zone have been calculated and tabulated in calc. 12846.38-RP-026-0<sup>(1)</sup> and 12846.54-RP-035-0<sup>(2)</sup>, respectively.
- The total integrated dose (LOCA plus 40 year) for each environmental zone is determined by choosing the radiation zone which gives the most conservative value.
- Doses in Penetration areas and charging pump cubicles are based on ref. (3)

References:

- S & W Calc. 12846.38-RP-026-0, "NUREG-0578 Shielding Review - Aux Bldg Rad. Zone Maps Following a LOCA" Surry stations
- S & W Surry Calc. 12846.54-RP-035-0, "40 year normal operating dose in Aux bldg for Equipment Qualification" 7-17-80
- Surry calc. 12846.38-RP-024-0<sup>1</sup>, "Equipment Qual. in Aux & S.G Bldgs"

STONE & WEBSTER ENGINEERING CORPORATION  
CALCULATION SHEET

▲ 5010.85

CALCULATION IDENTIFICATION NUMBER				PAGE <u>3</u>
J.O. OR W.O. NO. 12846.44	DIVISION & GROUP NT - RP	CALCULATION NO. UK(R)-043-0	OPTIONAL TASK CODE	

6 MONTHS' LOCA DOSE FROM UNIT #1  
(DOSE RATE IN MRHR)(ref. (4))

\* INTEGRATED

	OHR	1		2		8		24		96		192		360		720		2160		4320		DOSE (RADS)
		1	1	1	1	1	1	1	1	1	1	1	1	1	1	1	1	1	1	1	1	
8	A	2.1+5	1.2+5	7.5+4	3.3+4	1.2+4	3.6+3	2.5+3	1.6+3	7.9+2	2.7+2	1.1+2	3.8+3									
9	B	1.8+4	9.8+3	5.9+3	2.7+3	9.1+2	2.7+2	1.9+2	1.2+2	5.9+1	2.0+1	8.3+0	2.9+2									
10	C	2.5+7	1.4+7	9.7+6	4.0+6	1.7+6	6.2+5	4.2+5	2.6+5	1.2+5	4.0+4	1.7+4	5.5+5									
11	D	5.0+7	2.9+7	2.1+7	8.0+6	2.8+6	9.3+5	6.3+5	3.9+5	2.0+5	6.5+4	2.7+4	9.3+5									
12	E	1.6+8	1.0+8	7.2+7	3.0+7	1.4+7	5.1+6	3.5+6	2.1+6	1.0+6	3.3+5	1.4+5	4.5+6									
13	F	1.4+8	9.1+7	6.3+7	2.6+7	1.2+7	4.5+6	3.1+6	1.9+6	8.9+5	2.9+5	1.2+5	3.9+6									
14	G	1.4+5	7.1+4	4.8+4	1.8+4	6.2+3	1.8+3	1.3+3	8.1+2	4.1+2	1.3+2	5.6+1	2.0+3									
15	H	4.4+7	2.5+7	1.8+7	7.0+6	2.8+6	9.6+5	6.4+5	4.1+5	2.0+5	6.8+4	2.9+4	9.2+5									
16	I	7.1+6	4.3+6	3.1+6	1.2+6	5.6+5	2.1+5	1.4+5	8.8+4	4.1+4	1.3+4	5.9+3	1.8+5									
17	J	4.5+6	2.2+6	1.5+6	5.8+5	2.3+5	8.5+4	5.7+4	3.3+4	1.5+4	5.1+3	2.1+3	7.5+4									
18	K	2.4+2	1.4+2	9.6+1	3.9+1	4.5+0	1.6+0	1.0+0	6.6-1	—	—	—	1.7+0									
19	L	1.0+3	5.5+2	3.8+2	1.5+2	3.1+1	9.6+0	6.5+0	3.7+0	1.9+0	3.8-1	—	1.0+1									
20	M	3.0+6	1.8+6	1.2+6	5.2+5	1.9+5	6.9+4	4.7+4	3.0+4	1.4+4	4.5+3	2.0+3	6.4+4									
21	N	1.7+4	1.0+4	6.8+3	2.7+3	5.0+2	1.7+2	1.2+2	7.3+1	2.6+1	1.1+1	4.7+0	2.0+2									
22	O	3.1+6	1.2+6	8.1+5	3.2+5	1.2+5	3.6+4	2.2+4	1.4+4	5.1+3	1.0+3	4.0+2	3.1+4									
23	P	4.2+5	2.0+5	1.4+5	5.1+4	1.5+4	3.9+3	2.8+3	1.8+3	9.5+2	2.8+2	1.2+2	4.8+3									
24	Q	4.8+7	2.8+7	2.0+7	7.9+6	2.8+6	9.5+5	6.4+5	4.0+5	2.0+5	6.6+4	2.8+4	9.3+5									
25	R	4.0+6	1.2+6	8.8+5	3.4+5	1.3+5	4.8+4	2.9+4	1.4+4	3.8+3	4.6+2	1.9+2	3.2+4									
26	S	7.8+4	4.2+4	2.9+4	1.1+4	3.9+3	1.2+3	8.1+2	5.2+2	2.6+2	8.8+1	3.7+1	1.3+3									
27	T	1.0+7	6.1+6	4.2+6	1.7+6	7.1+5	2.3+5	1.6+5	1.0+5	5.0+4	1.4+4	7.0+3	2.2+5									
28	U	4.7+6	2.8+6	2.0+6	8.3+5	3.6+5	1.3+5	9.1+4	5.7+4	2.6+4	8.6+3	3.8+3	1.2+5									
29	V	3.6+6	1.6+6	1.1+6	4.2+5	1.6+5	6.4+4	4.0+4	2.2+4	9.9+3	3.7+3	1.3+3	5.2+4									
30	W	2.1+4	1.4+4	1.0+4	6.9+3	2.4+3	1.1+3	1.1+3	1.0+3	5.4+2	9.0+0	8.0-3	1.2+3									
31	X	5.0+4	1.8+4	1.3+4	5.1+3	2.1+3	7.0+2	4.7+2	2.9+2	1.5+2	4.9+1	2.0+1	6.8+2									
32	Y	1.3+7	5.3+6	3.7+6	1.4+6	5.4+5	2.1+5	1.3+5	7.4+4	3.3+4	1.3+4	4.3+3	1.8+5									
33	Z	6.1+3	2.0+3	1.4+3	5.0+2	1.7+2	6.7+1	4.3+1	2.5+1	1.1+1	3.3+0	1.1+0	5.8+1									
34	AA	6.0+4	2.1+4	1.4+4	5.5+3	2.2+3	7.4+2	5.0+2	3.1+2	1.5+2	5.0+1	2.1+1	7.2+2									
35	BB	2.7+3	4.7+2	3.2+2	9.2+1	2.0+1	6.2+0	4.0+0	2.0+0	6.0-1	—	—	7.0+0									
36	CC	3.9+4	1.2+4	7.8+3	2.5+3	7.5+2	2.4+2	1.7+2	1.0+2	5.0+1	1.4+1	5.1+0	2.6+2									
37	DD	2.5+4	1.4+4	1.0+4	6.3+3	2.2+3	9.9+2	9.7+2	9.2+2	4.9+2	9.2+0	7.1-3	1.1+3									
38	EE	7.0+4	2.4+4	1.5+4	5.0+3	1.3+3	3.4+2	2.5+2	1.6+2	7.7+1	1.8+1	5.8+0	4.4+2									
39	FF	2.3+4	3.5+3	2.6+3	5.2+2	3.9+1	1.7+0	6.7-1	—	—	—	—	3.2+1									
40	GG	1.6+7	3.8+6	2.8+6	9.8+5	3.5+5	1.1+5	6.9+4	3.1+4	6.5+3	2.9+1	2.8-2	8.0+4									
41	HH	8.4+4	3.0+4	2.2+4	8.6+3	2.9+3	1.1+3	6.9+2	4.2+2	2.0+2	5.6+1	1.9+1	9.7+2									
42	II	2.2+6	1.4+6	1.1+6	8.0+5	3.4+5	2.3+5	2.5+5	2.4+5	1.3+5	2.3+3	2.9+1	2.7+5									
43	JJ	9.7+4	3.4+4	2.5+4	1.0+4	3.6+3	1.3+3	8.5+2	4.9+2	2.3+2	5.6+1	1.9+1	1.1+3									
44	KK	4.2+4	1.4+4	1.1+4	5.7+3	1.6+3	4.0+2	3.3+2	2.9+2	1.5+2	2.4+0	2.2-3	5.0+2									
45	LL	7.9+4	2.7+4	2.0+4	9.5+3	9.3+3	9.2+2	6.7+2	4.6+2	2.2+2	2.3+1	7.0+0	1.2+3									

1-K-3

\* Integrated doses are calculated by linear integration.

**STONE & WEBSTER ENGINEERING CORPORATION**  
**CALCULATION SHEET**

▲ 5010.65

CALCULATION IDENTIFICATION NUMBER													PAGE <u>4</u>
J.O. OR W.O. NO.	DIVISION & GROUP	CALCULATION NO.	OPTIONAL TASK CODE										
12846.44	NT-RP	UR(B)-043-0											
6 MONTHS' LOCA DOSE FROM UNIT # 2													
(DOSE RATE IN MK/HR) ref (4)													
													INTEGRATE
	0 HR	1	2	8	24	96	192	360	720	2160	4320	DOSE	
				16	72	96	168	360	1440	2160		(RAD/S)	
A	1.5 +8	9.6 +7	6.7 +7	2.8 +7	1.3 +7	4.8 +6	3.3 +6	2.0 +6	9.3 +5	3.0 +5	1.3 +5	4.2 +6	
B	4.5 +6	2.1 +6	1.4 +6	5.0 +5	1.4 +5	3.5 +4	2.5 +4	1.7 +4	8.6 +3	2.5 +3	9.6 +2	4.5 +4	
C	2.5 +7	1.4 +7	9.7 +6	4.0 +6	1.7 +6	6.2 +5	4.2 +5	2.6 +5	1.2 +5	4.0 +4	1.7 +4	5.5 +5	
D	4.6 +7	2.7 +7	1.9 +7	7.5 +6	2.6 +6	8.9 +5	6.1 +5	3.8 +5	1.9 +5	6.3 +4	2.6 +4	8.8 +5	
E	1.3 +7	8.0 +6	5.6 +6	2.4 +6	1.0 +6	3.9 +5	2.6 +5	1.6 +5	7.7 +4	2.5 +4	1.1 +4	3.4 +5	
F	5.2 +5	2.9 +5	2.0 +5	8.3 +4	3.5 +4	1.3 +4	8.9 +3	5.5 +3	2.6 +3	8.5 +2	3.7 +2	1.2 +4	
G	1.4 +8	9.0 +7	6.3 +7	2.6 +7	1.2 +7	4.5 +6	3.1 +6	1.9 +6	8.9 +5	2.9 +5	1.2 +5	3.9 +6	
H	4.4 +7	2.5 +7	1.8 +7	7.0 +6	2.8 +6	9.6 +5	6.4 +5	4.1 +5	2.0 +5	6.8 +4	2.9 +4	9.2 +5	
I	7.1 +6	4.3 +6	3.1 +6	1.2 +6	5.6 +5	2.1 +5	1.4 +5	8.8 +4	4.1 +4	1.3 +4	5.9 +3	1.8 +5	
J	4.5 +6	2.2 +6	1.5 +6	5.8 +5	2.3 +5	8.5 +4	5.7 +4	3.3 +4	1.5 +4	5.1 +3	2.1 +3	7.5 +4	
K	4.0 +6	1.1 +6	8.2 +5	3.3 +5	1.3 +5	4.7 +4	2.8 +4	1.4 +4	3.4 +3	3.3 +2	1.3 +2	3.1 +4	
L	3.1 +5	9.5 +4	6.8 +4	2.6 +4	9.8 +3	3.6 +3	2.1 +3	1.1 +3	3.0 +2	4.7 +1	1.6 +1	2.5 +3	
M	3.0 +6	1.8 +6	1.2 +6	5.2 +5	1.9 +5	6.9 +4	4.7 +4	3.0 +4	1.4 +4	4.5 +3	2.0 +3	6.4 +4	
N	3.1 +6	1.1 +6	7.8 +5	3.2 +5	1.2 +5	3.5 +4	2.2 +4	1.3 +4	5.0 +3	9.6 +2	3.9 +2	3.0 +4	
O	7.7 +4	4.2 +4	2.9 +4	1.1 +4	2.3 +3	6.6 +2	4.6 +2	3.0 +2	1.5 +2	4.9 +1	2.0 +1	8.4 +2	
P	4.2 +5	2.0 +5	1.4 +5	5.1 +4	1.5 +4	3.9 +3	2.8 +3	1.8 +3	9.5 +2	2.8 +2	1.2 +2	4.8 +3	
Q	4.8 +7	2.8 +7	2.0 +7	7.8 +6	2.8 +6	9.5 +5	6.4 +5	4.0 +5	2.0 +5	6.6 +4	2.8 +4	9.3 +5	
R	2.0 +5	1.2 +5	8.0 +4	3.2 +4	6.1 +3	2.0 +3	1.4 +3	8.9 +2	4.4 +2	1.4 +2	6.0 +1	2.4 +3	
S	1.0 +7	6.1 +6	4.2 +6	1.7 +6	7.0 +5	2.3 +5	1.5 +5	9.9 +4	4.9 +4	1.3 +4	7.0 +3	2.2 +5	
T	1.4 +5	8.0 +4	5.7 +4	2.3 +4	9.3 +3	3.3 +3	2.2 +3	1.4 +3	6.6 +2	2.2 +2	9.4 +1	3.0 +3	
U	4.7 +6	2.8 +6	2.0 +6	8.3 +5	3.6 +5	1.3 +5	9.1 +4	5.7 +4	2.6 +4	8.6 +3	3.8 +3	1.2 +5	
V	3.6 +6	1.6 +6	1.1 +6	4.2 +5	1.6 +5	6.4 +4	4.0 +4	2.2 +4	9.9 +3	3.7 +3	1.3 +3	5.2 +4	
W	2.1 +4	1.4 +4	1.0 +4	6.9 +3	2.4 +3	1.1 +3	1.1 +3	1.0 +3	5.4 +2	9.0 +1	8.0 -3	1.2 +3	
X	5.0 +4	1.8 +4	1.3 +4	5.1 +3	2.1 +3	7.0 +2	4.7 +2	2.9 +2	1.5 +2	4.9 +1	2.0 +1	6.8 +2	
Y	1.3 +7	5.3 +6	3.7 +6	1.4 +6	5.4 +5	2.1 +5	1.3 +5	7.4 +4	3.3 +4	1.3 +4	4.3 +3	1.8 +5	
Z	6.0 +4	2.1 +4	1.4 +4	5.5 +3	2.2 +3	7.4 +2	5.0 +2	3.1 +2	1.5 +2	5.0 +1	2.1 +1	7.2 +2	
AA	6.2 +3	2.0 +3	1.4 +3	5.1 +2	1.7 +2	6.7 +1	4.3 +1	2.5 +1	1.1 +1	3.3 +0	1.1 +0	5.8 +1	
BB	3.0 +4	8.7 +3	5.5 +3	1.7 +3	4.4 +2	1.4 +2	9.8 +1	6.0 +1	2.8 +1	7.3 +0	2.4 +0	1.6 +2	
CC	1.1 +4	3.9 +3	2.6 +3	9.3 +2	3.3 +2	1.1 +2	7.4 +1	4.6 +1	2.2 +1	6.8 +0	2.7 +0	1.1 +2	
DD	2.5 +4	1.4 +4	1.0 +4	6.3 +3	2.2 +3	9.9 +2	9.7 +2	9.2 +2	4.9 +2	9.2 +0	7.1 -3	1.1 +3	
EE	7.0 +4	2.4 +4	1.5 +4	5.0 +3	1.3 +3	3.4 +2	2.5 +2	1.6 +2	7.7 +1	1.8 +1	5.8 +0	4.4 +2	
FF	1.6 +7	3.8 +6	2.8 +6	9.8 +5	3.5 +5	1.1 +5	6.9 +4	3.1 +4	6.5 +3	2.9 +1	2.8 -2	8.0 +4	
GG	2.3 +4	3.5 +3	2.6 +3	5.2 +2	3.9 +1	1.7 +0	6.7 -1	0.0	0.0	0.0	0.0	3.2 +1	
HH	9.7 +4	3.4 +4	2.5 +4	1.0 +4	3.6 +3	1.3 +3	8.5 +2	4.9 +2	2.3 +2	5.6 +1	1.9 +1	1.1 +3	
II	2.2 +6	1.4 +6	1.1 +6	8.0 +5	3.4 +5	2.3 +5	2.5 +5	2.4 +5	1.3 +5	2.3 +3	2.9 +1	2.7 +5	
JJ	8.4 +4	3.0 +4	2.2 +4	8.6 +3	2.9 +3	1.1 +3	6.9 +2	4.2 +2	2.0 +2	5.6 +1	1.9 +1	9.7 +2	
KK	4.2 +4	1.4 +4	1.1 +4	5.7 +3	1.6 +3	4.0 +2	3.3 +2	2.9 +2	1.5 +2	2.4 +0	2.2 -3	5.0 +2	
LL	7.9 +4	2.7 +4	2.0 +4	9.5 +3	9.3 +3	9.2 +2	6.7 +2	4.6 +2	2.2 +2	2.3 +1	7.0 +0	1.2 +3	

1-K-4

STONE & WEBSTER ENGINEERING CORPORATION  
CALCULATION SHEET

▲ 5010.65

CALCULATION IDENTIFICATION NUMBER				PAGE <u>5</u>
J.O. OR W.O. NO. 12846.44	DIVISION & GROUP NT-RP	CALCULATION NO. UR(87)-043-0	OPTIONAL TASK CODE	

3 TOTAL DOSES

ZONE	40 YEAR DOSE	UNIT # 1 ACCIDENT		UNIT # 2 ACCIDENT	
		LOCA	TOTAL	LOCA	TOTAL
A	2.50 +6	3.8 +3	2.5 +6	4.2 +6	6.7 +6
B	7.01 +6	2.9 +2	7.0 +6	4.5 +4	7.1 +6
C	1.11 +6	5.5 +5	1.7 +6	5.5 +5	1.7 +6
D	5.43 +6	9.3 +5	6.4 +6	8.8 +5	6.3 +6
E	2.50 +6	4.5 +6	7.0 +6	3.4 +5	2.8 +6
F	3.50 +6	3.9 +6	7.4 +6	1.2 +4	3.5 +6
G	3.50 +6	2.0 +3	3.5 +6	3.9 +6	7.4 +6
H	1.11 +6	9.2 +5	2.0 +6	9.2 +5	2.0 +6
I	1.11 +6	1.8 +5	1.3 +6	1.8 +5	1.3 +6
J	5.26 +5	7.5 +4	6.0 +5	7.5 +4	6.0 +5
K	1.96 +4	1.7 +0	2.0 +4	3.1 +4	5.1 +4
L	2.98 +6	1.0 +1	3.0 +6	2.5 +3	3.0 +6
M	2.18 +3	6.4 +4	6.6 +4	6.4 +4	6.6 +4
N	4.87 +3	2.0 +2	5.1 +3	3.0 +4	3.5 +4
O	4.87 +3	3.1 +4	3.6 +4	8.4 +2	5.7 +3
P	8.41 +2	4.8 +3	5.6 +3	4.8 +3	5.6 +3
Q	2.66 +7	9.3 +5	2.8 +7	9.3 +5	2.8 +7
R	1.96 +4	3.2 +4	5.2 +4	2.4 +3	2.2 +4
S	1.40 +5	1.3 +3	1.4 +5	2.2 +5	3.6 +5
T	1.40 +5	2.2 +5	3.6 +5	3.0 +3	1.4 +5
U	2.18 +3	1.2 +5	1.2 +5	1.2 +5	1.2 +5
V	5.26 +5	5.2 +4	5.8 +5	5.2 +4	5.8 +5
W	3.50 +3	1.2 +3	1.6 +3	1.2 +3	1.6 +3
X	1.26 +8	6.8 +2	1.3 +8	6.8 +2	1.3 +8
Y	3.88 +4	1.8 +5	2.2 +5	1.8 +5	2.2 +5
Z	5.26 +3	5.8 +1	5.3 +3	7.2 +2	6.0 +3
AA	5.26 +3	7.2 +2	6.0 +3	5.8 +1	5.3 +3
BB	3.50 +4	7.0 +0	3.5 +4	1.6 +2	3.5 +4
CC	4.91 +3	2.6 +2	5.2 +3	1.1 +2	5.0 +3
DD	5.26 +3	1.1 +3	6.4 +3	1.1 +3	6.4 +3
EE	2.45 +4	4.4 +2	2.9 +4	4.4 +2	2.9 +4
FF	8.76 +2	3.2 +1	9.1 +2	8.0 +4	8.1 +4
GG	8.76 +2	8.0 +4	8.1 +4	3.2 +1	9.1 +2
HH	8.76 +2	9.7 +2	1.8 +3	1.1 +3	2.0 +3
II	1.10 +5	2.7 +5	3.8 +5	2.7 +5	3.8 +5
JJ	8.76 +2	1.1 +3	2.0 +3	9.7 +2	1.8 +3
KK	8.76 +2	5.0 +2	1.4 +3	5.0 +2	1.4 +3
LL	8.76 +2	1.2 +3	2.1 +3	1.2 +3	2.1 +3

STONE & WEBSTER ENGINEERING CORPORATION  
CALCULATION SHEET

▲ 5010.65

CALCULATION IDENTIFICATION NUMBER				PAGE <u>6</u>
J.O. OR W.O. NO. 12846.44	DIVISION & GROUP NT RP	CALCULATION NO. UR(B) - 043-0	OPTIONAL TASK CODE	

Calculation

4. Determination of the most conservative radiation zone of each environmental zone and the total dose.

Environ. zone	Radia. Zone (Attached I.P.C.)	Radiation zone/ highest total dose	Total dose (rads)
AB-2A	B, C, D, H, I, J	B { 7.0 + 6 4.5 + 4	7.1 + 6
AB-2B	A, E (penetration areas)	E* { 2.50 + 6 2.50 + 6	5.0 + 6
AB-2C	F, G (charging pump cubicles)	F* { 2.8 + 6 8. + 6	1.1 + 7
AB-13A	L, M, N, O, P, Q, U, V	Q { 2.66 + 7 9.3 + 5	2.8 + 7*
AB-13B	K, R	R { 1.96 + 4 3.2 + 4	5.2 + 4
AB-13C	S, T	S { 1.40 + 5 2.2 + 5	3.6 + 5
AB-27	W, X, Y, Z, AA, BB, CC, DD, EE	X { 1.26 + 8 6.8 + 2	1.3 + 8+
AB-45	FF, GG, HH, II, JJ, KK, LL	II { 1.10 + 5 2.7 + 5	3.8 + 5

\* The high dose is from 40 year normal operation, due to primary drain tank and gas stripper inside the primary drain tank cubicle.  
+ Volume control tank contact dose.

\* : Doses in penetration areas (AB-2B) and charging pump cubicles (AB-2C) are based on equipment qualification calc. (ref. (3))  
Those numbers are in the same order of magnitude as the numbers in p. 5  
(E → 2.5 x 10<sup>6</sup> rads for 40 year & 4.5 x 10<sup>6</sup> rads for LOCA; F → 3.5 x 10<sup>6</sup> & 3.9 x 10<sup>6</sup> rads respectively)

USER'S GUIDE TO E2D REFERENCES

Facility: VEPCO, SURRY  
 Units: 1 and 2  
 Dockets: 50-280 and 50-281

E2D REFERENCE NO. 11  
 E2D REFERENCE DESCRIPTION: 12846.38-RP-031-0  
 ENVIRONMENTAL ZONE(S): CSPH-11, MSVH-11

<u>PARAMETER</u>	<u>NORMAL ENVIRONMENT</u>	<u>PAGE</u>	<u>LOCA ENVIRONMENT</u>	<u>PAGE</u>	<u>MSLB ENVIRONMENT</u>	<u>PAGE</u>	<u>HELB ENVIRONMENT</u>	<u>PAGE</u>
RADIATION (rads)	$8.8 \times 10^2$	27	$5.9 \times 10^6$	27				



USER'S GUIDE TO EZD REFERENCES

Facility: VEPCO, SURRY  
 Units: 1 and 2  
 Dockets: 50-280 and 50-281

EZD REFERENCE NO. 11  
 EZD REFERENCE DESCRIPTION: 12846.38-RP-031-0  
 ENVIRONMENTAL ZONE(S): CSPH-27

<u>PARAMETER</u>	<u>NORMAL ENVIRONMENT</u>	<u>PAGE</u>	<u>LOCA ENVIRONMENT</u>	<u>PAGE</u>	<u>MSLB ENVIRONMENT</u>	<u>PAGE</u>	<u>HELB ENVIRONMENT</u>	<u>PAGE</u>
RADIATION (rads)	8.8 x 10 <sup>2</sup>	27	5.3 x 10 <sup>2</sup>	27				

USER'S GUIDE TO EZD REFERENCES

Facility: VEPCO, SURRY  
 Units: 1 and 2  
 Dockets: 50-280 and 50-281

EZD REFERENCE NO. 11  
 EZD REFERENCE DESCRIPTION: 12846.38-RP-031-0  
 ENVIRONMENTAL ZONE (S): MSVH-27

<u>PARAMETER</u>	<u>NORMAL ENVIRONMENT</u>	<u>PAGE</u>	<u>LOCA ENVIRONMENT</u>	<u>PAGE</u>	<u>MSLB ENVIRONMENT</u>	<u>PAGE</u>	<u>HELB ENVIRONMENT</u>	<u>PAGE</u>
RADIATION (rads)	8.8 x 10 <sup>2</sup>	27	1.7 x 10 <sup>4</sup>	27				

USER'S GUIDE TO EZD REFERENCES

Facility: VEPCO, SURRY  
 Units: 1 and 2  
 Dockets: 50-280 and 50-281

EZD REFERENCE NO. 11  
 EZD REFERENCE DESCRIPTION: 12846.38-RP-031-0  
 ENVIRONMENTAL ZONE (S): SB-9B, TB-9, TB-35

<u>PARAMETER</u>	<u>NORMAL ENVIRONMENT</u>	<u>PAGE</u>	<u>LOCA ENVIRONMENT</u>	<u>PAGE</u>	<u>MSLB ENVIRONMENT</u>	<u>PAGE</u>	<u>HELB ENVIRONMENT</u>	<u>PAGE</u>
RADIATION (rads)			<2500	30				

**CALCULATION TITLE PAGE**

\*SEE INSTRUCTIONS ON REVERSE SIDE

▲ 5010.64 (FRONT)

CLIENT & PROJECT <b>VEPCO SURRY 1 &amp; 2</b>				PAGE 1 OF 31		
CALCULATION TITLE (Indicative of the Objective): <b>NUREG-0578 Shielding Review - Site Dose Rates following a LOCA.</b>				QA CATEGORY (✓) <input checked="" type="checkbox"/> I - NUCLEAR SAFETY RELATED <input type="checkbox"/> II <input type="checkbox"/> III <input type="checkbox"/> OTHER		
CALCULATION IDENTIFICATION NUMBER						
J. O. OR W.O. NO.	DIVISION & GROUP	CURRENT CALC. NO.	OPTIONAL TASK CODE	OPTIONAL WORK PACKAGE NO.		
12846.38	46/48 RP	RP-031-0				
* APPROVALS - SIGNATURE & DATE				REV. NO. OR NEW CALC NO.	SUPERSEDES * CALC. NO. OR REV. NO.	CONFIRMATION * REQUIRED (✓)
PREPARER(S)/DATE(S)	REVIEWER(S)/DATE(S)	INDEPENDENT REVIEWER(S)/DATE(S)			YES	NO
Wukung peng 6/30/81	Shuwan Lin 7/13/81	Shuwan Lin 7/13/81				(Ref. Code: GAMTRM QADMD ACTIVITY 2 RAD10150-TOPEs)
<b>DISTRIBUTION *</b>						
GROUP	NAME & LOCATION	COPY SENT (✓)	GROUP	NAME & LOCATION	COPY SENT (✓)	
RECORDS MGT. FILES (OR FIRE FILE IF NONE)	J. Barnhart (14)	✓				

STONE & WEBSTER ENGINEERING CORPORATION  
CALCULATION SHEET

▲ 5010.65

CALCULATION IDENTIFICATION NUMBER				PAGE <u>2</u>
J.O. OR W.O. NO. <i>12846.38</i>	DIVISION & GROUP <i>46/48 RP</i>	CALCULATION NO. <i>RP-031-0</i>	OPTIONAL TASK CODE	

1  
2  
3  
4  
5  
6  
7  
8  
9  
10  
11  
12  
13  
14  
15  
16  
17  
18  
19  
20  
21  
22  
23  
24  
25  
26  
27  
28  
29  
30  
31  
32  
33  
34  
35  
36  
37  
38  
39  
40  
41  
42  
43  
44  
45  
46

*Table of Contents*

*Page*

<i>I. Objective</i>		<i>3</i>
<i>II. Method / Approach</i>		<i>4</i>
<i>III. References</i>		<i>5</i>
<i>IV. Radiation Source strength and Site Dose points</i>		<i>6</i>
<i>V. Dose Rate Calculations</i>		<i>9</i>
<i>1. Containment atmosphere shine from containment dome (&amp; wall)</i>		<i>9</i>
<i>2. Containment atmosphere shine through the main steam line penetrations.</i>		<i>13</i>
<i>3. SI and DA lines in yard area under MSVH and CSPH.</i>		<i>15</i>
<i>4. Sources inside the aux. bldg.</i>		<i>18</i>
<i>5. Site dose rate tables.</i>		<i>23</i>
<i>VI Integrated Doses in Some Specific Areas</i>		<i>26</i>
<i>1. 40 year normal and 6 month LOCA dose in MSVH/CSPH.</i>		<i>26</i>
<i>2. 40 year normal and 6 month LOCA dose in Emergency switch gear and relay rooms</i>		<i>28</i>

STONE & WEBSTER ENGINEERING CORPORATION  
CALCULATION SHEET

▲ 5010.65

CALCULATION IDENTIFICATION NUMBER				PAGE <u>3</u>
J.O. OR W.O. NO.	DIVISION & GROUP	CALCULATION NO.	OPTIONAL TASK CODE	
12846.38	46 / 48 RP	031-0		

1  
2  
3 I. Objective.

4  
5 The objective of this calc. is to determine the site dose rates as  
6 a function of time up to 6 month after a LOCA. This is part of  
7 the shielding review for NUREG-0578 TMI accident short term  
8 recommendations. The locations being considered are areas outside the  
9 containment and aux. bldg, which may need personnel access after  
10 LOCA — including control room, counting lab inside the health physics,  
11 machine shops (proposed TSC), Lunch room (proposed OSC),  
12 emergency witchgear and relay rooms, heating boiler room, security bldg, office  
13 bldg, and information center. The radiation source terms are  
14 TID-14844 source terms and no letdown is assumed.

15  
16  
17  
18  
19  
20  
21  
22  
23  
24  
25 The 6 month LOCA and 40 year normal doses in main steam  
26 valve house / containment spray pump house and Emergency  
27 switch gear & relay room will also be calculated.  
28  
29  
30  
31  
32  
33  
34  
35  
36  
37  
38  
39  
40  
41  
42  
43  
44  
45  
46

STONE & WEBSTER ENGINEERING CORPORATION  
CALCULATION SHEET

▲ 5010.65

CALCULATION IDENTIFICATION NUMBER				PAGE <u>4</u>
J.O. OR W.O. NO.	DIVISION & GROUP	CALCULATION NO.	OPTIONAL TASK CODE	
<u>12846.38</u>	<u>46/48 RP</u>	<u>031-0</u>		

1  
2  
3  
4  
5  
6  
7  
8  
9  
10  
11  
12  
13  
14  
15  
16  
17  
18  
19  
20  
21  
22  
23  
24  
25  
26  
27  
28  
29  
30  
31  
32  
33  
34  
35  
36  
37  
38  
39  
40  
41  
42  
43  
44  
45  
46  
  
II. Method / Approach.

- The approach of this calc. is similar to that of aux. zone map calc. (ref (1)).
- A series of calc. had been performed to determine the site dose rates after a LOCA for North Anna Plant. <sup>ref (2)</sup>. Because of congruity between North Anna plant and Surry plant, North Anna dose rates are taken for Surry's use with the appropriate adjustment factors taking into consideration of the difference in power level, containment free volume, sump water volume, the distance between the dose point and the source, and the shields in between.

STONE & WEBSTER ENGINEERING CORPORATION  
**CALCULATION SHEET**

▲ 5010.65

CALCULATION IDENTIFICATION NUMBER				PAGE <u>5</u>
J.O. OR W.O. NO.	DIVISION & GROUP	CALCULATION NO.	OPTIONAL TASK CODE	
12846.38	46/48 RP	031-0		

III References.

- (1). Surry calc. 12846.38-RP-026-0, " NUREG 0578 Shielding Review, Auxiliary Bldg Radiation Zone Maps Following LOCA "
- (2). North Anna Calc. 13075-UR-022-0, " Radiation Zone Maps For Existing Facilities outside the auxiliary bldg for specific locations, due to Post LOCA sources during the mitigation phase (No letdown) - based on NUREG-0578. 1/6/81.
- (3). Surry calc. 12846.54-RP-037-0, " Direct & dose rates and integrated dose to electrical components in the safeguard area after a LOCA. " 9/5/80
- (4). Surry calc. 12846.54-RP-039-0, " 6 Month LOCA Doses as a function of distance from the containment direct shine. " 9/13/80
- (5). North Anna Calc. 12050-RP-84-0, " Generic calculation of factors of gamma attenuation through various thickness of concrete "
- (6). N. A. Calc. 12050-RP-087-0, " Dose rates at different locations and times after LOCA via main steam line penetrations in containment wall " 6/12/80
- (7). N. A. Calc. 13075-UR(B)-033-0, " Direct & dose rates to the technical support center, due to post LOCA sources based on NUREG-0578 "
- (8). N. A. Calc. 12050-RP-095-0 " Worst 6 month integrated LOCA & dose for the MSVH and QSPH for mitigation only (no letdown) "
- (9). Shielding Design Summary for Surry power station, VEPCO. 12/1970



STONE & WEBSTER ENGINEERING CORPORATION  
CALCULATION SHEET

▲ 5010.65

CALCULATION IDENTIFICATION NUMBER				PAGE <u>6</u>
J.O. OR W.O. NO.	DIVISION & GROUP	CALCULATION NO.	OPTIONAL TASK CODE	
12846.38	46/48 RP	-031-0		

IV. Radiation Source Strength and Site Dose Points

1. Identification of site location for which dose rate <sup>is</sup> to be calculated.

As shown in fig. 1, the dose rate at the following location will be calculated: (

- ① Control room
- ② Counting lab in the health physics area
- ③ Machine shops (proposed technical supporting center).
- ④ Lunch room (proposed operation supporting center)
- ⑤ Emergency switchgear and relay rooms.
- ⑥ Heating Boiler room.
- ⑦ Office Bldg.
- ⑧ Central Area Security Bldg (CAS)
- ⑨ Secondary Area Security Bldg (SAS)
- ⑩ Information Center

2. Radiation Sources.

The following radiation sources will be considered:

- ① Containment atmosphere shine from the dome (and wall)
- ② Containment atmosphere shine through main steam line penetrations.
- ③ SI/DA lines in yard area (under MSVH and CSPH).
- ④ Sources inside the aux bldg.

The following sources were considered in North Anna Calc. (ref (2)), but not considered here because their dose rate contribution is small compared to those listed above due to the following reasons.

(continued)

EL 26.5'

WASTE DRUM STORAGE

FILE NO 1

Information Center  
C.W. DISCH TUNNEL  
900 ft

12846.38 - RP-031-0

P. 7

ROAD 101+30.7

GATE

PERIMETER

100+62.75  
5000  
06402.133  
524577.385 282-03

REFS 65'43.29' E

PARKING

SAS

NEW 110,000 GAL. CONDENSATE STG. TANK

CONSTRUCTION OPENING

EXISTING 100,000 GAL. CONDENSATE STG. TANK

BRON RECOVERY PUMP HOUSE

DECONTAMINATION BUILDING

METER  
66.50  
100

CAS

CONST. SUBSTATION  
75' DIAMETER

REACTOR CONTAINMENT UNIT NO. 1

REACTOR CONTAINMENT UNIT NO. 2

SLIDE-GATE

TEST TANKS

AUXILIARY BUILDING

CABLE TUNNEL

PIPE BRIDGE

12'-4" BETWEEN TURBINE EXHAUSTS

BETWEEN TURBINE EXHAUSTS

WAREHOUSE

Lunch Room

CONTROL ROOM

LABS, LOCKERS & WASH ROOMS

EMERGEN. AREA

LAB STGE EQUIP ROOM

LOCKER ROOM

TURBINE-GENERATOR

UNIT NO. 1

UNIT NO. 2

Fig 1. Site Dose points

AREA CLEARING

VEI

FIELD

TRUCK UNLOAD AREA

CONT. STG. UNIT 1

CONT. STG. UNIT 2

STATION SERVICE TRANSFORMERS

MAIN POWER TRANSFORMERS

STATION SERVICE TRANSFORMERS

MAIN POWER TRANSFORMERS

SPARE MAIN TRANSFORMER

SEPTIC TANK

DRAINAGE DITCH

LIGHTNING ARRESTORS

ROAD EL 26.5'

LIGHTNING ARRESTORS

ROAD

STONE & WEBSTER ENGINEERING CORPORATION  
CALCULATION SHEET

▲ 5010.65

CALCULATION IDENTIFICATION NUMBER				PAGE <u>8</u>
J.O. OR W.O. NO.	DIVISION & GROUP	CALCULATION NO.	OPTIONAL TASK CODE	
12846.38	46/48 RP	-031-0		

- Containment dome recirculation spray headers — Those lines are located at an elevation lower than the top of crane wall (and thus lower than the bend line elevation) (see reference (4), S.I.19). They are shielded by 2' crane wall and 4.5' concrete wall.
- Containment atmosphere shine through purge air ducts = This is a local source, its contribution to control room is shielded by walls in Motor Control Center (MCC), aux. bldg and control room. The integrated dose in MCC was calculated in ref. (4).
- SI lines in safeguards bldg : They are all below grade and far away from the dose points (ref (3)). Dose contributions are small.
- H<sub>2</sub> recombiner system — It is inside containment for surry plant.
- SI lines in yard area between safeguards area and MSVH =  
The lines are at el. 18'-9" (DWG 11548-FP-60F); 8'-9" below the grade elevation (27'-6") and are far away <sup>from</sup> the dose points.

3. Source terms and specific source strength

Source terms and specific source strength are the same as ref. (4).  
(see ref (2). § VII)

4. Source strength adjustment factors

- SI & DA lines (containment sump water)  $f_1 = 1.1$
- Coolant sampling lines (RCS)  $f_2 = 0.89$
- Containment atmosphere  $f_3 = 0.90$

STONE & WEBSTER ENGINEERING CORPORATION  
CALCULATION SHEET

▲ 5010.85

CALCULATION IDENTIFICATION NUMBER				PAGE <u>9</u>
J.O. OR W.O. NO. 12846.38	DIVISION & GROUP NT RP	CALCULATION NO. -031-0	OPTIONAL TASK CODE	

IV Dose Rate Calculation

1. Containment Atmosphere shine from Containment dome (and wall).

In ref. (4), dose rates are given as a function of distance from the containment wall. The numbers are derived from North Anna calculations. The dose rates are plotted in fig. 2.

Dose Point	Description	Distance to unit #1 cont. center (ft)	Distance to unit #2 cont. center (ft)	Shielding Factor
1.	control room	~ 230	~ 230	$3.0 \times 10^{-3}$ (2)
2.	counting Lab	300	150	$3.2 \times 10^{-1}$ (3)
3.	Machine Shops	180	250	1.0
4.	Lunch Room	180	340	$3.2 \times 10^{-1}$ (4)
5.	swgr & Relay rooms	240	240	$5.6 \times 10^{-2}$ (5)
6.	Htg Boiler Room	460	240	1.0
7.	office Bldg	240	460	1.0
8.	CAS	300	550	1.0
9.	SAS	260	530	1.0
10.	Information Center	900	1000	1.0

Notes (1) Distances are chosen so that conservative dose rates are represented. (FY-1D)

(2) Concrete wall is at least 3'. Ceiling is 2' concrete @ el. 45' and 5" slab at el. 58'-6" (DWG 11448-FC-2P, FC-7E). The dose rate reduction factor is  $\sim 3.0 \times 10^{-3}$ , from ref. (5) for 2'-5" concrete.

(3) counting lab has at least 1' concrete walls and 6" concrete slab at el. 42' ceiling (DWG 11448-FC-7D)  $\Rightarrow 10^{-1/2} = (3.2)^{-1}$

(4) Lunch room has at least 8" concrete walls and 6" concrete slab at el. 42' ceiling (DWG 11448-FC-7D)  $\Rightarrow 0.32$  for shielding factor

(5) Swgr & Relay rooms have at least 6" concrete shield at el. 45' (FC-7D & FE27C) & 11548-FE-27A & 9" concrete shield at el. 27' (FC-2N)  $\Rightarrow 10^{-15/12} = 0.056$

1-L-9

MODEL

DATE

Fig 2. Dose Rate from Containment atmosphere above operating floor @ 6 ft above ground elevation.

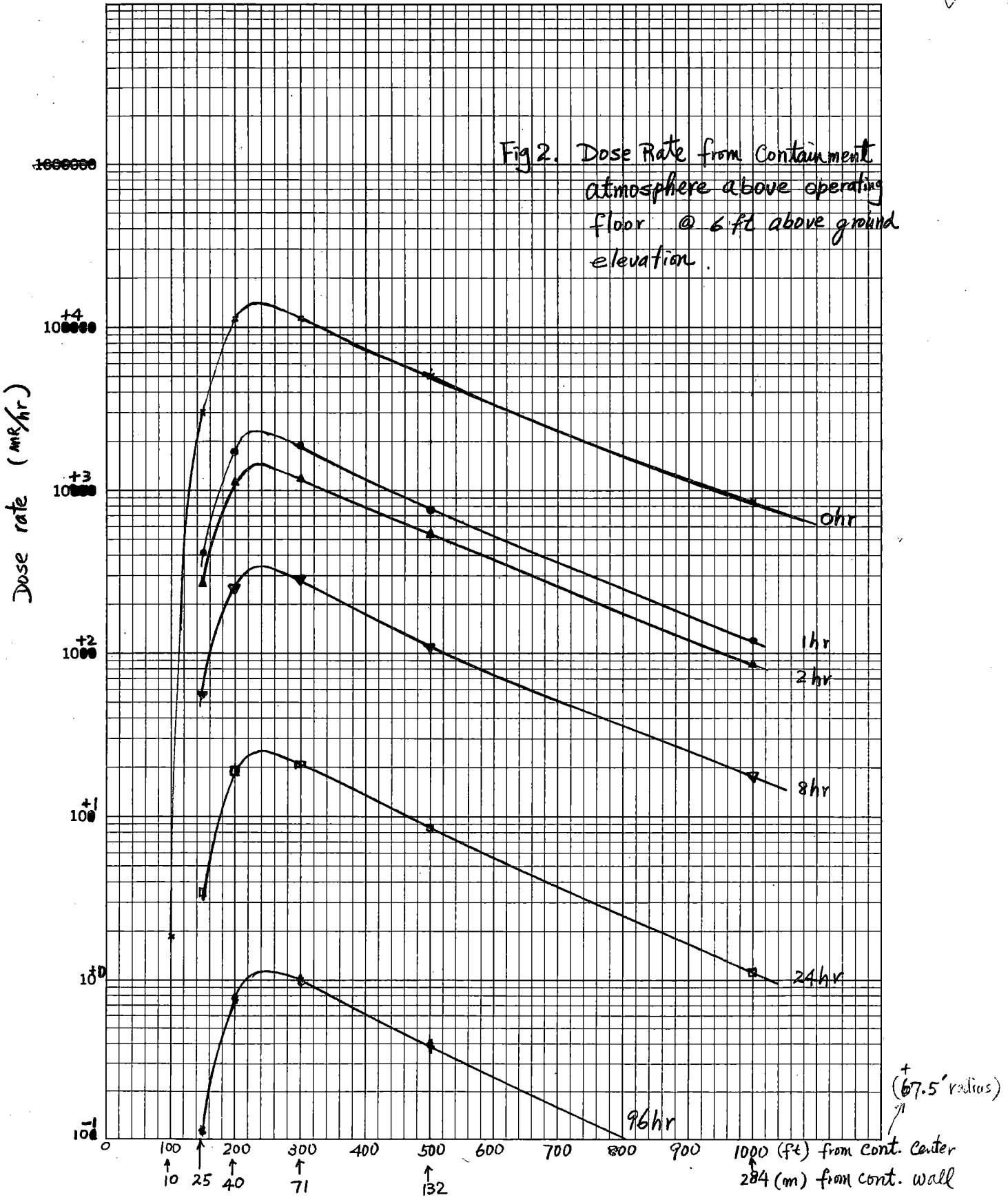

46 6460

SEMI-LOGARITHMIC 7 CYCLES X 60 DIVISIONS  
KEUFFEL & ESSER CO. MADE IN U.S.A.

STONE & WEBSTER ENGINEERING CORPORATION  
CALCULATION SHEET

▲ 5010.65

CALCULATION IDENTIFICATION NUMBER				PAGE <u>11</u>
J.O. OR W.O. NO. <u>12846.38</u>	DIVISION & GROUP <u>NT RP</u>	CALCULATION NO. <u>-031-0</u>	OPTIONAL TASK CODE	

• Dose rates

Table 1. Dose rates from Containment atmosphere shine from the dome for unit # 1 accident. ( $mR/hr$ )

D. P.	Location	0 hr	1 hr	2 hrs	8 hrs	24 hrs	96 hrs
1	Control room	4.4 +1	6.9 +0	5.0 +0	9.9 -1	—	—
2	Counting lab	3.9 +3	6.0 +2	4.2 +2	8.9 +1	6.8 +0	3.1 -1
3	Machine shops	7.5 +3	1.2 +3	7.5 +2	1.8 +2	1.2 +1	4.4 -1
4	Lunch room	2.4 +3	3.8 +2	2.4 +2	5.8 +1	3.8 +0	1.4 -1
5	SW gr & relay rooms	8.1 +2	1.3 +2	9.0 +1	1.9 +1	1.5 +0	6.7 -2
6	Htg boiler rm	5.8 +3	9.0 +2	6.2 +2	1.4 +2	1.1 +1	4.7 -1
7	Office Bldg	1.5 +4	2.3 +3	1.6 +3	3.5 +2	2.7 +1	1.2 +0
8	CAS	1.2 +4	1.9 +3	1.3 +3	2.8 +2	2.1 +1	9.7 -1
9	SAS	1.4 +4	2.2 +3	1.5 +3	3.4 +2	2.5 +1	1.2 +0
10	Information center	1.2 +3	1.7 +2	1.3 +2	2.6 +1	1.7 +0	—

All dose points are considered 6' above ground elevation

STONE & WEBSTER ENGINEERING CORPORATION  
CALCULATION SHEET

▲ 5010.65

CALCULATION IDENTIFICATION NUMBER				PAGE <u>12</u>
J.O. OR W.O. NO. <i>12846.38</i>	DIVISION & GROUP <i>NT RP</i>	CALCULATION NO. <i>-031-0</i>	OPTIONAL TASK CODE	

*Table 2. Dose Rates from containment atmosphere shine  
from the dome for unit #2 accident*

D.P.	Locations	0 hr	1 hr	2 hrs	8 hrs	24 hrs	96 hrs
1	<i>control room</i>	<i>4.4+1</i>	<i>6.9+0</i>	<i>5.0+0</i>	<i>9.9-1</i>	<i>-</i>	<i>-</i>
2	<i>countg lab</i>	<i>9.8+2</i>	<i>1.3+2</i>	<i>9.1+1</i>	<i>1.8+1</i>	<i>1.1+0</i>	<i>3.8-2</i>
3	<i>machine shops</i>	<i>1.4+4</i>	<i>2.3+3</i>	<i>1.6+3</i>	<i>3.5+2</i>	<i>2.6+1</i>	<i>1.2+0</i>
4	<i>Lunch rm</i>	<i>3.0+3</i>	<i>5.4+2</i>	<i>3.2+2</i>	<i>7.4+1</i>	<i>5.8+0</i>	<i>2.6-1</i>
5	<i>swgr &amp; relay rms</i>	<i>8.1+2</i>	<i>1.3+2</i>	<i>9.0+1</i>	<i>1.9+1</i>	<i>1.5+0</i>	<i>6.7-2</i>
6	<i>Htg boiler rm</i>	<i>1.5+4</i>	<i>2.3+3</i>	<i>1.6+3</i>	<i>3.5+2</i>	<i>2.7+1</i>	<i>1.2+0</i>
7	<i>office bldg</i>	<i>5.8+3</i>	<i>9.0+2</i>	<i>6.2+2</i>	<i>1.4+2</i>	<i>1.1+1</i>	<i>4.7-1</i>
8	<i>CAS</i>	<i>4.0+3</i>	<i>6.5+2</i>	<i>4.7+2</i>	<i>9.0+1</i>	<i>7.0+0</i>	<i>3.2-1</i>
9	<i>SAS</i>	<i>4.5+3</i>	<i>7.0+2</i>	<i>4.9+2</i>	<i>9.5+1</i>	<i>7.5+0</i>	<i>3.4-1</i>
10	<i>Information Center</i>	<i>8.6+2</i>	<i>1.2+2</i>	<i>8.6+1</i>	<i>1.8+1</i>	<i>1.2+0</i>	<i>5.0-2</i>

*All dose points are considered 6' above the ground elevation.*

STONE & WEBSTER ENGINEERING CORPORATION  
CALCULATION SHEET

▲ 5010.65

CALCULATION IDENTIFICATION NUMBER				PAGE <u>13</u>
J.O. OR W.O. NO. <u>12846.38</u>	DIVISION & GROUP <u>46/48 RP</u>	CALCULATION NO. <u>-031-0</u>	OPTIONAL TASK CODE	

2. Containment atmosphere shine through main steam line penetrations

(1) Unit # 1 accident

- Of all the concerned dose point locations listed in p. 6, only machine shops will receive significant dose rate from the  $\gamma$  ray shine through the three 30" steam line penetrations located at el. 39'-6". A detailed calc. for the North Anna plant was performed in ref. (6). These numbers will be adjusted by the source strength adjustment factor  $f_3 = 0.9$
- N. A. dose rates at the entrance of personnel doorway of the machine shops are

	<u>0 hr</u>	<u>1 hr</u>	<u>2 hrs</u>	<u>8 hrs</u>	<u>24 hrs</u>	
N. A.	56.2	8.01	— (not available)	1.13	0.07	mR/hr

- Surry's dose rates in machine shops due to unit #1 accident are  
(mR/hr)

	<u>0 hr</u>	<u>1 hr</u>	<u>2 hrs*</u>	<u>8 hrs</u>	<u>24 hrs</u>
Surry D.P. 3. (machine shops)	5.1+1	7.2+0	5.3+0	1.0+0	6.3-2

\* Dose rate at 2 hrs is taken as 73% of that of 1 hr.

$$\text{Ratio} = \frac{2.16 \times 10^8}{2.95 \times 10^8} = 0.73 \quad \text{based on specific activities. (Ref. 4)}$$



STONE & WEBSTER ENGINEERING CORPORATION  
CALCULATION SHEET

▲ 5010.65

CALCULATION IDENTIFICATION NUMBER				PAGE <u>14</u>
J.O. OR W.O. NO.	DIVISION & GROUP	CALCULATION NO.	OPTIONAL TASK CODE	
12846..38	46/48	-031-0		

1  
2  
3  
4  
5  
6  
7  
8  
9  
10  
11  
12  
13  
14  
15  
16  
17  
18  
19  
20  
21  
22  
23  
24  
25  
26  
27  
28  
29  
30  
31  
32  
33  
34  
35  
36  
37  
38  
39  
40  
41  
42  
43  
44  
45  
46

(2). Unit #2 accident

The dose point location that will receive significant dose rate from containment atmosphere shine through main steam line penetrations for the unit #2 accident is the counting lab in the health physics area. The dose point D8 of N.A. calc. (ref(6)) is a representative point in the counting lab. The lab is shielded by at least one foot of pour concrete.

	<u>0hr</u>	<u>1hr</u>	<u>8hrs</u>	
N.A				
D8	2.88 +1	4.09 +0	5.8 -1	(MR/hr)

Applying a source strength adjustment factor  $f_3 = 0.9$  and a shielding factor = 0.1, we have the following dose rates for Surry.

	<u>0hr</u>	<u>1hr</u>	<u>2hrs</u>	
Surry				
D.P.2 (Counting lab)	2.6 +0	3.7 -1	—	(MR/hr)

STONE & WEBSTER ENGINEERING CORPORATION  
CALCULATION SHEET

▲ 5010.85

CALCULATION IDENTIFICATION NUMBER				PAGE <u>15</u>
J.O. OR W.O. NO. 12846.38	DIVISION & GROUP 46/48 RP	CALCULATION NO. - 031-0	OPTIONAL TASK CODE	

3. SI and DA lines in yard area under MSVH and CSPH.

The two 8" safety injection lines and one 2" drain line carrying containment sump water are passing yard area under main steam valve house and containment spray pump house at el. 23' (BOP). (DWG. 11448-FP-5F). The ground elevation is 26'-6". Those SI and DA lines may contribute significant dose rates to bldgs in the neighborhood. The layout of these lines and the shields are similar to those of N.A. for which a detailed calc. had been performed in ref. (7). Comparison between N.A. model and Surry plant is listed in the following.

Sources	N.A. Model <sup>(ref(7))</sup>	Surry (11448-FP-5D, 5F, 5G.)
2 SI-lines - D	8"	8"
L	~ 65'	~ 59'
1 DA-line D	2"	2"
L	~ 57'	~ 61'
Distance to ground elevation	3'-3"	3'-2"

Shields

Walls of MSVH & CSPH	2' concrete	2' concrete
(South) wall of MSVH	3' concrete	3' concrete
(el. 27'-6") MSVH Floor	1' concrete	1' concrete
(el. 27'-6") CSPH Floor	2' concrete	2' concrete

Comparison indicates that results in ref (7) can be applied to Surry with appropriate source strength adjustment factor  $f_1=1.1$ , shielding factor if any exists).

**STONE & WEBSTER ENGINEERING CORPORATION**  
**CALCULATION SHEET**

▲ 5010.65

CALCULATION IDENTIFICATION NUMBER				PAGE <u>16</u>
J.O. OR W.O. NO.	DIVISION & GROUP	CALCULATION NO.	OPTIONAL TASK CODE	
12846.38	46/48 RP	-031-0		

(1) Unit #1 accident

D.P. & Location	corresponding N.A. Dose Pt	ref(7) N.A. D.R.(t=0)	adjustment factor	Surry D.R. @ t=0
1. Control room	C2	1.12+1 ( $\frac{mR}{hr}$ )	1.1 x 0.01*	1.2 -1 ( $\frac{mR}{hr}$ )
3. Machine shops	S1	4.82+2	1.1	5.3 +2 "
4. Lunch room	CL2	4.99+1	1.1 x 0.22**	1.2 +1 "

Dose rates at other locations are not significant.

\* 2' concrete wall ✓ } DWG 11448-FA-1C.  
 \*\* 8" concrete wall ✓ }

(2) Unit #2 accident.

D.P. & Location	corresponding N.A. D.P. (ref(7))	N.A. D.R @ t=0	Adjustment factor	Surry D.R. @ t=0
1 Control room	C2	1.12+1 ( $\frac{mR}{hr}$ )	1.1 x 0.01*	1.2 -1 ( $\frac{mR}{hr}$ )
2. Counting lab	CL2	4.99+1 ( $\frac{mR}{hr}$ )	1.1 x 0.1+	5.5 +0 ( $\frac{mR}{hr}$ )
6. Htg Boiler rm	B2	7.3-3 ( $\frac{mR}{hr}$ )	1.1	8.0 -3 ( $\frac{mR}{hr}$ )

Dose rates at other locations are not significant.

+ 12" concrete wall - DWG 11448-FA-1C. ✓

Dose rates at  $t > 0$  are determined by the same approach\* as ref(7),  
 that is, by ratioing up the source strength. (ref. (1), page 18)  
 Surry Sump water

	t ref(2)	0hr	1hr	2hrs	8hrs	24hrs	96hrs	192hrs	360hrs	720hrs	2160/4320
ST(t)		2.2+10	1.3+10	8.9+9	3.6+9	1.5+9	5.2+8	3.5+8	2.2+8	1.1+8	3.6+7/1.5+7
$\frac{ST(t)}{ST(0)}$		1.0	5.9-1	4.0-1	1.6-1	6.8-2	2.4-2	1.6-2	1.0-2	5.0-3	1.6-3/6.8-4

\* This approach will overestimate dose rates for  $t \geq 24$  hrs because spectrum becomes softer.

**STONE & WEBSTER ENGINEERING CORPORATION**  
**CALCULATION SHEET**

▲ 5010.05

CALCULATION IDENTIFICATION NUMBER				PAGE <u>17</u>
J.O. OR W.O. NO. <u>12846-38</u>	DIVISION & GROUP <u>46/48 RP</u>	CALCULATION NO. <u>-031-0</u>	OPTIONAL TASK CODE	

Site dose rates from SI/DA lines in yard area for unit #1 accident  
(mR/hr)

Location	0 hr	1 hr	2 hrs	8 hrs	24 hrs	96 hrs	192 hrs	360 hrs	720 hrs	2160 hrs
Control room	1.2-1	-	-	-	-	-	-	-	-	-
machine shops	5.3+2	3.1+2	2.1+2	8.5+1	3.6+1	1.3+1	8.5+0	5.3+0	2.7+0	8.5-1
Lunch room	1.2+1	7.1+0	4.8+0	1.9+0	8.2-1	-	-	-	-	-
Others	insignificant									

Site dose rates from SI/DA lines in yard area for unit #2 accident  
(mR/hr)

Location	0 hr	1 hr	2 hrs	8 hrs
Control room	1.2-1	-	-	-
Counting lab	5.5+0	3.2+0	2.2+0	8.8-1
Htg Boiler rm	8.0-3	-	-	-
Others	insignificant			

STONE & WEBSTER ENGINEERING CORPORATION  
CALCULATION SHEET

▲ 5010.65

CALCULATION IDENTIFICATION NUMBER				PAGE <u>18</u>
J.O. OR W.O. NO.	DIVISION & GROUP	CALCULATION NO.	OPTIONAL TASK CODE	
12846-38	46/48 RP	RP-031-0		

4. Sources inside the aux bldg

In our effort for the radiation zone mapping of the aux. bldg, the following sources were considered = ref(1)

- SI and CH lines in penetration area and charging pump cubicles
- Aux bldg sump, drain lines, LL WDT or HLWDT
- Reactor coolant sampling lines
- Containment vac. & Leakage monitoring system
- Hydrogen analyzers
- Main charcoal filter Banks.

(And radiation sources inside the containment).

Of all the site dose points we are concerned, only control room (D.P. 1) and emergency switchgear and relay rooms <sup>(D.P.5)</sup> are close enough to the aux bldg to receive any significant dose.

(1) Control room dose rates.

Control room is located at el. 27', south of zone EE of aux. bldg. Inspection of the dose rate contributors of that zone indicates that the <sup>main</sup> potential sources are LL WDT or HLWDT and the associated drain lines (of which WDT contribution is dominant).

Dose rates in zone DD (which is not directly above the HLWDT) of ref. (1) were derived from N.A. calc. It took 18" floor at el. 27'-6" into consideration. The shields from the tank to control room are either (continued).

STONE & WEBSTER ENGINEERING CORPORATION  
CALCULATION SHEET

▲ 5010.65

CALCULATION IDENTIFICATION NUMBER				PAGE <u>19</u>
J.O. OR W.O. NO.	DIVISION & GROUP	CALCULATION NO.	OPTIONAL TASK CODE	
12846.38	46/48 RP	RP-031-0		

- 24" aux bldg south concrete wall ( 11448-FE-27C )  
( 11548-FE-27A )
  - 18" shield wall of emergency switchgear room " )
  - 9" floor at el. 27' ( 11448-FC-2N )
- ( A total of 51" concrete shield )

- OR
- 18" floor at el. 27'-6" ( 11448-FM-5A )
  - 24" aux bldg south wall ( 11448-FM-5C )
  - 18" shield wall south of "line E" ( 11448-FC-2N )
- ( A total of 60" concrete shield )

Therefore, an extra shielding credit for 51"-18" = 33" should be taken into account, which is  $8.5 \times 10^{-4}$  by ref. (5).

$$t = \frac{0 \text{ hr}}{\quad} + \frac{1 \text{ hr}}{\quad}$$

Zone DD       $3.9 \times 10^3$        $1.0 \times 10^3$       ( mR/hr )  
ref (1)

Control Room       $3.3 + 0$        $8.5 \times 10^1$       ( mR/hr )

The above dose rates apply to both units.

STONE & WEBSTER ENGINEERING CORPORATION  
 CALCULATION SHEET

▲ 5010.65

CALCULATION IDENTIFICATION NUMBER				PAGE <u>20</u>
J.O. OR W.O. NO.	DIVISION & GROUP	CALCULATION NO.	OPTIONAL TASK CODE	
12846.38	46/48 RP	RP-031-0		

(2) Dose rates in the emergency switchgear and relay room

The emergency switchgear and relay rooms are located at elevation 9'6". The possible significant sources are the lines in penetration area, Drain lines and sampling lines in the pipe tunnel area south of charging pump cubicles, and the drain lines and HLWDT or LLWDT in waste drain tank cubicles.

The lines in penetration area are shielded by many walls of waste drain tank cubicles. Their dose rate contribution will be smaller than that of lines in the pipe tunnel area and LLWDT or HLWDT.

- The line sources in the pipe tunnel south of charging pump cubicles and the shields are identified as: (FP-19C, FP-17B)

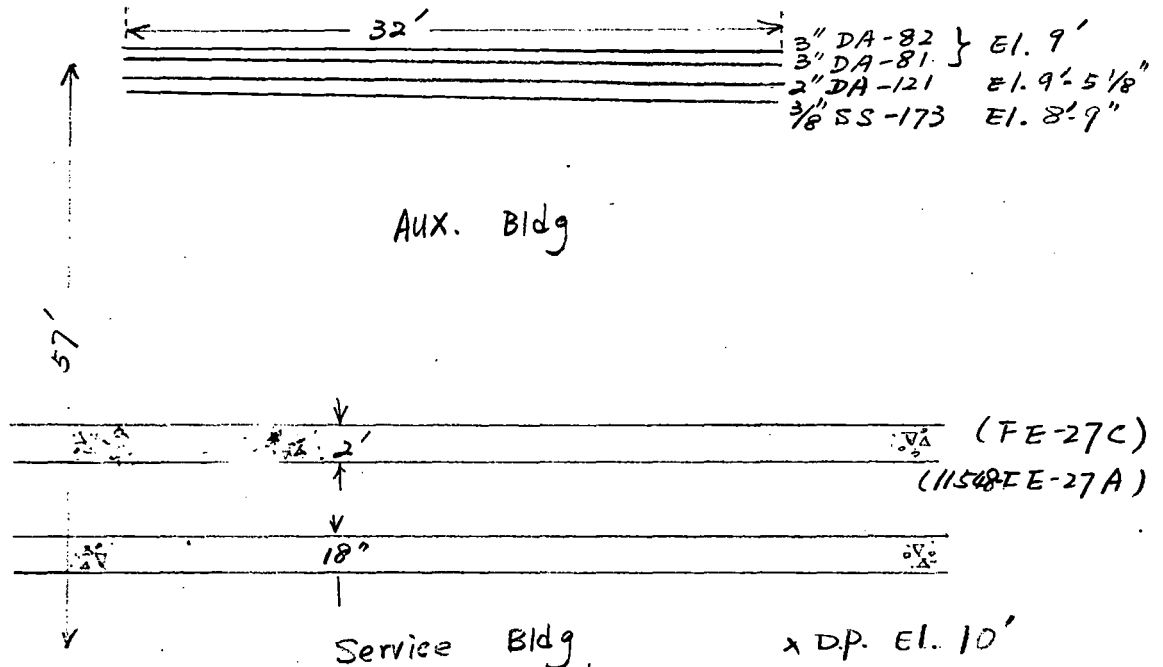

STONE & WEBSTER ENGINEERING CORPORATION  
CALCULATION SHEET

▲ 5010.65

CALCULATION IDENTIFICATION NUMBER				PAGE 2/
J.O. OR W.O. NO.	DIVISION & GROUP	CALCULATION NO.	OPTIONAL TASK CODE	
12846.38	46/48 RP	-RP-031-U		

The following line source equation is used for the dose rate calculation. The parameters are explained in § 5.8 of ref. (1).

$$D (\text{mR/hr}) = B(\mu t) e^{-\mu t} \frac{7.2 \times 10^{-5} S_T D^2}{R} \frac{\theta_1 + \theta_2}{\pi}$$

To be conservative and consistent, we assume the average energy of 1.5 MeV.  $\mu = 0.1163 \text{ cm}^{-1}$ . (ref (1) § 5.10)

$$t = 2' + 18'' = 10.7 \text{ cm}$$

$$\mu t = 12.41$$

$$B(\mu t) = 1 + 0.925 \mu t e^{+0.037 \mu t} = 19.2 \quad (\text{ref (1) § 5.10})$$

$$B(\mu t) e^{-\mu t} = 7.85 \times 10^{-5}$$

$$R \approx (57'^2 + (10' - 9')^2)^{1/2} = 57$$

$$(\theta_1 + \theta_2) / \pi = \tan^{-1}(32'/57') / \pi = 0.163$$

$$\begin{aligned} D^2 &= (3.068')^2 = 9.41 \text{ in}^2 && (\text{DA lines}) && (\text{standard pipe from Crane 410}) \\ &= (2.067')^2 = 4.27 \text{ in}^2 && (\text{D.A line}) \\ &= (0.493')^2 = 0.243 \text{ in}^2 && (\text{SS line}) \end{aligned}$$

The total dose rate is

$$\begin{aligned} D (\text{mR/hr}) &= 7.85 \times 10^{-5} \times 0.163 \times \frac{7.2 \times 10^{-5}}{57} \left[ (2 \times 9.41 + 4.27) S_T^{DA} + 0.243 S_T^{SS} \right] \\ &= 1.62 \times 10^{-11} (23.1 S_T^{DA} + 0.243 S_T^{SS}) \end{aligned}$$

• Results (These results are applicable to accident of either reactor unit)

Time	0 hr	1 hr	2 hr	8 hr	24 hr	96 hr	192 hr
$S_T^{DA}$ (mev/sec/cm <sup>2</sup> ) ref. (1)	2.2 <sup>+10</sup>	1.3 <sup>+10</sup>	8.9 <sup>+9</sup>	3.6 <sup>+9</sup>	1.5 <sup>+9</sup>	5.2 <sup>+8</sup>	3.5 <sup>+8</sup>
$S_T^{SS}$ (mev/sec/cm <sup>2</sup> ) ref. (1)	2.1 <sup>+11</sup>	8.6 <sup>+10</sup>	6.1 <sup>+10</sup>	2.3 <sup>+10</sup>	8.9 <sup>+9</sup>	3.5 <sup>+9</sup>	2.2 <sup>+9</sup>
D (mR/hr)	9.1 <sup>+0</sup>	5.2 <sup>+0</sup>	3.6 <sup>+0</sup>	1.4 <sup>+0</sup>	6.0 <sup>-1</sup>	-	-



STONE & WEBSTER ENGINEERING CORPORATION  
CALCULATION SHEET

▲ 5010.65

CALCULATION IDENTIFICATION NUMBER				PAGE <u>22</u>
J.O. OR W.O. NO.	DIVISION & GROUP	CALCULATION NO.	OPTIONAL TASK CODE	
12846.38	46/48 RP	RP-031-0		

• Dose rates from LLWDT / HLWDT.

A similar approach as ref (1), § X.9 can be used to estimate dose rates from LLWDT / HLWDT to emergency switch gear and relay rooms. The dosepoint is shielded by 2' concrete wall near line E and 18" radiation shield wall. The distance of switch gear room to the tank is ~16' (488cm).

The dose rates of zone E of ref. (1) are for a point 750 cm away from the tank and 18" concrete in between.

The distance adjustment factor is  $(\frac{750}{488})^2 = 2.36$ .

The shielding adjustment factor is  $10^{-\left(\frac{24+18-18}{12}\right)} = 0.01$

Therefore, the overall adjustment factor is

$$0.01 \times 2.36 = 2.36 \times 10^{-2}$$

Time (hrs)	0	1	2	8	24	96	192	360	720	2160	4320
Zone E ref (1) (mR/hr)	1.8+5	1.1+5	7.5+4	3.0+4	5.6+3	1.9+3	1.3+3	8.2+2	4.1+2	1.3+2	5.6+1
SWITCH GEAR ROOM (mR/hr)	4.2+3	2.6+3	1.8+3	7.1+2	1.3+2	4.5+1	3.1+1	1.9+1	9.7+0	3.1+0	1.3+0

The above dose rates apply to accidents of either unit.

STONE & WEBSTER ENGINEERING CORPORATION  
CALCULATION SHEET

▲ 5010.05

CALCULATION IDENTIFICATION NUMBER				PAGE <u>23</u>
J.O. OR W.O. NO.	DIVISION & GROUP	CALCULATION NO.	OPTIONAL TASK CODE	
12846.38	46/48 RP	RP-031-0		

5. Site dose rate tables

- Site dose rates from each of four listed source due to unit #1 accident are listed in table 3.
- Site dose rates due to unit #2 accident are listed in table 4.

1  
2  
3  
4  
5  
6  
7  
8  
9  
10  
11  
12  
13  
14  
15  
16  
17  
18  
19  
20  
21  
22  
23  
24  
25  
26  
27  
28  
29  
30  
31  
32  
33  
34  
35  
36  
37  
38  
39  
40  
41  
42  
43  
44  
45  
46

TABLE 3

SURRY SITE DIRECT & DOSE RATES ( $mR/hr$ ) FROM VARIOUS SOURCES DUE TO

A LOCA (TID-14844 SOURCE TERMS) AT REACTOR UNIT # 1

SITE	CONTROL ROOM					COUNTING LAB INSIDE THE HP					MACHINE SHOPS					LUNCH ROOM					EMERG. SWGR & RELAY ROOMS					
	SOURCE	CONTMNT DOME SHINE	CONTMNT SHINE THRU MAIN STM LINE PENE.	SI/DA LINES IN YARD AREA	AUX BLDG SOURCES	TOTAL	CONTMNT DOME SHINE	CONTMNT SHINE THRU MAIN STM LINE PENE.	SI/DA LINES IN YARD AREA	AUX BLDG SOURCES	TOTAL	CONTMNT DOME SHINE	CONTMNT SHINE THRU MAIN STM LINE PENE.	SI/DA LINES IN YARD AREA	AUX BLDG SOURCES	TOTAL	CONTMNT DOME SHINE	CONTMNT SHINE THRU MAIN STM LINE PENE.	SI/DA LINES IN YARD AREA	AUX BLDG SOURCES	TOTAL	CONTMNT DOME SHINE	CONTMNT SHINE THRU MAIN STM LINE PENE.	SI/DA LINES IN YARD AREA	AUX BLDG SOURCES	TOTAL
TIME (HRS)																										
0	4.4+1	-	1.2-1	3.3+0	4.7+1	3.9+3	-	-	-	3.9+3	7.5+3	5.1+1	5.3+2	-	8.1+3	2.4+3	-	1.2+1	-	2.4+3	8.1+2	-	-	-	4.2+3	5.0+3
1	6.9+0	-	-	8.5-1	7.8+0	6.0+2	-	-	-	6.0+2	1.2+3	7.2+0	3.1+2	-	1.5+3	3.8+2	-	7.0+0	-	3.9+2	1.3+2	-	-	-	2.6+3	2.7+3
2	5.0+0	-	-	-	5.0+0	4.2+2	-	-	-	4.2+2	7.5+2	5.3+0	2.1+2	-	9.7+2	2.4+2	-	4.8+0	-	2.4+2	9.0+1	-	-	-	1.8+3	1.9+3
8	9.9-1	-	-	-	9.9-1	8.9+1	-	-	-	8.9+1	1.8+2	1.0+0	8.5+1	-	2.7+2	5.8+1	-	1.9+0	-	6.0+1	1.9+1	-	-	-	7.1+2	7.3+2
24	-	-	-	-	-	6.8+0	-	-	-	6.8+0	1.2+1	6.3-2	3.6+1	-	4.8+1	3.8+0	-	8.2-1	-	4.6+0	1.5+0	-	-	-	1.3+2	1.3+2
96	-	-	-	-	-	3.1-1	-	-	-	3.1-1	4.4-1	-	1.3+1	-	1.3+1	1.4-1	-	-	-	1.4-1	6.7-2	-	-	-	4.5+1	4.5+1
192	-	-	-	-	-	-	-	-	-	-	-	-	8.5+0	-	8.5+0	-	-	-	-	-	-	-	-	-	3.1+1	3.1+1
360	-	-	-	-	-	-	-	-	-	-	-	-	5.3+0	-	5.3+0	-	-	-	-	-	-	-	-	-	1.9+1	1.9+1
720	-	-	-	-	-	-	-	-	-	-	-	-	2.7+0	-	2.7+0	-	-	-	-	-	-	-	-	-	9.7+0	9.7+0
2160	-	-	-	-	-	-	-	-	-	-	-	-	8.5-1	-	8.5-1	-	-	-	-	-	-	-	-	-	3.1+0	3.1+0
4320	-	-	-	-	-	-	-	-	-	-	-	-	-	-	-	-	-	-	-	-	-	-	-	-	1.3+0	1.3+0

SITE	HEATING BOILER ROOM					OFFICE BLDG					CAS					SAS					INFORMATION CENTER					
	SOURCE	CONTMNT DOME SHINE	CONTMNT SHINE THRU MAIN STM LINE PENE.	SI/DA LINES IN YARD AREA	AUX BLDG SOURCES	TOTAL	CONTMNT DOME SHINE	CONTMNT SHINE THRU MAIN STM LINE PENE.	SI/DA LINES IN YARD AREA	AUX BLDG SOURCES	TOTAL	CONTMNT DOME SHINE	CONTMNT SHINE THRU MAIN STM LINE PENE.	SI/DA LINES IN YARD AREA	AUX BLDG SOURCES	TOTAL	CONTMNT DOME SHINE	CONTMNT SHINE THRU MAIN STM LINE PENE.	SI/DA LINES IN YARD AREA	AUX BLDG SOURCES	TOTAL	CONTMNT DOME SHINE	CONTMNT SHINE THRU MAIN STM LINE PENE.	SI/DA LINES IN YARD AREA	AUX BLDG SOURCES	TOTAL
TIME (HRS)																										
0	5.8+3	-	-	-	5.8+3	1.5+4	-	-	-	1.5+4	1.2+4	-	-	-	1.2+4	1.4+4	-	-	-	-	1.4+4	1.2+3	-	-	-	1.2+3
1	9.0+2	-	-	-	9.0+2	2.3+3	-	-	-	2.3+3	1.9+3	-	-	-	1.9+3	2.2+3	-	-	-	-	2.2+3	1.7+2	-	-	-	1.7+2
2	6.2+2	-	-	-	6.2+2	1.6+3	-	-	-	1.6+3	1.3+3	-	-	-	1.3+3	1.5+3	-	-	-	-	1.5+3	1.3+2	-	-	-	1.3+2
8	1.4+2	-	-	-	1.4+2	3.5+2	-	-	-	3.5+2	2.8+2	-	-	-	2.8+2	3.4+2	-	-	-	-	3.4+2	2.6+1	-	-	-	2.6+1
24	1.1+1	-	-	-	1.1+1	2.7+1	-	-	-	2.7+1	2.1+1	-	-	-	2.1+1	2.5+1	-	-	-	-	2.5+1	1.7+0	-	-	-	1.7+0
96	4.7-1	-	-	-	4.7-1	1.2+0	-	-	-	1.2+0	9.7-1	-	-	-	9.7-1	1.2+0	-	-	-	-	1.2+0	7.0-2	-	-	-	7.0-2
192	-	-	-	-	-	-	-	-	-	-	-	-	-	-	-	-	-	-	-	-	-	-	-	-	-	-
360	-	-	-	-	-	-	-	-	-	-	-	-	-	-	-	-	-	-	-	-	-	-	-	-	-	-
720	-	-	-	-	-	-	-	-	-	-	-	-	-	-	-	-	-	-	-	-	-	-	-	-	-	-
2160	-	-	-	-	-	-	-	-	-	-	-	-	-	-	-	-	-	-	-	-	-	-	-	-	-	-
4320	-	-	-	-	-	-	-	-	-	-	-	-	-	-	-	-	-	-	-	-	-	-	-	-	-	-

(1) Aux bldg sources include one full tank of LLWDT filled with undiluted containment sump water.

TABLE 4 SURRY SITE DIRECT & DOSE RATES ( $mR/hr$ ) FROM VARIOUS SOURCES DUE TO

A LOCA (TID-14844 SOURCE TERMS) AT REACTOR UNIT # 2

SITE	CONTROL ROOM					COUNTING LAB INSIDE THE HP					MACHINE SHOPS					LUNCH ROOM					EMERG. SWGR & RELAY ROOMS					
	CONTMNT DOME SHINE	CONTMNT SHINE THRU MAIN STM LINE PENE.	SI/DA LINES IN YARD AREA	AUX BLDG SOURCES	TOTAL	CONTMNT DOME SHINE	CONTMNT SHINE THRU MAIN STM LINE PENE.	SI/DA LINES IN YARD AREA	AUX BLDG SOURCES	TOTAL	CONTMNT DOME SHINE	CONTMNT SHINE THRU MAIN STM LINE PENE.	SI/DA LINES IN YARD AREA	AUX BLDG SOURCES	TOTAL	CONTMNT DOME SHINE	CONTMNT SHINE THRU MAIN STM LINE PENE.	SI/DA LINES IN YARD AREA	AUX BLDG SOURCES	TOTAL	CONTMNT DOME SHINE	CONTMNT SHINE THRU MAIN STM LINE PENE.	SI/DA LINES IN YARD AREA	AUX BLDG SOURCES	TOTAL	
0	4.4+1	-	1.2-1	3.3+0	4.7+1	9.8+2	2.6+0	5.5+0	-	9.9+2	1.4+4	-	-	-	1.4+4	3.0+3	-	-	-	3.0+3	8.1+2	-	-	-	4.2+3	5.0+3
1	6.9+0	-	-	8.5-1	7.8+0	1.3+2	3.7-1	3.2+0	-	1.3+2	2.3+3	-	-	-	2.3+3	5.4+2	-	-	-	5.4+2	1.3+2	-	-	-	2.6+3	2.7+3
2	5.0+0	-	-	-	5.0+0	9.1+1	-	2.2+0	-	9.3+1	1.6+3	-	-	-	1.6+3	3.2+2	-	-	-	3.2+2	9.0+1	-	-	-	1.8+3	1.9+3
8	9.9-1	-	-	-	9.9-1	1.8+1	-	8.8-1	-	1.9+1	3.5+2	-	-	-	3.5+2	7.4+1	-	-	-	7.4+1	1.9+1	-	-	-	7.1+2	7.3+2
24	-	-	-	-	-	1.1+0	-	-	-	1.1+0	2.6+1	-	-	-	2.6+1	5.8+0	-	-	-	5.8+0	1.5+0	-	-	-	1.3+2	1.3+2
96	-	-	-	-	-	3.8-2	-	-	-	3.8-2	1.2+0	-	-	-	1.2+0	2.6-1	-	-	-	2.6-1	6.7-2	-	-	-	4.5+1	4.5+1
192	-	-	-	-	-	-	-	-	-	-	-	-	-	-	-	-	-	-	-	-	-	-	-	-	3.1+1	3.1+1
360	-	-	-	-	-	-	-	-	-	-	-	-	-	-	-	-	-	-	-	-	-	-	-	-	1.9+1	1.9+1
720	-	-	-	-	-	-	-	-	-	-	-	-	-	-	-	-	-	-	-	-	-	-	-	-	9.7+0	9.7+0
2160	-	-	-	-	-	-	-	-	-	-	-	-	-	-	-	-	-	-	-	-	-	-	-	-	3.1+0	3.1+0
4320	-	-	-	-	-	-	-	-	-	-	-	-	-	-	-	-	-	-	-	-	-	-	-	-	1.3+0	1.3+0

SITE	HEATING BOILER ROOM					OFFICE BLDG					CAS					SAS					INFORMATION CENTER					
	CONTMNT DOME SHINE	CONTMNT SHINE THRU MAIN STM LINE PENE.	SI/DA LINES IN YARD AREA	AUX BLDG SOURCES	TOTAL	CONTMNT DOME SHINE	CONTMNT SHINE THRU MAIN STM LINE PENE.	SI/DA LINES IN YARD AREA	AUX BLDG SOURCES	TOTAL	CONTMNT DOME SHINE	CONTMNT SHINE THRU MAIN STM LINE PENE.	SI/DA LINES IN YARD AREA	AUX BLDG SOURCES	TOTAL	CONTMNT DOME SHINE	CONTMNT SHINE THRU MAIN STM LINE PENE.	SI/DA LINES IN YARD AREA	AUX BLDG SOURCES	TOTAL	CONTMNT DOME SHINE	CONTMNT SHINE THRU MAIN STM LINE PENE.	SI/DA LINES IN YARD AREA	AUX BLDG SOURCES	TOTAL	
0	1.5+4	-	8.0-3	-	1.5+4	5.8+3	-	-	-	5.8+3	4.0+3	-	-	-	4.0+3	4.5+3	-	-	-	4.5+3	8.6+2	-	-	-	-	8.6+2
1	2.3+3	-	-	-	2.3+3	9.0+2	-	-	-	9.0+2	6.5+2	-	-	-	6.5+2	7.0+2	-	-	-	7.0+2	1.2+2	-	-	-	-	1.2+2
2	1.6+3	-	-	-	1.6+3	6.2+2	-	-	-	6.2+2	4.7+2	-	-	-	4.7+2	4.9+2	-	-	-	4.9+2	2.6+1	-	-	-	-	2.6+1
8	2.5+2	-	-	-	3.5+2	1.4+2	-	-	-	1.4+2	9.0+1	-	-	-	9.0+1	9.5+1	-	-	-	9.5+1	1.8+1	-	-	-	-	1.8+1
24	2.7+1	-	-	-	2.7+1	1.1+1	-	-	-	1.1+1	7.0+0	-	-	-	7.0+0	7.5+0	-	-	-	7.5+0	1.2+0	-	-	-	-	1.2+0
96	1.2+0	-	-	-	1.2+0	4.7-1	-	-	-	4.7-1	3.2-1	-	-	-	3.2-1	3.4-1	-	-	-	3.4-1	5.0-2	-	-	-	-	5.0-2
192	-	-	-	-	-	-	-	-	-	-	-	-	-	-	-	-	-	-	-	-	-	-	-	-	-	-
360	-	-	-	-	-	-	-	-	-	-	-	-	-	-	-	-	-	-	-	-	-	-	-	-	-	-
720	-	-	-	-	-	-	-	-	-	-	-	-	-	-	-	-	-	-	-	-	-	-	-	-	-	-
2160	-	-	-	-	-	-	-	-	-	-	-	-	-	-	-	-	-	-	-	-	-	-	-	-	-	-
4320	-	-	-	-	-	-	-	-	-	-	-	-	-	-	-	-	-	-	-	-	-	-	-	-	-	-

1) Aux bldg sources include one fuel tank of LLWDT filled with undiluted containment sump water.

STONE & WEBSTER ENGINEERING CORPORATION  
CALCULATION SHEET

▲ 5010.65

CALCULATION IDENTIFICATION NUMBER				PAGE <u>26</u>
J.O. OR W.O. NO. 12846.38	DIVISION & GROUP NT RP	CALCULATION NO. RP-031-0	OPTIONAL TASK CODE	

VI. Integrated Doses in some specific Areas

1. 40 year normal and 6 month LOCA dose in MSVH/CSPH.

- Here we are interested in 40 year normal and 6 month LOCA dose for equipment qualification for main steam valve house and containment spray pump house, both above and under the grade elevation (el. 27'-6").
- The main LOCA sources are the safety Injection lines and drain lines at el. 23' (BOP) and containment atmosphere shine through the main steam line penetrations at el. 39'-6".

• A detailed calc. had been performed to determine the 6 month LOCA doses in these areas for North Anna plant. <sup>ref. (8)</sup>. The results are listed in the following:

North Anna 1 & 2

MSVH	below grade elevation	-	5.4 x 10 <sup>6</sup> rads (SI/DA lines)
MSVH	above grade elevation	-	1.5 x 10 <sup>4</sup> rads (92% from SI/DA lines 8% from MS line penetrations)
QSPH	below grade elevation	-	5.4 x 10 <sup>6</sup> rads (SI/DA lines)
QSPH	above grade elevation	-	4.8 x 10 <sup>2</sup> rads (SI/DA lines)

- From the comparison between N. A and Surry plants in p. 15, the layout of the sources and shields is similar and we can use above doses for Surry with a proper source strength adjustment factor. Since majority of the doses are from SI/DA lines,

STONE & WEBSTER ENGINEERING CORPORATION  
CALCULATION SHEET

▲ 5010.65

CALCULATION IDENTIFICATION NUMBER				PAGE <u>27</u>
J.O. OR W.O. NO. <u>12846.38</u>	DIVISION & GROUP <u>46/48 RP</u>	CALCULATION NO. <u>RP-031-0</u>	OPTIONAL TASK CODE	

1  
2  
3  
4  
5  
6  
7  
8  
9  
10  
11  
12  
13  
14  
15  
16  
17  
18  
19  
20  
21  
22  
23  
24  
25  
26  
27  
28  
29  
30  
31  
32  
33  
34  
35  
36  
37  
38  
39  
40  
41  
42  
43  
44  
45  
46

the source strength adjustment factor is  $f_1 = 1.1$ .

- 40 year normal operation dose.

During normal operation, there is no radioactive source in these areas.

The main steam line penetrations will provide streaming path for radiation inside the containment. Since the areas are outside the containment wall, it is safe to designate the area as radiation zone II, with maximum dose rate  $2.5 \text{ mR/hr}$ .

The 40 year normal dose is therefore  $2.5 \times 24 \times 365 \times 40 = 8.8 \times 10^5 \text{ mR} = 8.8 \times 10^2 \text{ rads}$

- Total dose

Surry 1 & 2

	<u>6 Month LOCA</u>	<u>40 year normal</u>	<u>Total</u>
	(rads)	(rads)	(rads)
MSVH below el. 27'-6"	$5.9 \times 10^6$	880	$5.9 \times 10^6$
MSVH above el. 27'-6"	$1.7 \times 10^4$	880	$1.8 \times 10^4$
CSPH below el. 27'-6"	$5.9 \times 10^6$	880	$5.9 \times 10^6$
CSPH above el. 27'-6"	$5.3 \times 10^2$	880	$1.4 \times 10^3$

STONE & WEBSTER ENGINEERING CORPORATION  
CALCULATION SHEET

A 5010.65

CALCULATION IDENTIFICATION NUMBER				PAGE <u>28</u>
J.O. OR W.O. NO.	DIVISION & GROUP	CALCULATION NO.	OPTIONAL TASK CODE	
12846.38	46/48 RP	-RP-031-0		

1  
2  
3 2. 40 year normal and 6 month LOCA dose in emergency switch gear  
4 and relay rooms.  
5

6  
7  
8 • 6 month LOCA dose.  
9

10 In § II of this calc, the 6 month dose rates from containment  
11 dome shine and radioactive sources inside the aux. bldg have been  
12 calculated. Those numbers are for zone mapping effort. They will  
13 be further fine-tuned here for equipment qualification.  
14  
15

16  
17  
18 \* For the drain system as it is now, the drain from SI/CH lines  
19 during mitigation phase will eventually be pumped to LLWDT/  
20 HLWDT. If we assume one LLWDT is filled with the  
21 undiluted sump water, this will provide a <sup>very</sup> significant  
22 source to equipment inside the switch gear room. As described  
23 in p. 22, the switch gear room is shielded by 2' concrete wall  
24 near line E and 18" shield wall 8' south of line E. However,  
25 a radiation shield door of <sup>the</sup> 18" wall is located in such a way that  
26 an important equipment (MOV-1869B switch gear) will have  
27 direct shine from LLWDT. Therefore, this 18" shield wall  
28 will not be taken into credit for equipment qualification.  
29 The distance of this equipment to LLWDT is ~ 31' (945cm)  
30  
31 (From DWG 11448-FE-27C)  
32  
33  
34  
35  
36  
37  
38  
39  
40  
41  
42  
43  
44  
45  
46

1-6-28

STONE & WEBSTER ENGINEERING CORPORATION  
CALCULATION SHEET

▲ 5010.65

CALCULATION IDENTIFICATION NUMBER				PAGE <u>29</u>
J.O. OR W.O. NO.	DIVISION & GROUP	CALCULATION NO.	OPTIONAL TASK CODE	
12846.38	46/4R RP	RP-031-0		

Following the same procedure as described in p.22, we can estimate the dose rates by referring to the dose rates of zone E of ref. (1).

The distance adjustment factor =  $(\frac{750}{925})^2 = 0.63$

The shielding adjustment factor =  $10^{-\left(\frac{24'-18''}{12''}\right)} = 0.32$

The total adjustment factor is therefore  $0.63 \times 0.32 = 0.20$

Time (Hr)	0	1	2	8	24	96	192	360	720	2160	4320
Zone E ref(1) (mR/hr)	1.8+5	1.1+5	7.5+4	3.0+4	5.6+3	1.9+3	1.3+3	8.2+2	4.1+2	1.3+2	5.6+1
switch gr room (mR/hr)	3.6+4	2.2+4	1.5+4	6.0+3	1.1+3	3.8+2	2.6+2	1.6+2	8.2+1	2.6+1	1.1+1

The six month integrated dose by linear integration is, therefore, 450 rads

Time (hr)	LLWDT (mR/hr)	DA etc. lines (P.21) (mR/hr)	Dome shine (table 1) (mR/hr)	Total (mR/hr)	Avev. D.R (mR/hr)	Integ. Dose (mR)
0	3.6+4	9.1+0	8.1+2	3.7+4	2.95+4	2.95+4
1	2.2+4	5.2+0	1.3+2	2.2+4	1.85+4	1.85+4
2	1.5+4	3.6+0	9.0+1	1.5+4	1.05+4	6.30+4
8	6.0+3	1.4+0	1.9+1	6.0+3	3.55+3	5.68+4
24	1.1+3	6.0-1	1.5+0	1.1+3	7.4+2	5.33+4
96	3.8+2	-	6.7-2	3.8+2	3.2+2	3.07+4
192	2.6+2	-	-	2.6+2	2.1+2	3.53+4
360	1.6+2	-	-	1.6+2	1.21+2	4.36+4
720	8.2+1	-	-	8.2+1	5.4+1	7.78+4
2160	2.6+1	-	-	2.6+1	1.85+1	4.00+4
4320	1.1+1	-	-	1.1+1	+)	

$4.5 \times 10^5 \text{ mR}$   
= 450 rads.



STONE & WEBSTER ENGINEERING CORPORATION  
CALCULATION SHEET

▲ 5010.85

CALCULATION IDENTIFICATION NUMBER				PAGE <u>30</u>
J.O. OR W.O. NO.	DIVISION & GROUP	CALCULATION NO.	OPTIONAL TASK CODE	
12846.38	46/48 RP	RP-031-0		

\* In the future, the system will be revised so that the highly contaminated undiluted sump water will be returned to the containment instead <sup>of being returned</sup> to LLWDT/HLWDT. In this case, we have the following 6 month LOCA dose.

<u>Time</u> (Hr)	<u>Total D.R.</u> (mR/hr)	<u>Ave. D.R.</u> (mR/hr)	<u>Integ. Dose</u> (mR)
0	8.2+2	4.8+2	4.8+2
1	1.4+2	1.2+2	1.2+2
2	9.4+1	5.7+1	3.4+2
8	2.0+1	1.1+1	1.8+2
24	2.1+0	1.1+0	7.9+1
96	6.7-2		
		+)	
			= $1.2 \times 10^3$ mR = 1.2 rads.

- 40 year normal operation dose.

According to N.A. FSAR, Part B, Supplement Volume IV, the service bldg is designated as radiation zone I. The maximum dose rate for Surry zone I is 0.75 mR/hr (Shielding design summary for Surry power station) <sup>ref (9)</sup> (From ref. (9), dose rates outside the waste drain tank cubicle is  $\leq 15 \frac{\text{mR}}{\text{hr}}$ ). Additional shields (24"-15") and distance (31 ft relative to ~ 6ft) will reduce that dose rate to less than 0.75 mR/hr.

Therefore, the 40 year normal operation dose  
 $= 0.75 \times 10^{-3} \times 40 \times 365 \times 24 = 260 \text{ rads}^*$

\* This 40 year normal dose is also applicable to other areas of the service bldg. (N.A. FSAR, above,) and to the turbine bldg (ref. (9)).

STONE & WEBSTER ENGINEERING CORPORATION  
CALCULATION SHEET

▲ 5010.65

CALCULATION IDENTIFICATION NUMBER				PAGE <u>31</u>
J.O. OR W.O. NO. <i>12846.38</i>	DIVISION & GROUP <i>46/48 RP</i>	CALCULATION NO. <i>RP-031-0</i>	OPTIONAL TASK CODE	

1  
2  
3  
4  
5  
6  
7  
8  
9  
10  
11  
12  
13  
14  
15  
16  
17  
18  
19  
20  
21  
22  
23  
24  
25  
26  
27  
28  
29  
30  
31  
32  
33  
34  
35  
36  
37  
38  
39  
40  
41  
42  
43  
44  
45  
46

<i>• Results</i>	<i>6 Mo LOCA Dose</i>	<i>40 year Normal Dose</i>	<i>Total</i>
<i>- with LLWDT</i>	<i>450 rads ✓</i>	<i>260 rads</i>	<i>~ 710 rads</i>
<i>- without LLWDT</i>	<i>1.2 rads ✓</i>	<i>260 rads</i>	<i>~ 260 rads</i>

1-L-31

# INTEROFFICE CORRESPONDENCE

TO: Mike O'MEARA	LOCATION 14	SUBJECT / REFERENCE / J.O. NO. 12846.38 40 year and 6 month LOCA doses
FROM: Wu PENG	LOCATION 9	to

MESSAGE: - Ref. Calc. 12846.38-RP-031-0, "NUREG 0578 Shielding Review - site dose rates following a LOCA" dated 7/13/81.

<1> The referenced calc. has been finalized and checked. The following are 40 year normal dose and 6 month LOCA dose for some areas considered in this calc: (all units in rads)

	6 month LOCA	40 year normal	Total
MSVH below el. 27'-6"	$5.9 \times 10^6$	880	$5.9 \times 10^6$
MSVH above el. 27'-6"	$1.7 \times 10^4$	880	$1.8 \times 10^4$
CSPH below el. 27'-6"	$5.9 \times 10^6$	880	$5.9 \times 10^6$
CSPH above el. 27'-6"	$5.3 \times 10^2$	880	$1.4 \times 10^3$
Emerg. switch gear & relay rm (el. 9'-6")	260 *	450	710

DATE

SIGNATURE

TELEPHONE

REPLY:

\* This 40 year normal dose (based on radiation zone I with <sup>general</sup> maximum dose rate 0.75 mR/hr) is also applicable to other areas of service bldg and to the turbine bldg.

c.c. R. Westfahl  
J. Barnhart.

7/14/81

Wichung peng X0104  
NOTED JUL 17 1981 S. Inganeri

DATE

SIGNATURE

TELEPHONE

# INTEROFFICE CORRESPONDENCE

TO: Mike OMEARA	LOCATION 14	SUBJECT / REFERENCE / J.O. NO. 12846-38 NUREG 0578 Shielding Review -
FROM: Wu PENG	LOCATION 9	Site dose rates following a LOCA

MESSAGE: —

Ref. S&W calc. 12846-38-RP-031-0, "NUREG 0578 Shielding Review - site dose rates following a LOCA" dated 7/13/81

- <1> The referenced calc. had been checked, and the attached site dose rate tables (3 copies) are considered final.
- <2> The source terms and approach used for the site dose rate calculations are the same as those for aux. bldg. radiation zone map calc. (RP-026) <sup>previous</sup>. They were described in the <sup>previous</sup> IOIC associated with that calc.

7/14/81

cc. R. Westfahl.

Wuhung peng

X0104

NOTED JUL 17 1981 S.Ingeneri

DATE

SIGNATURE

TELEPHONE

REPLY:

DATE

SIGNATURE

TELEPHONE

USER'S GUIDE TO EZD REFERENCES

Facility: VEPCO, SURRY  
 Units: 1 and 2  
 Dockets: 50-280 and 50-281

EZD REFERENCE NO. 12  
 EZD REFERENCE DESCRIPTION: 12846.44-PE-044-0  
 ENVIRONMENTAL ZONE (S): MSVH-27

<u>PARAMETER</u>	<u>NORMAL ENVIRONMENT</u>	<u>PAGE</u>	<u>-LOCA ENVIRONMENT</u>	<u>PAGE</u>	<u>MSLB ENVIRONMENT</u>	<u>PAGE</u>	<u>HELB ENVIRONMENT</u>	<u>PAGE</u>
TEMPERATURE (°F)							300, 0-1 hr.	2, 34
PRESSURE (psia)							16.5, 0-10 sec 16.2, 10 sec-1 hr	*
RELATIVE HUMIDITY (%)							100	**
CHEMICAL SPRAY								

REMARKS: \* Profile is based on results of the referenced calculation by estimating a transient which conservatively bounds the calculated transient. Note that no HELB is specified for the region between el 11'6" and 27'6" since it is separated from the remainder of the MSVH, and there are no high energy lines located in the region.

\*\* Relative humidity bounds are results of computer runs.

CALCULATION TITLE PAGE

\*SEE INSTRUCTIONS ON REVERSE SIDE

▲ 5010.64 (FRONT)

CLIENT & PROJECT VEPCO <i>Surry 1 &amp; 2</i>				PAGE 1 OF 33	
CALCULATION TITLE (Indicative of the Objective): PIPE BREAK ANALYSIS - MAIN STEAM VALVE HOUSE				QA CATEGORY (✓) <input checked="" type="checkbox"/> I - NUCLEAR SAFETY RELATED <input type="checkbox"/> II <input type="checkbox"/> III <input type="checkbox"/> OTHER	
CALCULATION IDENTIFICATION NUMBER					
J. O. OR W.O. NO.	DIVISION & GROUP	CURRENT CALC. NO.	OPTIONAL TASK CODE	OPTIONAL WORK PACKAGE NO.	
12846.44	PE (B)	PE-044-0	00004		
* APPROVALS - SIGNATURE & DATE			REV. NO. OR NEW CALC. NO.	SUPERSEDES * CALC. NO. OR REV. NO.	CONFIRMATION * REQUIRED (✓)
PREPARER(S)/DATE(S)	REVIEWER(S)/DATE(S)	INDEPENDENT REVIEWER(S)/DATE(S)		YES	NO
<i>R. Phillips</i> 9/4/80	<i>W. Combs</i> 10/24/80 NOTED	<i>W. Combs</i> 10/24/80 NOV 20 1980 R.F. MILLER RFP	0		✓

DISTRIBUTION\*

GROUP	NAME & LOCATION	COPY SENT (✓)	GROUP	NAME & LOCATION	COPY SENT (✓)
RECORDS MGT. FILES (OR FIRE FILE IF NONE)	<i>M. Cliffe</i> 245/14	2			
Project	J. Barnhart	1			

CALCULATION SHEET

1	Client <u>VEPCO</u>	Location <u>SURRY 1 &amp; 2</u>	Est. No.	J.O. No. <u>12846.44</u>
2	Subject <u>PIPE BREAK - MSVH</u>	Date	By <u>R. BALLAHER</u>	
3		Checked	By	
4	Based on	Revised	By	

PROBLEM:

TO DETERMINE PRESSURE AND TEMPERATURE CONDITIONS IN MSVH FOLLOWING PIPE BREAK IN 6" LINE THAT CONNECTS A RELIEF VALVE TO RELIEF VALVE HEADER AS PER REF. 35

MODEL

SURRY UNIT #1 AND UNIT #2 MAIN STEAM VALVE HOUSES (MSVH) WERE MODELED INTO 6 NODES FROM LEVEL 27'6" TO 67'5". VENT TO ATMOSPHERE IS ONLY THROUGH ROOF OPENINGS. NO HEAT SINKS WILL BE USED. BREAK IS IN 6" LINE FROM HEADER TO RELIEF VALVES.

RESULTS:

BASED ON THREEED COMPUTER RUN (NU-92) 3800004 THE PEAK TEMPERATURE OF 294.07 °F IS REACHED AT 589.0 SEC.

THE MAX PRESSURE DIFFERENTIAL OCCURS BETWEEN NODE 6 AND ATMOSPHERE - 1.17 PSID AT .850 SEC.

TEMPERATURE IN BOTTOM OF BUILDING NEXT AUX. FEED PUMPS HAS A MAX. TEMP OF 244.91 °F

\* NOTE: NO PAGE # 11.

1	Client	<u>VERLO</u>	Location	<u>Surry 1 &amp; 2</u>	Est. No.		J.O. No.	<u>12846.44</u>
2	Subject	<u>PIPE BREAK - MSVH</u>			Date		By	<u>R. GALLAGHER</u>
3				Checked			By	
4	Based on			Revised			By	

ASSUMPTIONS:

- 1) DOOR BETWEEN CONTAINMENT SPRAY PUMP AREA AND MAIN STEAM VALVE HOUSE AT LEVEL 27'6" IS A DOUBLE SLIDING DOOR AND THEREFORE WILL NOT BE CONSIDERED AS A VENT PATH. ALSO STEAM PIPES GOING THROUGH WALL ARE PACKED WITH INSULATION AND NOT CONSIDERED A VENT PATH.
- 2) UNLESS OTHERWISE NOTED ALL PIPING IS ASSUMED TO HAVE 4" INSULATION PER SIDE.
- 3) A GRATING FACTOR OF .7 WILL BE USED TO ACCOUNT FOR AREA OF GRATING AND SUPPORT PIECES
- 4) THIS CALCULATION IS EQUALLY VALID FOR UNIT'S #1 AND #2 SINCE DRAWING FOR BOTH UNITS WERE COMPARED AND DIMENSIONS ARE COMPARABLE ALSO FLOOR HATCHES IN UNIT #1 FLOOR MUST BE IN PLACE DURING OPERATION.
- 5) ASSUMED THAT OPERATOR ACTION TAKEN SO AS TO SHUT OFF AUX. FEED FLOW SUCH THAT GENERATOR WOULD BE DRY AND THEREFORE NO BLOWDOWN AT 1800 SFC.



1	Client	VEPCO	Location	Sunny 1 & 2	Est. No.	J.O. No.	12846.44
2	Subject	PIPE BREAK MSVN	Date		By	R. GALLAGHER	
3			Checked		By		
4	Based on		Revised		By		

REFERENCES:

- 1) S+W DRG. 11548 - FP-1B-9
- 2) S+W DRG. 11548 - FP-2C-4
- 3) S+W DRG. 11548 - FP-2J-5
- 4) S+W DRG. 11548 - FP-2K-2
- 5) S+W DRG. 11548 - FP-2L-1
- 6) DRG # V-46 HMTA 86X4-A
- 7) DRG # V-38 HMTA 86X4
- 8) S+W DRG. 11448 - FS-19A-3
- 9) S+W DRG. 11448 - FS-19B-4
- 10) S+W DRG. 11548 - FS-19B-2
- 11) S+W DRG. 11548 - FS-19A-2
- 12) S+W DRG. 11448 - FC-19B-7
- 13) S+W DRG. 11448 - FC-19C-4
- 14) S+W DRG. 11448 - FP-5F-6
- 15) S+W DRG. 11548 - FC-19B-4
- 16) S+W DRG. 11548 - FC-19C-3
- 17) S+W DRG. 11548 - FB-40B-3
- 18) S+W DRG. 11548 - FB-43A-3
- 19) S+W DRG. 11548 - FM-14A-7
- 20) S+W DRG. 11548 - FP-5F-5
- 21) S+W DRG. 11448 - FP-2C-4

1	Client	<u>VERCO</u>	Location	<u>SURRY 1 &amp; 2</u>	Est. No.		J.O. No.	<u>12846-44</u>
2	Subject		Date				By	<u>R. GALLAGHER</u>
3			Checked				By	
4	Based on		Revised				By	

(REFERENCES CONT.)

- 22) S+W DRG 11448 - FP-2E-6
- 23) S+W DRG 11448 - FP-2J-7
- 24) S+W DRG 11448 - FP-2K-3
- 25) S+W DRG 11448 - FP-2L-2
- 26) S+W DRG 11448 - FM-14A-12
- 27) S+W DRG 11448 - FP-5C-6
- 28) S+W DRG 11448 - FP-1B-11
- 29) CRANE TECH. PAPER No. 410 © 1979
- 30) IDEL'CIK (HANDBOOK OF HYDRAULIC RESISTANCE) © 1966
- 31) THREAD VER 12 LEVEL 1 RUN # 3800004  
Summary (ATTACHMENT # 1)
- 32) SURRY 1 & 2 F.S.A.R., PART B VOL 3 p. 10.3.1-1
- 33) MOODY CRITICAL FLOW RATES TABLE 6B-2
- 34) ASME STEAM TABLES © 1967 p. 91
- 35) IOC W. KNAPP TO R. MILLER (ATTACHMENT # 2)
- 36) S+W DRG. - 11448 - FP-42A
- 37) S+W DRG. - 11448 - FP-2P-2
- 38) 1978 STRUCTURAL SHAPES (BETHLEHEM STEEL) CATALOG 32M
- 39) PIPING SPECIFICATION SURRY POWER STATION 1972

1	Client <u>VERCO</u>	Location <u>SURRY 192</u>	Est. No.	J.O. No. <u>12846.44</u>
2	Subject	Date	By <u>R. GALLAGHER</u>	
3		Checked	By	
4	Based on	Revised	By	

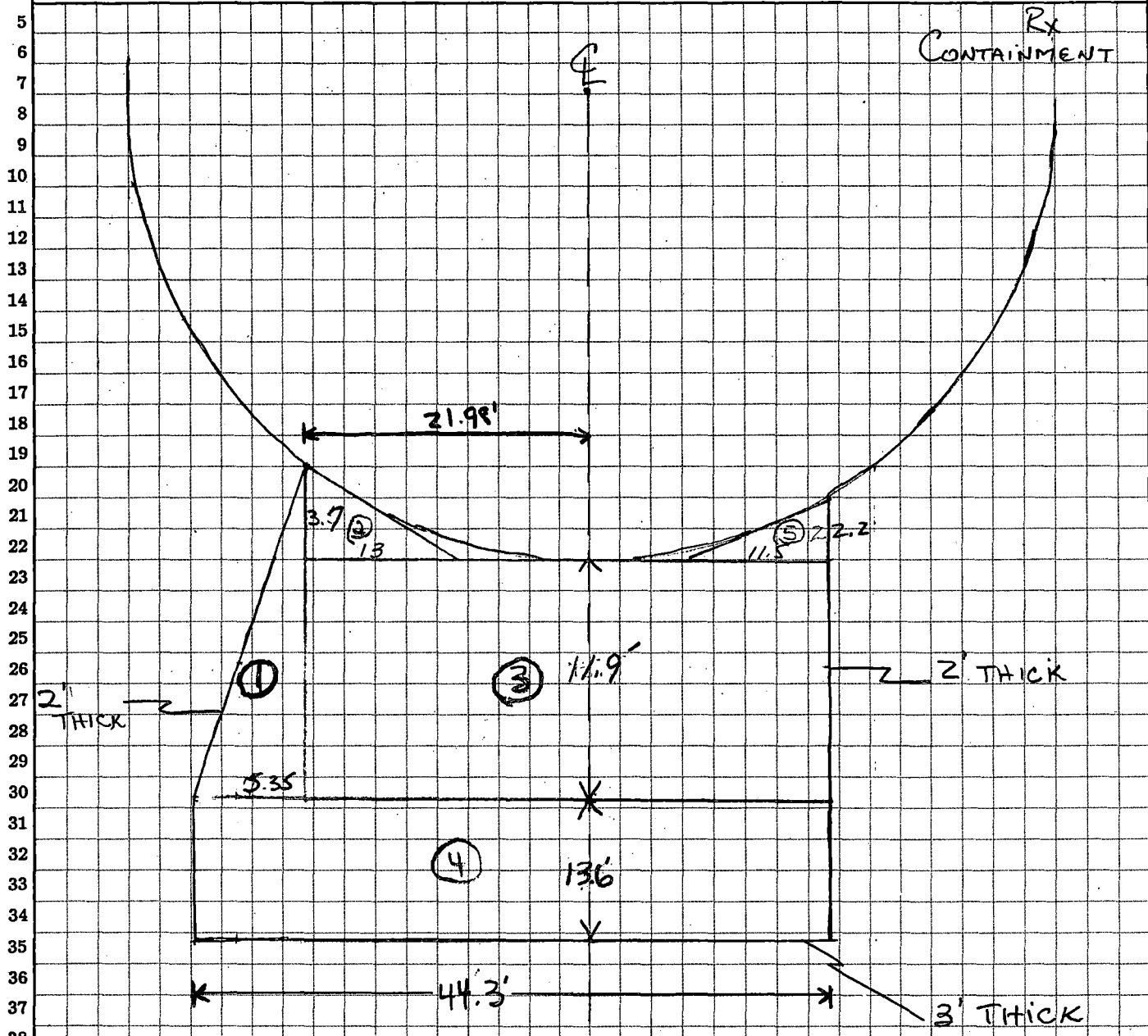

AREA OF BASE FROM 11548-FC-19B-4  
 DIVIDED IN RED AS SHOWN FOR CALCULATION  
 OF AREA.

DRAWN FOR UNIT #2 - UNIT #1 IS IDENTICAL IN  
 SIZE - ORIENTED OPPOSITE TO UNIT #2.

STONE & WEBSTER ENGINEERING CORPORATION  
CALCULATION SHEET

1	Client <u>Verco</u>	Location <u>Sunny 1 &amp; 2</u>	Est. No.	J.O. No. <u>12846.44</u>
2	Subject	Date	By <u>R. GALLAGHER</u>	
3		Checked	By	
4	Based on	Revised	By	

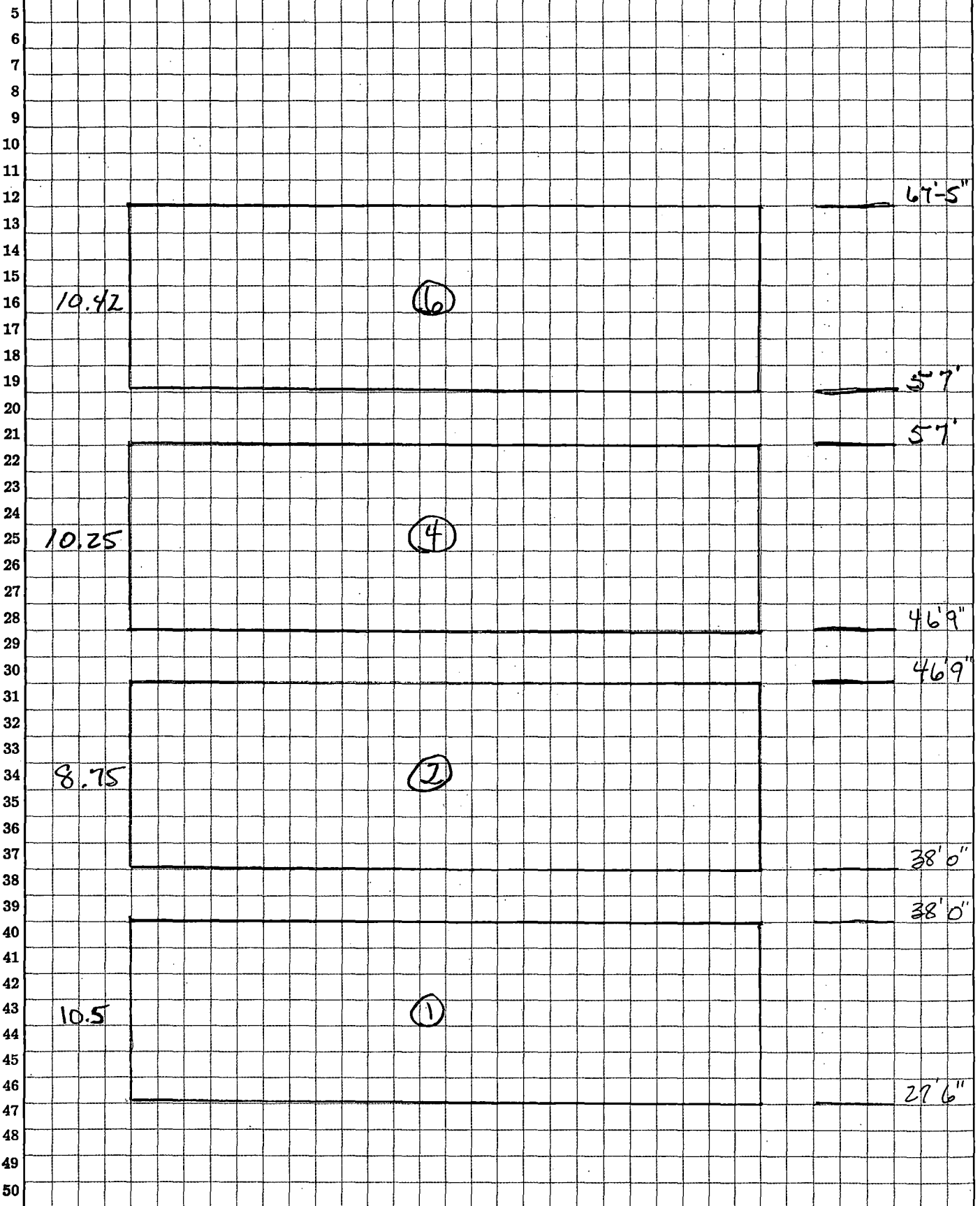

1 Client VAPCO Location SUNNY 1 & 2 Est. No. J.O. No. 12846.44  
 2 Subject Date By R. GALLAGHER  
 3 Checked By  
 4 Based on Revised By

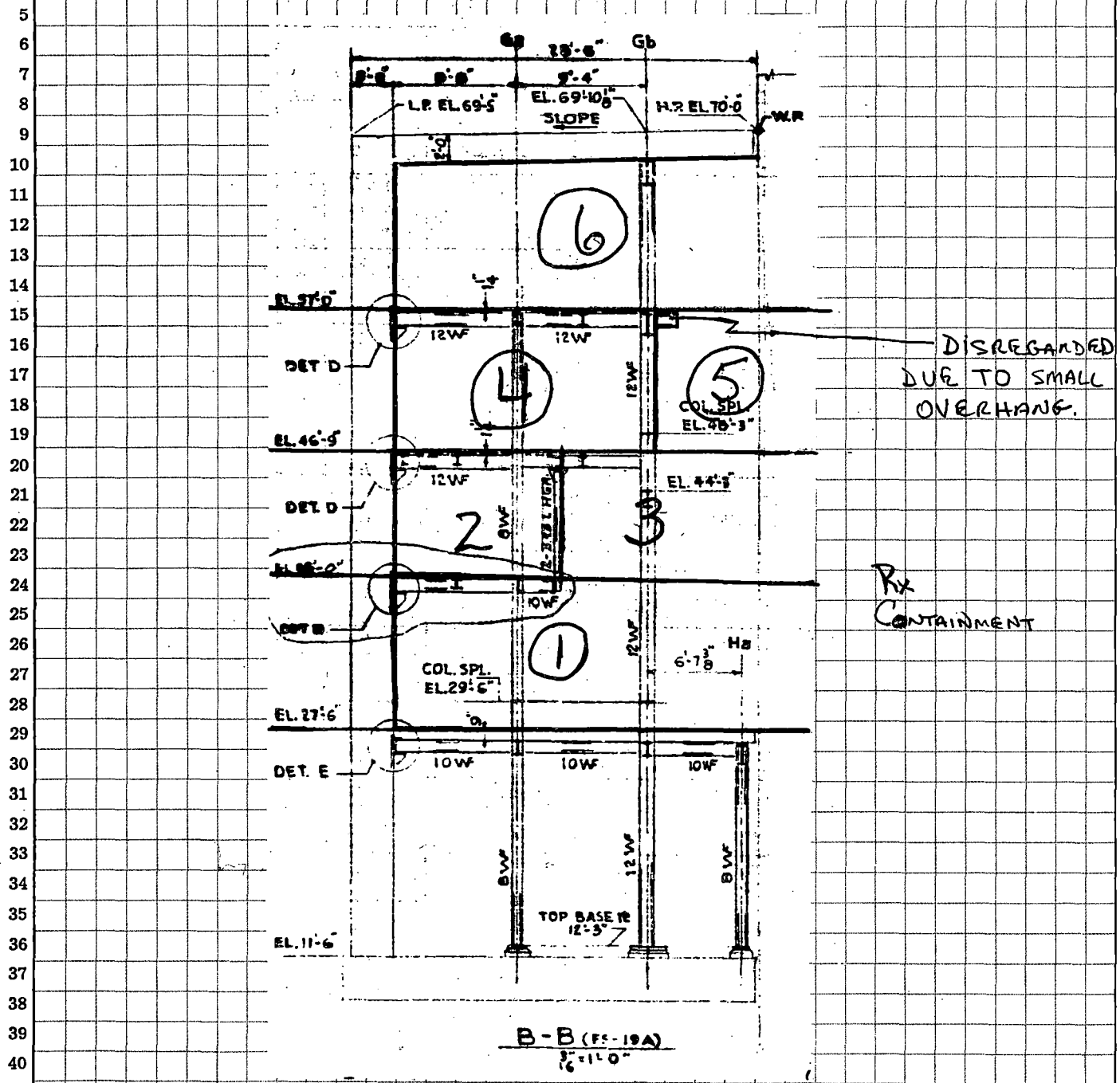

SIDE VIEW OF NODALIZATION MODEL.

NODES AS OUTLINED AND NUMBERED IN RED.

REF. 11548-FS-19B-Z

1 Client VEPCO Location Sunny 192 Est. No. J.O. No. 12846.44  
 2 Subject Date By R. GALLAGHER  
 3 Checked By  
 4 Based on Revised By

AREA OF BASEAREA DIVIDED AS SHOWN OF PAGE 6

① TRIANGLE UPPER LEFT -

$$.5(5.35)(11.9 + 3.7) = 41.73$$

② TRIANGLE

$$.5(3.7)(13) = 24.05$$

③ RECTANGLE

$$(11.9)(38.95) = 463.5$$

④ RECTANGLE

$$(13.6)(44.3) = 602.48$$

⑤ TRIANGLE

$$.5(2.2)(11.5) = 12.65$$

$$\begin{aligned} \text{TOTAL} &= 41.73 + 24.05 + 463.5 + 602.48 + 12.65 = \\ &= 1144.4 \text{ FT}^2 \end{aligned}$$

1	Client	VERCO	Location	SURRY 192	Est. No.	J.O. No.	12846.44
2	Subject		Date		Checked	By	R. GALLAGHER
3					Revised	By	
4	Based on						

GROSS VOLUMESNODE 1

$$\text{HEIGHT} = 38' - 27.5' = 10.5 \text{ FT}$$

$$\text{AREA OF BASE} = 1144.4 \text{ FT}^2$$

$$\text{TOTAL VOLUME} = 12016.2 \text{ FT}^3$$

NODE 2

$$\text{HEIGHT} = 46.75 - 38 = 8.75 \text{ FT}$$

$$\text{AREA OF BASE} = (W) \times L = 11.42 \times 44.33 = 506.25$$

$$\text{TOTAL VOLUME} = 4429.69 \text{ FT}^3$$

NODE 3

$$\text{HEIGHT} - \text{SAME AS NODE 2} = 8.75 \text{ FT}$$

$$\text{AREA OF BASE} = 1144.4 - 506.25 = 638.2 \text{ FT}^2$$

$$\text{TOTAL VOLUME} = 5584.25 \text{ FT}^3$$

$$\text{NODE 4 AND 5 HEIGHT} = 57 - 46.75 = 10.25 \text{ FT}$$

NODE 4

$$\text{BASE AREA} = 18 \times 44.3 = 797.4$$

$$\text{TOTAL VOLUME} = 8173.35 \text{ FT}^3$$

NODE 5

$$\text{BASE AREA} = 1144.4 - 797.4 = 347$$

$$\text{TOTAL VOLUME} = 3556.75 \text{ FT}^3$$

NODE 6

$$\text{HEIGHT} = 67.5' - 57' = 10.42 \text{ FT}$$

$$\text{AREA OF BASE} = 1144.4 \text{ FT}^2$$

$$\text{TOTAL VOLUME} = 11924.65 \text{ FT}^3$$

NODE 7

$$\text{ATMOSPHERE} = 1.0 \text{ FT}^2 \times 20 \text{ FT}^3$$

1	Client	VAPCO	Location	Sunny 1 & 2	Est. No.	J.O. No.	12846.44
2	Subject		Date		By	R. GALLAGHER	
3			Checked		By		
4	Based on		Revised		By		

MINUS VOLUME -

NODE 1 - 14.67 FT OF 14" FEEDWATER PIPE 4" INSULATION  
 $14.67 \times 3 = 44.0'$

$44.0 \times \pi/4 (22/12)^2 = 116.2 \text{ FT}^3$

WARD + WCMU LINES - NO INSULATION

45.25 FT OF 4" PIPE

$45.25 \times \pi/4 (4/12)^2 = 3.95 \text{ FT}^3$

21.5 FT OF 2" PIPE

$21.5 \times \pi/4 (2/12)^2 = .47 \text{ FT}^3$

11.0 FT OF 1" PIPE

$11 \times \pi/4 (1/12)^2 = .06 \text{ FT}^3$

179.63 FT OF 6" PIPE

$179.63 \times \pi/4 (6/12)^2 = 35.27 \text{ FT}^3$

TOTAL WARD - WCMU PIPING - 39.75 FT<sup>3</sup>

AUX. FEED PUMPS - (3)

(2)  $46.5' \times 12.33' \times 62' = 246.86 @$

(1)  $34.5' \times 8.5' \times 52 \frac{3}{8}' = 106.66 @$

TOTAL PUMPS = 600.38 FT<sup>3</sup>

MISC. STEEL, PIPES AND HANGERS

590 OF GROSS VOL = 573.2 FT<sup>3</sup>

STEEL =

2 (FWP) @ 10.5 =  $21 \times 35 \div 489 = 1.51$

2 (12 WFP) @ 10.5 =  $21 \times 96 \div 489 = 4.12$

5.63 FT<sup>3</sup>



1 Client Vepco Location Sunny 192 Est. No. J.O. No. 12846.44  
 2 Subject \_\_\_\_\_ Date \_\_\_\_\_ By R. GALLAGHER  
 3 \_\_\_\_\_ Checked \_\_\_\_\_ By \_\_\_\_\_  
 4 Based on \_\_\_\_\_ Revised \_\_\_\_\_ By \_\_\_\_\_

SHPD AND SHP Piping - 2 1/2" INSULATION

3"	-	68 FT	$68 \times \pi/4 (3/12)^2 =$	23.74 FT <sup>3</sup>
6"	-	35.0 FT	$35 \times \pi/4 (1 1/12)^2 =$	23.10 FT <sup>3</sup>
1"	-	36.5 FT	$36.5 \times \pi/4 (6/12)^2 =$	7.17 FT <sup>3</sup>
1 1/2"	-	83.5 FT	$83.5 \times \pi/4 (4 1/2)^2 =$	19.24 FT <sup>3</sup>

TOTAL SHPD = 73.25  
 (CC LINES) 3" - 89 FT (NO INSULATION)  $89 \times \pi/4 (3/12)^2 = 4.37$   
 1 1/2" - 30 FT  $30 \times \pi/4 (1 1/2)^2 = .37$   
 4.74

TOTAL MINUS = 116.2 + 39.75 + 600.38 + 573.2 + 5.63 + 73.25 + 4.74 = 1413.2 FT<sup>3</sup>

NODE 2

9.42 FT/LINE 3 LINES = 28.26 FT. OF 20" STAIN PIPE

$28.26 \times \pi/4 (38/12)^2 = 222.57 \text{ FT}^3$  4" OF INSULATION -

9.8 FT OF 14" MN. FR. PIPE

$9.8 \times \pi/4 (22/12)^2 = 25.87 \text{ FT}^3$

SHP + SHPD Piping - 2 1/2" INSULATION

1 1/2"	=	6.85 FT	$6.85 \times \pi/4 (6.5/12)^2 =$	1.58
3/4"	=	2 FT	$2 \times \pi/4 (5.75/12)^2 =$	.26

TOTAL = 1.84 FT<sup>3</sup>

STEEL -

2 (12 WF) @ 9.5 FT = 19 x 96 ÷ 489 = 3.72

2 (8 WF) @ 8.75 FT = 17.5 x 35 ÷ 489 = 1.26

2 (3x3) HGR. = .75 x 8.75 = 6.56 x 2 = 13.13

TOTAL 18.11 FT<sup>3</sup>

1	Client <u>Verco</u>	Location <u>Surry 1&amp;2</u>	Est. No.	J.O. No. <u>12846.411</u>
2	Subject	Date	By <u>R. GALLAGHER</u>	
3		Checked	By	
4	Based on	Revised	By	

MISC. PIPES, HANGARS, STEEL -

5% GROSS VOL. = 182.9 FT<sup>3</sup>

TOTAL MINUS = 182.9 + 18.11 + 1.94 + 25.87  
+ 222.57 = 451.39 FT<sup>3</sup>

NODE 3

21.92 FT / LINE      3 LINES      65.76 FT  
OF 30" STU LINE      4" INSULATION

65.76 x π/4 (30/12)<sup>2</sup> = 517.91 FT<sup>3</sup>

PIPE SUPPORTS, MISC STEEL AND SMALL PIPES

5% GROSS VOL. - 294.8 FT<sup>3</sup>

14" MN. FEED PIPE - 11.7 FT x 3 = 35.1

35.1 x π/4 (22/12)<sup>2</sup> = 92.66 FT<sup>3</sup>

STEEL

2 (12 WF) @ 9.25 FT ea = 18.5 x 96 ÷ 489 = 3.63

2 (12 WF) @ 8.75 FT ea = 17.5 x 96 ÷ 489 = 3.43

TOTAL. 7.06

3 VALVES

2 x 1.5 x 2 = 6 FT<sup>3</sup> / VALVE = 18 FT<sup>3</sup>

6" MN. STU. LINE      4" INSULATION

5 FT / LINE      3 LINES      = 15 FT

15 x π/4 (14/12)<sup>2</sup> = 16.04 FT<sup>3</sup>

1	Client	VERCO	Location	SUNNY 1 #2	Est. No.	J.O. No.	12846.44
2	Subject		Date		By	R. GALLAGHER	
3			Checked		By		
4	Based on		Revised		By		

5  
6 SHP LINES - 4" INSULATION  
7  
8 46 FT  
9  
10  $46 \times \pi/4 \left(\frac{12}{12}\right)^2 = 36.13 \text{ FT}^3$   
11

12  
13 SUB. TOTAL MINUS =  $517.91 + 92.66 + 7.06 + 18 + 16.04$   
14  $+ 36.13 + 394.8 = 982.60 \text{ FT}^3$   
15

16  
17 SHPD + SHP LINED. - 2 1/2" INSULATION  
18  
19  $1/2" - 18.8 \times \pi/4 \left(\frac{6.5}{12}\right)^2 = 4.33$   
20  $1" - 11 \times \pi/4 \left(\frac{6}{12}\right)^2 = 2.16$   
21  $3/4" - 30.25 \times \pi/4 \left(\frac{5.75}{12}\right)^2 = 5.45$   
22  $4" - 21.5 \times \pi/4 \left(\frac{9}{12}\right)^2 = 9.50$   
23  $3" - 49.0 \times \pi/4 \left(\frac{8}{12}\right)^2 = 17.1$   
24  
25  $38.54 \text{ FT}^3$   
26

27 TOTAL MINUS -  
28  
29  $982.60 + 38.54 = 1021.14 \text{ FT}^3$   
30

31  
32 NODE 4  
33  
34 30" MN STEEL LINE - 4" INSULATION  
35  
36 10.71 FT/LINE 3 LINES 32.13 FT  
37  
38  $32.13 \times \pi/4 \left(\frac{38}{12}\right)^2 = 253.05 \text{ FT}^3$   
39

40  
41 STEEL  
42  
43  $2 (12 \text{ WF}) @ 18.75 \text{ FT} \times 11 = 37.5 \times 96 \div 489 = 7.35$   
44  
45  $2 (12 \text{ WF}) @ 10.25 \text{ FT} \times 11 = 20.5 \times 96 \div 489 = 4.02$   
46  
47  $2 (8 \text{ WF}) @ 10.25 \text{ FT} \times 11 = 20.5 \times 35 \div 489 = 1.48$   
48

49  
50 TOTAL 12.85 FT<sup>3</sup>

1-M-14

1	Client	VERCO	Location	Sunny 1st	Est. No.	J.O. No.	12846.40
2	Subject		Date		By	R. GALLAGHER	
3			Checked		By		
4	Based on		Revised		By		

MIN. STM. VALVE OPERATOR

RECTANGLE

5.75 x 2.5 x 30 = 43.13 FT<sup>3</sup>

6" MIN. STM. PIPE — 4" INSULATION.

30.75 FT/LINE      3 LINES      92.25 FT

92.25 x π/4 (1 1/2)<sup>2</sup> = 98.62 FT<sup>3</sup>

PIPE SUPPORTS, MISC PIPES,

5% GROSS VOL. — 4/12.15 FT<sup>3</sup>

TOTAL MINUS = 253.05 + 12.85 + 43.13  
+ 98.62 + 4/12.15 = 819.80 FT<sup>3</sup>

NODE 5

30" MIN. STM. PIPE      4" INSULATION.

10.25 FT/LINE      3 LINES      30.75 FT

30.75 x π/4 (3 3/4)<sup>2</sup> = 242.18 FT<sup>3</sup>

SHP - 37, 38, 39      5 FT ea.

15 FT x π/4 (1 1/2)<sup>2</sup> = 11.78 FT<sup>3</sup>

1	Client	VERCO	Location	Sunny 1/2	Est. No.	J.O. No.	12846.44
2	Subject		Date			By	R. GALLAGHER
3			Checked			By	
4	Based on		Revised			By	

PIPE SUPPORTS, MISC PIPES

590 GROSS VOLUME 147.3 FT<sup>3</sup>

TOTAL MINUS - 242.18 + 11.78 + 147.37  
= 401.33 FT<sup>3</sup>

NODE 6

30" MN. STM. LINE

10.33 FT/LINE 3 LINES 30.99 FT

$30.99 \times \pi/4 \left(\frac{30}{12}\right)^2 = 244.07 \text{ FT}^3$

MN. STM. VALVE OPERATOR - 3 RECTANGLES -

1.75 X 2.5 X 3 = 13.13

1 X 3 X 6.5 = 19.5

3 X 6.5 X 0.5 = 48.75

TOTAL = 81.38 FT<sup>3</sup>

SHP 37, 38, 39 4" LINE 16 FT

48 FT X 4" INSULATION  
 $48 \text{ FT} \times \pi/4 \left(\frac{4}{12}\right)^2 = 37.7 \text{ FT}^3$

4.5 FT OF 16" MN. STM. PIPE / RELIEF VALVE  
15 RELIEF VALVES. 67.5 FT.

$67.5 \times \pi/4 \left(\frac{16}{12}\right)^2 = 212.06 \text{ FT}^3$

STEEL

2 (10WF) - 10.42 FT @ = 2084 X 96 / 489 = 4.08

(16WF45) - 10 FT = 16 X 95 / 489 = .92

24WF110 - 24.5 FT = 245 X 110 / 489 = 5.51

10.51 FT<sup>3</sup>

STONE & WEBSTER ENGINEERING CORPORATION  
CALCULATION SHEET

1	Client	Verco	Location	Sunny 1 & 2	Est. No.		J.O. No.	12846.44
2	Subject				Date		By	R. Callender
3					Checked		By	
4	Based on				Revised		By	

RELIEF VALVES - (15)

$10.94 \text{ FT}^3/\text{VALVE} \times 15 = 164.1 \text{ FT}^3$

$+ 1 \times \pi \times (19/12)^2 = .55 \times 15 = 8.18$

TOTAL = 172.28 FT<sup>3</sup>

Misc STEEL + PIPING SUPPORTS -

5% GROSS VOLUME 568.8 FT<sup>3</sup>

TOTAL MINUS =  $244.07 + 81.38 + 37.7 + 212.06$   
 $+ 10.51 + 172.28 + 568.8$   
 $= 1326.8 \text{ FT}^3$

STONE & WEBSTER ENGINEERING CORPORATION  
CALCULATION SHEET

Page No. 19  
Preliminary  
Item PE-074-0

1 Client VEPCO Location Sunny 1#2 Est. No. J.O. No. 12846.44  
 2 Subject Date By R. GALAGHER  
 3 Checked By  
 4 Based on Revised By

	<u>NET VOLUME</u>			
	<u>GROSS VOLUME</u>	<u>TOTAL MINUS VOLUME</u>	<u>NET (FT<sup>3</sup>) VOLUME</u>	
10	<u>NODE 1</u>	<u>12016.2</u>	<u>1913.20</u>	<u>10603.0</u>
13	<u>NODE 2</u>	<u>4429.69</u>	<u>451.39</u>	<u>3978.3</u>
16	<u>NODE 3</u>	<u>5584.25</u>	<u>1021.14</u>	<u>4563.11</u>
19	<u>NODE 4</u>	<u>8173.35</u>	<u>819.80</u>	<u>7353.55</u>
22	<u>NODE 5</u>	<u>3556.75</u>	<u>401.33</u>	<u>3155.42</u>
25	<u>NODE 6</u>	<u>11924.65</u>	<u>1326.8</u>	<u>10597.85</u>

1 Client VERCO Location Sunny 1 & 2 Est. No. J.O. No. 12846.44  
 2 Subject Date By R. GALLAGHER  
 3 Checked By  
 4 Based on Revised By

JUNCTION AREAS				
Junc. #	FROM NODE	TO NODE		JUNC. AREA. FT <sup>2</sup>
1	1	2	.7 (506.25)	354.38
2	1	3	BASE AREA OF NODE 3	638.2
3	2	4	.7 (506.25)	354.38
4	3	4	(638.2 - 347.0)	291.20
5	3	5	BASE AREA OF NODE 5	347.0
6	4	6	.7 (10797.4)	558.2
7	5	6	BASE OF NODE 5	347.0
8	2	3	(8.75 x 44.3)	387.63
9	4	5	(10.25 x 44.3)	454.08
10	6	7	(.17 x 6) x 18 *	18.36
11	6	7	.17 x 6 x 18 *	18.36
12	6	7	.17 x 6 x 18 *	18.36

\* FROM PAGE 27 each opening is 2' WIDE OR .17' by 6" AND THERE ARE 18 OPENINGS.  
 \*\* P. 3 ASSUMPTION \* 3



1 Client **VERCO** Location **Sunny 1 & 2** Est. No. J.O. No. **12846.44**  
 2 Subject Date By **R. GALLAGHER**  
 3 Checked By  
 4 Based on Revised By

INERTIA

Junc. #	$\frac{C_1}{A_1}$	+	$\frac{C_2}{A_2}$	+	$\frac{L_I}{A_i}$	+	0	I
1	$\frac{5.25}{1144.4}$	+	$\frac{4.375}{506.25}$	+	0	+	0	.014
2	$\frac{5.25}{1144.4}$	+	$\frac{4.375}{638.2}$	+	0	+	0	.012
3	$\frac{4.375}{506.25}$	+	$\frac{5.125}{797.4}$	+	0	+	0	.015
4	$\frac{4.375}{638.2}$	+	$\frac{5.125}{797.4}$	+	0	+	0	.013
5	$\frac{4.375}{638.2}$	+	$\frac{5.125}{347.0}$	+	0	+	0	.022
6	$\frac{5.125}{797.4}$	+	$\frac{5.21}{1144.4}$	+	0	+	0	.012
7	$\frac{5.125}{347.0}$	+	$\frac{5.21}{1144.4}$	+	0	+	0	.021
8	$\frac{5.71}{(8.75)(44.3)}$	+	$\frac{7.04}{(8.75)(44.3)}$	+	0	+	0	.033
9	$\frac{9.0}{(10.25)(44.3)}$	+	$\frac{3.75}{(10.25)(44.3)}$	+	0	+	0	.028
10	$\frac{5.21}{1144.4}$	+	<del>ATMOS.</del>	+	2	+	18.36	.114
11	$\frac{5.21}{1144.4}$	+	<del>ATMOS.</del>	+	2	+	18.36	.114
12	$\frac{5.21}{1144.4}$	+	<del>ATMOS.</del>	+	2	+	18.36	.114

STONE & WEBSTER ENGINEERING CORPORATION  
CALCULATION SHEET

1 Client VERCO. Location SUNNY 1 & 2 Est. No. J.O. No. 12846.44  
 2 Subject Date By R. GALLAGHER  
 3 Checked By  
 4 Based on Revised By

JUNC. #	FROM NODE	TO NODE	CONTRACTION COEFFICIENT	Kc
			$.5 (1 - A_2/A_1)$ $\nearrow$ ESG-19	
1	1	2	* $.5 (1 - 506.25 / 1144.4)$	.279
1	2	1	* $.5 (1 - 506.25 / 506.25)$	0
2	1	3	$.5 (1 - 638.2 / 1144.4)$	.221
2	3	1	$.5 (1 - 638.2 / 638.2)$	0
3	2	4	* $.5 (1 - 506.25 / 506.25)$	0
3	4	2	* $.5 (1 - 506.25 / 797.4)$	.183
4	3	4	$.5 (1 - 291.2 / 638.4)$	.272
4	4	3	$.5 (1 - 291.2 / 797.4)$	.317
5	3	5	$.5 (1 - 347.0 / 638.4)$	.228
5	5	3	$.5 (1 - 347.0 / 347.0)$	0
6	4	6	* $.5 (1 - 797.4 / 797.4)$	0
6	6	4	* $.5 (1 - 797.4 / 1144.4)$	.152
7	5	6	$.5 (1 - 347.0 / 347.0)$	0
7	6	5	$.5 (1 - 347.0 / 1144.4)$	.348
8	2	3	$.5 (1 - 387.63 / 387.63)$	0
8	3	2	$.5 (1 - 387.63 / 387.63)$	0
9	4	5	$.5 (1 - 454.08 / 454.08)$	0
9	5	4	$.5 (1 - 454.08 / 454.08)$	0

\*NOTE:  
 FOR JUNC. 1, 3, 6 FOR CONTRACTION TERM.  $A_1$  IS JUNC AREA ON P. 20 WITHOUT .7 AREA CORRECTION

1 Client VERCO Location Sunny 142 Est. No. J.O. No. 12846.44  
 2 Subject Date By R. GALLAGHER  
 3 Checked By  
 4 Based on Revised By

GRATING FACTOR - REF. Calc. 13075.49 - ES-224-0 p.5

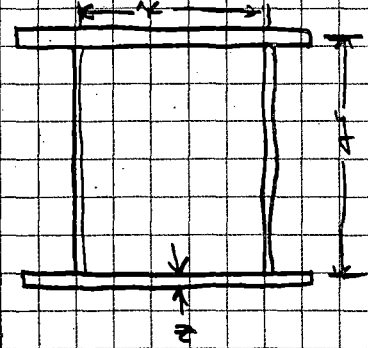

$x = 1.1875''$   
 $y = 4.0''$  THICKNESS =  $1.25''$   
 $z = .1875''$

$$F = \frac{(x-z)(y-z)}{4yz} = 80263$$

$$D_H = \frac{4(F \times y)}{2[(x-z) + (y-z)]} = 1.334$$

$$\frac{K}{D_H} = \frac{1.25}{1.334} = .937$$

using 7 OF 325 TABLE OF REF. 30  
→ Assumption 3

$R = .61$

$.61 (\bar{F})^2 = .298$

FOR CONSERVATISM A K FACTOR FOR GRATING OF .3 IS USED.

1 Client VERCO Location Sunny 192 Est. No. J.O. No. 12846.YV  
 2 Subject Date By R. GALLAGHER  
 3 Checked By  
 4 Based on Revised By

EXPANSION COEFFICIENT

[Formula (ESG-19)]

9	10	11	12	13	14	15	16	17	18	19	20	21	22	23	24	25	26	27	28	29	30	31	32	33	34	35	36	37	38
Joint #	From NODE	To NODE																											
	1	2	*	(	1	-	506.25	/	506.25	) <sup>2</sup>																			
	1	2	*	(	1	-	506.25	/	1144.4	) <sup>2</sup>																			
	2	3		(	1	-	638.2	/	638.2	) <sup>2</sup>																			
	2	3		(	1	-	638.2	/	1144.4	) <sup>2</sup>																			
	3	4	*	(	1	-	506.25	/	797.4	) <sup>2</sup>																			
	3	4	*	(	1	-	506.25	/	506.25	) <sup>2</sup>																			
	4	4		(	1	-	291.2	/	797.4	) <sup>2</sup>																			
	4	4		(	1	-	291.2	/	638.2	) <sup>2</sup>																			
	5	5		(	1	-	347.0	/	347.0	) <sup>2</sup>																			
	5	5		(	1	-	347.0	/	638.2	) <sup>2</sup>																			
	6	6	*	(	1	-	797.4	/	1144.4	) <sup>2</sup>																			
	6	6	*	(	1	-	797.4	/	797.4	) <sup>2</sup>																			
	7	6		(	1	-	347.0	/	1144.4	) <sup>2</sup>																			
	7	6		(	1	-	347.0	/	347.0	) <sup>2</sup>																			
	8	3		(	1	-	387.63	/	387.63	) <sup>2</sup>																			
	8	3		(	1	-	387.63	/	387.63	) <sup>2</sup>																			
	9	4		(	1	-	454.08	/	454.08	) <sup>2</sup>																			
	9	4		(	1	-	454.08	/	454.08	) <sup>2</sup>																			

\* SEE NOTE PAGE 22.

1 Client VERCO Location Sunny Est. No. J.O. No. 12846.44  
 2 Subject Date By R. GALLAGHER  
 3 Checked By  
 4 Based on Revised By

MOMENTUM FLUX - K'						
JUNC. #	FROM NODE	TO NODE	K' = $\left(\frac{A_2}{A_1}\right)^2 - \left(\frac{A_1}{A_2}\right)^2$		(FORMULA ESG-19)	K'
11	1	2	$(354.38/506.25)^2$	-	$(354.38/1144.4)^2$	.394
12	1	2	$(354.38/1144.4)^2$	-	$(354.38/506.25)^2$	-.394
14	2	3	$(638.2/638.2)^2$	-	$(638.2/1144.4)^2$	-.687
15	2	3	$(638.2/1144.4)^2$	-	$(638.2/638.2)^2$	-.687
17	3	4	$(354.38/797.4)^2$	-	$(354.38/506.25)^2$	-.294
18	3	4	$(354.38/506.25)^2$	-	$(354.38/797.4)^2$	.294
20	4	3	$(291.2/797.4)^2$	-	$(291.2/638.2)^2$	-.075
21	4	3	$(291.2/638.2)^2$	-	$(291.2/797.4)^2$	.075
23	5	5	$(347.0/347.0)^2$	-	$(347.0/638.2)^2$	-.704
24	5	5	$(347.0/638.2)^2$	-	$(347.0/347.0)^2$	-.704
26	6	6	$(558.2/1144.4)^2$	-	$(558.2/797.4)^2$	-.252
27	6	6	$(558.2/797.4)^2$	-	$(558.2/1144.4)^2$	.252
29	7	6	$(347.0/1144.4)^2$	-	$(347.0/347.0)^2$	-.908
30	7	6	$(347.0/347.0)^2$	-	$(347.0/1144.4)^2$	-.908
32	8	3	$(387.63/387.63)^2$	-	$(387.63/387.63)^2$	0
33	8	3	$(387.63/387.63)^2$	-	$(387.63/387.63)^2$	0
35	9	5	$(454.08/454.08)^2$	-	$(454.08/454.08)^2$	0
36	9	5	$(454.08/454.08)^2$	-	$(454.08/454.08)^2$	0
38	10	7	$(18.36/ATMOS.)^2$	-	$(18.36/1144.4)^2$	-.0003
39	10	7	$(18.36/1144.4)^2$	-	$(18.36/ATMOS.)^2$	.0003
41	11	7	$(18.36/ATMOS.)^2$	-	$(18.36/1144.4)^2$	-.0003
42	11	7	$(18.36/1144.4)^2$	-	$(18.36/ATMOS.)^2$	.0003
44	12	7	$(18.36/ATMOS.)^2$	-	$(18.36/1144.4)^2$	-.0003
45	12	7	$(18.36/1144.4)^2$	-	$(18.36/ATMOS.)^2$	.0003

1 Client VAPCO Location Sunny 1E2 Est. No. J.O. No. 12846.44  
 2 Subject \_\_\_\_\_ Date \_\_\_\_\_ By R. GALLAGHER  
 3 \_\_\_\_\_ Checked \_\_\_\_\_ By \_\_\_\_\_  
 4 Based on \_\_\_\_\_ Revised \_\_\_\_\_ By \_\_\_\_\_

Friction Coefficient -  $K_F$

Friction will be determined on one node and assumed to be constant for all nodes.  
 REF. 30.

$$D_H = \frac{(4) 506.25}{2(11.42 + 44.3)} = 18.17$$

$$A = \frac{2.5 (.03937)}{18.17 \times 12} = .00045$$

$$\bar{c} = \frac{1}{\left(2 \log \frac{3.7}{.00045}\right)^2} = .016$$

$$\frac{.016 \times 4.375}{18.17} = .004$$

$$= .004 \times 2 = .008$$

WILL USE K<sub>F</sub> = .01

5  
6 ODF  
7  
8  
9  
10  
11  
12  
13  
14  
15  
16  
17  
18  
19  
20  
21  
22  
23  
24  
25  
26  
27  
28  
29  
30  
31  
32  
33  
34  
35  
36  
37  
38  
39  
40  
41  
42  
43  
44  
45  
46  
47  
48  
49  
50  
51  
52  
53  
54

Client	ROOF	Location	Est. No.	J.O. No. P-827
Subject or Apparatus		Date	Checked	By R. Callaway
Based on		Revised		By

P-044-0

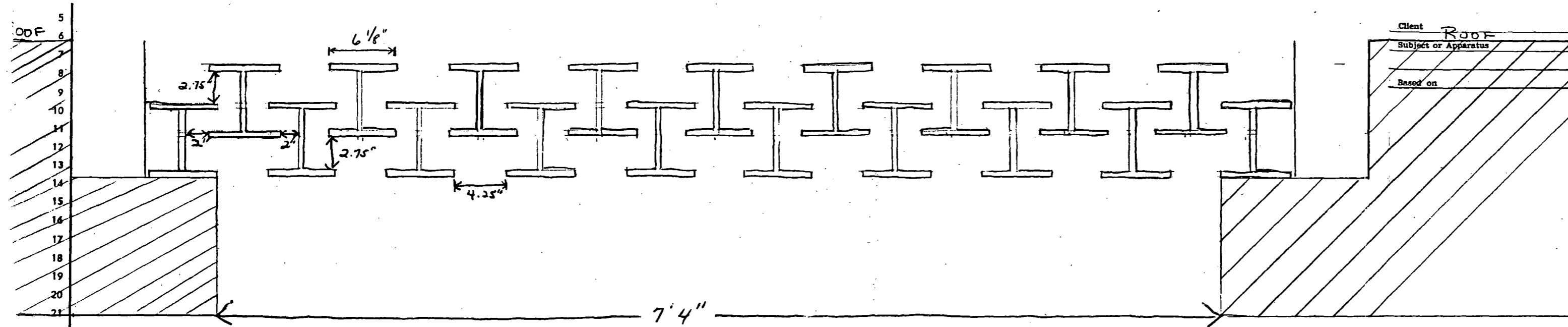

ALL DIMENSION SHOWN ARE TYP. TO DISTANCES BETWEEN  
ALL 6 WF25 I BEAMS.

OVERALL OPENING =  
6 x 7'4" = 43.98  
ft

NOTE: DIMENSIONS AS STATED ON THIS SKETCH ARE FROM A FIELD INSPECTION ON 7/8/80. THIS IS ALSO SHOWN ON REF. 12, SECT. C-C, EXCEPT THAT THE END BEAMS ARE SPACED OUT AS SHOWN AT LEFT. (MEASURED DIMENSIONS CAN BE CONFIRMED BY CALCULATION)

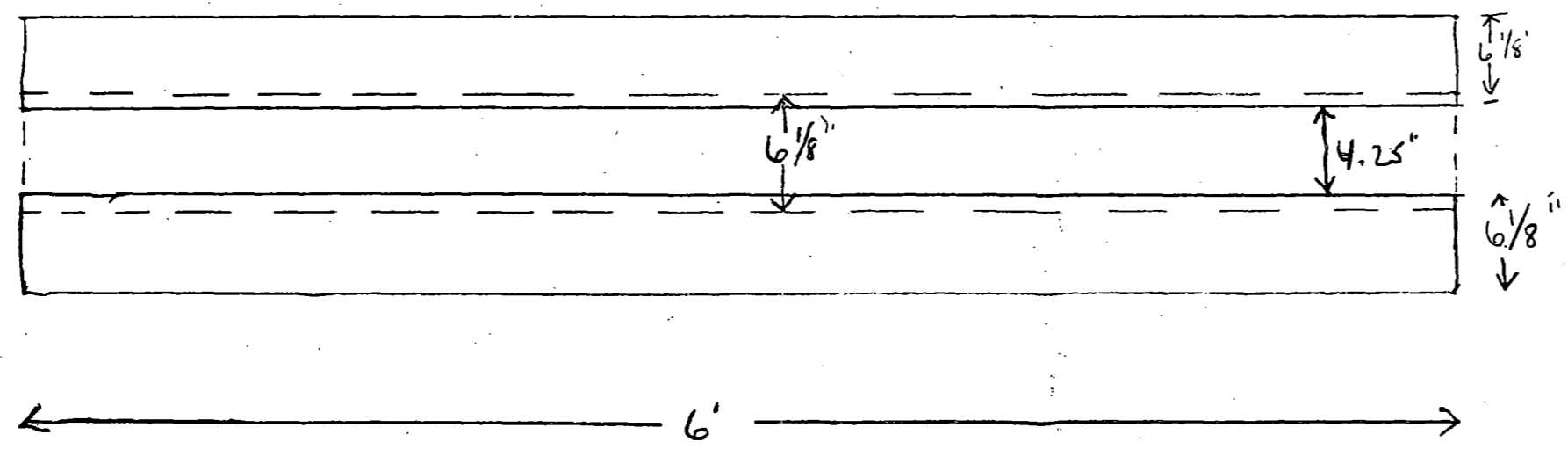

TYP. OVER 7'4" LENGTH

1	Client	Verco	Location	Sunny 1&2	Est. No.		J.O. No.	12846.44
2	Subject		Date		Checked		By	R. GALLAGHER
3	Based on		Revised		Checked		By	

ROOF OPENINGS

(AS SHOWN ON ATTACHED DRAWING.) P. 27

ROOF OPENINGS WERE MODELED AS A CONTRACTION FROM MODEL TO JUST INSIDE I BEAM FROM THERE AS A 180° TO ANOTHER 180°, THEN TO AN EXPANSION.

ROOF OPENING 7'4" X 6' BEFORE I BEAMS.

CONTRACTION -

$$.5 \left( 1 - \frac{18(1.02)}{1091.75} \right) = .492 \text{ (WILL USE)} \\ .5$$

EXPANSION -

$$\left( 1 - \frac{18(1.02)}{1091.75} \right)^2 = 1$$

180°

(REF 30 p. 230)

$$D_H = \frac{4 \left( \frac{1.374}{2} \right)}{2(6 + .229)} = \frac{5.496}{12.458} = .441$$

FROM REF. 30 A ROUGHNESS OF .15 WILL BE USED.

$$\frac{.15 (.03937)}{.441 \times 12} = .00112$$

$$\frac{1}{\left( 2 \log \frac{3.7}{.00112} \right)^2} = .020 = 2$$



1 Client VERLO Location SURRY 142 Est. No. J.O. No. 12846.44  
 2 Subject Date By R. GALLAGHER  
 3 Checked By  
 4 Based on Revised By

FLOW AREA = 1.02 FT<sup>2</sup>  
 $b_0 = 2.75" = .229 \text{ FT}$   
 $l_0 = .438" = .036 \text{ FT}$  REF. 38 p. 35 + (W6 x 25)  
 $b_1 = 2.75" = .229 \text{ FT}$   
 $a_0 = 6'$   
 $b_{ch} = 3" = .17 \text{ FT}$

$\frac{l_0}{b_0} = \frac{.036}{.229} = .157$        $\frac{b_{ch}}{b_0} = \frac{.17}{.229} = .742$

USING GRAPH A AND THE .73 CURVE  $C_1 = 3.9$

$\frac{a_0}{b_0} = \frac{6'}{.229} = 26.2$

ASSUME GRAPH B FLATTENS OUT, SO THAT A .7 VALUE OF C<sub>1</sub> WILL BE USED.

$I_{ca} = 2 \left( 1 + \frac{l_0}{b_0} \right)$   
 $= .020 ( 1 + .157 )$   
 $= .023$

$K = C_1 C_2 + I_{ca}$   
 $= .7 ( 3.9 ) + .023 = 2.753$

$2.753 \left( \frac{1.02}{1.374} \right)^2 = 1.517$

$K'_{atmos} = \left( \frac{18.36}{ATMOSP} \right)^2 - \left( \frac{18.36}{1144.4} \right)^2 = -.0003$

$K'_{vac} = \left( \frac{18.36}{1144.4} \right)^2 - \left( \frac{18.36}{ATMOSPHERE} \right)^2 = .0003$

STONE & WEBSTER ENGINEERING CORPORATION  
 CALCULATION SHEET

Client **VERCO** Location **SURAY 1&2** Est. No. **12846.44**  
 Subject **VERCO** Date **By R. GALLAGHER**

JUNE #	FROM NODE	TO NODE	K <sub>C</sub>	K <sub>E</sub>	K <sub>G</sub>	K <sub>F</sub>	K'	K <sub>180°</sub>	K <sub>180°(2)</sub>	K <sub>T</sub>
1	1	2	.299	0	3	.01	.394	—	—	.983
1	2	1	0	.317	3	.01	-.394	—	—	-.227
2	1	3	.221	0	—	.01	.687	—	—	.918
2	3	1	0	.196	—	.01	-.687	—	—	-.481
3	2	4	0	.133	3	.01	-.294	—	—	.149
3	4	2	.183	0	3	.01	.294	—	—	.787
4	3	4	.272	.403	—	.01	-.075	—	—	.610
4	4	3	.317	.296	—	.01	.075	—	—	.698
5	3	5	.228	0	—	.01	-.704	—	—	.942
5	5	3	0	.208	—	.01	-.704	—	—	-.486
6	4	6	0	.092	3	.01	-.252	—	—	.150
6	6	4	.152	.070	3	.01	.252	—	—	.714
7	5	6	0	.486	—	.01	-.908	—	—	-.412
7	6	5	.348	0	—	.01	.908	—	—	1.266
8	2	3	0	0	—	.01	0	—	—	.01
8	3	2	0	0	—	.01	0	—	—	.01
9	4	5	0	0	—	.01	0	—	—	.01
9	5	4	0	0	—	.01	0	—	—	.01
10	6	7	.5	1.0	—	.01	-.0003	7.517	1.517	4.54
10	7	6	.5	1.0	—	.01	.0003	1.517	7.517	4.54

(CONT.)

STONE & WEBSTER ENGINEERING CORPORATION  
CALCULATION SHEET

Preliminary Item 20440

Client Valco

Location Survey 12Z

Est. No.

J.O. No. 1284644

Subject

Date

By R. Gallagher

Checked

By

Based on

Junc. #	From Node	To Node	K <sub>C</sub>	K <sub>E</sub>	K <sub>AG</sub>	K <sub>F</sub>	K'	K <sub>180</sub>	K <sub>21</sub>
11	6	7	.5	1.0	—	.01	-.0003	1.517	1.517
11	7	6	.5	1.0	—	.01	.0003	1.517	1.517
12	6	7	.5	1.0	—	.01	-.0003	1.517	1.517
12	7	6	.5	1.0	—	.01	.0003	1.517	1.517
									4.54
									4.54
									4.54
									4.54

- 1
- 2
- 3
- 4
- 5
- 6
- 7
- 8
- 9
- 10
- 11
- 12
- 13
- 14
- 15
- 16
- 17
- 18
- 19
- 20
- 21
- 22
- 23
- 24
- 25
- 26
- 27
- 28
- 29
- 30
- 31
- 32
- 33
- 34
- 35
- 36
- 37
- 38
- 39
- 40
- 41
- 42
- 43
- 44
- 45
- 46
- 47
- 48
- 49
- 50

STONE & WEBSTER ENGINEERING CORPORATION  
 CALCULATION SHEET

▲ 5010.65

CALCULATION IDENTIFICATION NUMBER				PAGE <u>32</u>
J.O. OR W.O. NO.	DIVISION & GROUP	CALCULATION NO.	OPTIONAL TASK CODE	
12846.44		PE-074-0	00004	

BLOWDOWN

SATURATED STEAM AT 1,085 psig AT 600°F  
 FROM REF. 32 BREAK IS A 6" RELIEF

VALVE LINE TO STEAM RELIEF HEADEN.  
 (PIPING XS FROM REF. 39)  
 AREA OF OPENING =  $\frac{1085 \text{ psig}}{14.7} = 1099.7 \text{ psia}$

6" PIPE = XS SCH 80 ID. = 1.810 FT<sup>2</sup>  
 (REF. 29)

FROM REF. 33 USING ...  
 1000 AND 1100 psia AND 1.0 QUALITY A  
 VALUE OF 2.35  $\left( \frac{10^3 \text{ lb}}{\text{SEC-FT}^2} \right)$  WAS DETERMINED.

$$\frac{2.35 \times 10^3 \text{ lb}}{\text{SEC-FT}^2} \times 1.81 \text{ FT}^2 = .425 \frac{10^3 \text{ lb}}{\text{SEC}} = 425 \frac{\text{lb}}{\text{SEC}}$$

FROM REF. 34 - SATURATED STEAM TABLE AN  
 ENTHALPY (hg) OF 1189.5 WAS USED.

$$425 \times 1189.5 = 505537.5 \text{ BTU/SEC.} \\ = 5.06 \times 10^5$$

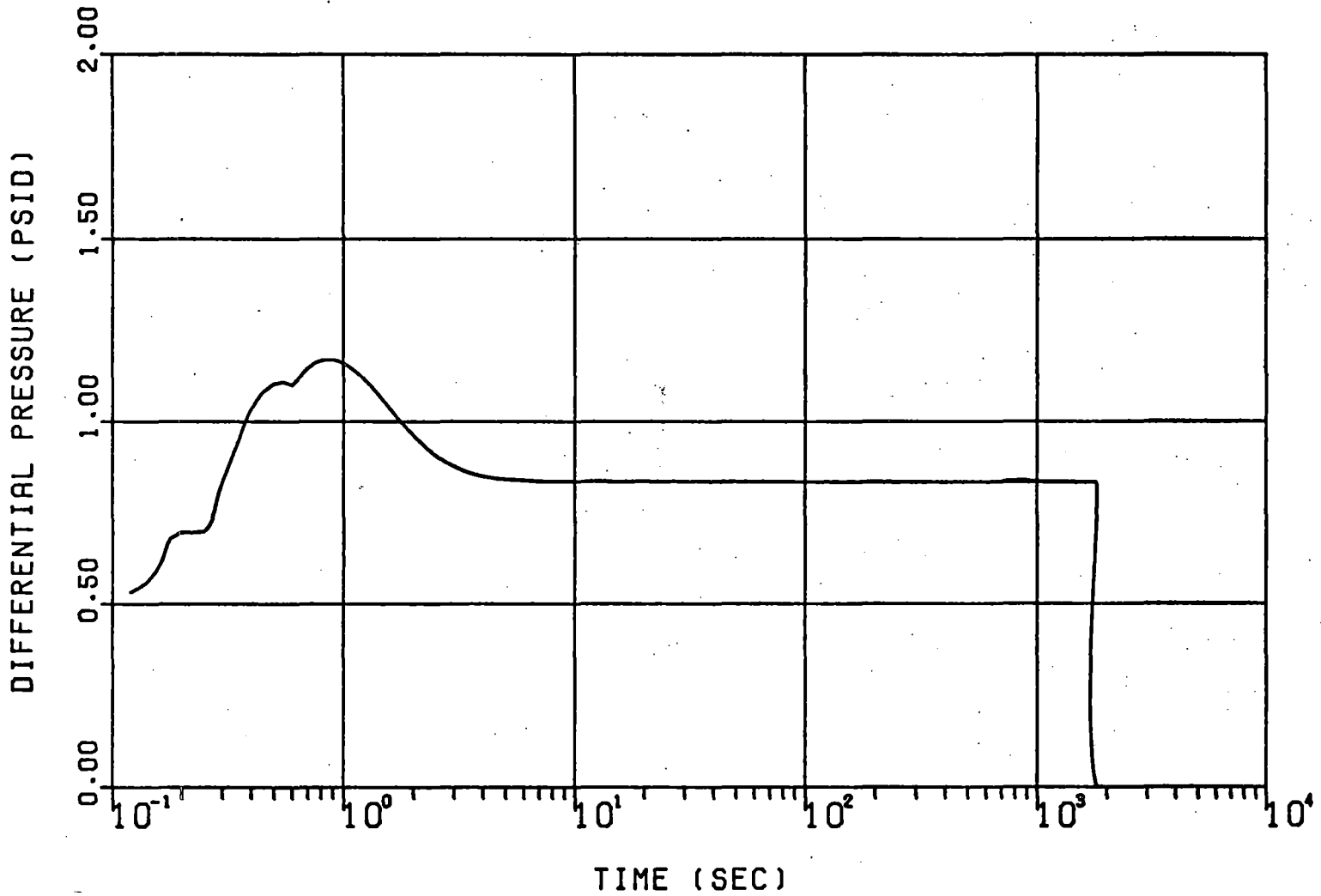

SURRY 1-2 7 NODE MSVH  
DIFFERENTIAL PRESSURE VERSUS TIME  
NN. 6TH. LINE RUPTURE IN NODE 06  
RUN = 3800004 NODES 6-7

PE-874-0

1-M-33

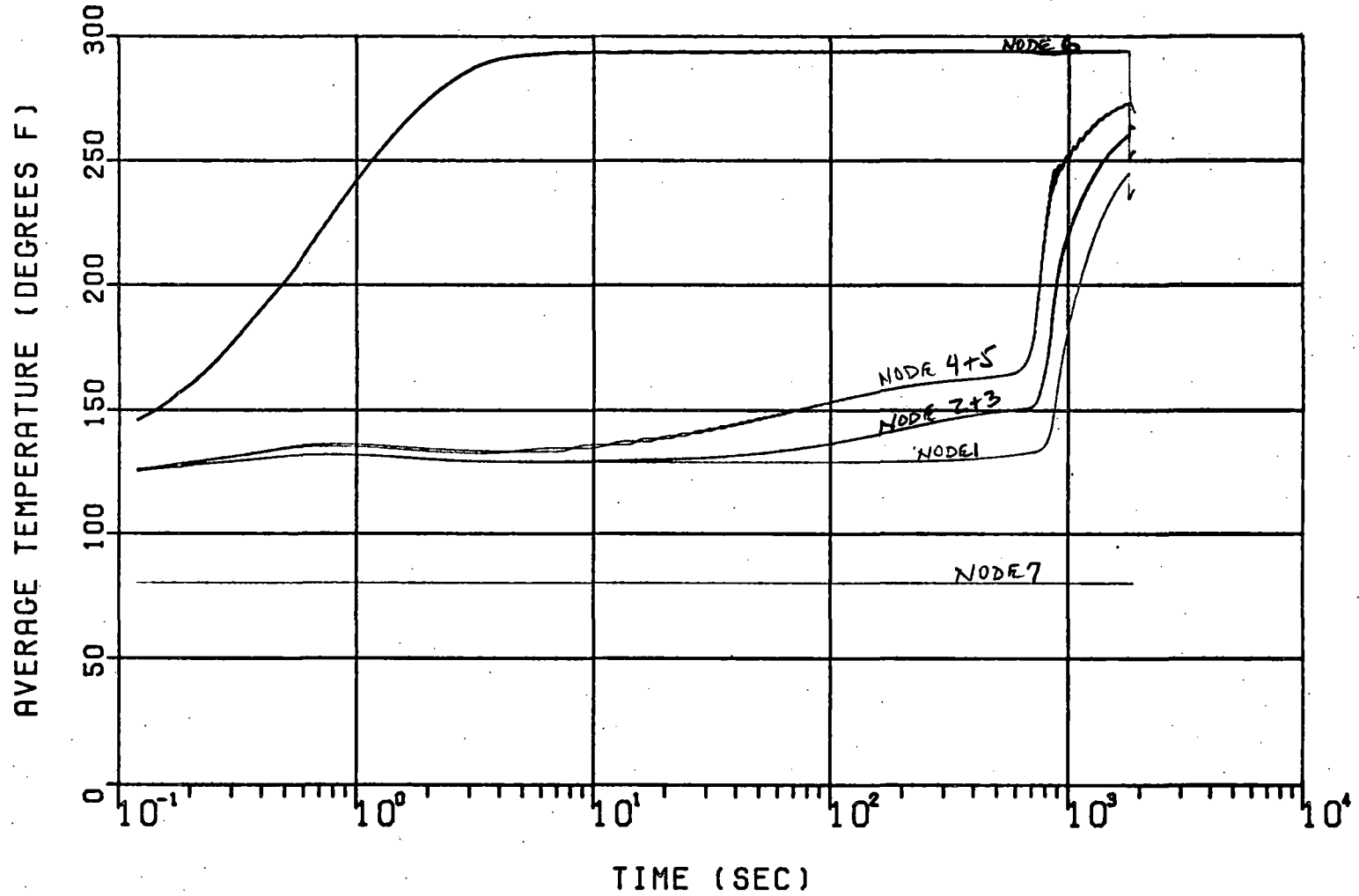

SURRY 1-2 7 NODE MSVH  
AVERAGE TEMPERATURE VERSUS TIME  
MH. 8TH. LINE RUPTURE IN NODE 6  
RUN # 3800004

PE-844-33

UNIT 55 (SEQ 1) INPUT ECHO 1 2 3 4 5 6 7 8  
1234567890123456789012345678901234567890123456789012345678901234567890

ATTACHMENT # 1  
10F4  
PS-244-0

```
1 SURRY 1-2 MSVH HIGH ENERGY LINE BREAK CASE 4 1
2 * 2
3 * 3
4 *PROBLEM DIMENSION DATA CARDS 4
5 * 5
6 * 6
7 1 4 2 7 13 1 0 0 0 0 7
8 * 8
9 * 9
10 *IMPLICIT/EXPLICIT COEFICIENT CARD 10
11 * 11
12 * 12
13 1.0 13
14 * 14
15 * 15
16 *TIME STEP CONTROL DATA CARDS 16
17 * 17
18 * 18
19 20 5 0 0 0.001 0.0001 .2 19
20 1 10 0 0 0.05 0.001 20.0 20
21 10 5 0 0 0.1 0.001 300.0 21
22 2 5 0 0 0.5 0.001 2000.0 22
23 * 23
24 * 24
25 *TRIP CONTROL DATA CARDS 25
26 * 26
27 * 27
28 1 0 0 1900.0 0.00 28
29 1 0 0 0.0 0.0 29
30 * 30
31 * 31
32 *NODAL DATA CARDS 32
33 * 33
34 * 34
35 14.7 120. 1.0 10603.00 0.0 10.5 0.0 0 35
36 14.7 120. 1.0 3978.30 10.5 8.75 0.0 0 36
37 14.7 120. 1.0 4563.11 10.5 8.75 0.0 0 37
38 14.7 120. 1.0 7353.55 19.25 10.25 0.0 0 38
39 14.7 120. 1.0 3155.42 19.25 10.25 0.0 0 39
40 14.7 120. 1.0 10597.05 29.50 10.42 0.0 0 40
41 14.7 80. 0.01 1.0E20 0.0 39.92 0.0 0 41
42 * 42
43 * 43
44 *JUNCTION DATA CARDS 44
45 * 45
46 * 46
47 1 2 0 0 354.38 .014 0.983 0.227 2 1.0 0 0.0 10.50 1.0 47
48 1 3 0 0 638.20 .012 0.918 -0.481 2 1.0 0 0.0 10.50 1.0 48
49 2 4 0 0 354.38 .015 0.149 0.787 2 1.0 0 0.0 19.25 1.0 49
50 3 4 0 0 203.84 .013 0.610 0.698 2 1.0 0 0.0 19.25 1.0 50
```

1234567890123456789012345678901234567890123456789012345678901234567890

SE-W-1

R3800004 SURRY 1-2 MSVH HIGH ENERGY LINE BREAK CASE 4  
S & W ENGR CORP NU-92 << SUBCOMPARTMENT ANALYSIS PROGRAM >>

THREED 17 NOV 1980 17:04:49 PAGE 2  
THREED.VER12.LEV01 CREATED 80.106 11:35:02 UNIT 10

UNIT 55 (SEQ 1) INPUT ECHO  
1 2 3 4 5 6 7 8  
1234567890123456789012345678901234567890123456789012345678901234567890

51	3	5	0	0	347.00	.022	0.942	-0.486	2	1.0	0	0.0	19.25	1.0	51
52	4	6	0	0	558.20	.012	0.150	0.714	2	1.0	0	0.0	29.50	1.0	52
53	5	6	0	0	347.00	.021	-0.412	1.266	2	1.0	0	0.0	29.50	1.0	53
54	2	3	0	0	387.63	.033	0.01	0.01	2	1.0	0	0.0	10.50	1.0	54
55	4	5	0	0	454.08	.028	0.01	0.01	2	1.0	0	0.0	19.25	1.0	55
56	6	7	0	0	18.36	.114	4.54	4.54	2	1.0	0	0.0	39.92	1.0	56
57	6	7	0	0	18.36	.114	4.54	4.54	2	1.0	0	0.0	39.92	1.0	57
58	6	7	0	0	18.36	.114	4.54	4.54	2	1.0	0	0.0	39.92	1.0	58
59	0	6	1	0	1.0	0.0	0.0	0.0	0	1.0	0	0.0	32.50	1.0	59
60	*														60
61	*														61
62	*FILL	TABLE	DATA	CARDS											62
63	*														63
64	*														64
65	4	2													65
66	0.0	425.0	505537.5												66
67	1800.0	425.0	505537.5												67
68	1800.001	0.0	0.0												68
69	2000.0	0.0	0.0												69

1234567890123456789012345678901234567890123456789012345678901234567890 <EOF> COPIED TO UNIT 5  
H/O CHTS

ATTACHMENT #1  
2 OF 4  
PC-044-0



R U N S U M M A R Y S H E E T

MISCELLANEOUS PROBLEM CONTROL DATA:

OUTPUT FLAG..... 1 TOTAL TIME OF RUN.....1900.500 SEC  
NUMBER OF TIME STEP CARDS... 4 NUMBER OF STANDARD TIME STEPS..... 6597  
NUMBER OF TRIP CONTROLS..... 2 NUMBER OF ACTUAL TIME STEPS..... 6607  
NUMBER OF VOLUMES..... 7 NUMBER OF TIMES GAUSSIAN ELIMINATION USED.. 6607  
NUMBER OF JUNCTIONS..... 13 NUMBER OF TIMES GAUSS-SEIDEL USED..... 0  
NUMBER OF FILL TABLES..... 1 NUMBER OF TRANSIENTS STORED FOR PLOTENUP... 27  
NUMBER OF FAH TABLES..... 0 NUMBER OF SELECTED NODAL DIFF. PRESS..... 0  
NUMBER OF HT SOURCE CURVES.. 0 NUMBER OF HEAT SINKS..... 0  
IMPLICIT/EXPLICIT COEFF..... 1.000 NUMBER OF INTERNAL JUNCTIONS..... 12

STEAM TABLES USED (FT15) VOLUME SERIAL NO. = SHARED DATA SET NAME = HEATBAL.ME190.STH20G.OUTPUT1

OUTPUT: TRANSIENTS TAPE (FT08) = 016308 FILE NUMBER = 19 DATA SET NAME = FE.GUARDS.PLOTTER  
TRANSMITTAL FILE (FT09) WAS NOT USED

PEAK PRESSURE DIFFERENTIAL

JUNCTION NUMBER	CONNECTING VOLUMES	PRESSURE PSID	TIME SEC
1	1 TO 2	0.06	0.040
2	1 TO 3	0.08	0.039
3	2 TO 4	-0.07	0.016
4	3 TO 4	-0.05	0.015
5	3 TO 5	-0.07	0.016
6	4 TO 6	-0.12	0.009
7	5 TO 6	-0.11	0.400
8	2 TO 3	0.03	862.500
9	4 TO 5	-0.04	867.000
10	6 TO 7	1.17	0.850
11	6 TO 7	1.17	0.850
12	6 TO 7	1.17	0.850

95-11-26  
ATTACHMENT #1  
3074  
8-044-6

LS-W-1

R3800004 SURRY 1-2 MSVH HIGH ENERGY LINE BREAK CASE 4  
S & W ENGR CORP NU-92 << SUBCOMPARTMENT ANALYSIS PROGRAM >>

THREED 17 NOV 1980 17:04:49 PAGE 4  
THREED.VER12.LEV01 CREATED 80.106 11:35:02 UNIT 10

ATTACHMENT #1  
4 OF 4  
PE-044-0

PEAK PRESSURES AND TEMPERATURES

NODE NUMBER	PRESSURE (PSIA)	TIME (SEC)	TEMPERATURE (DEG F)	TIME (SEC)
1	15.83	0.800	244.91	1799.500
2	15.83	0.800	260.76	1798.500
3	15.83	0.800	260.73	1792.000
4	15.83	0.800	273.38	1799.500
5	15.83	0.800	273.13	1790.000
6	15.86	0.800	294.07	589.000
7	14.70	1900.500	80.00	1900.500

# INTEROFFICE CORRESPONDENCE

1 OF 1  
PE-844-0

TO: <i>W. K. Wall</i> WF Emerson	LOCATION 14	SUBJECT / REFERENCE / J.O. NO. 12846.44
FROM: RF Miller	LOCATION 9	79-01B - Main Steam Valve House Surrey 122

MESSAGE: We need to establish a criteria for pipe breaks in the MSVH. Appendix D states an extensive NDT program was to be initiated for Main Steam Line and Main Feedwater Line break points in the MSVH. ~~It is~~ This program would preclude large breaks, so only smaller steam line breaks would need to be considered.

However App. D included a pressure transient for a large MSLB in the MSVH, anyway (Fig. D.5-1).

We would like the following questions answered:

1. Has the Inspection Program (Sect. D.5.1.6 and D.5.2.5) been implemented?
2. The pressure plot in Fig D.5-1 is not correct, mainly because much of the vent area assumed in that analysis is not available. If the analysis of a large steam break in the MSVH were done today with the proper input, very high pressures would be calculated.

DATE	SIGNATURE	TELEPHONE
------	-----------	-----------

REPLY: Do we need to do anything about this?

3. Despite the statement that smaller steam line breaks need to be considered, and despite there being many smaller steam lines in the MSVH, none are listed in Table D.3-1, High Energy Lines "Sources". (except for the 3" lines which went to the CSP turbine drives and have been since blanked off.) What are the lines and break locations which must be considered?

Reply

- 1) Yes
- 2) based upon the answer to #1 ~~no~~ it is felt no new rows are necessary
- 3) Break points are points 220, 307 and 520 as shown on MSV-103A2.  
5/1/80

cc: C. Wilson  
P. Reilly

7/31/80 DATE

RF Miller SIGNATURE

6816 TELEPHONE

USER'S GUIDE TO E2D REFERENCES

Facility: VEPCO, SURRY  
 Units: 1 and 2  
 Dockets: 50-280 and 50-281

E2D REFERENCE NO. 13  
 E2D REFERENCE DESCRIPTION: 12846.54-RP-039-0  
 ENVIRONMENTAL ZONE (S): SB-9B, TB-9, TB-35

<u>PARAMETER</u>	<u>NORMAL ENVIRONMENT</u>	<u>PAGE</u>	<u>LOCA ENVIRONMENT</u>	<u>PAGE</u>	<u>MSLB ENVIRONMENT</u>	<u>PAGE</u>	<u>HLB ENVIRONMENT</u>	<u>PAGE</u>
RADIATION (rads)			<2500	17				

CALCULATION TITLE PAGE

\*SEE INSTRUCTIONS ON REVERSE SIDE

▲ 5010.64 (FRONT)

CLIENT & PROJECT VEPCO SCARRY 1 & 2				PAGE 1 OF 18	
CALCULATION TITLE (Indicative of the Objective): 6 Month LOCA Doses As A Function of Distance From the Containment Direct Shine				QA CATEGORY (✓) <input checked="" type="checkbox"/> I - NUCLEAR SAFETY RELATED <input type="checkbox"/> II <input type="checkbox"/> III <input type="checkbox"/> OTHER	
CALCULATION IDENTIFICATION NUMBER					
J. O. OR W. O. NO.	DIVISION & GROUP	CURRENT CALC. NO.	OPTIONAL TASK CODE	OPTIONAL WORK PACKAGE NO.	
12846.54	Power / RP	RP-039-0			
* APPROVALS - SIGNATURE & DATE			REV. NO. OR NEW CALC NO.	SUPERSEDES * CALC. NO. OR REV. NO.	CONFIRMATION * REQUIRED (✓)
PREPARER(S)/DATE(S)	REVIEWER(S)/DATE(S)	INDEPENDENT REVIEWER(S)/DATE(S)			YES NO
Shuwan Lin 9-17-80	<i>James Lin</i> 9/18/80	<i>James Lin</i> 9/18/80			Ref. (ADMIN) ✓ (Activity) (Radioisotope)
DISTRIBUTION *					
GROUP	NAME & LOCATION	COPY SENT (✓)	GROUP	NAME & LOCATION	COPY SENT (✓)
RECORDS MGT. FILES (OR FIRE FILE IF NONE) Project	M. OMEARA (14) J. Barnhart (14)	✓ ✓			

STONE & WEBSTER ENGINEERING CORPORATION  
CALCULATION SHEET

▲ 5010.65

CALCULATION IDENTIFICATION NUMBER				PAGE <u>2</u>
J.O. OR W.O. NO.	DIVISION & GROUP	CALCULATION NO.	OPTIONAL TASK CODE	
12846.54	power RP	RP-039-0		

1  
2  
3  
4  
5  
6  
7  
8  
9  
10  
11  
12  
13  
14  
15  
16  
17  
18  
19  
20  
21  
22  
23  
24  
25  
26  
27  
28  
29  
30  
31  
32  
33  
34  
35  
36  
37  
38  
39  
40  
41  
42  
43  
44  
45  
46

TABLE OF CONTENTS

	Page
Title Page	1
PROBLEM	3
METHOD & APPROACH	3
REFERENCES	5
CALCULATIONS	6
CONCLUSION	17

LIST OF TABLES & FIGURE

	Page
TABLE 1 LOCA Dose Rates ( $mrem/hr$ ) at Operating Floor Elevation	7
TABLE 2 LOCA Dose Rates ( $mrem/hr$ ) at Ground Level	8
TABLE 3 Integrated Doses at Operating Floor Elevation	10 ~ 14
TABLE 4 Integrated Doses at Ground Level	15 ~ 16
TABLE 5 6-Month Integrated Dose at Operating Floor Elevation	17
TABLE 6 6-Month Integrated Dose at Ground Level	17
FIGURE 1 6-Month Integrated Dose vs Distance Curve	18

STONE & WEBSTER ENGINEERING CORPORATION  
CALCULATION SHEET

▲ 5010.65

CALCULATION IDENTIFICATION NUMBER				PAGE <u>3</u>
J.O. OR W.O. NO. 12846.54	DIVISION & GROUP power RP	CALCULATION NO. RP-039-0	OPTIONAL TASK CODE	

PROBLEM :

To determine 6-month integrated doses as a function of distance from the reactor building containment following a LOCA. (Direct shine only).

METHOD & APPROACH : \*

- (1) • This calculation utilizes the result of Calc. # 12050-RP-098-0 "Dose rates from containment building (direct r) after a LOCA" performed for North Anna 1 & 2 plants.
- (1) • The North Anna calculation was based on the following data.
  - Source Term : @  $t \geq 0.0$     100 % Noble Gases
  - @  $t = 0.0$      50 % Halogens (TID 14844)
  - @  $t > 0.0$     25 % Halogens (Reg. Guide 1.4)

Sepecific Activities : From North Anna Calc. # 12050-RP-073-0

Containment Volume :  $5.21 \times 10^{10} \text{ cm}^3$

Power Level : 2900 MWt
- Due to the congruence between the North Anna and Surry plants, the North Anna dose rates are taken to apply to the Surry plants with the following adjustment factor.

	<u>Surry</u>	<u>NA (ref. 1)</u>
(2)	Power level : 2546 MWt	2900 MWt
	Containment volume: $1.80 \times 10^6 \text{ ft}^3$	$1.84 \times 10^6 \text{ ft}^3$ ( $5.21 \times 10^{10} \text{ cm}^3$ )
	$\text{Adjustment Factor} = \frac{2546}{2900} \times \frac{1.84 \times 10^6}{1.80 \times 10^6} = 0.90$	

\* Only atmosphere inside the containment is considered as the radioactive source. Dose rate from R.S. headers is small as can be seen from cal. # 12846-RP-027-0.

STONE & WEBSTER ENGINEERING CORPORATION  
CALCULATION SHEET

▲ 5010.65

CALCULATION IDENTIFICATION NUMBER				PAGE <u>4</u>
J.O. OR W.O. NO.	DIVISION & GROUP	CALCULATION NO.	OPTIONAL TASK CODE	
12846.54	power RP	RP-039-0		

1  
2 METHOD & APPROACH (contd)  
3

- 4 • In North Anna Ref. (1) calculation part (B), the dose rates  
5 were determined at two different elevations (operating floor  
6 and ground level) for various distances outside the  
7 containment structure.  
8  
9  
10  
11  
12  
13 • At the operating floor elevation, only those dose rates  
14 obtained with crane wall opening in Ref. (1) calculation  
15 were used and adjusted by a factor of 0.90 for Surry.  
16 The dose rates were taken from Ref. (1) calculation Tables  
17 2 thru 6 for dose points 10 ~ 20 corresponding to 0 ~ 100 meters;  
18 and from Table 7 for dose points 3 ~ 7 corresponding to  
19 132 ~ 589 meters from the containment wall.  
20  
21  
22  
23  
24  
25  
26  
27 • At the ground level, dose rates were taken from Ref. (1)  
28 Table 7, dose points 8 ~ 13 which correspond to 10 ~ 284 meters  
29 from the containment wall.  
30  
31  
32  
33  
34  
35  
36  
37  
38  
39  
40  
41  
42  
43  
44  
45  
46



STONE & WEBSTER ENGINEERING CORPORATION  
CALCULATION SHEET

▲ 5010.65

CALCULATION IDENTIFICATION NUMBER				PAGE <u>5</u>
J.O. OR W.O. NO.	DIVISION & GROUP	CALCULATION NO.	OPTIONAL TASK CODE	
12846.34	power RP	RP-039-D		

1  
2  
3 REFERENCES :  
4  
5

- 6 (1) North Anna 1 & 2 calculation # 12050-RP-098-0  
7  
8 " Dose Rates From Containment Building (direct & ) after a  
9  
10 LOCA (REG. GUIDE 1.4 sources) " dated 1-14-80  
11  
12  
13  
14 (2) Surry 1 & 2 calculation # 12846.38-RP-026  
15  
16 " NUREG-0578 Shielding Review - Aux Bldg Rad. Zone Maps  
17  
18 Following a LOCA "  
19  
20  
21 (3) North Anna 1 & 2 calculation # 13675-PR(b)-018-0  
22  
23 " 6 mo. Integrated LOCA Dose & Dose Rates After LOCA  
24  
25 Due to Containment Shine via Electrical Penetration Area "  
26  
27 dated 8-29-80  
28  
29  
30  
31  
32  
33  
34  
35  
36  
37  
38  
39  
40  
41  
42  
43  
44  
45  
46

STONE & WEBSTER ENGINEERING CORPORATION  
CALCULATION SHEET

▲ 5010.65

CALCULATION IDENTIFICATION NUMBER				PAGE <u>6</u>
J.O. OR W.O. NO. 12846.54	DIVISION & GROUP Power RP	CALCULATION NO. RP-039-0	OPTIONAL TASK CODE	

CALCULATIONS :

The dose rates taken from the North Anna calculation are multiplied by 0.90 adjustment factor and are tabulated in Tables 1 and 2 for elevations at the operating floor and ground level respectively.

It should be noticed that, at the operating floor level, the dose rates were not available from the North Anna calculation for 0 to 100 meters at  $t = 2$  hr after LOCA. These dose rates were calculated from dose rates at  $t = 1$  hr by multiplying the ratio of total source strength (i.e. specific activities). The ratio is determined as follows :

	Specific Activity (MeV/cc-sec)							Total Sp. Act.
	.4 MeV	.8 MeV	1.3 MeV	1.7 MeV	2.2 MeV	2.5 MeV	3.5 MeV	
Ref. (3) $t = 1$ hr	2.52+7	9.36+7	3.79+7	3.32+7	4.11+7	6.37+7	7.07+5	2.95+8
$t = 2$ hr	2.42+7	6.45+7	2.92+7	2.58+7	2.75+7	4.45+7	1.91+5	2.16+8

$$\text{Ratio} = \frac{2.16 \times 10^8}{2.95 \times 10^8} = 0.73$$

IT IS USED IN THE NEXT PAGE

TABLE 1

1-N-7

Distance from Containment (meters)	LOCA Dose Rates (mrem/hr) at Operating Floor Elevation											J.O. OR W.O. NO. 12846.54	DIVISION & GROUP Power RP	CALCULATION IDENTIFICATION NUMBER RP-039-0	OPTIONAL TASK CODE	PAGE 7
	0 hr	1 hr	2 hr	8 hr	24 hr	96 hr	192 hr	360 hr	720 hr	2160 hr	4320 hr					
0 (contact)	7.50+3	7.80+2	5.70+2	1.01+2	4.57+0	1.29-1	4.75-2	1.12-2	2.21-8	1.27-12	Not Significant					
10	2.39+3	2.50+2	1.83+2	3.27+1	1.50+0	4.24-2	1.57-2	3.70-3	6.74-7	6.32-10						
20	5.99+3	7.78+2	5.69+2	1.08+2	6.32+0	2.17-1	8.07-2	2.31-2	2.99-3	1.42-5						
30	1.69+4	2.53+3	1.85+3	3.68+2	2.58+1	1.07+0	4.11-1	1.36-1	2.33-2	1.18-4						
40	2.27+4	3.50+3	2.56+3	5.19+2	3.86+1	1.74+0	6.71-1	2.31-1	4.19-2	2.14-4						
50	2.14+4	3.35+3	2.45+3	5.00+2	3.81+1	1.76+0	6.85-1	2.39-1	4.45-2	2.28-4						
60	1.82+4	2.85+3	2.08+3	4.26+2	3.26+1	1.52+0	5.93-1	2.09-1	3.88-2	1.99-4						
70	1.54+4	2.40+3	1.75+3	3.59+2	2.75+1	1.29+0	5.03-1	1.76-1	3.30-2	1.69-4						
80	1.30+4	2.03+3	1.48+3	3.03+2	2.32+1	1.08+0	4.24-1	1.49-1	2.78-2	1.43-4						
90	1.10+4	1.71+3	1.25+3	2.55+2	1.95+1	9.09-1	3.56-1	1.25-1	2.32-2	1.19-4						
100	9.36+3	1.47+3	1.07+3	2.19+2	1.67+1	7.75-1	3.02-1	1.06-1	1.97-2	1.01-4						
132	5.64+3	8.72+2	6.06+2	1.29+2	9.72+0	4.46-1	1.73-1	6.00-2	1.10-2	5.64-5						
193	2.50+3	3.77+2	2.62+2	5.53+1	4.05+0	1.76-1	6.80-2	2.30-2	4.09-3	2.08-5						
284	8.90+2	1.29+2	8.87+1	1.85+1	1.28+0	5.19-2	1.91-2	6.37-3	1.06-3	5.31-6						
406	3.04+2	4.12+1	2.84+1	5.83+0	3.75-1	1.41-2	5.29-3	1.60-3	2.39-4	1.17-6						
589	7.51+1	9.18+0	6.31+0	1.27+0	7.40-2	2.54-3	9.45-2	2.62-4	3.22-5	1.46-7						

AS01055

TABLE 2

LOCA Dose Rates (mrem/hr) at Ground Level

Distance from Containment (meters)	LOCA Dose Rates (mrem/hr) at Ground Level										
	0 hr	1 hr	2 hr	8 hr	24 hr	96 hr	192 hr	360 hr	720 hr	2160 hr	4320 hr
10	1.91+0	7.55-2	4.94-2	8.31-3	2.37-4	5.12-6	2.03-6	4.50-7	1.82-8	8.02-13	3.32-16
25	3.06+3	4.13+2	2.84+2	5.72+1	3.46+0	1.20-1	4.46-2	1.29-2	1.74-3	8.19-6	3.89-9
40	1.17+4	1.77+3	1.22+3	2.57+2	1.85+1	7.79-1	2.98-1	9.90-2	1.72-2	8.73-5	4.41-8
71	1.21+4	1.87+3	1.31+3	2.77+2	2.11+1	9.72-1	3.74-1	1.31-1	2.39-2	1.22-4	6.36-8
132	5.04+3	7.76+2	5.39+2	1.14+2	8.60+0	3.89-1	1.50-1	5.19-2	9.45-3	4.84-5	2.50-8
284	8.59+2	1.24+2	8.56+1	1.78+1	1.23+0	5.00-2	1.90-2	6.11-3	1.02-3	5.09-6	2.52-9

AS01085

CALCULATION IDENTIFICATION NUMBER

J.O. OR W.O. NO.  
12846.54

DIVISION & GROUP  
Power RP

CALCULATION NO.  
RP-039-0

OPTIONAL TASK CODE

PAGE 8

STONE & WEBSTER ENGINEERING CORPORATION  
CALCULATION SHEET

▲ 5010.65

CALCULATION IDENTIFICATION NUMBER				PAGE <u>9</u>
J.O. OR W.O. NO. 12846.54	DIVISION & GROUP Power RP	CALCULATION NO. RP-039-0	OPTIONAL TASK CODE	

1  
2 CALCULATIONS: (cont'd)

3  
4  
5 The 6-month integrated doses are calculated by using  
6 exponential interpolation as follows:  
7

8  
9 
$$D(t) = \alpha e^{-\beta t} \quad \text{where}$$

10  
11  
12 
$$\alpha = D(t_1) e^{\beta t_1}, \quad \beta = \frac{\ln \frac{D(t_1)}{D(t_2)}}{t_2 - t_1} \quad D(t) = \text{dose rate at time 't'}$$

13  
14  
15 
$$\Delta D = \int_{t_1}^{t_2} D(t) dt = \frac{\alpha}{\beta} [e^{-\beta t_1} - e^{-\beta t_2}]$$

16  
17  
18 (dose integration  
19 between  $t_1$  and  $t_2$ ) 
$$= \frac{D(t_1) e^{\beta t_1}}{\beta} [e^{-\beta t_1} - e^{-\beta t_2}]$$

20  
21  
22 
$$= \frac{D(t_1)}{\beta} [1 - e^{-\beta(t_2 - t_1)}]$$

23  
24  
25 
$$= \frac{D(t_1)}{\beta} \left[ 1 - \frac{D(t_2)}{D(t_1)} \right]$$

26  
27 Therefore,

28  
29 Integrated Dose =  $\sum_{i=1}^n \Delta D_i$  where  $n = \text{no. of time intervals}$

30  
31  
32  
33 The integrated doses are tabulated in Tables 3 and 4 for  
34 operating floor and ground level elevations respectively.  
35  
36  
37  
38  
39  
40  
41  
42  
43  
44  
45  
46

STONE & WEBSTER ENGINEERING CORPORATION  
CALCULATION SHEET

▲ 5010.65

CALCULATION IDENTIFICATION NUMBER				PAGE <u>10</u>
J.O. OR W.O. NO. <u>12846.54</u>	DIVISION & GROUP <u>POWER RP</u>	CALCULATION NO. <u>RP-039-0</u>	OPTIONAL TASK CODE	

*Table 3 Integrated Doses @ Operating Floor Elevation*

**0 METERS**

TIME (HOUR)	DOSE RATE (MR/HR)	EXPONENTIAL FIT		DELTA D (RADS)	INTEGRATED DOSE (RADS)
		ALPHA	BETA		
0.0	7.50E+03	0.0	0.0	0.0	0.0
1.0	7.80E+02	7.50E+03	2.26E+00	2.97E+00	2.97E+00
2.0	5.70E+02	1.07E+03	3.14E-01	6.70E-01	3.64E+00
8.0	1.01E+02	1.01E+03	2.88E-01	1.63E+00	5.26E+00
24.0	4.57E+00	4.75E+02	1.93E-01	4.98E-01	5.76E+00
96.0	1.29E-01	1.50E+01	4.95E-02	8.96E-02	5.85E+00
192.0	4.75E-02	3.50E-01	1.04E-02	7.83E-03	5.86E+00
360.0	1.12E-02	2.48E-01	8.60E-03	4.22E-03	5.86E+00
720.0	2.21E-08	5.68E+03	3.65E-02	3.07E-04	5.87E+00
2160.0	1.27E-12	2.92E-06	6.78E-03	3.26E-09	5.87E+00

\*

**10 METERS**

TIME (HOUR)	DOSE RATE (MR/HR)	EXPONENTIAL FIT		DELTA D (RADS)	INTEGRATED DOSE (RADS)
		ALPHA	BETA		
0.0	2.39E+03	0.0	0.0	0.0	0.0
1.0	2.50E+02	2.39E+03	2.26E+00	9.48E-01	9.48E-01
2.0	1.83E+02	3.42E+02	3.12E-01	2.15E-01	1.16E+00
8.0	3.27E+01	3.25E+02	2.87E-01	5.24E-01	1.69E+00
24.0	1.50E+00	1.53E+02	1.93E-01	1.62E-01	1.85E+00
96.0	4.24E-02	4.92E+00	4.95E-02	2.94E-02	1.88E+00
192.0	1.57E-02	1.15E-01	1.03E-02	2.58E-03	1.88E+00
360.0	3.70E-03	8.19E-02	8.60E-03	1.39E-03	1.88E+00
720.0	6.74E-07	2.03E+01	2.39E-02	1.55E-04	1.88E+00
2160.0	6.32E-10	2.20E-05	4.84E-03	1.39E-07	1.88E+00

**20 METERS**

TIME (HOUR)	DOSE RATE (MR/HR)	EXPONENTIAL FIT		DELTA D (RADS)	INTEGRATED DOSE (RADS)
		ALPHA	BETA		
0.0	5.99E+03	0.0	0.0	0.0	0.0
1.0	7.78E+02	5.99E+03	2.04E+00	2.55E+00	2.55E+00
2.0	5.69E+02	1.06E+03	3.13E-01	6.68E-01	3.22E+00
8.0	1.08E+02	9.90E+02	2.77E-01	1.66E+00	4.89E+00
24.0	6.32E+00	4.46E+02	1.77E-01	5.73E-01	5.46E+00
96.0	2.17E-01	1.94E+01	4.68E-02	1.30E-01	5.59E+00
192.0	8.07E-02	5.84E-01	1.03E-02	1.32E-02	5.60E+00
360.0	2.31E-02	3.37E-01	7.45E-03	7.74E-03	5.61E+00
720.0	2.99E-03	1.78E-01	5.68E-03	3.54E-03	5.61E+00
2160.0	1.42E-05	4.34E-02	3.72E-03	8.01E-04	5.61E+00

\* Dose rates at  $t = 4320$  hr are comparatively small, therefore, do not contribute significantly to the integrated dose.

STONE & WEBSTER ENGINEERING CORPORATION  
 CALCULATION SHEET

▲ 5010.65

CALCULATION IDENTIFICATION NUMBER				PAGE <u>11</u>
J.O. OR W.O. NO. 12846.54	DIVISION & GROUP POWER RP	CALCULATION NO. RP-039-0	OPTIONAL TASK CODE	

Table 3 cont'd

30 METERS

TIME (HOUR)	DOSE RATE (MR/HR)	EXPONENTIAL ALPHA	FIT BETA	DELTA D (RADS)	INTEGRATED DOSE (RADS)
0.0	1.69E+04	0.0	0.0	0.0	0.0
1.0	2.53E+03	1.69E+04	1.90E+00	7.57E+00	7.57E+00
2.0	1.85E+03	3.46E+03	3.13E-01	2.17E+00	9.74E+00
8.0	3.68E+02	3.17E+03	2.69E-01	5.51E+00	1.52E+01
24.0	2.58E+01	1.39E+03	1.66E-01	2.06E+00	1.73E+01
96.0	1.07E+00	7.45E+01	4.42E-02	5.59E-01	1.79E+01
192.0	4.11E-01	2.79E+00	9.97E-03	6.61E-02	1.79E+01
360.0	1.36E-01	1.45E+00	6.58E-03	4.18E-02	1.80E+01
720.0	2.33E-02	7.94E-01	4.90E-03	2.30E-02	1.80E+01
2160.0	1.18E-04	3.27E-01	3.67E-03	6.32E-03	1.80E+01

40 METERS

TIME (HOUR)	DOSE RATE (MR/HR)	EXPONENTIAL ALPHA	FIT BETA	DELTA D (RADS)	INTEGRATED DOSE (RADS)
0.0	2.27E+04	0.0	0.0	0.0	0.0
1.0	3.50E+03	2.27E+04	1.87E+00	1.03E+01	1.03E+01
2.0	2.56E+03	4.79E+03	3.13E-01	3.01E+00	1.33E+01
8.0	5.19E+02	4.36E+03	2.66E-01	7.67E+00	2.09E+01
24.0	3.86E+01	1.90E+03	1.62E-01	2.96E+00	2.39E+01
96.0	1.74E+00	1.08E+02	4.30E-02	8.56E-01	2.48E+01
192.0	6.71E-01	4.51E+00	9.93E-03	1.08E-01	2.49E+01
360.0	2.31E-01	2.27E+00	6.35E-03	6.93E-02	2.49E+01
720.0	4.19E-02	1.27E+00	4.74E-03	3.99E-02	2.50E+01
2160.0	2.14E-04	5.86E-01	3.66E-03	1.14E-02	2.50E+01

50 METERS

TIME (HOUR)	DOSE RATE (MR/HR)	EXPONENTIAL ALPHA	FIT BETA	DELTA D (RADS)	INTEGRATED DOSE (RADS)
0.0	2.14E+04	0.0	0.0	0.0	0.0
1.0	3.35E+03	2.14E+04	1.85E+00	9.73E+00	9.73E+00
2.0	2.45E+03	4.58E+03	3.13E-01	2.88E+00	1.26E+01
8.0	5.00E+02	4.16E+03	2.65E-01	7.36E+00	2.00E+01
24.0	3.81E+01	1.81E+03	1.61E-01	2.87E+00	2.28E+01
96.0	1.76E+00	1.06E+02	4.27E-02	8.51E-01	2.37E+01
192.0	6.85E-01	4.52E+00	9.83E-03	1.09E-01	2.38E+01
360.0	2.39E-01	2.28E+00	6.27E-03	7.12E-02	2.39E+01
720.0	4.45E-02	1.28E+00	4.67E-03	4.17E-02	2.39E+01
2160.0	2.28E-04	6.22E-01	3.66E-03	1.21E-02	2.39E+01

STONE & WEBSTER ENGINEERING CORPORATION  
CALCULATION SHEET

▲ 5010.65

CALCULATION IDENTIFICATION NUMBER				PAGE <u>12</u>
J.O. OR W.O. NO. <u>12846.54</u>	DIVISION & GROUP <u>POWER RP</u>	CALCULATION NO. <u>RP-039-0</u>	OPTIONAL TASK CODE	

Table 3. Cont'd

60 METERS

TIME (HOUR)	DOSE RATE (MR/HR)	EXPONENTIAL ALPHA	FIT BETA	DELTA D (RADS)	INTEGRATED DOSE (RADS)
0.0	1.82E+04	0.0	0.0	0.0	0.0
1.0	2.85E+03	1.82E+04	1.85E+00	8.28E+00	8.28E+00
2.0	2.08E+03	3.91E+03	3.15E-01	2.44E+00	1.07E+01
8.0	4.26E+02	3.53E+03	2.64E-01	6.26E+00	1.70E+01
24.0	3.26E+01	1.54E+03	1.61E-01	2.45E+00	1.94E+01
96.0	1.52E+00	9.06E+01	4.26E-02	7.30E-01	2.02E+01
192.0	5.93E-01	3.90E+00	9.80E-03	9.45E-02	2.03E+01
360.0	2.09E-01	1.95E+00	6.21E-03	6.19E-02	2.03E+01
720.0	3.88E-02	1.13E+00	4.68E-03	3.64E-02	2.04E+01
2160.0	1.99E-04	5.42E-01	3.66E-03	1.05E-02	2.04E+01

70 METERS

TIME (HOUR)	DOSE RATE (MR/HR)	EXPONENTIAL ALPHA	FIT BETA	DELTA D (RADS)	INTEGRATED DOSE (RADS)
0.0	1.54E+04	0.0	0.0	0.0	0.0
1.0	2.40E+03	1.54E+04	1.86E+00	6.99E+00	6.99E+00
2.0	1.75E+03	3.29E+03	3.16E-01	2.06E+00	9.05E+00
8.0	3.59E+02	2.97E+03	2.64E-01	5.27E+00	1.43E+01
24.0	2.75E+01	1.30E+03	1.61E-01	2.06E+00	1.64E+01
96.0	1.29E+00	7.63E+01	4.25E-02	6.17E-01	1.70E+01
192.0	5.03E-01	3.31E+00	9.81E-03	8.02E-02	1.71E+01
360.0	1.76E-01	1.67E+00	6.25E-03	5.23E-02	1.71E+01
720.0	3.30E-02	9.39E-01	4.65E-03	3.08E-02	1.72E+01
2160.0	1.69E-04	4.61E-01	3.66E-03	8.96E-03	1.72E+01

80 METERS

TIME (HOUR)	DOSE RATE (MR/HR)	EXPONENTIAL ALPHA	FIT BETA	DELTA D (RADS)	INTEGRATED DOSE (RADS)
0.0	1.30E+04	0.0	0.0	0.0	0.0
1.0	2.03E+03	1.30E+04	1.86E+00	5.91E+00	5.91E+00
2.0	1.48E+03	2.78E+03	3.16E-01	1.74E+00	7.65E+00
8.0	3.03E+02	2.51E+03	2.64E-01	4.45E+00	1.21E+01
24.0	2.32E+01	1.10E+03	1.61E-01	1.74E+00	1.38E+01
96.0	1.08E+00	6.45E+01	4.26E-02	5.19E-01	1.44E+01
192.0	4.24E-01	2.75E+00	9.74E-03	6.74E-02	1.44E+01
360.0	1.49E-01	1.40E+00	6.22E-03	4.42E-02	1.45E+01
720.0	2.78E-02	7.99E-01	4.66E-03	2.60E-02	1.45E+01
2160.0	1.43E-04	3.88E-01	3.66E-03	7.56E-03	1.45E+01



STONE & WEBSTER ENGINEERING CORPORATION  
CALCULATION SHEET

▲ 5010.65

CALCULATION IDENTIFICATION NUMBER				PAGE <u>13</u>
J.O. OR W.O. NO. <u>12846.54</u>	DIVISION & GROUP <u>power RP</u>	CALCULATION NO. <u>RP-039-0</u>	OPTIONAL TASK CODE	

Table 3 cont'd

90 METERS

TIME (HOUR)	DOSE RATE (MR/HR)	EXPONENTIAL ALPHA	FIT BETA	DELTA D (RADS)	INTEGRATED DOSE (RADS)
0.0	1.10E+04	0.0	0.0	0.0	0.0
1.0	1.71E+03	1.10E+04	1.86E+00	4.99E+00	4.99E+00
2.0	1.25E+03	2.34E+03	3.13E-01	1.47E+00	6.46E+00
8.0	2.55E+02	2.12E+03	2.65E-01	3.76E+00	1.02E+01
24.0	1.95E+01	9.22E+02	1.61E-01	1.47E+00	1.17E+01
96.0	9.09E-01	5.42E+01	4.26E-02	4.37E-01	1.21E+01
192.0	3.56E-01	2.32E+00	9.76E-03	5.66E-02	1.22E+01
360.0	1.25E-01	1.18E+00	6.23E-03	3.71E-02	1.22E+01
720.0	2.32E-02	6.73E-01	4.68E-03	2.18E-02	1.22E+01
2160.0	1.19E-04	3.24E-01	3.66E-03	6.30E-03	1.22E+01

100 METERS

TIME (HOUR)	DOSE RATE (MR/HR)	EXPONENTIAL ALPHA	FIT BETA	DELTA D (RADS)	INTEGRATED DOSE (RADS)
0.0	9.36E+03	0.0	0.0	0.0	0.0
1.0	1.47E+03	9.36E+03	1.85E+00	4.26E+00	4.26E+00
2.0	1.07E+03	2.02E+03	3.18E-01	1.26E+00	5.52E+00
8.0	2.19E+02	1.82E+03	2.64E-01	3.22E+00	8.74E+00
24.0	1.67E+01	7.93E+02	1.61E-01	1.26E+00	1.00E+01
96.0	7.75E-01	4.65E+01	4.26E-02	3.73E-01	1.04E+01
192.0	3.02E-01	1.99E+00	9.82E-03	4.82E-02	1.04E+01
360.0	1.06E-01	9.99E-01	6.23E-03	3.15E-02	1.05E+01
720.0	1.97E-02	5.70E-01	4.67E-03	1.85E-02	1.05E+01
2160.0	1.01E-04	2.75E-01	3.66E-03	5.35E-03	1.05E+01

132 METERS

TIME (HOUR)	DOSE RATE (MR/HR)	EXPONENTIAL ALPHA	FIT BETA	DELTA D (RADS)	INTEGRATED DOSE (RADS)
0.0	5.64E+03	0.0	0.0	0.0	0.0
1.0	8.72E+02	5.64E+03	1.87E+00	2.55E+00	2.55E+00
2.0	6.06E+02	1.25E+03	3.64E-01	7.31E-01	3.28E+00
8.0	1.29E+02	1.01E+03	2.58E-01	1.85E+00	5.13E+00
24.0	9.72E+00	4.70E+02	1.62E-01	7.38E-01	5.87E+00
96.0	4.46E-01	2.72E+01	4.28E-02	2.17E-01	6.09E+00
192.0	1.73E-01	1.15E+00	9.86E-03	2.77E-02	6.12E+00
360.0	6.00E-02	5.80E-01	6.30E-03	1.79E-02	6.14E+00
720.0	1.10E-02	3.27E-01	4.71E-03	1.04E-02	6.15E+00
2160.0	5.64E-05	1.54E-01	3.66E-03	2.99E-03	6.15E+00

Table 3 cont'd

▲ 5010.

193 METERS

	TIME (HOUR)	DOSE RATE (MR/HR)	EXPONENTIAL ALPHA	FIT BETA	DELTA D (RADS)	INTEGRATED DOSE (RADS)
1	0.0	2.50E+03	0.0	0.0	0.0	0.0
2	1.0	3.77E+02	2.50E+03	1.89E+00	1.12E+00	1.12E+00
3	2.0	2.62E+02	5.42E+02	3.64E-01	3.16E-01	1.44E+00
4	8.0	5.53E+01	4.40E+02	2.59E-01	7.97E-01	2.24E+00
5	24.0	4.05E+00	2.04E+02	1.63E-01	3.14E-01	2.55E+00
6	96.0	1.76E-01	1.15E+01	4.36E-02	8.89E-02	2.64E+00
7	192.0	6.80E-02	4.56E-01	9.91E-03	1.09E-02	2.65E+00
8	360.0	2.30E-02	2.35E-01	6.45E-03	6.97E-03	2.66E+00
9	720.0	4.09E-03	1.29E-01	4.80E-03	3.94E-03	2.66E+00
10	2160.0	2.08E-05	5.74E-02	3.67E-03	1.11E-03	2.66E+00

284 METERS

	TIME (HOUR)	DOSE RATE (MR/HR)	EXPONENTIAL ALPHA	FIT BETA	DELTA D (RADS)	INTEGRATED DOSE (RADS)
11	0.0	8.90E+02	0.0	0.0	0.0	0.0
12	1.0	1.29E+02	8.90E+02	1.93E+00	3.94E-01	3.94E-01
13	2.0	8.87E+01	1.88E+02	3.75E-01	1.08E-01	5.02E-01
14	8.0	1.85E+01	1.50E+02	2.61E-01	2.69E-01	7.70E-01
15	24.0	1.28E+00	7.03E+01	1.67E-01	1.03E-01	8.73E-01
16	96.0	5.19E-02	3.73E+00	4.45E-02	2.76E-02	9.01E-01
17	192.0	1.91E-02	1.41E-01	1.04E-02	3.15E-03	9.04E-01
18	360.0	6.37E-03	6.70E-02	6.54E-03	1.95E-03	9.06E-01
19	720.0	1.06E-03	3.83E-02	4.98E-03	1.07E-03	9.07E-01
20	2160.0	5.31E-06	1.50E-02	3.68E-03	2.87E-04	9.08E-01

406 METERS

	TIME (HOUR)	DOSE RATE (MR/HR)	EXPONENTIAL ALPHA	FIT BETA	DELTA D (RADS)	INTEGRATED DOSE (RADS)
21	0.0	3.04E+02	0.0	0.0	0.0	0.0
22	1.0	4.12E+01	3.04E+02	2.00E+00	1.31E-01	1.31E-01
23	2.0	2.84E+01	5.98E+01	3.72E-01	3.44E-02	1.66E-01
24	8.0	5.83E+00	4.81E+01	2.64E-01	8.55E-02	2.51E-01
25	24.0	3.75E-01	2.30E+01	1.71E-01	3.18E-02	2.83E-01
26	96.0	1.41E-02	1.12E+00	4.56E-02	7.92E-03	2.91E-01
27	192.0	5.29E-03	3.76E-02	1.02E-02	8.63E-04	2.92E-01
28	360.0	1.60E-03	2.07E-02	7.12E-03	5.18E-04	2.93E-01
29	720.0	2.39E-04	1.07E-02	5.28E-03	2.58E-04	2.93E-01
30	2160.0	1.17E-06	3.42E-03	3.69E-03	6.44E-05	2.93E-01

589 METERS

	TIME (HOUR)	DOSE RATE (MR/HR)	EXPONENTIAL ALPHA	FIT BETA	DELTA D (RADS)	INTEGRATED DOSE (RADS)
31	0.0	7.51E+01	0.0	0.0	0.0	0.0
32	1.0	9.18E+00	7.51E+01	2.10E+00	3.14E-02	3.14E-02
33	2.0	6.31E+00	1.34E+01	3.75E-01	7.66E-03	3.90E-02
34	8.0	1.27E+00	1.08E+01	2.67E-01	1.89E-02	5.79E-02
35	24.0	7.40E-02	5.26E+00	1.78E-01	6.73E-03	6.46E-02
36	96.0	2.54E-03	2.28E-01	4.68E-02	1.53E-03	6.61E-02
37	192.0	9.45E-04	6.83E-02	-3.77E-02	2.44E-03	6.86E-02
38	360.0	2.62E-04	7.90E+01	3.50E-02	2.69E-03	7.13E-02
39	720.0	3.22E-05	2.13E-03	5.82E-03	3.95E-05	7.13E-02
40	2160.0	1.46E-07	4.78E-04	3.75E-03	8.55E-06	7.13E-02

STONE & WEBSTER ENGINEERING CORPORATION  
CALCULATION SHEET

▲ 5010.65

CALCULATION IDENTIFICATION NUMBER				PAGE <u>15</u>
J.O. OR W.O. NO. <u>12846.54</u>	DIVISION & GROUP <u>power RP</u>	CALCULATION NO. <u>RP-039-0</u>	OPTIONAL TASK CODE	

Table 4 Integrated Doses @ Ground Level

10 METERS

TIME (HOUR)	DOSE RATE (MR/HR)	EXPONENTIAL ALPHA	FIT BETA	DELTA D (RADS)	INTEGRATED DOSE (RADS)
0.0	1.91E+00	0.0	0.0	0.0	0.0
1.0	7.55E-02	1.91E+00	3.23E+00	5.68E-04	5.68E-04
2.0	4.94E-02	1.15E-01	4.24E-01	6.15E-05	6.29E-04
8.0	8.31E-03	8.95E-02	2.97E-01	1.38E-04	7.68E-04
24.0	2.37E-04	4.92E-02	2.22E-01	3.63E-05	8.04E-04
96.0	5.12E-06	8.51E-04	5.33E-02	4.35E-06	8.08E-04
192.0	2.03E-06	1.29E-05	9.64E-03	3.21E-07	8.09E-04
360.0	4.50E-07	1.14E-05	8.97E-03	1.76E-07	8.09E-04
720.0	1.82E-08	1.11E-05	8.91E-03	4.85E-08	8.09E-04
2160.0	8.02E-13	2.74E-06	6.97E-03	2.61E-09	8.09E-04
4320.0	3.32E-16	1.94E-09	3.61E-03	2.22E-13	8.09E-04

25 METERS

TIME (HOUR)	DOSE RATE (MR/HR)	EXPONENTIAL ALPHA	FIT BETA	DELTA D (RADS)	INTEGRATED DOSE (RADS)
0.0	3.06E+03	0.0	0.0	0.0	0.0
1.0	4.13E+02	3.06E+03	2.00E+00	1.32E+00	1.32E+00
2.0	2.84E+02	6.01E+02	3.74E-01	3.44E-01	1.67E+00
8.0	5.72E+01	4.84E+02	2.67E-01	8.49E-01	2.52E+00
24.0	3.46E+00	2.33E+02	1.75E-01	3.07E-01	2.82E+00
96.0	1.20E-01	1.06E+01	4.67E-02	7.15E-02	2.89E+00
192.0	4.46E-02	3.23E-01	1.03E-02	7.31E-03	2.90E+00
360.0	1.29E-02	1.84E-01	7.38E-03	4.29E-03	2.91E+00
720.0	1.74E-03	9.56E-02	5.56E-03	2.01E-03	2.91E+00
2160.0	8.19E-06	2.54E-02	3.72E-03	4.65E-04	2.91E+00
4320.0	3.89E-09	1.72E-02	3.54E-03	2.31E-06	2.91E+00

40 METERS

TIME (HOUR)	DOSE RATE (MR/HR)	EXPONENTIAL ALPHA	FIT BETA	DELTA D (RADS)	INTEGRATED DOSE (RADS)
0.0	1.17E+04	0.0	0.0	0.0	0.0
1.0	1.77E+03	1.17E+04	1.89E+00	5.26E+00	5.26E+00
2.0	1.22E+03	2.57E+03	3.72E-01	1.48E+00	6.74E+00
8.0	2.57E+02	2.05E+03	2.60E-01	3.71E+00	1.04E+01
24.0	1.85E+01	9.58E+02	1.64E-01	1.45E+00	1.19E+01
96.0	7.79E-01	5.32E+01	4.40E-02	4.03E-01	1.23E+01
192.0	2.98E-01	2.04E+00	1.00E-02	4.81E-02	1.23E+01
360.0	9.90E-02	1.05E+00	6.56E-03	3.03E-02	1.24E+01
720.0	1.72E-02	5.70E-01	4.86E-03	1.68E-02	1.24E+01
2160.0	8.73E-05	2.41E-01	3.67E-03	4.66E-03	1.24E+01
4320.0	4.41E-08	1.73E-01	3.51E-03	2.48E-05	1.24E+01

STONE & WEBSTER ENGINEERING CORPORATION  
CALCULATION SHEET

▲ 5010.65

CALCULATION IDENTIFICATION NUMBER				PAGE <u>16</u>
J.O. OR W.O. NO. <u>12846.54</u>	DIVISION & GROUP <u>POWER RP</u>	CALCULATION NO. <u>RP-039-0</u>	OPTIONAL TASK CODE	

1  
2  
3  
4  
5  
6  
7  
8  
9  
10  
11  
12  
13  
14  
15  
16  
17  
18  
19  
20  
21  
22  
23  
24  
25  
26  
27  
28  
29  
30  
31  
32  
33  
34  
35  
36  
37  
38  
39  
40  
41  
42  
43  
44  
45  
46

Table 4 Cont'd

**71 METERS**

TIME (HOUR)	DOSE RATE (MR/HR)	EXPONENTIAL ALPHA	FIT BETA	DELTA D (RADS)	INTEGRATED DOSE (RADS)
0.0	1.21E+04	0.0	0.0	0.0	0.0
1.0	1.87E+03	1.21E+04	1.87E+00	5.48E+00	5.48E+00
2.0	1.31E+03	2.67E+03	3.56E-01	1.57E+00	7.05E+00
8.0	2.77E+02	2.20E+03	2.59E-01	3.99E+00	1.10E+01
24.0	2.11E+01	1.00E+03	1.61E-01	1.59E+00	1.26E+01
96.0	9.72E-01	5.89E+01	4.27E-02	4.71E-01	1.31E+01
192.0	3.74E-01	2.53E+00	9.95E-03	6.01E-02	1.32E+01
360.0	1.31E-01	1.24E+00	6.24E-03	3.89E-02	1.32E+01
720.0	2.39E-02	7.18E-01	4.73E-03	2.27E-02	1.32E+01
2160.0	1.22E-04	3.35E-01	3.67E-03	6.49E-03	1.32E+01
4320.0	6.36E-08	2.34E-01	3.50E-03	3.48E-05	1.32E+01

**132 METERS**

TIME (HOUR)	DOSE RATE (MR/HR)	EXPONENTIAL ALPHA	FIT BETA	DELTA D (RADS)	INTEGRATED DOSE (RADS)
0.0	5.04E+03	0.0	0.0	0.0	0.0
1.0	7.76E+02	5.04E+03	1.87E+00	2.28E+00	2.28E+00
2.0	5.39E+02	1.12E+03	3.64E-01	6.50E-01	2.93E+00
8.0	1.14E+02	9.05E+02	2.59E-01	1.64E+00	4.57E+00
24.0	8.60E+00	4.15E+02	1.62E-01	6.53E-01	5.22E+00
96.0	3.89E-01	2.41E+01	4.30E-02	1.91E-01	5.41E+00
192.0	1.50E-01	1.01E+00	9.93E-03	2.41E-02	5.44E+00
360.0	5.19E-02	5.04E-01	6.32E-03	1.55E-02	5.45E+00
720.0	9.45E-03	2.85E-01	4.73E-03	8.97E-03	5.46E+00
2160.0	4.84E-05	1.32E-01	3.66E-03	2.57E-03	5.47E+00
4320.0	2.50E-08	9.37E-02	3.50E-03	1.38E-05	5.47E+00

**284 METERS**

TIME (HOUR)	DOSE RATE (MR/HR)	EXPONENTIAL ALPHA	FIT BETA	DELTA D (RADS)	INTEGRATED DOSE (RADS)
0.0	8.59E+02	0.0	0.0	0.0	0.0
1.0	1.24E+02	8.59E+02	1.94E+00	3.80E-01	3.80E-01
2.0	8.56E+01	1.80E+02	3.71E-01	1.04E-01	4.83E-01
8.0	1.78E+01	1.44E+02	2.62E-01	2.59E-01	7.42E-01
24.0	1.23E+00	6.77E+01	1.67E-01	9.92E-02	8.42E-01
96.0	5.00E-02	3.58E+00	4.45E-02	2.65E-02	8.68E-01
192.0	1.90E-02	1.32E-01	1.01E-02	3.08E-03	8.71E-01
360.0	6.11E-03	6.95E-02	6.75E-03	1.91E-03	8.73E-01
720.0	1.02E-03	3.66E-02	4.97E-03	1.02E-03	8.74E-01
2160.0	5.09E-06	1.44E-02	3.68E-03	2.76E-04	8.74E-01
4320.0	2.52E-09	1.03E-02	3.52E-03	1.44E-06	8.74E-01

STONE & WEBSTER ENGINEERING CORPORATION  
 CALCULATION SHEET

▲ 5010.65

CALCULATION IDENTIFICATION NUMBER				PAGE <u>17</u>
J.O. OR W.O. NO. 12846.54	DIVISION & GROUP power RP	CALCULATION NO. RP-039-0	OPTIONAL TASK CODE	

CONCLUSION:

TABLE 5

6 - Month Integrated Dose at Operating Floor Elevation

<u>Distance from Containment Wall</u>	<u>Integrated Dose (Rads)</u>
0 meters	5.87+0
10	1.88+0
20	5.61+0
30	1.80+1
40	2.50+1
50	2.39+1
60	2.04+1
70	1.72+1
80	1.45+1
90	1.22+1
100	1.05+1
132	6.15+0
193	2.66+0
284	9.08-1
406	2.93-1
589	7.13-2

TABLE 6

6 - Month Integrated Dose at Ground Level

<u>Distance from Containment Wall</u>	<u>Integrated Dose (Rads)</u>
10 meters	8.09-4
25	2.91+0
40	1.24+1
71	1.32+1
132	5.47+0
284	8.74-1

Fig. 1

6-Month Integrated Dose vs. Distance Curve

12846.54 RP-039-0

Integrated Dose (Rads)

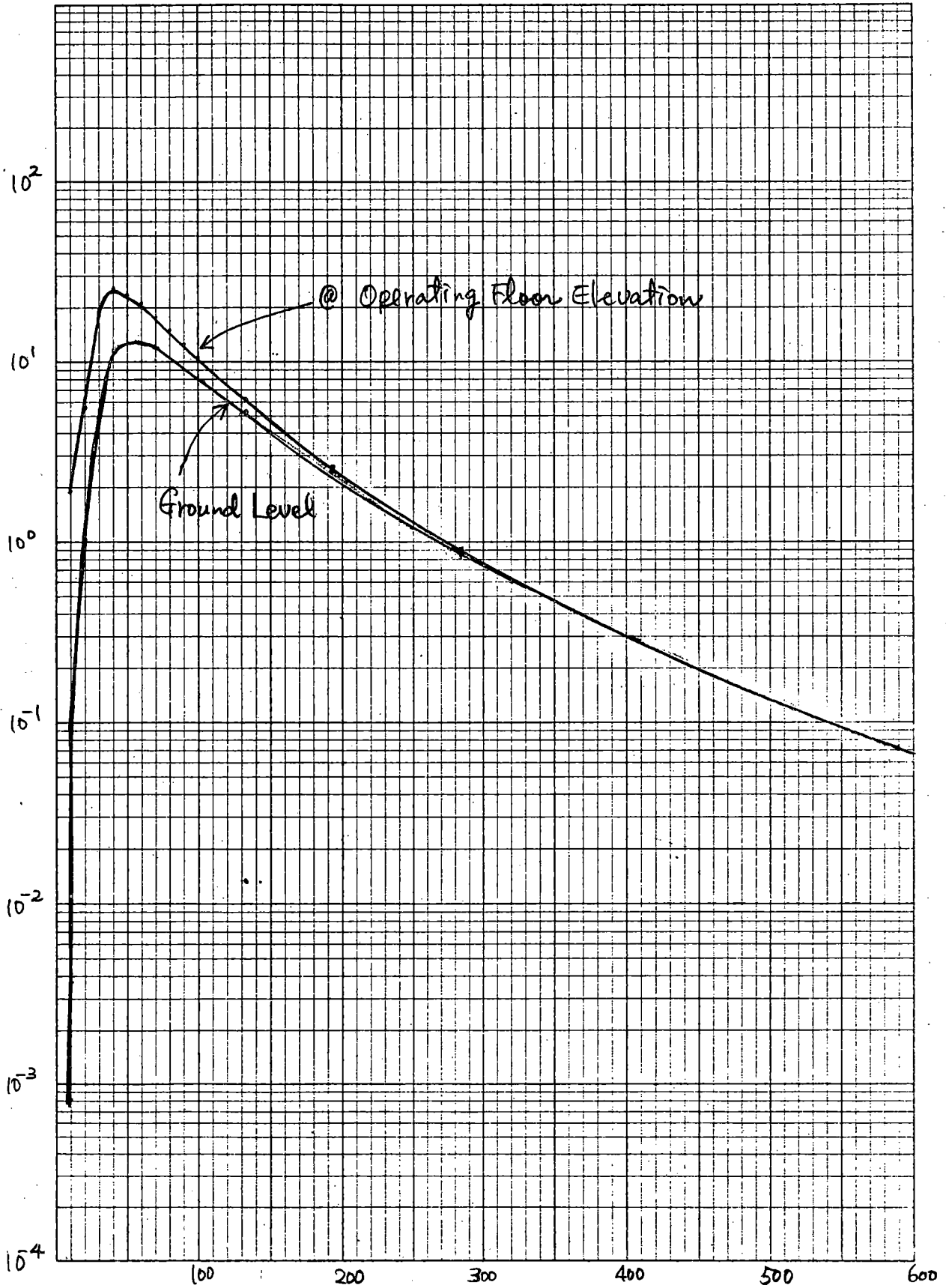

Distance From Containment Wall (Meters)

46 6460

SEMI-LOGARITHMIC 7 CYCLES X 60 DIVISIONS  
KEUFFEL & ESSER CO. MADE IN U.S.A.

USER'S GUIDE TO EZD REFERENCES

Facility: VEPCO, SURRY  
 Units: 1 and 2  
 Dockets: 50-280 and 50-281

EZD REFERENCE NO. 14

EZD REFERENCE DESCRIPTION: FSAR SECTION 9.13.2 (Page 9.13.2-1) Surry Power Station Units 1 & 2, December 1, 1969.

ENVIRONMENTAL ZONE(S): AB-2B, AB-13A, AB-27, AB-45, CSPH-27, SB-9B, SFGD-1, TB-9, TB-35

<u>PARAMETER</u>	<u>NORMAL ENVIRONMENT</u>	<u>PAGE</u>	<u>LOCA ENVIRONMENT</u>	<u>PAGE</u>	<u>MSLB ENVIRONMENT</u>	<u>PAGE</u>	<u>HELB ENVIRONMENT</u>	<u>PAGE</u>
TEMPERATURE (°F)	Occupied spaces 100 Normally unoccupied machinery spaces 120	9.13.2-1						
PRESSURE (psia)								
RELATIVE HUMIDITY (%)								
CHEMICAL SPRAY								

USER'S GUIDE TO EZD REFERENCES

Facility: VEPCO, SURRY  
 Units: 1 and 2  
 Dockets: 50-280 and 50-281

EZD REFERENCE NO. 14  
 EZD REFERENCE DESCRIPTION: FSAR Section 9.13.2 (page 9.13.2-1) Surry Power Station Units 1 & 2, December 1, 1969.  
 ENVIRONMENTAL ZONE (S): AB-2C, AB-13B, MSVH-11, MSVH-27

<u>PARAMETER</u>	<u>NORMAL ENVIRONMENT</u>	<u>PAGE</u>	<u>LOCA ENVIRONMENT</u>	<u>PAGE</u>	<u>MSLB ENVIRONMENT</u>	<u>PAGE</u>	<u>HELB ENVIRONMENT</u>	<u>PAGE</u>
TEMPERATURE (°F)	Normally unoccupied machinery spaces	120	9.13.2-1					
PRESSURE (psia)								
RELATIVE HUMIDITY (%)								
CHEMICAL SPRAY								



9.13.2 DESIGN BASIS

Outside ambient conditions used for design purposes are 93° F summer dry bulb, 78° F summer wet bulb, 73° F summer dew point, 10° F winter dry bulb, 58° F all year ground temperature, and 15 mph all year wind velocity.

Ventilation is based on limiting the temperature in occupied spaces to 100° F, limiting the temperature in normally unoccupied machinery spaces to 120° F, or providing 10 air changers per hour. Provisions are also made, by dual fans installed in parallel or two speed fan motors, to reduce air quantities in mild weather and during the heating season.

Ventilation for nuclear auxiliary systems is designed on a once-through basis. Supply air is introduced to areas least likely to be contaminated and exhausted directly from those with the greatest contamination potential.

Filter banks for radioactive contamination are designed to remove 99.97 percent of solid particles down to 0.3 micron in size and 99.9 percent of any methyl iodide or iodine vapor entrained in the ventilation exhaust. Filter assemblies consist of roughing, particulate and charcoal filters in series.

The Main Control Room and computer room air conditioning is designed to maintain 75° F dry bulb and 50 percent relative humidity during either normal or emergency conditions. The relay rooms are designed for 80° F dry bulb and 40 percent relative humidity during normal conditions, and 87° F dry bulb and 35 percent relative humidity during emergency operations.

USER'S GUIDE TO E2D REFERENCES

Facility: VEPCO, SURRY  
 Units: 1 and 2  
 Dockets: 50-280 and 50-281

E2D REFERENCE NO. 15

E2D REFERENCE DESCRIPTION: FSAR Section 5.3 (Page 5.3-1) Surry Power Station Units 1 & 2, December 1, 1969.

ENVIRONMENTAL ZONE(S): RC-3A, RC-3B, RC-18B, RC-27A, RC-27B, RC-47A, RC-47B

<u>PARAMETER</u>	<u>NORMAL ENVIRONMENT</u>	<u>PAGE</u>	<u>LOCA ENVIRONMENT</u>	<u>PAGE</u>	<u>MSLB ENVIRONMENT</u>	<u>PAGE</u>	<u>HELB ENVIRONMENT</u>	<u>PAGE</u>
TEMPERATURE	105 (Design)	5.3-1						
PRESSURE								
RELATIVE HUMIDITY (%)								
CHEMICAL SPRAY								

5.3.1 VENTILATION SYSTEM

5.3.1.1 General Description

Containment ventilation consists of an Air Cooling Recirculation System, an Air Cooling Control Rod Drive Mechanism System, a Filter System and a Purge System. They are shown on the composite Fig. 5.3.1-1. The reactor main coolant pump motors, Section 4.3.3, are cooled with an integral component cooling water system. The Recirculation System, Control Rod Drive Mechanism System and reactor pump motor coolers provide the total cooling required to limit the bulk air temperature to 105° F during normal summer operations. The minimum temperature during winter operations is about 80° F. The relative humidity, during both summer and winter operations, is about 40 percent.

5.3.1.2 Design Basis

The ventilation systems are designed to limit the containment bulk air temperature to 105° F when three of the recirculating fans are running, two of the three CRDM cooling systems are running, and the cooling systems for the main coolant pump motors are functioning.

The recirculation fan and cooling coil systems are designed to remove their portion of the heat load, under subatmospheric operating conditions, when supplied with 720 gpm of 70° F water.