

Penetration Seal Data

Appendix: B13

Penetration #: P133S0788

Penetration Type: RB-5A

Fire Area (Side 1): A-25

Fire Area (Side 2): A-1

Loc./Elev.: 2000'-0"

M-0X Dwg: M-0X1331

- | | | | |
|----------------------------------|--------------------------|----------------------------------|--------|
| 1. Barrier Thickness: | 12" | 10. Annular Gap (smallest): | 1-1/2" |
| 2. Opening Size: | 20"D | 11. Gap between pen: | N/A |
| 3. Penetrants: | (1) 14"P | 12. Barrier Type: | F R |
| 4. Sealant Type: | HDSE/HDLE, Ceramic Fiber | 13. Opening Sleeved or Concrete: | Steel |
| 5. Damming Side1: | Boot | 14. Pipe Insulated: | No ** |
| 6. Damming Side 2: | Boot | | |
| 7. Damming Continuity (Acc/Rej): | N/A | | |
| 8. Boot Condition (Acc/Rej): | Accept | | |
| 9. Sealant Depth: | Assumed Per Detail | | |

Wayne Aregood

Prepared By:

Jeff Suter

Reviewed By:

Walkdown Comments:

Slab thickness determined by Drawing C-1C1311. ** Top side pipe is covered with Armaflex with bottom side pipe covered with insulation.

Sketch:

FA: A-25
Side 1

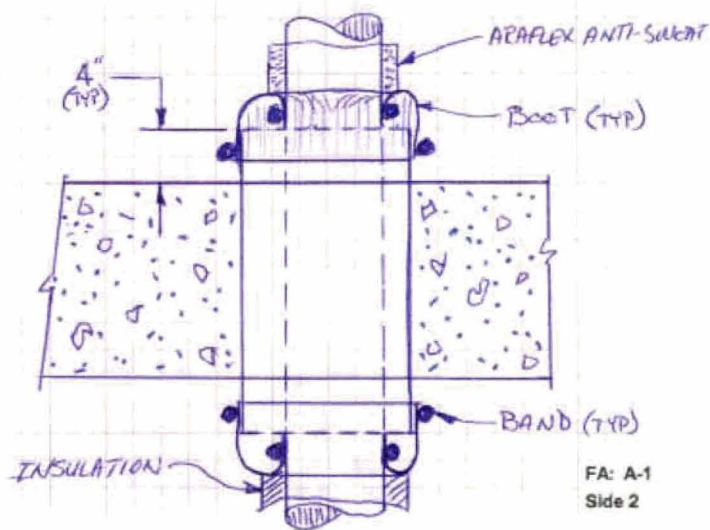

P133S0788

FA: A-1
Side 2

Penetration Seal Data

Appendix: B13

Photos: P133S0788

Fire Area A-25 (Side 1)

Fire Area A-25 (Side 1)



Fire Area A-1 (Side 2)

Fire Area A-1 (Side 2)

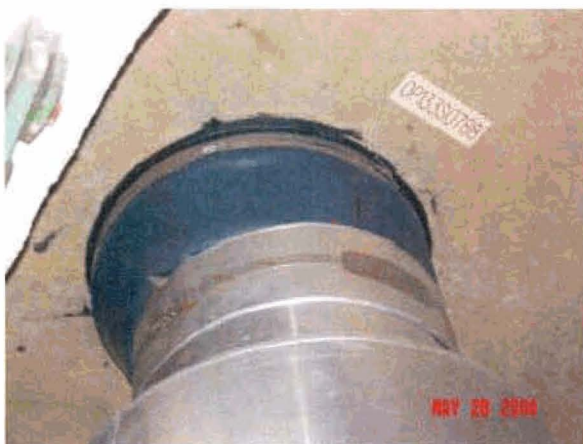

Penetration Seal Data

Appendix: B13

Heat Affected Zone Review: **P133S0788**

Fire Area (Side 1) A-25

1. Armaflex on pipe: Additional Evaluation Required

Fire Area (Side 2) A-1

No issues within Heat Affected Zone

Review Distances

(Reference M-663-00017A, Figure 7.2.3-1)

14" Pipe			
L1 & L2 Dist. (ft)	Temp. (°F)	R1 Radius (in)	R2 Radius (in)
0.5	1721	4.6	5.9
1	1539	3.8	5.1
1.5	1377	3	4.4
2	1233	2.4	3.8
2.5	1105	1.8	3.2
3	991	1.3	2.7
3.5	889	0.9	2.2
4	799	0.4	1.8
4.5	719	0.1	1.4
5	647	Contact	1.1
5.5	583		0.8
6	527		0.6
6.5	477		0.3
7	432		0.1
7.5	392		Contact

Side 1 Photo

Side 2 Photo

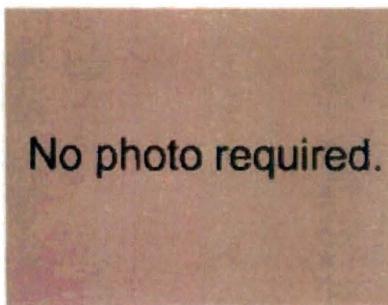

Sketch

FA: A-25
Side 1

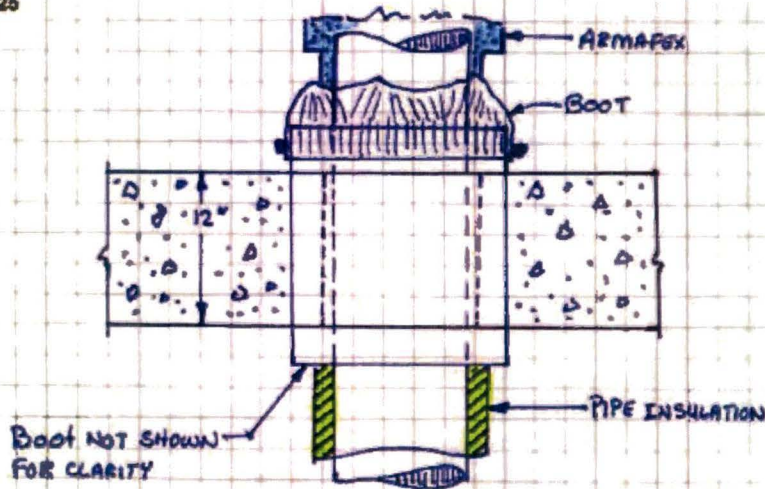

FA: A-1
Side 2

Penetration Seal Data

Appendix: B13

Penetration #: P133W2037

Penetration Type: M-1

Fire Area (Side 1): A-8

Fire Area (Side 2): A-25

Loc./Elev.: 2021'-6"

M-0X Dwg: M-1X1921

- | | | | |
|----------------------------------|--------------------------|----------------------------------|--------------------------|
| 1. Barrier Thickness: | 36" | 10. Annular Gap (smallest): | 1-1/2" |
| 2. Opening Size: | 18"D | 11. Gap between pen: | N/A |
| 3. Penetrants: | (1)12"P | 12. Barrier Type: | F W |
| 4. Sealant Type: | Foam | 13. Opening Sleeved or Concrete: | Steel |
| 5. Damming Side1: | Flush with barrier plane | 14. Pipe Insulated: | No |
| 6. Damming Side 2: | Recessed 26-1/2" | | |
| 7. Damming Continuity (Acc/Rej): | Accept | | |
| 8. Boot Condition (Acc/Rej): | N/A | | |
| 9. Sealant Depth: | 7-1/2" | | |

Jeff Suter

Prepared By:

Wayne Aregood

Reviewed By:

Walkdown Comments:

Barrier thickness determined by Drawing C-1C1331 (wsa)

Sketch:

FA: A-8
Side 1

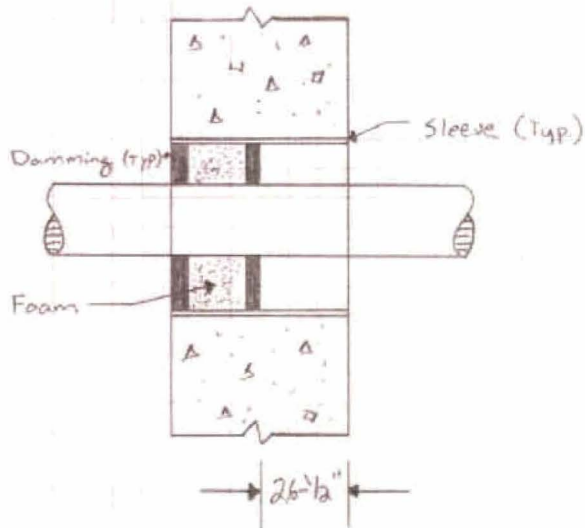

P133W2037

FA: A-25
Side 2

Penetration Seal Data

Appendix: B13

Photos: P133W2037

Fire Area A-8 (Side 1)

Fire Area A-8 (Side 1)

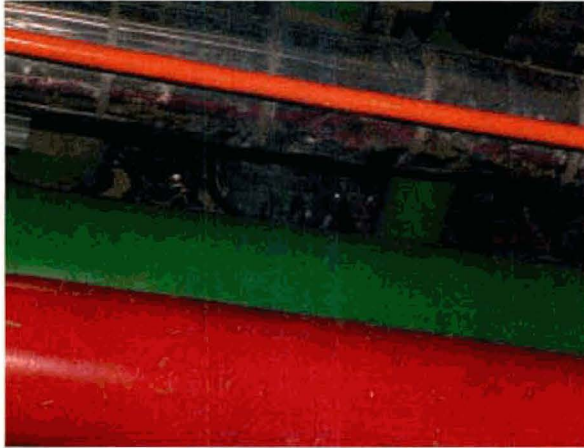

Fire Area A-25 (Side 2)

Fire Area A-25 (Side 2)



Penetration Seal Data

Appendix: B13

Heat Affected Zone Review: **P133W2037**

Fire Area (Side 1) A-8

1. 1" conduit (no ID) within Heat Affected Zone

Fire Area (Side 2) A-25

2. 2" Conduit (no ID) within Heat Affected Zone, routed up through ceiling and into Cont. Pene E-240.

Review Distances

(Reference M-663-00017A, Figure 7.2.3-1)

12" Pipe			
L1 & L2 Dist. (ft)	Temp. (°F)	R1 Radius (in)	R2 Radius (in)
0.5	1712	4.6	5.9
1	1524	3.7	5.1
1.5	1357	3	4.3
2	1209	2.3	3.6
2.5	1078	1.7	3.1
3	962	1.2	2.5
3.5	860	0.7	2.1
4	769	0.3	1.7
4.5	689	Contact	1.3
5	618		1
5.5	555		0.7
6	499		0.4
6.5	450		0.2
7	406		0
7.5	368		Contact

Side 1 Photo

Side 2 Photo

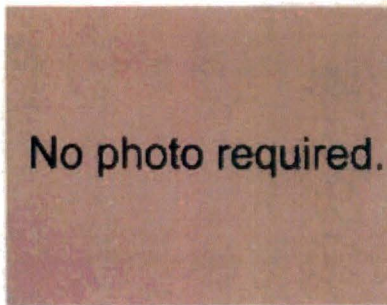
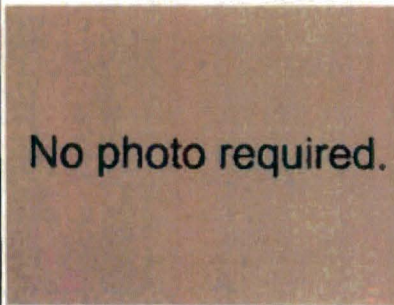

Sketch

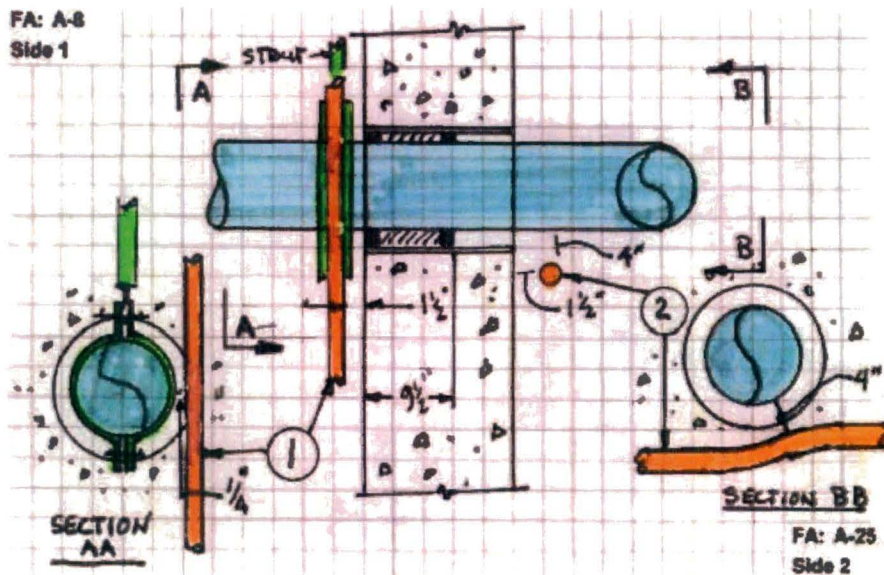

Penetration Seal Data

Appendix: B13

Penetration #: P133W2042

Penetration Type: M-1

Fire Area (Side 1): A-8

Fire Area (Side 2): A-25

Loc./Elev.: 2021'-6"

M-0X Dwg: M-1X1921

- | | | | |
|----------------------------------|--------------------------|----------------------------------|--------|
| 1. Barrier Thickness: | 36" | 10. Annular Gap (smallest): | 1-1/2" |
| 2. Opening Size: | 18"D | 11. Gap between pen: | N/A |
| 3. Penetrants: | (1)12"P | 12. Barrier Type: | F W |
| 4. Sealant Type: | Foam | 13. Opening Sleeved or Concrete: | Steel |
| 5. Damming Side1: | Flush with barrier plane | 14. Pipe Insulated: | No |
| 6. Damming Side 2: | Recessed 26-1/2" | | |
| 7. Damming Continuity (Acc/Rej): | Accept | | |
| 8. Boot Condition (Acc/Rej): | N/A | | |
| 9. Sealant Depth: | 7-1/2" | | |

Jeff Suter

Prepared By:

Wayne Aregood

Reviewed By:

Walkdown Comments:

Barrier thickness determined by Drawing C-1C1331 (wsa)

Sketch:

FA: A-8
Side 1

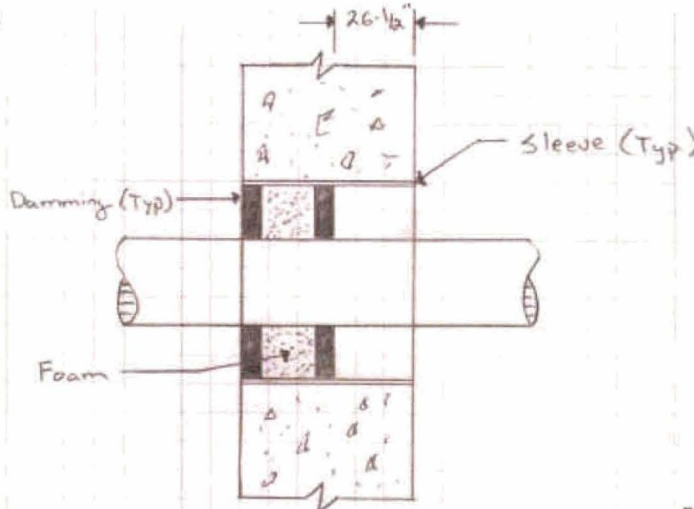

P133W2042

FA: A-25
Side 2

Penetration Seal Data

Appendix: B13

Photos: P133W2042

Fire Area A-8 (Side 1)

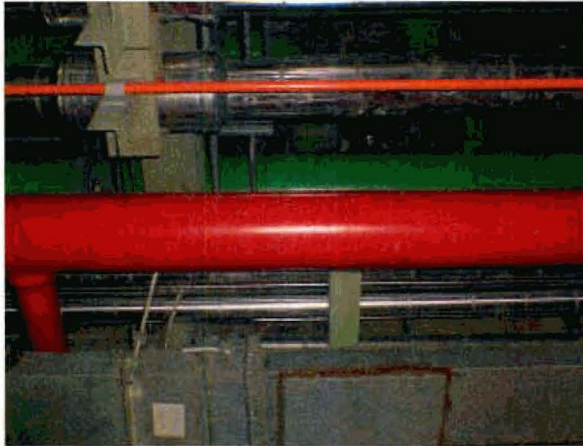

Fire Area A-8 (Side 1)

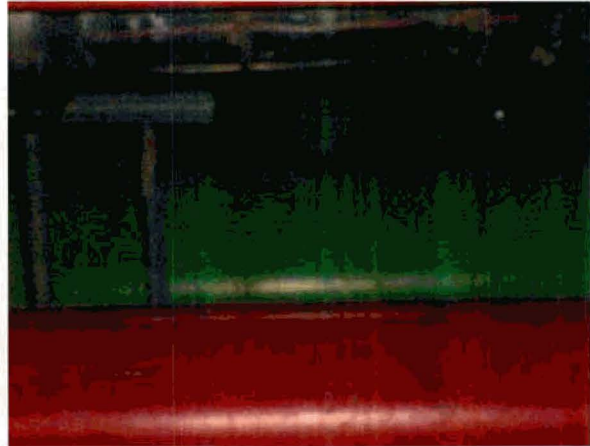

Fire Area A-25 (Side 2)



Fire Area A-25 (Side 2)

Penetration Seal Data

Appendix: B13

Heat Affected Zone Review: P133W2042

Fire Area (Side 1) A-8

1. 2" Conduit 1U1096 within Heat Affected Zone. Further review determined that this raceway is not PFSSD. Set-route control is necessary.

Fire Area (Side 2) A-25

2. Unscheduled 2" Conduit within Heat Affected Zone

Review Distances

(Reference M-663-00017A, Figure 7.2.3-1)

12" Pipe			
L1 & L2 Dist. (ft)	Temp. (°F)	R1 Radius (in)	R2 Radius (in)
0.5	1712	4.6	5.9
1	1524	3.7	5.1
1.5	1357	3	4.3
2	1209	2.3	3.6
2.5	1078	1.7	3.1
3	962	1.2	2.5
3.5	860	0.7	2.1
4	769	0.3	1.7
4.5	689	Contact	1.3
5	618		1
5.5	555		0.7
6	499		0.4
6.5	450		0.2
7	406		0
7.5	368		Contact

Side 1 Photo

Side 2 Photo

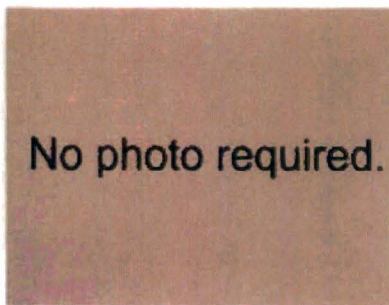
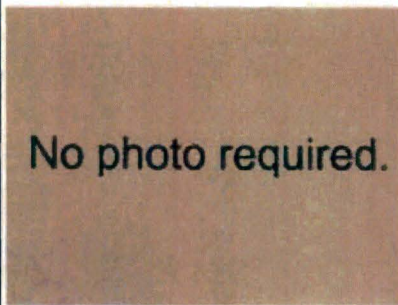

Sketch

Sketch FA: A-8 Side 1

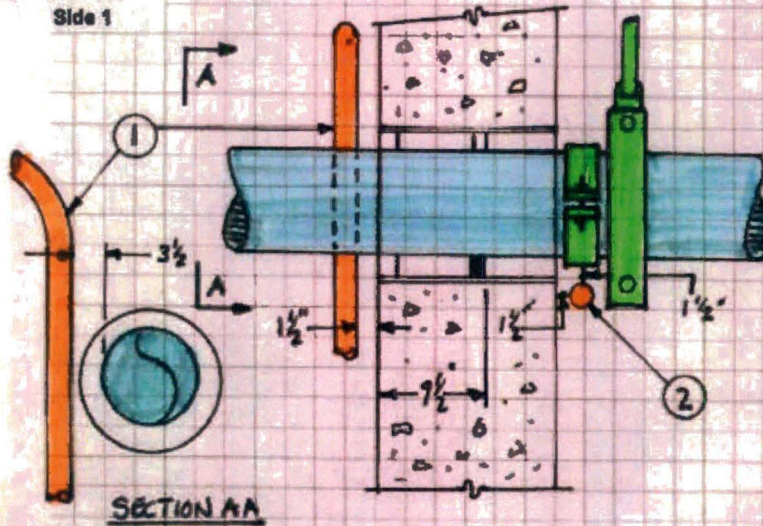

FA: A-25 Side 2

Penetration Seal Data

Appendix: B13

Penetration #: P134S0877

Penetration Type: RB-5A

Fire Area (Side 1): A-24

Fire Area (Side 2): A-1

Loc./Elev.: 2000'-0"

M-OX Dwg: M-1X1341

- | | | | |
|----------------------------------|--------------------------|----------------------------------|-------|
| 1. Barrier Thickness: | 12" | 10. Annular Gap (smallest): | 2" |
| 2. Opening Size: | 20"D | 11. Gap between pen: | N/A |
| 3. Penetrants: | (1) 14"P | 12. Barrier Type: | F R |
| 4. Sealant Type: | HDSE/HDLE, Ceramic Fiber | 13. Opening Sleeved or Concrete: | Steel |
| 5. Damming Side1: | Boot | 14. Pipe Insulated: | * No |
| 6. Damming Side 2: | Boot | | |
| 7. Damming Continuity (Acc/Rej): | N/A | | |
| 8. Boot Condition (Acc/Rej): | Accept | | |
| 9. Sealant Depth: | 14" ** | | |

Wayne Aregood

Prepared By:

Jeff Suter

Reviewed By:

Walkdown Comments:

Slab thickness based on drawing C-1C1311. * Pipe deemed not insulated due to topside pipe has Armaflex, no insulation. ** Sealant depth determined by inspection report.

Sketch:

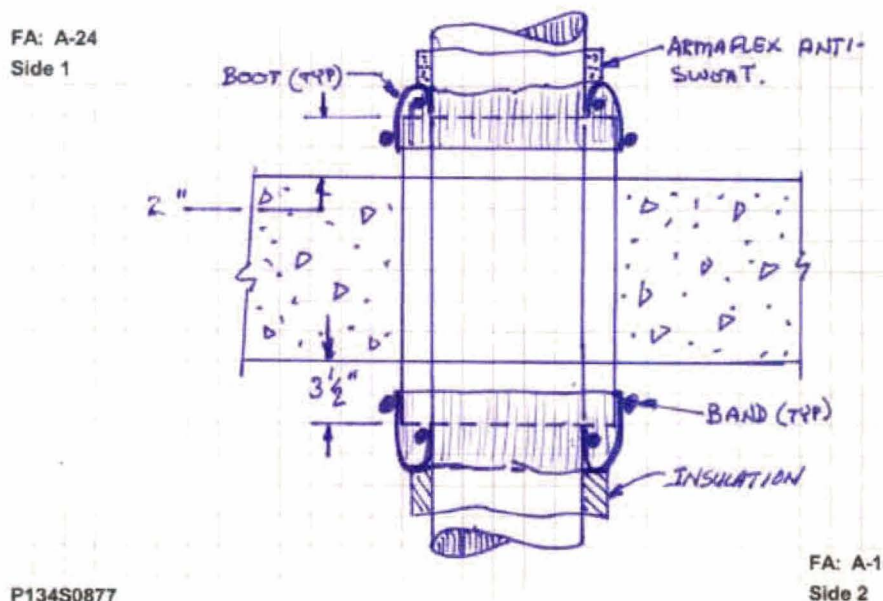

P134S0877

FA: A-1
Side 2

Penetration Seal Data

Appendix: B13

Photos: P134S0877

Fire Area A-24 (Side 1)

Fire Area A-24 (Side 1)

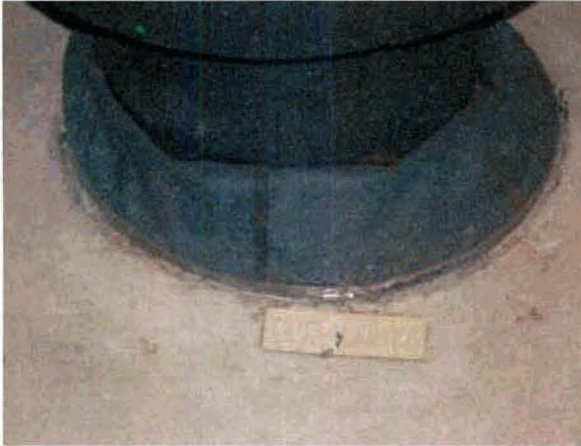

Fire Area A-1 (Side 2)

Fire Area A-1 (Side 2)



Penetration Seal Data

Appendix: B13

Heat Affected Zone Review: P134S0877

Fire Area (Side 1) A-24

1. Armaflex on pipe.

Fire Area (Side 2) A-1

No issues within Heat Affected Zone.

Review Distances

(Reference M-663-00017A, Figure 7.2.3-1)

14" Pipe			
L1 & L2 Dist. (ft)	Temp. (°F)	R1 Radius (in)	R2 Radius (in)
0.5	1721	4.6	5.9
1	1539	3.8	5.1
1.5	1377	3	4.4
2	1233	2.4	3.8
2.5	1105	1.8	3.2
3	991	1.3	2.7
3.5	889	0.9	2.2
4	799	0.4	1.8
4.5	719	0.1	1.4
5	647	Contact	1.1
5.5	583		0.8
6	527		0.6
6.5	477		0.3
7	432		0.1
7.5	392		Contact

Side 1 Photo

Side 2 Photo

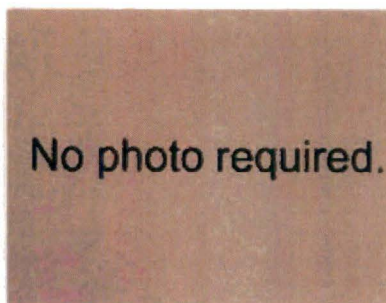

Sketch

FA: A-24
Side 1

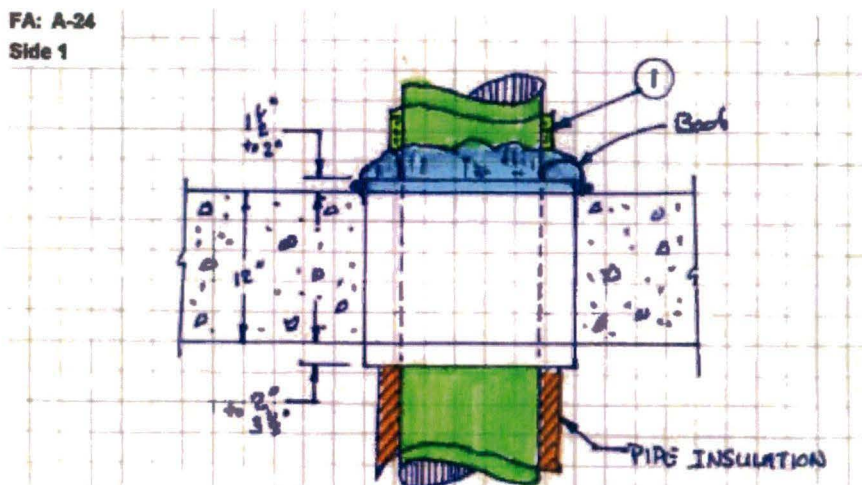

Bottom side BOOT NOT SHOWN FOR CLARITY.

FA: A-1
Side 2

Penetration Seal Data

Appendix: B13

Penetration #: P134W2054

Penetration Type: M-1

Fire Area (Side 1): A-8

Fire Area (Side 2): A-24

Loc./Elev.: 2012'-3"

M-0X Dwg: M-1X1921

- | | | | |
|----------------------------------|--------------------|----------------------------------|-------|
| 1. Barrier Thickness: | 36" | 10. Annular Gap (smallest): | 2" |
| 2. Opening Size: | 18"D | 11. Gap between pen: | N/A |
| 3. Penetrants: | (1)12"P | 12. Barrier Type: | F W |
| 4. Sealant Type: | Foam | 13. Opening Sleeved or Concrete: | Steel |
| 5. Damming Side1: | Recessed 26-1/2" | 14. Pipe Insulated: | No |
| 6. Damming Side 2: | Flush with barrier | | |
| 7. Damming Continuity (Acc/Rej): | Accept | | |
| 8. Boot Condition (Acc/Rej): | N/A | | |
| 9. Sealant Depth: | 8-1/2" | | |

Jeff Suter

Prepared By:

Wayne Aregood

Reviewed By:

Walkdown Comments:

Barrier thickness determined by Drawing C-0C1341 (wsa)

Sketch:

FA: A-8
Side 1

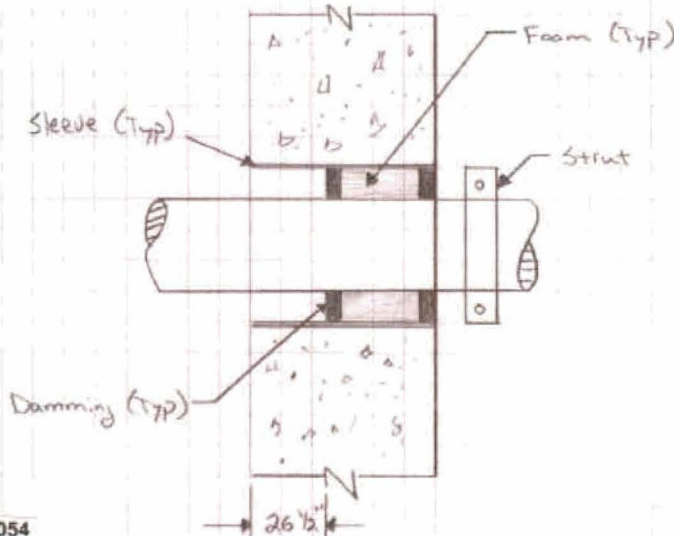

P134W2054

FA: A-24
Side 2

Penetration Seal Data

Appendix: B13

Photos: P134W2054

Fire Area A-8 (Side 1)

Fire Area A-8 (Side 1)

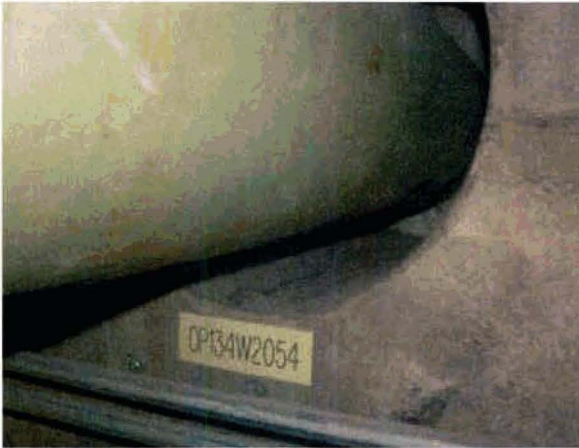

Fire Area A-24 (Side 2)

Fire Area A-24 (Side 2)

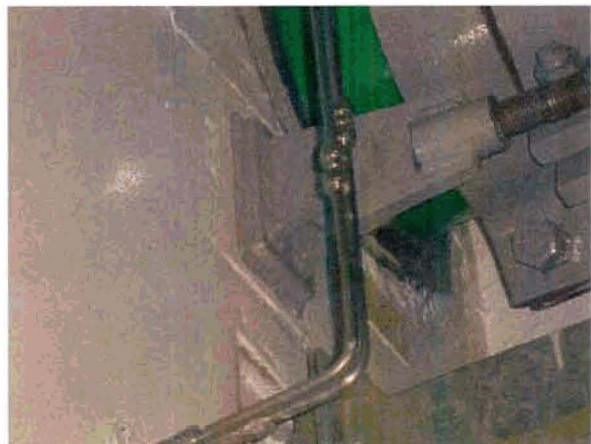

Penetration Seal Data

Appendix: B13

Heat Affected Zone Review: **P134W2054**

Fire Area (Side 1) A-8

- 3/4" CMT Lighting Conduit (to Panel QA08): Not within Heat Affected Zone.
- 24" Cable Tray 5A3C01: Not within Heat Affected Zone.

Fire Area (Side 2) A-24

No issues within Heat Affected Zone

Review Distances

(Reference M-663-00017A, Figure 7.2.3-1)

12" Pipe			
L1 & L2 Dist. (ft)	Temp. (°F)	R1 Radius (in)	R2 Radius (in)
0.5	1712	4.6	5.9
1	1524	3.7	5.1
1.5	1357	3	4.3
2	1209	2.3	3.6
2.5	1078	1.7	3.1
3	962	1.2	2.5
3.5	860	0.7	2.1
4	769	0.3	1.7
4.5	689	Contact	1.3
5	618		1
5.5	555		0.7
6	499		0.4
6.5	450		0.2
7	406		0
7.5	368		Contact

Side 1 Photo

Side 2 Photo



Sketch

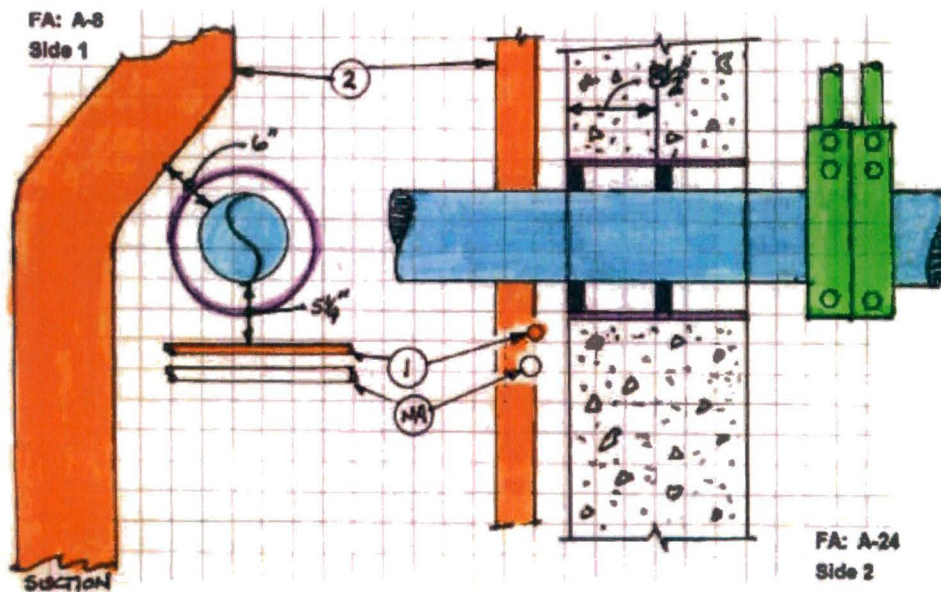

Penetration Seal Data

Appendix: B13

Penetration #: P141S1015

Penetration Type: M-6A

Fire Area (Side 1): A-16

Fire Area (Side 2): A-8

Loc./Elev.: 2026'-0"

M-0X Dwg: M-1X1411

- | | | | |
|----------------------------------|--------------|----------------------------------|--------|
| 1. Barrier Thickness: | 20" | 10. Annular Gap (smallest): | 13/16" |
| 2. Opening Size: | 30"D | 11. Gap between pen: | N/A |
| 3. Penetrants: | (1)24"P | 12. Barrier Type: | F |
| 4. Sealant Type: | Foam | 13. Opening Sleeved or Concrete: | Steel |
| 5. Damming Side1: | N/A | 14. Pipe Insulated: | No |
| 6. Damming Side 2: | Recessed 10" | | |
| 7. Damming Continuity (Acc/Rej): | Accept | | |
| 8. Boot Condition (Acc/Rej): | N/A | | |
| 9. Sealant Depth: | 9", Reject | | |

Jeff Suter

Prepared By:

Wayne Aregood

Reviewed By:

Walkdown Comments:

Slab thickness based on C-0C1411. 1/8" separation of foam at sleeve south end due to pipe movement. Recessed depth on bottom side is based on inspection from the floor. Detail changed to M-6A based on field inspection.

Sketch:

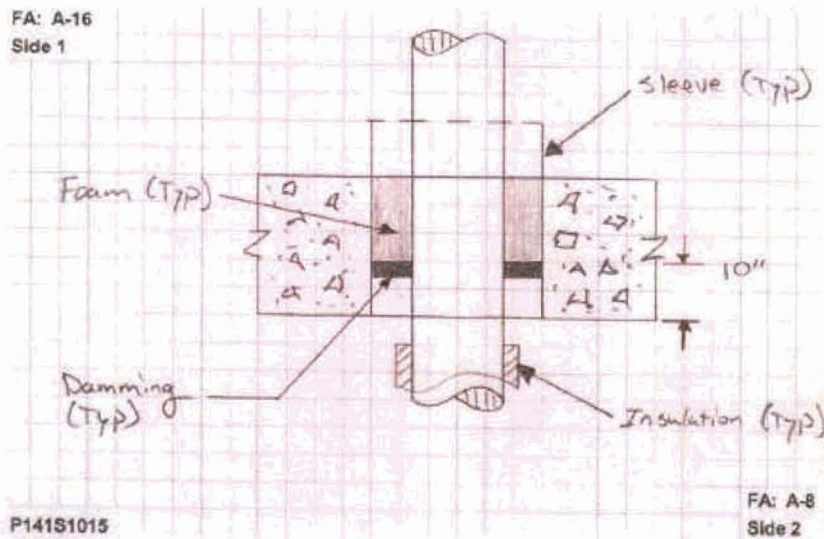

Penetration Seal Data

Appendix: B13

Photos: P141S1015

Fire Area A-16 (Side 1)



Fire Area A-16 (Side 1)



Fire Area A-8 (Side 2)



Fire Area A-8 (Side 2)

Penetration Seal Data

Appendix: B13

Heat Affected Zone Review: **P141S1015**

Fire Area (Side 1) A-16

- 1. 4" Pipe with Armaflex insulation
- 2. 4" Pipe with Armaflex insulation

Fire Area (Side 2) A-8

No issues within Heat Affected Zone.

Review Distances

(Reference M-663-00017A, Figure 7.2.3-1)

24" Pipe			
L1 & L2 Dist. (ft)	Temp. (°F)	R1 Radius (in)	R2 Radius (in)
0.5	1763	4.8	6.1
1	1615	4.1	5.5
1.5	1480	3.5	4.9
2	1357	3	4.3
2.5	1244	2.5	3.8
3	1141	2	3.3
3.5	1048	1.6	2.9
4	962	1.2	2.5
4.5	884	0.8	2.2
5	813	0.5	1.9
5.5	748	0.2	1.6
6	689	Contact	1.3
6.5	635		1.1
7	585		0.8
7.5	540		0.6
8	499		0.4
8.5	462		0.3
9	427		0.1
9.5	396		Contact

Side 1 Photo

Side 2 Photo

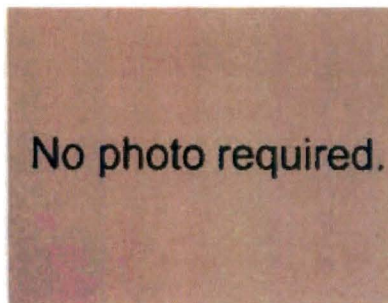
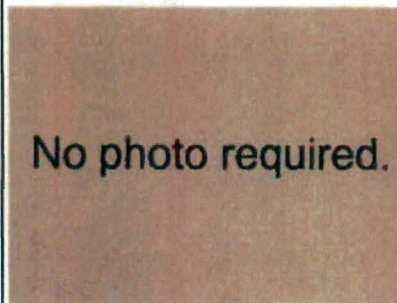

Sketch

FA: A-16
Side 1

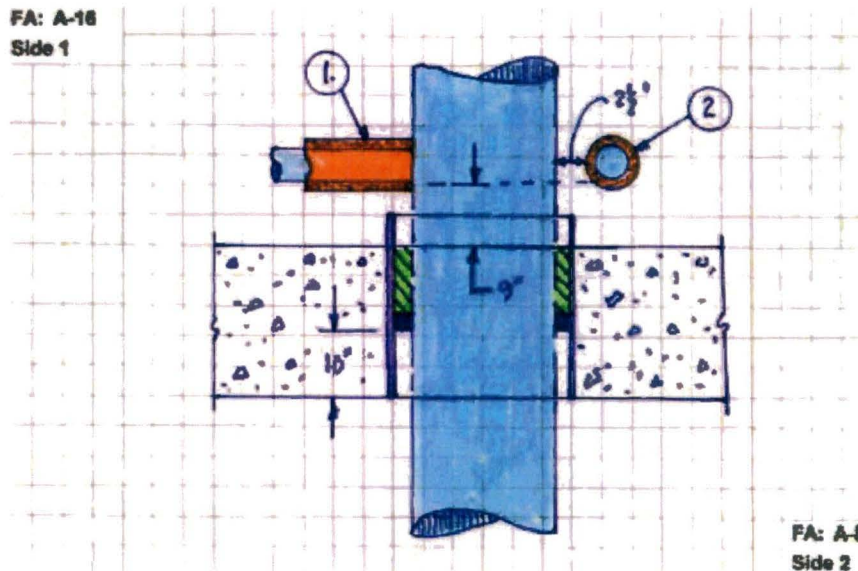

FA: A-8
Side 2

Penetration Seal Data

Appendix: B13

Penetration #: P141S1023

Penetration Type: M-6A

Fire Area (Side 1): A-16

Fire Area (Side 2): A-8

Loc./Elev.: 2026'-0"

M-0X Dwg: M-1X1411

- | | | | |
|----------------------------------|--------------------|----------------------------------|--------|
| 1. Barrier Thickness: | 12" | 10. Annular Gap (smallest): | 1-5/16 |
| 2. Opening Size: | 24"D | 11. Gap between pen: | N/A |
| 3. Penetrants: | (1)18"P | 12. Barrier Type: | F |
| 4. Sealant Type: | Foam | 13. Opening Sleeved or Concrete: | Steel |
| 5. Damming Side1: | N/A | 14. Pipe Insulated: | No |
| 6. Damming Side 2: | Flush with barrier | | |
| 7. Damming Continuity (Acc/Rej): | Accept | | |
| 8. Boot Condition (Acc/Rej): | N/A | | |
| 9. Sealant Depth: | 12" | | |

Jeff Suter

Prepared By:

Wayne Aregood

Reviewed By:

Walkdown Comments:

Slab thickness based on C-0C1411. Detail changed to M-6A.

Sketch:

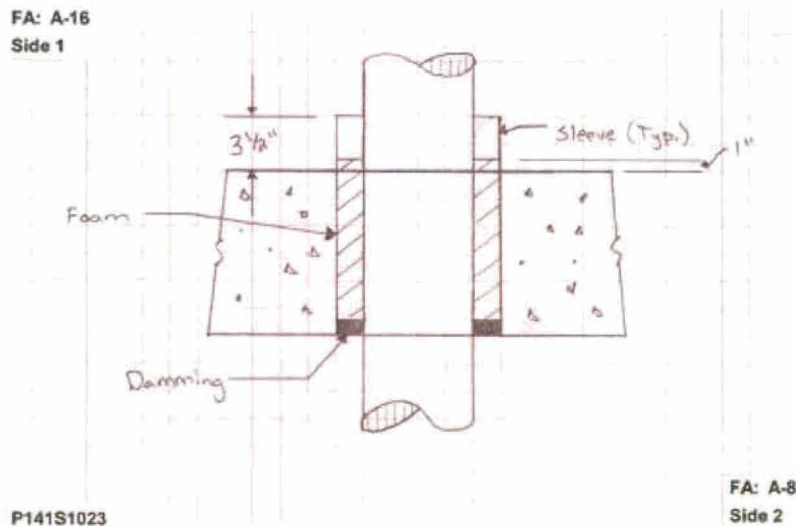

Penetration Seal Data

Appendix: B13

Photos: P141S1023

Fire Area A-16 (Side 1)



Fire Area A-16 (Side 1)



Fire Area A-8 (Side 2)



Fire Area A-8 (Side 2)

Penetration Seal Data

Appendix: B13

Heat Affected Zone Review: P141S1023

Fire Area (Side 1) A-16

No issues within Heat Affected Zone.

Fire Area (Side 2) A-8

No issues within Heat Affected Zone.

Review Distances

(Reference M-663-00017A, Figure 7.2.3-1)

18" Pipe			
L1 & L2 Dist. (ft)	Temp. (°F)	R1 Radius (in)	R2 Radius (in)
0.5	1741	4.7	6
1	1576	3.9	5.3
1.5	1426	3.3	4.6
2	1292	2.7	4
2.5	1171	2.1	3.5
3	1062	1.6	3
3.5	964	1.2	2.5
4	875	0.8	2.1
4.5	795	0.4	1.8
5	724	0.1	1.5
5.5	659	Contact	1.2
6	600		0.9
6.5	548		0.7
7	501		0.5
7.5	458		0.3
8	419		0.1
8.5	385		Contact

Side 1 Photo

Side 2 Photo

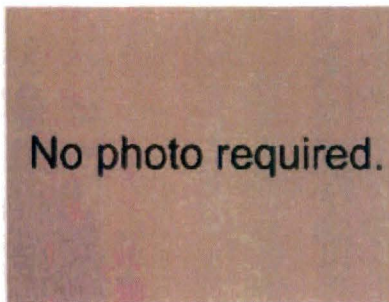
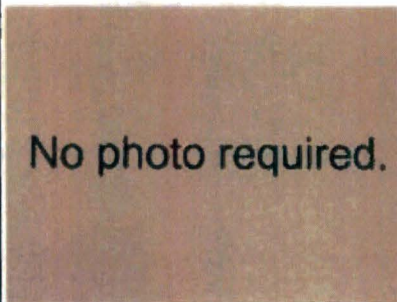

Sketch

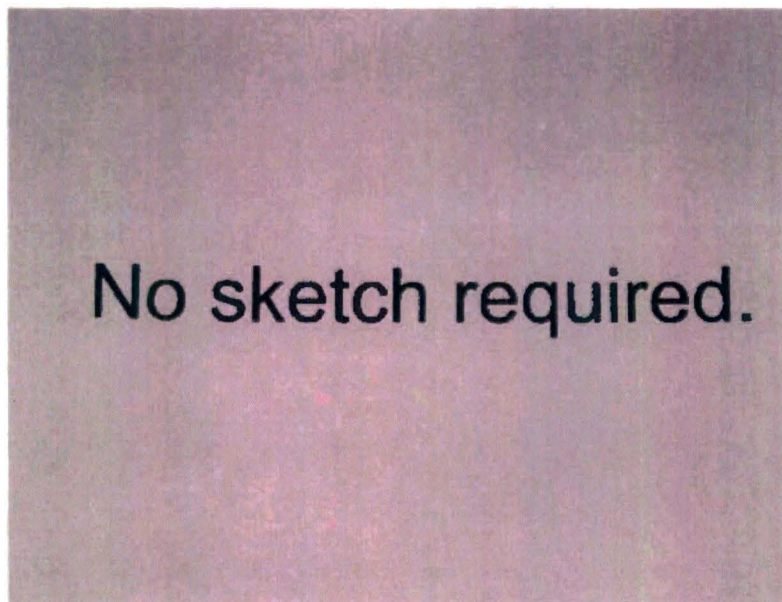

Penetration Seal Data

Appendix: B13

Penetration #: P141W1907

Penetration Type: M-1

Fire Area (Side 1): A-16

Fire Area (Side 2): A-26

Loc./Elev.: 2041'-6"

M-0X Dwg: M-1X1919

- | | | | |
|----------------------------------|--------------------------|----------------------------------|-------|
| 1. Barrier Thickness: | 12" | 10. Annular Gap (smallest): | 1" |
| 2. Opening Size: | 18"D | 11. Gap between pen: | N/A |
| 3. Penetrants: | (1)12"P | 12. Barrier Type: | F |
| 4. Sealant Type: | Foam | 13. Opening Sleeved or Concrete: | Steel |
| 5. Damming Side1: | Flush with barrier plane | 14. Pipe Insulated: | No |
| 6. Damming Side 2: | Recessed 2" | | |
| 7. Damming Continuity (Acc/Rej): | Accept | | |
| 8. Boot Condition (Acc/Rej): | N/A | | |
| 9. Sealant Depth: | 8" | | |

Jeff Suter

Prepared By:

Wayne Aregood

Reviewed By:

Walkdown Comments:

Sketch:

FA: A-16
Side 1

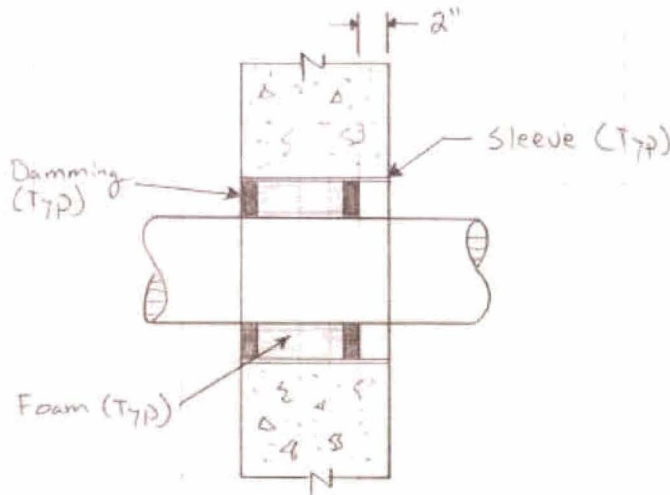

P141W1907

FA: A-26
Side 2

Penetration Seal Data

Appendix: B13

Photos: P141W1907

Fire Area A-16 (Side 1)

Fire Area A-16 (Side 1)



Fire Area A-26 (Side 2)

Fire Area A-26 (Side 2)

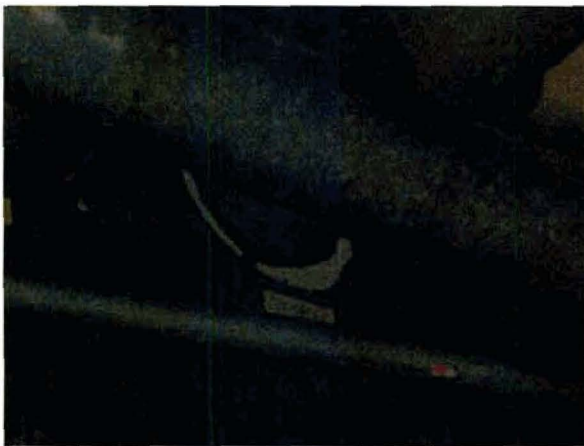

Penetration Seal Data

Appendix: B13

Heat Affected Zone Review: P141W1907

Fire Area (Side 1) A-16

No issues within Heat Affected Zone

Fire Area (Side 2) A-26

No issues within Heat Affected Zone

Review Distances

(Reference M-663-00017A, Figure 7.2.3-1)

12" Pipe			
L1 & L2 Dist. (ft)	Temp. (°F)	R1 Radius (in)	R2 Radius (in)
0.5	1712	4.6	5.9
1	1524	3.7	5.1
1.5	1357	3	4.3
2	1209	2.3	3.6
2.5	1078	1.7	3.1
3	962	1.2	2.5
3.5	860	0.7	2.1
4	769	0.3	1.7
4.5	689	Contact	1.3
5	618		1
5.5	555		0.7
6	499		0.4
6.5	450		0.2
7	406		0
7.5	368		Contact

Side 1 Photo

Side 2 Photo

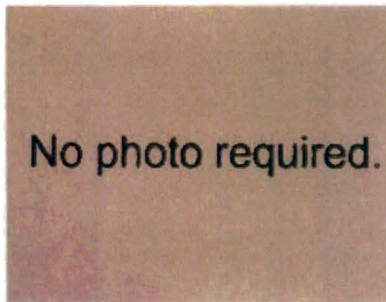
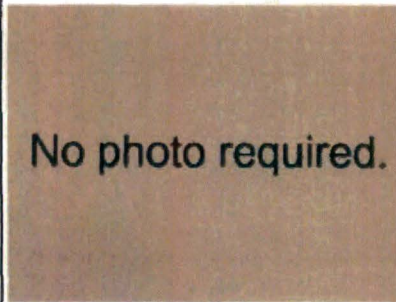

Sketch



Penetration Seal Data

Appendix: B13

Penetration #: P141W1908

Penetration Type: M-1

Fire Area (Side 1): A-16

Fire Area (Side 2): A-26

Loc./Elev.: 2041'-6"

M-0X Dwg: M-1X1919

- | | | | |
|----------------------------------|-------------|----------------------------------|--------|
| 1. Barrier Thickness: | 12" | 10. Annular Gap (smallest): | 1-1/2" |
| 2. Opening Size: | 18"D | 11. Gap between pen: | N/A |
| 3. Penetrants: | (1)12"P | 12. Barrier Type: | F |
| 4. Sealant Type: | Foam | 13. Opening Sleeved or Concrete: | Steel |
| 5. Damming Side1: | Flush | 14. Pipe Insulated: | No |
| 6. Damming Side 2: | Recessed 3" | | |
| 7. Damming Continuity (Acc/Rej): | Accept | | |
| 8. Boot Condition (Acc/Rej): | N/A | | |
| 9. Sealant Depth: | 7" | | |

Jeff Suter

Prepared By:

Wayne Aregood

Reviewed By:

Walkdown Comments:

Sketch:

FA: A-16
Side 1

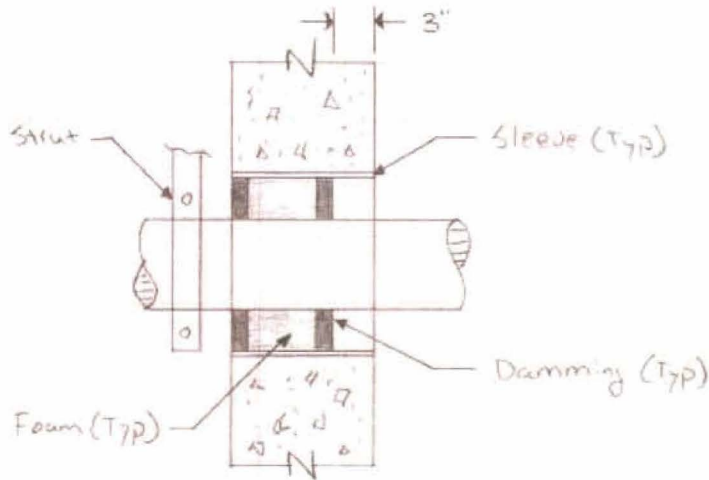

P141W1908

FA: A-26
Side 2

Penetration Seal Data

Appendix: B13

Photos: P141W1908

Fire Area A-16 (Side 1)

Fire Area A-16 (Side 1)



Fire Area A-26 (Side 2)

Fire Area A-26 (Side 2)



Penetration Seal Data

Appendix: B13

Heat Affected Zone Review: P141W1908

Fire Area (Side 1) A-16

No issues within Heat Affected Zone

Fire Area (Side 2) A-26

No issues within Heat Affected Zone

Review Distances

(Reference M-663-00017A, Figure 7.2.3-1)

12" Pipe			
L1 & L2 Dist. (ft)	Temp. (°F)	R1 Radius (in)	R2 Radius (in)
0.5	1712	4.6	5.9
1	1524	3.7	5.1
1.5	1357	3	4.3
2	1209	2.3	3.6
2.5	1078	1.7	3.1
3	962	1.2	2.5
3.5	860	0.7	2.1
4	769	0.3	1.7
4.5	689	Contact	1.3
5	618		1
5.5	555		0.7
6	499		0.4
6.5	450		0.2
7	406		0
7.5	368		Contact

Side 1 Photo

Side 2 Photo

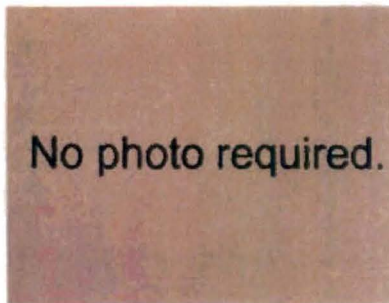

Sketch



Penetration Seal Data

Appendix: B13

Penetration #: P141W1913

Penetration Type: M-1

Fire Area (Side 1): A-16

Fire Area (Side 2): A-26

Loc./Elev.: 2042'-1 1

M-0X Dwg: M-1X1919

- | | | | |
|----------------------------------|-----------------|----------------------------------|--------|
| 1. Barrier Thickness: | 12" | 10. Annular Gap (smallest): | 1-1/2" |
| 2. Opening Size: | 12"D | 11. Gap between pen: | N/A |
| 3. Penetrants: | (1)8"P | 12. Barrier Type: | F |
| 4. Sealant Type: | Foam | 13. Opening Sleeved or Concrete: | Steel |
| 5. Damming Side1: | Recessed 3-1/2" | 14. Pipe Insulated: | No |
| 6. Damming Side 2: | Flush | | |
| 7. Damming Continuity (Acc/Rej): | Accept | | |
| 8. Boot Condition (Acc/Rej): | N/A | | |
| 9. Sealant Depth: | 6-1/2" | | |

Jeff Suter

Prepared By:

Wayne Aregood

Reviewed By:

Walkdown Comments:

Barrier thickness based on drawing M-1X1411.

Sketch:

FA: A-16
Side 1

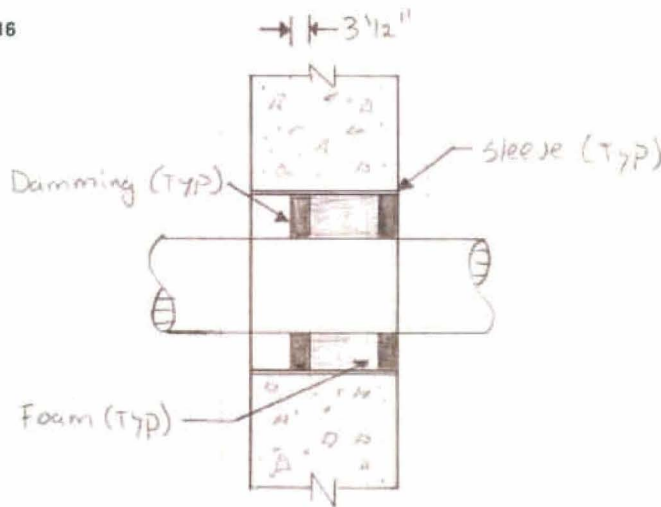

P141W1913

FA: A-26
Side 2

Penetration Seal Data

Appendix: B13

Photos: P141W1913

Fire Area A-16 (Side 1)

Fire Area A-16 (Side 1)



Fire Area A-26 (Side 2)

Fire Area A-26 (Side 2)



Penetration Seal Data

Appendix: B13

Penetration #: P142S1083

Penetration Type: M-1

Fire Area (Side 1): A-16

Fire Area (Side 2): A-3

Loc./Elev.: 2026'-0"

M-0X Dwg: M-1X1421

- | | | | |
|----------------------------------|--------------------|----------------------------------|-------|
| 1. Barrier Thickness: | 20" | 10. Annular Gap (smallest): | 2" |
| 2. Opening Size: | 30"D | 11. Gap between pen: | N/A |
| 3. Penetrants: | (1)24"P | 12. Barrier Type: | F |
| 4. Sealant Type: | Foam | 13. Opening Sleeved or Concrete: | Steel |
| 5. Damming Side1: | N/A | 14. Pipe Insulated: | No |
| 6. Damming Side 2: | Assumed per detail | | |
| 7. Damming Continuity (Acc/Rej): | Accept | | |
| 8. Boot Condition (Acc/Rej): | N/A | | |
| 9. Sealant Depth: | Assumed per detail | | |

Jeff Suter

Prepared By:

Wayne Aregood

Reviewed By:

Walkdown Comments:

Slab thickness based on C-0C1411. Insulation abuts bottom side of penetration. Top side is not insulated. Original inspection document indicates 6" foam depth (wsa).

Sketch:

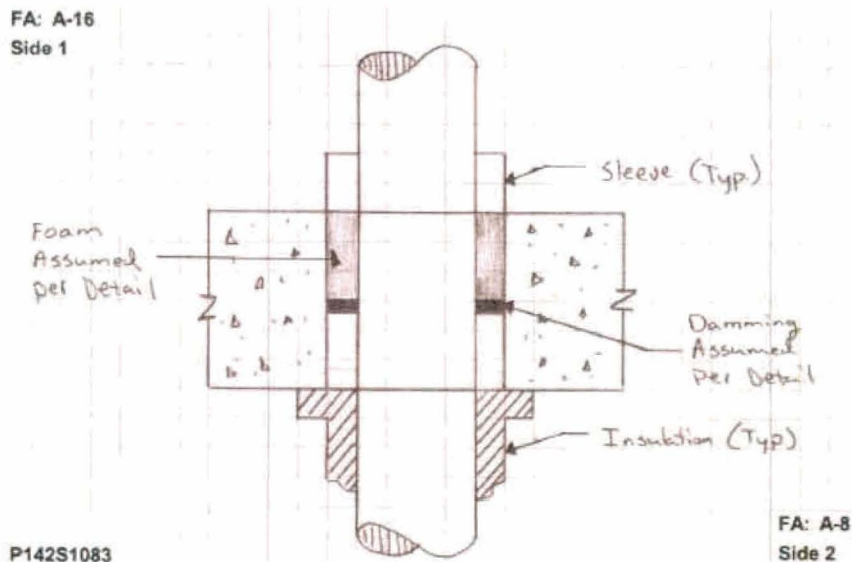

Penetration Seal Data

Appendix: B13

Photos: P142S1083

Fire Area A-16 (Side 1)



Fire Area A-16 (Side 1)



Fire Area A-3 (Side 2)



Fire Area A-3 (Side 2)

Penetration Seal Data

Appendix: **B13**

Heat Affected Zone Review: P142S1083

Fire Area (Side 1) A-16

There are no issues within the Heat Affected Zone.

Fire Area (Side 2) A-3

There are no issues within the Heat Affected Zone.

Review Distances

(Reference M-663-00017A, Figure 7.2.3-1)

24" Pipe			
L1 & L2 Dist. (ft)	Temp. (°F)	R1 Radius (in)	R2 Radius (in)
0.5	1763	4.8	6.1
1	1615	4.1	5.5
1.5	1480	3.5	4.9
2	1357	3	4.3
2.5	1244	2.5	3.8
3	1141	2	3.3
3.5	1048	1.6	2.9
4	962	1.2	2.5
4.5	884	0.8	2.2
5	813	0.5	1.9
5.5	748	0.2	1.6
6	689	Contact	1.3
6.5	635		1.1
7	585		0.8
7.5	540		0.6
8	499		0.4
8.5	462		0.3
9	427		0.1
9.5	396		Contact

Side 1 Photo

Side 2 Photo

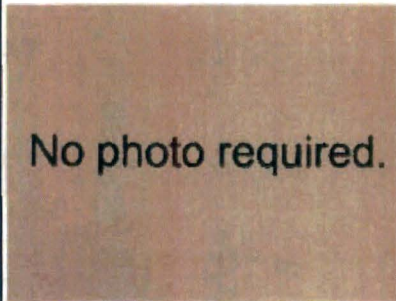

Sketch



Penetration Seal Data

Appendix: B13

Penetration #: P142S1086

Penetration Type: FB-1

Fire Area (Side 1): A-16

Fire Area (Side 2): A-3

Loc./Elev.: 2026'-0"

M-0X Dwg: M-1X1421

- | | | | |
|----------------------------------|--------------------|----------------------------------|-------|
| 1. Barrier Thickness: | 12" | 10. Annular Gap (smallest): | 2" |
| 2. Opening Size: | 30"D | 11. Gap between pen: | N/A |
| 3. Penetrants: | (1) 24"P | 12. Barrier Type: | F |
| 4. Sealant Type: | Ceramic Fiber | 13. Opening Sleeved or Concrete: | Steel |
| 5. Damming Side1: | Boot | 14. Pipe Insulated: | No |
| 6. Damming Side 2: | Boot | | |
| 7. Damming Continuity (Acc/Rej): | N/A | | |
| 8. Boot Condition (Acc/Rej): | Accept | | |
| 9. Sealant Depth: | Assumed per detail | | |

Jeff Suter

Prepared By:

Wayne Aregood

Reviewed By:

Walkdown Comments:

Slab thickness based on C-0C1411.

Sketch:

FA: A-16
Side 1

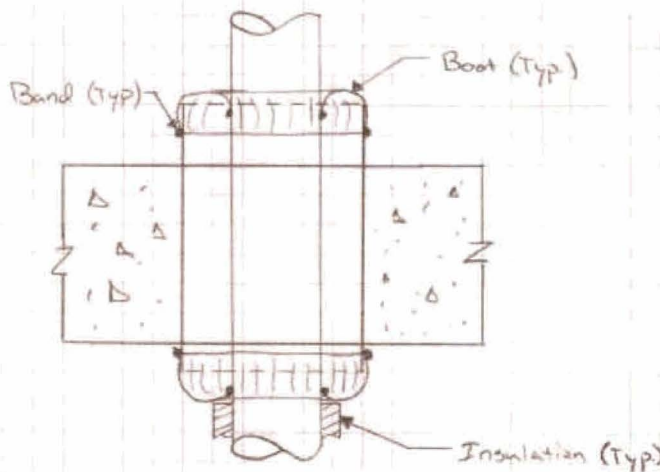

P142S1086

FA: A-8
Side 2

Penetration Seal Data

Appendix: B13

Photos: P142S1086

Fire Area A-16 (Side 1)



Fire Area A-16 (Side 1)



Fire Area A-3 (Side 2)



Fire Area A-3 (Side 2)



Penetration Seal Data

Appendix: B13

Heat Affected Zone Review: P142S1086

Fire Area (Side 1) A-16

1. Armaflex insulation

Fire Area (Side 2) A-3

1. 1-1/2" Cond. 1U1F2K, not within Heat Affected Zone
2. 1-1/2" Cond. 6J1118, not within Heat Affected Zone
3. 2" Cond. 6U1168, not within Heat Affected Zone

Review Distances

(Reference M-663-00017A, Figure 7.2.3-1)

24" Pipe			
L1 & L2 Dist. (ft)	Temp. (°F)	R1 Radius (in)	R2 Radius (in)
0.5	1763	4.8	6.1
1	1615	4.1	5.5
1.5	1480	3.5	4.9
2	1357	3	4.3
2.5	1244	2.5	3.8
3	1141	2	3.3
3.5	1048	1.6	2.9
4	962	1.2	2.5
4.5	884	0.8	2.2
5	813	0.5	1.9
5.5	748	0.2	1.6
6	689	Contact	1.3
6.5	635		1.1
7	585		0.8
7.5	540		0.6
8	499		0.4
8.5	462		0.3
9	427		0.1
9.5	396		Contact

Side 1 Photo

Side 2 Photo

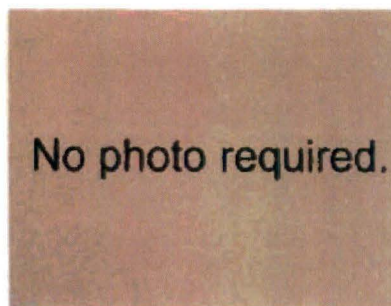
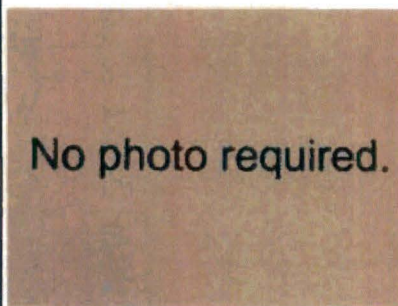

Sketch

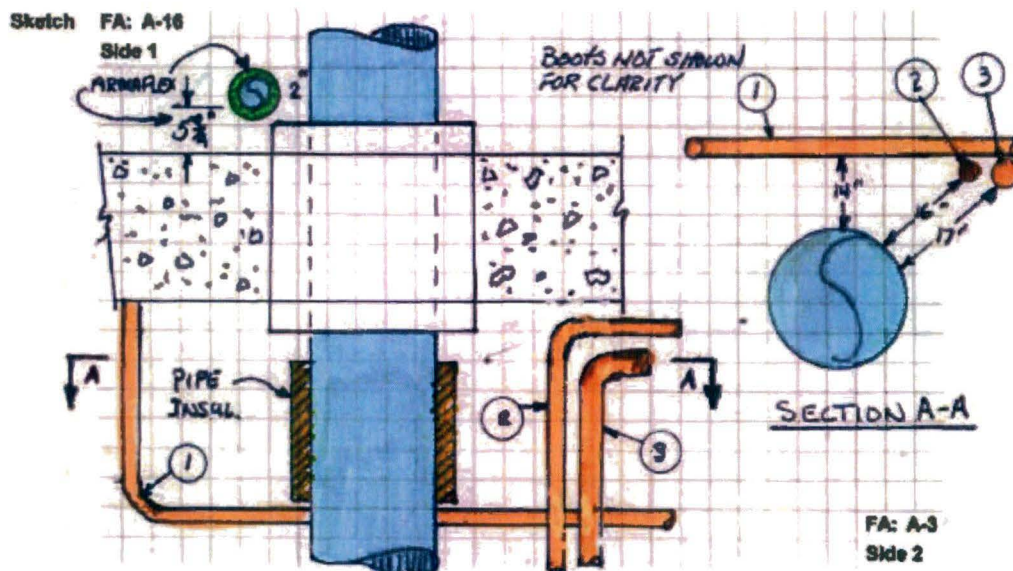

Penetration Seal Data

Appendix: B13

Penetration #: P142W1932

Penetration Type: M-6A

Fire Area (Side 1): A-16

Fire Area (Side 2): A-10

Loc./Elev.: 2030'-0"

M-0X Dwg: M-1X1919

- | | | | |
|----------------------------------|--------------|----------------------------------|-------|
| 1. Barrier Thickness: | 36" | 10. Annular Gap (smallest): | 2" |
| 2. Opening Size: | 24"D | 11. Gap between pen: | N/A |
| 3. Penetrants: | (1)18"P | 12. Barrier Type: | F |
| 4. Sealant Type: | Foam | 13. Opening Sleeved or Concrete: | Steel |
| 5. Damming Side1: | Flush | 14. Pipe Insulated: | No |
| 6. Damming Side 2: | Recessed 25" | | |
| 7. Damming Continuity (Acc/Rej): | Accept | | |
| 8. Boot Condition (Acc/Rej): | N/A | | |
| 9. Sealant Depth: | 9" | | |

Jeff Suter

Prepared By:

Wayne Aregood

Reviewed By:

Walkdown Comments:

Barrier thickness based on drawing C-1C1421. Changed detail to M-6A based on field inspection. Damming on side two is irregular in depth. Top portion of seal is recessed 25", while bottom portion is recessed 14".

Sketch:

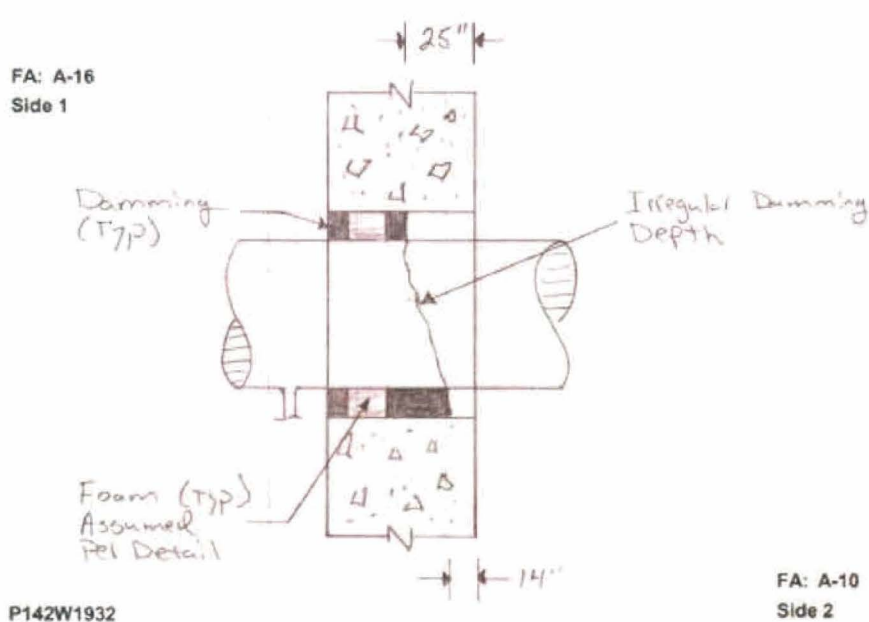

Penetration Seal Data

Appendix: B13

Photos: P142W1932

Fire Area A-16 (Side 1)



Fire Area A-16 (Side 1)

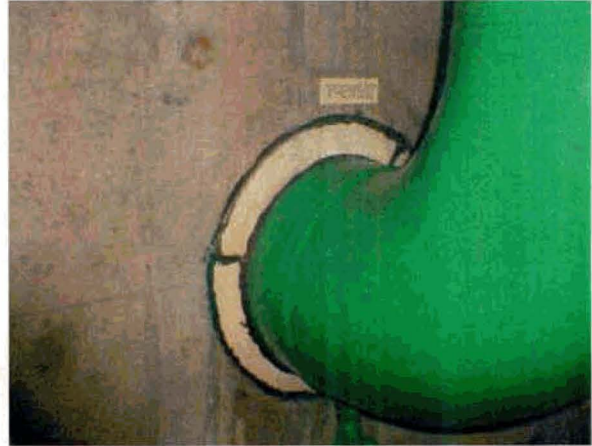

Fire Area A-10 (Side 2)



Fire Area A-10 (Side 2)



Penetration Seal Data

Appendix: B13

Heat Affected Zone Review: P142W1932

Fire Area (Side 1) A-16

1. 1-1/2" Cond. 1U1015: Not within Heat Affected Zone
2. 1-1/2" Cond. 1U1014: Not within Heat Affected Zone
3. 1-1/2" Cond. 1U1013: Not within Heat Affected Zone
4. 1-1/2" Cond. 1U1012: Not within Heat Affected Zone

Fire Area (Side 2) A-10

No issues within Heat Affected Zone

Review Distances

(Reference M-663-00017A, Figure 7.2.3-1)

18" Pipe			
L1 & L2 Dist. (ft)	Temp. (°F)	R1 Radius (in)	R2 Radius (in)
0.5	1741	4.7	6
1	1576	3.9	5.3
1.5	1426	3.3	4.6
2	1292	2.7	4
2.5	1171	2.1	3.5
3	1062	1.6	3
3.5	964	1.2	2.5
4	875	0.8	2.1
4.5	795	0.4	1.8
5	724	0.1	1.5
5.5	659	Contact	1.2
6	600		0.9
6.5	548		0.7
7	501		0.5
7.5	458		0.3
8	419		0.1
8.5	385		Contact

Side 1 Photo



Side 2 Photo

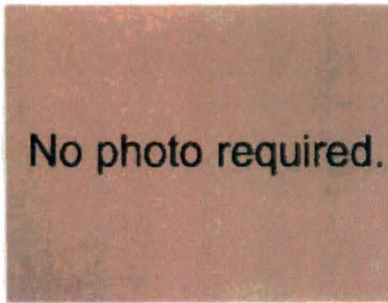

Sketch

FA: A-16
Side 1

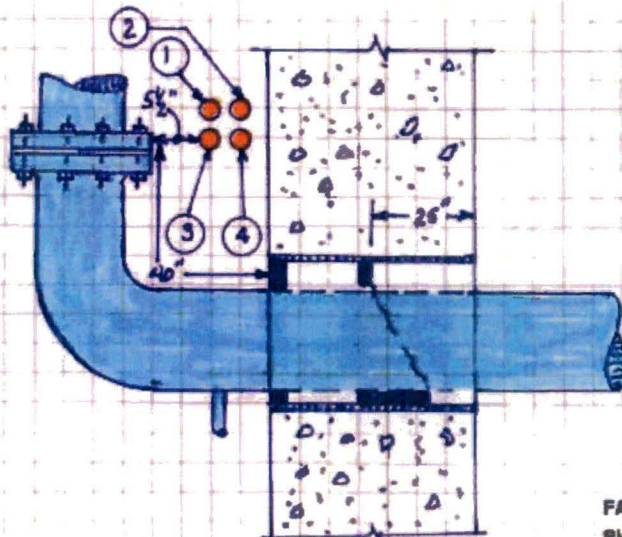

FA: A-10
Side 2

Penetration Seal Data

Appendix: B13

Penetration #: P143W2514

Penetration Type: M-1

Fire Area (Side 1): A-16

Fire Area (Side 2): A-5

Loc./Elev.: 2043'-0"

M-0X Dwg: M-1X1938

- | | | | |
|----------------------------------|-----------------|----------------------------------|-------|
| 1. Barrier Thickness: | 12" | 10. Annular Gap (smallest): | 1/2" |
| 2. Opening Size: | 18"D | 11. Gap between pen: | N/A |
| 3. Penetrants: | (1)12"P | 12. Barrier Type: | F |
| 4. Sealant Type: | Foam | 13. Opening Sleeved or Concrete: | Steel |
| 5. Damming Side1: | 3-1/2" recessed | 14. Pipe Insulated: | No |
| 6. Damming Side 2: | Flush | | |
| 7. Damming Continuity (Acc/Rej): | Accept | <u>Wayne Aregood</u> | |
| 8. Boot Condition (Acc/Rej): | N/A | Prepared By: | |
| 9. Sealant Depth: | 6-1/2" | <u>Jeff Suter</u> | |
| | | Reviewed By: | |

Walkdown Comments:

Barrier thickness determined by Drawing C-0C1431, see Plan View at Elevation 2038'-41/4".

Sketch:

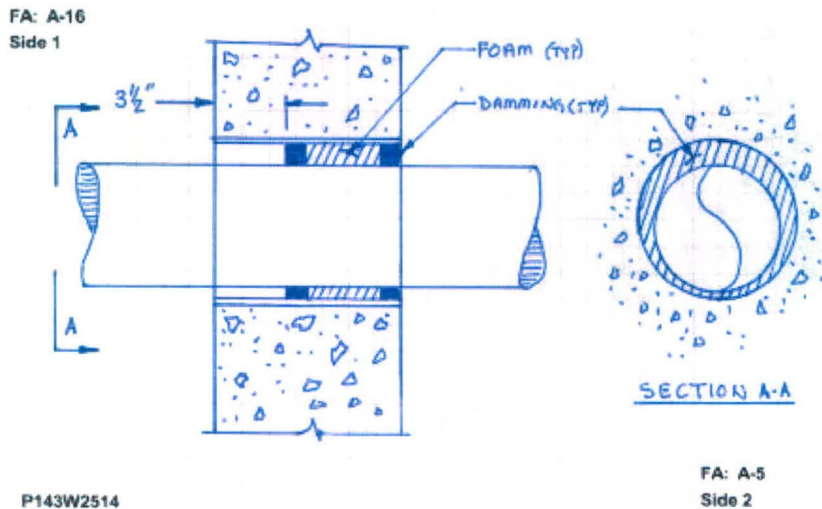

Penetration Seal Data

Appendix: B13

Photos: P143W2514

Fire Area A-16 (Side 1)

Fire Area A-16 (Side 1)



Fire Area A-5 (Side 2)

Fire Area A-5 (Side 2)



Penetration Seal Data

Appendix: B13

Heat Affected Zone Review: P143W2514

Fire Area (Side 1) A-16

- 24" Cable Tray 5U5A94 is within Heat Affected Zone. Further review determined that this cable tray is PFSSD. Document E-1F9910 provides the basis for acceptance.
- Cable Airdrop from 1" Conduit 5U5A1M, within Heat Affected Zone. Further review determined that this cable is not PFSSD. Set-route control is necessary.
- Cable Airdrop from 3/4" Conduit 5U438R, Not within Heat Affected Zone.

Fire Area (Side 2) A-5

- 24" Cable Tray 5U5A94 is within Heat Affected Zone. Further review determined that this cable tray is PFSSD. Document E-1F9910 provides the basis for acceptance.

Review Distances

(Reference M-663-00017A, Figure 7.2.3-1)

12" Pipe			
L1 & L2 Dist. (ft)	Temp. (°F)	R1 Radius (in)	R2 Radius (in)
0.5	1712	4.6	5.9
1	1524	3.7	5.1
1.5	1357	3	4.3
2	1209	2.3	3.6
2.5	1078	1.7	3.1
3	962	1.2	2.5
3.5	860	0.7	2.1
4	769	0.3	1.7
4.5	689	Contact	1.3
5	618		1
5.5	555		0.7
6	499		0.4
6.5	450		0.2
7	406		0
7.5	368		Contact

Side 1 Photo



Side 2 Photo



Sketch

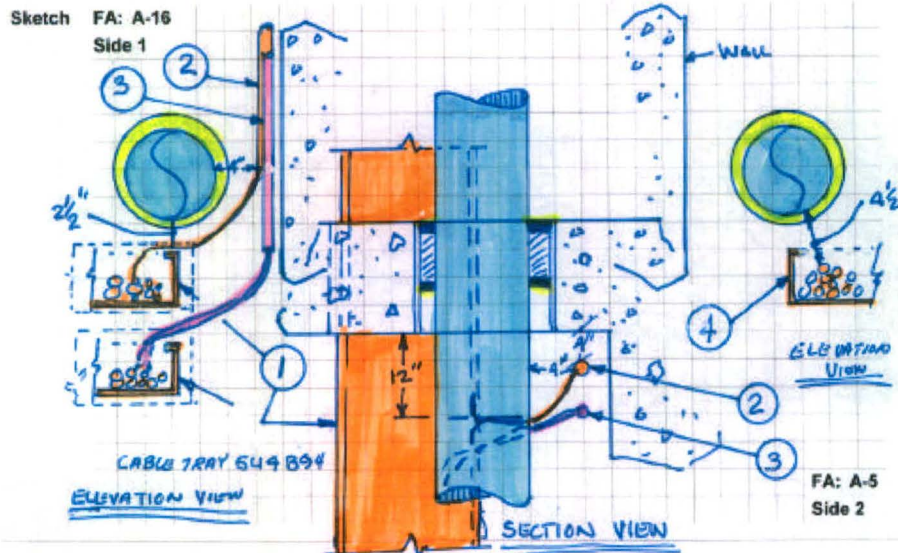

Penetration Seal Data

Appendix: B13

Penetration #: P143W2515

Penetration Type: M-6A

Fire Area (Side 1): A-16

Fire Area (Side 2): A-5

Loc./Elev.: 2043'-0"

M-0X Dwg: M-1X1938

- | | | | |
|----------------------------------|---------------|----------------------------------|-------|
| 1. Barrier Thickness: | 12" | 10. Annular Gap (smallest): | 1/2" |
| 2. Opening Size: | 18"D | 11. Gap between pen: | N/A |
| 3. Penetrants: | (1) 12"P | 12. Barrier Type: | F |
| 4. Sealant Type: | Foam | 13. Opening Sleeved or Concrete: | Steel |
| 5. Damming Side1: | 1/4" recessed | 14. Pipe Insulated: | No |
| 6. Damming Side 2: | Flush | | |
| 7. Damming Continuity (Acc/Rej): | Accept | <u>Wayne Aregood</u> | |
| 8. Boot Condition (Acc/Rej): | N/A | Prepared By: | |
| 9. Sealant Depth: | 9-3/4" | <u>Jeff Suter</u> | |
| | | Reviewed By: | |

Walkdown Comments:

Barrier thickness determined by Drawing C-0C1431, see Plan View at Elevation 2038'-41/4". Detail changed from M-1 to M-6A based on actual sealant depth.

Sketch:

FA: A-16
Side 1

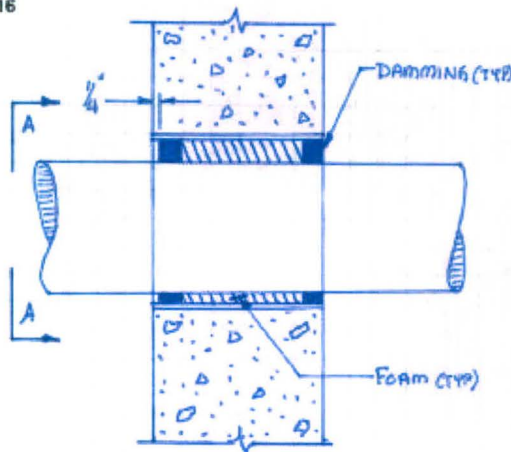

P143W2515

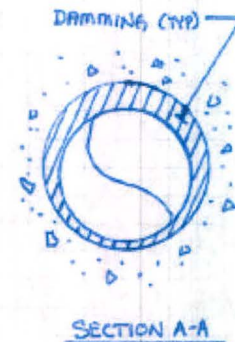

FA: A-5
Side 2

Penetration Seal Data

Appendix: B13

Photos: P143W2515

Fire Area A-16 (Side 1)

Fire Area A-16 (Side 1)



Fire Area A-5 (Side 2)

Fire Area A-5 (Side 2)



Penetration Seal Data

Appendix: B13

Heat Affected Zone Review: P143W2515

Fire Area (Side 1) A-16

1. 24" Cable Tray, 5U5A94 is within Heat Affected Zone (1/2" clearance to Pipe strut clamp). Further review determined that this cable tray is PFSSD. Document E-1F9910 provides the basis for acceptance.

Fire Area (Side 2) A-5

1. 24" Cable Tray, 5U5A94 is within Heat Affected Zone (3-1/2").+ Further review determined that this cable tray is PFSSD. Document E-1F9910 provides the basis for acceptance.

Review Distances

(Reference M-663-00017A, Figure 7.2.3-1)

12" Pipe			
L1 & L2 Dist. (ft)	Temp. (°F)	R1 Radius (in)	R2 Radius (in)
0.5	1712	4.6	5.9
1	1524	3.7	5.1
1.5	1357	3	4.3
2	1209	2.3	3.6
2.5	1078	1.7	3.1
3	962	1.2	2.5
3.5	860	0.7	2.1
4	769	0.3	1.7
4.5	689	Contact	1.3
5	618		1
5.5	555		0.7
6	499		0.4
6.5	450		0.2
7	406		0
7.5	368		Contact

Side 1 Photo



Side 2 Photo



Sketch

Sketch FA: A-16 Side 1

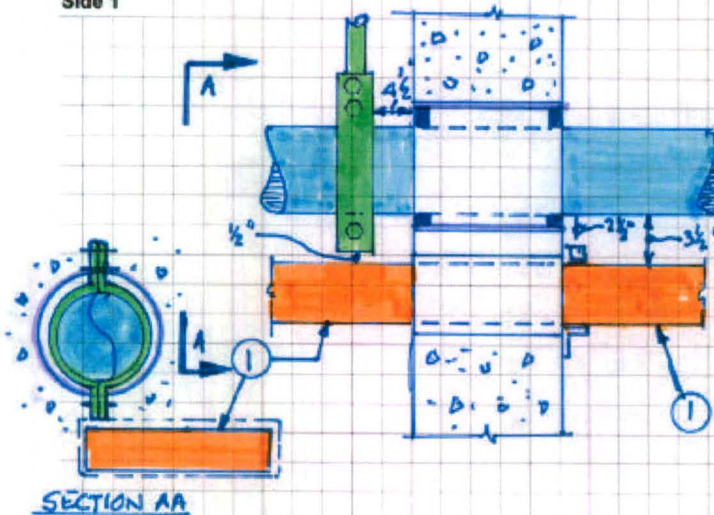

FA: A-5 Side 2

Penetration Seal Data

Appendix: B13

Penetration #: P145S0952

Penetration Type: FB-1

Fire Area (Side 1): A-23

Fire Area (Side 2): A-15

Loc./Elev.: 2026'-0"

M-0X Dwg: M-1X1352

- | | | | |
|----------------------------------|--------------------|----------------------------------|------------|
| 1. Barrier Thickness: | 24" | 10. Annular Gap (smallest): | * 1-11/16" |
| 2. Opening Size: | 14" D | 11. Gap between pen: | N/A |
| 3. Penetrants: | (1) 4"P | 12. Barrier Type: | A F W |
| 4. Sealant Type: | Ceramic Fiber | 13. Opening Sleeved or Concrete: | Steel |
| 5. Damming Side1: | Boot | 14. Pipe Insulated: | Yes |
| 6. Damming Side 2: | Boot | | |
| 7. Damming Continuity (Acc/Rej): | N/A | | |
| 8. Boot Condition (Acc/Rej): | Accept | | |
| 9. Sealant Depth: | Assumed per detail | | |

Jeff Suter

Prepared By:

Wayne Aregood

Reviewed By:

Walkdown Comments:

Slab thickness based on C-1C1352. Top side of penetration is not fully accessible for inspection due to a box enclosure above penetration. * Original inspection records indicate 1-11/16" annular gap and the installation of the Lap Seal per FCR 1-BBI-305 (wsa).

Sketch:

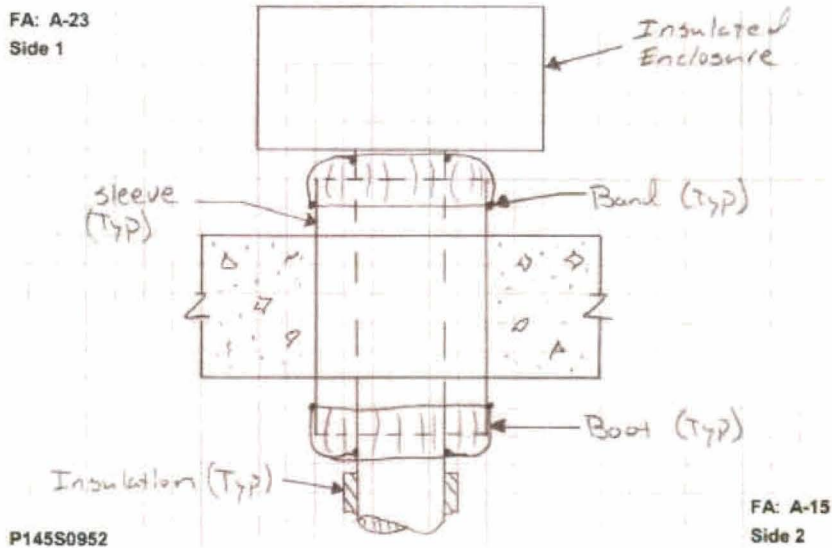

Penetration Seal Data

Appendix: B13

Photos: P145S0952

Fire Area A-23 (Side 1)



Fire Area A-23 (Side 1)



Fire Area A-15 (Side 2)



Fire Area A-15 (Side 2)



Penetration Seal Data

Appendix: B13

Penetration #: P145S0954

Penetration Type: FB-1

Fire Area (Side 1): A-23

Fire Area (Side 2): A-15

Loc./Elev.: 2026'-0"

M-0X Dwg: M-1X1352

- | | | | |
|----------------------------------|--------------------|----------------------------------|-------|
| 1. Barrier Thickness: | 24" | 10. Annular Gap (smallest): | 3/8" |
| 2. Opening Size: | 14"D | 11. Gap between pen: | N/A |
| 3. Penetrants: | (1) 4"P | 12. Barrier Type: | A F W |
| 4. Sealant Type: | Ceramic Fiber | 13. Opening Sleeved or Concrete: | Steel |
| 5. Damming Side1: | Boot | 14. Pipe Insulated: | Yes |
| 6. Damming Side 2: | Boot | | |
| 7. Damming Continuity (Acc/Rej): | N/A | | |
| 8. Boot Condition (Acc/Rej): | Accept | | |
| 9. Sealant Depth: | Assumed per detail | | |

Jeff Suter

Prepared By:

Wayne Aregood

Reviewed By:

Walkdown Comments:

Slab thickness based on C-1C1352. It appears that an FB-6 detail was utilized on the topside of penetration for flooding protection of insulation penetrating seal. Original inspection records indicate the installation of the Lap Seal per FCR 1-BBI-305 (wsa).

Sketch:

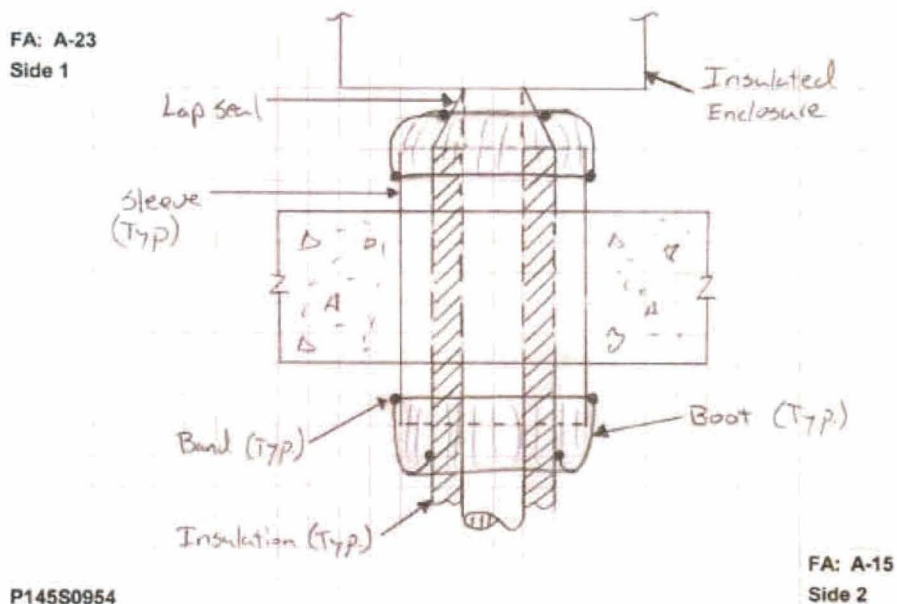

Penetration Seal Data

Appendix: B13

Photos: P145S0954

Fire Area A-23 (Side 1)

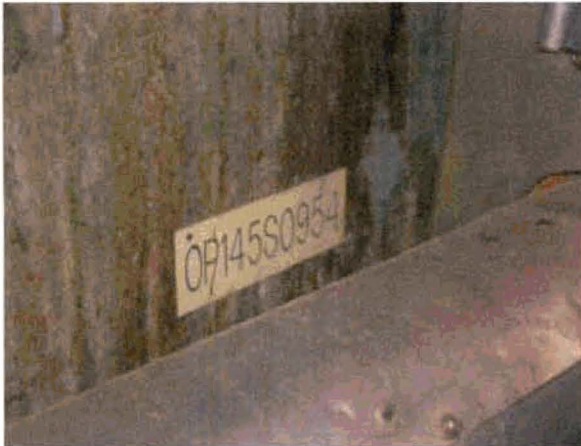

Fire Area A-23 (Side 1)



Fire Area A-15 (Side 2)



Fire Area A-15 (Side 2)

Penetration Seal Data

Appendix: B13

Penetration #: P152W1421

Penetration Type: M-1

Fire Area (Side 1): A-19

Fire Area (Side 2): CC-1

Loc./Elev.: 2055'-6 7

M-0X Dwg: M-1X1904

- | | | | |
|----------------------------------|--------------|----------------------------------|-------|
| 1. Barrier Thickness: | 24" | 10. Annular Gap (smallest): | 1/2" |
| 2. Opening Size: | 16"D | 11. Gap between pen: | N/A |
| 3. Penetrants: | (1)12"P | 12. Barrier Type: | A F |
| 4. Sealant Type: | Foam | 13. Opening Sleeved or Concrete: | Steel |
| 5. Damming Side1: | Flush | 14. Pipe Insulated: | No |
| 6. Damming Side 2: | 14" recessed | | |
| 7. Damming Continuity (Acc/Rej): | Accept | | |
| 8. Boot Condition (Acc/Rej): | N/A | | |
| 9. Sealant Depth: | 8" | | |

Wayne Aregood

Prepared By:

Jeff Suter

Reviewed By:

Walkdown Comments:

Sketch:

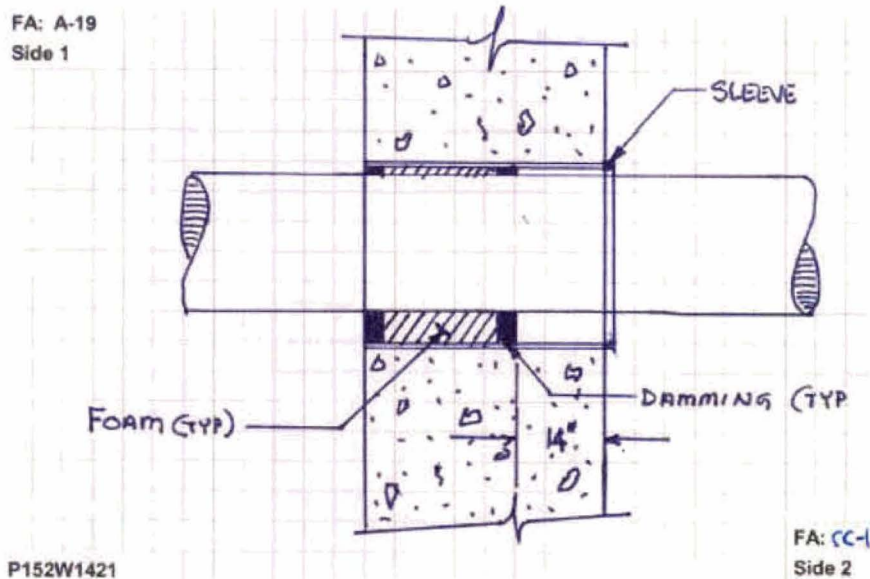

P152W1421

FA: CC-1
Side 2

Penetration Seal Data

Appendix: B13

Photos: P152W1421

Fire Area A-19 (Side 1)

Fire Area A-19 (Side 1)



Fire Area CC-1 (Side 2)

Fire Area CC-1 (Side 2)

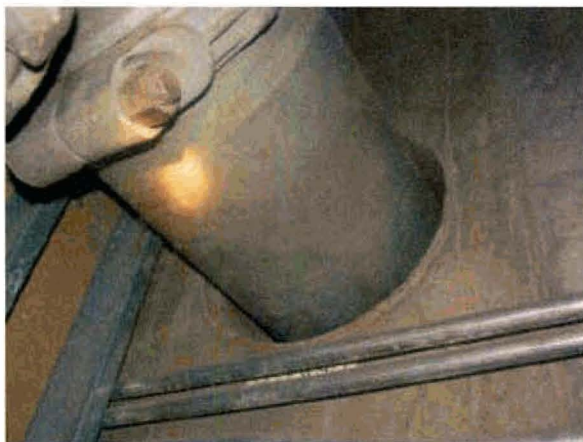

Penetration Seal Data

Appendix: B13

Heat Affected Zone Review: P152W1421

Fire Area (Side 1) A-19

1. 1-3/4" Conduit 5U1N2R, within Heat Affected Zone. Further review determined that this conduit is not PFSSD. Set-route control is necessary.

Fire Area (Side 2) CC-1

- 2. 1/2" EMT Lighting Conduit, not an issue
- 3. 1/2" EMT Lighting Conduit, not an issue
- 4. 1" EMT Lighting Conduit, not an issue
- 5. 1/2" EMT Lighting Conduit, not an issue

Review Distances

(Reference M-663-00017A, Figure 7.2.3-1)

12" Pipe			
L1 & L2 Dist. (ft)	Temp. (°F)	R1 Radius (in)	R2 Radius (in)
0.5	1712	4.6	5.9
1	1524	3.7	5.1
1.5	1357	3	4.3
2	1209	2.3	3.6
2.5	1078	1.7	3.1
3	962	1.2	2.5
3.5	860	0.7	2.1
4	769	0.3	1.7
4.5	689	Contact	1.3
5	618		1
5.5	555		0.7
6	499		0.4
6.5	450		0.2
7	406		0
7.5	368		Contact

Side 1 Photo

Side 2 Photo

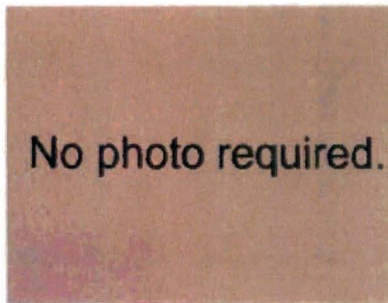
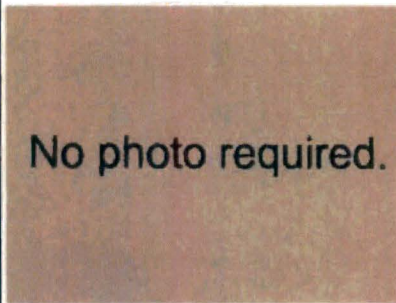

Sketch

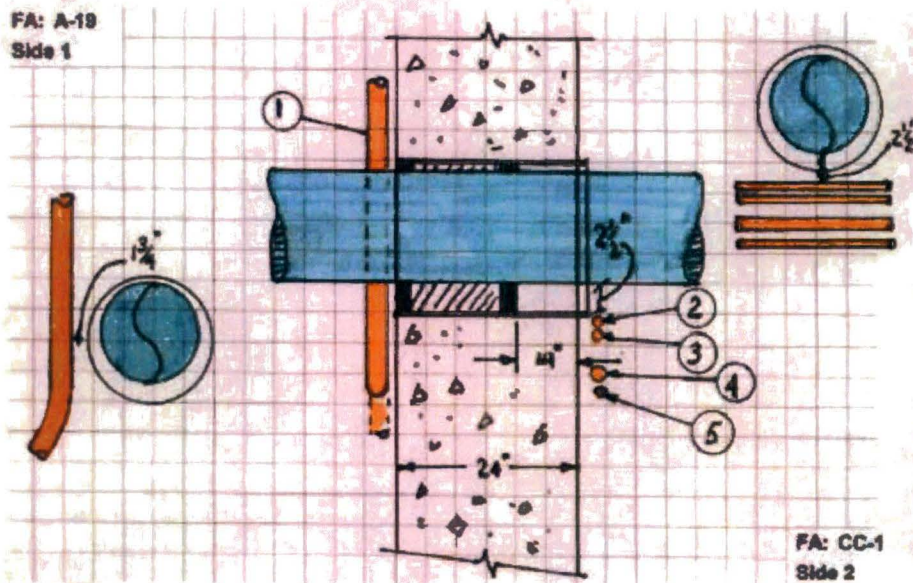

Penetration Seal Data

Appendix: B13

Penetration #: P311W0841

Penetration Type: M-6A

Fire Area (Side 1): C-1

Fire Area (Side 2): CC-1

Loc./Elev.: 1976'-0"

M-0X Dwg: M-1X3901

- | | | | |
|----------------------------------|--------------|----------------------------------|-------|
| 1. Barrier Thickness: | 36" | 10. Annular Gap (smallest): | 2" |
| 2. Opening Size: | 36"D | 11. Gap between pen: | N/A |
| 3. Penetrants: | (1)30"P | 12. Barrier Type: | A F W |
| 4. Sealant Type: | Foam | 13. Opening Sleeved or Concrete: | Steel |
| 5. Damming Side1: | Flush | 14. Pipe Insulated: | No |
| 6. Damming Side 2: | 19" recessed | | |
| 7. Damming Continuity (Acc/Rej): | Accept | | |
| 8. Boot Condition (Acc/Rej): | N/A | | |
| 9. Sealant Depth: | 15" | | |

Wayne Aregood

Prepared By:

Jeff Suter

Reviewed By:

Walkdown Comments:

Barrier thickness determined by Drawing C-1C3111. Side 2 is bulk fiber damming. Changed Detail from M-1 to M-6A based on actual sealant depth.

Sketch:

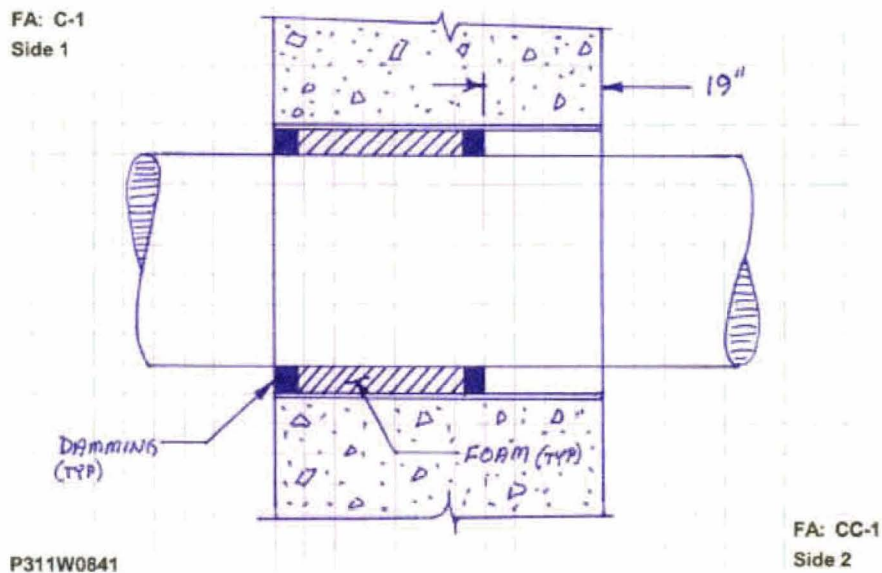

Penetration Seal Data

Appendix: B13

Photos: P311W0841

Fire Area C-1 (Side 1)

Fire Area C-1 (Side 1)

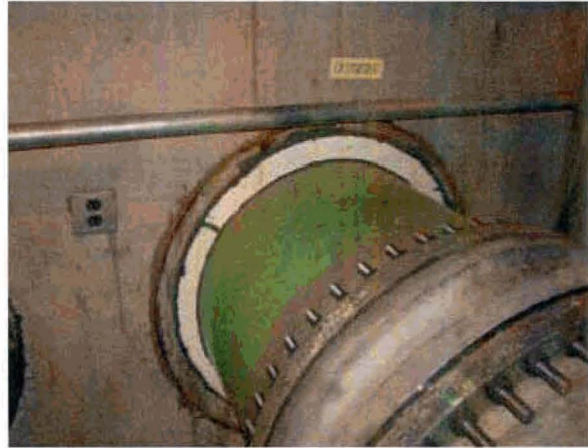

Fire Area CC-1 (Side 2)

Fire Area CC-1 (Side 2)



Penetration Seal Data

Appendix: B13

Heat Affected Zone Review: P311W0841

Fire Area (Side 1) C-1

1. 1-1/2" Cond 5JA1W: Not within Heat Affected Zone.

Fire Area (Side 2) CC-1

No issues within Heat Affected Zone.

Review Distances

(Reference M-663-00017A, Figure 7.2.3-1)

30" Pipe			
L1 & L2 Dist. (ft)	Temp. (°F)	R1 Radius (in)	R2 Radius (in)
0.5	1706	4.5	5.9
1	1513	3.7	5
1.5	1342	2.9	4.2
2	1192	2.2	3.6
2.5	1059	1.6	3
3	942	1.1	2.4
3.5	839	0.6	2
4	748	0.2	1.6
4.5	668	Contact	1.2
5	597		0.9
5.5	535		0.6
6	480		0.4
6.5	432		0.1
7	389		Contact

Side 1 Photo



Side 2 Photo

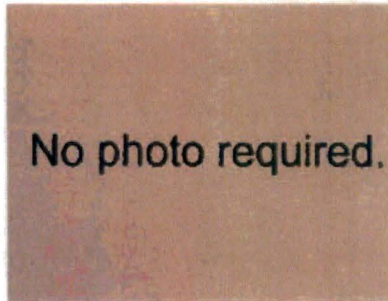

Sketch

FA: C-1
Side 1

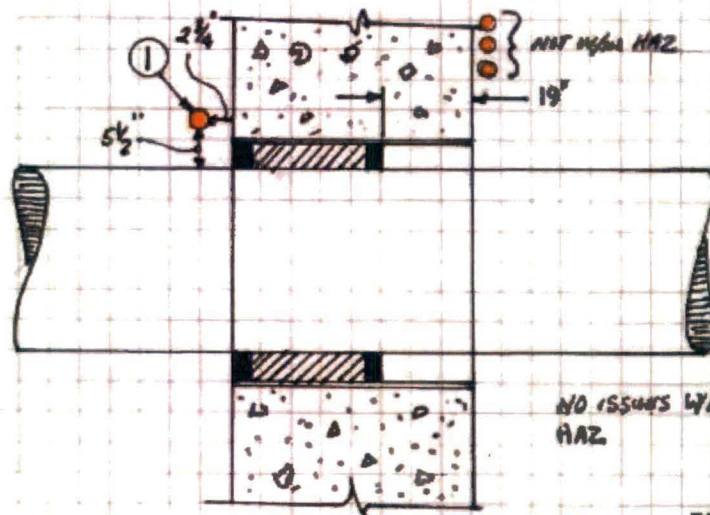

NO ISSUES W/IN HAZ

FA: CC-1
Side 2

Penetration Seal Data

Appendix: B13

Penetration #: P311W0842

Penetration Type: M-6A

Fire Area (Side 1): C-1

Fire Area (Side 2): CC-1

Loc./Elev.: 1976'-0"

M-0X Dwg: M-1X3901

- | | | | |
|----------------------------------|--------------|----------------------------------|-------|
| 1. Barrier Thickness: | 36" | 10. Annular Gap (smallest): | 2" |
| 2. Opening Size: | 36"D | 11. Gap between pen: | N/A |
| 3. Penetrants: | (1)30"P | 12. Barrier Type: | A F W |
| 4. Sealant Type: | Foam | 13. Opening Sleeved or Concrete: | Steel |
| 5. Damming Side1: | Flush | 14. Pipe Insulated: | No |
| 6. Damming Side 2: | 20" recessed | | |
| 7. Damming Continuity (Acc/Rej): | Accept | | |
| 8. Boot Condition (Acc/Rej): | N/A | | |
| 9. Sealant Depth: | 14" | | |

Wayne Aregood

Prepared By:

Jeff Suter

Reviewed By:

Walkdown Comments:

Barrier thickness determined by Drawing C-1C3111. Side 2 is bulk fiber damming. Changed Detail from M-1 to M-6A based on actual sealant depth.

Sketch:

FA: C-1
Side 1

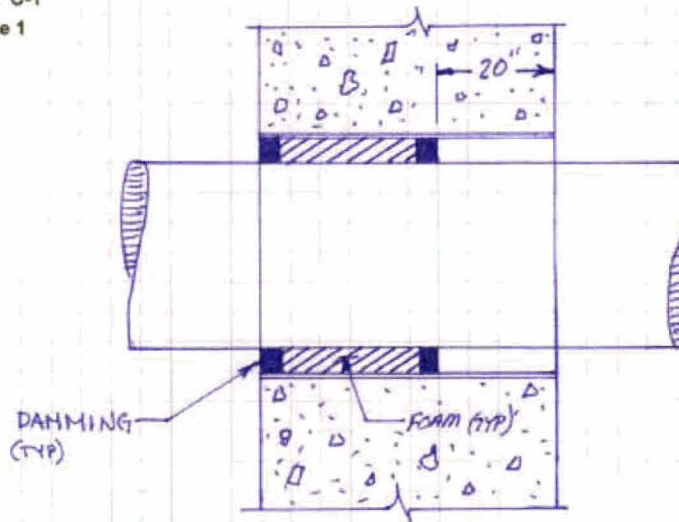

P311W0842

FA: CC-1
Side 2

Penetration Seal Data

Appendix: B13

Photos: P311W0842

Fire Area C-1 (Side 1)

Fire Area C-1 (Side 1)

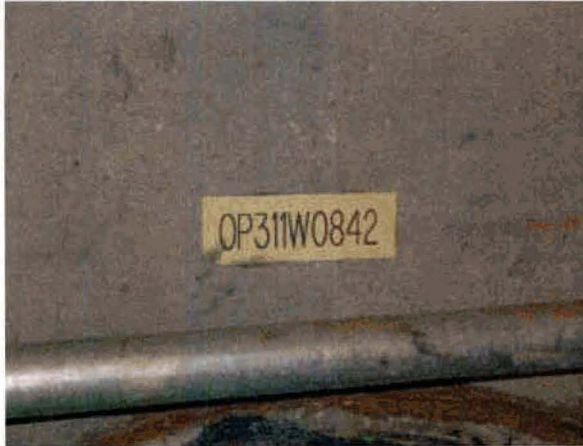

Fire Area CC-1 (Side 2)

Fire Area CC-1 (Side 2)

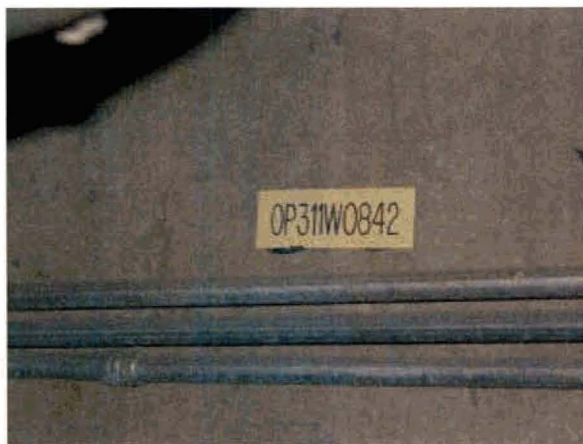

Penetration Seal Data

Appendix: B13

Heat Affected Zone Review: P311W0842

Fire Area (Side 1) C-1

- 1. 1-1/2" Cond 5JA1W: Not within Heat Affected Zone.

Fire Area (Side 2) CC-1

No issues within Heat Affected Zone.

Review Distances

(Reference M-663-00017A, Figure 7.2.3-1)

30" Pipe			
L1 & L2 Dist. (ft)	Temp. (°F)	R1 Radius (in)	R2 Radius (in)
0.5	1706	4.5	5.9
1	1513	3.7	5
1.5	1342	2.9	4.2
2	1192	2.2	3.6
2.5	1059	1.6	3
3	942	1.1	2.4
3.5	839	0.6	2
4	748	0.2	1.6
4.5	668	Contact	1.2
5	597		0.9
5.5	535		0.6
6	480		0.4
6.5	432		0.1
7	389		Contact

Side 1 Photo

Side 2 Photo



Sketch

FA: C-1
Side 1

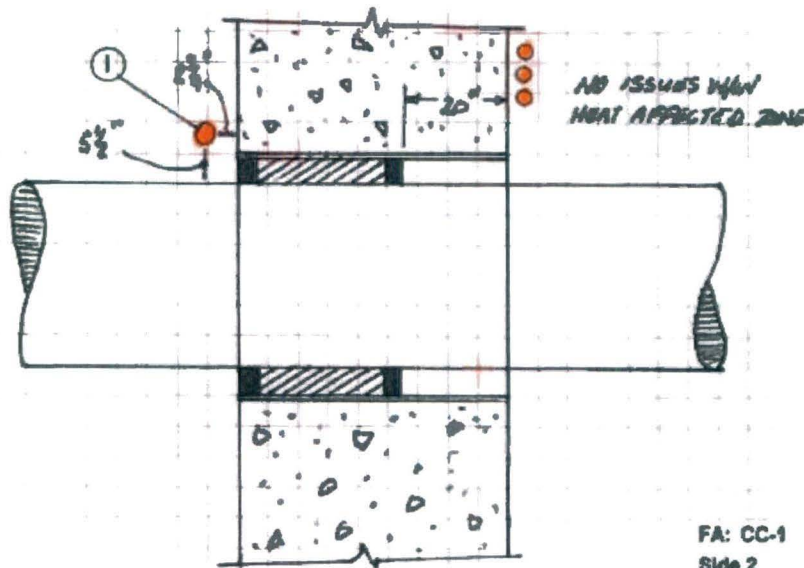

FA: CC-1
Side 2

Penetration Seal Data

Appendix: B13

Penetration #: P311W0845

Penetration Type: M-6A

Fire Area (Side 1): C-1

Fire Area (Side 2): CC-1

Loc./Elev.: 1976'-0"

M-0X Dwg: M-1X3901

- | | | | |
|----------------------------------|--------------|----------------------------------|-------|
| 1. Barrier Thickness: | 36" | 10. Annular Gap (smallest): | 2" |
| 2. Opening Size: | 36"D | 11. Gap between pen: | N/A |
| 3. Penetrants: | (1)30"P | 12. Barrier Type: | A F W |
| 4. Sealant Type: | Foam | 13. Opening Sleeved or Concrete: | Steel |
| 5. Damming Side1: | Flush | 14. Pipe Insulated: | No |
| 6. Damming Side 2: | 23" recessed | | |
| 7. Damming Continuity (Acc/Rej): | Accept | | |
| 8. Boot Condition (Acc/Rej): | N/A | | |
| 9. Sealant Depth: | 11" | | |

Wayne Aregood

Prepared By:

Jeff Suter

Reviewed By:

Walkdown Comments:

Barrier thickness determined by Drawing C-1C3111. Side 2 is bulk fiber damming. Changed Detail from M-1 to M-6A based on actual sealant depth.

Sketch:

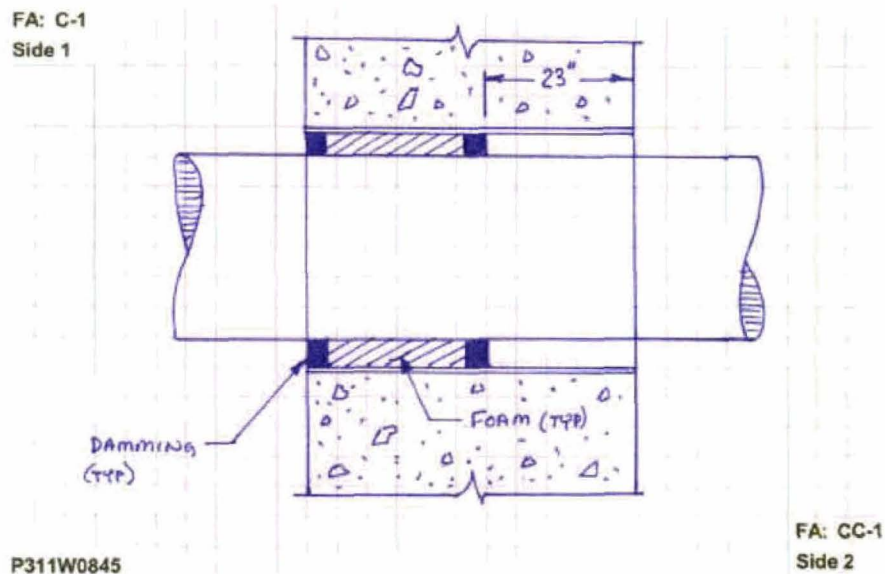

Penetration Seal Data

Appendix: B13

Photos: P311W0845

Fire Area C-1 (Side 1)



Fire Area C-1 (Side 1)

Fire Area CC-1 (Side 2)

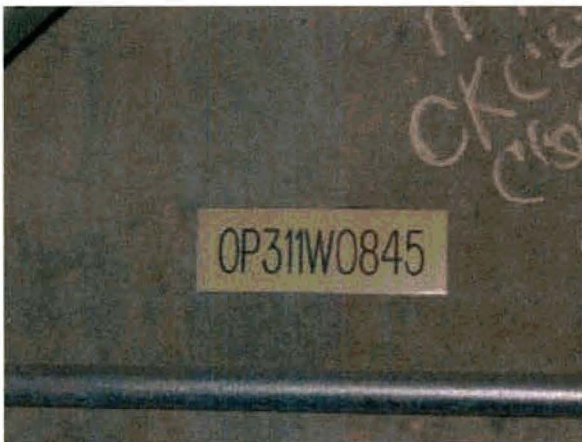

Fire Area CC-1 (Side 2)



Penetration Seal Data

Appendix: B13

Heat Affected Zone Review: P311W0845

Fire Area (Side 1) C-1

- 1. 1-1/2" Cond 5JA1W: Not within Heat Affected Zone.

Fire Area (Side 2) CC-1

No issues within Heat Affected Zone.

Review Distances

(Reference M-663-00017A, Figure 7.2.3-1)

30" Pipe			
L1 & L2 Dist. (ft)	Temp. (°F)	R1 Radius (in)	R2 Radius (in)
0.5	1706	4.5	5.9
1	1513	3.7	5
1.5	1342	2.9	4.2
2	1192	2.2	3.6
2.5	1059	1.6	3
3	942	1.1	2.4
3.5	839	0.6	2
4	748	0.2	1.6
4.5	668	Contact	1.2
5	597		0.9
5.5	535		0.6
6	480		0.4
6.5	432		0.1
7	389		Contact

Side 1 Photo

Side 2 Photo



Sketch

FA: C-1
Side 1

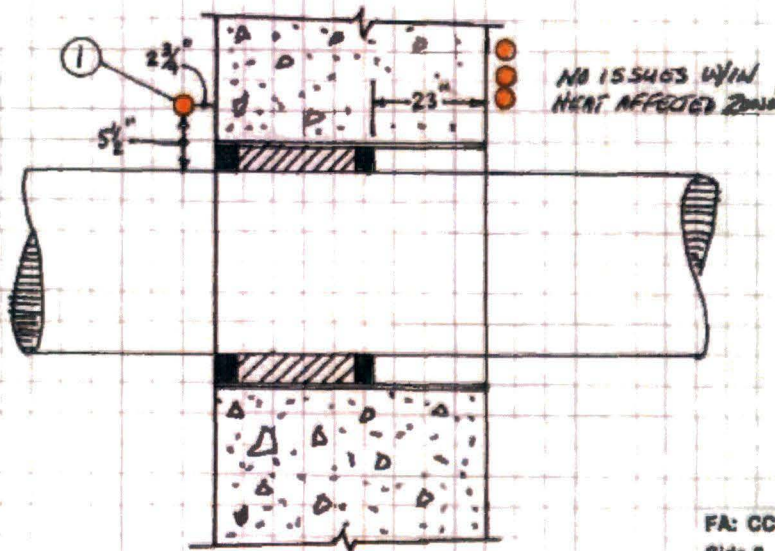

FA: CC-1
Side 2

Penetration Seal Data

Appendix: B13

Penetration #: P611W0206

Penetration Type: M-1

Fire Area (Side 1): F-2

Fire Area (Side 2): F-3

Loc./Elev.: 2019'-0"

M-0X Dwg: M-1X6906

- | | | | |
|----------------------------------|-------------|----------------------------------|-------|
| 1. Barrier Thickness: | 12" | 10. Annular Gap (smallest): | 1" |
| 2. Opening Size: | 16"D | 11. Gap between pen: | N/A |
| 3. Penetrants: | (1)12"P | 12. Barrier Type: | F |
| 4. Sealant Type: | Foam | 13. Opening Sleeved or Concrete: | Steel |
| 5. Damming Side1: | Recessed 2" | 14. Pipe Insulated: | No |
| 6. Damming Side 2: | Flush | | |
| 7. Damming Continuity (Acc/Rej): | Accept | <u>Wayne Aregood</u> | |
| 8. Boot Condition (Acc/Rej): | N/A | Prepared By: | |
| 9. Sealant Depth: | 8" | <u>Jeff Suter</u> | |
| | | Reviewed By: | |

Walkdown Comments:

Wall thickness determined by Drawing C-1C6111.

Sketch:

FA: F-2
Side 1

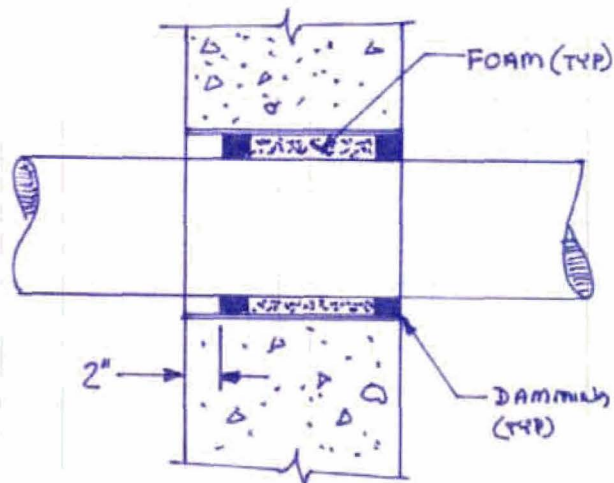

P611W0206

FA: F-3
Side 2

Penetration Seal Data

Appendix: B13

Photos: P611W0206

Fire Area F-2 (Side 1)

Fire Area F-2 (Side 1)



Fire Area F-3 (Side 2)

Fire Area F-3 (Side 2)



Penetration Seal Data

Appendix: B13

Heat Affected Zone Review: P611W0206

Fire Area (Side 1) F-2

No issues within Heat Affected Zone.

Fire Area (Side 2) F-3

No issues within Heat Affected Zone.

Review Distances

(Reference M-663-00017A, Figure 7.2.3-1)

12" Pipe			
L1 & L2 Dist. (ft)	Temp. (°F)	R1 Radius (in)	R2 Radius (in)
0.5	1712	4.6	5.9
1	1524	3.7	5.1
1.5	1357	3	4.3
2	1209	2.3	3.6
2.5	1078	1.7	3.1
3	962	1.2	2.5
3.5	860	0.7	2.1
4	769	0.3	1.7
4.5	689	Contact	1.3
5	618		1
5.5	555		0.7
6	499		0.4
6.5	450		0.2
7	406		0
7.5	368		Contact

Side 1 Photo

Side 2 Photo



Sketch

FA: F-2
Side 1

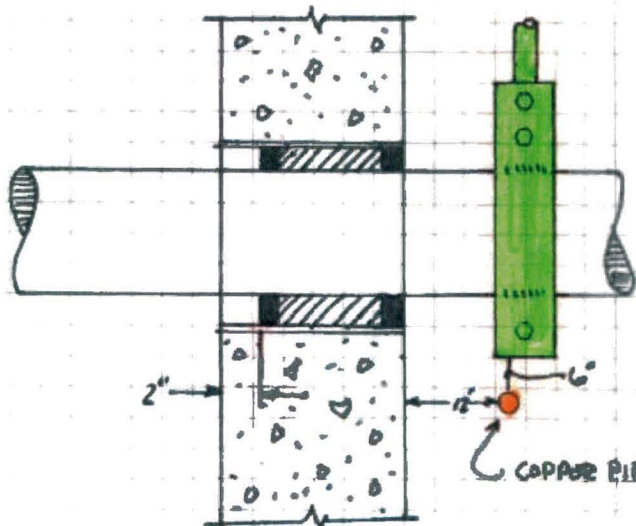

FA: F-3
Side 2

Attachment C

Fire Protection Evaluations for Unique or
Unbounded Fire Wrap Configurations

(There are currently no evaluations in this attachment)



M-663-00017A

Attachment D1

Fire Protection Evaluation For
Containment Post-Tensioning Openings at "C" Buttress



Rev. No.	Prepared By	Date	Reviewed By	Date
W01	 Wayne S Aregood	9/16/05	 Jeff Suter	9/16/05
W05	 Don Garbe	1/21/14	 Jeff Suter	01/22/2014

Table of Contents

Revision Log	3
1.0 Purpose.....	4
2.0 Scope.....	4
3.0 References.....	4
4.0 Evaluation	5
5.0 Conclusions	12

Revision Log

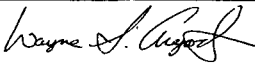
Revision	Reason for Revision
W01	Original Issue
W05	Incorporate Alternative C-Buttress Enclosure Design

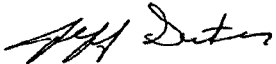
1.0 Purpose

- 1.1 The purpose of this document is to evaluate a unique fire barrier design for the hatch covers protecting the Containment post-tensioning openings at "C" Buttress. This evaluation was conducted in effort to satisfy regulatory expectation regarding qualification and documentation of fire barrier issues. This evaluation was conducted in accordance with the guidance of NRC Generic Letter 86-10.

2.0 Scope

- 2.1 Hatch covers for the Containment post-tensioning openings at "C" Buttress.

3.0 References

- 3.1 NRC Generic Letter 86-10, Implementation of Fire Protection Requirements, dated April 24, 1986
- 3.2 10 CFR 50 Appendix R, Fire Protection Program For Nuclear Power Facilities Operating Prior To January 1, 1979
- 3.3 USAR Section 9.5.1.2.2.3 (Page 9.5-21), Rev. 13
- 3.4 Drawing C-1C1441, Auxiliary Building – Area 4 Concrete Neat Lines Plan – Floor El. 2026', Rev. 1
- 3.5 Drawing C-1C1441A, Auxiliary Building – Area 4 C-Buttress Opening Design Details, Rev. 0
- 3.6 Drawing C-1C1541, Auxiliary Building – Area 4 Concrete Neat Lines Plan – Floor El. 2047 – 6", Rev. 0
- 3.7 Specification 10466-A-126, Technical Specification For Cementitious Fireproofing of Structural Steel For The Standard Nuclear Unit Power Plant System (SNUPPS), Rev. 7
- 3.8 UL Fire Test N-711 (A-126-00001), Fire Test Of Loaded Restrained Beams Protected By Cementitious Mixture
- 3.9 UL Fire Test N-712 (A-126-00002), Fire Test Of Loaded Restrained Beams Protected By Cementitious Mixture
- 3.10 Fire Endurance Test of a Wall Assembly Clad with Thermo-Lag 330-1 (Project No. 14980-98207)
- 3.11 ASTM E 119, Standard Test Methods for Fire Tests of Building Construction and Materials
- 3.12 M-663-00017, Penetration Seal Typical Details, W20

3.13 E-106-00014, Transco Installation Manual for Darmatt KM-1 Fire Protection Systems

4.0 Assumptions

4.1 None.

5.0 Evaluation

5.1 Assessment of Condition to Design Requirements

The floor slabs of the Auxiliary Building elevations 2026' and 2047' incorporate two hatchways that are located at each side of the containment Buttress "C". These four openings are provided to permit access to the containment post-tensioning system tendons located at the same elevations as the floor slabs.

In effort to prevent fire propagation from one Fire Area to another, a steel plate protected on both sides by fireproofing material, covers each hatch opening. Hatch cover steel support members are also protected with fireproofing material. This protection arrangement along with the interface with the seismic expansion gap at the Containment Building wall presents a unique fire barrier configuration that is not directly bounded by fire testing. Therefore, further review is necessary to assess acceptability. Figures 1 and 2 from Reference 3.4 depict the design configuration for the hatch covers and support steel, including the interface with the seismic gap seal. Also, depicted in Figure 3 from Reference 3.5 is an alternative design to allow access to the tendon covers without removing the enclosure design. This alternative design will permit access without damaging the fire protective material during tendon maintenance.

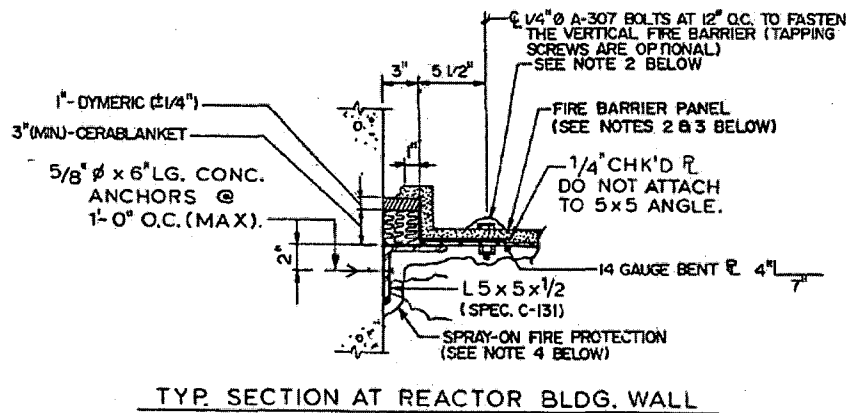

FIGURE 1

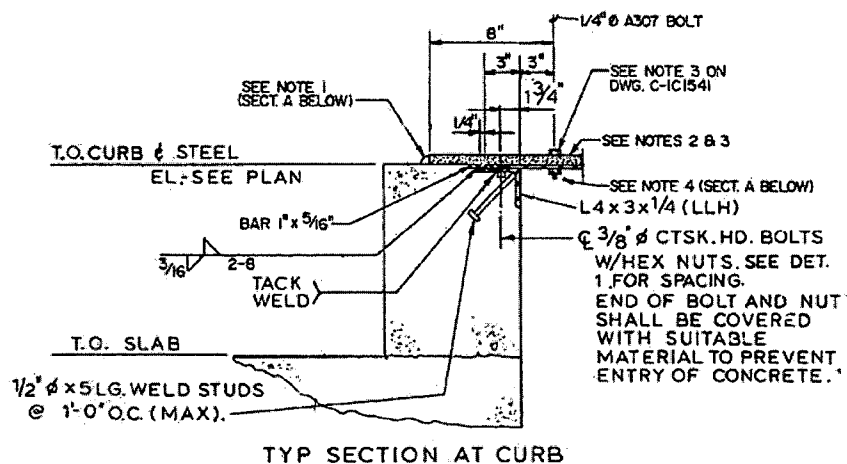

FIGURE 2

FIGURE 1 and 2 NOTES: (as extracted from Drawing C-1C1441)

1. ALL JOINTS SHALL BE CAULKED PER MANUFACTURERS INSTRUCTION (UNO) TOP SIDE ONLY.
2. ALL EXPOSED STRUCTURAL ITEMS SHALL BE FIRE PROOFED WITH 3-HOUR FIRE RATED THERMO-LAG PER MANUFACTURERS INSTRUCTIONS (UNO) TOP SIDE ONLY.
3. TRIM #14 GAGE PLATE & CERABLANKET AS REQUIRED TO AVOID INTERFERENCES WITH TENDON GREASE CAPS.
4. ALL EXPOSED STRUCTURAL STEEL ITEMS SHALL BE FIRE PROOFED WITH 3-HOUR FIRE RATED ALBI-DURASPRAY PER MANUFACTURERS INSTRUCTIONS BOTTOM SIDE ONLY.

5.2 Evaluation of Condition

5.2.1 Hatch Cover Plate

The bottom side of the 1/4" thick checker plate steel hatch covers and the heavy steel angle engaging the containment wall (slip joint) are protected with cementitious fire proofing. Cementitious fireproofing is also provided on the topside of one hatch, while the remaining three are protected with a 1" base layer of Thermo-Lag 330-1 on the topside.

The cementitious fireproofing thickness is provided in accordance with the requirements necessary to achieve a 3-hour rating for structural steel, which has less restrictive acceptance criteria (1,100°F for beams or 1,000°F columns) than the ASTM E 119 unexposed side requirements for a fire barrier (250°F plus ambient). Additionally, subsequent Thermo-Lag testing (Reference 3.10) has demonstrated that a 1" thick base layer panel achieves a 3-hour F rating and a 139-minute T rating when subjected to the fire barrier test requirements of ASTM E 119.

As discussed above, both materials satisfy a 3-hour F rating independent of each other. However, further review is necessary to assess temperature performance considering the combined affect of both materials collectively installed as a single protective barrier.

When structural or steel enclosures protected with fireproofing material are integral to a fire barrier, only one barrier side will be exposed to the fire, thus limiting heat flux through the unexposed fireproofing. The unexposed fireproofing can be expected to provide a significant insulator as demonstrated by comparing the delta between furnace temperature and the maximum steel exposure temperature.

Where cementitious fireproofing is provided on both sides of the hatch cover, subtracting the furnace temperature (1,925°F) from actual thermocouple data (1,100°F) from References 3.8 and 3.9 yields an approximate 825°F temperature drop across the exposed fireproofing during ASTM E-119 fire endurance testing. By applying this temperature drop logic to the unexposed fireproofing, conservatively the same results will be achieved, yielding an expected temperature of 275°F to the unexposed side of the barrier. This estimated 275°F is below the maximum cold side temperature limitations required by ASTM E 119. Therefore, this protection configuration is considered 3-hour T rated.

Where a combination of cementitious fireproofing and Thermo-Lag 330-1 is utilized as hatch cover protection, temperature performance is based on a comparison to the Thermo-Lag test (Reference 3.10) that obtained a 139 minute T rating and the previously discussed thermal performance of cementitious fireproofing. Reference 3.10, for the Thermo-Lag wall test configuration, presented an average unexposed side temperature of 498°F at 3-hours. Subtracting the furnace temperature (1,925°F) from the unexposed side thermal performance of the Thermo-Lag barrier (498°F) yields an approximate 1427°F temperature drop across the exposed Thermo-Lag during ASTM E-119 fire endurance testing. Considering this significant temperature drop coupled with the 825°F drop presented by the cementitious fireproofing, it is reasonable to estimate that the unexposed side temperature will not exceed the limits of ASTM E 119 (250° plus ambient). Therefore, this protection configuration is considered 3-hour T rated.

In plant inspection has revealed the presence of minor cracking within the Thermo-Lag 330-1 material. This minor surface cracking (up to 1/8" wide) is acceptable based on the intumescent properties of the material. When exposed to fire the material intumesces and forms a char layer to allow the subliming characteristics to cool the underlying substrate. Industry testing has demonstrated ¼" through holes were not specifically detrimental to the overall performance of the protective coating.

Exposed Thermo-Lag 330-1 and cementitious fireproofing providing hatch cover protection may be covered with a paint topcoat as necessary to protect against potential moisture intrusion. An acceptable topcoat is Thermo-Lag 311 (see Figure 3). This is the topcoat recommended for use by the Thermo-Lag vendor (Thermal Science Incorporated). Additionally, industry Thermo-Lag fire testing, in support of developing the NEI Thermo-Lag Application Guide, has demonstrated that topcoat products such as Thermo-Lag 311 have no net effect on the thermal performance capability of a Thermo-Lag fire barrier assembly. This topcoat does not present an increase to area combustible loading once cured.

No fire testing directly correlates the use of the Thermo-Lag 311 product for topcoating cementitious fireproofing. However, considering the acceptable fire performance when coating an intumescent Thermo-Lag material, and the static nature of the cementitious material when exposed to fire, the topcoat also will not negatively impact the thermal performance of cementitious fireproofing.

5.2.2 Hatch Cover Plate Interface with Seismic Gap

A seismic gap seal has been installed at the Containment wall and Auxiliary Building "C" Buttress hatch openings to maintain fire barrier continuity.

This seismic gap design is similar to that required by M-663-00017, typical detail SG-2. The installed seismic gap seal design at the hatchways differs slightly from the evaluated SG-2 typical detail, but is considered superior both structurally and from a fire resistant capability. This superiority is based on the bottom side, structural steel slip joint design installed between the Containment wall and the ¼" steel checker plate hatch cover as shown in Figure 1. This steel slip joint provides substantial corbel support for the primary fire resistant sealant (ceramic fiber) and is installed to be compatible with building moments. This steel is also protected with a cementitious fireproofing material to satisfy fire endurance requirements. Although the structural members sizes and configuration that make up the hatch support members are smaller than that fire tested, the considerable surface area contact with the underlying concrete provides significant value through heat transfer. Therefore, structural integrity is maintained as a result of thermal inertia and the insulating capability of the applied cementitious fireproofing clad.

The other differing element to the SG-2 typical detail is that no installed seismic Dymeric 511 caulk is provided on the bottom side of the seismic gap seal. The lack of bottom side Dymeric caulk has no impact to fire rating of the seal and is not a critical design attribute in the installed configuration based on the following,

- The openings are not required to satisfy Water, Air or Pressure design requirements based on a review of adjacent penetration seals design requirements.
- At the hatchway locations the openings are constructed with a flood curb to satisfy any flood issues caused by fire fighting activities.
- The presence of cementitious fireproofing on the bottom side provides protection from water intrusion.
- There are no safety related, PFSSD components or equipment located in close proximity to the openings, if inadvertent water intrusion were to occur during fire fighting activities.

Based on the above discussions the "C" Buttress hatch interface with the seismic gap seal provides an equivalent 3-hour F and T rated configuration.

5.2.3 Hatch Cover Plate Optional Protection and Configuration

An optional configuration is herewith evaluated to partially eliminate the fireproofing material on one side of the C-Buttress enclosure (¼" checker plate) that separates fire areas. The Bottom side protection will be revised to utilize 4 layers of Darmatt KM-1 panel secured to the ¼" checker plate with four (4) ¼" fasteners and stainless steel large (14 gauge min) washer restraining plate. The reason to eliminate the fireproofing on the topside and revising the material type on the bottom side of the hatch is to allow unrestricted access to the C-Buttress tendon tensioning covers without loss of fireproofing material during disassembly. The elimination of the fireproofing on one side of the C-Buttress enclosure checker plate will not negatively impact the barrier to prevent the passage of flame or negate the barrier F and T rating. The design will be also prevent water flow to the lower level as previously designed.

Installation of 3-hour Darmatt KM-1 panel configuration on the bottom side of the enclosure plate, abutting snugly to the required structural steel fireproofing and slab opening sides will provide a 3-hour fire rating (F & T).

Both design requirements (fire and flood) are being met with the optional design. The new design will also permit the one-piece removal of the enclosure plate without damaging the fireproofing material, reducing cost consequences as compared to the current design. The structural components of the design are unchanged and fire resistance is the only change requiring evaluation and bounding.

The physical differences between the original design and the optional design being evaluated are as follows:

- The optional C-Buttress enclosure is not protected on one side (top or bottom).
- Reduced SG-2 seismic gap ceramic fiberfill (2" as compared to 3") throughout the Tendon Cover interference.
- Use of 3-Hour Darmatt KM-1 material design to protect the SG-2 design along the Containment Building interface and on side of the C-Buttress closure plate.

The design change at the 2047'-6", South side C-Buttress enclosure will eliminate the need to cover the topside checker plate with fireproofing and changing the fireproofing material to Darmatt KM-1 along the side of the seismic gap configuration.

The hatch/C-Buttress enclosure plate shall be stenciled on top to ensure that material or combustibles are not stored on the enclosure plate and there are no combustibles within proximity to auto-ignite and propagate fire if a fire would occur in the fire area below. All four C-Buttress enclosures are similar and situated providing the same affect to combustibles. Therefore, this change may be applied to remaining C-Buttress enclosures when they are disassembled, provided the critical attributes evaluated are herein are incorporated.

By installing the four (4) layers of Darmatt KM-1 on the bottom side of the checker plate maintains the F and T rating of the enclosure. The Darmatt KM-1 is fit snug to the slab opening and the structural fireproofing installed on the steel angle supports and fitted with intumescent expanding gasket material, closing off any plate exposure during fire exposure. The reduced ceramic fiberfill along the tendon cover interface (2" min) within the seismic gap seal design is compensated with 1" of additional fireproofing material on the support steel below to reduce thermal heat flux through the seismic gap seal design. In addition, Darmatt KM-1 has been added to the side of the seismic gap design and at the transition sections at each end of the closure plate to protect the vertical portions of the seismic gap design and transition segments from direct flame impingement. It must be noted that the seismic gap design at the C-Buttress does not incorporate Dymeric compound on the bottom side but incorporates a heavy steel support angle and fireproofing protection. Therefore, heat flux would have to propagate through approximately 2-1/2" of fireproofing and through the large 1/2" thick steel angle and the (2" min) ceramic fiberfill to affect the code side temperature. The remaining seismic gap configuration is as required and bounded per M-663-00017, Detail SG-2.

Four layers of Darmatt KM-1 has demonstrated through industry testing programs, to satisfy cold side temperatures when applied to cable tray, conduit and boxed enclosures. Installing the Darmatt KM-1 with steel or stainless steel fasteners and a large stainless steel restraining plate will ensure that the Darmatt KM-1 will remain fixed to the enclosure plate during fire and hose stream exposures resulting from firefighting activities. Typically Darmatt KM-1 barriers are secured with tie wire at 6" intervals along the barrier seams. Because the cover plate protection is one piece that is restraining and covering the majority of the Darmatt KM-1 protective panels typical attachment methods will not be required. The Darmatt KM-1 panels covered by the restraining plate will perform at least equivalent to direct exposed Darmatt KM-1 panels. The large restraining plate will shield the underlying Darmatt KM-1 from direct flame impingement and equally spread the flame or hot gas throughout the exposed surface eliminating hot spots. Unlike similar fire protective barrier materials, Darmatt KM-1 does not require direct flame exposure to perform and insulate the underlying commodity during fire exposures. Darmatt KM-1 is not intumescent or subliming material. If necessary when consider reversing the Darmatt KM-1 to the top of the checker plate, notching the material at the fasteners is permissible. The small area notch is acceptable because the fastener will be recessed within the four layers and no combustible are permitted to be stored on the enclosure plate or with close proximity.

Water exposure during postulated flood conditions could expose some of the Darmatt KM-1 material to water. Industry Test, E-106-00031 performed a Soak and Drying test to ensure that repeater water exposures would not have a deleterious affect on the base material. The test sample was tested without the waterproof grey cloth to enable a worse case scenario by cyclic exposures with complete submersion. Post testing observations concluded that the material maintained its original physical conditions with no obvious degrading affects.

Based on the above discussions, the use of 3-hour Darmatt KM-1 material, either on top or the bottom of the enclosure plate, and on the vertical sides of

the seismic gap design provides an equivalent 3-hour F and T rated configuration as originally designed.

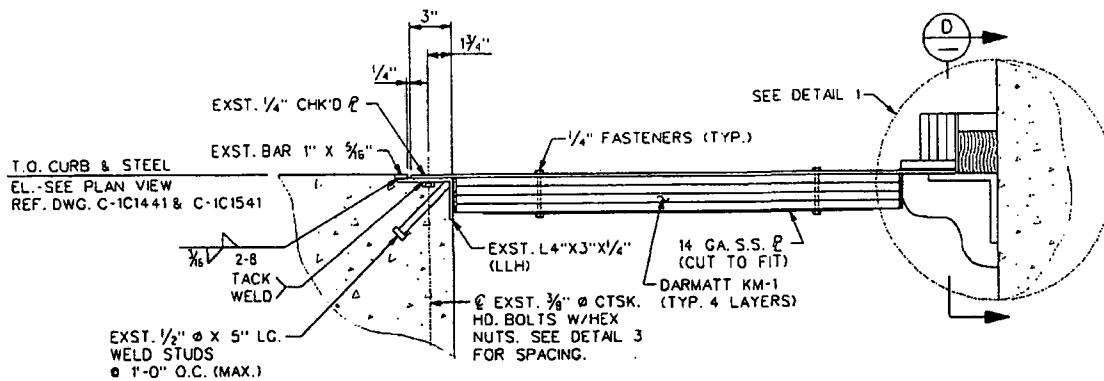

FIGURE 3
(Optional Detail Closure Plate – C-1C1441A)

FIGURE 3 NOTES:

1. ALL EXPOSED STRUCTURAL ITEMS SHALL BE FIREPROOFED WITH 3-HOUR FIRE RATED FIREPROOFING PER SPECIFICATION A-126 AND CNT-MC-600 AND MANUFACTURERS INSTRUCTIONS. THE AREA OF INTERFERENCE NOTCHING OF THE SG-2 SEISMIC GAP DESIGN REQUIRES INCREASED THICKNESS (1") TO COMPENSATE FOR THE REDUCED CERAMIC FIBER FILL AT THE TENDON COVER NOTCH. THE CHECKER PLATE DOES NOT REQUIRE FIREPROOFING ON ONE SIDE (TOP OR BOTTOM).
2. TRIM #14 GAGE PLATE & CERABLANKET AS REQUIRED TO AVOID INTERFERENCES WITH TENDON COVERS. MAINTAIN 2" MINIMUM CERAMIC FIBER THROUGHOUT THE INTERFERENCE AREA.
3. ALL CLOSURE INTERFACE JOINTS SHALL BE CAULKED WITH GREY DOW CORNING 732 CAULK TO PREVENT THE PASSAGE OF WATER (TOP SIDE ONLY).

5.3 Post Fire Safe Shutdown Impact

There is no impact to PFSSD systems or components as a result of this evaluation. The "C" Buttress hatch cover plates and associated interface with the seismic gap seal are evaluated as 3-hour F and T rated.

6.0 Conclusions

Based on the above discussions, it is reasonable to conclude that the "C" Buttress hatch cover plates and associated interface with the seismic gap seal are 3-hour F and T rated. The "C" Buttress hatch covers with one sided Darmatt KM-1 fireproofing protection or two sided protection as originally designed satisfy regulatory requirements and commitments as well as WCNOF Fire Protection Program requirements, to prevent spread of fire from one Fire Area to another.

Figure 3
Thermo-Lag 311 Product Data Sheet
(Page 1 of 2)



Thermo-Lag 311

Two Part Topcoat

PRODUCT DESCRIPTION

THERMO-LAG 311 Topcoat is a 2 component, waterborne acrylic, epoxy topcoat. Features include high-build, low odor, non-yellowing white, fade resistant, easy cleanup and stain-abrasion-chemical-moisture resistance.

BASIC USE

THERMO-LAG 311 is used in conjunction with the *THERMO-LAG 330* Fire Barrier System in nuclear power generating plants when a topcoat is required.

PACKAGING / SHIPPING

- 5 Gallon (U.S.) containers
- (4.5 gallons Part A; 0.5 gallons Part B)

STORAGE CONDITIONS

Store off ground and out of direct sunlight.

STORAGE TEMPERATURE

Minimum 35°F (2°C)
Maximum 110°F (43°C)

RECOMMENDED THICKNESS & THEORETICAL COVERAGE

	Dry Mils	Wet Mils	Ft ² /Gal
Recommended:	5	11.5	141
Minimum:	4	9.0	176
Maximum:	6	13.5	118

Note: Number of coats and thickness requirements will vary with substrate, application method and exposure.

THINNERS

Use clean water. For air, airless spray, brush or roller, thin up to 5% or 1/4 pint (190 ml) per gallon.. Note: Thin only after Part B has been thoroughly mixed with Part A according to mixing instructions.

PHYSICAL DATA

Net Weight Per Gallon	11.11 ± 0.25 Lbs. Mixed
Color	Antique White
Finish	Satin
Flash Point	190°F (88°C) Part A
	135°F (57°C) Part B

MIXING

Always use the entire contents of A and B components. Stir contents of Part A, making sure no pigment remains on the bottom. Slowly add the contents of Part B to Part A while under agitation. Continue agitation until thoroughly mixed.

POT LIFE

48 hours @ 50°F (10°C)
24 hours @ 77°F (25°C)
16 hours @ 100°F (38°C)

APPLICATION SUMMARY

All surfaces to be clean, dry and free contaminants. Allow for overspray and surface irregularities. Apply to the specified thickness. For previously Application of coating below minimum or above painted surfaces, apply a test patch to check maximum recommended dry film thicknesses might adhesion.adversely affect coating performance

Figure 3
Thermo-Lag 311 Product Data Sheet
(Page 2 of 2)

SURFACE TEMPERATURE

Minimum 50°F (10°C)
Maximum 120°F (49°C)

The surface should be dry and at least 5°F (3°C) above the dew point. Coating won't cure below minimum surface temperature.

APPLICATION EQUIPMENT

Air Spray

Gun DeVilbiss JGA 510
Fluid Tip .070
Air Cap 765
Air Hose ID 5/16" or 3/8"
Mat'l Hose 3/8" or 1/2"
Atomizing Pressure: 50 – 70 psi
Pot Pressure: 10-20 psi

Low temperatures or longer hoses require higher pot pressure.

Airless Spray

Tip Orifice 0.015"-0.019"
Atomizing Pressure 2400-3300 psi
Mat'l Hose ID 1/4" or 3/8"
Manifold Filter 60 mesh

Use appropriate tip/atomizing pressure for equipment, applicator technique and weather conditions.

Roller: Use short synthetic nap rollers for smooth surfaces, long nap for rough surfaces.

Brush: Use a good quality nylon or synthetic bristle brush.

TOUCH UP

To minimize variations in appearance, touch-up over existing material should be done by the same method as initial application.

CURING TIME

<u>Temperature</u>	<u>Touch</u>	<u>Handle</u>	<u>Recoat</u>
75°F (24°C)	30-45 min.	2-3 hrs	1-2 hrs

Curing time varies with surface temperature, air movement, humidity and film thickness.

CLEANUP

Clean all equipment immediately after use with clean water followed by a final washing with the recommended thinner or Ethanol.

WARRANTED SHELF LIFE

6 months from date of shipment

SAFETY PRECAUTIONS

This product must be installed by trained and certified applicators in accordance with the advice given on this sheet and Material Safety Data Sheet (MSDS).

All work involving application and use of this product should be performed in compliance with all relevant national and local health, safety and environmental standards and regulations.

Consult Thermal Science for any further questions or advice.

DISCLAIMER

The technical data contained in this data sheet is accurate to the best of our knowledge. No warranty is expressed or implied. For specific warranty information, refer to Thermal Science's terms and conditions, a copy is available upon request.



M-663-00017A

Attachment D2

Fire Protection Evaluation For
Resin Loading Chute Cover Plate (Penetration P141S1028)

Rev. No.	Prepared By	Date	Reviewed By	Date
W01	 Jeff Suter	8/22/05	 Wayne S Aregood	8/22/05

Table of Contents

Revision Log	3
1.0 Purpose.....	4
2.0 Scope.....	4
3.0 References.....	4
4.0 Evaluation	4
5.0 Conclusions.....	6

Revision Log

Revision	Reason for Revision
W01	Original Issue

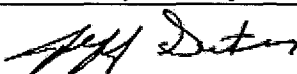
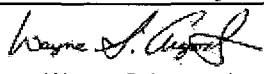
1.0 Purpose

- 1.1 The purpose of this document is to evaluate an existing penetration seal that is not directly bounded to the typical detail limitations established in M-663-00017. This evaluation was conducted in effort to satisfy regulatory expectation regarding qualification and documentation of fire barrier penetration seals, as discussed in NRC Information Notice 88-04. This evaluation was conducted in accordance with the guidance of NRC Generic Letter 86-10.

2.0 Scope

- 2.1 Resin loading chute cover plate (penetration P141S1028).

3.0 References

- 3.1 NRC Generic Letter 86-10, Implementation of Fire Protection Requirements, dated April 24, 1986
- 3.2 NRC Information Notice 88-04, "Inadequate Qualification and Documentation of Fire Barrier Penetration Seals".
- 3.3 10 CFR 50 Appendix R, Fire Protection Program For Nuclear Power Facilities Operating Prior To January 1, 1979
- 3.4 M-663-00017, Penetration Seal Typical Details, Rev. W20
- 3.5 USAR Section 9.5.1.2.2.3 (Page 9.5-23), Rev. 13
- 3.6 C-0C1441, Auxiliary Building – Area 1 Concrete Neat Lines Plan – Floor EL. 2026'-0", Rev. 17
- 3.7 AP 10-102, Control of Combustibles, Rev. 9
- 3.8 Underwriters Laboratory Fire Resistance Directory (UL System CAJ0010), 2002 Edition
- 3.9 XX-X-004, Combustible Fire Loading for Each Room in the Various Fire Areas at WCNOG, Rev. 3

4.0 Assumptions

- 4.1 None.

5.0 Evaluation

5.1 Assessment of Condition to Design Requirements

The steel cover plate over penetration P141S1028, shown in Photos 1 and 2, is not directly bounded by a typical seal detail from M663-00017. The plate protection was discussed in Revision 17 to USAR Section 9.5.1.2.2.3. However, additional discussion was deemed necessary in order to address the current,

primary use of Room 1405. This room, which is on the topside of the floor penetration, is designated as a combustibile material staging area per AP 10-102.



**Photo1, P141S1028 Topside
Room 1405 & Fire Area A-26**



**Photo 2, P141S1028 Bottom Side
Room 1307 and Fire Area A-8**

5.2 Evaluation of Condition

The resin loading chute is located in the Auxiliary Building, 2026' elevation floor slab between Rooms 1405 and 1307. The chute is used to facilitate the loading of resin into the demineralizer compartments. The chute opening is integral with an embedded steel floor sleeve that is elevated approximately 4" above the floor surface. The opening is covered with a ¼" thick steel plate. The steel plate design protecting the opening is depicted on drawing C-0C1441. The penetration opening is controlled via penetration number P141S1028.

The ¼" thick steel plate protection ensures that that the opening portion protected by steel will not allow the passage of flame comparable to UL System CAJ0010. This UL system reveals that a minimum 0.057" (16 gauge) thick steel plate on one barrier side provides a 3-hour Fire (F) rated seal. The design of the steel cover plate reduces the likelihood for plate distortion as it overlaps the penetration sleeve and is not subject to any load other than that presented by the weight of the plate. The elevated embedded sleeve will also prevent water intrusion from manual fire fighting activities entering the fire area below. In addition, there are no safety related, PFSSD components or equipment located in close proximity to the openings if inadvertent water intrusion would occur during manual fire fighting activities.

There is no direct testing demonstrating a Temperature (T) rating for the steel plate. Therefore, further review is required to assess acceptability. Calculation XX-X-004 reveals that the combustibile loading for the area below penetration P141S1028 is Low, while the topside combustibile loading still maintains a Low classification, even with an allowance for storage of up to 1,000 lbs of Class A material.

The floor slab containing penetration P141S1028 is 20" thick reinforced concrete (Reference 3.6). This substantial barrier thickness ensures that a fire in Fire Area A-26 (topside of penetration) will not result in unacceptable unexposed side temperatures beyond the barrier plane, as the significant air gap (24") will dramatically drop temperature influence from the exposed side. This

determination is based on the discussion provided in Section 7.2.3 of M-663-00017, which reveals a conservative linear temperature drop of 222°F for each inch of air space transition from the exposed element.

The recessed location of the plate from the bottom side provides some protection from direct flame impingement, as fire would need to travel up through the opening for a distance of 24" inches before reaching the plate. Since the opening will not promote a stack effect, flame transition into the barrier opening would be limited, especially considering the low combustible loading in the area. The platform area below the penetration is not typically subjected to a significant transient combustible package, as it is within horizontal travel path of the resin loading chute. Additionally, fixed, exposed combustible loading in proximity to the opening is Low. Considering area combustibles and the recessed location of the plate, a fire in Fire Area A-8 will not will not present a potential ignition source, via steel plate conduction, for combustibles within Fire Area A-26. Therefore, barrier integrity is ensured.

Based on the above discussion, the steel cover plate over penetration P141S1028 provides an acceptable level of fire protection commensurate with the hazards present in the area. The steel plate is considered 3-hour F rated. Additionally, it is reasonable to conclude that the non-T rated aspect of the steel cover plate will not negatively impact a communicating Fire Area based on the combustible loading for a fire in Fire Area A-8 and the separation distance of the steel plate from the unexposed barrier side for a fire in Fire Area A-26.

5.3 Post Fire Safe Shutdown Impact

There is no impact to PFSSD systems or components as a result of this evaluation. The steel cover plate for penetration P141S1028 provides a 3-hour F rated seal. The protection configuration and area hazards provide reasonable assurance that barrier integrity and PFSSD capability will not be compromised as a result of the non-T rated aspect of the penetration seal.

6.0 **Conclusions**

Based on the above discussions, it is reasonable to conclude that the steel cover plate for penetration P141S1028 is acceptable as 3-hour F rated and will perform its intended function, regardless of not achieving a T rating. The penetration seal satisfies regulatory requirements and commitments as well as WCNOF Fire Protection Program requirements, to prevent spread of fire from one fire area to another. It has also been determined through this evaluation that the lack of a T rating will not affect the plant's ability to achieve and maintain PFSSD.

Attachment E

Fire Protection Evaluations for Unique or
Unbounded Fire Door Configurations

(There are currently no evaluations in this attachment)



M-663-00017A

Attachment F1

Fire Protection Evaluation For
Fire Dampers Beyond Barrier Plane

Rev. No.	Prepared By	Date	Reviewed By	Date
W01	 Wayne S Aregood	8/22/05	 Jeff Suter	8/22/05

Table of Contents

Revision Log	3
1.0 Purpose.....	4
2.0 Scope	4
3.0 References.....	4
4.0 Evaluation	5
5.0 Conclusions.....	7

Revision Log

Revision	Reason for Revision
W01	Original Issue

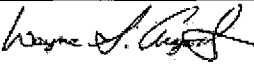
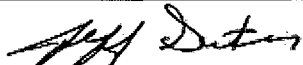
1.0 Purpose

- 1.1 The purpose of this document is to evaluate a unique design for two fire dampers located outside the plane of the fire barrier. This evaluation was conducted in effort to satisfy regulatory expectation regarding qualification and documentation of fire barrier issues. This evaluation was conducted in accordance with the guidance of NRC Generic Letter 86-10.

2.0 Scope

- 2.1 Fire dampers GKD0180 and GKD0182.

3.0 References

- 3.1 NRC Generic Letter 86-10, Implementation of Fire Protection Requirements, dated April 24, 1986
- 3.2 10 CFR 50 Appendix R, Fire Protection Program For Nuclear Power Facilities Operating Prior To January 1, 1979
- 3.3 SNUPPS FSAR Section 9.5.1.2.2.3.d (Page 9.5.1-16), Rev. 15
- 3.4 USAR Section 9.5.1.2.2.3.d (Page 9.5-19), Rev. 15
- 3.5 UL-555, UL Standard for Safety Fire Dampers
- 3.6 Drawing M-1H1521, Heating, Ventilating & Air Cond. Auxiliary Building EL. 2047'-6" Area 2, Rev. 9
- 3.7 Drawing M-0H1905, Heat and Ventilating & Air Cond. Fire Damper Details, Rev. 4
- 3.8 Specification 10466-M-627B, Technical Specification For Dampers For The Standard Nuclear Unit Power Plant System (SNUPPS), Rev. 13
- 3.9 Specification 10466-A-126, Technical Specification For Cementitious Fireproofing of Structural Steel For The Standard Nuclear Unit Power Plant System (SNUPPS), Rev. 7
- 3.10 UL Fire Test N-711 (A-126-00001), Fire Test Of Loaded Restrained Beams Protected By Cementitious Mixture
- 3.11 UL Fire Test N-712 (A-126-00001), Fire Test Of Loaded Restrained Beams Protected By Cementitious Mixture

4.0 Assumptions

- 4.1 None.

5.0 Evaluation

5.1 Assessment of Condition to Design Requirements

Vertical fire dampers GKD0180 and GKD0182 communicate between the 2047'-6" elevation of the Auxiliary Building Control Room AC and Filtration Unit 'A' (Room 1512 and Fire Area A-22) and the Control Building Equipment Cabinet Area (Room 3605 and Fire Area C-27). Drawing M-1H1521 reveals that these fire dampers are located outside the fire barrier plane on the Auxiliary Building side (see Photos 1 and 2) in accordance with the installation details of drawing M-0H1905. This configuration is not bounded by UL-555, which qualifies the fire resistive performance of fire dampers within the plane of the barrier. This issue was generally addressed in the original Fire Protection Licensing Basis (Reference 3.3). However, further discussion was deemed necessary to formally assess the acceptability of this fire barrier protective configuration.

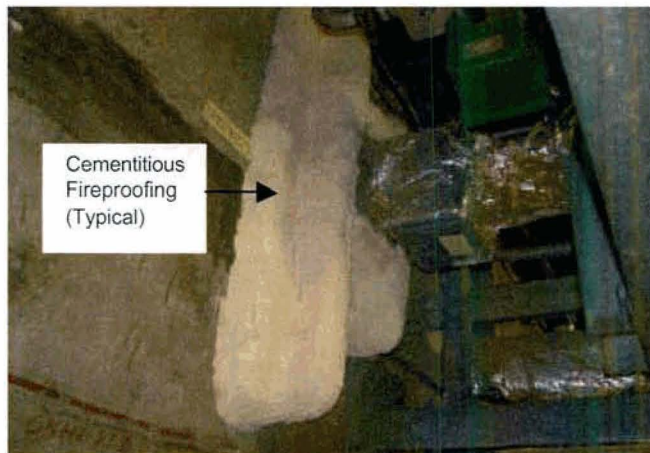

Photo 1
Fire Damper GKD0180 (from Auxiliary Building Side)



Photo 2
Fire Damper GKD0182 (from Auxiliary Building Side)

5.2 Evaluation of Condition

Fire rated dampers are typically mounted and positioned between barrier surfaces within the plane of the barrier to replicate as tested conditions, with the exception of two Control to Auxiliary Building fire dampers, GKD0180 and GKD0182. Fire dampers GKD0180 and GKD0182 are mounted within a heavy welded steel enclosure, seismically attached to the barrier surface with eight (8) 5/8" Hilti Kwik Bolt Type II anchors, as shown on Drawing M0H1905. These damper enclosures are constructed from 1/2" thick welded steel with a welded closure plate of 10-gauge steel. The duct is welded directly to the enclosure plate and the enclosure plate welded to the damper assembly enclosure. The surface mounted enclosures are fabricated in a manner that integrates the support structure and damper assembly enclosures into single unit that is conservatively protected with a clad of cementitious fireproofing material to resist the affects of direct flame impingement during fire exposure. Structurally, the damper enclosures are designed to satisfy both seismic requirements and fire exposure.

In the unlikely event that the attached duct sections would be exposed to direct flame impingement, the exposed duct sections could potentially become deformed during fire exposure. However, it is not credible that the small sections of 8" diameter duct would induce loads significant enough to structurally degrade or deform the robustly constructed damper enclosures during a fire exposure. Because damper tracks maintain a 1/4" expansion joint and are not physically attached to the enclosure, thermal expansion would not have a direct affect to the operation of the damper assembly. The cementitious fireproofing completely encapsulating the damper enclosure sides, support structure and associated anchors that attach the enclosure to the barrier surfaces add significant protection from the degrading affects of fire exposure. This protective configuration coupled with the significant heat sink capability of the barrier provides substantial protection from heat induced structural failures or significant deformation to the steel enclosure and fire damper assembly. Although the structural member sizes that make up the damper enclosures are smaller than that tested (Reference 3.10 and 3.11) with fireproofing protection, the considerable surface area contact with the underlying concrete provides significant value through heat transfer. Therefore, structural integrity is maintained as a result of thermal inertia and the insulating capability of the applied cementitious fireproofing clad.

Considering the robust damper enclosure design and the installed cementitious fireproof clad along with the heat transfer capability of the interfacing concrete wall, it is reasonable to conclude that a failure of the duct on either side of the wall will not violate the fire barrier or prevent the damper assembly from operating as designed.

5.3 Post Fire Safe Shutdown Impact

There is no impact to PFSSD systems or components as a result of this evaluation. Fire dampers GKD0180 and GKD0182 will prevent the passage of flame between communicating Fire Areas for a duration of 3-hours.

6.0 Conclusions

Based on the above discussions, it is reasonable to conclude that fire dampers GKD0180 and GKD0182 provide 3-hour protection equivalent to a fire damper located within the barrier plane as tested by UL 555. The fire dampers satisfy regulatory requirements and commitments as well as WCNOF Fire Protection Program requirements, to prevent spread of fire from one Fire Area to another.



M-663-00017A

Attachment G1

Fire Protection Evaluation For
Generic Fireproofing Issues

Rev. No.	Prepared By	Date	Reviewed By	Date
W03	<i>Wayne S. [Signature]</i>	6/13/07	<i>[Signature]</i>	6/13/07

Table of Contents

Revision Log	3
1.0 Purpose	4
2.0 Scope	4
3.0 References	4
4.0 Assumptions	5
5.0 Assessment of Condition to Design Requirements	5
6.0 Methodology	10
7.0 Evaluation	11
8.0 Conclusions	16
Appendix G1A, Room Data Sheets	(162 Total Pages)

Revision Log

Revision	Reason for Revision
W03	Original Issue

1.0 Purpose

- 1.1 The purpose of this document is to evaluate generic fireproofing issues resulting from plant walk downs conducted in effort to address the acceptability of protected structural steel with unprotected miscellaneous steel attachments (thermal shorts) that are welded to the building steel. This evaluation was conducted in accordance with the guidance of NRC Generic Letter 86-10 and Regulatory Guide 1.189.

2.0 Scope

- 2.1 This evaluation is applicable to the Rooms identified in Table II.

3.0 References

- 3.1 NRC Generic Letter 86-10, Implementation of Fire Protection Requirements, dated April 24, 1986
- 3.2 10 CFR 50 Appendix R, Fire Protection Program For Nuclear Power Facilities Operating Prior To January 1, 1979
- 3.3 Regulatory Guide 1.189, Fire Protection For Operating Nuclear Power Plants, April 2001
- 3.4 ASTM E-119, Standard Test Methods for Fire Tests of Building Construction and Materials
- 3.5 UL N-711, (A-126-00001), Fire Test Report Of Loaded Restrained Beams Protected By Cementitious Mixture, Dated August 11, 1976
- 3.6 UL N-712, (A-126-00002), Fire Test Report Of Loaded Restrained Beams Protected By Cementitious Mixture, Dated May 13, 1977
- 3.7 A-126, Technical Specification For Cementitious Fireproofing Of Structural Steel For The Standardized Nuclear Unit Power Plant Unit (SNUPPS)
- 3.8 PIR 2002-2287, Structural Steel Fireproofing With Unprotected Attachments
- 3.9 FP-M-012, Rev 0, Structural Steel Fireproofing Thermal Shorts and Omissions Evaluation
- 3.10 CNT-MC-600, Rev. 2, Fireproofing of Structural Steel
- 3.11 Drawing A-1801, Rev. 10, Architectural Fire Delineation Floor Plan EL 1974'-0"
- 3.12 Updated Safety Analysis Report (USAR) Section 9.5.1.2.2.3.c, Rev. 15 and Table 9.5A-1 Sheet 27, Rev. 4

4.0 Assumptions

- 4.1 It is assumed that fireproofing material used to protect building steel is applied to the thickness required by CNT-MC-600. This is an acceptable assumption based on a review of the Quality Control documentation maintained during initial fireproofing installation activities and subsequent inspections during ongoing plant repairs witnessed by Fire Protection personnel.

5.0 Assessment of Condition to Design Requirements

5.1 Requirements

USAR Section 9.5.1.2.2.3.c , identifies that the notes contained on Figure 9.5.1-2 [Drawing A-1801] define the structural steel fireproofing requirements. The structural steel of all of the ceilings of the fire areas is fireproofed with 3-hour protection with the exception that no fireproofing is provided on the underside of the fuel building roof.

USAR Table 9.5A-1 Sheet 27 (Rev. 4), that structural steel supporting the Control and Auxiliary Building roofs is protected with [3-hour] rated fireproofing.

Table I identifies the ASTM E-119 temperature limitations for structural steel protected with fireproofing.

TABLE I
ASTM E-119 Temperature Limitations for 3-Hour Fire Exposure

Structural Member Type	Maximum Single Point Temperature (°F)	Maximum Average Temperature (°F)
Beam	1300°(F)	1100°(F)
Column	1200°(F)	1000°(F)

5.2 Assessment

At Wolf Creek, fireproofing material is generally applied over exposed surfaces of structural members with the exception of thermal shorts and intervening items. Underwriters Laboratories (UL) has tested several different size members utilizing both Albi Duraspray and Monokote Z-146 coatings to 3-hour ASTM E-119 fire exposures. The testing for beams and columns, utilized W8 x 28 steel shapes incorporating two protection methods; contour and boxed. However, testing of both techniques did not incorporate thermal short attachments. Therefore, the affects of heat flux into plant structural steel with unprotected thermal shorts is not directly bounded by fire testing. FP-M-012 revealed that unprotected thermal shorts, larger than Unistrut, contribute to single point temperatures that in some cases exceed the ASTM E-119 acceptance criteria, assuming a 3-hour fire exposure. Typically, average temperatures satisfied the ASTM E-119 acceptance criteria.

Additionally, in various plant areas structural steel has been integrated as part of the fire barrier assembly. However, fire testing does not directly bound the use of protected steel as an element of a fire barrier assembly.

Refer to Table II for the specific rooms that are addressed by this evaluation.

TABLE II
Rooms Addressed By Evaluation

Fire Area	Room	Building	Elev.	Description:	Comments/References
A-1	1102	Auxiliary	1974-0	Chiller & Surge Tanks Area	See Section 7.3
	1103	Auxiliary	1974-0	Letdown Chiller Heat Exch Room	See Section 7.3
	1104	Auxiliary	1974-0	Letdown Reheat Heat Exch Room	See Section 7.3
	1105	Auxiliary	1974-0	Valve Compartment	See Section 7.3
	1106	Auxiliary	1974-0	Moderating Heat Exch Room	See Section 7.3
	1115	Auxiliary	1974-0	Normal Charging Pump Rm	See Section 7.3
	1123	Auxiliary	1974-0	Passage	See Section 7.3
	1124	Auxiliary	1974-0	Valve Compartment	See Section 7.3
	1125	Auxiliary	1974-0	Letdown Heat Exch Room	See Section 7.3
	1128	Auxiliary	1974-0	Auxiliary Feedwater Pump Room	See Section 7.3
	1129	Auxiliary	1974-0	Aux Steam Cond Recovery & Storage Tank	See Section 7.3
		1201	Auxiliary	1988-0	Vestibule
	1205	Auxiliary	1988-0	Access Area A	No Steel with concrete ceiling.
A-2	1111	Auxiliary	1974-0	Residual Heat Removal Pump Room A	See Section 7.3
	1112	Auxiliary	1974-0	Containment Spray Pump Room A	See Section 7.3
	1113	Auxiliary	1974-0	Safety Injection Pump Room A	See Section 7.3
	1114	Auxiliary	1974-0	Centrifugal Charging Pump Room A	See Section 7.3
A-3	1116	Auxiliary	1974-0	Boric Acid Tank Room B	See Section 7.3 and Attachment G5
A-4	1107	Auxiliary	1974-0	Centrifugal Charging Pump Room B	See Section 7.3
	1108	Auxiliary	1974-0	Safety Injection Pump Room B	See Section 7.3
	1109	Auxiliary	1974-0	Residual Heat Removal Pump Room B	See Section 7.3
	1110	Auxiliary	1974-0	Containment Spray Pump Room B	See Section 7.3
A-5	1119	Auxiliary	Stair	Aux. Stair A-1 & A-1A	See Section 7.5 and Attachment G5
	1601	Auxiliary	2064-4	Elevator Machine Room No. 2	See Section 7.5
A-6	1127	Auxiliary	Stair	Aux. Stair A-2	See Section 7.5 and Attachment G5
A-8	1302	Auxiliary	2000-0	Filter Compartments Typical of 5	No Steel with concrete ceiling.
	1306	Auxiliary	2000-0	Valve Compartments Typical of 5	No Steel with concrete ceiling.
	1308	Auxiliary	2000-0	Valve Compartments Typical of 8	No Steel with concrete ceiling.
	1312	Auxiliary	2000-0	Boron Meter & R.C. Activity Monitor Rm	Misc. Steel only, protected with mono rail attachments, See Section 7.4
	1313	Auxiliary	2000-0	Volume Control Tank Rm	No Thermal Short Issues
	1316	Auxiliary	2000-0	Valve Compartment	Misc. Steel only, protected with mono rail attachments, See Section 7.4
	1317	Auxiliary	2000-0	Seal Water Heat Exch Rm	Misc. Steel only, protected with mono rail attachments, See Section 7.4

Fire Area	Room	Building	Elev.	Description:	Comments/References
A-8 (Cont.)	1319	Auxiliary	2000-0	Demineralizer Compartments Typical of 8	No Steel with concrete ceiling.
	1321	Auxiliary	2000-0	Exit Vestibule	See Section 7.5 and Attachment G5
A-9	1309	Auxiliary	2000-0	Residual Heat Removal Heat Exch Rm B	See Section 7.1, No Thermal Short Issues
A-10	1310	Auxiliary	2000-0	Residual Heat Removal Heat Exch Rm A	See Section 7.1, No Thermal Short Issues
A-11	1335	Auxiliary	2000-0	Electrical Chase	See Section 7.1
A-12	1336	Auxiliary	2000-0	Electrical Chase	No Steel with concrete ceiling.
A-23	1411	Auxiliary	2037-7	Main Feedwater Rm No. 1	Misc. Steel, no structural steel within this Room, See Section 7.4
	1412	Auxiliary	2037-7	Main Feedwater Rm No. 2	Misc. Steel, no structural steel within this Room, See Section 7.4
A-26	1415	Auxiliary	2026-0	I & C Hot Shop	No Steel with Drop ceiling, above steel is evaluated in Room 1405, See Attachment G3
A-28	1413	Auxiliary	2026-0	Auxiliary Shutdown Panel Room	No Steel with concrete ceiling.
C-1	3104	Control	Stair	Control, Stair No. C-2, South Access Control to Aux Building	See Section 7.5
	Duct Chase	Control	1974-0	Duct Chase – East Wall of 3101	See Section 7.7
C-2	3106	Control	1974-0	Electrical Chase	See Sections 7.2 and Attachment G5
C-3	3105	Control	1974-0	Electrical Chase	See Sections 7.2 and Attachment G5
C-5	3206	Control	1984-0	Corridor	Partial Height Room, no structural steel within this Room. Steel above will be reviewed as part of Room NAC, Attachment G3
	3212	Control	1984-0	Women's Locker Room	Partial Height Room, no structural steel within this Room. Steel above will be reviewed as part of Room NAC, Attachment G3
	3213	Control	1984-0	Women's Toilet	Partial Height Room, no structural steel within this Room. Steel above will be reviewed as part of Room NAC, Attachment G3
	3214	Control	1984-0	Hall	Partial Height Room, no structural steel within this Room. Steel above will be reviewed as part of Room NAC, Attachment G3
	3215	Control	1984-0	Men's Shower Room	Partial Height Room, no structural steel within this Room. Steel above will be reviewed as part of Room NAC, Attachment G3
	3216	Control	1984-0	Drying Room	Partial Height Room, no structural steel within this Room. Steel above will be reviewed as part of Room NAC, Attachment G3
	3217	Control	1984-0	Men's Toilet	Partial Height Room, no structural steel within this Room. Steel above will be reviewed as part of Room NAC, Attachment G3
	3218	Control	1984-0	H.P. office Area	Partial Height Room, no structural steel within this Room. Steel above will be reviewed as part of Room NAC, Attachment G3

Fire Area	Room	Building	Elev.	Description:	Comments/References
C-5 (Cont.)	3219	Control	1984-0	H.P. office	Partial Height Room, no structural steel within this Room. Steel above will be reviewed as part of Room NAC, Attachment G3
	3220	Control	1984-0	Sign In/Out Area	Partial Height Room, no structural steel within this Room. Steel above will be reviewed as part of Room NAC, Attachment G3
	3221	Control	1984-0	Vestibule No. 1	Partial Height Room, no structural steel within this Room. Steel above will be reviewed as part of Room NAC, Attachment G3
	3222	Control	1984-0	H.P. office	Partial Height Room, no structural steel within this Room. Steel above will be reviewed as part of Room NAC, Attachment G3
	3223	Control	1984-0	Janitors Closet	No Steel with concrete ceiling.
	3224	Control	1984-0	Vestibule No. 2	Partial Height Room, no structural steel within this Room. Steel above will be reviewed as part of Room NAC, Attachment G3
C-6	3201	Control	Stair	Control, Stair C-1	See Section 7.5 and Attachment G5
	3202	Control	1984-0	Controlled H.P. Tool & Inst. Storage Room	Partial Height Room, no structural steel within this Room. Steel above will be reviewed as part of Room SAC, Attachment G3
	3203	Control	1984-0	Hot Janitors Closet	No Steel with concrete ceiling.
	3204	Control	1984-0	Corridor No. 1	Partial Height Room, no structural steel within this Room. Steel above will be reviewed as part of Room SAC, Attachment G3
	3205	Control	1984-0	H.P. Area	Partial Height Room, no structural steel within this Room. Steel above will be reviewed as part of Room SAC, Attachment G3
	3207	Control	1984-0	Exit Monitor Area	Partial Height Room, no structural steel within this Room. Steel above will be reviewed as part of Room SAC, Attachment G3
	3208	Control	1984-0	Laundry Room	Partial Height Room, no structural steel within this Room. Steel above will be reviewed as part of Room SAC, Attachment G3
	3209	Control	1984-0	Decon Area	Partial Height Room, no structural steel within this Room. Steel above will be reviewed as part of Room SAC, Attachment G3
	3210	Control	1984-0	Decon Shower	Partial Height Room, no structural steel within this Room. Steel above will be reviewed as part of Room SAC, Attachment G3
	3211	Control	1984-0	H.P. Area	Partial Height Room, no structural steel within this Room. Steel above will be reviewed as part of Room SAC, Attachment G3
C-7	3230	Control	1984-0	Electrical Chase	See Sections 7.1 & 7.2
C-8	3229	Control	1984-0	Electrical Chase	See Section 7.2 and Attachment G5
C-11	3305	Control	2000-0	Electrical Chase	See Sections 7.1 & 7.2, and Attachment G5
C-12	3306	Control	2000-0	Electrical Chase	See Sections 7.1 & 7.2

Fire Area	Room	Building	Elev.	Description:	Comments/References
C-17	3418	Control	2016-0	Electrical Chase	See Sections 7.1 & 7.2, and Attachment G5
C-18	3419	Control	2016-0	Electrical Chase	See Sections 7.1 & 7.2, and Attachment G5
C-19	C19	Control	2016-0	Cable Chase @ CA-C3, 2016-0 to 2032-0	See Section 7.1
C-20	C20	Control	2016-0	Cable Chase @ CA-C6, 2016-0 to 2032-0	See Section 7.1
C-23	3505	Control	2032-0	Electrical Chase	See Section 7.1 & 7.2 and Attachment G5
C-24	3504	Control	2032-0	Electrical Chase	See Section 7.1 & 7.2
C-25	C25	Control	2032-0	Cable Chase @ CA-C6, 2032-0 to 2047-6	See Section 7.1
C-26	C26	Control	2032-0	Cable Chase @ CA-C3, 2032-0 to 2047-6,	See Section 7.1
C-27	3601	Control	2047-6	Control Room	Control Room is a partial height room, no structural steel within this Room. Steel above will be reviewed as part of Room 3605, Attachment G3
	3603	Control	2047-6	Shift Supervisors office	Control Room is a partial height room, no structural steel within this Room. Steel above will be reviewed as part of Room 3605, Attachment G3
	3604	Control	2047-6	Foyer	Control Room is a partial height room, no structural steel within this Room. Steel above will be reviewed as part of Room 3605, Attachment G3
	3606	Control	2047-6	Emergency Equipment Storage Room	Partial Height Room with concrete ceiling, no structural steel within this Room.
	3616	Control	2047-6	Vestibule	Partial Height Room with concrete ceiling, no structural steel within this Room.
C-28	3602	Control	2047-6	Pantry	Partial Height Room with concrete ceiling, no structural steel within this Room.
	3607	Control	2047-6	Toilet	Partial Height Room with concrete ceiling, no structural steel within this Room.
	3608	Control	2047-6	Janitors Closet	Partial Height Room with concrete ceiling, no structural steel within this Room.
C-29	3609	Control	2047-6	SAS Room	Partial Height Room with concrete ceiling, no structural steel within this Room.
C-30	3617	Control	2047-6	Electrical Chase	See Section 7.1 & 7.2 and Attachment G5
C-31	3618	Control	2047-6	Electrical Chase	See Section 7.1 & 7.2
C-32	C32	Control	2047-6	Cable Chase @ CA-C6, 2047-6 to 2073-6,	See Section 7.1
C-33	3804	Control	2073-6	Electrical Chase	See Section 7.1 & 7.2
C-34	C34	Control	2073-6	Cable Chase @ CA-C6	No Steel
C-36	C36	Control	2000-0	Cable Chase @ CA-C6, 2000-0 to 2016-0,	See Section 7.1 and Attachment G5
C-37	C37	Control	2000-0	Cable Chase @ CA-C3, 2000-0 to 2016-0	See Section 7.1 and Attachment G5

Fire Area	Room	Building	Elev.	Description:	Comments/References
D-1	5203	Emergency Diesel Gen.	2000-0	Emergency Diesel Generator "A" Room	See Section 7.6
D-2	5201	Emergency Diesel Gen.	2000-0	Emergency Diesel Generator "B" Room	See Section 7.6
ESW A	K105	Essential Service Water	2000-0	ESW Pump House - Room A	No Steel, concrete reinforced beams and columns.
ESW B	K104	Essential Service Water	2000-0	ESW Pump House - Room B	No Steel, concrete reinforced beams and columns.
F-1	6101	Fuel	Stair	Stair F-1	No Steel
	6102	Fuel	2000-0	Laydown Area	See M-663-00017A, Sec. 12.2.1
	6103	Fuel	2000-0	Cask Loading Pool	No Steel
	6106	Fuel	2000-0	Spent Fuel Pool & Storage Racks	See M-663-00017A, Sec. 12.2.1
	6201	Fuel	2026-0	Passage	See M-663-00017A, Sec. 12.2.1
	6204	Fuel	2026-0	Cask Washdown Pit	See M-663-00017A, Sec. 12.2.1
	6205	Fuel	2026-0	Fuel Transfer Canal	No Steel
	6210	Fuel	2032-6	New Fuel Storage Area	See M-663-00017A, Sec. 12.2.1
	6301	Fuel	2047-6	General Floor Area	See M-663-00017A, Sec. 12.2.1
	6302	Fuel	2047-6	Laydown Area	See M-663-00017A, Sec. 12.2.1
RB	RB	Reactor	All	Reactor Building	No Fireproofing in Reactor Building

6.0 Methodology

Walk downs were conducted on a room-by-room basis utilizing structural steel drawings and a best effort visual inspection to determine the worse case thermal short configuration for columns, beams and where structural steel serves as an Appendix R fire boundary. For the purpose of this evaluation, all unprotected thermal shorts greater than Unistrut were reviewed and considered relevant to determine worse case scenario. FP-M-012 demonstrated that thermal short attachments equivalent to Unistrut did not present a thermal conductive path that would challenge structural steel integrity, assuming an ASTM E-119 fire exposure.

See section 12.2.3 of M-663-00017A for further discussion regarding the overall fireproofing assessment methodology utilized.

Based on categorization of walkdown results, the following generic issues are addressed by this evaluation:

- Appendix R Barriers with Incorporated Structural Steel
- Steel Internal to Cable Chases
- Embedded Steel
- Miscellaneous Steel
- Steel Protection for Stairwells and Elevators
- Diesel Building Structural Steel

- Control Building Duct Chase

Appendix G1A to this evaluation documents the result of the Fire Protection reviews and assessments for each room listed in Table II. The data sheets are provided to record input information critical to the overall assessment process. Where a room did not present a unique/unbounded structural steel fireproofing issue, the basis for acceptability is documented in the corresponding G1A walkdown data sheet, and is repeated in Table II.

7.0 Evaluation

7.1 Appendix R Barriers With Incorporated Structural Steel

Two-sided protected steel integral to a fire barrier assembly is typically used where cable chases have been erected to separate fire areas. The steel is located at the ceiling and forms a part of the fire barrier interfacing with concrete or CMU walls and concrete ceilings completing the separation from other fire areas.

When integrated fire barrier structural or steel enclosures are protected with fireproofing material on both sides of the barrier, only one barrier side will be exposed to the fire, thus limiting heat flux through the unexposed fireproofing. The unexposed fireproofing can be expected to provide a significant insulator as demonstrated by comparing the delta between furnace temperature and the maximum steel exposure temperature.

Where two-sided cementitious fireproofing is provided the protected steel is expected to meet WCNOC cold side temperatures requirements. This expectation is based on the following:

- During ASTM E-119 testing, furnace temperatures are maintained at 1925°F. By subtracting the furnace temperature (1,925°F) from actual thermocouple data (1,100°F) from References 3.5 and 3.6 yields an approximate 825°F temperature drop across the exposed fireproofing during ASTM E-119 fire endurance testing. By applying this temperature drop logic to the unexposed fireproofing, similar results will be achieved, yielding an expected temperature of approximately 275°F to the unexposed side of the barrier. This estimated 275°F is below the maximum cold side temperature limitations required by the WCNOC Fire Protection Program (250°F plus ambient for fire barrier construction and 325°F plus ambient for fire barrier penetration seals). Therefore, two sided protection configurations are considered 3-hour F and T rated, provided no unprotected thermal shorts greater than Unistrut in size or mass are present. Calculation FP-M-012 has demonstrated that unprotected Unistrut has no significant thermal influence to building steel under fire exposure conditions.

Where thermal shorts greater than Unistrut in size/mass are present, each location on the steel portion of the barrier was reviewed for Heat Affected Zone (HAZ) influence to ensure Post Fire Safe Shutdown (PFSSD) is not impacted or

insitu combustibles are not in proximity to allow auto ignition resulting in flame propagation. The HAZ review is documented in Attachment G5.

Cable chase fire barriers are typically constructed with reinforced concrete and/or solid CMU walls and steel at the ceiling interface that forms a part of the Appendix R barrier. This integrated barrier design incorporates an approximate 1" gap for seismic interaction that is filled full depth with compressed ceramic fiber and is coated on both sides with structural steel fireproofing. The concrete or CMU walls do not directly support the steel due to the approximate 1" gap between the bottom flange of the steel member(s) and the top of the barrier wall(s). The presence of the gap will not be a detriment or have a degrading affect to the barrier since the gap is completely filled with ceramic fiber and clad with cementitious fireproofing material on both sides of the barrier. The wall segments that make up the barrier portions of the wall and/or fire barrier will prevent catastrophic steel failure by supporting the steel from below if steel deflection occurs during fire exposures. However, because steel sizes are so much greater than that tested (W8 X 28), steel deflection is not expected to occur and barrier integrity will be maintained for a 3-hour duration. Additionally, transient combustible presence with the cable chases is limited and access is strictly controlled, with cable chase doors remaining locked during normal plant operation and/or refuel evolutions. Moreover, cable chases are provided with detection and a wet pipe sprinkler system (C-36 and C-37 are provided with sprinkler protection only) to rapidly suppress any fire that may occur, providing direct cooling to the steel portions of the barrier. Therefore, it is reasonable to conclude that barrier failure will not occur due to unsupported steel forming a part of the cable chase walls.

7.2 Steel Internal to Cable Chases

Several of the larger cable chases were found to contain smaller steel (typically W12 X 28) with moderately sized unprotected tube members attached. These smaller structural members have been provided for cable tray support designs not to support the building slab or equipment above. The larger perimeter steel of these cable chases is the primary support structure for the slab and associated building structures, which provides the required structural integrity. When comparing the other areas adjacent to the cable chases the slab thickness is the same, with significantly greater spans between main structural steel members within the adjacent rooms reviewed. Because cable chase room spans are minimal and the cable tray supports are from floor to ceiling, where they are attached to the smaller structural steel members, it is not credible that failure would occur from the affects of fire.

Based on the above discussions, it is reasonable to conclude that these rooms and/or areas are acceptable and will not require a detailed thermal short analysis for the reasons discussed above.

7.3 Embedded Steel

Building steel that is partially embedded into concrete slabs (ceilings) is not subject to failure by unprotected thermal shorts. The concrete slabs provide substantial reinforcement and significant heat sink capability to the embedded

steel. Therefore, it is not credible to postulate steel failure due to unprotected thermal short attachments when steel is embedded into reinforced concrete.

Building steel that is partially embedded or integrated to concrete walls forming a fire barrier is designed with concrete (6" thick, min) on one side and protected with fireproofing on the other side. This design also presents direct support to the steel from below and side. Thus, providing substantial reinforcement and significant heat sink capability to the structural steel if exposed to direct flame impingement. Therefore, it is not credible to postulate steel failure due to unprotected thermal short attachments when steel is embedded into reinforced concrete walls and supported from below.

7.4 Miscellaneous Steel

In some case miscellaneous steel was protected with fireproofing material. Failure of miscellaneous steel will not result in room/area building steel failure. Therefore, further review is not required. Degraded fireproofing on miscellaneous steel does not require repair.

7.5 Steel Protection for Stairwells and Elevators

Stairwell and elevator steel integral to the fire barrier assembly is only protected on the hazard side in accordance with Specification A-126 (Reference 3.7). Since the fire loading in the stairwells and elevator enclosure(s) are extremely low, a credible fire cannot occur or challenge the building steel integrated to stairwell or elevator barriers. Stairwell and elevator barriers are typically constructed with reinforced concrete and/or solid CMU walls and steel at the ceiling interface that forms a part of the Appendix R barrier. This integrated barrier design incorporates an approximate 1" gap for seismic interaction that is filled full depth with compressed ceramic fiber and is coated on the hazard side with structural steel fireproofing. The concrete or CMU walls do not directly support the steel due to the approximate 1" gap between the bottom flange of the steel member(s) and the top of the barrier wall(s). The presence of the gap will not be a detriment or have a degrading affect to the barrier since the gap is completely filled with ceramic fiber and clad with cementitious fireproofing material on the hazard side of the barrier. The wall segments that make up the barrier portions of the wall and/or fire barrier will prevent catastrophic steel failure by supporting the steel from below if steel deflection occurs during fire exposures. However, because steel sizes are so much greater than that tested (W8 X 28), steel deflection is not expected to occur and barrier integrity will be maintained for a 3-hour duration. Additionally, storage of transient combustibles within stairwells is not generally permitted due to egress and ingress requirements. The design of the elevator enclosure does not permit access or storage of combustible materials.

These one sided structural steel fireproofing configurations are determined to be "F" rated only and cannot satisfy "T" rating requirements if exposed to an ASTM E-119 3-hour fire duration. Specification A-126, section 7.1 states in part, "stair towers and elevator construction shall be protected from external hazards." Therefore, in these cases structural steel fireproofing is not required on both sides of the barrier. Where these barriers provide Appendix R separation, this

configuration does not satisfy cold side temperature limitations of the WCNOG Fire Protection Program. Therefore, for each location where one-sided fireproofing or significant attachments are present the area was reviewed for Heat Affected Zone (HAZ) influence to ensure PFSSD is not affected. This HAZ review is documented in Attachment G5. Thermal shorts attached to stairwell steel will not impact the structural integrity of the steel due to the corbel support afforded by the under supporting walls.

7.6 Diesel Building Structural Steel

The Diesel Building rooms 5201 and 5203 were reviewed for unprotected thermal short impact to fireproofed structural steel. However a worse case thermal short analysis review was not warranted. This is due to the fact that building steel for room 5201 is not directly connected to room 5203 building steel. If failure would occur in one room it will not influence the redundant room building steel. The center reinforced concrete wall is two feet thick which supports both steel structures in both Diesel rooms through large embeds. Because of the robust nature of the wall, it will remain unaffected by fire, thus preventing catastrophic structural failure. Industry testing for penetration seal and fire wrap has repeatedly demonstrated that concrete test slabs with substantially less thickness and grade of concrete were not affected to the point of failure for a 3-hour duration. Although, these test slabs were not load bearing, no evidence of heat stress occurred, further substantiating the integrity of the separation wall between the two fire areas for the emergency diesel generators.

Based on the above discussion it is reasonable to conclude that steel failure caused by fire in one diesel generator room will not affect the redundant train room or PFSSD capability. Therefore further thermal short analysis is not required.

7.7 Control Building Duct Chase

The Control Building Duct Chase (Fire Area C-1) is open to all levels of the Control Building, traversing up from 1974' elevation Room 3101 to the 2073' elevation interfacing with multiple Fire Areas. See Figure I for a simplified elevation view of the duct chase in relation to interface with other Control Building fire areas. Fire Protection has performed a visual inspection of the integrated barrier steel fireproofing as observed from the Control Building 1974' (Room 3101) elevation, and has determined that the Duct Chase steel is protected on the chase side as well as room sides (two-sided protection) throughout the Control Building. This visual inspection noted four (4) levels without difficulty and the remaining floors and associated steel could not be observed due to accessibility limitations presented by HVAC duct and support steel. However, based on that observed from 1974' (4 levels), it is reasonable to conclude that the remaining integrated steel members that make up the duct chase are protected with fireproofing consistent with the observed lower levels. Therefore, protected duct chase steel that is integral to an Appendix R fire barrier will perform consistent with that discussed in Section 7.1. A HAZ review is not required on the Duct Chase side since the opening is limited to mechanical components. Attachment G5 documents the HAZ review for the Control Building rooms interfacing with the duct chase.

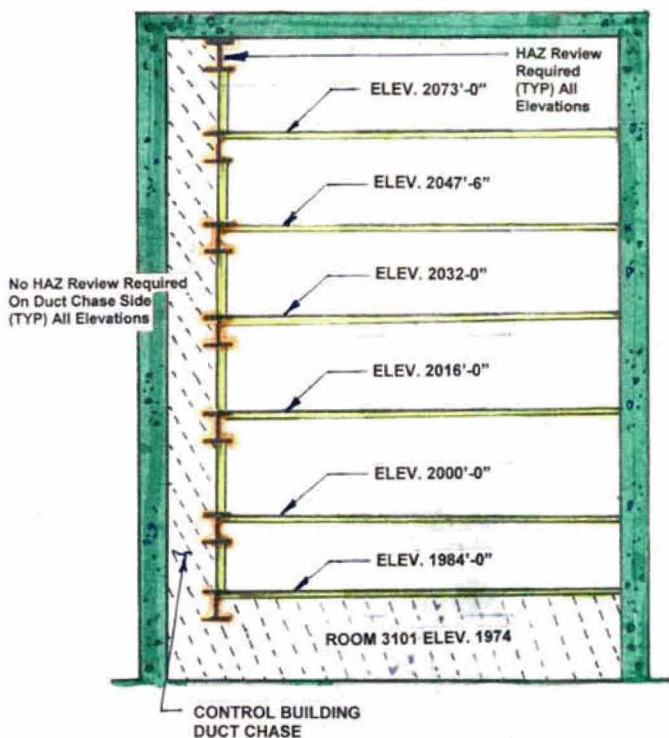

FIGURE I
Control Building Duct Chase

8.0 Post Fire Safe Shutdown Impact

Table II rooms with no exposed steel, no thermal short attachments, or worse case thermal short attachments equivalent to Unistrut, do not negatively affect post-fire safe shutdown (PFSSD) from a building structural integrity perspective, as the failure mode of concern (significant thermal insult path to structural steel) is not present.

For the remaining Table II rooms (with the exception Rooms 5201 and 5203), PFSSD is not negatively affected from a building structural integrity perspective as the evaluations above determined that room/fire area structural integrity would be maintained in the event of an ASTM E-119 3-hour fire exposure.

For Rooms 5201 and 5203 the unique or unbounded structural steel fireproofing configurations are acceptable, as fire barrier separation is maintained with no impact to PFSSD capability.

Refer to Attachment G5 for documentation of the HAZ review for steel that is incorporated as an element of an Appendix R fire barrier assembly.

9.0 Conclusions

Based on physical plant walk down reviews and assessments performed by Fire Protection, the rooms identified in Table II, containing protected structural steel (where applicable) have been determined to be acceptable due to steel configurations and/or supporting wall structures that ensure fire barrier separation will be maintained in the event of an ASTM E-119 3-hour fire exposure. Some rooms did not contain structural steel, and some steel structures had no thermal attachments and are bounded to UL testing. Others contained worse case thermal short attachments equivalent to Unistrut, which FP-M-012 demonstrated did not present a thermal conductive path failure mode for protected structural steel.

In conclusion, Table II rooms containing structural steel protected with fireproofing are acceptable, as fire barrier separation is maintained with no impact to PFSSD capability.

Structural Steel Fireproofing Data

Appendix G1A

Room-Elevation: 1102-1974 Building: Auxiliary Fire Area: A-01

Description: Chiller & Surge Tanks Area

Thermal Short #1 (TS1) Data

Thermal Short #2 (TS2) Data

Drawing: C-0S1211

N/A

Member Type: Beam

N/A

Member Size: 27 X 94

N/A

Comments: Embedded Steel, Not a Thermal Short Issue.

There are no Columns in this Room.

Room Sketch:

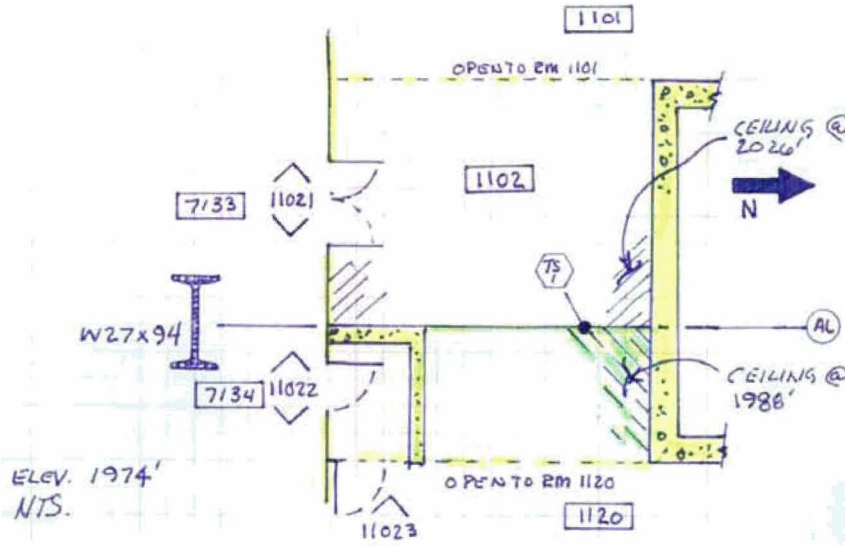

Thermal Short #1 Sketch

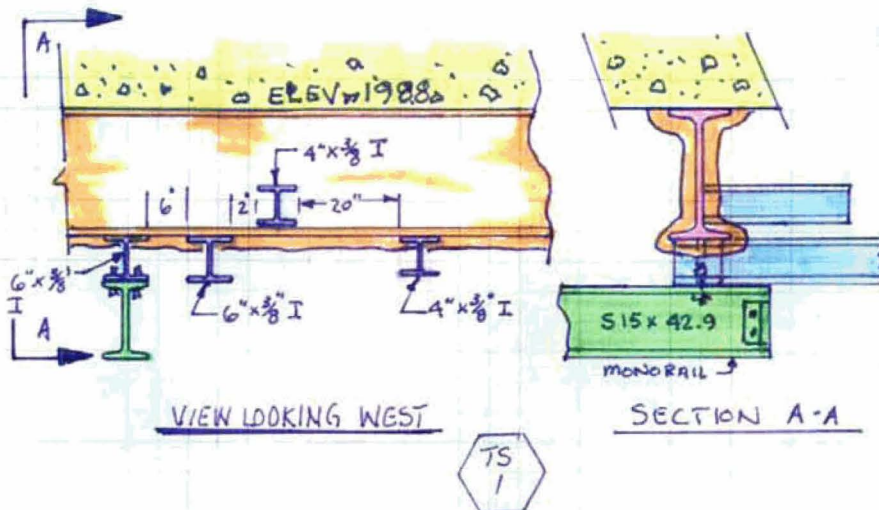

Structural Steel Fireproofing Data

Appendix G1A

1102-1974

Thermal Short #1 Photo 1



Thermal Short #1 Photo 2



Thermal Short #2 Sketch

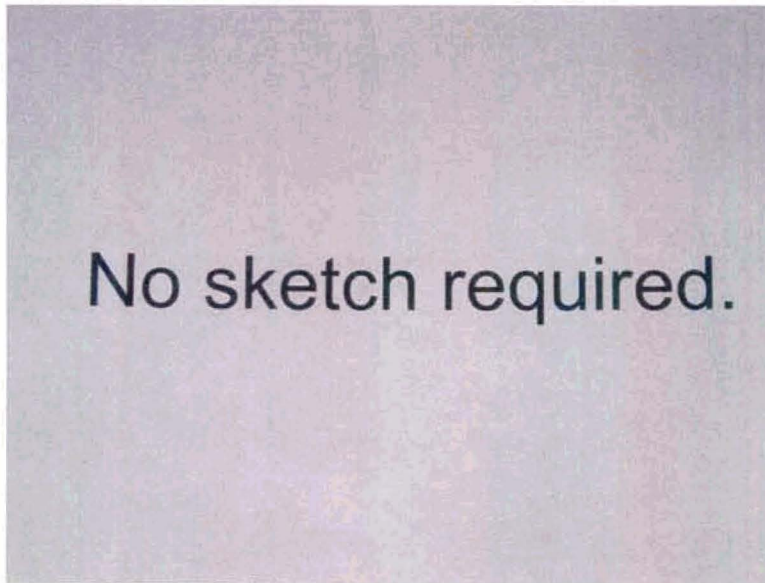

Thermal Short #2 Photo 1

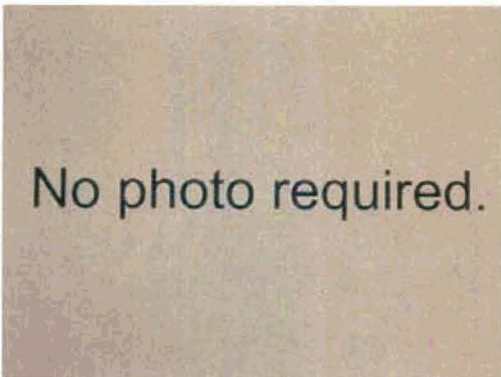

Thermal Short #2 Photo 2



Structural Steel Fireproofing Data

Appendix G1A

Room-Elevation: 1103-1974 Building: Auxiliary Fire Area: A-01

Description: Letdown Chiller Heat Exch Room

Thermal Short #1 (TS1) Data

Thermal Short #2 (TS2) Data

Drawing: C-0S1211

N/A

Member Type: Beam

N/A

Member Size: 24 X 68

N/A

Comments: Embedded Steel, Not a Thermal Short Issue.

There are no Columns in this Room.

Room Sketch:

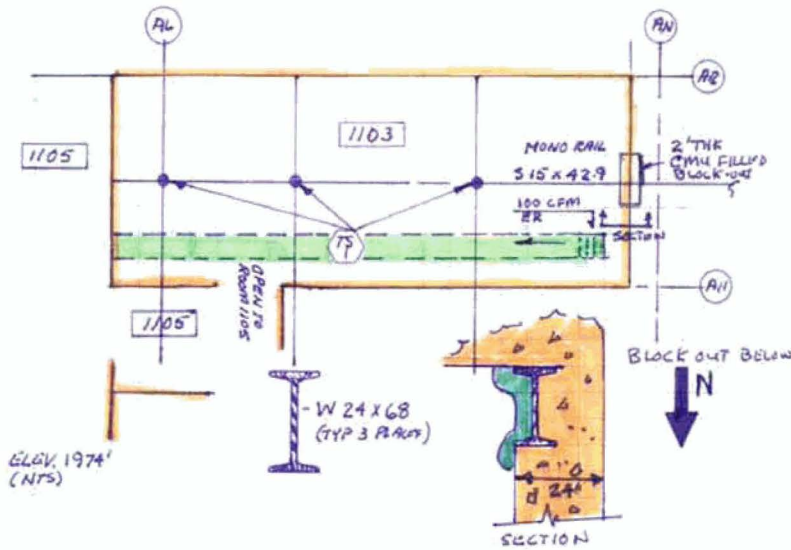

Thermal Short #1 Sketch

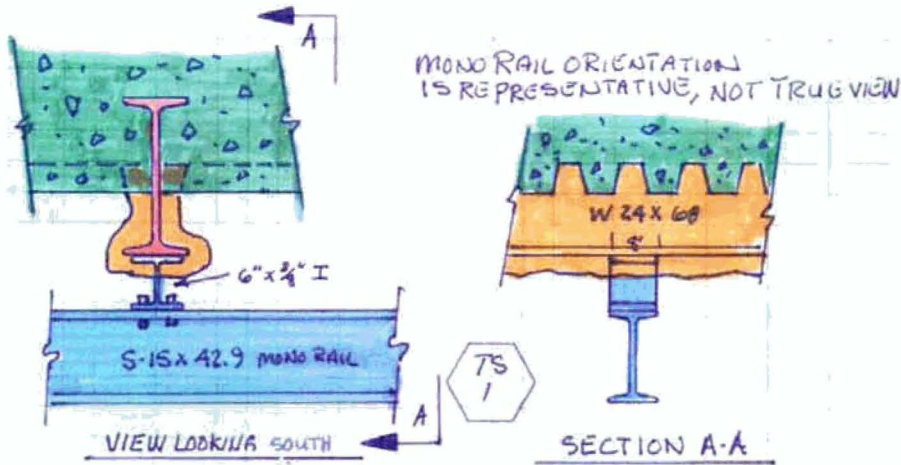

Structural Steel Fireproofing Data

Appendix G1A

1103-1974

Thermal Short #1 Photo 1



Thermal Short #1 Photo 2



Thermal Short #2 Sketch

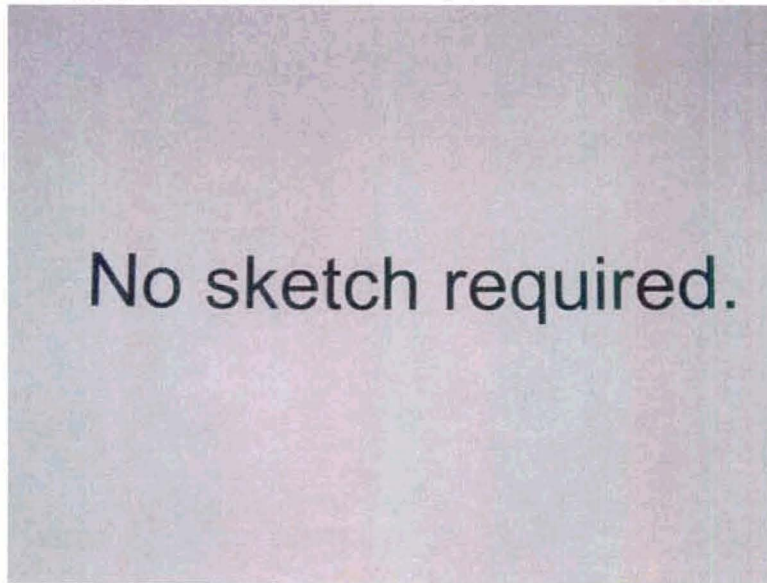

Thermal Short #2 Photo 1



Thermal Short #2 Photo 2



Structural Steel Fireproofing Data

Appendix G1A

Room-Elevation: 1104-1974 Building: Auxiliary Fire Area: A-01

Description: Letdown Reheat Heat Exch Room

Thermal Short #1 (TS1) Data

Thermal Short #2 (TS2) Data

Drawing: C-0S1211

N/A

Member Type: Beam

N/A

Member Size: 24 X 68

N/A

Comments: Embedded Steel, Not a Thermal Short Issue.

There are no Columns in this Room.

Room Sketch:

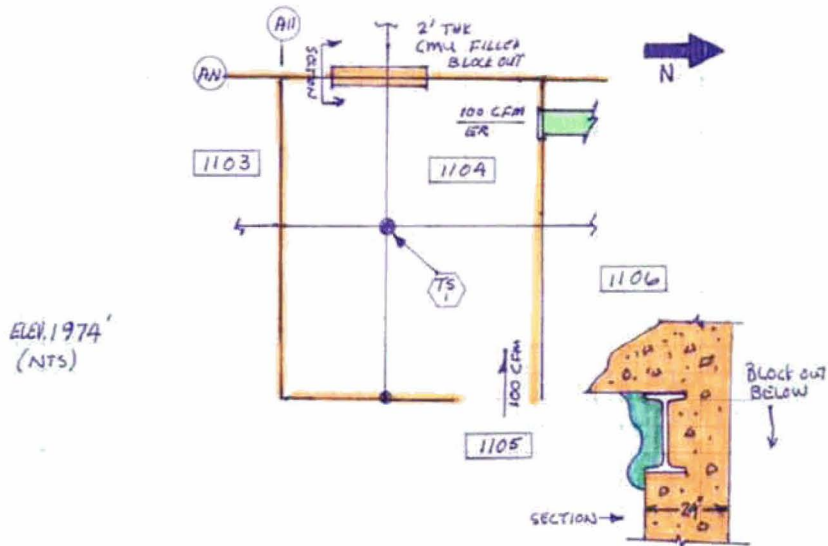

Thermal Short #1 Sketch

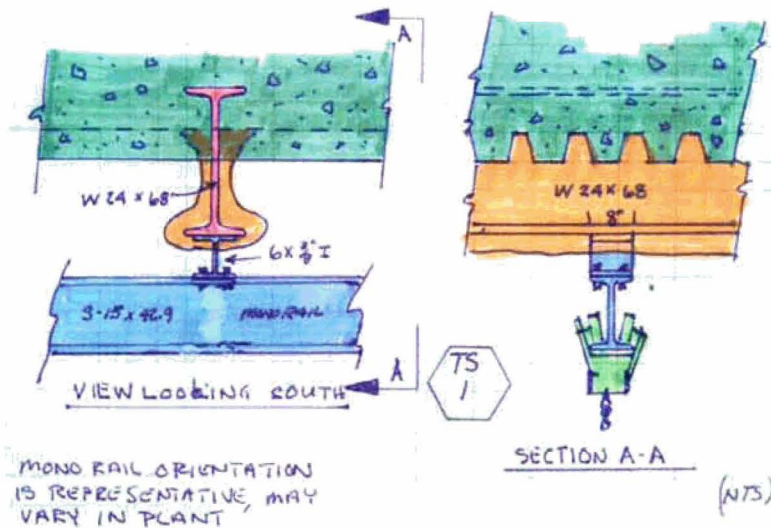

Structural Steel Fireproofing Data

Appendix G1A

1104-1974

Thermal Short #1 Photo 1



Thermal Short #1 Photo 2



Thermal Short #2 Sketch

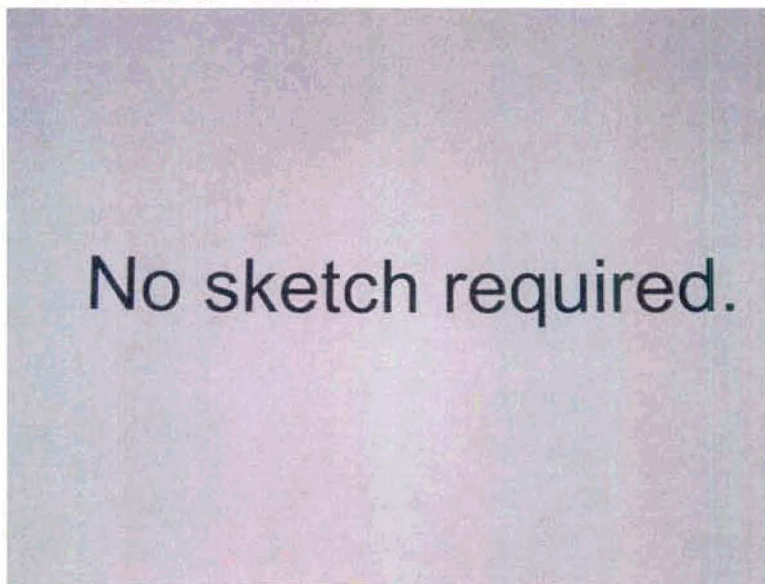

Thermal Short #2 Photo 1



Thermal Short #2 Photo 2



Structural Steel Fireproofing Data

Appendix G1A

Room-Elevation: 1105-1974 Building: Auxiliary Fire Area: A-01

Description: Valve Compartment

Thermal Short #1 (TS1) Data

Thermal Short #2 (TS2) Data

Drawing: C-0S1211

N/A

Member Type: Beam

N/A

Member Size: 30 X 99

N/A

Comments: Embedded Steel, Not a Thermal Short Issue.

There are no Columns in this Room.

Room Sketch:

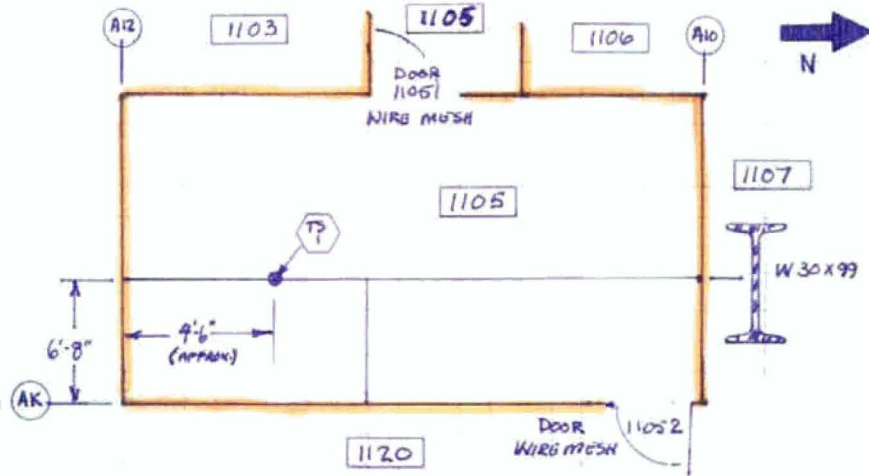

Thermal Short #1 Sketch

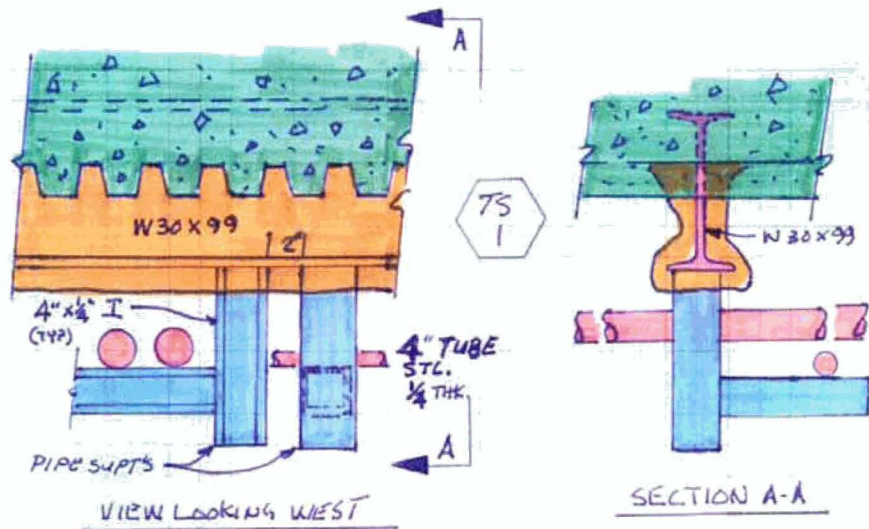

Structural Steel Fireproofing Data

Appendix G1A

1105-1974

Thermal Short #1 Photo 1



Thermal Short #1 Photo 2

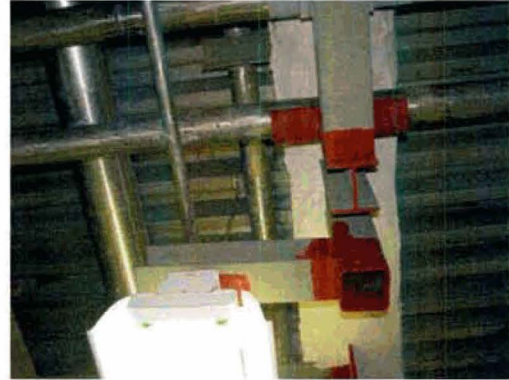

Thermal Short #2 Sketch

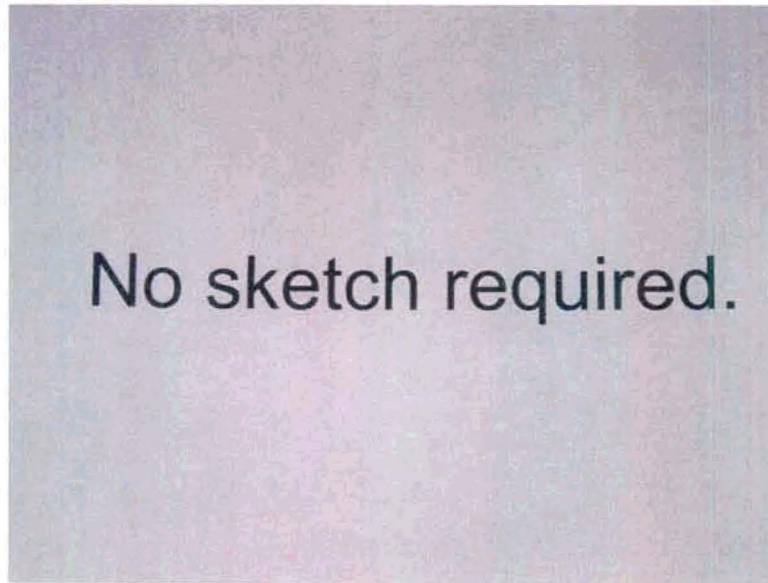

Thermal Short #2 Photo 1



Thermal Short #2 Photo 2



Structural Steel Fireproofing Data

Appendix G1A

Room-Elevation: 1106-1974 Building: Auxiliary Fire Area: A-01

Description: Moderating Heat Exch Room

Thermal Short #1 (TS1) Data

Thermal Short #2 (TS2) Data

Drawing: C-0S1211

N/A

Member Type: Beam

N/A

Member Size: 24 X 68

N/A

Comments: HAZ, Mono Rail extending through CMU filled Block out, Not an issue.

There are no Columns in this Room.

Room Sketch:

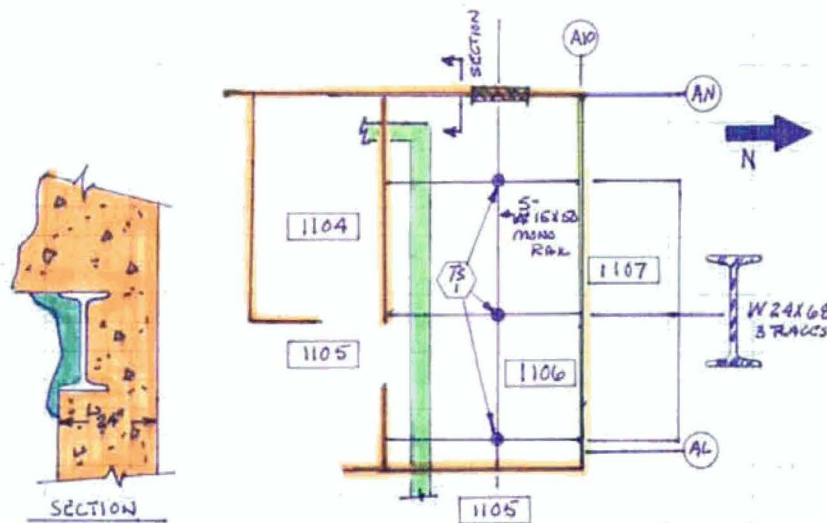

Thermal Short #1 Sketch

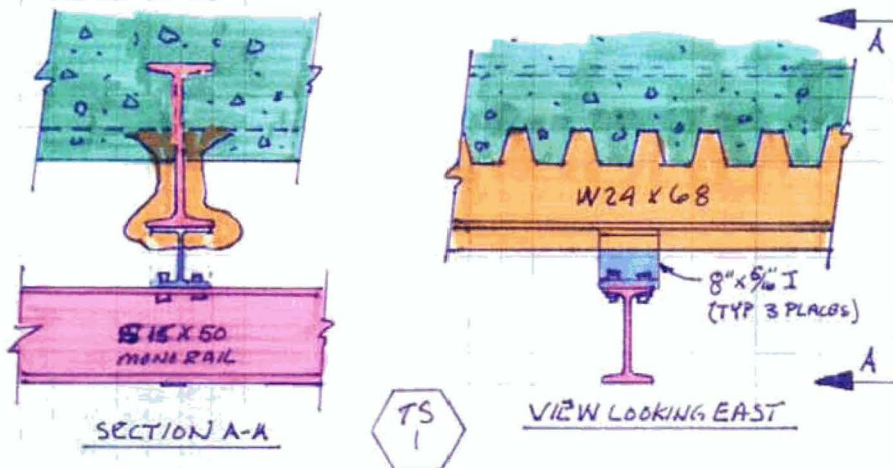

Structural Steel Fireproofing Data

Appendix G1A

1106-1974

Thermal Short #1 Photo 1



Thermal Short #1 Photo 2



Thermal Short #2 Sketch

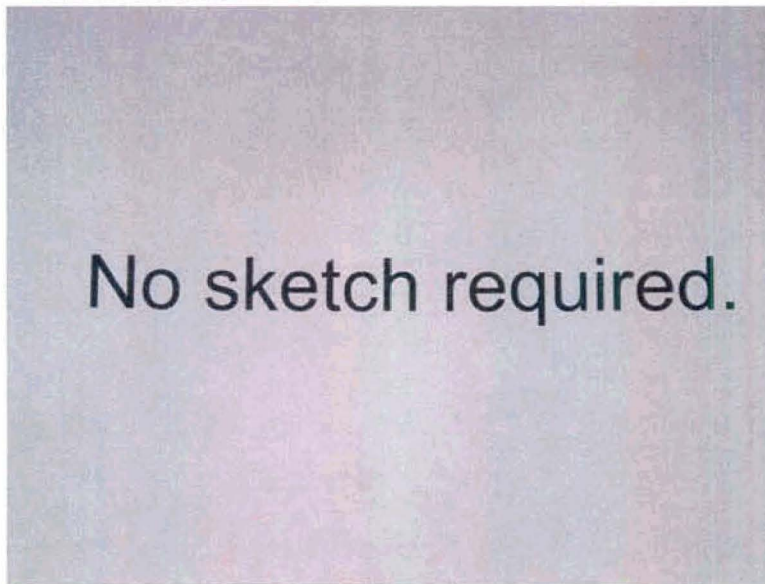

Thermal Short #2 Photo 1



Thermal Short #2 Photo 2



Structural Steel Fireproofing Data

Appendix G1A

Room-Elevation: 1115-1974 Building: Auxiliary Fire Area: A-01

Description: Normal Charging Pump Rm

Thermal Short #1 (TS1) Data

Thermal Short #2 (TS2) Data

Drawing: C-1S1221

N/A

Member Type: Beam

N/A

Member Size: 27 X 84

N/A

Comments: HAZ, Mono Rail extending through CMU filled Block out, Not an issue.

There are no Columns in this Room.

Room Sketch:

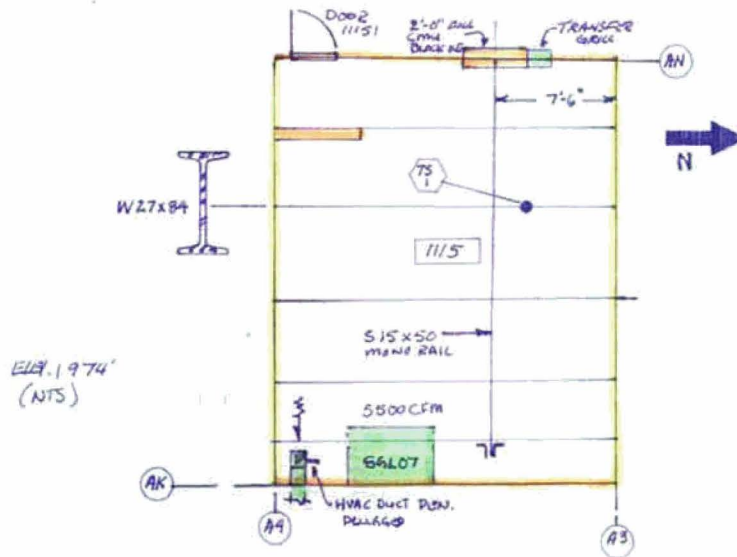

Thermal Short #1 Sketch

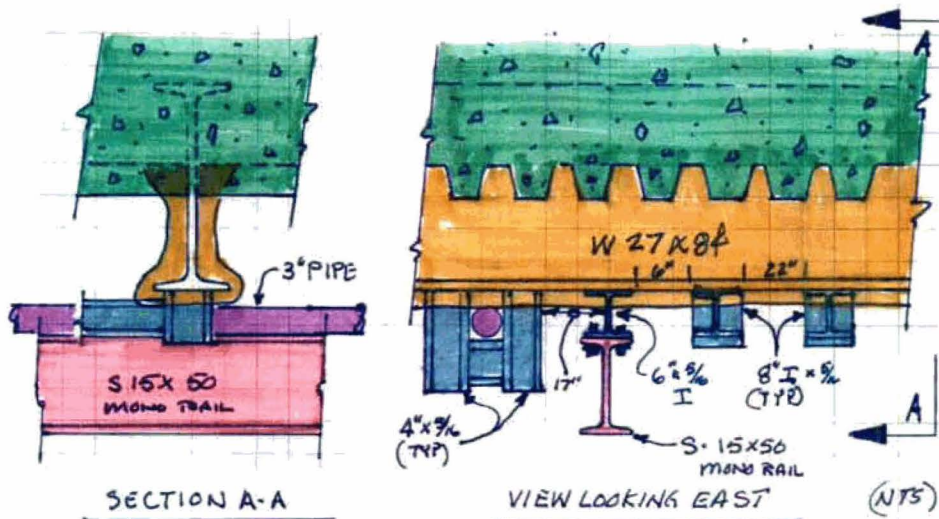

Structural Steel Fireproofing Data

Appendix G1A

1115-1974

Thermal Short #1 Photo 1



Thermal Short #1 Photo 2



Thermal Short #2 Sketch



Thermal Short #2 Photo 1

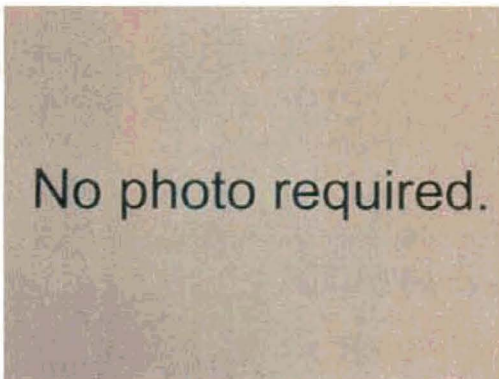

Thermal Short #2 Photo 2



Structural Steel Fireproofing Data

Appendix G1A

Room-Elevation: 1123-1974 Building: Auxiliary Fire Area: A-01

Description: Passage

Thermal Short #1 (TS1) Data

Thermal Short #2 (TS2) Data

Drawing: C-0S1231

N/A

Member Type: Beam

N/A

Member Size: 30 X 99

N/A

Comments: Embedded Steel no evaluation required.

No Columns within this Room

Room Sketch:

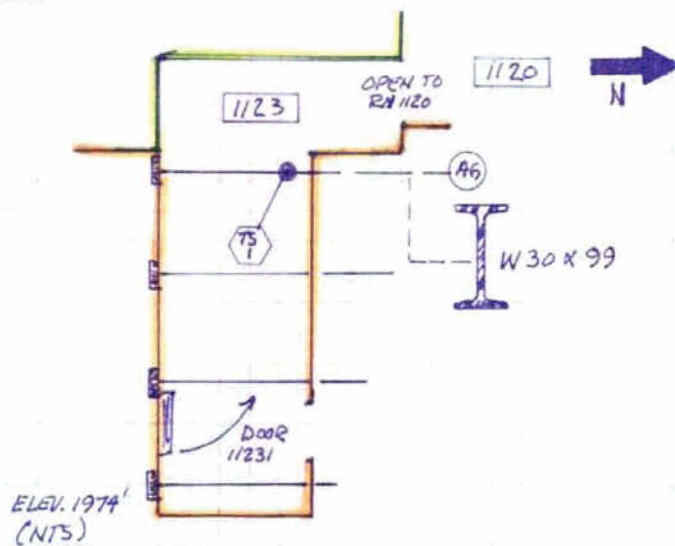

Thermal Short #1 Sketch

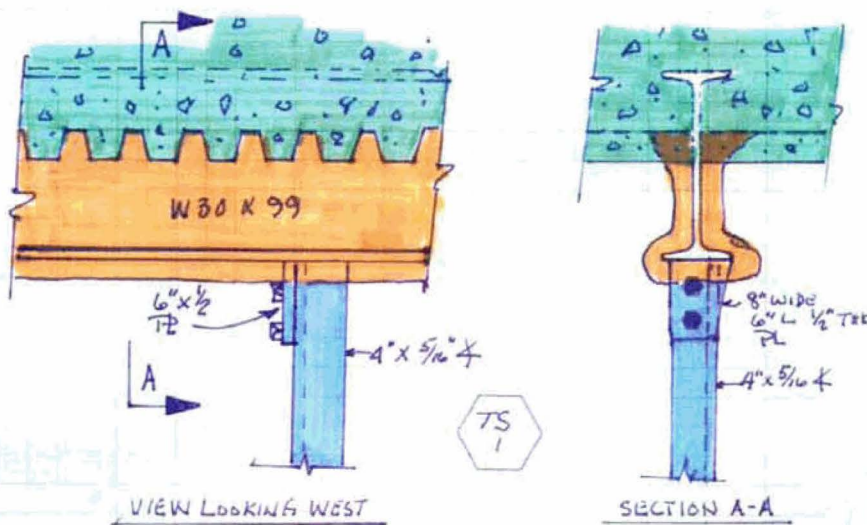

Structural Steel Fireproofing Data

Appendix G1A

1123-1974

Thermal Short #1 Photo 1



Thermal Short #1 Photo 2



Thermal Short #2 Sketch

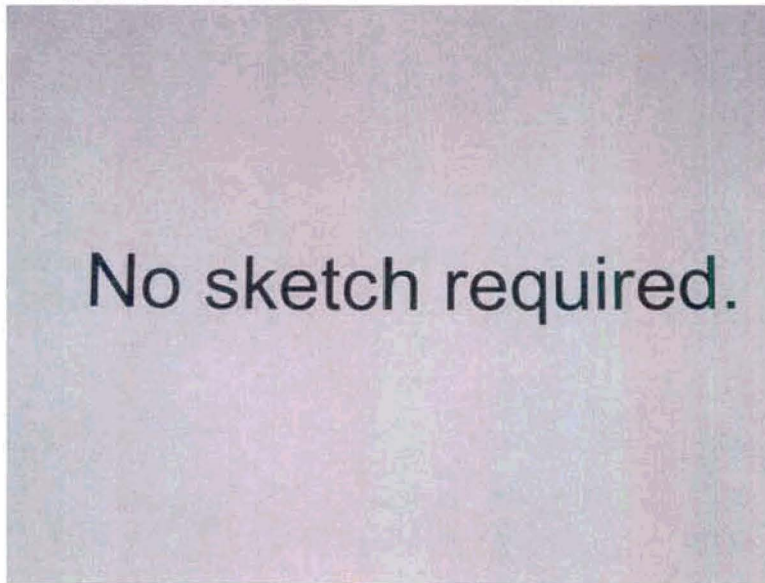

Thermal Short #2 Photo 1



Thermal Short #2 Photo 2

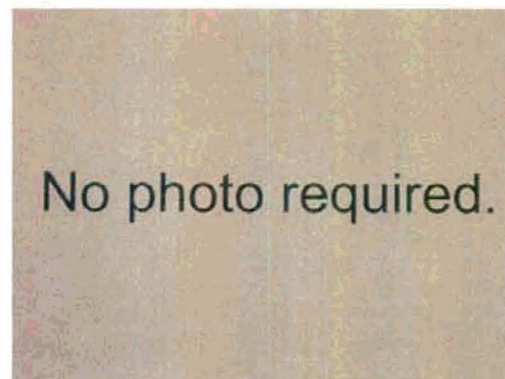

Structural Steel Fireproofing Data

Appendix G1A

Room-Elevation: 1124-1974 Building: Auxiliary Fire Area: A-01

Description: Valve Compartment

Thermal Short #1 (TS1) Data

Thermal Short #2 (TS2) Data

Drawing: C-0S1231

N/A

Member Type: Beam

N/A

Member Size: 24 X 68

N/A

Comments: Embedded Steel no evaluation required.

No Columns within this Room

Room Sketch:

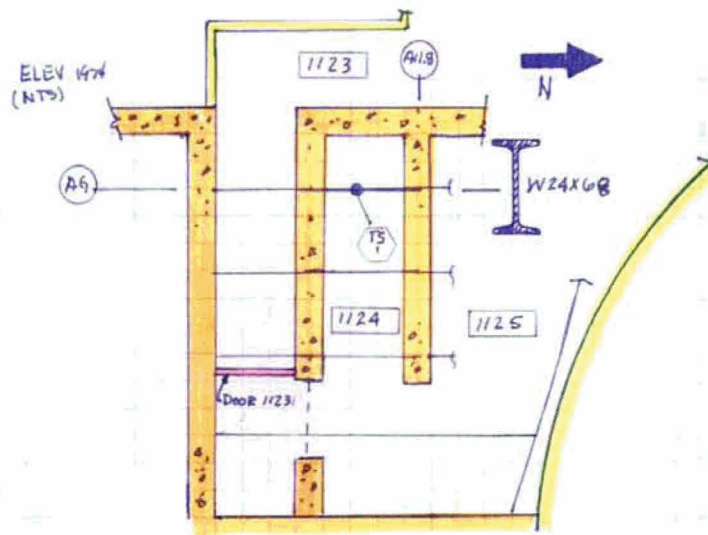

Thermal Short #1 Sketch

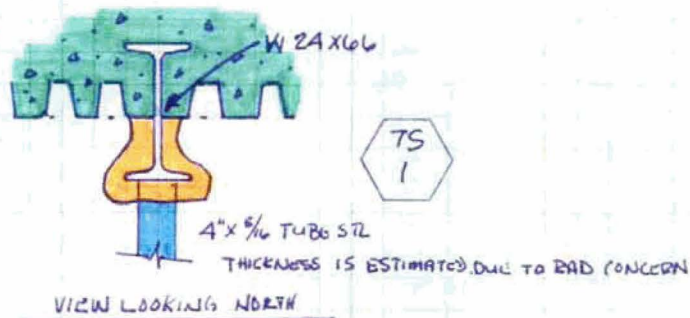

NOTE: MEMBER WAS VIEWED FROM A DISTANCE.
 4" TUBE IS REASONABLE BY VISUAL ONLY
 THICKNESS IS ESTIMATED AND IS SIMILAR TO
 OTHER TUBES IN THE AREA.

Structural Steel Fireproofing Data

Appendix G1A

1124-1974

Thermal Short #1 Photo 1



Thermal Short #1 Photo 2

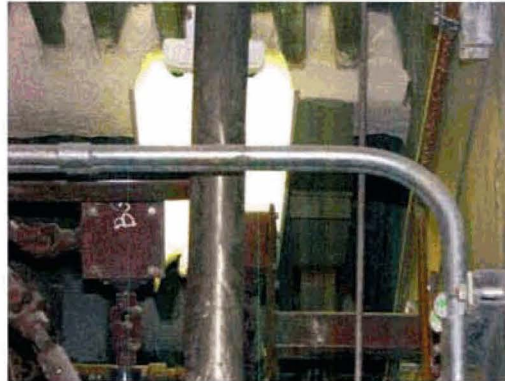

Thermal Short #2 Sketch

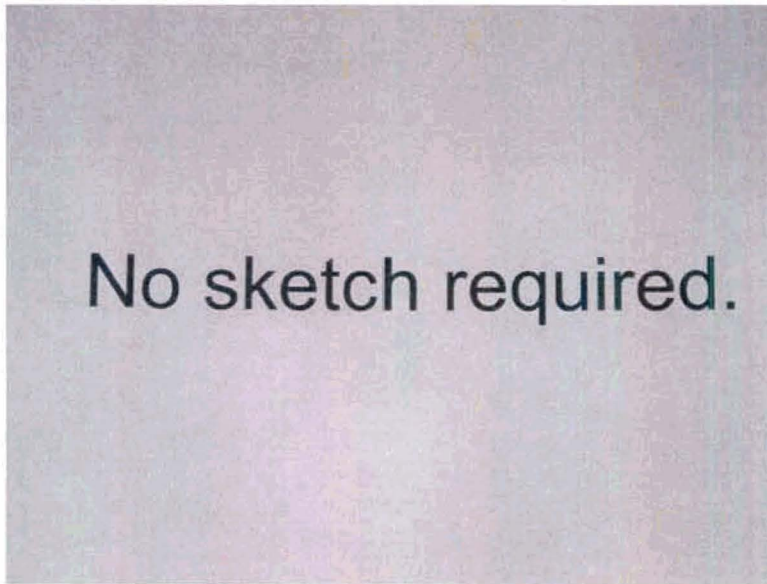

Thermal Short #2 Photo 1



Thermal Short #2 Photo 2



Structural Steel Fireproofing Data

Appendix G1A

Room-Elevation: 1125-1974 Building: Auxiliary Fire Area: A-01

Description: Letdown Heat Exch Room

Thermal Short #1 (TS1) Data

Thermal Short #2 (TS2) Data

Drawing: C-0S1231

N/A

Member Type: Beam

N/A

Member Size: 24 X 68

N/A

Comments: Embedded Steel no evaluation required.

No Columns within this Room

Room Sketch:

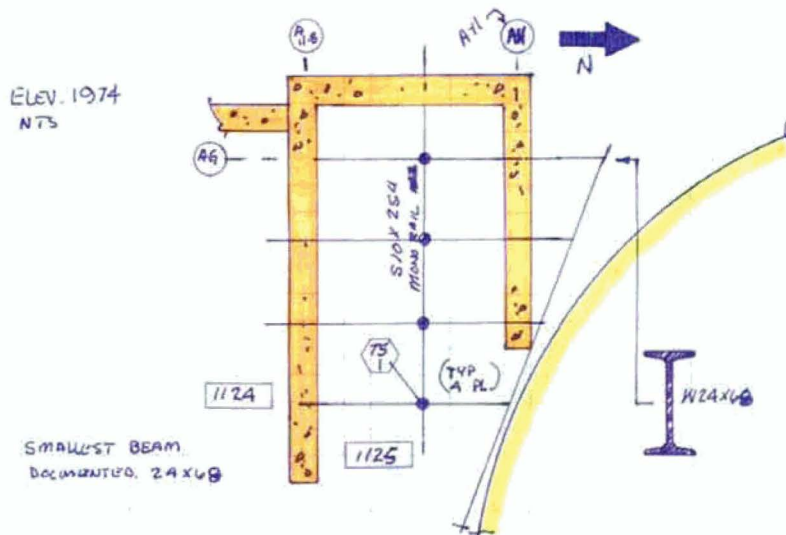

Thermal Short #1 Sketch

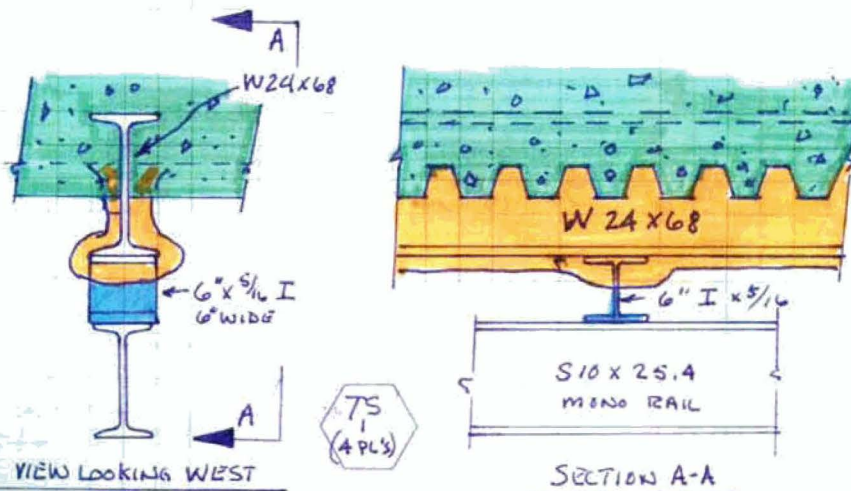

Structural Steel Fireproofing Data

Appendix G1A

1125-1974

Thermal Short #1 Photo 1



Thermal Short #1 Photo 2



Thermal Short #2 Sketch

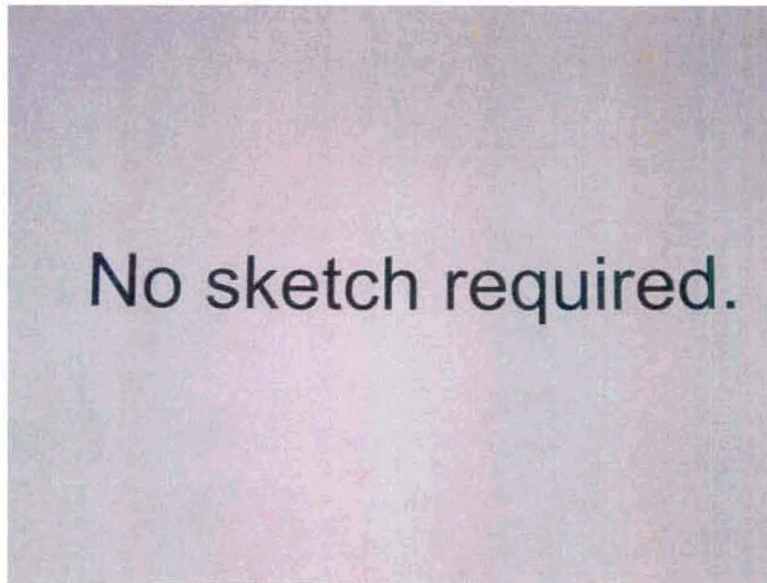

Thermal Short #2 Photo 1



Thermal Short #2 Photo 2



Structural Steel Fireproofing Data

Appendix G1A

Room-Elevation: 1128-1974 Building: Auxiliary Fire Area: A-01

Description: Auxiliary Feedwater Pump Room

Thermal Short #1 (TS1) Data

Thermal Short #2 (TS2) Data

Drawing: C-1S1352

Member Type: Beam

Column

Member Size: 14 X 34

N/R

Comments: Beam embedded with concrete on one side

Columns, Unistrut only, no issue.

Room Sketch:

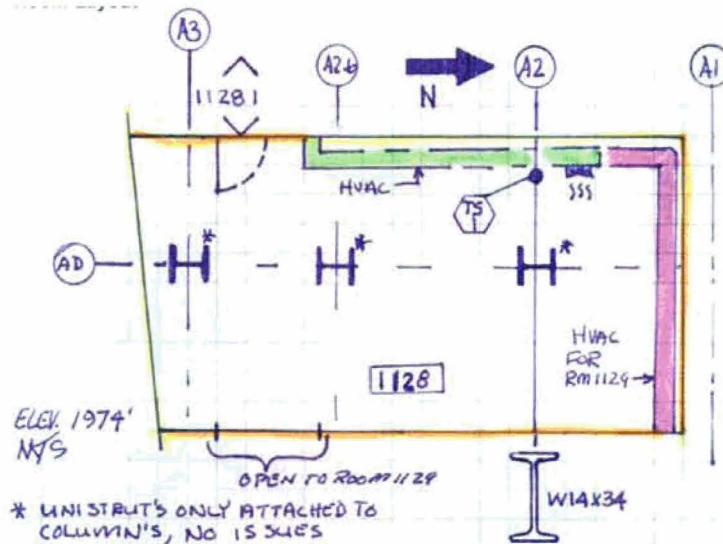

Thermal Short #1 Sketch

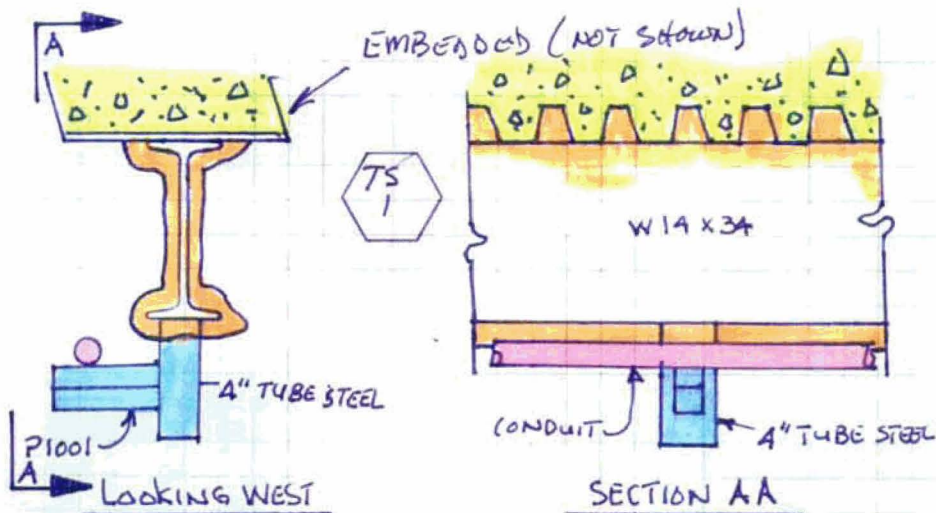

Structural Steel Fireproofing Data

Appendix G1A

1128-1974

Thermal Short #1 Photo 1



Thermal Short #1 Photo 2



Thermal Short #2 Sketch

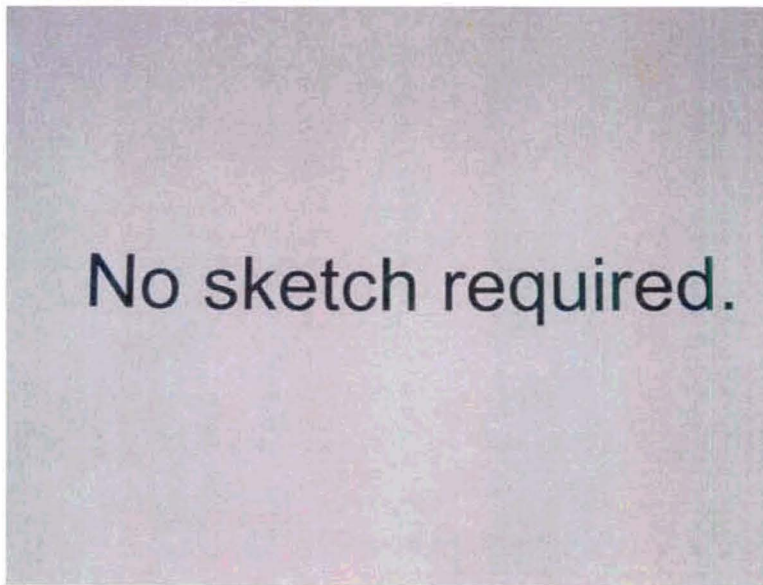

Thermal Short #2 Photo 1



Thermal Short #2 Photo 2



Structural Steel Fireproofing Data

Appendix G1A

Room-Elevation: 1129-1974 Building: Auxiliary Fire Area: A-01

Description: Aux Steam Cond Recovery & Storage Tank

Thermal Short #1 (TS1) Data Thermal Short #2 (TS2) Data

Drawing:	C-1S1352	N/A
Member Type:	Beam	Column
Member Size:	14 X 34	N/R
Comments:	Beam embedded with concrete on one side	Columns, Unistrut only, no issue.

Room Sketch:

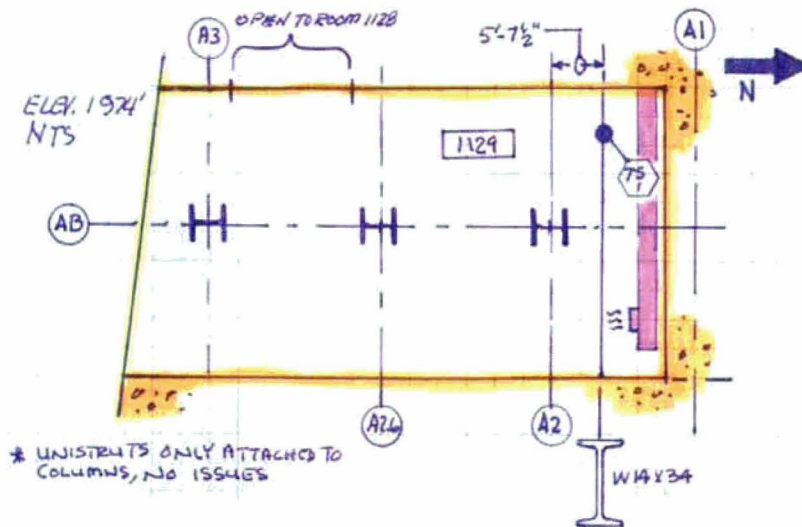

Thermal Short #1 Sketch

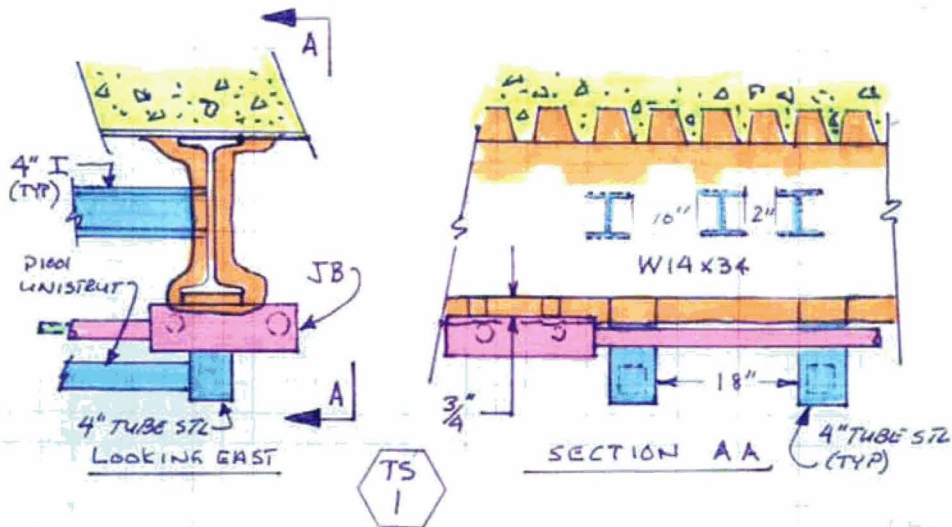

Structural Steel Fireproofing Data

Appendix G1A

1129-1974

Thermal Short #1 Photo 1



Thermal Short #1 Photo 2



Thermal Short #2 Sketch

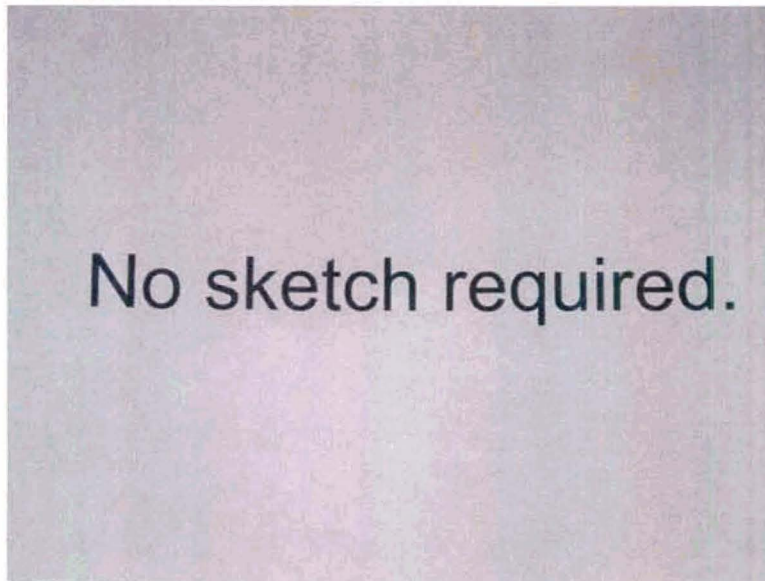

Thermal Short #2 Photo 1



Thermal Short #2 Photo 2



Structural Steel Fireproofing Data

Appendix G1A

Room-Elevation: 1201-1988 Building: Auxiliary Fire Area: A-01

Description: Vestibule

Thermal Short #1 (TS1) Data

Thermal Short #2 (TS2) Data

Drawing: C-0S1331

N/A

Member Type: Beam

N/A

Member Size: 24 X 68

N/A

Comments: Beam embedded or support by underlying wall., No Issue

No Columns

Room Sketch:

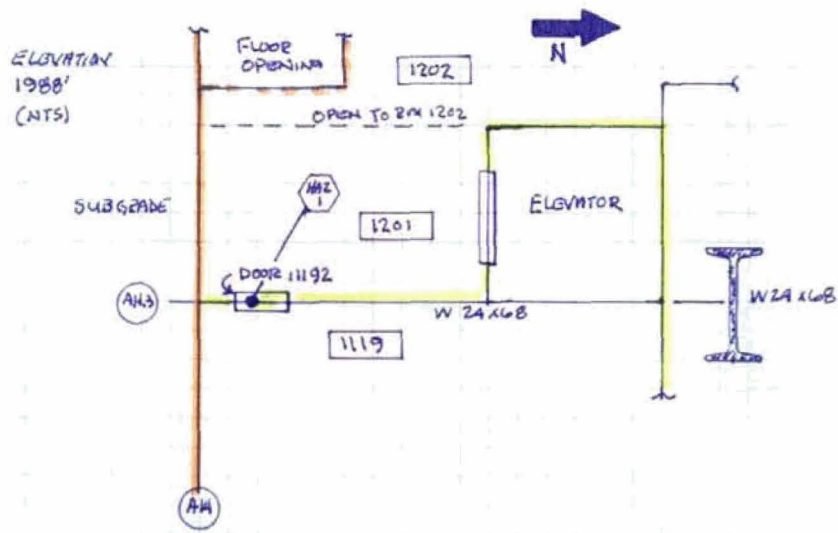

Thermal Short #1 Sketch

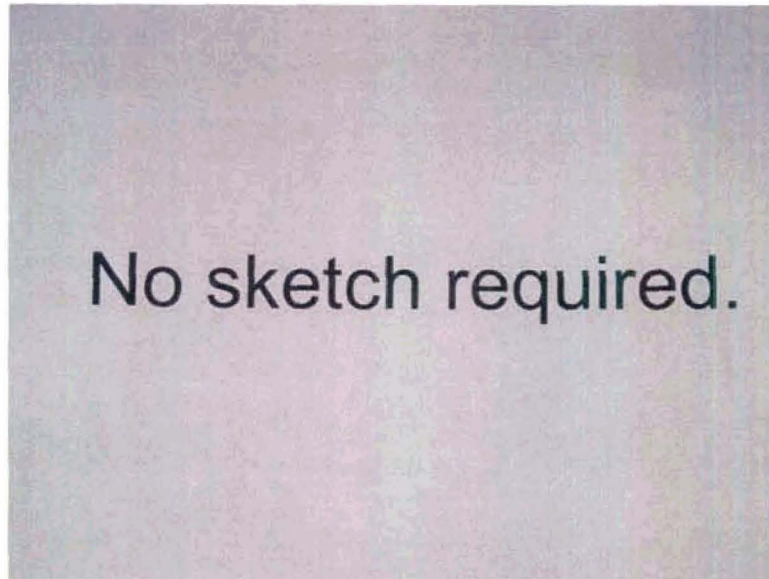

Structural Steel Fireproofing Data

Appendix G1A

Room-Elevation: 1205-1988 **Building:** Auxiliary **Fire Area:** A-01

Description: Access Area A

Thermal Short #1 (TS1) Data

Thermal Short #2 (TS2) Data

Drawing: N/A

N/A

Member Type: None

None

Member Size: N/A

N/A

Comments: No exposed steel

No exposed steel

Room Sketch:



Thermal Short #1 Sketch

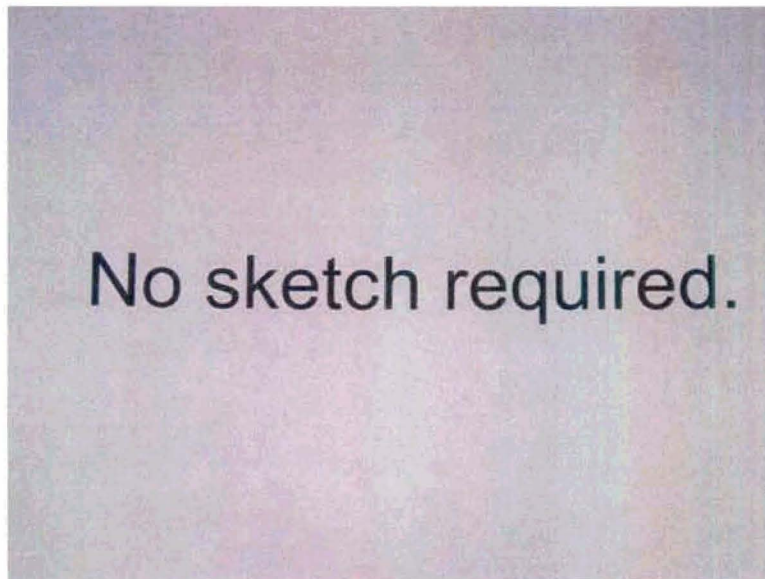

Structural Steel Fireproofing Data

Appendix G1A

Room-Elevation: 1111-1968 Building: Auxiliary Fire Area: A-02

Description: Residual Heat Removal Pump Room A

Thermal Short #1 (TS1) Data

Thermal Short #2 (TS2) Data

Drawing: C-1S1221

N/A

Member Type: Beam

N/A

Member Size: 24 X 68

N/A

Comments: HAZ, Mono Rail extending through CMU filled Block out, Not an issue. Section 12.2.2

There are no Columns in this Room.

Room Sketch:

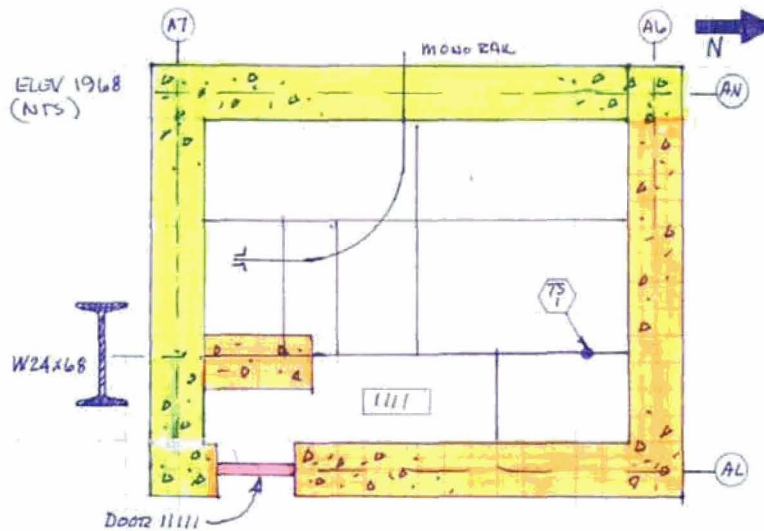

Thermal Short #1 Sketch

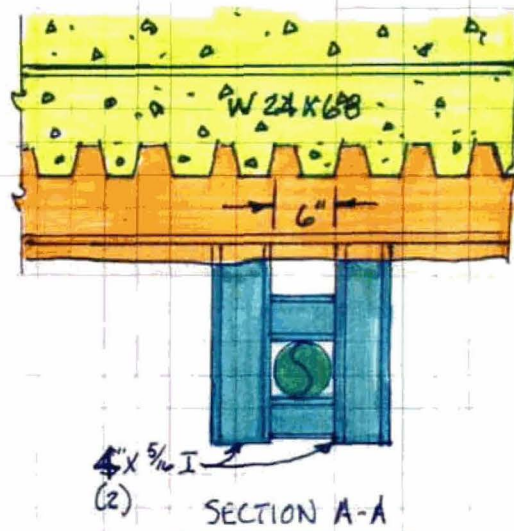
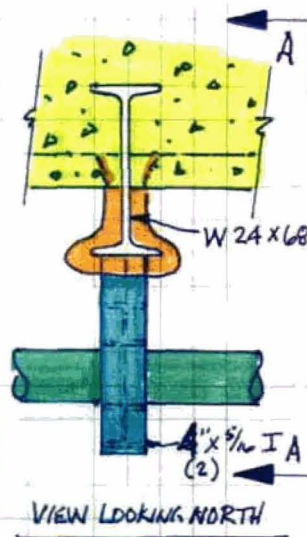

Structural Steel Fireproofing Data

Appendix G1A

1111-1968

Thermal Short #1 Photo 1



Thermal Short #1 Photo 2



Thermal Short #2 Sketch

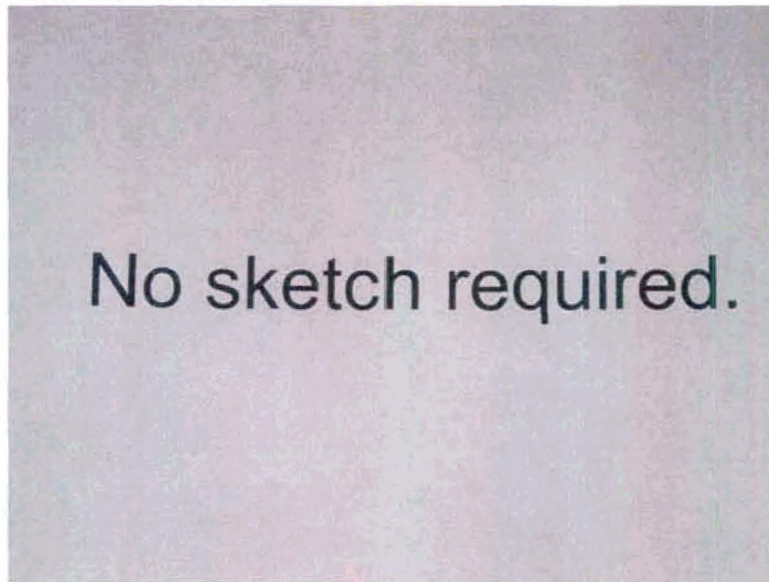

Thermal Short #2 Photo 1



Thermal Short #2 Photo 2



Structural Steel Fireproofing Data

Appendix G1A

Room-Elevation: 1112-1968 Building: Auxiliary Fire Area: A-02

Description: Containment Spray Pump Room A

Thermal Short #1 (TS1) Data

Thermal Short #2 (TS2) Data

Drawing: C-1S1221

N/A

Member Type: Beam

N/A

Member Size: 21 X 55

N/A

Comments: HAZ, Mono Rail extending through CMU filled Block out, Not an issue.

There are no Columns in this Room.

Room Sketch:

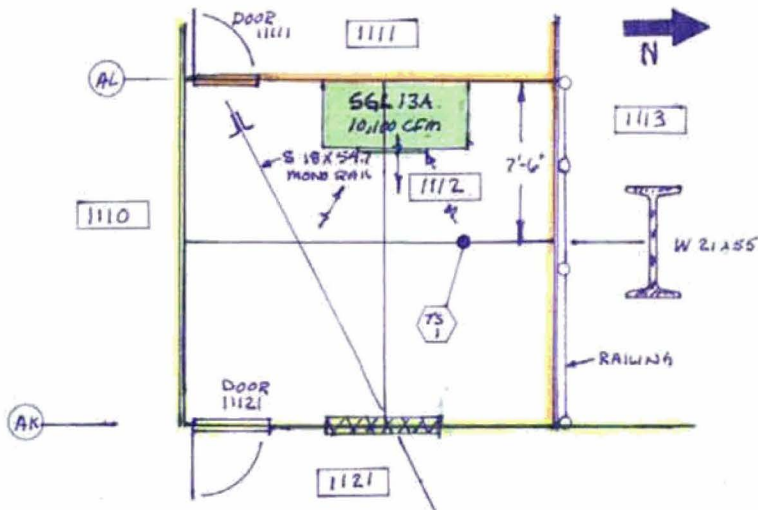

Thermal Short #1 Sketch

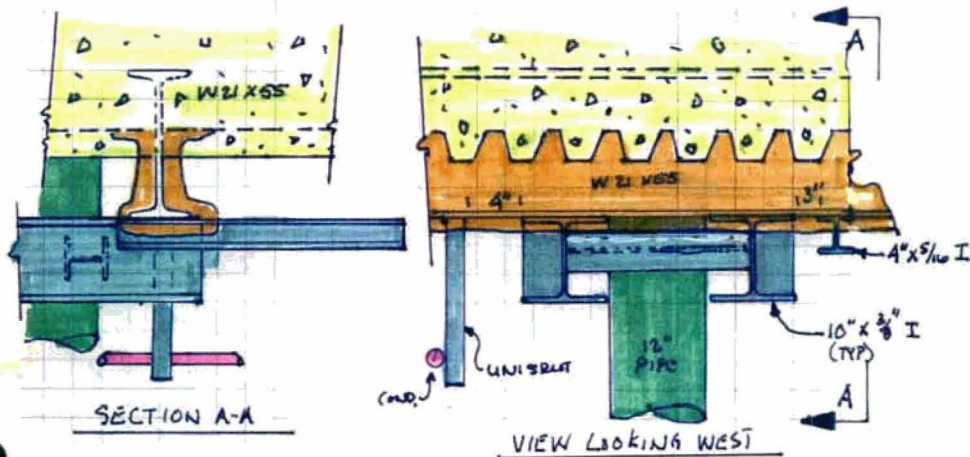

Structural Steel Fireproofing Data

Appendix G1A

1112-1968

Thermal Short #1 Photo 1

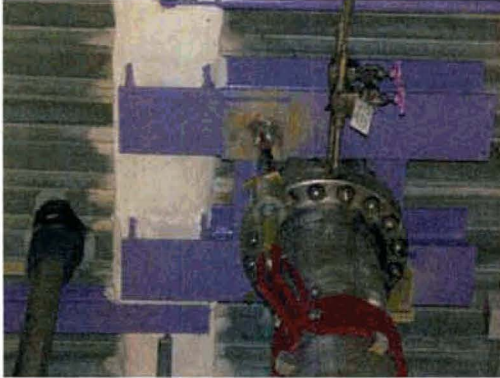

Thermal Short #1 Photo 2



Thermal Short #2 Sketch

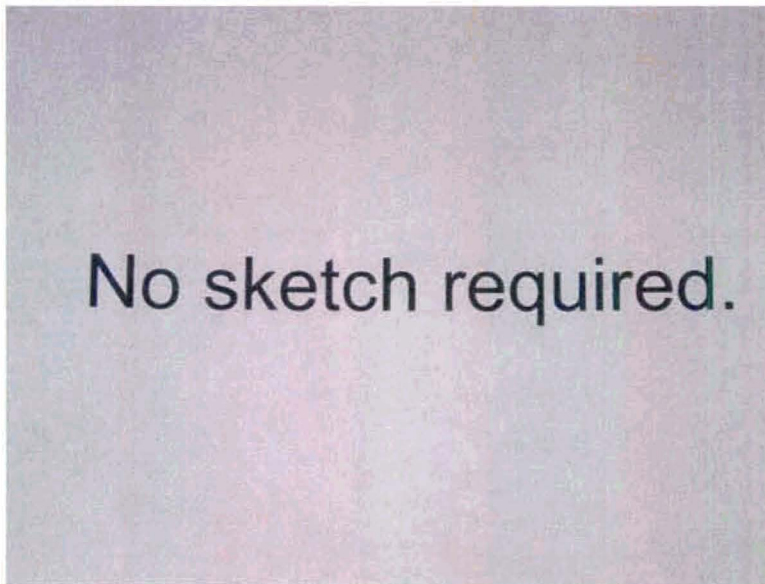

Thermal Short #2 Photo 1



Thermal Short #2 Photo 2



Structural Steel Fireproofing Data

Appendix G1A

Room-Elevation: 1113-1974 Building: Auxiliary Fire Area: A-02

Description: Safety Injection Pump Room A

Thermal Short #1 (TS1) Data

Thermal Short #2 (TS2) Data

Drawing: C-1S1221

N/A

Member Type: Beam

N/A

Member Size: 18 X 50

N/A

Comments: HAZ, Mono Rail extending through CMU filled Block out, Not an issue.

There are no Columns in this Room.

Room Sketch:

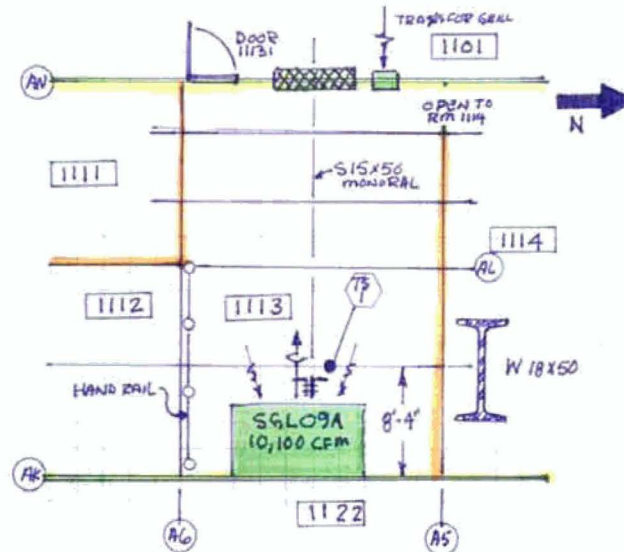

Thermal Short #1 Sketch

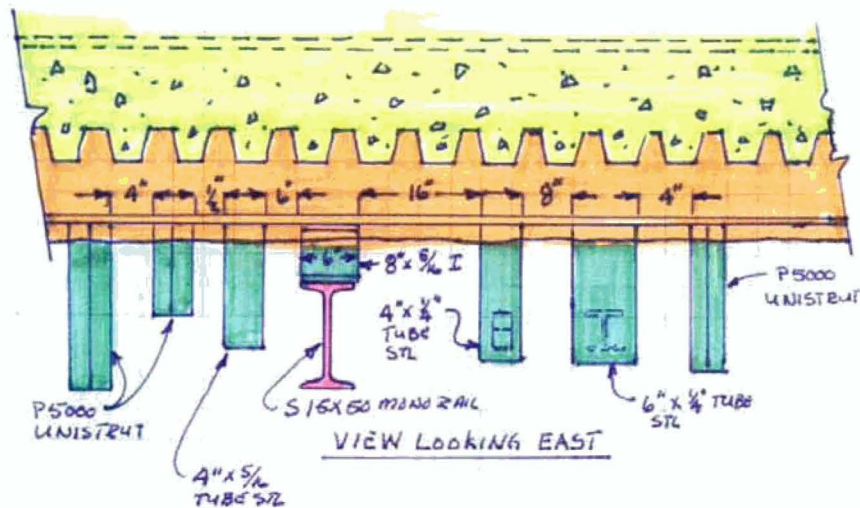

Structural Steel Fireproofing Data

Appendix G1A

1113-1974

Thermal Short #1 Photo 1



Thermal Short #1 Photo 2

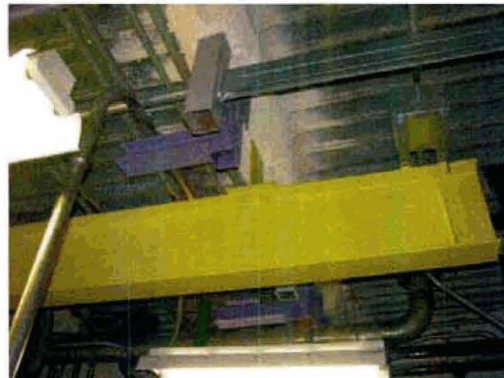

Thermal Short #2 Sketch

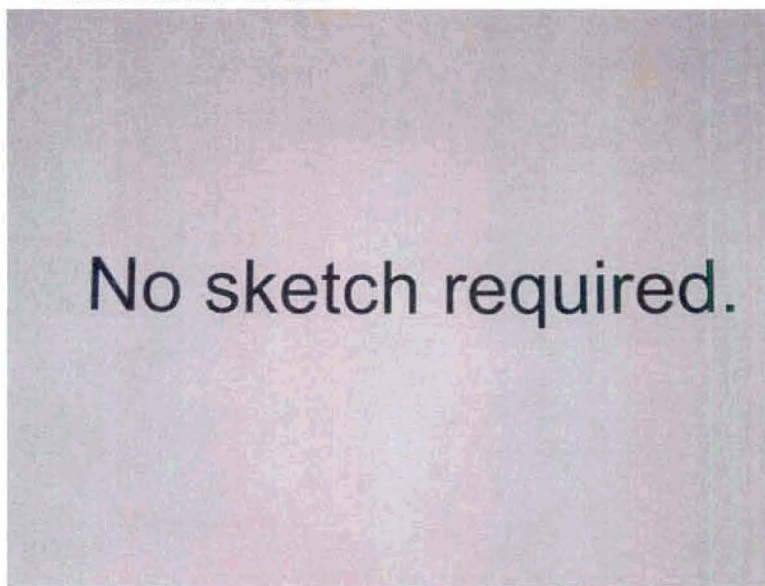

Thermal Short #2 Photo 1



Thermal Short #2 Photo 2

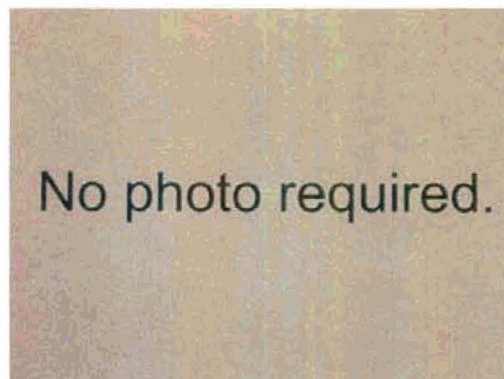

Structural Steel Fireproofing Data

Appendix G1A

Room-Elevation: 1114-1974 Building: Auxiliary Fire Area: A-02

Description: Centrifugal Charging Pump Room A

Thermal Short #1 (TS1) Data

Thermal Short #2 (TS2) Data

Drawing: C-1S1221

N/A

Member Type: Beam

N/A

Member Size: 27 X 84

N/A

Comments: HAZ, Mono Rail extending through CMU filled Block out, Not an issue.

There are no Columns in this Room.

Room Sketch:

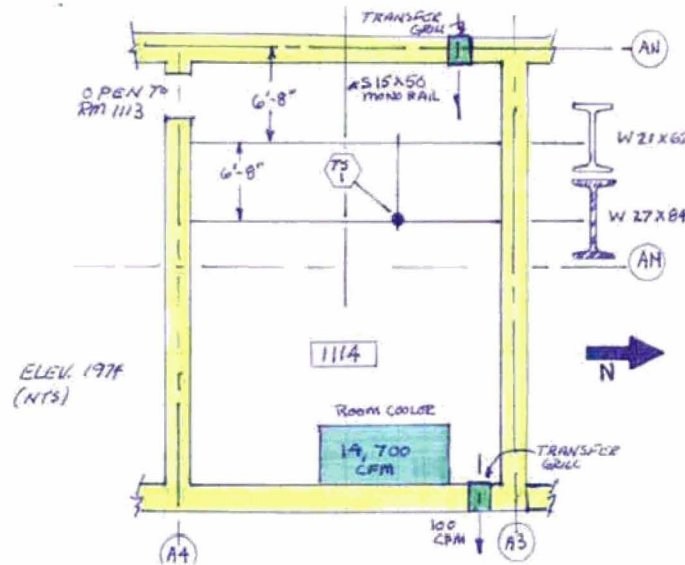

Thermal Short #1 Sketch

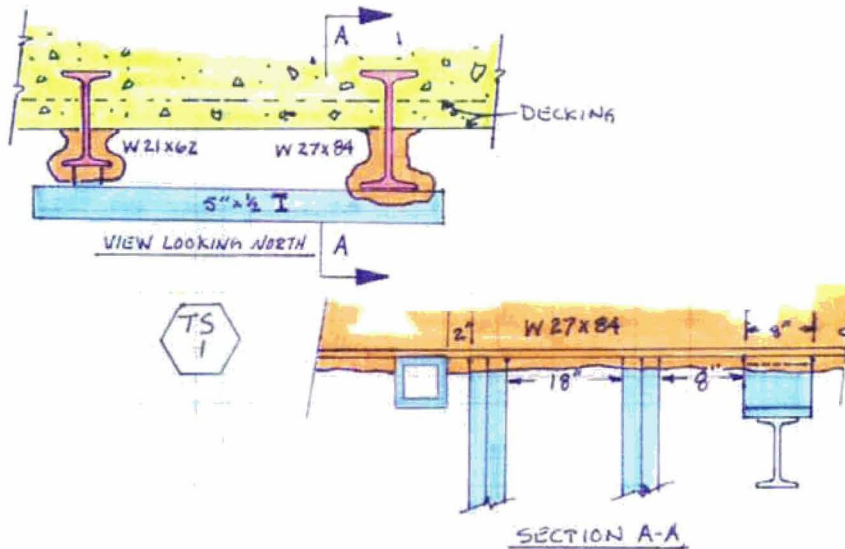

Structural Steel Fireproofing Data

Appendix G1A

1114-1974

Thermal Short #1 Photo 1



Thermal Short #1 Photo 2



Thermal Short #2 Sketch

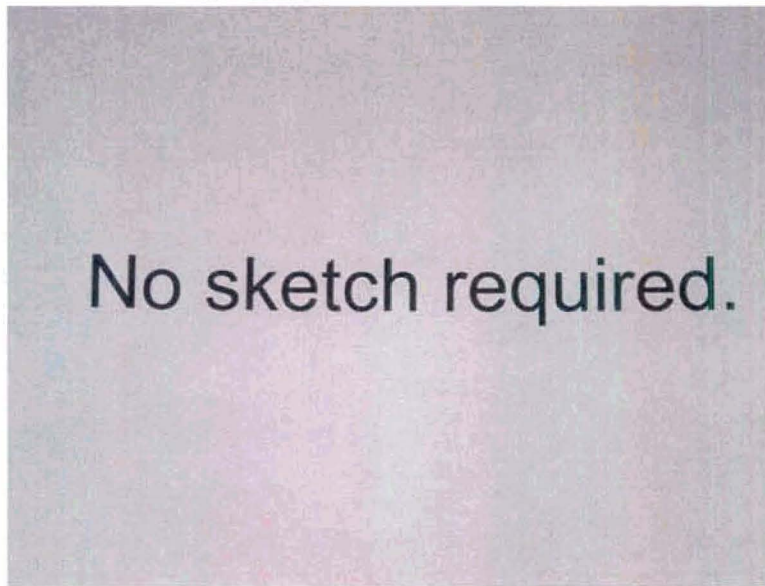

Thermal Short #2 Photo 1



Thermal Short #2 Photo 2



Structural Steel Fireproofing Data

Appendix G1A

Room-Elevation: 1116-1974 Building: Auxiliary Fire Area: A-03

Description: Boric Acid Tank Room B

Thermal Short #1 (TS1) Data

Thermal Short #2 (TS2) Data

Drawing: C-0S1421

N/A

Member Type: Beam

N/A

Member Size: 24 X 76

N/A

Comments: HAZ & thermal short is located on a beam that is partially embedded, concrete on the back side, not an issue. No HAZ Issue.

There are no Columns in this Room.

Room Sketch:

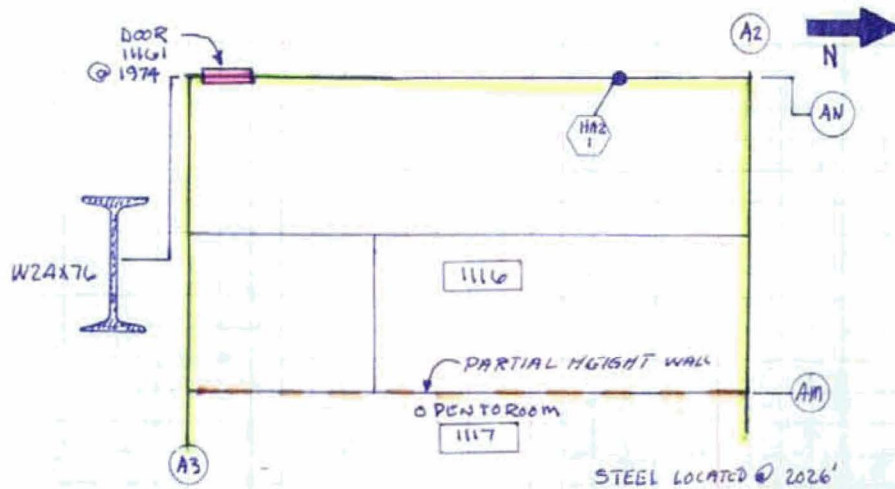

Thermal Short #1 Sketch

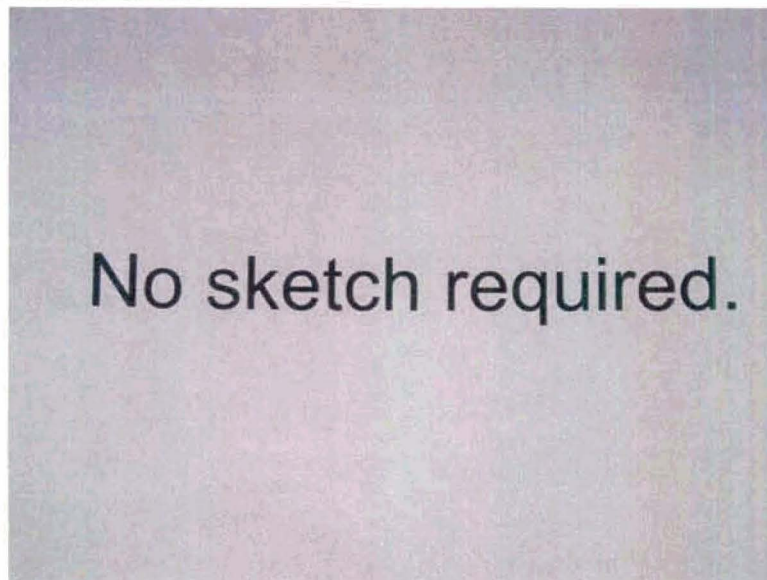

Structural Steel Fireproofing Data

Appendix G1A

1116-1974

Thermal Short #1 Photo 1



Thermal Short #1 Photo 2



Thermal Short #2 Sketch

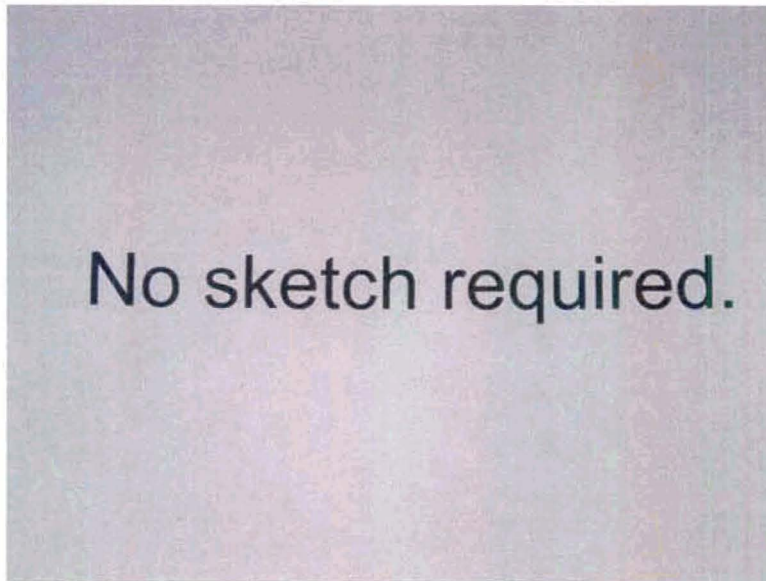

Thermal Short #2 Photo 1



Thermal Short #2 Photo 2



Structural Steel Fireproofing Data

Appendix G1A

Room-Elevation: 1107-1974 Building: Auxiliary Fire Area: A-04

Description: Centrifugal Charging Pump Room B

Thermal Short #1 (TS1) Data

Thermal Short #2 (TS2) Data

Drawing: C-0S1211

N/A

Member Type: Beam

N/A

Member Size: 21 X 55

N/A

Comments: HAZ, Mono Rail extending through CMU filled Block out, Not an issue.

There are no Columns in this Room.

Room Sketch:

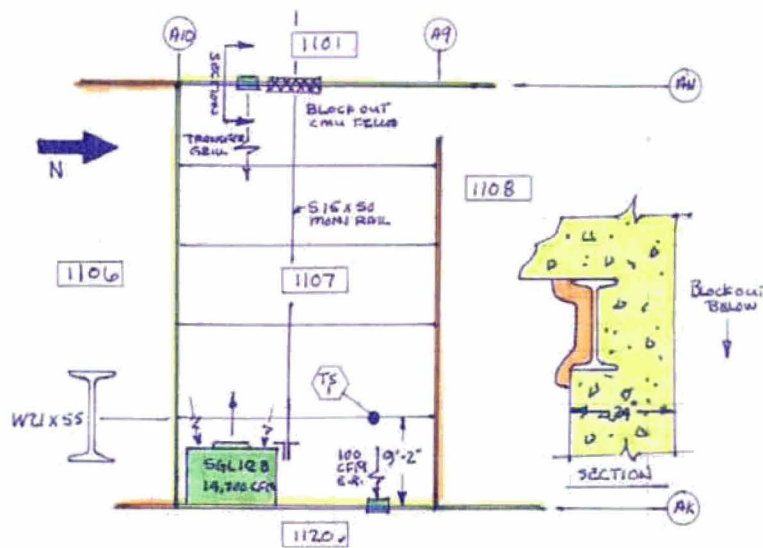

Thermal Short #1 Sketch

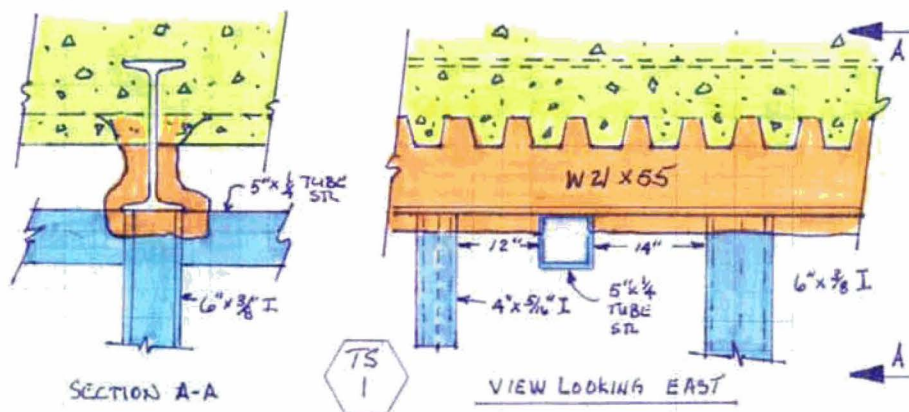

Structural Steel Fireproofing Data

Appendix G1A

1107-1974

Thermal Short #1 Photo 1



Thermal Short #1 Photo 2



Thermal Short #2 Sketch

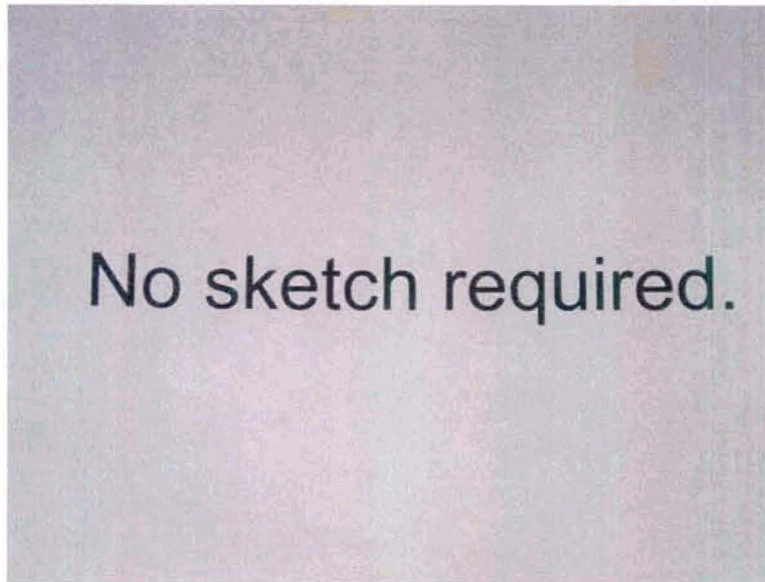

Thermal Short #2 Photo 1



Thermal Short #2 Photo 2



Structural Steel Fireproofing Data

Appendix G1A

Room-Elevation: 1108-1974 Building: Auxiliary Fire Area: A-04

Description: Safety Injection Pump Room B

Thermal Short #1 (TS1) Data

Thermal Short #2 (TS2) Data

Drawing: C-0S1211

N/A

Member Type: Beam

N/A

Member Size: 16 X 40

N/A

Comments: HAZ, Mono Rail extending through CMU filled Block out, Not an issue.

There are no Columns in this Room.

Room Sketch:

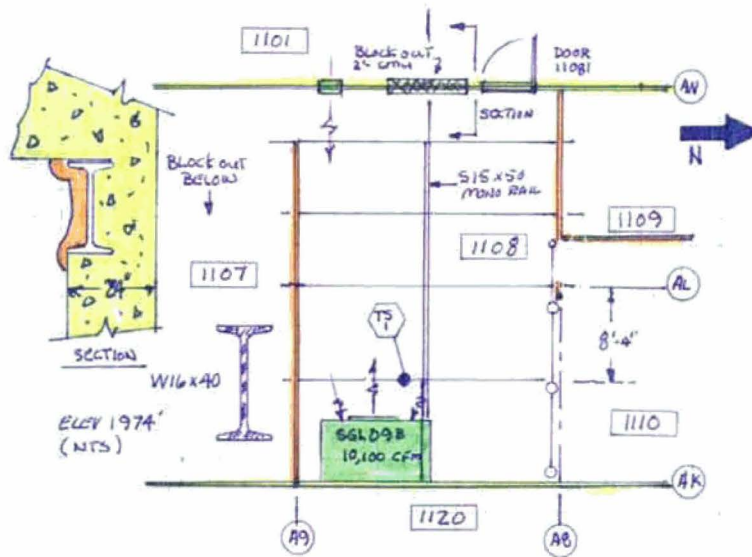

Thermal Short #1 Sketch

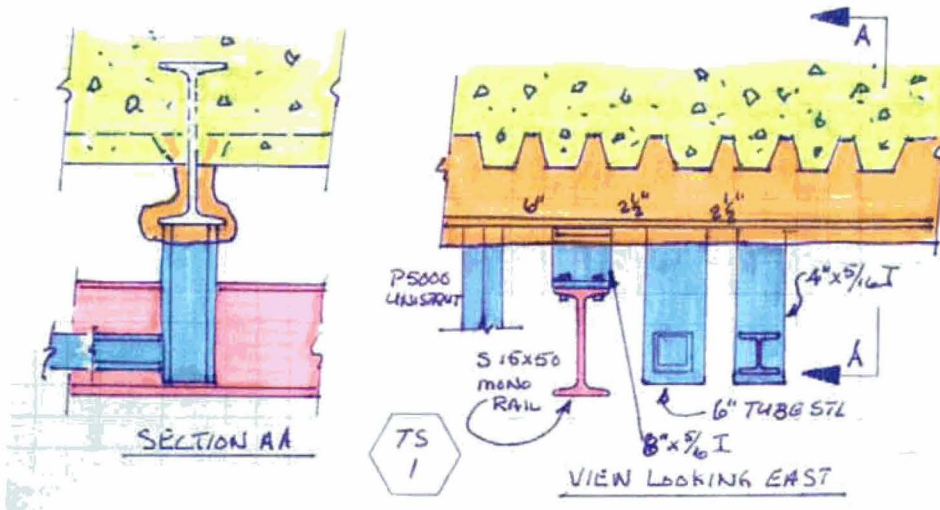

Structural Steel Fireproofing Data

Appendix G1A

1108-1974

Thermal Short #1 Photo 1



Thermal Short #1 Photo 2



Thermal Short #2 Sketch

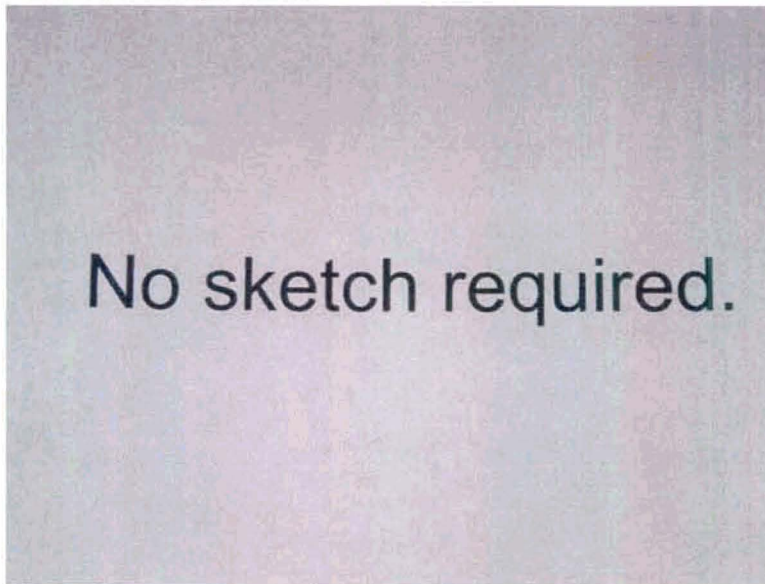

Thermal Short #2 Photo 1

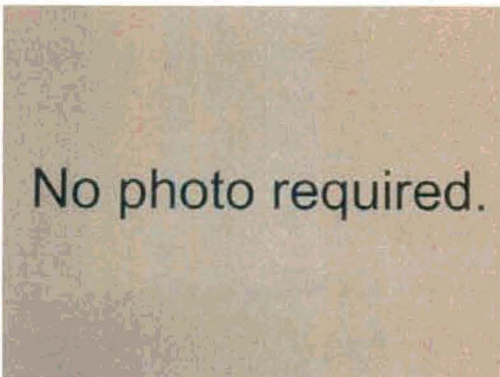

Thermal Short #2 Photo 2



Structural Steel Fireproofing Data

Appendix G1A

Room-Elevation: 1109-1968 Building: Auxiliary Fire Area: A-04

Description: Residual Heat Removal Pump Room B

Thermal Short #1 (TS1) Data

Thermal Short #2 (TS2) Data

Drawing: C-0S1211

N/A

Member Type: Beam

N/A

Member Size: 24 X 68

N/A

Comments: HAZ, Mono Rail extending through CMU filled Block out, Not an issue.

There are no Columns in this Room.

Room Sketch:

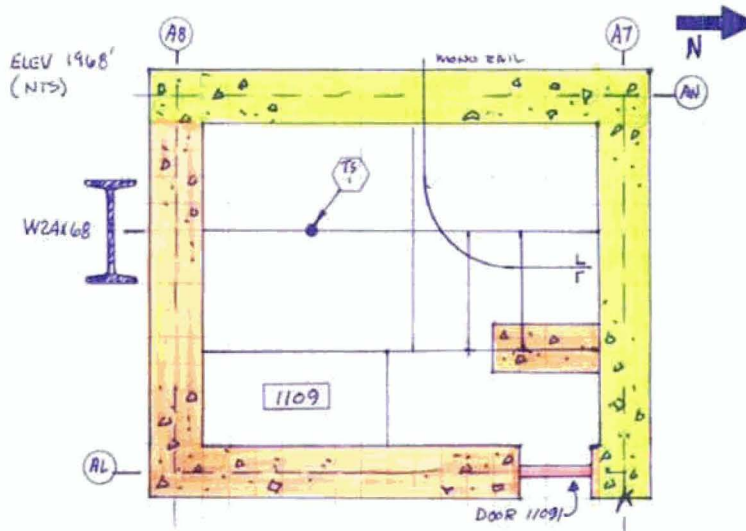

Thermal Short #1 Sketch

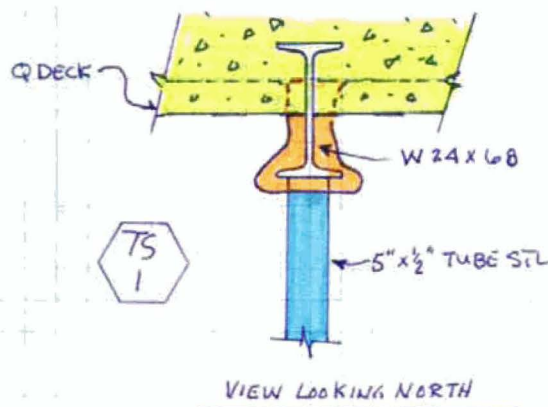

Structural Steel Fireproofing Data

Appendix G1A

1109-1968

Thermal Short #1 Photo 1



Thermal Short #1 Photo 2



Thermal Short #2 Sketch

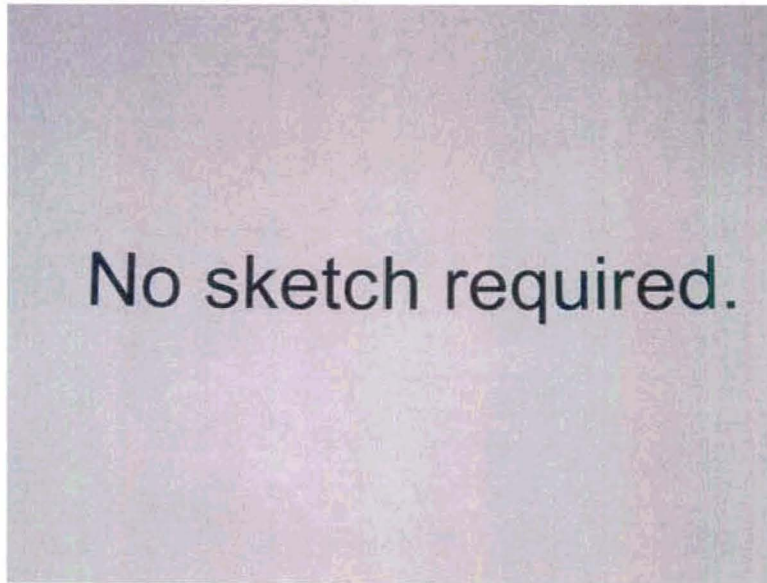

Thermal Short #2 Photo 1



Thermal Short #2 Photo 2



Structural Steel Fireproofing Data

Appendix G1A

Room-Elevation: 1110-1968 Building: Auxillary Fire Area: A-04

Description: Containment Spray Pump Room B

Thermal Short #1 (TS1) Data

Thermal Short #2 (TS2) Data

Drawing: C-0S1211

N/A

Member Type: Beam

N/A

Member Size: 21 X 62

N/A

Comments: HAZ, Mono Rail extending through CMU filled Block out, Not an issue.

There are no Columns in this Room.

Room Sketch:

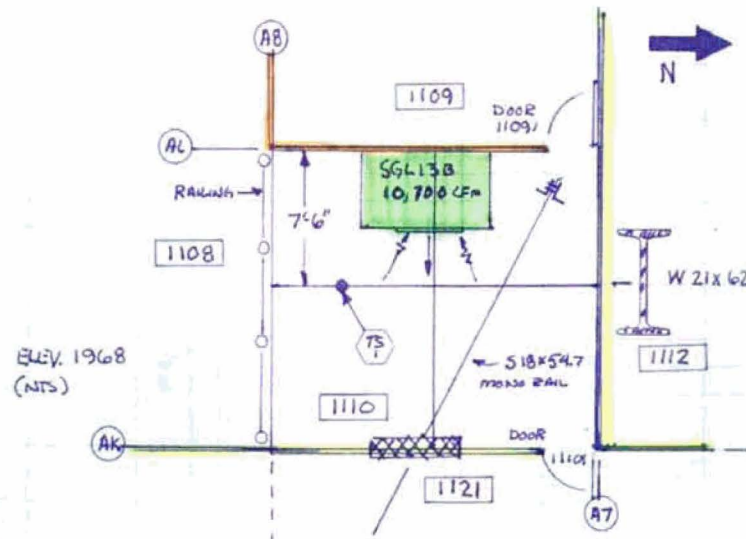

Thermal Short #1 Sketch

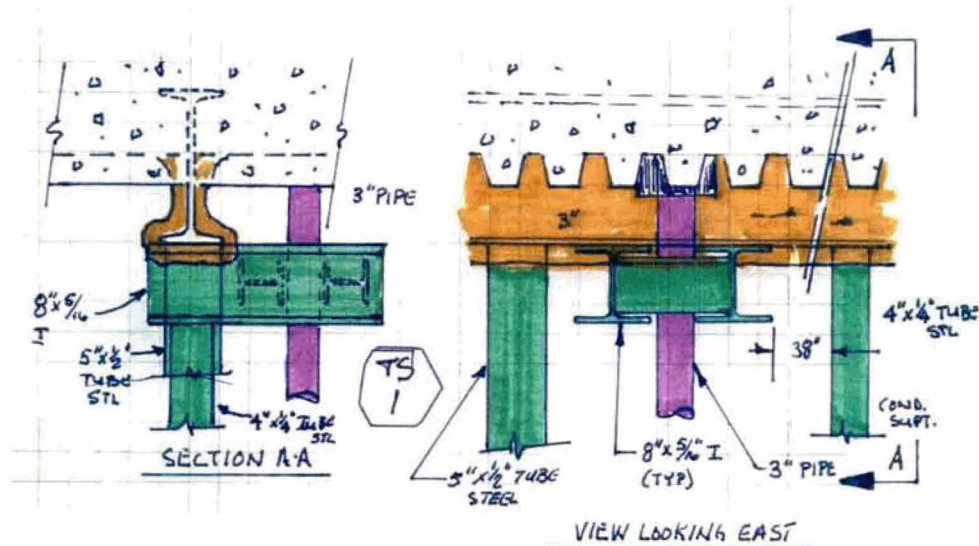

Structural Steel Fireproofing Data

Appendix G1A

1110-1968

Thermal Short #1 Photo 1

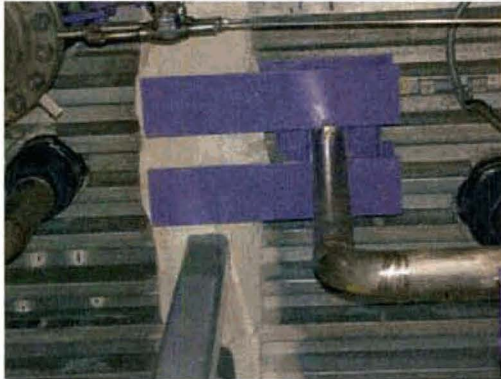

Thermal Short #1 Photo 2



Thermal Short #2 Sketch

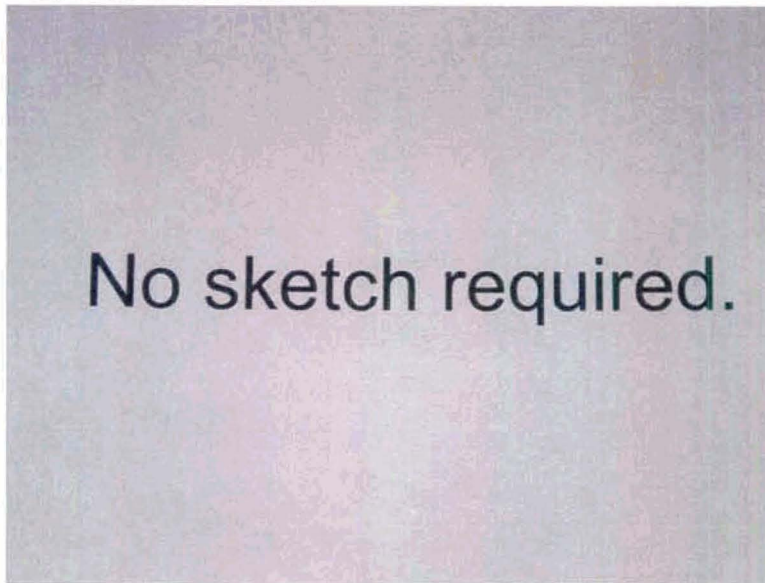

Thermal Short #2 Photo 1



Thermal Short #2 Photo 2



Structural Steel Fireproofing Data

Appendix G1A

Room-Elevation: 1119-1974 Building: Auxiliary Fire Area: A-05

Description: Aux. Stair A-1 & A-1A

Thermal Short #1 (TS1) Data

Thermal Short #2 (TS2) Data

Drawing: C-0S1231

N/A

Member Type: Beam

Column

Member Size: N/R

N/R

Comments: No Thermal Short Issues

There are no Thermal Shorts Attached to the Column

Room Sketch:

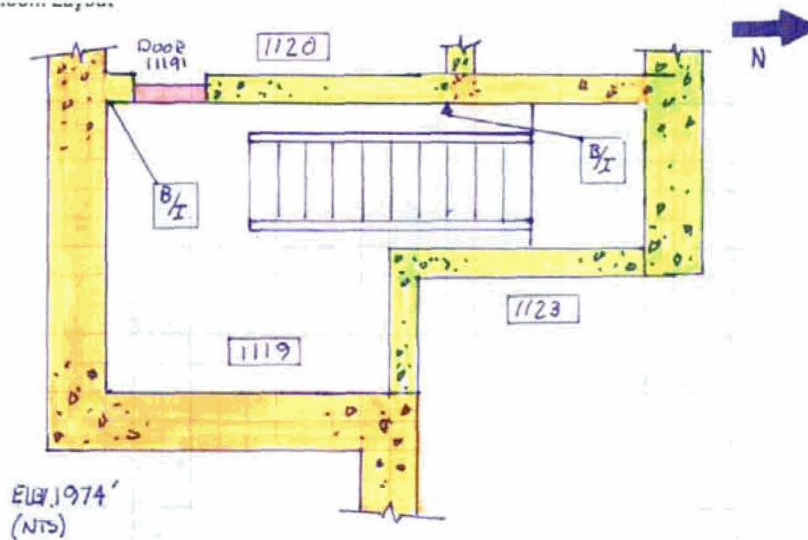

Thermal Short #1 Sketch

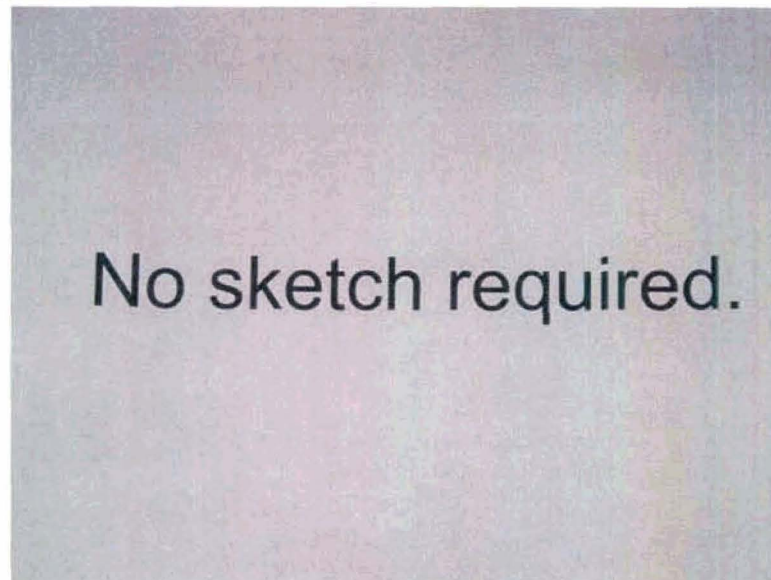

Structural Steel Fireproofing Data

Appendix G1A

Room-Elevation: 1119-1988 Building: Auxiliary Fire Area: A-05

Description: Aux. Stair A-1 & A-1A

Thermal Short #1 (TS1) Data

Thermal Short #2 (TS2) Data

Drawing: C-0S1331

N/A

Member Type: Beam

Column

Member Size: N/R

N/R

Comments: No Thermal Short Issues

There are no Thermal Shorts Attached to the Column

Room Sketch:

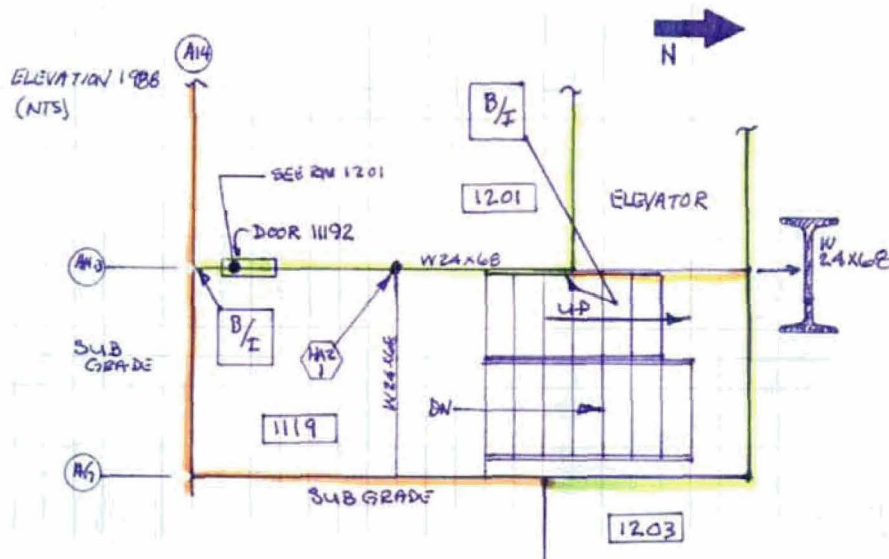

Thermal Short #1 Sketch

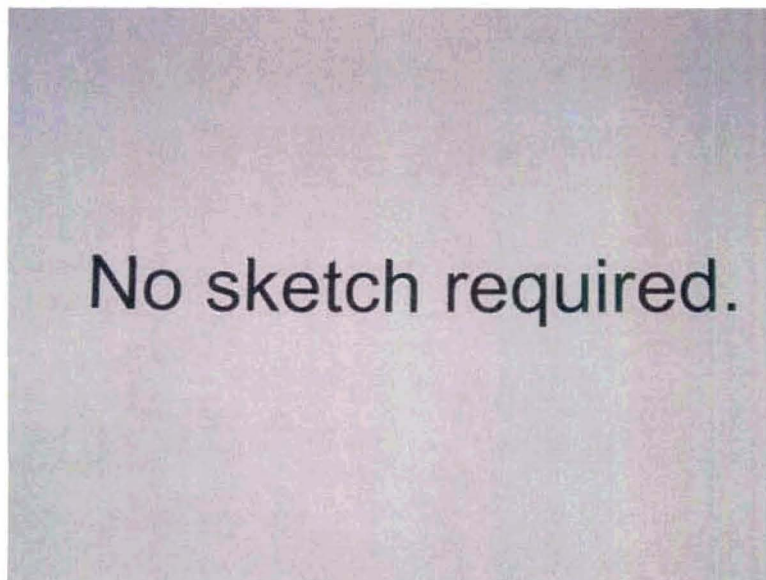

Structural Steel Fireproofing Data

Appendix G1A

Room-Elevation: 1119-2000 Building: Auxiliary Fire Area: A-05

Description: Aux. Stair A-1 & A-1A

Thermal Short #1 (TS1) Data

Thermal Short #2 (TS2) Data

Drawing: C-0S1431

N/A

Member Type: Beam

Column

Member Size: N/R

N/R

Comments: Beam is embedded or supported by underlying Wall, Thermal Short Review not required.

There are no Thermal Shorts Attached to the Column

Room Sketch:

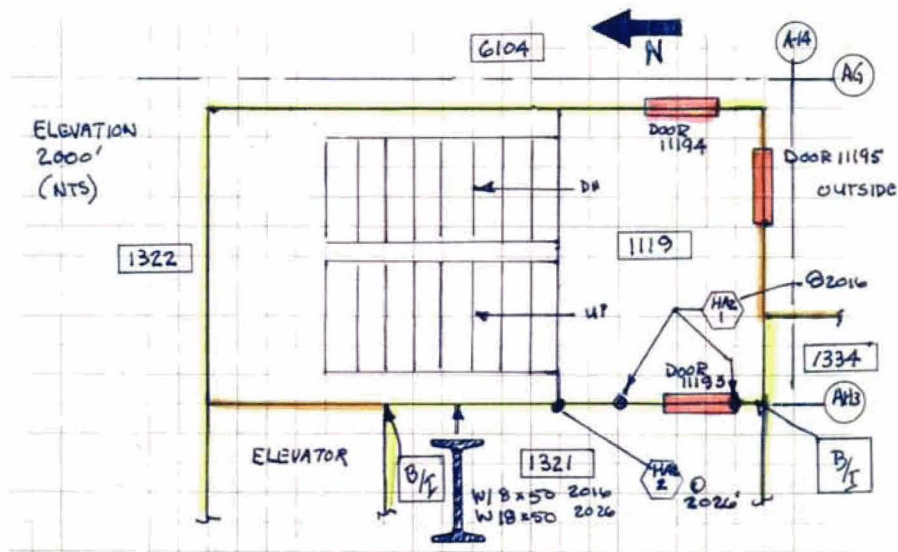

Thermal Short #1 Sketch

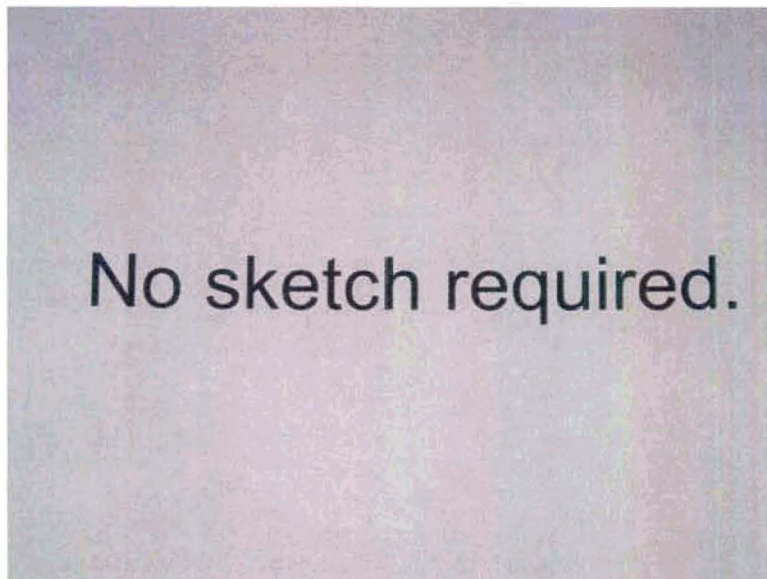

Structural Steel Fireproofing Data

Appendix G1A

1119-2000

Thermal Short #1 Photo 1



Thermal Short #1 Photo 2



Thermal Short #2 Sketch

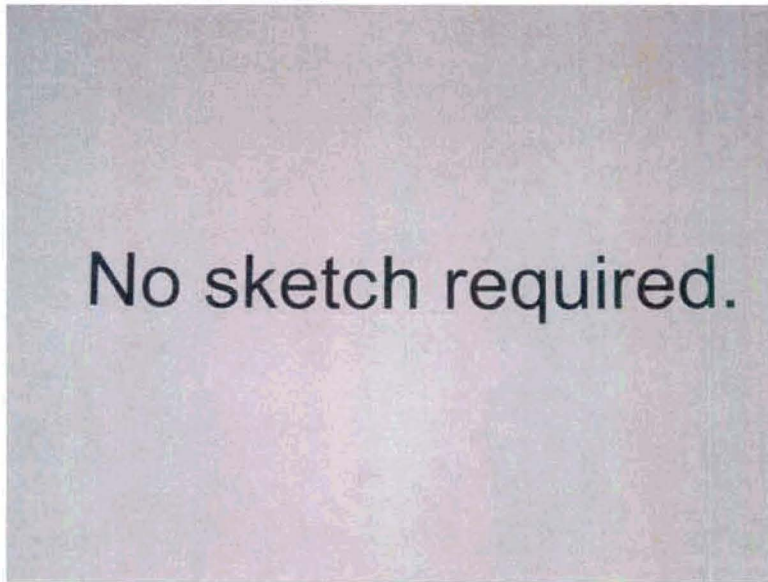

Thermal Short #2 Photo 1



Thermal Short #2 Photo 2

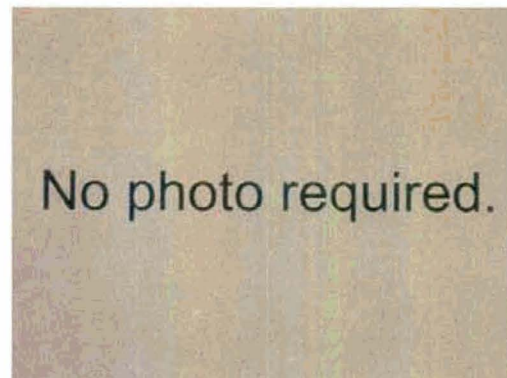

Structural Steel Fireproofing Data

Appendix G1A

Room-Elevation: 1119-2026 Building: Auxiliary Fire Area: A-05

Description: Aux. Stair A-1 & A-1A

Thermal Short #1 (TS1) Data

Thermal Short #2 (TS2) Data

Drawing: C-0S1531

N/A

Member Type: Beam

Column

Member Size: N/A

N/A

Comments: There are no Thermal Shorts Attached to the Beam

There are no Thermal Shorts Attached to the Column

Room Sketch:

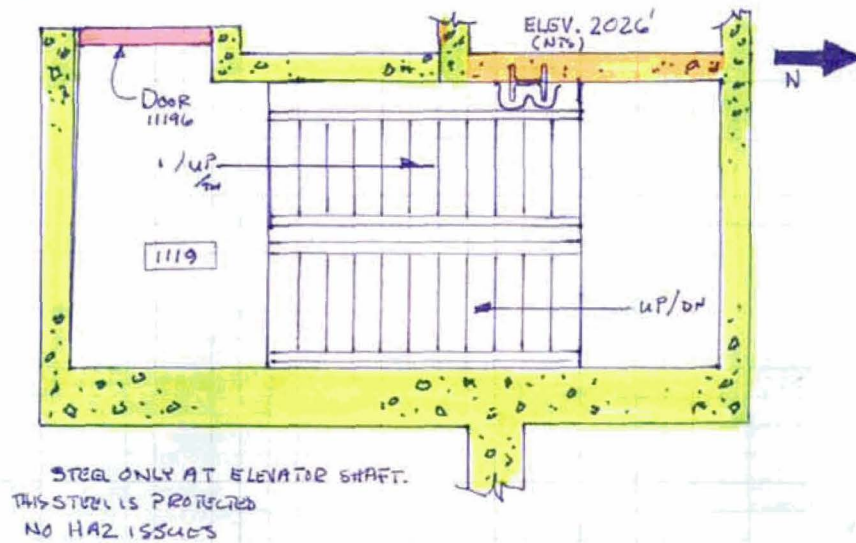

Thermal Short #1 Sketch

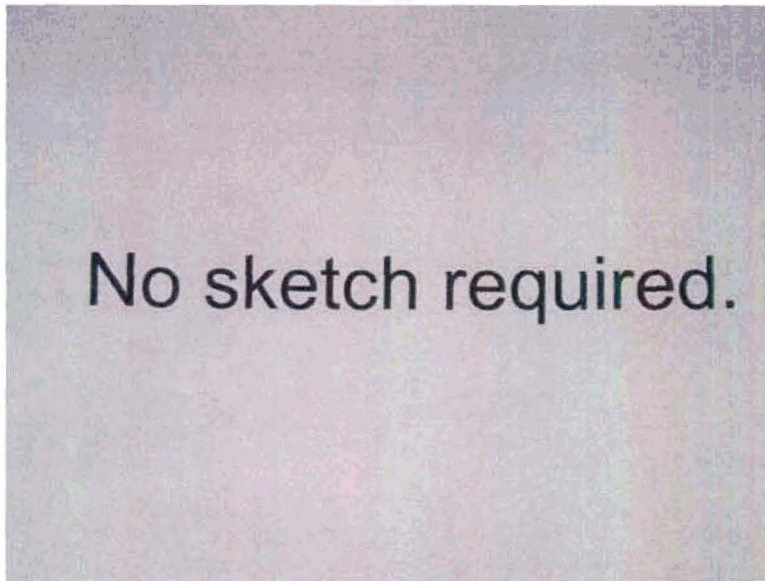

Structural Steel Fireproofing Data

Appendix G1A

Room-Elevation: 1119-2047 Building: Auxiliary Fire Area: A-05

Description: Aux. Stair A-1 & A-1A

Thermal Short #1 (TS1) Data

Thermal Short #2 (TS2) Data

Drawing: C-0S1631

N/A

Member Type: Beam

Column

Member Size: N/A

N/A

Comments: No Thermal Short Issues

No Thermal Short Issues

Room Sketch:

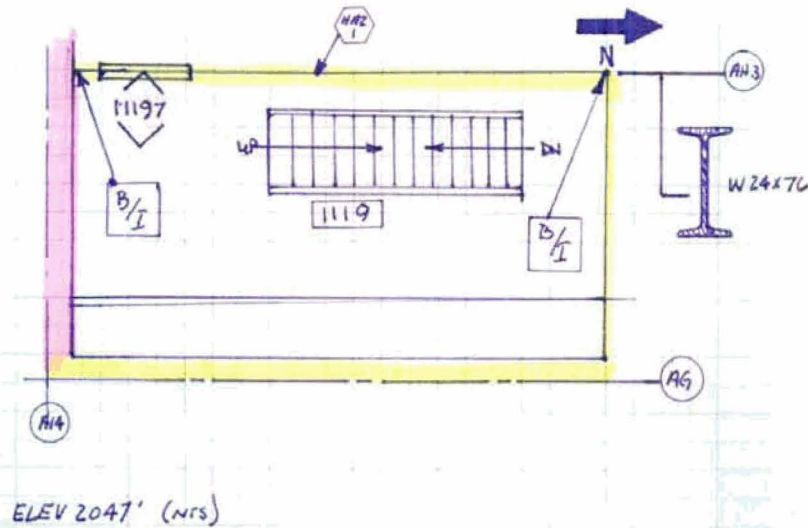

Thermal Short #1 Sketch

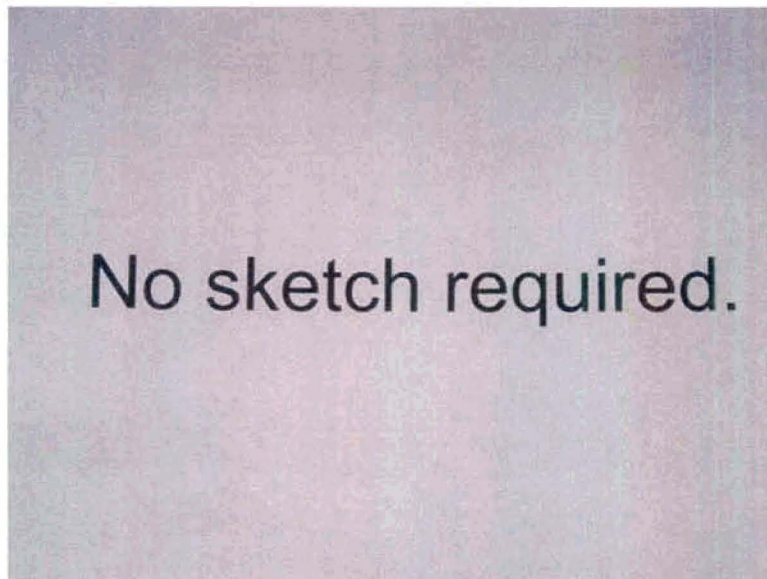

Structural Steel Fireproofing Data

Appendix G1A

Room-Elevation: 1119-2062 Building: Auxiliary Fire Area: A-05

Description: Aux. Stair A-1 & A-1A

Thermal Short #1 (TS1) Data

Thermal Short #2 (TS2) Data

Drawing: N/A

N/A

Member Type: Beam

Column

Member Size: N/A

N/A

Comments: No Thermal Short Issues

No Thermal Short Issues

Room Sketch:

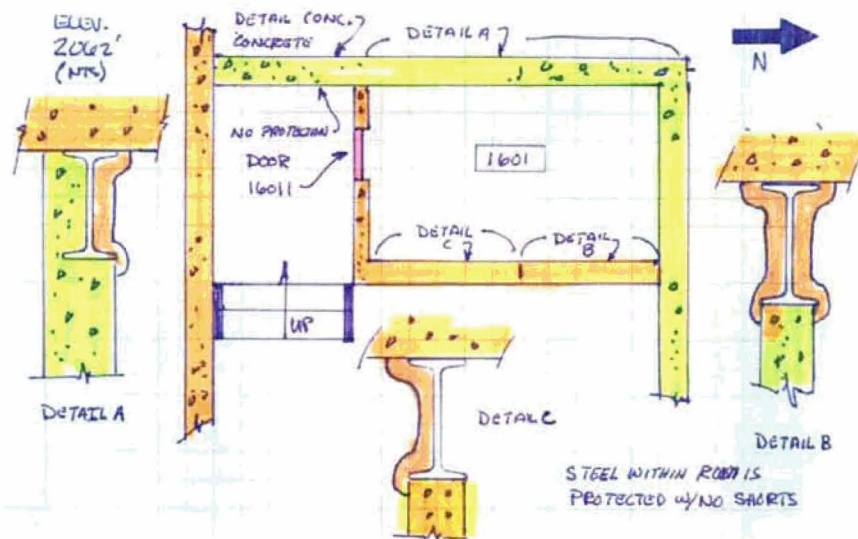

Thermal Short #1 Sketch

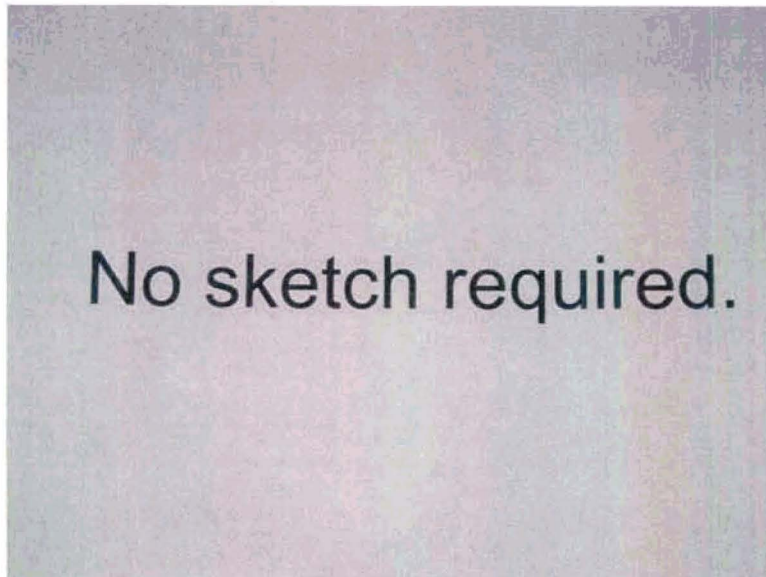

Structural Steel Fireproofing Data

Appendix G1A

Room-Elevation: 1601-2062 Building: Auxiliary Fire Area: A-05

Description: Aux. Stair A-1 & A-1A

Thermal Short #1 (TS1) Data

Thermal Short #2 (TS2) Data

Drawing: N/A

N/A

Member Type: Beam

N/A

Member Size: N/A

N/A

Comments: No Thermal Shorts

No Columns

Room Sketch:

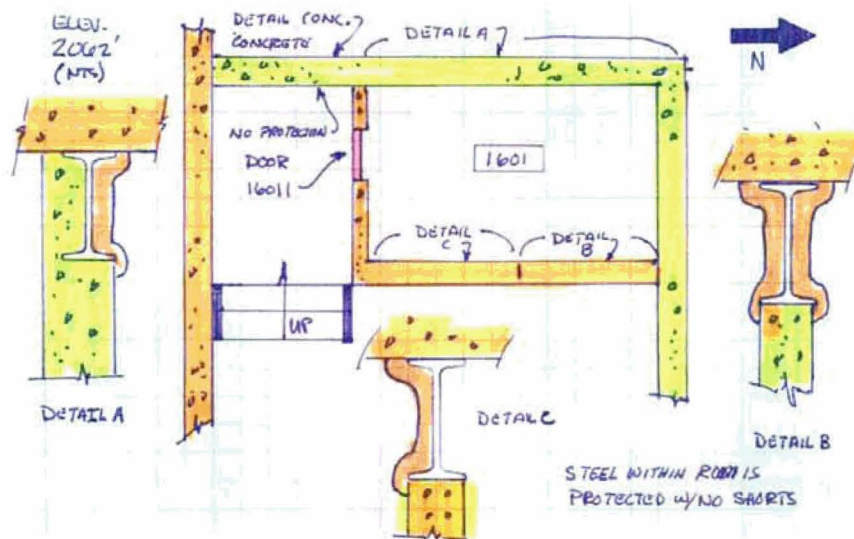

Thermal Short #1 Sketch

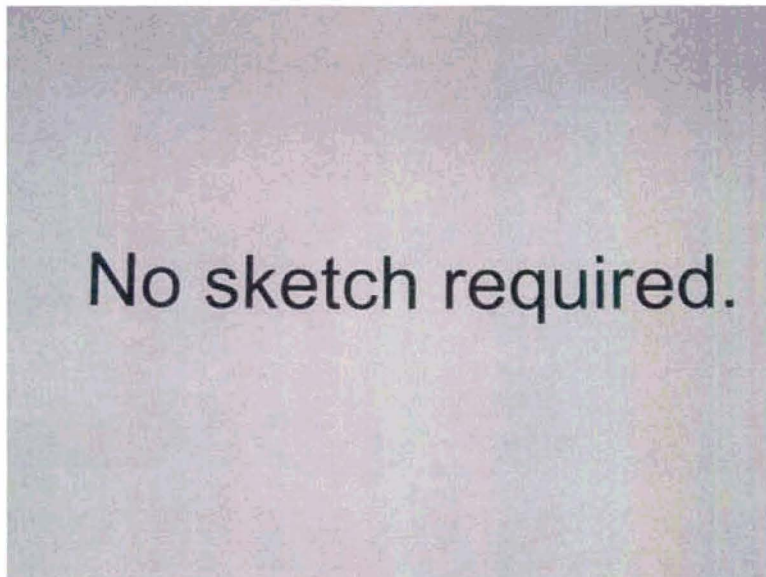

Structural Steel Fireproofing Data

Appendix G1A

Room-Elevation: 1127-1974 Building: Auxiliary Fire Area: A-06

Description: Aux. Stair A-2

Thermal Short #1 (TS1) Data

Thermal Short #2 (TS2) Data

Drawing: C-0S1341

Member Type: Beam Column

Member Size: 24 X 68 N/A

Comments: Beam is supported by underlying wall. No thermal shorts.

Room Sketch:

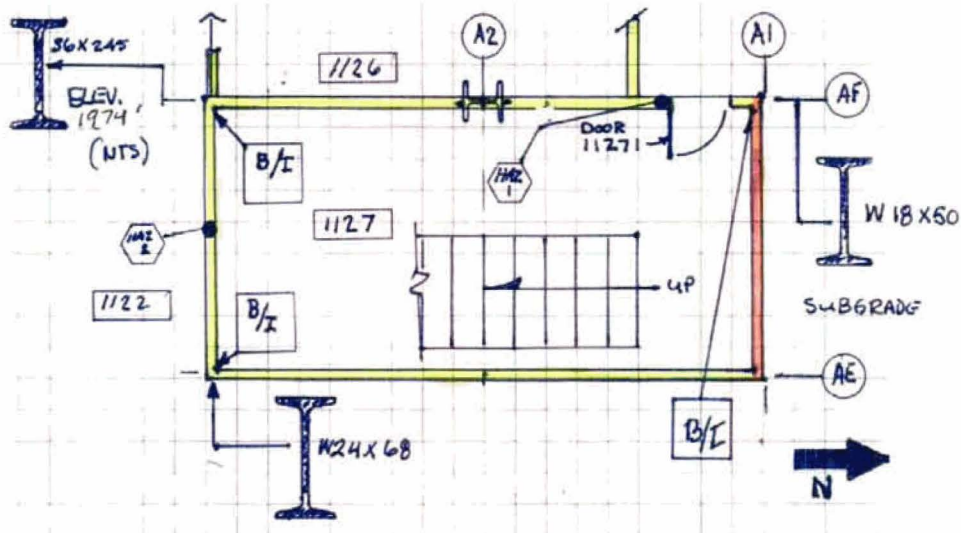

Thermal Short #1 Sketch

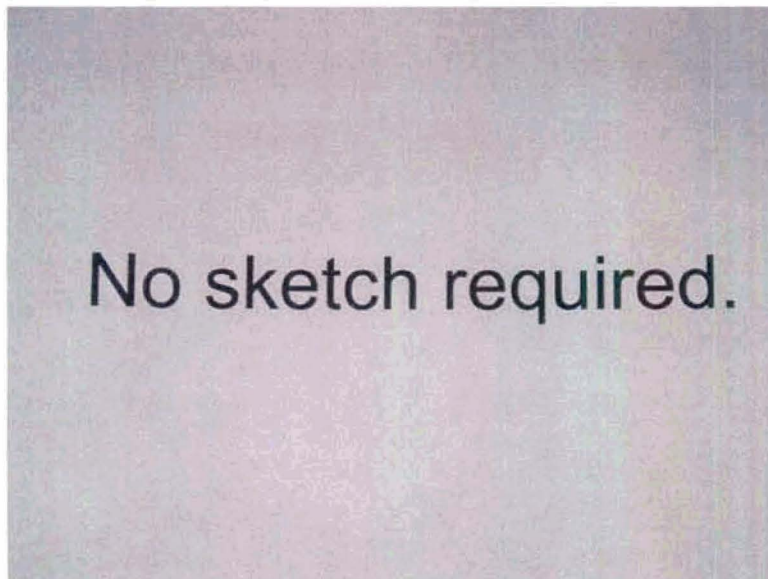

Structural Steel Fireproofing Data

Appendix G1A

1127-1974

Thermal Short #1 Photo 1



Thermal Short #1 Photo 2



Thermal Short #2 Sketch



Thermal Short #2 Photo 1



Thermal Short #2 Photo 2



Structural Steel Fireproofing Data

Appendix G1A

Room-Elevation: 1127-2000 Building: Auxiliary Fire Area: A-06

Description: Aux. Stair A-2

Thermal Short #1 (TS1) Data

Thermal Short #2 (TS2) Data

Drawing: C-0S1441

C-1S1001

Member Type: Beam

Column

Member Size: 18 X 50

14 X 228

Comments: Embedded Steel no evaluation required.

Embedded Steel no evaluation required.

Room Sketch:

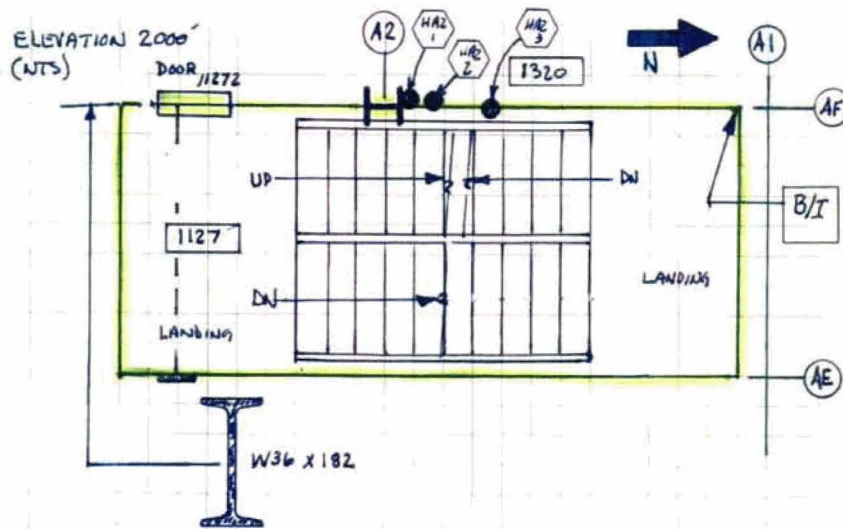

Thermal Short #1 Sketch

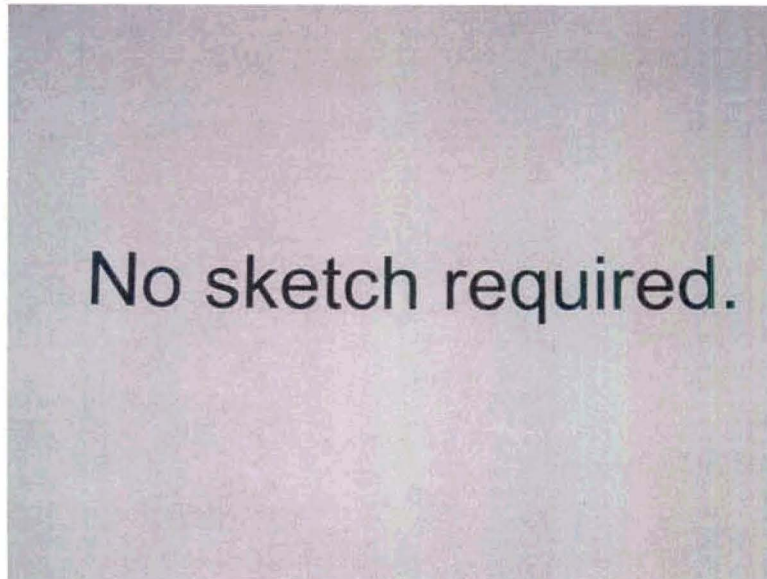

Structural Steel Fireproofing Data

Appendix G1A

Room-Elevation: 1127-2026 Building: Auxiliary Fire Area: A-06

Description: Aux. Stair A-2

Thermal Short #1 (TS1) Data

Thermal Short #2 (TS2) Data

Drawing: N/A

N/A

Member Type: Beam

N/A

Member Size: N/R

N/A

Comments: Beam embedded with concrete on one side

No Columns

Room Sketch:

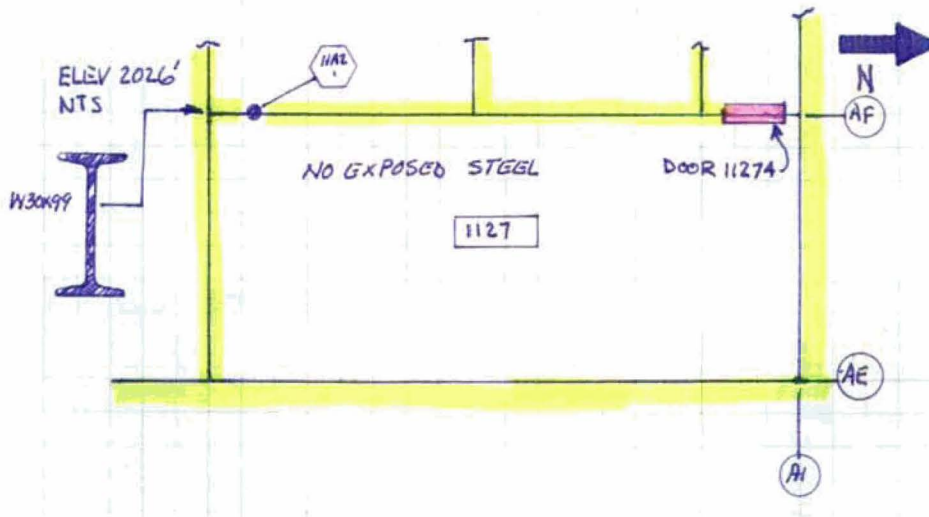

Thermal Short #1 Sketch

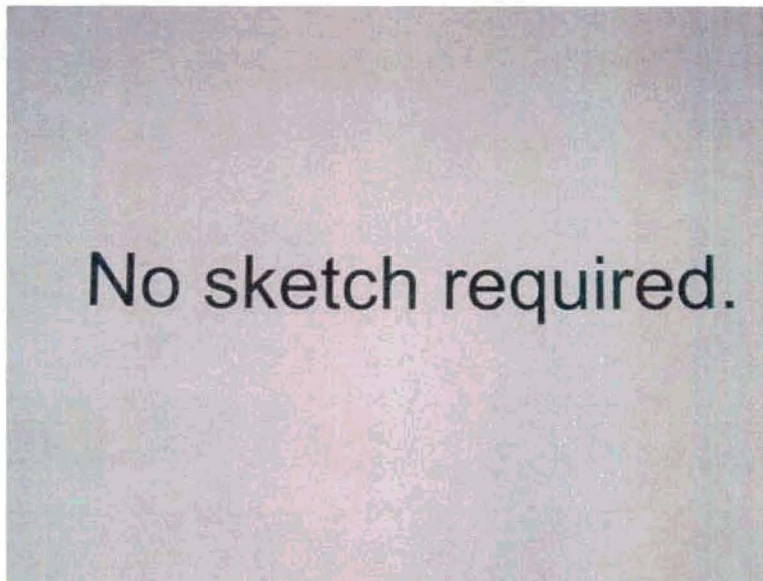

Structural Steel Fireproofing Data

Appendix G1A

Room-Elevation: 1127-2047 Building: Auxiliary Fire Area: A-06

Description: Aux. Stair A-2

Thermal Short #1 (TS1) Data

Thermal Short #2 (TS2) Data

Drawing: C-1S1641

N/A

Member Type: Beam

N/A

Member Size: 24 X 76

N/A

Comments: No fireproofing, steel protrudes through steel & concrete barrier, 6 (min) thick and is qualified. Beam is protected on one side with concrete and the other side with fireproofing.

No Columns.

Room Sketch:

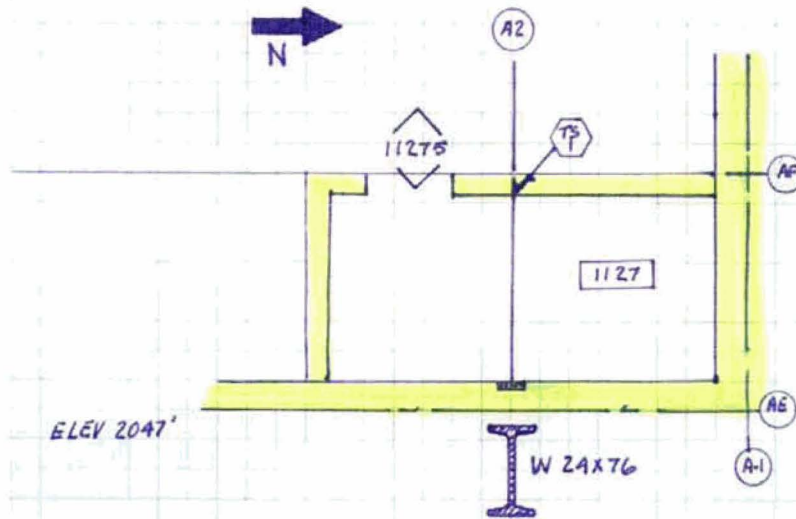

Thermal Short #1 Sketch

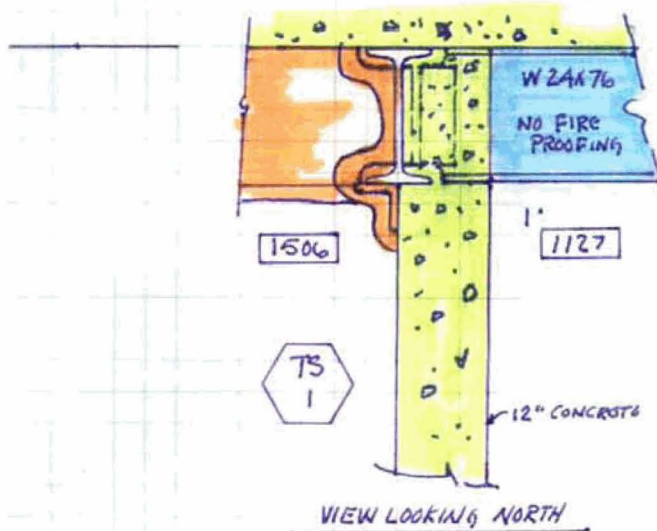

Structural Steel Fireproofing Data

Appendix G1A

1127-2047

Thermal Short #1 Photo 1



Thermal Short #1 Photo 2



Thermal Short #2 Sketch



Thermal Short #2 Photo 1



Thermal Short #2 Photo 2



Structural Steel Fireproofing Data

Appendix G1A

Room-Elevation: 1302-2000 Building: Auxiliary Fire Area: A-08

Description: Filter Compartments Typical of 5

Thermal Short #1 (TS1) Data

Thermal Short #2 (TS2) Data

Drawing: N/A

N/A

Member Type: None

None

Member Size: N/A

N/A

Comments: No exposed steel

No exposed steel

Room Sketch:

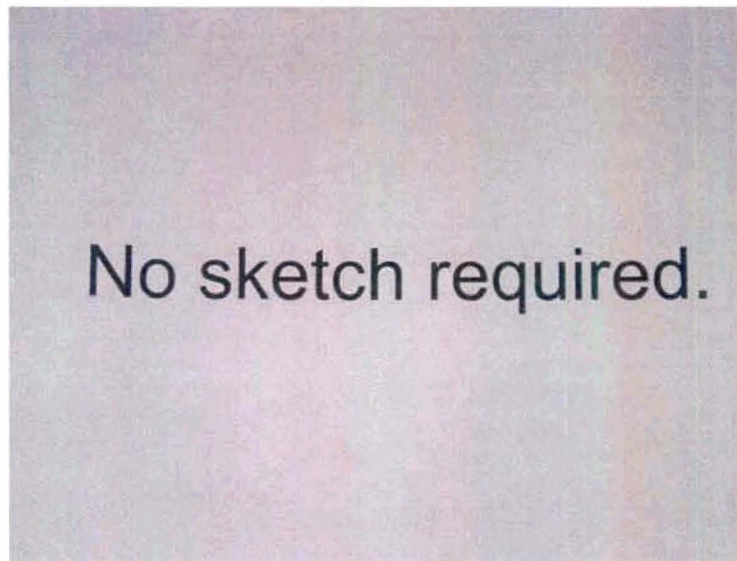

Thermal Short #1 Sketch

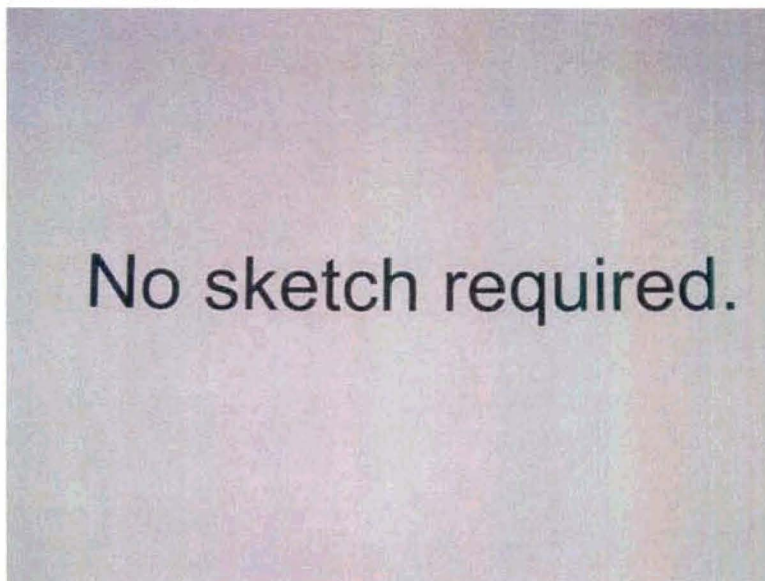

Structural Steel Fireproofing Data

Appendix G1A

Room-Elevation: 1306-2000 **Building:** Auxiliary **Fire Area:** A-08

Description: Valve Compartments Typical of 5

Thermal Short #1 (TS1) Data

Thermal Short #2 (TS2) Data

Drawing: N/A

N/A

Member Type: None

None

Member Size: N/A

N/A

Comments: No expose steel

No expose steel

Room Sketch:

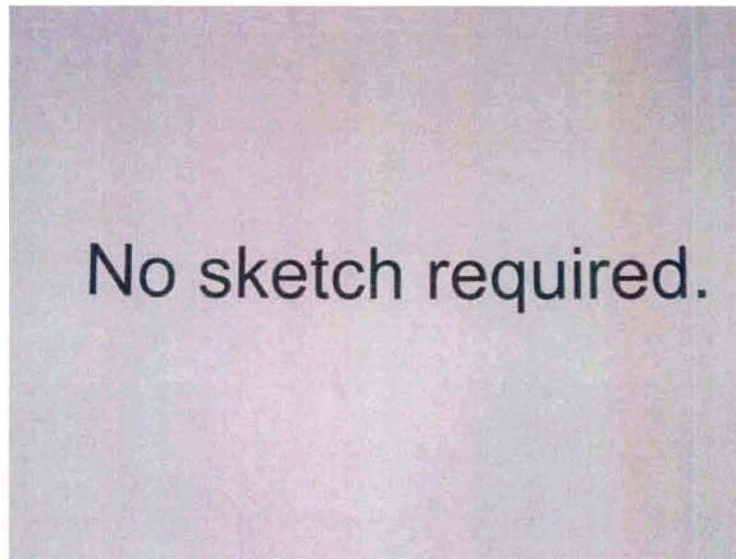

Thermal Short #1 Sketch

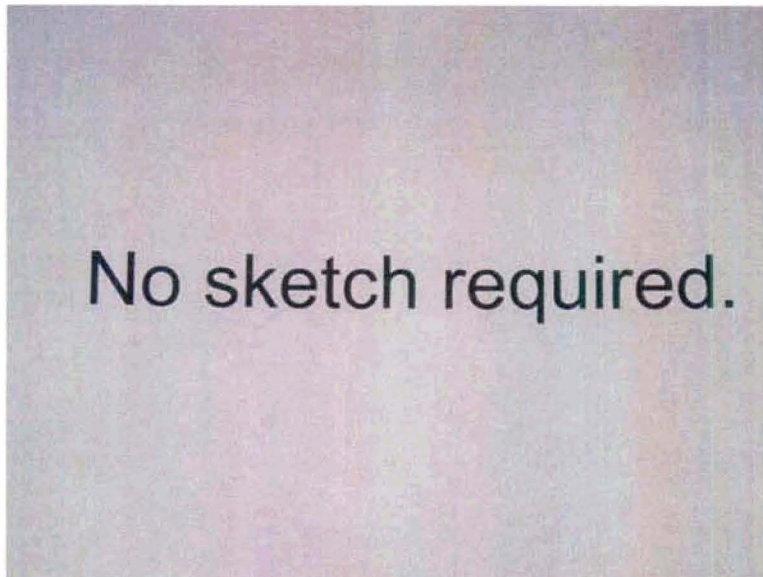

Structural Steel Fireproofing Data

Appendix G1A

Room-Elevation: 1308-2000 Building: Auxiliary Fire Area: A-08

Description: Valve Compartments Typical of 8

Thermal Short #1 (TS1) Data

Thermal Short #2 (TS2) Data

Drawing: N/A

N/A

Member Type: None

None

Member Size: N/A

N/A

Comments: No exposed steel

No exposed steel

Room Sketch:

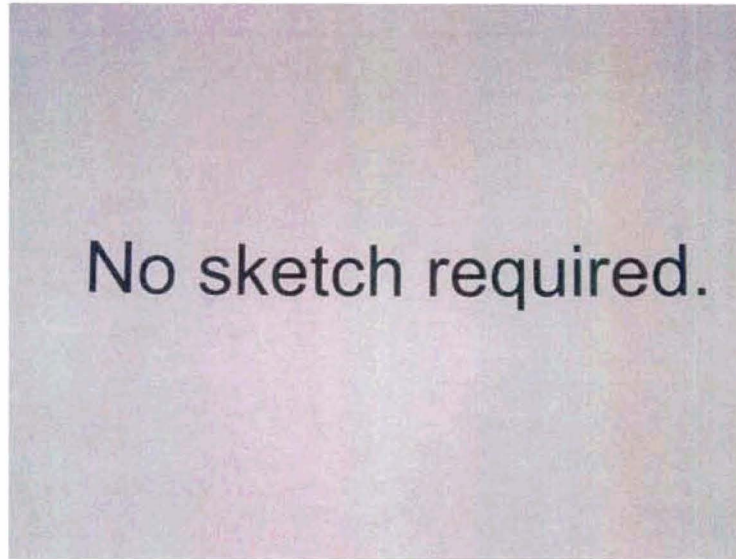

Thermal Short #1 Sketch

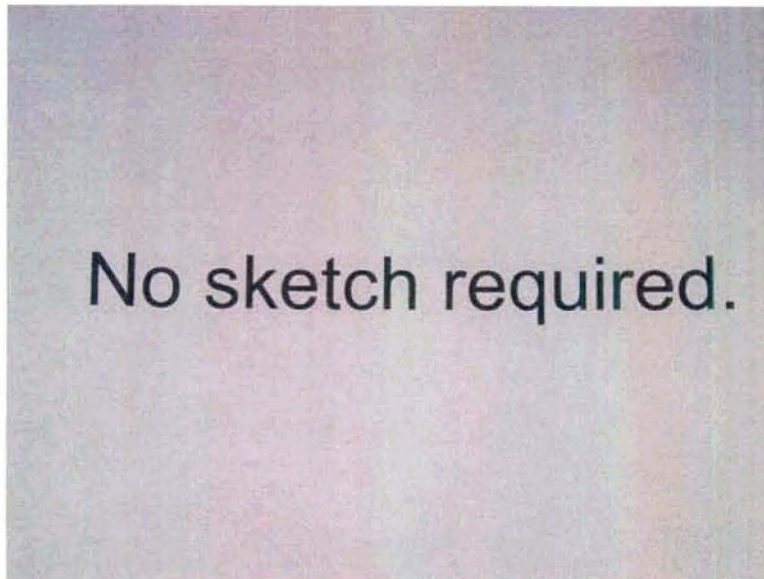

Structural Steel Fireproofing Data

Appendix G1A

Room-Elevation: 1312-2000 **Building:** Auxiliary **Fire Area:** A-08

Description: Boron Meter & R.C. Activity Monitor Rm

Thermal Short #1 (TS1) Data

Thermal Short #2 (TS2) Data

Drawing: N/A

N/A

Member Type: None

None

Member Size: N/R

N/A

Comments: No Building Steel in this room

No Columns in this room

Room Sketch:



Thermal Short #1 Sketch

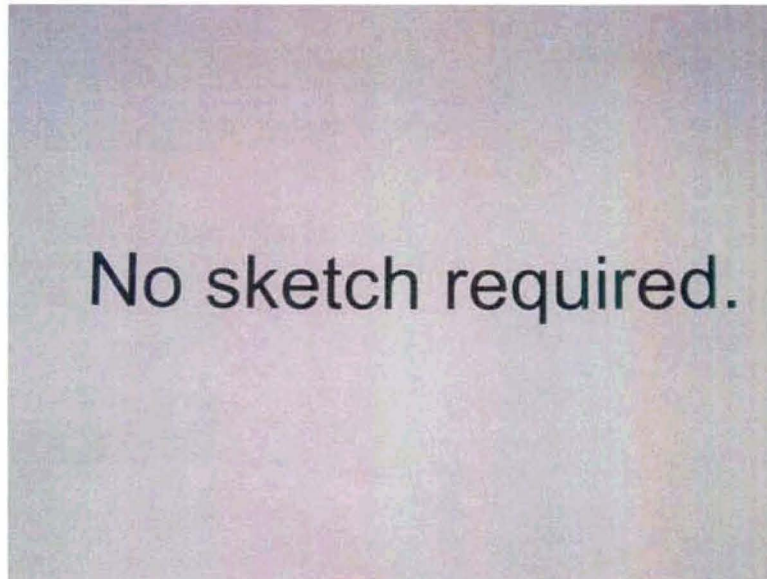

Structural Steel Fireproofing Data

Appendix G1A

1312-2000

Thermal Short #1 Photo 1



Thermal Short #1 Photo 2



Thermal Short #2 Sketch

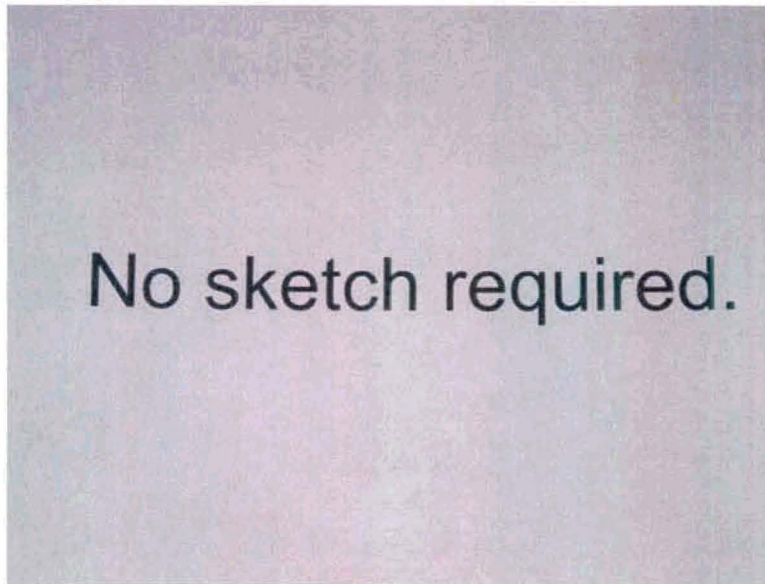

Thermal Short #2 Photo 1

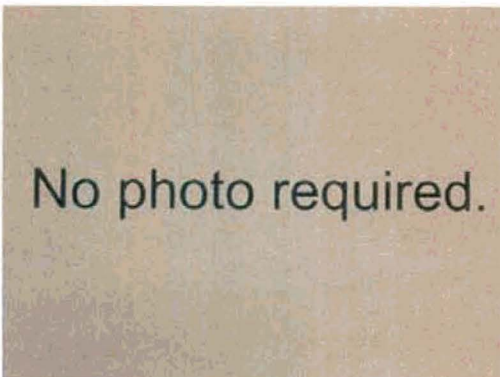

Thermal Short #2 Photo 2

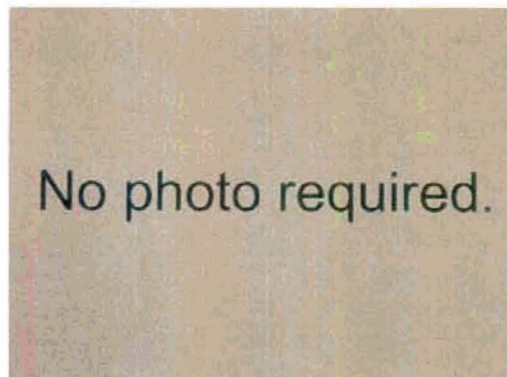

Structural Steel Fireproofing Data

Appendix G1A

Room-Elevation: 1313-2000 Building: Auxiliary Fire Area: A-08

Description: Volume Control Tank Rm

Thermal Short #1 (TS1) Data

Thermal Short #2 (TS2) Data

Drawing: C-0S1421

N/A

Member Type: Beam

N/A

Member Size: NR

N/A

Comments: Steel (Flange) is flush with slab (embedded) and protected with Fireproofing, No Attachments. Embedded steel member.

No Columns

Room Sketch:

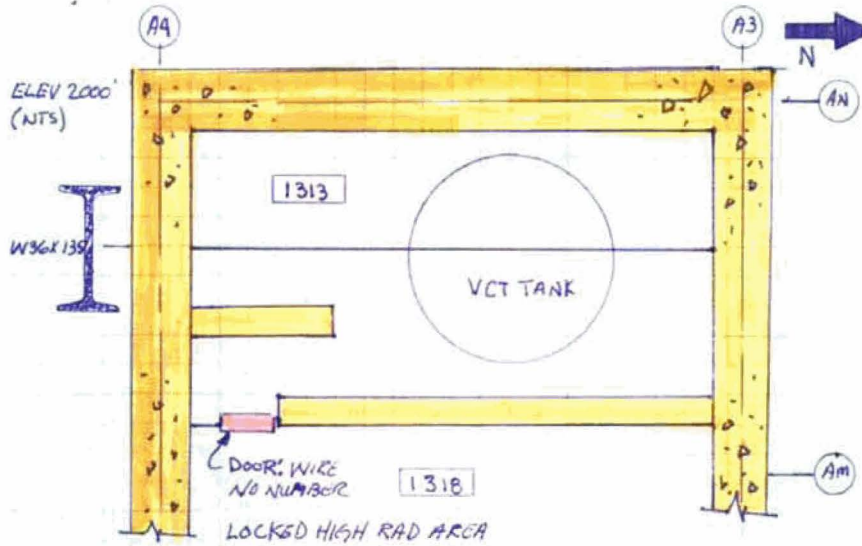

Thermal Short #1 Sketch

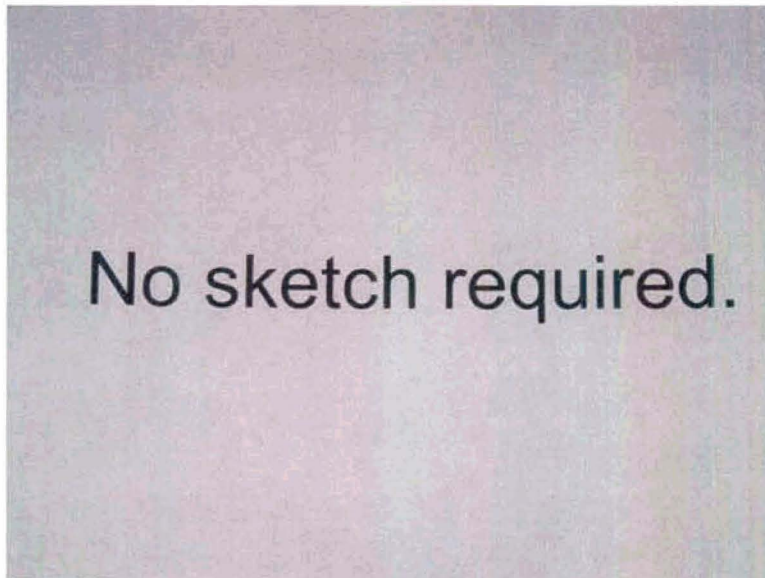

Structural Steel Fireproofing Data

Appendix G1A

1313-2000

Thermal Short #1 Photo 1



Thermal Short #1 Photo 2



Thermal Short #2 Sketch

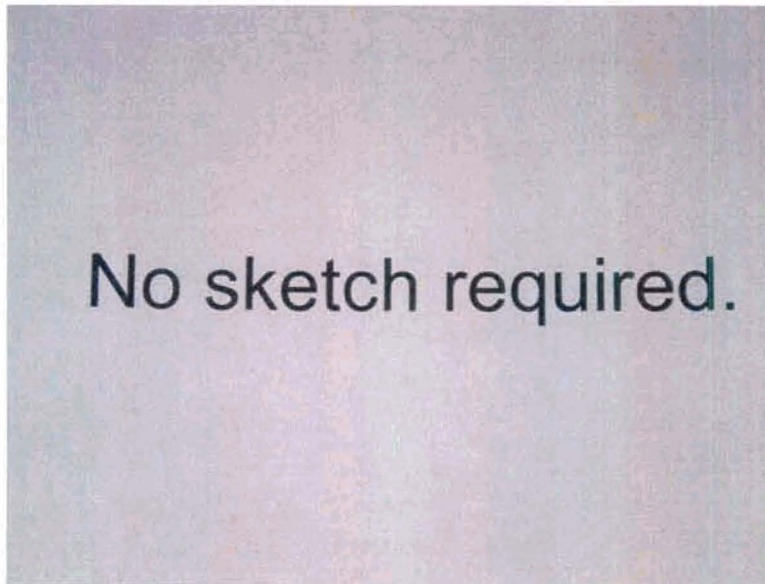

Thermal Short #2 Photo 1



Thermal Short #2 Photo 2

