

VERMONT YANKEE NUCLEAR POWER STATION

OFF-SITE DOSE CALCULATION MANUAL

REVISION 32

This document contains Vermont Yankee proprietary information. This information may not be transmitted, in whole or in part, to any other organization without permission of Vermont Yankee.

Effective Date: 06/24/08

Originator: Stephen P. Skibnicarsky / Stephen Skibnicarsky 5/27/08
Print/Sign Date

Reviewed: John Prefess / [Signature] 6/22/08
Print/Sign (Onsite Safety Review Committee) Date

Approved: Chris Wamser / [Signature] 6/24/08
Print/Sign (General Manager Plant Operations) Date

REVISION SUMMARY

<u>DATE</u>	<u>REVISION</u>	<u>DESCRIPTION</u>
06/24/08	32	Section 6.11 Factors revised in accordance with AREVA Calc. #32-9068362-000 recommendations REFERENCE Section – Added AREVA Calc. Reference

ABSTRACT

The VYNPS ODCM (Vermont Yankee Nuclear Power Station Off-Site Dose Calculation Manual) contains the effluent and environmental control limits, and approved methods to estimate the maximum individual doses and radionuclide concentrations occurring at or beyond the boundaries of the plant due to normal plant operation. The effluent dose models are based on the U.S. NRC Regulatory Guide 1.109. Revision 1.

With initial approval by the U.S. Nuclear Regulatory Commission and the VYNPS Plant Management and approval of subsequent revisions by the Plant Management (as per the Technical Specifications) the methods contained in the ODCM are suitable to demonstrate compliance with effluent controls.

TABLE OF CONTENTS

REVISION SUMMARY ii
ABSTRACT iii
TABLE OF CONTENTSiv
LIST OF TABLES viii
LIST OF FIGURESx

Section-Page

1.0 INTRODUCTION 1-1

 1.1 Summary of Methods, Dose Factors, Limits, Constants, and Radiological
 Effluent Control Cross References 1-2

2.0 DEFINITIONS..... 2-1

3/4.0 EFFLUENT AND ENVIRONMENTAL CONTROLS 3/4-1

 3/4.1 Instrumentation 3/4-1

 3/4.1.1 Radioactive Liquid Effluent Instrumentation 3/4-1

 3/4.1.2 Radioactive Gaseous Effluent Instrumentation 3/4-6

 3/4.2 Radioactive Liquid Effluents 3/4-11

 3/4.2.1 Liquid Effluents: Concentration 3/4-11

 3/4.2.2 Dose – Liquids 3/4-15

 3/4.2.3 Liquid Radwaste Treatment..... 3/4-16

 3/4.3 Radioactive Gaseous Effluents 3/4-17

 3/4.3.1 Gaseous Effluents: Dose Rate..... 3/4-17

 3/4.3.2 Gaseous Effluents: Dose from Noble Gases 3/4-20

 3/4.3.3 Gaseous Effluents: Dose from I-131, I-133, Tritium, and
 Radionuclides in Particulate Form..... 3/4-21

 3/4.3.4 Gaseous Radwaste Treatment 3/4-22

 3/4.3.5 Ventilation Exhaust Treatment 3/4-23

 3/4.3.6 Primary Containment..... 3/4-24

 3/4.3.7 Steam Jet Air Ejector (SJAE) 3/4-25

 3/4.4 Total Dose..... 3/4-26

 3/4.4.1 Total Dose..... 3/4-26

 3/4.5 Radiological Environmental Monitoring..... 3/4-27

 3/4.5.1 Radiological Environmental Monitoring Program 3/4-27

 3/4.5.2 Land Use Census 3/4-36

 3/4.5.3 Intercomparison Program..... 3/4-37

 3/4.6 Effluent and Environmental Control Bases 3/4-38

5.0	METHODS TO CALCULATE OFF-SITE LIQUID CONCENTRATIONS.....	5-1
5.1	Method to Determine F_1^{ENG} and C_1^{NG}	5-1
5.2	Method to Determine Radionuclide Concentration for Each Liquid Effluent Pathway.....	5-3
5.2.1	Sample Tanks Pathways	5-3
5.2.2	Service Water Pathway	5-3
5.2.3	Circulating Water Pathway	5-4
6.0	OFF SITE DOSE CALCULATION METHODS	6-1
6.1	Introductory Concepts.....	6-1
6.2	Method to Calculate the Total Body Dose from Liquid Releases	6-3
6.3	Method to Calculate Maximum Organ Dose from Liquid Releases.....	6-9
6.4	Method to Calculate the Total Body Dose Rate from Noble Gases	6-11
6.5	Method to Calculate the Skin Dose Rate from Noble Gases	6-16
6.6	Method to Calculate the Critical Organ Dose Rate from Iodines, Tritium and Particulates with T1/2 Greater Than 8 Days.....	6-22
6.7	Method to Calculate the Gamma Air Dose from Noble Gases.....	6-26
6.8	Method to Calculate the Beta Air Dose from Noble Gases	6-29
6.9	Method to Calculate the Critical Organ Dose from Iodines Tritium and Particulates	6-32
6.10	Receptor Points and Annual Average Atmospheric Dispersion Factors for Important Exposure Pathways	6-39
6.11	Method to Calculate Direct Dose From Plant Operation.....	6-45
6.12	Cumulative Doses	6-55
7.0	ENVIRONMENTAL MONITORING PROGRAM.....	7-1
8.0	SETPOINT DETERMINATIONS	8-1
8.1	Liquid Effluent Instrumentation Setpoints	8-1
8.2	Gaseous Effluent Instrumentation Setpoints.....	8-10
9.0	LIQUID AND GASEOUS EFFLUENT STREAMS, RADIATION MONITORS, AND RADWASTE TREATMENT SYSTEMS	9-1
9.1	In-Plant Radioactive Liquid Effluent Pathways.....	9-1
9.2	In-Plant Radioactive Gaseous Effluent Pathways.....	9-4
10.0	REPORTING REQUIREMENTS	10-1
R.	REFERENCES	R-1

APPENDIX A: Method I Example Calculations..... Deleted

APPENDIX B: Approval of Criteria for Disposal of Slightly Contaminated Septic Waste On-Site at Vermont Yankee.....B-1

APPENDIX C: Response to NRC/EG&G Evaluation of ODCM Update Through Revision 4 *On File

APPENDIX D: Assessment of Surveillance Criteria for Gas Releases from Waste Oil Incineration.....D-1

APPENDIX E: NRC Safety Evaluation for Disposal of Slightly Contaminated Soil On-Site at VY (Below the Chem Lab Floor) - TAC No. M82152..... *On File

APPENDIX F: Approval Pursuant to 10CFR20.2002 for On-Site Disposal of Cooling Tower Silt..... F-1

APPENDIX G: Maximum Permissible Concentrations (MPCs) in Air and Water Above Natural Background Taken from 10CFR20.1 to 20.602, Appendix BG-1

APPENDIX H:H-1

1) "Request to Amend Previous Approvals Granted Under 10CFR20.302(a) for Disposal of Contaminated Septic Waste and Cooling Tower Silt to Allow for Disposal of Contaminated Soil," dated June 23,1999, BVY 99-80.....H-2

2) "Supplement to Request to Amend Previous Approvals Granted Under 10CFR20.302(a) to Allow for Disposal of Contaminated Soil," dated January 4, 2000, BVY 00-02. H-19

3) "Vermont Yankee Nuclear Power Station, Request to Amend Previous Approvals Granted Under 10CFR20.302(a) to Allow for Disposal of Contaminated Soil (TAC No. MA5950)", dated June 15, 2000, NVY 00-58H-37

APPENDIX I: I-1

1) "Request to Amend Previous Approval Granted Under 10CFR20.2002 for Disposal of Contaminated Soil", dated September 11, 2000
BVY 00-71..... I-2

"Vermont Yankee Nuclear Power Station - Safety Evaluation for an Amendment to an Approved 10CFR20.2002 Application (TAC No. MA9972)", dated June 26, 2001, NVY 01-66 I-5

APPENDIX J:.....J-1

2) "Request to Amend Previous Approval Granted Pursuant to 10CFR20.2001 for Increase of the Annual Volume Limit and One-time Spreading of Current Inventory," dated October 4, 2004,
BVY 04-110.....J-2

3) "Safety Evaluation of Request to Amend Previous Approvals Granted Pursuant to 10CFR20.2002 – Vermont Yankee Nuclear Power Station (TAC No. MC5104)" dated July 19, 2005, NVY 05-090.....J-51

* To access this document, go to the Electronic Document Management System. Search using ODCM.

LIST OF TABLES

<u>Number</u>	<u>Title</u>	<u>Section-Page</u>
1.1.1	Summary of Radiological Effluent Controls and Implementing Equations	1-3
1.1.2	Summary of Methods to Calculate Unrestricted Area Liquid Concentrations	1-6
1.1.3	Summary of Methods to Calculate Off-Site Doses from Liquid Concentrations	1-7
1.1.4	Summary of Methods to Calculate Dose Rates	1-8
1.1.5	Summary of Methods to Calculate Doses to Air from Noble Gases	1-9
1.1.6	Summary of Methods to Calculate Dose to an Individual from Tritium, Iodine, and Particulates in Gas Releases and Direct Radiation	1-10
1.1.7	Summary of Methods for Setpoint Determinations	1-12
1.1.8	Effluent and Environmental Controls Cross-Reference	1-13
1.1.9	(Table Deleted)	
1.1.10	Dose Factors Specific for Vermont Yankee for Noble Gas Releases	1-16
1.1.10A	Combined Skin Dose Factors Specific for Vermont Yankee Ground Level Noble Gas Releases	1-17
1.1.11	Dose Factors Specific for Vermont Yankee for Liquid Releases	1-18
1.1.12	Dose and Dose Rate Factors Specific for Vermont Yankee for Iodines, Tritium, and Particulate Releases	1-19
2.1.1	Definitions	2-2
2.1.2	Summary of Variables	2-4
3.1.1	Liquid Effluent Monitoring Instrumentation	3/4-2
3.1.2	Gaseous Effluent Monitoring Instrumentation	3/4-7
4.1.1	Liquid Effluent Monitoring Instrumentation Surveillance Requirements	3/4-4
4.1.2	Gaseous Effluent Monitoring Instrumentation Surveillance Requirements	3/4-9
4.2.1	Radioactive Liquid Waste Sampling and Analysis Program	3/4-12
4.3.1	Radioactive Gaseous Waste Sampling and Analysis Program	3/4-18
3.5.1	Radiological Environmental Monitoring Program	3/4-28
3.5.2	Reporting Levels for Radioactivity Concentrations in Environmental Samples	3/4-33
4.5.1	Direction Capabilities for Environmental Sample Analysis	3/4-34
6.2.1	Environmental Parameters for Liquid Effluents at Vermont Yankee	6-7
6.2.2	Usage Factors for Various Liquid Pathways at Vermont Yankee	6-8

<u>Number</u>	<u>Title</u>	<u>Section-Page</u>
6.9.1	Environmental Parameters for Gaseous Effluents at Vermont Yankee	6-36
6.9.2	Usage Factors for Various Gaseous Pathways at Vermont Yankee	6-38
6.10.1	Atmospheric Dispersion Factors	6-42
6.10.2	Site Boundary Distances	6-43
6.10.3	Recirculation Correction Factors	6-44
7.1	Radiological Environmental Monitoring Stations	7-4
8.2.1	Relative Fractions of Core Inventory Noble Gases After Shutdown	8-21

LIST OF FIGURES

<u>Number</u>	<u>Title</u>	<u>Page</u>
7-1	Environmental Sampling Locations in Close Proximity to Plant	7-7
7-2	Environmental Sampling Locations Within 5 km of Plant.....	7-8
7-3	Environmental Sampling Locations Greater Than 5 km from Plant	7-9
7-4	TLD Locations in Close Proximity to Plant	7-10
7-5	TLD Locations Within 5 km of Plant	7-11
7-6	TLD Locations Greater than 5 km from Plant	7-12
9-1	Liquid Effluent Streams, Radiation Monitors, and Radwaste Treatment System at Vermont Yankee	9-9
9-2	Gaseous Effluent Streams, Radiation Monitors, and Radwaste Treatment System at Vermont Yankee	9-10

1.0 INTRODUCTION

The ODCM (Off-Site Dose Calculation Manual) provides formal and approved methods for the calculation of off-site concentration, off-site doses, and effluent monitor setpoints in order to comply with the Vermont Yankee Control Limits which implement the program requirements of Technical Specification 6.7.D. The ODCM forms the basis for plant procedures and is designed for use by the procedure writer. In addition, the ODCM will be useful to the writer of periodic reports required by the NRC on the dose consequences of plant operation. The dose methods contained herein follow accepted NRC guidance for calculation of doses necessary to demonstrate compliance with the dose objectives of Appendix I to 10CFR50 (Regulatory Guide 1.109) unless otherwise noted in the text.

Demonstration of compliance with the dose limits of 40CFR190 (see Control 3.4.1) will be considered as demonstrating compliance with the 0.1 rem limit of 10CFR20.1301(a)(1) for members of the public in unrestricted areas (Reference 56 FR 23374, third column.)

It shall be the responsibility of the Chemistry Superintendent and Radiation Protection Manager to ensure that the ODCM is used in the performance of the surveillance requirements of the appropriate portions of ODCM Controls. The administration of the program for the onsite disposal of slightly contaminated waste, as described in Appendices, is also the responsibility of the Chemistry Superintendent.

All changes to the ODCM must be reviewed by the Onsite Safety Review Committee (OSRC) and approved by the General Manager, in accordance with Technical Specification 6.7.B, prior to implementation. All approved changes shall be submitted to the NRC for their information in the Radioactive Effluent Release Report for the period in which the change(s) was made effective. The plant's Document Control Center (DCC) shall maintain the current version of the ODCM and issue under controlled distribution all approved changes to it.

1.1 Summary of Methods, Dose Factors, Limits, Constants, and Radiological Effluent Control Cross-References

This section summarizes the dose calculation methods. The concentration and setpoint methods are also summarized in Table 1.1.2 through Table 1.1.7, as well as the Method I Dose equations. Where more accurate dose calculations are needed use the Method II for the appropriate dose as described in Sections 6.2 through 6.9 and 6.11. The dose factors used in the equations are in Tables 1.1.10 through 1.1.12 and the Regulatory Limits are summarized in Table 1.1.1.

A cross-reference of old Technical Specification sections to the new ODCM sections containing the equivalent Controls is presented in Table 1.1.8.

Special definitions and equation variables used in the ODCM are in Tables 2.1.1 and 2.1.2.

TABLE 1.1.1
Summary of Radiological Effluent Controls
and Implementing Equations

	Control	Category	Method ⁽¹⁾	Limit
3.2.1	Liquid Effluent Concentration	Sum of the Fractions of Effluent Concentration Limits [Excluding Noble Gases]	Eq. 5-1	≤10
		Total Noble Gas Concentration	Eq. 5-2	≤2 x 10 ⁻⁴ μCi/cc
3.2.2	Liquid Effluent Dose	Total Body Dose	Eq. 6-1	≤1.5 mrem in a qtr. ≤3.0 mrem in a yr.
		Organ Dose	Eq. 6-3	≤5 mrem in a qtr. ≤10 mrem in a yr.
3.2.3	Liquid Radwaste Treatment Operability	Total Body Dose	Eq. 6-1	≤0.06 mrem in a mo.
		Organ Dose	Eq. 6-3	≤0.2 mrem in a mo.
3.3.1	Gaseous Effluents Dose Rate	Total Body Dose Rate from Noble Gases	Eq. 6-5 Eq. 6-39	≤500 mrem/yr.
		Skin Dose Rate from Noble Gases	Eq. 6-7 Eq. 6-38	≤3000 mrem/yr.
3.3.1	(Continued)	Organ Dose Rate from Iodines, Tritium and Particulates with T _{1/2} >8 Days	Eq. 6-16 Eq. 6-40	≤1500 mrem/yr.

TABLE 1.1.1 (Continued)

Summary of Radiological Effluent Controls
and Implementing Equations

	Control	Category	Method ⁽¹⁾	Limit
3.3.2	Gaseous Effluents Dose from Noble Gases	Gamma Air Dose from Noble Gases	Eq. 6-21 Eq. 6-41	≤ 5mrad in a qtr. ≤10 mrad in a yr.
		Beta Air Dose from Noble Gases	Eq. 6-23 Eq. 6-43	≤10 mrad in a qtr. ≤ 20 mrad in a yr.
3.3.3	Gaseous Effluents Dose from Iodines, Tritium, and Particulates	Organ Dose from I-131, I-133, Tritium, and Particulates with T _{1/2} >8 Days	Eq. 6-25 Eq. 6-44	≤ 7.5 mrem in a qtr. ≤15 mrem in a yr.
3.3.5	Ventilation Exhaust Treatment	Organ Dose	Eq. 6-25	≤0.3 mrem in a mo.
3.4.1	Total Dose (from All Sources)	Total Body Dose	Footnote ⁽²⁾	≤25 mrem in a yr.
		Organ Dose		≤25 mrem in a yr.
		Thyroid Dose		≤75 mrem in a yr.

TABLE 1.1.1 (Continued)

Summary of Radiological Effluent Controls
and Implementing Equations

	Control	Category	Method ⁽¹⁾	Limit
3.1.1	Liquid Effluent Monitor Setpoint			
	Liquid Radwaste Discharge Monitor	Alarm Setpoint	Eq. 8-1	Control 3.2.1
3.1.2	Gaseous Effluent Monitor Setpoint			
	Plant Stack and AOG Offgas System Noble Gas Activity Monitors	Alarm/Trip Setpoint for Total Body Dose Rate	Eq. 8-9	Control 3.3.1.a (Total Body)
		Alarm/Trip Setpoint for Skin Dose Rate	Eq. 8-10	Control 3.3.1.a (Skin)
	SJAE Noble Gas Activity Monitors	Alarm Setpoint	Eq. 8-21	T.S. 3.8.K.1 and Control 3.3.7

- (1) More accurate methods may be available (see subsequent chapters).
- (2) Effluent Control 3.4.1 requires this evaluation only if twice the limit of Equations 6-1, 6-3, 6-21, 6-23, or 6-25 is reached. If this occurs a Method II calculation shall be made considering available information for pathways of exposure to real individuals from liquid, gaseous, and direct radiation sources.

TABLE 1.1.2

Summary of Methods to Calculate
Unrestricted Area Liquid Concentrations

Equation Number	Category	Equation	Reference Section
5-1	Sum of the Fractions of Combined Effluent Concentrations in Liquids [Except Noble Gases]	$F_i^{ENG} = \sum_i \frac{C_{pi}}{ECL_i} \leq 10$	5.1
5-2	Total Activity of Dissolved and Entrained Noble Gases from all Station Sources	$C_i^{NG} \left(\frac{\mu Ci}{ml} \right) = \sum_i C_{ii}^{NG} \leq 2E-04$	5.1

TABLE 1.1.3

Summary of Methods to Calculate
Off-Site Doses from Liquid Concentrations

<u>Equation Number</u>	<u>Category</u>	<u>Equation</u>	<u>Reference Section</u>
6-1	Total Body Dose	$D_{tb}(\text{mrem}) = \sum_i Q_i \text{DFL}_{itb}$	6.2.1
6-3	Maximum Organ Dose	$D_{mo}(\text{mrem}) = \sum_i Q_i \text{DFL}_{imo}$	6.3.1

TABLE 1.1.4

Summary of Methods to Calculate
Dose Rates

Equation Number	Category	Equation	Reference Section
6-5	Total Body Dose Rate from Noble Gases Released from Stack	$\dot{R}_{tbs} \left(\frac{\text{mrem}}{\text{yr}} \right) = 0.75 \sum_i \dot{Q}_i^{ST} DFB_i$	6.4.1
6-39	Total Body Dose Rate from Noble Gases Released from Ground	$\dot{R}_{tbg} \left(\frac{\text{mrem}}{\text{yr}} \right) = 7.4 \sum_i \dot{Q}_i^{GL} DFB_i$	6.4.1
6-7	Skin Dose Rate from Noble Gases Released from Stack	$\dot{R}_{skins} \left(\frac{\text{mrem}}{\text{yr}} \right) = \sum_i \dot{Q}_i^{ST} DF'_{is}$	6.5.1
6-38	Skin Dose Rate from Noble Gases Released from Ground	$\dot{R}_{sking} \left(\frac{\text{mrem}}{\text{yr}} \right) = \sum_i \dot{Q}_i^{GL} DF'_{ig}$	6.5.1
6-16	Critical Organ Dose Rate from Stack Release of I-131, I-133, Tritium, and Particulates with $T_{1/2} > 8$ Days	$\dot{R}_{cos} \left(\frac{\text{mrem}}{\text{yr}} \right) = \sum_i \dot{Q}_i^{STP} DFG'_{sico}$	6.6.1
6-40	Critical Organ Dose Rate from Ground Level Release of I-131, I-133, Tritium, and Particulates with $T_{1/2} > 8$ Days	$\dot{R}_{cog} \left(\frac{\text{mrem}}{\text{yr}} \right) = \sum_i \dot{Q}_i^{GLP} DFG'_{gico}$	6.6.1

TABLE 1.1.5

Summary of Methods to Calculate
Doses to Air from Noble Gases

Equation Number	Category	Equation	Reference Section
6-21	Gamma Dose to Air from Noble Gases Released from Stack	$D_{\text{airs}}^{\gamma} (\text{mrad}) = 0.024 \sum_i Q_i^{\text{ST}} DF_i^{\gamma}$	6.7.1
6-41	Gamma Dose to Air from Noble Gases Released from Ground Level	$D_{\text{airg}}^{\gamma} (\text{mrad}) = 0.23 \sum_i Q_i^{\text{GL}} DF_i^{\gamma}$	6.7.1
6-23	Beta Dose to Air from Noble Gases Released from Stack	$D_{\text{airs}}^{\beta} (\text{mrad}) = 0.050 \sum_i Q_i^{\text{ST}} DF_i^{\beta}$	6.8.1
6-43	Beta Dose to Air from Noble Gases Released from Ground Level	$D_{\text{airg}}^{\beta} (\text{mrad}) = 1.16 \sum_i Q_i^{\text{GL}} DF_i^{\beta}$	6.8.1

TABLE 1.1.6

Summary of Methods to Calculate Dose to an Individual from Tritium, Iodine, and Particulates in Gas Releases and Direct Radiation

Equation Number	Category	Equation	Reference Section
6-25	Dose to Critical Organ from Stack Release of I-131, I-133, Tritium, and Particulates	$D_{cos}(\text{mrem}) = \sum_i Q_i^{STP} DFG_{sico}$	6.9.1
6-44	Dose to Critical Organ from Ground Level Release of I-131, I-133, Tritium, and Particulates	$D_{cog}(\text{mrem}) = \sum_i Q_i^{GLP} DFG_{gico}$	6.9.1
<u>Direct Dose</u>			
Turbine Building			
6-27a		$D_d = K_{N-16} K_{tissue} K_{calib} D_{MSLRM}$	6.11.1
6-27b		$D_{MSLRM} = \sum_{i=1}^n [\sum_{j=1}^m (R_{j,i}) / m]_i \Delta t_i$	6.11.1
6-27c		$\Delta t_i = t_{i+1} - t_i$	6.11.1
6-27d		$\Delta T = \sum_{i=1}^n \Delta t_i$	6.11.1
<u>North Warehouse</u>			
6-28	Shielded End	$D_s = 0.25 \times \dot{R}_s$	6.11.2
6-29	Unshielded End	$D_u = 0.53 \times \dot{R}_u$	6.11.2
<u>LLW Storage Pad</u>			
6-30	Direct Line (Module Short Side Out)	$D_{de} = 0.28 \times \dot{R}_d \times f_d$	6.11.3
6-31	Direct Line (Module Long Side Out)	$D_{ds} = 0.39 \times \dot{R}_d \times f_d$	6.11.3
6-32	Skyshine (Resin Liners)	$D_{SKR} = 0.016 \times \dot{R}_{SKR} \times f_{SK}$	6.11.3
6-33	Skyshine (DAW)	$D_{SKD} = 0.015 \times \dot{R}_{SKD} \times f_{SK}$	6.11.3

TABLE 1.1.6 (Continued)

Equation Number	Category	Equation	Reference Section
6-34	Resin Liner Transfer (Unshielded)	$D_{\text{Tran}} = 0.0025 \times \dot{R}_{\text{Tran}} \times T_{\text{Tran}}$	6.11.3
6-35	Intermodular Gap Dose	$D_{\text{Gap}} = 2.44E-2 \times W_{\text{Gap}} \times A_{\text{RL}} \times f_{\text{Gap}}$	6.11.3
6-36	ISFSI Individual Cask Dose at West Site Boundary – 266 meters	$D_{\text{ec-266m}} = 3.19E-5 \times H$	6.11.4
6-37	ISFSI Individual Cask Dose at West Site Boundary – 300 meters	$D_{\text{ec-300m}} = 2.05E-5 \times H$	6.11.4
6-38	Dose at West Site Boundary from all casks on the ISFSI Pad	$D_{\text{ac-Total}} = (D_{\text{ec-266m}} \times N_{(266m)}) + (D_{\text{ec-300m}} \times N_{(300m)})$	6.11.4

TABLE 1.1.7

Summary of Methods for
Setpoint Determinations

Equation Number	Category	Equation	Reference Section
8-1	Liquid Effluents: Liquid Radwaste Discharge Monitor (17/350)	$R_{spt}^L (cps) = \frac{DF}{DF_{min}} S_l \sum_i C_{mi}$	8.1.1.1
	Gaseous Effluents: Plant Stack (RR-108-1A, RR-108-1B) and AOG Offgas System (3127, 3128) Noble Gas Activity Monitors		
8-9	Total Body	$R_{spt}^{tb} (cpm) = 666 S_g \frac{1}{F} \frac{1}{DF B_c}$	8.2.1.1
8-10	Skin	$R_{spt}^{skin} (cpm) = 3000 S_g \frac{1}{F} \frac{1}{DF' c}$	8.2.1.1
8-21	SJAE Noble Gas Activity Monitors (17/150A, 17/150B)	$R_{spt}^{SJAE} (mR/hr) = 1.6E + 05 S_g \frac{1}{F}$	8.2.2.1

TABLE 1.1.8

Effluent and Environmental Controls Cross-Reference

Control Topic	Original Technical Specification Section	Revised ODCM Control Section
INSTRUMENTATION		
Radioactive Liquid Effluent Instrumentation	3/4.9.A	3/4.1.1
Effluent instrumentation list	Table 3.9.1	Table 3.1.1
Instrument surveillance requirements	Table 4.9.1	Table 4.1.1
Radioactive Gaseous Effluent Instrumentation	3/4.9.B	3/4.1.2
Effluent instrumentation list	Table 3.9.2	Table 3.1.2
Instrumentation requirements	Table 4.9.2	Table 4.1.2
RADIOACTIVE LIQUID EFFLUENTS		
Concentration	3/4.8.A	3/4.2.1
Liquid waste sampling & analysis program	Table 4.8.1	Table 4.2.1
Dose – Liquids	3/4.8.B	3/4.2.2
Liquid Radwaste Treatment	3/4.8.C	3/4.2.3
RADIOACTIVE GASEOUS EFFLUENTS		
Dose Rate	3/4.8.E	3/4.3.1
Gaseous waste sampling & analysis program	Table 4.8.2	Table 4.3.1
Dose from Noble Gases	3/4.8.F	3/4.3.2
Dose from I-131, I-133, Tritium and Radionuclides in Particulate Form	3/4.8.G	3/4.3.3
Gaseous Radwaste Treatment	3/4.8.H	3/4.3.4
Ventilation Exhaust Treatment	3/4.8.I	3/4.3.5
Primary Containment	3/4.8.L	3/4.3.6
Steam Jet Air Ejector	3/4.8.K*	3/4.3.7*
TOTAL DOSE		
Total Dose	3/4.8.M	3/4.4.1

* Specification 3/4.8.K remains in plant Technical Specifications and is duplicated in ODCM Control 3/4.3.7.

TABLE 1.1.8 (Continued)

Control Topic	Original Technical Specification Section	Revised ODCM Control Section
RADIOLOGICAL ENVIRONMENTAL MONITORING		
Radiological Environmental Monitoring Program	3/4.9.C	3/4.5.1
Listing of required monitoring criteria	Table 3.9.3	Table 3.5.1
Reporting levels for radioactivity in samples	Table 3.9.4	Table 3.5.2
Detector capability for environmental analysis	Table 4.9.3	Table 4.5.1
Land Use Census	3/4.9.D	3/4.5.2
Intercomparison Program	3/4.9.E	3/4.5.3
EFFLUENT CONTROL BASES	Bases: 3.8 & 3.9	3/4.6
UNIQUE REPORTING REQUIREMENTS		
Annual Radioactive Effluent Release Report	6.7.C.1	10.1
Environmental Radiological Monitoring	6.7.C.3	10.2
Special Reports	6.7.C.2	10.3
Major Changes to Radioactive Liquid, Gaseous, and Solid Waste Treatment Systems	6.14	10.4

TABLE 1.1.9

(Deleted)

TABLE 1.1.10
Dose Factors Specific for Vermont Yankee
for Noble Gas Releases

Radionuclide	Gamma Total Body Dose Factor	Beta Skin Dose Factor	Combined Skin Dose Factor (Stack Release)	Beta Air Dose Factor	Gamma Air Dose Factor
	DFB_i $\left(\frac{\text{mrem} \cdot \text{m}^3}{\text{pCi} \cdot \text{yr}}\right)$	DFS_i $\left(\frac{\text{mrem} \cdot \text{m}^3}{\text{pCi} \cdot \text{yr}}\right)$	DF'_{is} $\left(\frac{\text{mrem} \cdot \text{sec}}{\mu \text{Ci} \cdot \text{yr}}\right)$	DF_i^{β} $\left(\frac{\text{mrad} \cdot \text{m}^3}{\text{pCi} \cdot \text{yr}}\right)$	DF_i^{γ} $\left(\frac{\text{mrad} \cdot \text{m}^3}{\text{pCi} \cdot \text{yr}}\right)$
Ar-41	8.84E-03*	2.69E-03	1.20E-02	3.28E-03	9.30E-03
Kr-83m	7.56E-08	-----	1.61E-05	2.88E-04	1.93E-05
Kr-85m	1.17E-03	1.46E-03	3.35E-03	1.97E-03	1.23E-03
Kr-85	1.61E-05	1.34E-03	2.15E-03	1.95E-03	1.72E-05
Kr-87	5.92E-03	9.73E-03	2.06E-02	1.03E-02	6.17E-03
Kr-88	1.47E-02	2.37E-03	1.64E-02	2.93E-03	1.52E-02
Kr-89	1.66E-02	1.01E-02	3.05E-02	1.06E-02	1.73E-02
Kr-90	1.56E-02	7.29E-03	2.52E-02	7.83E-03	1.63E-02
Xe-131m	9.15E-05	4.76E-04	8.87E-04	1.11E-03	1.56E-04
Xe-133m	2.51E-04	9.94E-04	1.85E-03	1.48E-03	3.27E-04
Xe-133	2.94E-04	3.06E-04	7.81E-04	1.05E-03	3.53E-04
Xe-135m	3.12E-03	7.11E-04	3.93E-03	7.39E-04	3.36E-03
Xe-135	1.81E-03	1.86E-03	4.56E-03	2.46E-03	1.92E-03
Xe-137	1.42E-03	1.22E-02	2.07E-02	1.27E-02	1.51E-03
Xe-138	8.83E-03	4.13E-03	1.43E-02	4.75E-03	9.21E-03

* 8.84E-03 = 8.84 x 10⁻³

TABLE 1.1.10A

Combined Skin Dose Factors Specific for Vermont
Yankee Ground Level Noble Gas Releases

Radionuclide	$DF'_{ig} \left(\frac{\text{mrem- sec}}{\mu \text{ Ci- yr}} \right)$
Ar-41	1.74E-01
Kr-83M	1.58E-04
Kr-85M	6.34E-02
Kr-85	4.91E-02
Kr-87	4.06E-01
Kr-88	2.11E-01
Kr-89	5.10E-01
Kr-90	3.99E-01
Xe-131M	1.87E-02
Xe-133M	3.90E-02
Xe-133	1.41E-02
Xe-135M	5.34E-02
Xe-135	8.36E-02
Xe-137	4.58E-01
Xe-138	2.26E-01

TABLE 1.1.11

Dose Factors Specific for Vermont Yankee
for Liquid Releases

Radionuclide	Total Body Dose Factor $DFL_{itb} \left(\frac{\text{mrem}}{\text{Ci}} \right)$	Maximum Organ Dose Factor $DFL_{imo} \left(\frac{\text{mrem}}{\text{Ci}} \right)$
H-3	2.06E-04	2.06E-04
Na-24	3.38E-02	3.38E-02
Cr-51	3.10E-04	6.96E-02
Mn-54	2.08E-01	3.00E+00
Mn-56	8.53E-06	5.29E-03
Fe-55	4.18E-02	2.54E-01
Fe-59	2.49E-01	1.84E+00
Co-58	5.97E-02	4.34E-01
Co-60	2.13E-01	1.28E+00
Zn-65	8.06E+00	1.64E+01
Sr-89	2.55E-01	8.91E+00
Sr-90	4.23E+01	1.67E+02
Zr-95	4.21E-04	1.36E-01
Mo-99	4.79E-03	4.51E-02
Tc-99m	5.04E-06	2.33E-04
Ag-110m	6.90E-03	7.02E-01
Sb-124	8.44E-03	2.22E-01
Sb-125	7.52E-03	1.15E-01
I-131	2.57E-02	1.47E+01
I-132	3.10E-06	1.29E-04
I-133	3.31E-03	1.63E+00
I-135	3.16E-04	5.90E-02
Cs-134	1.28E+02	1.60E+02
Cs-137	7.58E+01	1.21E+02
Ba-140	4.08E-03	9.72E-02
Ce-141	2.31E-05	4.10E-02
W-187	1.18E-02	8.90E+00

TABLE 1.1.12

Dose and Dose Rate Factors Specific for Vermont Yankee
for Iodines, Tritium, and Particulate Releases

Radio-nuclide	<u>Stack Release</u>		<u>Ground Level Release*</u>	
	Critical Organ Dose Factor	Critical Organ Dose Rate Factor	Critical Organ Dose Factor	Critical Organ Dose Rate Factor
	$DFG_{sico} \left(\frac{\text{mrem}}{\text{Ci}} \right)$	$DFG'_{sico} \left(\frac{\text{mrem-sec}}{\text{yr-}\mu\text{Ci}} \right)$	$DFG_{gico} \left(\frac{\text{mrem}}{\text{Ci}} \right)$	$DFG'_{gico} \left(\frac{\text{mrem-sec}}{\text{yr-}\mu\text{Ci}} \right)$
H-3	4.79E-04	1.51E-02	1.10E-02	3.47E-01
C-14	2.91E-01	9.18E+00	6.68E+00	2.11E+02
Cr-51	8.15E-03	2.82E-01	4.45E-02	1.53E+00
Mn-54	9.34E-01	3.69E+01	4.97E+00	1.95E+02
Fe-55	4.22E-01	1.33E+01	2.20E+00	6.94E+01
Fe-59	9.33E-01	3.09E+01	4.92E+00	1.63E+02
Co-57	2.73E-01	1.03E+01	1.42E+00	5.30E+01
Co-58	4.83E-01	1.73E+01	2.56E+00	9.12E+01
Co-60	1.02E+01	4.54E+02	5.32E+01	2.32E+03
Zn-65	4.96E+00	1.60E+02	2.53E+01	8.20E+02
Se-75	3.19E+00	1.03E+02	1.63E+01	5.27E+02
Sn-113	1.47E+00	4.76E+01	7.56E+00	2.46E+02
Sr-89	1.52E+01	4.79E+02	7.79E+01	2.46E+03
Sr-90	5.75E+02	1.81E+04	3.03E+03	9.56E+04
Zr-95	9.23E-01	3.04E+01	4.84E+00	1.59E+02
Sb-124	1.69E+00	5.65E+01	8.95E+00	2.99E+02
Sb-125	1.67E+00	6.53E+01	8.59E+00	3.34E+02
I-131	1.03E+02	3.25E+03	5.38E+02	1.70E+04
I-133	1.10E+00	3.47E+01	8.75E+00	2.76E+02
Cs-134	2.12E+01	7.06E+02	1.09E+02	3.63E+03
Cs-137	2.17E+01	7.41E+02	1.11E+02	3.78E+03
Ba-140	1.50E-01	4.86E+00	2.26E+00	7.19E+01
Ce-141	2.26E-01	7.22E+00	1.27E+00	4.04E+01
Ce-144	5.14E+00	1.62E+02	2.69E+01	8.52E+02

* The release point reference is the North Warehouse. These dose and dose rate factors are conservative for potential release applications associated with ground level effluents from other major facilities (i.e., Turbine Building, Reactor Building, AOG, and CAB).

2.0 DEFINITIONS

This section lists definitions (Table 2.1.1) and dose equation variable names (Table 2.1.2) which are utilized in the VY ODCM.

TABLE 2.1.1
Definitions

1. Gaseous Radwaste Treatment System – The Augmented Off-Gas System (AOG) is the gaseous radwaste treatment system which has been designed and installed to reduce radioactive gaseous effluents by collecting primary coolant system off-gases from the primary system and providing for delay or holdup for the purpose of reducing the total radioactivity prior to release to the environment.
2. Hot Standby - Hot standby means operation with the reactor critical and the main steam line isolation valves closed.
3. Immediate - Immediate means that the required action will be initiated as soon as practicable considering the safe operation of the unit and the importance of the required action.
4. Instrument Calibration - An instrument calibration means the adjustment of an instrument signal output so that it corresponds, within acceptable range and accuracy, to a known value(s) of the parameter which the instrument monitors. Calibration shall encompass the entire instrument including actuation, alarm, or trip. Response time as specified is not part of the routine instrument calibration but will be checked once per operating cycle.
5. Instrument Check - An instrument check is qualitative determination of acceptable operability by observation of instrument behavior during operation. This determination shall include, where possible, comparison of the instrument with other independent instruments measuring the same variable.
6. Instrument Functional Test - An instrument functional test shall be:
 - a. Analog channels - the injection of a signal into the channel as close to the sensor as practicable to verify operability including alarm and/or trip functions.
 - b. Bistable channels - the injection of a signal into the sensor to verify the operability including alarm and/or trip functions.
7. Off-Site Dose Calculation Manual (ODCM) – A manual containing the current methodology and parameters used in the calculation of off-site doses due to radioactive gaseous and liquid effluents, in the calculation of gaseous and liquid effluent monitoring alarm/trip setpoints, and in the conduction of the environmental radiological monitoring program. The ODCM shall also contain (1) the Radioactive Effluent Controls (including the Radiological Environmental Monitoring) Program required by Technical Specification 6.7.D, and (2) descriptions of the information that should be included in the annual Radioactive Effluent Release Report and Annual Radiological Environmental Operating Report required by Technical Specifications 6.6.D and 6.6.E, respectively.

Off-Site Dose Calculation Manual
Section 2.0
Rev. 30
Page 2 of 10

TABLE 2.1.1 (Continued)

8. Refueling Outage - Refueling outage is the period of time between the shutdown of the unit prior to a refueling and the startup of the plant subsequent to that refueling. For the purpose of designating frequency of testing and surveillance, a refueling outage shall mean a regularly scheduled refueling outage; however, where such outages occur within 8 months of the completion of the previous refueling outage, the required surveillance testing need not be performed until the next regularly scheduled outage.
9. Site Boundary – The site boundary is shown in Plant Drawing 5920-6245.
10. Source Check - The qualitative assessment of channel response when the channel sensor is exposed to a radioactive source.
11. Surveillance Frequency - Unless otherwise stated in these specifications, periodic surveillance tests, checks, calibrations, and examinations shall be performed within the specified surveillance intervals. These intervals may be adjusted plus 25%. The operating cycle interval is considered to be 18 months and the tolerance stated above is applicable.
12. Surveillance Interval - The surveillance interval is the calendar time between surveillance tests, checks, calibrations, and examinations to be performed upon an instrument or component when it is required to be operable. These tests unless otherwise stated in these specifications may be waived when the instrument, component, or system is not required to be operable, but these tests shall be performed on the instrument, component, or system prior to being required to be operable.
13. Ventilation Exhaust Treatment System – The Radwaste Building and AOG Building ventilation HEPA filters are ventilation exhaust treatment systems which have been designed and installed to reduce radioactive material in particulate form in gaseous effluent by passing ventilation air through HEPA filters for the purpose of removing radioactive particulates from the gaseous exhaust stream prior to release to the environment. Engineered safety feature atmospheric cleanup systems, such as the Standby Gas Treatment (SBGT) System, are not considered to be ventilation exhaust treatment system components.
14. Vent/Purging – Vent/purging is the controlled process of discharging air or gas from the primary containment to control temperature, pressure, humidity, concentration or other operating conditions.

TABLE 2.1.2

Summary of Variables

Variable	=	Definition	Units
A_{RL}	=	Total gamma activity contained in a resin liner in storage directly in line with a gap between adjacent storage modules.	Ci
C_{li}^{NG}	=	Concentration at point of discharge to an unrestricted area of dissolved and entrained noble gas "i" in liquid pathways from all station sources.	$\mu\text{Ci/ml}$
C_i^{NG}	=	Total activity of all dissolved and entrained noble gases in liquid pathways from all station sources.	$\frac{\mu\text{Ci}}{\text{ml}}$
C_{di}	=	Concentration of radionuclide "i" at the point of liquid discharge to an unrestricted area.	$\frac{\mu\text{Ci}}{\text{ml}}$
C_i	=	Concentration of radionuclide "i."	$\frac{\mu\text{Ci}}{\text{cc}}$
C_{pi}	=	Concentration, exclusive of noble gases, of radionuclide "i" from tank "p" at point of discharge to an unrestricted area.	$\frac{\mu\text{Ci}}{\text{ml}}$
C_{mi}	=	Concentration of radionuclide "i" in mixture at the monitor.	$\frac{\mu\text{Ci}}{\text{ml}}$
D_{airs}^{β}	=	Beta dose to air from stack release.	mrad
D_{airg}^{β}	=	Beta dose to air from ground level release.	mrad
D_{airs}^{γ}	=	Gamma dose to air from stack release.	mrad
D_{airg}^{γ}	=	Gamma dose to air from ground level release.	mrad
D_{cos}	=	Dose to critical organ from stack release.	mrem
D_{cog}	=	Dose to the critical organ from ground level release.	mrem
D_d	=	Direct dose (Turbine Building).	mrem

TABLE 2.1.2 (Continued)

Variable		Definition	Units
$D_{ec-266m}$	=	ISFSI Individual Cask Dose @ Site Boundary -266 meters.	mrem
$D_{ec-300m}$	=	ISFSI Individual Cask Dose @ Site Boundary -300 meters.	mrem
$D_{ac-Total}$	=	Dose at West Site Boundary from all casks on the ISFSI Pad.	mrem
\dot{R}_d	=	Dose rate at 3 feet from unobstructed side of storage module facing site boundary.	$\frac{mrem}{hr}$
D_{dE}	=	Direct dose at site boundary per unobstructed storage module (short end).	$\frac{mrem}{yr - module}$
D_{dS}	=	Direct dose at site boundary per unobstructed storage module (long side).	$\frac{mrem}{yr - module}$
D_{finite}^Y	=	Gamma dose to air, corrected for finite cloud.	mrad
D_{Gap}	=	Intermodular gap dose projected to the maximum site boundary location from resin waste not directly shielded by DAW modules.	$\frac{mrem}{yr}$
D_{mo}	=	Dose to the maximum organ.	mrem
D^S	=	Dose to skin from beta and gamma.	mrem
\dot{R}_S	=	Dose rate at 1 meter from source in shielded end of North Warehouse.	$\frac{mrem}{hr}$
D_S	=	Annual dose at site boundary from fixed sources in shielded end of North Warehouse.	$\frac{mrem}{yr}$
\dot{R}_{SKD}	=	Maximum dose rate at 3 feet over top of DAW in a storage module.	$\frac{mrem}{hr}$
\dot{R}_{SKR}	=	Maximum dose rate at 3 feet over top of each resin liner in a storage module.	$\frac{mrem}{hr}$
D_{SKD}		Skyshine dose at the site boundary from DAW in storage modules (unobstructed top surfaces).	$\frac{mrem}{yr - module}$

TABLE 2.1.2 (Continued)

Variable		Definition	Units
D_{SKR}		Skyshine dose at the site boundary from resin liners in storage modules (unobstructed top surfaces).	$\frac{\text{mrem}}{\text{yr} - \text{liner}}$
D_{tb}	=	Dose to the total body.	mrem
$K_{N16}^{(L)}$	=	The direct dose conversion factor for N-16 scatter from the turbine hall to Location (L).	$\frac{\text{mrem}}{\text{MW}_e\text{h}}$
\dot{R}_{Tran}	=	Dose rate at contact from the unshielded top surface of resin liner.	$\frac{\text{rad}}{\text{hr}}$
D_{Tran}	=	Dose at the site boundary from unshielded movement of resin liner between transfer cask and storage module.	mrem
\dot{R}_U	=	Dose rate at 1 meter from source in unshielded end of North Warehouse.	$\frac{\text{mrem}}{\text{hr}}$
D_U	=	The annual dose at the site boundary from fixed sources in the unshielded end of North Warehouse.	$\frac{\text{mrem}}{\text{hr}}$
DF	=	Dilution factor.	ratio
DF_{min}	=	Minimum allowable dilution factor.	ratio
DF'_c	=	Composite skin dose factor.	$\frac{\text{mrem} - \text{sec}}{\text{pCi} - \text{yr}}$
DFB_i	=	Total body gamma dose factor for nuclide "i."	$\frac{\text{mrem} - \text{m}^3}{\text{pCi} - \text{yr}}$
DFB_c	=	Composite total body dose factor.	$\frac{\text{mrem} - \text{m}^3}{\text{pCi} - \text{yr}}$
DFL_{itb}	=	Site-specific, total body dose factor for a liquid release of nuclide "i."	$\frac{\text{mrem}}{\text{Ci}}$
DFL_{imo}	=	Site-specific, maximum organ dose factor for a liquid release of nuclide "i."	$\frac{\text{mrem}}{\text{Ci}}$

TABLE 2.1.2 (Continued)

Variable		Definition	Units
DFG_{sico}	=	Site-specific, critical organ dose factor for a stack gaseous release of nuclide "i."	$\frac{\text{mrem}}{\text{Ci}}$
DFG'_{sico}	=	Site-specific, critical organ dose rate factor for a stack gaseous release of nuclide "i."	$\frac{\text{mrem} - \text{sec}}{\mu\text{Ci} - \text{yr}}$
DFG_{gico}	=	Site-specific, critical organ dose factor for a ground level gaseous release of nuclide "i."	$\frac{\text{mrem}}{\text{Ci}}$
DFG'_{gico}	=	Site-specific, critical organ dose rate factor for a ground level gaseous release of nuclide "i."	$\frac{\text{mrem} - \text{sec}}{\mu\text{Ci} - \text{yr}}$
DFS_i	=	Beta skin dose factor for nuclide "i."	$\frac{\text{mrem} - \text{m}^3}{\rho\text{Ci} - \text{yr}}$
DF'_{is}	=	Combined skin dose factor for nuclide "i" from a stack release.	$\frac{\text{mrem} - \text{sec}}{\mu\text{Ci} - \text{yr}}$
DF'_{ig}	=	Combined skin dose factor for nuclide "i" from a ground level release.	$\frac{\text{mrem} - \text{sec}}{\mu\text{Ci} - \text{yr}}$
DF_1^γ	=	Gamma air dose factor for nuclide "i."	$\frac{\text{mrad} - \text{m}^3}{\rho\text{Ci} - \text{yr}}$
DF_i	=	Beta air dose factor for nuclide "i."	$\frac{\text{mrad} - \text{m}^3}{\rho\text{Ci} - \text{yr}}$
\dot{R}_{cos}	=	Critical organ dose rate due to iodines and particulates released from stack.	$\frac{\text{mrem}}{\text{yr}}$
\dot{R}_{cog}	=	Critical organ dose rate due to iodines and particulates released from ground.	$\frac{\text{mrem}}{\text{yr}}$
\dot{R}_{skins}	=	Skin dose rate due to stack release of noble gases.	$\frac{\text{mrem}}{\text{yr}}$
\dot{R}_{sking}	=	Skin dose rate due to ground release of noble gases.	$\frac{\text{mrem}}{\text{yr}}$

TABLE 2.1.2 (Continued)

Variable		Definition	Units
\dot{R}_{tbs}	=	Total body dose rate due to noble gases from stack release.	$\frac{\text{mrem}}{\text{yr}}$
\dot{R}_{tbg}	=	Total body dose rate due to noble gases from ground level release.	$\frac{\text{mrem}}{\text{yr}}$
D/Q	=	Deposition factor for dry deposition of elemental radioiodines and other particulates.	$\frac{1}{\text{m}^2}$
E	=	Gross electric output over the period of interest.	MW _e h
f_d	=	Fraction of a year that a storage module is in use with an unobstructed side oriented toward west site boundary.	fraction
f_{Gap}	=	Fraction of a year that the intermodular gap is not shielded.	fraction
f_{SK}	=	Fraction of a year that a storage module is in use with an unobstructed top surface.	fraction
F_d	=	Flow rate out of discharge canal.	gpm
F_m	=	Flow rate past liquid radwaste monitor.	gpm
F	=	Flow rate past gaseous radwaste monitor.	$\frac{\text{cc}}{\text{sec}}$
F_i^{ENG}	=	Sum of the fractions of combined effluent concentrations in liquid pathways (excluding noble gases).	fraction
ECL_i	=	Annual average effluent concentration limit for radionuclide "i" (10CFR20.1001-20.2401, Appendix B, Table 2, Column 2)	$\frac{\mu\text{Ci}}{\text{cc}}$
Q_i	=	Release for radionuclide "i" from the point of interest.	curies
\dot{Q}_i	=	Release rate for radionuclide "i" at the point of interest.	$\frac{\mu\text{Ci}}{\text{sec}}$

TABLE 2.1.2 (Continued)

Variable		Definition	Units
\dot{Q}_i^{ST}	=	The noble gas radionuclide "i" release rate at the plant stack.	$\frac{\mu\text{Ci}}{\text{sec}}$
\dot{Q}_i^{GL}	=	The noble gas radionuclide "i" release rate from ground level.	$\frac{\mu\text{Ci}}{\text{sec}}$
\dot{Q}_i^{SJAE}	=	The noble gas radionuclide "i" release rate at the steam jet air ejector.	$\frac{\mu\text{Ci}}{\text{sec}}$
\dot{Q}_i^{AOG}	=	The noble gas radionuclide "i" release rate at the exhaust of the Advanced Off-Gas System	$\frac{\mu\text{Ci}}{\text{sec}}$
\dot{Q}_i^{STP}	=	The iodine, tritium, and particulate radionuclide "i" release rate from the plant stack.	$\frac{\mu\text{Ci}}{\text{sec}}$
\dot{Q}_i^{GLP}	=	The iodine, tritium, and particulate radionuclide "i" release rate from ground level.	$\frac{\mu\text{Ci}}{\text{sec}}$
Q_i^{ST}	=	The release of noble gas radionuclide "i" from the plant stack.	curies
Q_i^{GL}	=	The release of noble gas radionuclide "i" from ground level.	curies
Q_i^{STP}	=	The release of iodine, tritium, and particulate radionuclide "i" from the plant stack.	curies
Q_i^{GLP}	=	The release of iodine, tritium, and particulate radionuclide "i" from ground level.	curies
R_{spt}^L	=	Liquid monitor response for the limiting concentration at the point of discharge.	cps
$R_{\text{spt}}^{\text{skin}}$		Response of the noble gas monitor at the limiting skin dose rate.	cpm
$R_{\text{spt}}^{\text{tb}}$		Response of the noble gas monitor to limiting total body dose rate.	cpm
S_F		Shielding factor.	Ratio
S_g		Detector counting efficiency from the most recent gas monitor calibration.	$\frac{\text{cpm}}{\mu\text{Ci/cc}}$ or $\frac{\text{mR/hr}}{\mu\text{Ci/cc}}$

TABLE 2.1.2 (Continued)

Variable	Definition	Units
S_{gi}	Detector counting efficiency for noble gas "i."	$\frac{\text{cpm}}{\mu\text{Ci/cc}}$ or $\frac{\text{mR/hr}}{\mu\text{Ci/cc}}$
S_1	Detector counting efficiency from the most recent liquid monitor calibration.	$\frac{\text{cps}}{\mu\text{Ci/ml}}$
S_{ii}	Detector counting efficiency for radionuclide ".i"	$\frac{\text{cps}}{\mu\text{Ci/ml}}$
T_{Tran}	Time that an unshielded resin liner is exposed in the storage pad area.	hours
W_{Gap}	Intermodule gap width between adjacent DAW storage modules which shield resin liner storage modules from the west site boundary.	inches
X/Q_s	Annual or long-term average undepleted atmospheric dispersion factor for stack release.	$\frac{\text{sec}}{\text{m}^3}$
X/Q_g	Annual or long-term average undepleted atmospheric dispersion factor for ground level release.	$\frac{\text{sec}}{\text{m}^3}$
$[X/Q]_s^{\gamma}$	Effective annual or long-term average gamma atmospheric dispersion factor.	$\frac{\text{sec}}{\text{m}^3}$
$[X/Q]_g^{\gamma}$	Effective annual or long-term average gamma atmospheric dispersion factor for a ground level release.	$\frac{\text{sec}}{\text{m}^3}$

3/4.0 EFFLUENT AND ENVIRONMENTAL CONTROLS

This section includes the effluent and environmental controls that were originally part of the Vermont Yankee Technical Specifications. These controls were relocated into the ODCM without any substantial changes, in accordance with NRC Generic Letter 89-01. Text and tables were reformatted to the style of the ODCM. The various controls were renumbered from the original numbering scheme of the Technical Specifications. A cross-reference of the old Technical Specifications section to the new ODCM section is presented in Table 1.1.8.

3/4.1 INSTRUMENTATION

3/4.1.1 Radioactive Liquid Effluent Instrumentation

CONTROLS

- 3.1.1 The radioactive liquid effluent monitoring instrumentation channel shall be operable in accordance with Control Table 3.1.1 with their alarm setpoints set to ensure that the limits of Control 3.2.1 are not exceeded.

APPLICABILITY:

During periods of release through monitored pathways as listed on Table 3.1.1.

ACTION:

- a. With a radioactive liquid effluent monitoring instrumentation channel alarm/trip setpoint less conservative than a value which will ensure that the limits of Control 3.2.1 are met, without delay suspend the release of radioactive liquid effluents monitored by the affected channel or change the setpoint so that it is acceptably conservative or declare the channel inoperable.
- b. With one or more radioactive liquid effluent monitoring instrumentation channels inoperable, take the action shown in Table 3.1.1.

SURVEILLANCE REQUIREMENTS

- 4.1.1.a Each radioactive liquid effluent monitoring instrumentation channel shall be tested and calibrated as indicated in Table 4.1.1.
- 4.1.1.b The setpoints for monitoring instrumentation shall be determined in accordance with the ODCM (Section 8.1).

TABLE 3.1.1

Liquid Effluent Monitoring Instrumentation

	Minimum Channels Operable	Notes
1. Gross Radioactivity Monitors not Providing Automatic Termination of Release		
a. Liquid Radwaste Discharge Monitor (RM-17-350)	1*	1,4
b. Service Water Discharge Monitor (RM-17-351)	1	2,4
2. Flow Rate Measurement Devices		
a. Liquid Radwaste Discharge Flow Rate Monitor (FIT-20-485/442)	1*	3,4

* During releases via this pathway

TABLE 3.1.1 NOTATION

NOTE 1 - With the number of channels operable less than required by the minimum channels operable requirement, effluent releases may continue provided that prior to initiating a release:

- a. At least two independent samples are analyzed in accordance with Control 4.2.1, and
- b. At least two technically qualified members of the Facility Staff independently verify the release rate calculations and discharge line valving.

Otherwise, suspend release of radioactive effluents via this pathway.

NOTE 2 - With the number of channels operable less than required by the minimum channels operable requirement, effluent releases via this pathway may continue provided that, at least once per 24 hours, grab samples are collected and analyzed for gross radioactivity (beta or gamma) at a lower limit of detection of at least 10^{-7} microcurie/ml.

NOTE 3 - With the number of channels operable less than required by the minimum channels operable requirement, effluent releases via this pathway may continue provided the flow rate is estimated at least once per 4 hours during actual releases. Pump performance curves may be used to estimate flow.

NOTE 4 - With the number of channels operable less than required by the minimum channels operable requirement, exert reasonable efforts to return the instrument(s) to operable status prior to the next release.

TABLE 4.1.1

Radioactive Liquid Effluent Monitoring Instrumentation Surveillance Requirements

Instrument	Instrument Check	Source Check	Instrument Calibration	Instrument Functional Test
1. Gross Radioactivity Monitors not Providing Automatic Termination of Release a. Liquid Radwaste Discharge Monitor (3)	Once each day*	Prior to each release, but no more than once each month	Once each 18 months (1)	Once each quarter (2)
b. Service Water Discharge Monitor (3)	Once each day	Once each month	Once each 18 months (1)	Once each quarter (2)
2. Flow Rate Measurement Devices a. Liquid Radwaste Discharge Flow Rate Monitor	Once each day*	Not Applicable	Not Applicable	Once each quarter*

* During releases via this pathway.

TABLE 4.1.1 NOTATION

- (1) The Instrument Calibration for radioactivity measurement instrumentation shall include the use of a known (traceable to National Institute for Standards and Technology) liquid radioactive source positioned in a reproducible geometry with respect to the sensor. These standards shall permit calibrating the system over its normal operating range of energy and rate.
- (2) The Instrument Functional Test shall also demonstrate the Control Room alarm annunciation occurs if any of the following conditions exists:
 - (a) Instrument indicate measured levels above the alarm setpoint.
 - (b) Circuit failure.
 - (c) Instrument indicates a downscale failure.
 - (d) Instrument controls not set in operate mode.
- (3) The alarm setpoints of these channels shall be determined and adjusted in accordance with the methodology and parameters in the Off-Site Dose Calculation Manual (see Section 8.1).

3/4.1 INSTRUMENTATION

3/4.1.2 Radioactive Gaseous Effluent Instrumentation

CONTROLS

3.1.2 The gaseous process and effluent monitoring instrumentation channels shall be operable in accordance with Control Table 3.1.2 with their alarm/trip setpoints set to ensure that the limits of Controls 3.3.1.a, and Technical Specifications 3.8.J.1 and 3.8.K.1 (Control 3.3.7) are not exceeded.

APPLICABILITY:

As shown in Table 3.1.2.

ACTION:

- a. With a gaseous process or effluent monitoring instrumentation channel alarm/trip setpoint less conservative than a value which will ensure that the limits of Control 3.3.1.a and Technical Specification 3.8.K.1 are met, immediately take actions to suspend the release of radioactive gaseous effluents monitored by the affected channel, or declare the channel inoperable, or change the setpoint so it is acceptably conservative.
- b. With less than the minimum number of radioactive gaseous effluent monitoring instrumentation channels operable, take actions noted in Table 3.1.2.

SURVEILLANCE REQUIREMENTS

- 4.1.2.a Each gaseous process or effluent monitoring instrumentation channel shall be tested and calibrated as indicated in Table 4.1.2.
- 4.1.2.b The setpoints for monitoring instrumentation shall be determined in accordance with the ODCM (Section 8.2).

TABLE 3.1.2

Gaseous Effluent Monitoring Instrumentation

Instrument	Minimum Channels Operable	Notes
1. Steam Jet Air Ejector (SJAE)		
a. Noble Gas Activity Monitor * (RM-17-150A/B)	1	7, 8, 9
2. Augmented Off-Gas System		
a. Noble Gas Activity Monitor Between the Charcoal Bed System and the Plant Stack (Providing Alarm and Automatic Termination of Release) (RAN-OG-3127, RAN-OG-3128)	1	2, 5, 6, 7
b. Flow Rate Monitor (FI-OG-2002, FI-OG-2004, FI-OG-2008)	1	1, 5, 6
c. Hydrogen Monitor (H2AN-OG-2921A/B, H2AN-OG-2922A/B)	1	3, 5, 6
3. Plant Stack		
a. Noble Gas Activity Monitor (RM-17-156, RM-17-157)	1	5, 7, 10
b. Iodine Sampler Cartridge	1	4, 5
c. Particulate Sampler Filter	1	4, 5
d. Sampler Flow Integrator (FI-17-156/157)	1	1, 5
e. Stack Flow Rate Monitor (FI-108-22)	1	1, 5

* This instrumentation channel(s) is required to support compliance with Technical Specification 3.8.K.

TABLE 3.1.2 NOTATION

- NOTE 1 - With the number of channels operable less than required by the minimum channels operable requirement, effluent releases via this pathway may continue provided the flow rate is estimated at least once per 4 hours.
- NOTE 2 - With the number of channels operable less than required by the minimum channels operable requirement, effluent releases via this pathway may continue for a period of up to 7 days provided that at least one of the stack monitoring systems is operable and off-gas system temperature and pressure are measured continuously.
- NOTE 3 - With the number of channels operable less than required by the minimum channels operable requirement, operation of the AOG System may continue provided gas samples are collected at least once per 24 hours and analyzed within the following 4 hours, or an orderly transfer of the off-gas effluents from the operating recombiner to the standby recombiner shall be made.
- NOTE 4 - With the number of channels operable less than required by the minimum channels operable requirement, effluent releases via the affected pathway may continue provided samples are continuously collected with auxiliary sampling equipment.
- NOTE 5 - With the number of channels operable less than required by the minimum channels operable requirement, exert reasonable efforts to return the instrument(s) to operable status within 30 days.
- NOTE 6 - During releases via this pathway.
- NOTE 7 - The alarm/trip setpoints of these channels shall be determined and adjusted in accordance with the methodology and parameters in the Off-Site Dose Calculation Manual (ODCM).
- NOTE 8 - Minimum channels operable required only during operation of the Steam Jet Air Ejector.
- NOTE 9 - With the number of channels operable less than required by the minimum channels operable requirement, gases from the SJAE may be released to the environment for up to 72 hours provided:
1. The AOG System is not bypassed; and
 2. The AOG System noble gas activity monitor is operable.
- NOTE 10 - With the number of channels operable less than required by the minimum channels operable requirement, effluent releases via this pathway may continue provided grab samples are taken at least once per 12 hours and these samples are analyzed for gross activity within 24 hours.

TABLE 4.1.2

Gaseous Effluent Monitoring Instrumentation Surveillance Requirements

Instrument	Instrument Check	Source Check	Instrument Calibration	Instrument Functional Test
1. Steam Jet Air Ejector (SJAE)				
a. Noble Gas Activity Monitor ⁺	Once each day**	Once each month	Once each 18 months (3)	Once each quarter (2)
2. Augmented Off-Gas System				
a. Noble Gas Activity Monitor	Once each day*	Once each month	Once each 18 months (3)	Once each quarter (1)
b. Flow Rate Monitor	Once each day*	Not Applicable	Once each 18 months	Not Applicable
c. Hydrogen Monitor ⁺⁺	Once each day*	Not Applicable	Once each quarter (4)	Once each month
3. Plant Stack				
a. Noble Gas Activity Monitor	Once each day	Once each month	Once each 18 months (3)	Once each quarter (2)
b. Sampler Flow Integrator	Once each week	Not Applicable	Once each 18 months	Not Applicable
c. System Flow Rate Monitor	Once each day	Not Applicable	R ^(a)	Once each quarter

* During releases via this pathway.

** During operation of main condenser SJAE.

+ This instrumentation channel(s) is required to support compliance with Technical Specification 3.8.K (same as Control 3.3.7).

++ This instrumentation channel(s) is required to support compliance with Technical Specification 3.8.J.

(a) R = once each refueling cycle.

TABLE 4.1.2 NOTATION

- (1) The Instrument Functional Test shall demonstrate that the instrument will provide an isolation signal to the system logic under the following conditions:
 - (a) Instrument indicates measured levels above the alarm setpoint.
 - (b) Circuit failure.
 - (c) Instrument indicates a downscale failure.
 - (d) Instrument controls not set in operate mode.
- (2) The Instrument Functional Test shall also demonstrate that Control Room alarm annunciation occurs when any of the following conditions exist:
 - (a) Instrument indicates measured levels above the alarm setpoint.
 - (b) Circuit failure.
 - (c) Instrument indicates a downscale failure.
 - (d) Instrument controls are not set in operate mode.
- (3) The Instrument Calibration for radioactivity measurement instrumentation shall include the use of a known (traceable to National Institute for Standards and Technology) radioactive source positioned in a reproducible geometry with respect to the sensor. These standards should permit calibrating the system over its normal operating range of rate capabilities.
- (4) The Instrument Calibration shall include the use of standard gas samples (high range and low range) containing suitable concentrations, hydrogen balance air, for the detection range of interest per Technical Specification 3.8.J.1.

3/4.2 RADIOACTIVE LIQUID EFFLUENTS

3/4.2.1 Liquid Effluent Concentration

CONTROLS

- 3.2.1 The concentration of radioactive material in liquid effluents released to Unrestricted Areas shall be limited to 10 times the concentrations specified in Appendix B to 10CFR Part 20.1001 – 20.2402, Table 2, Column 2 for radionuclides other than noble gases and 2×10^{-4} uCi/ml total activity concentration for all dissolved or entrained noble gases.

APPLICABILITY:

At all times.

ACTION:

With the concentration of radioactive material in liquid effluents released to Unrestricted Areas exceeding the limits of Control 3.2.1, immediately take action to decrease the release rate of radioactive materials and/or increase the dilution flow rate to restore the concentration to within the above limits.

SURVEILLANCE REQUIREMENTS

- 4.2.1.a Radioactive material in liquid waste shall be sampled and analyzed in accordance with requirements of Table 4.2.1.
- 4.2.1.b The results of the analyses shall be used in accordance with the methods in the ODCM to assure that the concentrations at the point of release to Unrestricted Areas are limited to the values in Control 3.2.1.

TABLE 4.2.1

Radioactive Liquid Waste Sampling and Analysis Program

Liquid Release Type	Sampling Frequency	Minimum Analysis Frequency	Type of Activity Analysis	Lower Limit of Detection (LLD) (uCi/ml) ^(a)
Batch Waste Release Tanks ^(b)	Prior to each release Each Batch	Prior to each release Each Batch	Principal Gamma Emitters ^(d)	5×10^{-7}
			I-131	1×10^{-6}
	One Batch per month sampled prior to a release	Once per month	Dissolved and Entrained Gases (Gamma Emitters)	1×10^{-5}
	Prior to each release Each Batch	Once per month Composite ^(c)	H-3	1×10^{-5}
			Gross Alpha	1×10^{-7}
	Prior to each release Each Batch	Once per quarter Composite ^(c)	Sr-89, Sr-90	5×10^{-8}
			Fe-55	1×10^{-6}

TABLE 4.2.1 NOTATION

- a. The LLD is the smallest concentration of radioactive material in a sample that will yield a net count, above system background, that will be detected with 95% probability with only 5% probability of falsely concluding that a blank observation represents a "real" signal.

For a particular measurement system (which may include radiochemical separation):

$$LLD = \frac{4.66 * S_b}{E * V * K * Y * e^{-\lambda * \Delta t}}$$

where:

LLD = the lower limit of detection as defined above (microcuries or picocuries/unit mass or volume)

S_b = the standard deviation of the background counting rate or of the counting rate of a blank sample as appropriate (counts/minute)

E = the counting efficiency (counts/disintegration)

V = the sample size (units of mass or volume)

K = 2.22×10^6 disintegrations/minute/microcurie or 2.22 disintegration/minute/picocurie as applicable

Y = the fractional radiochemical yield (when applicable)

λ = the radioactive decay constant for the particular radionuclide (/minute)

Δt = the elapsed time between sample collection and analysis (minutes)

Typical values of E, V, Y and Δt can be used in the calculation. In calculating the LLD for a radionuclide determined by gamma-ray spectrometry, the background shall include the typical contributions of other radionuclides normally present in the samples.

Analysis shall be performed in such a manner that the stated LLDs will be achieved under routine conditions. Occasionally, background fluctuations, unavoidably small sample sizes, the presence of interfering nuclides, or other uncontrollable circumstances may render these LLDs unavailable.

It should be recognized that the LLD is defined as a "before the fact" limit representing the capability of a measurement system and not as an "after the fact" limit for a particular measurement. This does not preclude the calculation of an "after the fact" LLD for a particular measurement based upon the actual parameters for the sample in question and appropriate decay correction parameters such as decay while sampling and during analysis.

TABLE 4.2.1 NOTATION

(Cont'd)

- b. A batch release is the discharge of liquid wastes of a discrete volume. Prior to sampling for analysis, each batch shall be isolated and then thoroughly mixed to assure representative sampling.
- c. A composite sample is one in which the quantity of liquid sampled is proportional to the quantity of liquid waste discharged and in which the method of sampling employed results in a specimen which is representative of the liquids released. Prior to analyses, all samples taken for the composite shall be thoroughly mixed in order for the composite sample to be representative of the effluent release.
- d. The principal gamma emitters for which the LLD specification will apply are exclusively the following radionuclides: Mn-54, Fe-59, Co-58, Co-60, Zn-65, Mo-99, Cs-134, Cs-137, Ce-141, and Ce-144. This list does not mean that only these nuclides are to be detected and reported. Other peaks which are measurable and identifiable, together with the above nuclides, shall also be identified and reported. Nuclides which are below the LLD for the analyses should not be reported as being present at the LLD level, but as "not detected." When unusual circumstances result in LLDs higher than required, the reasons shall be documented in the Radioactive Effluent Release Report.

3/4.2 RADIOACTIVE LIQUID EFFLUENTS

3/4.2.2 Dose - Liquids

CONTROLS

3.2.2 The dose or dose commitment to a member of the public from radioactive materials in liquid effluents released to Unrestricted Areas shall be limited to the following:

- a. During any calendar quarter:

less than or equal to 1.5 mrem to the total body, and
less than or equal to 5 mrem to any organ, and
- b. During any calendar year:

less than or equal to 3 mrem to the total body, and
less than or equal to 10 mrem to any organ.

APPLICABILITY:

At all times.

ACTION:

With the calculated dose from the release of radioactive materials in liquid effluents exceeding any of the above limits, prepare and submit to the Commission within 30 days, pursuant to ODCM Section 10, a Special Report that identifies the cause(s) for exceeding the limit(s) and defines the corrective actions that have been taken to reduce the releases and the proposed corrective actions to be taken to assure that subsequent releases will be in compliance with the above limits.

SURVEILLANCE REQUIREMENTS

4.2.2 Cumulative dose contributions shall be determined in accordance with the methods in the ODCM at least once per month if releases during the period have occurred.

3/4.2 RADIOACTIVE LIQUID EFFLUENTS

3/4.2.3 Liquid Radwaste Treatment

CONTROLS

3.2.3 The liquid radwaste treatment system shall be used in its designed modes of operation to reduce the radioactive materials in the liquid waste prior to its discharge when the projected doses due to the liquid effluents released to Unrestricted Areas, when averaged with all other liquid releases over the last month, would exceed 0.06 mrem to the total body, or 0.2 mrem to any organ.

APPLICABILITY:

At all times.

ACTION:

With radioactive liquid waste being discharged without treatment and in excess of the above limits and any portion of the Liquid Radwaste Treatment System not in operation, prepare and submit to the Commission within 30 days, a Special Report that includes the information detailed in ODCM Section 10.3.1.

SURVEILLANCE REQUIREMENTS

4.2.3.a See Control 4.2.2.

4.2.3.b The liquid radwaste treatment system schematic is shown in ODCM Figure 9.1.

3/4.3 RADIOACTIVE GASEOUS EFFLUENTS

3/4.3.1 Gaseous Effluents Dose Rate

CONTROLS

- 3.3.1 The dose rate due to radioactive materials released in gaseous effluents from the site to areas at and beyond the site boundary shall be limited to the following:
- a. For noble gases; less than or equal to 500 mrem/yr to the total body and less than or equal to 3,000 mrem/yr to the skin, and
 - b. For Iodine-131, Iodine-133, tritium and radionuclides in particulate form with half-lives greater than 8 days; less than or equal to 1,500 mrem/yr to any organ.

APPLICABILITY:

At all times.

ACTION:

With the dose rate(s) exceeding the above limits, immediately take action to decrease the release rate to within the limits of Control 3.3.1.

SURVEILLANCE REQUIREMENTS

- 4.3.1.a The dose rate due to noble gases in gaseous effluents shall be determined to be within the limits of Control 3.3.1 in accordance with the methods in the ODCM.
- 4.3.1.b The dose rate due to Iodine-131, Iodine-133, tritium and radionuclides in particulate form with half-lives greater than 8 days in gaseous effluents shall be determined to be within the limits of Control 3.3.1 in accordance with the methods in the ODCM by obtaining representative samples and performing analyses in accordance with the sampling and analysis program specified in Table 4.3.1.

TABLE 4.3.1

Radioactive Gaseous Waste Sampling And Analysis Program

Gaseous Release Type	Sampling Frequency	Minimum Analysis Frequency	Type of Activity Analysis	Lower Limit of Detection (LLD) (uCi/ml) ^(a)
A. Steam Jet Air Ejector	Once per week Grab Sample	Once per week	Xe-138, Xe-135, Xe-133, Kr-88, Kr-87, Kr-85M	1×10^{-4}
B. Containment Purge	Prior to each release/ Each Purge Grab Sample for Particulates	Prior to each release/ Each Purge	Principal Gamma Emitters ^(d,g) and I-131	1×10^{-9} ^(g)
C. Main Plant Stack	Once per month ^(c) Grab Sample	Once per month ^(c)	Principal Gamma Emitters ^(d)	1×10^{-4}
			H-3	1×10^{-6}
	Continuous ^(e)	Once per week ^(b) Charcoal Sample	I-131 ^(f)	1×10^{-12}
	Continuous ^(e)	Once per week ^(b) Particulate Sample	Principal Gamma Emitters ^(d,g) and I-131	1×10^{-11}
	Continuous ^(e)	Once per month Composite Particulate Sample	Gross Alpha	1×10^{-11}
	Continuous ^(e)	Once per quarter Composite Particulate Sample	Sr-89, Sr-90	1×10^{-11}
	Continuous	Noble Gas Monitor	Noble Gases Gross Beta or Gamma	1×10^{-5}

TABLE 4.3.1 NOTATION

- a. See footnote a. of Table 4.2.1.
- b. Samples shall be changed at least once per 7 days and analyses shall be completed within 48 hours after removal from samplers. Sampling shall also be performed at least once per 24 hours for at least 7 days following each shutdown, startup or thermal power change exceeding 25% of rated thermal power in one hour, and analyses shall be completed within 48 hours of changing the samples. When samples collected for 24 hours are analyzed, the corresponding LLDs may be increased by a factor of 10. This requirement to sample at least once per 24 hours for 7 days applies only if:
 - (1) analysis shows that the dose equivalent I-131 concentration in the primary coolant has increased more than a factor of 3 and the resultant concentration is at least 1×10^{-1} $\mu\text{Ci/ml}$; and
 - (2) the noble gas monitor shows that effluent activity has increased more than a factor of 3.
- c. Sampling and analyses shall also be performed following shutdown, startup, or a thermal power change exceeding 25% of rated thermal power per hour unless:
 - (1) analysis shows that the dose equivalent I-131 concentration in the primary coolant has not increased more than a factor of 3 and the resultant concentration is at least 1×10^{-1} $\mu\text{Ci/ml}$; and
 - (2) the noble gas monitor shows that effluent activity has not increased more than a factor of 3.
- d. The principal gamma emitters for which the LLD specification will apply are exclusively the following radionuclides: Kr-87, Kr-88, Xe-133, Xe-133m, Xe-135 and Xe-138 for gaseous emissions, and Mn-54, Fe-59, Co-58, Co-60, Zn-65, Mo-99, Cs-134, Cs-137, Ce-141 and Ce-144 for particulate emissions. This list does not mean that only these nuclides are to be detected and reported. Other peaks which are measurable and identifiable, together with the above nuclides, shall also be identified and reported. Nuclides which are below LLD for the analyses should not be reported as being present at the LLD level for that nuclide, but as "not detected." When unusual circumstances result in LLDs higher than required, the reasons shall be documented in the Radioactive Effluent Release Report.
- e. The ratio of the sample flow rate to the sampled stream flow rate shall be known for the time period covered by each dose or dose rate calculation made in accordance with Controls 3.3.1, 3.3.2, and 3.3.3.
- f. The gaseous waste sampling and analysis program does not explicitly require sampling and analysis at a specified LLD to determine the I-133 release. Estimates of I-133 releases shall be determined by counting the weekly charcoal sample for I-133 (as well as I-131) and assume a constant release rate for the release period.
- g. Lower Limit of Detection (LLD) applies only to particulate form radionuclides identified in Table Notation d. above.

3/4.3 RADIOACTIVE GASEOUS EFFLUENTS

3/4.3.2 Dose – Noble Gases

CONTROLS

- 3.3.2 The air dose due to noble gases released in gaseous effluents from the site to areas at and beyond the site boundary shall be limited to the following:
- a. During any calendar quarter:

less than or equal to 5 mrad for gamma radiation, and
less than or equal to 10 mrad for beta radiation, and
 - b. During any calendar year:

less than or equal to 10 mrad for gamma radiation, and
less than or equal to 20 mrad for beta radiation.

APPLICABILITY:

At all times.

ACTION:

With the calculated air dose from radioactive noble gases in gaseous effluents exceeding any of the above limits, prepare and submit to the Commission within 30 days, pursuant to ODCM Section 10.3.2, a Special Report that identifies the cause(s) for exceeding the limit(s) and defines the corrective actions that have been taken to reduce the releases and the proposed corrective actions to be taken to assure that subsequent releases will be in compliance with the above limits.

SURVEILLANCE REQUIREMENTS

- 4.3.2 Cumulative dose contributions for the total time period shall be determined in accordance with the methods in the ODCM at least once every month.

3/4.3 RADIOACTIVE GASEOUS EFFLUENTS

3/4.3.3 Dose – Iodine-131, Iodine-133, Radioactive Material in Particulate Form, and Tritium

CONTROLS

3.3.3 The dose to a member of the public from Iodine-131, Iodine-133, tritium, and radionuclides in particulate form with half-lives greater than 8 days in gaseous effluents released from the site to areas at and beyond the site boundary shall be limited to the following:

- a. During any calendar quarter:
less than or equal to 7.5 mrem to any organ, and
- b. During any calendar year:
less than or equal to 15 mrem to any organ.

APPLICABILITY:

At all times.

ACTION:

With the calculated dose from the release of Iodine-131, Iodine-133, tritium, and radionuclides in particulate form with half-lives greater than 8 days, in gaseous effluents exceeding any of the above limits, prepare and submit to the Commission within 30 days, pursuant to ODCM Section 10.3.2, a Special Report that identifies the cause(s) for exceeding the limit(s) and defines the corrective actions that have been taken to reduce the releases and the proposed corrective actions to be taken to assure that subsequent releases will be in compliance with the above limits.

SURVEILLANCE REQUIREMENTS

4.3.3 Cumulative dose contributions for the total time period shall be determined in accordance with the methods in the ODCM at least once every month.

3/4.3 RADIOACTIVE GASEOUS EFFLUENTS

3/4.3.4 Gaseous Radwaste Treatment

CONTROLS

- 3.3.4 The Augmented Off-Gas System (AOG) shall be used in its designed mode of operation to reduce noble gases in gaseous waste prior to their discharge whenever the main condenser steam jet air ejector (SJAE) is in operation.

APPLICABILITY:

At all times.

ACTION:

With gaseous radwaste from the main condenser air ejector system being discharged without treatment for more than 7 days, prepare and submit to the Commission within 30 days, a Special Report that includes the information detailed in ODCM Section 10.3.2.

SURVEILLANCE REQUIREMENTS

- 4.3.4.a The readings of the relevant instrument shall be checked every 12 hours when the main condenser SJAE is in use to ensure that the AOG is functioning.
- 4.3.4.b The gaseous effluent treatment system schematic is shown in ODCM Figure 9.2.

3/4.3 RADIOACTIVE GASEOUS EFFLUENTS

3/4.3.5 Ventilation Exhaust Treatment

CONTROLS

- 3.3.5 The AOG and Radwaste Building Ventilation Filter (HEPA) Systems shall be used to reduce particulate materials in gaseous waste prior to their discharge from those buildings when the projected doses due to gaseous effluent releases from the site to areas at and beyond the site boundary would exceed 0.3 mrem to any organ over one month.

APPLICABILITY:

At all times.

ACTION:

With gaseous radwaste being discharged without processing through appropriate treatment systems as noted above, and in excess of the limits of Control 3.3.5, prepare and submit to the Commission within 30 days, a Special Report that includes the information detailed in ODCM Section 10.3.2.

SURVEILLANCE REQUIREMENTS

- 4.3.5 See Control 4.3.2 for surveillance related to AOG and Radwaste Building ventilation filter system operation.

3/4.3 RADIOACTIVE GASEOUS EFFLUENTS

3/4.3.6 Primary Containment

CONTROLS

3.3.6 When the primary containment is to be Vented/Purged, it shall be Vented/Purged through the Standby Gas Treatment System whenever the airborne radioactivity levels in containment of Iodine-131, Iodine-133 or radionuclides in particulate form with half-lives greater than 8 days exceed the levels specified in Appendix B to 10CFR20.1001 - 20.2402, Table 1, Column 3.

APPLICABILITY:

At all times.

ACTION:

- a. With the requirements of Control 3.3.6 not satisfied, immediately suspend all Venting/Purging of the containment.
- b. During normal refueling and maintenance outages when primary containment is no longer required, then Control 3.3.3 shall supersede Control 3.3.6.

SURVEILLANCE REQUIREMENTS

4.3.6 The primary containment shall be sampled prior to venting/purging per Table 4.3.1, and if the results indicate radioactivity levels in excess of the limits of Control 3.3.6, the containment shall be aligned for venting/purging through the Standby Gas Treatment System. No sampling shall be required if the venting/purging is through the Standby Gas Treatment (SBGT) System.

3/4.3 RADIOACTIVE GASEOUS EFFLUENTS

| 3/4.3.7 Steam Jet Air Ejector (SJAE) [See Technical Specification 3/4.8.K.]

CONTROLS

3.3.7 Gross radioactivity release rate from the SJAE shall be limited to less than or equal to 0.16 Ci/sec (after 30 minutes decay).

APPLICABILITY:

At all times.

ACTION:

| a. See Technical Specification 3/4.8.K

SURVEILLANCE REQUIREMENTS

- 4.3.7 a. The gross radioactivity release rate shall be continuously monitored in accordance with Control 3.1.2.
- b. The gross radioactivity release rate of noble gases from the SJAE shall be determined to be within the limit of Control 3.3.7 at the following frequencies by performing an isotopic analysis (for Xe-138, Xe-135, Xe-133, Kr-88, Kr-85m, Kr-87) on a representative sample of gases taken at the discharge.
1. Once per week.
2. Within the 4 hours following an increase of 25% or 5000 microcuries/sec, whichever is greater, in steady-state activity levels during steady-state reactor operation, as indicated by the SJAE monitor.

3/4.4 TOTAL DOSE

3/4.4.1 Total Dose (40 CFR 190)

CONTROLS

- 3.4.1 The dose or dose commitment to a member of the public* in areas at and beyond the Site Boundary from all station sources is limited to less than or equal to 25 mrem to the total body or any organ (except the thyroid, which is limited to less than or equal to 75 mrem) over a calendar year.

APPLICABILITY:

At all times.

ACTION:

With the calculated dose from the release of radioactive materials in liquid or gaseous effluents exceeding twice the limits of Controls 3.2.2.a, 3.2.2.b, 3.3.2.a, 3.3.2.b, 3.3.3.a, or 3.3.3.b, calculations should be made, including direct radiation contributions from the station to determine whether the above limits of Control 3.4.1 have been exceeded. If such is the case, prepare and submit to the Commission within 30 days a Special Report that includes the information detailed in ODCM Section 10.3.3.

SURVEILLANCE REQUIREMENTS

- 4.4.1.a Cumulative dose contributions from liquid and gaseous effluents shall be determined in accordance with Controls 4.2.2, 4.3.2, and 4.3.3.
- 4.4.1.b Cumulative dose contributions from direct radiation from plant sources shall be determined in accordance with the methods in the ODCM. This requirement is applicable only under conditions set forth in Control 3.4.1 Action Statement.

* Note: For this Control, a member of the public may be taken as a real individual accounting for his actual activities.

3/4.5 RADIOLOGICAL ENVIRONMENTAL MONITORING

3/4.5.1 Environmental Monitoring Program

CONTROLS

3.5.1 The radiological environmental monitoring program shall be conducted as specified in Table 3.5.1.

APPLICABILITY:

At all times.

ACTION:

- a. With the radiological environmental monitoring program not being conducted as specified in Tables 3.5.1 or 4.5.1, prepare and submit to the Commission, in the Annual Radiological Environmental Monitoring Report (per ODCM Section 10.2), a description of the reasons for not conducting the program as required and the plans for preventing a recurrence.
- b. With the level of radioactivity as the result of plant effluents in an environmental sampling media at one or more locations specified in Control Table 3.5.1 exceeding the reporting levels of Control Table 3.5.2, prepare and submit to the Commission a Special Report within 30 days from receipt of the laboratory analysis (per ODCM Section 10.3.4).

SURVEILLANCE REQUIREMENTS

4.5.1 The radiological environmental monitoring samples shall be collected pursuant to Table 3.5.1 from the locations given in the ODCM and shall be analyzed pursuant to the requirements of Table 3.5.1 and the detection capabilities required by Table 4.5.1.

TABLE 3.5.1

Radiological Environmental Monitoring Program

Exposure Pathway and/or Sample	Number of Sample Locations ^(a)	Sampling and Collection Frequency	Type and Frequency of Analysis
<p>1. AIRBORNE</p> <p>a. Radioiodine and Particulates</p>	<p>Samples from 5 locations:</p> <p>1 sample from up valley, within 4 miles of Site Boundary. (major wind direction)</p> <p>1 sample from down valley, within 4 miles of Site Boundary. (major wind direction)</p> <p>1 sample each from the vicinity of two nearby communities, within 10 miles of Site Boundary.</p> <p>1 sample from a control location.</p>	<p>Continuous operation of sampler with sample collection weekly or more frequently as required by dust loading.</p>	<p>Radioiodine canister: Analyze each sample for I-131.</p> <p>Particulate sampler: Gross beta radioactivity analysis on each sample following filter change. ^(c) Composite (by location) for gamma isotopic ^(d) at least once per quarter.</p>

TABLE 3.5.1

(Cont'd)

Radiological Environmental Monitoring Program

Exposure Pathway and/or Sample	Number of Sample Locations ^(a)	Sampling and Collection Frequency	Type and Frequency of Analysis
2. DIRECT RADIATION ^b	40 routine monitoring stations as follows: 16 incident response stations (one in each meteorological sector) within a range of 0 to 4 km ^g ; 16 incident response stations (one in each meteorological sector) within a range of 2 to 8 km ^g ; the balance of the stations to be placed in special interest areas and control station areas.	Quarterly.	Gamma dose, at least once per quarter. Incident response TLDs in the outer monitoring locations, de-dose only quarterly unless gaseous release Controls were exceeded in period.

TABLE 3.5.1
(Cont'd)

Radiological Environmental Monitoring Program

Exposure Pathway and/or Sample	Number of Sample Locations ^(a)	Sampling and Collection Frequency	Type and Frequency of Analysis
3. WATERBORNE			
a. Surface ^(e)	1 sample upstream.	Monthly grab sample.	Gamma isotopic analysis ^(d) of each sample. Tritium analysis of composite sample at least once per quarter.
	1 sample downstream.	Composite sample collected over a period of one month ^(f)	
b. Ground	1 sample from within 8 km distance.	Quarterly.	Gamma isotopic ^(d) and tritium analyses of each sample.
	1 sample from a control location.	Quarterly.	
c. Sediment from Shoreline	1 sample from downstream area with existing or potential recreational value.	Semiannually.	Gamma isotopic analysis ^(d) of each sample.
	1 sample from north storm drain outfall.	Semiannually.	

TABLE 3.5.1
(Cont'd)

Radiological Environmental Monitoring Program

Exposure Pathway and/or Sample	Number of Sample Locations ^(a)	Sampling and Collection Frequency	Type and Frequency of Analysis
<p>4. INGESTION</p> <p>a. Milk</p> <p>b. Fish</p> <p>c. Vegetation</p>	<p>Samples from milking animals in 3 locations within 5 km distance having the highest dose potential. If there are less than 3 primary locations available then 1 or more secondary sample from milking animals in each of 3 areas between 5 to 8 km distance where doses are calculated to be greater than 1 mrem per year.</p> <p>1 sample from milking animals in a control location.</p> <p>1 sample of two recreationally important species in vicinity of plant discharge area.</p> <p>1 sample (preferably of same species) in areas not influenced by plant discharge.</p> <p>1 grass sample at each air sampling station.</p> <p>1 silage sample at each milk sampling station (as available).</p>	<p>Semimonthly if milking animals are identified on pasture; at least once per month at other times.</p> <p>Semiannually.</p> <p>Quarterly when available.</p> <p>At time of harvest.</p>	<p>Gamma isotopic ^(d) and I-131 analysis of each sample.</p> <p>Gamma isotopic analysis ^(d) on edible portions.</p> <p>Gamma isotopic analysis ^(d) of each sample.</p> <p>Gamma isotopic analysis ^(d) of each sample.</p>

TABLE 3.5.1 NOTATION

Off-Site Dose Calculation Manual
Section 3/4
Rev. 30
Page 31 of 46

- a Specific parameters of distance and direction sector from the centerline of the reactor and additional descriptions where pertinent, shall be provided for each and every sample location in Table 3.5.1 in a table and figure(s) in the ODCM (Section 7). Deviations are permitted from the required sampling schedule if specimens are unobtainable due to hazardous conditions, seasonal unavailability, malfunction of automatic sampling equipment and other legitimate reasons. If specimens are unobtainable due to sampling equipment malfunction, every reasonable effort shall be made to complete corrective action prior to the end of the next sampling period. All deviations from the sampling schedule shall be documented in the Annual Radiological Environmental Operating Report pursuant to ODCM Section 10.2. It is recognized that, at times, it may not be possible or practicable to continue to obtain samples of the media of choice at the most desired location or time. In these instances, suitable alternative media and locations may be chosen for the particular pathway in question and appropriate substitutions made within 30 days in the radiological environmental monitoring program. In lieu of a Licensee Event Report and pursuant to ODCM Section 10.1, identify the cause of the unavailability of samples for that pathway and identify the new location(s) for obtaining replacement samples in the next Radioactive Effluent Release Report and also include in the report a revised figure(s) and table for the ODCM reflecting the new location(s).
- b One or more instruments, such as a pressurized ion chamber, for measuring and recording dose rate continuously may be used in place of, or in addition to, integrating dosimeters. For the purposes of this table, a Thermoluminescent Dosimeter (TLD) is considered to be one phosphor; two or more phosphors in a packet are considered as two or more dosimeters. Film badges shall not be used as dosimeters for measuring direct radiation. The 40 stations is not an absolute number. The frequency of analysis or readout for TLD systems will depend upon the characteristics of the specific system used and should be selected to obtain optimum dose information with minimal fading.
- c Airborne particulate sample filters shall be analyzed for gross beta radioactivity 24 hours or more after sampling to allow for radon and thorium daughter decay. If gross beta activity in air particulate samples is greater than ten times the yearly mean of control samples, gamma isotopic analysis shall be performed on the individual samples.
- d Gamma isotopic analysis means the identification and quantification of gamma-emitting radionuclides that may be attributable to the effluents from the facility.
- e The "upstream sample" shall be taken at a distance beyond significant influence of the discharge. The "downstream" sample shall be taken in an area beyond but near the mixing zone.
- f Composite sample aliquots shall be collected at time intervals that are very short relative to the compositing period in order to assure obtaining a representative sample.
- g Each meteorological sector shall have an established "inner" and an "outer" monitoring location based on ease of recovery (i.e., response time) and year-round accessibility.
- h Deleted.

TABLE 3.5.2

Reporting Levels For Radioactivity Concentrations In Environmental Samples^(a)
Reporting Levels

Analysis	Water (pCi/l)	Airborne Particulate or Gases (pCi/m ³)	Fish (pCi/Kg, wet)	Milk (pCi/l)	Vegetation (pCi/Kg, wet)	Sediment (pCi/Kg, dry)
H-3	2 x 10 ^{4(b)}					
Mn-54	1 x 10 ³		3 x 10 ⁴			
Fe-59	4 x 10 ²		1 x 10 ⁴			
Co-58	1 x 10 ³		3 x 10 ⁴			
Co-60	3 x 10 ²		1 x 10 ⁴			3 x 10 ^{3(c)}
Zn-65	3 x 10 ²		2 x 10 ⁴			
Zr-Nb-95	4 x 10 ²					
I-131	2 ^(d)	0.9		3	1 x 10 ²	
Cs-134	30	10	1 x 10 ³	60	1 x 10 ³	
Cs-137	50	20	2 x 10 ³	70	2 x 10 ³	
Ba-La-140	2 x 10 ²			3 x 10 ²		

(a) Reporting levels may be averaged over a calendar quarter. When more than one of the radionuclides in Table 3.5.2 are detected in the sampling medium, the unique reporting requirements are not exercised if the following condition holds:

$$\frac{\text{concentration (1)}}{\text{reporting level (1)}} + \frac{\text{concentration (2)}}{\text{reporting level (2)}} + \dots < 1.0$$

When radionuclides other than those in Table 3.5.2 are detected and are the result of plant effluents, the potential annual dose to a member of the public must be less than or equal to the calendar year limits of Controls 3.2.2, 3.3.1, and 3.3.2.

- (b) Reporting level for drinking water pathways. For nondrinking water pathways, a value of 3 x 10⁴ pCi/l may be used.
- (c) Reporting level for individual grab samples taken at North Storm Drain Outfall only.
- (d) If no drinking water pathway exists, a value of 20 pci/liter may be used.

TABLE 4.5.1

Detection Capabilities For Environmental Sample Analysis^{(a)(c)}

Analysis ^(d)	Water (pCi/l)	Airborne Particulate or Gas (pCi/m ³)	Fish (pCi/Kg, wet)	Milk (pCi/l)	Vegetation (pCi/Kg, wet)	Sediment (pCi/Kg, dry)
Gross beta	4	0.01				
H-3	3000					
Mn-54	15		130			
Fe-59	30		260			
Co-58, 60	15		130			
Zn-65	30		260			
Zr-Nb-95	15 ^(b)					
I-131	1 ^(g)	0.07		1	60	
Cs-134	15	0.05	130	15	60	150
Cs-137	18	0.06	150	18	80	180
Ba-La-140	15 ^{(b)(e)}			15 ^{(b)(e)}		

TABLE 4.5.1 NOTATION

- (a) See Footnote (a) of Table 4.2.1.
- (b) Parent only.
- (c) If the measured concentration minus the 5 sigma counting statistics is found to exceed the specified LLD, the sample does not have to be analyzed to meet the specified LLD.
- (d) This list does not mean that only these nuclides are to be considered. Other peaks that are identifiable, together with those of the listed nuclides, shall also be analyzed and reported in the Annual Radiological Environmental Operating Report pursuant to Technical Specification 6.6.E and ODCM Section 10.2.
- (e) The Ba-140 LLD and concentration can be determined by the analysis of its short-lived daughter product La-140 subsequent to an 8 day period following collection. The calculation shall be predicted on the normal ingrowth equations for a parent-daughter situation and the assumption that any unsupported La-140 in the sample would have decayed to an insignificant amount (at least 3.6 percent of its original value). The ingrowth equations will assume that the supported La-140 activity at the time of the collection is zero.
- (f) Deleted.
- (g) If no drinking water pathway exists, a value of 15 pci/liter may be used.

3/4.5 RADIOLOGICAL ENVIRONMENTAL MONITORING

3/4.5.2 Land Use Census

CONTROLS

3.5.2 A land use census shall be conducted to identify the location of the nearest milk animal and the nearest residence in each of the 16 meteorological sectors within a distance of five miles. The survey shall also identify the nearest milk animal (within 3 miles of the plant) to the point of predicted highest annual average D/Q value in each of the three major meteorological sectors due to elevated releases from the plant stack.

APPLICABILITY:

At all times.

ACTION:

- a. With a land use census identifying one or more locations which yield a calculated dose or dose commitment (via the same exposure pathway) at least 20 percent greater than at a location from which samples are currently being obtained in accordance with Control 3.5.1, add the new location(s) to the radiological environmental monitoring program within 30 days if permission from the owner to collect samples can be obtained, and sufficient sample volume is available. The sampling location(s), excluding the control station location, having the lowest calculated dose or dose commitment (via the same exposure pathway) may be deleted from this monitoring program after October 31 of the year in which this land use census was conducted.
- b. With the land census not being conducted as required above, prepare and submit to the Commission within 30 days a Special Report that includes information detailed in ODCM Section 10.3.5.

SURVEILLANCE REQUIREMENTS

4.5.2 The land use census shall be conducted at least once per year between the dates of June 1 and October 1 by either a door-to-door survey, aerial survey, or by consulting local agricultural authorities. The results of the land use census shall be included in the Annual Radiological Environmental Operating Report pursuant to Technical Specification 6.6.E and ODCM Section 10.2.

3/4.5 RADIOLOGICAL ENVIRONMENTAL MONITORING

3/4.5.3 Interlaboratory Comparison Program

CONTROLS

3.5.3 Analyses shall be performed on referenced radioactive materials supplied as part of an Interlaboratory Program which has been approved by NRC.

APPLICABILITY:

At all times.

ACTION:

With analysis not being performed as required above, report the corrective actions taken to prevent a recurrence to the Commission in the Annual Radiological Environmental Operating Report pursuant to ODCM Section 10.2

SURVEILLANCE REQUIREMENTS

4.5.3 A summary of the results of analyses performed as part of the above required Interlaboratory Program shall be included in the Annual Radiological Environmental Operating Report. NRC-approved interlaboratory programs utilized by environmental laboratories in processing Vermont Yankee samples shall be identified in the ODCM.

EFFLUENT AND ENVIRONMENTAL CONTROL BASESINSTRUMENTATIONLiquid Effluent Instrumentation (3.1.1)

The radioactive liquid effluent instrumentation is provided to monitor and control, as applicable, the releases of radioactive materials in liquid effluents during actual or potential releases of liquid effluents. The alarm setpoints for these instruments are to ensure that the alarm will occur prior to exceeding 10 times the concentration limits of Appendix B to 10CFR20.1001-20.2402, Table 2, Column 2, values.

Automatic isolation function is not provided on the liquid radwaste discharge line due to the infrequent nature of batch, discrete volume, liquid discharges (on the order of once per year or less), and the administrative controls provided to ensure that conservative discharge flow rates/dilution flows are set such that the probability of exceeding the above concentration limits are low, and the potential off-site dose consequences are also low.

Gaseous Effluent Instrumentation (3.1.2)

The radioactive gaseous effluent instrumentation is provided to monitor and control, as applicable, the releases of radioactive materials in gaseous effluents during actual or potential releases of gaseous effluents. The alarm/trip setpoints for these instruments are provided to ensure that the alarm/trip will occur prior to exceeding design bases dose rates identified in Control 3.3.1.

RADIOACTIVE EFFLUENTSLiquid Effluents: Concentration (3.2.1)

This Control is provided to ensure that at any time the concentration of radioactive materials released in liquid waste effluents from the site above background (Unrestricted Area for liquids is at the point of discharge from the plant discharge into Connecticut River) will not exceed 10 times the concentration levels specified in 10CFR Part 20.1001-20.2402, Appendix B, Table 2, Column 2. These requirements provide operational flexibility, compatible with considerations of health and safety, which may temporarily result in releases higher than the absolute value of the concentration numbers in Appendix B, but still within the annual average limitation of the Regulation. Compliance with the design objective doses of Section II.A of Appendix I to 10CFR Part 50 assure that doses are maintained ALARA, and that annual concentration limits of Appendix B to 10CFR20.1001-20.2402 will not be exceeded.

EFFLUENT AND ENVIRONMENTAL CONTROL BASES

(cont.)

The concentration limit for noble gases is based upon the assumption that Xe-135 is the controlling radionuclide and that an effluent concentration in air (submersion dose equal to 500 mrem/yr) was converted to an equivalent concentration in water.

Liquid Effluents: Dose (3.2.2)

This Control is provided to implement the requirements of Sections II.A, III.A, and IV.A of Appendix I, 10CFR Part 50. The Limiting Condition for Operation implements the guides set forth in Section II.A of Appendix I. The requirements provide operating flexibility and at the same time implement the guides set forth in Section IV.A of Appendix I to assure that the releases of radioactive material in liquid effluents will be kept "as low as is reasonably achievable." The Surveillance Requirements implement the requirements in Section III.A of Appendix I, i.e., that conformance with the guides of Appendix I be shown by calculational procedures based on models and data such that the actual exposure of an individual through appropriate pathways is unlikely to be substantially underestimated. In addition, there is reasonable assurance that the operation of the facility will not result in radionuclide concentrations in potable drinking water that are in excess of the requirements of 40CFR141. No drinking water supplies drawn from the Connecticut River below the plant have been identified. The appropriate dose equations for implementation through requirements of the Specification are described in the Vermont Yankee Off-Site Dose Calculation Manual. The equations specified in the ODCM for calculating the doses due to the actual release rates of radioactive materials in liquid effluents were developed from the methodology provided in Regulatory Guide 1.109, "Calculation of Annual Doses to Man from Routine Releases of Reactor Effluents for the Purpose of Evaluating Compliance with 10CFR Part 50, Appendix I", Revision 1, October 1977 and Regulatory Guide 1.113, "Estimating Aquatic Dispersion of Effluents from Accidental and Routine Reactor Releases for the Purpose of Implementing Appendix I", Revision 1, April 1977.

EFFLUENT AND ENVIRONMENTAL CONTROL BASES

(cont.)

Liquid Radwaste Treatment (3.2.3)

The requirement that the appropriate portions of this system as indicated in the ODCM be used, when specified, provides assurance that the releases of radioactive materials in liquid effluents will be kept "as low as is reasonably achievable." This specification implements the requirements of 10CFR Part 50.36a and the design objective given in Section II.D of Appendix I to 10CFR Part 50. The specified limits governing the use of appropriate portions of the liquid radwaste treatment system were specified as a suitable fraction of the dose design objectives set forth in Section II.A of Appendix I, 10CFR Part 50, for liquid effluents.

Gaseous Effluents: Dose Rate (3.3.1)

The specified limits as determined by the methodology in the ODCM, restrict, at all times, the corresponding gamma and beta dose rates above background to a member of the public at or beyond the site boundary to (500) mrem/year to the total body or to (3,000) mrem/year to the skin. This instantaneous dose rate limit allows for operational flexibility when off normal occurrences may temporarily increase gaseous effluent release rates from the plant, while still providing controls to ensure that licensee meets the dose objectives of Appendix I to 10CFR50.

Control 3.3.1.b also restricts, at all times, comparable with the length of the sampling periods of Table 4.8.2 the corresponding thyroid dose rate above background to an infant via the cow-milk-infant pathway to 1500 mrem/year for the highest impacted cow.

Gaseous Effluents: Dose from Noble Gases (3.3.2)

This Control is provided to implement the requirements of Sections II.B, III.A, and IV.A of Appendix I, 10CFR Part 50. The Limiting Condition for Operation implements the guides set forth in Section II.B of Appendix I. The requirements provide operating flexibility and at the same time implement the guides set forth in Section IV.A of Appendix I to assure that the releases of radioactive material in gaseous effluents will be kept "as low as is reasonably achievable." The Surveillance Requirements implement the requirements in Section III.A of Appendix I, i.e., that conformance with the guides of Appendix I be shown by calculational procedures based on models and data such that the actual exposure of any member of the public through appropriate pathways is unlikely to be substantially underestimated. The appropriate dose equations are specified in the ODCM for calculating the doses due to the actual releases of radioactive noble gases in gaseous effluents. The ODCM also provides for determining the air doses at the site boundary based upon the historical average atmospheric conditions.

EFFLUENT AND ENVIRONMENTAL CONTROL BASES

(cont.)

The equations specified in the ODCM for calculating the doses due to the actual release rates of radioactive noble gases in gaseous effluents were developed from the methodology provided in Regulatory Guide 1.109, "Calculation of Annual Doses to Man from Routine Releases of Reactor Effluents for the Purpose of Evaluating Compliance with 10CFR Part 50, Appendix I", Revision 1, October 1977 and Regulatory Guide 1.111, "Methods for Estimating Atmospheric Transport and Dispersion of Gaseous Effluents in Routine Releases from Light-Water Cooled Reactors," Revision 1, July 1977.

Gaseous Effluents: Dose from Iodine-131, Iodine-133, Tritium, and Radionuclides in Particulate Form (3.3.3)

This Control is provided to implement the requirements of Section II.C, III.A, and IV.A of Appendix I, 10CFR Part 50. The Limiting Condition for Operation are the guides set forth in Section II.C of Appendix I. The requirements provide operating flexibility and at the same time implement the guides set forth in Section IV.A of Appendix I to assure that the releases of radioactive materials in gaseous effluents will be kept "as low as is reasonably achievable." The Surveillance Requirements implement the requirements in Section III.A of Appendix I that conformance with the guides of Appendix I be shown by calculational procedures based on models and data such that the actual exposure of a member of the public through appropriate pathways is unlikely to be substantially underestimated. The equations specified in the ODCM for calculating the doses due to the actual release rates of the subject materials were also developed using the methodology provided in Regulatory Guide 1.109, "Calculation of Annual Doses to Man from Routine Releases of Reactor Effluents for the Purpose of Evaluating Compliance with 10CFR Part 50, Appendix I," Revision 1, October 1977 and Regulatory Guide 1.111, "Methods for Estimating Atmospheric Transport and Dispersion of Gaseous Effluents in Routine Releases from Light-Water Cooled Reactors," Revision 1, July 1977. These equations also provide for determining the actual doses based upon the historical average atmospheric conditions. The release rate specifications for Iodine 131, Iodine-133, tritium, and radionuclides in particulate form with half-lives greater than 8 days are dependent on the existing radionuclide pathways to man, in areas at and beyond its site boundary. The pathways which were examined in the development of these specifications were: 1) individual inhalation of airborne radionuclides, 2) deposition of radionuclides onto green leafy vegetation with subsequent consumption by man, 3) deposition onto grassy areas where milk animals and meat producing animals graze with consumption of the milk and meat by man, and 4) deposition on the ground with subsequent exposure of man.

EFFLUENT AND ENVIRONMENTAL CONTROL BASES

(cont.)

Gaseous Radwaste Treatment (3.3.4)

The requirement that the appropriate portions of the Augmented Off-Gas (AOG) System be used whenever the SJAE is in operation provides reasonable assurance that the releases of radioactive materials in gaseous effluents will be kept "a low as is reasonably achievable." This specification implements the requirements of 10CFR Part 50.36a and the design objectives of Appendix I to 10CFR Part 50.

Ventilation Exhaust Treatment (3.3.5)

The requirement that the AOG Building and Radwaste Building HEPA filters be used when specified provides reasonable assurance that the release of radioactive materials in gaseous effluents will be kept "as low as is reasonably achievable." This specification implements the requirements of 10CFR Part 50.36a and the design objective of Appendix I to 10CFR Part 50. The requirements governing the use of the appropriate portions of the gaseous radwaste filter systems were specified by the NRC in NUREG-0473, Revision 2 (July 1979) as a suitable fraction of the guide set forth in Sections II.B and II.C of Appendix I, 10CFR Part 50, for gaseous effluents.

Primary Containment (MARK I) (3.3.6)

This Control provides reasonable assurance that releases from containment purging/venting operations will be filtered through the Standby Gas Treatment System (SBGT) so that the annual dose limits of 10CFR Part 20 for Members of the Public in areas at and beyond the Site Boundary will not be exceeded. The dose objectives of Control 3.3.3 restrict purge/venting operations when the Standby Gas Treatment System is not in use and gives reasonable assurance that all releases from the plant will be kept "as low as is reasonably achievable." The specification requires the use of SBGT only when Iodine-131, Iodine-133 or radionuclides in particulate form with half-lives greater than 8 days in containment exceeds the levels in Table 1, Column 3, to Appendix B of 10CFR 20.1001-20.2401 since the filter system is not considered effective in reducing noble gas radioactivity from gas streams.

EFFLUENT AND ENVIRONMENTAL CONTROL BASES

(cont.)

The use of the 18" purge and vent flow path isolation valves AC-7A (16-19-7A), AC-7B (16-19-7B), AC-8 (16-19-8), AC-10 (16-19-10) has been restricted to 90 hours per year. Normal plant operations (other than inerting and de-inerting) will have AC-8 and AC-10 closed and nitrogen will be supplied to the drywell via the 1" nitrogen makeup supply. The differential pressure maintained between the drywell and torus will allow the nitrogen to "bubble over" into the suppression chamber. A normally open AC-6B (3") allows for venting. A normally closed AC-6A (3") is periodically opened for performance of surveillances such as monthly torus to drywell vacuum breaker tests. Procedurally, when AC-6A is open, AC-6 and AC-7 are closed to prevent overpressurization of the SBT system or the reactor building ductwork, should a LOCA occur. For this and similar analyses performed, a spurious opening of AC-6 or AC-7 (one of the closed containment isolation valves) is not assumed as a failure simultaneous with a postulated LOCA. Analyses demonstrate that for normal plant operation system alignments, including surveillances such as those described above, that SBT integrity would be maintained if a LOCA was postulated. Therefore, during normal plant operations, the 90 hour clock does not apply. Accordingly, opening of the 18 inch atmospheric control isolation valves AC-7A, AC-7B, AC-8 and AC-10 will be limited to 90 hours per calendar year (except for performance of the subject valve stroke time surveillances - in which case the appropriate corresponding valves are closed to protect equipment should a LOCA occur). This restriction will apply whenever primary containment integrity is required. The 90 hour clock will apply anytime purge and vent evolutions can not assure the integrity of the SBT trains or related equipment.

Steam Jet Air Ejector (SJAE) (3.3.7)

Restricting the gross radioactivity release rate of gases from the main condenser SJAE provides reasonable assurance that the total body exposure to an individual at the exclusion area boundary will not exceed a small fraction of the limits of 10CFR Part 100 in the even this effluent is inadvertently discharged directly to the environment without treatment. This specification implements the requirements of General Design Criteria 60 and 64 of Appendix A to 10CFR Part 50. (This basis is a duplicate of that for plant Technical Specification 3.8.K.)

EFFLUENT AND ENVIRONMENTAL CONTROL BASES

(cont.)

Total Dose (40CFR190) (3.4.1)

This Control is provided to meet the dose limitations of 40CFR Part 190 to Members of the Public in areas at and beyond the Site Boundary. The specification requires the preparation and submittal of a Specific Report whenever the calculated doses from plant radioactive effluents exceed twice the design objective doses of Appendix I. For sites containing up to 4 reactors, it is highly unlikely that the resultant dose to a Member of the Public will exceed the dose limits of 40CFR Part 190 if the individual reactors remain within the reporting requirement level. The Special Report will describe a course of action that should result in the limitation of the annual dose to a Member of the Public to within the 40CFR Part 190 limits. For the purposes of the Special Report, it may be assumed that the dose commitment to the Member of the Public is estimated to exceed the requirements of 40CFR Part 190, the Special Report with a request for a variance (provided the release conditions resulting in violation of 40CFR Part 190 have not already been corrected), in accordance with the provisions of 40CFR Part 190.11 and 10CFR Part 20.2203(a)(4), is considered to be a timely request and fulfills the requirements of 40CFR Part 190 until NRC staff action is completed. The variance only relates to the limits of 40CFR Part 190, and does not apply in any way to the other requirements for dose limitation of 10CFR Part 20. An individual is not considered a Member of the Public during any period in which he/she is engaged in carrying out any operation that subjects them to occupational exposures. For individuals in controlled areas who are considered Members of the Public per 10CFR20, the dose limits of 10CFR20.1301 apply since the licensee has the authority to control and limit access to these areas.

Radiological Environmental Monitoring Program (3.5.1)

The radiological monitoring program required by this Control provides measurements of radiation and of radioactive materials in those exposure pathways and for those radionuclides which lead to the highest potential radiation exposures of member(s) of the public resulting from the station operation. This monitoring program implements Section IV.B.2 of Appendix I to 10 CFR Part 50 and thereby supplements the radiological effluent monitoring program by verifying that the measurable concentrations of radioactive materials and levels of radiation are not higher than expected on the basis of the effluent measurements and modeling of the environmental exposure pathways.

EFFLUENT AND ENVIRONMENTAL CONTROL BASES

(cont.)

Ten years of plant operation, including the years prior to the implementation of the Augmented Off-Gas System, have amply demonstrated via routine effluent and environmental reports that plant effluent measurements and modeling of environmental pathways are adequately conservative. In all cases, environmental sample results have been two to three orders of magnitude less than expected by the model employed, thereby representing small percentages of the ALARA and environmental reporting levels. This radiological environmental monitoring program has therefore been modified as provided for by Regulatory Guide 4.1 (C.2.b), Revision 1, April 1975. Due to the large local population of cows and the ready availability of milk samples, food product sampling has been eliminated from the program in lieu of milk sampling. Since milking cows in the area spend very little time on pasture, silage and grass sampling have been instituted as an indicator of radionuclide deposition.

The detection capabilities required by Table 4.5.1 are considered optimum for routine environmental measurements in industrial laboratories. It should be recognized that the LLD is defined as a before-the-fact limit representing the capability of a measurement system and not as an after-the-fact limit for a particular measurement. This does not preclude the calculation of an after-the-fact LLD for a particular measurement based upon the actual parameters for the sample in question.

Land Use Census (3.5.2)

This Control is provided to ensure that changes in the use of areas at and beyond the site boundaries are identified and that modifications to the monitoring program are made if required by the results of this census. This census satisfies the requirements of Section IV.B.3 of Appendix I to 10 CFR Part 50. The requirement of a garden census has been eliminated along with the food product monitoring requirement due to the substantial and widespread occurrence of dairy farming in the surrounding area which dominates the food uptake pathway.

The addition of new sampling locations to Control 3.5.1, based on the land use census, is limited to those locations which yield a calculated dose or dose commitment greater than 20 percent of the calculated dose or dose commitment at any location currently being sampled. This eliminates the unnecessary changing of the environmental radiation monitoring program for new locations which, within the accuracy of the calculation, contributes essentially the same to the dose or dose commitment as the location already sampled. The substitution of a new sampling point for one already sampled when the calculated difference in dose is less than 20 percent, would not be expected to result in a significant increase in the ability to detect plant effluent related nuclides.

EFFLUENT AND ENVIRONMENTAL CONTROL BASES

(cont.)

Interlaboratory Comparison Program (3.5.3)

The requirement for participation in an intercomparison program is provided to ensure that independent checks on the precision and accuracy of the measurements of radioactive material in environmental sample matrices are performed as part of a quality assurance program for environmental monitoring in order to demonstrate that the results are reasonably valid for the purposes of Section IV.B.2 of Appendix I to 10 CFR Part 50.

5.0 METHOD TO CALCULATE OFF-SITE LIQUID CONCENTRATIONS

Chapter 5 contains the basis for plant procedures that the plant operator requires to meet ODCM Control 3.2.1 which limits the total fraction of combined effluent concentration in liquid pathways, excluding noble gases, denoted here as, F_1^{ENG} at the point of discharge at any time (see Figure 9-1). F_1^{ENG} is limited to less than or equal to ten, i.e.,

$$F_1^{ENG} \leq 10$$

The total concentration of all dissolved and entrained noble gases at the point of discharge from all station sources, denoted C_1^{NG} , is limited to $2E-04 \mu\text{Ci/ml}$, i.e.,

$$C_1^{NG} \leq 2E - 04 \mu\text{Ci} / \text{ml}.$$

Evaluation of F_1^{ENG} and C_1^{NG} is required concurrent with the sampling and analysis program in Control Table 4.2.1.

5.1 Method to Determine F_1^{ENG} and C_1^{NG}

Determine the total fraction of combined effluent concentrations at the point of discharge in liquid pathways (excluding noble gases), denoted F_1^{ENG} , and determine the total concentration at the point of discharge of all dissolved and entrained noble gases in liquid pathways from all station sources, denoted C_1^{NG} , as follows:

$$F_1^{ENG} = \sum_i \frac{C_{pi}}{ECL_i} \leq 10 \quad (5-1)$$
$$\left(\frac{\mu\text{Ci/ml}}{\mu\text{Ci/ml}} \right)$$

and:

$$C_i^{NG} = \sum_i C_{ii}^{NG} \leq 2 E- 04 \quad (5-2)$$

(μ Ci/ml) (μ Ci/ml) (μ Ci/ml)

where:

F_1^{ENG} = Total sum of the fractions of each radionuclide concentration in liquid effluents (excluding noble gases) at the point of discharge to an unrestricted area, divided by each radionuclide's ECL value.

C_{pi} = Concentration at point of discharge to an unrestricted area of radionuclide "i", except for dissolved and entrained noble gases, from any tank or other significant source, p, from which a discharge may be made (including the floor drain sample tank, the waste sample tanks, the detergent waste tank and any other significant source from which a discharge can be made) (μ Ci/ml). This concentration can be calculated from: $C_{pi} = C_{TKi} \times F_{TK} / [F_{DIL} + F_{TK}]$ where: C_{TKi} equals the concentration of radionuclide i in the tank to be discharged (μ Ci/ml); F_{DIL} is equal to the dilution flow provided by the liquid radioactive waste dilution pumps (20,000 gpm); F_{TK} equals the liquid waste discharge pump flow rate which regulates the rate at which liquid from a waste collection tank is discharged (gpm).

ECL_i = Annual average effluent concentration limits of radionuclide "i", except for dissolved and entrained noble gases, from 10CFR20.1001-20.2402, Appendix B, Table 2, Column 2 (μ Ci/ml).

C_1^{NG} = Total concentration at point of discharge to an unrestricted area of all dissolved and entrained noble gases in liquid pathways from all station sources (μ Ci/ml).

C_{ii}^{NG} = Concentration at point of discharge to an unrestricted area of dissolved and entrained noble gas "i" in liquid pathways from all station sources (μ Ci/ml).

5.2 Method to Determine Radionuclide Concentration for Each Liquid Effluent Pathway

5.2.1 Sample Tanks Pathways

C_{pi} is determined for each radionuclide above LLD from the activity in a representative grab sample of any of the sample tanks and the predicted flow at the point of discharge to an unrestricted area.

Most periodic batch releases are made from the two 10,000-gallon capacity waste sample tanks. These tanks serve to hold all the high purity liquid wastes after they have been filtered through the waste collector and processed by ion exchange in the fuel pool and waste demineralizers. Other periodic batch releases may also come from the detergent waste tank or the floor drain sample tank.

The tanks are sampled from the radwaste sample sink and the contents analyzed for water quality and radioactivity. If the sample meets all the high purity requirements, the contents of the tank may be re-used in the nuclear system. If the sample does not meet all the high purity requirements, the contents are recycled through the radwaste system or discharged.

Prior to discharge each sample tank is analyzed for tritium, dissolved noble gases and dissolved and suspended gamma emitters.

5.2.2 Service Water Pathway

The service water pathway shown on Figure 9-1, flows from the intake structure through the heat exchangers and the discharge structure. Under normal operating conditions, the water in this line is not radioactive. For this reason, the service water line is not sampled routinely but it is continuously monitored with the service water discharge monitor (No. 17/351).

The alarm setpoint on the service water discharge monitor is set at a level which is three times the background of the instrument. The service water is sampled if the monitor is out of service or if the alarm sounds.

Under expected or anticipated operating conditions, the concentration at any time of radionuclides at the point of discharge from the service water effluent pathway to an unrestricted area will not exceed ten times the effluent concentration values of 10CFR20.1001-20.2402, Appendix B, Table 2, Column 2.

5.2.3 Circulating Water Pathway

The circulating water pathway shown on Figure 9-1, flows from the intake structure through the condenser and the discharge structure. Under normal operating conditions, the water in this line is not radioactive. For this reason, the circulating water line is not sampled routinely but it is monitored continuously by the discharge process monitor (No. 17/359) located in the discharge structure.

The alarm setpoint on the discharge process monitor is set at a level which is three times the background of the instrument. The circulating water is sampled if the monitor is out of service or if the alarm sounds.

Under normal operating conditions, the average concentration of radionuclides at the point of discharge from the circulating water pathway to an unrestricted area will not exceed the annual effluent concentration limits in 10CFR20.1001-20.2402, Appendix B, Table 2, Column 2.

6.0 OFF-SITE DOSE CALCULATION METHODS

Chapter 6 provides the basis for plant procedures required to meet the 10CFR50, Appendix I, ALARA dose objectives, and the 40CFR190 total dose limits to members of the public in unrestricted areas, as stated in the Radiological Effluent Controls (implementing the requirements of Technical Specification 6.7.D). A simple, conservative method (called Method I) is listed in Tables 1.1.2 to 1.1.7 for each of the Control requirements. Each of the Method I equations is presented, along with their bases in Sections 6.2 through 6.9 and Section 6.11. In addition, reference is provided to more sophisticated but still conservative methods (called Method II) for use when more accurate results are needed. This chapter provides the methods, data, and reference material with which the operator can calculate the needed doses and dose rates. Setpoint methods for effluent monitor alarms are described in Chapter 8.

Demonstration of compliance with the dose limits of 40CFR190 is considered to be a demonstration of compliance with the 0.1 rem limit of 10CFR20.1301(a)(1) for members of the public in unrestricted areas (Reference 56 FR23374, 3rd column).

6.1 Introductory Concepts

The Radiological Effluent Controls Program (Technical Specifications 6.7.D) either limit dose or dose rate. The term "Dose" for ingested or inhaled radioactivity means the dose commitment, measured in mrem, which results from the exposure to radioactive materials that, because of uptake and deposition in the body, will continue to expose the body to radiation for some period of time after the source of radioactivity is stopped. The time frame over which the dose commitment is evaluated is 50 years. The phrases "annual Dose" or "Dose in one year" then refers to the fifty-year dose commitment from one year's worth of releases. "Dose in a quarter" similarly means a fifty-year dose commitment from one quarter's releases. The term "Dose," with respect to external exposures, such as to noble gas clouds, refer only to the doses received during the actual time period of exposure to the radioactivity released from the plant. Once the source of the radioactivity is removed, there is no longer any additional accumulation to the dose commitment.

Gaseous effluents from the plant are also controlled such that the maximum "dose rates" at the site boundary at any time are limited to 500 mrem/year. This instantaneous dose rate limit allows for operational flexibility when off normal occurrences may temporarily increase gaseous effluent release rates from the plant, while still providing controls to ensure that licensees meet the dose objectives of Appendix I to 10CFR50.

It should also be noted that a dose rate due to noble gases that exceeds for a short time period (less than one hour in duration) the equivalent 500 mrem/year dose rate limit stated in Control 3.3.1.a, does not necessarily, by itself, constitute a Licensee Event Report (LER) under 10CFR Part 50.73 unless it is determined that the air concentration of radioactive effluents in unrestricted areas has also exceeded 20 times applicable concentration limits specified in Appendix B to 20.1001 - 20.2402, Table 2, Column 1 (four-hour notification per 10CFR50.72, and 30-day LER per 10CFR50.73).

The quantities D and \dot{R} are introduced to provide calculable quantities, related to off-site dose, or dose rate which demonstrates compliance with the effluent controls.

The dose D is the quantity calculated by the Chapter 6 dose equations. The D calculated by "Method I" equations is not necessarily the actual dose received by a real individual but usually provides an upper bound for a given release because of the conservative margin built into the dose factors and the selection and definition of critical receptors. The radioisotope specific dose factors in each "Method I" dose equation represent the greatest dose to any organ of any age group accounting for existing or potential pathways of exposure. The critical receptor assumed by "Method I" equations is typically a hypothetical individual whose behavior - in terms of location and intake - results in a dose which is expected to be higher than any real individual. The Method I equations employ five-year historical average atmospheric dispersion factors to define receptors of maximum impact. Method II allows for a more exact dose calculation for real individuals, if necessary, by considering only existing pathways of exposure, or actual concurrent meteorology with the recorded release. Maximum receptor doses determined using quarterly meteorology may be greater than doses calculated with Method I due to short time period variability of meteorological conditions from the long-term average. Quarterly average dispersion values for maximum receptors have been observed to differ from five-year average values by as much as 54%.

\dot{R} is the quantity calculated in the Chapter 6 dose rate equations. It is calculated using the plant's effluent monitoring system reading and an annual average or long-term atmospheric dispersion factor. Dispersion factors based on actual concurrent meteorology during effluent releases can also be used via Method II, if necessary, to demonstrate compliance with off-site dose rate limits.

Each of the methods to calculate dose or dose rate are presented in separate sections of Chapter 6, and are summarized in Tables 1.1.1 to 1.1.7. Each method has two levels of complexity and are called Method I and Method II. Method I is the simplest; generally a linear equation. Method II is a more detailed analysis which allows for use of site-specific factors and variable parameters to be selected to best fit the actual release conditions, within the bounds of the guidance provided.

The plant has both elevated and ground level gaseous release points: the main vent stack (elevated release), and the North Warehouse waste oil burner (ground level release). Therefore, total dose calculations for skin, whole body, and the critical organ from gaseous releases will be the sum of the elevated and ground level doses. Appendix D provides an assessment of the surveillance needs for waste oil to ensure that off-site doses from its incineration is maintained within the ALARA limits of the effluent Controls.

6.2 Method to Calculate the Total Body Dose from Liquid Releases

Effluent Control 3.2.2 limits the total body dose commitment to a Member of the Public from radioactive material in liquid effluents to 1.5 mrem per quarter and 3 mrem per year. Control 3.2.3 requires liquid radwaste treatment when the total body dose estimate exceeds 0.06 mrem in any month. Control 3.4.1 limits the total body dose commitment to any real member of the public from all station sources (including liquids) to 25 mrem in a year. Dose evaluation is required at least once per month. If the liquid radwaste treatment system is not being used, dose evaluation is required before each release.

Use Method I first to calculate the maximum total body dose from a liquid release to the Connecticut River as it is simpler to execute and more conservative than Method II.

Use Method II if a more accurate calculation of total body dose is needed (i.e., Method I indicates the dose is greater than the limit), or if Method I cannot be applied.

If the radwaste system is not operating, the total body dose must be estimated prior to a release (Control 3.2.3). To evaluate the total body dose, use Equation 6.1 to estimate the dose from the planned release and add this to the total body dose accumulated from prior releases during the month.

6.2.1 Method I

The increment in total body dose from a liquid release is:

$$D_{tb} = \sum_i Q_i DFL_{itb} \quad (6-1)$$

(mrem) (Ci) $\left(\frac{\text{mrem}}{\text{Ci}} \right)$

where:

DFL_{itb} = Site-specific total body dose factor (mrem/Ci) for a liquid release. See Table 1.1.11.

Q_i = Total activity (Ci) released for radionuclide "i." (For strontiums and Fe 55, use the most recent measurement available.)

Equation 6-1 can be applied under the following conditions (otherwise, justify Method I or consider Method II):

1. Normal operations (not emergency event),
2. Liquid releases were to the Connecticut River, and
3. Any continuous or batch release over any time period.

6.2.2 Basis for Method I

This section serves three purposes: (1) to document that Method I complies with appropriate NRC regulations, (2) to provide background and training information to Method I users, and (3) to provide an introductory user's guide to Method II.

Method I may be used to show that the effluent Controls which limit off-site total body dose from liquids (3.2.2 and 3.2.3) have been met for releases over the appropriate periods. Control 3.2.2 is based on the ALARA design objectives in 10CFR50, Appendix I Subsection II A. Control 3.2.3 is an "appropriate fraction," determined by the NRC, of that design objective (hereafter called the Objective). Control 3.4.1 is based on Environmental Standards for Uranium Fuel Cycle in 40CFR190 (hereafter called the Standard) which applies to direct radiation as well as liquid and gaseous effluents.

Exceeding the Objective or the Standard does not immediately limit plant operation but requires a report to the NRC within 30 days. In addition, a waiver may be required.

Method I was developed such that "the actual exposure of an individual ... is unlikely to be substantially underestimated" (10CFR50, Appendix I). The definition, below, of a single "critical receptor" (a hypothetical individual whose behavior results in an unrealistically high dose) provides part of the conservative margin to the calculation of total body dose in Method I. Method II allows that actual individuals, with real behaviors, be taken into account for any given release. In fact, Method I was based on a Method II analysis for the critical receptor with maximum exposure conditions instead of any real individual. That analysis was called the "base case;" it was then reduced to form Method I.

The steps performed in the Method I derivation follow. First, in the base case, the dose impact to the critical receptor (in the form of dose factors DFL_{itb} , mrem/Ci) for a 1 curie release of each radioisotope in liquid effluents was derived. The base case analysis uses the methods, data and assumptions in Regulatory Guide 1.109 (Equations A-2, A-3, A-7, A-13 and A-16, Reference A). The liquid pathways identified as contributing to an individual's dose are the consumption of fish from the Connecticut River, the ingestion of vegetables and leafy vegetation which were irrigated by river water, the consumption of milk and meat from cows and beef cattle who had river water available for drinking as well as having feed grown on irrigated land, and the direct exposure from the ground plane associated with activity deposited by the water pathway. A plant discharge flow rate of 44.6 ft³/sec was used with a mixing ratio of 0.0356 which corresponds to a minimum regulated river flow of 1250 cfs at the Vernon Dam just below the plant discharge outfall.* Tables 6.2.1 and 6.2.2 outline human consumption and environmental parameters used in the analysis. The resulting, site-specific, total body dose factors appear in Table 1.1.11.

For any liquid release, during any period, the increment in annual average total body dose from radionuclide "i" is:

$$\Delta D_{tb} = Q_i DFL_{itb} \tag{6-2}$$

$$(\text{mrem})(\text{Ci}) \left(\frac{\text{mrem}}{\text{Ci}} \right)$$

where:

DFL_{itb} = Site-specific total body dose factor (mrem/Ci) for a liquid release. See Table 1.1.11.

Q_i = Total activity (Ci) released from radionuclide "i."

* An Mp equal to 1.0 for the fish pathway is assumed between the discharge structure and the dam.

Method I is conservative because it is based on dose factors DFL_{itb} which were chosen from the base case to be the highest of the four age groups for each radionuclide, as well as assuming minimum river dilution flow.

6.2.3 Method II

If Method I cannot be applied, or if the Method I dose exceeds the limit or if a more exact calculation is required, then Method II should be applied. Method II consists of the models, input data and assumptions in Regulatory Guide 1.109, Rev. 1 (Reference A), except where site-specific models, data or assumptions are more applicable, such as the use of actual river flow at the time of actual discharge as opposed to the minimum river flow of 1,260 cfs that is assumed in the Method I dose factors (except for the fish pathway). The base case analysis, documented above, is a good example of the use of Method II. It is an acceptable starting point for a Method II analysis.

TABLE 6.2.1

Environmental Parameters for Liquid Effluents at Vermont Yankee
(Derived from Reference A)

VARIABLE		FOOD GROWN WITH CONTAMINATED					
		POTABLE WATER	AQUATIC FOOD	SHORELINE ACTIVITY	VEGETABLES	WATER LEAFY VEG.	COW MEAT MILK
MP	Mixing Ratio	-	1.0	0.0356	0.0356	0.0356	0.0356
TP	Transit Time (HRS)	-	24.0	0.000	0.0000	0.0000	48.0
YV	Agricultural Productivity (KG/M ²)				2.0	2.0	2.0
P	Soil Surface Density (KG/M ²)				240.0	240.0	240.0
IRR	Irrigation Rate (L/M ² /HR)				0.152	0.152	0.152
TE	Crop Exposure Time (HRS)				1440.0	1440.0	1440.0
TH	Holdup Time (HRS)				1440.0	24.0	2160.0
QAW	Water Uptake Rate for Animal (L/D)						50.0 60.0
QF	Feed Uptake Rate for Animal (KG/D)						50.0 50.0
FI	Fraction of Year Crops Irrigated				0.5	0.5	0.5
	Location of Critical Receptor						Connecticut River Below Vernon Dam

TABLE 6.2.2

Usage Factors for Various Liquid Pathways at Vermont Yankee
 (From Reference A, Table E-5. Zero Where No Pathway Exists)

AGE	VEG. (KG/YR)	LEAFY VEG. (KG/YR)	MILK (LITER/YR)	MEAT (KG/YR)	FISH (KG/YR)	INVERT. (KG/YR)	POTABLE WATER (LITER/YR)	SHORELINE (HR/YR)
Adult	520.00	64.00	310.00	110.00	21.00	0.00	0.00	12.00
Teen	630.00	42.00	400.00	65.00	16.00	0.00	0.00	67.00
Child	520.00	26.00	330.00	41.00	6.90	0.00	0.00	14.00
Infant	0.00	0.00	330.00	0.00	0.00	0.00	0.00	0.00

6.3 Method to Calculate Maximum Organ Dose from Liquid Releases

Effluent Control 3.2.2 limits the maximum organ dose commitment to a Member of the Public from radioactive material in liquid effluents to 5 mrem per quarter and 10 mrem per year. Control 3.2.3 requires liquid radwaste treatment when the maximum organ dose estimate exceeds 0.2 mrem in any month. Control 3.4.1 limits the maximum organ dose commitment to any real member of the public from all station sources (including liquids) to 25 mrem in a year except for the thyroid, which is limited to 75 mrem in a year. Dose evaluation is required at least once per month if releases have occurred. If the liquid radwaste treatment system is not being used, dose evaluation is required before each release.

Use Method I first to calculate the maximum organ dose from a liquid release to the Connecticut River as it is simpler to execute and more conservative than Method II.

Use Method II if a more accurate calculation of organ dose is needed (i.e., Method I indicates the dose is greater than the limit), or if Method I cannot be applied.

If the radwaste system is not operating, the maximum organ dose must be estimated prior to a release (Control 3.2.3). To evaluate the maximum organ dose, use Equation 6-3 to estimate the dose from the planned release and add this to the maximum organ dose accumulated from prior releases during the month.

6.3.1 Method I

The increment in maximum organ dose from a liquid release is:

$$D_{mo} = \sum_i Q_i DFL_{imo} \quad (6-3)$$

(mrem) (Ci) $\left(\frac{\text{mrem}}{\text{Ci}} \right)$

where:

DFL_{imo} = Site-specific maximum organ dose factor (mrem/Ci) for a liquid release. See Table 1.1.11.

Q_i = Total activity (Ci) released for radionuclide "i." (For strontiums and Fe-55, use the most recent measurement available.)

Equation 6-3 can be applied under the following conditions (otherwise, justify Method I or consider Method II):

1. Normal operations (not emergency event),
2. Liquid releases were to the Connecticut River, and
3. Any continuous or batch release over any time period.

6.3.2 Basis for Method I

This section serves three purposes: (1) to document that Method I complies with appropriate NRC regulations, (2) to provide background and training information to Method I users, and (3) to provide an introductory user's guide to Method II. The methods to calculate maximum organ dose parallel the total body dose methods (see Section 6.2.2). Only the differences are presented here.

For each radionuclide, a dose factor (mrem/Ci) was determined for each of seven organs and four age groups. The largest of these was chosen to be the maximum organ dose factor (DFL_{imo}) for that radionuclide.

For any liquid release, during any period, the increment in annual average dose from radionuclide "i" to the maximum organ is:

(6-4)

$$\Delta D_{mo} = Q_i DFL_{imo}$$

(mrem) (Ci) $\left(\frac{\text{mrem}}{\text{Ci}} \right)$

where:

DFL_{imo} = Site-specific maximum organ dose factor (mrem/Ci) for a liquid release. See Table 1.1.11.

Q_i = Total activity (Ci) released for radionuclide "i".

Because of the assumptions about receptors, environment, and radionuclides; and because of the low Objective and Standard, the lack of immediate restriction on plant operation, and the adherence to 10CFR20 concentrations (which limit public health consequences) a failure of Method I (i.e., the exposure of a real individual being underestimated) is improbable and the consequences of a failure are minimal.

6.3.3 Method II

If Method I cannot be applied, or if the Method I dose exceeds the limit or if a more exact calculation is required, then Method II should be applied. Method II consists of the models, input data and assumptions in Regulatory Guide 1.109, Rev. 1 (Reference A), except where site-specific models, data or assumptions are more applicable. The base case analysis, documented above, is a good example of the use of Method II. It is an acceptable starting point for a Method II analysis.

6.4 Method to Calculate the Total Body Dose Rate From Noble Gases

Effluent Control 3.3.1 limits the instantaneous dose rate at any time to the total body from all release sources of noble gases at any location at or beyond the site boundary equal to or less than 500 mrem/year.

Use Method I first to calculate the Total Body Dose Rate from the peak release rate via both elevated and ground level release points. The dose rate limit of Control 3.3.1.a is the total contribution from both ground and elevated releases occurring during the period of interest.

Use Method II if Method I predicts a dose rate greater than the Control limit (i.e., use of actual meteorology over the period of interest) to determine if, in fact, Control 3.3.1 had actually been exceeded during a short time interval.

Compliance with the dose rate limits for noble gases are continuously demonstrated when effluent release rates are below the plant stack noble gas activity monitor alarm setpoint by virtue of the fact that the alarm setpoint is based on a value which corresponds to the off-site dose rate limit of Control 3.3.1, or a value below it, taking into account the potential contribution of releases from all ground level sources.

Determinations of dose rates for compliance with Control (3.3.1) are performed when the effluent monitor alarm setpoint is exceeded and the corrective action required by Control 3.3.1 is unsuccessful, or as required by the notations to Control Table 3.1.2 when the stack noble gas monitor is inoperable.

6.4.1 Method I

The Total Body Dose Rate due to noble gases can be determined by multiplying the individual radionuclide release rates by their respective dose factors, summing all the products together, and then multiplying this total by a conversion constant (0.75), as seen in the following Equation 6-5:

$$\dot{R}_{tbs} = 0.75 \sum_i \dot{Q}_i^{ST} \text{DFB}_i \quad (6-5)$$

$$\left(\frac{\text{mrem}}{\text{yr}} \right) \left(\frac{\text{pCi-sec}}{\mu\text{Ci-m}^3} \right) \left(\frac{\mu\text{Ci}}{\text{sec}} \right) \left(\frac{\text{mrem-m}^3}{\text{pCi-yr}} \right)$$

where:

\dot{Q}_i^{ST} = In the case of noble gases, the release rate from the plant stack ($\mu\text{Ci}/\text{sec}$) for each radionuclide, "i", identified. The release rate at the plant stack is based on measured radionuclide concentrations and distributions in periodic grab samples taken at the stack. As an alternative method, the radionuclide distribution in the off-gas at the Steam Jet Air Ejector (SJAE) can be used during plant operations, along with the Stack Gas Monitor effluent count rate, to estimate stack radionuclide releases. The release rate at the stack when using SJAE samples can be stated as follows:

$$\dot{Q}_i^{ST} = \frac{\dot{Q}_i^{SJAE}}{\sum_i \dot{Q}_i^{SJAE}} M \frac{1}{S_g} F \quad (6-28)$$

$$\frac{\mu\text{Ci}}{\text{sec}} = (\text{cpm}) \left(\frac{\mu\text{Ci/cc}}{\text{cpm}} \right) \frac{(\text{cc})}{\text{sec}}$$

M = Plant Stack Gas Monitor I or II count rate (cpm).

S_g = Appropriate or conservative plant stack monitor detector counting efficiency for the given nuclide mix (cpm/ $(\mu\text{Ci}/\text{cc})$).

F = Stack flow rate (cc/sec).

\dot{Q}_i^{SJAE} = The last measured release rate at the steam jet air ejector of noble gas i ($\mu\text{Ci}/\text{sec}$).

DFB_i = Total body gamma dose factor (see Table 1.1.10).

For ground level noble gas releases, the total body dose rate is calculated as follows:

$$\dot{R}_{\text{tbg}} = 7.4 \sum_i \dot{Q}_i^{\text{GL}} \text{DFB}_i \left(\frac{\text{pCi} - \text{sec}}{\mu\text{Ci} - \text{m}^3} \right) \left(\frac{\mu\text{Ci}}{\text{sec}} \right) \left(\frac{\text{mrem} - \text{m}^3}{\text{pCi} - \text{yr}} \right) \quad (6-39)$$

where:

\dot{Q}_i^{GL} = Ground level release rate ($\mu\text{Ci}/\text{sec}$) of noble gas.

The total body dose rate for the site is equal to $\dot{R}_{\text{tbs}} + \dot{R}_{\text{tbg}}$.

During periods (beyond the first five days) when the plant is shutdown and no radioactivity release rates can be measured at the SJAE, Xe-133 may be used in place of the last SJAE measured mix as the referenced radionuclide to determine off-site dose rate and monitor setpoints. In this case, the ratio of each Q_i^{SJAE} to the sum of all Q_i^{SJAE} in Equation 6-28 above is assumed to reduce to a value of 1, and the total body gamma dose factor DFB_i for Xe-133 ($2.94 \text{ E-}04 \text{ mrem-m}^3/\text{pCi-yr}$) is used in Equation 6-5. Alternately, a relative radionuclide "i" mix fraction (f_i) may be taken from Table 8.2.1 as a function of time after shutdown, and substituted in place of the ratio of Q_i^{SJAE} to the sum of all Q_i^{SJAE} in Equation (6-28) above to determine the relative fraction of each noble gas potentially available for release to the total. Just prior to plant startup before a SJAE sample can be taken and analyzed, the monitor alarm setpoints should be based on Xe-138 as representing the most prevalent high dose factor noble gas expected to be present shortly after the plant returns to power. Monitor alarm setpoints which have been determined to be conservative under any plant conditions may be utilized at any time in lieu of the above assumptions.

Equations 6-5 and 6-39 can be applied under the following conditions (otherwise, justify Method I or consider Method II):

1. Normal operations (not emergency event), and
2. Noble gas releases via either elevated or ground level vents to the atmosphere.

6.4.2 Basis for Method I

Method I may be used to show that the Control limit for total body dose rate from noble gases released to the atmosphere has been met for the peak noble gas release rate.

Method I for stack releases was derived from Regulatory Guide 1.109 as follows:

$$\dot{R}_{tbs} = 1E + 06 S_F [X/Q]_s^{\gamma} \sum_i \dot{Q}_i^{ST} DFB_i$$

$$\left(\frac{\text{mrem}}{\text{yr}} \right) = \left(\frac{\text{pCi}}{\mu\text{Ci}} \right) (\#) \left(\frac{\text{sec}}{\text{m}^3} \right) \left(\frac{\mu\text{Ci}}{\text{sec}} \right) \left(\frac{\text{mrem} - \text{m}^3}{\text{pCi} - \text{yr}} \right) \quad (6-6)$$

where:

S_F = Shielding factor = 1.0 for dose rate determination.

$[X/Q]_s^{\gamma}$ = Maximum annual average gamma atmospheric dispersion factor for stack (elevated) releases; = $7.51E-07$ (sec/m³).

\dot{Q}_i^{ST} = Release rate from the plant stack of noble gas "i" (μCi/sec).

DFB_i = Gamma total body dose factor, $\left(\frac{\text{mrem} - \text{m}^3}{\text{pCi} - \text{yr}} \right)$. See Table 1.1.10.

Equation 6-6 reduces to:

$$\dot{R}_{tbs} = 0.75 \sum_i \dot{Q}_i^{ST} DFB_i$$

$$\left(\frac{\text{mrem}}{\text{yr}} \right) = \left(\frac{\text{pCi} - \text{sec}}{\mu\text{Ci} - \text{m}^3} \right) \left(\frac{\mu\text{Ci}}{\text{sec}} \right) \left(\frac{\text{mrem} - \text{m}^3}{\text{pCi} - \text{yr}} \right) \quad (6-5)$$

For ground level releases, the ground level maximum long-term average gamma atmospheric dispersion factor = $7.37E-06$ sec/m³, thus leading to:

$$\dot{R}_{tbg} = 1E+06 * 7.37E-06 \sum_i \dot{Q}_i^{GL} DFB_i$$

or

$$\dot{R}_{tbg} = 7.4 \sum_i \dot{Q}_i^{GL} DFB_i \quad (6-39)$$

The selection of critical receptor, outlined in Section 6.10, is inherent in Method I, as are the maximum expected off-site annual or long-term average atmospheric dispersion factors. Due to the holdup and decay of gases allowed in the AOG, off-gas concentrations at the plant stack during routine plant operations are usually too low for determination of the radionuclide mix at the plant stack. It is then conservatively assumed that most of the noble gas activity at the plant stack is the result of in-plant steam leaks which are removed to the plant stack by building ventilation air flow, and that this air flow has an isotopic distribution consistent with that routinely measured at the SJAE.

The calculation of ground level release dispersion parameters are based on the location of the North Warehouse with respect to the site boundary that would experience the highest exposure. The North Warehouse contains a waste oil burner that can be used for the incineration of low level contaminated waste oil, and is designated as a ground level release point to the atmosphere. Due to differences in building cross sectional areas and resulting building wake effects, the North Warehouse atmospheric dispersion factors are conservative in comparison to those associated with the main plant facilities, such as the Turbine Building. As a consequence, any potential or unexpected ground level release from the Turbine Building or adjoining structures can utilize the above ground release dose assessment equations.

In the case of noble gas dose rates, Method II cannot provide much extra realism because R_{tbs} and R_{tbg} are already based on several factors which make use of current plant parameters. However, should it be needed, the dose rate analysis for critical receptor can be performed making use of current meteorology during the time interval of recorded peak release rate in place of the default atmospheric dispersion factor used in Method I.

6.4.3 Method II

If Method I cannot be applied, or if the Method I dose exceeds the limit, then Method II may be applied. Method II consists of the models, input data and assumptions in Regulatory Guide 1.109, Rev. 1 (Reference A), except where site-specific models, data or assumptions are more applicable. The base case analysis, documented above, is a good example of the use of Method II. It is an acceptable starting point for a Method II analysis.

6.5 Method to Calculate the Skin Dose Rate from Noble Gases

Effluent Control 3.3.1 limits the instantaneous dose rate at any time to the skin from all release sources of noble gases at any location at or beyond the site boundary to 3,000 mrem/year.

Use Method I first to calculate the Skin Dose Rate from both elevated and ground level release points to the atmosphere. The dose rate limit of Control 3.3.1.a is the total contribution from both ground and elevated releases occurring during the period of interest. Method I applies at all release rates.

Use Method II if Method I predicts a dose rate greater than the Control limits (i.e., use of actual meteorology over the period of interest) to determine if, in fact, Control 3.3.1 had actually been exceeded during a short time interval.

Compliance with the dose rate limits for noble gases are continuously demonstrated when effluent release rates are below the plant stack noble gas activity monitor alarm setpoint by virtue of the fact that the alarm setpoint is based on a value which corresponds to the off-site Control dose rate limit, or a value below it, taking into account the potential contribution releases from all ground level sources.

Determinations of dose rate for compliance with Control (3.3.1) are performed when the effluent monitor alarm setpoint is exceeded and the corrective action required by Control 3.3.1 is unsuccessful, or as required by the notations to Control Table 3.1.2 when the stack noble gas monitor is inoperable.

6.5.1 Method I

The skin dose rate due to noble gases is determined by multiplying the individual radionuclide release rates by their respective dose factors, and summing all the products together as seen in the following Equation 6-7:

$$\dot{R}_{\text{skins}} = \sum_i \dot{Q}_i^{\text{ST}} \quad DF'_{\text{is}} \quad (6-7)$$

$$\left(\frac{\text{mrem}}{\text{yr}} \right) \quad \left(\frac{\mu \text{ Ci}}{\text{sec}} \right) \quad \left(\frac{\text{mrem- sec}}{\mu \text{ Ci- yr}} \right)$$

where:

\dot{Q}_i^{ST} = In the case of noble gases, the noble gas release rate from the plant stack ($\mu\text{Ci}/\text{sec}$) for each radionuclide, "i," identified. The release rate at the plant stack is based on measured radionuclide concentrations and distributions in periodic grab samples taken at the stack. As an alternative method, the radionuclide distribution in the off-gas at the Steam Jet Air Ejector (SJAE) can be used during plant operations, along with the Stack Gas Monitor effluent count rate, to estimate stack radionuclide releases. The release rate at the stack when using SJAE samples can be stated as follows:

$$\dot{Q}_i^{\text{ST}} = \frac{\dot{Q}_i^{\text{SJAE}}}{\sum_i \dot{Q}_i^{\text{SJAE}}} \quad M \quad \frac{1}{S_g} \quad F \quad (6-28)$$

$$\frac{\mu \text{ Ci}}{\text{sec}} = \quad (\text{cpm}) \quad \frac{(\mu \text{ Ci/cc})}{\text{cpm}} \quad \frac{(\text{cc})}{\text{sec}}$$

M = Plant stack gas monitor I or II count rate (cpm).

S_g = Appropriate or conservative plant stack monitor detector counting efficiency for the given nuclide mix (cpm/ $(\mu\text{Ci}/\text{cc})$).

F = Stack flow rate (cc/sec).

\dot{Q}_i^{SJAE} = The last measured release rate at the steam jet air ejector of noble gas i ($\mu\text{Ci}/\text{sec}$).

DF'_{is} = combined skin dose factor (see Table 1.1.10) for stack release.

For ground level releases, the skin dose rate from noble gases is calculated by Equation 6-38:

$$\dot{R}_{\text{sking}} = \sum_i \dot{Q}_i^{\text{GL}} DF'_{ig} \quad (6-38)$$

where:

\dot{Q}_i^{GL} = The noble gas release rate from ground level ($\mu\text{Ci}/\text{sec}$) for each radionuclide "i" identified.

DF'_{ig} = Combined skin dose factor for a ground level release [see Table 1.1.10A].

The skin dose rate for the site is equal to $\dot{R}_{\text{skins}} + \dot{R}_{\text{sking}}$.

During periods (beyond the first five days) when the plant is shutdown and no radioactivity release rates can be measured at the SJAE, Xe-133 may be used in place of the last SJAE measured mix as the referenced radionuclide to determine off-site dose rate and monitor setpoints. In this case, the ratio each of \dot{Q}_i^{SJAE} to the sum of all \dot{Q}_i^{SJAE} in Equation 6-28 above is assumed to reduce to a value of 1, and the combined skin dose factor DF'_{is} for Xe-133 ($7.81\text{E-}04 \text{ mrem-sec}/\mu\text{Ci-year}$) is used in Equation 6-7. Alternately, a relative radionuclide "i" mix fraction (f_i) may be taken from Table 8.2.1 as a function of time after shutdown, and substituted in place of the ratio of each \dot{Q}_i^{SJAE} to the sum of all \dot{Q}_i^{SJAE} in Equation 6-28 above to determine the relative fraction of each noble gas potentially available for release to the total. Just prior to plant startup before a SJAE sample can be taken and analyzed, the monitor alarm setpoints should be based on Xe-138 as representing the most prevalent high dose factor noble gas expected to be present shortly after the plant returns to power. Monitor alarm setpoints which have been determined to be conservative under any plant conditions may be utilized at any time in lieu of the above assumptions.

Equations 6-7 and 6-38 can be applied under the following conditions (otherwise, justify Method I or consider Method II):

1. Normal operations (not emergency event), and
2. Noble gas releases via both elevated and ground level vents to the atmosphere.

6.5.2 Basis For Method I

The methods to calculate skin dose rate parallel the total body dose rate methods in Section 6.4.3. Only the differences are presented here.

Method I may be used to show that the Control limit for skin dose rate from noble gases released to the atmosphere (Control 3.3.1) has been met for the peak noble gas release rate.

Method I was derived from Regulatory Guide 1.109 as follows:

$$D^s = 1.11 S_F D_{air}^{\gamma} + 3.17E+04 \sum_i Q_i [X/Q]_s DFS_i \quad (6-8)$$

$$\left(\frac{\text{mrem}}{\text{yr}} \right) = \left(\frac{\text{mrem}}{\text{mrad}} \right) (\#) \left(\frac{\text{mrad}}{\text{yr}} \right) \left(\frac{\text{pCi-yr}}{\text{Ci-sec}} \right) \left(\frac{\text{Ci}}{\text{yr}} \right) \left(\frac{\text{sec}}{\text{m}^3} \right) \left(\frac{\text{mrem-m}^3}{\text{pCi-yr}} \right)$$

where:

1.11 = Average ratio of tissue to air absorption coefficients will convert mrad in air to mrem in tissue.

$$D_{air}^{\gamma} = 3.17E + 04 \sum_i Q_i [X / Q]_s DF_i^{\gamma} \quad (6-9)$$

$$\left(\frac{\text{mrad}}{\text{yr}} \right) \left(\frac{\text{pCi-yr}}{\text{Ci-sec}} \right) \left(\frac{\text{Ci}}{\text{yr}} \right) \left(\frac{\text{sec}}{\text{m}^3} \right) \left(\frac{\text{mrad-m}^3}{\text{pCi-yr}} \right)$$

$$\text{now } D_{finite}^{\gamma} = D_{air}^{\gamma} [X / Q]_s^{\gamma} / [X / Q]_s \quad (6-10)$$

$$\left(\frac{\text{mrad}}{\text{yr}} \right) \left(\frac{\text{mrad}}{\text{yr}} \right) \left(\frac{\text{sec}}{\text{m}^3} \right) \left(\frac{\text{m}^3}{\text{sec}} \right)$$

$$\text{and } Q_i = 31.54 \dot{Q}_i^{ST} \quad (6-11)$$

$$\left(\frac{\text{Ci}}{\text{yr}} \right) \left(\frac{\text{Ci-sec}}{\mu\text{Ci-yr}} \right) \left(\frac{\mu\text{Ci}}{\text{sec}} \right)$$

$$\text{so } \dot{R}_{\text{skins}} = 1.11 S_F 1E+06 [X/Q]_s^y \sum_i \dot{Q}_i^{\text{ST}} DF_i^y \quad (6-12)$$

$$\left(\frac{\text{mrem}}{\text{yr}}\right) \left(\frac{\text{mrem}}{\text{mrad}}\right) (\#) \left(\frac{\text{pCi}}{\mu\text{Ci}}\right) \left(\frac{\text{sec}}{\text{m}^3}\right) \left(\frac{\mu\text{Ci}}{\text{sec}}\right) \left(\frac{\text{mrad} - \text{m}^3}{\text{pCi} - \text{yr}}\right)$$

$$+ 1E+06 X/Q_s \sum_i \dot{Q}_i^{\text{ST}} DFS_i$$

$$\left(\frac{\text{pCi}}{\text{Ci}}\right) \frac{\text{sec}}{\text{m}^3} \frac{\mu\text{Ci}}{\text{sec}} \left(\frac{\text{mrem} - \text{m}^3}{\text{pCi} - \text{yr}}\right)$$

substituting

$$[X/Q]_s^y = 7.51E-07 \text{ sec/m}^3$$

$$X/Q_s = 1.59E-06 \text{ sec/m}^3$$

$$S_F = \text{Shielding factor} = 1.0 \text{ for dose rate determinations}$$

gives

$$\dot{R}_{\text{skins}} = 0.83 \sum_i \dot{Q}_i^{\text{ST}} DF_i^y + 1.59 \sum_i \dot{Q}_i^{\text{ST}} DFS_i \quad (6-13)$$

$$\left(\frac{\text{mrem}}{\text{yr}}\right) \left(\frac{\text{pCi} - \text{sec} - \text{mrem}}{\mu\text{Ci} - \text{m}^3 - \text{mrad}}\right) \left(\frac{\mu\text{Ci}}{\text{sec}}\right) \left(\frac{\text{mrad} - \text{m}^3}{\text{pCi} - \text{yr}}\right) \left(\frac{\text{pCi} - \text{sec}}{\mu\text{Ci} - \text{m}^3}\right) \left(\frac{\mu\text{Ci}}{\text{sec}}\right) \left(\frac{\text{mrem} - \text{m}^3}{\text{pCi} - \text{yr}}\right)$$

$$= \sum_i \dot{Q}_i^{ST} [0.83 DF_i^Y + 1.59 DFS_i] \quad (6-14)$$

define

$$DF'_{is} = 0.83 DF_i^Y + 1.59 DFS_i \quad (6-15)$$

then

$$\dot{R}_{skins} = \sum_i \dot{Q}_i^{ST} DF'_{is} \quad (6-7)$$

$$\left(\frac{\text{mrem}}{\text{yr}} \right) \quad \left(\frac{\mu\text{Ci}}{\text{sec}} \right) \quad \left(\frac{\text{mrem} - \text{sec}}{\mu\text{Ci} - \text{yr}} \right)$$

For determining combined skin doses for ground level releases, a $[X/Q]_g^Y = 7.37E-06 \text{ sec/m}^3$ and an undepleted $X/Q_g = 3.65E-05 \text{ sec/m}^3$ have been substituted into Equation 6-12 to give:

$$\dot{R}_{sking} = \sum_i \dot{Q}_i^{GL} (8.18 DF_i^Y + 36.5 DFS_i)$$

$$\text{then } DF'_{ig} = 8.18 DF_i^Y + 36.5 DFS_i \quad (6-37)$$

$$\text{and } \dot{R}_{sking} = \sum_i \dot{Q}_i^{GL} DF'_{ig} \quad (6-38)$$

where:

\dot{Q}_i^{GL} = The noble gas release rate from ground level release points ($\mu\text{Ci/sec}$) for each radionuclide "i" identified.

DF'_{ig} = Combined skin dose factor for a ground level release [see Table 1.1.10A].

The selection of critical receptor, outlined in Section 6.10 is inherent in Method I, as it determined the maximum expected off-site atmospheric dispersion factors based on past long-term site-specific meteorology.

The calculation of ground level release dispersion parameters are based on the location of the North Warehouse with respect to the site boundary that would experience the highest exposure. The North Warehouse contains a waste oil burner that can be used for the incineration of low level contaminated waste oil, and is designated as a ground level release point to the atmosphere. Due to differences in building cross sectional areas and resulting building wake effects, the North Warehouse atmospheric dispersion factors are conservative in comparison to those associated with the main plant facilities, such as the Turbine Building. As a consequence, any potential or unexpected ground level release from the Turbine Building or adjoining structures can utilize the above ground release dose assessment equations.

6.5.3 Method II

If Method I cannot be applied, or if the Method I dose exceeds the limit, then Method II may be applied. Method II consists of the models, input data and assumptions in Regulatory Guide 1.109, Rev. 1 (Reference A), except where site-specific models, data or assumptions are more applicable. The base case analysis, documented above, is a good example of the use of Method II. It is an acceptable starting point for a Method II analysis.

6.6 Method to Calculate the Critical Organ Dose Rate from Iodines, Tritium and Particulates with $T_{1/2}$ Greater Than 8 Days

Effluent Control 3.3.1.b limits the dose rate to any organ, denoted \dot{R}_{co} , from all release sources of I-131, I-133, H-3, and radionuclides in particulate form with half lives greater than 8 days to 1500 mrem/year to any organ. The peak release rate averaging time in the case of iodines and particulates is commensurate with the time the iodine and particulate samplers are in service between changeouts (typically a week).

Use Method I first to calculate the critical organ dose rate from both elevated and ground level release points to the atmosphere. The dose rate limit of Control 3.3.1.b is the total contribution from both ground and elevated releases occurring during the period of interest. Method I applies at all release rates.

Use Method II if Method I predicts a dose rate greater than the Control limits (i.e., use of actual meteorology over the period of interest) to determine if, in fact, Control 3.3.1.b had actually been exceeded during the sampling period.

6.6.1 Method I

The critical organ dose rate from stack releases can be determined by multiplying the individual radionuclide release rates by their respective dose factors and summing all their products together, as seen in the following Equation 6-16:

$$\dot{R}_{cos} = \sum_i \dot{Q}_i^{STP} DFG'_{sico} \quad (6-16)$$

$$\left(\frac{\text{mrem}}{\text{yr}} \right) \quad \left(\frac{\mu\text{Ci}}{\text{sec}} \right) \left(\frac{\text{mrem} \cdot \text{sec}}{\mu\text{Ci} \cdot \text{yr}} \right)$$

where:

\dot{Q}_i^{STP} = Stack activity release rate determination of radionuclide "i" (Iodine-131, Iodine-133, particulates with half-lives greater than 8 days, and tritium), in $\mu\text{Ci}/\text{sec}$. For $i = \text{Sr89}, \text{Sr90}$ or tritium, use the best estimates (such as most recent measurements).

DFG'_{sico} = Site specific critical organ dose rate factor $\left(\frac{\text{mrem} \cdot \text{sec}}{\mu\text{Ci} \cdot \text{yr}} \right)$ for a ground level gaseous release. See Table 1.1.12.

For ground releases (North Warehouse waste oil burner) the critical organ dose rate from Iodine, Tritium, and Particulates with $T_{1/2}$ greater than 8 days is calculated as follows:

$$\dot{R}_{cog} = \sum_i \dot{Q}_i^{GLP} DFG'_{gico} \quad (6-40)$$

where:

\dot{Q}_i^{GLP} = Ground activity release rate determination of radionuclide "i" (Iodine-131, Iodine-133, particulates with half-lives greater than 8 days, and tritium), in $\mu\text{Ci}/\text{sec}$. For $i = \text{Sr89}, \text{Sr90}, \text{Fe-55}$, or tritium, use the best estimates (such as most recent measurements). For waste oil, the release rate is the total activity by radionuclide divided by the estimated burn time. (See Appendix D for surveillance criteria on waste oil burning).

DFG'_{gico} = Site specific critical organ dose rate factor $\left(\frac{\text{mrem} \cdot \text{sec}}{\mu\text{Ci} \cdot \text{yr}} \right)$ for a ground level gaseous release. See Table 1.1.12.

The critical organ dose rate for the site is equal to $\dot{R}_{cos} + \dot{R}_{cog}$.

Equations 6-16 and 6-40 can be applied under the following conditions (otherwise, justify Method I or consider Method II):

1. Normal operations (not emergency event), and
2. Tritium, iodine, and particulate releases via either elevated or ground level vents to the atmosphere.

6.6.2 Basis for Method I

The methods to calculate critical organ dose rate parallel the total body dose rate methods in Section 6.4.3. Only the differences are presented here.

Method I may be used to show that the Control limit for organ dose rate from iodines, tritium and radionuclides in particulate form with half lives greater than 8 days (hereafter called Iodines and Particulates or "I+P") released to the atmosphere (Control 3.3.1.b) has been met for the peak I + P release rate.

The equation for \dot{R}_{cos} and \dot{R}_{cog} is derived by modifying Equation 6-25 from Section 6.9 as follows:

$$\dot{D}_{cos} = \sum_i Q_i DFG_{ico}$$

(mrem) (Ci) $\left(\frac{\text{mrem}}{\text{Ci}} \right)$ (6-17)

applying the conversion factor, 31.54 (Ci-sec/ μ Ci-yr) and converting Q to \dot{Q} in μ Ci/sec as it applies to the plant stack yields:

$$\dot{R}_{cos} = 31.54 \sum_i \dot{Q}_i^{STP} DFG_{sico}$$

$\left(\frac{\text{mrem}}{\text{yr}} \right)$ $\left(\frac{\text{Ci-sec}}{\mu\text{Ci-yr}} \right)$ $\left(\frac{\mu\text{Ci}}{\text{sec}} \right)$ $\left(\frac{\text{mrem}}{\text{Ci}} \right)$ (6-18)

Equation 6.8 is written in the form:

$$\dot{R} = 31.54 \sum_i \dot{Q}_i^{STP} DFG_{sico} \quad (6-19)$$

$$\left(\frac{\text{mrem}}{\text{yr}} \right) \quad \left(\frac{\text{Ci} \cdot \text{sec}}{\mu\text{Ci} \cdot \text{yr}} \right) \quad \left(\frac{\mu\text{Ci}}{\text{sec}} \right) \quad \left(\frac{\text{mrem}}{\text{Ci}} \right)$$

DFG'_{sico} and DFG'_{gico} (North Warehouse waste oil burner vent releases) incorporates the conversion constant of 31.54 and has assumed that the shielding factor (SF) applied to the direct exposure pathway from radionuclides deposited on the ground plane is equal to 1.0 in place of the S_F value of 0.7 assumed in the determination of DFG_{sico} and DFG_{gico} for the integrated doses over time.

The selection of critical receptor (based on the combination of exposure pathways which include direct dose from the ground plane, inhalation and ingestion of vegetables, meat, and milk) which is outlined in Section 6.10 is inherent in Method I, as are the maximum expected off-site atmospheric dispersion factors based on past long-term site-specific meteorology.

The calculation of ground level release dispersion parameters are based on the location of the North Warehouse with respect to the site boundary that would experience the highest exposure. The North Warehouse contains a waste oil burner that can be used for the incineration of low level contaminated waste oil, and is designated as a ground level release point to the atmosphere. Due to differences in building cross sectional areas and resulting building wake effects, the North Warehouse atmospheric dispersion factors are conservative in comparison to those associated with the main plant facilities, such as the Turbine Building. As a consequence, any potential or unexpected ground level release from the Turbine Building or adjoining structures can utilize the above ground release dose assessment equations.

Should Method II be needed, the analysis for critical receptor critical pathway(s) and atmospheric dispersion factors may be performed with actual meteorologic and latest land use census data to identify the location of those pathways which are most impacted by these type of releases.

6.6.3 Method II

If Method I cannot be applied, or if the Method I dose exceeds the limit, then Method II may be applied. Method II consists of the models, input data and assumptions in Regulatory Guide 1.109, Rev. 1 (Reference A), except where site-specific models, data or assumptions are more applicable. The base case analysis, documented above, is a good example of the use of Method II. It is an acceptable starting point for a Method II analysis.

6.7 Method to Calculate the Gamma Air Dose from Noble Gases

Effluent Control 3.3.2 limits the gamma dose to air from all release sources of noble gases at any location at or beyond the site boundary to 5 mrad in any quarter and 10 mrad in any year. Dose evaluation is required at least once per month.

Use Method I first to calculate the gamma air dose for elevated and ground level vent releases during the period. The total gamma air dose limit of Control 3.3.2 is the total contribution from both ground and elevated releases occurring during the period of interest.

Use Method II if a more accurate calculation is needed.

6.7.1 Method I

The gamma air dose from plant stack releases is:

$$D_{\text{airs}}^{\gamma} = 0.024 \sum_i Q_i^{\text{ST}} DF_i^{\gamma} \quad (6-21)$$

(mrad) $\left(\frac{\text{pCi-yr}}{\text{Ci-m}^3} \right)$ (Ci) $\left(\frac{\text{mrad-m}^3}{\text{pCi-yr}} \right)$

where:

Q_i^{ST} = total noble gas activity (Curies) released to the atmosphere via the plant stack of each radionuclide "i" during the period of interest.

DF_i^{γ} = gamma dose factor to air for radionuclide "i." See Table 1.1.10.

For ground level noble gas releases, the gamma air dose is calculated as follows:

$$D_{\text{airg}}^{\gamma} = 0.23 \sum_i Q_i^{\text{GL}} DF_i^{\gamma} \quad (6-41)$$

where:

Q_i^{GL} = Total noble gas activity (curies) released to the atmosphere via ground level vents of each radionuclide, "i", during the period of interest.

The gamma air dose for the site is equal to $D_{\text{airs}}^{\gamma} + D_{\text{airg}}^{\gamma}$.

Equations 6-21 and 6-41 can be applied under the following conditions (otherwise justify Method I or consider Method II):

1. Normal operations (not emergency event), and
2. Noble gas releases via either elevated or ground level vents to the atmosphere.

6.7.2 Basis for Method I

Method I may be used to show that the Control limit for off-site gamma air dose from gaseous effluents (3.3.2) has been met for releases over appropriate periods. This Control is based on the Objective in 10CFR50, Appendix I, Subsection B.1, which limits the estimated annual gamma air dose at unrestricted area locations.

Exceeding the Objective does not immediately limit plant operation but requires a report to the NRC.

For any noble gas release, in any period, the dose is taken from Equations B-4 and B-5 of Regulatory Guide 1.109 with the added assumption that

$$D_{\text{finite}}^{\gamma} = D^{\gamma} [X/Q]^{\gamma} / [X/Q]:$$

$$D_{\text{airs}}^{\gamma} = 3.17E+04 [X/Q]_s^{\gamma} \sum_i Q_i^{\text{ST}} DF_i^{\gamma} \quad (6-22)$$

$$(\text{mrad}) \left(\frac{\text{pCi- yr}}{\text{Ci- sec}} \right) (\text{sec/ m}^3) (\text{Ci}) \left(\frac{\text{mrad- m}^3}{\text{yr- pCi}} \right)$$

where:

$[X/Q]_s^\gamma$ = maximum long term average gamma atmospheric dispersion factor for a stack release.

$$= 7.51E-07 \text{ (sec/m}^3\text{)}$$

Q_i^{ST} = number of curies of noble gas "i" released from the plant stack

which leads to:

$$D_{\text{airs}}^\gamma = 0.024 \sum_i Q_i^{ST} DF_i^\gamma \quad (6-21)$$

$$\text{(mrad)} \quad \left(\frac{\text{pCi-yr}}{\text{Ci-m}^3} \right) \quad (\text{Ci}) \quad \left(\frac{\text{mrad-m}^3}{\text{pCi-yr}} \right)$$

For the ground level release:

$$D_{\text{airg}}^\gamma = 3.17E+04 [X/Q]_g^\gamma \sum_i Q_i^{GL} DF_i^\gamma \quad (6-42)$$

where:

$(X/Q)_g^\gamma$ = Maximum long-term average gamma atmospheric dispersion factor for a ground level release

$$= 7.37E-06 \text{ sec/m}^3$$

leading to:

$$D_{\text{airg}}^\gamma = 0.23 \sum_i Q_i^{GL} DF_i^\gamma \quad (6-41)$$

The calculation of ground level release dispersion parameters are based on the location of the North Warehouse with respect to the site boundary that would experience the highest exposure. The North Warehouse contains a waste oil burner that can be used for the incineration of low level contaminated waste oil, and is designated as a ground level release point to the atmosphere. Due to differences in building cross sectional areas and resulting building wake effects, the North Warehouse atmospheric dispersion factors are conservative in comparison to those associated with the main plant facilities, such as the Turbine Building. As a consequence, any potential or unexpected ground level release from the Turbine Building or adjoining structures can utilize the above ground release dose assessment equations.

The main difference between Method I and Method II is that Method II would allow the use of actual meteorology to determine $[X/Q]^Y$ rather than use the maximum long-term average value obtained for the years 2002 to 2006.

6.7.3 Method II

If the Method I dose determination indicates that the Control limit may be exceeded, or if a more exact calculation is required, then Method II may be applied. Method II consists of the models, input data and assumptions in Regulatory Guide 1.109, Rev. 1 (Reference A), except where site-specific models, data or assumptions are more applicable.

6.8 Method to Calculate the Beta Air Dose from Noble Gases

Effluent Control 3.3.2 limits the beta dose to air from all release sources of noble gases at any location at or beyond the site boundary to 10 mrad in any quarter and 20 mrad in any year. Dose evaluation is required at least once per month.

Use Method I first to calculate the beta air dose for elevated and ground level vent releases during the period. The total beta air dose limit of Control 3.3.2 is the total contribution from both ground and elevated releases occurring during the period of interest.

Use Method II if a more accurate calculation is needed or if Method I cannot be applied.

6.8.1 Method I

The beta air dose from plant vent stack releases is:

$$D_{\text{airs}}^{\beta} = 0.050 \sum_i Q_i^{\text{ST}} DF_i^{\beta} \quad (6-23)$$

$$(\text{mrad}) \left(\frac{\text{pCi-yr}}{\text{Ci- m}^3} \right) (\text{Ci}) \left(\frac{\text{mrad- m}^3}{\text{pCi- yr}} \right)$$

where:

DF_i^{β} = beta dose factor to air for radionuclide "i". See Table 1.1.10.

Q_i^{ST} = total noble gas activity (curies) released to the atmosphere via the plant stack of each radionuclide "i" during the period of interest.

For ground level noble gas releases, the beta air dose is calculated as follows:

$$D_{\text{air}_g}^{\beta} = 1.16 \sum_i Q_i^{\text{GL}} DF_i^{\beta} \quad (6-43)$$

where:

Q_i^{GL} = Total noble gas activity (curies) released to the atmosphere via the ground level vents of each radionuclide "i" during the period of interest.

The beta air dose for the site is equal to $D_{\text{airs}}^{\beta} + D_{\text{air}_g}^{\beta}$.

Equations 6-23 and 6-43 can be applied under the following conditions (otherwise justify Method I or consider Method II):

1. Normal operations (not emergency event), and
2. Noble gas releases via either elevated or ground level vents to the atmosphere.

6.8.2 Basis for Method I

This section serves three purposes: (1) to document that Method I complies with appropriate NRC regulations, (2) to provide background and training information to Method I users, and (3) to provide an introductory user's guide to Method II. The methods to calculate beta air dose parallel the gamma air dose methods in Section 6.7.3. Only the differences are presented here.

Method I may be used to show that the Control limit for off-site beta air dose from gaseous effluents (3.3.2) has been met for releases over appropriate periods. This Control is based on the Objective in 10CFR50, Appendix I, Subsection B.1, which limits the estimated annual beta air dose at unrestricted area locations.

Exceeding the Objective does not immediately limit plant operation but requires a report to the NRC within 30 days.

For any noble gas release, in any period, the dose is taken from Equations B-4 and B-5 of Regulatory Guide 1.109:

$$D_{\text{airs}}^{\beta} = 3.17E+04 \quad X/Q_s \quad \sum_i Q_i^{\text{ST}} \quad DF_i^{\beta} \quad (6-24)$$

$$(\text{mrad}) \quad \left(\frac{\text{pCi} - \text{yr}}{\text{Ci} - \text{sec}} \right) \quad \left(\frac{\text{sec}}{\text{m}^3} \right) \quad (\text{Ci}) \quad \left(\frac{\text{mrad} - \text{m}^3}{\text{pCi} - \text{yr}} \right)$$

substituting

X/Q_s = Maximum long term average undepleted atmospheric dispersion factor for a stack release.

$$= 1.59E-06 \text{ sec/m}^3$$

We have (6-23)

$$D_{\text{airs}}^{\beta} = 0.050 \quad \sum_i Q_i^{\text{ST}} \quad DF_i^{\beta}$$

$$(\text{mrad}) \quad \left(\frac{\text{pCi} - \text{yr}}{\text{Ci} - \text{m}^3} \right) \quad (\text{Ci}) \quad \left(\frac{\text{mrad} - \text{m}^3}{\text{pCi} - \text{yr}} \right)$$

For the ground level release:

$$D_{\text{airg}}^{\beta} = 3.17E+04 \quad (X/Q)_g \quad \sum_i Q_i^{\text{GL}} \quad DF_i^{\beta} \quad (6-44)$$

where:

$(X/Q)_g$ = Maximum long-term average undepleted atmospheric dispersion factor for a ground level release.

$$= 3.65E-05 \text{ sec/m}^3$$

leading to:

$$D_{\text{airg}}^{\beta} = 1.16 \quad \sum_i Q_i^{\text{GL}} \quad DF_i^{\beta} \quad (6-43)$$

The calculation of ground level release dispersion parameters are based on the location of the North Warehouse with respect to the site boundary that would experience the highest exposure. The North Warehouse contains a waste oil burner that can be used for the incineration of low level contaminated waste oil, and is designated as a ground level release point to the atmosphere. Due to differences in building cross sectional areas and resulting building wake effects, the North Warehouse atmospheric dispersion factors are conservative in comparison to those associated with the main plant facilities, such as the Turbine Building. As a consequence, any potential or unexpected ground level release from the Turbine Building or adjoining structures can utilize the above ground release dose assessment equations.

6.8.3 Method II

If Method I cannot be applied, or if the Method I dose determination indicates that the Control limit may be exceeded, or if a more exact calculation is required, then Method II may be applied. Method II consists of the models, input data and assumptions in Regulatory Guide 1.109, Rev. 1 (Reference A), except where site-specific models, data or assumptions are more applicable.

6.9 Method to Calculate the Critical Organ Dose from Iodines, Tritium and Particulates

Effluent Control 3.3.3 limits the critical organ dose to a Member of the Public from all release sources of I-131, I-133, Tritium, and particulates with half-lives greater than 8 days (hereafter called "I+P") in gaseous effluents to 7.5 mrem per quarter and 15 mrem per year.

Use Method I first to calculate the critical organ dose from both elevated and ground level vent releases. The total critical organ dose limit of Control 3.3.3 is the total contribution from both ground level and elevated releases occurring during the period of interest

Use Method II if a more accurate calculation of critical organ dose is needed (i.e., Method I indicates the dose is greater than the limit).

6.9.1 Method I

$$D_{\text{cos}} = \sum_i Q_i^{\text{STP}} \text{DFG}_{\text{sico}} \quad (6-25)$$

(mrem) (Ci) $\left(\frac{\text{mrem}}{\text{Ci}} \right)$

Q_i^{STP} = Total activity (Ci) released from the stack to the atmosphere of radionuclide "i" during the period of interest. For strontiums and tritium, use the most recent measurement.

DFG_{sico} = Site-specific critical organ dose factor for a stack gaseous release of radionuclide "i" (mrem/Ci). For each radionuclide it is the age group and organ with the largest dose factor. See Table 1.1.12.

The critical organ dose is calculated for ground level releases as follows:

$$D_{\text{cog}} = \sum_i Q_i^{\text{GLP}} \text{DFG}_{\text{gico}} \quad (6-44)$$

(mrem) (Ci) $\left(\frac{\text{mrem}}{\text{Ci}} \right)$

Q_i^{GLP} = Total activity (Ci) released from ground level vents to the atmosphere of radionuclide "i" during the period of interest. For tritium, strontiums, and Fe-55 use the most recent measure.

DFG_{gico} = Site-specific critical organ dose factor for a ground level release of nuclide "i" (mrem/Ci). For each radionuclide it is the age group and organ with the largest dose factor. See Table 1.1.12.

The critical organ dose for the site is equal to $D_{\text{cos}} + D_{\text{cog}}$.

Equations 6-25 and 6-44 can be applied under the following conditions (otherwise, justify Method I or consider Method II):

1. Normal operations (not emergency event),
2. I+P releases via the plant stack, Turbine Building, and waste oil burner (see Appendix D for surveillance criteria on waste oil burning), to the atmosphere, and
3. Any continuous or batch release over any time period.

6.9.2 Basis for Method I

This section serves three purposes: (1) to document that Method I complies with appropriate NRC regulations, (2) to provide background and training information to Method I users, and (3) to provide an introductory user's guide to Method II.

Method I may be used to show that the Control limit for off-site organ dose from gases (3.3.3) has been met for releases over the appropriate periods.

Method I was developed such that "the actual exposure of an individual ... is unlikely to be substantially underestimated" (10CFR50, Appendix I). The use below of a single "critical receptor" provides part of the conservative margin to the calculation of critical organ dose in Method I. Method II allows that actual individuals, with real behaviors, be taken into account for any given release. In fact, Method I was based on a Method II analysis of the critical receptor for the annual average conditions. For purposes of complying with the Control 3.3.3, maximum annual average atmospheric dispersion factors are appropriate for batch and continuous releases. That analysis was called the "base case"; it was then reduced to form Method I. The base case, the method of reduction, and the assumptions and data used are presented below.

The steps performed in the Method I derivation follow. First, in the base case, the dose impact to the critical receptor in the form of dose factors (mrem/Ci) of 1 curie release of each I+P radionuclide to gaseous effluents was derived. Then Method I was determined using simplifying and further conservative assumptions. The base case analysis uses the methods, data and assumptions in Regulatory Guide 1.109 (Equations C-2, C-4 and C-13 in Reference A). Tables 6.9.1 and 6.9.2 outline human consumption and environmental parameters used in the analysis. It is conservatively assumed that the critical receptor lives at the "maximum off-site atmospheric dispersion factor location" as defined in Section 6.10. However, he is exposed, conservatively, to all pathways (see Section 6.10). The resulting site-specific dose factors are for the maximum organ and the age group with the highest dose factor for that organ. These critical organ, critical age dose factors are given in Table 1.1.12.

For any gas release, during any period, the increment in annual average dose from radionuclide "i" is:

$$\Delta D_{ico} = Q_i DFG_{ico} \quad (6-26)$$

where DFG_{ico} is the critical dose factor for radionuclide "i" and Q_i is the activity of radionuclide "i" released in curies.

Method I is more conservative than Method II in the region of the effluent dose Control limit because it is based on the following reduction of the base case. The dose factors DFG_{ico} used in Method I were chosen from the base case to be the highest of the set for that radionuclide. In effect each radionuclide is conservatively represented by its own critical age group and critical organ.

6.9.3 METHOD II

If Method I cannot be applied, or if the Method I dose exceeds the Control limit or if a more exact calculation is required, then Method II should be applied. Method II consists of the models, input data and assumptions in Regulatory Guide 1.109, Rev. 1 (Reference A), except where site-specific models, data or assumptions are more applicable. The base case analysis, documented above, is a good example of the use of Method II. It is an acceptable starting point for a Method II analysis.

TABLE 6.9.1

Environmental Parameters for Gaseous Effluents at Vermont Yankee
(Derived from Reference A)*

Variable		Vegetables		Cow Milk		Goat Milk		Meat		
		Stored	Leafy	Pasture	Stored	Pasture	Stored	Pasture	Stored	Stored
YV	Agricultural Productivity	(Kg/m ²)	2	2	0.70	2	0.70	2	0.70	2
P	Soil Surface Density	(Kg/m ²)	240	240	240	240	240	240	240	240
T	Transport Time to User ⁽⁵⁾	(Hrs)		48	48	48	48	480	480	480
TB	Soil Exposure Time ⁽¹⁾	(Hrs)	131400	131400	131400	131400	131400	131400	131400	131400
TE	Crop Exposure Time to Plume	(Hrs)	1440	1440	720	1440	720	1440	720	1440
TH	Holdup After Harvest	(Hrs)	1440	24	0	2160	0	2160	0	2160
QF	Animals Daily Feed	(Kg/Day)			50	50	6	6	50	50
FP	Fraction of Year on Pasture ⁽²⁾				0.50		0.50		0.50	
FS	Fraction Pasture When on Pasture ⁽³⁾				1		1		1	
FG	Fraction of Stored Veg. Grown in Garden		0.76							
FL	Fraction of Leafy Veg. Grown in Garden			1						
FI	Fraction Elemental Iodine = 0.5									
A	Absolute Humidity = 5.6 (gm/m ³) ⁽⁴⁾									

*Regulatory Guide 1.109, Revision 1.

TABLE 6.9.1 (Continued)

Notes:

- (1) For Method II dose/dose rate analyses of identified radioactivity releases of less than one year, the soil exposure time for that release may be set at 8760 hours (1 year) for all pathways.
- (2) For Method II dose/dose rate analyses performed for releases occurring during the first or fourth calendar quarters, the fraction of time animals are assumed to be on pasture is zero (nongrowing season). For the second and third calendar quarters, the fraction of time on pasture (FP) will be set at 1.0. FP may also be adjusted for specific farm locations if this information is so identified and reported as part of the land use census.
- (3) For Method II analyses, the fraction of pasture feed while on pasture may be set to less than 1.0 for specific farm locations if this information is so identified and reported as part of the land use census.
- (4) For all Method II analyses, an absolute humidity value equal to 5.6 (gm/m³) shall be used to reflect conditions in the Northeast (Reference: Health Physics Journal, Vol. 39 (August), 1980; Page 318-320, Pergamon Press).
- (5) Variable T is a combination of variables TF and TS in Regulatory Guide 1.109, Revision 1.

TABLE 6.9.2

Usage Factors for Various Gaseous Pathways at Vermont Yankee
(from Regulatory Guide 1.109, Table E-5)

Age Group	Vegetables (kg/yr)	Leafy Vegetables (kg/yr)	Milk (1/yr)	Meat (kg/yr)	Inhalation (m ³ /yr)
Adult	520.00	64.00	310.00	110.00	8000.00
Teen	630.00	42.00	400.00	65.00	8000.00
Child	520.00	26.00	330.00	41.00	3700.00
Infant	0.00	0.00	330.00	0.00	1400.00

6.10 Receptor Point and Long-Term Average Atmospheric Dispersion Factors for Important Exposure Pathways

The gaseous effluent dose methods have been simplified by assuming an individual whose behavior and living habits inevitably lead to a higher dose than anyone else. The following exposure pathways to gaseous effluents listed in Regulatory Guide 1.109 (Reference A) have been considered for radioiodines, tritium, and particulates with half lives greater than 8 days:

1. Direct exposure to contaminated ground;
2. Inhalation of air;
3. Ingestion of vegetables;
4. Ingestion of cow's milk; and
5. Ingestion of meat.

Beta and gamma air doses have also been considered for noble gases in plant effluents along with whole body and skin dose rate calculations.

Section 6.10.1 details the selection of important off-site locations and receptors. Section 6.10.2 describes the atmospheric model used to convert meteorological data into atmospheric dispersion factors. Section 6.10.3 presents the maximum atmospheric dispersion factors calculated at each of the off-site receptor locations.

6.10.1 Receptor Locations

Distances to the site boundary from the two evaluated gaseous release pathways (the Stack and North Warehouse) are provided in Table 6.10.2. Four important off-site receptor locations are considered in the dose and dose rate equations for gaseous radioactive effluents from these two release pathways. They are:

1. The point of maximum gamma exposure (maximum gamma X/Q) from an overhead noble gas cloud for determining skin and whole body dose rates and gamma air doses;
2. The point of maximum ground level air concentration (maximum undepleted X/Q) of noble gases for determining skin and beta air dose rates and doses;
3. The point of maximum ground level air concentration (maximum depleted X/Q) of radioiodines and other particulates for determining critical organ dose from inhalation; and
4. The point of maximum deposition (maximum D/Q) of radioiodines and other particulates for determining critical organ dose from ingestion.

The Stack release pathway was evaluated as an elevated release assuming a constant nominal Stack flow rate of 146,160 cfm. The point of maximum gamma exposure from Stack releases (SSE sector, 700 meters) was determined by finding the maximum five-year average gamma X/Q at any off-site location. The location of the maximum ground level air concentration and deposition of radioiodines and other particulates (WNW sector, 2150 meters) was determined by finding the maximum five-year average depleted X/Q and D/Q at any off-site location. For the purposes of determining the Method I dose factors for radioiodines, tritium, and particulates, a milk animal was assumed to exist at the location of highest calculated ground level air concentration and deposition of radioiodines and other particulates as noted above. This location then conservatively bounds the deposition of radionuclides at all real milk animal locations.

The North Warehouse release pathway was evaluated as a ground level release using the same meteorological period-of-record as the stack. The highest long-term atmospheric dispersion factors at the site boundary were determined (see Table 6.10.1) and doses and dose rates to the critical off-site receptor were calculated assuming the highest site boundary atmospheric dispersion factors all occurred at the same location.

6.10.2 Vermont Yankee Atmospheric Dispersion Model

The long-term average atmospheric dispersion factors are computed for routine releases using AEOLUS-2 Computer Code (Reference B). AEOLUS-2 is based, in part, on the constant mean wind direction model discussed in Regulatory Guide 1.111 (Reference C). Since AEOLUS-2 is a straight-line steady-state model, site-specific recirculation correction factors were developed for each release pathway to adjust the AEOLUS-2 results to account for temporal variations of atmospheric transport and diffusion conditions. The applicable recirculation correction factors are listed in Table 6.10.3.

AEOLUS-2 produces the following average atmospheric dispersion factors for each location:

1. Undepleted X/Q dispersion factors for evaluating ground level concentrations of noble gases;
2. Depleted X/Q dispersion factors for evaluating ground level concentrations of radioiodines and other particulates;
3. Gamma X/Q dispersion factors for evaluating gamma dose rates from a sector averaged finite cloud (undepleted source); and
4. D/Q deposition factors for evaluating dry deposition of elemental radioiodines and other particulates.

The North Warehouse depleted X/Q and D/Q factors were derived using the plume depletion and deposition curves provided in Regulatory Guide 1.111. However, because the Regulatory Guide 1.111 depletion and deposition curves are limited to an effective release height of 100 meters or less and the Vermont Yankee Stack effective release height (stack height plus plume rise) can exceed 100 meters, the Stack depleted X/Q and D/Q factors were derived using the deposition velocity concept presented in "Meteorology and Atomic Energy - 1968" (Reference E, Section 5-3.2) , assuming a constant deposition velocity of 1 cm/sec.

Gamma dose rate is calculated throughout this ODCM using the finite cloud model presented in "Meteorology and Atomic Energy - 1968 (Reference E, Section 7 5.2.5). That model is implemented through the definition of an effective gamma atmospheric dispersion factor, $[X/Q^y]$ (Reference B, Section 4), and the replacement of X/Q in infinite cloud dose equations by the $[X/Q^y]$.

6.10.3 Long-Term Average Atmospheric Dispersion Factors for Receptors

Actual measured meteorological data for the five-year period, 2002 through 2006, were analyzed to determine all the values and locations of the maximum off-site long-term average atmospheric dispersion factors. Each dose and dose rate calculation incorporates the maximum applicable off-site long-term average atmospheric dispersion factor. The values used and their locations are summarized in Table 6.10.1. Table 6.10.1 also indicates which atmospheric dispersion factors are used to calculate the various doses or dose rates of interest.

TABLE 6.10.1

Atmospheric Dispersion Factors

Release Pathway	Dispersion Factor	Dose to Individual			Dose to Air	
		Total Body	Skin	Critical Organ	Gamma	Beta
Stack	X/Q Depleted (sec/m ³)	-	-	1.25E-06 (2150m WNW)	-	-
	X/Q Undepleted (sec/m ³)	-	1.59E-06 (26500m SW)	-	-	1.59E-06 (2650m SW)
	D/Q (1/m ²)	-	-	1.25E-08 (2150m WNW)	-	-
	X/Q ^y (sec/m ³)	7.51E-07 (700m SSE)	7.51E-07 (700m SSE)	-	7.51E-07 (700m SSE)	-
North Warehouse	X/Q Depleted (sec/m ³)	-	-	3.44E-05 (451m ENE)	-	-
	X/Q Undepleted (sec/m ³)	-	3.65E-05 (451m ENE)	-	-	3.65E-05 (451m ENE)
	D/Q (1/m ²)	-	-	6.40E-08 (357m S)	-	-
	X/Q ^y (sec/m ³)	7.37E-06 (451m ENE)	7.37E-06 (451m ENE)	-	7.37E-06 (451m ENE)	-

TABLE 6.10.2

Site Boundary Distances

<u>Downwind Sector</u>	<u>Stack Releases</u>	<u>North Warehouse Releases</u>
N	400 m	459 m
NNE	350 m	417 m
NE	350 m	417 m
ENE	400 m	451 m
E	500 m	570 m
ESE	700 m	561 m
SE	750 m	612 m
SSE	850 m	663 m
S	385 m	357 m
SSW	300 m	238 m
SW	250 m	213 m
WSW	250 m	213 m
W	300 m	221 m
WNW	400 m	281 m
NW	550 m	697 m
NNW	550 m	680 m

TABLE 6.10.3

Recirculation Correction Factors

A. Stack Releases

<u>Sector</u>	<u>0.5 Mi</u>	<u>1.5 Mi</u>	<u>2.5 Mi</u>	<u>3.5 Mi</u>	<u>4.5 Mi</u>	<u>7.5 Mi</u>
N	1.4	1.4	1.2	1.1	1.0	1.0
NNE	1.8	1.8	1.4	1.2	1.0	1.0
NE	1.8	1.8	1.3	1.1	1.0	1.0
ENE	2.1	2.1	1.4	1.2	1.0	1.0
E	1.7	1.7	1.2	1.0	1.0	1.0
ESE	1.5	1.5	1.3	1.1	1.0	1.0
SE	1.8	1.8	1.3	1.2	1.1	1.0
SSE	1.4	1.4	1.2	1.2	1.2	1.2
S	1.3	1.3	1.1	1.1	1.2	1.2
SSW	1.8	1.8	1.5	1.4	1.4	1.2
SW	2.1	2.1	1.7	1.6	1.4	1.1
WSW	2.4	2.4	1.9	1.6	1.5	1.1
W	1.8	1.8	1.5	1.4	1.3	1.0
WNW	1.8	1.8	1.7	1.5	1.4	1.3
NW	1.5	1.5	1.3	1.3	1.3	1.1
NNW	1.5	1.5	1.2	1.2	1.1	1.1

B. North Warehouse Release

<u>Sector</u>	<u>0.5 Mi</u>	<u>1.5 Mi</u>	<u>2.5 Mi</u>	<u>3.5 Mi</u>	<u>4.5 Mi</u>	<u>7.5 Mi</u>
N	1.1	1.1	1.1	1.1	1.1	1.0
NNE	1.2	1.2	1.2	1.1	1.1	1.0
NE	1.1	1.2	1.1	1.1	1.0	1.0
ENE	1.2	1.3	1.4	1.4	1.4	1.3
E	1.1	1.3	1.4	1.4	1.4	1.2
ESE	1.1	1.1	1.2	1.1	1.1	1.0
SE	1.0	1.1	1.1	1.1	1.1	1.1
SSE	1.2	1.2	1.2	1.2	1.2	1.2
S	1.0	1.0	1.0	1.0	1.0	1.0
SSW	1.0	1.1	1.0	1.0	1.0	1.0
SW	1.2	1.3	1.2	1.0	1.0	1.0
WSW	1.1	1.1	1.0	1.0	1.0	1.0
W	1.2	1.2	1.1	1.0	1.0	1.0
WNW	1.2	1.4	1.3	1.2	1.2	1.0
NW	1.1	1.1	1.0	1.0	1.0	1.0
NNW	1.1	1.2	1.2	1.2	1.2	1.1

6.11 Method to Calculate Direct Dose From Plant Operation

Effluent Control 3.4.1 (40CFR190) restricts the dose to the whole body or any organ to any member of the public from all station sources (including direct radiation from fixed sources on-site) to 25 mrem in a calendar year (except the thyroid, which is limited to 75 mrem).

6.11.1 Turbine Building

The maximum contribution of direct dose to the whole body or to any organ due to N-16 decay from the turbine is:

$$D_d = K'_{N-16} K_{tissue} K_{calib} D_{MSLRM} \quad (6-27a)$$

where:

- D_d = Dose contribution (mrem) from N¹⁶ decay to the site boundary critical receptor (West sector),
- K'_{N-16} = 1.42E-05 [unitless correlation factor between the site boundary exposure (mR) and the time integral of the average MSLRM readings (mR)],
- K_{tissue} = 0.60 [conversion factor, from radiation exposure in air to tissue dose (mrem/mR)],
- K_{calib} = 508.8 (mR/hr) / [Average MSLRM reading (mR/hr) for a calibration source of 500 mR/hr during the exposure interval of interest]

[**Note:** MSLRM calibrations would normally fall within the time interval of interest. In such cases, one approach would be to calculate the time integrals of the MSLRM readings separately for the periods before and after calibration, and then adjust each result by the corresponding calibration correction factor. A second (less complicated, though more conservative) approach would be to use the highest K_{calib} factor during the interval for both the pre- and post-calibration periods.]

D_{MSLRM} = Time integral of the MSLRM average reading (mR) during the interval ΔT .

The last variable is defined as:

$$D_{MSLRM} = \sum_{i=1}^n \left[\sum_{j=1}^m (R_{j,i}) / m \right] \Delta t_i \quad (6-27b)$$

where

$R_{j,i}$ = MSLRM reading (mR/hr) by radiation monitor j at sequential time step t_i , assumed to be constant during the time subinterval Δt_i (as defined below),

m = Number of functioning MSLRMs during the subinterval Δt_i ,

Δt_i = Time subinterval (hr), within ΔT , defined to span the interval between t_i and the next monitor reading, i.e.:

$$\Delta t_i = t_{i+1} - t_i \quad (6-27c)$$

n = Number of subintervals Δt_i within ΔT , such that

$$\Delta T = \sum_{i=1}^n \Delta t_i \quad (6-27d)$$

During plant shutdown conditions, zero MSLRM readings should be assigned since there is no N^{16} production in the core. As a conservative alternative, actual readings (reflecting relatively-low background radiation) may be utilized. Also, archived monitor readings which get accidentally lost should be assigned estimated values; a single monitor reading may be provided for this, for any single time interval spanning the entire period with continuous loss in the archived data base.

The dose computed using the above equations may be conservatively applied to the nearest residence. However, it may be corrected for occupancy time (by multiplying the dose by the fraction of time typically spent by the resident at the location during the period of interest), if documented. Dose reduction by the shielding provided by the residential structure may also be considered.

6.11.2 North Warehouse

Radioactive materials and low level waste can be stored in the North Warehouse. The maximum annual dose contributions to off-site receptors (west site boundary line) from sources in the shielded (east) end and the unshielded (west) end of the North Warehouse are:

$$D_S = 0.25 \times \dot{R}_S \text{ for the shielded end} \quad (6-28)$$
$$\left(\frac{\text{mrem}}{\text{yr}}\right) \left(\frac{\text{mrem/yr}}{\text{mrem/hr}}\right) \left(\frac{\text{mrem}}{\text{hr}}\right)$$

and

$$D_U = 0.53 \times \dot{R}_U \text{ for the unshielded end} \quad (6-29)$$
$$\left(\frac{\text{mrem}}{\text{yr}}\right) \left(\frac{\text{mrem/yr}}{\text{mrem/hr}}\right) \left(\frac{\text{mrem}}{\text{hr}}\right)$$

where:

D_S = The annual dose contribution at the maximum site boundary location from fixed sources of radiation stored in the shielded east end of the North Warehouse $\left(\frac{\text{mrem}}{\text{yr}}\right)$.

D_U = The annual dose contribution at the maximum site boundary location from fixed sources of radiation stored in the unshielded west end of the North Warehouse $\left(\frac{\text{mrem}}{\text{yr}}\right)$.

\dot{R}_S = Dose rate measured at 1 meter from the source in the shielded end of the north warehouse $\left(\frac{\text{mrem}}{\text{hr}}\right)$.

\dot{R}_U = Dose rate measured at 1 meter from the source in the unshielded end of the north warehouse $\left(\frac{\text{mrem}}{\text{hr}}\right)$.

0.25 = Dose rate to dose conversion factor which relates mrem/yr at the west site boundary per mrem/hr measured at 1 meter from the source in the shielded end of the warehouse assuming it is full to capacity for one year

$$\left(\frac{\text{mrem/yr}}{\text{mrem/hr}} \right).$$

0.53 = Dose rate to dose conversion factor which relates mrem/yr at the west site boundary per mrem/hr measured at 1 meter from the source in the unshielded end of the warehouse assuming it is full to capacity for one year

$$\left(\frac{\text{mrem/yr}}{\text{mrem/hr}} \right).$$

6.11.3 Low Level Waste Storage Pad

Interim storage of packaged Dry Active Waste (DAW) and spent ion exchange and filter media is permitted in modular concrete storage overpacks on the LLW storage pad facility adjacent to the north warehouse. The arrangement of the storage modules is such that DAW is placed in modules which shield higher activity ion exchange media from the west site boundary. The dose at the maximum site boundary receptor from both direct radiation and skyshine scatter can be calculated as follows:

(a) Direct Dose (line of sight)

$$D_{dE} = 0.28 \times \dot{R}_d \times f_d$$

$$\left(\frac{\text{mrem}}{\text{yr-module}} \right) \left(\frac{\text{mrem/yr}}{\text{mrem/hr}} \right) \left(\frac{\text{mrem}}{\text{hr}} \right) (\#) \quad (6-30)$$

or

$$D_{dS} = 0.39 \times \dot{R}_d \times f_d$$

$$\left(\frac{\text{mrem}}{\text{yr-module}} \right) \left(\frac{\text{mrem/yr}}{\text{mrem/hr}} \right) \left(\frac{\text{mrem}}{\text{hr}} \right) (\#) \quad (6-31)$$

where:

- D_{dE} = The annual direct dose contribution at the maximum site boundary from a single rectangular storage module which has an unobstructed short end surface (not shielded by other modules) orientated toward the west site boundary $\left(\frac{\text{mrem}}{\text{yr- module}} \right)$.
- D_{dS} = The annual direct dose contribution at the maximum site boundary from a single rectangular storage module which has an unobstructed long side surface (not shielded by other modules) orientated toward the west site boundary $\left(\frac{\text{mrem}}{\text{yr- module}} \right)$.
- \dot{R}_d = Maximum dose rate measured at 3 feet from the side of the storage module whose unobstructed face (i.e., a side or end surface which is not shielded by other waste modules) is toward the west site boundary.
- f_d = The fraction of a year that a storage module is in use on the storage pad.
- 0.28 = Dose rate to dose conversion factor which relates mrem/yr at the west site boundary per mrem/hr measured at 3 feet from the narrow end of the rectangular storage module when that face is orientated toward the west boundary.
- 0.39 = Dose rate to dose conversion factor which relates mrem/yr at the west site boundary per mrem/hr measured at 3 feet from the long side of the rectangular storage module when that face is orientated toward the west boundary.

(b) Scatter From Skyshine

$$D_{SKR} = 0.016 \times \dot{R}_{SKR} \times f_{sk} \quad (6-32)$$
$$\left(\frac{\text{mrem}}{\text{yr-liner}} \right) \quad \left(\frac{\text{mrem/yr}}{\text{mrem/hr}} \right) \quad \left(\frac{\text{mrem}}{\text{hr}} \right) \quad (\#)$$

and

$$D_{SKD} = 0.015 \times \dot{R}_{SKD} \times f_{sk} \quad (6-33)$$
$$\left(\frac{\text{mrem}}{\text{yr-module}} \right) \quad \left(\frac{\text{mrem/yr}}{\text{mrem/hr}} \right) \quad \left(\frac{\text{mrem}}{\text{hr}} \right) \quad (\#)$$

where:

R_{SKR} = The annual skyshine scatter contribution to the dose at the maximum site boundary from a single spent ion exchange media liner in a storage module whose top surface is not obstructed due to stacking of modules $\left(\frac{\text{mrem}}{\text{yr-liner}} \right)$.

R_{SKD} = The annual skyshine scatter contribution to the dose at the maximum site boundary from a rectangular storage module containing DAW whose top surface is not obstructed due to stacking of modules $\left(\frac{\text{mrem}}{\text{yr-module}} \right)$.

\dot{R}_{SKR} = For Resins, the maximum dose rate measured at 3 feet over the top of each liner in a storage module (mrem/hr).

\dot{R}_{SKD} = For DAW, the maximum dose rate measured at 3 feet over the top surface of a storage module with DAW (mrem/hr).

f_{SK} = The fraction of a year that a storage module is in use on the storage pad.

- 0.016 = Dose rate to dose conversion factor for the scatter dose from each resin liner source in storage which relates mrem/yr at the west site boundary per mrem/hour at 3 feet from the top of the module.
- 0.015 = Dose rate to dose conversion factor for the scatter dose from DAW boxes in storage which relates mrem/yr at the west site boundary per mrem/hr at 3 feet from the top of the module.

(c) Dose From Resin Liners During Transfer

During the movement of resin liners from transfer casks to the storage modules, the liners will be unshielded in the storage pad area for a short period of time. The maximum dose contribution at the site boundary during the unshielded movement of resin liners can be calculated from:

$$D_{\text{trans}} = 0.0025 \times \dot{R}_{\text{tran}} \times T_{\text{trans}} \quad (6-34)$$

(mrem) $\left(\frac{\text{mrem/hr}}{\text{rad/hr}} \right)$ $\left(\frac{\text{rad}}{\text{hr}} \right)$ (hr)

where:

- D_{trans} = The dose contribution to maximum site boundary resulting from the unshielded movement of resin liners between a transfer cask and a storage module (mrem).
- \dot{R}_{trans} = Dose rate measured at contact (2") from the unshielded top surface of the resin liner in R/hr.
- T_{tran} = The time (in hours) that an unshielded resin liner is exposed in the storage pad area.
- 0.0025 = The dose rate to dose conversion factor for an unshielded resin liner which relates mrem/hour at the west site boundary per rad/hr at contact (2") from the unshielded surface of the liner.

(d) Intermodular Gap Dose

In addition to the above methods for determining doses at the west site boundary from the LLW storage pad, another dose assessment model has been included to address the possible condition of spaces or gaps existing between the placement of the DAW storage modules situated along the west facing side of the pad. This could result in a radiation streaming condition existing if ion exchange resin liners were placed in storage directly behind the gap. The direct dose equations (6-30 and 6-31) consider that the storage modules situated on the outside of the pad area provide a uniform shield to storage modules placed behind them. The intermodular gap dose equation (6-35) accounts for any physical spacing between the outside storage modules which have not been covered by additional external shielding.

$$D_{\text{Gap}} = 2.44 \text{ E-} 2 \times W_{\text{Gap}} \times A_{\text{RL}} \times f_{\text{Gap}} \quad (6-35)$$
$$\left(\frac{\text{mrem}}{\text{yr}} \right) \quad \left(\frac{\text{mrem}}{\text{yr-in-Ci}} \right) \quad (\text{in}) \quad (\text{Ci}) \quad (\#)$$

where:

D_{Gap} = The annual dose contribution at the maximum site boundary (west) from radiation streaming through the intermodular gap between DAW storage modules used to shield resin modules from direct radiation (mrem/yr).

W_{Gap} = The intermodular gap width (inches) between adjacent DAW storage modules facing the west site boundary.

A_{RL} = The total gamma activity contained in a condensate resin liner stored directly in line with the intermodular gap adjacent DAW modules (Ci).

f_{Gap} = The fraction of a year that the intermodular gap is not shielded.

2.44E-2 = The activity to site boundary dose conversion factor for a one-inch wide intermodular gap $\left(\frac{\text{mrem}}{\text{yr-in-Ci}} \right)$.

The site boundary dose from waste materials placed into storage on the Low Level Waste Storage Pad Facility is determined by combining the dose contribution due to direct radiation (line of sight) from Part (a) above with the skyshine scatter dose from Part (b), resin liner transfer dose from Part (c), and any intermodular gap dose from Part (d).

6.11.4 Independent Spent Fuel Storage Installation Dose Contribution

The Independent Spent Fuel Storage Installation (ISFSI) has been constructed to provide a secure location for the long term storage of spent nuclear fuel bundles. This installation is located just north of the Radwaste Building and just east of the North Warehouse within the Vermont Yankee Protected Area. The vendor, Holtec International, has prepared a study report to satisfy the requirements of 10CFR72.104 and this document is included as Reference H. During the first fuel storage evolution, five casks will be located on the installation pad. Over subsequent years, up to 35 casks will be stored on the pad.

The shielding analysis of the Independent Spent Fuel Storage Installation is provided in Reference H. The report analyzes the dose generated from a single cask as well as the dose generated from 5 casks for both the first row (266 meters to the west site boundary) and the last row (300 meters from the west site boundary) on the ISFSI pad. The dose from each cask to the west site boundary (DR-53 Location) is computed using the following equation:

(a) Direct Dose From Each Cask at 266 Meters Distance to the West Site Boundary

$$D_{ec-266m} = 3.19E-5 \times H \quad (6-36)$$

[mrem/cask] [mrem/hour] [hours per period]

where:

$D_{ec-266m}$ = Direct Dose calculated at the West Site Boundary where the cask is located at the west end of the pad approximately 266 meters from the DR-53 Location

3.19E-5 = Dose rate (hourly) from each cask calculated to the DR-53 Location

H = Number of hours in the period of interest (168 hours per week, 720 or 744 hours per month and 2208 hours per standard quarter)

(b) Direct Dose From Each Cask at 300 Meters Distance to the West Site Boundary

$$D_{ec-300m} = 2.05E-5 \times H \quad (6.37)$$

[mrem/cask] [mrem/hour] [hours per period]

where:

$D_{ec-300m}$ = Direct Dose calculated at the West Site Boundary where the cask is located at the west end of the pad approximately 300 meters from the DR-53 Location

$2.05E-5$ = Dose rate (hourly) from each cask calculated to the DR-53 Location

H = Number of hours in the period of interest (168 hours per week, 720 or 744 hours per month and 2208 hours per standard quarter)

(c) Dose From All Casks on the ISFSI Pad

The total dose at the west site boundary (DR-53 Location) for all casks located on the ISFSI Pad during a period of interest is calculated as follows:

$$D_{ac-Total} = (D_{ec-266m} \times N_{(266m)}) + (D_{ec-300m} \times N_{(300m)}) \quad (6-38)$$

[mrem/all casks] [mrem/period] [casks per period] [mrem/period] [casks per period]

where:

$D_{ac-Total}$ = Dose (mrem) at the West Site Boundary (DR-53 Location) from all Casks located on the ISFSI pad during the period of interest

$D_{ec-266m}$ = Direct Dose calculated at the West Site Boundary from cask(s) located at the west end of the pad approximately 266 meters from the DR-53 Location

$N_{(266m)}$ = Number of casks located at the west end of the pad approximately 266 meters from the DR-53 Location during the period of interest

$D_{ec-300m}$ = Direct Dose calculated at the West Site Boundary from casks located at the west end of the pad approximately 300 meters from the DR-53 Location

$N_{(300m)}$ = Number of casks located at the east end of the pad approximately 300 meters from the DR-53 Location during the period of interest

6.11.4 Total Direct Dose Summary

The dose contributions from the N-16 source in the Turbine Building, fixed sources in the North Warehouse, and fixed sources on the Low Level Waste Storage Pad Facility, shall be combined to obtain the estimate of total off-site dose to any member of the public from all fixed sources of radiation located on-site.

6.11.5 Other Fixed Sources

In addition to the fixed sources noted above (Turbine Building, North Warehouse, and LLW Storage Pad), other identified temporary or fixed sources that are created due to plant operations will be included in the total direct summary of 6.11.4 if the projected annual dose contribution would add any notable addition to the reported total (i.e., ≥ 0.1 mrem/yr).

In 1995, turbine rotors and casings were replaced in the Turbine Hall with the old rotors and casings placed in storage sheds located on site west of the switchyard along the railroad spur. Radiation surveys (December 1995) of low level contamination (principally Co-60) on the components led to a projected maximum west site boundary dose of 0.2 mrem/yr. This contribution will be added to the maximum site boundary total dose until the contribution is less than 0.1 mrem/yr, or the components are removed from storage location.

6.12 Cumulative Doses

Cumulative Doses for a calendar quarter and a calendar year must be maintained to demonstrate a compliance with Controls 3.2.2, 3.3.2, and 3.3.3 (10CFR50, Appendix I dose objectives). In addition, if the requirements of the Action Statement of Control 3.4.1 dictate, cumulative doses over a calendar year must be determined (demonstration of compliance with total dose, including direct radiation per requirements of 40CFR190). To ensure the limits are not exceeded, a running total must be kept for each release.

Demonstration of compliance with the dose limits of 40CFR190 is considered as demonstrating compliance with the 0.1 rem limit of 10CFR20.1301(a)(1) for members of the public in unrestricted areas.

7.0 ENVIRONMENTAL MONITORING PROGRAM

The radiological environmental monitoring stations are listed in Table 7.1. The locations of the stations with respect to the Vermont Yankee plant are shown on the maps in Figures 7-1 to 7-6.

7.1 Intercomparison Program

All routine radiological analyses for environmental samples are performed at offsite environmental laboratories. The laboratories participate in several commercial inter-comparison programs in addition to an internal QC sample analysis program and the analysis of client-introduced QC sample programs. The external programs may include the Department of Energy – Mixed Analyte Performance Evaluation Program (MAPEP), Analytics Cross-Check Program - Environmental Inter-laboratory Cross-Check Program, and Environmental Resources Association - Environmental Radioactivity Performance Evaluation Program or other NRC-approved sources.

7.2 Airborne Pathway Monitoring

The environmental sampling program is designed to achieve several major objectives, including sampling air in predominant up-valley and down-valley wind directions, and sampling air in nearby communities and at a proper control location, while maintaining continuity with two years of preoperational data and all subsequent years of operational data (post 1972.) The chosen air sampling locations are discussed below.

To assure that an unnecessarily frequent relocation of samplers will not be required due to short-term or annual fluctuations in meteorology, thus incurring needless expense and destroying the continuity of the program, long term, site specific ground level D/Qs (five-year averages - 1978 through 1982) were evaluated in comparison to the existing air monitoring locations to determine their adequacy in meeting the above-stated objectives of the program and the intent of the NRC general guidance. The long-term average meteorological data base precludes the need for an annual re-evaluation of air sampling locations based on a single year's meteorological history.

The Connecticut River Valley in the vicinity of the Vermont Yankee plant has a pronounced up- and down-valley wind flow. Based on five years of meteorological data, wind blows into the 3 "up-valley" sectors (N, NNW, and NW) 27 percent of the time, and the 4 "down-valley" sectors (S, SSE, SE, and ESE) 40 percent of the time, for a total "in-valley" time of 67 percent.

Station AP/CF-12 (NNW, 3.6 km) in North Hinsdale, New Hampshire, monitors the up-valley sectors. It is located in the sector that ranks fourth overall in terms of wind frequency (i.e., in terms of how often the wind blows into that sector), and is approximately 0.5 miles from the location of the calculated maximum ground level D/Q (i.e., for any location in any sector, for the entire Vermont Yankee environs). This station provides a second function by its location in that it also monitors North Hinsdale, New Hampshire, the community with the second highest ground level D/Q for surrounding communities, and it has been in operation since the preoperational period.

The down-valley direction is monitored by two stations - at River Station Number 3.3 (AP/CF-11, SSE, 1.9 km) and at Northfield, Massachusetts (AP/CF-14, SSE, 11.6 km). They both reside in the sector with the maximum wind frequency and they bound the down-valley point of calculated maximum ground level D/Q (the second highest overall ground level D/Q for any location in any sector). Station AP/CF-11 is approximately one mile from this point, between it and the plant. Station AP/CF-14 also serves as a community monitor for Northfield, Massachusetts. Both stations have been in operation since the preoperational period.

In addition to the up- and down-valley locations, two communities have been chosen for community sampling locations. The four nearest population groups with the highest long-term average D/Q values, in decreasing order, are Northfield, Massachusetts, North Hinsdale, New Hampshire, Brattleboro, Vermont, and Hinsdale, New Hampshire. The community sampler for Northfield is at Station AP/CF-14 (mentioned above). North Hinsdale is already monitored by the up-valley station (AP/CF-12, NNW, 3.6 km), which also indirectly monitors the city of Brattleboro, located further out in the same sector. The second sampler specifically designated for a community is at Hinsdale Substation (AP/CF-13, E, 3.1 km) in Hinsdale.

The control air sampler was located at Spofford Lake (AP/CF-21, NNE, 16.4 km) due to its distance from the plant and the low frequency for wind blowing in that direction based on the long-term (five-year) meteorological history. Sectors in the general west to southwest direction, which would otherwise have been preferable due to lower wind frequencies, were not chosen since they approached the region surrounding the Yankee Atomic plant in Rowe, Massachusetts.

An additional air sampler is maintained at the Tyler Hill site (AP/CF-15, WNW, 3.1 km), which is along the western side of the valley in general proximity of historical dairy operations. (The sixth location is not a specific Program requirement as detailed in Table 3.5.1.)

7.3 Distances and Directions to Monitoring Stations

It should be noted that the distances and directions for direct radiation monitoring locations in Table 7.1, as well as the sectors shown in Figures 7-5 and 7-6, are keyed to the center of the Turbine Building due to the critical nature of the Turbine Building-to-TLD distance for close-in stations. For simplicity, all other radiological environmental sampling locations use the plant stack as the origin.

Control Table 3.5.1, Footnote a, specifies that in the Annual Radiological Environmental Operating Report and ODCM, the reactor shall be used as the origin for all distances and directions to sampling locations. Vermont Yankee interprets “the reactor” to mean the reactor site which includes the plant stack and the Turbine Building. The distances to the plant stack and Turbine Building will, therefore, be used in the Annual Radiological Environmental Operating Reports and ODCM for the sampling and TLD monitoring stations, respectively.

Table 7.1

Radiological Environmental Monitoring Stations⁽¹⁾

<u>Exposure Pathway and/or Sample Direction⁽⁵⁾</u>	<u>Sample Location and Designated Code⁽²⁾</u>	<u>Distance (km)⁽⁵⁾</u>	
1. AIRBORNE (Radioiodine and Particulate)			
	AP/CF-11 River Station No. 3-3	1.88	SSE
	AP/CF-12 N. Hinsdale, NH	3.61	NNW
	AP/CF-13 Hinsdale Substation	3.05	E
	AP/CF-14 Northfield, MA	11.61	SSE
	AP/CF-15 Tyler Hill Road ⁽⁴⁾	3.14	WNW
	AP/CF-21 Spofford Lake	16.36	NNE
2. WATERBORNE			
a. Surface	WR-11 River Station No. 3-3	1.88	Downriver
	WR-21 Rt. 9 Bridge	11.83	Upriver
b. Ground	WG-11 Plant Well	0.24	On-Site
	WG-12 Vernon Nursing Well	2.13	SSE
	WG-13 COB Well ⁽⁴⁾	0.26	On-Site
	WG-14 Plant Support Bldg Well ⁽⁴⁾	0.27	On-Site
	WG-22 Copeland Well	13.73	N
c. Sediment From Shoreline	SE-11 Shoreline Downriver	0.57	SSE
	SE-12 North Storm Drain Outfall ⁽³⁾	0.13	E
3. INGESTION			
a. Milk ⁽⁸⁾	TM-11 Miller Farm	0.82	W
	TM-14 Brown Farm	2.22	S
	TM-18 Blodgett Farm	3.60	SE
	TM-22 Franklin Farm ⁽⁴⁾	9.73	WSW
	TM-24 County Farm	21.64	N
b. Mixed Grasses	TG-11 River Station No. 3-3	1.88	SSE
	TG-12 N. Hinsdale, NH	3.61	NNW
	TG-13 Hinsdale Substation	3.05	E
	TG-14 Northfield, MA	11.61	SSE
	TG-15 Tyler Hill Rd. ⁽⁴⁾	3.07	WNW
	TG-21 Spofford Lake	16.36	NNE

TABLE 7.1 (Continued)

<u>Exposure Pathway and/or Sample Direction⁽⁵⁾</u>	<u>Sample Location and Designated Code⁽²⁾</u>	<u>Distance (km)⁽⁵⁾</u>	
c. Silage	TC-11 Miller Farm	0.82	W
	TC-14 Brown Farm	2.22	S
	TC-18 Blodgett Farm	3.60	SE
	TC-22 Franklin Farm ⁽⁴⁾	9.73	WSW
	TC-24 County Farm	21.64	N
d. Fish	FH-11 Vernon Pond	(6)	(6)
	FH-21 Rt. 9 Bridge	11.83	Upriver
4. DIRECT RADIATION			
	DR-1 River Station No. 3-3	1.61	SSE
	DR-2 N. Hinsdale, NH	3.88	NNW
	DR-3 Hinsdale Substation	2.98	E
	DR-4 Northfield, MA	11.34	SSE
	DR-5 Spofford Lake	16.53	NNE
	DR-6 Vernon School	0.52	WSW
	DR-7 Site Boundary ⁽⁷⁾	0.28	W
	DR-8 Site Boundary	0.25	SSW
	DR-9 Inner Ring	1.72	N
	DR-10 Outer Ring	4.49	N
	DR-11 Inner Ring	1.65	NNE
	DR-12 Outer Ring	3.58	NNE
	DR-13 Inner Ring	1.23	NE
	DR-14 Outer Ring	3.88	NE
	DR-15 Inner Ring	1.46	ENE
	DR-16 Outer Ring	2.84	ENE
	DR-17 Inner Ring	1.24	E
	DR-18 Outer Ring	2.97	E
	DR-19 Inner Ring	3.65	ESE
	DR-20 Outer Ring	5.33	ESE
	DR-21 Inner Ring	1.82	SE
	DR-22 Outer Ring	3.28	SE
	DR-23 Inner Ring	1.96	SSE
	DR-24 Outer Ring	3.89	SSE
	DR-25 Inner Ring	1.91	S

TABLE 7.1 (Continued)

<u>Exposure Pathway and/or Sample Direction⁽⁵⁾</u>	<u>Sample Location and Designated Code⁽²⁾</u>	<u>Distance (km)⁽⁵⁾</u>	
	DR-26 Outer Ring	3.77	S
	DR-27 Inner Ring	1.10	SSW
	DR-28 Outer Ring	2.23	SSW
	DR-29 Inner Ring	0.92	SW
	DR-30 Outer Ring	2.36	SW
	DR-31 Inner Ring	0.71	WSW
	DR-32 Outer Ring	5.09	WSW
	DR-33 Inner Ring	0.66	WNW
	DR-34 Outer Ring	4.61	W
	DR-35 Inner Ring	1.30	WNW
	DR-36 Outer Ring	4.43	WNW
	DR-37 Inner Ring	2.76	NW
	DR-38 Outer Ring	7.34	NW
	DR-39 Inner Ring	3.13	NNW
	DR-40 Outer Ring	5.05	NNW

- (1) Sample locations are shown on Figures 7.1 to 7.6.
- (2) Station Nos. 10 through 19 are indicator stations. Station Nos. 20 through 29 are control stations (for all except milk, silage and the direct radiation stations).
- (3) To be sampled and analyzed semiannually.
- (4) Non-required Control station.
- (5) Distance and direction from the center of the Turbine Building for direct radiation monitors; from the plant stack for all others.
- (6) Fish samples are collected from anywhere in Vernon Pond, which is adjacent to the plant (see Figure 7-1).
- (7) DR-7 satisfies Control Table 3.5.1 for an inner ring direct radiation monitoring location. However, it is averaged as a Site Boundary TLD due to its close proximity to the plant.
- (8) In accordance with Control Table 3.5.1, notation a, samples will be collected on the required schedule as availability of milk permits. All deviations from the sample schedule will be reported in the Annual Radiological Environmental Operating Report.

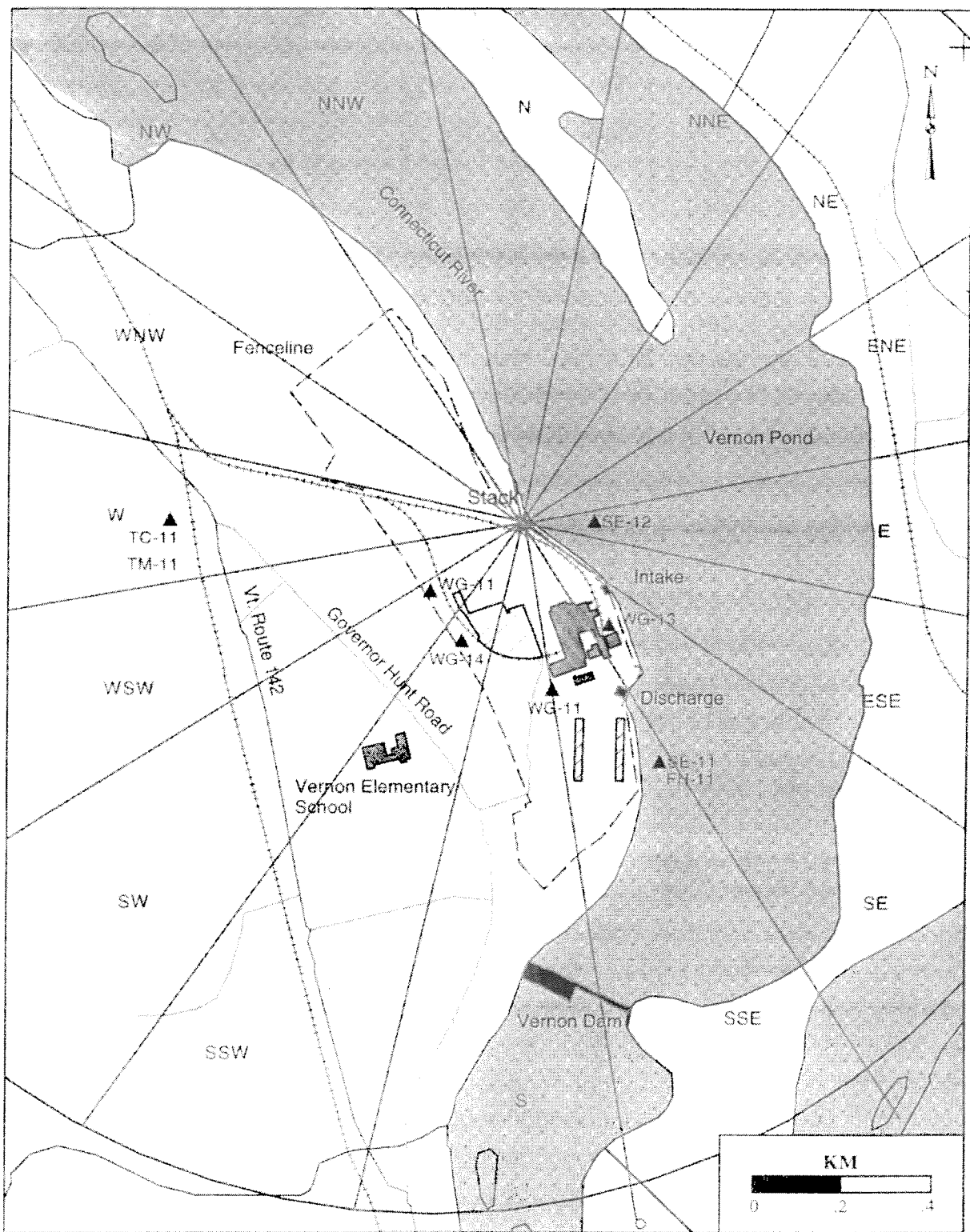

Figure 7-1 Environmental Sampling Locations in Close Proximity to the Plant

Off-Site Dose Calculation Manual
 Section 7
 Rev. 28
 Page 7 of 12

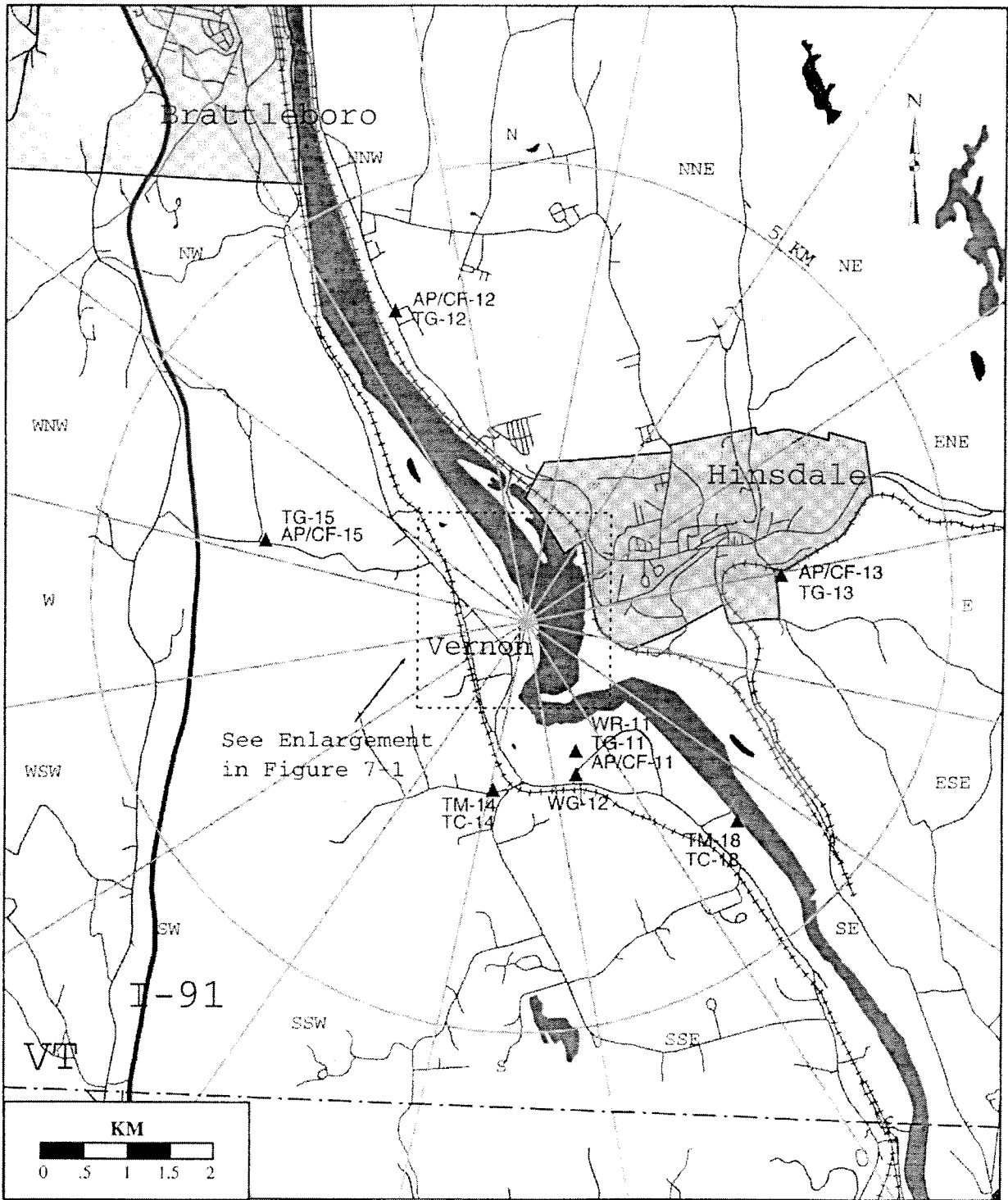

Figure 7-2 Environmental Sampling Locations Within 5 Km of Plant

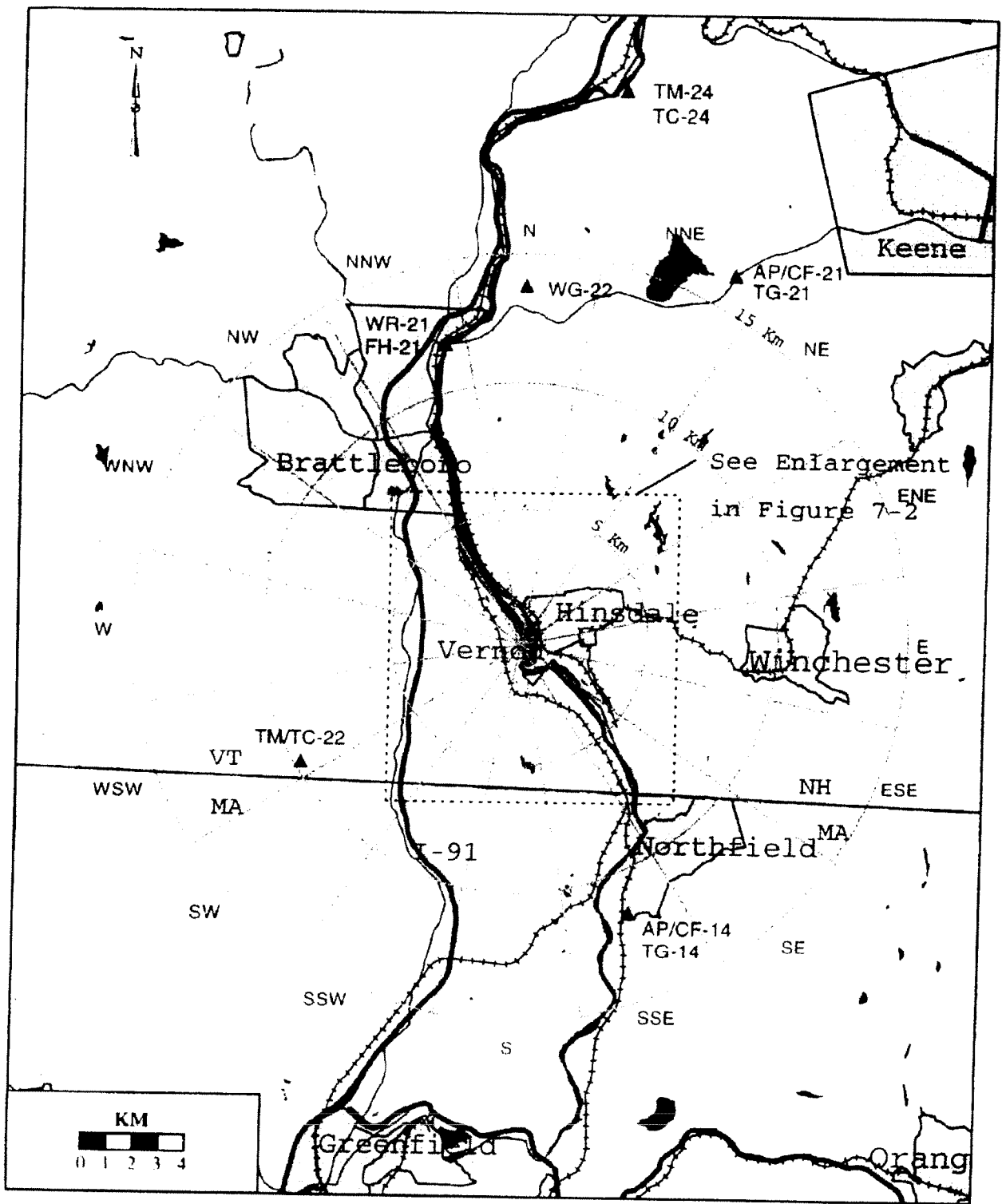

Figure 7-3 Environmental Sampling Locations Greater than 5 Km from Plant

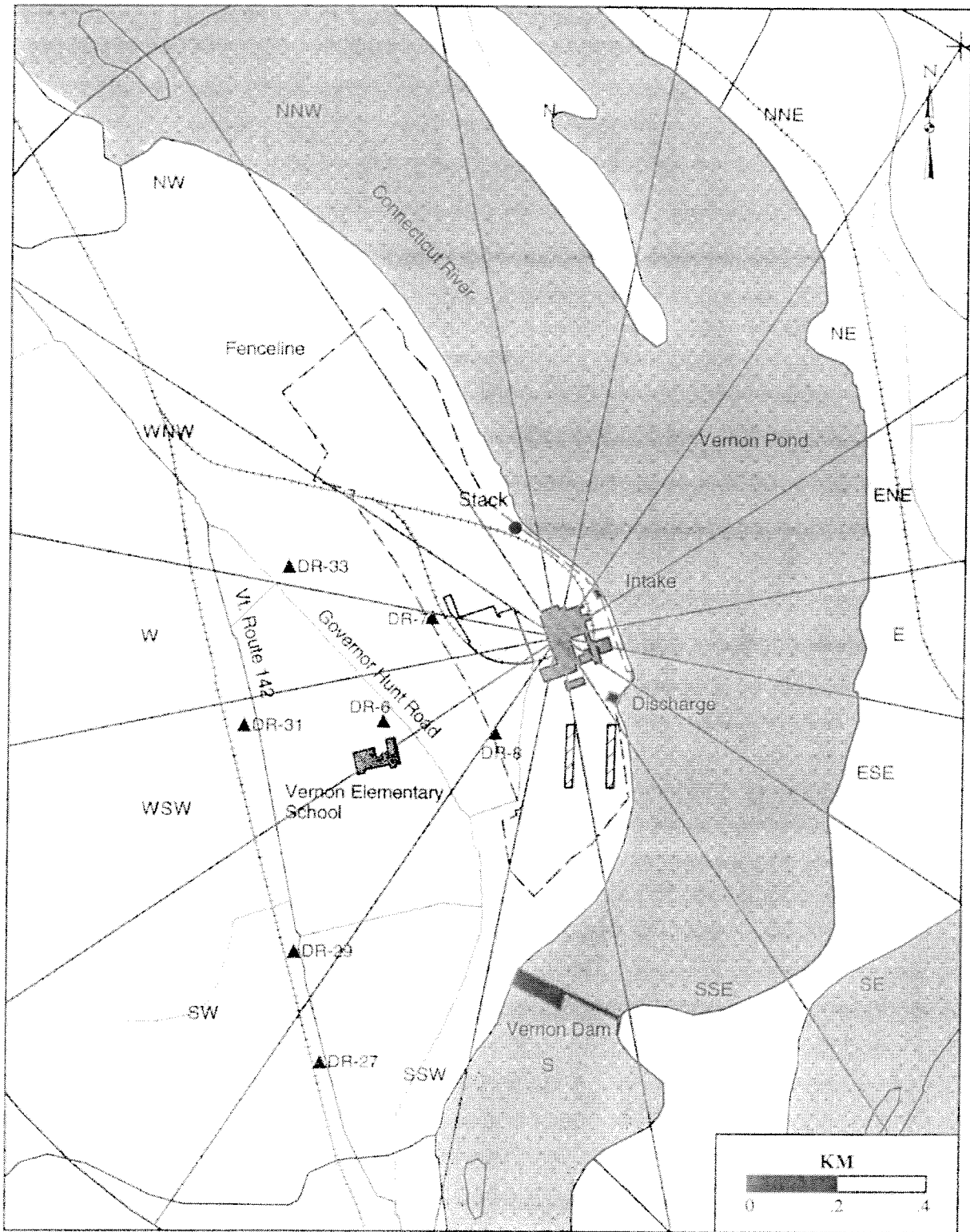

Figure 7-4 TLD Locations in Close Proximity to Plant

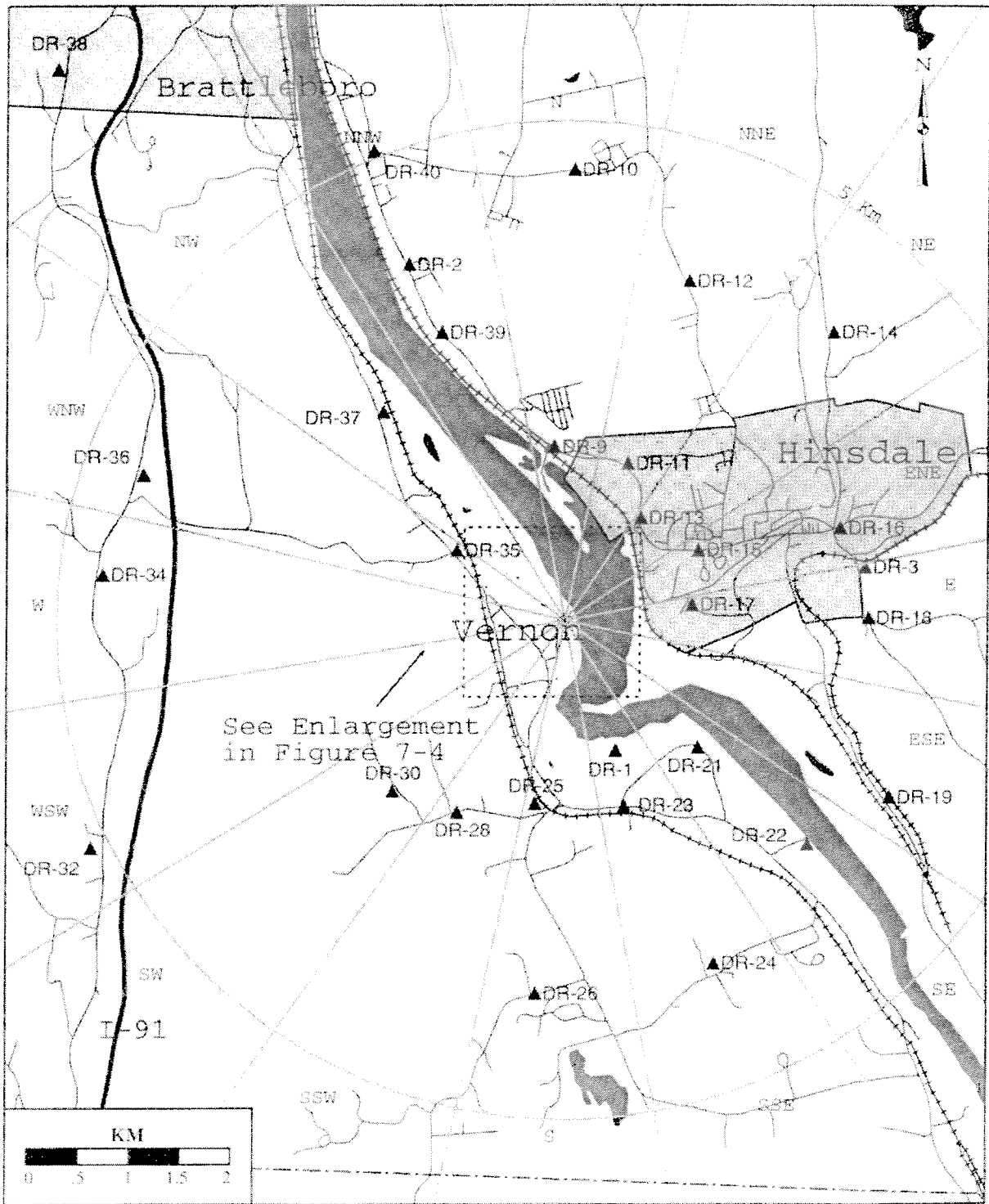

Figure 7-5 TLD Locations Within 5 Km of Plant

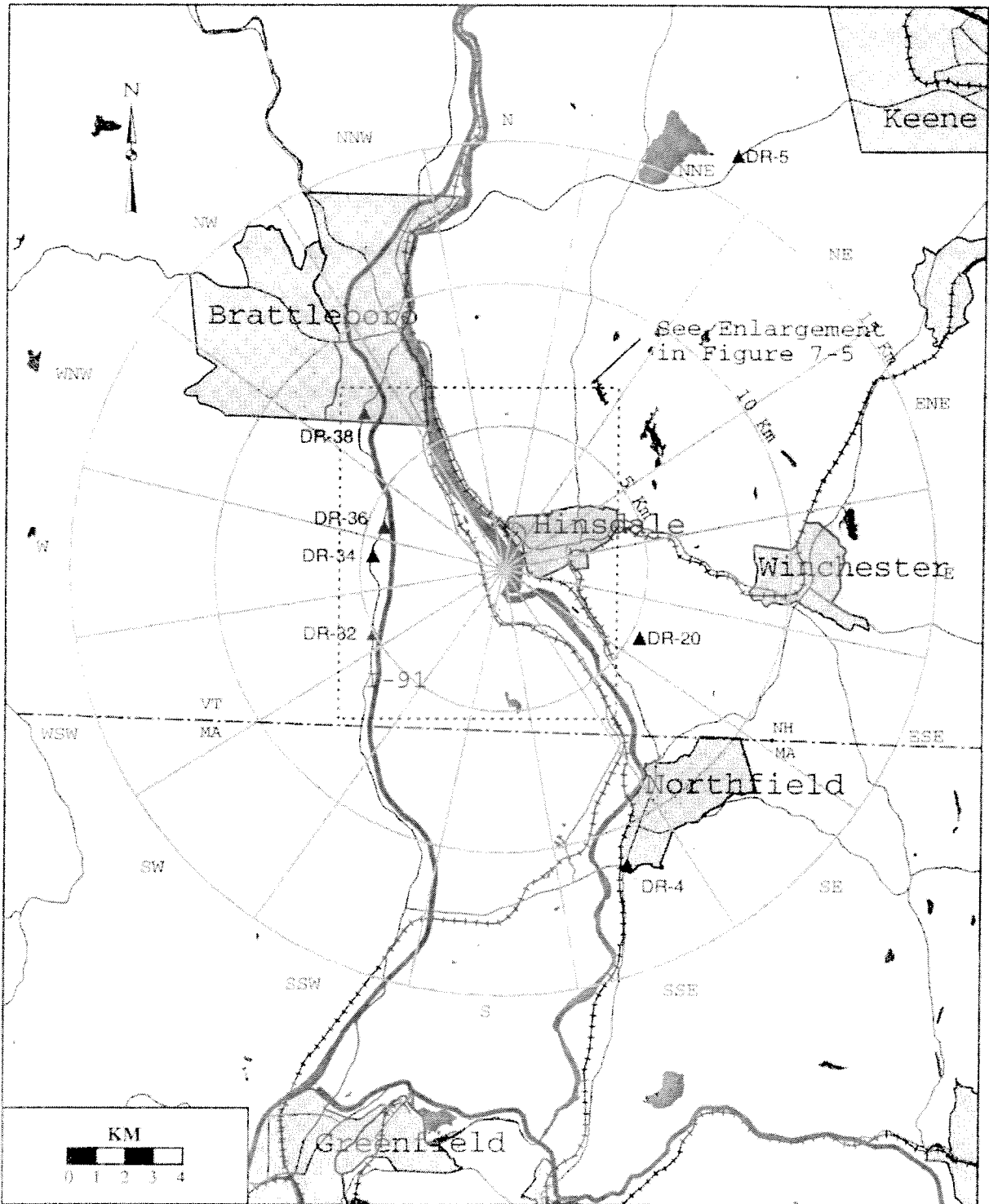

Figure 7-6 TLD Locations Greater Than 5 Km from Plant

8.0 SETPOINT DETERMINATIONS

Chapter 8 contains the basis for plant procedures used to meet the setpoint requirements of the Radioactive Effluent Instrumentation Controls. They are Control 3.1.1 for liquids and Control 3.1.2 for gases. Each outlines the instrumentation channels and the basis for each setpoint.

8.1 Liquid Effluent Instrumentation Setpoints

Control 3.1.1.1 requires that the radioactive liquid effluent instrumentation in Control Table 3.1.1 have alarm setpoints in order to ensure that Control 3.2.1 is not exceeded. Control 3.2.1 limits the activity concentration at any time in liquid effluents to ten items or less the effluent concentration values in Appendix B, Table 2, Column 2 of 10CFR20.1001 through 20.2402, and a total noble gas concentration limit of $2E-04$ $\mu\text{Ci/ml}$.

8.1.1 Liquid Radwaste Discharge Monitor (RM-17-350)

The sample tank pathways shown on Figure 9-1 are monitored by the liquid radwaste discharge monitor (RM-17-350). Periodic batch releases may be made from the waste sample tanks, detergent waste tank or floor drain sample tank.

8.1.1.1 Method to Determine the Setpoint of the Liquid Radwaste Discharge Monitor (RM-17-350)

The instrument response (in counts per second) for the limiting concentration at the point of discharge is the setpoint, denoted R_{setpoint} , and is determined as follows:

$$R_{\text{setpoint}} = \frac{DF}{DF_{\text{min}}} S_1 \sum_i C_{mi} \quad (8-1)$$

(cps) (#) $\left(\frac{\text{cps} - \text{ml}}{\mu\text{Ci}}\right)$ $\left(\frac{\mu\text{Ci}}{\text{ml}}\right)$

Where:

$$DF = \frac{F_d}{F_m} = \text{Dilution factor (as a conservative measure, a DF of at least 1000 is used) (dimensionless)} \quad (8-2)$$

F_m = Flow rate past monitor (gpm)

F_d = Flow rate out of discharge canal (gpm)

DF_{min} = Minimum allowable dilution factor (dimensionless)

$$= 0.1 \sum_i \frac{C_{mi}}{ECL_i} \quad (8-3)$$

ECL_i = Effluent concentration values for radionuclide "i" from 10CFR20.1001-20.2402, Appendix B, Table 2, Column 2 ($\mu\text{Ci/ml}$)

C_{mi} = Activity concentration of radionuclide "i" in mixture at the monitor ($\mu\text{Ci/ml}$)

S_1 = Detector counting efficiency from the most recent liquid radwaste discharge monitor calibration curve (cps/($\mu\text{Ci/ml}$))

8.1.1.2 Liquid Radwaste Discharge Monitor Setpoint Example

The following alarm setpoint example is for a discharge of the floor drain sample tank. The liquid radwaste discharge monitor has a typical counting efficiency, S_1 , of $4.9E+06$ cps per $1 \mu\text{Ci/ml}$ of gamma emitters which emit one photon per disintegration.

The activity concentration of each radionuclide, C_{mi} , in the floor drain sample tank is determined by analysis of a representative grab sample obtained at the radwaste sample sink. This setpoint example is based on the following data:

i	C_{mi} ($\mu\text{Ci/ml}$)	ECL_i ($\mu\text{Ci/ml}$)
Cs-134	$2.15E-05$	$9E-07$
Cs-137	$7.48E-05$	$1E-06$
Co-60	$2.56E-05$	$3E-06$

$$\sum_i C_{mi} = 2.15E-05 + 7.48E-05 + 2.56E-05$$

$$\left(\frac{\mu\text{Ci}}{\text{ml}}\right) \quad \left(\frac{\mu\text{Ci}}{\text{ml}}\right) \quad \left(\frac{\mu\text{Ci}}{\text{ml}}\right) \quad \left(\frac{\mu\text{Ci}}{\text{ml}}\right)$$

$$= 1.22E-04$$

$$\left(\frac{\mu\text{Ci}}{\text{ml}}\right)$$

(8-3)

$$DF_{\min} = 0.1 \sum_i \frac{C_{mi}}{ECL_i}$$

$$\left(\frac{\mu\text{Ci} - \text{ml}}{\text{ml} - \mu\text{Ci}}\right)$$

$$= 0.1 \left[\frac{2.15E-05}{9E-07} + \frac{7.48E-05}{1E-06} + \frac{2.56E-05}{3E-06} \right]$$

$$\left(\frac{\mu\text{Ci} - \text{ml}}{\text{ml} - \mu\text{Ci}}\right) \quad \left(\frac{\mu\text{Ci} - \text{ml}}{\text{ml} - \mu\text{Ci}}\right) \quad \left(\frac{\mu\text{Ci} - \text{ml}}{\text{ml} - \mu\text{Ci}}\right)$$

$$= 10.7$$

The minimum dilution factor, DF_{\min} , needed to discharge the mixture of radionuclides in this example is 10.7. As a conservative measure, an actual dilution factor, DF , of 1,000 is usually used. The release rate of the floor drain sample tank may be adjusted from 0 to 50 gpm and the dilution pumps can supply up to 20,000 gpm of dilution water. With the dilution flow taken as 18,000 gpm, the release rate from the floor drain sample tank may be determined as follows:

$$F_m = \frac{F_d}{DF} \quad (8-4)$$

(gpm) (gpm)

$$\frac{18,000 \text{ gpm}}{1,000} = 18 \text{ gpm}$$

Under these conditions, the setpoint of the liquid radwaste discharge monitor is:

$$R_{\text{setpoint}} = \frac{DF}{DF_{\min}} S_i \sum_i C_{mi} \quad (8-1)$$

$$\text{(cps)} \quad (\#) \quad \left(\frac{\text{cps} - \text{ml}}{\mu\text{Ci}} \right) \quad \left(\frac{\mu\text{Ci}}{\text{ml}} \right)$$

$$= \frac{1,000}{10.7} 4.9\text{E} + 06 \quad 1.22\text{E} - 04$$

$$\text{(cps)} \quad (\#) \quad \left(\frac{\text{cps} - \text{ml}}{\mu\text{Ci}} \right) \quad \left(\frac{\mu\text{Ci}}{\text{ml}} \right)$$

$$= 55,869 \text{ cps}$$

In this example, the calculated limiting count rate alarm point for the liquid radwaste discharge monitor would be 55,869 cps above background. Plant procedures apply administrative limits below the calculated limiting count rate to account for such elements as instrument uncertainty and early alarm warning before exceeding Control limits.

8.1.1.3 Basis for the Liquid Radwaste Discharge Monitor Setpoint

The liquid radwaste discharge monitor setpoint must ensure that Control 3.2.1 is not exceeded for the appropriate in-plant pathways. The liquid radwaste discharge monitor is placed upstream of the major source of dilution flow and responds to the concentration of radioactivity discharged in batch releases as follows:

$$R = \sum_i C_{mi} S_{li} \quad (8-5)$$

$$\text{(cps)} \quad \left(\frac{\mu\text{Ci}}{\text{ml}} \right) \quad \left(\frac{\text{cps} - \text{ml}}{\mu\text{Ci}} \right)$$

Where:

R = Response of the monitor (cps)

S_{li} = Detector counting efficiency for radionuclide "i" (cps/(μCi/ml))

C_{mi} = Activity concentration of radionuclide "i" in mixture at the monitor (μCi/ml)

The detector calibration procedure establishes a counting efficiency for a given mix of nuclides seen by the detector. Therefore, in Equation 8-5 one may substitute S_l for S_{li}, where S_l represents the counting efficiency determined for the current mix of nuclides. If the mix of nuclides changes significantly, a new counting efficiency should be determined for calculating the setpoint.

$$R = S_l \sum_i C_{mi} \quad (8-6)$$

$$\text{(cps)} \quad \left(\frac{\text{cps} - \text{ml}}{\mu\text{Ci}} \right) \quad \left(\frac{\mu\text{Ci}}{\text{ml}} \right)$$

The effluent concentration for a given radionuclide must not exceed 10 times the 10 CFR Part 20 ECL at the point of discharge to an unrestricted area at any time. When a mixture of radionuclides is present, the concentration at the point of discharge to an unrestricted area shall be limited as follows:

$$\sum_i \frac{C_{di}}{ECL_i} \leq 10 \quad (8-7)$$

$$\left(\frac{\mu\text{Ci} - \text{ml}}{\text{ml} - \mu\text{Ci}} \right)$$

Where:

C_{di} = Activity concentration of radionuclide "i" in the mixture at the point of discharge to an unrestricted area ($\mu\text{Ci}/\text{ml}$)

ECL_i = Effluent concentration limit for radionuclide "i" from 10CFR20.1001-20.2402, Appendix B, Table 2, Column 2 ($\mu\text{Ci}/\text{ml}$)

The activity concentration of radionuclide "i" at the point of discharge is related to the activity concentration of radionuclide "i" at the monitor as follows:

$$C_{di} = C_{mi} \frac{F_m}{F_d} \quad (8-8)$$

$$\left(\frac{\mu\text{Ci}}{\text{ml}} \right) \left(\frac{\mu\text{Ci}}{\text{ml}} \right) \left(\frac{\text{gpm}}{\text{gpm}} \right)$$

Where:

C_{di} = Activity concentration of radionuclide "i" in the mixture at the point of discharge ($\mu\text{Ci}/\text{ml}$)

F_m = Flow rate past monitor (gpm)

F_d = Flow rate out of discharge canal (gpm)

Substituting the right half of Equation 8-8 for C_{di} in Equation 8-7 and solving for F_d/F_m yields the minimum dilution factor needed to comply with Equation 8-7:

$$DF_{min} \leq \frac{F_d}{F_m} \geq \sum_i \frac{C_{mi}}{ECL_i * 10} \quad (8-3)$$

$$\left(\frac{gpm}{gpm} \right) \quad \left(\frac{\mu Ci - ml}{ml - \mu Ci} \right)$$

Where:

F_d = Flow rate out of discharge canal (gpm)

F_m = Flow rate past monitor (gpm)

C_{mi} = Activity concentration of radionuclide "i" in mixture at the monitor ($\mu Ci/ml$)

ECL_i = Effluent concentration limit for radionuclide "i" from 10CFR20.1001-20.2402, Appendix B, Table 2, Column 2 ($\mu Ci/ml$)

10 = The instantaneous concentration multiplier allowed by Control 3.2.1

If F_d/F_m is less than DF_{min} , then the tank may not be discharged until either F_d or F_m or both are adjusted such that:

$$\frac{F_d}{F_m} \geq DF_{min} \quad (8-3)$$

$$\left(\frac{gpm}{gpm} \right)$$

Usually F_d/F_m is greater than DF_{min} (i.e., there is more dilution than necessary to comply with Equation 8-7). The response of the liquid radwaste discharge monitor at the setpoint is therefore:

$$R_{\text{setpoint}} = \frac{DF}{DF_{\text{min}}} S_1 \sum_i C_{mi} \quad (8-1)$$

(cps) (#) $\left(\frac{\text{cps} \cdot \text{ml}}{\mu\text{Ci}} \right)$ $\left(\frac{\mu\text{Ci}}{\text{ml}} \right)$

8.1.2 Service Water Discharge Monitor (RM-17-351)

The service water pathway shown on Figure 9-1 is continuously monitored by the service water discharge monitor (RM-17-351). The water in this line is not radioactive under normal operating conditions. The alarm setpoint on the Service Water Monitor (SWM) is set in accordance with the monitor's ability to detect dilute concentrations of radionuclide mixes that are based on measured nuclide distributions in reactor coolant. From routine coolant sample gamma isotopic analyses, a Composite Maximum Permissible Concentration (CMPC) is calculated as follows:

$$C(f_1/MPC_1 + f_2/MPC_2 \dots) = C/CMPC$$

or

$$CMPC = 1/(f_1/MPC_1 + f_2/MPC_2 \dots) \quad (8-22)$$

where:

C = Total concentration of detected radioactivity in reactor coolant sample ($\mu\text{Ci/ml}$)

f_i = Fraction of total radionuclide concentration represented by the i th radionuclide in the mix

MPC_i = Maximum Permissible Concentration limit for radionuclide " i " as listed in 10CFR20.106, Appendix B, Table II, Column 2 ($\mu\text{Ci/ml}$)

The Composite Effluent Concentration Limit (CECL) is also calculated using the equation above by substituting the appropriate ECL value from 10CFR20.1001-20.2402, Appendix B, Table 2, Column 2, for MPC. If the SWM's minimum achievable alarm setpoint is higher than the required CMPC equivalent count rate (or the CECL equivalent count rate if it is lower than the CMPC count rate), the monitor is declared inoperable, and daily SWM grab samples are collected and analyzed until the calculated coolant CMPC (or CECL) equivalent count rate is above the SWM's alarm setpoint.

For example, if the reactor coolant radionuclide mix distribution is as listed below, then the corresponding CMPC is calculated as follows:

Nuclides	Conc ($\mu\text{Ci/ml}$)	f_i ($\text{conc}_i/\text{total conc}$)	10CFR20 MPC _i ($\mu\text{Ci/ml}$)	f_i/MPC_i ($\text{ml}/\mu\text{Ci}$)
I-131	6.00E-6	6.59E-2	3.0E-7	2.20E+5
I-133	5.00E-6	5.49E-2	1.0E-6	5.49E+4
Co-60	8.00E-5	8.79E-1	3.0E-5	2.93E+4
Totals	9.10E-5	1.00		3.04E+5

$$\text{CMPC} = 1/3.04\text{E}+5 = 3.29\text{E}-6 \text{ (}\mu\text{Ci/ml)}$$

The CECL is also calculated by using the above methodology and substituting the appropriate ECL listed in 10CFR20.1001-20.2402, Appendix B, Table 2, Column 2, for MPC values. For this example, the calculated CECL is equal to $2.73\text{E}-6 \mu\text{Ci/ml}$.)

If the SWM alarm is set at 5 CPS (300 CPM) above background, and the current calibration factor for this monitor is $1.17\text{E}+8 \text{ CPM}/\mu\text{Ci/ml}$, then the SWM will alarm if a concentration as low as $2.56\text{E}-6 \mu\text{Ci/ml}$ above background passes by the monitor. Since the most limiting CMPC or CECL (calculated above to be $2.73\text{E}-6 \mu\text{Ci/ml}$) is above the alarm setpoint (equal to $2.56\text{E}-6 \mu\text{Ci/ml}$), the SWM will be capable of alarming if radioactivity in excess of limiting concentration values for release to unrestricted areas passes by the monitor. However, if the composite concentration (CMPC or CECL) for the service water was found to be less than the SWM alarm setpoint of $2.56\text{E}-6 \mu\text{Ci/ml}$, then daily service water grab samples would have to be collected and analyzed until the composite concentration becomes greater than the concentration corresponding to the SWM's alarm setpoint.

Also, service water is sampled if the monitor is out of service or if the alarm sounds.

Under normal operating conditions, the concentration of radionuclides at the point of discharge to an unrestricted area from the service water effluent pathway will not exceed the effluent concentration limits specified in 10CFR20.1001-20.2402, Appendix B, Table 2, Column 2.

8.2 Gaseous Effluent Instrumentation Setpoints

Control 3.1.2 requires that the radioactive gaseous effluent instrumentation in Control Table 3.1.2 have their alarm setpoints set to ensure that Technical Specification 3.8.K.1 and Control 3.3.1 are not exceeded. Technical Specification 3.8.K.1 (and Control 3.3.7) limits the gross radioactivity release rate at the steam jet air ejector (SJAE) to 0.16 Ci/sec.

8.2.1 Plant Stack Noble Gas Activity Monitors (RM-17-156 and RM-17-157) and Augmented Off-Gas System Noble Gas Activity Monitors (RAN-OG-3127 and RAN-OG-3128)

The plant stack and AOG noble gas activity monitors are shown on Figure 9-2.

8.2.1.1 Method to Determine the Setpoint of the Plant Stack Noble Gas Activity Monitors (RM-17-156 and RM-17-157) and the Augmented Off-Gas System Noble Gas Activity Monitors (RAN-OG-3127 and RAN-OG-3128)

The setpoints of the plant stack and AOG system noble gas activity monitors are determined in the same manner. The plant stack or AOG system noble gas activity monitor response in counts per minute at the limiting off-site noble gas dose rate to the total body or to the skin is the setpoint, denoted R_{spt} . R_{spt} is the lesser of:

$$R_{spt}^{tb} = 666 S_g \frac{1}{F} \frac{1}{DFB_c} \quad (8-9)$$

$$(\text{cpm}) \left(\frac{\text{mrem} - \mu\text{Ci} - \text{m}^3}{\text{yr} - \text{pCi} - \text{sec}} \right) \left(\frac{\text{cpm} - \text{cm}^3}{\mu\text{Ci}} \right) \left(\frac{\text{sec}}{\text{cm}^3} \right) \left(\frac{\text{pCi} - \text{yr}}{\text{mrem} - \text{m}^3} \right)$$

and: (8-10)

$$R_{spt}^{skin} = 3,000 S_g \frac{1}{F} \frac{1}{DF'_c}$$

$$(\text{cpm}) \left(\frac{\text{mrem}}{\text{yr}} \right) \left(\frac{\text{cpm} - \text{cm}^3}{\mu\text{Ci}} \right) \left(\frac{\text{sec}}{\text{cm}^3} \right) \left(\frac{\mu\text{Ci} - \text{yr}}{\text{mrem} - \text{sec}} \right)$$

where:

R_{spt}^{tb} = Response of the monitor at the limiting total body dose rate (cpm)

$$666 = \frac{500}{(1E+06)(7.51E-07)} \left(\frac{\text{mrem} - \mu\text{Ci} - \text{m}^3}{\text{yr} - \text{pCi} - \text{sec}} \right)$$

500 = Limiting total body dose rate (mrem/yr)

1E+06 = Number of pCi per μCi (pCi/ μCi)

7.51E-07 = $[X/Q]^Y$, maximum five-year average gamma atmospheric dispersion factor (sec/m³)

S_g = Appropriate (plant stack or AOG system) detector counting efficiency from the most recent calibration (cpm/($\mu\text{Ci}/\text{cc}$))

F = Appropriate (plant stack or AOG system) flow rate (cm³/sec)

DFB_c = Composite total body dose factor (mrem-m³/pCi-yr)

(8-11)

$$= \frac{\sum_i \dot{Q}_i DFB_i}{\sum_i \dot{Q}_i}$$

\dot{Q}_i = The relative release rate of noble gas "i" in the mixture at the monitor (either the stack \dot{Q}^{ST} or the AOG, \dot{Q}^{AOG}) for noble gases identified ($\mu\text{Ci}/\text{sec}$)

DFB_i = Total body dose factor (see Table 1.1-10) (mrem-m³/pCi-yr)

R_{spt}^{skin} = Response of the monitor at the limiting skin dose rate (cpm)

3,000 = Limiting skin dose rate (mrem/yr)

DF'_c = Composite skin dose factor (mrem-sec/ μCi -yr)

$$= \frac{\sum_i \dot{Q}_i DF'_{is}}{\sum_i \dot{Q}_i}$$

DF'_{is} = Combined skin dose factor (see Table 1.1.10) (mrem-sec/ μ Ci-yr)

8.2.1.2 Plant Stack Noble Gas Activity Monitor Setpoint Example

The following setpoint example for the plant stack noble gas activity monitors demonstrates the use of Equations 8-9 and 8-10 for determining setpoints.

The plant stack noble gas activity monitors, referred to as "Stack Gas I" (RM-17-156) and "Stack Gas II" (RM-17-157), consist of beta sensitive scintillation detectors, electronics, a ratemeter readout, and a digital scaler which counts the detector output pulses. A strip chart recorder provides a permanent record of the ratemeter output. The monitors have typical calibration factors, S_g , of about $3E+07$ cpm per μ Ci/cc of noble gas. The nominal plant stack flow is $7.32E+07$ cc/sec ($(155,000 \text{ cfm} \times 28,300 \text{ cc/ft}^3)/60 \text{ sec/min}$).

When monitor responses indicate that activity levels are below the LLDs at the stack (or AOG) monitors, the relative contribution of each noble gas radionuclide can conservatively be approximated by analysis of a sample of off-gas obtained during plant operations at the steam jet air ejector (SJAE). This setpoint example is based on the following data (see Table 1.1.10 for DFB_i and DF'_i):

i	\dot{Q}_i^{SJAE} $\left(\frac{\mu\text{Ci}}{\text{sec}}\right)$	DFB_i $\left(\frac{\text{mrem} - \text{m}^3}{\text{pCi} - \text{yr}}\right)$	DF'_{is} $\left(\frac{\text{mrem} - \text{sec}}{\mu\text{Ci} - \text{yr}}\right)$
Xe-138	1.03E+04	8.83E-03	1.43E-02
Kr-87	4.73E+02	5.92E-03	2.06E-02
Kr-88	2.57E+02	1.47E-02	1.64E-02
Kr-85m	1.20E+02	1.17E-03	3.35E-03
Xe-135	3.70E+02	1.81E-03	4.56E-03
Xe-133	1.97E+01	2.94E-04	7.81E-04

(8-11)

$$DFB_c = \frac{\sum_i \dot{Q}_i^{SJA E} DFB_i}{\sum_i \dot{Q}_i^{SJA E}}$$

$$\begin{aligned} \sum_i \dot{Q}_i^{SJA E} DFB_i &= (1.03E+04) (8.83E-03) + (4.73E-02) (5.92E-03) \\ &\quad + (2.57E+02) (1.47E-02) + (1.20E+02) (1.17E-03) \\ &\quad + (3.70E+02) (1.81E-03) + (1.97E+01) (2.94E-04) \\ &= 9.83E+01 \text{ (}\mu\text{Ci-mrem-m}^3\text{/sec-pCi-yr)} \end{aligned}$$

$$\begin{aligned} \sum_i \dot{Q}_i^{SJA E} &= 1.03E+04 + 4.73E+02 + 2.57E+02 \\ &\quad + 1.20E+02 + 3.70E+02 + 1.97E+01 \\ &= 1.15E+04 \text{ }\mu\text{Ci/sec} \end{aligned}$$

$$DFB_C = \frac{9.83E+01}{1.15E+04}$$

$$= 8.52E-03 \text{ (mrem-m}^3\text{/pCi-yr)}$$

$$\begin{aligned} R_{\text{spt}}^{\text{tb}} &= 666 S_g \frac{1}{F} \frac{1}{DFB_c} \\ &= (666) (3E+07) \frac{1}{(7.32E+07)} \frac{1}{(8.52E-03)} \\ &= 32,036 \text{ cpm} \end{aligned}$$

Next:

(8-11)

$$DF'_c = \frac{\sum_i \dot{Q}_i^{SJA E} DF'_{is}}{\sum_i \dot{Q}_i^{SJA E}}$$

$$\begin{aligned} \sum_i \dot{Q}_i^{SJA E} DF'_{is} &= (1.03E+04) (1.43E-02) + (4.73E+02) (2.06E-02) \\ &+ (2.57E+02) (1.64E-02) + (1.20E+02) (3.35E-03) \\ &+ (3.70E+02) (4.56E-03) + (1.97E+01) (7.81E-04) \\ &= 1.63E+02 \text{ (}\mu\text{Ci-mrem-sec/sec-}\mu\text{Ci-yr)} \end{aligned}$$

$$\begin{aligned} DF'_c &= \frac{1.63E+02}{1.15E+04} \\ &= 1.42E-02 \text{ (mrem-sec/}\mu\text{Ci-yr)} \end{aligned}$$

$$\begin{aligned} R_{spt}^{skin} &= 3,000 \quad S_g \quad \frac{1}{F} \quad \frac{1}{DF'_c} \\ &= (3,000) (3E+07) \frac{1}{(7.32E+07)} \frac{1}{(1.42E-02)} \\ &= 86,585 \text{ cpm} \end{aligned}$$

The setpoint, R_{spt} , is the lesser of R_{spt}^{tb} and R_{spt}^{skin} . For the noble gas mixture in this example R_{spt}^{tb} is less than R_{spt}^{skin} , indicating that the total body dose rate is more restrictive. Therefore, in this example the "Stack Gas I" and "Stack Gas II" noble gas activity monitors should each be set at some administrative value below 32,036 cpm above background to provide conservatism for such issues as instrument uncertainty and secondary releases from other locations. As an example, a conservative value might be based on controlling release rates from the plant in order to maintain off-site air concentrations below 20 x ECL when averaged over an hour, or to account for other minor releases from the waste oil burner. For example, if an administrative limit of 70 percent of the Control whole body dose limit 500 mrem/yr (32,036 cpm) is chosen, then the noble gas monitor alarms should be set at no more than 22,425 cpm above background ($0.7 \times 32,036 = 22,425$).

8.2.1.3 Basis for the Plant Stack and AOG System Noble Gas Activity Monitor Setpoints

The setpoints of the plant stack and AOG system noble gas activity monitors must ensure that Control 3.3.1.a is not exceeded. Sections 6.4 and 6.5 show that Equations 6-5 and 6-7 are acceptable methods for determining compliance with the Control limits. Which equation (i.e., dose to total body or skin) is more limiting depends on the noble gas mixture. Therefore, each equation must be considered separately. The derivations of Equations 8-9 and 8-10 begin with the general equation for the response R of a radiation monitor:

$$R = \sum_i S_{gi} C_{mi} \quad (8-13)$$
$$(\text{cpm}) \quad \left(\frac{\text{cpm} - \text{cm}^3}{\mu\text{Ci}} \right) \quad \left(\frac{\mu\text{Ci}}{\text{cm}^3} \right)$$

where:

R = Response of the instrument (cpm)

S_{gi} = Detector counting efficiency for noble gas "i" (cpm/($\mu\text{Ci}/\text{cm}^3$))

C_{mi} = Activity concentration of noble gas "i" in the mixture at the noble gas activity monitor ($\mu\text{Ci}/\text{cm}^3$)

The relative release rate of each noble gas ($\dot{Q}_i \mu\text{Ci}/\text{cm}^3$), in the total release rate is normally determined by analysis of a sample of off-gas obtained at the Steam Jet Air Ejector (SJAE). Noble gas release rates at the plant stack and the AOG discharge are usually so low that the activity concentration is below the Lower Limit of Detection (LLD) for sample analysis. As a result, the release rate mix ratios measured at the SJAE are used to represent any radioactivity being discharged from the stack, such as may have resulted from plant steam leaks that have been collected by building ventilation. For the AOG monitor downstream of the charcoal delay beds, this leads to a conservative setpoint since several short-lived (high dose factor) noble gas radionuclides are then assumed to be present at the monitor, which in reality, would not be expected to be present in the system at that point. During periods when the plant is shutdown (after five days), and no radioactivity release rates can be measured at the SJAE, Xe-133 is the dominant long-lived noble gas and may be used as the referenced radionuclide to determine off-site dose rates and monitor setpoints. Alternately, a relative radionuclide, "i", mix fraction, (f_i), may be taken from Table 8.2.1 as a function of time after shutdown (including periods shorter than five days) to determine the relative fraction of each noble gas potentially available for release to the total. However, prior to plant startup before a SJAE sample can be taken and analyzed, the monitor alarm setpoints should be based on Xe-138 as representing the most prevalent high dose factor noble gas expected to be present shortly after the plant returns to power. Monitor alarm setpoints which have been determined to be conservative under any plant conditions may be utilized at any time in lieu of the above assumptions. C_{mi} , the activity concentration of noble gas "i" at the noble gas activity monitor, may be expressed in terms of \dot{Q}_i by dividing by F, the appropriate flow rate. In the case of the plant stack noble gas activity monitors the appropriate flow rate is the plant stack flow rate and for the AOG noble gas activity monitors the appropriate flow rate is the AOG system flow rate.

(8-14)

$$C_{mi} = \dot{Q}_i \frac{1}{F}$$

$$\left(\frac{\mu\text{Ci}}{\text{cm}^3} \right) \quad \left(\frac{\mu\text{Ci}}{\text{sec}} \right) \quad \left(\frac{\text{sec}}{\text{cm}^3} \right)$$

where:

\dot{Q}_i = The release rate of noble gas "i" in the mixture for each noble gas identified ($\mu\text{Ci}/\text{sec}$).

F = Appropriate flow rate (cm^3/sec)

Substituting the right half of Equation 8-14 into Equation 8-13 for C_{mi} yields:

$$R = \sum_i S_{gi} \dot{Q}_i \frac{1}{F} \quad (8-15)$$

$$(\text{cpm}) \left(\frac{\text{cpm} - \text{cm}^3}{\mu\text{Ci}} \right) \left(\frac{\mu\text{Ci}}{\text{sec}} \right) \left(\frac{\text{sec}}{\text{cm}^3} \right)$$

The detector calibration procedure establishes a counting efficiency for a reference radionuclide, Xe-133 (half life 5.24 days). For routine conditions where offgas is processed through the AOG, all short lived gases are decayed away before discharge leaving only long lived radionuclides as the significant contributors to the monitor response. In this case, Xe-133 as the reference radionuclide for the detector counting efficiency is representative of the expected release conditions. For off normal conditions that might lead to inclusion of short lived radioactivity in the gas stream being released, Xe-133 as the reference radionuclide is expected to lead to a conservative response factor for the detectors since the short lived noble gases tend to have higher energies that can cause them to over respond. Therefore, in Equation 8-15, one may substitute S_g for S_{gi} , where S_g represents the detector counting efficiency determined from the Xe-133 calibration. If necessary, the actual concentration and discharge rate of individual gases being released from the stack (or AOG) can be determined by direct grab sample and laboratory analysis during specific periods of interest.

$$R = S_g \frac{1}{F} \sum_i \dot{Q}_i \quad (8-16)$$

$$(\text{cpm}) \left(\frac{\text{cpm} - \text{cm}^3}{\mu\text{Ci}} \right) \left(\frac{\text{sec}}{\text{cm}^3} \right) \left(\frac{\mu\text{Ci}}{\text{sec}} \right)$$

The total body dose rate due to noble gases is determined with Equation 8-5:

$$\dot{R}_{tbs} = 0.75 \sum_i \dot{Q}_i \text{DFB}_i \quad (8-5)$$

$$\left(\frac{\text{mrem}}{\text{yr}} \right) \left(\frac{\text{pCi} \cdot \text{sec}}{\mu\text{Ci} \cdot \text{m}^3} \right) \left(\frac{\mu\text{Ci}}{\text{sec}} \right) \left(\frac{\text{mrem} \cdot \text{m}^3}{\text{pCi} \cdot \text{yr}} \right)$$

Where:

\dot{R}_{tbs} = total body dose rate (mrem/yr) due to noble gases from stack release

0.75 = $(1.0\text{E}+06) \times (7.51\text{E}-07)$ (pCi-sec/ $\mu\text{Ci} \cdot \text{m}^3$)

1E+06 = number of pCi per μCi (pCi/ μCi)

7.51E-07 = $[X/Q]^Y$, maximum long term average gamma atmospheric dispersion factor (sec/m^3)

\dot{Q}_i = the release rate of noble gas "i" in the mixture for each noble gas identified ($\mu\text{Ci}/\text{sec}$) (Equivalent to \dot{Q}_i^{ST} for noble gases released at the plant stack.)

DFB_i = total body dose factor (see Table 1.1.10) ($\text{mrem} \cdot \text{m}^3 / \text{pCi} \cdot \text{yr}$)

A composite total body gamma dose factor, DFB_c , may be defined such that:

$$\text{DFB}_c = \sum_i \dot{Q}_i = \sum_i \dot{Q}_i \text{DFB}_i \quad (8-17)$$

$$\left(\frac{\text{mrem} \cdot \text{m}^3}{\text{pCi} \cdot \text{yr}} \right) \left(\frac{\mu\text{Ci}}{\text{sec}} \right) \left(\frac{\mu\text{Ci}}{\text{sec}} \right) \left(\frac{\text{mrem} \cdot \text{m}^3}{\text{pCi} \cdot \text{yr}} \right)$$

Solving Equation 8-23 for DFB_c yields:

$$\text{DFB}_c = \frac{\sum_i \dot{Q}_i \text{DFB}_i}{\sum_i \dot{Q}_i} \quad (8-11)$$

Control 3.3.1.1.a limits the dose rate to the total body from noble gases at any location at or beyond the site boundary to 500 mrem/yr. By setting equal to 500 mrem/yr and substituting DFB_c for DFB_i in Equation 8-5, one may solve for $\sum_i \dot{Q}_i$ at the limiting whole body noble gas dose rate:

$$\sum_i \dot{Q}_i = 666 \frac{1}{DFB_c} \left(\frac{\mu Ci}{sec} \right) \left(\frac{mrem - \mu Ci - m^3}{yr - pCi - sec} \right) \left(\frac{pCi - yr}{mrem - m^3} \right) \quad (8-18)$$

Substituting this result for $\sum_i \dot{Q}_i$ in Equation 8-16 yields R_{spt}^{tb} , the response of the monitor at the limiting noble gas total body dose rate:

$$R_{spt}^{tb} = 666 S_g \frac{1}{F} \frac{1}{DFB_c} \left(\frac{mrem - \mu Ci - m^3}{yr - pCi - sec} \right) \left(\frac{cpm - cm^3}{\mu Ci} \right) \left(\frac{sec}{cm^3} \right) \left(\frac{pCi - yr}{mrem - m^3} \right) \quad (8-9)$$

The skin dose rate due to noble gases is determined with Equation 6-7:

$$\dot{R}_{skin} = \sum_i \dot{Q}_i DF'_{is} \left(\frac{mrem}{yr} \right) \left(\frac{\mu Ci}{sec} \right) \left(\frac{mrem - sec}{\mu Ci - yr} \right) \quad (6-7)$$

Where:

\dot{R}_{skin} = Skin dose rate (mrem/yr)

\dot{Q}_i = The release rate of noble gas "i" in the mixture for each noble gas identified ($\mu Ci/sec$) equivalent to \dot{Q}_i^{ST} for noble gases released at the plant stack).

DF'_{is} = Combined skin dose factor (see Table 1.1.10) (mrem-sec/ μCi -yr).

A composite combined skin dose factor, DF'_c , may be defined such that:

$$DF'_c \sum_i \dot{Q}_i = \sum_i \dot{Q}_i DF'_{is} \quad (8-19)$$

$$\left(\frac{\text{mrem} - \text{sec}}{\mu\text{Ci} - \text{yr}} \right) \left(\frac{\mu\text{Ci}}{\text{sec}} \right) \left(\frac{\mu\text{Ci}}{\text{sec}} \right) \left(\frac{\text{mrem} - \text{sec}}{\mu\text{Ci} - \text{yr}} \right)$$

Solving Equation 8-19 for DF'_c yields:

$$DF'_c = \frac{\sum_i \dot{Q}_i DF'_{is}}{\sum_i \dot{Q}_i}$$

Control 3.3.1.a limits the dose rate to the skin from noble gases at any location at or beyond the site boundary to 3,000 mrem/yr. By setting \dot{R}_{skin} equal to 3,000 mrem/yr and substituting DF'_c for DF'_i in Equation 6-7 one may solve for $\sum_i \dot{Q}_i$ at the limiting skin noble gas dose rate:

$$\sum_i \dot{Q}_i = 3,000 \frac{1}{DF'_c}$$

$$\left(\frac{\mu\text{Ci}}{\text{sec}} \right) \left(\frac{\text{mrem}}{\text{yr}} \right) \left(\frac{\mu\text{Ci} - \text{yr}}{\text{mrem} - \text{sec}} \right)$$

Substituting this result for $\sum_i \dot{Q}_i$ in Equation 8-16 yields $R_{\text{spt}}^{\text{skin}}$, the response of the monitor at the limiting noble gas skin dose rate:

$$R_{\text{spt}}^{\text{skin}} = 3,000 S_g \frac{1}{F} \frac{1}{DF'_c} \quad (8-10)$$

$$(\text{cpm}) \left(\frac{\text{mrem}}{\text{yr}} \right) \left(\frac{\text{cpm} - \text{cm}^3}{\mu\text{Ci}} \right) \left(\frac{\text{sec}}{\text{cm}^3} \right) \left(\frac{\mu\text{Ci} - \text{yr}}{\text{mrem} - \text{sec}} \right)$$

TABLE 8.2.1

Relative Fractions of Core Inventory
Noble Gases After Shutdown

<u>Time</u>	<u>Kr-83m</u>	<u>Kr-85m</u>	<u>Kr-85</u>	<u>Kr-87</u>	<u>Kr-88</u>	<u>Xe-131m</u>	<u>Xe-133m</u>	<u>Xe-133</u>	<u>Xe-135m</u>	<u>Xe-</u>	
<u>135 Xe-138</u>											
t <24 h	.02	.043	.001	.083	.118	.002	.010	.306	.061	.093	.263
24 hr ≤t <48 h	---	.003	.004	---	.001	.004	.022	.758	.010	.198	---
48 h ≤t <5 d	---	---	.005	---	---	.006	.024	.907	.001	.058	---
5 d ≤t <10 d	---	---	.007	---	---	.008	.016	.969	---	---	---
10 d ≤t <15 d	---	---	.014	---	---	.014	.006	.966	---	---	---
15 d ≤t <20 d	---	---	.026	---	---	.022	.002	.950	---	---	---
20 d ≤t <30 d	---	---	.048	---	---	.034	.001	.917	---	---	---
30 d ≤t <40 d	---	---	.152	---	---	.070	---	.777	---	---	---
40 d ≤t <50 d	---	---	.378	---	---	.105	---	.517	---	---	---
50 d ≤t <60 d	---	---	.652	---	---	.108	---	.240	---	---	---
60 d ≤ t <70 d	---	---	.835	---	---	.083	---	.082	---	---	---
t ≥70 d	---	---	.920	---	---	.055	---	.024	---	---	---

8.2.2 Steam Jet Air Ejector (SJAE) Noble Gas Activity Monitors (RM-17-150A and RM-17-150B)

The SJAE noble gas activity monitors are shown in Figure 9-2.

8.2.2.1 Method to Determine the Setpoints of the Steam Jet Air Ejector Offgas Activity Monitors (RM-17-150A and RM-17-150B)

The SJAE noble gas activity monitor response in mR/hr at the limiting release rate is the setpoint, denoted, and is determined as follows:

$$R_{\text{spt}}^{\text{SJAE}} = 1.6\text{E} + 05 \quad S_g \quad \frac{1}{F} \quad (8-21)$$

$$(\text{mR} / \text{hr}) \left(\frac{\mu\text{Ci}}{\text{sec}} \right) \left(\frac{\text{mR} - \text{cc}}{\text{hr} - \mu\text{Ci}} \right) \left(\frac{\text{sec}}{\text{cc}} \right)$$

$R_{\text{spt}}^{\text{SJAE}}$ = Response of the monitor at the limiting release rate (mR/hr)

1.6E+05 = Limiting release rate for the SJAE specified in Technical Specification 3.8.K.1 ($\mu\text{Ci}/\text{sec}$)

S_g = Detector counting efficiency from the most recent calibration ((mR/hr)/($\mu\text{Ci}/\text{cc}$))

F = SJAE gaseous discharge flow (cc/sec)

8.2.2.2 Basis for the SJAE Noble Gas Activity Monitor Setpoint

The SJAE noble gas activity monitor setpoint must ensure that Technical Specification 3.8.K.1 is not exceeded. The derivation of Equation 8-21 is straightforward. Simply taking Equation 8-16 and substituting the limiting release rate at the SJAE for \dot{Q} yields Equation 8-21, the setpoint equation for the SJAE noble gas activity monitor.

9.0 LIQUID AND GASEOUS EFFLUENT STREAMS, RADIATION MONITORS AND RADWASTE TREATMENT SYSTEMS

Figure 9-1 shows the normal (design) radioactive liquid effluent streams, radiation monitors, and the appropriate Liquid Radwaste Treatment System. Figure 9-2 shows the normal (design) gaseous effluent systems, radiation monitors, and the appropriate Gaseous Radwaste Treatment System.

9.1 In-Plant Radioactive Liquid Effluent Pathways

The Liquid Radwaste System collects, processes, stores, and disposes of all radioactive liquid wastes. Except for the cleanup phase separator equipment, the condensate backwash receiving tank and pump and waste sample tanks, floor drain sample tank and waste surge tank, the entire Radwaste System is located in the Radwaste Building. The Radwaste System is controlled from a panel in the Radwaste Building Control Room.

The Liquid Radwaste System consists of the following components:

1. Floor and equipment drain system for handling potentially radioactive wastes.
2. Tanks, piping, pumps, process equipment, instrumentation and auxiliaries necessary to collect, process, store, and dispose of potentially radioactive wastes.

The liquid radwastes are classified, collected, and treated as either high purity, low purity, chemical or detergent wastes. "High" purity and "low" purity mean that the wastes have low conductivity and high conductivity, respectively. The purity designation is not a measure of the amount of radioactivity in the wastes.

High purity liquid wastes are collected in the 25,000-gallon waste collector tank. They originate from the following sources:

1. Drywell equipment drains.
2. Reactor Building equipment drains.
3. Radwaste Building equipment drains.
4. Turbine Building equipment drains.
5. Decanted liquids from cleanup phase separators.
6. Decanted liquids from condensate phase separators.
7. Resin rinse.

Low purity liquid wastes are collected in the 25,000-gallon floor drain collector tank. They originate from the following sources:

1. Drywell floor drains.
2. Reactor Building floor drains.
3. Radwaste Building floor drains.
4. Turbine Building floor drains.
5. Other floor drains in RCA (e.g., AOG and Service Building, stack, etc.).

Chemical wastes are collected in the 4,000-gallon chemical waste tank and then pumped to the floor drain collector tank. Chemical wastes arise from the chemical laboratory sinks, the laboratory drains and sample sinks. Radioactive decontamination solutions are classified as detergent waste and collected in the 1,000-gallon detergent waste tank.

Once the wastes are collected in their respective waste tanks, they are processed in the most efficient manner and discharged or reused in the nuclear system. From the waste collector tank, the high purity wastes are processed in one of three alternative filter demineralizers and then, if needed, in one "polishing" demineralizer. After processing, the liquid is pumped to a waste sample tank for testing and then recycled for additional processing, transferred to the condensate storage tank for reuse in the nuclear system or discharged.

The low purity liquid wastes are normally processed through the floor drain filter demineralizer and collected in the floor drain sample tank for discharge or they are combined with high purity wastes and processed as high purity wastes.

Chemical wastes are neutralized and combined with low purity wastes for processing as low purity wastes.

Although there is only one discharge pathway from the Radwaste System to the river, there are three locations within the Radwaste System from which releases can be made. They are: the detergent waste tank (detergent wastes), the floor drain sample tank (chemical and low purity wastes), and waste sample tank (high purity wastes). The contents of any of these tanks can be released directly to the river.

The liquid wastes collected in the tanks are handled on a batch basis. The tanks are sampled from the radwaste sample sink and the contents analyzed for radioactivity and water purity. A release is allowed once it is determined that the activity in the liquid wastes will not exceed Control release limits.

Revision 27 Date 10/09/00

A discharge from any of the tanks is accomplished by first starting the sample pumps, opening the necessary valves, and positioning the flow controller. The release rate in the discharge line is set between 0 and 50 gpm. The dilution pumps which supply 20,000 gpm of dilution water are then started. An interlock does not allow discharge to the river when dilution water is unavailable.

The effluent monitor (No. 17/350) in the discharge line provides an additional check during the release. The alarm or trip setpoint on the monitor is set according to the effluent Control limits and an analysis of the contents of the tank. The monitor warns the operator if the activity of the liquid waste approaches regulatory limits. In response to a warning signal from the monitor, the operator may reduce the flow rate or stop the discharge.

9.2 In-Plant Radioactive Gaseous Effluent Pathways

The gaseous radwaste system includes subsystems that dispose of gases from the main condenser air ejectors, the startup vacuum pump, the gland seal condenser, the standby gas treatment system and station ventilation exhausts.

The processed gases are routed to the plant stack for dilution and elevated release to the atmosphere.

The plant stack provides an elevated release point for the release of waste gases. Stack drainage is routed to the liquid radwaste collection system through loop seals.

The air ejector Advanced Off-Gas Subsystem (AOG) reduces the ejector radioactive gaseous release rates to the atmosphere. The AOG System consists of a hydrogen dilution and recombiner subsystem, a dual moisture removal/dryer subsystem, a single charcoal absorber subsystem, and dual vacuum pumps. Equipment is located in shielded compartments to minimize the exposure of maintenance personnel.

Radioactive releases from the air ejector off-gas system consist of fission product noble gases, activation product gases, halogens, and particulate daughter products from the noble gases. The particulates and halogens are effectively removed by the charcoal beds and high efficiency particulate filters in the AOG System. The activation product gases that are generated in significant quantities have very short half-lives and will decay to low levels in the holdup pipe, as well as in the absorber beds. The noble gases, therefore, are expected to provide the only significant contribution to off-site dose. The charcoal off-gas system is designed to provide holdup of 24 hours for krypton and 16.6 days for xenon at a condenser air inleakage rate of 30 scfm.

Steam dilution, process control, and instrumentation systems are designed to prevent an explosive mixture of hydrogen from propagating beyond the air ejector stages. An explosive mixture of hydrogen should never exist in the recombiner subsystem, "30-minute" delay pipe, condenser/dryer, or charcoal absorber beds. To prevent a hydrogen explosion in the recombiner/preheater and upstream lines during shutdown, the residual off-gas steam mixture containing hydrogen is purged with steam or air. Starting procedures insure sufficient steam is introduced upstream of the preheater to dilute any hydrogen entering the AOG System as the air

ejector line is prepared for operation. To prevent operating unsafely, instrumentation is used to detect an explosive mixture.

Hydrogen control is accomplished by providing redundant hydrogen analyzers on the outlet from the Recombiner System. These analyzers initiate recombiner system shutdown and switchover if the hydrogen concentration at the system outlet exceeds 2% by volume. During an automatic shutdown, two main air process valves close to isolate the recombiner system. Additionally, the recombiner bed temperatures and recombiner outlet temperature provide information about recombiner performance to insure that inflammable hydrogen mixtures do not go beyond the recombiner.

Should a number of unlikely events occur, it would be hypothetically possible for a hydrogen explosion to occur in the off-gas system. Such an explosion within the recombiner system could propagate into the large "30-minute" delay pipe, through the condenser/dryer subsystem, and into the charcoal absorber tanks. However, the recombiner/adsorber subsystems, piping, and vessels are designed to withstand hydrogen detonation pressures of 500 psi at a minimum so that no loss of integrity would result. Furthermore, the seven tanks of charcoal would significantly attenuate a detonation shock wave and prevent damage to the downstream equipment.

During normal operation, the dryer/adsorber subsystem may be bypassed if it becomes unavailable provided the releases are within effluent Control limits. With the dryer/adsorber subsystem bypassed, the air ejector off-gas exhausts through the recombiner/condenser subsystems, and the 30-minute delay pipe.

The off-gas mixture combines with steam at the air ejector stage to prevent an inflammable hydrogen mixture of 4% by volume from entering the downstream hydrogen recombiners. Approximately 6,400 lb/hr of steam introduced at the second stage air ejector reduces the concentration of hydrogen to less than 3% by volume.

The recombiner subsystem consists of a single path leading from the hydrogen dilution steam jet ejectors to two parallel flow paths for hydrogen recombination. Each recombination subsystem is capable of operating independently of the other and each is capable of handling the condenser off-gas at a startup design flow of 1,600 lb/hr air and the normal off-gas design flow rate of 370 lb/hr. The major components of each recombiner flow path are a preheater, a hydrogen-oxygen recombiner, and a desuperheating condenser.

The preheater assures that the vapor entering the hydrogen-oxygen recombiner is heated to approximately 300°F. At this temperature, the water vapor in the stream becomes superheated steam, thereby, protecting the recombiner catalyst.

During passages through the recombiner, the recombination of H₂ and O₂ in an exothermic reaction increases the stream temperature to approximately 520°F. This recombination results in a maximum effluent H₂ concentration of 0.1% by volume.

The desuperheating condenser is designed to remove the heat of recombination and condense the steam from the remaining off-gas. The condensers discharge the off-gas through moisture separators into the initial portion of an underground 24-inch diameter delay pipe which allows for 40% of the total system holdup volume. The pipe slopes away from the off-gas particulate (HEPA) filters in both directions for drainage purposes. Loop seals prevent gas escaping through drainage connections. Shorter lived radionuclides undergo a substantial decrease in activity in this section of the system. The preheaters/recombiners operate at pressures slightly above atmospheric; the condenser and the subsystems that follow operate at subatmospheric pressures.

Particulate (HEPA) filters with flame suppressant prefilters are located at the exit side of the delay pipe ahead of the moisture removal subsystem to remove radioactive particulates generated in the delay pipe.

In the moisture removal/dryer subsystem, the moisture of the gas is reduced to increase the effectiveness of the charcoal absorber beds downstream. The subsystem consists of two parallel cooling condensers and gas dryer units. Each condenser is cooled by a mechanical glycol/water refrigeration system that cools the off-gas to -40°F as it removes bulk moisture. The dryer is designed to remove the remaining moisture by a molecular sieve desiccant to a dew point of less than -40°F (1% RH). One of the dryers absorbs moisture from the off-gas; the other desorbs moisture by circulating heated air through the bed in closed cycle.

The mixed refrigerant/dryer concept improves the reliability of the system. If the refrigerant system fails, the two dryer beds operate in parallel to remove the moisture and maintain the off-gas near the design dew point (-40°F). If the dryer fails, the -40°F dew point air leaving the mechanical system can enter the guard bed for over 6 hours without affecting the performance of the charcoal beds downstream.

The charcoal absorber subsystem consists of seven tanks of charcoal preceded by a smaller charcoal guard bed upstream. The guard bed protects the seven main tanks from excessive radioactivity levels or moisture in the event of a malfunction upstream in the moisture removal subsystem. The guard bed also removes compounds which might hinder noble gas delay. The seven tanks hold a minimum of approximately 90,000 pounds of charcoal.

The first two main tanks can be bypassed and used for storing a "batch of high activity" gas for static decay. The remaining five are all in series with no bypassing features so that the off-gas to the stack must be delayed.

Redundant particulate (HEPA) after-filters are used to remove charcoal fines prior to the vacuum pumps.

A water-sealed vacuum pump boosts the gas stream pressure to slightly over-atmospheric pressure before it is vented through the stack. To assure maintaining constant operating pressures in the system, a modulating bypass valve will recirculate process gas around the pump as required. During periods of high flow rates, both pumps can be operated in parallel.

Discharge of the vacuum pump then passes through the remaining 60% of the delay pipe prior to being vented through the station stack.

The gland seal off-gas subsystem collects gases from the gland seal condenser and the mechanical vacuum pump and passes them through a charcoal filter (if required) and then through holdup piping prior to release to the stack. The gases from the gland seal condenser system are discharged to the atmosphere via the ventilation stack after passing through the filter for iodine removal (if required) and then through the same 1-3/4 minute holdup piping that is used for the startup vacuum pump system. One automatic valve on the discharge side of each steam packing exhauster closes upon the receipt of high level radiation signal from the main steam line radiation monitoring subsystem to prevent the release of excessive radioactive material to the atmosphere. The exhausters are shut down at the same time the valves close. In addition, the mechanical vacuum pump is automatically isolated and stopped by a main steam line high radiation signal. The filter assembly is located in the air ejector room.

The release of significant quantities of gaseous and particulate radioactive material is prevented by the combination of the design of the air ejector AOG system and automatic isolation of the system from the stack. Gas flow from the main condenser stops when the air

ejectors are automatically isolated from the main condenser by either a high radiation signal in the main steam line or by high temperature and/or pressure signals from the AOG System. The gland seal off-gas system is automatically isolated and stopped by a main steam line high radiation signal. In addition, monitoring the stack release provides a backup warning of abnormal conditions.

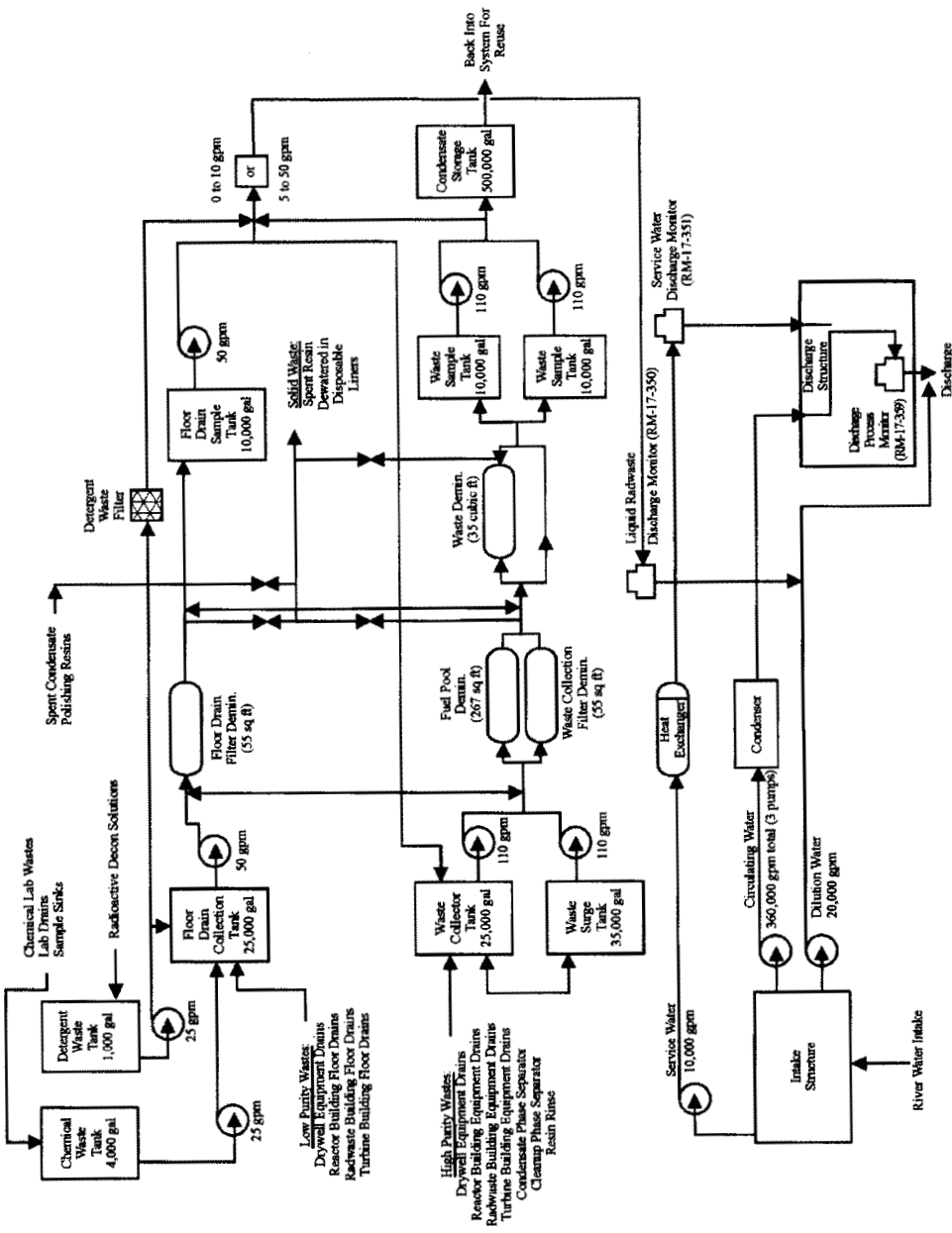

FIGURE 9-1: Radioactive Liquid Effluent Streams, Radiation Monitors, and Radwaste Treatment System at Vermont Yankee*

*Normal (design) radioactive process streams only are shown.

VY ZIPDISKVYDCMNEWFIGS

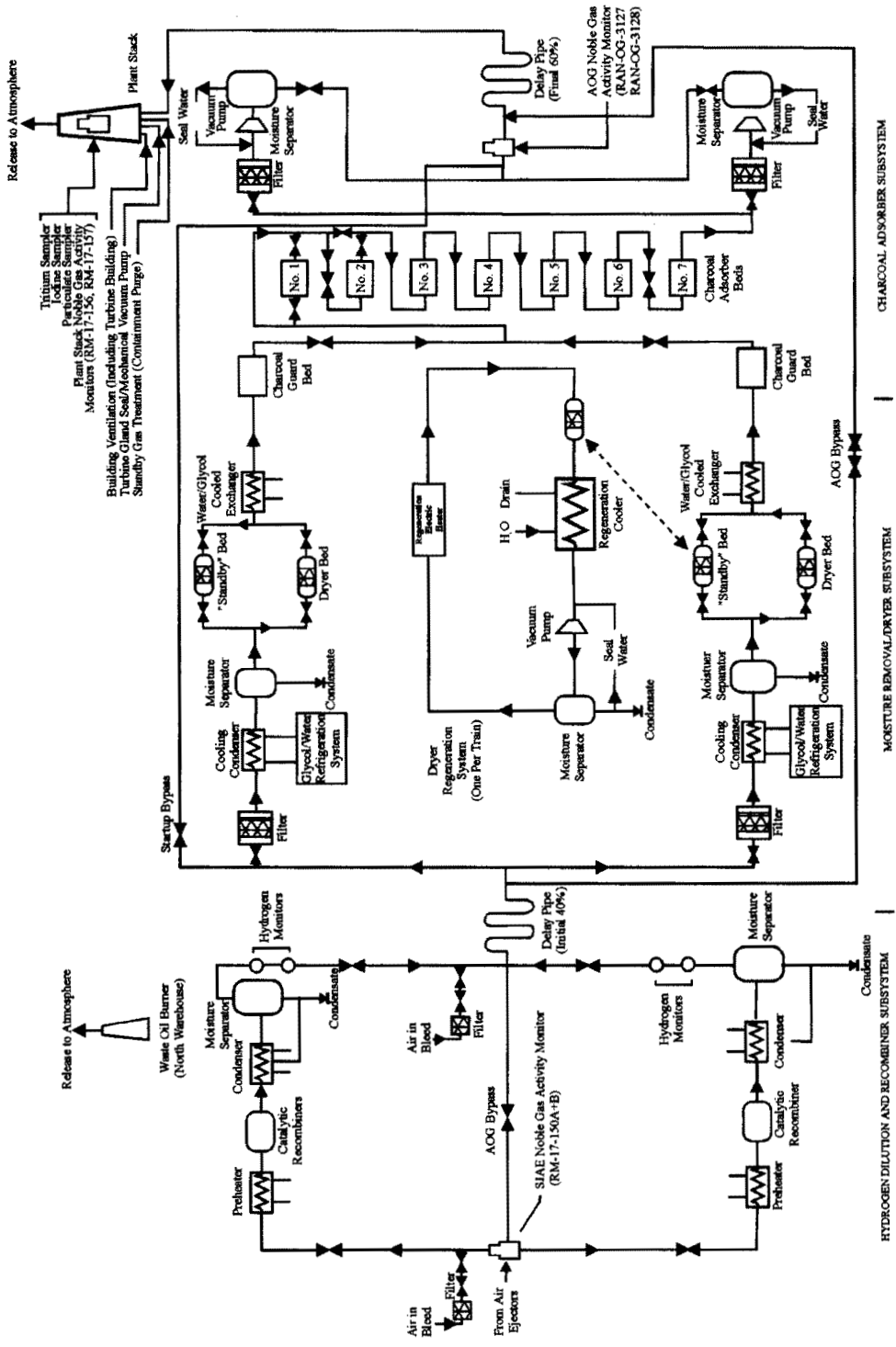

FIGURE 9-2: Radioactive Gaseous Effluent Streams, Radiation Monitors, and Radwaste Treatment System at Vermont Yankee*

*Normal (design) radioactive process streams only are shown.
 VY ZIPDISK\YV000\NEW\FIGS

10.0 UNIQUE REPORTING REQUIREMENTS

10.1 Annual Radioactive Effluent Release Report

In accordance with 10CFR 50.36a, the Radioactive Effluent Release Report covering the operation of the unit shall be submitted by May 15 of each year.

The Radioactive Effluent Release Report shall include a summary of the quantities of radioactive liquid and gaseous effluents and solid waste released from the unit as outlined in Regulatory Guide 1.21, Revision 1, June 1974, "Measuring, Evaluating and Reporting Radioactivity in Solid Wastes and Releases of Radioactive Materials in Liquid and Gaseous Effluents from Light-Water-Cooled Nuclear Power Plants," with data summarized on a quarterly basis following the format of Appendix B thereof. For solid wastes the format for Table 3 in Appendix B of Regulatory Guide 1.21 shall be supplemented with three additional categories: class of solid wastes (as defined by 10CFR Part 61), type of container (e.g., LSA, Type A, Type B, Large Quantity), and solidification agent or absorbent, if any.

In addition, the Radioactive Effluent Release Report shall include an annual summary of hourly meteorological data collected over the previous year. This annual summary may be either in the form of an hour-by-hour listing on magnetic tape of wind speed, wind direction, atmospheric stability, and precipitation (if measured), or in the form of joint frequency distributions of wind speed, wind direction, and atmospheric stability.* This same report shall include an assessment of the radiation doses due to the radioactive liquid and gaseous effluents released from the unit during the previous calendar year. The Radioactive Effluent Release Report shall also include an assessment of the radiation doses from radioactive effluents to member(s) of the public due to any allowed recreational activities inside the site boundary during the previous calendar year. All assumptions used in making these assessments (e.g., specific activity, exposure time and location) shall be included in these reports. For any batch or discrete gas volume releases, the meteorological conditions concurrent with the time of release of radioactive materials in gaseous effluents (as determined by sampling frequency and measurement) shall be used for determining the gaseous pathway doses. For radioactive materials released in continuous effluent streams, quarterly average meteorological conditions concurrent with the quarterly release period shall be used for determining the gaseous pathway doses. The assessment of radiation doses shall be performed in accordance with the Off-Site Dose Calculation Manual (ODCM).

*In lieu of submission with the Radioactive Effluent Release Report, the licensee has the options of retaining this summary of required meteorological data in a file that shall be provided to the NRC upon request.

With the limits of Control 3.4.1 being exceeded during the calendar year, the Radioactive Effluent Release Report shall also include an assessment of radiation doses to the likely most exposed real member(s) of the public from reactor releases (including doses from primary effluent pathways and direct radiation) for the previous calendar year to show conformance with 40CFR190, Environmental Radiation Protection Standards for Nuclear Power Operation.

The Radioactive Effluent Release Report shall include a list and description of unplanned releases from the site to site boundary of radioactive materials in gaseous and liquid effluents made during the reporting period.

With the quantity of radioactive material in any outside tank exceeding the limit of Technical Specification 3.8.D.1, describe the events leading to this condition in the next Radioactive Effluent Release Report.

If inoperable radioactive liquid effluent monitoring instrumentation is not returned to operable status prior to the next release pursuant to Note 4 of Control Table 3.1.1, explain in the next Radioactive Effluent Report the reason(s) for delay in correcting the inoperability.

If inoperable gaseous effluent monitoring instrumentation is not returned to operable status within 30 days pursuant to Note 5 of Control Table 3.1.2, explain in the next Radioactive Effluent Release Report the reason(s) for delay in correcting the inoperability.

With milk samples no longer available from one or more of the sample locations required by Control Table 3.5.1, identify the cause(s) of the sample(s) no longer being available, identify the new location(s) for obtaining available replacement samples, and include revised ODCM figure(s) and table(s) reflecting the new location(s) in the next Radioactive Effluent Release Report.

With a land use census identifying one or more locations which yield at least a 20 percent greater dose or dose commitment than the values currently being calculated in Control 4.3.3, identify the new location(s) in the next Radioactive Effluent Release Report.

Changes made during the reporting period to the Process Control Program (PCP) and to the Off-Site Dose Calculation Manual (ODCM), shall be identified in the next Radioactive Effluent Release Report.

10.2 Environmental Radiological Monitoring

The Annual Radiological Environmental Operating Report covering the operation of the unit during previous calendar year shall be submitted by May 15th of each year.

The report shall include summaries, interpretations, and an analysis of trends of the results of the radiological environmental surveillance activities for the report period. The material provided shall be consistent with the objectives outlined in the ODCM and in 10CFR 50, Appendix I, Sections IV.B.2, IV.B.3, and IV.C.

The Annual Radiological Environmental Operating Report shall include summarized and tabulated results of all radiological environmental samples taken during the report period pursuant to Table 7-1 and Figures 7-1 through 7-6. In the event that some results are not available for inclusion with the report, the report shall be submitted noting and explaining the reasons for the missing results. The missing data shall be submitted as soon as possible in a supplementary report.

With the level of radioactivity in an environmental sampling media at one or more of the locations specified in Control Table 3.5.1 exceeding the reporting levels of Control Table 3.5.2, the condition shall be described in the next Annual Radiological Environmental Operating Report only if the measured level of radioactivity was not the result of plant effluents. With the radiological environmental monitoring program not being conducted as specified in Control Table 3.5.1, a description of the reasons for not conducting the program as required and the plans for preventing a recurrence shall be included in the next Annual Radiological Environmental Operating Report.

The Annual Radiological Environmental Operating Report shall also include the results of the land use census required by Control 3.5.2. A summary description of the radiological environmental monitoring program including a map of all sampling locations keyed to a table giving distances and directions from the reactor shall be in the reports. If new environmental sampling locations are identified in accordance with Control 3.5.2, the new locations shall be identified in the next Annual Radiological Environmental Operating Report.

The reports shall also include a discussion of all analyses in which the LLD required by Control Table 4.5.1 was not achievable.

The results of license participation in the intercomparison program required by Control 3.5.3 shall be included in the reports. With analyses not being performed as required by Control 3.5.3, the corrective actions taken to prevent a recurrence shall be reported to the Commission in the next Annual Radiological Environmental Operating Report.

10.3 ISFSI Reporting Requirements

In accordance with 10CFR72.44(d)(3), the Annual Independent (Interim) Spent Fuel Storage Installation Radiative Effluent Control Program Report (AISFSIRECPR) will be generated and issued by February 28th of each year.

Since it has been determined by Holtec International in their Final Safety Analysis Report (Reference I) that the Holtec HI-STORM 100 Cask System does not create any radioactive materials or have any radioactive waste treatment systems, specific operating procedures for the control of radioactive effluents are not required. Specification 3.1.1, Multi-Purpose Canister (MPC), provides assurance that there are no radioactive effluents from the SFSC.

In light of the information presented in the previous paragraphs, the AISFSIRECPR, to be issued by February 28th of each year, shall state that no radioactive effluents were discharged from the Independent (Interim) Spent Fuel Storage Installation and therefore no ISFSI-specific monitoring program is in place at Vermont Yankee and there are no ISFSI-specific data to report for the previous calendar year reporting period.

10.4 Special Reports

Special reports shall be submitted to the Director of the Office of Inspection and Enforcement Regional Office within the time period specified for each report.

10.4.1 Liquid Effluents (Controls 3.2.2 and 3.2.3)

With the calculated dose from the release of radioactive materials in liquid effluents exceeding any of the limits of Control 3.2.2, prepare and submit to the Commission within 30 days a special report which identifies the cause(s) for exceeding the limit(s) and defines the corrective actions taken to assure that subsequent releases will be in compliance with the limits of Control 3.2.2.

With liquid radwaste being discharged without processing through appropriate treatment systems and estimated doses in excess of Control 3.2.3, prepare and submit to the Commission within 30 days a special report which includes the following information:

- (1) explanation of why liquid radwaste was being discharged without treatment, identification of any inoperable equipment or subsystems, and the reasons for the inoperability;
- (2) action(s) taken to restore the inoperable equipment to operable status; and
- (3) summary description of action(s) taken to prevent a recurrence.

10.4.2 Gaseous Effluents (Controls 3.3.2, 3.3.3, 3.3.4 and 3.3.5)

With the calculated air dose from radioactive noble gases in gaseous effluents exceeding any of the limits of Control 3.3.2, prepare and submit to the Commission within 30 days a special report which identifies the cause(s) for exceeding the limit(s) and the corrective action(s) taken to assure that subsequent releases will be in compliance with the limits of Control 3.3.2. With the calculated dose from the release of Iodine-131, Iodine-133, tritium, and/or radionuclides in particulate form exceeding any of the limits of Control 3.3.3, prepare and submit to the Commission within 30 days a special report which identifies the cause(s) for exceeding the limit(s) and the corrective action(s) taken to assure that subsequent releases will be in compliance with the limits of Control 3.3.3.

With gaseous radwaste being discharged without processing through appropriate treatment systems as defined in Control 3.3.4 for more than seven (7) consecutive days, or in excess of the limits of Control 3.3.5, prepare and submit to the Commission within 30 days a special report which includes the following information:

- (1) explanation of why gaseous radwaste was being discharged without treatment (Control 3.3.4), or with resultant doses in excess of Control 3.3.5, identification of any inoperable equipment or subsystems, and the reasons for the inoperability;
- (2) action(s) taken to restore the inoperable equipment to operable status; and
- (3) summary description of action(s) taken to prevent a recurrence.

10.4.3 Total Dose (Control 3.4.1)

With the calculated dose from the release of radioactive materials in liquid or gaseous effluents exceeding the limits of Control 3.4.1, prepare and submit to the Commission within 30 days a special report which defines the corrective action(s) to be taken to reduce subsequent releases to prevent recurrence of exceeding the limits of Control 3.4.1 and includes the schedule for achieving conformance with these limits. This special report, required by 10CFR Part 20.2203(a)(4), shall include an analysis that estimates the radiation exposure (dose) to a member of the public from station sources, including all effluent pathways and direct radiation, for the calendar year that includes the release(s) covered by this report. It shall also describe levels of radiation and concentrations of radioactive material involved, and the cause of the exposure levels or concentrations. If the estimated doses exceed any of the limits of Control 3.4.1, and if the release condition resulting in violation of 40CFR Part 190 has not already been corrected, the special report shall include a request for a variance in accordance with the provisions of 40CFR Part 190. Submittal of the report is considered a timely request, and a variance is granted until staff action on the request is complete.

10.4.4 Radiological Environmental Monitoring (Control 3.5.1)

With the level of radioactivity as the result of plant effluents in an environmental sampling media at one or more of the locations specified in Control Table 3.5.1 exceeding the reporting levels of Control Table 3.5.2, prepare and submit to the Commission within 30 days from the receipt of the Laboratory Analyses a special report which includes an evaluation of any release conditions, environmental factors or other factors which caused the limits of Control Table 3.5.2 to be exceeded. This report is not required if the measured level of radioactivity was not the result of plant effluents, however, in such an event, the condition shall be reported and described in the Annual Radiological Environmental Operating Report.

10.4.5 Land Use Census (Control 3.5.2)

With a land use census not being conducted as required by Control 3.5.2, prepare and submit to the Commission within 30 days a special report which identifies the reasons why the survey was not conducted, and what steps are being taken to correct the situation.

10.5 Major Changes to Radioactive Liquid, Gaseous, and Solid Waste Treatment Systems**

Licensee-initiated major changes to the radioactive waste systems (liquid, gaseous, and solid):

- A. Shall be reported to the commission in the Radioactive Effluent Release Report for the period in which the evaluation was reviewed by the Onsite Safety Review Committee (OSRC). The discussion of each change shall contain:
 - 1. A summary of the evaluation that led to the determination that the change could be made in accordance with 10CFR Part 50.59;
 - 2. Sufficient detailed information to support the reason for the change without benefit of additional or supplemental information;
 - 3. A detailed description of the equipment, components, and processes involved and the interfaces with other plant systems;
 - 4. An evaluation of the change, which shows the predicted releases of radioactive materials in liquid and gaseous effluents and/or quantity of solid waste that differ from those previously predicted in the license application and amendments thereto;

**Licensee may choose to submit the information called for in this reporting requirement as part of the annual FSAR update.

5. An evaluation of the change, which shows the expected maximum exposures to member(s) of the public at the site boundary and to the general population that differ from those previously estimated in the license application and amendments thereto;
 6. A comparison of the predicted releases of radioactive materials, in liquid and gaseous effluents and in solid waste, to the actual releases for the period prior to when the changes are to be made;
 7. An estimate of the exposure to plant operating personnel as a result of the change; and
 8. Documentation of the fact that the change was reviewed and found acceptable by OSRC.
- B. Shall become effective upon review and acceptance by OSRC and approval by the General Manager.

REFERENCES

- A. Regulatory Guide 1.109, "Calculation of Annual Doses to Man from Routine Releases of Reactor Effluents for the Purpose of Evaluating Compliance with 10CFR50, Appendix I," U.S. Nuclear Regulatory Commission, Revision 1, October 1977.
- B. Hamawi, J. N., "AEOLUS-2 - A Computer Code for the Determination of Continuous and Intermittent-Release Atmospheric Dispersion and Deposition of Nuclear Power Plant Effluents in Open-terrain Sites, Coastal Sites, and Deep-River Valleys for Assessment of Ensuing doses and Finite-Cloud Gamma Radiation Exposures," Entech Engineering, Inc., P100R13A, March 1988 (Mod 5, Revised by Yankee Atomic Electric Company, March 1992).
- C. Regulatory Guide 1.111, "Methods for Estimating Atmospheric Transport and Dispersion of Gaseous Effluents in Routine Releases from Light-Water Cooled Reactors," U.S. Nuclear Regulatory Commission, Rev. 1, July 1977.
- D. National Bureau of Standards, "Maximum Permissible Body Burdens and Maximum Permissible Concentrations of Radionuclides in Air and in Water for Occupational Exposure," Handbook 69, June 5, 1959.
- E. Slade, D. H., "Meteorology and Atomic Energy - 1968, USAEC, July 1968.
- F. Lowder, W. M., P. D. Raft, and G. dePlanque Burke, "Determination of N-16 Gamma Radiation Fields at BWR Nuclear Power Stations," Health and Safety Laboratory, Energy Research and Development Administration, Report No. 305, May 1976.
- G. Letter from Charles L. Miller of the United States Nuclear Regulatory Commission to John F. Schmidt of the Nuclear Energy Institute, dated December 26, 1995.
- H. "Dose vs Distance at the Vermont Yankee ISFSI" Holtec Report No: HI-2073701, Holtec Project No: 90348, Approved on 12/10/07.
- I. Certificate of Compliance, Holtec International, Final Safety Analysis Report, Amendment 2, 06/07/05.
- J. AREVA Calculation #32-9068362-000 "Vermont Yankee Site Boundary Direct Dose From N-16 Methodology", April 4, 2008, Mark Strum and John Hamawi.

APPENDIX B

Approval of Criteria for Disposal of Slightly Contaminated
Septic Waste On-Site at Vermont Yankee

Revision 9 Date 3/2/90



UNITED STATES
NUCLEAR REGULATORY COMMISSION
WASHINGTON, D. C. 20555

August 30, 1989

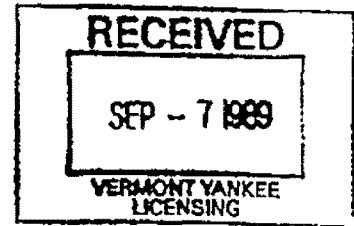

Docket No. 50-271

Mr. L. A. Tremblay
Licensing Engineering
Vermont Yankee Nuclear Power Corporation
Engineering Office
580 Main Street
Bolton, Massachusetts 01740-1398

Dear Mr. Tremblay:

SUBJECT: APPROVAL UNDER 10 CFR 20.302(a) OF PROCEDURES FOR DISPOSAL OF SLIGHTLY CONTAMINATED SEPTIC WASTE ON SITE AT VERMONT YANKEE (TAC NO. 73776)

REFERENCE: (a) June 28, 1989 letter from R. W. Capstick to US NRC Document Control Desk, including Attachment I and Attachment II.
(b) Final Environmental Statement related to the operation of Vermont Yankee Nuclear Power Station, dated July 1972.

In reference (a) Vermont Yankee Nuclear Power Corporation (Vermont Yankee, or the licensee) submitted an application for disposal of licensed material on site. This disposal was not previously considered by the staff in the Vermont Yankee Final Environmental Statement (FES), reference (b). This extensive application, prepared in accordance with 10 CFR 20.302(a), contains a detailed description of the licensed material, thoroughly analyzes and evaluates the information pertinent to the effects on the environment of the proposed disposal of the licensed material, and commits the licensee to follow specific procedures to minimize the risk of unexpected or hazardous exposures. In the FES, the NRC staff considered the potential effects on the environment of licensed material from operation of the plant and, in the assessment of the total radiological impact of the Vermont Yankee Station concluded that: "...operation of the Station will contribute only an extremely small increment to the radiation dose that area residents receive from natural background. Since fluctuations of the background dose may be expected to exceed the increment contributed by the plant, the dose will be immeasurable in itself and will constitute no meaningful risk to be balanced against the benefits of the plant."

Revision 9 Date 3/2/90

August 30, 1989

Since the disposal proposed by the licensee involves licensed material containing less than 0.1 percent of the radioactive materials, primarily cobalt-60 and cesium-137, already considered acceptable in the FES, and involves exposure pathways much less significant than those considered in the FES, we consider the site-specific application (Reference (a)) for Vermont Yankee Nuclear Power Station to have insignificant radiological impact. We accept the commitments and evaluations of the licensee, documented in reference (a), as further assurance that the proposed disposal procedures will have a negligible effect on the environment and the general population in comparison to normal background radiation.

LAI 855 | In conclusion, we find the licensee's procedures with commitments as documented in reference (a) to be acceptable, provided that reference (a) is permanently incorporated into the licensee's Offsite Dose Calculation Manual (ODCM) as an Appendix, and future modifications of reference (a) be reported to NRC in accordance with licensee commitments regarding ODCM changes.

Pursuant to 10 CFR 51.22(c)(9), no environmental assessment is required. This completes our review under TAC No.73776.

Sincerely,



Morton B. Fairtile, Project Manager
Project Directorate I-3 Division of
Reactor Projects I/II Office of
Nuclear Reactor Regulation

cc: See next page

Revision 9 Date 3/2/90

Mr. L. A. Tremblay

- 3 -

cc:

Mr. J. Gary Weigand
President & Chief Executive Officer
Vermont Yankee Nuclear Power Corp.
R.D. 5, Box 169
Ferry Road
Brattleboro, Vermont 05301

Mr. John DeVincentis, Vice President
Yankee Atomic Electric Company
580 Main Street
Bolton, Massachusetts 01740-1398

New England Coalition on Nuclear
Pollution
Hill and Dale Farm
R.D. 2, Box 223
Putney, Vermont 05346

Vermont Public Interest Research
Group, Inc.
43 State Street
Montpelier, Vermont 05602

Regional Administrator, Region I
U.S. Nuclear Regulatory Commission
475 Allendale Road
King of Prussia, Pennsylvania 19406

R. K. Gad, III
Ropes & Gray
225 Franklin Street
Boston, Massachusetts 02110

Mr. W. P. Murphy, Vice President
and Manager of Operations
Vermont Yankee Nuclear Power Corporation
R.D. 5, Box 169
Ferry Road
Brattleboro, Vermont 05301

Mr. George Sterzinger, Commissioner
Vermont Department of Public Service
120 State Street, 3rd Floor
Montpelier, Vermont 05602

Public Service Board
State of Vermont
120 State Street
Montpelier, Vermont 05602

G. Dean Weyman
Chairman, Board of Selectman
Post Office Box 116
Vernon, Vermont 05354

Mr. Raymond N. McCandless
Vermont Division of Occupational
and Radiological Health
Administration Building
Montpelier, Vermont 05602

Honorable John J. Easton
Attorney General
State of Vermont
109 State Street
Montpelier, Vermont 05602

Conner & Wetterhahn, P.C.
Suite 1050
1747 Pennsylvania Avenue, N.W.
Washington, D.C. 20006

Diane Curran, Esq.
Harmon, Curran & Tousley
2001 S Street, N.W., Suite 430
Washington, D.C. 20009

David J. Mullett, Esq.
Special Assistant Attorney General
Vermont Department of Public Service
120 State Street
Montpelier, Vermont 05602

Jay Gutierrez
Regional Counsel
U.S. Nuclear Regulatory Commission
475 Allendale Road
King of Prussia, Pennsylvania 19406

G. Dana Bisbee, Esq.
Office of the Attorney General
Environmental Protection Bureau
State House Annex
25 Capitol Street
Concord, New Hampshire 03301-6397

Atomic Safety and Licensing Board
U.S. Nuclear Regulatory Commission
Washington, D.C. 20555

Revision 9 Date 3/2/90

Mr. L. A. Tremblay

- 4 -

cc:

Mr. Gustave A. Linenberger, Jr.
Administrative Judge
Atomic Safety and Licensing Board
U.S. Nuclear Regulatory Commission
Washington, D.C. 20555

Resident Inspector
Vermont Yankee Nuclear Power Station
U.S. Nuclear Regulatory Commission
P.O. Box 176
Vernon, Vermont 05354

John Traficonte, Esq.
Chief Safety Unit
Office of the Attorney General
One Ashburton Place, 19th Floor
Boston, Massachusetts 02108

Geoffrey M. Huntington, Esquire
Office of the Attorney General
Environmental Protection Bureau
State House Annex
25 Capitol Street
Concord, New Hampshire 03301-6397

Charles Bechhoefer, Esq.
Administrative Judge
Atomic Safety and Licensing Board
U.S. Nuclear Regulatory Commission
Washington, D.C. 20555

Dr. James H. Carpenter
Administrative Judge
Atomic Safety and Licensing Board
U.S. Nuclear Regulatory Commission
Washington, D.C. 20555

Adjudicatory File (2)
Atomic Safety and Licensing Board Panel Docket
U.S. Nuclear Regulatory Commission
Washington, D.C. 20555

(25)

Revision 9 Date 3/2/90

B-5

VERMONT YANKEE NUCLEAR POWER CORPORATION



Ferry Road, Brattleboro, VT 05301-7002

June 28, 1989
BVY 89-59

REPLY TO
ENGINEERING OFFICE

580 MAIN STREET
BOLTON, MA 01740
(508) 779-6711

United States Nuclear Regulatory Commission
Washington, DC 20555

Attention: Document Control Desk

Reference: License No. DPR-28 (Docket No. 50-271).

Subject: Request to Routinely Dispose of Slightly Contaminated Septic Waste in
Accordance with 10 CFR 20.302(a)

Dear Sir:

In accordance with the criteria of the Code of Federal Regulations, Title 10, Section 20.302(a) (10CFR20.302(a)), enclosed please find the subject application for the disposal of very low level radioactive waste materials. Vermont Yankee Nuclear Power Corporation (Vermont Yankee) hereby requests NRC approval of the proposed procedures for the disposal of slightly contaminated septic waste generated at the Vermont Yankee Nuclear Power Plant in Vernon, Vermont.

This application specifically requests approval to dispose of septic tank waste, contaminated at minimal levels, which have been or might be generated through the end of station operations at the Vermont Yankee Nuclear Power Plant. The proposed method of disposal is for the on-site land spreading in designated areas in compliance with State of Vermont health code requirements for septic waste. Disposal of this waste in the manner proposed, rather than at a 10 CFR Part 61 licensed facility would save Vermont Yankee not only substantial cost, but also valuable disposal site space which would then be available for wastes of higher radioactivity levels. Disposal as radioactive waste would require treatment of the biological aspects of the septage and solidification to a stable waste form, thereby increasing the volume substantially.

A radiological assessment and proposed operational controls, based upon the continued on-site disposal of septic waste as presently contained in the plant's septic tanks, are detailed in Attachments 1 and 2. Based upon this analysis, Vermont Yankee requests approval to dispose of septic tank waste on-site by land spreading in such a manner that the radioactivity concentration limit in any batch of septage to be spread does not exceed one-tenth of the MPC values listed in 10 CFR 20, Appendix B, Table II; and the combined radiological impact for all disposal operations shall be limited to a total body or organ dose of a maximally exposed member of the public of less than one mrem/year (less than 5 mrem/year to an inadvertent intruder).

Revision 9 Date 3/2/90

United States Nuclear Regulatory Commission
June 28, 1989
Page 2

Due to our expected need to utilize the proposed methodology of land application of septic waste on-site during the spring of 1990, we request your review and approval of this proposed disposal method by the end of the first quarter of 1990.

We trust that the information contained in the submittal is sufficient; however, should you have any questions or require further information concerning this matter, please contact this office

Very truly yours,

VERMONT YANKEE NUCLEAR POWER CORPORATION



Robert W. Capstick, Jr.
Licensing Engineer

MSS/emd

Enclosures

cc: USNRC - Region I
USNRC - Resident Inspector, VTNPS

Revision 9 Date 3/2/90

ATTACHMENT 1

VERMONT YANKEE NUCLEAR POWER PLANT

APPLICATION FOR APPROVAL TO ROUTINELY DISPOSE OF
SEPTIC WASTE WITH MINIMAL LEVELS OF RADIOACTIVITY

Revision 9 Date 3/2/90

ATTACHMENT 1

VERMONT YANKEE NUCLEAR POWER PLANT

Application for Approval to Routinely Dispose of Septic Waste With Minimal Levels of Radioactivity

1.0 INTRODUCTION

Vermont Yankee Nuclear Power Corporation (Vermont Yankee) requests approval, pursuant to 10CFR20.302(a), of a method proposed herein for the routine disposal of slightly contaminated septic tank waste. Vermont Yankee proposes to dispose of this waste by spreading it on designated areas within the plant's site boundary fence. This application addresses specific information requested in 10CFR20.302(a).

2.0 WASTE STREAM DESCRIPTION

The waste involved in this application consists of residual solids and water associated with the sewage collection system at Vermont Yankee. The plant's sewage systems are of the septic tank and disposal field type. The two systems servicing the majority of the plant's sanitary waste are identified as (1) main septic system and (2) the south sewage disposal system.

The main septic system (design flow capacity 4,950 gallons/day) consists of a wastewater lift station, septic tank, and dual alternating disposal fields located on the north side of the plant. This system services the main complex of buildings central to the plant and processes approximately 3,500 gallons of wastewater per day. The septic tank, shown in Figure (1), will typically contain 9,250 gallons of septage.

The south sewage disposal system is a newly-installed (January 1989) pressurized mound system, which is used in lieu of the construction office building (COB) holding tank that had previously serviced the lavatory facilities on the south end of the plant. The new system is composed of a septic tank (5,700 gallon capacity, see Figure 2), pumping station, and pressurized mound disposal field. When dosing the field, a force main pressurizes the disposal field's piping system with the septic tank effluent, which distributes throughout the field. The south sewage disposal system has

Revision 9 Date 3/2/90

the design flow capacity to process 4,607 gallons of wastewater per day. The system is typically loaded at approximately 2,500 gallons per day during normal plant operations. Figure (3) indicates diagrammatically the flow of both potable and wastewater throughout Vermont Yankee.

Both the main septic system and the south sewage disposal system's septic tanks collect waste from the plant's lavatories, showers, kitchens, and janitorial facilities outside the Radiological Control Area (RCA). No radioactivity is intentionally discharged to either of the septic systems. However, plant investigations into the source of low levels of contamination found in septic waste have identified that very small quantities of radioactive materials, which are below detection limits for radioactivity releases from the RCA, are carried out of the control area on individuals and accumulate in the septic waste collection tanks by way of floor wash water, showers, and hand washing. As a means of minimizing the transport of radioactive materials into the septic collection tanks, the primary source of the radioactivity (i.e., floor wash water) is now poured through a filter bag to remove suspended solids and dirt before the water is released into a janitorial sink.

The majority of the radioactivity found in waste sludge has been associated with the main septic tank. Grab samples of sludge from the bottom of the COB and main septic tank were analyzed by gamma spectroscopy with the following results of plant-related radionuclides:

	<u>Isotope</u>	<u>Activity Concentration ±1 Sigma (pCi/kg Wet)</u>
COB Sludge (June 8, 1988)	Cs-137	10.3 ± 1.8
	Co-60	45.4 ± 3.1
Main Tank Sludge (June 8, 1988)	Mn-54	39.3 ± 4.3
	Co-60	853.0 ± 12.0
	Zn-65	52.7 ± 8.2
	Cs-134	13.0 ± 2.2
	Cs-137	120.7 ± 5.2

Revision 9 Date 3/2/90

The principle radionuclide is Cobalt-60, which accounts for 79% of the plant related activity in the septage samples. In comparison to in-plant smear samples taken for 10CFR61 waste characterizations, the septage sample from the main tank correlates very close with the distribution of radionuclides identified in-plant as shown below:

Relative Isotopic Distributions

<u>Isotope</u>	<u>In-Plant Smears</u>	<u>Main Tank Sludge</u>
Mn-54	3.6%	3.6%
Co-60	81.5	79.1
Zn-65	3.8	4.9
Cs-134	0.4	1.2
Cs-137	10.3	11.2

Additional analyses of the main tank septage showed that the liquid portion of the collected sample did not contain any plant-related activation or fission products, and that essentially all of the activity in the waste was associated with the solid sludge fraction. The average density of the collected sludge was found to be approximately equal to that of water, with a wet to dry ratio of 25.4 to 1.

Both the liquid and solid fractions of the main tank septic waste were also analyzed for strontium with no detectable activity found. The liquid portion of the waste sample was also analyzed for tritium with no activity above the minimum detectable levels found. Appendix A to Attachment 2 contains the laboratory analysis reports of the samples taken from the COB and main septic tanks.

Prior to identification of the plant-related radioactivity in septage waste, the COB holding tank was being pumped on the average of twice per week, with the sludge and waste liquid transported off-site primarily to the Brattleboro, Vermont, sewage treatment facility. Waste from the main septic tank was being pumped and transported off-site for disposal on the average of twice per year.

With the replacement of the COB holding tank by the new south sewage disposal system, and the requested implementation of on-site land disposal of accumulated septic waste, the frequency of collection tank pump-outs with land application of the waste is expected to be once per year. With the past pump-out frequency of the main tank being every six months, the accumulation of sludge at the bottom of the tank was well below its design capacity. During the 1988 sample collections, it was estimated that the sludge thickness was less than 1 foot of its 6-foot depth. However, for conservatism in the radiological evaluations, it is assumed that the sludge layer in the main septic tank and south disposal tank occupies 30% of their combined design volume, and that the frequency of pump-outs is semiannual as opposed to the expected annual cycle. Also, as noted above from laboratory analyses of the sludge layer taken from the bottom of the main tank, the average density of the tank contents is approximately equal to that of water, with a wet-to-dry ratio of 25.4 to 1. Hence, the weight of solids (W_{sol}) being disposed of is estimated, for purposes of this bounding dose assessment, to be approximately:

$$\begin{aligned} W_{sol} &= 14,950 \text{ [gal]} \times 3,785.4 \text{ [cc/gal]} \times 10^{-3} \text{ [kg/cc]} \\ &\quad \times 0.30 \text{ [solids fraction]} \times (1/25.4) \text{ [dry/wet ratio]} \\ &\quad \sim 700 \text{ [kg]} \text{ per pump-out of both tanks} \end{aligned}$$

or, 1,400 kg of dry solids per year.

3.0 DISPOSAL METHOD

Approval of this application will allow Vermont Yankee to dispose of septage by utilization of a technique of land spreading or surface injection in a manner consistent with all applicable state of Vermont health regulations regarding disposal of septic waste. Details of the chemical and biological controls necessary to satisfy state health code requirements are provided in Reference 5.

The septage will be spread or surface injected on land areas owned by Vermont Yankee and situated within the plant's site boundary. Transportation of the septage waste to the disposal areas will involve pumping from one of the septic waste collection tanks (i.e., main septic tank, COB holding tank,

new replacement COB septic tank, or from any other on-site septic waste collection point) into an enclosed truck-mounted tank. The enclosed tank truck is used to prevent spillage while in transit to the disposal areas. The septage will be transported to one of the two disposal sites designated for land application for septage from Vermont Yankee, and applied at a fixed rate based on either limitations imposed by the state of Vermont for heavy metals or organic content of the waste, or on the radioactivity content such that projected maximum individual doses will not exceed established dose objectives.

3.1 Septic Waste Disposal Procedure

Gamma isotopic analysis of septic waste shall be made prior to each disposal by obtaining a representative sample from each tank prior to pump-out. At least two septic waste samples will be collected from each tank to be pumped by taking a volumetric column of sludge and waste water which allows for analysis of the solid's distribution and content from top to bottom of each tank. The weight percent of solid content of the collected waste will be determined and applied to the gamma isotopic analysis in order to estimate the total radioactivity content of each tank to be pumped and spread on designated disposal fields.

These gamma isotopic analyses of the representative samples will be performed at the environmental Technical Specification lower limit of detection (LLD) requirements for liquids (see Technical Specification Table 4.9.3) in order to document the estimation of radiological impact from septage disposal.

The radionuclide concentrations and total radioactivity identified in the septage will be compared to the concentration and total curie limits established herein prior to disposal. The methodology and limits associated with determining compliance with the disposal dose and activity criteria are described in Attachment 2. If the concentration and total activity limits are met, compliance with the dose assessment criteria will have been demonstrated since the radiological analysis (Section 4.5 and Attachment 2) was based on evaluating the exposure to a maximally exposed individual and inadvertent intruder after the accumulation of twenty years of periodic semiannual

spreading of the septic waste on a single (2 acre) plot within one of the designated disposal areas. If the activity limit per disposal area is projected to be exceeded, the appropriate exposure pathways as described in Section 4.5 will be evaluated prior to each additional application, or a separate plot within the designated disposal area will be utilized.

Annually, for years in which disposal occurs, the potential dose impact from disposal operations conducted during the year, including the impact from previous years, will be performed and results reported in the plant's Semiannual Radioactive Effluent Release Report which is filed after January 1. All exposures will be assessed utilizing the methodology described in Attachment 2.

The established dose criteria requires that all applications of septage within the approved designated disposal areas shall be limited to ensure the dose to a maximally-exposed individual be maintained less than 1 mrem/year to the whole body and any organ, and the dose to the inadvertent intruder be maintained less than 5 mrem/year. The total activity based on the measured radionuclide distribution for any single disposal plot is not expected to exceed the following:

<u>Isotope</u>	Maximum Accumulated Radioactivity Allowed
	Per Acre <u>Q_i^{lim} [μCi]</u>
Mn-54	1.4
Co-60	120.0
Zn-65	1.4
Cs-134	0.7
Cs-137	46.5

If any of the above radionuclides are projected to exceed the indicated activity values, then dose calculations will be performed prior to spreading, in accordance with the methods detailed in Section 4.2.2 of Attachment 2, to make the determination that the dose limit criteria will not be exceeded.

The concentration of radionuclides in any tank of septic waste to be disposed of will also be limited to a combined Maximum Permissible Concentration of Water (MPC) (as listed in 10CFR, Part 20, Appendix B, Table II, Column 2) ratio of less than or equal to 0.1.

For radiological control, each application of septage will be applied on the designated land area by approved plant procedure which adheres to the following assumptions which were used in developing the dose impact:

- o During surface spreading or injection, the septage, and any precipitation falling onto or flowing onto the disposal field, shall not overflow the perimeter of the designated area.
- o Septage shall not be surface spread or injected into the top 6-inch soil layer within 300 feet from any drinking water well supply.
- o Septage shall not be surface spread closer than 300 feet from the nearest dwelling or public building (or within 100 feet if injected into the top 6-inch surface layer).
- o Septage shall not be surface spread closer than 50 feet (or within 25 feet if injected into the top 6-inch surface layer) from any roads or site boundary adjacent to land areas.
- o Septage shall not be surface spread within 100 feet (or within 50 feet if injected into the top 6-inch surface layer) of any surface water (rivers, streams, drainage ditches).
- o Low areas of the approved fields, subject to seasonally high groundwater levels, are excluded from the septage application.

In addition to the radiological controls to limit the total accumulation of radioactive materials released by septic waste spreading, state of Vermont health code requirements will be followed to ensure the protection of the public and environment from chemical and biological hazards. The application rate and acreage will be determined prior to each

disposal operation. This will vary with the chemical composition of the septage, the percent solids, and the radioactive concentrations.

3.2 Administrative Procedures

Complete records of each disposal will be maintained. These records will include the concentration of radionuclides in the septage, the total volume of septic waste disposed, the total activity in each batch as well as total accumulated on the disposal plot at time of spreading, the plot on which the septage was applied, and the results of any dose calculations required.

The annual disposal of septage on each of the approved plot areas will be limited to within the established dose, activity, and concentration criteria noted above, in addition to limitations dictated by chemical and biological conditions. Dose guidelines, and concentration and activity limits, will be maintained within the appropriate values as detailed in Attachment 2.

Any farmer using land which has been used for the disposal of septic waste will be notified of any applicable restrictions placed on the site due to the land spreading or injection of waste.

4.0 EVALUATION OF ENVIRONMENTAL IMPACT

4.1 Site Characteristics

4.1.1 Site Topography

The proposed disposal sites consist of two fields located on the Vermont Yankee Nuclear Power Plant site, which is located on the west bank of the Connecticut River in southwestern Vermont at latitude 42 degrees, 47 minutes north and longitude 72 degrees 31 minutes west. Both fields are on plant property within the site boundary and surrounded by a chain link fence.

Site A contains an approximate eight-acre parcel of usable land centered approximately 2,200 feet northwest of the Reactor Building. Site B contains about two acres and is centered approximately 1,700 feet south of the Reactor Building. The usable acreage of both the north and south disposal fields is restricted to those areas which have no slopes greater than five percent to limit surface runoff. A radiological assessment based on the 1988 measured radioactivity concentrations in sludge has determined that a single two-acre plot would be sufficient for the routine disposal of septage for twenty years without exceeding the dose criteria to maximum exposed individual or inadvertent intruder. As a result, the eight-acre field to the northwest could be divided into four disposal plots, with the two-acre site at the south end of the plant site, providing a fifth plot. A portion of the United States Geological Survey topographic map (Brattleboro quadrangle), showing the plant site, is presented in the Final Safety Analysis Report (FSAR) as Figure 2.5-1. A plan map showing the plant site and the disposal sites is given on Figure 4.

The sites are located along a glacial terrace on the west side of the Connecticut River. This terrace extends about 3,000 feet west rising gently and then more abruptly to a higher terrace and then to dissected uplands. Distance to the east from the disposal sites to the river is at least 100 feet if septage is disposed of by surface spreading within the designated areas, or 50 feet if septage is injected directly into the soil.

Relief of the proposed disposal sites is low, with elevation ranging between 250 feet and 265 feet (msl). Mean water surface elevation of the adjacent river is about 220 feet.

The topographic character of the site and surrounding area is compatible with this use. The spreading of septage at these locations will have no effect on the topography of the area.

4.1.2 Site Geology

Profiles of site exploratory borings are shown in the FSAR in Figures 2.5-8 through 2.5-11. Current site characteristics as determined from a recent detailed site investigation can be found in Reference 5.

Composition of surfacial materials is compatible with the proposed use of the site for septic waste disposal.

4.2 Area Characteristics

4.2.1 Meteorology

The site area experiences a continental-type climate with some modification due to the marine climate which prevails at the Atlantic seacoast to the east. Annual precipitation averages 43 inches and is fairly evenly distributed in each month of the year.

Potential impacts on septic waste disposal include occasional harsh weather: ice storms, severe thunderstorms, heavy rains due to hurricanes, the possibility of a tornado, and annual snowfall of from 30 to 118 inches per year. In addition, frozen ground can occur for up to 4 months of the year.

Septage spreading will be managed by written procedure such that material which is spread or a mix of that material with precipitation will not overflow the perimeter of the disposal site.

Additional information on meteorology of the site can be found in Section 2.3 of the Final Safety Analysis Report.

4.2.2 Hydrology

Hydrology of the site and local area is tied closely to flow in the adjacent Connecticut River. River flow is controlled by a series of hydroelectric and flood-control dams including the Vernon Dam which is about 3,500 feet downstream of the site.

Revision 9 Date 3/2/90

All local streams drain to the Connecticut River and the site is in the direct path of natural groundwater flow from the local watershed easterly toward the river. Site groundwater level is influenced by both precipitation and changes in the level of ponding of the Connecticut River behind the Vernon Dam due to natural flow or dam operation.

Flood flows on the Connecticut are controlled by numerous dams including five upstream of the site. Elevation of the 100-year flood is about 228 ft (msl); and, thus, well below the elevation of the proposed site which ranges from about 250 to 265 feet (msl). The 100-year flood level is based on information presented in References (1) and (2).

Septage disposal by means of land spreading on the proposed site will have no adverse impact on area hydrology.

Further information about site hydrology is in Section 2.4 of the FSAR.

4.3 Water Usage

4.3.1 Surface Water

The adjacent Connecticut River is used for hydroelectric power, for cooling water for the Vermont Yankee plant, as well as for a variety of recreational purposes such as fishing and boating. The Connecticut River is not used as a potable water supply within 50 miles downstream of the plant.

Locally, water from natural springs are used for domestic and farm purposes. FSAR Table 2.4.5 and Figure 2.4-2 show springs used within a 1-mile radius of the site. FSAR Table 2.4.4 and Figure 2.4-1 show water supplies with surface water sources which are within a ten-mile radius of the site.

There will be no impact on surface water usage or quality as a result of septage disposal due to the required separation distances between surface waters and the disposal plots.

4.3.2 Groundwater

Based on a review of groundwater measurements in various site borings presented in the FSAR and References 3 and 5, an upper estimate of groundwater levels at the plant is about 240 feet. Considering the proximity of the Connecticut River and Vernon Pond, with a mean water surface elevation of 220 feet, this estimate for the groundwater level appears to be reasonable. Given the topography of the proposed disposal sites, it is highly unlikely that the groundwater level will be within 3 feet of the disposal area surface elevation. Prior to each application of septic waste to a disposal plot, the groundwater level in nearby test wells will be determined and no application will be allowed if the groundwater level in the vicinity of the disposal plot is found to be less than 3 feet.

Groundwater provides potable water for public wells as shown in FSAR Table 2.4.5 and Figure 2.4-1. Groundwater flow in the vicinity of the proposed disposal sites is towards the Connecticut River. There are no drinking-water wells located between the site and the river. Therefore, it is highly unlikely that any drinking water wells could be affected by septage disposal. FSAR Figure 2.4-2 and Table 2.4-5 present information on private wells near the plant.

The Vermont Yankee on-site wells provide water for plant use. This supply is routinely monitored for radioactive contamination.

To quantify the impact of septage disposal on the Connecticut River, a conservative groundwater/radionuclide travel time analysis was performed. For an assumed average travel distance of 200 feet from the disposal site to the river, a groundwater travel time of 408 days was estimated from Darcy's Law. This estimate is based on a permeability for the glacial till of 10 gpd/ft², a hydraulic gradient of 0.11 ft/ft, and a soil porosity of 0.3. This analysis conservatively assumed that the septage placed on the ground was immediately available to the groundwater. In practice, a minimum of 3 feet separation between groundwater and the surface will be required at time of application of the septic waste.

Due to ionic adsorption of the radionuclides on solid particles in the groundwater flow regime, most radionuclides travel at only a small fraction of the groundwater velocity. For the radionuclides present in the sludge, retardation coefficients were developed from NUREG/CR-3130 (Reference 4). Retardation coefficients for Co-60, Cs-137, and Cs-134 were directly obtained from NUREG/CR-3130. The coefficients for Zn-65 and Mn-54 were conservatively estimated using NUREG/CR-3130 as a guide. The radionuclides, their half-lives, retardation coefficients, and their travel time to the river are summarized in Table 1.

TABLE 1
Radionuclide Travel Times

<u>Radionuclide</u>	<u>Half Life</u>	<u>Retardation Coefficient</u>	<u>Travel Time to River</u>
Co-60	5.3 years	860	961 years
Cs-137	30.2 years	173	193 years
Cs-134	2.1 years	173	193 years
Zn-65	244 days	3	1,224 days
Mn-54	312 days	3	1,224 days

The radiological impact on the river for the radionuclides reaching the river under this conservative analysis is discussed in Attachment 2. Water usage of the Connecticut River downstream from the disposal area is limited to drinking water for dairy cows, irrigation of vegetable crops, and irrigation of cow and cattle fodder.

Based on the assessments noted above, it is concluded that groundwater sources will not be adversely impacted as a result of septage disposal on the proposed site.

4.4 Land Use

Both the eight-acre and two-acre sites proposed for the disposal areas are currently part of the Vermont Yankee Nuclear Power Plant Site inside the plant's site boundary which is enclosed by a chain link fence. It is

undeveloped except for transmission line structures which traverse a portion of the northern disposal area. Development potential is under the control of Vermont Yankee. At present, the eight-acre site on the north end of the plant property is used by a local farmer for the growing of feed hay for use with his dairy herd. No curtailment of this activity as a result of the low levels of radioactivity in septage will be necessary.

Utilization of the proposed sites for septic waste disposal will result in no impact on adjacent land or properties because of the separation of the disposal plots from off-site properties, the general movement of groundwater toward the river and away from adjacent land areas, and the very low levels of radioactive materials contained in the waste. Administrative controls on spreading and the monitoring of disposal area conditions will provide added assurance that this proposed practice will not impact adjacent properties.

4.5 Radiological Impact

In addition to state of Vermont limits imposed on septage spreading, based on nutrient and heavy metal content, the amount of septage applied on each of the proposed disposal plots will also be procedurally controlled to insure doses are maintained within the stated limits. These limits are based on NRC Nuclear Reactor Regulation (NRR) staff proposed guidance (described in AIF/NESP-037, August 1986). The proposed dose criteria require that the maximally exposed member of the general public receive a dose less than 1 mrem/year to the whole body or any organ due to the disposal material, and less than 5 mrem/year to an inadvertent intruder.

To assess the doses received by the maximally-exposed individual and the inadvertent intruder, six potential pathways have been identified. These include:

- (a) Standing on contaminated ground,
- (b) Inhalation of resuspended radioactivity,

- (c) Ingestion of leafy vegetables,
- (d) Ingestion of stored vegetables,
- (f) Ingestion of meat, and
- (g) Ingestion of milk.

The liquid pathway was also evaluated and determined to be insignificant. Both the maximum individual and inadvertent intruder are assumed to be exposed to these pathways with difference between the two related to the occupancy time. The basic assumptions used in the radiological analyses include:

- (a) Exposure to the ground contamination and to resuspended radioactivity is for a period of 104 hours per year during Vermont Yankee active control of the disposal sites, and continuous thereafter. The 104-hour interval being representative of a farmer's time on a plot of land (4 hours per week for 6 months).
- (b) The septic tanks are emptied every two to three years. (The assumed practice is to pump septic tanks once per year. The actual practice may be to pump septic tanks every two to three years.)
- (c) The tank radioactivity remains constant at the currently determined level. To account for the uncertainty associated with the counting statistics, the measured activity concentrations listed in Section 2 were increased by 3 sigmas. That is, the activity concentrations employed in dose assessment and the total radioactivity content per pump-out (at 700 kg of solids per batch) are as follows:

<u>Isotope</u>	<u>Upper-Bound Activity Concentration [pCi/kg dry]</u>	<u>Upper-Bound Activity Content [Ci/tankful]</u>
Mn-54	1,348	9.436E-07
Co-60	23,060	1.614E-05
Zn-65	1,620	1.134E-06
Cs-134	322	2.254E-07
Cs-137	4,100	2.870E-06

- (d) The radiation source corresponds to the accumulation of radioactive material on a single plot (two-acre) within the proposed disposal sites over a period of 20 years (40 applications at 6-month intervals). (In actuality, the proposed sites will accommodate more than one disposal plot, and, in practice, more than one plot will most probably be used with an application frequency of once per year.)
- (e) For the analysis of the radiological impact during Vermont Yankee active control of the disposal sites, all dispersed radioactive material remains on the surface and forms a source of unshielded radiation. (In practice, the septic waste will be either surface spread or directly injected within the top 6 inches of the disposal plot, in which case, the radioactive material will be mixed with the soil. This, in effect, would reduce the ground plane source of exposure by a factor of about four due to self-shielding.)
- (f) No radioactive material is dispersed directly on crops for human or animal consumption, crop contamination being only through root uptake.
- (g) The deposition on crops of resuspended radioactivity is insignificantly small.

- (h) Pathway data and usage factors used in the analysis are the same as those used in the plant's ODCM assessment of the off-site radiological impact from routine releases, with the exception that the fraction of stored vegetables grown on the disposal plots was conservatively increased from 0.76 to 1.0 (at present no vegetable crops for direct human consumption are grown on any of the proposed disposal plots).
- (i) It is conservatively assumed that Vermont Yankee relinquishes control of the disposal sites after the fortieth pump-out (i.e., the above source term applies also for the inadvertent intruder).
- (j) For the analysis of the impact after Vermont Yankee control of the sites is relinquished, the radioactive material is plowed under and forms a uniform mix with the top six inches of soil; but, nonetheless, undergoes resuspension at the same rate as surface contamination.

From radiological impact assessments associated with the disposal of septage on different plot sizes (Attachment 2), it was determined that a single two-acre plot within the disposal sites would accommodate the 1 mrem/year prescribed dose to the critical organ of the maximally exposed individual for a period of up to 20 years, as well as the 5 mrem/year prescribed dose to the inadvertent intruder after control is assumed to be relinquished. The calculated potential radiation exposures following the spreading of 40 combined (main septic system and south disposal system) tankfuls (at six-month intervals) on a single two-acre plot are as follows:

<u>Control of Disposal Sites</u>	<u>Radiation Exposure</u>	<u>Individual/Organ</u>
Controlled by VYNPS (Maximum Exposed Individual)	0.1 mrem/yr 0.2 mrem/yr Maximum	Child/Whole Body Child/Liver
Uncontrolled (Inadvertent Intruder)	1.3 mrem/yr 3.9 mrem/yr Maximum	Adult/Whole Body Teenager/Lung

The individual pathway contributions to the total dose at the end of the 20-year accumulation of waste deposited on a single two-acre plot are as listed below:

Pathway-Dependent Critical Organ Doses

<u>Pathway</u>	Maximally Exposed Individual/Organ (Child/Liver) (mrem/year)	Inadvertent Intruder Critical Individual/Organ (Teenager/Lung) (mrem/year)
Ground Irradiation	0.0576	1.16
Inhalation	0.00122	2.74
Stored Vegetables	0.0913	0.00601
Leafy Vegetable	0.00467	0.00040
Milk Ingestion	0.0421	0.00229
Meat Ingestion	<u>0.00249</u>	<u>0.00012</u>
TOTAL	0.1994	3.909

In addition, an isotopic breakdown of the critical organ dose results listed above is shown in the following table:

Isotopic Breakdown of Maximum Radiation Exposures

<u>Description</u>	<u>Isotope</u>	<u>Radioactivity [μCi/2 Acres]</u>	<u>Exposure [mrem/yr]</u>
During Vermont Yankee control of the disposal sites. Maximally Exposed Individual/Organ: Child/Liver	Mn-54	2.831	0.000436
	Co-60	235.3	0.0559
	Zn-65	2.801	0.0230
	Cs-134	1.457	0.00231
	Cs-137	92.59	<u>0.118</u>
	TOTAL		
After Vermont Yankee control of sites is relinquished. Inadvertent Intruder Critical Individual/Organ: Teenager/Lung	Mn-54	2.831	0.0144
	Co-60	235.3	3.76
	Zn-65	2.801	0.00983
	Cs-134	1.457	0.000505
	Cs-137	92.59	<u>0.1247</u>
	TOTAL		

Revision 9 Date 3/2/90

Of interest are also derived dose conversion factors which provide a means of ensuring septage disposal operations within the prescribed radiological guidelines. The critical-organ (worst-case) all-pathway values per acre are as follows:

All-Pathway Critical-Organ Dose Conversion Factors
During Vermont Yankee Control of Disposal Sites

<u>Isotope</u>	<u>Individual/Organ</u>	<u>Exposure</u> <u>[mrem/yr-μCi/acre]</u>
Mn-54	Adult/GE-LLI	3.74E-4
Co-60	Teenager/Lung	7.14E-4
Zn-65	Child/Liver	1.64E-2
Cs-134	Child/Liver	3.18E-3
Cs-137	Child/Bone	2.66E-3

The calculational methodology and details of the radiological assessment and proposed operational controls on total activity and concentration of waste to be disposed are presented in Attachment 2.

5.0 RADIATION PROTECTION

The disposal operation will follow the applicable Vermont Yankee procedures to maintain doses as low as reasonably achievable and within the specified dose and release concentration criteria.

REFERENCES

1. Flood Insurance Study, Vernon, Vermont, Windham County, FEMA, Community No. 500137, July 25, 1980.
2. Flood Insurance Study, Town of Hinsdale, New Hampshire, Cheshire County, FEMA, Community No. 330022, October 15, 1980.
3. Vermont Yankee Well Development Evaluation by Wagner, Heindel, and Noyes, Inc. July 10, 1986.
4. NUREG/CR-3130, Influence of Leach Rate and Other Parameters on Groundwater Migration, by Dames & Moore, February 1983.
5. Vermont Yankee Nuclear Power Corporation On-Site Septage Disposal Plan, by Wagner, Heindel, and Noyes, Incorporated, June 1989.

FIGURE 1
MAIN SEPTIC TANK

ENLARGED SYSTEM PLAN
SCALE: 1" = 10'

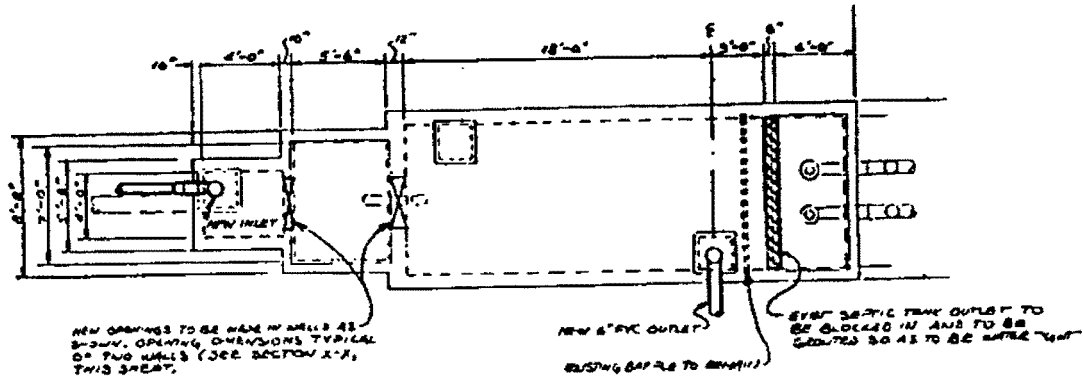

PLAN

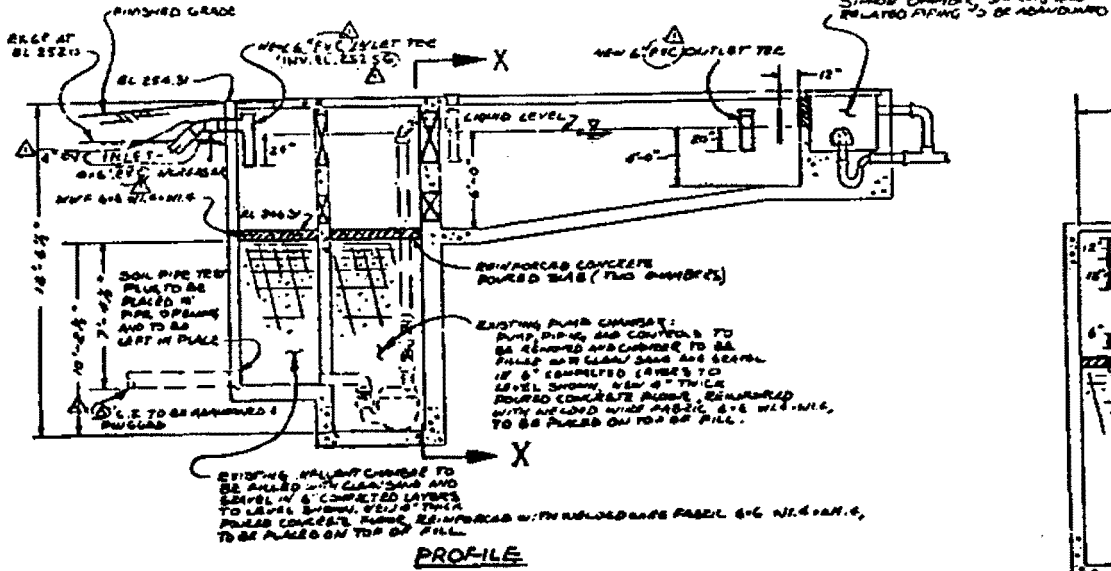

PROFILE

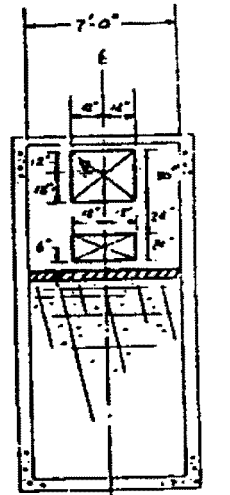

SECTION X-X
NOT TO SCALE

MODIFICATIONS TO EXISTING SEPTIC TANK AND CHAMBERS

NOT TO SCALE
SEE DWG. GISIGOT FOR DETAILS OF ORIGINAL SEPTIC TANK

FIGURE 2
SOUTH DISPOSAL SYSTEM
SEPTIC TANK

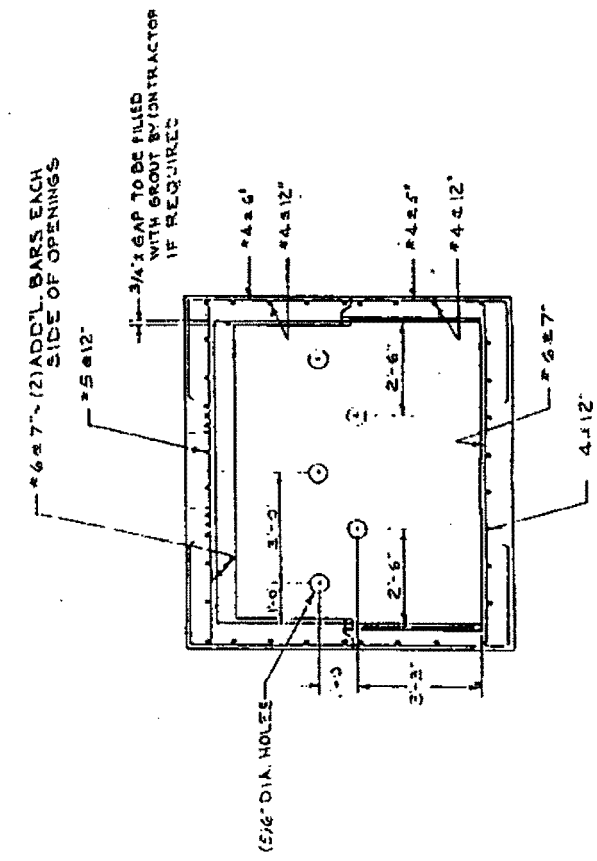
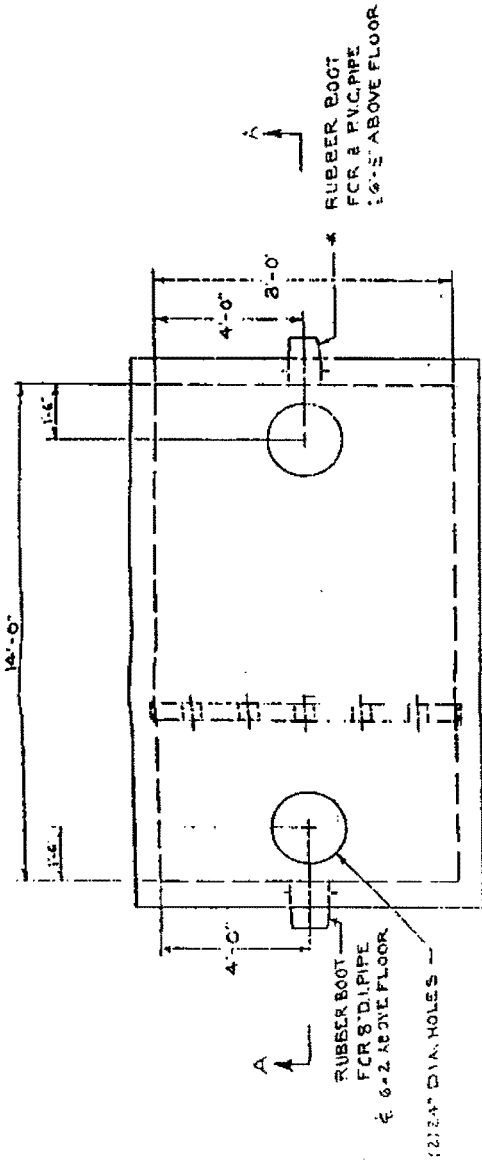

SECTION B-B

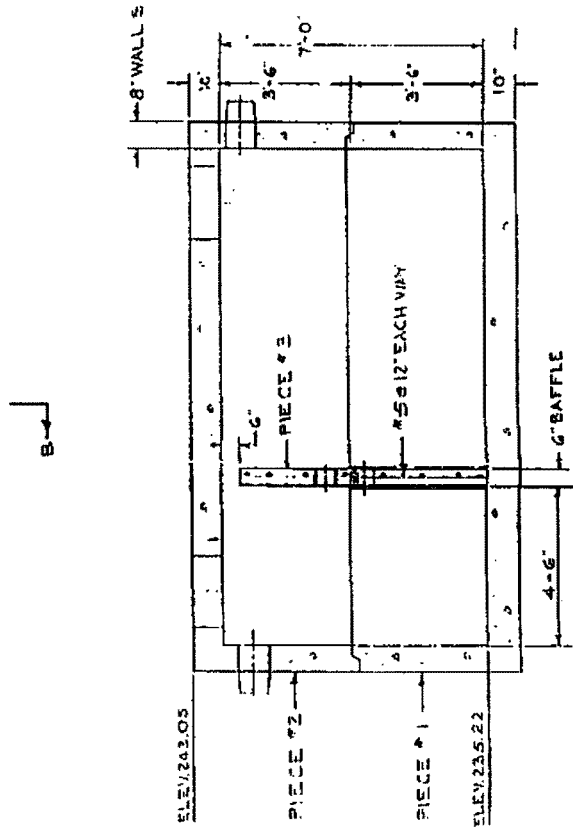

SECTION A-A

FIGURE 3
POTABLE AND WASTE WATER FLOW

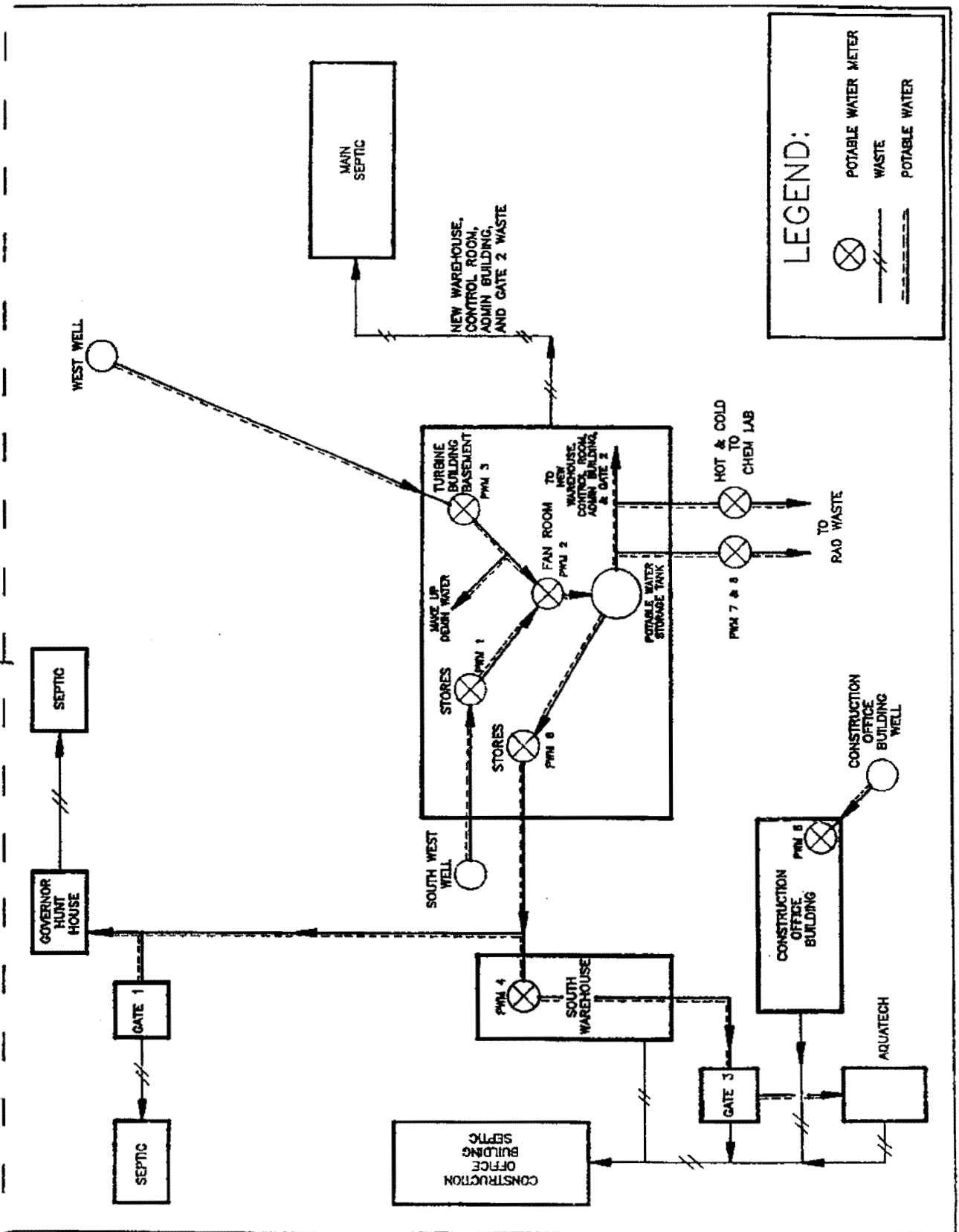

LEGEND:



-  POTABLE WATER METER
-  WASTE
-  POTABLE WATER

FIGURE 4
SEPTIC WASTE DISPOSAL AREAS



(This attachment to Appendix B is incorporated into the ODCM by reference due to size. A complete copy is on file with Vermont Yankee Document Control as part of Correspondence Letter BVY 89-59.)

ATTACHMENT 2

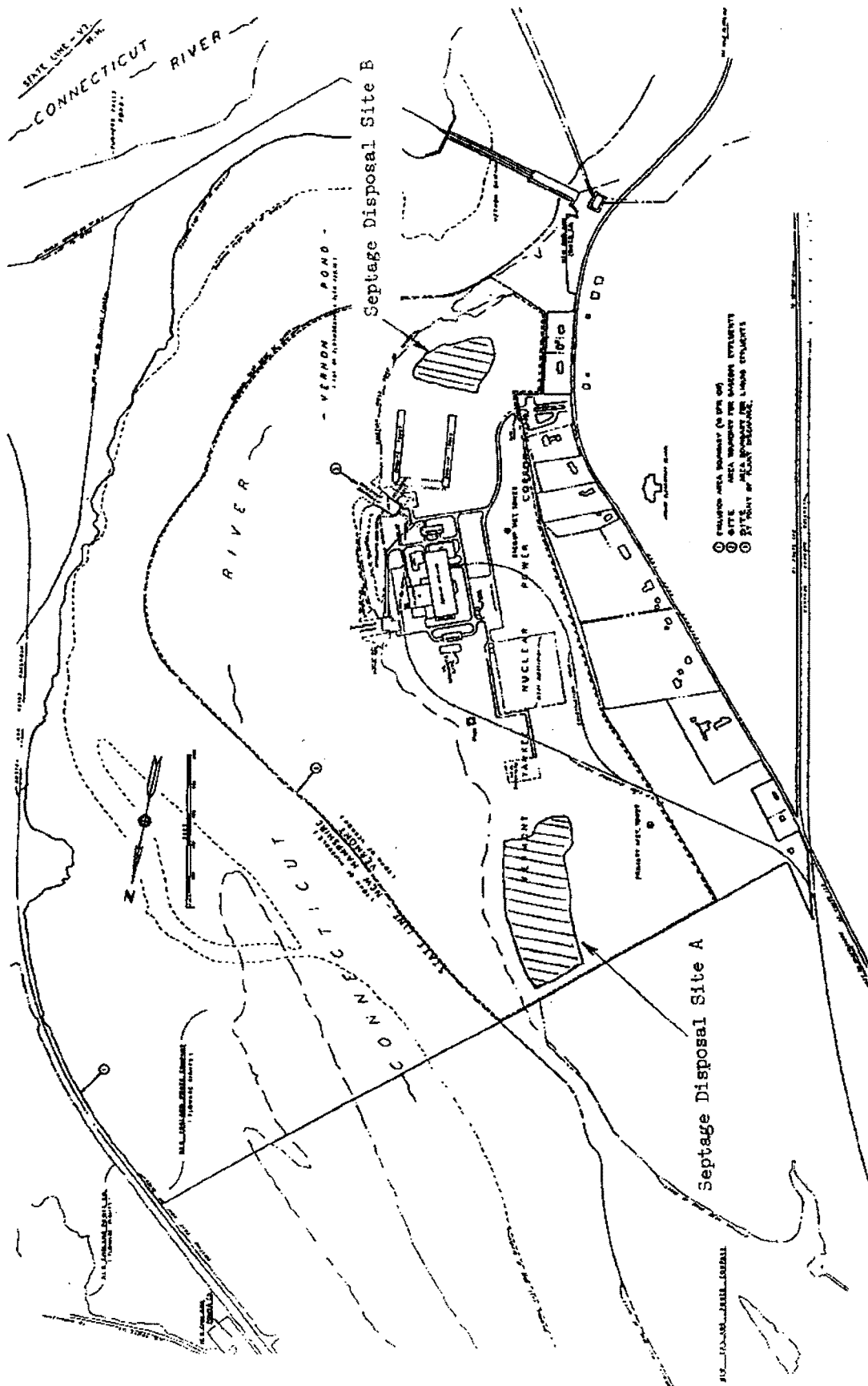
VERMONT YANKEE NUCLEAR POWER PLANT

RADIOLOGICAL ASSESSMENT OF

ON-SITE DISPOSAL OF SEPTIC WASTE

and

PROPOSED PROCEDURAL CONTROLS TO ENSURE

COMPLIANCE WITH RADIOLOGICAL LIMITS

Revision 9 Date 3/2/90

APPENDIX D

ASSESSMENT OF SURVEILLANCE CRITERIA
FOR GAS RELEASES FROM
WASTE OIL INCINERATION

Revision 16 Date 10/28/93

APPENDIX D

ASSESSMENT OF SURVEILLANCE CRITERIA FOR GAS RELEASES FROM WASTE OIL INCINERATION

INTRODUCTION:

The Nuclear Regulatory Commission amended its regulations (10CFR20) in a Federal Register Notice (Vol. 57, No. 235; page 57649 / Monday, December 7, 1992) that permitted the on-site incineration of contaminated waste oil generated at licensed nuclear power plants without the need to amend existing operating licenses. This action will help to ensure that the limited capacity of licensed low level waste disposal facilities is used efficiently while maintaining releases from operating nuclear power plants at levels which are "as low as reasonably achievable." Incineration of this class of waste must be in full compliance with the Commission's current regulations that restrict the release of radioactive materials to the environment. Any other applicable Federal, State, or local requirements that relate to the toxic or hazardous characteristics of the waste oil would also have to be satisfied.

Incineration of waste oil is to be carried out under existing effluent limits, recordkeeping and reporting requirements. Specifically, licensees must comply with the effluent release limitations of 10CFR Part 20, and Part 50; Appendix I. This includes the site gaseous pathway dose and dose rate limits contained in the plant's Technical Specifications (Section 3.8). The dose contribution to members of the public resulting from the on-site incineration of contaminated waste oil must not cause the total dose or dose rate from all effluent sources to exceed the dose or concentration limits imposed by 10CFR20, 10CFR50; Appendix I, and the Radiological Effluent Technical Specifications (RETS). It is expected that the actual contribution to public exposures caused by waste oil burning will be a small fraction of the site's effluent limits, as well as a small portion of the total releases from the site.

SOURCE DESCRIPTION

Contaminated waste oil suitable for on-site incineration can be burned in the Waste Oil Burner located in the North Warehouse. The burner has its own exhaust stack situated on the roof of the warehouse. However, due to the short height of the exhaust stack above the roof line, this release point is considered to be a ground level point source for modeling discharges to the environment. In addition, the building wake effects from the North Warehouse are assumed to be independent of the larger Turbine Hall/Reactor Building complex due to its distance from these main structures. Consequently, the relatively small size of the North Warehouse leads to

Revision 16 Date 10/28/93

meteorological dispersion factors that are conservative with respect to the dispersion factors for the main plant structures.

The waste oil burner is rated to process oil at a 2 gal./hour from a 500 gallon day tank. The offgas flow rate for the burner is rated as 199 cfm. This provides an air to oil dilution during the incineration of 44,800.

WASTE OIL SAMPLING/SURVEILLANCE REQUIREMENTS

The oil burner stack is not equipped with continuous air monitoring or sampling capability for the direct determination of radiological effluent releases during the incineration process. As a consequence, sampling and analysis of the waste oil prior to its incineration is necessary to project the dose and dose rate consequences of burning contaminated oil. Calculations of projected dose from the incineration of total quantity of oil to be added to the Waste Oil Burn Day Tank for each series of burns will be performed in accordance with the methods in the ODCM and compared to the accumulated site total dose for that period before initiation of incineration. Dose rate determinations will be determined by averaging the projected dose for the quantity of radioactivity determined to be present in the oil over the expected duration of the burn necessary to incinerate the total volume to be added to the Day Tank. Inherent in this determination is the assumption that all radioactivity found to be present in each batch of oil will be released to the atmosphere during the incineration. No retention of activity in the combustion chamber is assumed in calculating the offsite radiological impact.

Normal sampling and analysis methods for gaseous release streams cannot be applied directly to liquids (waste oil). Therefore, the sampling and analysis requirements for liquids as identified in Technical Specification Table 4.8.1 shall be used to determine the level of contamination in waste oil. The stated Lower Limits of Detection (LLD) given on Table 4.8.1 provide assurance that undetectable levels of contamination up to the LLD values will not result in a significant dose impact to the maximum offsite receptor. If waste oil was burned continuously for an entire calendar quarter, and the radionuclides listed in the ODCM Dose Conversion Factor Table 1.1-12 were assumed to be present in the oil at the LLD values specified in Technical Specification Table 4.8.1, the resultant maximum organ dose would amount to only 0.28% of the ALARA quarterly limit of 7.5 mrem.

The principle limitation in the incineration of waste oil is that the site release limits contained in RETS, and implemented by the ODCM methodology, shall not be exceeded. The use of the liquid LLDs on waste oil sample analyses provide sufficient sensitivity to ensure that site dose limits will not be exceeded as a consequence of burning slightly contaminated oil.

Revision 16 Date 10/28/93

APPENDIX F

APPROVAL PURSUANT TO 10CFR20.2002
FOR ONSITE DISPOSAL OF COOLING TOWER SILT

Revision 21 Date 08/14/97



UNITED STATES
NUCLEAR REGULATORY COMMISSION
WASHINGTON, D.C. 20555-0001

June 18, 1997
NVY 97-85

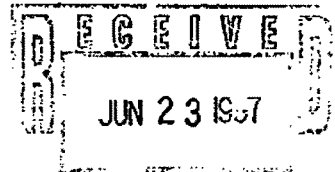

LAI 1130, 1210, 1193

Mr. Donald A. Reid
Vice President, Operations
Vermont Yankee Nuclear Power Corporation
Ferry Road
Brattleboro, VT 05301

SUBJECT: REVISED SAFETY EVALUATION - APPROVAL PURSUANT TO 10 CFR 20.2002
FOR ONSITE DISPOSAL OF COOLING TOWER SILT - VERMONT YANKEE NUCLEAR
POWER STATION (TAC NO. M96371)

Dear Mr. Reid:

By letter dated August 30, 1995, Vermont Yankee Nuclear Power Corporation (VYNPC) requested approval, pursuant to 10 CFR 20.2002, for the onsite disposal of slightly contaminated silt material removed from Vermont Yankee Nuclear Power Station's (Vermont Yankee's) cooling towers. In a safety evaluation (SE) dated March 4, 1996, the NRC staff approved the proposed silt disposal. However, because of discrepancies VYNPC identified between the safety evaluation and VYNPC's letter of August 30, 1995, VYNPC postponed implementation of the silt disposal until resolution of the discrepancies. By letter dated August 2, 1996, VYNPC informed the NRC staff of the discrepancies and requested that the SE be revised accordingly. Recognizing the discrepancies, the NRC staff has prepared the enclosed SE to resolve the discrepancies and to replace the SE of March 4, 1996.

LAI 1130 | The NRC staff's approval of VYNPC's silt disposal request is granted provided the enclosed replacement SE is permanently incorporated into Vermont Yankee's Offsite Dose Calculation Manual as an appendix. Any modification to the proposed action that may be considered in the future must have prior NRC staff approval

Pursuant to the provisions of 10 CFR Part 51, the Commission has published in the Federal Register an Environmental Assessment and Finding of No Significant Impact (61 FR 6662).

Revision 21 Date 08/14/97

D. Reid

- 2 -

If you have any further questions regarding this matter, please contact
Mr. Kahtan Jabbour at (301) 415-1496.

Sincerely,

A handwritten signature in black ink, appearing to read "Patrick D. Milano". The signature is fluid and cursive, with a large initial "P" and "M".

Patrick D. Milano, Acting Director
Project Directorate I-3
Division of Reactor Projects - I/II
Office of Nuclear Reactor Regulation

Docket No. 50-271

Enclosure: Safety Evaluation

cc w/encl: See next page

Revision 21 Date 08/14/97

Vermont Yankee Nuclear Power
Corporation

Vermont Yankee Nuclear Power Station

cc:

Regional Administrator, Region I
U. S. Nuclear Regulatory Commission
475 Allendale Road
King of Prussia, PA 19406

R. K. Gad, III
Ropes & Gray
One International Place
Boston, MA 02110-2624

Mr. Richard P. Sedano, Commissioner
Vermont Department of Public Service
120 State Street, 3rd Floor
Montpelier, VT 05602

Public Service Board
State of Vermont
120 State Street
Montpelier, VT 05602

Chairman, Board of Selectman
Town of Vernon
P.O. Box 116
Vernon, VT 05354-0116

Mr. Richard E. McCullough
Operating Experience Coordinator
Vermont Yankee Nuclear Power Station
P.O. Box 157
Governor Hunt Road
Vernon, VT 05354

G. Dana Bisbee, Esq.
Deputy Attorney General
33 Capitol Street
Concord, NH 03301-6937

Resident Inspector
Vermont Yankee Nuclear Power Station
U.S. Regulatory Commission
P.O. Box 176
Vernon, VT 05354

Chief, Safety Unit
Office of the Attorney General
One Ashburton Place, 19th Floor
Boston, MA 02108

Mr. Peter LaPorte, Director
ATTN: James Muckerheide
Massachusetts Emergency Management
Agency
400 Worcester Rd.
P.O. Box 1496
Framingham, MA 01701-0317

Mr. Raymond N. McCandless
Vermont Division of Occupational
and Radiological Health
Administration Building
Montpelier, VT 05602

Mr. J. J. Duffy
Licensing Engineer
Vermont Yankee Nuclear Power
Corporation
580 Main Street
Bolton, MA 01740-1398

Mr. Robert J. Wanczyk
Director of Safety and Regulatory
Affairs
Vermont Yankee Nuclear Power Corp.
Ferry Road
Brattleboro, VT 05301

Mr. Ross B. Barkhurst, President
Vermont Yankee Nuclear Power
Corporation
Ferry Road
Brattleboro, VT 05301

Mr. Gregory A. Maret, Plant Manager
Vermont Yankee Nuclear Power Station
P.O. Box 157
Governor Hunt Road
Vernon, VT 05354

Revision 21 Date 08/14/97



UNITED STATES
NUCLEAR REGULATORY COMMISSION
WASHINGTON, D.C. 20555-0001

SAFETY EVALUATION BY THE OFFICE OF NUCLEAR REACTOR REGULATION
RELATED TO ONSITE DISPOSAL OF SLIGHTLY CONTAMINATED COOLING TOWER SILT
VERMONT YANKEE NUCLEAR POWER CORPORATION
VERMONT YANKEE NUCLEAR POWER STATION

DOCKET NO. 50-271

1.0 INTRODUCTION

By letter dated August 30, 1995, Vermont Yankee Nuclear Power Corporation (VYNPC) requested approval for the onsite disposal of slightly contaminated silt material removed from Vermont Yankee Nuclear Power Station's (Vermont Yankee's) cooling towers. In a safety evaluation (SE) dated March 4, 1996, the NRC staff approved the proposed silt disposal. However, because of discrepancies between the SE and VYNPC's letter of August 30, 1995, VYNPC postponed implementation of the silt disposal until resolution of the discrepancies. By letter dated August 2, 1996, VYNPC informed the NRC staff of the discrepancies and requested that the SE be revised accordingly. Recognizing the discrepancies, the NRC staff has prepared this SE to resolve the discrepancies and to replace the SE of March 4, 1996.

2.0 BACKGROUND

VYNPC has previously obtained NRC staff approval of the onsite disposal of very-low-level radioactive material similar to the proposed silt disposal. By letter dated June 28, 1989, VYNPC proposed the onsite disposal of slightly contaminated septic waste material by land application at Vermont Yankee. By letter dated August 30, 1989, the NRC staff approved this request pursuant to 10 CFR 20.302 (now 10 CFR 20.2002). The NRC staff considered this site-specific application for Vermont Yankee to have insignificant radiological impact because the proposed septic waste material disposal involved licensed material containing less than 0.1 percent of the radioactive material, primarily cobalt-60 and cesium-137, already considered acceptable in the Final Environmental Statement (FES) of July 1972, and involved exposure pathways much less significant than those in the FES. In addition, the proposed septic waste material disposal satisfied the following applicable boundary conditions for the disposal of licensed material:

- a. The whole body dose to the hypothetical maximally exposed individual must be less than 1.0 mrem/year.

Revision 21 Date 08/14/97

- b. Doses to the whole body and any organ of an inadvertent intruder from the probable pathways of exposure are less than 5 mrem/year.
- c. The disposal must be at the same site.

Following the NRC staff's approval on August 30, 1989, VYNPC implemented the disposal of the contaminated septic waste material as proposed.

By letter dated August 30, 1995, VYNPC requested that the previous authorization for the onsite disposal of very-low-level radioactive material be amended to permit the onsite disposal of slightly contaminated silt material, within the boundary conditions of the previously approved septic waste material disposal.

3.0 EVALUATION

In its letter of August 30, 1995, VYNPC stated that the proposed silt disposal method is the same as the previously approved septic waste disposal method, and utilizes land spreading in the same onsite areas approved for septic waste disposal. The volume of silt proposed for onsite disposal consists of 14,000 cubic feet (396 cubic meters) accumulated through August 1995 plus approximately 4,000 cubic feet (113 cubic meters) to be removed from the cooling towers during each 18-month operating cycle. The activity contained in the currently accumulated silt, based on samples taken by VYNPC in June 1995, is 0.193 millicuries, principally from 0.034 millicuries of cobalt-60 and 0.159 millicuries of cesium-137. The activity contained in the additional silt to be removed from the cooling towers each 18-month operating cycle is anticipated to be 0.059 millicuries, principally from 0.012 millicuries of cobalt-60 and 0.047 millicuries of cesium-137.

VYNPC's radiological assessment enclosed with its August 30, 1995, letter demonstrates that the combined radiological impact for all onsite disposal operations, the proposed disposal of silt and the previously approved disposal of septic waste material, will continue to meet the applicable boundary conditions (given above) for the disposal of licensed material. Therefore, the proposed onsite disposal of slightly contaminated silt is acceptable.

As discussed in VYNPC's letter of August 2, 1996, if the onsite disposal of cooling tower silt or septic waste material would result in exceeding the applicable boundary conditions (given above), then VYNPC must obtain prior NRC staff approval of the disposal. In addition, VYNPC made the following commitments:

LAI
1193
1130

- a. VYNPC will report in the Annual Radiological Effluent Release Report a list of the radionuclides present and the total radioactivity associated with the onsite disposal activities at Vermont Yankee.

Revision 21 Date 08/14/97

AI
1130

- b. VYNPC will maintain records of radionuclide concentrations and total activity associated with onsite disposal activities at Vermont Yankee in accordance with 10 CFR 50.75(g).

4.0 CONCLUSION

The NRC staff finds that the radiological conditions at the Vermont Yankee site (see attachment) that would result from the onsite disposal of slightly contaminated silt material, as proposed by VYNPC pursuant to 10 CFR 20.2002, and the previously approved onsite disposal of slightly contaminated septic waste material, are within the applicable boundary conditions (given above) for the disposal of licensed material. Therefore, the proposed onsite disposal of slightly contaminated silt removed from Vermont Yankee's cooling towers is acceptable.

LAI
1130

VYNPC is required to permanently incorporate this SE into the Vermont Yankee Offsite Dose Calculation Manual as an Appendix to document the the radioactive material onsite disposal activities approved for Vermont Yankee, and VYNPC's related commitments regarding reporting and record keeping. Any additional modification of VYNPC's disposal activities which go beyond those proposed in the August 30, 1995, submittal, and are not addressed above must have prior NRC staff approval. In addition, any onsite disposal of cooling tower silt or septic waste material that would result in exceeding the applicable boundary conditions (given above), must also have prior NRC staff approval.

Principal Contributors: J. Minns
D. Dorman
C. Harbuck

Date: June 18, 1997

Attachment: Vermont Yankee Site Area Map

Revision 21 Date 08/14/97

FIGURE 4
SEPTIC WASTE DISPOSAL AREAS

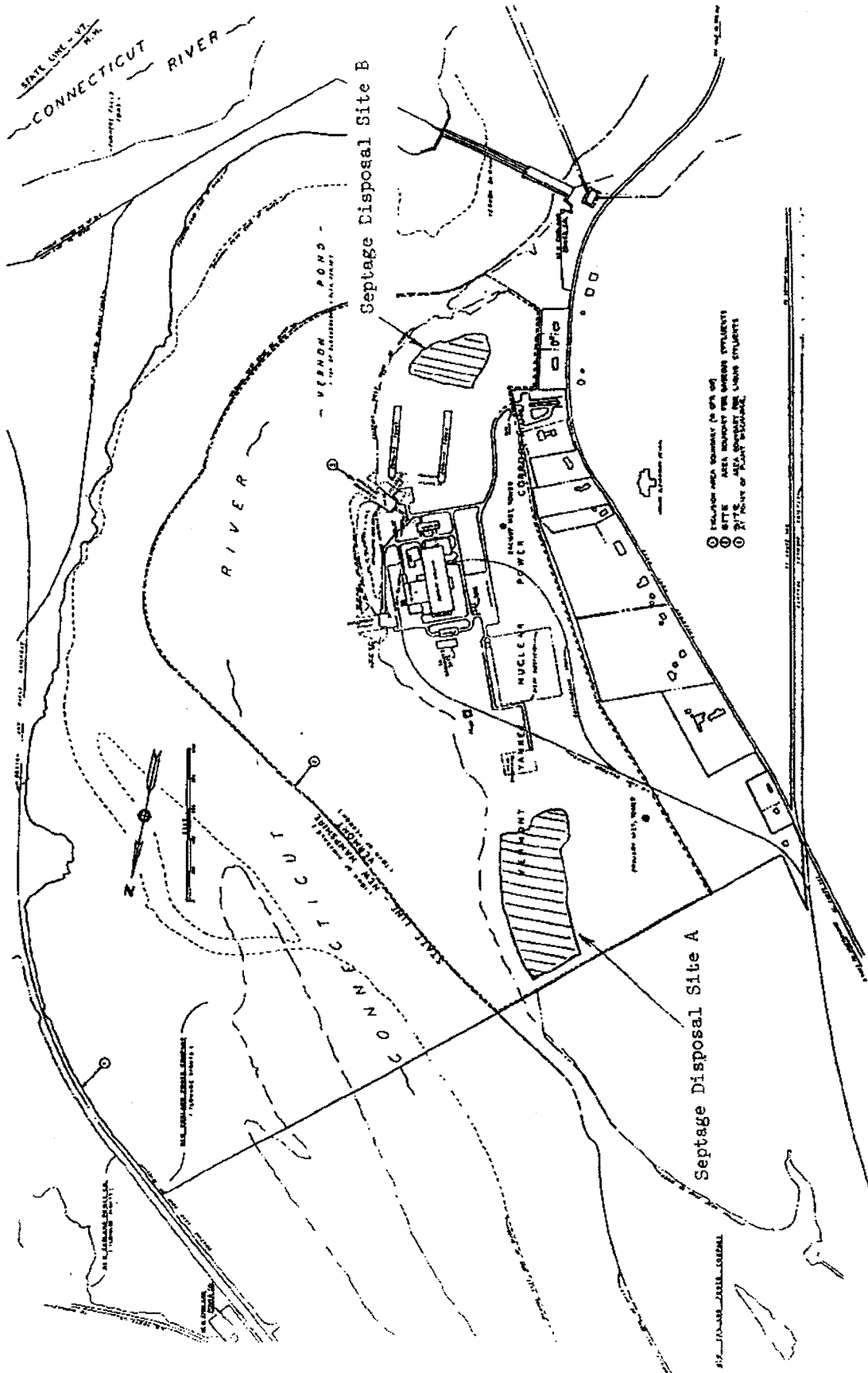

**VERMONT YANKEE
NUCLEAR POWER CORPORATION**

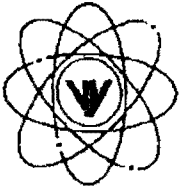

Ferry Road, Brattleboro, VT 05301-7002

RESPONSIBILITY

LAS (M) CLOSED

REPLY TO
ENGINEERING OFFICE
500 MAIN STREET
BOLTON, MA 01740
(508) 778-6711

August 30, 1995
BVY 95-97

United States Nuclear Regulatory Commission
Washington, DC 20555

ATTN: Document Control Desk

- References:
- (1) License No. DPR-28 (Docket No. 50-271)
 - (2) Letter from R. W. Capstick, Vermont Yankee, to USNRC, "Request to Routinely Dispose of Slightly Contaminated waste in Accordance with 10CFR20.302(a)", BVY 89-59, June 18, 1989.
 - (3) Letter from M. B. Fairtile, USNRC, to L. A. Tremblay, Vermont Yankee, "Approval Under 10 CFR 20.302(a) of Procedures for Disposal of Slightly Contaminated Septic Waste on Site at Vermont Yankee (TAC No. 73776)", dated August 30, 1989.

Subject: Request to Amend Previous Approval Granted Under 10 CFR 20.302(a) for Disposal of Contaminated Septic Waste

In accordance with the criteria of the Code of Federal Regulations, Title 10, Section 20.2002 (previously cited 10CFR20.302(a)), enclosed please find the subject application to amend the previously granted approval (Reference 3) to dispose of slightly contaminated septic waste on site at Vermont Yankee by expanding the allowable waste stream to include slightly contaminated Cooling Tower silt material.

This application specifically requests approval to dispose of Cooling Tower silt deposits, contaminated at minimal levels, which have been or might be generated through the end of station operations at the Vermont Yankee Nuclear Power Plant. The proposed silt disposal method is the same as the septic waste disposal method requested in Reference 2 and approved in Reference 3. The disposal method utilizes on site land spreading in the same designated areas used for septic waste. Disposal of this waste in the manner proposed, rather than holding it for future disposal at a 10CFR Part 61 licensed facility when access to one becomes available, will save substantial costs and valuable disposal site space for waste of higher radioactivity levels.

A radiological assessment and proposed operational controls based on continued on site disposal of accumulated river silt removed from the basins of the plant's mechanical draft cooling towers is contained in Enclosure A. The assessment demonstrates that the dose impact expected from the disposal of silt removed from the cooling towers during normal maintenance will not exceed the dose limits already imposed for septic waste disposal. The combined radiological impact for all on site disposal operations shall be limited to a total body or organ dose of a maximally exposed member of the public of less than one mrem/year during the period of active Vermont Yankee control of the site, or less than five mrem/year to an inadvertent intruder after termination of active site control. Enclosure B contains a copy of the original assessment and disposal procedures for

Revision 21 Date 08/14/97

septic waste (References 2 and 3) for your use and reference in evaluating the proposed amendment.

Upon receipt of your approval, Enclosure A will be incorporated into the Vermont Yankee ODCM.

LAI 1044 closed | We trust that the information contained in the submittal is sufficient, however, should you have any questions or require further information concerning this matter, please contact this office.

Sincerely,

VERMONT YANKEE NUCLEAR POWER CORPORATION



James J. Duffy
Licensing Engineer

Enclosures A & B

c: USNRC Region I Administrator (Letter and Enclosure A)
USNRC Resident Inspector - VYNPS (Letter and Enclosure A)
USNRC Project Manager - VYNPS (Letter and Enclosure A)

Revision 21 Date 08/14/97

ENCLOSURE A

VERMONT YANKEE NUCLEAR POWER PLANT

ASSESSMENT OF ROUTINE DISPOSAL OF COOLING TOWER SILT IN
AREAS ON SITE PREVIOUSLY DESIGNATED FOR SEPTIC WASTE DISPOSAL

Revision 21 Date 08/14/97

Table of Contents

	Page
1.0 INTRODUCTION	3
2.0 WASTE STREAM DESCRIPTION	4
3.0 DISPOSAL METHOD	9
3.1 Silt Disposal Procedure Requirements	9
3.2 Administrative Procedure Requirements	12
4.0 EVALUATION OF ENVIRONMENTAL IMPACTS	13
4.1 Site Characteristics	13
4.2 Radiological Impact	13
5.0 RADIATION PROTECTION	23
6.0 CONCLUSIONS	23
7.0 REFERENCES	24

VERMONT YANKEE NUCLEAR POWER PLANT

Assessment of Routine Disposal of Cooling Tower Silt in Areas On-Site Previously Designated for Septic Waste Disposal

1.0 INTRODUCTION:

Vermont Yankee Nuclear Power Corporation (Vermont Yankee) requested from the NRC in 1989 permission to routinely dispose of slightly contaminated septic waste in designated on-site areas in accordance with 10CFR20.302(a). The NRC responded to this request on August 30, 1989 by granting approval of the proposed procedures for on-site disposal of septic waste concluding that the commitments, as documented in our request, were acceptable provided that our request and analysis be permanently incorporated into the plant's Offsite Dose Calculation Manual (ODCM). Revision 9 to the ODCM (Appendix B) incorporated the assessment and approval of the methods utilized for on-site disposal of slightly contaminated sewage sludge.

In addition to the previously identified solids content of septic waste as a source of environmental, low level radioactive contaminated material, cooling tower silt deposits resulting from the settling of solids from river water passing through the mechanical draft cooling tower system have been identified to also contain low levels of plant-specific radionuclides. Periodic removal of the silt from the cooling tower basins is a necessary maintenance practice to insure operability of the cooling system. However, due to the presence of by-product materials in the silt, proper disposal requirements must be applied to insure that the potential radiological impact is within acceptable limits.

This assessment of silt disposal expands the original septic waste disposal assessment to include earthen type materials (cooling tower silt deposits) while maintaining the original radiological assessment modeling and dose limit criteria that have been approved for septic waste spreading on site. This assessment demonstrates that cooling tower silt can be disposed of in the same manner and under the same dose limit criteria as previously approved for septic waste in Appendix B to the Vermont Yankee ODCM. Implementation of the following commitments as an amendment to the original 10 CFR

Part 20.302(a) approval for septic waste shall be incorporated into the Vermont Yankee ODCM upon approval by the NRC.

2.0 WASTE STREAM DESCRIPTION:

The waste involved in this assessment is residual solids (silt) collected in the basins of the plant's mechanical draft cooling tower system. The silt consists of organic and inorganic sediments and earthen type materials that have settled from the cooling water flow taken from the Connecticut River as it passes through the towers. As a result of de-sludging the tower basins in 1993, an estimated 14,000 cubic feet of silt was accumulated on site. Clean-out operations will also occur periodically to ensure continued system operability. Sample analysis performed to the plant's environmental lower limits of detection requirements, as contained in Technical Specification Table 4.9.3., has identified Cobalt-60 and Cesium-137 in low concentrations as being present in silt collected in 1993.

The cooling towers are located at the southern end of the plant facility complex but are not directly connected to any system in the plant that contains radioactivity. The postulated mechanism of how plant-related radionuclides have been introduced into the cooling system silt assumes that past routine effluents discharged from nearby plant gaseous release points were entrained in the large mechanically-induced air flow that is pulled through the towers as a heat exchange medium. The cooling water flow provides a scrubbing action as it breaks up into fine water droplets due to the splash pans of the towers. This scrubbing action washes any airborne particulates out of the air. Over long periods of operation, any radioactivity removed from the air flow could buildup to measurable levels in silt that settles out in the basins at the bottom of the towers.

Table 1 lists the analyses of twenty-one samples collected from the silt pile removed from the cooling tower basins. Radioactivity measurements, averaged over all the samples, indicate that the silt material can be characterized as containing approximately 50 pCi/kg (dry wt.) of Cobalt-60 and 198 pCi/kg (dry wt.) of Cesium-137. Eight of the samples indicated no positive Cobalt-60 above a minimum detectable level achieved for the analysis.

Table 1

Cooling Tower Silt Radioactivity
(1993 samples*)

Sample #	Co-60 (pCi/kg dry)	Cs-137 (pCi/kg dry)
G12759	53	144
G12758	72	172
G12757	<14	201
G12756	<17	245
G12755	73	206
G12754	<16	165
G12753	<27	240
G12752	79	181
G12751	<29	180
G12750	35	107
G12749	59	171
G12748	<19	205
G12747	<38	209
G12746	< 7	218
G12745	50	241
G12744	40	220
G12743	68	264
G12742	45	195
G12724	71	115
G12723	104	264
G13940	126	218
Average:	50	198
Max.	126	264
Min.	< 7	107
Standard deviation:	30	42

* Average wet to dry sample weight ratio equal to 1.6. Dry weight silt density equal to 1.3 gm/cc.

For the purpose of estimating the total activity in the silt pile, the less than values in Table 1 are included as positives in the calculation of the average radioactivity concentration.

Cobalt-60, due to its relatively short half life, is typically associated with plant operations when measured in the near environment. However, Cesium-137 when measured in the environment may have a background component that is not related to power plant operations. Past weapons testing fallout has imposed a man made background level of Cesium-137 in New England soils and sediments that can vary over several hundred pCi/kg. The plant's Environmental Monitoring Program has shown that Connecticut River sediment in the vicinity of Vermont Yankee averages about 123 pCi/kg (dry wt.) of Cesium-137 (Table 2) with no plant related detectable level of Cobalt-60. The value of 123 pCi/kg may represent an estimate of background level of Cesium-137 in sediment that would be subject to entrainment in cooling water flow that enters the plant. In comparing the measured levels of Cesium-137 on Table 1 with the past river sediment level, the average concentration in the cooling tower silt is higher than that of the river sediment data but does fall within the observed range of recorded sediment Cs-137. The river sediment Cesium-137 concentration averages about 62% of the concentration value detected in the tower silt. For purposes of this assessment of plant-related dose impact from the on-site disposal of silt material, it is conservatively assumed that all detectable Cs-137 in cooling tower silt is directly related to plant operations. No background component is subtracted from the measured values for this case study since only a single sampling location (down stream) is included in the Environmental Monitoring Program which may not fully describe the true background levels in the region.

The total radioactivity for the current 14,000 cubic feet of silt collected on site can be estimated by multiplying this volume by its "as is" density of 2.1 gm/cc (i.e. 1.3 gm/cc dry weight density x 1.6 wet/dry weight ratio) and then conservatively assume that the measured average dry weight radioactivity concentrations for Cobalt and Cesium would be the same as in the collected silt. Multiplying the average Cobalt-60 and Cesium-137 concentration in silt by the mass of the collected material produces estimates (Table 3) of total radioactivity that was removed from the cooling tower basin in September 1993.

Table 2

Cesium-137 inConnecticut River Sediments*

Date	Cs-137 (pCi/kg dry)
05/24/94	61
10/13/93	85
06/02/93	60
10/15/92	137
05/20/92	176
10/24/91	178
05/16/91	230
10/25/90	84
05/16/90	62
10/04/89	<174
05/26/89	179
10/12/88	115
05/12/88	62
Average:	132
Max.	230
Min.	60
Standard deviation:	56

* Samples collected as part of the Vermont Yankee Radiological Environmental Monitoring Program (REMP) for river sediment sample location SE-11.

Table 3

Estimated Total Radioactive Material for 1993 Tower Clean-Out

	Volume of Silt (ft ³)	Mass (kg)	Average Concentration (pCi/kg)	Total Act. (as of 11/93) (uCi)	Decayed Act. (as of 6/95) (uCi)
Co-60	14,000	8.32E+5	50	42	34
Cs-137	14,000	8.32E+5	198	165	159

In addition to 14,000 cubic feet of silt already accumulated, it is anticipated that periodic maintenance work in cleaning out the cooling tower basins will generate approximately 4,000 cubic feet of new silt material over each successive 18 month operating cycle. Assuming the same level of plant-related radioactivity concentration that was originally observed, the additional amounts of radioactivity that will require on site disposal following each refueling cycle can also be estimated. Table 4 lists an estimate of the total radioactivity that might be present at each 18 month clean-out cycle.

Table 4

Estimated Total Radioactive Material for Each 18 Month Maintenance Cycle

	Volume of Silt (ft ³)	Mass (kg)	Average Concentration (pCi/kg)	Total Activity (uCi)
Co-60	4,000	2.38E+5	50	12
Cs-137	4,000	2.38E+5	198	57

3.0 DISPOSAL METHOD:

The method of silt disposal shall utilize a technique of land spreading in a manner consistent with the current commitments for the on-site disposal of septic waste as approved by the NRC and implemented as Appendix B of the Vermont Yankee ODCM (Reference 1). The same land areas designated and approved for septic waste disposal shall be used for the placement of silt removed from the cooling tower basins. Determination of the radiological dose impact shall also be made based on the same models and pathway assumptions as indicated in Appendix B of the ODCM.

3.1 Silt Disposal Procedure Requirements:

Gamma isotopic analysis of silt samples shall be made prior to each disposal by obtaining representative composite samples in sufficient numbers to characterize the material removed from the cooling tower basins. Each gamma isotopic analysis shall be required to achieve the environmental lower limits of detection as indicated for sediment on Table 4.9.3 of the Vermont Yankee Technical Specifications.

The estimation of total radioactivity to be disposed of shall be made based on the average of all composite sample analyses. The estimation of total radioactivity and projected dose impact shall be made prior to placing the collected silt on the designated disposal plots. The dose impact from each disposal operation shall be included with all past septic waste and silt spreading operations to ensure that the appropriate dose limits are not exceeded on any waste disposal area for the combination of all past operations.

The established dose criteria requires that all applications of earthen type materials within the approved designated disposal areas shall be limited to ensure that dose to a maximally exposed individual (during the Vermont Yankee control period) be maintained less than 1 mrem/year to the whole body and any organ, and the dose to an inadvertent intruder following termination of site control be maintained less than 5 mrem/year to the whole body and any organ.

The limits on concentrations of radionuclides as addressed in Appendix B to the ODCM for septic waste (i.e., each tank of septic sludge to be disposed are limited to a combined MPC ratio of less than 0.1) were included to ensure proper control was in place to address the situation of small quantities of relatively high concentration material. This limitation does not directly apply to silt deposits since the silt is handled as dewatered sediments as opposed to liquid slurries of septic waste.

For dry, earthen type material such as silt, a specific radionuclide concentration limit shall be applied in place of the septic waste liquid MPC ratio. No soil associated with a sample analysis that identifies a plant-related radionuclide in excess of the concentration limits of Table 5 will be permitted regardless of the total pathway dose assessment determined for the quantity material under consideration. For the case where more than one radionuclide is detected, the sum of the ratio rule will be applied. The measured concentration of each radionuclide divided by its limiting concentration value shall be added with the sum of all fractions equal to or less than 1. This limiting condition will prevent small volumes of relatively high specific radioactivity from being spread on the disposal plots, and therefore reduce the potential for creating unexpected hot spots of concentrated material.

Table 5 lists, by radionuclide, soil concentration values that would generate an annual external effective dose equivalent of 25 mrem/year if it were assumed that an individual continuously stood on an infinite plane of soil contaminated to a depth of 15 cm. The assumptions of an infinite plane and continuous occupancy are conservative for situations where the amount of contaminated soil identified would not provide for a 15 cm soil depth over an extended surface area and where disposal site access is limited. Twenty-five mrem/year was selected as a reference value based on the fact that it was a suitable fraction of the NRC annual dose limit (100 mrem/year per 10 CFR Part 20.1301) applied to members of the public from all station sources. The 25 mrem/year also equals the EPA dose limit from 40 CFR Part 190 which would apply to real members of the public offsite and allow for credit to be taken in accounting for actual usage patterns such as occupancy time. The external dose factors provided on Table 5 were derived from Table E-2 of NUREG/CR-5512 (Reference 3).

Table 5

Dry Soil Maximum Concentration Values

Radionuclide	Soil Concentration pCi/kg (equal to 25 mrem/yr)
Cr-51	1.51E+05
Mn-54	5.50E+03
Fe-59	3.83E+03
Co-58	4.70E+03
Co-60	1.82E+03
Zn-65	7.85E+03
Zr-95	6.18E+03
Ag-110m	1.66E+03
Sb-124	2.51E+03
Cs-134	2.95E+03
Cs-137	8.13E+03
Ce-141	7.85E+04
Ce-144	8.75E+04

Assumptions include infinite planar distribution, uniform depth distribution to 15 cm, soil density at 1.625E+06 gm/m³ and external direct dose pathway only with a 100% occupancy factor.

3.2 Administrative Procedure Requirements:

Dry silt material shall be dispersed using typical agricultural dry bulk surface spreading practices only in approved disposal areas on site.

Complete records of each disposal will be maintained. These records will include the concentration of radionuclides detected in the silt, an estimate of the total volume of silt disposed of, the total radioactivity in each disposal operation as well as the total accumulated on each disposal plot at the time of the spreading, the plot on which the silt was applied, and the results of any dose calculations or maximum allowable accumulated activity determinations required to demonstrate that the dose limits imposed on these land spreading operations have not been exceeded. The determination of the total radioactivity and dose calculations shall also include all past septic waste and silt disposal operations that placed low level radioactive material on the designated disposal plots.

The periodic disposal of silt on each of the approved land spreading areas will be limited to within the same established dose and radioactivity criteria that have been approved for septic waste disposal.

Concentration limits that are applied to the disposal of earthen type materials (dry soil) shall restrict the placement of small volumes of material that have relatively high concentrations of radioactivity such that direct exposure could not exceed a small proportion (25%) of the annual dose limits to members of the public that is contained in 10 CFR Part 20.1301.

Any farmer leasing land used for the disposal of silt deposits will be notified of the applicable restrictions placed on the site due to the land spreading of low level contaminated material. These restrictions are the same as detailed for septic waste spreading as given in Reference 1.

4.0 EVALUATION OF ENVIRONMENTAL IMPACTS:

4.1 Site Characteristics

The designated disposal sites consist of two fields located on the Vermont Yankee Nuclear Power Plant site. Both fields are on the plant property within the site boundary security fence. Site A contains an approximate ten-acre parcel of land centered approximately 2,000 feet northwest of the Reactor Building. Site B consist of approximately two acres and is centered approximately 1,500 feet south of the Reactor Building. These are the same land parcels approved by the NRC for the land disposal of septic waste and are described in detail in Reference 1 along with the boundary restrictions for the placement of contaminated material.

Radiological assessments of septic waste disposal have determined that a single two-acre plot would be sufficient for the routine disposal of that waste stream over a 20-year period without exceeding the dose criteria to a maximum exposed individual or inadvertent intruder. As a result, the ten-acre field to the northwest can be divided into five disposal plots, with the two-acre site at the south end of the plant site providing a sixth plot. It is therefore concluded that there is sufficient space within the already approved disposal plots to accommodate additional material from the cooling tower basins along with the septic waste without the likelihood of exceeding the approved dose limit criteria.

Since the residual organic and inorganic solids associated with river sediment (silt) are similar to the sand and residual organic material remaining after decomposition of septic waste that is removed from the plant's septic tanks, the conclusions of no significant environmental (non-radiological) impact associated with the disposal of septic waste are not changed by the addition of another earthen type material, namely silt.

4.2 Radiological Impact:

The amount of cooling tower silt, in combination with any septic waste disposals, will be procedurally controlled to insure doses are maintained within the prior approved limits (Reference 1). These limits are based on

past NRC proposed guidance (described in AIF/NESP-037), August 1986). The dose criteria require that the maximally exposed member of the general public receive a dose less than 1 mrem/year to the whole body or any organ due to the disposed material and less than 5 mrem/year to the whole body or any organ of an inadvertent intruder.

To assess the doses received by the maximally exposed individual and inadvertent intruder resulting from silt spreading, the same pathway modeling, assumptions and dose calculation methods as approved for septic disposal are used. These dose models implement the methodologies and dose conversion factors as provided in Regulatory Guide 1.109 (Reference 2).

Six potential pathways have been identified and include:

- (a) Standing on contaminated ground,
- (b) Inhalation of resuspended radioactivity,
- (c) Ingestion of leafy vegetables,
- (d) Ingestion of stored vegetables,
- (f) Ingestion of meat, and
- (g) Ingestion of cow's milk

Based on the septic waste evaluations, the liquid pathway was determined to be insignificant.

Both the maximum individual and inadvertent intruder are assumed to be exposed to these pathways with the difference between them related to occupancy time. The basic assumptions used in the radiological analyses include:

(a) Exposure to ground contamination and resuspended radioactivity is for a period of 104 hours per year during the Vermont Yankee active control of the disposal sites and continuous thereafter. The 104-hour interval is representative of a farmer's time spent on a plot of land (4 hours per week for 6 months).

(b) For the purpose of projecting and illustrating the magnitude of dose impacts over the remaining life of the plant, it is assumed that the current concentration levels of activity detected in silt remain

constant. Table 1 indicates the measured radioactivity levels for Cobalt-60 and Cesium-137 first noted in silt material.

(c) The maximum radiation source corresponds to the accumulation of radioactive material on a single plot (two acre) within the approved disposal sites over a period of 13 operating cycles. This extends over the next 18 years until after the operating license expires in 2012. The initial application (referenced to June 1995) consists of 14,000 cubic feet of silt collected in 1993 along with the first periodic clean out of the tower basins that adds an additional 4,000 cubic feet. All subsequent applications of 4,000 cubic feet occur at 18-month intervals.

(d) For the analysis of the radiological impact during the Vermont Yankee active control of the disposal sites, no plowing is assumed to take place and all dispersed radioactive material remains on the surface forming a source of unshielded direct radiation.

(e) No radioactive material is dispersed directly on crops for human or animal consumption. Crop contamination is only through root uptake.

(f) The deposition on crops of suspended radioactivity is insignificantly small.

(g) Pathway data and usage factors used in the analysis are the same as those used in the plant's ODCM assessment of off-site radiological impact from routine releases with the exception that the fraction of stored vegetables grown on the contaminated land was conservatively increased from 0.76 to 1.0 (at present no vegetable crops for human consumption are grown on any of the approved disposal plots).

(h) It is conservatively assumed that Vermont Yankee relinquishes control of the disposal sites after the operating license expires in 2012 (i.e., the source term accumulated on a single, 2-acre disposal plot applies also for the inadvertent intruder).

(i) For the analysis of the impact after Vermont Yankee control of the site is relinquished, the radioactive material is plowed under and forms a uniform mix with the top six inches of soil; but nonetheless, undergoes resuspension in air at the same rate as the unplowed surface contamination. For direct ground plane exposure the self shielding due to the six-inch plow layer reduces the surface dose rate by about a factor of four.

The dose models and methods used to generate deposition values and accumulated activity over the operating life of the plant are documented in Attachment 2 to Reference 1. Based on the measured concentrations and silt volumes noted in Section 2.0 above, the total radioactivity that remains on the disposal plots after the operating license expires is estimated on Table 6.

Table 6

Projected Radioactivity Buildup Due to Silt Spreading

Nuclide	Contribution from initial 14,000 ft ³ (uCi)	Accumulation from 13 cycles at 4,000 ft ³ /ea. (uCi)	Total Remaining in year 2013 (uCi)
Cobalt-60	3.2	61.9	65.1
Cesium-137	104.9	500.5	605.4

The calculated potential radiation exposure following the spreading of all silt material anticipated to be generated through the remainder of the operating license on a single, two-acre plot is provided on Table 7.

Table 7

Dose Impact Due to Continued Spreading to End of License

Disposal Site Access	Radiation Exposure	Individual/Organ
Controlled by VYNPS (max. exposed individual)	0.228 mrem/yr 0.820 mrem/yr max.	adult/whole body child/bone
Uncontrolled by VYNPS (inadvertent intruder after license termination)	1.46 mrem/yr 2.41 mrem/yr max.	adult/whole body child/bone

The individual pathway contributions to the total dose due to continued silt spreading are shown on Table 8.

Table 8

Pathway-Dependent Critical Organ Doses

Pathway	Maximally exposed Individual/Organ (Child/Bone) (mrem/year)	Inadvertent Intruder Critical Individual/Organ (Child/Bone) (mrem/year)
Ground Irradiation	0.0474	0.957
Inhalation	0.00814	0.685
Stored Vegetables	0.528	0.528
Leafy Vegetables	0.0265	0.0265
Milk Ingestion	0.201	0.201
Meat Ingestion	<u>0.00833</u>	<u>0.00833</u>
Total:	0.82	2.41

In addition, the isotopic breakdown of the critical organ doses listed above (Table 8) for the two detected radionuclides is seen to be:

Table 9

Isotopic Breakdown of Maximum Radiation Exposures

Description	Isotope	Radioactivity ($\mu\text{Ci}/2$ acres)	Dose (mrem/yr)	Percent of total
During control of disposal sites Max. organ: child/bone	Cs-137	605.4	0.805	98.2
	Co-60	65.1	<u>0.0144</u>	1.8
			0.82	
Termination of disposal site Max. organ: child/bone	Cs-137	605.4	2.12	88.0
	Co-60	65.1	<u>0.29</u>	12.0
			2.41	

For comparison to the total dose calculated assuming the continued disposal of silt removed from the tower basins through the end of the operating license, the dose from just the original 14,000 cubic feet collected is shown on Table 10.

Table 10

Dose Impact Due to Single (14,000 ft³) Silt Spreading

Disposal Site Access	Radiation Exposure	Individual/Organ
Controlled by VYNPS (max. exposed individual in 1995)	0.064 mrem/yr 0.219 mrem/yr max.	adult/whole body child/bone
Uncontrolled by VYNPS (inadvertent intruder after license termination)	0.224 mrem/yr 0.393 mrem/yr max.	adult/whole body child/bone

Table 10 shows that the application of the silt material initially collected (14,000 cubic feet) accounts for about 27 percent of the maximum individual organ dose during the control period as compared to the scenario of continued periodic silt spreading over the balance of the operating license. This illustrates that dose impacts from the material currently collected are well below the acceptance criteria of limiting the dose from any two-acre plot to no more than 1 mrem/year during the control period and 5 mrem/year after termination of the license, and is expected to remain below the acceptance criteria throughout the plant life. If unexpected buildup of radioactivity in future silt clean-out operations were to occur, the option for use of alternate disposal plots remains available to ensure that the impact from any single, two-acre plot stays within the acceptance criteria.

Also of interest are derived dose conversion factors which provide a means of ensuring that septic and silt disposal operations remain within the prescribed radiological guidelines noted above. The critical organ (worst case) and whole body dose factors for all pathways on a per acre bases are

given on Table 11 for periods during Vermont Yankee control of the disposal site and on Table 12 for post control periods associated with the inadvertent intruder scenario. The dose conversion factors have been expanded to include other potential radionuclide beyond the original five that were addressed in Reference 1. This provides a means to assess other nuclides if future disposal operations identify additional radionuclides not previously observed. The development of these additional nuclide dose conversion factors utilize the same modeling and pathway assumptions as used to derive the factors for the original five radionuclides identified in septic waste. The models for these site and pathway-specific dose factors are those in Regulatory Guide 1.109 (Reference 2) and are described in detail in Attachment II to Reference 1.

Table 11

All-Pathway Critical Organ / Whole Body Dose Conversion Factors
During Vermont Yankee Control of Disposal Sites

Nuclide	Individual/Organ	Critical Organ	Whole Body Dose
		Dose Factor	Factor
		(mrem/yr per uCi/acre)	
Cr-51	Teen/Lung	1.14E-05	5.76E-06
Mn-54	Adult/GI-LLI	3.75E-04	1.93E-04
Fe-55	Child/Bone	6.45E-06	1.06E-06
Fe-59	Teen/Lung	4.61E-04	2.13E-04
Co-58	Teen/Lung	3.27E-04	2.01E-04
Co-60	Teen/Lung	7.17E-04	5.31E-04
Zn-65	Child/Liver	1.64E-02	1.03E-02
Zr-95	Teen/Lung	4.47E-04	1.34E-04
Ag110m	Teen/GI-LLI	1.32E-02	5.24E-04
Sb-124	Teen/Lung	8.34E-04	3.54E-04
Cs-134	Child/Liver	3.18E-03	1.28E-03
Cs-137	Child/Bone	2.66E-03	7.02E-04
Ce-141	Teen/Lung	1.54E-04	1.50E-05
Ce-144	Teen/Lung	6.00E-04	2.44E-05

Table 12

All-Pathway Critical Organ / Whole Body Dose Conversion Factors
Post Vermont Yankee Control of Disposal Sites
(Inadvertent Intruder)

Nuclide	Individual/Organ	Critical Organ	Whole Body Dose
		Dose Factor	Factor
		(mrem/yr per uCi/acre)	
Cr-51	Teen/Lung	5.89E-04	1.19E-04
Mn-54	Teen/Lung	1.02E-02	3.12E-03
Fe-55	Teen/Lung	3.50E-04	2.27E-05
Fe-59	Teen/Lung	2.55E-02	4.43E-03
Co-58	Teen/Lung	1.59E-02	3.72E-03
Co-60	Teen/Lung	3.19E-02	9.09E-03
Zn-65	Child/Liver	1.89E-02	1.25E-02
Zr-95	Teen/Lung	2.93E-02	2.99E-03
Ag110m	Teen/Lung	3.59E-02	9.53E-03
Sb-124	Teen/Lung	4.73E-02	7.04E-03
Cs-134	Child/Liver	1.21E-02	9.36E-03
Cs-137	Child/Bone	6.98E-03	3.85E-03
Ce-141	Teen/Lung	1.21E-02	3.44E-04
Ce-144	Teen/Lung	5.00E-02	1.52E-03

5.0 RADIATION PROTECTION:

The disposal operation of silt material from the cooling tower basins will follow the applicable Vermont Yankee procedures to maintain doses as low as reasonably achievable and within the specific dose criteria as previously approved for septic waste disposal (Reference 1).

6.0 CONCLUSIONS:

Silt collected from the cooling tower basins is an earthen type material that is similar in characteristics to septic waste residual solids with respect to the radiological pathway behavior and modeling and can be disposed of through on-site land spreading on the same disposal plots as previously evaluated and approved for septic waste disposal. The radiological assessment of low level contaminated silt shows that the projected dose from the on-site periodic spreading of this material will have no significant dose impact to members of the public and can be maintained below the approved dose limitations already in place for septic waste.

7.0 REFERENCES:

(1) Vermont Yankee ODCM, Appendix B; "Approval of Criteria for Disposal of Slightly Contaminated Septic Water On-Site at Vermont Yankee". (Included NRC approval letter dated August 30, 1989, VY request for approval dated June 28, 1989 with Attachments I and II).

(2) USNRC Regulatory Guide 1.109, Rev. 1; "Calculation of Annual Doses to Man from Routine Releases of Reactor Effluents for the Purpose of Evaluating Compliance with 10 CFR Part 50, Appendix I", dated October 1977.

(3) NUREG/CR-5512, Vol. 1, "Residual Radioactive Contamination From Decommissioning", Final Report, dated October 1992.

file: vsilt.mss

APPENDIX G

MAXIMUM PERMISSIBLE CONCENTRATIONS (MPCs)
IN AIR AND WATER ABOVE NATURAL BACKGROUND
TAKEN FROM 10CFR20.1 TO 20.602, APPENDIX B

Revision 21 Date 08/14/97

APPENDIX G

With the implementation of the revised Part 20 to Title 10 of the Code of Federal Regulations (10CFR20.1001-20.2401), the Maximum Permissible Concentrations (MPCs) that were part of the old 10CFR20 were replaced by a new Appendix B to 10CFR20 for the limits that apply to effluents released to unrestricted areas. However, MPC values were also used and accepted as licensing conditions for the control of radioactive materials in situations other than those directly covered by the requirements of the regulations. One example is the on-site disposal of septic waste which used the MPC values as one criteria of acceptability for land spreading. Appendix B to the ODCM references 10CFR20.1-20.601 Appendix B MPCs as concentration criteria for this disposal option.

With the final publication of the revised 10CFR20.1001-20.2401, the original MPC tables of the old 10CFR20 are no longer in print. As such, this appendix to the ODCM is added to provide a reference source for the MPC values contained in the original Appendix B to 10CFR20.1-20.601 for those conditions that still refer to these requirements.

APPENDIX G

MAXIMUM PERMISSIBLE CONCENTRATIONS (MPCs)
(FROM 10CFR20.1 TO 20.602, APPENDIX B)

APPENDIX B TO §§20.1 - 20.602
 CONCENTRATIONS IN AIR AND WATER ABOVE NATURAL BACKGROUND

[See footnotes at end of Appendix B]

Element (atomic number)	Isotope ¹		Table I		Table II	
			Col. 1 Air ($\mu\text{Ci}/\text{ml}$)	Col. 2 Water ($\mu\text{Ci}/\text{ml}$)	Col. 1 Air ($\mu\text{Ci}/\text{ml}$)	Col. 2 Water ($\mu\text{Ci}/\text{ml}$)
Actinium (89)	Ac 227	S	2×10^{-12}	6×10^{-5}	8×10^{-14}	2×10^{-6}
		I	3×10^{-11}	9×10^{-3}	9×10^{-13}	3×10^{-4}
	Ac 228	S	8×10^{-8}	3×10^{-3}	3×10^{-9}	9×10^{-5}
		I	2×10^{-8}	3×10^{-3}	6×10^{-10}	9×10^{-5}
Americium (95)	Am 241	S	6×10^{-12}	1×10^{-4}	2×10^{-13}	4×10^{-6}
		I	1×10^{-10}	8×10^{-4}	4×10^{-12}	3×10^{-5}
	Am 242m	S	6×10^{-12}	1×10^{-4}	2×10^{-13}	4×10^{-6}
		I	3×10^{-10}	3×10^{-3}	9×10^{-12}	9×10^{-5}
	Am 242	S	4×10^{-8}	4×10^{-3}	1×10^{-9}	1×10^{-4}
I		5×10^{-8}	4×10^{-3}	2×10^{-9}	1×10^{-4}	
Am 243	S	6×10^{-12}	1×10^{-4}	2×10^{-13}	4×10^{-6}	
	I	1×10^{-10}	8×10^{-4}	4×10^{-12}	3×10^{-5}	
	Am 244	S	4×10^{-6}	1×10^{-1}	1×10^{-7}	5×10^{-3}
		I	2×10^{-5}	1×10^{-1}	8×10^{-7}	5×10^{-3}
Antimony	Sb 122	S	2×10^{-7}	8×10^{-4}	6×10^{-9}	3×10^{-5}
		I	1×10^{-7}	8×10^{-4}	5×10^{-9}	3×10^{-5}
	Sb 124	S	2×10^{-7}	7×10^{-4}	5×10^{-9}	2×10^{-5}
I		2×10^{-8}	7×10^{-4}	7×10^{-10}	2×10^{-5}	
Sb 125	S	5×10^{-7}	3×10^{-3}	2×10^{-8}	1×10^{-4}	
	I	3×10^{-8}	3×10^{-3}	9×10^{-10}	1×10^{-4}	
Argon (18)	A37	Sub ²	6×10^{-3}	1×10^{-4}
		Sub	2×10^{-6}	4×10^{-8}
Arsenic (33)	As 73	S	2×10^{-6}	1×10^{-2}	7×10^{-8}	5×10^{-4}
		I	4×10^{-7}	1×10^{-2}	1×10^{-8}	5×10^{-4}
	As 74	S	3×10^{-7}	2×10^{-3}	1×10^{-8}	5×10^{-5}
		I	1×10^{-7}	2×10^{-3}	4×10^{-9}	5×10^{-5}
	As 76	S	1×10^{-7}	6×10^{-4}	4×10^{-9}	2×10^{-5}
		I	1×10^{-7}	6×10^{-4}	3×10^{-9}	2×10^{-5}
	As 77	S	5×10^{-7}	2×10^{-3}	2×10^{-8}	8×10^{-5}
I		4×10^{-7}	2×10^{-3}	1×10^{-8}	8×10^{-5}	

Revision 21 Date 08/14/97

APPENDIX B TO §§20.1 - 20.602
CONCENTRATIONS IN AIR AND WATER ABOVE NATURAL BACKGROUND

[See footnotes at end of Appendix B]

Element (atomic number)	Isotope ¹		Table I		Table II	
			Col. 1 Air ($\mu\text{Ci}/\text{ml}$)	Col. 2 Water ($\mu\text{Ci}/\text{ml}$)	Col. 1 Air ($\mu\text{Ci}/\text{ml}$)	Col. 2 Water ($\mu\text{Ci}/\text{ml}$)
Astatine (85)	At 211	S I	7×10^{-9} 3×10^{-8}	5×10^{-5} 2×10^{-3}	2×10^{-10} 1×10^{-9}	2×10^{-6} 7×10^{-5}
Barium (56)	Ba 131	S I	1×10^{-6} 4×10^{-7}	5×10^{-3} 5×10^{-3}	4×10^{-8} 1×10^{-8}	2×10^{-4} 2×10^{-4}
	Ba 140	S I	1×10^{-7} 4×10^{-8}	8×10^{-4} 7×10^{-4}	4×10^{-9} 1×10^{-9}	3×10^{-5} 2×10^{-5}
Berkelium (97)	Bk 249	S I	9×10^{-10} 1×10^{-7}	2×10^{-2} 2×10^{-2}	3×10^{-11} 4×10^{-9}	6×10^{-4} 6×10^{-4}
	Bk 250	S I	1×10^{-7} 1×10^{-6}	6×10^{-3} 6×10^{-3}	5×10^{-9} 4×10^{-8}	2×10^{-4} 2×10^{-4}
Beryllium (4)	Be 7	S I	6×10^{-6} 1×10^{-6}	5×10^{-2} 5×10^{-2}	2×10^{-7} 4×10^{-8}	2×10^{-3} 2×10^{-3}
Bismuth (83)	Bi 206	S I	2×10^{-7} 1×10^{-7}	1×10^{-3} 1×10^{-3}	6×10^{-9} 5×10^{-9}	4×10^{-5} 4×10^{-5}
	Bi 207	S I	2×10^{-7} 1×10^{-8}	2×10^{-3} 2×10^{-3}	6×10^{-9} 5×10^{-10}	6×10^{-5} 6×10^{-5}
	Bi 210	S I	6×10^{-9} 6×10^{-9}	1×10^{-3} 1×10^{-3}	2×10^{-10} 2×10^{-10}	4×10^{-5} 4×10^{-5}
	Bi 212	S I	1×10^{-7} 2×10^{-7}	1×10^{-2} 1×10^{-2}	3×10^{-9} 7×10^{-9}	4×10^{-4} 4×10^{-4}
Bromine (35)	Br 82	S I	1×10^{-6} 2×10^{-7}	8×10^{-3} 1×10^{-3}	4×10^{-8} 6×10^{-9}	3×10^{-4} 4×10^{-5}
Cadmium (48)	Cd 109	S I	5×10^{-8} 7×10^{-8}	5×10^{-3} 5×10^{-3}	2×10^{-9} 3×10^{-9}	2×10^{-4} 2×10^{-4}
	Cd 115m	S I	4×10^{-8} 4×10^{-8}	7×10^{-4} 7×10^{-4}	1×10^{-9} 1×10^{-9}	3×10^{-5} 3×10^{-5}
	Cd 115	S I	2×10^{-7} 2×10^{-7}	1×10^{-3} 1×10^{-3}	8×10^{-9} 6×10^{-9}	3×10^{-5} 4×10^{-5}
Calcium (20)	Ca 45	S I	3×10^{-8} 1×10^{-7}	3×10^{-4} 5×10^{-3}	1×10^{-9} 4×10^{-9}	9×10^{-6} 2×10^{-4}
	Ca 47	S I	2×10^{-7} 2×10^{-7}	1×10^{-3} 1×10^{-3}	6×10^{-9} 6×10^{-9}	5×10^{-5} 3×10^{-5}

Revision 21 Date 08/14/97

APPENDIX B TO §§20.1 - 20.602
CONCENTRATIONS IN AIR AND WATER ABOVE NATURAL BACKGROUND

[See footnotes at end of Appendix B]

Element (atomic number)	Isotope ¹		Table I		Table II	
			Col. 1 Air ($\mu\text{Ci/ml}$)	Col. 2 Water ($\mu\text{Ci/ml}$)	Col. 1 Air ($\mu\text{Ci/ml}$)	Col. 2 Water ($\mu\text{Ci/ml}$)
Californium (98)	Cf 249	S	2×10^{-12}	1×10^{-4}	5×10^{-14}	4×10^{-6}
		I	1×10^{-10}	7×10^{-4}	3×10^{-12}	2×10^{-5}
	Cf 250	S	5×10^{-12}	4×10^{-4}	2×10^{-13}	1×10^{-5}
		I	1×10^{-10}	7×10^{-4}	3×10^{-12}	3×10^{-5}
	Cf 251	S	2×10^{-12}	1×10^{-4}	6×10^{-14}	4×10^{-6}
		I	1×10^{-10}	8×10^{-4}	3×10^{-12}	3×10^{-5}
Cf 252	S	6×10^{-12}	2×10^{-4}	2×10^{-13}	7×10^{-6}	
	I	3×10^{-11}	2×10^{-4}	1×10^{-12}	7×10^{-6}	
Cf 253	S	8×10^{-10}	4×10^{-3}	3×10^{-11}	1×10^{-4}	
	I	8×10^{-10}	4×10^{-3}	3×10^{-11}	1×10^{-4}	
Cf 254	S	5×10^{-12}	4×10^{-6}	2×10^{-13}	1×10^{-7}	
	I	5×10^{-12}	4×10^{-6}	2×10^{-13}	1×10^{-7}	
Carbon (6)	C 14 (CO ₂)	S	4×10^{-6}	2×10^{-2}	1×10^{-7}	8×10^{-4}
		Sub	5×10^{-5}	1×10^{-6}
Cerium (58)	Ce 141	S	4×10^{-7}	3×10^{-3}	2×10^{-8}	9×10^{-5}
		I	2×10^{-7}	3×10^{-3}	5×10^{-9}	9×10^{-5}
	Ce 143	S	3×10^{-7}	1×10^{-3}	9×10^{-9}	4×10^{-5}
I		2×10^{-7}	1×10^{-3}	7×10^{-9}	4×10^{-5}	
Ce 144	S	1×10^{-8}	3×10^{-4}	3×10^{-10}	1×10^{-5}	
	I	6×10^{-9}	3×10^{-4}	2×10^{-10}	1×10^{-5}	
Cesium (55)	Cs 131	S	1×10^{-5}	7×10^{-2}	4×10^{-7}	2×10^{-3}
		I	3×10^{-6}	3×10^{-2}	1×10^{-7}	9×10^{-4}
	Cs 134m	S	4×10^{-5}	2×10^{-1}	1×10^{-6}	6×10^{-3}
		I	6×10^{-6}	3×10^{-2}	2×10^{-7}	1×10^{-3}
	Cs 134	S	4×10^{-8}	3×10^{-4}	1×10^{-9}	9×10^{-6}
		I	1×10^{-8}	1×10^{-3}	4×10^{-10}	4×10^{-5}
Cs 135	S	5×10^{-7}	3×10^{-3}	2×10^{-8}	1×10^{-4}	
	I	9×10^{-8}	7×10^{-3}	3×10^{-9}	2×10^{-4}	
Cs 136	S	4×10^{-7}	2×10^{-3}	1×10^{-8}	9×10^{-5}	
	I	2×10^{-7}	2×10^{-3}	6×10^{-9}	6×10^{-5}	
Cs 137	S	6×10^{-8}	4×10^{-4}	2×10^{-9}	2×10^{-5}	
	I	1×10^{-8}	1×10^{-3}	5×10^{-10}	4×10^{-5}	

Revision 21 Date 08/14/97

APPENDIX B TO §§20.1 - 20.602
CONCENTRATIONS IN AIR AND WATER ABOVE NATURAL BACKGROUND

[See footnotes at end of Appendix B]

Element (atomic number)	Isotope ¹		Table I		Table II	
			Col. 1 Air ($\mu\text{Ci}/\text{ml}$)	Col. 2 Water ($\mu\text{Ci}/\text{ml}$)	Col. 1 Air ($\mu\text{Ci}/\text{ml}$)	Col. 2 Water ($\mu\text{Ci}/\text{ml}$)
Chlorine (17)	Cl 36	S	4×10^{-7}	2×10^{-3}	1×10^{-8}	8×10^{-5}
		I	2×10^{-8}	2×10^{-3}	8×10^{-10}	6×10^{-5}
	Cl 38	S	3×10^{-6}	1×10^{-2}	9×10^{-8}	4×10^{-4}
		I	2×10^{-6}	1×10^{-2}	7×10^{-8}	4×10^{-4}
Chromium (24)	Cr 51	S	1×10^{-5}	5×10^{-2}	4×10^{-7}	2×10^{-3}
		I	2×10^{-6}	5×10^{-2}	8×10^{-8}	2×10^{-3}
Cobalt (27)	Co 57	S	3×10^{-6}	2×10^{-2}	1×10^{-7}	5×10^{-4}
		I	2×10^{-7}	1×10^{-2}	6×10^{-9}	4×10^{-4}
	Co 58m	S	2×10^{-5}	8×10^{-2}	6×10^{-7}	3×10^{-3}
		I	9×10^{-6}	6×10^{-2}	3×10^{-7}	2×10^{-3}
Co 58	S	8×10^{-7}	4×10^{-3}	3×10^{-8}	1×10^{-4}	
	I	5×10^{-8}	3×10^{-3}	2×10^{-9}	9×10^{-5}	
Co 60	S	3×10^{-7}	1×10^{-3}	1×10^{-8}	5×10^{-5}	
	I	9×10^{-9}	1×10^{-3}	3×10^{-10}	3×10^{-5}	
Copper (29)	Cu 64	S	2×10^{-6}	1×10^{-2}	7×10^{-8}	3×10^{-4}
		I	1×10^{-6}	6×10^{-3}	4×10^{-8}	2×10^{-4}
Curium (96)	Cm 242	S	1×10^{-10}	7×10^{-4}	4×10^{-12}	2×10^{-5}
		I	2×10^{-10}	7×10^{-4}	6×10^{-12}	2×10^{-5}
	Cm 243	S	6×10^{-12}	1×10^{-4}	2×10^{-13}	5×10^{-6}
		I	1×10^{-10}	7×10^{-4}	3×10^{-12}	2×10^{-5}
	Cm 244	S	9×10^{-12}	2×10^{-4}	3×10^{-13}	7×10^{-6}
		I	1×10^{-10}	8×10^{-4}	3×10^{-12}	3×10^{-5}
	Cm 245	S	5×10^{-12}	1×10^{-4}	2×10^{-13}	4×10^{-6}
		I	1×10^{-10}	8×10^{-4}	4×10^{-12}	3×10^{-5}
Cm 246	S	5×10^{-12}	1×10^{-4}	2×10^{-13}	4×10^{-6}	
	I	1×10^{-10}	8×10^{-4}	4×10^{-12}	3×10^{-5}	
Cm 247	S	5×10^{-12}	1×10^{-4}	2×10^{-13}	4×10^{-6}	
	I	1×10^{-10}	6×10^{-4}	4×10^{-12}	2×10^{-5}	
Cm 248	S	6×10^{-13}	1×10^{-5}	2×10^{-14}	4×10^{-7}	
	I	1×10^{-11}	4×10^{-5}	4×10^{-13}	1×10^{-6}	
Cm 249	S	1×10^{-5}	6×10^{-2}	4×10^{-7}	2×10^{-3}	
	I	1×10^{-5}	6×10^{-2}	4×10^{-7}	2×10^{-3}	

Revision 21 Date 08/14/97

APPENDIX B TO §§20.1 - 20.602
CONCENTRATIONS IN AIR AND WATER ABOVE NATURAL BACKGROUND

[See footnotes at end of Appendix B]

Element (atomic number)	Isotope ¹		Table I		Table II	
			Col. 1 Air ($\mu\text{Ci}/\text{ml}$)	Col. 2 Water ($\mu\text{Ci}/\text{ml}$)	Col. 1 Air ($\mu\text{Ci}/\text{ml}$)	Col. 2 Water ($\mu\text{Ci}/\text{ml}$)
Dysprosium (66)	Dy 165	S	3×10^{-6}	1×10^{-2}	9×10^{-8}	4×10^{-4}
		I	2×10^{-6}	1×10^{-2}	7×10^{-8}	4×10^{-4}
	Dy 166	S	2×10^{-7}	1×10^{-3}	8×10^{-9}	4×10^{-5}
		I	2×10^{-7}	1×10^{-3}	7×10^{-9}	4×10^{-5}
Einsteinium (99)	Es 253	S	8×10^{-10}	7×10^{-4}	3×10^{-11}	2×10^{-5}
		I	6×10^{-10}	7×10^{-4}	2×10^{-11}	2×10^{-5}
	Es 254m	S	5×10^{-9}	5×10^{-4}	2×10^{-10}	2×10^{-5}
		I	6×10^{-9}	5×10^{-4}	2×10^{-10}	2×10^{-5}
Es 254	S	2×10^{-11}	4×10^{-4}	6×10^{-13}	1×10^{-5}	
	I	1×10^{-10}	4×10^{-4}	4×10^{-12}	1×10^{-5}	
Es 255	S	5×10^{-10}	8×10^{-4}	2×10^{-11}	3×10^{-5}	
	I	4×10^{-10}	8×10^{-4}	1×10^{-11}	3×10^{-5}	
Erbium (68)	Er 169	S	6×10^{-7}	3×10^{-3}	2×10^{-8}	9×10^{-5}
		I	4×10^{-7}	3×10^{-3}	1×10^{-8}	9×10^{-5}
	Er 171	S	7×10^{-7}	3×10^{-3}	2×10^{-8}	1×10^{-4}
		I	6×10^{-7}	3×10^{-3}	2×10^{-8}	1×10^{-4}
Europium (63)	Eu 152 (T/2=9.2 hrs)	S	4×10^{-7}	2×10^{-3}	1×10^{-8}	6×10^{-5}
		I	3×10^{-7}	2×10^{-3}	1×10^{-8}	6×10^{-5}
	Eu 152 (T/2=13 yrs)	S	1×10^{-8}	2×10^{-3}	4×10^{-10}	8×10^{-5}
		I	2×10^{-8}	2×10^{-3}	6×10^{-10}	8×10^{-5}
Eu 154	S	4×10^{-9}	6×10^{-4}	1×10^{-10}	2×10^{-5}	
	I	7×10^{-9}	6×10^{-4}	2×10^{-10}	2×10^{-5}	
Eu 155	S	9×10^{-8}	6×10^{-3}	3×10^{-9}	2×10^{-4}	
	I	7×10^{-8}	6×10^{-3}	3×10^{-9}	2×10^{-4}	
Fermium (100)	Fm 254	S	6×10^{-8}	4×10^{-3}	2×10^{-9}	1×10^{-4}
		I	7×10^{-8}	4×10^{-3}	2×10^{-9}	1×10^{-4}
	Fm 255	S	2×10^{-8}	1×10^{-3}	6×10^{-10}	3×10^{-5}
I		1×10^{-8}	1×10^{-3}	4×10^{-10}	3×10^{-5}	
Fm 256	S	3×10^{-9}	3×10^{-5}	1×10^{-10}	9×10^{-7}	
	I	2×10^{-9}	3×10^{-5}	6×10^{-11}	9×10^{-7}	
Fluorine (9)	F 18	S	5×10^{-6}	2×10^{-2}	2×10^{-7}	8×10^{-4}
		I	3×10^{-6}	1×10^{-2}	9×10^{-8}	5×10^{-4}

Revision 21 Date 08/14/97

APPENDIX B TO §§20.1 - 20.602
CONCENTRATIONS IN AIR AND WATER ABOVE NATURAL BACKGROUND

[See footnotes at end of Appendix B]

Element (atomic number)	Isotope ¹		Table I		Table II	
			Col. 1 Air ($\mu\text{Ci}/\text{ml}$)	Col. 2 Water ($\mu\text{Ci}/\text{ml}$)	Col. 1 Air ($\mu\text{Ci}/\text{ml}$)	Col. 2 Water ($\mu\text{Ci}/\text{ml}$)
Gadolinium (64)	Gd 153	S	2×10^{-7}	6×10^{-3}	8×10^{-9}	2×10^{-4}
		I	9×10^{-8}	6×10^{-3}	3×10^{-9}	2×10^{-4}
	Gd 159	S	5×10^{-7}	2×10^{-3}	2×10^{-8}	8×10^{-5}
		I	4×10^{-7}	2×10^{-3}	1×10^{-8}	8×10^{-5}
Gallium (31)	Ga 72	S	2×10^{-7}	1×10^{-3}	8×10^{-9}	4×10^{-5}
		I	2×10^{-7}	1×10^{-3}	6×10^{-9}	4×10^{-5}
Germanium (32)	Ge 71	S	1×10^{-5}	5×10^{-2}	4×10^{-7}	2×10^{-3}
		I	6×10^{-6}	5×10^{-2}	2×10^{-7}	2×10^{-3}
Gold (79)	Au 196	S	1×10^{-6}	5×10^{-3}	4×10^{-8}	2×10^{-4}
		I	6×10^{-7}	4×10^{-3}	2×10^{-8}	1×10^{-4}
	Au 198	S	3×10^{-7}	2×10^{-3}	1×10^{-8}	5×10^{-5}
		I	2×10^{-7}	1×10^{-3}	8×10^{-9}	5×10^{-5}
	Au 199	S	1×10^{-6}	5×10^{-3}	4×10^{-8}	2×10^{-4}
		I	8×10^{-7}	4×10^{-3}	3×10^{-8}	2×10^{-4}
Hafnium (72)	Hf 181	S	4×10^{-8}	2×10^{-3}	1×10^{-9}	7×10^{-5}
		I	7×10^{-8}	2×10^{-3}	3×10^{-9}	7×10^{-5}
Holmium (67)	Ho 166	S	2×10^{-7}	9×10^{-4}	7×10^{-9}	3×10^{-5}
		I	2×10^{-7}	9×10^{-4}	6×10^{-9}	3×10^{-5}
Hydrogen (1)	H3	S	5×10^{-6}	1×10^{-1}	2×10^{-7}	3×10^{-3}
		I	5×10^{-6}	1×10^{-1}	2×10^{-7}	3×10^{-3}
		Sub	2×10^{-3}	4×10^{-5}
Indium (49)	In 113m	S	8×10^{-6}	4×10^{-2}	3×10^{-7}	1×10^{-3}
		I	7×10^{-6}	4×10^{-2}	2×10^{-7}	1×10^{-3}
	In 114m	S	1×10^{-7}	5×10^{-4}	4×10^{-9}	2×10^{-5}
		I	2×10^{-8}	5×10^{-4}	7×10^{-10}	2×10^{-5}
In 115m	S	2×10^{-6}	1×10^{-2}	8×10^{-8}	4×10^{-4}	
	I	2×10^{-6}	1×10^{-2}	6×10^{-8}	4×10^{-4}	
In 115	S	2×10^{-7}	3×10^{-3}	9×10^{-9}	9×10^{-5}	
	I	3×10^{-8}	3×10^{-3}	1×10^{-9}	9×10^{-5}	
Iodine (53)	I 125	S	5×10^{-9}	4×10^{-5}	8×10^{-11}	2×10^{-7}
		I	2×10^{-7}	6×10^{-3}	6×10^{-9}	2×10^{-4}
	I 126	S	8×10^{-9}	5×10^{-5}	9×10^{-11}	3×10^{-7}
I		3×10^{-7}	3×10^{-3}	1×10^{-8}	9×10^{-5}	
I 129	S	2×10^{-9}	1×10^{-5}	2×10^{-11}	6×10^{-8}	
	I	7×10^{-8}	6×10^{-3}	2×10^{-9}	2×10^{-4}	

Revision 21 Date 08/14/97

APPENDIX B TO §§20.1 - 20.602
CONCENTRATIONS IN AIR AND WATER ABOVE NATURAL BACKGROUND

[See footnotes at end of Appendix B]

Element (atomic number)	Isotope ¹		Table I		Table II	
			Col. 1 Air ($\mu\text{Ci}/\text{ml}$)	Col. 2 Water ($\mu\text{Ci}/\text{ml}$)	Col. 1 Air ($\mu\text{Ci}/\text{ml}$)	Col. 2 Water ($\mu\text{Ci}/\text{ml}$)
Iodine (53) (Continued)	I 131	S	9×10^{-9}	6×10^{-5}	1×10^{-10}	3×10^{-7}
		I	3×10^{-7}	2×10^{-3}	1×10^{-8}	6×10^{-5}
	I 132	S	2×10^{-7}	2×10^{-3}	3×10^{-9}	8×10^{-6}
		I	9×10^{-7}	5×10^{-3}	3×10^{-8}	2×10^{-4}
	I 133	S	3×10^{-8}	2×10^{-4}	4×10^{-10}	1×10^{-6}
I		2×10^{-7}	1×10^{-3}	7×10^{-9}	4×10^{-5}	
I 134	S	5×10^{-7}	4×10^{-3}	6×10^{-9}	2×10^{-5}	
	I	3×10^{-6}	2×10^{-2}	1×10^{-7}	6×10^{-4}	
I 135	S	1×10^{-7}	7×10^{-4}	1×10^{-9}	4×10^{-6}	
	I	4×10^{-7}	2×10^{-3}	1×10^{-8}	7×10^{-5}	
Iridium (77)	Ir 190	S	1×10^{-6}	6×10^{-3}	4×10^{-8}	2×10^{-4}
		I	4×10^{-7}	5×10^{-3}	1×10^{-8}	2×10^{-4}
	Ir 192	S	1×10^{-7}	1×10^{-3}	4×10^{-9}	4×10^{-5}
I		3×10^{-8}	1×10^{-3}	9×10^{-10}	4×10^{-5}	
Ir 194	S	2×10^{-7}	1×10^{-3}	8×10^{-9}	3×10^{-5}	
	I	2×10^{-7}	9×10^{-4}	5×10^{-9}	3×10^{-5}	
Iron (26)	Fe 55	S	9×10^{-7}	2×10^{-2}	3×10^{-8}	8×10^{-4}
		I	1×10^{-6}	7×10^{-2}	3×10^{-8}	2×10^{-3}
Fe 59	S	1×10^{-7}	2×10^{-3}	5×10^{-9}	6×10^{-5}	
	I	5×10^{-8}	2×10^{-3}	2×10^{-9}	5×10^{-5}	
Krypton (36)	Kr 85m	Sub	6×10^{-6}	1×10^{-7}
		Sub	1×10^{-5}	3×10^{-7}
	Kr 87	Sub	1×10^{-6}	2×10^{-8}
		Sub	1×10^{-6}	2×10^{-8}
Lanthanum (57)	La 140	S	2×10^{-7}	7×10^{-4}	5×10^{-9}	2×10^{-5}
		I	1×10^{-7}	7×10^{-4}	4×10^{-9}	2×10^{-5}
Lead (82)	Pb 203	S	3×10^{-6}	1×10^{-2}	9×10^{-8}	4×10^{-4}
		I	2×10^{-6}	1×10^{-2}	6×10^{-8}	4×10^{-4}
	Pb 210	S	1×10^{-10}	4×10^{-6}	4×10^{-12}	1×10^{-7}
I		2×10^{-10}	5×10^{-3}	8×10^{-12}	2×10^{-4}	
Pb 212	S	2×10^{-8}	6×10^{-4}	6×10^{-10}	2×10^{-5}	
	I	2×10^{-8}	5×10^{-4}	7×10^{-10}	2×10^{-5}	

Revision 21 Date 08/14/97

APPENDIX B TO §§20.1 - 20.602
CONCENTRATIONS IN AIR AND WATER ABOVE NATURAL BACKGROUND

[See footnotes at end of Appendix B]

Element (atomic number)	Isotope ¹		Table I		Table II	
			Col. 1 Air ($\mu\text{Ci}/\text{ml}$)	Col. 2 Water ($\mu\text{Ci}/\text{ml}$)	Col. 1 Air ($\mu\text{Ci}/\text{ml}$)	Col. 2 Water ($\mu\text{Ci}/\text{ml}$)
Lutetium (71)	Lu 177	S	6×10^{-7}	3×10^{-3}	2×10^{-8}	1×10^{-4}
		I	5×10^{-7}	3×10^{-3}	2×10^{-8}	1×10^{-4}
Manganese (25)	Mn 52	S	2×10^{-7}	1×10^{-3}	7×10^{-9}	3×10^{-5}
		I	1×10^{-7}	9×10^{-4}	5×10^{-9}	3×10^{-5}
	Mn 54	S	4×10^{-7}	4×10^{-3}	1×10^{-8}	1×10^{-4}
		I	4×10^{-8}	3×10^{-3}	1×10^{-9}	1×10^{-4}
	Mn 56	S	8×10^{-7}	4×10^{-3}	3×10^{-8}	1×10^{-4}
		I	5×10^{-7}	3×10^{-3}	2×10^{-8}	1×10^{-4}
Mercury (80)	Hg 197m	S	7×10^{-7}	6×10^{-3}	3×10^{-8}	2×10^{-4}
		I	8×10^{-7}	5×10^{-3}	3×10^{-8}	2×10^{-4}
	Hg 197	S	1×10^{-6}	9×10^{-3}	4×10^{-8}	3×10^{-4}
		I	3×10^{-6}	1×10^{-2}	9×10^{-8}	5×10^{-4}
	Hg 203	S	7×10^{-8}	5×10^{-4}	2×10^{-9}	2×10^{-5}
		I	1×10^{-7}	3×10^{-3}	4×10^{-9}	1×10^{-4}
Molybdenum (42)	Mo 99	S	7×10^{-7}	5×10^{-3}	3×10^{-8}	2×10^{-4}
		I	2×10^{-7}	1×10^{-3}	7×10^{-9}	4×10^{-5}
Neodymium (60)	Nd 144	S	8×10^{-11}	2×10^{-3}	3×10^{-12}	7×10^{-5}
		I	3×10^{-10}	2×10^{-3}	1×10^{-11}	8×10^{-5}
	Nd 147	S	4×10^{-7}	2×10^{-3}	1×10^{-8}	$.6 \times 10^{-5}$
		I	2×10^{-7}	2×10^{-3}	8×10^{-9}	6×10^{-5}
	Nd 149	S	2×10^{-6}	8×10^{-3}	6×10^{-8}	3×10^{-4}
		I	1×10^{-6}	8×10^{-3}	5×10^{-8}	3×10^{-4}
Neptunium (93)	Np 237	S	4×10^{-12}	9×10^{-5}	1×10^{-13}	3×10^{-6}
		I	1×10^{-10}	9×10^{-4}	4×10^{-12}	3×10^{-5}
	Np 239	S	8×10^{-7}	4×10^{-3}	3×10^{-8}	1×10^{-4}
		I	7×10^{-7}	4×10^{-3}	2×10^{-8}	1×10^{-4}
Nickel (28)	Ni 59	S	5×10^{-7}	6×10^{-3}	2×10^{-8}	2×10^{-4}
		I	8×10^{-7}	6×10^{-2}	3×10^{-8}	2×10^{-3}
	Ni 63	S	6×10^{-8}	8×10^{-4}	2×10^{-9}	3×10^{-5}
		I	3×10^{-7}	2×10^{-2}	1×10^{-8}	7×10^{-4}
	Ni 65	S	9×10^{-7}	4×10^{-3}	3×10^{-8}	1×10^{-4}
		I	5×10^{-7}	3×10^{-3}	2×10^{-8}	1×10^{-4}

Revision 21 Date 08/14/97

APPENDIX B TO §§20.1 - 20.602
CONCENTRATIONS IN AIR AND WATER ABOVE NATURAL BACKGROUND

[See footnotes at end of Appendix B]

Element (atomic number)	Isotope ¹		Table I		Table II	
			Col. 1 Air ($\mu\text{Ci}/\text{ml}$)	Col. 2 Water ($\mu\text{Ci}/\text{ml}$)	Col. 1 Air ($\mu\text{Ci}/\text{ml}$)	Col. 2 Water ($\mu\text{Ci}/\text{ml}$)
Niobium (Columbium) (41)	Nb 93m	S	1×10^{-7}	1×10^{-2}	4×10^{-9}	4×10^{-4}
		I	2×10^{-7}	1×10^{-2}	5×10^{-9}	4×10^{-4}
	Nb 95	S	5×10^{-7}	3×10^{-3}	2×10^{-8}	1×10^{-4}
		I	1×10^{-7}	3×10^{-3}	3×10^{-9}	1×10^{-4}
	Nb 97	S	6×10^{-6}	3×10^{-2}	2×10^{-7}	9×10^{-4}
		I	5×10^{-6}	3×10^{-2}	2×10^{-7}	9×10^{-4}
Osmium (76)	Os 185	S	5×10^{-7}	2×10^{-3}	2×10^{-8}	7×10^{-5}
		I	5×10^{-8}	2×10^{-3}	2×10^{-9}	7×10^{-5}
	Os 191m	S	2×10^{-5}	7×10^{-2}	6×10^{-7}	3×10^{-3}
		I	9×10^{-6}	7×10^{-2}	3×10^{-7}	2×10^{-3}
	Os 191	S	1×10^{-6}	5×10^{-3}	4×10^{-8}	2×10^{-4}
		I	4×10^{-7}	5×10^{-3}	1×10^{-8}	2×10^{-4}
	Os 193	S	4×10^{-7}	2×10^{-3}	1×10^{-8}	6×10^{-5}
		I	3×10^{-7}	2×10^{-3}	9×10^{-9}	5×10^{-5}
Palladium (46)	Pd 103	S	1×10^{-6}	1×10^{-2}	5×10^{-8}	3×10^{-4}
		I	7×10^{-7}	8×10^{-3}	3×10^{-8}	3×10^{-4}
	Pd 109	S	6×10^{-7}	3×10^{-3}	2×10^{-8}	9×10^{-5}
		I	4×10^{-7}	2×10^{-3}	1×10^{-8}	7×10^{-5}
Phosphorus (15)	P 32	S	7×10^{-8}	5×10^{-4}	2×10^{-9}	2×10^{-5}
		I	8×10^{-8}	7×10^{-4}	3×10^{-9}	2×10^{-5}
Platinum (78)	Pt 191	S	8×10^{-7}	4×10^{-3}	3×10^{-8}	1×10^{-4}
		I	6×10^{-7}	3×10^{-3}	2×10^{-8}	1×10^{-4}
	Pt 193m	S	7×10^{-6}	3×10^{-2}	2×10^{-7}	1×10^{-3}
		I	5×10^{-6}	3×10^{-2}	2×10^{-7}	1×10^{-3}
	Pt 193	S	1×10^{-6}	3×10^{-2}	4×10^{-8}	9×10^{-4}
		I	3×10^{-7}	5×10^{-2}	1×10^{-8}	2×10^{-3}
	Pt 197m	S	6×10^{-6}	3×10^{-2}	2×10^{-7}	1×10^{-3}
		I	5×10^{-6}	3×10^{-2}	2×10^{-7}	9×10^{-4}
Pt 197	S	8×10^{-7}	4×10^{-3}	3×10^{-8}	1×10^{-4}	
	I	6×10^{-7}	3×10^{-3}	2×10^{-8}	1×10^{-4}	

Revision 21 Date 08/14/97

APPENDIX B TO §§20.1 - 20.602
CONCENTRATIONS IN AIR AND WATER ABOVE NATURAL BACKGROUND

[See footnotes at end of Appendix B]

Element (atomic number)	Isotope ¹		Table I		Table II	
			Col. 1 Air ($\mu\text{Ci}/\text{ml}$)	Col. 2 Water ($\mu\text{Ci}/\text{ml}$)	Col. 1 Air ($\mu\text{Ci}/\text{ml}$)	Col. 2 Water ($\mu\text{Ci}/\text{ml}$)
Plutonium (94)	Pu 238	S	2×10^{-12}	1×10^{-4}	7×10^{-14}	5×10^{-6}
		I	3×10^{-11}	8×10^{-4}	1×10^{-12}	3×10^{-5}
	Pu 239	S	2×10^{-12}	1×10^{-4}	6×10^{-14}	5×10^{-6}
		I	4×10^{-11}	8×10^{-4}	1×10^{-12}	3×10^{-5}
	Pu 240	S	2×10^{-12}	1×10^{-4}	6×10^{-14}	5×10^{-6}
		I	4×10^{-11}	8×10^{-4}	1×10^{-12}	3×10^{-5}
	Pu 241	S	9×10^{-11}	7×10^{-3}	3×10^{-12}	2×10^{-4}
I		4×10^{-8}	4×10^{-2}	1×10^{-9}	1×10^{-3}	
Pu 242	S	2×10^{-12}	1×10^{-4}	6×10^{-14}	5×10^{-6}	
	I	4×10^{-11}	9×10^{-4}	1×10^{-12}	3×10^{-5}	
Pu 243	S	2×10^{-6}	1×10^{-2}	6×10^{-8}	3×10^{-4}	
	I	2×10^{-6}	1×10^{-2}	8×10^{-8}	3×10^{-4}	
Pu 244	S	2×10^{-12}	1×10^{-4}	6×10^{-14}	4×10^{-6}	
	I	3×10^{-11}	3×10^{-4}	1×10^{-12}	1×10^{-5}	
Polonium (84)	Po 210	S	5×10^{-10}	2×10^{-5}	2×10^{-11}	7×10^{-7}
		I	2×10^{-10}	8×10^{-4}	7×10^{-12}	3×10^{-5}
Potassium (19)	K42	S	2×10^{-6}	9×10^{-3}	7×10^{-8}	3×10^{-4}
		I	1×10^{-7}	6×10^{-4}	4×10^{-9}	2×10^{-5}
Praseodymium (59)	Pr 142	S	2×10^{-7}	9×10^{-4}	7×10^{-9}	3×10^{-5}
		I	2×10^{-7}	9×10^{-4}	5×10^{-9}	3×10^{-5}
Pr 143	S	3×10^{-7}	1×10^{-3}	1×10^{-8}	5×10^{-5}	
	I	2×10^{-7}	1×10^{-3}	6×10^{-9}	5×10^{-5}	
Promethium (61)	Pm 147	S	6×10^{-8}	6×10^{-3}	2×10^{-9}	2×10^{-4}
		I	1×10^{-7}	6×10^{-3}	3×10^{-9}	2×10^{-4}
Pm 149	S	3×10^{-7}	1×10^{-3}	1×10^{-8}	4×10^{-5}	
	I	2×10^{-7}	1×10^{-3}	8×10^{-9}	4×10^{-5}	
Protoactinium (91)	Pa 230	S	2×10^{-9}	7×10^{-3}	6×10^{-11}	2×10^{-4}
		I	8×10^{-10}	7×10^{-3}	3×10^{-11}	2×10^{-4}
	Pa 231	S	1×10^{-12}	3×10^{-5}	4×10^{-14}	9×10^{-7}
I		1×10^{-10}	8×10^{-4}	4×10^{-12}	2×10^{-5}	
Pa 233	S	6×10^{-7}	4×10^{-3}	2×10^{-8}	1×10^{-4}	
	I	2×10^{-7}	3×10^{-3}	6×10^{-9}	1×10^{-4}	

Revision 21 Date 08/14/97

APPENDIX B TO §§20.1 - 20.602
CONCENTRATIONS IN AIR AND WATER ABOVE NATURAL BACKGROUND

[See footnotes at end of Appendix B]

Element (atomic number)	Isotope ¹		Table I		Table II	
			Col. 1 Air ($\mu\text{Ci/ml}$)	Col. 2 Water ($\mu\text{Ci/ml}$)	Col. 1 Air ($\mu\text{Ci/ml}$)	Col. 2 Water ($\mu\text{Ci/ml}$)
Radium (88)	Ra 223	S	2×10^{-9}	2×10^{-5}	6×10^{-11}	7×10^{-7}
		I	2×10^{-10}	1×10^{-4}	8×10^{-12}	4×10^{-6}
	Ra 224	S	5×10^{-9}	7×10^{-5}	2×10^{-10}	2×10^{-6}
		I	7×10^{-10}	2×10^{-4}	2×10^{-11}	5×10^{-6}
Ra 226	S	3×10^{-11}	4×10^{-7}	3×10^{-12}	3×10^{-8}	
	I	5×10^{-11}	9×10^{-4}	2×10^{-12}	3×10^{-5}	
Ra 228	S	7×10^{-11}	8×10^{-7}	2×10^{-12}	3×10^{-8}	
	I	4×10^{-11}	7×10^{-4}	1×10^{-12}	3×10^{-5}	
Radon (86)	Rn 220	S	3×10^{-7}	1×10^{-8}
	Rn 222 ³		3×10^{-8}	3×10^{-9}
Rhenium (75)	Re 183	S	3×10^{-6}	2×10^{-2}	9×10^{-8}	6×10^{-4}
		I	2×10^{-7}	8×10^{-3}	5×10^{-9}	3×10^{-4}
	Re 186	S	6×10^{-7}	3×10^{-3}	2×10^{-8}	9×10^{-5}
		I	2×10^{-7}	1×10^{-3}	8×10^{-9}	5×10^{-5}
Re 187	S	9×10^{-6}	7×10^{-2}	3×10^{-7}	3×10^{-3}	
	I	5×10^{-7}	4×10^{-2}	2×10^{-8}	2×10^{-3}	
Re 188	S	4×10^{-7}	2×10^{-3}	1×10^{-8}	6×10^{-5}	
	I	2×10^{-7}	9×10^{-4}	6×10^{-9}	3×10^{-5}	
Rhodium (45)	Rh 103m	S	8×10^{-5}	4×10^{-1}	3×10^{-6}	1×10^{-2}
		I	6×10^{-5}	3×10^{-1}	2×10^{-6}	1×10^{-2}
Rh 105	S	8×10^{-7}	4×10^{-3}	3×10^{-8}	1×10^{-4}	
	I	5×10^{-7}	3×10^{-3}	2×10^{-8}	1×10^{-4}	
Rubidium (37)	Rb 86	S	3×10^{-7}	2×10^{-3}	1×10^{-8}	7×10^{-5}
		I	7×10^{-8}	7×10^{-4}	2×10^{-9}	2×10^{-5}
Rb 87	S	5×10^{-7}	3×10^{-3}	2×10^{-8}	1×10^{-4}	
	I	7×10^{-8}	5×10^{-3}	2×10^{-9}	2×10^{-4}	
Ruthenium (44)	Ru 97	S	2×10^{-6}	1×10^{-2}	8×10^{-8}	4×10^{-4}
		I	2×10^{-6}	1×10^{-2}	6×10^{-8}	3×10^{-4}
	Ru 103	S	5×10^{-7}	2×10^{-3}	2×10^{-8}	8×10^{-5}
		I	8×10^{-8}	2×10^{-3}	3×10^{-9}	8×10^{-5}
Ru 105	S	7×10^{-7}	3×10^{-3}	2×10^{-8}	1×10^{-4}	
	I	5×10^{-7}	3×10^{-3}	2×10^{-8}	1×10^{-4}	
Ru 106	S	8×10^{-8}	4×10^{-4}	3×10^{-9}	1×10^{-5}	
	I	6×10^{-9}	3×10^{-4}	2×10^{-10}	1×10^{-5}	

Revision 21 Date 08/14/97

APPENDIX B TO §§20.1 - 20.602
CONCENTRATIONS IN AIR AND WATER ABOVE NATURAL BACKGROUND

[See footnotes at end of Appendix B]

Element (atomic number)	Isotope ¹		Table I		Table II	
			Col. 1 Air ($\mu\text{Ci}/\text{ml}$)	Col. 2 Water ($\mu\text{Ci}/\text{ml}$)	Col. 1 Air ($\mu\text{Ci}/\text{ml}$)	Col. 2 Water ($\mu\text{Ci}/\text{ml}$)
Samarium (62)	Sm 147	S	7×10^{-11}	2×10^{-3}	2×10^{-12}	6×10^{-5}
		I	3×10^{-10}	2×10^{-3}	9×10^{-12}	7×10^{-5}
	Sm 151	S	6×10^{-8}	1×10^{-2}	2×10^{-9}	4×10^{-4}
		I	1×10^{-7}	1×10^{-2}	5×10^{-9}	4×10^{-4}
Scandium (21)	Sm 153	S	5×10^{-7}	2×10^{-3}	2×10^{-8}	8×10^{-5}
		I	4×10^{-7}	2×10^{-3}	1×10^{-8}	8×10^{-5}
	Sc 46	S	2×10^{-7}	1×10^{-3}	8×10^{-9}	4×10^{-5}
		I	2×10^{-8}	1×10^{-3}	8×10^{-10}	4×10^{-5}
Selenium (34)	Sc 47	S	6×10^{-7}	3×10^{-3}	2×10^{-8}	9×10^{-5}
		I	5×10^{-7}	3×10^{-3}	2×10^{-8}	9×10^{-5}
	Sc 48	S	2×10^{-7}	8×10^{-4}	6×10^{-9}	3×10^{-5}
		I	1×10^{-7}	8×10^{-4}	5×10^{-9}	3×10^{-5}
Silicon (14)	Se 75	S	1×10^{-6}	9×10^{-3}	4×10^{-8}	3×10^{-4}
		I	1×10^{-7}	8×10^{-3}	4×10^{-9}	3×10^{-4}
Silver (47)	Si 31	S	6×10^{-6}	3×10^{-2}	2×10^{-7}	9×10^{-4}
		I	1×10^{-6}	6×10^{-3}	3×10^{-8}	2×10^{-4}
Sodium (11)	Ag 105	S	6×10^{-7}	3×10^{-3}	2×10^{-8}	1×10^{-4}
		I	8×10^{-8}	3×10^{-3}	3×10^{-9}	1×10^{-4}
	Ag 110m	S	2×10^{-7}	9×10^{-4}	7×10^{-9}	3×10^{-5}
		I	1×10^{-8}	9×10^{-4}	3×10^{-10}	3×10^{-5}
Strontium (38)	Ag 111	S	3×10^{-7}	1×10^{-3}	1×10^{-8}	4×10^{-5}
		I	2×10^{-7}	1×10^{-3}	8×10^{-9}	4×10^{-5}
Sodium (11)	Na 22	S	2×10^{-7}	1×10^{-3}	6×10^{-9}	4×10^{-5}
		I	9×10^{-9}	9×10^{-4}	3×10^{-10}	3×10^{-5}
Strontium (38)	Na 24	S	1×10^{-6}	6×10^{-3}	4×10^{-8}	2×10^{-4}
		I	1×10^{-7}	8×10^{-4}	5×10^{-9}	3×10^{-5}
	Sr 85m	S	4×10^{-5}	2×10^{-1}	1×10^{-6}	7×10^{-3}
		I	3×10^{-5}	2×10^{-1}	1×10^{-6}	7×10^{-3}
Sr 85	S	2×10^{-7}	3×10^{-3}	8×10^{-9}	1×10^{-4}	
	I	1×10^{-7}	5×10^{-3}	4×10^{-9}	2×10^{-4}	
Sr 89	S	3×10^{-8}	3×10^{-4}	3×10^{-10}	3×10^{-6}	
	I	4×10^{-8}	8×10^{-4}	1×10^{-9}	3×10^{-5}	
Sr 90	S	1×10^{-9}	1×10^{-5}	3×10^{-11}	3×10^{-7}	
	I	5×10^{-9}	1×10^{-3}	2×10^{-10}	4×10^{-5}	

Revision 21 Date 08/14/97

APPENDIX B TO §§20.1 - 20.602
CONCENTRATIONS IN AIR AND WATER ABOVE NATURAL BACKGROUND

[See footnotes at end of Appendix B]

Element (atomic number)	Isotope ¹		Table I		Table II	
			Col. 1 Air ($\mu\text{Ci/ml}$)	Col. 2 Water ($\mu\text{Ci/ml}$)	Col. 1 Air ($\mu\text{Ci/ml}$)	Col. 2 Water ($\mu\text{Ci/ml}$)
Strontium (38) (Continued)	Sr 91	S	4×10^{-7}	2×10^{-3}	2×10^{-8}	7×10^{-5}
		I	3×10^{-7}	1×10^{-3}	9×10^{-9}	5×10^{-5}
	Sr 92	S	4×10^{-7}	2×10^{-3}	2×10^{-8}	7×10^{-5}
		I	3×10^{-7}	2×10^{-3}	1×10^{-8}	6×10^{-5}
Sulfur (16)	S 35	S	3×10^{-7}	2×10^{-3}	9×10^{-9}	6×10^{-5}
		I	3×10^{-7}	8×10^{-3}	9×10^{-9}	3×10^{-4}
Tantalum (73)	Ta 182	S	4×10^{-8}	1×10^{-3}	1×10^{-9}	4×10^{-5}
		I	2×10^{-8}	1×10^{-3}	7×10^{-10}	4×10^{-5}
Technetium (43)	Tc 96m	S	8×10^{-5}	4×10^{-1}	3×10^{-6}	1×10^{-2}
		I	3×10^{-5}	3×10^{-1}	1×10^{-6}	1×10^{-2}
	Tc 96	S	6×10^{-7}	3×10^{-3}	2×10^{-8}	1×10^{-4}
		I	2×10^{-7}	1×10^{-3}	8×10^{-9}	5×10^{-5}
	Tc 97m	S	2×10^{-6}	1×10^{-2}	8×10^{-8}	4×10^{-4}
		I	2×10^{-7}	5×10^{-3}	5×10^{-9}	2×10^{-4}
Tc 97	S	1×10^{-5}	5×10^{-2}	4×10^{-7}	2×10^{-3}	
	I	3×10^{-7}	2×10^{-2}	1×10^{-8}	8×10^{-4}	
Tc 99m	S	4×10^{-5}	2×10^{-1}	1×10^{-6}	6×10^{-3}	
	I	1×10^{-5}	8×10^{-2}	5×10^{-7}	3×10^{-3}	
Tc 99	S	2×10^{-6}	1×10^{-2}	7×10^{-8}	3×10^{-4}	
	I	6×10^{-8}	5×10^{-3}	2×10^{-9}	2×10^{-4}	
Tellurium (52)	Te 125m	S	4×10^{-7}	5×10^{-3}	1×10^{-8}	2×10^{-4}
		I	1×10^{-7}	3×10^{-3}	4×10^{-9}	1×10^{-4}
	Te 127m	S	1×10^{-7}	2×10^{-3}	5×10^{-9}	6×10^{-5}
		I	4×10^{-8}	2×10^{-3}	1×10^{-9}	5×10^{-5}
	Te 127	S	2×10^{-6}	8×10^{-3}	6×10^{-8}	3×10^{-4}
		I	9×10^{-7}	5×10^{-3}	3×10^{-8}	2×10^{-4}
	Te 129m	S	8×10^{-8}	1×10^{-3}	3×10^{-9}	3×10^{-5}
I		3×10^{-8}	6×10^{-4}	1×10^{-9}	2×10^{-5}	
Te 129	S	5×10^{-6}	2×10^{-2}	2×10^{-7}	8×10^{-4}	
	I	4×10^{-6}	2×10^{-2}	1×10^{-7}	8×10^{-4}	
Te 131m	S	4×10^{-7}	2×10^{-3}	1×10^{-8}	6×10^{-5}	
	I	2×10^{-7}	1×10^{-3}	6×10^{-9}	4×10^{-5}	
Te 132	S	2×10^{-7}	9×10^{-4}	7×10^{-9}	3×10^{-5}	
	I	1×10^{-7}	6×10^{-4}	4×10^{-9}	2×10^{-5}	

Revision 21 Date 08/14/97

APPENDIX B TO §§20.1 - 20.602
CONCENTRATIONS IN AIR AND WATER ABOVE NATURAL BACKGROUND

[See footnotes at end of Appendix B]

Element (atomic number)	Isotope ¹		Table I		Table II	
			Col. 1 Air ($\mu\text{Ci/ml}$)	Col. 2 Water ($\mu\text{Ci/ml}$)	Col. 1 Air ($\mu\text{Ci/ml}$)	Col. 2 Water ($\mu\text{Ci/ml}$)
Terbium (65)	Tb 160	S	1×10^{-7}	1×10^{-3}	3×10^{-9}	4×10^{-5}
		I	3×10^{-8}	1×10^{-3}	1×10^{-9}	4×10^{-5}
Thalium (81)	Tl 200	S	3×10^{-6}	1×10^{-2}	9×10^{-8}	4×10^{-4}
		I	1×10^{-6}	7×10^{-3}	4×10^{-8}	2×10^{-4}
	Tl 201	S	2×10^{-6}	9×10^{-3}	7×10^{-8}	3×10^{-4}
		I	9×10^{-7}	5×10^{-3}	3×10^{-8}	2×10^{-4}
Tl 202	S	8×10^{-7}	4×10^{-3}	3×10^{-8}	1×10^{-4}	
	I	2×10^{-7}	2×10^{-3}	8×10^{-9}	7×10^{-5}	
Tl 204	S	6×10^{-7}	3×10^{-3}	2×10^{-8}	1×10^{-4}	
	I	3×10^{-8}	2×10^{-3}	9×10^{-10}	6×10^{-5}	
Thorium (90)	Th 227	S	3×10^{-10}	5×10^{-4}	1×10^{-11}	2×10^{-5}
		I	2×10^{-10}	5×10^{-4}	6×10^{-12}	2×10^{-5}
	Th 228	S	9×10^{-12}	2×10^{-4}	3×10^{-13}	7×10^{-6}
		I	6×10^{-12}	4×10^{-4}	2×10^{-13}	1×10^{-5}
	Th 230	S	2×10^{-12}	5×10^{-5}	8×10^{-14}	2×10^{-6}
		I	1×10^{-11}	9×10^{-4}	3×10^{-13}	3×10^{-5}
	Th 231	S	1×10^{-6}	7×10^{-3}	5×10^{-8}	2×10^{-4}
I		1×10^{-6}	7×10^{-3}	4×10^{-8}	2×10^{-4}	
Th 232	S	3×10^{-11}	5×10^{-5}	1×10^{-12}	2×10^{-6}	
	I	3×10^{-11}	1×10^{-3}	1×10^{-12}	4×10^{-5}	
Th natural	S	6×10^{-11}	6×10^{-5}	2×10^{-12}	2×10^{-6}	
	I	6×10^{-11}	6×10^{-4}	2×10^{-12}	2×10^{-5}	
Th 234	S	6×10^{-8}	5×10^{-4}	2×10^{-9}	2×10^{-5}	
	I	3×10^{-8}	5×10^{-4}	1×10^{-9}	2×10^{-5}	
Thulium (69)	Tm 170	S	4×10^{-8}	1×10^{-3}	1×10^{-9}	5×10^{-5}
		I	3×10^{-8}	1×10^{-3}	1×10^{-9}	5×10^{-5}
Tm 171	S	1×10^{-7}	1×10^{-2}	4×10^{-9}	5×10^{-4}	
	I	2×10^{-7}	1×10^{-2}	8×10^{-9}	5×10^{-4}	
Tin (50)	Sn 113	S	4×10^{-7}	2×10^{-3}	1×10^{-8}	9×10^{-5}
		I	5×10^{-8}	2×10^{-3}	2×10^{-9}	8×10^{-5}
Sn 125	S	1×10^{-7}	5×10^{-4}	4×10^{-9}	2×10^{-5}	
	I	8×10^{-8}	5×10^{-4}	3×10^{-9}	2×10^{-5}	

Revision 21 Date 08/14/97

APPENDIX B TO §§20.1 - 20.602
CONCENTRATIONS IN AIR AND WATER ABOVE NATURAL BACKGROUND

[See footnotes at end of Appendix B]

Element (atomic number)	Isotope ¹		Table I		Table II	
			Col. 1 Air ($\mu\text{Ci}/\text{ml}$)	Col. 2 Water ($\mu\text{Ci}/\text{ml}$)	Col. 1 Air ($\mu\text{Ci}/\text{ml}$)	Col. 2 Water ($\mu\text{Ci}/\text{ml}$)
Tungsten (Wolfram) (74) .	W 181	S	2×10^{-6}	1×10^{-2}	8×10^{-8}	4×10^{-4}
		I	1×10^{-7}	1×10^{-2}	4×10^{-9}	3×10^{-4}
	W 185	S	8×10^{-7}	4×10^{-3}	3×10^{-8}	1×10^{-4}
I		1×10^{-7}	3×10^{-3}	4×10^{-9}	1×10^{-4}	
W 187	S	4×10^{-7}	2×10^{-3}	2×10^{-8}	7×10^{-5}	
	I	3×10^{-7}	2×10^{-3}	1×10^{-8}	6×10^{-5}	
Uranium (92)	U 230	S	3×10^{-10}	1×10^{-4}	1×10^{-11}	5×10^{-6}
		I	1×10^{-10}	1×10^{-4}	4×10^{-12}	5×10^{-6}
	U 232	S	1×10^{-10}	8×10^{-4}	3×10^{-12}	3×10^{-5}
		I	3×10^{-11}	8×10^{-4}	9×10^{-13}	3×10^{-5}
	U 233	S	5×10^{-10}	9×10^{-4}	2×10^{-11}	3×10^{-5}
		I	1×10^{-10}	9×10^{-4}	4×10^{-12}	3×10^{-5}
	U 234	S ⁴	6×10^{-10}	9×10^{-4}	2×10^{-11}	3×10^{-5}
		I	1×10^{-10}	9×10^{-4}	4×10^{-12}	3×10^{-5}
	U 235	S ⁴	5×10^{-10}	8×10^{-4}	2×10^{-11}	3×10^{-5}
I		1×10^{-10}	8×10^{-4}	4×10^{-12}	3×10^{-5}	
U 236	S	6×10^{-10}	1×10^{-3}	2×10^{-11}	3×10^{-5}	
	I	1×10^{-10}	1×10^{-3}	4×10^{-12}	3×10^{-5}	
U 238	S ⁴	7×10^{-11}	1×10^{-3}	3×10^{-12}	4×10^{-5}	
	I	1×10^{-10}	1×10^{-3}	5×10^{-12}	4×10^{-5}	
U 240	S	2×10^{-7}	1×10^{-3}	8×10^{-9}	3×10^{-5}	
	I	2×10^{-7}	1×10^{-3}	6×10^{-9}	3×10^{-5}	
U-natural	S ⁴	1×10^{-10}	1×10^{-3}	5×10^{-12}	3×10^{-5}	
	I	1×10^{-10}	1×10^{-3}	5×10^{-12}	3×10^{-5}	
Vanadium (23)	V 48	S	2×10^{-7}	9×10^{-4}	6×10^{-9}	3×10^{-5}
I		6×10^{-8}	8×10^{-4}	2×10^{-9}	3×10^{-5}	
Xenon (54)	Xe 131m	Sub	2×10^{-5}	4×10^{-7}
	Xe 133	Sub	1×10^{-5}	3×10^{-7}
	Xe 133m	Sub	1×10^{-5}	3×10^{-7}
	Xe 135	Sub	4×10^{-6}	1×10^{-7}
Ytterbium (70)	Yb 175	S	7×10^{-7}	3×10^{-3}	2×10^{-8}	1×10^{-4}
		I	6×10^{-7}	3×10^{-3}	2×10^{-8}	1×10^{-4}
Yttrium (39)	Y 90	S	1×10^{-7}	6×10^{-4}	4×10^{-9}	2×10^{-5}
		I	1×10^{-7}	6×10^{-4}	3×10^{-9}	2×10^{-5}

Revision 21 Date 08/14/97

APPENDIX B TO §§20.1 - 20.602
CONCENTRATIONS IN AIR AND WATER ABOVE NATURAL BACKGROUND

[See footnotes at end of Appendix B]

Element (atomic number)	Isotope ¹		Table I		Table II	
			Col. 1 Air ($\mu\text{Ci/ml}$)	Col. 2 Water ($\mu\text{Ci/ml}$)	Col. 1 Air ($\mu\text{Ci/ml}$)	Col. 2 Water ($\mu\text{Ci/ml}$)
	Y 91m	S	2×10^{-5}	1×10^{-1}	8×10^{-7}	3×10^{-3}
		I	2×10^{-5}	1×10^{-1}	6×10^{-7}	3×10^{-3}
	Y 91	S	4×10^{-8}	8×10^{-4}	1×10^{-9}	3×10^{-5}
		I	3×10^{-8}	8×10^{-4}	1×10^{-9}	3×10^{-5}
Y 92	S	4×10^{-7}	2×10^{-3}	1×10^{-8}	6×10^{-5}	
	I	3×10^{-7}	2×10^{-3}	1×10^{-8}	6×10^{-5}	
Y 93	S	2×10^{-7}	8×10^{-4}	6×10^{-9}	3×10^{-5}	
	I	1×10^{-7}	8×10^{-4}	5×10^{-9}	3×10^{-5}	
Zinc (30)	Zn 65	S	1×10^{-7}	3×10^{-3}	4×10^{-9}	1×10^{-4}
		I	6×10^{-8}	5×10^{-3}	2×10^{-9}	2×10^{-4}
	Zn 69m	S	4×10^{-7}	2×10^{-3}	1×10^{-8}	7×10^{-5}
		I	3×10^{-7}	2×10^{-3}	1×10^{-8}	6×10^{-5}
Zn 69	S	7×10^{-6}	5×10^{-2}	2×10^{-7}	2×10^{-3}	
	I	9×10^{-6}	5×10^{-2}	3×10^{-7}	2×10^{-3}	
Zirconium (40)	Zr 93	S	1×10^{-7}	2×10^{-2}	4×10^{-9}	8×10^{-4}
		I	3×10^{-7}	2×10^{-2}	1×10^{-8}	8×10^{-4}
	Zr 95	S	1×10^{-7}	2×10^{-3}	4×10^{-9}	6×10^{-5}
		I	3×10^{-8}	2×10^{-3}	1×10^{-9}	6×10^{-5}
Zr 97	S	1×10^{-7}	5×10^{-4}	4×10^{-9}	2×10^{-5}	
	I	9×10^{-8}	5×10^{-4}	3×10^{-9}	2×10^{-5}	
Any single radionuclide not listed above with decay mode other than alpha emission or spontaneous fission and with radioactive half-life less than 2 hours.	Sub	1×10^{-6}	3×10^{-8}
Any single radionuclide not listed above with decay mode other than alpha emission or spontaneous fission and with radioactive half-life greater than 2 hours.		3×10^{-9}	9×10^{-5}	1×10^{-10}	3×10^{-6}
Any single radionuclide not listed above which decays by alpha emission or spontaneous fission.		6×10^{-13}	4×10^{-7}	2×10^{-14}	3×10^{-8}

Revision 21 Date 08/14/97

¹Soluble (S); Insoluble (I).

²"Sub" means that values given are for submersion in a semispherical infinite cloud of airborne material.

³These radon concentrations are appropriate for protection from radon-222 combined with its short-lived daughters. Alternatively, the value in Table I may be replaced by one-third (1/3) "working level." (A "working level" is defined as any combination of short-lived radon-222 daughters, polonium-218, lead-214, bismuth-214 and polonium-214, in one liter of air, without regard to the degree of equilibrium, that will result in the ultimate emission of 1.3×10^5 MeV of alpha particle energy.) The Table II value may be replaced by one-thirtieth (1/30) of a "working level." The limit on radon-222 concentrations in restricted areas may be based on an annual average.

⁴For soluble mixtures of U-238, U-234 and U-235 in air chemical toxicity may be the limiting factor. If the percent by weight-enrichment of U-235 is less than 5, the concentration value for a 40-hour work week, Table I, is 0.2 milligrams uranium per cubic meter of air average. For any enrichment, the product of the average concentration and time of exposure during a 40-hour work week shall not exceed 8×10^{-3} SA μ Ci-hr/ml, where SA is the specific activity of the uranium inhaled. The concentration value for Table II is 0.007 milligrams uranium per cubic meter of air. The specific activity for natural uranium is 6.77×10^{-7} curies per gram U. The specific activity for other mixtures of U-238, U-235 and U-234, if not known, shall be:

$$SA = 3.6 \times 10^{-7} \text{ curies/gram U} \quad \text{U-depleted}$$

$$SA = (0.4 + 0.38 E + 0.0034 E^2) 10^{-6} \quad E \geq 0.72$$

where E is the percentage by weight of U-235, expressed as percent.

NOTE: In any case where there is a mixture in air or water of more than one radionuclide, the limiting values for purposes of this Appendix should be determined as follows:

1. If the identity and concentration of each radionuclide in the mixture are known, the limiting values should be derived as follows: Determine, for each radionuclide in the mixture, the ratio between the quantity present in the mixture and the limit otherwise established in Appendix B for the specific radionuclide when not in a mixture. The sum of such ratios for all the radionuclides in the mixture may not exceed "1" (i.e., "unity").

EXAMPLE: If radionuclides A, B, and C are present in concentrations C_A , C_B , and C_C , and if the applicable MPC's are MPC_A , MPC_B , and MPC_C respectively, then the concentrations shall be limited so that the following relationship exists:

$$(C_A/MPC_A) + (C_B/MPC_B) + (C_C/MPC_C) \leq 1$$

2. If either the identity or the concentration of any radionuclide in the mixture is not known, the limiting values for purposes of Appendix B shall be:

- a. For purposes of Table I, Col. 1 - 6×10^{-13}
- b. For purposes of Table I, Col. 2 - 4×10^{-7}
- c. For purposes of Table II, Col. 1 - 2×10^{-14}
- d. For purposes of Table II, Col. 2 - 3×10^{-8}

3. If any of the conditions specified below are met, the corresponding values specified below may be used in lieu of those specified in paragraph 2 above.

a. If the identity of each radionuclide in the mixture is known but the concentration of one or more of the radionuclides in the mixture is not known, the concentration limit for the mixture is the limit specified in Appendix "B" for the radionuclide in the mixture having the lowest concentration limit; or

b. If the identity of each radionuclide in the mixture is not known, but it is known that certain radionuclides specified in Appendix "B" are not present in the mixture, the concentration limit for the mixture is the lowest concentration limit specified in Appendix "B" for any radionuclide which is not known to be absent from the mixture; or

c. Element (atomic number) and isotope	Table I		Table II	
	Col. 1 Air (^{PT1} μCi/ml)	Col. 2 Water (μCi/ml)	Col. 1 Air (μCi/ml)	Col. 2 Water (μCi/ml)
If it is known that Sr 90, I 125, I 126, I 129, I 131 (I 133, Table II only), Pb 210, Po 210, At 211, Ra 23, Ra 224, Ra 226, Ac 227, Ra 228, Th 230, Pa 231, Th 232, Th-nat, Cm 248, Cf 254, and Fm 256 are not present	9x10 ⁻⁵	3x10 ⁻⁶
If it is known that Sr 90, I 125, I 126, I 129 (I 131, I 133, Table II only), Pb 210, Po 210, Ra 223, Ra 226, Ra 228, Pa 231, Th-nat, Cm 248, Cf 254, and Fm 256 are not present	6x10 ⁻⁵	2x10 ⁻⁶
If it is known that Sr 90, I 129 (I 125, I 126, I 131, Table II only), Pb 210, Ra 226, Ra 228, Cm 248, and Cf 254 are not present	2x10 ⁻⁵	6x10 ⁻⁷
If it is known that (I 129, Table II only), Ra 226, and Ra 228 are not present	3x10 ⁻⁶	1x10 ⁻⁷
If it is known that alpha-emitters and Sr 90, I 129, Pb 210, Ac 227, Ra 228, Pa 230, Pu 241, and Bk 249 are not present	3x10 ⁻⁹	1x10 ⁻¹⁰
If it is known that alpha-emitters and Pb 210, Ac 227, Ra 228, and Pu 241 are not present	3x10 ⁻¹⁰	1x10 ⁻¹¹
If it is known that alpha-emitters and Ac 227 are not present	3x10 ⁻¹¹	1x10 ⁻¹²
If it is known that Ac 227, Th 230, Pa 231, Pu 238, Pu 239, Pu 240, Pu 242, Pu 244, Cm 248, Cf 249 and Cf 251 are not present	3x10 ⁻¹²	1x10 ⁻¹³

4. If a mixture of radionuclides consists of uranium and its daughters in ore dust prior to chemical separation of the uranium from the ore, the values specified below may be used for uranium and its daughters through radium-266, instead of those from paragraphs 1, 2, or 3 above.

a. For purposes of Table I, Col. 1 - 1x10⁻¹⁰ μCi/ml gross alpha activity; or 5x10⁻¹¹ μCi/ml natural uranium or 75 micrograms per cubic meter of air natural uranium.

b. For purposes of Table II, Col. 1 - 3x10⁻¹² μCi/ml gross alpha activity; 2x10⁻¹² μCi/ml natural uranium; or 3 micrograms per cubic meter of air natural uranium.

5. For purposes of this note, a radionuclide may be considered as not present in a mixture if (a) the ratio of the concentration of that radionuclide in the mixture (C_A) to the concentration limit for that radionuclide specified in Table II of Appendix "B" (MPC_A) does not exceed 1/10, (i.e. C_A/MPC_A ≤ 1/10) and (b) the sum of such ratios for all the radionuclides considered as not present in the mixture does not exceed 1/4 i.e.

$$(C_A/MPC_A + C_B/MPC_B \dots + \leq 1/4).$$

Appendix H

1. "Request to Amend Previous Approvals Granted Under 10CFR20.302(a) for Disposal of Contaminated Septic Waste and Cooling Tower Silt to Allow for Disposal of Contaminated Soil", dated June 23rd, 1999, BVY 99-80
2. "Supplement to Request to Amend Previous Approvals Granted Under 10CFR20.30(a) to Allow for Disposal of Contaminated Soil", dated January 4th, BVY 00-02
3. "Vermont Yankee Nuclear Power Station, Request to Amend Previous Approvals Granted under 10CFR20.302(a) to Allow for Disposal of Contaminated Soil (TAC No. MA5950), dated June 15th, 2000, NYY 00-58

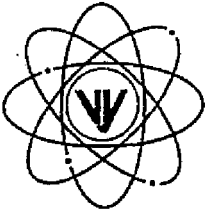

VERMONT YANKEE NUCLEAR POWER CORPORATION

185 Old Ferry Road, Brattleboro, VT 05301-7002
(802) 257-5271

June 23, 1999
BVY 99-80

United States Nuclear Regulatory Commission
ATTN: Document Control Desk
Washington, DC 20555

References:

- (a) Letter from R.W. Capstick, Vermont Yankee, to USNRC, "Request to Routinely Dispose of Slightly Contaminated Waste in Accordance with 10CFR20.302(a)", BVY 89-59, June 28, 1989
- (b) Letter from M.B. Fairtile, USNRC, to L. A. Trembley, Vermont Yankee, "Approval Under 10CFR20.302(a) of Procedures for Disposal of Slightly Contaminated Septic Waste on Site at Vermont Yankee (TAC No. 73776)", NVEY 89-189, dated August 30, 1989
- (c) Letter from J.J. Duffy, Vermont Yankee, to USNRC, "Request to Amend Previous Approval Granted Under 10CFR20.302(a) for Disposal of Contaminated Septic Waste", BVY 95-97, dated August 30, 1995
- (d) Letter from S.A. Varga, USNRC, to D. A. Reid, Vermont Yankee, "Approval Pursuant to 10CFR20.2002 for Onsite Disposal of Cooling Tower Silt - Vermont Yankee Nuclear Power Station (TAC No. M93420)", NVEY 96-39, dated March 4, 1996
- (e) Letter from P.D. Milano, USNRC, to D. A. Reid, Vermont Yankee, "Revised Safety Evaluation - Approval Pursuant to 10CFR20.2002 for Onsite Disposal of Cooling Tower Silt - Vermont Yankee Nuclear Power Station (TAC No. M96371)", NVEY 97-85, dated June 18, 1997

Subject: Vermont Yankee Nuclear Power Station
License No. DPR-28 (Docket No. 50-271)
Request to Amend Previous Approvals Granted Under 10 CFR 20.302(a) for Disposal of Contaminated Septic Waste and Cooling Tower Silt to Allow for Disposal of Contaminated Soil

In accordance with 10CFR 20.2002 (previously 10CFR20.302(a)), Vermont Yankee submits this application to amend the previously granted approvals to dispose of slightly contaminated septic waste and cooling tower silt on-site. This application expands the allowable waste stream to include slightly contaminated soil generated as a residual by-product of on-site construction activities.

This application specifically requests approval to dispose of soil contaminated at minimal levels, which has been or might be generated through end of station operations at the Vermont Yankee Nuclear Power Plant. The proposed soil disposal method is the same as the septic waste and cooling tower silt disposal methods requested in References (a) and (c), and approved in References (b) and (e). The disposal method utilizes on-site land spreading in the same designated areas used for septic waste and cooling tower silt. Disposal of this waste in the manner proposed, rather than holding it for future disposal at a 10CFR Part 61 licensed facility will save substantial costs and reserve valuable disposal site space for waste of higher radioactivity levels.

BVY 99-80 / Page 2 of 2

A radiological assessment and proposed operational controls for the inclusion of additional earthen material (soil) for on-site disposal with septic waste and cooling tower silt is provided in Attachment A. The assessment demonstrates that the dose impact expected from the existing accumulation of approximately 25.5 cubic meters of soil, in total with all past waste spreading operations, will not approach the dose limits already imposed for septic and cooling tower silt disposal. In addition to the existing accumulated soil, VY also requests that any future low level contaminated soil that might be generated as a by-product of plant construction and maintenance activities be allowed to be disposed of in the same manner provided the approved acceptance dose criteria are met. All soil analyses will be to environmental lower limits of detection. The results of all disposal operations will also be reported in the Annual Radioactive Effluent Release Report. The combined radiological impact for all on-site disposal operations will continue to be limited to a total body or organ dose of a maximally exposed member of the public of less than one mrem/year during the period of active Vermont Yankee control of the site, or less than five mrem/year to an inadvertent intruder after termination of active site control.

The Vermont Yankee Off-Site Dose Calculation Manual (ODCM) contains a copy of the original assessment and NRC approval for septic waste disposal (References a and b) and the previous amendment for cooling tower silt (References c and e). Upon receipt of your approval, the information contained in Attachment 1 as well as the basis for approval will be incorporated into the ODCM.

We trust that the information contained in the submittal is sufficient. However, should you have any questions or require further information concerning this matter, please contact Mr. Jim DeVincentis at 802-258-4236.

Sincerely,

VERMONT YANKEE NUCLEAR POWER CORPORATION

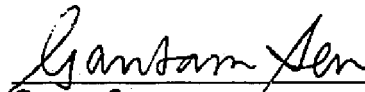

Gautam Sen
Licensing Manager

Attachment

cc: USNRC Region I Administrator
USNRC Resident Inspector - VYNPS
USNRC Project Manager - VYNPS
VT Department of Public Service

Revision 29 Date 1/11/02

SUMMARY OF VERMONT YANKEE COMMITMENTS

BVY NO.: 99-80

The following table identifies commitments made in this document by Vermont Yankee. Any other actions discussed in the submittal represent intended or planned actions by Vermont Yankee. They are described to the NRC for the NRC's information and are not regulatory commitments. Please notify the Licensing Manager of any questions regarding this document or any associated commitments.

COMMITMENT	COMMITTED DATE OR "OUTAGE"
None	

VYAPF 0058.04 (Sample)
AP 0058 Original
Page 1 of 1

H-4

Revision 29 Date 1/11/02

Docket No. 50-271
BVY 99-80

Attachment 1

Vermont Yankee Nuclear Power Station

Assessment of On-site Disposal of Contaminated Soil by Land Spreading

Revision 29 Date 1/11/02

TABLE OF CONTENTS

	Page
LIST OF TABLES	2
1.0 INTRODUCTION	3
1.1 Background	3
1.2 Objective	3
2.0 WASTE DESCRIPTION.....	4
3.0 SOIL DISPOSAL AND ADMINISTRATIVE PROCEDURE REQUIREMENTS.....	5
4.0 EVALUATION OF ENVIRONMENTAL IMPACTS.....	6
4.1 Site Characteristics.....	6
4.2 Radiological Impact.....	6
5.0 RADIOLOGICAL PROTECTION.....	8
6.0 CONCLUSIONS.....	9
7.0 REFERENCES	9

LIST OF TABLES

Table 1: Radioanalytical Results of Composite Soil Samples.....10

Table 2: Estimated Total Radioactivity in Soil Volume.....10

Table 3: Total Activity on South Field After Last Spreading Event..... 11

Table 4: Total Projected Radioactivity Remaining on South Field at License
Expiration..... 11

Table 5: All-Pathway Critical Organ/Whole Body Dose Conversion Factors During
Vermont Yankee Control of Disposal Site..... 11

Table 6: All-Pathway Critical Organ/Whole Body Dose Conversion Factors Post
Vermont Yankee Control of Disposal Sites (Inadvertent Intruder)..... 12

Table 7: Dose Contribution from Co-60 and Cs-137 in Soil Volume after Land
Spreading 12

Table 8: Present and Future Dose Impact Due to the Soil Spreading
for Two Cases..... 13

1.0 INTRODUCTION

1.1 Background

In 1989, Vermont Yankee Nuclear Power Corporation requested approval from the NRC to routinely dispose of slightly contaminated septic waste in designated on-site areas in accordance with 10CFR20.302(a). Approval from the NRC was granted on August 30, 1989 and the information was permanently incorporated into the Offsite Dose Calculation Manual (ODCM) as Appendix B.

In 1995, Vermont Yankee Nuclear Power Corporation requested that the previous authorization for on-site disposal of very low-level radioactive material in septic waste be amended to permit the on-site disposal of slightly contaminated cooling tower silt material. Approval from the NRC was granted on June 18, 1997 and the information was permanently incorporated into the ODCM as Appendix F.

In 1994, approximately 25.5 m³ of excess soil was generated during on-site construction activities. Sampling of the soil revealed low levels of radioactivity that were similar in radionuclides and activity to the septic waste and cooling tower silts previously encountered. An evaluation determined that the soil could be managed in similar fashion as the septic waste and cooling tower silts; however, prior approval from the NRC would be required under 10 CFR 20.2002 (formerly 20.302(a)).

1.2 Objective

The objective of this assessment is to present the data and radiological evaluation to demonstrate that the proposed disposition of the soil will meet the existing boundary conditions as approved by the NRC for septic waste and cooling tower silt. The boundary conditions established for disposal of the septic waste and cooling tower silts on the designated plots are:

The dose to the whole body or any organ of a hypothetical maximally exposed individual must be less than 1.0 mrem/yr.

Doses to the whole body and any organ dose of an inadvertent intruder from the probable pathways of exposure are less than 5 mrem/yr.

Disposal operations must be at one of the approved on-site locations.

2.0 WASTE DESCRIPTION

The soil that is the subject of this evaluation was derived from excavations resulting from activities associated with a new security fence along the plant's Protected Area boundary. The volume of soil generated was approximately 25.5 m^3 , and is typical of fill material containing light to dark brown poorly sorted soils with some small stones, and includes small incidental pieces of asphalt. The soil was removed from its original location by shovel, backhoe and front-end loader, and placed into dump trucks for transport to the location between the cooling towers where it was deposited on the ground surface and covered to prevent erosion. This location was selected because it was away from areas routinely occupied by plant staff, and could easily be controlled. The most probable source of the low levels of radioactive contamination is the presence of below detectable removable contamination redistributed by foot traffic from inside the plant to walkways and parking areas. Subsequent surface runoff carries the contamination to nearby exposed soil near the Protected Area boundary where it had accumulated over time to low level detectable concentrations.

In April 1995, a total of 20 composite soil samples were collected to characterize the volume. Composites were obtained by collecting a grab sample from one side, the top and the opposite side at equal distances along the length of the pile, then combining the three into one sample. Soil samples were sent to the Yankee Atomic Environmental Laboratory for analysis and counted to environmental lower limits of detection required of environmental media. Results of the analyses are presented in Table 1. Analytical results are provided for when the samples were collected and decay corrected to the present. The results identified both Cs-137 and Co-60 in most of the composite samples, which verified that plant-related radioactivity was present in the soil.

For the purpose of estimating the total activity in the soil pile, the actual analytical result was used for those samples that were less than the MDC to calculate the average radioactivity concentration.

The mass of soil (dry) was estimated by multiplying the total in-situ volume (25.5 m^3) by its wet density, $1.47\text{E}+03 \text{ kg/m}^3$, and then dividing by the wet:dry ratio of 1.12, thus yielding a mass of $3.35\text{E}+04 \text{ kg}$ (dry). The mass of the soil was then multiplied by the average Co-60 and Cs-137 concentrations measured in the soil to obtain the total activity of each radionuclide in the 25.5 m^3 . Table 2 presents the estimated total radioactivity in the 25.5 m^3 of soil at the time of sample collection and analysis, and decay corrected to the present.

3.0 SOIL DISPOSAL AND ADMINISTRATIVE PROCEDURE REQUIREMENTS

The method of soil disposal will use the technique of land spreading in a manner consistent with the current commitments for the on-site disposal of septic waste and cooling tower silts as approved by the NRC. The accumulation of radioactivity on the disposal plot for this soil spreading operation will be treated as if cooling tower silt or septic waste was being disposed of since the characteristics of all these residual solids are similar (earthen-type matter). The south field (approximately 1.9 acres in size) designated and approved for septic waste and cooling tower silts disposal has been used for all past disposal operations, and will be used for the placement of this soil. Determination of the radiological dose impact has been made based on the same models and pathway assumptions used in the previous submittals.

Dry soil material will be dispersed using typical agricultural dry bulk surface spreading practices in approved disposal areas on-site. Incidental pieces of asphalt and stones that were picked up with the soil from area where paving ran along the fence line will be screened out before the soil is spread and disposed of as radioactive material at an off-site licensed facility if detectable radioactivity is found.

Records of the disposal that will be maintained include the following:

- (a) The radionuclide concentrations detected in the soil (measured to environmental lower limits of detection).
- (b) The total volume of soil disposed of.
- (c) The total radioactivity in the disposal operation as well as the total accumulated on each disposal plot at the time of spreading.
- (d) The plot on which the soil was applied.
- (e) Dose calculations or maximum allowable accumulated activity determinations required to demonstrate that the dose limits imposed on the land spreading operations have not been exceeded.

To ensure that the addition of the soil containing the radioactivity will not exceed the boundary conditions, the total radioactivity and dose calculation will include all past disposals of septic waste and cooling tower silt containing low-level radioactive material on the designated disposal plots. In addition, concentration limits applied to the disposal of earthen type materials (dry soil) restrict the placement of small volumes of materials that have relatively high radioactivity concentrations.

Any farmer leasing land used for the disposal of soil will be notified of the applicable restrictions placed on the site due to the spreading of low level contaminated material. These restrictions are the same as detailed for the previously approved septic waste spreading application.

4.0 EVALUATION OF ENVIRONMENTAL IMPACTS

4.1 Site Characteristics

The designated disposal site is located on the Vermont Yankee Nuclear Power Plant site and is within the site boundary security fence. The south field consists of approximately 1.9 acres and is centered approximately 1500 feet south of the Reactor Building. This parcel of land has been previously approved by the NRC for the land disposal of septic waste and cooling tower silt.

4.2 Radiological Impact

The amount of radioactivity added to the south field soil is procedurally controlled to ensure that doses are maintained within the prior approved limits of the boundary conditions.

To assess the dose received (after spreading the soil) by the maximally exposed individual during the period of plant controls over the property, and to an inadvertent intruder after plants controls of access ends, the same pathway modeling, assumptions and dose calculation methods as approved for septic and cooling tower silt disposal were used. These dose models implement the methods and dose conversion factors as provided in Regulatory Guide 1.109.

The following six potential pathways were identified and included in the analysis:

- (a) Standing on contaminated ground.
- (b) Inhalation of resuspended radioactivity.
- (c) Ingestion of leafy vegetables.
- (d) Ingestion of stored vegetables.
- (e) Ingestion of meat.
- (f) Ingestion of cow's milk.

Both the maximum individual and inadvertent intruder are assumed to be exposed to these pathways; the difference between them is due to the occupancy time. The basic assumptions used in the radiological analyses include:

- (a) Exposure to ground contamination and re-suspended radioactivity is for a period of 104 hours per year during the Vermont Yankee active control of the disposal sites and continuous thereafter. The 104-hour interval is representative of a farmer's time spent on a plot of land (4 hours per week for 6 months).

- (b) For the purpose of projecting and illustrating the magnitude of dose impacts over the remaining life of the plant, it is assumed that the concentration levels of activity as of April 1, 1999 remain constant. Table 1 indicates the measured radioactivity levels for Co-60 and Cs-137 first noted in the soil, and decay corrected to April 1, 1999.
- (b) For the analysis of the radiological impact during the Vermont Yankee active control of the disposal sites until 2013, no plowing is assumed to take place and all dispersed radioactive material remains on the surface forming a source of unshielded direct radiation.
- (c) The crop exposure time was changed from 2160 hours to 0 hours to reflect the condition that no radioactive material is dispersed directly on crops for human or animal consumption. Crop contamination is only through root uptake.
- (d) The deposition on crops of re-suspended radioactivity is insignificant.
- (e) The pathway data and usage factors used in the analysis are the same as those used in the Vermont Yankee's ODCM assessment of off-site radiological impact from routine releases, with the following exceptions. The fraction of stored vegetables grown on the contaminated land was conservatively increased from 0.76 to 1.0 (at present no vegetable crops for human consumption are grown on any of the approved disposal plots). Also, the soil exposure time to account for buildup was changed from the standard 15 years to 1 year.
- (f) It is conservatively assumed that Vermont Yankee relinquishes control of the disposal sites after the operating license expires in 2012 (i.e., the source term accumulated on a single disposal plot applies also for the inadvertent intruder).
- (g) For the analysis of the impact after Vermont Yankee control of the site is relinquished, the radioactive material is plowed under and forms a uniform mix with the top six inches of the soil; but nonetheless, undergoes re-suspension in the air at the same rate as the unplowed surface contamination. However, for direct ground plane exposure the self-shielding due to the six-inch plow layer reduces the surface dose rate by about a factor of four.

As shown in the previous submittals, in which the concentrations of Co-60 and Cs-137 in septic waste exceed those identified in the soil, the liquid pathway was found to be an insignificant contributor to the dose. Therefore, the liquid pathway is not considered in this analysis.

The dose models and methods used to generate deposition values and accumulated activity over the operating life of the plant are documented the ODCM. Table 3 presents the radioactivity that currently exists on the south field after the last spreading event which occurred on September 28, 1998 (total elapsed time from September 28, 1998 to April 1, 1999 is 184 days). In addition, the total activity on the south field is presented assuming the addition of the 25.5 m³ of soil subject of this evaluation.

The total activity that would be present on south field at license termination (i.e., total elapsed time of 14 years post April 1, 1999, or 2013), assuming no future additions of material containing radioactivity after disposal of the proposed soil volume was also evaluated and is presented in Table 4.

In order to demonstrate compliance with the boundary conditions, the critical organ and whole body dose from all pathways to a maximally exposed individual during Vermont Yankee control, and to the inadvertent intruder were calculated. The dose calculations were performed using the dose conversion factors presented in Table 5 and 6 below which were obtained from the ODCM. The contribution to dose from Co-60 and Cs-137 to the whole body and organ at the present and at license expiration is presented in Table 7. The present and future total dose impact from the south field with and without spreading of the soil is presented in Table 8.

These results demonstrate that disposal of the approximately 25.5 m³ of accumulated soil will be well within the accepted dose limit criteria of 1 mrem/yr to any organ or whole body during the control period, and 5 mrem/yr to an inadvertent intruder after control of the site is assumed to be relinquished. This analysis shows that significant dose margin still exists on the approved disposal plots to accommodate potential future spreading operations.

5.0 RADIOLOGICAL PROTECTION

The disposal operation of soil piles will follow the applicable Vermont Yankee procedures to maintain doses as low as reasonably achievable and within the specific dose criteria as previously approved for septic waste and cooling tower silt disposal.

6.0 CONCLUSIONS

Soil generated from on-site construction activities reflects an earthen type material similar in characteristics to septic waste residual solids and cooling tower silt with respect to the radiological pathway behavior and modeling. Based on the similarity in characteristics between the proposed soil volume and waste streams that have already been approved for disposal, and the evaluation of the incremental dose impact, it is concluded that disposal of the approximately 25.5 m³ of existing soil through on-site land spreading will meet the boundary conditions specified in the ODCM. That is, with respect to the addition of the approximately 25.5 m³ soil pile to the existing radioactivity already spread on the south field:

1. Total doses to the whole body and critical organ to the hypothetically maximally exposed individual were estimated as 3.00E-02 mrem/yr and 1.04E-01, respectively, which are less than the prescribed 1.0 mrem/yr.
2. Total doses to the whole body and critical organ of an inadvertent intruder from the probable pathways of exposure were estimated as 1.13E-01 mrem/yr and 2.21E-01 mrem/yr, respectively, which are less than 5 mrem/yr.
3. The disposal is assumed to take place on the south field that is the same site approved for disposal of septic waste and cooling tower silts.

If the soil were spread on an approved plot which had not yet been used for disposal, the dose impact from the approximately 25.5 m³ of soil alone would at present be 4.17E-03 mrem/yr whole body and a maximum organ dose of 1.46E-02 mrem/yr. In addition, for the inadvertent intruder, the whole body dose would be 1.60E-02 mrem/yr, and a maximum organ dose of 3.11E-02 mrem/yr. Each of these doses also meet the boundary conditions specified in the ODCM.

7.0 REFERENCES

- (1) Vermont Yankee ODCM, Rev 23, Appendix B, "Approval of Criteria for Disposal of Slightly Contaminated Septic Waste On-Site at Vermont Yankee".
- (2) Vermont Yankee ODCM, Rev 23, Appendix F, "Approval Pursuant to 10CFR20.2002 for On-Site Disposal of Cooling Tower Silt".
- (3) USNRC Regulatory Guide 1.109, Rev 1, "Calculation of Annual Doses to Man from Routine Releases of Reactor Effluents for the Purpose of Evaluating Compliance with 10CFR Part 40, Appendix I", dated October 1997.

Table 1
Radioanalytical Results of Composite Soil Samples

Sample ID	Cs-137 (pCi/kg)		Co-60 (pCi/kg)	
	April, 1995	April, 1999	April, 1995	April, 1999
G22716	234	213	49**	29
G22717	522	476	143	84
G22718	337	307	37**	22
G22719	291	265	111	66
G22720	348	317	47**	28
G22721	135	123	73	43
G22722	107	98	82	48
G22723	222	203	140	83
G22724	180	164	92	54
G22725	269	245	118	70
G22726	810	739	114	67
G22727	378	345	106	63
G22728	810	739	124	73
G22729	376	343	62	37
G22730	331	302	87	51
G22731	253	231	5**	3
G22732	150	137	58	34
G22733	247	225	105	62
G22734	326	297	54**	32
G22735	235	214	100	59
<i>Average</i>	<i>328</i>	<i>299</i>	<i>85</i>	<i>50</i>
<i>Maximum Value</i>	<i>810</i>	<i>739</i>	<i>143</i>	<i>84</i>
<i>Minimum Value</i>	<i>107</i>	<i>98</i>	<i>5</i>	<i>3</i>
<i>Standard Deviation</i>	<i>191</i>	<i>174</i>	<i>37</i>	<i>22</i>

* Average wet to dry sample weight ratio equal to 1.12. Average wet density equal to 1.47 gm/cc.

** The apparent response of the gamma isotopic analysis which was less than Minimum Detectable Concentration.

Table 2
Estimated Total Radioactivity in Soil Volume

Radionuclide	Volume of Soil (m ³)	Mass (kg-dry)	Average Concentration (pCi/kg-dry)		Total Activity (μCi)	
			April, 1995	April, 1999	April, 1995	April, 1999
Cs-137	25.5	3.35E+04	328	299	11.0	10.0
Co-60	25.5	3.35E+04	85	50	2.8	1.7

Table 3
Total Activity on South Field After Last Spreading Event

Radionuclide	Total activity after last spreading event ($\mu\text{Ci}/\text{acre}$)	Total activity decay corrected to April 1, 1999 ($\mu\text{Ci}/\text{acre}$)	Total activity after proposed soil disposal ($\mu\text{Ci}/\text{acre}$)
Mn-54	0.17	0.11	0.11
Co-60	5.93	5.55	6.44
Zn-65	0.074	0.044	0.044
Cs-137	32.27	31.90	37.16

Table 4
Total Projected Radioactivity on South Field Remaining at License Expiration

Radionuclide	Total Activity as of License Expiration ($\mu\text{Ci}/\text{acre}$)
Mn-54	8.9E-07
Co-60	0.89
Zn-65	7.6E-09
Cs-137	26.33

Table 5
All Pathway Critical Organ/Whole Body Dose Conversion Factors During Vermont Yankee Control of Disposal Sites

Radionuclide	Individual/Organ	Critical Organ Dose Factor (mrem/yr per $\mu\text{Ci}/\text{acre}$)	Whole Body Dose Factor (mrem/yr per $\mu\text{Ci}/\text{acre}$)
Mn-54	Adult/GI-LLI	3.75E-04	1.93E-04
Co-60	Teen/Lung	7.17E-04	5.31E-04
Zn-65	Child/Liver	1.64E-02	1.03E-02
Cs-137	Child/Bone	2.66E-03	7.02E-04

Table 6
All Pathway Critical Organ/Whole Body Dose Conversion Factors Post Vermont
Yankee Control of Disposal Sites (Inadvertent Intruder)

Radionuclide	Individual/Organ	Critical Organ Dose Factor (mrem/yr per $\mu\text{Ci}/\text{acre}$)	Whole Body Dose Factor (mrem/yr per $\mu\text{Ci}/\text{acre}$)
Mn-54	Teen/Lung	1.02E-02	3.12E-03
Co-60	Teen/Lung	3.19E-02	9.09E-03
Zn-65	Child/Liver	1.89E-02	1.25E-02
Cs-137	Child/Bone	6.98E-03	3.85E-03

Table 7
Dose Contribution from Co-60 and Cs-137 in 25.5 m³ Soil Volume after Land
Spreading

Case	Present Dose Impact¹ (Maximally exposed individual)		Future Dose Impact² (Inadvertent Intruder)	
	Dose (mrem/yr)	Individual/ Organ	Dose (mrem/yr)	Individual/ Organ
Cobalt-60	4.75E-04 6.42E-04	Whole body Max. Organ	1.29E-03 4.51E-03	Whole body Max. Organ
Cesium-137	3.69E-03 1.40E-02	Whole body Max. Organ	1.47E-02 2.66E-02	Whole body Max. Organ

¹ Based on inventory of Co-60 of 0.895 $\mu\text{Ci}/\text{acre}$ and Cs-137 of 5.26 $\mu\text{Ci}/\text{acre}$ in April 1, 1999.

² Based on inventory of Co-60 of 0.141 $\mu\text{Ci}/\text{acre}$ and Cs-137 of 3.82 $\mu\text{Ci}/\text{acre}$ in April 1, 2013.

Table 8
Present and Future Dose Impact Due to the Soil Spreading for Two Cases

Case	Present Dose Impact (Maximally exposed individual)		Future Dose Impact (Inadvertent Intruder)	
	Dose (mrem/yr)	Individual/ Organ	Dose (mrem/yr)	Individual/ Organ
<i>Case One</i> South Field as it currently exists	2.58E-02 8.96E-02	Whole body Max. Organ	9.70E-02 1.89E-01	Whole body Max. Organ
<i>Case Two</i> South Field if disposal of soil volume is approved	3.00E-02 1.04E-02	Whole body Max. Organ	1.13E-01 2.21E-01	Whole body Child/Bone
Increase in dose impact from disposal of soil	4.17E-03 1.46E-02	Whole body Max. Organ	1.60E-02 3.11E-02	Whole body Max. Organ

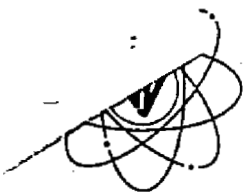

VERMONT YANKEE NUCLEAR POWER CORPORATION

185 Old Ferry Road, Brattleboro, VT 05301-7002
(802) 257-5271

January 4, 2000
BVY 00-02

United States Nuclear Regulatory Commission
ATTN: Document Control Desk
Washington, DC 20555

References: (a) Letter, VYNPC to USNRC, "Request to Amend Previous Approvals Granted Under 10 CFR 20.302(a) for Disposal of Contaminated Septic Waste and Cooling Tower Silt to Allow for Disposal of Contaminated Soil," BVY 99-80, dated June 23, 1999

Subject: **Vermont Yankee Nuclear Power Station
License No. DPR-28 (Docket No. 50-271)
Supplement to Request to Amend Previous Approvals Granted
Under 10 CFR 20.302(a) to Allow for Disposal of Contaminated Soil**

Reference (a) provided Vermont Yankee's application to amend the previously granted approvals to dispose of slightly contaminated septic waste and cooling tower silt on-site to include slightly contaminated soil generated as a residual by-product of on-site construction activities. The request was to allow the disposal of approximately 25.5 cubic meters of waste that has been accumulated to date and to allow for disposal of future waste from construction related activities.

Based on discussions with USNRC staff, additional information related to the estimated volume and dose consequences of the proposed future material was needed to complete your review. Attachment 1 has been revised accordingly to include the information requested. Attachment 1 supercedes the evaluation previously submitted.

We trust that the information will allow you to complete your review of our submittal. However, should you have any questions or require further information concerning this matter, please contact Mr. Jim DeVincentis at 802-258-4236.

Sincerely,

Vermont Yankee Nuclear Power Corporation

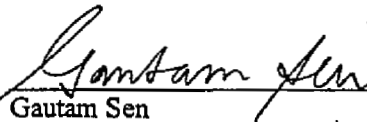

Gautam Sen
Licensing Manager

Attachment

cc: USNRC Region I Administrator
USNRC Resident Inspector - VYNPS
USNRC Project Manager - VYNPS
VT Department of Public Service

SUMMARY OF VERMONT YANKEE COMMITMENTS

BVY NO.: 00-02

The following table identifies commitments made in this document by Vermont Yankee. Any other actions discussed in the submittal represent intended or planned actions by Vermont Yankee. They are described to the NRC for the NRC's information and are not regulatory commitments. Please notify the Licensing Manager of any questions regarding this document or any associated commitments.

COMMITMENT	COMMITTED DATE OR "OUTAGE"
None	N/A

VYAPF 0058.04
AP 0058 Original
Page 1 of 1

Docket No. 50-271
BVY 00-02

Attachment 1

Vermont Yankee Nuclear Power Station

Assessment of On-site Disposal of Contaminated Soil by Land Spreading

TABLE OF CONTENTS

	Page
LIST OF TABLES	2
1.0 INTRODUCTION	3
1.1 Background	3
1.2 Objective	3
2.0 WASTE DESCRIPTION.....	4
3.0 SOIL DISPOSAL AND ADMINISTRATIVE PROCEDURE REQUIREMENTS.....	5
4.0 EVALUATION OF ENVIRONMENTAL IMPACTS.....	6
4.1 Site Characteristics	6
4.2 Radiological Impact.....	7
5.0 RADIOLOGICAL PROTECTION.....	9
6.0 CONCLUSIONS.....	9
7.0 REFERENCES	11

LIST OF TABLES

Table 1: Radioanalytical Results of Composite Soil Samples.....	12
Table 2: Estimated Total Radioactivity in 25.5 m ³ Soil Volume.....	12
Table 3: Estimated Total Radioactivity in Future Soil Additions.....	13
Table 4: Record of Septic and Silt Radioactive Material Spread each Year on South Field Disposal Plot.....	13
Table 5: Total Projected Radioactivity Remaining on South Filed at License Expiration.....	14
Table 6: All-Pathway Critical Organ/Whole Body Dose Conversion Factors.....	14
Table 7: Dose Impact from Past Septic and Silt Spreading Activity.....	15
Table 8: Dose Impact from Past Septic and Silt Spreading and Single 25.5m ³ Soil Disposal.....	15
Table 9: Dose Impact from Present and Future Soil Disposal Along with Past Septic and Silt Disposal.....	16
Table 10: Dose Impact from Past Disposals through 7/15/99 Plus all Annual Projected Disposals of Septic, Silt and Soil.....	16
Table 11: Summary of Dose Impacts Associated with Different Disposal Scenarios.....	17

1.0 INTRODUCTION

1.1 Background

In 1989, Vermont Yankee Nuclear Power Corporation requested approval from the NRC to routinely dispose of slightly contaminated septic waste in designated on-site areas in accordance with 10CFR20.302(a). Approval from the NRC was granted on August 30, 1989 and the information was permanently incorporated into the Offsite Dose Calculation Manual (ODCM) as Appendix B.

In 1995, Vermont Yankee Nuclear Power Corporation requested that the previous authorization for on-site disposal of very low-level radioactive material in septic waste be amended to permit the on-site disposal of slightly contaminated cooling tower silt material. Approval from the NRC was granted on June 18, 1997 and the information was permanently incorporated into the ODCM as Appendix F.

In 1994, approximately 25.5 m³ of excess soil was generated during on-site construction activities. Subsequent sampling and analysis of the soil revealed low levels of radioactivity that were similar in radionuclides and activity to the septic waste and cooling tower silts previously encountered. An evaluation determined that the soil could be managed in similar fashion as the septic waste and cooling tower silts; however, prior approval from the NRC would be required under 10 CFR 20.2002 (formerly 20.302(a)).

1.2 Objective

The purpose of this assessment is to present the data and radiological evaluation to demonstrate that the proposed disposition of the soil (i.e., on-site disposal via land spreading on designated fields) will meet the existing boundary dose conditions as approved by the NRC for septic waste and cooling tower silt. The boundary conditions established for disposal of the septic waste and cooling tower silt on designated plots are:

1. The dose to the whole body or any organ of a hypothetical maximally exposed individual must be less than 1.0 mrem/yr.
2. Doses to the whole body and any organ of an inadvertent intruder from the probable pathways of exposure are less than 5 mrem/yr.
3. Disposal operations must be at one of the approved on-site locations.

2.0 WASTE DESCRIPTION

The existing accumulation of contaminated soil was derived from excavation activities associated with the construction of a new security fence along the plant's Protected Area boundary. The volume of soil generated was approximately 25.5 m^3 , and is typical of fill material containing light to dark brown poorly sorted soils with some small stones, and includes small incidental pieces of asphalt. The soil was removed from its original location by shovel, backhoe and front-end loader, and placed into dump trucks for transport to a location between the cooling towers where it was deposited on the ground surface and covered to prevent erosion. This location was selected because it was away from areas routinely occupied by plant staff, and could easily be controlled. The most probable source of the low levels of radioactive contamination is the presence of below detectable removable contamination redistributed by foot traffic from inside the plant to walkways and parking areas. Subsequent surface runoff carries the contamination to nearby exposed soil near the Protected Area boundary where it had accumulated over time to low level detectable concentrations.

In April 1995, a total of 20 composite soil samples were collected to characterize the accumulated volume. Composites were obtained by taking a grab sample from opposite sides of the pile and the top at equal distances along its length. These three grab samples were then combined into one composite sample. Soil samples were sent to the Yankee Atomic Environmental Laboratory for analysis and counted to environmental lower limits of detection required of environmental media. Results of the analyses are presented in Table 1. For estimating the total activity in the soil pile, the actual analytical result was used for those samples that were less than the MDC to calculate the average radioactivity concentration. Analytical results are provided for both the times when the samples were collected as well as decay corrected to the present (7/15/99). The results identified both Cs-137 and Co-60 in most of the composite samples, which verified that plant-related radioactivity, was present in the soil.

The mass of accumulated soil (dry) was estimated by multiplying the total in-situ volume (25.5 m^3) by its wet density, $1.47\text{E}+03 \text{ kg/m}^3$, and then dividing by the wet:dry ratio of 1.12, thus yielding a mass of $3.35\text{E}+04 \text{ kg}$ (dry). The mass of the soil was then multiplied by the average measured Co-60 and Cs-137 concentrations to obtain the total activity of each radionuclide in the 25.5 m^3 . Table 2 presents the estimated total radioactivity in the 25.5 m^3 volume at the time of sample collection and analysis, and decay corrected to the date of the most recent disposal (septic waste) spreading operation (i.e., July 15, 1999).

In addition to the existing 25.5 m^3 (900 ft^3) of soil included in this request, it is anticipated that the need to dispose of very low-level contaminated soil will occur in the future. Each spring, approximately 28.3 m^3 (1000 ft^3) of road and walkway sand spread during the winter season is swept up from inside the Protected Area. This material is subject to the same contamination mechanisms that are believed to have lead to the observed contamination in the construction fill removed from within the Protected Area in the past. For purposes of

evaluating the radiological impact of potential future soil disposals, it is assumed that an additional 28.3 m³ per year of sand / soil is contaminated at the same concentration levels as originally observed (April 1995) in the currently collected 25.5m³ of soil. It is also assumed that this material is placed on the same approved disposal field used for all past septic and cooling tower silt disposal operations. Table 3 shows the estimated amount of radioactivity associated with the annual disposal of the 28.3m³ of soil. It is assumed that this material is disposed of each year for the next 14 years (until the end of plant operating license in 2013) on the same field (South Disposal Plot) along with the continued application of septic waste and cooling tower silt.

Table 4 shows a record of the actual amount of septic/silt material that has been spread on south field for the past 10 years. A review of the actual waste disposal operations show that the annual average radioactivity content placed on the 1.9 acre South field from septic and silt disposals are as follows:

Mn-54	0.147	uCi/year
Co-60	2.58	uCi/year
Zn-65	0.269	uCi/year
Cs-134	0.010	uCi/year
Cs-137	6.21	uCi/year

The maximum radioactivity inventory resulting from the accumulated buildup of past and projected future disposal operations (i.e., septic waste, cooling tower silt, plus the existing 25.5m³ of accumulated soil along with a projected annual addition of 28.3m³ of soil each year until the termination of the operating license) is shown on Table 5.

3.0 SOIL DISPOSAL AND ADMINISTRATIVE PROCEDURE REQUIREMENTS

The method of soil disposal will use the technique of land spreading in a manner consistent with the current commitments for the on-site disposal of septic waste and cooling tower silts as approved by the NRC. The accumulation of radioactivity on the disposal plot for this soil spreading operation will be treated as if cooling tower silt or septic waste was being disposed of since the characteristics of all these residual solids are similar (earthen-type matter). The south field (approximately 1.9 acres in size) has been designated and approved for septic waste and cooling tower silt disposal and has been used for all past disposal operations, and is expected to be used for the placement of soil. Determination of the radiological dose impact has been made based on the same models and pathway assumptions used in the previous submittals.

Dry soil material will be dispersed using typical agricultural dry bulk surface spreading practices in approved disposal areas on-site. Incidental pieces of asphalt and stones that are picked up with the soil will be screened out before the soil is spread and disposed of as radioactive material at an off-site licensed facility if detectable radioactivity is found.

Records of the disposal that will be maintained include the following:

- (a) The radionuclide concentrations detected in the soil (measured to environmental lower limits of detection).
- (b) The total volume of soil disposed of.
- (c) The total radioactivity in the disposal operation as well as the total accumulated on each disposal plot at the time of spreading.
- (d) The plot on which the soil was applied.
- (e) Dose calculations or maximum allowable accumulated activity determinations required to demonstrate that the dose limits imposed on the land spreading operations have not been exceeded.

To ensure that the addition of soil containing low levels of radioactivity will not exceed the boundary dose limits, each new spreading operation will require an estimate of total radioactivity that includes all past disposals of septic waste, cooling tower silt and soil material on the designated disposal plots. This will be compared with the boundary dose limits or equivalent radioactivity limits on a per acre basis. In addition, concentration limits applied to the disposal of earthen type materials (dry soil) restrict the placement of small volumes of materials that have relatively high radioactivity concentrations.

Any farmer leasing land used for the disposal of soil (or other approved waste) will be notified of the applicable restrictions placed on the site due to the spreading of low level contaminated material. These restrictions are the same as detailed for the previously approved septic waste spreading application.

4.0 EVALUATION OF ENVIRONMENTAL IMPACTS

4.1 Site Characteristics

All designated disposal sites are located on the Vermont Yankee Nuclear Power Plant site and are within the site boundary security fence. The south field consists of approximately 1.9 acres and is centered approximately 1500 feet south of the Reactor Building. This parcel of land has been previously approved by the NRC for the land disposal of septic waste and cooling tower silt, and is the only portion of the approved disposal areas which has been utilized to-date for the spreading of contaminated material. For estimating the maximum future radiological impact, it is assumed in the analysis that all future disposal operations will continue to use the South field as the disposal plot.

4.2 Radiological Impact

The amount of radioactivity added to the south field is procedurally controlled to ensure that doses are maintained within the prior approved limits of the boundary conditions.

To assess the dose received by the maximally exposed individual during the period of plant controls over the property, and to an inadvertent intruder after it is assumed plant access controls end, the same pathway modeling, assumptions and dose calculation methods as approved for septic and cooling tower silt disposal were used. These dose models implement the methods and dose conversion factors as provided in Regulatory Guide 1.109, Revision 1 (1977).

The following six potential pathways were identified and included in the analysis:

- (a) Standing on contaminated ground.
- (b) Inhalation of resuspended radioactivity.
- (c) Ingestion of leafy vegetables.
- (d) Ingestion of stored vegetables.
- (e) Ingestion of meat.
- (f) Ingestion of cow's milk.

As shown in the previous application for septic waste disposal, the liquid pathway was found to be an insignificant contributor to the dose for the radionuclides identified fixed in the soil type matrixes associated these waste forms. Therefore, the liquid pathway is not considered in this analysis.

Both the maximum individual and inadvertent intruder are assumed to be exposed to these pathways, the difference between them being due to the occupancy time. The basic assumptions used in the radiological analyses include:

- (a) Exposure to ground contamination and re-suspended radioactivity is for a period of 104 hours per year during the Vermont Yankee active control of the disposal sites and continuous thereafter. The 104-hour interval is representative of a farmer's time spent on a plot of land (4 hours per week for 6 months).
- (b) For the purpose of projecting and illustrating the magnitude of dose impact over the remaining life of the plant, it is assumed that future disposals of septic and silt material will be placed annually on the same field at the annual average radioactivity levels observed for these waste streams over the past ten years. The future disposals will also consist of the additional 28.3 m³ (1000 ft³) annual volume of new soil at the same radioactivity concentrations observed at the time of collection of the existing 25.5 m³ soil volume. The maximum individual dose impact from the buildup of disposed material

occurs at the same time (2013) for both the Control Period and Intruder scenarios.

- (c) For the analysis of the radiological impact during the Vermont Yankee active control of the disposal sites until 2013, no plowing is assumed to take place and all dispersed radioactive material remains on the surface forming a source of unshielded direct radiation.
- (d) The crop exposure time was changed from 2160 hours to 0 hours to reflect the condition that no radioactive material is dispersed directly on crops for human or animal consumption. Crop contamination is only through root uptake.
- (e) The deposition on crops of re-suspended radioactivity is insignificant.
- (f) Most of the pathway data and usage factors used in the analysis are the same as those used in the Vermont Yankee's ODCM assessment of off-site radiological impact from routine releases. The fraction of stored vegetables grown on the contaminated land was conservatively increased from 0.76 to 1.0 (at present no vegetable crops for human consumption are grown on any of the approved disposal plots). For each year's spreading operations, the soil exposure time to account for buildup was changed from the standard 15 years to 1 year.
- (g) It is conservatively assumed that Vermont Yankee relinquishes control of the disposal sites after the operating license expires in 2013 (i.e., the source term accumulated on a single disposal plot applies also for the inadvertent intruder).
- (h) For the analysis of the impact after Vermont Yankee control of the site is relinquished, the radioactive material is plowed under and forms a uniform mix with the top six inches of the soil; but nonetheless, undergoes re-suspension in the air at the same rate as the unplowed surface contamination. However, for direct ground plane exposure the self-shielding due to the six-inch plow layer reduces the surface dose rate by about a factor of four.

The dose models and methods used to generate deposition values and accumulated activity over the operating life of the plant are documented in the Vermont Yankee ODCM. The total activity that would be present on south field at the end of the operating period (i.e., total elapsed time of 14 years post July 15, 1999, or 2013) from the buildup of all waste streams (i.e., septic, cooling tower silt and soil) is presented in Table 5.

In order to evaluate the dose impact associated with the different disposal streams, a dose assessment was performed for the following four disposal scenarios:

- (I) Impact from past septic and silt spreading only – Table 7
- (II) Impact from past septic and silt spreading, plus a single 25.5 m³ soil disposal operation for the existing accumulated soil – Table 8
- (III) Impact from past septic and silt disposals along with the existing 25.5 m³ of accumulated soil and postulated future annual soil disposal volumes (28.3 m³ /yr). –Table 9
- (IV) Impact from past septic and silt disposals plus annual projected disposals of septic, silt and soil. – Table 10

For each scenario, the critical organ and whole body dose from all pathways to a maximally exposed individual for both the Vermont Yankee control period and the inadvertent intruder situation were calculated. The dose calculations were performed using the dose conversion factors presented in Table 5, which were obtained from the Vermont Yankee ODCM, Appendix F, "Approval Pursuant to 10CFR20.2002 for On-Site Disposal of Cooling Tower Silt."

A summary of the calculated dose impact associated with the four different scenarios is shown in Table 11. These results demonstrate that disposal of the 25.5 m³ of accumulated soil will be well within the accepted dose limit criteria of 1 mrem/yr to any organ or whole body during the control period, and 5 mrem/yr to an inadvertent intruder. In addition, if continued soil spreading is necessary, the resulting dose is expected to also remain below the established limits even assuming the annual application of already approved disposal media (i.e., septic waste and cooling tower silt).

5.0 RADIOLOGICAL PROTECTION

The disposal operation of the soil will follow the applicable Vermont Yankee procedures to maintain doses as low as reasonably achievable and within the specific dose criteria as previously approved for septic waste and cooling tower silt disposal.

6.0 CONCLUSIONS

Soil generated from on-site construction and maintenance activities constitutes an earthen type material similar in characteristics to septic waste residual solids and cooling tower silt with respect to the radiological pathway behavior and modeling. Based on the similarity in characteristics between the proposed soil volume and waste streams that have already been approved for disposal and the evaluation of the incremental dose impact, it is concluded that the disposal of the existing 25.5 m³ and the projected 28.3 m³/year of soil through on-site land spreading will meet the existing NRC approved boundary dose conditions specified in

the Vermont Yankee ODCM (see Appendix B for Septic Waste Disposal). That is, with respect to the addition of the initial 25.5 m³ of soil along with the projected 28.3 m³/year of soil and the projected future disposal of septic and silt waste to the existing radioactivity already spread on the south field:

1. Total doses to the whole body and critical organ of the hypothetically maximally exposed individual were estimated as 1.15E-01 mrem/yr and 4.03E-01 mrem/yr, respectively, which are less than the prescribed 1.0 mrem/yr limit during the period of active site control.
2. Total doses to the whole body and critical organ of an inadvertent intruder from the probable pathways of exposure were estimated as 7.57E-01 mrem/yr and 1.17 mrem/yr, respectively, which are less than 5 mrem/yr limit associated with an intruder scenario following assumed loss of site access control as the end of the operating license.
3. For purposes of projecting maximum impact, all disposals (past and future) are assumed to take place on the south disposal plot.

Therefore, the disposition of the present 25.5 m³ and the projected 28.3 m³/year of soil will continue to meet the existing boundary conditions as approved by the NRC for septic waste and cooling tower silt.

7.0 REFERENCES

- (1) Vermont Yankee ODCM, Rev 23, Appendix B, "Approval of Criteria for Disposal of Slightly Contaminated Septic Waste On-Site at Vermont Yankee".
- (2) Vermont Yankee ODCM, Rev 23, Appendix F, "Approval Pursuant to 10CFR20.2002 for On-Site Disposal of Cooling Tower Silt".
- (3) USNRC Regulatory Guide 1.109, Rev 1, "Calculation of Annual Doses to Man from Routine Releases of Reactor Effluents for the Purpose of Evaluating Compliance with 10CFR Part 40, Appendix I", dated October 1977.

Table 1

Radioanalytical Results of Composite Samples Taken from 25.5m³ Soil Pile

Sample ID	Cs-137 (pCi/kg)		Co-60 (pCi/kg)		
	April, 1995	July 15, 1999	April, 1995	July 15, 1999	
	G22716	234	212.2	49	
G22717	522	473.4	143	81.7	
G22718	337	305.7	37	21.1	*
G22719	291	263.9	111	63.4	
G22720	348	315.6	47	26.8	*
G22721	135	122.4	73	41.7	
G22722	107	97.0	82	46.8	
G22723	222	201.4	140	80.0	
G22724	180	163.3	92	52.6	
G22725	269	244.0	118	67.4	
G22726	810	734.7	114	65.1	
G22727	378	342.8	106	60.6	
G22728	810	734.7	124	70.8	
G22729	376	341.0	62	35.4	
G22730	331	300.2	87	49.7	
G22731	253	229.5	5	2.9	*
G22732	150	136.0	58	33.1	
G22733	247	224.0	105	60.0	
G22734	326	295.7	54	30.8	*
G22735	235	213.1	100	57.1	
Average	328	298	85	49	
Maximum	810	735	143	82	
Minimum	107	97	5	3	
Std Dev.	186	169	36	20	

*The apparent response of the gamma isotopic analysis was less than the Minimum Detectable Concentration.

Table 2

Estimated Total Radioactivity in 25.5m³ Accumulated Soil

Nuclide	Volume of Soil (m ³)	Soil Mass (kg - dry)	Average Concentration (pCi/kg - dry)		Total Activity (uCi)	
			April 1995	July 15, 1999	April 1995	July 15, 1999
Cs-137	25.5	3.35E+04	328	298	11.0	10.0
Co-60	25.5	3.35E+04	85	49	2.8	1.6

Table 3
Estimated Total Radioactivity in Future Soil Additions

<u>Nuclide</u>	<u>Volume of soil (m³)</u>	<u>Soil Mass (kg-dry)</u>	<u>Average Concentration (pCi/kg-dry assuming) (April, 1995 concentrations)</u>	<u>Total Activity (uCi/yr)</u>
Cs-137	28.3	3.72E+04	328	12.8
Co-60	28.3	3.72E+04	85	3.16

Table 4
Record of Septic and Silt Radioactive Material Spread Each Year on the South Field

<u>Year</u>	<u>Spreading Date</u>	<u>Material Type</u>	<u>Mn-54 (uCi/acre)</u>	<u>Co-60 (uCi/acre)</u>	<u>Zn-65 (uCi/acre)</u>	<u>Cs-134 (uCi/acre)</u>	<u>Cs137 (uCi/acre)</u>	<u>Ce-141 (uCi/acre)</u>
1990	10/31/90	Septage	0.00	3.89	0.00	0.00	0.26	0.00
1990	11/20/90	Septage	0.17	2.03	0.41	0.00	0.29	1.40E-08
1991		no spreading	0.00	0.00	0.00	0.00	0.00	0.00
1992	10/19/92	septage	0.11	1.73	0.52	0.05	0.32	0.006
1993	10/14/93	septage	0.05	1.41	0.21	0.00	0.30	0.00
1994	06/14/94	septage	0.08	0.43	0.00	0.00	0.09	0.00
1995	06/29/95	septage	0.00	0.88	0.00	0.00	0.00	0.00
1996		no spreading	0.00	0.00	0.00	0.00	0.00	0.00
1997	06/18/97	septage	0.12	1.00	0.00	0.00	0.19	0.00
1998	07/30/98	septage	0.14	0.72	0.09	0.00	0.12	0.00
1998	09/28/98	Silt	0.00	0.00	0.00	0.00	30.87	0.00
1999	07/15/99	Septage	0.11	1.47	0.20	0.00	0.25	0.00
Average Activity/yr (uCi/acre):			0.08	1.36	0.14	0.01	3.27	0.01
Average Activity (uCi/yr) to be disposed of on 1.9 acre field			0.147	2.58	0.269	0.010	6.21	0.001 not significant

Table 5

Total Projected Radioactivity Remaining on South Field after License Termination

<u>Nuclide</u>	<u>Accum. Activity in Silt & Septic @ Year 2013 (uCi)</u>	<u>Accum. Activity in Soil @ year 2013 (uCi)</u>	<u>Accum. Activity Total All Paths @ year 2013 (uCi)</u>	<u>Accum. Activity Total All Paths @ Year 2013 (uCi/acre)*</u>
Mn-54	0.26	-	0.26	0.14
Co-60	19.68	21.83	41.51	21.85
Zn-65	0.42	-	0.42	0.22
Cs-137	119.03	154.74	273.78	144.09
Cs-134	0.04	-	0.04	0.02

* The total activity is assumed to be spread on the 1.9 acre South field to generate the uCi/acre value.

Table 6

All Pathway Critical Organ/Whole Body Dose Conversion Factors

<u>Radionuclide</u>	<u>Individual/Organ</u>	<u>During VY Control</u>		<u>Post VY Control (Intruder Scenario)</u>	
		<u>Critical Organ Dose Factor (mrem/yr per uCi/acre)</u>	<u>Whole Body Dose Factor (mrem/yr per uCi/acre)</u>	<u>Critical Organ Dose Factor (mrem/yr per uCi/acre)</u>	<u>Whole Body Dose Factor (mrem/yr per uCi/acre)</u>
Mn-54	Adult/GI-LLI	3.75E-04	1.93E-04	1.02E-02	3.12E-03
Co-60	Teen/Lung	7.17E-04	5.31E-04	3.19E-02	9.09E-03
Zn-65	Child/Liver	1.62E-02	1.03E-02	1.89E-02	1.25E-02
Cs-137	Child/Bone	2.66E-03	7.02E-04	6.98E-03	3.85E-03

Table 7 (Scenario I)

Dose Impact from Past Septic and Silt Spreading on South Field (as of 7/15/99)

Control Scenario:

	Half-Life (Years)	All Other Spreadings To Date (uCi/acre)	Maximum Organ Dose Factor (mrem/yr/uCi/acre)	Whole Body Dose Factor (mrem/yr/uCi/acre)	Maximum Organ Dose (mrem/yr)	Whole Body Dose (mrem/yr)
Mn-54	0.86	0.20	3.75E-04	1.93E-04	7.35E-05	3.78E-05
Co-60	5.27	6.86	7.17E-04	5.31E-04	4.92E-03	3.64E-03
Zn-65	0.67	0.23	1.62E-02	1.03E-02	3.77E-03	2.40E-03
Cs-137	30.17	31.92	2.66E-03	7.02E-04	8.49E-02	2.24E-02
Total Dose:					9.37E-02	2.85E-02
Dose Limit:					1	1
% of Limit:					9.37%	2.85%

Intruder Scenario:

	Half-Life (Years)	All Other Spreadings To Date (uCi/acre)	Activity on Plot Decayed to Year 2013 (uCi/acre)	Maximum Organ Dose Factor (mrem/yr/uCi/acre)	Whole Body Dose Factor (mrem/yr/uCi/acre)	Maximum Organ Dose (mrem/yr)	Whole Body Dose (mrem/yr)
Mn-54	0.86	0.20	2.31E-06	1.02E-02	3.12E-03	2.36E-08	7.22E-09
Co-60	5.27	6.86	1.08E+00	3.19E-02	9.09E-03	3.46E-02	9.85E-03
Zn-65	0.67	0.23	1.15E-07	1.89E-02	1.25E-02	2.17E-09	1.43E-09
Cs-137	30.17	31.92	2.31E+01	6.98E-03	3.85E-03	1.62E-01	8.91E-02
Total Dose:					1.96E-01	9.90E-02	
Dose Limit:					5	5	
% of Limit:					3.92%	1.98%	

Table 8 (Scenario II)

Dose Impact from Past Septic/Silt Spreading and Single 25.5m³ Soil Disposal

Control Scenario:

	Half-Life (Years)	All Spreadings to Date (uCi/acre)	Maximum Organ Dose Factor (mrem/yr/uCi/acre)	Whole Body Dose Factor (mrem/yr/uCi/acre)	Maximum Organ Dose (mrem/yr)	Whole Body Dose (mrem/yr)
Mn-54	0.86	0.196	3.75E-04	1.93E-04	7.35E-05	3.78E-05
Co-60	5.27	7.70	7.17E-04	5.31E-04	5.52E-03	4.09E-03
Zn-65	0.67	0.233	1.62E-02	1.03E-02	3.77E-03	2.40E-03
Cs-137	30.17	37.19	2.66E-03	7.02E-04	9.89E-02	2.61E-02
Total Dose:					1.08E-01	3.26E-02
Dose Limit:					1	1
% of Limit:					10.83%	3.26%

Intruder Scenario:

	Half-Life (Years)	All Spreadings to Date (uCi/acre)	Activity on Plot Decayed to 2013 (uCi/acre)	Maximum Organ Dose Factor (mrem/yr/uCi/acre)	Whole Body Dose Factor (mrem/yr/uCi/acre)	Maximum Organ Dose (mrem/yr)	Whole Body Dose (mrem/yr)
Mn-54	0.86	0.196	2.31E-06	1.02E-02	3.12E-03	2.36E-08	7.22E-09
Co-60	5.27	7.70	1.22E+00	3.19E-02	9.09E-03	3.88E-02	1.11E-02
Zn-65	0.67	0.233	1.15E-07	1.89E-02	1.25E-02	2.17E-09	1.43E-09
Cs-137	30.17	37.19	2.70E+01	6.98E-03	3.85E-03	1.88E-01	1.04E-01
Total Dose:					2.27E-01	1.15E-01	
Dose Limit:					5	5	
% of Limit:					4.54%	2.30%	



UNITED STATES
NUCLEAR REGULATORY COMMISSION
WASHINGTON, D.C. 20555-0001

June 15, 2000

NVY 00-58

Mr. Samuel L. Newton
Vice President, Operations
Vermont Yankee Nuclear Power Corporation
185 Old Ferry Road
Brattleboro, VT 05301

SUBJECT: VERMONT YANKEE NUCLEAR POWER STATION, REQUEST TO AMEND
PREVIOUS APPROVALS GRANTED UNDER 10 CFR 20.302(a) TO ALLOW
FOR DISPOSAL OF CONTAMINATED SOIL (TAC NO. MA5950)

Dear Mr. Newton:

By letter dated June 23, 1999, as supplemented on January 4, 2000, you submitted a request to amend a previously approved application granted by the Nuclear Regulatory Commission (NRC) pursuant to 10 CFR 20.2002 (previously 10 CFR 20.302) to allow the addition of slightly contaminated soil and soil/sand material to the list of already approved materials (i.e., septic waste and cooling tower silt) for on-site disposal via land spreading on designated fields.

We have completed our review of your proposal and find it to be acceptable because the previously approved bounding conditions will continue to be met.

Pursuant to the provisions of 10 CFR Part 51, the NRC has published an Environmental Assessment and Finding of No Significant Impact in the *Federal Register* on June 15, 2000 (65 FR 37583).

Sincerely,

A handwritten signature in black ink, appearing to read "John A. Zwolinski".

John A. Zwolinski, Director
Division of Licensing Project Management
Office of Nuclear Reactor Regulation

Docket No. 50-271

Enclosure: Safety Evaluation

cc w/encl: See next page

Revision 29 Date 1/11/02

H-37

Vermont Yankee Nuclear Power Station

cc:

Regional Administrator, Region I
U. S. Nuclear Regulatory Commission
475 Allendale Road
King of Prussia, PA 19406

Mr. David R. Lewis
Shaw, Pittman, Potts & Trowbridge
2300 N Street, N.W.
Washington, DC 20037-1128

Mr. Richard P. Sedano, Commissioner
Vermont Department of Public Service
112 State Street
Montpelier, VT 05620-2601

Mr. Michael H. Dworkin, Chairman
Public Service Board
State of Vermont
112 State Street
Montpelier, VT 05620-2701

Chairman, Board of Selectmen
Town of Vernon
P.O. Box 116
Vernon, VT 05354-0116

Mr. Richard E. McCullough
Operating Experience Coordinator
Vermont Yankee Nuclear Power Station
P.O. Box 157
Governor Hunt Road
Vernon, VT 05354

G. Dana Bisbee, Esq.
Deputy Attorney General
33 Capitol Street
Concord, NH 03301-6937

Chief, Safety Unit
Office of the Attorney General
One Ashburton Place, 19th Floor
Boston, MA 02108

Ms. Deborah B. Katz
Box 83
Shelburne Falls, MA 01370

Mr. Raymond N. McCandless
Vermont Department of Health
Division of Occupational
and Radiological Health
108 Cherry Street
Burlington, VT 05402

Mr. Gautam Sen
Licensing Manager
Vermont Yankee Nuclear Power
Corporation
185 Old Ferry Road
P.O. Box 7002
Brattleboro, VT 05302-7002

Resident Inspector
Vermont Yankee Nuclear Power Station
U. S. Nuclear Regulatory Commission
P.O. Box 176
Vernon, VT 05354

Director, Massachusetts Emergency
Management Agency
ATTN: James Muckerheide
400 Worcester Rd.
Framingham, MA 01702-5399

Jonathan M. Block, Esq.
Main Street
P. O. Box 566
Putney, VT 05346-0566



UNITED STATES
NUCLEAR REGULATORY COMMISSION
WASHINGTON, D.C. 20555-0001

SAFETY EVALUATION BY THE
OFFICE OF NUCLEAR REACTOR REGULATION
VERMONT YANKEE NUCLEAR POWER STATION
DOCKET NO. 50-271

1.0 INTRODUCTION

By letter dated June 23, 1999, as supplemented on January 4, 2000, Vermont Yankee Nuclear Power Corporation (the licensee), submitted a request to amend a previously approved application granted by the Nuclear Regulatory Commission (NRC) pursuant to 10 CFR 20.2002 (previously 10 CFR 20.302) to allow the addition of slightly contaminated soil and soil/sand material to the list of already approved materials (i.e., septic waste and cooling tower silt) for on-site disposal via land spreading on designated fields.

In 1989, pursuant to 10 CFR 20.302 (current 10 CFR 20.2002), the licensee received approval from the NRC to routinely dispose of contaminated septic waste in designated on-site areas. In 1997, the NRC amended the approved on-site disposal application to also include contaminated cooling tower silt material.

In this 10 CFR 20.2002 amendment application, the licensee identified 25.5 cubic meters of soil to be disposed of on-site immediately, and approximately 28.3 cubic meters of soil/sand material to be disposed of on an annual basis until the expiration of the plant's operating license in 2013. The 25.5 cubic meters of contaminated soil were generated as a result of on-site construction activities. The anticipated 28.3 cubic meters of soil/sand material will be generated from the annual winter spreading of sand on roads and walkways at the plant site. The licensee has performed a comprehensive radiological evaluation that includes all of the anticipated materials (i.e., the current 25.5 cubic meters and the 28.3 cubic meters generated annually thereafter). The licensee's evaluation shows that the soil/sand can be managed on-site in the same manner as the septic waste and cooling tower silt (i.e., by land spreading on designated fields).

2.0 EVALUATION

The licensee will dispose of the soil and future soil/sand material using a land spreading technique consistent with its current commitments for on-site disposal of septic waste and cooling tower silts previously approved by the NRC. The licensee will continue to use the designated and approved areas of their property (approximately 1.9 acres in size) which currently receives the septic waste and cooling tower silts. Determination of the radiological dose impact of the new material has been made based on the same dose assessment models and pathway assumptions used in the previously approved submittals.

The licensee will procedurally control and maintain records of all disposals. The following information will be recorded:

1. The radionuclide concentrations detected in the material (measured to radiation levels consistent with the licensee's radiological environmental monitoring program).
2. The total volume of material disposed.
3. The total radioactivity in the disposal operation as well as the total radioactivity accumulated on each disposal plot at the time of spreading.
4. The plot on which the material was applied.
5. Dose calculations or maximum allowable accumulated activity determinations required to demonstrate that the dose condition values imposed (i.e., imposed by this 10 CFR 20.2002 application) on the land spreading operation have not been exceeded.

The bounding dose conditions for the on-site disposals are as follows:

1. The annual dose to the whole body or any organ of a hypothetical maximally exposed individual must be less than 1.0 mrem.
2. Annual doses to the whole body and any organ of an inadvertent intruder from the probable pathways of exposure must be less than 5 mrem.
3. Disposal operations must be at one of the approved on-site locations.

To ensure that the addition of new material containing low levels of radioactivity will not exceed the bounding dose conditions, for each new spreading operation the licensee will calculate an estimate of the total radioactivity applied to the designated disposal plots. These calculated estimates will include all past disposals of septic waste, cooling tower silt, soil and soil/sand material on the designated disposal plots. This will be compared with the bounding dose condition value or equivalent radioactivity value on a per acre basis. In addition, concentration limits will be applied to the disposed material to restrict the placement of small volumes of material that may have relatively high radioactivity concentrations.

The licensee assessed the dose that may be received by the maximally exposed individual during the period of plant control over the property, and to an inadvertent intruder after plant access control ends using the same pathway modeling, assumptions, and dose calculation methods that were previously approved by the NRC for the septic waste and cooling tower silt disposals. The dose models are based on the guidance in NRC Regulatory Guide 1.109, Revision 1 (1977).

The licensee's dose assessment is as follows:

1. Total annual doses to the whole body and critical organ of the hypothetically maximally exposed individual were estimated to be 0.115 mrem and 0.403 mrem, respectively. These values are less than the prescribed annual dose condition value of 1.0 mrem for the time period of active site control.

2. Total annual doses to the whole body and critical organ of an inadvertent intruder from the probable pathways of exposure were estimated to be 0.757 mrem and 1.17 mrem. These values are less than the prescribed annual dose condition value of 5.0 mrem for the time period after active site control.
3. The dose calculations are based on projecting the maximum potential impact of all disposals (past and future) on the designated disposal plot of land.

3.0 CONCLUSION

The staff finds the licensee's proposal to dispose of the low-level radioactive soil and soil/sand material, pursuant to 10 CFR 20.2002, in the same manner, location, and within the bounding dose conditions as the materials (i.e., septic waste and cooling tower silt) previously approved by the NRC to be acceptable because the bounding conditions will continue to be met.

Principal Contributor: S. Klementowicz

Date: June 15, 2000

Appendix I

1. "Request to Amend Previous Approval Granted Pursuant to 10CFR20.2002 for Disposal of Contaminated Soil", dated September 11th, 2000, BVY 00-71
2. Vermont Yankee Nuclear Power Station – Safety Evaluation for an Amendment to an Approved 10CFR20.2002 Application (TAC No. MA9972)", dated June 26th, 2001, NVY 01-66

VERMONT YANKEE NUCLEAR POWER CORPORATION

185 OLD FERRY ROAD, PO BOX 7002, BRATTLEBORO, VT 05302-7002
(802) 257-5271

September 11, 2000
BVY 00-71

United States Nuclear Regulatory Commission
ATTN: Document Control Desk
Washington, DC 20555

References:

- (a) Letter, VYNPC to USNRC, "Request to Amend Previous Approvals Granted under 10 CFR 20.302(a) for Disposal of Contaminated Septic Waste and Cooling Tower Silt to Allow for Disposal of Contaminated Soil," BVY 99-80, dated June 23, 1999.
- (b) Letter, VYNPC to USNRC, "Supplement to Request to Amend Previous Approvals Granted under 10 CFR 20.302(a) to Allow for Disposal of Contaminated Soil," BVY 00-02, dated January 4, 2000.
- (c) Letter, USNRC to VYNPC, "Vermont Yankee Nuclear Power Station, Request to Amend Previous Approvals Granted under 10 CFR 20.302(a) to Allow for Disposal of Contaminated Soil (TAC No. MA5950)," NVEY 00-58, dated June 15, 2000.
- (d) Letter, USNRC to VYNPC, "Revised Safety Evaluation -- Approval Pursuant to 10 CFR 20.2002 for Onsite Disposal of Cooling Tower Silt -- Vermont Yankee Nuclear Power Station (TAC No. M96371)," NVEY 97-85, dated June 18, 1997.

**Subject: Vermont Yankee Nuclear Power Station
License No. DPR-28 (Docket No. 50-271)
Request to Amend Previous Approval Granted Pursuant to
10 CFR 20.2002 for Disposal of Contaminated Soil**

In accordance with 10 CFR 20.2002 (previously 10 CFR 20.302(a)), Vermont Yankee (VY) submits this application to amend the previously granted approval to dispose of slightly contaminated soil. This application expands the allowable waste stream to include slightly contaminated soil generated as a residual by-product of other types of on-site construction activities.

In References (a) and (b), VY requested approval to dispose of approximately 25.5 m³ of accumulated soil that was generated due to construction activities. In addition, it was requested that VY be allowed to dispose of approximately 28.3 m³ of soil that is spread annually on station roads and walkways during the winter. NRC acceptance is documented in Reference (c).

This application specifically requests approval to dispose of contaminated soil that is created due to other on-site construction related activities including but not limited to design change implementation and land maintenance.

In addition, VY requests that NRC's review recognize that, although VY indicated in Reference (b) that the south disposal field (approximately 1.9 acres in size) is currently expected to be used for disposal of the subject material, VY is also authorized to use the alternate north disposal field (approximately 10 acres in size). Approval to use both the north and south fields for disposal was granted in Reference (d). VY's radiological impact assessments have conservatively assumed all of the disposal activities occur on the smaller south field to maximize potential calculated doses. These assessments bound the situation where a portion of the land spreading occurs on the north field.

VY will continue to limit the total activity spread, from approximately 28.3 m³ of soil generated each year, to within the limits assumed in the radiological assessment previously submitted in Reference (b).

A radiological assessment and proposed operational controls for the inclusion of the additional material for on-site disposal was provided in Reference (b). The assessment demonstrates that the dose impact expected from the proposed activity, in total with all past waste spreading operations, will not approach the dose limits already imposed for septic and cooling tower silt disposal. All soil analyses will be to environmental lower limits of detection.

The results of all disposal operations will be reported in the Annual Radioactive Effluent Release Report. The combined radiological impact, for all on-site disposal operations, will continue to be limited to a total body or organ dose of a maximally exposed member of the public of less than one mrem/year during the period of active VY control of the site, or less than five mrem/year to an inadvertent intruder after termination of active site control.

Upon receipt of your approval, this request as well as the basis for approval will be incorporated into the Off-Site Dose Calculation Manual.

We trust that the information contained in the submittal is sufficient. However, should you have any questions or require further information concerning this matter, please contact Mr. Jim DeVincentis at 802-258-4236.

Sincerely,

Vermont Yankee Nuclear Power Corporation

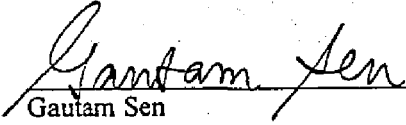
Gautam Sen
Licensing Manager

cc: USNRC Region I Administrator
USNRC Resident Inspector - VYNPS
USNRC Project Manager - VYNPS
VT Department of Public Service

SUMMARY OF VERMONT YANKEE COMMITMENTS

BVY NO.: 00-71

The following table identifies commitments made in this document by Vermont Yankee. Any other actions discussed in the submittal represent intended or planned actions by Vermont Yankee. They are described to the NRC for the NRC's information and are not regulatory commitments. Please notify the Licensing Manager of any questions regarding this document or any associated commitments.

COMMITMENT	COMMITTED DATE OR "OUTAGE"
None	N/A

VYAPF 0058.04
AP 0058, Revision 1
Page 1 of 1



UNITED STATES
NUCLEAR REGULATORY COMMISSION
WASHINGTON, D.C. 20555-0001

RECEIVED
6/29/01

June 26, 2001

Mr. Michael A. Balduzzi
Vice President, Operations
Vermont Yankee Nuclear Power Corporation
185 Old Ferry Road
P.O. Box 7002
Brattleboro, VT 05302-7002

NVY 01-66

SUBJECT: VERMONT YANKEE NUCLEAR POWER STATION - SAFETY EVALUATION
FOR AN AMENDMENT TO AN APPROVED 10 CFR 20.2002 APPLICATION
(TAC NO. MA9972)

Dear Mr. Balduzzi:

The U.S. Nuclear Regulatory Commission (NRC) staff has completed its review of the Vermont Yankee Nuclear Power Corporation (VYNPC) request dated September 11, 2000, to amend an approved 10 CFR 20.2002 (previously 10 CFR 20.302) application dated June 23, 1999, as supplemented on January 4, 2000. The licensee requested NRC approval to allow the addition of slightly contaminated soil resulting from on-site construction-related activities, including but not limited to, design change implementation and land maintenance, to the list of already approved materials (i.e., septic waste, cooling tower silt and soil/sand from roads and walkways) for on-site disposal.

Based on our review, we find the proposed changes to be acceptable because the previously approved bounding conditions will continue to be met. The enclosure to this letter provides our safety evaluation of VYNPC's application.

Pursuant to the provisions of 10 CFR Part 51, the NRC has published an Environmental Assessment and finding of No Significant Impact in the *Federal Register* on June 14, 2001 (66 FR 32399).

Sincerely,

A handwritten signature in black ink, appearing to read "John A. Zwolinski".

John A. Zwolinski, Director
Division of Licensing Project Management
Office of Nuclear Reactor Regulation

Docket No. 50-271

Enclosure: Safety Evaluation

cc w/encl: See next page

Vermont Yankee Nuclear Power Station

cc:

Regional Administrator, Region I
U. S. Nuclear Regulatory Commission
475 Allendale Road
King of Prussia, PA 19406

Mr. David R. Lewis
Shaw, Pittman, Potts & Trowbridge
2300 N Street, N.W.
Washington, DC 20037-1128

Ms. Christine S. Salembier, Commissioner
Vermont Department of Public Service
112 State Street
Montpelier, VT 05620-2601

Mr. Michael H. Dworkin, Chairman
Public Service Board
State of Vermont
112 State Street
Montpelier, VT 05620-2701

Chairman, Board of Selectmen
Town of Vernon
P.O. Box 116
Vernon, VT 05354-0116

Mr. Richard E. McCullough
Operating Experience Coordinator
Vermont Yankee Nuclear Power Station
P.O. Box 157
Governor Hunt Road
Vernon, VT 05354

G. Dana Bisbee, Esq.
Deputy Attorney General
33 Capitol Street
Concord, NH 03301-6937

Chief, Safety Unit
Office of the Attorney General
One Ashburton Place, 19th Floor
Boston, MA 02108

Ms. Deborah B. Katz
Box 83
Shelburne Falls, MA 01370

Mr. Raymond N. McCandless
Vermont Department of Health
Division of Occupational
and Radiological Health
108 Cherry Street
Burlington, VT 05402

Mr. Gautam Sen
Licensing Manager
Vermont Yankee Nuclear Power
Corporation
185 Old Ferry Road
P.O. Box 7002
Brattleboro, VT 05302-7002

Resident Inspector
Vermont Yankee Nuclear Power Station
U. S. Nuclear Regulatory Commission
P.O. Box 176
Vernon, VT 05354

Director, Massachusetts Emergency
Management Agency
ATTN: James Muckerheide
400 Worcester Rd.
Framingham, MA 01702-5399

Jonathan M. Block, Esq.
Main Street
P. O. Box 566
Putney, VT 05346-0566



UNITED STATES
NUCLEAR REGULATORY COMMISSION
WASHINGTON, D.C. 20555-0001

SAFETY EVALUATION BY THE OFFICE OF NUCLEAR REACTOR REGULATION

VERMONT YANKEE NUCLEAR POWER CORPORATION

VERMONT YANKEE NUCLEAR POWER STATION

DOCKET NO. 50-271

1.0 INTRODUCTION

By letter dated September 11, 2000, Vermont Yankee Nuclear Power Corporation (VYNPC/ licensee) submitted a request to amend a Title 10 of the *Code of Federal Regulations* (10 CFR) Section 20.2002 (former 10 CFR 20.302) application, dated June 23, 1999, as supplemented on January 4, 2000, that was approved by the U.S. Nuclear Regulatory Commission (NRC). This amendment will allow the addition of slightly contaminated soil resulting from on-site construction-related activities, including but not limited to, design change implementation and land maintenance, to the list of already approved materials (i.e., septic waste, cooling tower silt and soil/sand from roads and walkways) for on-site disposal via land spreading on designated disposal fields.

In 1989, pursuant to 10 CFR 20.302 (current 10 CFR 20.2002), the licensee received approval from the NRC to routinely dispose of contaminated septic waste in designated on-site areas. In 1997, the NRC amended the approved on-site disposal application to also include contaminated cooling tower silt material. In 2000, the NRC amended the approved on-site disposal application to also include a one-time disposal of slightly contaminated soil and an annual disposal of 28.3 cubic meters of slightly contaminated soil/sand material.

In this 10 CFR 20.2002 amendment application, the licensee requested that slightly contaminated soil resulting from on-site construction-related activities be disposed of on-site on an annual basis until the end of the plant's operating license in 2013. The anticipated annual volume of soil generated by on-site construction, as identified by the licensee, combined with the soil/sand generated from the annual winter spreading of sand on roads and walkways at the plant site will not exceed 28.3 cubic meters. This volume is the same volume that was approved in the January 4, 2000, request. The licensee performed a comprehensive radiological evaluation which included the annual disposal of 28.3 cubic meters of soil and soil/sand materials, and shows that these materials can be managed on-site in the same manner as the septic waste and cooling tower silt (i.e., land spreading on designated fields).

2.0 EVALUATION

The licensee will dispose of the future soil material using a land spreading technique consistent with the current commitments for on-site disposal of septic waste, cooling tower silts and sand/soil material previously approved by the NRC. The licensee will continue to use the

designated and approved areas of their property which include approximately 1.9 acres, which currently receive the septic waste, cooling tower silts and soil/sand material, and approximately 10 acres which have not been previously used for disposal. Determination of the radiological dose impact of the new material has been made based on the same dose assessment models and pathway assumptions used in the previously approved submittals.

The licensee will procedurally control and maintain records of all disposals. The following information will be recorded:

1. The radionuclide concentrations detected in the material (measured to radiation levels consistent with the licensee's radiological environmental monitoring program);
2. The total volume of material disposed;
3. The total radioactivity in the disposal operation as well as the total radioactivity accumulated on each disposal plot at the time of spreading;
4. The plot on which the material was applied;
5. Dose calculations or maximum allowable accumulated activity determinations required to demonstrate that the dose condition values imposed (i.e., imposed by the approved 10 CFR 20.2002 application dated June 23, 1999) on the land spreading operation have not been exceeded.

The bounding dose conditions for the on-site disposals are as follows:

1. The annual dose to the whole body or any organ of a hypothetical maximally exposed individual must be less than 1.0 mrem.
2. Annual doses to the whole body and any organ of an inadvertent intruder from the probable pathways of exposure must be less than 5 mrem.
3. Disposal operations must be at one of the approved on-site locations.
4. Total annual combined volume of soil and soil/sand materials must not exceed 28.3 cubic meters.

To ensure that the addition of new material containing low levels of radioactivity will not exceed the bounding dose conditions, for each new spreading operation the licensee will calculate an estimate of the total radioactivity that includes all past disposals of septic waste, cooling tower silt, and soil/sand and soil material on the designated disposal plots. This will be compared with the bounding dose condition value or equivalent radioactivity value on a per acre basis.

The licensee assessed the dose from soil and soil/sand material that may be received by the maximally exposed individual during the period of plant control over the property, and to an inadvertent intruder after plant access control ends using the same pathway modeling, assumptions, and dose calculation methods that were previously approved by the NRC for the septic waste and cooling tower silt disposals. The dose models are based on the guidance in NRC Regulatory Guide 1.109, Revision 1 (1977).

The licensee's dose assessment is as follows:

1. Total annual doses to the whole body and critical organ of the hypothetically maximally exposed individual were estimated to be 0.115 mrem and 0.403 mrem respectively. These values are less than the prescribed annual dose condition value of 1.0 mrem for the time period of active site control.
2. Total annual doses to the whole body and critical organ of an inadvertent intruder from the probable pathways of exposure were estimated to be 0.757 mrem and 1.17 mrem. These values are less than the prescribed annual dose condition value of 5.0 mrem for the time period after active site control.
3. The dose calculations are based on projecting the maximum potential impact, of all disposals (past and future) on the approved disposal site.

3.0 CONCLUSION

The staff finds the licensee's proposal to dispose of the low-level radioactive soil material, pursuant to 10 CFR 20.2002, in the same manner, location, and within the bounding dose conditions as the materials (i.e., septic waste, cooling tower silt and soil/sand from roads and walkways) previously approved by the NRC to be acceptable.

The licensee has committed to permanently incorporate this modification into their Offsite Dose Calculation Manual.

Principal Contributor: A. Hayes

Date: June 26, 2001

APPENDIX J

1. "Request to Amend Previous Approval Granted Pursuant to 10CFR20.2001 for Increase of the Annual Volume Limit and One-time Spreading of Current Inventory," dated October 4, 2004, BVY 04-110.....2
2. "Safety Evaluation of Request to Amend Previous Approvals Granted Pursuant to 10CFR20.2002 – Vermont Yankee Nuclear Power Station (TAC No. MC5104)" dated July 19, 2005, NVY 05-090.....51

APPENDIX J (Continued)



Entergy Nuclear Northe
Entergy Nuclear Operations, Inc.
Vermont Yankee
185 Old Ferry Rd.
P.O. Box 500
Brattleboro, VT 05302
Tel 802-257-5271

October 4, 2004

Docket No. 50-271

BVY 04-110

Attn: Document Control Desk
U.S. Nuclear Regulatory Commission
Washington, DC 20555-0001

References:

- a) Letter, VYNPC to USNRC, "Request to Amend Previous Approval Granted Pursuant to 10 CFR 20.2002 for Disposal of Contaminated Soil", BVY 00-71, dated September 11, 2000.
- b) Letter, USNRC to VYNPC, "Vermont Yankee Nuclear Power Station – Safety Evaluation for an Amendment to an Approved 10CFR 20.2002 Application (TAC No. MA9972)", NVCY 01-66, Dated June 26, 2001.
- c) Letter, VYNPC to USNRC, "Supplement to Request to Amend Previous Approvals Granted under 10 CFR 20.302(a) to Allow for Disposal of Contaminated Soil", BVY 00-02, dated January 4, 2000.

**Subject: Vermont Yankee Nuclear Power Station
Request to Amend Previous Approval Granted Pursuant
to 10CFR20.2002 for Increase of the Annual Volume
Limit and One-time Spreading of Current Inventory**

In accordance with 10CFR20.2002 (previously 10CFR20.302(a)), Entergy Nuclear Operations, Inc. (ENO) submits this application to amend the previously granted Vermont Yankee (VY) approval to dispose of slightly contaminated soil. This application requests an increase of the current annual volume limit of 28.3 cubic meters of soil as specified in the previous approval (Reference (b)) to a new volume limit of 150 cubic meters of soil. This application also requests permission to spread the current inventory of approximately 528 cubic meters of soil as described in Attachment A in a one-time spreading activity following receipt of your approval.

ENO will continue to limit the total activity spread each year to remain within the limits specified in the radiological assessment previously submitted in Reference (c).

A radiological assessment of the impact of spreading the current inventory of soils and sediments located at VY is provided in Attachment A. The assessment concludes that:

- a) There is significant capacity remaining in the South Disposal Plot to continue to accept additional earthen materials for land spreading without exceeding established dose limitations.

Appendix J Original
Off-Site Dose Calculation Manual
Page 2 of 57

APPENDIX J (Continued)

BVY 04-110 / Page 2

- b) The existing inventory of waste soils in storage can be placed on the South Disposal Plot without exceeding dose impact limits previously established for a single disposal field.
- c) The continued use of the South Disposal Plot will not exceed the limiting dose criteria established in the VY Offsite Dose Calculation Manual.
- d) The approved dose impact methodology used to determine compliance with the on-site spreading dose limits are not driven by the volume of waste material disposed of, but by the total radioactivity content of the material that is spread over a fixed disposal plot area (1.9 acres for the South Disposal Plot). The dose modeling conservatively assumes that all radioactivity spread on the field remains in the top 15 centimeter surface layer, even after subsequent additions are placed on the same field area. Existing limits on the concentration of radioactivity in waste media provides protection from small volumes of "hot" or high specific activity materials from being spread on the disposal field.

The results of all disposal operations will continue to be reported in the Annual Radioactive Effluent Release Report. The combined radiological impact, for all on-site disposal operations, will continue to be limited to a total body or organ dose of a maximally exposed member of the public of less than one mrem/year during the period of active VY control of the site, or less than five mrem/year to an inadvertent intruder after termination of active site control.

Upon receipt of your approval, this request as well as the basis for approval will be incorporated into the VY Offsite Dose Calculation Manual.

There are no new commitments being made in this submittal.

We trust that the information contained in the submittal is sufficient. However, should you have any questions or require further information concerning this matter, please contact me at (802) 258-4236.

Sincerely,



James M. DeVincentis
Manager, Licensing
Vermont Yankee Nuclear Power Station

Attachment (1)

cc: USNRC Regional Administrator – Region 1
USNRC Resident Inspector – VYNPS
USNRC Project Manager – VYNPS
Vermont Department of Public Service

Appendix J Original
Off-Site Dose Calculation Manual
Page 3 of 57

**Assessment of On-Site Disposal of Contaminated
Stored Soils by Land Spreading**

Entergy Nuclear Operations, Inc.
Vermont Yankee Nuclear Power Station

APPENDIX J (Continued)

TABLE OF CONTENTS

	<u>Page No.</u>
Table of Contents	2
List of Tables	3
1.0 Evaluation Objective	4
1.1 Background	4
2.0 Summary of Results	6
3.0 Method of Evaluation	7
3.1 Waste Characterization	7
3.2 Soil Disposal and Administrative Procedure Requirements	8
3.3 Disposal Plot Characteristics	9
3.4 Radiological Impact Methodology	9
4.0 Assumptions and Inputs	12
5.0 Evaluations	14
5.1 Case Study I (Past Spreading Impacts)	14
5.2 Case Study II (Stored Soil/Sand Inventory Impacts)	14
5.3 Case Study III (Projected Future Spreading Impacts)	15
6.0 Results / Conclusions	17
7.0 References	34
Appendix A: Security Fence Upgrade Soil Pile #2002-01	A-1
Appendix B: Security Fence Upgrade Soil Pile #2002-02	B-1
Appendix C: Security Fence Upgrade Soil Pile #2002-03	C-1
Appendix D: 2001 protected Area Road Sweeping Pile	D-1
Appendix E: 2001 HWC Soil Excavations	E-1
Appendix F: 1996 Soil Remnants Analysis – Security Fence Upgrade	F-1
Appendix G: Record of Most Recent Spreadings (2003) on South Disposal Field	G-1

APPENDIX J (Continued)

List of Tables

<u>Table #</u>	<u>Title</u>	<u>Page</u>
1	Inventory of Contaminated Soil Piles In Storage (December 2003)	8
2	Site Specific Control Period Dose Conversion Factors	12
3	Site Specific Intruder Dose Conversion Factors	13
4	Record of Septic/CT Silt/Construction Soil Radioactive Material Spreading Each Year on the South Disposal Field	19
5	Record of Septic Waste Only for Radioactive Material Spreading Each Year on the South Disposal Field	20
6	Record of Cooling Tower Silt Only for Radioactive Material Spreading Each Year on the South Disposal Field	21
7	Record of Construction Soil/Sand Waste Only for Radioactive Material Spreading Each Year on the South Disposal Field	21
8	Cs-137 in Storage Piles after Last Spreading in 2003	22
9	Co-60 in Storage Piles after Last Spreading in 2003	23
10	Zn-65 in Storage Piles after Last Spreading in 2003	24
11	Mn-54 in Storage Piles after Last Spreading in 2003	25
12	Soil/Sand Storage: Total Activity to be Spread on 6/1/04 and Decayed to 2013	26
13	Projection of Additional Septic/Silt/Soil-Sand at Current Generation Rates to 2013	26
14	Projection of Additional Sand/Soil Mix	27
15	Projection of additional Cooling Tower Silt	27
16	Projection of Additional Septic Waste	27
17	Projected 1 Yr Septage & Silt Spreading for 6/1/04 and decayed to 2013	28
18	Current Total Spreading as of 11/4/03 & How Much Remains at 6/1/04 and 2013	28
19	Current Spreading Totals Plus Total Projected Future Spreadings to 2013	29
20	Radioactivity Content from Existing Materials	29
21	Past Spreading Control Period Dose Only (No Stored Material or Future Additions)	30
22	Past Spreading Only (No Stored Materials or Future Additions) Intruder Dose at End of Plant Operations in 2013	30
23	Control Period Dose : Past Spreadings & Current Stored Soil Material Inventory	31
24	Past Spreading & Current Stored Soil Inventory Intruder Dose at End Plant Ops	31
25	Dose Impact from Spreading of Current Inventory of Stored Material Only	32
26	Past, Stored Material and Projected Future Disposal (all septage/silt/soils) Doses at End of Plant License	33

APPENDIX J (Continued)

1.0 EVALUATION OBJECTIVE

Current restrictions on the annual volume of slightly contaminated soil (1000 ft³ or 28.3 m³) that can be disposed of on-site (ODCM, Appendix I, Reference 1), coupled with several plant facility construction projects in recent years, has resulted in the accumulation of a back-log of low level contaminated earthen material that is awaiting to be dispositioned by land spreading on previously approved on-site disposal areas.

The objective of this assessment is to present the data and formal evaluation to demonstrate that the proposed one time disposal of the existing accumulated backlog of soil / sand materials (as of November 2003) without regards to the annual soil volume limit, will meet the existing dose objective boundary conditions as approved by the NRC for septic waste, Cooling Tower silt and other earthen type materials (Reference 1), even if use of the same disposal field for future spreading is assumed to continue over the remaining plant operating license.

The established dose based boundary conditions (NRC approved) for disposal and accumulation of low-level contaminated septic waste, Cooling Tower silts and soil/sand mixes on designated plots within the VY site boundary will continue to be applied without change. These dose limit criteria are taken from Appendix B of Reference 1, and are:

- The dose to the whole body or any organ of a hypothetical maximally exposed individual must be less than 1.0 mrem/yr during the period that VY has active control over the disposal plots (plant operating life).
- The doses to the whole body and any organ of an inadvertent intruder following the period of active plant control over the property from the probable pathways of exposure is less than 5 mrem/yr.
- Disposal operations must be at one of the approved on-site locations.

1.1 Background

In 1989, Vermont Yankee Nuclear Power Corporation requested from the NRC permission to routinely dispose of slightly contaminated septic waste in designated on-site areas in accordance with 10CFR20.302(a). Approval from the NRC was granted on August 30, 1989, provided that the request and analysis be permanently incorporated into the plant's Offsite Dose Calculation Manual (ODCM). Revision 9 to the ODCM (Appendix B) incorporated the assessment and the approval of methods utilized for on-site disposal of slightly contaminated sewage sludge by land spreading. The approval allowed for the existing septic inventory to be disposed of on-site along with future quantities anticipated to be generated as part of routine system maintenance. For purposes of demonstrating that future addition of waste materials could be added to the disposal plots, the radiological analysis projected an annual generation rate of about 18,600 gallons of sewage containing about 1400 kg of solid materials that might require on-site spreading. NRC permission for these future disposals was granted as long as both the projected dose (for both current and all past disposal operations) and radionuclide concentration limits ($\leq 10\%$ of the 10CFR20, Appendix B, Table II, concentration values) are satisfied. No specific limit on annual volume of septic waste that could be disposed of was included in the approval.

In 1995, Vermont Yankee requested from the NRC that the previous authorization for on-site disposal of septic waste be amended to permit the on-site disposal of slightly contaminated Cooling

APPENDIX J (Continued)

Tower silt material. The application analyzed the expected radiological impact from both the existing inventory at that time of about $14,000 \text{ ft}^3$ ($\sim 396 \text{ m}^3$) of accumulated silt, along with an operating cycle (18 months) generation rate of about 4000 ft^3 ($\sim 113 \text{ m}^3$). The NRC returned their safety evaluation, dated March 4, 1996, granting approval for the proposed silt disposal. Similar to the sewage waste disposal, NRC acceptance required that all disposal operations be conducted such that both the projected dose (for both current and all past disposal operations) and radionuclide concentration limits are satisfied. The soil concentration limits (for any sample) were based on limiting external annual dose to 25 mrem assuming continuous occupancy on an infinite plot at that concentration uniformly spread to a 15 cm depth. No specific limit on annual volume of Cooling Tower silt that could be disposed of was included in the approval. The NRC also required that any further modification to the proposed action have prior NRC staff approval.

In 1999 (with a supplemental filing in 2000), Vermont Yankee filed a third request under 10 CFR 20.2002 with the NRC to amend the previously approved applications for on-site land disposal of slightly contaminated earth type materials (septic sludge and Cooling Tower silt) to include approximately 900 ft^3 (25.5 m^3) of accumulated contaminated soil generated during construction activities within the VY Protected Area. Sampling of the soil revealed low levels of radioactivity that were similar in radionuclides and activity levels to the septic waste and Cooling Tower silts previously encountered. The request to the NRC for this additional material also indicated that additional amounts of contaminated soil / sand associated with road sweepings following winter sanding of road and walkways in the Protected Area could result in an estimated 1000 ft^3 per year (28.3 m^3 per year) that might need to be disposed of as slightly contaminated materials.

The NRC requested that the initial submittal (1999) of the soil spreading 20.2002 application include an analysis that evaluated projected future additions of an estimated annual volume of soil being added to the designated disposal plots. This information was required if Vermont Yankee intended to use the 20.2002 soil disposal application for approval to dispose of potential future volumes (i.e., not just a one-time disposal application) of low level contaminated soil in the same manner as already approved for septic waste and Cooling Tower silt. Vermont Yankee revised its application by adding an analysis for a projected annual volume of 1000 ft^3 , or equivalently 28.3 m^3 , of contaminated soil starting in the year 2000 and continuing on a yearly basis until end of plant license in 2013. At the end of the projected disposal stream, the accumulated buildup of contamination from all sources (septic waste, Cooling Tower silt and soil / sand mixes) on the disposal field was evaluated for both the dose impact to the critical receptor at the end of the control period and the assumed intruder. These dose impacts were found acceptable when compared against the original on-site spreading dose acceptance criteria of 1 mrem/yr (Control Period) and 5 mrem/yr (Intruder Scenario). The 1000 ft^3 (28.3 m^3) annual generation rate of soil was based on plant staff estimates that approximately that amount of soil and sand is collected from road and walkway sweepings inside the Protected Area following each year's winter clean-up as part of routine maintenance. This is the only type of earthen materials that has a specific annual volume limit associated with it in addition to the projected dose and concentration limits associated with the disposal of septic waste and Cooling Tower silt. No volume estimate for unidentified future site excavation and construction activities was provided.

APPENDIX J (Continued)

2.0 SUMMARY OF RESULTS

The evaluation of the radiological impact of all past, accumulated storage inventory, and projected future waste spreading operations on a single disposal plot (1.9 acres at South end of site) have indicated the following results and conclusions:

- All past spreading of septic waste, Cooling Tower silt, and soil/sand mixes through the end of 2003 have resulted in a maximum organ dose to a critical receptor (control Period use) that accounts for only 13.7% of the 1 mrem/year limit. With respect to the Intruder dose limit of 5 mrem/year, all past spreadings through the end of 2003 account for only 7.2% of the maximum organ dose to the limiting receptor at the end of plant license.
- The impact from the projected spreading of the existing waste materials in storage is estimated to account for only 5.3% of the 1 mrem/year Control Period dose limit, or only 17.7% of the same limit when all past spreadings are combined with the materials currently in storage (as of the end of November 2003). The maximum Intruder organ dose from all past spreading and stored materials is 0.456 mrem/yr, or 9.1% of the 5 mrem/yr Intruder scenario dose limit. These results indicate that the existing inventory of waste materials in storage can be placed on the South disposal plot without exceeding dose impact limits previously established for a single disposal field.
- Assuming the same annual average generation rate of radioactivity in waste materials (septage/silt/soil) that has been observed over the last fourteen years is added to all past waste spreadings and stored soil commitments, the projected dose at the end of the current plant licensing period (year 2013) yields a limiting maximum critical receptor dose (for either the control period or inadvertent intruder) equivalent to only 25.3% of the most restrictive annual dose limit (associated with the 1 mrem/year limit for the maximum organ during the Control Period). This finding demonstrates that the continued use of the South disposal plot, even with the addition of 18,653 ft³ of slightly contaminated soil currently in storage, will not exceed the approved limiting dose criteria established in the ODCM.
- The dose impact methodology used to determine compliance with the on-site spreading dose limits are not driven by the volume of waste material disposed of, but by the total radioactivity content of the material. Existing limits on the concentration of radioactivity in waste media provides protection from small volumes of "hot" or high specific activity materials from being spread on the disposal field.

3.0 METHOD OF EVALUATION

The method of evaluating the impacts from the on-site spreading is the same as used and approved in the original exemption request made to the NRC under 10CFR20.302 for septic waste and which has been applied in all subsequent amendment requests for additional types of earthen materials to be disposed by land spreading on-site. The pathway and dose models found in Regulatory Guide 1.109 (Reference 2) are employed in performing the radiological dose impact assessment. The application of the dose models begins with the characterization of the waste materials that are to be subject to the dose evaluation.

3.1 Waste Characterization

The existing accumulated soil / sand that has created a backlog of accumulated material over the last several years is identified on Table 1, along with the estimated volume and origination of material. The soil materials were primarily derived from excavation activities associated with the construction of new security fences along the plant's Protected Area boundary and the construction of new plant installations associated with the capability to perform hydrogen water chemistry treatment of the plant's coolant system. Also included are road treatment sands used for winter traction inside the protected area.

The soil / sand mix is typical of fill material containing light to dark brown poorly sorted soils with some small stones, and may include small incidental pieces of asphalt. The soil was removed from its original location by shovel, backhoe and front-end loader, and placed into dump trucks for transport to the temporary storage area located between the Cooling Towers where it was deposited on the ground surface and covered to prevent erosion. This location was selected because it was away from areas routinely occupied by plant staff, and could easily be controlled. The most probable source of the low levels of radioactive contamination is due to the presence of below detectable removable contamination redistributed by foot traffic from inside the plant to walkways and parking areas. Subsequent surface runoff carries the contamination to nearby exposed soil near the Protected Area boundary where it accumulates over time to low-level detectable concentrations. Down wash and deposition of particulate activity released from the plant's Primary Vent Stack as part of routine gaseous emissions may also have contributed to the low levels of detectable activity.

For potential future disposal volumes of sand and soil, the current volume limit (1000 ft³ [28.3 m³], ODCM Appendix H, Reference 1) was based on the expected rate of road sand used for winter road and walkway traction, but did not anticipate or reflect the potential for future site construction activities that could excavate soils on-site that also contain low levels of plant related radioactivity. The present inventory of stored soil / sand between the Cooling Towers includes approximately 18,653 ft³ (528 m³) of material of which only 3.3% or 616 ft³ (17.4 m³) originated as roadway sweepings. In accordance with Appendixes B and F of the ODCM, disposal of septic waste and Cooling Tower silt material is not limited by an annual volume limit but by total dose impact related to the radioactivity content of the silt and the concentration of radioactivity contained within it. Currently, only soils / sand mixtures have an annual on-site disposal limit equal to 1000 ft³ (28.3 m³).

APPENDIX J (Continued)

Table 1
Inventory of Contaminated Soil Piles
In Storage
(December 2003)

Pile description	Overall Length	Overall width	Max Height	Estimated Volume
	ft	ft	inches	
(1) 2002-01: Security Fence Upgrade	75	21	44	4,679
(2) 2002-02: Security Fence Upgrade	75	28	60	9,000
(3) 2002-03: Security Fence Upgrade	39	22	42	2,457
(4) Sand Sweepings (inside protected area)	16	11	42	616
(5) 2001 HWC Soils Excavation	38	11	42	931
(6) 1996 Soil Remnants from Fence Upgrade	24	6.4	84	970
	total Vol. (ft ³) =			18,653

3.2 Soil Disposal and Administrative Procedure Requirements

The method of soil/sand disposal of the existing backlog inventory will use the technique of land spreading in a manner consistent with the current commitments for the on-site disposal of septic waste and Cooling Tower silts as approved by the NRC and implemented in Appendices B and F of the Vermont Yankee ODCM (Reference 1). The accumulation of radioactivity on the disposal plot for this proposed soil spreading operation will be treated as if Cooling Tower silt or septic waste was being disposed of since the characteristics of all these residual solids are similar (earthen-type matter). The South field (approximately 1.9 acres in size) has been used for all past disposal operations and is expected to be used for the placement of the existing backlog (see Table 1 above) of approximately 18,653 ft³ (528 m³) of soil and all annual projected future disposals of septic waste, Cooling Tower silt, and low-level contaminated soil volumes through the end of the plant's current operating license (year 2013). Determination of the radiological dose impact has been made based on the same models and pathway assumptions as indicated in Appendix B of the Vermont Yankee ODCM and approved as part of the original disposal analysis application for septic waste.

Both the existing accumulated and future potential soil material will be dispersed using typical agricultural dry bulk surface spreading practices in approved disposal areas on site. Incidental pieces of asphalt and large stones that are picked up with the soil will be screened out before the soil/sand is spread.

Records of the disposal that will be maintained include the following (as prescribed in Reference 1, Appendix B):

- (a) the radionuclide concentrations detected in the soil/sand (measured to environmental lower limits of detection)
- (b) the total volume of material disposed of
- (c) the total radioactivity in the disposal operation as well as the total accumulated on each disposal plot at the time of spreading
- (d) the plot on which the soil was applied, and

APPENDIX J (Continued)

- (e) dose calculations or maximum allowable accumulated activity determinations required to demonstrate that the dose limits imposed on the land spreading operations have not been exceeded.

To ensure that the addition of the soil containing the radioactivity will not exceed the boundary conditions, the total radioactivity and dose calculation will include all past disposal operations of septic waste, Cooling Tower silt and soil/sand decay-corrected to the date of the latest spreading placed on the designated disposal plots. In addition, concentration limits applied to the disposal of earthen type materials (dry soil) restrict the placement of small volumes of materials that have relatively high radioactivity concentrations.

Any farmer leasing land used for the disposal of soil will be notified of the applicable restrictions placed on the site due to the spreading of low level contaminated material. These restrictions are the same as detailed for septic waste spreading as given in Reference 1.

The disposal operation of the soil piles will follow the applicable Vermont Yankee procedures to maintain doses as low as reasonably achievable and within the specific dose criteria as previously approved for septic and Cooling Tower silt waste disposal.

3.3 Disposal Plot Characteristics

All designated disposal sites (six different plots) are located on the Entergy Nuclear Northeast Vermont Yankee plant site and are within the site boundary security fence. The South field consists of approximately 1.9 acres and is centered approximately 1500 feet South of the Reactor Building. This field has been the only one of the NRC approved fields that has actually been utilized for this purpose to-date. It is anticipated that future disposal operations will also utilize the South field since sufficient margin in comparison to the approved dose limit criteria still exists for anticipated waste disposal of the existing backlog of soil now in storage, plus all expected future disposals of septic waste, Cooling Tower silt and soil / sand mixes assuming the same observed generation rates (see Tables 13 through 19) persist to the end of the plant license in 2013.

In addition to the South field, the north end of the site has an additional ten acre parcel centered approximately 2,000 feet northwest of the Reactor Building. Prior assessments have demonstrated that a single plot of about 2 acres is sufficient to meet routine or expected disposal needs. Therefore the northern site could be subdivided into 5 plots if additional capacity was needed.

3.4 Radiological Impact Methodology

The amount of radioactivity added to any of the disposal fields is procedurally controlled to insure that doses are maintained within the prior approved limits of the boundary conditions (see Section 1.0 above).

To assess the dose received (after the spreading of the existing 18,653 ft³ [528 m³] along with both past recorded disposal applications, plus projected future applications) by the maximally exposed individual during the period of plant control, and to an inadvertent intruder after plant control of access ends (reference year of 2013), the same pathway modeling, assumptions and dose calculation methods as approved for septic waste, Cooling Tower silt and past soil / sand disposals are used.

APPENDIX J (Continued)

These dose models implement the methods and dose conversion factors as provided in Regulatory Guide 1.109 (Reference 2).

The following six potential pathways were identified and included in the analysis:

- (a) Standing on contaminated ground,
- (b) Inhalation of resuspended radioactivity,
- (c) Ingestion of leafy vegetables,
- (d) Ingestion of stored vegetables,
- (e) Ingestion of meat, and
- (f) Ingestion of cow's milk

Both the maximum individual and inadvertent intruder are assumed to be exposed to these pathways, with the difference between them being the occupancy time. The basic assumptions used in the radiological analyses include:

- (a) Direct exposure to ground contamination and inhalation of resuspended radioactivity from the ground by movement of air is for a period of 104 hours per year during the Vermont Yankee active control of the disposal sites and continuous thereafter. The 104-hour interval is representative of a farmer's time spent on a plot of land (4 hours per week for 6 months). The resuspension factor for soil material on the ground back into the air is taken as $1.0E-05$ based on an assumption that the disposal field will display characteristics similar to semiarid grassland experimental results. [NUREG-75/014; WASH-1400, "Reactor Safety Study", Appendix VI, Table VI E-3; USNRC, October 1975]
- (b) For the purpose of projecting and illustrating the magnitude of dose impacts over the remaining life of the plant, it is assumed that future disposals of septic, silt and soil material will be placed annually on the same field at the annual average radioactivity levels observed for these waste streams over the past fourteen years. The future disposals will also consist of the annual average radioactivity content observed in the accumulated soil/sand materials collected over the last several years that involved site facility construction projects that has lead to the existing backlog. The maximum individual dose impact from the buildup of disposed material occurs at the same time (2013) for both the Control Period and Intruder scenarios.
- (c) For the analysis of the radiological impact during the Vermont Yankee active control of the disposal sites until 2013, no plowing is assumed to take place and all dispersed radioactive material remains on the surface forming a source of unshielded direct radiation.
- (d) The crop exposure time was changed from 2160 hours to 0 hours to reflect the condition that no radioactive material is dispersed directly on crops for human or animal consumption. Crop contamination is only through root uptake.
- (e) The deposition on crops of resuspended radioactivity is insignificant.

APPENDIX J (Continued)

- (f) Most of the pathway data and usage factors used in the analysis are the same as those used in the Vermont Yankee's ODCM assessment of off-site radiological impacts from routine releases. The fraction of stored vegetables grown on the contaminated land was conservatively increased from 0.76 to 1.0 (at present no vegetable crops for human consumption are grown on any of the approved disposal plots). Also, the soil exposure time to account for buildup was changed from the standard 15 years (given in Reference 2) to 1 year.
- (g) It is conservatively assumed that Vermont Yankee relinquishes control of the disposal sites after the current operating license expires in 2013 (i.e., the source term accumulated on a single disposal plot applies also for the inadvertent intruder at that time).
- (h) For the analysis of the impact after Vermont Yankee control of the site is relinquished, the radioactive material is plowed under and forms a uniform mix with the top six inches of the soil, but, nonetheless, undergoes resuspension in the air at the same rate as the unplowed surface contamination. However, for direct ground plane exposure the self-shielding due to the six-inch plow layer reduces the surface dose rate by about a factor of four.

As shown in Reference 1 (Appendix B) for the original analysis in septic waste, the liquid transport and exposure pathway was found to be an insignificant contributor to the dose. Restrictions on the placement of the disposal plots put them at significant distances from wet lands, potable well supplies, and surface waters (Connecticut River). Therefore, the liquid pathway is not considered in this analysis.

The dose models and methods used to generate deposition values and accumulated activity over the operating life of the plant are documented in Reference 1 (Appendixes B and F). Table 18 presents the radioactivity that currently exists on the South field after the last spreading event, which occurred on November 4, 2003. Table 18 also indicates the residual radioactivity that would remain on South field at the end of the plant operating period (2013) if no additional disposals were to take place.

11

J-14

APPENDIX J (Continued)

4.0 ASSUMPTIONS AND INPUTS

- 1) The volume of the accumulated soil / sand currently in storage between the Cooling Towers (as of December, 2003) was estimated from field measurements of length, width, height and general shape of each pile taken in 2003. The estimated volume of each pile is summarized on Table 1.
- 2) The radioactivity content of each pile was determined by averaging the numerous grab samples (typically 30 samples per pile) collected for characterization of the soil material collected. Appendixes A through F provide the individual results of positive analysis for plant related radionuclides. Laboratory analyses were performed either by Vermont Yankee or the AREVA-Framatome (formerly the Yankee Atomic / Duke Engineering) Environmental laboratory with samples counted with respect to the NRC environmental LLD requirements as indicated in the VY ODCM.
- 3) Appendix G provides the total accumulated radioactivity on the South disposal Plot (1.9 acres) decayed to the date of the last spreading of waste materials of November 4, 2003.
- 4) Dose Conversion Factors (DCF) specific to the land spreading of materials at Vermont Yankee were taken from the VY ODCM, Appendix F, Tables 11 and 12 (Reference 1). These DCF's were based on the same dosimetric models and input parameters as used in the original analysis of septic waste spreading at VY and which was approved by the NRC for inclusion in the ODCM as Appendix B. Section 3.2 of this calculation provides an outline of the key aspects of the dose model and assumptions used. The following (Tables 2 & 3) listing notes these site specific dose conversion factors for both the Control Period and the Intruder scenario for the nuclides detected as positive in one or more of the sample analyses.

Table 2
Site Specific Control Period Dose Conversion Factors

Isotope	Individual/Organ	Max Organ	Whole Body	Half-Life days	Decay Constant (λ) Yr ⁻¹
		DCF Control (mrem/yr- μ Cl/acre)	DCF Control (mrem/yr- μ Cl/acre)		
Mn-54	Adult/GI-LLI	3.75E-04	1.93E-04	3.125E+02	8.113E-01
Co-60	Teen/Lung	7.17E-04	5.31E-04	1.925E+03	1.315E-01
Zn-65	Child/Liver	1.64E-02	1.03E-02	2.438E+02	1.038E+00
Cs-134	Child/Liver	3.18E-03	1.28E-03	7.531E+02	3.356E-01
Cs-137	Child/Bone	2.66E-03	7.02E-04	1.102E+04	2.290E-02
Ce-141	Teen/Lung	1.54E-04	1.50E-05	3.250E+01	7.788E+00
Ce-144	Teen/Lung	6.00E-04	2.44E-05	284.6	8.888E-01

APPENDIX J (Continued)

Table 3
Site Specific Intruder Dose Conversion Factors

Isotope		Max Organ	Whole Body
		DCF Intruder	DCF Intruder
		(mrem/yr- μ Ci/acre)	(mrem/yr- μ Ci/acre)
Mn-54	Teen/Lung	1.02E-02	3.12E-03
Co-60	Teen/Lung	3.19E-02	9.09E-03
Zn-65	Child/Liver	1.89E-02	1.25E-02
Cs-134	Child/Liver	1.21E-02	9.36E-03
Cs-137	Child/Bone	6.98E-03	3.85E-03
Ce-141	Teen/Lung	1.21E-02	3.44E-04
Ce-144	Teen/Lung	5.00E-02	1.52E-03

5.0 EVALUATIONS

In order to demonstrate compliance with the boundary dose conditions as stated in the ODCM, the critical organ and whole body dose from all pathways to the maximally exposed individual during Vermont Yankee Control Period and to the Inadvertent Intruder (for time periods following the end of the current operating plant license scheduled for 2013) were calculated for several scenarios (case studies) or combinations of disposal options. The dose calculations were performed using the site-specific dose factors for detected radionuclides as presented in Tables 2 and 3 (obtained from the VY ODCM, Appendix F, Tables 11 and 12). The objective is to demonstrate that the addition of the existing soil/sand materials currently in storage will not cause the radiological dose limits for materials spread on the South disposal field to be exceeded, even if it is assumed that all projected future annual disposals of septic waste, cooling tower silt and excavated soils/roadway sand containing the observed historical levels of plant related radionuclides are also placed on the same disposal plot.

5.1 Case Study I (Past Spreading Impacts)

The first case study (Case I) evaluated the spreading related dose impact associated with the past septic, Cooling Tower silt and soil spreading activity only. Table 4 shows the annual history and total amount of radioactivity in septic, silt and soil/sand waste materials by radionuclide that has been spread on the South field for the past 14 years (last spreading on 11/4/03). These radioactivity disposal values were taken from the past spreading records. Using (multiplying) the dose conversion factors listed on Tables 2 and 3 along with the total accumulated radioactivity content on the South disposal plot as of the last waste spreading in 2003 as shown on Table 18, the committed dose impact is found on Tables 21 and 22 for the Control Period dose as of the last spreading on November 4, 2003, as well as the Intruder Dose projected to 2013 from all materials currently spread on the South disposal plot. This assessment assumes no other material is spread on the disposal plot in the future, and therefore represents the existing dose commitments from all past spreadings. This establishes the dose margin in comparison to the Control Period and Intruder dose limits still available for the South disposal plot.

5.2 Case Study II (Stored Soil/Sand Inventory Impacts)

The second case study (Case II) looks at the spreading dose impact (Control Period and the Intruder impact at the end of plant license) first from the radioactivity associated with the existing soil in storage (18,653 ft³ as indicated on Table 1) between the Cooling Towers, and then in combination with all past spreadings in order to demonstrate that the single south disposal plot can accommodate the current backlog of soil now being stored if it were all spread on top of all past disposals.

Table 18 indicates the total accumulated septic, silt and soil activity per radionuclide remaining on the disposal plot as of the last spreading (11/04/03), as well as decayed to the projected reference date (6/1/04) for the spreading of all existing soil being held in storage, and to the projected end of the current plant license in 2013.

Tables 8, 9, 10 and 11 provide the estimate of radioactivity content in each of the storage piles of soil/sand being held between the Cooling Towers for the detected nuclides Cs-137, Co-60, Zn-65, and Mn-54, respectively. The activity concentrations are based on multiple grab samples collected

APPENDIX J (Continued)

from each of the six separate storage piles, and are taken from the grab sample laboratory radiological analyses for each of the storage piles provided in Appendixes A through F. The average Cs-137 concentration in each of the soil piles was determined by including in the average the minimum detectable concentration (MDC) of each radionuclide because most of the samples indicated a positive concentration for Cs-137. This slightly biases the assessment towards a conservative upper bound estimate of the potential activity in the pile since the use of the MDC does not represent the existence of positive measured activity in the sample, but is treated as such. For the other detected radionuclides (Co-60, Zn-65 and Mn-54), this biasing of the data was not applied since the occurrence of positive values only represented a small fraction of the total number of samples taken. The total activity determination for each pile is then calculated by taking the average measured concentration times the measured soil density times the estimated volume of the storage pile, correcting for decay time between the date of the sample analysis date to the estimated date of field disposal (6/1/04). This calculated total radionuclide activity value for each pile is assumed to be placed on the single 1.9 acre South disposal plot with the resulting surface concentration (uCi/acre) for the projected disposal calculated for each pile and totaled for all six piles currently in storage. The estimated average concentration for each of the four detected radionuclides is decay corrected from the date of the sample collection to June 1, 2004, as the reference date for estimating dose impacts from the proposed disposal of the accumulated material in storage. Table 12 summarizes the radioactivity associated with the soil/sand in storage decayed to June 1, 2004, and to the estimated end of the current plant license in 2013 for determining the Intruder dose impact at that time. Table 20 combines the radioactivity content of all soil/sand materials stored between the Cooling Towers with all remaining activity previously spread on the South disposal plot, decayed to 2013 for use in determining the Intruder dose at the end of plant license.

Table 23 applies the dose conversion factors from Table 2 for maximum organ and whole body doses with the projected activity on the South disposal plot from Tables 12, 18 and 20 to find the Control Period dose for all past material spreadings, stored material additions, and the sum total of past spreadings and proposed stored material additions. Table 24 illustrates the same dose impact combination of waste streams as applied to the site Intruder at the end of plant license. The combination of all past spreadings and the current stored soil material results in a maximum organ dose of only 17.7 % (0.177 mrem/yr) of the 1 mrem/yr Control Period dose limit. The maximum Intruder organ dose is estimated to be 0.456 mrem/yr or 9.1% of the 5 mrem/yr Intruder scenario dose limit. For comparison, Table 25 indicates that the maximum organ dose during the Control Period from only the inventory of 18,653 ft³ of soil/sand is estimated to be 0.0526 mrem/yr, or 5.3% of the 1 mrem/yr dose limit.

5.3 Case Study III (Projected Future Spreading Impacts)

The third case study (Case III) projects what the likely annual spreading additions of earthen material from all sources (septic waste, Cooling Tower silt, soil/sand mixes) would be based on historical records, combined with the existing 18,653 ft³ (528 m³) of material in storage, in order to determine the long term acceptability of the South disposal plot to continue to be used for all waste spreading applications.

Based on the historical spreading data listed in Table 4, Tables 5, 6 and 7 show the total accumulated septic waste, Cooling Tower silt and soil/sand annual average field spreading surface concentrations by radionuclide and waste source, respectively. This data breakdown is used in this disposal case study to predict future disposal rates to be applied to the South disposal plot. Table 13 provides a

APPENDIX J (Continued)

summary of the buildup of future spreadings over time after 2004 from all three waste streams (Septic waste, Cooling Tower silt, and soil/sand mixes), which could be projected to accumulate on the South disposal plot by 2013. The annual disposal quantity for each waste stream is based on the average annual disposal quantity observed for each stream since on-site disposal was originally approved in 1990. The total of all three streams (septic waste, Cooling Tower silt, and soil/sand) is taken to be representative of the future generation rate for each year from 2004 until 2013. The last column of Table 13 indicates the decay corrected accumulated activity on the South disposal plot from only additions to the South field from all future waste earthen materials. Tables 14, 15 and 16 provide additional detail of the projected annual and accumulated materials by waste stream (i.e., sand/soil mix, Cooling Tower silt and septic waste). The buildup equation used in Tables 13 through 18 accounts for both annual additions to the field as well as decay over this in-growth period is given by:

$$Act_i(t) = Act_i(a) * (1 - E^{t-1}) / (1 - E)$$

Where:

- $Act_i(t)$ = the total activity of radionuclide "i" (uCi) remaining at the end of the buildup period, t (years).
- $Act_i(a)$ = the annual radioactivity addition of nuclide "i" to the disposal plot in uCi. The values for projected future additions are based on the annual average value observed for that nuclide for the specific disposal stream (i.e., septic waste, cooling tower slit, soil/sand).
- E = $\exp(-\lambda_i \Delta t)$
- λ_i = is the decay constant for the selected radionuclide "i" (1/year)
- Δt = time interval between applications = 1 year.

In addition, Case Study II above evaluated the radiological impact from the disposal of the existing inventory of soil projected for mid-year, 2004 (including all past waste spreading operations), the total impact for 2004 should also include a projected disposal of both septic waste and Cooling Tower silt from one year's operation. Table 17 combines one year's generation of both septage and silt for assumed spreading in 2004, plus subsequent decay to 2013.

Table 26 combines the site-specific dose conversion factors from Tables 2 and 3 for the Control Period and Intruder scenario, respectively, with all previously spread radioactivity on the South disposal plot (Table 18) with both the proposed disposal of the existing soil stored inventory (Table 12) and projected annual additions of earth type waste materials based on the observed average annual generation rate (Tables 13 through 17). Table 19 provides a summary of accumulated radioactivity on the South field from the past spreading, materials in storage and future annual disposals on the same plot out to the assumed end of plant license, which corresponds to the Intruder dose scenario time frame. The resulting doses to the maximum organ and whole body of the maximum individual at the end of plant license (Table 26) reflects the maximum expected impact from all past and future disposals being placed on the South disposal field.

6.0 RESULTS / CONCLUSIONS

The evaluation of the radiological impact of all past, accumulated storage inventory, and projected future waste spreading operations on the 1.9 acre South disposal plot have shown that the existing field is being operated within the previously approved dose limit criteria. The specific findings include:

1. For Case Study I (Past Spreading Impacts), Table 21 shows that after 14 years of spreading septic waste, Cooling Tower silt, and soil/sand mixes on the a single, 1.9 acre disposal plot the committed dose impact results in a maximum organ dose to a critical receptor (Control Period use) that accounts for only 13.7% of the 1 mrem/year limit. With respect to the Intruder dose limit of 5 mrem/year at the end of assumed active property control (i.e., end of plant license assumed for dose projection purposes), Table 22 indicates that all past spreadings through the end of 2003 account for only 7.2% of the maximum organ dose to the limiting receptor at the end of plant license. These finding illustrate that there is significant capacity remaining in the South disposal plot to continue to accept additional earthen materials that are suitable for land spreading without exceeding established dose limitations.
2. Table 23 shows that the impact from the projected spreading of the existing 18,653 ft³ of soil/sand material in storage is estimated to account for only 5.3% of the 1 mrem/year Control Period dose limit, or only 17.7% of the same limit when all past spreadings are combined with the materials currently in storage (as of the end of November 2003). The maximum Intruder organ dose from all past spreading and stored materials is calculated to be 0.456 mrem/yr (Table 24), or 9.1% of the 5 mrem/yr Intruder scenario dose limit. These results indicate that the existing inventory of waste materials in storage can be placed on the South disposal plot without exceeding dose impact limits previously established for a single disposal field, or using a significant proportion of the South disposal plot's capacity to receive additional materials for disposal in the future.
3. Assuming the same annual average generation rate of radioactivity in waste materials (septage/silt/soil) that has been observed over the last 14 years is added each year through 2013 to all past waste spreadings (including the stored soils inventory) already committed to the South disposal plot, Table 26 indicates that the projected dose at the end of the current plant licensing period (year 2013) yields a limiting maximum critical receptor dose (for either the control period or inadvertent intruder) equivalent to only 25.3% of the most restrictive annual dose limit (associated with the 1 mrem/year limit for the maximum organ during the Control Period). This finding demonstrates that the continued use of the South disposal plot, even with the addition of 18,653 ft³ of slightly contaminated soil currently in storage, will not exceed the approved limiting dose criteria established in the ODCM.
4. The approved dose impact methodology used to determine compliance with the on-site spreading dose limits are not driven by the volume of waste material disposed of, but by the total radioactivity content of the material that is spread over a fixed disposal plot area (1.9 acres for the South field). The dose modeling assumes that all radioactivity spread on the field remains in the top 15 cm surface layer of soil, even after subsequent additions are

APPENDIX J (Continued)

placed on the same field area. Existing limits on the concentration of radioactivity in waste media provides protection from small volumes of "hot" or high specific activity materials from being spread on the disposal field.

18

J-21

APPENDIX J (Continued)

Table 4

Record of Septic / Cooling Tower Silt / Construction Soil Radioactive Material Spreading
Each Year on the South Disposal Field

Year	Spreading Date	Material Type	Mn-54 (uCi/acre)	Co-60 (uCi/acre)	Zn-65 (uCi/acre)	Cs-134 (uCi/acre)	Cs-137 (uCi/acre)	Ce-141 (uCi/acre)
1990	10/31/90	Septage	0	3.89	0	0	0.28	0
	11/20/90	Septage	0.17	2.03	0.41	0	0.29	1.40E-08
1991		none	0	0	0	0	0	0
1992	10/19/92	Septage	0.11	1.73	0.52	0.05	0.32	0.006
1993	10/14/93	Septage	0.05	1.41	0.21	0	0.3	0
1994	08/14/94	Septage	0.08	0.43	0	0	0.09	0
1995	06/29/95	Septage	0	0.88	0	0	0	0
1996		none	0	0	0	0	0	0
1997	06/18/97	Septage	0.12	1	0	0	0.19	0
1998	07/30/98	Septage	0.14	0.72	0.09	0	0.12	0
	09/18/98	CT Silt	0	0	0	0	30.87	0
1999	07/15/99	Septage	0.11	1.47	0.2	0	0.25	0
2000	08/09/00	Septage*	0	0	0	0	0	0
	10/24/00	CT Silt	0.117	0.68	0	0	0	0
	10/24/00	Soil/Sand	0	0.602	0	0	3.698	0
2001	06-20-01	Septage	0	4.078	1.088	0	0.156	0.089
	09/25/01	Soil/Sand	0	0	0	0	1.4	0
2002	06/21/02	Septage	0.01	0.04	0	0.001	0.01	0
	11/11/02	Soil/Sand	0	0	0	0	1.37	0
2003	07/01/03	Septage	0	1.03	0	0	0	0
	10/25/03	Septage	0	0.12	0	0	0	0
	11/04/03	Soil/Sand	0	0	0	0	1.34	0
	11/04/03	CT Silt	0	0.256	0	0	0	0
Average Activity/yr (uCi/acre): (Over 14 year spreading history)			0.06	1.45	0.18	0.0036	2.90	0.01
Average activity (uCi/yr) disposed of on 1.9 acre field each year			0.123	2.76	0.342	0.007	5.52	0.013

* No radioactivity detected in septic waste samples.

J-12

APPENDIX J (Continued)

Table 5

Record of Septic Waste Only for Radioactive Material Spreading
Each Year on the South Disposal Field

Year	Spreading Date	Material Type	Mn-54 (uCi/acre)	Co-60 (uCi/acre)	Zn-65 (uCi/acre)	Cs-134 (uCi/acre)	Cs-137 (uCi/acre)	Ce-141 (uCi/acre)
1990	10/31/90	Septage	0	3.89	0	0	0.28	0
	11/20/90	Septage	0.17	2.03	0.41	0	0.29	1.40E-08
1991		none	0	0	0	0	0	0
1992	10/19/92	Septage	0.11	1.73	0.52	0.05	0.32	0.008
1993	10/14/93	Septage	0.05	1.41	0.21	0	0.3	0
1994	08/14/94	Septage	0.08	0.43	0	0	0.09	0
1995	06/29/95	Septage	0	0.88	0	0	0	0
1996		none	0	0	0	0	0	0
1997	06/18/97	Septage	0.12	1	0	0	0.19	0
1998	07/30/98	Septage	0.14	0.72	0.09	0	0.12	0
1999	07/15/99	Septage	0.11	1.47	0.2	0	0.25	0
2000	08/09/00	Septage*	0	0	0	0	0	0
2001	06-20-01	Septage	0	4.078	1.088	0	0.156	0.089
2002	06/21/02	Septage	0.01	0.04	0	0.001	0.01	0
2003	07/01/03	Septage	0	1.03	0	0	0	0
	10/25/03	Septage	0	0.12	0	0	0	0
Average Activity/yr (uCi/acre): (Over 14 year spreading history)			0.06	1.34	0.18	0.004	0.14	0.01
Average activity (uCi/yr) disposed of on 1.9 acre field each year			0.107	2.56	0.342	0.007	0.27	0.013

* No radioactivity detected in septic waste samples.

T-23

APPENDIX J (Continued)

Table 6

Record of Cooling Tower Silt Waste Only for Radioactive Material Spreading
Each Year on the South Disposal Field

Year	Spreading Date	Material Type	Mn-54 (uCi/acre)	Co-60 (uCi/acre)	Zn-65 (uCi/acre)	Cs-134 (uCi/acre)	Cs-137 (uCi/acre)	Ce-141 (uCi/acre)
1998	09/18/98	Silt	0	0	0	0	30.87	0
2000	10/24/00	Silt	0.117	0.68	0	0	0	0
2003	11/04/03	Silt	0	0.256	0	0	0	0
Average Activity/yr (uCi/acre) (31 year silt generation history)			0.004	0.030	0.000	0.000	0.996	0.000
Average activity (uCi/yr) disposed of on 1.9 acre field			0.007	0.057	0.000	0.000	1.892	0.000

Note: Cooling Tower yearly average is over 31 years of operation since the first disposal in 1998 included all accumulated material since plant startup

Table 7

Record of Construction Soil/Sand Waste Only for Radioactive Material Spreading
Each Year on the South Disposal Field

Year	Spreading Date	Material Type	Mn-54 (uCi/acre)	Co-60 (uCi/acre)	Zn-65 (uCi/acre)	Cs-134 (uCi/acre)	Cs-137 (uCi/acre)	Ce-141 (uCi/acre)
2000	10/24/00	Soil/Sand	0	0.602	0	0	3.698	0
2001	09/25/01	Soil/Sand	0	0	0	0	1.4	0
2002	11/11/02	Soil/Sand	0	0	0	0	1.37	0
2003	11/04/03	Soil/Sand	0	0	0	0	1.34	0
Average Activity/yr (uCi/acre):			0.00	0.15	0.00	0.00	1.95	0.00
Average activity (uCi/yr) disposed of on 1.9 acre field per year			0.00	0.29	0.00	0.00	3.71	0.00

Note: Soil/ road sand yearly average is over only the 4 years of operation since that is the period of material collection.

Table 8

Cesium -137 in storage Piles after Last Spreading 2003*
 Activity decayed to 09/01/04

Pile description	Estimated Volume ft ³	Date of Analysis	Decay time to 9/1/04 years	Aver. Cs-137 Conc.(w/LLD) No decay uCi/gm	Measured density gm/cc	Total Cs-137 (decayed) (w/LLD) uCi	Aver. Cs-137 Conc.(w/LLD) decayed uCi/gm	Cs-137 applied to 1.9 acre field uCi/acre	% Cs-137 of total
2002-01: Security Fence Upgrade	4,679	05/06/02	2.08	7.12E-08	1.07	9.62E+00	6.79E-08	5.07E+00	31.48%
2002-02: Security Fence Upgrade	9,000	06/04/02	2.00	4.18E-08	1.11	1.13E+01	3.99E-08	5.94E+00	36.95%
Park Lot Sweep (inside protected area)	616	11/02/01	2.58	4.80E-08	1.56	1.23E+00	4.52E-08	6.48E-01	4.03%
2001 HWC Soils Excavation	931	10/22/01	2.58	5.41E-08	1.057	1.42E+00	5.10E-08	7.48E-01	4.65%
1996 Remnants(mixed contam. + non-cont)	970	04/13/95	8.13	9.22E-08	1.7	3.57E+00	7.66E-08	1.88E+00	11.89%
2002-03 Security Fence Chunks & soil mix	2,457	12/16/02	1.54	4.11E-08	1.24	3.42E+00	3.97E-08	1.80E+00	11.20%
totals =	18,653			Average = 5.81E-08	total =	3.06E+01	5.34E-08	1.61E+01	100.00%

* Note: Soil analysis data provided in Appendixes A through F.

Table 9

Cobalt -60 in Storage Piles after Last Spreading in 2003*
Activity decayed to 06/01/04

Pile description	Estimated Volume ft ³	Date of Analysis	Decay time to 6/1/04 years	Aver. Co-60 Conc., no decay uCi/gm	Measured density gm/cc	Total Co-60 (decayed) uCi	Aver. Co-60 Conc., decayed uCi/gm	Co-60 applied to 1.9 acre field uCi/acre	% Co-60 of total
2002-01: Security Fence Upgrade	4,679	05/08/02	2.08	0.00E+00	1.07	0.00E+00	0.00E+00	0.00E+00	0.00%
2002-02: Security Fence Upgrade	9,000	06/04/02	2.00	0.00E+00	1.11	0.00E+00	0.00E+00	0.00E+00	0.00%
Park Lot Sweep (inside protected area)	616	11/02/01	2.58	8.72E-09	1.56	1.89E-01	8.22E-09	8.80E-02	0.00%
2001 HWC Soils Excavation	931	10/22/01	2.58	0.00E+00	1.057	0.00E+00	0.00E+00	0.00E+00	33.01%
1998 Remnantis(mixed contam. + non-cont)	870	04/13/85	8.13	2.14E-08	1.7	3.43E-01	1.78E-08	1.81E-01	0.00%
2002-03 Security Fence Chunks & soil mix	2,457	12/16/02	1.54	0.00E+00	1.24	0.00E+00	0.00E+00	0.00E+00	66.99%
totals =	18,653		average =	5.02E-09	total =	5.12E-01	4.33E-09	2.70E-01	100.00%

* Note: Soil analysis data provided in Appendixes A through F.

J-26

Table 10

Zinc -65 in Storage Piles after Last Spreading in 2003*

Activity decayed to 06/01/04

Pile description	Estimated Volume ft ³	Date of Analysis	Decay time to 6/1/04 years	Aver. Zn-65 Conc., no decay uCi/gm	Measured density gm/cc	Total Zn-65 (decayed) uCi	Aver. Zn-65 Conc., decayed uCi/gm	Zn-65 applied to 1.9 acre field uCi/acre	% Zn-65 of total
2002-01: Security Fence Upgrade	4,679	05/06/02	2.08	0.00E+00	1.07	0.00E+00	0.00E+00	0.00E+00	0.00%
2002-02: Security Fence Upgrade	9,000	06/04/02	2.00	3.87E-08	1.11	1.05E+00	3.70E-08	5.50E-01	95.04%
Park Lot Sweep (inside protected area)	616	11/02/01	2.58	0.00E+00	1.56	0.00E+00	0.00E+00	0.00E+00	0.00%
2001 HWC Soils Excavation	831	10/22/01	2.58	2.08E-08	1.057	5.46E-02	1.98E-08	2.87E-02	4.96%
1996 Remnants(mixed contam. + non-cont)	970	04/13/85	8.13	0.00E+00	1.7	0.00E+00	0.00E+00	0.00E+00	0.00%
2002-03 Security Fence Chunks & soil mix	2,457	12/18/02	1.54	0.00E+00	1.24	0.00E+00	0.00E+00	0.00E+00	0.00%
totals =	18,653		Average =	9.92E-10	total =	1.10E+00	9.43E-10	5.78E-01	100.00%

* Note: Soil analysis data provided in Appendixes A through F.

J-20

Table 11

Mn-54 in Storage Piles after Last Spreading in 2003* Activity decayed to 06/01/04

Pile description	Estimated Volume ft ³	Date of Analysis	Decay time to 6/1/04 years	Aver. Mn-54 Conc., no decay uCi/gm	Measured density gm/cc	Total Mn-54 (decayed) uCi	Aver. Mn-54 Conc., decayed uCi/gm	Mn-54 applied to 1.9 acre field uCi/acre	% Mn-54 of total
2002-01: Security Fence Upgrade	4,879	05/06/02	2.08	2.08E-09	1.07	2.82E-01	1.99E-08	1.49E-01	68.78%
2002-02: Security Fence Upgrade	9,000	06/04/02	2.00	0.00E+00	1.11	0.00E+00	0.00E+00	0.00E+00	0.00%
Park Lot Sweep (inside protected area)	616	11/02/01	2.58	4.77E-09	1.56	1.22E-01	4.50E-08	8.44E-02	30.22%
2001 HWC Soils Excavation	931	10/22/01	2.58	0.00E+00	1.057	0.00E+00	0.00E+00	0.00E+00	0.00%
1996 Remnants (mixed contam. + non-cont)	970	04/13/85	8.13	0.00E+00	1.7	0.00E+00	0.00E+00	0.00E+00	0.00%
2002-03 Security Fence Chunks & soil mix	2,457	12/16/02	1.54	0.00E+00	1.24	0.00E+00	0.00E+00	0.00E+00	0.00%
totals =	18,853		Averages=	1.14E-09	total =	4.05E-01	1.08E-08	2.13E-01	100.00%

* Note: Soil analysis data provided in Appendixes A through F.

J-19

APPENDIX J (Continued)

Table 12

Soil/Sand in Storage Total Activity to be spread on 6/1/04 and decayed to 2013

Isotope	lambda 1/yr	As of 6/1/04 Qa (uCi/acre)*	Decay Time to 6/1/2013 (yrs)	As of 2013 Qa (uCi/acre)
Mn-54	0.8113	0.213	9	1.44E-04
Co-60	0.1315	0.270	9	8.27E-02
Zn-65	1.0382	0.579	9	5.07E-05
Cs-134	0.3356	0.000	9	0.00E+00
Cs137	0.0229	16.1	9	1.31E+01
Ce-141	7.7883	0.000	9	0.00E+00

* Note: Qa values from Table 8 (Cs-137), Table 9 (Co-60), Table 10 (Zn-65), and Table 11 (Mn-54)

Table 13

Projection of Additional Septic, silt, and soil/sand at Current Generation Rates to 2013

Isotope	lambda 1/yr	Annual Septic Addition Qa (uCi/acre)	Annual Silt Addition Qa (uCi/acre)	Annual Soil/Sand Addition Qa (uCi/acre)	Annual Total Additions Qa (uCi/acre)	Additional Accumulation at end of 9 years Qe (uCi/acre)
Mn-54	0.8113	0.056	0.0038	0.043	0.103	0.185
Co-60	0.1315	1.345	0.0302	0.174	1.549	8.183
Zn-65	1.0382	0.180	0.0000	0.116	0.296	0.458
Cs-134	0.3356	0.004	0.0000	0.000	0.004	0.012
Cs137	0.0229	0.142	0.9958	4.782	5.919	43.767
Ce-141	7.7883	0.007	0.0000	0.000	0.007	0.007

J-29

APPENDIX J (Continued)

Table 14
 Projection of Additional Sand/Soil Mix
 At Historical Generation Rates To Year 2013 (9 years after 2004)

Isotope	lamda 1/yr	Projected Annual Soil/Sand Additions to Field	Accumulated Sand/Soil at end of 9 years
		Qa (uCi/acre)	Qe (uCi/acre)
Mn-54	0.8113	4.26E-02	7.65E-02
Co-60	0.1315	1.74E-01	9.21E-01
Zn-65	1.0382	1.16E-01	1.79E-01
Cs-134	0.3356	0.00E+00	0.00E+00
Cs137	0.0229	4.78E+00	3.54E+01
Ce-141	7.7883	0.00E+00	0.00E+00

Table 15
 Projection of Additional Cooling Tower (CT) Silt
 At Historical Generation Rates To Year 2013 (9 years after 2004)

Isotope	lamda 1/yr	Projected Annual CT Silt Additions to Field	Accumulated CT Silt at end of 9 years
		Qa (uCi/acre)	Qe (uCi/acre)
Mn-54	0.8113	3.77E-03	6.78E-03
Co-60	0.1315	3.02E-02	1.59E-01
Zn-65	1.0382	0.00E+00	0.00E+00
Cs-134	0.3356	0.00E+00	0.00E+00
Cs137	0.0229	9.96E-01	7.36E+00
Ce-141	7.7883	0.00E+00	0.00E+00

Table 16
 Projection of Additional Septic Waste
 At Historical Generation Rates To Year 2013 (9 years after 2004)

Isotope	lamda 1/yr	Projected Annual Septic Additions to Field	Accumulated Septic Waste at end of 9 years
		Qa (uCi/acre)	Qe (uCi/acre)
Mn-54	0.8113	5.64E-02	1.01E-01
Co-60	0.1315	1.34E+00	7.10E+00
Zn-65	1.0382	1.80E-01	2.78E-01
Cs-134	0.3356	3.64E-03	1.19E-02
Cs137	0.0229	1.42E-01	1.05E+00
Ce-141	7.7883	6.79E-03	6.79E-03

J-30

APPENDIX J (Continued)

Table 17

Projected 1 Yr Septage + Silt Spreading for 6/1/04 and decayed to 2013

Isotope	lamda 1/yr	As of 6/1/04 Qa (uCi/acre)	Decay Time to 6/1/2013	As of 2013 Qa (uCi/acre)
Mn-54	0.8113	0.060	9	4.06E-05
Co-60	0.1315	1.375	9	4.21E-01
Zn-65	1.0382	0.180	9	1.57E-05
Cs-134	0.3356	0.004	9	1.78E-04
Cs137	0.0229	1.138	9	9.26E-01
Ce-141	7.7883	0.007	9	2.45E-33

Table 18

Current Total Spreadings as of 11/4/03 and How much Remains at 6/1/04 and 2013

Isotope	lamda 1/yr	As of 11/4/03 Qa (uCi/acre)*	Decay Time to 6/1/04 (yrs)	As of 6/1/04 Qa (uCi/acre)	Decay Time to 2013 (yrs)	As of 2013 Qa (uCi/acre)
Mn-54	0.8113	0.241	0.5753	0.151	9	1.02E-04
Co-60	0.1315	16.33	0.5753	15.140	9	4.64
Zn-65	1.0382	1.47	0.5753	0.809	9	7.08E-05
Cs-134	0.3356	0.00063	0.5753	0.001	9	2.53E-05
Cs137	0.0229	38.18	0.5753	37.68	9	30.66
Ce-141	7.7883	8.80E-10	0.5753	1.0E-11	9	3.60E-42

* Data Taken from Plant Disposal
Records

APPENDIX J (Continued)

Table 19

Current Spreading Totals Plus Total Projected Future Spreadings to 2013

	Current Field Act. Decayed to 2013*	Stored Soil/sand Decayed to 2013**	1 Yr Septage+silt Decayed to 2013***	All Future Spreading Decayed to 2013****	Total all Activity Decayed to 2013
Isotope	(uCi/acre)	(uCi/acre)	(uCi/acre)	(uCi/acre)	(uCi/acre)
Mn-54	1.02E-04	1.44E-04	4.06E-05	0.185	1.85E-01
Co-60	4.636	8.27E-02	0.421	8.183	1.33E+01
Zn-65	7.08E-05	5.07E-05	1.57E-05	0.458	4.58E-01
Cs-134	2.53E-05	0.00E+00	1.78E-04	0.012	1.21E-02
Cs-137	30.66	13.10	0.926	43.767	8.85E+01
Ce-141	3.60E-42	0.00E+00	2.45E-33	0.007	6.79E-03

- Notes: * Activity Concentration from Table 18.
 ** Activity Concentration from Table 12.
 *** Activity Concentration from Table 15, 16 and 17.
 **** Activity Concentration from Table 13 and 14.

Table 20

Radioactivity Content from Existing Materials (Past Spreadings & Stored Materials Only)

End Plant Operations for Intruder Dose:
 End Date 6/1/2013 Last Application Date 6/1/2004

Decay duration to end of Plant
 Operations: 9 years

Isotope	Total Activity on South Field plus storage piles (uCi/acre)* (6/1/04)	Total Activity decayed to year 2013 (uCi/acre)	Past Material Spread only up to 11/4/03 decayed to 2013 (uCi/acre)	Stored Material to be Spread decayed to 2013 (uCi/acre)	Total Past + Current Material decayed to 2013 (uCi/acre)
Mn-54	0.364	2.46E-04	1.02E-04	1.44E-04	2.46E-04
Co-60	15.41	4.72E+00	4.64E+00	8.27E-02	4.72E+00
Zn-65	1.388	1.21E-04	7.08E-05	5.07E-05	1.21E-04
Cs-134	0.001	2.53E-05	2.53E-05	0.00E+00	2.53E-05
Cs-137	53.78	4.38E+01	3.06E+01	1.31E+01	4.38E+01
Ce-141	1.0E-11	3.60E-42	3.60E-42	0.00E+00	3.60E-42

* Includes all material spread as of 11/4/03 decay corrected to the indicated date.

J-32

APPENDIX J (Continued)

Table 21
 Past Spreading Control Period Doses
 As of 11/04/03
 (No Stored Material or Future Additions Included)

Isotope	Total Activity Remaining on South Field as of 11/04/03 uCi/acre	Max Organ Existing Material from Past Spreading Mrem/year	Whole Body Existing Material from Past Spreading Mrem/year
Mn-54	0.241	9.04E-05	4.65E-05
Co-60	16.33	1.17E-02	8.67E-03
Zn-65	1.47	2.41E-02	1.51E-02
Cs-134	0.00063	2.00E-06	8.06E-07
Cs-137	38.18	1.02E-01	2.68E-02
Ce-141	8.8E-10	1.36E-13	1.32E-14
	Total Dose = Dose Limit per field = % of Dose limit	1.37E-01 1 13.7%	5.07E-02 1 5.1%

Table 22
 Past Spreading Intruder Period Doses
 At End of Plant License in 2013
 (No Stored Material or Future Additions Included after 11/4/03)

Isotope	Total Activity Remaining on South Field as of 11/04/03 uCi/acre	Total Activity Remaining on South Field decayed corrected to 2013 uCi/acre	Max Organ Existing Material from Past Spreading Mrem/year	Whole Body Existing Material from Past Spreading Mrem/year
Mn-54	0.241	1.02E-04	1.04E-06	3.18E-07
Co-60	16.33	4.636	1.48E-01	4.21E-02
Zn-65	1.47	7.08E-05	1.34E-06	8.85E-07
Cs-134	0.00063	2.53E-05	3.07E-07	2.37E-07
Cs-137	38.18	30.66	2.14E-01	1.18E-01
Ce-141	8.8E-10	3.60E-42	4.36E-44	1.24E-45
		Total Dose = Dose Limit per field = % of Dose limit	3.62E-01 5 7.2%	1.60E-01 5 3.2%

J-33

APPENDIX J (Continued)

Table 23
Control Period Dose: Past
Spreading & Current Stored Soil
Inventory (as of 6/1/04)

Isotope	Max Organ Existing Material from Past Spreading Mrem/year	Whole Body Existing Material from Past Spreading Mrem/year	Max Organ Stored Material to be Spread Mrem/year	Whole Body Stored Material to be Spread Mrem/year	Max Organ All Past Spreading Plus Stored Inventory Mrem/year	Whole Body All Past Spreading Plus Stored Inventory Mrem/year
Mn-54	5.67E-05	2.92E-05	7.99E-05	4.11E-05	1.37E-04	7.03E-05
Co-60	1.09E-02	8.04E-03	1.94E-04	1.43E-04	1.10E-02	8.18E-03
Zn-65	1.33E-02	8.33E-03	9.50E-03	5.96E-03	2.28E-02	1.43E-02
Cs-134	1.65E-08	6.65E-07	0.00E+00	0.00E+00	1.65E-08	6.65E-07
Cs-137	1.00E-01	2.65E-02	4.28E-02	1.13E-02	1.43E-01	3.78E-02
Ce-141	1.54E-15	1.50E-16	0.00E+00	0.00E+00	1.54E-15	1.50E-16
Total Dose = Dose Limit per field = % of Dose limit	1.24E-01 1 12.4%	4.29E-02 1 4.3%	6.26E-02 1 6.3%	1.75E-02 1 1.7%	1.77E-01 1 17.7%	6.03E-02 1 6.0%

Table 24
Past Spreading & Stored Soil Inventory (No Future Additions)
Intruder Dose at End of Plant License in 2013

Isotope	Max Organ Existing Material from Past Spreading Mrem/year	Whole Body Existing Material from Past Spreading Mrem/year	Max Organ Stored Material to be Spread Mrem/year	Whole Body Stored Material to be Spread Mrem/year	Max Organ All Past Spreading Plus Stored Inventory Mrem/year	Whole Body All Past Spreading Plus Stored Inventory Mrem/year
Mn-54	1.04E-06	3.18E-07	1.47E-06	4.48E-07	2.50E-06	7.66E-07
Co-60	1.48E-01	4.21E-02	2.64E-03	7.52E-04	1.51E-01	4.29E-02
Zn-65	1.34E-08	8.85E-07	9.58E-07	6.33E-07	2.30E-08	1.52E-06
Cs-134	3.07E-07	2.37E-07	0.00E+00	0.00E+00	3.07E-07	2.37E-07
Cs-137	2.14E-01	1.18E-01	9.14E-02	5.04E-02	3.05E-01	1.68E-01
Ce-141	4.36E-44	1.24E-45	0.00E+00	0.00E+00	4.36E-44	1.25E-45
Total Dose = Dose Limit per field = % of Dose limit	3.62E-01 5 7.2%	1.60E-01 5 3.2%	9.41E-02 5 1.9%	5.12E-02 5 1.0%	4.56E-01 5 9.1%	2.11E-01 5 4.2%

Table 25
Dose Impact from Spreading of Current Inventory of Stored Material Only*

isotope	Total Stored Waste Activity As of 06/01/04** (uCi/acre)	Max Organ Control (06/01/04) mrem/year	Whole Body Control (06/01/04) mrem/year	Max Organ Intruder (2013) mrem/year	Whole Body Intruder (2013) mrem/yr	% Contribution Max organ by isotope Intruder Dose	% Contribution Max organ by isotope Control Period Dose
Mn-54	2.13E-01	7.98E-05	4.11E-05	1.47E-06	4.48E-07	0.00%	0.032%
Co-60	2.70E-01	1.94E-04	1.43E-04	2.64E-03	7.52E-04	0.25%	0.077%
Zn-65	5.78E-01	9.50E-03	5.96E-03	9.58E-07	6.33E-07	0.00%	3.760%
Cs-134	0.00E+00	0.00E+00	0.00E+00	0.00E+00	0.00E+00	0.00000%	0.00000%
Cs-137	1.61E+01	4.28E-02	1.13E-02	9.14E-02	5.04E-02	8.7%	17.0%
Ce-141	0.00E+00	0.00E+00	0.00E+00	0.00E+00	0.00E+00	0.00000%	0.00000%
Ce-144	0.00E+00	0.00E+00	0.00E+00	0.00E+00	0.00E+00	0.00000%	0.00000%
	Total Dose =	5.28E-02	1.75E-02	9.41E-02	5.12E-02	8.6%	20.8%
	Dose Limit ^a	1	1	5	5		
	% of Dose Limit	5.3%	1.7%	1.9%	1.0%		

* Includes only Stored soil/sand materials collected as of end of 2003 (See Table 1)
 ** Total Activity values from Table 12.

J-35

APPENDIX J (Continued)

Table 26

Past, Stored Materials and Projected Future Disposal (all septage/silt and soils) Doses at End of Plant License*

Isotope	Total Waste Activity	Max. Organ	Whole Body	Max. Organ	Whole Body	% Contribution Max organ by isotope Intruder Dose	% Contribution Max organ by isotope Control Period Dose
	In 2013** (uCi/acre)	Control mrem/year	Control mrem/year	Intruder mrem/year	Intruder mrem/yr		
Mn-54	1.85E-01	6.94E-05	3.57E-05	1.89E-03	5.77E-04	0.18%	0.027%
Co-60	1.33E+01	9.54E-03	7.06E-03	4.24E-01	1.21E-01	40.30%	3.776%
Zn-65	4.58E-01	7.51E-03	4.72E-03	8.66E-03	5.73E-03	0.82%	2.974%
Cs-134	1.21E-02	3.85E-05	1.55E-05	1.46E-04	1.13E-04	0.0139%	0.0152%
Cs-137	8.85E+01	2.35E-01	6.21E-02	6.18E-01	3.41E-01	58.7%	93.2%
Ce-141	6.79E-03	1.05E-06	1.02E-07	8.22E-05	2.34E-06	0.0078%	0.0004%
Ce-144	0.00E+00	0.00E+00	0.00E+00	0.00E+00	0.00E+00	0.0000%	0.0000%
	Total Dose =	2.53E-01	7.40E-02	1.05E+00	4.68E-01	100.0%	100.0%
	Dose Limit =	1	1	5	5		
	% of Dose Limit	25.3%	7.4%	21.1%	9.4%		

* Includes all past spreadings, soil stored Between Cooling Towers (as of 11/4/03), and all annual projected additions of septage/silt/soil.

** Total Activity values from last column of Table 19.

J-36

APPENDIX J (Continued)

REFERENCES

- (1) Vermont Yankee Off site Dose Calculation Manual (ODCM), Revision 30, including the following appendixes:
 - (i) Appendix B, "Approval of Criteria for Disposal of Slightly Contaminated Septic Waste On-Site at Vermont Yankee" (Included NRC approval letter dated August 30, 1989, VY request for approval dated June 28, 1989 with Attachments I and II.)
 - (ii) Appendix F, "Approval Pursuant to 10CFR20.2002 For Onsite Disposal of Cooling Tower Silt" (Included NRC approval letter dated March 4, 1996, VY Request for Approval dated August 30, 1995.)
 - (iii) Appendix H, "Request to Amend Previous Approvals Granted Under 10CFR20.302(a) for Disposal of Contaminated Septic Waste and Cooling Tower Silt to Allow for Disposal of Contaminated Soil" dated June 23, 1999, with supplements dated January 4, 2000, and June 15, 2000.
- (2) USNRC Regulatory Guide 1.109, Rev.1; "Calculation of Annul Doses to Man from Routine Releases of Reactor Effluents for the Purpose of Evaluating Compliance with 10 CFR Part 40, Appendix I," dated October 1997.

APPENDIX J (Continued)

Appendix A

Security Fence Upgrade
Soil
Pile #2002-01

Sample location #	Soil Analysis Data			Density from samples data	
	Cs137 detected (uCi/gm)	Cs-137 LLD reported (uCi/gm)	Mn-54 detected (uCi/gm)	Volume (cc)	wet weight (gm)
3B	5.76E-08			1200	1266
3F	1.16E-07			1200	1062
4A	7.76E-08			1200	1393
4B	5.62E-08			1200	1512
4D	4.81E-08			1200	1483
4F	1.15E-07			1200	1137
5A	6.95E-08			1200	1390
5D	1.84E-07			1200	1194
5F	1.72E-07		5.86E-08	1200	1051
1A		3.93E-08		1200	985
1B		5.97E-08		1200	1335
1C		2.92E-08		1200	1188
1D		7.39E-08		1200	1355
1E		3.65E-08		1200	1686
1F	4.18E-08			1200	1294
2A		6.83E-08		1200	1240
2B		8.53E-08		1200	1043
2C		4.88E-08		1200	1171
2D		4.16E-08		1200	1420
2E		3.43E-08		1200	1304
2F		4.75E-08		1200	1360
3A		8.35E-08		1200	1189
3C	9.59E-08			1200	1348
3E	5.65E-08			1200	1073
4C		4.44E-08		1200	1486
4E		9.37E-08		1200	1057
5B		7.23E-08		1200	1428
5C	4.53E-08			1200	1551

Wt Positive Ave. =	4.06E-08	averages	1200	1285.75
		Density	1.07	gm/cc
Positive & LLD ave. =	7.12E-08	Density	1071.46	kg/m3

A-1

J-38

APPENDIX J (Continued)

Appendix B

Security Fence Upgrade Soil
Pile # 2002-02

Soil Analysis data

Density from Sample
Data

Sample location #	Cs137 detected (uCi/gm)	Cs-137 LLD reported (uCi/gm)	Zn-65 detected (uCi/gm)	Volume (ml)	wet weight (gm)
A3	3.98E-08			1200	1388
A4		6.93E-08		1200	1221
A5		4.53E-08		1200	1278
A6		4.69E-08		1200	1249
A7		4.04E-08		1200	1335
A8		7.29E-08		1200	1274
B1		4.06E-08	7.73E-08	1200	1392
B2		3.02E-08		1200	1404
B3		4.08E-08		1200	1313
B4		3.34E-08		1200	1230
B5		3.38E-08		1200	1241
B6	2.13E-08			1200	1299
B7		4.24E-08		1200	1297
B8		3.73E-08		1200	1475
C3		3.90E-08		1200	1696
C4		4.25E-08		1200	1329
C5	4.06E-08			1200	1318
C6		4.14E-08		1200	1230
C7		4.60E-08		1200	1335
D7		3.22E-08		1200	1294

wtd positive ave. 5.09E-09 average 1200 1329.9

Positive & LLD ave. = 4.18E-08 density 1.11 gm/cc
1108.25 kg/m3

B-1

J-39

APPENDIX J (Continued)

Appendix C

Security Fence Upgrade
Soil
Pile # 2002-03

Sample location #	Soil Analysis Data		Density from samples data	
	Cs137 detected (uCi/gm)	Cs-137 LLD reported (uCi/gm)	Volume (ml)	Wet weight (gm)
1		3.00E-08	1000	1348
2		3.46E-08	1100	1424
3		2.58E-08	1100	1410
4		3.72E-08	1100	1410
5	3.84E-08		1000	1034
6		4.58E-08	1200	1108
7		3.14E-08	1000	1526
8		4.29E-08	1000	1532
9		5.42E-08	1000	1086
10		5.00E-08	1000	1289
11		5.68E-08	1000	1185
12		4.62E-08	1000	1135

wt positive aver. =	3.2E-09	average density	1041.67	1290.58
			1.24	gm/cc
Positive & LLD ave. =	4.11E-08		1238.96	kg/m3

C-1

J-40

APPENDIX J (Continued)

Appendix D

2001 Protected Area Road Sweeping Pile

Soil Analysis Data

Density from Sample Data

Sample location #	Cs137 detected (uCi/gm)	Cs-137 LLD reported (uCi/gm)	Co-60 detected (uCi/gm)	Co-60 LLD reported (uCi/gm)	Mn-54 detected (uCi/gm)	Density from Sample Data	
						Volume (ml)	wet weight (gm)
1	6.55E-08			5.36E-08		1000	1435
2		3.43E-08		4.24E-08		1100	1753
3		2.91E-08		3.03E-08		1000	1550
4		4.83E-08		4.95E-08		1000	1615
5		6.37E-08		7.83E-08		1000	1657
6		3.67E-08		4.10E-08		1000	1609
7	1.96E-08		3.13E-08			1000	1565
8						1000	1650
9	3.11E-08			2.26E-08		1000	1439
10	6.09E-08		6.05E-08			1005	1762
11	4.07E-08		4.63E-08			1000	1421
12	4.75E-08			2.35E-08	1.23E-08	1000	1454
13	7.14E-08			4.30E-08		1000	1561
14	4.04E-08			3.22E-08		1000	1659
15		6.65E-08		6.47E-08	5.92E-08	1000	1503
16	4.20E-08			3.73E-08		1000	1607
17	4.69E-08			3.13E-08		1000	1536
18	5.05E-08			6.21E-08		1000	1594
19	5.45E-08			5.59E-08		1000	1474
20	6.25E-08		3.62E-08		2.38E-08	1000	1427
wt positive ave. =	3.17E-08		8.72E-09		4.77E-09	average	1005.2 1563.5
Positive & LLD ave. =		4.80E-08		4.43E-08		density	1.56 gm/cc 1555.4 kg/m3

D-1

J-41

APPENDIX J (Continued)

Appendix E
2001 HWC Soil Excavations

Sample location #	Soil Analysis Data		Zn-65 detected (uCi/gm)	Density from Sample data	
	Cs137 detected (uCi/gm)	Cs-137 LLD reported (uCi/gm)		Volume (ml)	wet weight (gm)
1	4.09E-08			1000	1099
2		6.11E-08		1000	1043
3	6.04E-08			1000	1007
4	4.78E-08			1000	1008
5		5.30E-08		1000	1103
6		5.77E-08		1000	1025
7		5.94E-08		1000	956
8	4.75E-08			1000	957
9	5.05E-08			1000	976
10		6.16E-08		1000	1050
11		5.54E-08		1000	1043
12		6.50E-08		1000	1126
13	3.44E-08			1000	1141
14	5.67E-08			1000	997
15		5.26E-08		1000	1105
16		5.80E-08		1000	1190
17		5.58E-08	na	1000	1040
18		5.29E-08		1000	1141
19		5.85E-08		1000	1050
20	5.20E-08			1000	1073
wt positive ave.=	1.95E-08			average= 1000	1056.5
Positive & LLD ave.=		5.41E-08		density = 1.0565	gm/cc 1056.5 kg/m3

E-1

J-42

APPENDIX J (Continued)

Appendix F

1996 Soil Remnants Analysis—Security Fence Upgrade

The attached report ("Radioactivity Analyses for Soil Piles Stored Between Cooling Towers", REG-115/96, dated July 15, 1996) indicates that two soil piles totaling 4000 ft³ were collected in 1995 and stored between the Cooling Towers. Even though the larger of the two piles (3100 ft³) did not indicate any detectable plant related radioactivity, the two piles were eventually combined with portions disposed of by land spreading on the South disposal plot as annual disposal volume limits for soil/sand mixes permitted. The remnants of the piles currently contain about 970 ft³ of material. For the estimated concentration of Cs-137 in the combined piles, concentration values from Tables 1 and 3 were averaged in proportion to their volumes as shown:

Cs-137: 900 ft³ at an average concentration of 328 pCi/kg
3100 ft³ with no detectable activity (average absolute value = 11 pCi/kg)

$$\begin{aligned} \text{Average concentration (weighted ave.)} &= \frac{900 \text{ ft}^3 * 328 \text{ pCi/kg} + 3100 \text{ ft}^3 * 11 \text{ pCi/kg}}{900 \text{ ft}^3 + 3100 \text{ ft}^3} \\ &= 82.33 \text{ pCi/kg (dry)} \end{aligned}$$

Therefore, on a wet weight basis applicable to the measured volume of the remaining pile of soil between the Cooling Towers, the weighted average concentration for Cs-137 is:

$$\begin{aligned} &= 82.33 \text{ pCi/kg} * 1 \text{ kg/1000 g} * 1\text{E-}06 \text{ uCi/pCi} * 1.12 \text{ wet/dry volume ratio} \\ &= 9.22 \text{ E-}08 \text{ uCi/gm (wet) for Cs-137} \end{aligned}$$

For Co-60:

$$\begin{aligned} \text{Average concentration (weighted ave.)} &= \frac{900 \text{ ft}^3 * 85 \text{ pCi/kg} + 3100 \text{ ft}^3 * 0.034 \text{ pCi/kg}}{900 \text{ ft}^3 + 3100 \text{ ft}^3} \\ &= 19.15 \text{ pCi/kg} \end{aligned}$$

On a wet weight basis applicable to the measured volume of the remaining pile of soil between the Cooling Towers, the weighted average concentration for Co-60 is:

$$\begin{aligned} &= 19.5 \text{ pCi/kg} * 1 \text{ kg/1000 g} * 1\text{E-}06 \text{ uCi/pCi} * 1.12 \text{ wet/dry volume ratio} \\ &= 2.14 \text{ E-}08 \text{ uCi/gm (wet) for Co-60.} \end{aligned}$$

F-1

J-43

APPENDIX J (Continued)

MEMORANDUM

YANKEE ATOMIC - BOLTON

To	G. D. Weyman	Date	July 15, 1996
From	M. S. Sturm	Group #	REG-115/96
		W.O.#	
Subject	Radioactivity Analyses for Soil Piles Stored Between the Cooling Towers	I.M.S.#	
		File #	vysoilac.doc

REFERENCES

(1) Environmental Laboratory Analysis Reports Sample Numbers G22686 through G22735, soil - Fence and Repaving. Reference Date 4/13/95.

BACKGROUND

Site area construction activities have generated two piles of soil from the protected area that were placed between the plant's cooling towers pending radiological assessment and final disposal disposition. One pile was estimated at 3100 cubic feet and was initially marked as having come from security fence excavation. The second pile, estimated at about 900 cubic feet, was placed directly south of the first pile and east of the 14,000 cubic feet of cooling tower silt also stored between the towers. This second pile was initially designated as coming from repaving activities. (Note that these designations may have been reversed with the repaving activity generating the 3100 cubic feet of material and the security fence excavation generating the 900 cubic feet of material.)

DISCUSSION

As we discussed last week, I'm forwarding copies of the laboratory analyses (Reference 1) for two piles of dirt currently located immediately east of the cooling tower silt pile between the plant's cooling towers.

The 3100 cubic foot pile was sampled by collecting 30 composite grab samples (G22686 through G22715) taken at equal distances long its 82 foot length (the pile is about 15.5 feet wide and 4 feet high at its peak). Each composite sample is consist of 3 grab aliquots taken on the left, top, and right side of the pile at each reference distance starting from the pile's north end. The comment field on each analysis report indicates a sample location relative to the north end of the pile. As an example, sample G22691 has a comment of 6-15.0, indicating the 6th sample taken at a distance of 15.0 feet from the north end of the pile.

Tables 1 and 2 summarize the results of the gamma isotopic analyses for Cs-137 and Co-60. None of the 30 composite samples indicated any positive Cesium or Cobalt, or any other plant related radionuclide. As a consequence, this pile appears to be free from any radioactivity contamination.

The 900 cubic foot pile was sampled in the same manner as above, with a total of 20 composite samples collected (G22716 through G22735). Table 3 shows that both Cs-137 and Co-60 were detected in all or most of the grab samples, indicating that positive plant related radioactivity exists in the soil, and that 10CFR20.2002 approval for disposal will be needed.

F-2

J-44

APPENDIX J (Continued)

REG-115/96, July 15, 1996
Page 2

Please call at your convenience to discuss the next steps necessary to handle the 900 cubic foot pile.



Mark S. Strum
Lead Radiological Engineer
Environmental Engineering Depart.

Attachments

c

R. Marcello
P. Littlefield
M. Marian

F-3

J-47

APPENDIX J (Continued)

Table 1
Vermont Yankee Soil Analysis
 E-Lab soil data for 3100 ft³ soil marked as
 "Fence" line construction material
 Cs-137
 (pCi/kg dry)

Sample I.D.	Conc.	+ - sigma	3 sigma	MDC
1-1.4	9	21	63	78
2-4.1	33	22	66	74
3-6.8	33	26	78	89
4-9.6	-9	23	69	91
5-12.3	20	21	63	73
6-16.0	16	19	57	69
7-17.8	-41	25	75	110
8-20.6	-6	21	63	86
9-23.2	-6	33	99	120
10-26.0	17	23	69	80
11-28.7	11	18	48	60
12-31.4	-14	21	63	82
13-34.2	-12	21	63	83
14-36.9	22	18	54	69
15-39.6	-12	22	66	87
16-42.4	18	18	54	64
17-45.1	12	28	84	99
18-47.8	17	21	63	77
19-50.6	-33	20	60	84
20-53.3	-42	23	69	94
21-56.0	26	36	108	130
22-58.8	26	27	81	93
23-61.5	30	25	75	86
24-64.2	18	25	75	89
25-67.0	28	26	78	89
26-69.7	46	23	69	73
27-72.4	33	23	69	76
28-76.2	48	23	69	70
29-77.9	37	25	75	84
30-80.6	9	29	87	100
Average:	11	23	70	86
Max. value:	48	36	108	130
Min. value:	-42	16	48	59

F-4

J-46

APPENDIX J (Continued)

Table 2
 Vermont Yankee Soil Analysis
 E-Lab soil data for 3100 ft³ soil marked as
 "Fence" line construction material
 Co-60
 (pCi/kg dry)

Sample I.D.	Conc.	1 - sigma	3 sigma	MDC
1-1.4	10	18	54	70
2-4.1	-12	23	69	100
3-6.8	-11	21	63	97
4-9.6	39	30	90	100
5-12.3	1	21	63	88
6-15.0	32	18	54	57
7-17.8	-50	25	75	120
8-20.6	16	15	45	56
9-23.2	43	28	84	91
10-26.0	-17	23	69	97
11-28.7	-13	21	63	93
12-31.4	-4	20	60	84
13-34.2	-2	17	51	75
14-36.8	4	25	75	98
15-39.6	-15	24	72	100
16-42.4	-39	28	84	120
17-45.1	-17	23	69	100
18-47.8	-14	29	87	130
19-50.6	-9	18	54	82
20-53.3	37	22	66	72
21-56.0	17	27	81	140
22-58.8	5	30	90	120
23-61.5	7	28	84	110
24-64.2	-10	19	57	90
25-67.0	27	27	81	98
26-69.7	1	29	87	120
27-72.4	16	21	63	79
28-75.2	6	25	75	98
29-77.9	-8	32	96	130
30-80.6	-27	23	69	110
Average:	0	24	71	97
Max. value:	43	32	96	140
Min. value:	-50	15	45	56

F-5

J-47

APPENDIX J (Continued)

Table 3
Vermont Yankee Soil Analysis

E-Lab Analysis of soil from 900 ft3 pile initial marked "repaving dirt"

sample I.D.	Conc.	Ca-137 (pCi/kg dry) +- sigma	3 sigma	Positive Act. > 3 sigma	Conc.	Co-60 (pCi/kg dry) +- sigma	3 sigma	Positive Act. > 3 sigma
1-1.1	234	53	159	positive	49	38	114	ND
2-3.3	522	57	171	positive	143	29	87	positive
3-5.5	337	43	129	positive	37	21	63	ND
4-7.7	291	29	87	positive	111	17	51	positive
6-9.9	348	51	153	positive	47	29	87	ND
8-12.1	135	26	78	positive	73	23	69	positive
7-14.3	107	24	72	positive	82	15	45	positive
8-16.5	222	44	132	positive	140	28	84	positive
9-18.7	180	37	111	positive	92	21	63	positive
10-20.9	269	51	153	positive	118	31	93	positive
11-2.0	810	51	153	positive	114	21	63	positive
12-4.2	378	38	114	positive	108	21	63	positive
13-6.4	810	66	198	positive	124	27	81	positive
14-8.6	378	24	72	positive	62	13	39	positive
15-10.8	331	22	66	positive	87	12	36	positive
16-13	253	33	99	positive	5	22	66	ND
17-15.2	180	12	36	positive	57	9	27	positive
18-17.4	247	30	90	positive	105	17	51	positive
19-19.6	328	55	165	positive	54	40	120	ND
20-21.8	235	32	96	positive	100	23	69	positive
Average:	328	39			85	23		
Max. value:	810	66			143	40		
Min. value:	107	12			5	9		

J-48

APPENDIX J (Continued)

Appendix G

Record for Last Spreadings (2003) on South Disposal Field

G-1

J-49

APPENDIX J (Continued)

Total Recorded Spreading Data for 2003

Serial #	Spreading Date	Media Type	Mn-54 (uCi/acre)	Co-60 (uCi/acre)	Zn-65 (uCi/acre)	Cs-134 (uCi/acre)	Cs-137 (uCi/acre)	Ce-141 (uCi/acre)	Ce-144 (uCi/acre)
2003-01	7-1-3	Septic	--	1.03	--	--	--	--	--
2003-02	10-25-03	Septic	--	0.12	--	--	--	--	--
2003-03	11-4-03	Sand/soil	--	--	--	--	1.34	--	--
2003-04	11-4-03	CT Silt	--	0.256	--	--	--	--	--
		Total	--	1.41	--	--	1.34	--	--

G-2

J-50

APPENDIX J (Continued)



UNITED STATES
NUCLEAR REGULATORY COMMISSION
WASHINGTON, D.C. 20555-0001

7/25/05 D

July 19, 2005

NW 05-090

Mr. Michael Kansler
President
Entergy Nuclear Operations, Inc.
440 Hamilton Avenue
White Plains, NY 10601

SUBJECT: SAFETY EVALUATION OF REQUEST TO AMEND PREVIOUS APPROVALS
GRANTED PURSUANT TO 10 CFR 20.2002 - VERMONT YANKEE NUCLEAR
POWER STATION (TAC NO. MC5104)

Dear Mr. Kansler:

By letter dated October 4, 2004, as supplemented on January 17, 2005, Entergy Nuclear Operations, Inc. (Entergy) submitted a request to the Nuclear Regulatory Commission (NRC) to modify previous approvals granted pursuant to Title 10 of the *Code of Federal Regulations* (10 CFR) Section 20.2002 (previously 10 CFR 20.302(a)), for on-site disposal of slightly contaminated material at Vermont Yankee Nuclear Power Station. Specifically, Entergy requested an increase of the current approved annual volume limit of 28.3 cubic meters of soil/sand to a new annual volume limit of 150 cubic meters of soil/sand. In addition, Entergy has requested a one-time approval for on-site disposal of the current backlog inventory of approximately 528 cubic meters of soil/sand.

The NRC staff has completed its review of the request and has determined that the proposed changes are acceptable as documented in the enclosed Safety Evaluation.

Pursuant to the provisions of 10 CFR Part 51, the NRC has published an Environmental Assessment and Finding of No Significant Impact in the Federal Register on July 19, 2005 (70 FR 41440).

Sincerely,

A handwritten signature in black ink, appearing to read "R B Ennis".

Richard B. Ennis, Senior Project Manager, Section 2
Project Directorate I
Division of Licensing Project Management
Office of Nuclear Reactor Regulation

Docket No. 50-271

Enclosure: As stated

cc w/encl: See next page

Handwritten initials in black ink, possibly "J-91".

Appendix J Original
Off-Site Dose Calculation Manual
Page 51 of 57

APPENDIX J (Continued)

Vermont Yankee Nuclear Power Station

cc:

Regional Administrator, Region I
U. S. Nuclear Regulatory Commission
475 Allendale Road
King of Prussia, PA 19406-1415

Mr. David R. Lewis
Pillsbury, Winthrop, Shaw, Pittman, LLP
2300 N Street, N.W.
Washington, DC 20037-1128

Ms. Christine S. Salembier, Commissioner
Vermont Department of Public Service
112 State Street
Montpelier, VT 05620-2601

Mr. Michael H. Dworkin, Chairman
Public Service Board
State of Vermont
112 State Street
Montpelier, VT 05620-2701

Chairman, Board of Selectmen
Town of Vernon
P.O. Box 116
Vernon, VT 05354-0116

Operating Experience Coordinator
Vermont Yankee Nuclear Power Station
320 Governor Hunt Road
Vernon, VT 05354

G. Dana Bisbee, Esq.
Deputy Attorney General
33 Capitol Street
Concord, NH 03301-6937

Chief, Safety Unit
Office of the Attorney General
One Ashburton Place, 19th Floor
Boston, MA 02108

Ms. Deborah B. Katz
Box 83
Shelburne Falls, MA 01370

Ms. Carla A. White, RRPT, CHP
Radiological Health
Vermont Department of Health
P.O. Box 70, Drawer #43
108 Cherry Street
Burlington, VT 05402-0070

Mr. James M. DeVincentis
Manager, Licensing
Vermont Yankee Nuclear Power Station
P.O. Box 0500
185 Old Ferry Road
Brattleboro, VT 05302-0500

Resident Inspector
Vermont Yankee Nuclear Power Station
U. S. Nuclear Regulatory Commission
P.O. Box 176
Vernon, VT 05354

Director, Massachusetts Emergency
Management Agency
ATTN: James Muckerheide
400 Worcester Rd.
Framingham, MA 01702-5399

Jonathan M. Block, Esq.
Main Street
P.O. Box 566
Putney, VT 05346-0566

Mr. John F. McCann
Director, Nuclear Safety Assurance
Entergy Nuclear Operations, Inc.
440 Hamilton Avenue
White Plains, NY 10601

Mr. Gary J. Taylor
Chief Executive Officer
Entergy Operations
1340 Echelon Parkway
Jackson, MS 39213

J-52

APPENDIX J (Continued)

Vermont Yankee Nuclear Power Station

cc:

Mr. John T. Herron
Sr. VP and Chief Operating Officer
Entergy Nuclear Operations, Inc.
440 Hamilton Avenue
White Plains, NY 10601

Mr. Danny L. Pace
Vice President, Engineering
Entergy Nuclear Operations, Inc.
440 Hamilton Avenue
White Plains, NY 10601

Mr. Brian O'Grady
Vice President, Operations Support
Entergy Nuclear Operations, Inc.
440 Hamilton Avenue
White Plains, NY 10601

Mr. Michael J. Colomb
Director of Oversight
Entergy Nuclear Operations, Inc.
440 Hamilton Avenue
White Plains, NY 10601

Mr. John M. Fulton
Assistant General Counsel
Entergy Nuclear Operations, Inc.
440 Hamilton Avenue
White Plains, NY 10601

Mr. Jay K. Thayer
Site Vice President
Entergy Nuclear Operations, Inc.
Vermont Yankee Nuclear Power Station
P.O. Box 0500
185 Old Ferry Road
Brattleboro, VT 05302-0500

Mr. Kenneth L. Graesser
38832 N. Ashley Drive
Lake Villa, IL 60046

Mr. James Sniezek
5486 Nithsdale Drive
Salisbury, MD 21801

Mr. Ronald Toole
1282 Valley of Lakes
Box R-10
Hazelton, PA 18202

Ms. Stacey M. Lousteau
Treasury Department
Entergy Services, Inc.
639 Loyola Avenue
New Orleans, LA 70113

Mr. Raymond Shadis
New England Coalition
Post Office Box 98
Edgecomb, ME 04556

Mr. James P. Matteau
Executive Director
Windham Regional Commission
139 Main Street, Suite 505
Brattleboro, VT 05301

Mr. William K. Sherman
Vermont Department of Public Service
112 State Street
Drawer 20
Montpelier, VT 05620-2601

J-53

APPENDIX J (Continued)



UNITED STATES
NUCLEAR REGULATORY COMMISSION
WASHINGTON, D.C. 20555-0001

SAFETY EVALUATION BY THE OFFICE OF NUCLEAR REACTOR REGULATION

ENTERGY NUCLEAR OPERATIONS, INC.

VERMONT YANKEE NUCLEAR POWER STATION

DOCKET NO. 50-271

1.0 INTRODUCTION

By letter dated October 4, 2004, as supplemented on January 17, 2005, Entergy Nuclear Operations, Inc. (Entergy or the licensee) submitted a request to the Nuclear Regulatory Commission (NRC) to modify previous approvals granted pursuant to Title 10 of the *Code of Federal Regulations* (10 CFR) Section 20.2002 (previously 10 CFR 20.302(a)), for on-site disposal of slightly contaminated material at Vermont Yankee Nuclear Power Station (VYNPS). Specifically, Entergy requested an increase of the current approved annual volume limit of 28.3 cubic meters of soil/sand to a new annual volume limit of 150 cubic meters of soil/sand. In addition, Entergy has requested a one-time approval for on-site disposal of the current backlog inventory of approximately 528 cubic meters of soil/sand.

2.0 REGULATORY EVALUATION

As described in 10 CFR 20.2002, "Method for obtaining approval of proposed disposal procedures," licensees are required to obtain NRC approval of proposed procedures, not otherwise authorized in the regulations, to dispose of licensed material generated in the licensee's activities.

Previous NRC approval for VYNPS on-site disposal of various slightly contaminated waste materials is documented in letters dated August 30, 1989, March 4, 1996, June 18, 1997, June 15, 2000, and June 26, 2001. Based on these previous approvals, the licensee is currently authorized to dispose, in designated on-site areas, the following materials: (1) septic waste; (2) cooling tower silt; (3) soil/sand generated from the annual winter spreading on roads and walkways; and (4) soil resulting from on-site construction-related activities. Disposal of septic waste and cooling tower silt material is not limited by an annual volume, but by a total dose impact related to the radiological content of the material and the concentration of radioactivity contained within it. The combination of the soil/sand generated from the annual winter spreading on roads and walkways and the soil resulting from on-site construction-related activities is currently subject to an annual volume limit of 28.3 cubic meters. The licensee's application dated October 4, 2004, proposed to increase this annual volume limit for the same materials (i.e., soil/sand) to 150 cubic meters. In addition, the application proposed a one-time disposal of the current backlog inventory of approximately 528 cubic meters of soil/sand.

The current restrictions on the annual volume of slightly contaminated soil/sand that can be disposed on-site coupled with several plant facility projects in recent years, has resulted in the

J-54

accumulation of a backlog of low-level contaminated earthen material that is awaiting disposal by land spreading on previously-approved on-site disposal areas. The current approved annual volume limit of 28.3 cubic meters of soil/sand for disposal was based on licensee estimates of soil and sand collected from road and walkway sweepings inside the Protected Area following each year's winter cleanup (i.e., current annual limit does not account for future site excavation and construction activities).

3.0 TECHNICAL EVALUATION

The licensee proposes to dispose of the current backlog inventory of soil/sand and the future soil/sand material using a land spreading technique consistent with the current commitments for on-site disposal of slightly contaminated material previously approved by the NRC. The licensee will continue to use designated areas of its property approved for this waste material. Determination of the radiological dose impact of the new material has been made based on the same dose assessment models and pathway assumptions used in the previously-approved applications.

The licensee will procedurally control and maintain records of all disposals. The following information will be recorded:

1. the radionuclide concentrations detected in the material;
2. the total volume of material disposed;
3. the total radioactivity in the disposal operation as well as the total radioactivity accumulated on each disposal plot at the time of spreading;
4. the plot of land on which the material was applied; and
5. dose calculations or maximum allowable accumulated activity determinations required to demonstrate that the dose values have not been exceeded.

The licensee's application states that the existing NRC-approved bounding dose conditions for the proposed on-site disposals will continue to be applied without change. The bounding dose conditions for the on-site disposals are as follows:

1. the annual dose to the whole body or any organ of a hypothetical maximally exposed individual will be less than 1.0 millirem (mrem) (during the period the licensee has active control over the disposal sites, i.e., during the current operating license period);
2. annual doses to the whole body and any organ of an inadvertent intruder from the probable pathways of exposure will be less than 5 mrem (following the period the licensee has active control over the disposal sites); and
3. disposal operations will be at an approved on-site location.

To ensure that the addition of new waste material will not exceed the bounding dose conditions for each new spreading operation, the licensee's total radioactivity and dose calculation will include all past disposals of septic waste, cooling tower silt, soil and soil/sand material on the

J-55

APPENDIX J (Continued)

designated disposal plots. In addition, concentration limits will be applied to the disposed material to restrict the placement of small volumes of material that may have relatively high radioactivity concentrations.

VYNPS is currently authorized to dispose of licensed material, pursuant to 10 CFR 20.2002, in two designated locations both within the site boundary security fence. The South field (approximately 1.9 acres in size) is centered approximately 1500 feet south of the reactor building. The North field (approximately 10 acres in size) is centered approximately 2000 feet northwest of the reactor building. The South field has been the only field utilized for disposal of licensed material to date. The licensee's application states that it is anticipated that future disposal operations will also use the South field since sufficient margin in comparison to the approved dose limit criteria still exists for anticipated waste disposal of the existing backlog of material now in storage, plus all expected future disposals of material, assuming the same observed generation rates.

The licensee performed an evaluation of the radiological impact of all past, accumulated storage inventory, and projected future waste spreading operations on the South field. The licensee assessed the dose that may be received by the maximally exposed individual during the period of plant control over the property, and to an inadvertent intruder after plant access control ends using the same pathway modeling, assumptions, and dose calculation methods that were previously approved by the NRC for the waste material. The dose models are based on the guidance in Regulatory Guide 1.109, Revision 1.

Table 26 in the attachment to the licensee's October 4, 2004, application provides the calculated maximum organ and whole-body doses, at the end of the current plant license period, based on the combination of all past disposal of waste materials, disposal of the current backlog inventory of waste material and projected annual disposal of waste materials. The results are summarized as follows:

	Individual Organ Dose (mrem/year)	Individual Whole Body Dose (mrem/year)	Intruder Organ Dose (mrem/year)	Intruder Whole Body Dose (mrem/year)
Total Dose	0.253	0.074	1.05	0.468
Dose Limit	1	1	5	5
% of Dose Limit	25.3%	7.4%	21.1%	9.4%

Based on the above calculated dose rates, the NRC staff concludes that the proposed increase of the current approved annual volume limit of 28.3 cubic meters of soil/sand to a new annual volume limit of 150 cubic meters of soil/sand and a one-time approval for on-site disposal of the current backlog inventory of approximately 528 cubic meters of soil/sand would result in dose rates within the bounding dose conditions for on-site disposal previously approved by the NRC.

J-56

APPENDIX J (Continued)

- 4 -

4.0 CONCLUSION

The NRC staff finds the licensee's request for disposal of a new annual volume limit of 150 cubic meters of soil/sand and a one-time approval for on-site disposal of the current backlog inventory of approximately 528 cubic meters of soil/sand, pursuant to 10 CFR 20.2002, in the same manner, location, and within the bounding dose conditions as previously approved by the NRC, to be acceptable.

Principal Contributors: S. Klementowicz
R. Ennis

Date: July 19, 2005

J-57