



Entergy Nuclear Northeast
Indian Point Energy Center
450 Broadway, GSB
P.O. Box 249
Buchanan, NY 10511-0249
Tel 914 734 6700

J. E. Pollock
Site Vice President
Administration

July 9, 2008

Re: Indian Point Unit 2
Docket 50-247

NL-08-101

U.S. Nuclear Regulatory Commission
ATTN: Document Control Desk
Washington, DC 20555-0001

**SUBJECT: Proposed Changes to Indian Point 2 Technical Specifications
Regarding Diesel Generator Endurance Test Surveillance**

- References:
1. NRC Letter regarding Issuance of Amendment for Indian Point Nuclear Generating Unit No. 2 (TAC No. 76009), May 9, 1991.
 2. Entergy Letter NL-07-038 regarding "Proposed Changes to Indian Point 2 Technical Specifications Regarding Diesel Generator Endurance Test Surveillance," dated March 22, 2007.
 3. Entergy Letter NL-07-128 regarding "Reply to Request for Additional Information Regarding Proposed Technical Specification Changes for the Diesel Generator Endurance Test Surveillance (TAC MD4923)," dated November 13, 2007.
 4. NRC Letter requesting additional information regarding "Amendment Application to Modify Technical Specifications for the Diesel Generator Endurance Test (TAC No. MD4923)" dated February 7, 2008.
 5. Entergy Letter NL-08-067 regarding "Withdrawal of License Amendment Request (LAR) for Indian Point Unit 2 Regarding Emergency Diesel Generator Endurance Test," dated April 10, 2008.

Dear Sir or Madam:

Pursuant to 10 CFR 50.90, Entergy Nuclear Operations, Inc, (Entergy) hereby requests an amendment to the Technical Specifications (TS) for Indian Point Nuclear Generating Unit 2 (IP2). The proposed change will revise the test acceptance criteria specified in Surveillance Requirement (SR) 3.8.1.10 for the Diesel Generator endurance test surveillance. Changes in the load ranges and power factors specified for the test are proposed for consistency with the associated safety analyses.

ADD
NRR

The changes to the load ranges are bounded by those previously approved by the NRC staff in a license amendment, Reference 1. These load ranges were changed in a non-conservative manner and non-conservative power factors were put into the TS during the conversion to standard technical specifications (Amendment 238 approved November 3, 2003).

A proposed change to the TS was submitted in Reference 2 and a response to additional information was submitted in Reference 3. Entergy was unable to respond to an additional request for information, Reference 4, and withdrew the proposed amendment, Reference 5, consistent with NRC policies.

Entergy has evaluated the proposed change in accordance with 10 CFR 50.91 (a)(1) using the criteria of 10 CFR 50.92 (c) and Entergy has determined that this proposed change involves no significant hazards considerations, as described in Attachment 1. The proposed changes to the Technical Specifications are shown in Attachment 2. Attachments 1 and 2 are consistent with the information submitted in References 2 and 3. Planned changes to the TS Bases are provided in Attachment 3. Attachment 3 includes the changes discussed in Reference 3. Responses to the request for additional information are included in Attachment 4. Attachment 4 contains 8 enclosures for information being submitted to support the responses. A copy of this application and the associated attachments are being submitted to the designated New York State official.

Entergy requests approval of the proposed amendment by October 15, 2008. Entergy is preparing a one time TS change allowing testing in compliance with the proposed change in anticipation that this schedule may not be met. Entergy tested to the proposed TS criteria in refuel outage 18 per the guidance of Administrative Letter 98-10. However, the test which demonstrates strict compliance with the TS was done in refuel outage 17 and the grace period expires November 1, 2008. There are no new commitments being made in this submittal. If you have any questions or require additional information, please contact Mr. Robert Walpole, IPEC Licensing Manager at (914) 734-6710.

I declare under penalty of perjury that the foregoing is true and correct. Executed on 7-9-08.

Sincerely,



J. E. Pollock
Site Vice President
Indian Point Energy Center

Attachments:

- 1: Analysis of Proposed Technical Specification Changes Regarding Diesel Generator Endurance Test Surveillance
- 2: Markup of Technical Specification Page for Proposed Changes Regarding Diesel Generator Endurance Test Surveillance

3: Proposed Changes to Technical Specification Bases Section 3.8.1 Regarding Diesel Generator Endurance Test Surveillance – For Information

4: Response to Request For Additional Information on February 7, 2008

cc: Mr. John P. Boska, Senior Project Manager, NRC NRR DORL
Mr. Samuel J. Collins, Regional Administrator, NRC Region 1
NRC Resident Inspector, IP2
Mr. Paul D. Tonko, President, NYSERDA
Mr. Paul Eddy, New York State Dept. of Public Service

ATTACHMENT 1 TO NL-08-101

ANALYSIS OF PROPOSED TECHNICAL SPECIFICATION CHANGES

REGARDING

DIESEL GENERATOR ENDURANCE TEST SURVEILLANCE

**ENTERGY NUCLEAR OPERATIONS, INC.
INDIAN POINT NUCLEAR GENERATING UNIT NO. 2
DOCKET NO. 50-247**

1.0 DESCRIPTION

Entergy Nuclear Operations, Inc (Entergy) is requesting an amendment to Operating License DPR-26, Docket No. 50-247 for Indian Point Nuclear Generating Unit No. 2 (IP2). The proposed change will revise the test acceptance criteria specified in SR 3.8.1.10 for the Diesel Generator endurance run surveillance. Changes in the load ranges and power factors specified for the test are proposed for consistency with the associated safety analyses. The proposed changes are the result of corrective actions taken by Entergy to address NRC inspection results reported in Reference 1.

The specific proposed changes are listed in the following section.

2.0 PROPOSED CHANGES

The surveillance test acceptance criteria in Diesel Generator Surveillance SR 3.8.1.10 will be revised as follows:

A. The required **load ranges** will be changed as follows:

FROM:

- a. For ≥ 2 hours loaded ≥ 1837 kW and ≤ 1925 kW and
- b. For the remaining hours of the test loaded ≥ 1575 kW and ≤ 1750 kW.

TO:

- a. For ≥ 15 minutes and ≤ 30 minutes loaded ≥ 2270 kW and ≤ 2300 kW, and
- b. For ≥ 105 minutes and ≤ 2 hours loaded ≥ 2050 kW and ≤ 2100 kW, and
- c. For the remaining hours of the test loaded ≥ 1700 kW and ≤ 1750 kW.

B. The **power factor** limits will be changed as follows:

FROM:

≤ 0.85 (applicable for all three DGs)

TO:

≤ 0.88 (applicable to DGs 21 and 23)
 ≤ 0.87 (applicable to DG 22)

The Technical Specification markup page for these changes is provided in Attachment 2. The Technical Specification Bases changes needed to reflect these proposed new test values are found in Attachment 3 for information.

3.0 BACKGROUND

3.1 Load Range

IP2 Improved Technical Specification (ITS) surveillance SR 3.8.1.10 is a test of the emergency diesel generators, similar to Standard Technical Specification (STS, Reference 2) surveillance SR 3.8.1.14. This surveillance requires that each DG be started and loaded for a specified period of time at specified loading conditions, which include kilowatt (kW) output and power factor. Prior to conversion to ITS, the IP2 Custom Technical Specifications (CTS) contained a requirement for diesel testing (Specification 4.6.A.2) which stated:

“At each Refueling Interval (R###), each diesel shall be manually started, synchronized and loaded up to its continuous (nameplate) and short term ratings.”

The CTS Bases stated:

“Each diesel is rated for operation for 0.5 hours of operation out of any 24 hours at 2300 kW plus 2.0 hours of operation out of any 24 hours at 2100 kW with the remaining 21.5 hours of operation out of any twenty four hours at 1750 kW.”

This CTS testing requirement was established in IP2 License Amendment 153 (Reference 3) which reflected the installation of a plant modification designed to provide for an increase in the DG short-term rating.

During the conversion to ITS for IP2 (Reference 4), the CTS requirement was expanded to specify test acceptance criteria in the technical specification surveillance; acceptance criteria for test duration and power factor were added. In addition, the loading requirement for this test was modified to specify two test intervals; one at a load range that corresponds to 90% - 100% of the DG continuous rating and the other at a load range that corresponds to 105% - 110% of the DG continuous rating.

During NRC inspection activities described in Reference 1, questions were raised regarding the adequacy of the load ranges specified in ITS SR 3.8.1.10 to demonstrate the capability of the DGs to operate at the peak loading conditions identified in plant safety analyses for the limiting design basis accident (DBA). As a result Entergy acknowledged the need to submit a license amendment request to establish new load ranges that would bound the peak accident loads. Entergy is proposing to establish load ranges based on the diesel ratings previously described in amendment 153, and Entergy has verified that the proposed new load ranges bound the peak accident loads. The values for the peak accident loads are included on Table One, which provides a comparison of the various DG loading values discussed in this section.

3.2 Power Factor

While investigating the above changes regarding DG kW loading, Entergy also determined that a change to the power factor test value is also appropriate. At IP2, the emergency diesel generator and associated electrical distribution system is a 480 volt system. Surveillance testing cannot be performed using the 480 V loads that would be powered under an accident scenario; rather the

**TABLE ONE
COMPARISON OF VARIOUS DIESEL GENERATOR LOADING VALUES**

DG Rating (Note A)	Continuous Rating 1750 kW			120-Minute Rating 2100 kW			30-Min Rating 2300 kW								
			◆			◆			◆						
Peak DG Loading for limiting DBA				DG 22 2076 kW			DG 23 2194 kW			DG 21 2268 kW					
						◆			◆			◆			
Existing SR.3.8.1.10	$\geq 1575\text{kW}$ to $\leq 1750\text{ kW}$ For the remaining hours of the ≥ 8 -hour test (= 90% - 100% of Continuous Rating)			$\geq 1837\text{kW}$ to $\leq 1925\text{ kW}$ For ≥ 2 hours (= 105% - 110% of Continuous Rating)											
		◆	-----	◆		◆	-----	◆							
Proposed new SR	$\geq 1700\text{ kW}$ to $\leq 1750\text{ kW}$ For the remaining hours of the ≥ 8 -hour test						$\geq 2050\text{ kW}$ to $\leq 2100\text{ kW}$ For ≥ 105 to ≤ 120 min			$\geq 2270\text{ kW}$ to $\leq 2300\text{ kW}$ For ≥ 15 to ≤ 30 min					
			◆	-----	◆			◆	-----	◆			◆	-----	◆
Kw scale	1500kw	1575	1650	1725	1800	1875	1950	2025	2100	2175	2250	2325			

Note A: These rating are based on limitations imposed on the diesel engine, circuit breaker, and bus portions of the DG which are more limiting than the rating of the generator portion of the DG, which is rated for continuous operation at 2875 KVa.

loading of the DG must be accomplished by picking up load from the offsite grid. This involves step-up transformers from 480 V to 6.9 kV and then additional step-up to either 13.8 kV or 138 kV, depending on which feeder circuits are available between the station and the grid. This testing configuration can make it difficult to establish a low power factor test configuration and maintain other electrical parameters within operational limits of the DG. As part of the review of the electrical loading study to address the kW limit issue, Entergy has determined that there is margin between the existing technical specification power factor test requirement and the analysis power factor for the limiting load scenarios. Therefore, the proposed change will eliminate unnecessary conservatism from the test and provide greater ability to perform the test without crediting the technical specification note regarding limitations on power factor caused by grid conditions.

4.0 TECHNICAL ANALYSIS

4.1 Load Range

The peak DG loading conditions reported in this LAR are based on the current version of the Indian Point 2 Emergency Diesel Generator Loading Study. The methodology consists of an evaluation of emergency safeguards equipment powered from the 480 Vac emergency safeguards bus under hypothetical accident scenarios which also involve loss of normal offsite power. The evaluation accounts for the time-dependent electrical power requirements of various safeguards components as the accident scenario progresses.

The evaluation concludes that the limiting loading condition occurs for the LBLOCA scenario during the time period when plant operators are implementing the recirculation switch sequencing activity that completes the transition from injection flow (refueling water storage tank via the safety injection pumps) to recirculation flow (recirculation sump via recirculation pumps). This activity occurs at approximately 40 minutes after the initiation of the accident sequence. In addition, the evaluation accounts for the single-failure of one of the DGs. The duration of the peak loading condition is limited to a few minutes, associated with the elapsed time between operator actuation of one switch (switch 4) that starts the required recirculation pump and operator actuation of another switch (switch 7) that secures the running safety injection pump. The resulting peak loading for each DG is as follows:

DG	Peak Load
21	2268 kW, with loss of DG 23
22	2076 kW, with loss of DG 23
23	2194 kW, with loss of DG 21

The peak loading conditions are bounded by the DG short-term (30-minute) rating limit of 2300 kW. The proposed new SR acceptance criterion of ≥ 2270 kW to ≤ 2300 kW for ≥ 15 to ≤ 30 minutes also bounds these peak loading conditions, without exceeding the DG 30-minute rating limit.

In addition to peak loading conditions, the load study evaluation considers the time dependent electrical power demands with respect to the other DG rating values. The evaluation concludes that the 2-hour rating and continuous rating limits for the DG bound the electrical requirements of the hypothetical accident scenarios and the proposed new SR acceptance criteria provide assurance that the DGs can perform at these rated limits.

4.2 Power Factor

The existing ITS SR acceptance criterion for power factor (≤ 0.85) was determined based on engineering judgment. Prior to ITS (CTS), a test acceptance criterion for power factor was not specified. During tests conducted since ITS implementation, it was determined that procedure limits set for certain DG operating parameters (e.g., generator field amps and output voltage) served as a constraint in some cases to consistently achieve the new power factor acceptance criterion. Therefore Entergy performed further engineering evaluations regarding power factor and procedure limits on DG operating parameters.

The evaluation accounted for peak loading conditions from the DG loading study discussed in Section 4.1 and information from motor data sheets for the safeguards equipment motors rated at ≥ 50 kW. Affected motors include those associated with the Service Water Pumps, Safety Injection Pumps, Residual Heat Removal Pumps, Recirculation Pumps, Auxiliary Feedwater Pumps, and Containment Recirculation Fans. Loads smaller than 50 kW were not considered due to the negligible impact on the overall power factor. The evaluation concluded that the existing technical specification power factor test requirement is overly conservative with respect to the DG loading requirements under hypothetical accident scenarios. Therefore the proposed new values of ≤ 0.87 (for DG 22) and ≤ 0.88 (for DGs 21 and 23) are more appropriate test acceptance criteria.

Entergy has determined that these power factor values are achievable under the test conditions applicable for this surveillance, based on a review of past test results and recent implementation of procedure changes regarding generator operating limits to be used for this test.

5.0 REGULATORY ANALYSIS

5.1 No Significant Hazards Consideration

Entergy Nuclear Operations, Inc. (Entergy) has evaluated the safety significance of the proposed change to the Indian Point 2 Technical Specification that revises EDG load testing and power factor requirements. This proposed change has been evaluated according to the criteria of 10 CFR 50.92, "Issuance of Amendment". Entergy has determined that the subject change does not involve a Significant Hazards Consideration as discussed below:

1. Does the proposed change involve a significant increase in the probability or consequences of an accident previously evaluated?

No. The proposed change revises the acceptance criteria to be applied to an existing surveillance test of the facility emergency diesel generators (DGs). Performing a surveillance test is not an accident initiator and does not increase the probability of an accident occurring. The proposed new acceptance criteria will assure that the DGs are capable of carrying the peak electrical loading assumed in the various existing safety analyses which take credit for the operation of the DGs. Establishing acceptance criteria that bound existing analyses validates the related assumption used in those analyses

regarding the capability of equipment to mitigate accident conditions. Therefore the proposed change does not involve a significant increase in the probability or consequences of an accident previously evaluated.

2. Does the change create the possibility of a new or different kind of accident from any accident previously evaluated?

No. The proposed change revises the test acceptance criteria for a specific performance test conducted on the existing DGs. The proposed change does not involve installation of new equipment or modification of existing equipment, so no new equipment failure modes are introduced. The proposed revision to the DG surveillance test acceptance criteria also is not a change to the way that the equipment or facility is operated and no new accident initiators are created. Therefore the proposed change does not create the possibility of a new or different kind of accident from any accident previously evaluated.

3. Does the proposed change involve a significant reduction in a margin of safety?

No. The conduct of performance tests on safety-related plant equipment is a means of assuring that the equipment is capable of maintaining the margin of safety established in the safety analyses for the facility. The proposed change in the DG technical specification surveillance test acceptance criteria is consistent with values assumed in existing safety analyses and is consistent with the design rating of the DGs. Therefore the proposed change does not involve a significant reduction in a margin of safety.

Based on the above, Entergy concludes that the proposed amendment to the Indian Point 2 Technical Specifications presents no significant hazards consideration under the standards set forth in 10 CFR 50.92 (c), and, accordingly, a finding of "no significant hazards consideration" is justified.

5.2 Applicable Regulatory Requirements / Criteria

General Design Criterion (GDC) 17; "Electric Power Systems" requires that onsite electric power systems have sufficient independence, capacity, capability, redundancy, and testability to ensure that (1) specified acceptable fuel design limits and design conditions of the reactor coolant pressure boundary are not exceeded as a result of anticipated operational occurrences and (2) the core is cooled and containment integrity and other vital functions are maintained in the event of postulated accidents, assuming a single failure.

GDC 18; "Inspection and Testing of Electric Power Systems" requires that electric power systems important to safety be designed to permit appropriate periodic inspection and testing to assess the continuity of the systems and the condition of their components.

IP2 Final Safety Analysis Report (FSAR) section 8.1 describes how the requirements of GDC 17 and 18 are met at IP2. Also, Technical Specification section 3.8.1 contains testing requirements for the DGs.

Regulatory Guide 1.9, Revision 3 describes methods for meeting the above requirements based on NRC staff endorsement of IEEE Standard 387-1984, with exceptions as stated in the Regulatory Guide. Regulatory Position 2.2 describes various DG tests, including test 2.2.9 for the Endurance and Margin Test. The loading requirements for this test are specified as a percentage of the continuous rating of the DGs, and these load ranges (105% - 110% of continuous rating and 90% - 100% of continuous rating) are specified in the existing technical specification surveillance requirement (SR) 3.8.1.10.

IP2 License Amendment 153 established the current continuous and short-term ratings of the DGs. The Technical Specification in effect at that time (4.6.A.2) stated that at each refueling outage, each DG shall be manually started, synchronized and loaded up to its continuous and short term ratings. This testing requirement was implemented in plant surveillance procedures.

In the conversion to Improved Technical Specifications (Reference 4) Entergy adopted test ranges based on Regulatory Guide 1.9. However, these ranges do not bound the peak DBA loading. Therefore, Entergy is proposing to revise the test load ranges specified for SR 3.8.1.10 based on the continuous and short term ratings defined in License Amendment 153. Testing at these ranges will assure that applicable criteria are met.

5.3 Environmental Considerations

The proposed changes to the IP2 Technical Specifications do not involve (i) a significant hazards consideration, (ii) a significant change in the types or significant increase in the amounts of any effluent that may be released offsite, or (iii) a significant increase in individual or cumulative occupational radiation exposure. Accordingly, the proposed amendment meets the eligibility criterion for categorical exclusion set forth in 10 CFR 51.22(c)(9). Therefore, pursuant to 10 CFR 51.22(b), no environmental impact statement or environmental assessment need be prepared in connection with the proposed amendment.

6.0 PRECEDENCE

IP2 License Amendment 153 established requirements for testing the DGs at the continuous and short term ratings.

7.0 REFERENCES

1. NRC Inspection Report 05000247 / 2006-003, dated August 11, 2006. (NCV 2006-003-05 and -08)
2. Standard Technical Specifications for Westinghouse plants, NUREG 1431.
3. NRC letter to Consolidated Edison Company; "Issuance of Amendment 153 for Indian Point Nuclear Generating Unit 2," dated May 9, 1991.
4. NRC letter to Entergy; regarding issuance of Amendment 238 for Indian Point Nuclear Generating Unit 2, dated November 21, 2003.

ATTACHMENT 2 TO NL-08-101

**MARKUP OF TECHNICAL SPECIFICATION PAGE FOR PROPOSED CHANGES
REGARDING
DIESEL GENERATOR ENDURANCE TEST SURVEILLANCE**

Affected Page: 3.8.1-8 Amendment 238

SURVEILLANCE REQUIREMENTS (continued)

SURVEILLANCE	FREQUENCY
<p>SR 3.8.1.10</p> <p style="text-align: center;">-----</p> <p style="text-align: center;">- NOTES -</p> <ol style="list-style-type: none"> 1. Momentary transients outside the load and power factor ranges do not invalidate this test. 2. This SR shall not normally be performed in MODE 1 or 2. However, this Surveillance may be performed to reestablish OPERABILITY provided an assessment determines the safety of the plant is maintained or enhanced. 3. If performed with DG synchronized with offsite power, it shall be performed at a power factor of ≤ 0.88 for DG 21, ≤ 0.87 for DG 22, and ≤ 0.88 for DG 23 ≤ 0.85. However, if grid conditions do not permit, the power factor limit is not required to be met. Under this condition the power factor shall be maintained as close to the limit as practicable. <p style="text-align: center;">-----</p> <div style="border: 1px solid black; padding: 2px; display: inline-block; margin-bottom: 5px;">INSERT A</div> <p>Verify each DG operating at a power factor as stated in Note 3 ≤ 0.85 operates for ≥ 8 hours:</p> <ol style="list-style-type: none"> a. For ≥ 2 hours loaded ≥ 1837 kW and ≤ 1925 kW and b. For the remaining hours of the test loaded ≥ 1575 kW and ≤ 1750 kW. 	<p>24 months</p>
<p>SR 3.8.1.11</p> <p style="text-align: center;">-----</p> <p style="text-align: center;">- NOTE -</p> <p>Load sequence timers associated with equipment that has automatic initiation capability disabled are not required to be OPERABLE.</p> <p style="text-align: center;">-----</p> <p>Verify each load sequence timer relay functions within the required design interval.</p>	<p>24 months</p>

INSERT A, for SR 3.8.1.10

- a. For ≥ 15 minutes and ≤ 30 minutes loaded
 ≥ 2270 kW and ≤ 2300 kW, and
- b. For ≥ 105 minutes and ≤ 2 hours loaded
 ≥ 2050 kW and ≤ 2100 kW, and
- c. For the remaining hours of the test loaded
 ≥ 1700 kW and ≤ 1750 kW.

ATTACHMENT 3 TO NL-08-101

PROPOSED CHANGES TO TECHNICAL SPECIFICATION BASES SECTION 3.8.1

REGARDING DIESEL GENERATOR ENDURANCE TEST SURVEILLANCE

– FOR INFORMATION

Additions – bold and italic

Deletion – line through

ENTERGY NUCLEAR OPERATIONS, INC.
INDIAN POINT NUCLEAR GENERATING UNIT NO. 2
DOCKET NO. 50-247

B 3.8 ELECTRICAL POWER SYSTEMS

B 3.8.1 AC Sources - Operating

BASES

BACKGROUND

The unit AC Electrical Power Distribution System AC sources consist of the following: two offsite circuits (a 138 kV circuit and a 13.8 kV circuit), each of which has a preferred and backup feeder; and, the onsite standby power circuit consisting of three diesel generators. As required by 10 CFR 50, Appendix A, GDC 17 (Ref. 1), the design of the AC electrical power system provides independence and redundancy to ensure an available source of power to the Engineered Safety Feature (ESF) systems.

The plant distribution system is configured around 6.9 kV buses Nos. 1, 2, 3, 4, 5, and 6. All offsite power to the safeguards buses enters the plant via 6.9 kV buses Nos. 5 and 6. 6.9 kV buses Nos. 5 and 6 are normally supplied by the 138 kV offsite circuit but may be supplied by the 13.8 kV offsite circuit. When the plant is operating, 6.9 kV buses 1, 2, 3, and 4 (which supply power to the four reactor coolant pumps) typically receive power from the main generator via the unit auxiliary transformer (UAT). However, when the main generator or UAT is not capable of supporting this arrangement, 6.9 kV buses 1 and 2 receive offsite power via 6.9 kV bus 5 and 6.9 kV buses 3 and 4 receive offsite power via 6.9 kV bus 6. Following a unit trip, 6.9 kV buses 1, 2, 3, and 4 will auto transfer (dead fast transfer) to 6.9 kV buses 5 and 6 in order to receive offsite power.

The 6.9 kV buses Nos. 2, 3, 5 and 6 supply power to the 480 V safeguards power buses using 6.9 kV/480 V station service transformers (SSTs) as follows:

- a. 6.9 kV bus 5 supplies 480 V bus 5A via SST 5;
- b. 6.9 kV bus 6 supplies 480 V bus 6A via SST 6;
- c. 6.9 kV bus 2 supplies 480 V bus 2A via SST 2; and,
- d. 6.9 kV bus 3 supplies 480 V bus 3A via SST 3.

The onsite AC Power Distribution System begins with the four 480 V safeguards power buses 5A, 6A, 2A and 3A. The four 480 V safeguards power buses can be supplied by either of the two offsite circuits or the emergency diesel generators. The onsite Power Distribution System is divided into the following:

- a. Three safeguards power trains (trains) consisting of the 480 volt safeguards bus(es) and associated AC electrical power distribution subsystems;

BASES

BACKGROUND (continued)

- b. Four 125 volt DC bus subsystems; and
- c. Four 118 volt vital AC instrument subsystems.

The three safeguards power trains are designed so that any two trains are capable of meeting minimum requirements for accident mitigation and/or safe shutdown. The three safeguards power trains are as follows:

- a. train 5A (480 volt bus 5A and associated DG 21);
- b. train 6A (480 volt bus 6A and associated DG 23); and
- c. train 2A/3A (480 volt buses 2A and 3A and associated DG 22).

OFFSITE SOURCES

An offsite circuit consists of all breakers, transformers, switches, interrupting devices, cabling, and controls required to transmit power from the offsite transmission network to the onsite 480 V ESF bus(es). A detailed description of the offsite power network and the circuits to the 480 V safeguards buses is found in the UFSAR, Chapter 8 (Ref. 2).

Offsite power is supplied from the offsite transmission network to the plant by two electrically and physically separated circuits (a 138 kV circuit and a 13.8 kV circuit). All offsite power enters the plant via 6.9 kV buses Nos. 5 and 6 which are normally connected to the 138 kV offsite circuit but have the ability to be connected to the 13.8 kV offsite circuit. The 138 kV offsite circuit satisfies the requirement in GDC 17 that at least one of the two required circuits can, within a few seconds, provide power to safety-related equipment following a loss-of-coolant accident. The 13.8 kV offsite circuit is considered a delayed access circuit because operator action is normally required to supply offsite power to the plant using the 13.8 kV offsite source.

Both the 138 kV offsite circuit and the 13.8 kV offsite circuit have a preferred and a backup feeder that connects the circuit to the Buchanan substation. For both the 138 kV and 13.8 kV offsite circuits, the preferred IP2 feeder is the backup IP3 feeder and the backup IP2 feeder is the preferred IP3 feeder.

For the 138 kV offsite circuit, IP2 and IP3 each have a dedicated Station Auxiliary Transformer (SAT) that can be supplied by either the preferred or the backup 138 kV feeder. The 138 kV offsite circuit, including the SAT used exclusively for IP2, is designed to supply all IP2 loads, including 4 operating RCPs and ESF loads, when using either the preferred (95332) or backup (95331) feeder. There are no restrictions when IP2 and IP3 are both using the same 138 kV feeder concurrently.

BASES

BACKGROUND (continued)

For the 13.8 kV offsite circuit, there is a 13.8 kV/6.9 kV auto-transformer associated with feeder 13W92 and a 13.8 kV/6.9 kV auto-transformer associated with feeder 13W93. Feeder 13W92 and its associated auto-transformer is the preferred feeder for the IP2 13.8 kV circuit and the backup feeder for the IP3 13.8 kV circuit. Feeder 13W93 and its associated auto-transformer is the backup feeder for the IP2 13.8 kV circuit and the preferred feeder for the IP3 13.8 kV circuit.

Certain required unit loads are returned to service in a predetermined sequence in order to prevent overloading the transformer supplying offsite power to the onsite Distribution System. Within 1 minute after the initiating signal is received, all automatic and permanently connected loads needed to recover the unit or maintain it in a safe condition are returned to service via individual load timers associated with each large load.

ONSITE SOURCES

The onsite standby power source consists of three 480 V diesel generators (DGs) with a separate DG dedicated to each of the safeguards power trains. Safeguards power train 5A (480 V bus 5A) is supported by DG 21; safeguards power train 6A (480 V bus 6A) is supported by DG 23; and, safeguards power train 2A/3A (480 V buses 2A and 3A) is supported by DG 22. A DG starts automatically on a safety injection (SI) signal or on an ESF bus degraded voltage or undervoltage signal (refer to LCO 3.3.5, "Loss of Power (LOP) Diesel Generator (DG) Start Instrumentation"). After the DG has started, it will automatically tie to its respective bus after offsite power is tripped as a consequence of ESF bus 5A or 6A undervoltage or degraded voltage, coincident with an SI signal or unit trip. The DGs will also start and operate in the standby mode without tying to the ESF bus on an SI signal alone. Following the trip of offsite power, an undervoltage signal strips nonpermanent loads from the ESF bus. When the DG is tied to the ESF bus, loads are then sequentially connected to its respective ESF bus by individual load timers. The sequencing logic controls the permissive and starting signals to motor breakers to prevent overloading the DG by automatic load application.

BASES

BACKGROUND (continued)

In the event of a loss of the 138 kV offsite circuit, the ESF electrical loads are automatically connected to the DGs in sufficient time to provide for safe reactor shutdown and to mitigate the consequences of a Design Basis Accident (DBA) such as a loss of coolant accident (LOCA).

Certain required unit loads are returned to service in a predetermined sequence in order to prevent overloading the DG in the process. Within 1 minute after the initiating signal is received, all loads needed to recover the unit or maintain it in a safe condition are returned to service.

~~Ratings for DGs 21, 22 and 23 are consistent with the requirements of Regulatory Guide 1.9 (Ref. 3). Each diesel generator consists of an Alco Model 16-251-E engine coupled to a Westinghouse 900 rpm, 3-phase, 60 cycle, 480 V generator. Each diesel generator has a capability of 1750 kW (continuous), 2300 kW for 1/2 hour in any 24 hour period, and 2100 kW for 2 hours in any 24 hour period. There is a sequential limitation whereby it is unacceptable to operate DGs for two hours at 2100 kW followed by operating at 2300 kW for a half hour. Any other combination of the above ratings is acceptable. The ESF loads that are powered from the 480 V ESF buses are listed in Reference 2.~~

INSERT A

**APPLICABLE
SAFETY
ANALYSES**

The initial conditions of DBA and transient analyses in the UFSAR, Chapter 6 (Ref. 4) and Chapter 14 (Ref. 5), assume ESF systems are OPERABLE. The AC electrical power sources are designed to provide sufficient capacity, capability, redundancy, and reliability to ensure the availability of necessary power to ESF systems so that the fuel, Reactor Coolant System (RCS), and containment design limits are not exceeded. These limits are discussed in more detail in the Bases for Section 3.2, Power Distribution Limits; Section 3.4, Reactor Coolant System (RCS); and Section 3.6, Containment Systems.

The OPERABILITY of the AC electrical power sources is consistent with the initial assumptions of the accident analyses and is based upon meeting the design basis of the unit. This results in maintaining at least 2 of the 3 safeguards power trains energized from either onsite or offsite AC sources during accident conditions in the event of:

- a. An assumed loss of all offsite power or all onsite AC power and
- b. A worst case single failure.

The AC sources satisfy Criterion 3 of 10 CFR 50.36.

BASES

LCO

Two qualified circuits between the offsite transmission network and the onsite Electrical Power System and separate and independent DGs for each train ensure availability of the required power to shut down the reactor and maintain it in a safe shutdown condition after an anticipated operational occurrence (AOO) or a postulated DBA.

Qualified offsite circuits are those that are described in the UFSAR and are part of the licensing basis for the unit. In addition, required individual load timers for ESF loads must be OPERABLE unless associated with equipment that has automatic initiation capability disabled.

Each offsite circuit must be capable of maintaining rated frequency and voltage, and accepting required loads during an accident, while connected to the ESF buses.

There are two qualified circuits from the transmission network at the Buchanan substation to the onsite electric distribution system. Each of these circuits must be supported by a circuit from the offsite network into the Buchanan substation that is physically independent from the other circuit to the extent practical. The circuits into the Buchanan substation that satisfy these requirements are 96951, 96952 and 95891. The 138 kV connection to Buchanan substation from the Westchester Refuse Energy Services Company (RESCO) plant may not be used to satisfy requirements for a circuit from the offsite network into the Buchanan substation.

The 138 kV offsite circuit consists of the following:

- a. Either 138 kV feeder 95332 (the preferred feeder for IP2 and the backup feeder for IP3) or 138 kV feeder 95331 (the backup feeder for IP2 and the preferred feeder for IP3);
- b. The 138 kV/6.9 kV station auxiliary transformer including the automatic tap changer, circuit breakers ST5 and ST6 which supply 6.9 kV buses 5 and 6, and
- c. The following components which are common to both the 138 kV and 13.8 kV offsite circuits:

BASES

LCO (continued)

- i. The supply to 480 V bus 5A consisting of 6.9 kV bus 5, circuit breaker SS5, station service transformer 5, and circuit breaker 52/5A;
- ii. The supply to 480 V bus 6A consisting of 6.9 kV bus 6, circuit breaker SS6, station service transformer 6, and circuit breaker 6A;
- iii. The supply to 480 V bus 2A consisting of 6.9 kV bus 5, circuit breaker UT2-ST5 (including fast transfer function), 6.9 kV bus 2, circuit breaker SS2, station service transformer 2, and circuit breaker 52/2A; and
- iv. The supply to 480 V bus 3A consisting of 6.9 kV bus 6, circuit breaker UT3-ST6 (including fast transfer function), 6.9 kV bus 3, circuit breaker SS3, station service transformer 3, and circuit breaker 52/3A.

LCO 3.8.1 is modified by a Note that requires that the automatic transfer function for 6.9 kV buses 1, 2, 3, and 4 from the UAT (main generator) to 6.9 kV buses 5 and 6 (the 138 offsite circuit) to be OPERABLE whenever the 138 kV offsite circuit is being used to supply 6.9 kV bus 5 and 6 and the Unit Auxiliary Transformer (main generator) is supplying 6.9 kV bus 1, 2, 3 or 4. This is necessary to ensure that safeguards power train 2A/3A (480 volt buses 2A and 3A) will be transferred automatically from the UAT (main generator) to 6.9 kV buses 5 and 6 (the 138 offsite circuit) following a plant trip.

The 13.8 kV offsite circuit consists of the following:

- a. Either 13.8 kV feeder 13W92 and its associated 13.8/6.9 kV autotransformer (the preferred for IP2 and the backup feeder for IP3) or 13.8 kV feeder 13W93 and its associated 13.8/6.9 kV autotransformer (the backup for IP2 and the preferred feeder for IP3),
- b. Circuit breakers GT25 and GT26, which supply 6.9 kV buses 5 and 6, and
- c. The following components which are common to both the 138 kV and 13.8 kV offsite circuits:

BASES

LCO (continued)

- i. The supply to 480 V bus 5A consisting of 6.9 kV bus 5, circuit breaker SS5, station service transformer 5, and circuit breaker 52/5A;
- ii. The supply to 480 V bus 6A consisting of 6.9 kV bus 6, circuit breaker SS6, station service transformer 6, and circuit breaker 6A;
- iii. The supply to 480 V bus 2A consisting of 6.9 kV bus 5, circuit breaker UT2-ST5 (not including fast transfer function), 6.9 kV bus 2, circuit breaker SS2, station service transformer 2, and circuit breaker 52/2A; and
- iv. The supply to 480 V bus 3A consisting of 6.9 kV bus 6, circuit breaker UT3-ST6 (not including the fast transfer function), 6.9 kV bus 3, circuit breaker SS3, station service transformer 3, and circuit breaker 52/3A.

If the 13.8 kV offsite circuit is being used to supply 6.9 kV bus 5 and/or 6 and the Unit Auxiliary Transformer (main generator) is supplying 6.9 kV bus 1, 2, 3 or 4, the automatic transfer of 6.9 kV buses 1, 2, 3, and 4 from the UAT (main generator) to 6.9 kV buses 5 and 6 (the 13.8 offsite circuit) must be disabled. This is necessary because neither the preferred or the backup 13.8 kV/6.9 kV auto-transformer is capable of supplying all 4 operating RCPs. This requirement is not intended to preclude supplying 6.9 kV buses 1, 2, 3, and 4 using the 13.8 kV offsite circuit via the 13.8 kV/6.9 kV auto-transformers once sufficient loads have been stripped from 6.9 kV buses 1, 2, 3, and 4 to assure that the 13.8 kV/6.9 kV auto-transformer will not be overloaded by these manual actions.

If IP3 and IP2 are both using a single 13.8 kV feeder (13W92 or 13W93), administrative controls are used to ensure that the 13.8 kV/6.9 kV auto-transformer load restrictions will not be exceeded.

Operability of the offsite power sources requires the ability to provide the required capacity during design basis conditions. The minimum offsite voltage necessary to provide the required capacity was determined, using system load flow studies with conservative assumptions (Reference 11), to be greater than or equal to 136 kV and 13.4 kV for the 138 kV and 13.8 kV circuits, respectively. Upon notification by Con Ed that these limits are not met, the LCO is considered not met at the time of the initial alarm. When the grid monitoring system is operating the minimum acceptable voltage varies with grid conditions and Con Ed will provide notification.

BASES

LCO (continued)

Each DG must be capable of starting, accelerating to rated speed and voltage, and connecting to its respective ESF bus on detection of bus undervoltage. This will be accomplished within 10 seconds. Each DG must also be capable of accepting required loads within the assumed loading sequence intervals, and continue to operate until offsite power can be restored to the ESF buses.

Proper sequencing of loads, including tripping of nonessential loads, is a required function for DG OPERABILITY.

The AC sources in safeguards power train must be separate and independent (to the extent possible) of the AC sources in the other train. For the DGs, separation and independence are complete.

For the offsite AC sources, separation and independence are to the extent practical. A circuit may be connected to more than one ESF bus and not violate separation criteria. An offsite circuit that is not connected to an ESF bus is required to have OPERABLE automatic or manual transfer capability to the ESF buses to support OPERABILITY of that circuit.

APPLICABILITY

The AC sources are required to be OPERABLE in MODES 1, 2, 3, and 4 to ensure that:

- a. Acceptable fuel design limits and reactor coolant pressure boundary limits are not exceeded as a result of AOOs or abnormal transients and
- b. Adequate core cooling is provided and containment OPERABILITY and other vital functions are maintained in the event of a postulated DBA.

The AC power requirements for MODES 5 and 6 are covered in LCO 3.8.2, "AC Sources - Shutdown."

ACTIONS

A Note prohibits the application of LCO 3.0.4.b to an inoperable DG or the 138 kV offsite circuit. There is an increased risk associated with entering a MODE or other specified condition in the Applicability with an inoperable DG. This also applies to the 138 kV offsite circuit which is the only immediate access offsite circuit. Therefore, the provisions of LCO 3.0.4.b, which allow entry into a MODE or other specified condition in the Applicability with the LCO not met after performance of a risk assessment

BASES

addressing inoperable systems and components, should not be applied in these circumstances.

A.1

To ensure a highly reliable power source remains with one offsite circuit inoperable, it is necessary to verify the OPERABILITY of the remaining required offsite circuit on a more frequent basis. For activities that will require entry into the associated Condition, performance of SR 3.8.1.1 for the offsite circuit(s) could be completed up to 8 hours prior to entry into the Condition. Performance of this SR before entry into the Condition can be credited to establish the accelerated Frequency and therefore is equivalent to performing the SR within 1 hour after entry into the Condition. The LCO Bases describes the components and features which comprise the offsite circuits. Since the Required Action only specifies "perform," a failure of SR 3.8.1.1 acceptance criteria does not result in a Required Action not met. However, if a second required circuit fails SR 3.8.1.1, the second offsite circuit is inoperable, and Condition C, for two offsite circuits inoperable, is entered.

A.2

Required Action A.2, which applies only if the 13.8 kV offsite power circuit is being used to feed 6.9 kV buses 5 or 6 and the UAT is supplying 6.9 kV bus 1, 2, 3 or 4, prevents the automatic transfer of 6.9 kV buses 1, 2, 3, and 4 from the UAT to the 13.8 kV offsite power circuit after a unit trip. Transfer of buses 1, 2, 3, and 4 from the UAT to the 13.8 kV offsite power circuit could result in overloading the 13.8 kV/6.9 kV autotransformer. This requirement is not intended to preclude supplying 6.9 kV buses 1, 2, 3, and 4 using the 13.8 kV offsite circuit via the 13.8 kV/6.9 kV auto-transformers once sufficient loads have been stripped from 6.9 kV buses 1, 2, 3, and 4 to assure that the 13.8 kV/6.9 kV auto-transformer will not be overloaded. Automatic transfer of buses 1, 2, 3, and 4 can be disabled by placing 6.9 kV bus tie breaker control switches 1-5, 2-5, 3-6, and 4-6 in the "pull-out" position. These breaker control switches should be "tagged" in the pull-out position if this condition is expected to last more than one full shift.

Although the auto-transfer feature is normally disabled prior to placing the 13.8 kV offsite power circuit in service, a Completion Time of 1 hour ensures that the 13.8 kV circuit meets requirements for OPERABILITY promptly when the alternate offsite circuit is configured to support the response of ESF functions.

BASES

ACTIONS (continued)

A.3

Required Action A.3, which only applies if the train will not be automatically powered from an offsite source, is intended to provide assurance that an event coincident with a single failure of the associated DG will not result in a complete loss of redundant required features. When one or more offsite sources are inoperable, a train may not be automatically powered from an offsite source if: 1) the automatic transfer of 6.9 kV buses 1, 2, 3, and 4 to 6.9 kV bus 5 and 6 is disabled; or 2) the immediate access circuit (138 kV) is inoperable and the delayed access circuit (13.8 kV) is not aligned to replace the inoperable circuit.

Required safety features are designed with a redundant safety feature that is powered from a different safeguards power train. Therefore, if a required safety feature is supported by an inoperable offsite circuit, then the failure of the DG associated with that required safety feature will not result in the loss of a safety function because the safety function will be accomplished by the redundant safety feature that is powered from a different safeguards power train. However, if a required safety feature is supported by an inoperable offsite circuit and the redundant safety feature that is powered from a different safeguards power train is also inoperable, then the failure of the DG associated with that required safety feature will result in the loss of a safety function. Required Action A.3 ensures that appropriate compensatory measures are taken for a Condition where the loss of a DG could result in the loss of a safety function when an offsite circuit is not OPERABLE.

The turbine driven auxiliary feedwater pump is not required to be considered a redundant required feature, and, therefore, required to be determined OPERABLE by this Required Action, because the design is such that the remaining OPERABLE motor driven auxiliary feedwater pump is by itself capable (without any reliance on the motor driven auxiliary feedwater pump powered by the emergency bus associated with the inoperable diesel generator) of providing 100% of the auxiliary feedwater flow assumed in the safety analysis.

The Completion Time for Required Action A.3 is intended to allow the operator time to evaluate and repair any discovered inoperabilities. This Completion Time also allows for an exception to the normal "time zero" for beginning the allowed outage time "clock." In this Required Action, the Completion Time only begins on discovery that both:

BASES

ACTIONS (continued)

- a. The train will not have offsite power automatically supplying its loads following a trip of the main turbine generator or following the loss of the immediate access offsite circuit, and
- b. A required feature powered from a different safeguards power train is inoperable.

If at any time during the existence of Condition A (one offsite circuit inoperable) a redundant required feature subsequently becomes inoperable, this Completion Time begins to be tracked.

Discovering that offsite power is not automatically available to one train of the onsite Class 1E Electrical Power Distribution System coincident with one or more inoperable required support or supported features, or both, that are associated with the other train that has offsite power, results in starting the Completion Times for the Required Action. Twenty-four hours is acceptable because it minimizes risk while allowing time for restoration before subjecting the unit to transients associated with shutdown.

The remaining OPERABLE offsite circuit and DGs are adequate to supply electrical power to the two remaining safeguards power trains of the onsite Distribution System. The 24 hour Completion Time takes into account the component OPERABILITY of the redundant counterpart to the inoperable required feature. Additionally, the 24 hour Completion Time takes into account the capacity and capability of the remaining AC sources, a reasonable time for repairs, and the low probability of a DBA occurring during this period.

A.4

According to Regulatory Guide 1.93 (Ref. 6), operation may continue in Condition A for a period that should not exceed 72 hours. With one offsite circuit inoperable, the reliability of the offsite system is degraded, and the potential for a loss of offsite power is increased, with attendant potential for a challenge to the unit safety systems. In this Condition, however, the remaining OPERABLE offsite circuit and DGs are adequate to supply electrical power to the onsite Distribution System.

The 72 hour Completion Time takes into account the capacity and capability of the remaining AC sources, a reasonable time for repairs, and the low probability of a DBA occurring during this period.

BASES

ACTIONS (continued)

B.1

To ensure a highly reliable power source remains with an inoperable DG, it is necessary to verify the availability of the offsite circuits on a more frequent basis. For activities that will require entry into the associated Condition, performance of SR 3.8.1.1 for the offsite circuit(s) could be completed up to 8 hours prior to entry into the Condition. Performance of this SR before entry into the Condition can be credited to establish the accelerated Frequency and therefore is equivalent to performing the SR within 1 hour after entry into the Condition. Since the Required Action only specifies "perform," a failure of SR 3.8.1.1 acceptance criteria does not result in a Required Action being not met. However, if an offsite circuit fails to pass SR 3.8.1.1, it is inoperable. Upon offsite circuit inoperability, additional Conditions and Required Actions must then be entered.

B.2

Required Action B.2 is intended to provide assurance that a loss of offsite power, during the period that a DG is inoperable, does not result in a complete loss of redundant required features. Required safety features are designed with a redundant safety feature that is powered from a different safeguards power train. Therefore, if a required safety feature is supported by an inoperable DG, then the failure of the offsite circuit will not result in the loss of a safety function because the safety function will be accomplished by the redundant safety feature that is powered from a different safeguards power train (and DG). However, if a required safety feature is supported by an inoperable DG and the redundant safety feature that is powered from a different safeguards power train is also inoperable, then a loss of offsite power will result in the loss of a safety function. Required Action B.2 ensures that appropriate compensatory measures are taken for a Condition where the loss of offsite power could result in the loss of a safety function when a DG is not OPERABLE.

The turbine driven auxiliary feedwater pump is not required to be considered a redundant required feature, and, therefore, not required to be determined OPERABLE by this Required Action, because the design is such that the remaining OPERABLE motor driven auxiliary feedwater pump is by itself capable (without any reliance on the motor driven auxiliary feedwater pump powered by the emergency bus associated with the inoperable diesel generator) of providing 100% of the auxiliary feedwater flow assumed in the safety analysis.

BASES

ACTIONS (continued)

The Completion Time for Required Action B.2 is intended to allow the operator time to evaluate and repair any discovered inoperabilities. This Completion Time also allows for an exception to the normal "time zero" for beginning the allowed outage time "clock." In this Required Action, the Completion Time only begins on discovery that both:

- a. An inoperable DG exists and
- b. A required feature powered from a different safeguards power train is inoperable.

If at any time during the existence of this Condition (one DG inoperable) a required feature subsequently becomes inoperable, this Completion Time would begin to be tracked.

Discovering one required DG inoperable coincident with one or more inoperable required support or supported features, or both, that are associated with either OPERABLE DG, results in starting the Completion Time for the Required Action. A Completion Time of four hours from the discovery of these events existing concurrently is acceptable because it minimizes risk while allowing time for restoration before subjecting the unit to transients associated with shutdown.

In this Condition, the remaining OPERABLE DGs and offsite circuits are adequate to supply electrical power to the onsite Distribution System. Thus, on a component basis, single failure protection for the required feature's function may have been lost; however, function has not been lost. The 4 hour Completion Time takes into account the OPERABILITY of the redundant counterpart to the inoperable required feature. Additionally, the 4 hour Completion Time takes into account the capacity and capability of the remaining AC sources, a reasonable time for repairs, and the low probability of a DBA occurring during this period.

B.3.1 and B.3.2

Required Action B.3.1 provides an allowance to avoid unnecessary testing of OPERABLE DG(s). If it can be determined that the cause of the inoperable DG does not exist on the OPERABLE DGs, SR 3.8.1.2 does not have to be performed. If the cause of inoperability exists on other DG(s), the other DG(s) would be declared inoperable upon discovery and Condition E of LCO 3.8.1 would be entered. Once the failure is repaired, the common

BASES

ACTIONS (continued)

cause failure no longer exists, and Required Action B.3.1 is satisfied. If the cause of the initial inoperable DG cannot be confirmed not to exist on the remaining DG(s), performance of SR 3.8.1.2 suffices to provide assurance of continued OPERABILITY of that DG.

In the event the inoperable DG is restored to OPERABLE status prior to completing either B.3.1 or B.3.2, the plant corrective action program will continue to evaluate the common cause possibility. This continued evaluation, however, is no longer under the 24 hour constraint imposed while in Condition B.

According to Generic Letter 84-15 (Ref. 10), 24 hours is reasonable to confirm that the OPERABLE DGs are not affected by the same problem as the inoperable DG.

B.4

In Condition B, the remaining OPERABLE DGs and offsite circuits are adequate to supply electrical power to the onsite Distribution System. The 7 day Completion Time takes into account the capacity and capability of the remaining AC sources, a reasonable time for repairs, and the low probability of a DBA occurring during this period.

C.1 and C.2

Required Action C.1, which applies when two offsite circuits are inoperable, is intended to provide assurance that an event with a coincident single failure will not result in a complete loss of redundant required safety functions. The Completion Time for this failure of redundant required features is reduced to 12 hours from that allowed for one train without offsite power (Required Action A.3). The rationale for the reduction to 12 hours is that Regulatory Guide 1.93 (Ref. 6) allows a Completion Time of 24 hours for two required offsite circuits inoperable, based upon the assumption that three complete safeguards power trains are OPERABLE. When a redundant required feature is not OPERABLE, this assumption is not the case, and a shorter Completion Time of 12 hours is appropriate. These features are powered from redundant AC safety trains. This includes motor driven auxiliary feedwater pumps. Single train features, such as turbine driven auxiliary pumps, are not included as discussed in the Bases for Required Action A.3.

BASES

ACTIONS (continued)

The Completion Time for Required Action C.1 is intended to allow the operator time to evaluate and repair any discovered inoperabilities. This Completion Time also allows for an exception to the normal "time zero" for beginning the allowed outage time "clock." In this Required Action the Completion Time only begins on discovery that both:

- a. All required offsite circuits are inoperable and
- b. A required feature is inoperable.

If at any time during the existence of Condition C (two offsite circuits inoperable) a required feature becomes inoperable, this Completion Time begins to be tracked.

According to Regulatory Guide 1.93 (Ref. 6), operation may continue in Condition C for a period that should not exceed 24 hours. This level of degradation means that the offsite electrical power system does not have the capability to effect a safe shutdown and to mitigate the effects of an accident; however, the onsite AC sources have not been degraded. This level of degradation generally corresponds to a total loss of the immediately accessible offsite power sources.

Because of the normally high availability of the offsite sources, this level of degradation may appear to be more severe than other combinations of two AC sources inoperable that involve one or more DGs inoperable. However, two factors tend to decrease the severity of this level of degradation:

- a. The configuration of the redundant AC electrical power system that remains available is not susceptible to a single bus or switching failure and
- b. The time required to detect and restore an unavailable offsite power source is generally much less than that required to detect and restore an unavailable onsite AC source.

With both of the required offsite circuits inoperable, sufficient onsite AC sources are available to maintain the unit in a safe shutdown condition in the event of a DBA or transient. In fact, a simultaneous loss of offsite AC sources, a LOCA, and a worst case single failure were postulated as a part of the design basis in the safety analysis. Thus, the 24 hour Completion Time provides a period of time to effect restoration of one of

BASES

ACTIONS (continued)

the offsite circuits commensurate with the importance of maintaining an AC electrical power system capable of meeting its design criteria.

According to Reference 6, with the available offsite AC sources, two less than required by the LCO, operation may continue for 24 hours. If two offsite sources are restored within 24 hours, unrestricted operation may continue. If only one offsite source is restored within 24 hours, power operation continues in accordance with Condition A.

D.1 and D.2

Pursuant to LCO 3.0.6, the Distribution System ACTIONS would not be entered even if all AC sources to it were inoperable, resulting in de-energization. Similarly, when the UAT is being used to supply 6.9 kV bus 1, 2, 3 or 4 and the 13.8 kV offsite circuit is being used to supply 6.9 kV buses 5 and 6, the autotransfer function is disabled. Therefore, 480 V safeguards buses 2A and 3A (safeguards train 2A/3A) will not be automatically re-energized with offsite power following a plant trip until connected to the offsite circuit by operator action. Therefore, the Required Actions of Condition D are modified by a Note to indicate that when Condition D is entered with no AC offsite or DG source to any train, the Conditions and Required Actions for LCO 3.8.9, "Distribution Systems - Operating," must be immediately entered. This allows Condition D to provide requirements for the loss of one offsite circuit and one DG, without regard to whether a train is or would be de-energized. LCO 3.8.9 provides the appropriate restrictions for a train that is or would be de-energized.

According to Regulatory Guide 1.93 (Ref. 6), operation may continue in Condition D for a period that should not exceed 12 hours.

In Condition D, individual redundancy is lost in both the offsite electrical power system and the onsite AC electrical power system. Since power system redundancy is provided by two diverse sources of power, however, the reliability of the power systems in this Condition may appear higher than that in Condition C (loss of both required offsite circuits). This difference in reliability is offset by the susceptibility of this power system configuration to a single bus or switching failure. The 12 hour Completion Time takes into account the capacity and capability of the remaining AC sources, a reasonable time for repairs, and the low probability of a DBA occurring during this period.

BASES

ACTIONS (continued)

E.1

With two or more DGs inoperable, the remaining standby AC sources are not adequate to satisfy accident analysis assumptions. Thus, with an assumed loss of offsite electrical power, insufficient standby AC sources are available to power the minimum required ESF functions. Since the offsite electrical power system is the only source of AC power for this level of degradation, the risk associated with continued operation for a very short time could be less than that associated with an immediate controlled shutdown (the immediate shutdown could cause grid instability, which could result in a total loss of AC power). Since any inadvertent generator trip could also result in a total loss of offsite AC power, however, the time allowed for continued operation is severely restricted. The intent here is to avoid the risk associated with an immediate controlled shutdown and to minimize the risk associated with this level of degradation.

According to Reference 6, with two or more DGs inoperable, operation may continue for a period that should not exceed 2 hours.

F.1 and F.2

If the inoperable AC electric power sources cannot be restored to OPERABLE status within the required Completion Time, the unit must be brought to a MODE in which the LCO does not apply. To achieve this status, the unit must be brought to at least MODE 3 within 6 hours and to MODE 5 within 36 hours. The allowed Completion Times are reasonable, based on operating experience, to reach the required unit conditions from full power conditions in an orderly manner and without challenging plant systems.

G.1 and H.1

Conditions G and H correspond to a level of degradation in which all redundancy in the AC electrical power supplies has been lost or a loss of safety function has already occurred. Therefore, no additional time is justified for continued operation. The unit is required by LCO 3.0.3 to commence a controlled shutdown.

BASES

SURVEILLANCE
REQUIREMENTS

The AC sources are designed to permit inspection and testing of all important areas and features, especially those that have a standby function, in accordance with 10 CFR 50, Appendix A, GDC 18 (Ref. 7). Periodic component tests are supplemented by functional tests during refueling outages (under simulated accident conditions). The SRs for demonstrating the OPERABILITY of the DGs are in accordance with the recommendations of Regulatory Guide 1.9 (Ref. 3) and Regulatory Guide 1.137 (Ref. 8), as addressed in the UFSAR.

Where the SRs discussed herein specify voltage and frequency tolerances, the following is applicable. The minimum steady state output voltage of 428 V is the value determined to be acceptable in the analysis of the degraded grid condition. This value allows for voltage drop to the terminals of 480 V motors. It also allows for voltage drops to motors and other equipment down through the 120 V level where minimum operating voltage is also usually specified as 90% of name plate rating. The specified maximum steady state output voltage of 500 V is equal to the maximum operating voltage specified for 480 V circuit breakers. The specified minimum and maximum frequencies of the DG are 58.8 Hz and 61.2 Hz, respectively. These values are equal to $\pm 2\%$ of the 60 Hz nominal frequency and are derived from the recommendations given in Regulatory Guide 1.9 (Ref. 3).

SR 3.8.1.1

This SR ensures proper circuit continuity for the offsite AC electrical power supply to the onsite distribution network and availability of offsite AC electrical power. The lineup check verifies breaker alignment between 480 V buses 5A and 6A and the point where the 138 kV and 13.8 kV feeders being used to satisfy this LCO lose their identity in the offsite network. The breaker alignment verifies that each breaker is in its correct position to ensure that distribution buses and loads are connected to their preferred power source, and that appropriate independence of offsite circuits is maintained. The 7 day Frequency is adequate since breaker position is not likely to change without the operator being aware of it and because 6.9 kV bus status and 13.8 kV circuit status is displayed in the control room. For breakers that do not have position indication in the control room, this SR is satisfied by telephone communication with Consolidated Edison personnel capable of confirming the status of the offsite circuits. This SR includes confirmation of the requirement for two independent circuits (i.e., 96951, 96952 or 95891) into the Buchanan substation.

BASES

SURVEILLANCE REQUIREMENTS (continued)

SR 3.8.1.2

This SR helps to ensure the availability of the standby electrical power supply to mitigate DBAs and transients and to maintain the unit in a safe shutdown condition.

To minimize the wear on moving parts that do not get lubricated when the engine is not running, this SR is modified by a Note to indicate that all DG starts for the Surveillance may be preceded by an engine prelube period.

For the purpose of SR 3.8.1.2 testing, the DGs are started from standby conditions. Standby conditions for a DG mean that the diesel engine coolant and oil are being continuously circulated and temperature is being maintained consistent with manufacturer recommendations.

SR 3.8.1.2 requires that, at a 31 day Frequency, the DG starts from standby conditions and achieves required voltage and frequency within 10 seconds. The 10 second start requirement supports the assumptions of the design basis LOCA analysis in the UFSAR, Chapter 14 (Ref. 5).

In addition to the SR requirements, the time for the DG to reach steady state operation is periodically monitored and the trend evaluated to identify degradation of governor and voltage regulator performance.

The 31 day Frequency for SR 3.8.1.2 is consistent with Regulatory Guide 1.9 (Ref. 3). This Frequency provides adequate assurance of DG OPERABILITY, while minimizing degradation resulting from testing. DG 21 and DG 23 have redundant air start motors and both air start motors are actuated by both channels of the start logic. DGG 21 and DG 23 are operable when either air start motor is operable; however, this SR will not demonstrate that both air start motors are independently capable of starting the DG. If an air start motor is not capable of performing its intended function, a DG is inoperable until a timed start is conducted using the remaining air start motor. Alternately, this SR may be performed using one air start motor (i.e. redundant air start motor isolated) on a staggered basis to ensure that the DG will start with either air start motor. The foregoing does not apply to DG 22 as the starting logic is not actuated by both channels. With either air start motor inoperable DG 22 is also inoperable.

BASES

SURVEILLANCE REQUIREMENTS (continued)

SR 3.8.1.3

This Surveillance verifies that the DGs are capable of synchronizing with the offsite electrical system and accepting loads greater than or equal to the equivalent of the maximum expected accident loads. A minimum run time of 60 minutes is required to stabilize engine temperatures, while minimizing the time that the DG is connected to the offsite source.

Although no power factor requirements are established by this SR, the DG is normally operated at a power factor between 0.8 lagging and 1.0. The 0.8 value is the design rating of the machine, while the 1.0 is an operational limitation to ensure circulating currents are minimized. The load band is provided to avoid routine overloading of the DG. Routine overloading may result in more frequent teardown inspections in accordance with vendor recommendations in order to maintain DG OPERABILITY.

The 31 day Frequency for this Surveillance is consistent with Regulatory Guide 1.9 (Ref. 3).

This SR is modified by four Notes. Note 1 indicates that diesel engine runs for this Surveillance may include gradual loading, as recommended by the manufacturer, so that mechanical stress and wear on the diesel engine are minimized. Note 2 states that momentary transients, because of changing bus loads, do not invalidate this test. Similarly, momentary power factor transients above the limit do not invalidate the test. Note 3 indicates that this Surveillance should be conducted on only one DG at a time in order to avoid common cause failures that might result from offsite circuit or grid perturbations. Note 4 stipulates a prerequisite requirement for performance of this SR. A successful DG start, without an intervening shutdown, must precede this test to credit satisfactory performance.

SR 3.8.1.4

This SR provides verification that the level of fuel oil in the day tank is at or above the level at which fuel oil is automatically added. The level is expressed as an equivalent volume in gallons, and ensures adequate fuel oil for approximately 53 minutes of DG operation at full load.

A 24 hour Frequency is needed because the day tank level alarm is not set to alarm when the day tank level falls just below the minimum required level. Instead, the day tank level alarm is set to indicate a lower level indicative of a failure of the transfer pump after allowing sufficient time for manually

BASES

SURVEILLANCE REQUIREMENTS (continued)

restoring power to the transfer pumps which are stripped following a Safety Injection signal or undervoltage signal on buses 5A or 6A. The 24 hour Frequency is acceptable because operators would be aware of any large uses of fuel oil during this period.

SR 3.8.1.5

Microbiological fouling is a major cause of fuel oil degradation. There are numerous bacteria that can grow in fuel oil and cause fouling, but all must have a water environment in order to survive. Removal of water from the fuel oil day tanks once every 31 days eliminates the necessary environment for bacterial survival. This is the most effective means of controlling microbiological fouling. In addition, it eliminates the potential for water entrainment in the fuel oil during DG operation. Water may come from any of several sources, including condensation, ground water, rain water, contaminated fuel oil, and breakdown of the fuel oil by bacteria. Frequent checking for and removal of accumulated water minimizes fouling and provides data regarding the watertight integrity of the fuel oil system. The Surveillance Frequencies are established by Regulatory Guide 1.137 (Ref. 8). This SR is for preventative maintenance. The presence of water does not necessarily represent failure of this SR, provided the accumulated water is removed during the performance of this Surveillance.

SR 3.8.1.6

This Surveillance demonstrates that each required fuel oil transfer pump operates and transfers fuel oil from its associated storage tank to its associated day tank. This is required to support continuous operation of standby power sources. This Surveillance provides assurance that the fuel oil transfer pump is OPERABLE, the fuel oil piping system is intact, the fuel delivery piping is not obstructed, and the controls and control systems for automatic fuel transfer systems are OPERABLE.

The IP2 design includes the following backup feature. If a fuel oil transfer pump fails to refill the day tank, one of the fuel oil transfer pumps associated with a different DG will receive an automatic starting signal and will fill the day tank for the affected DG via the common makeup line to all three diesel-generator fuel-oil day tanks. This backup feature is not required for DG OPERABILITY; however, the feature is tested because its existence is part of the justification for the 92 day SR Frequency. Therefore, the need for accelerated testing of the transfer function should be evaluated when this backup feature is out of service.

BASES

SURVEILLANCE REQUIREMENTS (continued)

The Frequency for this SR is 92 days. The 92 day Frequency corresponds to the testing requirements for pumps as contained in the ASME Code, Section XI.

SR 3.8.1.7

Transfer of each offsite power supply from the 138 kV offsite circuit to the 13.8 kV offsite circuit demonstrates the OPERABILITY of the alternate circuit distribution network to power the shutdown loads. The 24 month Frequency of the Surveillance is based on engineering judgment, taking into consideration the unit conditions required to perform the Surveillance, and is intended to be consistent with expected fuel cycle lengths. Operating experience has shown that these components usually pass the SR when performed at the 24 month Frequency. Therefore, the Frequency was concluded to be acceptable from a reliability standpoint.

This SR is modified by a Note. The reason for the Note is that, during operation with the reactor critical, performance of this SR could cause perturbations to the electrical distribution systems that could challenge continued steady state operation and, as a result, unit safety systems. This restriction from normally performing the Surveillance in MODE 1 or 2 is further amplified to allow the Surveillance to be performed for the purpose of reestablishing OPERABILITY (e.g. post work testing following corrective maintenance, corrective modification, deficient or incomplete surveillance testing, and other unanticipated OPERABILITY concerns) provided an assessment determines plant safety is maintained or enhanced.

SR 3.8.1.8

Verification that 6.9 kV buses 2 and 3 will auto transfer (dead fast transfer) from the Unit Auxiliary Transformer (the main generator) to 6.9 kV buses 5 and 6 (the offsite circuit) following a loss of voltage on 6.9 kV buses 2 and 3 is needed to confirm the OPERABILITY of a function assumed to operate to provide offsite power to safeguards power train 2A/3A following a trip of the main generator. (Note that when the main generator trips on over-frequency, the transfer is blocked by an over-frequency transfer interrupt circuit provided for bus protection of out of phase transfer.)

An actual demonstration of this feature requires the tripping the main generator while the reactor is at power with the main generator supplying 6.9 kV buses 2 and 3. Credit may be taken for planned plant trips or for unplanned events that satisfy this SR. Other than

BASES

SURVEILLANCE REQUIREMENTS (continued)

planned plant trips or unplanned events, Note 1 specifies that this SR is not normally performed in MODE 1 or 2 because performance of this SR could cause perturbations to the electrical distribution systems that could challenge continued steady state operation and, as a result, unit safety systems. This restriction from normally performing the Surveillance in MODE 1 or 2 is further amplified to allow the Surveillance to be performed for the purpose of reestablishing OPERABILITY (e.g. post work testing following corrective maintenance, corrective modification, deficient or incomplete surveillance testing, and other unanticipated OPERABILITY concerns) provided an assessment determines plant safety is maintained or enhanced.

In lieu of actually initiating a circuit transfer, this SR may be satisfied by testing that adequately shows the capability of the transfer. This transfer testing may include any sequence of sequential, overlapping, or total steps so that the entire transfer sequence is verified.

The 24 month Frequency is based on engineering judgement taking into consideration the plant conditions required to perform the Surveillance, and is intended to be consistent with expected fuel cycle length.

Note 2 specifies that this SR is required to be met only when the 138 kV offsite circuit is supplying 6.9 kV bus 5 and 6 and the Unit Auxiliary Transformer is supplying 6.9 kV bus 1, 2, 3 or 4. This is acceptable because the feature being tested does not perform a safety function if the 138 kV offsite circuit is already supplying 6.9 kV buses 2 and 3. Likewise, if the 13.8 kV circuit is supplying 6.9 kV buses 5 or 6, then the feature being tested by this SR is required to be disabled by Required Action A.2.

SR 3.8.1.9

This Surveillance demonstrates that DG noncritical protective functions are bypassed on a loss of voltage signal concurrent with an ESF actuation test signal, and critical protective functions (engine overspeed, low lube oil pressure, high crankcase pressure, and start failure relay (engine overcrank)) trip the DG to avert substantial damage to the DG unit. The noncritical trips are bypassed during DBAs and provide an alarm on an abnormal engine condition. This alarm provides the operator with sufficient time to react appropriately. The DG availability to mitigate the DBA is more critical than protecting the engine against minor problems that are not immediately detrimental to emergency operation of the DG.

BASES

SURVEILLANCE REQUIREMENTS (continued)

The 24 month Frequency is based on engineering judgment, taking into consideration unit conditions required to perform the Surveillance, and is intended to be consistent with expected fuel cycle lengths. Operating experience has shown that these components usually pass the SR when performed at the 24 month Frequency. Therefore, the Frequency was concluded to be acceptable from a reliability standpoint.

The SR is modified by a Note. The reason for the Note is that performing the Surveillance would remove a required DG from service. This restriction from normally performing the Surveillance in MODE 1 or 2 is further amplified to allow the Surveillance to be performed for the purpose of reestablishing OPERABILITY (e.g. post work testing following corrective maintenance, corrective modification, deficient or incomplete surveillance testing, and other unanticipated OPERABILITY concerns) provided an assessment determines plant safety is maintained or enhanced. This assessment shall, as a minimum, consider the potential outcomes and transients associated with a failed Surveillance, a successful Surveillance, and a perturbation of the offsite or onsite system when they are tied together or operated independently for the Surveillance; as well as the operator procedures available to cope with these outcomes. These shall be measured against the avoided risk of a plant shutdown and startup to determine that plant safety is maintained or enhanced when the Surveillance is performed in MODE 1 or 2. Risk insights or deterministic methods may be used for this assessment.

SR 3.8.1.10

~~IEEE 387-1995 (Ref. 9) requires demonstration~~ ***This surveillance demonstrates*** once per 24 months that the DGs can start and run continuously at full load capability for an interval of not less than 8 hours, ***where ≥ 15 minutes and ≤ 30 minutes loaded ≥ 2270 kW and ≤ 2300 kW, the $\frac{1}{2}$ hour rating, followed by ≥ 105 minutes and ≤ 2 hours loaded at ≥ 2050 kW and ≤ 2100 kW, the 2 hour rating, and the remainder of the time ≥ 1700 kW and ≤ 1750 kW, the continuous rating.*** ~~≥ 2 hours of which is at a load equivalent to 105% to 110% of the continuous duty rating (1837 kW to 1925 kW) and the remainder of the time at a load equivalent to 90% to 100% of the continuous duty rating of the DG (1750 kW).~~ The DG starts for this Surveillance can be performed either from standby or hot conditions. The provisions for prelubricating and warmup, discussed in SR 3.8.1.2, and for gradual loading, discussed in SR 3.8.1.3, are applicable to this SR. ***The load interval is consistent with the recommendations of IEEE 387-1995 (Ref. 9).***

~~This SR does not require~~ that the DG is ***be*** operated at the peak load expected during an accident. ~~The load band is provided to avoid routine~~

BASES

SURVEILLANCE REQUIREMENTS (continued)

~~overloading of the DG. Routine overloading may result in more frequent teardown inspections in accordance with vendor recommendations in order to maintain~~ **to demonstrate** DG OPERABILITY.

The 24 month Frequency is consistent with the recommendations of Reference 9, takes into consideration unit conditions required to perform the Surveillance, and is intended to be consistent with expected fuel cycle lengths.

This Surveillance is modified by three Notes. Note 1 states that momentary transients due to changing bus loads do not invalidate this test. Similarly, momentary power factor transients above the power factor limit will not invalidate the test. The reason for Note 2 is that during operation with the reactor critical, performance of this Surveillance could cause perturbations to the electrical distribution systems that could challenge continued steady state operation and, as a result, unit safety systems.

This restriction from normally performing the Surveillance in MODE 1 or 2 is further amplified to allow the Surveillance to be performed for the purpose of reestablishing OPERABILITY (e.g. post work testing following corrective maintenance, corrective modification, deficient or incomplete surveillance testing, and other unanticipated OPERABILITY concerns) provided an assessment determines plant safety is maintained or enhanced. This assessment shall, as a minimum, consider the potential outcomes and transients associated with a failed Surveillance, a successful Surveillance, and a perturbation of the offsite or onsite system when they are tied together or operated independently for the Surveillance; as well as the operator procedures available to cope with these outcomes. These shall be measured against the avoided risk of a plant shutdown and startup to determine that plant safety is maintained or enhanced when the Surveillance is performed in MODE 1 or 2. Risk insights or deterministic methods may be used for this assessment.

Note 3 ensures that the DG is tested under load conditions that are as close to design basis conditions as possible. When synchronized with offsite power, testing should be performed at a power factor of ≤ 0.85 **for DG 21 and 22 and ≤ 0.87 for DG 22**. This power factor is representative of the actual inductive loading a DG would see under design basis accident conditions. Under certain conditions, however, Note 3 allows the surveillance to be conducted **at another** power factor ~~other than ≤ 0.85~~ . These conditions occur when grid voltage is high, and the additional field excitation needed to get the power factor to ~~≤ 0.85~~ **desired values** results in voltages on the emergency busses that are too high. Under these conditions, the power factor should be maintained as

BASES

SURVEILLANCE REQUIREMENTS (continued)

close as practicable to ~~0.85~~ **the desired values** while still maintaining acceptable voltage limits on the emergency busses. In other circumstances, the grid voltage may be such that the DG excitation levels needed to obtain a power factor of ~~0.85~~ **as desired** may not cause unacceptable voltages on the emergency busses, but the excitation levels are in excess of those recommended for the DG. In such cases, the power factor shall be maintained close as practicable to ~~0.85~~ **the desired values** without exceeding the DG excitation limits.

SR 3.8.1.11

Under accident conditions loads are sequentially connected to the bus by the individual load timers to prevent overloading of the DGs or offsite circuits due to high motor starting currents. The design load sequence time interval tolerance ensures that sufficient time exists for the DG to restore frequency and voltage or the offsite circuit to restore voltage prior to applying the next load and that safety analysis assumptions regarding ESF equipment time delays are not violated. Reference 2 provides a summary of the automatic loading of ESF buses.

The Frequency of 24 months is based on engineering judgment, taking into consideration operating experience that has shown that these components usually pass the SR. Therefore, the Frequency was concluded to be acceptable from a reliability standpoint.

This SR is modified by a Note that specifies that load timers associated with equipment that has automatic initiation capability disabled are not required to be OPERABLE. This note is needed because these time delay relays affect the OPERABILITY of both the AC sources (offsite power and DG) and the specific load that the relay starts. If a timer fails to start a required load or if a timer starts the load later than assumed in the analysis, then the required load is not OPERABLE. If a timer starts the load outside the design interval (early or late), then the DG and offsite source are not OPERABLE because overlap of equipment starts may cause an offsite source to exceed limits for voltage or current or a DG to exceed limits for voltage, current or frequency. Therefore, when an individual load sequence timer is not OPERABLE, it is conservative to disable the automatic initiation capability of that component (and declare the specific component inoperable) rather than declare the associated DG and offsite circuit inoperable because of the following: the potential for adverse impact on the DG by simultaneous start of ESF equipment is eliminated; all other loads powered from the safeguards power train are available to respond to the event; and, the load with the inoperable timer remains available for a manual start after the one minute completion of the normal starting sequence.

BASES

SURVEILLANCE REQUIREMENTS (continued)

If a load sequence timer is inoperable and the automatic initiation capability of that component has not been disabled, Condition D applies

because both the associated DG and the 138 kV offsite circuit are inoperable until automatic initiation capability of the associated component has been disabled.

SR 3.8.1.12

In the event of a DBA coincident with a loss of offsite power, the DGs are required to supply the necessary power to ESF systems so that the fuel, RCS, and containment design limits are not exceeded.

This Surveillance demonstrates the DG operation during a loss of offsite power actuation test signal in conjunction with an ESF actuation signal. This SR verifies all actions encountered from an ESF signal concurrent with the loss of offsite power, including shedding of the nonessential loads and energization of the emergency buses and respective loads from the DG. It further demonstrates the capability of the DG to automatically achieve the required voltage and frequency within the specified time.

The DG autostart time of 10 seconds is derived from requirements of the accident analysis to respond to a design basis large break LOCA. The Surveillance should be continued for a minimum of 5 minutes in order to demonstrate that all starting transients have decayed and stability is achieved.

The requirement to verify the connection and power supply of permanent and auto-connected loads is intended to satisfactorily show the relationship of these loads to the DG loading logic. In certain circumstances, many of these loads cannot actually be connected or loaded without undue hardship or potential for undesired operation. For instance, Emergency Core Cooling Systems (ECCS) injection valves are not desired to be stroked open, or high pressure injection systems are not capable of being operated at full flow, or residual heat removal (RHR) systems performing a decay heat removal function are not desired to be realigned to the ECCS mode of operation.

In lieu of actual demonstration of connection and loading of loads, testing that adequately shows the capability of the DG system to perform these functions is acceptable. This testing may include any series of sequential, overlapping, or total steps so that the entire connection and loading sequence is verified.

BASES

SURVEILLANCE REQUIREMENTS (continued)

The Frequency of 24 months takes into consideration unit conditions required to perform the Surveillance and is intended to be consistent with an expected fuel cycle length of 24 months.

This SR is modified by three Notes. The reason for Note 1 is to minimize wear and tear on the DGs during testing. For the purpose of this testing, the DGs must be started from standby conditions, that is, with the engine coolant and oil continuously circulated and temperature maintained consistent with manufacturer recommendations for DGs.

The reason for Note 2 is that the performance of the Surveillance would remove a required offsite circuit from service, perturb the electrical distribution system, and challenge safety systems. This restriction from normally performing the Surveillance in MODE 1 or 2 is further amplified to allow portions of the Surveillance to be performed for the purpose of reestablishing OPERABILITY (e.g. post work testing following corrective maintenance, corrective modification, deficient or incomplete surveillance testing, and other unanticipated OPERABILITY concerns) provided an assessment determines plant safety is maintained or enhanced. This assessment shall, as a minimum, consider the potential outcomes and transients associated with a failed partial Surveillance, a successful partial Surveillance, and a perturbation of the offsite or onsite system when they are tied together or operated independently for the partial Surveillance; as well as the operator procedures available to cope with these outcomes. These shall be measured against the avoided risk of a plant shutdown and startup to determine that plant safety is maintained or enhanced when portions of the Surveillance are performed in MODE 1 or 2. Risk insights or deterministic methods may be used for the assessment.

The reason for Note 3 is to allow the SR to be conducted with only one safeguards train at a time or with two or three safeguards trains concurrently. Allowing the LOOP/LOCA test to be conducted using one safeguards power train and one DG at a time is acceptable because the safeguards power trains are designed to respond to this event independently. Therefore, an individual test for each safeguards power train will provide an adequate verification of plant response to this event.

Simultaneous testing of all three safeguards power trains is acceptable as long as the following plant conditions are established:

- a. All three DGs are available;

BASES

SURVEILLANCE REQUIREMENTS (continued)

- b. Redundant decay heat removal capability is available, preferably including passive decay heat removal capability;
- c. No offsite power circuits are inoperable; and
- d. No activities that are precursors to events requiring AC power for mitigation (e.g., fuel handling accident or inadvertent RCS draindown) are conducted during performance of this test.

SR 3.8.1.13

This Surveillance demonstrates that the DG starting independence has not been compromised. Also, this Surveillance demonstrates that each engine can achieve proper speed within the specified time when the DGs are started simultaneously.

The 10 year Frequency is consistent with the recommendations of Regulatory Guide 1.9 (Ref. 3).

This SR is modified by two Notes. The reason for Note 1 is to minimize wear on the DG during testing. For the purpose of this testing, the DGs must be started from standby conditions, that is, with the engine coolant and oil continuously circulated and temperature maintained consistent with manufacturer recommendations. The reason for Note 2 is to allow SR 3.8.1.12 to satisfy the requirements of this SR if SR 3.8.1.12 is performed with more than one safeguards power train concurrently.

REFERENCES

- 1. 10 CFR 50, Appendix A, GDC 17.
- 2. UFSAR, Chapter 8.
- 3. Regulatory Guide 1.9, Rev. 3, July 1993.
- 4. UFSAR, Chapter 6.
- 5. UFSAR, Chapter 14.
- 6. Regulatory Guide 1.93, Rev. 0, December 1974.
- 7. 10 CFR 50, Appendix A, GDC 18.
- 8. Regulatory Guide 1.137.

BASES

REFERENCES (continued)

9. IEEE Standard 387-1995, IEEE Standard Criteria for Diesel-Generator Units Applied as Standby Power Supplies for Nuclear Power Generating Stations.
10. Generic Letter 84-15, July 2, 1984.
11. Calculation SGX-00073-01, dated February 6, 2004.
12. ***Indian Point Unit 2 License Amendment 153, dated May 9, 1991.***

INSERT A for page B 3.8.1-4:

Each diesel generator consists of an Alco Model 16-251-E engine coupled to a Westinghouse 900 rpm, 3-phase, 60-cycle, 480 V generator. The ESF loads that are powered from the 480 V ESF buses are listed in Reference 2. The DG ratings (Reference 12) are as follows:

Continuous	Normal steady-state electrical power output capability that can be maintained 24 hours/day, with no time constraint.
2-hour	An overload electrical power output capability that can be maintained for up to 2 hours in any 24-hour period.
½-hour	An overload electrical power output capability that can be maintained for up to 30 minutes in any 24 hour period.

The electrical output capabilities applicable to these three ratings are as follows:

RATING	DG LOAD	TIME CONSTRAINT
Continuous	≤ 1750 kW	None
2-hour	≤ 2100 kW	≤ 2 hours in any 24-hour period [Note A]
½-hour	≤ 2300 kW	≤ 30 minutes in any 24-hour period [Note A]

Note A: Operation at the overload ratings is allowed only for ≤ 2300 kW (1/2-hour) followed by ≤ 2100 (2-hour), not vice versa.

The loading cycle (½ -hour, 2-hour, continuous) may be repeated in successive 24-hour periods. Operation in excess of 2300 kW, regardless of duration is not analyzed. In such cases, the DG is assumed to be inoperable and the vendor should be consulted.

ATTACHMENT 4 TO NL-08-101

RESPONSE TO REQUEST FOR ADDITIONAL INFORMATION

ON FEBRUARY 7, 2008

**ENTERGY NUCLEAR OPERATIONS, INC.
INDIAN POINT NUCLEAR GENERATING UNIT NO. 2
DOCKET NO. 50-247**

Question 1

The IP2 response to Question 2a on the EDGs in the Entergy letter dated November 13, 2007, stated, "The sequential limitation applied to the overload rating results from test and evaluation of the EDG output breaker (Westinghouse DB-75 switchgear) which has a continuous rating of 3000 A at 40° C. With the EDG upgrade to 2100 kW and 2300 kW, the equivalent amperes are 3000 A and 3300 A, respectively. Since 3300 A is above the continuous rating of the switchgear, evaluation and testing of the short-term ratings was performed. Testing was performed by Satin American Corp on a Westinghouse breaker of similar vintage and considered bus duct and switchgear sections. The limiting component was identified as the phenolic insulators on the breakers."

Question 1a

Provide documentation from the breaker and switchgear vendors/manufacturers that operation above the breaker's and switchgear's continuous rating of 3000 A is acceptable (provide time constraints for currents above 3000 A if such operation is allowed). Provide justification that the breaker is operable during worst-case accident scenarios when current exceeds 3000 A. Also provide documentation from the breaker manufacturer that there is sufficient margin in the published ratings to handle the design-basis accident (DBA) loading (for loss of offsite power (LOOP) with a large-break loss-of-coolant accident (LBLOCA) and LOOP with a small-break loss-of-coolant accident (SBLOCA)).

ENO Response:

The 480V breaker and switchgear assemblies at Indian Point Unit 2 were designed and manufactured by Westinghouse Electric. Westinghouse was originally contacted to determine if they could support the diesel generator rating upgrade, and to help demonstrate the equipments capability. But since the equipment was tested and certified in the early to late fifties, Westinghouse indicated that the required information (heat run data) could no longer be retrieved. They did provide the limiting component and its associated temperature rise, which was identified as the phenolics used to isolate and support live components from ground. Total temperature capability was indicated as 105°C. As a result of this absence of original test data, Con-Ed initiated a test program to prove equipment capabilities above the 3000 ampere rating. (details provided in Reference 1)

Operation above the breaker and switchgear rating for limited durations is permitted under ANSI standards, and C37.13 and C37.010 were referenced in the evaluations. Testing and evaluations considered temperature limitations of various insulating materials as specified in the standards, and calculations determined allowable temperature time constants and operating times. The goal was to stay within the permissible temperature limitations as indicated under "short-time load current capability" described in ANSI C37.010. These standards provide for margin above rated values for limited durations.

Testing indicated that components can safely operate within their allowable temperature limits;

- Breakers for 46 minutes at 3300 amperes (representing 2300kW), after temperature was initially stabilized with a continuous current of 2500 amperes (1750kW).
- Breakers for 80 minutes at 3400 amperes, starting at ambient temperature (40°C) with no initial loading.

- load reduction to 3000 amperes after the above tests indicated temperatures stayed within allowable limits. This test was stopped after approximately 2 hours at this value.
- Bus duct testing showed temperatures stayed within allowable values for the above tests.

Since testing bounded worst case accident profiles, for both LBLOCA and SBLOCA, equipment was considered operable with currents exceeding 3000 amperes.

Question 1b

Provide the testing documentation (which includes set-up, procedure, sample size, and results) from Satin American Corp. Verify that the testing was performed under a 10 CFR Part 50 Appendix B program.

ENO Response:

Test documentation from Satin American is provided in Reference 2, and all work was performed in accordance with a 10CFR Part 50 Appendix B program.

Con-Ed performed a vendor evaluation prior to testing, and found the vendor acceptable for safety related work, including 1E applications and 10CFR21. Vendor was placed on the Class A approved vendor list. (see Reference 3).

Question 1c

Tables 5.3-2b, 5.5-2a, 6.1-2a, and 6.1-2c of the EDG loading calc show conditions where the loading exceeds the 2-hour short-term rating after a half-hour of operation into an event. Provide justification that the EDG output breaker and switchgear will remain operable under these accident scenarios given the sequential limitation for operating at the ratings as discussed in the TS Bases.

ENO Response:

The sequential limitation is due to thermal limits primarily on phenolics, and prohibits operation at 2100 kW (3000 amps) for 2 hours, followed by 2300 kW (3300 amps) for the additional 30 minutes. This is based on operation at 3000 amps for a full 2 hour time period. Currents less than 3000 amps, or time periods less than the full 2 hours, produce lower heating effects and less temperature rise on the phenolics.

Testing has shown that when starting from ambient temperature, operation at 3000 amps for a full 2 hours produces a temperature rise in the phenolics of approximately 55°C. Increasing current to 3300 amps for an additional 30 minutes, could exceed the allowable temperature rise of 65°C. Reviewing the various temperature rise curves from testing at different loads, conclusions can be drawn that running at less than 3000 amps (for periods less than 2 hours) plus 3300 amps for up to 10 minutes would result in acceptable temperature rise.

EDG loading calcs show conditions where operation is within the 2-hour rating for short periods, and then load increases to within the 30 minute rating. This appears to be contrary to the sequential limitation, but loading within the 2-hour rating is for time durations much less

than 2 hours (worst case is ~ 32 minutes). Load increases to within the 30 minute rating are also less than the allowed time period (worst case is ~ 8 minutes). Based on expected time durations within the short time ratings, operation under the accident scenarios is considered acceptable.

Question 1d

Provide documentation which supports that the 480 V switchgear (including the EDG output breakers) is properly sized following the EDG upgrade modification.

ENO Response:

Operation above the 3000 ampere continuous rating for limited durations was justified based on testing and evaluations performed in References 1 and 2. Testing supported equipment operation at 2300 kW for 30 minutes, and 2100 kW for an additional 2 hours. Operation above rated values for limited durations is also consistent with industry standards from ANSI.

Question 2

Demonstrate that the worst case load profiles (and the proposed TS SR acceptance criteria) take into account the 90 kW instrument uncertainty stated on page 2-1 of the loading calculation. If not, explain how this uncertainty would be incorporated into the proposed testing given that in some instances, the added uncertainty would exceed the 2300 kW rating threshold. Consider the effects of operating the EDGs at the upper range of the allowable frequency, minimum acceptable voltage and the average power factor of the total load. These factors affect the EDG loading and current flow through the output breaker.

ENO Response:

Worst case load profiles account for automatically sequenced loading, and loads applied through use of the various recirculation switches and as required per steps in emergency operating procedures (EOPs). The intent is to show that this worst case load is within the diesel generator and switchgear ratings, and calculations consider allowable frequency variation. As such, load profile calculations do not account for instrument uncertainty. This is addressed in EOPs for manually applied loads to ensure that diesel and switchgear ratings are not exceeded.

The 90 kW instrument uncertainty applies to control room meters only. During surveillance testing, local digital meters will be used to monitor machine loading and provide more accurate readings. Their uncertainty is addressed by the allowable kW range, and margins provided in the original test program performed with Satin American.

Question 3

Provide the vendor/major manufacturer's supporting documentation for the EDG short term and extended operation ratings (after the upgrade modification).

ENO Response:

Supporting documentation is provided for the GE/ALCO diesel engine (Reference 4), Westinghouse generator (Reference 5), and Basler exciter (Reference 6).

Question 4

How were the short-time ratings determined, and what are the consequences for operating the EDGs beyond these ratings (the license amendment request is proposing to test the EDGs for a half-hour beyond the 2-hour short-time rating)?

ENO Response:

The 2-hour and 30 minute ratings were determined based on the test program performed by Satin American and Con-Ed. Testing included operation at continuous load (1750kW) for temperature stability, running at 3300 amps (2300kW) until the maximum allowed temperature rise was reached, and then dropping the load to 2800 amps (<2100kW).

The 30 minute rating was conservatively determined based on taking 46 minutes to reach the maximum allowed temperature rise. Testing then continued for an additional 2 hours, at a reduced load of 2800 amps, and breaker and bus temperatures dropped to less than the allowable rises. Total test time, after temperatures stabilized with continuous load, was approximately 2 hours and 46 minutes. Testing was also performed with 3000 amps (2100kW), and similar temperature affects were observed. This was used to justify the 2-hour, 2100kW rating.

Diesel, generator, and exciter operation was determined to be acceptable for time frames longer than the test durations. Therefore, testing served as the basis for the short time ratings.

Diesel engines, with the upgraded components, are acceptable for operation at 2300 kW for 200 hours/year. No special maintenance or inspections would be required for these limits.

Generators were determined to be acceptable for continuous operation at 2300 kW (0.8pf) at 104°F, and for a maximum of 2 hours at 125°F.

Exciter was tested and analyzed based on the new ratings, and considered maximum temperature up to 126°F. All excitation system components stayed within their temperature limitations.

Question 5

What is the design basis temperature of the EDG room, and what is the peak temperature that the room will reach during a DBA? Provide the EDG vendor's derating curves for temperatures. Also, provide confirmation that the generator set is adequately rated for the peak temperatures.

ENO Response:

The design basis maximum room ambient temperature for the EDG building is 126°F (Reference 7). Peak temperatures were determined to remain within this limit for DBAs with all

diesels running, outdoor temperatures up to 93°F, and a minimum of 3 exhaust fans running (Reference 8).

Question 6

Provide the loading profile for at least 8 hours of a LOOP/SBLOCA assuming the failure of one EDG. Also provide the loading profile for the LOOP/LBLOCA and LOOP/SBLOCA for long-term operation (at least 8 hours).

ENO Response:

Detailed analysis of loading profiles for 8 hours into an event is not available in our existing studies, but the EDG loading calculation does address long term loads (greater than 2 hours). Long term loads for SBLOCA are addressed in Section 6, and conclusions indicate that long term loading is expected to remain within the continuous rating of the EDG (page 6-3). This section also addresses the amount of time that load is expected to exceed the continuous rating, and provides justification on why this is acceptable (page 6-3). Loading tables consider single failures, as well as multiple composite failures of equipment.

Similar analysis is provided for LBLOCA in Section 5, and also considers single and composite failures of equipment. Long term cooling/loading is addressed in Pages 5-41 thru 5-44, and determines the amount of time that loading is expected to be above the continuous rating of the EDG.

Question 7

The SBLOCA loading profiles show peak loads of 2300 kW (Table 6.1-2a) and 2266 kW (Table 6.1-2c). Provide documentation to support that the proposed power factor values bound these scenarios.

ENO Response:

The EDG loading calculation does not address power factors, but this was considered in Condition Reports CR-IP2-2006-03530 and CR-IP2-2006-03685. A detailed evaluation was performed on kW and kVAR loading for all three EDGs as part of an operability determination, and also determined the equivalent power factors. The analysis determined the power factors as follows; EDG21 – 0.88pf; EDG22 – 0.87pf; EDG23 – 0.88pf. (see Reference 9 for details)

Question 8

IP2 is proposing EDG load curtailment after 70 minutes into an event. Verify that the safety analyses evaluation for the worst-case scenario envelopes the core decay heat load with electrical loads curtailed or reduced.

ENO Response:

A general discussion of EDG loading versus accident analysis is provided in Section 1 of the EDG Loading Study. Original studies were in agreement with accident analyses at the time, but

in 1989 a re-evaluation was performed, and it was determined that under certain conditions accident loading on EDGs could exceed the short time rating. This resulted in upgrades to the EDGs, and the test program performed by Satin American to confirm the capabilities of breakers and bus. With the upgraded diesels, revised ratings and greater load capability, EDG loading studies and safety analyses were once again in agreement. Load curtailment after a period of time is consistent with accident analysis, automatic load sequencing, operation of recirculation switches, and the actions required by emergency operating procedures. Time frames for all expected actions are discussed throughout the EDG loading study, and appropriate references are identified in Section 9.

The PSA also considers a 24 hour mission time, and assumes EDG loading in accordance with emergency operating procedures. This includes maintaining long term loads within the continuous rating of the EDGs. These EOPs are the same procedures used to develop the EDG loading study.

References:

1. Calculation EGE-00006-00, "Indian Point Generating Station Emergency Diesel Generator Upgrade DB-75 Breaker & Switchgear Testing".
2. Satin American Report QA-1181-R01, "Report for the Thermal/Current Testing and Evaluation of Westinghouse, Type DB 480 Volt, 3000 amp, Switchgear, Air Circuit Breaker, and Bus Duct, for Class 1E Service", dated June 18, 1991.
3. Procurement QA Reference No 906-9, "Class A Vendor Evaluation – Satin American", dated June 27, 1990.
4. GE Report DER-1691, "Engineering Evaluation of Increasing Overloading Capacity on the Diesel Stand-By Gen Set at Indian Point Nuclear Power Plant, Consolidated Edison Co of New York", dated October 13, 1989.
5. Westinghouse Engineering Report WMC-EER-90-005, "1750 kW Diesel Generator Study for the Westinghouse Energy Center", dated September 19, 1990.
6. Calculation EGE-00016-00, "Emergency Diesel Generator – Basler Exciter Test Report".
7. IP2-EDG-DBD, "Emergency Diesel Generator System".
8. Calculation IP-CALC-06-00281, "Ventilation System for the EDG Building".
9. Condition Report CR-IP2-2006-03685-CA-002, "Operability Evaluation".

ATTACHMENT 4, ENCLOSURE 1 TO NL-08-101

**Calculation EGE-00006-00, "Indian Point Generating Station Emergency Diesel
Generator Upgrade DB-75 Breaker & Switchgear Testing"**

ENERGY NUCLEAR OPERATIONS, INC.
INDIAN POINT NUCLEAR GENERATING UNIT NO. 2
DOCKET NO. 50-247

CON EDISON CALCULATION/ANALYSIS
COVER SHEET

Page 1 of 84

Section: ROTATING MACH. + PLANT EQUIP.

Code: EGE

Doc. No.: EGE-00006-00 Calc.Type: ELECTRICAL SYSTEM

Title: INDIAN POINT GENERATING STATION EMERGENCY DIESEL GENERATOR
UPGRADE DB-75 BREAKER & SWITCHGEAR TESTING

Object: MODIFICATION: NONE
Document Page Count: 084 Old Calc.No.: NONE

* * * TAG NUMBERS * * *

none)

* * * COMPONENT(S) AFFECTED * * *

Equip.Type 013 CIRCUIT BREAKER
Structure 36 TURBINE GENERATOR BUILDING
System 80 480 VOLT ELECTRICAL

Preparer/Date (Print/Sign)	Reviewer/Date (Print/Sign)	Approval/Date (Print/Sign)	Rev.No.	Super- cedes	Confirm. Required?
<i>Bruce G. Hurd</i> 11/94	<i>ROBERT R. BROWN</i> <i>Robert R. Brown</i> 12/16/94	<i>RICHARD M. BOGLIA</i> <i>Richard M. Boglia</i> 12/20/94			

Reference (If Required)

CON EDISON CALCULATION/ANALYSIS
DESCRIPTION OF CHANGE SHEET

Calculation No. EGE-000000-00

Revision Number	Description of Change	Reasons for Change

CON EDISON CALCULATION/ANALYSIS SUMMARY SHEET	CALCULATION NO. EGE-00006-	REVISION 00	PAGE 3 OF 84
PREPARER/DATE Bruce Harvick 12/19/94	REVIEWER/DATE Robert R. Brown 12/16/94	CLASS	
SUBJECT/TITLE INDIAN POINT GENERATING STATION EMERGENCY DIESEL GENERATOR UPGRADE DB 75 BREAKER & SWITCHGEAR TESTING		PROJECT NO	MOD NO
			REV

OBJECTIVE OF CALCULATION

TO DEMONSTRATE THAT THE SWITCHGEAR (DB-75 EDG Breaker) and Bus duct is capable of carrying the upgraded EDG Load under the postulated loading scenario.

CALCULATION METHOD/ASSUMPTIONS

ANSI C37.13 IEEE STANDARD FOR LOW VOLTAGE AC POWER CIRCUIT BREAKERS USED IN ENCLOSURES
ANSI C37.010 IEEE APPLICATION GUIDE FOR AC HIGH VOLTAGE CIRCUIT BREAKERS RATED ON A Symmetrical Current Basis.

DESIGN BASIS AND REFERENCES

ANSI C37.13
ANSI C37.010
WEAP 12656 "EMERGENCY DIESEL GENERATOR LOADING STUDY
SATIN American Report QA-1181-R01

CONCLUSIONS

During test and analysis, at no time did the loading (current) being carried by the breaker & switchgear cause the temperature to EXCEED ANY of the components design rated temperature.

CON EDISON CALCULATION/ANALYSIS SHEET		CALCULATION NO. EGE-00006	REVISION 00	PAGE 4 OF 84
PREPARER/DATE B. Horowitz B. N. [Signature] 12/15/94		REVIEWER/DATE Robert R. Brown 12/16/94		CLASS
SUBJECT/TITLE INDIAN POINT GENERATING STATION EMERGENCY DIESEL GENERATOR UPGRADE DB-75 BREAKER & SWITCHGEAR TESTING		PROJECT NO.		MOD NO.
				REV

The 480 volt switchgear equipment at the Indian Point Unit 2 Nuclear Generating Station was designed and manufactured by the Westinghouse Electric Corporation. The equipment consists of the switchgear housing (bus, supports, enclosure etc), breakers (60 - DB 50's and 11 - DB 75's) along with its associated auxiliary equipment (PT's, relays, etc.). This equipment was purchased and built in the late sixties. At the time of this equipment's fabrication, Westinghouse was starting to phase out the DB line of switchgear and was introducing the DS line of switchgear. The DS line of switchgear has higher current carrying capability along with solid state electronic trip devices, where the DB breakers were originally equipped with electromechanical trip devices. The DB breakers at Indian Point Unit 2 subsequently were modified to include the new electronic trip devices (Amptectors) in 1982.

The 480 volt switchgear at Indian Point is rated for 3000 amperes continuous current. The individual breakers have various current ratings dependent on the frame size of the breaker and the trip coils used. The DB-75s have a continuous current rating equal to that of the switchgear, 3000 amperes. The switchgear is arranged in 4 bus sections, which are contained in 2 separate housings (2 bus sections per housing). The electrical one line is shown in Figure one. Each bus section is interconnected with bus tie breakers which are kept in the open and racked out position. Bus section 5A is either feed from Station Service Transformer 5 or Emergency Diesel 21 via independent DB 75 breakers. Bus section 6A is feed from either Station Service Transformer 6 or diesel 23, also via independent DB-75 breakers. Bus section 2A is feed from Station Service Transformer 2 and bus section 3A is feed from Station Service Transformer 3 via their own DB-75 breakers. Diesel generator 22 feeds both bus sections 2A and 3A from 2 separate, independent DB-75 breakers.

As part of the Diesel Generator upgrade, the short time output capability of the diesel generators was being increased from 2800 amperes to 3300 amperes. Since this current would be supplied to the switchgear assembly via the Emergency Diesel Generator Bus Duct and the 480 volt switchgear, this equipment would have to be capable of handling the new, short time overload. The original equipment is rated for 3000 amperes continuous, a analysis or test would be required to determine the equipments short time capabilities.

Westinghouse was originally contacted to determine if they could support us in our effort to demonstrate the equipments capability. Since this equipment was tested and certified some time in the early to late fifties, Westinghouse stated that they could no longer retrieve the required information (heat run data). They did supply us with the limiting component and its associated temperature rise. This component is the phenolics used to isolate and support the live components from ground. This material is an organic compound which has a total temperature capability of 105° C. With the lack of original test data to help in analyzing the potential capability of the switchgear assembly (including breakers and bus), it was determined that a heat run test (high power current) was necessary.

CON EDISON CALCULATION/ANALYSIS SHEET	CALCULATION NO. EGE-00006	REVISION 00	PAGE 5 OF 84
PREPARER/DATE B. Horowitz B. K... 12/15/94	REVIEWER/DATE Robert R. Brown 12/16/94	CLASS	
SUBJECT/TITLE INDIAN POINT GENERATING STATION EMERGENCY DIESEL GENERATOR UPGRADE DB-7'S BREAKER & SWITCHGEAR TESTING		PROJECT NO.	
		MOD NO.	REV

Satin American Corp was contracted by Con Edison to assist in the determination of the equipment's capability. A test mock up along with test plans was jointly developed. This information is contained within the Satin American Report QA-1181-R01. A breaker of similar vintage (manufactured approximately the same time as our breakers) was supplied along with one vertical section of switchgear containing a duplicate of the bus work that is employed at the plant. The testing consisted of three parts, which are:

- 1) Full load heat run (3000 amperes continuous)
- 2) Load duty cycle (2500 amperes to stability; followed by 3300 amperes till first component reaches its design limitation; followed by 2800 amperes to stability.)
- 3) 3400 amperes from a cold condition until the first component reaches its design temperature limitation.

The objectives of the test was to determine the breakers maximum continuous current rating along with the thermal time constants of the equipment. This would allow calculation of the allowable operating time, to reach the maximum allowable limiting component temperature, for any expected overload condition. Also, the testing was to demonstrate that the expected load profile, as defined by the EBASCO load study and the Westinghouse Diesel Generator Study, could be met, with margin. Since the EDG breaker is not normally energized and is in the lower of the breaker cubicles, there are no preloading concerns. The final test was to determine the time duration for the first component to reach its maximum allowable total temperature. The testing was conducted at Power Test Inc, located in Calfont Pa. Testing was conducted on three separate occasions, occurring over a span of 3 months.

The analysis to demonstrate the equipments capability is divided into three sections:

BREAKER

BUS DUCT

SWITCHGEAR LINEUP

CON EDISON CALCULATION/ANALYSIS SHEET		CALCULATION NO. EGE-00006	REVISION 00	PAGE 6 OF 84
PREPARER/DATE B. Horowitz B. Nozawa 12/15/94		REVIEWER/DATE Robert R. Brown 12/16/94		CLASS
SUBJECT/TITLE INDIAN Point GENERATING STATION EMERGENCY DIESEL GENERATOR UPGRADE. DB-75 BREAKER & SWITCHGEAR TESTING.			PROJECT NO.	
			MOD NO.	REV

The breaker of concern is the DB-75 which feeds the power from the Emergency Diesel Generator to the switchgear. This breaker is rated 3000 amperes continuous at an ambient air temperature of 40° C. The breaker has also been upgraded to include the Amptector Electronic trip device. The breaker was segregated into two classes of components based on allowable total temperature. The first is rated 105° C total temperature. These components are the phenolics that the contacts and breaker stabs are connected to. They also provide insulation from the live components to ground. Since it was impossible to attach thermocouples to the phenolic without damaging the phenolic material and also assuring that we obtained an accurate temperature reading, the thermocouples were attached to the copper at the phenolic to copper junction. Since the copper is the heat source, this is representative of the phenolics temperature, as the copper will be hotter than the phenolic.

Even though Westinghouse verbally informed us that the limiting component of the switchgear assembly was the phenolic insulators on the breaker, and its associated temperature limitation is 105° C, they did not formally transmit that information to Con Edison. To ensure that this information was correct, Con Edison performed a review of the standards and an inspection of the breaker. A review of ANSI C37.13-1963 and ANSI/IEEE C37.010-1987, shows the various classes of insulating materials and their acceptable temperature limitations. Class O, which is the lowest temperature class, has such materials as cotton, silk and paper, which is used without an impregnation medium. This material can be operated at a total temperature of 90° C without degradation to the material. The next insulating class is that of Class A materials which have an upper boundary operating temperature of 105° C. This class of materials are the same as those in class O, but an impregnation medium is used to bind the material. A visual inspection of our equipment revealed that the insulating medium was a form of phenolic, which utilizes impregnation. Since Class A materials have the lowest allowable operating temperature of any of the impregnated materials, and the material observed is at least a class A insulating material, it is conservative to use the Class A temperature limitations on the non metallic items located within the breaker. Our visual observations agree with previous verbal communications with Westinghouse in which the limiting component maximum temperature rise was the phenolic material's.

Table 1 of ANSI C37.13, 1963 along with ANSI/IEEE C37.010 indicate that contacts, conducting joints, and other parts (Except thermal elements or heaters) have a maximum allowable temperature of 125° C. Also, silver surfaced, silver, silver alloy, or equivalent can also be operated up to 125° C without detrimental effects. For the testing, we broke up the breaker into the two temperature classes; insulating materials(105° C) and current carrying components(125° C). For ease of testing, it was decided to use allowable temperature rise verses maximum allowable temperature. A temperature rise of 65° C would be used for the 105 limitation and 85° C would be used for the 125 limitation components. The bases for this is that the maximum expected ambient air temperature in the switchgear room is 40° C. The instrumentation used would automatically subtract the existing ambient temperature from the components total temperature, allowing us to obtain temperature rises directly, without have to perform any calculation during testing.

CON EDISON CALCULATION/ANALYSIS SHEET	CALCULATION NO. EGE-00006	REVISION 00	PAGE 7 OF 84
PREPARER/DATE P. Horowitz & B. Nowak 12/15/94	REVIEWER/DATE Robert R. Brown 12/16/94	CLASS	
SUBJECT/TITLE INDIAN POINT GENERATING STATION		PROJECT NO.	
EMERGENCY DIESEL GENERATOR UPGRADE		MOD NO.	REV
DB-75 BREAKER & SWITCHGEAR TESTING			

Figure 2 shows pictorially the breaker, its individual components and the associated allowable temperature rise.

During the first series of tests (3000 ampere continuous) a problem was noted with the transition section of the bus duct. This prevented the equipment from being fully tested at its nameplate rating. This will be discussed in detail in the bus duct section. However, because of this problem, we limited the maximum applied current to 2800 amperes. This allowed us to obtain critical data for future tests (ie: time constants etc.). Figures 3 through 10 are the temperature rise data for 2500 amperes applied from ambient until the temperatures stabilized. Figures 11 through 18 are the temperature rise data for 2800 amperes applied from ambient until the temperatures stabilized. Figures 19 through 26 were the last series of tests and are the temperature rise data for the application of 3000 amperes continuous until all temperatures stabilized. Table 1 tabulates the maximum stabilized temperature along with the various thermal time constants for each individual point. The thermal time constant is calculated by taking the stabilized temperature and multiplying it by .631 (see Appendix A). This temperature value is then used to find the intersecting point of temperature and time. The time associated with that temperature is the thermal time constant.

Per attached Table 1, the thermal time constant varies slightly for each test. The range is from 58.5 minutes to 62.5 minutes. This is partially due to the fact that as the test progressed, the current changed as a result of the area voltage changing (source voltage). For the purpose of this analysis, a thermal time constant of 58 minutes was used which will encompass all the thermal time constants and also provides additional margin.

The testing demonstrated that maximum allowable temperature rise was that of the phenolic insulator on the breaker, which confirms Westinghouse's statement on limiting component temperature. This is shown in Table 1 by the maximum temperature rise for each test. Using the formulas delineated in ANSI/IEEE C37.010-1987, page 23 we can calculate the maximum expected current carrying capability of each of the limiting breaker components (see Appendix B). Table 2 shows the results of that calculation. The data was escalated from both the 2500 and 2800 ampere case to determine if the test data was consistent and reasonable. The values obtained were consistent and reasonable. This data was analyzed to determine if in the future, additional current carrying capability is needed, what portions of the breaker would have to be retrofitted to meet those requirements.

Temperature rises presented in table 1 indicate that the breaker has a 3000 ampere continuous rating based on the phenolics being the limiting component. In the future, if additional capacity is required, the phenolic material would have to be replaced with higher temperature material.

CON EDISON CALCULATION/ANALYSIS SHEET	CALCULATION NO. EGE-00006	REVISION 00	PAGE 8 OF 84
PREPARER/DATE B. Horowitz B. Brown 12/15/94	REVIEWER/DATE Robert R. Brown 12/16/94	CLASS	
SUBJECT/TITLE INDIAN POINT GENERATING STATION EMERGENCY DIESEL GENERATOR UPGRADE. DB-75 BREAKER & SWITCHGEAR TESTING		PROJECT NO.	REV

The next requirement and test the breaker was subjected to was the ability to carry the expected current during the load duty cycle. The load duty cycle utilized is based on Westinghouse WCAP 12656, "Emergency Diesel Generator Loading Study" (Appendix C tabulates the various scenarios and highlights the limiting case). The most severe of the duty cycles was selected. The duty cycle utilized was 2500 amperes (1750 kW) until all temperatures reached stability, followed by 3400 amperes (2300 kW) until the first component reached its maximum allowable temperature rise followed by reducing the current to 2800 amperes for 2 hours. The 2800 amperes does not constitute 2100 kW (3000 amperes), but duplicates the load duty cycle. However, since the diesel generator is capable of 3000 amperes following the 3300 amperes, this condition was reviewed to determine that this is an acceptable operating condition. The temperature versus time curves demonstrate, that when the current is removed, the temperature does not increase, but immediately starts to decrease to the steady state temperature of the new current. Therefore, we can substitute the previously obtained temperature data of the 3000 ampere run for the 2800 ampere loading condition. This confirms that we are still within equipment limitations.

Figures 27 through 34 show the temperature versus time plots for the various breaker points during the load duty cycle. Again the limiting component was the phenolic. At the 349 minute mark the current was raised from 2500 amperes to 3300 amperes. The curve indicates that at the 349 minute mark the temperature was up some. This is due to the way the current was increased. It takes some time to raise the current and balance the 3 phases to about the same value of current. The 349 minute mark is the point in time when all adjustments have been complete. At this point, the timer was started. At the 395 minute mark the phenolic component reached its maximum operating limit. This confirms that the breaker can safely operate for 46 minutes at 3300 amperes after the temperature is stabilized at 2500 amperes. The time associated with reaching the maximum temperature was the actual time and not the time to reduce the current. A review of the curve shows that after the 395 minute mark, the temperature starts to decay even though the current was reduced a short time later. The reason is that the sampling time is every 30 minutes during stability runs, and once the current is reduced, the temperature decays rapidly.

Figures 35 through 42 show the same test data as figures 27-34. The data indicates that with the breaker pre-loaded and stabilized at 2500 amperes, it can sustain 3300 amperes for 48 minutes. The reason for the difference is that during testing, there was another test set up in the area which failed causing a loss of power for approximately 30 seconds. Even with this minor anomaly, the test data is consistent with previously obtained data.

Since normally the EDG breaker is at ambient temperature, (not preloaded), the breaker should be able to operate for a longer time at 2300 kW. The last of the series of tests on the breaker was to energize the breaker from ambient with 3400 amperes until the first component reached its maximum allowable temperature rise. 3400 amperes was chosen to demonstrate margin over the 3300 amperes, which represents 2300 kW (maximum diesel generator output). Figures 43 through 50 show the testing performed during test

CON EDISON CALCULATION/ANALYSIS SHEET		CALCULATION NO. EGE-00006	REVISION 00	PAGE 9 OF 84
PREPARER/DATE P. Horowitz B. N. [Signature] 12/15/94		REVIEWER/DATE Robert R. Brown 12/16/94		CLASS
SUBJECT/TITLE INDIAN Point GENERATING STATION EMERGENCY DIESEL GENERATOR UPGRADE DB-75 BREAKER & SWITCHGEAR TESTING			PROJECT NO.	
			MOD NO.	REV

cycle 2. The time for the first component to reach its limiting temperature was 80 minutes. For test cycle 3 figures 51 through 58 show the time verses temperature for that test. During that test it took 84 minutes for the breaker phenolic to reach its maximum temperature once 3400 amperes was applied to the cold (no preloaded) breaker.

CON EDISON CALCULATION/ANALYSIS SHEET	CALCULATION NO. EGE-00006	REVISION 00	PAGE 10 OF 84
PREPARER/DATE B. Horowitz & B. Harney 12/15/94	REVIEWER/DATE Robert R. Brown 12/16/94	CLASS	
SUBJECT/TITLE INDIAN Point GENERATING STATION EMERGENCY DIESEL GENERATOR UPGRADE DB-75 BREAKER & SWITCHGEAR TESTING		PROJECT NO.	
		MOD NO.	REV

The bus duct from the output of the diesel generator to the switchgear was manufactured by the Westinghouse Electric Corp. The division which manufactured the bus duct is no longer an active division of Westinghouse. Information concerning the design and capabilities was requested but was not available. This bus duct is made up of 6 - 1/4" x 6" aluminum conductors, 2 per phase insulated with scotchlite heat shrink insulation. A visual inspection of the insulating material found that it was stamped with a temperature rating of 105° C. This bus duct is a low impedance design. The phase relation of the bus conductors are A-B-C-C-B-A. Since the internals of the switchgear use either 2 or 3 conductors per phase, bundled together, a special transition section of bus is used at the entrance of the switchgear to convert the A-B-C-C-B-A arrangement to a A-A-B-B-C-C phase arrangement. During testing each conductor temperature was monitored. During the initial testing, it was determined that the transition piece exceeded the maximum allowable temperature for the insulating material. Figure 59 shows the temperature verses time curve for the transition with 2800 amperes applied from ambient.

Based on the above, it was determined that the bus had a limiting current capacity of 2800 amperes resulting from excessive temperatures at the transition area. Testing was continued to determine if other components would be limiting at the required maximum loadings with full understanding that modifications would be required to provide increased current capability of the transition section.

Analyzing the data on the bus duct transition, it was determined that the cause was related to the fact, that in the vertical portion, the bus duct would act like a chimney and funnel the hot air through the opening in the top of the switchgear, thus bypassing the normal ventilation scheme. To demonstrate this, it was decided to block the opening in the bus duct to switchgear transition and cut an additional opening in the top of the switchgear cubicle. The opening in the top of the cubicle was blocked for the 3000 ampere testing.

The other factor that lead us to the determination that the cause was related to ventilation, was that approximately one foot away from the transition, in the horizontal portion, temperatures were monitored of the bus duct. In this location, the highest conductor temperature was a 50° C rise for the 2800 ampere continuous current from ambient test. This would correspond to rated temperature rise at rated current(3000 amperes). This confirmed that the problem was ventilation related and not was insufficient conductor area.

A series of tests were performed where the ventilation scheme at the transition was altered by stuffing the area with insulation. The results indicated that the problem was a restriction in external air flow into the bus enclosure. This was caused by the transition assembly partially blocking the louvers in the bus enclosure. The problem was solved by replacing the existing aluminum transition assembly with a copper transition assembly.

The conductors were replaced with copper conductors replicated to the existing dimension and insulating material. The three series of tests were repeated. During the 3000 ampere stability test, the highest temperature rise achieved was 58° C for the transition. The bus duct approximately one foot away had a high temperature of 52° C. This is shown in

CON EDISON CALCULATION/ANALYSIS SHEET	CALCULATION NO. EGE-00006	REVISION 00	PAGE 11 OF 84
PREPARER/DATE B. Horowitz / 12/15/94	REVIEWER/DATE Robert R. Brown / 12/16/94	CLASS	
SUBJECT/TITLE INDIAN POINT GENERATING STATION EMERGENCY DIESEL GENERATOR UPGRADE DB-75 BREAKER & SWITCHGEAR TESTING		PROJECT NO.	
		MOD NO.	REV

figures 60 & 61. This temperature is lower than previous test runs in that the new transition section and was transmitting less heat to the bus conductors. Table 3 shows the thermal time constants for the bus transition and bus duct. Based on the new temperature rises, our calculations indicate that the transition piece has a full load rating of 3196 amperes and the bus duct has an associated full load current rating of 3396 amperes.

Figures 62 & 63 show the load duty cycle for the transition and bus duct. During the testing, the highest temperatures obtained during the 3300 ampere portion of the test were 54° C for the transition and 50° C for the bus duct. Figures 64 & 65 show the 3400 ampere test from stability, with the transition piece having the highest temperature of 54° C and the bus duct hitting 54° C also.

Table 3 shows the thermal time constant for the transition piece and the bus duct. The change out of the aluminum to copper has significantly improved the performance of the bus duct.

CON EDISON
CALCULATION/ANALYSIS SHEET

CALCULATION NO.

REVISION

PAGE 12 OF 84

PREPARER/DATE

EGE-00006

00

B. Horowitz B. Kowalski 12/15/94

REVIEWER/DATE

Robert R. Brown

12/16/94

CLASS

SUBJECT/TITLE INDIAN Point GENERATING STATION

PROJECT NO.

EMERGENCY DIESEL GENERATOR UPGRADE

MOD NO.

REV

DB-75 BREAKER & SWITCHGEAR TESTING

The switchgear housing is divided into two sections, the front and rear. The front section contains the breaker components, which has been analyzed in the first section. The rear portion contains the interconnecting bus work, which brings the power into the switchgear and distributes it to the individual load breakers. The components within the rear of the structure are the bus conductors and their associated supports (insulators). The supports are glass epoxy (red in color) insulators rated for a 85° C rise, or a total temperature of 125° C. This information was also supplied by Westinghouse. ANSI/IEEE C37.010 indicates that "contacts, conducting joints and other parts, silver surfaced, silver, silver alloy or equivalent" can also have a maximum temperature rise limitation of 85° C. This supports Westinghouse's information on the insulators temperature rating in that it should be capable of handling the maximum expected temperature of the conductors.

As part of the test requirements, the conductors located in the rear of the switchgear housing were instrumented and monitored to determine that their associated temperature rise was within the standards. The hottest internal bus component was the middle section (commonly referred to as "B" phase) of vertical bus. The maximum temperature rise of this component obtained during the 3000 ampere stability run was 75.74° C. Temperature measurements indicated that the other conductors were operating approximately 10° C cooler. Based on this it was decided to modify the rear panel of the housing to improve the performance of the center section of the bus. This revised ventilation lowered the "B" phase conductor temperature rise at 3000 amperes to 64.63° C.

Although without this modification, the equipment meets the requirements set forth in ANSI/IEEE C37.010, this modification is considered a design improvement and was not required to meet the new loading requirements.

PREPARER/DATE
B. Brown 12/15/94

REVIEWER/DATE
Robert R. Brown

SUBJECT/TITLE
INDIAN Point GENERATING STATION

EMERGENCY DIESEL GENERATOR UPGRADE

PROJECT NO.
12/16/94

DB-75 BREAKER & SWITCHGEAR TESTING

MOD NO.

REV

INDIAN POINT UNIT 2

	PHASE	2500 AMPERES			2800 AMPERES			3000 AMPERES			AVERAGE THERMAL TIME CONSTANT (MINUTES)
		MAX TEMP RISE (C)	63% OF MAXIMUM TEMPERATURE RISE (C)	THERMAL TIME CONSTANT (MINUTES)	MAX TEMP RISE (C)	63% OF MAXIMUM TEMPERATURE RISE (C)	THERMAL TIME CONSTANT (MINUTES)	MAX TEMP RISE (C)	63% OF MAXIMUM TEMPERATURE RISE (C)	THERMAL TIME CONSTANT (MINUTES)	
UPPER PHENOLICS	B	46	29	62.5	57	36	58	64	40.3	59.5	60
	A	43.5	27.4	61	52	33	60	61.5	38.8	58.5	60
LOWER PHENOLICS	B	43.5	27.4	59	54	34	58.5	66	41.6	59	59
	A	43.5	27.4	59	52	33	58.5	53	33.4	61	59
	C	43.5	27.4	59	52	33	58.5	50	31.5	60	59
MOVEABLE PIVOTS	B	52	32.8	61	64	40.3	60	72	45.4	59	60
	A	49	31	60	60	38	59	63	40	59	59
	C	49	31	60	59	37	59	63	40	59	59
STATIONARY PIVOTS	B	49	31	60	62	39	59.3	70	44	58.5	60
	A	48	30.2	59	57	36	59	60	38	59.5	59
	C	46	29	59	57	36	59	60	38	58.5	59
STATIONARY MAINS	B	50	31.5	61.5	62	39	61	71	45	59.5	60
	A	46	29	60	57	36	60	68	43	59	60
	C	46	29	60	54	34	59.5	65	41.6	58.5	59
MOVEABLE MAINS	B	50	31.5	60	63	40	60.5	69	43.5	60	60
	A	48	30.2	60	60	38	59.5	67	42.3	60	60
	C	48	30.2	60	60	38	59.5	65.8	41.5	59	59.5
UPPER BREAKER STABS	B	42	26.5	62	52	33	62	58	36.6	59	61.5
	A	39	24.6	61	47	30	61.5	55.5	35	57.5	60
	C	38	24	62	47.5	30	62.5	54.5	34.4	58.5	61
LOWER BREAKER STABS	B	43	27.1	59.5	54	34	59	66	41.6	59.5	59
	A	42	26.5	59	50	31.5	58.5	61	38.5	59.5	59
	C	41	26	58.5	50	31.5	58.5	59.5	37.5	58.5	58.5

TABLE 1

CON EDISON
CALCULATION/ANALYSIS SHEET

CALCULATION NO.

REVISION

PAGE 14 OF 84

EGE-00006

00

PREPARER/DATE

REVIEWER/DATE

CLASS

B. Horowitz B. Brown 12/15/94

Robert R. Brown 12/16/94

SUBJECT/TITLE INDIAN Point GENERATING STATION
EMERGENCY DIESEL GENERATOR UPGRADE

PROJECT NO.

DB'S BREAKER & SWITCHGEAR TESTING

MOD NO.

REV

	ESCALATED FROM 2500 AMPERES TO MAX. RATING	ESCALATED FROM 2800 AMPERES TO MAX. RATING
MOVEABLE PIVOTS	3285	3290
STATIONARY PIVOTS	3395	3342
STATIONARY MAINS	3357	3315
MOVEABLE MAINS	3357	3369
UPPER BREAKER STABS	3698	3709
LOWER BREAKER STABS	3650	3453
UPPER PHENOLICS	3011	3029
LOWER PHENOLICS	3104	3125

TABLE 2

CON EDISON
CALCULATION/ANALYSIS SHEET

CALCULATION NO.

REVISION

PAGE 15 OF 84

EGE-00006

00

PREPARER/DATE

REVIEWER/DATE

CLASS

B. Herzog & B. Brown 12/15/94

Robert R. Brown 12/16/94

SUBJECT/TITLE INDIAN Point GENERATING STATION
EMERGENCY DIESEL GENERATOR UPGRADE
DB-75 BREAKER & SWITCHGEAR TESTING

PROJECT NO.

MOD NO.

REV

		3000 AMPERES		
		MAX TEMP RISE (C)	63% OF MAXIMUM TEMPERATURE RISE (C)	THERMAL TIME CONSTANT (MINUTES)
PHASE				
BUS DUCT	B-1	57	36	60
TRANSITION	B-2	55	35	61
	A-1	55	35	63
	A-2	58	37	63
	C-1	44.5	28	60
	C-2	42	27	66
BUS DUCT	B-1	52	33	52.5
NON-	B-2	50.5	32	52.5
TRANSITION				
	A-1	46	29	52
	A-2	48	30	52.5
	C-1	34	21	52.5
	C-2	32	20	52.5

TABLE 3

CON EDISON
CALCULATION/ANALYSIS SHEET

PREPARER/DATE
B. Howard 12/15/94
SUBJECT/TITLE
INDIAN POINT GENERATING STATION
EMERGENCY DIESEL GENERATOR UPGRADE
DB-75 BREAKER & SWITCHGEAR TESTING

CALCULATION NO.
EGE-00006

REVIEWER/DATE
Robert R. Brown 12/16/94
PROJECT NO.
MOD NO.
REV

REVISION

00

PAGE 16 OF 84

CLASS.

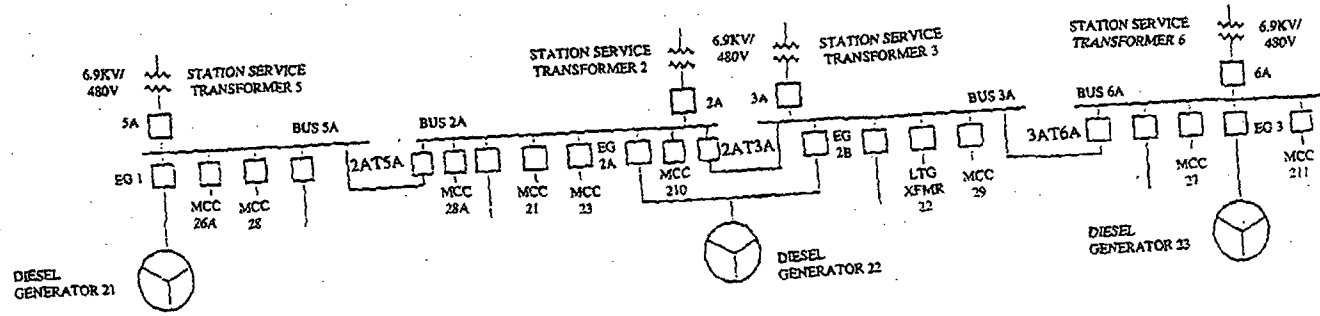
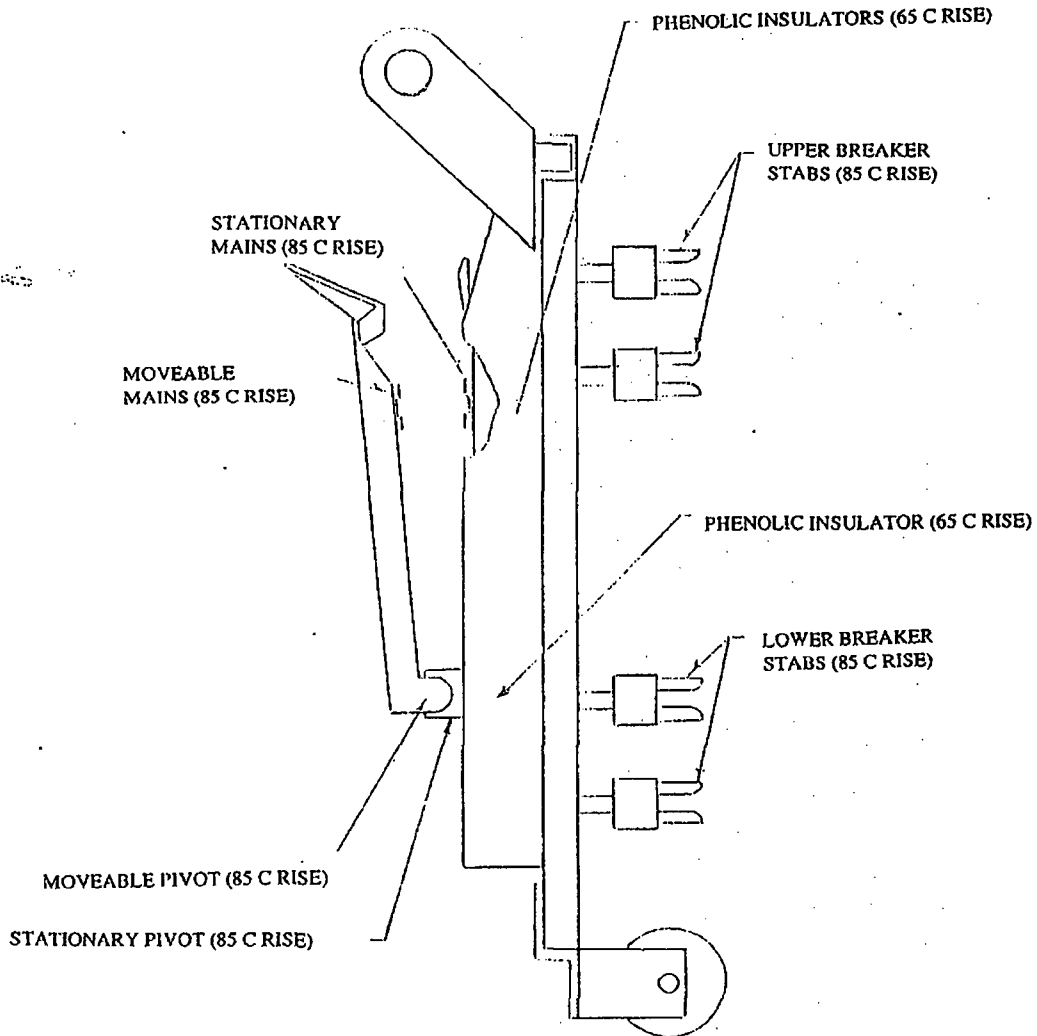

FIGURE 1

CON EDISON CALCULATION/ANALYSIS SHEET	CALCULATION NO. EGE-00006	REVISION 00	PAGE 17 OF 84
PREPARER/DATE B. Horowitz B. Newberg 12/15/94	REVIEWER/DATE Robert R. Brown 12/16/94	CLASS.	
SUBJECT/TITLE INDIAN POINT GENERATING STATION EMERGENCY DIESEL GENERATOR UPGRADE DB-75 BREAKER & SWITCHGEAR TESTING		PROJECT NO.	
		MOD NO.	REV



WESTINGHOUSE DB-75 CIRCUIT BREAKER
RIGHT SIDE VIEW

FIGURE 2

CON EDISON
CALCULATION/ANALYSIS SHEET

CALCULATION NO.
EGE-00006

REVIEWER/DATE
Robert R. Brown

PREPARER/DATE
B. Horowitz 12/15/94

SUBJECT/TITLE
INDIAN POINT GENERATING STATION
EMERGENCY DIESEL GENERATOR UPGRADE

DB-75 BREAKER & SWITCHGEAR TESTING

REVISION

00

CLASS

12/16/94

PROJECT NO.

MOD NO.

REV

PAGE 18 OF 84

INDIAN POINT UNIT 2

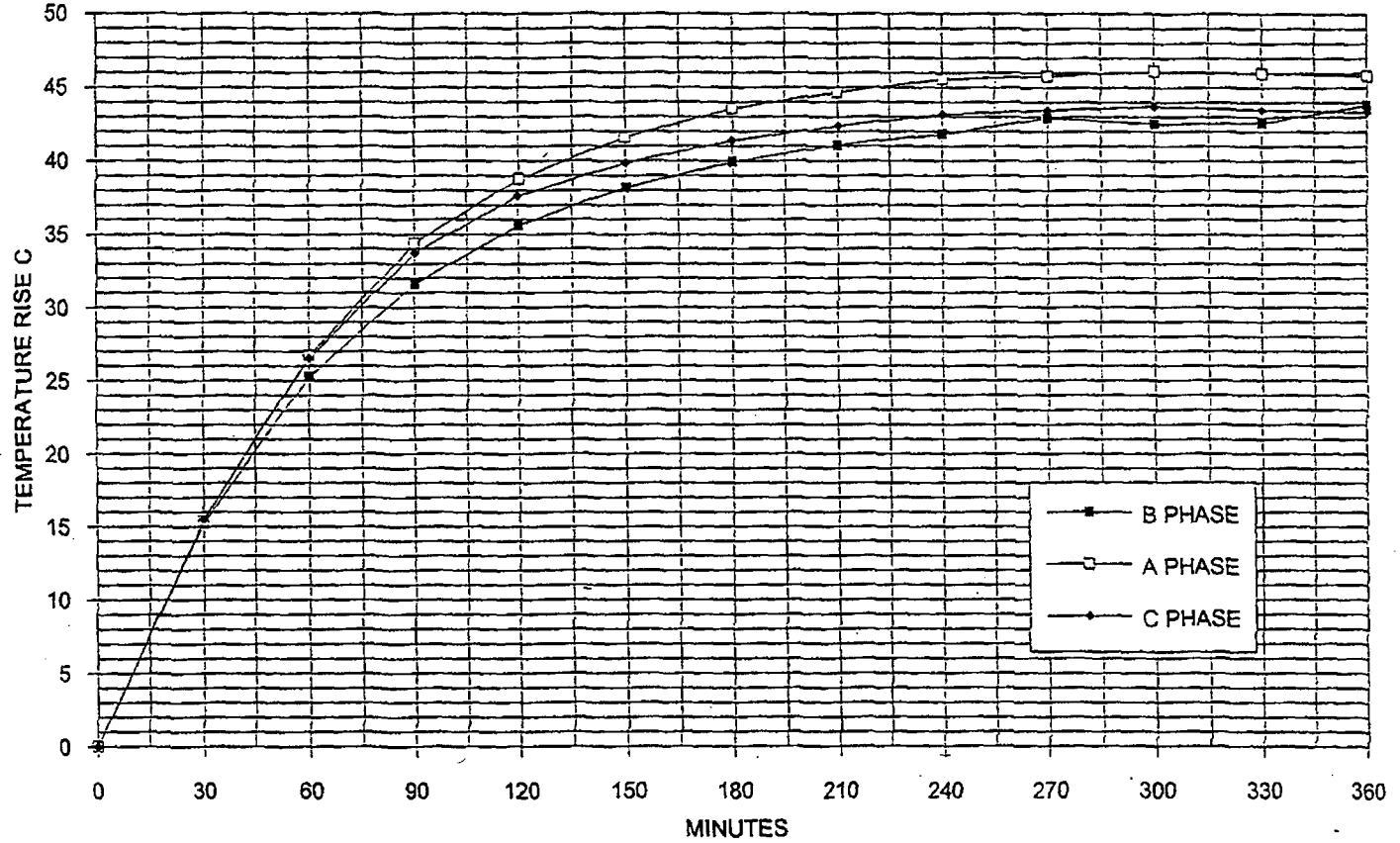

FIGURE 3 - TEST 1 - 2500 AMPERES UPPER PHENOLIC

CON EDISON CALCULATION/ANALYSIS SHEET	CALCULATION NO. EGE-00006	REVISION 00	PAGE 19 OF 84
PREPARER/DATE B. Howard B. Howard 12/15/94	REVIEWER/DATE Robert R. Brown 12/16/94	PROJECT NO.	CLASS
SUBJECT/TITLE INDIAN POINT GENERATING STATION EMERGENCY DIESEL GENERATOR UPGRADE DB-75 BREAKER & SWITCHGEAR TESTING	MOD NO.	REV	

INDIAN POINT UNIT 2

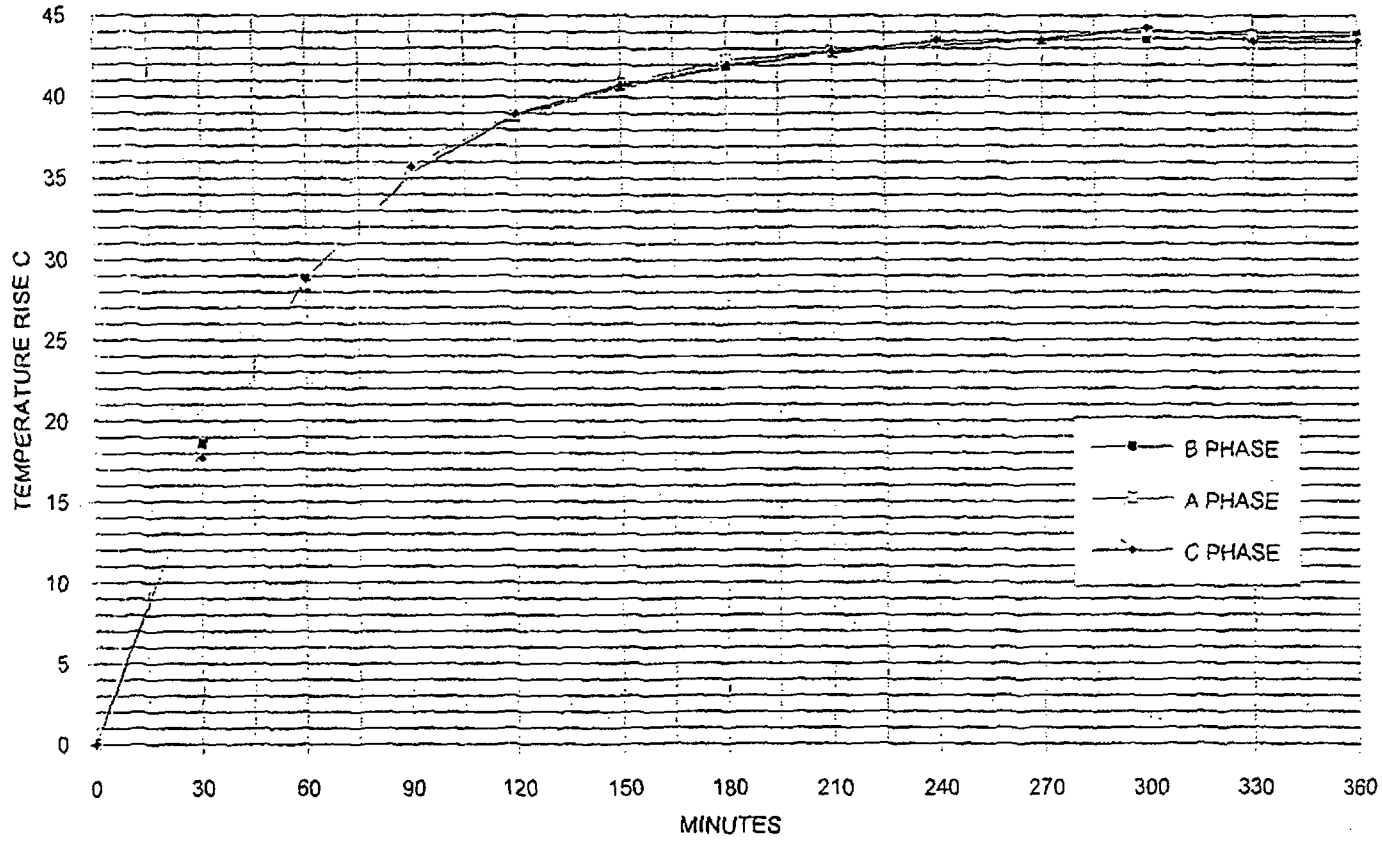

FIGURE 4 - TEST 1 - 2500 AMPERES LOWER PHENOLICS

CON EDISON CALCULATION/ANALYSIS SHEET	CALCULATION NO. EGE-00006	REVISION 00	PAGE 20 OF 84
PREPARER/DATE B. Horowitz B. New 12/15/94	REVIEWER/DATE Robert R. Brown 12/16/94	PROJECT NO.	CLASS
SUBJECT/TITLE INDIAN POINT GENERATING STATION EMERGENCY DIESEL GENERATOR UPGRADE DB-7'S BREAKER & SWITCHGEAR TESTING	MOD NO.	REV	

INDIAN POINT UNIT 2

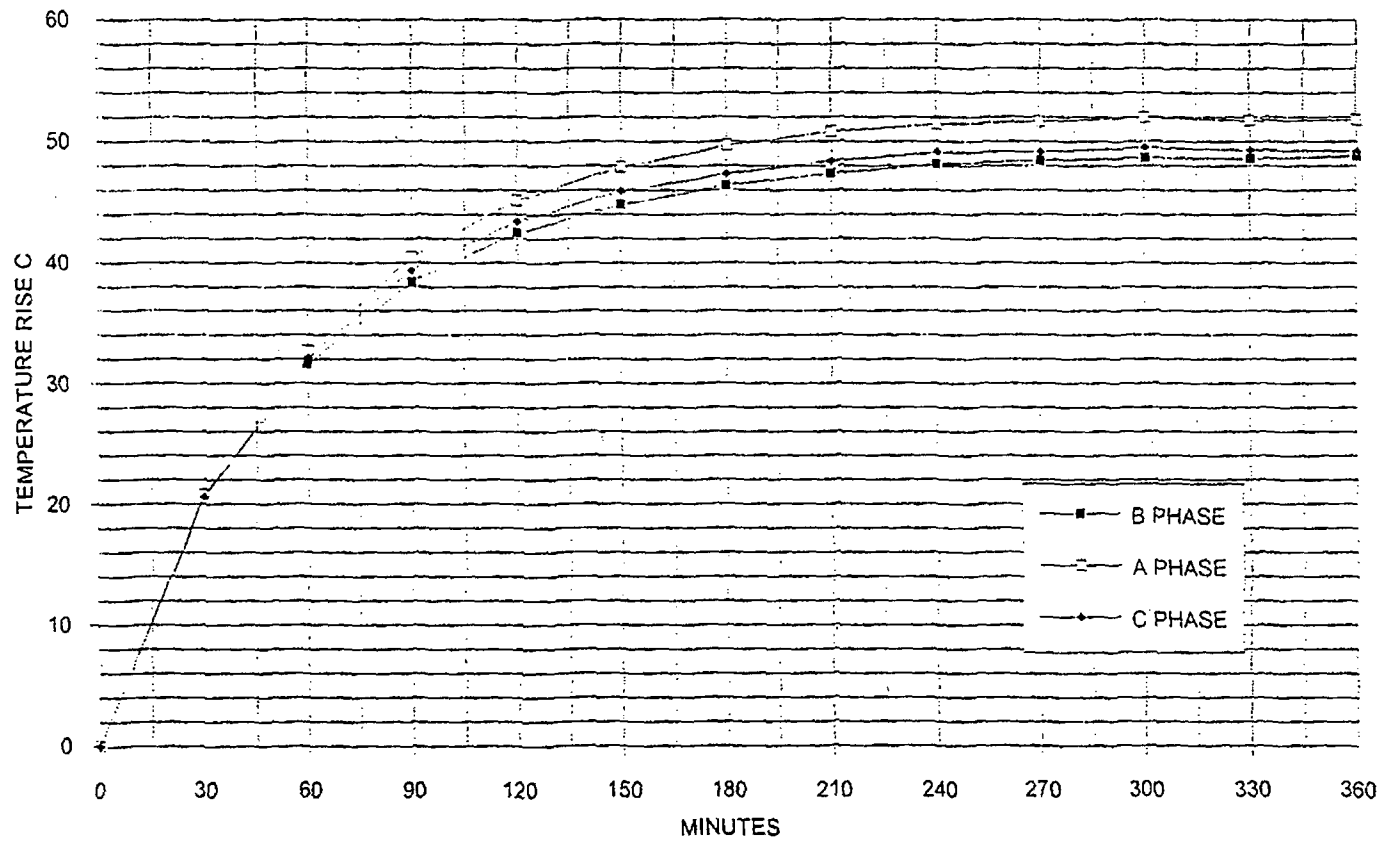

FIGURE 5 - TEST 1 2500 AMPERES MOVABLE PIVOTS

CON EDISON CALCULATION/ANALYSIS SHEET	CALCULATION NO. EGE-00006	REVISION 00	PAGE 21 OF 84
PREPARER/DATE B. H. ... 12/15/94	REVIEWER/DATE Robert R. Brown 12/16/94	PROJECT NO.	CLASS
SUBJECT/TITLE INDIAN POINT GENERATING STATION EMERGENCY DIESEL GENERATOR UPGRADE DB-15 BREAKER & SWITCHGEAR TESTING	MOD NO.	REV	

INDIAN POINT UNIT 2

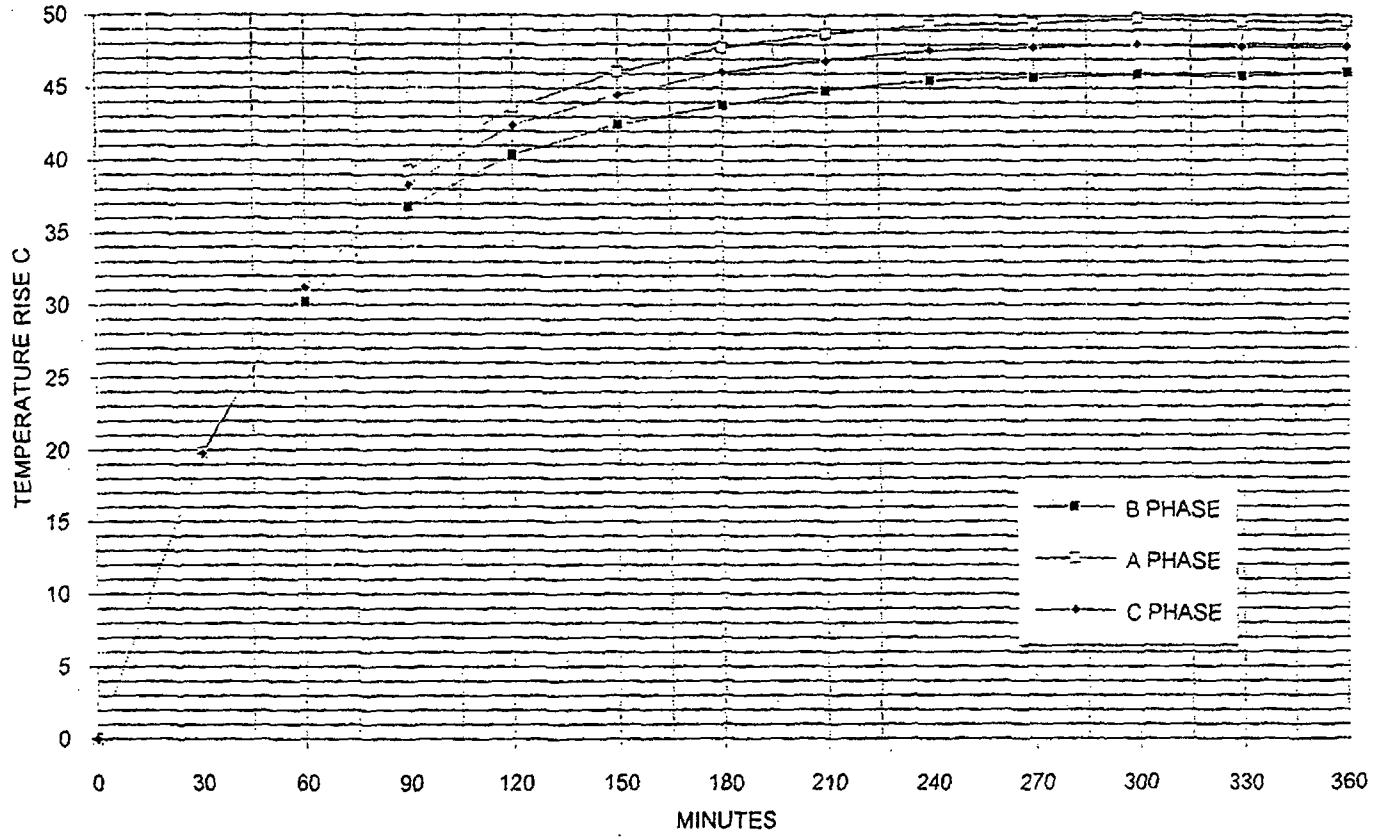

FIGURE 6 - TEST 1 - 2500 AMPERES STATIONARY PIVOTS

CON EDISON CALCULATION/ANALYSIS SHEET	CALCULATION NO. EGE-00006	REVISION 00	PAGE 22 OF 84
PREPARER/DATE B. Horowitz 12/15/94	REVIEWER/DATE Robert R. Brown 12/16/94	PROJECT NO.	CLASS
SUBJECT/TITLE INDIAN POINT GENERATING STATION EMERGENCY DIESEL GENERATOR UPGRADE DB-75 BREAKER & SWITCHGEAR TESTING		MOD NO.	REV

INDIAN POINT UNIT 2

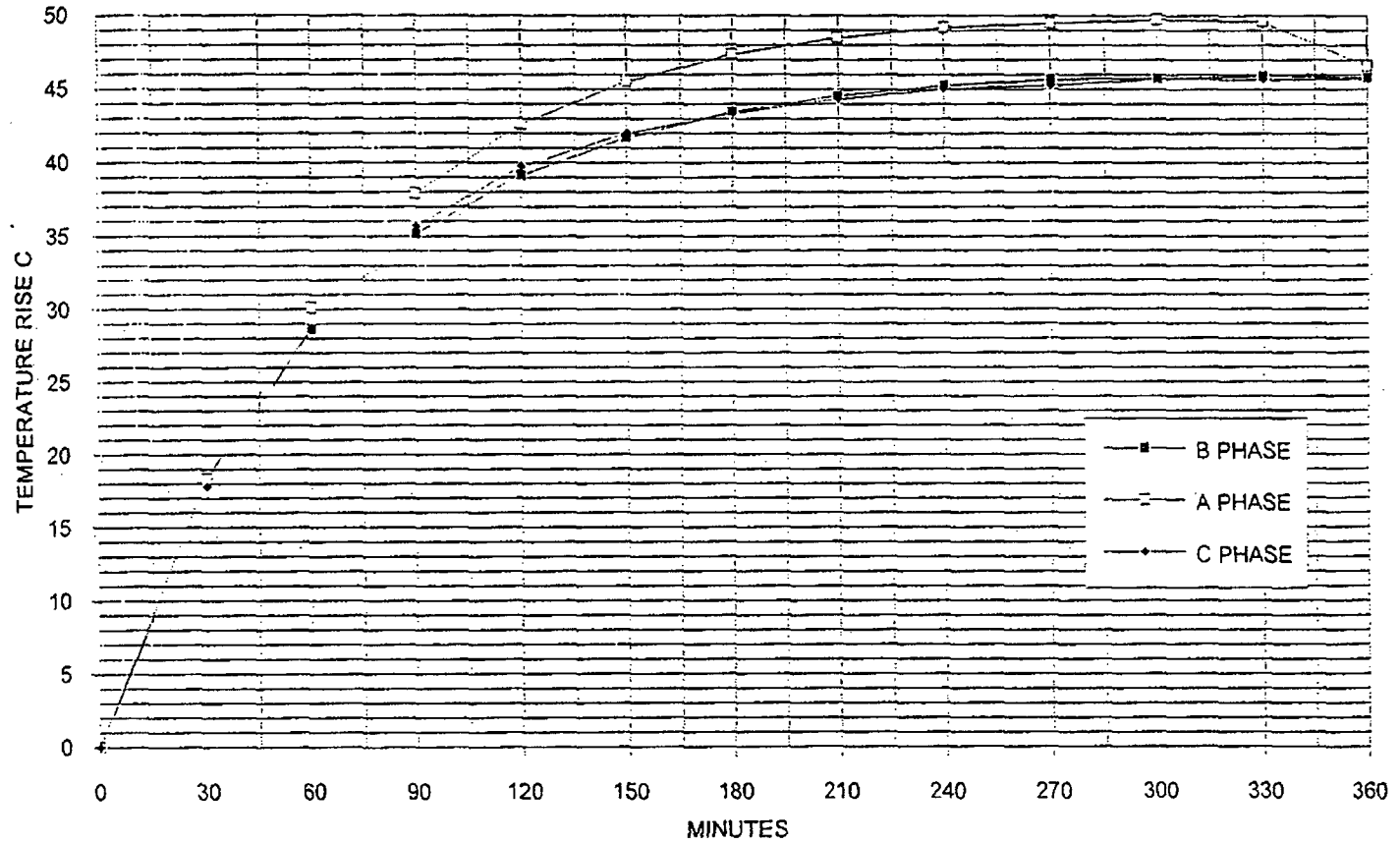

FIGURE 7 - TEST 1 - 2500 AMPERES STATIONARY MAIN CONTACTS

CON EDISON CALCULATION/ANALYSIS SHEET	CALCULATION NO. EGE-00006	REVISION 00	PAGE 23 OF 84
PREPARER/DATE B. Herzog/12/16/94	REVIEWER/DATE Robert R. Brown/12/16/94	PROJECT NO.	CLASS
SUBJECT/TITLE INDIAN POINT GENERATING STATION EMERGENCY DIESEL GENERATOR UPGRADE	MOD NO.	REV	
DB-75 BREAKER & SWITCHGEAR TESTING			

INDIAN POINT UNIT 2

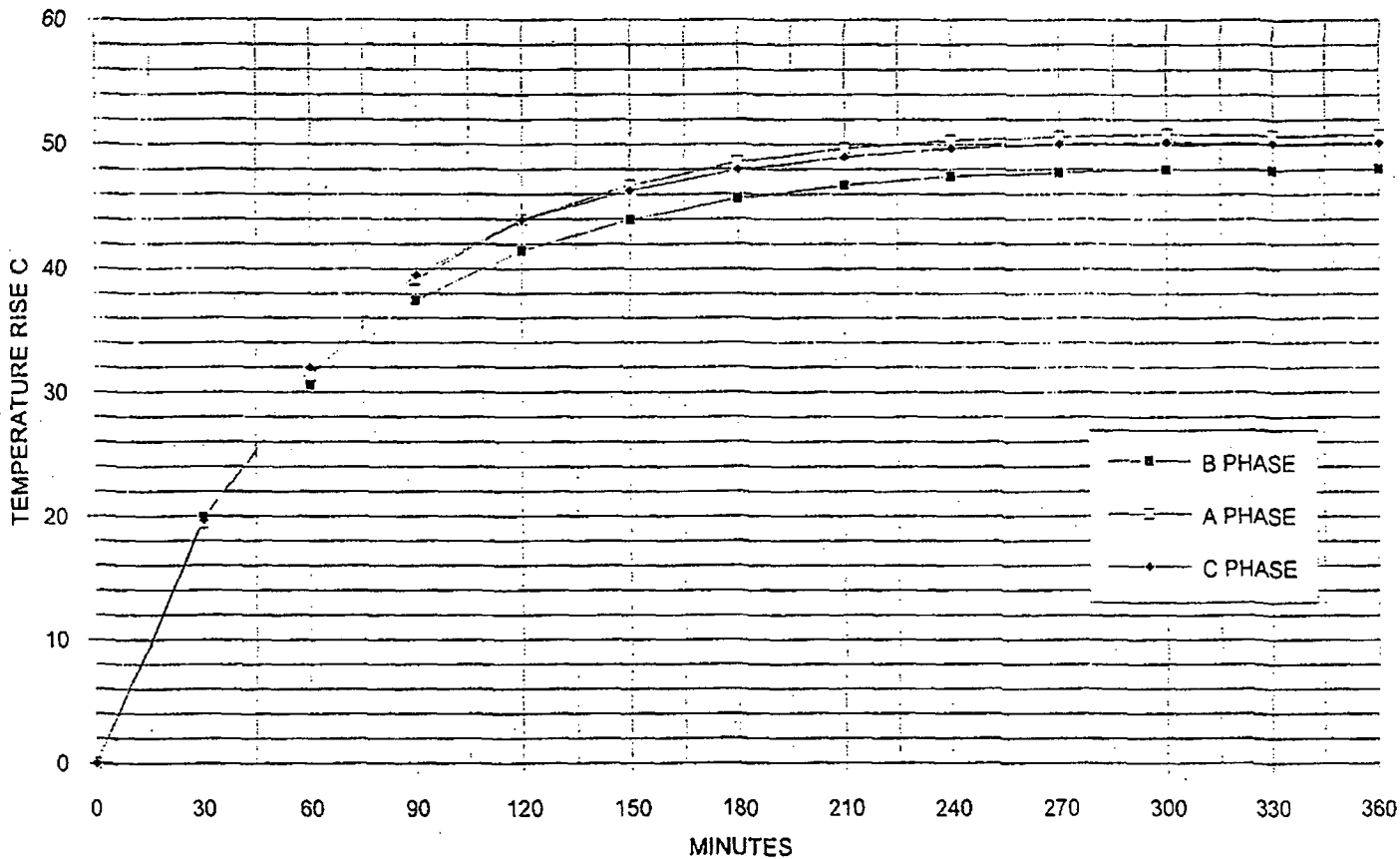

FIGURE 8 - TEST 1 - 2500 AMPERES MAIN MOVABLE CONTACTS

CON EDISON CALCULATION/ANALYSIS SHEET	CALCULATION NO. EGE-00006	REVISION 00	PAGE 24 OF 84
PREPARER/DATE B. H. Lewis 12/15/94	REVIEWER/DATE Robert R. Brown 12/16/94	MOD NO.	CLASS
SUBJECT/TITLE INDIAN POINT GENERATING STATION EMERGENCY DIESEL GENERATOR UPGRADE		PROJECT NO.	
DB-75 BREAKER & SWITCHGEAR TESTING			REV

INDIAN POINT UNIT 2

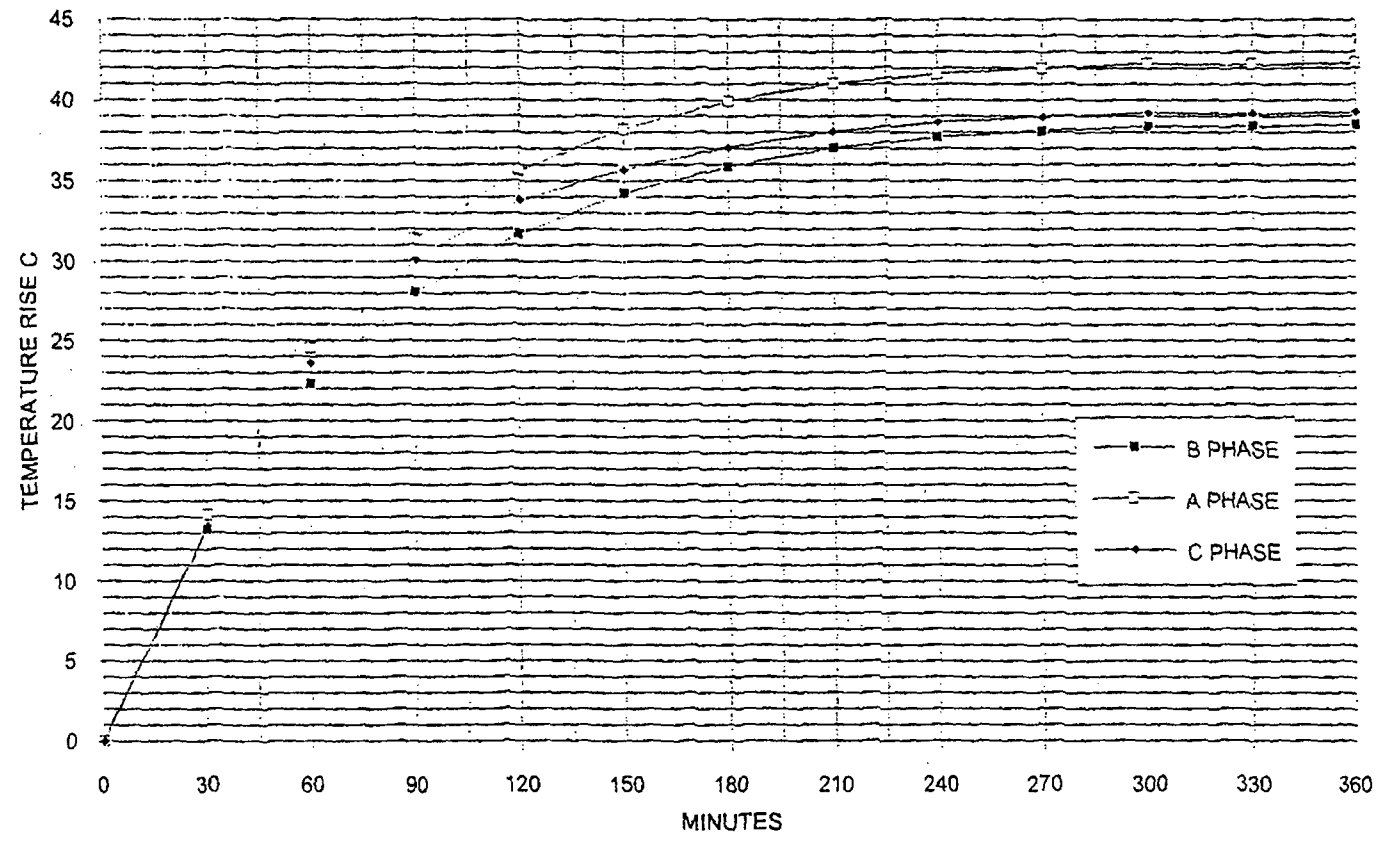

FIGURE 9 - TEST 1 - 2500 AMPERES UPPER BREAKER STABS

CON EDISON CALCULATION/ANALYSIS SHEET	CALCULATION NO. EGE-00006	REVISION 00	PAGE 25 OF 84
PREPARER/DATE B. Horowitz 12/15/94	REVIEWER/DATE Robert R. Brown 12/16/94	PROJECT NO.	CLASS
SUBJECT/TITLE INDIAN POINT GENERATING STATION EMERGENCY DIESEL GENERATOR UPGRADE DB-75 BREAKER & SWITCHGEAR TESTING		MOD NO.	REV

INDIAN POINT UNIT 2

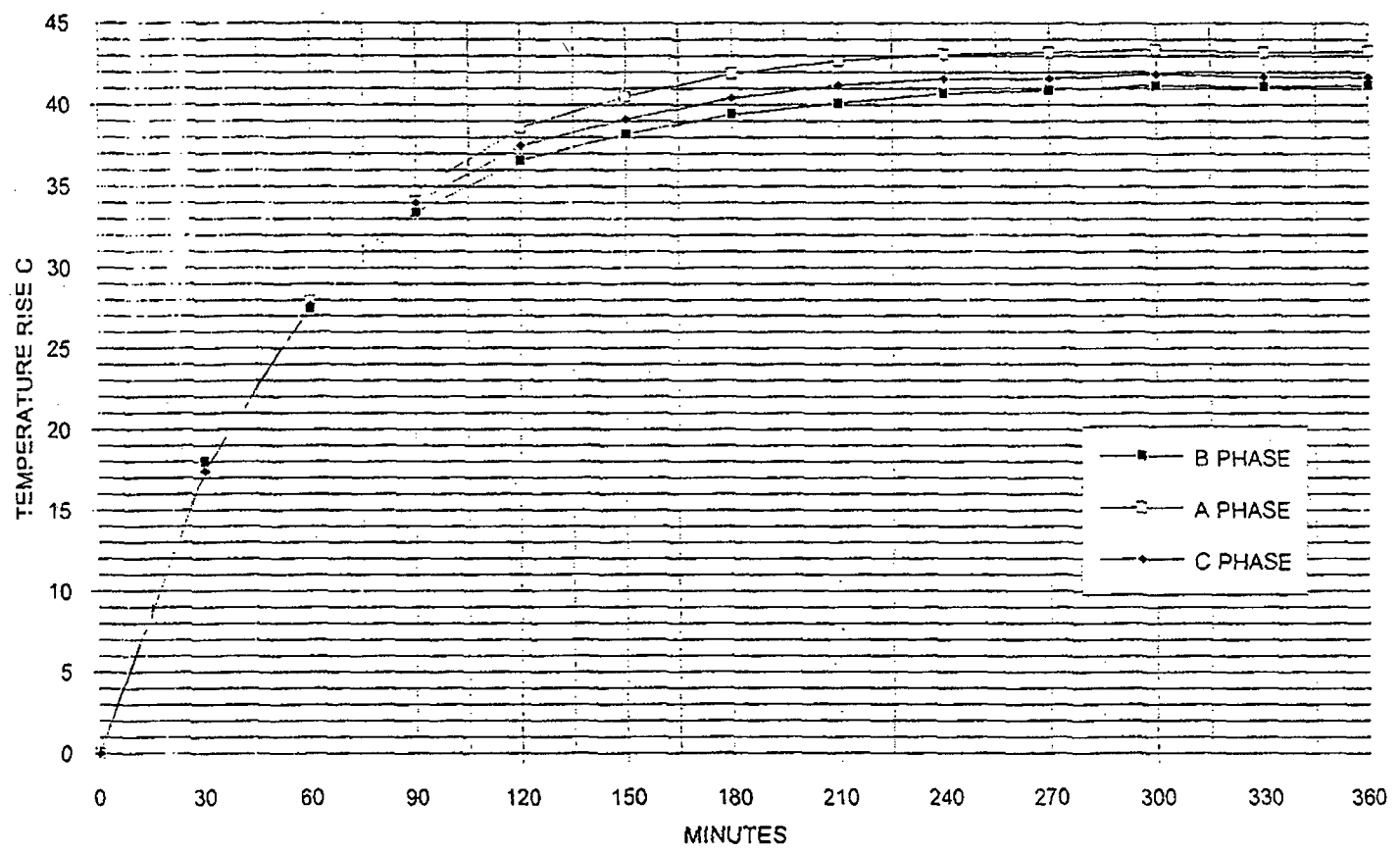

FIGURE 10 - TEST 1 2500 AMPERES LOWER BREAKER STABS

CON EDISON
CALCULATION/ANALYSIS SHEET

CALCULATION NO.
EGE-000006

REVISION
00

PAGE 26 OF 84

PREPARER/DATE
B. Hezlett 12/15/94

REVIEWER/DATE
Robert R. Brown 12/16/94

CLASS

SUBJECT/TITLE INDIAN POINT GENERATING STATION
EMERGENCY DIESEL GENERATOR UPGRADE
DB-75 BREAKER & SWITCHGEAR TESTING

PROJECT NO.

MOD NO.
REV

INDIAN POINT UNIT 2

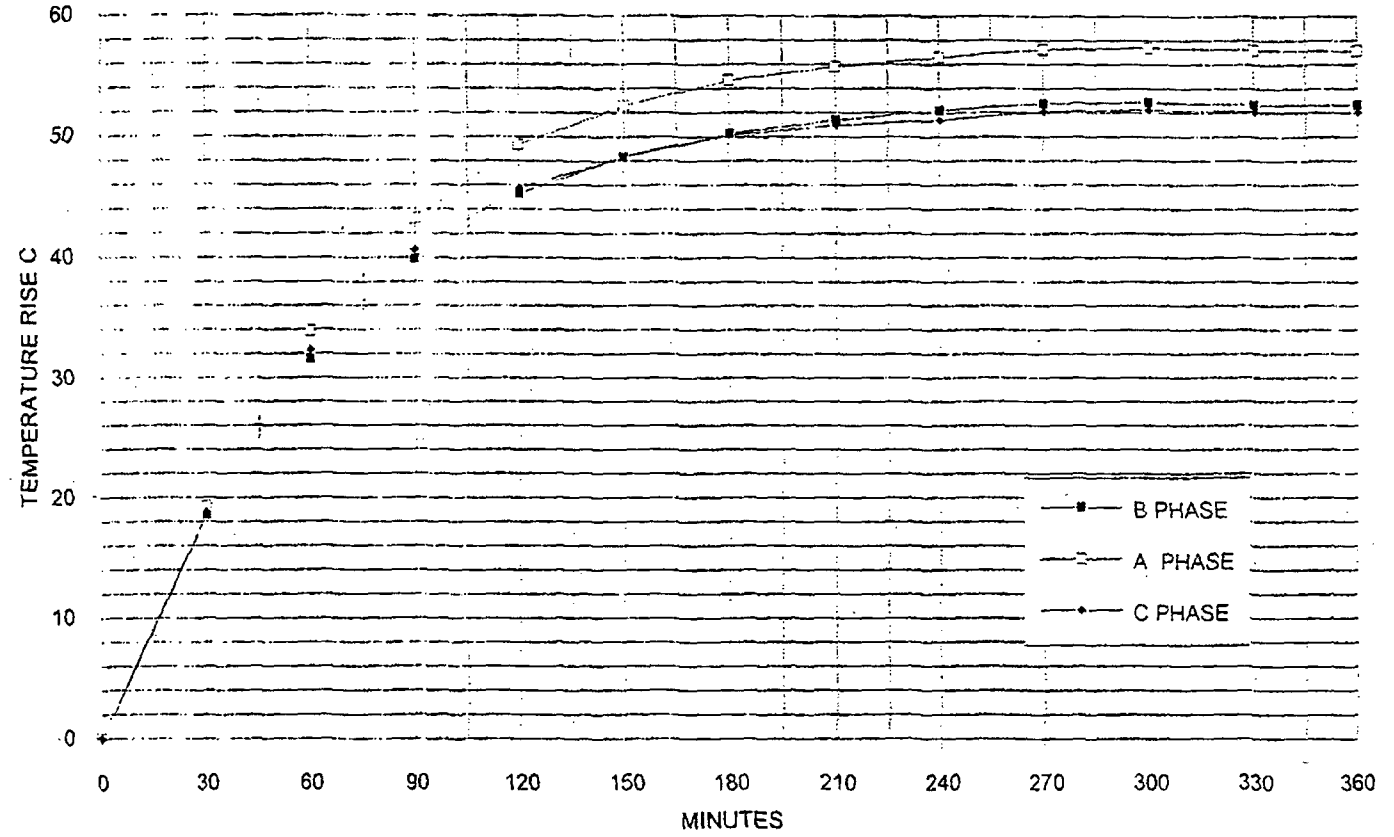

FIGURE 11 - TEST 1 - 2800 AMPERES UPPER PHENOLIC

CON EDISON
CALCULATION/ANALYSIS SHEET

PREPARER/DATE

B. Horowitz 12/15/94

SUBJECT/TITLE INDIAN POINT GENERATING STATION
EMERGENCY DIESEL GENERATOR UPGRADE
DB-75 BREAKER & SWITCHGEAR TESTING

CALCULATION NO.

EGE-00006

REVIEWER/DATE

Robert R. Brown 12/16/94

REVISION

00

PAGE 27 OF 84

CLASS

PROJECT NO.

MOD NO.

REV

INDIAN POINT UNIT 2

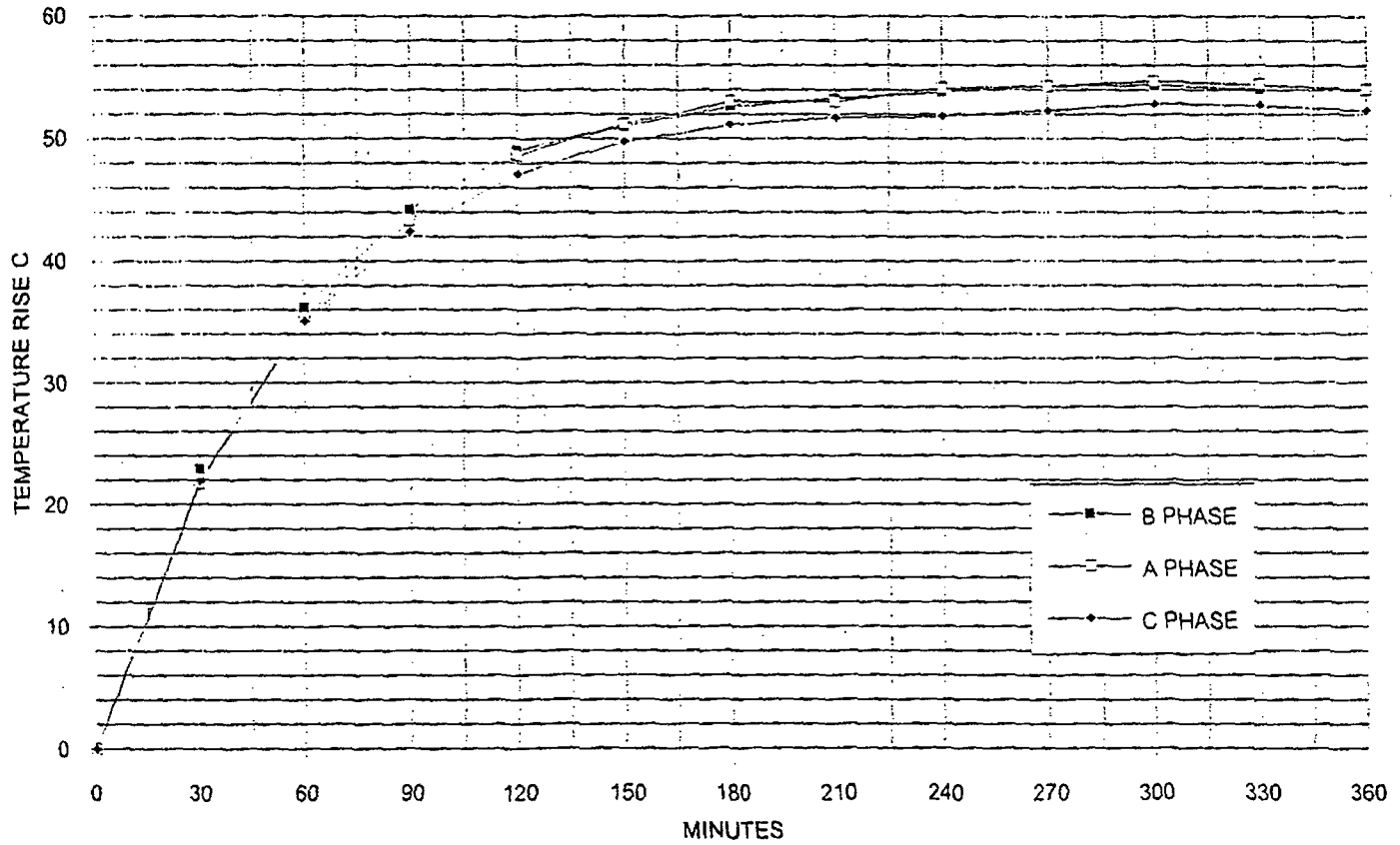

FIGURE 12 - TEST 1 - 2800 AMPERES LOWER PHENOLICS

CON EDISON
CALCULATION/ANALYSIS SHEET

PREPARER/DATE
B. Horowitz 12/15/94

REVIEWER/DATE
Robert R. Brown 12/16/94

SUBJECT/TITLE
INDIAN POINT GENERATING STATION
EMERGENCY DIESEL GENERATOR UPGRADE
DB-75 BREAKER & SWITCHGEAR TESTING

CALCULATION NO.
EGE-00006

REVISION
00

PROJECT NO.

PAGE 28 OF 84

CLASS

MOD NO.

REV

INDIAN POINT UNIT 2

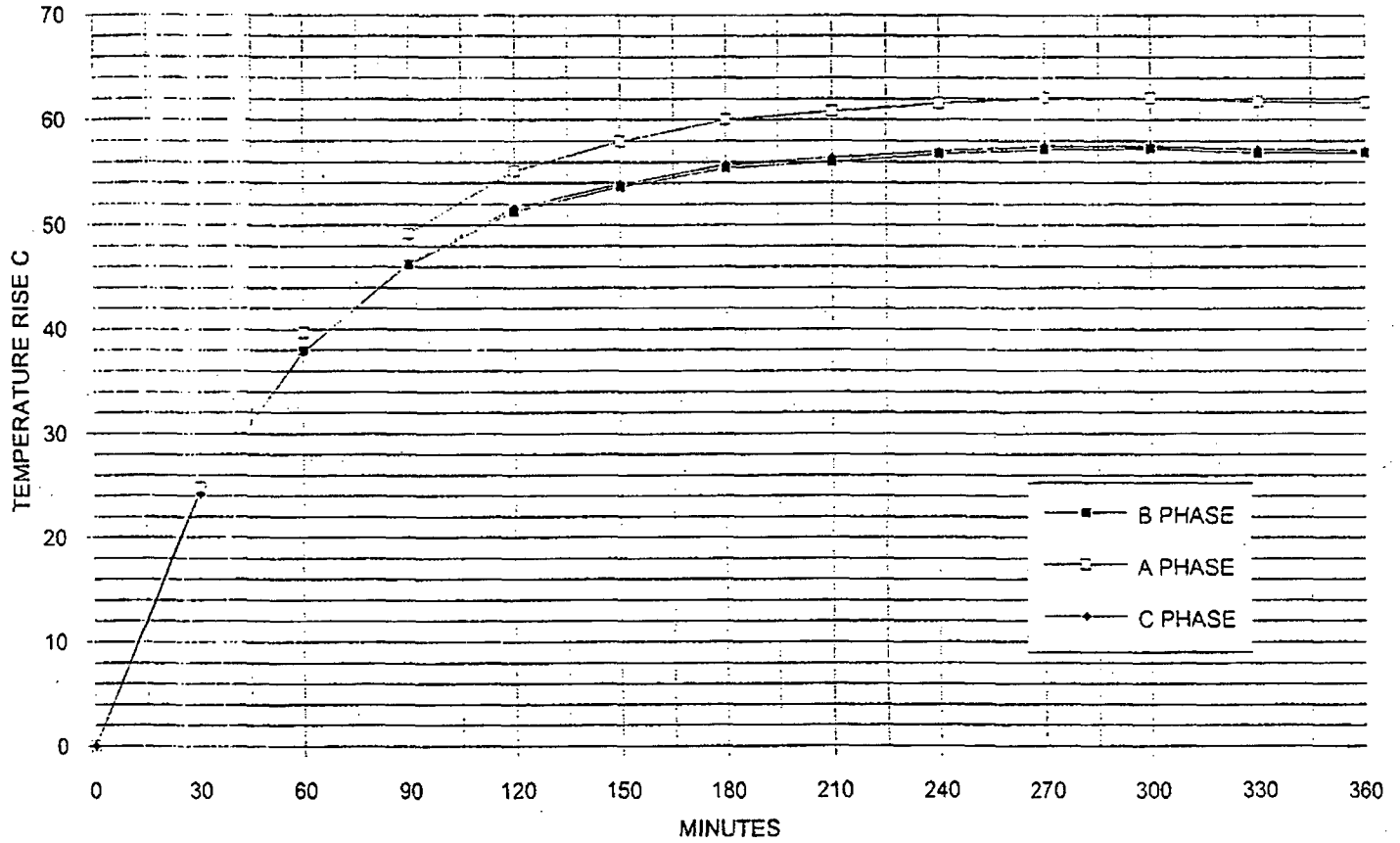

FIGURE 13 - TEST 1 - 2800 AMPERES STATIONARY PIVOTS

CON EDISON
CALCULATION/ANALYSIS SHEET

CALCULATION NO.
EGE-00006

REVISION
00

PAGE 29 OF 84

PREPARED/DATE
B. Horowitz 12/15/94

REVIEWER/DATE
Robert R. Brown 12/16/94

SUBJECT/TITLE
INDIAN POINT GENERATING STATION
EMERGENCY DIESEL GENERATOR UPGRADE
DB-75 BREAKER & SWITCHGEAR TESTING

PROJECT NO.

MOD NO.

REV

INDIAN POINT UNIT 2

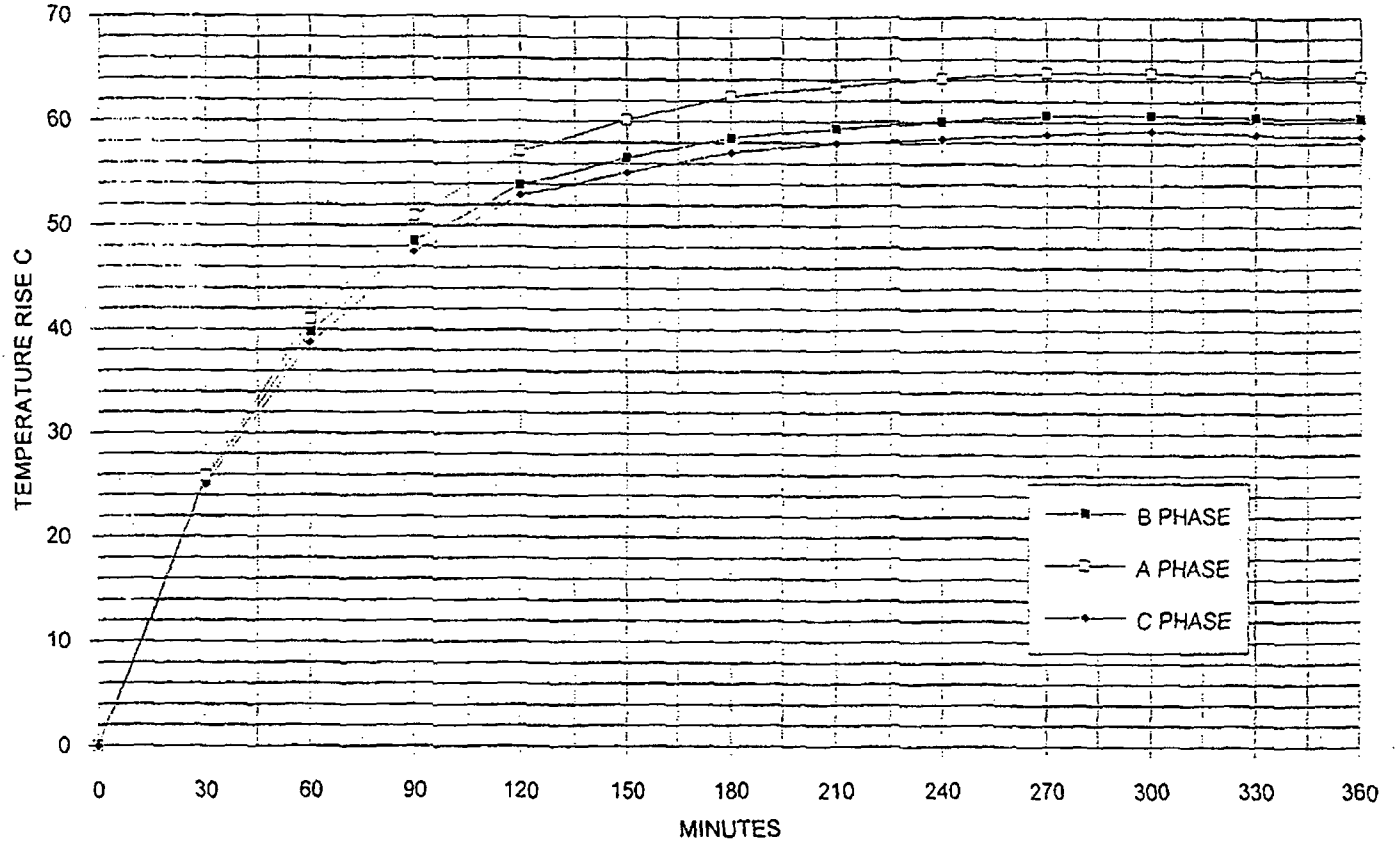

FIGURE 14 - TEST 1 - 2800 AMPERES MOVABLE PIVOTS

CON EDISON
CALCULATION/ANALYSIS SHEET

CALCULATION NO.

EGE-00006

REVISION

00

PAGE 30 OF 84

PREPARER/DATE

B. Howard 1/15/94

REVIEWER/DATE

Robert R. Brown 12/16/94

CLASS

PROJECT NO.

INDIAN POINT GENERATING STATION

EMERGENCY DIESEL GENERATOR UPGRADE

REV

MOD NO.

DB-75 BREAKER & SWITCHGEAR TESTING

INDIAN POINT UNIT 2

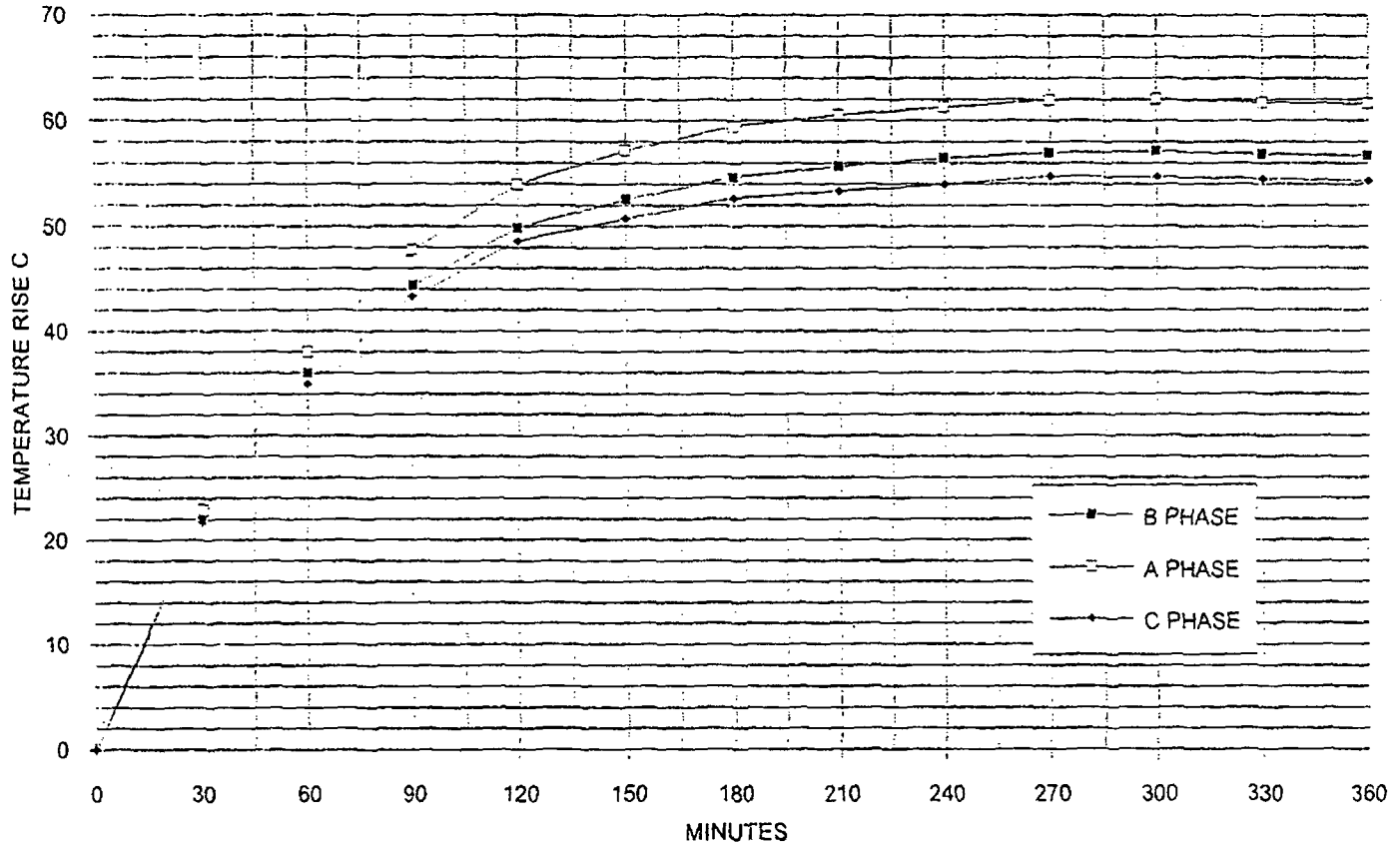

FIGURE 15 - TEST 1 - 2800 AMPERES STATIONARY MAIN CONTACTS

CON EDISON CALCULATION/ANALYSIS SHEET	CALCULATION NO. EGE-00006	REVISION 00	PAGE 31 OF 84
PREPARER/DATE B. Herwitz 12/15/94	REVIEWER/DATE Robert A. Brown 12/16/94	PROJECT NO.	CLASS
SUBJECT/TITLE INDIAN POINT GENERATING STATION EMERGENCY DIESEL GENERATOR UPGRADE		MOD NO.	REV
DB-75 BREAKER & SWITCHGEAR TESTING			

INDIAN POINT UNIT 2

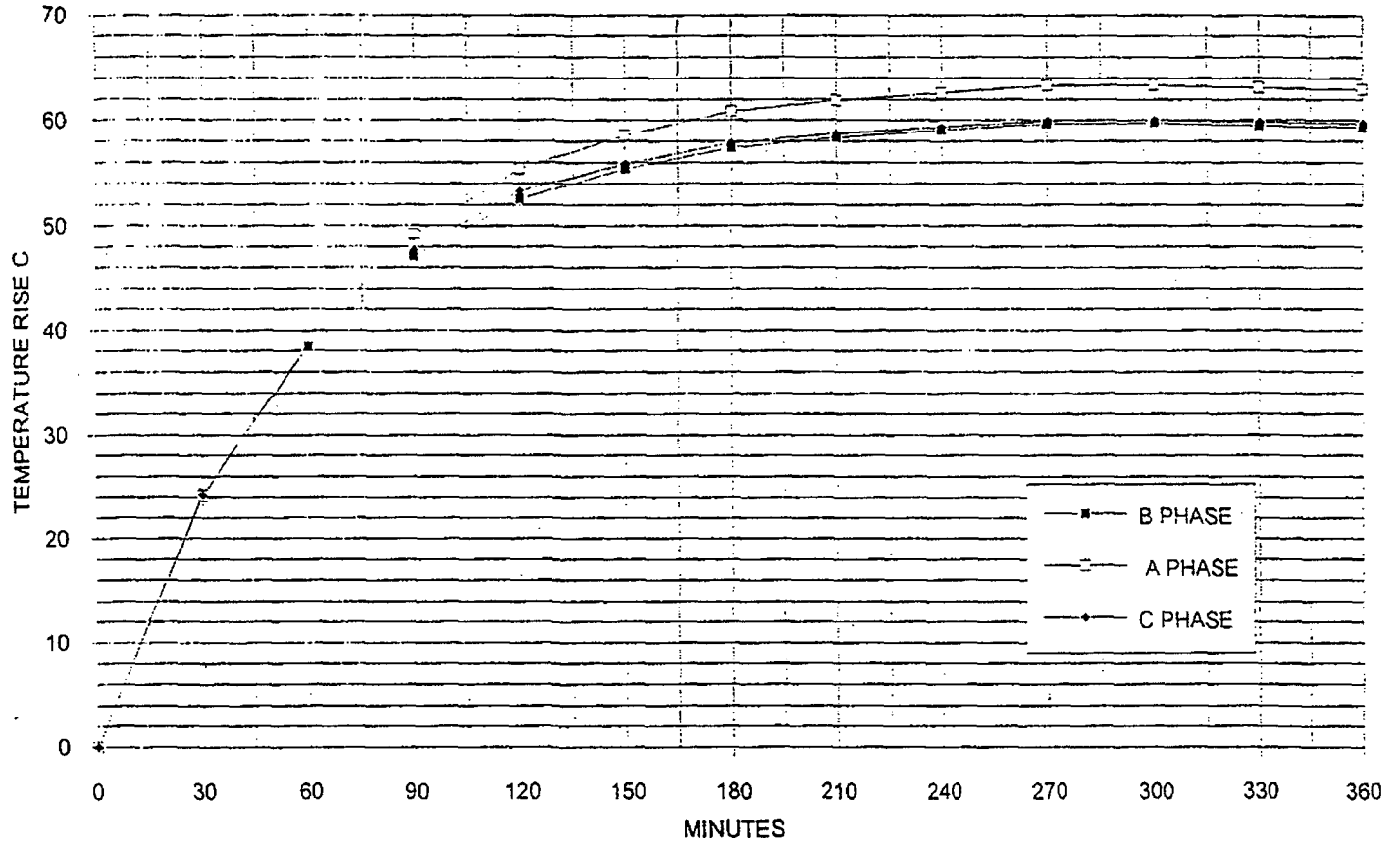

FIGURE 16 - TEST 1 -2800 AMPERES MOVABLE MAIN CONTACTS

CON EDISON CALCULATION/ANALYSIS SHEET	CALCULATION NO. EGE-00006	REVISION 00	PAGE 32 OF 84
PREPARER/DATE B. Morgan 12/5/94	REVIEWER/DATE Robert R. Brown 12/16/94	PROJECT NO.	CLASS
SUBJECT/TITLE INDIAN POINT GENERATING STATION EMERGENCY DIESEL GENERATOR UPGRADE DB-75 BREAKER & SWITCHGEAR TESTING		MOD NO.	REV

INDIAN POINT UNIT 2

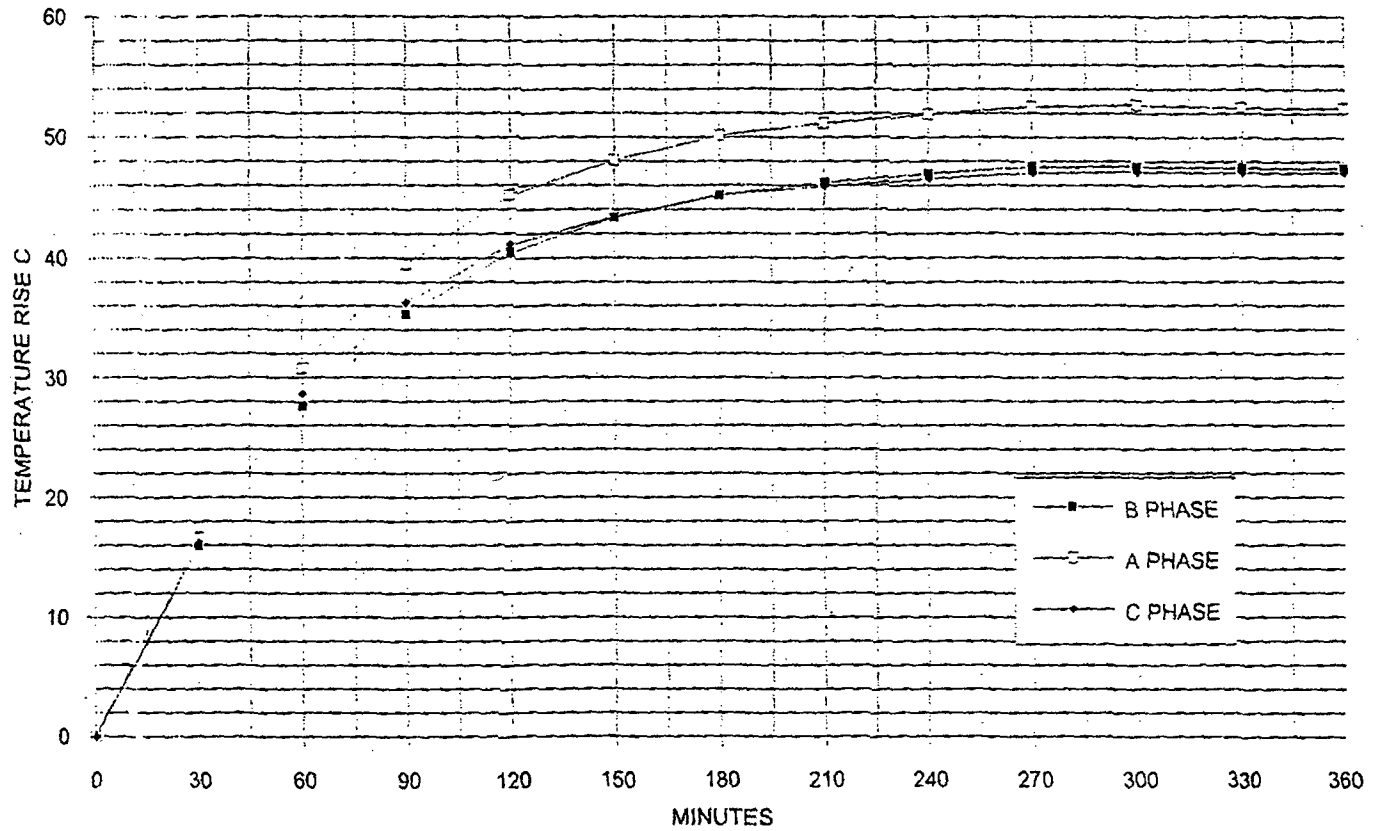

FIGURE 17 - TEST 1 - 2800 AMPERES UPPER BREAKER STABS

CON EDISON
 CALCULATION/ANALYSIS SHEET

PREPARER/DATE
 P.H. [Signature] 12/15/94

SUBJECT/TITLE
 INDIAN POINT GENERATING STATION
 EMERGENCY DIESEL GENERATOR UPGRADE
 DB-75 BREAKER & SWITCHGEAR TESTING

REVISION
 00

REVISION
 12/16/94

PROJECT NO.

MOD NO.

REV

CALCULATION NO.
 EGE-00006

REVIEWER/DATE
 Robert R. Brown 12/16/94

PAGE 33 OF 84
 CLASS

INDIAN POINT UNIT 2

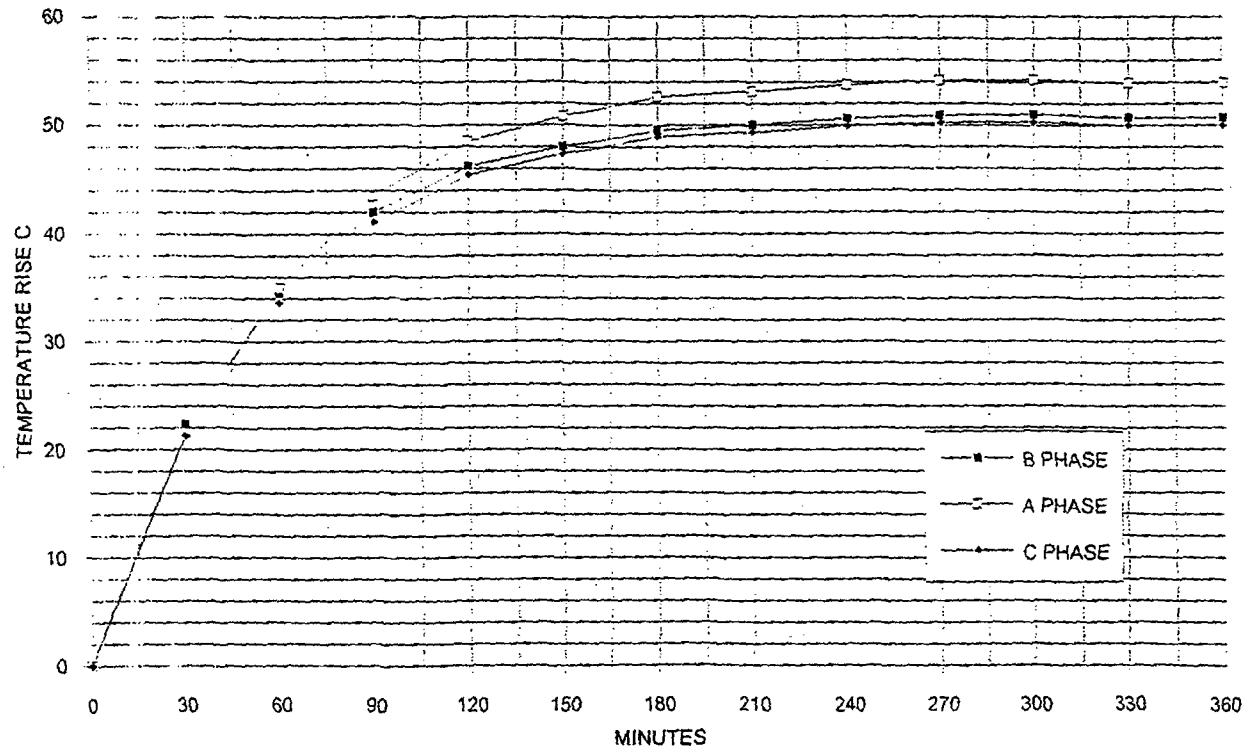

FIGURE 18 - TEST 1 - 2800 AMPERES LOWER BREAKER STABS

CON EDISON
CALCULATION/ANALYSIS SHEET

PREPARER/DATE
B. Horowitz 12/15/94

SUBJECT/TITLE
INDIAN POINT GENERATING STATION
EMERGENCY DIESEL GENERATOR UPGRADE
DB-75 BREAKER & SWITCHGEAR TESTING

CALCULATION NO.
EGE-00006

REVIEWER/DATE
Robert R. Brown 12/16/94

REVISION
00

PROJECT NO.

PAGE 34 OF 84

CLASS

MOD NO.

REV

INDIAN POINT UNIT 2

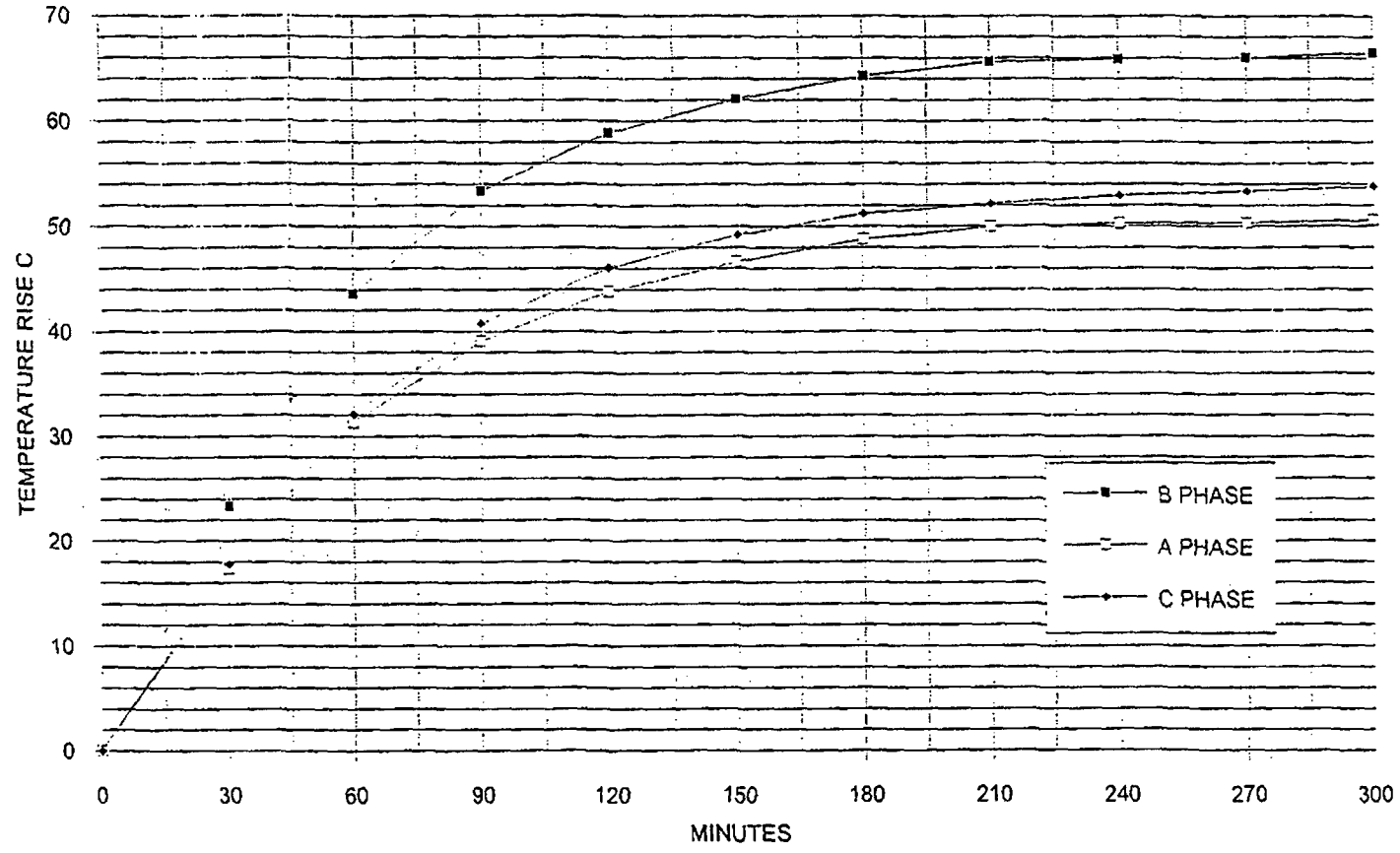

FIGURE 19 - TEST 3 - 3000 AMPERES LOWER PHENOLICS

CON EDISON CALCULATION/ANALYSIS SHEET	CALCULATION NO. EGE-00006	REVISION 00	PAGE 35 OF 84
PREPARER/DATE B. Horowitz / 12/15/94	REVIEWER/DATE Robert R. Brown / 12/16/94	PROJECT NO.	CLASS
SUBJECT/TITLE INDIAN POINT GENERATOR UPGRADE EMERGENCY DIESEL GENERATOR UPGRADE DB-75 BREAKER & SWITCHGEAR TESTING	MOD NO.	REV	

INDIAN POINT UNIT 2

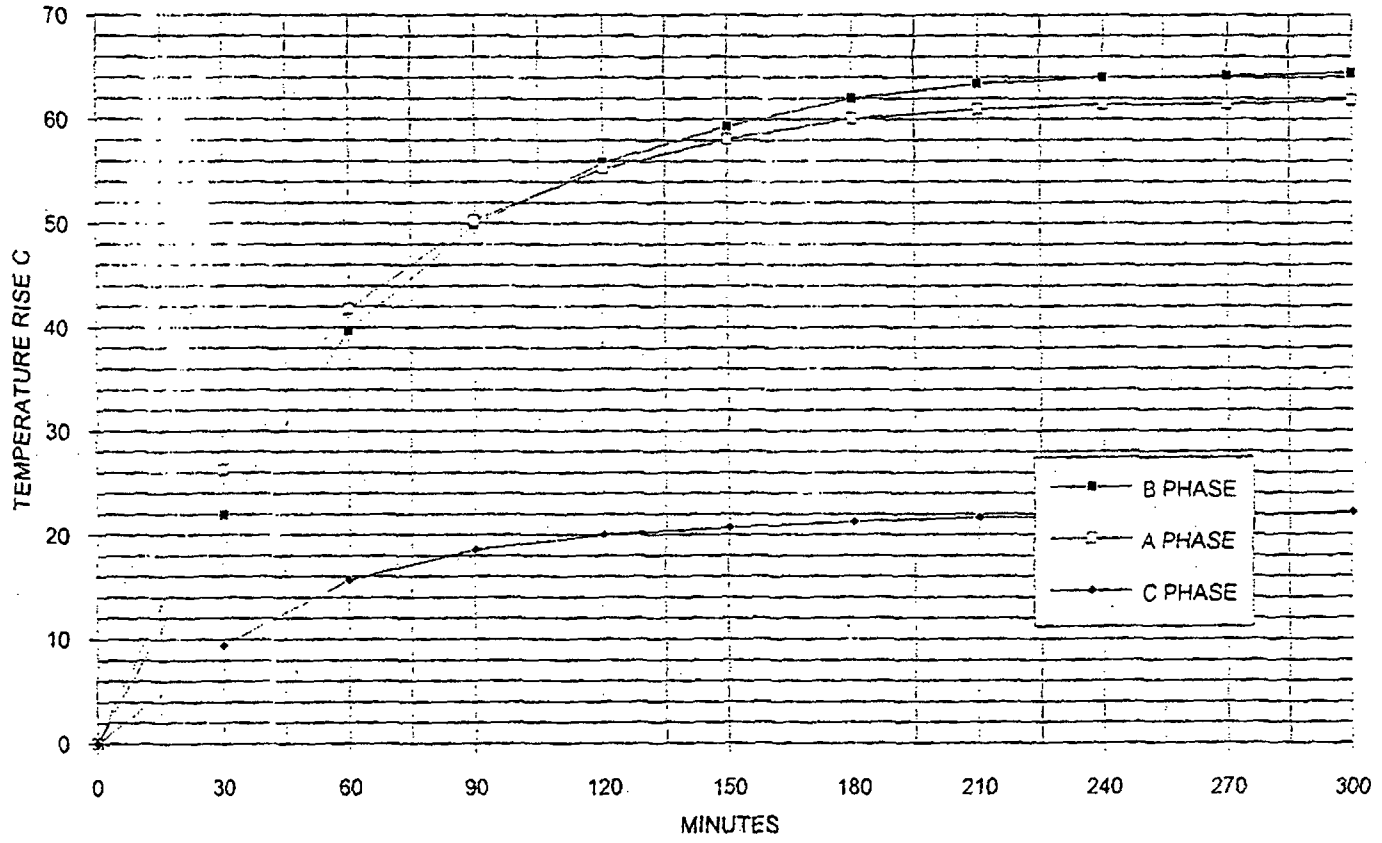

FIGURE 20 - TEST 3 - 3000 AMPERES UPPER PHENOLIC

CON EDISON
CALCULATION/ANALYSIS SHEET

PREPARER/DATE
P. Horvath 12/15/94

SUBJECT/TITLE INDIAN POINT GENERATING STATION
EMERGENCY DIESEL GENERATOR UPGRADE
DB-75 BREAKER & SWITCHGEAR TESTING

CALCULATION NO.
EGE-00006

REVIEWER/DATE
Robert R. Brown

REVISION
00
12/16/94

PROJECT NO.

MOD NO.

REV

PAGE 36 OF 84

CLASS

INDIAN POINT UNIT 2

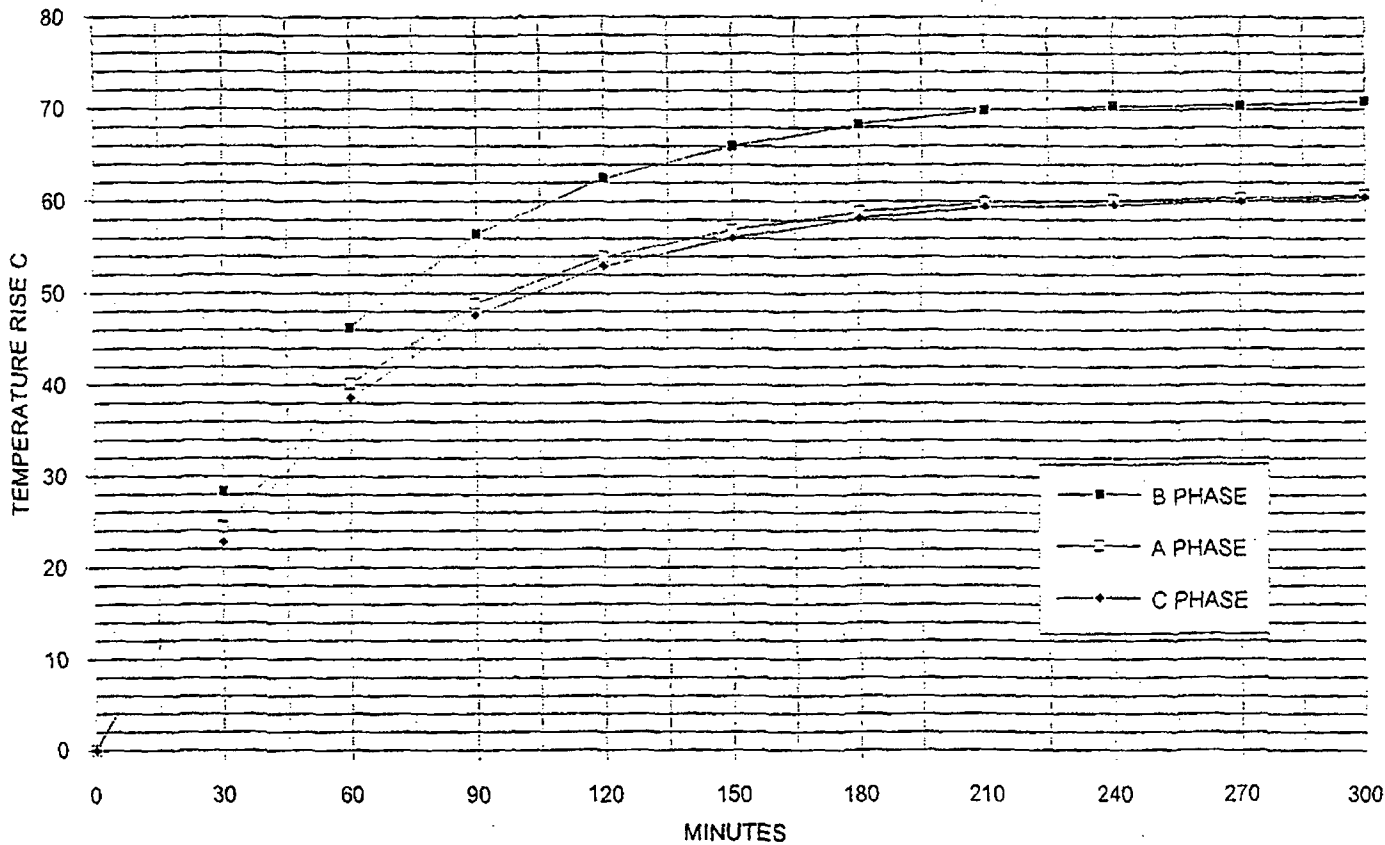

FIGURE 21 - TEST 3 - 3000 AMPERES STATIONARY PIVOTS

CON EDISON
CALCULATION/ANALYSIS SHEET

CALCULATION NO.
EGE-000006

REVISION
00

PAGE 37 OF 84
CLASS

PREPARER/DATE
B. Horowitz 12/15/94

REVIEWER/DATE
Robert R. Brown

12/16/94

SUBJECT/TITLE INDIAN POINT GENERATING STATION
EMERGENCY DIESEL GENERATOR UPGRADE
DB-75 BREAKER & SWITCHGEAR TESTING

PROJECT NO.

MOD NO.

REV

INDIAN POINT UNIT 2

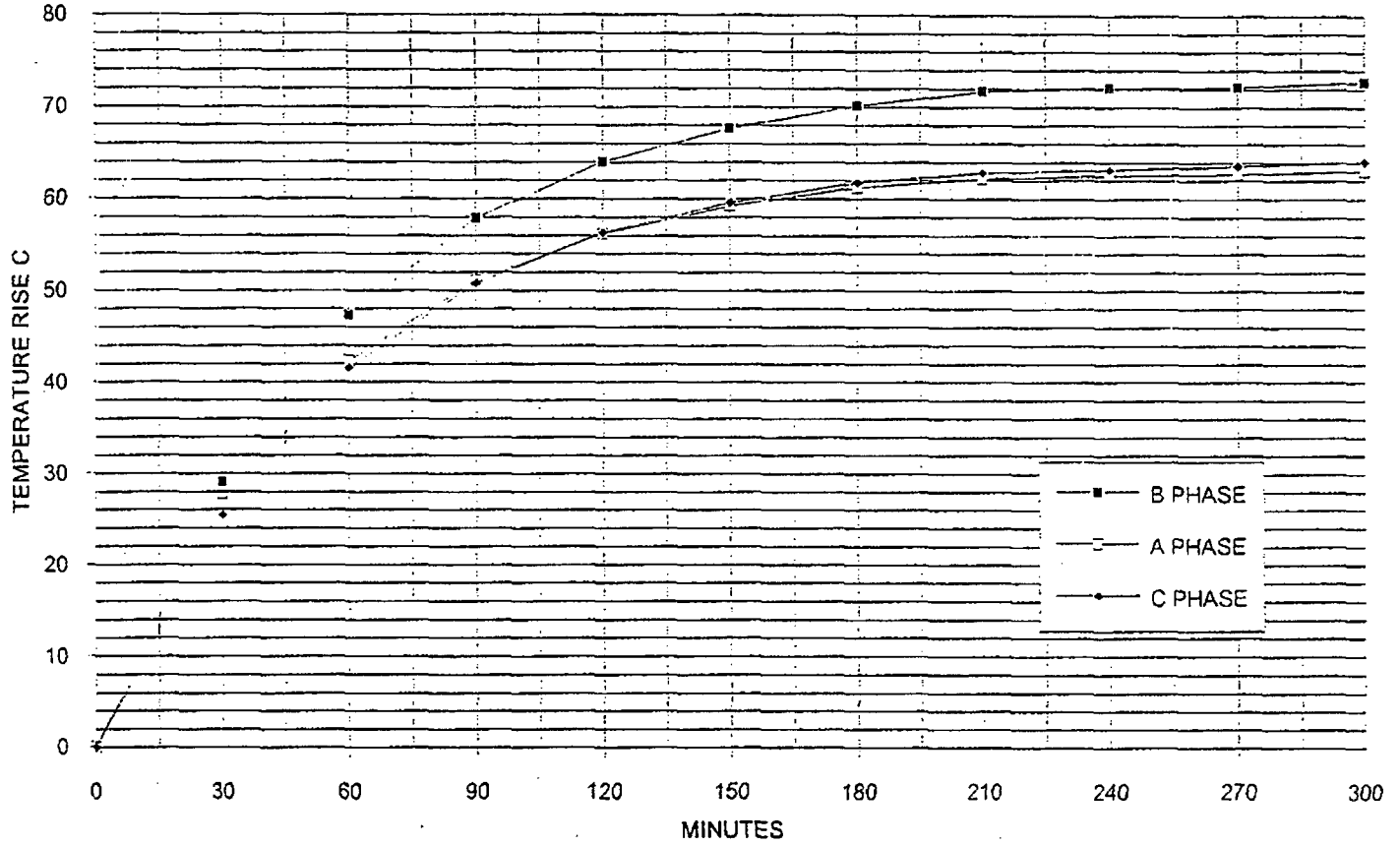

FIGURE 22 - TEST3 - 3000 AMPERES MOVABLE PIVOTS

CON EDISON
CALCULATION/ANALYSIS SHEET

CALCULATION NO.

EGE-00006

REVISION

00

PAGE 38 OF 84

PREPARER/DATE
B. Horowitz / 12/15/94

REVIEWER/DATE
Robert R. Berman

12/16/94

CLASS

SUBJECT/TITLE INDIAN Point GENERATING STATION
EMERGENCY DIESEL GENERATOR UPGRADE
DB-75 BREAKER & SWITCHGEAR TESTING

PROJECT NO.

MOD NO.

REV

INDIAN POINT UNIT 2

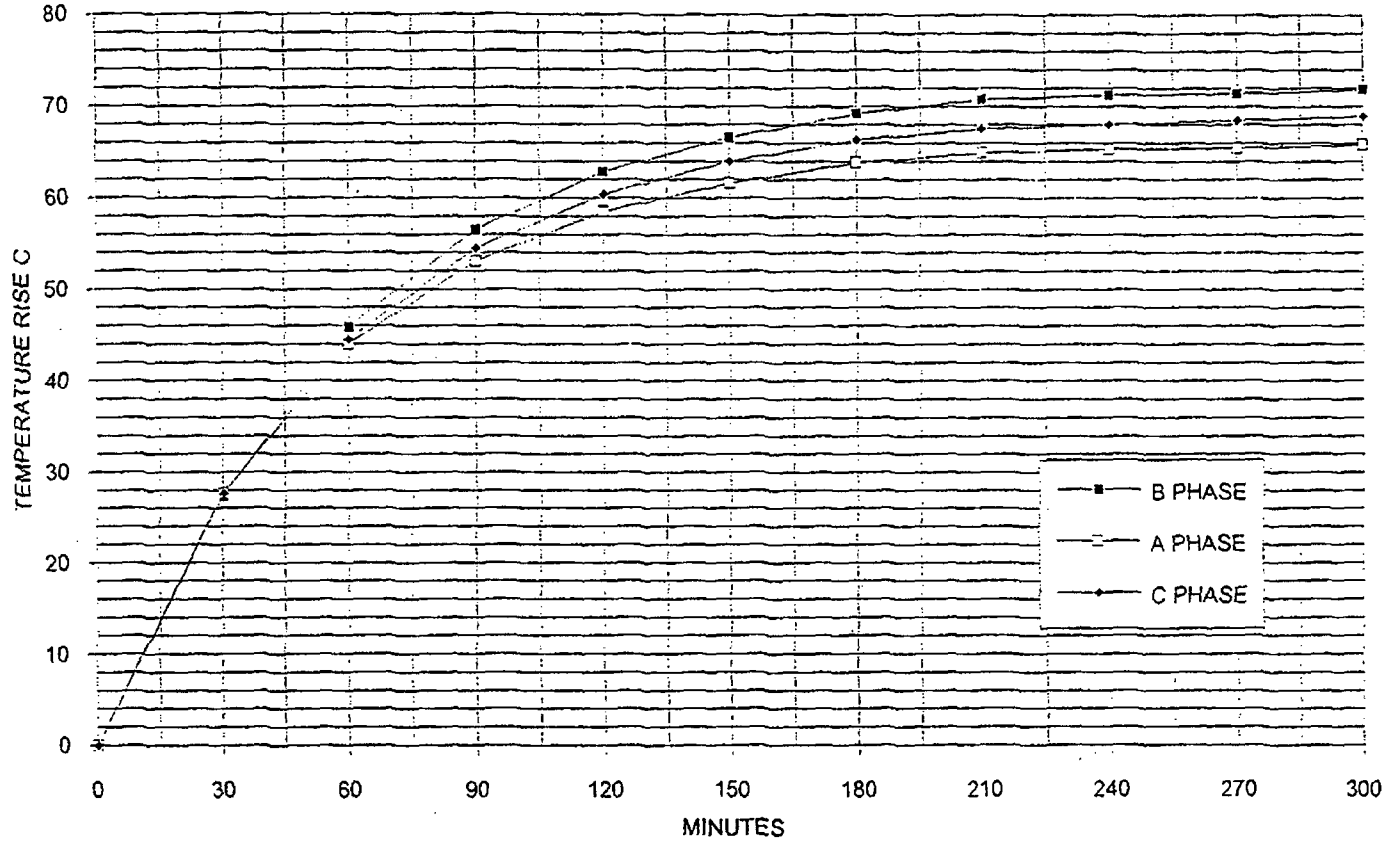

FIGURE 23 - TEST 3 - 3000 AMPERES STATIONARY MAIN CONTACTS

CON EDISON
CALCULATION/ANALYSIS SHEET

PREPARER/DATE
B. Horowitz 12/15/94

SUBJECT/TITLE
*INDIAN POINT GENERATING STATION
EMERGENCY DIESEL GENERATOR UPGRADE
DB-75 BREAKER & SWITCHGEAR TESTING*

CALCULATION NO.
EGE-00006

REVIEWER/DATE
Robert R. Brown 12/16/94

REVISION
00

PROJECT NO.

MOD NO.

REV

PAGE 39 OF 84

CLASS

INDIAN POINT UNIT 2

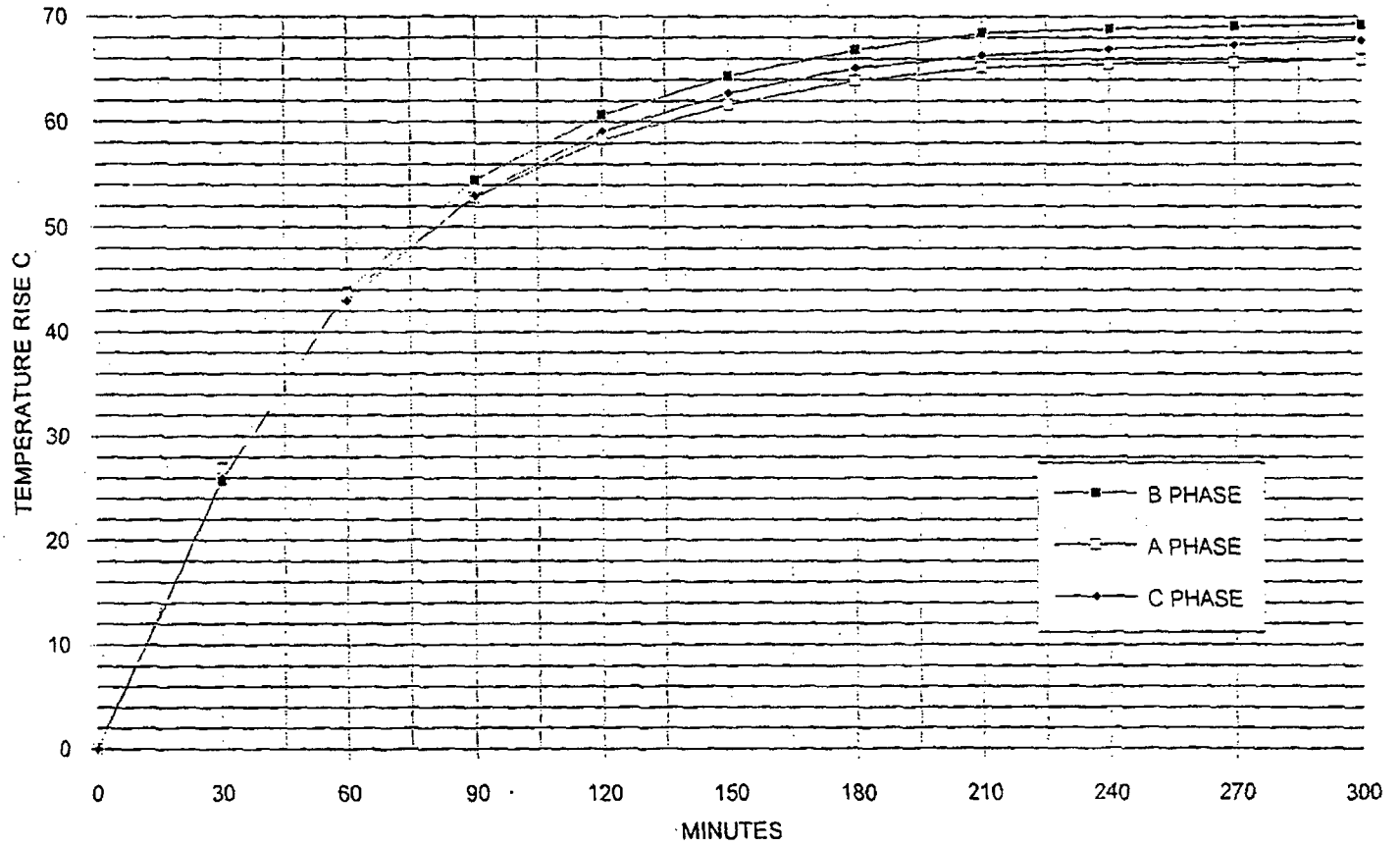

FIGURE 24 - TEST 3 - 3000 AMPERES MOVABLE MAIN CONTACTS

CON EDISON
CALCULATION/ANALYSIS SHEET

PREPARER/DATE
B. Herwitz / 12/15/94

SUBJECT/TITLE
*INDIAN POINT GENERATING STATION
EMERGENCY DIESEL GENERATOR UPGRADE
DB-75 BREAKER & SWITCHGEAR TESTING*

CALCULATION NO.
EGE-00006

REVIEWER/DATE
Robert R. Brown / 12/16/94

PROJECT NO.

MOD NO.

REVISION

PAGE *40* OF *84*

CLASS

REV

INDIAN POINT UNIT 2

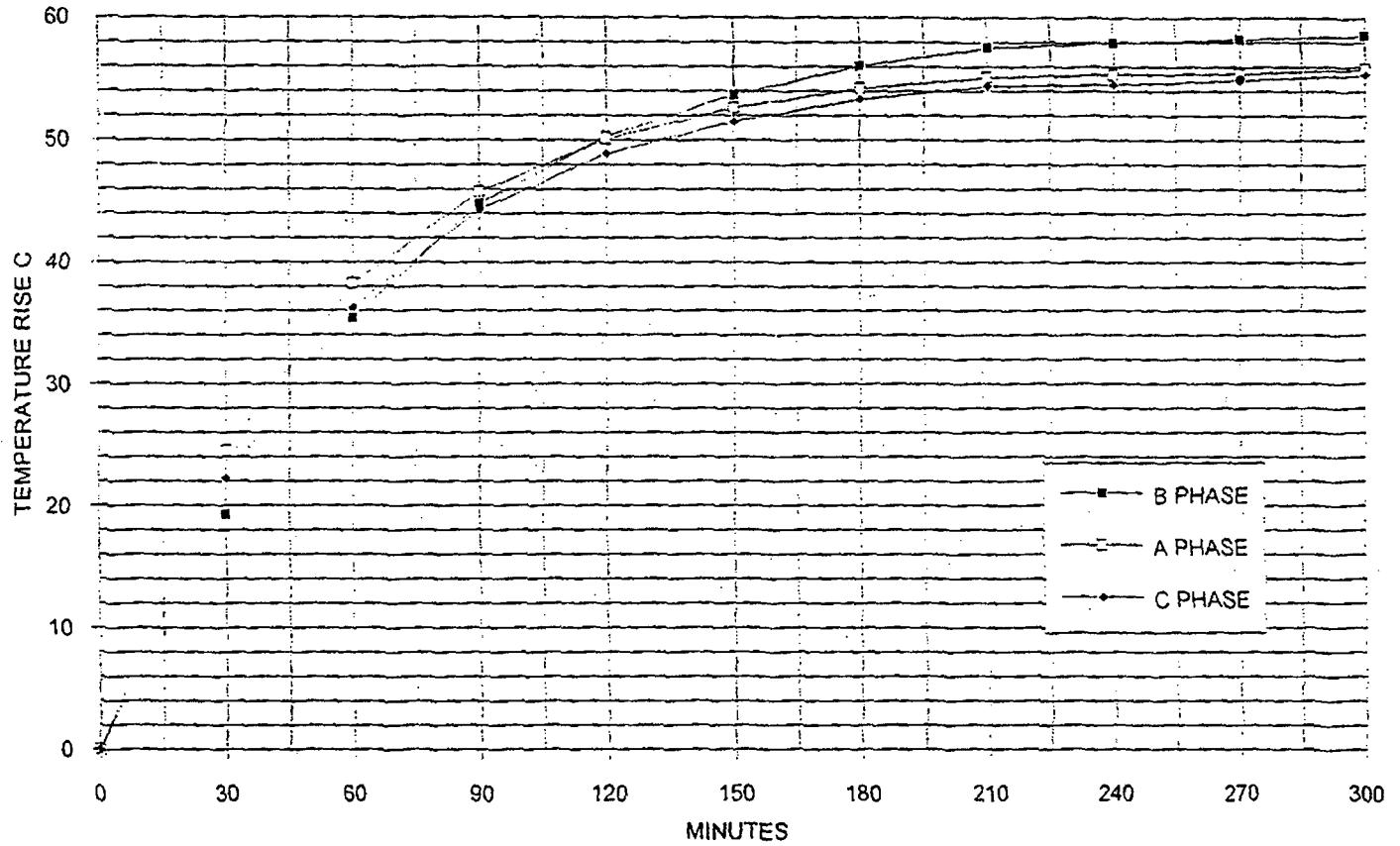

FIGURE 25 - TEST 3 - 3000 AMPERES UPPER BREAKER STABS

CON EDISON CALCULATION/ANALYSIS SHEET	CALCULATION NO. EGE-00006	REVISION 00	PAGE 41 OF 84
PREPARER/DATE B. Howard / 11/15/94	REVIEWER/DATE Robert R. Brown / 12/16/94	PROJECT NO.	CLASS
SUBJECT/TITLE INDIAN POINT GENERATING STATION EMERGENCY DIESEL GENERATOR UPGRADE DB-75 BREAKER & SWITCHGEAR TESTING		MOD NO.	REV

INDIAN POINT UNIT 2

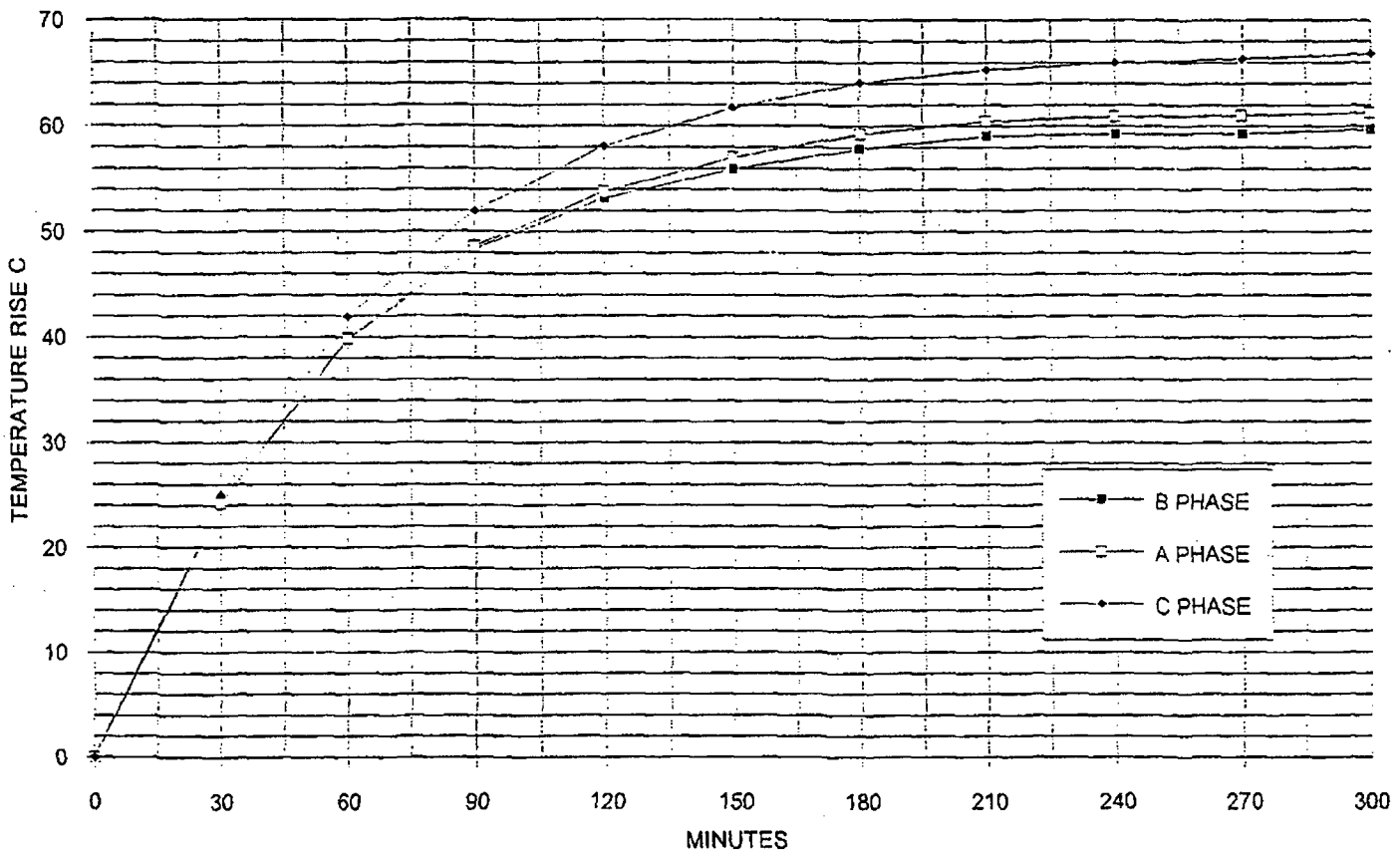

FIGURE 26 - TEST 3 - 3000 AMPERES LOWER BREAKER STABS

CON EDISON
CALCULATION/ANALYSIS SHEET

CALCULATION NO.
EGE-00006

REVISION
00

PAGE 42 OF 84

PREPARER/DATE
M. H. [Signature] 12/15/94

REVIEWER/DATE
Robert R. Bartram 12/16/94

CLASS

SUBJECT/TITLE INDIAN POINT GENERATING STATION
EMERGENCY DIESEL GENERATOR UPGRADE
DB-75 BREAKER & SWITCHGEAR TESTING

PROJECT NO.

MOD NO.

REV

INDIAN POINT UNIT 2

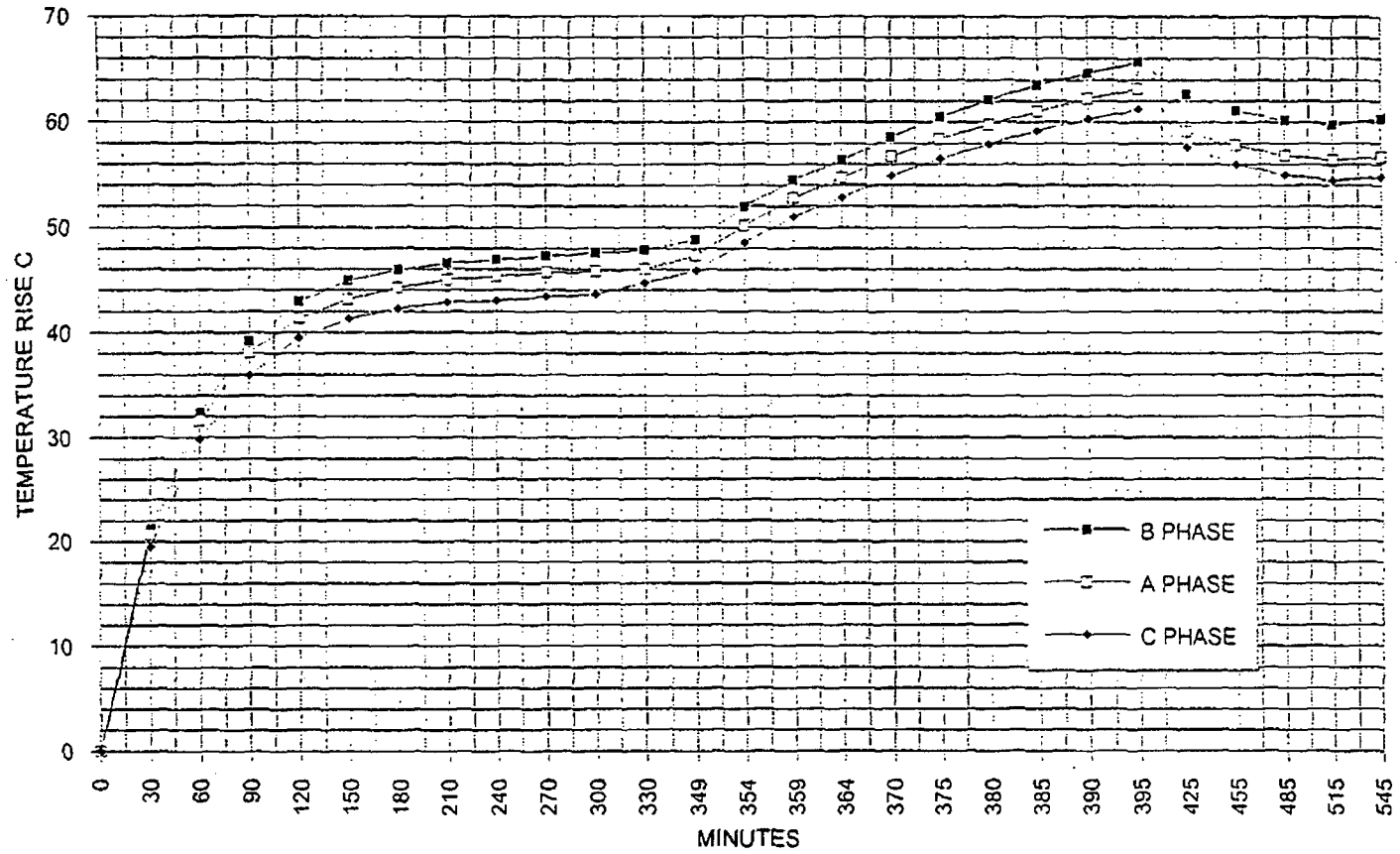

FIGURE 27 - TEST 2 LOAD DUTY CYCLE LOWER PHENOLICS

CON EDISON
CALCULATION/ANALYSIS SHEET

PREPARER/DATE
B. Horowitz / 12/15/94
SUBJECT/TITLE
*INDIAN Point GENERATING STATION
EMERGENCY DIESEL GENERATOR UPGRADE
DB-7S BREAKER & SWITCHGEAR TESTING*

CALCULATION NO.
EGE-00006
REVIEWER/DATE
*Robert R. Brown
12/16/94*

REVISION
00
PROJECT NO.

PAGE *43* OF *84*
CLASS
MOD NO.
REV

INDIAN POINT UNIT 2

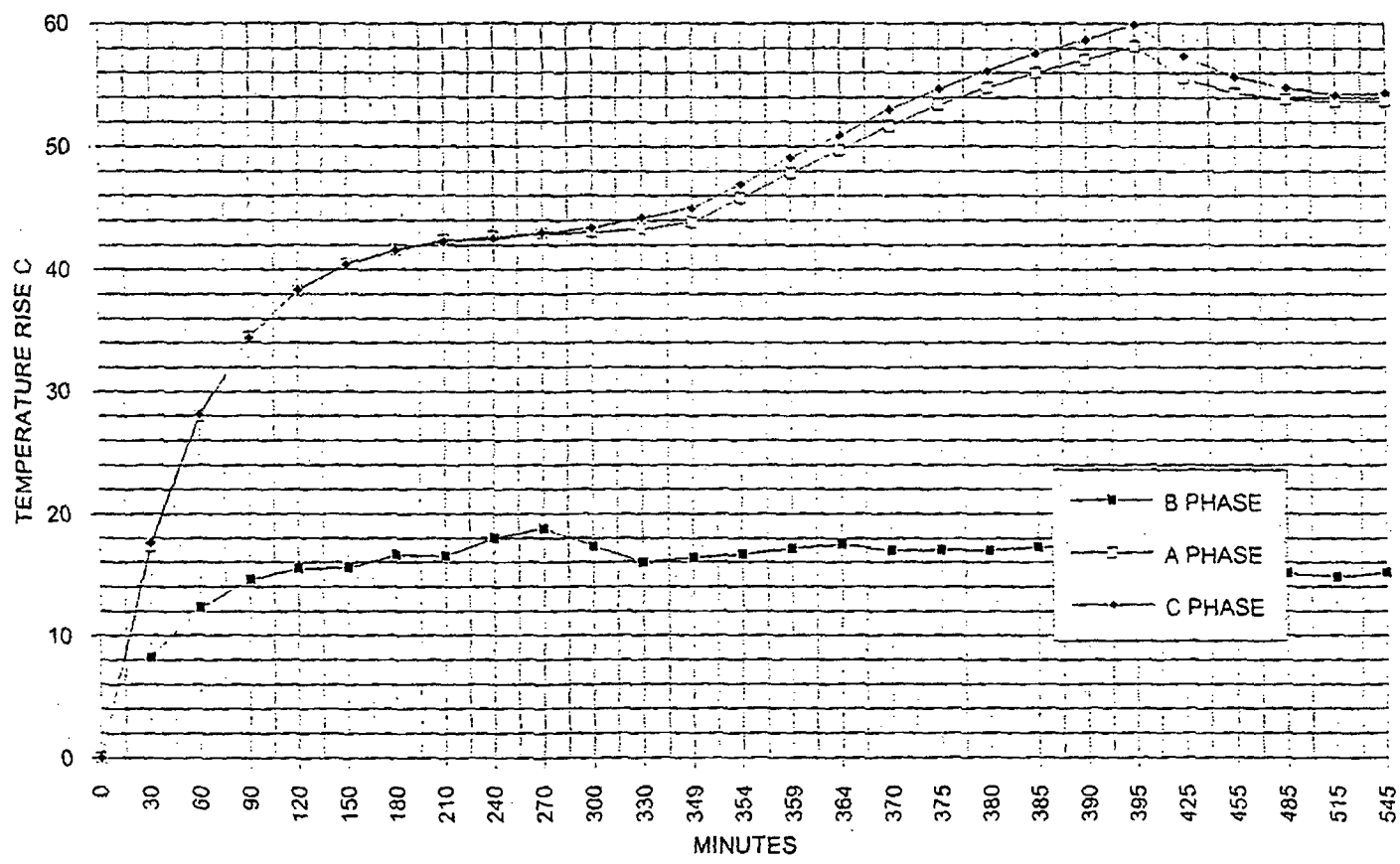

FIGURE 28 - TEST 2 LOAD DUTY CYCLE UPPER PHENOLICS

CON EDISON
CALCULATION/ANALYSIS SHEET

CALCULATION NO.

EGE-00006

REVISION

00

PAGE 44 OF 54

PREPARER/DATE

D. Herzog / 12/15/94

REVIEWER/DATE

Robert R. Brown / 12/16/94

CLASS

PROJECT NO.

INDIAN POINT GENERATING STATION
EMERGENCY DIESEL GENERATOR UPGRADE

MOD NO.

DB-75 BREAKER & SWITCHGEAR TESTING

INDIAN POINT UNIT 2

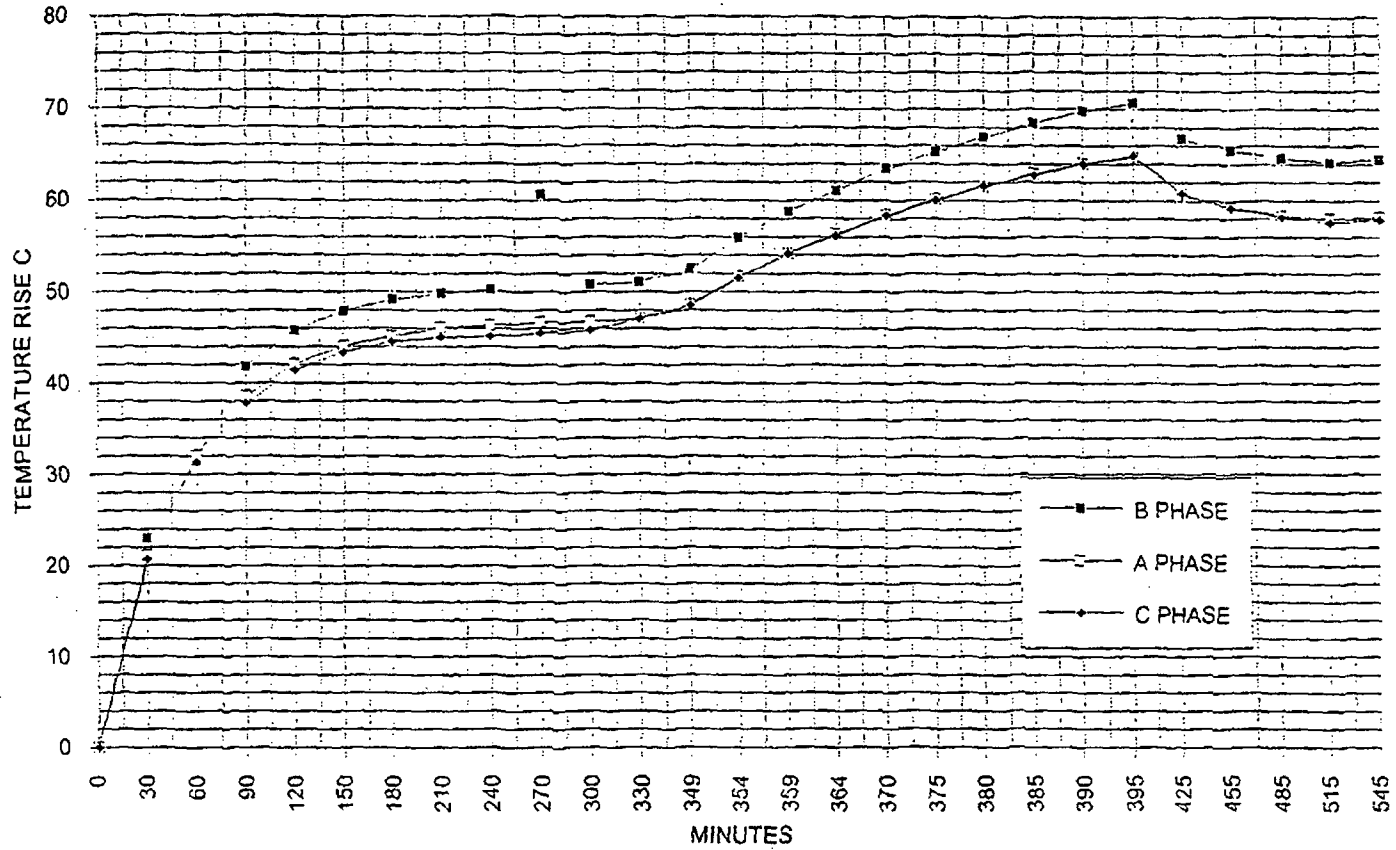

FIGURE 29 - TEST 2 LOAD DUTY CYCLE STATIONARY PIVOTS

CON EDISON
CALCULATION/ANALYSIS SHEET

PREPARER/DATE
B. Horowitz 12/15/94

SUBJECT/TITLE
INDIAN POINT GENERATING STATION
EMERGENCY DIESEL GENERATOR UPGRADE
DB-75 BREAKER & SWITCHGEAR TESTING

CALCULATION NO.
EGE-00006

REVIEWER/DATE
Robert R. Braun

REVISION
00

CLASS

PROJECT NO.

MOD NO.

REV

PAGE 45 OF 84

INDIAN POINT UNIT 2

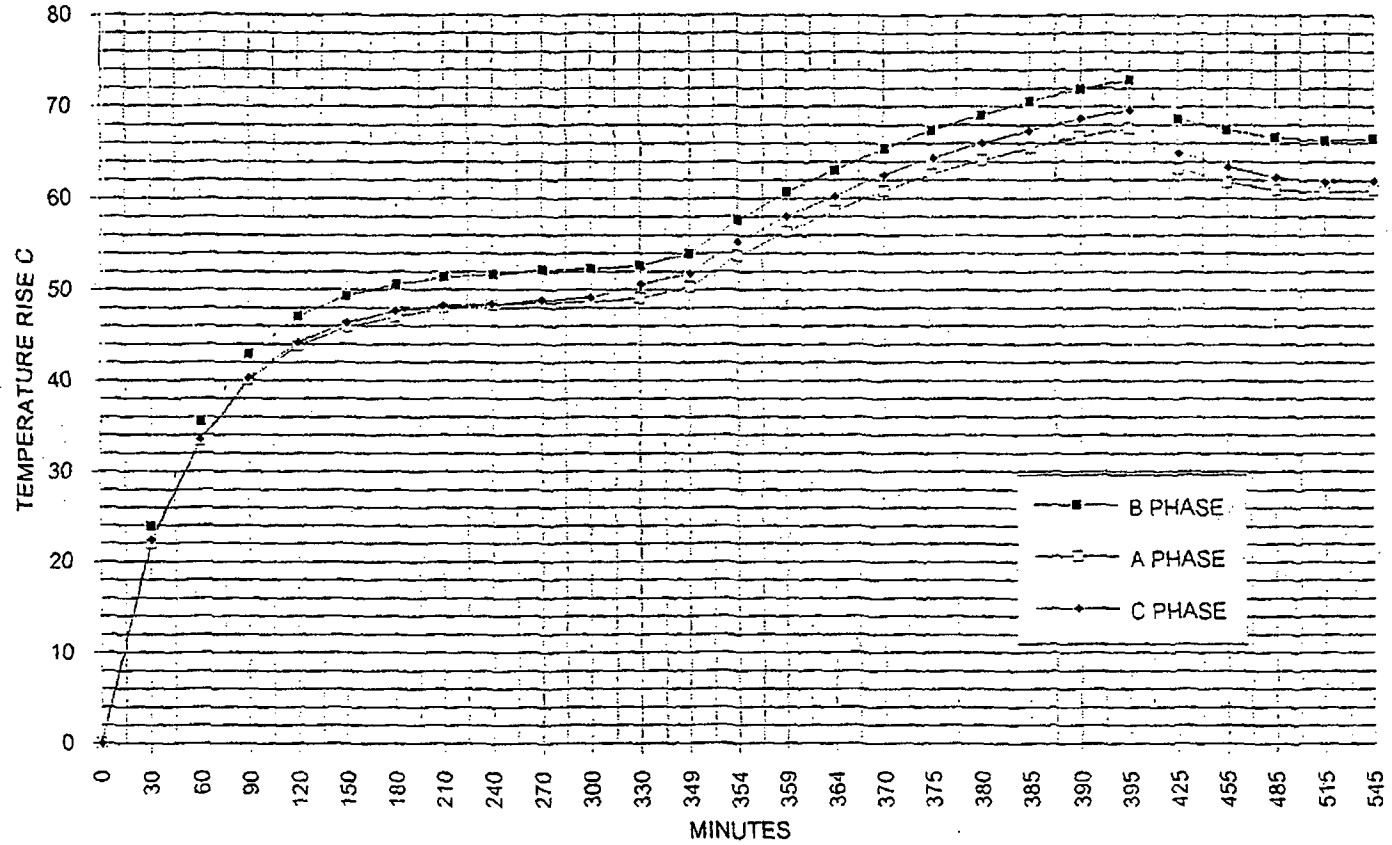

FIGURE 30 - TEST 2 LOAD DUTY CYCLE MOVABLE PIVOTS

CON EDISON
CALCULATION/ANALYSIS SHEET

CALCULATION NO.
EGE-00006

REVISION
00

PAGE 44 OF 84

PREPARER/DATE
B. H. Lewis 12/15/94

REVIEWER/DATE
Robert R. Brown 12/16/94

CLASS

SUBJECT/TITLE INDIAN POINT GENERATING STATION
PROJECT NO.

EMERGENCY DIESEL GENERATOR UPGRADE
MOD NO.

REV

DB-75 BREAKER & SWITCHGEAR TESTING

INDIAN POINT UNIT 2

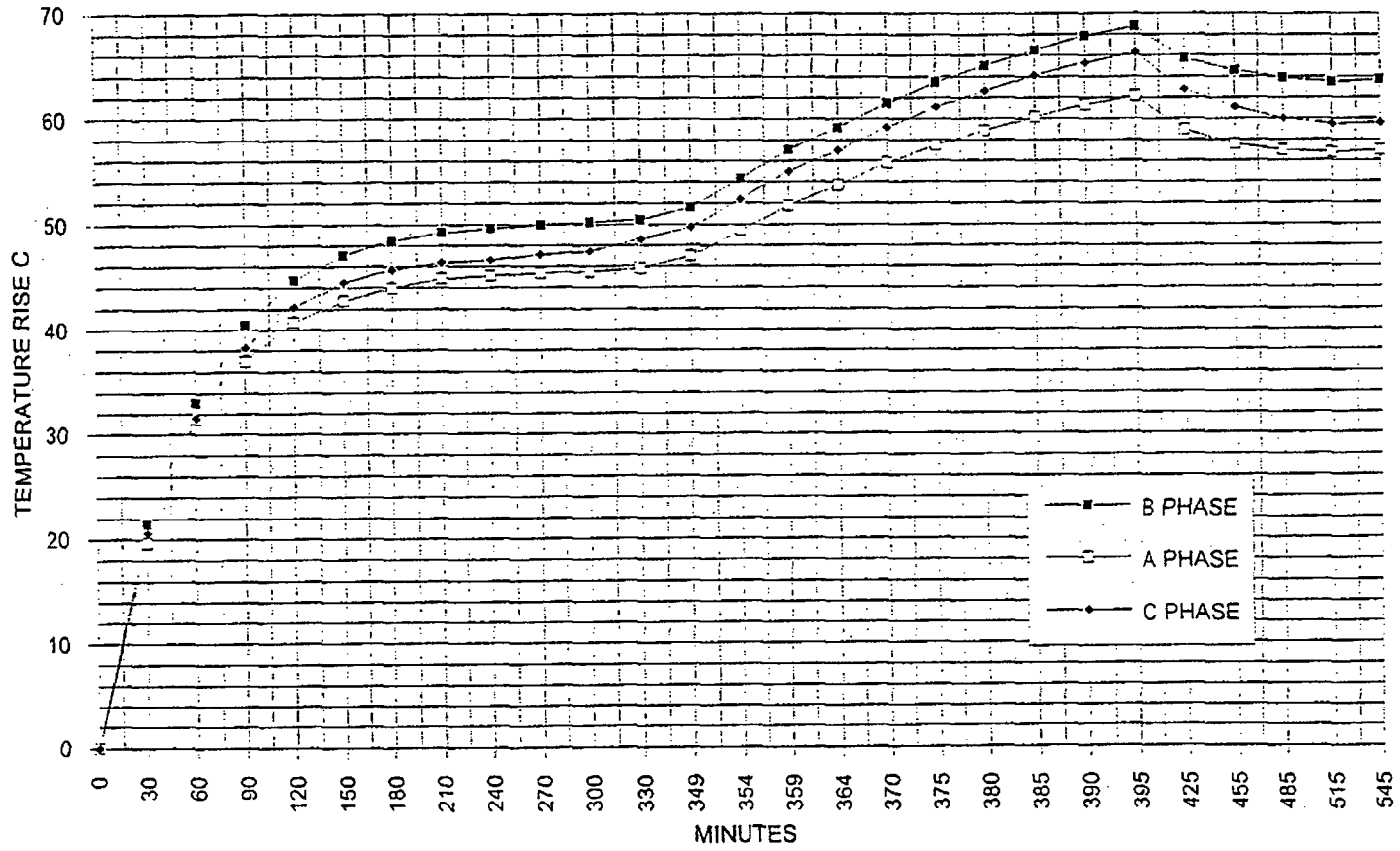

FIGURE 31 - TEST 2 LOAD DUTY CYCLE STATIONARY MAIN CONTACTS

CON EDISON
CALCULATION/ANALYSIS SHEET

CALCULATION NO.
EGE-00006

REVISION
00

PAGE 46 OF 84

PREPARER/DATE
B. Harwitz 12/15/94

REVIEWER/DATE
Robert R. Braun 12/16/94

CLASS

SUBJECT/TITLE INDIAN POINT GENERATING STATION
EMERGENCY DIESEL GENERATOR UPGRADE

PROJECT NO.

DB-75 BREAKER & SWITCHGEAR TESTING

MOD NO.

REV

INDIAN POINT UNIT 2

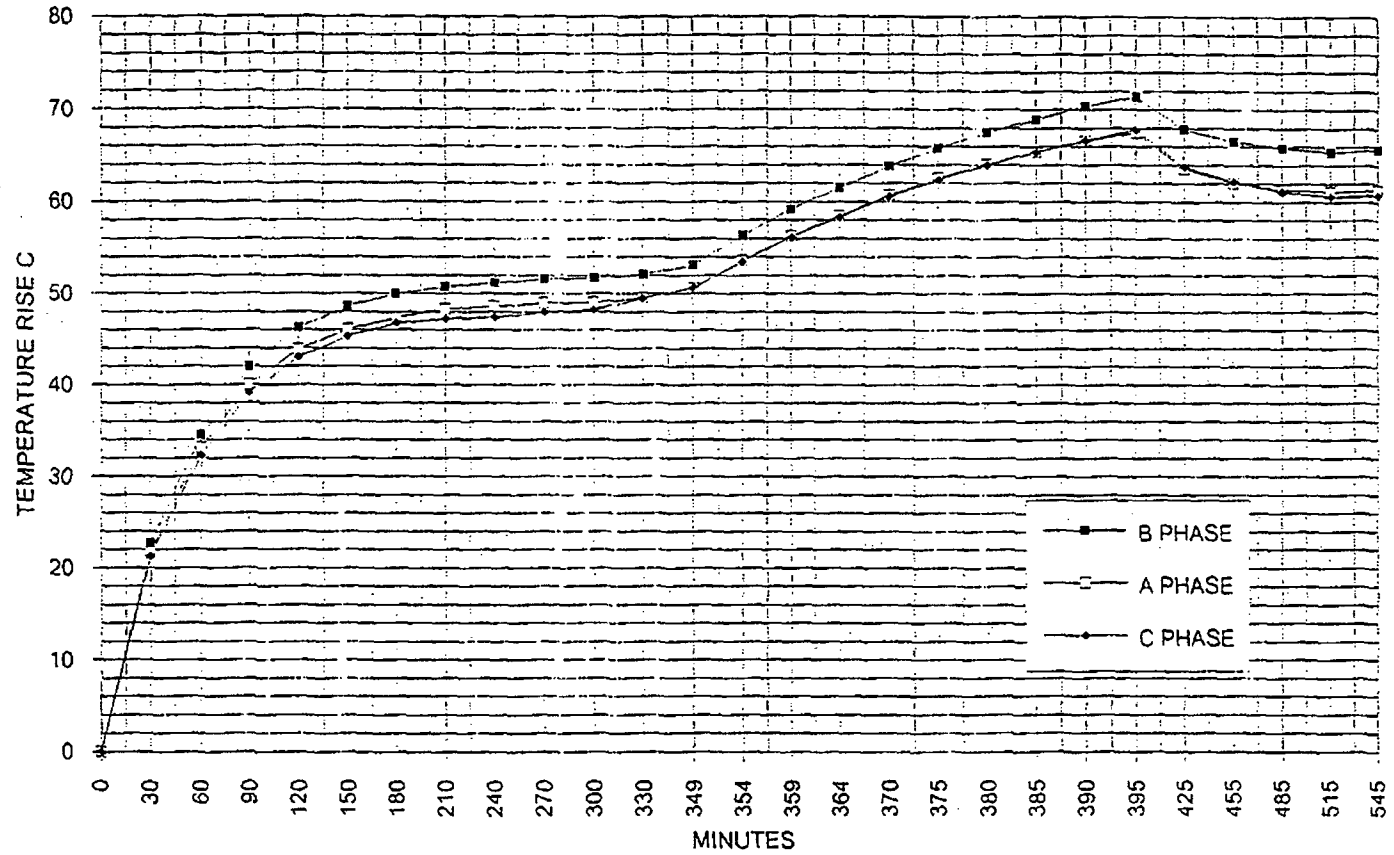

FIGURE 32 - TEST 2 LOAD DUTY CYCLE MOVABLE MAIN CONTACTS

CON EDISON
CALCULATION/ANALYSIS SHEET

PREPARER/DATE
B. Horowitz *12/15/94*

SUBJECT/TITLE
INDIAN POINT GENERATING STATION
EMERGENCY DIESEL GENERATOR UPGRADE
DB-75 BREAKER & SWITCHGEAR TESTING

CALCULATION NO.
EGE-00006

REVIEWER/DATE
Robert R. Brown *12/16/94*

PROJECT NO.

REVISION
00

PAGE *48* OF *84*

CLASS

MOD NO.

REV

INDIAN POINT UNIT 2

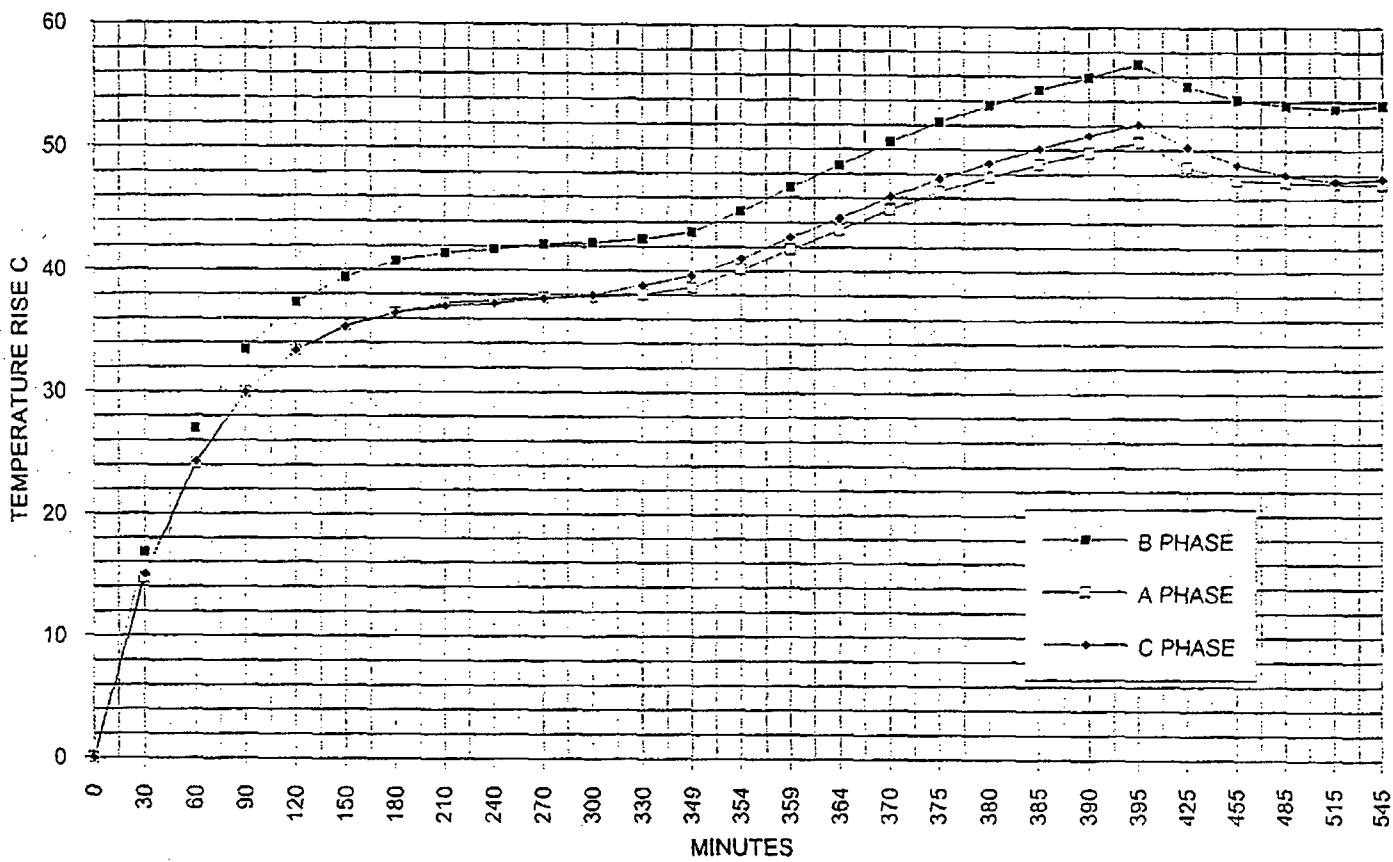

FIGURE 33 - TEST 2 LOAD DUTY CYCLE UPPER BREAKER STABS

CON EDISON
CALCULATION/ANALYSIS SHEET

PREPARER/DATE
B. Horowitz 12/15/94

SUBJECT/TITLE INDIAN POINT GENERATING STATION
EMERGENCY DIESEL GENERATOR UPGRADE
DB-7'S BREAKER & SWITCHGEAR TESTING

CALCULATION NO.
EGE-00006

REVIEWER/DATE
Robert R. Brown 12/16/94

PROJECT NO.
MOD NO.

REVISION
00

PAGE 49 OF 84

CLASS

REV

INDIAN POINT UNIT 2

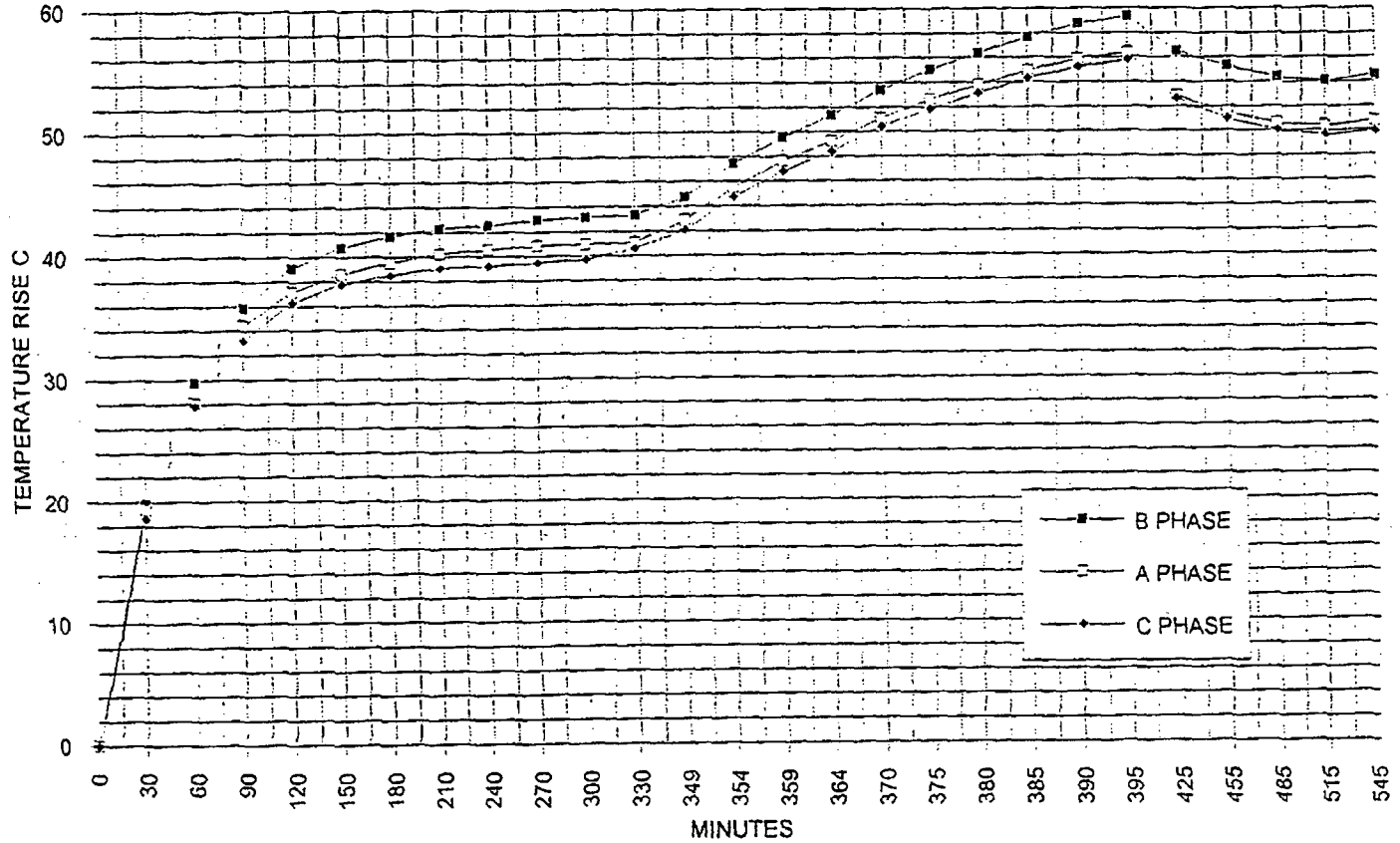

FIGURE 34 - TEST 2 LOAD DUTY CYLCE LOWER BREAKER STABS

CON EDISON CALCULATION/ANALYSIS SHEET	CALCULATION NO. EGE-0000G	REVISION 00	PAGE 50 OF 84
PREPARER/DATE B. Herwitz 12/15/94	REVIEWER/DATE Robert R. Brown 12/16/94	PROJECT NO.	CLASS
SUBJECT/TITLE EMERGENCY DIESEL GENERATOR UPGRADE DB-75 BREAKER & SWITCHGEAR TESTING		MOD NO.	REV

INDIAN POINT UNIT 2

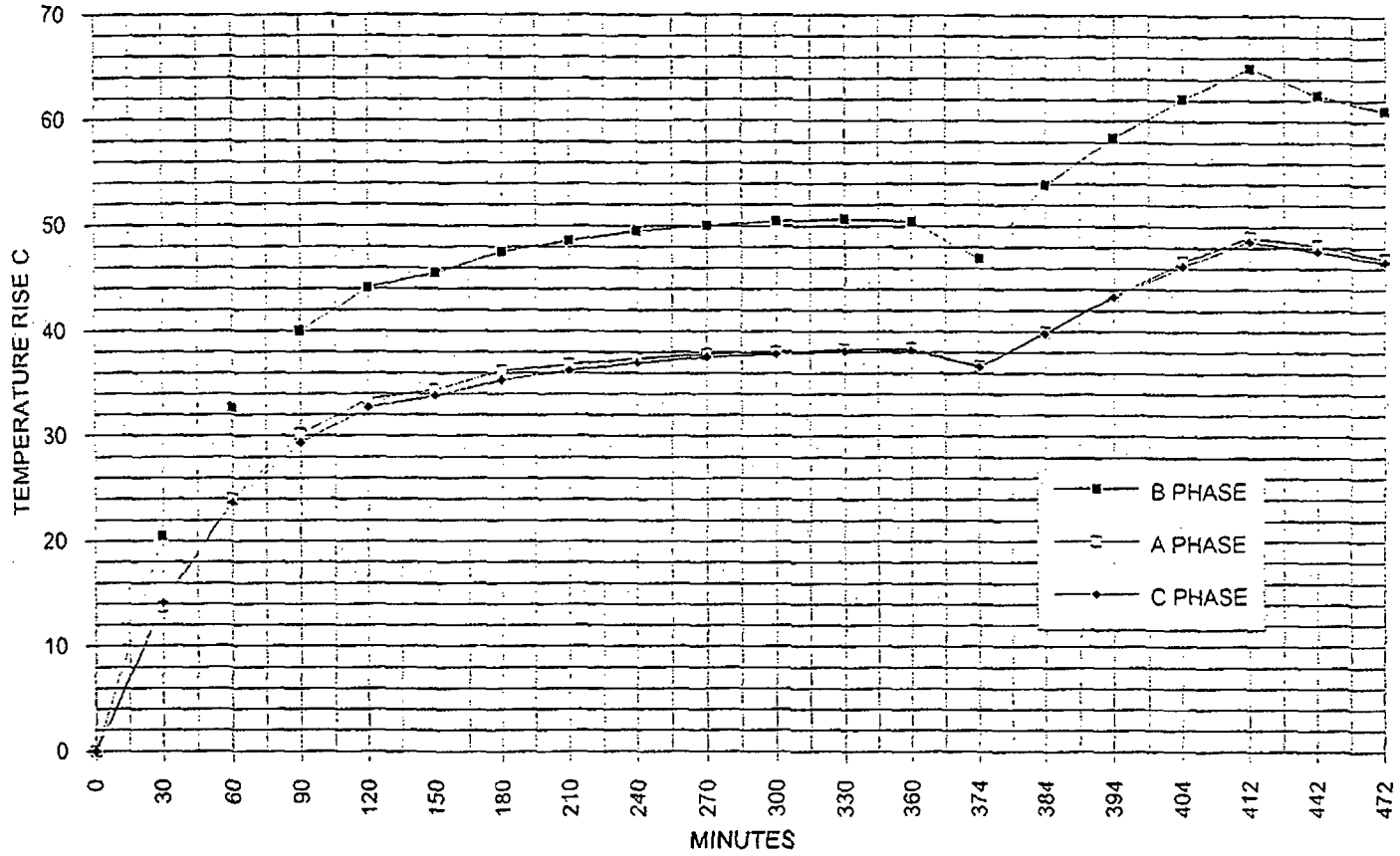

FIGURE 35 - TEST 3 LOAD DUTY CYCLE LOWER PHENOLICS

CON EDISON CALCULATION/ANALYSIS SHEET	CALCULATION NO. EGE-00006	REVISION 00	PAGE 51 OF 84
PREPARER/DATE B. Brown 12/16/84	REVIEWER/DATE Robert R. Brown 12/16/84	PROJECT NO.	CLASS
SUBJECT/TITLE INDIAN POINT GENERATING STATION EMERGENCY DIESEL GENERATOR UPGRADE DB-7'S BREAKER & SWITCHGEAR TESTING		MOD NO.	REV

INDIAN POINT UNIT 2

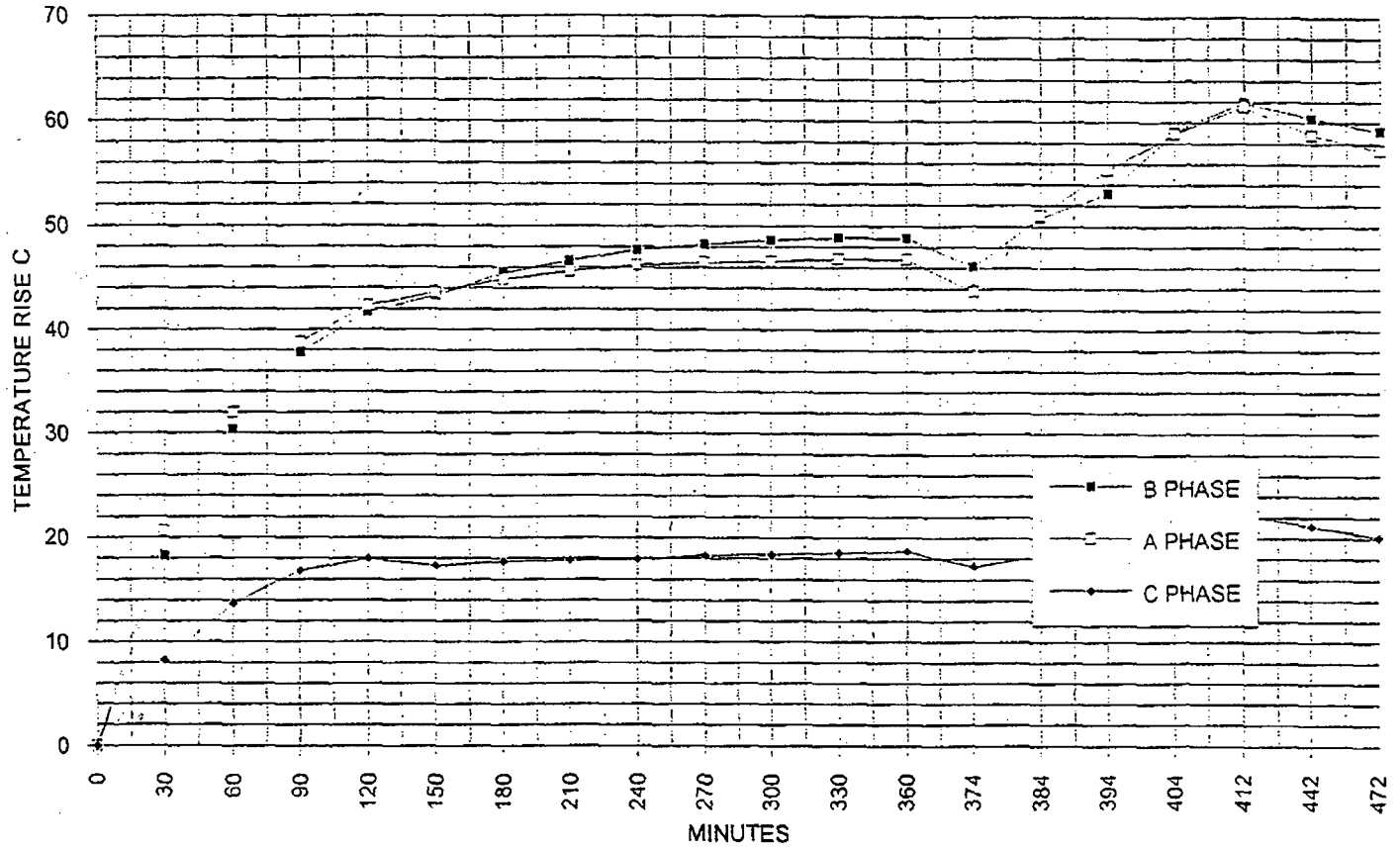

FIGURE 36 - TEST 3 LOAD DUTY CYCLE UPPR PHENOLIC

CON EDISON
CALCULATION/ANALYSIS SHEET

CALCULATION NO.

REVISION

PREPARER/DATE

EGE-00006

PAGE 52 OF 84

REVIEWER/DATE
Robert P. Brown 12/16/94

CLASS

PROJECT NO.

SUBJECT/TITLE
INDIAN POINT GENERATING STATION
EMERGENCY DIESEL GENERATOR UPGRADE

MOD NO. REV

DB-75 BREAKER & SWITCHGEAR TESTING

INDIAN POINT UNIT 2

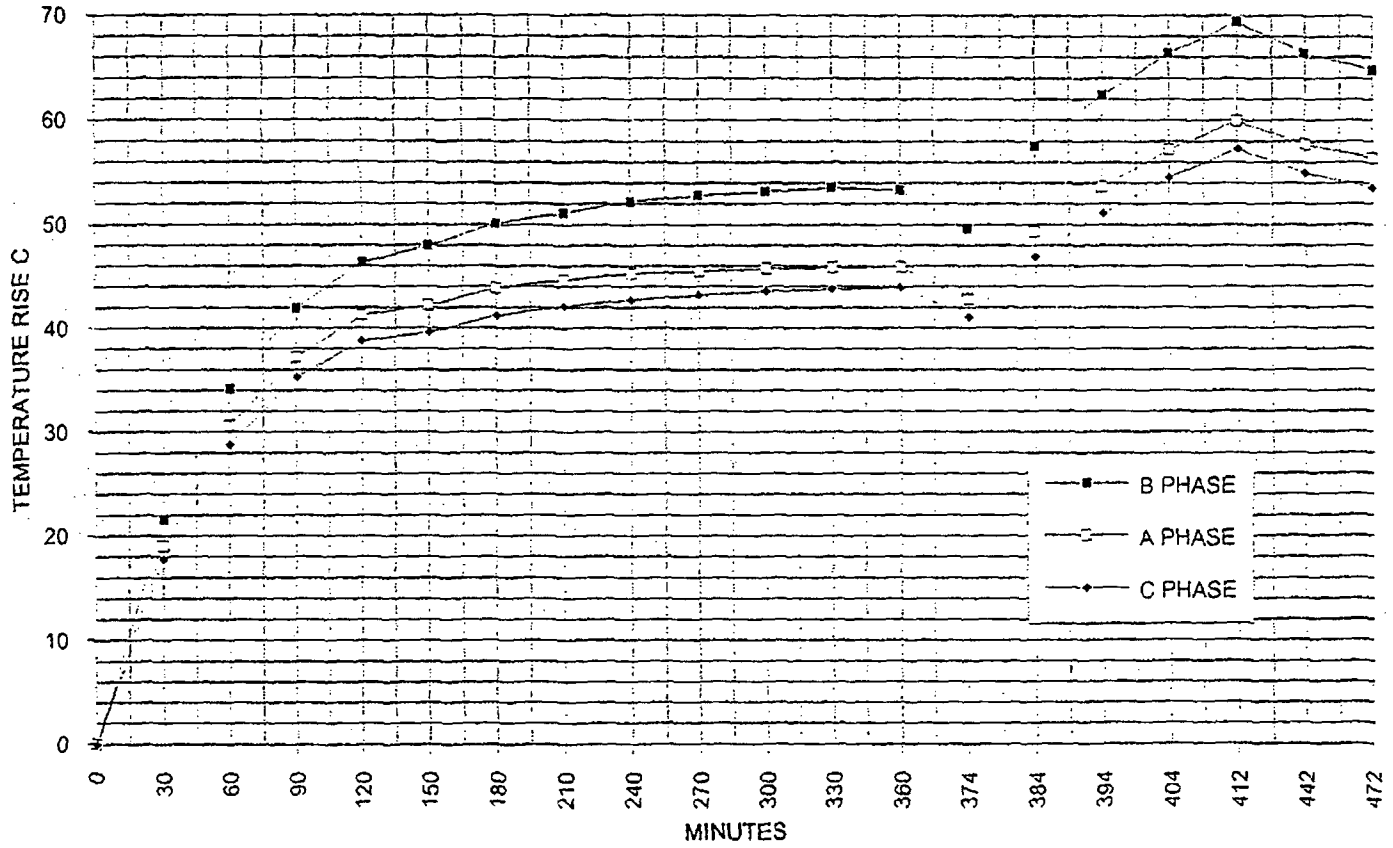

FIGURE 37 - TEST 3 LOAD DUTY CYCLE STATIONARY PIVOTS

CON EDISON
CALCULATION/ANALYSIS SHEET

PREPARER/DATE
B. Horowitz/B. Brown 11/15/94

SUBJECT/TITLE INDIAN POINT GENERATING STATION
EMERGENCY DIESEL GENERATOR UPGRADE
DB-75 BREAKER & SWITCHGEAR TESTING

CALCULATION NO.
EGE-00006

REVIEWER/DATE
Robert R. Brown 12/16/94

PROJECT NO.
MOD NO.

PAGE 53 OF 84

CLASS

REV

INDIAN POINT UNIT 2

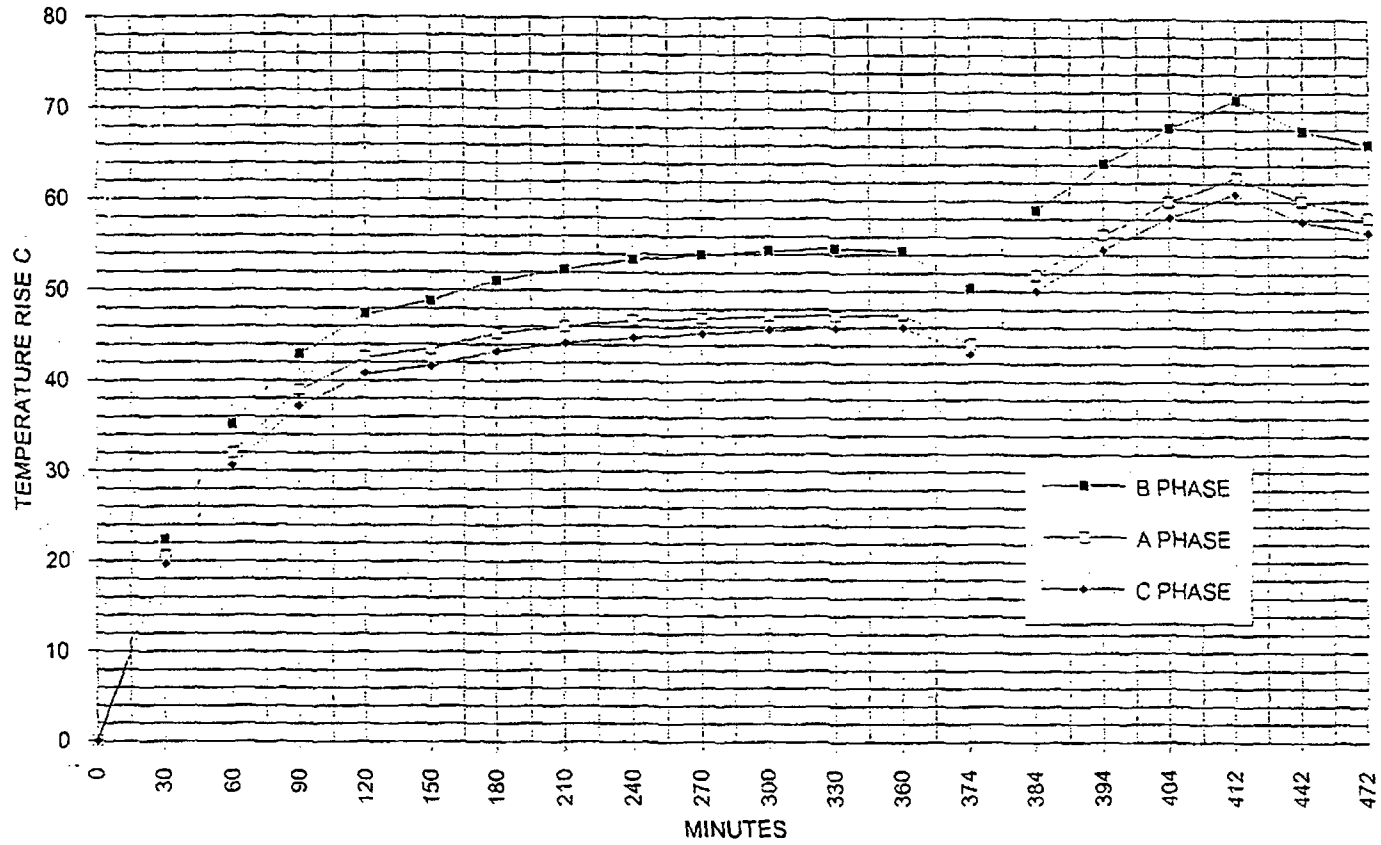

FIGURE 38 - TEST 3 LOAD DUTY CYCLE MOVABLE PIVOTS

CON EDISON
CALCULATION/ANALYSIS SHEET

PREPARER/DATE
Robert R. Brown 12/15/94
SUBJECT/TITLE INDIAN POINT GENERATING STATION
EMERGENCY DIESEL GENERATOR UPGRADE
DB-75 BREAKER & SWITCHGEAR TESTING

CALCULATION NO.
EGE-00006

REVISION/DATE
REVIEWER/DATE
12/16/94

REVISION
00
PROJECT NO.
MOD NO.
REV

INDIAN POINT UNIT 2

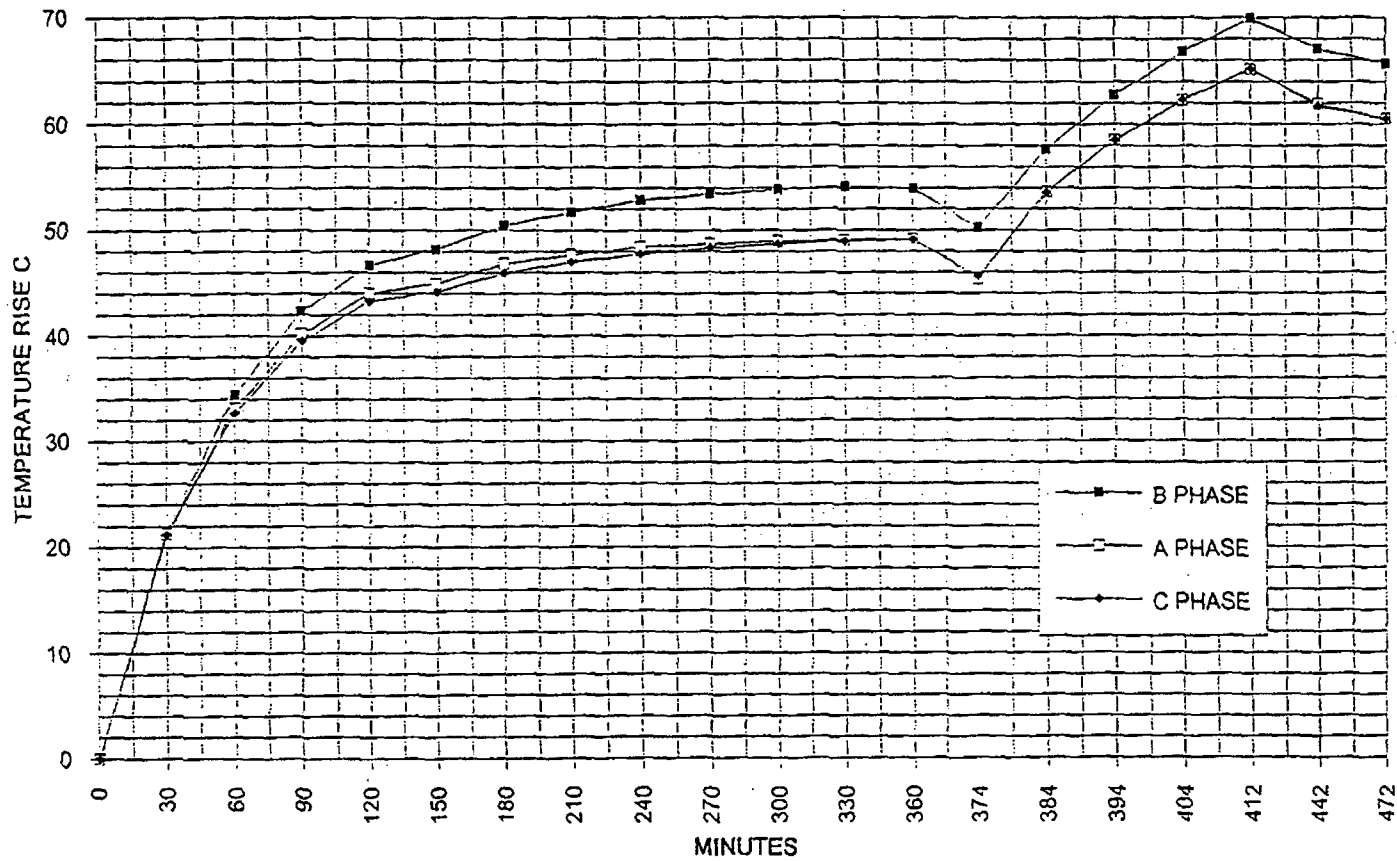

FIGURE 39 - TEST 3 LOAD DUTY CYCLE STATIONARY MAIN CONTACTS

CON EDISON
CALCULATION/ANALYSIS SHEET

PREPARER/DATE

B. Horowitz / 12/15/94

SUBJECT/TITLE *INDIAN POINT GENERATING STATION*

EMERGENCY DIESEL GENERATOR UPGRADE

DB-75 BREAKER & SWITCHGEAR TESTING

CALCULATION NO.

EGE-00006

REVIEWER/DATE

Robert R. Brown 12/16/94

PROJECT NO.

MOD NO.

REV

PAGE *55* OF *84*

CLASS

INDIAN POINT UNIT 2

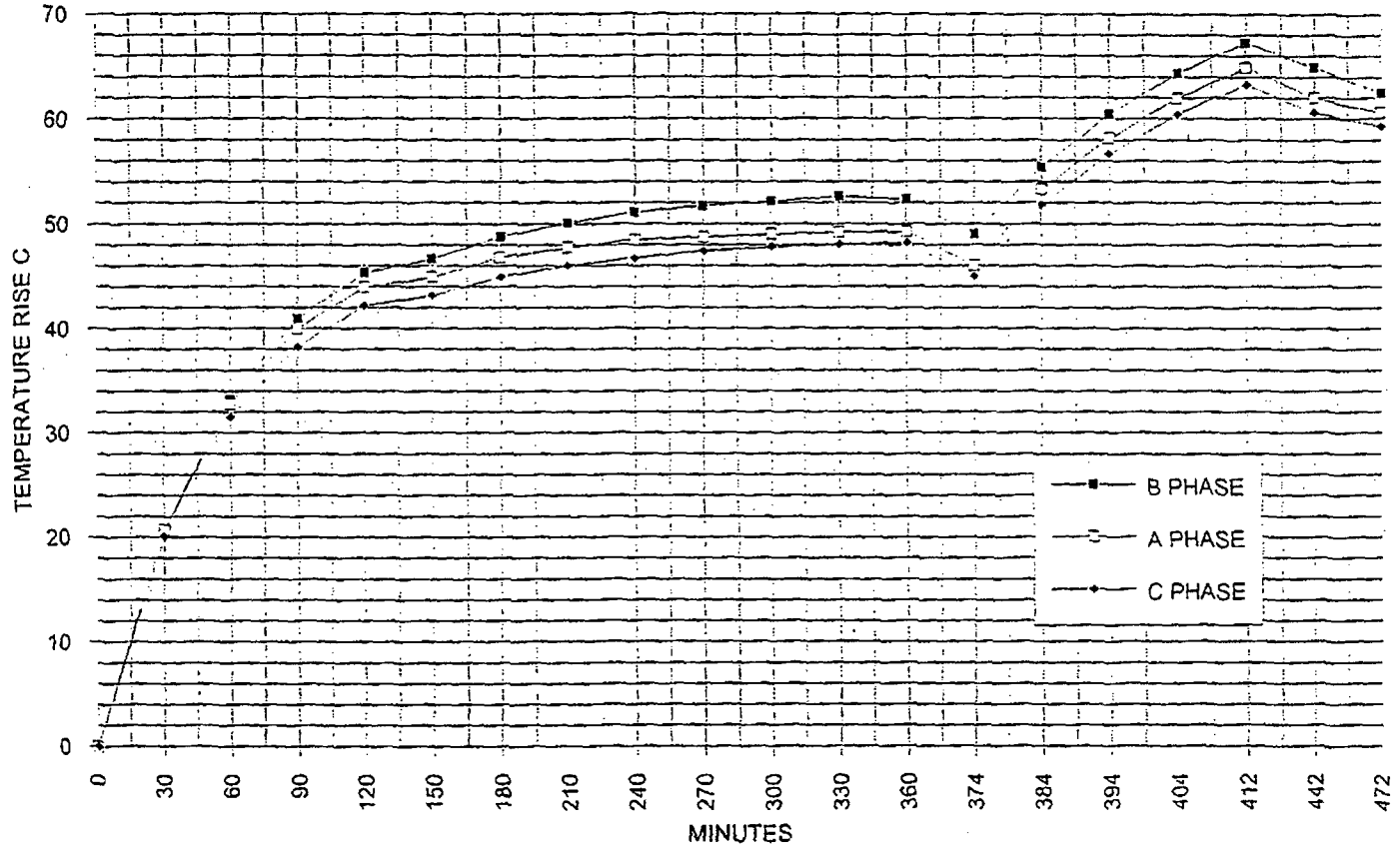

FIGURE 40 - TEST 3 LOAD DUTY CYCLE MOVABLE MAIN CONTACTS

CON EDISON
CALCULATION/ANALYSIS SHEET

CALCULATION NO.
EGE-00006

REVIEWER/DATE
Robert R. Brown
12/16/94

REVISION
00

PROJECT NO.

PAGE 56 OF 84

CLASS

MOD NO.

REV

PREPARER/DATE
B. Horowitz
12/15/94

SUBJECT/TITLE
INDIAN POINT GENERATING STATION
EMERGENCY DIESEL GENERATOR UPGRADE
DB-75 BREAKER & SWITCHGEAR TESTING

INDIAN POINT UNIT 2

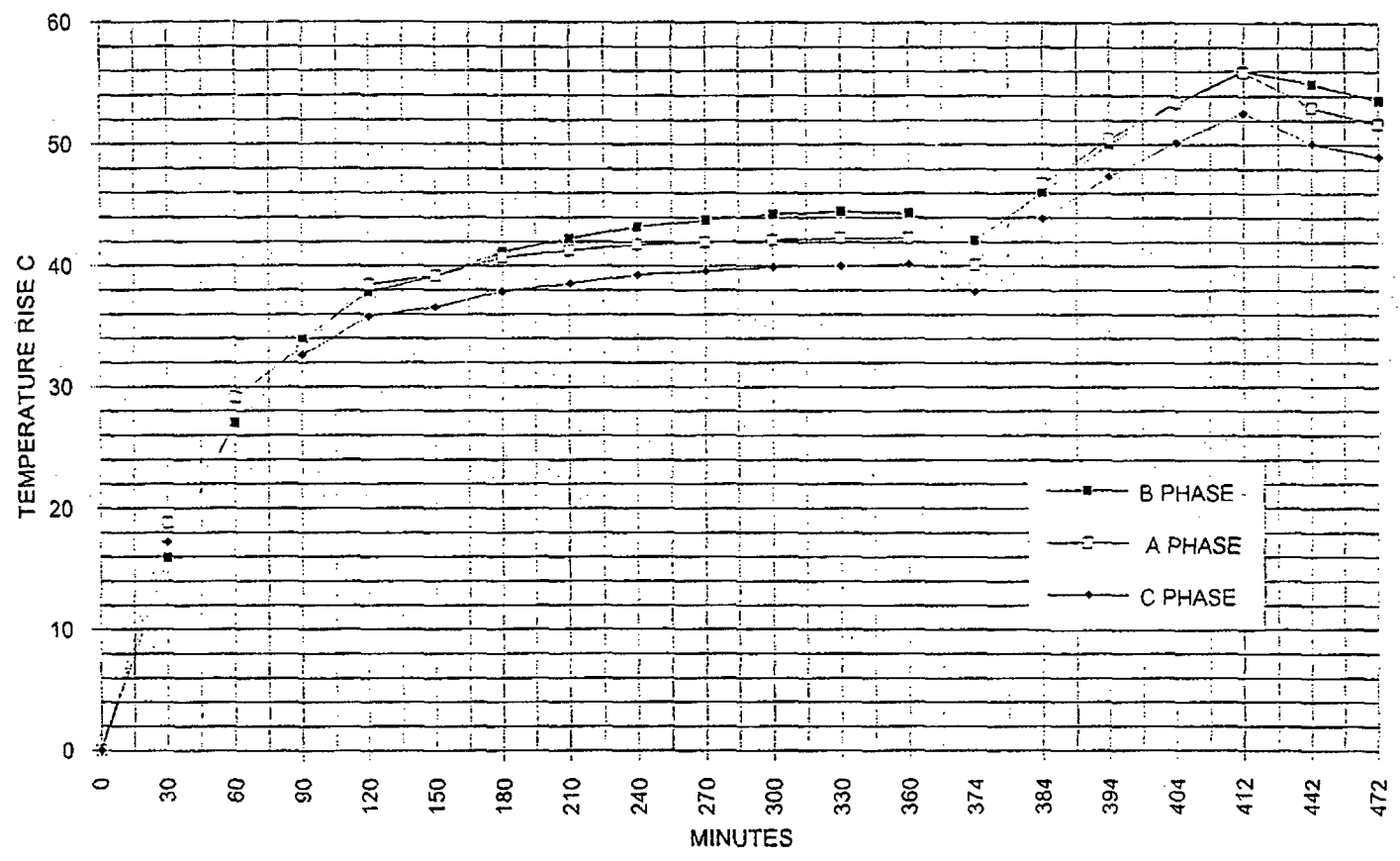

FIGURE 41 - TEST 3 LOAD DUTY CYCLE UPPER BREAKER STABS

CON EDISON
CALCULATION/ANALYSIS SHEET

PREPARER/DATE

B. Horowitz 12/15/94

SUBJECT/TITLE INDIAN POINT GENERATING STATION
EMERGENCY DIESEL GENERATOR UPGRADE
DB-75 BREAKER & SWITCHGEAR TESTING

CALCULATION NO.

EGE-00006

REVIEWER/DATE

Robert R. Brown

REVISION

00

12/16/94

PROJECT NO.

MOD NO.

REV

PAGE 57 OF 84

CLASS

INDIAN POINT UNIT 2

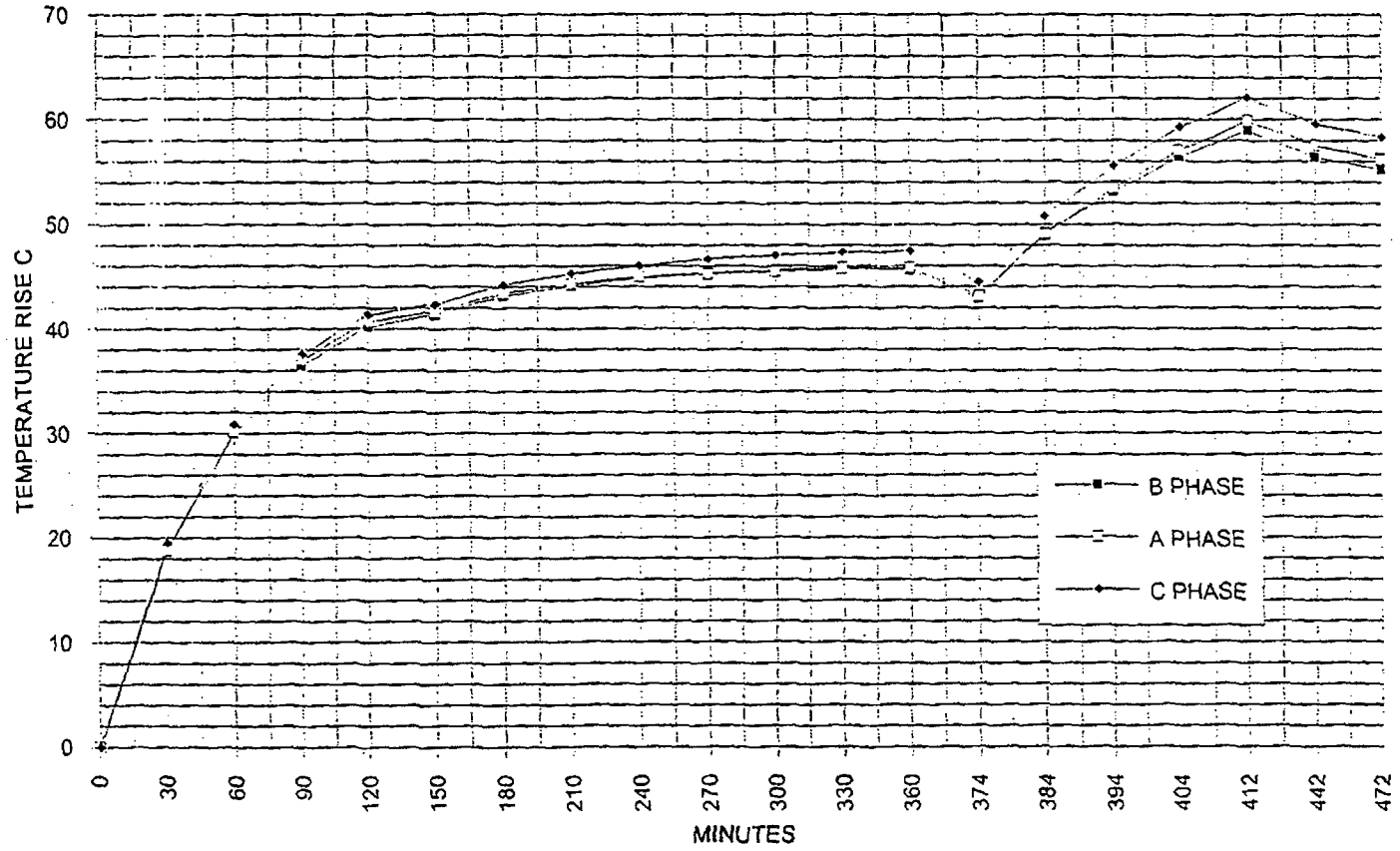

FIGURE 42 - TEST 3 LOAD DUTY CYCLE LOWER BREAKER STABS

CON EDISON
CALCULATION/ANALYSIS SHEET

CALCULATION NO.
EGE-00006

REVISION
00

PAGE 58 OF 84

PREPARER/DATE
B. Horowitz 12/15/94

REVIEWER/DATE
Robert R. Brown 12/16/94

CLASS

PROJECT NO.

SUBJECT/TITLE INDIAN POINT GENERATING STATION
EMERGENCY DIESEL GENERATOR UPGRADE
DB-75 BREAKER & SWITCHGEAR TESTING

MOD NO.
REV

INDIAN POINT UNIT 2

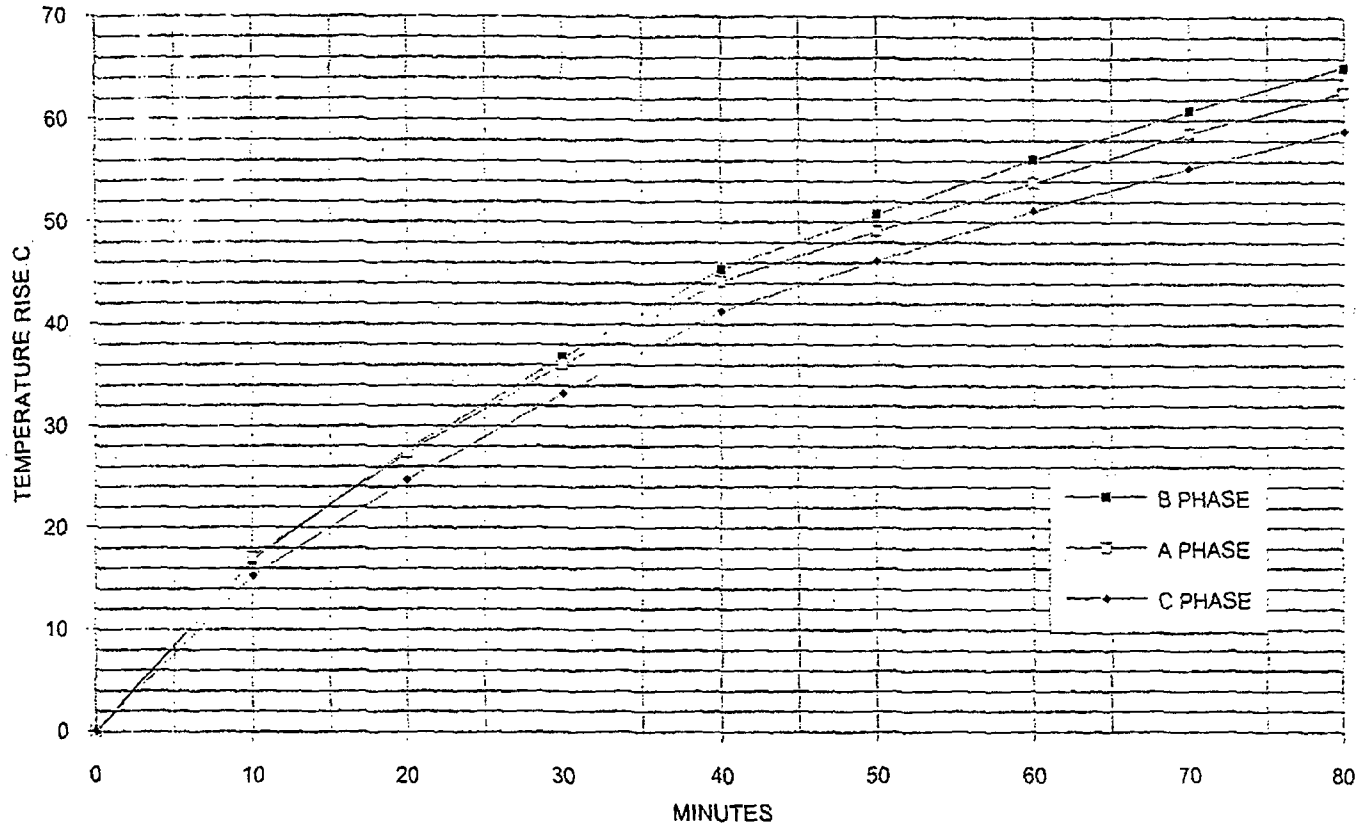

FIGURE 43 - TEST 2 3400 AMPERES LOWER PHENOLICS

CON EDISON
CALCULATION/ANALYSIS SHEET

CALCULATION NO.
EGE-00006

REVISION
00

PAGE 59 OF 84
CLASS

PREPARER/DATE
B. Horowitz 12/15/94

REVIEWER/DATE
Robert R. Brown 12/16/94

SUBJECT/TITLE
INDIAN POINT GENERATING STATION
EMERGENCY DIESEL GENERATOR UPGRADE
DB-75 BREAKER & SWITCHGEAR TESTING

PROJECT NO.

MOD NO.
REV

INDIAN POINT UNIT 2

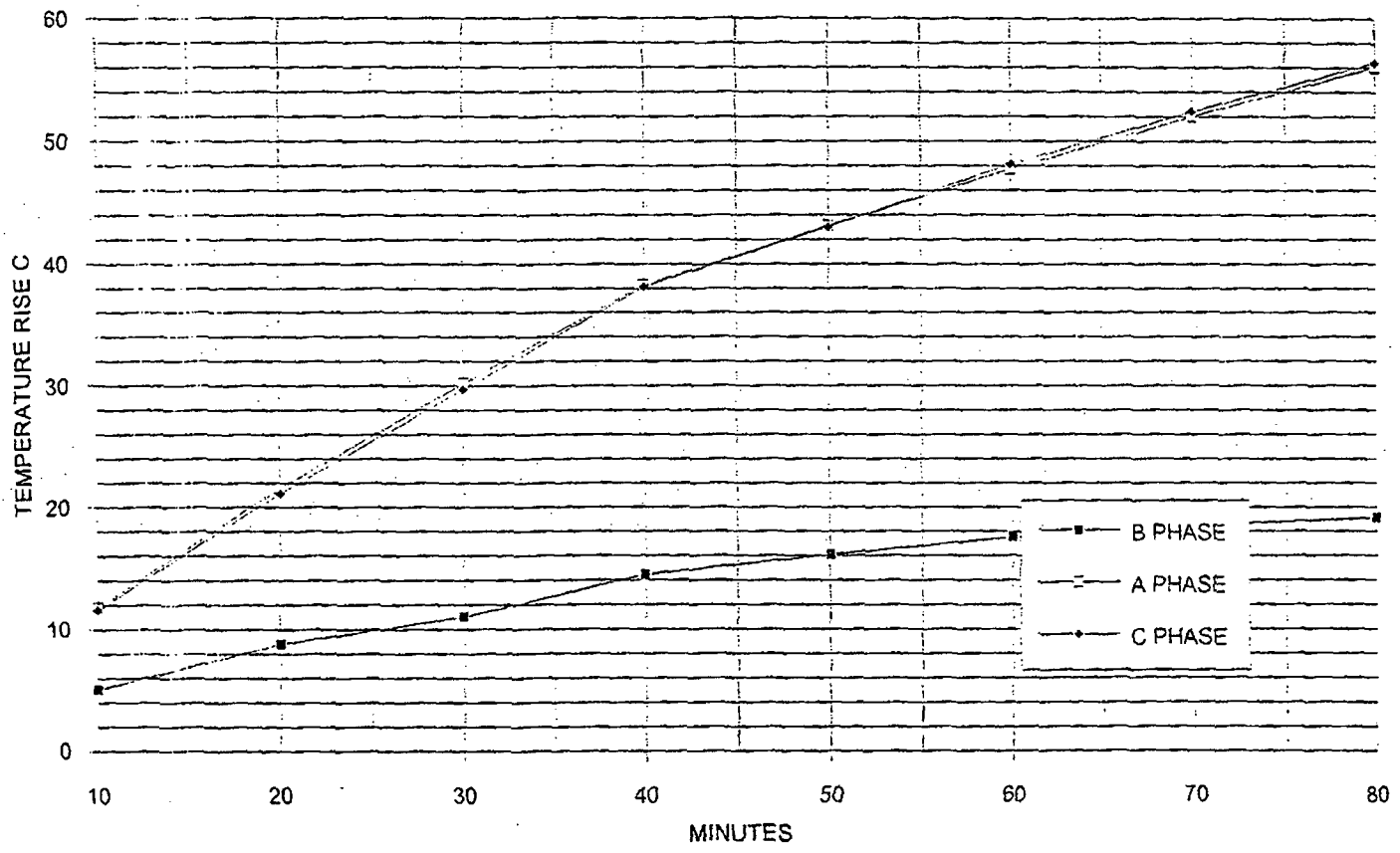

FIGURE 44 - TEST 2 3400 AMPERES UPPER PHENOLIC

CON EDISON
CALCULATION/ANALYSIS SHEET

PREPARER/DATE
B. Horowitz / 12/15/94

SUBJECT/TITLE
INDIAN POINT GENERATING STATION

EMERGENCY DIESEL GENERATOR UPGRADE

DB-75 BREAKER & SWITCHGEAR TESTING

CALCULATION NO.
EGE-00006

REVIEWER/DATE
Robert R. Brown

PROJECT NO.

MOD NO.

REVISION
00

12/16/94

CLASS

REV

PAGE *60* OF *84*

CLASS

INDIAN POINT UNIT 2

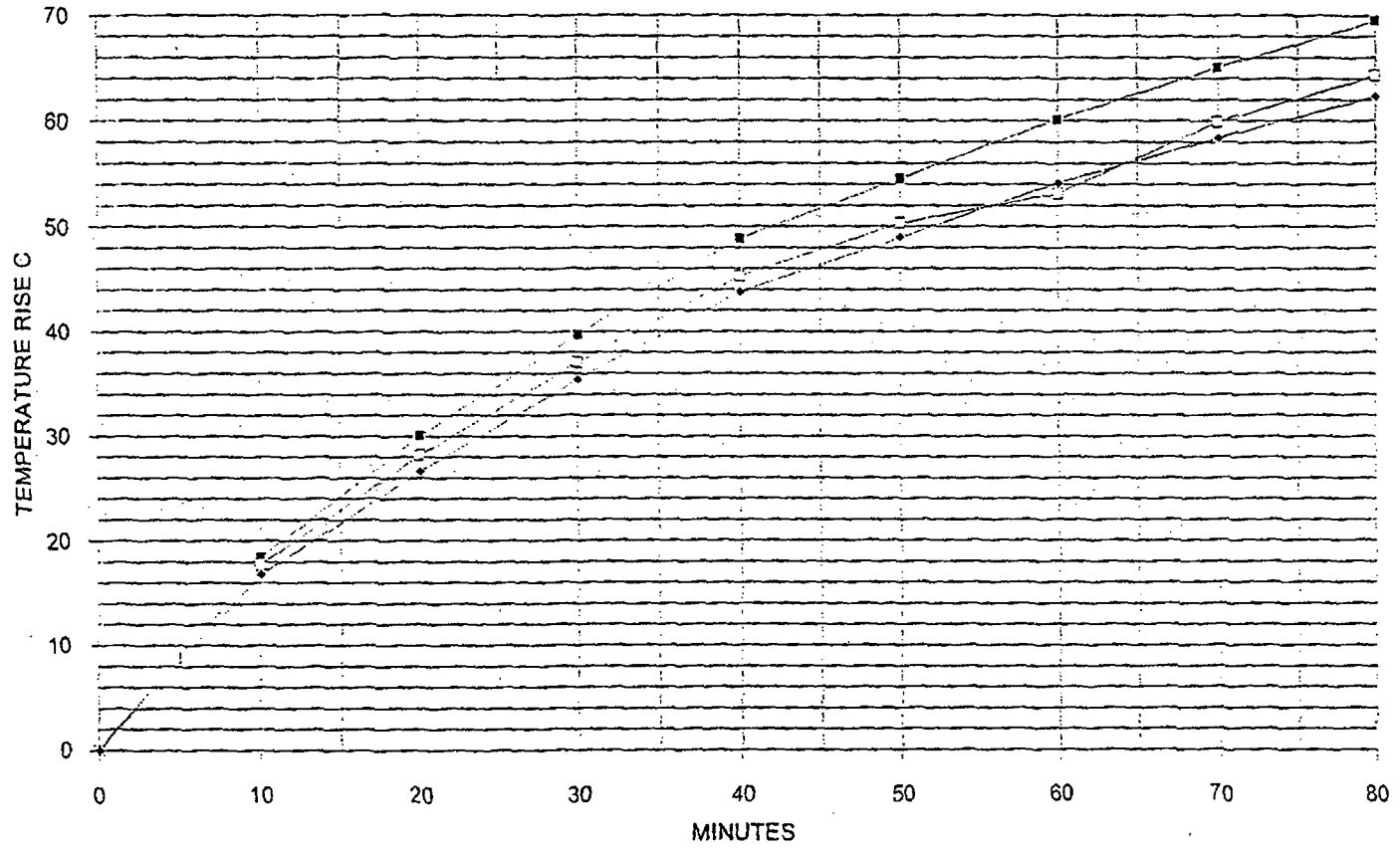

FIGURE 45 - TEST 2 3400 AMPERES STATIONARY PIVOTS

CON EDISON CALCULATION/ANALYSIS SHEET	CALCULATION NO. EGE-00006	REVISION 00	PAGE 61 OF 84
PREPARER/DATE B. Howard S. Naughton 12/15/94	REVIEWER/DATE Robert R. Brown 12/16/94	PROJECT NO.	CLASS
SUBJECT/TITLE EMERGENCY DIESEL GENERATOR UPGRADE DB-75 BREAKER & SWITCHGEAR TESTING		MOD NO.	REV

INDIAN POINT UNIT 2

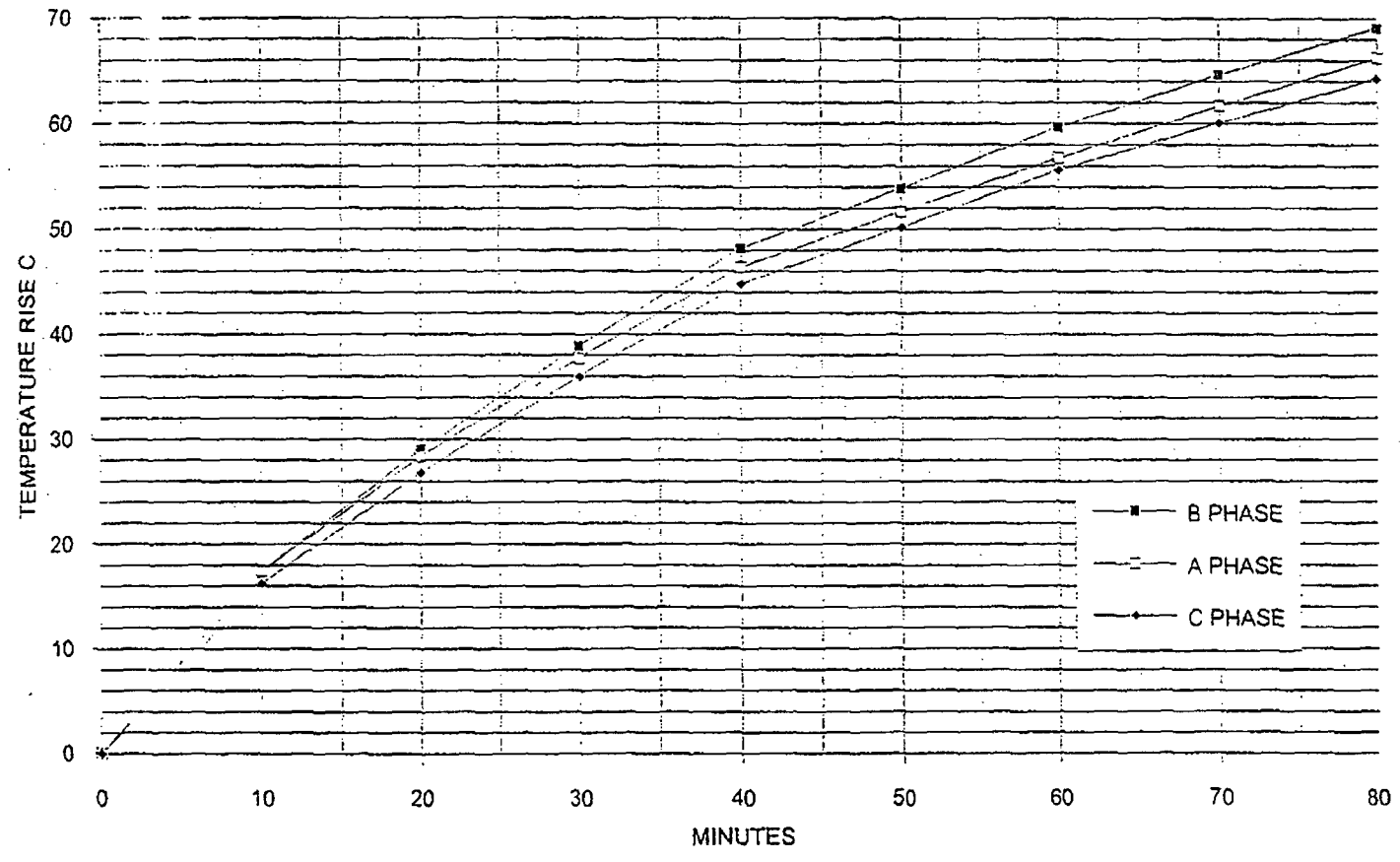

FIGURE 46 - TEST 2 3400 AMPERES MAIN MOVABLE CONTACTS

CON EDISON
CALCULATION/ANALYSIS SHEET

PREPARER/DATE

B. Horowitz 12/15/94

SUBJECT/TITLE INDIAN Point GENERATING STATION
EMERGENCY DIESEL GENERATOR UPGRADE
DB'S BREAKER & SWITCHGEAR TESTING

CALCULATION NO.

EGE-00006

REVIEWER/DATE

Robert F. Brennan

REVISION

00

PROJECT NO.

12/16/94

MOD NO.

REV

PAGE 62 OF 84

CLASS

INDIAN POINT UNIT 2

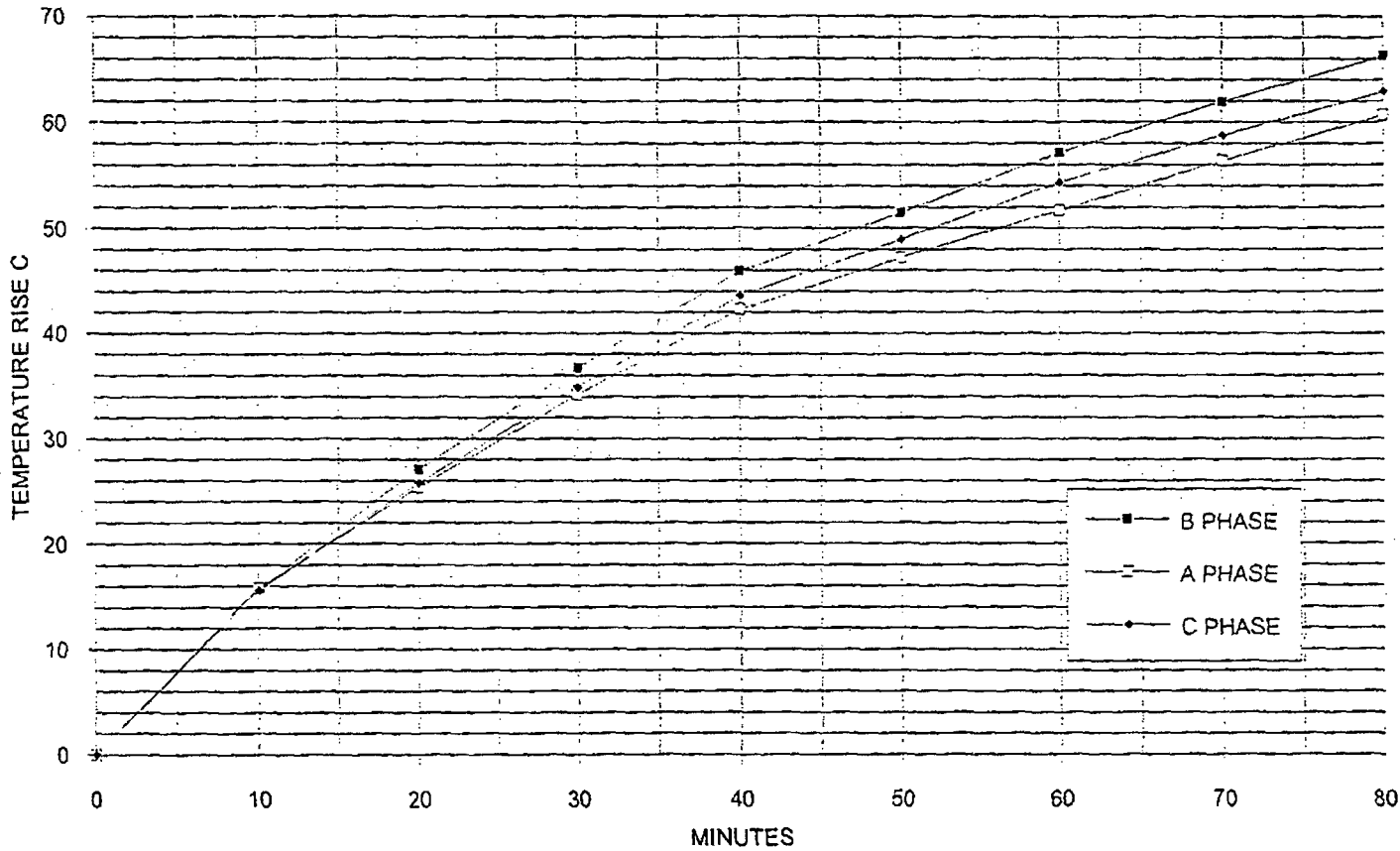

FIGURE 47 - TEST 2 3400 AMPERES STATIONARY MAIN CONTACTS

CON EDISON
CALCULATION/ANALYSIS SHEET

PREPARER/DATE

B. Howarth 12/15/94

SUBJECT/TITLE INDIAN POINT GENERATING STATION
EMERGENCY DIESEL GENERATOR UPGRADE
DB-75 BREAKER & SWITCHGEAR TESTING

CALCULATION NO.

EGE-000006

REVIEWER/DATE

Robert R. Brown

REVISION

00

PAGE 63 OF 84

CLASS

PROJECT NO.

MOD NO.

REV

INDIAN POINT UNIT 2

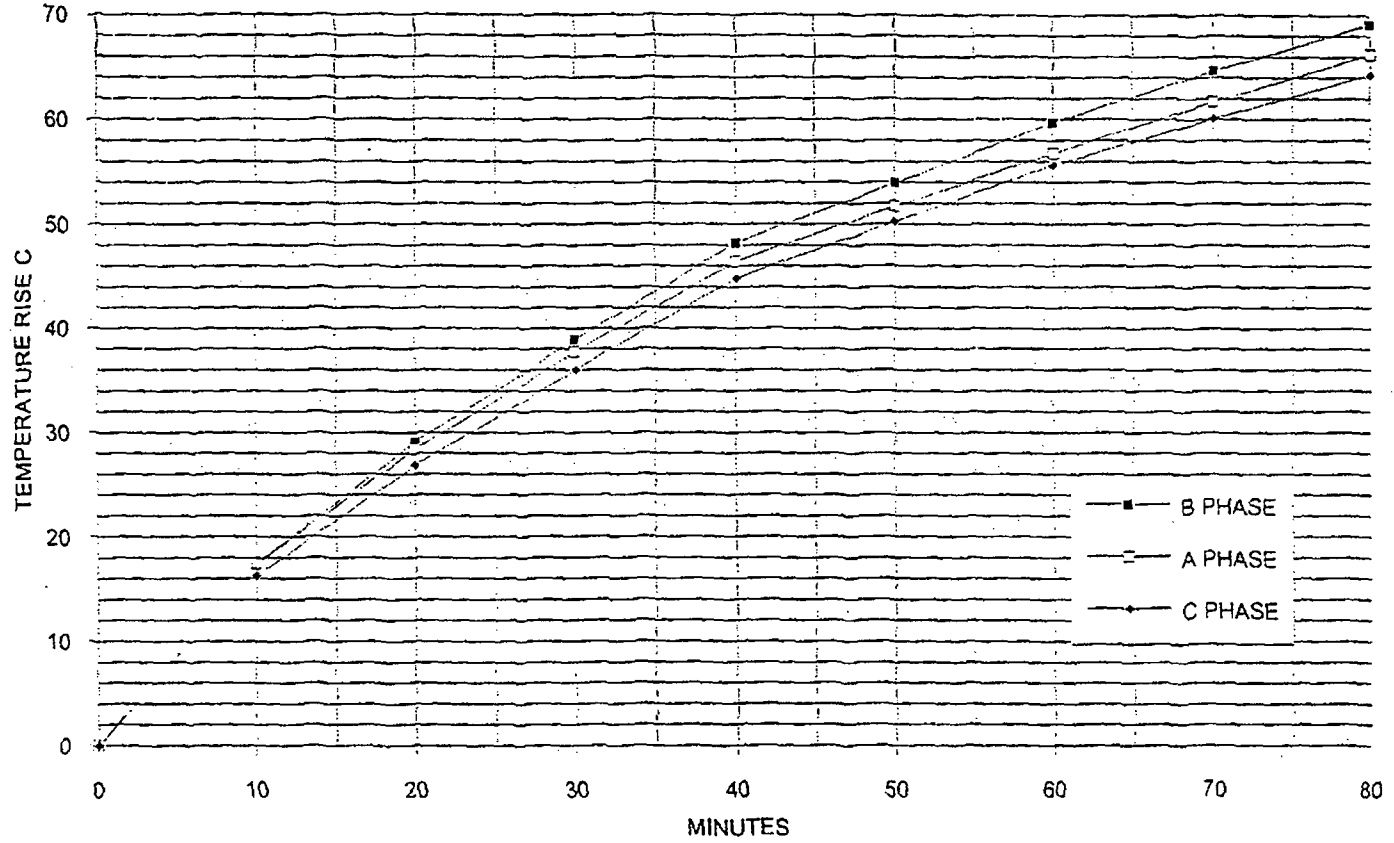

FIGURE 48 - TEST 2 3400 AMPERES MAIN MOVABLE CONTACTS

CON EDISON
CALCULATION/ANALYSIS SHEET

PREPARER/DATE
B. Horwitz / 12/13/94
SUBJECT/TITLE INDIAN POINT GENERATING STATION
EMERGENCY DIESEL GENERATOR UPGRADE
DB-75 BREAKER & SWITCHGEAR TESTING

CALCULATION NO.
EGE-00006
REVIEWER/DATE
Robert R. Bannan / 12/16/94

REVISION
00
PROJECT NO.

PAGE *64* OF *84*
CLASS
MOD NO.
REV

INDIAN POINT UNIT 2

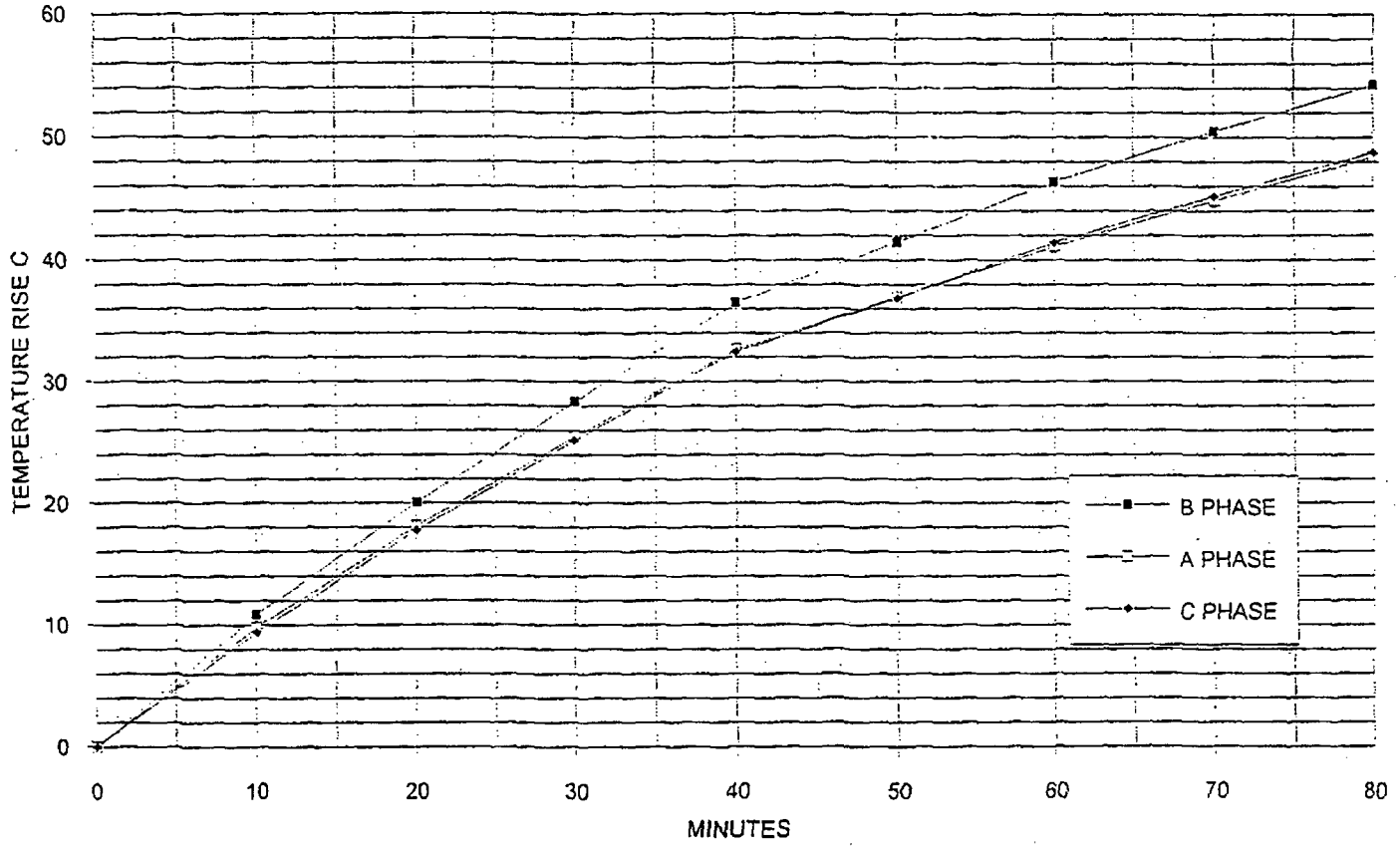

FIGURE 49 - TEST 2 3400 AMPERES UPPER BREAKER STABS

CON EDISON CALCULATION/ANALYSIS SHEET		CALCULATION NO. EGE-00006	REVISION 00	PAGE 65 OF 84
PREPARER/DATE B. H. BROWN / 12/15/84	REVIEWER/DATE Robert R. Brown / 12/16/84	CLASS		
SUBJECT/TITLE EMERGENCY DIESEL GENERATOR UPGRADE		PROJECT NO.		
DB-75 BREAKER & SWITCHGEAR TESTING		MOD NO.		
		REV		

INDIAN POINT UNIT 2

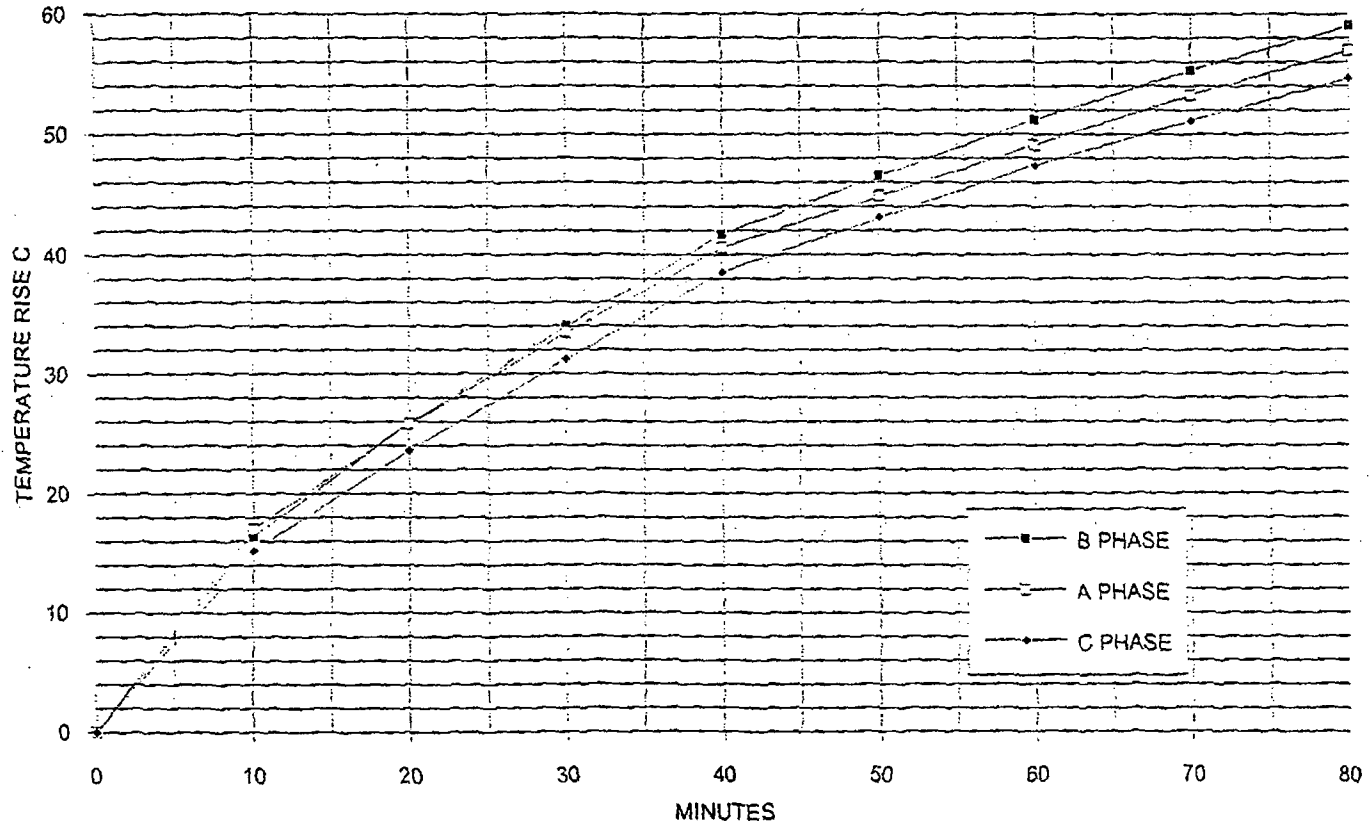

FIGURE 50 - TEST 2 3400 AMPERES LOWER BREAKER STABS

CON EDISON CALCULATION/ANALYSIS SHEET	CALCULATION NO. EGE-00006	REVISION 00	PAGE OF 84 64
PREPARER/DATE B. Horowitz 12/15/94	REVIEWER/DATE Robert R. Brown 12/16/94	PROJECT NO.	CLASS
SUBJECT/TITLE INDIAN POINT GENERATING STATION EMERGENCY DIESEL GENERATOR UPGRADE DB-7'S BREAKER & SWITCHGEAR TESTING		MOD NO.	REV

INDIAN POINT UNIT 2

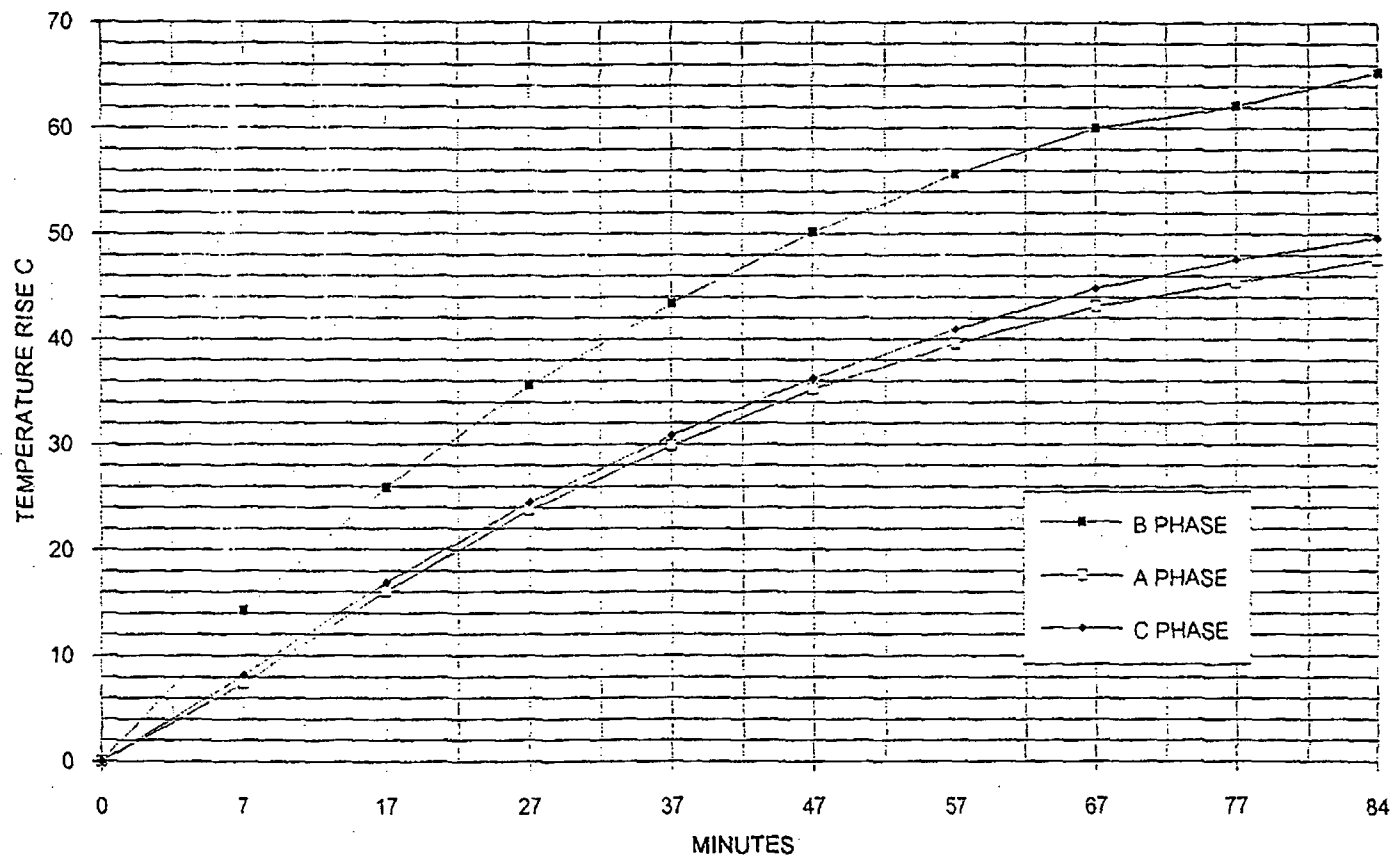

FIGURE 51 - TEST 3 - 3400 AMPERES LOWER PHENOLICS

CON EDISON CALCULATION/ANALYSIS SHEET	CALCULATION NO. EGE-00006	REVISION 00	PAGE 67 OF 84
PREPARER/DATE B. Horowitz 12/15/94	REVIEWER/DATE Robert R. Bennett 12/16/94	PROJECT NO.	CLASS
SUBJECT/TITLE INDIAN POINT GENERATING STATION EMERGENCY DIESEL GENERATOR UPGRADE DB-75 BREAKER & SWITCHGEAR TESTING	MOD NO.	REV	

INDIAN POINT UNIT 2

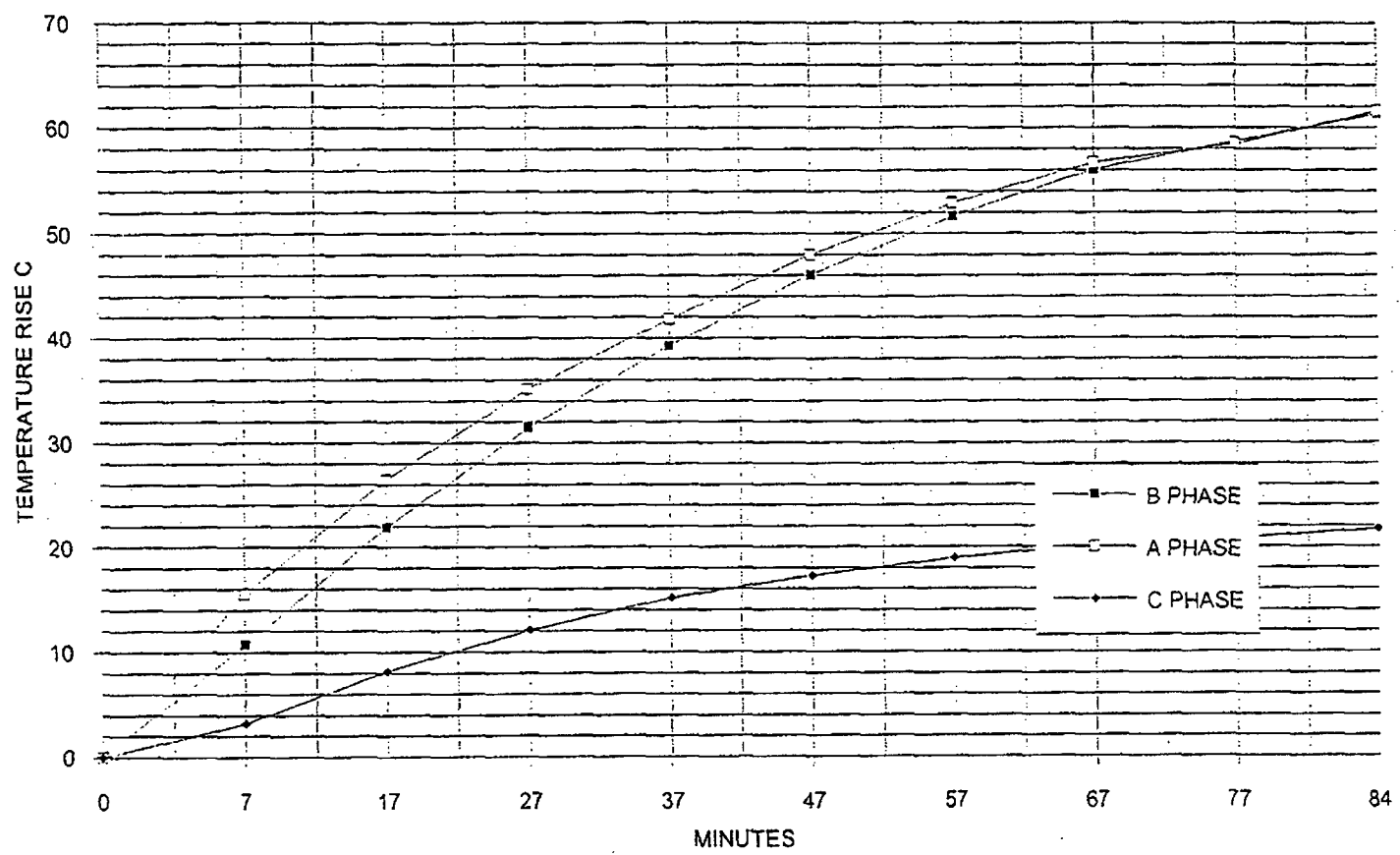

FIGURE 52 - TEST 3 - 3400 AMPERES UPPER BREAKER PHENOLICS

INDIAN POINT UNIT 2

CON EDISON CALCULATION/ANALYSIS SHEET	CALCULATION NO. EGE-00006	REVISION 00	PAGE 68	OF 84
PREPARER/DATE B. Hebert 12/15/84	REVIEWER/DATE Robert R. Brown 12/16/84	PROJECT NO.	CLASS	
SUBJECT/TITLE EMERGENCY DIESEL GENERATOR UPGRADE DB-15 BREAKER & SWITCHGEAR TESTING		MOD NO.		REV

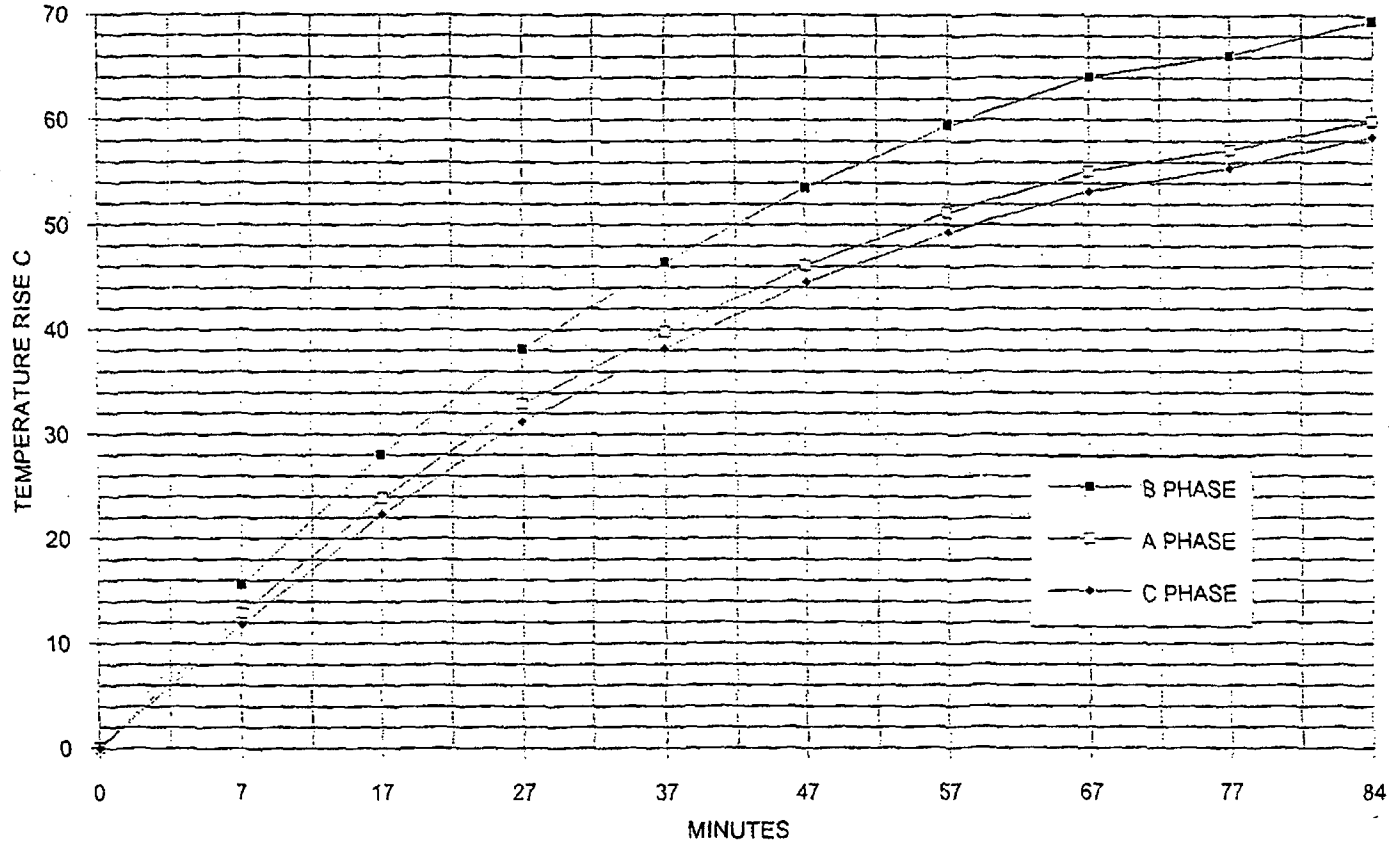

FIGURE 53 - TEST 3 - 3400 AMPERES STATIONARY PIVOTS

CON EDISON CALCULATION/ANALYSIS SHEET	CALCULATION NO. EGE-00006	REVISION 00	PAGE 69 OF 84
PREPARER/DATE B. Howard 12/15/84	REVIEWER/DATE Robert R. Bennett 12/16/84	PROJECT NO.	CLASS
SUBJECT/TITLE INDIAN POINT GENERATING STATION EMERGENCY DIESEL GENERATOR UPGRADE	MOD NO.	REV	
DB-75 BREAKER & SWITCHGEAR TESTING			

INDIAN POINT UNIT 2

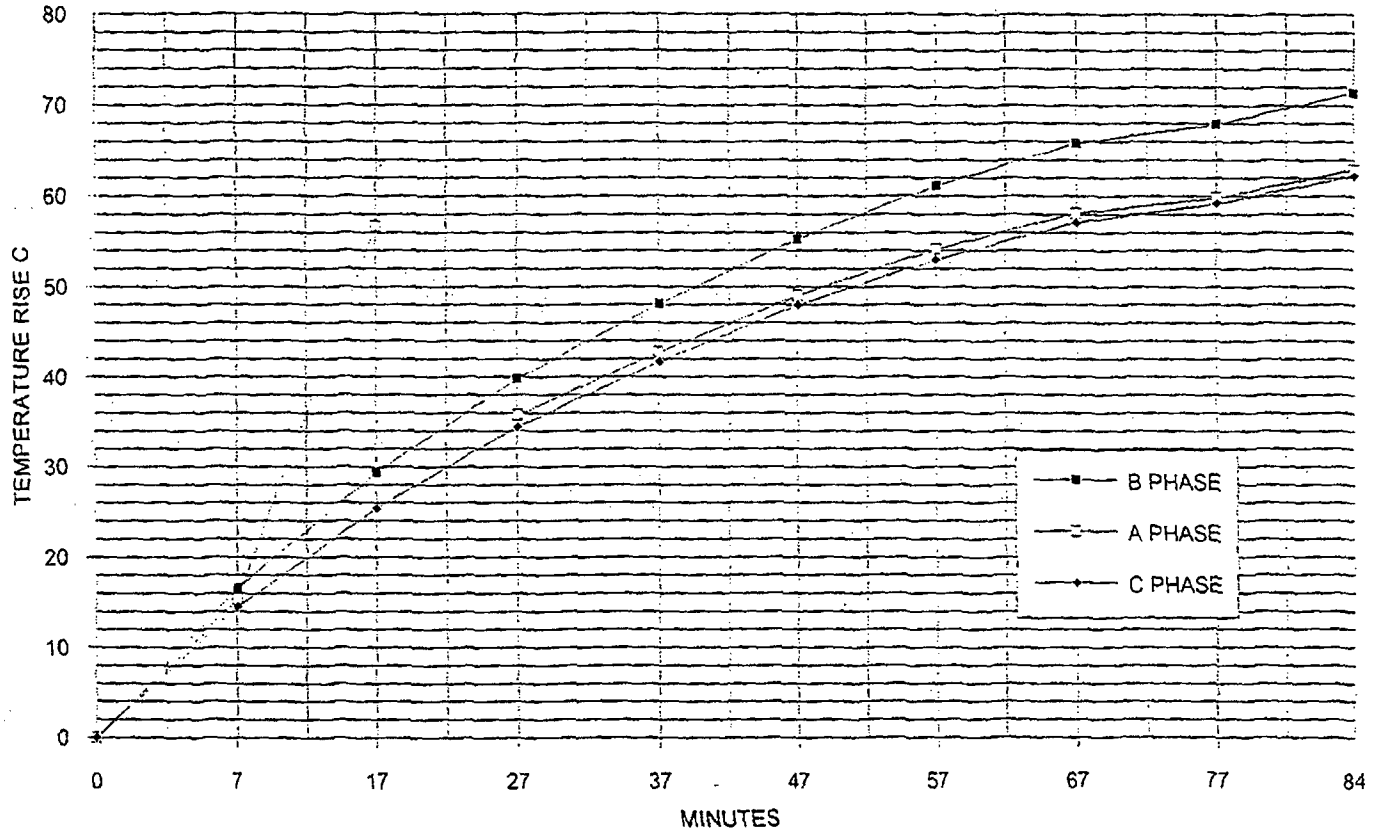

FIGURE 54 - TEST 3 - 3400 AMPERES MOVABLE PIVOTS

CON EDISON
CALCULATION/ANALYSIS SHEET

PREPARER/DATE
B. Howard 12/15/94
SUBJECT/TITLE INDIAN POINT GENERATING STATION
EMERGENCY DIESEL GENERATOR UPGRADE
DB-75 BREAKER & SWITCHGEAR TESTING

CALCULATION NO.
EGE-00006
REVIEWER/DATE
Robert R. Brown
PROJECT NO.

REVISION
00
12/16/94
MOD NO.

PAGE 70 OF 84
CLASS
REV

INDIAN POINT UNIT 2

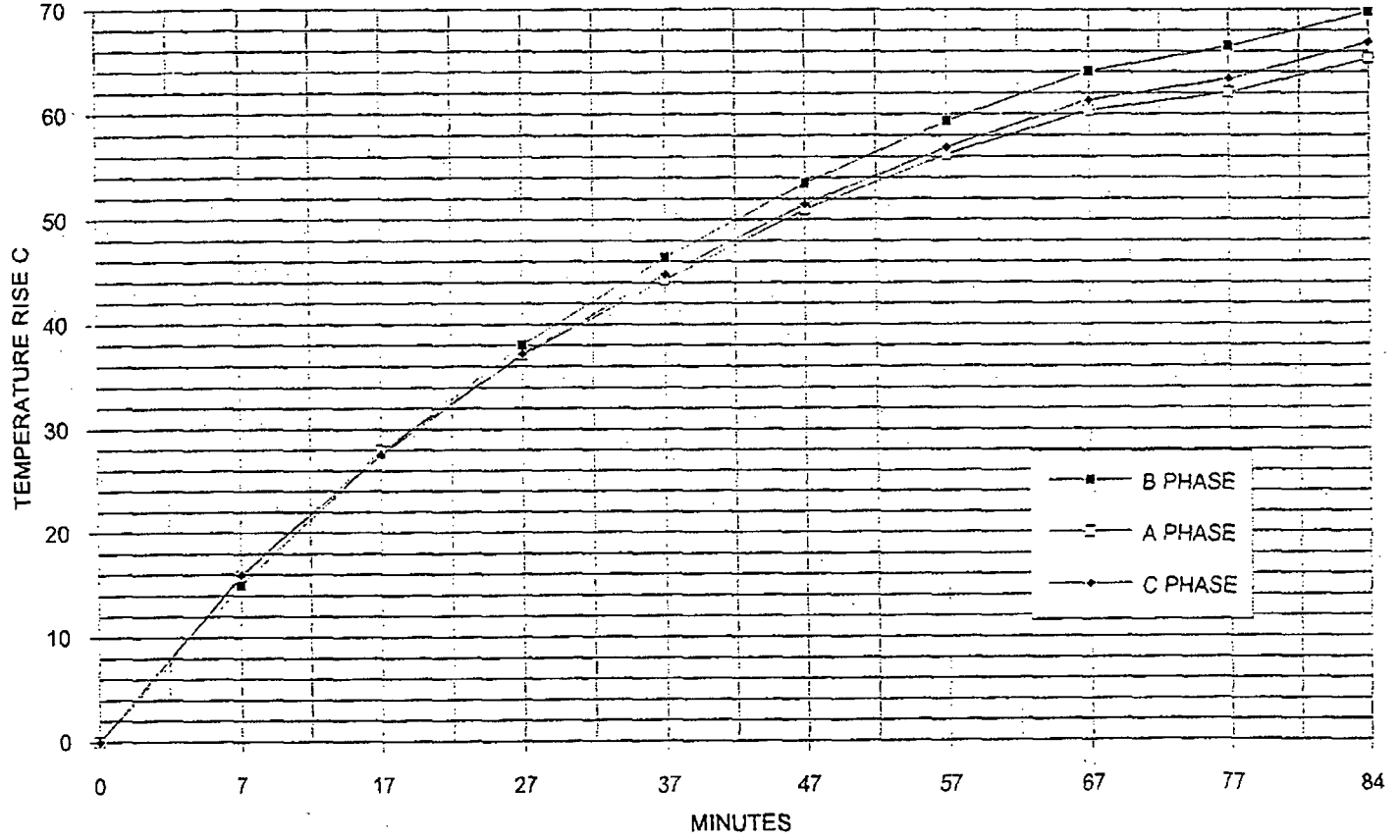

FIGURE 55 - TEST 3 - 3400 AMPERES STATIONARY CONTACTS

CON EDISON CALCULATION/ANALYSIS SHEET	CALCULATION NO. EGE-00006	REVISION 00	PAGE 71 OF 84 CLASS
PREPARER/DATE B. Horvath 12/15/84	REVIEWER/DATE Robert R. Brown 12/16/84	PROJECT NO.	MOD NO.
SUBJECT/TITLE INDIAN POINT GENERATING STATION EMERGENCY DIESEL GENERATOR UPGRADE DB'S BREAKER & SWITCHGEAR TESTING			
REV			

INDIAN POINT UNIT 2

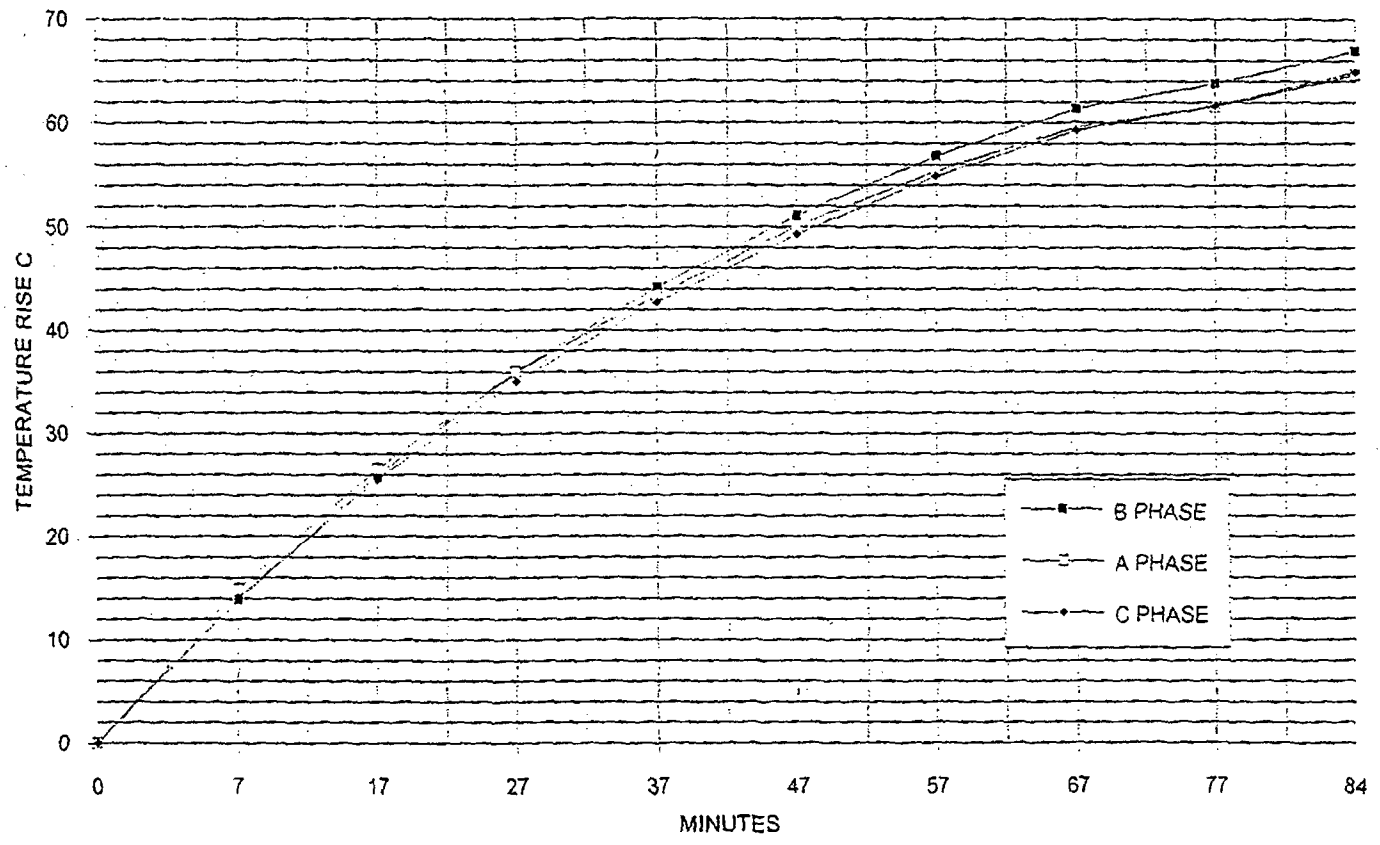

FIGURE 56 - TEST 3 - 3400 AMPERES MAIN MOVABLE CONTACTS

CON EDISON
CALCULATION/ANALYSIS SHEET

PREPARER/DATE
A. Horowitz / 12/15/94

SUBJECT/TITLE
INDIAN POINT GENERATING STATION

EMERGENCY DIESEL GENERATOR UPGRADE
DB-75 BREAKER & SWITCHGEAR TESTING

CALCULATION NO.
EGE-00006

REVIEWER/DATE
Robert R. Brown

12/16/94

PROJECT NO.

MOD NO.

REV

PAGE 72 OF 84

CLASS

INDIAN POINT UNIT 2

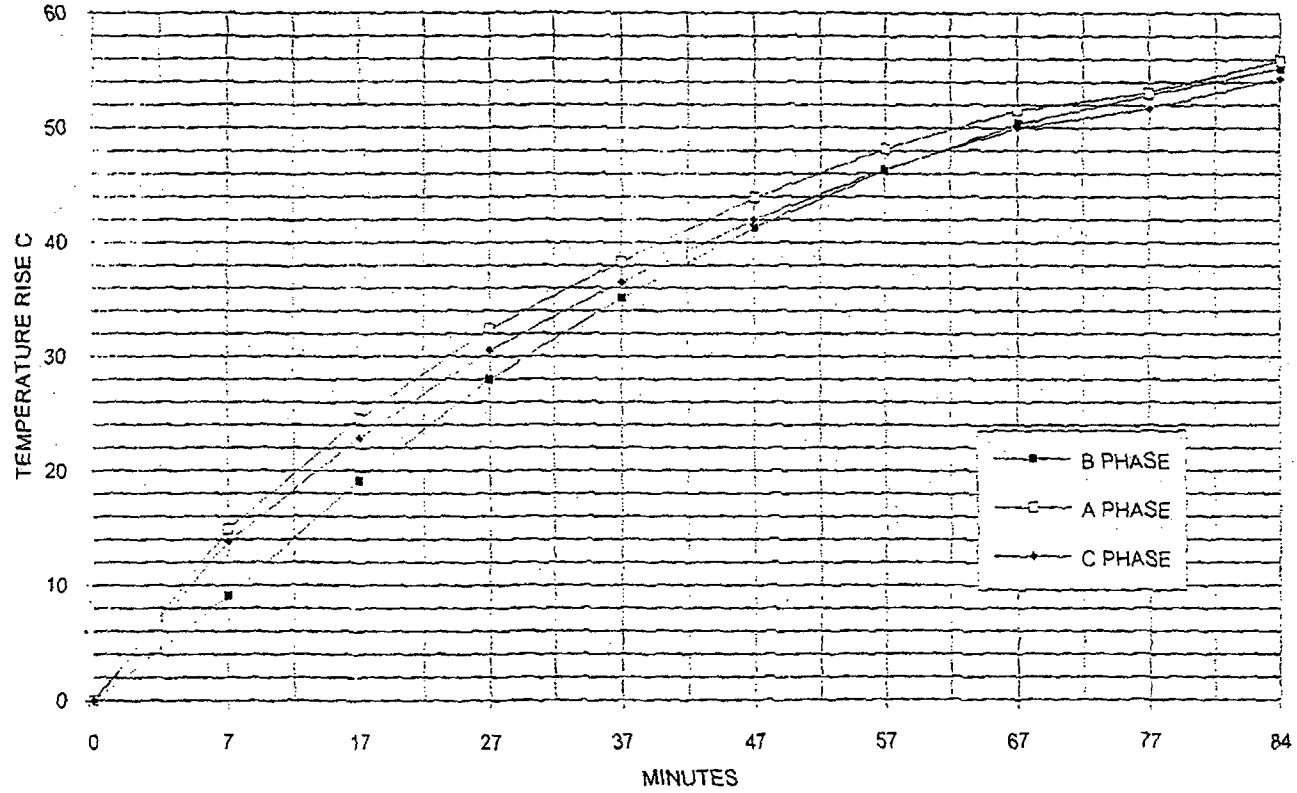

FIGURE 57 - TEST 3 - 3400 AMPERES UPPER BREAKER STABS

CON EDISON
CALCULATION/ANALYSIS SHEET

PREPARER/DATE
B. Herzog / 12/16/94

SUBJECT/TITLE
INDIAN POINT GENERATING STATION
EMERGENCY DIESEL GENERATOR UPGRADE
DB-75 BREAKER & SWITCHGEAR TESTING

CALCULATION NO.
EGE-00006

REVIEWER/DATE
Robert R. Brown / 12/16/94

PROJECT NO.

MOD NO.

REV

PAGE 73 OF 84

CLASS

INDIAN POINT UNIT 2

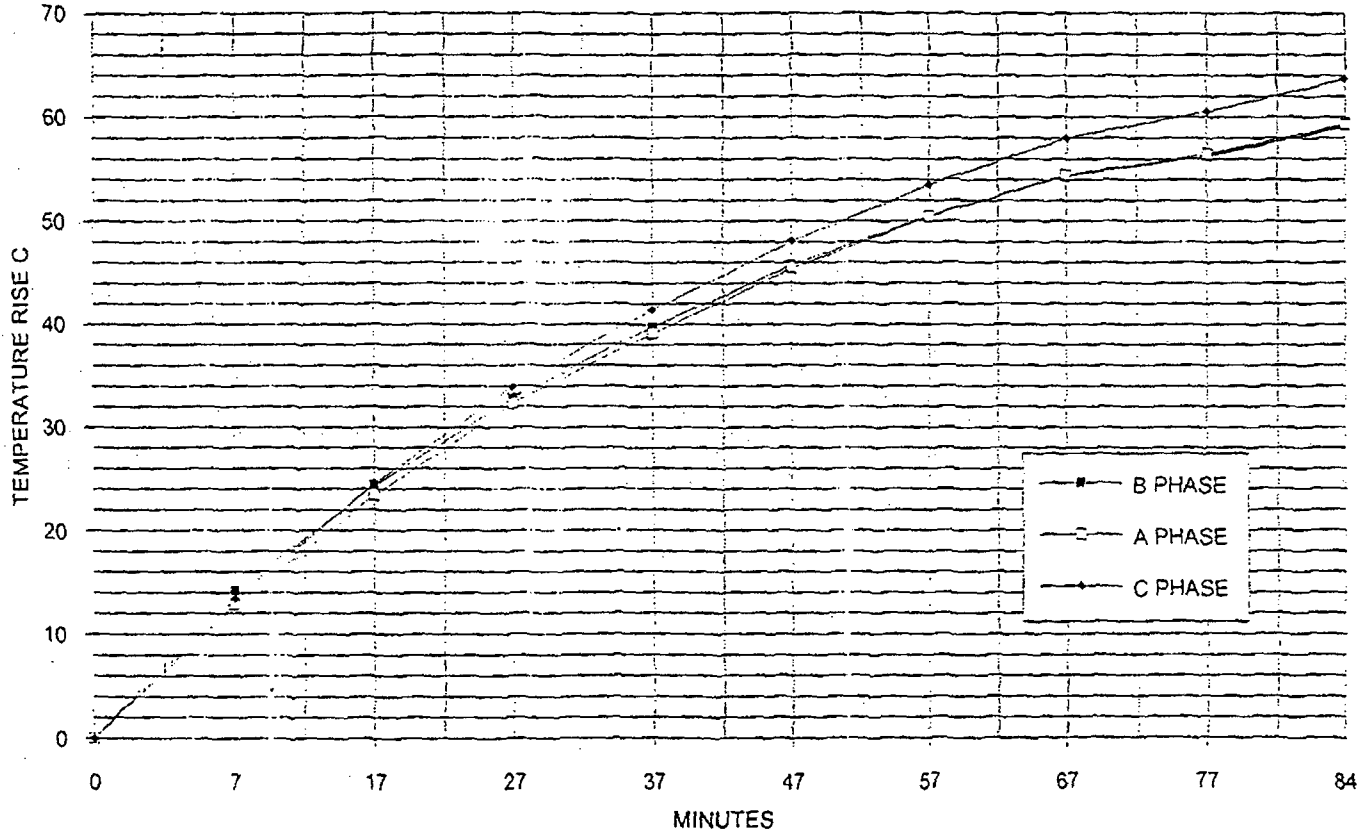

FIGURE 58 - TEST 3 - 3400 AMPERES LOWER BREAKER STABS

CON EDISON
CALCULATION/ANALYSIS SHEET

PREPARER/DATE
B. MORGENTHAU 12/16/94

SUBJECT/TITLE INDIAN POINT GENERATING STATION
EMERGENCY DIESEL GENERATOR UPGRADE

DB-75 BREAKER & SWITCHGEAR TESTING

CALCULATION NO.
EGE-00006

REVIEWER/DATE
Robert R. Brown 12/16/94

REVISION
00

PROJECT NO.

MOD NO.

REV

INDIAN POINT UNIT 2

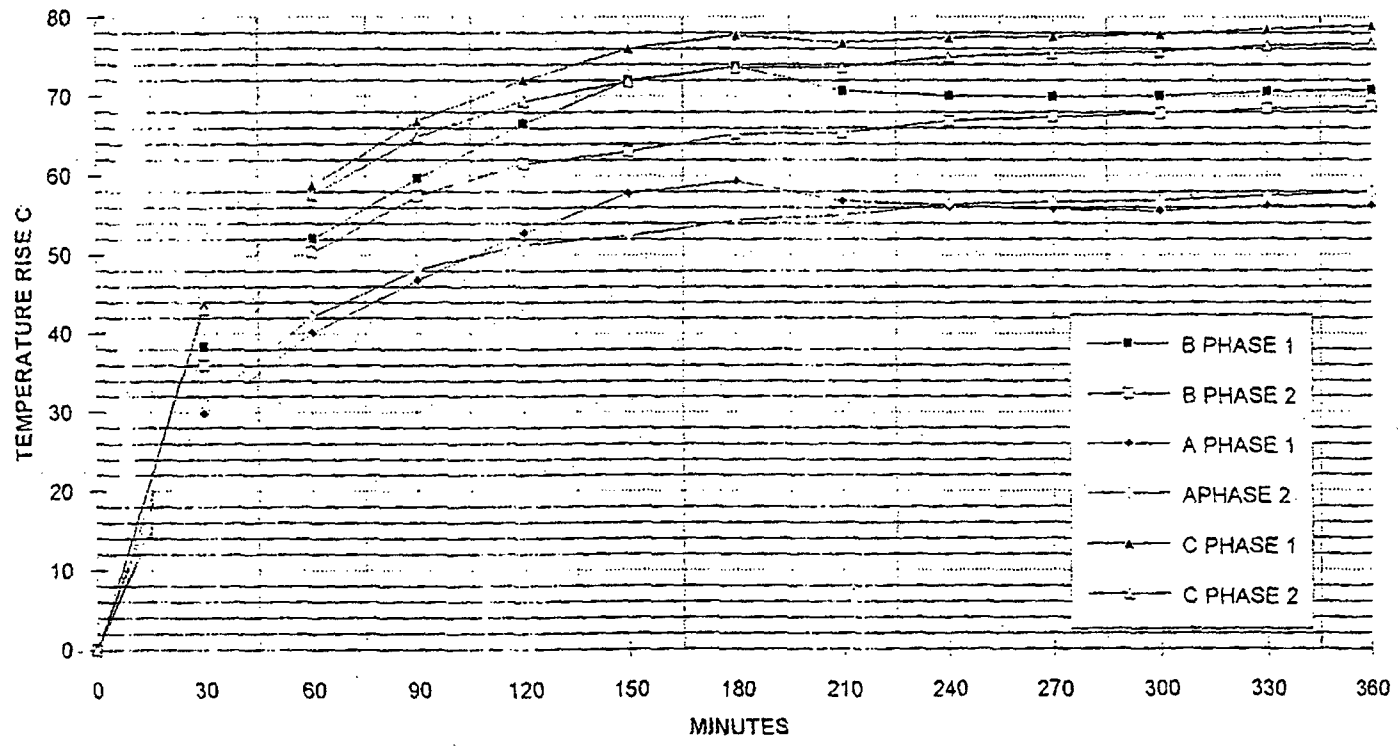

FIGURE 59 - TEST 2 - 3000 AMPERES BUS DUCT TRANSITION

CON EDISON
CALCULATION/ANALYSIS SHEET

PREPARER/DATE
B. Horowitz 12/15/94

SUBJECT/TITLE INDIAN POINT GENERATING STATION
EMERGENCY DIESEL GENERATOR UPGRADE
DB-7S BREAKER & SWITCHGEAR TESTING

CALCULATION NO.
EGE-00006

REVIEWER/DATE
Robert R. Brown

PROJECT NO.

REVISION

00

CLASS

PAGE 75 OF 84

MOD NO. REV

INDIAN POINT UNIT 2

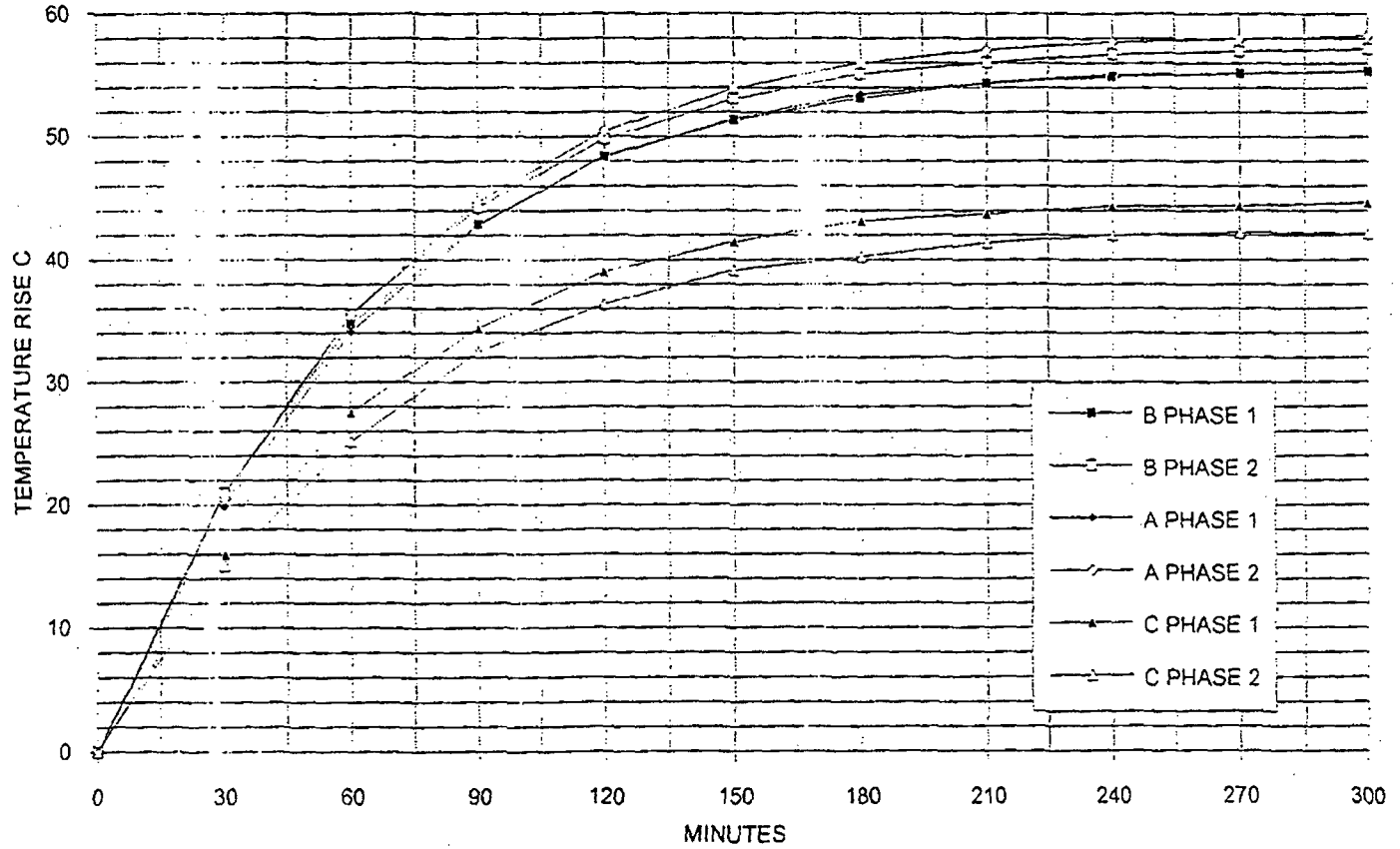

FIGURE 60 - TEST 3 - 3000 AMPERES BUS DUCT TRANSITION

CON EDISON CALCULATION/ANALYSIS SHEET	CALCULATION NO. EGE-00006	REVISION 00	PAGE 76 OF 84
PREPARER/DATE B. Horowitz 12/15/94	REVIEWER/DATE Robert R. Brown 12/16/94	PROJECT NO.	CLASS
SUBJECT/TITLE INDIAN POINT GENERATING STATION EMERGENCY DIESEL GENERATOR UPGRADE		MOD NO.	REV
DB-15 BREAKER & SWITCHGEAR TESTING			

INDIAN POINT UNIT 2

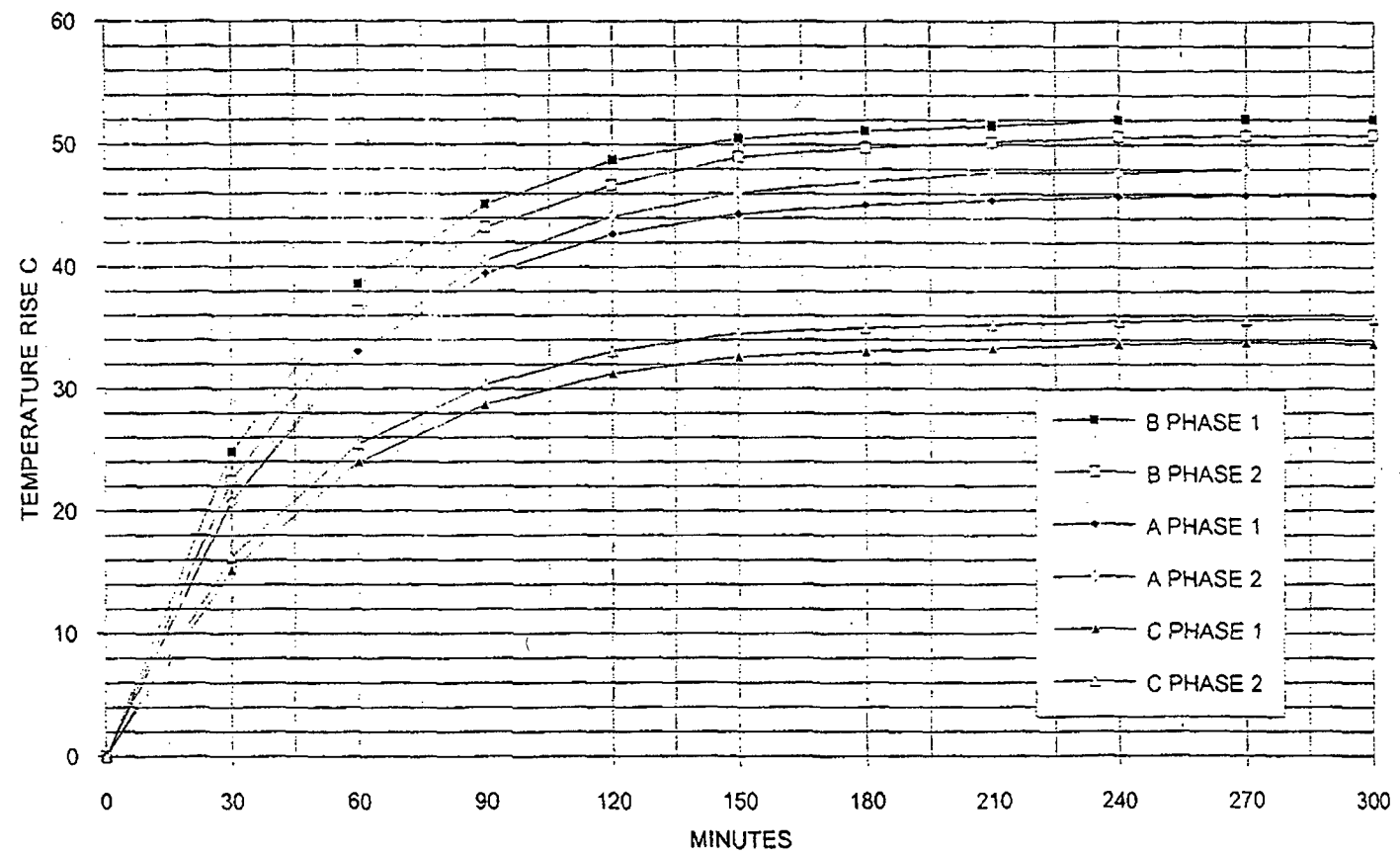

FIGURE 61 - TEST 3 - 3000 AMPERES BUS DUCT

CON EDISON
CALCULATION/ANALYSIS SHEET

PREPARER/DATE
B. Herwitz / 12/15/84

SUBJECT/TITLE
INDIAN POINT GENERATOR UPGRADE
EMERGENCY DIESEL GENERATOR UPGRADE
DB-15 BREAKER & SWITCHGEAR TESTING

CALCULATION NO.
EGE-00006

REVIEWER/DATE
Robert R. Brown 12/16/84

REVISION

00

PROJECT NO.

MOD NO.

PAGE 77 OF 84

CLASS

REV

INDIAN POINT UNIT 2

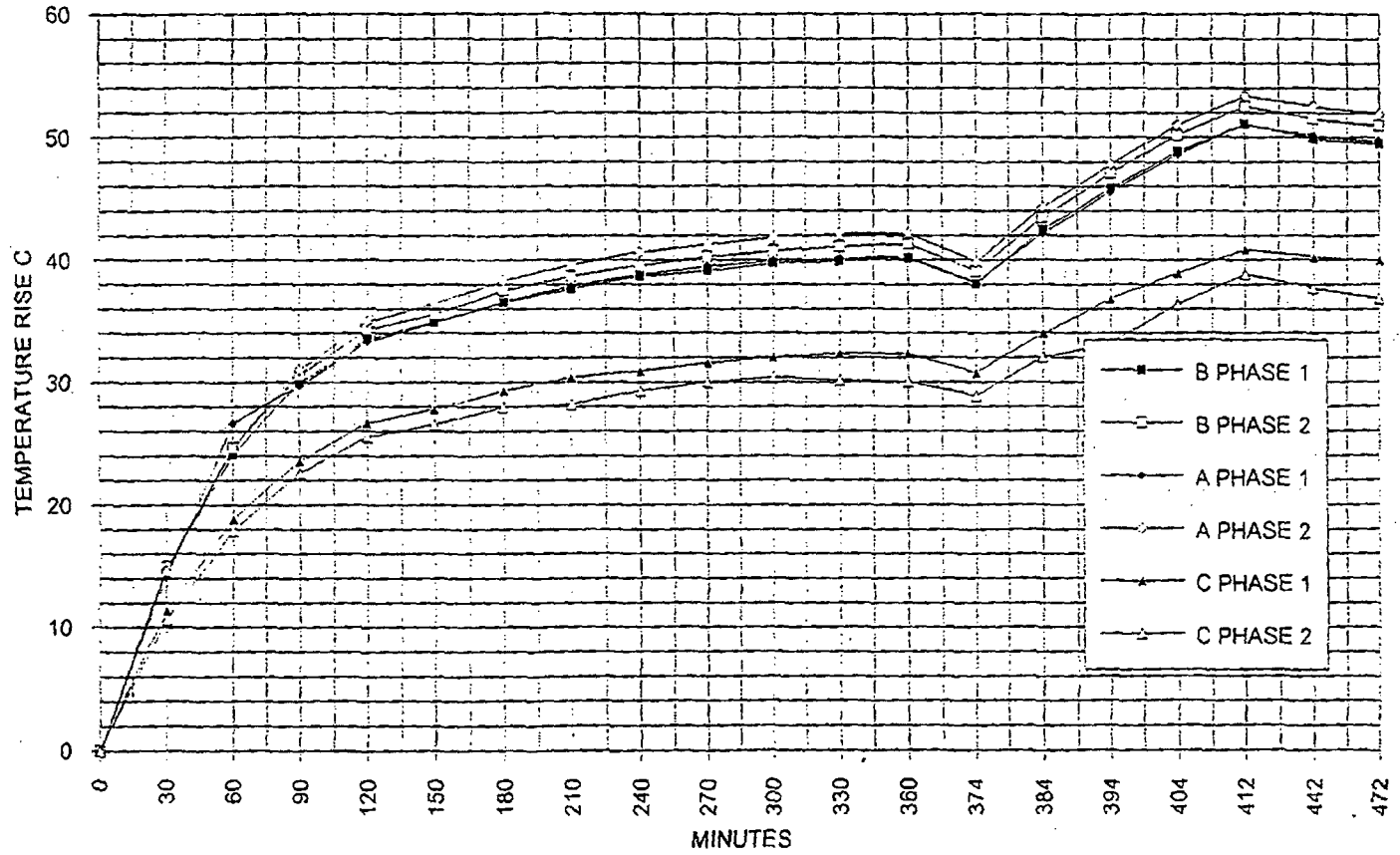

FIGURE 62 - TEST 3 LOAD DUTY CYCLE BUS DUCT TRANSITION

CON EDISON
CALCULATION/ANALYSIS SHEET

PREPARER/DATE
B. Horowitz 12/15/94

SUBJECT/TITLE
INDIAN POINT GENERATOR UPGRADE
EMERGENCY DIESEL GENERATOR UPGRADE
DB'S BREAKER & SWITCHGEAR TESTING

CALCULATION NO.
EGE-00006

REVIEWER/DATE
Robert R. Brown 12/16/94

REVISION
00

PROJECT NO.

MOD NO.

PAGE 78 OF 84

CLASS

REV

INDIAN POINT UNIT 2

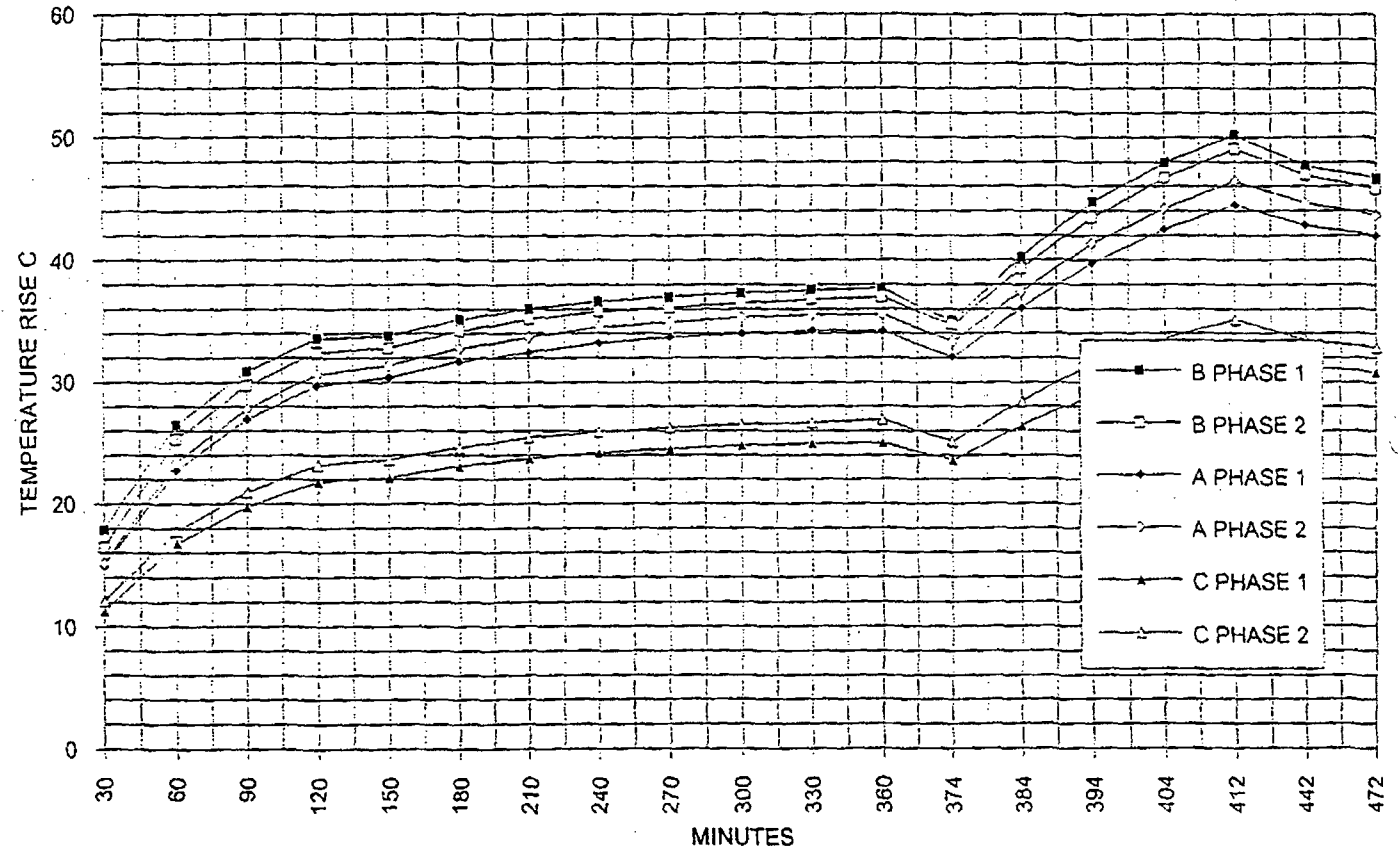

FIGURE 63 - TEST 3 LOAD DUTY CYCLE BUS DUCT

• Page 79

• missing

•

CON EDISON CALCULATION/ANALYSIS SHEET		CALCULATION NO. EGE-00006		REVISION 00		PAGE 50 OF 84	
PREPARER/DATE B. Horowitz B. A. Talsky		REVIEWER/DATE Robert R. Brown 12/16/94		PROJECT NO.		CLASS	
SUBJECT/TITLE INDIAN POINT GENERATOR UPGRADE		MOD NO.		REV			
EMERGENCY DIESEL GENERATOR UPGRADE							
DB-75 BREAKER & SWITCHGEAR TESTING							

INDIAN POINT UNIT 2

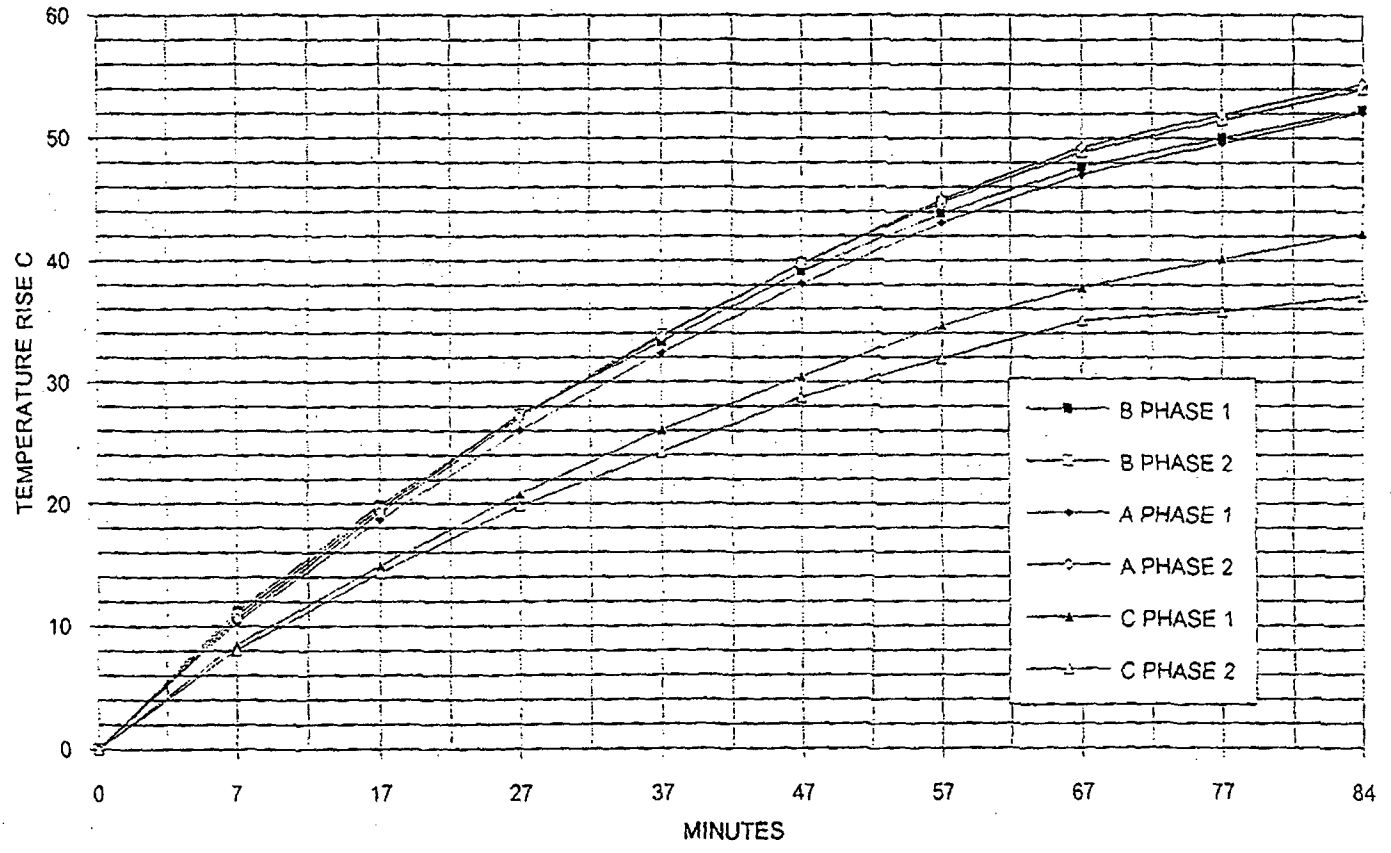

FIGURE 64 - TEST 3 3400 AMPERES BUS DUCT TRANSITION

CON EDISON
CALCULATION/ANALYSIS SHEET

PREPARER/DATE
B. Horowitz 12/15/94
SUBJECT/TITLE INDIAN POINT GENERATING STATION
EMERGENCY DIESEL GENERATOR UPGRADE
DB-75 BREAKER & SWITCHGEAR TESTING

CALCULATION NO.
ESE-00006

REVIEWER/DATE
Robert R. Brown 12/16/94
PROJECT NO.

REVISION
00

CLASS

MOD NO. REV

INDIAN POINT UNIT 2

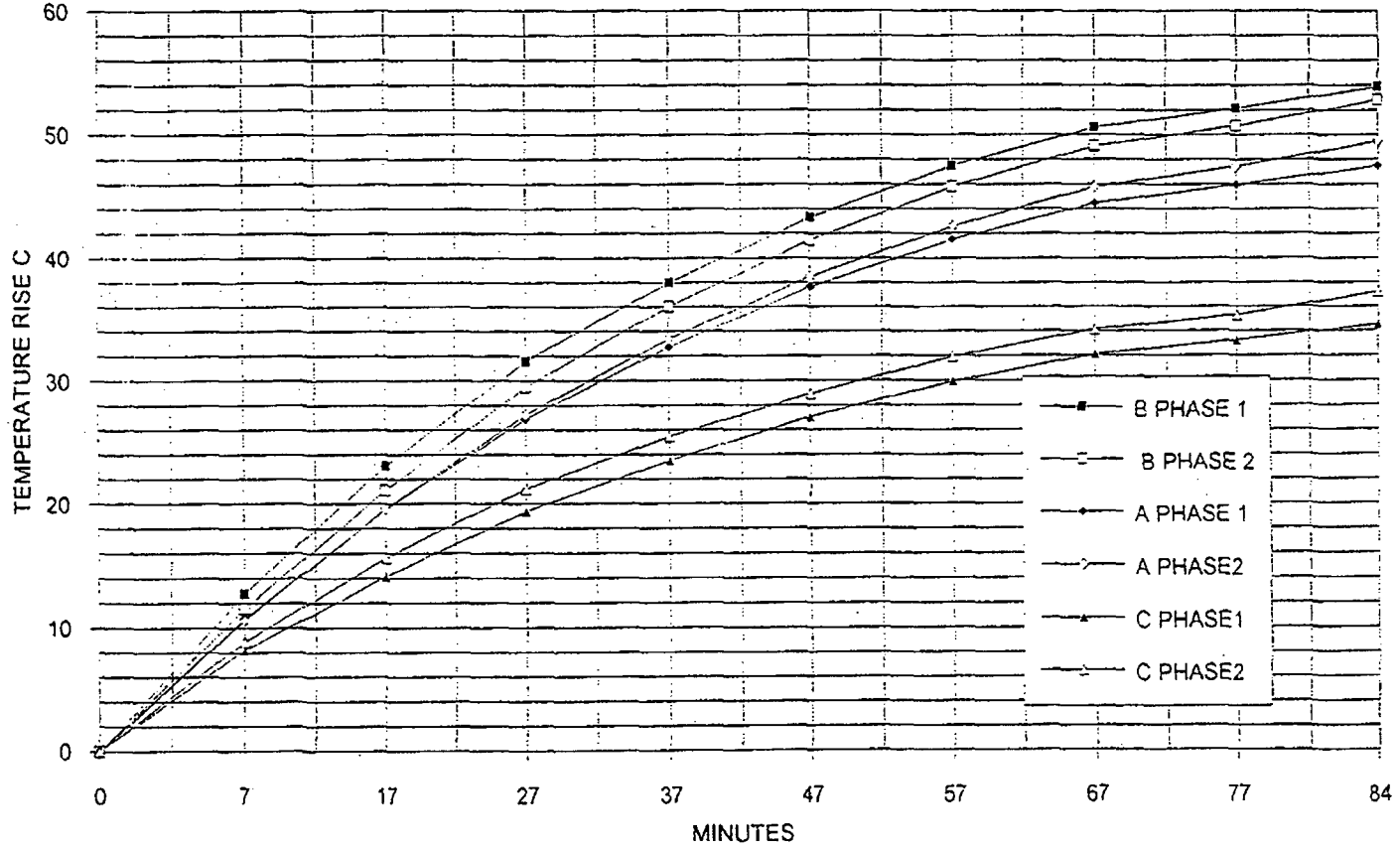

FIGURE 65 - TEST 3 - 3400 AMPERES BUS DUCT

CON EDISON CALCULATION/ANALYSIS SHEET	CALCULATION NO. EGE-00006	REVISION 00	PAGE 82 OF 84
PREPARER/DATE B. Horowitz / B. Morgan / 12/18/94	REVIEWER/DATE Robert R. Brown / 12/16/94	CLASS	
SUBJECT/TITLE INDIAN POINT GENERATING STATION EMERGENCY DIESEL GENERATOR UPGRADE DB-75 BREAKER & SWITCHGEAR TESTING		PROJECT NO.	
		MOD NO.	REV

from C37.010-1487, page 23

APPENDIX A
THERMAL TIME CONSTANT

$$\theta_t = (\theta_s - \theta_i) (1 - e^{-t/\tau}) + \theta_i$$

θ_t = Total temperature, in degrees Celsius, at some time t after the current is raised from I_1 to I_2 .

θ_s = Total temperature, in degrees Celsius, due to continuous current I_2 at ambient θ_a .

θ_a = Total temperature, in degrees Celsius, that would be reached if current I_2 were applied continuously at ambient θ_a .

τ = Thermal time constant of the circuit breaker

t = time

Let: $t = \tau$

$$e^{-t/\tau} = e^{-1} = 1/e = 1/2.71 = .369$$

Substituting this back into the equation we obtain:

$$\theta_t = (\theta_s - \theta_i) (1 - .369) + \theta_i$$

$$\theta_t = (\theta_s - \theta_i) (.631) + \theta_i$$

If the current applied from an ambient (no current preload condition) then θ_i is equal to zero. The formula then becomes:

$$\theta_t = (\theta_s) (.631)$$

With t equal to τ (thermal time constant), the associated temperature is .631 of the final temperature.

CON EDISON CALCULATION/ANALYSIS SHEET	CALCULATION NO. EGE-00006	REVISION 00	PAGE 43 OF 84
PREPARER/DATE B. Horowitz / 12/15/94	REVIEWER/DATE Robert R. Brown 12/16/94	CLASS	
SUBJECT/TITLE INDIAN Point GENERATING STATION EMERGENCY DIESEL GENERATOR UPGRADE DB-7'S BREAKER & SWITCHGEAR TESTING		PROJECT NO.	MOD NO. REV

APPENDIX B
CONTINUOUS OVERLOAD CAPABILITY

From ANSI/IEEE C37.010-1987 page 23

$$Y = (\theta_{max} - 40^{\circ} C) (I_1 / I_r)^{1.8}$$

θ_{max} = Allowable hottest spot total temperature from Table 1, in degrees Celsius

I_1 = Initial current carried prior to application of I_r , in amperes (the maximum current carried by the breaker during the 4 hour period immediately preceding the application of current I_r).

I_r = rated current, in amperes

The above formula is used in conjunction with the formula which calculates allowable operating time for short time overload. This formula determines the temperature at any given current based on the known rated current and its associated rated temperature rise. We can use this formula to perform the reverse. Knowing the temperature rise for a given current, can calculate the current necessary to reach the maximum allowable temperature for that component. The formula for this is then:

$$I_r = 1.8\sqrt{((\theta_{max} - 40^{\circ} C) I_1^{1.8} / Y)}$$

Example: For the movable pivots during the 2500 ampere test, the temperature rise for B phase was 52° C. The maximum current rating based on the above temperature rise and current is as follows:

$$I_r = 1.8\sqrt{((125-40) 2500^{1.8} / 52)} = 3285$$

CON EDISON CALCULATION/ANALYSIS SHEET	CALCULATION NO. EGE-00006	REVISION 00	PAGE 84 OF 84
PREPARER/DATE B. Horowitz 12/15/94	REVIEWER/DATE Robert R. Brown 12/16/94	PROJECT NO.	CLASS
SUBJECT/TITLE INDIAN Point GENERATING STATION EMERGENCY DIESEL GENERATOR UPGRADE DB-7S BREAKER & SWITCHGEAR TESTING		MOD NO.	REV

TIME IN MINUTES	WITH ALL EDG OPERABLE						WITH LOSE OF EDG 21				WITH LOSS OF EDG 22				WITH LOSE OF EDG 23			
	EDG 21		EDG22		EDG23		EDG22		EDG23		EDG21		EDG23		EDG21		EDG22	
	LOAD IN KW	LOAD IN AMPS	LOAD IN KW	LOAD IN AMPS	LOAD IN KW	LOAD IN AMPS	LOAD IN KW	LOAD IN AMPS	LOAD IN KW	LOAD IN AMPS	LOAD IN KW	LOAD IN AMPS	LOAD IN KW	LOAD IN AMPS	LOAD IN KW	LOAD IN AMPS	LOAD IN KW	LOAD IN AMPS
1	1467	2076	1811	2563	1892	2677	1811	2563	1894	2680	1492	2111	1932	2734	1469	2079	1851	2619
5	1519	2149	1793	2537	1872	2649	1863	2636	1883	2665	1552	2196	1916	2711	1541	2181	1853	2622
10	1509	2135	1783	2523	1867	2642	1875	2653	1889	2673	1552	2196	1916	2711	1553	2198	1865	2639
15	1569	2220	1913	2707	1885	2667	1873	2650	1888	2672	1536	2174	1908	2700	1551	2195	1863	2636
17	1421	2011	1903	2693	1882	2663	1948	2757	1914	2708	1614	2284	1938	2742	1621	2294	1938	2742
20	1060	1500	1562	2210	1876	2655	1897	2684	1541	2181	1477	2090	1940	2745	1483	2099	1937	2741
22	1056	1494	1278	1808	1595	2257	1899	2687	1542	2182	1130	1599	1941	2747	1486	2103	1939	2744
23	1554	2199	1778	2516	2096	2966	1620	2292	1265	1790	1131	1600	1623	2297	1487	2104	1620	2292
25	1842	2607	1772	2508	2094	2963	2125	3007	1768	2502	1634	2312	2126	3008	1990	2816	2125	3007
28	1506	2131	1762	2493	1762	2493	2125	3007	2062	2918	1928	2728	2127	3010	2284	3232	2125	3007
30	1498	2120	1754	2482	2051	2902	1799	2546	1735	2455	1601	2266	1800	2547	1957	2769	1799	2546
32	1498	2120	1754	2482	2051	2902	1799	2546	1735	2455	1601	2266	1800	2547	1958	2777	1799	2546
34	1498	2120	1754	2482	1704	2411	1799	2546	1735	2455	1601	2266	1799	2546	1956	2759	1797	2543
38	1498	2120	1754	2482	1703	2410	1797	2543	1387	1963	1601	2266	1452	2055	1608	2275	1797	2543
40	1508	2134	1754	2482	1714	2425	1798	2544	1761	2492	1655	2342	1451	2053	1608	2275	1797	2543
45	1498	2120	1754	2482	1703	2410	1795	2540	1772	2508	1666	2358	1462	2069	1618	2290	1797	2543
60	1496	2117	1688	2389	1683	2382	1731	2449	1696	2400	1653	2339	1386	1961	1605	2271	1731	2449

NOTE: 1) CURRENTS ARE BASED ON A POWER FACTOR OF .85
 2) DATA DERIVED FROM WCAP 12656 "EMERGENCY DIESEL GENERATOR LOADING STUDY"
 DATED 11/90
 ■ LIMITING CASE

INDIAN POINT UNIT 2
 LOAD SEQUENCE FROM WESTINGHOUSE DIESEL GENERATOR STUDY

DESIGN VERIFICATION CHECKLIST

Answer all questions. Attach copies of all comment forms and additional sheets as needed. Checklist questions that do not apply to the items being verified shall be noted as N/A, not applicable.

*Document No. EGE-00006-00 Revision 0
INDIAN POINT GENERATING STATION EMERGENCY

Title DIESEL GENERATOR UPGRADE DB 75 BREAKER & SWITCHGEAR TESTING

Project No. _____ Mod No. _____ Rev _____

Design Verifier _____ Disc Engr _____

<u>Item</u>	<u>Comments</u>
1. Were the inputs correctly selected and incorporated into the design?	yes <input checked="" type="checkbox"/> Diesel Load Study & EPASCO load studies were used to select worst case operating conditions.
2. Are assumptions necessary to perform the design activity adequately described and reasonable? Where necessary, are the assumptions identified for subsequent reverification when the detailed activities are completed?	NO.
3. Are the appropriate quality and quality assurance requirements specified?	YES the purchase order for the equipment testing specified the appropriate Q.A. checks. In turn the testing facility was also verified for Q.A.
4. Are the applicable codes, standards and regulatory requirements, including issue and addenda properly identified and are their requirements for design met?	yes we looked at the various standards in effect at the time of manufacture of the equipment and present day standards. The more stringent requirements were always used.

* For multiple design documents, subject to a single verification, enter the words "see attached list" and attach a list of all documents, their revision numbers and titles.

DESIGN VERIFICATION CHECKLIST

<u>Item</u>	<u>Comments</u>
5. Have applicable construction and operating experience been considered?	YES
6. Have the design interface requirements been satisfied?	N/A
7. Was an appropriate design method used?	N/A
8. Is the output reasonable compared to the inputs?	YES
9. Are the specified parts, equipment and processes suitable for the required application?	N/A
10. Are the specified materials compatible with each other and the design environmental conditions to which the material will be exposed?	N/A
11. Have adequate maintenance features and requirements been specified?	N/A
12. Are accessibility and other design provisions adequate for performance of needed maintenance and repair?	N/A
13. Has adequate accessibility been provided to perform the in-service inspection expected to be required during the plant life?	N/A

DESIGN VERIFICATION CHECKLIST

<u>Item</u>	<u>Comments</u>
14. Has the design properly considered radiation exposure to the public and plant personnel?	N/A
15. Are the acceptance criteria incorporated in the design documents sufficient to allow verification that design requirements have been satisfactorily accomplished?	The acceptance criteria is the same as the original equipment
16. Have adequate pre-operational and subsequent periodic test requirements been appropriately specified?	N/A
17. Are adequate handling, storage, cleaning and shipping requirements specified?	N/A
18. Are adequate identification requirements specified?	N/A
19. Has ALARA been adequately considered using E as a guide?	N/A
20. Were the results of the EQ and SQ evaluation guidelines contained in Section 5.2 of OP-290-1 reviewed?	N/A
21. Are the applicable standards for EQ and SQ listed in the equipment specification?	All applicable industry standard were applied

DESIGN VERIFICATION CHECKLIST

- | <u>Item</u> | <u>Comments</u> |
|--|---|
| 22. Are the vendor qualification documents for EQ and SQ requested in the equipment specification? | YES, but because of a lack of detailed analysis this calculation was performed to supplement the vendors results. |
| 23. Have system/equipment electrical protection requirements been appropriately specified? (see EI-2028, "Protection Setting and Coordination Criteria") | N/A |
| 24. Have the corrosion effects of boric acid been considered? | N/A |
| 25. Are the necessary supporting calculations completed, checked and approved? Are all required calculations completed?* | YES |
| 26. Have all the affected design documents been identified? | YES |
| 27. Does the design satisfy the requirements of the initial request? | YES TO determine limiting component and verify that operating conditions do not cause it to be exceeded |
| 28. Have the impacts on all DBDs been considered? | N/A |
| 29. Are the safety margins for the impacted systems for the proposed modification still adequate? | YES They did not change. |

* The person verifying this item may be a different person than the person(s) who reviewed the calculations for correctness. In such situations, it is not necessary to do another check of the correctness of the calculations provided the "Calculation/ Analysis Summary Sheet" is properly signed off by the reviewer.

ROBERT R. BROWN IF

Design Reviewer: Robert R. Brown 12/16/94
 (print/signature) date

Supervisory Concurrence: RICHARD M. BODEN 12/20/94
 (if required) (print/signature) date

ATTACHMENT 4, ENCLOSURE 2 TO NL-08-101

Satin American Report QA-1181-R01, "Report for the Thermal/Current Testing and Evaluation of Westinghouse, Type DB 480 Volt, 3000 amp, Switchgear, Air Circuit Breaker, and Bus Duct, for Class 1E Service", dated June 18, 1991.

ENERGY NUCLEAR OPERATIONS, INC.
INDIAN POINT NUCLEAR GENERATING UNIT NO. 2
DOCKET NO. 50-247

The Satin American Report QA-1181-R01 is labeled proprietary. It is available for review pending response to a request to release the report.

ATTACHMENT 4, ENCLOSURE 3 TO NL-08-101

**Procurement QA Reference No 906-9, "Class A Vendor Evaluation – Satin American",
dated June 27, 1990.**

ENTERGY NUCLEAR OPERATIONS, INC.
INDIAN POINT NUCLEAR GENERATING UNIT NO. 2
DOCKET NO. 50-247

Con Edison memorandum

CLASS A VENDOR EVALUATION

Procurement QA Reference No.: 906-9
 N , R , Date: JUNE 27, 1990; M
 Vendor Code: _____
 Report Date: June 27, 1990

TO: John A. Nutant, Vice President
 Purchasing Department

FROM: Joint Committee for Vendor Evaluation

SUBJECT: Class A Vendor Evaluation

The following vendor has been evaluated in accordance with CI-240-1 for the commodity listed. Placement on the Class A approved vendor list is hereby approved based on the statement below.

VENDOR	CODE	COMMODITY DESCRIPTION
22190 SATIN AMERICAN P.O. BOX 619 40 OLIVER TERRACE SHELTON, CONN 06484 (203)928-6364	580-0099 580-0073	REBUILTBREAKERS/SWITCHGEAR & TESTING OF SAME
E.O.: 30C		

SUPPLEMENTARY CAPABILITIES APPROVED

The vendor will be responsible for 10CFR21. Yes , No
 The vendor has qualified his products for 1E applications. Yes , No
 Other: _____ Yes , No

BASIS FOR APPROVAL

Manual Review Verification of Implementation Procedure Review
 Past Performance Other _____

FOR SPECIAL QA PROGRAM IMPLEMENTATION SEE EXAMINER'S SUMMARY Yes No

Evaluation findings and identification of documents reviewed are listed on page 2 of this report. Purchase orders or requests for quotations placed with this vendor must contain the following statement(s): "Compliance to Satin American's QA Manual dated 10/88 is a requirement of this purchase order. Con E.J. Dadson to schedule surveillance of first order. If this is not your current manual, please send a copy of the latest revision to the office of E. J. Dadson, Manager of Procurement Quality Assurance, Room 615S, 4 Irving Place, New York, NY 10003. Overnight delivery is preferred."

Quality Assurance: *Alice Ferris* Date: 6-27-90
 Engineering: *[Signature]* Date: 1/25/91
 Purchasing: *[Signature]* Date: 1/28/91

Distribution by PGA:
 Original for Action
 Chief Mechanical Engineer - by Tom Talbot
 Purchasing Director - R. J. Ver Hoven
 For Information Only
 George Owens
 Jim Sheehan
 PGA Vendor Folder
 PGA Central Files

Distribution by Purchasing for Information Only
 IP#2 QA Manager - John McAvoy
 Evaluation Requestor - G. BLENKLE
 Procurement QA

CLASS A VENDOR EVALUATION REPORT

E.O. #: 300

QA Manual: QAM

Rev.:

Date: 10/88

Evaluation Requested By: GERARD BLENKLE

Ext.:

Vendor Contact: R. MATTNERICH Title: QA MANAGER

Tel.: (203)929-6364

<u>EVALUATION METHOD:</u>	<u>PERFORMED BY</u>	<u>EXTENSION</u>
<u>X</u> QA Manual Review	<u>V FERRETTI</u>	<u>6277</u>
<u>X</u> Facility Implementation Check	<u>V FERRETTI</u>	<u>6277</u>
<u>X</u> Past Performance Review	<u>V FERRETTI</u>	<u>6277</u>
<u> </u> Other: <u> </u>	<u> </u>	<u> </u>

Vendor Quality Rated QCIR's (in past five years): 0

EXAMINER'S SUMMARY:

SEE ATTACHED REPORT

2

Evaluation of Satin American

Organization/Facility Satin American
 40 Oliver Terrace
 Shelton, Connecticut
 06484
 203-929-6354

Product/Service Rebuild/Test of
 Breakers/Switchgear

Survey Performed by: Vincent C. Ferretti

Date May 23, 1990

Scope

An implementation survey of Satin American's QA Program dated 5/14/90 was performed. The written program was found to be in compliance with CI-240-1 and 10CFR50, Appendix B. Implementation of the QA program could not be adequately verified in all areas, as there was no nuclear work in process. A review of two nuclear jobs that were recently performed was used as the survey basis.

The following areas of the QA program were verified during the course of the survey:

Organization/QA Program

Satin American has a well defined Organization as spelled out in their written QA program. All responsibilities and authority is detailed with the QA Manager having complete responsibility for the administration of the QA program.

Procurement Document Control

All purchase orders are prepared by the purchasing department with the QA Manager reviewing all orders. PO # 7877-7,7877-8,7877-99 were reviewed to assure QA review and QA requirements were included.

Instructions, Procedures, Drawings

Satin American has a complete list of Standard Operating Procedures (SOPs) which augment the QA manual. SOPs are available for all areas of the QA program along with manufacturing procedures for the assembly and test operations.

Document Control

Revision levels of all documents (SOPS and QA Manual) was reviewed and found to be up to date. On reviewing travellers in previous job folders, it was noted that Satin American did not call out revision level of drawings on traveller. This was noted as an observation to Satins' QA Manager and will be followed up on for Con Edison work.

Control of Purchased Material

All purchase orders reviewed were verified to be procurements from approved vendors. Satin Americans' Approved Vendors' List was reviewed and was found to be up to date. Specific audits of Power Test and file for Echo Tech were reviewed to assure compliance with Satin's QA program. In the case of Power Test, it was noted that audit findings had yet to be closed out. A follow up will be conducted during the next visit to Satin American.

Identification and Control of Materials/Inspection Status

Travellers and tags are used to identify materials and maintain status of manufacturing and test operations.

Control of Special Processes

As the only special processes employed by Satin is brazing, this operation was verified to be controlled in accordance with SOP 9-1 which requires 4 hours training of employees performing brazing operations.

Control of Measuring and Test Equipment

Calibration of test equipment is performed by an outside approved laboratory. Verification of Satins current calibration status of Hi-pot test unit #00115 and electric test meter # 00133 was performed to assure compliance with the written program (SOP-12-1).

Nonconformances/Corrective Action

Nonconformance reports from previous jobs were reviewed to assure compliance with Satins' QA manual. Nonconformance # 5-90-001 was reviewed and was found to be in accordance with the QA program. In reviewing the past nonconformance reports, it was noted that the signature block for the Project Engineer had been inadvertently removed. As no new reports had been issued, a recommendation was made for Satin to revise the form as per the QA Manual.

QA Records

Although, QA records reviewed were found to be intact with indexes and traceability for all materials, it was noted that the files are not kept in fireproof files as required by Satin's QA Program. The QA Manager explained that Satin had just had a fire, and the new files were not available. A review of QA records will be performed during the next visit to Satin American.

Audits

Internal audits of the QA program are performed by an outside agency. Audits were found to be up to date with no outstanding findings open. It was noted that the independent auditors certification had recently expired, but since no audits had been performed since the expiration, a recommendation was made to update the auditors' certification.

Areas not checked:

Because Satin American had no nuclear work in process the following areas of their QA Program could not be verified:

Inspection, Handling, Storage and Shipping, Test Control, Design Control is limited to control of customer drawings.

Summary

During the course of this survey, it was noted that Satin Americans QA Program is written for nuclear work, with no controls over non nuclear work.

As the work presently being proposed by Satin American to Con Edison is for the IP-2 project, the writer recommends all work be performed in accordance with the written QA program. This includes rebuilding of DB-75 breaker for the Diesel Generator upgrade and testing of the subject breaker. This breaker will be a mock up (like and kind) of the type installed at Indian Point.

Additionally, it was noted during the survey, that Satin American has no written procedures for the breaker testing. However, standard test checklists are available.

Should Con Edison require a special test procedure, Con Edison Engineering should specify this requirement to Satin American.

Recommendation

It is hereby recommended that Satin American be approved for the noted work with the requirement that Con Edison Engineering witness all testing both at Satin American and at Satins' vendors-Power Test and Echo Tech.

cc: G. Blenkle
B. Horowitz

Janie Ferretti / JFM

(6)

ATTACHMENT 4, ENCLOSURE 4 TO NL-08-101

**GE Report DER-1691, "Engineering Evaluation of Increasing Overloading Capacity
on the Diesel Stand-By Gen Set at Indian Point Nuclear Power Plant,
Consolidated Edison Co of New York", dated October 13, 1989.**

ENTERGY NUCLEAR OPERATIONS, INC.
INDIAN POINT NUCLEAR GENERATING UNIT NO. 2
DOCKET NO. 50-247

Con
Edison memorandum

EDG Ref 7.5.5.2

Edison

October 30, 1989



TO: Michael Miele
General Manager
Indian Point Station

FROM: Howard Somers *HS*
Project Engineer-Nuclear
Central Engineering

SUBJECT: GE/ALCO Diesel Generator Capacity Study

Attached is the completed GE/ALCO diesel generator analytical capacity study. The report stated that with minor changes to the EDG an output of 2035 KW can be achieved for a half hour within a 24 hour period. However, from the data presented in the report, it may be possible to obtain a half hour rating of 2100 kW if the diesel air inlet temperature is limited to 90°F or below. Mr. Martin Lu of GE/ALCO confirmed this fact. I am pursuing with GE/ALCO and Engineering an interim rating increase either on a seasonal basis (ie. Oct.-May) or a rating contingent upon daily temperature monitoring of the diesel air inlet. This interim modification may be able to be performed during the mid cycle outage.

Mr. Lu also verified that the half hour rating was in addition to the two hour rating. This would, therefore, enable you to operate up to 2035 kW for a half hour followed by one and half hours at 1950 kW.

ie. continuous rating = 1750 KW
2 hour rating = 1950 KW
1/2 hour rating = 2035 KW

I have forwarded the analytical report to the appropriate Central Engineering Department for their evaluation regarding its assumptions, accuracy, and results concluded. It will also be forwarded to station personnel by copy of this memo.

The report also contains the enhancement package to increase the engine output to 2205 KW which I am currently discussing with GE/ALCO. The longest lead item listed in the report is nine months which would accommodate the 1991 Refueling Outage schedule. I will keep you informed as additional information becomes available and as to whether Engineering or GE/ALCO feel an actual test of the diesels, at this time, would be necessary.

cc: S. Bram w/o attachment	C. Jackson
M. Caputo w/o	G. Perry
J. Curry	B. Shepard
A. DeDonato w/o	P. Szabados
C. Durkin, Jr. w/o	T. Talbot w/o
R. Eifler	R. Williams



REPORT NBR.
DER-1691

GENERAL ELECTRIC CANADA INC.

DIESEL ENGINEERING

SUBJECT: *ENGINEERING EVALUATION OF INCREASING OVERLOADING CAPACITY ON THE DIESEL STAND-BY GEN. SET AT INDIAN POINT NUCLEAR POWER PLANT, CONSOLIDATED EDISON CO OF NEW YORK INC.*

COMPILED BY: C. CATANU / M.Y.S. LU

APPROVED BY: *M.Y.S. LU*
M.Y.S. LU

DISTRIBUTION

WAYNE MORRELL
DUNCAN WATT
D. CAWLEY
J. DOWELL
C. OLIVIERA

J. STEBBINS
J. JOHNSTON
J. FAIRLEY
H. SOMERS (CON-ED)

PROJECT NBR.
005699

DATE: 13 October 1989

I INTRODUCTION:

Three stand-by diesel generating sets were installed at Indian point nuclear power generating station in the late 60's. Utility had conducted a loading study at different operating requirements, which concluded there is a need to increase the overloading capacity of the diesel stand-by generating set.

The objective of this report is to present the engineering evaluation on the diesel engine performance and diesel supporting system and the recommended course of action to modernize the diesel engine and to upgrade the supporting systems.

II DIESEL ENGINE

(1) Existing Engine and Limiting Factors

The diesel engine was sold under Alco order number DE-35211 and with following features:

- (a) 16-251E engine, rated at 1750 Kw, 900 RPM
- (b) 730 turbocharger
- (c) 4 pipe exhaust manifold
- (d) Flat top piston
- (e) 140° camshaft
- (f) 27 1/2° timing

Majority of engine components are common to those used on higher rated 251 engines, except components related to engine performance, i.e. turbocharger, exhaust pipe and piston. Hence, the limiting factors of the engine will be the engine performance at higher loading conditions. The analysis of the engine performance is based upon following assumptions:

- (a) Adequate air supply to the engine
- (b) 110°F max. air temperature at the engine air inlet
- (c) The back pressure to be lower than 15 inches of water.

After reviewing the engine test results, turbine inlet temperature and cylinder head exhaust temperature are identified to be limiting factors preventing from having the maximum desired load from the engine.

(a) Turbine inlet temperature:

The average turbine inlet temperature of the 4 pipe manifold on the existing engine is given in Fig. (1). Based upon this curve, the temperature at higher loading and at different air inlet conditions are estimated. At 110°F air inlet temperature, the turbine inlet temperature will reach the limit of 1250°F at 2065 Kw.

(b) Cylinder head exhaust temperature:

As shown in Fig. (2), there is a difference about 180°F in the average cylinder head exhaust temperature between right bank and left bank of the engine. The prime reason for this phenomenon is the cylinder grouping of the 4 pipe exhaust manifold. The result of this is the cyl. head exhaust temperature of the left bank is very close to the limit of 1100°F. At 110°F air inlet temperature, 2035 Kw is the output limit due to the cyl. head exhaust temperature.

(2) Modernized Engine and its Performance

Since the existing engine imposes the output limitation at the overload condition, a modernization package is provided to overcome the above limiting factors on the existing engine. The basic changes on the engine are:

- (a) 165 turbocharger
- (b) 8 pipe exhaust manifold
- (c) Mex. hat piston

The performance of the modernized engine is compared to that of the existing engine in the following:

- (a) In Fig. (1), the turbine inlet temperature is lower by 150°F and will not be a problem even at the maximum rating of the generator.
- (b) In Fig. (2), the cylinder head exhaust temperature is very even between the two banks and lower than the existing engine.
- (c) In Fig. (3), for a given Kw output, the modernized engine operates at a lower fuel rack setting, which translates into a fuel saving, as shown in Fig. (4).

- (d) Since this study is for the overloading capacity of the diesel generating set, the basic requirement for the load pick up has not been changed and the existing engine has fulfilled this requirement. The modernized engine will have as good load pick up capability as the existing one, as illustrated in Figs (5) and (6). In Fig. (5), for a given allowable speed drop, the modernized engine can pick up more load. In Fig. (6), for a given load to be picked up, the modernized engine will take less recovery time.

III SUPPORTING SYSTEMS

1. JACKET WATER AND LUBE OIL COOLING SYSTEM

1.1 DESCRIPTION

Separate cooling circuits are used for jacket water and lubricating oil. Two stacked heat exchangers, shell and tube type are used. The service water, used as coolant, enters the lube oil cooler first and the jacket water cooler after.

1.1.1 JACKET WATER CIRCUIT

The jacket water is circulated by a centrifugal pump driven by the engine.

The water out of the pump flows mostly to the engine block. A small amount of water is diverted to the turbocharger. From the engine block outlet headers the water flows to a thermostatic three-way valve set at 170°F.

This valve directs part of the water to the jacket water cooler and bypasses the rest.

The water out of the cooler is splitted between the engine after cooler and the suction of the pump.

The thermostatic valve bypass and the A/C return are merging at the pump suction as well.

A high water alarm switch set at 175°F and a high-high water alarm switch at 185°F are installed at the engine outlet.

1.1.2 LUBRICATING OIL CIRCUIT

An engine mounted gear pump circulates the oil out of the engine sump through a thermostatic three way valve set at 180°F. The valve controls the amount of oil going to the heat exchanger.

The lube oil cooler oil output merges with the thermostatic valve bypass and flows to the engine.

A pressure relief valve is mounted on the pump and a pressure control valve regulates the lube oil pressure into the engine.

Full flow filtration at the pump outlet and a duplex strainer at the engine inlet are provided.

A high lube oil alarm switch set at 185°F is installed at the engine outlet.

1.2 SYSTEM LIMITS AND DESIGN CRITERIA

The following parameters are the system limits:

- Water engine out temperature Max 190°F
- Lube oil engine out temperature Max 210°F

The cooling system design takes also following into account:

- Aftercooler A/C in water temperature Max 155°F
- A/C water flow Max 150 GPM
- Thermostatic valve settings shall allow them to operate in their controlling range.

The heat loads considered at the design for sizing the heat exchangers were:

- Jacket water cooler 4 365 900 BTU/HR
- Lube oil cooler 808 500 BTU/HR

This is equivalent to the specific heat loads listed below:

- Engine heat to water 27 BTU/min/HP
- Engine heat to oil 5 BTU/min/HP

27 BTU/min/HP specific heat load to water is retained for the higher output analysis.

5 BTU/min/HP specific heat load to oil has to be increased for a higher horsepower to 5.3 BTU/min/HP.

The original design considered 400 GPM and 85°F as worst condition for service water supply.

1.3 SYSTEM EVALUATION

1.3.1 AS DESIGNED PERFORMANCE

The system performance "as designed" was calculated for the full engine power range. The curves 7 and 8 are attached as reference.

1.3.2 PERFORMANCE UNDER MODIFIED CONDITIONS

New conditions are considered in the system evaluation to upgrade the diesel generator power:

Service water	Minimum flow	400 GPM *
Service water	Maximum Temperature	95°F *
Specific engine heat load to water		27 BTU/min/HP
Specific engine heat load to oil		5.3 BTU/min/HP

* As specified by the customer

The heat exchangers do not have plugged tubes and no additional fouling but what is provided by the initial design is allowed.

The curves 9 and 10 are showing the system performance under these conditions. Jacket water and lube oil thermostatic control valves are as per actual setting at 170°F and 180°F respectively. They are used to analyze the possibility of upgrading the power with minimum changes.

From the curves 9 and 10 the system limits are reached at the following power outputs:

	<u>Limit</u>	<u>Power</u> <u>(Kw)</u>
Water engine out temperature	190°F	>2300
Lube oil engine out temperature	205°F	2240
After cooler in water temperature	155°F	2090
After cooler water flow	150 GPM	1750
Jacket water thermostatic valve	fully open	2190
Lube oil thermostatic valve	fully open	1950

From the above data we conclude that at the new conditions the A/C flow is at the limit at the current power output.

Two options are available:

- A) A new orifice has to be sized and a flow balance shall be performed.
- B) Change the jacket water thermostatic valve setting at 180°F.

Both these options will make possible to obtain 1950 Kw overload under the required conditions.

If option A was chosen, in order to increase the power, the change of the lube oil thermostatic valve for a 195°F setting is required. Curves 9 and 11 will apply in this configuration and the following power limits are established:

	<u>Limit</u>	<u>Power</u> <u>(Kw)</u>
Water engine out temperature	190°F	>2300
Lube oil engine out temperature	205°F	2250
Aftercooler water in temperature	155°F	2090
Aftercooler water flow	150GPM	Orifice to be sized accordingly
Jacket water thermostatic valve	Fully open	2150
Lube oil thermostatic valve	Fully open	2240

From the above we can see that the system will support now 2090 Kw with L.O. thermostatic valve changed and new orifice size.

The limitation factor is the water temperature at the after cooler inlet. This temperature can be reduced by changing the water thermostatic valve setting to 180°F.

The curves 11 and 12 will apply, and the power limits are as follows:

	<u>Limit</u>	<u>Power</u> <u>Kw</u>
Water engine out temperature	190°F	>2300
Lube oil temperature	205°F	2250
Aftercooler water in temperature	155°F	2205
Aftercooler flow	150 GPM	Orifice to be sized accordingly
Jacket water thermostatic valve	Fully open	>2300
Lube oil thermostatic valve	Fully open	>2240

This configuration (new orifice, new water thermostatic valve - 180°F, new lube oil thermostatic valve - 195°F) makes the system capable to support 2205 Kw.

If option B was chosen, to increase the power above 1950 Kw, the lube oil thermostatic valve elements have to be changed for a higher setting (195°F) and a new orifice. This will bring the system to the same configuration as described by the curves 11 and 12 with the power limits as per the above table.

Then, under these configuration and conditions with 400 GPM and 95°F service water, the system will support 2205 Kw.

Power higher than 2205 Kw under the worst conditions (400 Service water GPM at 95°F) will require the heat exchangers upgraded. To size the new heat exchangers for 2300 Kw the following data shall be used:

Jacket Water Cooler:

- Heat load	5 185 700 BTU/HR
- J.W. temperature in	180°F
- J.W. temperature out	130-140°F

Lube Oil Cooler:

- Heat load	1 017 900 BTU/HR
- L.O. temperature cooler in	200°F
- L.O. temperature cooler out	168°F

Table 1 summarizes the above, including the operational parameters and the alarm switch settings.

2. EXHAUST STACK SYSTEM

At current installation, 18 inches stack is applied, which is good for 2650 Hp (1975 Kw) engine output as shown in Fig. (13). Therefore, any increasing in the power output, the size of stack requires to change to 20 inches.

IV CONCLUSION

From the above analysis, the maximum output for each limiting factor can be summarized as follows:

- (A) Without change on the engine
 - (1) 2065 Kw due to the turbine inlet temperature
 - (2) 2035 Kw due to the cyl. head exhaust temperature
- (B) Without change on the supporting systems as designed (400GPM, 85°F service water)
 - (1) 1975 Kw due to the exhaust stack
 - (2) 2000 Kw due to A/C water flow
- (C) At 400 GPM, 95°F service water with following changes on the supporting systems:
 - (i) Exhaust stack
 - (ii) New L.O. thermostatic valve elements
 - (iii) New orifice size after the flow balance

2090 Kw due to A/C water in temperature.
- (D) As (C) and new water thermostatic valve elements
 - 2205 Kw due to A/C water in temperature

V RECOMMENDATION:

Short term and long term solutions are suggested to obtain a higher overload capability of the diesel generating set.

(A) Short Term:

Engine output: 1750 Kw continuous
1950 Kw 2 hr in 24 hrs
2035 Kw 1/2 hr in 24 hrs

Changes required:

- (1) Increase the stack to 20 inches
- (2) Pipe the engine air inlet to outside
- (3) Apply new lube oil thermostatic valve element
- (4) Conduct the flow balance to size the orifice
- (5) Re-adjust the temperature alarm setting
- (6) Re-set the engine fuel pump setting

(B) Long Term:

Engine output: 1750 Kw continuous
1950 Kw 6000 hrs/year
2150 Kw 3000 hrs/year
2205 Kw 1000 hrs/year

Changes required:

- (1) Changes as described for the short term solution
- (2) Apply the modernization kit as defined in Section (VI)
- (3) Apply new jacket water thermostatic valve element
- (4) Ensure the availability of the designed service water flow (400 GPM) under the worst operating condition
- (5) Install a larger capacity lube oil cooler, if the existing cooler loses its performance and needs the replacement.

VI THE ENGINE MODERNIZATION KIT

The engine modernization kit as proposed consists of three groups:

- (1) 165 turbocharger and its associated piping and connections
- (2) Mex. hat piston and matching nozzle
- (3) 8 pipe exhaust manifold

The cost of the above items is given in Table (2) for reference only. A up-dated price will be provided when an official request for quotation is received. The lead time and availability of parts in Table (2) provide the guideline for scheduling the implementation of the above recommendation.

TABLE I

	1950	1950	2150	2205	2300
MAXIMUM POWER (KW)					
SERVICE WATER CONDITIONS:					
FLOW (GPM)	400	400	400	400	400
TEMP °F	95	95	95	95	95
CONFIGURATION	NEW ORIFICE	-NEW WATER AMOT VALVE SET: 180	-NEW ORIFICE -NEW LUBE OIL AMOT VALVE SET: 195	-NEW ORIFICE -NEW LUBE OIL AMOT VALVE SET: 195 -NEW WATER AMOT VALVE SET 180	-NEW ORIFICE -NEW LUBE OIL AMOT VALVE SET: 195 -NEW WATER AMOT VALVE SET 180 -NEW LOC -NEW JWC
HIGH WATER TEMP ALARM °F	180	190	190	190	185
HIGH-HIGH WATER TEMP ALARM °F	185	195	195	195	190
HIGH LUBE OIL TEMP ALARM °F	195	195	207	210	205
MAX. HEAT LOAD TO WATER BTU/HR	4 393 500	4 393 500	4 846 400	4 970 800	5 185 700
MAX. HEAT LOAD TO OIL BTU/HR	862 400	862 400	951 300	975 750	1 017 900
WATER ENGINE OUT TEMP °F	172.5	178.8	182	182	180
OIL ENGINE OUT TEMP °F	191	190	202	204	200
AFTER COOLER WATER IN TEMP °F	148	140.7	152	155	~135

ENGINE MODERNIZATION KIT

DE-35211

ITEM	QTY	CAT. #	DESCRIPTION	COST US \$	STOCK ITEM	LEAD TIME (MONTH)
------	-----	--------	-------------	---------------	---------------	----------------------

GROUP A: TURBO AND MOUNTING

1	1	8260038-2	165 TURBO.	68888.68	N	8
2	2	22610213	SHIMS	63.08	Y	2
3	4	21553616	CAPSCREWS	5.56	Y	3
4	4	2151319-1	LOCKWASHERS	1.04	Y	2

GROUP B: EXPANSION JOINT AT TURBO DISCHARGE

1	1	22811912	FLANGE	427.95	N	6
2	2	21542948	"O" RINGS	37.94	Y	3
3	1	2281677	UPPER FLANGE	378.80	Y	5
4	1	21548737	GASKET	21.89	Y	3
5	1	21548741	GASKET	9.33	Y	2
6	19	21513510-1	CAPSCREWS	5.89	Y	3
7	19	2151313-1	LOCKWASHERS 1/2"	2.85	Y	2

GROUP C: 8 PIPE EXHAUST MANIFOLDS, INLET ADAPTORS

1	1	8280013	EXH. MANIFOLD	88664.64	N	8
2	1	19710118	SLEEVE	83.89	N	2
3	2	16340170	CLAMPS	70.32	Y	3

GROUP D: MEX. HAT PISTON

1	16	24200423	MEX HAT PISTONS	23610.40	N	9
2	16	24200517	PISTON RING SET	2547.68	Y	6

GROUP E: FUEL INJECTOR & TIMING POINTER

1	16	22300128	INJECT. & HOLDERS	4564.96	Y	8
2	1	21916624	TIMING POINTER	112.71	N	5

TABLE 2

PAGE 2

ITEM	QTY	CAT. #	DESCRIPTION	COST US \$	STOCK ITEM	LEAD TIME (MONTH)
GROUP F: WATER INLET TO TURBO MAIN CASING						
1	1	24031162	FLEX. HOSE	81.65	Y	3
2	1	24012724	FLANGE	10.40	Y	3
3	1	2402865	"O" RING	1.69	Y	3
4	4	21513510-1	CAPSCREWS	1.24	Y	3
5	4	2151313-1	LOCKWASHERS	0.60	Y	2
GROUP G: WATER OUTLET FROM TURBO AND GAS INLET CASING						
1	1	24031199	HOSE ASSY	42.32	Y	3
2	1	1641415	FLANGE	6.57	Y	3
3	4	21555893	CAPSCREWS	4.36	Y	3
4	4	2151312-1	LOCKWASHERS	0.08	Y	2
5	1	16391358	"O" RING	1.56	Y	3
6	1	16397320	NIPPLE	1.47	Y	3
7	1	16394280	TEE	5.20	Y	3
8	1	16393486	ELBOW	4.60	N	3
9	1	16393647	NIPPLE	1.93	N	3
10	1	16412260	ADAPTER	18.07	N	3
11	1	24031198	HOSE ASSY	41.51	Y	2
GROUP H: WATER INLET TO GAS INLET CASING						
1	1	24031154	HOSE ASSY	49.76	Y	3
2	1	1641415	FLANGE	6.57	Y	3
3	1	16391358	"O" RING	1.56	Y	3
4	4	21555893	CAPSCREWS	0.36	Y	3
5	4	2151312-1	LOCKWASHERS	0.08	Y	2
6	1	16360123	CLAMP	1.16	N	3
7	1	21513513-1	CAPSCREW	0.32	Y	3
8	1	2151697-1	NUT	0.10	Y	3
9	1	2151495-1	PLAIN WASHER 1/2"	0.09	Y	2
10	1	2151313-1	LOCKWASHER 1/2"	0.15	Y	2
GROUP I: MOISTURE DRAIN						
1	1	2154434-1	GASKET	0.97	Y	3
2	1	24031059	PIPE	180.46	N	4
3	2	21555893	CAPSCREWS	0.18	Y	3
4	2	2151312-1	LOCKWASHERS 3/8	0.04	Y	3
5	1	1639457	PIPE CAP	1.89	Y	2

TABLE 2

PAGE 3

ITEM	QTY	CAT. #	DESCRIPTION	COST US \$	STOCK ITEM	LEAD TIME (MONTH)
GROUP J: MODIFICATION L.O. PIPING TO CAMSHAFT						
1	1	1639373	PIPE PLUG	0.80	Y	3
2	2	24022837	MALE CONNECTORS	20.42	N	4
3	1	16394020-1	TUBE 7/8 X 30"	55.76	Y	3
4	1	24030854	CLAMP	229.35	N	4
5	1	2151353-1	CAPSCREW	0.07	Y	3
6	1	2151312-1	LOCKWASHER 3/8	0.02	Y	2
7	1	2403265	UNION TEE	52.57	N	3
8	1	24022633	TUBE	38.17	N	4
GROUP K: L.O. PIPING TO TURBO						
1	1	24030731	FLEX. HOSE	25.23	N	2
2	1	24012985	HOSE CLAMP	2.50	N	3
3	1	24018336	CLAMP	17.12	Y	3
4	1	8401189	NIPPLE	1.03	N	3
5	1	16396169	90° ELBOW	8.75	Y	3
6	1	24020548	TUBE	64.38	N	3
7	2	24022851	FEM. CONNECTORS	9.52	Y	4
8	1	24023135	ADAPTER	179.40	N	3
GROUP L: L.O. DRAIN FROM TURBO						
1	1	24031152	HOSE ASSY	152.04	Y	3
2	1	24012717	FLANGE	8.08	N	3
3	1	21542920	"O" RING	0.58	Y	3
4	4	21513510-1	CAPSCREWS	1.24	Y	3
5	4	2151313-1	LOCKWASHERS	6.60	Y	3
6	1	16396120	90° ELBOW	7.87	Y	3
7	1	1639869	NIPPLE	3.71	Y	3
8	1	24030670	CLAMP	2.00	N	3
* GROUP M: EXHAUST ADAPTOR						
1	1	22613824	ADAPTOR 20"	7180.20	N	7
* GROUP N: CROSSOVER PIPE						
1	1	40E72470-1	PIPE	5000.00	N	4

*NOTE THE ITEM INDICATED BY ASTERISK IS FOR COST REFERENCE ONLY, NEW DESIGN WILL BE NEEDED.

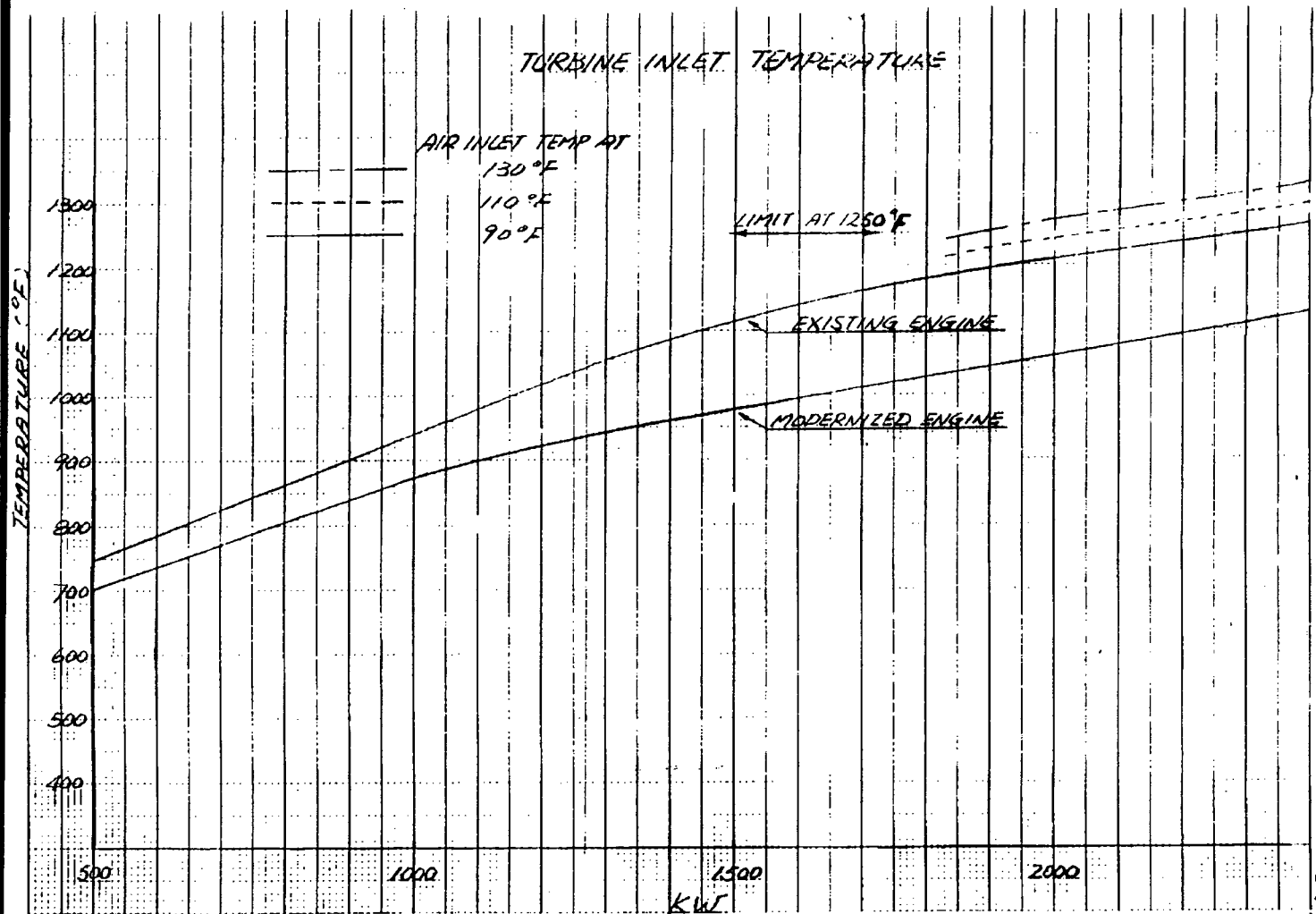

FIG (1)

CYL. HEAD EXHAUST TEMPERATURE

AIR INLET TEMP. AT

130°F

110°F

90°F

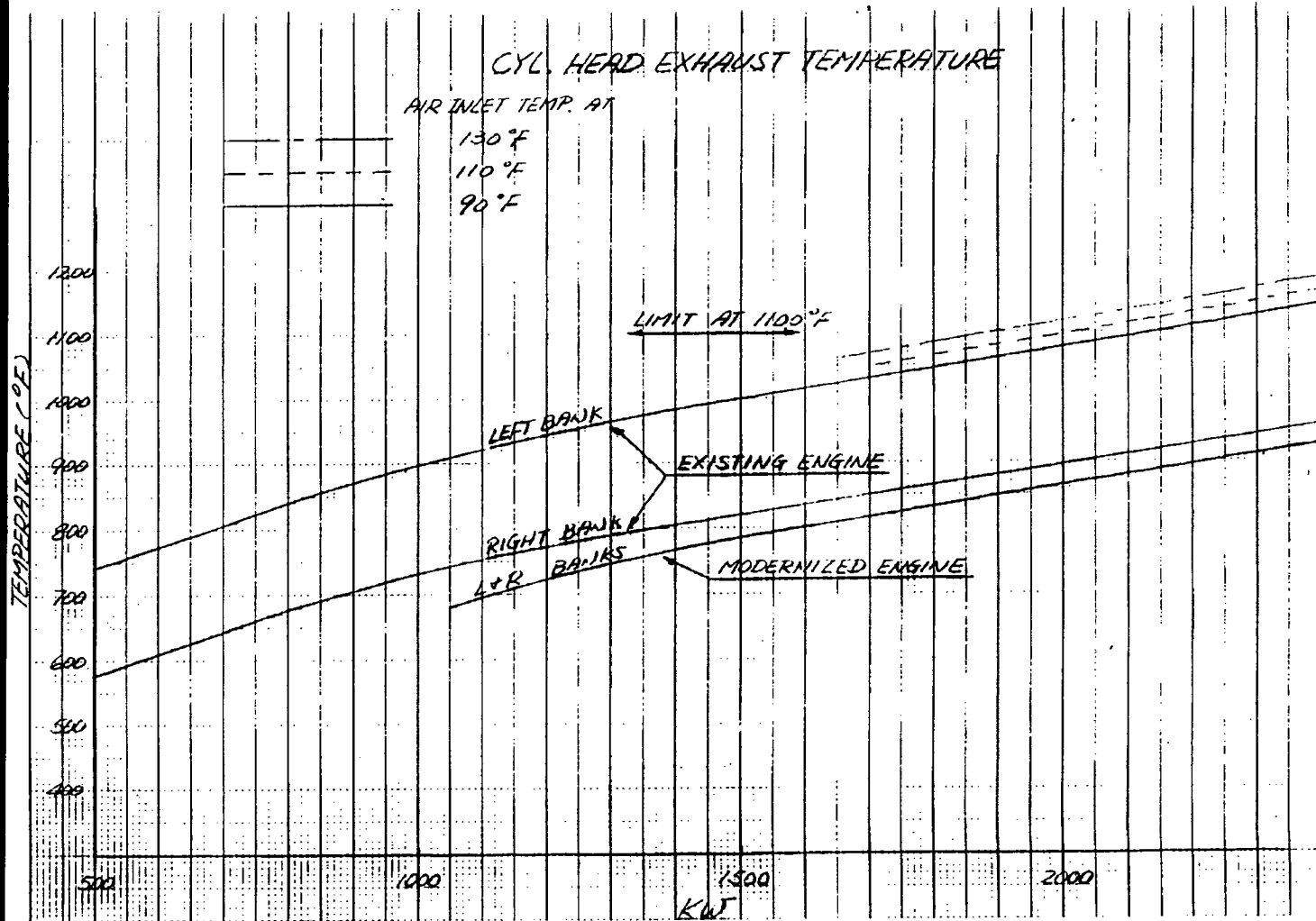

Fig. (2)

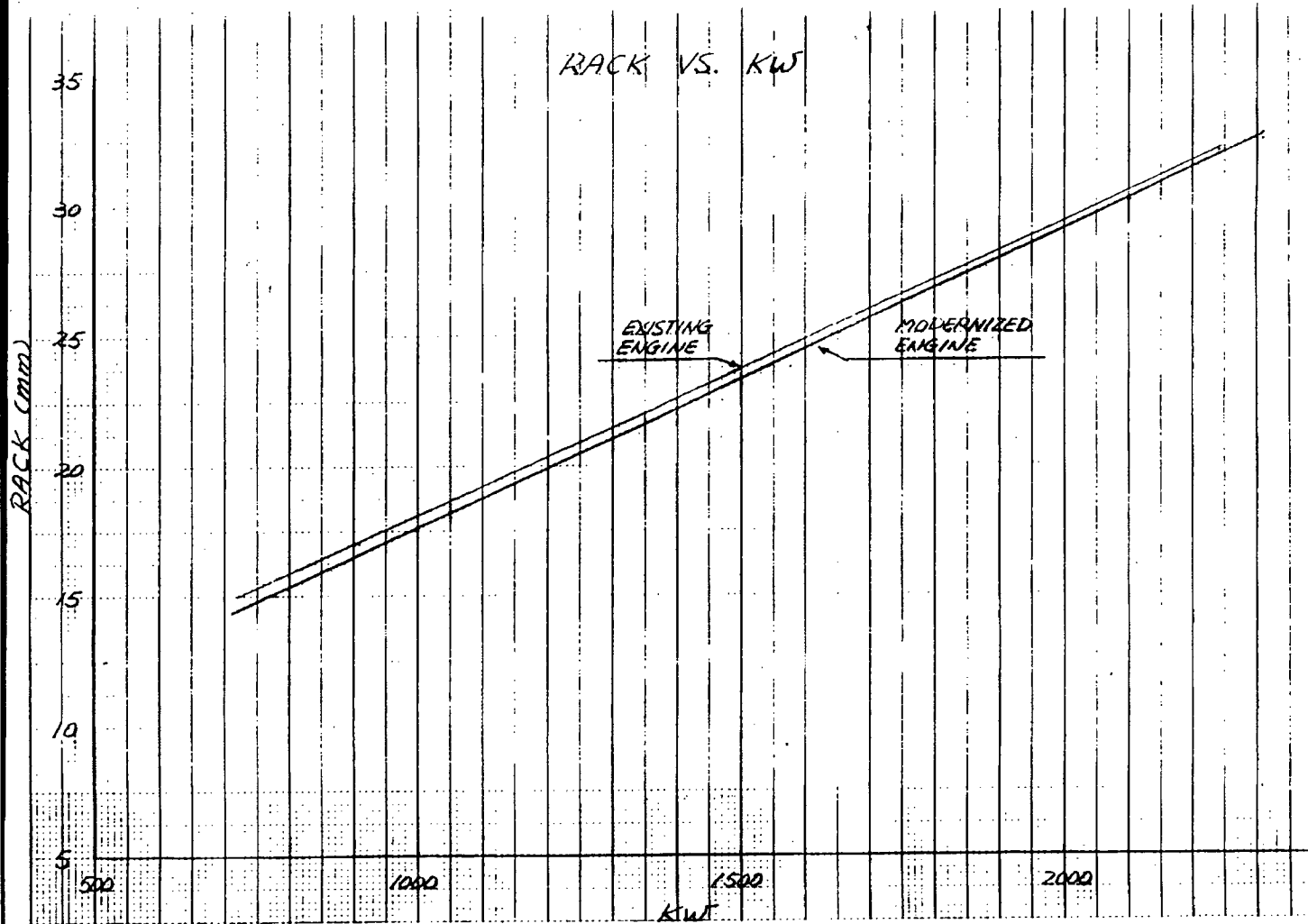

FIG (3)

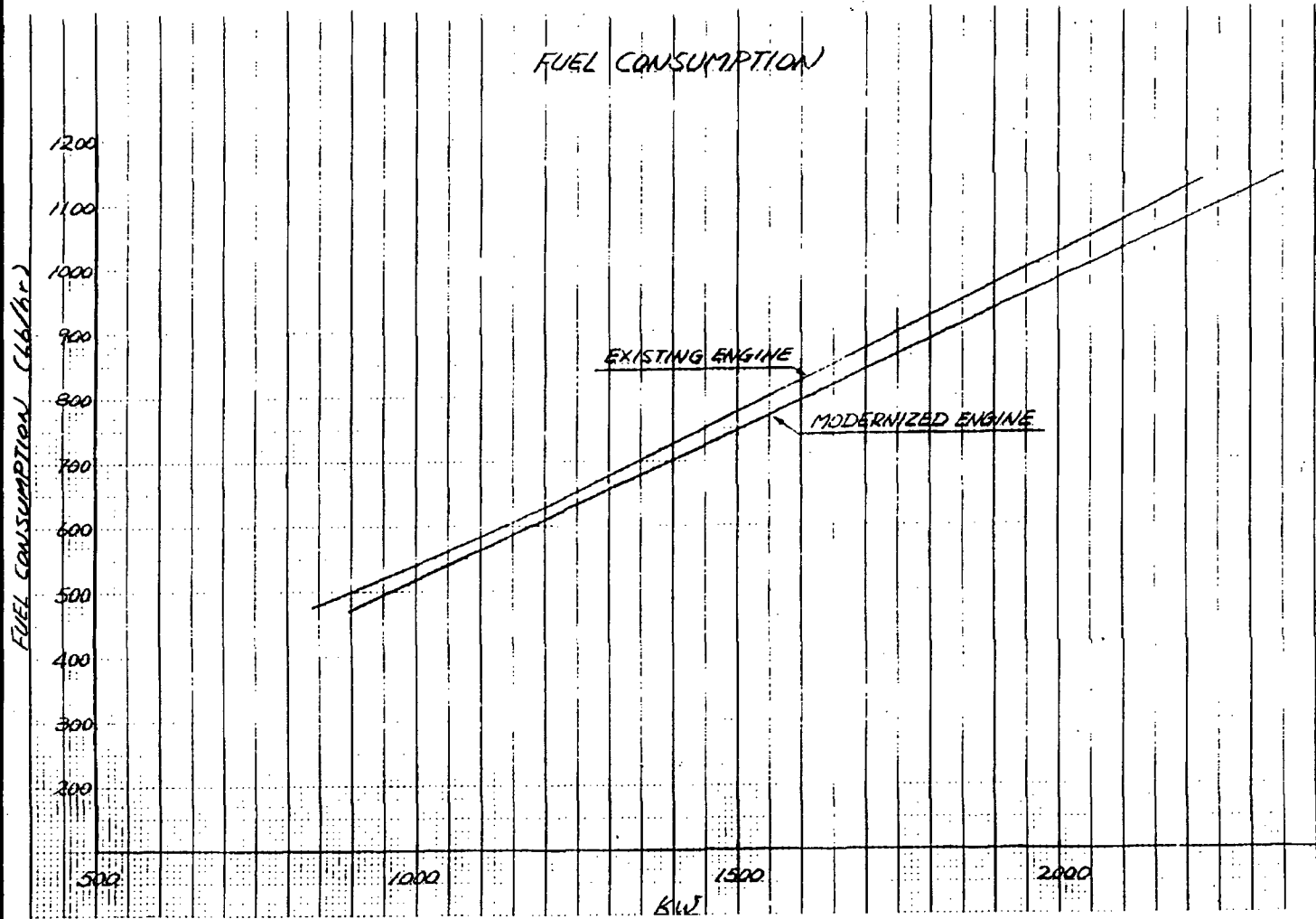
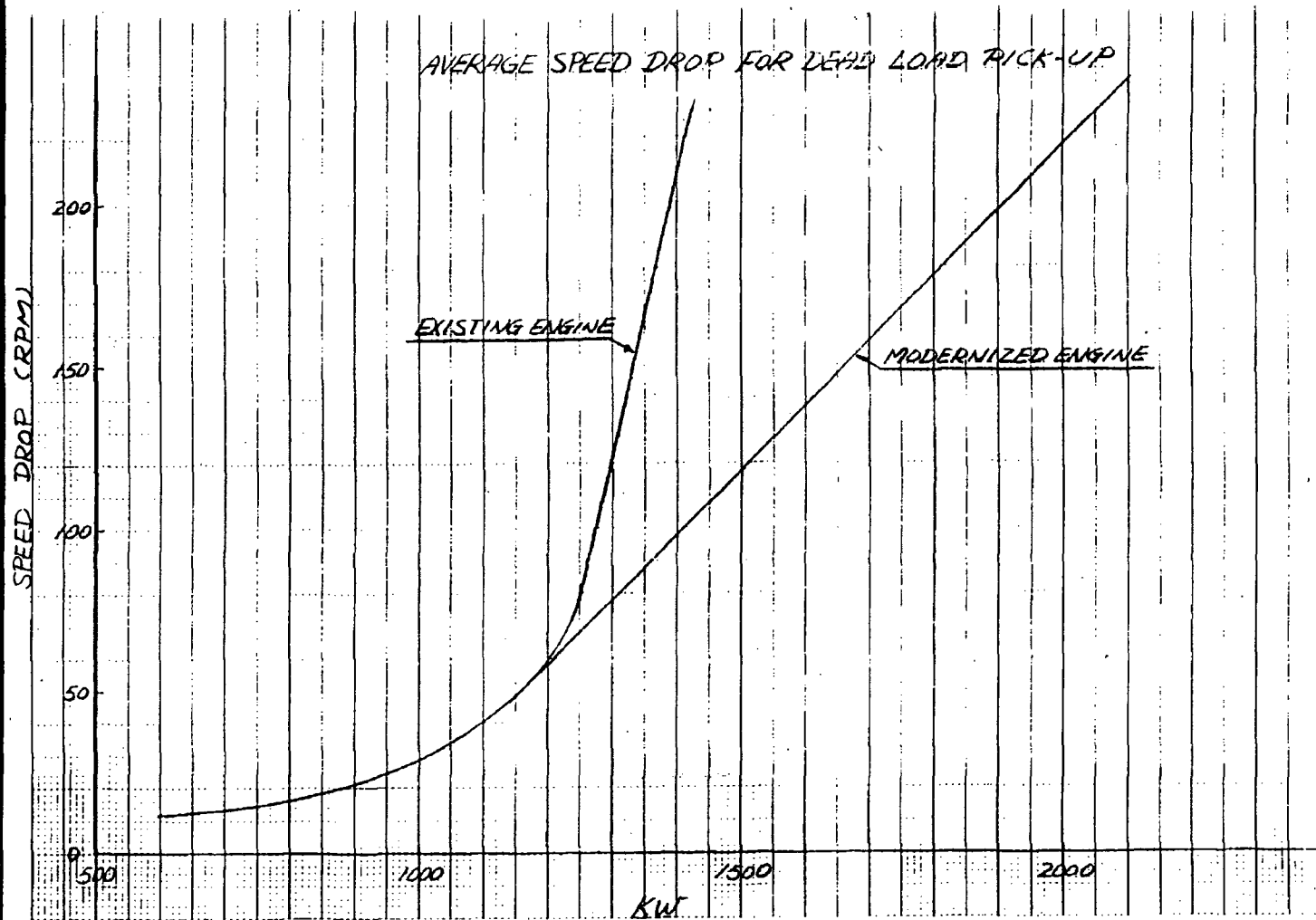

FIG (4)



FIG(5)

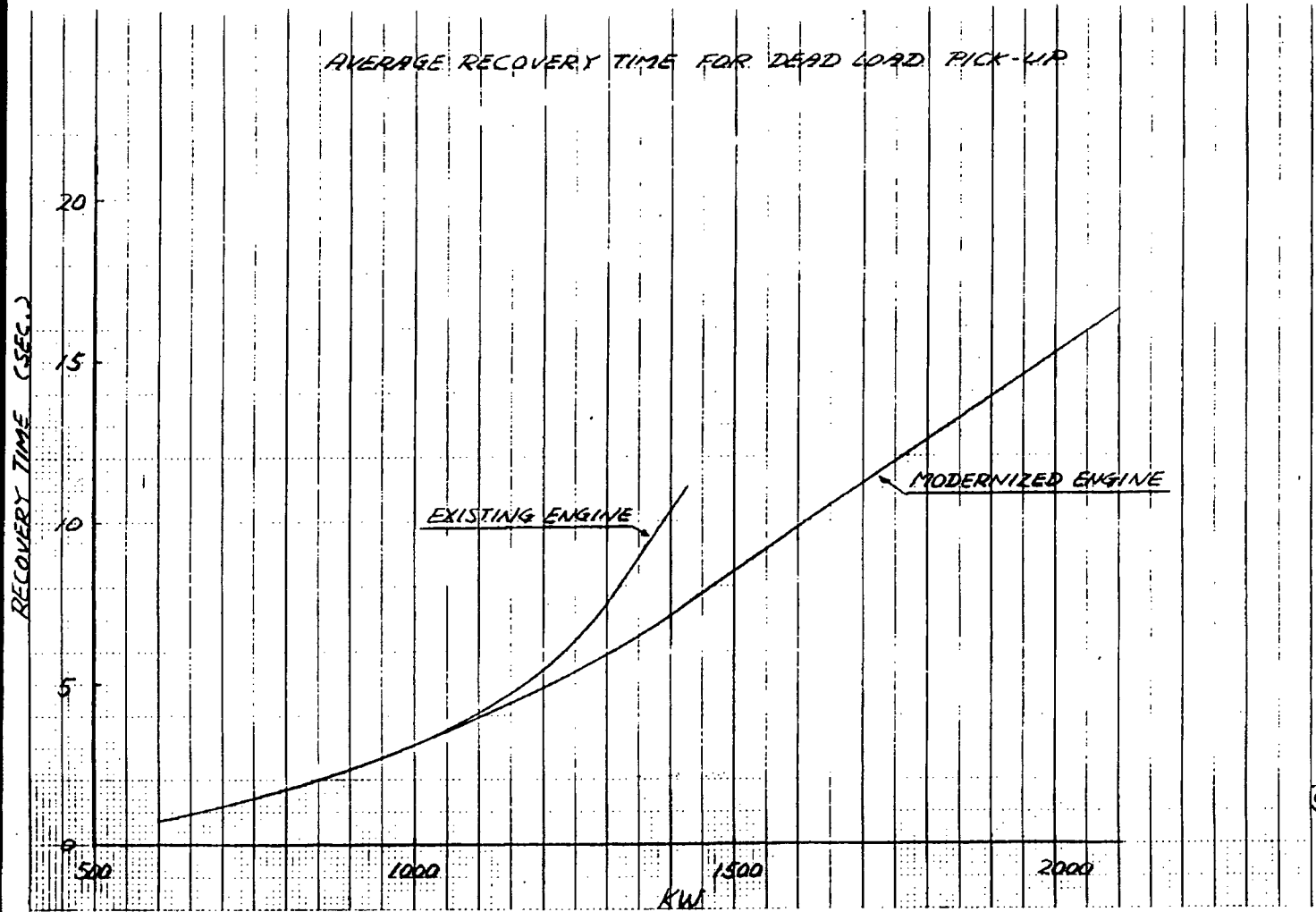
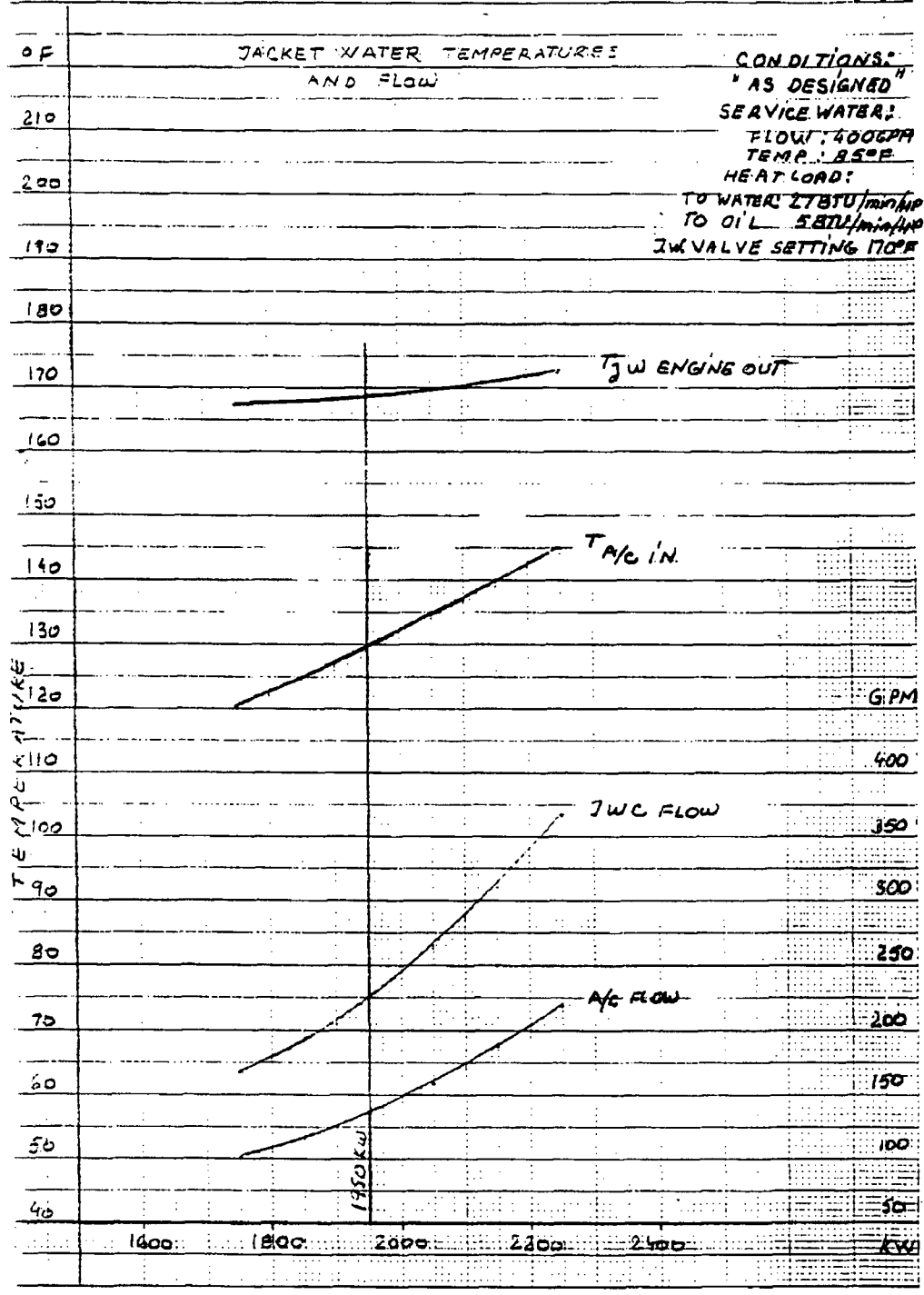

FIG (6)

FIG (7)



10 1025

15 2 1000 1000

FIG (B)

LUBRICATING OIL TEMPERATURES AND FLOW

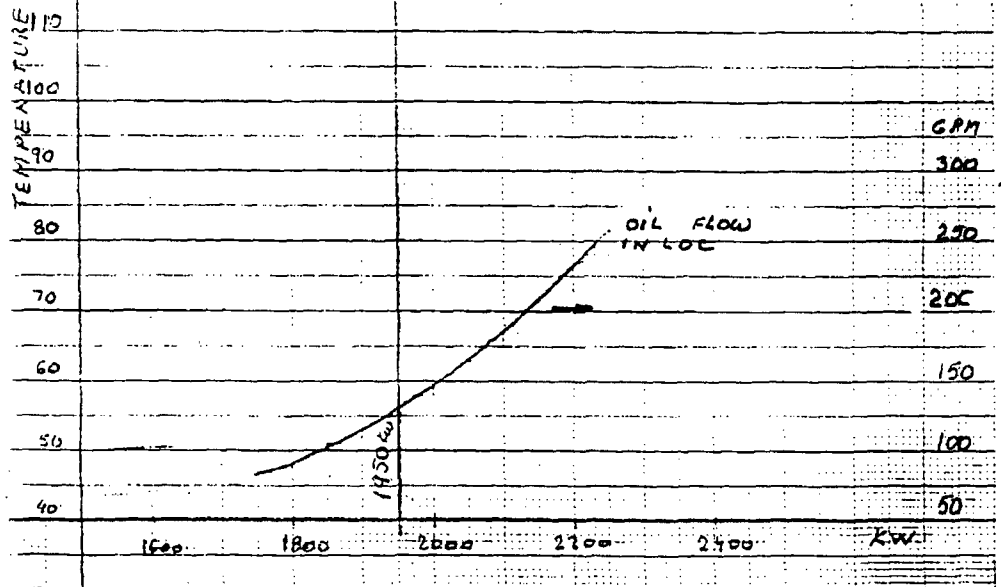
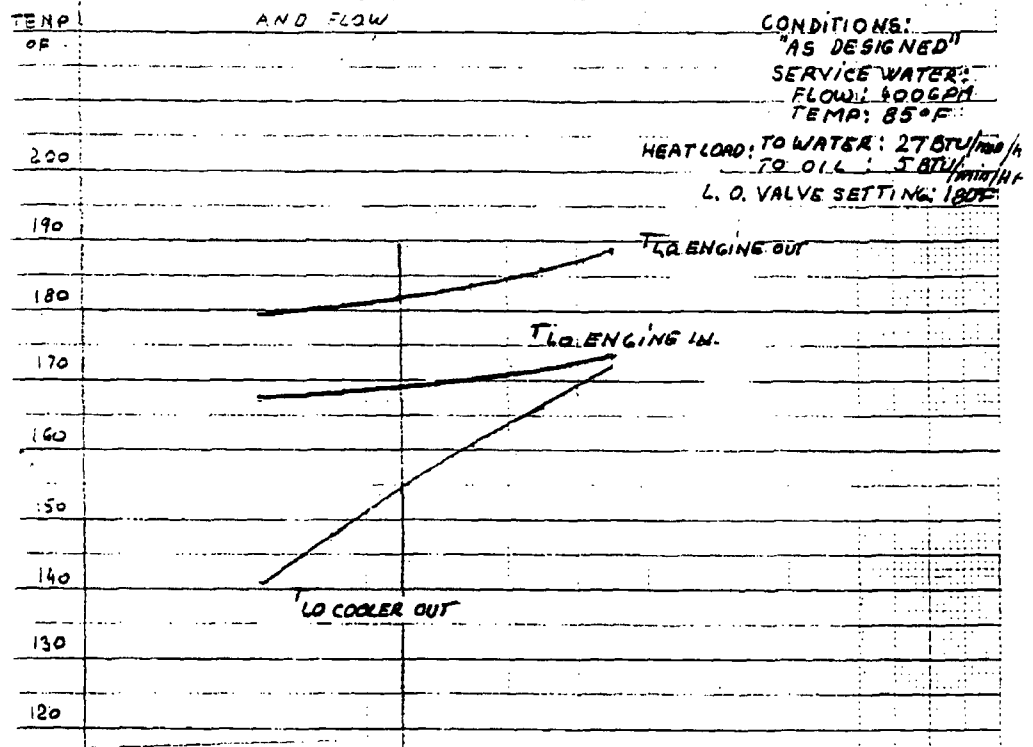
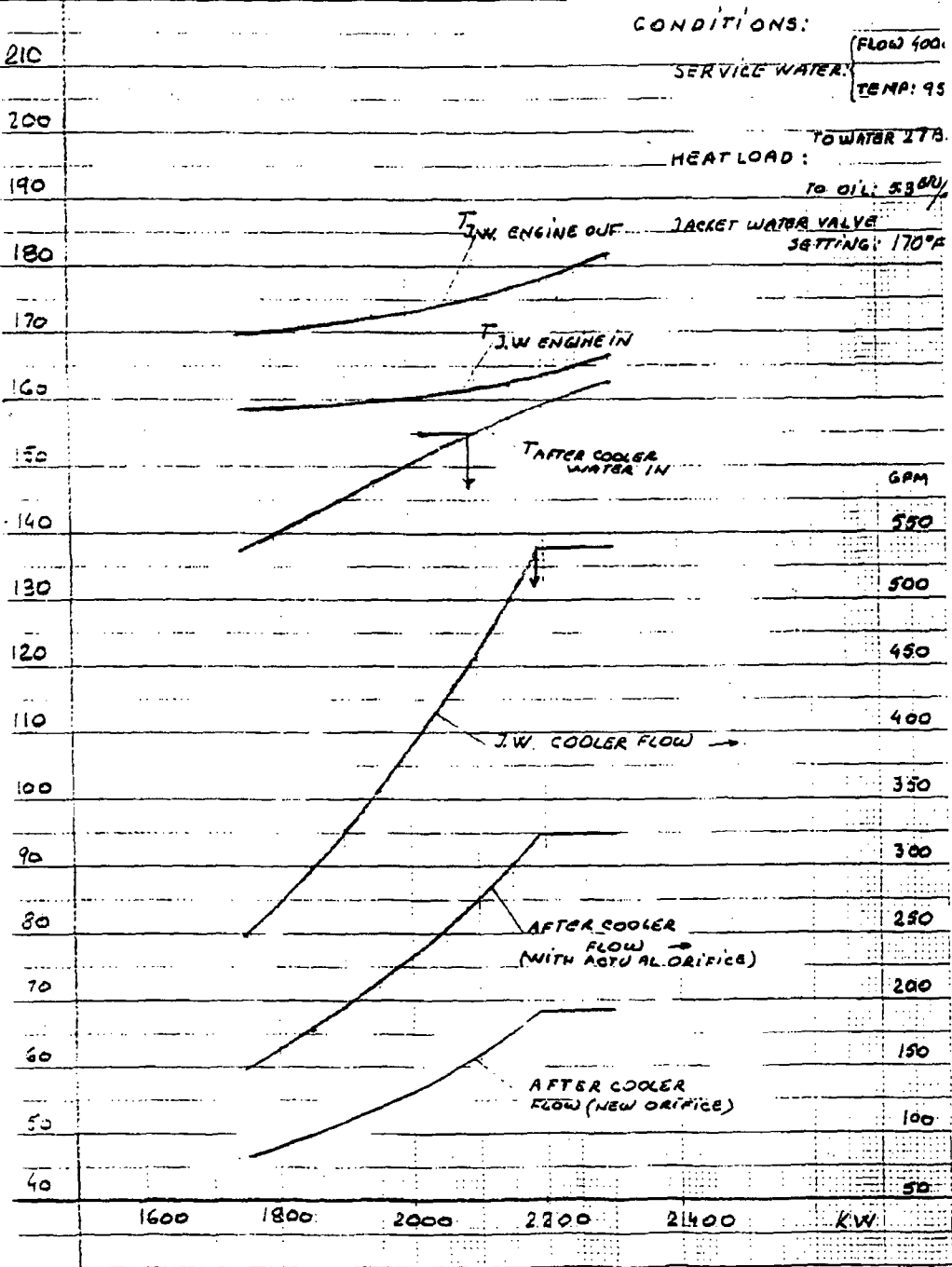
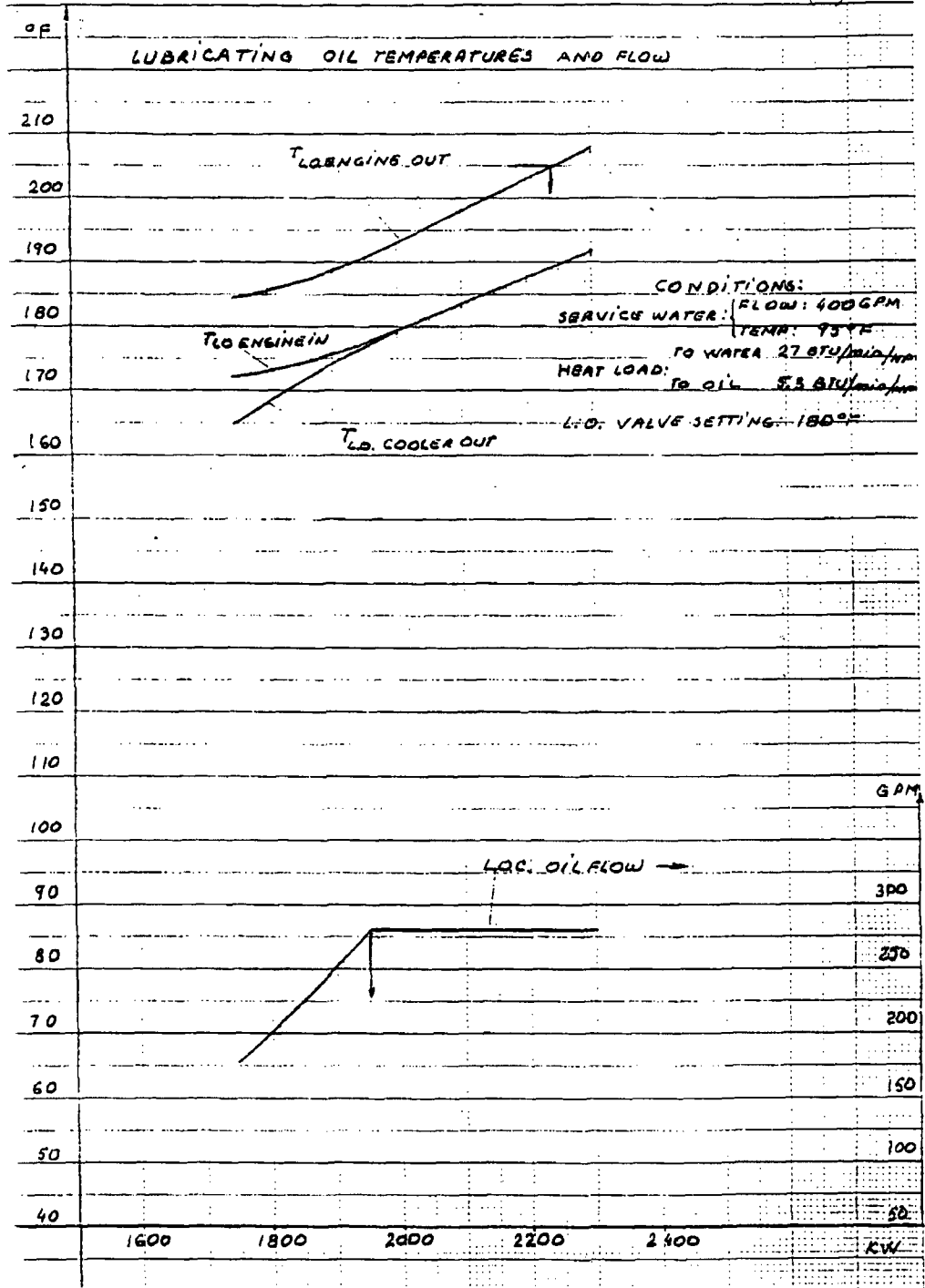

FIG (9)

JACKET WATER TEMPERATURES AND FLOWS



FIG(10)



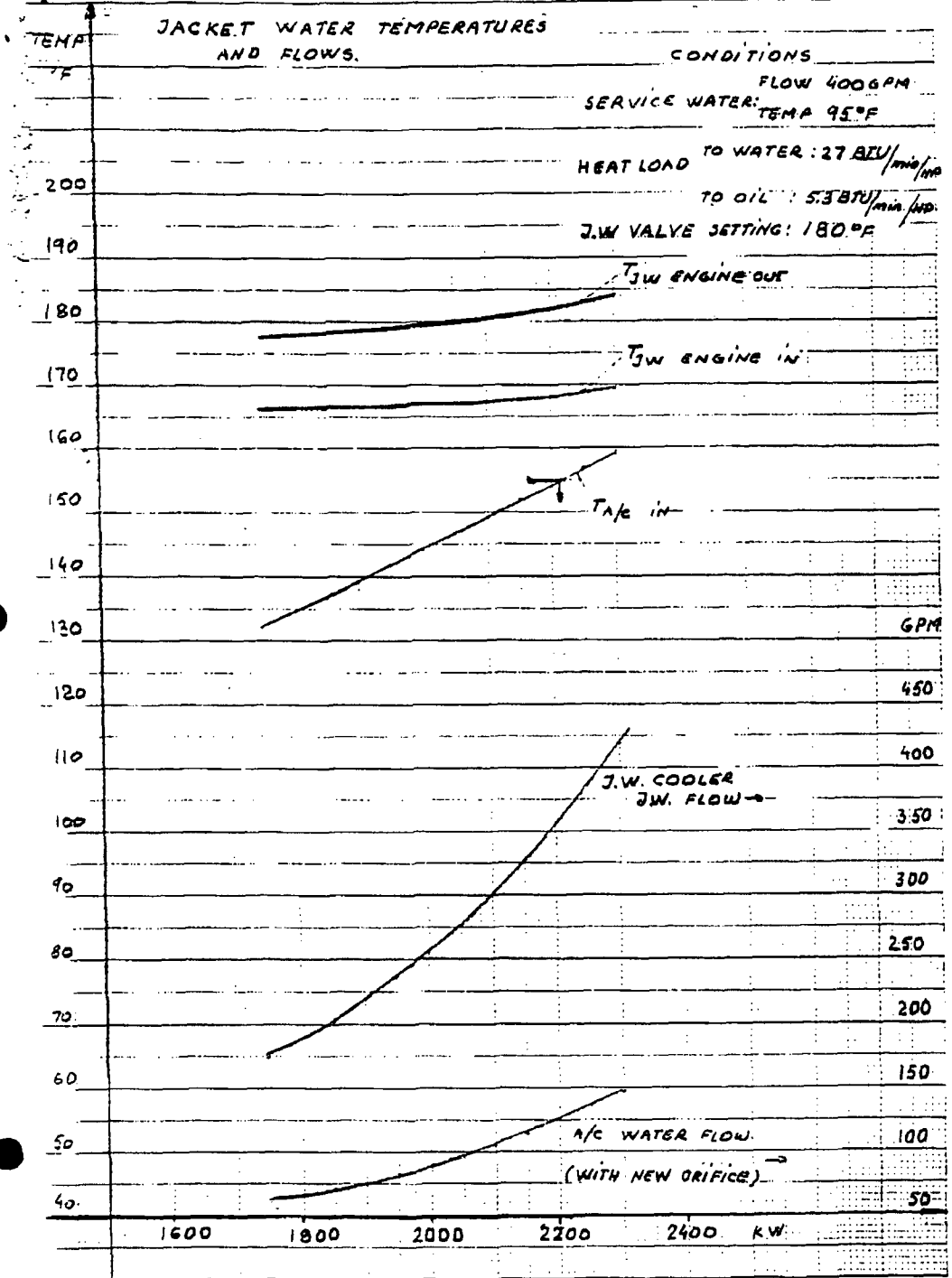

MODEL 251 EXHAUST GAS FLOW

CONDITIONS

SPECIFIC AIR CONSUMPTION 11.6 LB/BHP/HR
 SPECIFIC FUEL CONSUMPTION 0.365 LB/BHP/HR
 EXHAUST STACK PRESSURE 14.7 PSIA
 STACK DIA. BASED ON 11,000 FT/MIN EXHAUST VELOCITY

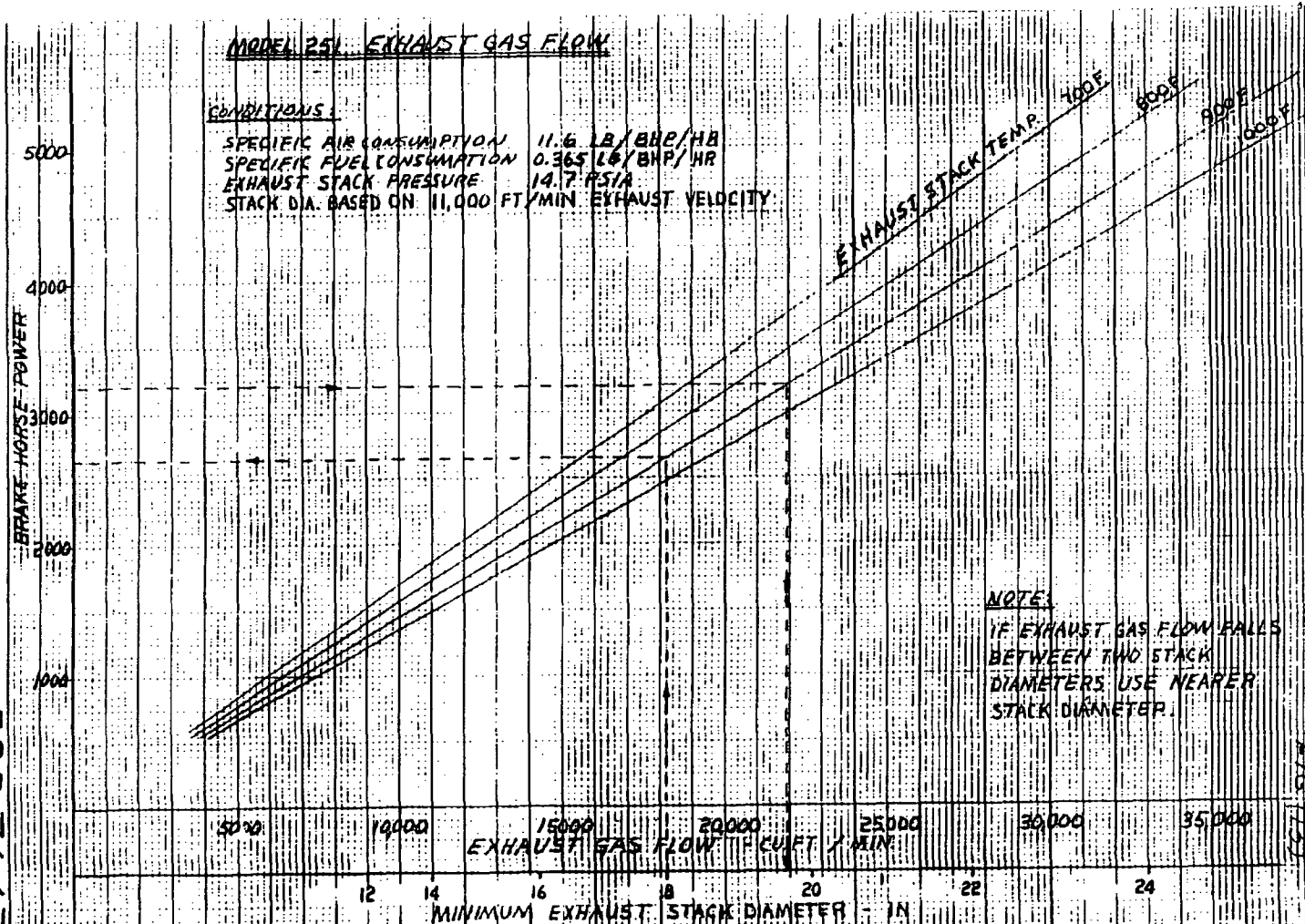

NOTE:
 IF EXHAUST GAS FLOW FALLS
 BETWEEN TWO STACK
 DIAMETERS USE NEARER
 STACK DIAMETER.

NOTICE: THIS DOCUMENT CONTAINS PROPRIETARY INFORMATION AND IT SHALL NOT BE REPRODUCED OR TRANSMITTED IN ANY FORM OR BY ANY MEANS, WITHOUT THE PRIOR WRITTEN CONSENT OF THE MANUFACTURER DIVISION, WHITE INDUSTRIES

50D76472

50D76472

RHS 11-24-69



Consolidated Edison Company of New York, Inc.
4 Irving Place, New York, N.Y. 10003

November 15, 1990

General Electric Canada, Inc.
1505 Dickson Street
Montreal, Canada

Attention: Martin Y.S. Lu
Diesel Engineering

Subject: Indian Point 2 EDC Combustion Air
P.N. 03369-89

Reference: G.E. Canada, Inc. Report No. DER-1691
Dated October 13, 1989

The intent of this letter is to receive concurrence from you that inside air may be used as combustion air for the subject diesels under all ambient and load conditions.

The referenced report, page 9, indicates that changes required for short term and long term solutions include "pipe the engine air inlet to the outside". We agree that for the short term solution, without modifying the diesel engines, this was required.

The long term modifications to the engines result with lower operating temperatures as per Figures 1 & 2 of referenced report. We are upgrading the ventilation system in the EDC building by increasing the exhaust fans capability and increasing the inlet air louvers surface area. With this modification, there will be a sufficient volume of air delivered to each of the diesels at maximum load. Further, the maximum room temperature under the worst scenario will provide an ample margin to the operating limits of the emergency diesels at maximum load (see attached OPTIONS table and sketch). The static pressure in the EDC building will be maintained at .25 inches of water, negative.

To approach the maximum temperatures as indicated in the table requires a combination of:

- Loss of coolant accident
- Loss of offsite power
- Outside temperature at max. design limit (100 deg F)

Note that the maximum load would not be continuous, but only peak for approximately 15 minutes.

Based on the above information, we have decided to draw combustion air from inside the EDC building. Please sign below if you concur with our decision. If you have any questions or comments, please feel free to call me on 212-460-3099.

Please return the signed letter to me at the above address, room 1075-3, or by fax on 212-677-5353.

Very truly yours,

Anthony DeDonato

Anthony DeDonato
Engineer

Concurred by:

Martin Y.S. Lu
Martin Y.S. Lu
Diesel Engineering Dec. 3, 1994

c: M. Caputo
J. Basile
P. Duggan
H. Somers
R. Basu
R. Louia
Project File

ATTACHMENT 4, ENCLOSURE 5 TO NL-08-101

Westinghouse Engineering Report WMC-EER-90-005, "1750 kW Diesel Generator Study for the Westinghouse Energy Center", dated September 19, 1990

ENTERGY NUCLEAR OPERATIONS, INC.
INDIAN POINT NUCLEAR GENERATING UNIT NO. 2
DOCKET NO. 50-247



7.7.3.3



Westinghouse
Electric Corporation

Energy Systems

ACTION: YES^X NO

Nuclear and Advanced
Technology Division

Box 355
Pittsburgh Pennsylvania 15230-0355

IPP-90-850
IC-NATD-90-60

Mr. John A. Basile
Special Nuclear Projects
Consolidated Edison Company
Broadway & Bleakley Avenues
Buchanan, NY 10511

INDIAN POINT UNIT 2
EMERGENCY DIESEL GENERATOR (EDG)
UPGRADE PROJECT
Diesel Generator Study

Dear John:

Please find enclosed revision 1 of WMC Engineering Report WMC-EER-90-005. This study was performed due to the increased room temperatures in certain operating scenarios.

The conclusion reached in this report is that the generator can operate at 2300kw in 125°F ambient temperatures for a maximum of two hours without adverse effects on the generator set.

Also included with this letter are the findings in the review of Consolidated Edison's drawing 9321-F-3007-10. If you have any questions, please feel free to contact me.

Very truly yours,

WESTINGHOUSE ELECTRIC CORPORATION

W. C. Leslie, Manager
Installation, Construction &
Startup Services

HCD:bp

Enclosures

J. A. Basile

-2-

IPP-90-850

cc: T. DeDonato, Con Ed - w/attachment
P. Duggan, Con Ed - w/attachment
R. Louie, Con Ed - w/attachment
W. C. Leslie, W - w/o attachment
B. L. Palowitch, W - w/attachment
R. M. Span, W - w/attachment
S. P. Swigart, W - w/o attachment
NSD Project File - w/attachment
J. G. Kern, W Field Sales - w/o attachment
Project File 16.01 - w/attachment

WESTINGHOUSE MOTOR COMPANY
ROUND ROCK, TEXAS

WMC Engineering Report
WMC-EER-90-005

Revision 1 -- November 28, 1990

Date: September 19, 1990

Subject: 1750 KW Diesel Generator study for the Westinghouse Energy Center

Abstract: This report records the results of an engineering study done on
S.O. 25090LN to re-rate the Indian Point #2 diesel generator
(S.O. 3574P714) for continuous operation at 2300 KW.

By: D.R. Perttula
D. R. Perttula
Staff Engineer

Approved: J.R. Misage
J. R. Misage
Manager
DC & Synchronous Design

I. INTRODUCTION

The existing 1750 KW diesel generators at Indian Point #2 had a continuous rating of 1750 KW and Class B insulation. In 1984 the Westinghouse Heavy Industry Motor Division did an engineering study under S.O. 21754AA to determine the continuous overload rating of these generators. The conclusion was that these generators are capable of delivering 2250 KW at 0.8 power factor and 480 V continuously. This study documents the performance characteristics for continuous generator operation at 2300 KW.

II. DESCRIPTION OF THE EXISTING DIESEL GENERATORS

Type	GS-5E
Rated active output	1750 KW
Rated apparent output	2188 KVA
Rated voltage	480 volts
Rated current	2630 amperes
Rated power factor	0.8 lagging
Rated frequency	60 HZ
Rated speed	900 RPM
Number of phases	3
Number of poles	8
Rated excitation voltage	125 Volts D.C.
Rated excitation current	112 Amps D.C.
Frame size	8-51-22
Reference ambient temperature	40°C
Class of insulation	Class B
Permissible temp. rise by thermometer	60°C
Method of cooling	Self-ventilated
Enclosure	Drip proof
Service factors	1.11

III. RESULTS OF TESTS ON 1750 KW GENERATORS

A. Resistances at 75°C:

Armature, line-to-line	0.001225 ohm
Field	0.8720 ohm

B. Efficiencies:

Full load	96.43%
3/4 load	96.12%
1/2 load	95.19%

C. Short Circuit Ratio

0.965

D. Temperature Rises on Zero Power Factor Temperature Rise Test

Armature voltage	480 volts
Armature current	2930 amps
Field Current	139.6 amps D.C.
Armature winding temp. rise	32.7°C by thermocouple
Field winding temp. rise	77.2°C by resistance
Stator core temp. rise	30.7°C by thermocouple
Collector rings temp. rise	36.7°C by thermometer

IV. ANALYSIS

The generators reach steady state temperature rises within 2 hours. Therefore, only maximum continuous output needs to be determined.

The effect of air temperature on surface thermal resistances, windage loss and air temperature rise being small have been neglected. The effect of rotor surface loss on field winding temperature rise being small has also been neglected.

The shaft diameter at critical section for this generator is 9.75 inch with keyway. The material is AISI 1035 carbon steel with shear yield strength of 22,800 psi. It is adequate to deliver a load of 2300 KW at 0.8 power factor. The mean shear stress will be 1160 psi which is well within the capabilities of the material.

The field excitation at 2300 KW, 0.8 power factor at 480 V is 131 amperes. The stator current for this load point is 3458 amperes. Based on the temperature test conducted on this machine, the expected temperature rises are as follows:

<u>Part</u>	<u>Calculated</u>	<u>Maximum permissible per NEMA MG1 Part 22 - 1980</u>
Armature winding by detector	37°C	85°C
Field winding by resistance	69°C	80°C
Stator core by detector	34°C	-
Collector rings by tharmometer	37°C	85°C

V. CONCLUSIONS

These generators are capable of delivering 2300 KW at 0.8 power factor and 480 V continuously.

The performance of the machines at this load point will be as follows:

A. Efficiencies

Full load	96.35%
3/4 load	96.31%
1/2 load	95.79%

B. Short Circuit Ratio 0.733

C. Field Voltage 131 Volts D.C.

D. Field Current 131 Amperes D.C.

VI. Addition -- (Revision 1 - November 28, 1990)

It is anticipated that, though infrequent, an operating condition will exist where the three diesels and three fans are operating at full load output. This condition will cause the ambient air temperature to reach 125°F (52°C). In Part IV of this report the expected rises for an ambient air temperature of 40°C are listed. It is expected that the temperature rises of the armature and field windings for a 52°C ambient will be 40°C and 72°C respectively. The total operating temperature of the field winding for this condition will be 124°C (72°C + 52°C). This is 4°C more than maximum permissible total operating temperature per NEMA of 120°C (80°C rise over 40°C). However, since this operating condition is so infrequent, it will be acceptable to operate at 2300 KW with a 125°F ambient for a maximum of 2 hours.

ATTACHMENT 4, ENCLOSURE 6 TO NL-08-101

Calculation EGE-00016-00, "Emergency Diesel Generator – Basler Exciter Test Report".

ENERGY NUCLEAR OPERATIONS, INC.
INDIAN POINT NUCLEAR GENERATING UNIT NO. 2
DOCKET NO. 50-247

CON EDISON CALCULATION/ANALYSIS
COVER SHEET

Subsection: ROTATING MACH. + PLANT EQUIP.

Code: EGE

Calc.No.: EGE-00016-00 Calc.Type: ELECTRICAL SYSTEM

Title: EMERGENCY DIESEL GENERATOR - BASLER EXCITER TEST REPORT

Project: NONE

Modification: NONE

Document Page Count: 032

* * * TAG NUMBERS * * *

(none)

* * * COMPONENT(S) AFFECTED * * *

Equip.Type 028 DIESEL GENERATOR

Structure 13 EMERGENCY DIESEL GENERATOR BUILDING

System 20 EMERGENCY DIESEL GENERATORS

Class (Check as appropriate): A FP MET IE Non-Class

Preparer/Date (Print/Sign)	Reviewer/Date (Print/Sign)	Approval/Date (Print/Sign)	Rev.No.	Super- cedes	Confirm. Required?
THOMAS J. MAGEE <i>Thomas J. Magee</i> 9/7/91	BRUCE HORGWITZ <i>Bruce Horgwitz</i> 9/26/91	RICHARD BOGGIA <i>Richard Boggia</i> 9/27/91			

Concurrence (If Required)

CON EDISON CALCULATION/ANALYSIS SUMMARY SHEET

CALCULATION NO. EGE-00016	REVISION 0	PAGE 2 OF 32
------------------------------	---------------	-----------------

PREPARER/DATE
Thomas J. Magee 9/7/91

REVIEWER/DATE
B. Horowitz 9/26/91

CLASS
1E

SUBJECT/TITLE
Emergency Diesel Generator Basler Exciter Test Report

PROJECT NO.
MOD NO. REV

OBJECTIVE OF CALCULATION

To verify that the Basler Exciter is capable of operating within its design temperature limits at the new Emergency Diesel Generator load profile of 1750 kw continuous, 2300 kw for 1/2 hour and 2100 kw for 2 hours in any 24 hour period.

CALCULATION METHOD/ASSUMPTIONS

Temperature data from a series of tests was used in conjunction with an operational analysis or a calculation. Component analysis based on a worst-case room ambient temperature of 126 degrees F.

DESIGN BASIS AND REFERENCES

- 1.) Component temperature limits provided by Basler Electric of 130 degrees C for rectifier diodes and 135 degrees C for the linear reactors, saturable transformers and current transformers.
- 2.) ANSI Appendix C57.96 Guide For Loading Dry Type Distribution and Power Transformers pp 18 and 19.
- 3.) EPRI Power Plant Electrical Reference Series, Volume 4 pp.42-43.
- 4.) Basler Electric report The SB Exciter Regulator Application Note 112. May 1966
- 5.) Test Data

CONCLUSIONS

The Emergency Diesel Generator Excitation System components will operate below their design temperature limits at the upgraded diesel generator load rating.

CON EDISON CALCULATION/ANALYSIS SHEET

CALCULATION NO. EGE-00016	REVISION 0	PAGE 3 OF 32
PREPARED BY/DATE Thomas J. Magee 9/7/91	REVIEWED BY/DATE B. Horowitz 9/26/91	CLASS 1E
SUBJECT/TITLE Emergency Diesel Generator Basler Exciter Test Report		PROJECT NO. REV

INDIAN POINT UNIT No.2 EMERGENCY DIESEL GENERATOR
BASLER EXCITER SYSTEM COMPONENT TESTING
SUMMARY REPORT

Final Report
Prepared By Thomas J. Magee
Electrical Plant Engineering
September 6, 1991

CON EDISON CALCULATION/ANALYSIS SHEET

CALCULATION NO. EGE-00016	REVISION 0	PAGE 4 OF 32
DATE/NAME Thomas J. Magee 9/7/91	DATE/NAME B. Horowitz 9/26/91	CLASS 1E
SUBJECT/TITLE Emergency Diesel Generator Basler Exciter Test Report		PROJECT NO. NOV NO. REV

EXECUTIVE SUMMARY

As part of the Indian Point Unit No.2 Emergency Diesel Generator upgrade, the Basler Excitation system will be required to operate at higher current levels. To verify that design temperatures would not be exceeded, testing was performed during the diesel generator break in period in which the temperatures of various current carrying components were measured. The measured temperature rises during various load conditions were analyzed to determine maximum component total temperatures for the worst case loading scenario (1750 kw continuous followed by operation at 2300 kw for 1/2 hour followed by 2100 kw for 2 hours). The results clearly show that the new rating can be adequately met without exceeding maximum component design limitations.

CALCULATION NO. EGE-00016	REVISION 0	PAGE 5	OF 32
APPROVER/DATE Thomas J. Magee 9/7/91	REVISOR/DATE B. Horowitz 9/26/91	CLASS 1E	
SUBJECT/TITLE Emergency Diesel Generator Basler Exciter Test Report		PROJECT NO.	
		ROW NO.	REV

BASLER EXCITATION SYSTEM TESTING

Testing of the Basler excitation system for the Indian Point No. 2 Emergency Diesel Generators consisted of measuring the temperatures of system components on EDG 22 during a series of tests conducted on 4/30/91 through 5/2/91, 6/1/91 and 6/22/91. The objective of the tests was to ensure that each component could operate within its design temperature rating with the upgraded diesel generator operating at its new load ratings of 1750 kw continuous, 2300 kw for one-half hour and 2100 kw for two hours in any 24 hour load period.

The four major components tested were the rectifier diodes, the saturable transformers, the linear reactors and the current transformers. The manufacturer provided total temperature limits for testing of 266 degrees F for the rectifier diodes and 275 degrees F for the magnetic components (i.e.- the linear reactors, the saturable transformers and the current transformers).

Each component tested had a different thermal time constant as well as a different function within the excitation system circuit. The capability of each component to remain within its thermal limit was analyzed by utilizing the temperature data from one or a combination of test runs or test run data in conjunction with a calculation and/or analysis of the component operation within the circuit. The test summary chart on page #3 summarizes the results of the analysis performed on each component. A detailed analysis of the testing of each component follows on pages 4 through 14.

CON EDISON CALCULATION/ANALYSIS SHEET

DESIGNER/DATE
Thomas J. Magee

9/7/91

REVIEWER/DATE
B. Horowitz

9/24/91

CALCULATION NO.
EGE-00016

REVISION
0

PAGE 6 OF 32

PROJECT TITLE

Emergency Diesel Generator Basler Exciter Test Report

PRODUCT NO.

1E

JOB NO.

REV

INDIAN POINT NO. 2 EMERGENCY DIESEL GENERATOR EXCITATION SYSTEM TEMPERATURE EVALUATION

COMPONENT	MFR. SPECIFIED MAX. TOTAL TEMPERATURE	MAX. WORST CASE COMPONENT TEMP. RISE AS DETERMINED BY TEST/ANALYSIS	MAXIMUM TOTAL TEMP. BASED ON WORST CASE AMBIENT (126 F)	DESIGN MARGIN AT WORST CASE OPERATING CONDITION
RECTIFIER DIODES	266 F	127.1 F	253.1 F	12.9 F (see note 1)
CURRENT TRANSFORMER	275 F	135 F	267 F	8 F (see note 2)
LINEAR REACTORS	275 F	104.1 F	230.1 F	44.9 F (see note 3)
SATURABLE TRANSFORMERS	275 F	104.1 F	230.1 F	44.9 F (see note 3)
VOLTAGE REGULATOR	The Voltage Regulator's capability is not load dependent and is only limited by range and Ambient temperature. The existing voltage regulator is designed for operation in a 131 F ambient. The Voltage regulators were adjusted by the manufacturer during the performance testing to provide for the full range of diesel generator output at the upgraded rating. (see note 4)			
CONCLUSION:	ALL OF THE COMPONENTS ASSOCIATED WITH THE BASLER EXCITER / VOLTAGE REGULATOR ARE CAPABLE OF OPERATION AT MAXIMUM RATED EMERGENCY DIESEL GENERATOR RATING WITHOUT EXCEEDING THE MANUFACTURER SPECIFIED MAXIMUM TOTAL TEMPERATURES.			

- (1) SEE PAGE 4 "RECTIFIER DIODE ANALYSIS"
- (2) SEE PAGE 6 "CURRENT TRANSFORMER ANALYSIS"
- (3) SEE PAGE 11 "LINEAR REACTOR AND SATURABLE TRANSFORMER ANALYSIS"
- (4) SEE ALCO DRAWING NO. C9G4490C910 REV. A (CON EDISON MICRO FILM NO. 335207) FOR VOLTAGE REGULATOR RATING INFORMATION

CALCULATION NO. EGE-00016	REVISION 0	PAGE 7	OF 32
DATE/NAME Thomas J. Magee 9/7/91	REVISION/DATE B. Horowitz 9/20/91	CLASS 1E	
SUBJECT/TITLE Emergency Diesel Generator Basler Exciter Test Report		PROJECT NO.	
		ROW NO.	REV

RECTIFIER DIODES:

1.) Test/Analysis Overview

The rectifier diode analysis was based solely on the temperature data provided during two separate load runs performed on June 1, 1991. The test results indicate that the rectifier diode temperature rise followed changes in excitation system field current with a very small time lag, hence, temperature stability was reached during this testing. The first test run described below started at approximately 10:30 a.m. and ran for about 2 hours. The second test run started at approximately 3:15 and ran for just over two hours. The temperature printout data sheets for these tests are shown on pages A-1 through A-4.

2.) Test Details

a.) First Test Run

During the first run, the desired load of 3300 generator stator amps could not be attained with the exciter on automatic control due to the existing range set point of the automatic voltage regulator. (The maximum generator stator current that could be reached was a three phase stator current average of 3137 amps.) Stabilized total temperatures for the two diodes while at 2500 amps was reached, with diode #1 measuring 194.5 degrees F and diode #2 measuring 184.1 degrees F.

b.) Second Test Run

This run was conducted with the excitation system on manual control. At 4:30 p.m., after operating at 1750 kw and 2500 amps with the diode temperatures stabilized (195 F and 186 F degrees), the generator load was increased to 2300 kw and an average of 3330 stator amps for one-half hour. Since it was necessary to increase the generator output voltage to approximately 500 volts to reach the desired stator amperage of 3300 amps, the excitation system output was 141 amps for the one-half hour run. According to the generator V-curves, 126 field amps is required for 2300 kw at rated voltage and .85 power factor. Thus, this test was much more severe than the actual worst case operating duty. The maximum total temperatures reached were 222.1 and 210.3 degrees F with an average room ambient of 95 degrees F. Thus, when accounting for the worst case room ambient temperature of 126 degrees F, the total maximum diode temperature would be 253.1 F. [maximum temperature rise of 127.1 F (222.1 total - 95 ambient) + 126 F maximum room ambient = 253.1 F].

CON EDISON CALCULATION/ANALYSIS SHEET

CALCULATION NO. EGE-00016		REVISION 0	PAGE 8 OF 32
PREPARED BY Thomas J. Magee 9/7/91		REVIEWER/DATE B. Horowitz 9/26/91	
SUBJECT/TITLE Emergency Diesel Generator Basler Exciter Test Report			CLASS 1E
			PROJECT NO.
			NUM NO. REV

Page 5

When the generator load was reduced to 2100 kw and 3000 amps, the diode temperatures dropped rapidly and stabilized at 213 F and 204 F in a 95 F room ambient. The temperatures of these diodes at an ambient of 126 degrees F would be 244 F and 235 F.

3.) Test Summary

The rectifier diodes are capable of operating at the upgraded diesel generator ratings without exceeding their design temperature limits. The margin between the maximum design temperature limit and expected worst case temperatures is 12.9 degrees F. The rectifier diode test data was based on operation at 141 field amps, much higher than the generator V-Curve requirement of 126 field amps for operation at 2300 kw at rated power factor and rated system voltage.

CALCULATION NO. EGE-00016	REVISION 0	PAGE 9 OF 32
DATE Thomas J. Magee 9/7/91	REVISOR/DATE B. Horowitz 9/24/91	CLASS 1E
SUBJECT/TITLE Emergency Diesel Generator Basler Exciter Test Report		PROJECT NO.
		JOB NO. REV

CURRENT TRANSFORMERS

1.) Test/Analysis Overview

In the analysis performed on the current transformers, stabilized test temperature data for the current transformers at 2600 amps was used to calculate the final stabilized temperatures for operation at 3000 amps and 3300 amps. The equation used to calculate the 3300 amp and 3000 amp stabilized temperatures was more conservative than the ANSI Standard approved method.

The temperature printout showing the stabilized temperatures at 2600 amps is shown on page A-5. The applicable portion of the referenced ANSI code is shown on page A-6 and a summary chart showing the results of the calculations is shown on page A-7.

2.) Test/Analysis Details

Stabilized test temperature data for the current transformers at 2600 amps was used to calculate the final stabilized temperatures at 3300 amps and 3000 amps. The calculation method used is more conservative than the ANSI Standard approved method.

Knowing the actual stabilized temperature rise for the current transformers at 2600 amps, the stabilized temperatures for any other loading can be safely calculated according to the method presented in ANSI C57.96, section 96-05.600, the GUIDE FOR LOADING DRY-TYPE DISTRIBUTION AND POWER TRANSFORMERS. According to Equation 96-05.610d on page 19 of this standard, the average winding conductor rise can be calculated according to the following formula:

$$\theta_{c1}/\theta_{c0} = (L1/L0)^{2n}$$

where

θ_{c1} = average winding conductor rise over room air temperature at any other load in degrees C

θ_{c0} = average winding conductor rise over room air temperature at rated load in degrees C

L1 = any other per unit load

L0 = rated load

n = an empirical constant; for ventilated self cooled dry type, n = .8; for sealed self-cooled dry type, n = .7.

CALCULATION NO. EGE-00016	REVISION 0	PAGE 10 OF 32
DATE 9/7/91	APPROVER/DATE B. Horowitz 9/26/91	CLASS 1E
PROJECT NO.		REV

Thomas J. Magee

B. Horowitz 9/26/91

Emergency Diesel Generator Basler Exciter Test Report

In the EPRI Power Plant Electrical Reference Series, Volume 4 pages 4-42 to 4-43, the following equation is used to calculate the final stabilized temperature of a conductor if the temperature rise is known for a given current load:

$$\frac{T_c(f) - T_a}{T_c - T_a} = (I_c/I_a)^2$$

where:

- Tc = conductor temperature associated with ampacity in degrees C
- Ta = ambient temperature associated with Tc and Ia in degrees C
- Ic = conductor load current in amperes
- Ia = cable ampacity associated with Tc and Ta in amperes

Although this formula appears in the cable section of the EPRI series, it is derived using the exponential relationship between time and temperature. In the EPRI referenced equation, the temperature rise varies with the current ratio squared, making it a more conservative method than the ANSI Standard method in which the temperature rise varies with the current ratio raised to a power of 1.6.

During the testing, a thermocouple was available to monitor the temperature of the ambient air in the vicinity of the generator wye box, the location of the current transformers. This temperature was found to be approximately 6 degrees F warmer than the average room temperature as measured by three thermocouples located at the diesel generator control panel. As such, in order to account for this higher ambient, 6 degrees F is added to each final stability temperature.

The calculations of the final stability temperatures of each current transformer at 3300 amp and 3000 amp loads based on the EPRI endorsed method and using 2600 amp stabilized temperature data follow on pages 8 and 9. The results of these calculations are shown in table form on page A-7.

CALCULATION NO. EGE-00016	REVISION 0	PAGE 11	OF 47	32
APPROVED/DATE Thomas J. Magee 9/7/91	REVIEWER/DATE B. Horowitz 9/26/91	CLASS 1E		
SUBJECT/TITLE Emergency Diesel Generator Basler Exciter Test Report		PROJECT NO.	REV	
		NO. NO.		

A.) A PHASE CURRENT TRANSFORMER

i.) 3300 Amp Stabilized Temperature calculation using temperature rise data from 2600 amp testing and a worst case room ambient condition of 52.2 degrees C:

2600 amp temperature rise = 73.3 F or 40.7 C. In an ambient of 52.2 C, the total temperature would be 52.2 C + 40.7 C = 92.9 or 93 C.

$$\frac{T_c(f) - 52.2}{93 - 52.2} = (3300/2600)^2$$

$$T_c(f) - 52.2 = 65.7 \text{ C}$$

$$T_c(f) = 117.9 \text{ C}$$

$$= 244.2 \text{ F}$$

Adding the 6 degree F higher wye box ambient = 244.2 + 6 = 250.2 F.

ii.) Solving for the final stabilized temperature at the 3000 amps:

$$\frac{T_c(f) - 52.2}{93 - 52.2} = (3000/2600)^2$$

$$T_c(f) - 52.2 = 54.3 \text{ C}$$

$$T_c(f) = 106.5 \text{ C}$$

$$= 223.7 \text{ F}$$

Adding the 6 degrees F higher wye box ambient = 223.7 + 6 = 229.7 F.

B.) B PHASE CURRENT TRANSFORMER

i.) 3300 amp final stabilized temperature calculation using temperature rise data from 2600 amp testing and a worst case room ambient temperature of 52.2 C.

2600 test temperature rise = 83.8 F = 46.6 C rise. In an ambient temperature of 52.2 C, the total temperature would be 52.2 + 46.6 = 98.8 C.

$$\frac{T_c(f) - 52.2}{98.8 - 52.2} = (3300/2600)^2$$

$$T_c(f) - 52.2 = 75.0 \text{ C}$$

$$T_c(f) = 127.2 \text{ C}$$

$$= 261 \text{ F}$$

Adding the 6 degrees F higher wye box ambient = 261 + 6 = 267 F.

CALCULATION NO.	EGE-00016	REVISION	0	PAGE	12	OF	32
DATE	Thomas J. Magee 9/7/91	REVISOR/DATE	B. Horowitz 9/26/91	CLASS	1E		
SUBJECT/TITLE				PROJECT NO.			
Emergency Diesel Generator Basler Exciter Test Report				NO. NO.	REV		

ii.) Solving for the stabilized temperature at 3000 amps:

$$\frac{T_c(f) - 52.2}{98.8 - 52.2} = (3000/2600)^2$$

$$T_c(f) - 52.2 = 62.0 \text{ C}$$

$$T_c(f) = 114.2 \text{ C}$$

$$= 237.6 \text{ F}$$

Adding the 6 degrees F higher wye box ambient = 237.6 + 6 = 243.6 F.

C.) C PHASE CURRENT TRANSFORMER

i.) 3300 amp stabilized temperature calculation using temperature rise data from 2600 amp testing and a worst case room ambient condition of 52.2 C:

2600 amp temperature rise = 77.8 F = 43.2 C. In an ambient of 52.2 C, the total temperature would be 52.2 + 43.2 = 95.4 C

$$\frac{T_c(f) - 52.2}{95.4 - 52.2} = (3300/2600)^2$$

$$T_c(f) - 52.2 = 69.5 \text{ C}$$

$$T_c(f) = 121.8 \text{ C}$$

$$= 251.2 \text{ F}$$

Adding 6 F for higher wye box ambient = 257.2 F

ii.) Solving for the final stabilized temperature at 3000 amps:

$$\frac{T_c(f) - 52.2}{95.4 - 52.2} = (3000/2600)^2$$

$$T_c(f) - 52.2 = 57.5 \text{ C}$$

$$T_c(f) = 109.7 \text{ C}$$

$$= 229.5 \text{ F}$$

Adding the 6 F higher wye box ambient = 229.5 + 6 = 235.5 F.

CALCULATION NO. EGE-00016	REVISION 0	PAGE 13 of 32
DESIGNER/DATE Thomas J. Magee 9/7/91	REVISOR/DATE B. Horowitz 9/26/91	CLASS 1E
SUBJECT/TITLE Emergency Diesel Generator Basler Exciter Test Report		PROJECT NO. REV NO. REV

3.) Test Summary

The stabilized test temperature data at 2600 amps was used to calculate the final stabilized temperatures for 3300 amp and 3000 amp loads. All calculations assumed a worst case room ambient temperature of 126 F and also took into account the higher wye box ambient temperature noted during the test runs. The equation in our calculations was more conservative than the ANSI Standard endorsed equation.

The results of the calculations indicate that the current transformer with the maximum temperature rise, the B phase transformer, would reach a final stability temperature of 267 F if loaded at 3300 amps. Thus, an 8 degree F margin exists for the worst case loading condition of 3300 amps if this transformer were loaded until stabilization.

CALCULATION NO. EGE-00016	REVISION 0	PAGE 14 OF 32
DATE/INITIALS Thomas J. Magee 9/7/91	REVISOR/DATE B. Horowitz 9/26/91	CLASS 1E
SUBJECT/TITLE Emergency Diesel Generator Basler Exciter Test Report		PROJECT NO.
		REV NO.

LINEAR REACTORS AND SATURABLE TRANSFORMERS:

1.) Test/Analysis Overview

These components were determined to be acceptable to operate at the upgraded diesel generator ratings based on an understanding of their operation coupled with supporting test data.

The linear reactors and saturable transformers are components in the shunt section of the excitation system. The following information pertaining to their operation was found in Basler Application Note 112:

- o The shunt section is primarily used to establish sufficient field excitation power for no load operation of the generator.
- o The field excitation power at full load is produced primarily by the series current transformers and can be considered due to the power factor of the system as being obtained entirely from them.
- o The current flow through the control windings of the saturable transformers remains steady under any steady load on the generator. It remains at the same current level (within + or - 10%) regardless of the load or the load power factor.

This description of operation was supported by the results of our temperature data. These components ran well below their design temperatures throughout the tests performed. Test data for the referenced test runs is shown on pages A-8 through A-15.

2.) Test Details

The results of each test are described in detail below. The test findings support the description of operation provided in the manufacturer's literature. These components exhibited a temperature rise that was unaffected by increases in excitation system current while operating at or near rated loads. An increased rate of change of temperature rise was shown only when the current contribution of the shunt section was required to increase, as when reducing load on the generator. During the test performed on 6/1/91, in which the excitation was raised to well above the worst case field excitation requirement, these components exhibited a reduced rate of temperature change over the entire test period.

The component with the highest temperature rise was the A phase linear reactor. This component had a maximum stabilized temperature rise of 104.1 F during the load run performed on 4/30 to 5/1/91 and is used to envelope the maximum temperature rises for the saturable transformers and the B and C phase linear reactors.

The following test details provide conclusions from each test:

CALCULATION NO. EGE-00016		REVISION 0.	DATE 15 40 32
DESIGNED BY Thomas J. Magee	9/7/91	REVIEWED BY B. Horowitz	9/26/91
SUBJECT/TITLE Emergency Diesel Generator Basler Exciter Test Report			CLASS 1E
			PROJECT NO.
			NO. NO. REV

A.) Test Date - 4/30/91 - 5/1/91

Description - Approximately an 8 hour 45 minute run with the following loadings of EDG 22:

Approx. 1957 - Start EDG and warm-up.

2200 - 2315 - Load range from 1700 kw to 1750 kw and approximately 2150 to 2300 stator amps.

2315 - 2355 - Dropped load to 750 kw and 925 stator amps.

2355 - 0158 - Load at 1750 kw and 2300 stator amps.

0158 - 0215 - Increased load from 1750 kw to 2300 kw and 2830 stator amps.

0215 - 0313 - Load at 2300 kw and 2820 to 2830 stator amps.

0313 - 0446 - Load reduced to 2100 kw and 2600 stator amps.

Conclusions/Notes

- i.) All linear reactors and saturable transformers operated within their design temperature limits.
- ii.) When load was reduced from 1750 kw to 750 kw, the rate of change of temperature increased. This was the result of an increase in the excitation contribution from the shunt section as the series section contribution decreased with decreasing load. Items iii, iv, v and vi also confirm proper operation of the shunt section with load changes.
- iii.) When load was increased from 750 kw & 925 amps to 1750 kw and 2300 amps, temperature rate of change decreased and temperatures stabilized at 104.1 degree F rise (172.6 - 68.5) for component with the maximum temperature.
- iv.) When load was increased to 2300 kw & 2820 amps, the temperatures of these components decreased slightly.
- v.) At 2600 amps and 2100 kw the component with the maximum temperature stabilized at 103.2 degrees F rise (172.5 - 69.2).

CALCULATION NO. EGE-00016	REVISION 0	PAGE 16 of 32
DESIGNED BY Thomas J. Magee 9/7/91	REVISIONS/DATE B. Horowitz 9/6/91	CLASS 1E
SUBJECT/TITLE Emergency Diesel Generator Basler Exciter Test Report		PROJECT NO. REV

vi.) While reducing load to secure machine after 2100 kw and 2600 amp run, temperatures of these components began to rise prior to tripping the generator.

B.) Test Date - 5/2/91

Description - A continuous run at the following loads for approximately 4 hours and 45 minutes.

Start at approximately 0043 hours. Load at 1750 kw and 2200 to 2300 amps at approximately 0100.

0145 - 0215: Increased load to 2300 kw and 2800 amps.

0215 - 0245: Decreased load to 1750 kw and 2250 amps.

0315 - 0415: Increased stator amperage to 2450 amps w/ 1750 kw load.

0415 - 0445: Increased load to 2300 kw and 3050 amps.

0445 - 0458: Decreased load to 2100 kw and 2850 amps.

Conclusions/Notes:

i.) Reached stability at 2300 kw and 3050 amps with a temperature rise of 91.7 degrees F (159.6 - 67.9).

C.) Test Date: 6/1/91

Description - A continuous run approximately 2 and 1/2 hours in length with the following loadings:

1020 hours: Start engine and warm-up at 500 kw and 700 amps for 1/2 hour.

1047- 1205: Loaded at 1750 kw and 2500 stator amps.

1205 - 1210: Increased load to 2300 kw and 3137 average stator amps. Remained at 2300 kw until 1240.

Conclusions/Notes

i.) At end of testing, temperature rise was 58.6 degrees F above ambient (150-91.4).

CALCULATION NO. EGE-00016	REVISION 0	PAGE 17 of 32
DATE/DRAWN/DATE Thomas J. Magee 9/7/91	REVISOR/DATE B. Horowitz 9/26/91	CLASS 1E
SUBJECT/TITLE Emergency Diesel Generator Basler Exciter Test Report		PROJECT NO. REV

ii.) Temperature rate of change for entire test period decreased with the exception for the last portion of the test when the machine load was reduced in the process of removing the generator from service.

D.) Test Date: 6/1/91

Description: A continuous load run for approximately 2 and one half hours with the following load profile:

Started engine and gradually raised engine load. At approximately 45 minutes after start, a load of 2300 kw with 3300 amps was reached.

1545 - 1630: Load held at 1750 kw and 2500 stator amps.

1630 - 1700: Load increased to 2300 kw and average of 3330 amps.

1700 - 1725: Load reduced to 2100 kw and 3000 stator amps.

Conclusions/Notes

- i.) Maximum temperature reached was 71.5 degrees F over ambient (166.5- 95). This occurred at the end of the test period.
- ii.) Temperature rise over entire test was 44.5 degrees F. Temperature rise over final one hour was approximately 6 degrees.
- iii.) Rate of change of temperature rise decreased throughout entire test.

3.) Test Conclusions

The linear reactors and saturable transformers are capable of operating at the upgraded emergency diesel generator ratings. The maximum stabilized temperatures reached during the testing was a temperature rise of 104.1 F. Based on this, these components can operate with a worst case room ambient temperature of 126 degrees F and still have a 44.9 degree F margin before reaching their maximum design temperatures.

CON EDISON CALCULATION/ANALYSIS SHEET

CALCULATION NO. EGE-00016	REVISION 0	PAGE 18 OF 32
APPROVER/DATE Thomas J. Magee 9/7/91	REVIEWER/DATE Bruce Horowitz 9/20/91	CLASS 1E
SUBJECT/TITLE Emergency Diesel Generator Basler Exciter Test Report		PROJECT NO.
		ROW NO. REV

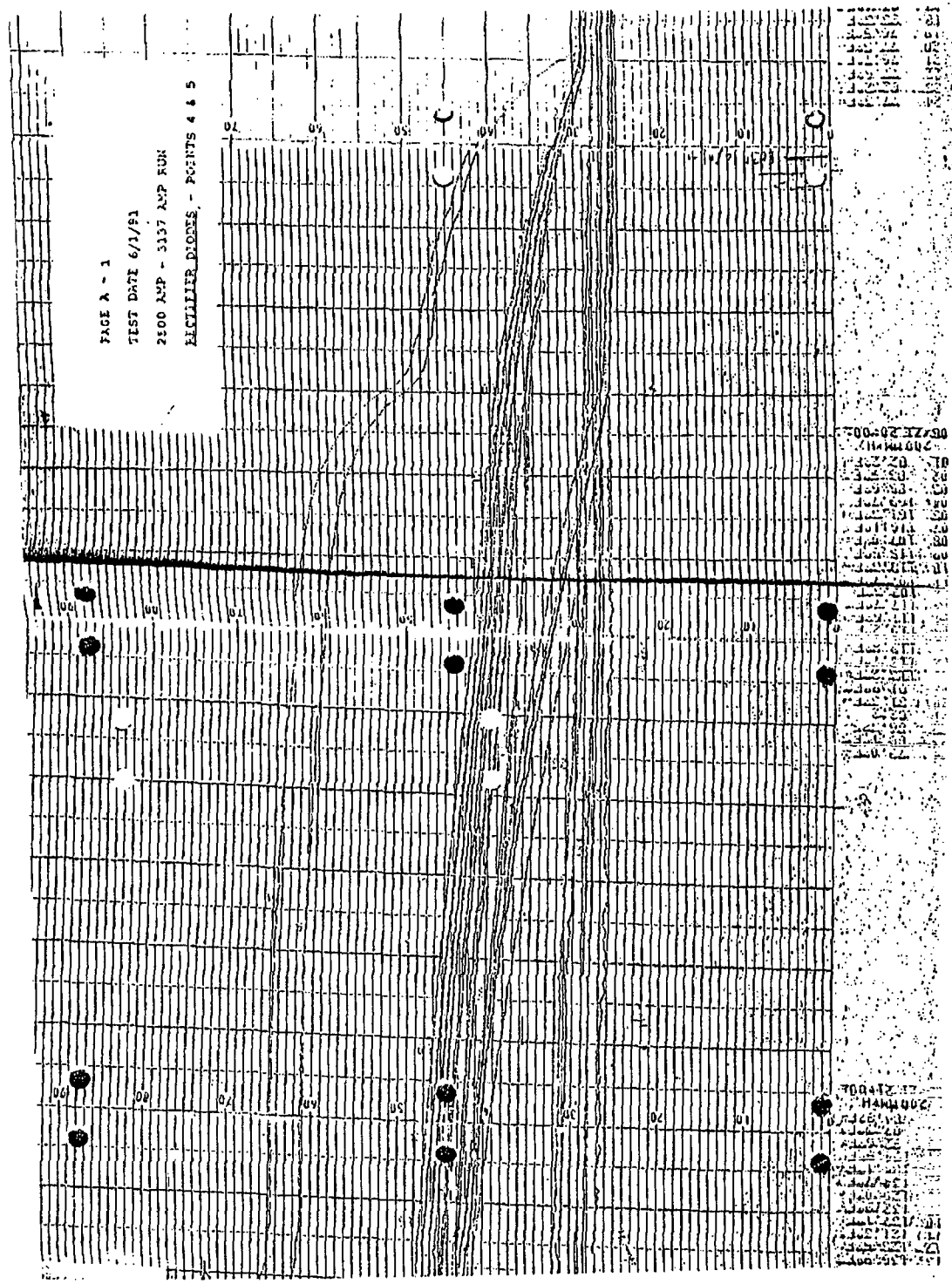

CALCULATION NO.

EGE-00016

REVISION

0

PAGE

19 OF 32

PREPARED BY/DATE

Thomas J. Magee 9/7/91

REVIEWED BY/DATE

Bruce Horowitz 9/26/91

CLASS

1E

SUBJECT/TITLE

Emergency Diesel Generator Basler Exciter Test Report

PROJECT NO.

MOD NO.

REV

PAGE A - 2

TEST DATE 6/1/91

2500 AMP - 3137 AMP RUN

RECTIFIER DIODES - POINTS 4 & 5

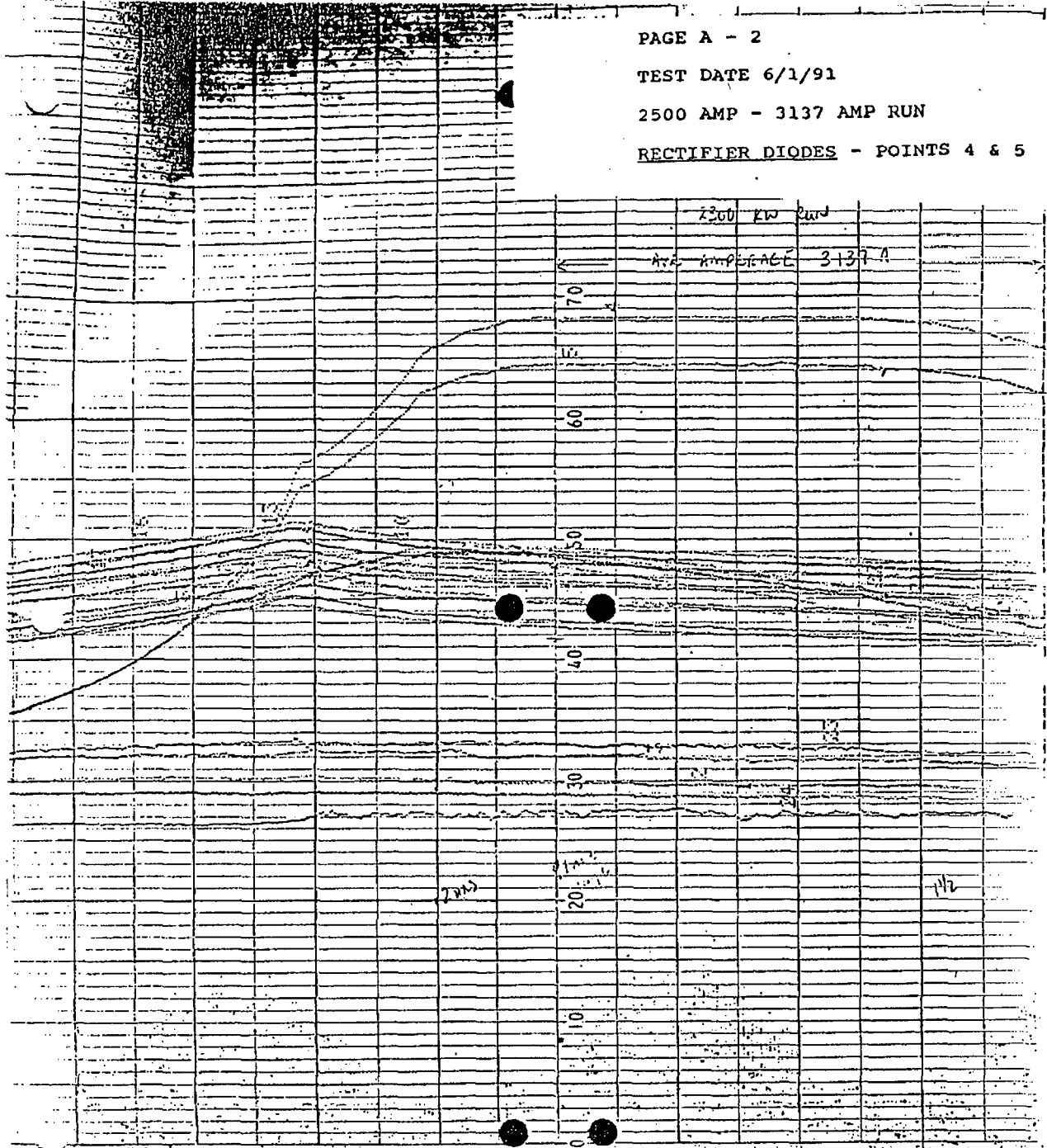

1. 201.40F
 2. 195.00F
 3. 172.00F
 4. 155.00F
 5. 128.00F
 6. 144.00F
 7. 146.80F
 8. 178.80F
 9. 186.70F
 10. 178.00F
 11. 171.20F
 12. 171.50F
 13. 171.50F
 14. 171.50F
 15. 171.50F
 16. 171.50F
 17. 171.50F
 18. 171.50F
 19. 171.50F
 20. 171.50F
 21. 171.50F
 22. 171.50F
 23. 171.50F
 24. 171.50F
 25. 171.50F
 26. 171.50F
 27. 171.50F
 28. 171.50F
 29. 171.50F
 30. 171.50F
 31. 171.50F
 32. 171.50F
 33. 171.50F
 34. 171.50F
 35. 171.50F
 36. 171.50F
 37. 171.50F
 38. 171.50F
 39. 171.50F
 40. 171.50F
 41. 171.50F
 42. 171.50F
 43. 171.50F
 44. 171.50F
 45. 171.50F
 46. 171.50F
 47. 171.50F
 48. 171.50F
 49. 171.50F
 50. 171.50F
 51. 171.50F
 52. 171.50F
 53. 171.50F
 54. 171.50F
 55. 171.50F
 56. 171.50F
 57. 171.50F
 58. 171.50F
 59. 171.50F
 60. 171.50F
 61. 171.50F
 62. 171.50F
 63. 171.50F
 64. 171.50F
 65. 171.50F
 66. 171.50F
 67. 171.50F
 68. 171.50F
 69. 171.50F
 70. 171.50F
 71. 171.50F
 72. 171.50F
 73. 171.50F
 74. 171.50F
 75. 171.50F
 76. 171.50F
 77. 171.50F
 78. 171.50F
 79. 171.50F
 80. 171.50F
 81. 171.50F
 82. 171.50F
 83. 171.50F
 84. 171.50F
 85. 171.50F
 86. 171.50F
 87. 171.50F
 88. 171.50F
 89. 171.50F
 90. 171.50F
 91. 171.50F
 92. 171.50F
 93. 171.50F
 94. 171.50F
 95. 171.50F
 96. 171.50F
 97. 171.50F
 98. 171.50F
 99. 171.50F
 100. 171.50F

1. 201.40F
 2. 195.00F
 3. 172.00F
 4. 155.00F
 5. 128.00F
 6. 144.00F
 7. 146.80F
 8. 178.80F
 9. 186.70F
 10. 178.00F
 11. 171.20F
 12. 171.50F
 13. 171.50F
 14. 171.50F
 15. 171.50F
 16. 171.50F
 17. 171.50F
 18. 171.50F
 19. 171.50F
 20. 171.50F
 21. 171.50F
 22. 171.50F
 23. 171.50F
 24. 171.50F
 25. 171.50F
 26. 171.50F
 27. 171.50F
 28. 171.50F
 29. 171.50F
 30. 171.50F
 31. 171.50F
 32. 171.50F
 33. 171.50F
 34. 171.50F
 35. 171.50F
 36. 171.50F
 37. 171.50F
 38. 171.50F
 39. 171.50F
 40. 171.50F
 41. 171.50F
 42. 171.50F
 43. 171.50F
 44. 171.50F
 45. 171.50F
 46. 171.50F
 47. 171.50F
 48. 171.50F
 49. 171.50F
 50. 171.50F
 51. 171.50F
 52. 171.50F
 53. 171.50F
 54. 171.50F
 55. 171.50F
 56. 171.50F
 57. 171.50F
 58. 171.50F
 59. 171.50F
 60. 171.50F
 61. 171.50F
 62. 171.50F
 63. 171.50F
 64. 171.50F
 65. 171.50F
 66. 171.50F
 67. 171.50F
 68. 171.50F
 69. 171.50F
 70. 171.50F
 71. 171.50F
 72. 171.50F
 73. 171.50F
 74. 171.50F
 75. 171.50F
 76. 171.50F
 77. 171.50F
 78. 171.50F
 79. 171.50F
 80. 171.50F
 81. 171.50F
 82. 171.50F
 83. 171.50F
 84. 171.50F
 85. 171.50F
 86. 171.50F
 87. 171.50F
 88. 171.50F
 89. 171.50F
 90. 171.50F
 91. 171.50F
 92. 171.50F
 93. 171.50F
 94. 171.50F
 95. 171.50F
 96. 171.50F
 97. 171.50F
 98. 171.50F
 99. 171.50F
 100. 171.50F

Thomas J. Magee

9/7/91

Bruce Horowitz

9/20/91

1E

Emergency Diesel Generator Basler Exciter Test Report

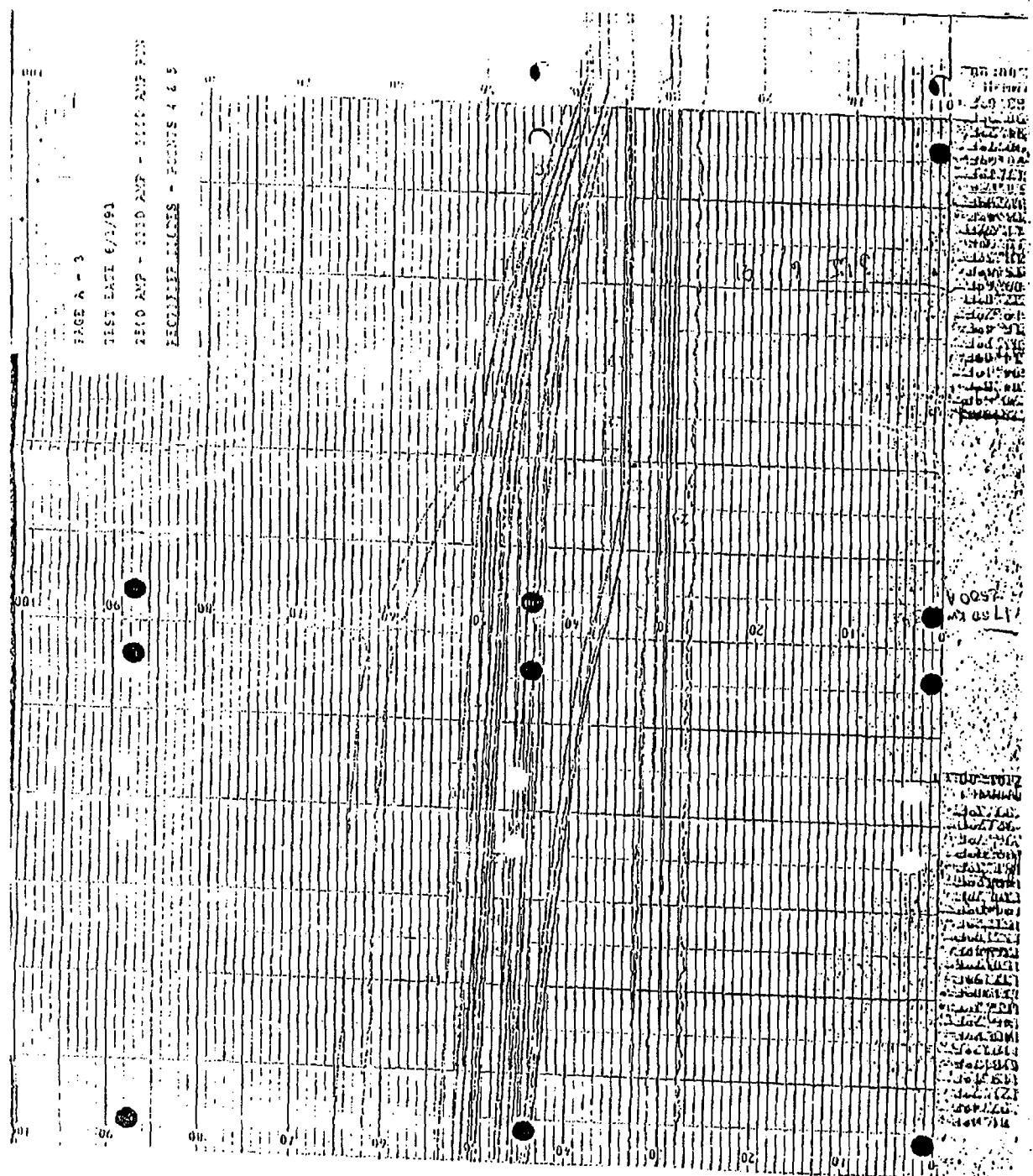

CON EDISON CALCULATION/ANALYSIS SHEET

CALCULATION NO.
EGE-00016

REVISION
0

PAGE 21 OF 32

DATE/DATE

Thomas J. Magee 9/7/91

REVISION/DATE

B. Horowitz 9/20/91

CLASS 1E

SUBJECT/TITLE

Emergency Diesel Generator Basler Exciter Test Report

PROJECT NO.

ROW NO.

REV

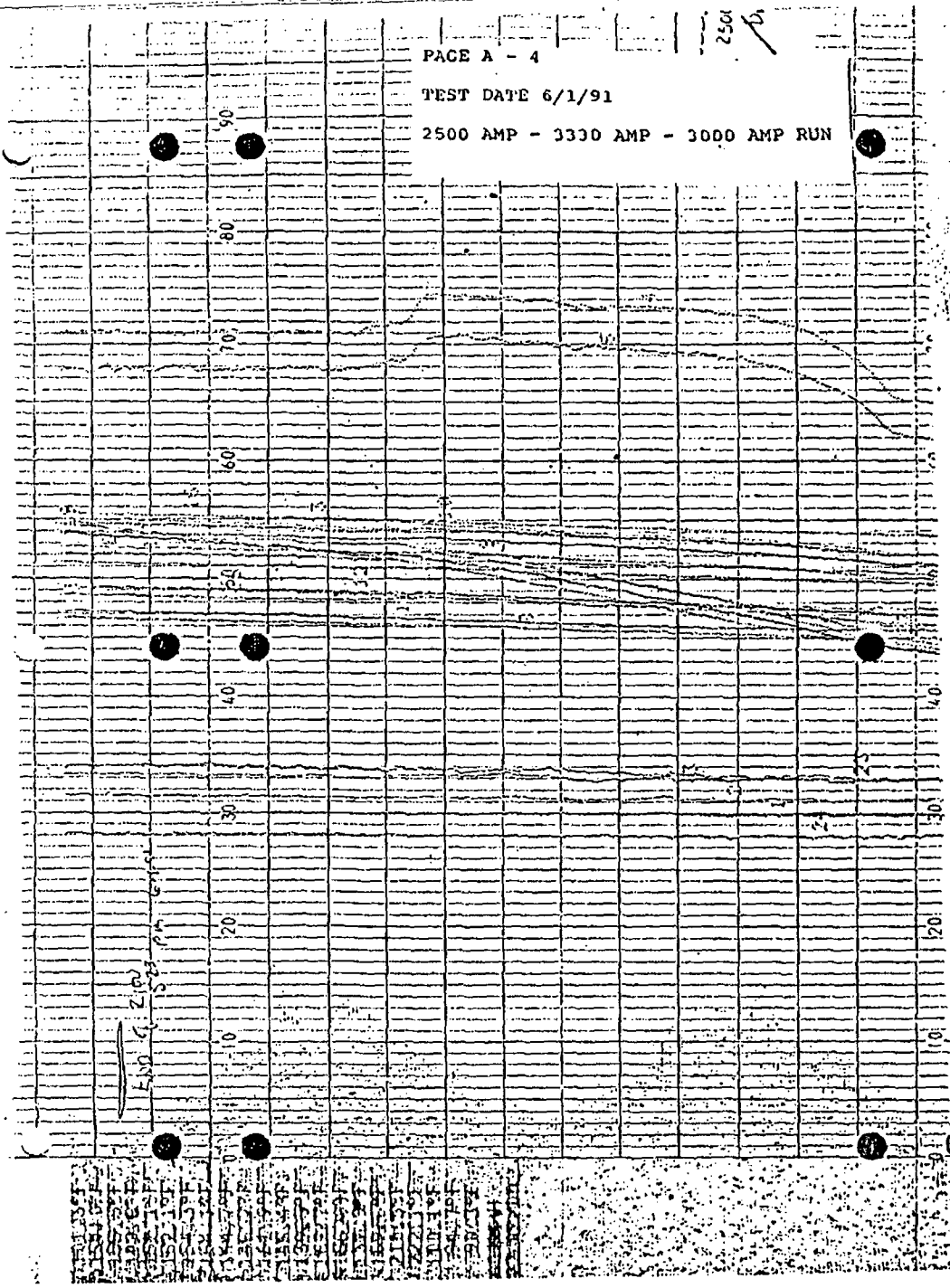

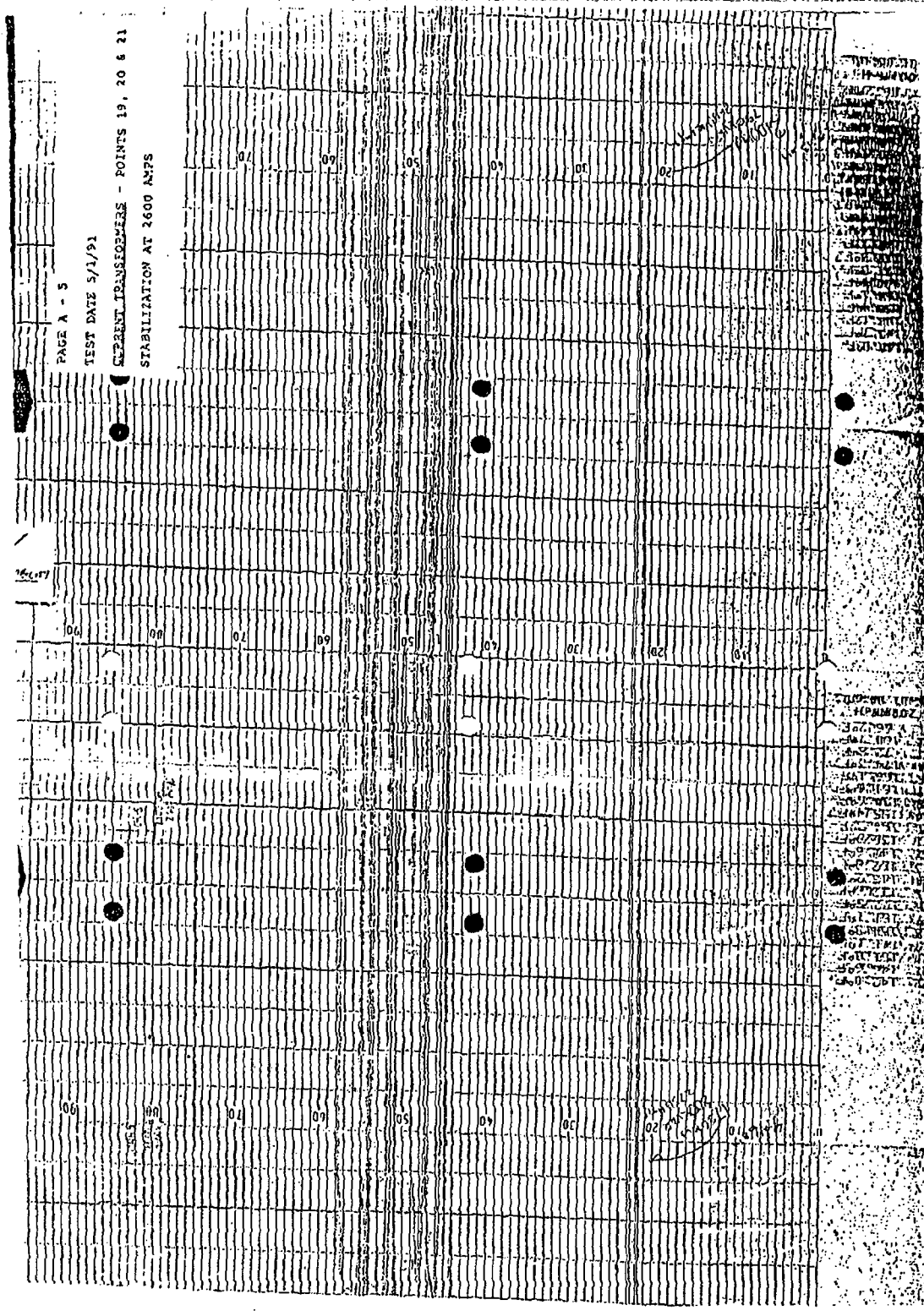

CALCULATION NO. EGE-00016	REVISION 0	PAGE 23 OF 32
APPROVER/DATE Thomas J. Magee 9/7/91	REVIEWER/DATE Bruce Horowitz 9/26/91	CLASS 1E
SUBJECT/TITLE Emergency Diesel Generator Basler Exciter Test Report		PROJECT NO. REV

GUIDE FOR LOADING

not be less than 90 percent of the integrated half-hour maximum demand.

96-05.560 This method may be used to convert an irregular load cycle, as in Fig. 96-05.520, to a rectangular load cycle. In this case, the continuous portion is 70 percent and the peak 125 percent of rated kva for 2 hours. Table 96-01.250 shows that for a ventilated transformer the permissible load following a continuous load of 70 percent is 125 percent; therefore, the transformer will carry this load cycle daily without sacrifice of normal life expectancy.

96-05.600 Equations for Calculation of Temperature, Load, and Loss of Life

96-05.601 List of Symbols. The following symbols and terms are used in this section.

- θ , with any subscript, is temperature in degrees C.
- θ_a = ambient temperature
- θ_{H1} = hottest-spot winding conductor temperature
- θ_{s1} = hottest-spot winding conductor temperature rise
- θ_c = average winding conductor temperature rise over room air temperature, determined by resistance
- θ_g = hottest-spot winding conductor to average winding conductor temperature gradient
- τ = time constant for the transformer at rated load, approximately equal to the time required to reach 63 percent of final temperature
- n = an empirical constant; for ventilated self-cooled dry type, $n = 0.8$; for sealed self-cooled dry type, $n = 0.7$
- T = absolute temperature = $\theta + 273$
- C = thermal capacity of transformer, watt-hours per degree C
- t = duration of load
- W_0 = total watts loss at full load and at 75 degrees C
- L = per unit load
- R = relative rate of aging
- P = relative life expectancy in percent

Subscript 0 indicates rated load, normal life, or rated temperature.

Subscript 1 indicates any other load, temperature, or time.

Subscript i indicates initial load, temperature, or time for transients.

Subscript u indicates ultimate load, temperature, or time for transients.

Example: θ_{H0} = hottest-spot winding conductor temperature at rated load.

DRY-TYPE DISTRIBUTION AND POWER TRANSFORMERS

96-05.610 Temperature Determination Equations

The hottest-spot winding conductor temperature

$$\theta_{H1} = \theta_{s1} + \theta_{c1} + 30 \left(\frac{L_1}{L_0} \right)^{2n} \quad (\text{Eq 96-05.610a})$$

$$\theta_{H1} = \theta_{s1} + \theta_{s1} \quad (\text{Eq 96-05.610b})$$

The hottest-spot winding conductor rise

$$\frac{\theta_{s1}}{\theta_{s0}} = \left(\frac{L_1}{L_0} \right)^{2n} \quad (\text{Eq 96-05.610c})$$

The average winding conductor rise

$$\frac{\theta_{c1}}{\theta_{c0}} = \left(\frac{L_1}{L_0} \right)^{2n} \quad (\text{Eq 96-05.610d})$$

The time constant at rated load

$$\tau = \frac{C \theta_{c0}}{W_0} \quad (\text{Eq 96-05.610e})$$

where $C = 0.035 \times$ weight of core and coils, in pounds, from napheplate.

96-05.620 Corrections for Equations. Theoretically, several corrections should be made when using the foregoing equations, such as corrections for change in

- (1) Time constant for loads other than rated load
- (2) Ultimate winding conductor loss at end of long period

In making general calculations based on assumptions of transformer characteristics and maximum hottest-spot temperatures which generally have a large factor of safety, results close enough for all practical purposes are obtained if all these corrections are omitted and the simpler formulae are used.

The methods and tables in 96-01.200 and 96-02 are based on the equations without corrections, together with averages of data from independent sources.

96-05.630 Time Constant. The concept of a transformer time constant is based on the assumption that a single heat source supplies heat to a single heat sink and that the temperature rise of the sink is an exponential function of the heat input. The limited data available for dry-type transformers indicate that transient temperatures may be calculated safely on the basis of these assumptions.

CALCULATION NO. EGE-00016		REVISION 0	PAGE 24 of 32
DATE/USER/DATE Thomas J. Magee 9/7/91		DATE/USER/DATE Bruce Horowitz 9/26/91	
SUBJECT/TITLE Emergency Diesel Generator Basler Exciter Test Report			CLASS 1E
			PROJECT NO. REV

Current Transformer Summary Chart

Current Trans. Phase	2600 Amp Test Data	Calculated 3000 Amp Temp @ Stability	Calculated 3300 Amp Temp @ Stability
A	205.3	229.7	250.2
B	215.8	243.6	267
C	209.8	235.5	257.2

Notes:

- 1.) The above temperatures are total temperatures in degrees F.
- 2.) The above temperatures assume a worst case room ambient of 126 F plus an additional 6 degrees F to account for the higher wye box ambient.
- 3.) The calculated temperatures for 3000 amps and 3300 amps were performed using an equation in which the temperature varied with the current ratio squared. This is more conservative equation than the ANSI Standard endorsed method in which the temperature rise varies with the current ratio raised to a power of 1.6.
- 4.) The calculated temperatures represent final stabilized temperatures at the 3000 amp and 3300 amp loadings. Since the diesel generator is rated for 2100 kw for 2 hours and 2300 kw for 1/2 hour, the current transformers will not reach these temperatures.

CALCULATION NO. EGE-00016	REVISION 0	PAGE 25 OF 32
------------------------------	---------------	------------------

DATE/DATE
Thomas J. Magee 9/7/91

REVIEWER/DATE
Bruce Horowitz 9/26/91

CLASS
1E

SUBJECT/TITLE
Emergency Diesel Generator Basler Exciter Test Report

PROJECT NO.
JOB NO. 28V

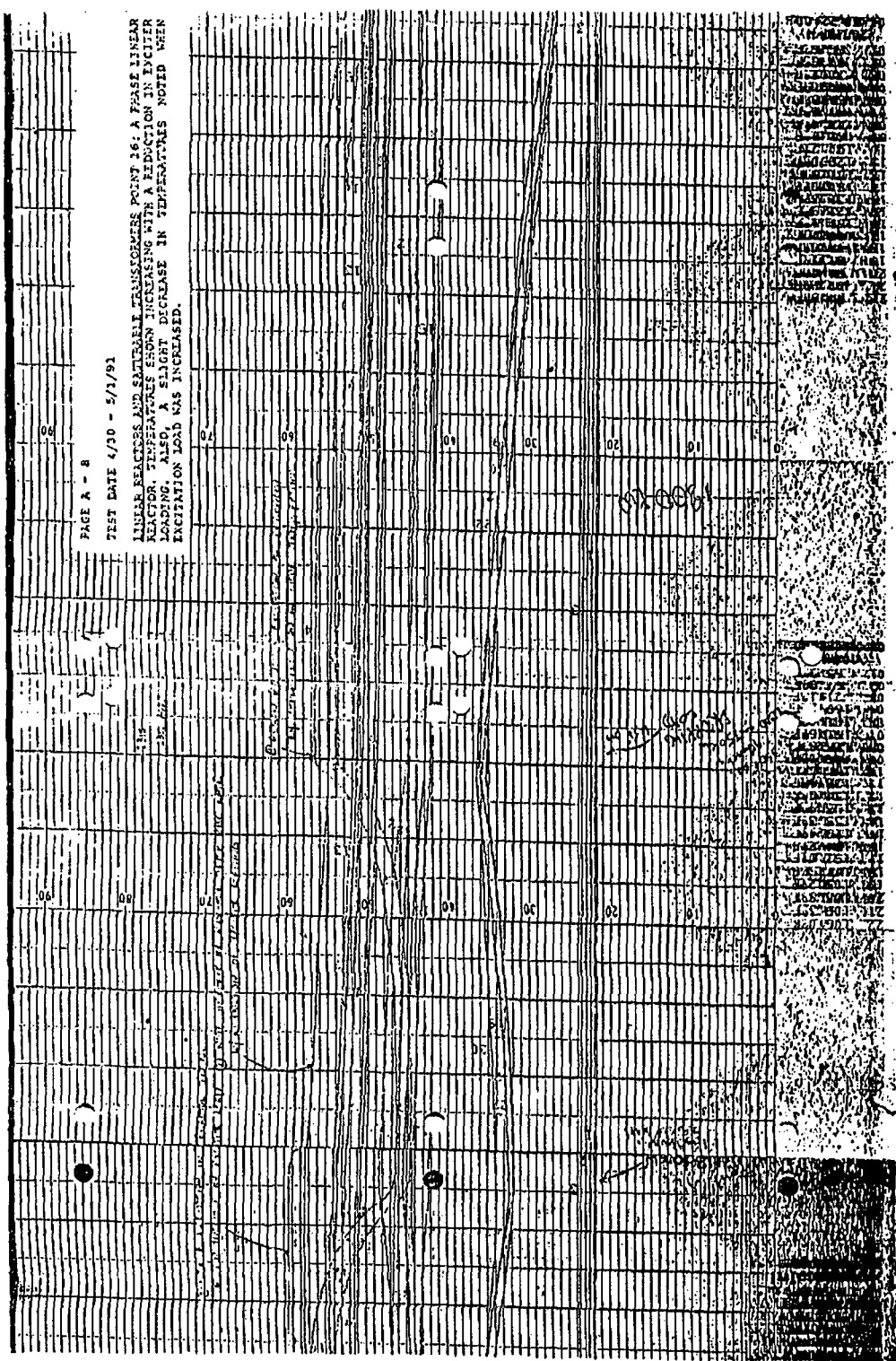

PAGE A - B
TEST DATE 4/30 - 5/1/91

LINEAR REGRESS AND SATURABLE TRANSFORMERS POINT 16. A THREE LINEAR REACTOR. TEMPERATURE EDISON INCLUDING WITH A REACTION IN EXCITER LOADING. ALSO, DECREASE IN TEMPERATURES NOTED WHEN EXCITATION LOAD WAS INCREASED.

Vertical text on the right side of the grid, possibly a legend or additional notes, which is mostly illegible due to the quality of the scan and the density of the grid lines.

CALCULATION NO.
EGE-00016

REVISION
0

PAGE 26 OF 32

PREPARED/DATE

Thomas J. Magee 9/7/91

REVIEWER/DATE

Bruce Horowitz 9/20/91

CLASS 1E

SUBJECT/TITLE

Emergency Diesel Generator Exciter Test Report

PROJECT NO.

REV NO.

REV

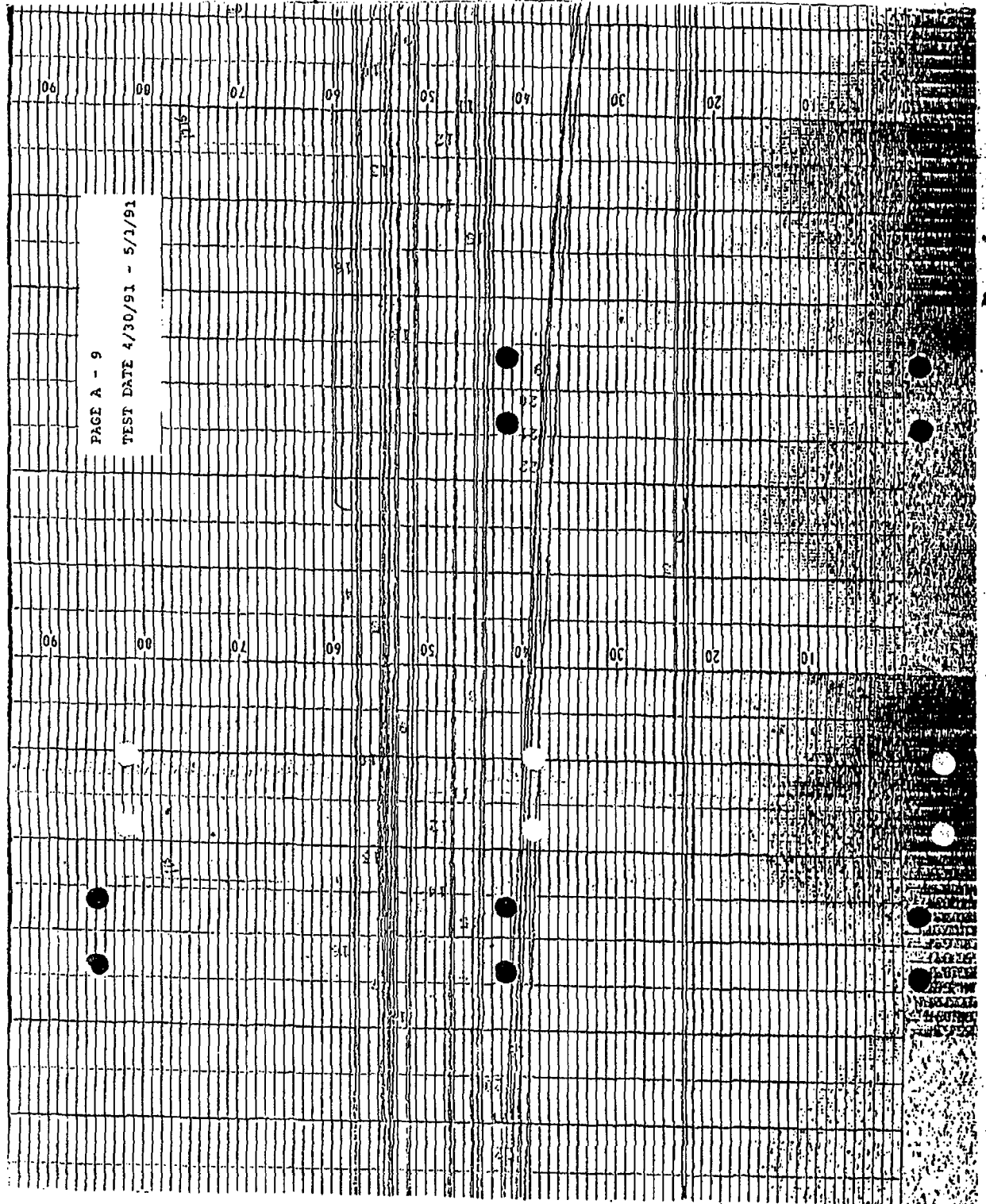

PREPARED BY
Thomas J. Magee 9/7/91

REVIEWER/DATE
Bruce Horowitz 9/26/91

CLASS
1E

SUBJECT/TITLE
Emergency Diesel Generator Basler Exciter Test Report

PROJECT NO.
JOB NO. REV

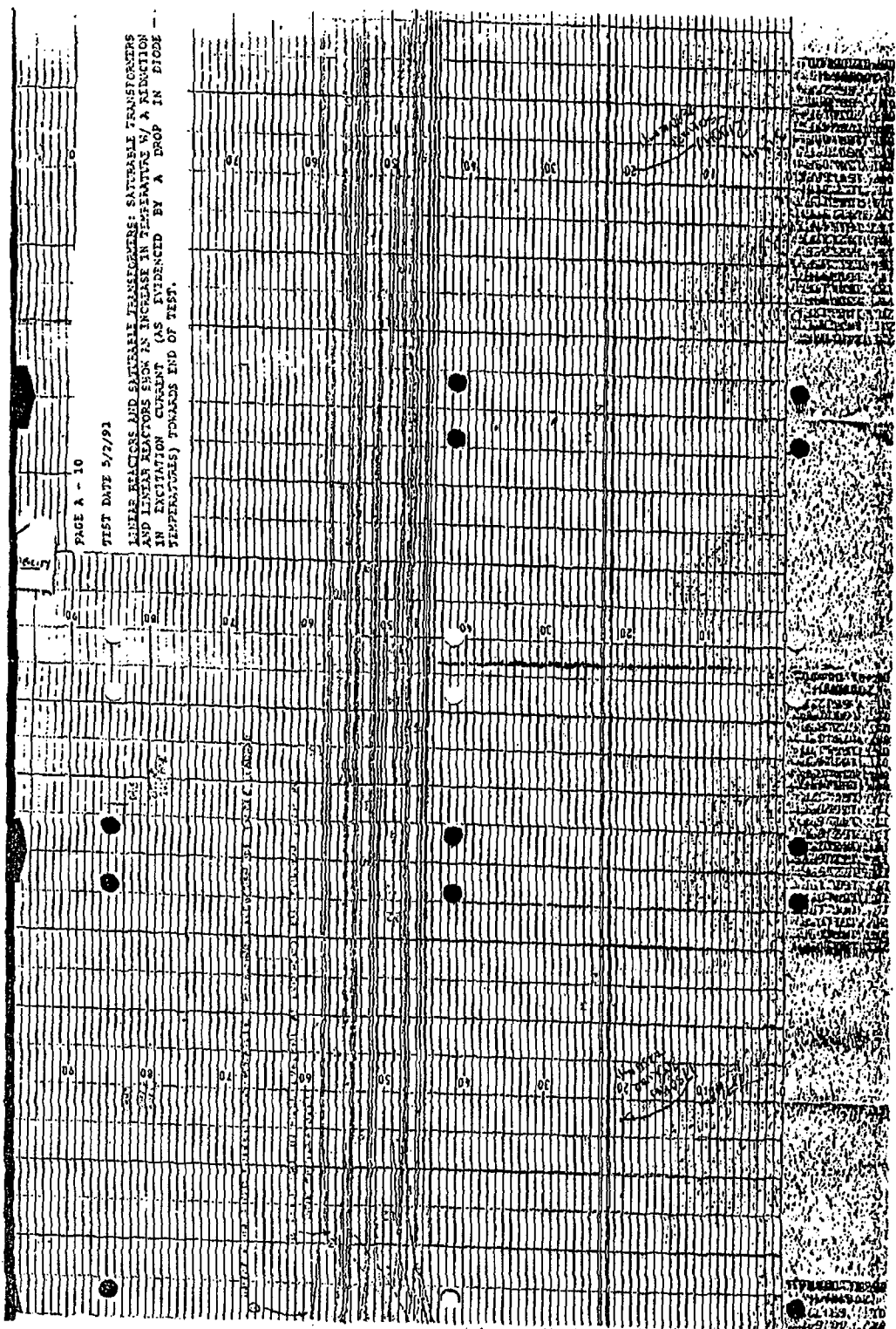

CALCULATION NO.
EGE-00016

REVISION
0.

PAGE 28 OF 32

PREPARED BY
Thomas J. Magee 9/7/91

REVISION BY
Bruce Horowitz 9/20/91

CLASS 1E

SUBJECT/TITLE
Emergency Diesel Generator Basler Exciter Test Report

PROJECT NO.
JOB NO. REV

PAGE A - 11

TEST DATE 6/1/91

2500 AMP - 3330 AMP - 3000 AMP RUN

LINEAR REACTORS AND SATURABLE TRANSFORMERS: TEMPERATURE RISES OF THESE COMPONENTS IS UNAFFECTED BY SHARP CHANGES IN EXCITATION CURRENT.

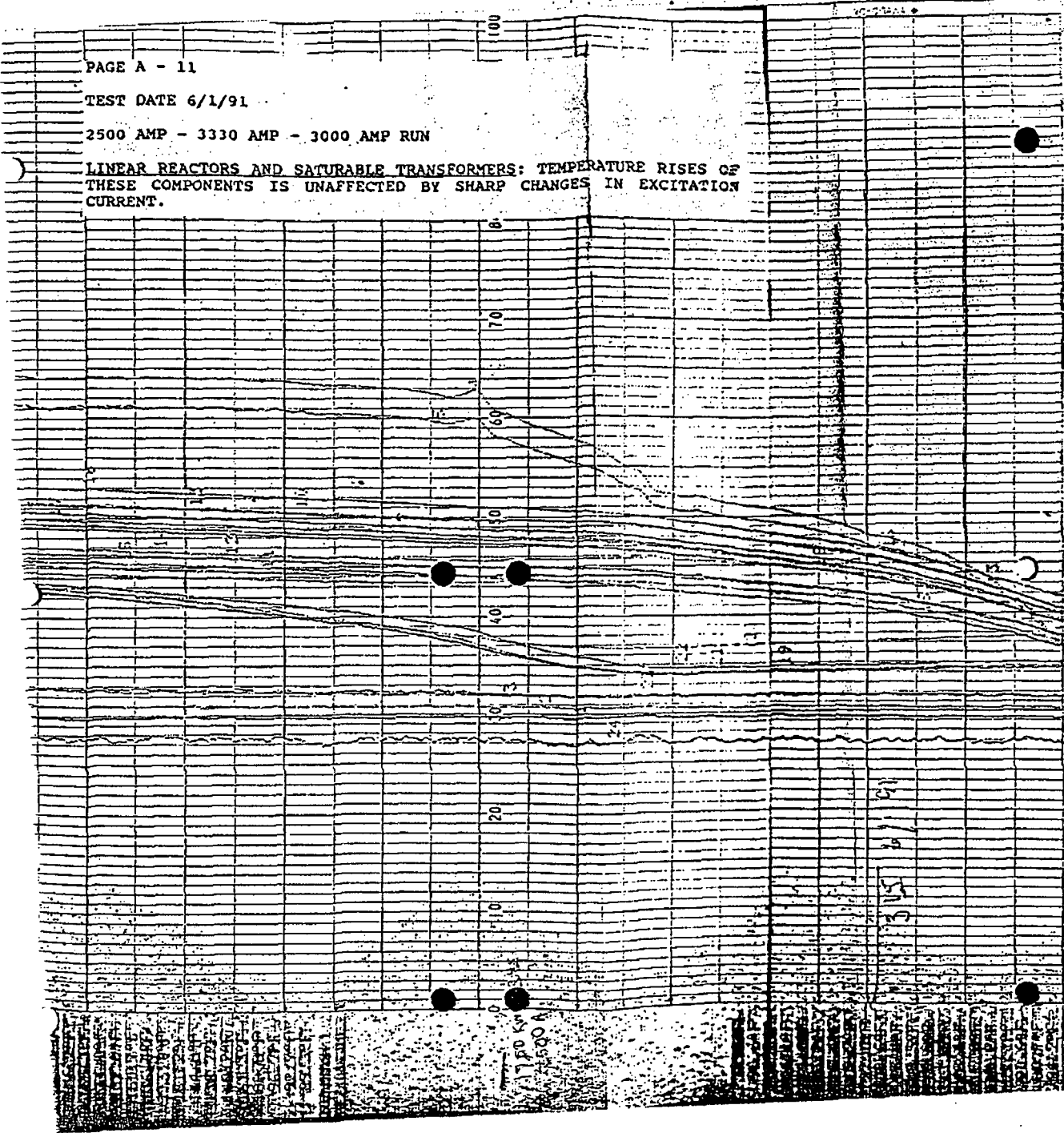

CALCULATION NO.
EGE-00016

REVISION
0

PAGE
29 32

PREPARED BY/DATE

Thomas J. Magee

9/7/91

REVIEWER/DATE

Bruce Horowitz

9/26/91

CLASS
1E

SUBJECT/TITLE

Emergency Diesel Generator Basler Exciter Test Report

PROJECT NO.

POB NO. REV

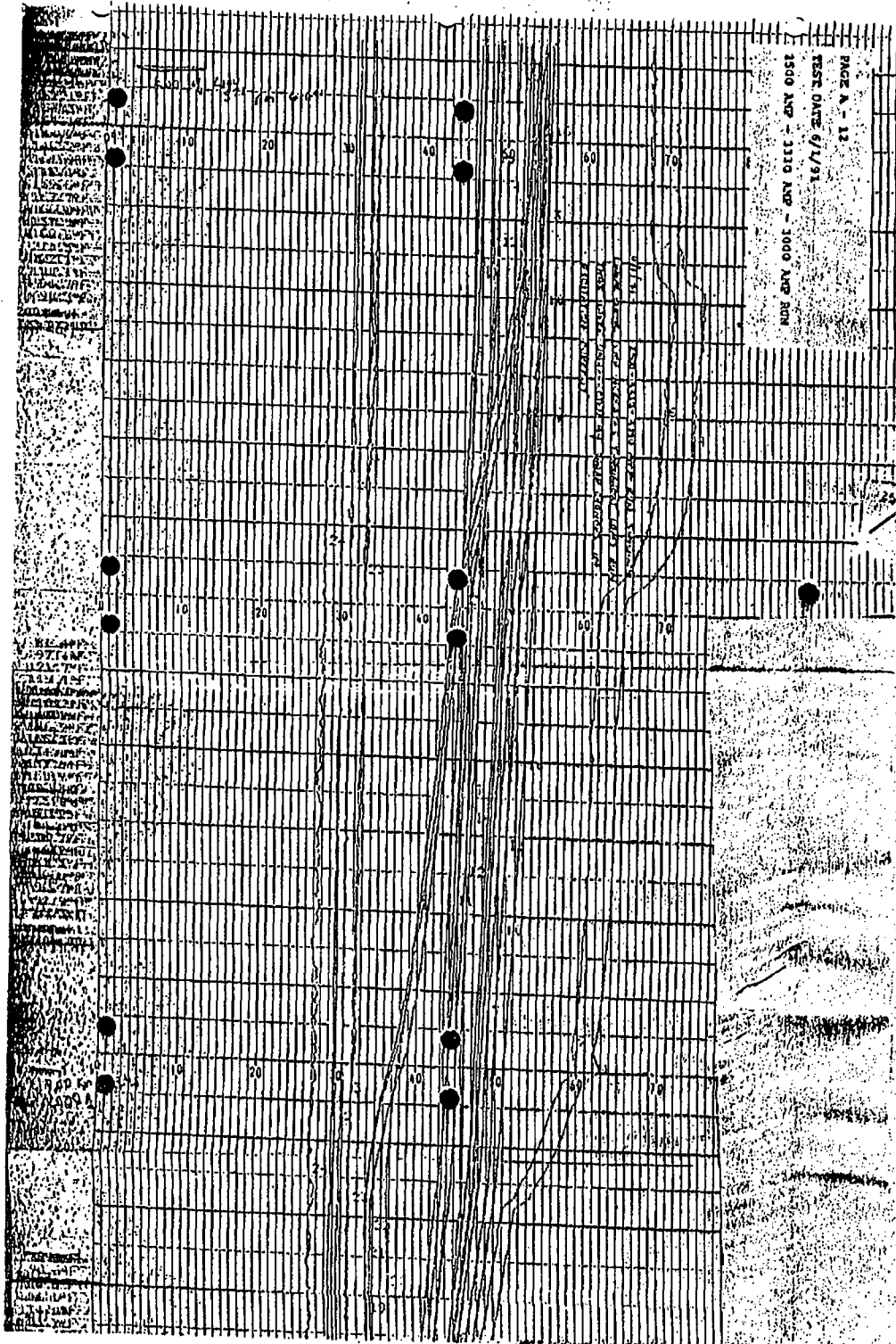

CALCULATION NO.	REVISION	PAGE
EGE-00016	0	30 OF 32
REVISOR/DATE	CLASS	PROJECT NO.
B. Horowitz 9/20/91	1E	
SUBJECT/TITLE		NOB NO. REV
Emergency Diesel Generator Basler Exciter Test Report		

PAGE A - 33
TEST DATE 6/1/91
2500 AXP - 3137 AXP RUN

LINES REACTORS AND SATURABLE TRANSFORMERS SHORT SECTION COMPONENTS
SHOWED AN INCREASED RATE OF TEMPERATURE CHANGE WITH A REDUCTION IN
EXCITER LOADING FROM THE SERIES SECTION PRIOR TO TRIPPING THE
GENERATOR.

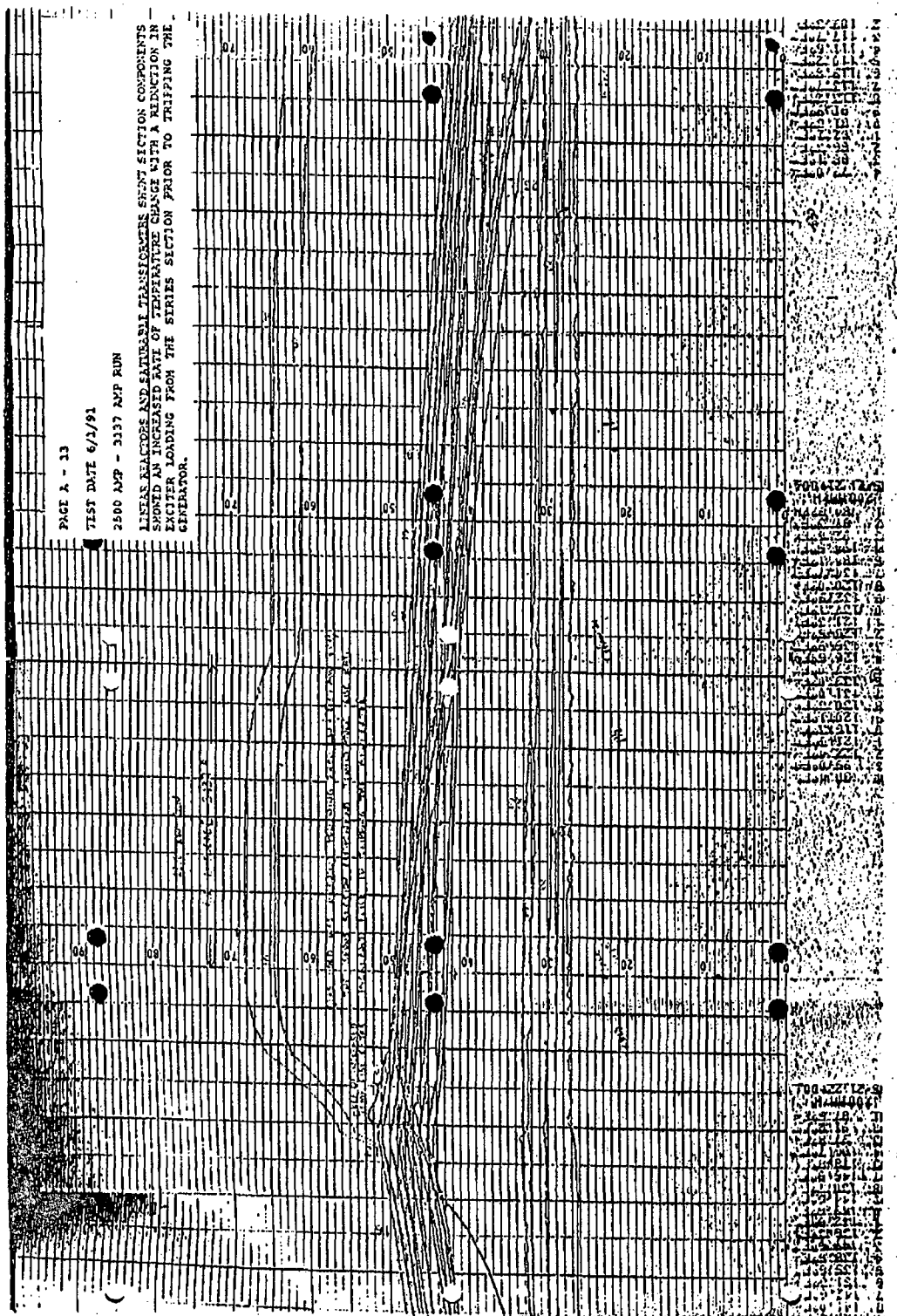

Vertical text on the right side of the grid, likely a legend or data key, containing various alphanumeric codes and labels. The text is partially obscured by the grid lines and is difficult to read in detail.

CALCULATION NO. EGE-00016	REVISION 0	PAGE 31 OF 32
REVISOR/DATE B. Horowitz 9/26/91	CLASS 1E	PROJECT NO.
SUBJECT/TITLE Emergency Diesel Generator Basler Exciter Test Report		MOD NO. REV

46 1323

M-S REACTOR DIVISION

PAGE A - 14

LINEAR REACTOR TEMP PROFILE - TEST A

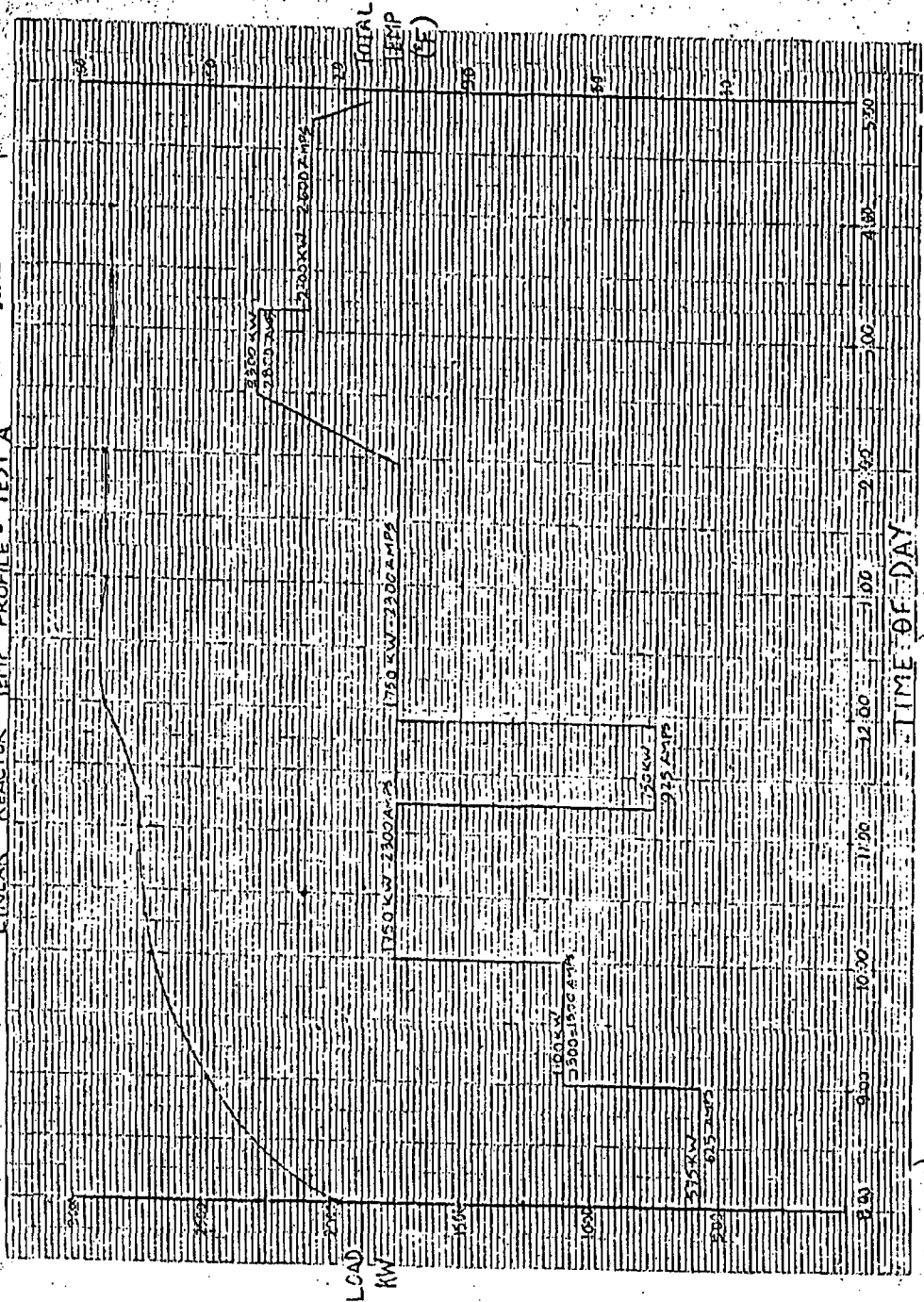

(4/30-5/1)

CALCULATION NO. EGE-00016	REVISION 0.	PAGE 32 OF 32
PREPARED BY/DATE Thomas J. Magee 9/7/91	REVIEWER/DATE B. Horowitz 9/26/91	CLASS 1E
SUBJECT/TITLE Emergency Diesel Generator Basler Exciter Test Report		PROJECT NO. REV

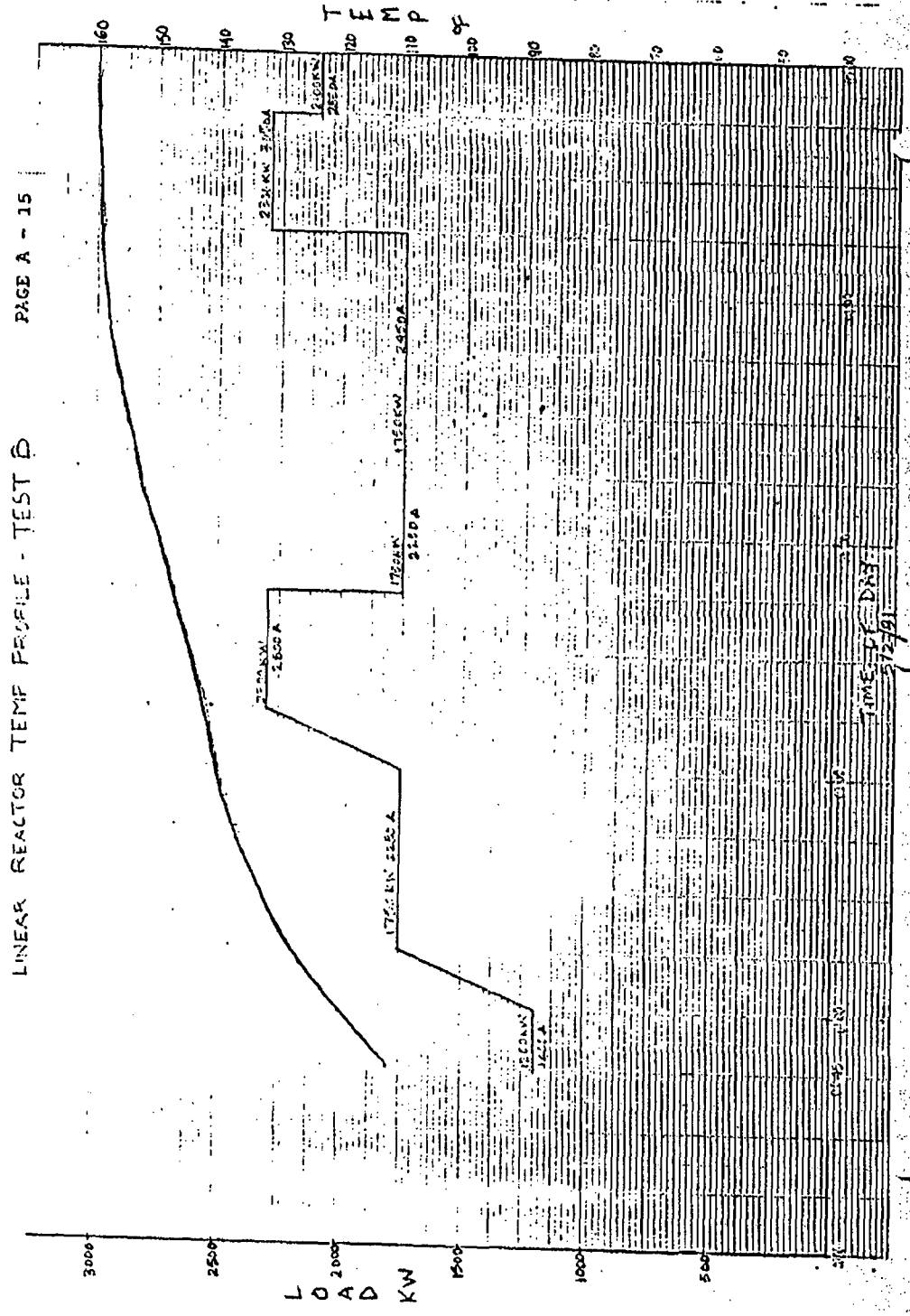

ATTACHMENT 4, ENCLOSURE 7 TO NL-08-101

Calculation IP-CALC-06-00281, "Ventilation System for the EDG Building".

**ENERGY NUCLEAR OPERATIONS, INC.
INDIAN POINT NUCLEAR GENERATING UNIT NO. 2
DOCKET NO. 50-247**

	NUCLEAR MANAGEMENT MANUAL	QUALITY RELATED	ENN-DC-126	REV. 6
		INFORMATIONAL USE	PAGE 32 OF 59	
Calculations				

ATTACHMENT 9.2

CALCULATION COVER PAGE

Sheet 1 of 1

CALCULATION COVER PAGE

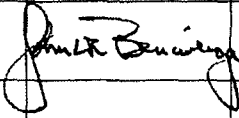
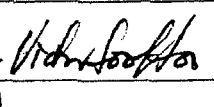
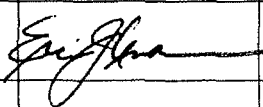
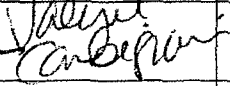
<input checked="" type="checkbox"/> IP-2 <input type="checkbox"/> IP-3 <input type="checkbox"/> JAF <input type="checkbox"/> PNPS <input type="checkbox"/> VY					
Calculation No. IP-CALC-06-00281		This revision incorporates the following MERLIN DRNs or Minor Calc Changes: None			Sheet 1 of 12
Title: Ventilation System for the EDG Building					<input checked="" type="checkbox"/> QR <input type="checkbox"/> AQR <input type="checkbox"/> NQR
Discipline: Mechanical			Design Basis Calculation? <input checked="" type="checkbox"/> Yes <input type="checkbox"/> No		
This calculation supersedes/voids calculation: GMH-00006-00 Rev. 0					
Modification No./Task No/ER No: IP2-06-27668					
<input checked="" type="checkbox"/> No software used (Also check this box if spreadsheet application such as MathCAD or Excel is used.) <input type="checkbox"/> Software used and filed separately (Include Computer Run Summary Sheet). If "YES", Code: _____ <input type="checkbox"/> Software used and filed with this calculation. If "YES", Code: _____					
System No./Name: <u>36 / HVAC / EDG Building</u>					
Component No./Name: <u>Wall Fans 318, 319, 320, 321, 322, & 323</u> (Attach additional pages if necessary)					
Print/Sign					
REV #/DRN # (*)	PREPARER	REVIEWER/ DESIGN VERIFIER	OTHER REVIEWER/ DESIGN VERIFIER	APPROVER	DATE
0	John Bencivenga	Victor Soohoo	Eric Anderson	Valerie Cambigianis	
					1/18/07

* Refer to the Site EDMS for current status of the REV#/DRN# listed.

	NUCLEAR MANAGEMENT MANUAL	QUALITY RELATED	ENN-DC-126	REV. 6
		INFORMATIONAL USE	PAGE 35 OF 59	
Calculations				

ATTACHMENT 9.4

CALCULATION SUMMARY PAGE

Sheet 1 of 1

CALCULATION SUMMARY PAGE	Page 3 of 12
Calculation No. <u>IP-CALC-06-00281</u>	Revision No. <u>0</u>
<p>CALCULATION OBJECTIVE: To calculate the EDG Building room temperature rise above ambient temperature.</p>	
<p>CONCLUSIONS:</p> <p>At the site Design Basis ambient temperature of 93 degrees F, 3 fans are required to be operating (4 fans operable) in order to maintain the EDG Building temperature below 126 degrees F.</p> <p>For temperature rise results at various conditions see section 6.8 Results.</p>	
<p>ASSUMPTIONS: None</p>	
<p>DESIGN INPUT DOCUMENTS:</p> <ol style="list-style-type: none"> 1) FEX-00039 Rev.2 "Emergency Diesel Load Study" 2) HIMD-ER-84-020 "Engineering Report" 3) ALCO Letter dated 1/16/1968 4) Westinghouse App Guide for 3000A Bus 5) UE&C #WIP-134-9321-01-102-1 "Proposal" 6) Drawing 9321-F-3050 "3000A Diesel Gen Bus Duct" 	
<p>AFFECTED DOCUMENTS: None</p>	
<p>METHODOLOGY: Standard HVAC methodology using ASHRAE fundamentals.</p>	

Table of Contents

<u>Section #</u>		<u>Page #</u>
1.0	Calculation Cover Page	1
2.0	Record of Revision	2
3.0	Summary Page	3
4.0	Table of Contents	4
5.0	List of Effective Pages	5
6.0	Calculation	6
6.1	Background	6
6.2	Purpose	6
6.3	Method of Analysis	6
6.4	Assumptions	6
6.5	Design Input	6
6.6	References	7
6.7	Analysis	7
6.8	Results	11
6.9	Conclusions	12
<u>Attachments</u>		<u># of pages</u>
Attachment 1	Air Properties Table	1
Attachment 2	ALCO Letter	1

Calculation # IP-CALC-06-00281
Revision # 0

List of Effective Pages

<u>Page Number</u>	<u>Revision Number</u>
1 to 12	0
Attachment 1	0
Attachment 2	0

Calculation # IP-CALC-06-00281

Revision # 0

6.1 Background

A heat wave was experienced during the first week of August 2006 during which time the site ambient temperatures approached 100 degrees F. Several questions were raised by an NRC resident inspector regarding the Unit 2 calculation GMH-00006-00 "Ventilation System for EDG Building". CR-IP2-2006-04678 was generated on this matter. Although it was concluded that the results of GMH-00006-00 were conservative, it was decided to prepare a new calculation to eliminate the potential for future questions on the same subject.

6.2 Purpose

This calculation will determine the Emergency Diesel Generator Building (EDGB) room temperature rise with a varying number of fans operating.

6.3 Method of Analysis

The internally generated heat load in the EDGB will be determined. Then using standard HVAC equations the room temperature rise will be calculated.

6.4 Assumptions

None

6.5 Design Input

6.5.1 Generator Output Ratings (Ref. 6.6.1)

2300 Kw - 0.5 hour

2100 Kw - 2.0 hours

1750 Kw - 21.5 hours

6.5.2 Heat Loads (Ref. 6.6.6)

Diesel 770,000 BTU/Hr

Generator 275,000 BTU/Hr

Switchgear 7150 BTU/Hr

6.5.3 Machine Efficiency (Ref. 6.6.5)

Generator - 96.43 %

6.5.4 Bus Resistance (Ref. 6.6.7)

5.58×10^{-6} ohms/ft

6.5 Design Input (con't)

6.5.6 Diesel Combustion Air (Ref. 6.6.6)

33,075 lb/hr @ 100% load

6.5.7 Exhaust Fan Capacities (Ref. 6.6.4)

Wall Fan 318 through 322 - 27,775 cfm (per fan)

Wall Fan 323 - 29,950 cfm

6.6 References

6.6.1 FEX-00039 Rev.2 Emergency Diesel Load Study

6.6.2 9321-F-3050 3000A Diesel Gen Bus Duct

6.6.3 2001 ASHRAE Fundamentals I-P Edition

6.6.4 MAXIMO

6.6.5 HIMD-ER-84-020 "Engineering Report" 10/23/84

6.6.6 ALCO Letter dated 1/16/1968

6.6.7 Westinghouse App Guide for 3000A Bus

6.6.8 UE&C #WIP-134-9321-01-102-1 "Proposal" 8/67

6.6.9 Ugly's Electrical References 1993 edition

6.7 Analysis

The first thing to do is to determine the amount of heat that is generated in the EDGB. For this analysis the heat generated due to hot pipes, lighting and other miscellaneous items are considered negligible compared to the heat load from the EDG and switchgear.

The major heat contributors that will be evaluated are the Diesel, the Generator, the Switchgear and the Bus. The heat rejected into the room from the equipment has been provided. Therefore only the heat rejected due to the Bus needs to be calculated. The heat load from the Bus is due to its resistance and the current it carries.

Calculation # IP-CALC-06-00281
Revision # 0

6.7.1 Room Heat Load

The average output load for each Generator will be determined based on its 24 hour profile ratings that were obtained from Ref. 6.6.1 and conservatively bounds all operating scenarios greater than 1 day duration events.

$$\begin{aligned}(2300 \text{ Kw}) \times (0.5 \text{ hour}) &= 1150 \text{ KwH} \\ (2100 \text{ Kw}) \times (2 \text{ hours}) &= 4200 \text{ KwH} \\ (1750 \text{ Kw}) \times (21.5 \text{ hours}) &= \underline{37,625 \text{ KwH}} \\ &42,975 \text{ KwH} \quad \text{total in 24 hours}\end{aligned}$$

Average generator output load
 $(42,925 \text{ KwH}) / 24 \text{ hours} = 1790.6 \text{ Kw}$

A) Room heat load due to Bus

The heat rejected to the room from the Bus is due to its resistance losses expressed as I^2R , where I is the current and R is the resistance for each Bus.

I can be found by the equation: (Ref. 6.6.9)
 $I/\text{phase} = (\text{Watts}) / [(3)^{0.5}(\text{Volts})(\text{power factor})]$

$$\begin{aligned}I/\text{phase} &= (1,790,600 \text{ watts}) / [(3)^{0.5}(480 \text{ volts})(0.85)] \\ I/\text{phase} &= 2533.83 \text{ amps/phase}\end{aligned}$$

$$\begin{aligned}\text{Power Loss/ft} &= I^2R \\ \text{Power Loss/ft} &= (2533.83 \text{ amps/phase})^2 \times (5.58 \times 10^{-6} \text{ ohms/ft}) \\ \text{Power Loss/ft} &= 35.8 \text{ watts/ft/phase}\end{aligned}$$

Since there are 3 phases per Bus and there is approximately 114 ft of Bus in the EDGB (Ref. 6.6.2), the heat rejected to the room from the Bus is:

$$\begin{aligned}\text{Bus heat load} &= (35.8 \text{ watts/ft/phase}) \times (3 \text{ phases/Bus}) \times (114 \text{ ft total Bus length}) \\ \text{Bus heat load} &= 12,243.6 \text{ watts} = 12.24 \text{ Kw} \\ \text{Bus heat load} &= (12.24 \text{ Kw}) \times (3413 \text{ BTU/KwH}) \\ \text{Bus heat load} &= 41775.1 \text{ BTU/Hr}\end{aligned}$$

B) Total room heat load

The total room heat load is the total of all the major contributors.

Generators	$(275,000 \text{ BTU/Hr}) \times (3)$	=	825,000 BTU/Hr
Diesel	$(770,000 \text{ BTU/Hr}) \times (3)$	=	2,310,000 BTU/Hr
Switchgear	$(7,150 \text{ BTU/Hr}) \times (3)$	=	21,450 BTU/Hr
Bus			<u>41,775 BTU/Hr</u>
			3,198,225 BTU/Hr total

6.7.2 Room Temperature Rise

The temperature rise in the room is a function of the total room heat load and the amount of ventilation air flow.

From Ref 6.6.3 - pg 26.9 - equation 26:

$$q_s = (60) (Q) (\rho) (c_p) (\Delta T)$$

where q_s = sensible heat load (BTU/hr)
 Q = airflow rate (cfm)
 ρ = air density (lb/ft³)
 c_p = specific heat of air (BTU/lb-°F)
 ΔT = room temperature rise (°F)

This equation can be represented as:

$$q_s = (K) (Q) (\Delta T)$$

and rearranging to solve for temperature rise:

$$\Delta T = q_s / [(K) \times (Q)]$$

where $K = (60) (c_p) (\rho)$

Since air density and specific heat vary slightly with temperature between 70 and 150 degrees F, results will be calculated for the site ambient design temperature of 93 degrees F as well as 100 and 105 degrees F ambient temperatures for additional information.

Air density can be calculated at varying temperature based on the ideal gas law:

$$\rho = (144) (P_a) / (R) (459.67 + T_a) \quad \text{[equation from Mark's Handbook]}$$

where R = gas constant (53.352 ft-lbs/lbm-°R)
 T_a = ambient temperature (degrees F)
 P_a = absolute pressure (psia)

The specific heat of air at varying temperature was obtained from the 1972 Fundamentals Volume of the ASHRAE Handbook (see Attachment 1).

Based on the above, the properties of air are as follows:

	$T_a = 93^\circ\text{F}$	$T_a = 100^\circ\text{F}$	$T_a = 105^\circ\text{F}$
c_p	0.240415	0.240459	0.240493
ρ	0.071770	0.070873	0.070245

Calculation # IP-CALC-06-00281
 Revision # 0

With these air properties the K value in the above equation for temperature rise can be written as follows:

	$T_a = 93\text{ }^\circ\text{F}$	$T_a = 100\text{ }^\circ\text{F}$	$T_a = 105\text{ }^\circ\text{F}$
K =	1.035	1.023	1.014

The amount of ventilating air flow is dependant on the number of fans operating and the amount of air drawn into the building by the Diesel for combustion.

Fan Air Flow

There are a total of 6 exhaust fans available to ventilate the EDGB. The worst case for minimum fans operating considers 1 fan out for maintenance and a failure of 1 EDG to start. This results in a minimum of 3 fans operating. In order to envelope these conditions, we will determine the room temperature rise with 2, 3, 4, and 5 fans operating.

Since 1 fan in the EDGB has a higher capacity than the other 5 fans we will consider this fan out for maintenance. This will give conservative results and they will be bounding for all combinations of operating fan. The cfm air flow per operating fan is 27,775.

Combustion Air Flow

The amount of air for combustion is determined by the Diesel and is given by the manufacturer and has a value of 33,075 lb/hr (Ref. 6.6.6). The total air flow needed by all 3 Diesels for combustion is then:

$$A_c \text{ (cfm)} = \text{Combustion air flow} = [(33,075 \text{ lb/hr}) \times (3 \text{ EDG's}) \times (1 \text{ hr}/60 \text{ min})] / p$$

	$T_a = 93\text{ }^\circ\text{F}$	$T_a = 100\text{ }^\circ\text{F}$	$T_a = 105\text{ }^\circ\text{F}$
p	0.071770	0.070873	0.070245
A_c	23,042	23,334	23543

Total EDGB Air Flow

The total building air flow is the sum of the air flow from the operating fans added to the air flow required for combustion.

Total EDGB Air Flow (cfm)

		$T_a = 93\text{ }^\circ\text{F}$	$T_a = 100\text{ }^\circ\text{F}$	$T_a = 105\text{ }^\circ\text{F}$
# of operating fans	Fan flow total			
2	55,550	78,592	78,884	79,093
3	83,325	106,367	106,659	106,868
4	111,100	134,142	134,434	134,643
5	138,875	161,917	162,209	162,418

Calculation # IP-CALC-06-00281
Revision # 0

Using the temperature rise equations developed above, the total room heat load from section 6.7.1 of this calculation and the total EDGB air flow, the room temperature rise can be calculated from the equation:

$$\text{delta T} = (3,198,225) / [(K) \times (\text{cfm})]$$

Two cases will be analyzed. Case 1 will be for all three EDG's operating and therefore the maximum number of operating fans analyzed is limited to 5 fans, allowing that 1 fan is out of service (OOS) for maintenance. Case 2 will be for two EDG's operating and therefore the maximum number of operating fans analyzed is limited to 3 fans. This accounts for 1 fan OOS for maintenance and 2 fans lost due to a failed start of an EDG.

6.8 Results

6.8.1 Case 1 (3 EDG's operating)

# of operating fans	delta T @ 93°F ambient	delta T @ 100°F ambient	delta T @ 105°F ambient
2	39.3	39.6	39.9
3	29.0	29.3	29.5
4	23.0	23.3	23.4
5	19.1	19.3	19.4

6.8.2 Case 2 (2 EDG's operating)

With only 2 EDG's are operating the internal heat in the EDGB will be less.

The heat load due to the Bus will be conservatively reduced by taking the 21 EDG as the non-operating EDG since it has the shortest length of Bus, 25 feet, in the EDGB. This results in a new total Bus length of 89 feet.

Calculation # IP-CALC-06-00281
 Revision # 0

The new heat load is then:

Generators	(275,000 BTU/Hr) x (2)	=	550,000 BTU/Hr
Diesel	(770,000 BTU/Hr) x (2)	=	1,540,000 BTU/ Hr
Switchgear	(7,150 BTU/Hr) x (2)	=	14,300 BTU/Hr
Bus	(41,775 BTU/Hr) x (89/114)	=	<u>32,614 BTU/Hr</u>
			2,136,914 BTU/Hr total

The resultant room temperature rise in this case is then:

# of operating fans	delta T @ 93°F ambient	delta T @ 100°F ambient	delta T @ 105°F ambient
2	26.3	26.5	26.6
3	19.4	19.6	19.7

6.9 Conclusion

From the results tabulated above, it can be seen that a minimum of 3 fans are required to be operating (4 operable) in order to maintain the EDGB below the maximum allowable temperature of 126 degrees F when all 3 EDG's are operating (Case 1) at Design Basis ambient temperature of 93 degrees F. (Note: in this case, single failure is postulated as a fan failure).

Additionally, a minimum of 2 fans are required to be operating (4 operable) in order to maintain the the EDGB below the maximum allowable temperature of 126 degrees F when 2 EDG's are operating (Case 2) at Design Basis ambient temperature of 93 degrees F. (Note: in this case, single failure is postulated as an EDG failure to start. For room temperature it is conservative to postulate the worst failed start EDG is one that powers 2 EDGB fans).

Table A-4a Air—English Units

Fahrenheit Temperature	Viscosity μ , lbm/(ft-hr)			Thermal Conductivity k , Btu/(hr-ft-F)			Specific Heat c_p , Btu/(lbm-F)				Fahrenheit Temperature	
	Saturated Liquid	Saturated Vapor	Gas, $P = 1$ atm	Saturated Liquid	Saturated Vapor	Gas $P = 1$ atm	Saturated Liquid	Saturated Vapor	Gas $P = 0$	Gas $P = 1$ atm		
-352	0.7865			0.1040	0.00312							-352
-334	0.5348			0.0942	0.00370							-334
-316	0.3993	0.0133		0.0838	0.00433		0.4690		0.2394			-316
-298	0.3194	0.0157	0.0154	0.0740	0.00497	0.00480	0.4962	0.2676	0.2394			-298
-280	0.2664	0.0182	0.0171	0.0636	0.00584	0.00532	0.5268	0.2891	0.2394	0.2456		-280
-262	0.2297	0.0208	0.0188	0.0537	0.00705	0.00589	0.5784	0.3440	0.2394	0.2442		-262
-244	0.1815	0.0247	0.0204	0.0439	0.00890	0.00641	0.6689	0.4778	0.2394	0.2430		-244
-266	0.1016	0.0346	0.0220	0.0312	0.01213	0.00693			0.2394	0.2422		-226
-220.6	0.05009	0.05009	0.0225	0.01964	0.01964	0.00711			0.2394	0.2420		-220.6
-208			0.0236			0.00745			0.2394	0.2418		-208
-190			0.0251			0.00797			0.2394	0.2415		-190
-172			0.0266			0.00844			0.2394	0.2411		-172
-136			0.0295			0.00948			0.2394	0.2406		-136
-100			0.0324			0.0105			0.2394	0.2403		-100
-64			0.0351			0.0114			0.2396	0.2403		-64
-28			0.0375			0.0124			0.2396	0.2401		-28
8			0.0402			0.0134			0.2396	0.2401		-8
44			0.0426			0.0142			0.2399	0.2403		-44
80			0.0448			0.0151			0.2401	0.2403		-80
116			0.0472			0.0160			0.2403	0.2406		116
152			0.0494			0.0168			0.2406	0.2408		152
188			0.0516			0.0176			0.2411	0.2413		188
224			0.0535			0.0183			0.2415	0.2418		224
260			0.0554			0.0191			0.2420	0.2422		260
296			0.0576			0.0199			0.2427	0.2430		296
332			0.0593			0.0206			0.2434	0.2437		332
368			0.0612			0.0214			0.2442	0.2444		368
404			0.0632			0.0221			0.2449	0.2451		404
440			0.0649			0.0228			0.2458	0.2461		440
620			0.0733			0.0264			0.2511	0.2513		620

Source: Adapted by permission from ASHRAE Handbook, Fundamentals Volume, 1972.

IP-CALC-06-00281
 Attachment 1
 pg 1 of 1

RECORDS MANAGEMENT SERVICES

EOG, G.C. 2.1

278486

Power File 9321-01-02

ALCO PRODUCTS, INCORPORATED

1 NOTT STREET SCHEENECTADY, NEW YORK 12305

JUN 13 1968

IP-CALC-06-00281
Attachment 2
Pg 1 of 1

UNIT No 3

APPLICABLE to UNIT 2

January 16, 1968

JW 2/18/68

Mr. F. W. Convey
United Engineers & Constructors
1101 Arch Street
Philadelphia, Pa.

Re: Your 9321-01-102-1
Alco DE-35211

Dear Sir:

This letter will confirm the following information given to you by phone by our Mr. Blanchard:

1. Total heat released to room
 - a. By diesel 770,000 Btu/hr.
 - b. By generator 275,000 Btu/hr.
 - c. By switchgear 7150 Btu/hr.
2. Combustion air required at full load: 33075 lb/hr.
3. Allowable ambient air temp range - minimum and maximum
 - a. Diesel: 32°F to 130°F (ambient may go below 32°F if intake air is preheated).
 - b. Generator: 0°F to 140°F
 - c. Switchgear: 40°F to 126°F

770,000
275,000
7150

1,052,150

If there are any questions, let us know.

Yours truly,

DATA TRANSCRIBED FROM ABOVE
EDG 770,000 Diesel generator
275,000 generator
7150 switchgear

K. A. Delmator
K. A. Delmator
Engine Sales Service

JLRB
11/8/67

When

- Messrs: J. S. Sunkes - U.E. & C. - Pur. Dept. - Philadelphia
R. Murphy - Worth. - Philadelphia
L. Blanchard - Alco - Schenectady

ATTACHMENT 4, ENCLOSURE 8 TO NL-08-101

Condition Report CR-IP2-2006-03685-CA-002, "Operability Evaluation"

**ENTERGY NUCLEAR OPERATIONS, INC.
INDIAN POINT NUCLEAR GENERATING UNIT NO. 2
DOCKET NO. 50-247**

	NUCLEAR MANAGEMENT MANUAL	QUALITY RELATED	EN-OP-104	REV. 1
		INFORMATIONAL USE	PAGE 23 OF 41	
Operability Determinations				

ATTACHMENT 9.4

OPERABILITY EVALUATION FORM

Sheet 1 of 1

Operability Evaluation	Page 1 of 24
1. Condition Report No./Operability Evaluation No.: CR-IP2-2006-03530 & 03685	
2. Summary of Operability Evaluation: See attached detailed Operability Evaluation.	
3. Basis for Operability Evaluation attached. <input checked="" type="checkbox"/>	
4. Are there any other affected SSCs? <input checked="" type="checkbox"/> No <input type="checkbox"/> Yes	
5. Recommendation: <input checked="" type="checkbox"/> Operable; <input type="checkbox"/> Operable - Judgment; <input type="checkbox"/> Inoperable	
6. Identify any Limitations, Long Term Actions and/or Compensatory Measures to maintain Operability: <input type="checkbox"/> N/A <input type="checkbox"/> Yes (List WO, CA, tracking no., etc.) See attached.	
Approvals:	
Prepared By (Name/Date): <u>E Anderson / F Weinert / M Kempski</u>	
Additional Reviews (Assign thru CA Process) By (Name/Date): <u>J Raffaele</u> CA No. <u>2</u> 6/28/06	
Additional Reviews (Assign thru CA Process) By (Name/Date): <u>(via telecon)</u> CA No. <u>6/28/06</u>	
Engineering Manager Approval By (Complete only if not entered in PCRS) (Print/Sign/Date) _____	
Shift Manager (Complete only if not entered in PCRS) (Print/Sign/Date) _____	
Send a copy of the Operability Evaluation to the System Engineer for use in the System Health Report.	
(Attach additional pages as necessary)	

	NUCLEAR MANAGEMENT MANUAL	QUALITY RELATED	EN-OP-104	REV. 1
		INFORMATIONAL USE	PAGE 23 OF 41	
Operability Determinations				

BASIS FOR OPERABILITY

1. Summary Statements

Component: Emergency Diesel Generators (EDG's) 21, 22 and 23

Component Safety Function: The Emergency Diesel Generators (EDG's) are designed to provide reliable power to the plant safeguards components during Design Basis Accident (DBA) conditions concurrent with a Loss of Offsite Power (LOOP) Event.

Basis for Operability:

The EDG's are operable based on a detailed review of past and present Technical Specification surveillance, preventative maintenance and post work testing as well as analytical considerations as follows:

ENGINE:

For the diesel engine, a review of the Engine PM's and Engine Signature Analysis (ESA) and recent surveillance and post work testing shows that the mechanical parameters / capability of the EDG's remain essentially unchanged since Outage 2R15. Starting with Outage 2R15, the governors on all three EDG's were replaced. Post work tests were performed on all three EDG's; however, EDG 21's governor was not fully tested to the maximum required 2300kW output of the engine. This test was subsequently performed and resulted in the inability of EDG 21 to reach its required kW output. This was documented in a Condition Report and follow-up engine adjustments and testing corrected the condition and EDG 21 was able to reach its maximum required kW output. Accordingly, all three EDG's, at present, would meet the required horsepower demand to sustain operation at 2300kW.

GENERATOR / EXCITER:

The basis for showing generator kVA (Total Power) capability is the 8 hour EDG load tests (References 9, 10 and 11) that were performed during Outage 2R15, November of 2002. These tests demonstrate compliance with the TS Surveillance Requirements that were part of the original Custom Technical Specifications (CTS) prior to implementing the Improved Technical Specifications (ITS).

No significant changes have been made to the safeguards bus loading that the generators supply, the accident loading analysis and its basis has not been modified and no physical changes have been made to the generator itself.

In consideration of the exciter, the most recent 8 hour EDG load tests (References 1, 2 and 3), that were performed during Outage 2R17, were

	NUCLEAR MANAGEMENT MANUAL	QUALITY RELATED	EN-OP-104	REV. 1
		INFORMATIONAL USE	PAGE 23 OF 41	
Operability Determinations				

reviewed to verify that no equipment or component degradation has occurred since the Outage 2R15 testing was performed. Also, the rated continuous load test data from the 8 hour EDG load tests from Outage 2R15 were compared to the same continuous load test data from the Outage 2R17 tests for each generator. There were no significant differences noted in the generator / exciter parameter data for any of the generators when reviewing the tests individually and when comparing between the two sets of test data. This provides a reasonable assurance that the performance of the generator / exciter remains consistent and acceptable up to the present time.

2. References

1. IP2 Procedure 2-PT-R084A, Revision 8, 21 EDG 8 Hour Load Test (As performed on April 27, 2006)
2. IP2 Procedure 2-PT-R084B, Revision 8, 22 EDG 8 Hour Load Test (As performed on May 4, 2006)
3. IP2 Procedure 2-PT-R084C, Revision 7, 23 EDG 8 Hour Load Test (As performed on April 20, 2006)
4. Calculation FEX-00039-02, Revision 2, Emergency Diesel Generator Loading Study, (WCAP – 12655)
5. Calculation FEX-00143-01, Revision 1, IP2 Load Flow Analysis of the Electrical Distribution System
6. Attachments 1 through 3 - Calculated DBA Load Power Factor and kVA Load for EDG's 21, 22 and 23 respectively & Operator Hourly Log Data from Outage 2R17 Tests (References 1 through 3 above)
7. IEEE Std 387 – 1995 – IEEE Standard Criteria for Diesel-Generator Units Applied as Standby Power Supplies for Nuclear Power Generating Stations
8. USNRC Regulatory Guide 1.9, Revision 3 - Selection, Design, Qualification, and Testing of Emergency Diesel Generator Units used as Class 1E Onsite Electric Power Systems at Nuclear Power Plants
9. IP2 Procedure PT-R84A, Revision 2, 21 EDG 8 Hour Load Test (As performed on November 18, 2002)
10. IP2 Procedure PT-R84B, Revision 1, 22 EDG 8 Hour Load Test (As performed on November 19, 2002)
11. IP2 Procedure PT-R84C, Revision 2, 23 EDG 8 Hour Load Test (As performed on November 17, 2002)
12. EDG 22 PWT – WO IP2-06-20099 for 2-SOP-27-3.1.2
13. EDG 23 PWT – WO IP2-02-33712 for 2PT-R084B
14. EDG 21 PWT – 2PT-M21A
15. Mechanical Modification MMM-89-03369P, "EDG Upgrades"
16. EDG 21 WO IP2-06-24143 – EDG 21 Troubleshooting
17. Westinghouse Memorandum NATD-IC-90-52 dated October 23, 1990 regarding IP2 generator ratings (Attachment 8)

	NUCLEAR MANAGEMENT MANUAL	QUALITY RELATED	EN-OP-104	REV. 1
		INFORMATIONAL USE	PAGE 23 OF 41	
Operability Determinations				

- 18. Calculation EGE-00016-00, Revision 0, "EDG – Basler Exciter Test Report"
- 19. Calculation FEX-00152-00, Revision 0, "EDG Generator Ratings Analysis"

3. Detailed Problem Statements

IP2 Technical Specification Surveillance Requirement (TS SR) 3.8.1.10 is an 8-hour endurance run for each of the three diesel generators (EDG's) performed at a refueling interval. Entergy has been notified by NRC that the intent of this TS SR is to bound the DBA load profile. The load ranges specified in the TS SR for test acceptance criteria do not fully bound the DBA load profile.

4. Assumptions

There are no assumptions applied to this Operability Evaluation.

5. Engineering Evaluation

GENERAL INFORMATION AND DATA:

IP2 TS SR 3.8.1.10 is an 8-hour endurance run for each of the three diesel generators (EDG's) needed to be performed at each refueling interval. At present, the TS SR is to test each EDG at a power factor ≤ 0.85 for ≥ 8 hours at the following load values:

TABLE 1 – TS SR Test Values

- 1. For ≥ 2 hours at ≥ 1837 kW and ≤ 1925 kW
- 2. For the remaining test duration at ≥ 1575 kW and ≤ 1750 kW

The above test values are derived from the requirements of Reference 7 and 8, which contain the nuclear industry utilized basis for the application and testing of EDG's. Each IP2 EDG has a capability of 1750 kW (continuous), 2100 kW for two hours in any 24 hour period and 2300 kW for a half hour in any 24 hour period per Reference 15. There is a sequential limitation whereby it is unacceptable to operate an EDG for two hours at 2100 kW followed by operation at 2300 kW for a half hour. Any other combination of these ratings is acceptable.

Entergy has been notified by the NRC that the intent of this TS SR is to bound the DBA load profile and that the above Table 1 test values are non-conservative. The load ranges specified in the TS SR for test acceptance criteria do not fully bound the DBA load profile. The purpose of this Operability Evaluation is to show that when considering the results of past and present EDG testing, including engineering analysis of the associated recorded data, that the

	NUCLEAR MANAGEMENT MANUAL	QUALITY RELATED	EN-OP-104	REV. 1
		INFORMATIONAL USE	PAGE 23 OF 41	
Operability Determinations				

EDG's are capable of supplying power to safeguards components based on calculated worst case DBA loading requirements.

Reference 4 evaluates various EDG DBA load configurations including the assumed loss of one EDG. Reference 4 is the basis for the DBA load profile. The worst case peak loading kW, for each EDG, is as follows:

TABLE 2 – Peak EDG DBA Loading

1. EDG 21 – 2268kW Recirculation Switch Sequence at T= 42 minutes with the Loss of EDG 23 assumed. Reference 4, Table 5.5-2a
2. EDG 22 – 2076kW Recirculation Switch Sequence at T = 40 minutes with the Loss of EDG 23 assumed. Reference 4, Table 5.5-2b
3. EDG 23 – 2194kW Recirculation Switch Sequence at T = 37 minutes with the Loss of EDG 21 assumed. Reference 4, Table 5.3-2b

(NOTE: Reference 4 includes a SBLOCA Scenario Load Profile which exceeds the peak kW values shown in Table 2 above. However, the scenario is extremely conservative with composite failures evaluated. In an extreme situation the load can approach the 2300kW limit. However, generally the small LOCA loads will be bounded by the large LOCA loads.)

References 1 through 3 are the EDG test procedures performed during Outage 2R17 for the purpose of satisfying the IP2 TS SR to demonstrate that the EDG's can operate at load values that simulate, as far as practical, the worst case DBA loading conditions. Test results are shown in the Operator Hourly Log Data included in Attachments 1 through 3 of this OE. These tests are run approximately every two years during scheduled Refueling Outages. During the performance of these tests Operations Personnel had difficulty reaching the required load test parameters, including maintaining power factor ≤ 0.85 for the duration of the test without exceeding generator parameters. The limiting generator parameters include generator output voltage and field current. The limitations are reached primarily because the EDG's are tested in parallel with the offsite power source (grid) and it is recognized that in order to get an EDG paralleled to the grid to assume more test load, including beyond its nominal continuous load rating, that it has to be operated at higher generator output voltages and field currents in order to push load flow through the grid. Further, since IP2's EDG's operate on the 480V system, which is downstream of the plant's 6.9kV System, there is the added complication that the EDG's must push load flow through the 6.9kV system as well.

ENGINE OPERABILITY EVALUATION:

In order to demonstrate the ability of the EDG's to meet the worst case Table 2 DBA peak load, which occurs for EDG 21 with the loss of EDG 23 as shown above, System Engineering has evaluated the mechanical capability of the Unit 2 EDG's. System Engineering concludes that the EDG's are capable of achieving

	NUCLEAR MANAGEMENT MANUAL	QUALITY RELATED	EN-OP-104	REV. 1
		INFORMATIONAL USE	PAGE 23 OF 41	
Operability Determinations				

the required horsepower to develop a generator output of 2300kW. The basis for this conclusion is predicated on engineering judgment that has been substantiated by a review of the mechanical integrity of the diesel via Engine Signature Analysis, Preventative Maintenance (PM) schedule, and performed surveillance tests.

IPEC utilizes a condition based maintenance approach for the EDG's which combines periodic maintenance activities with Engine Signature Analysis (ESA) to insure the mechanical integrity of the diesel engines. The specifics of the ESA define the combustion and mechanical performance, as well as the material condition of the diesel. A review of the ESA's performed on EDG's 21, 22 and 23, since 2000 (2 year frequency), determined that the overall health, mechanical integrity, and combustion parameters remain unchanged and unchallenged. Minor tuning has been implemented which optimized the peak performance of the engine to maximize output and reduce engine vibrations and cylinder imbalance. Visual inspections (PM based) and vibration analysis (included with ESA) have determined the health of the turbocharger as sound. The diesels are characterized as having sound fuel and air delivery capability.

Review of the 8 Hour tests performed during 2R15 (References 9, 10 and 11) found that the diesels successfully completed the functional ½ Hour 2300kW test with additional thermal margin for turbocharger performance. Subsequent to 2R15, EDG work scope has been limited to PM activities which primarily focus on inspections and specific wear material/part replacement. Post work tests for the work performed have demonstrated satisfactory recovery of the diesels and are independent of maximum diesel loading. Mechanical governor replacement has been performed on all three diesels with output capability validated on EDG 22 by Reference 12 and EDG 23 by Reference 13. EDG 21's mechanical governor was replaced during 2R16 but was not cycled to 2300kW. This fact was identified during the preparation of the OE associated with CR-IP2-2006-3530. The OE identified an Immediate Action in Section 7 to test EDG 21 to 2300kW for 3 minutes to verify operation of the governor replacement similar to that performed for EDG's 22 and 23. This action was completed on June 16, 2006 via a Temporary Procedure Change to the normal monthly test procedure (Reference 14). The initial test run of EDG 21 resulted in a maximum output of 2250kW, which is less than the required 2300kW output and CR-IP2-2006-03691 was generated. Troubleshooting of the EDG governor and fuel delivery system was performed under Reference 16. The troubleshooting determined that the fuel delivery system was not optimized and adjustments were made. Subsequent to this work a second EDG 21 test to 2300kW was performed and resulted in satisfactory operation of the engine. Therefore, based on the above, there is no reason to suspect that EDG 21 will not achieve 2300 kW if required to do during accident conditions.

	NUCLEAR MANAGEMENT MANUAL	QUALITY RELATED	EN-OP-104	REV. 1
		INFORMATIONAL USE	PAGE 23 OF 41	
Operability Determinations				

System Engineering concludes, through review of the PM's, PWT's, Surveillances, and ESA that the mechanical parameters/capability of the EDG's performance remains unchanged since Outage 2R15. Accordingly, the EDG's would meet the required horsepower demand to sustain operation at 2300kW.

GENERATOR / EXCITER OPERABILITY EVALUATION:

Reference 4, the EDG Loading Study, determines the worst case accident loading on IP2's EDG's for various accident scenarios. However, this study only analyzes the required kW output of the EDG's and does not address the required generator output, which is measured in kVA. The generator output, in kVA, is the vector summation of the kW output and kVAR output. In order to assess the kVA output of the generators relative to the required accident values, it is necessary to determine the expected worst case accident kVAR output. To calculate the kVAR output, the overall power factor of the accident load must be determined first. The power factor calculation is shown in Attachments 1 through 3 of this Operability Evaluation. The power factor used for this calculation is associated with the worst case peak load as shown in Table 2 above using data from Reference 5, the IP2 Load Flow Analysis, and calculating the equivalent power factor during the worst case peak output. The specific loads that are considered in the power factor calculation are those loads "running" during the time the peak is reached. The power factor data is taken from motor test data sheets for the specific motors used in the calculation. For the purpose of determining power factor, the calculations only considered running loads 50kW and above and included all major safety related motors including Auxiliary Feedwater Pumps, Service Water Pumps, SI Pumps, RHR Pumps, Recirculation Pumps and Recirculation Fans. The remaining loads on the EDG's represent a mix of lighting, heating, battery charger and small motors, including MOV's and when considered together, would not significantly change the resulting power factor value. This power factor value is then used to calculate a worst case DBA peak kVAR. The worst case peak kVA is then calculated from the vector summation of the worst case peak kW and peak kVAR. It must be emphasized that the worst case peak DBA kVA load is based on the loss of one EDG, which is the assumed single failure for the accident loading analysis. The peak DBA loads used in this OE for all three EDG's occurs during the Recirculation Switch Sequence for duration of approximately one minute at the time points shown above in Table 2 with the loss of one EDG assumed. The peak DBA loads in Reference 4 for cases where all EDG's are available are significantly less than those with the loss of one EDG, including the loss of a single safety related pump on one EDG. The following table summarizes the results of Attachments 1 through 3:

TABLE 3 – Summary of Results

<u>EDG</u>	<u>Worst Case DBA Peak kVAR</u>	<u>Worst Case DBA Peak kVA</u>
21	1224 kVAR	2577 kVA
22	1177 kVAR	2386 kVA
23	1184 kVAR	2493 kVA

The capability of the generator to produce maximum required DBA kVA output, calculated above, can be found in the review of past surveillance tests. References 9, 10 and 11 are 8 hour EDG load tests that were performed during Outage 2R15 to demonstrate compliance with the TS Surveillance Requirements that were part of the original Custom Technical Specifications (CTS) prior to implementing the Improved Technical Specification (ITS). Attachment 4 is a comparison of the worst case DBA peak loading, calculated in Attachments 1 through 3, with this load test data. Referring to the attachment, for the DBA loading, the peak kW is the values listed in Table 2, the power factor is from Attachments 1 through 3 for the respective EDG, the peak kVAR is calculated from the power factor and the peak kW, the kVA is calculated from the peak kW and peak kVAR and the load current is calculated from the kVA for the nominal safeguards bus voltage (480V) and the tested EDG output voltages (494V and 504V). For the test loading, the test kW and test kVAR is from Step 7.4 of the test procedure for each EDG, the power factor and kVA are calculated from the test kW and kVAR, and the load current is calculated from the kVA for the nominal safeguards bus voltage (480V) and the tested EDG output voltages (494V and 504V). By comparing the DBA load data for kW, kVAR, kVA, pf, and Amps to the associated test data it is concluded that the EDG testing performed prior to the implementation of ITS bounded the worst case DBA peak loading. Of particular interest is the kVA output data which shows DBA required and tested kVA output significantly higher than the generator rated kVA output of 2188kVA. IP2 generators are capable of a continuous output of 2300kW, 480 volts at 0.8pf. This corresponds to a rated kVA output of 2875kVA. This rating is documented via a memorandum from Westinghouse included in this OE as Attachment 8. This provides additional supporting documentation that the EDG's are operable and capable of performing their DBA safety function.

When reviewing the exciter performance in the most recent 2R17 EDG testing (References 1, 2 and 3), it was noted that when checking the relationship of the EDG test data for AC current and AC volts with the test data for field current, that the field current was significantly higher than the expected value extrapolated from the Synchronous Generator V Curves, included in this OE as Attachment 5. Does the test result indicate potential generator degradation?

	NUCLEAR MANAGEMENT MANUAL	QUALITY RELATED	EN-OP-104	REV. 1
		INFORMATIONAL USE	PAGE 23 OF 41	
Operability Determinations				

The generator field current limits specified in the TS SR test procedures are derived from the Synchronous Generator V Curves (Attachment 5) and are based on the specified TS SR test kW output (See Table 1), power factor and the associated maximum output current. For the 2R17 tests, these values are shown below in Table 4.

Table 4 – Generator TS SR Field Current Limits

<u>TS SR Test kW</u>	<u>pf</u>	<u>Output Current</u>	<u>Field Current</u>
1750kW	0.8	2631A	112A
1925kW	0.8	2894A	114A

The output current and associated field current in the above table is based on a generator voltage of 480V.

Attachment 6 is data taken from the Operator Log for the test associated with EDG 22 (Reference 2). The particular data used in the test review was at Time = 1400 hours. Using this data from Attachment 6 for AC current of 2575 amps and power factor (pf) of 0.86, enter the V Curve at a Per Unit (PU) Stator Current of $2575A/2630A = 0.98$ PU. (Note: 1.0 PU Stator Current is equal to the generator rated output current or 2630A.) Move across the curve at 0.98 PU Stator Current, to an overexcited power factor equal to approximately 0.86 and then down to the PU Field Amps and the expected value is 1.9 PU or approximately 105 amps. (Note: 1.0 PU Field Amps is equal to 55 amps for the IP2 Generators.) Comparing this value from the V Curve with the recorded test value of 114A, shows that the generator field current was higher than indicated from the V Curve. The V Curve for the IP2 generators is based on a generator voltage equal to rated nameplate volts, which is 480 volts, and the field current is based on a power factor of 0.8 as shown in Table 4. The generator voltage (AC Volts) during the test was 494 volts as documented on Attachment 6. When the generator is operated in parallel mode with the grid, the field current may need to be varied through a wide range if the generator is required to maintain a near constant kW output while maintaining rated voltage. When it is necessary for the generator to assume a higher reactive load, for example during the higher output part of the test, it is necessary to raise the field current so that the generator takes on more reactive load from the system it is paralleled with. This is accomplished by raising the generator terminal voltage and monitoring the field current until the desired kVAR output is reached. (Note: Output voltage and field current adjustments have no impact on the kW output; this can only be varied by a change to the engine governor settings.)

	NUCLEAR MANAGEMENT MANUAL	QUALITY RELATED	EN-OP-104	REV. 1
		INFORMATIONAL USE	PAGE 23 OF 41	
Operability Determinations				

A check of the higher output voltage versus the generator field current can be performed by review of the generator "Saturation Curves" for the IP2 generators. These curves are included in Attachment 7. Saturation Curves are provided for "No Load Saturation" and "Full Load Saturation at 0 pf". An additional check point is provided for Full Load Saturation at 0.8 pf. The Saturation Curves show the relationship between generator output voltage (Line Volts) and Field Current (Field Amps). As generator output voltage increases for a constant load, the generator field current also increases. Using the test values for AC Volts, AC Current, and power factor shown in Attachment 7 at Time = 1400 hours and by interpolation of the Saturation Curve for these values, it can be shown that the expected generator field current is approximately 114A, which is consistent with the recorded data.

The exciter operation was evaluated as part of the EDG upgrade modification performed in the early 1990's. Reference 18 is the Basler exciter test report and this report concludes that the generator field current could be operated as high as 141 amps without exceeding the worst case exciter component temperature limits. Reference 19 provides a validation of the IP2 generator V Curves and this analysis shows that the expected field current values at 480V output and 0.8pf are 112 amps for 1750kW output, 124 amps for 2100kW output and 131 amps for 2300kW output. This demonstrates that the maximum expected field current value of 131 amps at the peak EDG kW loading of 2300kW is bounded by the Basler report test results and would not be exceeded by operation at the calculated DBA peak kW loading shown in Table 2.

As a final check of generator performance consistency, the rated continuous load test data from the Outage 2R15 tests were compared to the same continuous load test data from the Outage 2R17 tests for each generator. This data is summarized in Attachment 9. There were no significant differences noted in the generator parameter data for any of the generators when comparing between the two sets of test data. This provides a reasonable assurance that the performance of the generators, including the exciters, remains consistent and acceptable up to the present time.

6. Impact on Nuclear Safety

The EDG System provides reliable 480V emergency power of sufficient capacity to those plant auxiliaries required for accident mitigation and recovery. The EDG System is designed to have sufficient capacity and redundancy to provide 480V AC power to the ESF loads during a DBA. Any two of the three EDG's have sufficient capacity to start and run a fully loaded set of engineered safeguard equipment.

The 480V Switchgear Buses 2A, 3A, 5A or 6A are automatically powered from the onsite EDG's if offsite power is not available.

	NUCLEAR MANAGEMENT MANUAL	QUALITY RELATED	EN-OP-104	REV. 1
		INFORMATIONAL USE	PAGE 23 OF 41	
Operability Determinations				

The EDG's provide emergency power to 480V Switchgear Buses 5A, 2A, 3A and 6A via Supply Breakers 52/EG1, 52/EG2A, 52/EG2B and 52/EG3, respectively. Each EDG has a capability of 1750 kW (continuous), 2100 kW for two hours in any 24 hour period and 2300 kW for a half hour in any 24 hour period. There is a sequential limitation whereby it is unacceptable to operate an EDG for two hours at 2100 kW followed by operation at 2300 kW for a half hour. Any other combination of these ratings is acceptable. EDG 22 provides power to Buses 2A and 3A. EDG 21 and EDG 23 provide power to Bus 5A and 6A, respectively. Each EDG starts automatically on a Safety Injection (SI) signal or upon an undervoltage condition on its 480V switchgear bus. On a SI signal or upon undervoltage on any of the buses, the engines run at idle and can be connected to the de-energized buses by the operator from the Central Control Room (CCR). Upon blackout (loss of power to Bus 5A or 6A) plus a unit trip (with no SI), the EDG's will be automatically connected to the de-energized buses and are sequentially loaded. Any two of the three EDG's have sufficient capacity to start and run a fully loaded set of engineered safeguard equipment. The EDG's are capable of starting and load sequencing within 10 seconds after the initial start signal and have the capability of being fully loaded within 30 seconds.

Since the EDG's are considered operable there is no safety impact on the engineered safeguards equipment.

7. Immediate Actions

No further immediate actions are required.

Recently completed actions included testing EDG 21 to 2300 kW for 3 minutes during the scheduled EDG 21 monthly test. This test, which determined that additional engine adjustments were necessary, was documented in References 14, 16, and CR-IP2-2006-03691. The final testing performed via Reference 16 ultimately proved that the governor replacement on EDG 21 does not restrict the ability of the diesel engine to reach 2300 kW.

8. Long Term Actions

The long term actions will be determined upon completion of the Apparent Cause Evaluation's performed for CR-IP2-2006-03530, CR-IP2-2006-03685 associated with this OE and related CR-IP2-2006-03396.

9. Attachments

1. Attachment 1 - Calculated DBA Load Power Factor and kVA Load for EDG 21
2. Attachment 2 - Calculated DBA Load Power Factor and kVA Load for EDG 22

	NUCLEAR MANAGEMENT MANUAL	QUALITY RELATED	EN-OP-104	REV. 1
		INFORMATIONAL USE	PAGE 23 OF 41	
Operability Determinations				

3. Attachment 3 - Calculated DBA Load Power Factor and kVA Load for EDG 23
4. Attachment 4 – Comparison of DBA Peak Load and CTS EDG Load Testing
5. Attachment 5 – Synchronous Generator V- Curves for IP2 Generators
6. Attachment 6 – Operator Log Hourly Data for EDG 22 8 Hour Test Run on 5/4/06
7. Attachment 7 – IP2 Generator Saturation Curves
8. Attachment 8 – Westinghouse Memorandum on Generator Ratings
9. Attachment 9 – Comparison of Outage 2R15 and 2R17 8 Hour Continuous Rating Test Data

10. Review / Approval

Prepared by: *E Anderson / F Weinert / M Kemp* Date: 6/28/06
E Anderson / F Weinert / M Kempski

Reviewed by: *Joe Raffaele (VIA TELECON)* Date: 6/28/06
J Raffaele

Approved by: *S Petrosi* Date: 6/28/06
S Petrosi

CR-IP2-2006-03530 and 3685 Operability Evaluation
Attachment 1
Calculated DBA Load Power Factor and kVA Load for EDG 21

Load ID	kW	PF	Calculated kVA	Calculated kVAR
SI Pump 21	345	0.910	379.12	157.18
CS Pump 21	350	0.906	386.31	163.51
CR Fan 21	223	0.850	262.35	138.20
CR Fan 22	223	0.850	262.35	138.20
RC Pump 21	294	0.874	336.38	163.45
ESW Pp 24	282	0.885	318.64	148.35
NSW Pp 21	282	0.885	318.64	148.35
IAC 21	56	0.830	67.47	37.63

Total = 2055 kW 1094.87 kVAR
 Calculated PF = 0.88

EDG Worst Case DBA Peak kW = 2268 kW
 EDG Worst Case DBA Peak kVAR = 1224 kVAR
 EDG Worst Case DBA Peak kVA = 2577 kVA

Remarks:

EDG Worst Case Peak kW = This is based on Westinghouse EDG Loading Study, FEX-00039-02, Table 5.5-2a @ T=42 minutes
 EDG Worst Case DBA Peak kVAR = (EDG DBA Peak kW) X (Tan (Acos(Calculated PF)))
 EDG Worst Case DBA Peak kVA = Vector Sum of Peak kW and Peak kVAR
 PF = Power factor based on motor data sheets (Reference 5)

CR-IP2-2006-03530 and 3685 OE

EDG 21 Operator Log Data

2R17 8 Hour Test 2-PT-R084A Performed 4/27/06

Time	16:00	17:00	18:00	19:00	20:00	21:00	22:00	23:00	0:00
Field Current (A)	94	94	95	108	108	108	108	114	114
AC Current (A)	2010	2010	2010	2300	2400	2350	2300	2530	2500
AC Volts (V)	494	494	494	494	494	494	494	501	500
kW	1650	1650	1650	1690	1740	1730	1650	1900	1900
kVAR	625	625	690	1125	1190	1140	1150	1250	1300
kVA	1764.4	1764.4	1788.5	2030.2	2108.0	2071.8	2011.2	2274.3	2302.2
pf	0.935	0.935	0.923	0.832	0.825	0.835	0.820	0.835	0.825

CR-IP2-2006-03530 and 3685 OE

EDG 22 Operator Log Data

2R17 8 Hour Test 2-PT-R084B Performed 5/4/06

Time	6:00	7:00	8:00	9:00	10:00	11:00	12:00	13:00	14:00
Field Current (A)	112	103	107	108	108	110	109	114	114
AC Current (A)	2450	2250	2300	2300	2350	2400	2400	2550	2575
AC Volts (V)	494	494	494	494	494	494	494	496	494
kW	1750	1750	1725	1700	1740	1725	1750	1850	1870
kVAR	1150	850	1000	1025	1000	1100	1020	1100	1100
kVA	2094.0	1945.5	1993.9	1985.1	2006.9	2045.9	2025.6	2152.3	2169.5
pf	0.836	0.900	0.865	0.856	0.867	0.843	0.864	0.860	0.862

CR-IP2-2006-03530 and 3685 Operability Evaluation
Attachment 3
Calculated DBA Load Power Factor and kVA Load for EDG 23

Load ID	kW	PF	Calculated kVA	Calculated kVAR
SI Pump 23	345	0.910	379.12	157.18
CS Pump 22	350	0.906	386.31	163.51
AFW Pump 23	223	0.840	265.48	144.05
CR Fan 25	223	0.850	262.35	138.20
RC Pump 22	294	0.874	336.38	163.45
ESW Pump 26	282	0.885	318.64	148.35
NSW Pump 23	282	0.885	318.64	148.35

Total = 1999 kW 1063.09 kVAR
 Calculated PF = 0.88

EDG Worst Case DBA Peak kW = 2194 kW
 EDG Worst Case DBA Peak kVAR = 1184 kVAR
 EDG Worst Case DBA Peak kVA = 2493 kVA

Remarks:
 EDG Worst Case Peak kW = This is based on Westinghouse EDG Loading Study, FEX-00039-02, Table 5.3-2b @ T=37 minutes
 EDG Worst Case DBA Peak kVAR = (EDG DBA Peak kW) X (Tan (Acos(Calculated PF)))
 EDG Worst Case DBA Peak kVA = Vector Sum of Peak kW and Peak kVAR
 PF = Power factor based on motor data sheets (Reference 5)

CR-IP2-2006-03530 and 3685 OE

EDG 23 Operator Log Data

2R17 8 Hour Test 2-PT-R084C Performed 4/20/06

Time	3:00	4:00	5:00	6:00	7:00	8:00	9:00	10:00	11:00
Field Current (A)	108	105	105	105	110	107	114	114	114
AC Current (A)	2225	2200	2220	2350	2330	2300	2530	2550	2510
AC Volts (V)	494	494	494	494	494	494	500	499	499
kW	1650	1675	1720	1750	1725	1740	1900	1900	1898
kVAR	1025	925	925	990	1100	1060	1200	1200	1195
kVA	1942.5	1913.4	1953.0	2010.6	2045.9	2037.4	2247.2	2247.2	2242.9
pf	0.849	0.875	0.881	0.870	0.843	0.854	0.845	0.845	0.846

CR-IP2-2006-03530 and 3685 Operability Evaluation

Attachment 4

Comparison of DBA Peak Load and CTS EDG Load Testing

EDG	Peak kW	Peak kVAR	pf	kVA	Amps (480V)	Amps (494V)	Amps (504V)
21	2268	1224	0.88	2577	3100	3012	2952
22	2076	1177	0.87	2386	2870	2789	2734
23	2194	1184	0.88	2493	2999	2914	2856
EDG	Test kW	Test kVAR	pf	kVA	Amps (480V)	Amps (494V)	Amps (504V)
21	2300	1280	0.87	2632	3166	3076	3015
22	2300	1400	0.85	2693	3239	3147	3085
23	2300	1300	0.87	2642	3178	3088	3027

CR-IP2 - 2006-03530/3685 DE

ATTACHMENT 5

SYNCHRONOUS GENERATOR V-CURVES

(1750KW)

2188 KVA 480 VOLTS 3 PHASE 60 HZ
0.80 PF 2630 AMPS 8 POLES 900 RPM

S.O. GENERATOR G.O. OR

CUST. ORDER ENGINEER PERTTULA

CUSTOMER CONSOLIDATED EDISON

1 P.U. STATOR CURRENT = 2630 AMPS

1 P.U. FIELD CURRENT = 55 AMPS

1 P.U. LOAD = 1750 KW

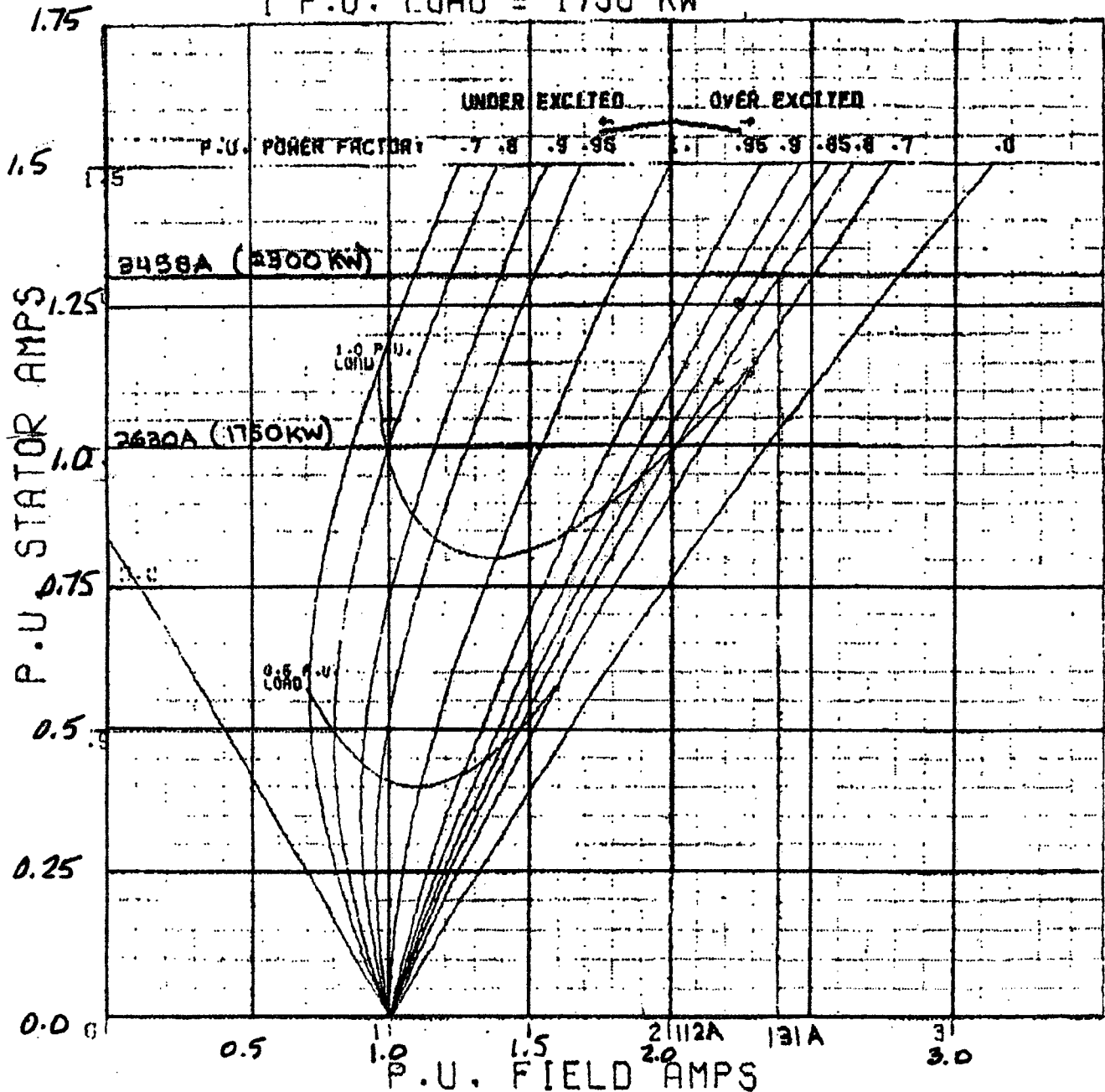

WESTINGHOUSE ELECTRIC CORPORATION - HINDS POINT, TEXAS

CR-IP2-2006-03530 and 3685 OE

EDG 22 Operator Log Data

2R17 8 Hour Test 2-PT-R084B Performed 5/4/06

Time	6:00	7:00	8:00	9:00	10:00	11:00	12:00	13:00	14:00
Field Current (A)	112	103	107	108	108	110	109	114	114
AC Current (A)	2450	2250	2300	2300	2350	2400	2400	2550	2575
AC Volts (V)	494	494	494	494	494	494	494	496	494
kW	1750	1750	1725	1700	1740	1725	1750	1850	1870
kVAR	1150	850	1000	1025	1000	1100	1020	1100	1100
kVA	2094.0	1945.5	1993.9	1985.1	2006.9	2045.9	2025.6	2152.3	2169.5
pf	0.836	0.900	0.865	0.856	0.867	0.843	0.864	0.860	0.862

CR-IP2-2006-03530/3685 OE

ATTACHMENT 7

CURVE NO. G27597

FR. NO. 8-51 X R2 TYPE GF Synch. Gen
2188 KVA 480 Volts 2630 Amps
3 Phase 60 Cycles 900 R.P.M.

444V

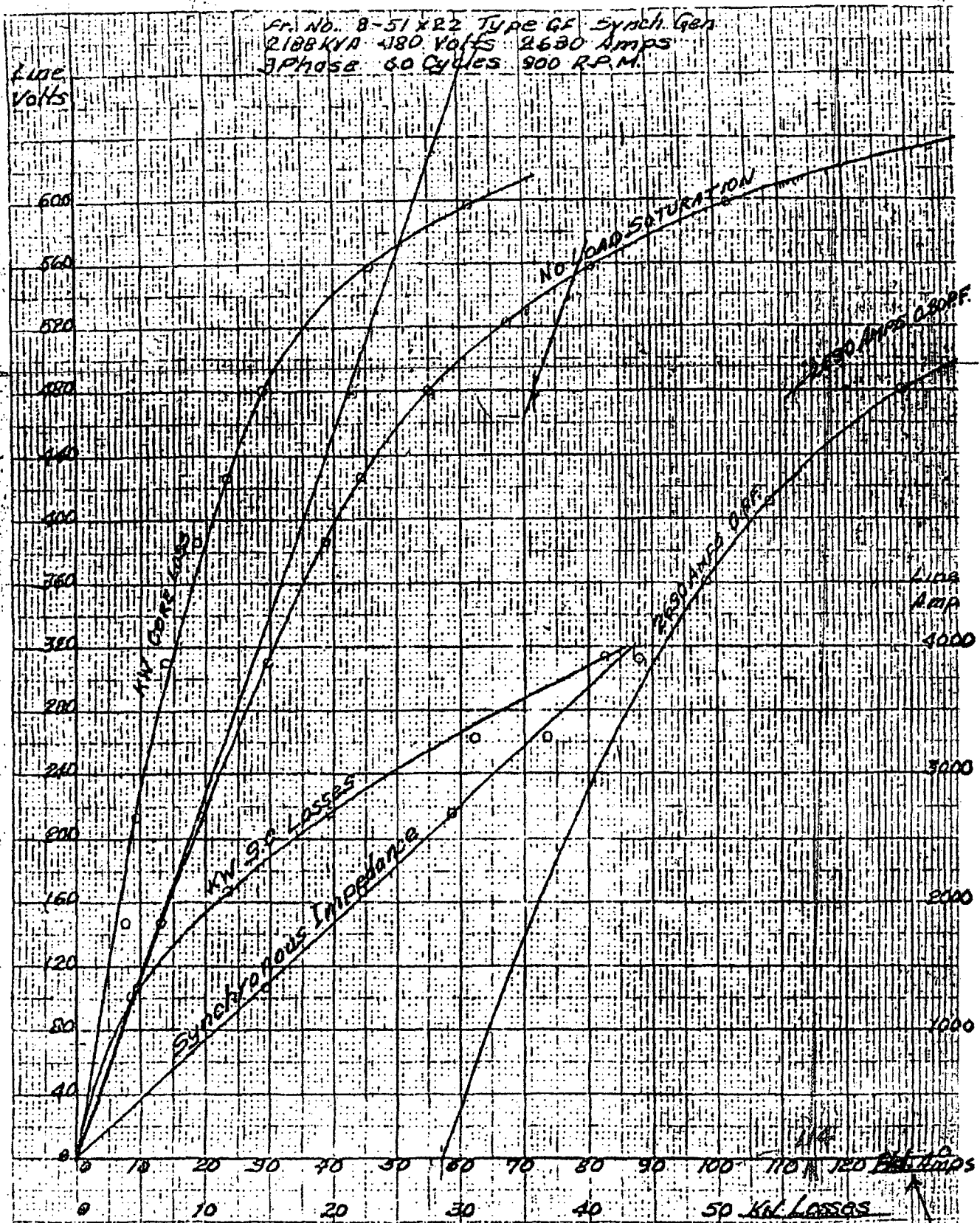

INDIAN POINT NO. 2 DIESEL GENERATORS

S.O. TAPUA

SERIES 2R TAPUA

D-828178

PAGE 1 OF 1

FIELD AMPS

JMA



FEX-0015Z-00
ATTCH. 3
Page 1 of 5

Westinghouse
Electric Corporation

Energy Systems

Nuclear and Advanced
Technology Division

Box 355
Pittsburgh Pennsylvania 15230-0355

NAED-IC-90-52

October 23, 1990

Mr. John A. Basile, General Manager
Special Nuclear Projects
Consolidated Edison Company of New York, Inc.
Broadway & Eleakley Avenues
Buchanan, NY 10511

WESTINGHOUSE MOTOR COMPANY
ENGINEERING REPORT
WMC-EER-90-005

Dear Mr. Basile:

Enclosed for your information is the completed study on the re-rating of the Indian Point 2 generators for the emergency diesel generators. The conclusions of the report are that the generators are capable of continuous operation at 2300 KW, 480 volts at a 0.8 power factor.

If you have further questions or comments, please advise.

Sincerely,

W. C. Leslie, Manager
Installation & Construction Services

Enclosure

CC: G. Blenkle
P. Duggan
A. De Donato
J. Curry
R. Williams
H. Sager
C. Jackson

CR-IP2-2006-03530 #3685 OE
ATTACHMENT 8
PAGE 1 OF 1

**CR-IP2-2006-03530 and 3685 Operability Evaluation
Attachment 9**

Comparison of Outage 2R15 and 2R17 8 Hour Continuous Test Data

2R15 Test Data							
EDG	kW	kVAR	pf	kVA	Generator Volts	Field Amps	AC Amps
21	1750	1190	0.83	2116.3	491.0	112.0	2500.0
22	1750	1250	0.81	2150.6	494.0	107.0	2500.0
23	1750	1200	0.82	2121.9	490.0	112.0	2500.0
2R17 Test Data							
EDG	kW	kVAR	pf	kVA	Generator Volts	Field Amps	AC Amps
21	1740	1190	0.83	2108.0	494.0	108.0	2400.0
22	1750	1150	0.84	2094.0	494.0	112.0	2450.0
23	1725	1100	0.84	2045.9	494.0	110.0	2330.0