

Private Fuel Storage L.L.C.

Safety Analysis Report

Private Fuel Storage Facility

Docket No. 72-22

**Skull Valley Indian Reservation
Tooele County, Utah**

DOCUMENT CONTROL

PAGE	REVISION
Document Control Tab	
a	0
b	0
c	0
d	0
e	0
f	0
g	0
h	0
i	0
j	0
k	0
l	0
m	0
n	0
o	0
p	0
q	0
r	0
s	0
t	0
Table of Contents Tab	
i	0
ii	0
iii	0
iv	0
Chapter 1 Tab	
1-i	0
1-ii	0
1.1-1	0
1.1-2	0
1.1-3	0
1.1-4	0
1.2-1	0
1.2-2	0
1.3-1	0
1.3-2	0
1.3-3	0
1.3-4	0
1.4-1	0
1.4-2	0
1.5-1	0

DOCUMENT CONTROL

PAGE	REVISION
1.5-2	0
1.6-1	0
1.6-2	0
1.7-1	0
1.7-2	0
Figure 1.1-1	0
Figure 1.1-2	0
Figure 1.2-1	0
Figure 1.3-1	0
Figure 1.3-2	0
Chapter 2 Tab	
2-i	0
2-ii	0
2-iii	0
2-iv	0
2-v	0
2-vi	0
2-vii	0
2-viii	0
2-ix	0
2-x	0
2.1-1	0
2.1-2	0
2.1-3	0
2.1-4	0
2.1-5	0
2.1-6	0
2.2-1	0
2.2-2	0
2.2-3	0
2.2-4	0
2.3-1	0
2.3-2	0
2.3-3	0
2.3-4	0
2.3-5	0
2.3-6	0
2.3-7	0
2.3-8	0
2.3-9	0
2.3-10	0
2.3-11	0
2.3-12	0

DOCUMENT CONTROL

PAGE	REVISION
2.3-13	0
2.3-14	0
2.3-15	0
2.3-16	0
2.3-17	0
2.3-18	0
2.3-19	0
2.3-20	0
2.4-1	0
2.4-2	0
2.4-3	0
2.4-4	0
2.4-5	0
2.4-6	0
2.4-7	0
2.4-8	0
2.4-9	0
2.4-10	0
2.4-11	0
2.4-12	0
2.4-13	0
2.4-14	0
2.5-1	0
2.5-2	0
2.5-3	0
2.5-4	0
2.5-5	0
2.5-6	0
2.6-1	0
2.6-2	0
2.6-3	0
2.6-4	0
2.6-5	0
2.6-6	0
2.6-7	0
2.6-8	0
2.6-9	0
2.6-10	0
2.6-11	0
2.6-12	0
2.6-13	0
2.6-14	0
2.6-15	0
2.6-16	0

DOCUMENT CONTROL

PAGE	REVISION
2.6-17	0
2.6-18	0
2.6-19	0
2.6-20	0
2.6-21	0
2.6-22	0
2.6-23	0
2.6-24	0
2.6-25	0
2.6-26	0
2.6-27	0
2.6-28	0
2.6-29	0
2.6-30	0
2.6-31	0
2.6-32	0
2.6-33	0
2.6-34	0
2.6-35	0
2.6-36	0
2.6-37	0
2.6-38	0
2.6-39	0
2.6-40	0
2.6-41	0
2.6-42	0
2.7-1	0
2.7-2	0
2.8-1	0
2.8-2	0
2.8-3	0
2.8-4	0
2.8-5	0
2.8-6	0
2.8-7	0
2.8-8	0
2.8-9	0
2.8-10	0
Table 2.3-1	0
Table 2.3-2	0
Table 2.3-3	0
Table 2.3-4	0
Table 2.3-5	0
Table 2.3-6	0

DOCUMENT CONTROL

PAGE	REVISION
Table 2.3-7	0
Table 2.3-8	0
Table 2.3-9	0
Table 2.3-10	0
Table 2.6-1	0
Table 2.6-2	0
Table 2.6-3	0
Table 2.6-4 (1 of 14)	0
Table 2.6-4 (2 of 14)	0
Table 2.6-4 (3 of 14)	0
Table 2.6-4 (4 of 14)	0
Table 2.6-4 (5 of 14)	0
Table 2.6-4 (6 of 14)	0
Table 2.6-4 (7 of 14)	0
Table 2.6-4 (8 of 14)	0
Table 2.6-4 (9 of 14)	0
Table 2.6-4 (10 of 14)	0
Table 2.6-4 (11 of 14)	0
Table 2.6-4 (12 of 14)	0
Table 2.6-4 (13 of 14)	0
Table 2.6-4 (14 of 14)	0
Figure 2.1-1	0
Figure 2.1-2 (1 of 2)	0
Figure 2.1-2 (2 of 2)	0
Figure 2.3-1	0
Figure 2.3-2	0
Figure 2.3-3	0
Figure 2.3-4	0
Figure 2.3-5	0
Figure 2.3-6	0
Figure 2.4-1	0
Figure 2.6-1	0
Figure 2.6-2 (1 of 2)	0
Figure 2.6-2 (2 of 2)	0
Figure 2.6-3	0
Figure 2.6-4	0
Figure 2.6-5	0
Figure 2.6-6	0
Figure 2.6-7	0
Figure 2.6-8	0
Figure 2.6-9	0
Figure 2.6-10	0
Figure 2.6-11	0
Figure 2.6-12	0

DOCUMENT CONTROL

PAGE	REVISION
Figure 2.6-13	0
Figure 2.6-14	0
Figure 2.6-15	0
Figure 2.6-16	0
Appendix 2A Tab	
Report	0
Appendix 2B Tab	
Survey	0
Appendix 2C Tab	
Analysis	0
Appendix 2D Tab	
Analysis	0
Appendix 2E Tab	
Analysis	0
Chapter 3 Tab	
3-i	0
3-ii	0
3-iii	0
3-iv	0
3-v	0
3-vi	0
3.1-1	0
3.1-2	0
3.1-3	0
3.1-4	0
3.1-5	0
3.1-6	0
3.2-1	0
3.2-2	0
3.2-3	0
3.2-4	0
3.2-5	0
3.2-6	0

DOCUMENT CONTROL

PAGE	REVISION
3.2-7	0
3.2-8	0
3.2-9	0
3.2-10	0
3.2-11	0
3.2-12	0
3.2-13	0
3.2-14	0
3.2-15	0
3.2-16	0
3.2-17	0
3.2-18	0
3.2-19	0
3.2-20	0
3.2-21	0
3.2-22	0
3.2-23	0
3.2-24	0
3.2-25	0
3.2-26	0
3.2-27	0
3.2-28	0
3.2-29	0
3.2-30	0
3.2-31	0
3.2-32	0
3.3-1	0
3.3-2	0
3.3-3	0
3.3-4	0
3.3-5	0
3.3-6	0
3.3-7	0
3.3-8	0
3.3-9	0
3.3-10	0
3.3-11	0
3.3-12	0
3.4-1	0
3.4-2	0
3.4-3	0
3.4-4	0
3.4-5	0
3.4-6	0

DOCUMENT CONTROL

PAGE	REVISION
3.5-1	0
3.5-2	0
3.6-1	0
3.6-2	0
3.7-1	0
3.7-2	0
3.7-3	0
3.7-4	0
Table 3.1-1	0
Table 3.1-2	0
Table 3.1-3 (1 of 2)	0
Table 3.1-3 (2 of 2)	0
Table 3.2-1	0
Table 3.2-2	0
Table 3.2-3	0
Table 3.4-1	0
Table 3.6-1 (1 of 5)	0
Table 3.6-1 (2 of 5)	0
Table 3.6-1 (3 of 5)	0
Table 3.6-1 (4 of 5)	0
Table 3.6-1 (5 of 5)	0
Chapter 4 Tab	
4-i	0
4-ii	0
4-iii	0
4-iv	0
4-v	0
4-vi	0
4-vii	0
4-viii	0
4-ix	0
4-x	0
4.1-1	0
4.1-2	0
4.1-3	0
4.1-4	0
4.2-1	0
4.2-2	0
4.2-3	0
4.2-4	0
4.2-5	0
4.2-6	0
4.2-7	0

DOCUMENT CONTROL

PAGE	REVISION
4.2-8	0
4.2-9	0
4.2-10	0
4.2-11	0
4.2-12	0
4.2-13	0
4.2-14	0
4.2-15	0
4.2-16	0
4.2-17	0
4.2-18	0
4.2-19	0
4.2-20	0
4.2-21	0
4.2-22	0
4.2-23	0
4.2-24	0
4.2-25	0
4.2-26	0
4.2-27	0
4.2-28	0
4.2-29	0
4.2-30	0
4.2-31	0
4.2-32	0
4.2-33	0
4.2-34	0
4.2-35	0
4.2-36	0
4.2-37	0
4.2-38	0
4.2-39	0
4.2-40	0
4.2-41	0
4.2-42	0
4.2-43	0
4.2-44	0
4.2-45	0
4.2-46	0
4.2-47	0
4.2-48	0
4.3-1	0
4.3-2	0
4.3-3	0

DOCUMENT CONTROL

PAGE	REVISION
4.3-4	0
4.3-5	0
4.3-6	0
4.3-7	0
4.3-8	0
4.4-1	0
4.4-2	0
4.5-1	0
4.5-2	0
4.5-3	0
4.5-4	0
4.5-5	0
4.5-6	0
4.6-1	0
4.6-2	0
4.7-1	0
4.7-2	0
4.7-3	0
4.7-4	0
4.7-5	0
4.7-6	0
4.7-7	0
4.7-8	0
4.7-9	0
4.7-10	0
4.7-11	0
4.7-12	0
4.7-13	0
4.7-14	0
4.7-15	0
4.7-16	0
4.7-17	0
4.7-18	0
4.7-19	0
4.7-20	0
4.7-21	0
4.7-22	0
4.7-23	0
4.7-24	0
4.7-25	0
4.7-26	0
4.7-27	0
4.7-28	0
4.7-29	0

DOCUMENT CONTROL

PAGE	REVISION
4.7-30	0
4.7-31	0
4.7-32	0
4.8-1	0
4.8-2	0
4.8-3	0
4.8-4	0
4.8-5	0
4.8-6	0
Table 4.1-1 (1 of 7)	0
Table 4.1-1 (2 of 7)	0
Table 4.1-1 (3 of 7)	0
Table 4.1-1 (4 of 7)	0
Table 4.1-1 (5 of 7)	0
Table 4.1-1 (6 of 7)	0
Table 4.1-1 (7 of 7)	0
Table 4.2-1	0
Table 4.2-2	0
Table 4.2-3	0
Table 4.2-4	0
Table 4.2-5	0
Table 4.2-6	0
Table 4.2-7	0
Table 4.2-8	0
Table 4.7-1	0
Table 4.7-2	0
Table 4.7-3	0
Figure 4.1-1	0
Figure 4.1-2	0
Figure 4.1-3	0
Figure 4.1-4	0
Figure 4.2-1	0
Figure 4.2-2 (1 of 3)	0
Figure 4.2-2 (2 of 3)	0
Figure 4.2-2 (3 of 3)	0
Figure 4.2-3	0
Figure 4.2-4	0
Figure 4.2-5 (1 of 4)	0
Figure 4.2-5 (2 of 4)	0
Figure 4.2-5 (3 of 4)	0
Figure 4.2-5 (4 of 4)	0
Figure 4.2-6	0
Figure 4.2-7	0
Figure 4.2-8	0

DOCUMENT CONTROL

PAGE	REVISION
Figure 4.5-1	0
Figure 4.5-2	0
Figure 4.5-3	0
Figure 4.5-4	0
Figure 4.5-5	0
Figure 4.7-1 (1 of 3)	0
Figure 4.7-1 (2 of 3)	0
Figure 4.7-1 (3 of 3)	0
Figure 4.7-2	0
Figure 4.7-3	0
Figure 4.7-4	0
Chapter 5 Tab	
5-i	0
5-ii	0
5-iii	0
5-iv	0
5-v	0
5-vi	0
5.1-1	0
5.1-2	0
5.1-3	0
5.1-4	0
5.1-5	0
5.1-6	0
5.1-7	0
5.1-8	0
5.1-9	0
5.1-10	0
5.2-1	0
5.2-2	0
5.2-3	0
5.2-4	0
5.2-5	0
5.2-6	0
5.3-1	0
5.3-2	0
5.4-1	0
5.4-2	0
5.5-1	0
5.5-2	0
5.6-1	0
5.6-2	0
5.7-1	0

DOCUMENT CONTROL

PAGE	REVISION
5.7-2	0
Table 5.1-1 (1 of 2)	0
Table 5.1-1 (2 of 2)	0
Table 5.1-2 (1 of 2)	0
Table 5.1-2 (2 of 2)	0
Figure 5.1-1	0
Figure 5.1-2	0
Figure 5.1-3	0
Figure 5.1-4	0
Figure 5.1-5	0
Chapter 6 Tab	
6-i	0
6-ii	0
6.1-1	0
6-1-2	0
6.2-1	0
6.2-2	0
6.3-1	0
6.3-2	0
6.4-1	0
6.4-2	0
6.5-1	0
6.5-2	0
6.6-1	0
6.6-2	0
Chapter 7 Tab	
7-i	0
7-ii	0
7-iii	0
7-iv	0
7-v	0
7-vi	0
7.1-1	0
7.1-2	0
7.1-3	0
7.1-4	0
7.1-5	0
7.1-6	0
7.1-7	0
7.1-8	0
7.1-9	0
7.1-10	0

DOCUMENT CONTROL

PAGE	REVISION
7.1-11	0
7.1-12	0
7.2-1	0
7.2-2	0
7.2-3	0
7.2-4	0
7.2-5	0
7.2-6	0
7.2-7	0
7.2-8	0
7.2-9	0
7.2-10	0
7.2-11	0
7.2-12	0
7.3-1	0
7.3-2	0
7.3-3	0
7.3-4	0
7.3-5	0
7.3-6	0
7.3-7	0
7.3-8	0
7.3-9	0
7.3-10	0
7.3-11	0
7.3-12	0
7.3-13	0
7.3-14	0
7.3-15	0
7.3-16	0
7.3-17	0
7.3-18	0
7.4-1	0
7.4-2	0
7.4-3	0
7.4-4	0
7.5-1	0
7.5-2	0
7.5-3	0
7.5-4	0
7.5-5	0
7.5-6	0
7.6-1	0
7.6-2	0

DOCUMENT CONTROL

PAGE	REVISION
7.6-3	0
7.6-4	0
7.7-1	0
7.7-2	0
7.7-3	0
7.7-4	0
Table 7.3-1	0
Table 7.3-2	0
Table 7.3-3	0
Table 7.3-4	0
Table 7.3-5	0
Table 7.3-6	0
Table 7.3-7	0
Table 7.3-8	0
Table 7.4-1 (1 of 4)	0
Table 7.4-1 (2 of 4)	0
Table 7.4-1 (3 of 4)	0
Table 7.4-1 (4 of 4)	0
Table 7.4-2 (1 of 4)	0
Table 7.4-2 (2 of 4)	0
Table 7.4-2 (3 of 4)	0
Table 7.4-2 (4 of 4)	0
Figure 7.3-1	0
Figure 7.3-2	0
Chapter 8 Tab	
8-i	0
8-ii	0
8-iii	0
8-iv	0
8-v	0
8-vi	0
8.1-1	0
8.1-2	0
8.1-3	0
8.1-4	0
8.1-5	0
8.1-6	0
8.1-7	0
8.1-8	0
8.1-9	0
8.1-10	0
8.1-11	0
8.1-12	0

DOCUMENT CONTROL

PAGE	REVISION
8.1-13	0
8.1-14	0
8.1-15	0
8.1-16	0
8.1-17	0
8.1-18	0
8.2-1	0
8.2-2	0
8.2-3	0
8.2-4	0
8.2-5	0
8.2-6	0
8.2-7	0
8.2-8	0
8.2-9	0
8.2-10	0
8.2-11	0
8.2-12	0
8.2-13	0
8.2-14	0
8.2-15	0
8.2-16	0
8.2-17	0
8.2-18	0
8.2-19	0
8.2-20	0
8.2-21	0
8.2-22	0
8.2-23	0
8.2-24	0
8.2-25	0
8.2-26	0
8.2-27	0
8.2-28	0
8.2-29	0
8.2-30	0
8.2-31	0
8.2-32	0
8.2-33	0
8.2-34	0
8.2-35	0
8.2-36	0
8.2-37	0
8.2-38	0

DOCUMENT CONTROL

PAGE	REVISION
8.2-39	0
8.2-40	0
8.2-41	0
8.2-42	0
8.2-43	0
8.2-44	0
8.2-45	0
8.2-46	0
8.2-47	0
8.2-48	0
8.2-49	0
8.2-50	0
8.3-1	0
8.3-2	0
8.4-1	0
8.4-2	0
8.4-3	0
8.4-4	0
Table 8.1-1	0
Table 8.1-2	0
Chapter 9 Tab	
9-i	0
9-ii	0
9-iii	0
9-iv	0
9-v	
9-vi	
9.1-1	0
9.1-2	0
9.1-3	0
9.1-4	0
9.1-5	0
9.1-6	0
9.1-7	0
9.1-8	0
9.1-9	0
9.1-10	0
9.1-11	0
9.1-12	0
9.1-13	0
9.1-14	0
9.1-15	0
9.1-16	0

DOCUMENT CONTROL

PAGE	REVISION
9.1-17	0
9.1-18	0
9.1-19	0
9.1-20	0
9.1-21	0
9.1-22	0
9.1-23	0
9.1-24	0
9.1-25	0
9.1-26	0
9.1-27	0
9.1-28	0
9.2-1	0
9.2-2	0
9.2-3	0
9.2-4	0
9.2-5	0
9.2-6	0
9.2-7	0
9.2-8	0
9.3-1	0
9.3-2	0
9.3-3	0
9.3-4	0
9.3-5	0
9.3-6	0
9.4-1	0
9.4-2	0
9.4-3	0
9.4-4	0
9.4-5	0
9.4-6	0
9.4-7	0
9.4-8	0
9.5-1	0
9.5-2	0
9.5-3	0
9.5-4	0
9.6-1	0
9.6-2	0
9.7-1	0
9.7-2	0
9.7-3	0
9.7-4	0

DOCUMENT CONTROL

PAGE	REVISION
Figure 9.1-1	0
Figure 9.1-2	0
Figure 9.1-3	0
Chapter 10 Tab	
10-i	0
10-ii	0
10.1-1	0
10.1-2	0
10.2-1	0
10.2-2	0
10.2-3	0
10.2-4	0
10.2-5	0
10.2-6	0
10.2-7	0
10.2-8	0
10.2-9	0
10.2-10	0
10.2-11	0
10.2-12	0
10.2-13	0
10.2-14	0
10.2-15	0
10.2-16	0
10.2-17	0
10.1-18	0
10.2-19	0
10.2-20	0
10.2-21	0
10.2-22	0
10.2-23	0
10.2-24	0
10.3-1	0
10.3-2	0
Chapter 11 Tab	
11-i	0
11-ii	0
11.1-1	0
11.1-2	0
11.1-3	0
11.1-4	0
11.1-5	0

DOCUMENT CONTROL

PAGE	REVISION
11.1-6	0
11.1-7	0
11.1-8	0
11.1-9	0
11.1-10	0
11.2-1	0
11.2-2	0

TABLE OF CONTENTS

CHAPTER 1 INTRODUCTION AND GENERAL DESCRIPTION OF FACILITY

- 1.1 Introduction
- 1.2 General Description of Facility
- 1.3 General Systems Description
- 1.4 Spent Fuel Transportation to the PFSF
- 1.5 Identification of Agents and Contractors
- 1.6 Material Incorporated by Reference
- 1.7 References

CHAPTER 2 SITE CHARACTERISTICS

- 2.1 Geography and Demography
- 2.2 Nearby Industrial, Transportation, and Military Facilities
- 2.3 Meteorology
- 2.4 Surface Hydrology
- 2.5 Subsurface Hydrology
- 2.6 Geology and Seismology
- 2.7 Summary of Site Conditions Affecting Construction And
Operating Requirements
- 2.8 References

Appendix 2A Geotechnical Data Report

Appendix 2B Seismic Survey of the Private Fuel Storage Facility

Appendix 2C Final Report of a Geomorphological Survey of
Surficial Lineaments North of Hickman Knolls,
Tooele County, Utah

Appendix 2D Deterministic Earthquake Ground Motions Analysis

Appendix 2E Analysis of Volcanic Ash

TABLE OF CONTENTS (cont.)

CHAPTER 3	<u>PRINCIPAL DESIGN CRITERIA</u>
	3.1 Purposes of Installation
	3.2 Structural and Mechanical Safety Criteria
	3.3 Safety Protection Systems
	3.4 Classification of Structures, Systems, and Components
	3.5 Decommissioning Considerations
	3.6 Summary of Design Criteria
	3.7 References
CHAPTER 4	<u>FACILITY DESIGN</u>
	4.1 Summary Description
	4.2 Storage Structures
	4.3 Auxiliary Systems
	4.4 Decontamination Systems
	4.5 Shipping Casks and Associated Components
	4.6 Cathodic Protection
	4.7 Spent Fuel Handling Operation Systems
	4.8 References
CHAPTER 5	<u>OPERATION SYSTEMS</u>
	5.1 Operation Description
	5.2 Spent Fuel Canister Handling Systems
	5.3 Other Operating Systems
	5.4 Operation Support Systems
	5.5 Control Room and Control Area
	5.6 Analytical Sampling
	5.7 References

TABLE OF CONTENTS (cont.)

CHAPTER 6	<u>SITE-GENERATED WASTE CONFINEMENT AND MANAGEMENT</u>
6.1	Onsite Waste Sources
6.2	Offgas Treatment and Ventilation
6.3	Liquid Waste Treatment and Retention
6.4	Solid Wastes
6.5	Radiological Impact of Normal Operations - Summary
6.6	References
CHAPTER 7	<u>RADIATION PROTECTION</u>
7.1	Ensuring that Occupational Radiation Exposures Are as Low as Reasonably Achievable (ALARA)
7.2	Radiation Sources
7.3	Radiation Protection Design Features
7.4	Estimated Onsite Collective Dose Assessment
7.5	Radiation Protection Program
7.6	Estimated Offsite Collective Dose Assessment
7.7	References
CHAPTER 8	<u>ACCIDENT ANALYSIS</u>
8.1	Off-normal Operations
8.2	Accidents
8.3	Site Characteristics Affecting Safety Analysis
8.4	References

TABLE OF CONTENTS (cont.)

CHAPTER 9	<u>CONDUCT OF OPERATIONS</u>
	9.1 Organizational Structure
	9.2 Pre-operational Testing and Operation
	9.3 Training Program
	9.4 Normal Operations
	9.5 Emergency Planning
	9.6 Decommissioning Plan
	9.7 Physical Security and Safeguards Contingency Plans
CHAPTER 10	<u>OPERATING CONTROLS AND LIMITS</u>
	10.1 Operating Controls and Limits
	10.2 Development of Operating Controls and Limits
	10.3 References
CHAPTER 11	<u>QUALITY ASSURANCE</u>
	11.1 QA Program Description
	11.2 References

CHAPTER 1

INTRODUCTION AND GENERAL DESCRIPTION OF FACILITY

TABLE OF CONTENTS

SECTION	TITLE	PAGE
1.1	INTRODUCTION	1.1-1
1.2	GENERAL DESCRIPTION OF FACILITY	1.2-1
1.3	GENERAL SYSTEMS DESCRIPTION	1.3-1
1.4	SPENT FUEL TRANSPORTATION TO THE PFSF	1.4-1
1.5	IDENTIFICATION OF AGENTS AND CONTRACTORS	1.5-1
1.6	MATERIAL INCORPORATED BY REFERENCE	1.6-1
1.7	REFERENCES	1.7-1

TABLE OF CONTENTS (cont.)

LIST OF FIGURES

FIGURE	TITLE
1.1-1	PFSF LOCATION
1.1-2	PFSF SITE PLAN
1.2-1	PFSF GENERAL ARRANGEMENT
1.3-1	HI-STORM 100 CASK SYSTEM COMPONENTS
1.3-2	TRANSTOR STORAGE CASK SYSTEM COMPONENTS

CHAPTER 1

INTRODUCTION AND GENERAL DESCRIPTION OF FACILITY

1.1 INTRODUCTION

Electric utilities operating nuclear power plants in the United States are rapidly reaching their maximum capacity for onsite storage of spent fuel. The Nuclear Waste Policy Act (NWPA) of 1982 mandated that the Department of Energy (DOE) was responsible for the permanent disposal of spent nuclear fuel from the nation's commercial nuclear power plants. The NWPA obligated DOE, beginning not later than January 31, 1998, to dispose of the spent fuel. In a December 17, 1996 letter to all utilities, DOE stated that it would not meet the 1998 deadline. As a result, utilities have had to plan for alternate means of interim storage for their spent fuel beyond 1998.

One such alternate means of spent fuel storage includes dry cask storage. Using this concept, a consortium of utilities have joined in a cooperative agreement through the Private Fuel Storage L.L.C. (PFSLLC) with the Skull Valley Band of Goshute Indians (Band) to undertake the development, licensing, construction, and operation of an Independent Spent Fuel Storage Installation (ISFSI) called the Private Fuel Storage Facility (PFSF). The PFSF will be built on the Skull Valley Indian Reservation and will provide timely, centralized, cost-effective spent fuel storage capacity to meet the needs of the utilities and provide long-term, stable financial income, employment, and training opportunities for Band members and the surrounding community. Preservation of the site and surrounding environment has resulted in the adoption of a "Start Clean / Stay Clean" philosophy that will permit utilization of the land and all buildings constructed in this project for other traditional industrial uses after the facility is decommissioned.

The PFSF will utilize the dry cask storage technology. Dry cask storage safely stores spent nuclear fuel inside of sealed canisters rather than in a spent fuel pool. The storage system technology is compatible with the long-term plans of the DOE interim storage facility and permanent repository. The PFSF is designed to store spent fuel for up to 40 years by which time it is anticipated that all of the spent fuel will be transferred offsite and the facility ready for decommissioning. The initial request for a license is for a term of 20 years. Prior to the end of the initial license term an application for license renewal will be submitted.

The Skull Valley Indian Reservation is located within the boundaries of Tooele County, northwestern Utah, approximately 22 miles west-southwest of Tooele City¹ (see Figure 1.1-1). There are no major towns within 10 miles of the PFSF site. The Skull Valley Band of Goshute Indian village is approximately 3.5 miles east-southeast of the site. This village has approximately 30 residents.

The reservation consists of approximately 18,000 acres, of which the PFSF site area is approximately 820 acres. Interstate Highway 80 and the Union Pacific Railroad main line are about 24 miles north of the site. Due to the proximity of the PFSF to the railroad mainline, the shipping cask will either be off-loaded at an intermodal transfer point near Timpie, Utah, and loaded onto a heavy haul tractor/trailer for transporting to the PFSF, or transported via a new railroad spur connecting the PFSF directly to the Union Pacific mainline. The PFSF will be accessed by a new road from the Skull Valley Road as shown on Figure 1.1-2.

It is anticipated that the PFSF will be issued a specific license to receive, transfer and possess spent fuel, in accordance with the requirements of 10 CFR 72 (Reference 1), prior to January 1, 2000. As part of the license application, this Safety Analysis Report

¹ Tooele City is used to distinguish the City of Tooele from Tooele County.

(SAR) has been prepared in accordance with the guidelines contained in NRC Regulatory Guide 3.48 (Reference 2) and NRC NUREG-1567, draft Standard Review Plan for Spent Fuel Dry Storage Facilities, (Reference 3). Construction of the PFSF is scheduled to start on January 1, 2000, and commercial operation is scheduled for June 1, 2002.

THIS PAGE INTENTIONALLY LEFT BLANK

1.2 GENERAL DESCRIPTION OF FACILITY

The PFSF is designed to store up to 40,000 Metric Tons of Uranium ²(MTU) of spent fuel from U.S. commercial power reactors in sealed metal canisters (approximately 4,000 storage casks). A detailed description of the fuel types that can be stored is provided in Chapter 3 and 10. The canister-based spent fuel storage system selected for use at the PFSF utilizes sealed metal canisters to store multiple spent fuel assemblies. Each canister is placed inside of a concrete storage cask. The storage system is passive and relies on natural convection for cooling. The system is an integral part of the facility "Start Clean / Stay Clean" philosophy which eliminates the need to handle individual fuel assemblies at the site. The system assures there is negligible contamination or radioactive waste generated at the site and facilitates the ease of decommissioning at the end of the life of the facility. Design criteria are described in more detail in Chapter 3.

The passive nature of the storage systems results in a relatively simple facility as shown on Figure 1.2-1. The Restricted Area (RA), is approximately 99 acres and is surrounded by a chain link security fence and an outer chain link nuisance fence with an isolation zone and intrusion detection system between the two fences. The cask storage area within the RA is surfaced with compacted gravel that slopes slightly to allow for runoff of storm water. The cask storage area consists of concrete cask storage pads that support the storage casks. Each pad is designed to support up to 8 storage casks in a 2 by 4 array. The Canister Transfer Building, as well as the Security and Health Physics Building, are also located within the RA. An overhead bridge crane and a semi-gantry crane are located within the Canister Transfer Building to facilitate shipping cask load/unload operations and canister transfer operations.

² Metric Tons of Uranium (initial uranium). This includes the small amount of mixed oxide fuels that are anticipated to require storage.

A main gate is provided for vehicular access to the RA. Light poles are located within the RA inside the security fence. Outside the RA is an Administration Building, and an Operations and Maintenance Building. The overall site or owner controlled area (OCA) is approximately 820 acres and is bounded by a range fence. The range fence will have wooden posts and 3 horizontal strands of barbed wire.

The PFSF is designed to accommodate the storage system and the transportation of spent fuel canisters to and within the facility. The amount of yard area provided within the RA is sized to limit the radiation dose outside of the RA from the storage casks to less than 2 mrem/hr per 10 CFR 20.1301(a)(2). The yard area is also sized to provide adequate space for maneuvering the onsite cask transporter used during storage cask placement. The area of the OCA is based on 10 CFR 72.104(a) requirements of maintaining the annual dose to any real individual outside the OCA during normal operations to less than 25 mrem whole body, as well as 10 CFR 72.106(b) requirements of maintaining a minimum distance of 100 meters (328 ft) from spent fuel storage and handling areas to the OCA boundary and limiting the dose to 5 rem, to the whole body or any organ, from any design basis accident.

In compliance with 10 CFR 72.122 (d), the PFSF does not share structures, systems, or components with other facilities.

1.3 GENERAL SYSTEMS DESCRIPTION

In order to store spent fuel at a centralized facility, an appropriate system is required to accommodate transfer of the spent fuel from nuclear power plants to the PFSF and to provide storage of the spent fuel at the PFSF.

The PFSLLC has selected the canister-based system for use at the PFSF because it eliminates the need to handle individual spent fuel assemblies once a canister is loaded and is sealed at the originating nuclear power plant. In addition, the canister-based system is expected to be compatible with the final DOE system for spent fuel management (Reference 4).

The canister-based system utilizes a sealed metal canister to store multiple spent fuel assemblies in a controlled environment. The sealed metal canister is placed in casks that provide radiation shielding and physical protection of the fuel during fuel transfer, transportation, storage, and disposal. The vendors selected to provide canister-based storage systems at the PFSF are Holtec International (Holtec) and Sierra Nuclear Corporation (SNC). Holtec is supplying their Holtec International Storage and Transfer Operation Reinforced Module Cask System (HI-STORM 100) (Reference 5) and SNC is supplying their TranStor Storage Cask System (TranStor) (Reference 6). These canister-based storage systems and their components are shown on Figures 1.3-1 and 1.3-2, respectively.

The metal canister is a cylindrical shell with structural and shield lids, shell assembly, and bottom plate, that houses a spent fuel basket. The canister is designed to accommodate PWR or BWR fuel types, including failed and mixed oxide fuel. The spent fuel basket provides structural support for the spent fuel assemblies and a path for the transfer of heat generated by the spent fuel to the canister shell. The spent fuel basket also provides criticality control to ensure that a nuclear fission reaction can not

be sustained. The cylindrical shell provides structural support for the fuel basket structure and spent fuel assemblies. During storage, the cylindrical shell, bottom plate, and the inner lid provide the primary confinement boundary to prevent the release of radioactive material from the spent fuel. The canister is designed to provide radiation shielding and physical protection for the spent fuel and uses casks to provide additional shielding and protection. Spent fuel assembly capacities of the canisters are as follows:

	Holtec HI-STORM <u>100 Cask System</u>	SNC TranStor <u>Storage Cask System</u>
PWR fuel	24	24
BWR fuel	68	61

After the spent fuel is loaded into a canister at the originating nuclear power plant, the canister is drained and the lid is welded to the canister. The canister is then vacuum dried, filled with helium, and sealed closed by welding the vent and drain port cover plates. Additional details of the canister design are discussed and shown in Chapter 4.

There are three types of casks used to transfer and store the canister. These are a shipping cask, transfer cask, and storage cask.

The shipping casks are used to transport the spent fuel canisters from the originating power plants to the PFSF. The shipping casks are designed to provide a complete confinement barrier, canister cooling, and to protect the canister from the effects of environmental conditions and natural phenomena. Each shipping cask is fitted with impact absorbing devices and is designed to withstand postulated transportation accidents. After the spent fuel canister is unloaded, the empty shipping cask is returned to the power plants for reloading with another canister of spent fuel.

The metal transfer cask is used to provide radiation shielding, physical protection, and canister cooling for the spent fuel canister when transferring the canister from the shipping cask to the storage cask at the PFSF.

The storage cask is a concrete and steel cylindrical structure which provides structural support for the spent fuel canister, physical protection, radiation shielding, and provides for natural convection cooling of the canister to remove decay heat while in storage at the PFSF.

At the PFSF, the shipping cask is lifted off the transport vehicle and placed in a shielded area of the Canister Transfer Building, called a transfer cell, using the overhead bridge crane. The canister is transferred from the shipping cask to the transfer cask, then transferred from the transfer cask into the concrete storage cask using either the overhead bridge crane or the semi-gantry crane. The concrete storage cask, loaded with the canister, is then sealed closed and moved to the storage area using a cask transporter and placed on a concrete pad. Details of the HI-STORM 100 and TranStor casks are discussed and shown in Chapter 4.

The design of the canister system and the loading procedures minimizes the potential for contamination of the canister at the originating nuclear power plant. Contamination that does occur is removed to within acceptable limits at the power plant. The system assures there is negligible contamination or radioactive waste generated at the site and facilitates the ease of decommissioning at the end of the life of the facility. Site generated waste confinement and management is discussed in Chapter 6.

THIS PAGE INTENTIONALLY LEFT BLANK

1.4 SPENT FUEL TRANSPORTATION TO THE PFSF

Although transportation activities are not part of the 10 CFR 72 license application for the PFSF, the transportation process is briefly described herein to provide an understanding of the overall program. Spent fuel enroute to the PFSF will be transported in accordance with applicable U.S. Department of Transportation (DOT) regulations (49 CFR 173-Shippers General Requirements for Shipments and Packaging, Subpart A-"General" and Subpart I - "Radioactive Materials", 49 CFR 171-"General Information, Regulations, and Definitions", 49 CFR 172-"Hazardous Materials Tables and Hazardous Materials Communications Regulations", 49 CFR 174-"Carriage by Rail", 49 CFR 177-"Carriage by Public Highway"), and NRC regulations (10 CFR 71 - "Packaging and Transportation of Radioactive Material"). Holtec is supplying their Holtec International Storage, Transport, and Repository Cask System (HI-STAR 100) (Reference 7) and SNC is supplying their TranStor Shipping Cask System (TranStor) (Reference 8).

As a result of adherence to strict controls, utilities and carriers have a long history of safe spent fuel transportation. In more than 20 years of shipping fuel in the United States, no accident has caused a release of radioactive material. Moreover, no deaths or serious injuries to the public or to transportation industry personnel have ever occurred as the result of the radioactive nature of any radioactive material shipment (Reference 9).

There is no direct rail line to the PFSF. Therefore the PFSF will employ one of two transport vehicle alternatives to ship the cask from the railroad mainline to the site. The first alternative is to transfer the shipping cask from the rail car to a heavy haul transport tractor/trailer at an intermodal point near Timpie and haul the shipping cask the final 24 miles by road to the PFSF. The second alternative is to ship the shipping cask the remaining 24 miles by rail on a new railroad spur track. The PFSF is expected to

receive 100 to 200 shipments of loaded spent fuel canisters annually. The PFSF will accept delivery and perform receipt inspection of the spent fuel shipping casks at the PFSF.

1.5 IDENTIFICATION OF AGENTS AND CONTRACTORS

Holtec International and Sierra Nuclear Corporation are providing the spent fuel storage systems for use at the PFSF. They are responsible for the design and licensing of their canisters, casks, and transfer equipment.

Stone & Webster Engineering Corporation is providing the engineering and supporting preparation of the 10 CFR 72 license documentation of the PFSF site.

The construction contractor for the PFSF has not yet been determined.

The PFSLLC will be responsible for operation of the PFSF.

THIS PAGE INTENTIONALLY LEFT BLANK

1.6 MATERIAL INCORPORATED BY REFERENCE

The Safety Analysis Reports for the Holtec HI-STORM 100 Storage System and SNC TranStor Storage Cask System (References 5 and 6) have been submitted to the NRC for approval and are incorporated by reference into this document. The HI-STORM 100 storage system contains some proprietary information and therefore is not available to the public. A non-proprietary version, which is available to the public, is listed in section 1.7 as Reference 10.

The PFSLLC QA Program (Reference 11) was approved by the NRC on November 3, 1996 for use under 10 CFR 71, Subpart H (Docket 71-0829) and is incorporated by reference into this document. It is proposed that this PFSLLC QA Program be used to satisfy the requirements of 10 CFR 72, Subpart G. Chapter 11 provides a detailed discussion of the PFSLLC QA program.

THIS PAGE INTENTIONALLY LEFT BLANK

1.7 REFERENCES

1. 10 CFR 72, Licensing Requirements for the Independent Storage of Spent Nuclear Fuel and High Level Radioactive Waste.
2. U.S. Nuclear Regulatory Commission, Regulatory Guide 3.48, Standard Format and Content for the Safety Analysis Report for an Independent Fuel Storage Installation or Monitored Retrievable Storage Installation (Dry Storage), August 1989.
3. U.S. Nuclear Regulatory Commission, NUREG-1567, draft Standard Review Plan for Spent Fuel Dry Storage Facilities, October, 1996.
4. DOE/RW-0445, Multi-Purpose Canister System Evaluation, U.S. Department of Energy Civilian Radioactive Waste Management, September 1994.
5. Topical Safety Analysis Report for the Holtec International Storage and Transfer Operation Reinforced Module Cask System (HI-STORM 100 Cask System), Holtec Report HI-951312, Revision 1, Docket 72-1014, January 1997.
6. Safety Analysis Report for the TranStor Storage Cask System, SNC-96-72SAR, Sierra Nuclear Corporation, Revision B, Docket 72-1023, March 1997.
7. Topical Safety Analysis Report for the Holtec International Storage, Transport, and Repository Cask System (HI-STAR 100 Cask System), Holtec Report HI-951251, Revision 4, Docket 71-9261, September 1996.

8. Safety Analysis Report for the TranStor Shipping Cask System, SNC-95-71SAR, Sierra Nuclear Corporation, Revision 1, Docket 71-9268, September 1996.
9. U.S. Department of Energy, "Transporting Spent Nuclear Fuel: An Overview, DOE/RW-0065 (1986).
10. Topical Safety Analysis Report (non proprietary) for Holtec International Storage and Transfer Operation Reinforced Module Cask System (HI-STORM 100 Cask System), Holtec Report HI-951312, Revision 2, May 1997, Docket 72-1014.
11. PFSLLC QA Program Manual, Current Revision, Docket 71-0829.

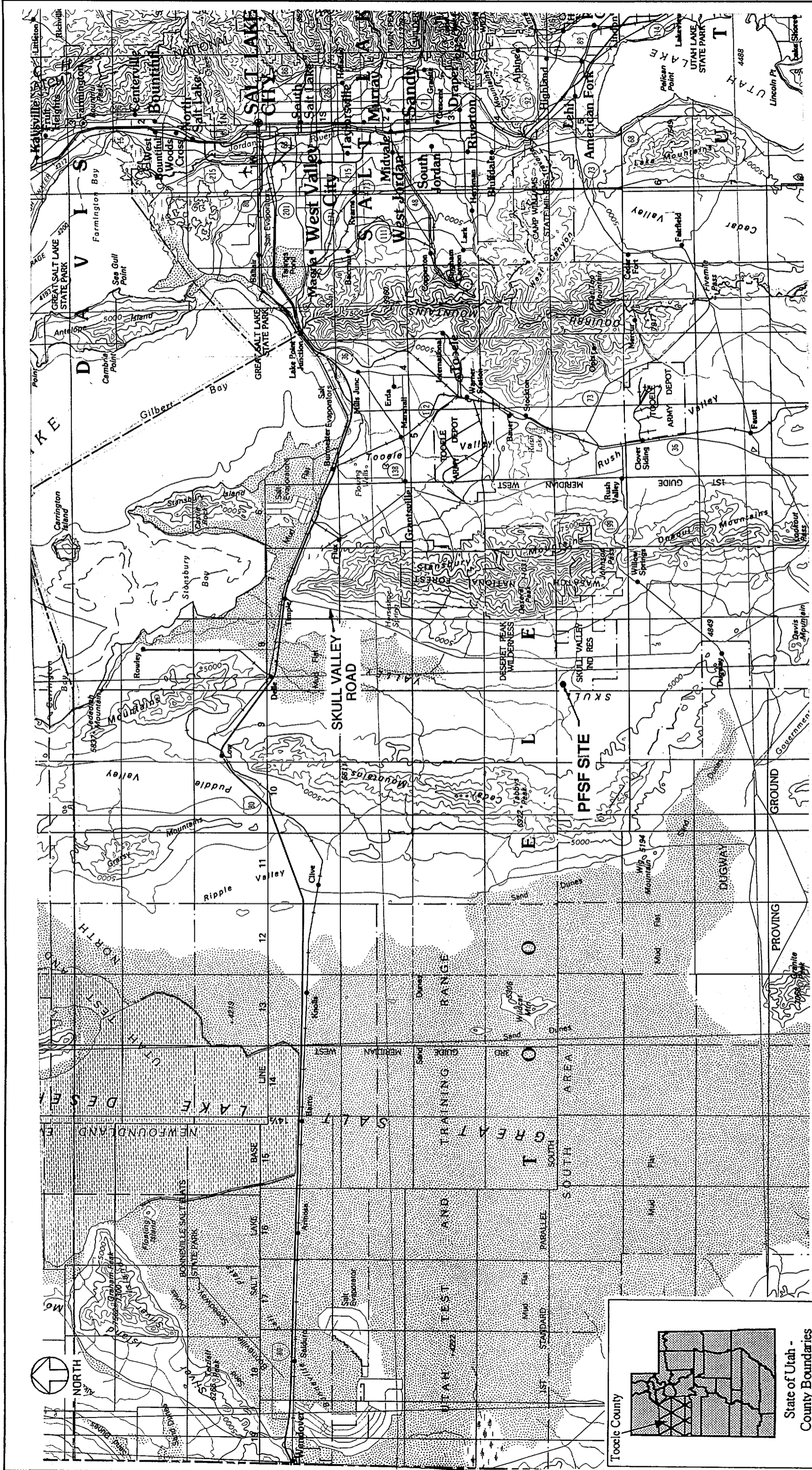

Tooele County

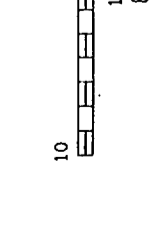

State of Utah -
County Boundaries

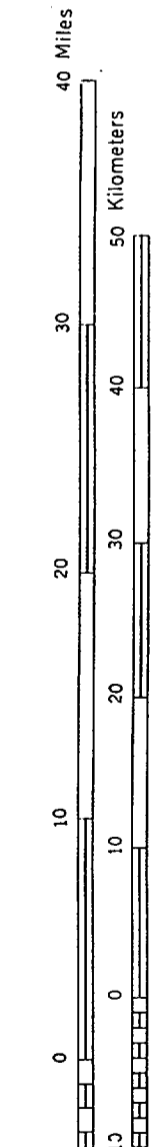

Scale 1:500 000
1 inch equals approximately 8 miles
Contour interval 500 feet
National Geodetic Vertical Datum of 1929

ANSTEC APERTURE CARD

Figure 1.1-1

PFSF LOCATION
PRIVATE FUEL STORAGE FACILITY
SAFETY ANALYSIS REPORT

Also Available on
Aperture Card

9707020145-01

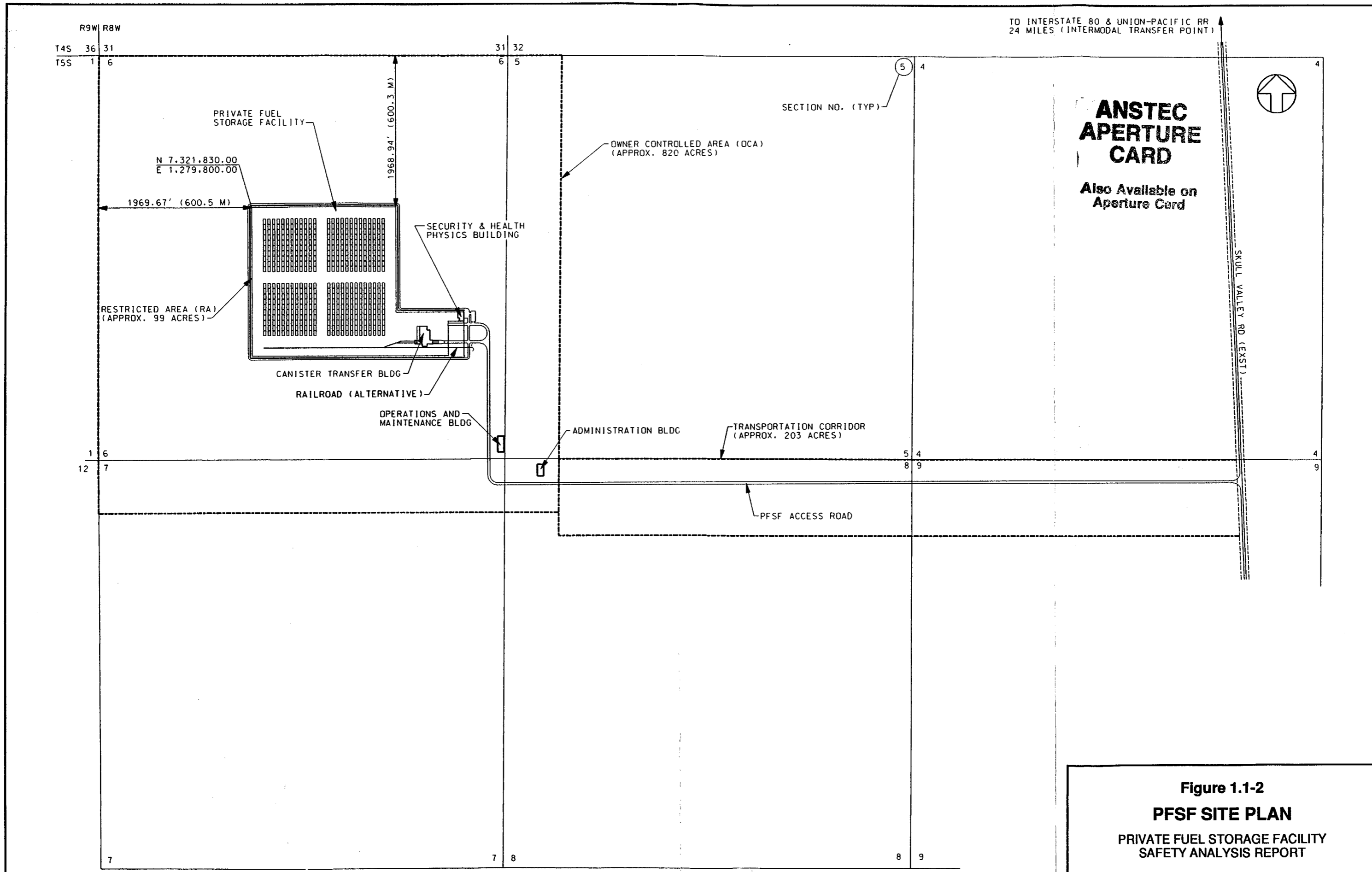

Figure 1.1-2
PFSF SITE PLAN
 PRIVATE FUEL STORAGE FACILITY
 SAFETY ANALYSIS REPORT

9707020145-02

ANSTEC APERTURE CARD

Also Available on Aperture Card

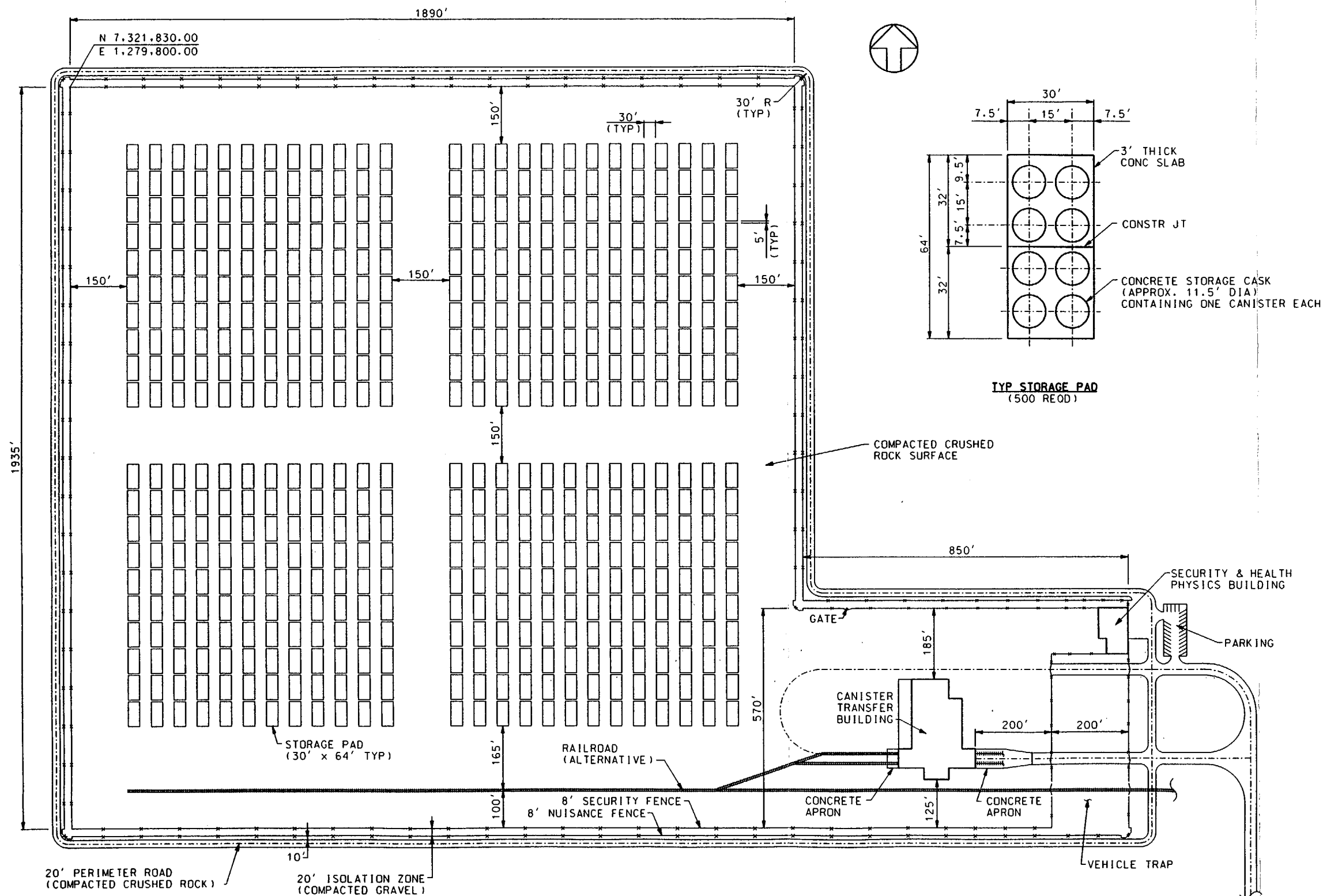

Figure 1.2-1
PFSS GENERAL ARRANGEMENT
 PRIVATE FUEL STORAGE FACILITY
 SAFETY ANALYSIS REPORT

9707020145-03

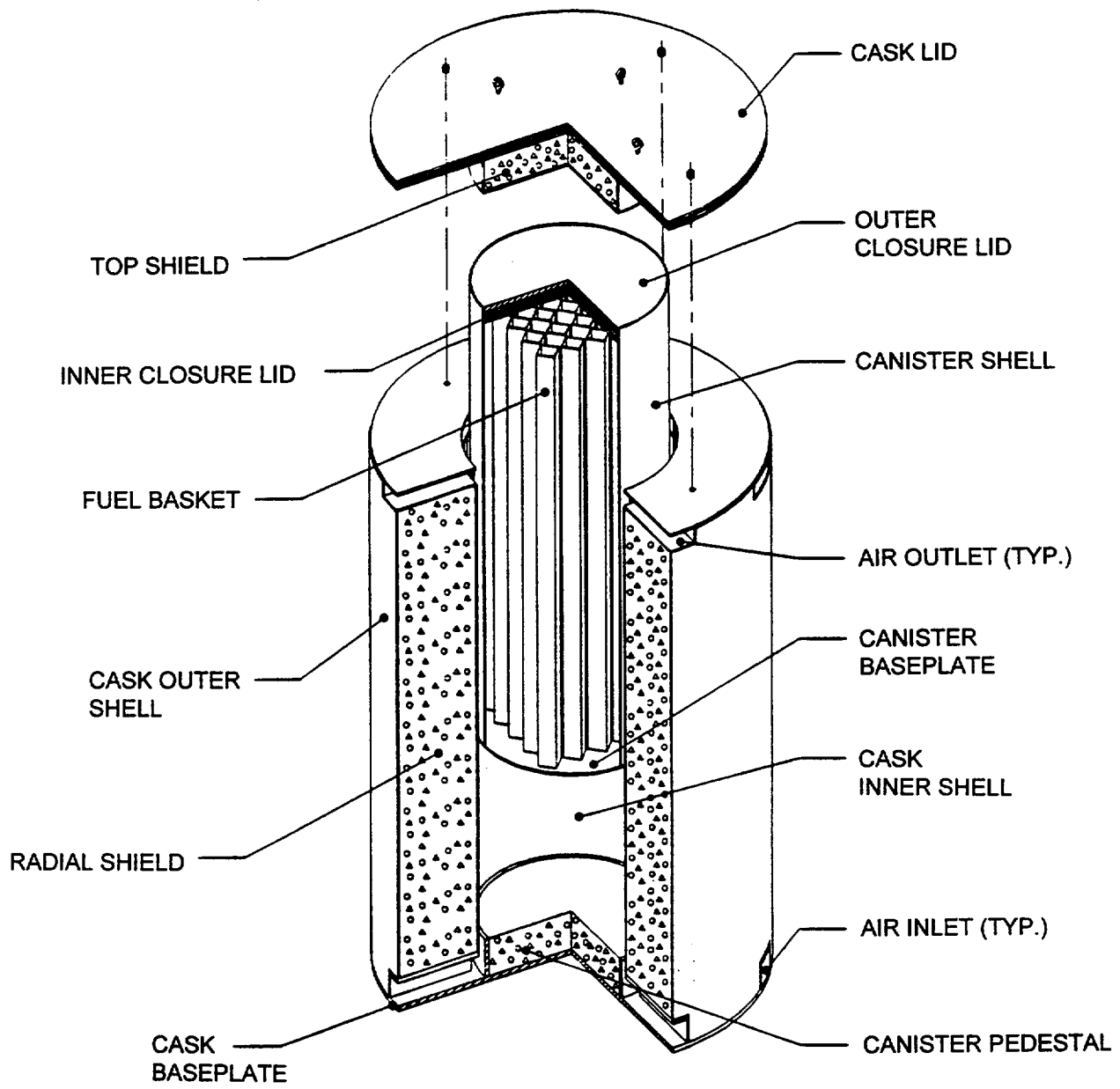

Figure 1.3-1
HI-STORM 100 CASK
SYSTEM COMPONENTS
 PRIVATE FUEL STORAGE FACILITY
 SAFETY ANALYSIS REPORT

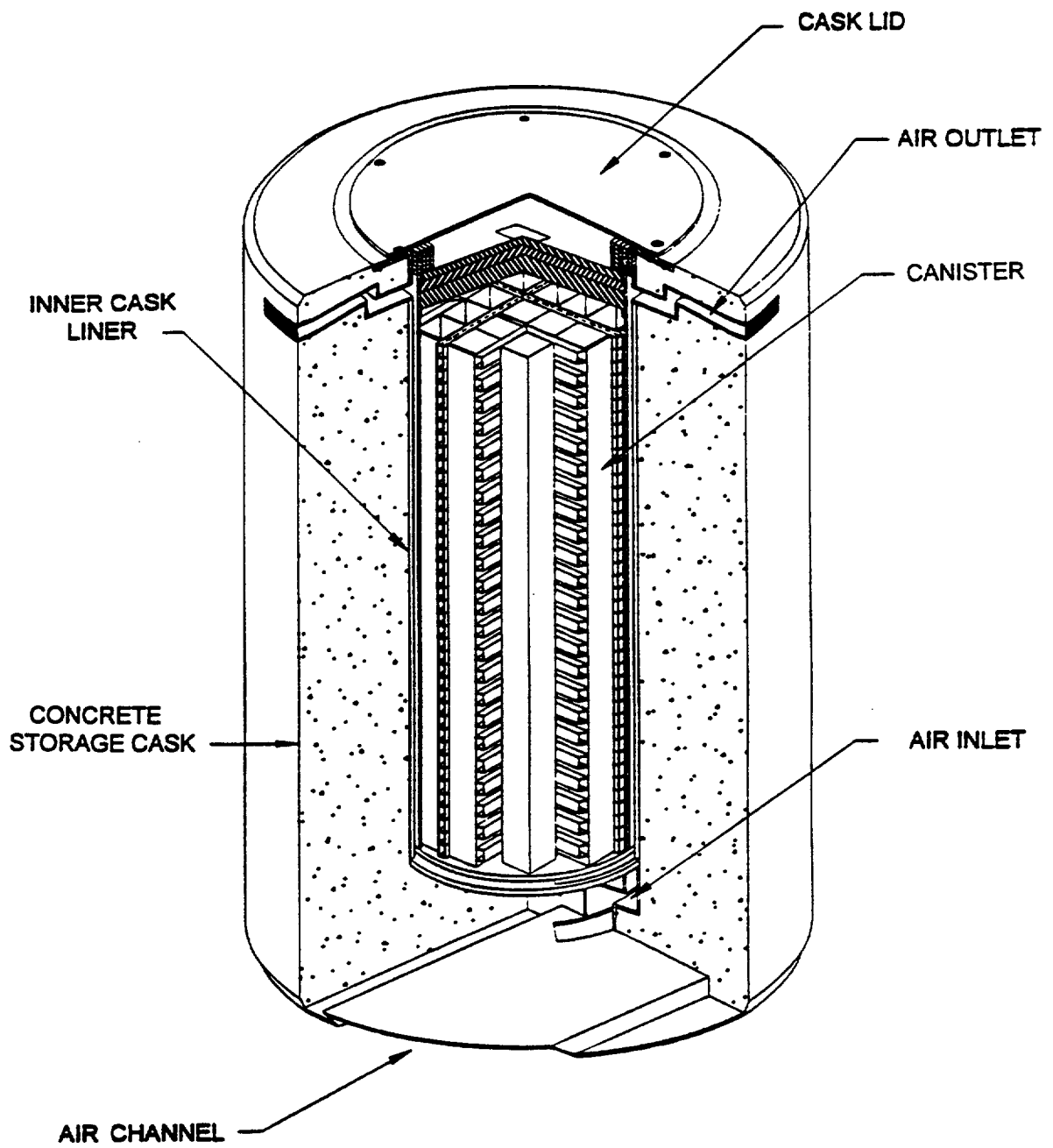

Figure 1.3-2
TRANSTOR STORAGE CASK
SYSTEM COMPONENTS
 PRIVATE FUEL STORAGE FACILITY
 SAFETY ANALYSIS REPORT

CHAPTER 2
SITE CHARACTERISTICS

TABLE OF CONTENTS

SECTION	TITLE	PAGE
2.1	GEOGRAPHY AND DEMOGRAPHY	2.1-1
2.1.1	Site Location	2.1-1
2.1.2	Site Description	2.1-2
2.1.2.1	Other Activities Within the Site Boundary	2.1-2
2.1.2.2	Boundaries for Establishing Effluent Release Limits	2.1-2
2.1.3	Population Distribution and Trends	2.1-3
2.1.4	Uses of Nearby Land and Waters	2.1-4
2.2	NEARBY INDUSTRIAL, TRANSPORTATION, AND MILITARY FACILITIES	2.2-1
2.3	METEOROLOGY	2.3-1
2.3.1	Regional Climatology	2.3-1
2.3.1.1	Data Sources	2.3-1
2.3.1.2	General Climate	2.3-2
2.3.1.3	Severe Weather	2.3-5
2.3.1.3.1	Maximum and Minimum Temperatures	2.3-5
2.3.1.3.2	Extreme Winds	2.3-5
2.3.1.3.3	Tornadoes	2.3-6
2.3.1.3.4	Hurricanes and Tropical Storms	2.3-7
2.3.1.3.5	Precipitation Extremes	2.3-8
2.3.1.3.6	Thunderstorms and Lightning Strikes	2.3-8

TABLE OF CONTENTS (cont.)

SECTION	TITLE	PAGE
2.3.1.3.7	Snowstorms	2.3-9
2.3.1.3.8	Hail and Ice Storms	2.3-9
2.3.1.3.9	Poor Dispersion Conditions	2.3-9
2.3.2	Local Meteorology	2.3-11
2.3.2.1	Data Sources	2.3-11
2.3.2.1.1	Precipitation	2.3-12
2.3.2.1.2	Temperature	2.3-13
2.3.2.1.3	Wind Direction and Speed	2.3-14
2.3.2.1.4	Humidity, Fog, Thunderstorms	2.3-14
2.3.2.1.5	Atmospheric Stability and Mixing Heights	2.3-15
2.3.2.1.6	Air Quality	2.3-16
2.3.2.2	Topography	2.3-17
2.3.3	Onsite Meteorological Measurement Program	2.3-17
2.3.4	Diffusion Estimates	2.3-20
2.4	SURFACE HYDROLOGY	2.4-1
2.4.1	Surface Hydrologic Description	2.4-1
2.4.1.1	Site and Structures	2.4-3
2.4.1.2	Hydrosphere	2.4-3
2.4.2	Floods	2.4-5
2.4.2.1	Flood History	2.4-6
2.4.2.2	Flood Design Considerations	2.4-7
2.4.2.3	Effects of Local Intense Precipitation	2.4-8
2.4.3	Potential Maximum Flood on Streams and Rivers	2.4-12

TABLE OF CONTENTS (cont.)

SECTION	TITLE	PAGE
2.4.4	Potential Dam Failures (Seismically Induced)	2.4-13
2.4.5	Probable Maximum Surge and Seiche Flooding	2.4-13
2.4.6	Probable Maximum Tsunami Flooding	2.4-13
2.4.7	Ice Flooding	2.4-13
2.4.8	Flooding Protection Requirements	2.4-13
2.4.9	Environmental Acceptance of Effluents	2.4-14
2.5	SUBSURFACE HYDROLOGY	2.5-1
2.5.1	Regional Characteristics	2.5-1
2.5.2	Site Characteristics	2.5-4
2.5.3	Contaminant Transport Analysis	2.5-5
2.6	GEOLOGY AND SEISMOLOGY	2.6-1
2.6.1	Basic Geologic and Seismic Information	2.6-1
2.6.1.1	Site Geomorphology	2.6-3
2.6.1.2	Geologic History of Site and Region	2.6-5
2.6.1.2.1	Bedrock	2.6-5
2.6.1.2.2	Site Area Structural Geology and Geologic History	2.6-8
2.6.1.2.3	Surficial (Basin-fill deposits)	2.6-10
2.6.1.3	Site Geology	2.6-12
2.6.1.4	Geologic Map of Site Area	2.6-13
2.6.1.5	Facility Plot Plan and Geologic Investigations	2.6-14
2.6.1.6	Relationship of Major Foundations to Subsurface Materials	2.6-14
2.6.1.7	Excavations and Backfill	2.6-16

TABLE OF CONTENTS (cont.)

SECTION	TITLE	PAGE
2.6.1.8	Engineering-Geology Features Affecting ISFSI Structures	2.6-17
2.6.1.9	Site Groundwater Conditions	2.6-17
2.6.1.10	Geophysical Surveys	2.6-19
2.6.1.11	Static and Dynamic Soil and Rock Properties at the Site	2.6-19
2.6.1.12	Stability of Foundations for Structures and Embankments	2.6-21
2.6.1.12.1	Bearing Capacity and Settlement Analyses—Storage Pads	2.6-22
2.6.1.12.2	Allowable Bearing Capacity—Other Structures	2.6-24
2.6.2	Vibratory Ground Motion	2.6-25
2.6.2.1	Engineering Properties of Materials for Seismic Wave Propagation and Soil-Structure Interaction Analyses	2.6-27
2.6.2.2	Earthquake History	2.6-28
2.6.2.3	Determining the Design Earthquake	2.6-31
2.6.2.3.1	Capable Faults	2.6-32
2.6.2.3.2	Maximum Earthquake	2.6-34
2.6.3	Surface Faulting	2.6-35
2.6.4	Stability of Subsurface Materials	2.6-37
2.6.4.1	Geologic Features That Could Affect Foundations	2.6-37
2.6.4.2	Properties of Underlying Materials	2.6-38
2.6.4.3	Plot Plan	2.6-38
2.6.4.4	Soil and Rock Characteristics	2.6-38
2.6.4.5	Excavations and Backfill	2.6-38
2.6.4.6	Groundwater Conditions	2.6-39
2.6.4.7	Response of Soil and Rock to Dynamic Loading	2.6-39
2.6.4.8	Liquefaction Potential	2.6-40

TABLE OF CONTENTS (cont.)

SECTION	TITLE	PAGE
2.6.4.9	Earthquake Design Basis	2.6-41
2.6.4.10	Static Analyses	2.6-41
2.6.4.11	Techniques to Improve Subsurface Conditions	2.6-41
2.6.4.12	Criteria and Design Methods	2.6-41
2.6.5	Slope Stability	2.6-42
2.7	SUMMARY OF SITE CONDITIONS AFFECTING CONSTRUCTION AND OPERATING REQUIREMENTS	2.7-1
2.8	REFERENCES	2.8-1

TABLE OF CONTENTS (cont.)

LIST OF APPENDICES

APPENDIX	TITLE
2A	Geotechnical Data Report, prepared by Stone & Webster Engineering Corporation, Revision 1, June, 1997.
2B	Seismic Survey of the Private Fuel Storage Facility, Skull Valley Utah, by Geosphere Midwest, February 1997.
2C	Final Report of a Geomorphological Survey of Surficial Lineaments North of Hickman Knolls, Tooele County, Utah, by Dr. Donald R. Currey, November 1996.
2D	Deterministic Earthquake Ground Motions Analysis, prepared by Geomatrix Consultants, Inc., March 1997.
2E	Analysis of Volcanic Ash, prepared by William P. Nash, March 1997.

TABLE OF CONTENTS (cont.)

LIST OF TABLES

TABLE	TITLE
2.3-1	SUMMARY OF TORNADO DATA FOR PFSF SITE 1° BOX
2.3-2	FUJITA TORNADO INTENSITY SCALE
2.3-3	NORMAL MONTHLY PRECIPITATION FOR SALT LAKE CITY, DUGWAY, AND IOSEPA SOUTH RANCH
2.3-4	NORMAL MONTHLY TEMPERATURES FOR SALT LAKE CITY, DUGWAY, AND IOSEPA SOUTH RANCH
2.3-5	MEAN WIND SPEEDS AND PREVAILING DIRECTIONS FOR SALT LAKE CITY
2.3-6	FREQUENCY OF OCCURRENCE OF ATMOSPHERIC STABILITY CLASSES FOR SALT LAKE CITY
2.3-7	MEAN SEASONAL MORNING AND AFTERNOON MIXING HEIGHTS FOR SALT LAKE CITY
2.3-8	NATIONAL AMBIENT AIR QUALITY STANDARDS
2.3-9	AMBIENT AIR QUALITY MONITORING DATA FOR WASATCH FRONT INTRASTATE AQCR
2.3-10	METEOROLOGICAL MONITORING SYSTEM SPECIFICATIONS
2.6-1	SUMMARY OF DYNAMIC SOIL PROPERTIES
2.6-2	DYNAMIC SOIL PARAMETERS FOR SPRING, DASHPOT, AND MASS MODEL
2.6-3	DYNAMIC SOIL PARAMETERS FOR SASSI MODEL
2.6-4	EARTHQUAKES: MAGNITUDE 3.0 AND GREATER, 1850—1996, 160 KM RADIUS AROUND 40° 24.50' N AND 112°47.50' W (14 pages)

TABLE OF CONTENTS (cont.)

LIST OF FIGURES

FIGURE	TITLE
2.1-1	POPULATION DISTRIBUTION WITHIN 5 MILES OF PFSF
2.1-2	SITE AND ACCESS ROAD LOCATION PLAN (2 SHEETS)
2.3-1	WIND ROSE, SALT LAKE CITY; 1988-1992, WINTER
2.3-2	WIND ROSE, SALT LAKE CITY; 1988-1992, SPRING
2.3-3	WIND ROSE, SALT LAKE CITY; 1988-1992, SUMMER
2.3-4	WIND ROSE, SALT LAKE CITY; 1988-1992, AUTUMN
2.3-5	WIND ROSE, SALT LAKE CITY; 1988-1992
2.3-6	METEOROLOGICAL TOWER LOCATION RELATIVE TO THE PFSF SITE
2.4-1	WATERSHED BASINS IN THE VICINITY OF THE PFSF SITE
2.6-1	PHYSIOGRAPHY OF UTAH
2.6-2	PLOT PLAN AND LOCATIONS OF GEOTECHNICAL INVESTIGATIONS (SHEETS 1 & 2)
2.6-3	GEOLOGIC MAP OF UTAH
2.6-4	SURFICIAL GEOLOGY AND PFSF SITE
2.6-5	FOUNDATION PROFILE A-A' — LOOKING NORTHEAST
2.6-6	RATE OF SECONDARY COMPRESSION VS STRESS RATIO
2.6-7	STATIC AND DYNAMIC LATERAL EARTH PRESSURES
2.6-8	LATERAL EARTH PRESSURE COEFFICIENTS VS WALL MOVEMENT
2.6-9	COMPACTION-INDUCED LATERAL STRESSES
2.6-10	GROSS ALLOWABLE BEARING PRESSURE VS FOOTING WIDTH & DEPTH FOR STRIP FOOTINGS

TABLE OF CONTENTS (cont.)

LIST OF FIGURES

FIGURE	TITLE
2.6-11	GROSS ALLOWABLE BEARING PRESSURE VS FOOTING WIDTH & DEPTH FOR SQUARE FOOTINGS
2.6-12	INTERMOUNTAIN SEISMIC BELT HISTORICAL EARTHQUAKES, MAGNITUDE ≥ 6.0
2.6-13	STRAIN-COMPATIBLE SHEAR-WAVE VELOCITY PROFILE
2.6-14	STRAIN-COMPATIBLE DAMPING RATIO PROFILE
2.6-15	MAGNITUDE ≥ 3.0 EARTHQUAKES WITHIN 100 MILES OF PFSF, 1850—1996
2.6-16	QUATERNARY STRUCTURES AND SEISMICITY, 1884 TO 1989

THIS PAGE INTENTIONALLY BLANK

CHAPTER 2

SITE CHARACTERISTICS

2.1 GEOGRAPHY AND DEMOGRAPHY

2.1.1 Site Location

The proposed site for the Private Fuel Storage Facility (PFSF) is located on the Skull Valley Indian Reservation in Tooele County, Utah. This county is in the northwestern portion of the state bordered on the north by Box Elder County; to the east by Davis, Salt Lake, and Utah Counties; to the south by Juab County; and to the west by the State of Nevada (Elko County). Tooele County is a combination of environments including the Great Salt Lake, western deserts, fertile valleys, and rugged mountains. Many areas of the county are undeveloped and isolated. Most land in Tooele County is under the administration of the Bureau of Land Management (BLM) and the military where large portions of the county are used for federal and military land uses (at Dugway Proving Ground, the Utah Test and Training Range, Tooele Army Depot North and South Areas) and for hazardous waste incineration and storage (at USPCI, Aptus, and Envirocare facilities) (Tooele, 1995).

The proposed PFSF site is located in a valley floor typical of the local basin-range topography. The Stansbury Mountains (maximum elevation 11,031 ft) separate the PFSF from Tooele City, which is located approximately 27 miles east northeast (Figure 1.1-1). Skull Valley is sparsely populated with limited agricultural or other activity. Land owners and administrators of the Skull Valley area include the BLM, privately owned ranches, the Skull Valley Indian Reservation, the Wasatch National Forest, and the

Dugway Proving Ground (Tooele, 1995). There are no existing industrial, recreational, or residential uses within the boundaries of the proposed site.

2.1.2 Site Description

The proposed facility would be located on property leased from the Skull Valley Band of Goshute Indians (Band), within Township 5 South, Range 8 West, Section 6, with appurtenant facilities located along the project access road through sections 4, 5, 7, 8, and 9. The northwest corner of the PFSF is located at 40° 24' 50"N, 112° 47' 37" W. The area immediately surrounding the site consists of undeveloped range land owned by the Band, BLM, and private landowners. The PFSF has a restricted area enclosing an area of approximately 99 acres for cask storage. In addition, an owner-controlled area (OCA) encompassing 820 acres will be bounded by typical range fencing to identify the limits of site activity. Figure 2.1-2 shows details of the plant perimeter and the proposed configuration of facilities. Skull Valley Road (designated as Federal Aid Secondary Road (FAS) 108) is located to the east of the site and traverses Skull Valley from Interstate 80 south to the intersection with State Route 199.

2.1.2.1 Other Activities Within the Site Boundaries

No activities are currently conducted within the area proposed for development of the PFSF.

2.1.2.2 Boundaries for Establishing Effluent Release Limits

There are no radioactive or other effluent releases associated with the proposed facility.

2.1.3 Population Distribution and Trends

Population within a 5-mile circle centered on the proposed PFSS consists of tribal residents on the Skull Valley Indian Reservation and two isolated ranches on Skull Valley Road north of the Reservation boundary. The closest residents to the PFSS are two tribal homes located approximately 2 miles southeast of the project and those residences in the Skull Valley Indian Reservation village, approximately 3.5 miles east-southeast of the site. There are about 30 residents currently living on the Reservation.

Two private residences are located northeast of the proposed site along Skull Valley Road, approximately 2.75 and 4.0 miles away. Therefore, the estimated population within a 5-mile radius is 36 persons (30 Goshutes and 2 households of approximately 3 persons each) (Figure 2.1-1). Because of the remoteness of the Skull Valley and because a majority of the land within 5 miles is owned by either the BLM or the Reservation, it is unlikely that the permanent population within a 5-mile radius of the proposed PFSS would change significantly during the proposed license period.

No transient or institutional populations are present within 5 miles of the proposed PFSS. The Skull Valley Road passes through the Reservation approximately 2.5 miles from the site. Traffic on this roadway is primarily related to local resident travel and travel between Interstate 80 and Dugway Proving Ground. During October 1996, a survey was conducted to identify existing and planned public facilities and institutions within a 5-mile radius of the facility. Due to the remoteness and extreme low population density of the area (36 persons within 5-mile radius), no facilities such as hospitals, prisons, and recreational areas are located or planned within the 5-mile study area.

2.1.4 Uses of Nearby Land and Waters

Land use within the Reservation boundary consists of residential uses by tribal members (approximately 30 persons living on the Reservation) and the Tekoi Rocket Engine Test Facility operated by Alliant Techsystems on leased Reservation lands. This facility, located approximately 2.5 miles south-southeast of the PFSS on the south side of Hickman Knolls, has been operated at this location since 1975. The current lease agreement for this facility will expire in 1998 (Quintanna, 1995).

In the 5-mile radius around the site there are approximately 28,000 acres of BLM land, 9,000 acres of privately-owned land, and 13,000 acres of land that are part of the Skull Valley Indian Reservation. The section is nearly flat, sloping gently downward to the north with small, local elevation changes of about 1 ft.

The principal land use in Skull Valley is range land for livestock grazing. Cattle and sheep are grazed, especially in winter when the livestock is brought down from the higher mountain elevations. The majority of land (55 percent) within a 5-mile radius of the site is owned and managed by the BLM as part of the Pony Express Resource Area (PERA). The remainder of the land is split almost evenly between Reservation property and private ownership.

BLM land within the 5-mile radius is part of the Skull Valley and South Skull Valley grazing allotments.¹ Most of the range land within the Skull Valley allotment (85 percent) is considered to be of fair to poor condition with the overall conditions in decline (BLM, 1988). The allotment is divided into three pastures: West Cedar, Eightmile, and Black Knoll. The southeast corner of the Black Knoll Pasture is within

¹ An allotment is an area of land where one or more permittees may graze livestock.

the 5-mile radius. Two operators are authorized to graze up to 5,000 sheep and 2,300 cattle within the Skull Valley allotment from November 1 to April 30. Sheep graze in alternate years. Cattle graze following a 3-year cycle: from November 1 to April 30th one year, November 1 to February 28th the following year, and November 1 to February 28 and April 1 to April 30th the third year (BLM, 1985).² Portions of two pastures in the South Skull Valley allotment are within the 5-mile radius: the east end of the Cochrane Pasture (Pasture 1) and the northern edge of the Post Hollow Pasture (Pasture 2). The permittee for these pastures is authorized to graze a maximum of 700 cattle and 3,800 sheep from November 1 to April 30th in alternating years (BLM, 1986).³

In addition to grazing, recreation use is also allowed on BLM land within the PERA. Off-highway vehicle (OHV) use, dispersed camping, and hunting are principal uses of BLM property within the PERA (BLM, 1988). There are no designated camping areas or OHV trails or roads within the 5-mile radius, though the BLM land within the radius is given an OHV designation category "A," meaning that it is open to all types of motor vehicle use (BLM, 1992).

² The maximum authorized for the three pastures in the 271,000-acre Skull Valley allotment are 5,000 sheep and 2,300 cattle. Considerably fewer sheep and cattle would be expected within the corner of the allotment inside the 5-mile radius.

³ The permittee is allowed to graze livestock at two other pastures within the South Skull Valley allotment outside the 5-mile radius so we would expect considerably fewer sheep or cattle grazing within the 5-mile radius.

THIS PAGE INTENTIONALLY BLANK

2.2 NEARBY INDUSTRIAL, TRANSPORTATION, AND MILITARY FACILITIES

The PFSF site is situated in the northwest corner of the Skull Valley Indian Reservation in Tooele County, Utah. The Reservation consists of approximately 18,000 acres, of which the PFSF site area is approximately 820 acres, or less than 5% of the reservation area. The PFSF site location was selected by the Skull Valley Band of Goshute Indians in order to avoid disruption of tribal roads, housing or cultural facilities. Figure 1.1-1 shows the facilities and locations addressed in this section.

The area surrounding the PFSF site is very sparsely populated, with the nearest residence 2 miles southeast of the site. The Skull Valley Band of the Goshute Village, with a population of about 30, is 3.5 miles east-southeast of the PFSF site. Terra, a small residential community with a population of 120 (Tooele County Commission, 1995), is located 10 miles east-southeast of the PFSF.

The only industrial, transportation or military facility within 5 miles of the PFSF is the Tekoi Rocket Engine Test facility, located about 2.5 miles south-southeast of the PFSF. This facility is used periodically to test engines mounted on stationary bases. Hickman Knolls, with an elevation of approximately 4873 ft, is situated directly between the PFSF (approximate elevation 4465 ft) and the Tekoi Test facility (elevation 4600 ft). The relative location of Hickman Knolls between the PFSF and Tekoi Test facility, and the distance of 2.5 miles would substantially deflect and disperse overpressures from an explosion at the Tekoi Test facility, precluding any hazard to the PFSF. There are no other facilities which could present the threat of an explosion or other hazard within 5 miles of the PFSF.

Interstate Highway 80 and the Union Pacific Railroad main line are located 24 miles north of the PFSF site. Any events associated with either the interstate highway or the railroad will not present a hazard to the PFSF due to the relatively large distance involved. The Skull Valley Road runs essentially north-south between Interstate 80 and the town of Dugway, population 1,700, 12 miles south of the PFSF. Dugway is a residential community supporting the nearby Dugway Proving Ground and has no facilities which could present a hazard to the PFSF.

The U.S. Army's Dugway Proving Ground is a 1,315 square mile range and test facility located west of the town of Dugway. The Dugway Proving Ground performs testing of all types of military equipment in chemical and biological environments, as well as smoke, obscurant and incendiary testing, and munitions testing. Open air testing is not permitted by law, and there have been no accidents or releases of toxic gas from the facility or associated transportation activities. The Proving Ground has a mean elevation of 4,350 ft above sea level and is surrounded on three sides by mountain ranges. The Cedar Mountains, with an elevation of 5,300 ft or greater, lie between the Proving Ground and the PFSF. The activities and materials at Dugway Proving Ground will therefore present no credible hazard to the PFSF, because of their relative distance and the intervening Cedar Mountains.

The Dugway Proving Ground receives and ships conventional Army weapons approximately 95 times a year. Some of these shipments could travel the Skull Valley Road, which present the only credible potential for an explosion near the PFSF. An accident associated with the transportation of explosives along the Skull Valley Road would be a minimum of 1.9 miles from the canister transfer building and 2 miles from the nearest cask storage pad. Based on the methodology of Regulatory Guide 1.91, the Skull Valley Road is located much further from the PFSF than the distances

required to exceed 1 psi overpressure for detonation of explosives transported by highway.

Michael Army Air Field is located on the Dugway Proving Ground, 15 miles south-southwest of the PFSF. This military airfield has a 13,125 foot runway, and can accommodate all operative aircraft in the Department of Defense inventory. The airspace over the Dugway Proving Ground is restricted. Military airway IR-420 passes over the PFSF site area. The methods of NUREG-0800 were used to estimate the probability of an aircraft impacting the PFSF from this airway, using the equation:

$$P = C \times N \times A / w, \text{ where}$$

P = probability per year of an aircraft crashing into the PFSF

C = in-flight crash rate per mile

N = number of flights per year along the airway

A = effective area of the PFSF in square miles

w = width of airway in miles

NUREG-0800 states the in-flight crash rate as 4 E-10 per mile. Information provided by the Dugway Proving Ground states that there are approximately 414 flights annually at this airfield. The effective area of the facility (restricted area) is 99 acres x 1.562 E-3 mi²/acre = 0.1546 mi². The width of the airway is 5 nautical miles (NM) according to the FAA flight map, or 5NM x 1.15 NM/mile = 5.75 miles. The probability of an aircraft impacting the PFSF is therefore 4.45 E-9 per year. This is an extremely low probability of occurrence, below the NUREG-0800 guideline of 1 E-7 per year, and is not considered a credible event. With this low probability of occurrence and the fact that the Michael Army Air Field is located 15 miles away, the PFSF is not designed to withstand the direct impact of an aircraft crash.

The Tooele Army Depot facilities, where toxic gas munitions are stored and incinerated, are located west and south, respectively, of Tooele City. The North Tooele Army Depot is 17 miles east-northeast of the PFSF and the South Tooele Army Depot is 21 miles east-southeast of the PFSF. The Stansbury Mountains, with an elevation of approximately 8,000 feet, lie between the PFSF and the Tooele Army Depots. The activities and materials at the Tooele Army Depots will therefore present no credible hazard to the PFSF, because of their relative distance and the intervening Stansbury Mountains.

2.3 METEOROLOGY

2.3.1 Regional Climatology

2.3.1.1 Data Sources

The description of the regional climatology of Skull Valley and the characterization of the PFSF site climate are based on "Climatography of the United States No. 60, Climate of Utah" published by the National Climatic Data Center (NOAA, 1960), long-term meteorological data collected by the National Weather Service at the Salt Lake City International Airport (SLCIA) as summarized by the National Climatic Data Center (NOAA, 1992), and "Utah Climate" published by the Utah Climate Center, Utah State University (Ashcroft et al., 1992). Normals, means, and extremes of temperature, precipitation, relative humidity, and wind speeds are taken from NOAA (1992). The SLCIA is located approximately 50 miles northeast of the site at an elevation of approximately 4,220 ft; the PFSF site is at an elevation of approximately 4,465 ft. Meteorological data collected at SLCIA, within 50 miles of the site, can be considered representative of the general climate of the site.

Extreme wind data are also obtained from Simiu et al. (1979), and extreme precipitation data are supplemented by the U.S. Department of Commerce (1955). Data on tornado occurrences and probabilities are derived from NOAA (1975-1995), Ramsdell and Andrews (1986), and Grazulis (1993). Occurrences of severe storms, hail, ice storms, and unusual events are taken from NOAA (1975-1995). Information on the frequency of stagnation conditions (poor dispersion) are obtained from Hosler (1961) and Holzworth (1974).

2.3.1.2 General Climate

The climate of the PFSF site in Skull Valley, Tooele County, Utah, can best be described as "semi-arid continental" marked with four well-defined seasons. Summers are characterized by hot, dry weather but the high temperatures are usually not oppressive because the relative humidity is generally low and the nights usually cool. July is the hottest month with temperature readings above 90°F. The mean diurnal temperature range is about 30°F in the summer and 18°F during the winter. Temperatures above 100°F in the summer or colder than 0°F in the winter occur occasionally. Winters are cold, but usually not severe. Mountains to the north and east act as a barrier to frequent invasions of cold continental air.

Heavy fog can develop under temperature inversions in the winter and persist for several days. Precipitation is generally light with the driest months being in summer and early fall and the wetter months in the spring when storms from the Pacific Ocean are moving through the area more frequently than at any other season of the year. Winds are usually light to moderate, although occasional high winds have occurred in every month of the year, particularly in March.

Utah's climate is the result of several factors. These factors include its latitude, elevation above sea level, location with respect to the average storm track over the Intermountain Region, and its distance from the principal moisture sources, the Pacific Ocean and Gulf of Mexico. The mountain ranges in the western United States also have a significant impact on the climate of the region, particularly the Cascade and Sierra Nevada Ranges and the Rocky Mountains. Pacific storms must cross the Cascades and Sierras before reaching Utah, resulting in much of the moisture being removed by precipitation as the moist air rises over the high mountains. Therefore, the prevailing westerly air flow reaching Utah is relatively dry, which results in light precipitation.

Besides the mountain ranges, the most influential natural feature affecting the climate of the area is the Great Salt Lake. This large inland body of water, which never freezes over because of its high salt content, can moderate the temperatures of cold winter winds blowing from the northwest and north and helps drive a lake/valley wind system. This system is characterized by on-shore breezes flowing southward off the lake during warm sunny days when the lake temperature is colder than the land. This wind system reverses to off-shore breezes during evening and nighttime hours when the land cools below the temperature of the lake. The warmer lake water during the winter and spring also contributes to increased precipitation in the valley downwind from the lake.

The range of temperatures in the area is rather large from winter to summer. Summers are generally hot and dry with temperatures reaching 90°F or higher approximately 56.5 days per year on average at Salt Lake City. The mean monthly temperature in July is 77.5°F with an average maximum temperature of 93.2°F. Winters are cold but usually not severe with an average monthly temperature of 28.6°F in January along with a daily minimum temperature of 19.7°F. The average number of days with temperatures reaching 32°F or below at Salt Lake City is 124.6 days with the first freeze normally occurring in mid-October and the last freeze occurring in late April. The growing season is normally over 5 months in length.

Precipitation tends to be heaviest in the spring months with the larger amounts occurring between March and May and the least amounts in the summer. The annual average rainfall amount at Salt Lake City is 15.3 inches with the largest amounts occurring in April with 2.21 inches and least amounts occurring in July at 0.72 inches. Precipitation occurs an average of 90.3 days per year (0.01 inches or more) at Salt Lake City. The average annual snowfall (1963 - 1992) is 57.6 inches per year occurring mostly between November and April and ranging from a low of 30.2 inches to a high of 110.8 inches.

On an annual average basis, relative humidities at Salt Lake City range from a high of 67 percent in the early morning hours to 43 percent in the afternoon. On a seasonal basis, the highest relative humidities occur in the fall and winter while summer relative humidities are generally the lowest. A better measure of humidity is dew point, which indicates the actual amount of moisture in the air as it is the temperature at which saturation occurs. Monthly average dew point temperatures in this area generally range from a high of mid-40°F in the summer to lows of low-to-mid 20°F in winter. Heavy fog with visibility below 0.25 mile at Salt Lake City is not a frequently occurring phenomenon, with an average annual frequency of 11.6 days per year, but does normally occur about 2 to 4 times per month during winter.

Winds at Salt Lake City are generally light to moderate with the highest speeds occurring during spring and summer with an average of approximately 10 mph for those months. The lightest winds occur in late fall and winter with the lowest monthly average wind speed of 7.4 mph occurring in December. The highest monthly wind speed of 9.7 mph occurs in August, and the long-term mean wind speed for the year is 8.8 mph. The prevailing wind direction at Salt Lake City is from the south-southeast or southeast throughout the year. The overall prevailing wind direction is from the south-southeast.

The winds observed at Salt Lake City for the years 1988 through 1992 are depicted on a seasonal and annual basis in wind roses presented in Figures 2.3-1 through 2.3-5. The wind roses show the percent of the time (rings) that the wind blows from each of 16 directions (N, NNE, NE, ... NNW) by the length of the bars. The shading of the bars also indicates the frequency of occurrence of wind speeds within the wind speed classes shown on the figures. For example, Figure 2.3-5 indicates that for the prevailing winds from the south-southeast, approximately 3 percent are in the 0 to 3 miles per hour (mph) wind speed class while about 16 percent of the winds are in the 3 to 7 mph class.

2.3.1.3 Severe Weather

2.3.1.3.1 Maximum and Minimum Temperatures

Based on observations taken by the National Weather Service at SLCIA, temperatures reaching 90°F or higher occur 56.5 days per year on average. The record high temperature at Salt Lake City based on 63 years of observations is 107°F occurring in July 1960, with record high temperatures ranging from 105°F (1951 - 1958 Iosepa South Ranch data) to 109°F (1950 - 1992 Dugway data) in Skull Valley (Ashcroft et al., 1992). The lowest recorded temperature at Salt Lake City is -30°F occurring in February 1933, with record low temperatures from -11°F (Iosepa South Ranch) to -29°F (Dugway) in Skull Valley (Ashcroft et al., 1992).

2.3.1.3.2 Extreme Winds

The highest observed fastest-mile wind speed at Salt Lake City is 71 mph from the northwest (March 1954) based on 56 years of observations while the peak gust is 69 mph from the southwest (May 1989) based on 8 years of observations. The fastest mile wind speed is the fastest speed of any "mile" of wind (Huschke, 1959). These wind gusts observed at Salt Lake City are consistent with observations of peak gusts observed in Skull Valley and Tooele County with Dugway Proving Grounds recording a peak gust of 68 mph from a thunderstorm and Tooele reporting a gust of 72 mph in a severe thunderstorm (NOAA, 1975-1995).

The 50- and 100-year return period fastest-mile wind speeds at a height of 10 meters for Salt Lake City are 70.4 and 74.5 mph based on an extreme value Type I probability distribution (Simiu et al., 1979). These fastest-mile winds should be multiplied by a "gust response factor" to account for the fluctuating nature of wind and its interaction with

buildings and other structures (ANSI, 1982). For exposures in open terrain with scattered obstructions having heights generally less than 30 feet (includes flat, open country and grasslands), the gust response factor at a height of 30 feet is 1.26. Therefore, the 50- and 100-year design wind speeds at an elevation of approximately 30 feet are 88.7 and 93.9 mph, respectively.

2.3.1.3.3 Tornadoes

The state of Utah experiences relatively few tornadoes. A total of 77 tornadoes were reported for the period from 1953 to 1995 (NOAA, 1975-1995), and only four were considered "significant" based on an examination of tornadoes from 1880 to 1993 (Grazulis, 1993). None of the "significant" tornadoes occurred in Tooele County. The state averages one tornado per year with a density of 0.12 tornadoes per 10,000 square miles (NOAA, 1975-1995), ranking 43rd out of the 50 states plus the District of Columbia. By contrast, the state of Texas has reported 5,674 tornadoes over the same period of time with a density of 4.90 tornadoes per 10,000 square miles.

Table 2.3-1 summarizes occurrences of tornadoes within a 1-degree latitude-longitude square centered on the PFSF site. This list of four tornadoes covering the period from 1975 to 1995 is based on the publication "Storm Data" (NOAA, 1975-1995). For each tornado, Table 2.3-1 identifies the date of occurrence, the county in which the tornado occurred, path length in miles, path width in yards, and the Fujita Scale classification (explained in Table 2.3-2).

Using the information provided in Table 2.3-1, the probability of a tornado striking a point within the 1-degree latitude-longitude square centered on the PFSF site is estimated as follows (Thom, 1963):

$$P = z \times t / A,$$

where:

P = mean probability of a tornado strike per year

z = geometric mean tornado path area (mi²)

t = mean number of tornadoes per year

A = area of 1-degree square (mi²)

The area (A) of the 1-degree box centered on the site can be estimated in square miles according to $4774.3 \cos(L)$ (Ramsdell and Andrews, 1986) where L is the latitude of the middle of the box. With an estimated latitude of 40.3 degrees north, A is approximately 3,641 square miles. The geometric mean of the tornado path lengths and widths given in Table 2.3-1 are 0.93 mile and 66.9 yards, respectively, yielding a geometric mean tornado path area of 0.035 mi². The mean number of tornadoes per year is 0.14 based on three observed tornadoes within the area over a 21-year period of record. Therefore, the probability of a tornado striking the PFSF site is estimated to be 1.37×10^{-6} per year or a recurrence interval of 728,200 years. This value compares with an arithmetic average tornado strike probability of 9.72×10^{-7} per year and an expected probability of 3.06×10^{-6} per year (based on a log normal distribution) for the entire state as computed in NUREG/CR-4461 (Ramsdell and Andrews, 1986) based on tornadoes for the period 1954 to 1983.

2.3.1.3.4 Hurricanes and Tropical Storms

Because of the site's location, approximately 800 miles from the Pacific Coast and more than 1,200 miles from the Gulf of Mexico, hurricanes and tropical storms do not affect this area.

2.3.1.3.5 Precipitation Extremes

The maximum observed 24-hour rainfall amount at Salt Lake City is 2.4 inches occurring in April 1957 along with a maximum monthly amount of 7.0 inches. The highest recorded daily and monthly precipitation amounts at Dugway are 1.46 and 3.16 inches, respectively (Ashcroft et al., 1992). The highest short-term rainfall rate observed in Skull Valley was 0.95 inch in 30 minutes at Dugway during a thunderstorm in August 1984 (NOAA, 1975-1995). The extreme hourly rainfall rate for Salt Lake City with a 50-year return period is approximately 1.2 inches per hour (U.S. Dept. of Commerce, 1955).

The maximum recorded monthly snowfall at Salt Lake City is 41.9 inches in March, 1977 along with a maximum 24-hour snowfall of 18.4 inches in October, 1984. At Dugway, the maximum monthly and daily snowfall amounts for the period 1950 to 1992 are 21.2 and 9.0 inches, respectively.

2.3.1.3.6 Thunderstorms and Lightning Strikes

Salt Lake City averages 36.7 thunderstorm days per year with the highest number of days (7-8 days per month) occurring in July and August (NOAA, 1992). An examination of "Storm Data" from 1975 through 1995 (NOAA, 1975-1995) indicates that there were approximately 20 occurrences of severe thunderstorms in Tooele County during this time and two instances of lightning strikes causing injuries reported in Tooele County. According to "Storm Data", there were a total of 82 lightning injuries in the entire state during the period 1959 to 1995.

2.3.1.3.7 Snowstorms

Heavy snowfalls with blizzard conditions (snow, temperature < 20°F, wind speed > 35 mph) can affect the state but are relatively infrequent. In the Tooele County area, only a few unusually heavy snowfalls (> 12 inches) were reported between 1975 and 1995 (NOAA, 1975-1995).

2.3.1.3.8 Hail and Ice Storms

Hail in Utah is relatively infrequent but it may damage fruit and vegetables in limited areas during the spring and summer (NOAA, 1960). In Tooele County specifically, only four instances of sizable hail were noted during the period from 1975 to 1995 (NOAA, 1975-1995) with some hail stones reaching 1.25 inches in size in Tooele.

Freezing rain and glazing events are not numerous in Utah but do occur occasionally. There were only four reported ice storm events in Tooele County and the northwest valleys over the 1975-1995 period (NOAA, 1975-1995). These ice storms have caused power outages, traffic accidents, and downed tree limbs.

2.3.1.3.9 Poor Dispersion Conditions

The most commonly occurring meteorological condition leading to poor dispersion is the low-level (< 500 feet) or ground-based inversion. Because temperature normally decreases with altitude, an inversion is a condition in which temperature increases with height or is inverted from the normal condition. This vertical temperature profile leads to very stable atmospheric conditions in which very little motion or turbulence takes place. Thus, a pollutant emitted into such an atmosphere experiences very little dilution due to atmospheric turbulence. Inversions tend to be diurnal in nature, generally occurring

during nighttime and early morning hours and breaking up during the heating of the day. As a result of this behavior, inversions are usually not a very persistent phenomenon.

The frequency of occurrence of low-level inversions in the PFSF site area can be estimated from isopleths of inversion frequency developed by Hosler (1961). The PFSF site falls on the 45 percent of total hours per year isopleth on an annual basis for inversion frequency. Seasonally, winter and fall experience the highest inversion frequencies at approximately 50 percent of total hours. Summer and spring inversion frequencies have been estimated to be approximately 35 to 40 percent.

A more persistent condition of poor dispersion leading to air pollution episodes is the stagnating anticyclone, which is an area of high atmospheric pressure that essentially remains stationary for a period of several days. The stagnating anticyclone is characterized by light wind speeds (<9.0 mph), no precipitation, and shallow mixing depths (< 1,600 feet). These conditions lead to very little dilution or ventilation of pollutants emitted into this air mass, which tend to recirculate within the anticyclone.

The degree to which these poor dispersion conditions occur at a given location can be estimated from a study of episodes of limited dilution conducted by Holzworth (1974). In this study, a ventilation or dilution factor was calculated as the product of mixing height (meters) and layer average wind speed (meters/second) for 62 upper air stations throughout the United States for the period 1960-1964. A low value of this factor indicates slower dilution. The Salt Lake City upper air station was found to have 1-, 2-, 3-, 4-, and 5-day episode ventilation factors of 99.9, 236.3, 322.1, 357.2, and 463.5 m²/sec compared to those of the worst case station in Lander, Wyoming, of 14, 17, 34, 57, and 55 m²/sec. Salt Lake City ranked 9th, 18th, 13th, 12th, and 16th out of 62 stations in 1-, 2-, 3-, 4-, and 5-day episode ventilation factors.

2.3.2 Local Meteorology

2.3.2.1 Data Sources

The meteorology of the Skull Valley site can be partially characterized using long-term meteorological data collected by the National Weather Service at the SLCIA (NOAA, 1992). This climatological data set is the most comprehensive available for this area. The SLCIA is located approximately 50 miles northeast of the site at an elevation of approximately 4,220 ft. With the PFSF site being located at an elevation of approximately 4,465 ft, meteorological data collected at SLCIA can be considered representative of the general climate of the site but need to be supplemented with data more representative of local conditions.

The valley location of the PFSF site has an influence on the local meteorology relative to that of SLCIA with the Stansbury and Oquirrh Mountains rising to elevations of above 10,000 ft between the two locations. The location of the Great Salt Lake to the north of Skull Valley as opposed to west and northwest of SLCIA also probably causes some meteorological differences between the two locations. Therefore, meteorological data collected in Skull Valley are also needed to characterize the local conditions. Monthly average temperature and precipitation data collected at various locations in Skull Valley are available from a book published by the Utah Climate Center (Ashcroft et al., 1992). The data collected at Dugway, located approximately 12 miles south of the PFSF site at an elevation of 4,340 ft, have the longest period of record (1950 - 1992) and appear to be the most reliable. Other useful data were collected at Iosepa South Ranch, which is located about 12 miles north of the PFSF site at an elevation of 4,415 ft, during the period from 1951 - 1958.

The Onsite Meteorological Monitoring Program, described in detail in Section 2.3.3, will provide hourly average data on wind speed, wind direction, temperature, relative humidity, precipitation, barometric pressure, and solar radiation for characterization of the local meteorology because many of these parameters are not available from other sources. The tower is located approximately 3 miles southeast of the PFSF site at the closest point where power and a telephone line are available. This location is judged to be a suitable representative for "onsite" meteorological data collection. The tower location is in the same topographic setting as the proposed site with the Stansbury Mountains to the east and northeast being sufficiently distant from both locations as to cause insignificant differences in meteorological observations between the two locations. Both sites are essentially the same distance from the Great Salt Lake and the Wasatch Mountains to the east. Given that the intent of the meteorological data collection program is to characterize the local meteorology and not for radiological dispersion calculations, this location provides representative data.

2.3.2.1.1 Precipitation

Normal monthly precipitation tends to be concentrated in the winter and spring months with the larger amounts occurring between December and May and the least amounts in the summer and early fall. The annual average rainfall rate at Salt Lake City is 15.3 inches per year with a record 24-hour rainfall of 2.4 inches. Precipitation occurs an average of 90 days per year (0.01 inch or more). Precipitation data collected in Skull Valley indicate a range of annual precipitation of from 7 to 12 inches per year with increasing amounts at higher elevations in the Stansbury Mountains, maximizing at Deseret Peak with approximately 40 inches per year (Hood and Waddell, 1968). A 43-year record (1950 - 1992) of precipitation data at Dugway indicates a normal annual precipitation rate of 8.2 inches per year. An 8-year record (1951 - 1958) at Iosepa South Ranch indicates an average annual precipitation rate of 9.6 inches per year. Therefore,

the valley location of the PFSF site tends toward the lowest precipitation amounts in the area. Table 2.3-3 summarizes monthly precipitation amounts for Salt Lake City and Skull Valley locations.

The long-term average annual snowfall (1963 - 1992) at Salt Lake City is 57.6 inches per year occurring mostly between November and April and ranging from a low of 30.2 inches in 1979 - 1980 to 110.8 inches in 1973 - 1974. The maximum recorded monthly snowfall is 41.9 inches in March 1977 along with a maximum 24-hour snowfall of 18.4 inches in October 1984. Information on snowfall amounts at Dugway and Iosepa South Ranch indicate normal annual snowfalls of 16.0 and 21.3 inches, respectively, with maximum monthly amounts of 21.2 and 17.7 inches. The record daily snowfalls at Dugway and Iosepa South Ranch are 9.0 and 8.0 inches each.

2.3.2.1.2 Temperature

The average daily maximum temperature at Salt Lake City in July is 93.2°F and mean maximum temperatures at Dugway and Iosepa South Ranch exceed 90°F during July and August. Winters are moderately cold with an average monthly temperature of 28.6°F in January at Salt Lake City along with a daily minimum temperature of 19.7°F. Similar winter temperatures are experienced in Skull Valley with average monthly values near 30°F in December and January. The average number of days with temperatures reaching 32°F or below at Salt Lake City is 125 days with the first freeze normally occurring in October and the last freeze occurring in April. The annual average temperatures at Salt Lake City is approximately 52°F for the period 1951 - 1980 with Skull Valley average temperatures ranging from 50 to 51°F. Normal monthly, daily maximum, and daily minimum temperatures for the period 1951 to 1980 for Salt Lake City, 1950 to 1992 for Dugway, and 1951 to 1958 for Iosepa South Ranch are provided in Table 2.3-4.

2.3.2.1.3 Wind Direction and Speed

Winds at Salt Lake City are moderate and are fairly uniform over the year with the highest average speed (9.7 mph) occurring in August and the lightest average wind speed (7.4 mph) occurring in December. The long-term mean wind speed for the year is 8.8 mph. The prevailing wind direction at Salt Lake City is from the southeast or south-southeast throughout the year. Table 2.3-5 provides mean wind speeds by month for a 62-year period of record and prevailing wind directions by month. Long-term wind information is not available specifically for the Skull Valley. Wind speed and direction data will be provided by the on-site monitoring program.

2.3.2.1.4 Humidity, Fog, Thunderstorms

On an annual average basis, relative humidities at Salt Lake City range from a high of 67 percent in the early morning hours to 43 percent in the afternoon. On a seasonal basis, the highest relative humidities tend to occur in late fall and winter while summer relative humidities are generally the smallest.

Heavy fog with visibility below 0.25 mile at Salt Lake City is not a frequently occurring phenomenon, with an average annual frequency of 11.6 days per year, but does normally occur 2 to 4 times per month during winter.

Salt Lake City also has a mean of 36.7 thunderstorm days per year and approximately 5 to 8 thunderstorm days per month from May through August.

2.3.2.1.5 Atmospheric Stability and Mixing Heights

The dispersion of an air contaminant by atmospheric turbulence and diffusion can be characterized by the stability of the atmosphere. Pasquill (1961) has developed an atmospheric stability classification scheme that divides atmospheric diffusion levels into six classes labeled A through F. Stability class A represents the most "unstable" and diffusive category representative of conditions during warm sunny afternoons while F is the most "stable" and least diffusive class generally occurring during the night and early morning hours under light or calm winds. The intermediate stability class D represents "neutral" atmospheric stability and is typified by cloudy, windy conditions. These stability classes are generally determined from National Weather Service meteorological data using a combination of wind speed, cloud cover, and daytime solar insolation observations.

Table 2.3-6 presents the frequency of occurrence of each Pasquill stability class as determined for Salt Lake City based on 5 years (1988 - 1992) of meteorological data collected at the airport. This table indicates that the dispersion environment of the area is dominated by "neutral" (stability class D) stability (moderate dispersion) with stable atmospheric conditions (weak dispersion) being approximately 60 percent more frequent than unstable conditions (strong dispersion).

Table 2.3-7 presents seasonal average mixing heights for Salt Lake City (Holzworth, 1972). The morning and afternoon mixing heights in Table 2.3-7 were approximated by the National Climatic Data Center from vertical temperature measurements taken by the National Weather Service twice daily for the period 1960 to 1964. The mixing height is defined as the height above the surface through which relatively vigorous vertical mixing occurs (Holzworth, 1972). As such, the mixing height defines the vertical layer of the atmosphere through which pollutants can be mixed. Low mixing heights, which are

characteristic of the nighttime dispersion environment, generally result in higher pollutant concentrations at the surface for low-level sources (below the mixing height). The higher mixing heights occurring during midday are conducive to greater dispersion and lower ground level pollutant concentrations.

2.3.2.1.6 Air Quality

The air quality in the site area is generally very good. The U.S. Environmental Protection Agency (EPA) has adopted National Ambient Air Quality Standards (NAAQS) for six air pollutants known as criteria pollutants. The primary standards are designed to protect public health while the secondary standards are designed to protect public welfare (includes protection of economic interests, vegetation, and visibility). The Utah Department of Environmental Quality (DEQ) has adopted the federal NAAQS as the state ambient air quality standards; Table 2.3-8 shows these standards.

Ambient air monitoring data collected by the DEQ at several monitoring stations throughout the state are used to determine whether or not these NAAQS are being met. Areas where the standards are attained are referred to as "attainment" areas and those areas not attaining the standards are called "nonattainment" areas. This project is located in the Wasatch Front Intrastate Air Quality Control Region (AQCR) which is in attainment for nitrogen dioxide (NO₂), carbon monoxide (CO), particulate matter with aerodynamic diameter less than 10 microns (PM₁₀), lead (Pb), and ozone based on monitoring data collected in the AQCR. A portion of eastern Tooele County is currently non-attainment for the primary and secondary sulfur dioxide (SO₂) standard.

The attainment status of the Wasatch Front Intrastate AQCR is supported by the three most recent years (1993 - 1995) of available ambient air quality monitoring data collected by the DEQ in the AQCR. Table 2.3-9 summarizes these data showing the highest

annual average and second highest short-term (1-, 3-, 8-, 24-hour) monitored values in the county for each pollutant and averaging time. These data demonstrate that ambient criteria pollutant concentrations are well below the NAAQS.

Given that all of Tooele County, except for the highest elevation areas in the far eastern part of the county, is currently in attainment of the NAAQS for all criteria pollutants and the available monitoring data indicate air pollutant concentrations generally well below the NAAQS, air quality is not expected to have any effect on the operation of the PFSF facility.

2.3.2.2 Topography

The PFSF is located in Skull Valley at an elevation of approximately 4,465 ft. The Stansbury Mountains, located 9 miles to the east, rise to a maximum elevation of 11,031 ft. The Cedar Mountains, located approximately 11 miles to the west, rise to a maximum elevation of approximately 7,600 ft. The detailed topographic features in proximity to the site are shown on Figure 1.1-1.

2.3.3 Onsite Meteorological Measurement Program

The On-site Meteorological Monitoring Program provides hourly average data on wind speed, wind direction, air and soil temperature, relative humidity, precipitation, barometric pressure, and solar radiation for characterization of the local meteorology since several of these parameters are not available from other sources. The tower is located approximately 2 miles southeast of the PFSF site at a roadside shop where AC power and a telephone line are available as shown on a section of a 7.5 minute United States Geological Survey (USGS) topographic map in Figure 2.3-6.

This location is suitable for "onsite" data collection from a meteorological representativeness perspective. The tower location is in the same topographic setting as the proposed site with the Stansbury Mountains to the east and northeast being sufficiently distant from both locations as to cause insignificant differences in meteorological observations between the two locations. Both sites are essentially the same distance from the Great Salt Lake and the Wasatch Mountains to the east. Given that the intent of the meteorological data collection program is to characterize the local meteorology and not for radiological dispersion calculations, this location provides representative data.

The meteorological monitoring system consists of a heavy-duty 10-meter tower with wind speed and direction sensors at the 10-meter level and temperature, relative humidity, and solar radiation sensors at the 2-meter level. Barometric pressure and precipitation (rain and snow) are recorded at ground level. Soil temperature is recorded at 1 meter below the surface. The tower is equipped with a lightning protection and grounding system and a signal line surge protector. The monitoring system is protected by a 6-foot-high fence made of galvanized steel that includes a lockable gate. The system meets the intent of 10 CFR 50, Appendix B and the siting and accuracy requirements of Safety Guide 23 and the recommendations of the ANSI standard, ANSI/ANS-2.5.

All measurements are recorded using a Campbell Scientific CR10X digital datalogger which is configured for periodic download of data to laptop PC or data cartridges. The system is also configured with a dial-up modem for remote data interrogation and downloading. All systems are capable of operating and recording data without outside power using a 12-volt battery and solar panel, with the exception of the rain gage heater. Sampling interval for all parameters, except precipitation and sigma theta, is 60 seconds or less with mean values computed using 30 instantaneous values equally spaced over a 15-minute period. Hourly averages of these parameters are calculated from the 15-

minute averages. Precipitation is recorded once per hour. Sigma theta is determined from no less than 180 instantaneous values of lateral wind direction during a 15-minute sampling period. The datalogger is located in a weather tight enclosure near the base of the tower. The detailed specifications the vendor was required to meet are provided in Table 2.3-10. The system consists of the following sensors and equipment as provided by Climatronics Corporation:

1. One 10-meter heavy duty folding aluminum tower.
2. Two WM-III A wind speed/direction sensors (one as spare).
3. Two platinum temperature sensors (one as spare).
4. Two naturally aspirated radiation shields for temperature (one as spare).
5. One relative humidity sensor and radiation shield.
6. One soil temperature sensor.
7. Two solar radiation sensors (one as spare).
8. One tower boom.
9. One matrix radiation cable.
10. One recording rain gauge (tipping bucket).
11. Precipitation heater cables.
12. One analog barometric pressure sensor.
13. One Campbell Scientific CR10X datalogger with weather tight enclosure.
14. One 12-V 20-amp/hour battery.
15. One 20-watt solar panel.
16. Datalogger software (including sigma theta calculation).
17. Data display software with archiving.
18. One Opto-Isolated RS232 interface.
19. One phone modem (1200 baud).
20. One full height grounding kit for lightning protection.
21. One signal line surge protector.

The system is designed to assure at least a 90 percent data recovery and to minimize extended periods of instrument outage through the use of spare parts and surveillance procedures. The initial calibration of all instruments, sensors, recorders, and test equipment, including spare parts and spare instruments, was performed by Climatronics and audited by Stone & Webster. Future calibrations will be performed at six month intervals. A calibration history is kept for each sensor and recorder and for the test equipment. The measurements for wind speed, wind direction, and temperature are traceable to the National Institute of Standards and Technology (NIST). The instruments used for calibration have a certificate traceable to NIST, where applicable.

All data collected by the meteorological monitoring system are validated by a Certified Consulting Meteorologist (CCM) using validation procedures that compare monitored values with other sources of nearby meteorological data where possible and by checking values against a set of reasonableness criteria for each parameter. Meteorological parameter values that fall outside of prescribed ranges are checked for validity using other sources of data where possible and by examining the synoptic conditions that caused the readings.

2.3.4 Diffusion Estimates

No atmospheric diffusion estimates have been developed for the PFSF as there are no routine or accidental radiological releases that can be postulated for this facility. Although a postulated release of radionuclides is assumed for the hypothetical loss of confinement accident analysis in Chapter 8, the atmospheric diffusion characteristics are based on Regulatory Guide 1.145 with a wind speed of 1 meter/sec, atmospheric stability class F, with no consideration for plume meander.

2.4 SURFACE HYDROLOGY

2.4.1 Surface Hydrologic Description

The PFSF site is situated near the middle of Skull Valley about 24 miles south of highway I-80 and the Great Salt Lake. Figure 2.4-1 shows the topography of the site and surrounding area. Skull Valley was formerly occupied by Lake Bonneville, an inland sea that covered the area from about 30,000 to 10,000 years before present (B.P.). The valley is nearly 50 miles long and 22 miles wide at its widest point and slopes gently northward to Great Salt Lake at approximately 30 ft per mile.

North-south trending mountain ranges rise abruptly from the valley floor on both sides. On the east side of the valley, the Stansbury Mountains rise to 11,031 ft elevation at Deseret Peak, while on the west side, the Cedar Mountains rise to about 7,600 ft elevation. Both ranges are composed mainly of limestone and dolomite with lesser amounts of quartzite, sandstone, and shale, ranging in age from Early Cambrian to Tertiary.

A thick alluvial apron exists at the base of the ranges, formed by a series of coalescing alluvial fans. This apron (or bajada) is composed mainly of coarse clastic material derived from erosion of the adjacent ranges by high gradient streams. The surface of the bajada in the vicinity of the PFSF site slopes westward at about 165 ft per mile and meets the valley bottom about 1.5 miles east of the PFSF location.

Precipitation in Skull Valley ranges from 7 to 12 inches per year with only about one-third that amount falling during the growing season (Hood and Waddell, 1968). The uplands receive considerably more precipitation, up to 40 inches in the Stansbury Mountains and 16 to 20 inches in the lower Cedar Mountains. Much of this is in the

form of snow that enters the hydrologic system as runoff in the spring. However, very little of this water actually reaches the valley bottom as stream flow.

The pervious unconsolidated deposits of the bajada intercept runoff and serve as the main zone of recharge to the groundwater system. As a consequence, there are few perennial streams in Skull Valley and none in the vicinity of the site. The poorly developed intermittent drainages are mainly dry washes incised a few feet into the valley bottom. All of these washes in the site vicinity drain northward or northwestward and likely carry water for only short periods during spring runoff or during infrequent summer thunderstorms.

At a few locations in Skull Valley, especially along the eastern foothills, ground water intersects the surface in the form of springs. These springs have created surface channels, such as those near Timpie and Delle. In general, most spring flow is lost to the recharge area or is consumed by evapotranspiration. No springs occur within a 5-mile radius of the site. The nearest perennial surface flow downstream from the proposed site occurs about 10 miles to the north near Salt Mountain. This flow is attributed mainly to springs at the base of the hill, west of Skull Valley Road. It eventually joins other spring and stream flow, creating a large wetland/mudflat system, before draining to Great Salt Lake.

There are no perennial lakes or ponds in the site area other than a few stock ponds or small reservoirs built for irrigation purposes. These impoundments are commonly filled by water diverted in ditches or pipelines whose sources are in the canyons of the Stansbury Mountains.

There are no public or private surface drinking-water supplies in the site vicinity. Potable water supplies for the Skull Valley Indian Reservation, and the few scattered

ranches or farms along the east side of the valley, are wells drilled into the unconsolidated or semi-consolidated sediments that form the alluvial fan along the base of the Stansbury Mountains. Consequently, there is no potable surface water supply that could be subject to normal or accidental effluents from the facility.

2.4.1.1 Site and Structures

The land surface at the site is approximately 4,465 ft elevation and is nearly flat, sloping gently to the north. A few shallow, dry washes and former beach or lake bottom features provide slight relief to the site area. Desert shrubs and grasses form a thin vegetative cover.

No streams that would even be considered intermittent cross the facility area. The closest stream with a significant channel crosses the northeast corner of Section 6 and the center of Section 5, about 1,500 ft from the northeast corner of the facility (Figure 2.4-1). The channel is up to 3 ft deep and 6 to 8 ft wide in some areas. It carried no water during the observation period between June 1996 and February 1997.

The facility and its structures are described in Chapter 1. The PFSF storage area is approximately 99 acres. The storage area is graded for surface drainage with slopes from south to north of approximately 0.5%. Site elevations vary from approximately 4,460 ft at the north to 4,470 ft at the south. A stormwater retention basin is located on the north side of the storage area to collect runoff from the storage area.

2.4.1.2 Hydrosphere

Watersheds contributing runoff to the areas of the access road and the PFSF site are shown in Figure 2.4-1. Watershed runoff contributing to the access road area is from the

Stansbury mountains and is designated as Basin I in Figure 2.4-1. Basin I is a watershed comprising an area of approximately 26 square miles. Watershed runoff contributing to the PFSF site area is from the Hickman Knolls and is designated as Basin II in Figure 2.4-1. Basin II is a watershed comprising an area of approximately 0.93 square miles (595 acres). Basin I is separated from Basin II by an earthen berm proposed for construction at the PFSF to control offsite runoff. The topography and approximate sheet flow direction in the site vicinity are also shown in Figure 2.4-1.

Basin I runoff originates in the upland of the Stansbury Mountains. Runoff is drained westerly by a perennial stream in Indian Hickman Canyon and an intermittent stream in Dry Canyon (see Figure 2.4-1). These flow from the mountain front, cross the alluvial fans, and turn to the north crossing the access road. At the foothills of the mountain, the stream flow of Indian Hickman Canyon is quickly lost to the pervious sublayer and evapotranspiration to become an intermittent stream. Stream flow would be produced only by very heavy rainfall or during snowmelt conditions.

Basin I consists of three subbasins, i.e., the mountain slope (I_A), the alluvial fans (I_B), and the lowlands of the valley (I_C) which are shown in Figure 2.4-1. Top soils are mainly poorly sorted, coarse to fine grained lacustrine deposits (Hood and Waddell, 1968), and fine grained silt (USDA, unpublished report). Slopes of the subbasins are approximately 19.7%, 3.9%, and 1.4%, respectively.

Basin II runoff is from the nearby Hickman Knolls and flows directly toward the PFSF site. The northward runoff mainly flows as a sheet flow through the fine grained lacustrine deposits and few sedimentary rocks on its way past the site. The average basin slope is approximately 3.7%.

During site visits conducted between June 1996 and February 1997, several hydrologic observations were made. No perennial streams were observed to cross Skull Valley road from the uplands to the east, nor were any perennial streams observed west of the site to the base of the Cedar Mountains. There are no upstream or downstream flow control structures whose failure could conceivably affect the site or its access road. The only structures located in the area are very small reservoirs in the foothills used as stock ponds or for collection of water for irrigation purposes.

Hood and Waddell (1968) indicate that the groundwater table in Skull Valley in the vicinity of the site ranges from elevation 4,300 to 4,350 ft. By interpolation, the groundwater table at the site is estimated to be at elevation 4,333 ft, which is at a depth of approximately 132 ft. This value is consistent with the upper bound of the range of depths to the water table reported by Geosphere Midwest (Appendix 2B), who report seismic refraction results indicate that the water table may be located at depths of between 90 and 136 ft (Seismic Lines 1, 2, & 3) below existing grade. Since the accuracy of these depth values is reported by Geosphere Midwest as $\pm 15\%$ and since ground water was not encountered within the 100 ft maximum depth of the borings (Appendix 2A), it is concluded that the depth to the groundwater table is greater than 100 ft below existing grade at the site. Therefore, because of the great depth to the groundwater table, it is very unlikely that the groundwater regime could have any influence on the site.

2.4.2 Floods

The site area has not experienced any flooding in the past. Storm-induced local runoff will provide sheet flow toward the site which will easily be controlled by construction of short diversion berms near the southern portions of the PFSF.

Analyses of the probable maximum precipitation were performed to determine a PMF for stormwater drainage Basins I and II (SWEC, 1997). The analyses demonstrated that the site is not in the flood plain caused by either event.

2.4.2.1 Flood History

The PFSF site is located in an area of western Utah with a semi-arid climate, receiving average annual precipitation of 7 to 12 inches (Hood and Waddell, 1968). There are no perennial water courses within 4 miles of the site. The nearest streams are high gradient streams that drain the slopes of the Stansbury Mountains through steep-walled canyons. This flow is quickly lost to the unconsolidated sediments comprising the alluvial apron at the foot of the mountains and becomes part of the groundwater system. No perennial surface flow makes its way across Skull Valley road which runs north-south, approximately 1.5 miles east of the PFSF site.

There is no evidence of past flooding in the site area and only minor development of drainage channels created by infrequent thunderstorms (<1 to 2 ft deep). There is no evidence of flash-flooding in the area, such as flood deposits, nor are there channels that could affect the site if they were subject to a flash flood.

The only conceivable scenario for floods would involve a return to climatic conditions of the Late Pleistocene causing a significant rise (~300 ft) in the level of Great Salt Lake. Those conditions generally require millennia to develop, therefore, this scenario is dismissed.

2.4.2.2 Flood Design Considerations

A hypothetical PMP event was analyzed to determine maximum flooding elevation at the PFSF site due to both watershed Basins I and II. The analyses included the general and the local PMP for Basins I and II. The PMF was based on the procedures given in Hydrometeorological Report (HMR) 49 (Department of Commerce, 1977). As discussed below in section 2.4.2.3, the PMF generated by the local PMP is much greater than that generated by the general PMP.

Results of hydraulic analysis are described in Section 2.4.2.3. The maximum Basin I PMF water elevation predicted at the location nearest the site, approximately 6,500 ft downstream (north) from the access road, is 4,453.4 feet. The site grade elevations are higher than 4,460 feet. Consequently, all Structures, Systems, and Components (SSCs) classified as being Important to Safety are located above the Basin I PMF flood plain.

Basin II stormwater runoff from Hickman Knolls drains as a sheet flow toward the PFSF site. An earthen berm and drainage ditch system will be constructed on the south and west sides of the PFSF storage site to divert the PMF stormwater flows around the site and into the Skull Valley natural drainage system. Consequently, all Structures, Systems, and Components (SSCs) classified as being Important to Safety are protected from the sheet flow associated with the Basin II PMF by an earthen berm.

The PFSF site drainage systems (both offsite and onsite) are designed for the 100-yr. storm event. Offsite drainage system design due to Hickman Knolls runoff is conveyed around the south and west sides of the PFSF. This flow is then discharged at a permissible velocity to the Skull Valley natural drainage system. Flows resulting from a storm event more severe than a 100-year event from Hickman Knolls are also diverted

into the Skull Valley drainage system. Onsite drainage system design due to local runoff is conveyed by a surface flow system utilizing swales channeled to a stormwater collection and retention basin where it can evaporate and seep into the soil.

The PFSF access road drainage system is designed to safely convey the surface water under the roadway during a 100-yr. storm event. During a PMP, the excess runoff will overtop the access road embankment. The access road flood overflow will be contained with a north-south berm tied into Hickman Knolls to prevent flows from approaching the PFSF site. Downstream of the access road, the PMF returns to the natural flow conditions. Access to the site by normal vehicular traffic, as well as emergency vehicles, will be provided at all times except during a storm which is more severe than a 100-yr. storm event.

2.4.2.3 Effects of Local Intense Precipitation

The PMP was estimated based on HMR 49. HMR 49 requires several different evaluations for combinations of storm events. After these evaluations are completed, the PMP events are used with the hydrologic program HEC-1 to determine peak discharges. The largest peak discharge is selected for the Basin I PMF. Basin I PMF profiles corresponding to the peak discharges were determined with HEC-RAS backwater program.

According to the procedures given in HMR 49, the total precipitation for the general PMP were estimated to be approximately 9.65 and 9.49 inches during a 24-hour duration (or 4.99 and 4.89 inches during a 6-hour duration) for the month of August (SWEC, 1997) at the PFSF site and at the access road, respectively.

Since the greatest precipitation of the season is in the month of August, general PMP in August was selected for analysis. The total precipitation during the local PMP were estimated to be approximately 13.2 and 11.75 inches during a 6-hr duration at the site and the access road, respectively.

The 1-hr local PMP induced by a short duration thunderstorm over a 1 square mile basin at the site was determined to be 10 inches. The 15-minute local PMP was 7.2 inches. Durational variation and areal reduction described in HMR 49 were employed to estimate the incremental PMP.

The total duration of the local PMP was divided into six increments. The sequence of hourly incremental PMP for the 6-hr thunderstorm was arranged in accordance with HMR No. 5 (U.S. Dept. of Commerce, 1977). The largest hourly amount was placed at the third sequence; followed by the second largest, the fourth, and the sixth. The third largest and the fifth largest preceded the greatest increment.

The local PMP depths at 15-minute intervals for the first hour were determined by the procedures provided in HMR 49. The remaining 15-minute intervals were estimated from the depth-duration curve as documented in the calculation (SWEC, 1997). The sequence of the four 15-minute incremental PMP has the greatest intensity in the first 15-minute interval. The second, the third, and the fourth largest were placed after.

The general PMP depths at 1st, 6th, 12th, 18th, 24th, 48th, and 72nd hours were determined by HMR 49. The remaining 3-hr increments can be found from the depth-duration relationship. Time distribution procedures given by the Corps of Engineers (1952) were used for all other storms except the local PMP. The total duration of the storm was divided into four increments. The increments were arranged in a sequence

with the largest one at the middle and decreased progressively to either side of the greatest increment.

The HEC-1 computer program (US Army, COE, 1990) was used to determine the Basin II peak discharge at the site and the Basin I peak discharges at the access road for the various PMP events. The Soil Conservation Service (SCS) curve number was used for estimating rainfall loss rate. The SCS dimensionless unit hydrograph parameter, entitled SCS lag time, was approximated by a multiplier of 0.6 factor to the time of concentration (USDA, 1985).

Soil type and its corresponding hydrological group, runoff curve number, were estimated based on USDA's unpublished county soil report. The average runoff curve numbers computed for the drainage basins at the access road (Basin I) and the PFSF site (Basin II) are 72 and 79 (USDA, 1986), respectively.

The Kirpich formula (Chow, 1964) was used to estimate the time of concentration for the overland flow on grassed surface. Based on the measured watershed length and the slope of the basin, the times of concentrations at the access road (Basin I) and the PFSF site (Basin II) are 4.46 hr and 1.1 hr, respectively.

As a result of the HEC-1 computation, the PMF generated by the local PMP is much greater than that generated by the general PMP. The flood flow and the flood elevation presented were determined from the local PMP only.

For design purposes, the Basin I and Basin II 100-yr. floods were simulated at the site and the access road using the HEC-1 program. The same precipitation loss parameters were used. Precipitation was estimated based on U.S. Department of

Agriculture, Soil Conservation Service, Engineering Division (USDA, 1973). The spatial distribution of the 100-yr. precipitation was weighted by a subbasin area ratio.

The HEC-1 computed 100-yr. flood flows for Basin I (access road) and Basin II (PFSF site) as 2,065 cfs and 182 cfs, respectively. These discharges were compared to those estimated by a regression method for the region (USGS, 1994). For a drainage area having the same size, the regression 100-yr. peak discharges are approximately 1,700 cfs and 200 cfs respectively (SWEC, 1997). The two methods are in reasonable agreement. This agreement suggests the HEC-1 rainfall loss parameters are prudent.

The PMF flows were computed to be 31,934 cfs and 2,643 cfs for Basin I (access road) and Basin II (PFSF site), respectively. The PMF would most likely flow to the north along the east fringe of the PFSF site to Great Salt Lake. A combined peak discharge of 34,577 cfs was used for backwater computation. The computer program HEC-RAS (US Army, COE, 1995) was used to compute the Basin I maximum flood profile elevation and flood plain at the adjacent site. The maximum water elevation predicted is 4,453.4 ft, approximately 6,500 ft downstream from the access road. The site elevation at the northeast corner of the site is approximately 4,460 ft. Consequently, the site is not in the Basin I PMF flood plain.

The Basin II maximum flow depth of local drainage from Hickman Knolls was computed using normal depth procedures (Chow, 1959). Using a maximum discharge of 2,643 cfs, a Manning's 'n' value of 0.03, and the natural ground slope in the area, the computed flow depth was 0.7 ft. All Structures, Systems, and Components (SSCs) classified as being Important to Safety are protected from the sheet flow associated with the Basin II PMF by an earthen berm.

In summary, all Structures, Systems, and Components (SSCs) classified as being Important to Safety are protected from flooding by diversion berms to deflect potential flows from the PMF due to both the Stansbury Mountains and the Hickman Knolls watersheds (see Section 2.7).

2.4.3 Potential Maximum Flood on Streams and Rivers

Since there are no perennial streams or rivers in the vicinity of the PFSF, a PMF analysis is not required on streams and rivers. However, an ephemeral stream bed is present; therefore, a PMF analysis was performed for this ephemeral stream. This analysis is described above in Section 2.4.2 under the term "local PMP."

2.4.4 Potential Dam Failures (Seismically Induced)

There are no flow control structures on any stream upgradient from the site; therefore, there is no potential for impact on the site from potential dam failures.

2.4.5 Probable Maximum Surge and Seiche Flooding

No surge or seiche flooding is possible, as there is no large water body near the site.

2.4.6 Probable Maximum Tsunami Flooding

The site is not located near a coastal area. As a result no tsunami sea waves are anticipated.

2.4.7 Ice Flooding

There are no water bodies near the site on which ice flooding conditions could arise.

2.4.8 Flooding Protection Requirements

All Structures, Systems, and Components (SSCs) classified as being Important to Safety are protected from flooding by diversion berms to deflect potential flows from the PMF due to the both the Stansbury Mountains and the Hickman Knolls watersheds.

2.4.9 Environmental Acceptance of Effluents -SSC-

With the exception of the sanitary system, there are no liquid releases that result from the normal operation of the PFSF.

THIS PAGE INTENTIONALLY BLANK

2.5 SUBSURFACE HYDROLOGY

2.5.1 Regional Characteristics

Skull Valley is a north-trending valley extending 50 miles from Lookout Pass in the Onaqui Mountains, to the southwest shore of the Great Salt Lake. It is one of many linear valleys of the Basin and Range bordered by relatively young fault-block mountains. These blocks are composed mainly of limestone and dolomite with a few beds of quartzite, sandstone, and shale, ranging in age from Early Cambrian to Tertiary. Primary permeability of these rocks is generally low; secondary permeability exists as joints, fractures, faults, and bedding plane separations.

A large portion of the precipitation that falls in the uplands runs off the steep hillsides as spring snowmelt in short, high-gradient streams, with little infiltration into the mountain blocks. Another portion drains eastward, becoming part of the hydrologic system of the adjacent Tooele and Rush valleys while some is discharged as springs in the foothills along the edges of the valley.

Another portion enters the valley-fill aquifers through an extensive recharge area consisting of alluvial fans at the base of the ranges. Hood and Waddell (1968) estimated the long-term average annual runoff from the uplands is about 32,000 acre-feet with only a small part of this actually flowing out of Skull Valley. They estimated the average annual groundwater discharge and recharge is between 30,000 to 50,000 acre-feet with evapotranspiration accounting for 80 to 90 percent of the total discharge.

The valley-fill deposits are unconsolidated and semi-consolidated rocks of Tertiary and Quaternary age. They consist of inter-stratified colluvium, alluvium, lacustrine, and fluvial deposits with minor basalt and ash, and some eolian material. These sediments

are derived almost entirely from the surrounding uplands and constitute the main groundwater reservoir.

In general, the coarser deposits are near the perimeter of the valley, grading into well-sorted sand and gravel, and interlayered with lacustrine silt and clay towards the center of the valley. Thick beds of clay exist in some areas and may create local, confined aquifers where they interfinger with sand and gravel along the alluvial fans.

The Salt Lake Group of Tertiary age comprises the majority of the valley fill ranging in thickness from 2,000 ft to over 6,000 ft (Arabasz et al., 1987). The younger Quaternary rocks were deposited in Lake Bonneville and are mainly silt and clay, and may be up to 1,000 ft thick in the central portion of the valley. Sack (1993) has recently mapped and described the various Quaternary and Holocene surficial deposits in Skull Valley.

The Tertiary and older Quaternary deposits are slightly to highly permeable, depending upon grain size and degree of cementation. The deeper, more consolidated deposits contain some volcanic deposits that may reduce the permeability. The Tertiary and Quaternary deposits probably contain most of the groundwater of usable quality in storage in this part of Utah.

The younger Quaternary and Holocene sediments in the valley bottom have generally low permeability except for areas of windblown sand, and old beach and bar deposits. Precipitation on or surface runoff to the valley bottom remains ponded until it evaporates. The precipitation that is absorbed does not reach the water table in the southern and central parts of the valley because of the depth of the water table, the low permeability of the soil materials, and the low amount of precipitation. Most of this water is captured by plants and transpired; a small portion evaporates directly through

capillary action and contributes to the development of a high alkali content in the surface soils.

Groundwater flow is generally northward toward the Great Salt Lake. Hood and Waddell (1968) calculated that with a transmissivity of 2,675 sq ft/day, the annual volume of underflow out of the valley is about 800 acre-feet per year. Pumpage from wells for all purposes was estimated at 5,000 acre-feet per year in Skull Valley and is not believed to have changed significantly in the last 30 years.

Domestic water wells are developed almost exclusively in the unconsolidated alluvial fan deposits along the east side of Skull Valley. This same area serves as the main recharge area for the valley. Water quality is also the highest in this area. Discrete sand and gravel lenses are sufficiently interconnected so that water moves from bed to bed as a single hydrologic unit. Groundwater is commonly between 110 and 160 ft below ground in this area.

Farther out in the valley where lake clays have been deposited between granular layers, some degree of confinement occurs and, as a result, many irrigation and stock wells are under artesian conditions. These wells are commonly drilled to depths between 250 to 500 ft but maintain static water depth of 100 ft or less. Some well records indicate artesian flow at the ground surface from wells just south of the Reservation. This information dates from the 1940's to 1960's (Arabasz et al., Appendix F, 1987).

Groundwater quality varies significantly in Skull Valley, dependent mainly on proximity to the bordering ranges. The alluvial apron along the base of the Stansbury Mountains contains the lowest total dissolved solids (TDS) in the valley, with concentrations from 100 to 800 mg/l. In the southernmost part of the valley, TDS concentrations range from

700 to about 900 mg/l with a few isolated wells above 1,000 mg/l TDS. A well south of the Reservation yielded a TDS concentration of greater than 2,500 mg/l (Arabasz et al., Appendix F, 1987). Sodium and chloride are the major ions found in these waters.

Toward the center part of the valley, away from the alluvial apron, unconsolidated lacustrine materials are interstratified with clastic material. Wells in this area tend to have lower yields and poorer quality water (TDS > 1,000 mg/l) and are used mainly for irrigation and stock watering. The north end of the valley has generally high TDS concentrations, in the range of 1,600 to 7,900 mg/l with sodium and chloride again being the main constituents (Arabasz et al., Appendix F, 1987).

2.5.2 Site Characteristics

Based on boring data obtained at the site, the uppermost soil layer consists of interbedded silt, silty clay, and clayey silt with a thickness of approximately 30 ft. This layer is underlain by very dense fine sand and silt. The groundwater table was not encountered in the borings, which were completed to depths of 100 ft below grade; therefore, no hydraulic characteristics of the soil in the PFSS vicinity or specific groundwater potentiometric levels are available from the on-site boring program.

As indicated in Section 2.4.1.2, the depth to the groundwater table is greater than 100 ft below grade at the site. Hood and Waddell (1968) indicate that ground water flows from the south to the north in Skull Valley, toward Great Salt Lake. Based on their Plate 1, the hydraulic gradient is estimated to be approximately 9.5×10^{-4} .

Soil interpretations prepared by USDA (undated) indicate that the permeability of a silt soil in Skull Valley ranges from 0.2 to 0.6 inches/hr. The average groundwater velocity was estimated to be approximately 2.8×10^{-3} to 8.5×10^{-3} gallons/day/sq ft.

The source of groundwater flow at the site is mainly derived from precipitation that falls at the higher elevations of the Stansbury Mountains. As a result of the low permeability deposits and high evapotranspiration at the site, rainfall at the site is unlikely to contribute to groundwater flow.

Operation of the PFSF will have no measurable off-site effects on existing groundwater quality or levels.

2.5.3 Contaminant Transport Analysis

The nature and form of the material stored (spent fuel assemblies in sealed metal canisters) and the method of storage (dry casks) preclude the possibility of a liquid contaminant spill. Discussion of potential contamination of groundwater is not applicable since the depth to groundwater at the site is substantially removed from any activity at the site finished grade.

Water needs during construction (5,000 gallons/day) and operation (1,500 gallons/day) of the PFSF are modest. During operation, it will be similar to light industrial facility with a 24-hour a day contingent of security personnel. Highest water demand is associated with the larger daytime work-force as well as operation of a concrete batching plant during construction. It is anticipated that surface storage tanks would be erected for potable water, emergency fire water, and for the concrete batching plant, as it is unlikely that water wells drilled into the main valley aquifer would yield adequate quantities of water for these purposes on demand. Several wells on the site may be required to meet the demand. Localized drawdown of the valley aquifer would occur in the vicinity of the wells, the extent of which can not be estimated until the wells are drilled, developed, and pump-tested, but which would not extend beyond the site

boundary. Site water wells will be located and developed such that the drawdown will have no impact on adjacent wells, the nearest of which is 1.5 miles from the PFSF.

2.6 GEOLOGY AND SEISMOLOGY

2.6.1 Basic Geologic and Seismic Information

Geological and seismological investigations for the PFSF site and area included review of pertinent published and unpublished literature, consultation with geologists and seismologists familiar with the area, and reconnaissance level geologic mapping. In addition, a test boring program was completed at the site and along the 2.5-mile-long access road to characterize subsurface soil conditions. This work was performed by Earthcore, Inc. of Salt Lake City under the direct supervision of Stone & Webster Engineering Corporation (SWEC). Laboratory testing of soil for engineering properties was performed in SWEC's Soil Testing Laboratory in Boston, Massachusetts. Seismic reflection and refraction (both P- and S-wave) surveys were completed at the site in order to determine soil and rock stratigraphy, bedrock surface profiles, depth to the water table, seismic velocities of the underlying rock and soil, and engineering parameters of near-surface soils from shear wave velocities. This work was performed by Geosphere Midwest of Brooklyn Park, Minnesota, also under the direct supervision of Stone & Webster.

Analysis of the seismic risk and determination of potential ground motion at the site for seismic design bases was performed by Geomatrix Consultants, Inc. of San Francisco, California. Professor Donald Currey of the University of Utah completed an evaluation of surficial linear features near the site at Stone & Webster's request. Dr. William Nash of the University of Utah performed an analysis of volcanic ash from a site boring for age correlation purposes.

The site is situated in western Utah near the eastern boundary of the Basin and Range Physiographic Province with the Middle Rocky Mountain Province (Figure 2.6-1). This

area is characterized by a series of roughly North-South trending, tilted fault block ranges separated by down-faulted linear basins. The PFSF is located near the middle of the Skull Valley basin, at approximate elevation 4,465 ft, between the Stansbury Mountain range on the east and the Cedar Mountains on the west. The top 25 to 35 ft of surficial soils at the site are mainly lacustrine silts and clays deposited by Lake Bonneville during the Late Pleistocene. Below about 25 to 35 ft is a very dense fine sand with minor gravel and silt layers to at least 100 ft deep (Appendix 2A). Bedrock was not encountered in the borings but is believed to occur at a depth of between 520 and 880 ft, based on seismic survey results (Appendix 2B). Bedrock outcroppings, about 1.5 miles south of the site at Hickman Knolls, have been mapped as the Fish Haven Dolomite of Late Ordovician age (Moore and Sorensen, 1979). As indicated in Section 2.4.1.2, the groundwater table is greater than 100 ft below grade at the site, based on the borings and seismic refraction surveys.

The Stansbury fault, exposed along the base of the western escarpment of the Stansbury Mountains, about 6 miles east of the site, is considered to be "capable" as defined in 10 CFR 100, Appendix A. The fault dips to the west and is projected beneath the PFSF site at a depth of 4.2 miles (45 degree dip assumed). Arabasz et al. (1987) consider the Stansbury fault capable of a maximum magnitude 7.3 earthquake. Wells and Coppersmith (1994) suggest the maximum earthquake magnitude on the Stansbury fault is 7.0 ± 0.28 (moment mag.), using surface rupture length. Helm (1995) has calculated that the next seismic event on the fault should be a $6.8-6.9 \pm 0.04 M_s$, based on strain accumulation rates of previous events. The maximum "random" earthquake for this region has been defined by Pechmann and Arabasz (1995) as $M_L = 6.5$. Movement on the Stansbury fault would produce greater accelerations at the site than the random event. Consequently, an earthquake on the Stansbury fault is the "controlling" event for seismic design considerations. As a result of the maximum earthquake occurring on the

Stansbury fault, the peak horizontal ground acceleration is 0.67 g and the peak vertical ground acceleration is 0.69 g at the PFSF site (Appendix 2D).

The closest Quaternary igneous activity is located 50 miles south of the PFSF site at Fumarole Butte on Crater Bench. Basaltic volcanic activity here is believed to be between 950,000 and 880,000 years old (Hecker, 1993) and does not present a threat to the integrity of the PFSF at that distance, if it were to become active.

2.6.1.1 Site Geomorphology

Site topography is shown on Figure 2.6-2. Topography in the site vicinity is shown on Figures 1.1-1 and 2.6-4. The PFSF site lies near the center of Skull Valley about midway between the Stansbury Mountains and the Cedar Mountains. Skull Valley is in a part of the Great Basin that was once occupied by Lake Bonneville, a large lake that developed in the Late Pleistocene (30,000 to 25,000 years B.P.). As the climate became warmer in the latest Pleistocene and outlets for the lake were abandoned, the lake shrank in size and the water became saline. The gently north-sloping floor of Skull Valley is the former bottom of the lake and the unconsolidated deposits at the site are sediments laid down in and by Lake Bonneville. About 2 miles east of the site, the valley bottom meets the toe of an alluvial apron built up from a series of coalescing alluvial fans along the base of the Stansbury Mountains. The apron slopes at about 200 ft/mile in the vicinity of the Skull Valley Indian Reservation village. A wave-cut bench or terrace can be seen near the head of the apron representing the maximum level of Lake Bonneville about 15,300 years B.P. at elevation 5,092 ft. Also present here is a scarp and small graben in Quaternary deposits reflecting Quaternary movement on the Stansbury fault (Barnhard and Dodge, 1988).

The apron is only slightly dissected by streams originating in the steep bedrock terrain of the Stansbury Mountains. Stream and spring flow is rapidly absorbed into the coarse granular fan deposits resulting in very little water reaching the valley bottom as surface runoff in this area.

The valley floor is relatively smooth, being interrupted in only a few locations by bedrock outcrops, such as Hickman Knolls rising about 400 ft above the valley bottom near the site. Relief on the valley bottom is slight consisting of a few shallow (1 to 3 ft) north-trending dry washes and low (1 to 3 ft) linear soil ridges. The washes are marked by more dense desert shrub vegetation, whereas the ridges tend to be grass covered. The washes carry water for very short periods during spring snowmelt and infrequent, local thunderstorms. A few shallow depressions appear to pond water at times until they are evaporated. This network of shallow washes eventually leads offsite to the north where it joins the central valley drainage system leading to the Great Salt Lake. Perennial surface water is found about 10 miles north of the site in a large mudflat fed mainly by springs along the base of the Stansbury Mountains.

Other features recognized on the valley bottom near the site include beach ridges and shoreline deposits associated with Lake Bonneville and eolian dune deposits in various forms, mainly parabolic or shrub-coppice dunes (Sack, 1993). Sack (1993) interpreted linear and curvilinear tonal features from air photos as possible fault traces in soil near the site. Dr. Donald Currey of the University of Utah examined these features in the field and believes they are not of tectonic origin, but are beach ridges developed during the transgression of Lake Bonneville. His report on these features is included as Appendix 2C.

There is no evidence of flash-flooding near the site area nor any deposits indicative of mudflows or landslides. The great depth to bedrock and the very dense condition of most

subsurface soils preclude the development of collapse or uplift features associated with karst terrains or tectonic depressions. There is no history of mineral extraction or injection in the area and little likelihood of future development. Withdrawal of water in the area is widely scattered and consists of a few domestic supply wells, irrigation wells, and stock-watering wells. There is no potential for subsidence from water withdrawal because of the distance from these sources and the present depth to water at the site (greater than 100 ft).

In summary, the geomorphology of the site is typical of a semi-arid to arid desert setting. The adjacent ranges are affected by mass-wasting processes and stream erosion that deliver their load of sediments to a complex of alluvial fans at the edge of the ranges. Most of the sediment load is dropped here as the water infiltrates or evaporates. The central part of the valley is relatively unaffected by fluvial processes. Mechanical and chemical weathering of rock and soil proceeds very slowly in this flat dry environment. Essentially, the only geomorphic processes to affect the site are microprocesses wherein soil moisture from occasional precipitation is drawn upward by capillary action and evaporates near the ground surface. This results in a gradual buildup of calcium carbonate, alkali, and sulfate in the near-surface soils. Soils at the site are described in the County soil report (USDA, unpublished report) as being calcareous and saline.

2.6.1.2 Geologic History of Site and Region

2.6.1.2.1 Bedrock

The Skull Valley PFSF site lies above a sediment-filled, structural basin that is bounded on the east and west by uplifted range blocks, the Stansbury-Onaqui Mountains and the Cedar Mountains, respectively. This pattern is repeated throughout western Utah and Nevada and elsewhere and is so characteristic that the name Basin and Range is applied

to the physiographic area containing this structural arrangement (Figure 2.6-1). The eastern border of this province is generally drawn along the North-South trending Wasatch Front about 55 miles east of the site. The western boundary of the Front is known to be a major, active normal fault, the Wasatch fault, along which the Front has been uplifted and the Salt Lake basin is down-dropped. This major structural element is believed to have persisted since at least Late Precambrian time. The Uinta arch, which includes the present Uinta Mountains east of the Wasatch Front, is an east-west trending, anticlinal structure with a similarly long history of uplift. It intersects the Wasatch line at right angles and is believed to have influenced sedimentation patterns, as well as provided a stable buttress during tectonic episodes. Evidence of the Uinta arch has been traced as far west as central Nevada (Roberts et al., 1965) and is postulated to have affected sedimentation patterns in the rocks of the Stansbury Mountains and patterns of faulting and mineralization (Zoback, 1983; Helm, 1995; Stokes, 1986). The regional bedrock geology is depicted on Figure 2.6-3.

The Wasatch line may have its origin during the Late Precambrian breakup of the North American craton as the resulting rift margin. Clastic deposition off the craton margin eventually became carbonate shelf deposition as the shoreline migrated eastward. The site of this deposition is believed to be the Cordilleran geosyncline, receiving some of the greatest thicknesses of Precambrian and Paleozoic sediments found anywhere (Stewart, 1976). Shallow marine deposition persisted throughout much of the Paleozoic, except along the Uinta arch where periodic uplift caused erosion of previously deposited sediments or non-deposition. Orogenic events during the Mid to Late Paleozoic, such as the Antler orogeny, greatly affected the edge of the continent, then located in Nevada, and detrital sedimentation became predominant.

During the Triassic and Jurassic Periods, shallow marine deposition alternated with long episodes of subaerial erosion and deposition, mainly east of the Wasatch line. No

sedimentary rocks from this period are known in the site vicinity (Moore and Sorensen, 1979). Orogenic events continued to affect the Cordilleran geosyncline, compressing and uplifting these sediments progressively from west to east.

A distinct orogenic event has been identified in western Utah, occurring during the Late Cretaceous. It is called the Sevier orogeny and is characterized by extensive tectonic shortening of the geosyncline and eastward folding and thrusting of sediments along numerous low angle thrust faults. Tooker (1983), Tooker and Roberts (1971), and Christie-Blick (1983) discuss evidence for these thrust sheets in several mountain ranges near the PFSF site, including the Stansbury, Cedar, Sheeprock, and Oquirrh Mountains. The Uinta arch and the Wasatch line are believed to have influenced the lateral extent and placement of some of these thrust sheets.

The Laramide orogeny closely followed the Sevier orogeny beginning in the Late Cretaceous and ending in early Eocene time. Its effects were felt mostly east of the Wasatch line; uplift of the Uinta Mountains by block faulting is one of the results of this event. The Laramide orogeny ended in the mid-Eocene with a major change in the regional stress regime. Extensional tectonics replaced compressional and were accompanied by widespread igneous activity. Low angle normal faulting was the common expression of the extension.

The timing of development of basin-and-range tectonics varies considerably in the western U.S. and several theories of origin have been proposed. Stewart (1978) provides a summary of much of the evidence, based mainly on age relationships to volcanism associated with the extension of the crust. He concludes that extensional faulting of the Great Basin, of which the Skull Valley area is a part, probably started about 17 million years ago (m.y.a.). Moore and McKee (1983) conclude basin-and-range faulting is no older than 12 to 13 m.y. in the Stansbury Mountains, based on ages of basalt flows there.

Evidence of Quaternary movement is indicated by the fault scarps offsetting Quaternary deposits along the west side of the Stansbury Mountains, as well as numerous other areas in the Great Basin. Seismicity along some of these faults, in situ stress measurements, and earthquake focal plane solutions (summarized in Smith, 1978) indicate extensional activity continues today.

2.6.1.2.2 Site Area Structural Geology and Geologic History

The Stansbury Mountains are a north-trending range in the eastern Great Basin. They are about 30 miles long and 10 miles wide with a maximum elevation of 11,031 ft at Deseret Peak, just northeast of the PFSF. A smaller range, the Onaqui Mountains, is an extension of the Stansbury range to the south. A generalized profile of the range includes a steep, curvilinear western slope dissected by a series of young canyons. The eastern slope into Tooele and Rush Valleys is much less rugged, perhaps reflecting a typical tilted fault block origin.

The overall structure of the range is a doubly-plunging anticline uplifted along the steep westerly-dipping Stansbury fault (Tooker and Roberts, 1971). The stratigraphy and general geology of the Stansbury Mountains has been studied most completely by Rigby (1958). He divided the history of the range into two episodes of uplift and folding, each followed by long periods of erosion. These activities took place with the rocks at or near the present location of the range.

Tooker and Roberts (1971), Tooker (1983), and Roberts et al. (1965) reinterpreted much of Rigby's work to include a sequence of at least four thrust slices derived mainly from a site an unknown distance to the west. Most of the folding and faulting internal to the mountain block is believed to have occurred prior to or during the deformation that carried these rocks to their present location during the Late Cretaceous.

Regardless of the provenance of the rocks in the Stansbury Mountains, it is evident the range itself is the result of normal faulting associated with extensional tectonics developed since the beginning of the Miocene, about 24 m.y.a. This process continues today and is a major focus of seismic safety considerations for the PFSF, as well as other facilities in the region.

The Stansbury Mountains are but one of numerous mountain ranges in the Great Basin with similar origins and characteristics. The ranges are oriented roughly North-South, are commonly 9 to 12 miles wide, and are separated by valleys or basins filled with alluvium and colluvium derived from the ranges. The thickness of sediment in the valleys ranges from 1,000 ft to as much as 12,000 ft. Elevation of the ranges (and subsidence of adjacent basins) occurs by movement along major faults on one or both sides of the blocks. It is generally believed that the faulting is distributed along several range-front faults, many of which are buried beneath the valley-fill deposits. Many of the mountain blocks show significant tilt; in the eastern Great Basin, most blocks are tilted to the east (Stewart, 1978).

Latest movement is known to be Quaternary or younger on many of the range front faults. Offset of Quaternary sediments or Holocene alluvial fans is well documented in numerous studies, particularly along the Wasatch fault. The Stansbury fault has been considered to be active or "capable" at least since the work of Rigby (1958). More recent analyses suggest the fault may be segmented with movement on the southern segment occurring less than 18,000 years B.P. (latest Pleistocene) (Helm, 1995). Detailed discussion of the Stansbury fault and the seismic implications are found in Section 2.6.2.3 and Appendix 2D.

2.6.1.2.3 Surficial (Basin-fill deposits)

Unconsolidated and semi-consolidated rocks of Tertiary and Quaternary age are believed to underlie Skull Valley. The total thickness is unknown but has been inferred to be 6,000 to 7,000 ft near the Cedar Mountains on the west side of the valley (Johnson and Cook, 1957) to 6,000 to 8,000 ft near I-80 (Baer and Benson, 1987). These materials are believed to include complex interlayered conglomerates, alluvium, lake deposits, and a few volcanic ash deposits, some of which must date from the beginning of Basin and Range faulting (12 to 13 m.y.a.) (Moore and McKee, 1983). The oldest of these deposits are included as the Salt Lake Group of Miocene-Pliocene age. This formation outcrops in the southern part of Rush Valley and is in the subsurface of Tooele Valley, east of the Stansbury Mountains (Everitt and Kaliser, 1980). The Salt Lake Group is not mapped at the surface on the Quaternary geologic map of Sack (1993) (Figure 2.6-4). Davis Knolls, about 5 miles southeast of Dugway, is identified on the State Geologic Map (Hintze, 1980) as part of the Salt Lake Formation. Sack (1993) shows this area as bedrock. Moore and Sorensen (1979) mapped this area as early Tertiary conglomerate, tuffaceous sandstone, and fresh-water limestone. Borings at the PFSF site encountered volcanic ash at a depth of 85 to 90 ft. The ash was correlated with the Walcott tuff, known to be 6.6 million years old (Appendix 2E).

Everitt and Kaliser (1980) believe there is an unconformity at the top of the Salt Lake Group prior to deposition of the largely unconsolidated sand, silt, gravel, and clay of Quaternary age. Fossils are rare from these deposits; as a result, the boundary between the Tertiary and Quaternary is somewhat arbitrarily drawn on the bases of degree of consolidation, relative amount of volcanic material, and degree of deformation evident.

The surficial geology of Skull Valley is predominantly unconsolidated material of Quaternary age deposited by Lake Bonneville (~ 30,000 to 14,000 years B.P.). Pre-Lake

Bonneville lacustrine deposits have been found in other valleys in the region indicating numerous lakes occupied the Salt Lake basin prior to Lake Bonneville. These deposits date from at least 600,000 B.P. to 30,000 B.P. (Lund et al., 1990). However, it is not known if similar deposits exist in Skull Valley and no correlation has been attempted, to date.

Gilbert (cited in Sack, 1993) believed that the extensive pre-Bonneville alluvial fans were an indication of a long period of hot, dry climate prior to the transgression of Lake Bonneville. Most investigators believe that the Bonneville lake cycle began between 32,000 and 25,000 years B.P., coinciding with the final glacial maximum in the Rocky Mountains (Scott, 1988). Lake levels continued to rise until about 21,000 to 20,000 years B.P. when the level remained somewhat stable for an extended period of time. The Stansbury shoreline developed at this time and has been identified throughout the Bonneville Basin (Oviatt et al., 1990), near elevation 4,468 ft. Sack (1993) has mapped the Stansbury shoreline through the southern part of Section 6, T5S-R8W near the PFSF, based on aerial photographs (Figure 2.6-4).

Continued filling of the basin after 20,000 years B.P. caused the lake to rise to its maximum elevation of about 5,092 ft approximately 15,300 years B.P. At that time, an outlet for the lake into the Snake River drainage was reached. The Bonneville shoreline was created at this time and can be seen as a bench on the alluvial fan east of the PFSF. At about 14,500 years B.P., unconsolidated deposits in the lake outlet channel were rapidly eroded. The lake dropped more than 300 ft in a matter of a few weeks, and the Bonneville flood resulted. The outlet stabilized at about elevation 4,740 ft, and the Provo level developed (Malde, 1968). Sack (1993) has also mapped this shoreline east of the PFSF site on the alluvial fan (Figure 2.6-4).

Climatic change beginning about 14,000 years B.P. caused the gradual shrinkage of Lake Bonneville to at least the lowest level of present Great Salt Lake by about 12,000 years B.P. (Currey, 1990). A brief transgression of the lake occurred between about 10,900 and 10,300 years B.P. to about elevation 4,250 ft (Currey, 1990). This level is known as the Gilbert level of the Great Salt Lake and has been mapped about 11 miles north of the PFSF site (Sack, 1993). Since that time the lake has receded and fluctuates within about 20 ft elevation of its historic average (Lund et al., 1990). Only once in the past 10,000 years has the level of the lake been as high as 4,220 ft (Atwood and Mabey, 1995). The PFSF site is at approximate elevation 4,450 ft, well above any probable historic level of the Great Salt Lake.

2.6.1.3 Site Geology

The site geology was investigated by a subsurface drilling program totaling 24 borings to a maximum depth of 100 ft and a seismic refraction and reflection program. Logs of borings are included in Appendix 2A and the results of the seismic surveys are found in Appendix 2B. Refer to Section 2.6.1.6 for a description of the subsurface profile and engineering characteristics of the subsurface materials.

Unconsolidated deposits at the PFSF site extend to depths of between 520 and 880 ft beneath the site. These materials consist of mainly lacustrine and alluvial deposits derived from the bordering mountain ranges and deposited either in alluvial fans extending into the basin or by various levels of Lake Bonneville and earlier lakes occupying the valley. In general, the fine grained materials, such as silt and clay, were deposited in the deeper portions of the lake, whereas the coarser sand and gravel layers represent near-shore environments or alluvial fans built out into the lake. Sack (1993) describes the surface soils at the site as fine-grained lacustrine consisting of calcareous sand, silt, and clay deposited in Lake Bonneville. Eolian and fluvial activities have

reworked these deposits to some extent, locally. Laboratory analyses of near-surface soil indicate silt, clayey silt, and silty sand are the main constituents. At depths of 25 to 35 ft to at least 100 ft depth below ground surface, very dense fine sand and silt predominate with a few gravel or clay layers interspersed. East of the site along the proposed access road to the Skull Valley Road, the influence of the proximity to alluvial fans is apparent as an increase in the abundance of gravel at shallow intervals (see Appendix 2A).

Bedrock is not exposed at the PFSF site but is found about 1.5 mile to the south at Hickman Knolls, and about 1.5 mile northeast in a series of unnamed low hills. Hickman Knolls has been mapped as Fish Haven Dolomite of Ordovician age (Moore and Sorensen, 1979). At this location the formation is a nondescript, medium to dark gray conglomeratic dolomite. Bedding is massive to indistinct and conglomeratic pebbles are angular to sub-round and appear to be the same composition as the enclosing matrix. Jointing is rare, with most fractures occurring along bedding planes, and there is no evidence of folding or faulting. Bedding strikes northerly to northeasterly and dips to the east at moderate to steep angles. The rock surface is differentially weathered, presenting very rough, sharp surfaces. There has been some enlargement of a few joints resulting from dissolution and a few small caves or openings (1 to 4 ft deep) can be seen on some of the steeper rock faces. Karst conditions do not exist at Hickman Knolls nor are they likely to develop because of the near-desert environment and the depth to groundwater (greater than 100 ft). The outcrop mapped northeast of the PFSF site has been identified as Deseret Limestone of Mississippian age (Moore and Sorensen, 1979).

2.6.1.4 Geologic Map of Site Area

Figure 2.6-4 is the geologic map of the PFSF site, reproduced from Sack (1993). Areas of bedrock outcrop are indicated in addition to the surficial deposits. Fault scarps in soil near the site identified on Sack's map have been investigated by Dr. Donald Currey for

this project (Appendix 2C). Currey concluded the features were related to lacustrine processes of Lake Bonneville and are not of tectonic origin.

2.6.1.5 Facility Plot Plan and Geologic Investigations

Figure 2.6-2 is a plot plan showing the locations of the major structures of the PFSF, the locations of geotechnical borings and geophysical survey lines, and the location of Foundation Profile A-A'. Results of the borings, laboratory tests, and geophysical surveys are found in Appendices 2A and 2B.

2.6.1.6 Relationship of Major Foundations to Subsurface Materials

Figure 2.6-5 presents Foundation Profile A-A', which shows the locations of the proposed structures in relationship to the subsurface materials encountered in the borings. As indicated, the generalized subsurface profile consists of three layers. The uppermost layer extends to a depth of between 25 and 35 ft below existing grade and is mainly interlayered silt, silty clay, and clayey silt. Standard Penetration Test (SPT) N-values for this layer are mostly between 8 and 20 blows per ft, with an average value of 16 blows per ft and a median value of 14 blows per ft, indicating that these are "stiff" or "medium dense" materials. The proposed structures will be constructed on strip and spread footings and the casks will be placed on mat foundations founded in this layer.

A distinct change in material occurs at about 25 to 35 ft, where refusal (N>100 blows per 6 inches) conditions are often encountered. The following 25 to 30 ft consists of very dense, dry, fine sand. Thin layers of fine gravel and coarse sand also are evident.

A few clayey zones were encountered, but they had no apparent effect on the blow counts. The two borings that were drilled to a depth of 100 ft (Borings A-1 and D-4)

indicate that this layer is underlain by very dense silt, with occasional layers of silty sand and clayey silt.

The groundwater table was not encountered in the borings, which were completed to 100 ft. Seismic refraction results (Appendix 2B) in the vicinity of the Storage Facility (see Figure 2.6-2, Seismic Lines 1 & 2) indicate the compression wave (P-wave) velocity changes from approximately 2,780 ft/sec to approximately 5,525 ft/sec at depths of between 90 and 131 ft below grade, which may represent the water table.

As shown in Figure 2.6-2, Borings AR-1 through AR-5 were drilled along the proposed corridor for the access road, which extends easterly from the area in the vicinity of the proposed Operations & Maintenance (O&M) Building and the Administration Building to Skull Valley Road. These borings indicate that the near-surface soils are similar to the uppermost layer described above; i.e., silt, silty clay, and clayey silt. Sands were encountered at depths of 5 and 10 ft in Boring AR-1 and from a depth of 5 ft to 20 ft in Boring AR-2. Silty or sandy gravels were encountered at a depth of 30 ft in Boring AR-3, 20 ft in Boring AR-4, and 6 ft in Boring AR-5.

These borings did not encounter bedrock. Interpretation of the seismic reflection survey data indicates that the depth to bedrock is between 520 ft and 820 ft below the surface at the site in the vicinity of the Storage Facility and that it drops off towards the east, dipping from an estimated depth of 740 ft at Station 700 on Seismic Line 3 (shown on Figure 2.6-2) to approximately 1020 ft at the eastern end of this seismic line.

Refer to Sections 2.6.1.6, 2.6.1.11 and 2.6.2.1 for a discussion of the engineering characteristics of these soils.

2.6.1.7 Excavations and Backfill

The proposed retention basin, which will be excavated approximately 5 ft deep over an area that is approximately 200 ft x 800 ft at the north side of the proposed storage facility, is the only major excavation proposed for the PFSF. Shallow excavations will be required to construct the cask storage pads and the strip and spread footings supporting the other structures at least 30 inches below finished grade (to provide protection against frost heave), as well as to provide drainage ditches along the proposed access road.

Excavations for footings deeper than 3 ft shall be completed to the design grades, maintaining stable slopes of not steeper than 2 horizontal to 1 vertical. After construction of the foundations, the excavations will be backfilled with structural fill to minimize potential problems in the future.

The in situ materials generally are not adequate for use as structural backfill; therefore, it is expected that structural fill materials will be obtained from an offsite source. Structural fill material shall be granular material consisting of well graded sand and gravel, containing no more than 10% of material passing the #200 sieve and a maximum particle size not greater than 6 inches. Samples of the structural fill material shall be tested for gradation in accordance with ASTM D-422 and for moisture-density relationship in accordance with ASTM D-1557, Method D. New gradation and moisture-density tests shall be required whenever a change in material is observed.

Structural fill material shall be placed in thin lifts, not exceeding 8-inch loose thickness, spread evenly, and compacted to 95% of the maximum dry density as determined in accordance with ASTM D-1557, Method D. Compacted surfaces shall be protected from freezing and, if found frozen, shall be excavated, wasted, and replaced with new

compacted fill. Compacted surfaces shall be pitched to freely drain to eliminate puddling of storm water. Compacted material shall be tested frequently by performing in-place density and moisture tests, as specified in the construction specifications.

2.6.1.8 Engineering-Geology Features Affecting ISFSI Structures

Engineering Geology is discussed in Section 2.6.4.

2.6.1.9 Site Groundwater Conditions

The groundwater table at the site was not encountered during the drilling of the boreholes, which terminated at a depth of 100 ft. Seismic refraction velocities along Seismic Lines 1, 2, & 3 (Appendix 2B) are indicative of saturated conditions at depths ranging from 90 ft to 136 ft below ground surface across the site area (elevation 4,334 ft to 4385 ft). Local groundwater conditions, based on limited water well data in the area, are somewhat variable and dependent upon the subsurface extent of alluvial fan materials. Stock-watering wells four and five miles westerly from the site have water depths of 280 and 295 ft, (elevations 4,350 ft and 4,325 ft, respectively). About 2.5 miles northeast of the site the water table is at 188 ft depth (elevation 4,350 ft), and 6 miles southeast several wells flow at the surface (elevation 4,605 ft). A well at the Tekoi Rocket Engine Test Facility about 3 miles south of the site was drilled to 400 ft and has static water at 80 ft below ground surface (elevation about 4,480 ft). All the above-mentioned wells were completed in unconsolidated materials without drilling into the bedrock.

These data suggest that the main aquifer in the central part of Skull Valley is confined or semi-confined and occurs within the fine-grained lacustrine sediments of former Lake Bonneville or Tertiary Salt Lake Group deposits. These sediments interfinger with coarse-grained alluvial fan material along the toe of the fan and may create confined

conditions where they overlap the fan deposits. The fan deposits are the main recharge zone for the valley aquifers and the main source for domestic water wells in the valley. The aquifer in the fans is unconfined for the most part, but becomes confined and under artesian conditions downslope where the lake and basinal deposits onlap the fan at depth. Water wells drilled near the lower edge of the fan, such as at the Rocket Engine Test Facility, may penetrate several hundred feet of lake sediments before encountering a coarse alluvial fan layer. Since the coarse layer is under artesian pressure, the level of water in the well will rise upward to the static condition or may flow at the surface, such as occurs just south of the Reservation.

Groundwater levels at the site appear to closely correlate with levels in the main valley aquifer. They do not appear to be affected by proximity to the alluvial fan. At this time it is believed an adequate quantity of suitable quality water can be developed within the site area for the PFSF needs. Specific properties of aquifer materials are unknown at this time. Surface soil at the site has a permeability of 0.2 to 0.6 inch/hr, whereas the soil on the alluvial fan has a permeability of 6 to 20 inches/hr (USDA, unpub. data). It is estimated that 1,500 gallons per day would meet facility daily requirements.

Groundwater quality in the area is variable, with the best quality associated with wells developed in the alluvial fans near the Stansbury Mountains. In general, water quality is lower in the valley bottom, but it is suitable for irrigation or stock watering without treatment. The main dissolved ions are sodium and chloride (Hood and Waddell, 1968). There is also a tendency for the quality to be lower farther north, down-valley, towards the Great Salt Lake, although there are exceptions to this trend. Total dissolved solids range from 1,600 to 7,900 mg/l at the northern end of the valley (Arabasz et al., 1987, App. F). Most sources of water in the valley are high in calcium and would be classified as very hard. Aquifer transmissivities range from 500 to 30,000 sq ft/day with an average for Skull Valley estimated at 5,000 sq ft/day (Arabasz et al., 1987, App. F).

2.6.1.10 Geophysical Surveys

Results of seismic refraction and reflection surveys performed at the site are found in Appendix 2B and are summarized in Table 2.6-1. Engineering properties of site materials based on the geophysical investigations are discussed in Section 2.6.1.11.

2.6.1.11 Static and Dynamic Soil and Rock Properties at the Site

Geotechnical laboratory tests were performed on samples obtained in the borings of the upper layer of silt, silty clay, and clayey silt that is shown in Figure 2.6-5. The results of these tests indicate:

- Water content: 28% < ω < 47%, ω_{avg} 36%,
- Liquid Limit: 29% < LL < 61%, LL_{avg} 42%
- Plastic Limit: 20% < PL < 44%, PL_{avg} 29%
- Plasticity Index: 5% < PI < 23%, PI_{avg} 13%
- Specific gravity: 2.72
- Saturation: 51%
- Initial void ratio: 1.9
- Unit weight: Dry 59 pcf
Moist 80 pcf
Saturated 100 to 105 pcf
- Consolidation parameters:
 - Maximum past pressure: 6 ksf
 - Virgin compression ratio, CR: 0.294
 - Recompression ratio, RR: 0.014
 - Rate of secondary compression, as shown by the dashed curve in Figure 2.6-6.

Effective-stress strength parameters for drained analyses are estimated to be $\phi = 30^\circ$ and $c = 0$, based on the plasticity index of this material.

Total-stress strength parameters for undrained analyses (e.g., earthquake loadings) are estimated to be $\phi = 0^\circ$ and $c = 2.2$ ksf, based on unconsolidated-undrained triaxial tests, and Poisson's ratio = 0.433.

The recommended coefficients of earth pressure for this material are as follows:

- At-rest, K_o , is 0.5
- Active, K_a , is 0.33
- Passive, K_p , is 3.0.

The recommended coefficient of friction between concrete placed on the in situ soils is 0.58 for long-term loadings, and a cohesion of 2.2 ksf (i.e., the undrained shear strength) should be used to resist sliding for short-term (e.g., earthquake) loadings.

The recommended value of the coefficient of vertical subgrade reaction of the silt, silty clay, clayey silt for a 1 ft x 1 ft square is 120 kips/ft³. This value should be reduced for footing widths greater than 1 ft by applying a reduction factor, RF, calculated as follows:

$$RF = [(B+1) / 2B]^2$$

where B is the effective width of the footing.

The recommended value of the coefficient of vertical subgrade reaction of the in situ soils for use in design of the storage pads is 20 kips/ft³.

The recommended value of the coefficient of horizontal subgrade reaction of the in situ soils for use in the design of drilled caissons is $20 \cdot z / B$ kips/ft³, where z is the depth below finished grade and B is the effective width of the caisson.

The dynamic foundation parameters in support of the soil-structure interaction analyses are discussed in Section 2.6.2.1.

2.6.1.12 Stability of Foundations for Structures and Embankments

All exterior footings shall be founded at a depth of no less than 30 inches below finished grade to provide protection against frost, in accordance with local code requirements. Interior footings in heated areas may be founded at shallower depths, if desired.

The minimum factor of safety against a bearing capacity failure due to static loads (dead load plus maximum live loads) is 3.0.

In accordance with the requirements of NUREG-75/087, Section 3.8.5, "Foundations," Section II.5, "Structural Acceptance Criteria," the recommended minimum factor of safety against overturning or sliding failure from static loads (dead load plus maximum live loads) is 1.5 and due to static loads plus loads from extreme environmental conditions, such as the DE, is 1.1. In addition, it is recommended that a factor of safety of 1.1 be used to design footings against a bearing capacity failure from static loads plus loads due to the DE.

Recommended design earth pressure distributions are presented in Figure 2.6-7.

Lateral earth pressures for determining driving forces shall be based on K_0 , the at-rest earth pressure coefficient. These can be reduced to "active" earth pressures if the yield ratio exceeds 0.1%, where yield ratio, S/H , is defined as shown for the active case in

Figure 2.6-8. In determining “passive” pressures resisting lateral movement, assume the lateral earth pressure coefficient varies from K_0 at a yield ratio of 0% to a maximum of K_p at a yield ratio of 2%, where yield ratio, S/H , is defined as shown for the passive case in Figure 2.6-8. Compaction-induced lateral stresses are determined as shown in Figure 2.6-9.

2.6.1.12.1 Bearing Capacity and Settlement Analyses—Cask Storage Pads

The gross allowable bearing pressure for the cask storage pads to obtain a factor of safety of 3.0 against a shear failure from static loads is 4 ksf. However, loading the storage pads to this value may result in undesirable settlements.

Analyses were performed to estimate the settlement of the storage pads as a result of the weight of the pad and the weight of eight, fully loaded, Holtec HI-STORM casks (356.5 K vs. 310 K for the SNC cask). The actual bearing pressure for this case was about 1.9 ksf, and the estimated total settlement of the pad is about 3.3 inches.

The total settlement consists of the following three components:

• Elastic settlement	0.5 inch
• Primary consolidation settlement	1.7 inches
• Secondary compression	1.1 inches
<hr/>	
• Total estimated settlement	3.3 inches

In order to accommodate the total estimated settlement, the storage pads will be constructed 3.5 inches above adjacent finished grade. Exposed edges of the pads will be chamfered and the crushed rock surface material will be feathered to meet the edges of the raised pads for transporter access.

The allowable bearing pressure for the storage pads for dynamic loads from the DE was determined based on the assumption that the horizontal inertia of the casks due to the earthquake may exceed the frictional resistance available between the cask and the top of the pad. If this were to occur, the horizontal force that would be imparted to the pad from the casks would equal $\mu \cdot F_v$, where:

μ = the coefficient of friction between the steel bottom of the cask and the top of the concrete storage pad.

F_v = weight of the casks + the vertical inertia force of the casks as result of the DE.

These analyses were performed for various values of μ and the following values of gross allowable bearing pressures were determined:

Coefficient of friction (μ)	Gross Allowable ($q_{\text{allowable}}$, ksf)
0.00	8.98
0.10	8.07
0.20	7.23
0.30	6.47
0.40	5.79
0.50	5.18
0.60	4.64
≥ 0.67	4.30

It is expected that the minimum coefficient of friction between the cask and the storage pad (steel to concrete) will be 0.3.

Because of the nature of the subsurface materials, dynamic settlements due to the design earthquake are not expected to occur. See Section 2.6.4.7 for more details.

2.6.1.12.2 Allowable Bearing Capacity—Other Structures

Other structures at the PFSF shall be founded on strip and spread footings. These include the Canister Transfer Building, Administration Building, Operating and Maintenance Building, and Security and Health Physics Building. The allowable bearing capacity of these footings is limited by shear failure of the soil underlying the footing and by footing settlement.

Bearing capacity analyses were performed for a variety of footing widths and depths for both strip footings and square footings, for vertical loads, and for loads inclined 10 and 20 degrees from the vertical. These analyses were performed using effective-stress strength parameters to investigate long-term conditions, which are applicable for static loads. For these analyses, the allowable bearing pressure was determined using a factor of safety of three. Bearing capacity analyses were also performed using total-stress strength parameters, which are applicable for earthquake loads. The former analyses yielded the minimum allowable bearing pressures.

To limit the expected differential settlements to tolerable values, wall footings of all structures should be designed such that the maximum estimated settlement at the center of the wall along the minimum width of the building is less than or equal to 2 inches. Spread footings supporting column loads spaced approximately 16 ft to 24 ft should be designed such that the maximum estimated settlement at the center of the footing is less than or equal to 1.5 inches. These criteria are based on Table 14.1, "Allowable Settlement," of Lambe & Whitman (1969).

The gross allowable bearing pressure of these footings is presented as a function of the minimum effective footing width and depth in Figure 2.6-10 for strip footings and Figure 2.6-11 for square footings. In these figures, the straight lines represent the allowable

bearing pressure that will provide the required factor of safety against a shear failure and the curves represent the bearing pressure that will result in a given amount of settlement. As indicated, the bearing pressure based on shear failure increases with increasing depth (and, typically, increasing width) of footing. Footing settlement increases as the load increases; therefore, for a given bearing pressure, as the width of the footing increases, there comes a point at which the amount of settlement exceeds the allowable settlement. Thus, as the footing width increases beyond this point, the allowable bearing pressure must decrease as shown by the curves in Figures 2.6-10 and 2.6-11, in order to limit the settlement to a tolerable value.

The design curves in these figures are for vertical loads applied at the center of the footings. For inclined or eccentrically applied loads, the allowable bearing pressures must be reduced. For loadings inclined at 10 degrees from the vertical, these allowables must be reduced by 25%, and for loadings inclined at 20 degrees from the vertical, these allowables must be reduced by 50%. Eccentric loads are addressed using the concept of "effective footing width", where the effective width (and length, if appropriate) of the footing is determined as shown in Figures 2.6-10 and 2.6-11.

2.6.2 Vibratory Ground Motion

The PFSF site is situated near the eastern margin of the Basin and Range province in an area known as the Great Basin. It has long been recognized that the pattern of North-South trending ranges and valleys in the Basin and Range is the result of periodic movement on normal faults that border the ranges on one or both sides. This activity is believed to be related to east-west horizontal extension starting in the late Cenozoic (Zoback and Zoback, 1989) and continues today, as evidenced by historic seismicity patterns, ground surface ruptures associated with infrequent, large magnitude, historic

seismic events (6.5 M to 7.5 M), and deformation of late Quaternary and Holocene sediments across range-bounding faults.

The eastern boundary of the Basin and Range with the Middle Rocky Mountains province is commonly placed along the Wasatch Front, the north-south trending and west-facing escarpment that follows the Wasatch fault zone. This boundary is much less distinct than it appears physiographically, however. A transition zone up to 60 miles wide occurs east of the fault zone, in which block faulting overprints compressional features of the Sevier orogeny. Historic seismicity is actually higher east of the Wasatch fault than along it and geophysical data indicate the crustal boundary between the provinces occurs here as well (Smith, 1978). When examined on a regional scale, this belt of seismicity can be seen to be part of a larger zone that extends in a curvilinear pattern from northern Arizona and southern Nevada to northwestern Montana (Figure 2.6-12). This zone was first recognized in 1970 and is known as the Intermountain Seismic Belt (ISB) (Smith and Sbar, 1970; Sbar and Barazangi, 1970). Since that time, numerous investigators have discussed the origin and history of the ISB and have attempted to define the seismicity in a plate tectonic setting. Notable among these are the following: Smith and Sbar (1974), Anderson (1989), Stickney and Bartholomew (1987), Smith (1978), Smith et al. (1989), and Smith and Arabasz (1991).

The Skull Valley PFSF is interpreted to lie within the ISB near its western boundary (Arabasz et al., 1987) although it should be noted the boundary is somewhat arbitrary because of the diffuse, low level of seismic activity in this area. At least 16 earthquakes of magnitude 6.0 or greater have occurred in the ISB since settlement of the area began in the late 1840s (Figure 2.6-12). Ground surface faulting has been documented for three of these events: 1959 Hebgen Lake, MT (M_s 7.5); 1983 Borah Peak, ID (M_s 7.3); and 1934 Hansel Valley, UT (M_s 6.6). Surface faulting has also occurred elsewhere in the Basin and Range, in central and western Nevada and eastern California (Slemmons,

1980). The largest of these events were the 1915 Pleasant Valley, NV (7.75 magnitude) and the 1872 Owens Valley, CA (8.0 magnitude). Arabasz et al. (1987) discuss these events in relation to determining a maximum size for Wasatch Front earthquakes. They concur with studies by Youngs et al. (1987) that the maximum probable event is M_s 7.5 and could have up to 6 meters of vertical displacement. (For an explanation of the various magnitude designations, see Stover and Coffman, 1993, page 2-3.)

Other studies, summarized by Arabasz et al. (1987), indicate there is a threshold magnitude value below which surface faulting is not likely in the Basin and Range. This value is approximately magnitude 6.0 to 6.5. More recent studies also suggest an estimated maximum magnitude of M_L about 6.5 (Arabasz et al, 1992; dePolo, 1994). This value represents the hypothetical maximum "background" or "random" earthquake for this area, one of several seismic sources evaluated to determine maximum horizontal accelerations at the PFSF site. Geomatrix Consultants, Inc. (Appendix 2D) considers the maximum magnitude for the "random" event to be between M 5.5 and 6.5, with a mean value of 6.0. The site response during the random earthquake is discussed in Appendix 2D.

2.6.2.1 Engineering Properties of Materials for Seismic Wave Propagation and Soil-Structure Interaction Analyses

The dynamic foundation parameters in support of the soil-structure interaction analyses were derived from the results of a one-dimensional site response analysis. Figures 2.6-13 and 2.6-14 present the strain-compatible shear-wave velocity and damping ratio profiles.

Strain-compatible soil properties of the upper layer of silt, silty clay, and clayey silt, developed based on the weighted average of the values within 30 ft below the foundation, include:

- Shear-wave velocity 515 ft/sec
- Shear-wave damping 11%
- Compressional-wave velocity 1500 ft/sec
- Shear modulus 668 ksf
- Young's modulus 1915 ksf
- Poisson's ratio 0.433

Table 2.6-2 presents the equivalent dynamic soil parameters for the storage pad, developed based on Newmark and Rosenblueth (1971). Table 2.6-3 presents dynamic soil parameters for the design of the concrete storage pads.

Refer to Section 2.6.1.6 for discussion of the static engineering properties of the materials underlying the site.

2.6.2.2 Earthquake History

The historic record of earthquakes in Utah began in 1850 with the publication of the region's first newspapers in Salt Lake City. Prior to mid-1962 when a scattered, state-wide network of seismographic stations became operational, most records were based upon felt reports. A few larger events were recorded instrumentally at regional stations beginning in the 1950's, including seismograph stations at Salt Lake City and Logan since 1955. Since 1974, a network of modern stations (presently > 85 stations) has provided data to the University of Utah's Seismograph Station (Arabasz et al., 1980). Coverage in the PFSF site area has been provided since 1968 by a station at Dugway, about 14 miles

to the south; at Fish Springs, about 50 miles southwest; and on Stansbury Island, about 30 miles north-northeast. Arabasz et al. (1980) estimated the historical catalog for the Wasatch Front region to be complete for Modified Mercalli (MM) intensity greater than VIII since 1850; greater than VII since 1880; greater than VI since 1940; and greater than V since 1950. They judged that instrumental monitoring has provided a complete record down to magnitude (M_L) 2.3 since mid-1962.

Arabasz et al. (1987) provide a comprehensive evaluation of the University of Utah earthquake data base with particular application to an area at the north end of the Cedar Mountains, west of Skull Valley. They conclude that the threshold of earthquake detection is M_L approximately 2.0 or less in an area that includes the PFSF site.

Figure 2.6-15 is a map of all earthquakes within 160 km (100 miles) of the PFSF site of magnitude 3.0 or greater from the University of Utah Seismograph Station catalog. Table 2.6-4 is a chronological listing and description of those events. Only one earthquake greater than magnitude 3.0 has been reported within 50 km of the PFSF site. This event occurred on August 11, 1915 at an assumed location north of Deseret Peak in the Stansbury Mountains. It was reported at Iosepa, a settlement on the western foothill of the Stansbury Mountains. The University of Utah catalog indicates a magnitude 4.3, based on conversion of MM intensity V from the felt report (Arabasz et al., 1987). Stover et al. (1986) list an intensity VI for this event. However, Stover and Coffman (1993) do not list this event in their catalog, which has a threshold magnitude of 4.5. The earthquake was not reported in Tooele, less than 20 miles from Iosepa (Everitt and Kaliser, 1980), nor in Salt Lake City, about 43 miles to the east of Tooele (Arabasz et al., 1987).

The largest historic earthquakes to occur within 160 km (100 mi.) of the PFSF site occurred in the Hansel Valley at the northern end of Great Salt Lake. A magnitude 6.6

earthquake occurred on March 12, 1934 and produced the only surface offset associated with an historic earthquake in Utah. The event occurred beneath an alluvium-filled valley and resulted in 50 cm of vertical ground surface displacement in a zone 12 km long. Some lateral displacement may also have occurred. Liquefaction and land subsidence occurred locally (Smith, 1978). Slight damage was reported in Grantsville and Tooele with MM intensity V experienced at Tooele (Everitt and Kaliser, 1980). Oaks (1987) reports MM intensity VIII in Salt Lake City caused buildings to sway and a 2-ton clock mechanism fell from the tower of the Salt Lake County Building. Chimneys were toppled and structures were shifted on their foundations. The location of the earthquake is about 90 miles north of the PFSF site and appears to be associated with northerly-trending faults along the base of the Hansel Mountains (dePolo et al., 1989). Four aftershocks occurred within the following 2 months, ranging in size from magnitude 4.8 to 6.1. It is not known what effects, if any, these events had in the PFSF site area. An isoseismal map indicates the PFSF site would have been subject to MM intensity V effects from the original event (Stover and Coffman, 1993).

The Hansel Valley was the site of a prior moderate event magnitude 6.3 on October 6, 1909. Everitt and Kaliser (1980) indicate an MM intensity VII in the epicentral area; the event received no mention in the Tooele paper. The Salt Lake City paper indicated some buildings at the Saltair Resort on the southern shore of the Great Salt Lake were knocked out of plumb. Waves reportedly rolled over the boathouse pier and windows were cracked in Salt Lake City.

The closest magnitude 5.0 or greater earthquakes to the PFSF site occurred near Magna, UT, about 42 miles to the northeast. A magnitude 5.0 event on February 22, 1943 and a magnitude 5.2 event on September 5, 1962 were felt locally in Tooele but no damage was reported (Everitt and Kaliser, 1980). Other sources (Coffman and von Hake, 1973; Stover and Coffman, 1993) report cracked plaster and windows in Salt Lake City and

damage to chimneys at Magna from both of these events. Wong et al. (1995) speculate this activity is occurring on the "Saltair structure" and estimate a maximum magnitude 6 for this feature.

Another historic earthquake worthy of mention occurred on August 1, 1900 near the towns of Eureka and Goshen. This magnitude 5.7 event damaged chimneys and plaster in the epicentral area and caused a mine shaft nearby to be thrown out of alignment (Stover and Coffman, 1993). The epicenter is about 48 miles southeast of the PFSF site.

There is no evidence of any effects from any historic earthquake in the PFSF site vicinity.

2.6.2.3 Determining the Design Earthquake

Regulations 10 CFR 72 specifies that seismicity be evaluated by the techniques of Appendix A, 10 CFR 100 for sites west of the Rocky Mountain Front. Appendix A requires that the design basis for vibratory ground motion be determined by identifying a Safe Shutdown Earthquake (which equals the Design Earthquake for ISFSI or MRS facilities), the earthquake which could cause the largest ground motion at the facility. The Design Earthquake (DE) is determined from the following:

- The greatest magnitude historic event correlated to a specific tectonic structure is applied at the closest approach of the structure to the site. Geologic evidence of larger than historic events is also considered.
- The greatest magnitude event not associated with a specific structure but occurring within the same tectonic province as the facility site, is assumed to occur near the site.

- The greatest magnitude event not associated with a specific structure in any adjacent tectonic province is applied at the closest approach of those provinces to the facility site.

Geomatrix Consultants, Inc. (Appendix 2D) identified all "capable" faults within 100 km of the PFSF site and determined that the largest ground motions at the site will be derived from the Stansbury fault. They also determined that the largest ground motion associated with adjacent tectonic provinces would be considerably lower than from the Stansbury fault. The largest earthquake not associated with a known structure, but occurring within the same tectonic province as the PFSF site, is the so-called "random" event and was determined to be magnitude 6.0. This event is also considerably smaller than the magnitude 7.0 determined for the Stansbury fault as the DE (Appendix 2D).

2.6.2.3.1 Capable Faults

The historical record of earthquakes does not provide a complete assessment of seismic potential in the Basin and Range province. There is considerable evidence of late Quaternary and Holocene surface faulting throughout the Basin and Range of Utah. Hecker (1993) has compiled all known or suspected Quaternary fault locations in Utah and provides a description and summary of the evidence for each feature. Goter (1990) provides a 1:500,000 scale map of Hecker's faults with historic seismicity plotted as well. A portion of Goter's map is reproduced as Figure 2.6-16. Figure 2.6-15 also includes Quaternary faults from Hecker's (1993). Geomatrix Consultants, Inc. (Appendix 2D) also provides a detailed discussion of capable and potentially capable faults within 100 km, as shown on their Plate 1. As can be seen on these maps, it is evident there are numerous Quaternary age faults within 100 miles (160 km) of the PFSF site. Several, such as parts of the Wasatch fault and the West Valley fault, have apparent historical seismicity associated with them. Many have no apparent seismicity and in other areas, there are

concentrations of seismicity without any faults being mapped at the ground surface. Most of the mapped faults are too limited in extent to generate large ground motions that would affect the PFSF site.

The Stansbury fault, along the western edge of the Stansbury Mountains, is located 6 miles east (9.5 km) (horizontal distance) from the PFSF. The proximity of this large capable fault dominates the seismic design to such an extent that accelerations from larger events on more distant structures, such as a maximum M 7.5 on the Wasatch fault, need not be considered in detail. Discussion of all capable faults within 100 km is presented in Appendix 2D.

The Stansbury fault was first mapped in detail by Rigby (1958) but has been recognized as a major fault offsetting Quaternary alluvial fans since publication of Gilbert's Monograph 1 (1890). Moore and Sorensen (1979) extended the fault to the south along the base of the Onaqui Mountains and Barnhard and Dodge (1988) documented a history of recurrent movements, assigning a pre-Lake Bonneville shoreline (>15,000 years B.P.) age to the most recent event. Their assignment was based on geomorphic analysis of soil scarp heights and slope angles. Recently, Helm (1994, 1995) presented evidence that suggested the Stansbury fault is divided into two segments that may rupture independently. An east-west cross-fault at Pass Canyon, about 10 miles northeast of the PFSF, is believed to form the structural boundary between north and south segments. Helm cites evidence that the most recent event on the north segment occurred before the Lake Bonneville shoreline, about 15,000 years B.P. Scarp height/angle data for the south segment suggest faulting may be younger than on the north segment.

Geomatrix Consultants, Inc. (Appendix 2D) divided the Stansbury fault into four segments and evaluated several rupture scenarios based on different combinations of segment ruptures.

2.6.2.3.2 Maximum Earthquake

Several estimates have been made of maximum earthquake magnitude on the Stansbury fault. Arabasz et al. (1987), in their evaluation of seismic parameters for the Superconducting Supercollider facility proposed for a location just west of Skull Valley, calculate a maximum magnitude of M_s 7.3. This value is based on a measured maximum displacement on the fault of 12.6 ft (3.86 m) for a single event and regression relationships derived by Youngs et al. (1987).

Helm (1994, 1995) recently studied the Stansbury fault and identified evidence for segmentation of the fault, as mentioned above. Helm calculated a maximum magnitude of $M = 7.0 \pm 0.28$, based on Wells and Coppersmith's (1994) regression and a surface rupture length of 45 km. This length is for the entire Stansbury fault as if both segments ruptured together. If the north segment (20 km) ruptures next, as Helm (1995) suggests is more likely, a moment magnitude 6.6 ± 0.28 event would be generated.

Pechmann and Arabasz (1995) accept Helm's (1995) subdivision of the Stansbury fault and calculate a maximum magnitude (M_w) of $6\frac{1}{2}$ for each segment. They also utilize the empirical relations of Wells and Coppersmith (1994) but their segment lengths are 17 km and 21 km (straightline length).

Wong et al. (1995) estimate a maximum earthquake of $M_w = 6\frac{3}{4}$ for the Stansbury fault, again based on Wells and Coppersmith (1994), but their possible rupture length is 34 km.

Geomatrix Consultants, Inc. (Appendix 2D) divided the Stansbury fault into four segments and analyzed several rupture combination scenarios. Based on relationships between rupture length and rupture area and empirical data from Wells and Coppersmith (1994), as well as rupture length and slip rate to empirical data from Anderson et al. (1996),

Geomatrix Consultants, Inc. determined the maximum magnitude distribution for the Stansbury fault is M 6.5 to 7.5 with a mean of 7.0. The minimum distances to the Stansbury fault projected beneath the site are between 6.7 to 8.6 km, depending upon the assumed fault dips. Utilizing site-specific soil and rock properties data to estimate attenuation characteristics, Geomatrix calculated a peak horizontal ground acceleration of 0.67 g and a peak vertical ground acceleration of 0.69 g from the Stansbury fault at the PFSF site at the 84th percentile of the ground motion attenuation relationships. This value is based on a number of conservative assumptions and, thus provides a conservative assessment of the site ground motions for design purposes.

The precedent of using the 84th percentile has been made on several western U.S. nuclear power plant dockets, including Diablo Canyon, Trojan, and San Onofre, and has been accepted by the NRC as being conservative. For example, Diablo Canyon used the 84th percentile to define deterministic ground motions (PG&E, 1988). This was endorsed in Supplement No. 34 to their SER (USNRC, 1991).

Geomatrix Consultants, Inc. also evaluated horizontal and vertical accelerations from a proposed mean magnitude 6.0 "random" event 16.7 km from the PFSF site. These accelerations were considerably lower than those from the Stansbury fault (Appendix 2D), as one would expect for a smaller event at a greater distance.

2.6.3 Surface Faulting

The site and immediate environs have been examined for evidence of surface faulting using aerial photos and extensive walkover surveys. No evidence of fault offset of the surficial soils was evident, nor was any faulting of bedrock observed at Hickman Knolls, 1.5 miles south of the PFSF. Sack (1993) speculated that certain tonal patterns on aerial photographs of the site area were fault scarp lineaments in the soil. Currey examined

these features on the ground surface and concluded they were not of tectonic origin, but were most likely beach ridges created during transgression of Lake Bonneville. His report is included as Appendix 2C. Other evidence for a non-tectonic origin includes the following:

- The relatively short length of the features argues against faulting because of the fact that ground-surface offset requires an approximate magnitude 5.5 to 6.5 seismic event. An event of this magnitude would only be generated by a much longer fault rupture.
- The arcuate shape of the lineaments is more consistent with a geomorphologic origin than with faulting of bedrock in an extensional environment.
- There is no net vertical displacement of soil types across the area, as would occur if the ground surface were offset.

The Stansbury fault, a capable fault about 6 miles from the PFSF, occurs at the edge of the existing range where most tectonic movement presently occurs. This fault is discussed in Section 2.6.2.3 and Appendix 2D.

The seismic reflection survey performed at the PFSF site (Appendix 2B) indicated the presence of faults in bedrock beneath the site and access road with offsets of about 20 ft to over 50 ft. The offsets do not appear to extend into the overlying unconsolidated sediments, however. Geomatrix Consultants, Inc. made an independent evaluation of the reflection profiles and reached the same conclusion (Appendix 2D). The age of the sediments on the bedrock surface is not known at this time. However, analysis of a volcanic ash found in the soil sample measured at a depth of 85 to 90 ft in the site borings indicates correlation with "Walcott tuff" material, known to be about 6.4 million years old (late Miocene) (Appendix 2E). Sediments at depths of 500 to 800 ft would be significantly

older than the 500,000-year guideline for "capable" faulting set forth in 10 CFR 100, Appendix A.

Capable faults are discussed in Section 2.6.2.3 and Appendix 2D.

2.6.4 Stability of Subsurface Materials

2.6.4.1 Geologic Features that Could Affect Foundations

Dolomite or limestone bedrock is believed to underlie the site at depths between 520 to 880 ft. Examination of outcrops in the area indicates no evidence of cavernous or karst conditions in these rocks and there is no history of karst development in the region. The near-desert conditions make the development of karst very unlikely and the great depth to bedrock precludes effects at the ground surface. There is no evidence of soluble mineral deposits in the unconsolidated materials beneath the site to at least a depth of 100 ft, and no record from water wells in the valley indicates the presence of similar material at greater depths. Evaporites associated with the waning stages of Lake Bonneville and the Great Salt Lake were not deposited here as the area remained above the extent of saline stages of these lakes.

There is no history of oil or gas development or subsurface mining in the Skull Valley and little potential for development in the future. There are no injection wells in the area and no evidence of past activities affecting the ground surface. Groundwater is withdrawn at a few scattered locations in the valley bottom for irrigation and stock watering but not to such an extent to cause surface subsidence or ground cracking. The nearest wells of this type are located 2.5 miles northeast of the PFSF and 3 miles southeast.

Tectonic warping of bedrock is unlikely in this area given the present extensional tectonic regime in the Basin and Range.

Bedrock is not exposed at the PFSF site and will not be encountered by excavation or foundations. As a result, problems associated with alteration, deformation, or weathering of bedrock or anomalous in situ stresses are not a consideration for the foundations.

The stability of soils at the site for foundations is discussed in Sections 2.6.4.4 and 2.6.4.8.

2.6.4.2 Properties of Underlying Materials

Static and dynamic engineering properties of the soils underlying the site are discussed in Sections 2.6.1.6, 2.6.1.11, and 2.6.2.1.

2.6.4.3 Plot Plan

The plot plan is shown in Figure 2.6-2 and discussed in Section 2.6.1.5. Refer to Section 2.6.1.6 for a description of the subsurface profile.

2.6.4.4 Soil and Rock Characteristics

Soil and rock characteristics are described in detail in Sections 2.6.1.6 and 2.6.2.1.

2.6.4.5 Excavations and Backfill

Refer to Section 2.6.1.7 for a discussion of excavations and backfill.

2.6.4.6 Groundwater Conditions

Groundwater conditions at and near the PFSF are discussed in Sections 2.5 and 2.6.1.9.

2.6.4.7 Response of Soil and Rock to Dynamic Loading

The dynamic engineering properties of the soils underlying the site are discussed in Section 2.6.2.1.

Dynamic settlements due to the DE are not expected to occur at the PFSF site because of the nature of the subsurface materials. Dynamic settlements, as reported in the geotechnical literature, are based on two different mechanisms, depending on whether the soils are above the groundwater table or below the groundwater table. Silver and Seed (1971) developed a technique for estimating dynamic settlements of dry cohesionless sands above the groundwater table. For such soils, the dynamic settlement mechanism is compaction due to soil grain slip, and it is a function of the magnitude of the cyclic shear strain developed due to the earthquake, the applied number of cycles of this shear strain, and the relative density of the soils.

As indicated in Section 2.4.1.2, the groundwater table is greater than 100 ft deep at the site. The top 30 ft of the profile consists of silt, silty clay, and clayey silt. The median blow count for this material is 14 blows per ft, indicating that it is "stiff", it appears to be weakly cemented, and unconsolidated-undrained triaxial tests on this material indicate that it has a cohesion of greater than 2000 psf. Therefore, the technique for estimating dynamic settlements of soils above the groundwater table is not applicable for these materials, since they are not expected to compact as a result of soil grain slip.

This material is underlain by very dense, fine sands, which have uncorrected blow counts that commonly exceed 100 blows per ft. This material is underlain by silts that have even higher blow counts. Because of their very dense nature, these materials are not susceptible to settlement due to the dynamic settlement mechanism applicable for soils above the groundwater table; i.e., compaction due to grain slip.

The underlying soils that are below the groundwater table are greater than 100 ft below grade, and the P-wave velocities (5,100 ft/sec to 5,900 ft/sec), reported by Geosphere Midwest, Inc. (Appendix 2B), indicate that these soils are also very dense. Further, these soils are too far removed from the surface to cause problems if they were to experience dynamic settlement.

2.6.4.8 Liquefaction Potential

The soils underlying the proposed PFSF site are not susceptible to liquefaction as a result of the DE because they are essentially dry from grade down to a depth greater than 100 ft. Figure 2.6-5 presents a generalized subsurface profile, which was developed based on the borings that were drilled in late 1996. As indicated in Section 2.4.1.2, the groundwater table is greater than 100 ft below grade at the site.

Figure 2.6-5 illustrates that from a depth of about 30 ft down to 100 ft (the depth of the deepest boring) the soils are very dense, as the standard penetration test N-values for these soils typically exceed 100 blows per ft, and they increase with depth. The presence of this greater than 60-ft-thick, very dense layer is expected to preclude any surface manifestation of liquefaction (e.g., sand boils) of soils below the groundwater table, if it were possible for them to liquefy. This is considered unlikely, however, because the density of the soils encountered in the borings increases with depth, and the P-wave

velocities (5,100 ft/sec to 5,900 ft/sec), reported by Geosphere Midwest, Inc. (Appendix 2B), of the soils below the groundwater table indicate that these soils too are very dense.

2.6.4.9 Earthquake Design Basis

The DE is conservatively defined as having a peak horizontal ground acceleration of 0.67 g and a peak vertical ground acceleration of 0.69 g. Refer to Section 2.6.2.3 for a detailed description of the bases for this definition. The site-specific response spectra are presented in Figure 4-8 of Appendix 2D.

2.6.4.10 Static Analyses

Refer to Section 2.6.1.12 for a detailed discussion of static analyses in the stability of foundations for structures.

2.6.4.11 Techniques to Improve Subsurface Conditions

The subsurface conditions at the PFSF site are suitable for support of the proposed structures; therefore, no special construction techniques are required for improving the subsurface conditions.

2.6.4.12 Criteria and Design Methods

The allowable bearing capacity of footings is limited by shear failure of the underlying soil and by footing settlement. The minimum factor of safety against a bearing capacity failure from static loads (dead load plus maximum live loads) is 3.0 and from static loads plus loads due to extreme environmental conditions, such as the DE, is 1.1. Allowable settlements are determined based on Table 14.1, "Allowable Settlement," of

Lambe & Whitman (1969) and assume that the differential settlement will be 3/4 of the maximum settlement. Section 2.6.1.12 provides more details.

In order to comply with the requirements of NUREG-75/087, Section 3.8.5, "Foundations," Section II.5, "Structural Acceptance Criteria," the recommended minimum factor of safety against overturning or sliding failure from static loads (dead load plus maximum live loads) is 1.5 and from static loads plus loads due to extreme environmental conditions, such as the DE, is 1.1.

2.6.5 Slope Stability

There are no slopes close enough to the proposed important to safety facilities that their failure could adversely affect the operation of these facilities.

2.7 SUMMARY OF SITE CONDITIONS AFFECTING CONSTRUCTION AND OPERATING REQUIREMENTS

The PFSF site is located near the middle of Skull Valley. The valley is approximately 50 miles long, 22 miles wide, and slopes gently to the north at about a 0.6% grade. The finished grade of the storage facility is sloped gently from elevation 4,475 ft at the southeastern corner to elevation 4,457 ft at the north, where a stormwater retention basin is located. The stormwater retention basin is at elevation 4,450 ft. The Canister Transfer Building, located within the restricted area, has a floor elevation of 4,475 ft. The access road is graded to match the Skull Valley road at the east end (elevation 4,487 ft) and the storage facility at the west end (elevation 4,475 ft) with a maximum slope of approximately 3%.

The entire site, including the access road, is above the 100-year flood elevation. However, diversion berms are required to deflect the anticipated flows from the PMF due to the both the Stansbury Mountains and the Hickman Knolls watersheds.

A diversion berm is provided perpendicular to the access road to channel the Stansbury Mountain PMF to flow away from the PFSF. The PMF berm elevation is 4,505 ft where it intersects the access road. The berm is a maximum of 9 ft high at the access road and tapers down in height as it joins the Hickman Knolls to the south. The berm is located approximately 200 ft east of the storage facility along the access road and extends approximately 1,600 ft south and 280 ft north of the access road. The berm will divert PMF-generated flow emanating from the Stansbury Mountains, east of the site, to the north and east of the storage facility. Box culverts are provided under the access road to allow normal and 100-yr. floodwater to pass beneath the access road toward the north. PMF flows will flow over the top of the access road.

The storage facility and buildings within the restricted area are protected from the smaller Hickman Knolls PMF by a partial perimeter berm. The berm is located along the entire southern side and halfway along the western side of the storage facility. The berm is approximately 5 ft high and is designed to divert the PMF sheet flow of less than one foot deep to the west and north of the storage facility.

The largest ground motions at the site will be derived from the Stansbury fault, located about 6 miles east of the site. The DE is defined as a magnitude 6.7 event occurring on the Stansbury fault, which may result in a peak horizontal ground acceleration of 0.67 g and a peak vertical ground acceleration of 0.69 g.

Subsurface soils at the site are suitable for supporting conventional foundations under both the static and dynamic loading conditions. There is no potential for liquefaction, collapse, or excessive settlement of these soils. There are no slopes, natural or manmade, close enough to the proposed important to safety facilities that their failure could adversely affect these facilities.

Dry casks will be used to store canisters containing spent fuel. The canisters will be drained of all liquid prior to being shipped to the facility. Therefore, liquid releases cannot result from operation of the facility.

Groundwater is greater than 100 ft deep at the site. The method of storage (dry cask), the nature of the storage casks, and the depth to groundwater beneath the site preclude the possibility of groundwater contamination from operation of the facility.

2.8 REFERENCES

American National Standards Institute, 1982, American national standard minimum design loads for buildings and other structures: ANSI A58.1-1982, published by the American National Standards Institute, Inc., New York, New York.

Anderson, J.G., Wesnousky, S.G., and Stirling, M.W., 1996, Earthquake size as a function of fault slip rate: Bulletin of the Seismological Society of America, v. 86, No. 3, p. 683-690.

Anderson, R.E., 1989, Tectonic evolution of the Intermontane system; Basin and Range, Colorado Plateau, and High Lava Plains, *in* Pakiser, L.C., and Mooney, W.D., eds., Geophysical framework of the continental United States: Geological Society of America Memoir 172, pp. 163-176.

Arabasz, W.J., Pechmann, J.C., and Brown, E.D., 1987, Evaluation of seismicity relevant to the proposed siting of a Superconducting Supercollider (SSC) in Tooele County, Utah: Technical report for the Dames and Moore Utah SSC Proposal Team, June 1987, 107 pp.

Arabasz, W.J., Pechmann, J.C., and Brown, E.D., 1992, Observational seismology and the evaluation of earthquake hazards and risk in the Wasatch Front area, Utah, *in* Gori, P.L., and Hays, W.W., eds., Assessment of regional earthquake hazards and risk along the Wasatch Front, Utah: U.S. Geological Survey Professional Paper 1500-A-J, pp. D1-D36.

Arabasz, W.J., Smith, R.B., and Richins, W.D., 1980, Earthquake studies along the Wasatch Front, Utah: Network monitoring, seismicity, and seismic hazards: Bulletin of Seismological Society of America, vol. 70, pp. 1479-1499.

Ashcroft, G.L., D.T. Jensen and J. L. Brown, 1992, Utah climate: Logan, UT, Utah Climate Center, Utah State University, 127 p.

Atwood, G., and Mabey, D.R., 1995, Flooding hazards associated with Great Salt Lake, *in* Lund, W.R., ed., Environmental and engineering geology of the Wasatch Front Region: Utah Geological Assoc. Pub. 24, pp. 483-493.

Baer, J.L. and Bensen, A.K., 1987, Results of gravity survey, Skull Valley - Ripple Valley, Tooele County, Utah, *in* Dames and Moore, The Ralph M. Parsons Company, and Roger Foott Associates, Inc. (preparers), Site Proposal for the Superconducting Super Collider, Geotechnical Report, v. 2, pages E1-E8.

Barnhard, T.P. and Dodge, R.L., 1988, Map of fault scarps formed on unconsolidated sediments, Tooele 1° x 2° quadrangle, northwestern Utah: U.S. Geological Survey Miscellaneous Field Studies Map MF-1990, scale 1:250,000.

BLM, 1985, Skull Valley Allotment Management Plan. Salt Lake District, BLM, US Department of the Interior, Salt Lake City, UT. August, 1985.

BLM, 1986, South Skull Valley Allotment Management Plan. Salt Lake District, BLM, US Department of the Interior, Salt Lake City, UT. January, 1986.

BLM, 1988, Bureau of Land Management, Draft Pony Express Resource Management Plan and Environmental Impact Statement. Salt Lake District, BLM, US Department of the Interior, Salt Lake City, UT. May 1988.

BLM, 1992, Horseshoe Springs Habitat Management Plan. UT-020-WHA-T-7. Salt Lake District, BLM, US Department of the Interior, Salt Lake City, UT. February 26, 1992

Chow, V.T., 1964, Handbook of applied hydrology, McGraw-Hill Book Company, New York.

Christie-Blick, N., 1983, Structural geology of the southern Sheeprock Mountains, Utah: regional significance, *in* Miller, D.M., Todd, V.R., and Howard, K.A., editors, Tectonic and stratigraphic studies in the eastern Great Basin: Geological Society of America Memoir 157, pp. 101-124.

Coffman, J.L. and von Hake, C.A., 1973, Earthquake history of the United States, revised edition (through 1970): U.S. Dept. of Commerce - NOAA Publication 41-1, 208 pp.

Currey, D.R., 1990, Quaternary paleolakes in the evolution of semi-desert basins, with special emphasis on Lake Bonneville and the Great Basin, U.S.A.: Paleogeography, Paleoclimatology, and Paleoecology, vol. 76, pp. 189-214.

dePolo, C.M., 1994, The maximum background earthquake for the Basin and Range Province, western North America: Bulletin of the Seismological Society of America, v. 84, pp. 466-472.

dePolo, C.M., Clark, D.G., Slemmons, D.B., and Aymard, W.G., 1989, Historical Basin and Range Province surface faulting and fault segmentation, *in* Schwartz, D.P., and Sibson, R.H., editors, Fault segmentation and controls of rupture initiation and termination--proceedings of conference XLV: U.S. Geological Survey Open-file Report 89-315, pp. 131-162.

Everitt, B.L. and Kaliser, B.N., 1980, Geology for assessment of seismic risk in the Tooele and Rush Valleys, Tooele County, Utah: Utah Geological and Mineral Survey Special Study 51, 33 pp.

Geomatrix Consultants, Inc, 1997, PFSF Calculation 05996.01-G(PO5)-1, "Development of Soil and Foundation Parameters in Support of Dynamic Soil-Structure Interaction Analyses," San Francisco, CA, March (73 pp).

Gilbert, G.K., 1890, Lake Bonneville, U.S. Geological Survey Monograph 1, 428 pp.

Goter, S.K., compiler, 1990, Earthquakes in Utah, 1884-1989: U.S. Geological Survey, National Earthquake Information Center, scale 1:500,000.

Grazulis, Thomas P., 1993, Significant tornadoes 1680 - 1991: Published by The Tornado Project of Environmental Films, St. Johnsbury, Vermont.

Hecker, Suzanne, 1993, Quaternary tectonics of Utah with emphasis on earthquake-hazard characterization: Utah Geological Survey Bulletin 127, Salt Lake City, UT, 156 pp.

Helm, J.M., 1994, Structure and tectonic geomorphology of the Stansbury fault zone, Tooele County, Utah, and the effect of crustal structure on Cenozoic faulting patterns, M.S. thesis, Univ. of Utah, Salt Lake City, Utah, 128 pp.

Helm, J.M., 1995, Quaternary faulting in the Stansbury fault zone, Tooele County, Utah, in Lund, W.R., editor, Environmental and engineering geology of the Wasatch Front Region: Utah Geological Association Publication 24, pp. 31-44.

Hintze, L.H. (compiler), 1980, Geologic Map of Utah, Utah Geological and Mineral Survey, Salt Lake City, UT, scale 1:500,000.

Holzworth, G.C., 1972, Mixing heights, wind speeds, and potential for urban air pollution throughout the contiguous United States: Environmental Protection Agency, Office of Air Programs, Research Triangle Park, North Carolina.

Holzworth, G.C., 1974, Meteorological episodes of slowest dilution in contiguous United States: National Environmental Research Center, Research Triangle Park, North Carolina, Report No. EPA-650/4-74-002.

Hood, J.W., and Waddell, K.M., 1968, Hydrologic reconnaissance of Skull Valley, Tooele County, Utah, DNR Tech Pub. No. 18, 57 pp.

Hosler, Charles R., 1961, Low-level inversion frequency in the contiguous United States: Monthly Weather Review, pp. 319-339.

Howard, K.A. editors, Tectonic and stratigraphic studies in the eastern Great Basin: Geological Society of America Memoir 157, pp. 61-73.

Huschke, R. E., ed., 1959, Glossary of meteorology: Published by the American Meteorological Society, Boston, Massachusetts.

Johnson, J.B., and Cook, K.L., 1957, Regional gravity survey of parts of Tooele, Juab, and Millard Counties, Utah: Geophysics, vol. 22, pp. 48-61.

Lambe, T.W., and R.V. Whitman, 1969, Soil Mechanics, John Wiley & Sons, Inc., N.Y., 553 pp.

Lund, W.R., Christenson, G.E., Harty, K.M., Hecker, S., Atwood, G., Case, W.F., Gill, H.E., Gwynn, J.W., Klauk, R.H., Mabey, D.R., Mulvey, W.E., Sprinkel, D.A., Tripp, B.T., Black, W.D., and Nelson, C.V., 1990, Geology of Salt Lake City, Utah, U.S.A.: Assoc. of Engineering Geologists Bull., vol. XXVII, pp. 391-478.

Malde, H.E., 1968, The catastrophic late Pleistocene Bonneville flood in the Snake River plain, Idaho: U.S. Geological Survey Professional Paper 596, 52 pp.

Moore, W.J., and McKee, E.H., 1983, Phanerozoic magmatism and mineralization in the Tooele 1° x 2° quadrangle, Utah, in Miller, D.M., Todd, V.R., and Howard, K.A., eds., Tectonic and stratigraphic studies in the eastern Great Basin: Geological Society of America Memoir 157, pp. 183-190.

Moore, W.J., and Sorensen, M.L., 1979, Geologic map of the Tooele 1° x 2° quadrangle: U.S. Geological Survey Miscellaneous Investigations Series Map I-1132, scale 1:250,000.

National Oceanic and Atmospheric Administration, National Environmental Satellite, Data, and Information Service, National Climatic Data Center, 1960, Climatology of the United States No. 60, Climate of Utah.

National Oceanic and Atmospheric Administration, National Environmental Satellite, Data, and Information Service, National Climatic Data Center, 1992, Local climatological data, annual summary with comparative data for 1991: Salt Lake City, Utah.

National Oceanic and Atmospheric Administration, National Environmental Satellite, Data, and Information Service, National Climatic Data Center, 1975-1995, Storm data and unusual weather phenomena with late reports and corrections.

Newmark, N. M., and Rosenblueth, E., 1971, Fundamentals of Earthquake Engineering, Prentice-Hall, Englewood Cliffs, NJ.

Oaks, S.D., 1987, Effects of six damaging earthquakes in Salt Lake City, Utah, in Gori, P.L., and Hays, W.W., editors, Assessment of regional earthquake hazards and risk along the Wasatch Front, Utah: U.S. Geological Survey Open-file Report 87-585, vol. 2, pp. P-1-95.

Oviatt, C.G., Currey, D.R., and Miller, D.M., 1990, Age and paleoclimatic significance of the Stansbury shoreline of Lake Bonneville, northwestern Great Basin: Quaternary Research, vol. 33, pp. 291-305.

Pacific Gas and Electric Company, 1988, Final Report of the Diablo Canyon Long Term Seismic Program, Docket Nos. 50-275 and 50-323, July 31, 1988.

Pasquill, F., 1961, The estimation of the dispersion of windborne material: Meteorol. Mag., 90, 1063, 33-49.

Pechmann, J.C. and Arabasz, W.J., 1995, The problem of the random earthquake in seismic hazard analysis: Wasatch Front region, Utah, in Lund, W.R., editor, Environmental and engineering geology of the Wasatch Front region: Utah Geological Association Publication 24, pp. 77-93.

Quintana, 1995. Letter from Danny Quintana & Associates to Scott Northard, dated March 9, 1995. Subject: Private Spent Fuel Storage Facility on the Skull Valley Goshute Reservation.

Ramsdell, J. V. and G. L. Andrews, 1986, Tornado climatology of the contiguous United States: Prepared by Pacific Northwest Laboratory for the U.S. Nuclear Regulatory Commission, NUREG/CR-4461, PNL-5697.

Rigby, J.K., 1958, Geology of the Stansbury Mountains, Tooele County, Utah: Utah Geological Society Guidebook 13, 168 pp.

Roberts, R.J., Crittenden, M.D., Jr., Tooker, E.W., Morris, H.T., Hose, R.K., and Cheney, T.M., 1965, Pennsylvanian and Permian basins in northwestern Utah, northeastern Nevada and south-central Idaho: Amer. Assoc. Petrol. Geologists Bulletin, vol. 49, pp. 1926-1956.

Sack, Dorothy, 1993, Quaternary geologic map of Skull Valley, Tooele County, Utah: Utah Geological Survey Map 150, Scale 1:100,000, 16 p.

Sbar, M.L., and Barazangi, M., 1970, Tectonics of the intermountain seismic belt, western United States, Part I, microearthquake seismicity and composite fault plane solutions: Geological Society of America Abst. with Programs, vol. 2, p. 675.

Scott, W.E., 1988, Temporal relations of lacustrine and glacial events at Little Cottonwood Canyon and Bells Canyon, Utah, in Machette, M.N. and Currey, D.E., editors: In the footsteps of G.K. Gilbert - Lake Bonneville and neotectonics of the eastern Basin and Range Province, guidebook for field trip twelve, Utah Geological and Mineral Survey Misc. Publ. 88-1, pp. 78-82.

Silver, M. and Seed, H. B., 1971, "Volume Changes in Sands During Cyclic Loading," Proceedings of the American Society of Civil Engineers, Journal of the Soil Mechanics and Foundations Division, Vol 97, SM9, September.

Simiu, E., M. J. Changery, and J. J. Filliben, 1979, Extreme wind speeds at 129 stations in the contiguous United States, NBS building science series 118: U.S. Department of Commerce, National Bureau of Standards.

Slemmons, D.B., 1980, Design earthquake magnitudes for the western Great Basin, in Proc. of Conference X, Earthquake hazards along the Wasatch-Sierra Nevada frontal fault zones: U.S. Geological Survey Open-file Report 80-801, pp. 62-85.

Smith, R.B., 1978, Seismicity, crustal structure, and intraplate tectonics of the interior of the western Cordillera, in Smith, R.B., and Eaton, G.P., editors, Cenozoic tectonics and regional geophysics of the western Cordillera: Geological Society of America Memoir 152, pp. 111-144.

Smith, R.B., and Arabasz, W.J., 1991, Seismicity of the intermountain seismic belt, in Slemmons, D.B., Engdahl, E.R., Zoback, M.D., and Blackwell, D.C., eds., Neotectonics of North America: Geological Society of America, Decade Map Volume 1, pp. 185-228.

Smith, R.B., and Sbar, M.L., 1970, Seismicity and tectonics of the intermountain seismic belt, western United States, Part II, Focal mechanism of major earthquakes: Geological Society of America Abst. with Programs, vol. 2, p. 657.

Smith, R.B., and Sbar, M.L., 1974, Contemporary tectonics and seismicity of the western United States with emphasis on the intermountain seismic belt: Geological Society of America Bulletin, vol. 85, pp. 1205-1218.

Smith, R.B., Nagy, W.C., Julander, D.R., Viveiros, J.J., Baker, C.A., and Gants, D.G., 1989, Geophysical and tectonic framework of the eastern Basin and Range-Colorado Plateau-Rocky Mountain transition, in Pakiser, L.C., and Mooney, W.D., eds., Geophysical framework of the continental United States: Geological Society of America Memoir 172, pp. 205-233.

Stewart, J.H., 1976, Late Precambrian evolution of North America: plate tectonic implication: Geology, vol. 4, pp. 11-15.

Stewart, J.H., 1978, Basin-range structure in western North America: A review, in Smith, R.B. and Eaton, G.P., editors, Cenozoic tectonics and regional geophysics of the western Cordillera: Geological Society of America Memoir 152, pp. 1-31.

Stickney, M.C., and Bartholomew, M.J., 1987, Seismicity and late Quaternary faulting of the northern Basin and Range province, Montana and Idaho: Seismological Society of America Bulletin, vol. 77, pp. 1602-1625.

Stokes, W.L., 1986, Geology of Utah, Utah Museum of Natural History and Utah Geological and Mineral Survey, Salt Lake City, UT, 280 pp.

Stover, C.W. and Coffman, J.L., 1993, Seismicity of the United States, 1568-1989 (Revised): U.S. Geological Survey Professional Paper 1527, 418 pp.

Stover, C.W., Reagor, B.G., and Algermissen, S.T., 1986, Seismicity map of the State of Utah, U.S. Geological Survey Miscellaneous Field Studies Map MF-1856, scale 1:1,000,000.

SWEC, 1997, Calc. No. 05996.01-G(B)-02, 95 pp.

Thom, H. C. S., 1963, Tornado probabilities: Monthly Weather Review 91, pp. 730-736.

Tooele County Commission, 1995, Brochure entitled "Tooele County, Utah, Where Land And Sky Embrace."

Tooele, 1995. Tooele County General Plan, November 1995.

Tooker, E.W., 1983, Variations in structural style and correlation of thrust plates in the Sevier foreland thrust belt, Great Salt Lake area, Utah, in Miller, D.M., Todd, V.R., and Howard, K.A. editors, Tectonic and stratigraphic studies in the eastern Great Basin: Geological Society of America Memoir 157, pp. 61-73.

Tooker, E.W., and Roberts, R.J., 1971, Structures related to thrust faults in the Stansbury Mountains, Utah: U.S. Geological Survey Professional Paper 750-B, pp. B1-B12.

U.S. Army Corps of Engineers, Hydrologic Center, 1995, River analysis system, HEC-RAS, Davis, CA.

U.S. Army Corps of Engineers, Office of the Chief of Engineers, 1990, Flood hydrograph package, HEC-1, Hydrologic Engineering Center, 283 pp.

U.S. Department of Agriculture, Soil Conservation Service, 1985, National engineering handbook, Sect. 4, Hydrology, Washington, DC, 665 pp.

U.S. Department of Agriculture, Soil Conservation Service, 1986, Urban hydrology for small watersheds, TR-55.

U.S. Department of Agriculture, Soil Conservation Service, Engineering Division, 1973, Precipitation-frequency atlas of the western United States, Volume IV, Utah, NOAA Atlas 2, 67 pp.

U.S. Department of Army, 1952, Standard project flood determinations, Civil Engineer Bulletin, No. 52-8, Washington DC, 19 pp.

U.S. Department of Commerce, National Oceanic and Atmospheric Administration, 1977, Probable maximum precipitation estimates, Colorado River and Great Basin drainage, Hydrometeorological Report No. 49 (HMR 49), 161 pp.

U.S. Department of Commerce, Weather Bureau, 1955, Rainfall intensity-duration-frequency curves for selected stations in the United States, Alaska, Hawaiian Islands, and Puerto Rico: Technical Paper No. 25.

U.S. Geological Survey, 1994, Methods for estimating magnitude and frequency of floods in the southwestern United States, Open-File Report 93-419, 211 pp.

USDA, undated, Soil survey of Tooele County, Utah, unpublished maps and data, National Resources Conservation Service, Tooele, UT.

U.S. Nuclear Regulatory Commission, 1991, Safety Evaluation Report related to the operation of Diablo Canyon Nuclear Power Plant Units 1 and 2, NUREG-0675, Supplement No. 34, June 1991.

Wells, D.L., and Coppersmith, K.J., 1994, Analysis of empirical relationships among magnitude, rupture length, rupture area, and surface displacement: Seismological Society of America Bulletin, vol. 84, pp. 974-1002.

Wong, I., Olig, S., Green, R., Moriwaki, Y., Abrahamson, N., Baures, D., Silva, W., Somerville, P., Davidson, D., Pilz, J., and Dunne, B., 1995, Seismic hazard analysis of the Magna tailings impoundment, *in* Lund, W.R., ed., Environmental and engineering geology of the Wasatch Front Region: 1995 Symposium and Field Conference, Utah Geological Association Publication 24, pp. 95-110.

Youngs, R.R., Swan, F.H., III, Power, M.S., Schwartz, D.P., and Green, R.K., 1987, Probabilistic analysis of earthquake ground shaking hazard along the Wasatch Front, Utah, *in* Gori, P.L. and Hays, W.W., editors, Assessment of regional earthquake hazards and risk along the Wasatch Front, Utah: U.S. Geological Survey Open-File Report 87-585, Vol. 2, pp. M-1-110.

Zoback, M.L., 1983, Structure and Cenozoic tectonism along the Wasatch fault zone, in Miller, D.M., Todd, V.R., and Howard, K.A., editors, Tectonic and stratigraphic studies in the eastern Great Basin: Geological Society of America Memoir 157, pp. 3-27.

Zoback, M.L., and Zoback, M.D., 1989, Tectonic stress field of the continental United States, in Pakiser, L.C., and Mooney, W.D., eds., Geophysical framework of the continental United States: Geological Society of America Memoir 172, pp. 523-539.

THIS PAGE INTENTIONALLY BLANK

TABLE 2.3-1

SUMMARY OF TORNADO DATA FOR PFSF SITE 1⁰ BOX
(1880 - 1995)*

<u>COUNTY</u>	<u>DATE</u>	<u>PATH LENGTH</u> (MILES)	<u>PATH WIDTH</u> (YARDS)	<u>F-SCALE</u>
Tooele	05/03/1993	0.1	15	F1
Tooele	09/23/1992	N/A	N/A	F0
Tooele	08/30/1992	0.8	200	F0
Tooele	07/25/1991	10	100	F1

* Period of record is 1880 to December 1995.

TABLE 2.3-2

FUJITA TORNADO INTENSITY SCALE

	<u>Classification</u>	<u>Wind Speed (mph)</u>	<u>Description of Damage</u>
F0	Gale Tornado	40 - 72	Light damage. Some damage to chimneys; breaks branches off trees; pushes over shallow-rooted trees; damages sign boards.
F1	Moderate Tornado	73 - 112	Moderate damage. The lower limits is the beginning of hurricane wind speed; peels surface off roofs; mobile homes pushed off foundations or overturned; moving autos pushed off the roads; attached garages may be destroyed.
F2	Significant Tornado	113 - 157	Considerable damage. Roofs torn off frame houses; mobile homes demolished; boxcars pushed over; large trees snapped or uprooted; light-object missiles generated.
F3	Severe Tornado	158 - 206	Severe damage. Roof and some walls torn off well-constructed houses; trains overturned; most trees in forest uprooted; heavy cars lifted off ground and thrown.
F4	Devastating Tornado	207 - 260	Devastating damage. Well-constructed houses leveled; structures with weak foundations blown off some distance; cars thrown and large missiles generated.
F5	Incredible Tornado	261 - 318	Incredible damage. Strong frame houses lifted off foundation and carried considerable distances to disintegrate; automobile-sized missiles fly through the air in excess of 100 meters; trees debarked; steel-reinforced concrete structures badly damaged.
F6	Inconceivable Tornado	319 - 379	These winds are very unlikely. The small area of damage they might produce would probably not be recognizable along with the mess produced by the F4 and F5 wind that would surround the F6 winds. Missiles, such as cars and refrigerators, would do serious secondary damage that could not be directly identified as F6 damage. If this level is ever achieved, evidence for it might only be found in some manner of ground swirl pattern, for it may never be identifiable through engineering studies.

TABLE 2.3-3

**NORMAL MONTHLY PRECIPITATION FOR SALT LAKE CITY, DUGWAY,
AND IOSEPA SOUTH RANCH**

Month	Precipitation (inches)		
	Salt Lake City ¹	Dugway ²	Iosepa Ranch ³
January	1.35	0.46	0.97
February	1.33	0.57	0.59
March	1.72	0.84	1.05
April	2.21	0.81	1.44
May	1.47	1.06	1.26
June	0.97	0.53	0.64
July	0.72	0.57	0.47
August	0.92	0.61	0.63
September	0.89	0.72	0.15
October	1.14	0.81	0.65
November	1.22	0.58	0.82
December	1.37	0.59	0.98
Annual	15.31	8.15	9.64

1. Period of record for Salt Lake City is 1951 - 1980
2. Period of record for Dugway is 1950 - 1992
3. Period of record for Iosepa South Ranch is 1951 - 1958

TABLE 2.3-4

**NORMAL MONTHLY TEMPERATURES (°F) FOR
SALT LAKE CITY¹, DUGWAY², AND IOSEPA SOUTH RANCH³**

<u>MONTH</u>	<u>DAILY MAXIMUM</u>			<u>DAILY MINIMUM</u>			<u>AVERAGE</u>		
	SLC	DUGWAY	IOSEPA	SLC	DUGWAY	IOSEPA	SLC	DUGWAY	IOSEPA
January	37	37	42	20	15	17	28.5	25.7	29.2
February	44	45	46	24	23	20	34.0	34.0	33.3
March	52	53	53	30	29	25	41.0	40.9	38.9
April	61	63	64	37	35	31	49.0	49.0	47.8
May	72	73	76	45	44	38	58.5	58.6	56.9
June	83	85	86	53	53	45	68.0	69.0	65.5
July	93	94	95	62	62	52	77.5	78.2	73.5
August	90	91	93	60	59	53	75.0	75.3	72.9
September	80	80	86	50	48	41	65.0	64.1	63.5
October	67	66	71	39	36	32	53.0	51.0	51.6
November	50	51	52	29	27	22	39.5	38.6	36.9
December	39	38	43	22	17	17	30.5	27.7	30.2

1. Period of record for Salt Lake City is 1951 - 1980.
2. Period of record for Dugway is 1950 - 1992.
3. Period of record for Iosepa South Ranch is 1951 - 1958.

TABLE 2.3-5

MEAN WIND SPEEDS AND PREVAILING DIRECTIONS FOR SALT LAKE CITY

<u>MONTH</u>	<u>WIND SPEED (MPH)</u>	<u>PREVAILING DIRECTION</u>
January	7.6	SSE
February	8.2	SE
March	9.4	SSE
April	9.6	SE
May	9.5	SE
June	9.4	SSE
July	9.6	SSE
August	9.7	SSE
September	9.1	SE
October	8.5	SE
November	8.0	SSE
December	7.4	SSE

1. Period of record is 1951 - 1980.

TABLE 2.3-6

FREQUENCY OF OCCURRENCE OF
ATMOSPHERIC STABILITY CLASSES FOR SALT LAKE CITY

<u>STABILITY CLASS</u>	<u>FREQUENCY OF OCCURRENCE (percent)</u>
A	0.70
B	6.34
C	14.94
D	43.05
E	17.93
F	17.04

1. Period of record is 1988 - 1992.

TABLE 2.3-7

MEAN SEASONAL MORNING AND AFTERNOON MIXING HEIGHTS
FOR SALT LAKE CITY¹

<u>SEASON</u>	<u>MEAN MIXING HEIGHT (meters)</u>	
	<u>MORNING</u>	<u>AFTERNOON</u>
Winter	329	944
Spring	419	2,675
Summer	216	3,737
Fall	238	1,933
Annual	300	2,322

1. Period of record is 1960 - 1964.

TABLE 2.3-8

NATIONAL AMBIENT AIR QUALITY STANDARDS

POLLUTANT	AVERAGING INTERVAL	PRIMARY STANDARD		SECONDARY STANDARD	
		$\mu\text{g}/\text{m}^3$	ppmv	$\mu\text{g}/\text{m}^3$	ppmv
SO ₂	Annual	80	0.03	-	-
	24-hr	365	0.14	-	-
	3-hr	-	-	1,300	0.50
PM10	Annual	50	-	50	-
	24-hr	150	-	150	-
CO	8-hr	101	9	101	9
	1-hr	401	35	401	35
O3	1-hr	235	0.12	235	0.12
NO2	Annual	100	0.053	100	0.053
Pb	3 months	1.5	-	1.5	-

1. mg/m^3 (milligrams per cubic meter).

TABLE 2.3-9

AMBIENT AIR QUALITY MONITORING DATA FOR
WASATCH FRONT INTRASTATE AQCR

POLLUTANT	AVERAGING INTERVAL	SECOND HIGHEST OBSERVED VALUE (ppmv)			
		1993	1994	1995	AAQS
SO ₂ ¹	Annual	0.001	0.001	0.001	0.03
	24-hr	0.003	0.003	0.003	0.14
	3-hr	0.010	0.008	0.008	0.50
PM-10 ²	Annual	26.0	26.0	23.0	50
	24-hr	75.0	98.0	49.0	150
CO ³	8-hr	6.0	6.0	5.0	9.0
	1-hr	12.0	11.0	NA	35.0
O ₃ ⁴	1-hr	0.100	0.109	0.097	0.12
NO ₂ ⁵	Annual	0.033	0.026	0.024	0.053

1. SO₂ data are from Grantsville, Tooele County.
2. PM-10 data are from Grantsville, Tooele County. Concentrations are in units of µg/m³.
3. CO monitoring data from Cottonwood, Salt Lake County.
4. Ozone monitoring data from Herriman, Salt Lake County for 1994 and 1995, from Salt Lake for 1993.
5. NO₂ monitoring data from Salt Lake, Salt Lake County.

TABLE 2.3-10

METEOROLOGICAL MONITORING SYSTEM SPECIFICATIONS

Wind Speed Sensor - Low Speed Operating Threshold

- | | | |
|----|-------------------------------|--|
| a. | Operating principle - | three cup anemometer utilizing a photochopper |
| b. | Range - | 0.45 - 55 m/s |
| c. | Threshold - | < 0.45 m/s |
| d. | Accuracy - | ±0.22 m/s for speeds < 2.2 m/s
±10% of measured value otherwise |
| e. | Operating temperature range - | -40°F to 120°F |
| f. | Response distance constant - | 5 ft of flow for 63 percent recovery |

Wind Direction Sensor - Low Speed Operating Threshold

- | | | |
|----|-------------------------------|--|
| a. | Operating principle - | lightweight counterbalanced vane |
| b. | Range - | 0° - 540° azimuth |
| c. | Threshold - | < 0.45 m/s |
| d. | Accuracy - | ±5° azimuth |
| e. | Operating temperature range - | -4°F to 120°F |
| f. | Response distance constant - | < 2 meters of flow for 63 percent recovery |
| g. | Damping ratio - | 0.4 - 0.6 |

Temperature Sensors

- | | | |
|----|-----------------|--------------|
| a. | Range - | -40°C - 50°C |
| b. | Accuracy - | ±0.5°C |
| c. | Sensitivity - | < 0.5°F |
| d. | Response time - | 30 sec |

Relative Humidity Sensor

- | | | |
|----|-------------------------------|--|
| a. | Range - | 0 - 100% |
| b. | Accuracy - | ±1.5°C dew point equivalent (-30°C to +30°C) |
| c. | Operating temperature range - | -40°F to 120°F |

Barometric Pressure Sensor

- | | | |
|----|------------|---------------------|
| a. | Range - | 17.72 - 32.48 in Hg |
| b. | Accuracy - | ±0.04 in Hg |

Precipitation Gage

- | | | |
|----|-------------------------------|--|
| a. | Operating principle - | tipping bucket type (all precipitation types) |
| b. | Range - | 0 - 76 mm/hr |
| c. | Accuracy - | ±10% of total accumulated catch for amts. >5 mm. |
| d. | Resolution - | 0.25 mm |
| e. | Operating temperature range - | -40°F to 120°F |

Solar Radiation Sensor

- | | | |
|----|-----------------|------------------------------------|
| a. | Sensitivity - | 50 mV per cal/cm ² /min |
| b. | Linearity - | ±2% |
| c. | Response time - | < 1 millisecond |

TABLE 2.6-1
SUMMARY OF DYNAMIC SOIL PROPERTIES
Private Fuel Storage Facility—Skull Valley, Utah

Vicinity of Storage Facility		Layer 1	Layer 2	Layer 3	Layer 4
Geotechnical Parameter		z < 30'	30' < z < 60'	60' < z < 120'	z > 120'
Low-strain values of:					
Shear wave velocity	ft/sec	750		2,110	
Compressional wave velocity	ft/sec	1,550		2,780	5,525
Poisson's ratio		0.35		0.3	~0.5
Shear modulus	ksf	1,400		17,280	
Elastic modulus	ksf	3,780		44,940	
Constrained modulus	ksf	6,070		60,490	118,500
Bulk modulus	ksf	4,200		37,450	46,080
Moist unit weight	pcf	80	125	125	130

Vicinity of Op's & Maintenance Bldg		Layer 1	Layers 2 & 3	Layer 4
Geotechnical Parameter		z < 50'	50' < z < 130'	z > 130'
Low-strain values of:				
Compressional wave velocity	ft/sec	1,610	2,850	5,650

TABLE 2.6-2
DYNAMIC SOIL PARAMETERS FOR SPRING, DASHPOT, AND MASS MODEL

Vertical Vibration Mode:

- Distributed Mass per Area = 30.0 pcf-sec²
- Distributed Vertical Dashpot Constant per Area = 1.94 kcf-sec
- Distributed Vertical Spring Constant per Area = 59 kcf

Horizontal Vibration Mode:

- Distributed Mass per Area = 5.5 pcf-sec²
- Distributed Vertical Dashpot Constant per Area = 0.97 kcf-sec
- Distributed Vertical Spring Constant per Area = 40 kcf

Rocking Vibration Mode:

- Distributed Mass per Area = 38.6 pcf-sec²
- Distributed Vertical Dashpot Constant per Area = 1.39 kcf-sec
- Distributed Vertical Spring Constant per Area = 138 kcf

Source: Geomatrix Consultants, Inc, 1997

**TABLE 2.6-3
DYNAMIC SOIL PARAMETERS FOR SASSI MODEL**

Depth (ft)		Density (pcf)	Wave Velocity (ft/sec)		Damping Ratio (%)	
Top	Bottom		Shear	Compressional	Shear	Compressional
0	5	81	637	1,500	5	5
5	10	81	520	1,500	10	10
10	15	81	469	1,500	12	10
15	20	81	353	1,500	16	10
20	25	81	327	1,500	17	10
25	30	81	280	1,500	19	10
30	60	115	1,809	4,000	4	4
60	120	120	1,861	4,000	8	8
120	300	130	2,080	5,600	8	8
300	600	130	2,440	5,600	8	8
600		150	5,000	10,000	2	1

Source: Geomatrix Consultants, Inc, 1997

TABLE 2.6-4
(Page 1 of 14)

EARTHQUAKES: MAGNITUDE 3.0 AND GREATER, 1850—1996
160KM RADIUS AROUND 40° 24.50'N AND 112°47.50'W
1850—July 1962

Year	Date	Origin Time	Latitude	Longitude	Mag	Int	Comments
1850	222	2200	40° 44.94 '	111° 50.95 '	3.7 I	4	(18)
1853	1201	1815	39° 42.36 '	111° 49.90 '	4.3 I	5	(1)
1853	1201	1845	40° 14.35 '	111° 39.33 '	4.3 I	5	(1)
1868	1017	1030	39° 21.67 '	111° 35.26 '	3.0 I	3	THREE SHOCKS (1)
1873	1227	0300	40° 58.75 '	111° 53.08 '	3.7 I	4	
1874	618	0600	40° 44.94 '	111° 50.95 '	3.7 I	4	
1874	618	0700	40° 44.94 '	111° 50.95 '	3.7 I	4	(1)
1876	322		39° 31.64 '	111° 34.89 '	5.0 I	6	THREE SHOCKS (1)
1878	821	1200	40° 44.94 '	111° 50.95 '	3.0 I	3	
1878	907	1900	40° 44.94 '	111° 50.95 '	3.0 I	3	
1880	917	0627	40° 44.94 '	111° 50.95 '	3.7 I	4	INT=4-5
1880	1227		41° 42.00 '	113° 6.60 '	3.0 I	3	TWO SHOCKS,LATE PM (1)
1881	1016	0700	39° 32.54 '	111° 27.35 '	3.0 I	3	
1883	928	1100	39° 54.60 '	112° 7.80 '	3.7 I	4	
1884	1208		41° 13.45 '	111° 57.55 '	3.0 I	3	
1889	1207	1100	39° 15.83 '	111° 38.23 '	3.7 I	4	
1894	108	1800	39° 45.60 '	113° 23.40 '	4.3 I	5	(4) HAS WRONG DATE
1894	718	2250	41° 13.45 '	111° 57.55 '	5.0 I	6	INT=5-7
1895	727	2225	39° 32.54 '	111° 27.35 '	3.7 I	4	
1896	607	0530	39° 9.19 '	111° 49.10 '	3.0 I	3	
1896	913	0130	39° 42.36 '	111° 49.90 '	3.7 I	4	
1896	1003	1550	41° 44.26 '	111° 49.85 '	3.0 I	3	
1899	1213	1350	40° 44.94 '	111° 50.95 '	3.7 I	4	
1900	801	0745	39° 57.15 '	112° 6.84 '	5.7 I	7	
1901	811	1600	40° 44.94 '	111° 50.95 '	3.0 I	3	
1901	811	1800	40° 14.35 '	111° 39.33 '	3.0 I	3	
1903	723	0834	41° 5.00 '	111° 55.00 '	3.0 I	3	LOC ASSUMED (1)
1906	524	2110	41° 13.45 '	111° 57.55 '	4.3 I	5	THREE SHOCKS (1)
1909	1006	0250	41° 46.00 '	112° 40.00 '	6.3 I	8	INT=7-9
1909	1117	0630	41° 44.66 '	112° 9.72 '	4.3 I	5	
1910	522	1428	40° 44.94 '	111° 50.95 '	5.7 I	7	
1910	523	1545	40° 44.94 '	111° 50.95 '	3.0 I	3	A'SHOCK (1)
1914	408	1606	40° 59.00 '	111° 55.00 '	4.3 I	5	LOC ASSUMED (1)
1914	513	1715	41° 13.45 '	111° 57.55 '	5.7 I	7	INT=6-7
1915	715	2200	40° 14.35 '	111° 39.33 '	5.0 I	6	

TABLE 2.6-4
(Page 2 of 14)

EARTHQUAKES: MAGNITUDE 3.0 AND GREATER, 1850—1996
160KM RADIUS AROUND 40° 24.50'N AND 112°47.50'W
1850—July 1962

Year	Date	Origin Time	Latitude	Longitude	Mag	Int	Comments
1915	730	1850	41° 44.66 '	112° 9.72 '	4.3 I	5	ASSGN GARLAND,UT (1)
1915	811	1020	40° 30.00 '	112° 39.00 '	4.3 I	5	INT=5-8,LOC ASSUMED (1)
1915	920	0128	39° 59.58 '	111° 29.40 '	3.0 I	3	TWO SHOCKS (1)
1915	1003	0150	40° 44.94 '	111° 50.95 '	3.0 I	3	(1)
1915	1005	0800	40° 6.00 '	114° 0.00 '	4.3 I	5	INT=5-7,LOC FROM (4)
1916	205	0625	39° 58.37 '	111° 46.87 '	4.3 I	5	ASSGN SANTAQUIN,UT (1,3)
1919	507	2230	39° 31.64 '	111° 34.89 '	3.7 I	4	
1920	918	2010	41° 30.61 '	112° 0.95 '	4.3 I	5	INT=5-6
1920	919	1350	41° 30.61 '	112° 0.95 '	4.3 I	5	INT=5-6
1920	1120	0435	41° 30.61 '	112° 0.95 '	4.3 I	5	INT=5-6
1920	1217	0955	41° 30.61 '	112° 0.95 '	3.7 I	4	A'SHOCK? (1)
1923	607	0415	41° 44.26 '	111° 49.85 '	4.3 I	5	
1925	1201	0730	40° 44.94 '	111° 50.95 '	3.0 I	3	
1926	1219	0330	39° 57.00 '	111° 57.60 '	3.7 I	4	
1932	1111	1000	40° 31.04 '	111° 28.27 '	3.7 I	4	
1932	1221	0613	40° 44.94 '	111° 50.95 '	3.0 I	3	
1934	130	2021	40° 44.94 '	111° 50.95 '	3.0 I	3	
1934	312	1505	41° 42.00 '	112° 48.00 '	6.6 M	9	INT=8-9,PAS (5,8,9)
1934	312	1820	41° 42.00 '	112° 48.00 '	6.1 N	7	A'SHOCK,PAS (5,8,9)
1934	315	1202	41° 42.00 '	112° 48.00 '	5.1 N	6	INT ASSUMED,A'SHOCK (5)
1934	315	1347	41° 42.00 '	112° 48.00 '	4.8 N	5	INT ASSUMED,A'SHOCK (5)
1934	317	2240	41° 46.50 '	112° 5.70 '	3.0 I	3	
1934	414	2126	41° 30.00 '	112° 30.00 '	5.6 N	7	A'SHOCK (1,5,6,8,9)
1934	506	0809	41° 42.00 '	112° 48.00 '	5.6 N	6	A'SHOCK,PAS (5,8,9)
1935	709	1059	40° 44.94 '	111° 50.95 '	3.7 I	4	INT=4-5
1938	318		39° 59.58 '	111° 29.40 '	3.0 I	3	
1938	630	1337	40° 44.94 '	111° 50.95 '	4.3 I	5	SALT LK VALLEY? (1)
1939	331	0640	40° 44.94 '	111° 50.95 '	3.7 I	4	
1940	1123	1300	39° 15.83 '	111° 38.23 '	3.7 I	4	
1940	1125	1425	39° 15.83 '	111° 38.23 '	3.7 I	4	A'SHOCK?
1941	620	1520	41° 44.26 '	111° 49.85 '	3.0 I	3	
1942	418	0545	41° 30.00 '	112° 18.00 '	4.3 I	5	HANSEL VALLEY? (1,6,8)
1942	604	2204	39° 34.80 '	111° 39.00 '	4.3 I	5	TWO SHOCKS (1)
1943	222	1420	40° 42.00 '	112° 4.80 '	5.0 I	6	W. SALT LK VALLEY (1,6,8)
1943	312	1245	39° 21.67 '	111° 35.26 '	3.7 I	4	

TABLE 2.6-4
(Page 3 of 14)

EARTHQUAKES: MAGNITUDE 3.0 AND GREATER, 1850—1996
160KM RADIUS AROUND 40° 24.50'N AND 112°47.50'W
1850—July 1962

Year	Date	Origin Time	Latitude	Longitude	Mag	Int	Comments
1943	410	2242	40° 42.00 '	112° 4.80 '	4.3 I	5	W. SALT LK VALLEY (1,8)
1943	411	1932	40° 42.00 '	112° 4.80 '	3.0 I	3	A'SHOCK
1946	506	0230	41° 43.80 '	112° 7.80 '	4.3 I	5	LOC ASSUMED (1)
1946	1025	1653	40° 42.60 '	112° 6.30 '	3.0 I	3	
1947	307	1414	40° 44.94 '	111° 50.95 '	3.0 I	3	
1947	328	1102	40° 39.90 '	111° 53.40 '	3.7 I	4	INT=4-5
1948	1104	1318	39° 15.83 '	111° 38.23 '	4.3 I	5	
1949	307	0650	40° 44.94 '	111° 50.95 '	5.0 I	6	
1949	307	0709	40° 44.94 '	111° 50.95 '	3.7 I	4	INT=4-6,A'SHOCK (1,4)
1950	102	1953	41° 30.00 '	112° 0.00 '	4.3 N	4	(5,6,8)
1950	220	1459	40° 2.32 '	111° 43.76 '	3.7 I	4	
1950	225	1337	40° 0.00 '	112° 0.00 '	3.0 X	0	(6)
1950	508	2235	40° 2.32 '	111° 43.76 '	4.3 I	5	
1950	721	1923	41° 44.26 '	111° 49.85 '	3.7 I	4	TWO SHOCKS (8)
1951	123	1333	39° 42.36 '	111° 49.90 '	3.7 I	4	
1951	812	0026	40° 14.35 '	111° 39.33 '	4.3 I	5	
1952	721	0100	39° 58.37 '	111° 46.87 '	3.7 I	4	
1952	723	1928	40° 44.94 '	111° 50.95 '	3.7 I	4	
1952	928	2000	40° 23.81 '	111° 51.64 '	4.3 I	5	
1953	524	0254	40° 30.00 '	111° 30.00 '	4.3 I	5	INT=4-6 (4,6,8,11)
1953	816	1600	40° 46.80 '	111° 57.00 '	3.7 I	4	
1954	1101	0745	41° 44.26 '	111° 49.85 '	3.7 I	4	
1955	202	1923	40° 47.00 '	111° 56.00 '	4.3 I	5	INT=4-5,FEB 4? (4,8,12)
1955	512	2257	40° 54.82 '	111° 52.64 '	4.3 I	5	LOC ASSUMED (8)
1955	625	0500	41° 2.51 '	111° 40.49 '	3.7 I	4	
1957	721	1730	41° 30.00 '	113° 0.00 '	3.0 X	0	(6)
1957	1025	1626	40° 0.00 '	111° 0.00 '	3.0 X	0	(6)
1957	1026	0146	40° 0.00 '	111° 0.00 '	3.0 X	0	A'SHOCK? (6)
1958	105	1700	41° 0.00 '	112° 30.00 '	3.0 X	0	(6)
1958	213	2252	40° 20.50 '	111° 26.40 '	5.0 I	6	(6,8,10)
1958	217	1157	39° 30.00 '	113° 0.00 '	3.0 X	0	(6)
1958	1128	1330	39° 42.70 '	111° 50.00 '	4.3 I	5	INT=4-5 (4,8,13)
1958	1201	2050	39° 42.70 '	111° 50.00 '	4.3 I	5	INT=4-5 (4,8,13)**
1958	1201	2230	39° 42.70 '	111° 50.00 '	3.7 I	4	INT=3-4,A'SHOCK(4,6,8,13)
1958	1202	0323	39° 42.70 '	111° 50.00 '	4.3 I	5	INT=4-5,A'SHOCK(4,6,8,13)

TABLE 2.6-4
(Page 4 of 14)

**EARTHQUAKES: MAGNITUDE 3.0 AND GREATER, 1850—1996
160KM RADIUS AROUND 40° 24.50'N AND 112°47.50'W
1850—July 1962**

Year	Date	Origin Time	Latitude	Longitude	Mag	Int	Comments
1958	1211	0930	39° 31.80 '	111° 1.20 '	3.7 I	4	(8)
1960	506	2028	39° 30.00 '	111° 0.00 '	3.0 X	0	(6)
1960	709	2136	41° 30.00 '	112° 0.00 '	3.0 X	0	(6)
1961	416	0502	39° 20.40 '	111° 39.60 '	5.0 I	6	INT=4-6 (4,6,8,14)
1961	1015	2105	39° 12.00 '	111° 24.00 '	3.0 X	0	(6)
1961	1016	1913	39° 12.00 '	111° 30.00 '	3.0 X	0	A'SHOCK? (6)
1961	1017	0059	39° 12.00 '	111° 30.00 '	3.0 X	0	A'SHOCK? (6)
1961	1017	0354	40° 0.00 '	112° 30.00 '	3.0 X	0	(6)

Number of Earthquakes = 113

TABLE 2.6-4
(Page 5 of 14)

**EARTHQUAKES: MAGNITUDE 3.0 AND GREATER, 1850—1996
160KM RADIUS AROUND 40° 24.50'N AND 112°47.50'W
1850—July 1962**

DATA EXPLANATION FOR PRE-JULY 1962 EARTHQUAKE LISTING

(From Pages 119-121 of Earthquake Studies in Utah, 1850 to 1978, edited by W.J. Arabasz, R.B. Smith, and W.D. Richins)

The University of Utah historic catalog contains earthquakes from 1850, the year of publication of the first newspaper in Utah, through June 1962.

The following data are listed for each event:

1. Year (YR), date, and origin time (ORIG TIME) in Universal or Greenwich Mean Time (GMT). "Local time" is 7 hours earlier than GMT (i.e., local time = GMT - 7 hours) except for three time periods when it was 6 hours earlier:

- (1) 02:00 Mar. 31, 1918 - 02:00 Oct. 27, 1918);
- (2) 02:00 Mar. 30, 1919 - 02:00 Oct. 26, 1919; and
- (3) 02:00 Feb. 9, 1942 - 02:00 Sept. 30, 1945.

Origin time given in hours and minutes for non-instrumental locations, and in hours, minutes, and seconds for instrumental locations.

2. Earthquake location coordinates in degrees and minutes of north latitude (LAT-N) and west longitude (LONG-W). For non-instrumental locations, epicenter is assumed; in most cases, assigned coordinates correspond to location of town or city where felt effects were strongest. Epicentral accuracy $\sim\pm 25$ -50 km.

3. MAG, estimated Richter magnitude determined in one of four ways, as indicated by a suffix: (1) I implies estimate from maximum Modified Mercalli Intensity (INT) assuming the Gutenberg-Richter relation (Gutenberg and Richter, 1956, Bull. Seism. Soc. Am. 46, 105-145): $MAG = 1 + 2/3 (INT)$; (2) M implies magnitude determined by Seismological Laboratory in Pasadena, (3) N implies magnitude estimated by University of Nevada (Reference 5, see below); and (4) X implies value arbitrarily assumed for event of unidentified size; $X = 2.3$ for non-instrumental locations, and 3.0 for instrumental locations.

4. INT, maximum Modified Mercalli Intensity. Unless otherwise noted, intensity is from Reference 1 (see below) for earthquakes through 1949, and from Reference 8 (see below) thereafter. Where sources disagree on maximum intensity, range is indicated as a comment and a maximum value has been interpreted. For events of unidentified size (X suffix in MAG column), intensity II arbitrarily assumed for non-instrumental locations—and no intensity assigned for instrumental locations.

TABLE 2.6-4
(Page 6 of 14)

**EARTHQUAKES: MAGNITUDE 3.0 AND GREATER, 1850—1996
160KM RADIUS AROUND 40° 24.50'N AND 112°47.50'W
1850—July 1962**

5. Comments: Compilation of the 1850-1962 catalog has involved the careful checking and correlation of numerous sources—and extensive annotation. For convenience, several abbreviations and numbered references have been used, as outlined below. Earthquakes without comments generally are from Reference 1 for 1850-1949, and from either Reference 6 (instrumental) or Reference 8 (non-instrumental) for 1950-1962.

Abbreviations

LOC: location
ASSGN: assigned
INT: intensity (Modified Mercalli)
MAG: magnitude
A'SHOCK: aftershock
F'SHOCK: foreshock
PAS: Pasadena, Seismological Laboratory
NEV: University of Nevada, Reno
ID: Idaho
UT: Utah
SALT LK: Salt Lake

References and Footnotes

- (1) Williams, J. S. and M. L. Tapper (1953). Earthquake history of Utah, 1850-1949, Bulletin of the Seismological Society of America, 43, 191-218.
- (2) U.S. Geological Survey (1976). A study of earthquake losses in the Salt Lake City, Utah area, U.S. Geological Survey Open-File Report 76-89, 357 p.
- (3) Townley, S. D. and M. W. Allen (1939). Descriptive catalog of earthquakes of the Pacific Coast of the United States, 1769 to 1928, Bulletin of the Seismological Society of America, 29, (1), Ch. 4,5,6.
- (4) Coffman, J. L. and C. A. von Hake, editors (1973). Earthquake History of the United States, Publ. 41-1, U.S. Dept. Commerce, 208 p.
- (5) Jones, A. E. (1975). Recording of earthquakes at Reno, 1916-1951, Bulletin of the Seismological Laboratory, University of Nevada, Reno, 199 p.

TABLE 2.6-4
(Page 7 of 14)

EARTHQUAKES: MAGNITUDE 3.0 AND GREATER, 1850—1996
160KM RADIUS AROUND 40° 24.50'N AND 112°47.50'W
1850—July 1962

- (6) NOAA earthquake data file, National Geophysical and Solar-Terrestrial Data Center, Boulder, Colorado.
- (7) Pack, F. J. (1921). The Elsinore earthquakes in central Utah, September 29 and October 1, 1921, Bulletin of the Seismological Society of America, 11, 155-165.
- (8) U.S. Department of Commerce. United States Earthquakes, annual publication, U.S. Government Printing Office, Washington, D.C.
- (9) Gutenberg, B. and C. F. Richter (1954). Seismicity of the Earth, 2nd ed., Princeton Univ. Press, Princeton, N.J.
- (10) Berg, J. W. Jr. and R. C. Resler (1958). Investigation of local earthquakes February 13, 1958, near Wallsburg, Utah, Utah Acad. Sci., Arts, Lett. Proc. 35, 113-117.
- (11) Hardy, C. T. and G. Gaeth (1959). Field investigation of Utah earthquake, May 23, 1953, Utah Acad. Sci., Arts, Lett. Proc. 36, 137-140.
- (12) Hardy, C. T. (1959). Field investigation of Utah earthquake, February 4, 1955, Utah Acad. Sci. Arts, Lett. Proc. 36, 141-143.
- (13) Berg, J. W. Jr. (1960). Earthquakes near Nephi, Utah, on November 28, 1958, and December 1, 1958, Utah Acad. Sci. Arts, Lett. Proc. 37, 77-79.
- (14) Algermissen, S. T. and K. L. Cook (1962). The Ephraim, Utah, earthquake of April 15, 1961, Utah Acad. Sci. Arts, Lett. Proc. 39, 106-110.
- (15) Cook, K. L. and R. B. Smith (1967). Seismicity in Utah, 1850 through June 1965, Bulletin of the Seismological Society of America, 57, 689-718.
- (16) Carr, S. L. (1972). The Historical Guide to Utah Ghost Towns, Western Epics, Salt Lake City, Utah, 166 p.
- (17) University of Utah (1952). Gazeteer of Utah Localities and Altitudes, Division of Biology, University of Utah, Salt Lake City, 216 p.
- (18) Stansbury, H. (1852). An Expedition to the Valley of the Great Salt Lake of Utah, Lipincott, Grambo and Co., 487 pp (see pp. 149-150).

TABLE 2.6-4
(Page 8 of 14)

EARTHQUAKES: MAGNITUDE 3.0 AND GREATER, 1850—1996
160KM RADIUS AROUND 40° 24.50'N AND 112°47.50'W
July 1962—September 1996

<i>Year</i>	<i>Date</i>	<i>Origin Time</i>		<i>Latitude</i>	<i>Longitude</i>		<i>Depth</i>	<i>MAG</i>	<i>NO</i>	<i>GAP</i>	<i>DMN</i>	<i>RMS</i>
1962	905	1604	27.78	40° 42.92'	112°	5.33'	7.0 *	5.2 W	9	188	21	0.41
1962	909	1438	8.92	41° 50.80'	111°	46.17'	7.0 *	3.1	8	214	120	0.44
1963	707	1920	39.59	39° 31.96'	111°	54.51'	7.0 *	4.4 W	9	89	95	0.33
1963	709	1520	40.85	39° 31.71'	111°	54.29'	7.0 *	3.1	5	229	95	0.11
1963	709	2025	25.80	40° 1.70'	111°	11.41'	7.0 *	4.0 W	6	92	57	0.78
1963	710	1832	49.76	40° 1.20'	111°	14.95'	7.0 *	3.7 W	7	93	60	0.39
1963	814	1230	2.44	41° 37.30'	112°	4.24'	7.0 *	3.2	7	267	97	0.15
1963	816	700	58.87	41° 39.66'	112°	9.82'	7.0 *	3.0	6	236	103	0.49
1963	1229	415	0.20	39° 8.39'	114°	17.44'	7.0 *	3.9 W	6	219	173	0.20
1964	220	2019	48.20	39° 24.79'	114°	13.06'	7.0 *	3.2 W	7	141	148	0.44
1964	906	1903	33.75	39° 10.93'	111°	27.81'	7.0 *	3.1	10	223	74	0.74
1964	1018	1833	20.80	41° 43.55'	111°	43.77'	7.0 *	4.1 W	7	207	7	0.36
1965	1029	1652	50.28	41° 19.15'	113°	23.26'	7.0 *	3.7 W	9	203	134	0.51
1966	317	1147	47.41	41° 39.66'	111°	33.63'	7.0 *	4.6 W	8	199	23	0.46
1966	1114	1430	49.88	41° 44.70'	112°	43.85'	7.0 *	3.2	8	144	76	0.46
1967	216	1921	35.19	41° 16.40'	113°	20.03'	7.0 *	4.0 W	10	199	128	0.60
1967	721	1527	57.49	41° 15.85'	113°	17.91'	7.0 *	3.6 W	8	198	126	0.28
1967	922	739	53.92	41° 20.75'	113°	21.97'	7.0 *	3.1	8	204	136	0.59
1967	924	500	28.58	40° 42.46'	112°	5.90'	7.0 *	3.0	8	145	22	0.17
1967	1207	1333	22.49	41° 17.17'	111°	44.26'	7.0 *	3.7 W	15	127	51	0.53
1968	116	858	41.53	39° 18.00'	112°	3.72'	4.1	3.5 W	7	156	113	0.25
1968	116	917	50.54	39° 17.40'	112°	2.69'	7.0 *	3.4 W	13	102	112	0.45
1968	116	920	10.26	39° 18.78'	112°	2.69'	7.0 *	3.3 W	9	155	112	0.38
1968	116	941	44.38	39° 16.78'	112°	1.52'	7.0 *	3.2 W	13	131	111	0.44
1968	116	942	52.13	39° 15.93'	112°	2.28'	7.0 *	3.9 W	7	156	113	0.27
1970	329	1240	40.34	41° 39.74'	113°	50.39'	7.0 *	4.7 W	10	203	169	0.57
1970	1025	748	21.94	39° 10.28'	111°	24.72'	7.0 *	3.1 W	6	174	71	0.49
1971	422	2301	2.81	39° 24.63'	111°	56.46'	7.0 *	3.1 W	8	96	100	0.34
1972	1001	1942	29.52	40° 30.36'	111°	20.91'	7.0 *	4.3 W	13	90	36	0.53
1972	1016	2149	31.19	40° 25.27'	111°	0.97'	7.0 *	3.4 W	9	129	66	0.53
1976	1105	115	7.06	41° 49.35'	112°	41.65'	7.0 *	3.3 W	21	199	39	0.22
1976	1105	248	55.59	41° 48.59'	112°	41.88'	7.0 *	4.0 W	15	199	40	0.19
1976	1105	554	0.92	41° 48.94'	112°	41.77'	7.0 *	3.4 W	21	199	40	0.25
1976	1126	2226	29.43	39° 30.79'	111°	15.72'	7.0 *	3.1 W	15	248	41	0.40
1977	209	42	16.13	39° 17.55'	111°	6.69'	7.0 *	3.2 W	16	187	44	0.52

TABLE 2.6-4
(Page 9 of 14)

EARTHQUAKES: MAGNITUDE 3.0 AND GREATER, 1850—1996
160KM RADIUS AROUND 40° 24.50'N AND 112°47.50'W
July 1962—September 1996

<i>Year</i>	<i>Date</i>	<i>Origin Time</i>		<i>Latitude</i>	<i>Longitude</i>		<i>Depth</i>	<i>MAG</i>	<i>NO</i>	<i>GAP</i>	<i>DMN</i>	<i>RMS</i>
1978	309	630	51.88	40° 45.82 '	112°	5.27 '	8.8	3.2 W	18	70	14	0.26
1978	729	1404	3.36	41° 50.92 '	112°	7.84 '	4.2	3.1 W	27	63	18	0.23
1979	224	1243	41.17	41° 43.02 '	111°	8.90 '	90.5	3.8 W	29	129	41	0.30
1979	325	2141	55.74	41° 20.59 '	113°	17.07 '	7.0 *	3.2 W	24	218	65	0.30
1980	404	45	4.50	41° 20.19 '	113°	17.17 '	7.0 *	3.1 W	23	213	65	0.30
1980	406	1045	4.03	39° 56.86 '	111°	58.46 '	4.4	3.5 W	28	70	17	0.25
1980	517	903	38.64	39° 42.55 '	112°	1.59 '	7.0 *	3.0	9	121	67	0.29
1980	524	1003	36.47	39° 56.21 '	111°	57.59 '	7.0 *	4.4 W	17	113	61	0.37
1980	815	625	23.72	41° 39.74 '	111°	41.10 '	7.0 *	3.1 W	20	106	35	0.35
1981	220	913	1.19	40° 19.33 '	111°	44.11 '	0.7	3.9 W	32	110	20	0.29
1981	331	2040	45.51	41° 41.42 '	111°	2.60 '	0.1	3.1 W	37	143	33	0.29
1981	514	511	4.34	39° 28.86 '	111°	4.72 '	0.7	3.5 W	27	133	59	0.51
1983	829	1253	11.45	41° 4.99 '	111°	25.60 '	9.8	3.0 W	12	165	50	0.24
1983	1008	1157	53.83	40° 44.88 '	111°	59.56 '	5.5	4.3 W	30	66	16	0.33
1984	816	1419	21.71	39° 23.50 '	111°	56.16 '	6.1	3.7 W	12	95	34	0.33
1984	1015	2323	56.53	41° 48.27 '	112°	24.10 '	4.1	3.4 W	25	81	15	0.17
1985	611	721	45.12	39° 9.93 '	111°	28.21 '	0.1	3.0	8	169	15	0.42
1986	113	1232	4.63	41° 42.91 '	111°	39.88 '	7.5	3.3 W	20	64	13	0.24
1986	221	2320	12.51	41° 44.69 '	112°	49.11 '	7.4	3.6 W	19	225	5	0.23
1986	324	2233	41.23	39° 13.34 '	111°	59.90 '	0.1	3.3 W	16	105	23	0.25
1986	324	2240	23.41	39° 14.04 '	112°	0.37 '	0.9	4.4 W	17	87	21	0.27
1986	325	253	1.34	39° 13.53 '	112°	0.68 '	1.5	3.9 W	17	90	22	0.28
1986	605	805	41.73	41° 15.99 '	111°	41.03 '	9.6	3.6 W	17	153	18	0.25
1986	919	1041	28.20	41° 27.99 '	111°	42.11 '	7.5	3.4 W	27	70	16	0.27
1986	1026	1431	56.67	41° 49.47 '	112°	18.97 '	4.1	3.0 W	27	73	12	0.26
1986	1029	2213	14.48	41° 49.27 '	112°	19.09 '	4.7	3.6 W	19	75	12	0.15
1986	1031	1158	28.16	41° 49.38 '	112°	18.97 '	3.6	3.5 W	22	73	12	0.15
1986	1231	1121	56.48	41° 49.31 '	112°	18.98 '	4.7	3.3 W	18	73	12	0.16
1987	225	1230	33.50	41° 49.10 '	112°	19.09 '	3.1	3.7 W	21	74	12	0.18
1987	311	156	7.80	40° 7.40 '	114°	20.11 '	5.4	3.4 W	25	207	92	0.41
1987	323	406	59.94	40° 6.81 '	114°	23.27 '	1.4	3.4 W	34	200	95	0.36
1987	323	559	12.48	40° 6.63 '	114°	19.09 '	3.7	3.0 W	22	199	90	0.26
1987	401	1640	41.08	41° 49.23 '	112°	19.60 '	5.6	3.6 W	18	75	12	0.17
1987	401	2144	46.00	41° 49.34 '	112°	19.67 '	4.4	3.3 W	18	74	12	0.17
1987	917	831	26.85	41° 12.52 '	113°	6.94 '	10.2	3.8 W	27	217	62	0.15

TABLE 2.6-4
(Page 10 of 14)

EARTHQUAKES: MAGNITUDE 3.0 AND GREATER, 1850—1996
160KM RADIUS AROUND 40° 24.50'N AND 112°47.50'W
July 1962—September 1996

<i>Year</i>	<i>Date</i>	<i>Origin Time</i>		<i>Latitude</i>		<i>Longitude</i>		<i>Depth</i>	<i>MAG</i>	<i>NO</i>	<i>GAP</i>	<i>DMN</i>	<i>RMS</i>
1987	925	409	54.54	41°	12.41'	113°	8.14'	10.8	4.1 W	20	197	64	0.32
1987	925	427	58.36	41°	12.81'	113°	7.91'	10.7	4.8 W	23	219	64	0.25
1987	925	518	13.58	41°	11.74'	113°	12.82'	6.2	4.3 W	24	239	68	0.26
1987	926	28	2.11	41°	12.54'	113°	9.00'	10.1	4.0 W	31	221	6	0.27
1987	926	1447	49.38	41°	12.01'	113°	10.70'	10.0	3.1 W	21	88	14	0.18
1987	928	606	52.25	41°	13.60'	113°	10.85'	9.2	4.0 W	23	93	8	0.23
1987	1001	916	31.25	41°	12.70'	113°	10.83'	7.8	3.6 W	25	86	9	0.21
1987	1002	1435	48.79	41°	33.80'	112°	25.77'	7.7	3.4 W	25	124	16	0.18
1987	1004	1738	26.44	41°	33.52'	112°	25.49'	11.9	3.3 W	20	125	15	0.21
1987	1005	1031	3.09	41°	12.13'	113°	10.52'	8.0	3.3 W	26	86	9	0.20
1987	1019	717	9.92	39°	40.11'	111°	25.52'	1.0	3.6 W	19	72	40	0.18
1987	1023	1944	50.45	41°	11.78'	113°	10.16'	9.5	4.2 W	22	120	8	0.17
1987	1026	416	0.94	41°	12.05'	113°	10.66'	9.4	4.7 W	23	123	9	0.22
1987	1216	1743	7.50	39°	18.70'	111°	12.92'	0.5	3.3 W	26	78	28	0.44
1988	130	537	13.27	41°	12.31'	113°	10.46'	9.1	3.1 W	22	125	4	0.17
1988	522	1910	47.95	39°	53.38'	114°	10.82'	4.6	3.6 W	30	187	70	0.31
1988	710	2045	59.41	41°	13.49'	111°	37.73'	7.0	3.6 W	8	154	51	0.23
1988	711	1146	55.99	39°	11.51'	111°	59.25'	1.7	3.1 W	17	63	26	0.26
1988	921	1758	25.89	39°	18.48'	111°	9.88'	9.1	3.1	20	80	32	0.18
1988	1106	1530	58.83	40°	43.30'	111°	25.07'	11.0	3.3 W	23	131	14	0.31
1989	211	2037	57.28	39°	20.65'	111°	9.67'	7.3	3.2	17	83	33	0.32
1989	327	1141	54.03	41°	37.53'	112°	50.20'	6.5	3.0 W	15	223	44	0.14
1989	621	2154	18.59	41°	42.46'	112°	22.40'	7.8	4.1 W	23	96	17	0.15
1989	627	1551	49.68	41°	47.67'	112°	44.04'	5.6	3.0 W	17	129	4	0.18
1989	703	2244	28.64	41°	42.39'	112°	22.40'	7.4	4.8 W	21	96	17	0.13
1989	705	2251	56.35	41°	42.40'	112°	22.28'	10.0	4.6 W	18	96	3	0.17
1989	719	24	47.60	41°	42.86'	112°	23.05'	9.4	3.2 W	14	99	4	0.13
1989	820	2123	15.61	41°	42.81'	112°	23.70'	6.9	3.0 W	25	79	5	0.11
1989	823	721	19.94	41°	42.64'	112°	23.73'	8.0	3.2 W	22	82	5	0.15
1990	124	903	30.97	41°	45.77'	112°	37.69'	10.0	3.6 W	14	105	12	0.15
1990	205	1023	25.23	39°	30.23'	111°	31.02'	10.2	3.1 W	11	85	21	0.15
1990	223	2240	12.71	41°	11.92'	113°	10.75'	6.9	3.0 W	20	223	66	0.19
1990	504	403	8.09	39°	31.63'	111°	6.05'	1.3	3.0	13	96	40	0.26
1990	901	1812	29.38	39°	17.95'	111°	8.12'	7.4	3.3	10	81	35	0.22
1990	927	1505	55.47	39°	30.01'	111°	1.86'	15.1	3.2	11	105	40	0.20

TABLE 2.6-4
(Page 11 of 14)

EARTHQUAKES: MAGNITUDE 3.0 AND GREATER, 1850—1996
160KM RADIUS AROUND 40° 24.50'N AND 112°47.50'W
July 1962—September 1996

Year	Date	Origin Time	Latitude	Longitude	Depth	MAG	NO	GAP	DMN	RMS
1990	1121	1216 54.67	39° 29.60'	111° 4.27'	3.5	3.0 W	16	101	42	0.17
1991	206	1346 46.66	39° 29.99'	111° 4.61'	4.3	3.1 W	11	100	42	0.27
1991	315	2033 14.72	39° 21.05'	111° 10.34'	8.5	3.0 W	15	85	32	0.22
1991	821	1347 6.25	39° 21.83'	111° 52.66'	3.7	3.0 W	18	55	25	0.23
1991	1123	1625 6.45	39° 17.56'	111° 8.97'	8.8	3.1	12	84	34	0.18
1992	316	1442 49.64	40° 28.21'	112° 2.69'	10.5	4.2 W	35	79	6	0.29
1992	603	508 30.95	39° 19.04'	111° 9.80'	0.6	3.3 W	24	85	44	0.55
1992	609	2330 18.57	39° 18.12'	111° 9.56'	6.1	3.4	16	84	33	0.29
1992	626	1107 50.17	39° 18.64'	111° 9.52'	4.4	3.0	21	84	33	0.40
1992	628	715 13.77	39° 19.07'	111° 9.64'	9.2	3.0	12	88	33	0.27
1992	705	1222 22.76	39° 18.81'	111° 9.60'	5.6	3.7 W	17	84	33	0.37
1992	711	1323 7.62	39° 18.52'	111° 8.94'	9.3	3.0 W	19	85	34	0.33
1992	1104	1822 10.10	41° 30.59'	113° 23.27'	7.1	4.8 W	30	208	59	0.27
1992	1104	1825 3.53	41° 32.42'	113° 22.16'	7.6	3.8 W	18	254	56	0.19
1992	1109	1811 25.56	39° 16.17'	111° 48.20'	8.9	3.0	26	51	17	0.34
1992	1110	736 6.89	39° 20.36'	111° 9.73'	6.3	3.0	18	86	7	0.24
1992	1205	701 25.50	39° 20.13'	111° 9.57'	3.3	3.0	15	84	6	0.27
1993	117	1926 40.33	39° 41.36'	111° 14.39'	4.5	3.0	18	71	39	0.31
1993	927	1121 0.87	39° 19.95'	111° 9.55'	1.1	3.3	22	86	33	0.37
1994	128	2247 39.37	39° 19.70'	111° 8.75'	9.2	3.1	8	99	34	0.12
1994	216	57 7.24	39° 42.13'	111° 15.19'	4.9	3.1	9	74	40	0.14
1994	402	545 25.85	39° 41.62'	111° 15.18'	7.0	3.0	11	74	40	0.12
1994	505	1804 35.04	41° 40.91'	111° 42.72'	16.4	3.2	18	59	14	0.11
1994	506	137 54.19	41° 47.19'	112° 22.10'	0.3	3.6	32	74	11	0.31
1994	506	2242 45.91	40° 4.02'	111° 23.91'	2.8	3.2	28	103	37	0.21
1994	601	48 17.73	39° 42.05'	111° 14.77'	0.8	3.3	7	109	39	0.49
1994	909	2006 42.14	39° 27.67'	111° 30.70'	9.9	3.3	14	79	16	0.19
1994	909	2013 29.83	39° 27.73'	111° 30.60'	7.7	3.3	12	84	16	0.23
1994	910	633 42.42	39° 27.92'	111° 31.04'	7.7	3.9	16	58	16	0.18
1994	910	923 33.30	39° 28.05'	111° 30.65'	6.6	3.6	15	79	17	0.17
1994	1108	157 56.76	39° 19.81'	111° 10.70'	9.2	3.0	12	155	31	0.11
1994	1110	540 6.65	39° 19.87'	111° 10.33'	5.1	3.1	19	84	32	0.25
1994	1123	1630 49.24	39° 27.47'	111° 31.46'	1.8	3.5	22	58	15	0.37
1994	1203	2039 35.28	39° 42.12'	111° 15.73'	8.7	3.1	14	73	40	0.16
1995	105	2123 28.93	39° 42.15'	111° 15.09'	4.1	3.0	12	74	39	0.16

TABLE 2.6-4
(Page 12 of 14)

EARTHQUAKES: MAGNITUDE 3.0 AND GREATER, 1850—1996
160KM RADIUS AROUND 40° 24.50'N AND 112°47.50'W
July 1962—September 1996

Year	Date	Origin Time	Latitude	Longitude	Depth	MAG	NO	GAP	DMN	RMS
1995	204	1048 57.87	41° 29.13 '	112° 8.86 '	13.0	3.3	14	64	14	0.11
1995	303	1458 37.21	39° 19.36 '	111° 10.10 '	7.5	3.6	9	87	32	0.15
1995	315	2307 0.24	39° 42.06 '	111° 15.20 '	1.4	3.1	14	79	40	0.19
1995	428	1139 1.72	39° 41.78 '	111° 14.89 '	1.2	3.0	21	71	39	0.22
1995	430	1623 12.54	41° 43.42 '	112° 17.90 '	1.7	3.2	34	69	13	0.23
1995	525	512 58.12	39° 41.20 '	111° 14.37 '	1.1	3.3	9	133	39	0.05
1995	706	22 23.54	39° 54.74 '	111° 38.48 '	7.8	3.5	12	142	13	0.27
1995	727	1704 36.22	41° 38.44 '	111° 58.88 '	3.9	3.7	14	75	4	0.09
1995	803	802 47.10	39° 41.27 '	111° 14.27 '	0.2	3.0	15	70	2	0.18
1995	804	204 54.50	39° 41.31 '	111° 14.49 '	0.2	3.1	13	70	3	0.37
1995	930	925 58.54	41° 38.75 '	111° 1.32 '	1.2	3.2	25	215	34	0.23
1995	1008	625 2.97	40° 55.15 '	111° 39.69 '	5.8	3.4	22	114	19	0.22
1995	1009	2151 15.51	39° 36.87 '	111° 6.04 '	7.4	3.3	20	90	13	0.14
1995	1011	1336 0.50	39° 37.68 '	111° 6.10 '	1.3	3.0	20	89	12	0.28
1995	1102	1409 57.68	41° 41.92 '	111° 41.01 '	11.2	3.2	18	62	14	0.25
1995	1105	1020 12.01	41° 13.46 '	113° 12.12 '	5.1	3.1	22	225	69	0.30
1995	1108	732 52.75	39° 31.16 '	111° 7.57 '	2.9	3.4	22	92	20	0.20
1995	1206	425 28.24	40° 44.23 '	111° 32.40 '	10.9	3.5	36	89	12	0.22
1995	1206	741 6.41	39° 41.70 '	111° 14.45 '	1.2	3.0	13	75	3	0.36
1995	1215	1243 22.11	39° 42.36 '	111° 12.75 '	0.2	3.0	17	80	2	0.38
1995	1231	1823 13.66	39° 41.88 '	111° 14.47 '	1.3	3.0	23	71	3	0.34
1996	202	211 14.62	39° 28.00 '	111° 13.81 '	1.5	3.5	27	80	25	0.30
1996	318	724 15.43	39° 41.31 '	111° 14.61 '	1.6	3.0	15	76	3	0.28
1996	429	252 19.24	39° 42.11 '	111° 14.50 '	0.3	3.3	25	70	3	0.25
1996	602	809 10.01	39° 37.54 '	111° 14.46 '	5.6	3.5	24	73	8	0.18
1996	705	300 29.98	41° 42.53 '	112° 22.68 '	1.4	3.8	35	78	6	0.26

Number of earthquakes = 166

* indicates poor depth control

W indicates Wood-Anderson data used for magnitude calculation

TABLE 2.6-4
(Page 13 of 14)

**EARTHQUAKES: MAGNITUDE 3.0 AND GREATER, 1850—1996
160KM RADIUS AROUND 40° 24.50'N AND 112°47.50'W
July 1962—September 1996**

DATA EXPLANATION FOR POST-JULY 1962 EARTHQUAKE LISTING

The following data are listed for each event:

1. Year, Date and Origin Time in Universal Coordinated Time (UTC). Subtract seven hours to convert to Mountain Standard Time (MST).
2. Earthquake location coordinates in degrees and minutes of north latitude (LAT-N) and west longitude (LONG-W), and Depth in kilometers. "*" indicates poor depth resolution: no recording stations within 10km or twice the depth.
3. MAG, computed local magnitude for each earthquake. "W" indicates Wood-Anderson records were used.
4. NO, number of P and S readings used in solution.
5. GAP, largest azimuthal separation in degrees between recording stations used in the solution.
6. DMN, epicentral distance in kilometers to the closest station.
7. RMS, root-mean-square error in seconds of the travel-time residuals:

$$RMS = [\sum_i (W_i R_i)^2 / \sum_i (W_i)^2]^{1/2}$$

where:

R_i is the observed minus the computed arrival time for the i^{th} P or S reading,

W_i is the relative weight given to the i^{th} P or S arrival time
(0.0 for no weight through 1.0 for full weight).

TABLE 2.6-4
(Page 14 of 14)

EARTHQUAKES: MAGNITUDE 3.0 AND GREATER, 1850—1996
160KM RADIUS AROUND 40° 24.50'N AND 112°47.50'W
July 1962—September 1996

The Utah region includes the state of Utah and extends approximately 15 miles from the state line in the east, south and west directions, and 30 miles to the north of the state line (36de 45min - 42de 30min North latitude and 108de 45min - 114de 15min West longitude).

The University of Utah's instrumental earthquake catalog begins in July, 1962. The July 1, 1962 to September 30, 1974 catalog is based on instrumental earthquake locations from a skeletal regional seismic network (< 26 stations statewide). Beginning in October, 1974, data is available from a dense network of high-gain telemetered stations with significantly better locations and magnitude determinations than those for the previous period. The network expanded from 26 stations in late 1974, though southern and central Utah (1975-1977), into southeastern Idaho and western Wyoming (1976-1977), and in the Wasatch Front (1975-1979), until reaching a stable network of 50-60 stations in the late 1970's. From 1974 though 1980, earthquake data was recorded primarily on 16mm analog film recorders (Develocorders). Beginning in January, 1981, earthquake data was recorded digitally on a DEC PDP 11/34 computer system. Digital recording was switched from the PDP 11/34 computer to a Concurrent 7200 computer in September 1992. Digital seismograms are available for all located earthquakes occurring since January 1, 1981.

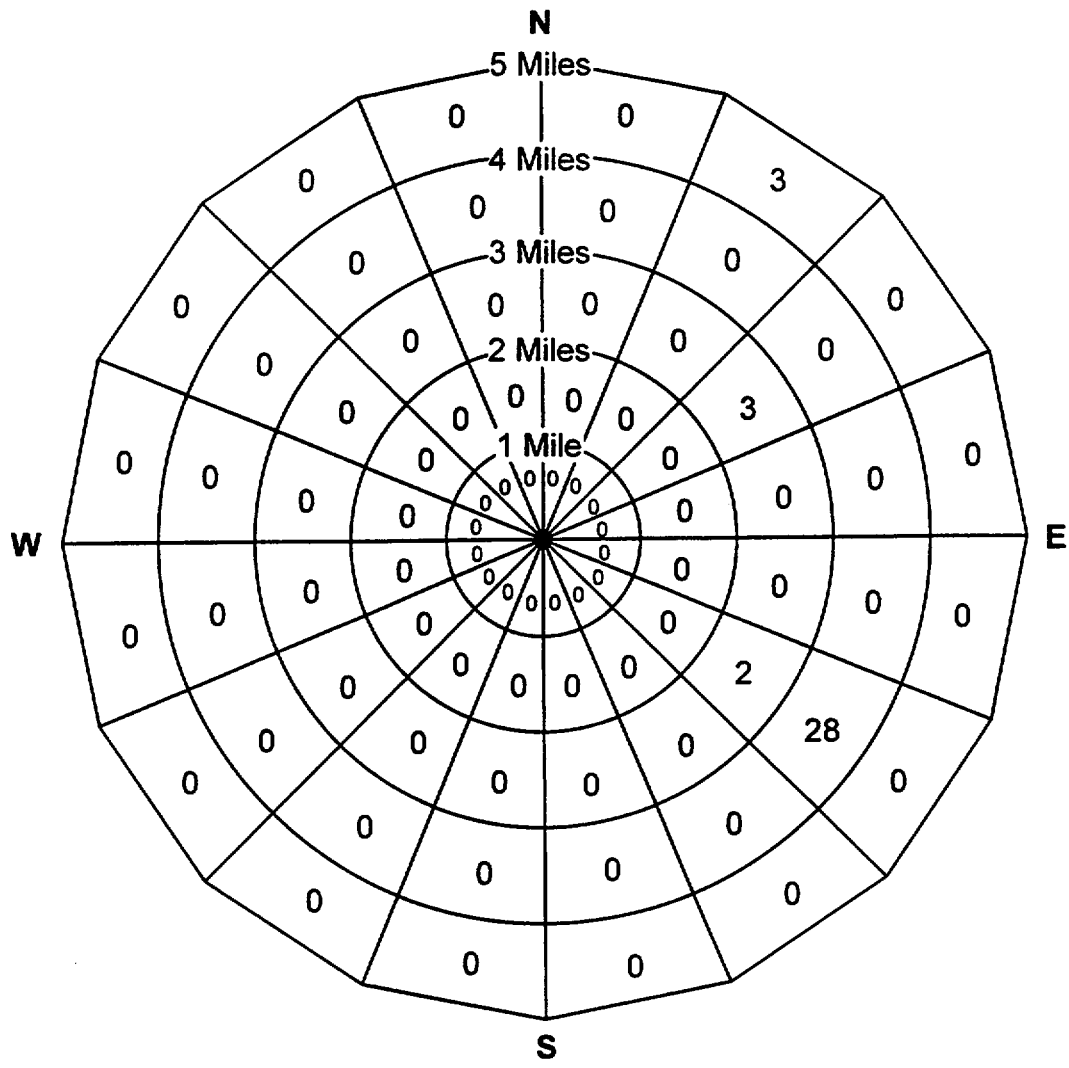

Total Population: 36



Figure 2.1-1
POPULATION DISTRIBUTION WITHIN
5 MILES OF PFSF
PRIVATE FUEL STORAGE FACILITY
SAFETY ANALYSIS REPORT

Source: 1990 Census, adapted by SWEC.

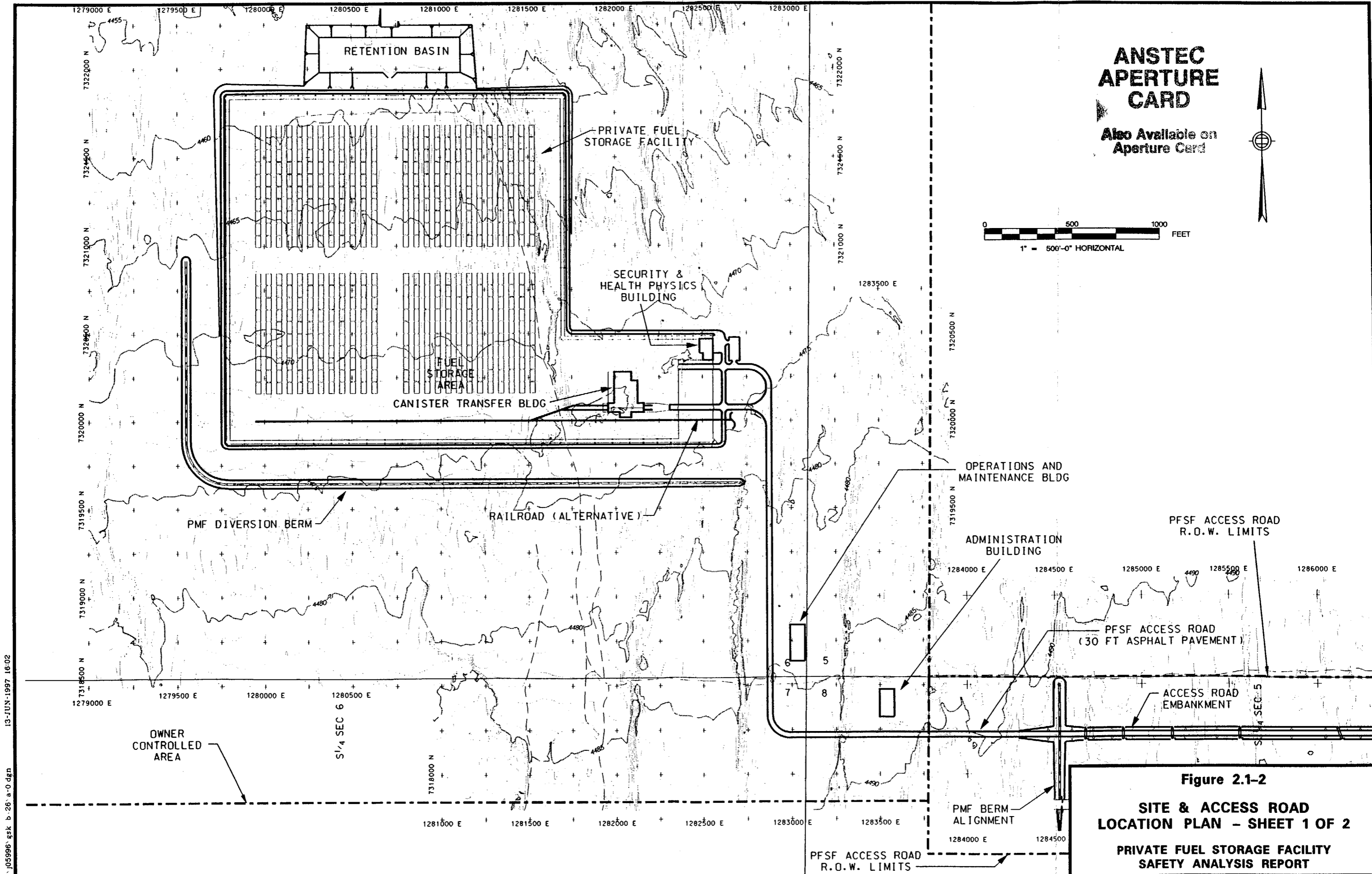

**ANSTEC
APERTURE
CARD**
Also Available on
Aperture Card

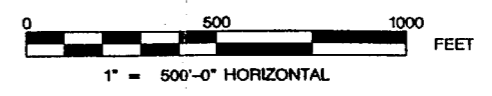

Figure 2.1-2
SITE & ACCESS ROAD
LOCATION PLAN - SHEET 1 OF 2
PRIVATE FUEL STORAGE FACILITY
SAFETY ANALYSIS REPORT

G:\J05996.gsk b.26 a.0 dgn 13-JUN-1997 16:02

9707020145-04

Revision 0

ANSTEC APERTURE CARD

Also Available on
Aperture Card

SKULL VALLEY RD (EXST)



PFSF ACCESS ROAD
(30 FT ASPHALT PAVEMENT)

PFSF ACCESS ROAD
R.O.W. LIMITS

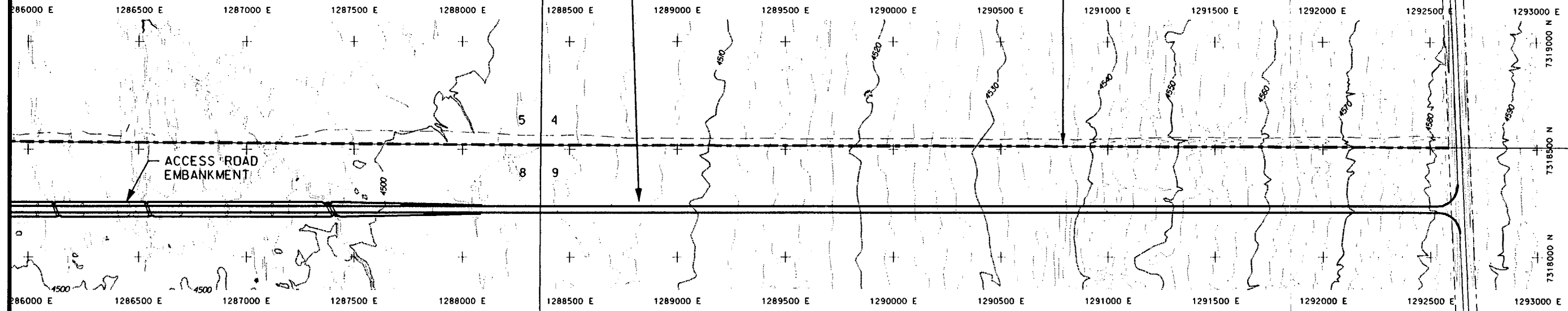

PFSF ACCESS ROAD
R.O.W. LIMITS

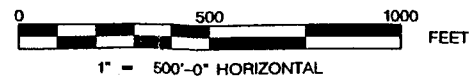
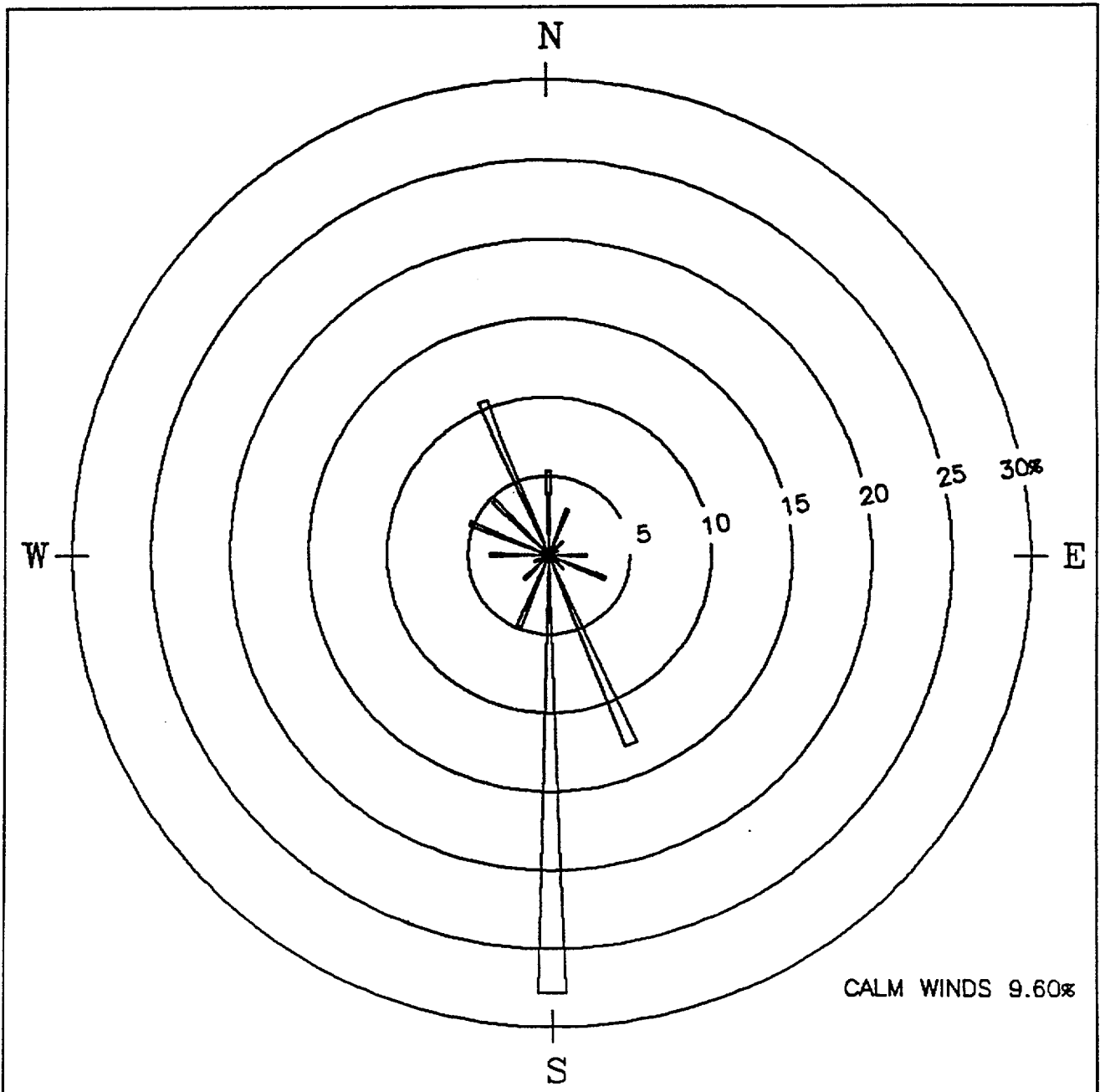

Figure 2.1-2
SITE & ACCESS ROAD
LOCATION PLAN - SHEET 2 OF 2
PRIVATE FUEL STORAGE FACILITY
SAFETY ANALYSIS REPORT

G:\05996\gsk b\28 b-0.dgn 13-JUN-1997 16:03

9707020145-05

Revision 0



CALM WINDS 9.60%

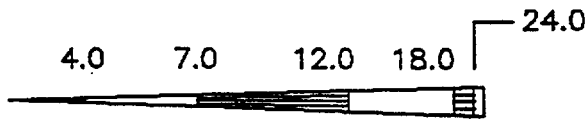

WIND SPEED CLASS BOUNDARIES
(MILES/HOUR)

Notes:
 Diagram of the frequency of occurrence for each wind direction. Wind direction is the direction from which the wind is blowing. Example - wind is blowing from the north 5.3 percent of the time.

Figure 2.3-1
SALT LAKE CITY WINDROSE: 1988-1992 WINTER
 PRIVATE FUEL STORAGE FACILITY
 SAFETY ANALYSIS REPORT

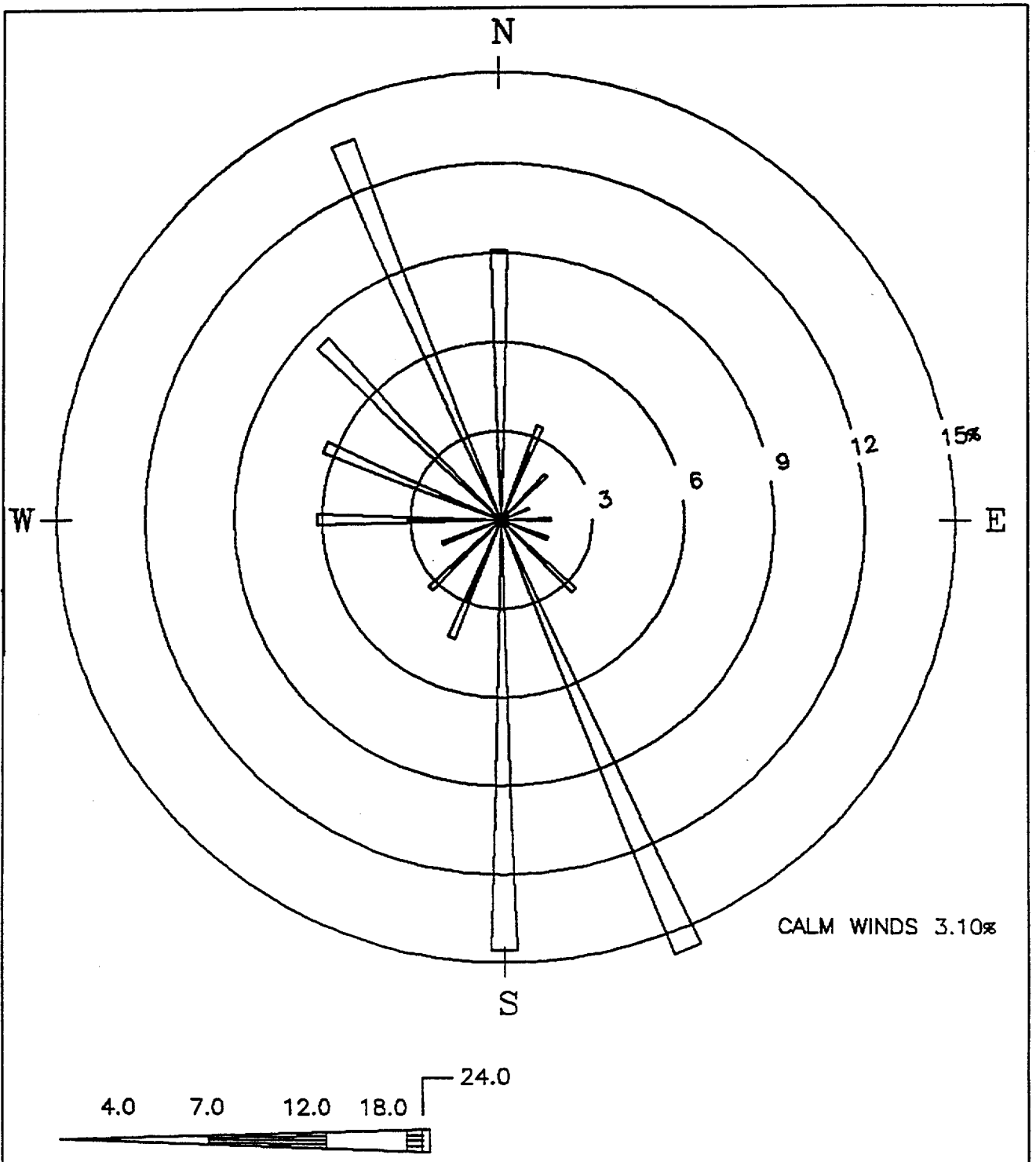

WIND SPEED CLASS BOUNDARIES
(MILES/HOUR)

Notes:
 Diagram of the frequency of occurrence for each wind direction.
 Wind direction is the direction from which the wind is blowing.
 Example - wind is blowing from the north 9.1 percent of the time.

Figure 2.3-2
SALT LAKE CITY WINDROSE: 1988-1992 SPRING
 PRIVATE FUEL STORAGE FACILITY
 SAFETY ANALYSIS REPORT

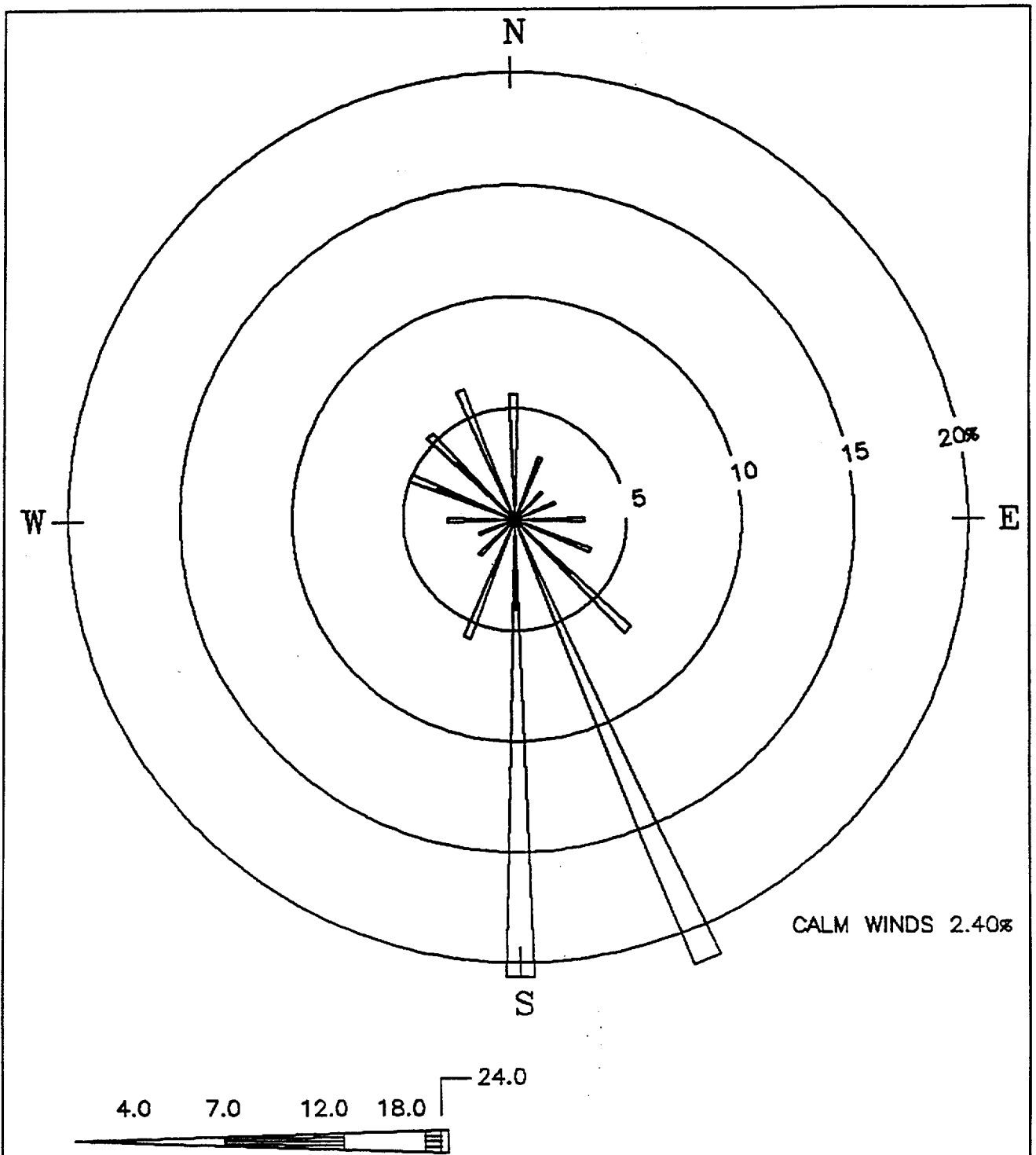

WIND SPEED CLASS BOUNDARIES
(MILES/HOUR)

Notes:
 Diagram of the frequency of occurrence for each wind direction. Wind direction is the direction from which the wind is blowing. Example - wind is blowing from the north 5.7 percent of the time.

Figure 2.3-3
SALT LAKE CITY WINDROSE: 1988-1992
SUMMER
 PRIVATE FUEL STORAGE FACILITY
 SAFETY ANALYSIS REPORT

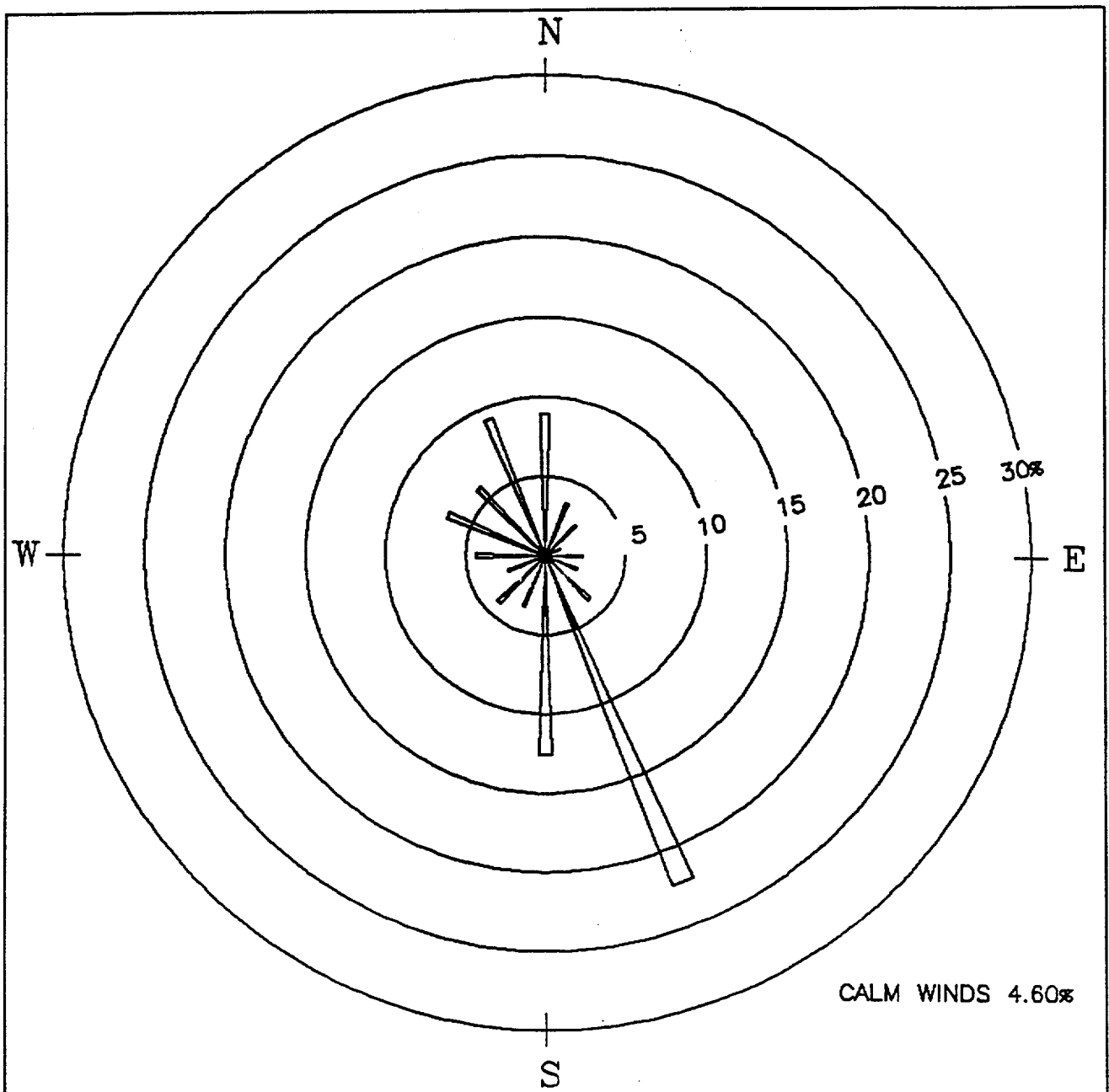

CALM WINDS 4.60%

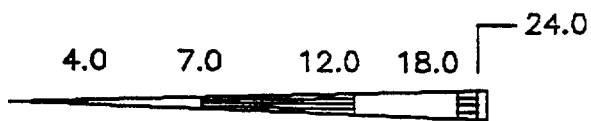

WIND SPEED CLASS BOUNDARIES
(MILES/HOUR)

Notes:
 Diagram of the frequency of occurrence for each wind direction.
 Wind direction is the direction from which the wind is blowing.
 Example - wind is blowing from the north 8.9 percent of the time.

Figure 2.3-4
SALT LAKE CITY WINDROSE: 1988-1992
AUTUMN
 PRIVATE FUEL STORAGE FACILITY
 SAFETY ANALYSIS REPORT

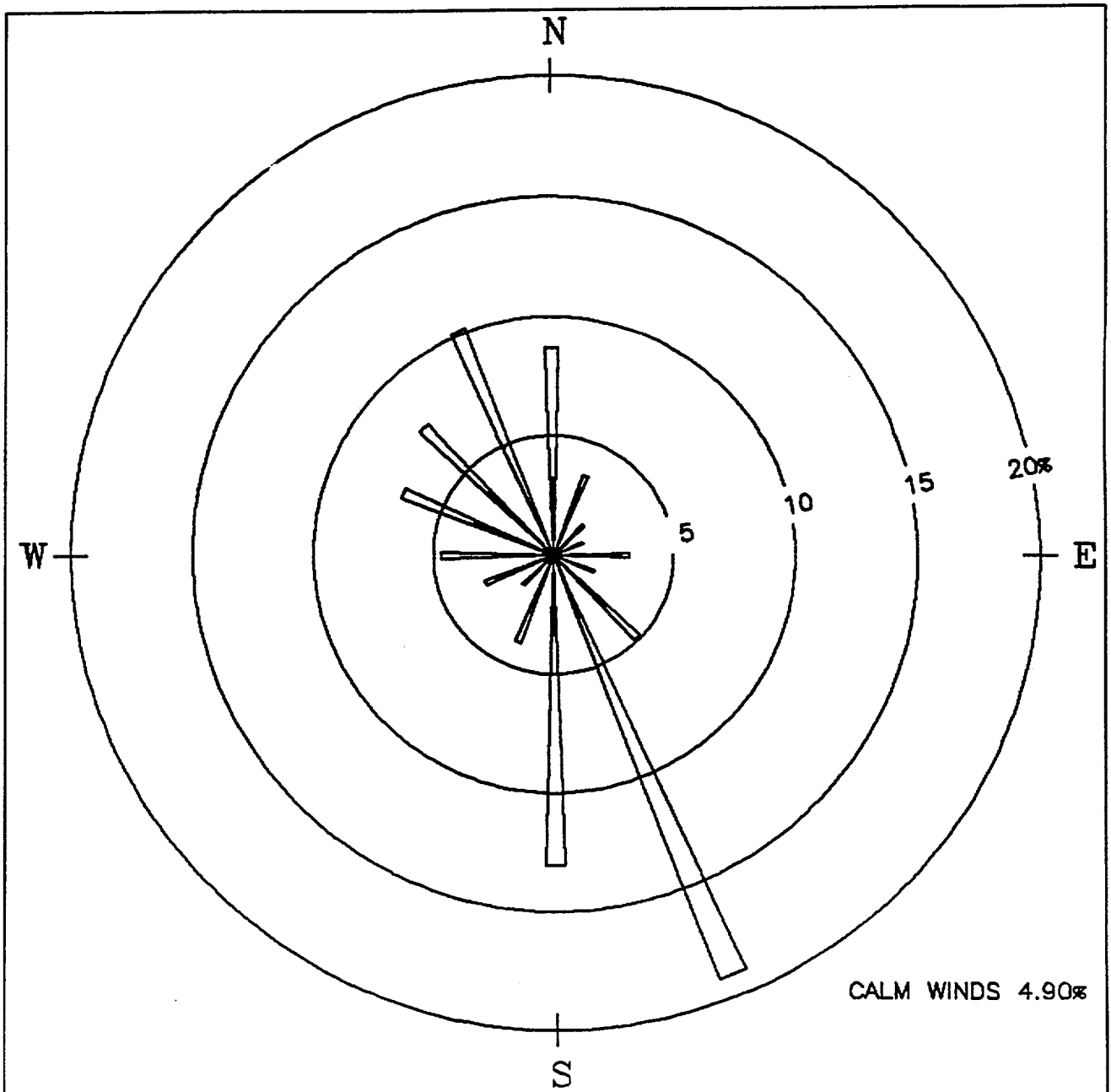

CALM WINDS 4.90%

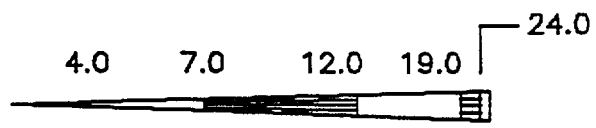

**WIND SPEED CLASS BOUNDARIES
(MILES/HOUR)**

Notes:
 Diagram of the frequency of occurrence for each wind direction.
 Wind direction is the direction from which the wind is blowing.
 Example - wind is blowing from the north 8.7 percent of the time.

Figure 2.3-5
SALT LAKE CITY WINDROSE: 1988-1992
 PRIVATE FUEL STORAGE FACILITY
 SAFETY ANALYSIS REPORT

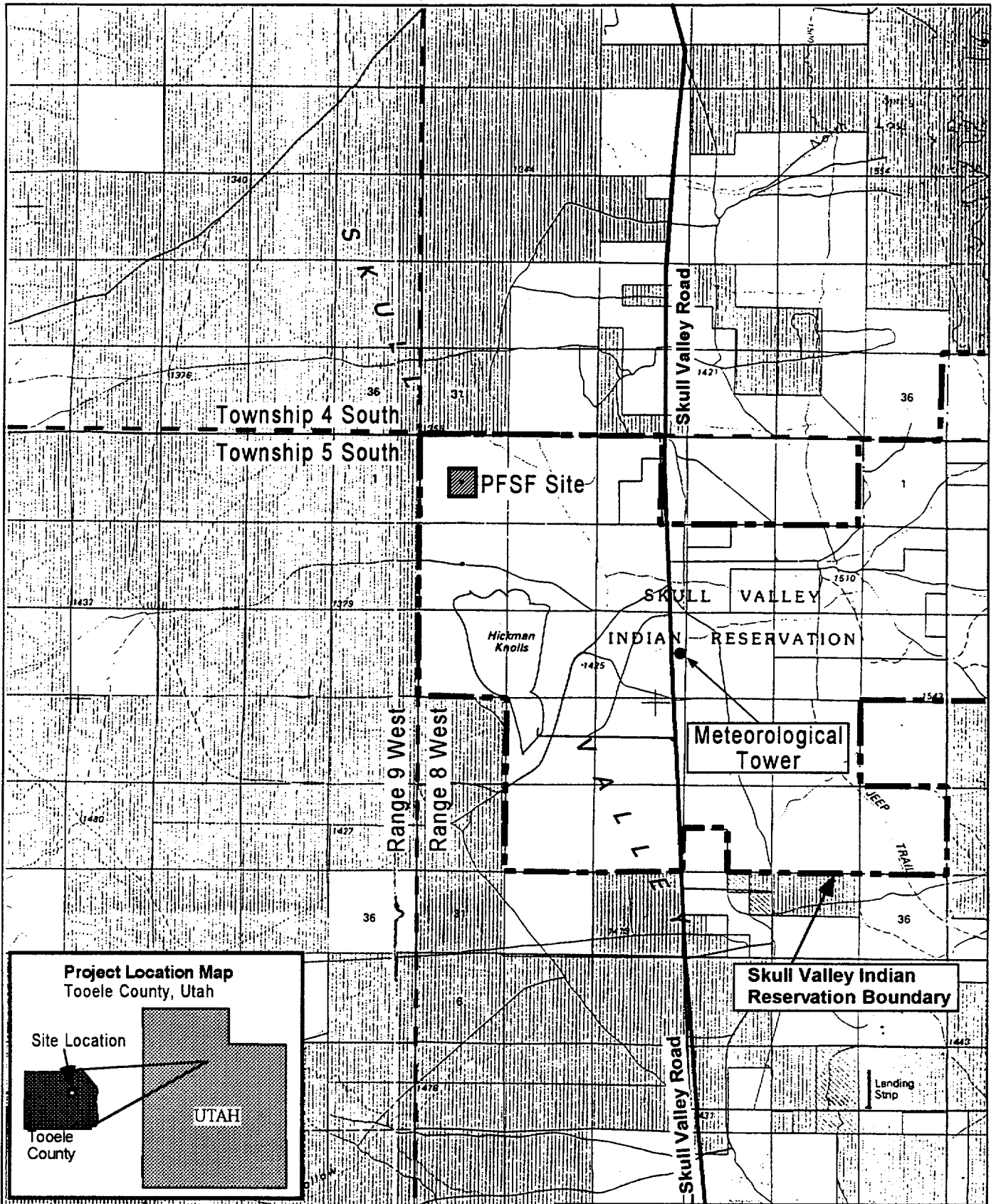
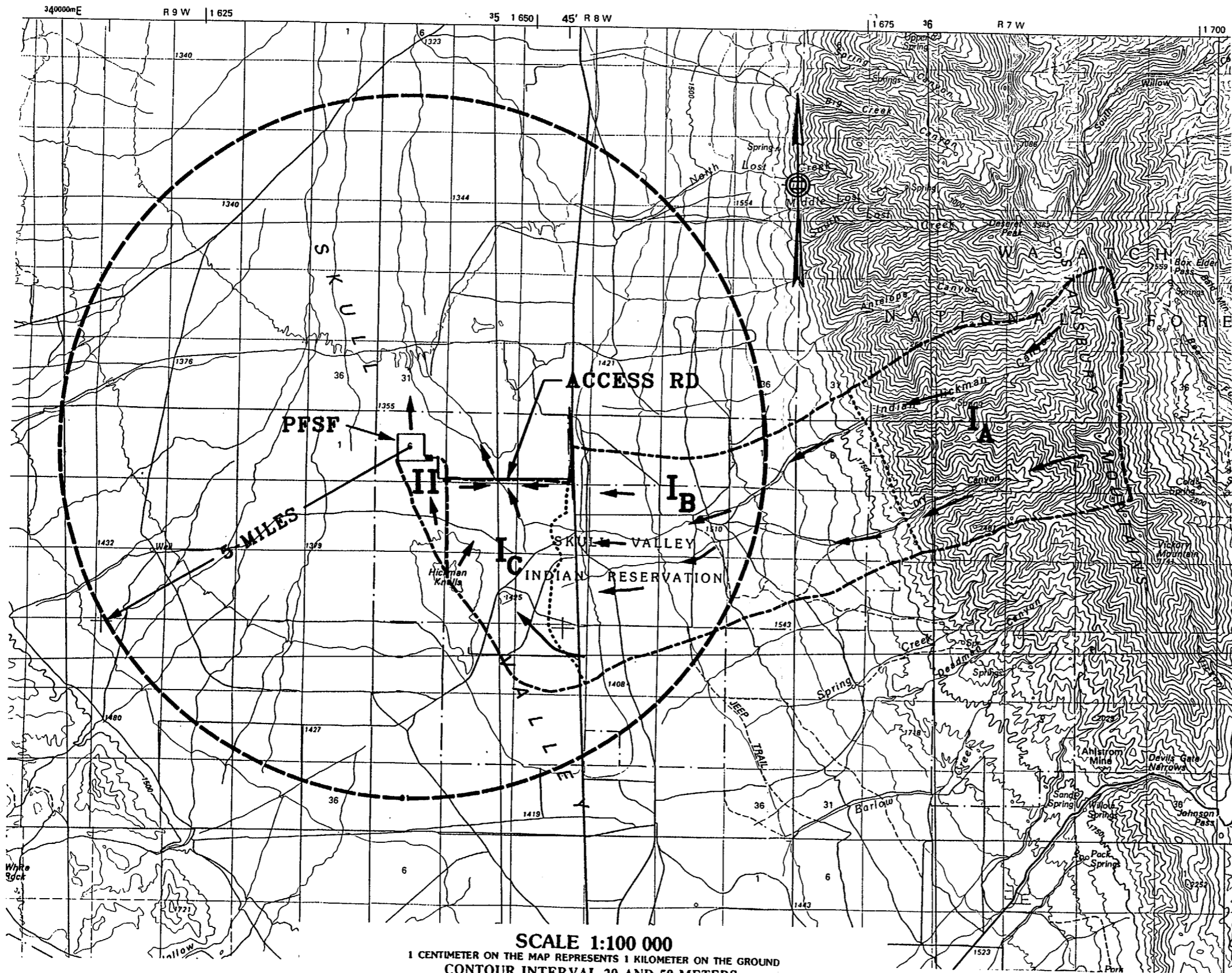

FIGURE 2.3-6
METEOROLOGICAL TOWER LOCATION
RELATIVE TO THE PFSF SITE

PRIVATE FUEL STORAGE FACILITY
SAFETY ANALYSIS REPORT

Source: Bureau of Land Management 1:100,000 Scale
 Topographic Map of Rush Valley, 1979.



BASEMAP FROM USGS 1:100,000 RUSH VALLEY QUADRANGLE

Figure 2.4-1
WATERSHED BASINS IN VICINITY OF PFSF SITE
 PRIVATE FUEL STORAGE FACILITY SAFETY ANALYSIS REPORT

9707020/45-06

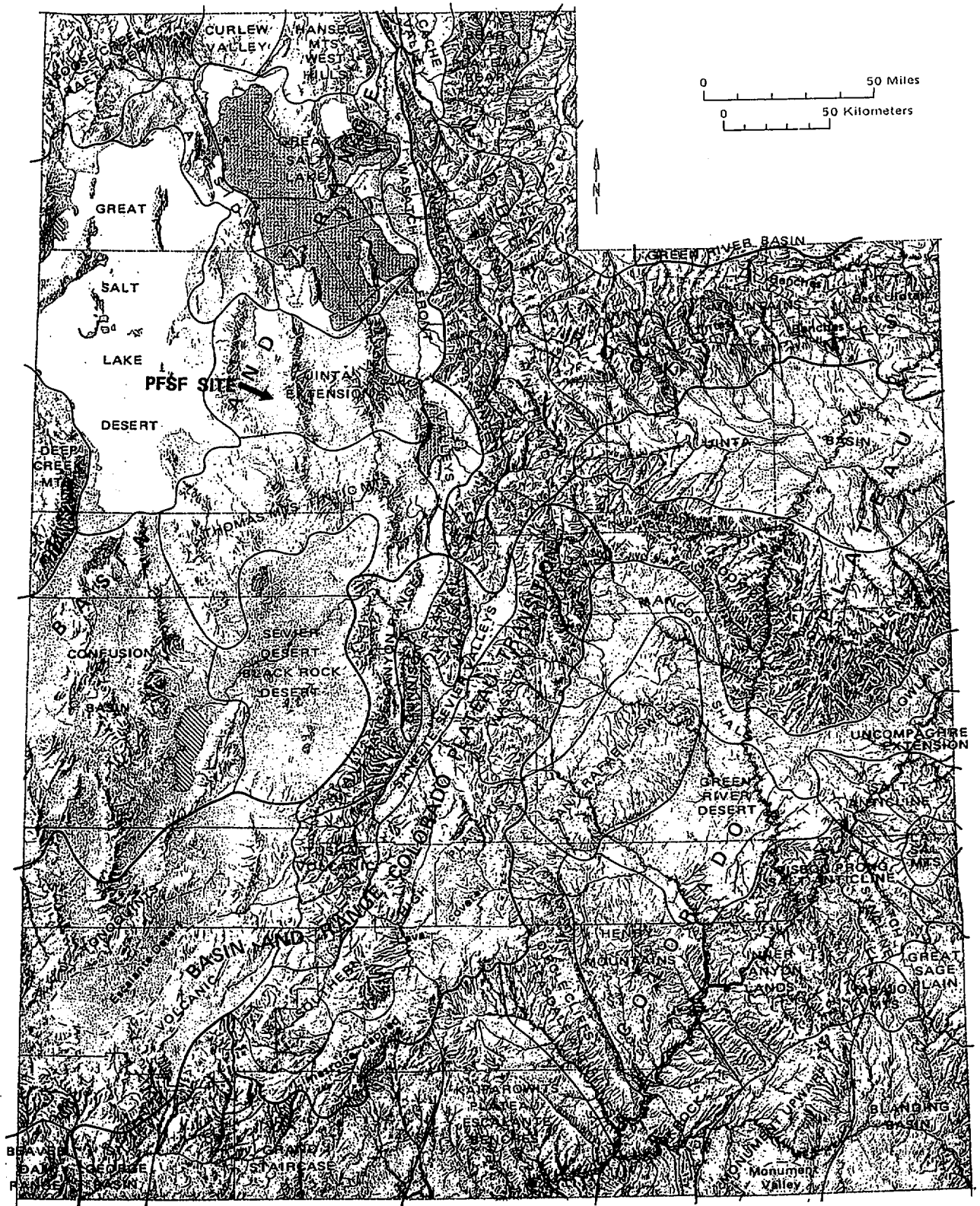

SOURCE: STOKES, 1986

Figure 2.6-1
PHYSIOGRAPHY OF UTAH
PRIVATE FUEL STORAGE FACILITY
SAFETY ANALYSIS REPORT

ANSTEC APERTURE CARD

Also Available on
Aperture Card

KEY

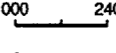
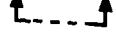
-  BORING LOCATION
-  SEISMIC SURVEY LOCATION
-  LOCATION OF FOUNDATION PROFILE

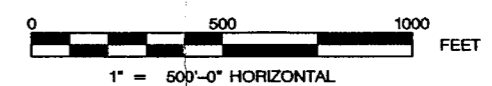

CONTOUR INTERVAL = 1 FT (2 FT ABOVE EL 4490)

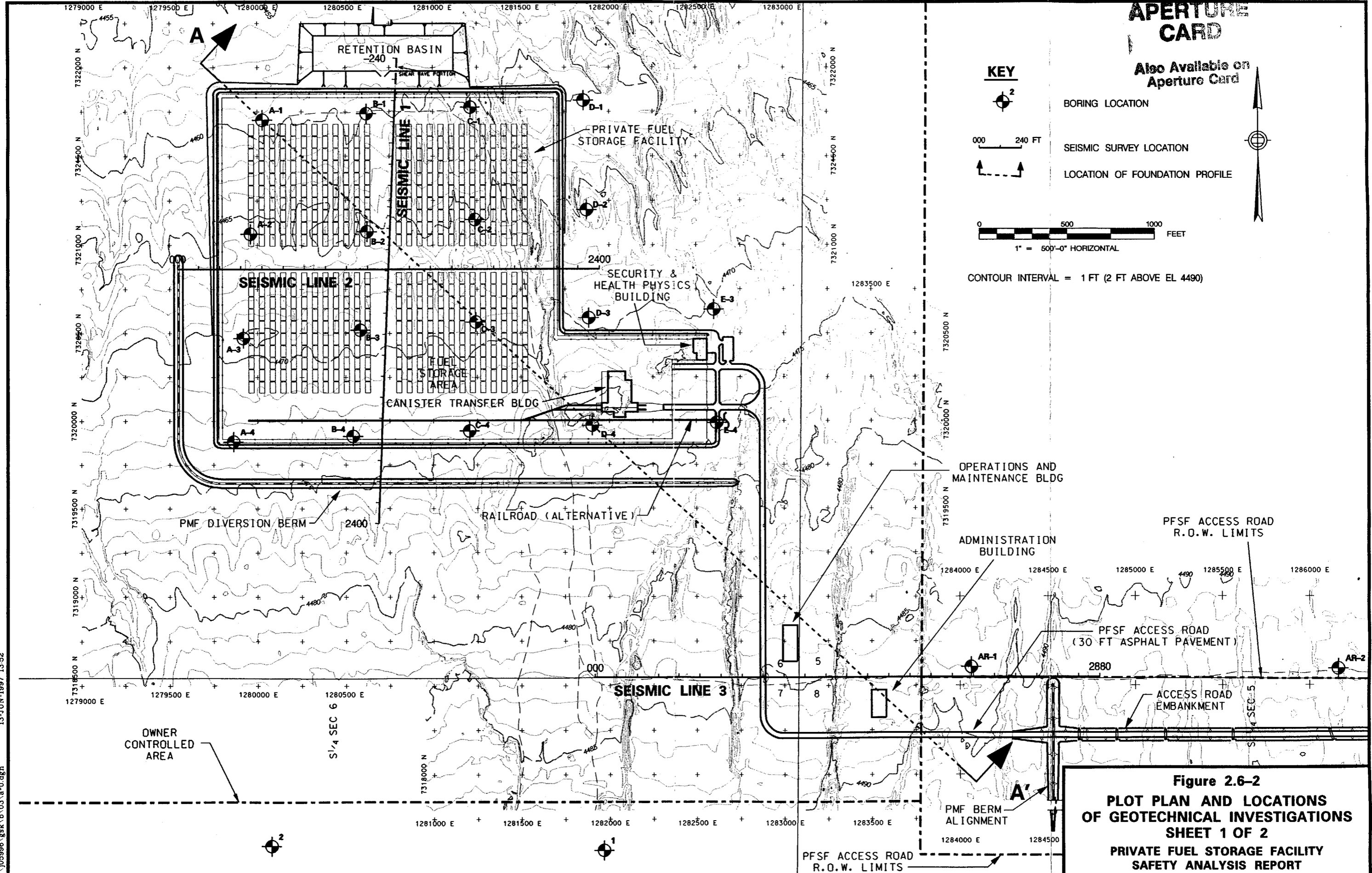

**Figure 2.6-2
PLOT PLAN AND LOCATIONS
OF GEOTECHNICAL INVESTIGATIONS
SHEET 1 OF 2
PRIVATE FUEL STORAGE FACILITY
SAFETY ANALYSIS REPORT**

G:\j05996\gsk\b\03\va-0.dgn 13-JUN-1997 13:52

9707020145-07

Revision 0

**ANSTEC
APERTURE
CARD**

Also Available on
Aperture Card



SKULL VALLEY RD (EXST)

PFSF ACCESS ROAD
(30 FT ASPHALT PAVEMENT)

PFSF ACCESS ROAD
R.O.W. LIMITS

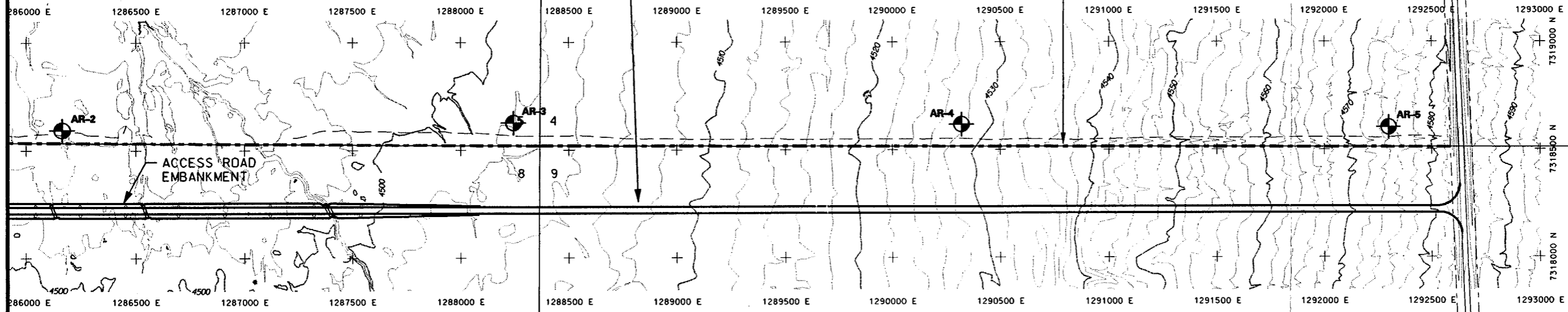

PFSF ACCESS ROAD
R.O.W. LIMITS

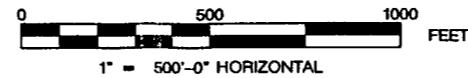
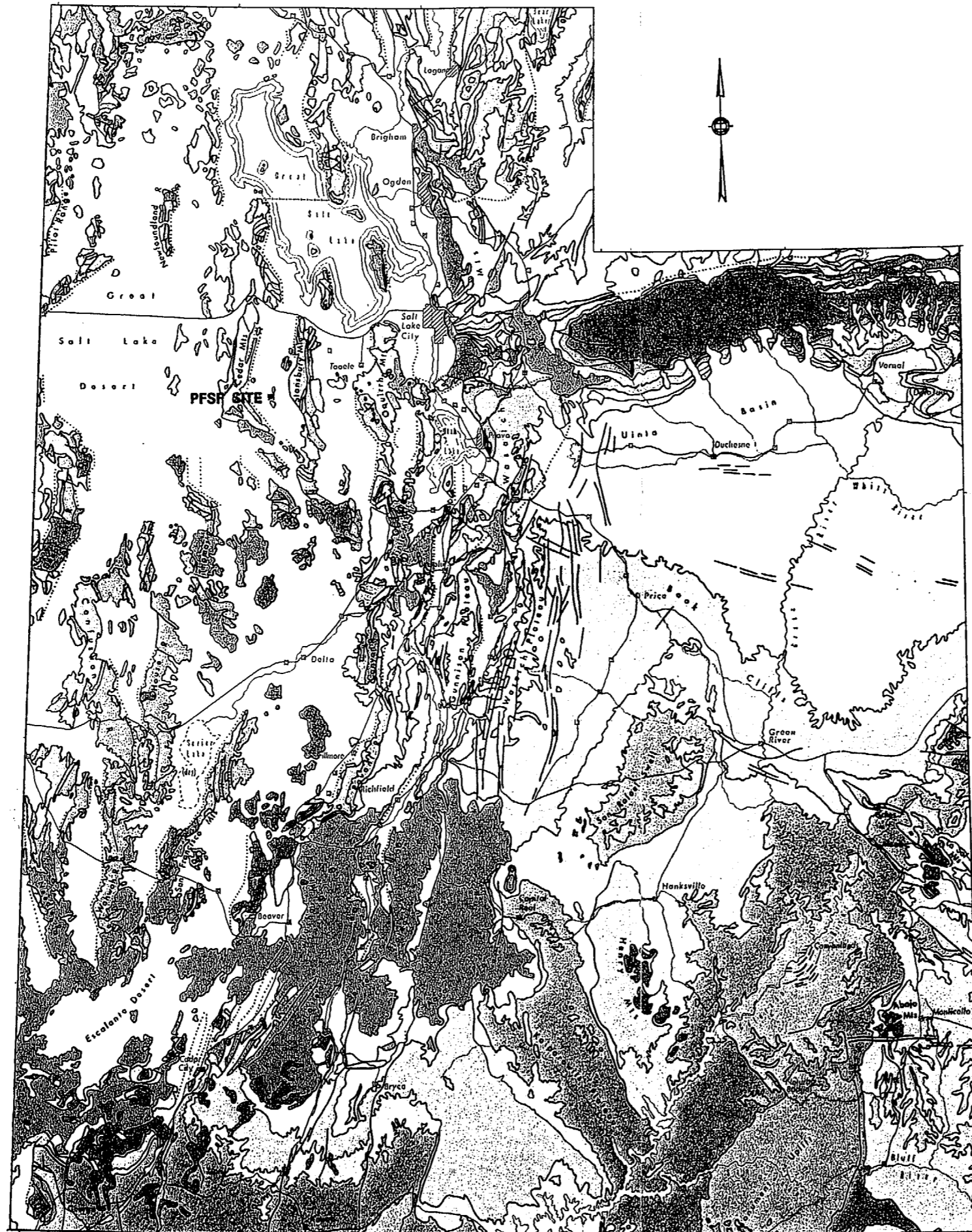

**Figure 2.6-2
PLOT PLAN AND LOCATIONS
OF GEOTECHNICAL INVESTIGATIONS
SHEET 2 OF 2
PRIVATE FUEL STORAGE FACILITY
SAFETY ANALYSIS REPORT**

Revision 0

9707020145-08

13-JUN-1997 13:53
c:\j05996\gsk\03\b-0.dgn



ANSTEC APERTURE CARD

Also Available on
Aperture Card

KEY

- Quaternary
- Tertiary
- Cretaceous
- Jurassic
- Triassic (with Mesozoic)
- Pennsylvanian-Permian
- Mississippian
- Silurian-Devonian
- Ordovician
- Cambrian
- Precambrian
- Precambrian, Jurassic, Tertiary
- Intrusive igneous rocks

SCALE

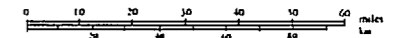

SOURCE: HINTZE, in STOKES, 1986



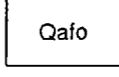
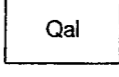

Figure 2.6-3





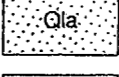
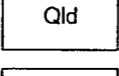
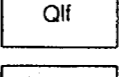
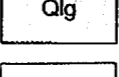
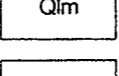
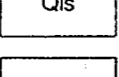
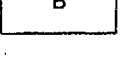

GEOLOGIC MAP OF UTAH

PRIVATE FUEL STORAGE FACILITY
SAFETY ANALYSIS REPORT

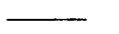
9707020145-09

MAP EXPLANATION

-  Active alluvial-fan deposits
-  Abandoned alluvial-fan deposits
-  Inactive alluvial-fan deposits
-  Channel alluvium
-  Eolian dune deposits
-  Nondunal eolian deposits
-  Mixed lacustrine and alluvial deposits
-  Lacustrine mud
-  Fine-grained lacustrine deposits
-  Lacustrine gravel
-  White marl
-  Lacustrine sand
-  Undifferentiated bedrock

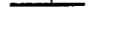
-  Contact
-  Bonneville shoreline
-  Provo shoreline
-  Stansbury shoreline
-  Gilbert shoreline
-  Piedmont fault scarps; bar and ball on downthrown side
-  Faults or fractures having small or undetermined displacement

**ANSTEC
APERTURE
CARD**

Also Available on
Aperture Card

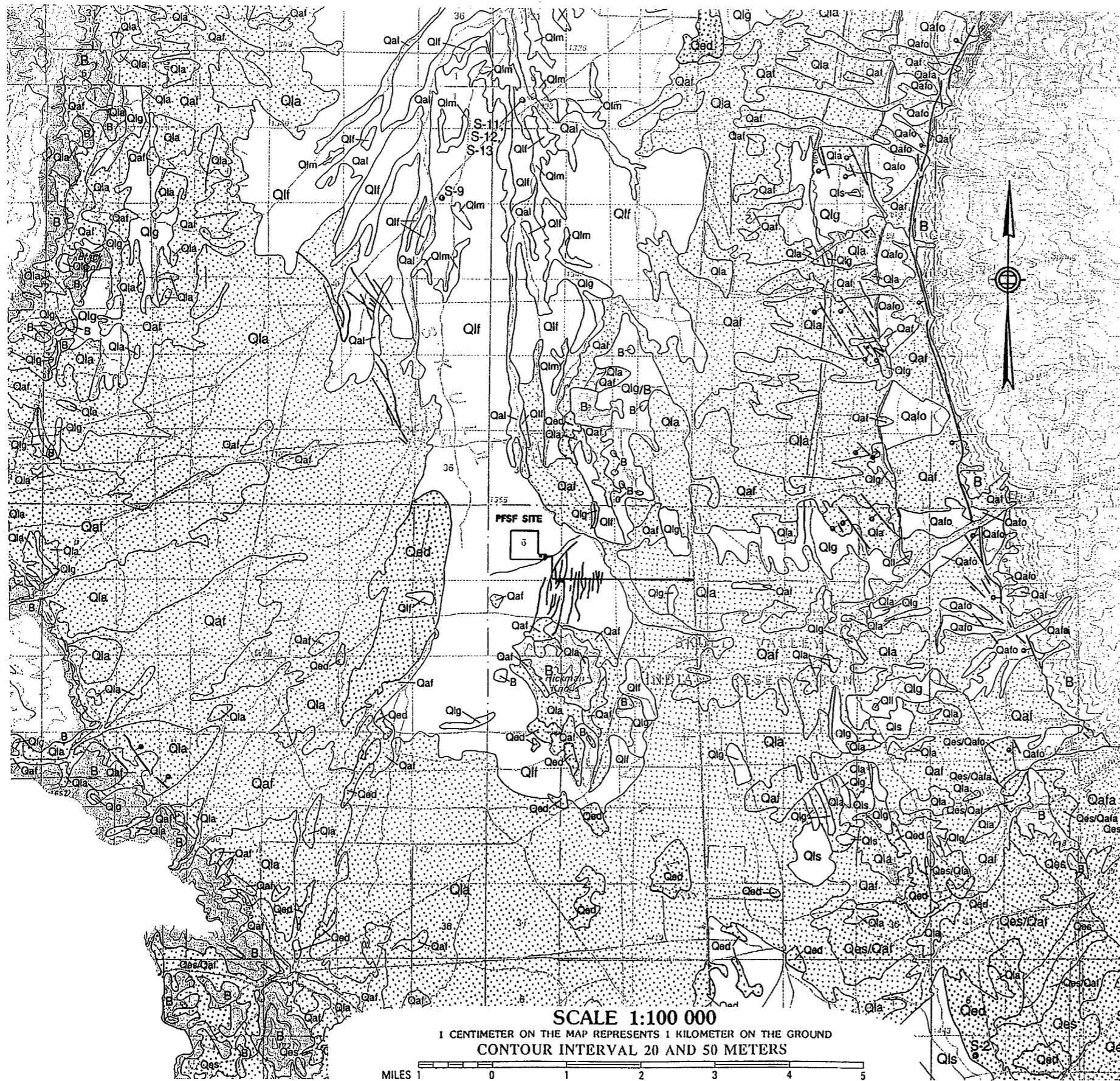

SCALE 1:100 000

1 CENTIMETER ON THE MAP REPRESENTS 1 KILOMETER ON THE GROUND
CONTOUR INTERVAL 20 AND 50 METERS



SOURCE: SACK, 1993

Figure 2.6-4
SURFICIAL GEOLOGY
AND PFSF SITE
PRIVATE FUEL STORAGE FACILITY
SAFETY ANALYSIS REPORT

9707020145-09/01

**ANSTEC
APERTURE
CARD**

Also Available on
Aperture Card

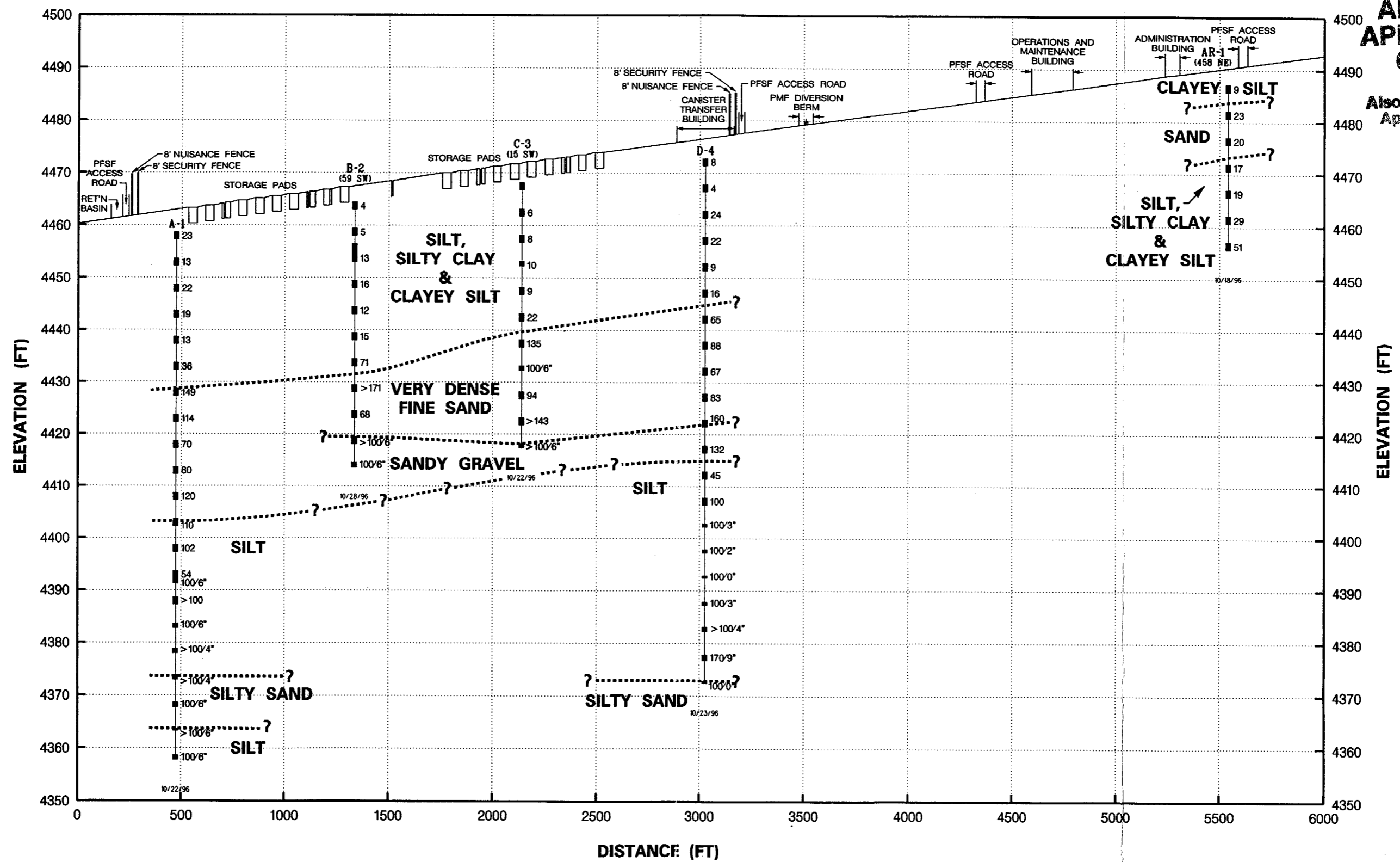

30-MAY-1997 17:07
G:\J05996\gsk\b\25\0.dgn

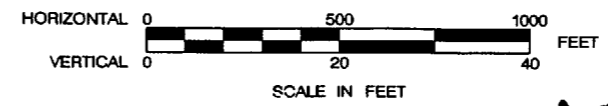

9707020145-10

Figure 2.6-5
FOUNDATION PROFILE A-A'
LOOKING NORTHEAST
PRIVATE FUEL STORAGE FACILITY
SAFETY ANALYSIS REPORT

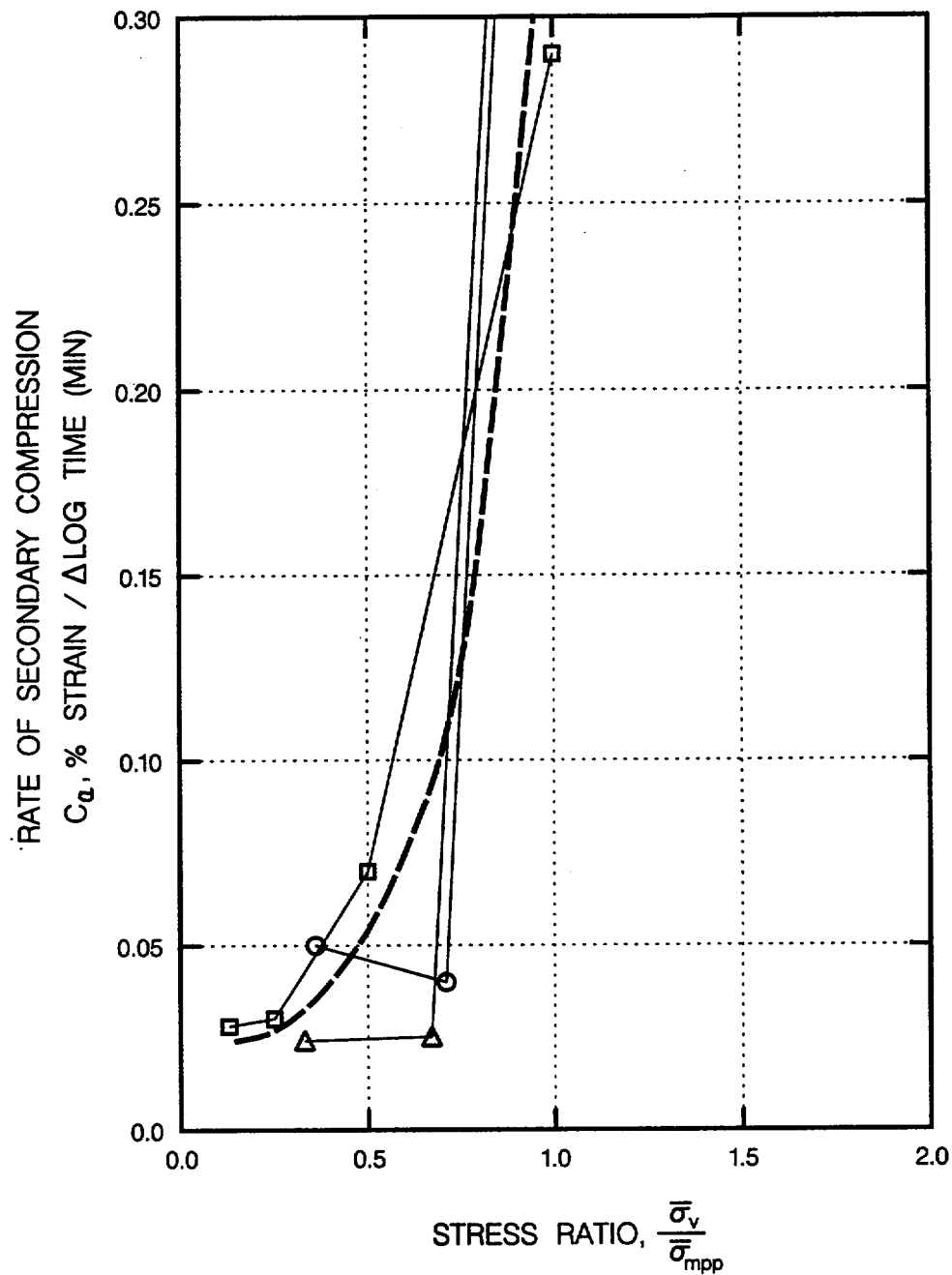

KEY

SYMBOL	TEST ID
○	C1-U3C
□	C1-U3D
△	C2-U2C

BASED ON RELOADING PORTIONS OF CONSOLIDATION TESTS

Figure 2.6-6
RATE OF SECONDARY COMPRESSION
VS STRESS RATIO
PRIVATE FUEL STORAGE FACILITY
SAFETY ANALYSIS REPORT

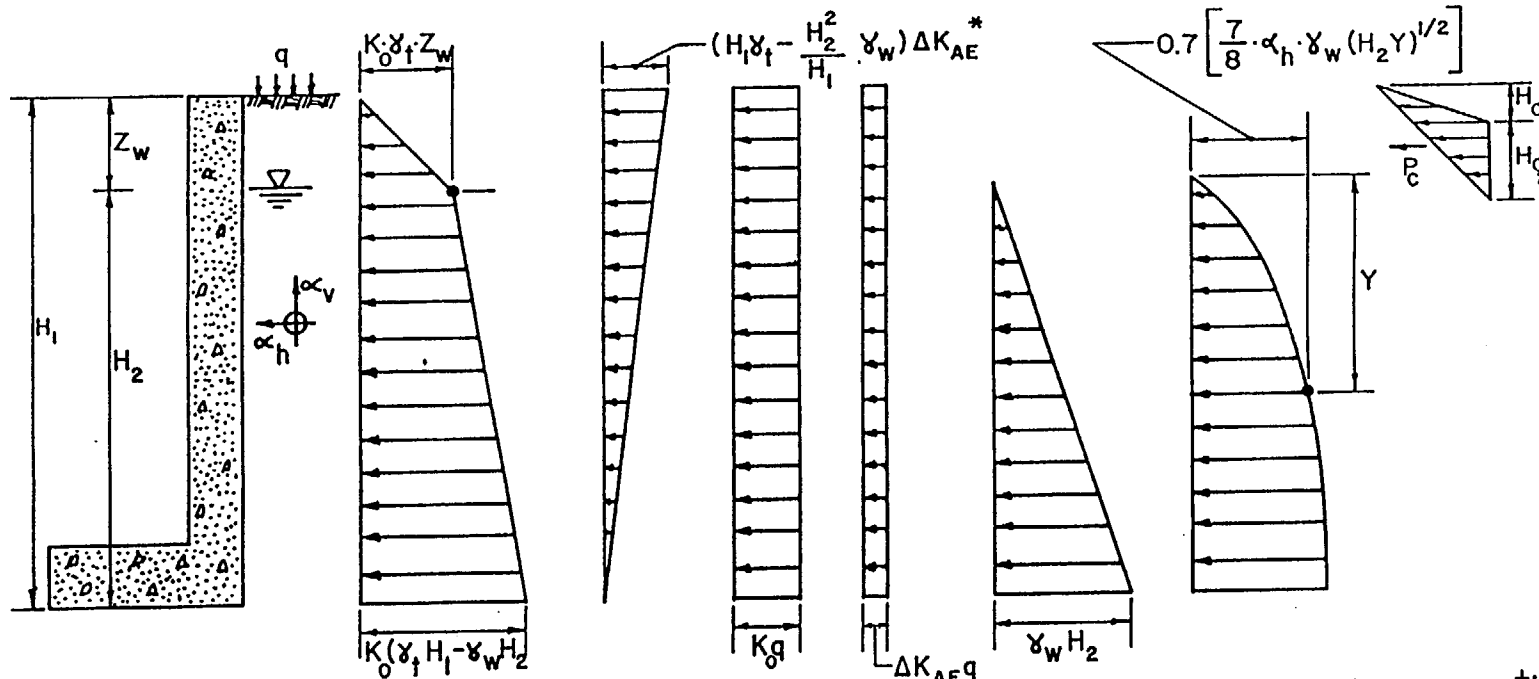

LOAD/LIN. FT. OF WALL	SOIL	SURCHARGE**	WATER	COMPACTION ⁺
STATIC	$(H_1^2 \gamma_s - H_2^2 \gamma_w) \frac{K_0}{2}$	$K_0 H_1$	$\frac{1}{2} H_2^2 \gamma_w$	$\frac{1}{2} \sigma_c H_{c2}$
DYNAMIC	$(H_1^2 \gamma_s - H_2^2 \gamma_w) \frac{1}{2} \Delta K_{AE}^*$	$\Delta K_{AE} q H_1$	$0.7 \left[\frac{7}{12} \alpha_h \gamma_w H_2^2 \right]$	—
COMBINED	$\frac{1}{2} (H_1^2 \gamma_s - H_2^2 \gamma_w) (K_0 + \Delta K_{AE})$	$q (K_0 + \Delta K_{AE}) H_1$	$\frac{\gamma_w H_2^2}{2} (1 + 0.82 \alpha_h)$	$\frac{1}{2} \sigma_c H_{c2}$

*APPLICABLE FOR $H_2 \leq H_1$; IF $H_2 > H_1$, H_2 SHOULD BE TAKEN TO BE EQUAL TO H_1 SINCE STANDING WATER DOES NOT EFFECT THE MAGNITUDE OF EFFECTIVE STRESS.

**FOR UNIFORM SURCHARGE ONLY.

Figure 2.6-7

**STATIC AND DYNAMIC
LATERAL EARTH PRESSURES**

**PRIVATE FUEL STORAGE FACILITY
SAFETY ANALYSIS REPORT**

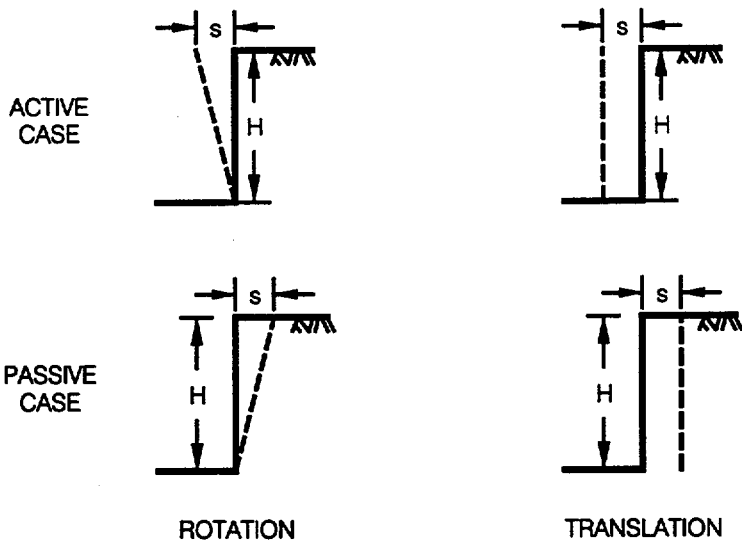
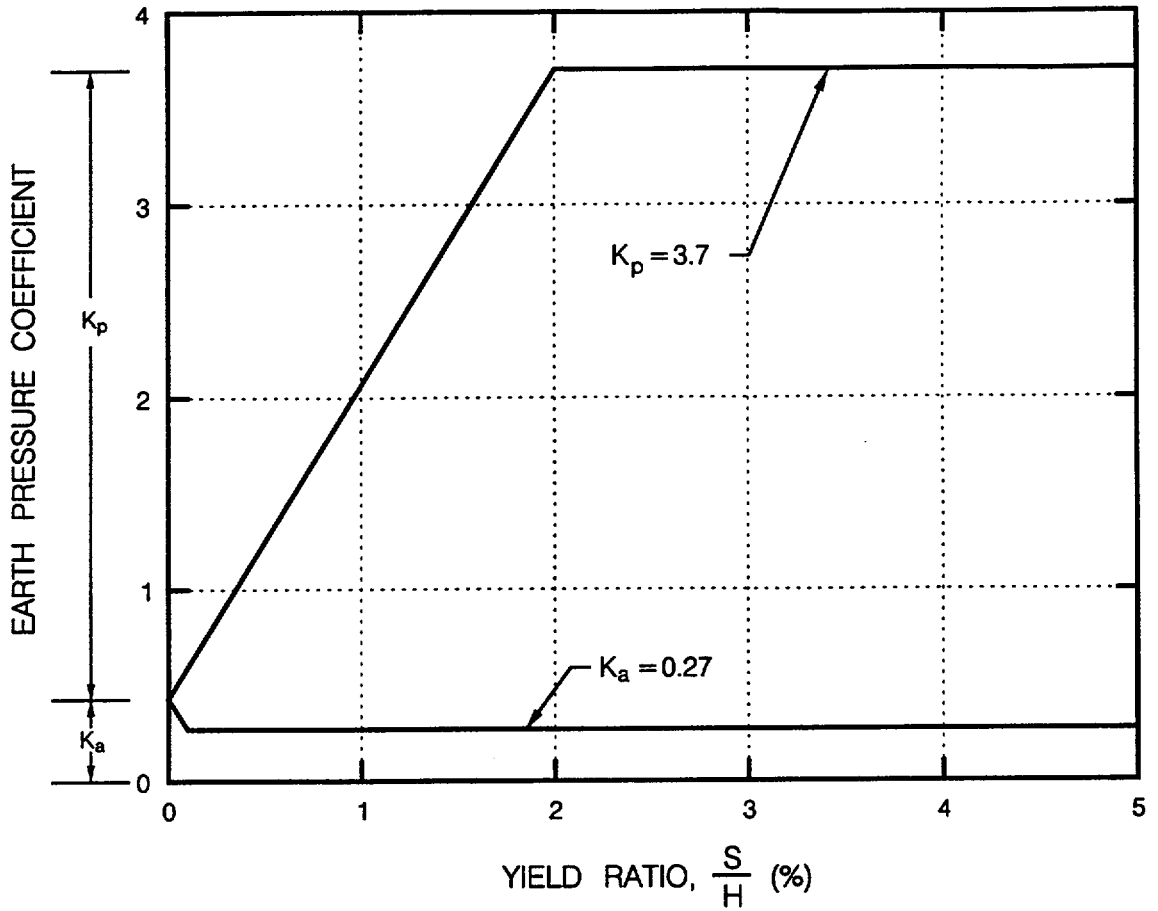

Figure 2.6-8
LATERAL EARTH PRESSURE
COEFFICIENTS VS WALL MOVEMENT
 PRIVATE FUEL STORAGE FACILITY
 SAFETY ANALYSIS REPORT

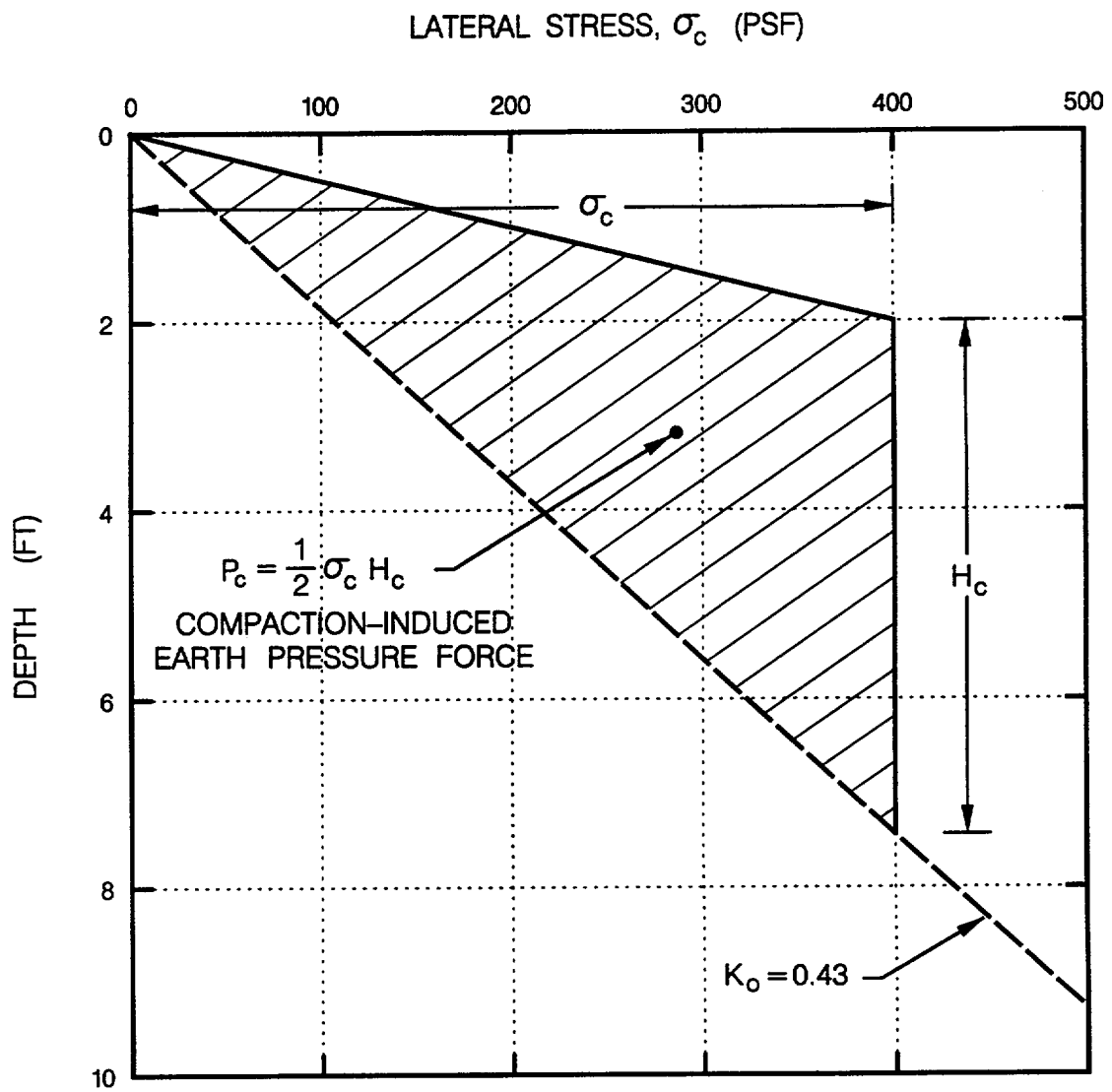
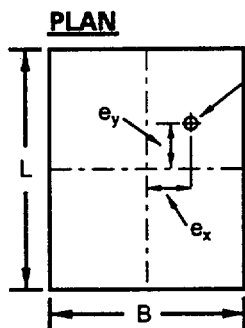
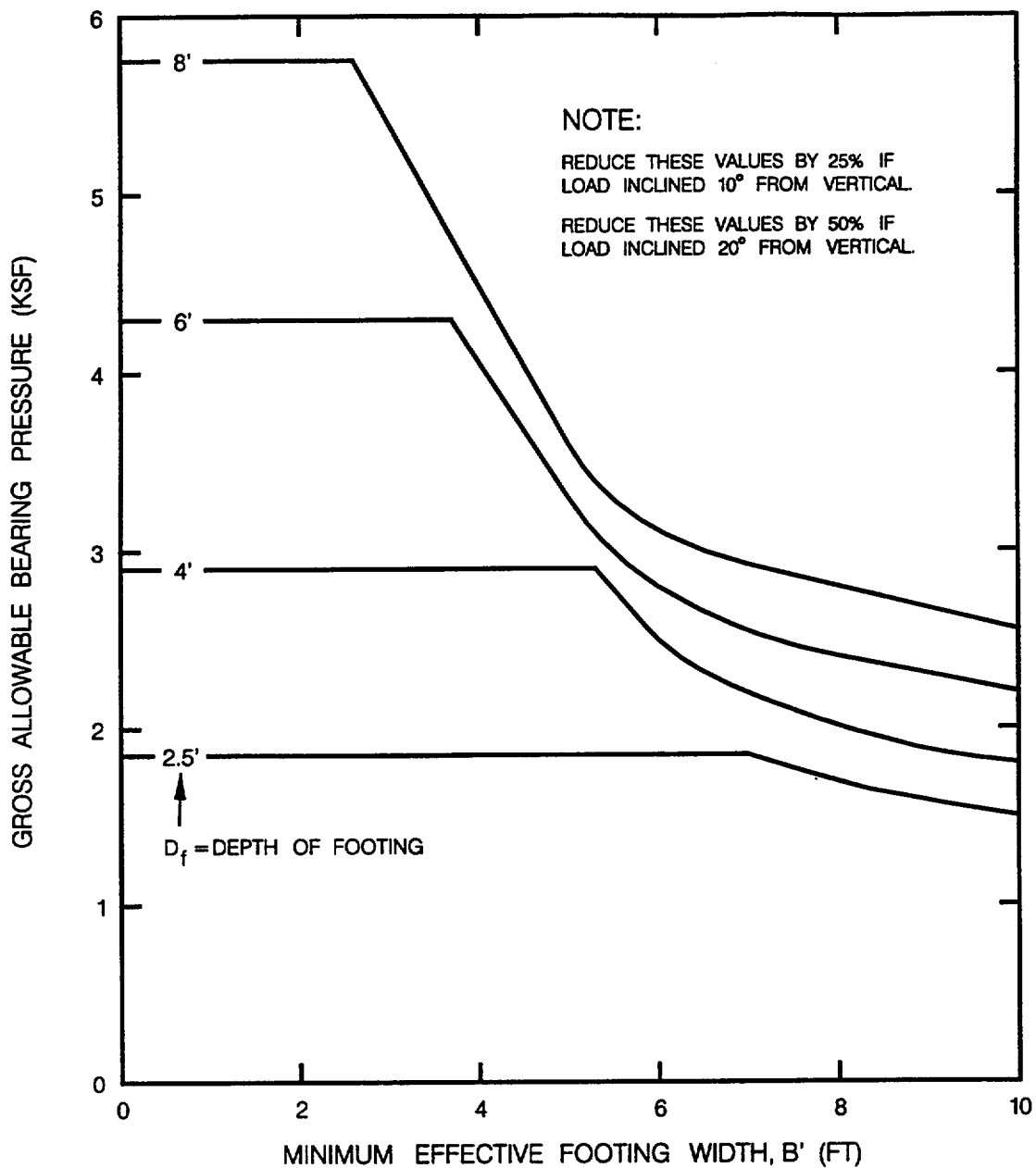

Figure 2.6-9
**COMPACTION-INDUCED
LATERAL STRESSES**
**PRIVATE FUEL STORAGE FACILITY
SAFETY ANALYSIS REPORT**



POINT OF APPLICATION OF F_v DUE TO M_x & M_y

$$e_x = \frac{M_x}{F_v} \quad e_y = \frac{M_y}{F_v}$$

$$B' = B - 2e_x \quad L' = L - 2e_y$$

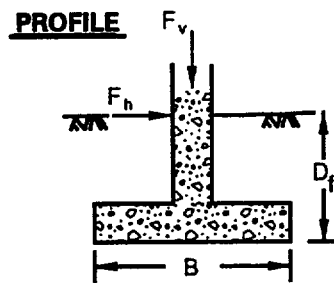
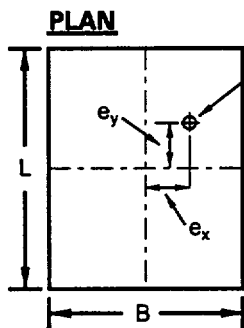
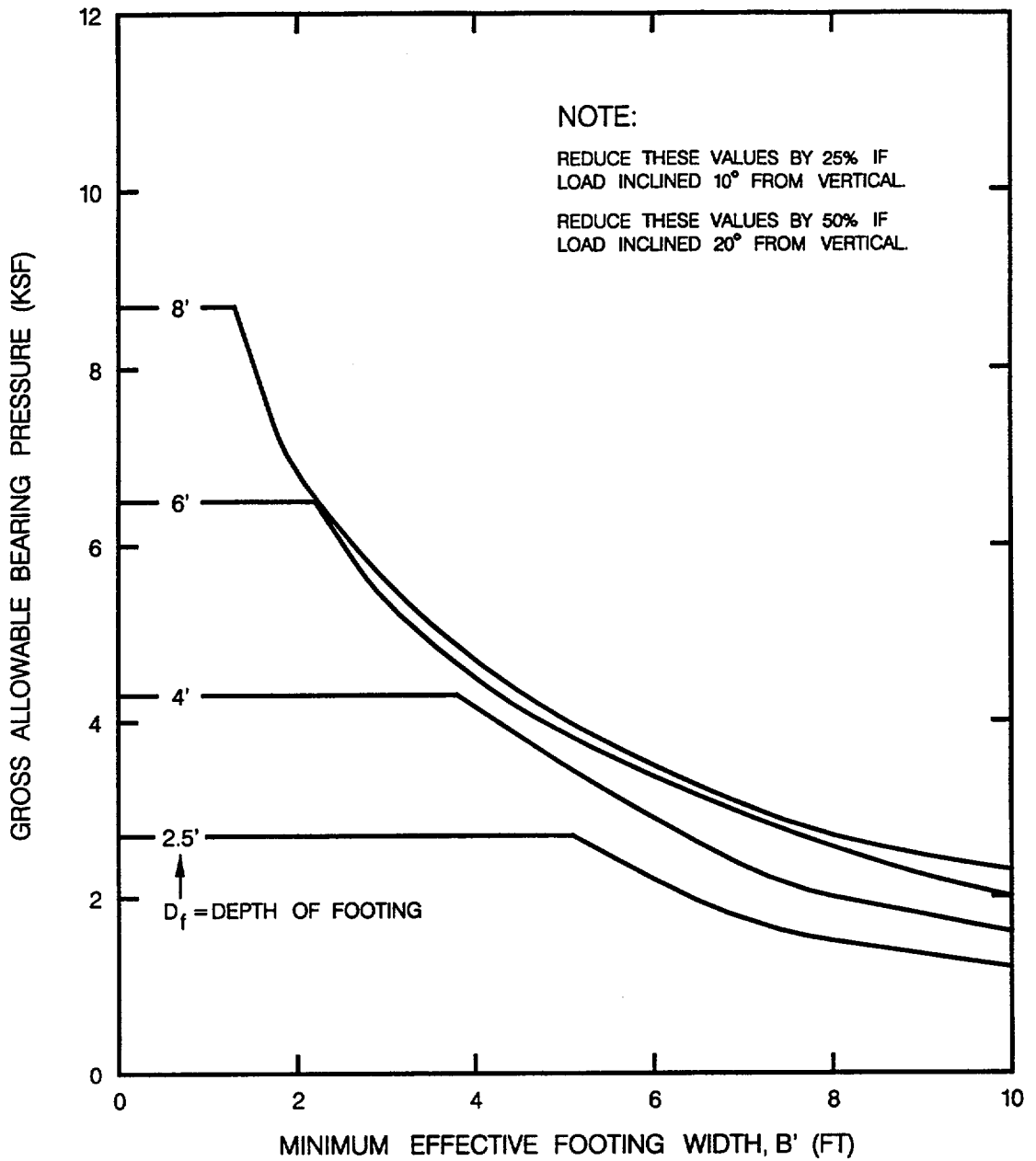

Figure 2.6-10
GROSS ALLOWABLE BEARING PRESSURE VS FOOTING WIDTH & DEPTH FOR STRIP FOOTINGS
PRIVATE FUEL STORAGE FACILITY
SAFETY ANALYSIS REPORT

BASED ON MAXIMUM ALLOWABLE SETTLEMENT = 2" @ 40 YRS
 USING STRAIN-COMPATIBLE MODULI RECOMMENDED BY
 GEOMATRIX (1997)



POINT OF APPLICATION
 OF F_v DUE TO M_x & M_y

$$e_x = \frac{M_x}{F_v} \quad e_y = \frac{M_y}{F_v}$$

$$B' = B - 2e_x \quad L' = L - 2e_y$$

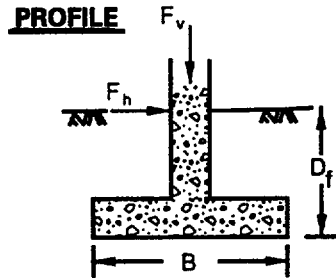
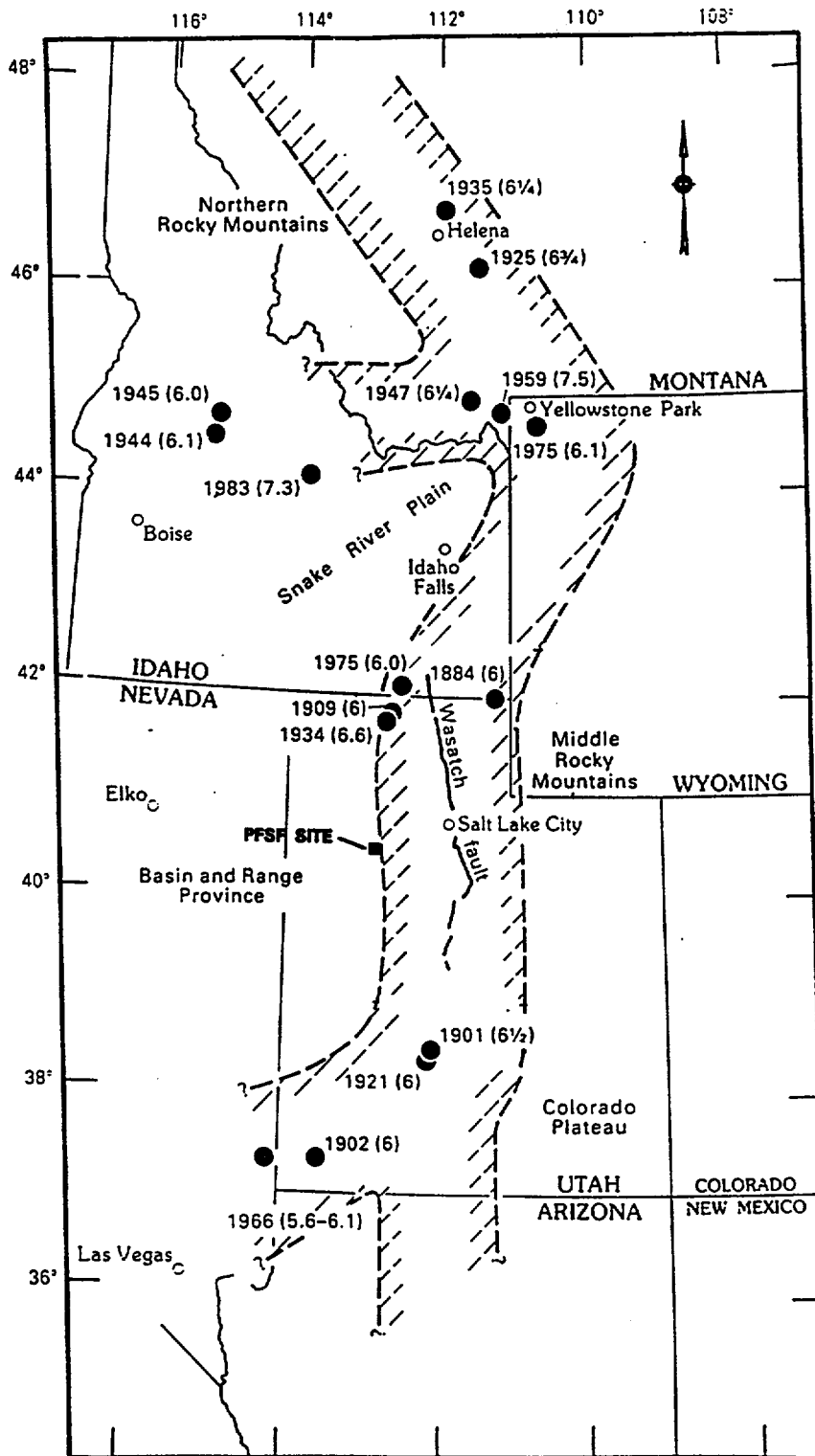

Figure 2.6-11
GROSS ALLOWABLE BEARING
PRESSURE VS FOOTING WIDTH &
DEPTH FOR SQUARE FOOTINGS
PRIVATE FUEL STORAGE FACILITY
SAFETY ANALYSIS REPORT

BASED ON MAXIMUM ALLOWABLE SETTLEMENT = 1.5" @ 40 YRS
 USING STRAIN-COMPATIBLE MODULI RECOMMENDED BY
 GEOMATRIX (1997)



SOURCE: ARABASZ ET AL., 1992

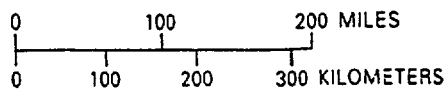

Figure 2.6-12
INTERMOUNTAIN SEISMIC BELT
HISTORICAL EARTHQUAKES,
MAGNITUDE ≥ 6.0
PRIVATE FUEL STORAGE FACILITY
SAFETY ANALYSIS REPORT

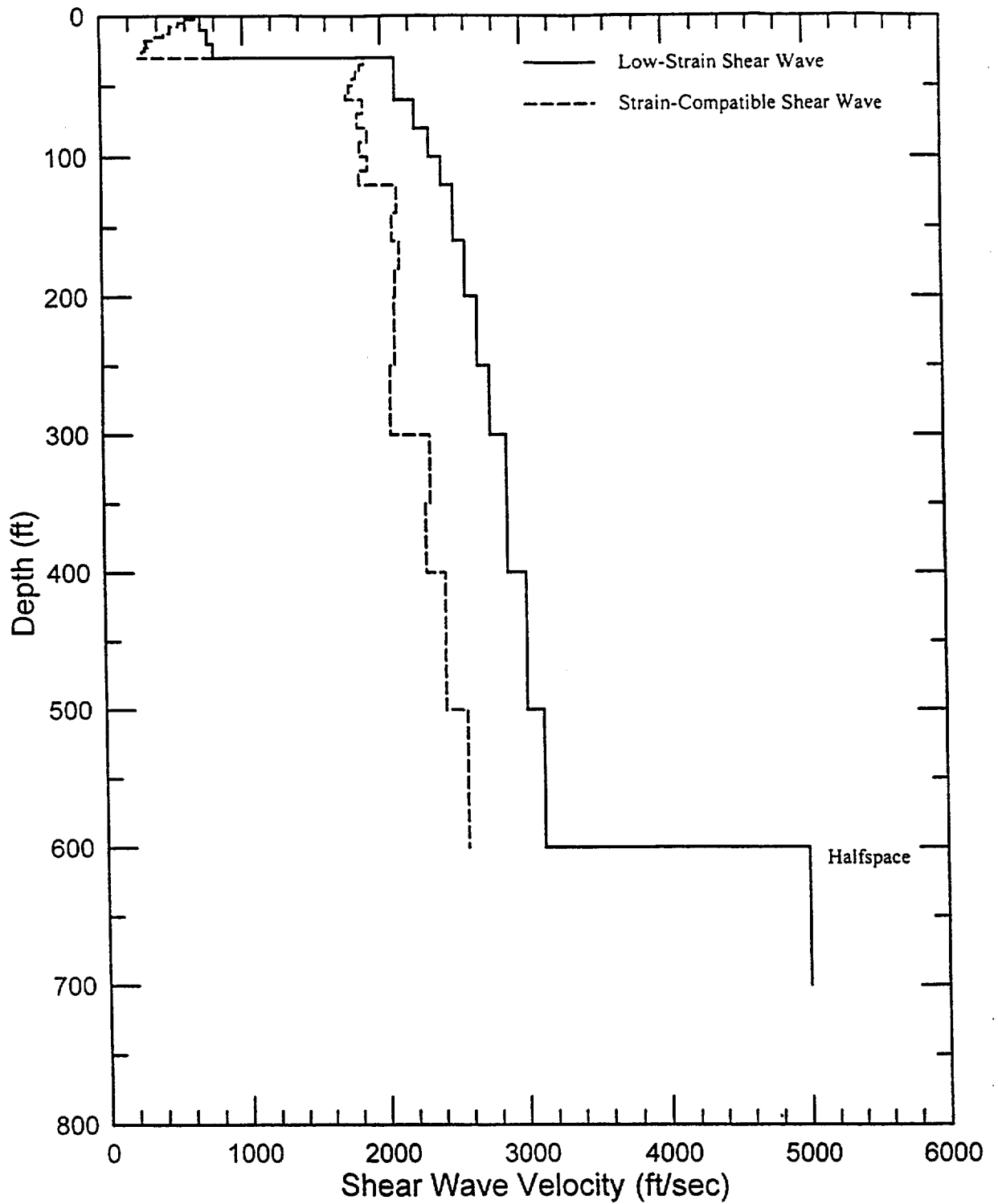

Figure 2.6-13

**STRAIN-COMPATIBLE
SHEAR-WAVE VELOCITY PROFILE**

**PRIVATE FUEL STORAGE FACILITY
SAFETY ANALYSIS REPORT**

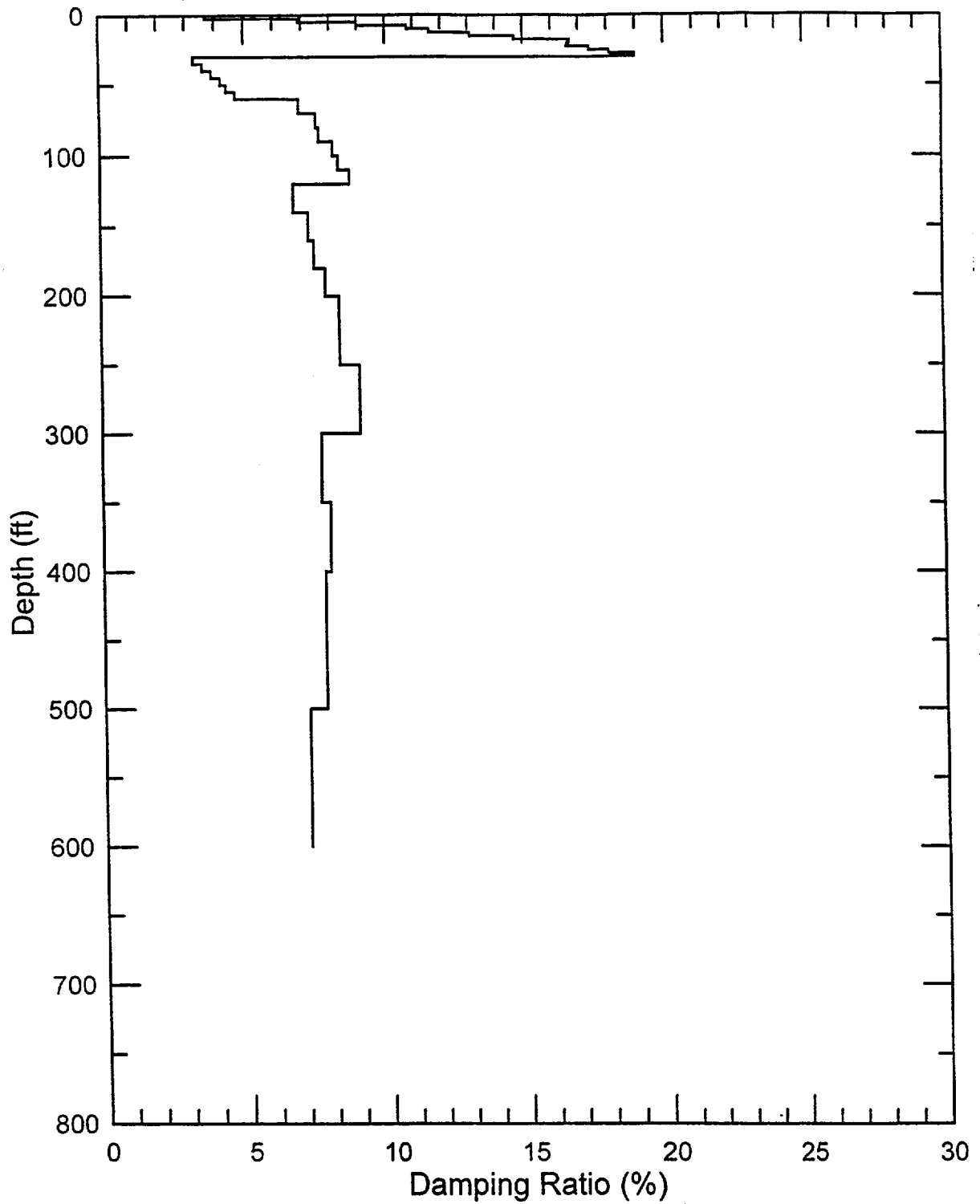
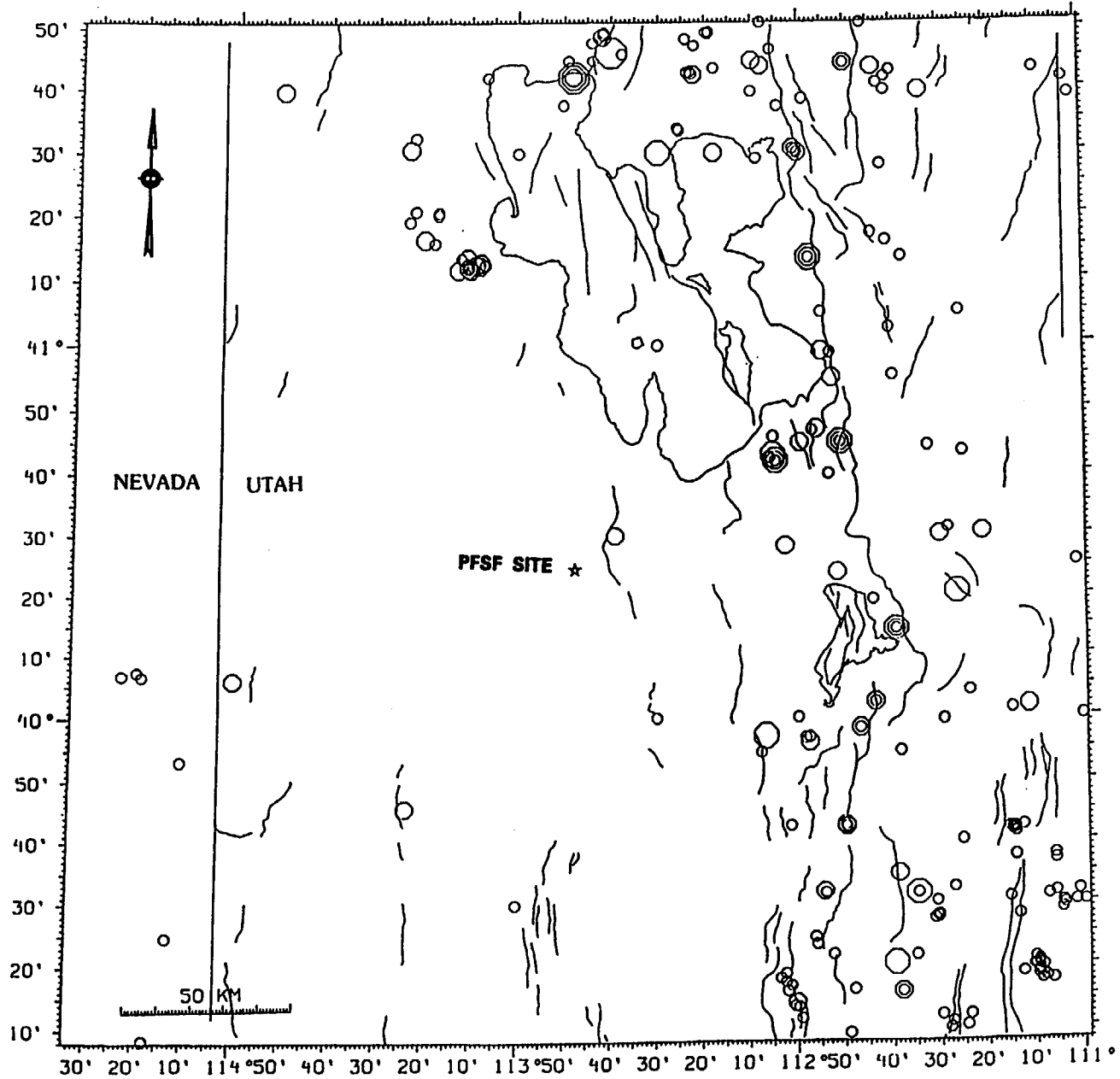

Figure 2.6-14

**STRAIN-COMPATIBLE
DAMPING RATIO PROFILE**

**PRIVATE FUEL STORAGE FACILITY
SAFETY ANALYSIS REPORT**

SOURCE: GEOMATRIX CONSULTANTS, INC, 1997



MAGNITUDES

- 3.0+
- 4.0+
- 5.0+
- 6.0+

FAULTS, QUATERNARY OR YOUNGER
(FROM HECKER, 1993)

SOURCE: UNIVERSITY OF UTAH
SEISMOGRAPH STATIONS

Figure 2.6-15

**MAGNITUDE ≥ 3.0 EARTHQUAKES WITHIN
100 MILES OF PFSF
1850 - 1996**

**PRIVATE FUEL STORAGE FACILITY
SAFETY ANALYSIS REPORT**

ANSTEC APERTURE CARD

Also Available on
Aperture Card

QUATERNARY FAULTS AND FOLDS (generalized from Hecker, 1983)

- Younger—Known or probable Holocene and latest Pleistocene (0–30,000 years old)
- Older—Probable Pleistocene and suspected Quaternary (10,000–1.6 million years old)
- Faults—Dashed where approximately located
- ⊕ Anticline—Showing axial trace and direction of plunge
- ⊖ Syncline—Showing axial trace
- ⊓ Monocline—Showing axial trace

EPICENTERS

Magnitude				Date
2.0-3.9	4.0-4.9	5.0-5.9	≥ 6.0*	
○	⊙	⊗	⊕	1884-1974
●	●	●	●	1975-1989

SCALE

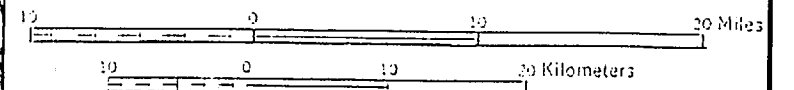

MODIFIED FROM: GÖTER, 1990

Figure 2.6-16
QUATERNARY STRUCTURES AND SEISMICITY, 1884 TO 1989
PRIVATE FUEL STORAGE FACILITY SAFETY ANALYSIS REPORT

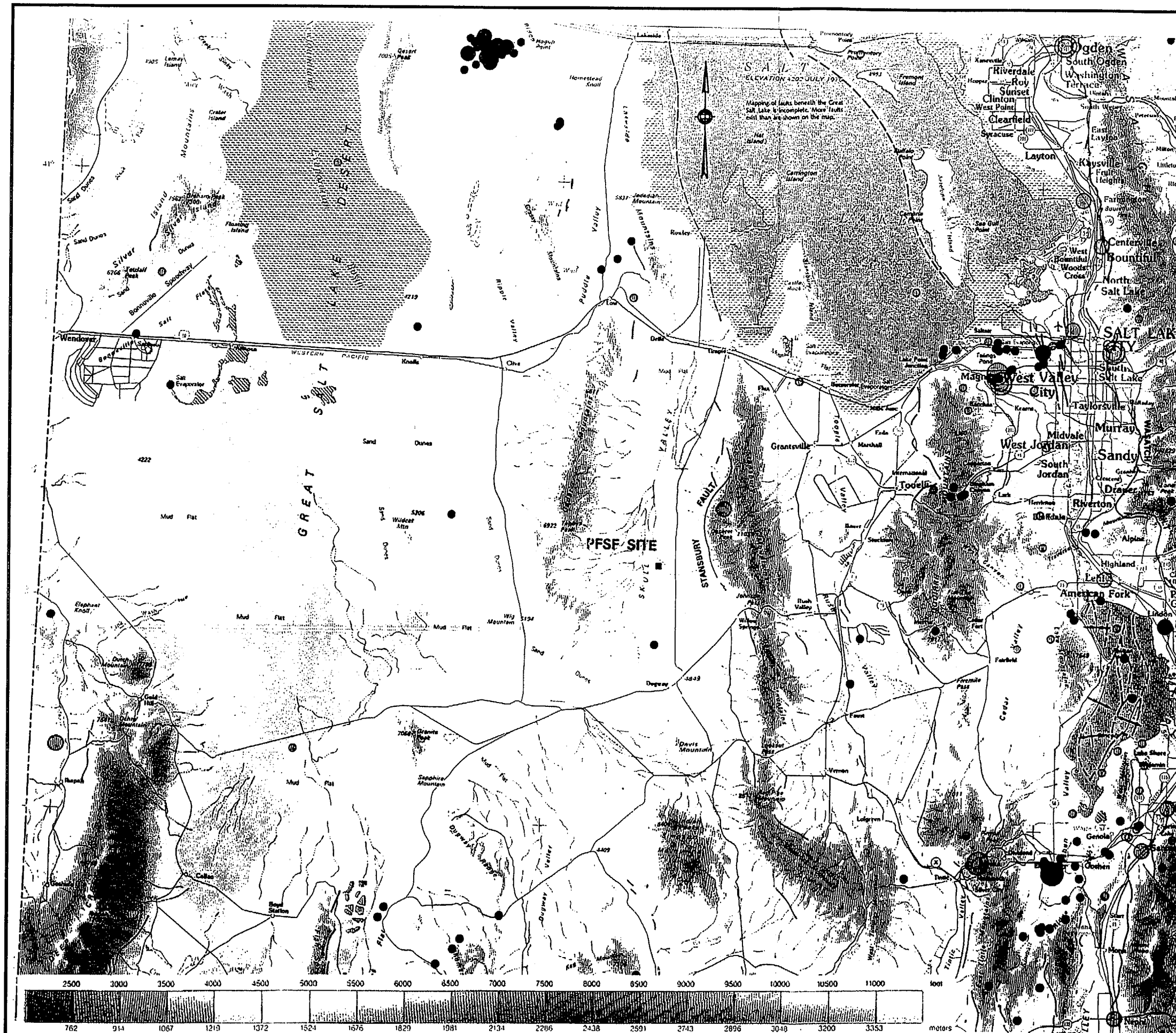

9707020145-11

APPENDIX 2A

GEOTECHNICAL DATA REPORT

GEOTECHNICAL DATA REPORT

Prepared for:

Private Fuel Storage Facility
Private Fuel Storage, LLC

Prepared by: RP Gillegue by NGA/Alan C Smith 6/11/97
Date

Reviewed by: Paul J. Trudeau 6/11/97
Date

Independent Review by: Paul J. Trudeau 6/11/97
Date

Approved by: Ann T. Seeger 6/11/97
Date

TABLE OF CONTENTS

	Page
GENERALIZED SUBSURFACE PROFILE	1
HICKMAN KNOLLS	2
SUMMARY	2
REFERENCES	3
FIGURES	
Figure 1 - Plot Plan and Location of Geotechnical Investigations	4
Figure 2 - Generalized Subsurface Profile	6
ATTACHMENTS	
Attachment 1 - Boring Logs	
Attachment 2 - Geotechnical Laboratory Testing	

Generalized Subsurface Profile

The subsurface profile at the site was investigated with a series of exploratory borings up to 100 ft deep, as well as seismic refraction (S and P-wave) and reflection surveys. These borings were drilled in accordance with the requirements of SWEC, 1996A & B, and Standard Penetration Test (SPT) samples were obtained at 5 ft intervals. The locations of these borings and the geophysical survey lines are shown in Figure 1, and logs of these borings are presented in Attachment 1.

Based on these borings, the generalized subsurface profile, which is shown in Figure 2, consists of three layers. The uppermost layer extends to a depth of between 25 and 35 ft and is mainly interlayered silt, silty clay, and clayey silt. The clayey silts and silty clays are commonly slightly to moderately plastic, with some being highly plastic. SPT N-values are mostly between 8 and 20 blows per ft, indicating "stiff" or "medium dense" materials. Most samples were dry or damp.

A distinct change in material occurs at about 25 to 35 ft, depending upon location at the site. SPT N-values commonly exceed 100 blows per ft, and refusal (>100 blows per 6 in.) conditions are often encountered. The upper 25 to 30 ft consists of very dense, dry, fine sand. This layer is underlain by very dense silt. Thin layers of fine gravel and coarse sand also are evident, indicating a near-shore environment of deposition. A few clayey zones were encountered, but they had no apparent effect on the blow counts.

The groundwater table was not encountered in the borings, which were completed to 100 ft depth; therefore, the groundwater table is greater than 100 ft below existing grade.

These borings did not encounter bedrock; however, interpretation of the seismic reflection survey data indicates that the depth to bedrock is between 520 ft and 880 ft below the surface at the site (Geosphere, 1997).

Geotechnical laboratory tests, performed on samples obtained in these borings, are described in detail in Attachment 2. These tests included determination of water content, Atterberg Limits, percent fines, and specific gravity. Unconsolidated-undrained triaxial compression tests and consolidation tests also were performed. See Attachment 2 for additional information regarding these laboratory tests.

Hickman Knolls

Recent personal communication with Dr. James Baer at Brigham Young University introduced the possibility that Hickman Knolls may be a detached slide block, which is "floating" in the valley-fill sediments. A gravity survey performed by him at the north end of Skull Valley revealed that several rock knobs are apparently detached from the bedrock surface and appear to be surrounded on all sides by unconsolidated sediments. He speculated that Hickman Knolls could be a similar structure.

Summary

Results of the test boring program, the geotechnical laboratory testing program, and the geophysical survey program formed the bases for the geotechnical design criteria and the earthquake determination analysis. For results of these analyses and foundation recommendations, see Section 4, "Geotechnical Design Criteria," of the PFSF Project Design Criteria Manual (SWEC, 1997), and Geomatrix and Lettis (1997).

References

- Geomatrix and Lettis, 1997, "Deterministic Earthquake Ground Motions Analysis, Private Fuel Storage Facility, Skull Valley, Utah," PFSF Project Report No. 0599601-G(PO5)-1, Revision 0, prepared by Geomatrix Consultants, Inc and William Lettis & Associates, Inc, San Francisco, California, March 1997.
- Geosphere, 1997, "Seismic Survey of the Private Fuel Storage Facility, Skull Valley, Utah," PFSF Project Report No. 0599601-G(PO9)-1, Revision 0, prepared by Geosphere Midwest, Inc, Midland, Michigan, February 1997.
- SWEC, 1996A, "Geotechnical Requirements Document," PFSF Project Report No. 05996.01-G(B)-01, Revision 0, SWEC Project No. 05996.01, prepared by Stone & Webster Engineering Corporation, Boston, Massachusetts, 1996.
- SWEC, 1996B, "ESSOW for Test Borings and Laboratory Testing," PFSF Project ESSOW No. 05996.01-G001, prepared by Stone & Webster Engineering Corporation, Boston, Massachusetts, September 24, 1996.
- SWEC, 1997, "Design Criteria Manual, Private Fuel Storage Facility," prepared by Stone & Webster Engineering Corporation, Denver, Colorado, June 1997.

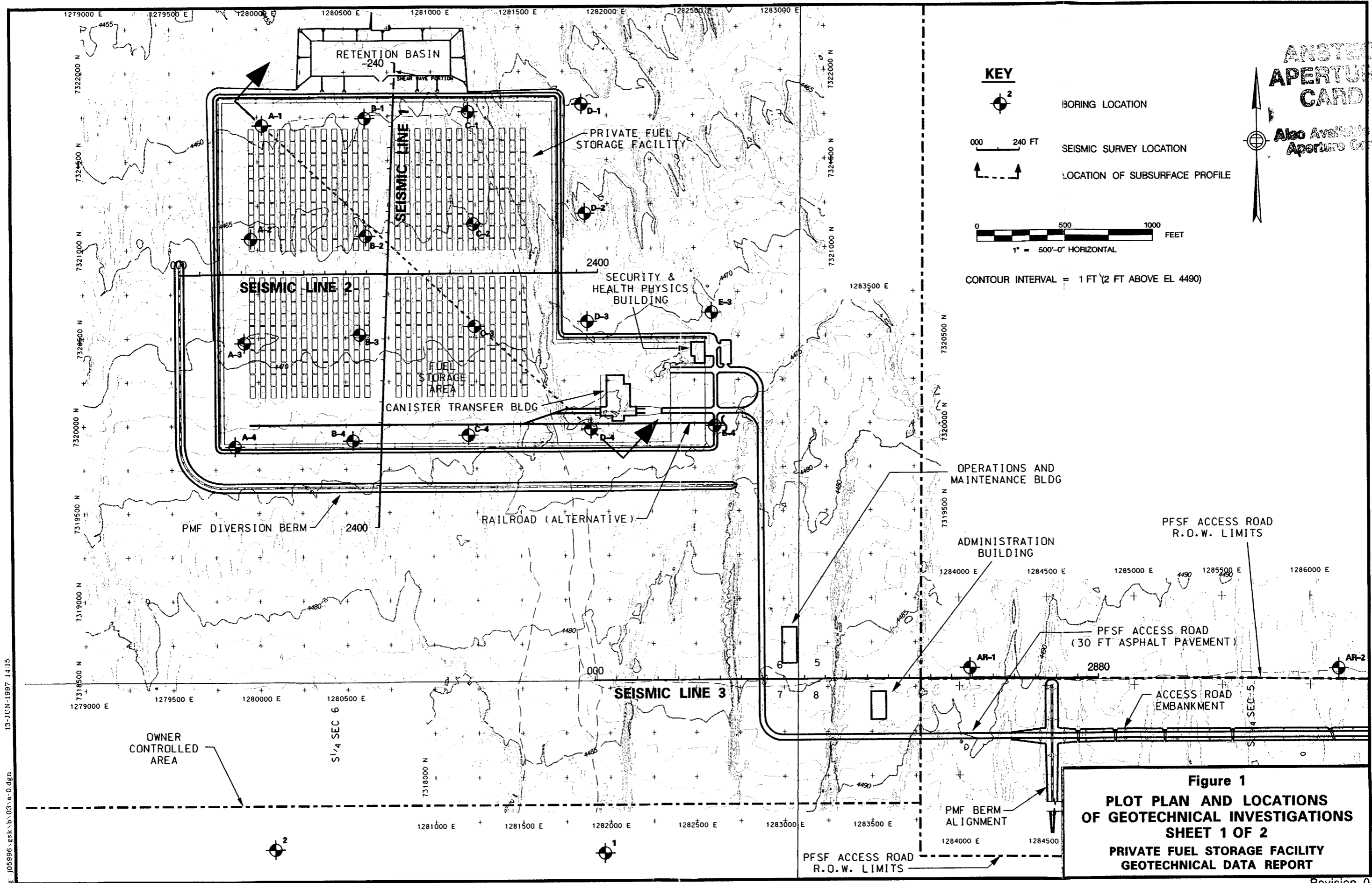

Figure 1
PLOT PLAN AND LOCATIONS
OF GEOTECHNICAL INVESTIGATIONS
SHEET 1 OF 2
PRIVATE FUEL STORAGE FACILITY
GEOTECHNICAL DATA REPORT

Revision 0

970 70 20145-12

13-JUN-1997 14:15
 e:\j05996.gsk\b\03\1-a-0.dgn

**ANSTEC
APERTURE
CARD**

Also Available in
Aperture Grid



SKULL VALLEY RD (EXST)

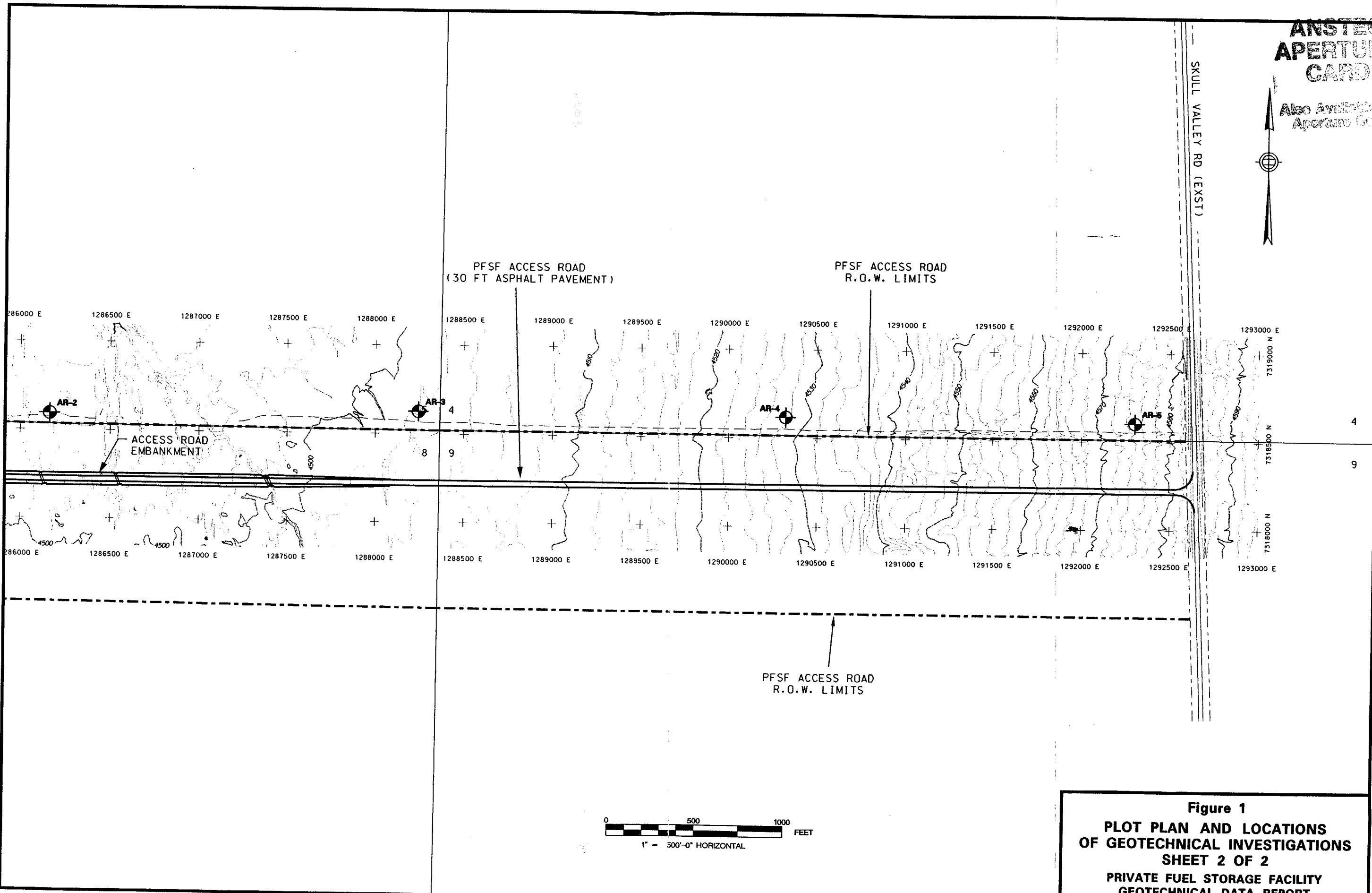

G:\05996.gsk\b.03.b-0.dgn 13-JUN-1997 14:16

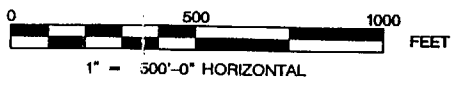

**Figure 1
PLOT PLAN AND LOCATIONS
OF GEOTECHNICAL INVESTIGATIONS
SHEET 2 OF 2
PRIVATE FUEL STORAGE FACILITY
GEOTECHNICAL DATA REPORT**

Revision 0

9707020145-13

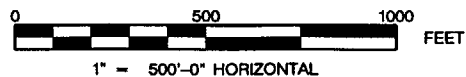
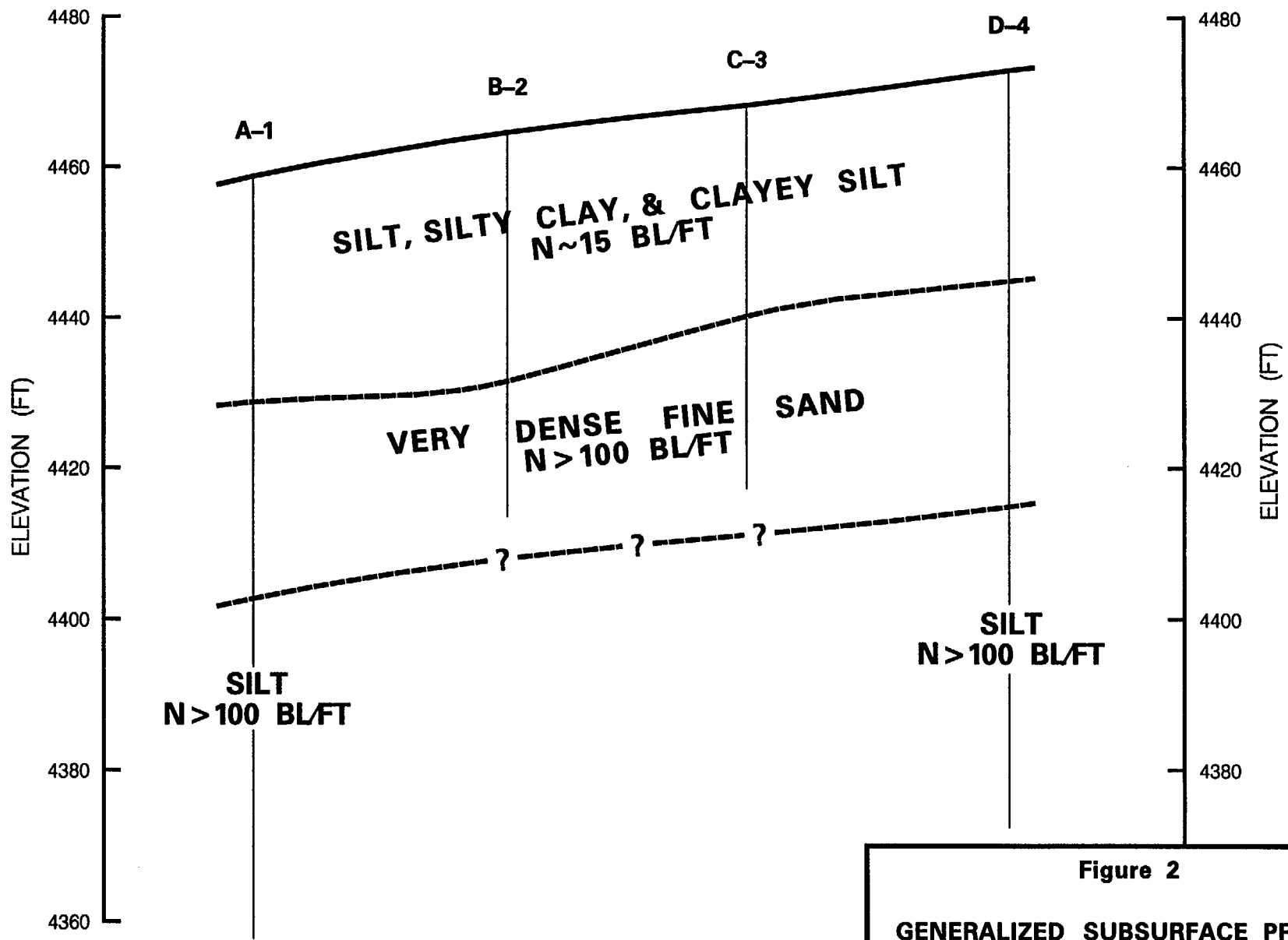

Figure 2
GENERALIZED SUBSURFACE PROFILE
PRIVATE FUEL STORAGE FACILITY
GEOTECHNICAL DATA REPORT

Report No. 05996.01-G(B)-2 Rev 1
SWEC Project No. 05996.01

GEOTECHNICAL DATA REPORT

ATTACHMENT 1

BORING LOGS

Private Fuel Storage Facility
Skull Valley
Private Fuel Storage, LLC

Responsible Engineer	<u>RP Gillespie by NTG</u>	<u>6/11/97</u> Date
Reviewer	<u>Paul J. Dandean (I)</u>	<u>6/11/97</u> Date
Approved	<u>Muri F. Scoger</u>	<u>6/11/97</u> Date

(I) = Independent Review

QUALITY ASSURANCE CATEGORY I
STONE & WEBSTER ENGINEERING CORPORATION
BOSTON, MASSACHUSETTS
Copyright 1997

Report No. 05996.01-G(B)-2 Rev 1
SWEC Project No. 05996.01

GEOTECHNICAL DATA REPORT

ATTACHMENT 1

BORING LOGS

QUALITY ASSURANCE CATEGORY I
STONE & WEBSTER ENGINEERING CORPORATION
BOSTON, MASSACHUSETTS
Copyright 1997

Report No. 05996.01-G(B)-2 Rev 1
SWEC Project No. 05996.01

GEOTECHNICAL DATA REPORT

ATTACHMENT 1

TABLE OF CONTENTS

	No. of Pages
Boring 1	2
Boring 2	2
Boring A-1	3
Boring A-2	2
Boring A-3	2
Boring A-4	2
Boring AR-1	2
Boring AR-2	2
Boring AR-3	2
Boring AR-4	2
Boring AR-5	1
Boring B-1	2
Boring B-2	2
Boring B-3	2
Boring B-4	2
Boring C-1	2
Boring C-2	2
Boring C-3	2
Boring C-4	2
Boring D-1	2
Boring D-2	2
Boring D-3	2
Boring D-4	3
Boring E-3	2
Boring E-4	2

Site: Skull Valley Goshute Reservation
Client: Private Fuel Storage Facility, LLC
Coordinates: N 7317572.25 E 1281965.96
Groundwater Depth: N/A ft
Contractor: Earthcore, Inc.

Logged by: A.C Smith
Date Start - Finish: 10/17/96 - 10/17/96
Ground Elevation: 4489.6 ft
Total Depth Drilled: 51.5 ft
Rig Type: Mobile B-80

Methods: Drilling Soil: 3 1/4" I.D. Hollow Stem Augers
Sampling Soil: 2" O.D. Split Spoon, SPT, 18" long
Drilling Rock:

Casing Used:

Comments: No bedrock or groundwater encountered. Backfilled with soil to surface, marked with stake.

Elev (ft)	Depth (ft)	Sample		Blows or Recovery RQD	SPT N Value	USC Symbol	Sample Description
		Type	No.				
4489.6	0	S	1	2-4-6 (4.0")	10	ML	SILT, nonplastic, light brown.
4485	5	S	2	5-13-36 (18.0")	49	ML SP	Top 12": SILT, nonplastic with occasional 1/4" layer of silty clay, moderately plastic, moist, brown. Bot. 6": SAND, fine, < 10% nonplastic fines, dry, light brown.
4480	10	S	3	13-30-35 (18.0")	65	ML	SILT, nonplastic, 5-15% fine sand, light brown, dry.
4475	15	S	4	8-9-14 (15.0")	23	ML	Sandy SILT, nonplastic, 10-20% fine sand; 4" section in middle, slightly plastic, brown, moist.
4470	20	S	5	7-14-13 (15.0")	27	ML	Top 11": SILT, stratified, nonplastic, < 10% fine sand, mottled light gray and orange brown, moist. Bot. 4": Silt, slightly plastic, light gray and orange brown, moist.

Legend/Notes

- Datum is NAVD 88.
- ∇ indicates groundwater level.
- ■ indicates location of samples.
- Blows = number of blows required to drive 2" O.D. sample spoon 6" or distance shown using 140 pound hammer falling 30".
- () = inches of sample recovery.
- Recovery = % rock core recovery.
- RQD = Rock Quality Designation.
- SPT N = Standard Penetration Test resistance to driving, blows/ft.
- USC = Unified Soil Classification system.
- * indicates use of 300 pound hammer.

- Sample Type:
S = Split Spoon
U = Undisturbed (Shelby Tube)

Approved: *[Signature]* Date: 02/25/97

Site: Skull Valley Goshute Reservation

Logged by: A.C Smith

Elev (ft)	depth (ft)	Sample		Blows or Recovery RQD	SPT N Value	USC Symbol	Sample Description
		Type	No.				
4465	25	S	6	15-28-50 (14.0")	78	SM	SAND, uniform, fine, 10-20% nonplastic fines, light brown, dry to moist.
4460	30	S	7	9-9-13 (14.0")	22	ML	SILT, nonplastic, light brown, dry.
4455	35	S	8	38-50- 50/4" (5.0")		ML	SILT, nonplastic, <10% fine sand, light brown, trace of coarse sand.
4450	40	S	9	35-55 (10.0")		GM	GRAVEL, fine, up to 1/2", 20-30% sand, 10-20% nonplastic fines, light brown, dry.
4445	45	S	10	50/5" (5.0")		GM	Silty GRAVEL, up to 1 1/2", 10-20% sand, 30-40% nonplastic fines, light gray (gravel mostly 2 pieces of 1 1/2" diameter.)
4440	50	S	11	60-65-62 (10.0")	127	GM	Silty GRAVEL, up to 1 1/2", subangular to subrounded, 20-30% sand, 20-30% nonplastic fines, light brown.
BOTTOM OF BORING AT 51.5 FEET							
4435	55						
4430	60						

Note: See Sheet 1 for Boring Summary and Legend Information

Approved
[Signature]

Date
02/25/97

Site: **Skull Valley Goshute Reservation**
Client: **Private Fuel Storage Facility, LLC**
Coordinates: **N 7317598.43 E 1280074.22**
Groundwater Depth: **N/A** ft
Contractor: **Earthcore, Inc.**

Logged by: **R. Gillespie**
Date Start - Finish: **10/12/96 - 10/12/96**
Ground Elevation: **4488.1** ft
Total Depth Drilled: **49.3** ft
Rig Type: **Acker Soil Sentry**

Methods: **Drilling Soil: 3 1/4" Hollow Stem Augers 6 1/4" O.D**
Sampling Soil: 2.0" O.D. Split Spoon, 140 lb hammer, 30" fall.
Drilling Rock:

Casing Used:

Comments: **No groundwater or bedrock encountered.**

Elev (ft)	Depth (ft)	Sample		Blows or Recovery RQD	SPT N Value	USC Symbol	Sample Description
		Type	No.				
4488.1	0	S	1	2-2-2 (14.0")	4	CL	Silty CLAY, slightly plastic, damp, soft, light yellow-brown, very thinly layered.
4485	5	S	2	2-2-2 (19.0")	4	CL	Silty CLAY, similar to above, mottles of white calcareous material (?)
4480	10	S	3	5-9-12 (18.0")	21	SM	Silty SAND, uniform, fine, 5-8% nonplastic fines, compact, dry, light red-brown at top to light brown at bottom. Calcareous (?)
4475	15	S	4	5-6-8 (16.0")	14	ML	SILT, nonplastic, compact, dry, light yellow-brown, trace fine sand, very thin layers.
4470	20	S	5	13-15-23 (16.0")	38	ML	SILT, nonplastic, dense, dry, light brown-gray, trace clay in very thin layers, minor red-brown mottling.

Legend/Notes

- Datum is NAVD 88.
- ∇ indicates groundwater level.
- ■ indicates location of samples.
- Blows = number of blows required to drive 2" O.D. sample spoon 6" or distance shown using 140 pound hammer falling 30".
- () = inches of sample recovery.
- Recovery = % rock core recovery.
- RQD = Rock Quality Designation.
- SPT N = Standard Penetration Test resistance to driving, blows/ft.
- USC = Unified Soil Classification system.
- * indicates use of 300 pound hammer.

Sample Type:

- S = Split Spoon
- U = Undisturbed (Shelby Tube)

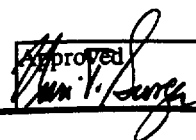
Approved:  Date: 02/25/97

Site: Skull Valley Goshute Reservation

Logged by: R. Gillespie

Elev (ft)	depth (ft)	Sample		Blows or Recovery RQD	SPT N value	USC Symbol	Sample Description
		Type	No.				
4465	25	S	6	12-17-19 (18.0")	36	ML SM	Top 14": SILT, nonplastic, dense, dry, very light brown to gray-white. Bot. 4": Silty SAND, uniform, fine, 3-5% nonplastic fines, dry, light brown.
4460	30	S	7	15-34-61 (15.0")	95	ML	Top 11": SILT, nonplastic, very dense, dry, light brown, trace subrounded medium gravel. Bot. 3": SILT, slightly plastic, hard, dry, light gray-white, trace medium to coarse gravel.
4455	35	S	8	45-40-30 (12.0")	70	GC	Clayey Gravel, poorly graded, 15-25% slightly plastic fines, coarse to fine gravel, dry, very dense, whitish-gray, most gravel with caliche coating.
4450	40	S	9	100/4" (5.0")		ML	Gravelly SILT, slightly plastic, 10-20% coarse sand to fine gravel, dry, very dense, very light gray, caliche coating.
4445	45	S	10	15-32-55 (15.0")	87	CL	Silty CLAY, slightly plastic, trace fine sand, dry, hard, olive-gray, desiccation cracks.
4440	50	S	11	70-89- 100/4" (18.0")		ML	Clayey SILT, slightly plastic, very dry, very dense, light olive-gray. Interlayers of clay, moderately plastic.
BOTTOM OF BORING AT 49.3 FEET							
4435	55						
4430	60						

Note: See Sheet 1 for Boring Summary and Legend Information

Approved

[Signature]

Date

02/25/97

Site: Skull Valley Goshute Reservation Client: Private Fuel Storage Facility, LLC Coordinates: N 7321702.84 E 1280027.61 Groundwater Depth: N/A ft Contractor: Earthcore, Inc.	Logged by: A.C. Smith Date Start - Finish: 10/17/96 - 10/22/96 Ground Elevation: 4458.7 ft Total Depth Drilled: 101 ft Driller: W. Westbrook Rig Type: Mobile B-80
---	---

Methods: Drilling Soil: 3 1/4" I.D. Hollow Stem Augers to 65'. 65-100' roller cone bit with compressed air.
 Sampling Soil: 2.0" O.D. Split-barrel Spoon, 18" long.
 Drilling Rock: Casing Used:

Comments: No rock or groundwater encountered. Backfilled with soil to surface, marked with stake.

Elev (ft)	Depth (ft)	Sample		Blows or Recovery RQD	SPT N value	USC Symbol	Sample Description
		Type	No.				
4458.7	0	S	1	6-13-10 (4.0")	23	ML	SILT, nonplastic, light brown, bottom 1" clayey, dry.
4455	5	S	2	4-5-8 (12.0")	13	CL ML	Top 6": Silty CLAY, moderately plastic, numerous silt partings, light brown and gray, slightly moist. Bot 6": SILT, nonplastic.
4450	10	S	3	6-9-13 (13.0")	22	ML	SILT, nonplastic, brown, stratified, slightly moist.
4445	15	S	4	7-9-10 (15.0")	19	ML	SILT, nonplastic, brown, stratified, slightly moist.
4440	20	S	5	5-6-7 (18.0")	13	ML	Clayey SILT, slightly plastic, light gray, moist.

Legend/Notes

- Datum is NAVD 88.
- ▽ indicates groundwater level.
- ■ indicates location of samples.
- Blows = number of blows required to drive 2" O.D. sample spoon 6" or distance shown using 140 pound hammer falling 30".
- () = inches of sample recovery.
- Recovery = % rock core recovery.
- RQD = Rock Quality Designation.
- SPT N = Standard Penetration Test resistance to driving, blows/ft.
- USC = Unified Soil Classification system.
- * indicates use of 300 pound hammer.

· Sample Type:
 S = Split Spoon
 U = Undisturbed (Shelby Tube)

Approved <i>[Signature]</i>	Date 02/25/97
--------------------------------	------------------

Site: Skull Valley Goshute Reservation

Logged by: A.C. Smith

Elev (ft)	depth (ft)	Sample		Blows or Recovery RQD	SPT N Value	USC Symbol	Sample Description
		Type	No.				
4435	25	S	6	7-15-21 (12.0")	36	ML	SILT, nonplastic, light gray, dry, occasional 2-4 mm thick layer of clayey silt; bottom 4" sandy silt, 10-20% fine sand.
4430	30	S	7	20-55-94 (10.0")	149	SP	SAND, fine, <5% nonplastic fines, some stratification, dry.
4425	35	S	8	20-54-60 (11.0")	114	SP	SAND, similar to S-7, except bottom 3" contained few coarse sand pieces.
4420	40	S	9	20-35-35 (12.0")	70	SP	SAND, similar to S-7, except bottom 2" sandy silt, nonplastic, 10-20% fine sand.
4415	45	S	10	20-35-45 (13.0")	80	SP	SAND, similar to S-7, except two 1/2" thick layers of silty clay.
4410	50	S	11	20-50-70 (12.0")	120	SP	SAND, similar to S-7, except occasional piece of fine gravel and 1" layer with trace coarse sand.
4405	55	S	12	45-60-50 (12.0")	110	SW ML	Top 6": Gravelly SAND, coarse to fine, 10-20% fine gravel, <5% nonplastic fines, light brown, dry. Bot 6": SILT, nonplastic, trace coarse sand, 20-30% fine sand, light brown, dry.
4400	60	S	13	27-57-45 (14.0")	102	CL/CH	CLAY, moderately plastic, few pieces of fine gravel, trace sand, light brown, bottom 2" damp. (Below 65' hole advanced with compressed air and roller bit to.)

Note: See Sheet 1 for Boring Summary and Legend Information

Approved
Paul T. George

Date
02/25/97

Site: Skull Valley Goshute Reservation

Logged by: A.C. Smith

Elev (ft)	depth (ft)	Sample		Blows or Recovery RQD	SPT N Value	USC Symbol	Sample Description
		Type	No.				
4395	65	S	14	10-20-34 (14.0")	54	ML	Clayey SILT, slightly plastic, 10-20% mostly fine sand, 5-10% fine gravel, brown, damp. (At 66", auger advancing very slow.)
		S	15	42-100 (9.0")		ML	Clayey SILT, similar to S-14, except 15-25% gravel up to 1".
4390	70	S	16	100+ (10.0")		ML	SILT, nonplastic, <10% fine sand, dry, light brown. (Driller lost count) Driller took out 65' of 3" auger, replaced with 4 1/4" advance using compressed air and rollerbit.
4385	75	S	17	45-100 (10.0")		ML	Sandy SILT, nonplastic, 10-20% fine sand, dry, light brown, contained two 1/2" layers of clayey silt, slightly plastic.
4380	80	S	18	100/4"		ML	No recovery, second attempt recovered 2". Similar to S-17.
4375	85	S	19	100/4" (4.0")		SM	Silty SAND, fine, uniform, 20-30% nonplastic fines, dry, light gray.
4370	90	S	20	50-100 (10.0")		SM	Silty SAND, similar to S-19.
4365	95	S	21	100/6" (6.0")		ML	SILT, nonplastic, <10% fine sand, light brown.
4360	100	S	22	50-100 (12.0")		CL/CH	Silty CLAY, moderately to highly plastic, slightly damp, brown.

BOTTOM OF BORING AT 101 FEET

Note: See Sheet 1 for Boring Summary and Legend Information

Approved
[Signature]

Date 02/25/97

Site: Skull Valley Goshute Reservation Client: Private Fuel Storage Facility, LLC Coordinates: N 7321062.28 E 1279960.29 Groundwater Depth: N/A ft Contractor: Earthcore, Inc.	Logged by: A.C. Smith Date Start - Finish: 10/28/96 - 10/28/96 Ground Elevation: 4464.6 ft Total Depth Drilled: 51.0 ft Driller: W. Westbrook Rig Type: Mobile B-80
---	--

Methods: Drilling Soil: 3 1/4" I.D. Hollow Stem Augers
 Sampling Soil: 2.0" O.D. Split Spoon, 24" long. 3" Shelby Sampler, 30" long.
 Drilling Rock: _____
Casing Used: _____

Comments: No bedrock or groundwater encountered, backfilled with soil to ground surface, marked with stake.

Elev (ft)	Depth (ft)	Sample		Blows or Recovery RQD	SPT N Value	USC Symbol	Sample Description
		Type	No.				
4464.6	0	S	1	1/12"-1 (3.0")	1	ML	SILT, nonplastic, damp, light brown.
4460	5	U	2	push (25.0")		ML	Top: SILT, very slightly plastic. Bot.: Clayey SILT, slightly plastic, moist, light brown.
4455	10	S	3	5-5-6 (14.0")	11	ML	SILT, nonplastic, damp, light brown.
4450	15	S	4	7-7-7 (13.0")	14	ML	SILT, nonplastic, damp, light brown, a few thin layers of slightly plastic silt.
4445	20	S	5	5-6-11 (14.0")	17	ML	Clayey SILT, slightly plastic, moist, light brown.

Legend/Notes

- Datum is NAVD 88.
- ▽ indicates groundwater level.
- ■ indicates location of samples.
- Blows = number of blows required to drive 2" O.D. sample spoon 6" or distance shown using 140 pound hammer falling 30".
- () = inches of sample recovery.
- Recovery = % rock core recovery.
- RQD = Rock Quality Designation.
- SPT N = Standard Penetration Test resistance to driving, blows/ft.
- USC = Unified Soil Classification system.
- * indicates use of 300 pound hammer.

· Sample Type:
 S = Split Spoon
 U = Undisturbed (Shelby Tube)

	Date 02/25/97
--	------------------

Site: Skull Valley Goshute Reservation

Logged by: A.C. Smith

Elev (ft)	depth (ft)	Sample		Blows or Recovery RQD	SPT N Value	USC Symbol	Sample Description
		Type	No.				
4440	25	S	6	5-6-10 (15.0")	16	ML	Clayey SILT, similar to S-5.
4435	30	S	7	13-25-26 (13.0")	51	SP	SAND, fine, <10% nonplastic fines, dry, light brown, contained 1 1/2" layer of clayey silt, slightly plastic.
4430	35	S	8	25-75- 100/5" (12.0")		SP	SAND, fine, <5% nonplastic fines, dry, light brown, trace coarse sand.
4425	40	S	9	35-100/4" (8.0")		SP	SAND, similar to S-8.
4420	45	S	10	30-50-55 (12.0")	105	SW	Gravelly SAND, coarse to fine, 20-30% fine gravel, <5% nonplastic fines, dry, light brown.
4415	50	S	11	35-100 (9.0")		SP	Top 5": SAND, fine, <5% nonplastic fines, dry, light brown, trace coarse sand. Bot. 4": Gravelly SAND, coarse to fine, 30-40% fine gravel, <5% nonplastic fines, dry, light brown.
BOTTOM OF BORING AT 51.0 FEET							
4410	55						
4405	60						

Note: See Sheet 1 for Boring Summary and Legend Information

Approved
[Signature]

Date
02/25/97

Site: **Skull Valley Goshute Reservation**
Client: **Private Fuel Storage Facility, LLC**
Coordinates: **N 7320471.57 E 1279918.87**
Groundwater Depth: **N/A** ft
Contractor: **Earthcore, Inc.**

Logged by: **R. Gillespie**
Date Start - Finish: **10/24/96 - 10/24/96**
Ground Elevation: **4469.2** ft
Total Depth Drilled: **50.9** ft
Rig Type: **Acker Soil Sentry**

Methods: **Drilling Soil: 3 1/4" I.D. Hollow Stem Augers**
Sampling Soil: 2.0" O.D. Split Spoon, SPT
Drilling Rock:

Casing Used:

Comments: **No groundwater or bedrock encountered**

Elev (ft)	Depth (ft)	Sample		Blows or Recovery RQD	SPT N Value	USC Symbol	Sample Description
		Type	No.				
4469.2	0	S	1	1-2-2 (11.0")	4	ML	Clayey SILT, slightly plastic, dry to damp, very loose, light brown.
4465	5	S	2	4-4-5 (15.0")	9	CL	Silty CLAY, moderately plastic, stiff, damp, green-gray with white and dark brown mottling throughout.
4460	10	S	3	4-5-10 (14.0")	15	CL	Silty CLAY, similar to S-2, very thinly layered, some layers of silt, yellow brown.
4455	15	S	4	6-7-8 (13.0")	15	ML	Clayey SILT, slightly plastic, compact, damp, light yellow-brown, thinly layered.
4450	20	S	5	6-8-12 (13.0")	20	ML	Clayey SILT, similar to S-4.

Legend/Notes

- Datum is NAVD 88.
- ▽ indicates groundwater level.
- ■ indicates location of samples.
- Blows = number of blows required to drive 2" O.D. sample spoon 6" or distance shown using 140 pound hammer falling 30".
- () = inches of sample recovery.
- Recovery = % rock core recovery.
- RQD = Rock Quality Designation.
- SPT N = Standard Penetration Test resistance to driving, blows/ft.
- USC = Unified Soil Classification system.
- * indicates use of 300 pound hammer.

· Sample Type:

- S = Split Spoon
- U = Undisturbed (Shelby Tube)

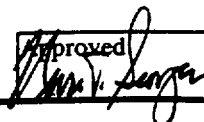
Approved:  Date: 02/25/97

Site: Skull Valley Goshute Reservation

Logged by: R. Gillespie

Elev (ft)	depth (ft)	Sample		Blows or Recovery RQD	SPT N Value	USC Symbol	Sample Description
		Type	No.				
4445	25	S	6	8-12-18 (16.0")	30	ML	Clayey SILT, slightly plastic, compact, damp, yellow-brown, thinly layered, occasional thin clay layer.
4440	30	S	7	12-14-20 (14.0")	34	ML	SILT, nonplastic, dense, dry, light gray, occasional layer of clayey silt, slightly plastic, some orange mottling.
4435	35	S	8	28-50-64 (18.0")	114	SP	SAND, uniform, fine, trace coarse sand and fine gravel, very dense, dry, light gray, 3-5% nonplastic fines.
4430	40	S	9	24-75- 100 (16.0")		SP	SAND, mostly uniform, fine, 3-5% nonplastic fines, few layers of medium to coarse sand, very dense, dry, light brown.
4425	45	S	10	17-30-52 (16.0")	82	CL ML	Top 4": Silty CLAY, slightly plastic, damp, brown. Bot. 12": Sandy SILT, 15-20% fine sand, nonplastic, very dense, damp, light brown, slightly cemented.
4420	50	S	11	38-100/5"		ML	Clayey SILT, slightly plastic, damp, very dense, slightly cemented, very light brown.
BOTTOM OF BORING AT 50.9 FEET							
4415	55						
4410	60						

Note: See Sheet 1 for Boring Summary and Legend Information

Approved
R. Gillespie

Date
02/25/97

Site: Skull Valley Goshute Reservation
Client: Private Fuel Storage Facility, LLC
Coordinates: N 7319880.79 E 1279861.82
Groundwater Depth: N/A ft
Contractor: Earthcore, Inc.

Logged by: R. Gillespie
Date Start - Finish: 10/24/96 - 10/24/96
Ground Elevation: 4471.9 ft
Total Depth Drilled: 36.5 ft
Rig Type: Acker Soil Sentry

Methods: Drilling Soil: 3 1/4" I.D. Hollow Stem Augers
Sampling Soil: 2.0" O.D. Split Spoon, SPT
Drilling Rock:
Casing Used:

Comments: No groundwater or bedrock encountered

Elev (ft)	Depth (ft)	Sample		Blows or Recovery RQD	SPT N Value	USC Symbol	Sample Description
		Type	No.				
4471.9	0	S	1	1-6-8 (6.0")	14	ML	Clayey SILT, slightly plastic, dry, compact, light brown.
4470	5	S	2	4-8-10 (14.0")	18	CL	Silty CLAY, slightly to moderately plastic, damp, very stiff, light green-gray, very thinly layered, white and orange mottling.
4465	10	S	3	6-6-7 (12.0")	13	ML	Top 6": Clayey SILT, slightly plastic, loose, damp, light brown. Bot. 6": SILT, nonplastic, compact, dry, light gray.
4460	15	S	4	6-8-10 (14.0")	18	ML	Clayey SILT, slightly plastic, compact, damp, light yellow-brown, thinly layered, occasional clay layer.
4455	20	S	5	6-6-6 (18.0")	12	ML CL	Top 10": Clayey SILT, similar to S-4. Bot. 8": Silty CLAY, slightly plastic, stiff, damp, light yellow-gray with white mottling, thinly layered.

Legend/Notes

- Datum is NAVD 88.
- ▽ indicates groundwater level.
- ■ indicates location of samples.
- Blows = number of blows required to drive 2" O.D. sample spoon 6" or distance shown using 140 pound hammer falling 30".
- () = inches of sample recovery.
- Recovery = % rock core recovery.
- RQD = Rock Quality Designation.
- SPT N = Standard Penetration Test resistance to driving, blows/ft.
- USC = Unified Soil Classification system.
- * indicates use of 300 pound hammer.

• Sample Type:

- S = Split Spoon
- U = Undisturbed (Shelby Tube)

Approved: *W. George* Date: 02/25/97

Site: Skull Valley Goshute Reservation

Logged by: R. Gillespie

Elev (ft)	depth (ft)	Sample		Blows or Recovery RQD	SPT N Value	USC Symbol	Sample Description
		Type	No.				
4450	25	S	6	4-8-12 (12.0")	20	ML	Clayey SILT, slightly plastic, compact, damp, brown-gray with orange mottling.
4445	30	S	7	15-20-30 (16.0")	50	ML	Sandy SILT, nonplastic, 10-20% sand, mostly fine, dense, dry, light gray.
4440	35	S	8	17-42-51 (18.0")	93	ML	Sandy SILT, nonplastic, very dense, dry, 30-40% fine sand, light brown.
4435	BOTTOM OF BORING AT 36.5 FEET						
4430	40						
4425	45						
4420	50						
4415	55						
4410	60						

Note: See Sheet 1 for Boring Summary and Legend Information

Approved *[Signature]* Date 02/25/97

Site: Skull Valley Goshute Reservation Client: Private Fuel Storage Facility, LLC Coordinates: N 7318603.98 E 1284062.70 Groundwater Depth: N/A ft Depth to Bedrock: N/A ft Contractor: Earthcore, Inc. Driller: Strickland	Logged by: R. Gillespie Date Start - Finish: 10/18/96 - 10/18/96 Ground Elevation: 4487.2 ft Total Depth Drilled: 31.5 ft Rig Type: Acker Soil Sentry
---	--

Methods: Casing Used:
 Drilling Soil: **3 1/4" I.D. Hollow Stem Augers**
 Sampling Soil: **2" O.D. Split Spoon, 140# hammer.**
 Drilling Rock:

Comments: **No groundwater or bedrock encountered**

Elev (ft)	Depth (ft)	Sample		Blows or Recovery RQD	SPT N Value	USC Symbol	Sample Description
		Type	No.				
4487.2	0	S	1	2-4-5 (9.0")	9	ML	Clayey SILT, slightly plastic, compact, dry, light brown with white mottling and roots.
4485	5	S	2	8-11-12 (12.0")	23	SP	SAND, uniform, fine, < 3% nonplastic fines, dry, compact, light brown.
4480	10	S	3	7-8-12 (11.0")	20	SP	SAND, uniform, fine, 3-5% nonplastic fines, dry, compact, light brown.
4475	15	S	4	7-7-10 (15.0")	17	ML,CL	Interlayered SILT and CLAY, slightly plastic, trace fine sand, very stiff, damp, yellow-gray and yellow-brown.
4470	20	S	5	6-9-10 (18.0")	19	CL	Silty CLAY, slightly plastic, very stiff, damp, yellow-gray, very thinly layered, trace white mottling.

Legend/Notes

- Datum is NAVD 88.
- ▽ indicates groundwater level.
- ■ indicates location of samples.
- Blows = number of blows required to drive 2" O.D. sample spoon 6" or distance shown using 140 pound hammer falling 30".
- () = inches of sample recovery.
- Recovery = % rock core recovery.
- RQD = Rock Quality Designation.
- SPT N = Standard Penetration Test resistance to driving, blows/ft.
- USC = Unified Soil Classification system.
- * indicates use of 300 pound hammer.

· Sample Type:
 S = Split Spoon
 U = Undisturbed (Shelby Tube)

Approved <i>[Signature]</i>	Date 02/25/97
-----------------------------	---------------

Site: Skull Valley Goshute Reservation

Logged by: R. Gillespie

Elev (ft)	depth (ft)	Sample		Blows or Recovery RQD	SPT N Value	USC Symbol	Sample Description
		Type	No.				
4465	25	S	6	10-15-14 (16.0")	29	CL ML	Top 12": Silty CLAY, moderately to slightly plastic, very stiff, damp, yellow-gray and yellow-brown. Bot. 4": SILT, nonplastic, trace fine sand, very dense, slightly damp, light gray.
4460	30	S	7	17-27-24 (16.0")	51	ML	SILT and Clayey SILT, interlayered, non to slightly plastic, very dense, slightly damp, some fine sand, light yellow-gray.
4455	BOTTOM OF BORING AT 31.5 FEET						
4450	35						
4445	40						
4440	45						
4435	50						
4430	55						
4425	60						

Note: See Sheet 1 for Boring Summary and Legend Information

Approved

[Signature]

Date

02/25/97

Site: Skull Valley Goshute Reservation Client: Private Fuel Storage Facility, LLC Coordinates: N 7318592.99 E 1286161.25 Groundwater Depth: N/A ft Depth to Bedrock: N/A ft Contractor: Earthcore, Inc. Driller: Strickland	Logged by: R. Gillespie Date Start - Finish: 10/18/96 - 10/18/96 Ground Elevation: 4494.6 ft Total Depth Drilled: 31.5 ft Rig Type: Acker Soil Sentry
---	--

Methods: Casing Used:

Drilling Soil: **3 1/4" I.D. Hollow Stem Augers**

Sampling Soil: **2.0" O.D. Split Spoon, SPT**

Drilling Rock:

Comments: **No groundwater or bedrock encountered**

Elev (ft)	Depth (ft)	Sample		Blows or Recovery RQD	SPT N Value	USC Symbol	Sample Description
		Type	No.				
4494.6	0	S	1	2-2-4 (8.0")	6	ML	SILT, non to slightly plastic, loose, damp, light brown, trace roots.
4490	5	S	2	4-10-12 (14.0")	22	SP	SAND, uniform, fine, trace silt, slightly damp, compact, light brown with orange streaks.
4485	10	S	3	7-8-10 (15.0")	18	SP	SAND, similar to S-2.
4480	15	S	4	9-9-14 (14.0")	23	ML	Sandy SILT, nonplastic, fine sand, dry, compact, red-brown, trace of clay in pockets and seams, moderately plastic, gray.
4475	20	S	5	17-20-30 (13.0")	50	SP	SAND, uniform, fine, 5-8% nonplastic silt, dense, dry, light brown.

Legend/Notes

- Datum is NAVD 88.
- ▽ indicates groundwater level.
- ■ indicates location of samples.
- Blows = number of blows required to drive 2" O.D. sample spoon 6" or distance shown using 140 pound hammer falling 30".
- () = inches of sample recovery.
- Recovery = % rock core recovery.
- RQD = Rock Quality Designation.
- SPT N = Standard Penetration Test resistance to driving, blows/ft.
- USC = Unified Soil Classification system.
- * indicates use of 300 pound hammer.

· Sample Type:
 S = Split Spoon
 U = Undisturbed (Shelby Tube)

Approved <i>[Signature]</i>	Date 02/25/97
--------------------------------	------------------

Site: Skull Valley Goshute Reservation

Logged by: R. Gillespie

Elev (ft)	depth (ft)	Sample		Blows or Recovery RQD	SPT N Value	USC Symbol	Sample Description
		Type	No.				
4470	25	S	6	11-14-11 (16.0")	25	ML,CL	SILT, nonplastic, compact, light gray with orange mottling. Occasional thin layer of Silty CLAY, slightly plastic, light gray, dry to slightly damp.
4465	30	S	7	2-10-12 (18.0")	22	CL	Silty CLAY, slightly to moderately plastic, very stiff, damp, light gray, very thinly layered, some orange-brown stained layers, trace of perched water.
BOTTOM OF BORING AT 31.5 FEET							
4460	35						
4455	40						
4450	45						
4445	50						
4440	55						
4435	60						

Note: See Sheet 1 for Boring Summary and Legend Information

Approved

[Signature]

Date

02/25/97

Site: Skull Valley Goshute Reservation
Client: Private Fuel Storage Facility, LLC
Coordinates: N 7318625.48 E 1288244.35
Groundwater Depth: N/A ft
Contractor: Earthcore, Inc.

Logged by: R. Gillespie
Date Start - Finish: 10/21/96 - 10/21/96
Ground Elevation: 4501.1 ft
Total Depth Drilled: 31.5 ft
Rig Type: Acker Soil Sentry

Methods: Drilling Soil: 3 1/4" I.D. Hollow Stem Augers
Sampling Soil: 2.0" O.D. Split Spoon, SPT
Drilling Rock:
Casing Used:

Comments: No groundwater or bedrock encountered

Elev (ft)	Depth (ft)	Sample		Blows or Recovery RQD	SPT N Value	USC Symbol	Sample Description
		Type	No.				
4501.1	0	S	1	1-3-4 (8.0")	7	ML	SILT, slightly plastic, loose, dry, light brown.
4500							
	5	S	2	4-4-7	11	CL	Silty CLAY, slightly plastic, stiff, dry, light brown, some roots.
4495							
	10	S	3	4-6-14 (10.0")	20	ML	SILT, slightly plastic, compact, dry, thinly layered, very light gray and light brown. (calichified?)
4490							
	15	S	4	7-12-13 (8.0")	25	ML	Clayey SILT, slightly plastic, compact, dry, very thinly layered, very light gray. (calichified?)
4485							
	20	S	5	20-36-57 (16.0")	93	SP-SM	Silty SAND, uniform, fine, 8-12% nonplastic fines, very dense, dry, light brown. Occasional layer of gravel and pebbles intermixed with sand. Gravel to 3/4" max., subangular to subrounded. (Fractured by spoon)
4480							

Legend/Notes

- Datum is NAVD 88.
- ∇ indicates groundwater level.
- ■ indicates location of samples.
- Blows = number of blows required to drive 2" O.D. sample spoon 6" or distance shown using 140 pound hammer falling 30".
- () = inches of sample recovery.
- Recovery = % rock core recovery.
- RQD = Rock Quality Designation.
- SPT N = Standard Penetration Test resistance to driving, blows/ft.
- USC = Unified Soil Classification system.
- * indicates use of 300 pound hammer.

· Sample Type:

- S = Split Spoon
- U = Undisturbed (Shelby Tube)

Approved: *[Signature]* Date: 02/25/97

Site: Skull Valley Goshute Reservation

Logged by: R. Gillespie

Elev (ft)	depth (ft)	Sample		Blows or Recovery RQD	SPT N Value	USC Symbol	Sample Description
		Type	No.				
4475	25	S	6	100/5" (8.0")		GM	Silty GRAVEL, 20-30% nonplastic fines, coarse to fine gravel, subangular to subrounded gravel to 1.5" max., very dense, dry, light brown.
4470	30	S	7	7-10-14 (14.0")	24	GM CL	Top 4": Silty GRAVEL, similar to S-6. Bot. 10": Silty CLAY, slightly to moderately plastic, very stiff, dry, light gray. BOTTOM OF BORING AT 31.5 FEET
4465	35						
4460	40						
4455	45						
4450	50						
4445	55						
4440	60						

Note: See Sheet 1 for Boring Summary and Legend Information

Approved

[Signature]

Date

02/25/97

Site: Skull Valley Goshute Reservation Client: Private Fuel Storage Facility, LLC Coordinates: N 7318616.84 E 1290320.39 Groundwater Depth: N/A ft Contractor: Earthcore, Inc.	Logged by: R. Gillespie Date Start - Finish: 10/21/96 - 10/21/96 Ground Elevation: 4527.0 ft Total Depth Drilled: 25.0 ft Rig Type: Acker Soil Sentry
---	--

Methods: Drilling Soil: 3 1/4" I.D Hollow Stem Augers Sampling Soil: 2.0" O.D. Split Spoon, SPT Drilling Rock:	Casing Used:
--	---------------------

Comments: No groundwater or bedrock encountered

Elev (ft)	Depth (ft)	Sample		Blows or Recovery RQD	SPT N Value	USC Symbol	Sample Description
		Type	No.				
4527.0	0	S	1	1-2-3 (6.0")	5	CL	Silty CLAY, slightly plastic, firm, dry, light brown.
4525	5	S	2	2-2-3 (5.0")	5	ML	Clayey SILT, slightly plastic, compact, dry, light gray-yellow.
4520	10	S	3	7-8-11 (9.0")	19	ML	Sandy SILT, nonplastic, 10-15% fine sand, compact, dry, brown.
4515	15	S	4	8-12-17 (10.0")	29	ML	Clayey SILT, slightly plastic, compact, dry, brown, trace fine sand.
4510	20	S	5	100 (7.0")		GP	Sandy GRAVEL, poorly graded, 10-15% slightly plastic fines, coarse to fine sand, subrounded to subangular gravel to 1.5", very dense, dry, light brown. Gravel to 3-4" upon augers.

Legend/Notes

- Datum is NAVD 88.
- ▽ indicates groundwater level.
- ■ indicates location of samples.
- Blows = number of blows required to drive 2" O.D. sample spoon 6" or distance shown using 140 pound hammer falling 30".
- () = inches of sample recovery.
- Recovery = % rock core recovery.
- RQD = Rock Quality Designation.
- SPT N = Standard Penetration Test resistance to driving, blows/ft.
- USC = Unified Soil Classification system.
- * indicates use of 300 pound hammer.

· Sample Type:
 S = Split Spoon
 U = Undisturbed (Shelby Tube)

Approved 	Date 02/25/97
--------------	------------------

Site: Skull Valley Goshute Reservation

Logged by: R. Gillespie

Elev (ft)	depth (ft)	Sample		Blows or Recovery RQD	SPT N Value	USC Symbol	Sample Description
		Type	No.				
4505							
	25	S	6	50/0*		NR	No recovery. Very hard augering through gravel. BOTTOM OF BORING AT 25 FEET
4500							
	30						
4495							
	35						
4490							
	40						
4485							
	45						
4480							
	50						
4475							
	55						
4470							
	60						
4465							

Note: See Sheet 1 for Boring Summary and Legend Information

Approved
Tom V. George

Date 02/25/97

Site: Skull Valley Goshute Reservation Client: Private Fuel Storage Facility, LLC Coordinates: N 7318601.97 E 1292299.14 Groundwater Depth: N/A ft Contractor: Earthcore, Inc.	Logged by: R. Gillespie Date Start - Finish: 10/21/96 - 10/22/96 Ground Elevation: 4575.0 ft Depth to Bedrock: N/A ft Driller: Strickland Total Depth Drilled: 14 ft Rig Type: Acker Soil Sentry
---	---

Methods: Drilling Soil: 3 1/4" I.D. Hollow Stem Augers
 Sampling Soil: 2.0" O.D. Split Spoon, SPT
 Drilling Rock:
Casing Used:

Comments: No groundwater or bedrock encountered

Elev (ft)	Depth (ft)	Sample		Blows or Recovery RQD	SPT N Value	USC Symbol	Sample Description
		Type	No.				
4575.0	0	S	1	1-2-4 (8.0")	6	ML	SILT, nonplastic, loose, dry, brown, trace fine sand and gravel.
4570	5	S	2	7-10-47 (16.0")	57	ML GM	Top 8": Sandy SILT, slightly plastic, 10-15% fine sand, very dense, dry, very light tan, trace gravel. Bot. 8": Silty GRAVEL, 10-20% nonplastic fines, coarse to fine sand, angular to subrounded gravel to 2" max., dry, very dense, brown.
4565	10	S	3	24-34-63 (6.0")	97	GM	Silty GRAVEL, similar to S-2 bot. 8". (3.0" spoon used)
4560	15	S	4	100/1*		NR	No recovery BOTTOM OF BORING AT 14 FEET
4555	20						

Legend/Notes

- Datum is NAVD 88.
- ▽ indicates groundwater level.
- ■ indicates location of samples.
- Blows = number of blows required to drive 2" O.D. sample spoon 6" or distance shown using 140 pound hammer falling 30".
- () = inches of sample recovery.
- Recovery = % rock core recovery.
- RQD = Rock Quality Designation.
- SPT N = Standard Penetration Test resistance to driving, blows/ft.
- USC = Unified Soil Classification system.
- * indicates use of 300 pound hammer.

• Sample Type:
 S = Split Spoon
 U = Undisturbed (Shelby Tube)

Approved 	Date 02/25/97
--------------	------------------

Site: Skull Valley Goshute Reservation
Client: Private Fuel Storage Facility, LLC
Coordinates: N 7321739.31 E 1280619.03
Groundwater Depth: N/A ft
Contractor: Earthcore, Inc.

Logged by: A.C. Smith
Date Start - Finish: 10/28/96 - 10/28/96
Ground Elevation: 4459.5 ft
Total Depth Drilled: 51.5 ft
Driller: W. Westbrook
Rig Type: Mobile B-80

Methods: Drilling Soil: 3 1/4" I.D. Hollow Stem Augers
Sampling Soil: 2.0" O.D. Split Spoon, 24" long. 3" O.D. Shelby Sampler, 30" long.
Drilling Rock:
Casing Used:

Comments: No groundwater or bedrock encountered. Backfilled to ground surface with soil, marked with stake.

Elev (ft)	Depth (ft)	Sample		Blows or Recovery RQD	SPT N Value	USC Symbol	Sample Description
		Type	No.				
4459.5	0	S	1	2-4-9 (8.0")	13	ML	SILT, nonplastic, damp, light brown, bottom 1" slightly plastic.
4455	5	U	2	push (27.0")		ML-CL	Clayey SILT/Silty CLAY, slightly to moderately plastic, moist, light gray and brown.
4450	10	S	3	7-7-8 (13.0")	15	ML	Silt, very slightly plastic, damp, light brown.
4445	15	S	4	6-10-10 (16.0")	20	ML	Clayey SILT, slightly plastic, moist, light brown.
4440	20	S	5	4-5-7 (16.0")	12	ML	Clayey SILT, slightly plastic, moist, light brown (pale green?)

Legend/Notes

- Datum is NAVD 88.
- ▽ indicates groundwater level.
- ■ indicates location of samples.
- Blows = number of blows required to drive 2" O.D. sample spoon 6" or distance shown using 140 pound hammer falling 30".
- () = inches of sample recovery.
- Recovery = % rock core recovery.
- RQD = Rock Quality Designation.
- SPT N = Standard Penetration Test resistance to driving, blows/ft.
- USC = Unified Soil Classification system.
- * indicates use of 300 pound hammer.

- Sample Type:
S = Split Spoon
U = Undisturbed (Shelby Tube)

Approved
Wm. V. Sarger

Date
02/25/97

Site: Skull Valley Goshute Reservation

Logged by: A.C. Smith

Elev (ft)	depth (ft)	Sample		Blows or Recovery RQD	SPT N V a l u e	USC Symbol	Sample Description
		Type	No.				
4435	25	S	6	8-15-30 (12.0")	45	ML SP	Top 6": SILT, nonplastic, damp, light brown. Bot. 6": Silty SAND, fine, 20-30% nonplastic fines, nearly dry, light brown.
4430	30	S	7	12-35-35 (14.0")	70	SP	SAND, fine, <5% nonplastic fines, dry, light brown.
4425	35	S	8	20-35-55 (13.0")	90	SP	SAND, similar to S-7, 1" layer with some coarse sand.
4420	40	S	9	10-14-19 (11.0")	33	CL	Silty CLAY, moderately plastic, damp, light gray.
4415	45	S	10	25-33-30 (15.0")	63	SW ML	Top 6": Gravelly SAND, coarse to fine, 20-30% mostly fine gravel, up to 1", <5% nonplastic fines, dry light brown. Bot. 9": Sandy SILT, nonplastic, 20-30% fine sand, dry, yellow brown.
4410	50	S	11	25-75-50 (12.0")	125	SP SM	Top 8": SAND, <5% nonplastic fines, dry, light brown. Bot. 4": Silty SAND, fine, 10-20% nonplastic fines, dry, yellow brown.
BOTTOM OF BORING AT 51.5 FEET							
4405	55						
4400	60						

Note: See Sheet 1 for Boring Summary and Legend Information

Approved
David L. Surge

Date 02/25/97

Site: **Skull Valley Goshute Reservation**
Client: **Private Fuel Storage Facility, LLC**
Coordinates: **N 7321074.91 E 1280621.39**
Groundwater Depth: **N/A** ft
Contractor: **Earthcore, Inc.**

Logged by: **R. Gillespie**
Date Start - Finish: **10/28/96 - 10/28/96**
Ground Elevation: **4464.5** ft
Total Depth Drilled: **51.0** ft
Rig Type: **Acker Soil Sentry**

Methods: **Drilling Soil: 3 1/4" I.D. Hollow Stem Augers**
Sampling Soil: 2.0" O.D. Split Spoon, SPT. 3" Shelby Tube, 30" long.
Drilling Rock:

Casing Used:

Comments: **No groundwater or bedrock encountered**

Elev (ft)	Depth (ft)	Sample		Blows or Recovery RQD	SPT N Value	USC Symbol	Sample Description
		Type	No.				
4464.5	0	S	1	1-2-2	4	ML	Clayey SILT, slightly plastic, very loose, dry, light brown.
4460	5	S	2	2-2-3 (8.0")	5	CL	Silty CLAY, slightly to moderately plastic, firm, damp, light gray with white and orange-brown mottling.
		U	1	push			
4455	10	S	3	4-6-7 (12.0")	13	ML	Clayey SILT, slightly plastic, compact, damp, light brown with white mottling.
4450	15	S	4	3-7-9 (14.0")	16	ML	Clayey SILT, similar to S-3, light yellow-brown and light gray.
4445	20	S	5	5-6-6 (18.0")	12	ML	Clayey SILT, similar to S-3, light yellow-brown and light gray.

Legend/Notes

- Datum is NAVD 88.
- ▽ indicates groundwater level.
- ■ indicates location of samples.
- Blows = number of blows required to drive 2" O.D. sample spoon 6" or distance shown using 140 pound hammer falling 30".
- () = inches of sample recovery.
- Recovery = % rock core recovery.
- RQD = Rock Quality Designation.
- SPT N = Standard Penetration Test resistance to driving, blows/ft.
- USC = Unified Soil Classification system.
- * indicates use of 300 pound hammer.

- Sample Type:
S = Split Spoon
U = Undisturbed (Shelby Tube)

Approved: *[Signature]* Date: 02/25/97

Site: Skull Valley Goshute Reservation

Logged by: R. Gillespie

Elev (ft)	depth (ft)	Sample		Blows or Recovery RQD	SPT N Value	USC Symbol	Sample Description
		Type	No.				
4440	25	S	6	6-7-8 (13.0")	15	ML	Clayey SILT, moderately plastic, damp, light yellow and light gray.
4435	30	S	7	21-34-37 (18.0")	71	ML	Sandy SILT, nonplastic, 10-15% fine sand, very dense, dry, light gray.
4430	35	S	8	46-71- 100/5" (18.0")		SP	SAND, uniform, fine, 3-5% nonplastic fines, dry, very dense, light brown.
4425	40	S	9	16-32-36 (16.0")	68	SP	SAND, uniform, fine, 3-8% nonplastic fines, very dense, dry, light brown, trace fine gravel. Bot. 2" becomes gravelly silt and silty sand, slightly cemented.
4420	45	S	10	65- 100/5" (7.0")		GP	Sandy GRAVEL, poorly graded, 30-40% sand, mostly fine, 3-8% nonplastic fines, gravel to 1.0", dry, very dense, light brown.
4415	50	S	11	40-100 (14.0")		GP	Sandy GRAVEL, similar to S-10, 20-30% sand, 8-12% nonplastic fines, slightly cemented.
BOTTOM OF BORING AT 51.0 FEET							
4410	55						
4405	60						

Note: See Sheet 1 for Boring Summary and Legend Information

Approved: *[Signature]* Date: 02/25/97

Site: Skull Valley Goshute Reservation
Client: Private Fuel Storage Facility, LLC
Coordinates: N 7320517.02 E 1280582.67
Groundwater Depth: N/A ft
Contractor: Earthcore, Inc.

Logged by: R. Gillespie
Date Start - Finish: 10/23/96 - 10/23/96
Ground Elevation: 4467.9 ft
Total Depth Drilled: 51.5 ft
Rig Type: Acker Soil Sentry

Methods: Drilling Soil: 3 1/4" I.D. Hollow Stem Augers
Sampling Soil: 2.0" O.D. Split Spoon, SPT. 3" Shelby Tube, 30" long.
Drilling Rock:
Casing Used:

Comments: No groundwater or bedrock encountered

Elev (ft)	Depth (ft)	Sample		Blows or Recovery RQD	SPT N Value	USC Symbol	Sample Description
		Type	No.				
4467.9	0	S	1	1-4-5 (4.0")	9	ML	SILT, nonplastic, loose, dry, light brown.
4465	5	U	1	push		CL	Silty CLAY, slightly to moderately plastic, damp, light brown.
4460	10	U	2	push		CL	Silty CLAY, moderately plastic, damp, yellow-brown with white mottling.
4455	15	S	2	5-8-10 (14.0")	18	ML	Clayey SILT, slightly plastic, damp, compact, yellow-brown, very thinly layered.
4450	20	S	3	4-6-6 (18.0")	12	ML	Clayey SILT, slightly plastic, damp, compact, yellow-gray, thinly layered.

Legend/Notes

- Datum is NAVD 88.
- ▽ indicates groundwater level.
- ■ indicates location of samples.
- Blows = number of blows required to drive 2" O.D. sample spoon 6" or distance shown using 140 pound hammer falling 30".
- () = inches of sample recovery.
- Recovery = % rock core recovery.
- RQD = Rock Quality Designation.
- SPT N = Standard Penetration Test resistance to driving, blows/ft.
- USC = Unified Soil Classification system.
- * indicates use of 300 pound hammer.

- Sample Type:
S = Split Spoon
U = Undisturbed (Shelby Tube)

Approved: *[Signature]* Date: 02/25/97

Site: Skull Valley Goshute Reservation

Logged by: R. Gillespie

Elev (ft)	depth (ft)	Sample		Blows or Recovery RQD	SPT N Value	USC Symbol	Sample Description
		Type	No.				
4445	25	S	4	8-10-14 (16.0")	24	ML	Clayey SILT, similar to S-3, white and orange mottling (very small.)
4440	30	S	5	8-12-16 (16.0")	28	ML	Sandy SILT, nonplastic, compact, dry, 5-10% fine sand, light brown.
4435	35	S	6	28-45-96 (18.0")	141	SP	SAND, uniform, fine, <3% nonplastic fines, very dense, dry, trace of coarse sand, light brown.
4430	40	S	7	26-50-100 (18.0")	150	SP	SAND, uniform, fine, 3-5% nonplastic fines, very dense, dry, light brown, trace fine gravel.
4425	45	S	8	18-18-34 (15.0")	52	SP CL	Top 6": SAND, similar to S-7. Bot. 9": Silty CLAY, slightly plastic, trace fine sand, hard, damp, light brown-gray.
4420	50	S	9	46-50-65 (18.0")	115	GP	Sandy GRAVEL, poorly graded, 5-8% nonplastic fines, 20-30% coarse to fine sand, subrounded to subangular gravel to 3/4", very dense, dry, light brown.
4415							BOTTOM OF BORING AT 51.5 FEET
	55						
4410	60						

Note: See Sheet 1 for Boring Summary and Legend Information

Approved: *[Signature]*

Date: 02/25/97

Site: Skull Valley Goshute Reservation
Client: Private Fuel Storage Facility, LLC
Coordinates: N 7319912.39 E 1280540.31
Groundwater Depth: N/A ft
Contractor: Earthcore, Inc.

Logged by: A.C. Smith
Date Start - Finish: 10/28/96 - 10/28/96
Ground Elevation: 4472.2 ft
Total Depth Drilled: 51.5 ft
Driller: W. Westbrook
Rig Type: Mobile B-80

Methods: Drilling Soil: 3 1/4" I.D. Hollow Stem Augers
Sampling Soil: 2.0" O.D. Split Spoon, SPT, 24" long. 3" O.D. Shelby Tube Sampler, 30" long
Drilling Rock:
Casing Used:

Comments: No groundwater or bedrock encountered. Backfilled with soil, marked with stake.

Elev (ft)	Depth (ft)	Sample		Blows or Recovery RQD	SPT N Value	USC Symbol	Sample Description
		Type	No.				
4472.2	0	S	1	2-9-13 (6.0")	22	ML	SILT, nonplastic, damp, light brown.
4470	5	S	2	3-4-5 (13.0")	9	ML	Clayey SILT, slightly plastic, damp, light brown.
4465	10	U	3	push (27.0")		ML	Top: Clayey SILT/Silty CLAY, moderately plastic, moist, light brown. Bot.: SILT, nonplastic, < 10% fine sand.
4460	15	S	4	8-7-8 (12.0")	15	ML	SILT, nonplastic, < 10% fine sand, damp, light brown.
4455	20	S	5	5-10-11 (13.0")	21	ML	SILT, similar to S-4, except 1" layers of slightly plastic silt.

Legend/Notes

- Datum is NAVD 88.
- ∇ indicates groundwater level.
- █ indicates location of samples.
- Blows = number of blows required to drive 2" O.D. sample spoon 6" or distance shown using 140 pound hammer falling 30".
- () = inches of sample recovery.
- Recovery = % rock core recovery.
- RQD = Rock Quality Designation.
- SPT N = Standard Penetration Test resistance to driving, blows/ft.
- USC = Unified Soil Classification system.
- * indicates use of 300 pound hammer.

- Sample Type:
S = Split Spoon
U = Undisturbed (Shelby Tube)

Approved: *[Signature]* Date: 02/25/97

Site: Skull Valley Goshute Reservation

Logged by: A.C. Smith

Elev (ft)	depth (ft)	Sample		Blows or Recovery RQD	SPT N V a l u e	USC Symbol	Sample Description
		Type	No.				
4450	25	S	6	6-10-11 (14.0")	21	ML	SILT, similar to S-4.
4445	30	S	7	9-14-20 (14.0")	34	ML	Sandy SILT, nonplastic, 30-40% fine sand, light brown, dry.
4440	35	S	8	5-11-30 (13.0")	41	ML SP	Top 7": Stratified, 1/4" to 1/2" thick layers of fine SAND, <10% nonplastic fines, 1/4" to 1/2" thick layers of clayey SILT, slightly to moderately plastic, damp, light gray. Bot. 6": SAND, fine, <5% nonplastic fines, dry, light brown.
4435	40	S	9	20-45-50 (13.0")	95	SP	SAND, fine, <5% nonplastic fines, light brown.
4430	45	S	10	14-45-55 (14.0")	100	SP	SAND, similar to S-9, except trace coarse sand and fine gravel (top 2" moderately plastic clay), dry, light brown.
4425	50	S	11	25-45-90 (14.0")	135	SP	SAND, similar to S-9, except trace coarse sand and fine gravel, 1/2" layer of nonplastic silt.
4420	BOTTOM OF BORING AT 51.5 FEET						
4415	55						
4410	60						

Note: See Sheet 1 for Boring Summary and Legend Information

Approved

[Signature]

Date

02/25/97

Site: **Skull Valley Goshute Reservation**
Client: **Private Fuel Storage Facility, LLC**
Coordinates: **N 7321775.38 E 1281211.00**
Groundwater Depth: **N/A** ft
Contractor: **Earthcore, Inc.**

Logged by: **A.C. Smith**
Date Start - Finish: **10/28/96 - 10/28/96**
Ground Elevation: **4460.5** ft
Total Depth Drilled: **51.5** ft
Driller: **W. Westbrook**
Rig Type: **Mobile B-80**

Methods: **Drilling Soil: 3 1/4" I.D. Hollow Stem Augers**
Sampling Soil: 2.0" O.D. Split Spoon, 24" long. 3" O.D. Shelby Sampler, 30" long.
Casing Used:
Drilling Rock:

Comments: **No groundwater or bedrock encountered. Backfilled with soil to ground surface, marked with a stake.**

Elev (ft)	Depth (ft)	Sample		Blows or Recovery RQD	SPT N Value	USC Symbol	Sample Description
		Type	No.				
4460.5	0	S	1	2-1-2 (4.0")	3	ML	SILT, nonplastic, damp, light brown.
4455	5	S	2	3-4-4 (16.0")	8	ML	Clayey SILT, moderately plastic, moist, light brown.
4450	10	U	3	push (24.0")		ML	Clayey SILT, moderately to highly plastic, moist, light brown.
4445	15	S	4	8-8-8 (15.0")	16	ML	SILT, slightly plastic, damp, light brown.
4440	20	S	5	4-4-4 (18.0")	8	ML	Clayey SILT, slightly to moderately plastic, moist, light brown.

Legend/Notes

- Datum is NAVD 88.
- ▽ indicates groundwater level.
- ■ indicates location of samples.
- Blows = number of blows required to drive 2" O.D. sample spoon 6" or distance shown using 140 pound hammer falling 30".
- () = inches of sample recovery.
- Recovery = % rock core recovery.
- RQD = Rock Quality Designation.
- SPT N = Standard Penetration Test resistance to driving, blows/ft.
- USC = Unified Soil Classification system.
- * indicates use of 300 pound hammer.

- Sample Type:
S = Split Spoon
U = Undisturbed (Shelby Tube)

Approved: *[Signature]* Date: 02/25/97

Site: Skull Valley Goshute Reservation

Logged by: A.C. Smith

Elev (ft)	depth (ft)	Sample		Blows or Recovery RQD	SPT N Value	USC Symbol	Sample Description
		Type	No.				
4435	25	S	6	13-25-35 (13.0")	60	SP	SAND, fine, < 10% nonplastic fines, light brown and gray, nearly dry.
4430	30	S	7	17-36-55 (13.0")	91	SP	SAND, fine, < 5% nonplastic fines, dry, light brown.
4425	35	S	8	20-20-25 (15.0")	45	SM	Silty SAND, 10-20% nonplastic fines, nearly dry, light brown. (Top 5" similar to S-7)
4420	40	S	9	20-45-70 (14.0")	115	SP	SAND, fine, < 5% nonplastic fines, dry, light brown, gravelly layers every 2 to 3", 1" thick, 20-30% fine gravel and coarse sand.
4415	45	S	10	20-45-40 (10.0")	85	ML	SILT, nonplastic, light brown, a few 1/2" layers of fine sand, top and bottom, 1" of clayey silt and silty clay.
4410	50	S	11	25-50-60 (13.0")	110	SP	SAND, fine, < 5% nonplastic fines, nearly dry, light brown, 2" layer of 5-15% nonplastic fines.
BOTTOM OF BORING AT 51.5 FEET							
4405	55						
4400	60						

Note: See Sheet 1 for Boring Summary and Legend Information

Approved
[Signature]

Date 02/25/97

Site: **Skull Valley Goshute Reservation**
Client: **Private Fuel Storage Facility, LLC**
Coordinates: **N 7321142.12 E 1281237.18**
Groundwater Depth: **N/A** ft
Contractor: **Earthcore, Inc.**

Logged by: **R. Gillespie**
Date Start - Finish: **10/28/96 - 10/28/96**
Ground Elevation: **4464.2** ft
Total Depth Drilled: **51.5** ft
Rig Type: **Acker Soil Sentry**

Methods: **Drilling Soil: 3 1/4" I.D. Hollow Stem Augers**
Sampling Soil: 2.0" O.D. Split Spoon, SPT. 3.0" O.D. Shelby Tube, 30" long.
Drilling Rock:

Casing Used:

Comments: **No groundwater or bedrock encountered**

Elev (ft)	Depth (ft)	Sample		Blows or Recovery RQD	SPT N Value	USC Symbol	Sample Description
		Type	No.				
4464.2	0	S	1	3-8-10 (4.0")	18	ML	Clayey SILT, slightly plastic, compact, dry, light brown, trace fine sand, roots.
4460	5	U	1	push		ML	Clayey SILT, slightly plastic, yellow-brown, damp.
4455	10	U	2	push		CL	Silty CLAY, slightly to moderately plastic, damp, yellow-brown.
4450	15	S	2	5-6-7 (13.0")	13	CL,ML	Interbedded Silty CLAY - Clayey SILT, slightly plastic, compact (stiff), damp, yellow-brown with orange mottling, very thinly layered.
4445	20	S	3	4-5-6 (18.0")	11	CL	Silty CLAY, slightly to moderately plastic, stiff, damp, yellow-gray and yellow-brown, very thinly bedded with clayey silt.

Legend/Notes

- Datum is NAVD 88.
- ▽ indicates groundwater level.
- █ indicates location of samples.
- Blows = number of blows required to drive 2" O.D. sample spoon 6" or distance shown using 140 pound hammer falling 30".
- () = inches of sample recovery.
- Recovery = % rock core recovery.
- RQD = Rock Quality Designation.
- SPT N = Standard Penetration Test resistance to driving, blows/ft.
- USC = Unified Soil Classification system.
- * indicates use of 300 pound hammer.

Sample Type:

- S = Split Spoon
- U = Undisturbed (Shelby Tube)

Approved: *[Signature]* Date: 02/25/97

Site: Skull Valley Goshute Reservation

Logged by: R. Gillespie

Elev (ft)	depth (ft)	Sample		Blows or Recovery RQD	SPT N Value	USC Symbol	Sample Description
		Type	No.				
4440	25	S	4	7-14-20 (14.0")	34	CL ML	Top 6": Silty CLAY, similar to S-3. Bot. 8": Sandy SILT, nonplastic, damp, 10-15% fine sand, light brown-gray, compact.
4435	30	S	5	30-87- 100/2" (14.0")		SP	SAND, uniform, fine, 3-5% nonplastic fines, trace medium to coarse sand and fine gravel, dry, very dense, light brown.
4430	35	S	6	21-51-77 (18.0")	128	SP	SAND, uniform, fine, 8-12% nonplastic fines, very dense, damp, light brown.
4425	40	S	7	30-81- 100/5" (18.0")		SP	Top 10": SAND, similar to S-6, except slightly cemented. Bot. 8": Gravelly SAND, poorly graded, 30-40% coarse to fine gravel, subangular to subrounded, mostly fine sand, 8-12% nonplastic fines, very dense, dry, brown.
4420	45	S	8	41-40-44 (16.0")	84	ML	Sandy SILT, nonplastic, 25-35% fine sand, very dense, dry, light brown, slightly cemented.
4415	50	S	9	31-40-80 (12.0")	120	SP	SAND, uniform, fine, 3-8% nonplastic fines, very dense, dry, light brown, few very thin black mineral layers. Bot. 2" Sandy gravel.
BOTTOM OF BORING AT 51.5 FEET							
4410	55						
4405	60						

Note: See Sheet 1 for Boring Summary and Legend Information

Approved
Man T. Senger

Date
02/25/97

Site: Skull Valley Goshute Reservation
Client: Private Fuel Storage Facility, LLC
Coordinates: N 7320563.12 E 1281241.31
Groundwater Depth: N/A ft
Contractor: Earthcore, Inc.

Logged by: R. Gillespie
Date Start - Finish: 10/22/96 - 10/22/96
Ground Elevation: 4468.2 ft
Total Depth Drilled: 51.0 ft
Rig Type: Acker Soil Sentry

Methods: Drilling Soil: 3 1/4" I.D. Hollow Stem Augers
Sampling Soil: 2.0" O.D. Split Spoon, SPT
Drilling Rock:
Casing Used:

Comments: No groundwater or bedrock encountered

Elev (ft)	Depth (ft)	Sample		Blows or Recovery RQD	SPT N Value	USC Symbol	Sample Description
		Type	No.				
4468.2	0	S	1	1-4-7 (6.0")	11	CL	Silty CLAY, moderately plastic, stiff, dry, brown.
4465	5	S	2	3-3-3 (6.0")	6	CL	Silty CLAY, moderately plastic, stiff, damp, green-gray with white and orange mottling.
4460	10	S	3	3-3-5 (14.0")	8	CL	Silty CLAY, slightly plastic, stiff, damp, yellow-green with minor orange and white mottling, trace sand and piece of gravel. Thinly layered.
4455	15	S	4	4-5-5 (12.0")	10	CL	Silty CLAY, slightly plastic, stiff, damp, yellow-brown, trace sand, little mottling.
4450	20	S	5	3-3-6 (18.0")	9	CL	Silty CLAY, similar to S-4, thinly layered, some white mottling.

Legend/Notes

- Datum is NAVD 88.
- ▽ indicates groundwater level.
- ■ indicates location of samples.
- Blows = number of blows required to drive 2" O.D. sample spoon 6" or distance shown using 140 pound hammer falling 30".
- () = inches of sample recovery.
- Recovery = % rock core recovery.
- RQD = Rock Quality Designation.
- SPT N = Standard Penetration Test resistance to driving, blows/ft.
- USC = Unified Soil Classification system.
- * indicates use of 300 pound hammer.

- Sample Type:
S = Split Spoon
U = Undisturbed (Shelby Tube)

Approved: *[Signature]* Date: 02/25/97

Site: Skull Valley Goshute Reservation

Logged by: R. Gillespie

Elev (ft)	depth (ft)	Sample		Blows or Recovery RQD	SPT N V a l u e	USC Symbol	Sample Description
		Type	No.				
4445	25	S	6	6-8-14 (15.0")	22	CL	Silty CLAY, similar to S-4, few layers of silt, thinly laminated, some with white and orange mottling, very stiff.
4440	30	S	7	16-56-79 (17.0")	135	SP	SAND, uniform, fine, very dense, dry, light brown, trace medium sand, 3-5% nonplastic fines.
4435	35	S	8	33-100 (12.0")		SP	SAND, uniform, fine, < 3% nonplastic fines, trace medium to coarse sand, very dense, dry, light brown.
4430	40	S	9	27-34-60 (14.0")	94	SP SM	Top 7": SAND, similar to S-8. Bot. 7": Silty SAND, 15-20% nonplastic fines, very dense, dry, light green-brown, slightly cemented.
4425	45	S	10	27-43- 100/5"		SP	SAND, uniform, fine, 3-5% nonplastic fines, very dense, dry, light brown.
4420	50	S	11	95- 100/5" (10.0")		GP	Sandy GRAVEL, poorly graded, 3-5% nonplastic fines, 15-25% coarse to fine sand, subangular to subrounded gravel to maximum 1.0", very dense, dry, brown.
4415							BOTTOM OF BORING AT 51.0 FEET
4410	55						
	60						

Note: See Sheet 1 for Boring Summary and Legend Information

Approved
R. Gillespie

Date
02/25/97

Site: Skull Valley Goshute Reservation
Client: Private Fuel Storage Facility, LLC
Coordinates: N 7319942.04 E 1281203.84
Groundwater Depth: N/A ft
Contractor: Earthcore, Inc.

Logged by: A.C. Smith
Date Start - Finish: 10/24/96 - 10/24/96
Ground Elevation: 4472.9 ft
Total Depth Drilled: 51.5 ft
Rig Type: Mobile B-80

Methods: Drilling Soil: 3 1/4" I.D Hollow Stem Augers
Sampling Soil: 2.0" O.D. Split Spoon, SPT, 24" long.
Drilling Rock:

Casing Used:

Comments: No bedrock or groundwater encountered. Backfilled with soil, marked with a stick.

Elev (ft)	Depth (ft)	Sample		Blows or Recovery RQD	SPT N Value	USC Symbol	Sample Description
		Type	No.				
4472.9	0	S	1	2-6-9 (7.0")	15	ML	SILT, dry, light brown.
4470	5	S	2	4-3-4 (12.0")	7	CL/CH ML	Top 4": CLAY, moderately to highly plastic, gray, moist. Bot. 8": Clayey SILT, slightly plastic, damp, light gray.
4465	10	S	3	3-4-7 (15.0")	11	ML	SILT, nonplastic, <5% fine sand, damp, light brown.
4460	15	S	4	6-6-8 (12.0")	14	ML	SILT, similar to S-3.
4455	20	S	5	5-7-8 (13.0")	15	ML	Clayey SILT, slightly plastic, damp, thinly laminated, light brown and gray.

Legend/Notes

- Datum is NAVD 88.
- ∇ indicates groundwater level.
- ■ indicates location of samples.
- Blows = number of blows required to drive 2" O.D. sample spoon 6" or distance shown using 140 pound hammer falling 30".
- () = inches of sample recovery.
- Recovery = % rock core recovery.
- RQD = Rock Quality Designation.
- SPT N = Standard Penetration Test resistance to driving, blows/ft.
- USC = Unified Soil Classification system.
- * indicates use of 300 pound hammer.

· Sample Type:

- S = Split Spoon
- U = Undisturbed (Shelby Tube)

Approved: *[Signature]* Date: 02/25/97

Site: Skull Valley Goshute Reservation

Logged by: A.C. Smith

Elev (ft)	depth (ft)	Sample		Blows or Recovery RQD	SPT N value	USC Symbol	Sample Description
		Type	No.				
4450	25	S	6	10-10-10 (14.0")	20	ML	SILT, nonplastic, <10% fine sand, damp, light brown, occasional thin layer of clay.
4445	30	S	7	8-10-11 (13.0")	21	ML	SILT, nonplastic, nearly dry, light brown. Top 3": Silty fine SAND, 30-40% nonplastic fines.
4440	35	S	8	16-30-50 (13.0")	80	SP	SAND, fine, <5% nonplastic fines, light brown, nearly dry.
4435	40	S	9	30-50-100 (13.0")	150	SP	SAND, similar to S-8, trace coarse sand.
4430	45	S	10	25-30-40 (14.0")	70	SP SM	Top 5": Gravelly SAND, coarse to fine, mostly fine, 30-40% rounded fine gravel, <5% nonplastic fines, dry, light brown. Bot. 9": Silty SAND, fine, 35-50% nonplastic fines, dry, light brown.
4425	50	S	11	15-35- 100/5" (13.0")		SP GP	SAND, fine, trace fine gravel, <5% nonplastic fines, dry, light brown. Bottom 5", 30-40% fine GRAVEL and little coarse sand.
4420							BOTTOM OF BORING AT 51.5 FEET
	55						
4415	60						

Note: See Sheet 1 for Boring Summary and Legend Information

Approved
Max V. Berger

Date 02/25/97

Site: Skull Valley Goshute Reservation
Client: Private Fuel Storage Facility, LLC
Coordinates: N 7321814.43 E 1281856.37
Groundwater Depth: N/A ft
Contractor: Earthcore, Inc.

Logged by: A.C. Smith
Date Start - Finish: 10/24/96 - 10/24/96
Ground Elevation: 4459.9 ft
Total Depth Drilled: 51.5 ft
Rig Type: Mobile B-80

Methods: Drilling Soil: 3.0" I.D. Hollow Stem Augers
Sampling Soil: 2.0" O.D. Split Spoon, SPT, 24" long.
Drilling Rock:
Casing Used:

Comments: No groundwater or bedrock encountered

Elev (ft)	Depth (ft)	Sample		Blows or Recovery RQD	SPT N Value	USC Symbol	Sample Description
		Type	No.				
4459.9	0	S	1	6-20-20 (6.0")	40	ML	SILT, nonplastic, dry, light brown, damp at tip.
4455	5	S	2	3-5-7 (14.0")	12	ML	SILT, nonplastic, damp, light brown, two 1" layers of slightly plastic clayey silt.
4450	10	S	3	5-7-7 (14.0")	14	ML	SILT, similar to S-2, except < 10% fine sand.
4445	15	S	4	4-6-7 (16.0")	13	ML	Clayey SILT, slightly plastic, damp to moist, thinly laminated, light brown and light gray.
4440	20	S	5	6-7-9 (15.0")	16	ML	SILT, nonplastic, < 10% fine sand, damp, laminated, light gray and yellow brown.

Legend/Notes

- Datum is NAVD 88.
- ▽ indicates groundwater level.
- ■ indicates location of samples.
- Blows = number of blows required to drive 2" O.D. sample spoon 6" or distance shown using 140 pound hammer falling 30".
- () = inches of sample recovery.
- Recovery = % rock core recovery.
- RQD = Rock Quality Designation.
- SPT N = Standard Penetration Test resistance to driving, blows/ft.
- USC = Unified Soil Classification system.
- * indicates use of 300 pound hammer.

- Sample Type:
S = Split Spoon
U = Undisturbed (Shelby Tube)

Approved: *[Signature]* Date: 02/25/97

Site: Skull Valley Goshute Reservation

Logged by: A.C. Smith

Elev (ft)	depth (ft)	Sample		Blows or Recovery RQD	SPT N Value	USC Symbol	Sample Description
		Type	No.				
4435	25	S	6	20-40-60 (6.0")	100	SP	SAND, fine, <7% nonplastic fines, light brown, nearly dry.
4430	30	S	7	15-40-50 (12.0")	90	SP	SAND, similar to S-6.
4425	35	S	8	15-37-38 (15.0")	75	ML	SILT, nonplastic, 10-20% fine sand, dry, light gray, trace of clay, 3" layer of silty fine sand, 30-40% nonplastic fines.
4420	40	S	9	20-40-60 (11.0")	100	SP	SAND, fine, <5% nonplastic fines, nearly dry, light brown. Two 2" layers with little medium and coarse sand, 20-30% fine gravel up to 1".
4415	45	S	10	20-60-50 (13.0")	110	SP	SAND, fine, <10% fines, nearly dry, light brown.
4410	50	S	11	25-55-83 (13.0")	138	SP	SAND, similar to S-10.
BOTTOM OF BORING AT 51.5 FEET							
4405	55						
4400	60						

Note: See Sheet 1 for Boring Summary and Legend Information

Approved
[Signature]

Date 02/25/97

Site: Skull Valley Goshute Reservation
Client: Private Fuel Storage Facility, LLC
Coordinates: N 7321198.17 E 1281873.25
Groundwater Depth: N/A ft
Contractor: Earthcore, Inc.

Logged by: A.C. Smith
Date Start - Finish: 10/24/96 - 10/24/96
Ground Elevation: 4467.4 ft
Total Depth Drilled: 51.5 ft
Rig Type: Mobile B-80

Methods: Drilling Soil: 4 1/4" I.D. Hollow Stem Augers
Sampling Soil: 2.0" O.D. Split Spoon, SPT, 24" long.
Drilling Rock:

Casing Used:

Comments: No groundwater or bedrock encountered. Backfilled with soil, marked with a stake.

Elev (ft)	Depth (ft)	Sample		Blows or Recovery RQD	SPT N Value	USC Symbol	Sample Description
		Type	No.				
4467.4	0	S	1	2-3-3 (6.0")	6	ML	SILT, nonplastic, dry, light brown.
4465	5	S	2	3-3-3 (15.0")	6	ML	Clayey SILT, slightly plastic, damp, light brown, middle 3" nonplastic.
4460	10	S	3	3-4-7 (16.0")	11	ML	Clayey SILT, similar to S-2.
4455	15	S	4	5-7-8 (16.0")	15	ML	SILT, nonplastic, damp, light brown, a few 1/4" layers of silty fine sand.
4450	20	S	5	6-9-9 (15.0")	18	ML	SILT, nonplastic, damp, thinly laminated, light brown and light gray.

Legend/Notes

- Datum is NAVD 88.
- ▽ indicates groundwater level.
- ■ indicates location of samples.
- Blows = number of blows required to drive 2" O.D. sample spoon 6" or distance shown using 140 pound hammer falling 30".
- () = inches of sample recovery.
- Recovery = % rock core recovery.
- RQD = Rock Quality Designation.
- SPT N = Standard Penetration Test resistance to driving, blows/ft.
- USC = Unified Soil Classification system.
- * indicates use of 300 pound hammer.

Sample Type:

- S = Split Spoon
- U = Undisturbed (Shelby Tube)

Approved: *Wm. T. Berger* Date: 02/25/97

Site: Skull Valley Goshute Reservation

Logged by: A.C. Smith

Elev (ft)	depth (ft)	Sample		Blows or Recovery RQD	SPT N Value	USC Symbol	Sample Description
		Type	No.				
4445	25	S	6	6-8-9 (15.0")	17	ML	SILT, similar to S-5.
4440	30	S	7	21-47-60 (13.0")	107	SP	SAND, fine, <10% nonplastic fines, light brown and gray, nearly dry.
4435	35	S	8	15-50-71 (12.0")	121	SP	SAND, similar to S-7, trace coarse sand.
4430	40	S	9	10-50-55 (12.0")	105	SP	Similar to S-7, trace coarse sand and fine gravel.
4425	45	S	10	20-40-40 (12.0")	80	SP CL	Top 7": Gravelly SAND, coarse to fine, mostly fine, 20-30% fine gravel, <5% nonplastic fines, dry, light brown. Bot. 5": CLAY, highly plastic, nearly dry, gravelly at top of layer, contained 1" layer of silty clay.
4420	50	S	11	20-60-90 (11.0")	150	SP	SAND, fine, <5% nonplastic fines, dry, light brown, 2" thick layer of coarse to fine sand with 10-20% fine gravel.
4415	BOTTOM OF BORING AT 51.5 FEET						
4410	55						
4405	60						

Note: See Sheet 1 for Boring Summary and Legend Information

Approved
Ann Y. Berger

Date
02/25/97

Site: **Skull Valley Goshute Reservation**
Client: **Private Fuel Storage Facility, LLC**
Coordinates: **N 7320587.09 E 1281884.33**
Groundwater Depth: **N/A** ft
Contractor: **Earthcore, Inc.**

Logged by: **R. Gillespie**
Date Start - Finish: **10/22/96 - 10/22/96**
Ground Elevation: **4468.9** ft
Total Depth Drilled: **51.5** ft
Rig Type: **Acker Soil Sentry**

Methods: **Drilling Soil: 3 1/4" I.D. Hollow Stem Augers**
Sampling Soil: 2.0" O.D Split Spoon, SPT
Drilling Rock:

Casing Used:

Comments: **No groundwater or bedrock encountered**

Elev (ft)	Depth (ft)	Sample		Blows or Recovery RQD	SPT N Value	USC Symbol	Sample Description
		Type	No.				
4468.9	0	S	1	1-3-3 (7.0")	6	CL	Silty CLAY, moderately plastic, slightly damp, light green with white and orange-brown mottling.
4465	5	S	2	1-5-9 (11.0")	14	CL	Silty Clay, slightly plastic, stiff, dry, light brown, trace roots.
4460	10	S	3	3-4-7 (15.0")	11	CL ML	Top 10": Silty CLAY, similar to S-2. Bot. 5": Clayey SILT, slightly plastic, loose, slightly damp, light brown with white mottling.
4455	15	S	4	4-4-5 (18.0")	9	CL	Silty CLAY, slightly plastic, stiff, damp, yellow-brown, thinly layered, minor orange mottling.
4450	20	S	5	4-5-6 (18.0")	11	CL	Silty CLAY, similar to above, few thin layers of silt, some white mottling.

Legend/Notes

- Datum is NAVD 88.
- ▽ indicates groundwater level.
- ■ indicates location of samples.
- Blows = number of blows required to drive 2" O.D. sample spoon 6" or distance shown using 140 pound hammer falling 30".
- () = inches of sample recovery.
- Recovery = % rock core recovery.
- RQD = Rock Quality Designation.
- SPT N = Standard Penetration Test resistance to driving, blows/ft.
- USC = Unified Soil Classification system.
- * indicates use of 300 pound hammer.

- Sample Type:
S = Split Spoon
U = Undisturbed (Shelby Tube)

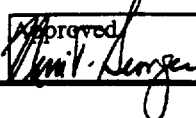
Approved:  Date: 02/25/97

Site: Skull Valley Goshute Reservation

Logged by: R. Gillespie

Elev (ft)	depth (ft)	Sample		Blows or Recovery RQD	SPT N Value	USC Symbol	Sample Description
		Type	No.				
4445	25	S	6	8-14-25 (16.0")	39	ML	SILT, nonplastic, dense, slightly damp, light gray, minor thin layers of silty clay, some orange mottling.
4440	30	S	7	37-100/4" (12.0")		SP	SAND, uniform, fine, 3-5% nonplastic fines, very dense, dry, light gray-brown.
4435	35	S	8	40-100/5" (12.0")		SP	SAND, similar to S-7.
4430	40	S	9	38-100/5" (16.0")		SP	SAND, similar to S-7, few thin layers of silt.
4425	45	S	10	78-100/4" (18.0")		SP SP	Top 8": SAND, similar to S-7, few thin layers of silt, some medium to coarse sand. Bot. 10": Gravelly SAND, well graded, 3-5% nonplastic fines, coarse to fine gravel, coarse to fine sand, mostly fine, dry, very dense, light brown.
4420	50	S	11	70-75		CL-CH	Silty CLAY, moderately to highly plastic, hard, slightly damp, trace sand and gravel, occasional silt layer, green-brown.
BOTTOM OF BORING AT 51.5 FEET							
4415	55						
4410	60						

Note: See Sheet 1 for Boring Summary and Legend Information

Approved
David V. George

Date
02/25/97

Site: **Skull Valley Goshute Reservation**
Client: **Private Fuel Storage Facility, LLC**
Coordinates: **N 7319973.03 E 1281903.10**
Groundwater Depth: **N/A** ft
Contractor: **Earthcore, Inc.**

Logged by: **A.C. Smith**
Date Start - Finish: **10/22/96 - 10/23/96**
Ground Elevation: **4472.9** ft
Total Depth Drilled: **100.5** ft
Rig Type: **Mobile B-80**
Driller: **W. Westbrook**

Methods: **Drilling Soil: 4 1/4" I.D. Hollow Stem Augers to 65", below 65' roller cone bit with compressed air, open hole.**
Sampling Soil: 2.0" O.D. Split Spoon, SPT, 18" and 24" long.
Casing Used:
Drilling Rock:

Comments: **No groundwater or bedrock encountered. Backfilled with soil, marked with stake.**

Elev (ft)	Depth (ft)	Sample		Blows or Recovery RQD	SPT N Value	USC Symbol	Sample Description
		Type	No.				
4472.9	0	S	1	4-4-4 (3.0")	8	ML	SILT, nonplastic, <10% fine sand, dry, light brown.
4470	5	S	2	3-2-2 (3.0")	4	ML	SILT, similar to S-1, except bottom 2" moist.
4465	10	S	3	5-10-14 (8.0")	24	ML SM	Top 7": SILT, similar to S-1, except 20-30% fine sand, damp, bottom 2" contained 20-30% fine sand. Bot. 1": Silty SAND, fine, 20-30% nonplastic fines, dry, light brown.
4460	15	S	4	10-12-10 (12.0")	22	ML	Top 7": SILT, nonplastic, <10% fine sand, slightly damp. Bot. 5": SILT, similar to top 7", except thin layers of clay, moist, brown.
4455	20	S	5	4-4-5 (14.0")	9	ML	Clayey SILT, slightly plastic, moist, stratified with light brown and light gray bands 1/8-1/2" thick.

Legend/Notes

- Datum is NAVD 88.
- ▽ indicates groundwater level.
- ■ indicates location of samples.
- Blows = number of blows required to drive 2" O.D. sample spoon 6" or distance shown using 140 pound hammer falling 30".
- () = inches of sample recovery.
- Recovery = % rock core recovery.
- RQD = Rock Quality Designation.
- SPT N = Standard Penetration Test resistance to driving, blows/ft.
- USC = Unified Soil Classification system.
- * indicates use of 300 pound hammer.

- Sample Type:
S = Split Spoon
U = Undisturbed (Shelby Tube)

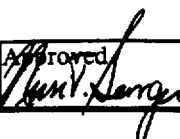
Approved:  Date: 02/25/97

Site: Skull Valley Goshute Reservation

Logged by: A.C. Smith

Elev (ft)	depth (ft)	Sample		Blows or Recovery RQD	SPT N Value	USC Symbol	Sample Description
		Type	No.				
4450	25	S	6	6-7-9 (14.0")	16	ML	SILT, nonplastic, 10-20% fine sand, damp, stratified light brown and light gray. Clayey silt in tip of spoon.
4445	30	S	7	8-31-34 (10.0")	65	SP	SAND, uniform, fine, <5% nonplastic fines, light brown-gray, dry, stratified with thin black layers at top 1/8-1/4".
4440	35	S	8	15-38-50 (13.0")	88	SP	SAND, uniform, fine, <10% nonplastic fines, light brown and gray, two silty layers near bottom 1/4" thick, dry.
4435	40	S	9	14-27-40 (12.0")	67	SP	SAND, similar to S-8, contained 1" layer with 20-30% nonplastic fines.
4430	45	S	10	18-33-50 (12.0")	83	SM	Silty SAND, fine, 10-20% nonplastic fines, light brown, dry, occasional 1/8-1/4" layer of silt.
4425	50	S	11	20-70-90 (13.0")	160	SM GP	Top 6": Silty SAND, fine 30-40% nonplastic fines, dry, light brown. Bot. 7": Sandy GRAVEL, mostly fine, up to 1 1/2", subrounded, 30-40% coarse to fine sand, <10% nonplastic fines, light gray.
4420	55	S	12	28-57-75 (12.0")	132	SP	SAND, fine, 10-20% fine gravel, <5% nonplastic fines, light brown, dry.
4415	60	S	13	14-22-23 (11.0")	45	ML	SILT, nonplastic, 10-20% fine sand, dry, light brown.

Note: See Sheet 1 for Boring Summary and Legend Information

Approved
[Signature]

Date
02/25/97

Site: Skull Valley Goshute Reservation

Logged by: A.C. Smith

Elev (ft)	depth (ft)	Sample		Blows or Recovery RQD	SPT N value	USC Symbol	Sample Description
		Type	No.				
4410	65	S	14	30-50/30 (13.0")	100	SM	Silty SAND, fine, 30-40% nonplastic fines, dry, light brown.
4405	70	S	15	60-100/3" (9.0")		ML	SILT, nonplastic, <10% fine sand, dry, light brown.
4400	75	S	16	65-100/2" (8.0")		ML	SILT, similar to S-15, slightly damp.
4395	80	S	17	50-50/0" (6.0")		ML	SILT, similar to S-15, slightly damp.
4390	85	S	18	35-100/3" (7.0")		ML	SILT, similar to S-15, slightly damp, piece of gravel in tip.
4385	90	S	19	100/4" (4.0")		ML	SILT, similar to S-15, except damp.
4380	95	S	20	50-70- 100/3" (14.0")		ML	Clayey SILT, slightly plastic, slightly damp, light brown, some areas of silty clay, some nonplastic up to 2" thick.
4375	100	S	21	50-50/0" (6.0")		SM	Silty SAND, fine, 20-30% nonplastic fines, dry, light brown, top 2" coarse to fine sand. BOTTOM OF BORING AT 100.5 FEET
4370							

Note: See Sheet 1 for Boring Summary and Legend Information

Approved
[Signature]

Date
02/25/97

Site: Skull Valley Goshute Reservation
Client: Private Fuel Storage Facility, LLC
Coordinates: N 7320635.00 E 1282600.00
Groundwater Depth: N/A ft
Contractor: Earthcore, Inc.

Logged by: A.C. Smith
Date Start - Finish: 10/23/96 - 10/23/96
Ground Elevation: 4471.0 ft
Total Depth Drilled: 51.1 ft
Rig Type: Mobile B-80

Methods: Drilling Soil: 4 1/4" I.D Hollow Stem Augers
Sampling Soil: 2.0" O.D. Split Spoon, SPT
Drilling Rock:
Casing Used:

Comments: No groundwater or bedrock encountered. Backfilled with soil, marked with stake.

Elev (ft)	Depth (ft)	Sample		Blows or Recovery RQD	SPT N Value	USC Symbol	Sample Description
		Type	No.				
4471.0	0	S	1	2-4-5 (7.0")	9	ML	SILT, nonplastic, dry, light brown.
4470							
	5	S	2	2-4-7	11	CL	CLAY, moderately plastic, moist, light gray, numerous silt partings.
4465							
	10	S	3	3-5-7 (16.0")	12	ML	Silty CLAY/clayey SILT, moderately to highly plastic, moist, light brown, bottom 4" nonplastic.
4460							
	15	S	4	7-10-12 (16.0")	22	ML	SILT, nonplastic, < 10% fine sand, damp, light brown, 1/4" layer of gray clay every 3-4".
4455							
	20	S	5	4-7-8 (16.0")	15	ML	Clayey SILT (Silty CLAY), slightly plastic, moist, thinly laminated, light brown and gray.
4450							

Legend/Notes

- Datum is NAVD 88.
- ▽ indicates groundwater level.
- ■ indicates location of samples.
- Blows = number of blows required to drive 2" O.D. sample spoon 6" or distance shown using 140 pound hammer falling 30".
- () = inches of sample recovery.
- Recovery = % rock core recovery.
- RQD = Rock Quality Designation.
- SPT N = Standard Penetration Test resistance to driving, blows/ft.
- USC = Unified Soil Classification system.
- * indicates use of 300 pound hammer.

- Sample Type:
S = Split Spoon
U = Undisturbed (Shelby Tube)

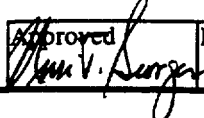
Approved:  Date: 02/25/97

Site: Skull Valley Goshute Reservation

Logged by: A.C. Smith

Elev (ft)	depth (ft)	Sample		Blows or Recovery RQD	SPT N Value	USC Symbol	Sample Description
		Type	No.				
4445	25	S	6	5-6-12 (15.0")	18	ML	SILT, nonplastic, damp, light brown and gray, a few zones of clayey silt. Bottom 4" contained 10-20% fine sand.
4440	30	S	7	15-50-75 (14.0")	125	SP	SAND, fine, <5% nonplastic fines, nearly dry, light brown.
4435	35	S	8	20-50-80 (12.0")	130	SP	SAND, similar to S-7, trace coarse sand.
4430	40	S	9	15-50-60 (13.0")	110	SP	SAND, similar to S-7, mottled with yellow brown.
4425	45	S	10	15-55-50 (12.0")	105	SP	SAND, similar to S-7, contained two layers 1-2" thick of gravelly sand, coarse to fine, mostly fine, 20-30% fine gravel, subrounded, <5% nonplastic fines.
4420	50	S	11	32-55-95 (13.0")	150	SP	SAND, similar to S-7, contained 2" thick layer of gravelly sand similar to S-10.
BOTTOM OF BORING AT 51.5 FEET							
4415	55						
4410	60						

Note: See Sheet 1 for Boring Summary and Legend Information

Approved
[Signature]

Date
02/25/97

Site: **Skull Valley Goshute Reservation**
Client: **Private Fuel Storage Facility, LLC**
Coordinates: **N 7319988 E 1282615**
Groundwater Depth: **N/A** ft
Contractor: **Earthcore, Inc.**

Logged by: **A.C. Smith**
Date Start - Finish: **10/23/96 - 10/23/96**
Ground Elevation: **4474.3** ft
Total Depth Drilled: **51.5** ft
Driller: **W. Westbrook**
Rig Type: **Mobile B-80**

Methods: **Drilling Soil: 4 1/4" Hollow Stem Augers**
Sampling Soil: 2.0" O.D. Split Spoon, SPT, 24" long.
Drilling Rock:

Casing Used:

Comments: **No groundwater or bedrock encountered. Backfilled with soil, marked with stake.**

Elev (ft)	Depth (ft)	Sample		Blows or Recovery RQD	SPT N Value	USC Symbol	Sample Description
		Type	No.				
4474.3	0	S	1	3-7-10 (7.0")	17	ML	SILT, nonplastic, light brown, a few roots, dry.
4470	5	S	2	9-10-16 (13.0")	26	SM	Silty SAND, fine, 20-30% nonplastic fines, dry, light brown. Top 1" clayey silt.
4465	10	S	3	13-25-27 (12.0")	52	SM	Silty SAND, fine, 10-20% nonplastic fines, dry, light brown.
4460	15	S	4	8-20-20 (12.0")	40	ML	SILT, nonplastic, <10% fine sand, dry, light brown. Bottom 2" stratified with 1/8" layers of clay.
4455	20	S	5	6-6-10 (17.0")	16	ML	Clayey SILT, slightly plastic, thinly laminated, damp, light brown and light gray.

Legend/Notes

- Datum is NAVD 88.
- ∇ indicates groundwater level.
- ■ indicates location of samples.
- Blows = number of blows required to drive 2" O.D. sample spoon 6" or distance shown using 140 pound hammer falling 30".
- () = inches of sample recovery.
- Recovery = % rock core recovery.
- RQD = Rock Quality Designation.
- SPT N = Standard Penetration Test resistance to driving, blows/ft.
- USC = Unified Soil Classification system.
- * indicates use of 300 pound hammer.

- Sample Type:
S = Split Spoon
U = Undisturbed (Shelby Tube)

Approved
W. V. Seeger

Date
02/25/97

Site: Skull Valley Goshute Reservation

Logged by: A.C. Smith

Elev (ft)	depth (ft)	Sample		Blows or Recovery RQD	SPT N Value	USC Symbol	Sample Description
		Type	No.				
4450	25	S	6	7-10-14 (16.0")	24	ML	SILT, nonplastic, <5% fine sand, damp, light brown, occasional thin layer of clay.
4445	30	S	7	30-50-65 (12.0")	115	SP	SAND, fine, <10% nonplastic fines, dry, light brown, top 1" damp silt, nonplastic.
4440	35	S	8	17-55-75 (13.0")	130	SP	SAND, similar to S-7, slightly damp.
4435	40	S	9	12-25-50 (13.0")	75	SP	SAND, similar to S-7, slightly damp, contained 2" layer of sandy silt.
4430	45	S	10	12-55-75	130	SP	SAND, similar to S-7, slightly damp.
4425	50	S	11	20-80-50 (12.0")	130	SP	Gravelly SAND, coarse to fine, mostly fine, 10-20% mostly fine gravel, up to 1 1/2", rounded, <5% nonplastic fines, dry, light brown.
BOTTOM OF BORING AT 51.5 FEET							
4420	55						
4415	60						

Note: See Sheet 1 for Boring Summary and Legend Information

Approved
[Signature]

Date
02/25/97

Report No. 05996.01-G(B)-2 Rev 1
SWEC Project No. 05996.01

GEOTECHNICAL DATA REPORT

ATTACHMENT 2

GEOTECHNICAL LABORATORY TESTING
January 1997

Private Fuel Storage Facility
Skull Valley
Private Fuel Storage, LLC

Responsible Engineer

Alan C. Smith

6/11/97
Date

Reviewer

Paul J. Dudgeon (I)

6/11/97
Date

Approved

Ami V. Seeger

6/11/97
Date

(I) = Independent Review

QUALITY ASSURANCE CATEGORY I AND III
STONE & WEBSTER ENGINEERING CORPORATION
BOSTON, MASSACHUSETTS
Copyright 1997

Report No. 05996.01-G(B)-2 Rev 1
SWEC Project No. 05996.01

GEOTECHNICAL DATA REPORT

ATTACHMENT 2

GEOTECHNICAL LABORATORY TESTING
January 1997

QUALITY ASSURANCE CATEGORY I
STONE & WEBSTER ENGINEERING CORPORATION
BOSTON, MASSACHUSETTS
Copyright 1997

Report No. 05996.01-G(B)-2 Rev 1
SWEC Project No. 05996.01

GEOTECHNICAL DATA REPORT

ATTACHMENT 2

TABLE OF CONTENTS

	Page
INTRODUCTION	1
TEST RESULTS	1
LABORATORY TESTING PROGRAM—UTILIZATION OF SAMPLES	3
TABLES	
Table 1 Lab Test Results—% Passing #200 Sieve	5
Table 2 Lab Test Results—Atterberg Limits	6
TRIAXIAL TEST PLOTS AND DATA	(4 pages)
CONSOLIDATION TEST PLOTS AND DATA	
Boring C-1, Sample U-3B	(22 pages)
Boring C-1, Sample U-3C	(38 pages)
Boring C-1, Sample U-3D	(48 pages)
Boring C-2, Sample U-2C	(40 pages)
Boring C-2, Sample U-2E	(19 pages)

INTRODUCTION

The Geotechnical Laboratory received 20 boxes of split spoon jar samples and 9 undisturbed tube samples from the Skull Valley site on November 13, 1996. A testing program was developed identifying types of tests to be performed and which samples to test. Testing began on November 15, 1996 and ended on January 10, 1997.

The tests performed were water content, Atterberg limits, percent fines, specific gravity, consolidation, and unconsolidated - undrained triaxial compression. They were conducted in accordance with the following American Society for Testing and Materials standards.

C-136	1996	Test Method for Sieve Analysis of Fine and Coarse Aggregates
D-854	1992	Test Method for Specific Gravity of Soils
D-1140	1992	Test Method for Amount of Material in Soils Finer Than the No. 200 Sieve
D-2216	1992	Test Method for Laboratory Determination of Water (Moisture) Content of Soil, Rock, and Soil-Aggregate Mixtures
D-2435	1990	Test Method for One-Dimensional Consolidation Properties of Soils
D-2850	1995	Test Method for Unconsolidated, Undrained Compressive Strength of Cohesive Soils in Triaxial Compression
D-4318	1995	Test Method for Liquid Limit, Plastic Limit, and Plasticity Index of Soils

All laboratory equipment and materials used to conduct this testing program were calibrated and maintained in accordance with the requirements of the Stone & Webster Standard Nuclear Quality Assurance Program.

TEST RESULTS

The results of testing for percent passing the no. 200 sieve are presented in Table 1. The Atterberg Limit test results are shown in Table 2.

Two undisturbed tube samples were tested for unconsolidated-undrained compressive strength. The plots and data are shown in Appendix A. We were unable to conduct the triaxial test in accordance with ASTM D-2166, Unconfined Compressive Strength of Cohesive Soils, due to the weak soil structure. The samples would have collapsed while unconfined before the test began. We used ASTM D-2850 because we could extrude the sample directly into a membrane preventing a collapse of the sample. The compressive strength measured using this procedure should be the same obtained if D-2166 had been used. An attempt was made to perform a third test but could not find a suitable sample in the tubes taken between 8 and 12 ft depth.

A total of 5 consolidation tests were conducted on undisturbed tube samples from borings C-1 and C-2. The stress vs. strain plots, strain vs. time plots, and data are presented in Appendix B. Initially two tests were started (C-1/U-3D and C-2/U-2E). When the applied stress reached 0.5 tsf they were inundated with distilled water. The incremental loads were added every 30 to 60 minutes until the applied stress was 2 tsf. At that load the strain vs. log of time plot appeared to indicate primary consolidation was not completed. The 2 tsf applied stress was left on the

samples for more than 10,000 minutes. Another sample was trimmed (C-2/U-2C) and started, when we assumed we had loaded the first two tests too rapidly. But, when we examined the strain vs. square root of time plot, it showed primary consolidation was finished within 2 to 4 minutes after applying the new load. We now consider the additional strain after 4 minutes of elapsed time to be secondary consolidation. We were concerned that the large amount of secondary consolidation may be due to the inundation of the samples with distilled water. Therefore, another test was started (C-1/U-3C), the porous stones were moistened and the apparatus was wrapped in plastic to prevent loss of moisture. Since all load frames were occupied, test C-2/U-2E was stopped at 0.5 tsf and replaced with test C-1/U-3C. When test C-1/U-3C was completed, it was discovered that the sample had pulled moisture from the porous stones. A fifth test (C-1/U-2B) was conducted using dry porous stones with new loads added every 30 to 60 minutes.

The soil tested is a moderately to highly plastic, clayey silt, partially saturated. It appears to be alkaline since the conductivity of the distilled water inundating the samples was high (over 18,000 umho). Also, the soil reacts immediately to a 10% solution of hydrochloric acid. The stress vs. strain plots appear to show the maximum past pressure to be approximately 3 tsf. The secondary consolidation is significant after exceeding the maximum past pressure. The large secondary consolidation may be due to the deformation of a weakly cemented structure of the silt. The distilled water inundating the consolidation samples does not seem to have effected the results since the stress-strain curves are similar to those tests conducted without inundating the sample.

LABORATORY TESTING PROGRAM
UTILIZATION OF SAMPLE

STONE & WEBSTER
ENGINEERING CORPORATION

~~test~~ cancelled

CLIENT <i>Private Fuel Storage, LLC</i>	J.O. NUMBER <i>05996.01</i>	REVISION	1	2	3	4	PREPARED BY <i>ACS</i>	SHEET <i>1/2</i>
SITE <i>Skull Valley Goshute Indian Reservation</i>		DATE <i>12/12/96</i>					APPROVED BY <i>NTG</i>	DATE PREPARED <i>11/14/96</i>
		REVISED BY <i>ACS</i>						RECEIVED BY <i>ACS</i>

BORING NO.	SAMPLE		DEPTH (FT.)	LETTERS BELOW SPECIFIC TYPES OF TESTS CORRESPOND TO SIMILARLY LETTERED NOTES GIVEN ON SHEET 2																	REMARKS OR REQUIREMENTS FOR TESTING OF SPECIFIC SAMPLES (REFER TO COL. NO. FOR TYPE OF TEST)
	TYPE	NO.		TYPE OF TEST	CLASSIFICATION	WATER CONTENT	ATTERBERG LIMITS	PERCENT FINES	GRADATION ANALYSES	SPECIFIC GRAVITY	UNIT WEIGHT	UNDRAINED COMPRESSION	CONSOLIDATED TRIAXIAL	DRAINED DIRECT SHEAR	CONSOLIDATION	COMPACTION	RELATIVE DENSITY	PERMEABILITY			
A1	S	7	30-31½																		changed gradation to % fines
A3	S	8	35-36½																		
A4	S	7	30-31½																		
B3	UD	2	10-12																		unable to trim into ring, UU sample unsuitable
B4	U	3	10-12																		unable to trim into ring
C2	U	2	10-12																		
D1	S	4	15-16½																		cancelled
D1	S	5	20-21½																		
D1	S	6	25-26½																		
D4	S	5	20-21½																		cancelled
D4	S	6	25-26½																		
D4	S	7	30-31½																		

TEST TO BE PERFORMED (NUMBERS USED TO INDICATE PRIORITIES)

TEST COMPLETED AND CHECKED BUT FINAL REPORT NOT COMPLETE

TEST RESULTS REPORTED IN FINAL FORM (ALL LABORATORY WORK DONE)

~~test cancelled~~

LABORATORY TESTING PROGRAM
UTILIZATION OF SAMPLE

STONE & WEBSTER
ENGINEERING CORPORATION

SHEET	2/2
DATE PREPARED	11/14/96
RECEIVED BY	ACS

CLIENT	Private Fuel Storage, LLC	J.O. NUMBER	05996.01	REVISION	1	2	3	4	PREPARED BY	ACS
SITE	Skull Valley Goshute Indian Reservation	DATE	12/12/96	REVISOR	ACS				APPROVED BY	NTG

BORING NO.	SAMPLE		DEPTH (FT.)	LETTERS BELOW SPECIFIC TYPES OF TESTS CORRESPOND TO SIMILARLY LETTERED NOTES GIVEN ON SHEET 2																	REMARKS OR REQUIREMENTS FOR TESTING OF SPECIFIC SAMPLES (REFER TO COL. NO. FOR TYPE OF TEST)			
	TYPE	NO.		TYPE OF TEST	CLASSIFICATION	WATER CONTENT	ATTERBERG LIMITS	PERCENT FINES	GRADATION ANALYSES	SPECIFIC GRAVITY	UNIT WEIGHT	UNDRAINED COMPRESSION	CONSOLIDATED TRIAXIAL	DRAINED DIRECT SHEAR	CONSOLIDATION	COMPACTION	RELATIVE DENSITY	PERMEABILITY						
				1	2	3	4	5	6	7	8	9	10	11	12	13	14	15	16	17				
E3	S	3	10-11 1/2		X	X																		
E3	S	7	30-31 1/2					X																
E4	S	6	25-26 1/2					X																
AR3	S	2	5-6 1/2		X	X																		
AR4	S	2	5-6 1/2		X	X																		
C1	U	3	10-12		X	X			X				X											
B2	U	1	8-10		X	X							X											

added due to unsuitable B3 & B4 soils
soil unsuitable, fractured vertically

JO 05996.01
PRIVATE FUEL STORAGE, LLC
SKULL VALLEY

TABLE 1
LAB TEST RESULTS - % PASSING #200 SIEVE

BORING	SAMPLE	DEPTH (ft)	WATER CONTENT	% PASSING
A1	S7	30-31.5	1.1	4.3
A3	S8	35-36.5	1.3	4.1
A4	S7	30-31.5	3.8	13.9
D1	S5	20-21.5	20.7	91.1
D1	S6	25-26.5	2.9	5.7
D4	S6	25-26.5	18.0	84.2
D4	S7	30-31.5	1.1	3.8
E3	S7	30-31.5	1.5	3.2
E4	S6	25-26.5	20.5	93.9

JO 05996.01
PRIVATE FUEL STORAGE, LLC
SKULL VALLEY

TABLE 2
LAB TEST RESULTS - ATTERBERG LIMITS

BORING	SAMPLE	DEPTH (ft)	WATER CONTENT	LL	PL	PI
B4	U3D	10.4	42.6	42.5	24.7	17.8
C1	U3B	10.8	30.3	33.0	28.1	4.9
C1	U3C	11.2	38.9	47.8	34.6	13.2
C1	U3D	11.4	46.7	61.1	44.1	17.0
C2	U2C	10.9	27.6	34.6	26.9	7.7
C2	U2E	11.7	39.7	41.2	28.5	12.7
E3	S3	10-11.5	37.3	49.9	27.2	22.7
AR3	S2	5-6.5	16.7	29.3	20.3	9.0
AR4	S2	5-6.5	20.5	36.4	30.1	6.3

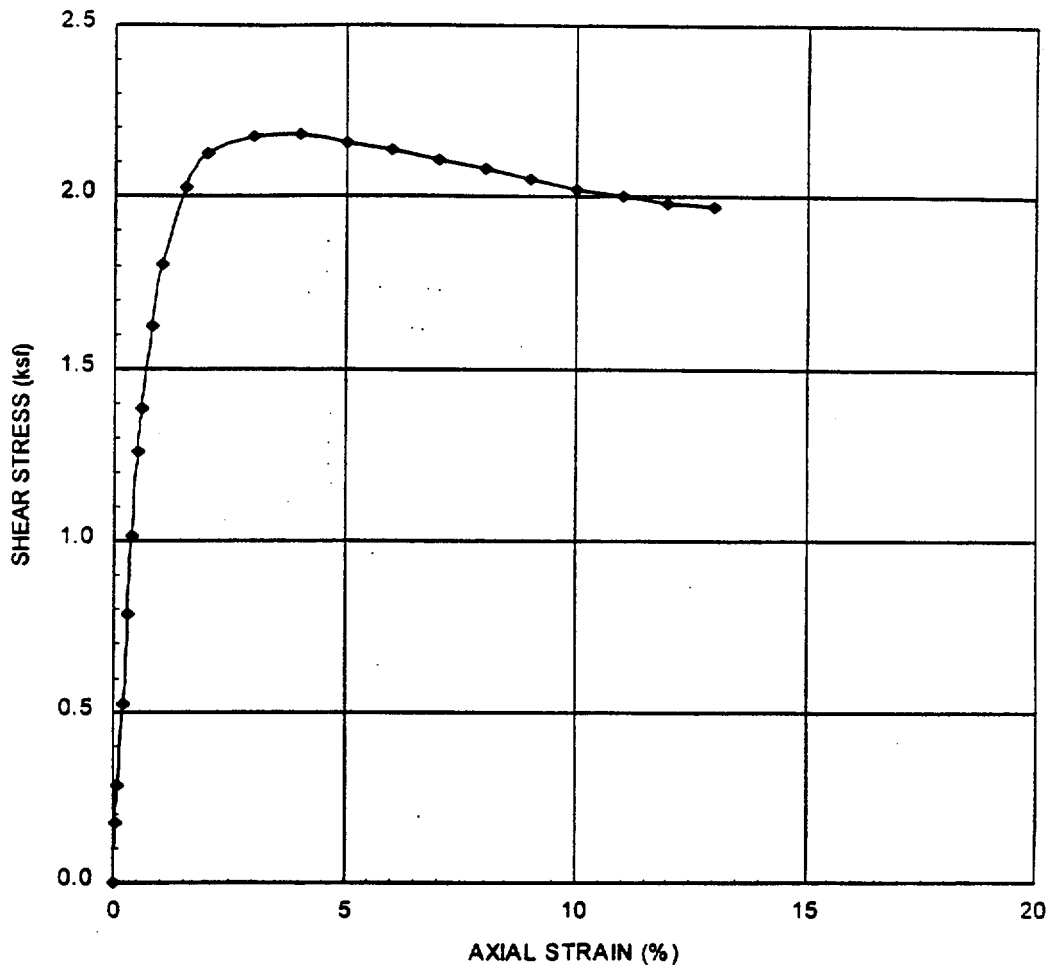

SAMPLE INFORMATION:

BORING: B-4
 SAMPLE: U-3D
 DEPTH: 10.4 ft
 DESCRIPTION: silty CLAY/clayey SILT

DATE: 12/21/96
 TESTED BY: ACS
 CHECKED: PJT

SPECIMEN INFORMATION: (start of shear)

HEIGHT: 0.532 ft
 DIAMETER: 0.238 ft
 AREA: 0.0443 ft²

WATER CONTENT: 27.4 %
 DRY UNIT WEIGHT: 67.1 pcf

TEST DATA:

LOADING: Axial Compression
 CELL PRESSURE: 1.3 ksf

STRAIN RATE: 0.6 %/min

UNDRAINED SHEAR STRENGTH: 2.18 ksf
 COMPRESSIVE STRENGTH: 4.36 ksf
 FAILURE STRAIN: 4.0 %

PRIVATE FUEL STORAGE FACILITY
 SKULL VALLEY
 PRIVATE FUEL STORAGE, LLC



STONE & WEBSTER ENGINEERING CORP.
 BOSTON, MASSACHUSETTS

UNCONSOLIDATED UNDRAINED COMPRESSION TEST
 BORING B-4, SAMPLE U-3D

JO 05996.01
 January 1997

Report No. 05996.01-G(B)-2 Rev 1
SWEC Project No. 05996.01

GEOTECHNICAL DATA REPORT

ATTACHMENT 2

GEOTECHNICAL LABORATORY TESTING

TRIAXIAL TEST PLOTS and DATA

UNCONSOLIDATED UNDRAINED TRIAXIAL COMPRESSION TEST DATA

SAMPLE INFORMATION:

BORING:	B-4	DATE:	12/21/96
SAMPLE:	U-3D	TESTED BY:	ACS
DEPTH:	10.4 ft	CHECKED:	PJT
DESCRIPTION:	silty CLAY/clayey SILT		

SPECIMEN INFORMATION: (start of shear)

HEIGHT:	0.532 ft	WATER CONTENT:	27.4 %
DIAMETER:	0.238 ft	DRY UNIT WEIGHT:	67.1 pcf
AREA:	0.0443 ft ²		

TEST DATA:

LOADING:	Axial Compression	STRAIN RATE:	0.6 %/min
CELL PRESSURE:	1.3 ksf		

UNDRAINED SHEAR STRENGTH:	2.18 ksf
COMPRESSIVE STRENGTH:	4.36 ksf
FAILURE STRAIN:	4.0 %

DIAL READING	FORCE GAGE	AXIAL STRAIN	FORCE	AREA	AXIAL STRESS	SHEAR STRESS
mm	mV	%	kip	sq ft.	ksf	ksf
0.34	2.70	0.00	0.000	0.0443	0.00	0.00
0.42	5.38	0.05	0.016	0.0443	0.35	0.18
0.50	7.06	0.10	0.025	0.0443	0.57	0.29
0.66	10.69	0.20	0.047	0.0444	1.05	0.52
0.83	14.72	0.30	0.070	0.0444	1.57	0.79
0.99	18.23	0.40	0.090	0.0445	2.03	1.02
1.15	22.00	0.50	0.112	0.0445	2.52	1.26
1.31	23.88	0.60	0.123	0.0446	2.77	1.38
1.64	27.64	0.80	0.145	0.0447	3.25	1.63
1.96	30.45	1.00	0.162	0.0447	3.61	1.80
2.77	34.06	1.50	0.183	0.0450	4.06	2.03
3.58	35.70	2.00	0.192	0.0452	4.25	2.12
5.20	36.85	3.00	0.199	0.0457	4.35	2.18
6.83	37.27	4.00	0.201	0.0461	4.36	2.18
8.45	37.27	5.00	0.201	0.0466	4.31	2.16
10.07	37.30	6.00	0.201	0.0471	4.27	2.14
11.69	37.22	7.00	0.201	0.0476	4.22	2.11
13.31	37.13	8.00	0.200	0.0482	4.16	2.08
14.93	37.00	9.00	0.200	0.0487	4.10	2.05
16.56	36.88	10.00	0.199	0.0492	4.04	2.02
18.18	36.92	11.00	0.199	0.0498	4.00	2.00
19.80	37.03	12.00	0.200	0.0503	3.97	1.98
21.42	37.20	13.00	0.201	0.0509	3.94	1.97

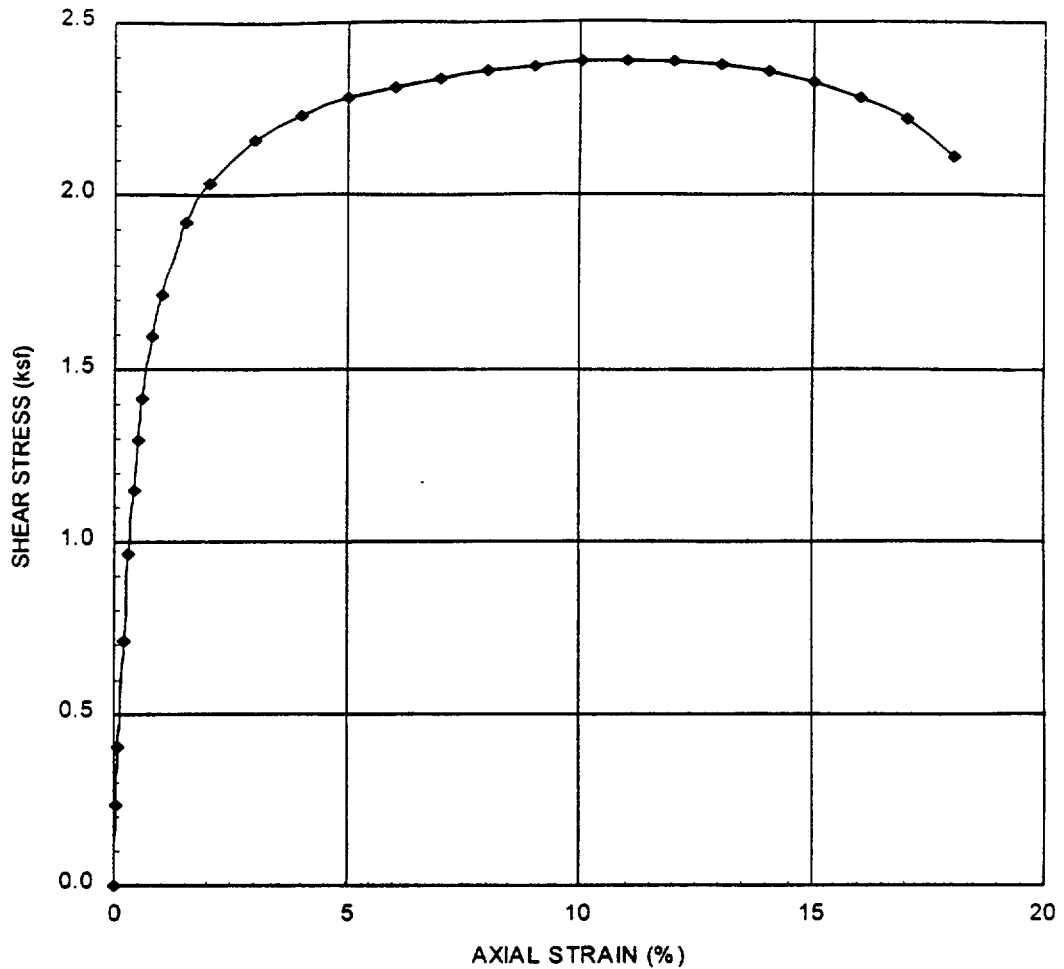

SAMPLE INFORMATION:

BORING: C-2
 SAMPLE: U-2D
 DEPTH: 11.1 ft
 DESCRIPTION: clayey SILT

DATE: 12/18/96
 TESTED BY: ACS
 CHECKED: PJT

SPECIMEN INFORMATION: (start of shear)

HEIGHT: 0.553 ft
 DIAMETER: 0.238 ft
 AREA: 0.0444 ft²

WATER CONTENT: 35.6 %
 DRY UNIT WEIGHT: 57.9 pcf

TEST DATA:

LOADING: Axial Compression
 CELL PRESSURE: 1.3 ksf

STRAIN RATE: 0.6 %/min

UNDRAINED SHEAR STRENGTH: 2.39 ksf
 COMPRESSIVE STRENGTH: 4.77 ksf
 FAILURE STRAIN: 11.0 %

PRIVATE FUEL STORAGE FACILITY
 SKULL VALLEY
 PRIVATE FUEL STORAGE, LLC



STONE & WEBSTER ENGINEERING CORP.
 BOSTON, MASSACHUSETTS

UNCONSOLIDATED UNDRAINED COMPRESSION TEST
 BORING C-2, SAMPLE U-2D

JO 05996.01
 January 1997

UNCONSOLIDATED UNDRAINED TRIAXIAL COMPRESSION TEST DATA

SAMPLE INFORMATION:

BORING:	C-2	DATE:	12/18/96
SAMPLE:	U-2D	TESTED BY:	ACS
DEPTH:	11.1 ft	CHECKED:	PJT
DESCRIPTION:	clayey SILT		

SPECIMEN INFORMATION: (start of shear)

HEIGHT:	0.553 ft	WATER CONTENT:	35.6 %
DIAMETER:	0.238 ft	DRY UNIT WEIGHT:	57.9 pcf
AREA:	0.0444 ft ²		

TEST DATA:

LOADING:	Axial Compression	STRAIN RATE:	0.6 %/min
CELL PRESSURE:	1.3 ksf		

UNDRAINED SHEAR STRENGTH:	2.39 ksf
COMPRESSIVE STRENGTH:	4.77 ksf
FAILURE STRAIN:	11.0 %

DIAL READING	FORCE GAGE	AXIAL STRAIN	FORCE	AREA	AXIAL STRESS	SHEAR STRESS
mm	mV	%	kip	sq ft.	ksf	ksf
0.44	2.73	0.00	0.000	0.0444	0.00	0.00
0.52	6.30	0.05	0.021	0.0444	0.47	0.23
0.61	8.92	0.10	0.036	0.0444	0.81	0.41
0.78	13.65	0.20	0.064	0.0445	1.43	0.71
0.95	17.50	0.30	0.086	0.0445	1.93	0.97
1.12	20.34	0.40	0.102	0.0446	2.30	1.15
1.28	22.60	0.50	0.116	0.0446	2.59	1.30
1.45	24.42	0.60	0.126	0.0447	2.83	1.41
1.79	27.22	0.80	0.143	0.0447	3.19	1.59
2.13	29.13	1.00	0.154	0.0448	3.43	1.71
2.97	32.50	1.50	0.173	0.0451	3.84	1.92
3.82	34.45	2.01	0.185	0.0453	4.08	2.04
5.51	36.75	3.01	0.198	0.0458	4.33	2.16
7.20	38.21	4.01	0.206	0.0462	4.47	2.23
8.89	39.32	5.02	0.213	0.0467	4.56	2.28
10.57	40.24	6.01	0.218	0.0472	4.62	2.31
12.26	41.08	7.02	0.223	0.0477	4.68	2.34
13.95	41.85	8.02	0.228	0.0483	4.72	2.36
15.64	42.46	9.02	0.231	0.0488	4.74	2.37
17.33	43.13	10.03	0.235	0.0493	4.77	2.38
19.02	43.64	11.03	0.238	0.0499	4.77	2.39
20.71	44.05	12.03	0.240	0.0505	4.77	2.38
22.40	44.38	13.04	0.242	0.0510	4.75	2.37
24.09	44.54	14.04	0.243	0.0516	4.71	2.36
25.78	44.48	15.04	0.243	0.0522	4.65	2.33
27.46	44.20	16.04	0.241	0.0529	4.57	2.28
29.15	43.57	17.04	0.238	0.0535	4.44	2.22
30.84	42.00	18.05	0.229	0.0542	4.22	2.11

Report No. 05996.01-G(B)-2 Rev 1
SWEC Project No. 05996.01

GEOTECHNICAL DATA REPORT

ATTACHMENT 2

GEOTECHNICAL LABORATORY TESTING

CONSOLIDATION TEST PLOTS and DATA

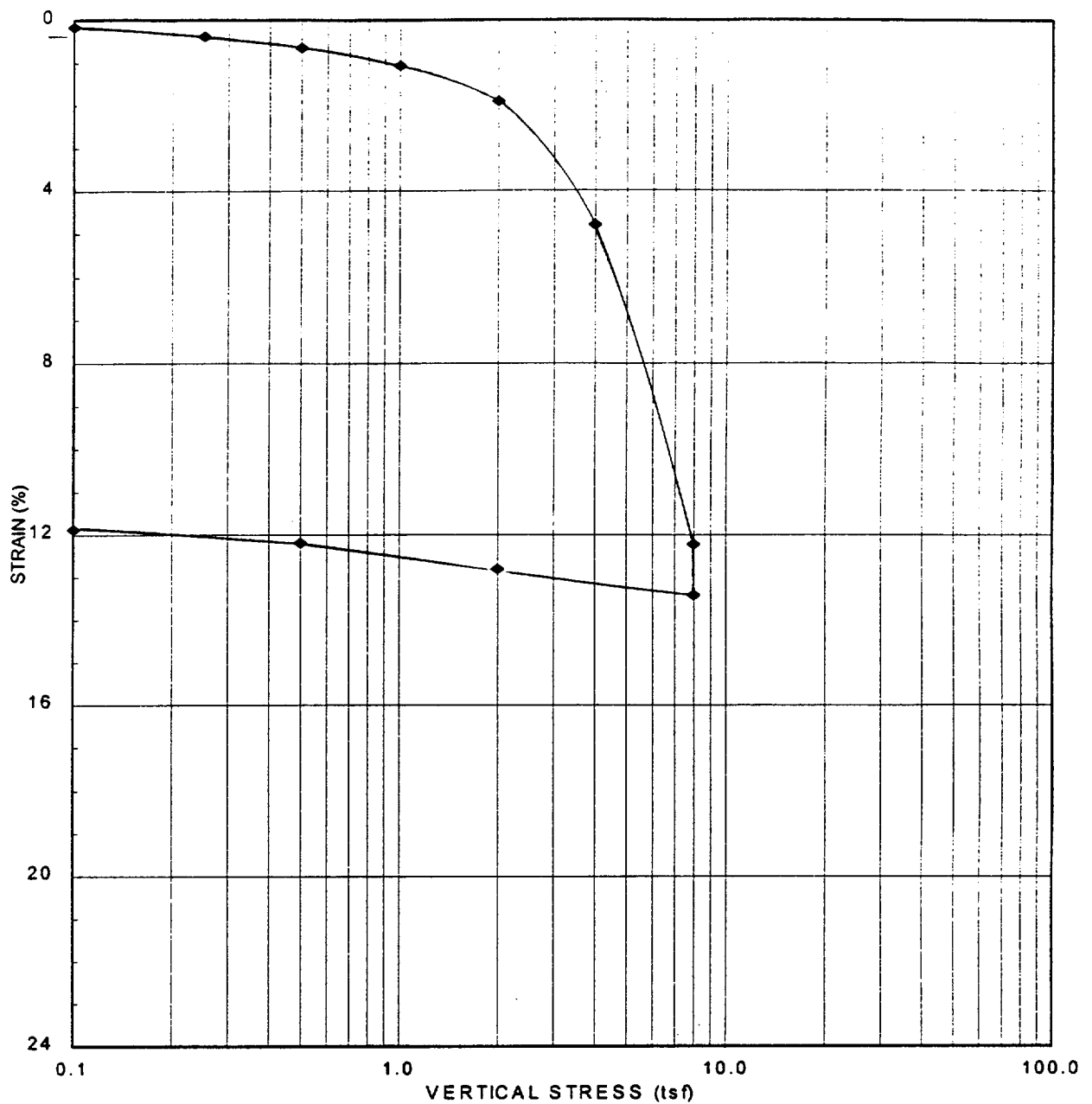

SAMPLE INFORMATION:

BORING: C-1
 SAMPLE: U-3B
 DEPTH: 10.8 ft
 DESCRIPTION: Clayey SILT

DATE: 1/9/97
 TESTED BY: ACS
 CHECKED: PJT

SPECIMEN INFORMATION:

	INITIAL	FINAL
WATER CONTENT:	30.3 %	28.7 %
DRY UNIT WEIGHT:	64.7 pcf	73.4 pcf
VOID RATIO:	1.625	1.315
SATURATION:	50.7 %	59.3 %

SPECIFIC GRAVITY: 2.72 (est)

NOTE: Sample was not inundated and porous stones were dry

PRIVATE FUEL STORAGE FACILITY
 SKULL VALLEY
 PRIVATE FUEL STORAGE, LLC



STONE & WEBSTER ENGINEERING CORP.
 BOSTON, MASSACHUSETTS

CONSOLIDATION TEST RESULTS
 BORING C-1, SAMPLE U-3B

JO 05996.01
 January 1997

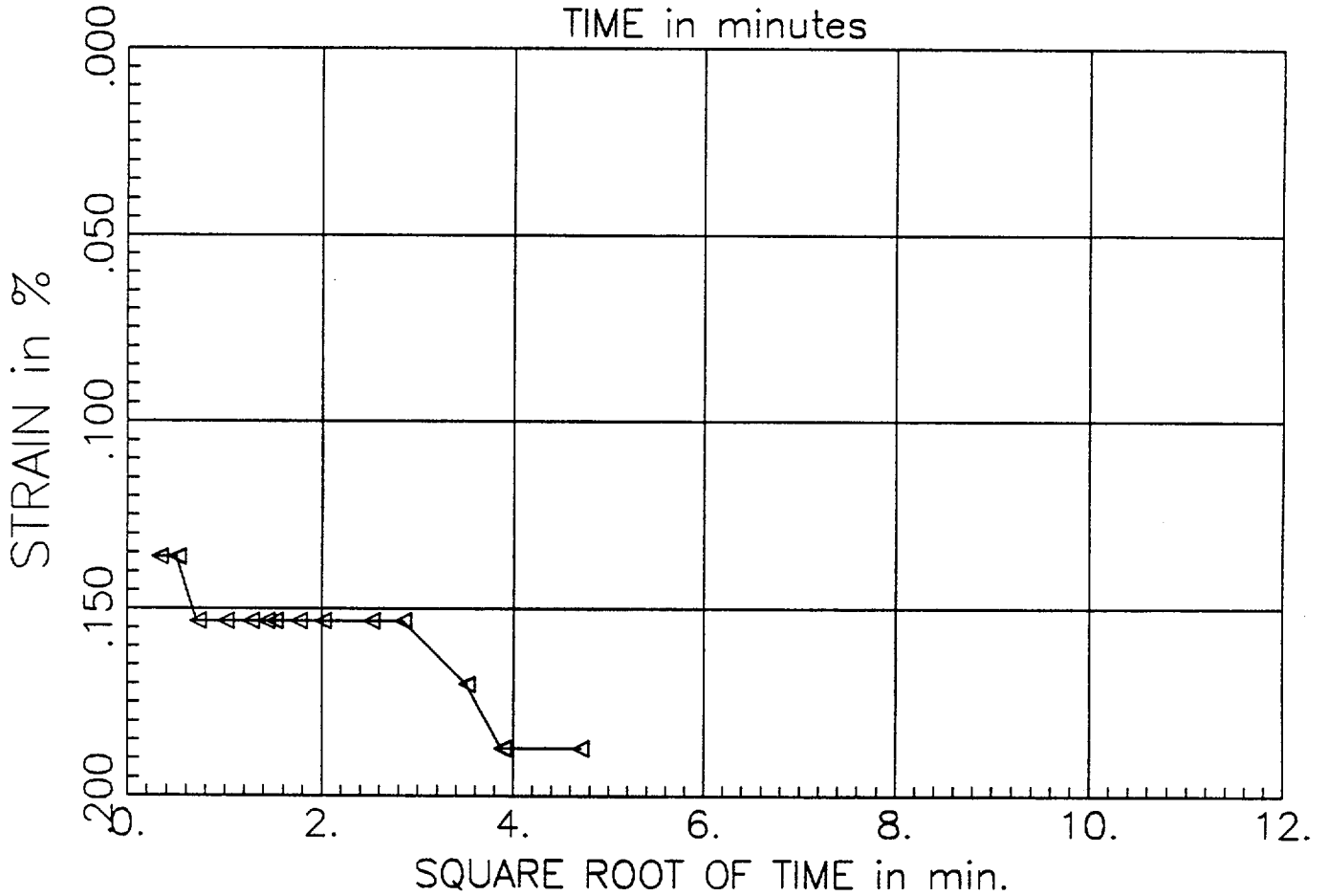
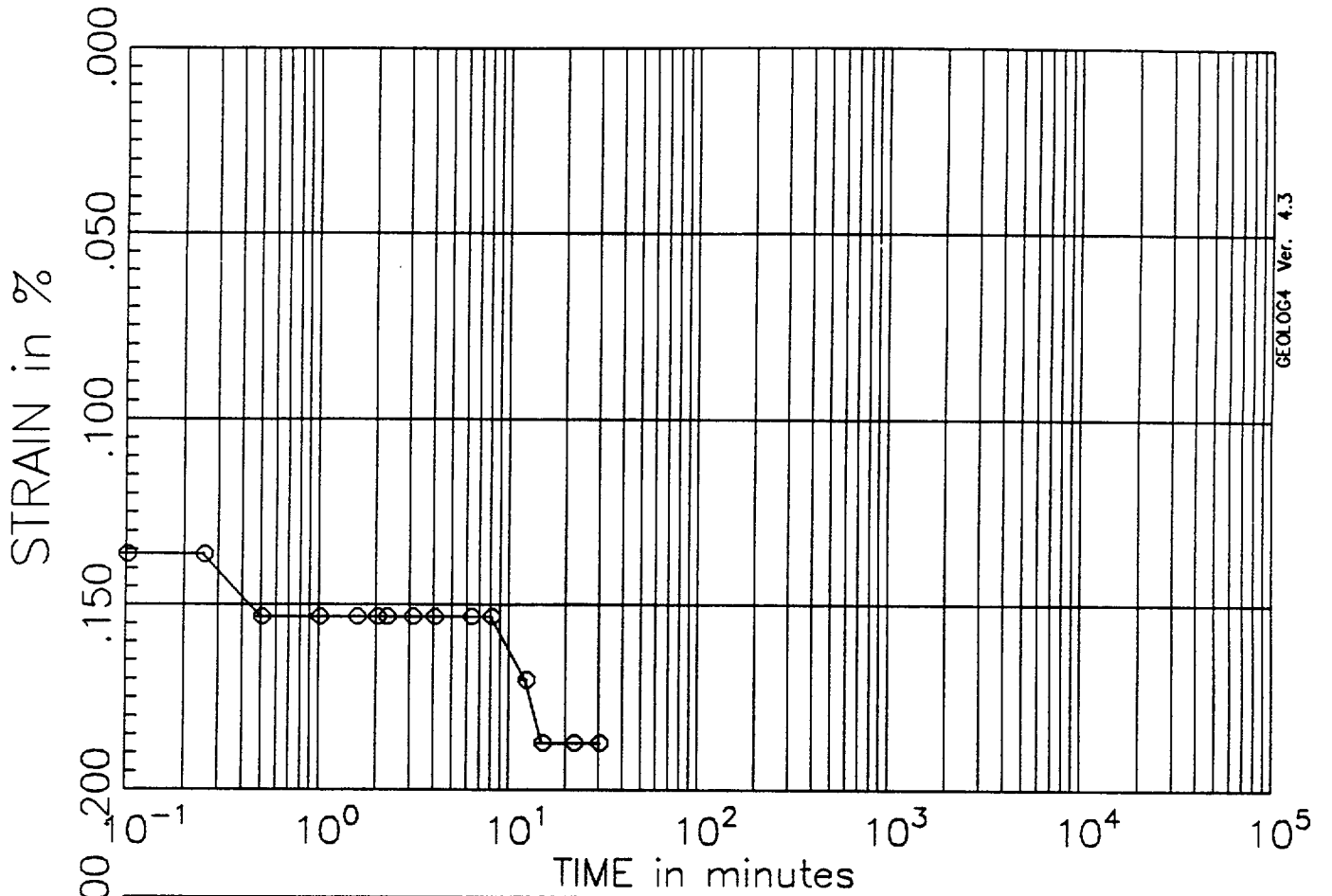

PRESSURE INCREMENT
from 0.00 tsf to 0.10 tsf

Test No: 5
Testname: C1-U3B

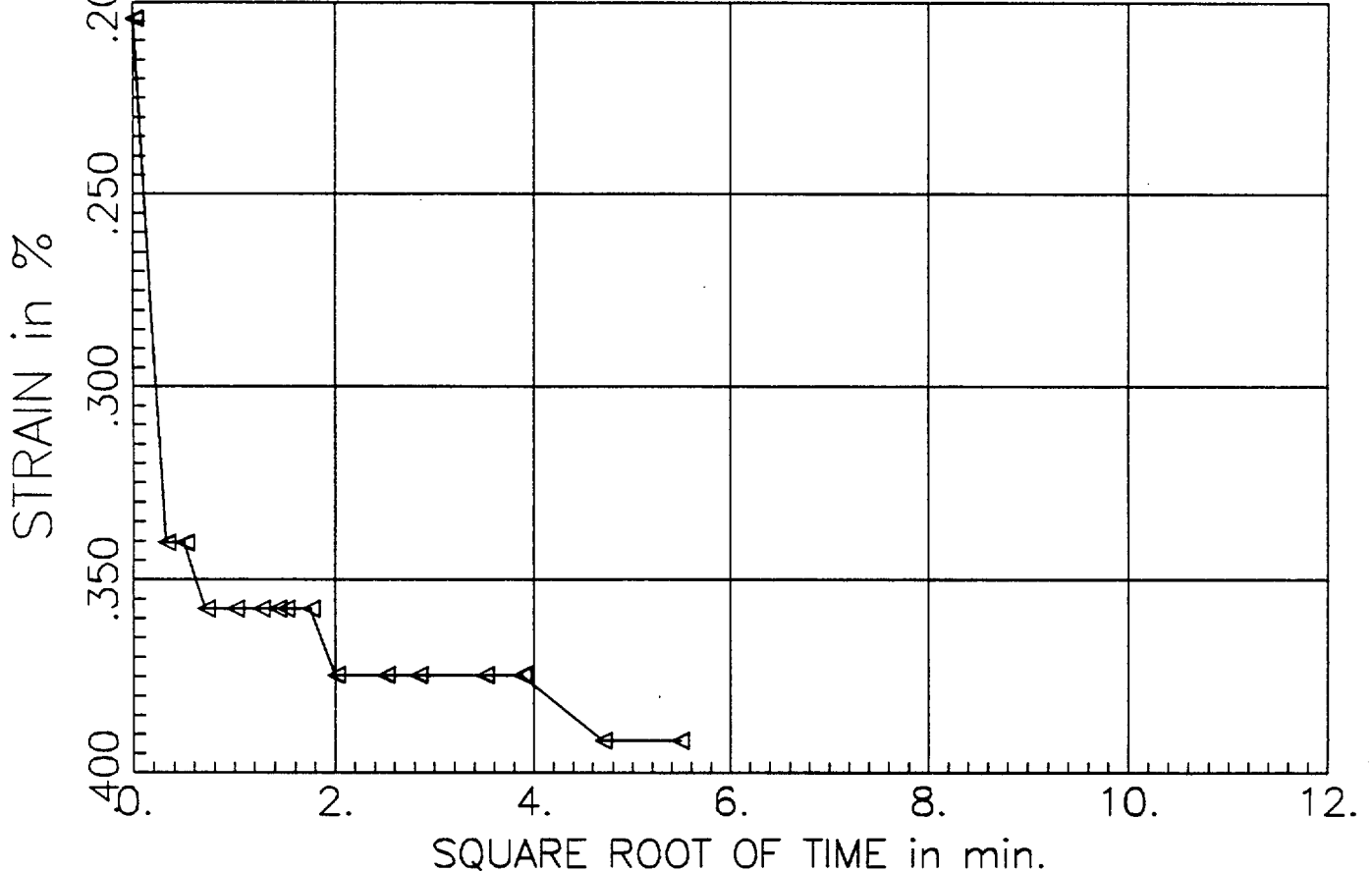
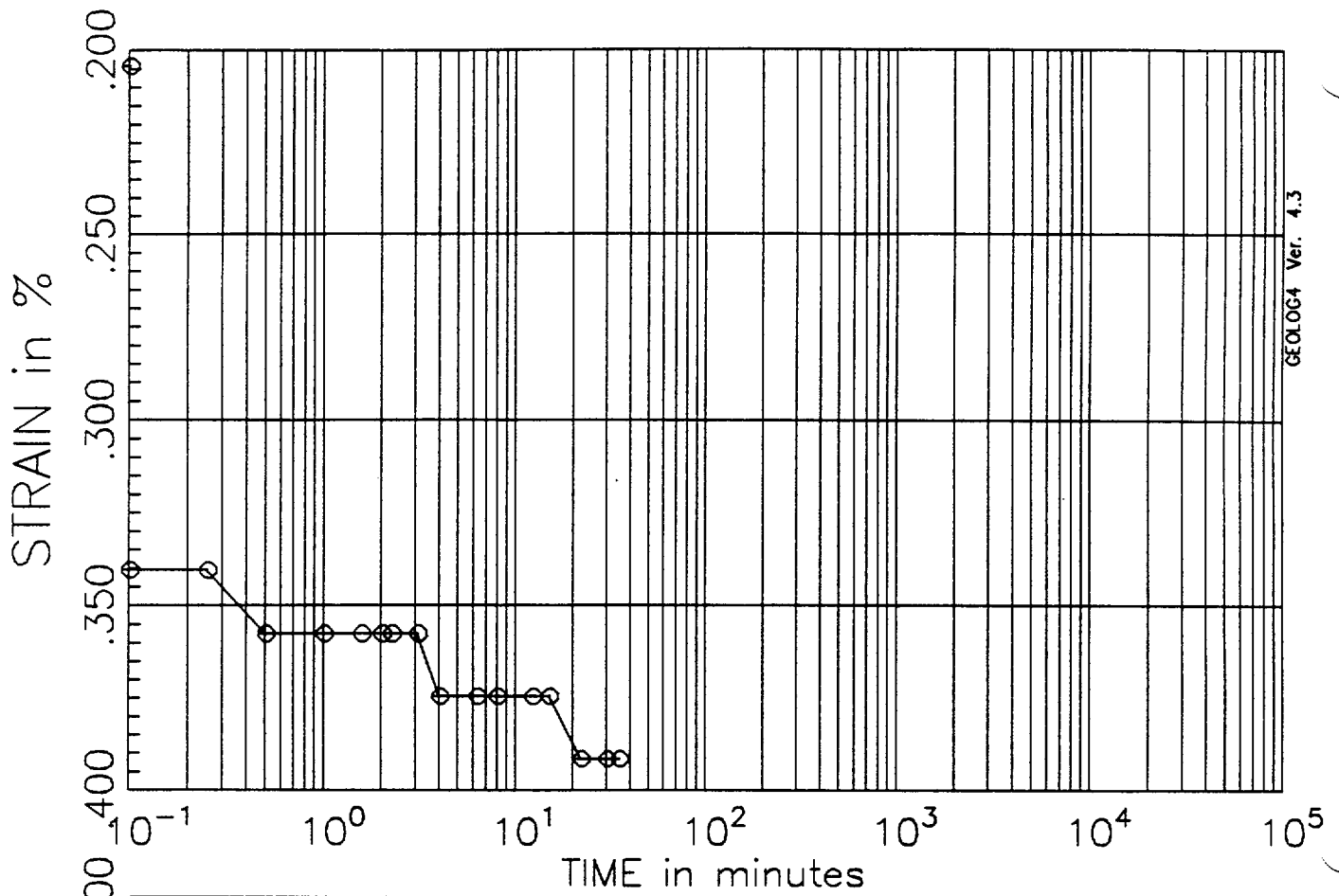

PRESSURE INCREMENT
from 0.10 tsf to 0.25 tsf

Test No: 5
Testname: C1-U3B

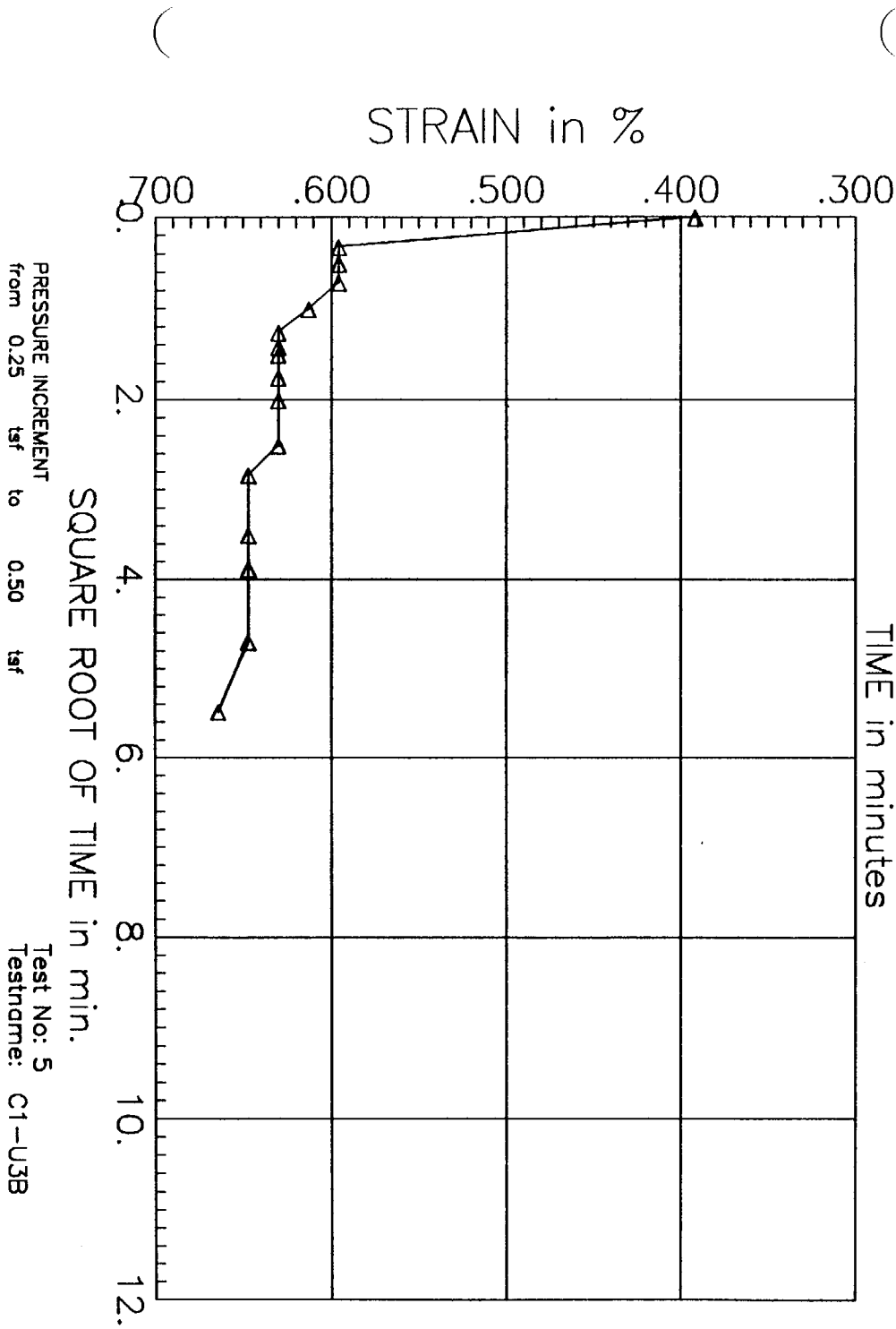
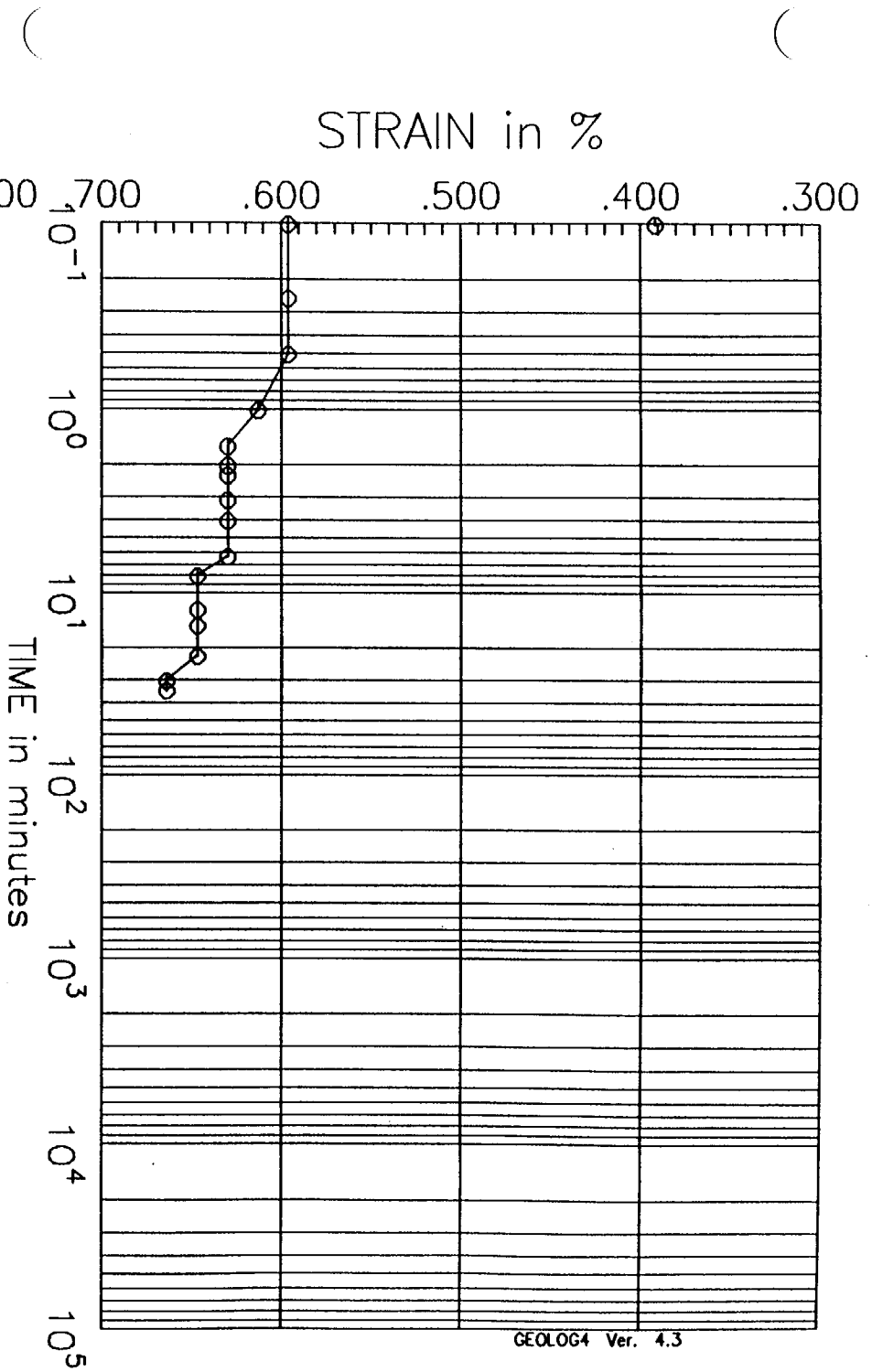

PRESSURE INCREMENT
from 0.25 1st

to 0.50 1st

Test No: 5

Testname: C1-U3B

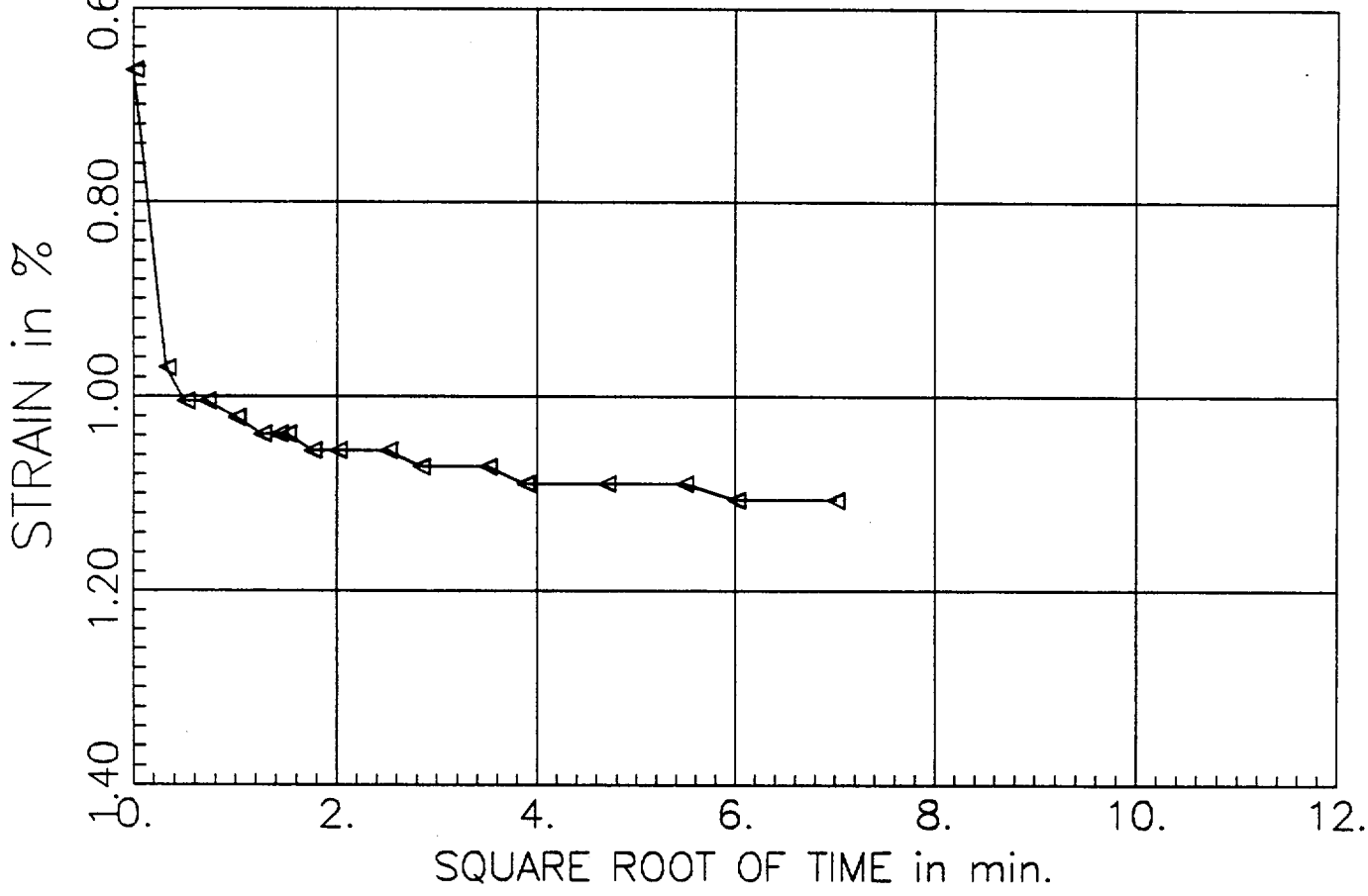
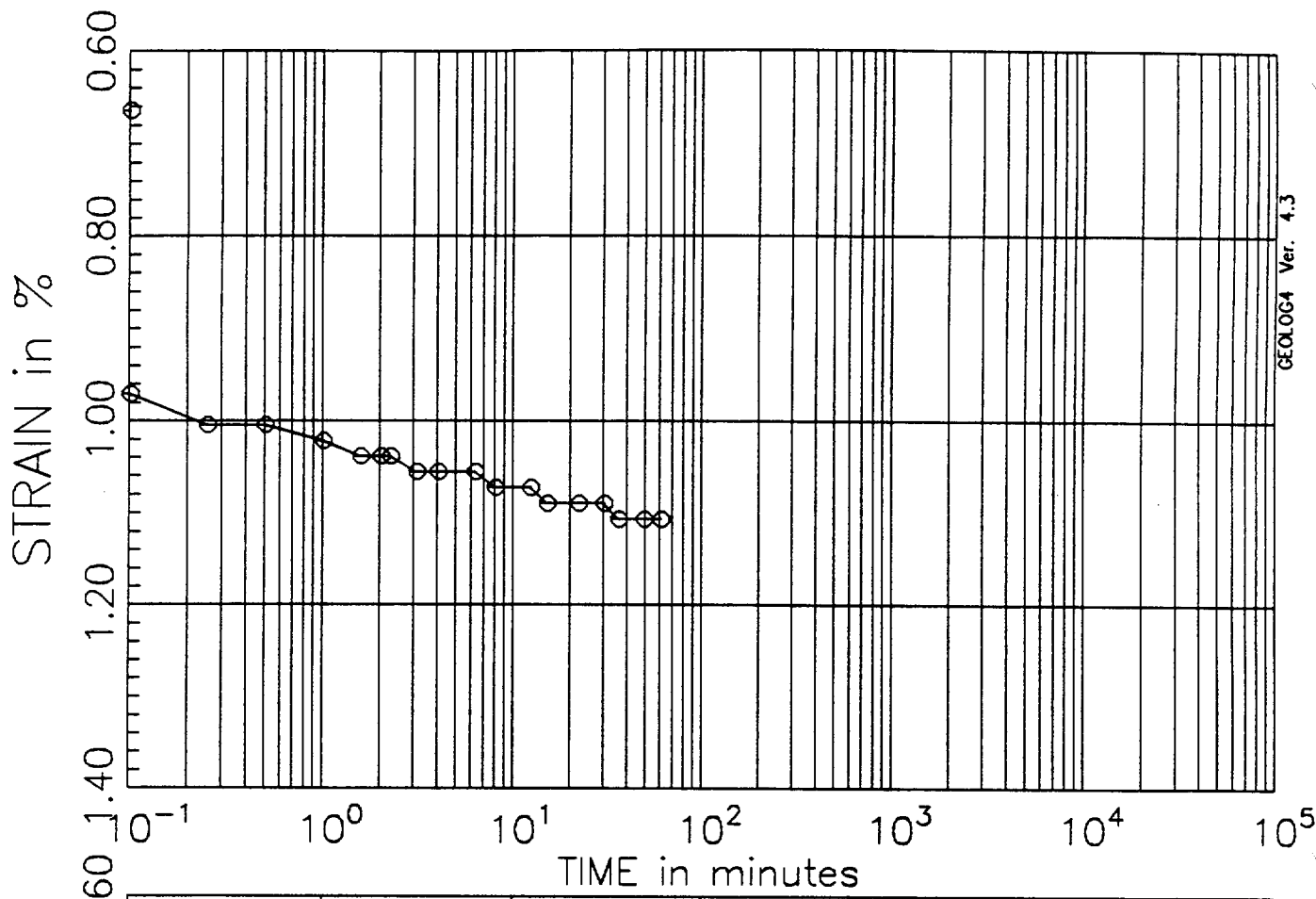

PRESSURE INCREMENT
from 0.50 tsf to 1.00 tsf

Test No: 5
Testname: C1-U3B

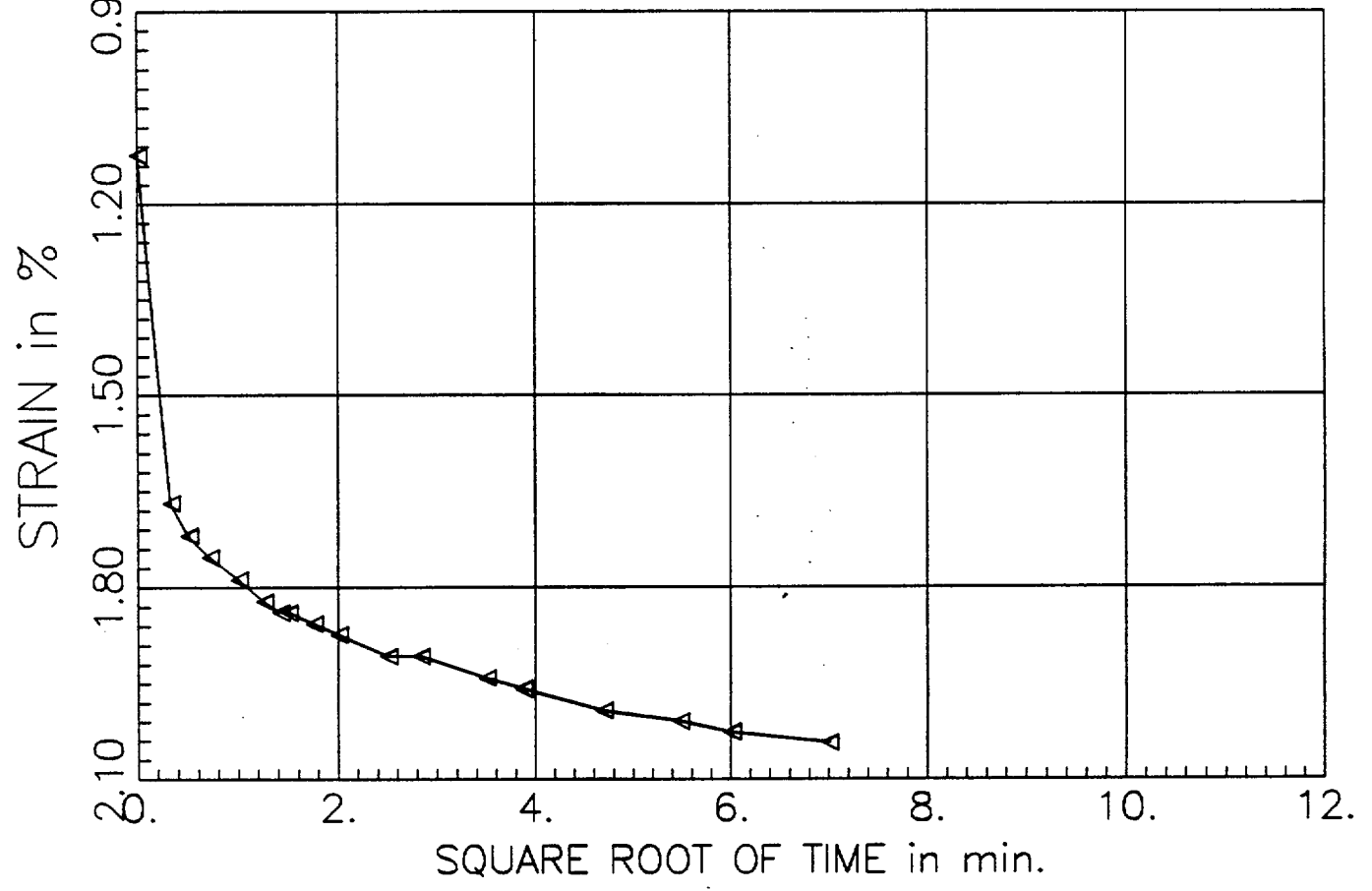
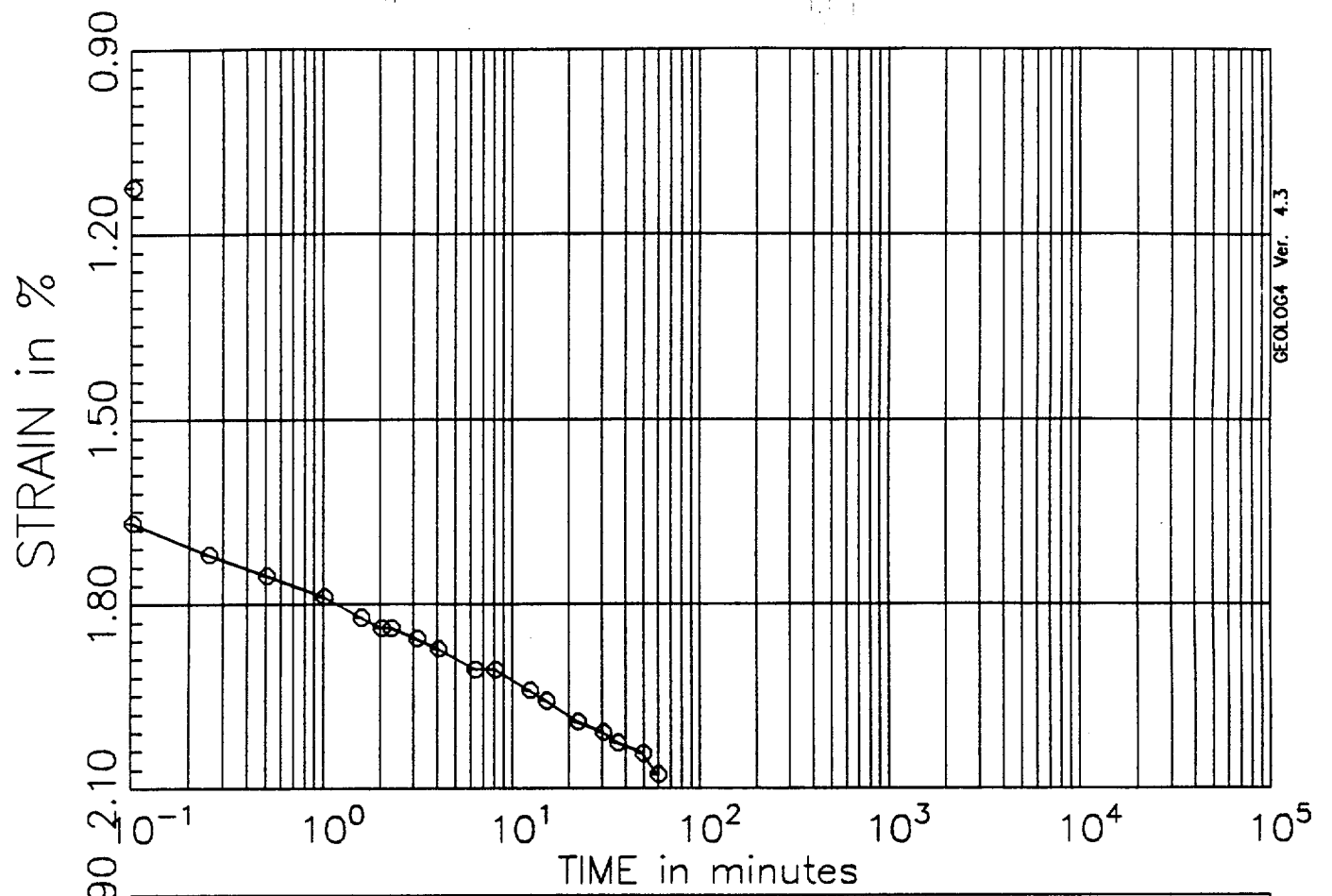

PRESSURE INCREMENT
from 1.00 tsf to 2.00 tsf

Test No: 5
Testname: C1-U3B

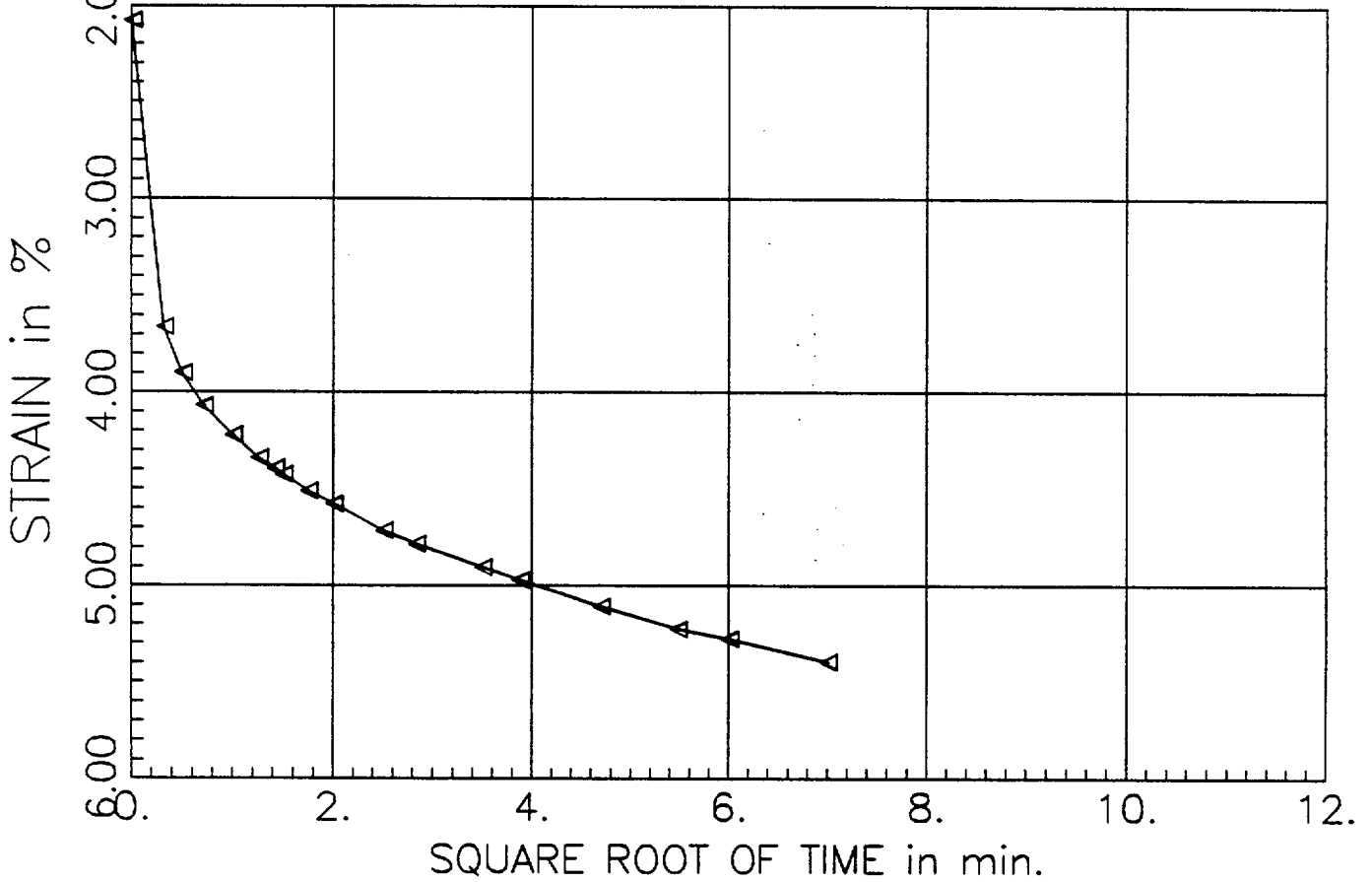
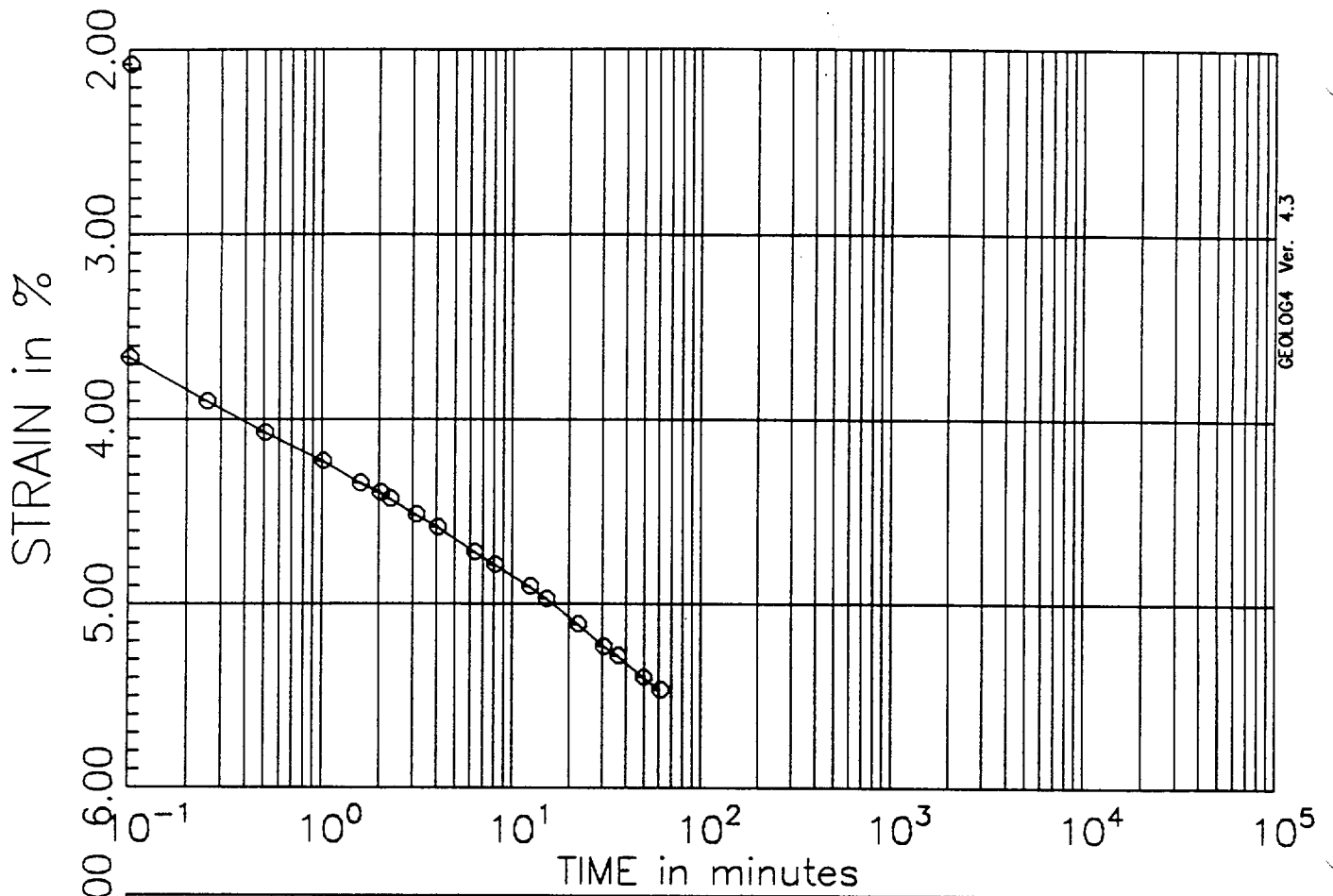

PRESSURE INCREMENT
from 2.00 tsf to 4.00 tsf

Test No: 5
Testname: C1-U3B

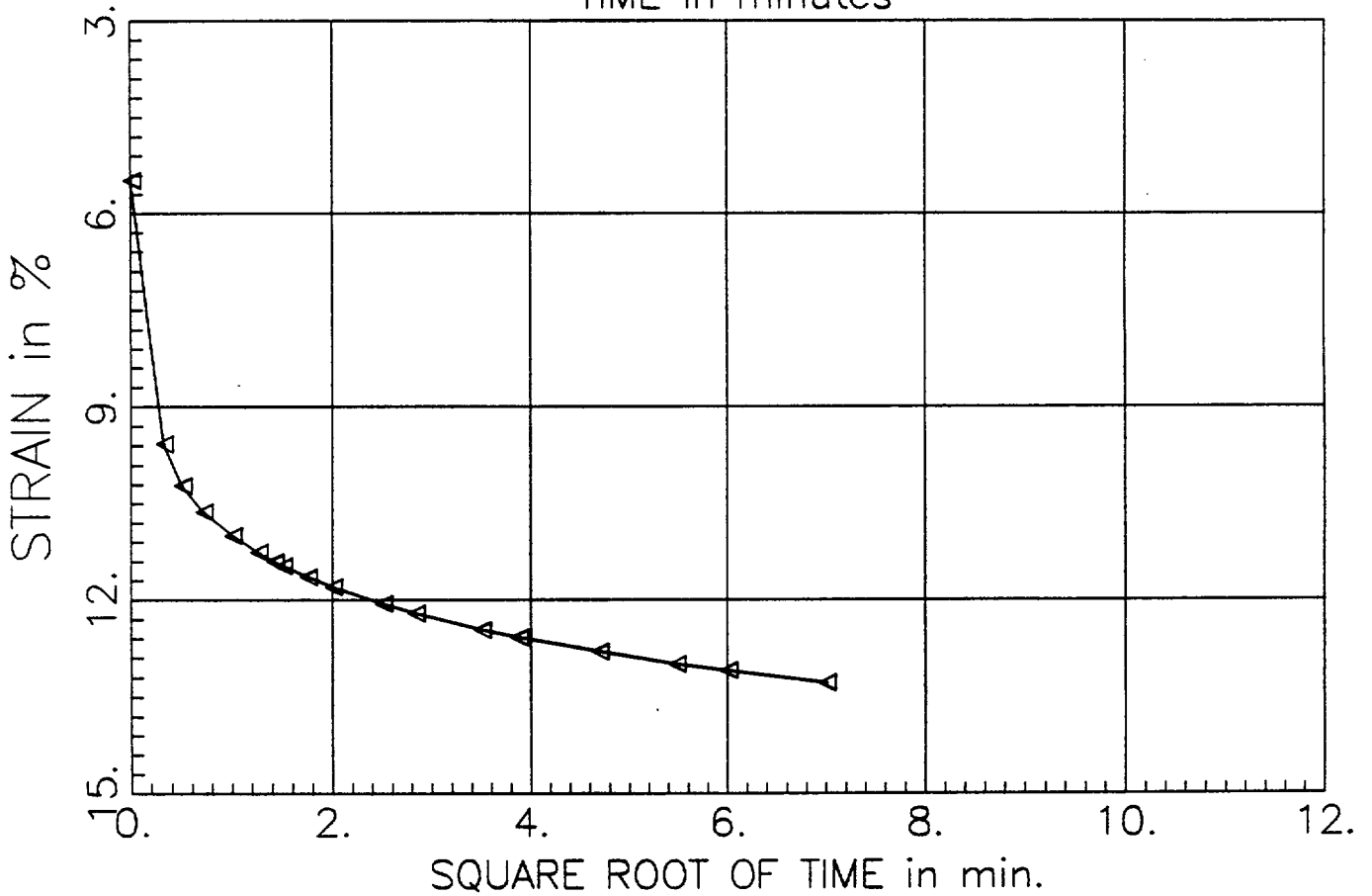
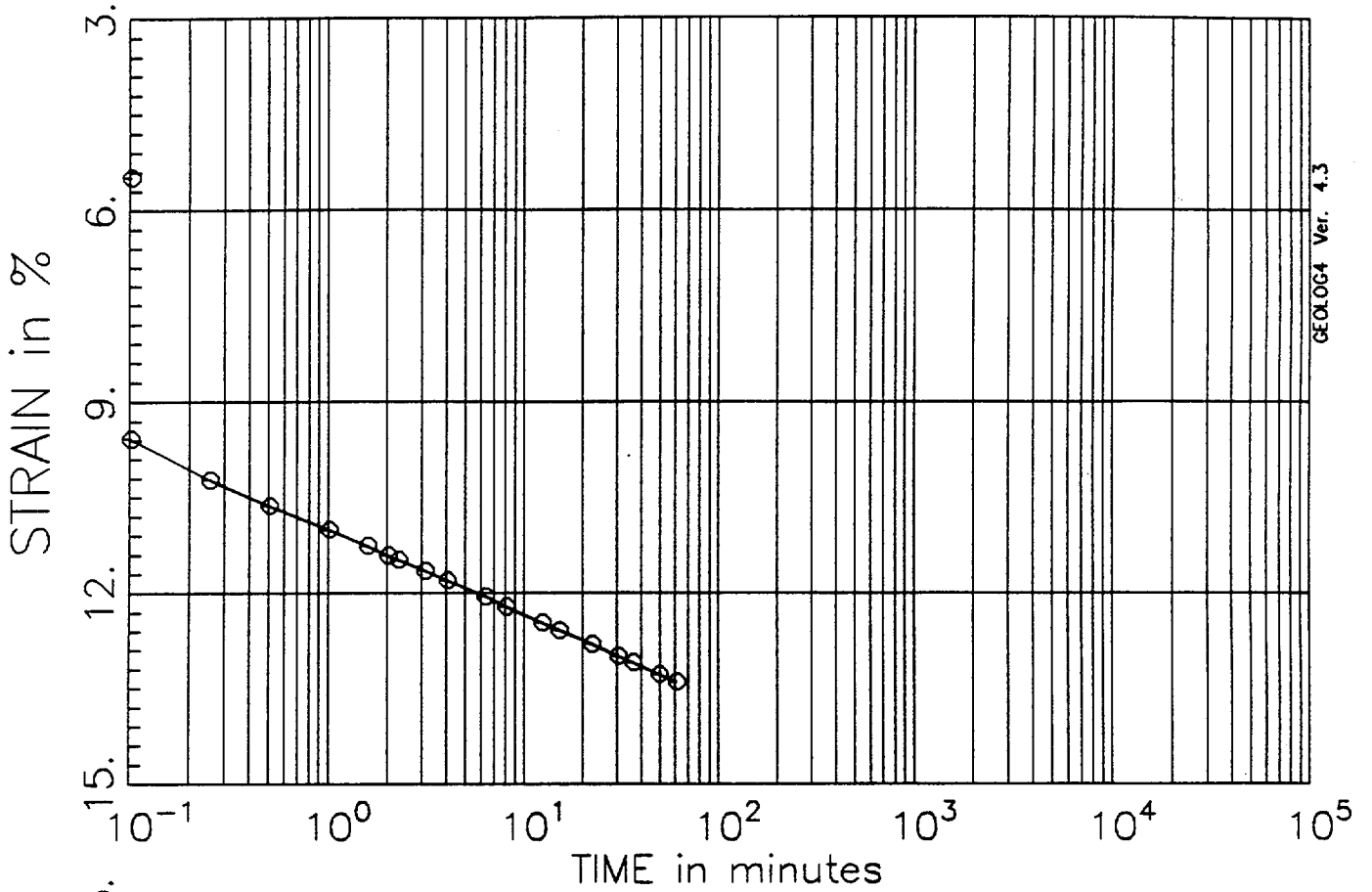

PRESSURE INCREMENT
from 4.00 tsf to 8.00 tsf

Test No: 5
Testname: C1-U3B

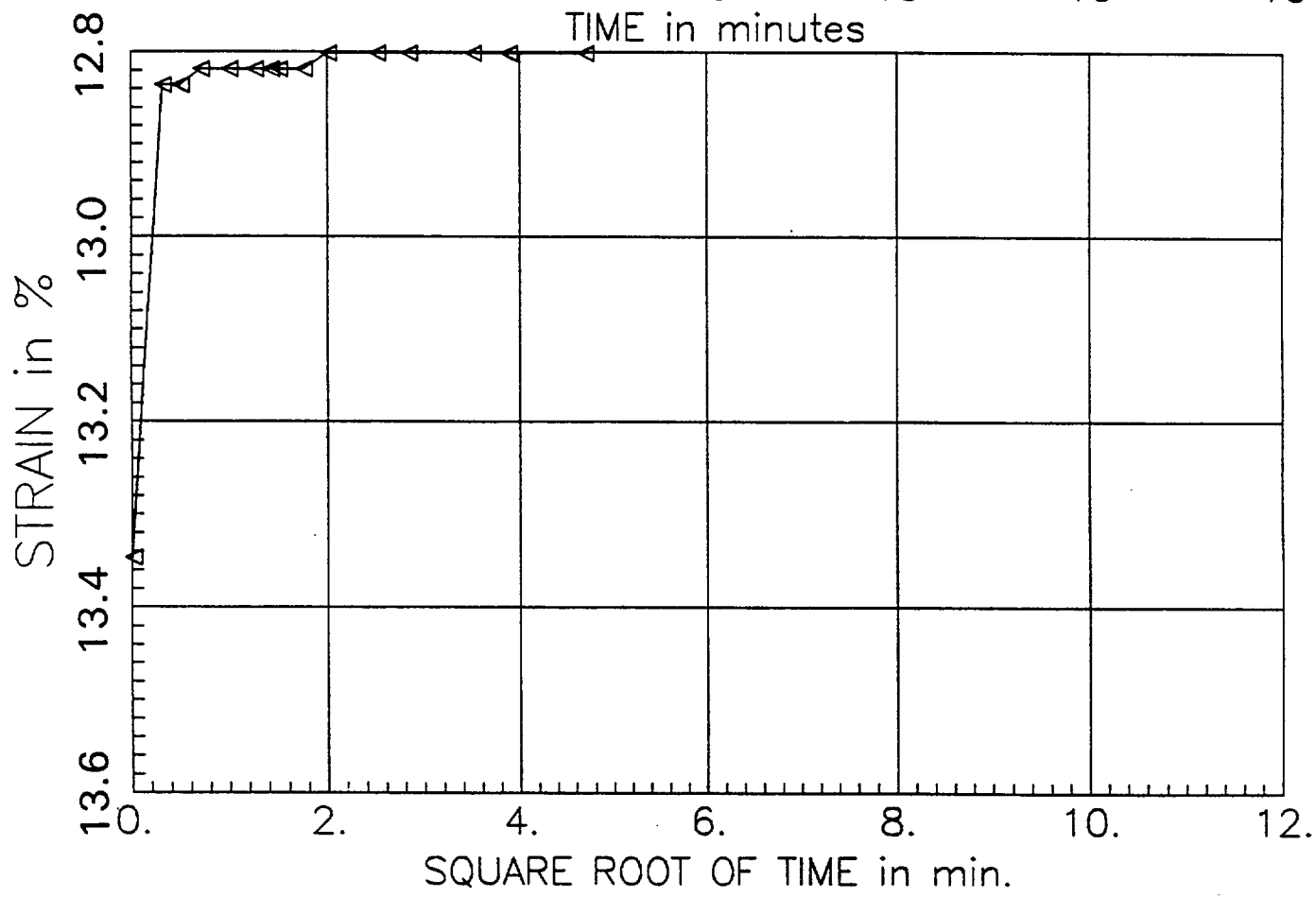
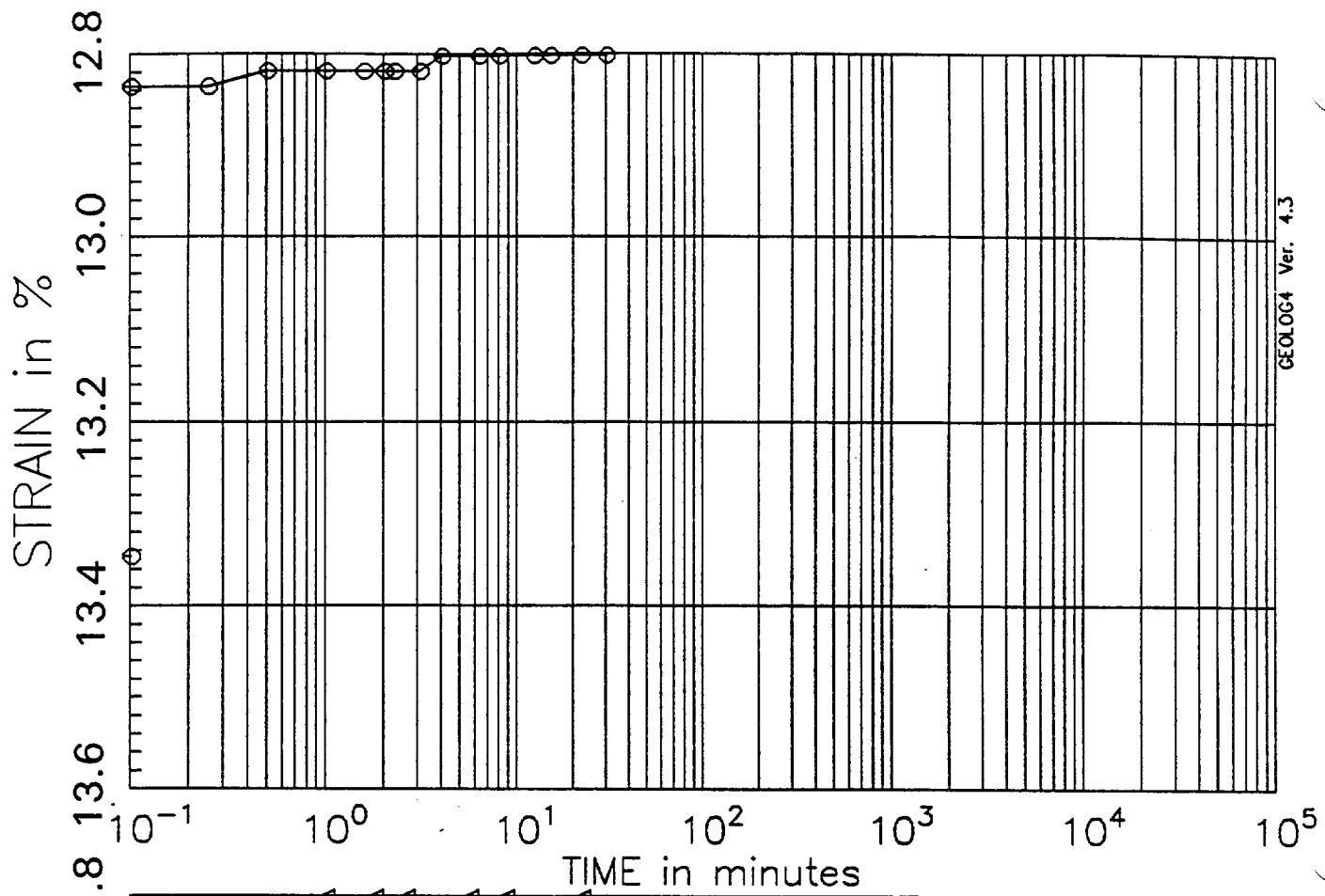

PRESSURE INCREMENT
from 8.00 tsf to 2.00 tsf

Test No: 5
Testname: C1-U3B

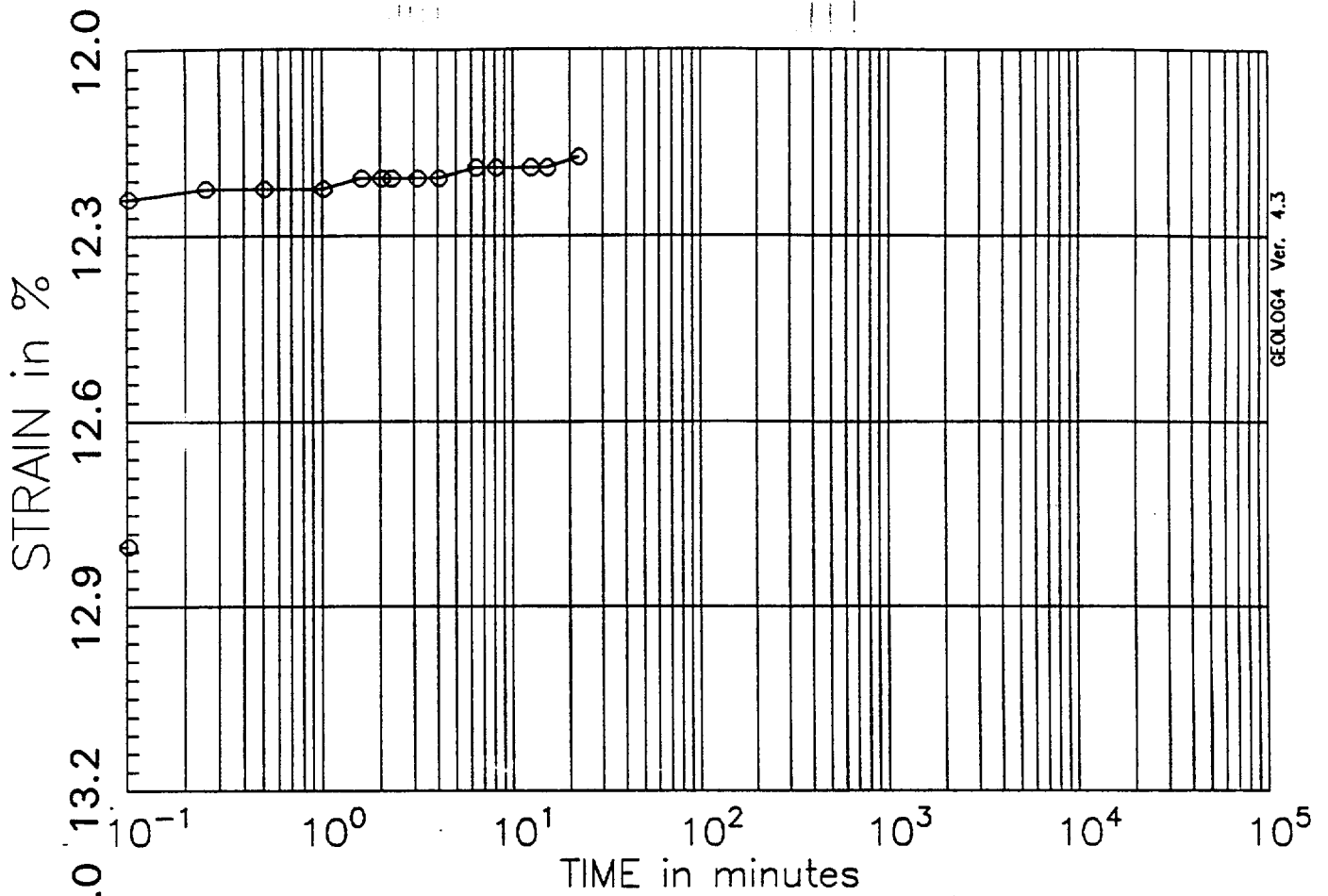

GEOLOG4 Ver. 4.3

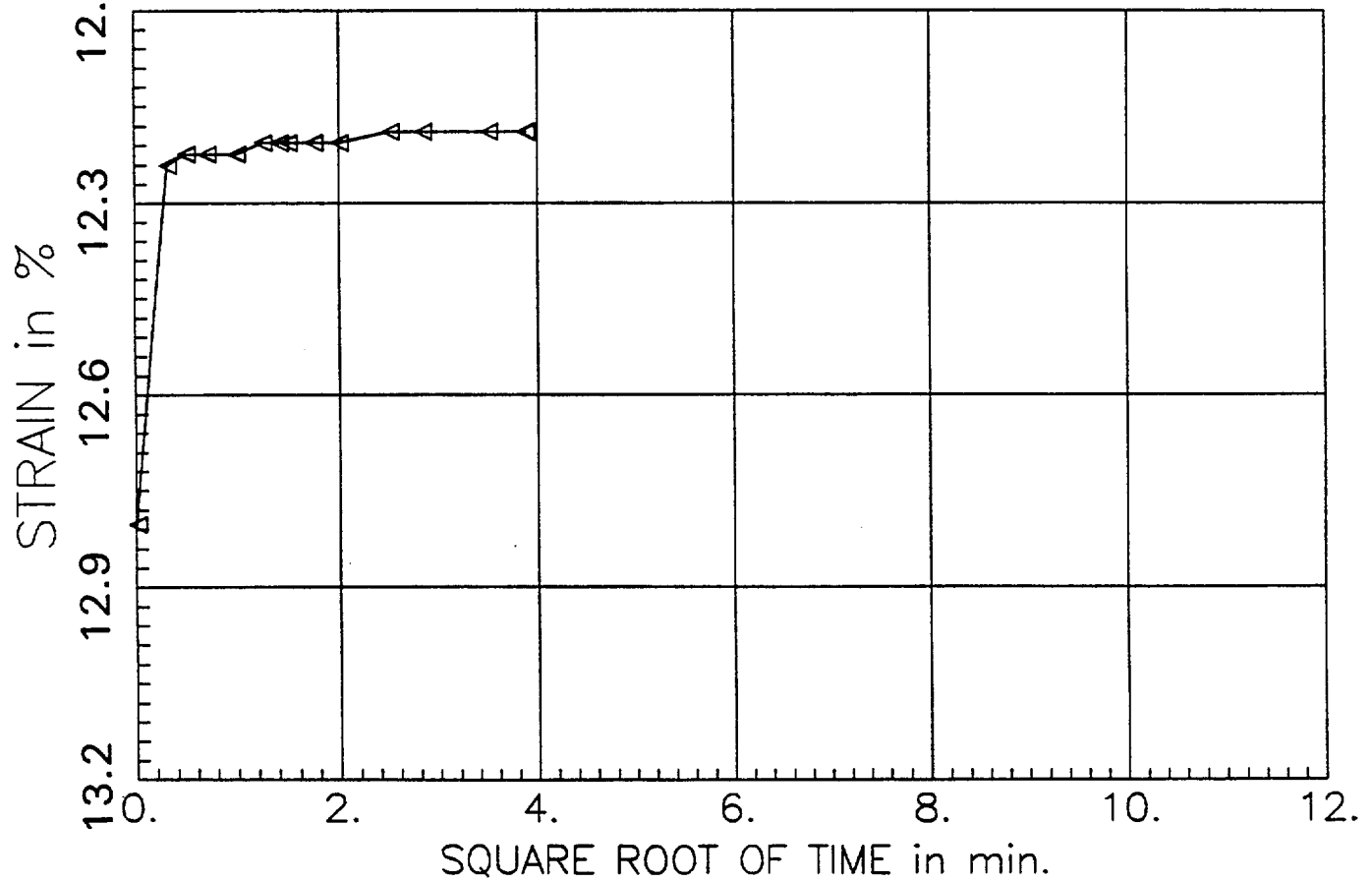

PRESSURE INCREMENT
from 2.00 tsf to 0.50 tsf

Test No: 5
Testname: C1-U3B

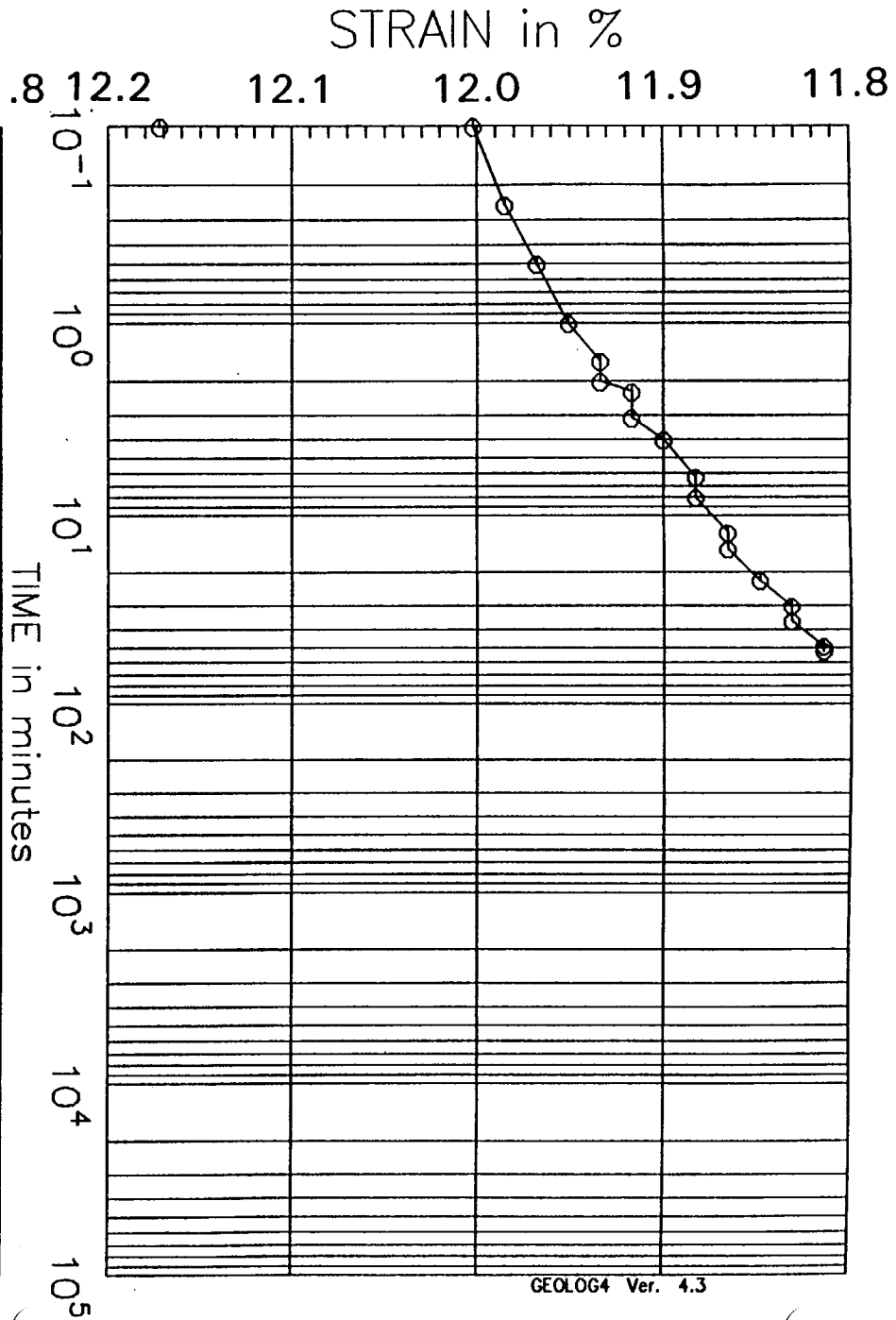
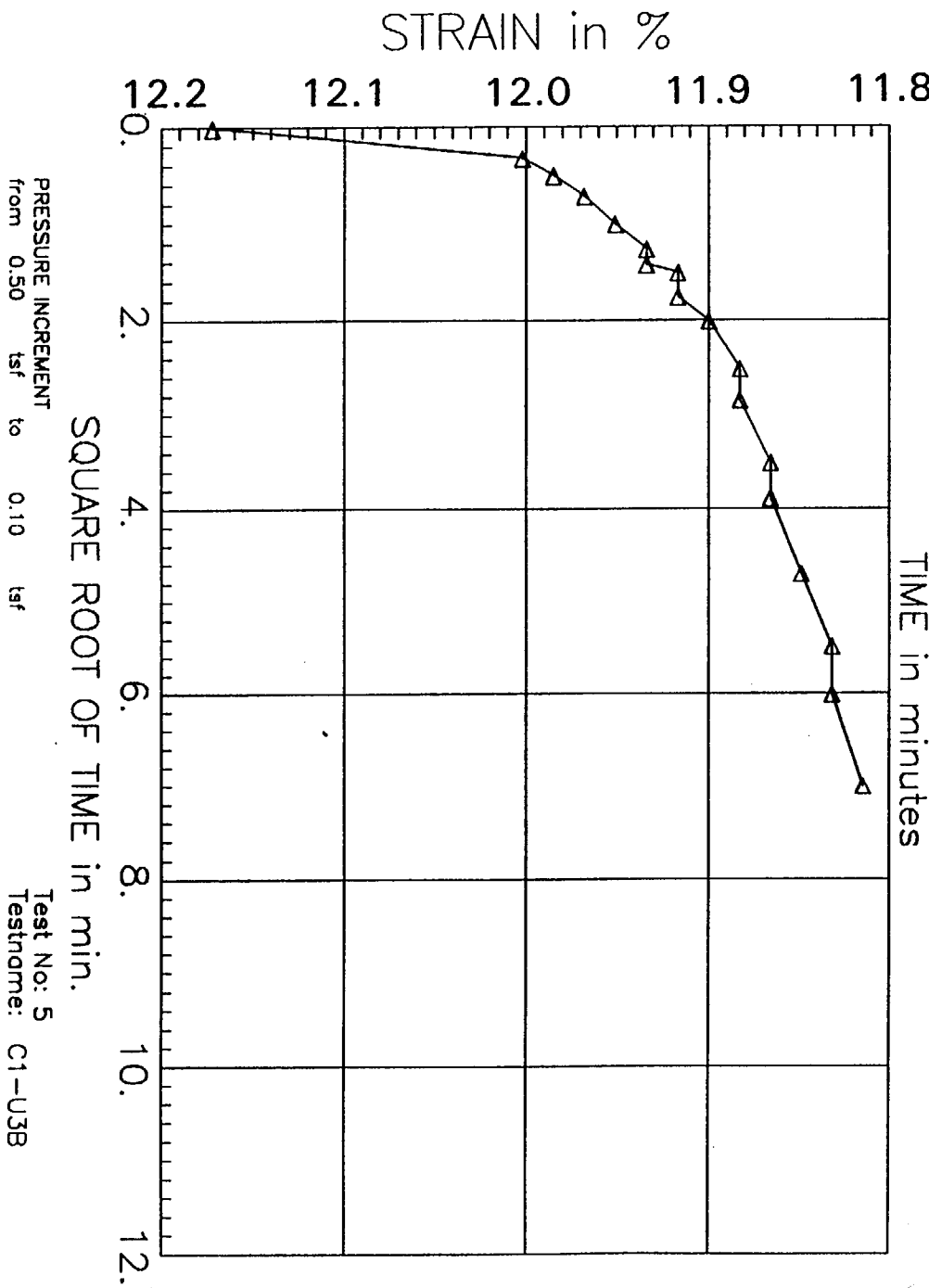

CONSOLIDATION TEST DATA

SAMPLE INFORMATION:

BORING:	C-1	DATE:	1/9/97
SAMPLE:	U-3B	TESTED BY:	ACS
DEPTH:	10.8 ft	CHECKED:	PJT
DESCRIPTION:	Clayey SILT		

SPECIMEN INFORMATION:

	INITIAL	FINAL
WATER CONTENT:	30.3 %	28.7 %
DRY UNIT WEIGHT:	64.7 pcf	73.4 pcf
VOID RATIO:	1.625	1.315
SATURATION:	50.7 %	59.3 %
HEIGHT:	1.893 cm	1.669 cm
AREA:	31.63 sq cm	
SP. GRAVITY :	2.72 (est)	

TEST DATA:

APPLIED PRESSURE	STRAIN
tsf	%
0.10	0.15
0.25	0.37
0.50	0.65
1.00	1.07
2.00	1.91
4.00	4.78
8.00	12.21
8.00	13.40
2.00	12.80
0.50	12.19
0.10	11.88

LOAD INCREMENT DATA

TEST NAME: C1-U3B
 TESTED BY: ACS

PAGE NO: 1
 JO: 05996.01

PRESSURE INCREMENT FROM 0.00 tsf to 0.10 tsf

DATE	TIME	ELAPSED TIME (min)	SQ RT OF TIME(min)	CHANGE IN HEIGHT(in)	VOID RATIO	STRAIN (%)
01-09-97	09:36:19	0.10	0.32	0.0010	1.621	0.14
		0.25	0.50	0.0010	1.621	0.14
		0.50	0.71	0.0011	1.621	0.15
		1.00	1.00	0.0011	1.621	0.15
		1.57	1.25	0.0011	1.621	0.15
		2.00	1.41	0.0011	1.621	0.15
		2.25	1.50	0.0011	1.621	0.15
		3.07	1.75	0.0011	1.621	0.15
		4.00	2.00	0.0011	1.621	0.15
		6.25	2.50	0.0011	1.621	0.15
		8.00	2.83	0.0011	1.621	0.15
		12.25	3.50	0.0013	1.621	0.17
		15.00	3.87	0.0014	1.620	0.19
		22.00	4.69	0.0014	1.620	0.19
		30.00	5.48	0.0014	1.620	0.19

LOAD INCREMENT DATA

TEST NAME C1-U3B
 TESTED BY: ACS

PAGE NO: 2
 JO: 05996.01

PRESSURE INCREMENT FROM 0.10 tsf to 0.25 tsf

DATE	TIME	ELAPSED TIME (min)	SQ RT OF TIME(min)	CHANGE IN HEIGHT(in)	VOID RATIO	STRAIN (%)
01-09-97	10:09:47	0.00	0.00	0.0015	1.620	0.20
		0.10	0.32	0.0025	1.616	0.34
		0.25	0.50	0.0025	1.616	0.34
		0.50	0.71	0.0027	1.616	0.36
		1.00	1.00	0.0027	1.616	0.36
		1.57	1.25	0.0027	1.616	0.36
		2.00	1.41	0.0027	1.616	0.36
		2.25	1.50	0.0027	1.616	0.36
		3.07	1.75	0.0027	1.616	0.36
		4.00	2.00	0.0028	1.615	0.37
		6.25	2.50	0.0028	1.615	0.37
		8.00	2.83	0.0028	1.615	0.37
		12.25	3.50	0.0028	1.615	0.37
		15.00	3.87	0.0028	1.615	0.37
		22.00	4.69	0.0029	1.615	0.39
		30.00	5.48	0.0029	1.615	0.39
		35.00	5.92	0.0029	1.615	0.39

LOAD INCREMENT DATA

TEST NAME C1-U3B
 TESTED BY: ACS

PAGE NO: 3
 JO: 05996.01

PRESSURE INCREMENT FROM 0.25 tsf to 0.50 tsf

DATE	TIME	ELAPSED TIME (min)	SQ RT OF TIME(min)	CHANGE IN HEIGHT(in)	VOID RATIO	STRAIN (%)
01-09-97	10:45:24	0.00	0.00	0.0029	1.615	0.39
		0.10	0.32	0.0044	1.609	0.60
		0.25	0.50	0.0044	1.609	0.60
		0.50	0.71	0.0044	1.609	0.60
		1.00	1.00	0.0046	1.609	0.61
		1.57	1.25	0.0047	1.608	0.63
		2.00	1.41	0.0047	1.608	0.63
		2.25	1.50	0.0047	1.608	0.63
		3.07	1.75	0.0047	1.608	0.63
		4.00	2.00	0.0047	1.608	0.63
		6.25	2.50	0.0047	1.608	0.63
		8.00	2.83	0.0048	1.608	0.65
		12.25	3.50	0.0048	1.608	0.65
		15.00	3.87	0.0048	1.608	0.65
		22.00	4.69	0.0048	1.608	0.65
		30.00	5.48	0.0049	1.608	0.66
		34.00	5.83	0.0049	1.608	0.66

LOAD INCREMENT DATA

TEST NAME C1-U3B
TESTED BY: ACS

PAGE NO: 4
JO: 05996.01

PRESSURE INCREMENT FROM 0.50 tsf to 1.00 tsf

DATE	TIME	ELAPSED TIME (min)	SQ RT OF TIME(min)	CHANGE IN HEIGHT(in)	VOID RATIO	STRAIN (%)
01-09-97	11:20:05	0.00	0.00	0.0049	1.608	0.66
		0.10	0.32	0.0072	1.600	0.97
		0.25	0.50	0.0075	1.599	1.00
		0.50	0.71	0.0075	1.599	1.00
		1.00	1.00	0.0076	1.598	1.02
		1.57	1.25	0.0077	1.598	1.04
		2.00	1.41	0.0077	1.598	1.04
		2.25	1.50	0.0077	1.598	1.04
		3.07	1.75	0.0079	1.597	1.06
		4.00	2.00	0.0079	1.597	1.06
		6.25	2.50	0.0079	1.597	1.06
		8.00	2.83	0.0080	1.597	1.07
		12.25	3.50	0.0080	1.597	1.07
		15.00	3.87	0.0081	1.596	1.09
		22.00	4.69	0.0081	1.596	1.09
		30.00	5.48	0.0081	1.596	1.09
		36.00	6.00	0.0082	1.596	1.11
		49.00	7.00	0.0082	1.596	1.11
		60.00	7.75	0.0082	1.596	1.11

LOAD INCREMENT DATA

TEST NAME C1-U3B
 TESTED BY: ACS

PAGE NO: 5
 JO: 05996.01

PRESSURE INCREMENT FROM 1.00 tsf to 2.00 tsf

DATE	TIME	ELAPSED TIME (min)	SQ RT OF TIME(min)	CHANGE IN HEIGHT(in)	VOID RATIO	STRAIN (%)
01-09-97	12:21:07	0.00	0.00	0.0084	1.596	1.12
		0.10	0.32	0.0124	1.581	1.67
		0.25	0.50	0.0128	1.580	1.72
		0.50	0.71	0.0131	1.579	1.75
		1.00	1.00	0.0133	1.578	1.79
		1.57	1.25	0.0136	1.577	1.82
		2.00	1.41	0.0137	1.577	1.84
		2.25	1.50	0.0137	1.577	1.84
		3.07	1.75	0.0138	1.576	1.86
		4.00	2.00	0.0140	1.576	1.87
		6.25	2.50	0.0142	1.575	1.91
		8.00	2.83	0.0142	1.575	1.91
		12.25	3.50	0.0145	1.574	1.94
		15.00	3.87	0.0146	1.574	1.96
		22.00	4.69	0.0148	1.573	1.99
		30.00	5.48	0.0150	1.572	2.01
		36.00	6.00	0.0151	1.572	2.03
		49.00	7.00	0.0152	1.571	2.04
		59.00	7.68	0.0155	1.570	2.08

LOAD INCREMENT DATA

TEST NAME C1-U3B
 TESTED BY: ACS

PAGE NO: 6
 JO: 05996.01

PRESSURE INCREMENT FROM 2.00 tsf to 4.00 tsf

DATE	TIME	ELAPSED TIME (min)	SQ RT OF TIME(min)	CHANGE IN HEIGHT(in)	VOID RATIO	STRAIN (%)
01-09-97	13:20:45	0.00	0.00	0.0155	1.570	2.08
		0.10	0.32	0.0273	1.529	3.66
		0.25	0.50	0.0291	1.523	3.90
		0.50	0.71	0.0303	1.518	4.07
		1.00	1.00	0.0315	1.514	4.22
		1.57	1.25	0.0324	1.511	4.34
		2.00	1.41	0.0327	1.510	4.39
		2.25	1.50	0.0330	1.509	4.43
		3.07	1.75	0.0336	1.507	4.51
		4.00	2.00	0.0341	1.505	4.58
		6.25	2.50	0.0351	1.501	4.72
		8.00	2.83	0.0357	1.499	4.78
		12.25	3.50	0.0365	1.496	4.90
		15.00	3.87	0.0370	1.495	4.97
		22.00	4.69	0.0381	1.491	5.11
		30.00	5.48	0.0390	1.488	5.23
		36.00	6.00	0.0393	1.486	5.28
		49.00	7.00	0.0402	1.483	5.40
		60.00	7.75	0.0407	1.482	5.46

LOAD INCREMENT DATA

TEST NAME C1-U3B
 TESTED BY: ACS

PAGE NO: 7
 JO: 05996.01

PRESSURE INCREMENT FROM 4.00 tsf to 8.00 tsf

DATE	TIME	ELAPSED TIME (min)	SQ RT OF TIME(min)	CHANGE IN HEIGHT(in)	VOID RATIO	STRAIN (%)
01-09-97	14:22:24	0.00	0.00	0.0409	1.481	5.48
		0.10	0.32	0.0713	1.374	9.57
		0.25	0.50	0.0761	1.357	10.21
		0.50	0.71	0.0792	1.346	10.62
		1.00	1.00	0.0820	1.336	11.00
		1.57	1.25	0.0839	1.330	11.25
		2.00	1.41	0.0850	1.326	11.41
		2.25	1.50	0.0855	1.324	11.47
		3.07	1.75	0.0868	1.319	11.64
		4.00	2.00	0.0879	1.315	11.80
		6.25	2.50	0.0898	1.309	12.05
		8.00	2.83	0.0910	1.305	12.21
		12.25	3.50	0.0929	1.298	12.46
		15.00	3.87	0.0938	1.295	12.58
		22.00	4.69	0.0954	1.289	12.80
		30.00	5.48	0.0968	1.284	12.99
		36.00	6.00	0.0976	1.281	13.09
		49.00	7.00	0.0990	1.276	13.28
		60.00	7.75	0.0999	1.273	13.40

LOAD INCREMENT DATA

TEST NAME C1-U3B
 TESTED BY: ACS

PAGE NO: 8
 JO: 05996.01

PRESSURE INCREMENT FROM 8.00 tsf to 2.00 tsf

DATE	TIME	ELAPSED TIME (min)	SQ RT OF TIME(min)	CHANGE IN HEIGHT(in)	VOID RATIO	STRAIN (%)
01-09-97	15:27:57	0.00	0.00	0.0995	1.275	13.35
		0.10	0.32	0.0957	1.288	12.84
		0.25	0.50	0.0957	1.288	12.84
		0.50	0.71	0.0955	1.289	12.82
		1.00	1.00	0.0955	1.289	12.82
		1.57	1.25	0.0955	1.289	12.82
		2.00	1.41	0.0955	1.289	12.82
		2.25	1.50	0.0955	1.289	12.82
		3.07	1.75	0.0955	1.289	12.82
		4.00	2.00	0.0954	1.289	12.80
		6.25	2.50	0.0954	1.289	12.80
		8.00	2.83	0.0954	1.289	12.80
		12.25	3.50	0.0954	1.289	12.80
		15.00	3.87	0.0954	1.289	12.80
		22.00	4.69	0.0954	1.289	12.80
		30.00	5.48	0.0954	1.289	12.80

LOAD INCREMENT DATA

TEST NAME C1-U3B
 TESTED BY: ACS

PAGE NO: 9
 JO: 05996.01

PRESSURE INCREMENT FROM 2.00 tsf to 0.50 tsf

DATE	TIME	ELAPSED TIME (min)	SQ RT OF TIME(min)	CHANGE IN HEIGHT(in)	VOID RATIO	STRAIN (%)
01-09-97	16:00:47	0.00	0.00	0.0954	1.289	12.80
		0.10	0.32	0.0912	1.304	12.24
		0.25	0.50	0.0911	1.304	12.22
		0.50	0.71	0.0911	1.304	12.22
		1.00	1.00	0.0911	1.304	12.22
		1.57	1.25	0.0910	1.305	12.21
		2.00	1.41	0.0910	1.305	12.21
		2.25	1.50	0.0910	1.305	12.21
		3.07	1.75	0.0910	1.305	12.21
		4.00	2.00	0.0910	1.305	12.21
		6.25	2.50	0.0908	1.305	12.19
		8.00	2.83	0.0908	1.305	12.19
		12.25	3.50	0.0908	1.305	12.19
		15.00	3.87	0.0908	1.305	12.19
		22.00	4.69	0.0907	1.305	12.17

LOAD INCREMENT DATA

TEST NAME C1-U3B
 TESTED BY: ACS

PAGE NO: 10
 JO: 05996.01

PRESSURE INCREMENT FROM 0.50 tsf to 0.10 tsf

DATE	TIME	ELAPSED TIME (min)	SQ RT OF TIME(min)	CHANGE IN HEIGHT(in)	VOID RATIO	STRAIN (%)
01-09-97	16:26:57	0.00	0.00	0.0907	1.305	12.17
		0.10	0.32	0.0894	1.310	12.00
		0.25	0.50	0.0893	1.310	11.98
		0.50	0.71	0.0892	1.311	11.97
		1.00	1.00	0.0891	1.311	11.95
		1.57	1.25	0.0889	1.312	11.93
		2.00	1.41	0.0889	1.312	11.93
		2.25	1.50	0.0888	1.312	11.92
		3.07	1.75	0.0888	1.312	11.92
		4.00	2.00	0.0887	1.313	11.90
		6.25	2.50	0.0886	1.313	11.88
		8.00	2.83	0.0886	1.313	11.88
		12.25	3.50	0.0884	1.314	11.87
		15.00	3.87	0.0884	1.314	11.87
		22.00	4.69	0.0883	1.314	11.85
		30.00	5.48	0.0882	1.314	11.83
		36.00	6.00	0.0882	1.314	11.83
		49.00	7.00	0.0881	1.315	11.81
		51.82	7.20	0.0881	1.315	11.81

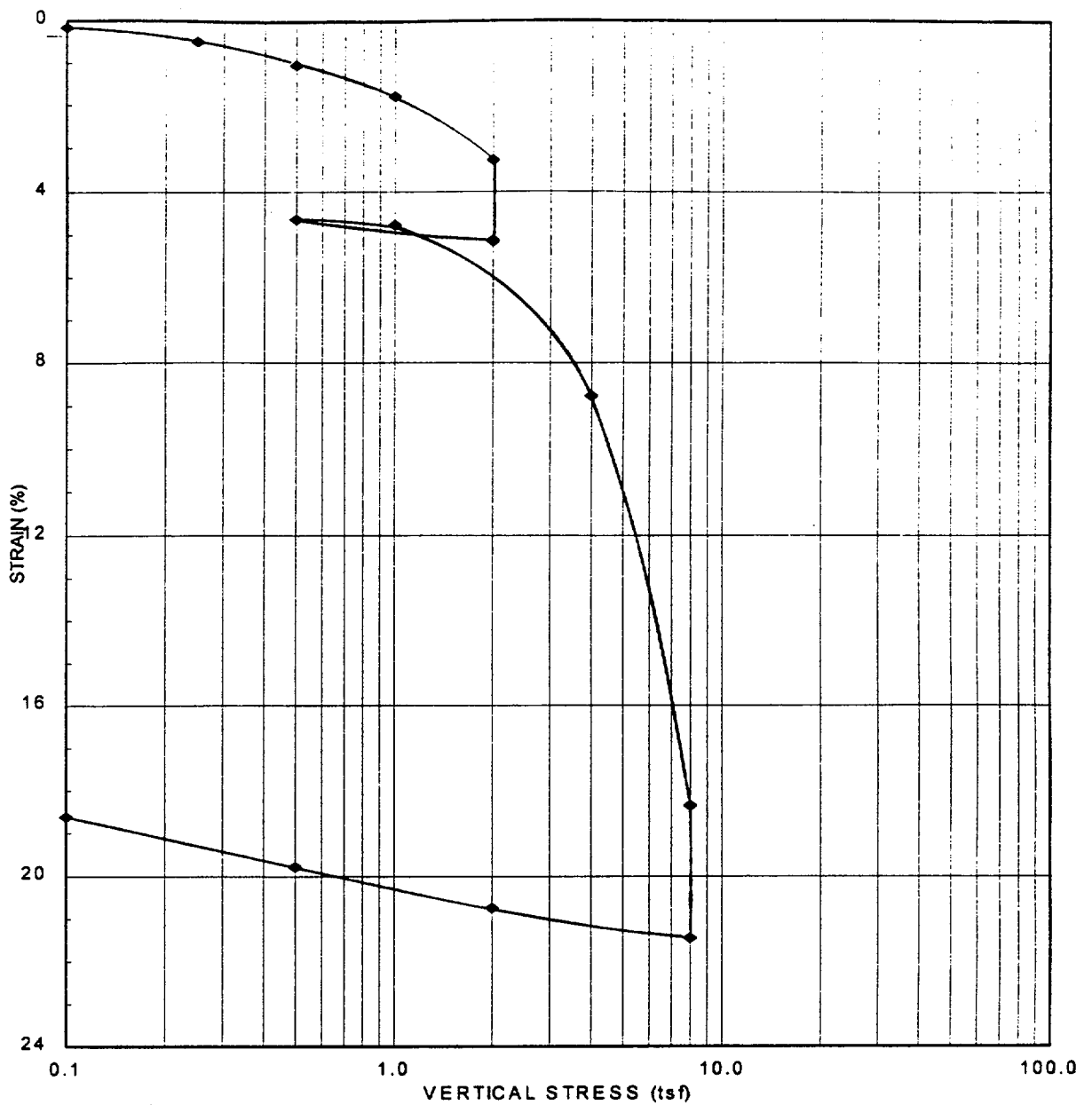

SAMPLE INFORMATION:

BORING:	C-1	DATE:	12/20/96
SAMPLE:	U-3C	TESTED BY:	ACS
DEPTH:	11.2 ft	CHECKED:	PJT
DESCRIPTION:	Clayey SILT		

SPECIMEN INFORMATION:

	INITIAL	FINAL	SPECIFIC GRAVITY:
WATER CONTENT:	38.9 %	51.9 %	2.72
DRY UNIT WEIGHT:	55.8 pcf	68.4 pcf	
VOID RATIO:	2.041	1.484	
SATURATION:	51.8 %	95.2 %	

NOTE: Sample was not inundated and porous stones were moist

PRIVATE FUEL STORAGE FACILITY
SKULL VALLEY
PRIVATE FUEL STORAGE, LLC



STONE & WEBSTER ENGINEERING CORP.
BOSTON, MASSACHUSETTS

CONSOLIDATION TEST RESULTS
BORING C-1, SAMPLE U-3C

JO 05996.01
January 1997

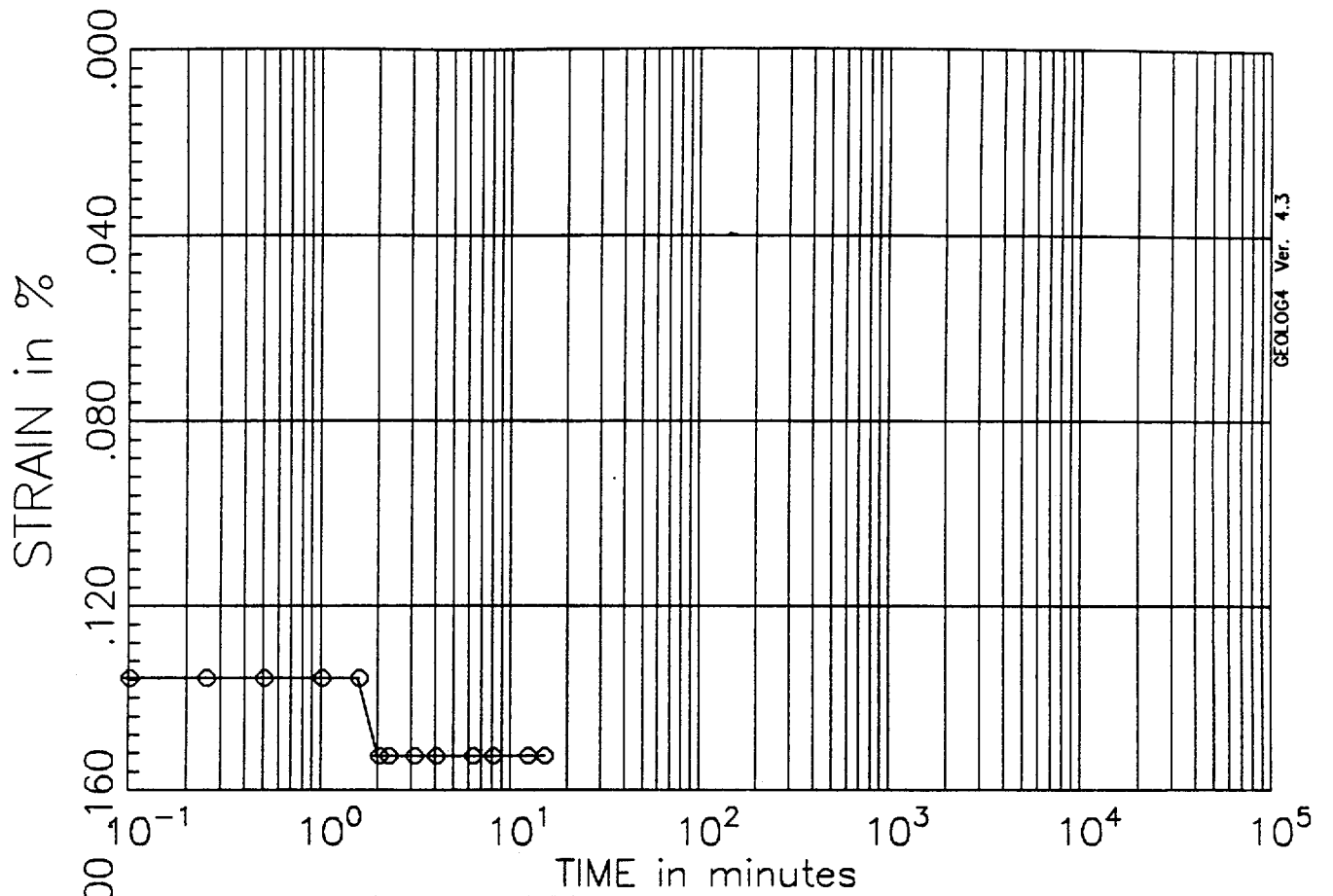

GEOLOG4 Ver. 4.3

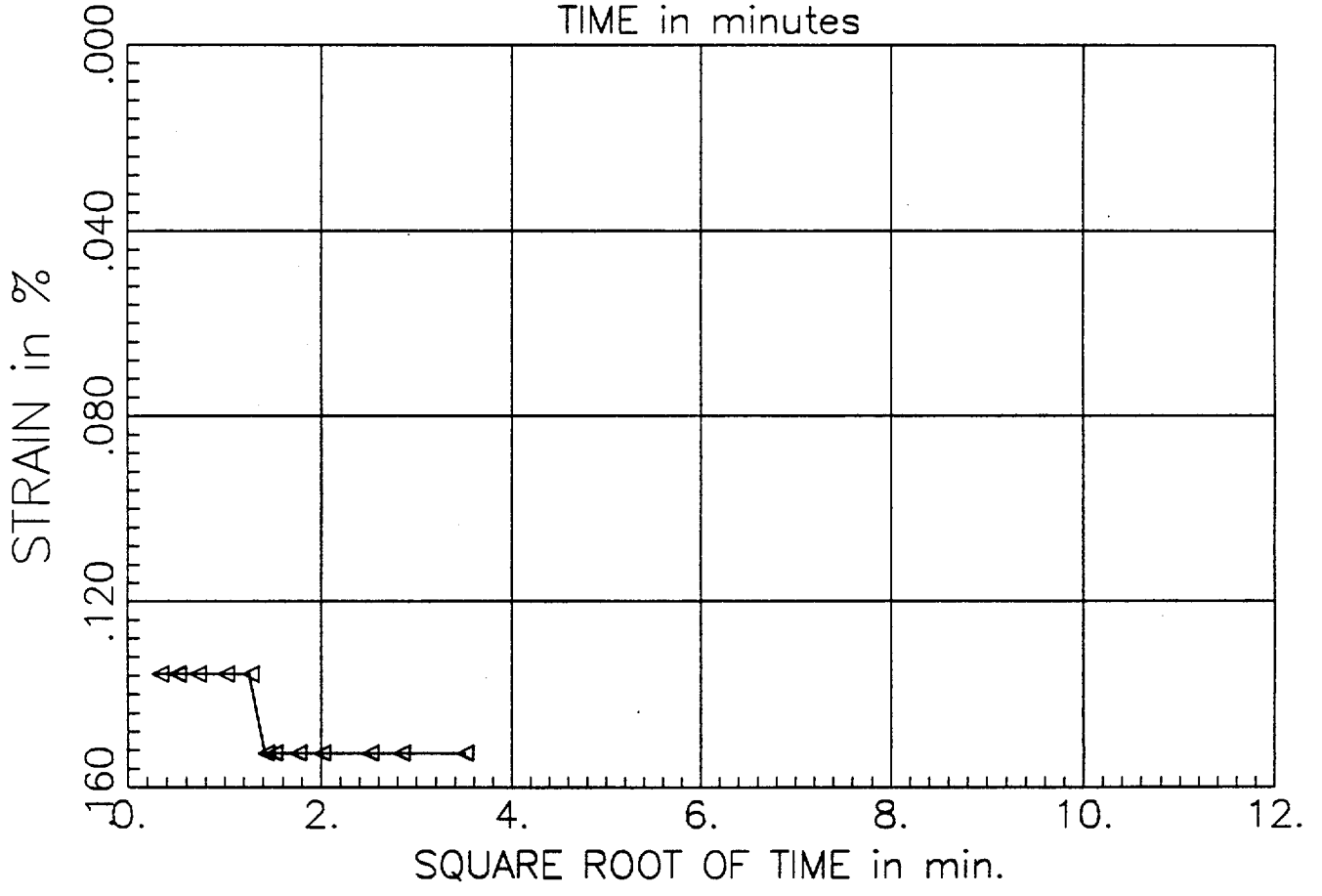

PRESSURE INCREMENT
from 0.00 tsf to 0.10 tsf

Test No: 4
Testname: C1-U3C

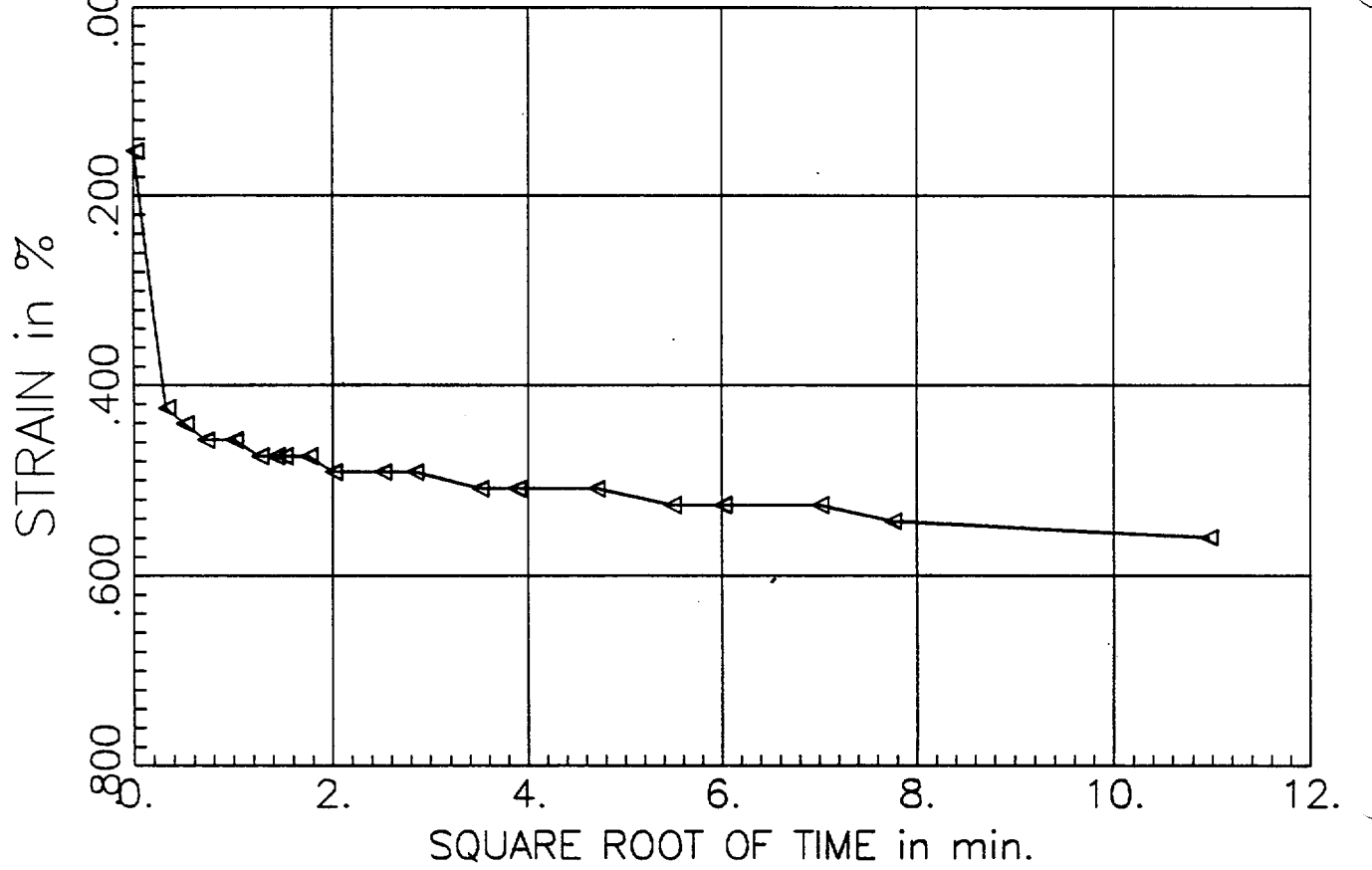
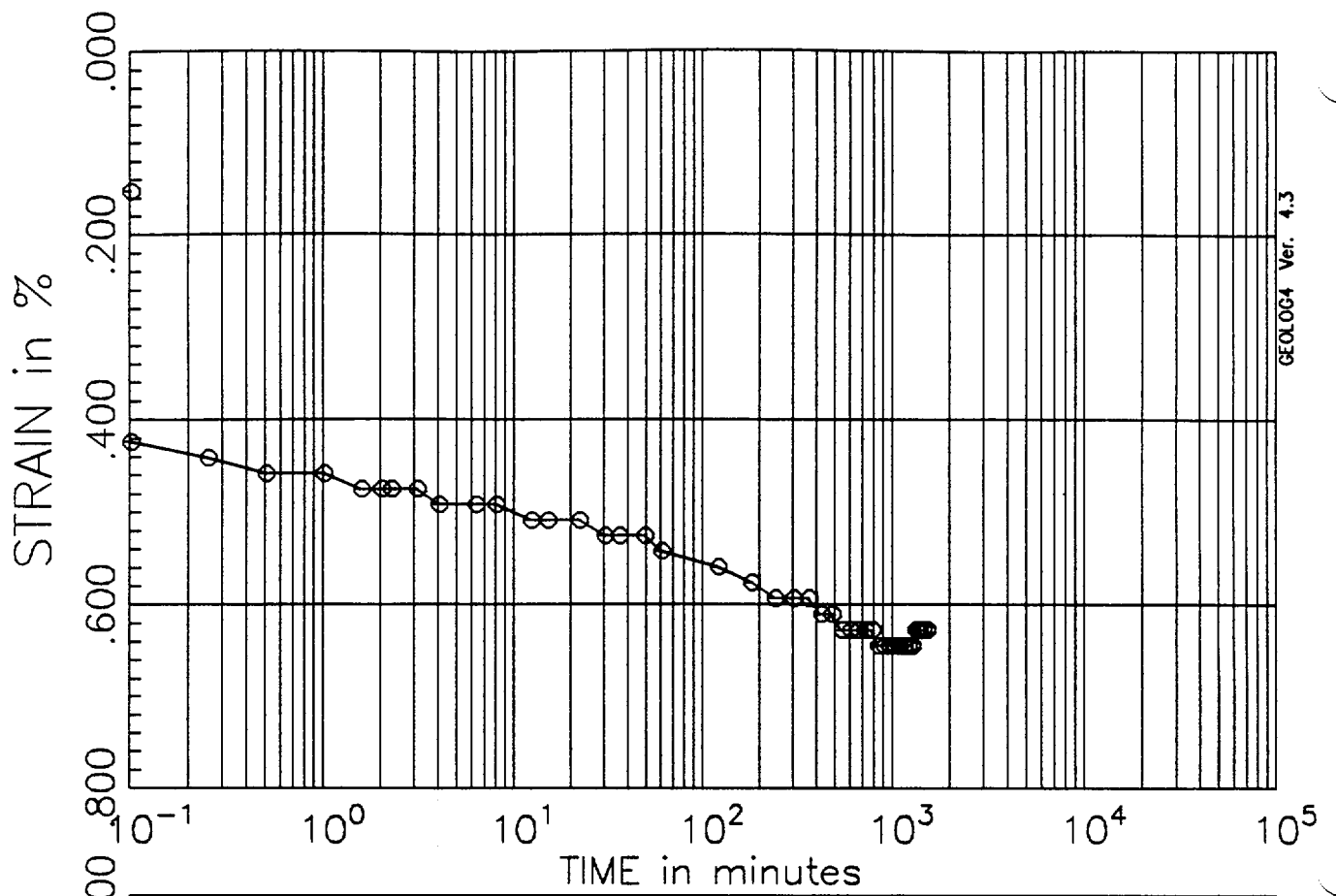

PRESSURE INCREMENT
from 0.10 tsf to 0.25 tsf

Test No: 4
Testname: C1-U3C

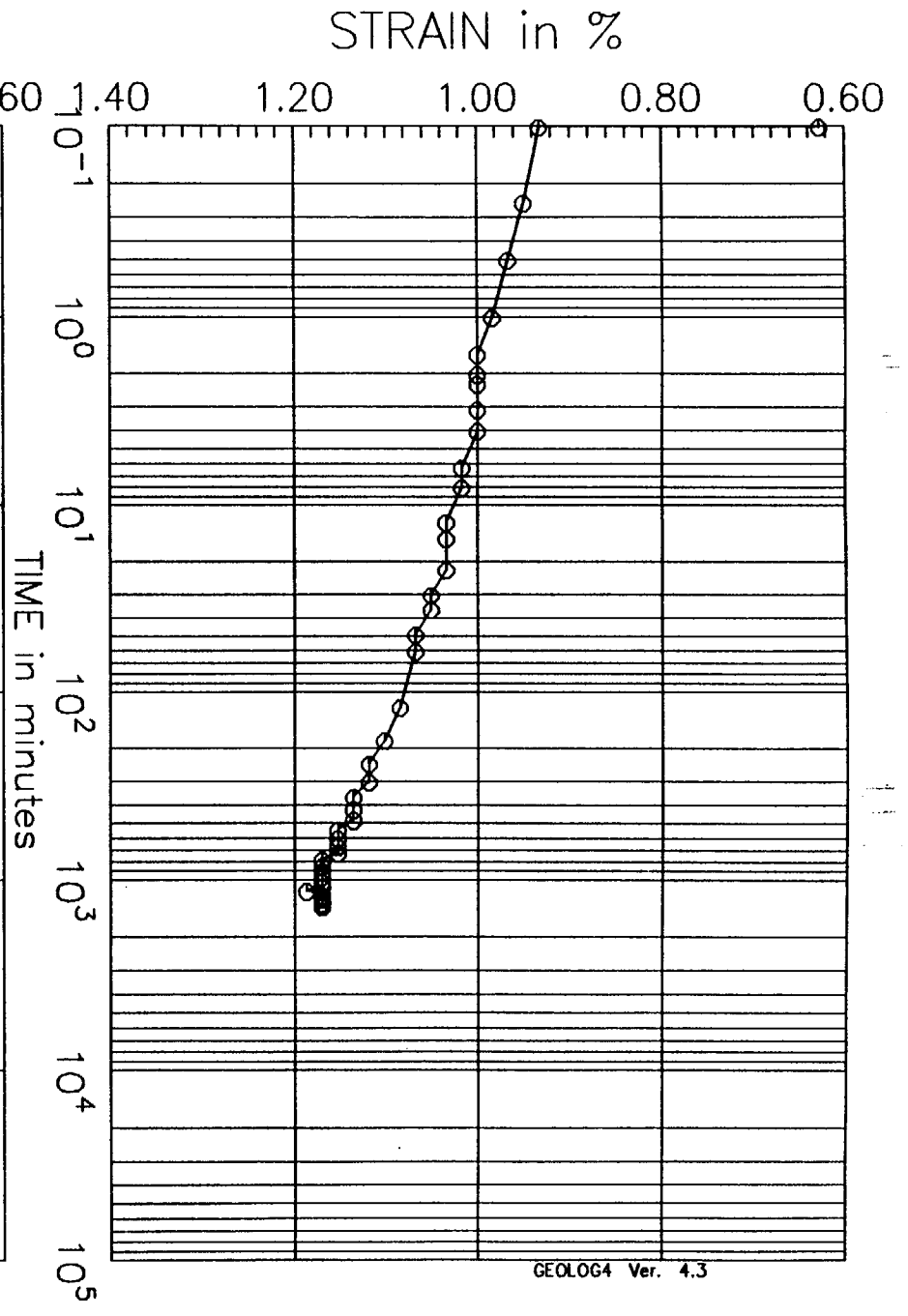
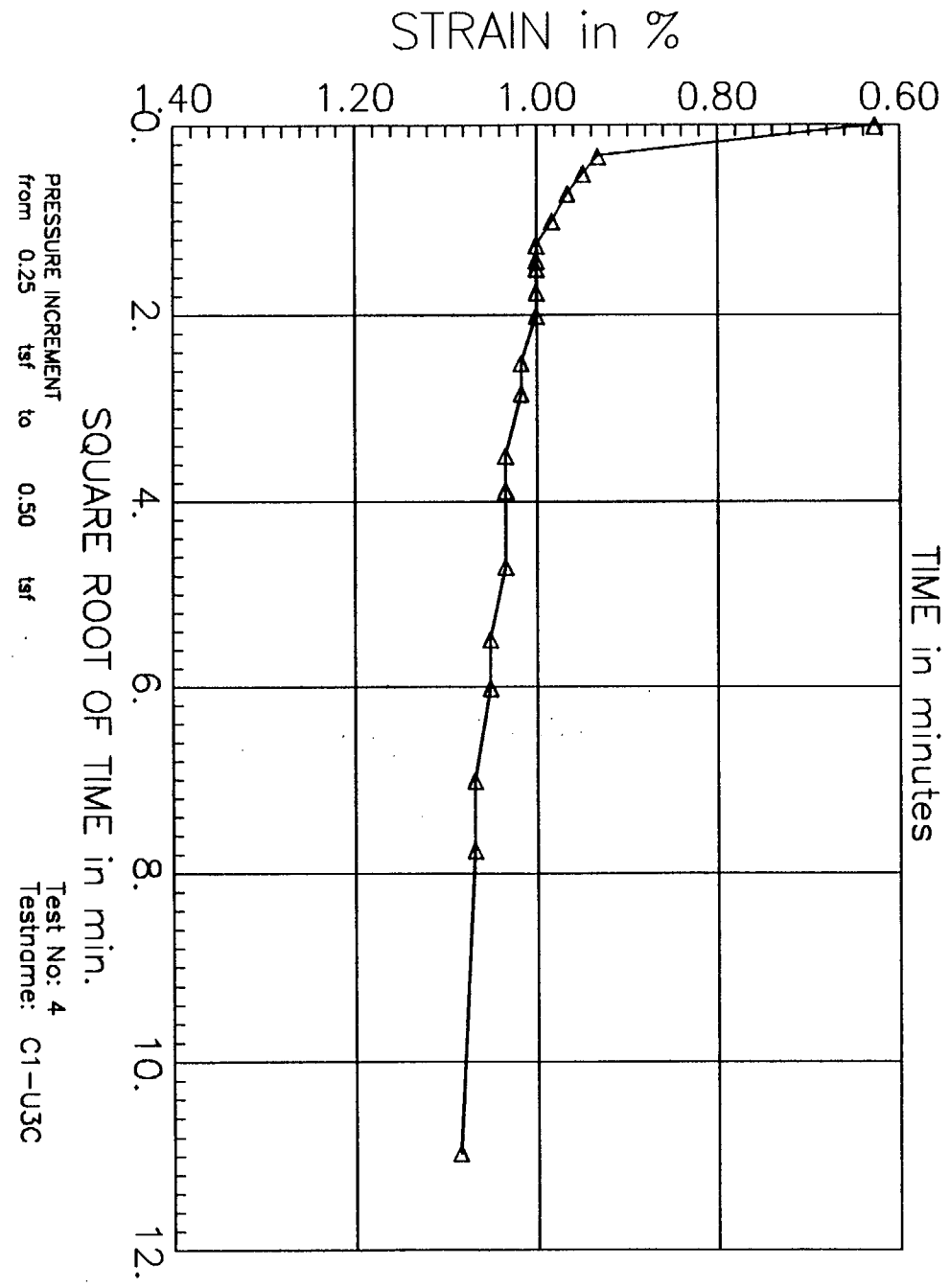

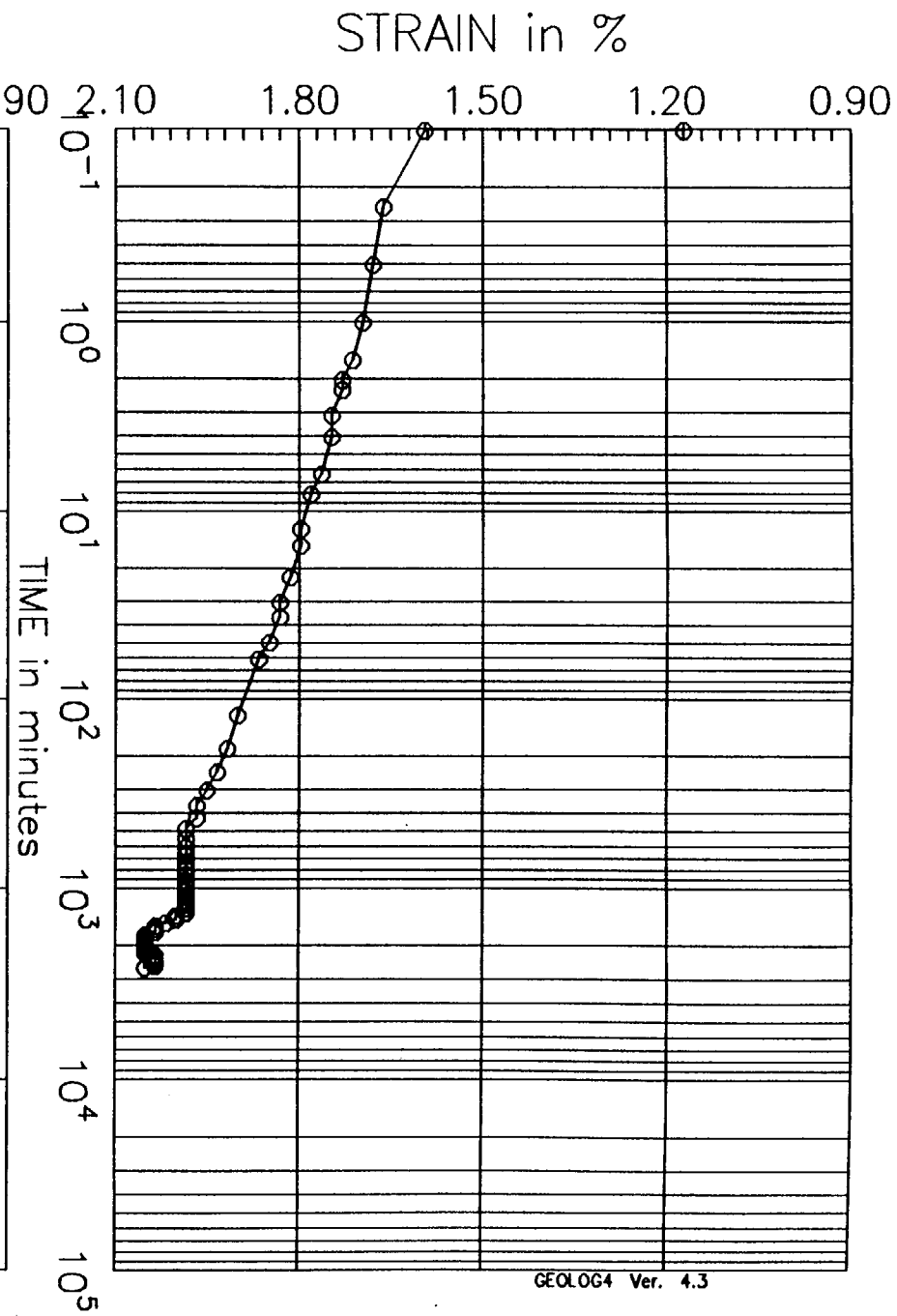
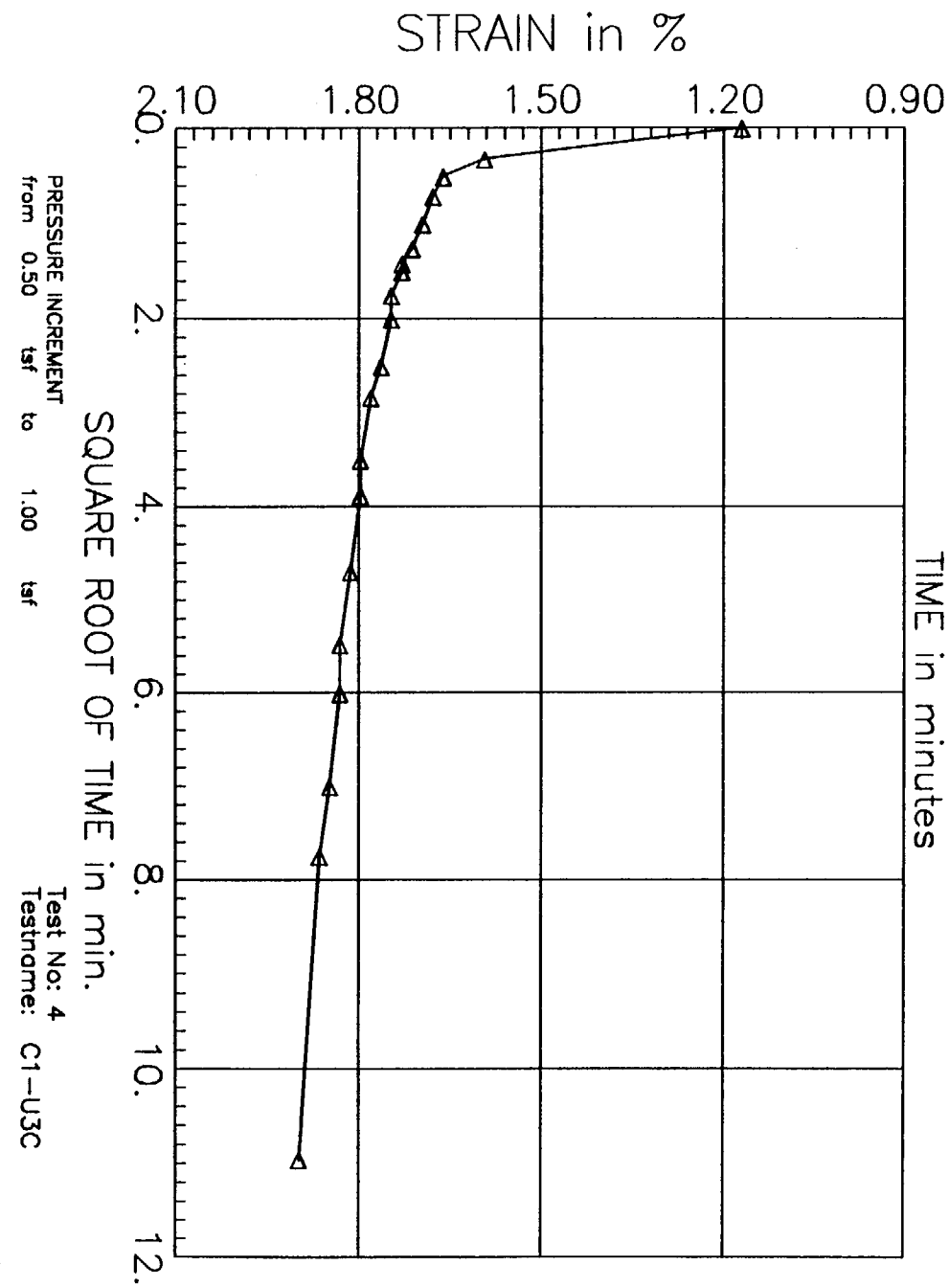

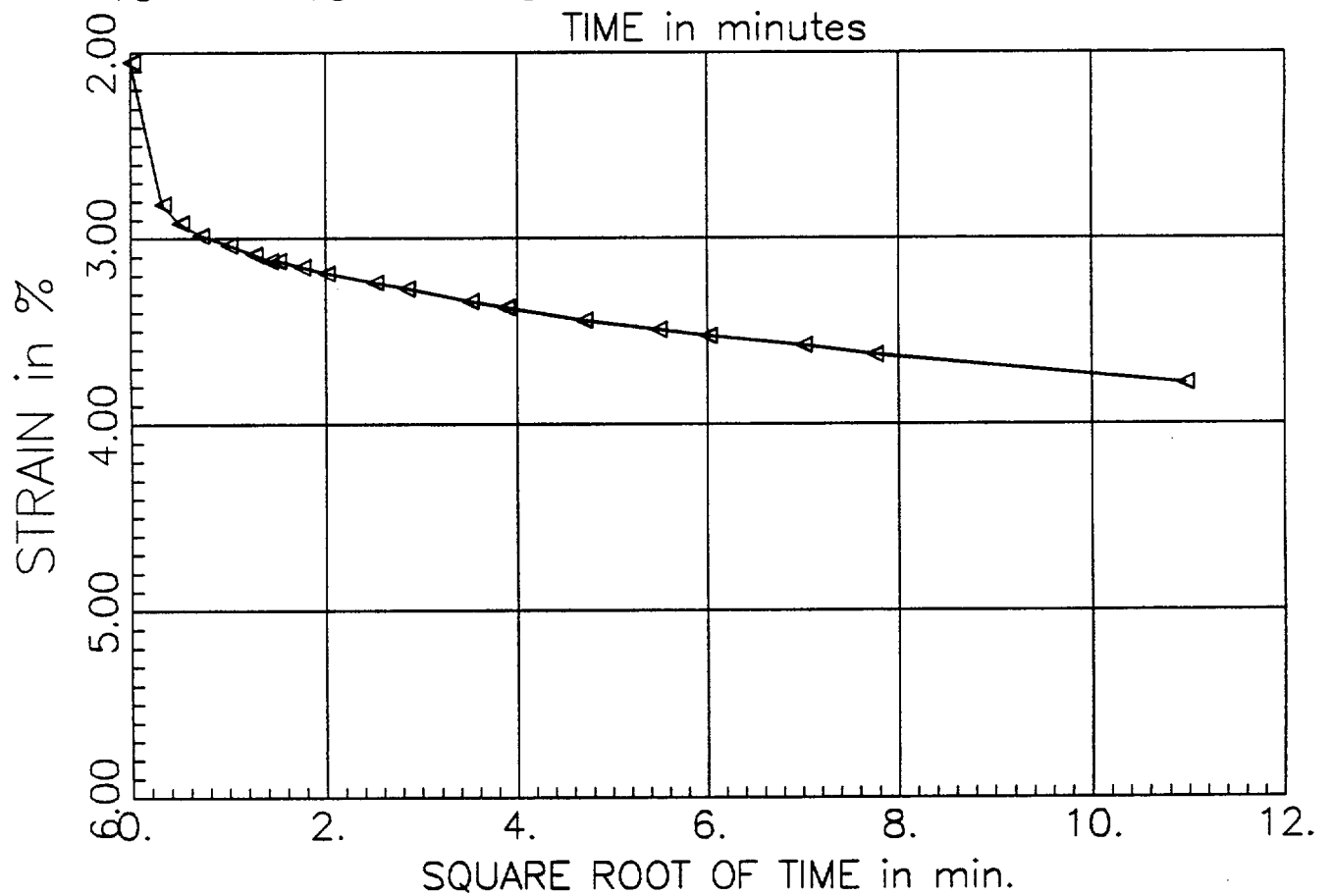
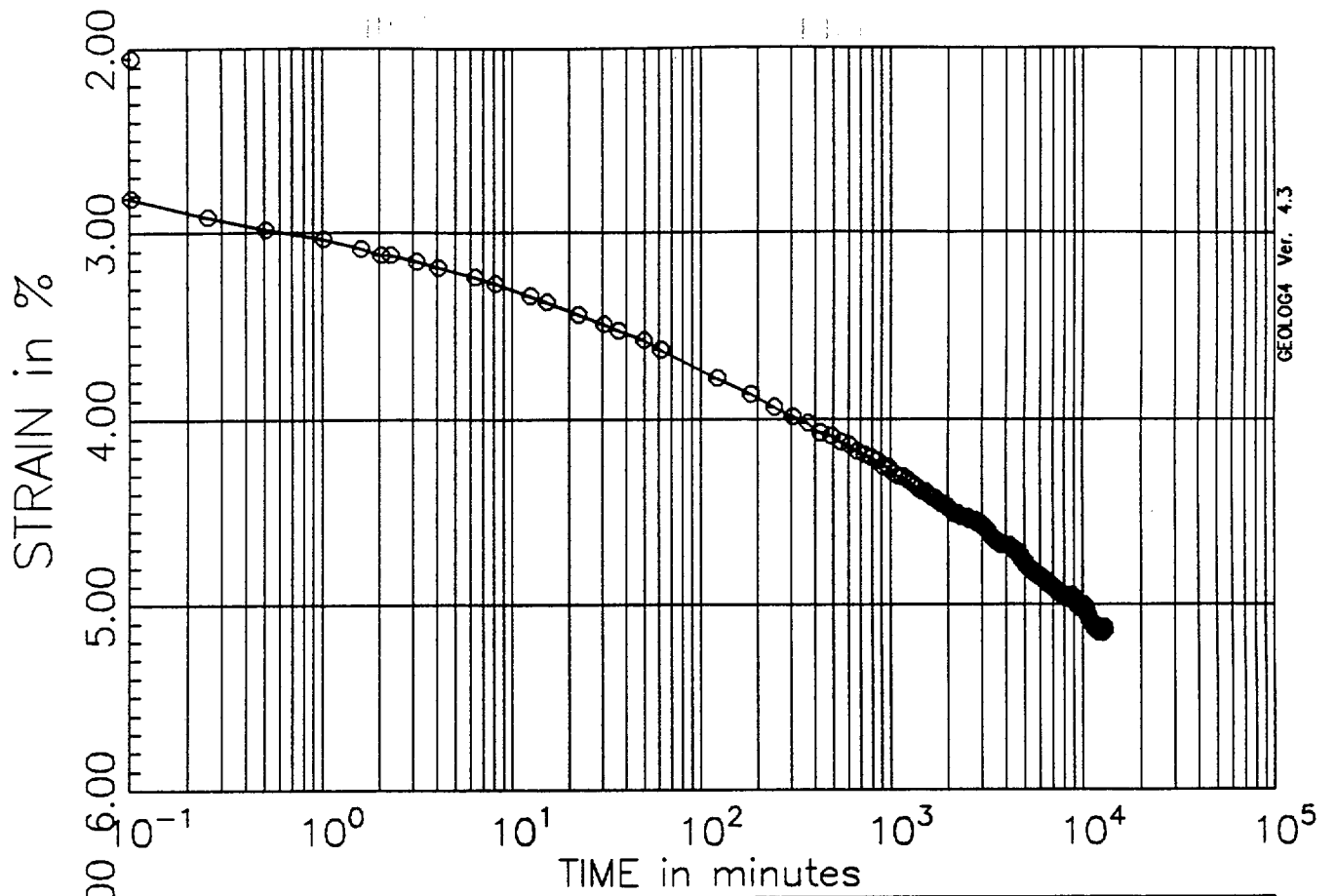

PRESSURE INCREMENT
from 1.00 tsf to 2.00 tsf

Test No: 4
Testname: C1-U3C

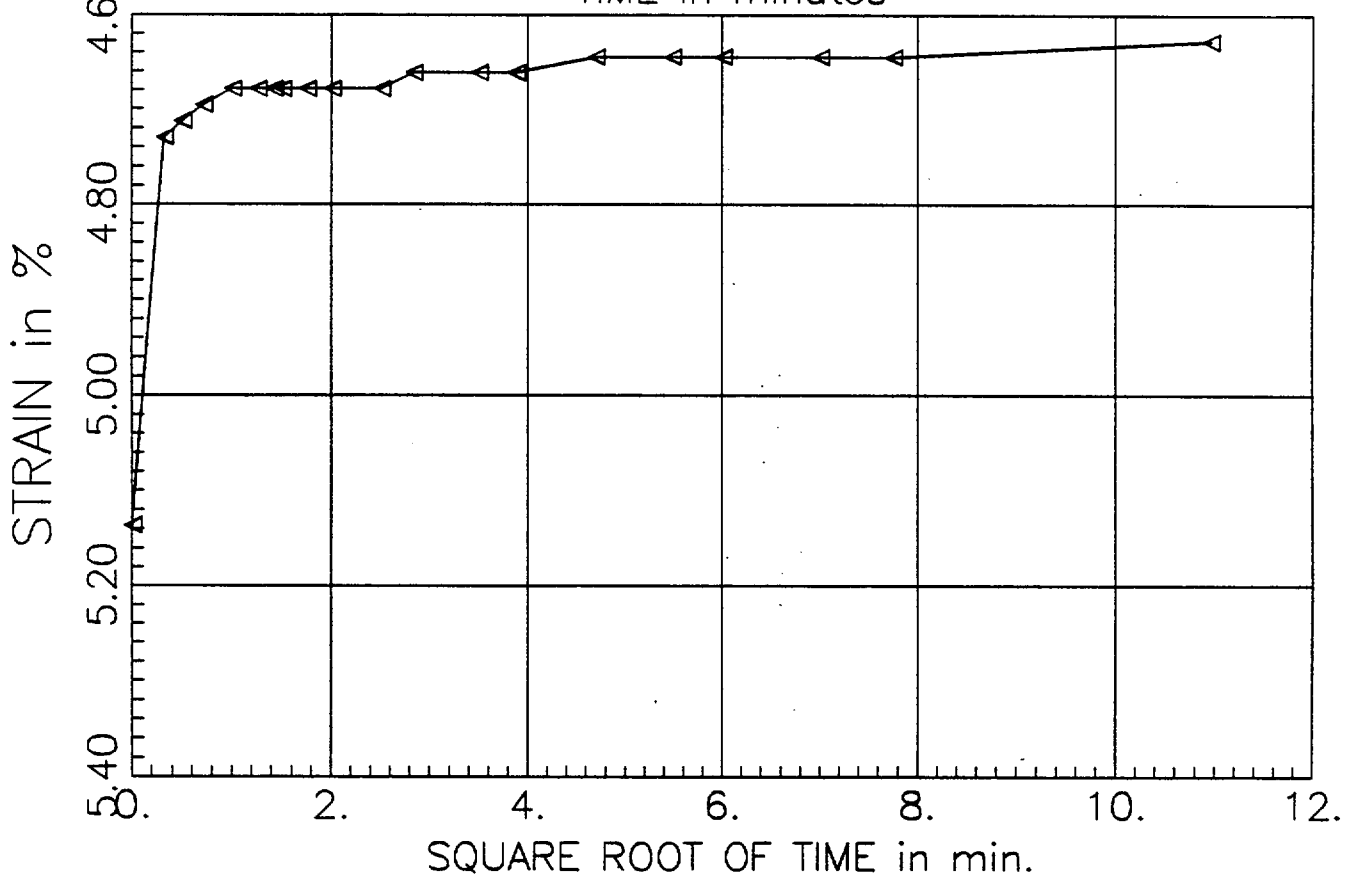
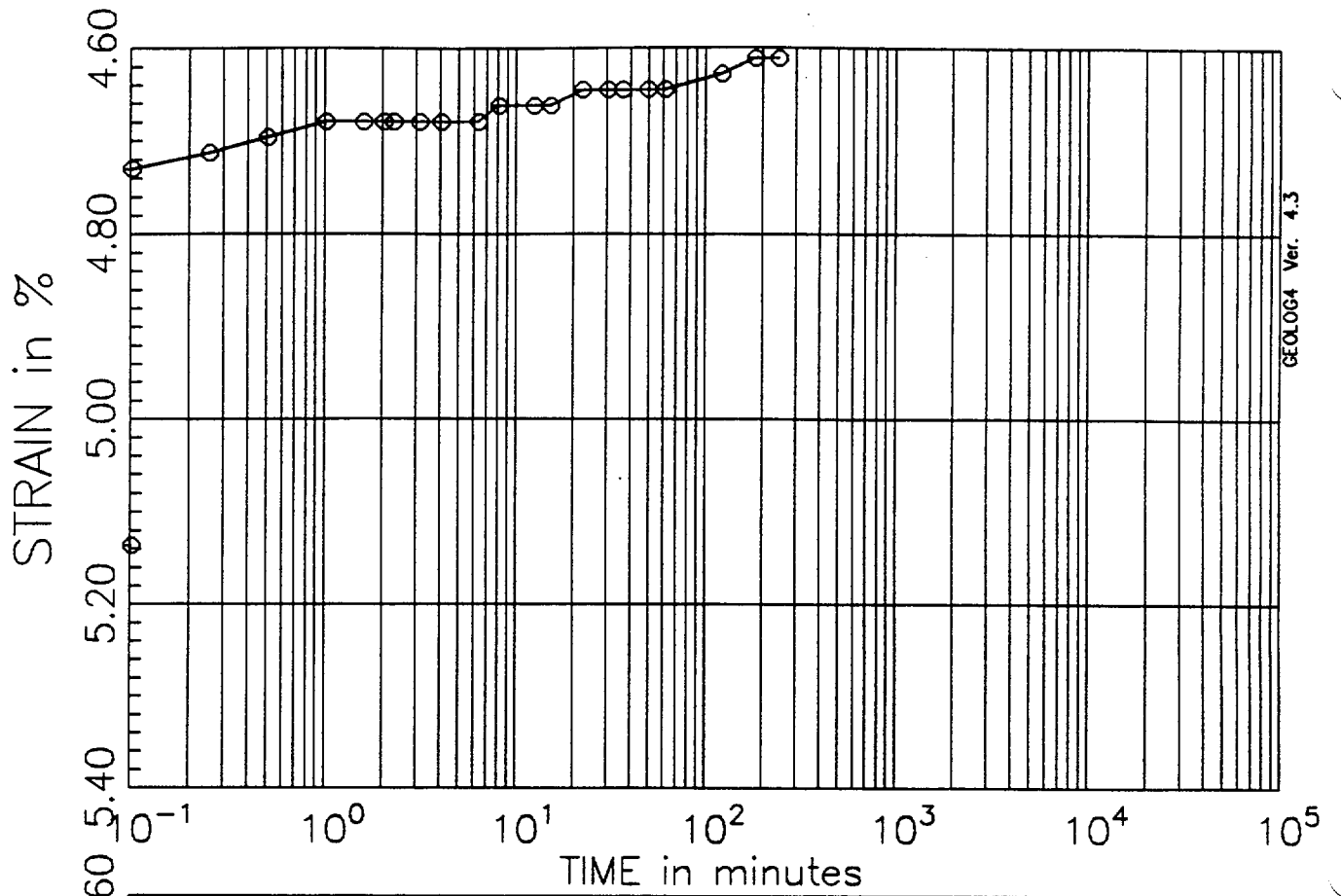

PRESSURE INCREMENT
 from 2.00 tsf to 0.50 tsf

Test No: 4
 Testname: C1-U3C

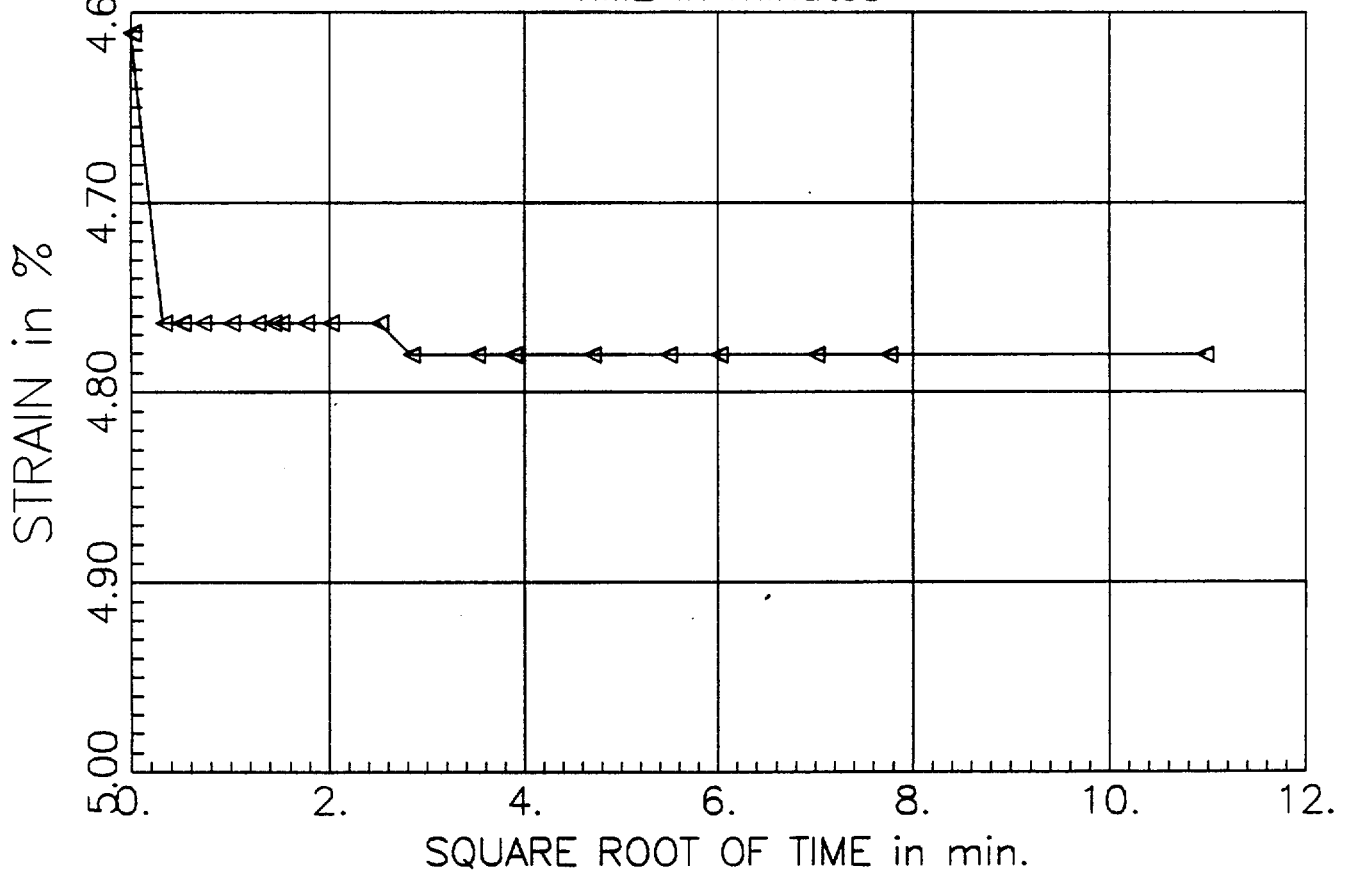
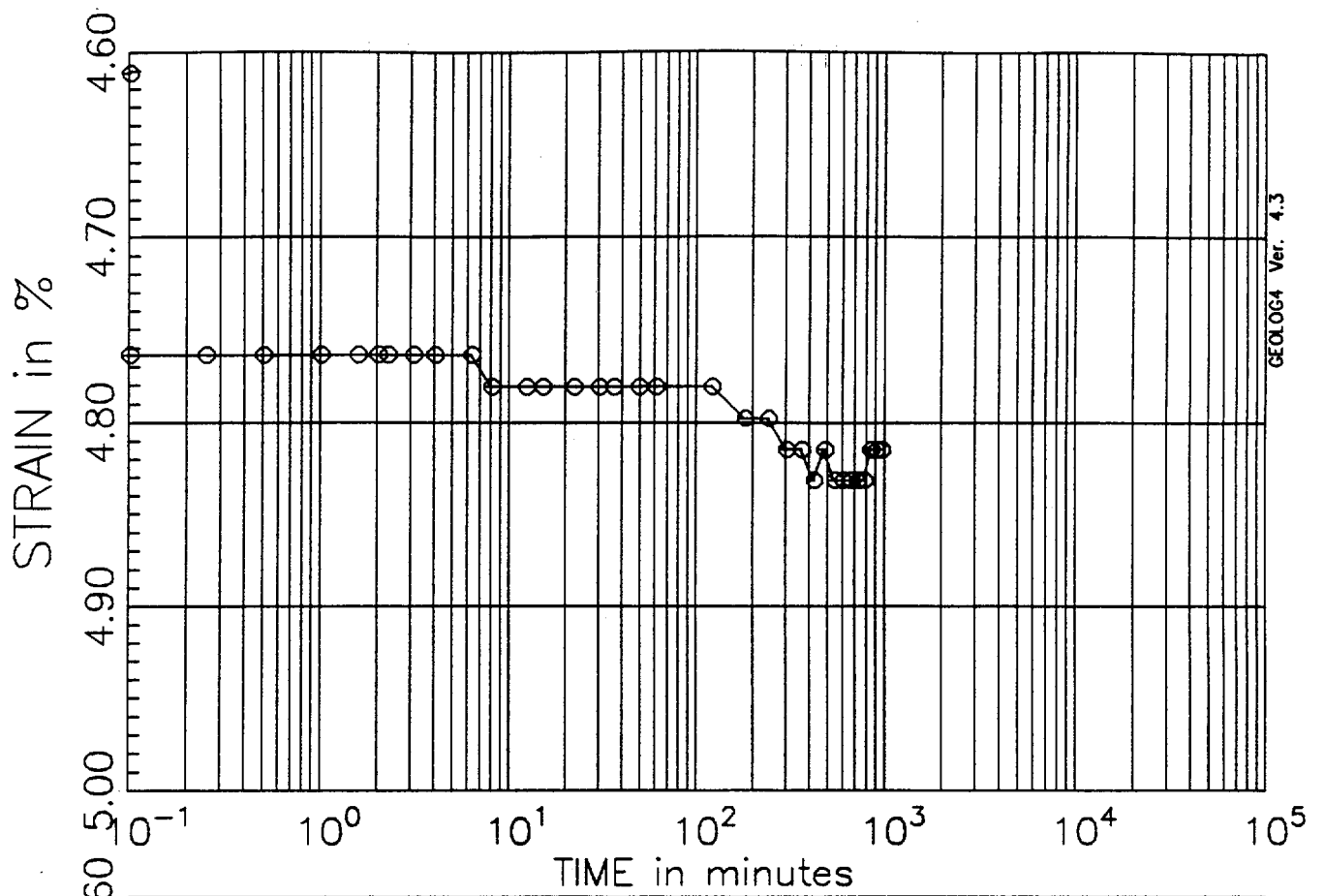

PRESSURE INCREMENT
from 0.50 tsf to 1.00 tsf

Test No: 4
Testname: C1-U3C

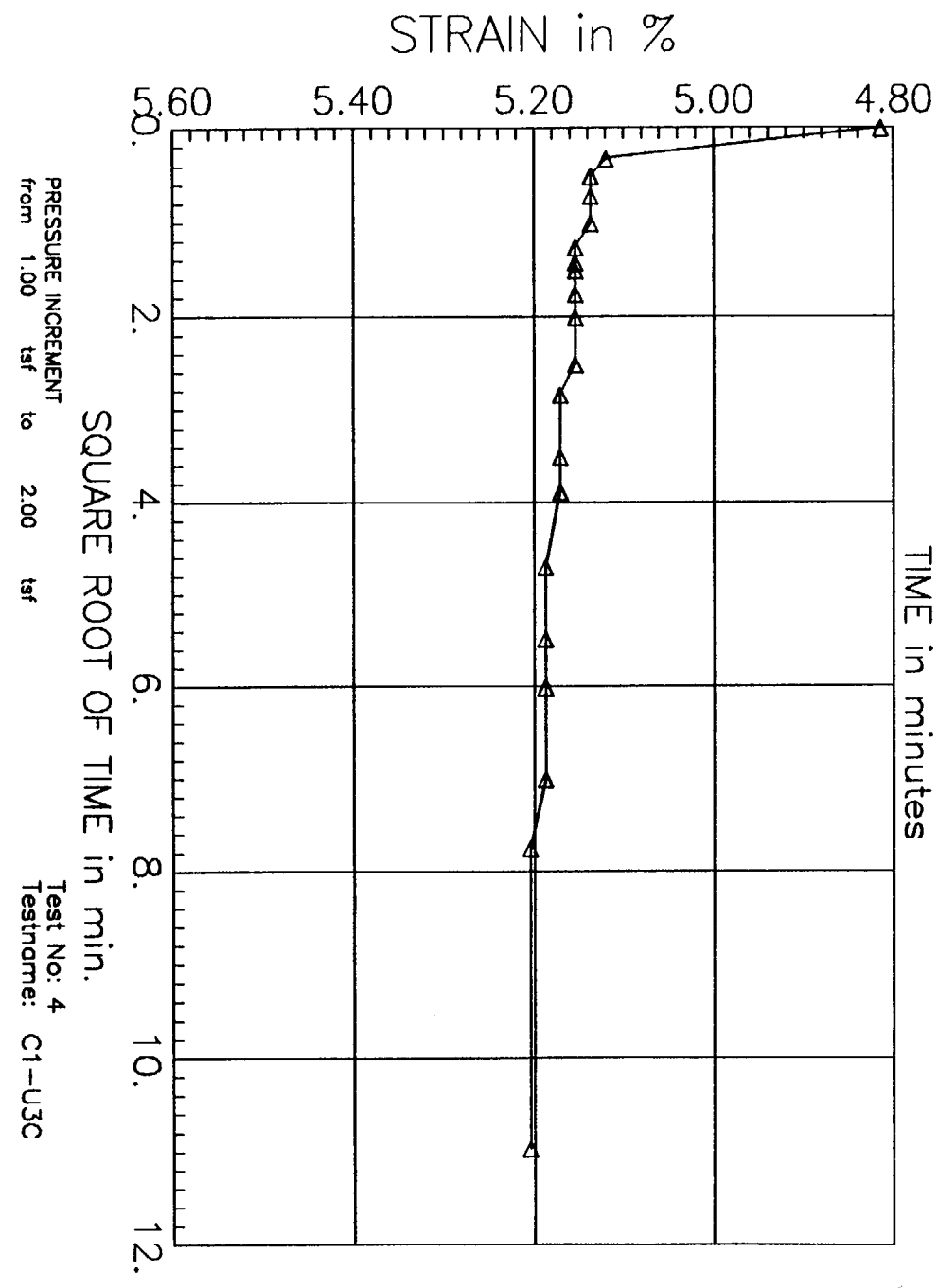
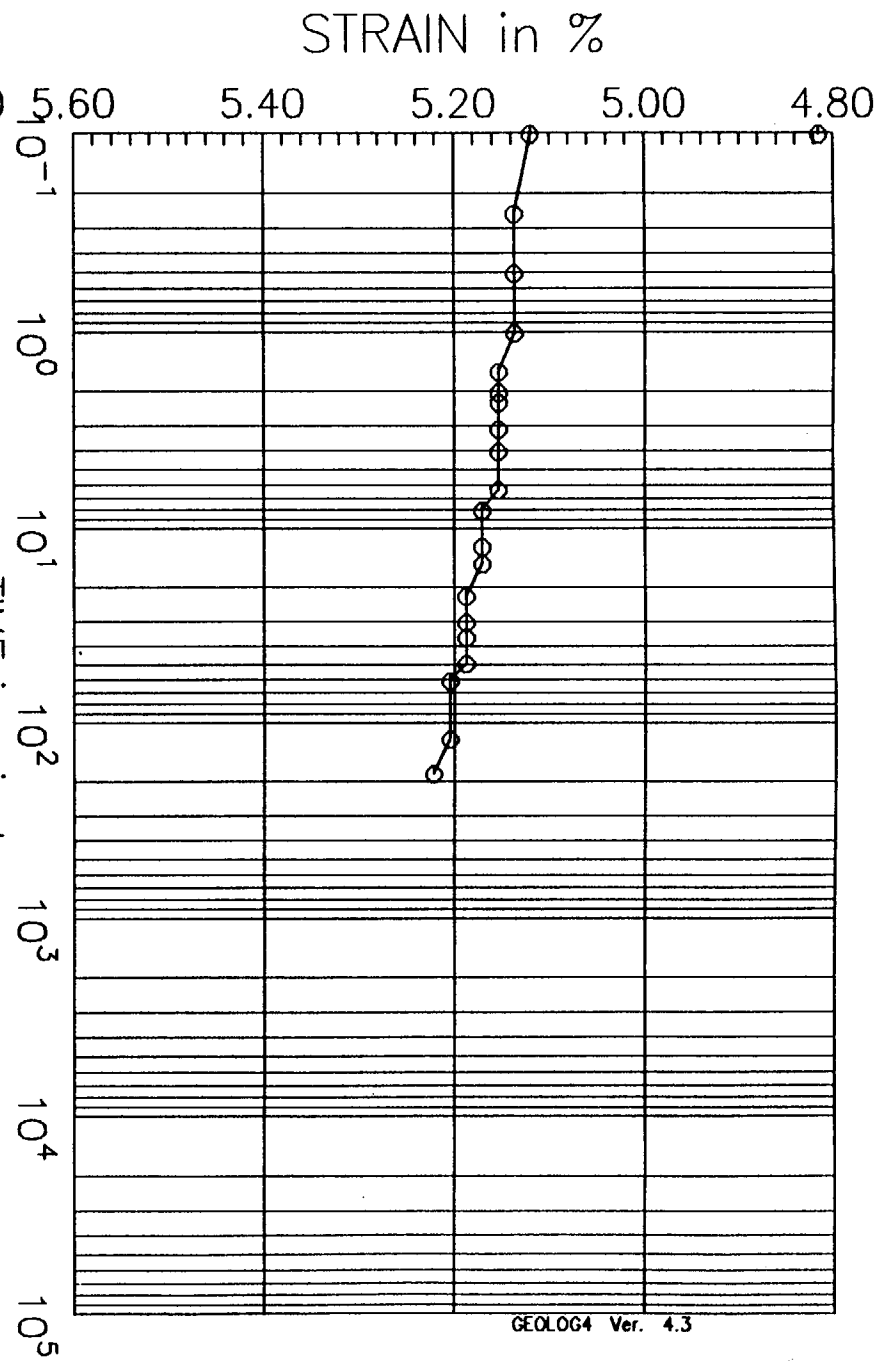

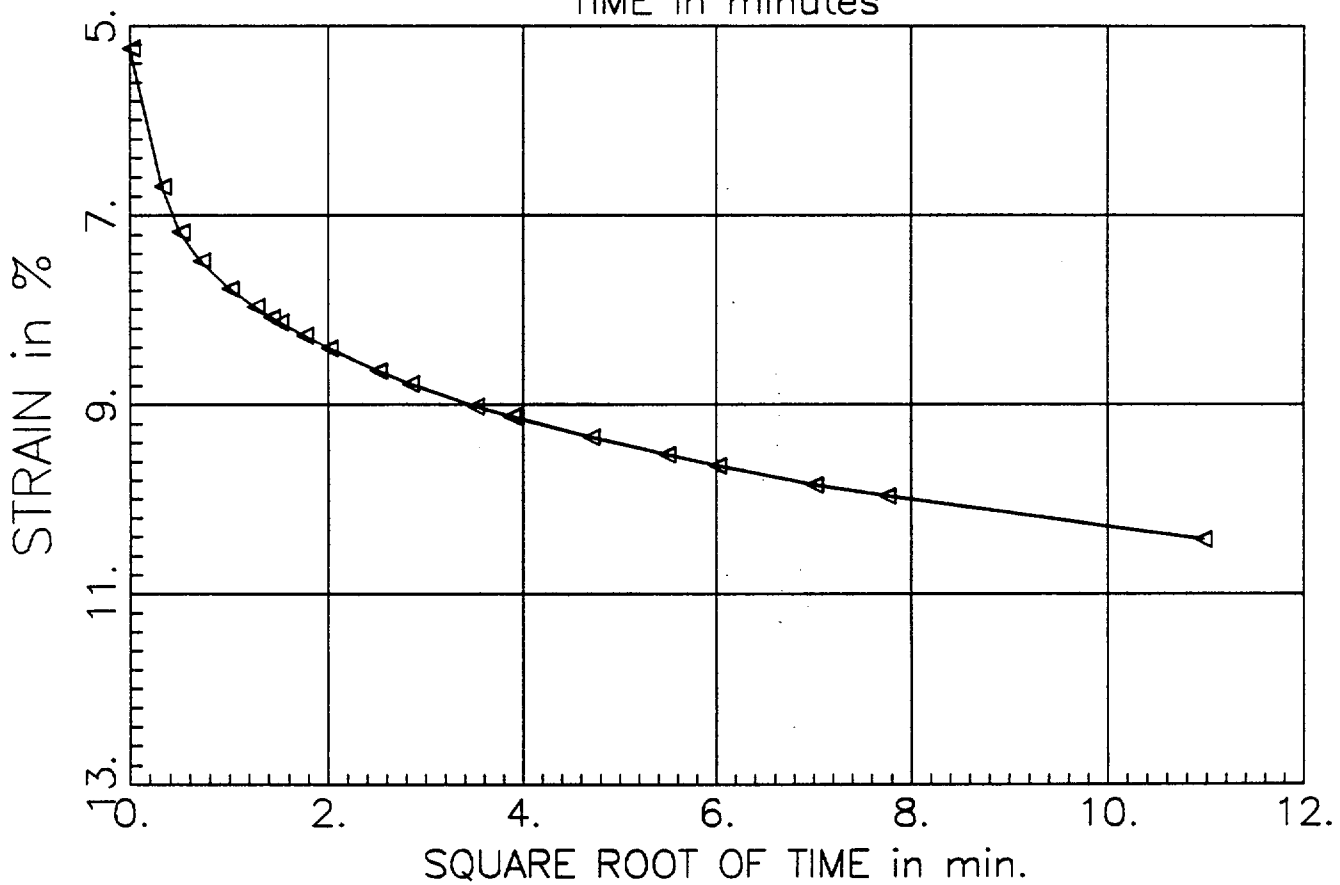
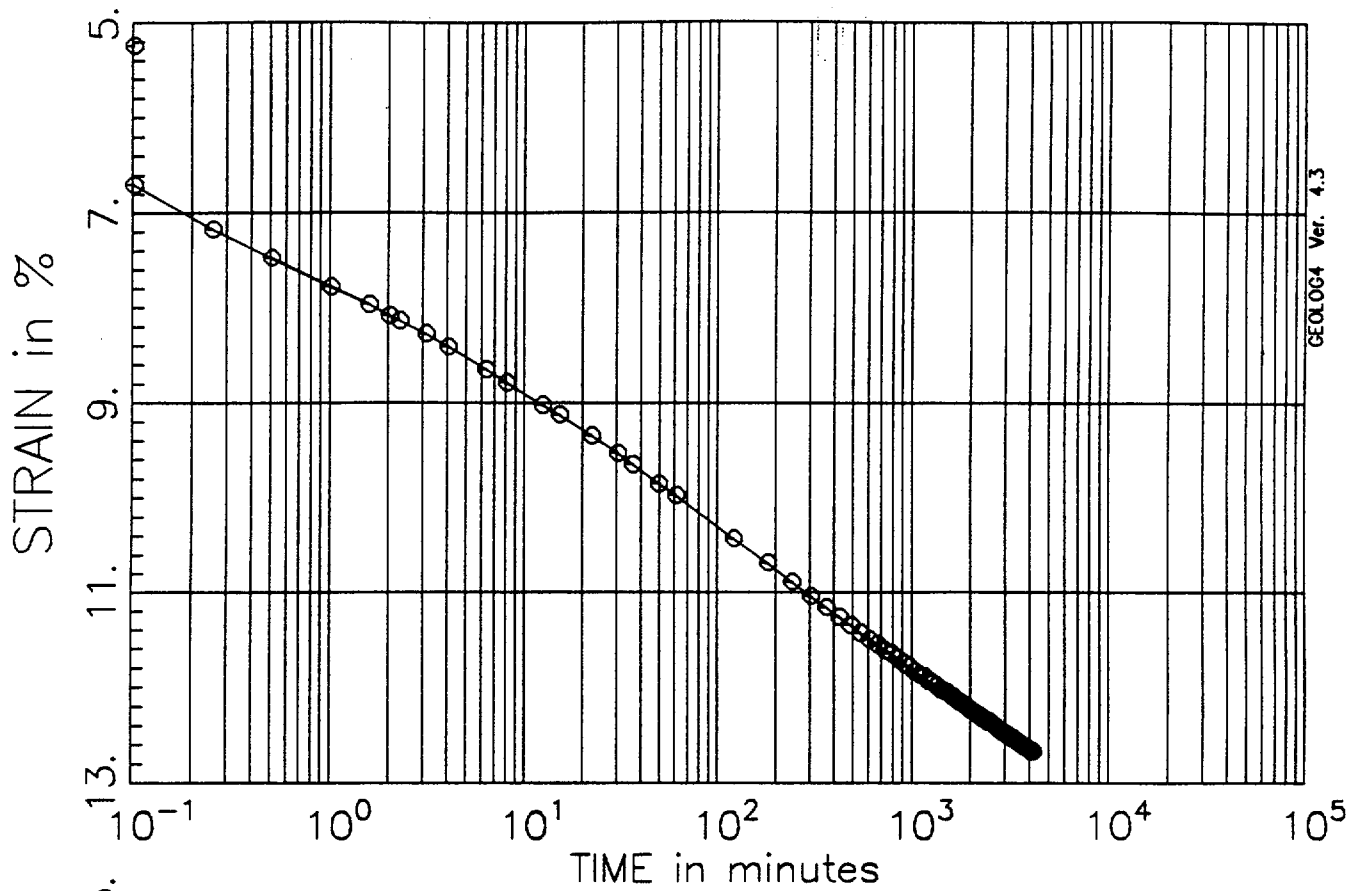

PRESSURE INCREMENT
from 2.00 tsf to 4.00 tsf

Test No: 4
Testname: C1-U3C

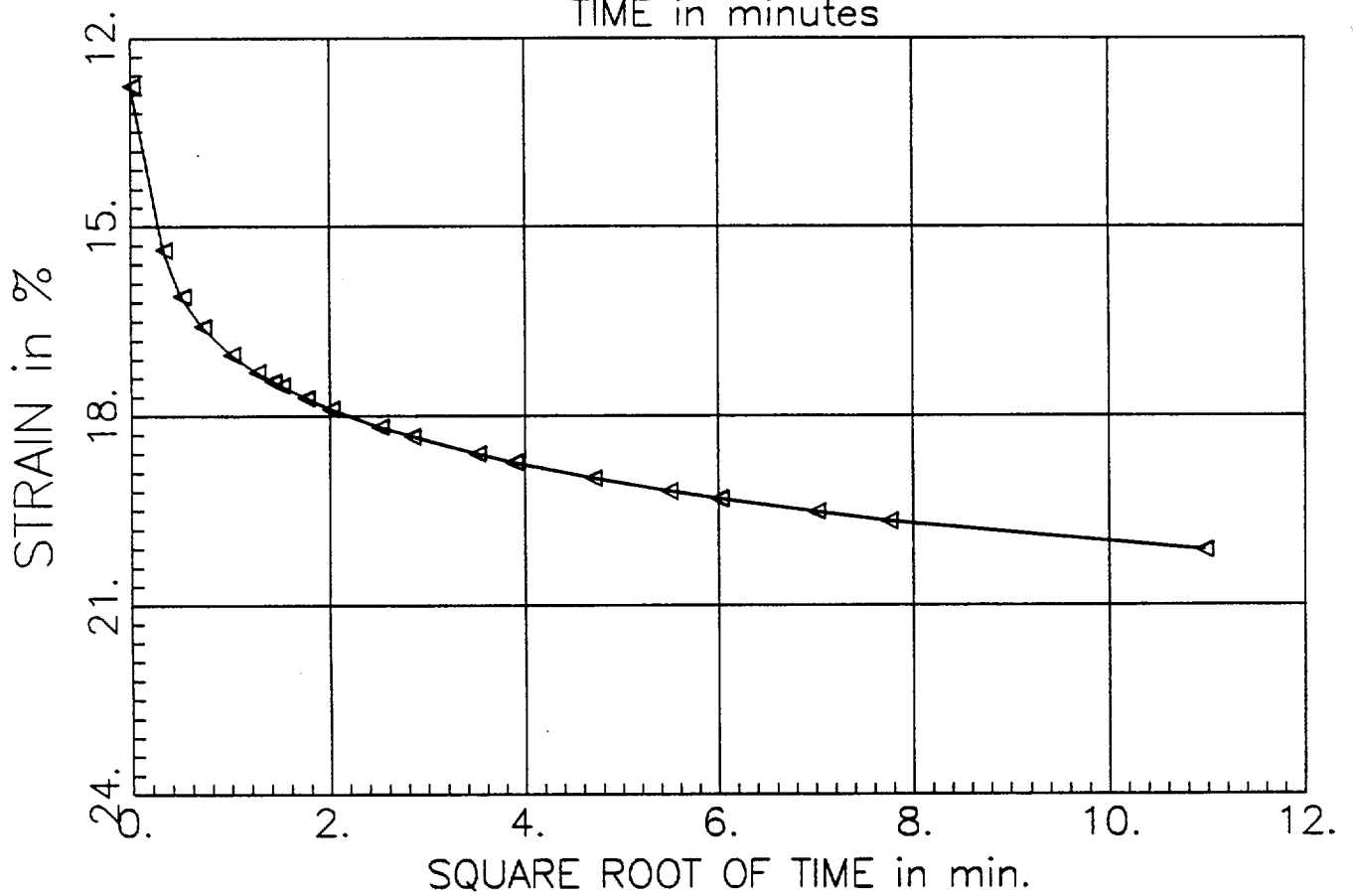
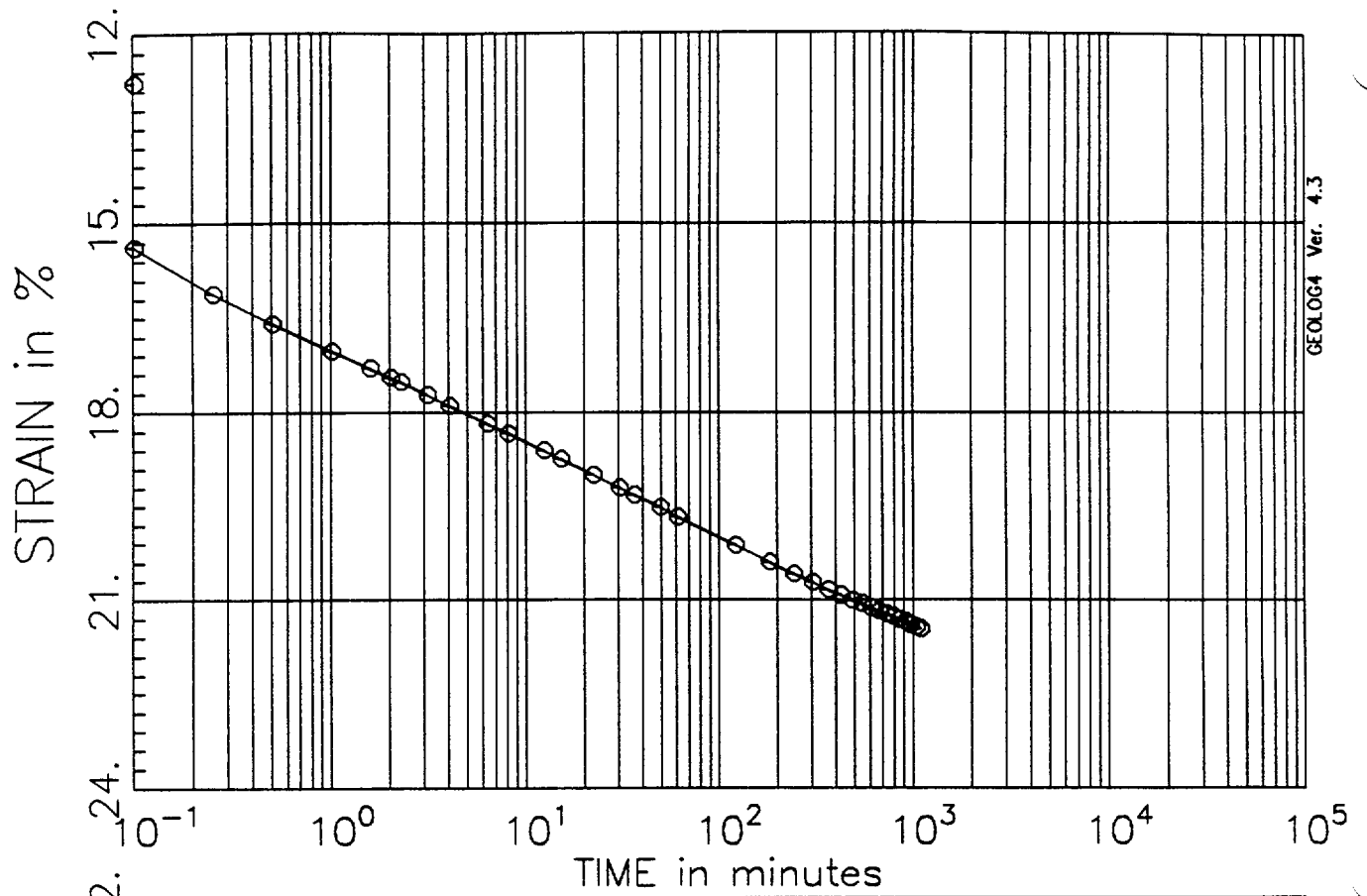

PRESSURE INCREMENT
from 4.00 tsf to 8.00 tsf

Test No: 4
Testname: C1-U3C

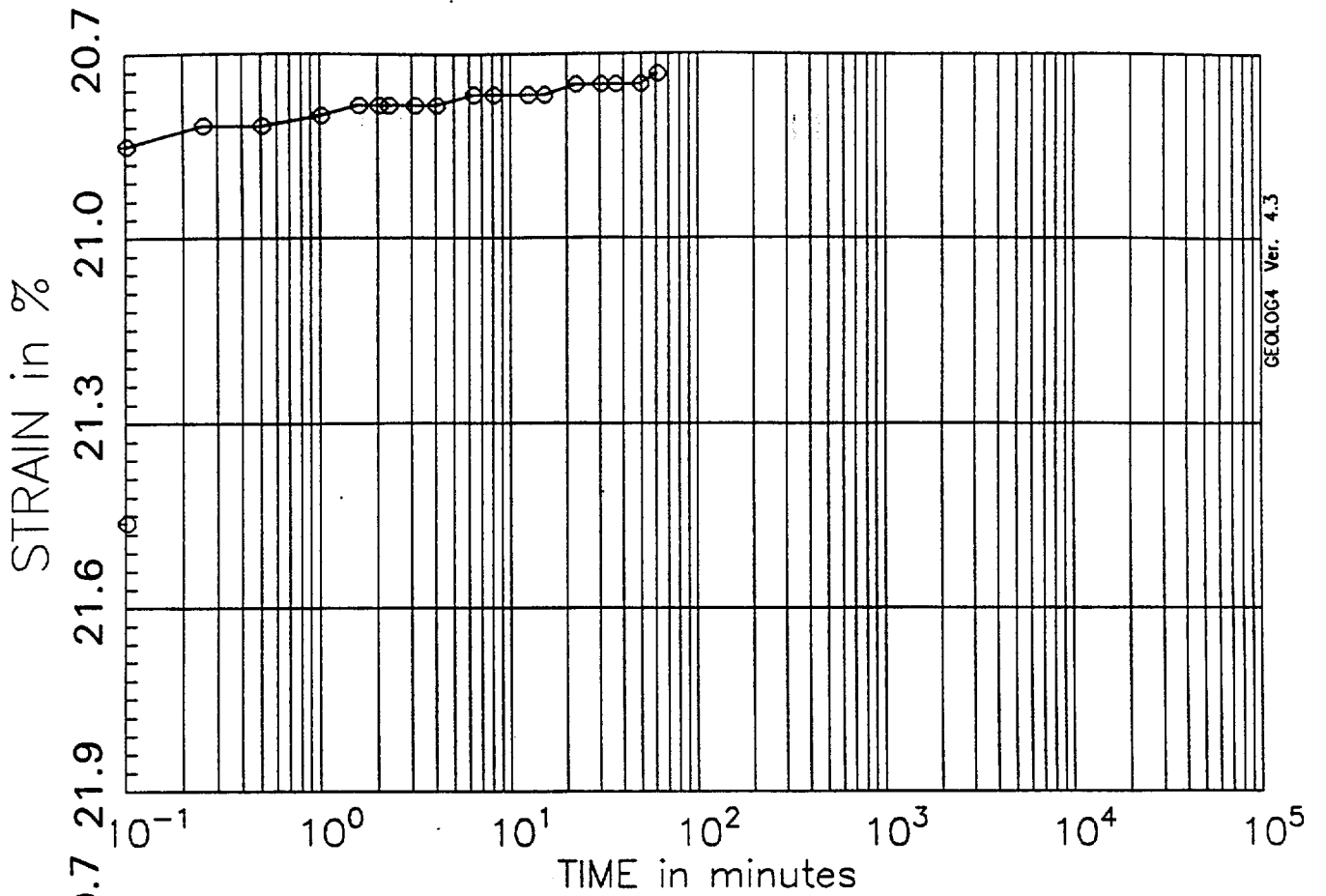

GEOL064 Ver. 4.3

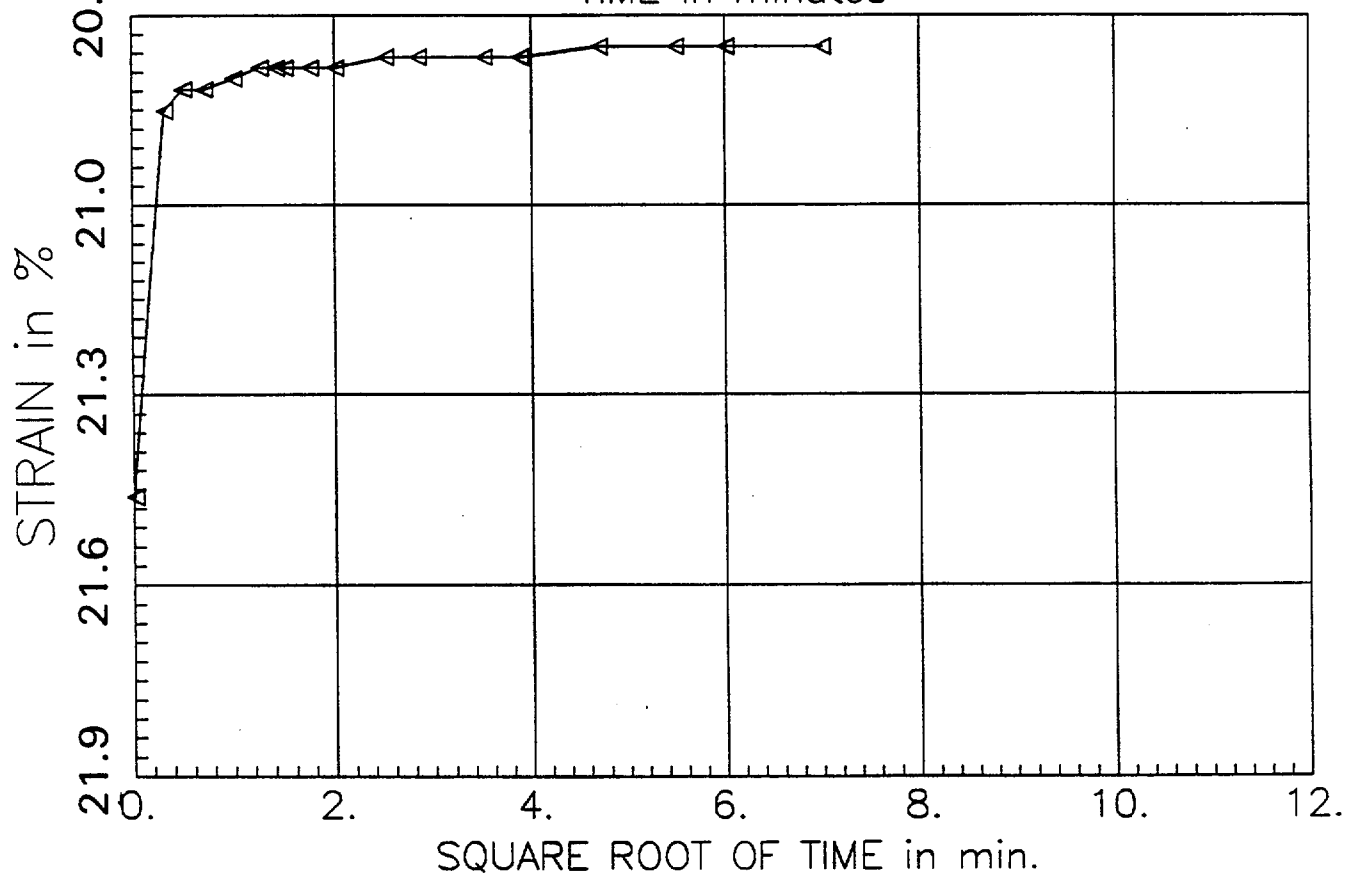

PRESSURE INCREMENT
from 8.00 tsf to 2.00 tsf

Test No: 4
Testname: C1-U3C

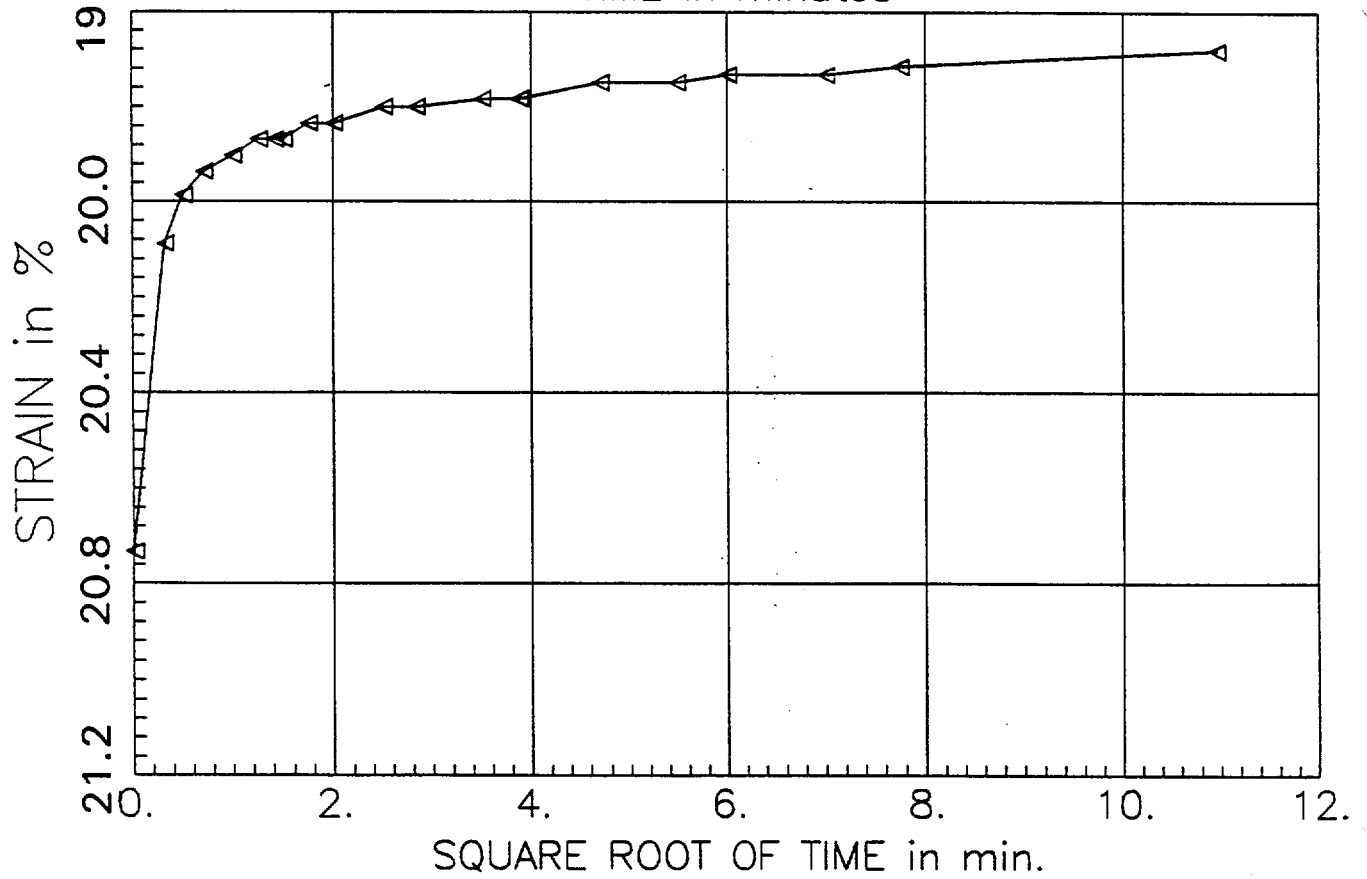
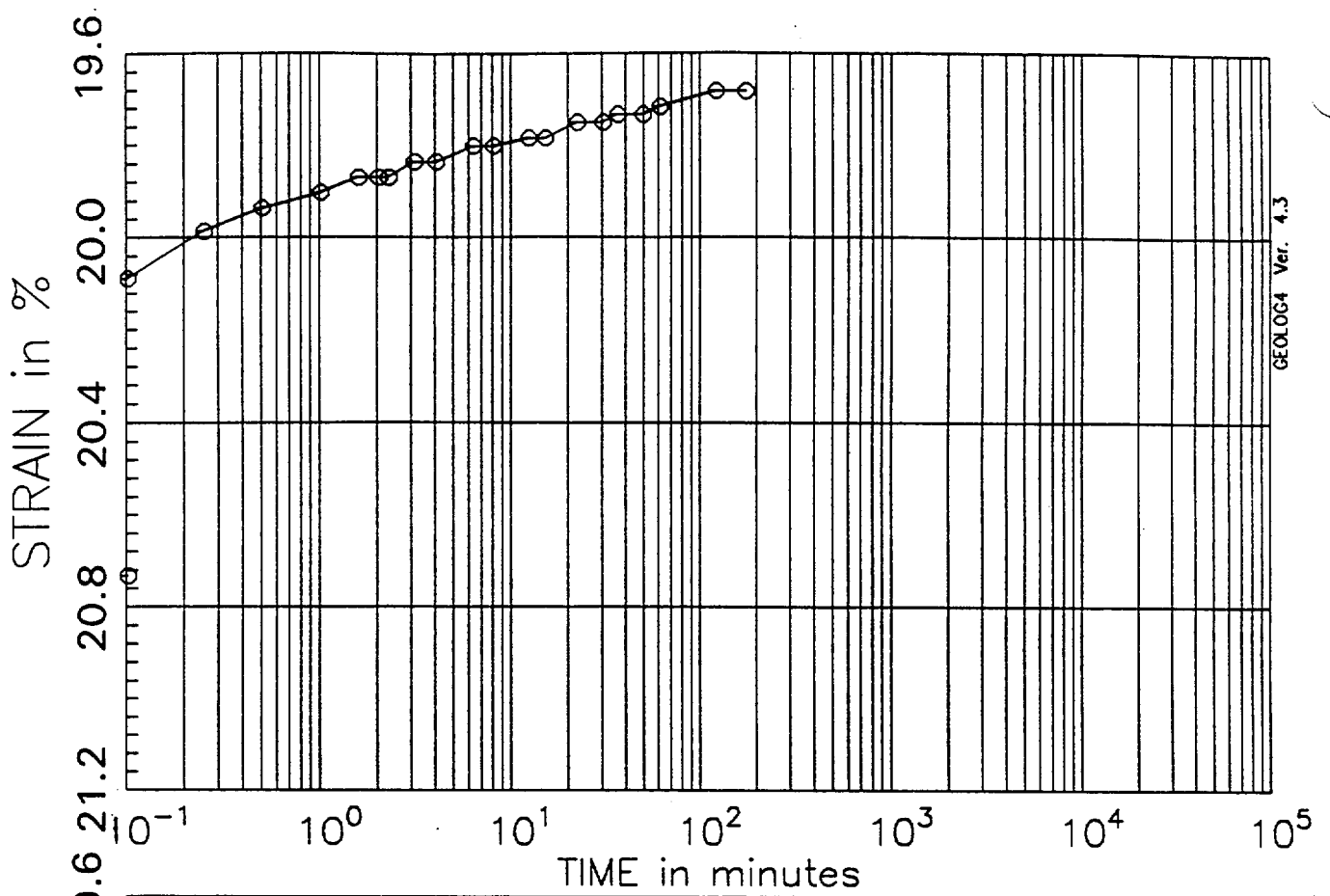

PRESSURE INCREMENT
from 2.00 tsf to 0.50 tsf

Test No: 4
Testname: C1-U3C

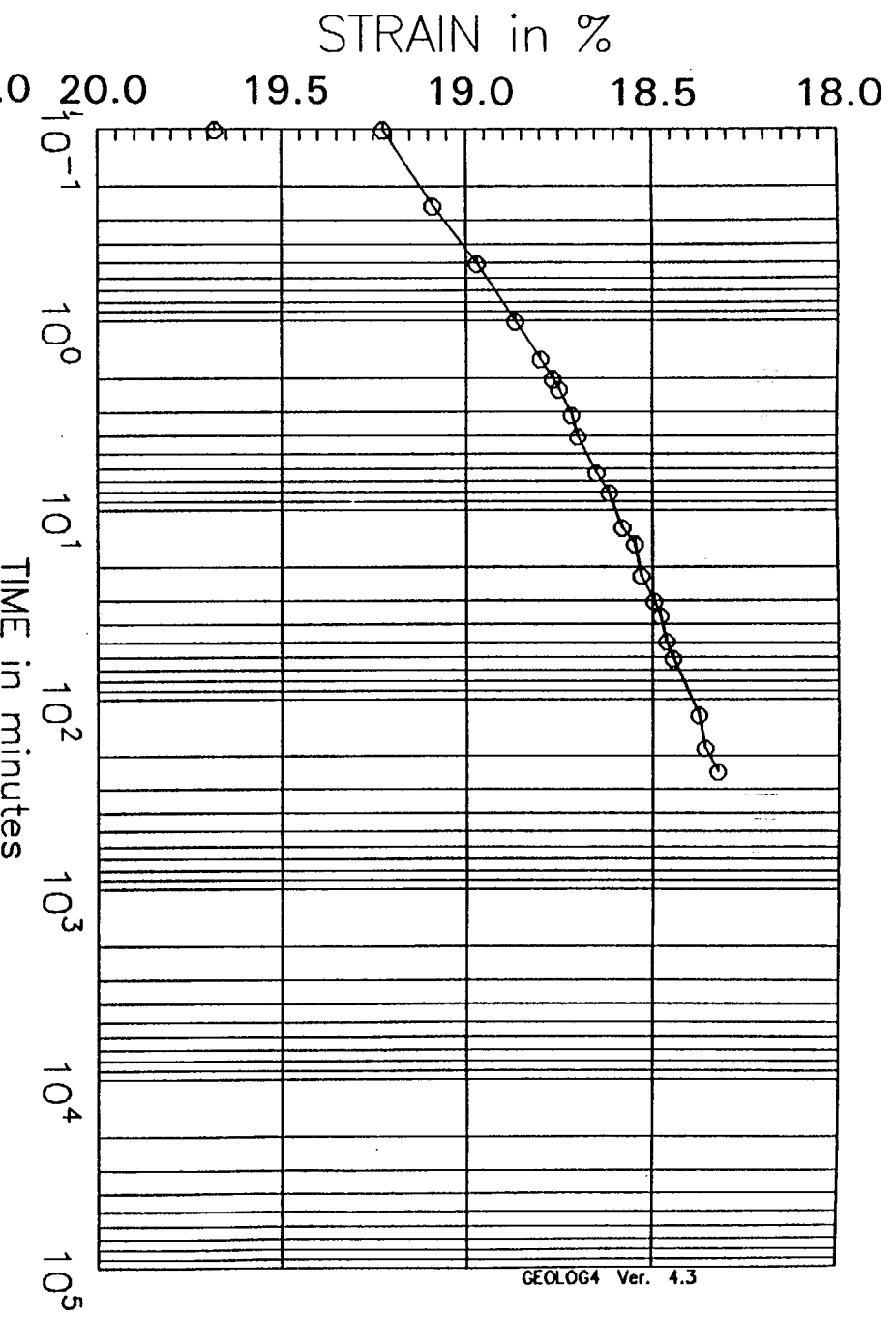

GEOLOG4 Ver. 4.3

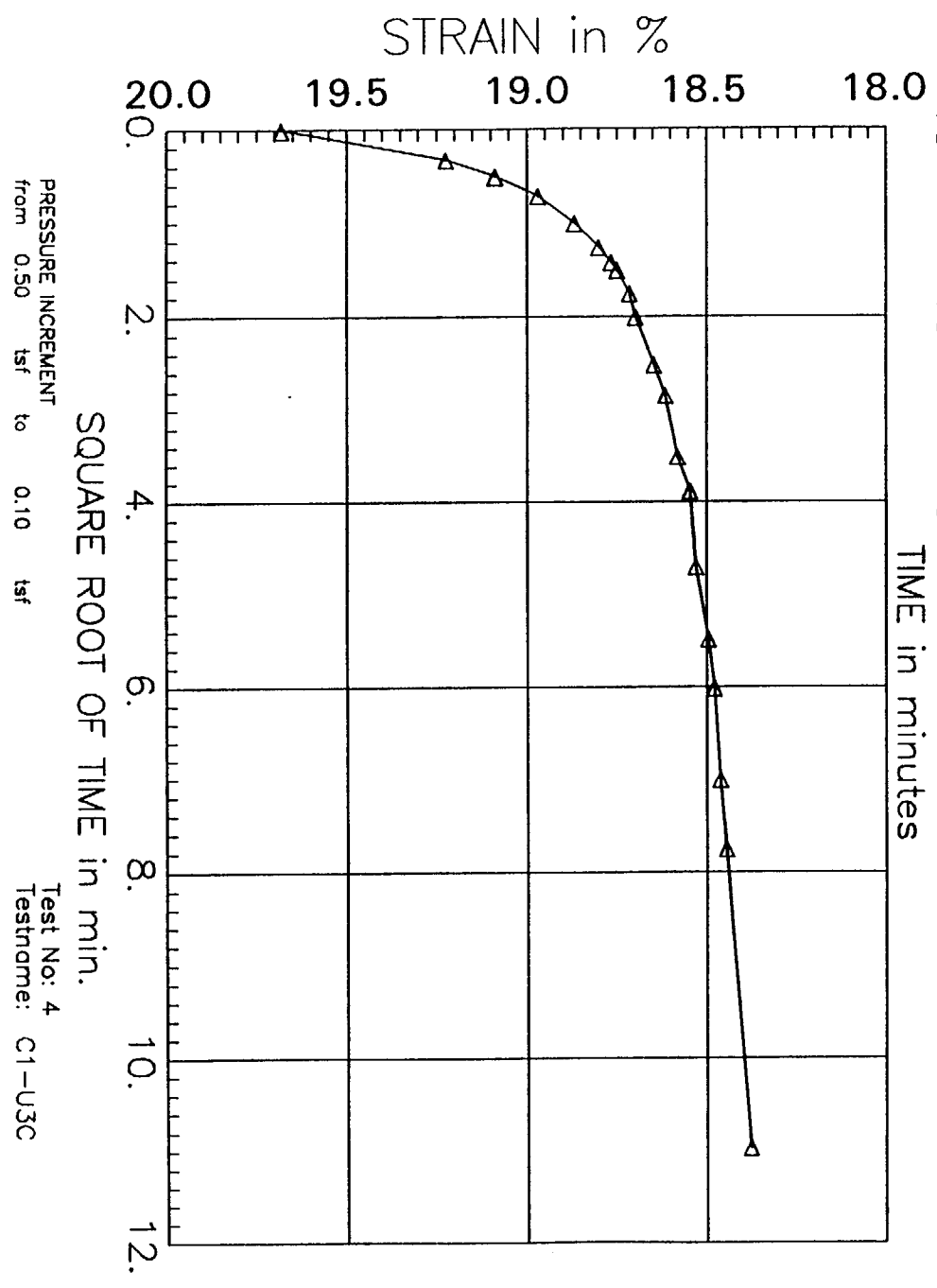

CONSOLIDATION TEST DATA

SAMPLE INFORMATION:

BORING:	C-1	DATE:	12/20/96
SAMPLE:	U-3C	TESTED BY:	ACS
DEPTH:	11.2 ft	CHECKED:	PJT
DESCRIPTION:	Clayey SILT		

SPECIMEN INFORMATION:

	INITIAL	FINAL
WATER CONTENT:	38.9 %	51.9 %
DRY UNIT WEIGHT:	55.8 pcf	68.4 pcf
VOID RATIO:	2.041	1.484
SATURATION:	51.8 %	95.2 %
HEIGHT:	1.901 cm	1.553 cm
AREA:	31.61 sq cm	
SP. GRAVITY :	2.72	

TEST DATA:

APPLIED PRESSURE	STRAIN
tsf	%
0.10	0.15
0.25	0.49
0.50	1.02
1.00	1.78
2.00	3.27
2.00	5.15
0.50	4.66
1.00	4.78
2.00	5.17
4.00	8.78
8.00	18.33
8.00	21.46
2.00	20.77
0.50	19.80
0.10	18.61

LOAD INCREMENT DATA

TEST NAME C1-U3C
 TESTED BY: ACS

PAGE NO: 1
 JO: 05996.01

PRESSURE INCREMENT FROM 0.00 tsf to 0.10 tsf

DATE	TIME	ELAPSED TIME (min)	SQ RT OF TIME(min)	CHANGE IN HEIGHT(in)	VOID RATIO	STRAIN (%)
12-20-96	18:05:09	0.10	0.32	0.0010	2.037	0.14
		0.25	0.50	0.0010	2.037	0.14
		0.50	0.71	0.0010	2.037	0.14
		1.00	1.00	0.0010	2.037	0.14
		1.57	1.25	0.0010	2.037	0.14
		2.00	1.41	0.0011	2.036	0.15
		2.25	1.50	0.0011	2.036	0.15
		3.07	1.75	0.0011	2.036	0.15
		4.00	2.00	0.0011	2.036	0.15
		6.25	2.50	0.0011	2.036	0.15
		8.00	2.83	0.0011	2.036	0.15
		12.25	3.50	0.0011	2.036	0.15
		15.00	3.87	0.0011	2.036	0.15

LOAD INCREMENT DATA

TEST NAME C1-U3C
 TESTED BY: ACS

PAGE NO: 2
 JO: 05996.01

PRESSURE INCREMENT FROM 0.10 tsf to 0.25 tsf

DATE	TIME	ELAPSED TIME (min)	SQ RT OF TIME(min)	CHANGE IN HEIGHT(in)	VOID RATIO	STRAIN (%)
12-20-96	18:24:30	0.00	0.00	0.0011	2.036	0.15
		0.10	0.32	0.0032	2.028	0.42
		0.25	0.50	0.0033	2.028	0.44
		0.50	0.71	0.0034	2.027	0.46
		1.00	1.00	0.0034	2.027	0.46
		1.57	1.25	0.0036	2.027	0.47
		2.00	1.41	0.0036	2.027	0.47
		2.25	1.50	0.0036	2.027	0.47
		3.07	1.75	0.0036	2.027	0.47
		4.00	2.00	0.0037	2.026	0.49
		6.25	2.50	0.0037	2.026	0.49
		8.00	2.83	0.0037	2.026	0.49
		12.25	3.50	0.0038	2.026	0.51
		15.00	3.87	0.0038	2.026	0.51
		22.00	4.69	0.0038	2.026	0.51
		30.00	5.48	0.0039	2.025	0.53
		36.00	6.00	0.0039	2.025	0.53
		49.00	7.00	0.0039	2.025	0.53
		60.00	7.75	0.0041	2.025	0.54
		12-21-96	00:24:30	120.00	10.95	0.0042
180.00	13.42			0.0043	2.023	0.58
240.00	15.49			0.0044	2.023	0.59
300.00	17.32			0.0044	2.023	0.59
360.00	18.97			0.0044	2.023	0.59
420.00	20.49			0.0046	2.022	0.61
480.00	21.91			0.0046	2.022	0.61
540.00	23.24			0.0047	2.022	0.63
600.00	24.49			0.0047	2.022	0.63
660.00	25.69			0.0047	2.022	0.63
720.00	26.83	0.0047	2.022	0.63		
780.00	27.93	0.0047	2.022	0.63		
840.00	28.98	0.0048	2.021	0.64		
900.00	30.00	0.0048	2.021	0.64		
960.00	30.98	0.0048	2.021	0.64		
1020.00	31.94	0.0048	2.021	0.64		
1080.00	32.86	0.0048	2.021	0.64		

LOAD INCREMENT DATA

TEST NAME C1-U3C
TESTED BY: ACS

PAGE NO: 3
JO: 05996.01

PRESSURE INCREMENT FROM 0.10 tsf to 0.25 tsf

DATE	TIME	ELAPSED TIME (min)	SQ RT OF TIME(min)	CHANGE IN HEIGHT(in)	VOID RATIO	STRAIN (%)
		1140.00	33.76	0.0048	2.021	0.64
		1200.00	34.64	0.0048	2.021	0.64
		1260.00	35.50	0.0048	2.021	0.64
		1320.00	36.33	0.0047	2.022	0.63
		1380.00	37.15	0.0047	2.022	0.63
		1440.00	37.95	0.0047	2.022	0.63
		1500.00	38.73	0.0047	2.022	0.63

LOAD INCREMENT DATA

TEST NAME C1-U3C
 TESTED BY: ACS

PAGE NO: 4
 JO: 05996.01

PRESSURE INCREMENT FROM 0.25 tsf to 0.50 tsf

DATE	TIME	ELAPSED TIME (min)	SQ RT OF TIME(min)	CHANGE IN HEIGHT(in)	VOID RATIO	STRAIN (%)
12-21-96	19:35:55	0.00	0.00	0.0047	2.022	0.63
		0.10	0.32	0.0070	2.013	0.93
		0.25	0.50	0.0071	2.012	0.95
		0.50	0.71	0.0072	2.012	0.97
		1.00	1.00	0.0074	2.011	0.98
		1.57	1.25	0.0075	2.011	1.00
		2.00	1.41	0.0075	2.011	1.00
		2.25	1.50	0.0075	2.011	1.00
		3.07	1.75	0.0075	2.011	1.00
		4.00	2.00	0.0075	2.011	1.00
		6.25	2.50	0.0076	2.010	1.02
		8.00	2.83	0.0076	2.010	1.02
		12.25	3.50	0.0077	2.010	1.03
		15.00	3.87	0.0077	2.010	1.03
		22.00	4.69	0.0077	2.010	1.03
		30.00	5.48	0.0079	2.009	1.05
		36.00	6.00	0.0079	2.009	1.05
		49.00	7.00	0.0080	2.009	1.07
		60.00	7.75	0.0080	2.009	1.07
		12-22-96	00:35:55	120.00	10.95	0.0081
180.00	13.42			0.0082	2.007	1.10
240.00	15.49			0.0084	2.007	1.12
300.00	17.32			0.0084	2.007	1.12
360.00	18.97			0.0085	2.006	1.14
420.00	20.49			0.0085	2.006	1.14
480.00	21.91			0.0085	2.006	1.14
540.00	23.24			0.0086	2.006	1.15
600.00	24.49			0.0086	2.006	1.15
660.00	25.69			0.0086	2.006	1.15
720.00	26.83			0.0086	2.006	1.15
780.00	27.93			0.0088	2.005	1.17
840.00	28.98			0.0088	2.005	1.17
900.00	30.00			0.0088	2.005	1.17
960.00	30.98			0.0088	2.005	1.17
1020.00	31.94			0.0088	2.005	1.17
1080.00	32.86			0.0088	2.005	1.17
1140.00	33.76			0.0089	2.005	1.19
1200.00	34.64	0.0088	2.005	1.17		
1260.00	35.50	0.0088	2.005	1.17		
1320.00	36.33	0.0088	2.005	1.17		
1380.00	37.15	0.0088	2.005	1.17		

LOAD INCREMENT DATA

TEST NAME C1-U3C
 TESTED BY: ACS

PAGE NO: 5
 JO: 05996.01

PRESSURE INCREMENT FROM 0.50 tsf to 1.00 tsf

DATE	TIME	ELAPSED TIME (min)	SQ RT OF TIME(min)	CHANGE IN HEIGHT(in)	VOID RATIO	STRAIN (%)
12-22-96	19:29:40	0.00	0.00	0.0088	2.005	1.17
		0.10	0.32	0.0119	1.993	1.59
		0.25	0.50	0.0124	1.990	1.66
		0.50	0.71	0.0126	1.990	1.68
		1.00	1.00	0.0127	1.989	1.70
		1.57	1.25	0.0128	1.989	1.71
		2.00	1.41	0.0129	1.988	1.73
		2.25	1.50	0.0129	1.988	1.73
		3.07	1.75	0.0131	1.988	1.75
		4.00	2.00	0.0131	1.988	1.75
		6.25	2.50	0.0132	1.987	1.76
		8.00	2.83	0.0133	1.987	1.78
		12.25	3.50	0.0134	1.986	1.80
		15.00	3.87	0.0134	1.986	1.80
		22.00	4.69	0.0136	1.986	1.81
		30.00	5.48	0.0137	1.985	1.83
		36.00	6.00	0.0137	1.985	1.83
		49.00	7.00	0.0138	1.985	1.85
		60.00	7.75	0.0140	1.984	1.86
12-23-96	00:29:40	120.00	10.95	0.0142	1.983	1.90
		180.00	13.42	0.0143	1.983	1.92
		240.00	15.49	0.0145	1.982	1.93
		300.00	17.32	0.0146	1.982	1.95
		360.00	18.97	0.0147	1.981	1.97
		420.00	20.49	0.0147	1.981	1.97
		480.00	21.91	0.0148	1.981	1.98
		540.00	23.24	0.0148	1.981	1.98
		600.00	24.49	0.0148	1.981	1.98
		660.00	25.69	0.0148	1.981	1.98
		720.00	26.83	0.0148	1.981	1.98
780.00	27.93	0.0148	1.981	1.98		
840.00	28.98	0.0148	1.981	1.98		
900.00	30.00	0.0148	1.981	1.98		
960.00	30.98	0.0148	1.981	1.98		
1020.00	31.94	0.0148	1.981	1.98		
1080.00	32.86	0.0148	1.981	1.98		

LOAD INCREMENT DATA

TEST NAME C1-U3C
 TESTED BY: ACS

PAGE NO: 6
 JO: 05996.01

PRESSURE INCREMENT FROM 0.50 tsf to 1.00 tsf

DATE	TIME	ELAPSED TIME (min)	SQ RT OF TIME(min)	CHANGE IN HEIGHT(in)	VOID RATIO	STRAIN (%)
		1140.00	33.76	0.0148	1.981	1.98
		1200.00	34.64	0.0148	1.981	1.98
		1260.00	35.50	0.0148	1.981	1.98
		1320.00	36.33	0.0148	1.981	1.98
		1380.00	37.15	0.0150	1.980	2.00
		1440.00	37.95	0.0150	1.980	2.00
		1500.00	38.73	0.0151	1.980	2.02
		1560.00	39.50	0.0152	1.979	2.03
		1620.00	40.25	0.0152	1.979	2.03
		1680.00	40.99	0.0152	1.979	2.03
12-24-96	00:29:40	1740.00	41.71	0.0154	1.979	2.05
		1800.00	42.43	0.0154	1.979	2.05
		1860.00	43.13	0.0154	1.979	2.05
		1920.00	43.82	0.0154	1.979	2.05
		1980.00	44.50	0.0154	1.979	2.05
		2040.00	45.17	0.0154	1.979	2.05
		2100.00	45.83	0.0154	1.979	2.05
		2160.00	46.48	0.0154	1.979	2.05
		2220.00	47.12	0.0152	1.979	2.03
		2280.00	47.75	0.0152	1.979	2.03
		2340.00	48.37	0.0152	1.979	2.03
		2400.00	48.99	0.0152	1.979	2.03
		2460.00	49.60	0.0152	1.979	2.03
		2520.00	50.20	0.0152	1.979	2.03
		2580.00	50.79	0.0154	1.979	2.05

LOAD INCREMENT DATA

TEST NAME C1-U3C
 TESTED BY: ACS

PAGE NO: 7
 JO: 05996.01

PRESSURE INCREMENT FROM 1.00 tsf to 2.00 tsf

DATE	TIME	ELAPSED TIME (min)	SQ RT OF TIME(min)	CHANGE IN HEIGHT(in)	VOID RATIO	STRAIN (%)
12-24-96	14:45:04	0.00	0.00	0.0154	1.979	2.05
		0.10	0.32	0.0211	1.955	2.81
		0.25	0.50	0.0218	1.952	2.92
		0.50	0.71	0.0223	1.950	2.98
		1.00	1.00	0.0227	1.949	3.03
		1.57	1.25	0.0231	1.947	3.09
		2.00	1.41	0.0233	1.946	3.12
		2.25	1.50	0.0233	1.946	3.12
		3.07	1.75	0.0236	1.945	3.15
		4.00	2.00	0.0239	1.944	3.19
		6.25	2.50	0.0242	1.943	3.24
		8.00	2.83	0.0245	1.942	3.27
		12.25	3.50	0.0250	1.939	3.34
		15.00	3.87	0.0252	1.938	3.37
		22.00	4.69	0.0258	1.936	3.44
		30.00	5.48	0.0261	1.935	3.49
		36.00	6.00	0.0264	1.934	3.53
		49.00	7.00	0.0268	1.932	3.58
		60.00	7.75	0.0272	1.931	3.63
		120.00	10.95	0.0283	1.926	3.78
		180.00	13.42	0.0289	1.923	3.87
		240.00	15.49	0.0294	1.921	3.93
		300.00	17.32	0.0298	1.920	3.98
		360.00	18.97	0.0301	1.919	4.02
420.00	20.49	0.0305	1.917	4.07		
480.00	21.91	0.0306	1.917	4.09		
540.00	23.24	0.0308	1.916	4.12		
12-25-96	00:45:04	600.00	24.49	0.0310	1.915	4.14
		660.00	25.69	0.0312	1.914	4.17
		720.00	26.83	0.0313	1.914	4.19
		780.00	27.93	0.0315	1.913	4.20
		840.00	28.98	0.0316	1.913	4.22
		900.00	30.00	0.0318	1.912	4.26
		960.00	30.98	0.0318	1.912	4.26
		1020.00	31.94	0.0321	1.911	4.29
1080.00	32.86	0.0322	1.910	4.31		

LOAD INCREMENT DATA

TEST NAME C1-U3C
 TESTED BY: ACS

PAGE NO: 8
 JO: 05996.01

PRESSURE INCREMENT FROM 1.00 tsf to 2.00 tsf

DATE	TIME	ELAPSED TIME (min)	SQ RT OF TIME(min)	CHANGE IN HEIGHT(in)	VOID RATIO	STRAIN (%)
		1140.00	33.76	0.0322	1.910	4.31
		1200.00	34.64	0.0324	1.910	4.32
		1260.00	35.50	0.0325	1.909	4.34
		1320.00	36.33	0.0326	1.909	4.36
		1380.00	37.15	0.0327	1.908	4.37
		1440.00	37.95	0.0329	1.907	4.39
		1500.00	38.73	0.0329	1.907	4.39
		1560.00	39.50	0.0330	1.907	4.41
		1620.00	40.25	0.0331	1.906	4.42
		1680.00	40.99	0.0331	1.906	4.42
		1740.00	41.71	0.0332	1.906	4.44
		1800.00	42.43	0.0334	1.905	4.46
		1860.00	43.13	0.0334	1.905	4.46
		1920.00	43.82	0.0335	1.905	4.48
		1980.00	44.50	0.0335	1.905	4.48
12-26-96	00:45:04	2040.00	45.17	0.0336	1.904	4.49
		2100.00	45.83	0.0337	1.904	4.51
		2160.00	46.48	0.0337	1.904	4.51
		2220.00	47.12	0.0337	1.904	4.51
		2280.00	47.75	0.0339	1.903	4.53
		2340.00	48.37	0.0339	1.903	4.53
		2400.00	48.99	0.0339	1.903	4.53
		2460.00	49.60	0.0339	1.903	4.53
		2520.00	50.20	0.0340	1.903	4.54
		2580.00	50.79	0.0340	1.903	4.54
		2640.00	51.38	0.0340	1.903	4.54
		2700.00	51.96	0.0340	1.903	4.54
		2760.00	52.54	0.0341	1.902	4.56
		2820.00	53.10	0.0341	1.902	4.56
		2880.00	53.67	0.0341	1.902	4.56
		2940.00	54.22	0.0343	1.902	4.58
		3000.00	54.77	0.0343	1.902	4.58
		3060.00	55.32	0.0344	1.901	4.59
		3120.00	55.86	0.0344	1.901	4.59

LOAD INCREMENT DATA

TEST NAME C1-U3C
 TESTED BY: ACS

PAGE NO: 9
 JO: 05996.01

PRESSURE INCREMENT FROM 1.00 tsf to 2.00 tsf

DATE	TIME	ELAPSED TIME (min)	SQ RT OF TIME(min)	CHANGE IN HEIGHT(in)	VOID RATIO	STRAIN (%)
		3180.00	56.39	0.0345	1.901	4.61
		3240.00	56.92	0.0346	1.900	4.63
		3300.00	57.45	0.0346	1.900	4.63
		3360.00	57.97	0.0348	1.900	4.64
		3420.00	58.48	0.0348	1.900	4.64
12-27-96	00:45:04	3480.00	58.99	0.0349	1.899	4.66
		3540.00	59.50	0.0349	1.899	4.66
		3600.00	60.00	0.0349	1.899	4.66
		3660.00	60.50	0.0350	1.899	4.68
		3720.00	60.99	0.0350	1.899	4.68
		3780.00	61.48	0.0350	1.899	4.68
		3840.00	61.97	0.0350	1.899	4.68
		3900.00	62.45	0.0350	1.899	4.68
		3960.00	62.93	0.0350	1.899	4.68
		4020.00	63.40	0.0350	1.899	4.68
		4080.00	63.87	0.0350	1.899	4.68
		4140.00	64.34	0.0351	1.898	4.70
		4200.00	64.81	0.0351	1.898	4.70
		4260.00	65.27	0.0351	1.898	4.70
		4320.00	65.73	0.0353	1.898	4.71
		4380.00	66.18	0.0353	1.898	4.71
		4440.00	66.63	0.0353	1.898	4.71
		4500.00	67.08	0.0353	1.898	4.71
		4560.00	67.53	0.0354	1.897	4.73
		4620.00	67.97	0.0354	1.897	4.73
		4680.00	68.41	0.0355	1.897	4.75
		4740.00	68.85	0.0357	1.896	4.76
		4800.00	69.28	0.0357	1.896	4.76
		4860.00	69.71	0.0357	1.896	4.76
12-28-96	00:45:04	4920.00	70.14	0.0358	1.896	4.78
		4980.00	70.57	0.0358	1.896	4.78
		5040.00	70.99	0.0359	1.895	4.80
		5100.00	71.41	0.0359	1.895	4.80
		5160.00	71.83	0.0359	1.895	4.80

LOAD INCREMENT DATA

TEST NAME C1-U3C
 TESTED BY: ACS

PAGE NO: 10
 JO: 05996.01

PRESSURE INCREMENT FROM 1.00 tsf to 2.00 tsf

DATE	TIME	ELAPSED TIME (min)	SQ RT OF TIME(min)	CHANGE IN HEIGHT(in)	VOID RATIO	STRAIN (%)
		5220.00	72.25	0.0360	1.895	4.81
		5280.00	72.66	0.0360	1.895	4.81
		5340.00	73.08	0.0360	1.895	4.81
		5400.00	73.48	0.0360	1.895	4.81
		5460.00	73.89	0.0362	1.894	4.83
		5520.00	74.30	0.0362	1.894	4.83
		5580.00	74.70	0.0362	1.894	4.83
		5640.00	75.10	0.0362	1.894	4.83
		5700.00	75.50	0.0362	1.894	4.83
		5760.00	75.89	0.0363	1.894	4.85
		5820.00	76.29	0.0363	1.894	4.85
		5880.00	76.68	0.0363	1.894	4.85
		5940.00	77.07	0.0363	1.894	4.85
		6000.00	77.46	0.0363	1.894	4.85
		6060.00	77.85	0.0364	1.893	4.87
		6120.00	78.23	0.0364	1.893	4.87
		6180.00	78.61	0.0364	1.893	4.87
		6240.00	78.99	0.0364	1.893	4.87
		6300.00	79.37	0.0365	1.893	4.88
12-29-96	00:45:04	6360.00	79.75	0.0365	1.893	4.88
		6420.00	80.12	0.0365	1.893	4.88
		6480.00	80.50	0.0365	1.893	4.88
		6540.00	80.87	0.0365	1.893	4.88
		6600.00	81.24	0.0367	1.892	4.90
		6660.00	81.61	0.0367	1.892	4.90
		6720.00	81.98	0.0367	1.892	4.90
		6780.00	82.34	0.0367	1.892	4.90
		6840.00	82.70	0.0367	1.892	4.90
		6900.00	83.07	0.0368	1.891	4.92
		6960.00	83.43	0.0368	1.891	4.92
		7020.00	83.79	0.0368	1.891	4.92
		7080.00	84.14	0.0368	1.891	4.92
		7140.00	84.50	0.0368	1.891	4.92
		7200.00	84.85	0.0369	1.891	4.93

LOAD INCREMENT DATA

TEST NAME C1-U3C
 TESTED BY: ACS

PAGE NO: 11
 JO: 05996.01

PRESSURE INCREMENT FROM 1.00 tsf to 2.00 tsf

DATE	TIME	ELAPSED TIME (min)	SQ RT OF TIME(min)	CHANGE IN HEIGHT(in)	VOID RATIO	STRAIN (%)
		7260.00	85.21	0.0369	1.891	4.93
		7320.00	85.56	0.0369	1.891	4.93
		7380.00	85.91	0.0369	1.891	4.93
		7440.00	86.26	0.0369	1.891	4.93
		7500.00	86.60	0.0369	1.891	4.93
		7560.00	86.95	0.0369	1.891	4.93
		7620.00	87.29	0.0370	1.890	4.95
		7680.00	87.64	0.0370	1.890	4.95
		7740.00	87.98	0.0370	1.890	4.95
12-30-96	00:45:04	7800.00	88.32	0.0370	1.890	4.95
		7860.00	88.66	0.0370	1.890	4.95
		7920.00	88.99	0.0370	1.890	4.95
		7980.00	89.33	0.0370	1.890	4.95
		8040.00	89.67	0.0372	1.890	4.97
		8100.00	90.00	0.0372	1.890	4.97
		8160.00	90.33	0.0370	1.890	4.95
		8220.00	90.66	0.0370	1.890	4.95
		8280.00	90.99	0.0370	1.890	4.95
		8340.00	91.32	0.0370	1.890	4.95
		8400.00	91.65	0.0370	1.890	4.95
		8460.00	91.98	0.0370	1.890	4.95
		8520.00	92.30	0.0370	1.890	4.95
		8580.00	92.63	0.0370	1.890	4.95
		8640.00	92.95	0.0370	1.890	4.95
		8700.00	93.27	0.0370	1.890	4.95
		8760.00	93.59	0.0372	1.890	4.97
		8820.00	93.91	0.0372	1.890	4.97
		8880.00	94.23	0.0372	1.890	4.97
		8940.00	94.55	0.0373	1.889	4.98
		9000.00	94.87	0.0373	1.889	4.98
		9060.00	95.18	0.0373	1.889	4.98
		9120.00	95.50	0.0374	1.889	5.00
		9180.00	95.81	0.0374	1.889	5.00
12-31-96	00:45:04	9240.00	96.12	0.0374	1.889	5.00

LOAD INCREMENT DATA

TEST NAME C1-U3C
 TESTED BY: ACS

PAGE NO: 12
 JO: 05996.01

PRESSURE INCREMENT FROM 1.00 tsf to 2.00 tsf

DATE	TIME	ELAPSED TIME (min)	SQ RT OF TIME(min)	CHANGE IN HEIGHT(in)	VOID RATIO	STRAIN (%)
		9300.00	96.44	0.0374	1.889	5.00
		9360.00	96.75	0.0376	1.888	5.02
		9420.00	97.06	0.0376	1.888	5.02
		9480.00	97.37	0.0376	1.888	5.02
		9540.00	97.67	0.0376	1.888	5.02
		9600.00	97.98	0.0376	1.888	5.02
		9660.00	98.29	0.0376	1.888	5.02
		9720.00	98.59	0.0376	1.888	5.02
		9780.00	98.89	0.0374	1.889	5.00
		9840.00	99.20	0.0374	1.889	5.00
		9900.00	99.50	0.0374	1.889	5.00
		9960.00	99.80	0.0374	1.889	5.00
		1002.00E+01	100.10	0.0374	1.889	5.00
		1008.00E+01	100.40	0.0376	1.888	5.02
		1014.00E+01	100.70	0.0376	1.888	5.02
		1020.00E+01	101.00	0.0376	1.888	5.02
		1026.00E+01	101.29	0.0377	1.888	5.03
		1032.00E+01	101.59	0.0377	1.888	5.03
		1038.00E+01	101.88	0.0378	1.887	5.05
		1044.00E+01	102.18	0.0378	1.887	5.05
		1050.00E+01	102.47	0.0379	1.887	5.07
		1056.00E+01	102.76	0.0379	1.887	5.07
		1062.00E+01	103.05	0.0379	1.887	5.07
01-01-97	00:45:04	1068.00E+01	103.34	0.0381	1.886	5.09
		1074.00E+01	103.63	0.0381	1.886	5.09
		1080.00E+01	103.92	0.0381	1.886	5.09
		1086.00E+01	104.21	0.0382	1.886	5.10
		1092.00E+01	104.50	0.0382	1.886	5.10
		1098.00E+01	104.79	0.0382	1.886	5.10
		1104.00E+01	105.07	0.0382	1.886	5.10
		1110.00E+01	105.36	0.0382	1.886	5.10
		1116.00E+01	105.64	0.0382	1.886	5.10
		1122.00E+01	105.92	0.0383	1.885	5.12
		1128.00E+01	106.21	0.0383	1.885	5.12

LOAD INCREMENT DATA

TEST NAME C1-U3C
 TESTED BY: ACS

PAGE NO: 13
 JO: 05996.01

PRESSURE INCREMENT FROM 1.00 tsf to 2.00 tsf

DATE	TIME	ELAPSED TIME (min)	SQ RT OF TIME(min)	CHANGE IN HEIGHT(in)	VOID RATIO	STRAIN (%)
		1134.00E+01	106.49	0.0383	1.885	5.12
		1140.00E+01	106.77	0.0384	1.885	5.14
		1146.00E+01	107.05	0.0384	1.885	5.14
		1152.00E+01	107.33	0.0384	1.885	5.14
		1158.00E+01	107.61	0.0384	1.885	5.14
		1164.00E+01	107.89	0.0384	1.885	5.14
		1170.00E+01	108.17	0.0384	1.885	5.14
		1176.00E+01	108.44	0.0384	1.885	5.14
		1182.00E+01	108.72	0.0384	1.885	5.14
		1188.00E+01	109.00	0.0384	1.885	5.14
		1194.00E+01	109.27	0.0384	1.885	5.14
		1200.00E+01	109.54	0.0386	1.884	5.15
		1206.00E+01	109.82	0.0384	1.885	5.14
01-02-97	00:45:04	1212.00E+01	110.09	0.0386	1.884	5.15
		1218.00E+01	110.36	0.0386	1.884	5.15
		1224.00E+01	110.63	0.0386	1.884	5.15
		1230.00E+01	110.91	0.0386	1.884	5.15
		1236.00E+01	111.18	0.0386	1.884	5.15
		1242.00E+01	111.45	0.0386	1.884	5.15
		1248.00E+01	111.71	0.0384	1.885	5.14
		1254.00E+01	111.98	0.0384	1.885	5.14
		1260.00E+01	112.25	0.0384	1.885	5.14
		1266.00E+01	112.52	0.0383	1.885	5.12
		1272.00E+01	112.78	0.0384	1.885	5.14
		1278.00E+01	113.05	0.0384	1.885	5.14

LOAD INCREMENT DATA

TEST NAME C1-U3C
 TESTED BY: ACS

PAGE NO: 14
 JO: 05996.01

PRESSURE INCREMENT FROM 2.00 tsf to 0.50 tsf

DATE	TIME	ELAPSED TIME (min)	SQ RT OF TIME(min)	CHANGE IN HEIGHT(in)	VOID RATIO	STRAIN (%)
01-02-97	11:56:36	0.00	0.00	0.0384	1.885	5.14
		0.10	0.32	0.0354	1.897	4.73
		0.25	0.50	0.0353	1.898	4.71
		0.50	0.71	0.0351	1.898	4.70
		1.00	1.00	0.0350	1.899	4.68
		1.57	1.25	0.0350	1.899	4.68
		2.00	1.41	0.0350	1.899	4.68
		2.25	1.50	0.0350	1.899	4.68
		3.07	1.75	0.0350	1.899	4.68
		4.00	2.00	0.0350	1.899	4.68
		6.25	2.50	0.0350	1.899	4.68
		8.00	2.83	0.0349	1.899	4.66
		12.25	3.50	0.0349	1.899	4.66
		15.00	3.87	0.0349	1.899	4.66
		22.00	4.69	0.0348	1.900	4.64
		30.00	5.48	0.0348	1.900	4.64
		36.00	6.00	0.0348	1.900	4.64
		49.00	7.00	0.0348	1.900	4.64
		60.00	7.75	0.0348	1.900	4.64
		120.00	10.95	0.0346	1.900	4.63
		180.00	13.42	0.0345	1.901	4.61
		240.00	15.49	0.0345	1.901	4.61

LOAD INCREMENT DATA

TEST NAME C1-U3C
 TESTED BY: ACS

PAGE NO: 15
 JO: 05996.01

PRESSURE INCREMENT FROM 0.50 tsf to 1.00 tsf

DATE	TIME	ELAPSED TIME (min)	SQ RT OF TIME(min)	CHANGE IN HEIGHT(in)	VOID RATIO	STRAIN (%)
01-02-97	16:56:49	0.00	0.00	0.0345	1.901	4.61
		0.10	0.32	0.0357	1.896	4.76
		0.25	0.50	0.0357	1.896	4.76
		0.50	0.71	0.0357	1.896	4.76
		1.00	1.00	0.0357	1.896	4.76
		1.57	1.25	0.0357	1.896	4.76
		2.00	1.41	0.0357	1.896	4.76
		2.25	1.50	0.0357	1.896	4.76
		3.07	1.75	0.0357	1.896	4.76
		4.00	2.00	0.0357	1.896	4.76
		6.25	2.50	0.0357	1.896	4.76
		8.00	2.83	0.0358	1.896	4.78
		12.25	3.50	0.0358	1.896	4.78
		15.00	3.87	0.0358	1.896	4.78
		22.00	4.69	0.0358	1.896	4.78
		30.00	5.48	0.0358	1.896	4.78
		36.00	6.00	0.0358	1.896	4.78
		49.00	7.00	0.0358	1.896	4.78
		60.00	7.75	0.0358	1.896	4.78
		01-03-97	00:56:49	120.00	10.95	0.0358
180.00	13.42			0.0359	1.895	4.80
240.00	15.49			0.0359	1.895	4.80
300.00	17.32			0.0360	1.895	4.81
360.00	18.97			0.0360	1.895	4.81
420.00	20.49			0.0362	1.894	4.83
480.00	21.91			0.0360	1.895	4.81
540.00	23.24			0.0362	1.894	4.83
600.00	24.49			0.0362	1.894	4.83
660.00	25.69			0.0362	1.894	4.83
720.00	26.83	0.0362	1.894	4.83		
780.00	27.93	0.0362	1.894	4.83		
840.00	28.98	0.0360	1.895	4.81		
900.00	30.00	0.0360	1.895	4.81		
960.00	30.98	0.0360	1.895	4.81		

LOAD INCREMENT DATA

TEST NAME C1-U3C
 TESTED BY: ACS

PAGE NO: 16
 JO: 05996.01

PRESSURE INCREMENT FROM 1.00 tsf to 2.00 tsf

DATE	TIME	ELAPSED TIME (min)	SQ RT OF TIME(min)	CHANGE IN HEIGHT(in)	VOID RATIO	STRAIN (%)
01-03-97	09:03:56	0.00	0.00	0.0360	1.895	4.81
		0.10	0.32	0.0383	1.885	5.12
		0.25	0.50	0.0384	1.885	5.14
		0.50	0.71	0.0384	1.885	5.14
		1.00	1.00	0.0384	1.885	5.14
		1.57	1.25	0.0386	1.884	5.15
		2.00	1.41	0.0386	1.884	5.15
		2.25	1.50	0.0386	1.884	5.15
		3.07	1.75	0.0386	1.884	5.15
		4.00	2.00	0.0386	1.884	5.15
		6.25	2.50	0.0386	1.884	5.15
		8.00	2.83	0.0387	1.884	5.17
		12.25	3.50	0.0387	1.884	5.17
		15.00	3.87	0.0387	1.884	5.17
		22.00	4.69	0.0388	1.883	5.19
		30.00	5.48	0.0388	1.883	5.19
		36.00	6.00	0.0388	1.883	5.19
		49.00	7.00	0.0388	1.883	5.19
		60.00	7.75	0.0390	1.883	5.20
		120.00	10.95	0.0390	1.883	5.20
		180.00	13.42	0.0391	1.882	5.22

LOAD INCREMENT DATA

TEST NAME C1-U3C
 TESTED BY: ACS

PAGE NO: 17
 JO: 05996.01

PRESSURE INCREMENT FROM 2.00 tsf to 4.00 tsf

DATE	TIME	ELAPSED TIME (min)	SQ RT OF TIME(min)	CHANGE IN HEIGHT(in)	VOID RATIO	STRAIN (%)
01-03-97	12:22:29	0.00	0.00	0.0392	1.882	5.24
		0.10	0.32	0.0501	1.837	6.70
		0.25	0.50	0.0537	1.823	7.17
		0.50	0.71	0.0560	1.814	7.48
		1.00	1.00	0.0582	1.804	7.78
		1.57	1.25	0.0596	1.799	7.97
		2.00	1.41	0.0605	1.795	8.09
		2.25	1.50	0.0609	1.794	8.14
		3.07	1.75	0.0619	1.789	8.27
		4.00	2.00	0.0629	1.785	8.41
		6.25	2.50	0.0647	1.778	8.65
		8.00	2.83	0.0657	1.774	8.78
		12.25	3.50	0.0675	1.767	9.02
		15.00	3.87	0.0683	1.764	9.12
		22.00	4.69	0.0699	1.757	9.34
		30.00	5.48	0.0713	1.751	9.53
		36.00	6.00	0.0722	1.748	9.65
		49.00	7.00	0.0737	1.741	9.85
		60.00	7.75	0.0746	1.738	9.97
		120.00	10.95	0.0780	1.724	10.43
		180.00	13.42	0.0799	1.716	10.68
		240.00	15.49	0.0815	1.710	10.88
		300.00	17.32	0.0826	1.705	11.04
		360.00	18.97	0.0835	1.702	11.15
420.00	20.49	0.0842	1.699	11.26		
480.00	21.91	0.0849	1.696	11.34		
540.00	23.24	0.0855	1.694	11.43		
600.00	24.49	0.0860	1.691	11.49		
660.00	25.69	0.0864	1.690	11.54		
01-04-97	00:22:29	720.00	26.83	0.0869	1.688	11.61
		780.00	27.93	0.0872	1.687	11.65
		840.00	28.98	0.0875	1.685	11.70
		900.00	30.00	0.0879	1.684	11.75
		960.00	30.98	0.0882	1.683	11.78
		1020.00	31.94	0.0886	1.681	11.83
		1080.00	32.86	0.0888	1.680	11.87

LOAD INCREMENT DATA

TEST NAME C1-U3C
 TESTED BY: ACS

PAGE NO: 18
 JO: 05996.01

PRESSURE INCREMENT FROM 2.00 tsf to 4.00 tsf

DATE	TIME	ELAPSED TIME (min)	SQ RT OF TIME(min)	CHANGE IN HEIGHT(in)	VOID RATIO	STRAIN (%)
		1140.00	33.76	0.0889	1.680	11.88
		1200.00	34.64	0.0893	1.678	11.93
		1260.00	35.50	0.0894	1.678	11.95
		1320.00	36.33	0.0897	1.677	11.99
		1380.00	37.15	0.0900	1.675	12.02
		1440.00	37.95	0.0901	1.675	12.04
		1500.00	38.73	0.0902	1.674	12.05
		1560.00	39.50	0.0905	1.673	12.09
		1620.00	40.25	0.0906	1.673	12.10
		1680.00	40.99	0.0908	1.672	12.14
		1740.00	41.71	0.0910	1.671	12.15
		1800.00	42.43	0.0911	1.671	12.17
		1860.00	43.13	0.0912	1.670	12.19
		1920.00	43.82	0.0915	1.669	12.22
		1980.00	44.50	0.0916	1.669	12.24
		2040.00	45.17	0.0917	1.668	12.26
		2100.00	45.83	0.0919	1.668	12.27
01-05-97	00:22:29	2160.00	46.48	0.0920	1.667	12.29
		2220.00	47.12	0.0921	1.667	12.31
		2280.00	47.75	0.0922	1.666	12.32
		2340.00	48.37	0.0924	1.666	12.34
		2400.00	48.99	0.0925	1.665	12.36
		2460.00	49.60	0.0925	1.665	12.36
		2520.00	50.20	0.0926	1.665	12.38
		2580.00	50.79	0.0927	1.664	12.39
		2640.00	51.38	0.0929	1.664	12.41
		2700.00	51.96	0.0930	1.663	12.43
		2760.00	52.54	0.0931	1.663	12.44
		2820.00	53.10	0.0933	1.662	12.46
		2880.00	53.67	0.0933	1.662	12.46
		2940.00	54.22	0.0934	1.662	12.48
		3000.00	54.77	0.0935	1.661	12.49
		3060.00	55.32	0.0935	1.661	12.49
		3120.00	55.86	0.0936	1.661	12.51

LOAD INCREMENT DATA

TEST NAME C1-U3C
 TESTED BY: ACS

PAGE NO: 19
 JO: 05996.01

PRESSURE INCREMENT FROM 2.00 tsf to 4.00 tsf

DATE	TIME	ELAPSED TIME (min)	SQ RT OF TIME(min)	CHANGE IN HEIGHT(in)	VOID RATIO	STRAIN (%)
		3180.00	56.39	0.0938	1.660	12.53
		3240.00	56.92	0.0938	1.660	12.53
		3300.00	57.45	0.0939	1.660	12.54
		3360.00	57.97	0.0940	1.659	12.56
		3420.00	58.48	0.0940	1.659	12.56
		3480.00	58.99	0.0941	1.658	12.58
		3540.00	59.50	0.0943	1.658	12.60
01-06-97	00:22:29	3600.00	60.00	0.0943	1.658	12.60
		3660.00	60.50	0.0944	1.657	12.61
		3720.00	60.99	0.0944	1.657	12.61
		3780.00	61.48	0.0945	1.657	12.63
		3840.00	61.97	0.0945	1.657	12.63
		3900.00	62.45	0.0946	1.656	12.65
		3960.00	62.93	0.0948	1.656	12.66
		4020.00	63.40	0.0948	1.656	12.66
		4080.00	63.87	0.0948	1.656	12.66
		4320.27	65.73	0.0950	1.655	12.70

LOAD INCREMENT DATA

TEST NAME C1-U3C
 TESTED BY: ACS

PAGE NO: 20
 JO: 05996.01

PRESSURE INCREMENT FROM 4.00 tsf to 8.00 tsf

DATE	TIME	ELAPSED TIME (min)	SQ RT OF TIME(min)	CHANGE IN HEIGHT(in)	VOID RATIO	STRAIN (%)
01-06-97	13:45:09	0.00	0.00	0.0955	1.653	12.77
		0.10	0.32	0.1151	1.573	15.38
		0.25	0.50	0.1205	1.551	16.10
		0.50	0.71	0.1241	1.537	16.58
		1.00	1.00	0.1274	1.523	17.02
		1.57	1.25	0.1294	1.515	17.29
		2.00	1.41	0.1306	1.511	17.44
		2.25	1.50	0.1311	1.508	17.51
		3.07	1.75	0.1326	1.502	17.72
		4.00	2.00	0.1339	1.497	17.88
		6.25	2.50	0.1360	1.488	18.17
		8.00	2.83	0.1372	1.484	18.33
		12.25	3.50	0.1392	1.475	18.60
		15.00	3.87	0.1402	1.471	18.73
		22.00	4.69	0.1421	1.464	18.99
		30.00	5.48	0.1436	1.457	19.19
		36.00	6.00	0.1445	1.454	19.31
		49.00	7.00	0.1460	1.448	19.51
		60.00	7.75	0.1472	1.443	19.66
		120.00	10.95	0.1506	1.429	20.12
180.00	13.42	0.1526	1.421	20.39		
240.00	15.49	0.1540	1.415	20.58		
300.00	17.32	0.1550	1.411	20.72		
360.00	18.97	0.1559	1.407	20.83		
420.00	20.49	0.1566	1.405	20.92		
480.00	21.91	0.1572	1.402	21.00		
540.00	23.24	0.1576	1.401	21.05		
600.00	24.49	0.1581	1.399	21.12		
01-07-97	00:45:09	660.00	25.69	0.1585	1.397	21.17
		720.00	26.83	0.1588	1.396	21.22
		780.00	27.93	0.1591	1.395	21.26
		840.00	28.98	0.1595	1.393	21.31
		900.00	30.00	0.1597	1.392	21.34
		960.00	30.98	0.1601	1.390	21.39
		1020.00	31.94	0.1604	1.389	21.43
		1080.00	32.86	0.1606	1.388	21.46

LOAD INCREMENT DATA

TEST NAME C1-U3C
 TESTED BY: ACS

PAGE NO: 21
 JO: 05996.01

PRESSURE INCREMENT FROM 8.00 tsf to 2.00 tsf

DATE	TIME	ELAPSED TIME (min)	SQ RT OF TIME(min)	CHANGE IN HEIGHT(in)	VOID RATIO	STRAIN (%)
01-07-97	08:03:59	0.00	0.00	0.1606	1.388	21.46
		0.10	0.32	0.1561	1.407	20.85
		0.25	0.50	0.1558	1.408	20.82
		0.50	0.71	0.1558	1.408	20.82
		1.00	1.00	0.1557	1.408	20.80
		1.57	1.25	0.1556	1.409	20.78
		2.00	1.41	0.1556	1.409	20.78
		2.25	1.50	0.1556	1.409	20.78
		3.07	1.75	0.1556	1.409	20.78
		4.00	2.00	0.1556	1.409	20.78
		6.25	2.50	0.1554	1.409	20.77
		8.00	2.83	0.1554	1.409	20.77
		12.25	3.50	0.1554	1.409	20.77
		15.00	3.87	0.1554	1.409	20.77
		22.00	4.69	0.1553	1.410	20.75
		30.00	5.48	0.1553	1.410	20.75
		36.00	6.00	0.1553	1.410	20.75
		49.00	7.00	0.1553	1.410	20.75
		60.00	7.75	0.1552	1.411	20.73

LOAD INCREMENT DATA

TEST NAME C1-U3C
 TESTED BY: ACS

PAGE NO: 22
 JO: 05996.01

PRESSURE INCREMENT FROM 2.00 tsf to 0.50 tsf

DATE	TIME	ELAPSED TIME (min)	SQ RT OF TIME(min)	CHANGE IN HEIGHT(in)	VOID RATIO	STRAIN (%)
01-07-97	09:18:11	0.00	0.00	0.1552	1.411	20.73
		0.10	0.32	0.1503	1.430	20.09
		0.25	0.50	0.1496	1.433	19.99
		0.50	0.71	0.1492	1.435	19.94
		1.00	1.00	0.1490	1.436	19.90
		1.57	1.25	0.1487	1.437	19.87
		2.00	1.41	0.1487	1.437	19.87
		2.25	1.50	0.1487	1.437	19.87
		3.07	1.75	0.1484	1.438	19.83
		4.00	2.00	0.1484	1.438	19.83
		6.25	2.50	0.1482	1.439	19.80
		8.00	2.83	0.1482	1.439	19.80
		12.25	3.50	0.1481	1.439	19.78
		15.00	3.87	0.1481	1.439	19.78
		22.00	4.69	0.1478	1.440	19.75
		30.00	5.48	0.1478	1.440	19.75
		36.00	6.00	0.1477	1.441	19.73
		49.00	7.00	0.1477	1.441	19.73
		60.00	7.75	0.1476	1.441	19.72
		120.00	10.95	0.1473	1.442	19.68

LOAD INCREMENT DATA

TEST NAME C1-U3C

PAGE NO: 23

TESTED BY: ACS

JO: 05996.01

PRESSURE INCREMENT FROM 0.50 tsf to 0.10 tsf

DATE	TIME	ELAPSED TIME (min)	SQ RT OF TIME(min)	CHANGE IN HEIGHT(in)	VOID RATIO	STRAIN (%)
01-07-97	12:11:24	0.00	0.00	0.1473	1.442	19.68
		0.10	0.32	0.1439	1.456	19.22
		0.25	0.50	0.1429	1.461	19.09
		0.50	0.71	0.1420	1.464	18.97
		1.00	1.00	0.1412	1.467	18.87
		1.57	1.25	0.1407	1.469	18.80
		2.00	1.41	0.1405	1.470	18.77
		2.25	1.50	0.1403	1.471	18.75
		3.07	1.75	0.1401	1.472	18.72
		4.00	2.00	0.1399	1.472	18.70
		6.25	2.50	0.1396	1.474	18.65
		8.00	2.83	0.1393	1.475	18.61
		12.25	3.50	0.1391	1.476	18.58
		15.00	3.87	0.1388	1.477	18.55
		22.00	4.69	0.1387	1.478	18.53
		30.00	5.48	0.1384	1.479	18.50
		36.00	6.00	0.1383	1.479	18.48
		49.00	7.00	0.1382	1.480	18.46
		60.00	7.75	0.1380	1.480	18.44
		120.00	10.95	0.1375	1.482	18.38
		180.00	13.42	0.1374	1.483	18.36
		240.00	15.49	0.1372	1.484	18.33

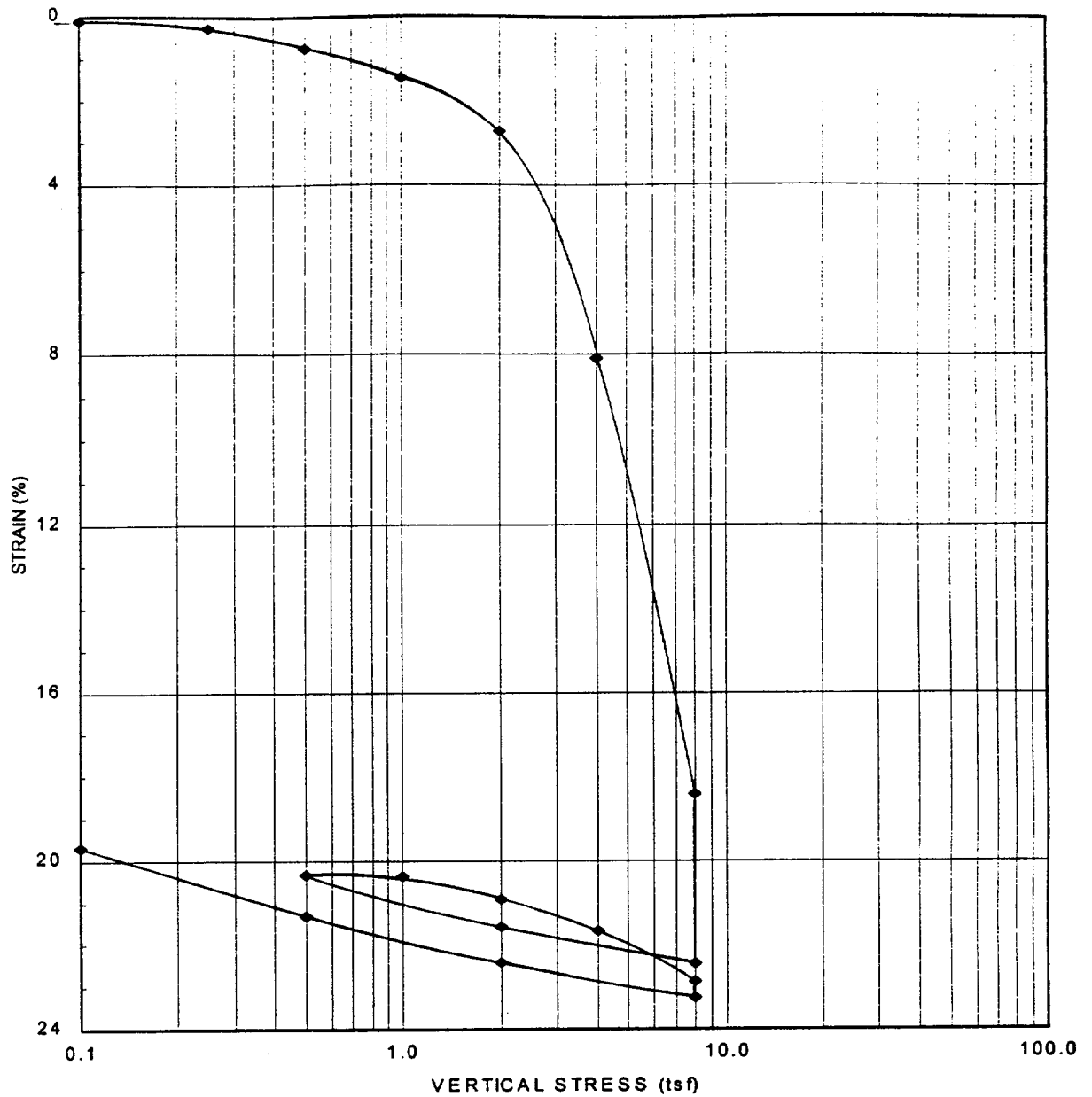

SAMPLE INFORMATION:

BORING: C-1
 SAMPLE: U-3D
 DEPTH: 11.4 ft
 DESCRIPTION: Clayey SILT

DATE: 12/12/96
 TESTED BY: ACS
 CHECKED: PJT

SPECIMEN INFORMATION:

	INITIAL	FINAL	
WATER CONTENT:	46.7 %	62.4 %	SPECIFIC GRAVITY: 2.72
DRY UNIT WEIGHT:	51.7 pcf	64.1 pcf	
VOID RATIO:	2.285	1.649	
SATURATION:	55.6 %	103.0 %	

NOTE: Sample was inundated when the applied pressure was 0.5 tsf.

PRIVATE FUEL STORAGE FACILITY
 SKULL VALLEY
 PRIVATE FUEL STORAGE, LLC



STONE & WEBSTER ENGINEERING CORP.
 BOSTON, MASSACHUSETTS

CONSOLIDATION TEST RESULTS
 BORING C-1, SAMPLE U-3D

JO 05996.01
 January 1997

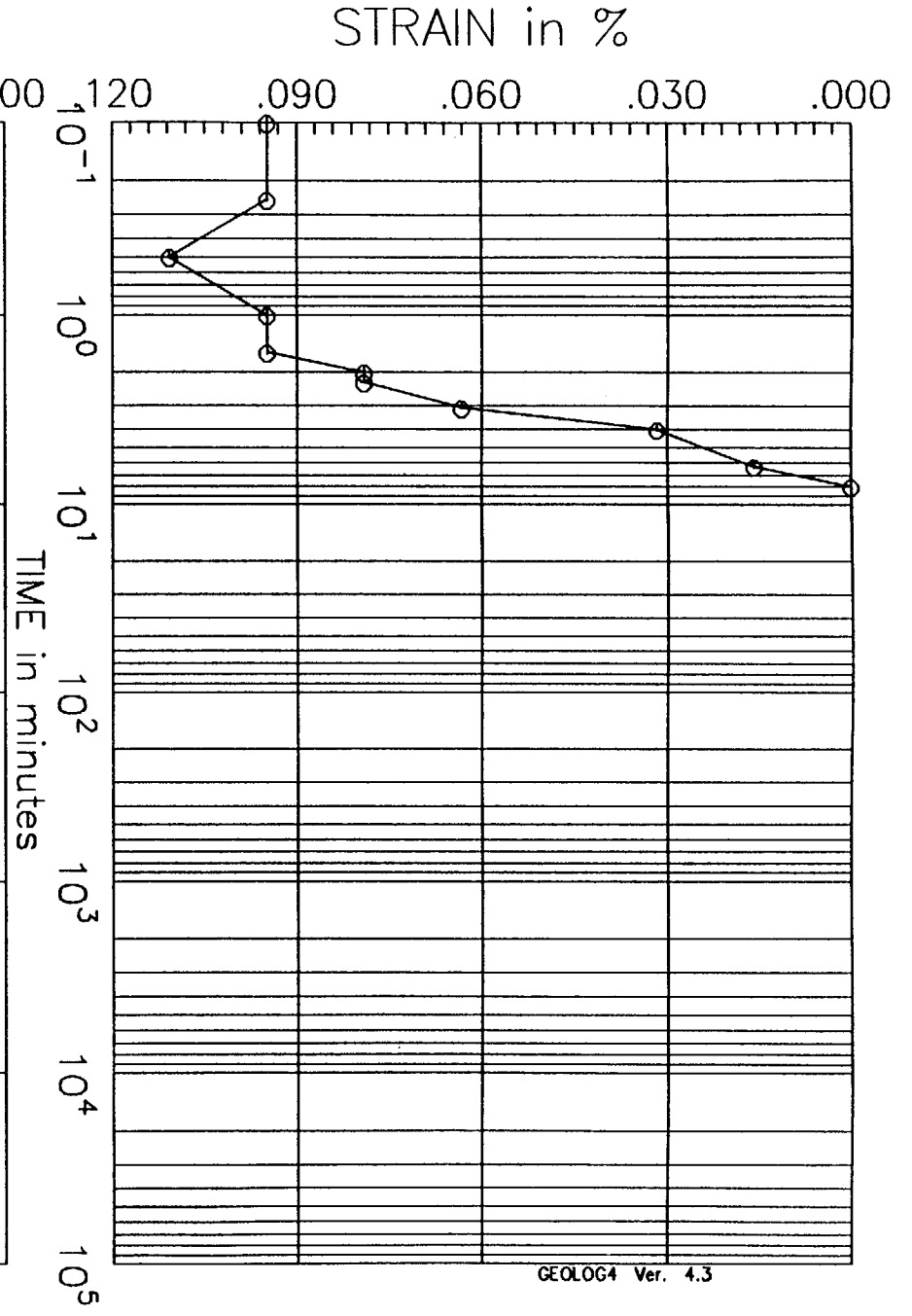
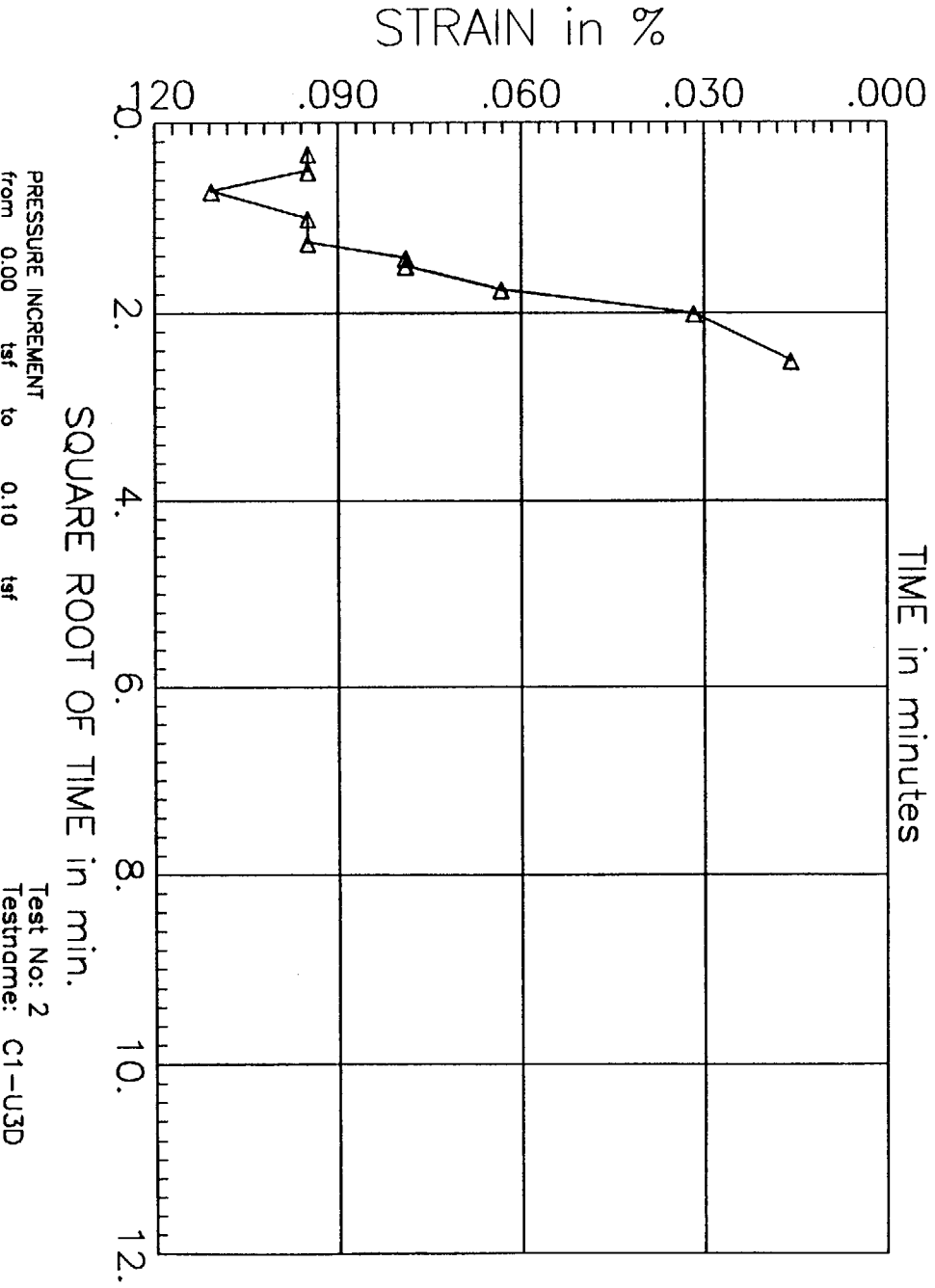

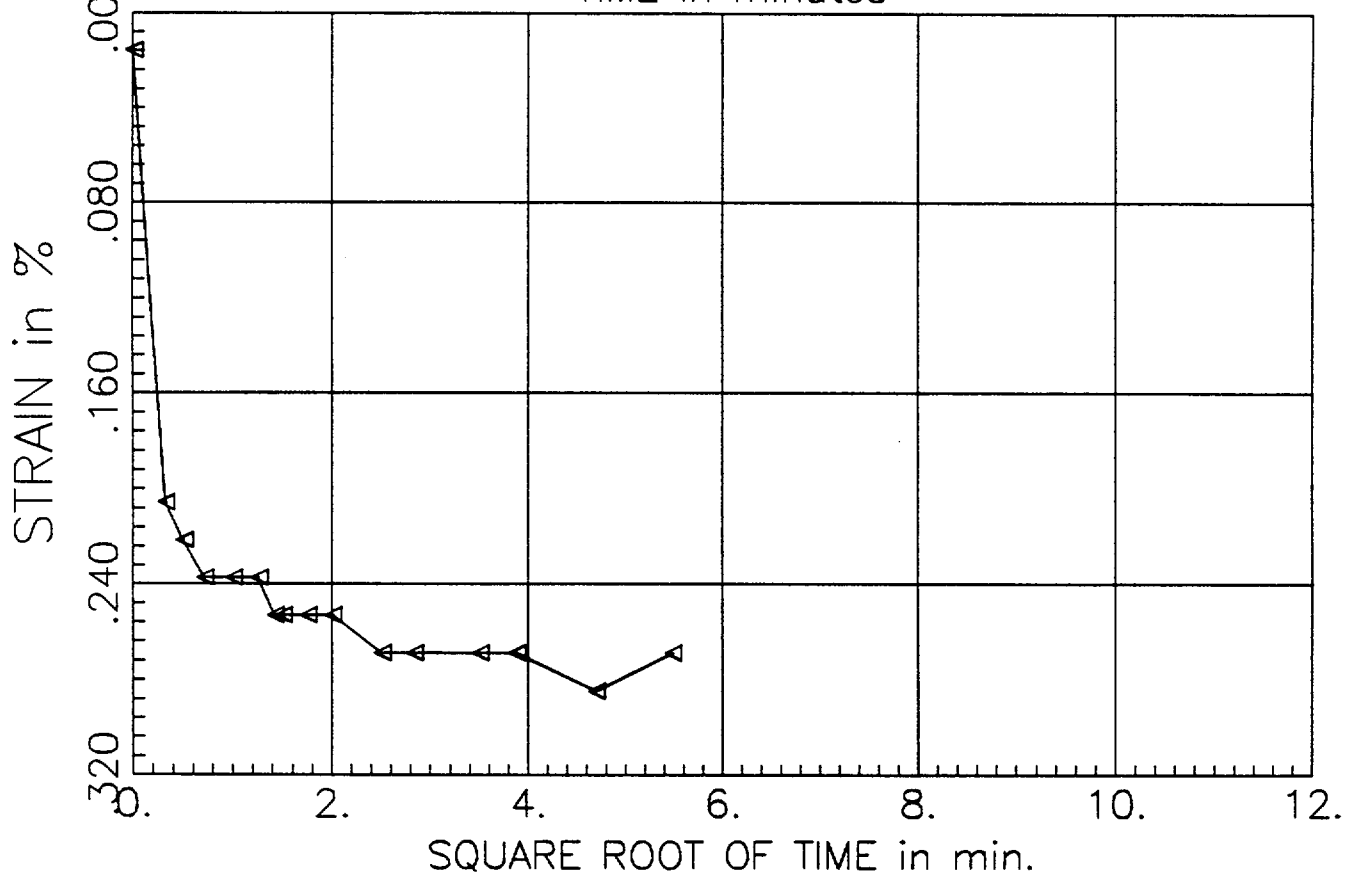
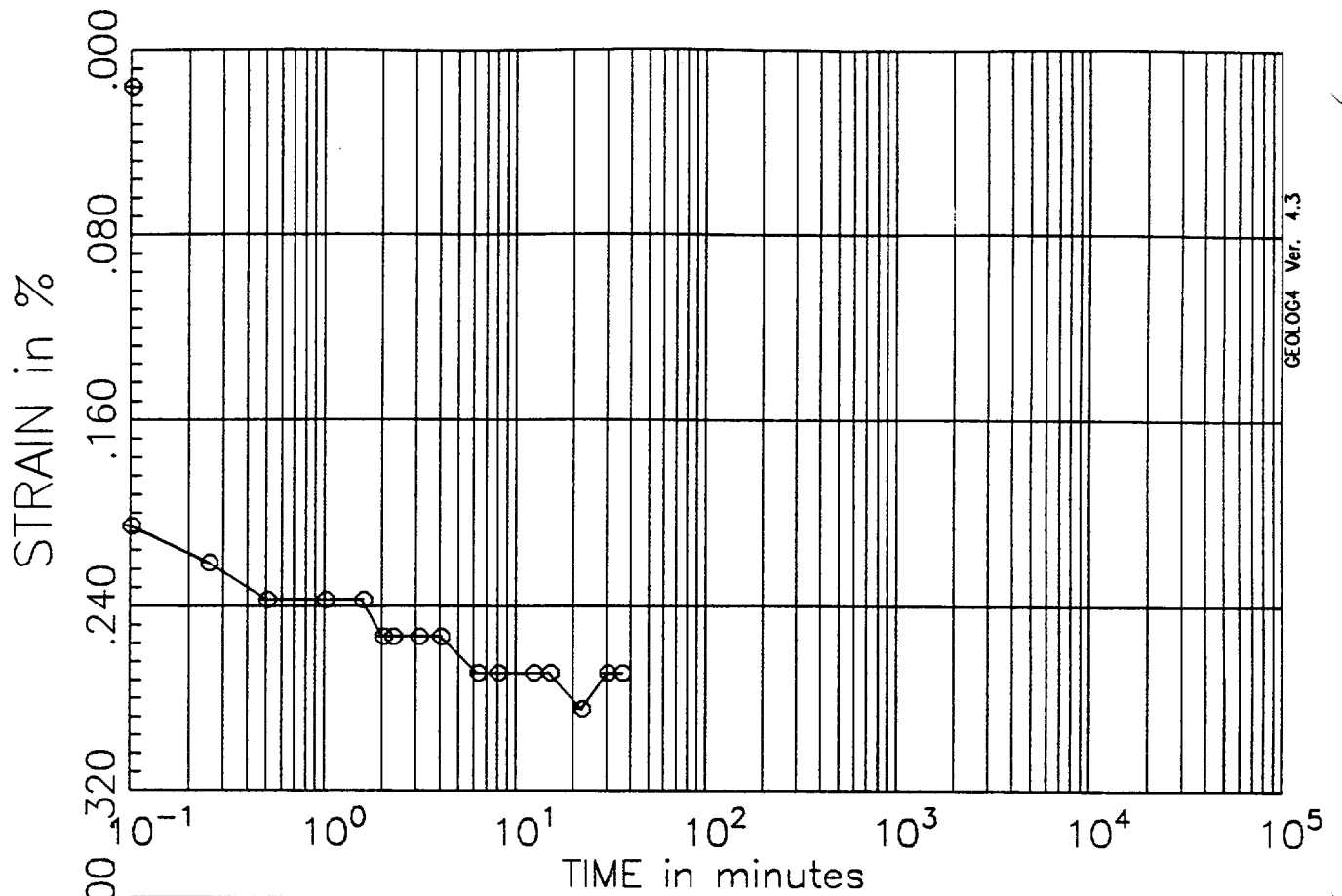

PRESSURE INCREMENT
from 0.10 tsf to 0.25 tsf

Test No: 2
Testname: C1-U3D

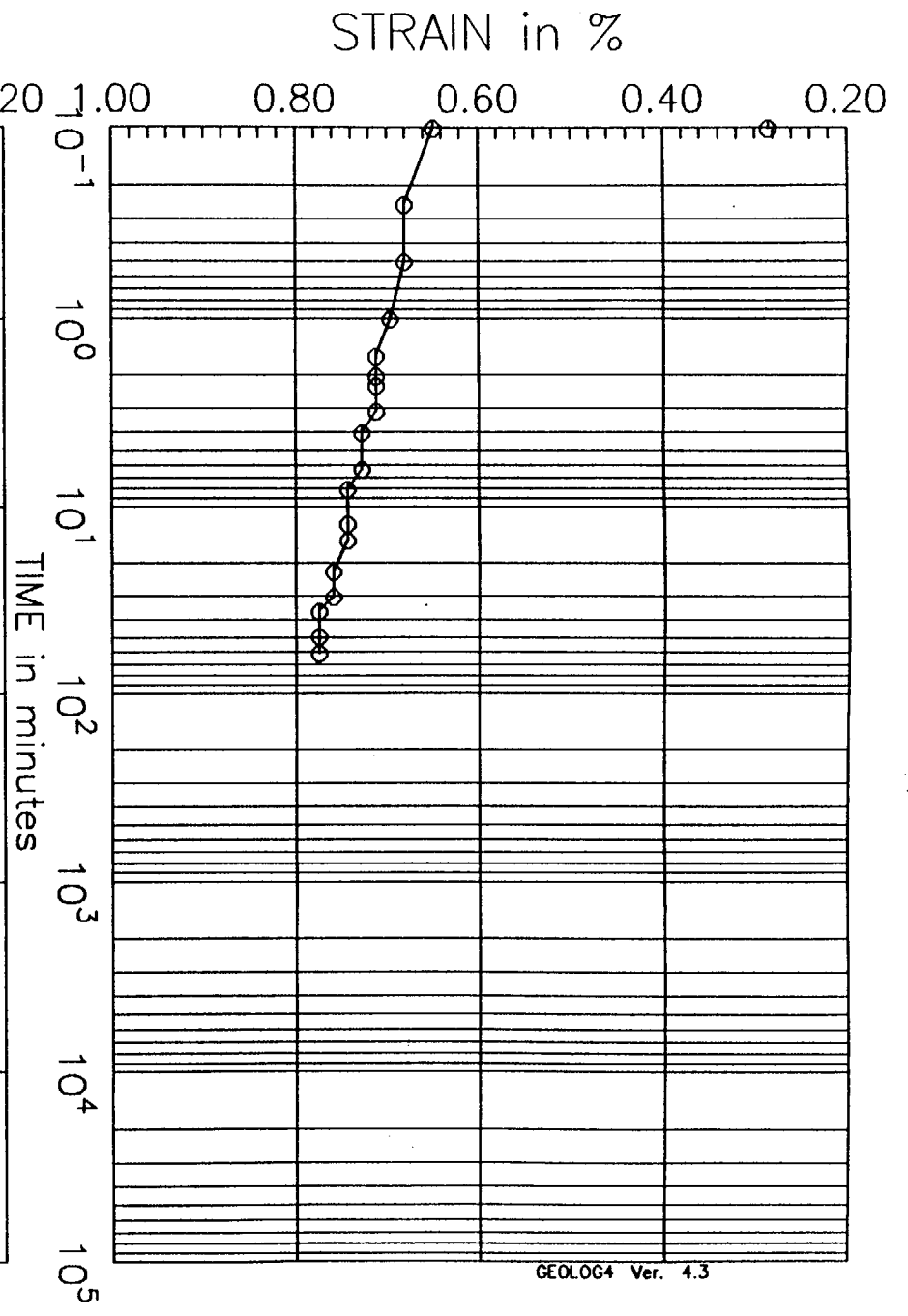
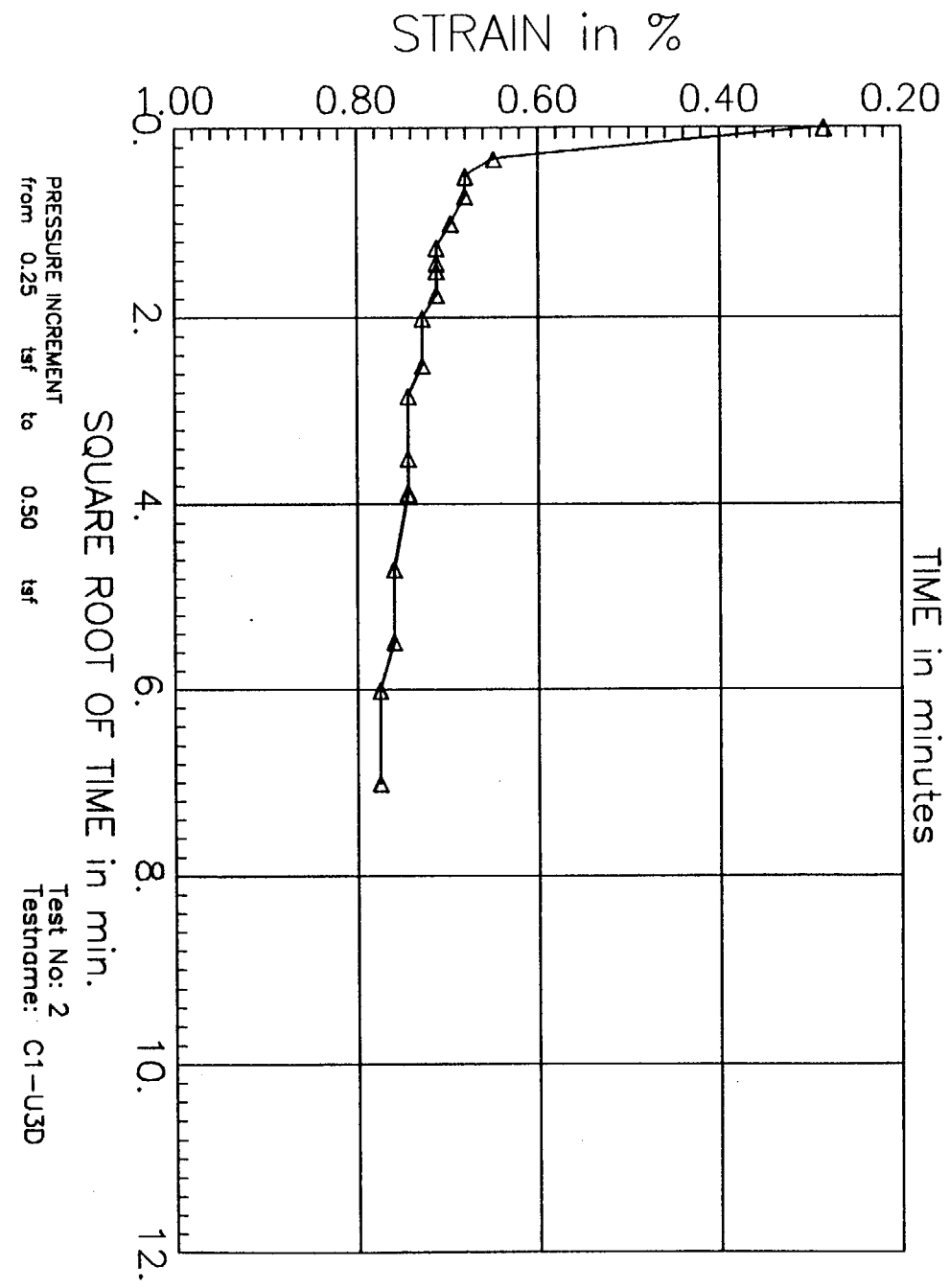

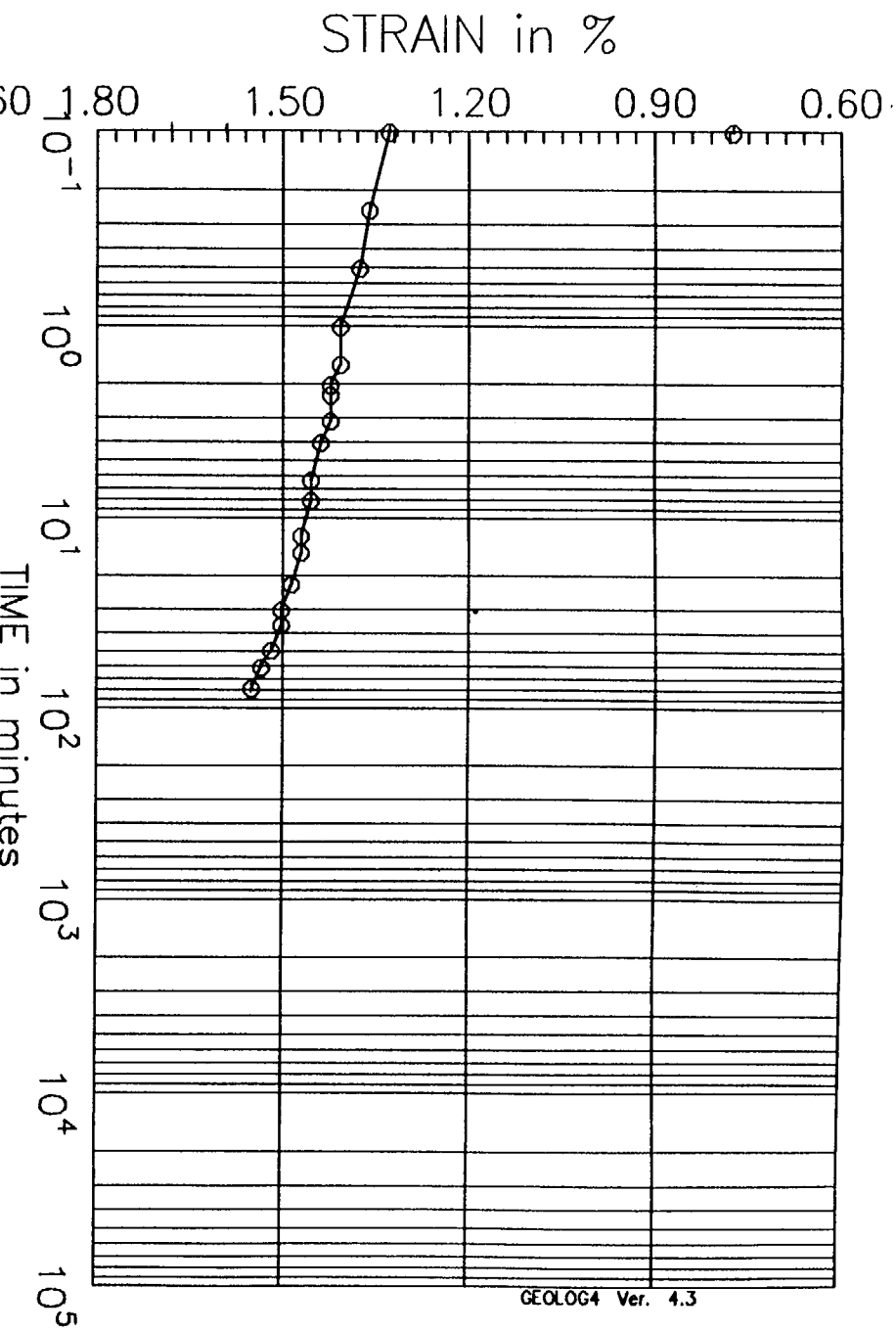

GEOLOG4 Ver. 4.3

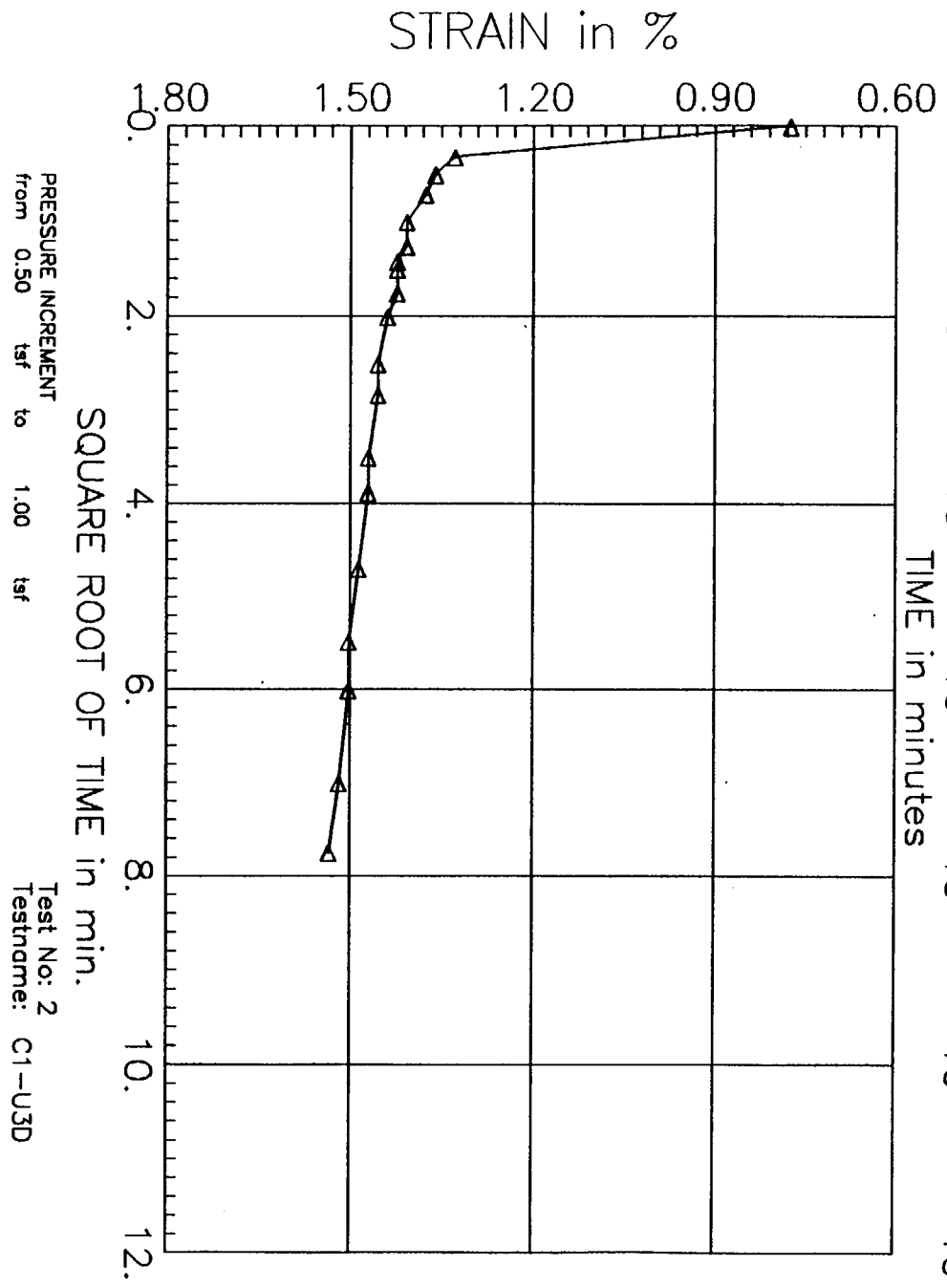

PRESSURE INCREMENT
from 0.50 tsf to 1.00 tsf

Test No: 2
Testname: C1-U3D

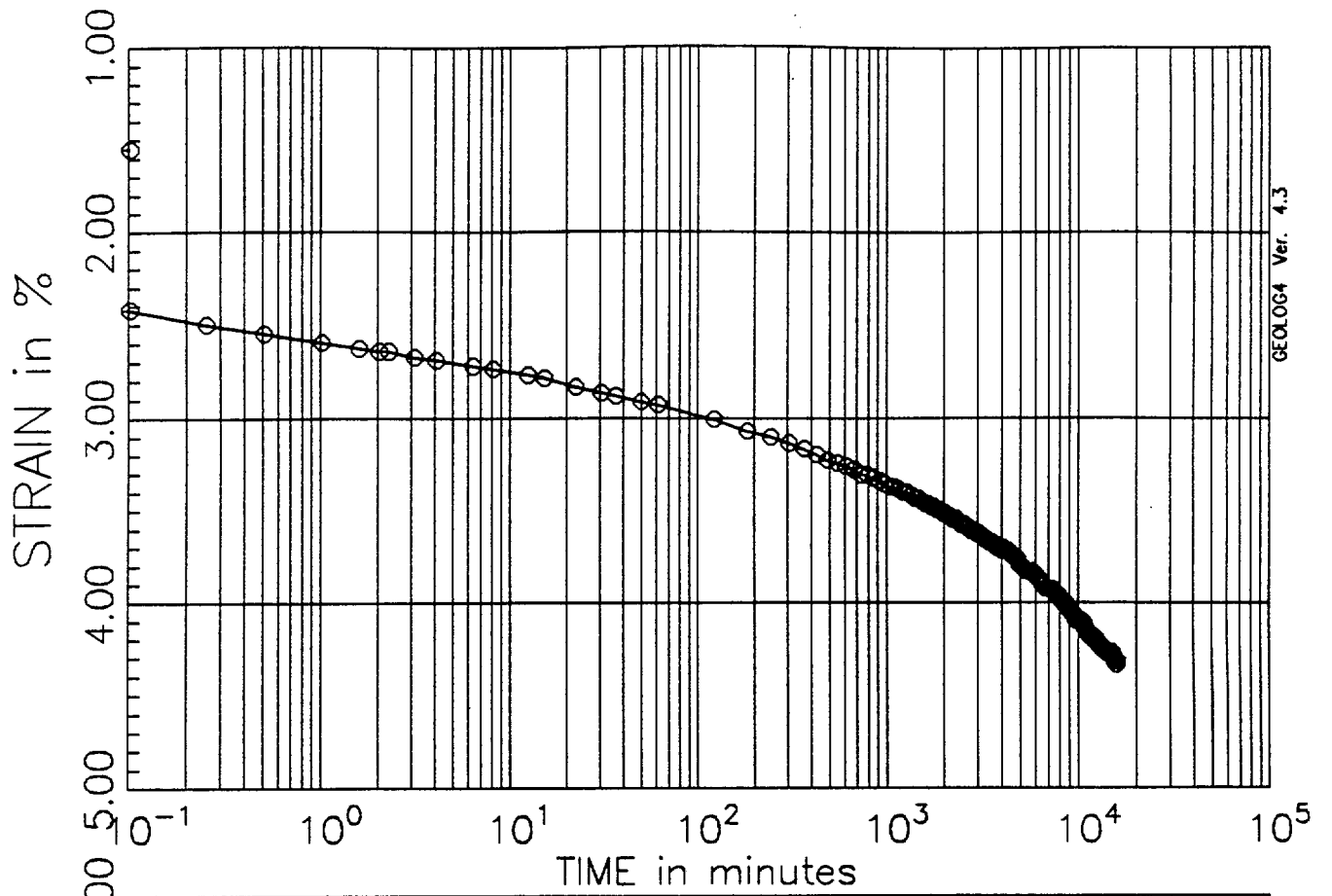

GEOL064 Ver. 4.3

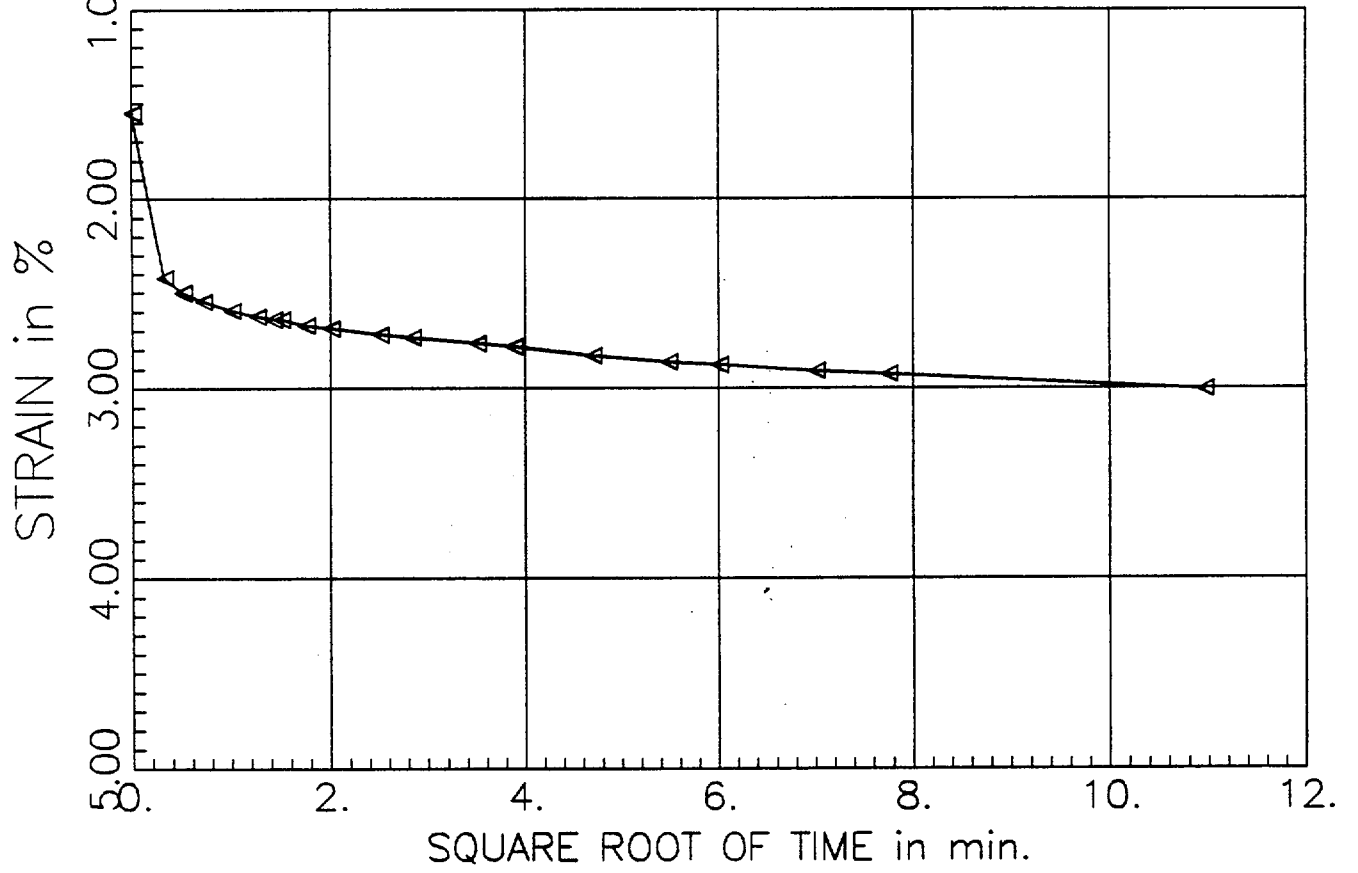

PRESSURE INCREMENT
from 1.00 tsf to 2.00 tsf

Test No: 2
Testname: C1-U3D

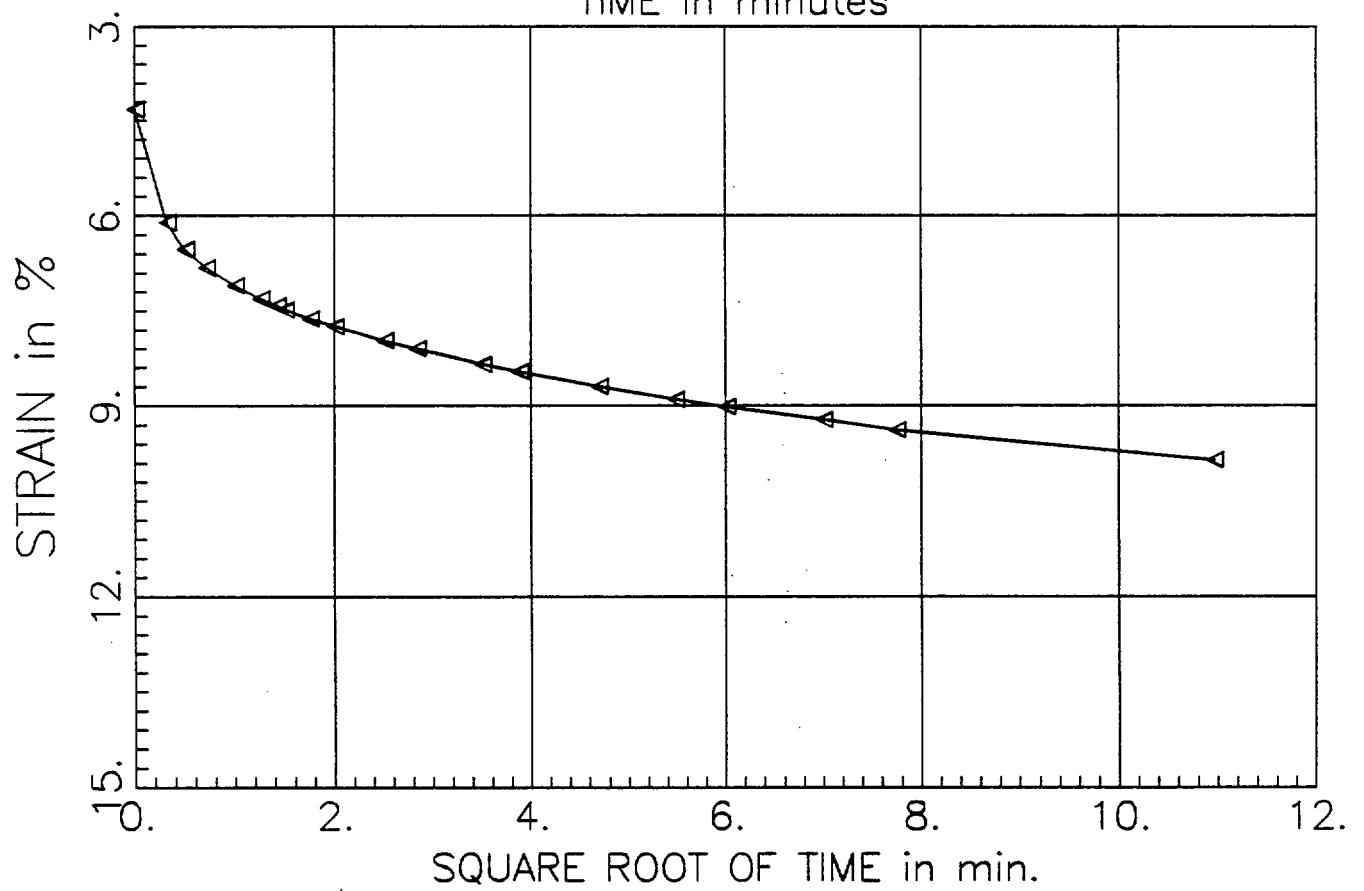
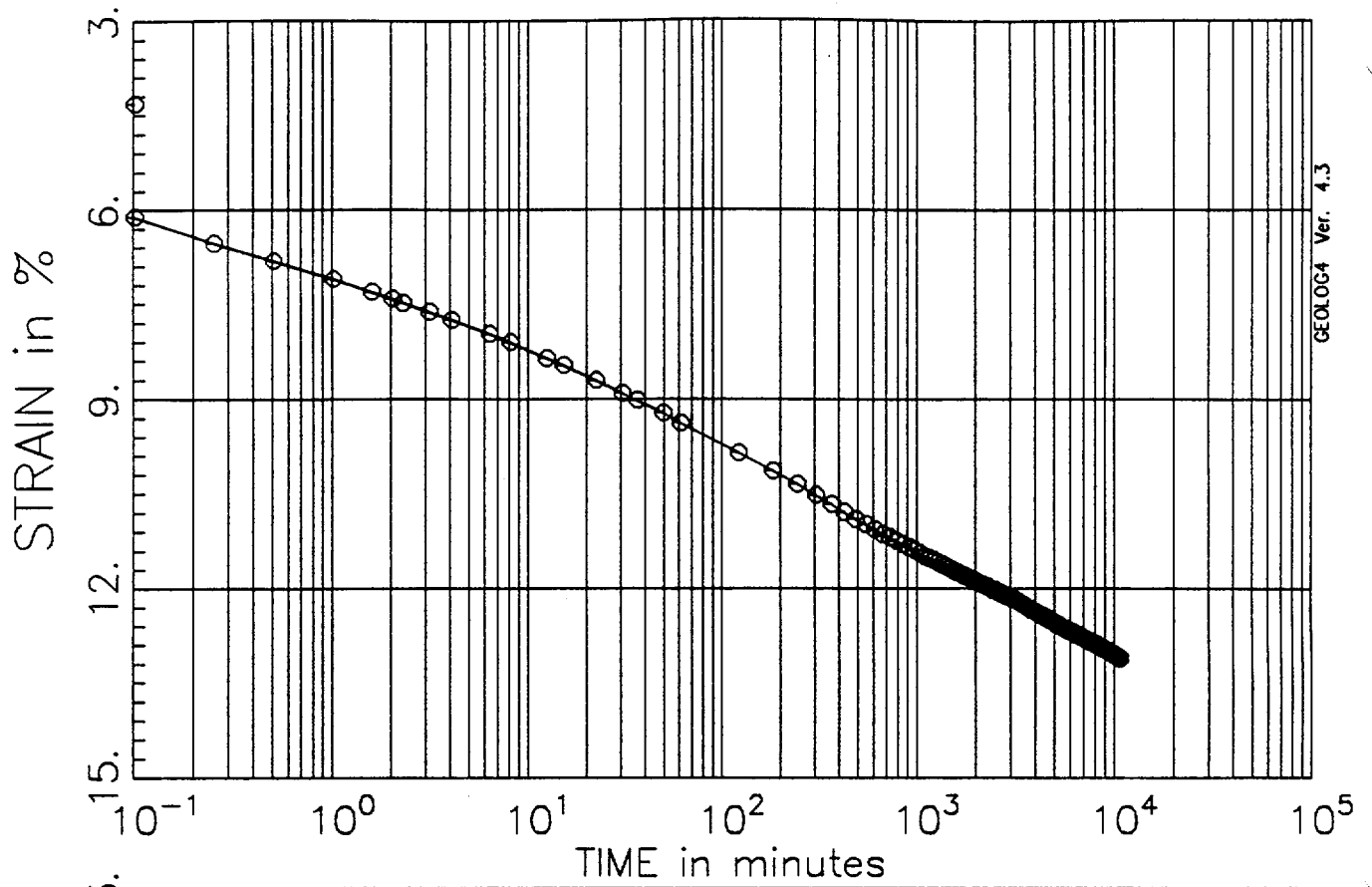

PRESSURE INCREMENT
from 2.00 tsf to 4.00 tsf

Test No: 2
Testname: C1-U3D

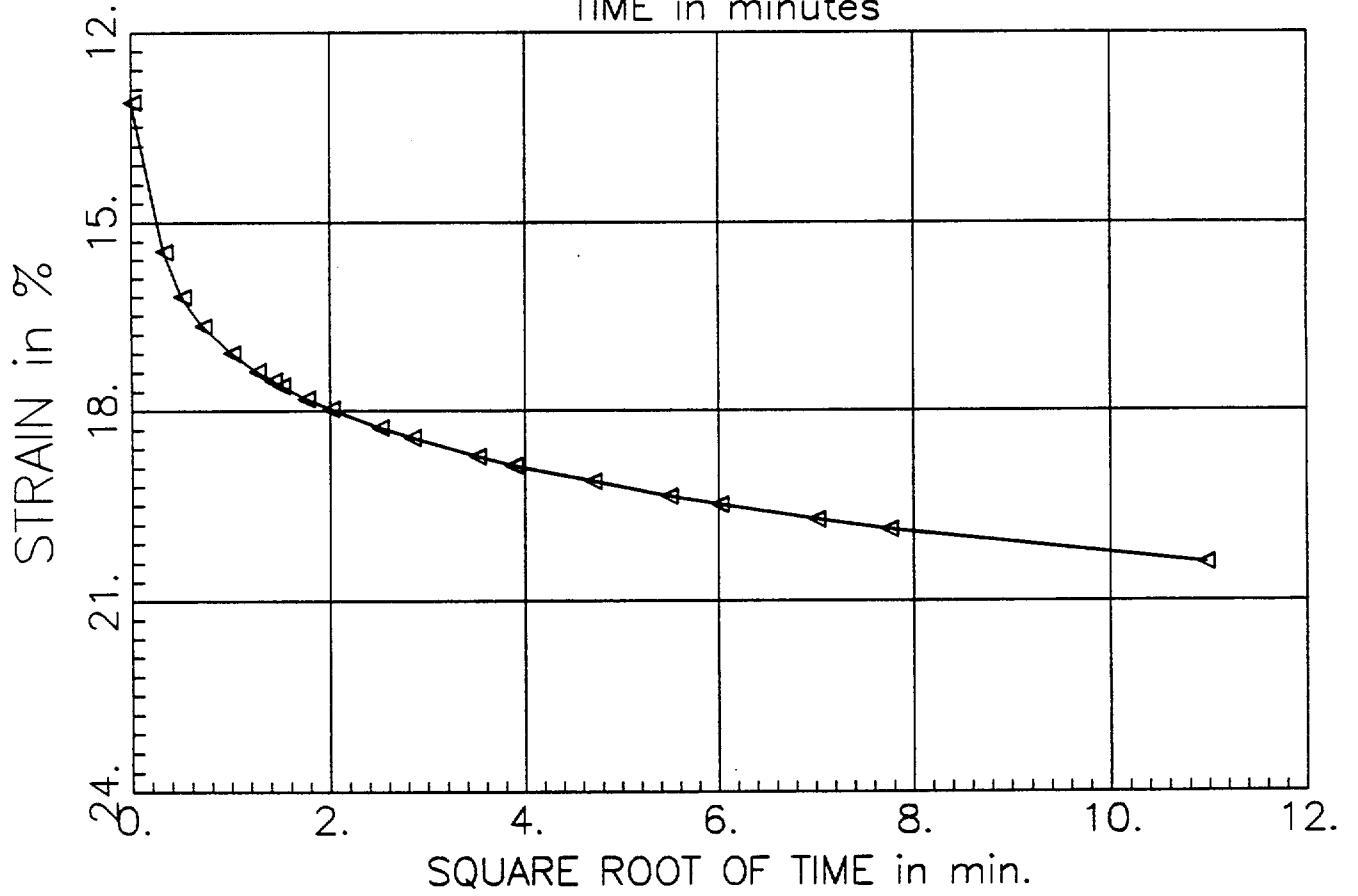
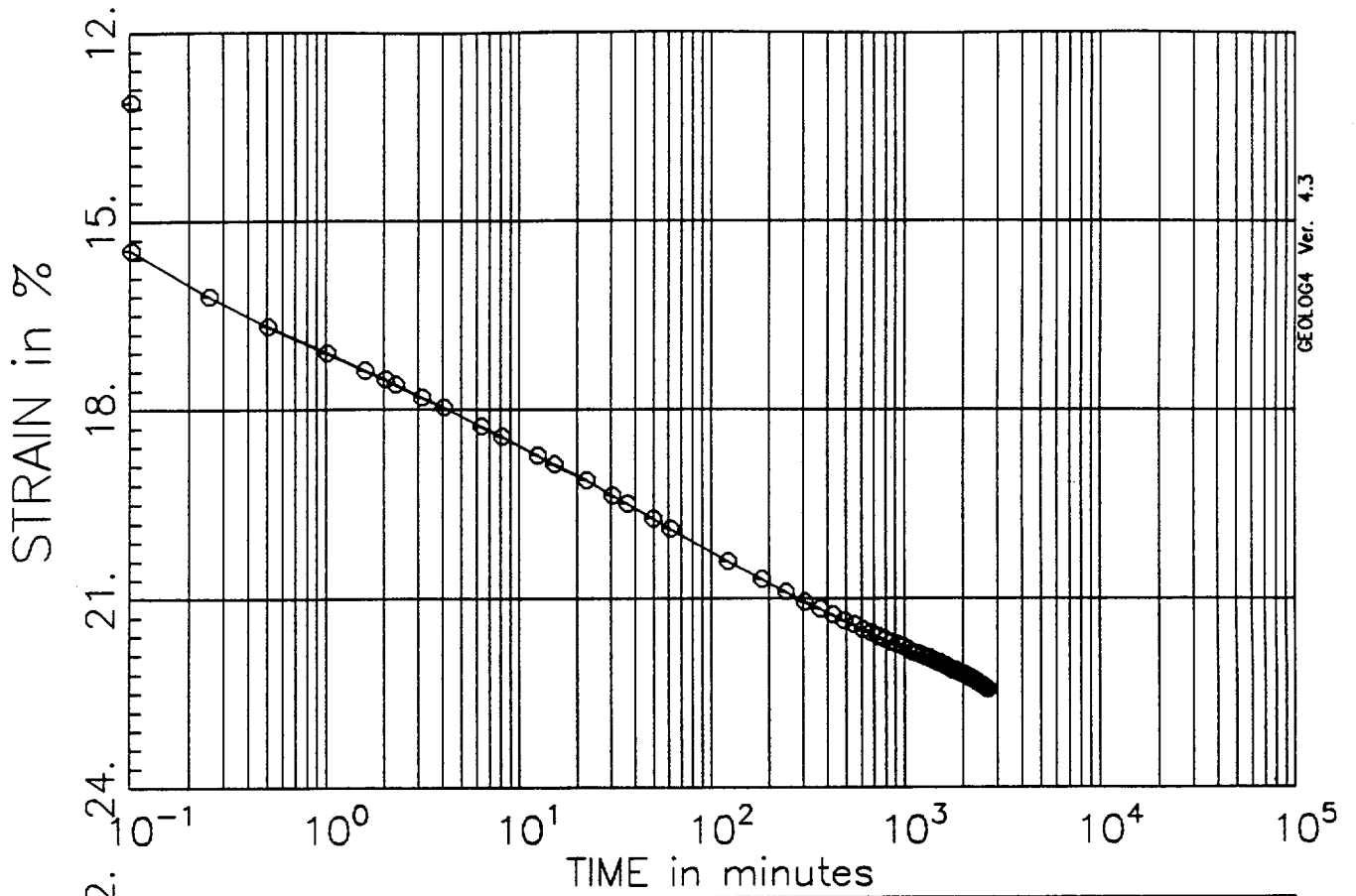

PRESSURE INCREMENT
from 4.00 tsf to 8.00 tsf

Test No: 2
Testname: C1-U3D

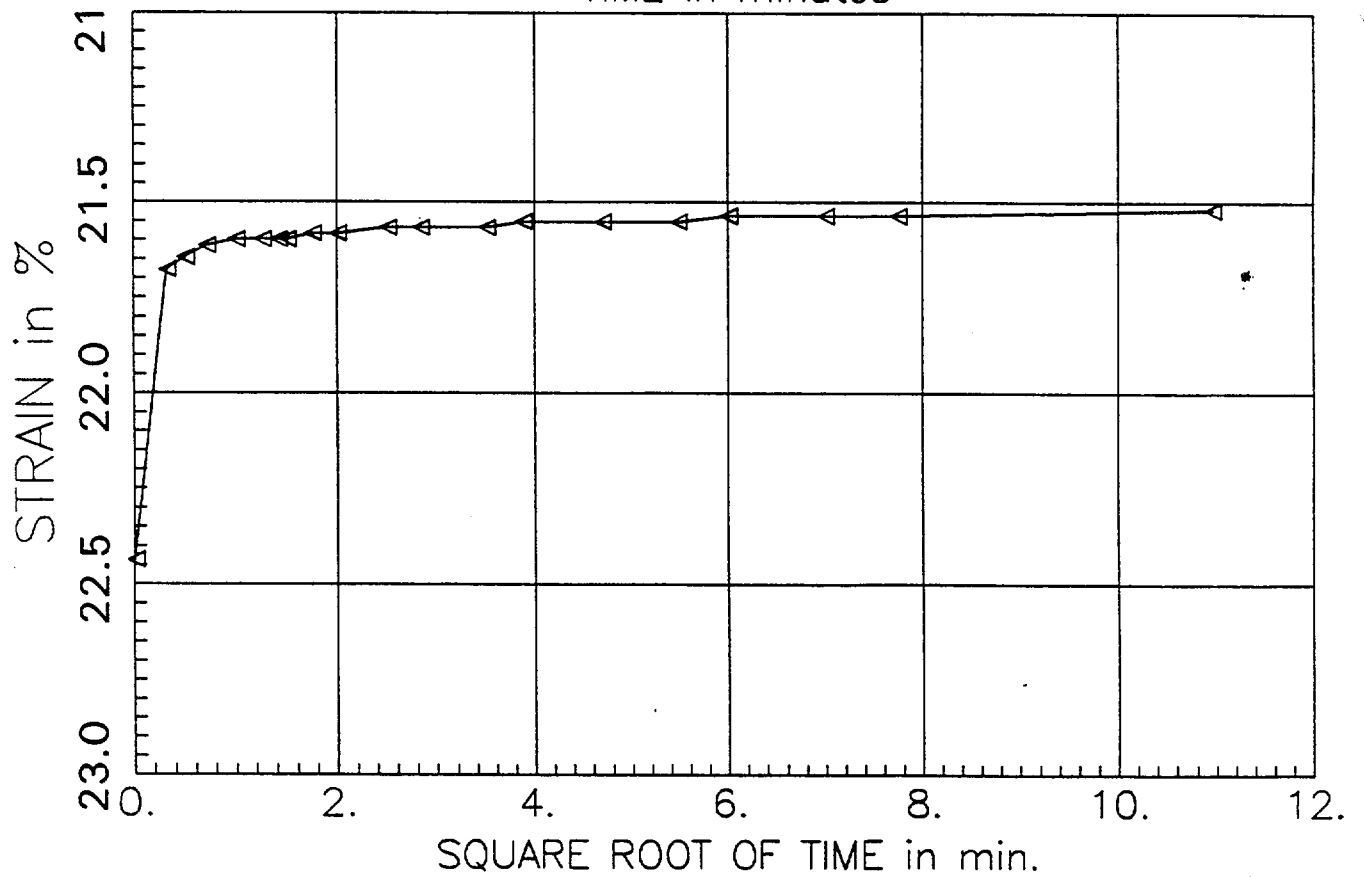
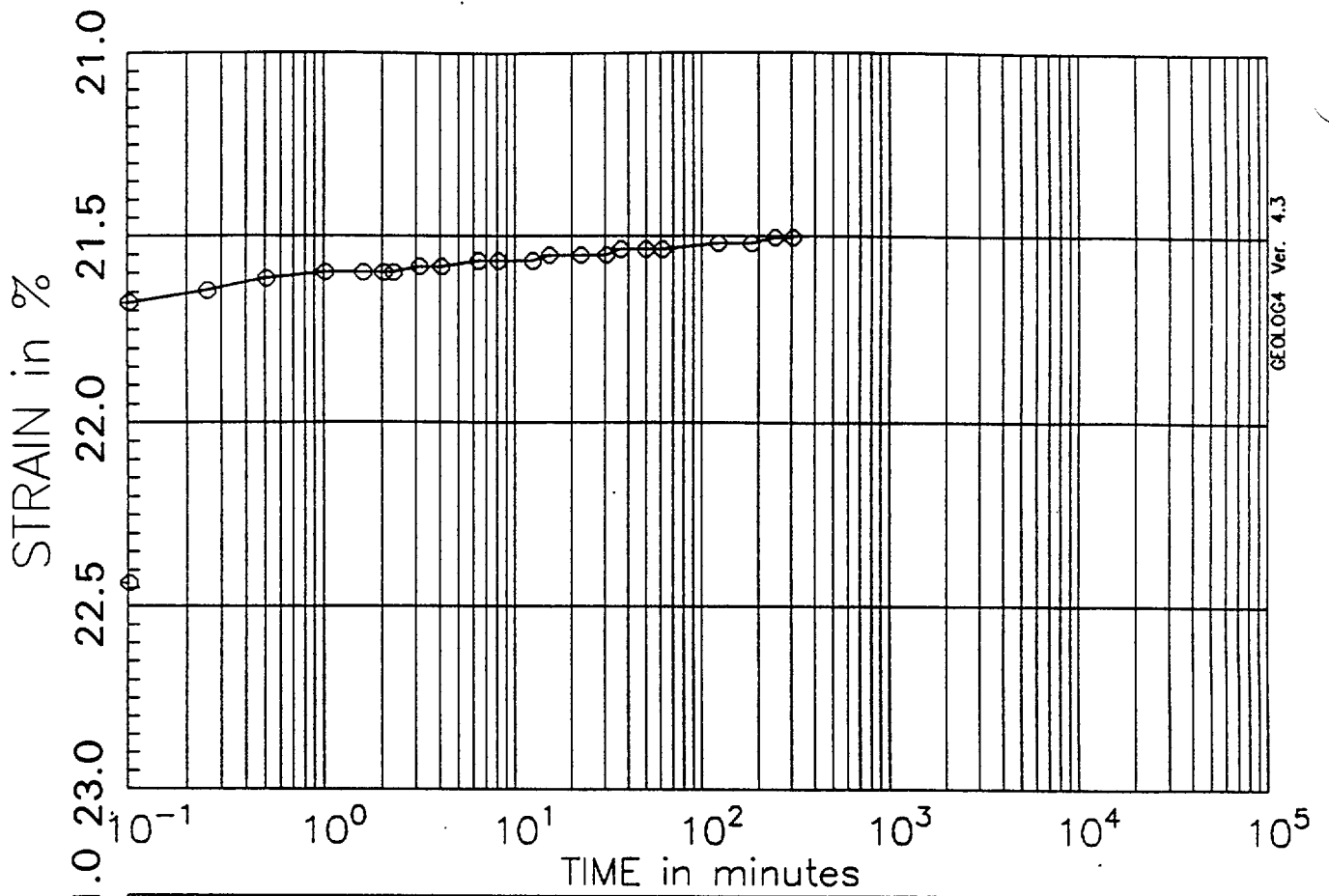

PRESSURE INCREMENT
from 8.00 tsf to 2.00 tsf

Test No: 2
Testname: C1-U3D

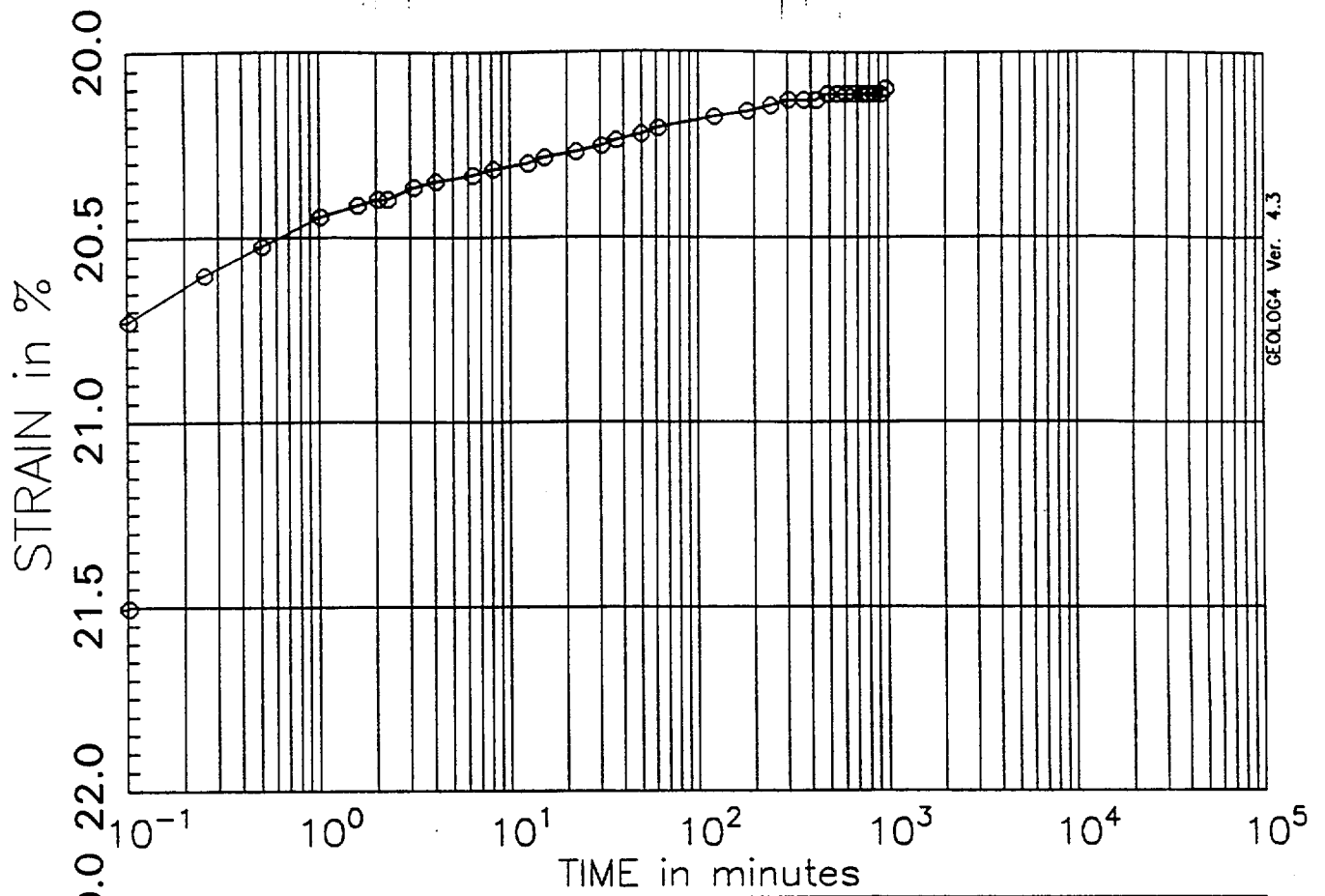

GEOLOG4 Ver. 4.3

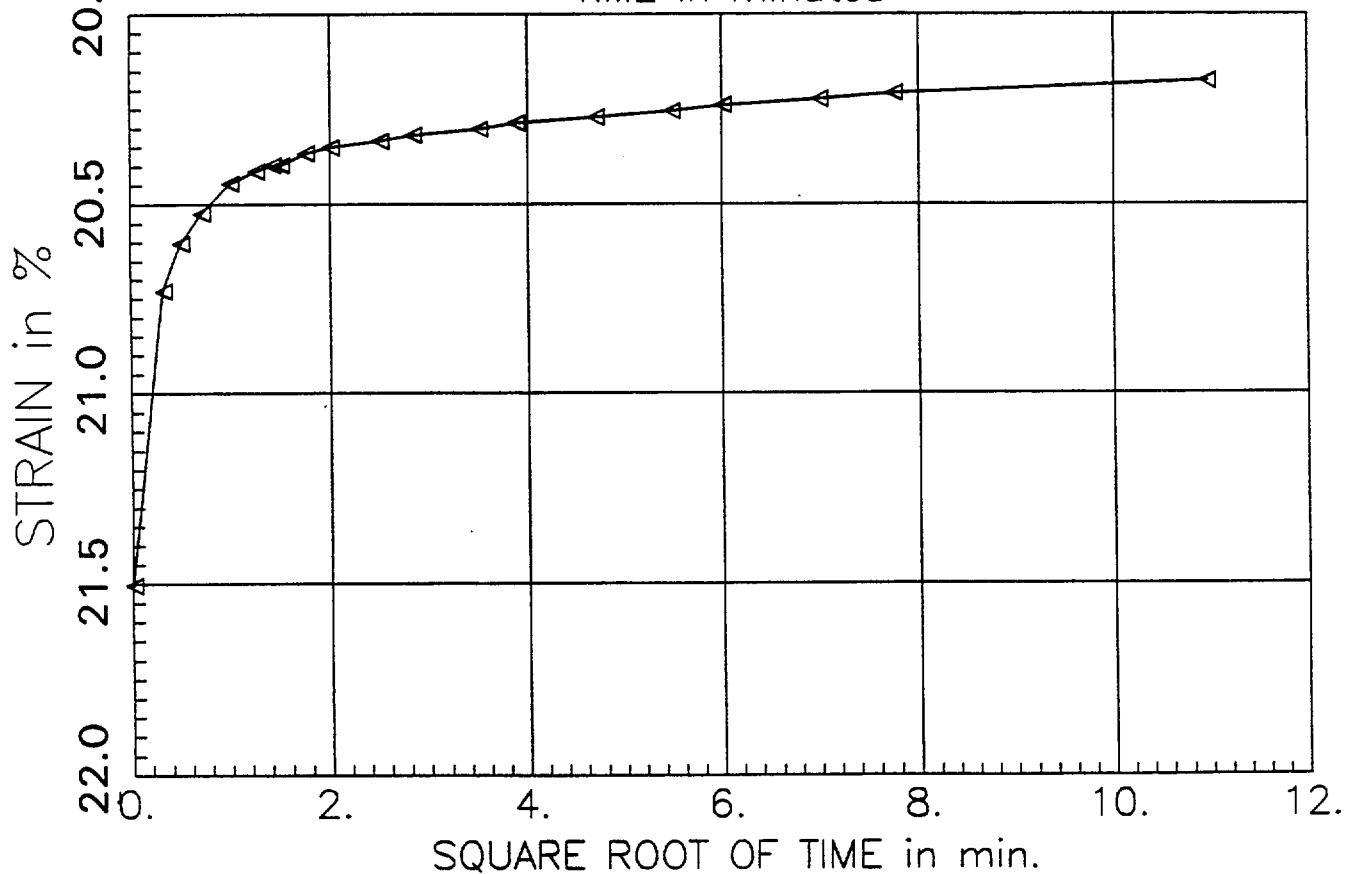

PRESSURE INCREMENT
from 2.00 tsf to 0.50 tsf

Test No: 2
Testname: C1-U3D

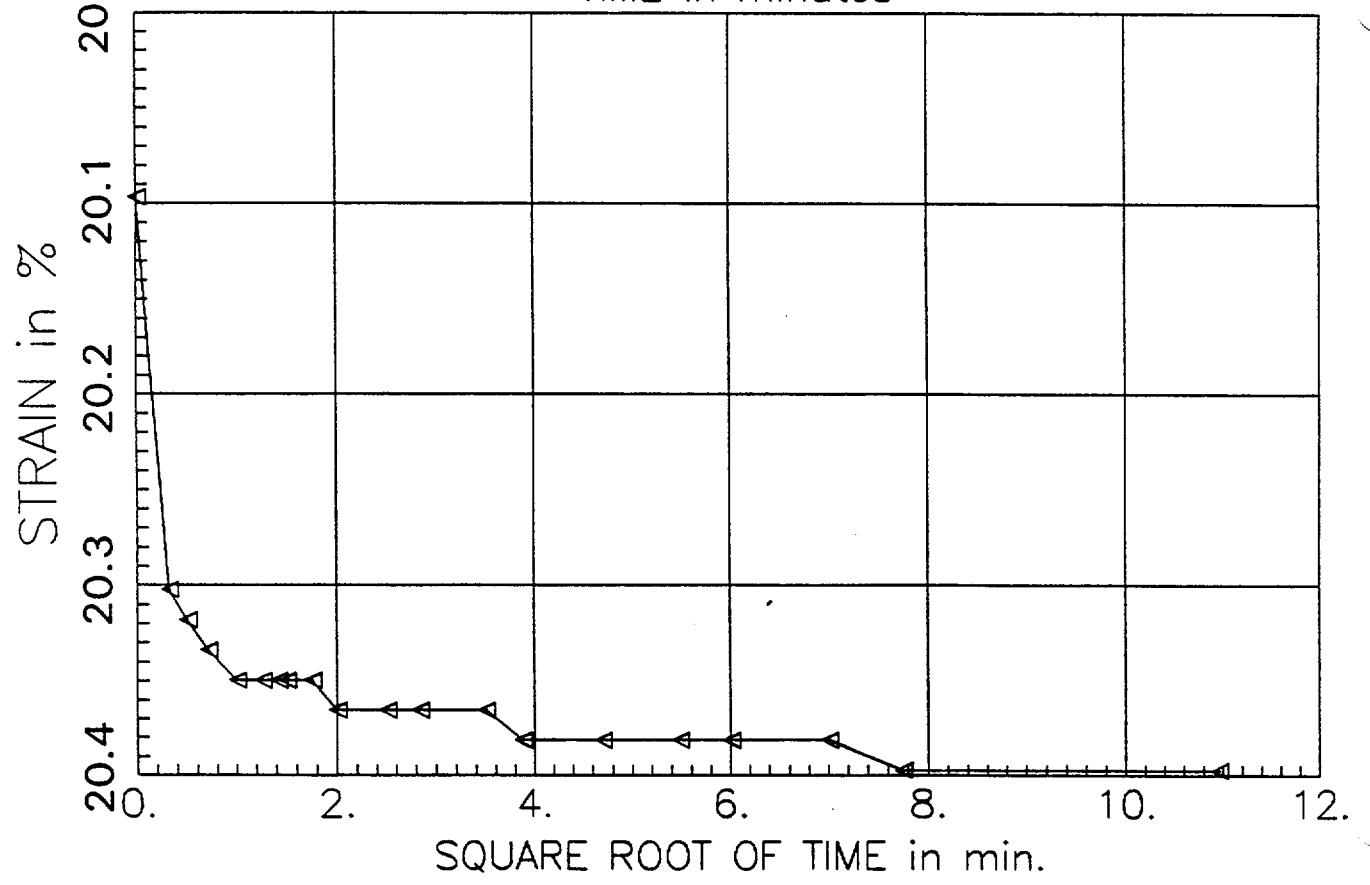
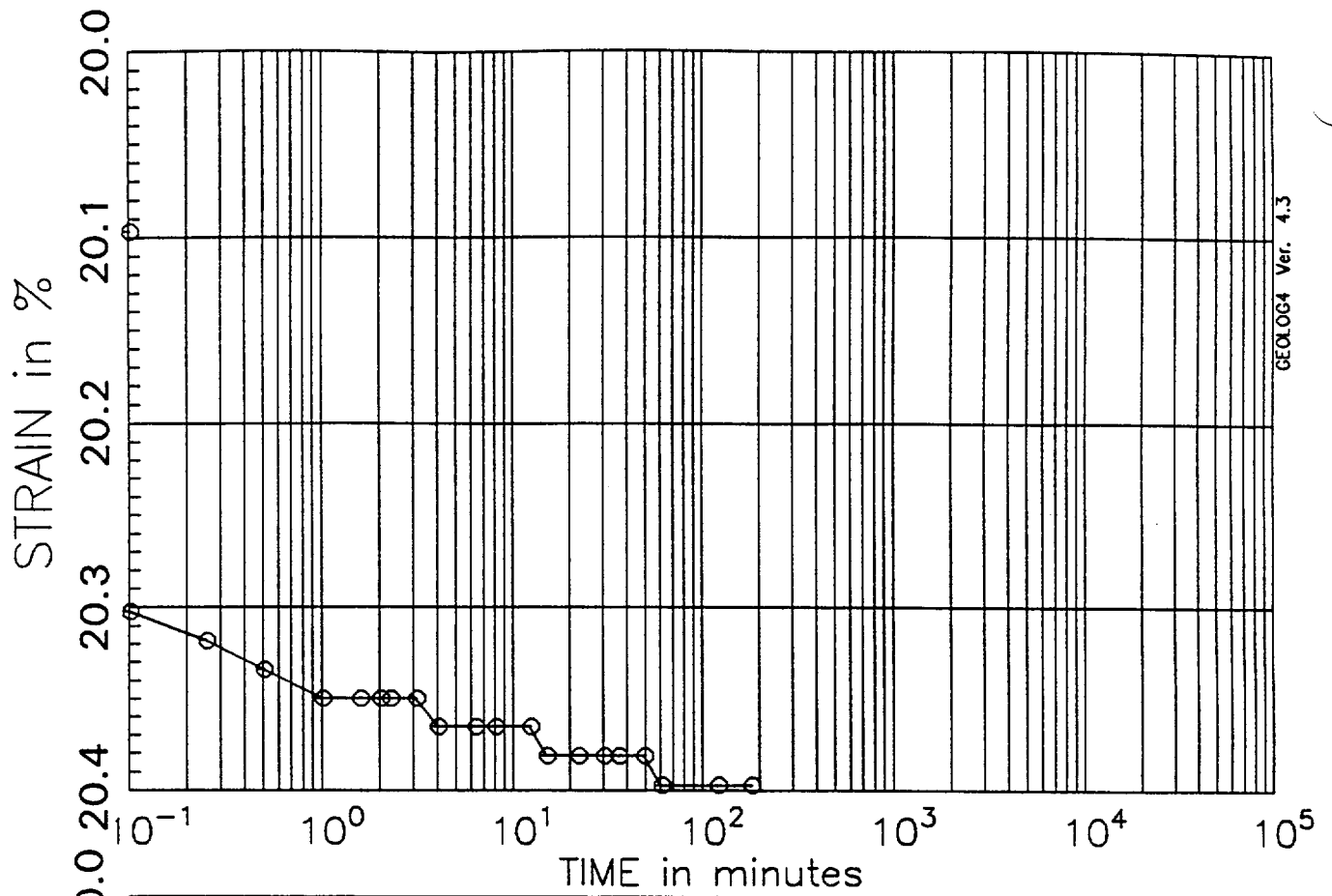

PRESSURE INCREMENT
from 0.50 tsf to 1.00 tsf

Test No: 2
Testname: C1-U3D

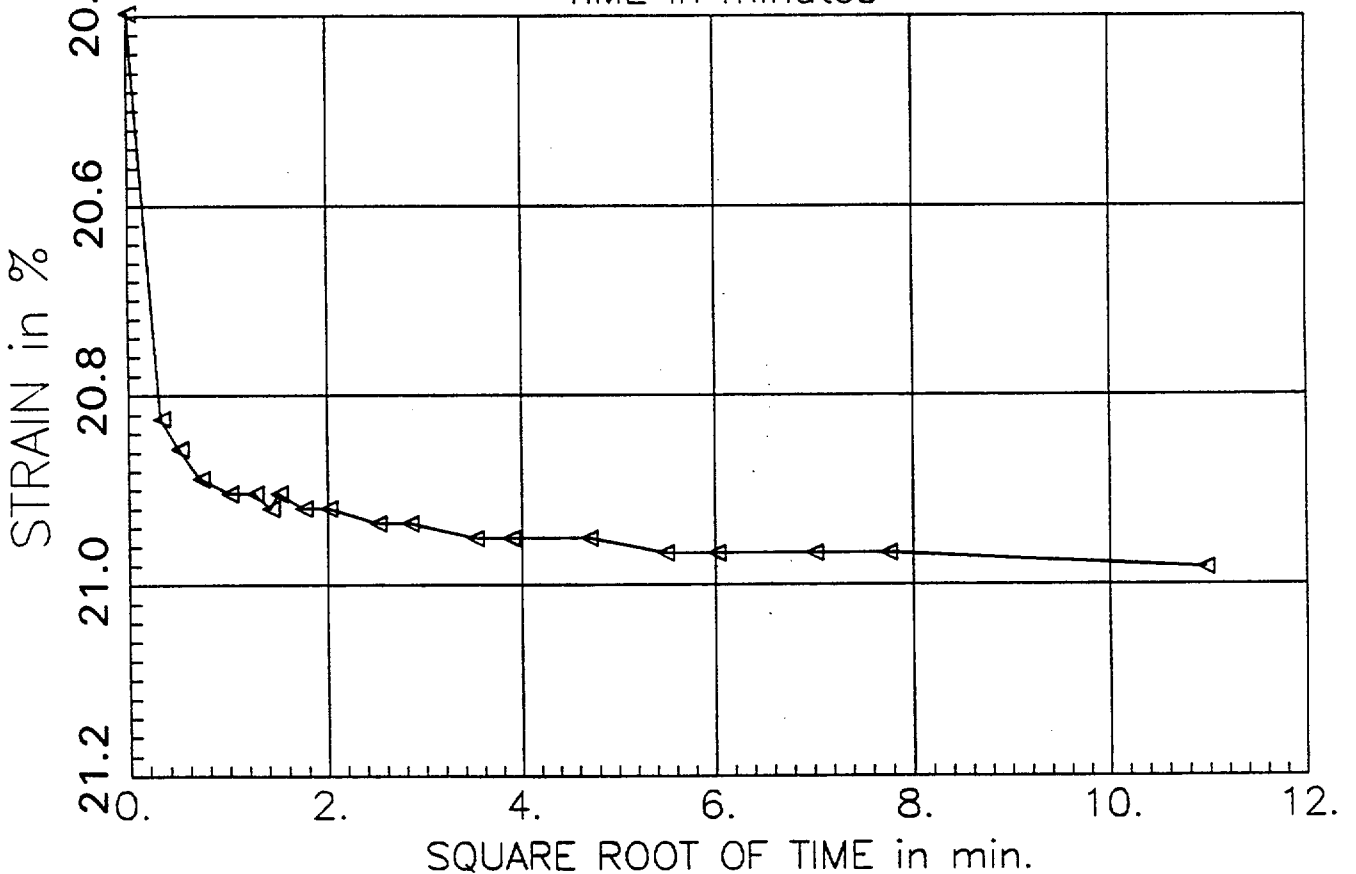
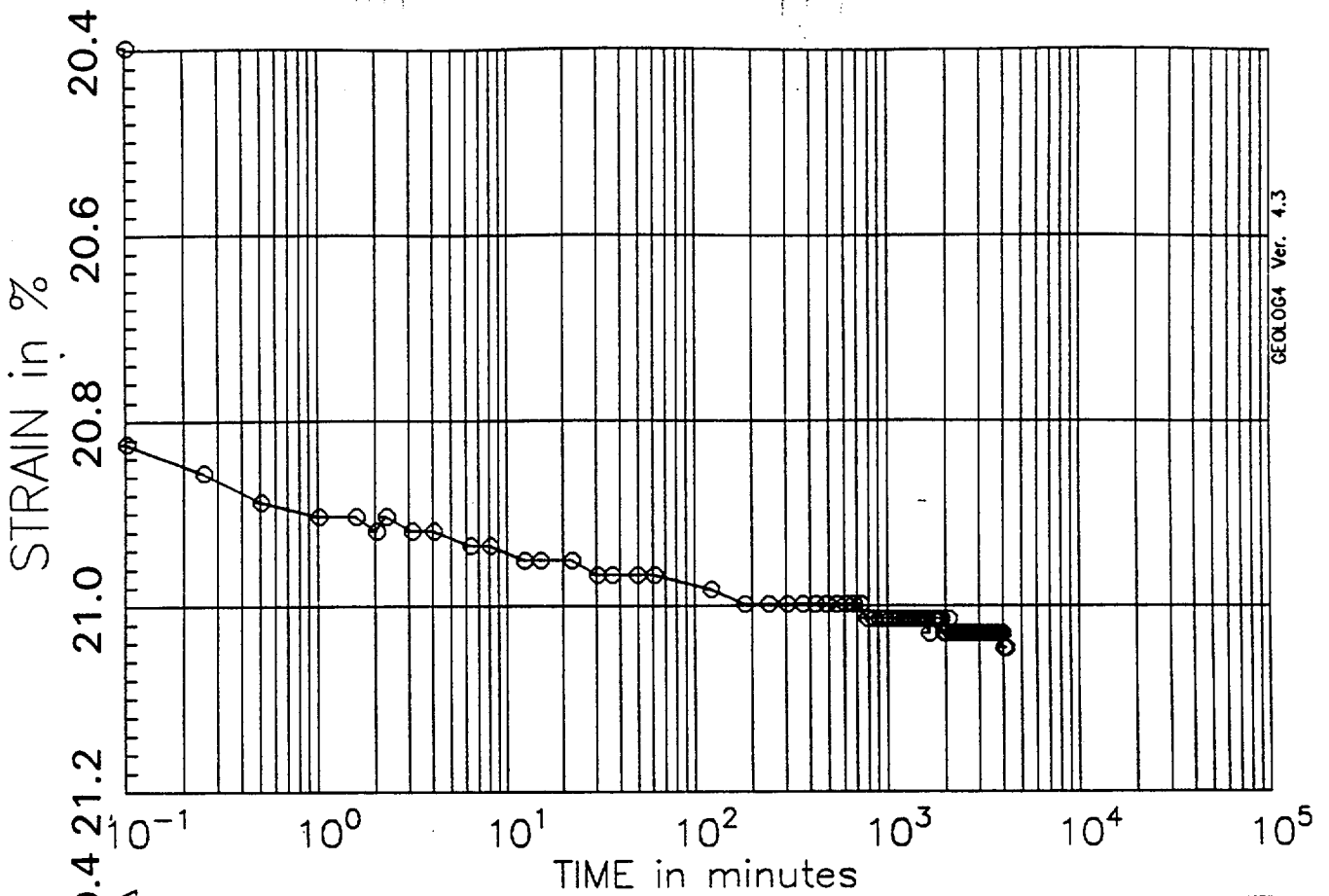

PRESSURE INCREMENT
 from 1.00 tsf to 2.00 tsf

Test No: 2
 Testname: C1-U3D

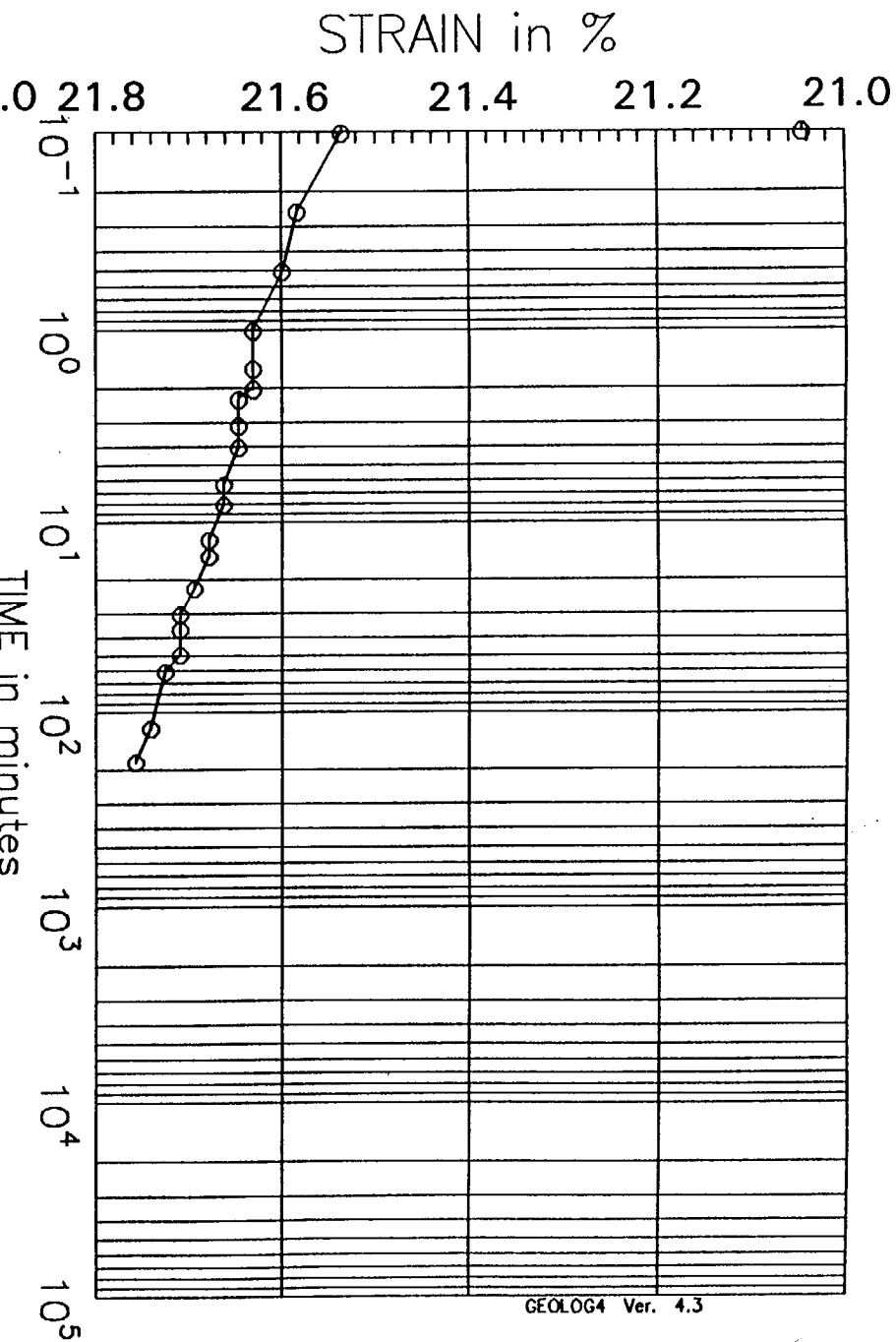

GEOLOG4 Ver. 4.3

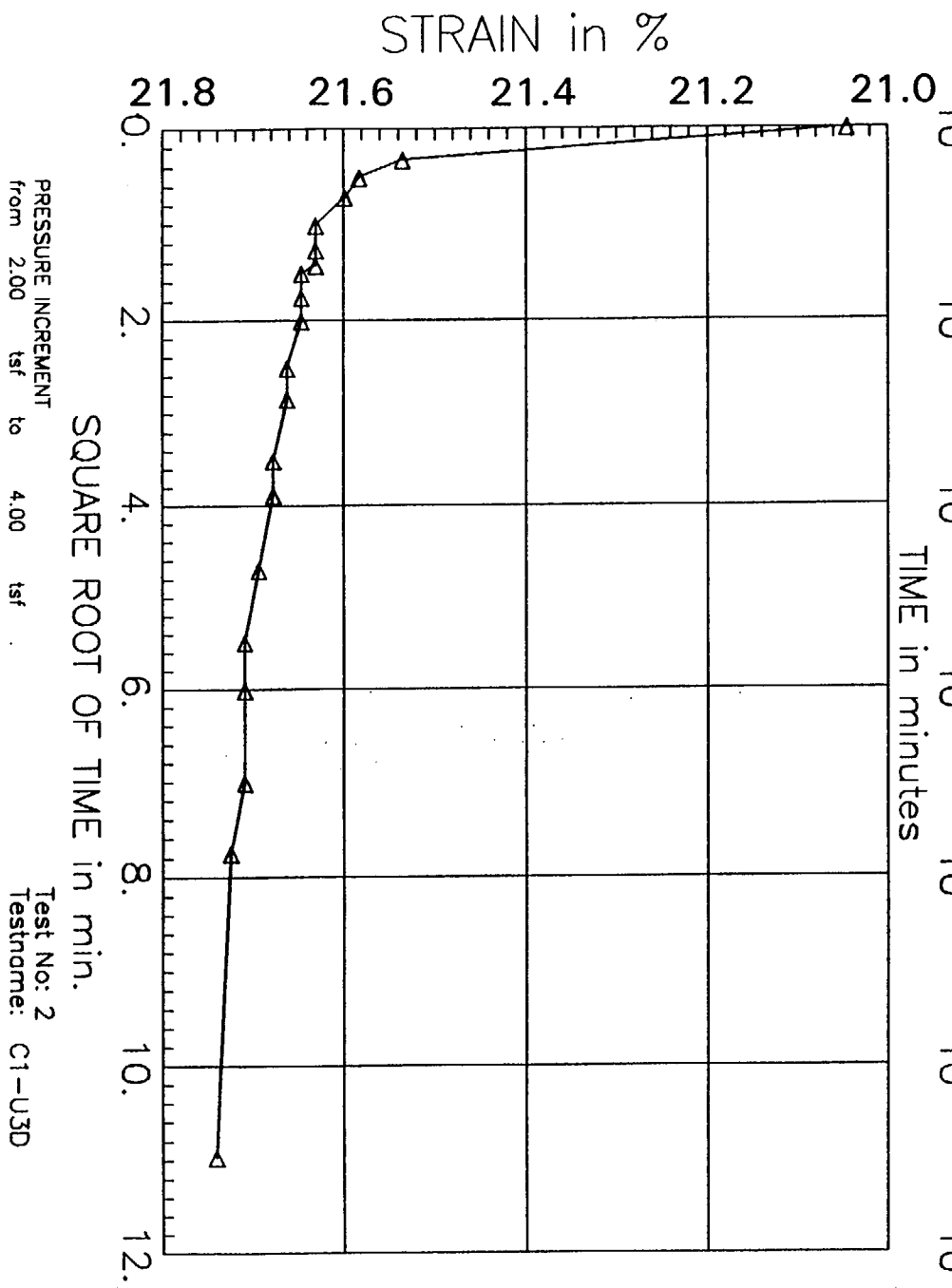

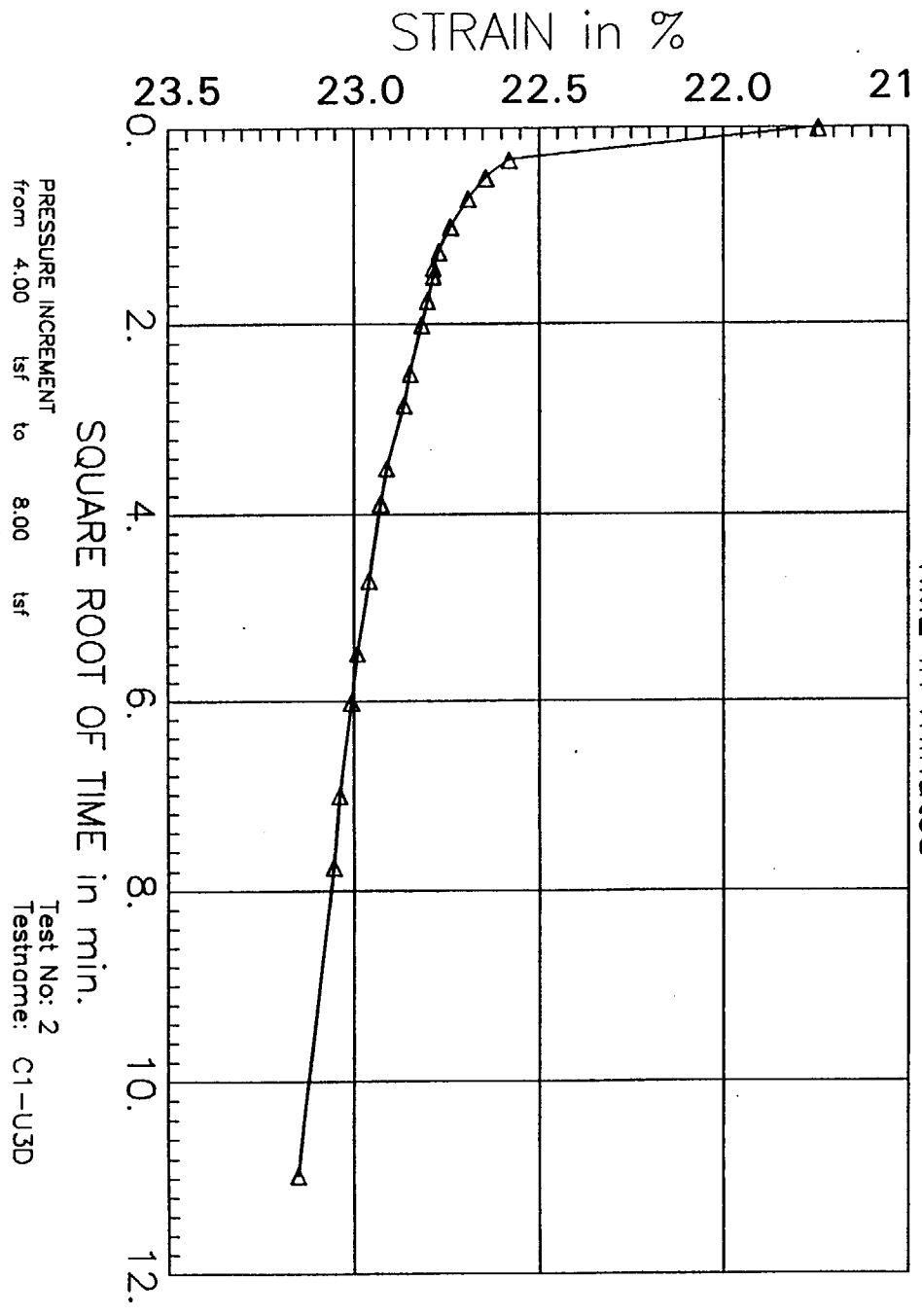
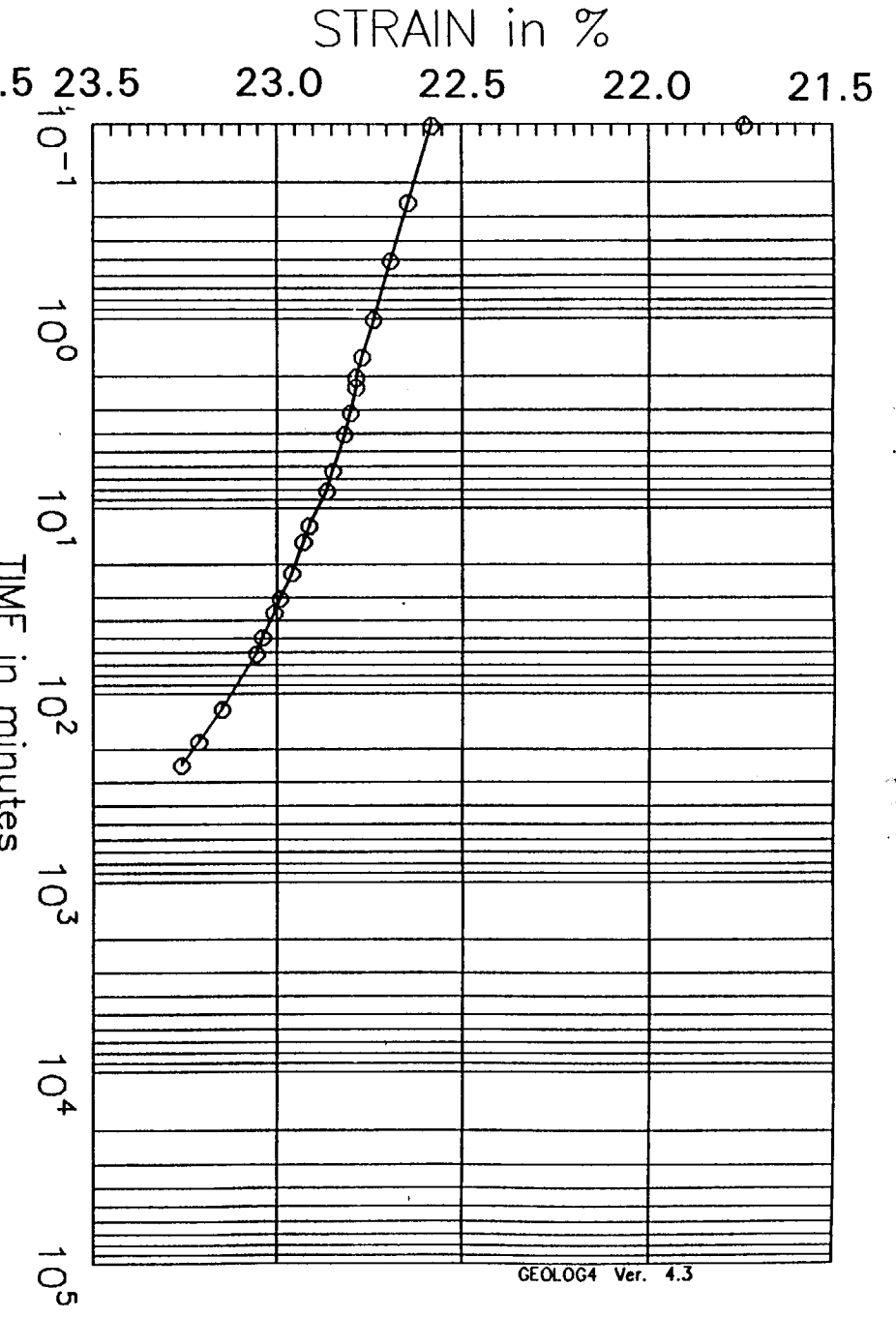

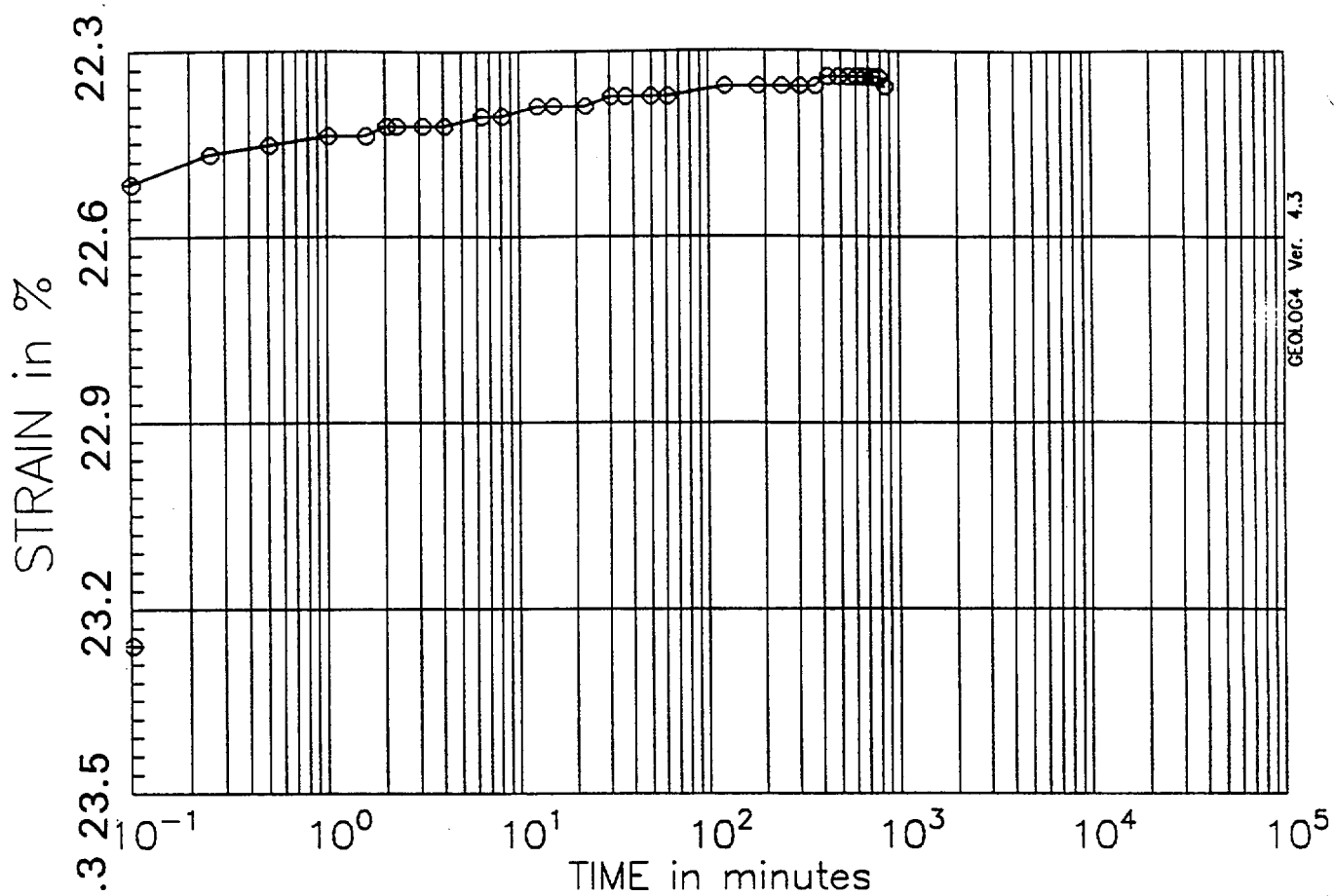

GEOLOG4 Ver. 4.3

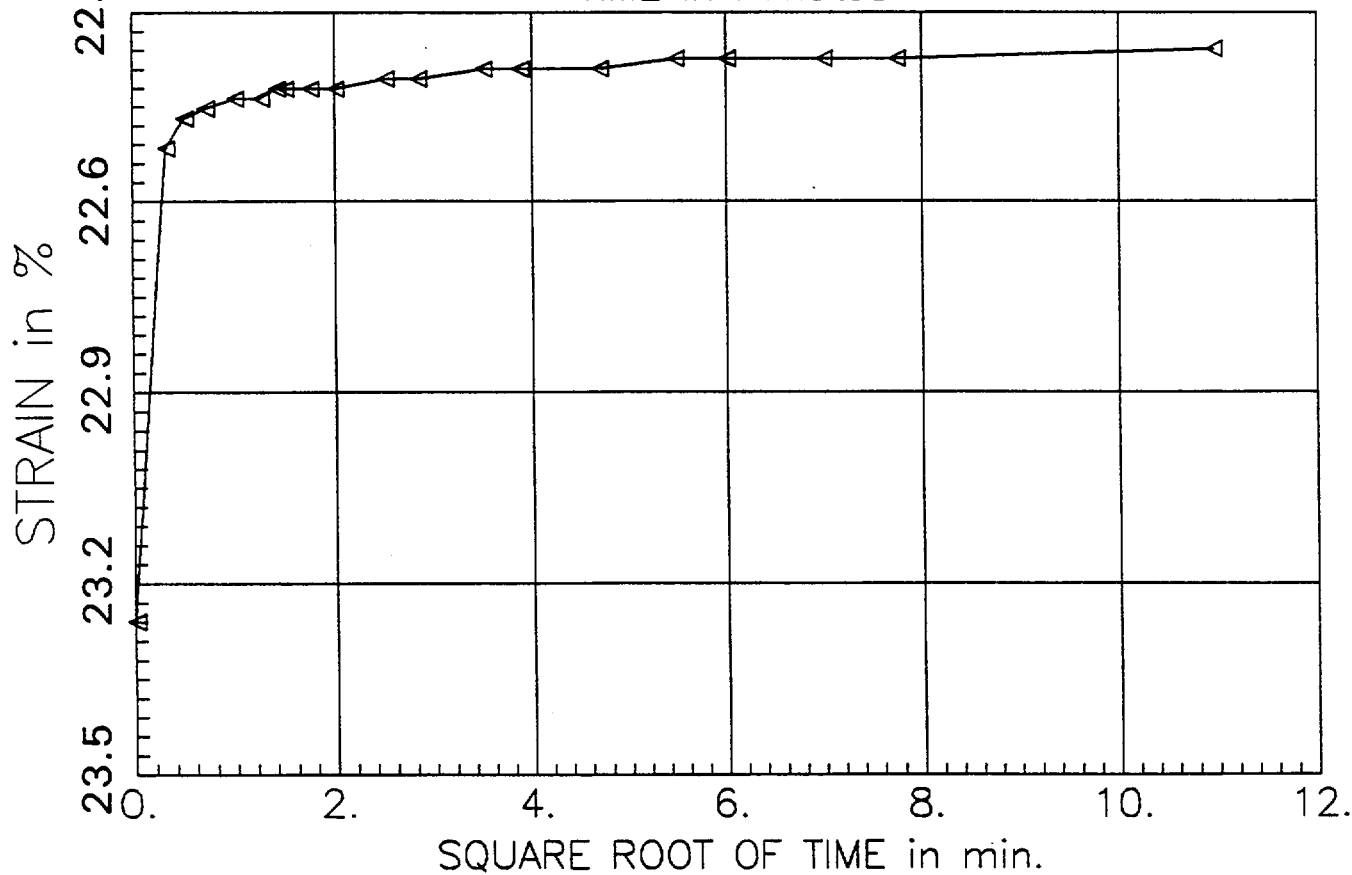

PRESSURE INCREMENT
from 8.00 tsf to 2.00 tsf

Test No: 2
Testname: C1-U3D

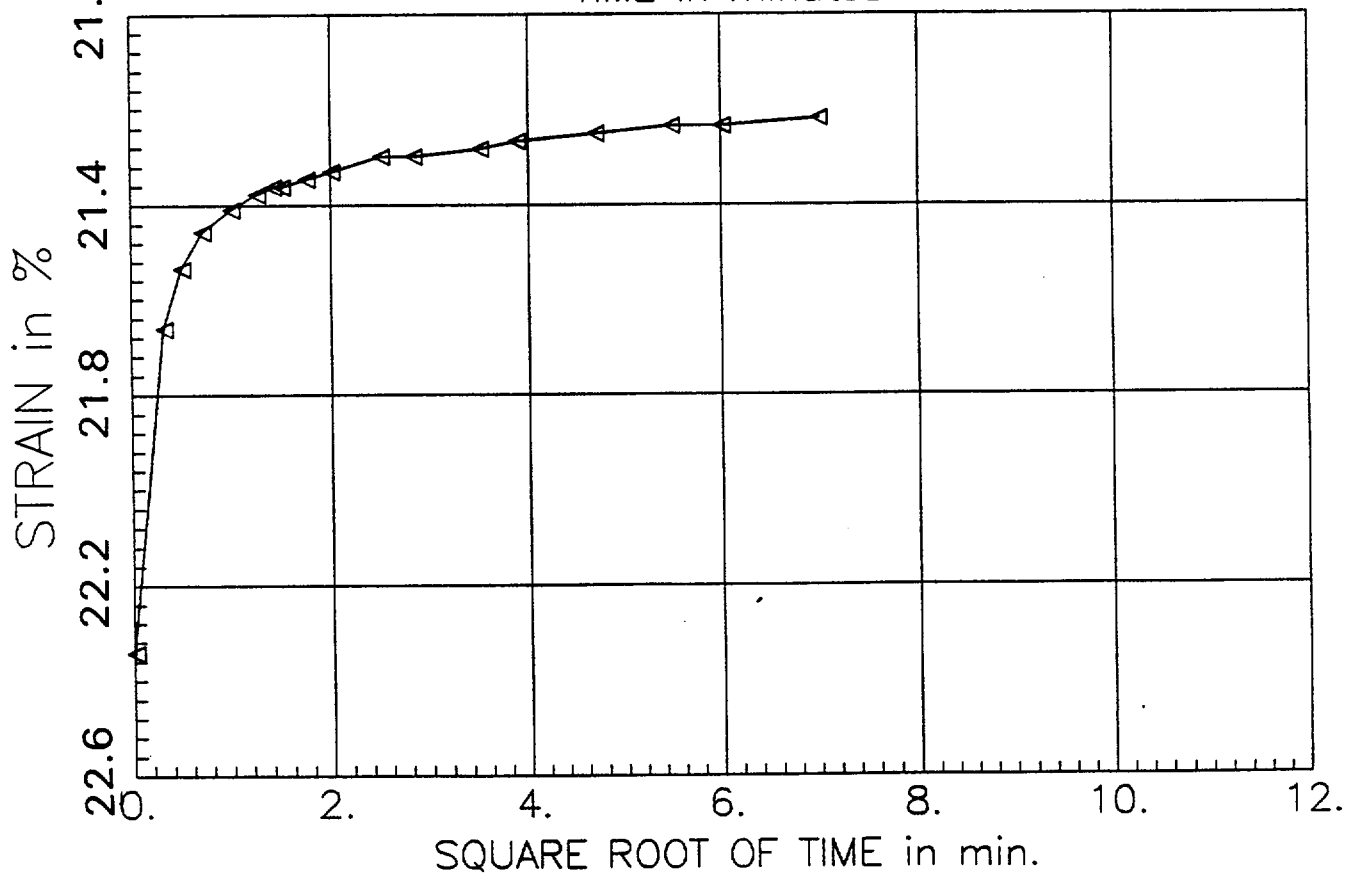
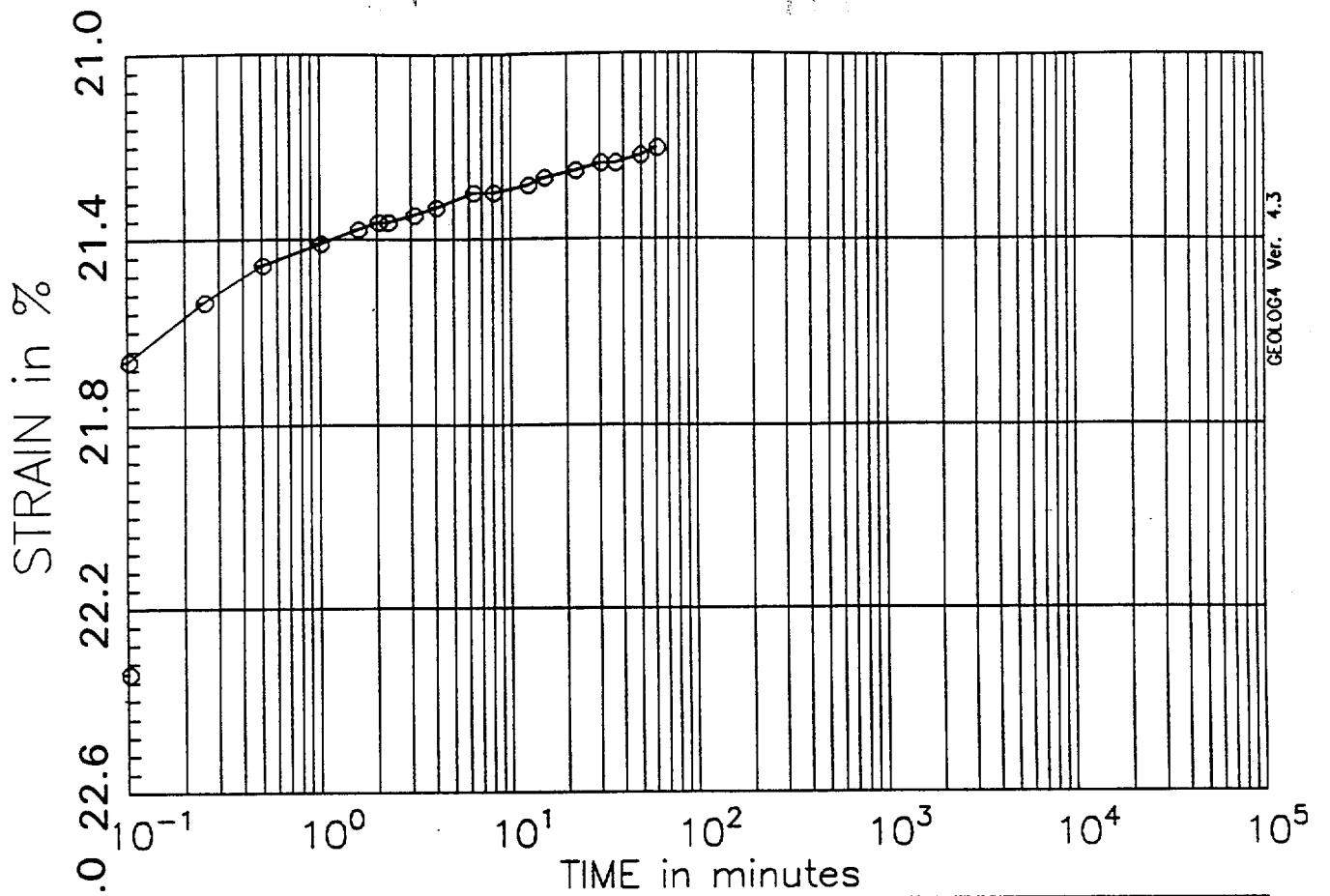

PRESSURE INCREMENT
 from 2.00 tsf to 0.50 tsf

Test No: 2
 Testname: C1-U3D

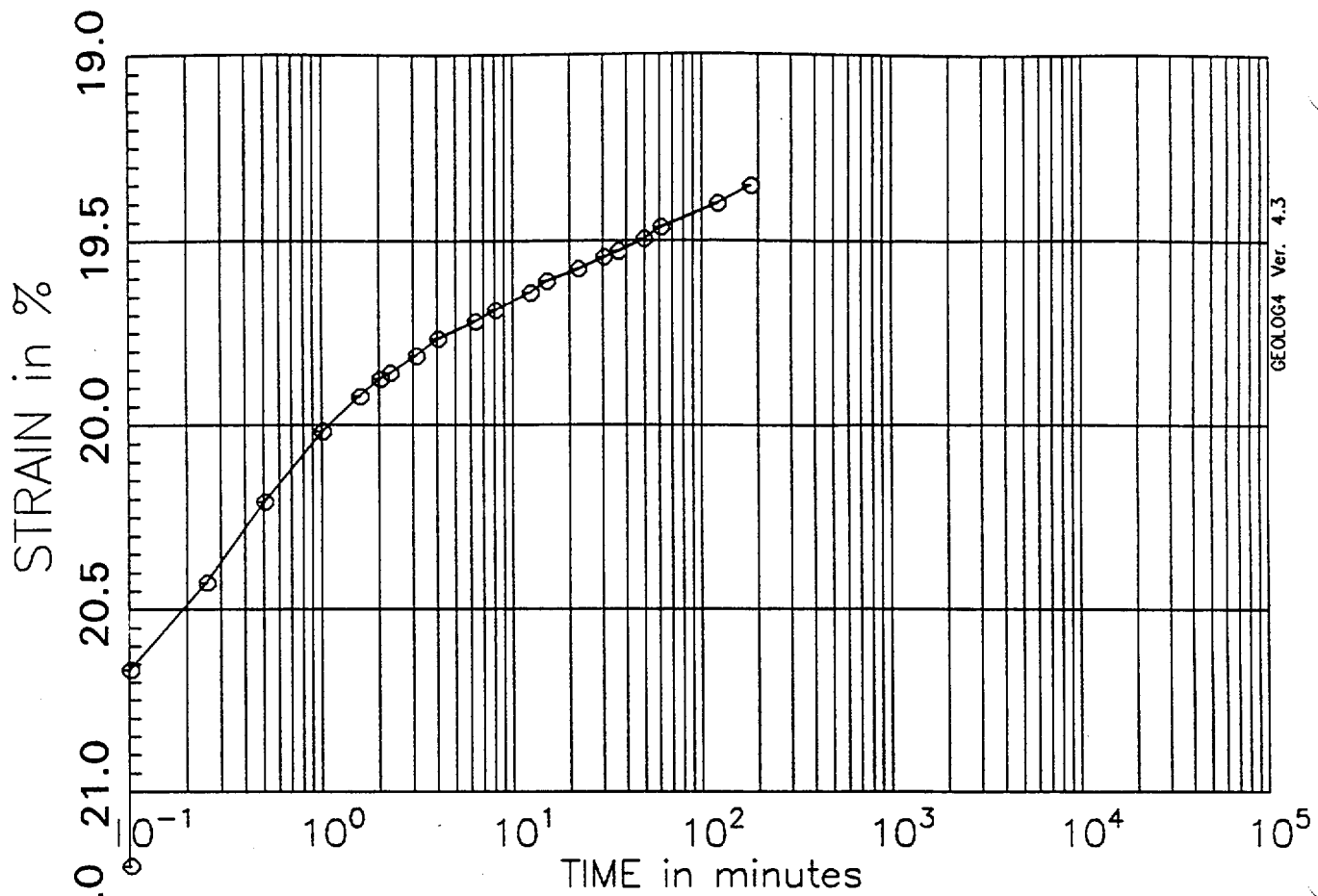

GEOLOG4 Ver. 4.3

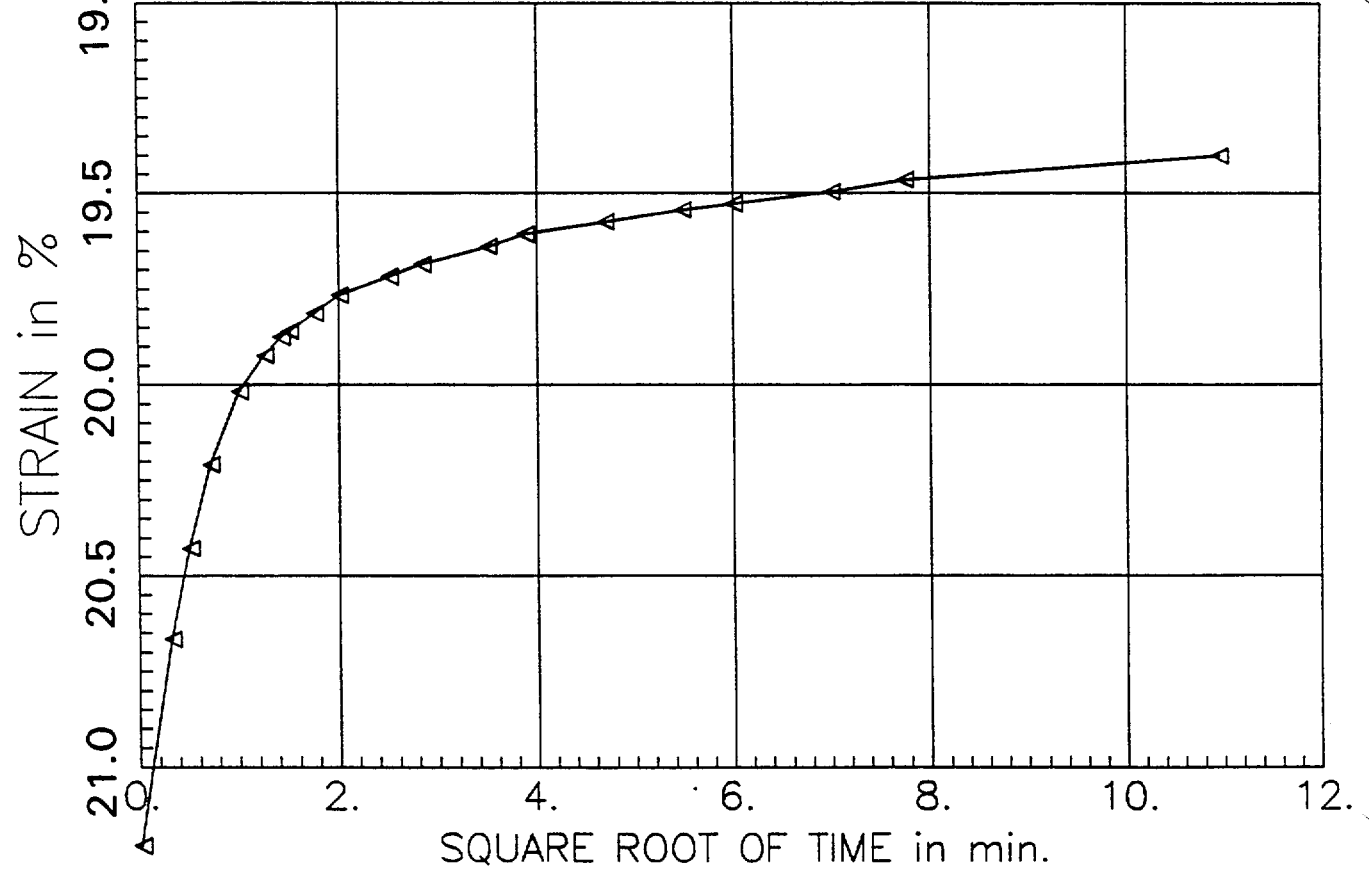

PRESSURE INCREMENT
from 0.50 tsf to 0.10 tsf

Test No: 2
Testname: C1-U3D

CONSOLIDATION TEST DATA

SAMPLE INFORMATION:

BORING:	C-1	DATE:	12/12/96
SAMPLE:	U-3D	TESTED BY:	ACS
DEPTH:	11.4 ft	CHECKED:	PJT
DESCRIPTION:	Clayey SILT		

SPECIMEN INFORMATION:

	INITIAL	FINAL
WATER CONTENT:	46.7 %	62.4 %
DRY UNIT WEIGHT:	51.7 pcf	64.1 pcf
VOID RATIO:	2.285	1.649
SATURATION:	55.6 %	103 %
HEIGHT:	1.893 cm	1.527 cm
AREA:	31.63 sq cm	
SP. GRAVITY :	2.72	

TEST DATA:

APPLIED PRESSURE	STRAIN
tsf	%
0.10	0.11
0.25	0.27
0.50	0.74
1.00	1.45
2.00	2.74
4.00	8.10
8.00	18.42
8.00	22.44
2.00	21.57
0.50	20.32
1.00	20.37
2.00	20.93
4.00	21.66
8.00	22.86
8.00	23.26
2.00	22.41
0.50	21.30
0.10	19.69

LOAD INCREMENT DATA

TEST NAME: C1-U3D
TESTED BY: ACS

PAGE NO: 1
JO: 05996.01

PRESSURE INCREMENT FROM 0.00 tsf to 0.10 tsf

DATE	TIME	ELAPSED TIME (min)	SQ RT OF TIME(min)	CHANGE IN HEIGHT(in)	VOID RATIO	STRAIN (%)
12-13-96	09:31:06	0.10	0.32	0.0007	2.282	0.09
		0.25	0.50	0.0007	2.282	0.09
		0.50	0.71	0.0008	2.281	0.11
		1.00	1.00	0.0007	2.282	0.09
		1.57	1.25	0.0007	2.282	0.09
		2.00	1.41	0.0006	2.282	0.08
		2.25	1.50	0.0006	2.282	0.08
		3.07	1.75	0.0005	2.283	0.06
		4.00	2.00	0.0002	2.284	0.03
		6.25	2.50	0.0001	2.284	0.02
		8.00	2.83	0.0000	2.285	0.00

LOAD INCREMENT DATA

TEST NAME C1-U3D
 TESTED BY: ACS

PAGE NO: 2
 JO: 05996.01

PRESSURE INCREMENT FROM 0.10 tsf to 0.25 tsf

DATE	TIME	ELAPSED TIME (min)	SQ RT OF TIME(min)	CHANGE IN HEIGHT(in)	VOID RATIO	STRAIN (%)
12-13-96	09:40:45	0.00	0.00	0.0001	2.284	0.02
		0.10	0.32	0.0015	2.278	0.21
		0.25	0.50	0.0016	2.278	0.22
		0.50	0.71	0.0018	2.277	0.24
		1.00	1.00	0.0018	2.277	0.24
		1.57	1.25	0.0018	2.277	0.24
		2.00	1.41	0.0019	2.277	0.25
		2.25	1.50	0.0019	2.277	0.25
		3.07	1.75	0.0019	2.277	0.25
		4.00	2.00	0.0019	2.277	0.25
		6.25	2.50	0.0020	2.276	0.27
		8.00	2.83	0.0020	2.276	0.27
		12.25	3.50	0.0020	2.276	0.27
		15.00	3.87	0.0020	2.276	0.27
		22.00	4.69	0.0021	2.276	0.28
		30.00	5.48	0.0020	2.276	0.27
		36.00	6.00	0.0020	2.276	0.27

LOAD INCREMENT DATA

TEST NAME C1-U3D
 TESTED BY: ACS

PAGE NO: 3
 JO: 05996.01

PRESSURE INCREMENT FROM 0.25 tsf to 0.50 tsf

DATE	TIME	ELAPSED TIME (min)	SQ RT OF TIME(min)	CHANGE IN HEIGHT(in)	VOID RATIO	STRAIN (%)
12-13-96	10:17:48	0.00	0.00	0.0021	2.276	0.28
		0.10	0.32	0.0048	2.264	0.65
		0.25	0.50	0.0051	2.263	0.68
		0.50	0.71	0.0051	2.263	0.68
		1.00	1.00	0.0052	2.262	0.70
		1.57	1.25	0.0053	2.262	0.71
		2.00	1.41	0.0053	2.262	0.71
		2.25	1.50	0.0053	2.262	0.71
		3.07	1.75	0.0053	2.262	0.71
		4.00	2.00	0.0054	2.261	0.73
		6.25	2.50	0.0054	2.261	0.73
		8.00	2.83	0.0055	2.261	0.74
		12.25	3.50	0.0055	2.261	0.74
		15.00	3.87	0.0055	2.261	0.74
		22.00	4.69	0.0057	2.260	0.76
		30.00	5.48	0.0057	2.260	0.76
		36.00	6.00	0.0058	2.260	0.77
		49.00	7.00	0.0058	2.260	0.77
		60.00	7.75	0.0058	2.260	0.77

LOAD INCREMENT DATA

TEST NAME C1-U3D
 TESTED BY: ACS

PAGE NO: 4
 JO: 05996.01

PRESSURE INCREMENT FROM 0.50 tsf to 1.00 tsf

DATE	TIME	ELAPSED TIME (min)	SQ RT OF TIME(min)	CHANGE IN HEIGHT(in)	VOID RATIO	STRAIN (%)
12-13-96	11:27:07	0.00	0.00	0.0058	2.260	0.77
		0.10	0.32	0.0099	2.241	1.33
		0.25	0.50	0.0101	2.240	1.36
		0.50	0.71	0.0103	2.240	1.38
		1.00	1.00	0.0105	2.239	1.41
		1.57	1.25	0.0105	2.239	1.41
		2.00	1.41	0.0106	2.238	1.42
		2.25	1.50	0.0106	2.238	1.42
		3.07	1.75	0.0106	2.238	1.42
		4.00	2.00	0.0107	2.238	1.44
		6.25	2.50	0.0108	2.237	1.45
		8.00	2.83	0.0108	2.237	1.45
		12.25	3.50	0.0110	2.237	1.47
		15.00	3.87	0.0110	2.237	1.47
		22.00	4.69	0.0111	2.236	1.49
		30.00	5.48	0.0112	2.236	1.50
		36.00	6.00	0.0112	2.236	1.50
		49.00	7.00	0.0113	2.235	1.52
		60.00	7.75	0.0114	2.235	1.53
		77.68	8.81	0.0115	2.234	1.55

LOAD INCREMENT DATA

TEST NAME C1-U3D
 TESTED BY: ACS

PAGE NO: 5
 JO: 05996.01

PRESSURE INCREMENT FROM 1.00 tsf to 2.00 tsf

DATE	TIME	ELAPSED TIME (min)	SQ RT OF TIME(min)	CHANGE IN HEIGHT(in)	VOID RATIO	STRAIN (%)
12-13-96	12:44:49	0.00	0.00	0.0115	2.234	1.55
		0.10	0.32	0.0180	2.206	2.42
		0.25	0.50	0.0186	2.203	2.50
		0.50	0.71	0.0190	2.201	2.55
		1.00	1.00	0.0193	2.200	2.59
		1.57	1.25	0.0196	2.199	2.62
		2.00	1.41	0.0197	2.198	2.64
		2.25	1.50	0.0197	2.198	2.64
		3.07	1.75	0.0199	2.197	2.67
		4.00	2.00	0.0200	2.197	2.69
		6.25	2.50	0.0203	2.196	2.72
		8.00	2.83	0.0204	2.195	2.74
		12.25	3.50	0.0206	2.194	2.77
		15.00	3.87	0.0207	2.194	2.78
		22.00	4.69	0.0211	2.192	2.83
		30.00	5.48	0.0213	2.191	2.86
		36.00	6.00	0.0214	2.190	2.88
		49.00	7.00	0.0217	2.189	2.91
		60.00	7.75	0.0218	2.189	2.93
		120.00	10.95	0.0224	2.186	3.00
180.00	13.42	0.0229	2.184	3.07		
240.00	15.49	0.0231	2.183	3.10		
300.00	17.32	0.0233	2.182	3.13		
360.00	18.97	0.0236	2.181	3.16		
420.00	20.49	0.0238	2.180	3.19		
480.00	21.91	0.0240	2.179	3.23		
540.00	23.24	0.0242	2.179	3.24		
600.00	24.49	0.0243	2.178	3.26		
660.00	25.69	0.0244	2.177	3.27		
12-14-96	00:44:49	720.00	26.83	0.0246	2.176	3.30
		780.00	27.93	0.0246	2.176	3.30
		840.00	28.98	0.0247	2.176	3.32
		900.00	30.00	0.0249	2.175	3.34
		960.00	30.98	0.0250	2.175	3.35
		1020.00	31.94	0.0251	2.174	3.37
		1080.00	32.86	0.0251	2.174	3.37

LOAD INCREMENT DATA

TEST NAME C1-U3D
 TESTED BY: ACS

PAGE NO: 6
 JO: 05996.01

PRESSURE INCREMENT FROM 1.00 tsf to 2.00 tsf

DATE	TIME	ELAPSED TIME (min)	SQ RT OF TIME(min)	CHANGE IN HEIGHT(in)	VOID RATIO	STRAIN (%)
		1140.00	33.76	0.0252	2.174	3.38
		1200.00	34.64	0.0253	2.173	3.40
		1260.00	35.50	0.0253	2.173	3.40
		1320.00	36.33	0.0255	2.173	3.42
		1380.00	37.15	0.0256	2.172	3.43
		1440.00	37.95	0.0256	2.172	3.43
		1500.00	38.73	0.0257	2.172	3.45
		1560.00	39.50	0.0258	2.171	3.46
		1620.00	40.25	0.0258	2.171	3.46
		1680.00	40.99	0.0259	2.171	3.48
		1740.00	41.71	0.0259	2.171	3.48
		1800.00	42.43	0.0260	2.170	3.49
		1860.00	43.13	0.0260	2.170	3.49
		1920.00	43.82	0.0262	2.170	3.51
		1980.00	44.50	0.0262	2.170	3.51
		2040.00	45.17	0.0263	2.169	3.53
		2100.00	45.83	0.0263	2.169	3.53
12-15-96	00:44:49	2160.00	46.48	0.0264	2.169	3.54
		2220.00	47.12	0.0264	2.169	3.54
		2280.00	47.75	0.0264	2.169	3.54
		2340.00	48.37	0.0265	2.168	3.56
		2400.00	48.99	0.0266	2.168	3.57
		2460.00	49.60	0.0266	2.168	3.57
		2520.00	50.20	0.0266	2.168	3.57
		2580.00	50.79	0.0267	2.167	3.59
		2640.00	51.38	0.0267	2.167	3.59
		2700.00	51.96	0.0269	2.167	3.61
		2760.00	52.54	0.0269	2.167	3.61
		2820.00	53.10	0.0269	2.167	3.61
		2880.00	53.67	0.0270	2.166	3.62
		2940.00	54.22	0.0270	2.166	3.62
		3000.00	54.77	0.0270	2.166	3.62
		3060.00	55.32	0.0271	2.166	3.64
		3120.00	55.86	0.0271	2.166	3.64

LOAD INCREMENT DATA

TEST NAME C1-U3D
 TESTED BY: ACS

PAGE NO: 7
 JO: 05996.01

PRESSURE INCREMENT FROM 1.00 tsf to 2.00 tsf

DATE	TIME	ELAPSED TIME (min)	SQ RT OF TIME(min)	CHANGE IN HEIGHT(in)	VOID RATIO	STRAIN (%)
		3180.00	56.39	0.0272	2.165	3.65
		3240.00	56.92	0.0272	2.165	3.65
		3300.00	57.45	0.0272	2.165	3.65
		3360.00	57.97	0.0273	2.164	3.67
		3420.00	58.48	0.0273	2.164	3.67
		3480.00	58.99	0.0273	2.164	3.67
		3540.00	59.50	0.0275	2.164	3.68
12-16-96	00:44:49	3600.00	60.00	0.0275	2.164	3.68
		3660.00	60.50	0.0275	2.164	3.68
		3720.00	60.99	0.0276	2.163	3.70
		3780.00	61.48	0.0276	2.163	3.70
		3840.00	61.97	0.0276	2.163	3.70
		3900.00	62.45	0.0277	2.163	3.72
		3960.00	62.93	0.0277	2.163	3.72
		4020.00	63.40	0.0276	2.163	3.70
		4080.00	63.87	0.0277	2.163	3.72
		4140.00	64.34	0.0277	2.163	3.72
		4200.00	64.81	0.0277	2.163	3.72
		4260.00	65.27	0.0277	2.163	3.72
		4320.00	65.73	0.0278	2.162	3.73
		4380.00	66.18	0.0278	2.162	3.73
		4440.00	66.63	0.0278	2.162	3.73
		4500.00	67.08	0.0279	2.162	3.75
		4560.00	67.53	0.0279	2.162	3.75
		4620.00	67.97	0.0279	2.162	3.75
		4680.00	68.41	0.0280	2.161	3.76
		4740.00	68.85	0.0280	2.161	3.76
		4800.00	69.28	0.0282	2.161	3.78
		4860.00	69.71	0.0283	2.160	3.79
		4920.00	70.14	0.0283	2.160	3.79
		4980.00	70.57	0.0283	2.160	3.79
12-17-96	00:44:49	5040.00	70.99	0.0284	2.160	3.81
		5100.00	71.41	0.0284	2.160	3.81
		5160.00	71.83	0.0284	2.160	3.81

LOAD INCREMENT DATA

TEST NAME C1-U3D
 TESTED BY: ACS

PAGE NO: 8
 JO: 05996.01

PRESSURE INCREMENT FROM 1.00 tsf to 2.00 tsf

DATE	TIME	ELAPSED TIME (min)	SQ RT OF TIME(min)	CHANGE IN HEIGHT(in)	VOID RATIO	STRAIN (%)
		5220.00	72.25	0.0285	2.159	3.83
		5280.00	72.66	0.0285	2.159	3.83
		5340.00	73.08	0.0285	2.159	3.83
		5400.00	73.48	0.0285	2.159	3.83
		5460.00	73.89	0.0285	2.159	3.83
		5520.00	74.30	0.0285	2.159	3.83
		5580.00	74.70	0.0285	2.159	3.83
		5640.00	75.10	0.0285	2.159	3.83
		5700.00	75.50	0.0286	2.159	3.84
		5760.00	75.89	0.0286	2.159	3.84
		5820.00	76.29	0.0286	2.159	3.84
		5880.00	76.68	0.0286	2.159	3.84
		5940.00	77.07	0.0288	2.158	3.86
		6000.00	77.46	0.0288	2.158	3.86
		6060.00	77.85	0.0288	2.158	3.86
		6120.00	78.23	0.0289	2.158	3.87
		6180.00	78.61	0.0289	2.158	3.87
		6240.00	78.99	0.0289	2.158	3.87
		6300.00	79.37	0.0290	2.157	3.89
		6360.00	79.75	0.0290	2.157	3.89
		6420.00	80.12	0.0291	2.157	3.91
12-18-96	00:44:49	6480.00	80.50	0.0291	2.157	3.91
		6540.00	80.87	0.0291	2.157	3.91
		6600.00	81.24	0.0292	2.156	3.92
		6660.00	81.61	0.0292	2.156	3.92
		6720.00	81.98	0.0292	2.156	3.92
		6780.00	82.34	0.0292	2.156	3.92
		6840.00	82.70	0.0292	2.156	3.92
		6900.00	83.07	0.0292	2.156	3.92
		6960.00	83.43	0.0292	2.156	3.92
		7020.00	83.79	0.0292	2.156	3.92
		7080.00	84.14	0.0292	2.156	3.92
		7140.00	84.50	0.0292	2.156	3.92
		7200.00	84.85	0.0293	2.156	3.94

LOAD INCREMENT DATA

TEST NAME C1-U3D
 TESTED BY: ACS

PAGE NO: 9
 JO: 05996.01

PRESSURE INCREMENT FROM 1.00 tsf to 2.00 tsf

DATE	TIME	ELAPSED TIME (min)	SQ RT OF TIME(min)	CHANGE IN HEIGHT(in)	VOID RATIO	STRAIN (%)
		7260.00	85.21	0.0293	2.156	3.94
		7320.00	85.56	0.0293	2.156	3.94
		7380.00	85.91	0.0293	2.156	3.94
		7440.00	86.26	0.0295	2.155	3.95
		7500.00	86.60	0.0295	2.155	3.95
		7560.00	86.95	0.0295	2.155	3.95
		7620.00	87.29	0.0295	2.155	3.95
		7680.00	87.64	0.0295	2.155	3.95
		7740.00	87.98	0.0296	2.155	3.97
		7800.00	88.32	0.0296	2.155	3.97
		7860.00	88.66	0.0296	2.155	3.97
12-19-96	00:44:49	7920.00	88.99	0.0297	2.154	3.98
		7980.00	89.33	0.0297	2.154	3.98
		8040.00	89.67	0.0297	2.154	3.98
		8100.00	90.00	0.0297	2.154	3.98
		8160.00	90.33	0.0298	2.154	4.00
		8220.00	90.66	0.0298	2.154	4.00
		8280.00	90.99	0.0298	2.154	4.00
		8340.00	91.32	0.0298	2.154	4.00
		8400.00	91.65	0.0298	2.154	4.00
		8460.00	91.98	0.0299	2.153	4.02
		8520.00	92.30	0.0299	2.153	4.02
		8580.00	92.63	0.0299	2.153	4.02
		8640.00	92.95	0.0299	2.153	4.02
		8700.00	93.27	0.0299	2.153	4.02
		8760.00	93.59	0.0300	2.153	4.03
		8820.00	93.91	0.0300	2.153	4.03
		8880.00	94.23	0.0300	2.153	4.03
		8940.00	94.55	0.0302	2.152	4.05
		9000.00	94.87	0.0302	2.152	4.05
		9060.00	95.18	0.0302	2.152	4.05
		9120.00	95.50	0.0302	2.152	4.05
		9180.00	95.81	0.0303	2.152	4.06
		9240.00	96.12	0.0303	2.152	4.06

LOAD INCREMENT DATA

TEST NAME C1-U3D
 TESTED BY: ACS

PAGE NO: 10
 JO: 05996.01

PRESSURE INCREMENT FROM 1.00 tsf to 2.00 tsf

DATE	TIME	ELAPSED TIME (min)	SQ RT OF TIME(min)	CHANGE IN HEIGHT(in)	VOID RATIO	STRAIN (%)
		9300.00	96.44	0.0303	2.152	4.06
12-20-96	00:44:49	9360.00	96.75	0.0303	2.152	4.06
		9420.00	97.06	0.0304	2.151	4.08
		9480.00	97.37	0.0304	2.151	4.08
		9540.00	97.67	0.0304	2.151	4.08
		9600.00	97.98	0.0305	2.150	4.10
		9660.00	98.29	0.0305	2.150	4.10
		9720.00	98.59	0.0305	2.150	4.10
		9780.00	98.89	0.0305	2.150	4.10
		9840.00	99.20	0.0305	2.150	4.10
		9900.00	99.50	0.0305	2.150	4.10
		9960.00	99.80	0.0305	2.150	4.10
		1002.00E+01	100.10	0.0305	2.150	4.10
		1008.00E+01	100.40	0.0305	2.150	4.10
		1014.00E+01	100.70	0.0305	2.150	4.10
		1020.00E+01	101.00	0.0305	2.150	4.10
		1026.00E+01	101.29	0.0306	2.150	4.11
		1032.00E+01	101.59	0.0306	2.150	4.11
		1038.00E+01	101.88	0.0306	2.150	4.11
		1044.00E+01	102.18	0.0306	2.150	4.11
		1050.00E+01	102.47	0.0308	2.149	4.13
		1056.00E+01	102.76	0.0308	2.149	4.13
		1062.00E+01	103.05	0.0308	2.149	4.13
		1068.00E+01	103.34	0.0309	2.149	4.14
		1074.00E+01	103.63	0.0309	2.149	4.14
12-21-96	00:44:49	1080.00E+01	103.92	0.0310	2.148	4.16
		1086.00E+01	104.21	0.0310	2.148	4.16
		1092.00E+01	104.50	0.0310	2.148	4.16
		1098.00E+01	104.79	0.0310	2.148	4.16
		1104.00E+01	105.07	0.0310	2.148	4.16
		1110.00E+01	105.36	0.0311	2.148	4.17
		1116.00E+01	105.64	0.0311	2.148	4.17
		1122.00E+01	105.92	0.0311	2.148	4.17
		1128.00E+01	106.21	0.0311	2.148	4.17

LOAD INCREMENT DATA

TEST NAME C1-U3D
 TESTED BY: ACS

PAGE NO: 11
 JO: 05996.01

PRESSURE INCREMENT FROM 1.00 tsf to 2.00 tsf

DATE	TIME	ELAPSED TIME (min)	SQ RT OF TIME(min)	CHANGE IN HEIGHT(in)	VOID RATIO	STRAIN (%)
		1134.00E+01	106.49	0.0311	2.148	4.17
		1140.00E+01	106.77	0.0311	2.148	4.17
		1146.00E+01	107.05	0.0312	2.147	4.19
		1152.00E+01	107.33	0.0312	2.147	4.19
		1158.00E+01	107.61	0.0312	2.147	4.19
		1164.00E+01	107.89	0.0312	2.147	4.19
		1170.00E+01	108.17	0.0312	2.147	4.19
		1176.00E+01	108.44	0.0312	2.147	4.19
		1182.00E+01	108.72	0.0312	2.147	4.19
		1188.00E+01	109.00	0.0312	2.147	4.19
		1194.00E+01	109.27	0.0312	2.147	4.19
		1200.00E+01	109.54	0.0312	2.147	4.19
		1206.00E+01	109.82	0.0313	2.147	4.21
		1212.00E+01	110.09	0.0313	2.147	4.21
		1218.00E+01	110.36	0.0313	2.147	4.21
12-22-96	00:44:49	1224.00E+01	110.63	0.0313	2.147	4.21
		1230.00E+01	110.91	0.0315	2.146	4.22
		1236.00E+01	111.18	0.0315	2.146	4.22
		1242.00E+01	111.45	0.0315	2.146	4.22
		1248.00E+01	111.71	0.0315	2.146	4.22
		1254.00E+01	111.98	0.0315	2.146	4.22
		1260.00E+01	112.25	0.0315	2.146	4.22
		1266.00E+01	112.52	0.0316	2.146	4.24
		1272.00E+01	112.78	0.0316	2.146	4.24
		1278.00E+01	113.05	0.0316	2.146	4.24
		1284.00E+01	113.31	0.0316	2.146	4.24
		1290.00E+01	113.58	0.0316	2.146	4.24
		1296.00E+01	113.84	0.0316	2.146	4.24
		1302.00E+01	114.11	0.0317	2.145	4.25
		1308.00E+01	114.37	0.0316	2.146	4.24
		1314.00E+01	114.63	0.0317	2.145	4.25
		1320.00E+01	114.89	0.0317	2.145	4.25
		1326.00E+01	115.15	0.0317	2.145	4.25
		1332.00E+01	115.41	0.0317	2.145	4.25

LOAD INCREMENT DATA

TEST NAME C1-U3D
 TESTED BY: ACS

PAGE NO: 12
 JO: 05996.01

PRESSURE INCREMENT FROM 1.00 tsf to 2.00 tsf

DATE	TIME	ELAPSED TIME (min)	SQ RT OF TIME(min)	CHANGE IN HEIGHT(in)	VOID RATIO	STRAIN (%)
		1338.00E+01	115.67	0.0317	2.145	4.25
		1344.00E+01	115.93	0.0317	2.145	4.25
		1350.00E+01	116.19	0.0317	2.145	4.25
		1356.00E+01	116.45	0.0317	2.145	4.25
		1362.00E+01	116.70	0.0318	2.145	4.27
12-23-96	00:44:49	1368.00E+01	116.96	0.0318	2.145	4.27
		1374.00E+01	117.22	0.0318	2.145	4.27
		1380.00E+01	117.47	0.0318	2.145	4.27
		1386.00E+01	117.73	0.0318	2.145	4.27
		1392.00E+01	117.98	0.0318	2.145	4.27
		1398.00E+01	118.24	0.0318	2.145	4.27
		1404.00E+01	118.49	0.0318	2.145	4.27
		1410.00E+01	118.74	0.0318	2.145	4.27
		1416.00E+01	119.00	0.0318	2.145	4.27
		1422.00E+01	119.25	0.0318	2.145	4.27
		1428.00E+01	119.50	0.0318	2.145	4.27
		1434.00E+01	119.75	0.0318	2.145	4.27
		1440.00E+01	120.00	0.0318	2.145	4.27
		1446.00E+01	120.25	0.0318	2.145	4.27
		1452.00E+01	120.50	0.0318	2.145	4.27
		1458.00E+01	120.75	0.0318	2.145	4.27
		1464.00E+01	121.00	0.0318	2.145	4.27
		1470.00E+01	121.24	0.0318	2.145	4.27
		1476.00E+01	121.49	0.0319	2.144	4.28
		1482.00E+01	121.74	0.0319	2.144	4.28
		1488.00E+01	121.98	0.0319	2.144	4.28
		1494.00E+01	122.23	0.0321	2.144	4.30
		1500.00E+01	122.47	0.0321	2.144	4.30
		1506.00E+01	122.72	0.0321	2.144	4.30
12-24-96	00:44:49	1512.00E+01	122.96	0.0321	2.144	4.30
		1518.00E+01	123.21	0.0322	2.143	4.32
		1524.00E+01	123.45	0.0322	2.143	4.32
		1530.00E+01	123.69	0.0322	2.143	4.32
		1536.00E+01	123.94	0.0322	2.143	4.32
		1542.00E+01	124.18	0.0322	2.143	4.32
		1548.00E+01	124.42	0.0323	2.143	4.33
		1554.00E+01	124.66	0.0322	2.143	4.32

LOAD INCREMENT DATA

TEST NAME C1-U3D
 TESTED BY: ACS

PAGE NO: 13
 JO: 05996.01

PRESSURE INCREMENT FROM 2.00 tsf to 4.00 tsf

DATE	TIME	ELAPSED TIME (min)	SQ RT OF TIME(min)	CHANGE IN HEIGHT(in)	VOID RATIO	STRAIN (%)
12-24-96	08:09:25	0.00	0.00	0.0322	2.143	4.32
		0.10	0.32	0.0455	2.085	6.10
		0.25	0.50	0.0487	2.070	6.53
		0.50	0.71	0.0508	2.061	6.81
		1.00	1.00	0.0529	2.052	7.10
		1.57	1.25	0.0544	2.045	7.31
		2.00	1.41	0.0553	2.041	7.42
		2.25	1.50	0.0557	2.039	7.48
		3.07	1.75	0.0568	2.035	7.62
		4.00	2.00	0.0577	2.030	7.75
		6.25	2.50	0.0594	2.023	7.97
		8.00	2.83	0.0603	2.019	8.10
		12.25	3.50	0.0622	2.011	8.35
		15.00	3.87	0.0630	2.007	8.46
		22.00	4.69	0.0648	1.999	8.70
		30.00	5.48	0.0663	1.993	8.90
		36.00	6.00	0.0672	1.989	9.01
		49.00	7.00	0.0687	1.982	9.22
		60.00	7.75	0.0699	1.977	9.38
		120.00	10.95	0.0734	1.961	9.85
180.00	13.42	0.0755	1.952	10.14		
240.00	15.49	0.0771	1.945	10.34		
300.00	17.32	0.0784	1.940	10.51		
360.00	18.97	0.0794	1.935	10.66		
420.00	20.49	0.0804	1.931	10.78		
480.00	21.91	0.0812	1.927	10.89		
540.00	23.24	0.0818	1.925	10.97		
600.00	24.49	0.0824	1.922	11.05		
660.00	25.69	0.0830	1.919	11.13		
720.00	26.83	0.0833	1.918	11.18		
780.00	27.93	0.0838	1.916	11.24		
840.00	28.98	0.0841	1.914	11.29		
900.00	30.00	0.0845	1.913	11.34		
12-25-96	00:09:25	960.00	30.98	0.0848	1.911	11.38
		1020.00	31.94	0.0852	1.909	11.43
		1080.00	32.86	0.0856	1.908	11.48

LOAD INCREMENT DATA

TEST NAME C1-U3D
 TESTED BY: ACS

PAGE NO: 14
 JO: 05996.01

PRESSURE INCREMENT FROM 2.00 tsf to 4.00 tsf

DATE	TIME	ELAPSED TIME (min)	SQ RT OF TIME(min)	CHANGE IN HEIGHT(in)	VOID RATIO	STRAIN (%)
		1140.00	33.76	0.0858	1.907	11.51
		1200.00	34.64	0.0860	1.906	11.54
		1260.00	35.50	0.0863	1.905	11.57
		1320.00	36.33	0.0865	1.904	11.61
		1380.00	37.15	0.0867	1.903	11.64
		1440.00	37.95	0.0870	1.902	11.67
		1500.00	38.73	0.0872	1.901	11.70
		1560.00	39.50	0.0874	1.900	11.73
		1620.00	40.25	0.0876	1.899	11.75
		1680.00	40.99	0.0878	1.898	11.78
		1740.00	41.71	0.0879	1.898	11.80
		1800.00	42.43	0.0881	1.896	11.83
		1860.00	43.13	0.0883	1.896	11.84
		1920.00	43.82	0.0884	1.895	11.86
		1980.00	44.50	0.0886	1.894	11.89
		2040.00	45.17	0.0887	1.894	11.91
		2100.00	45.83	0.0889	1.893	11.92
		2160.00	46.48	0.0890	1.893	11.94
		2220.00	47.12	0.0891	1.892	11.95
		2280.00	47.75	0.0892	1.892	11.97
		2340.00	48.37	0.0894	1.891	12.00
12-26-96	00:09:25	2400.00	48.99	0.0896	1.890	12.02
		2460.00	49.60	0.0896	1.890	12.02
		2520.00	50.20	0.0898	1.889	12.05
		2580.00	50.79	0.0898	1.889	12.05
		2640.00	51.38	0.0900	1.888	12.08
		2700.00	51.96	0.0900	1.888	12.08
		2760.00	52.54	0.0903	1.887	12.11
		2820.00	53.10	0.0903	1.887	12.11
		2880.00	53.67	0.0904	1.887	12.13
		2940.00	54.22	0.0905	1.886	12.14
		3000.00	54.77	0.0906	1.886	12.16
		3060.00	55.32	0.0906	1.886	12.16
		3120.00	55.86	0.0907	1.885	12.18

LOAD INCREMENT DATA

TEST NAME C1-U3D
 TESTED BY: ACS

PAGE NO: 15
 JO: 05996.01

PRESSURE INCREMENT FROM 2.00 tsf to 4.00 tsf

DATE	TIME	ELAPSED TIME (min)	SQ RT OF TIME(min)	CHANGE IN HEIGHT(in)	VOID RATIO	STRAIN (%)
		3180.00	56.39	0.0909	1.885	12.19
		3240.00	56.92	0.0910	1.884	12.21
		3300.00	57.45	0.0911	1.883	12.22
		3360.00	57.97	0.0912	1.883	12.24
		3420.00	58.48	0.0913	1.882	12.25
		3480.00	58.99	0.0914	1.882	12.27
		3540.00	59.50	0.0916	1.881	12.29
		3600.00	60.00	0.0917	1.881	12.30
		3660.00	60.50	0.0918	1.880	12.32
		3720.00	60.99	0.0919	1.880	12.33
		3780.00	61.48	0.0919	1.880	12.33
12-27-96	00:09:25	3840.00	61.97	0.0920	1.879	12.35
		3900.00	62.45	0.0922	1.879	12.36
		3960.00	62.93	0.0923	1.878	12.38
		4020.00	63.40	0.0923	1.878	12.38
		4080.00	63.87	0.0924	1.878	12.40
		4140.00	64.34	0.0925	1.877	12.41
		4200.00	64.81	0.0926	1.877	12.43
		4260.00	65.27	0.0926	1.877	12.43
		4320.00	65.73	0.0927	1.876	12.44
		4380.00	66.18	0.0929	1.876	12.46
		4440.00	66.63	0.0929	1.876	12.46
		4500.00	67.08	0.0930	1.875	12.48
		4560.00	67.53	0.0930	1.875	12.48
		4620.00	67.97	0.0931	1.875	12.49
		4680.00	68.41	0.0932	1.874	12.51
		4740.00	68.85	0.0932	1.874	12.51
		4800.00	69.28	0.0933	1.874	12.52
		4860.00	69.71	0.0934	1.873	12.54
		4920.00	70.14	0.0936	1.873	12.55
		4980.00	70.57	0.0936	1.873	12.55
		5040.00	70.99	0.0937	1.872	12.57
		5100.00	71.41	0.0937	1.872	12.57
		5160.00	71.83	0.0938	1.872	12.59

LOAD INCREMENT DATA

TEST NAME C1-U3D
 TESTED BY: ACS

PAGE NO: 16
 JO: 05996.01

PRESSURE INCREMENT FROM 2.00 tsf to 4.00 tsf

DATE	TIME	ELAPSED TIME (min)	SQ RT OF TIME(min)	CHANGE IN HEIGHT(in)	VOID RATIO	STRAIN (%)
		5220.00	72.25	0.0938	1.872	12.59
12-28-96	00:09:25	5280.00	72.66	0.0939	1.871	12.60
		5340.00	73.08	0.0939	1.871	12.60
		5400.00	73.48	0.0940	1.871	12.62
		5460.00	73.89	0.0942	1.870	12.63
		5520.00	74.30	0.0942	1.870	12.63
		5580.00	74.70	0.0942	1.870	12.63
		5640.00	75.10	0.0943	1.869	12.65
		5700.00	75.50	0.0944	1.869	12.67
		5760.00	75.89	0.0944	1.869	12.67
		5820.00	76.29	0.0944	1.869	12.67
		5880.00	76.68	0.0945	1.868	12.68
		5940.00	77.07	0.0945	1.868	12.68
		6000.00	77.46	0.0946	1.868	12.70
		6060.00	77.85	0.0946	1.868	12.70
		6120.00	78.23	0.0946	1.868	12.70
		6180.00	78.61	0.0947	1.867	12.71
		6240.00	78.99	0.0947	1.867	12.71
		6300.00	79.37	0.0949	1.867	12.73
		6360.00	79.75	0.0949	1.867	12.73
		6420.00	80.12	0.0949	1.867	12.73
		6480.00	80.50	0.0950	1.866	12.74
		6540.00	80.87	0.0950	1.866	12.74
		6600.00	81.24	0.0951	1.866	12.76
		6660.00	81.61	0.0951	1.866	12.76
12-29-96	00:09:25	6720.00	81.98	0.0951	1.866	12.76
		6780.00	82.34	0.0952	1.865	12.78
		6840.00	82.70	0.0952	1.865	12.78
		6900.00	83.07	0.0953	1.865	12.79
		6960.00	83.43	0.0953	1.865	12.79
		7020.00	83.79	0.0955	1.864	12.81
		7080.00	84.14	0.0955	1.864	12.81
		7140.00	84.50	0.0955	1.864	12.81
		7200.00	84.85	0.0956	1.864	12.82

LOAD INCREMENT DATA

TEST NAME C1-U3D
 TESTED BY: ACS

PAGE NO: 17
 JO: 05996.01

PRESSURE INCREMENT FROM 2.00 tsf to 4.00 tsf

DATE	TIME	ELAPSED TIME (min)	SQ RT OF TIME(min)	CHANGE IN HEIGHT(in)	VOID RATIO	STRAIN (%)
		7260.00	85.21	0.0956	1.864	12.82
		7320.00	85.56	0.0957	1.863	12.84
		7380.00	85.91	0.0957	1.863	12.84
		7440.00	86.26	0.0957	1.863	12.84
		7500.00	86.60	0.0957	1.863	12.84
		7560.00	86.95	0.0958	1.863	12.85
		7620.00	87.29	0.0958	1.863	12.85
		7680.00	87.64	0.0958	1.863	12.85
		7740.00	87.98	0.0959	1.862	12.87
		7800.00	88.32	0.0959	1.862	12.87
		7860.00	88.66	0.0959	1.862	12.87
		7920.00	88.99	0.0960	1.862	12.89
		7980.00	89.33	0.0960	1.862	12.89
		8040.00	89.67	0.0960	1.862	12.89
		8100.00	90.00	0.0960	1.862	12.89
12-30-96	01:09:25	8220.00	90.66	0.0962	1.861	12.90
		8340.00	91.32	0.0963	1.861	12.92
		8460.00	91.98	0.0964	1.860	12.93
		8580.00	92.63	0.0964	1.860	12.93
		8700.00	93.27	0.0965	1.860	12.95
		8820.00	93.91	0.0966	1.859	12.97
		8940.00	94.55	0.0966	1.859	12.97
		9060.00	95.18	0.0967	1.859	12.98
		9180.00	95.81	0.0967	1.859	12.98
		9300.00	96.44	0.0969	1.858	13.00
		9420.00	97.06	0.0970	1.858	13.01
		9480.00	97.37	0.0970	1.858	13.01
		9540.00	97.67	0.0971	1.857	13.03
12-31-96	01:09:25	9660.00	98.29	0.0971	1.857	13.03
		9780.00	98.89	0.0972	1.856	13.04
		9900.00	99.50	0.0972	1.856	13.04
		1002.00E+01	100.10	0.0973	1.856	13.06
		1014.00E+01	100.70	0.0975	1.855	13.08
		1026.00E+01	101.29	0.0975	1.855	13.08
		1038.00E+01	101.88	0.0976	1.855	13.09
		1050.00E+01	102.47	0.0977	1.854	13.11

LOAD INCREMENT DATA

TEST NAME C1-U3D
 TESTED BY: ACS

PAGE NO: 18
 JO: 05996.01

PRESSURE INCREMENT FROM 4.00 tsf to 8.00 tsf

DATE	TIME	ELAPSED TIME (min)	SQ RT OF TIME(min)	CHANGE IN HEIGHT(in)	VOID RATIO	STRAIN (%)
12-31-96	15:32:16	0.00	0.00	0.0977	1.854	13.11
		0.10	0.32	0.1152	1.777	15.46
		0.25	0.50	0.1207	1.753	16.19
		0.50	0.71	0.1242	1.738	16.67
		1.00	1.00	0.1274	1.724	17.09
		1.57	1.25	0.1295	1.714	17.38
		2.00	1.41	0.1306	1.709	17.52
		2.25	1.50	0.1312	1.707	17.60
		3.07	1.75	0.1327	1.700	17.80
		4.00	2.00	0.1339	1.695	17.96
		6.25	2.50	0.1361	1.685	18.26
		8.00	2.83	0.1373	1.680	18.42
		12.25	3.50	0.1395	1.670	18.72
		15.00	3.87	0.1406	1.665	18.86
		22.00	4.69	0.1425	1.657	19.12
		30.00	5.48	0.1442	1.649	19.35
		36.00	6.00	0.1452	1.645	19.48
		49.00	7.00	0.1469	1.637	19.72
		60.00	7.75	0.1481	1.632	19.88
		120.00	10.95	0.1520	1.615	20.40
		180.00	13.42	0.1541	1.606	20.68
240.00	15.49	0.1557	1.599	20.89		
300.00	17.32	0.1568	1.594	21.05		
360.00	18.97	0.1577	1.590	21.16		
420.00	20.49	0.1584	1.587	21.25		
480.00	21.91	0.1591	1.584	21.35		
01-01-97	00:32:16	540.00	23.24	0.1596	1.582	21.41
		600.00	24.49	0.1601	1.579	21.49
		660.00	25.69	0.1605	1.578	21.54
		720.00	26.83	0.1610	1.575	21.60
		780.00	27.93	0.1613	1.574	21.65
		840.00	28.98	0.1617	1.572	21.69
		900.00	30.00	0.1619	1.571	21.73
		960.00	30.98	0.1621	1.570	21.76
		1020.00	31.94	0.1625	1.569	21.80
		1080.00	32.86	0.1629	1.567	21.85

LOAD INCREMENT DATA

TEST NAME C1-U3D
 TESTED BY: ACS

PAGE NO: 19
 JO: 05996.01

PRESSURE INCREMENT FROM 4.00 tsf to 8.00 tsf

DATE	TIME	ELAPSED TIME (min)	SQ RT OF TIME(min)	CHANGE IN HEIGHT(in)	VOID RATIO	STRAIN (%)
		1140.00	33.76	0.1630	1.567	21.87
		1200.00	34.64	0.1632	1.566	21.90
		1260.00	35.50	0.1634	1.565	21.93
		1320.00	36.33	0.1636	1.564	21.95
		1380.00	37.15	0.1638	1.563	21.98
		1440.00	37.95	0.1640	1.562	22.01
		1500.00	38.73	0.1642	1.561	22.03
		1560.00	39.50	0.1644	1.560	22.06
		1620.00	40.25	0.1645	1.560	22.07
		1680.00	40.99	0.1647	1.559	22.10
		1740.00	41.71	0.1650	1.558	22.14
		1800.00	42.43	0.1650	1.558	22.14
		1860.00	43.13	0.1652	1.557	22.17
		1920.00	43.82	0.1653	1.556	22.18
01-02-97	00:32:16	1980.00	44.50	0.1654	1.556	22.20
		2040.00	45.17	0.1656	1.555	22.22
		2100.00	45.83	0.1658	1.554	22.25
		2160.00	46.48	0.1659	1.554	22.26
		2220.00	47.12	0.1660	1.553	22.28
		2280.00	47.75	0.1663	1.552	22.31
		2340.00	48.37	0.1664	1.552	22.33
		2400.00	48.99	0.1666	1.551	22.36
		2460.00	49.60	0.1667	1.550	22.37
		2520.00	50.20	0.1669	1.550	22.39
		2580.00	50.79	0.1671	1.548	22.42
		2640.00	51.38	0.1672	1.548	22.44

LOAD INCREMENT DATA

TEST NAME C1-U3D
 TESTED BY: ACS

PAGE NO: 20
 JO: 05996.01

PRESSURE INCREMENT FROM 8.00 tsf to 2.00 tsf

DATE	TIME	ELAPSED TIME (min)	SQ RT OF TIME(min)	CHANGE IN HEIGHT(in)	VOID RATIO	STRAIN (%)
01-02-97	11:37:38	0.00	0.00	0.1672	1.548	22.44
		0.10	0.32	0.1616	1.573	21.68
		0.25	0.50	0.1613	1.574	21.65
		0.50	0.71	0.1611	1.575	21.61
		1.00	1.00	0.1610	1.575	21.60
		1.57	1.25	0.1610	1.575	21.60
		2.00	1.41	0.1610	1.575	21.60
		2.25	1.50	0.1610	1.575	21.60
		3.07	1.75	0.1609	1.576	21.58
		4.00	2.00	0.1609	1.576	21.58
		6.25	2.50	0.1607	1.577	21.57
		8.00	2.83	0.1607	1.577	21.57
		12.25	3.50	0.1607	1.577	21.57
		15.00	3.87	0.1606	1.577	21.55
		22.00	4.69	0.1606	1.577	21.55
		30.00	5.48	0.1606	1.577	21.55
		36.00	6.00	0.1605	1.578	21.54
		49.00	7.00	0.1605	1.578	21.54
		60.00	7.75	0.1605	1.578	21.54
		120.00	10.95	0.1604	1.578	21.52
		180.00	13.42	0.1604	1.578	21.52
		240.00	15.49	0.1603	1.579	21.50
		300.00	17.32	0.1603	1.579	21.50

LOAD INCREMENT DATA

TEST NAME C1-U3D
 TESTED BY: ACS

PAGE NO: 21
 JO: 05996.01

PRESSURE INCREMENT FROM 2.00 tsf to 0.50 tsf

DATE	TIME	ELAPSED TIME (min)	SQ RT OF TIME(min)	CHANGE IN HEIGHT(in)	VOID RATIO	STRAIN (%)
01-02-97	16:55:06	0.00	0.00	0.1603	1.579	21.50
		0.10	0.32	0.1545	1.604	20.73
		0.25	0.50	0.1535	1.608	20.60
		0.50	0.71	0.1530	1.611	20.52
		1.00	1.00	0.1524	1.613	20.44
		1.57	1.25	0.1521	1.614	20.41
		2.00	1.41	0.1520	1.615	20.40
		2.25	1.50	0.1520	1.615	20.40
		3.07	1.75	0.1518	1.616	20.37
		4.00	2.00	0.1517	1.617	20.35
		6.25	2.50	0.1515	1.617	20.33
		8.00	2.83	0.1514	1.618	20.32
		12.25	3.50	0.1513	1.618	20.30
		15.00	3.87	0.1512	1.619	20.29
		22.00	4.69	0.1511	1.619	20.27
		30.00	5.48	0.1510	1.620	20.25
		36.00	6.00	0.1508	1.620	20.24
		49.00	7.00	0.1507	1.621	20.22
		60.00	7.75	0.1506	1.621	20.21
		120.00	10.95	0.1504	1.622	20.18
180.00	13.42	0.1502	1.623	20.16		
240.00	15.49	0.1501	1.623	20.14		
300.00	17.32	0.1500	1.624	20.13		
360.00	18.97	0.1500	1.624	20.13		
420.00	20.49	0.1500	1.624	20.13		
01-03-97	00:55:06	480.00	21.91	0.1499	1.624	20.11
		540.00	23.24	0.1499	1.624	20.11
		600.00	24.49	0.1499	1.624	20.11
		660.00	25.69	0.1499	1.624	20.11
		720.00	26.83	0.1499	1.624	20.11
		780.00	27.93	0.1499	1.624	20.11
		840.00	28.98	0.1499	1.624	20.11
		900.00	30.00	0.1499	1.624	20.11
960.00	30.98	0.1498	1.625	20.10		

LOAD INCREMENT DATA

TEST NAME C1-U3D
 TESTED BY: ACS

PAGE NO: 22
 JO: 05996.01

PRESSURE INCREMENT FROM 0.50 tsf to 1.00 tsf

DATE	TIME	ELAPSED TIME (min)	SQ RT OF TIME(min)	CHANGE IN HEIGHT(in)	VOID RATIO	STRAIN (%)
01-03-97	09:02:18	0.00	0.00	0.1498	1.625	20.10
		0.10	0.32	0.1513	1.618	20.30
		0.25	0.50	0.1514	1.618	20.32
		0.50	0.71	0.1515	1.617	20.33
		1.00	1.00	0.1517	1.617	20.35
		1.57	1.25	0.1517	1.617	20.35
		2.00	1.41	0.1517	1.617	20.35
		2.25	1.50	0.1517	1.617	20.35
		3.07	1.75	0.1517	1.617	20.35
		4.00	2.00	0.1518	1.616	20.37
		6.25	2.50	0.1518	1.616	20.37
		8.00	2.83	0.1518	1.616	20.37
		12.25	3.50	0.1518	1.616	20.37
		15.00	3.87	0.1519	1.615	20.38
		22.00	4.69	0.1519	1.615	20.38
		30.00	5.48	0.1519	1.615	20.38
		36.00	6.00	0.1519	1.615	20.38
		49.00	7.00	0.1519	1.615	20.38
		60.00	7.75	0.1520	1.615	20.40
		120.00	10.95	0.1520	1.615	20.40
		180.00	13.42	0.1520	1.615	20.40

LOAD INCREMENT DATA

TEST NAME C1-U3D
 TESTED BY: ACS

PAGE NO: 23
 JO: 05996.01

PRESSURE INCREMENT FROM 1.00 tsf to 2.00 tsf

DATE	TIME	ELAPSED TIME (min)	SQ RT OF TIME(min)	CHANGE IN HEIGHT(in)	VOID RATIO	STRAIN (%)
01-03-97	12:20:30	0.00	0.00	0.1520	1.615	20.40
		0.10	0.32	0.1552	1.601	20.82
		0.25	0.50	0.1554	1.600	20.86
		0.50	0.71	0.1557	1.599	20.89
		1.00	1.00	0.1558	1.598	20.90
		1.57	1.25	0.1558	1.598	20.90
		2.00	1.41	0.1559	1.598	20.92
		2.25	1.50	0.1558	1.598	20.90
		3.07	1.75	0.1559	1.598	20.92
		4.00	2.00	0.1559	1.598	20.92
		6.25	2.50	0.1560	1.597	20.93
		8.00	2.83	0.1560	1.597	20.93
		12.25	3.50	0.1561	1.597	20.95
		15.00	3.87	0.1561	1.597	20.95
		22.00	4.69	0.1561	1.597	20.95
		30.00	5.48	0.1563	1.596	20.97
		36.00	6.00	0.1563	1.596	20.97
		49.00	7.00	0.1563	1.596	20.97
		60.00	7.75	0.1563	1.596	20.97
		120.00	10.95	0.1564	1.596	20.98
180.00	13.42	0.1565	1.595	21.00		
240.00	15.49	0.1565	1.595	21.00		
300.00	17.32	0.1565	1.595	21.00		
360.00	18.97	0.1565	1.595	21.00		
420.00	20.49	0.1565	1.595	21.00		
480.00	21.91	0.1565	1.595	21.00		
540.00	23.24	0.1565	1.595	21.00		
600.00	24.49	0.1565	1.595	21.00		
660.00	25.69	0.1565	1.595	21.00		
01-04-97	00:20:30	720.00	26.83	0.1565	1.595	21.00
		780.00	27.93	0.1566	1.595	21.01
		840.00	28.98	0.1566	1.595	21.01
		900.00	30.00	0.1566	1.595	21.01
		960.00	30.98	0.1566	1.595	21.01
		1020.00	31.94	0.1566	1.595	21.01
		1080.00	32.86	0.1566	1.595	21.01

LOAD INCREMENT DATA

TEST NAME C1-U3D
 TESTED BY: ACS

PAGE NO: 24
 JO: 05996.01

PRESSURE INCREMENT FROM 1.00 tsf to 2.00 tsf

DATE	TIME	ELAPSED TIME (min)	SO RT OF TIME(min)	CHANGE IN HEIGHT(in)	VOID RATIO	STRAIN (%)
		1140.00	33.76	0.1566	1.595	21.01
		1200.00	34.64	0.1566	1.595	21.01
		1260.00	35.50	0.1566	1.595	21.01
		1320.00	36.33	0.1566	1.595	21.01
		1380.00	37.15	0.1566	1.595	21.01
		1440.00	37.95	0.1566	1.595	21.01
		1500.00	38.73	0.1566	1.595	21.01
		1560.00	39.50	0.1566	1.595	21.01
		1620.00	40.25	0.1567	1.594	21.03
		1680.00	40.99	0.1566	1.595	21.01
		1740.00	41.71	0.1566	1.595	21.01
		1800.00	42.43	0.1566	1.595	21.01
		1860.00	43.13	0.1566	1.595	21.01
		1920.00	43.82	0.1567	1.594	21.03
		1980.00	44.50	0.1567	1.594	21.03
		2040.00	45.17	0.1566	1.595	21.01
		2100.00	45.83	0.1567	1.594	21.03
01-05-97	00:20:30	2160.00	46.48	0.1567	1.594	21.03
		2220.00	47.12	0.1567	1.594	21.03
		2280.00	47.75	0.1567	1.594	21.03
		2340.00	48.37	0.1567	1.594	21.03
		2400.00	48.99	0.1567	1.594	21.03
		2460.00	49.60	0.1567	1.594	21.03
		2520.00	50.20	0.1567	1.594	21.03
		2580.00	50.79	0.1567	1.594	21.03
		2640.00	51.38	0.1567	1.594	21.03
		2700.00	51.96	0.1567	1.594	21.03
		2760.00	52.54	0.1567	1.594	21.03
		2820.00	53.10	0.1567	1.594	21.03
		2880.00	53.67	0.1567	1.594	21.03
		2940.00	54.22	0.1567	1.594	21.03
		3000.00	54.77	0.1567	1.594	21.03
		3060.00	55.32	0.1567	1.594	21.03
		3120.00	55.86	0.1567	1.594	21.03

LOAD INCREMENT DATA

TEST NAME C1-U3D
 TESTED BY: ACS

PAGE NO: 25
 JO: 05996.01

PRESSURE INCREMENT FROM 1.00 tsf to 2.00 tsf

DATE	TIME	ELAPSED TIME (min)	SQ RT OF TIME(min)	CHANGE IN HEIGHT(in)	VOID RATIO	STRAIN (%)
		3180.00	56.39	0.1567	1.594	21.03
		3240.00	56.92	0.1567	1.594	21.03
		3300.00	57.45	0.1567	1.594	21.03
		3360.00	57.97	0.1567	1.594	21.03
		3420.00	58.48	0.1567	1.594	21.03
		3480.00	58.99	0.1567	1.594	21.03
		3540.00	59.50	0.1567	1.594	21.03
01-06-97	00:20:30	3600.00	60.00	0.1567	1.594	21.03
		3660.00	60.50	0.1567	1.594	21.03
		3720.00	60.99	0.1567	1.594	21.03
		3780.00	61.48	0.1567	1.594	21.03
		3840.00	61.97	0.1567	1.594	21.03
		3900.00	62.45	0.1567	1.594	21.03
		3960.00	62.93	0.1568	1.594	21.05
		4020.00	63.40	0.1568	1.594	21.05
		4080.00	63.87	0.1568	1.594	21.05

LOAD INCREMENT DATA

TEST NAME C1-U3D
 TESTED BY: ACS

PAGE NO: 26
 JO: 05996.01

PRESSURE INCREMENT FROM 2.00 tsf to 4.00 tsf

DATE	TIME	ELAPSED TIME (min)	SQ RT OF TIME(min)	CHANGE IN HEIGHT(in)	VOID RATIO	STRAIN (%)
01-06-97	08:46:30	0.00	0.00	0.1568	1.594	21.05
		0.10	0.32	0.1605	1.578	21.54
		0.25	0.50	0.1609	1.576	21.58
		0.50	0.71	0.1610	1.575	21.60
		1.00	1.00	0.1612	1.574	21.63
		1.57	1.25	0.1612	1.574	21.63
		2.00	1.41	0.1612	1.574	21.63
		2.25	1.50	0.1613	1.574	21.65
		3.07	1.75	0.1613	1.574	21.65
		4.00	2.00	0.1613	1.574	21.65
		6.25	2.50	0.1614	1.573	21.66
		8.00	2.83	0.1614	1.573	21.66
		12.25	3.50	0.1616	1.573	21.68
		15.00	3.87	0.1616	1.573	21.68
		22.00	4.69	0.1617	1.572	21.69
		30.00	5.48	0.1618	1.572	21.71
		36.00	6.00	0.1618	1.572	21.71
		49.00	7.00	0.1618	1.572	21.71
		60.00	7.75	0.1619	1.571	21.73
		120.00	10.95	0.1620	1.571	21.74
		180.00	13.42	0.1621	1.570	21.76

LOAD INCREMENT DATA

TEST NAME C1-U3D
TESTED BY: ACS

PAGE NO: 27
JO: 05996.01

PRESSURE INCREMENT FROM 4.00 tsf to 8.00 tsf

DATE	TIME	ELAPSED TIME (min)	SQ RT OF TIME(min)	CHANGE IN HEIGHT(in)	VOID RATIO	STRAIN (%)
01-06-97	12:18:50	0.00	0.00	0.1620	1.571	21.74
		0.10	0.32	0.1683	1.543	22.58
		0.25	0.50	0.1687	1.541	22.64
		0.50	0.71	0.1691	1.540	22.69
		1.00	1.00	0.1695	1.538	22.74
		1.57	1.25	0.1697	1.537	22.77
		2.00	1.41	0.1698	1.537	22.78
		2.25	1.50	0.1698	1.537	22.78
		3.07	1.75	0.1699	1.536	22.80
		4.00	2.00	0.1700	1.535	22.82
		6.25	2.50	0.1703	1.534	22.85
		8.00	2.83	0.1704	1.534	22.86
		12.25	3.50	0.1708	1.532	22.91
		15.00	3.87	0.1709	1.532	22.93
		22.00	4.69	0.1711	1.531	22.96
		30.00	5.48	0.1713	1.530	22.99
		36.00	6.00	0.1715	1.529	23.01
		49.00	7.00	0.1717	1.528	23.04
		60.00	7.75	0.1718	1.528	23.05
		120.00	10.95	0.1725	1.525	23.15
		180.00	13.42	0.1730	1.522	23.21
		240.00	15.49	0.1733	1.521	23.26

LOAD INCREMENT DATA

TEST NAME C1-U3D
 TESTED BY: ACS

PAGE NO: 28
 JO: 05996.01

PRESSURE INCREMENT FROM 8.00 tsf to 2.00 tsf

DATE	TIME	ELAPSED TIME (min)	SQ RT OF TIME(min)	CHANGE IN HEIGHT(in)	VOID RATIO	STRAIN (%)
01-06-97	16:36:27	0.00	0.00	0.1733	1.521	23.26
		0.10	0.32	0.1678	1.545	22.52
		0.25	0.50	0.1675	1.547	22.47
		0.50	0.71	0.1673	1.547	22.45
		1.00	1.00	0.1672	1.548	22.44
		1.57	1.25	0.1672	1.548	22.44
		2.00	1.41	0.1671	1.548	22.42
		2.25	1.50	0.1671	1.548	22.42
		3.07	1.75	0.1671	1.548	22.42
		4.00	2.00	0.1671	1.548	22.42
		6.25	2.50	0.1670	1.549	22.41
		8.00	2.83	0.1670	1.549	22.41
		12.25	3.50	0.1669	1.550	22.39
		15.00	3.87	0.1669	1.550	22.39
		22.00	4.69	0.1669	1.550	22.39
		30.00	5.48	0.1667	1.550	22.37
		36.00	6.00	0.1667	1.550	22.37
		49.00	7.00	0.1667	1.550	22.37
		60.00	7.75	0.1667	1.550	22.37
		01-07-97	00:36:27	120.00	10.95	0.1666
180.00	13.42			0.1666	1.551	22.36
240.00	15.49			0.1666	1.551	22.36
300.00	17.32			0.1666	1.551	22.36
360.00	18.97			0.1666	1.551	22.36
420.00	20.49			0.1665	1.551	22.34
480.00	21.91			0.1665	1.551	22.34
540.00	23.24			0.1665	1.551	22.34
600.00	24.49			0.1665	1.551	22.34
660.00	25.69			0.1665	1.551	22.34
720.00	26.83	0.1665	1.551	22.34		
780.00	27.93	0.1665	1.551	22.34		
840.00	28.98	0.1666	1.551	22.36		
900.00	30.00	0.1666	1.551	22.36		

LOAD INCREMENT DATA

TEST NAME C1-U3D
 TESTED BY: ACS

PAGE NO: 29
 JO: 05996.01

PRESSURE INCREMENT FROM 2.00 tsf to 0.50 tsf

DATE	TIME	ELAPSED TIME (min)	SQ RT OF TIME(min)	CHANGE IN HEIGHT(in)	VOID RATIO	STRAIN (%)
01-07-97	08:02:44	0.00	0.00	0.1665	1.551	22.34
		0.10	0.32	0.1614	1.573	21.66
		0.25	0.50	0.1605	1.578	21.54
		0.50	0.71	0.1599	1.580	21.46
		1.00	1.00	0.1596	1.582	21.41
		1.57	1.25	0.1593	1.583	21.38
		2.00	1.41	0.1592	1.583	21.36
		2.25	1.50	0.1592	1.583	21.36
		3.07	1.75	0.1591	1.584	21.35
		4.00	2.00	0.1590	1.584	21.33
		6.25	2.50	0.1587	1.585	21.30
		8.00	2.83	0.1587	1.585	21.30
		12.25	3.50	0.1586	1.586	21.28
		15.00	3.87	0.1585	1.586	21.27
		22.00	4.69	0.1584	1.587	21.25
		30.00	5.48	0.1583	1.587	21.24
		36.00	6.00	0.1583	1.587	21.24
		49.00	7.00	0.1581	1.588	21.22
		60.00	7.75	0.1580	1.588	21.20

LOAD INCREMENT DATA

TEST NAME C1-U3D
TESTED BY: ACSPAGE NO: 30
JO: 05996.01

PRESSURE INCREMENT FROM 0.50 tsf to 0.10 tsf

DATE	TIME	ELAPSED TIME (min)	SQ RT OF TIME(min)	CHANGE IN HEIGHT(in)	VOID RATIO	STRAIN (%)
01-07-97	09:16:44	0.00	0.00	0.1580	1.588	21.20
		0.10	0.32	0.1540	1.606	20.67
		0.25	0.50	0.1523	1.614	20.43
		0.50	0.71	0.1506	1.621	20.21
		1.00	1.00	0.1492	1.627	20.02
		1.57	1.25	0.1485	1.631	19.92
		2.00	1.41	0.1481	1.632	19.88
		2.25	1.50	0.1480	1.633	19.86
		3.07	1.75	0.1477	1.634	19.81
		4.00	2.00	0.1473	1.636	19.76
		6.25	2.50	0.1469	1.637	19.72
		8.00	2.83	0.1467	1.638	19.69
		12.25	3.50	0.1464	1.640	19.64
		15.00	3.87	0.1461	1.641	19.61
		22.00	4.69	0.1459	1.642	19.57
		30.00	5.48	0.1457	1.643	19.54
		36.00	6.00	0.1455	1.644	19.53
		49.00	7.00	0.1453	1.645	19.50
		60.00	7.75	0.1451	1.646	19.46
		120.00	10.95	0.1446	1.648	19.40
		180.00	13.42	0.1442	1.649	19.35

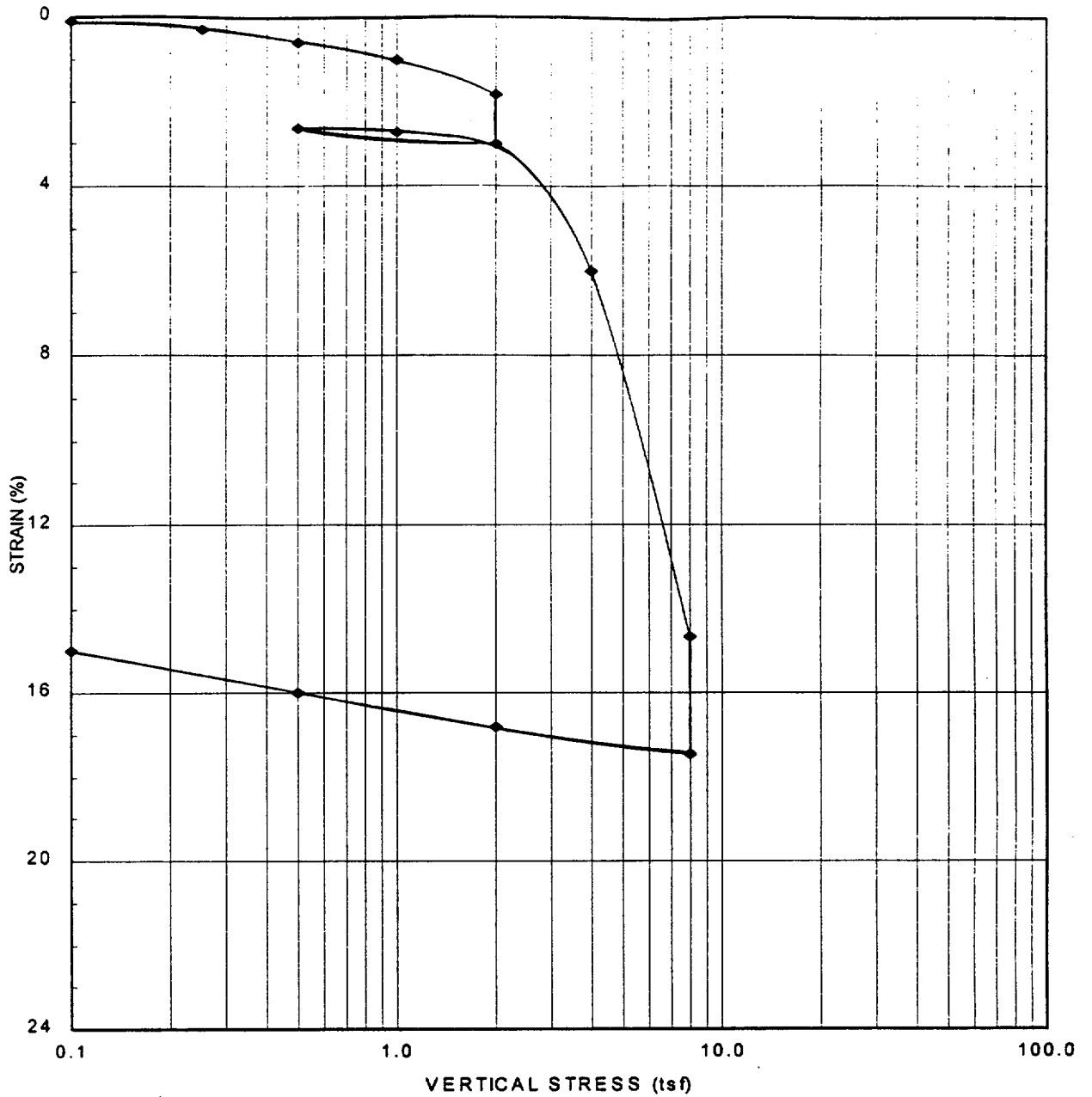

SAMPLE INFORMATION:

BORING: C-2
 SAMPLE: U-2C
 DEPTH: 10.9 ft
 DESCRIPTION: Clayey SILT

DATE: 12/17/96
 TESTED BY: ACS
 CHECKED: PJT

SPECIMEN INFORMATION:

	INITIAL	FINAL
WATER CONTENT:	27.6 %	44.2 %
DRY UNIT WEIGHT:	64.9 pcf	76.2 pcf
VOID RATIO:	1.615	1.230
SATURATION:	46.4 %	97.7 %

SPECIFIC GRAVITY: 2.72 (est)

NOTE: Sample was inundated when the applied pressure was 0.5 tsf.

PRIVATE FUEL STORAGE FACILITY
 SKULL VALLEY
 PRIVATE FUEL STORAGE, LLC



STONE & WEBSTER ENGINEERING CORP.
 BOSTON, MASSACHUSETTS

CONSOLIDATION TEST RESULTS
 BORING C-2, SAMPLE U-2C

JO 05996.01
 January 1997

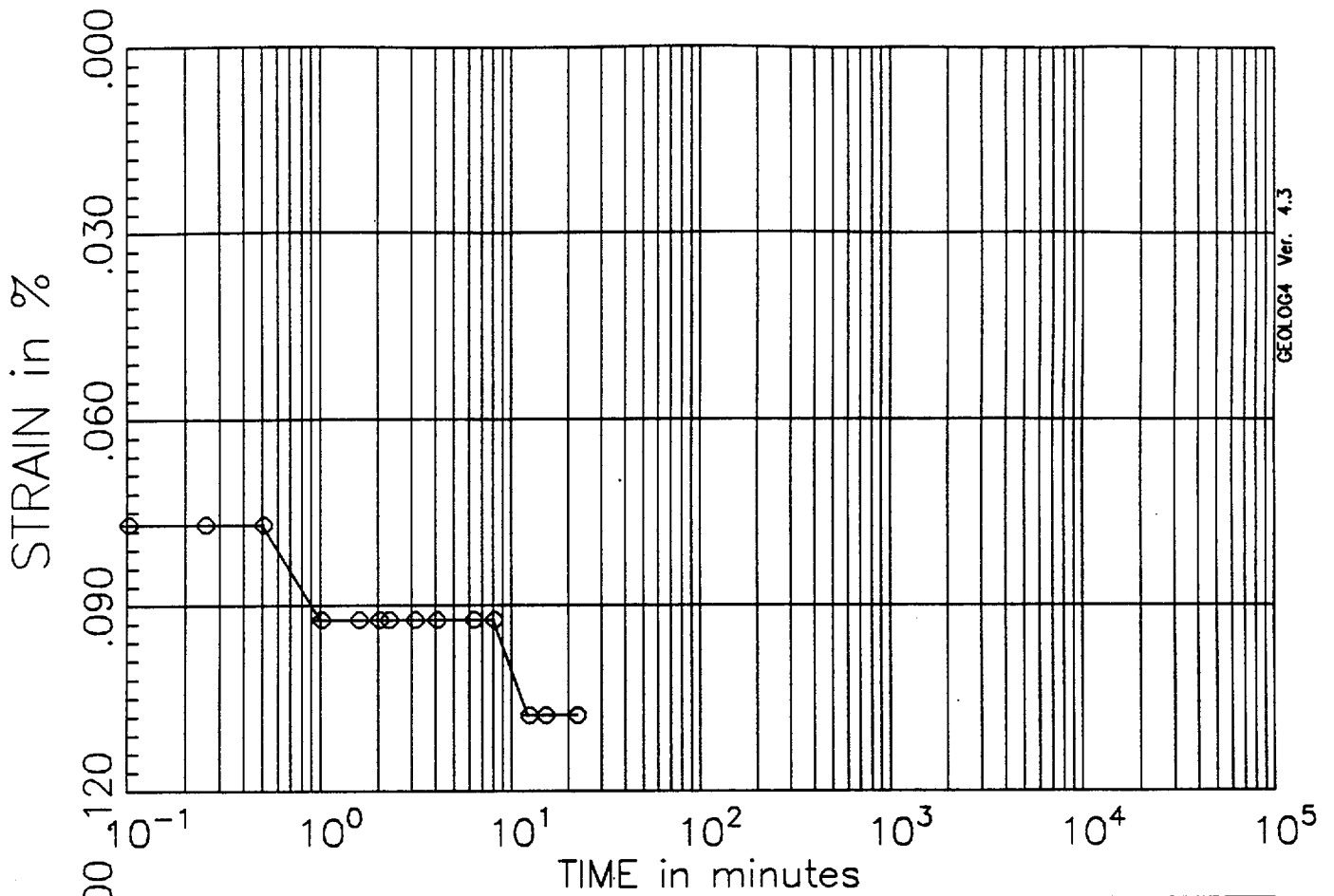

GEOLOG4 Ver. 4.3

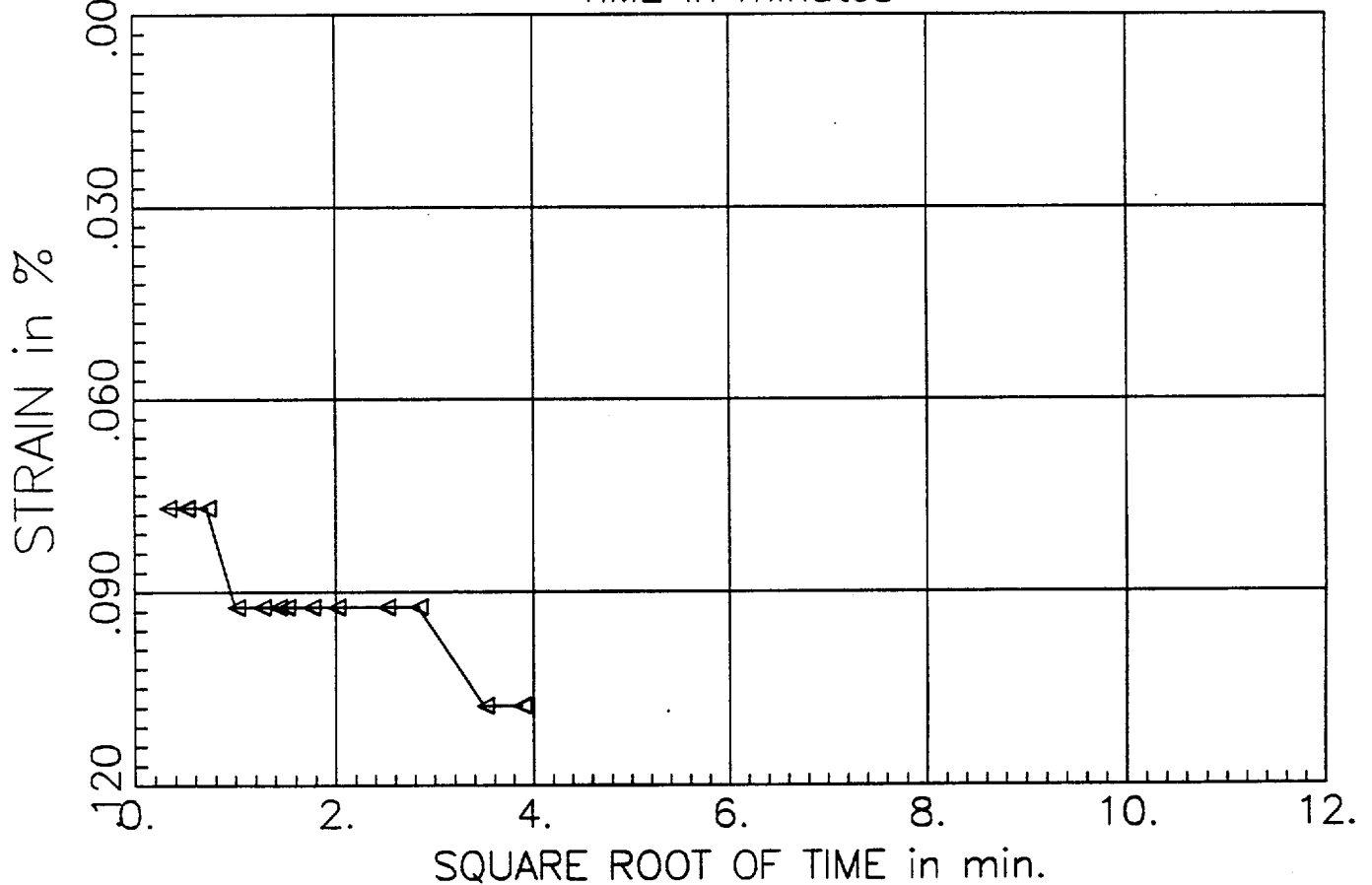

PRESSURE INCREMENT
from 0.00 tsf to 0.10 tsf

Test No: 3
Testname: C2-U2C

STRAIN in %

STRAIN in %

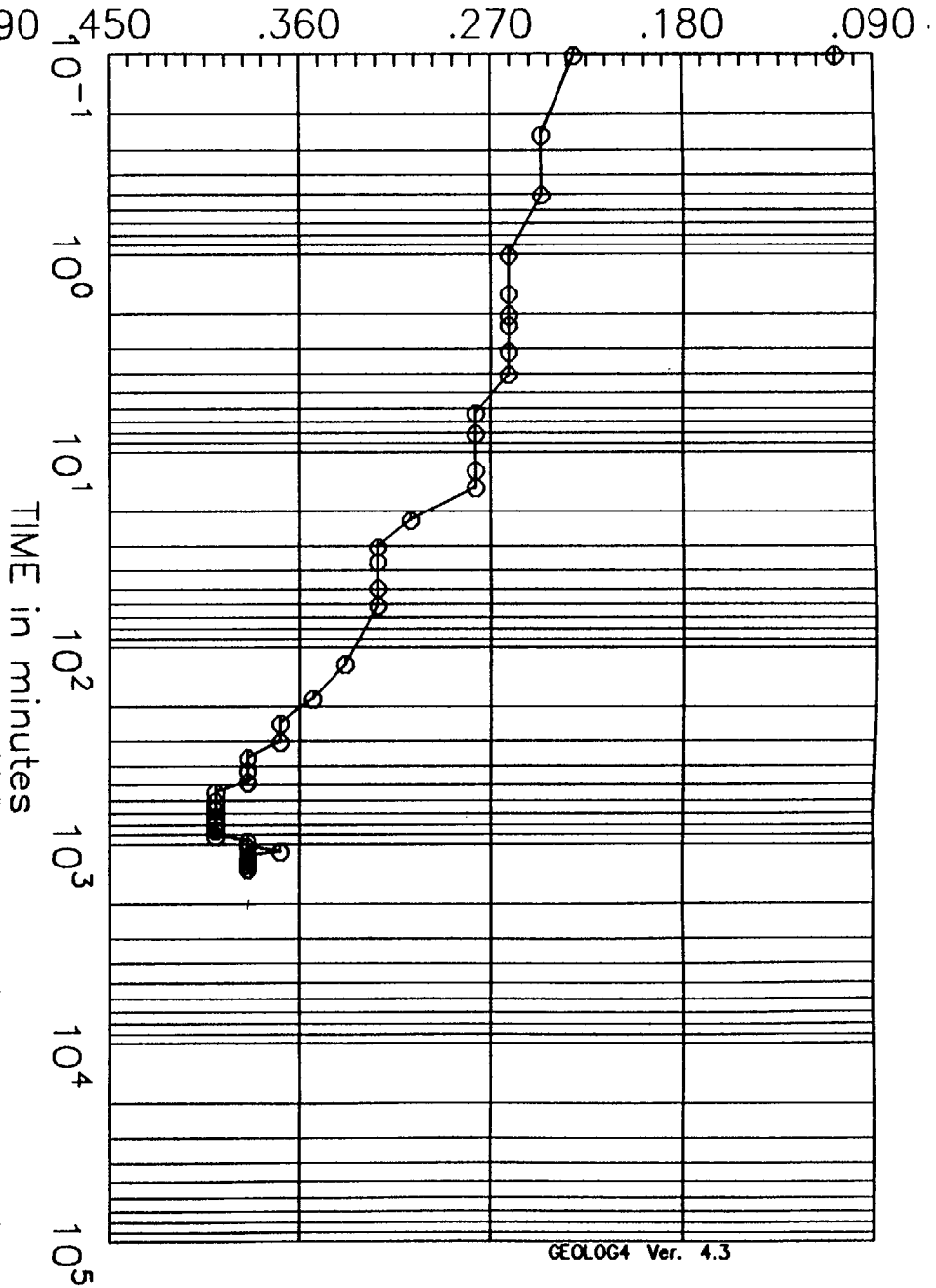
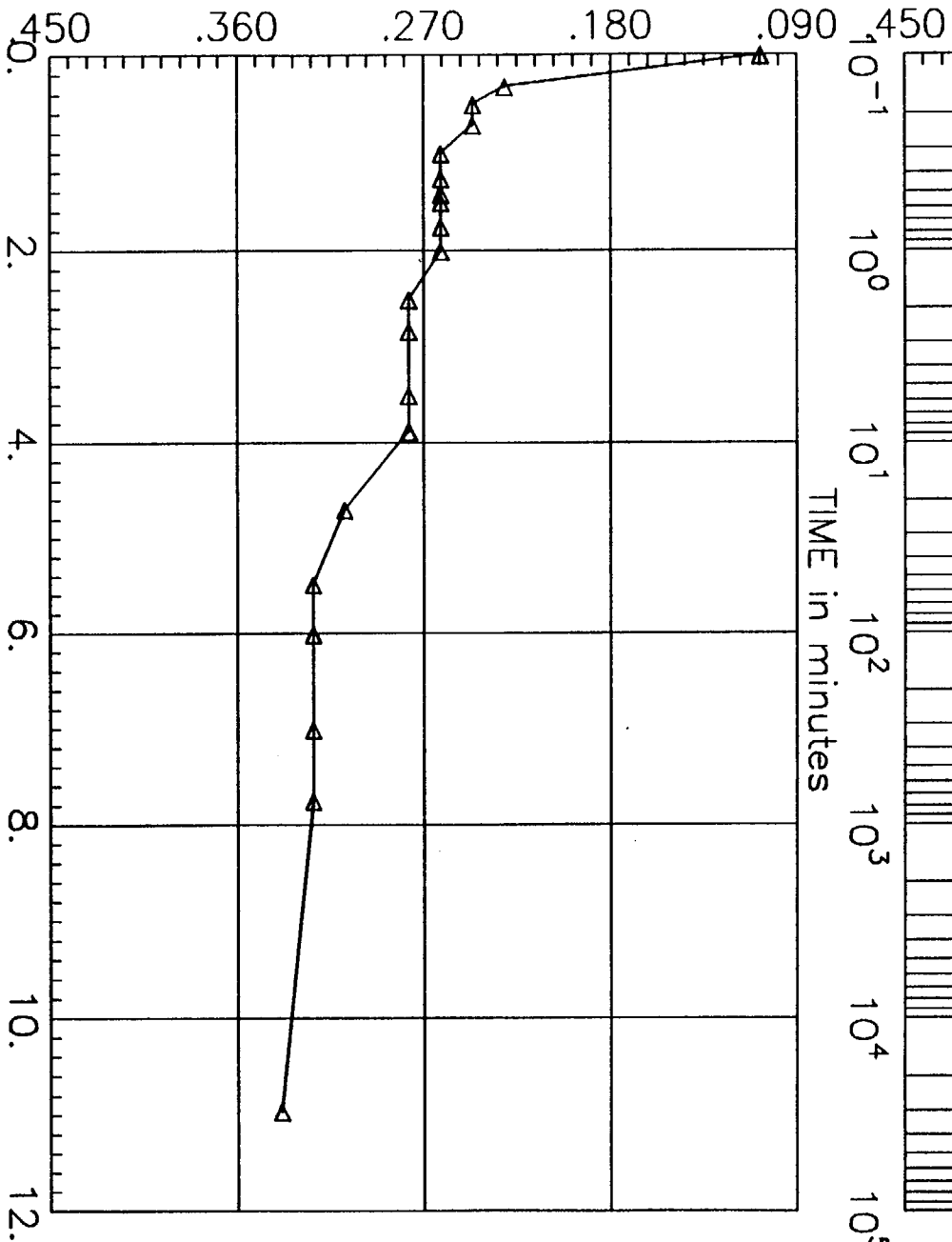

PRESSURE INCREMENT
from 0.10 tsf to 0.25 tsf

SQUARE ROOT OF TIME in min.

Test No: 3
Testname: C2-U2C

TIME in minutes

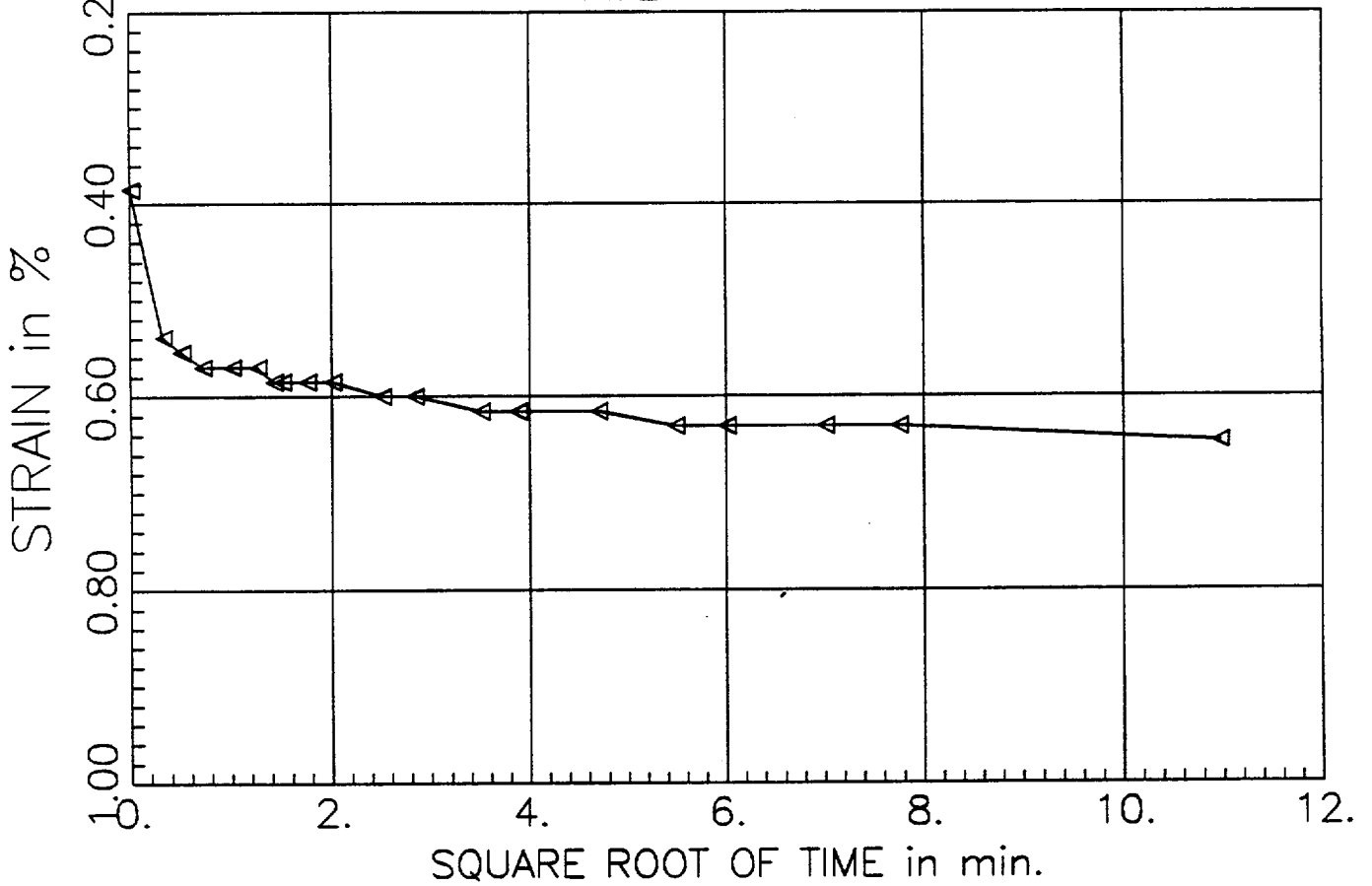
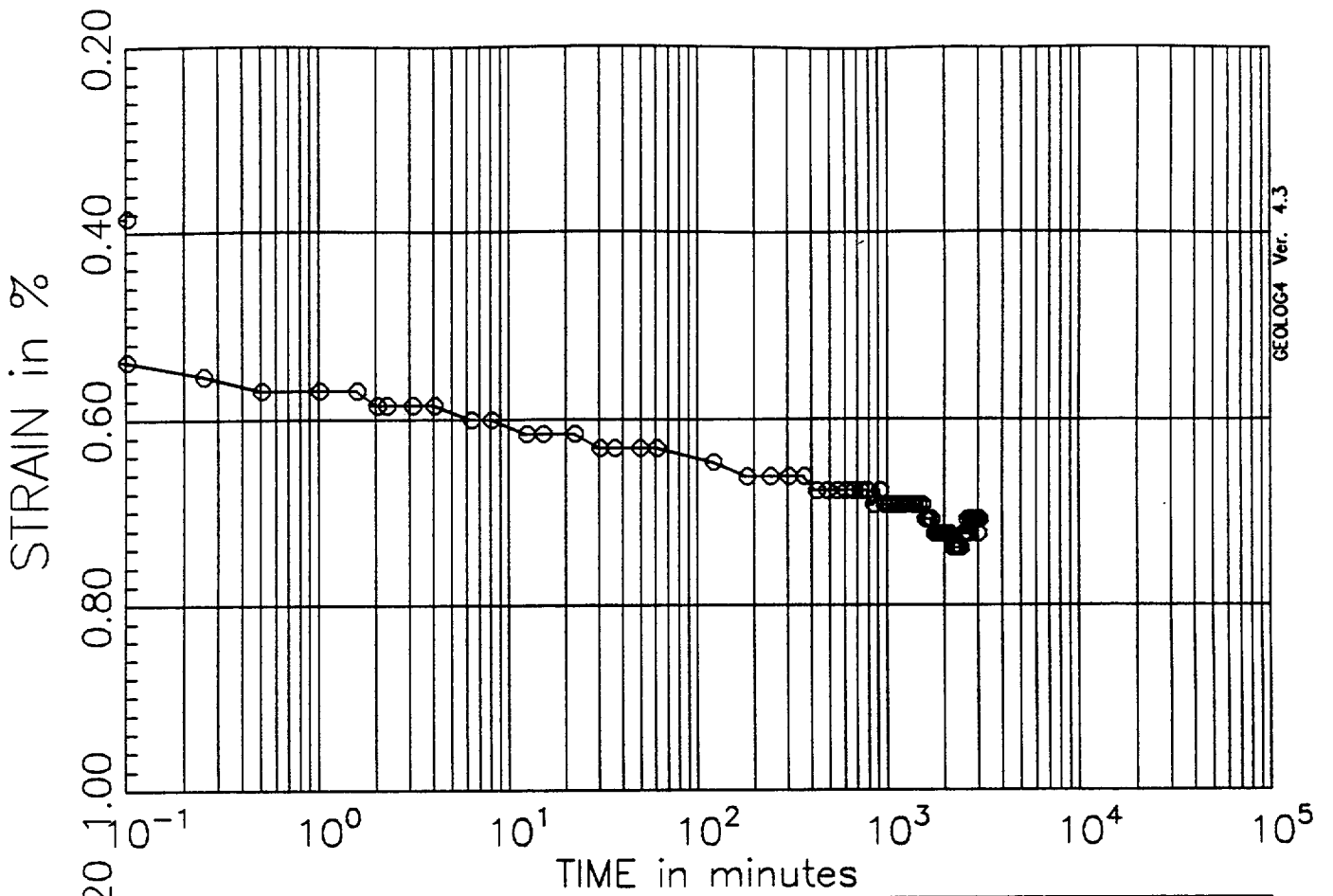

PRESSURE INCREMENT
from 0.25 tsf to 0.50 tsf

Test No: 3
Testname: C2-U2C

STRAIN in %

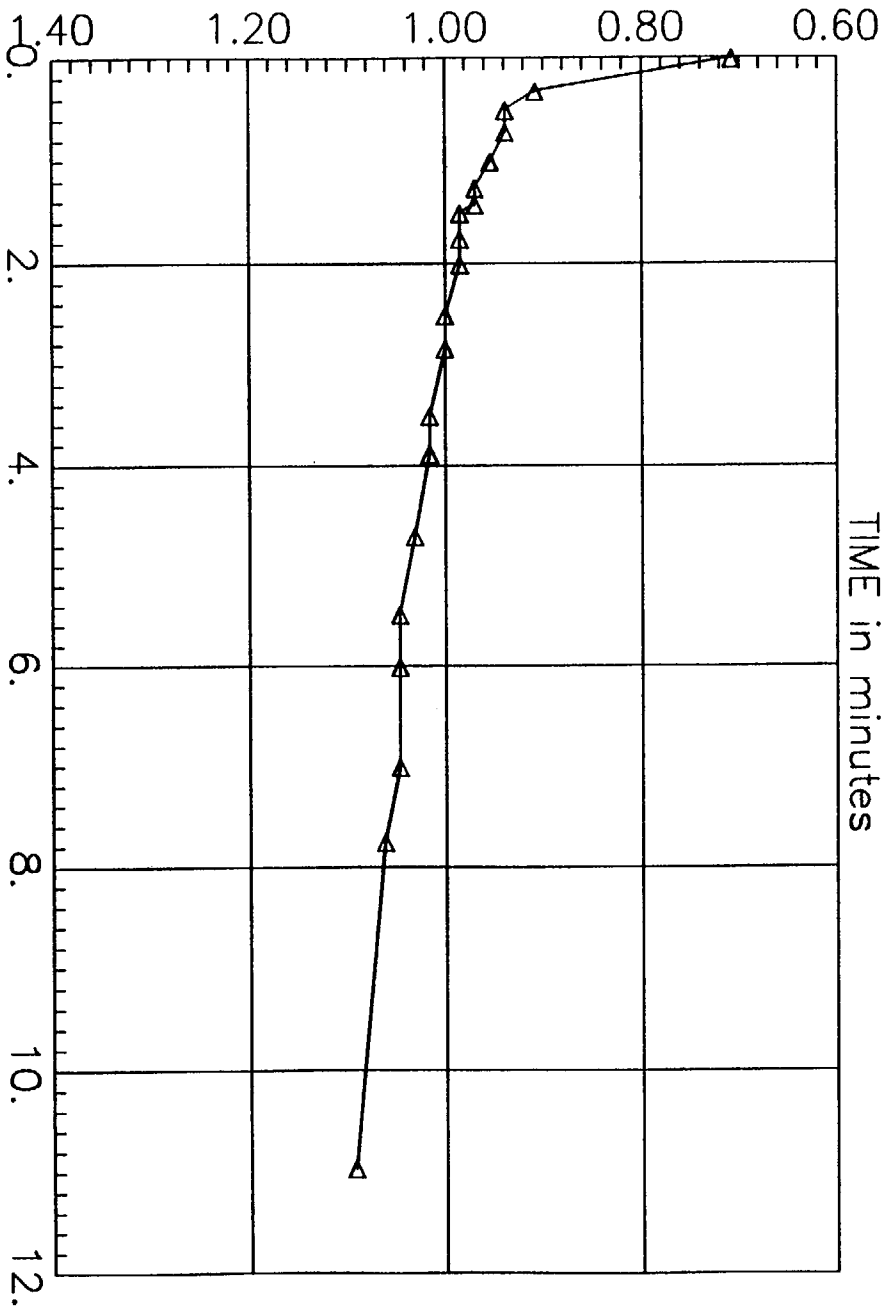

PRESSURE INCREMENT
from 0.50 tsf
to 1.00 tsf

SQUARE ROOT OF TIME in min.

Test No: 3
Testname: C2-U2C

STRAIN in %

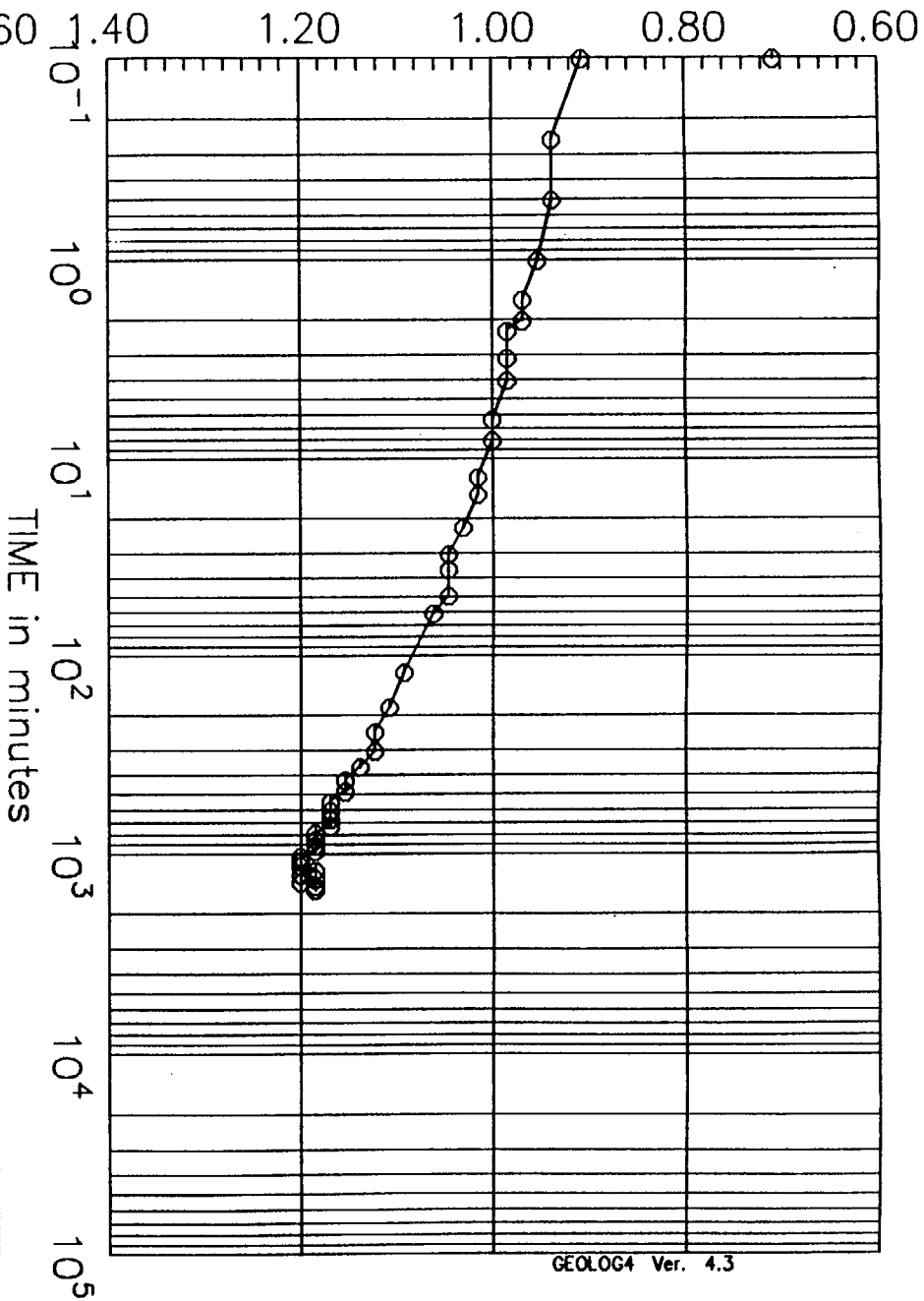

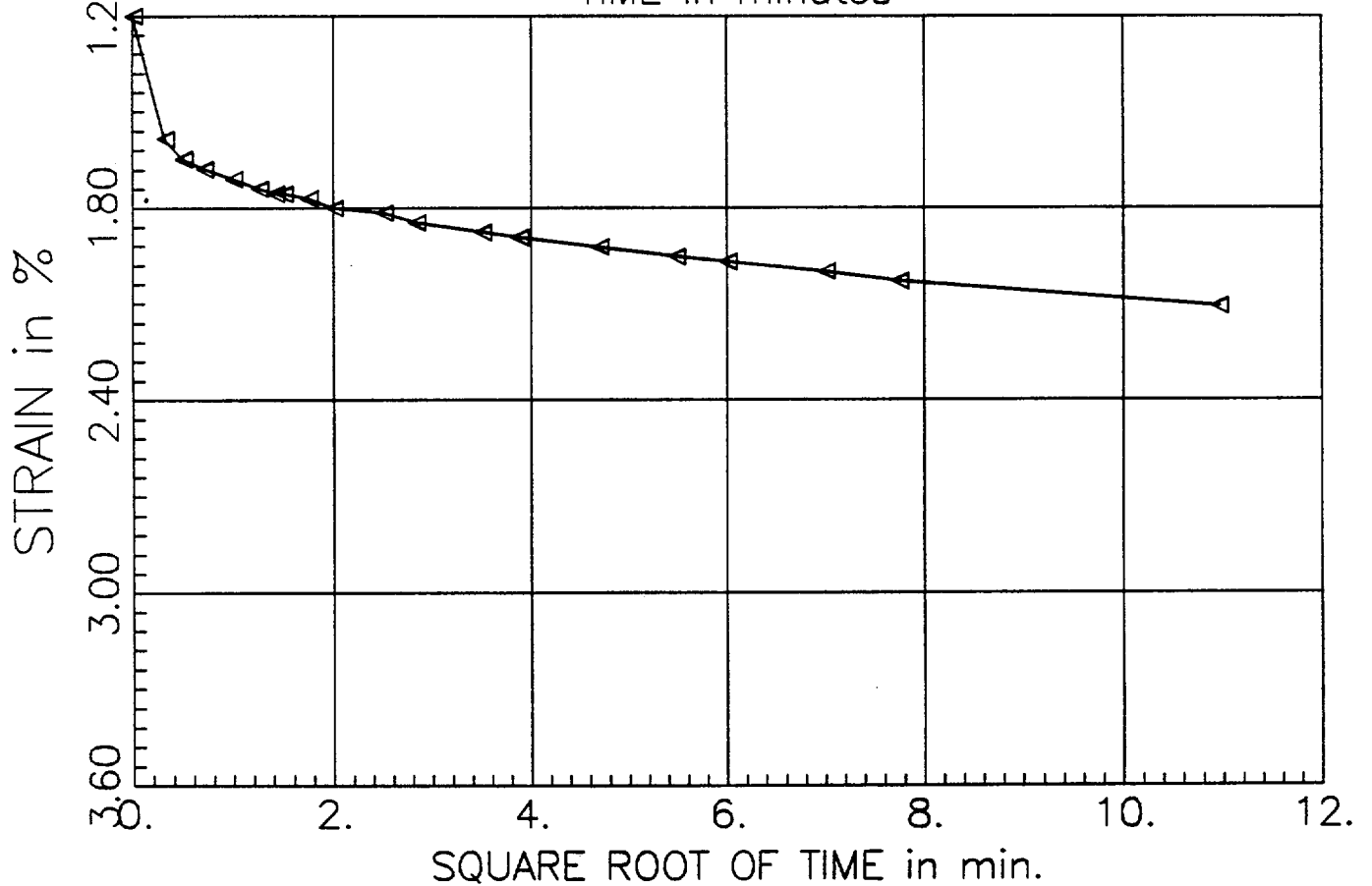
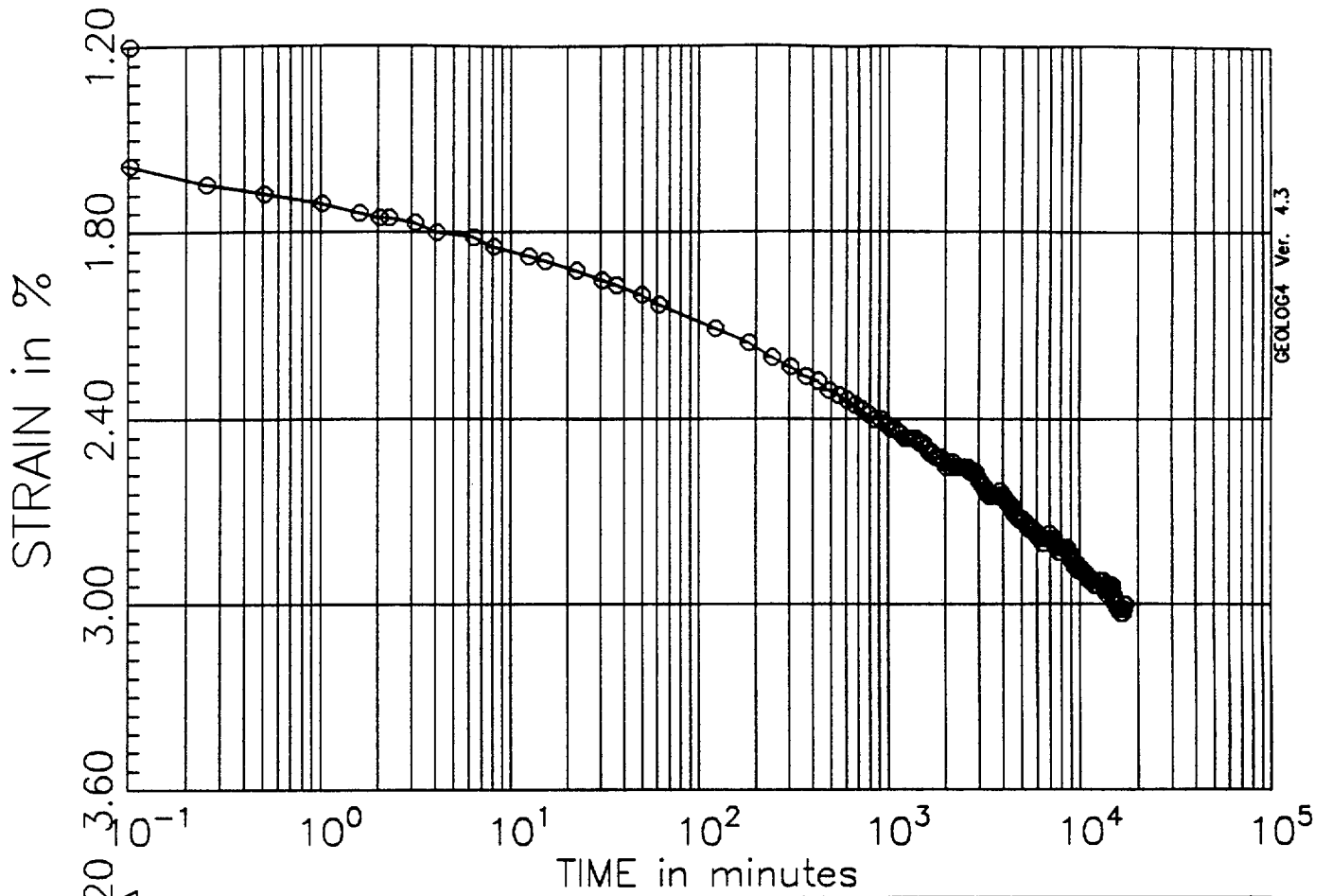

PRESSURE INCREMENT
from 1.00 tsf to 2.00 tsf

Test No: 3
Testname: C2-U2C

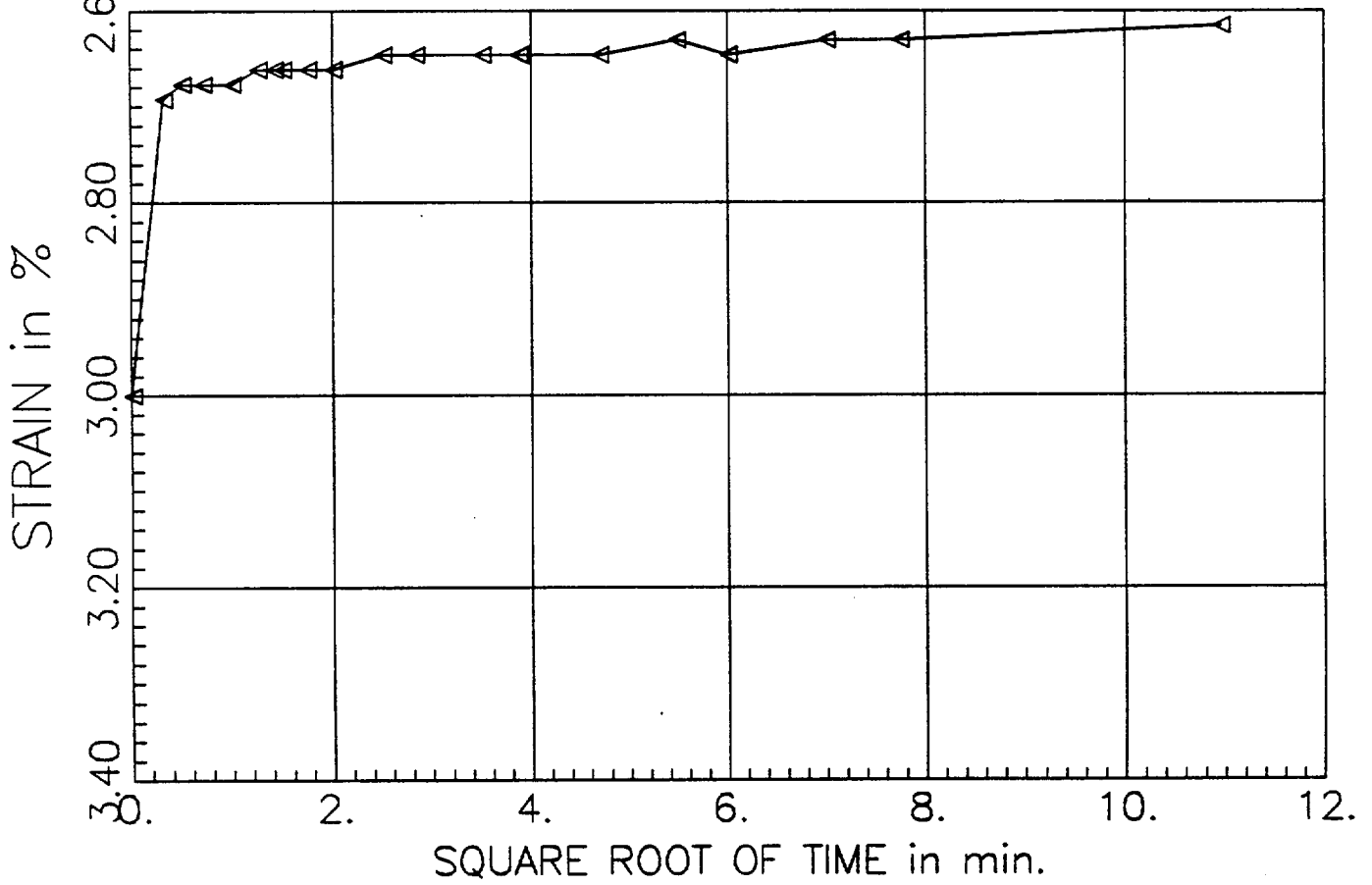
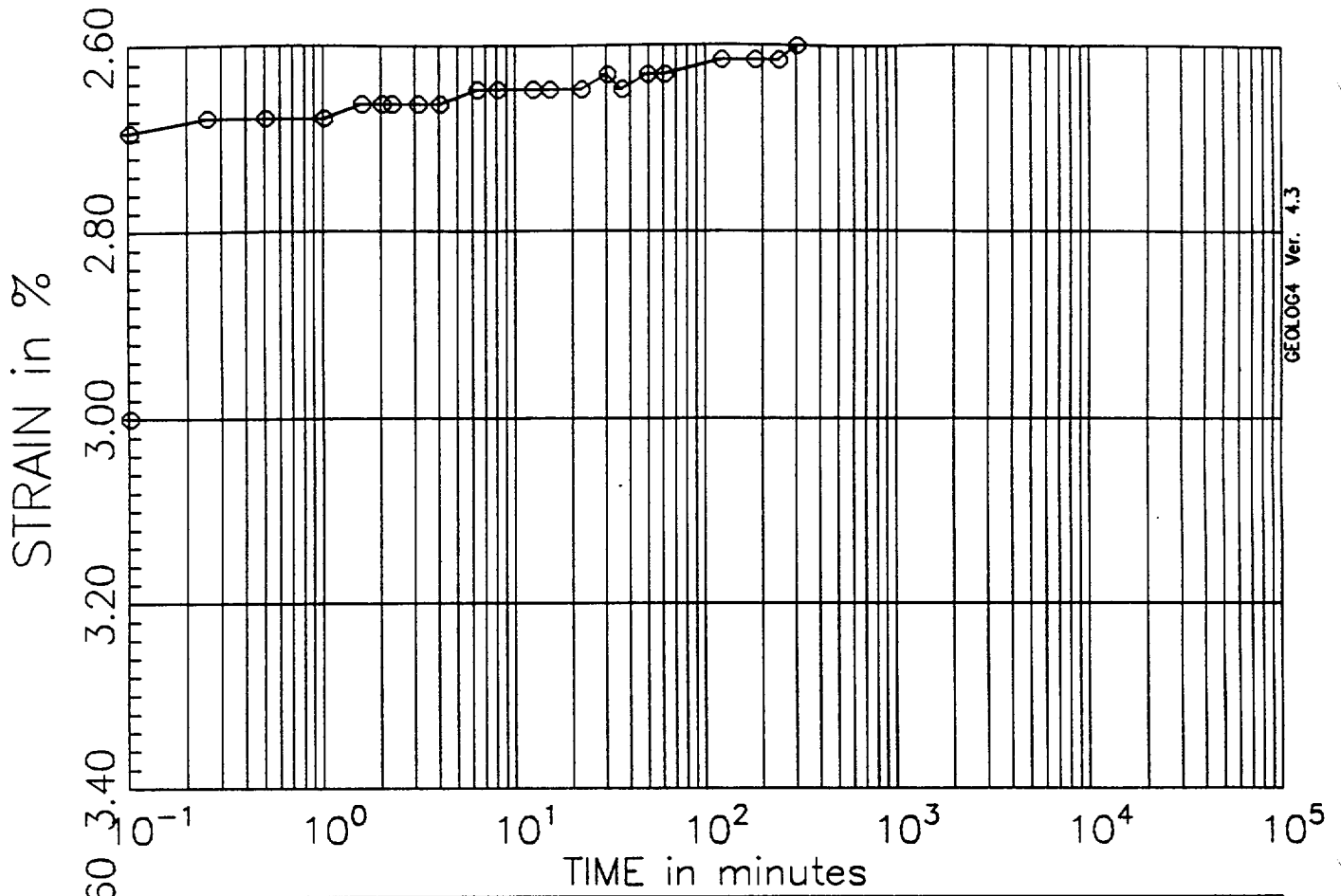

PRESSURE INCREMENT
from 2.00 tsf to 0.50 tsf

Test No: 3
Testname: C2-U2C

STRAIN in %

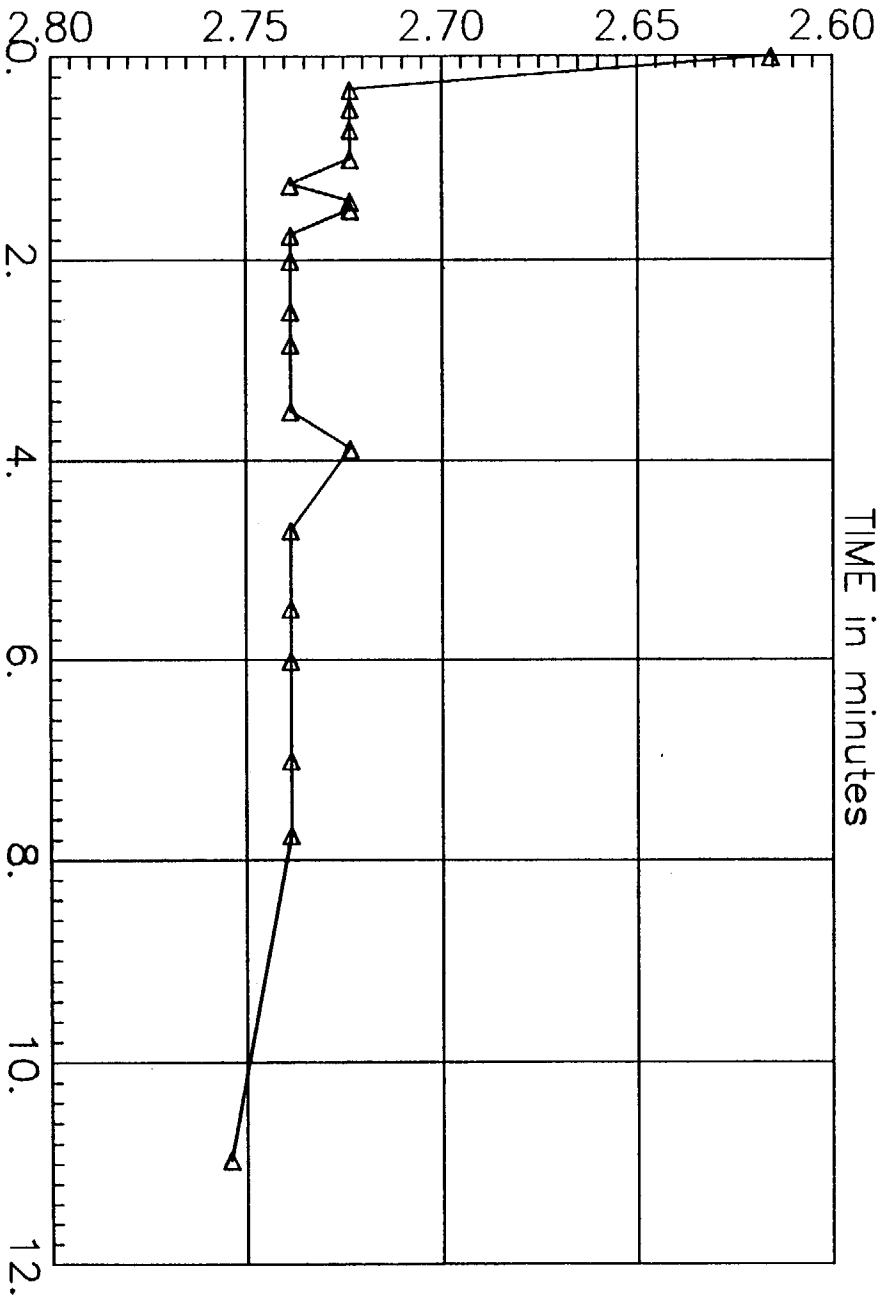

STRAIN in %

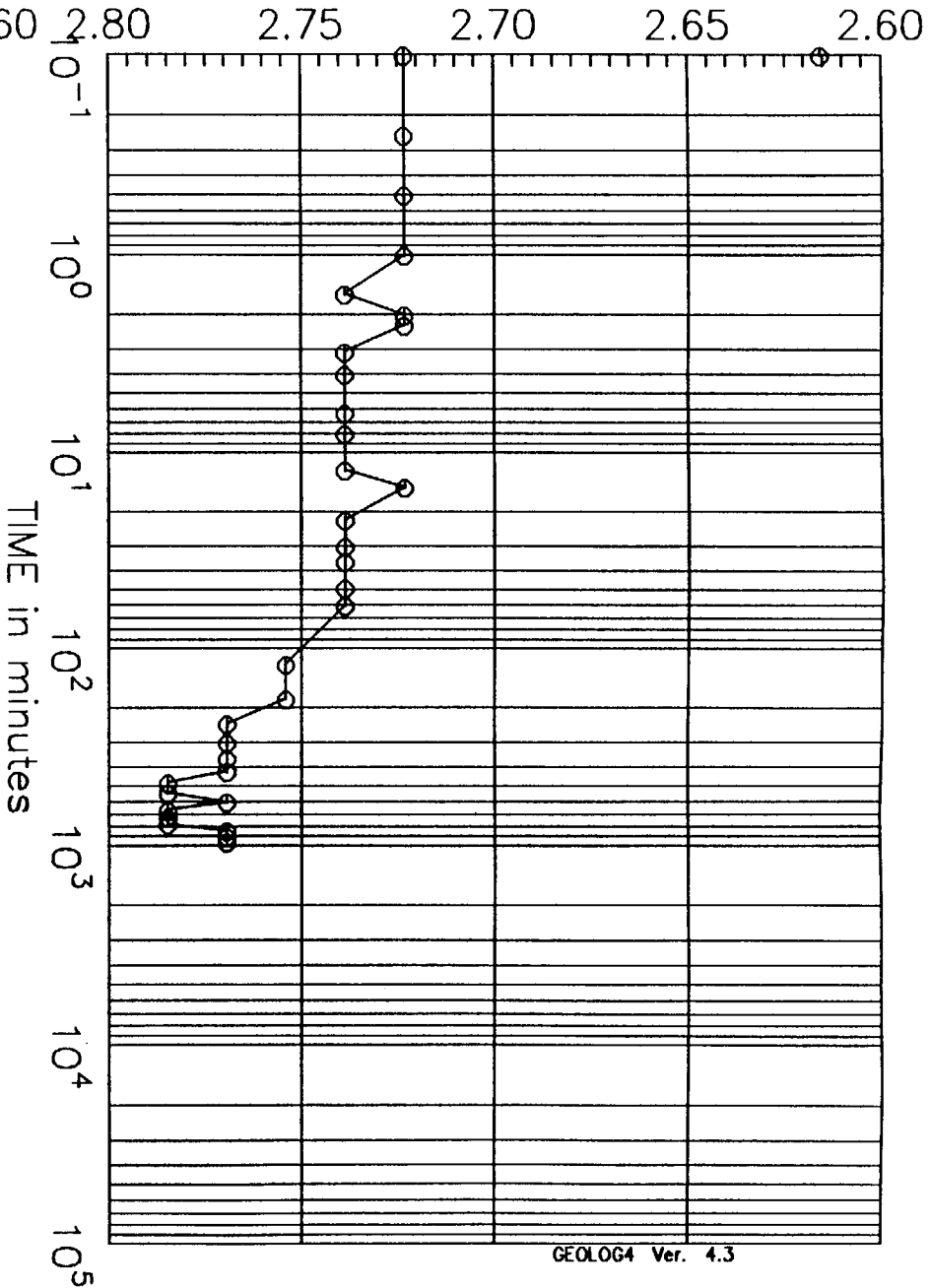

PRESSURE INCREMENT
from 0.50 tsf to 1.00 tsf

SQUARE ROOT OF TIME in min.

Test No: 3
Testname: C2-U2C

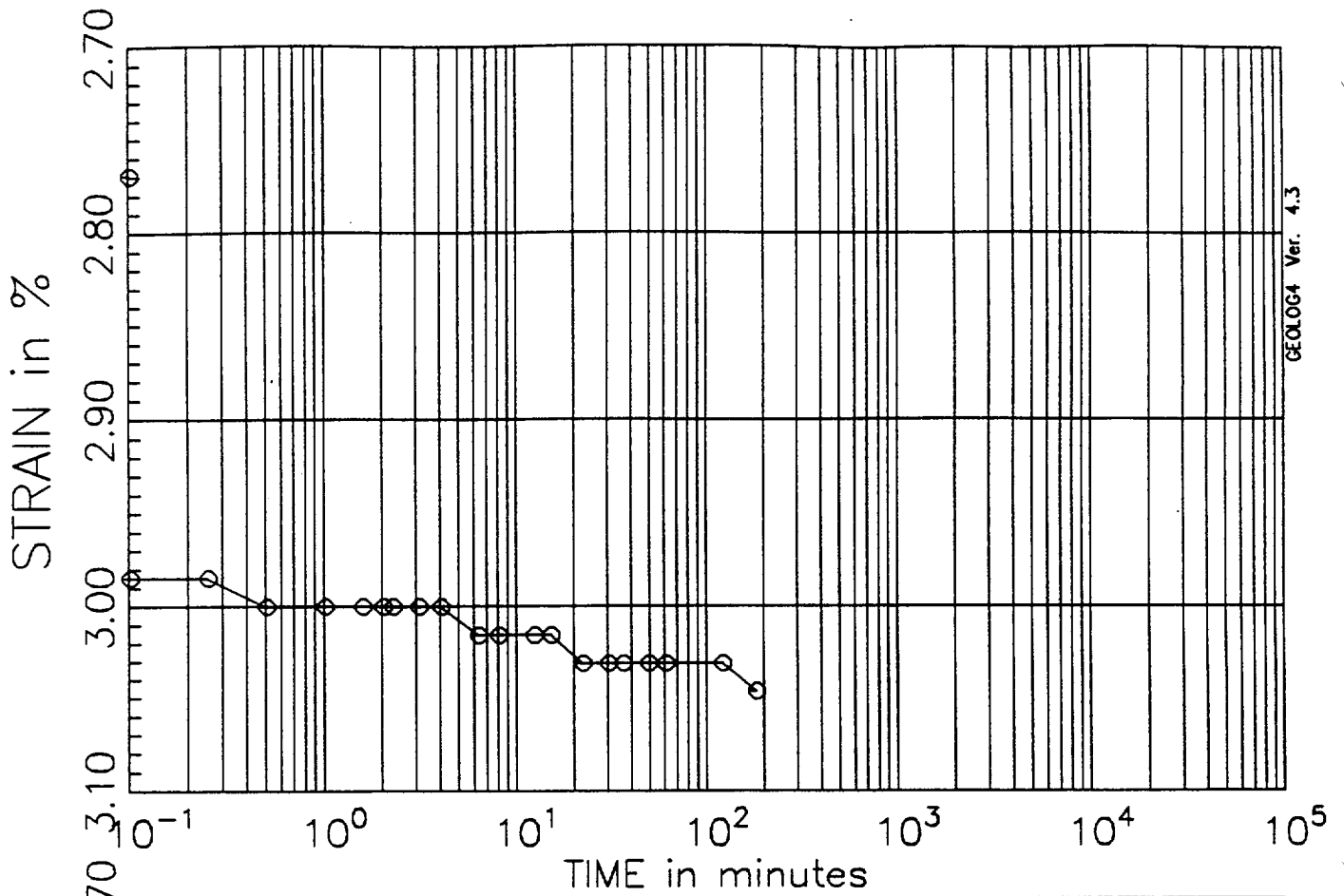

GEOLOG4 Ver. 4.3

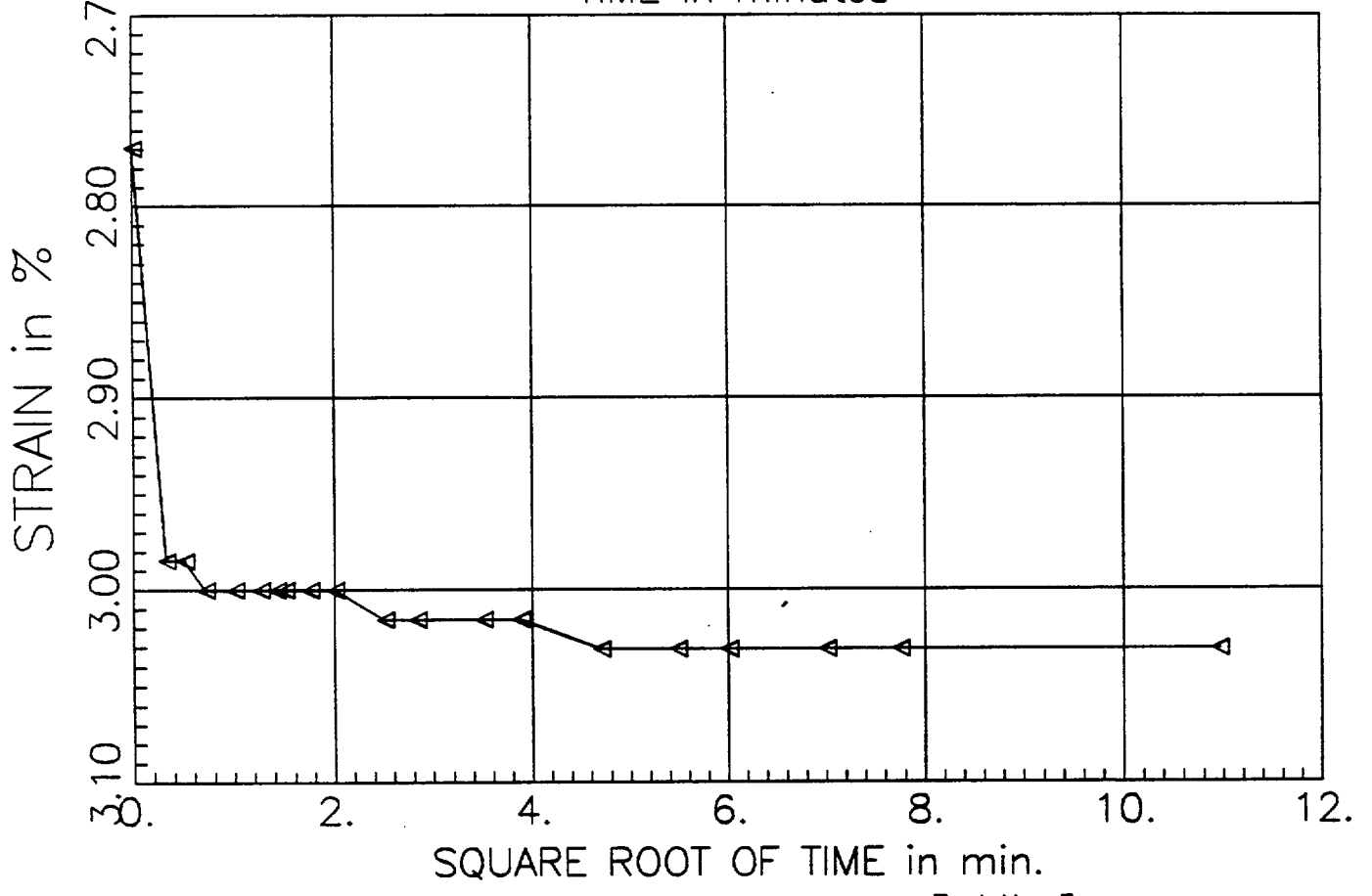

PRESSURE INCREMENT
from 1.00 tsf to 2.00 tsf

Test No: 3
Testname: C2-U2C

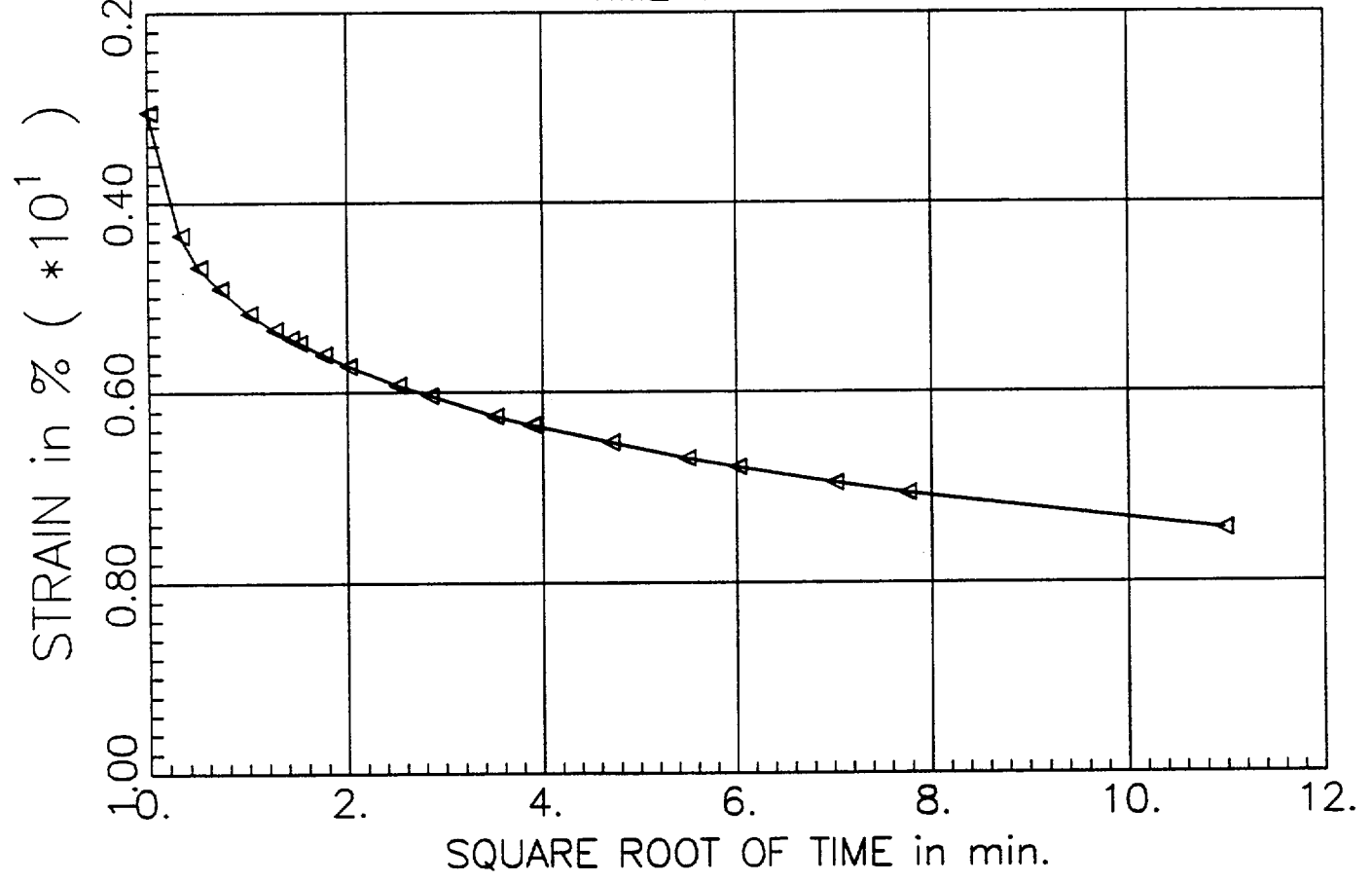
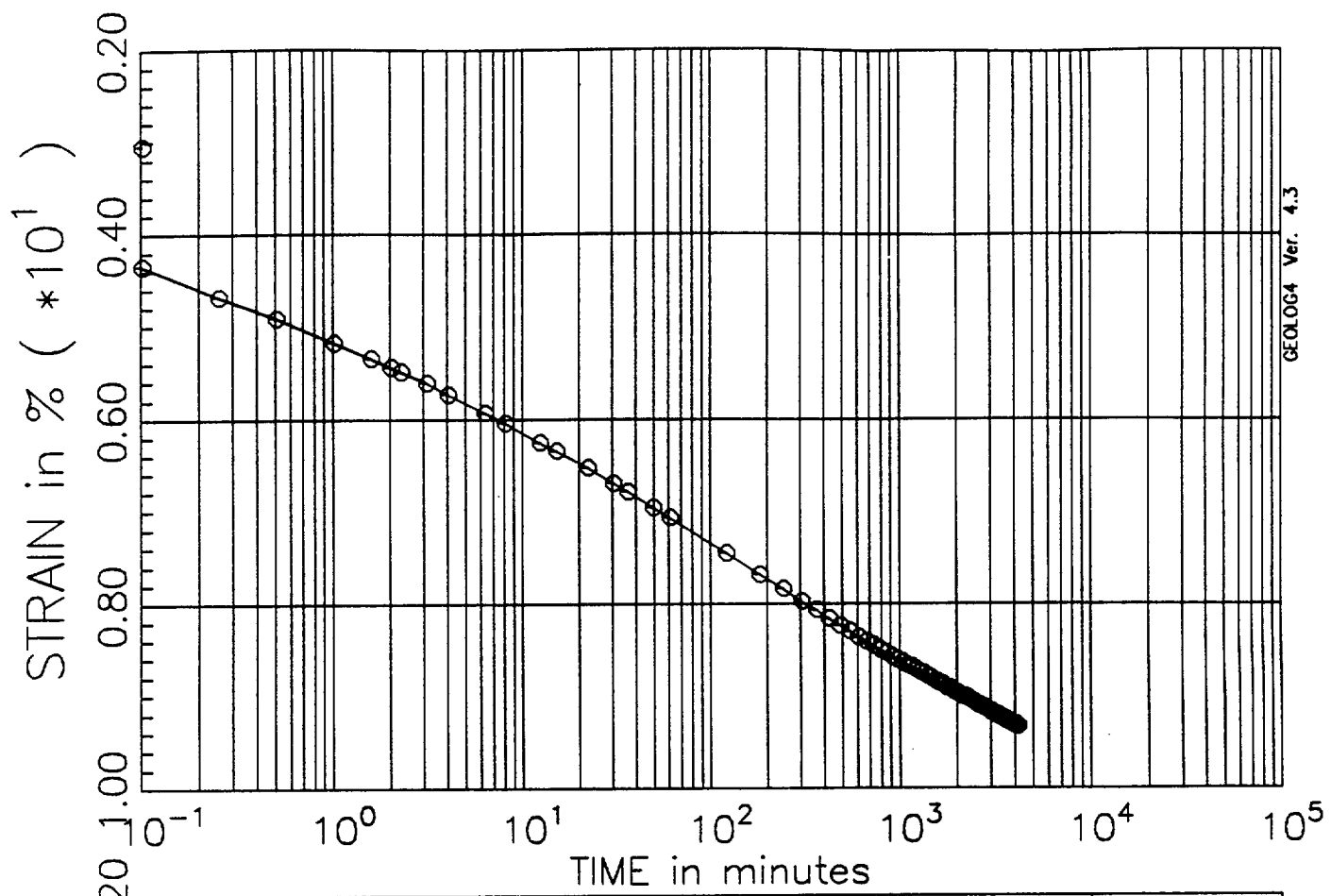

PRESSURE INCREMENT
from 2.00 tsf to 4.00 tsf

Test No: 3
Testname: C2-U2C

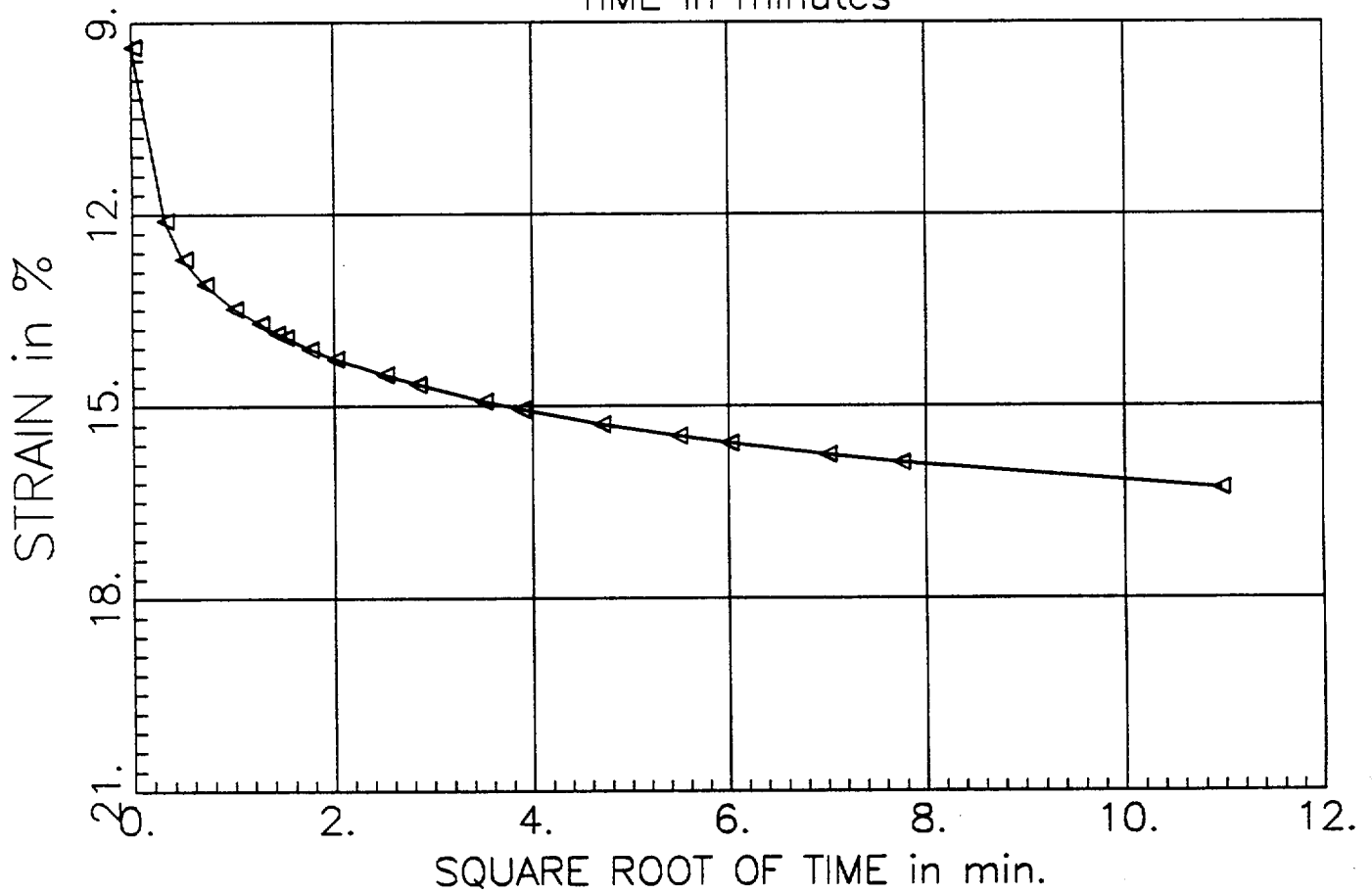
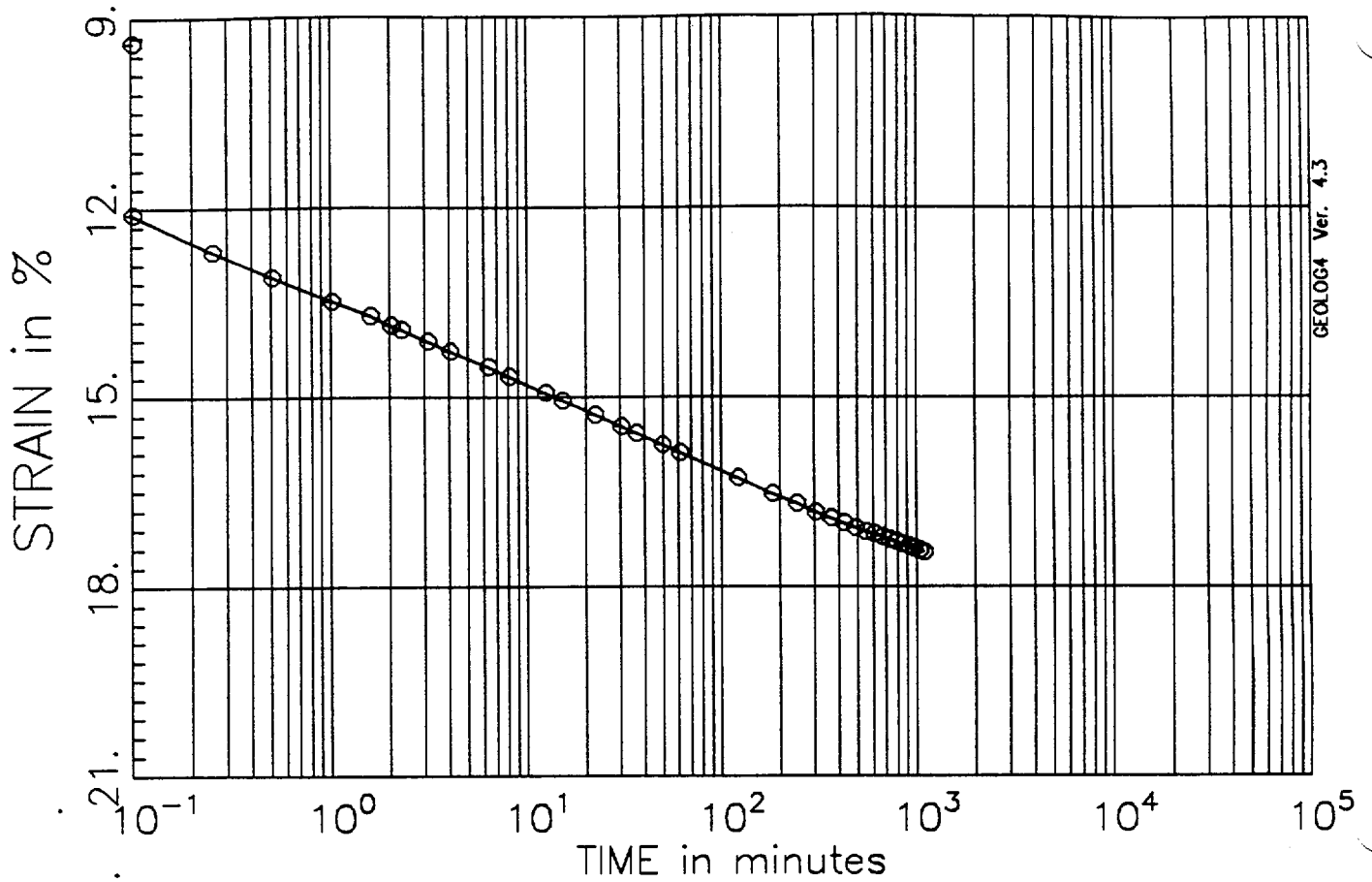

PRESSURE INCREMENT
from 4.00 tsf to 8.00 tsf

Test No: 3
Testname: C2-U2C

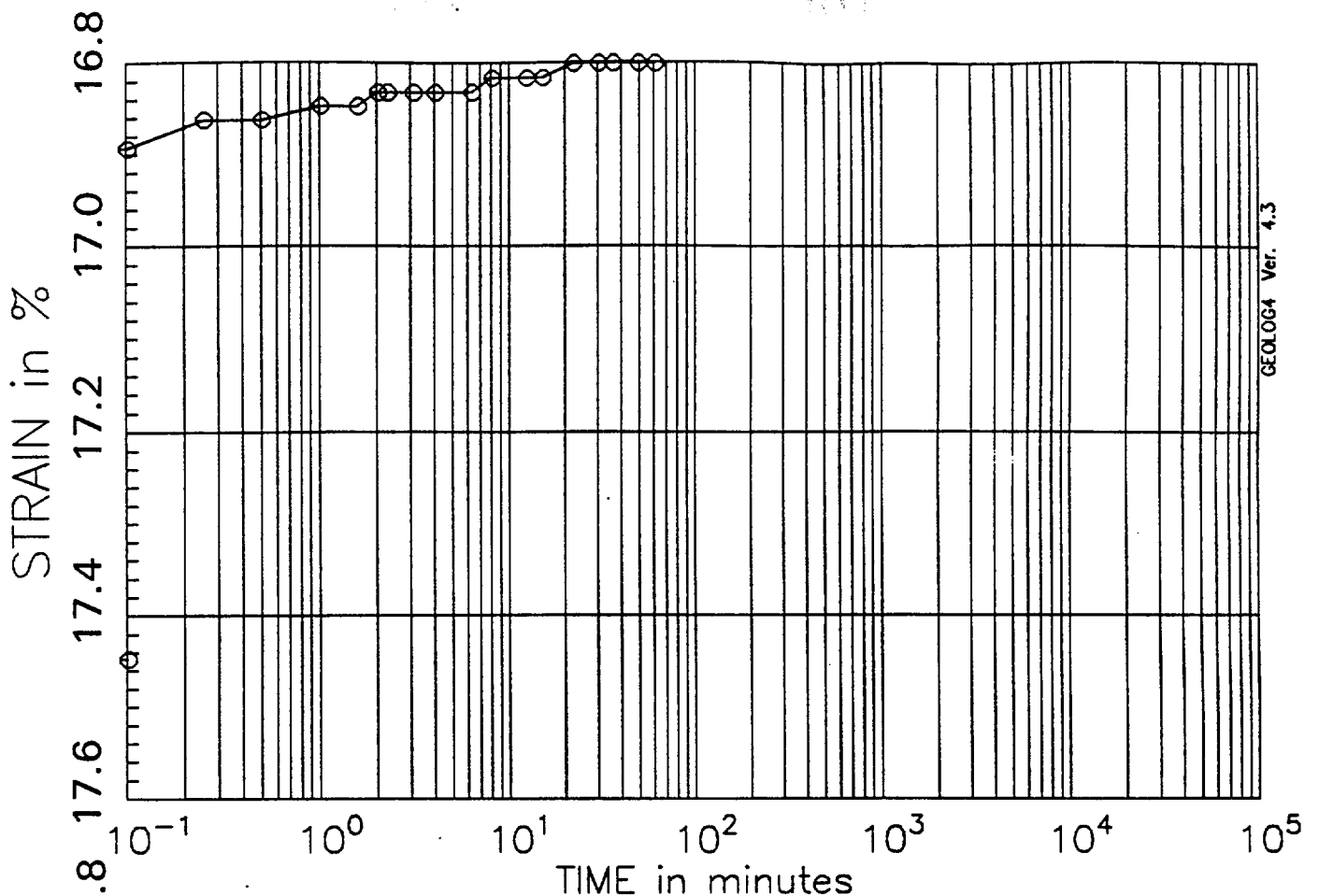

GEOLOG4 Ver. 4.3

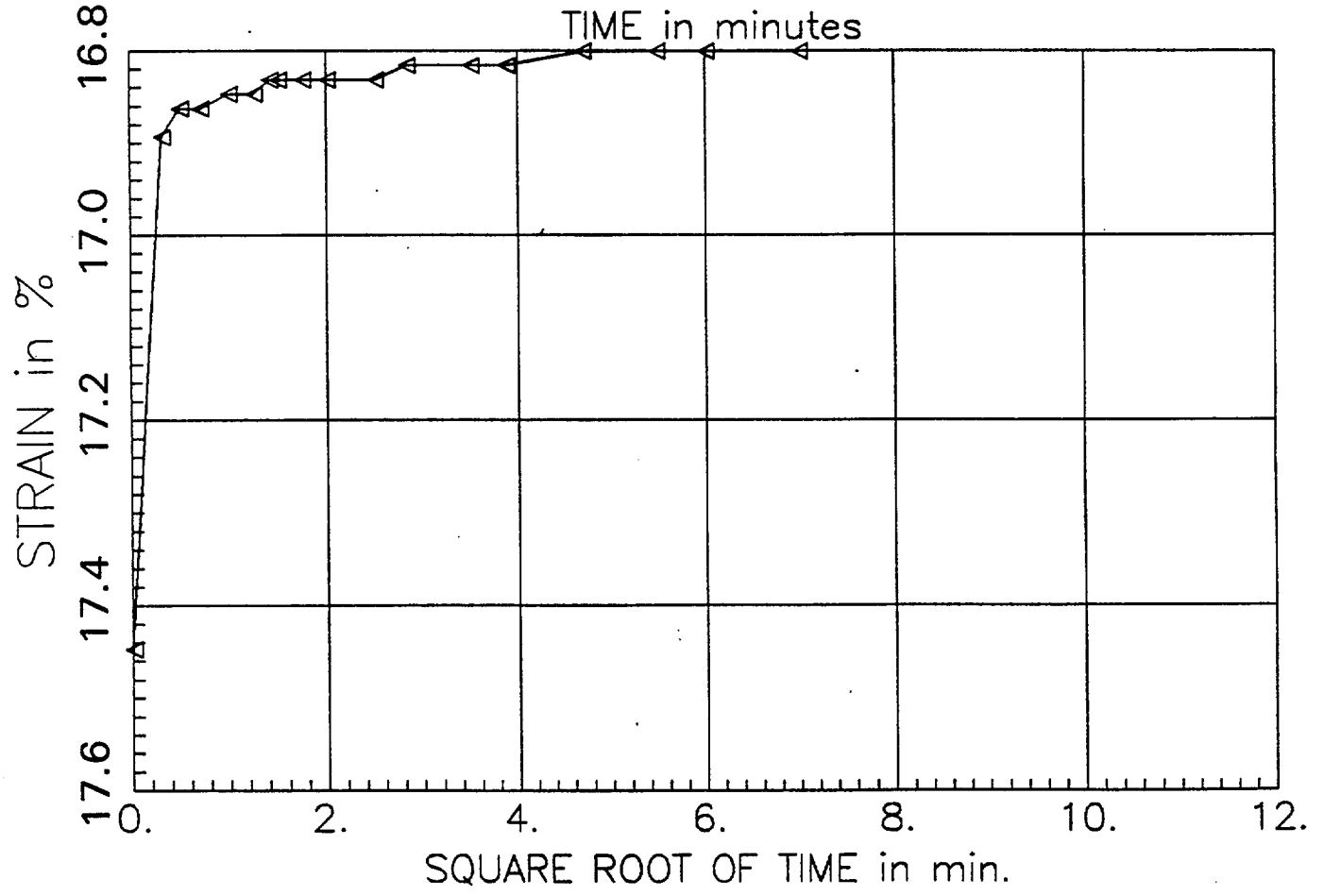

PRESSURE INCREMENT
from 8.00 tsf to 2.00 tsf

Test No: 3
Testname: C2-U2C

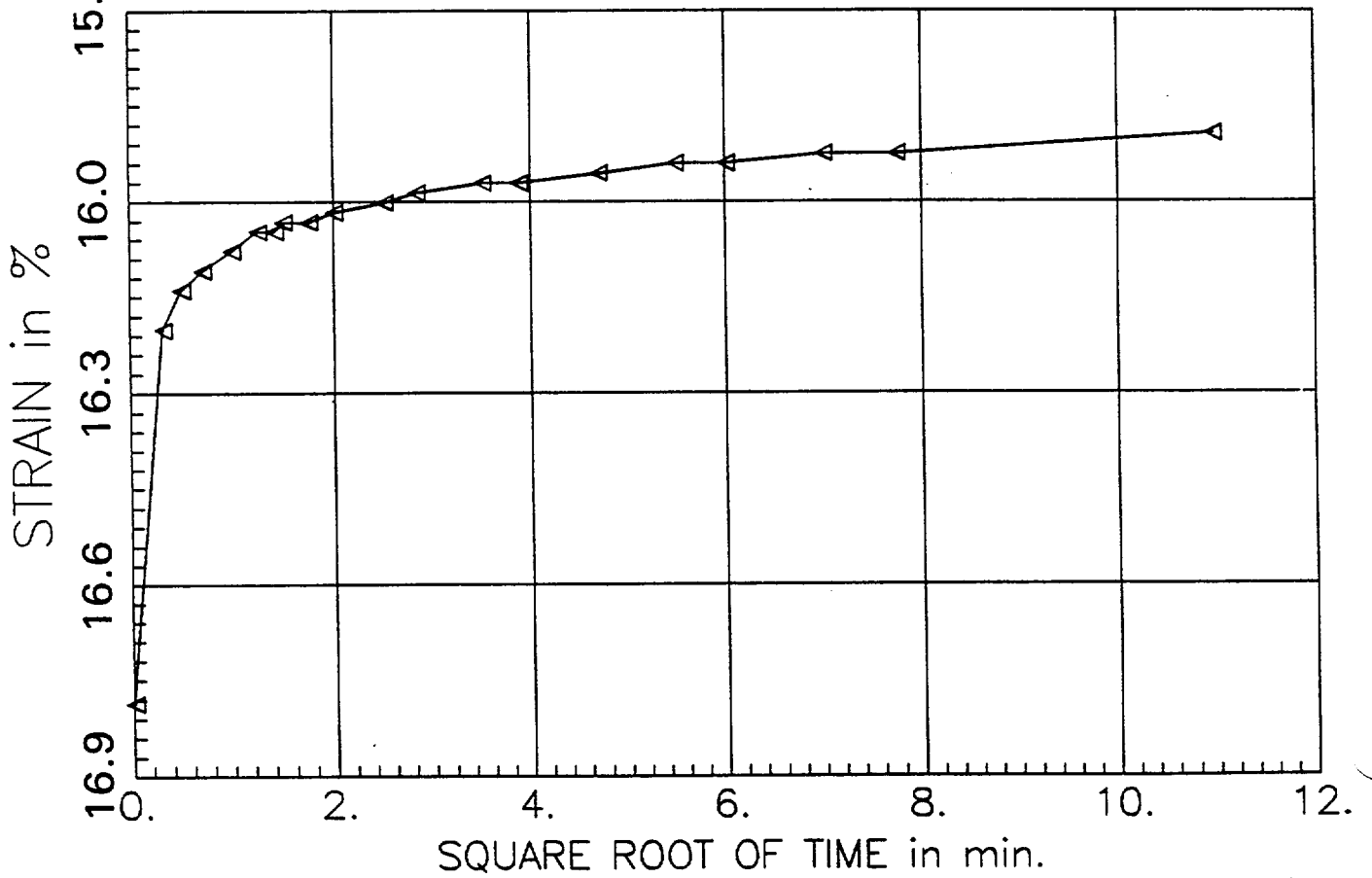
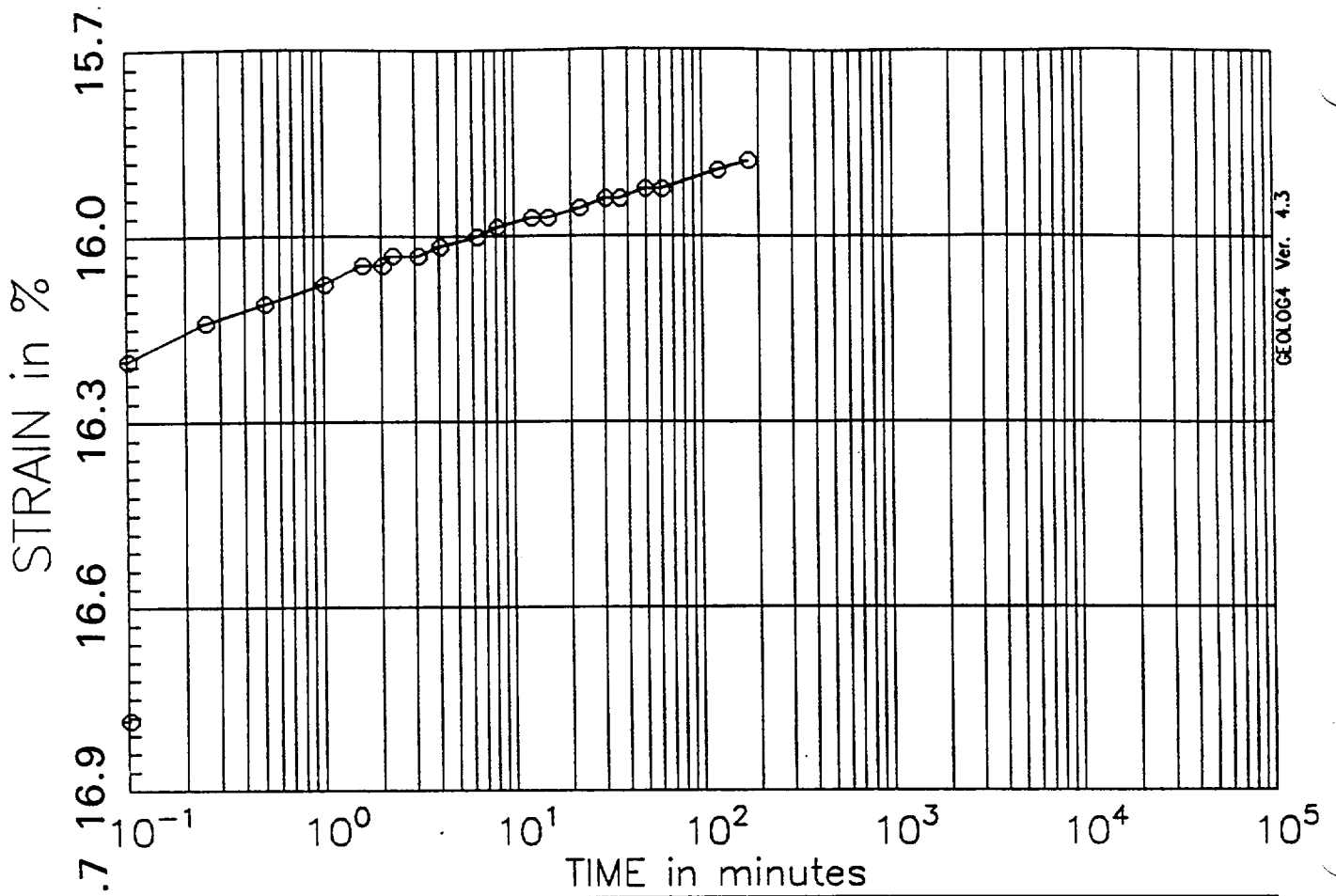

PRESSURE INCREMENT
from 2.00 tsf to 0.50 tsf

Test No: 3
Testname: C2-U2C

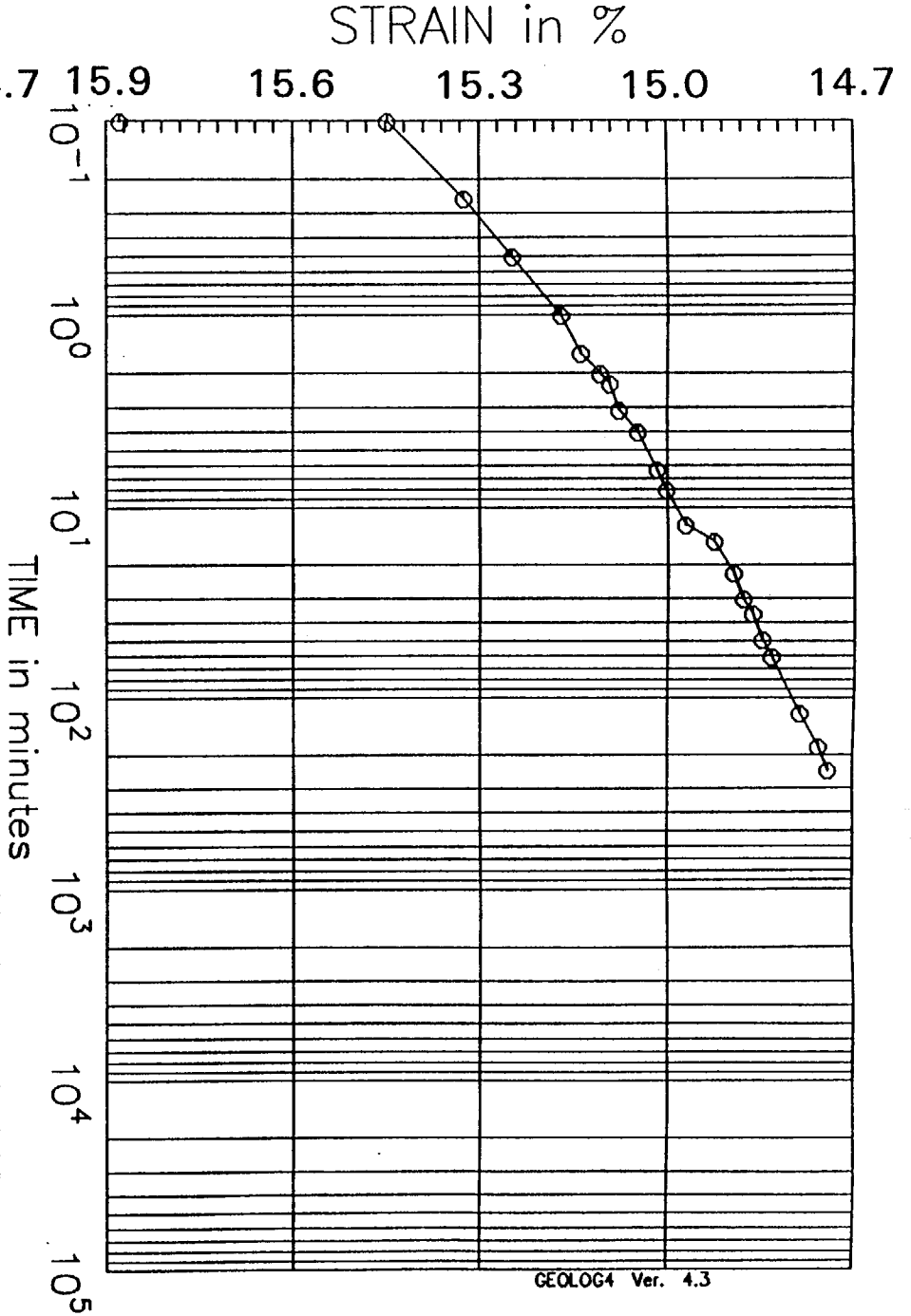
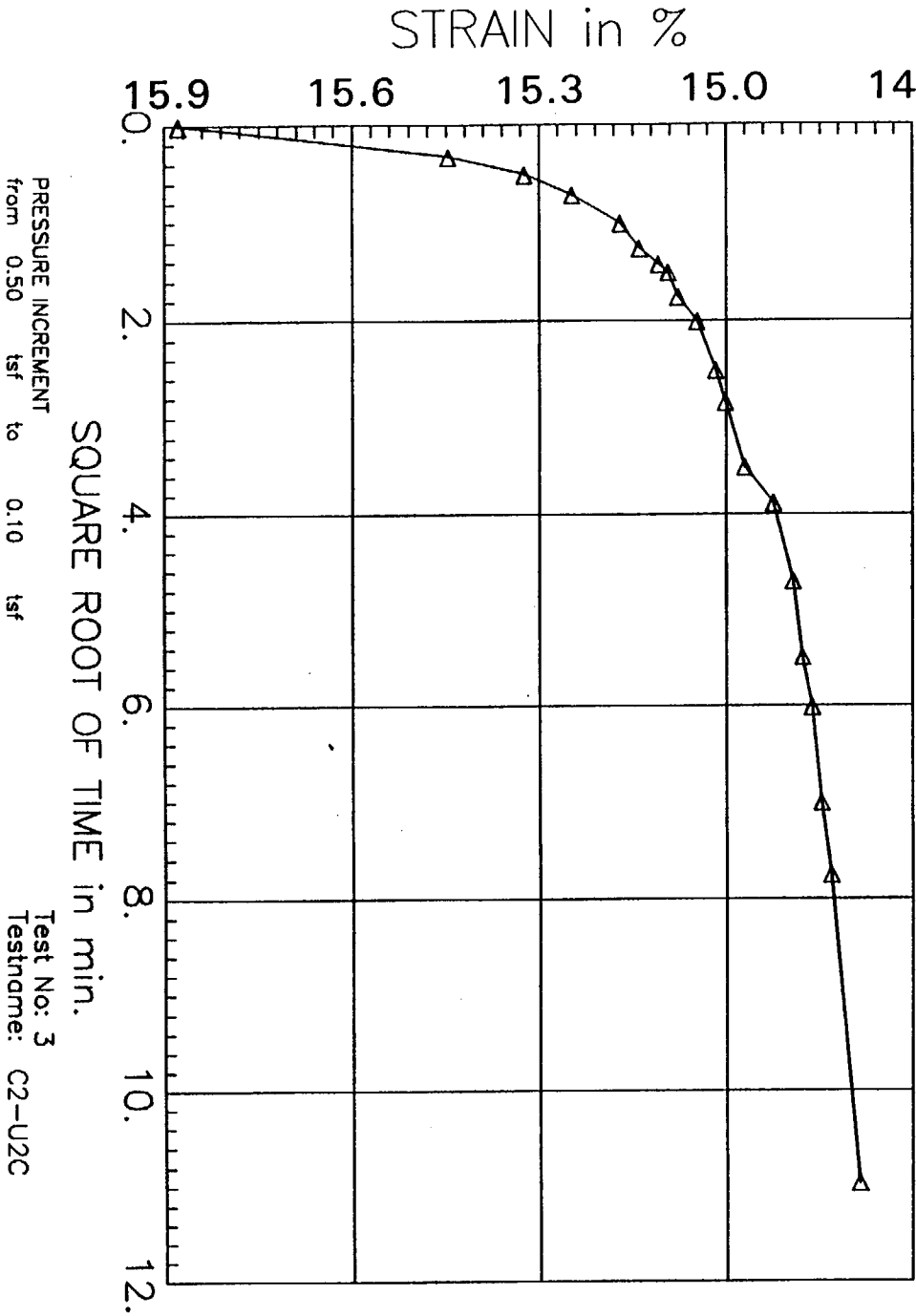

CONSOLIDATION TEST DATA

SAMPLE INFORMATION:

BORING:	C-2	DATE:	12/17/96
SAMPLE:	U-2C	TESTED BY:	ACS
DEPTH:	10.9 ft	CHECKED:	PJT
DESCRIPTION:	Clayey SILT		

SPECIMEN INFORMATION:

	INITIAL	FINAL
WATER CONTENT:	27.6 %	44.2 %
DRY UNIT WEIGHT:	64.9 pcf	76.2 pcf
VOID RATIO:	1.615	1.230
SATURATION:	46.4 %	97.7 %
HEIGHT:	1.901 cm	1.621 cm
AREA:	31.65 sq cm	
SP. GRAVITY :	2.72 (est)	

TEST DATA:

APPLIED PRESSURE	STRAIN
tsf	%
0.10	0.09
0.25	0.28
0.50	0.60
1.00	1.00
2.00	1.85
2.00	3.03
0.50	2.65
1.00	2.74
2.00	3.02
4.00	6.03
8.00	14.66
8.00	17.45
2.00	16.82
0.50	15.99
0.10	15.00

LOAD INCREMENT DATA

TEST NAME: C2-U2C
 TESTED BY: ACS

PAGE NO: 1
 JO: 05996.01

PRESSURE INCREMENT FROM 0.00 tsf to 0.10 tsf

DATE	TIME	ELAPSED TIME (min)	SQ RT OF TIME(min)	CHANGE IN HEIGHT(in)	VOID RATIO	STRAIN (%)
12-17-96	17:02:30	0.10	0.32	0.0006	1.613	0.08
		0.25	0.50	0.0006	1.613	0.08
		0.50	0.71	0.0006	1.613	0.08
		1.00	1.00	0.0007	1.613	0.09
		1.57	1.25	0.0007	1.613	0.09
		2.00	1.41	0.0007	1.613	0.09
		2.25	1.50	0.0007	1.613	0.09
		3.07	1.75	0.0007	1.613	0.09
		4.00	2.00	0.0007	1.613	0.09
		6.25	2.50	0.0007	1.613	0.09
		8.00	2.83	0.0007	1.613	0.09
		12.25	3.50	0.0008	1.612	0.11
		15.00	3.87	0.0008	1.612	0.11
		22.00	4.69	0.0008	1.612	0.11

LOAD INCREMENT DATA

TEST NAME C2-U2C
 TESTED BY: ACS

PAGE NO: 2
 JO: 05996.01

PRESSURE INCREMENT FROM 0.10 tsf to 0.25 tsf

DATE	TIME	ELAPSED TIME (min)	SQ RT OF TIME(min)	CHANGE IN HEIGHT(in)	VOID RATIO	STRAIN (%)
12-17-96	17:31:17	0.00	0.00	0.0008	1.612	0.11
		0.10	0.32	0.0017	1.609	0.23
		0.25	0.50	0.0018	1.609	0.25
		0.50	0.71	0.0018	1.609	0.25
		1.00	1.00	0.0020	1.608	0.26
		1.57	1.25	0.0020	1.608	0.26
		2.00	1.41	0.0020	1.608	0.26
		2.25	1.50	0.0020	1.608	0.26
		3.07	1.75	0.0020	1.608	0.26
		4.00	2.00	0.0020	1.608	0.26
		6.25	2.50	0.0021	1.608	0.28
		8.00	2.83	0.0021	1.608	0.28
		12.25	3.50	0.0021	1.608	0.28
		15.00	3.87	0.0021	1.608	0.28
		22.00	4.69	0.0023	1.607	0.31
		30.00	5.48	0.0024	1.607	0.32
		36.00	6.00	0.0024	1.607	0.32
		49.00	7.00	0.0024	1.607	0.32
		60.00	7.75	0.0024	1.607	0.32
		12-18-96	00:31:17	120.00	10.95	0.0025
180.00	13.42			0.0026	1.606	0.35
240.00	15.49			0.0028	1.605	0.37
300.00	17.32			0.0028	1.605	0.37
360.00	18.97			0.0029	1.605	0.38
420.00	20.49			0.0029	1.605	0.38
480.00	21.91			0.0029	1.605	0.38
540.00	23.24			0.0030	1.605	0.40
600.00	24.49			0.0030	1.605	0.40
660.00	25.69			0.0030	1.605	0.40
720.00	26.83			0.0030	1.605	0.40
780.00	27.93			0.0030	1.605	0.40
840.00	28.98			0.0030	1.605	0.40
900.00	30.00			0.0030	1.605	0.40
960.00	30.98			0.0029	1.605	0.38
1020.00	31.94			0.0029	1.605	0.38
1080.00	32.86			0.0028	1.605	0.37
1140.00	33.76			0.0029	1.605	0.38
1200.00	34.64	0.0029	1.605	0.38		
1260.00	35.50	0.0029	1.605	0.38		
1320.00	36.33	0.0029	1.605	0.38		
1380.00	37.15	0.0029	1.605	0.38		

LOAD INCREMENT DATA

TEST NAME C2-U2C
 TESTED BY: ACS

PAGE NO: 3
 JO: 05996.01

PRESSURE INCREMENT FROM 0.25 tsf to 0.50 tsf

DATE	TIME	ELAPSED TIME (min)	SQ RT OF TIME(min)	CHANGE IN HEIGHT(in)	VOID RATIO	STRAIN (%)
12-18-96	16:33:21	0.00	0.00	0.0029	1.605	0.38
		0.10	0.32	0.0040	1.601	0.54
		0.25	0.50	0.0041	1.601	0.55
		0.50	0.71	0.0043	1.600	0.57
		1.00	1.00	0.0043	1.600	0.57
		1.57	1.25	0.0043	1.600	0.57
		2.00	1.41	0.0044	1.600	0.58
		2.25	1.50	0.0044	1.600	0.58
		3.07	1.75	0.0044	1.600	0.58
		4.00	2.00	0.0044	1.600	0.58
		6.25	2.50	0.0045	1.599	0.60
		8.00	2.83	0.0045	1.599	0.60
		12.25	3.50	0.0046	1.599	0.62
		15.00	3.87	0.0046	1.599	0.62
		22.00	4.69	0.0046	1.599	0.62
		30.00	5.48	0.0047	1.599	0.63
		36.00	6.00	0.0047	1.599	0.63
		49.00	7.00	0.0047	1.599	0.63
		60.00	7.75	0.0047	1.599	0.63
		120.00	10.95	0.0048	1.598	0.65
		180.00	13.42	0.0050	1.598	0.66
		240.00	15.49	0.0050	1.598	0.66
		300.00	17.32	0.0050	1.598	0.66
360.00	18.97	0.0050	1.598	0.66		
420.00	20.49	0.0051	1.597	0.68		
12-19-96	00:33:21	480.00	21.91	0.0051	1.597	0.68
		540.00	23.24	0.0051	1.597	0.68
		600.00	24.49	0.0051	1.597	0.68
		660.00	25.69	0.0051	1.597	0.68
		720.00	26.83	0.0051	1.597	0.68
		780.00	27.93	0.0051	1.597	0.68
		840.00	28.98	0.0052	1.597	0.69
		900.00	30.00	0.0051	1.597	0.68
		960.00	30.98	0.0052	1.597	0.69
		1020.00	31.94	0.0052	1.597	0.69
1080.00	32.86	0.0052	1.597	0.69		

LOAD INCREMENT DATA

TEST NAME C2-U2C
 TESTED BY: ACS

PAGE NO: 4
 JO: 05996.01

PRESSURE INCREMENT FROM 0.25 tsf to 0.50 tsf

DATE	TIME	ELAPSED TIME (min)	SQ RT OF TIME(min)	CHANGE IN HEIGHT(in)	VOID RATIO	STRAIN (%)
		1140.00	33.76	0.0052	1.597	0.69
		1200.00	34.64	0.0052	1.597	0.69
		1260.00	35.50	0.0052	1.597	0.69
		1320.00	36.33	0.0052	1.597	0.69
		1380.00	37.15	0.0052	1.597	0.69
		1440.00	37.95	0.0052	1.597	0.69
		1500.00	38.73	0.0052	1.597	0.69
		1560.00	39.50	0.0053	1.596	0.71
		1620.00	40.25	0.0053	1.596	0.71
		1680.00	40.99	0.0053	1.596	0.71
		1740.00	41.71	0.0054	1.596	0.72
		1800.00	42.43	0.0054	1.596	0.72
		1860.00	43.13	0.0054	1.596	0.72
12-20-96	00:33:21	1920.00	43.82	0.0054	1.596	0.72
		1980.00	44.50	0.0054	1.596	0.72
		2040.00	45.17	0.0054	1.596	0.72
		2100.00	45.83	0.0054	1.596	0.72
		2160.00	46.48	0.0055	1.596	0.74
		2220.00	47.12	0.0055	1.596	0.74
		2280.00	47.75	0.0055	1.596	0.74
		2340.00	48.37	0.0055	1.596	0.74
		2400.00	48.99	0.0055	1.596	0.74
		2460.00	49.60	0.0054	1.596	0.72
		2520.00	50.20	0.0054	1.596	0.72
		2580.00	50.79	0.0053	1.596	0.71
		2640.00	51.38	0.0054	1.596	0.72
		2700.00	51.96	0.0053	1.596	0.71
		2760.00	52.54	0.0053	1.596	0.71
		2820.00	53.10	0.0053	1.596	0.71
		2880.00	53.67	0.0053	1.596	0.71
		2940.00	54.22	0.0054	1.596	0.72
		2989.77	54.68	0.0053	1.596	0.71

LOAD INCREMENT DATA

TEST NAME C2-U2C
 TESTED BY: ACS

PAGE NO: 5
 JO: 05996.01

PRESSURE INCREMENT FROM 0.50 tsf to 1.00 tsf

DATE	TIME	ELAPSED TIME (min)	SQ RT OF TIME(min)	CHANGE IN HEIGHT(in)	VOID RATIO	STRAIN (%)
12-20-96	18:23:08	0.00	0.00	0.0053	1.596	0.71
		0.10	0.32	0.0068	1.591	0.91
		0.25	0.50	0.0070	1.590	0.94
		0.50	0.71	0.0070	1.590	0.94
		1.00	1.00	0.0071	1.590	0.95
		1.57	1.25	0.0073	1.590	0.97
		2.00	1.41	0.0073	1.590	0.97
		2.25	1.50	0.0074	1.589	0.98
		3.07	1.75	0.0074	1.589	0.98
		4.00	2.00	0.0074	1.589	0.98
		6.25	2.50	0.0075	1.589	1.00
		8.00	2.83	0.0075	1.589	1.00
		12.25	3.50	0.0076	1.588	1.02
		15.00	3.87	0.0076	1.588	1.02
		22.00	4.69	0.0077	1.588	1.03
		30.00	5.48	0.0078	1.588	1.05
		36.00	6.00	0.0078	1.588	1.05
		49.00	7.00	0.0078	1.588	1.05
		60.00	7.75	0.0079	1.587	1.06
		12-21-96	00:23:08	120.00	10.95	0.0082
180.00	13.42			0.0083	1.586	1.11
240.00	15.49			0.0084	1.586	1.12
300.00	17.32			0.0084	1.586	1.12
360.00	18.97			0.0085	1.585	1.14
420.00	20.49			0.0086	1.585	1.15
480.00	21.91			0.0086	1.585	1.15
540.00	23.24			0.0088	1.584	1.17
600.00	24.49			0.0088	1.584	1.17
660.00	25.69			0.0088	1.584	1.17
720.00	26.83			0.0088	1.584	1.17
780.00	27.93			0.0089	1.584	1.18
840.00	28.98			0.0089	1.584	1.18
900.00	30.00			0.0089	1.584	1.18
960.00	30.98			0.0089	1.584	1.18
1020.00	31.94			0.0090	1.584	1.20
1080.00	32.86			0.0090	1.584	1.20

LOAD INCREMENT DATA

TEST NAME C2-U2C
TESTED BY: ACS

PAGE NO: 6
JO: 05996.01

PRESSURE INCREMENT FROM 0.50 tsf to 1.00 tsf

DATE	TIME	ELAPSED TIME (min)	SQ RT OF TIME(min)	CHANGE IN HEIGHT(in)	VOID RATIO	STRAIN (%)
		1140.00	33.76	0.0090	1.584	1.20
		1200.00	34.64	0.0089	1.584	1.18
		1260.00	35.50	0.0090	1.584	1.20
		1320.00	36.33	0.0089	1.584	1.18
		1380.00	37.15	0.0090	1.584	1.20
		1440.00	37.95	0.0089	1.584	1.18
		1500.00	38.73	0.0089	1.584	1.18

LOAD INCREMENT DATA

TEST NAME C2-U2C
 TESTED BY: ACS

PAGE NO: 7
 JO: 05996.01

PRESSURE INCREMENT FROM 1.00 tsf to 2.00 tsf

DATE	TIME	ELAPSED TIME (min)	SQ RT OF TIME(min)	CHANGE IN HEIGHT(in)	VOID RATIO	STRAIN (%)
12-21-96	19:33:48	0.00	0.00	0.0090	1.584	1.20
		0.10	0.32	0.0119	1.574	1.58
		0.25	0.50	0.0123	1.572	1.65
		0.50	0.71	0.0126	1.571	1.68
		1.00	1.00	0.0128	1.570	1.71
		1.57	1.25	0.0130	1.570	1.74
		2.00	1.41	0.0131	1.569	1.75
		2.25	1.50	0.0131	1.569	1.75
		3.07	1.75	0.0132	1.569	1.77
		4.00	2.00	0.0135	1.568	1.80
		6.25	2.50	0.0136	1.568	1.82
		8.00	2.83	0.0138	1.567	1.85
		12.25	3.50	0.0140	1.566	1.88
		15.00	3.87	0.0142	1.566	1.89
		22.00	4.69	0.0144	1.565	1.92
		30.00	5.48	0.0146	1.564	1.95
		36.00	6.00	0.0147	1.564	1.97
		49.00	7.00	0.0150	1.563	2.00
		60.00	7.75	0.0152	1.562	2.03
		120.00	10.95	0.0158	1.560	2.11
180.00	13.42	0.0161	1.559	2.15		
240.00	15.49	0.0165	1.557	2.20		
12-22-96	00:33:48	300.00	17.32	0.0167	1.557	2.23
		360.00	18.97	0.0169	1.556	2.26
		420.00	20.49	0.0170	1.555	2.28
		480.00	21.91	0.0173	1.555	2.31
		540.00	23.24	0.0174	1.554	2.32
		600.00	24.49	0.0175	1.554	2.34
		660.00	25.69	0.0176	1.553	2.35
		720.00	26.83	0.0177	1.553	2.37
		780.00	27.93	0.0178	1.553	2.38
		840.00	28.98	0.0180	1.552	2.40
		900.00	30.00	0.0180	1.552	2.40
		960.00	30.98	0.0181	1.552	2.42
1020.00	31.94	0.0182	1.551	2.43		
1080.00	32.86	0.0182	1.551	2.43		

LOAD INCREMENT DATA

TEST NAME C2-U2C
 TESTED BY: ACS

PAGE NO: 8
 JO: 05996.01

PRESSURE INCREMENT FROM 1.00 tsf to 2.00 tsf

DATE	TIME	ELAPSED TIME (min)	SQ RT OF TIME(min)	CHANGE IN HEIGHT(in)	VOID RATIO	STRAIN (%)
		1140.00	33.76	0.0183	1.551	2.45
		1200.00	34.64	0.0184	1.551	2.46
		1260.00	35.50	0.0184	1.551	2.46
		1320.00	36.33	0.0184	1.551	2.46
		1380.00	37.15	0.0184	1.551	2.46
		1440.00	37.95	0.0185	1.550	2.48
		1500.00	38.73	0.0185	1.550	2.48
		1560.00	39.50	0.0187	1.550	2.49
		1620.00	40.25	0.0188	1.549	2.51
		1680.00	40.99	0.0188	1.549	2.51
12-23-96	00:33:48	1740.00	41.71	0.0189	1.549	2.52
		1800.00	42.43	0.0189	1.549	2.52
		1860.00	43.13	0.0189	1.549	2.52
		1920.00	43.82	0.0190	1.549	2.54
		1980.00	44.50	0.0191	1.548	2.55
		2040.00	45.17	0.0190	1.549	2.54
		2100.00	45.83	0.0191	1.548	2.55
		2160.00	46.48	0.0190	1.549	2.54
		2220.00	47.12	0.0191	1.548	2.55
		2280.00	47.75	0.0191	1.548	2.55
		2340.00	48.37	0.0191	1.548	2.55
		2400.00	48.99	0.0191	1.548	2.55
		2460.00	49.60	0.0191	1.548	2.55
		2520.00	50.20	0.0191	1.548	2.55
		2580.00	50.79	0.0191	1.548	2.55
		2640.00	51.38	0.0192	1.548	2.57
		2700.00	51.96	0.0192	1.548	2.57
		2760.00	52.54	0.0192	1.548	2.57
		2820.00	53.10	0.0192	1.548	2.57
		2880.00	53.67	0.0193	1.547	2.58
		2940.00	54.22	0.0195	1.547	2.60
		3000.00	54.77	0.0195	1.547	2.60
		3060.00	55.32	0.0196	1.547	2.62
		3120.00	55.86	0.0196	1.547	2.62

LOAD INCREMENT DATA

TEST NAME C2-U2C
 TESTED BY: ACS

PAGE NO: 9
 JO: 05996.01

PRESSURE INCREMENT FROM 1.00 tsf to 2.00 tsf

DATE	TIME	ELAPSED TIME (min)	SQ RT OF TIME(min)	CHANGE IN HEIGHT(in)	VOID RATIO	STRAIN (%)
12-24-96	00:33:48	3180.00	56.39	0.0197	1.546	2.63
		3240.00	56.92	0.0197	1.546	2.63
		3300.00	57.45	0.0198	1.546	2.65
		3360.00	57.97	0.0198	1.546	2.65
		3420.00	58.48	0.0198	1.546	2.65
		3480.00	58.99	0.0198	1.546	2.65
		3540.00	59.50	0.0198	1.546	2.65
		3600.00	60.00	0.0198	1.546	2.65
		3660.00	60.50	0.0198	1.546	2.65
		3720.00	60.99	0.0198	1.546	2.65
		3780.00	61.48	0.0197	1.546	2.63
		3840.00	61.97	0.0198	1.546	2.65
		3900.00	62.45	0.0198	1.546	2.65
		3960.00	62.93	0.0198	1.546	2.65
		4020.00	63.40	0.0199	1.545	2.66
		4080.00	63.87	0.0199	1.545	2.66
		4140.00	64.34	0.0199	1.545	2.66
		4200.00	64.81	0.0200	1.545	2.68
		4260.00	65.27	0.0200	1.545	2.68
		4320.00	65.73	0.0200	1.545	2.68
4380.00	66.18	0.0202	1.545	2.69		
4440.00	66.63	0.0202	1.545	2.69		
4500.00	67.08	0.0203	1.544	2.71		
4560.00	67.53	0.0203	1.544	2.71		
12-25-96	00:33:48	4620.00	67.97	0.0203	1.544	2.71
		4680.00	68.41	0.0203	1.544	2.71
		4740.00	68.85	0.0204	1.544	2.72
		4800.00	69.28	0.0204	1.544	2.72
		4860.00	69.71	0.0204	1.544	2.72
		4920.00	70.14	0.0204	1.544	2.72
		4980.00	70.57	0.0204	1.544	2.72
		5040.00	70.99	0.0204	1.544	2.72
		5100.00	71.41	0.0205	1.543	2.74
		5160.00	71.83	0.0205	1.543	2.74

LOAD INCREMENT DATA

TEST NAME C2-U2C
 TESTED BY: ACS

PAGE NO: 10
 JO: 05996.01

PRESSURE INCREMENT FROM 1.00 tsf to 2.00 tsf

DATE	TIME	ELAPSED TIME (min)	SQ RT OF TIME(min)	CHANGE IN HEIGHT(in)	VOID RATIO	STRAIN (%)
		5220.00	72.25	0.0205	1.543	2.74
		5280.00	72.66	0.0206	1.543	2.75
		5340.00	73.08	0.0205	1.543	2.74
		5400.00	73.48	0.0206	1.543	2.75
		5460.00	73.89	0.0206	1.543	2.75
		5520.00	74.30	0.0206	1.543	2.75
		5580.00	74.70	0.0206	1.543	2.75
		5640.00	75.10	0.0206	1.543	2.75
		5700.00	75.50	0.0207	1.543	2.77
		5760.00	75.89	0.0207	1.543	2.77
		5820.00	76.29	0.0207	1.543	2.77
		5880.00	76.68	0.0207	1.543	2.77
		5940.00	77.07	0.0207	1.543	2.77
		6000.00	77.46	0.0208	1.542	2.78
12-26-96	00:33:48	6060.00	77.85	0.0208	1.542	2.78
		6120.00	78.23	0.0208	1.542	2.78
		6180.00	78.61	0.0208	1.542	2.78
		6240.00	78.99	0.0208	1.542	2.78
		6300.00	79.37	0.0210	1.542	2.80
		6360.00	79.75	0.0210	1.542	2.80
		6420.00	80.12	0.0210	1.542	2.80
		6480.00	80.50	0.0208	1.542	2.78
		6540.00	80.87	0.0208	1.542	2.78
		6600.00	81.24	0.0208	1.542	2.78
		6660.00	81.61	0.0208	1.542	2.78
		6720.00	81.98	0.0208	1.542	2.78
		6780.00	82.34	0.0208	1.542	2.78
		6840.00	82.70	0.0207	1.543	2.77
		6900.00	83.07	0.0208	1.542	2.78
		6960.00	83.43	0.0208	1.542	2.78
		7020.00	83.79	0.0208	1.542	2.78
		7080.00	84.14	0.0208	1.542	2.78
		7140.00	84.50	0.0208	1.542	2.78
		7200.00	84.85	0.0208	1.542	2.78

LOAD INCREMENT DATA

TEST NAME C2-U2C
 TESTED BY: ACS

PAGE NO: 11
 JO: 05996.01

PRESSURE INCREMENT FROM 1.00 tsf to 2.00 tsf

DATE	TIME	ELAPSED TIME (min)	SQ RT OF TIME(min)	CHANGE IN HEIGHT(in)	VOID RATIO	STRAIN (%)
		7260.00	85.21	0.0210	1.542	2.80
		7320.00	85.56	0.0210	1.542	2.80
		7380.00	85.91	0.0211	1.541	2.82
		7440.00	86.26	0.0211	1.541	2.82
12-27-96	00:33:48	7500.00	86.60	0.0211	1.541	2.82
		7560.00	86.95	0.0211	1.541	2.82
		7620.00	87.29	0.0212	1.541	2.83
		7680.00	87.64	0.0211	1.541	2.82
		7740.00	87.98	0.0212	1.541	2.83
		7800.00	88.32	0.0212	1.541	2.83
		7860.00	88.66	0.0212	1.541	2.83
		7920.00	88.99	0.0211	1.541	2.82
		7980.00	89.33	0.0211	1.541	2.82
		8040.00	89.67	0.0211	1.541	2.82
		8100.00	90.00	0.0211	1.541	2.82
		8160.00	90.33	0.0211	1.541	2.82
		8220.00	90.66	0.0211	1.541	2.82
		8280.00	90.99	0.0211	1.541	2.82
		8340.00	91.32	0.0211	1.541	2.82
		8400.00	91.65	0.0211	1.541	2.82
		8460.00	91.98	0.0211	1.541	2.82
		8520.00	92.30	0.0212	1.541	2.83
		8580.00	92.63	0.0212	1.541	2.83
		8640.00	92.95	0.0212	1.541	2.83
		8700.00	93.27	0.0213	1.541	2.85
		8760.00	93.59	0.0213	1.541	2.85
		8820.00	93.91	0.0213	1.541	2.85
		8880.00	94.23	0.0213	1.541	2.85
12-28-96	00:33:48	8940.00	94.55	0.0214	1.540	2.86
		9000.00	94.87	0.0214	1.540	2.86
		9060.00	95.18	0.0214	1.540	2.86
		9120.00	95.50	0.0214	1.540	2.86
		9180.00	95.81	0.0215	1.540	2.88
		9240.00	96.12	0.0214	1.540	2.86

LOAD INCREMENT DATA

TEST NAME C2-U2C
 TESTED BY: ACS

PAGE NO: 12
 JO: 05996.01

PRESSURE INCREMENT FROM 1.00 tsf to 2.00 tsf

DATE	TIME	ELAPSED TIME (min)	SQ RT OF TIME(min)	CHANGE IN HEIGHT(in)	VOID RATIO	STRAIN (%)
		9300.00	96.44	0.0215	1.540	2.88
		9360.00	96.75	0.0215	1.540	2.88
		9420.00	97.06	0.0215	1.540	2.88
		9480.00	97.37	0.0215	1.540	2.88
		9540.00	97.67	0.0215	1.540	2.88
		9600.00	97.98	0.0215	1.540	2.88
		9660.00	98.29	0.0216	1.539	2.89
		9720.00	98.59	0.0216	1.539	2.89
		9780.00	98.89	0.0215	1.540	2.88
		9840.00	99.20	0.0216	1.539	2.89
		9900.00	99.50	0.0216	1.539	2.89
		9960.00	99.80	0.0216	1.539	2.89
		1002.00E+01	100.10	0.0216	1.539	2.89
		1008.00E+01	100.40	0.0216	1.539	2.89
		1014.00E+01	100.70	0.0216	1.539	2.89
		1020.00E+01	101.00	0.0216	1.539	2.89
		1026.00E+01	101.29	0.0216	1.539	2.89
		1032.00E+01	101.59	0.0216	1.539	2.89
12-29-96	00:33:48	1038.00E+01	101.88	0.0216	1.539	2.89
		1044.00E+01	102.18	0.0218	1.539	2.91
		1050.00E+01	102.47	0.0218	1.539	2.91
		1056.00E+01	102.76	0.0218	1.539	2.91
		1062.00E+01	103.05	0.0218	1.539	2.91
		1068.00E+01	103.34	0.0218	1.539	2.91
		1074.00E+01	103.63	0.0218	1.539	2.91
		1080.00E+01	103.92	0.0218	1.539	2.91
		1086.00E+01	104.21	0.0218	1.539	2.91
		1092.00E+01	104.50	0.0219	1.539	2.92
		1098.00E+01	104.79	0.0219	1.539	2.92
		1104.00E+01	105.07	0.0219	1.539	2.92
		1110.00E+01	105.36	0.0219	1.539	2.92
		1116.00E+01	105.64	0.0219	1.539	2.92
		1122.00E+01	105.92	0.0219	1.539	2.92
		1128.00E+01	106.21	0.0219	1.539	2.92

LOAD INCREMENT DATA

TEST NAME C2-U2C
 TESTED BY: ACS

PAGE NO: 13
 JO: 05996.01

PRESSURE INCREMENT FROM 1.00 tsf to 2.00 tsf

DATE	TIME	ELAPSED TIME (min)	SQ RT OF TIME(min)	CHANGE IN HEIGHT(in)	VOID RATIO	STRAIN (%)
		1134.00E+01	106.49	0.0219	1.539	2.92
		1140.00E+01	106.77	0.0219	1.539	2.92
		1146.00E+01	107.05	0.0219	1.539	2.92
		1152.00E+01	107.33	0.0219	1.539	2.92
		1158.00E+01	107.61	0.0219	1.539	2.92
		1164.00E+01	107.89	0.0220	1.538	2.94
		1170.00E+01	108.17	0.0220	1.538	2.94
		1176.00E+01	108.44	0.0220	1.538	2.94
12-30-96	00:33:48	1182.00E+01	108.72	0.0220	1.538	2.94
		1188.00E+01	109.00	0.0220	1.538	2.94
		1194.00E+01	109.27	0.0220	1.538	2.94
		1200.00E+01	109.54	0.0220	1.538	2.94
		1206.00E+01	109.82	0.0220	1.538	2.94
		1212.00E+01	110.09	0.0220	1.538	2.94
		1218.00E+01	110.36	0.0220	1.538	2.94
		1224.00E+01	110.63	0.0219	1.539	2.92
		1230.00E+01	110.91	0.0219	1.539	2.92
		1236.00E+01	111.18	0.0219	1.539	2.92
		1242.00E+01	111.45	0.0219	1.539	2.92
		1248.00E+01	111.71	0.0219	1.539	2.92
		1254.00E+01	111.98	0.0219	1.539	2.92
		1260.00E+01	112.25	0.0219	1.539	2.92
		1266.00E+01	112.52	0.0219	1.539	2.92
		1272.00E+01	112.78	0.0219	1.539	2.92
		1278.00E+01	113.05	0.0219	1.539	2.92
		1284.00E+01	113.31	0.0219	1.539	2.92
		1290.00E+01	113.58	0.0219	1.539	2.92
		1296.00E+01	113.84	0.0219	1.539	2.92
		1302.00E+01	114.11	0.0220	1.538	2.94
		1308.00E+01	114.37	0.0220	1.538	2.94
		1314.00E+01	114.63	0.0220	1.538	2.94
		1320.00E+01	114.89	0.0221	1.538	2.95
12-31-96	00:33:48	1326.00E+01	115.15	0.0221	1.538	2.95
		1332.00E+01	115.41	0.0221	1.538	2.95

LOAD INCREMENT DATA

TEST NAME C2-U2C
 TESTED BY: ACS

PAGE NO: 14
 JO: 05996.01

PRESSURE INCREMENT FROM 1.00 tsf to 2.00 tsf

DATE	TIME	ELAPSED TIME (min)	SQ RT OF TIME(min)	CHANGE IN HEIGHT(in)	VOID RATIO	STRAIN (%)
		1338.00E+01	115.67	0.0221	1.538	2.95
		1344.00E+01	115.93	0.0221	1.538	2.95
		1350.00E+01	116.19	0.0221	1.538	2.95
		1356.00E+01	116.45	0.0222	1.537	2.97
		1362.00E+01	116.70	0.0221	1.538	2.95
		1368.00E+01	116.96	0.0221	1.538	2.95
		1374.00E+01	117.22	0.0220	1.538	2.94
		1380.00E+01	117.47	0.0220	1.538	2.94
		1386.00E+01	117.73	0.0220	1.538	2.94
		1392.00E+01	117.98	0.0220	1.538	2.94
		1398.00E+01	118.24	0.0220	1.538	2.94
		1404.00E+01	118.49	0.0220	1.538	2.94
		1410.00E+01	118.74	0.0220	1.538	2.94
		1416.00E+01	119.00	0.0220	1.538	2.94
		1422.00E+01	119.25	0.0220	1.538	2.94
		1428.00E+01	119.50	0.0220	1.538	2.94
		1434.00E+01	119.75	0.0220	1.538	2.94
		1440.00E+01	120.00	0.0221	1.538	2.95
		1446.00E+01	120.25	0.0221	1.538	2.95
		1452.00E+01	120.50	0.0222	1.537	2.97
		1458.00E+01	120.75	0.0222	1.537	2.97
		1464.00E+01	121.00	0.0222	1.537	2.97
01-01-97	00:33:48	1470.00E+01	121.24	0.0222	1.537	2.97
		1476.00E+01	121.49	0.0223	1.537	2.98
		1482.00E+01	121.74	0.0223	1.537	2.98
		1488.00E+01	121.98	0.0223	1.537	2.98
		1494.00E+01	122.23	0.0225	1.537	3.00
		1500.00E+01	122.47	0.0225	1.537	3.00
		1506.00E+01	122.72	0.0225	1.537	3.00
		1512.00E+01	122.96	0.0225	1.537	3.00
		1518.00E+01	123.21	0.0225	1.537	3.00
		1524.00E+01	123.45	0.0225	1.537	3.00
		1530.00E+01	123.69	0.0225	1.537	3.00
		1536.00E+01	123.94	0.0226	1.536	3.02

LOAD INCREMENT DATA

TEST NAME C2-U2C
 TESTED BY: ACS

PAGE NO: 15
 JO: 05996.01

PRESSURE INCREMENT FROM 1.00 tsf to 2.00 tsf

DATE	TIME	ELAPSED TIME (min)	SQ RT OF TIME(min)	CHANGE IN HEIGHT(in)	VOID RATIO	STRAIN (%)
		1542.00E+01	124.18	0.0226	1.536	3.02
		1548.00E+01	124.42	0.0226	1.536	3.02
		1554.00E+01	124.66	0.0226	1.536	3.02
		1560.00E+01	124.90	0.0226	1.536	3.02
		1566.00E+01	125.14	0.0226	1.536	3.02
		1572.00E+01	125.38	0.0226	1.536	3.02
		1578.00E+01	125.62	0.0226	1.536	3.02
		1584.00E+01	125.86	0.0226	1.536	3.02
		1590.00E+01	126.10	0.0226	1.536	3.02
		1596.00E+01	126.33	0.0227	1.536	3.03
		1602.00E+01	126.57	0.0226	1.536	3.02
		1608.00E+01	126.81	0.0226	1.536	3.02
01-02-97	00:33:48	1614.00E+01	127.04	0.0227	1.536	3.03
		1620.00E+01	127.28	0.0227	1.536	3.03
		1626.00E+01	127.51	0.0227	1.536	3.03
		1632.00E+01	127.75	0.0227	1.536	3.03
		1638.00E+01	127.98	0.0227	1.536	3.03
		1644.00E+01	128.22	0.0226	1.536	3.02
		1650.00E+01	128.45	0.0226	1.536	3.02
		1656.00E+01	128.69	0.0226	1.536	3.02
		1662.00E+01	128.92	0.0226	1.536	3.02
		1668.00E+01	129.15	0.0225	1.537	3.00
		1674.00E+01	129.38	0.0225	1.537	3.00
		1680.00E+01	129.61	0.0225	1.537	3.00

LOAD INCREMENT DATA

TEST NAME C2-U2C
 TESTED BY: ACS

PAGE NO: 16
 JO: 05996.01

PRESSURE INCREMENT FROM 2.00 tsf to 0.50 tsf

DATE	TIME	ELAPSED TIME (min)	SQ RT OF TIME(min)	CHANGE IN HEIGHT(in)	VOID RATIO	STRAIN (%)
01-02-97	11:42:46	0.00	0.00	0.0225	1.537	3.00
		0.10	0.32	0.0202	1.545	2.69
		0.25	0.50	0.0200	1.545	2.68
		0.50	0.71	0.0200	1.545	2.68
		1.00	1.00	0.0200	1.545	2.68
		1.57	1.25	0.0199	1.545	2.66
		2.00	1.41	0.0199	1.545	2.66
		2.25	1.50	0.0199	1.545	2.66
		3.07	1.75	0.0199	1.545	2.66
		4.00	2.00	0.0199	1.545	2.66
		6.25	2.50	0.0198	1.546	2.65
		8.00	2.83	0.0198	1.546	2.65
		12.25	3.50	0.0198	1.546	2.65
		15.00	3.87	0.0198	1.546	2.65
		22.00	4.69	0.0198	1.546	2.65
		30.00	5.48	0.0197	1.546	2.63
		36.00	6.00	0.0198	1.546	2.65
		49.00	7.00	0.0197	1.546	2.63
		60.00	7.75	0.0197	1.546	2.63
		120.00	10.95	0.0196	1.547	2.62
		180.00	13.42	0.0196	1.547	2.62
		240.00	15.49	0.0196	1.547	2.62
		300.00	17.32	0.0195	1.547	2.60

LOAD INCREMENT DATA

TEST NAME C2-U2C
TESTED BY: ACS

PAGE NO: 17
JO: 05996.01

PRESSURE INCREMENT FROM 0.50 tsf to 1.00 tsf

DATE	TIME	ELAPSED TIME (min)	SQ RT OF TIME(min)	CHANGE IN HEIGHT(in)	VOID RATIO	STRAIN (%)
01-02-97	16:53:53	0.00	0.00	0.0196	1.547	2.62
		0.10	0.32	0.0204	1.544	2.72
		0.25	0.50	0.0204	1.544	2.72
		0.50	0.71	0.0204	1.544	2.72
		1.00	1.00	0.0204	1.544	2.72
		1.57	1.25	0.0205	1.543	2.74
		2.00	1.41	0.0204	1.544	2.72
		2.25	1.50	0.0204	1.544	2.72
		3.07	1.75	0.0205	1.543	2.74
		4.00	2.00	0.0205	1.543	2.74
		6.25	2.50	0.0205	1.543	2.74
		8.00	2.83	0.0205	1.543	2.74
		12.25	3.50	0.0205	1.543	2.74
		15.00	3.87	0.0204	1.544	2.72
		22.00	4.69	0.0205	1.543	2.74
		30.00	5.48	0.0205	1.543	2.74
		36.00	6.00	0.0205	1.543	2.74
		49.00	7.00	0.0205	1.543	2.74
		60.00	7.75	0.0205	1.543	2.74
		01-03-97	00:53:53	120.00	10.95	0.0206
180.00	13.42			0.0206	1.543	2.75
240.00	15.49			0.0207	1.543	2.77
300.00	17.32			0.0207	1.543	2.77
360.00	18.97			0.0207	1.543	2.77
420.00	20.49			0.0207	1.543	2.77
480.00	21.91			0.0208	1.542	2.78
540.00	23.24			0.0208	1.542	2.78
600.00	24.49			0.0207	1.543	2.77
660.00	25.69			0.0208	1.542	2.78
720.00	26.83			0.0208	1.542	2.78
780.00	27.93			0.0208	1.542	2.78
840.00	28.98			0.0207	1.543	2.77
900.00	30.00			0.0207	1.543	2.77
960.00	30.98			0.0207	1.543	2.77

LOAD INCREMENT DATA

TEST NAME C2-U2C
 TESTED BY: ACS

PAGE NO: 18
 JO: 05996.01

PRESSURE INCREMENT FROM 1.00 tsf to 2.00 tsf

DATE	TIME	ELAPSED TIME (min)	SQ RT OF TIME(min)	CHANGE IN HEIGHT(in)	VOID RATIO	STRAIN (%)
01-03-97	09:00:15	0.00	0.00	0.0207	1.543	2.77
		0.10	0.32	0.0223	1.537	2.98
		0.25	0.50	0.0223	1.537	2.98
		0.50	0.71	0.0225	1.537	3.00
		1.00	1.00	0.0225	1.537	3.00
		1.57	1.25	0.0225	1.537	3.00
		2.00	1.41	0.0225	1.537	3.00
		2.25	1.50	0.0225	1.537	3.00
		3.07	1.75	0.0225	1.537	3.00
		4.00	2.00	0.0225	1.537	3.00
		6.25	2.50	0.0226	1.536	3.02
		8.00	2.83	0.0226	1.536	3.02
		12.25	3.50	0.0226	1.536	3.02
		15.00	3.87	0.0226	1.536	3.02
		22.00	4.69	0.0227	1.536	3.03
		30.00	5.48	0.0227	1.536	3.03
		36.00	6.00	0.0227	1.536	3.03
		49.00	7.00	0.0227	1.536	3.03
		60.00	7.75	0.0227	1.536	3.03
		120.00	10.95	0.0227	1.536	3.03
		180.00	13.42	0.0228	1.535	3.05

LOAD INCREMENT DATA

TEST NAME C2-U2C
 TESTED BY: ACS

PAGE NO: 19
 JO: 05996.01

PRESSURE INCREMENT FROM 2.00 tsf to 4.00 tsf

DATE	TIME	ELAPSED TIME (min)	SQ RT OF TIME(min)	CHANGE IN HEIGHT(in)	VOID RATIO	STRAIN (%)
01-03-97	12:18:35	0.00	0.00	0.0228	1.535	3.05
		0.10	0.32	0.0325	1.502	4.34
		0.25	0.50	0.0350	1.493	4.68
		0.50	0.71	0.0367	1.487	4.91
		1.00	1.00	0.0387	1.480	5.17
		1.57	1.25	0.0400	1.475	5.34
		2.00	1.41	0.0406	1.473	5.43
		2.25	1.50	0.0410	1.472	5.48
		3.07	1.75	0.0419	1.469	5.60
		4.00	2.00	0.0428	1.465	5.72
		6.25	2.50	0.0443	1.460	5.92
		8.00	2.83	0.0451	1.457	6.03
		12.25	3.50	0.0468	1.452	6.25
		15.00	3.87	0.0474	1.449	6.34
		22.00	4.69	0.0488	1.444	6.52
		30.00	5.48	0.0501	1.440	6.69
		36.00	6.00	0.0508	1.438	6.79
		49.00	7.00	0.0520	1.433	6.95
		60.00	7.75	0.0529	1.430	7.06
		120.00	10.95	0.0557	1.420	7.45
		180.00	13.42	0.0575	1.414	7.68
240.00	15.49	0.0586	1.410	7.83		
300.00	17.32	0.0596	1.407	7.97		
360.00	18.97	0.0603	1.404	8.06		
420.00	20.49	0.0610	1.402	8.15		
480.00	21.91	0.0616	1.400	8.23		
540.00	23.24	0.0621	1.398	8.29		
600.00	24.49	0.0625	1.397	8.35		
660.00	25.69	0.0629	1.395	8.40		
01-04-97	00:18:35	720.00	26.83	0.0632	1.394	8.45
		780.00	27.93	0.0636	1.393	8.49
		840.00	28.98	0.0638	1.392	8.52
		900.00	30.00	0.0641	1.391	8.57
		960.00	30.98	0.0644	1.390	8.60
		1020.00	31.94	0.0646	1.389	8.63
		1080.00	32.86	0.0648	1.388	8.66

LOAD INCREMENT DATA

TEST NAME C2-U2C
 TESTED BY: ACS

PAGE NO: 20
 JO: 05996.01

PRESSURE INCREMENT FROM 2.00 tsf to 4.00 tsf

DATE	TIME	ELAPSED TIME (min)	SQ RT OF TIME(min)	CHANGE IN HEIGHT(in)	VOID RATIO	STRAIN (%)
		1140.00	33.76	0.0649	1.388	8.68
		1200.00	34.64	0.0652	1.387	8.71
		1260.00	35.50	0.0654	1.386	8.74
		1320.00	36.33	0.0655	1.386	8.75
		1380.00	37.15	0.0658	1.385	8.79
		1440.00	37.95	0.0659	1.385	8.80
		1500.00	38.73	0.0661	1.384	8.83
		1560.00	39.50	0.0662	1.384	8.85
		1620.00	40.25	0.0663	1.383	8.86
		1680.00	40.99	0.0664	1.383	8.88
		1740.00	41.71	0.0667	1.382	8.91
		1800.00	42.43	0.0667	1.382	8.91
		1860.00	43.13	0.0669	1.381	8.94
		1920.00	43.82	0.0670	1.381	8.95
		1980.00	44.50	0.0671	1.380	8.97
		2040.00	45.17	0.0672	1.380	8.99
		2100.00	45.83	0.0674	1.380	9.00
01-05-97	00:18:35	2160.00	46.48	0.0674	1.380	9.00
		2220.00	47.12	0.0675	1.379	9.02
		2280.00	47.75	0.0676	1.379	9.03
		2340.00	48.37	0.0677	1.378	9.05
		2400.00	48.99	0.0678	1.378	9.06
		2460.00	49.60	0.0679	1.378	9.08
		2520.00	50.20	0.0681	1.377	9.09
		2580.00	50.79	0.0681	1.377	9.09
		2640.00	51.38	0.0682	1.377	9.11
		2700.00	51.96	0.0683	1.376	9.12
		2760.00	52.54	0.0683	1.376	9.12
		2820.00	53.10	0.0684	1.376	9.14
		2880.00	53.67	0.0685	1.376	9.15
		2940.00	54.22	0.0686	1.375	9.17
		3000.00	54.77	0.0686	1.375	9.17
		3060.00	55.32	0.0687	1.375	9.19
		3120.00	55.86	0.0689	1.374	9.20

LOAD INCREMENT DATA

TEST NAME C2-U2C
 TESTED BY: ACS

PAGE NO: 21
 JO: 05996.01

PRESSURE INCREMENT FROM 2.00 tsf to 4.00 tsf

DATE	TIME	ELAPSED TIME (min)	SQ RT OF TIME(min)	CHANGE IN HEIGHT(in)	VOID RATIO	STRAIN (%)
		3180.00	56.39	0.0689	1.374	9.20
		3240.00	56.92	0.0690	1.374	9.22
		3300.00	57.45	0.0690	1.374	9.22
		3360.00	57.97	0.0691	1.374	9.23
		3420.00	58.48	0.0692	1.373	9.25
		3480.00	58.99	0.0692	1.373	9.25
		3540.00	59.50	0.0693	1.373	9.26
01-06-97	00:18:35	3600.00	60.00	0.0693	1.373	9.26
		3660.00	60.50	0.0694	1.372	9.28
		3720.00	60.99	0.0694	1.372	9.28
		3780.00	61.48	0.0696	1.372	9.29
		3840.00	61.97	0.0696	1.372	9.29
		3900.00	62.45	0.0697	1.372	9.31
		3960.00	62.93	0.0697	1.372	9.31
		4020.00	63.40	0.0697	1.372	9.31
		4080.00	63.87	0.0698	1.371	9.32
		4319.92	65.73	0.0698	1.371	9.32

LOAD INCREMENT DATA

TEST NAME C2-U2C
 TESTED BY: ACS

PAGE NO: 22
 JO: 05996.01

PRESSURE INCREMENT FROM 4.00 tsf to 8.00 tsf

DATE	TIME	ELAPSED TIME (min)	SQ RT OF TIME(min)	CHANGE IN HEIGHT(in)	VOID RATIO	STRAIN (%)
01-06-97	13:43:29	0.00	0.00	0.0702	1.370	9.39
		0.10	0.32	0.0905	1.299	12.09
		0.25	0.50	0.0950	1.283	12.69
		0.50	0.71	0.0980	1.273	13.09
		1.00	1.00	0.1009	1.263	13.48
		1.57	1.25	0.1026	1.257	13.71
		2.00	1.41	0.1038	1.253	13.86
		2.25	1.50	0.1042	1.251	13.92
		3.07	1.75	0.1056	1.246	14.11
		4.00	2.00	0.1067	1.242	14.26
		6.25	2.50	0.1086	1.236	14.51
		8.00	2.83	0.1097	1.232	14.66
		12.25	3.50	0.1117	1.225	14.92
		15.00	3.87	0.1126	1.222	15.05
		22.00	4.69	0.1143	1.215	15.28
		30.00	5.48	0.1157	1.211	15.46
		36.00	6.00	0.1165	1.208	15.57
		49.00	7.00	0.1179	1.203	15.75
		60.00	7.75	0.1188	1.200	15.88
		120.00	10.95	0.1218	1.189	16.28
180.00	13.42	0.1237	1.183	16.52		
240.00	15.49	0.1248	1.179	16.68		
300.00	17.32	0.1259	1.175	16.82		
360.00	18.97	0.1265	1.173	16.91		
420.00	20.49	0.1271	1.171	16.99		
480.00	21.91	0.1277	1.169	17.06		
540.00	23.24	0.1282	1.167	17.12		
600.00	24.49	0.1284	1.166	17.15		
01-07-97	00:43:29	660.00	25.69	0.1287	1.165	17.20
		720.00	26.83	0.1291	1.164	17.25
		780.00	27.93	0.1293	1.163	17.28
		840.00	28.98	0.1297	1.162	17.32
		900.00	30.00	0.1299	1.161	17.35
		960.00	30.98	0.1301	1.160	17.39
		1020.00	31.94	0.1303	1.160	17.42
		1080.00	32.86	0.1306	1.159	17.45

LOAD INCREMENT DATA

TEST NAME C2-U2C
 TESTED BY: ACS

PAGE NO: 23
 JO: 05996.01

PRESSURE INCREMENT FROM 8.00 tsf to 2.00 tsf

DATE	TIME	ELAPSED TIME (min)	SQ RT OF TIME(min)	CHANGE IN HEIGHT(in)	VOID RATIO	STRAIN (%)
01-07-97	08:01:01	0.00	0.00	0.1306	1.159	17.45
		0.10	0.32	0.1264	1.173	16.89
		0.25	0.50	0.1262	1.174	16.86
		0.50	0.71	0.1262	1.174	16.86
		1.00	1.00	0.1261	1.174	16.85
		1.57	1.25	0.1261	1.174	16.85
		2.00	1.41	0.1260	1.175	16.83
		2.25	1.50	0.1260	1.175	16.83
		3.07	1.75	0.1260	1.175	16.83
		4.00	2.00	0.1260	1.175	16.83
		6.25	2.50	0.1260	1.175	16.83
		8.00	2.83	0.1259	1.175	16.82
		12.25	3.50	0.1259	1.175	16.82
		15.00	3.87	0.1259	1.175	16.82
		22.00	4.69	0.1257	1.176	16.80
		30.00	5.48	0.1257	1.176	16.80
		36.00	6.00	0.1257	1.176	16.80
		49.00	7.00	0.1257	1.176	16.80
		60.00	7.75	0.1257	1.176	16.80

LOAD INCREMENT DATA

TEST NAME C2-U2C
 TESTED BY: ACS

PAGE NO: 24
 JO: 05996.01

PRESSURE INCREMENT FROM 2.00 tsf to 0.50 tsf

DATE	TIME	ELAPSED TIME (min)	SQ RT OF TIME(min)	CHANGE IN HEIGHT(in)	VOID RATIO	STRAIN (%)
01-07-97	09:15:12	0.00	0.00	0.1256	1.176	16.79
		0.10	0.32	0.1213	1.191	16.20
		0.25	0.50	0.1208	1.193	16.14
		0.50	0.71	0.1206	1.194	16.11
		1.00	1.00	0.1203	1.195	16.08
		1.57	1.25	0.1201	1.195	16.05
		2.00	1.41	0.1201	1.195	16.05
		2.25	1.50	0.1200	1.196	16.03
		3.07	1.75	0.1200	1.196	16.03
		4.00	2.00	0.1199	1.196	16.02
		6.25	2.50	0.1198	1.197	16.00
		8.00	2.83	0.1196	1.197	15.99
		12.25	3.50	0.1195	1.197	15.97
		15.00	3.87	0.1195	1.197	15.97
		22.00	4.69	0.1194	1.198	15.95
		30.00	5.48	0.1193	1.198	15.94
		36.00	6.00	0.1193	1.198	15.94
		49.00	7.00	0.1192	1.199	15.92
		60.00	7.75	0.1192	1.199	15.92
		120.00	10.95	0.1189	1.199	15.89
		174.00	13.19	0.1188	1.200	15.88

LOAD INCREMENT DATA

TEST NAME C2-U2C

PAGE NO: 25

TESTED BY: ACS

JO: 05996.01

PRESSURE INCREMENT FROM 0.50 tsf to 0.10 tsf

DATE	TIME	ELAPSED TIME (min)	SQ RT OF TIME(min)	CHANGE IN HEIGHT(in)	VOID RATIO	STRAIN (%)
01-07-97	12:09:39	0.00	0.00	0.1188	1.200	15.88
		0.10	0.32	0.1156	1.211	15.45
		0.25	0.50	0.1147	1.214	15.32
		0.50	0.71	0.1141	1.216	15.25
		1.00	1.00	0.1135	1.218	15.17
		1.57	1.25	0.1133	1.219	15.14
		2.00	1.41	0.1131	1.220	15.11
		2.25	1.50	0.1130	1.220	15.09
		3.07	1.75	0.1128	1.221	15.08
		4.00	2.00	0.1126	1.222	15.05
		6.25	2.50	0.1124	1.222	15.02
		8.00	2.83	0.1123	1.223	15.00
		12.25	3.50	0.1120	1.224	14.97
		15.00	3.87	0.1117	1.225	14.92
		22.00	4.69	0.1115	1.226	14.89
		30.00	5.48	0.1113	1.226	14.88
		36.00	6.00	0.1112	1.226	14.86
		49.00	7.00	0.1111	1.227	14.85
		60.00	7.75	0.1110	1.227	14.83
		120.00	10.95	0.1107	1.228	14.79
		180.00	13.42	0.1104	1.229	14.75
		240.00	15.49	0.1103	1.230	14.74

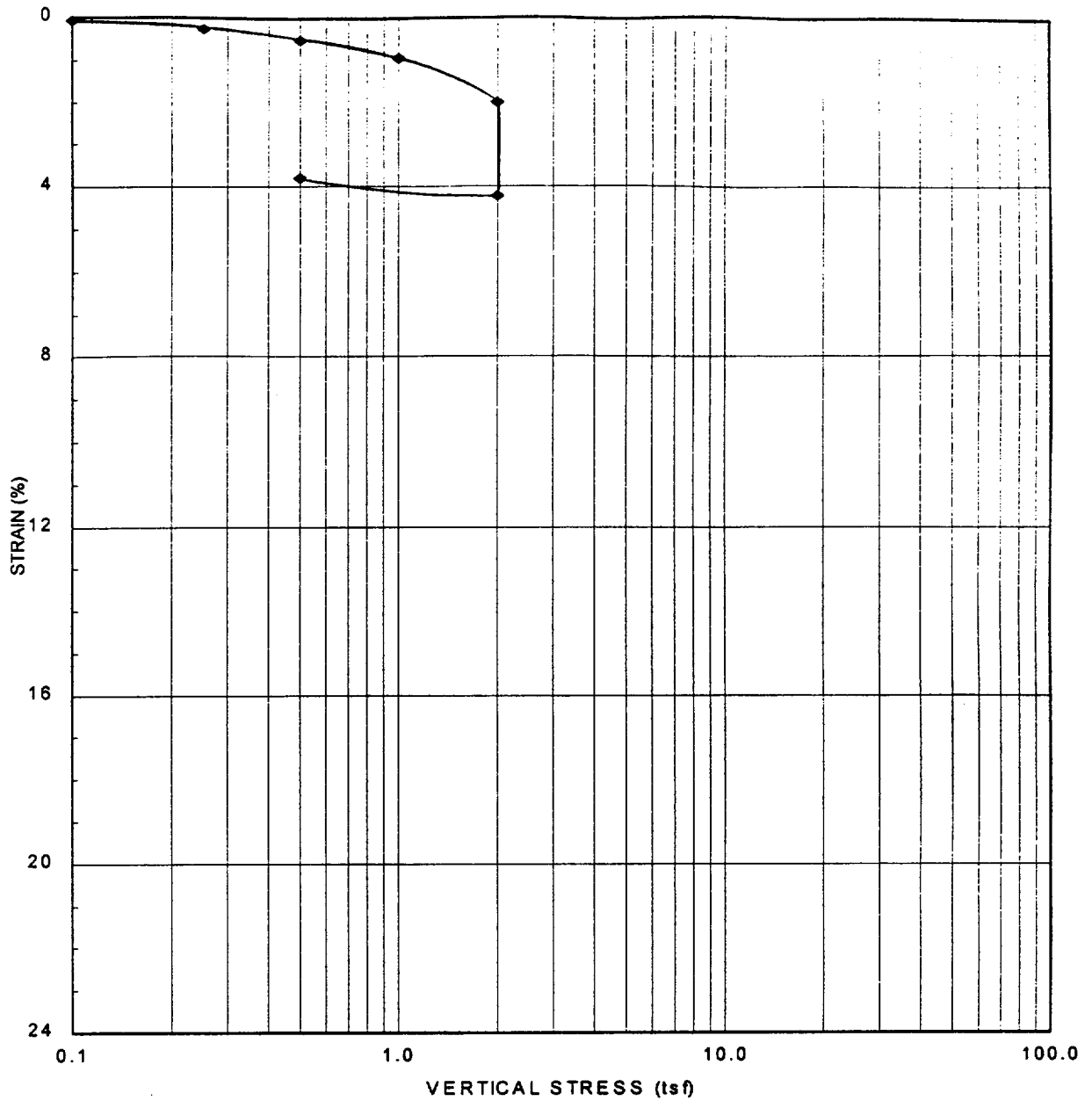

SAMPLE INFORMATION:

BORING: C-2
 SAMPLE: U-2E
 DEPTH: 11.7 ft
 DESCRIPTION: Clayey SILT

DATE: 12/10/96
 TESTED BY: ACS
 CHECKED: PJT

SPECIMEN INFORMATION:

	INITIAL	FINAL	
WATER CONTENT:	39.7 %	65.0 %	SPECIFIC GRAVITY: 2.72 (est)
DRY UNIT WEIGHT:	57.5 pcf	59.8 pcf	
VOID RATIO:	1.952	1.840	
SATURATION:	55.3 %	96.0 %	

NOTE: Sample was inundated when the applied pressure was 0.5 tsf.

PRIVATE FUEL STORAGE FACILITY
 SKULL VALLEY
 PRIVATE FUEL STORAGE, LLC



STONE & WEBSTER ENGINEERING CORP.
 BOSTON, MASSACHUSETTS

CONSOLIDATION TEST RESULTS
 BORING C-2, SAMPLE U-2E

JO 05996.01
 January 1997

PRESSURE INCREMENT
from 0.00 tsf to 0.10 tsf

Test No: 1
Testname: C2-U2E

SQUARE ROOT OF TIME in min.

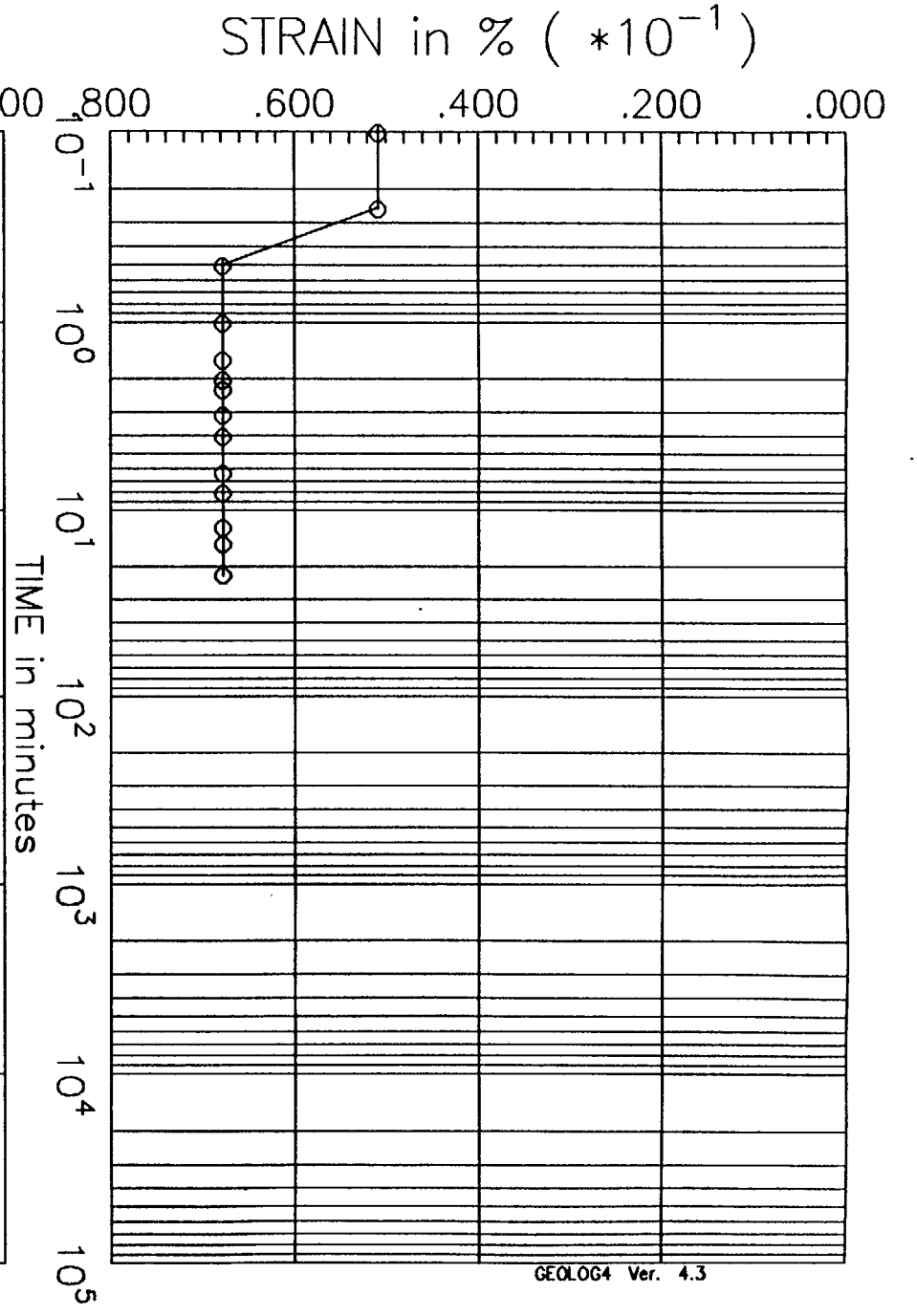
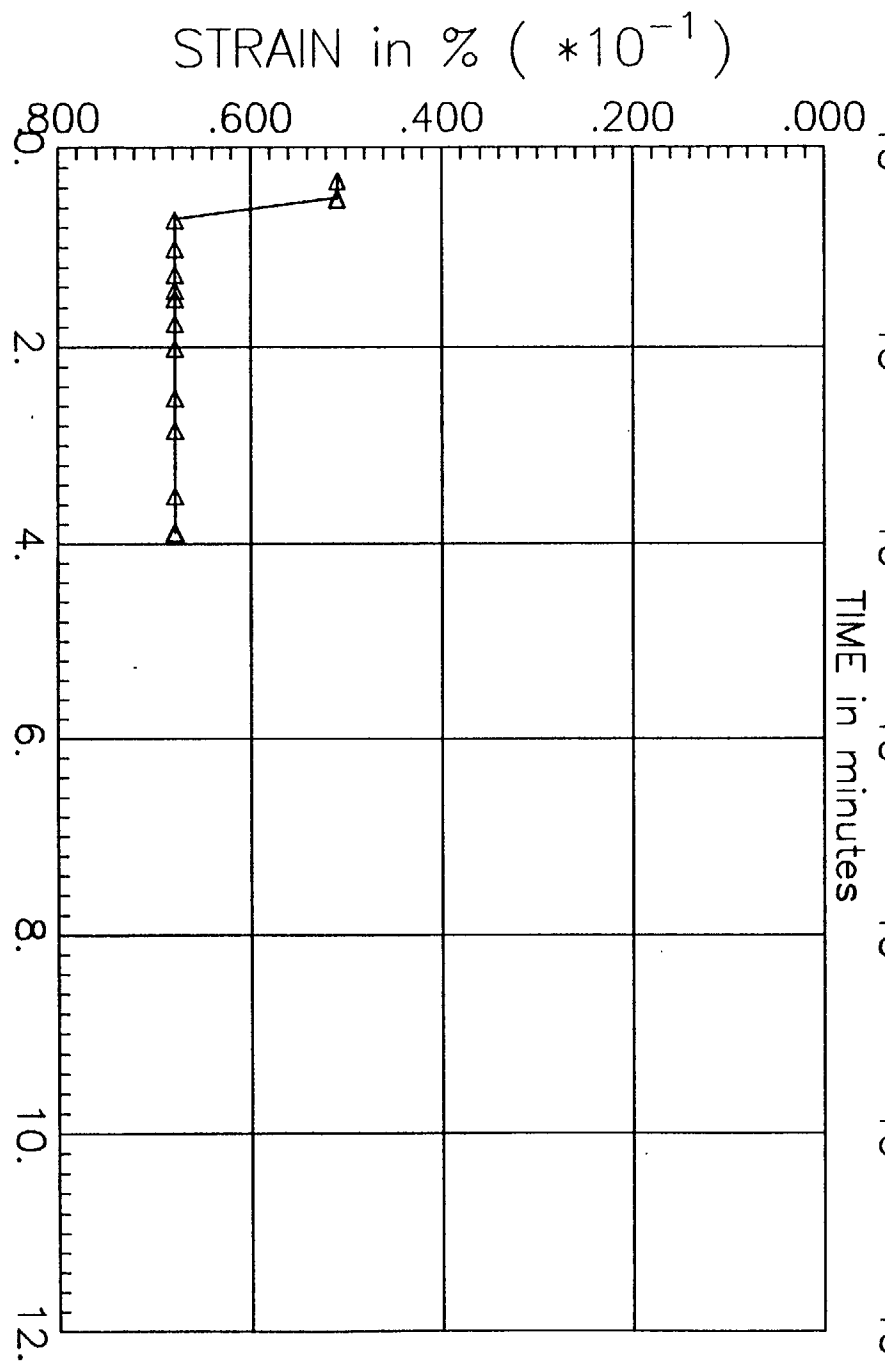

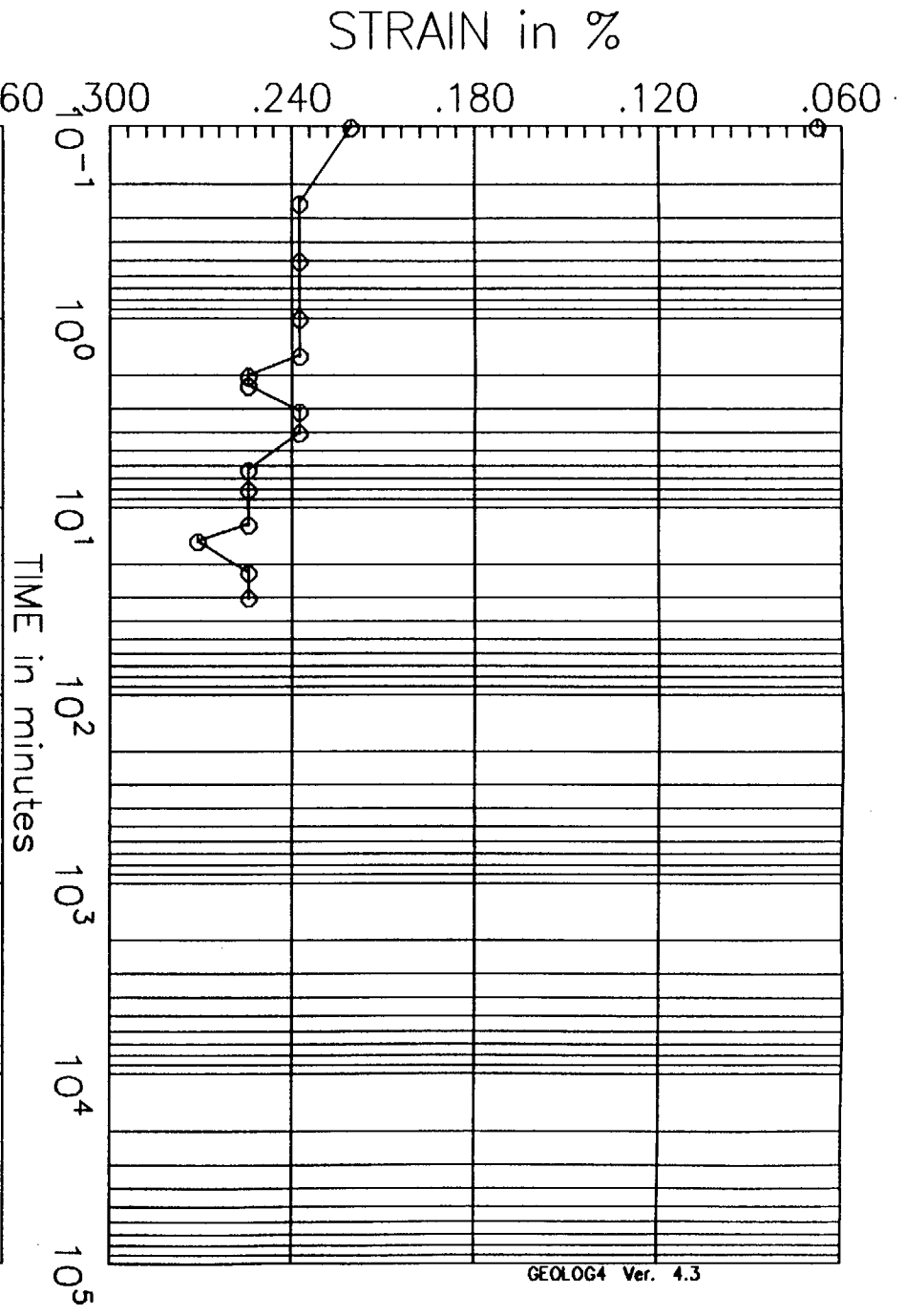
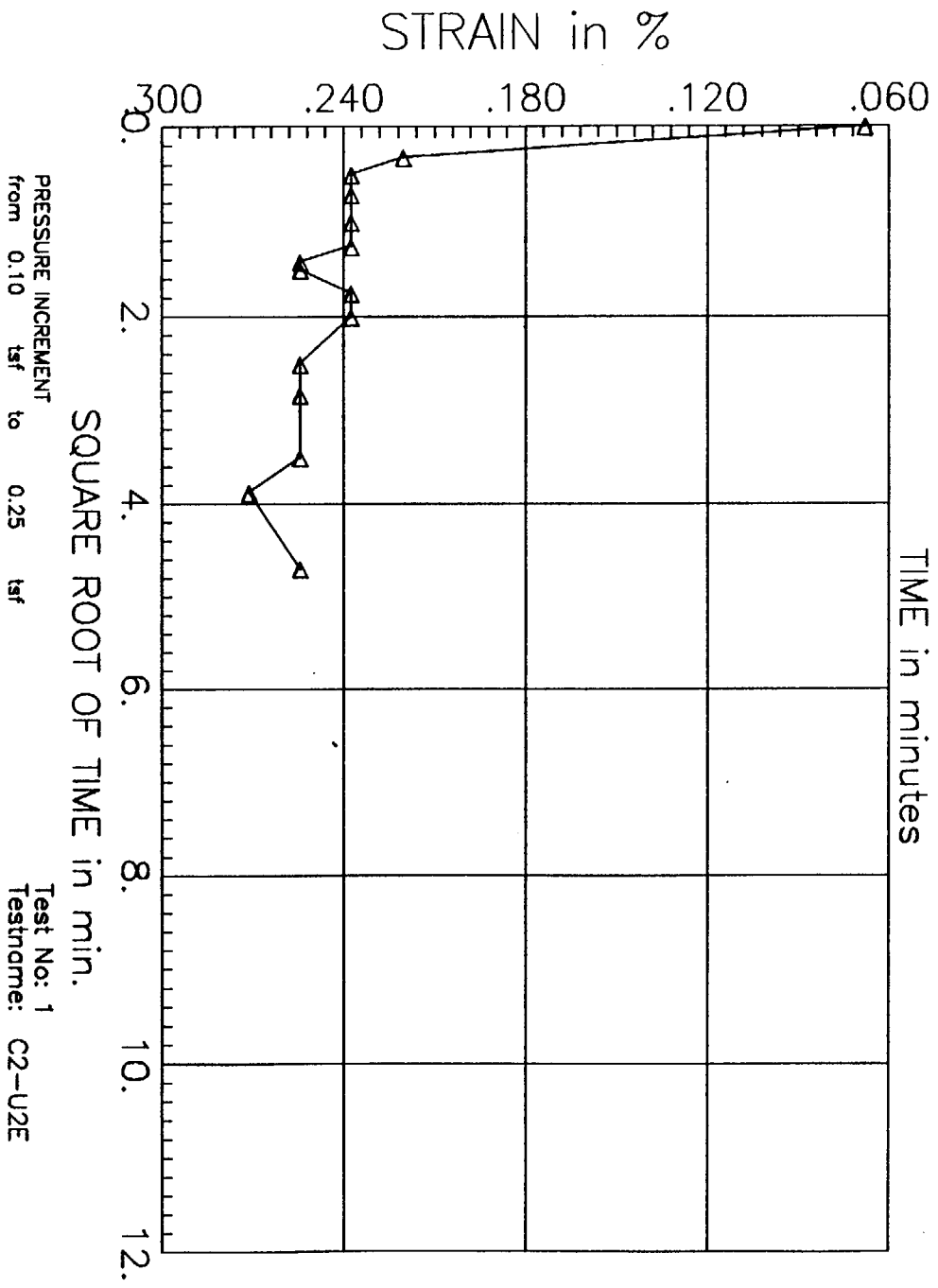

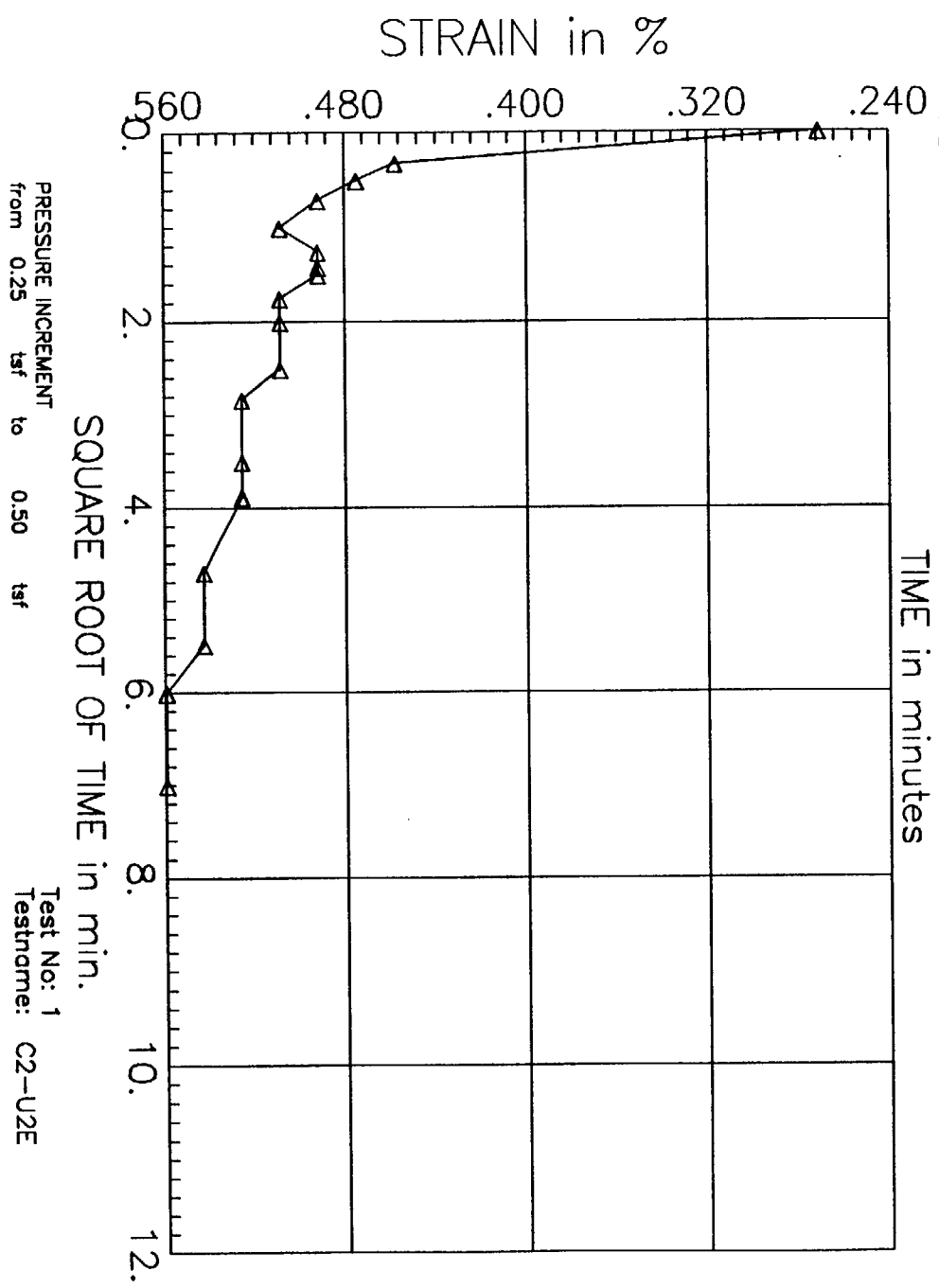

PRESSURE INCREMENT
from 0.25 tsf
to 0.50 tsf

Test No: 1
Testname: C2-U2E

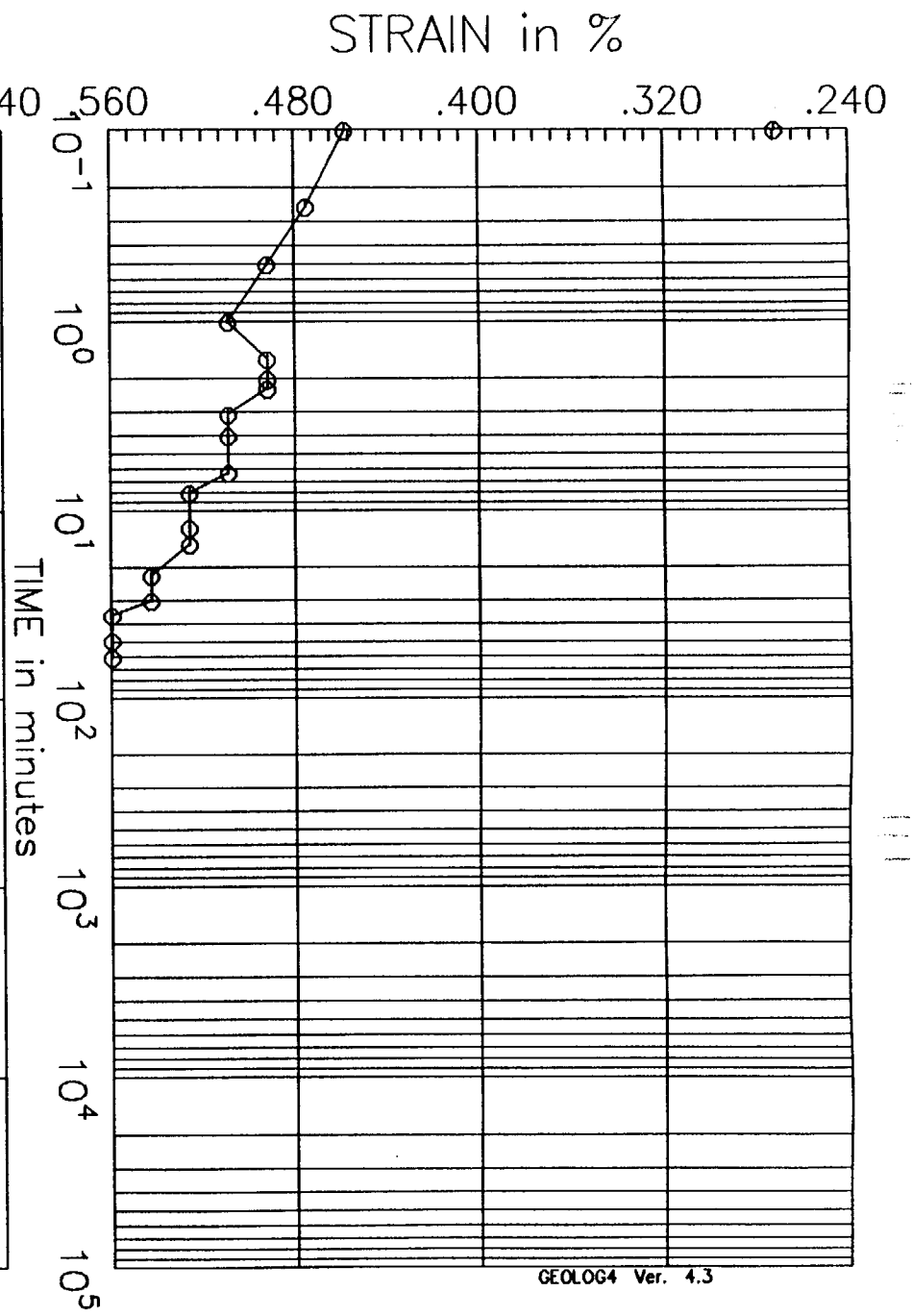

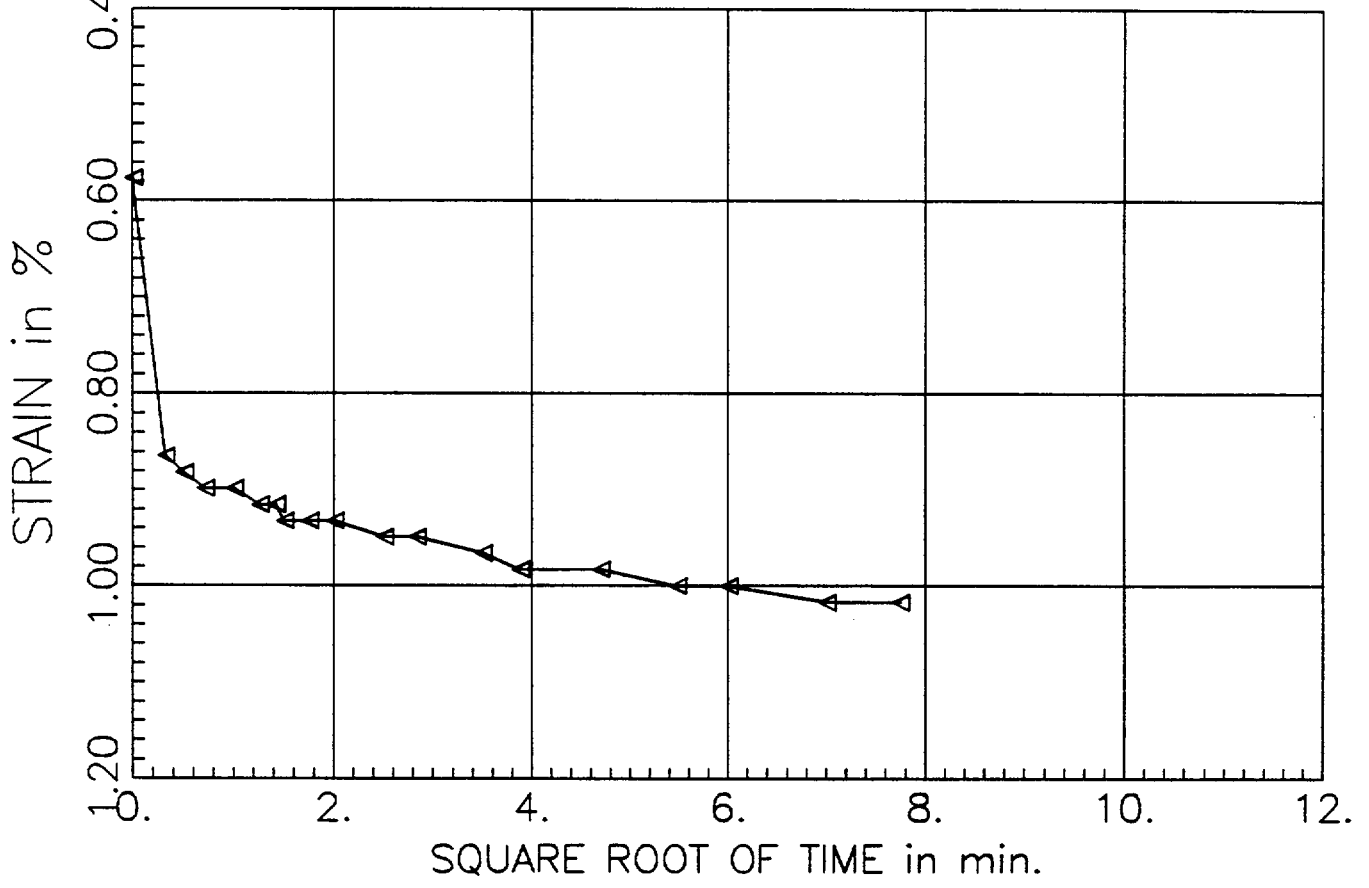
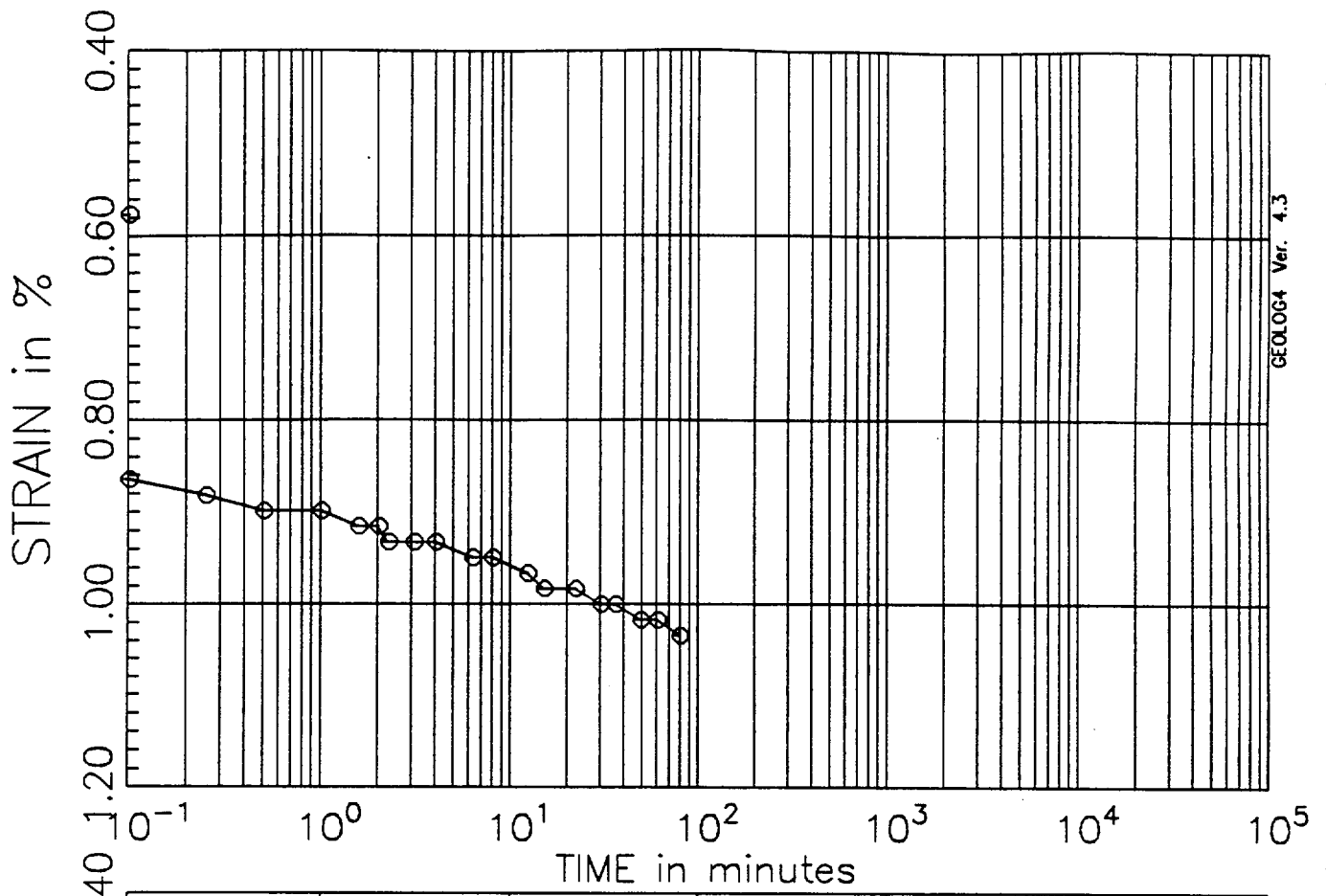

PRESSURE INCREMENT
from 0.50 tsf to 1.00 tsf

Test No: 1
Testname: C2-U2E

STRAIN in %

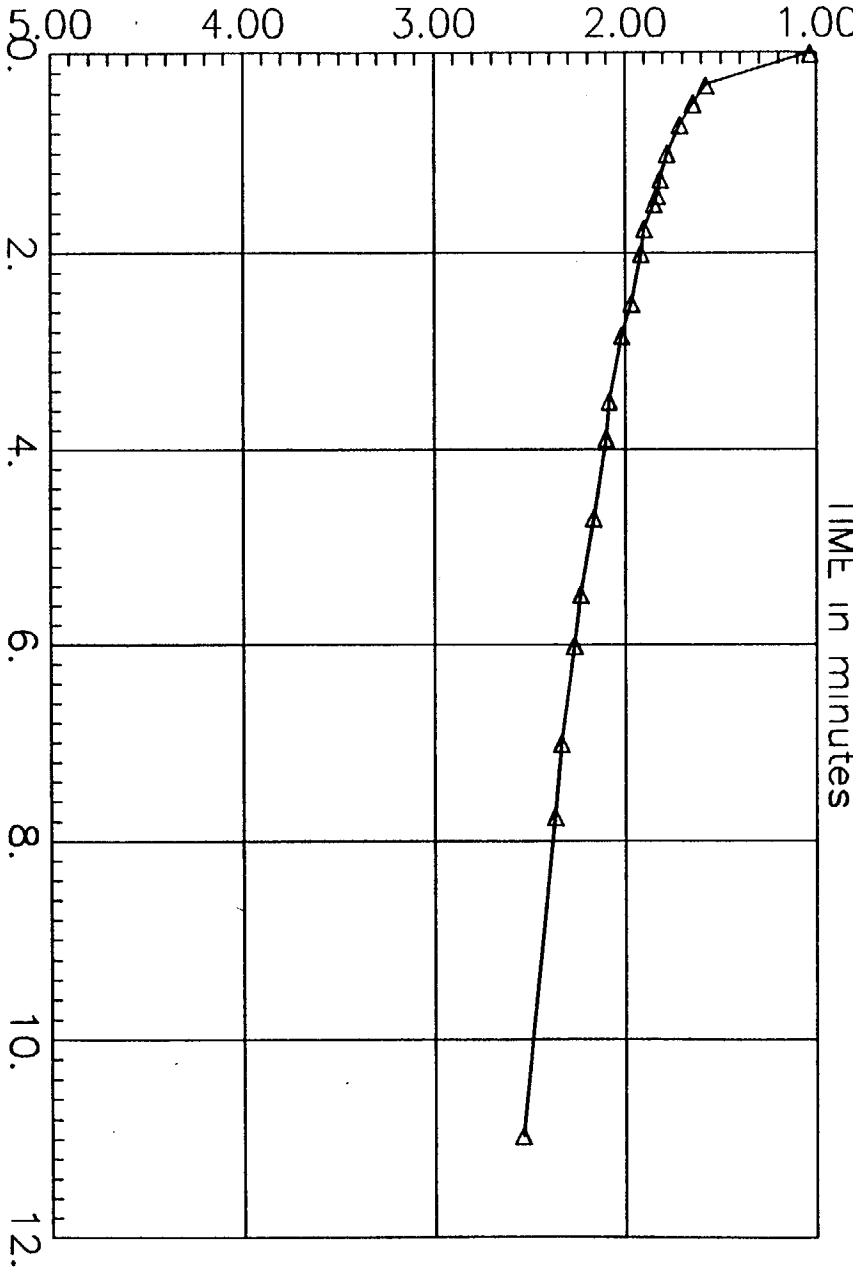

PRESSURE INCREMENT
from 1.00 tsf to 2.00 tsf

Test No: 1
Testname: C2-U2E

STRAIN in %

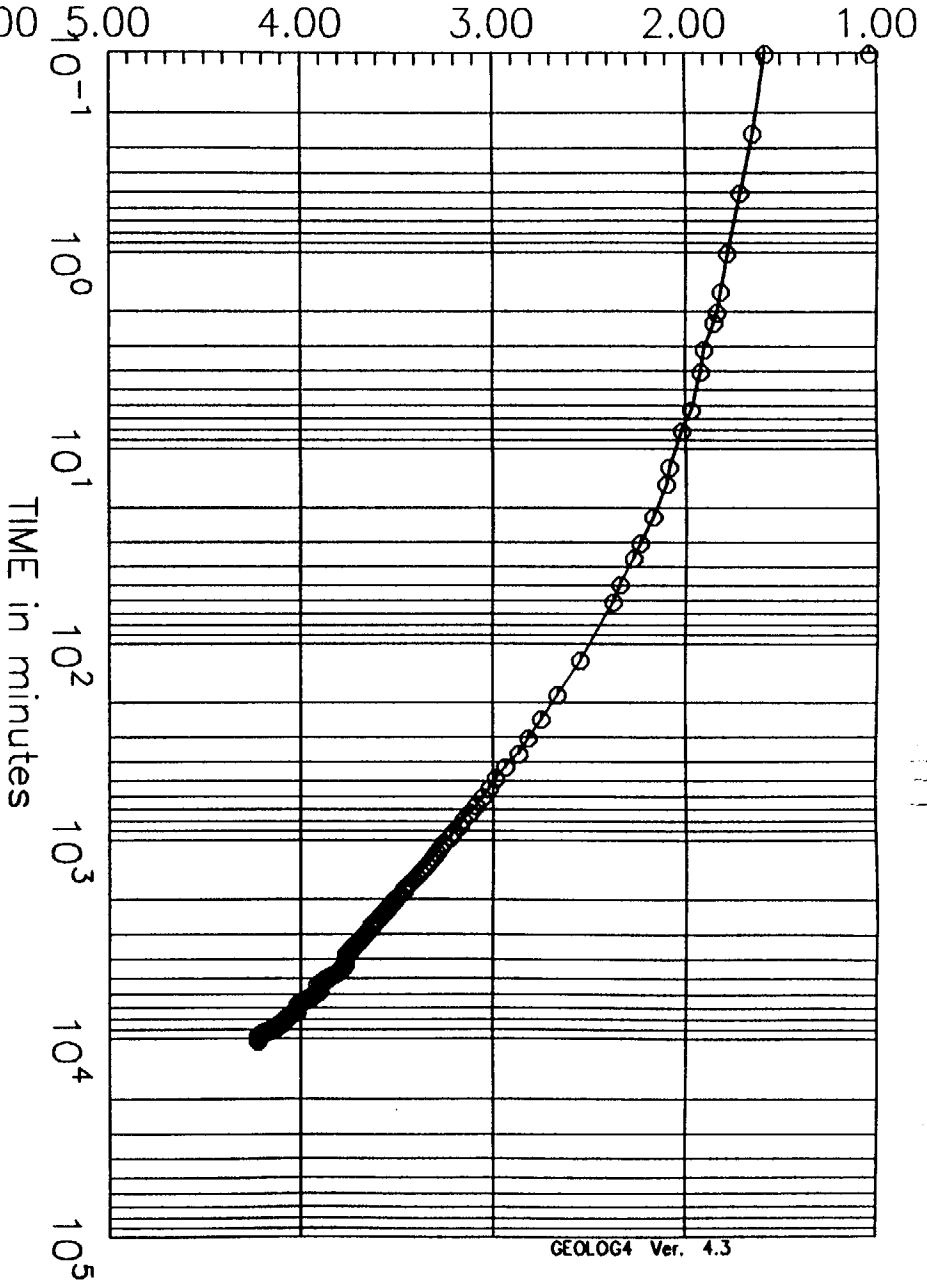

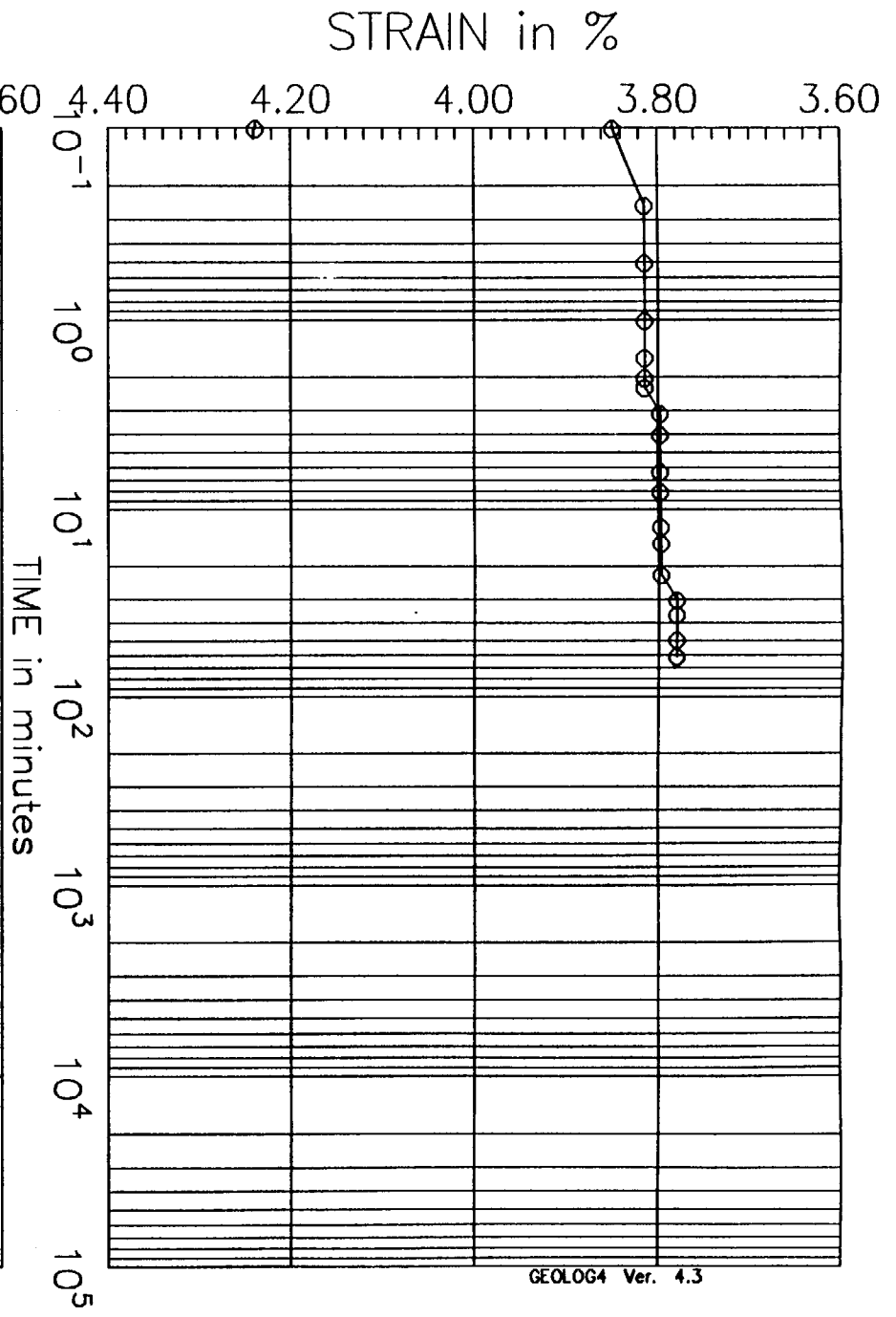
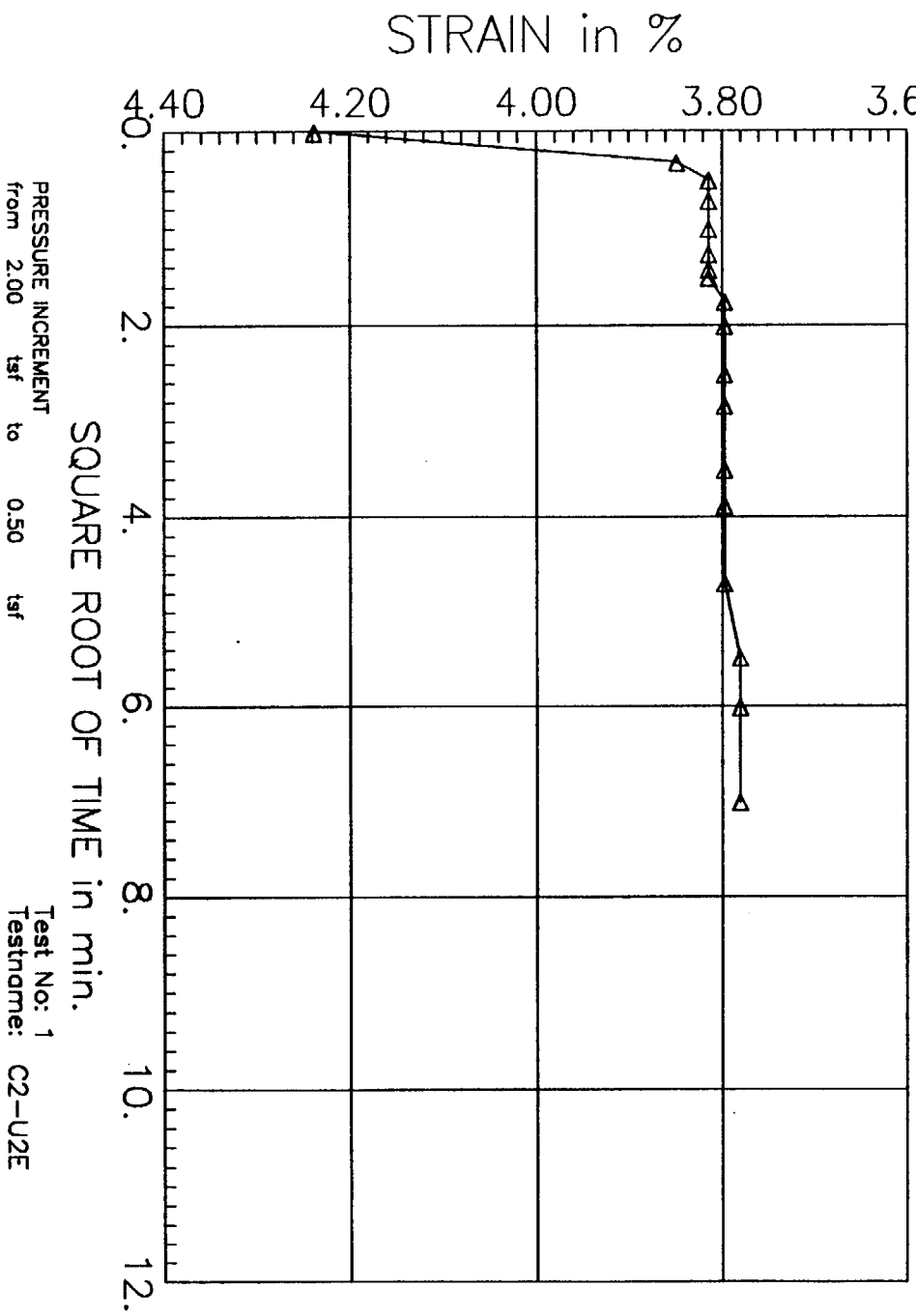

CONSOLIDATION TEST DATA

SAMPLE INFORMATION:

BORING:	C-2	DATE:	12/10/96
SAMPLE:	U-2E	TESTED BY:	ACS
DEPTH:	11.7 ft	CHECKED:	PJT
DESCRIPTION:	Clayey SILT		

SPECIMEN INFORMATION:

	INITIAL	FINAL
WATER CONTENT:	39.7 %	65.0 %
DRY UNIT WEIGHT:	57.5 pcf	59.8 pcf
VOID RATIO:	1.952	1.840
SATURATION:	55.3 %	96.0 %
HEIGHT:	1.901 cm	1.829 cm
AREA:	31.61 sq cm	
SP. GRAVITY :	2.72 (est)	

TEST DATA:

APPLIED PRESSURE	STRAIN
tsf	%
0.10	0.07
0.25	0.25
0.50	0.53
1.00	0.95
2.00	2.02
2.00	4.22
0.50	3.80

LOAD INCREMENT DATA

TEST NAME: C2-U2E
 TESTED BY: ACS

PAGE NO: 1
 JO: 05996.01

PRESSURE INCREMENT FROM 0.00 tsf to 0.10 tsf

DATE	TIME	ELAPSED TIME (min)	SQ RT OF TIME(min)	CHANGE IN HEIGHT(in)	VOID RATIO	STRAIN (%)
12-13-96	09:17:19	0.10	0.32	0.0004	1.950	0.05
		0.25	0.50	0.0004	1.950	0.05
		0.50	0.71	0.0005	1.950	0.07
		1.00	1.00	0.0005	1.950	0.07
		1.57	1.25	0.0005	1.950	0.07
		2.00	1.41	0.0005	1.950	0.07
		2.25	1.50	0.0005	1.950	0.07
		3.07	1.75	0.0005	1.950	0.07
		4.00	2.00	0.0005	1.950	0.07
		6.25	2.50	0.0005	1.950	0.07
		8.00	2.83	0.0005	1.950	0.07
		12.25	3.50	0.0005	1.950	0.07
		15.00	3.87	0.0005	1.950	0.07
		22.00	4.69	0.0005	1.950	0.07

LOAD INCREMENT DATA

TEST NAME C2-U2E
 TESTED BY: ACS

PAGE NO: 2
 JO: 05996.01

PRESSURE INCREMENT FROM 0.10 tsf to 0.25 tsf

DATE	TIME	ELAPSED TIME (min)	SQ RT OF TIME(min)	CHANGE IN HEIGHT(in)	VOID RATIO	STRAIN (%)
12-13-96	09:43:58	0.00	0.00	0.0005	1.950	0.07
		0.10	0.32	0.0016	1.945	0.22
		0.25	0.50	0.0018	1.945	0.24
		0.50	0.71	0.0018	1.945	0.24
		1.00	1.00	0.0018	1.945	0.24
		1.57	1.25	0.0018	1.945	0.24
		2.00	1.41	0.0019	1.944	0.25
		2.25	1.50	0.0019	1.944	0.25
		3.07	1.75	0.0018	1.945	0.24
		4.00	2.00	0.0018	1.945	0.24
		6.25	2.50	0.0019	1.944	0.25
		8.00	2.83	0.0019	1.944	0.25
		12.25	3.50	0.0019	1.944	0.25
		15.00	3.87	0.0020	1.944	0.27
		22.00	4.69	0.0019	1.944	0.25
		30.00	5.48	0.0019	1.944	0.25

LOAD INCREMENT DATA

TEST NAME C2-U2E
 TESTED BY: ACS

PAGE NO: 3
 JO: 05996.01

PRESSURE INCREMENT FROM 0.25 tsf to 0.50 tsf

DATE	TIME	ELAPSED TIME (min)	SQ RT OF TIME(min)	CHANGE IN HEIGHT(in)	VOID RATIO	STRAIN (%)
12-13-96	10:19:46	0.00	0.00	0.0020	1.944	0.27
		0.10	0.32	0.0034	1.938	0.46
		0.25	0.50	0.0036	1.938	0.47
		0.50	0.71	0.0037	1.937	0.49
		1.00	1.00	0.0038	1.937	0.51
		1.57	1.25	0.0037	1.937	0.49
		2.00	1.41	0.0037	1.937	0.49
		2.25	1.50	0.0037	1.937	0.49
		3.07	1.75	0.0038	1.937	0.51
		4.00	2.00	0.0038	1.937	0.51
		6.25	2.50	0.0038	1.937	0.51
		8.00	2.83	0.0039	1.936	0.53
		12.25	3.50	0.0039	1.936	0.53
		15.00	3.87	0.0039	1.936	0.53
		22.00	4.69	0.0041	1.936	0.54
		30.00	5.48	0.0041	1.936	0.54
		36.00	6.00	0.0042	1.935	0.56
		49.00	7.00	0.0042	1.935	0.56
		60.00	7.75	0.0042	1.935	0.56

LOAD INCREMENT DATA

TEST NAME C2-U2E
 TESTED BY: ACS

PAGE NO: 4
 JO: 05996.01

PRESSURE INCREMENT FROM 0.50 tsf to 1.00 tsf

DATE	TIME	ELAPSED TIME (min)	SQ RT OF TIME(min)	CHANGE IN HEIGHT(in)	VOID RATIO	STRAIN (%)
12-13-96	11:23:52	0.00	0.00	0.0043	1.935	0.58
		0.10	0.32	0.0065	1.926	0.86
		0.25	0.50	0.0066	1.926	0.88
		0.50	0.71	0.0067	1.925	0.90
		1.00	1.00	0.0067	1.925	0.90
		1.57	1.25	0.0069	1.925	0.92
		2.00	1.41	0.0069	1.925	0.92
		2.25	1.50	0.0070	1.924	0.93
		3.07	1.75	0.0070	1.924	0.93
		4.00	2.00	0.0070	1.924	0.93
		6.25	2.50	0.0071	1.924	0.95
		8.00	2.83	0.0071	1.924	0.95
		12.25	3.50	0.0072	1.923	0.97
		15.00	3.87	0.0074	1.923	0.98
		22.00	4.69	0.0074	1.923	0.98
		30.00	5.48	0.0075	1.922	1.00
		36.00	6.00	0.0075	1.922	1.00
		49.00	7.00	0.0076	1.922	1.02
		60.00	7.75	0.0076	1.922	1.02
		79.52	8.92	0.0077	1.921	1.03

LOAD INCREMENT DATA

TEST NAME C2-U2E
 TESTED BY: ACS

PAGE NO: 5
 JO: 05996.01

PRESSURE INCREMENT FROM 1.00 tsf to 2.00 tsf

DATE	TIME	ELAPSED TIME (min)	SQ RT OF TIME(min)	CHANGE IN HEIGHT(in)	VOID RATIO	STRAIN (%)
12-13-96	12:43:24	0.00	0.00	0.0077	1.921	1.03
		0.10	0.32	0.0118	1.905	1.58
		0.25	0.50	0.0123	1.903	1.64
		0.50	0.71	0.0128	1.901	1.71
		1.00	1.00	0.0133	1.899	1.78
		1.57	1.25	0.0136	1.898	1.81
		2.00	1.41	0.0137	1.898	1.83
		2.25	1.50	0.0138	1.897	1.85
		3.07	1.75	0.0142	1.896	1.90
		4.00	2.00	0.0143	1.895	1.92
		6.25	2.50	0.0147	1.894	1.97
		8.00	2.83	0.0151	1.892	2.02
		12.25	3.50	0.0156	1.890	2.09
		15.00	3.87	0.0157	1.890	2.10
		22.00	4.69	0.0162	1.888	2.17
		30.00	5.48	0.0167	1.886	2.24
		36.00	6.00	0.0170	1.885	2.27
		49.00	7.00	0.0175	1.883	2.34
		60.00	7.75	0.0178	1.882	2.37
		120.00	10.95	0.0190	1.877	2.54
		180.00	13.42	0.0199	1.873	2.66
		240.00	15.49	0.0206	1.871	2.75
		300.00	17.32	0.0211	1.869	2.81
		360.00	18.97	0.0214	1.867	2.86
420.00	20.49	0.0219	1.865	2.93		
480.00	21.91	0.0223	1.864	2.98		
540.00	23.24	0.0226	1.863	3.02		
600.00	24.49	0.0228	1.862	3.05		
660.00	25.69	0.0231	1.861	3.09		
12-14-96	00:43:24	720.00	26.83	0.0233	1.860	3.12
		780.00	27.93	0.0236	1.859	3.15
		840.00	28.98	0.0237	1.858	3.17
		900.00	30.00	0.0240	1.857	3.20
		960.00	30.98	0.0241	1.857	3.22
		1020.00	31.94	0.0244	1.856	3.25
		1080.00	32.86	0.0245	1.855	3.27

LOAD INCREMENT DATA

TEST NAME C2-U2E
 TESTED BY: ACS

PAGE NO: 6
 JO: 05996.01

PRESSURE INCREMENT FROM 1.00 tsf to 2.00 tsf

DATE	TIME	ELAPSED TIME (min)	SQ RT OF TIME(min)	CHANGE IN HEIGHT(in)	VOID RATIO	STRAIN (%)
		1140.00	33.76	0.0246	1.855	3.29
		1200.00	34.64	0.0247	1.854	3.31
		1260.00	35.50	0.0249	1.854	3.32
		1320.00	36.33	0.0250	1.853	3.34
		1380.00	37.15	0.0251	1.853	3.36
		1440.00	37.95	0.0252	1.852	3.37
		1500.00	38.73	0.0254	1.852	3.39
		1560.00	39.50	0.0255	1.851	3.41
		1620.00	40.25	0.0256	1.851	3.42
		1680.00	40.99	0.0258	1.850	3.44
		1740.00	41.71	0.0259	1.850	3.46
		1800.00	42.43	0.0259	1.850	3.46
		1860.00	43.13	0.0260	1.849	3.48
		1920.00	43.82	0.0261	1.849	3.49
		1980.00	44.50	0.0263	1.848	3.51
		2040.00	45.17	0.0263	1.848	3.51
		2100.00	45.83	0.0264	1.848	3.53
12-15-96	00:43:24	2160.00	46.48	0.0265	1.847	3.54
		2220.00	47.12	0.0265	1.847	3.54
		2280.00	47.75	0.0266	1.847	3.56
		2340.00	48.37	0.0268	1.846	3.58
		2400.00	48.99	0.0268	1.846	3.58
		2460.00	49.60	0.0269	1.846	3.59
		2520.00	50.20	0.0269	1.846	3.59
		2580.00	50.79	0.0270	1.845	3.61
		2640.00	51.38	0.0272	1.845	3.63
		2700.00	51.96	0.0272	1.845	3.63
		2760.00	52.54	0.0272	1.845	3.63
		2820.00	53.10	0.0273	1.844	3.64
		2880.00	53.67	0.0273	1.844	3.64
		2940.00	54.22	0.0274	1.844	3.66
		3000.00	54.77	0.0274	1.844	3.66
		3060.00	55.32	0.0275	1.843	3.68
		3120.00	55.86	0.0275	1.843	3.68

LOAD INCREMENT DATA

TEST NAME C2-U2E
 TESTED BY: ACS

PAGE NO: 7
 JO: 05996.01

PRESSURE INCREMENT FROM 1.00 tsf to 2.00 tsf

DATE	TIME	ELAPSED TIME (min)	SQ RT OF TIME(min)	CHANGE IN HEIGHT(in)	VOID RATIO	STRAIN (%)
		3180.00	56.39	0.0277	1.843	3.70
		3240.00	56.92	0.0277	1.843	3.70
		3300.00	57.45	0.0278	1.842	3.71
		3360.00	57.97	0.0278	1.842	3.71
		3420.00	58.48	0.0279	1.842	3.73
		3480.00	58.99	0.0279	1.842	3.73
		3540.00	59.50	0.0279	1.842	3.73
12-16-96	00:43:24	3600.00	60.00	0.0280	1.841	3.75
		3660.00	60.50	0.0280	1.841	3.75
		3720.00	60.99	0.0282	1.841	3.76
		3780.00	61.48	0.0282	1.841	3.76
		3840.00	61.97	0.0282	1.841	3.76
		3900.00	62.45	0.0282	1.841	3.76
		3960.00	62.93	0.0282	1.841	3.76
		4020.00	63.40	0.0282	1.841	3.76
		4080.00	63.87	0.0282	1.841	3.76
		4140.00	64.34	0.0282	1.841	3.76
		4200.00	64.81	0.0282	1.841	3.76
		4260.00	65.27	0.0283	1.840	3.78
		4320.00	65.73	0.0283	1.840	3.78
		4380.00	66.18	0.0283	1.840	3.78
		4440.00	66.63	0.0283	1.840	3.78
		4500.00	67.08	0.0284	1.840	3.80
		4560.00	67.53	0.0284	1.840	3.80
		4620.00	67.97	0.0285	1.839	3.81
		4680.00	68.41	0.0285	1.839	3.81
		4740.00	68.85	0.0287	1.839	3.83
		4800.00	69.28	0.0288	1.838	3.85
		4860.00	69.71	0.0288	1.838	3.85
		4920.00	70.14	0.0289	1.838	3.87
		4980.00	70.57	0.0289	1.838	3.87
12-17-96	00:43:24	5040.00	70.99	0.0291	1.837	3.88
		5100.00	71.41	0.0291	1.837	3.88
		5160.00	71.83	0.0292	1.837	3.90

LOAD INCREMENT DATA

TEST NAME C2-U2E
 TESTED BY: ACS

PAGE NO: 8
 JO: 05996.01

PRESSURE INCREMENT FROM 1.00 tsf to 2.00 tsf

DATE	TIME	ELAPSED TIME (min)	SQ RT OF TIME(min)	CHANGE IN HEIGHT(in)	VOID RATIO	STRAIN (%)
		5220.00	72.25	0.0292	1.837	3.90
		5280.00	72.66	0.0292	1.837	3.90
		5340.00	73.08	0.0293	1.836	3.92
		5400.00	73.48	0.0292	1.837	3.90
		5460.00	73.89	0.0292	1.837	3.90
		5520.00	74.30	0.0292	1.837	3.90
		5580.00	74.70	0.0292	1.837	3.90
		5640.00	75.10	0.0292	1.837	3.90
		5700.00	75.50	0.0292	1.837	3.90
		5760.00	75.89	0.0293	1.836	3.92
		5820.00	76.29	0.0293	1.836	3.92
		5880.00	76.68	0.0293	1.836	3.92
		5940.00	77.07	0.0294	1.836	3.93
		6000.00	77.46	0.0294	1.836	3.93
		6060.00	77.85	0.0294	1.836	3.93
		6120.00	78.23	0.0296	1.835	3.95
		6180.00	78.61	0.0296	1.835	3.95
		6240.00	78.99	0.0297	1.835	3.97
		6300.00	79.37	0.0297	1.835	3.97
		6360.00	79.75	0.0298	1.834	3.98
		6420.00	80.12	0.0298	1.834	3.98
12-18-96	00:43:24	6480.00	80.50	0.0299	1.834	4.00
		6540.00	80.87	0.0299	1.834	4.00
		6600.00	81.24	0.0299	1.834	4.00
		6660.00	81.61	0.0301	1.833	4.02
		6720.00	81.98	0.0301	1.833	4.02
		6780.00	82.34	0.0301	1.833	4.02
		6840.00	82.70	0.0301	1.833	4.02
		6900.00	83.07	0.0301	1.833	4.02
		6960.00	83.43	0.0301	1.833	4.02
		7020.00	83.79	0.0301	1.833	4.02
		7080.00	84.14	0.0301	1.833	4.02
		7140.00	84.50	0.0301	1.833	4.02
		7200.00	84.85	0.0301	1.833	4.02

LOAD INCREMENT DATA

TEST NAME C2-U2E
 TESTED BY: ACS

PAGE NO: 9
 JO: 05996.01

PRESSURE INCREMENT FROM 1.00 tsf to 2.00 tsf

DATE	TIME	ELAPSED TIME (min)	SQ RT OF TIME(min)	CHANGE IN HEIGHT(in)	VOID RATIO	STRAIN (%)
		7260.00	85.21	0.0301	1.833	4.02
		7320.00	85.56	0.0302	1.833	4.03
		7380.00	85.91	0.0302	1.833	4.03
		7440.00	86.26	0.0303	1.832	4.05
		7500.00	86.60	0.0303	1.832	4.05
		7560.00	86.95	0.0303	1.832	4.05
		7620.00	87.29	0.0303	1.832	4.05
		7680.00	87.64	0.0305	1.832	4.07
		7740.00	87.98	0.0305	1.832	4.07
		7800.00	88.32	0.0305	1.832	4.07
		7860.00	88.66	0.0305	1.832	4.07
12-19-96	00:43:24	7920.00	88.99	0.0306	1.831	4.09
		7980.00	89.33	0.0306	1.831	4.09
		8040.00	89.67	0.0306	1.831	4.09
		8100.00	90.00	0.0306	1.831	4.09
		8160.00	90.33	0.0306	1.831	4.09
		8220.00	90.66	0.0307	1.831	4.10
		8280.00	90.99	0.0307	1.831	4.10
		8340.00	91.32	0.0307	1.831	4.10
		8400.00	91.65	0.0308	1.830	4.12
		8460.00	91.98	0.0308	1.830	4.12
		8520.00	92.30	0.0308	1.830	4.12
		8580.00	92.63	0.0310	1.830	4.14
		8640.00	92.95	0.0308	1.830	4.12
		8700.00	93.27	0.0310	1.830	4.14
		8760.00	93.59	0.0310	1.830	4.14
		8820.00	93.91	0.0311	1.829	4.15
		8880.00	94.23	0.0311	1.829	4.15
		8940.00	94.55	0.0311	1.829	4.15
		9000.00	94.87	0.0311	1.829	4.15
		9060.00	95.18	0.0312	1.829	4.17
		9120.00	95.50	0.0313	1.828	4.19
		9180.00	95.81	0.0313	1.828	4.19
		9240.00	96.12	0.0313	1.828	4.19

LOAD INCREMENT DATA

TEST NAME C2-U2E
 TESTED BY: ACS

PAGE NO: 10
 JO: 05996.01

PRESSURE INCREMENT FROM 1.00 tsf to 2.00 tsf

DATE	TIME	ELAPSED TIME (min)	SQ RT OF TIME(min)	CHANGE IN HEIGHT(in)	VOID RATIO	STRAIN (%)
		9300.00	96.44	0.0315	1.828	4.20
12-20-96	00:43:24	9360.00	96.75	0.0315	1.828	4.20
		9420.00	97.06	0.0315	1.828	4.20
		9480.00	97.37	0.0315	1.828	4.20
		9540.00	97.67	0.0316	1.827	4.22
		9600.00	97.98	0.0316	1.827	4.22
		9660.00	98.29	0.0316	1.827	4.22
		9720.00	98.59	0.0316	1.827	4.22
		9780.00	98.89	0.0316	1.827	4.22
		9840.00	99.20	0.0316	1.827	4.22
		9900.00	99.50	0.0316	1.827	4.22
		9960.00	99.80	0.0316	1.827	4.22
		1002.00E+01	100.10	0.0316	1.827	4.22
		1008.00E+01	100.40	0.0316	1.827	4.22
		1014.00E+01	100.70	0.0316	1.827	4.22

LOAD INCREMENT DATA

TEST NAME C2-U2E
 TESTED BY: ACS

PAGE NO: 11
 JO: 05996.01

PRESSURE INCREMENT FROM 2.00 tsf to 0.50 tsf

DATE	TIME	ELAPSED TIME (min)	SQ RT OF TIME(min)	CHANGE IN HEIGHT(in)	VOID RATIO	STRAIN (%)
12-20-96	13:55:53	0.00	0.00	0.0317	1.827	4.24
		0.10	0.32	0.0288	1.838	3.85
		0.25	0.50	0.0285	1.839	3.81
		0.50	0.71	0.0285	1.839	3.81
		1.00	1.00	0.0285	1.839	3.81
		1.57	1.25	0.0285	1.839	3.81
		2.00	1.41	0.0285	1.839	3.81
		2.25	1.50	0.0285	1.839	3.81
		3.07	1.75	0.0284	1.840	3.80
		4.00	2.00	0.0284	1.840	3.80
		6.25	2.50	0.0284	1.840	3.80
		8.00	2.83	0.0284	1.840	3.80
		12.25	3.50	0.0284	1.840	3.80
		15.00	3.87	0.0284	1.840	3.80
		22.00	4.69	0.0284	1.840	3.80
		30.00	5.48	0.0283	1.840	3.78
		36.00	6.00	0.0283	1.840	3.78
		49.00	7.00	0.0283	1.840	3.78
		60.00	7.75	0.0283	1.840	3.78

APPENDIX 2B

SEISMIC SURVEY OF THE PRIVATE FUEL STORAGE FACILITY

SEISMIC SURVEY
OF THE
PRIVATE FUEL STORAGE FACILITY
Skull Valley, Utah

for
Stone & Webster Engineering Corporation

February 1997

GEOSPHERE MIDWEST
Midland, Michigan

SWEC #0599601-009
GSM #96-538

SEISMIC SURVEY
OF THE
PRIVATE FUEL STORAGE FACILITY
Skull Valley, Utah

Prepared for
Stone & Webster Engineering Corporation

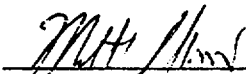
Prepared by	<u></u> Robert A. Glaccum	Date	<u>2/28/97</u>
Reviewed by	<u></u> Matthew B. Glaccum	Date	<u>2/28/97</u>
Independent Review by	<u>(Geomatrix, Inc.)</u> (see separate letter)	Date	<u> </u>

QA Category I / III

GEOSPHERE MIDWEST
Midland, Michigan

100 Pine Street, 10th Floor
San Francisco, CA 94111
(415) 434-9400 • FAX (415) 434-1365



March 12, 1997
Project 3801

Mr. John Donnell
Stone & Webster Engineering Corporation
7677 E. Berry Avenue
Engelwood, CO 80111-2137

Subject: Confirmation of Satisfactory Revision of
"Seismic Survey of the Private Fuel Storage Facility, Skull Valley, Utah"
by Geosphere Midwest, February, 1997, Final Report #96-538 SWEC#0599601-009

Dear John:

We have reviewed the subject Final Report by Geosphere Midwest relative to the comments and questions that we raised in our review of their Draft Report (see our review dated February 20). This letter verifies that the Final Report satisfactorily addresses our comments and questions.

If you have any questions, please feel free to give me a call.

Sincerely,

A handwritten signature in black ink, appearing to read "K. Coppersmith", with a long horizontal line extending to the right.

Kevin J. Coppersmith
Project Manager

L:\PA\3801\RV-CNFRM.DOC

KJC\nji

cc: William Lettis
William Lettis & Associates
777 Botelho Drive, Suite 262
Walnut Creek, CA 94596

TABLE OF CONTENTS

List of Figures iii

1 INTRODUCTION 1

 1.1 LOCATION AND DESCRIPTION 1

 1.2 PURPOSE 1

2 GEOPHYSICAL METHODS 4

 2.1 GENERAL DESCRIPTION 4

 2.2 SEISMIC TECHNIQUES 4

 2.2.1 EQUIPMENT 5

 2.3 QUALITY CONTROL 6

3 DATA ACQUISITION 7

 3.1 SURVEY LINES AND COVERAGE 7

 3.1.1 LINE LAYOUT AND PROFILE POSITIONS 7

 3.2 SEISMIC REFRACTION SURVEY 7

 3.2.1 DATA ACQUISITION 7

 3.3 SEISMIC REFLECTION SURVEY 8

 3.3.1 DATA ACQUISITION 8

4 SEISMIC RESULTS AND INTERPRETATION 10

 4.1 REFRACTION RESULTS 10

 4.1.1 LINE 1 10

 4.1.2 LINE 2 11

 4.1.3 LINE 3 12

 4.2 REFLECTION RESULTS 13

 4.2.1 LINE 2 13

 4.2.2 LINE 3 14

5 SUMMARY OF SEISMIC RESULTS 22

 5.1 OVERBURDEN SOIL/SEDIMENT LAYERS 22

 5.2 BEDROCK CONDITIONS 22

APPENDICES 23

APPENDIX A A-1

APPENDIX B B-1

APPENDIX C C-1

List of Figures

Figure		Page
1.1	Site location map 2
1.2	Detailed site map with seismic line locations 3
4.1	P-wave refraction line 1 15
4.2	S-wave refraction line 1 16
4.3	P-wave refraction line 2 17
4.4	S-wave refraction line 2 18
4.5	P-wave refraction line 3 19
4.6	Reflection line 2 20
4.7	Reflection line 3 21

1 INTRODUCTION

1.1 LOCATION AND DESCRIPTION

The Private Fuel Storage Facility (PFSF) site is located in the southeast portion of Skull Valley, about 60 miles southwest of the city of Salt Lake City and directly south of the Great Salt Lake in northwestern Utah. Oriented in a north-south direction, Skull Valley is part of the basin and range province. The PFSF site lies some 25 miles south of the Lake from Interstate 80 and is situated about 2 miles west of Skull Valley Road which runs down the east side of the valley (Figure 1.1). The site was accessed using a series of two-track roads through the desert brush.

The area consists of eroded former lake terraces and alluvial deposits situated between two north-south mountain ranges located east and west of the proposed storage facility. The site lies on alluvial/lake deposits in a relatively flat topographic setting; elevations vary from 4450 to 4500 feet over the site and access road easement where the survey was conducted. A bedrock hill called Hickman Knolls protrudes through the alluvial sediments about 2 miles south of the storage area; it rises some 350 feet above the surrounding desert. Drainage in the vicinity of the site is towards the west and north into small drying basins and ephemeral stream beds (Figure 1.2) that extend to the Salt Lake.

Previous drilling information shows that subsurface soils are composed predominantly of silt, sand and clay deposits with occasional gravel constituents. The deepest (two) boreholes did not encounter bedrock or the water table to a depth of 100 feet.

1.2 PURPOSE

As part of an overall assessment study of the PFSF site as an interim spent fuel storage site, Stone & Webster Engineering Corporation (SWEC) required an investigation of subsurface conditions including soil conditions, depth to water table, and topography and character of the underlying bedrock. Such information will assist them in the design of appropriate foundations and structures for the stored materials.

Geosphere was contracted to conduct seismic geophysical surveys along two perpendicular lines across the proposed storage site and one traverse line southeast of the site along a proposed easement towards Skull Valley Road. Primary (P) wave and shear (S) wave refraction data were requested on two lines over the center of the storage area; only P-wave data were requested in the easement area. Deeper reflection information was required over the second and third refraction lines. The field work was completed between 9 and 20 December 1996.

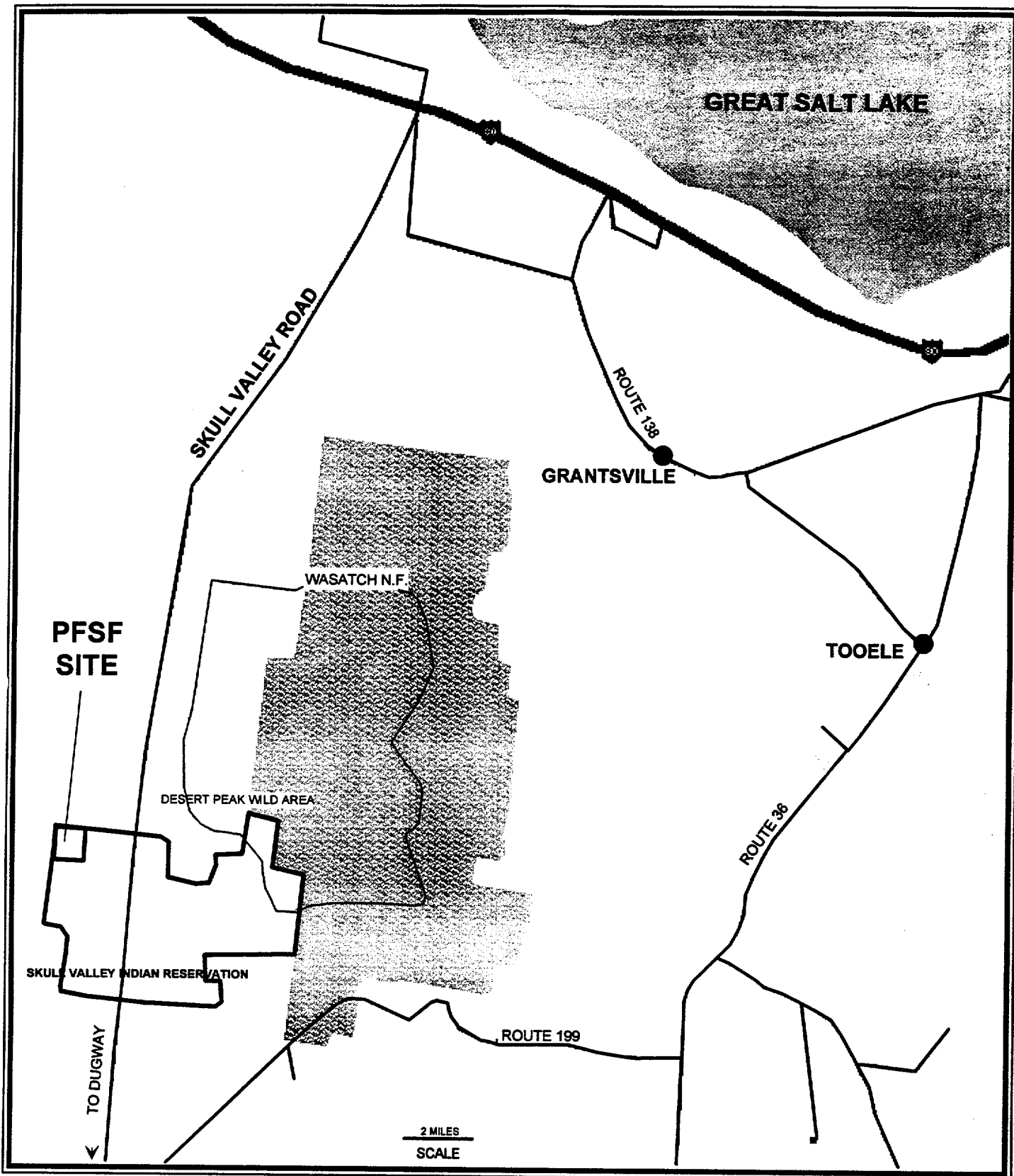

PFSF SITE, SKULL VALLEY, UTAH

SITE LOCATION MAP
FIGURE 1.1

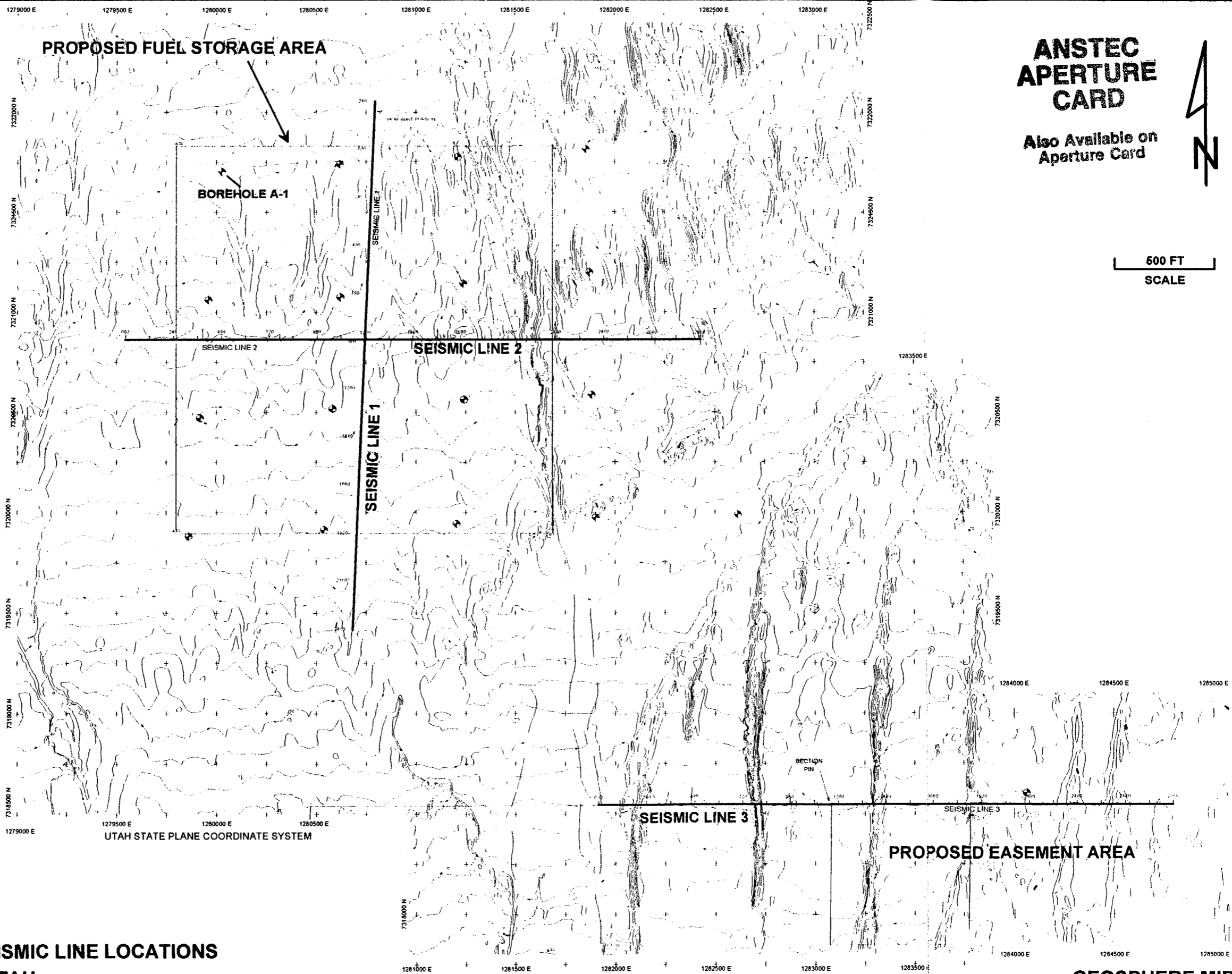

**DETAILED SITE MAP WITH SEISMIC LINE LOCATIONS
PFSF SITE, SKULL VALLEY, UTAH**

9707020145-14

2 GEOPHYSICAL METHODS

2.1 GENERAL DESCRIPTION

Two seismic geophysical methods were used at the PFSF site:

- 1) Seismic Refraction Profiling for both P-wave and S-wave data
- 2) Seismic Reflection Profiling.

Descriptions for both seismic methods are given below as they apply to the site. Although all seismic data contain both refraction and reflection events, differences between the two methods occur during (field) data collection and processing of results. In this report, the term "seismic velocity" is in reference to compressional or primary (or P-wave) seismic velocity through soil and rock layers; seismic velocities are given in units of feet per second (ft/sec). The term "S-velocity" is used for shear wave seismic velocities, also given in ft/sec.

2.2 SEISMIC TECHNIQUES

Seismic refraction was employed to detect subsurface soil and sediment layers. By determining seismic velocities in these layers, lateral variability within each layer could be assessed and provide input for calculating the engineering properties of these layers. The refraction data could also provide depth to water table and bedrock if they were sufficiently shallow. (The depths of water and rock were not known at the onset of the survey). Refraction results were processed using the Generalized Reciprocal Method (GRM) of analysis, that provides much greater detail of subsurface conditions than the older plane methods of forward/reverse refraction.

The Common Depth Point (CDP) method was employed as the seismic reflection technique to detect and map the surface of the underlying bedrock in the depth range of 300 to over 1000 feet. Similar in principle to reflection techniques used by the petroleum industry, field methods employed at the PFSF site were designed to provide higher resolution of reflectors. This included high frequency geophones, a state-of-the-art seismograph, low-cut filters, and special software designed for shallow reflection data.

Seismic methods are used to measure the depth and thickness of geologic strata using acoustic (sound) waves transmitted into the ground. These waves, generated from a controlled source, travel in different directions and velocities through various soil and rock layers. During this travel, these waves are refracted and reflected from various interfaces in the subsurface. The time required for the wave to traverse this path through these layers and return to the surface permits calculation of layer depth and velocity (Appendix A). Reflections and refractions are most often received from significant interfaces in the subsurface between clay, sand, gravel, top of water, top of bedrock, and intra-bedrock layers.

Primary and shear seismic waves move through subsurface geologic layers in response to layer physical properties (acoustic impedance), layer thickness, and layer sequence. A significant change in any one of these parameters will cause a notable shift in the seismic wave's velocity and path of

travel. Layer density and elastic properties primarily determine the velocity at which the acoustic energy will travel through the layer; these properties are determined largely by the more recognizable attributes of water content, compaction, porosity, and mineral composition.

Reflection and the new (GRM) refraction methods require extensive computer processing. Processing utilizes the time of wave arrivals occurring from subsurface reflections and the geometry of the wave path. Different methods have been developed using reflections in deriving layer depth and average velocities of the geologic section. Typically, the CDP methods are limited to discerning layers at minimum depths of 50-250 feet, dependent on near-surface seismic velocities, the depth to water table and frequencies transmitted by the soil or rock. Using geophone spacings of 2-5 feet, specialized field methods may permit acquisition of data as shallow as 10-20 feet with the CDP method. GRM refraction can be used to determine layer depths of less than 5 feet to over 200 feet and variations of the clay or rock interface along the line. Unlike reflection methods, refraction spreads need to cover greater lateral distances to detect and map deeper interfaces. Refraction data are based on "picks" of the first primary seismic wave arrival times for each geophone in the array; reflection results are derived from coherent wavelet events farther down in the seismic trace. Most seismic surveys measure P-wave first arrivals and reflections; S-wave work employs a special seismic source and geophones to generate and receive transverse waves through the ground.

A seismograph is used to process and display seismic wave arrivals from a geophone array. The seismic energy source may be a hammer striking a metal plate, explosives, shotgun device or a drop weight. Deep reflected wave energies are usually stronger signals than most refraction arrivals, even though the reflecting layer may be several hundred or thousand feet in depth.

The vertical resolution and minimum usable depth of both methods are dependent on several factors:

- 1) Frequency transmitted by the subsurface (often a function of grain size and depth to water table)
- 2) Seismic velocities of surface soils/sediments
- 3) Frequency characteristics of geophones
- 4) Filter capabilities of seismograph
- 5) Resolution capabilities of seismograph.

Higher seismic frequencies will permit better resolution of subsurface layers as well as detection of shallower layers. Different ground conditions will transmit different frequencies (ranging from less than 1 to over 500 Hz) with various attenuation. Acoustic frequencies of 30 to 150 Hz are often obtained in reflection surveys and will provide good results. Subsurface transmittal of frequencies of 100 Hz or better are less common or very rare in some areas, but, if obtained, will provide excellent resolution results. Lower frequency filters are usually set in refraction studies to permit reception of greater amounts of the refraction energy (signal). The lower frequencies (4-16 hertz) travel better than higher frequencies within geologic materials.

2.2.1 EQUIPMENT

The seismic data were collected with a 24 channel Bison 9024 seismograph with digital floating point gain control. The system was coupled to an Input/Output Instrument 120 channel roll switch which permitted sequential collection of 24 channel data from a 48 geophone array per spread. A

modified Bison Elastic Wave Generator (EWG-5) was employed as a seismic energy source. Hydraulically lifted to a height of approximately 2.5 feet, the 1,500 pound weight of the EWG-5 is accelerated by four 6-inch elastic bands as it is released towards a (40x40-inch) steel plate on the ground to generate P-wave energy. The steel plate is employed to generate a "sharper" seismic signal than that obtainable on normal, uncompacted surfaces in order to obtain higher frequency values and, consequently, better resolution. To generate shear wave energy, two special 150 pound transverse hammers are mounted on the left and right sides of the EWG-5's frame. These hammers strike the ends of a 4-foot long, 6x7-inch wooden beam that has been pressed into the ground surface by 6,000 pounds of weight (from the EWG-5 trailer) and secured with steel spikes. Signals are stacked from the two hammers in such a manner to accentuate S-waves and cancel P-waves. An electronic switch mounted on the EWG provided the trigger signal via cable to the seismograph. Thirty hertz (low-cut) Mark Product geophones were used with a 32 hertz low-cut filter (set in the seismograph) for reflection data and 16 hertz low-cut for refraction data. The collected data were stored within the seismograph and downloaded each evening to a computer for processing.

2.3 QUALITY CONTROL

A quality assurance survey was conducted at Geosphere Midwest's facility by SWEC on 5 December 1996. The inspector was G. Sauter from SWEC's Denver Office. The objective of the surveillance was to verify that Geosphere Midwest controls those items determined to be critical as documented in Commercial Grade Application Evaluation number PI-0199, Rev 0. The surveillance also included a visit by Northern States Power auditor T. Iseman to witness and audit the seismic field work in progress at the PFSF site in Utah.

The surveillance documented that Geosphere Midwest controls critical characteristics:

- 1) Geosphere has qualified personnel to take, read, and interpret seismic readings. Three individuals who conducted the survey have a total of 41 man-years of geophysical experience with seismic methods.
- 2) Calibrated measuring equipment was identified, controlled and traceable to recognized national standard. The Bison 9024 seismograph was the only calibrated instrument used. The seismograph was returned to Bison Instruments for evaluation prior to and following the work for SWEC. Bison certified that the instrument performed to specifications on both occasions.
- 3) Qualified software was used to record, process and output the seismic data. This software included "Eavesdropper," written and sold by the Kansas Geological Survey (KGS) and Firstpix/Gremix software from Interpex of Golden, Colorado. Software was validated by processing known data sets and comparing the results with previously documented results. Results from PFSF were compared to actual drilling logs obtained near the seismic lines for validation of the shallow seismic results. Deeper bedrock depth results (over 100 feet) are based on calculations from seismic stacking velocities, as no drilling data were available to these depths.
- 4) Geosphere has written procedures and instructions to direct work activities. These include "Field Procedures, Seismic Reflection Surveys" Revision 00, 10/13/95 and "Field Procedures, Seismic Refraction Surveys" Revision 00, 10/13/95.

3 DATA ACQUISITION

3.1 SURVEY LINES AND COVERAGE

Two seismic lines were run across the central portion of the site perpendicular to each other: Line 1 in a north-to-south direction and Line 2 in a west-to-east direction. A third seismic line (Line 3) was run in an area southeast of the proposed storage area, along the easement to Skull Valley Road. Line locations are given in Figure 1.2.

Both P- and S-wave data were obtained along Lines 1 and 2 for a distance of 2,400 feet each. In addition, reflection data were acquired along Line 2 for 2880 feet, centered on the 2,000x2000 foot site. P-wave refraction and reflection data were acquired along Line 3 for a distance of 2880 feet.

The ground surface along Line 1 was relatively flat whereas Line 2 cut across two dried stream beds at its eastern end. Line 1 has a 17 foot drop in elevation towards the north from elevation 4477 to 4460 feet; Line 2 has a slight concave shape with higher elevation (4470 feet) near the center of the line. The topography along Line 3 rises towards the east from an elevation of 4482 to 4497 feet; Line 3 cut across several linear (north-south) ridges believed to be old lake sand bars.

The reflection and refraction data were acquired during the period of 9 through 20 December 1996.

3.1.1 LINE LAYOUT AND PROFILE POSITIONS

During the field survey, shot points and geophone positions were keyed to a system of linear stations along each line. The lines were positioned to be centered relative to the approximate edges of the 2000x2000 foot site. Each station line was laid out using surveyor's tapes, wooden stakes and colored pin flags. Labeled wooden markers were placed at the beginning and end of each line for future reference. To simplify matters, our results and discussions below describe events and features in terms of our linear footage along each seismic line; however, each seismic figure has a lower scale that correlates Utah State Plane Coordinates with our Spread Distance station numbers.

3.2 SEISMIC REFRACTION SURVEY

3.2.1 DATA ACQUISITION

Refraction data for Lines 1 and 2 were acquired along a series of five 24 channel geophone arrays, using a geophone interval of 20 feet, for a total distance of 2,400 feet. Data for Line 3 were acquired along a series of six 24 channel geophone arrays, using a geophone interval of 20 feet, for a total distance of 2,880 feet. Each array of 24 geophones was connected to a 24 channel seismograph through a large 120 channel roll switch (Input/Output Instrument); this setup permitted selecting different groups of 24 phones using the roll switch as the seismic source was advanced to each refraction shot position (every 240 feet along the line). Where possible, two 24 channel records were combined from a common shot location to yield 48 channel data sets. The Bison EWG-5

seismic source was employed starting at near offset distances of 490, 250 and 10 feet from the first geophone of the first array. This pattern was repeated through the entire line; far offset (reverse) shots were also made back into the geophone arrays at the same 240 foot spacings, resulting in symmetrical forward and reverse data sets. Timing between the EWG and seismograph was established using a trigger switch on the source and a connecting cable to the seismograph.

After each shot, the 24 geophone signals (channels) were dumped onto a thermal paper record for viewing and quality control. Data were checked for signal strength, proper triggering and any unusual features. Dependent on ground conditions and surface (auditory and wind) noise, a number of multiple hits were made, causing the seismic signals to be stacked (added together) within the seismograph. After the operator determined that ample signal strength had been acquired through stacking (usually 15-30 times), the 24 channel record was saved into harddrive memory in the seismograph. Then, the EWG-5 source and roll switch were advanced for the next shot position (240 feet up the line).

Records saved in the seismograph were downloaded each evening to a computer for preliminary processing. GRM processing at the office included picking the first arrival times for each channel and entry of phone and source position geometries and elevation data. The processed refraction profiles consist of interpreted layers detected in the first pick data (Appendix B).

3.3 SEISMIC REFLECTION SURVEY

3.3.1 DATA ACQUISITION

The reflection data were acquired along Lines 2 and 3 as the refraction survey described above, (ie, a series of five and six 24-channel geophone arrays using a geophone interval of 20 feet). Each array of 24 active geophones was connected to the 24 channel seismograph through the 120 channel roll switch; this setup permitted the selection of 24 successive groups of 24 phones to be connected to the seismograph using the roll switch as the seismic source was advanced 20 feet per shot along the line. The Bison EWG-5 seismic source was employed at a constant offset distance of 490 feet from the first geophone of the array at each shot position. Timing between the EWG and seismograph was established using a trigger switch on the source and a connecting cable to the seismograph.

After each shot, the 24 geophone channels were dumped onto a paper record for viewing and quality control. Data were checked for signal strength, proper triggering, and any unusual features. Dependent on ground conditions and surface (auditory and wind) noise, a number of multiple hits were made using the EWG, causing the seismic signals to be stacked (added together) within the seismograph. After the operator determined that ample signal strength had been acquired through stacking (usually 15-25 times), the 24 channel record was saved into harddrive memory in the seismograph. Then, the EWG source and roll switch (connecting the next group of 24 phones) were advanced for the next shot position (20 feet up the line).

Records saved in the seismograph were downloaded each evening to a computer for processing and preliminary analysis. CDP processing of the field seismic records included filtering, muting, sorting, deconvolution, velocity analysis, normal moveout (NMO) correction, statics, stacking, and gain

correction. The processed reflection profiles consist of individual wiggle traces that represent CDP gathers of 12 traces each, yielding a 12 fold data set. During processing, the seismic results were corrected using elevations taken from a detailed map of the site; an elevation datum of 4460 feet was used to normalize all profile results.

4 SEISMIC RESULTS AND INTERPRETATION

The seismic results and interpretation are described below for each of the three survey lines. P- and S-wave refraction results for Line 1 are given in Figures 4.1 and 4.2; corresponding results for Line 2 are given in Figures 4.3 and 4.4. Line 3 P-wave results are presented in Figure 4.5. Deep bedrock reflection sections are given in Figure 4.6 for Line 2 and Figure 4.7 for Line 3. Each figure includes the Spread Station Distance as the x-axis with a corresponding Utah State Plane Coordinate axis below. The refraction figures include an elevation scale (in feet above sea level) on the left and right sides; the reflection figures provide a reflection time scale on the left and an approximate depth scale on the right side of the reflection record. Elevations are given in feet above mean sea level (MSL). The reflection profiles have been normalized to an elevation datum of 4460 feet above MSL.

Interpretation of the **P-wave refraction** profile data shows:

- 1) three layers and their associated seismic velocities to a depth of about 120 feet:
 - a) a near surface low velocity layer (dry soil)
 - b) an unsaturated sediment layer and
 - c) an interpreted saturated layer
- 2) that the water table (top of the interpreted saturated layer) is not flat
- 3) that the top of bedrock is greater than 120 feet deep
- 4) that no evidence exists for faulting or movement within the alluvium section.

Interpretation of the **S-wave refraction** profile data shows:

- 1) two layers and their associated seismic velocities to a depth of about 60 feet:
 - a) a near surface low velocity layer (dry soil) and
 - b) an unsaturated sediment layer
- 2) that the water table and bedrock were not encountered.

Interpretation of the **reflection** section data shows:

- 1) an irregular bedrock surface that dips towards the east in both Lines 2 and 3
- 2) Line 2 bedrock depths of 520 to 880 feet and Line 3 bedrock depths of 740 to 1020 feet
- 3) distinctive lower layers within the bedrock
- 4) interpreted folded and faulted zones within the bedrock, but no evidence of faults extending up into the overburden.

4.1 REFRACTION RESULTS

4.1.1 LINE 1

P-wave refraction results for Line 1 (Figure 4.1) provide subsurface information from the ground surface to a depth of approximately 120 feet. Analysis of the first arrival picks reveals the presence of three seismic layers which correlate to a low-velocity layer, an unsaturated sediment layer and an interpreted saturated layer. A plot of the first arrival data for Line 1 is given in Figure B-1

(Appendix B). Seismic velocities characteristic of bedrock were not encountered. The low velocity soil layer is interpreted as an uncompacted, dry soil zone; it has an approximate thickness of 33 to 40 feet with seismic velocities ranging from 1,125 to 1,300 ft/sec. Due to the coarseness of the geophone spacing (20 feet), the thickness and velocity values for the first layer are probably within 20% of the stated value.

The second layer at a depth of about 35 feet is interpreted as a zone of unsaturated sediments; this layer is approximately 60 to 90 feet thick. Measured seismic velocities (2,725 to 3,475 ft/sec) are likely derived from more compacted sand and silt layers recorded in nearby drilling logs; due to the 20 foot geophone spacing, velocities are likely within 15% of the stated value. The bottom of this second layer is interpreted as the water table which ranges in depth from 103 to 131 feet (elevation 4334 to 4369), being higher near Spread Station 1500.

The third layer is believed to represent saturated sediments, occurring below the interpreted water table. This layer is likely composed of wet sand, silt, clay, and gravel lake and alluvial layers and lenses typical of the area. Seismic velocities range from about 5,200 to 5,900 ft/sec which are characteristic of water-saturated sand and silt sediments; velocity accuracy is estimated to lie within 10% of the stated value. An alternative interpretation is that the third layer is not saturated and represents a more compacted (or cemented) sequence of alluvial/lake sediments; such layers have been previously identified in Basin and Range surveys. The surface of the third layer has a concave shape, dipping both towards the north and south from a high between Stations 1200 and 1500. The unevenness of the third layer surface may be caused by capillary action in varying lenses of fine sand and clayey silt deposits or local artesian conditions. Another explanation may be that substantial vertical and lateral variations in seismic velocities exist in the alluvium, leading to apparent higher velocities and yielding greater thickness of Layer 2 at specific locations (see Appendix B). Thickness of the third layer extends beyond the depth limits of the refraction survey. A deeper layer having seismic velocities characteristic of bedrock was not detected nor was any evidence of faulting or movements within the upper alluvium section.

S-wave refraction results for Line 1 (Figure 4.2) show two seismic layers, a near-surface low velocity zone and a deeper unsaturated sediment zone. Due to very slow shear velocities, depth to the interpreted top of water (at about 110 feet) was beyond the limits of the survey; however, the shear results probably record seismic events to a maximum depth of about 80-90 feet. The upper soil layer yielded shear velocities in the range of 725 to 825 ft/sec; the lower unsaturated layer yielded velocities ranging from 1,750 to 2,600 ft/sec. Due to the coarseness of the geophone spacing (20 feet), these depth and velocity values probably range within 20% of the stated value.

4.1.2 LINE 2

P-wave refraction results for Line 2 (Figure 4.3) provide subsurface information from the ground surface to a depth of about 120 feet. As in Line 1, analysis reveals the presence of three seismic layers which correlate to a low-velocity layer, an unsaturated sediment layer and an interpreted saturated layer. The first arrival data for Line 2 is given in Figure B-3 (Appendix B). Seismic velocities characteristic of bedrock were not encountered. The low velocity soil layer is interpreted as an uncompacted, dry soil zone; it has an approximate thickness of 31 to 49 feet with seismic velocities ranging from 1,150 to 1,550 ft/sec. Due to the coarseness of the geophone spacing (20

feet), the thickness and velocity values for the first layer are probably within 20% of the stated value.

The second layer at a depth of about 35 feet is interpreted as a zone of unsaturated sediments; this layer is approximately 55 to 85 feet thick. Measured seismic velocities (2,200 to 2,725 ft/sec) are likely derived from compacted sand and silt layers; due to the 20 foot geophone spacing, velocities are likely within 15% of the stated value. The bottom of this second layer is interpreted as the water table which ranges in depth from 90 to 115 feet (elevation 4352 to 4378), being higher near Spread Station 1900.

The third layer is believed to consist of saturated sediments, occurring below the interpreted water table. This zone is likely composed of wet sand, silt, clay, and gravel lake and alluvial layers and lenses. Seismic velocities range from about 5,100 to 5,900 ft/sec which are characteristic of water-saturated sand and silt sediments. An alternative interpretation is that the third layer is not saturated and represents a more compacted (or cemented) sequence of alluvial/lake sediments; such layers have been previously identified in Basin and Range surveys. The surface of the third layer has an apparent dip towards the west. The unevenness of the interpreted saturated layer surface may be caused by capillary action in varying lenses of fine sand and silt deposits or artesian conditions. Another explanation may be that substantial vertical and lateral variations in seismic velocities exist in the alluvium, leading to apparent higher velocities and yielding greater thickness of Layer 2 at specific locations (see Appendix B). Thickness of the third layer extends beyond the depth limits of the refraction survey. A deeper layer having seismic velocities characteristic of bedrock was not detected nor was any evidence of faulting within the upper alluvium section.

S-wave refraction results for Line 2 (Figure 4.4) show two seismic layers, a near-surface low velocity zone and a deeper unsaturated sediment zone. Due to very slow shear velocities, depth to the interpreted top of water (at about 110 feet) was beyond the limits of the survey; however, the shear results probably record seismic events to a maximum depth of about 80-90 feet. The upper soil layer yielded shear velocities in the range of 700 to 950 ft/sec; the lower unsaturated layer yielded velocities ranging from 1,675 to 2,425 ft/sec. Due to the coarseness of the geophone spacing (20 feet), these depth and velocity values probably range within 20% of the stated value.

4.1.3 LINE 3

P-wave refraction results for Line 3 (Figure 4.5) provide subsurface information from the ground surface to a depth of approximately 140 feet. As in Lines 1 and 2, analysis reveals the presence of three seismic layers which correlate to a low-velocity layer, an unsaturated sediment layer and an interpreted saturated layer. The first arrival data for Line 3 is given in Figure B-5 (Appendix B). Seismic velocities characteristic of bedrock were not encountered. The low velocity soil layer is interpreted as an uncompacted, dry soil layer; it has an approximate thickness of 44-53 feet with seismic velocities ranging from 1,500 to 1,725 ft/sec. These velocities are significantly higher than the average values recorded at Lines 1 and 2. Due to the coarseness of the geophone spacing (20 feet), these depth and velocity values probably range within 20% of the stated value.

The second layer at a depth of about 50 feet is interpreted as a zone of unsaturated sediments; this layer is approximately 45 to 82 feet thick. Measured seismic velocities (2,300 to 3,400 ft/sec) are likely derived from compacted sand and silt layers that are recorded in drilling logs; due to the 20

foot geophone spacing, velocities are likely within 15% of the stated value. The bottom of this second layer is interpreted as the water table which ranges in depth from 97 to 136 feet (elevation 4352 to 4385), being higher near Spread Stations 0000 and 1100.

The third layer, interpreted as saturated sediments, is likely composed of wet sand, silt, clay, and gravel lake/alluvial sediment layers and lenses. Seismic velocities range from about 5,200 to 6,100 ft/sec which are characteristic of water-saturated sand and silt sediments. An alternative interpretation is that the third layer is not saturated and represents a more compacted (or cemented) layer of sediments; such layers have been previously identified in Basin and Range surveys. The surface of the third layer is irregular and has an apparent overall dip towards the east. The unevenness of the saturated layer surface may be caused by capillary action in varying lenses of fine sand and silt deposits or artesian conditions. Another explanation may be that substantial vertical and lateral variations in seismic velocities exist in the alluvium, leading to apparent higher velocities and yielding greater thickness of Layer 2 at specific locations (see Appendix B). Thickness of the third layer extends beyond the depth limits of the refraction survey. A deeper layer having seismic velocities characteristic of bedrock was not detected nor was any evidence of faulting within the upper alluvium section.

4.2 REFLECTION RESULTS

4.2.1 LINE 2

Figure 4.6 presents the processed reflection section generated for Line 2. The reflection profile presents seismic events in a different manner than the refraction results: the data are displayed as reflection wavelets as a function of time with an estimated depth scale on the right margin.

Reflection Line 2 (as well as Line 3) were processed using filtering, statics, editing, muting, sorting, and stacking functions (Appendix C). Bandpass and fan filtering was used to remove low frequency events and enhance higher frequency reflections; many velocity scans were performed to determine optimum stacking velocities for the section. Deconvolution and migration methods were also used in attempts to enhance the reflection information; however, they provided little or no improvement to the data and were not used in the final section given in Figure 4.6.

The interpreted top of bedrock is represented by the upper edge of the strong black wavelets in Figure 4.6. The character of reflectors is different above and below this line. Strong and weak, discontinuous reflectors above the bedrock are interpreted as various alluvial layers that have been deposited on top of bedrock in recent geological times. Layers within the bedrock are interpreted from lower, dipping reflection patterns; these reflections are stronger on the western end of the line. At Station 1000, a series of apparent parallel reflections (300-450 msec) are interpreted as multiples from the strong bedrock surface; these should not be interpreted as geologic layers. Apparent discontinuities within the rock are interpreted as geologic faults that, in times past, have disturbed the normal geologic stratigraphy. Offsets on several faults are observed between Spread Stations 450 and 800, ranging from about 20 feet to over 50 feet. A less pronounced feature is found near Station 1800. These results do not contain any evidence of fault continuation into the overlying alluvial sediments; hence, the bedrock faulting is interpreted to be older than the age of the

sediments. The reflection method is estimated to be able to detect displacements of 10-20 feet within the bedrock with conditions found at this site.

The strong bedrock reflection occurs in the time interval of 210 to 330 msec. To relate seismic travel time (left scale, Figure 4.6) to bedrock depth (right scale), reflector event times were multiplied by the average stacking velocities for that portion of the section. In this manner, the depth scale was derived for Figure 4.6. Normally, depths are calibrated by comparing reflector time to drilling information, but no information was available at these depths. Thus, our depth scale should only be considered a rough approximation, and less accuracy should be expected at greater depths below the bedrock surface. Using this information, the bedrock surface dips from an estimated depth of 520 feet in the west to over 880 feet in the east.

4.2.2 LINE 3

Figure 4.7 presents the processed reflection section generated for Line 3. The data are displayed as reflection wavelets as a function of time with an estimated depth scale on the right margin.

Reflection Line 3 was processed using filtering, editing, muting, sorting, and stacking functions (Appendix C). Bandpass and fan filtering was used to remove low frequency events and enhance higher frequency reflections; many velocity scans were performed to determine optimum stacking velocities for the section.

The interpreted top of bedrock is represented by the upper edge of the strong black wavelets in Figure 4.7. Very few coherent reflectors were resolved above the bedrock due to the small "time window" between the first arrival energy (which was muted) and the bedrock reflectors. Layers within the bedrock are interpreted from lower, flat-lying and dipping reflection patterns. Apparent discontinuities within the rock are interpreted as geologic faults that, in times past, have disturbed the normal geologic stratigraphy. Offsets on several faults are observed between Spread Stations 1000 and 1300. Similar, less pronounced features, are found between Stations -100 and 250.

The strong bedrock reflection occurs in the time interval of 200 to 265 msec. To relate seismic travel time (left scale, Figure 4.7) to bedrock depth (right scale), reflector event times were multiplied by the average stacking velocities for that portion of the section. In this manner, the depth scale was derived for Figure 4.7. Normally, depths are calibrated by comparing reflector time to drilling information, but no information was available at these depths. Thus, our depth scale should only be considered a rough approximation, and less accuracy should be expected at greater depths below the bedrock surface. Using this information, the bedrock surface dips from an estimated depth of 740 feet at Station 700 to 1020 feet at the eastern end of the line.

Deep intermittent reflectors observed below 430 milliseconds are in a region of weak reflectors and should **not** be considered significant or "real".

SEISMIC LINE 1: PRIMARY WAVE REFRACTION SECTION

SURVEYED: DECEMBER 1996

**ANSTEC
APERTURE
CARD**

Also Available on
Aperture Card

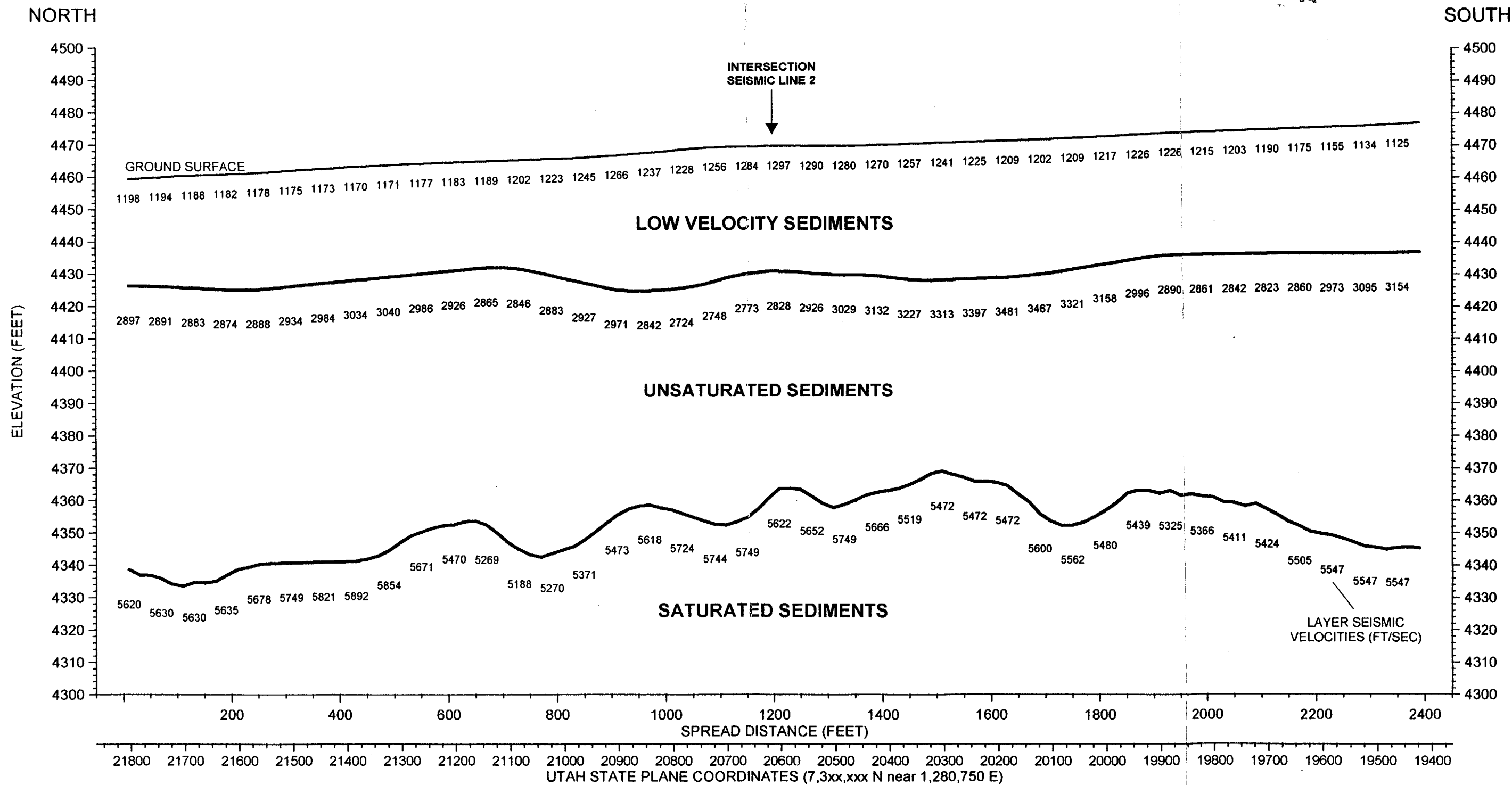

PFSF SITE, SKULL VALLEY, UTAH

GEOSPHERE

9707020145 15

SEISMIC LINE 1: SHEAR WAVE REFRACTION SECTION

SURVEYED: DECEMBER 1996

ANSTEC APERTURE CARD

Also Available on Aperture Card

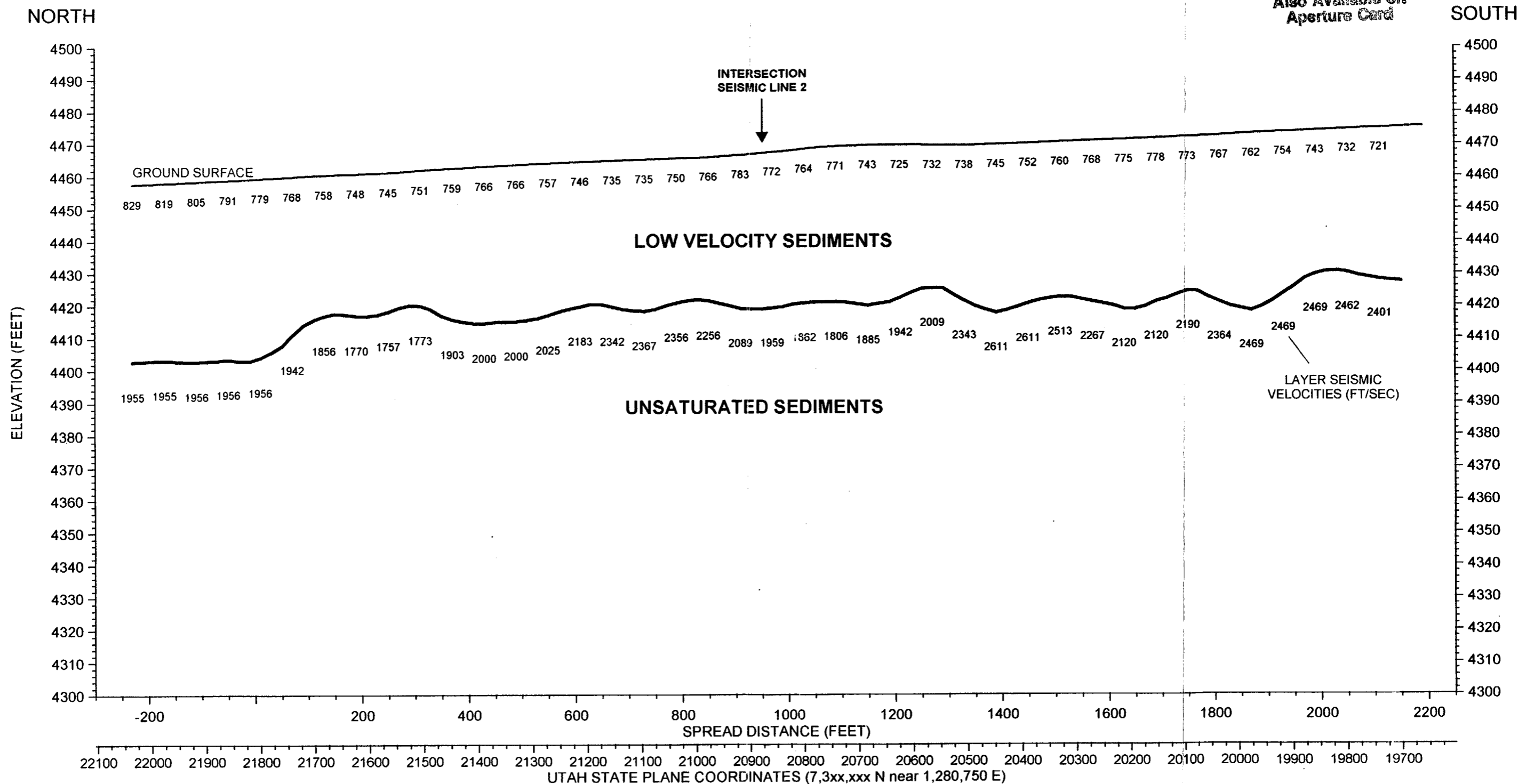

PFSF SITE, SKULL VALLEY, UTAH

GEOSPHERE

9707020145-16

SEISMIC LINE 2: PRIMARY WAVE REFRACTION SECTION

SURVEYED: DECEMBER 1996

ANGTEC
APERTURE
CARD

Also Available on
Aperture Card

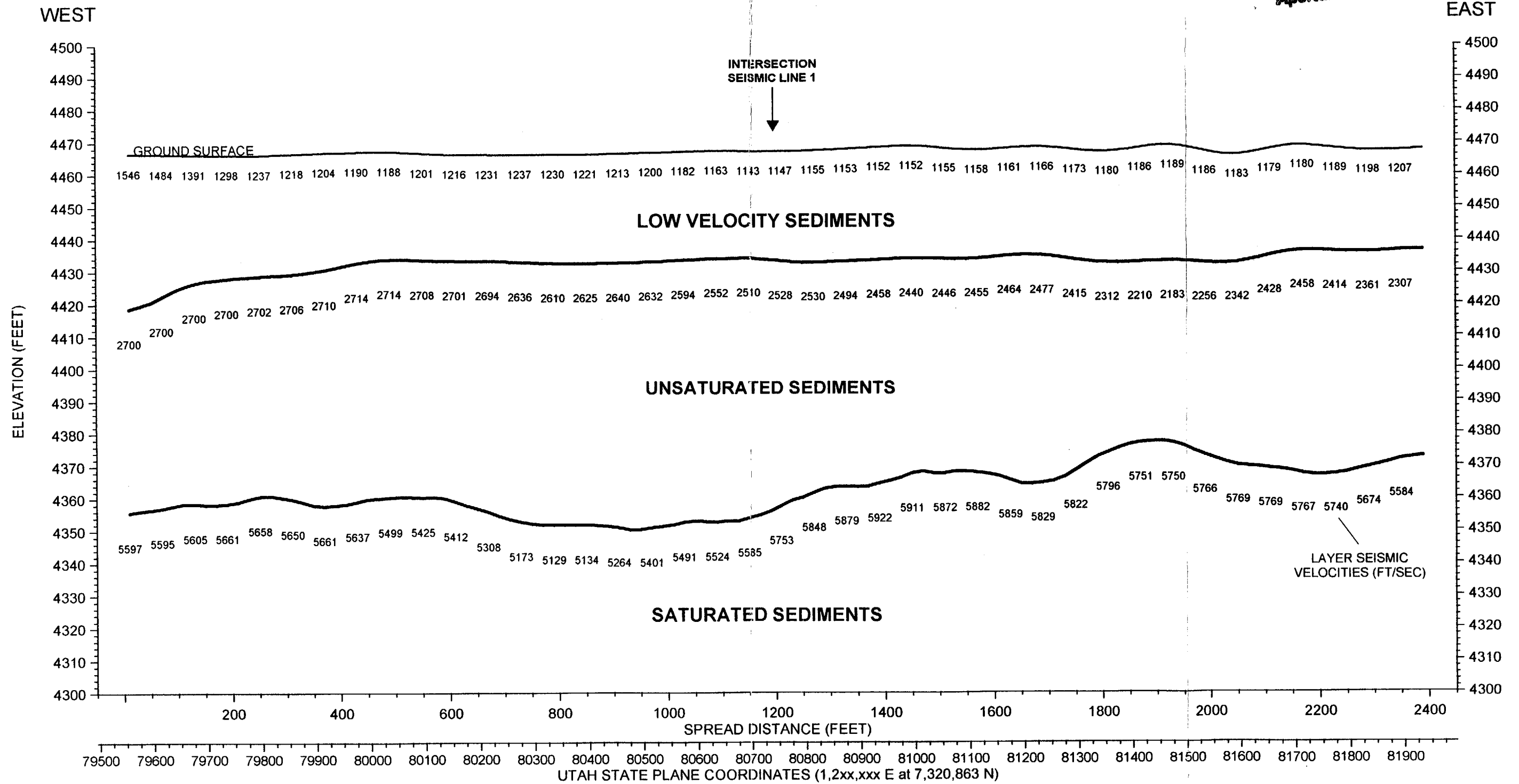

PFSF SITE, SKULL VALLEY, UTAH

GEOSPHERE

97070 20145-17

SEISMIC LINE 2: SHEAR WAVE REFRACTION SECTION
 SURVEYED: DECEMBER 1996

**ANSTEC
 APERTURE
 CARD**

Also Available on
 Aperture Card

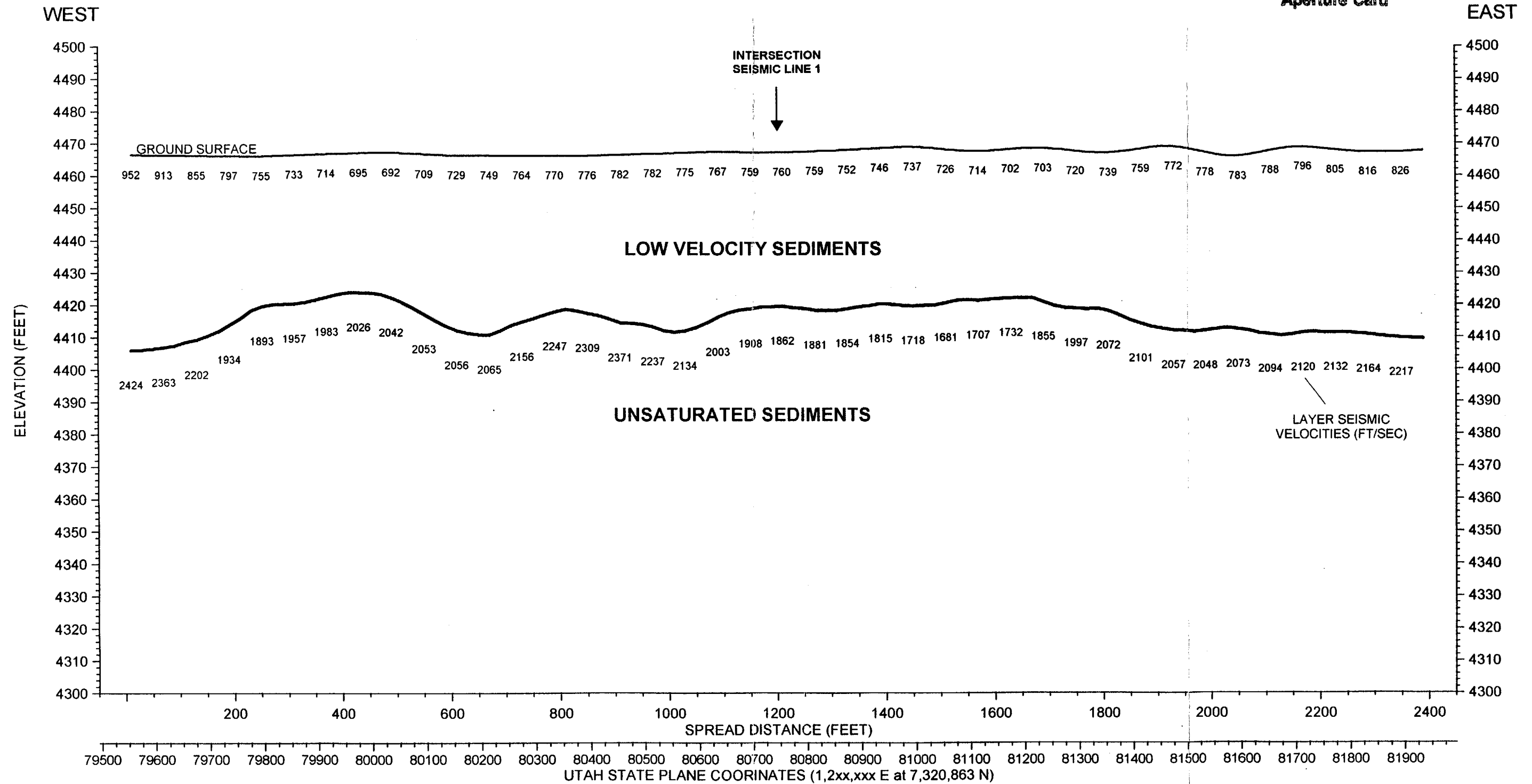

PFSF SITE, SKULL VALLEY, UTAH

GEOSPHERE

9707020145-18

SEISMIC LINE 3: PRIMARY WAVE REFRACTION SECTION

SURVEYED: DECEMBER 1996

ANSTEC APERTURE CARD

Also Available on Aperture Card

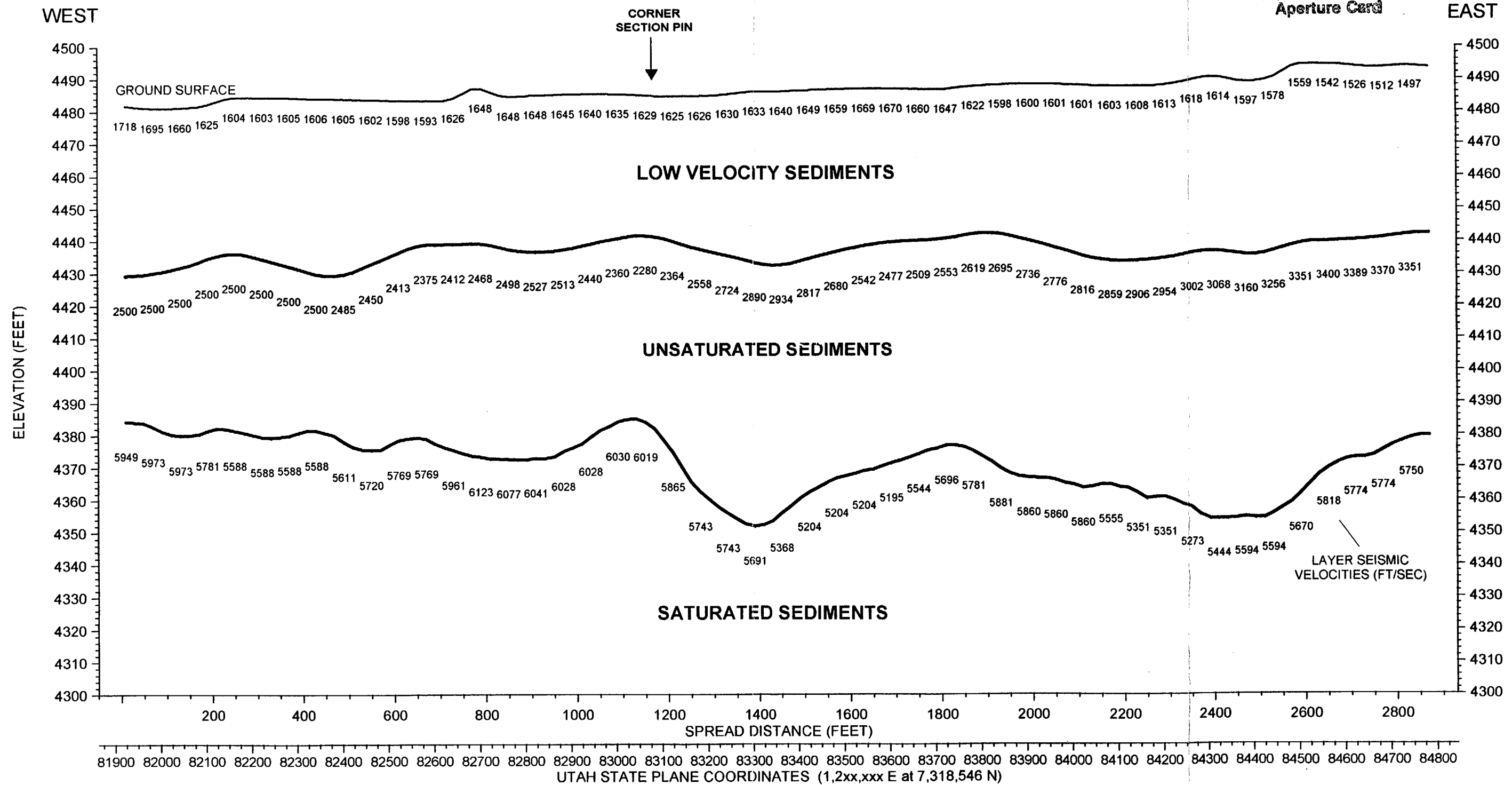

PFSF SITE, SKULL VALLEY, UTAH

GEOSPHERE

970 7020145- 19

SEISMIC LINE 2: REFLECTION SECTION ACROSS CENTER OF SITE

SURVEYED: DECEMBER 1996

ANSTEC APERTURE CARD

Also Available on
Aperture Card

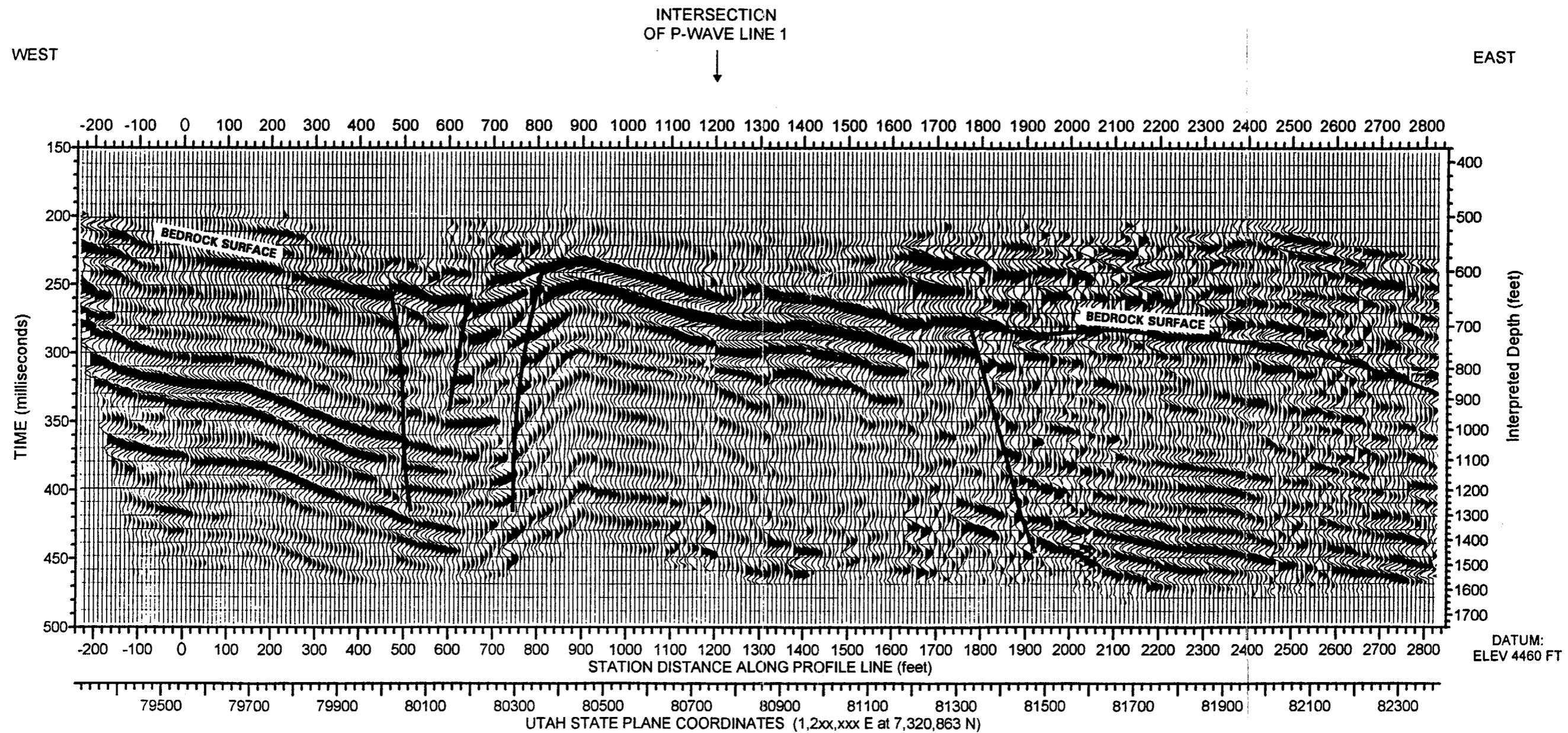

9707020145-20

SEISMIC LINE 3: REFLECTION SECTION SOUTHEAST OF SITE

SURVEYED: DECEMBER 1996

ANSTEC APERTURE CARD

Also Available on
Aperture Card

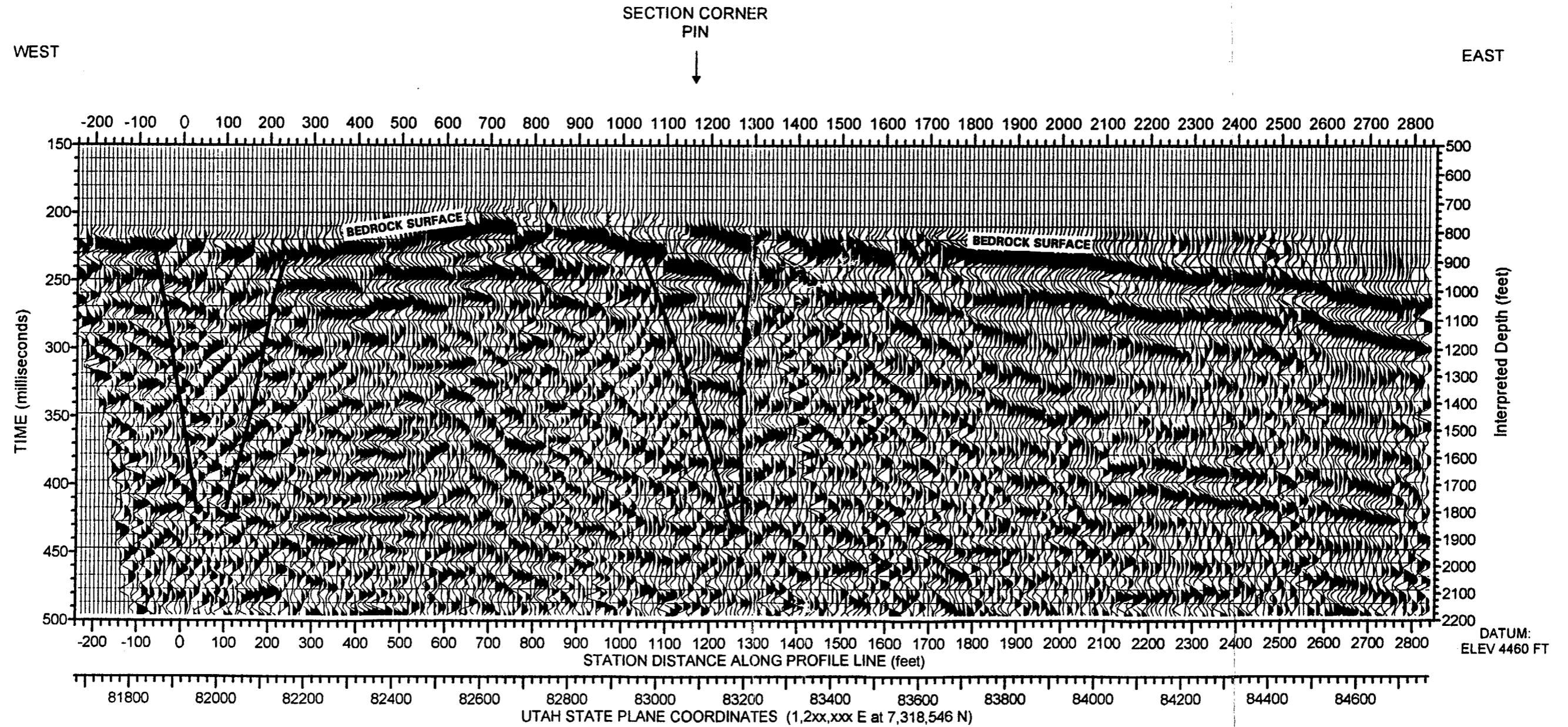

9707020145-21