

Complete drive solutions  
from a single source

Technical manual



# NORD DRIVESYSTEMS Group



Industrial gear units



Geared motors



Frequency inverters and motor starters

- ▶ Headquarters and technology centre in Bargteheide near Hamburg.
- ▶ Innovative drive solutions for more than 100 branches of industry.
- ▶ 7 production locations with cutting edge technology produce gear units, motors and drive electronics for complete drive systems from a single source.
- ▶ NORD has 48 subsidiaries in 36 countries and further sales partners in more than 50 countries, providing local stocks, assembly centres, technical support and customer service.
- ▶ More than 4,900 employees throughout the world create customised solutions.



Headquarters in Bargteheide



Motor production



Motor assembly



Production and assembly



Gear unit production



Inverter production



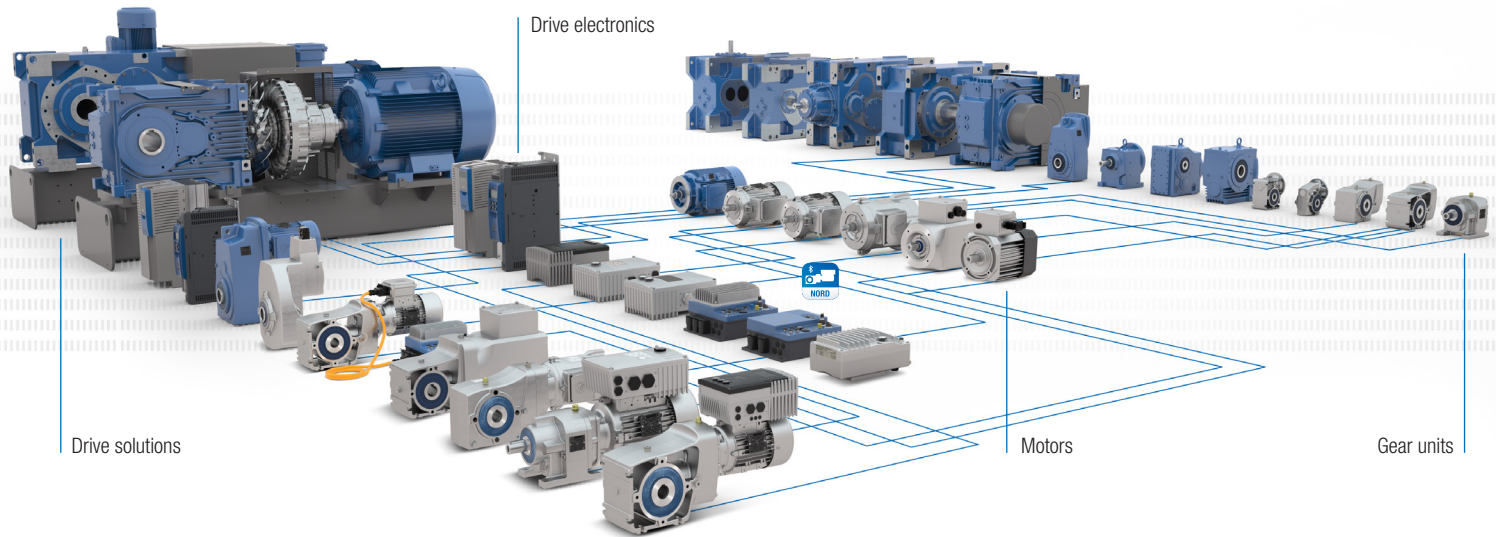

## Complete drive solutions from a single source

An optimum and individual drive solution can be created using the modular NORD system consisting of the gear unit, motor and drive electronics. Each of the variants combine: the highest product quality, short planning and assembly times, high delivery availability, and a good price/performance ratio.

## Safe

- ▶ Reliable products
- ▶ Coordinated components
- ▶ Own development and production

## Flexible

- ▶ Modular products
- ▶ Scalable functions
- ▶ Large range of drive units
- ▶ Complete drive solutions
- ▶ Integrated customer logistics

## International

- ▶ Globally networked organisation
- ▶ Local advice, assembly and service

# NORD DRIVESYSTEMS Group

## Gear units

UNICASE helical in-line gear units	10
NORDBLOC.1® helical in-line gear units	12
STANDARD helical gear units	14
UNICASE parallel shaft gear units	16
UNICASE bevel gear units	18
NORDBLOC.1® bevel gear units	20
UNICASE worm gear units	22
UNIVERSAL SI worm gear units	24
UNIVERSAL SMI worm gear units	24
DuoDrive	26
Gear unit options	28

## MAXXDRIVE® Industrial gear units

MAXXDRIVE® parallel gear units and right-angle gear units	32
Industrial gear units options	36

## Electric motors

Asynchronous motors	40
Smooth motors	46
UNIVERSAL motor	48
Synchronous motors	50
IE5+ motors	52
Explosion protected motors	55
Motor options	56

## Frequency inverters and motor starters

Frequency inverter NORDAC <i>PRO</i> SK 500P	60
Frequency inverter NORDAC <i>PRO</i> SK 500E	62
Frequency inverter NORDAC <i>ON/ON+</i> SK 300P	64
Frequency inverter NORDAC <i>LINK</i> SK 250E	66
Frequency inverter NORDAC <i>FLEX</i> SK 200E	68

Frequency inverter NORDAC <i>BASE</i> SK 180E	70
Motor starter NORDAC <i>LINK</i> SK 155/175E	72
Motor starter NORDAC <i>START</i> SK 135E	74
Software NORDCON	76
NORDAC <i>ACCESS BT / NORDCON APP</i>	77
PROFIsafe	78
Bus systems and Industrial Ethernet	79
Correct connection technology	80
Condition monitoring for predictive maintenance	82

## Technical information

Surface protection for NORD drive solutions	88
Overview energy saving directives for motors	90
Nominal operating modes according to IEC 60034-1	92
Cooling types for NORD motors according to IEC 60034-6 and NEMA	94
International Protection Codes (IP protection class)	96
Overview labels	97

## Installation orientations

Installation orientations – helical gear units	98
Installation orientations – parallel shaft gear units	99
Installation orientations – bevel gear units	100
Installation orientations – worm gear units	101
Installations positions and cable glands DuoDrive	102
Installation orientations – MAXXDRIVE® parallel gear units	104
Installation orientations – MAXXDRIVE® right-angle gear units	105
Installation orientations for motors and terminal boxes	106
Enquiry process	108



Industrial gear units

Worm gear units

Bevel gear units

Helical gear units

Parallel shaft gear units

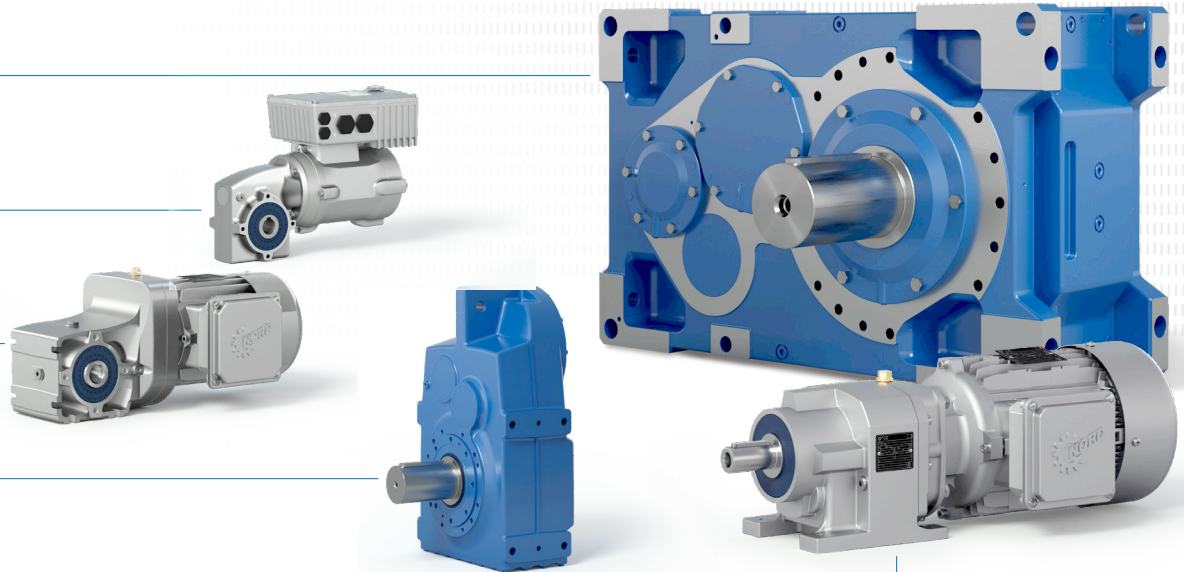

UNICASE helical in-line gear units – the robust all-rounder (Catalogue G1000)



- ▶ Foot or flange mounted versions
- ▶ Long life, low-maintenance
- ▶ Optimum sealing
- ▶ UNICASE housing

Sizes: 11  
Power: 0.12 – 160 kW  
Torque: 10 – 26,000 Nm  
Speed ratio: 1.35 – 14,340.31:1

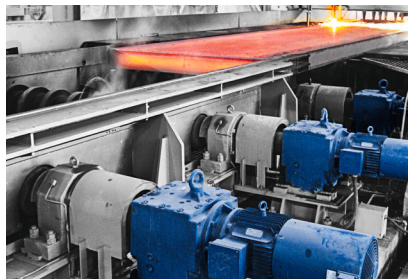

UNICASE helical in-line gear units

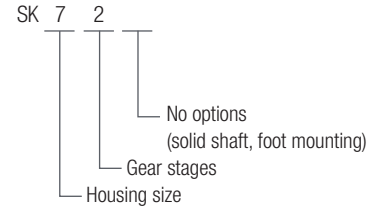

Special nomenclature:

- ▶ SK 33 = Standard series
- ▶ SK 33N = UNICASE series

**NORDBLOC.1® helical in-line gear units – the innovative performer** (Catalogue G1000)

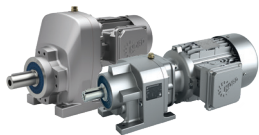

- ▶ Foot or flange mounted versions
- ▶ Die-cast aluminium alloy housing (cast iron housing for SK 772.1 and above)
- ▶ UNICASE housing
- ▶ Single-stage version available for high speed applications (SK x71.1)
- ▶ Long bearing life
- ▶ High permissible radial and axial forces
- ▶ Smooth surface
- ▶ Compact design, even with IEC/NEMA adapter
- ▶ Natural corrosion protection, even without painting

Sizes: 13  
Power: 0.12 – 37 kW  
Torque: 30 – 3,300 Nm  
Speed ratio: 1.07 – 456.77:1



**NORDBLOC.1® 1-stage helical in-line gear units**

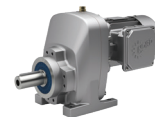
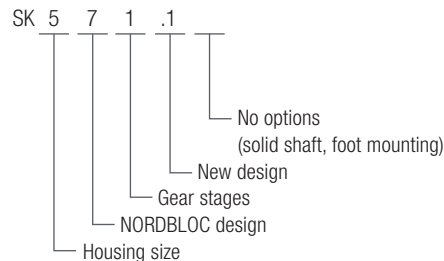

**NORDBLOC.1® 2-, 3-stage helical in-line gear units**

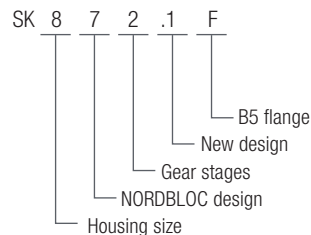

STANDARD helical gear units – the proven classic (Catalogue G1000)



- ▶ Foot or flange mounted versions
- ▶ Long life, low-maintenance
- ▶ Grey cast iron housing
- ▶ Reinforced output side (optional)

Sizes: 6

Power: 0.12 – 7.5 kW

Torque: 50 – 700 Nm

Speed ratio: 1.92 – 488.07:1



STANDARD helical gear units

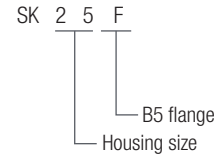

Special nomenclature:

- ▶ The number of digits corresponds to the number of gear stages; exception SK 0: these gear units have two stages
- ▶ A 5 at the designation end (e.g. SK 225) indicates a reinforced output configuration (shaft and bearings)

UNICASE parallel shaft gear units – slim and powerful (Catalogue G1000)



- ▶ Foot, flange or face mounted
- ▶ Hollow or solid shaft
- ▶ Compact design
- ▶ UNICASE housing
- ▶ Long service life
- ▶ Low-maintenance
- ▶ Quiet running – e.g. for theatre applications
- ▶ NORDBLOC.1® aluminium parallel shaft gear units up to Size 4

Sizes: 15

Power: 0.12 – 200 kW

Torque: 110 – 100,000 Nm

Speed ratio: 4.03 – 15,685.03:1



UNICASE parallel shaft gear units

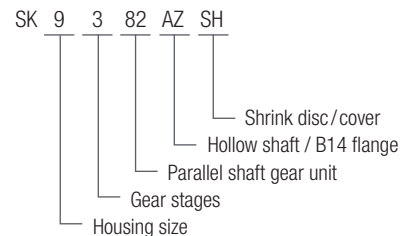

NORDBLOC.1® parallel shaft gear units

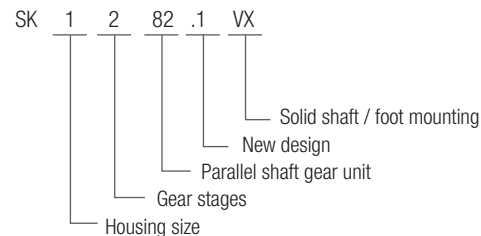

Special nomenclature (NORDBLOC.1®):

- ▶ For SK 0182.1 and SK 0282.1 the number of stages can be obtained from the nomenclature (a 2- and 3-stage version is available)

UNICASE bevel gear units – powerful and proven (Catalogue G1000)

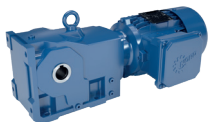

- ▶ Foot, flange or face mounted
- ▶ Hollow or solid shaft
- ▶ UNICASE housing
- ▶ High efficiency
- ▶ Robust design
- ▶ Grey cast iron housing
- ▶ Various bearing concepts for high axial and radial load capacities
- ▶ Quiet running – e.g. for theatre applications

Sizes: 11

Power: 0.12 – 200 kW

Torque: 180 – 50,000 Nm

Speed ratio: 8.04 – 13,432.68:1



UNICASE bevel gear units

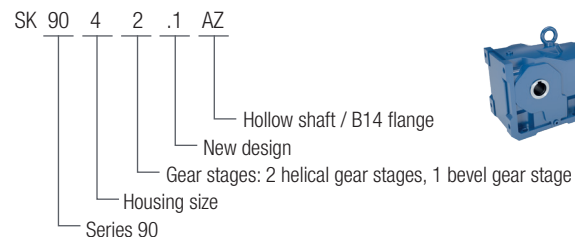

Special nomenclature:

- ▶ A 6 at the designation end indicates a reinforced version, 3-stage
- ▶ A 7 at the designation end indicates a reinforced version, 4-stage (including the bevel gear stage)

NORDBLOC.1® 2-stage bevel gear units – power and design (Catalogue G1014)

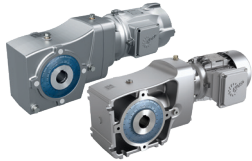

- ▶ Foot, flange or face mounted
- ▶ Hollow or solid shaft
- ▶ UNICASE housing
- ▶ Aluminium housing
- ▶ Wash-down design
- ▶ High power density

Sizes: 6  
Power: 0.12 – 9.2 kW  
Torque: 50 – 660 Nm  
Speed ratio: 3.03 – 70:1



NORDBLOC.1® 2-stage bevel gear units

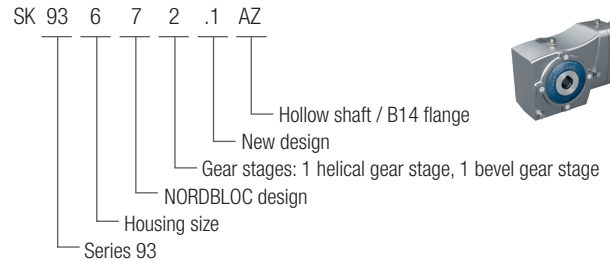
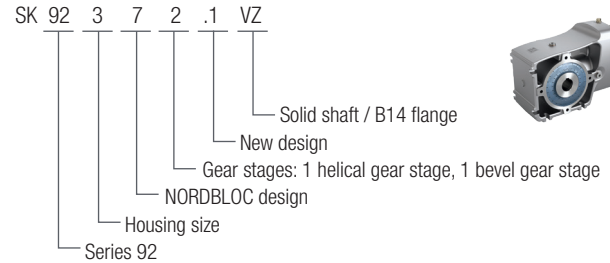

- ▶ SK 920072.1 / SK 930072.1 have the smallest available housing (Size 00)



UNICASE worm gear units – quiet and powerful (Catalogue G1000)



- ▶ Foot, flange or face mounted
- ▶ Hollow or solid shaft
- ▶ UNICASE housing
- ▶ Soft and quiet running
- ▶ High overload capacity
- ▶ High axial and radial loads
- ▶ Grey cast iron housing

Sizes: 6  
Power: 0.12 – 15 kW  
Torque: 93 – 3,058 Nm  
Speed ratio: 4.40 – 7,095.12:1



UNICASE worm gear units

SK 1 2 080

Worm gear size  
(centre distance between gear and pinion 80 mm)  
Gear stages: 1 helical gear stage, 1 worm gear stage  
Housing size  
(in combination with worm gear size)



- ▶ The nomenclature can also be used for SK 02040.1

UNIVERSAL SI worm gear units – modular and flexible (Catalogue G1035)



- ▶ Modular
- ▶ Universal mounting
- ▶ Life-long lubrication
- ▶ IEC version
- ▶ Aluminium housing

Sizes: 5  
Power: 0.12 – 4.0 kW  
Torque: 21 – 427 Nm  
Speed ratio: 5.00 – 3,000:1

UNIVERSAL SMI worm gear units – modular and flexible (Catalogue G1035)



- ▶ Smooth surfaces
- ▶ Life-long lubrication
- ▶ IEC version
- ▶ Aluminium housing

Sizes: 5  
Power: 0.12 – 4.0 kW  
Torque: 21 – 427 Nm  
Speed ratio: 5.00 – 3,000:1

UNIVERSAL SI worm gear units

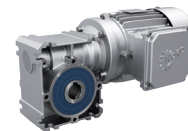
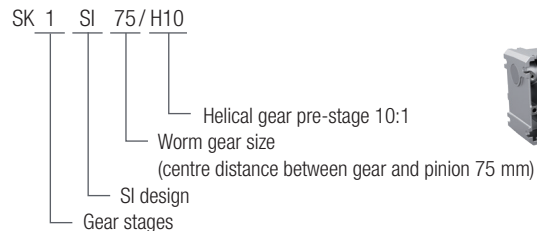

UNIVERSAL SMI worm gear units

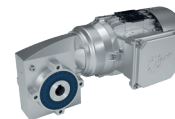
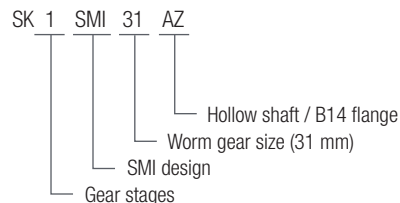

DuoDrive – integrated geared motor concept (Catalogue G5010)



- ▶ High-efficiency IE5+ motor
- ▶ System efficiency up to 92%
- ▶ Results in a significant reduction of the TCO (Total Cost of Ownership) compared to other drive systems
- ▶ High power density
- ▶ Minimal noise emissions
- ▶ Simple plug-and-play commissioning
- ▶ Hygienic design (wash-down)
- ▶ Design: M1, M4, M5, M6

Sizes: 2

Power: 0.35 – 3.0 kW

Torque: 26 – 247 Nm

Speed ratio: 3.24 – 18.1:1

DuoDrive

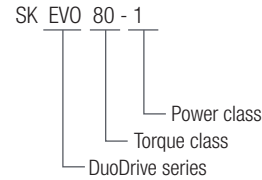

## Gear unit options

Designation	Meaning
A	Hollow shaft
AF	Hollow shaft, B5 flange
AX	Hollow shaft, foot mounting
AXF	Hollow shaft, foot mounting, B5 flange
AZ	Hollow shaft, B14 flange
AZD	Hollow shaft, B14 flange with torque arm
AZK	Hollow shaft, B14 flange with torque bracket
B	Fastening element for hollow shaft
D	Torque support
EA	Hollow shaft, splined, DIN 5480
G	Rubber buffer for torque arm
H	Cover as contact guard
IEC	Adapter for fitting IEC standard motors
LX	Solid shaft - both sides, foot mounting
MK	Motor bracket
R	Integrated backstop
RLS	Backstop in W adapter
S	Hollow shaft with shrink disc
SEK	Servo adapter with clamp coupling

Designation	Meaning
SEP	Servo adapter with parallel key coupling
V	Solid shaft
VF	Solid shaft, B5 flange
VL	Reinforced bearings
VL2	Agitator version
VL3	Agitator design with „Drywell“
VX	Solid shaft, foot mounting
VXF	Solid shaft, foot mounting, B5 flange
VXZ	Solid shaft, foot mounting, B14 flange
VZ	Solid shaft, B14 flange
W	Drive cylinder with free drive shaft
XF	Foot mounting, B5 flange
XZ	Foot mounting, B14 flange

- ▶ Not all options are available for all gear units
- ▶ Detailed descriptions and diagrams can be found in the relevant catalogues
- ▶ Further options in the cited catalogues or on request (e.g. belt drives)
- ▶ Multiple options are stated in consecutively, e.g. SK 2282 S H G (hollow shaft with shrink disk, cover, rubber buffer)

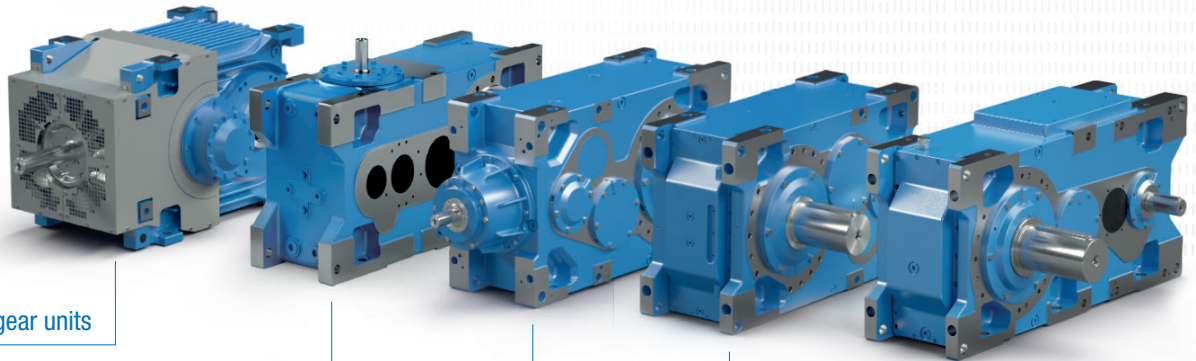

MAXXDRIVE® XT right-angle gear units

MAXXDRIVE® XJ right-angle gear units

MAXXDRIVE® right-angle gear units

MAXXDRIVE® parallel gear units

MAXXDRIVE® XD parallel gear units

## MAXXDRIVE® industrial gear units

- ▶ UNICASE housing, no joints subject to torque
- ▶ All bearing points and sealing surfaces are machined in a single operation
- ▶ High precision axis alignment, quiet running
- ▶ Long life, low-maintenance
- ▶ Helical and bevel gear units

## MAXXDRIVE® parallel gear units (Catalogue G1050)

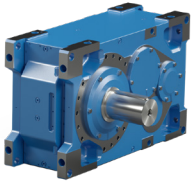

- ▶ Universal gear units
- ▶ 2- and 3-stage
- ▶ Multiple mounting and cooling options
- ▶ Modified bearing options for high radial and axial load capacity
- ▶ Compact design
- ▶ All installation positions

Sizes: 11  
 Power: 1.5 – 6,000 kW  
 Torque: 15,000 – 282,000 Nm  
 Speed ratio: 5.54 – 30,000:1

## MAXXDRIVE® right-angle gear units (Catalogue G1050)

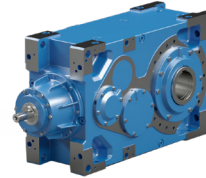

- ▶ Universal gear units
- ▶ 3- and 4-stage
- ▶ Multiple mounting and cooling options
- ▶ Modified bearing options for high radial and axial load capacity
- ▶ Compact design
- ▶ All installation positions

Sizes: 11  
 Power: 1.5 – 2,150 kW  
 Torque: 15,000 – 260,000 Nm  
 Speed ratio: 12.61 – 30,000:1

## MAXXDRIVE® XT right-angle gear units (T160-0011)



- ▶ 2-stage
- ▶ Thermally optimised gear units
- ▶ Integrated high power axial fan
- ▶ High powers with low speed ratios
- ▶ Optimised for horizontal installation orientation
- ▶ Ideal for applications such as belt or bucket conveyors

Sizes: 7  
 Power: 22 – 2,100 kW  
 Torque: 15,000 – 75,000 Nm  
 Speed ratio: 6.14 – 22.91:1

## MAXXDRIVE® XD parallel gear units (Flyer G1056)

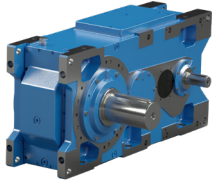

- ▶ 3- and 4-stage
- ▶ Housing with increased centre distance
- ▶ Inspection cover
- ▶ Housing optimised for downward radial loads
- ▶ Ideal for lifting equipment

Sizes: 5

Power: 1.5–925 kW

Torque: 15,000–112,000 Nm

Ratio: 22.4–355:1

## MAXXDRIVE® XJ right-angle gear unit

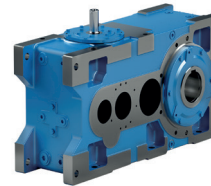

- ▶ 3-stage
- ▶ New input shaft position “J-Mount”
- ▶ Horizontal and vertical installation positions
- ▶ Modular
- ▶ Flexible

Sizes: 5

Power: 5.5–1,275 kW

Torque: 15,000–107,000 Nm

Ratio: 12.5–100:1



# Industrial gear units

## MAXXDRIVE® industrial gear units

SK 11 2 17 AS H MS FAN 355LP/4

Motor designation  
 Additional options (FAN, CC, ...)  
 Motor adapters (IEC, NEMA, MS, ...)  
 Additional options (D, H, B, ...)  
 Shaft and mounting options (A, V, L, ...)  
 Type designation

	Parallel Gear Units		Right-Angle Units		
	07	21 (XD)	07	17 (XT)	18 (XJ)
2-stage	2	–	–	2	–
3-stage	3	3	4	–	4
4-stage	–	4	5	–	–

Size (5 – 15)

## MAXXDRIVE® drive systems

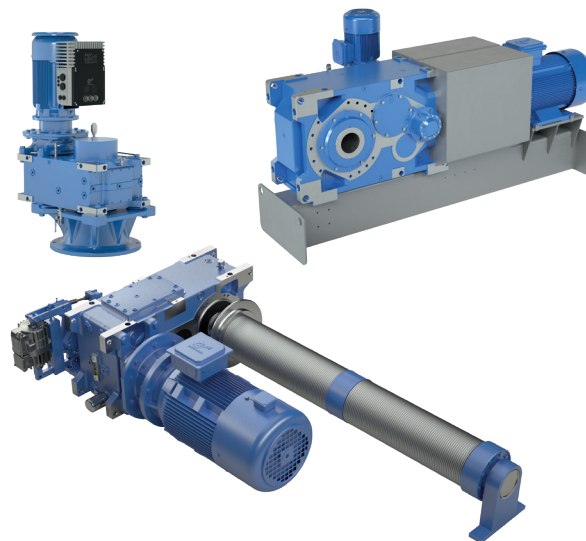

- ▶ Complete drive systems consisting of the gear unit, motor and drive electronics
- ▶ Wide selection of other components, e.g. couplings, brakes, etc.
- ▶ Standardised solutions for rockers and base frames, e.g. for belt conveyors or bucket elevators, etc.
- ▶ Systems tailored to applications, e.g. agitators, hoists, extruders, etc.
- ▶ Individually adaptable

## Industrial gear unit options

Designation	Meaning
A	Hollow output shaft with key groove
AS	Hollow output shaft for shrink disc
B	Fastening set for hollow shaft
CC	Internal water cooling system
CS1	External oil-water cooler
CS2	External oil-air cooler
D	Torque arm
DRY	"True Drywell" agitator version with standard bearing
EA	Splined hollow output shaft, DIN 5480
ED	Elastic torque arm
EV	Splined solid output shaft, DIN 5480
EW	Splined solid input shaft, DIN 5480
F	Flat output flange (B14 with threaded holes)
FAN	Fan or electrical fan
FK	High output flange (B5 with through holes)
F1	Drive flange (SK..207 / SK..307)
H/H66	Cover (contact guard) / IP66 cover
IEC	Adapter for B5 mounting, IEC standard motors
L	Double solid output shaft
LC	Pressurised oil lubrication (bearings)
LCX	Pressurised oil lubrication with "Drywell" (bearings and gearwheels)
MC	Motor bracket
MO	Measuring devices and sensors
MF	Motor frame (options: see MF...)
MFB	Base frame with brake
MS	Motor swing base (options: see MS...)
MSB	Motor swing base with brake
MFK	Motor frame with elastic coupling

Designation	Meaning
MFT	Motor frame with turbo coupling
MSK	Motor swing base with elastic coupling
MSKB	Motor swing base with elastic coupling and brake
MST	Motor swing base with turbo coupling
MFTB	Motor frame with turbo coupling and brake
MSTB	Motor swing base with turbo coupling and brake
MT	Motor mount
NEMA	Adapter for fitting B5 NEMA C flange, standard motors
OT	Oil reservoir tank
OH	Oil heater
R*	Back stop
V	Solid output shaft
VL2	Agitator version
VL3	Agitator version with "Drywell"
VL4	Agitator version with "True Drywell"
VL5	Extruder flange
VL6	Agitator version with "True Drywell" without flange
WX	Auxiliary drive unit
WG	First-stage gear unit
W1, W2*, W3*	W1/2/3 – number of solid input shafts, W3 – for 407 and 507 types
–	Brakes
–	Couplings
–	Paintings
–	Endurance Package

\* R, W2, W3 – not available for all ratios

- ▶ Not all options/combinations are available for all gear units
- ▶ Detailed descriptions and diagrams can be found in the relevant catalogues
- ▶ Further options can be found in the relevant catalogues or on request
- ▶ Multiple options are stated consecutively, e.g. SK 11217 AS H ED (hollow output shaft with shrink disc, cover and elastic torque arm)

UNIVERSAL motor

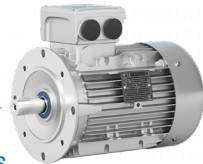

Synchronous- and asynchronous motors



IE5+ Synchronous motors

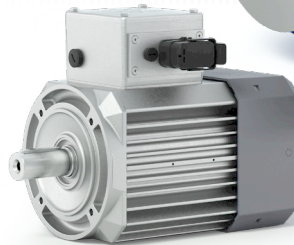

Smooth surface motors



### Standard asynchronous motors (Catalogue M7000)



- ▶ Comply with international regulations and directives
- ▶ Extensive options possible
- ▶ ISO F used according to B (ISO H as option)
- ▶ Suited for inverter operation
- ▶ High overload reserves

Sizes: 63 – 225

Power: 0.12 – 55 kW

Number of poles: 2, 4, 6, 8

Protection class: IP55 optional IP66

Efficiency class: IE1, IE3

### Switchable pole asynchronous motors (Catalogue M7000)

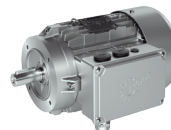

- ▶ ISO F used according to B

Sizes: 63 – 160

Power: 0.10 – 17 kW

Number of poles: 4-2, 8-2, 8-4 (others on request)

Protection class: IP55 optional IP66

Efficiency class: IE1

### Single-phase asynchronous motors (Catalogue M7000)



- ▶ ISO F used according to B
- ▶ With operating and starting capacitor and as single-phase motors with Steinmetz circuit

Sizes: 63 – 90

Power: 0.12 – 1.5 kW

Number of poles: 4

Protection class: IP55 optional IP66

Efficiency class: IE1

# Electric motors

## IEC asynchronous motors

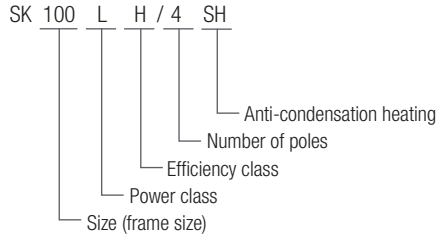

- ▶ X or W in the nomenclature designates a smaller size, e.g. SK 250WP is a 55 kW Motor in a size 225 housing

## NEMA C-FACE asynchronous motors

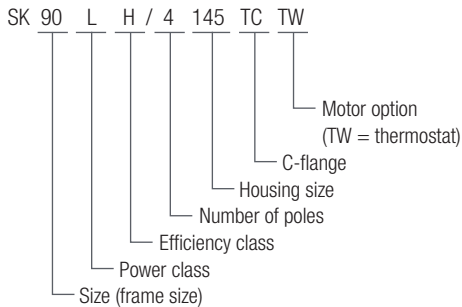

## Switchable pole asynchronous motors

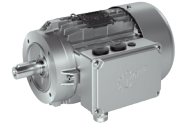
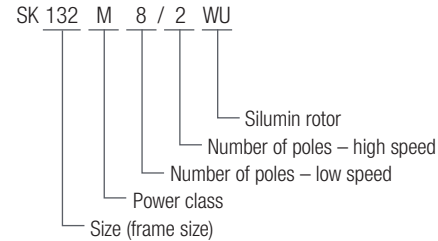

## Single-phase asynchronous motors

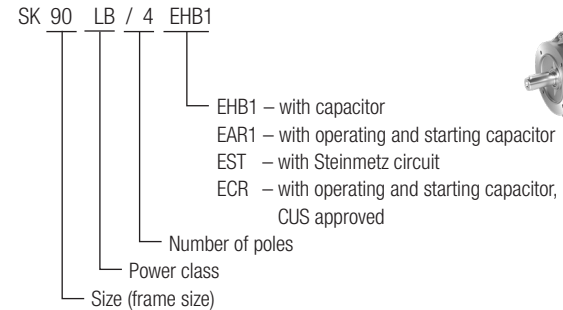

### Asynchronous smooth surface motors (Catalogue M7010)



- ▶ ISO F
- ▶ Suited for inverter operation
- ▶ Wash-down design
- ▶ Smooth surfaces, especially suitable for food industry applications

Sizes: 71 – 100

Power: 0.12 – 2.2 kW

Number of poles: 4

Protection class: IP66 optional IP69K  
(in combination with the gear unit)

Efficiency class: IE3

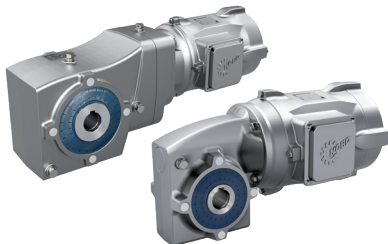

### Asynchronous smooth surface motors

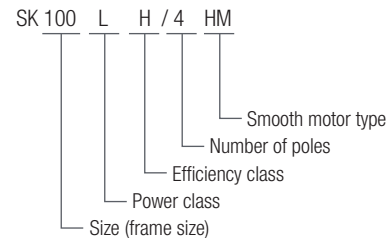

- ▶ For non-ventilated smooth motors, the efficiency code letter is H or P for Premium Efficiency (IE3)

UNIVERSAL motor (DS1005)



International certification

- ▶ CE
- ▶ UL standard 1004
- ▶ CSA
- ▶ CCC
- ▶ EAC
- ▶ ISI
- ▶ UA
- ▶ UKCA
- ▶ NOM

International energy standards

- ▶ IEC 60034-30
- ▶ EISA 2007
- ▶ EER 2010
- ▶ CEL/GB 18613
- ▶ MEPS AS/NZ 1359.5

Dual-Mode: 50 Hz and 60 Hz  
Four different operating points

Sizes: 63 – 225  
Power: 0.12 – 45 kW  
Number of poles: 4  
Protection class: IP55 optional IP66  
Efficiency class: IE3 / Premium

3~Mot. SK 90 SP/4 CUS TF BRE20								
V	D/Y	Hz	A	kW	hp	cosφ	r/min	Nom.EFF
220/380		50	4,25/2,45	1,1	1,5	0,81	1420	84,9
230/400		50	4,12/2,38	1,1	1,5	0,78	1430	85,3
240/415		50	4,19/2,42	1,1	1,5	0,76	1435	85,5
265/460		60	3,64/2,14	1,1	1,5	0,76	1740	86,9
S1		Tamb 40 °C				20,7 kg		
IEC/EN 60034 (H) SF 1,15 NEMA CODE L								
Th. Cl 155(F) IP 55 TEFC DP								
三相异步电动机 Usable at 440V Y 60Hz								
Over Temp Prot-2 Class F Usable at 480V Y 60Hz								
Brake 20 Nm 230 VAC 205 VDC								
201912345-1200		930	12345678			2020		
Getriebebau NORD GmbH & Co. KG, 22939 Bargteheide / GERMANY <a href="http://www.nord.com">www.nord.com</a>								

Example type plate UNIVERSAL Motor  
(UA as well as UKCA are marked separately on the motor)



**Standard synchronous motors** (T160-0001 and T160-0004)



- ▶ ISO B
- ▶ Only for inverter operation
- ▶ Open or closed loop operation with NORD frequency inverters
- ▶ High overload reserves

Sizes: 80 – 100  
 Power: 1.1 – 5.5 kW  
 Number of poles: 4  
 Protection class: IP55 optional IP66  
 Efficiency class: IE4

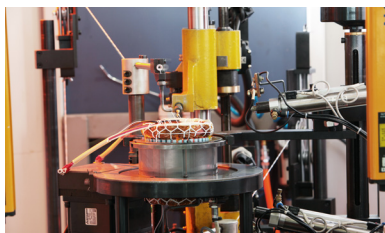

**Standard synchronous motors**

SK 100 T 2 / 4 Δ

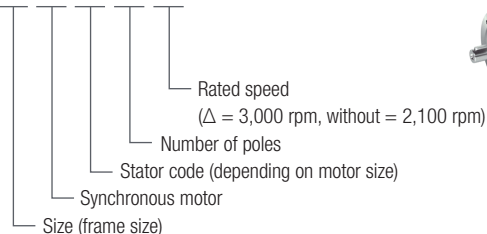

**IE5+ synchronous motors** (Catalogue M5000)

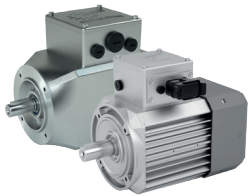

- ▶ Ultimate operational efficiency with IE5 technology
- ▶ Reduced TCO (Total cost of Ownership) and fast ROI (Return on Investment)
- ▶ Reduced number of versions through constant torque over a wide speed range
- ▶ Motor can be operated worldwide
- ▶ Flexible motor mounting: direct mounting, IEC, NEMA
- ▶ Unventilated motors in smooth housing for wash-down applications
- ▶ Optional motor-integrated encoder
- ▶ Optional integrated mechanical brake

Sizes: 71, 90

Power: Unventilated (TENV) 0.35 – 2.2 kW

Ventilated (TEFC) 0.5 – 3.7 kW

Number of poles: 8

Torque: 1.6 – 14.7 Nm

Protection class: IP55

optional IP66 or IP69K

(in combination with the gear unit)

Efficiency class: IE5 is exceeded in some cases

**IE5+ synchronous motors**

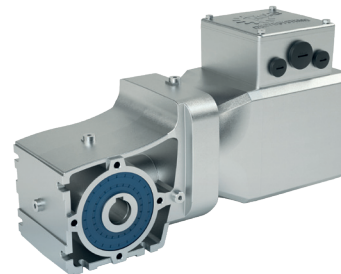
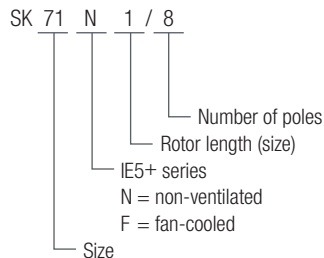

**IE5+ synchronous motors**

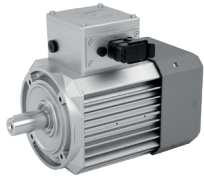

IE5

The IE5+ synchronous motor is characterised by its very high efficiency. Compared to asynchronous motors, high energy savings are possible, especially in the partial load and partial speed range.\* This minimises the customer's TCO.

\* Efficiency example:  
 Load 50% / speed 37.5%

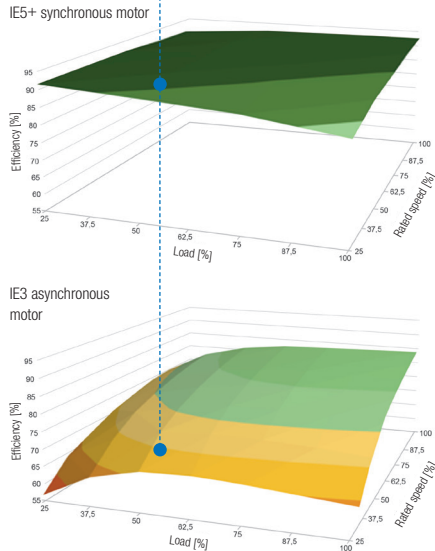

**Dust explosion-protected motors** (Catalogue G2122)

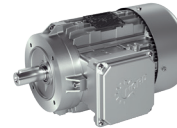

- ▶ Zone 21, device category 2D, Ex tb 125° C
- ▶ Zone 22, device category 3D, Ex tb 125° C
- ▶ Direct and IEC mounting

Sizes: 2D: 63 – 180, 3D: 63 – 250  
 Power: 2D: 0.12 – 22 kW, 3D: 0.12 – 55 kW  
 Number of poles: 4  
 Protection class: IP55 optional IP66  
 Efficiency class: IE3

**Gas explosion-protected motors** (Catalogue G2122)

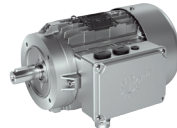

- ▶ Zone 1, device category 2G, Exe T3
- ▶ Zone 2, device category 3G, Exn T3
- ▶ Direct and IEC mounting

Sizes: 63 – 180  
 Power: 0.12 – 17.5 kW  
 Number of poles: 4  
 Protection class: IP55 optional IP66  
 Efficiency class: IE3



- ▶ Motors compliant with IEC Ex, EAC Ex, CCC Ex and NEC 500 (HazLoc) are also available, see catalogue G2122
- ▶ Further information about European explosion protection is given in Manual Part No. 6091602
- ▶ Other motor sizes and ignition protection types on request

## Motor options

Designation	Meaning
BRE +	Brake/brake torque + sub-options
DBR +	Double brake + sub-options
RG *	Rust protected version
SR *	Dust and rust protected version
IR *	Current relay
FHL *	Lockable manual release
HL	Manual release
MIK	Microswitch
AS55 *	Outdoor installation
BRB	Anti-condensation heater / brake
NRB1/2	Noise-reduced brake
ERD	External earthing terminal
TF	Thermistor, PTC resistor
TW	Temperature sensor, bi-metal
SH	Anti-condensation heater
WU	Silumin rotor
Z	Additional flywheel, cast iron fan
WE	Second shaft end
HR	Hand wheel
RD	Protective shield
RDT	Protective shield, textile fan cowl
RDD	Double fan cowl
AS66	Outdoor installation
OL	Without fan

## Motor options

Designation	Meaning
OL/H	Without fan, without fan cowl
KB	Closed condensation drain hole
MS	Motor plug connection
EKK	One-piece terminal box
KKV	Encapsulated terminal box
FEU	Humidity protection insulation
TRO	Tropical protection insulation
MOL	Dairy version
VIK	Regulation – Vereinigung Industrieller Kraftwirtschaft (Association of the Industrial Power Industry)
F	External fan
RLS	Backstop
MG	Magnetic incremental encoder
SL	Sensor bearings
IG	Incremental encoder
IG.P	Incremental encoder with plug connector
IG.K	Incremental encoder with terminal box
AG	Absolute encoder

\* not for DBR



- ▶ Not all options are available for all motors
- ▶ Detailed descriptions and drawings of the options can be found in M7000
- ▶ Further options on request (e.g. 2xTF, PT100 etc.)

Frequency inverter NORDAC *LINK FDS*

Motor starter NORDAC *START*

Cabinet frequency inverter NORDAC *PRO*

Decentralised frequency inverter NORDAC *FLEX*

Decentralised frequency inverter NORDAC *BASE*

Cabinet frequency inverter NORDAC *PRO*



## NORDAC PRO SK 500P – for versatile use (Catalogue E3000)



### Cabinet frequency inverter

- ▶ Universal drive in various basic versions, can be modularly extended
- ▶ Precise current vector control with high overload reserve up to 200% for operation of asynchronous and synchronous motors
- ▶ POSICON – Integrated positioning mode
- ▶ Universal interface for real-time Ethernet PROFINET, ETHERCAT, ETHERNET IP and POWERLINK
- ▶ CANopen as series equipment
- ▶ Drive profile DS402 for CANopen, ETHERCAT and POWERLINK
- ▶ Integrated PLC for drive-related functions, even in the basic device
- ▶ TTL encoder interface and optional universal encoder interface
- ▶ Optional: Safe Stop with “Safe Torque Off” (STO) and “Safe Stop 1” (SS1-t) according to EN 61800-5-2
- ▶ MicroSD Card
- ▶ USB interface for connection to NORDCON, may also be used without a power supply
- ▶ Compact slim design, can be mounted directly adjacent to other components
- ▶ In Size 1 and 2 all terminals are implemented as plug connections, including the power

Sizes: 5

Voltage: 1~ 200 – 240 V, 3~ 380 – 480 V

Power: 0.25 – 22 kW

## NORDAC PRO SK 500P

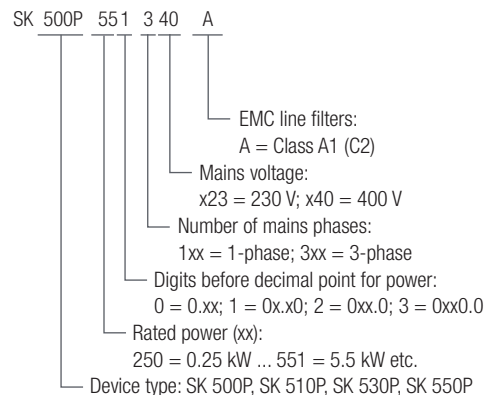

## NORDAC PRO SK 500E – for versatile use (Catalogue E3000)



### Cabinet frequency inverter

- ▶ Maximum functionality
- ▶ Sensorless current vector control (ISD control)
- ▶ Multi-encoder interface
- ▶ PLC functionality for drive-integrated functions SK 520E and higher
- ▶ Optional: POSICON positioning SK 530E and higher
- ▶ Optional: Safe stop with “Safe Torque Off” (STO) and “Safe Stop 1” (SS1) according to EN 61800-5-2 (for SK 510E and SK 530E)
- ▶ ASM and PMSM motor operation
- ▶ Energy-saving function
- ▶ High overload reserves (200%) for all power ratings up to 160 kW
- ▶ Many field bus and Industrial Ethernet-based bus systems
- ▶ Optional: CANopen integrated in SK 511E and higher
- ▶ Integrated Class C1 line filter
- ▶ Alternative cooling systems, e.g. “Cold Plate”
- ▶ IP20 control cabinet installation

Sizes: 11

Voltage: 1~ 110 – 120 V, 1~ 200 – 240 V, 3~ 200 – 240 V,  
3~ 380 – 480 V

Power: 0.25 – 160 kW

## NORDAC PRO SK 500E

SK 500E 11 3 40 A

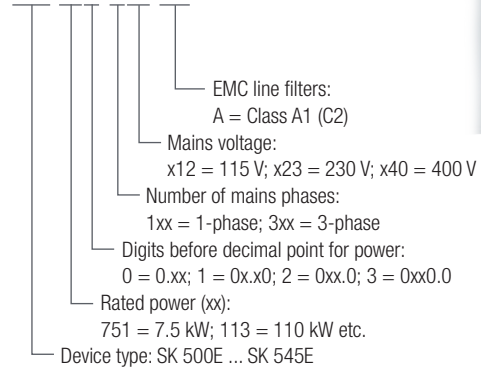



## NORDAC ON/ON+ SK 300P (FCatalogue E3000)



### Decentralised frequency inverter

The frequency inverter particularly serves the special requirements of horizontal conveyor technology. The NORDAC ON has been developed for IE3 drives while the NORDAC ON+ has been optimised for the combination with the IE5+ synchronous motor. It is characterised by an integrated Ethernet interface, full pluggability as well as a very compact design. An economic plug-and-play solution for IIoT environments.

- ▶ 4 digital inputs, 2 digital outputs
- ▶ Functional safety: STO, SS1
- ▶ Integrated Ethernet interface can be configured for each parameter
- ▶ Firmware update via Ethernet
- ▶ Encoder interfaces: RS485
- ▶ Simple installation and maintenance due to full pluggability
- ▶ 4 parameter sets which can be switched online
- ▶ 4-quadrant operation with integrated brake chopper
- ▶ V/f control, current vector control in open-loop and closed-loop mode
- ▶ High precision control and high overload characteristics for synchronous and asynchronous motors
- ▶ PLC functionality for drive-related functions
- ▶ POSICON – integrated positioning mode
- ▶ Ambient temperature: -30...+40° C (S1)

## NORDAC ON/ON+ SK 300P

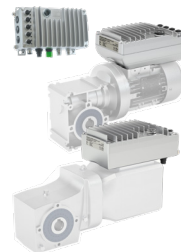

- NORDAC ON ▶ With optimised IE3 motor
- NORDAC ON+ ▶ With the latest IE5+ motor

Sizes: 2

Power: 0.37 – 0.95 kW

Mains voltage: 3 ~ 400 V

Supply voltage: 24V DC external

- ▶ NORDAC ON typical overload capacity:  
150 % for 60 s, 200 % for 5 s, 250 % for 1 s
- ▶ NORDAC ON+ typical overload capacity:  
150 % for 60 s, 200 % for 5 s, up to 300 % for 1 s
- ▶ NORDAC ON protection class: IP55
- ▶ NORDAC ON+ protection class: IP55 /IP66

SK 300P 360 340 A

EMC line filters: A = Class A1 (C2)  
Mains voltage: 3-phase, 400 V

Power: 360 = 0.37 kW in Size 1  
370 = 0.37 kW in Size 2  
450 = 0.45 kW in Size 1  
750 = 0.75 kW in Size 2  
950 = 0.95 kW in Size 2

Device type: 300P = NORDAC ON without functional safety  
301P = NORDAC ON with functional safety  
310P = NORDAC ON+ without functional safety  
311P = NORDAC ON+ with functional safety



## NORDAC LINK SK 250E FDS — easy to install (Catalogue E3000)



### Frequency inverter

- ▶ Simple installation and maintenance due to full pluggability
- ▶ Optional maintenance switch and plug-in EEPROM for easy servicing
- ▶ Free configuration for your application
- ▶ Field installation close to the geared motor thanks to high protection class IP55/IP65
- ▶ Operation of asynchronous and synchronous motors
- ▶ High overload up to 200 % and 4-quadrant operation thanks to optional braking resistor solutions
- ▶ Many field bus and Industrial Ethernet-based bus systems as well as ASi
- ▶ Local control via optional key/manual switches, buttons and potentiometers
- ▶ Safe stop with “Safe Torque Off” (STO) and “Safe Stop 1” (SS1) according to EN 61800-5-2 as well as ProfiSAFE with functional safety functions, e.g. Safe Limit Speed
- ▶ POSICON – integrated positioning mode

Sizes: 3

Voltage: 3~ 380 – 500 V

Power: 0.37 – 7.5 kW

## NORDAC LINK SK 250E FDS

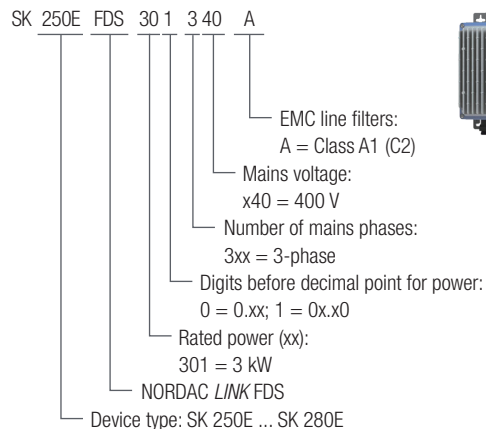

- ▶ FDS = Field Distribution System

## NORDAC FLEX SK 200E – for flexible use (Catalogue E3000)



### Decentralised frequency inverter

- ▶ Sensorless current vector control (ISD control)
- ▶ PLC functionality for drive-integrated functions
- ▶ Integrated POSICON positioning control
- ▶ Safe stop with “Safe Torque Off” (STO) and “Safe Stop 1” (SS1) according to EN 61800-5-2 as well as ProfiSAFE with functional safety functions, e.g. Safe Limit Speed
- ▶ ASM and PMSM motor operation
- ▶ Energy-saving function
- ▶ Motor or wall mounting
- ▶ IP55 (optional IP66)
- ▶ AS-Interface integrated in SK 22xE and SK 23xE
- ▶ Many field bus and Industrial Ethernet-based bus systems
- ▶ Extensive selection of plug connectors for control and power cable connections
- ▶ ATEX Zone 22, Category 3D (Sizes 1 – 3)
- ▶ POSICON – integrated positioning mode

Sizes: 4

Voltage: 1~ 110 – 120 V, 1~ 200 – 240 V, 3~ 200 – 240 V,  
3~ 380 – 500 V

Power: 0.25 – 22 kW

## NORDAC FLEX SK 200E

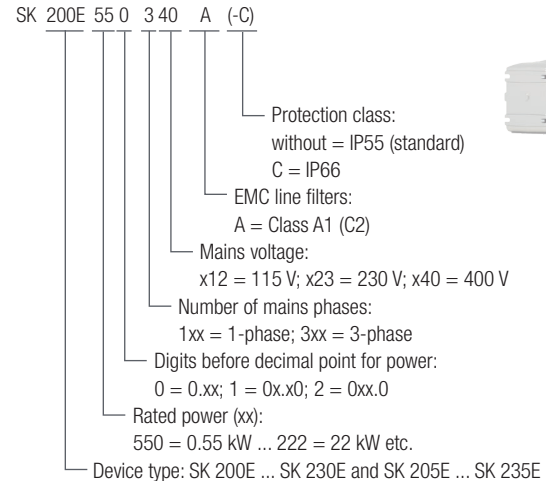



## NORDAC LINK SK 155E/175E FDS – for economical operation (Catalogue E3000)



### Motor starter

- ▶ All I/O, bus interface and power connections in plug-in version for easy commissioning and maintenance
- ▶ Extensive options e.g. key switch maintenance switch
- ▶ PLC functionality for drive-integrated functions
- ▶ Wear-free fully electronic starting with reversing function
- ▶ Functions compatible with modular NORDAC START
- ▶ Protection class IP65
- ▶ Simple commissioning
- ▶ AS-Interface or PROFIBUS can be used
- ▶ Field installation
- ▶ Can be parameterised on-site

Sizes: 1  
 Voltage: 3~ 380 – 500 V  
 Power: 0.12 – 3 kW

## NORDAC LINK SK 155E/175E FDS

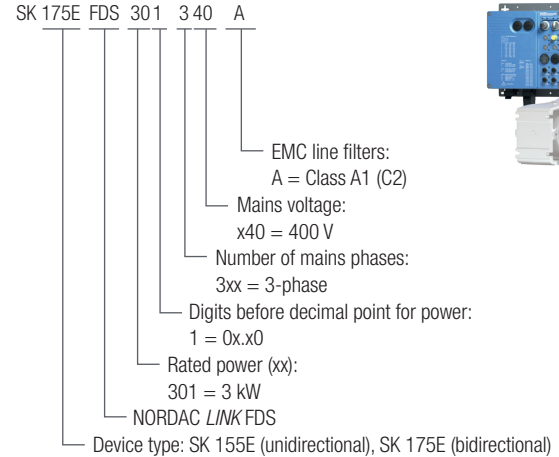

- ▶ FDS = Field Distribution System

## NORDAC START SK 135E – for economical operation (Catalogue E3000)



### Decentralised motor starter

- ▶ Motor starter with soft start and reversing function
- ▶ Integrated brake rectifier to control a brake (BRE)
- ▶ PROFIBUS or AS-Interface integrated
- ▶ Wall or motor mounting
- ▶ IP55 (optional IP66 and IP69K)
- ▶ Integrated line filter
- ▶ 2 digital inputs, 2 digital outputs
- ▶ Temperature sensor input (TF+ /TF-)
- ▶ RS232 interface
- ▶ ATEX Zone 22, Category 3D
- ▶ Electronic starter switches without wear
- ▶ Reduced mechanical wear due to reduced start-up torque

Sizes: 2

Voltage: 3~ 200 – 240 V, 3~ 380 – 500 V

Power: 0.12 – 3 kW resp. up to 7.5 kW

## NORDAC START SK 135E

SK 135E 301 340 B ASI C (-NSD) for IP69K

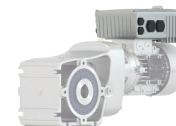
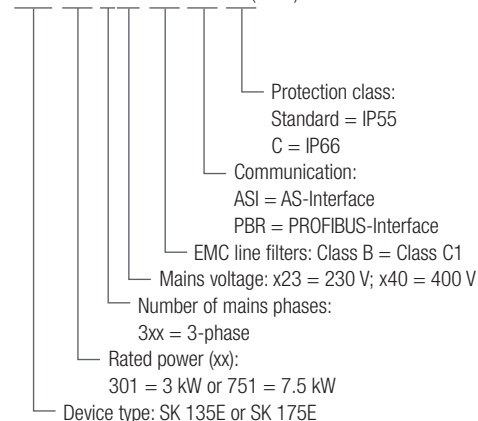

## NORDCON software



NORDCON is the free operating software for control, parameterisation and diagnostics of all NORD frequency inverters and motor starters.

### ▶ Control

A virtual control unit, analogous to a SimpleBox (optional control and parameterisation unit), enables the display of operating values, parameterisation and control of a connected frequency inverter or motor starter.



### ▶ Parameterisation

By means of a convenient overview the user can view and adjust each available parameter. With the corresponding printing option, parameter lists are generated in printed form either completely or only with the values which deviate from the factory settings. The final data sets can be saved on a PC/laptop and archived for future use or sent by e-mail.



### ▶ Diagnostics

The oscilloscope function of the NORDCON software is an extremely useful instrument for the optimum adjustment of drive systems. By means of line graphs, all drive characteristics (current, torque, etc.) can be recorded and analysed. On the basis of the results, fine tuning of the ideal parameter settings of the relevant drive unit is possible.



### ▶ Programming the PLC

A PLC editor is available for creating, editing and managing a PLC program. The PLC programs can also be tested (debugged) with this editor and communicated to the frequency inverter. The programming languages "Structured Text" and "Instruction List" according to IEC 61131-3 are supported.

## Mobile commissioning and service solution

### NORDAC ACCESS BT



With the NORDAC *ACCESS BT* removable Bluetooth stick you can now make 1:1 connections to your mobile terminal device. Together with the free NORDCON *APP*, which of course is available for both Android and iOS, you have a practical, smart tool in your pocket, with which you can conveniently access your frequency inverter. The available functions (display operating values, parameterisation and oscilloscope) are familiar from the Windows-based NORDCON software, but are now a little smarter.

- ▶ Stand-alone parameter memory
- ▶ Bluetooth interface for inverter and NORDCON *APP*
- ▶ Data transfer to PC via USB
- ▶ Can be plugged in or disconnected during operation

### NORDCON APP



- ▶ Dashboard-based visualisation for drive monitoring and fault diagnosis
- ▶ Parameterisation with help function and rapid access to parameters
- ▶ Individually configurable oscilloscope function for drive analysis
- ▶ Backup and recovery function for simple handling of drive parameters

## PROFIsafe



Safe Motion PROFIsafe via PROFINET with module SK TU4-PNS



Safety functions for drives according to IEC 61800-5-2

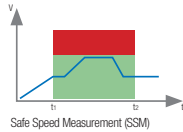
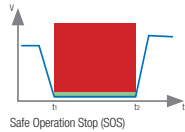
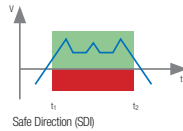
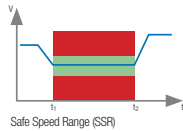
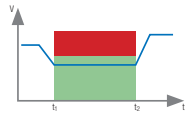

▶ PL<sub>e</sub> (Performance Level)  
Cat. 4 according to ISO 13849-1

▶ SIL 3 (Safety Integrity Level)  
according to IEC 62061

+ user-defined safe I/O configuration

- ▶ Easy implementation of safe reactions available for NORDAC *FLEX* and NORDAC *LINK*
- ▶ Comprehensive safety for reliable operation of plant and machinery
- ▶ Functional safety with a single network cable
- ▶ Minimum wiring effort
- ▶ Global availability of fail-safe machine data

## Bus systems and Industrial Ethernet

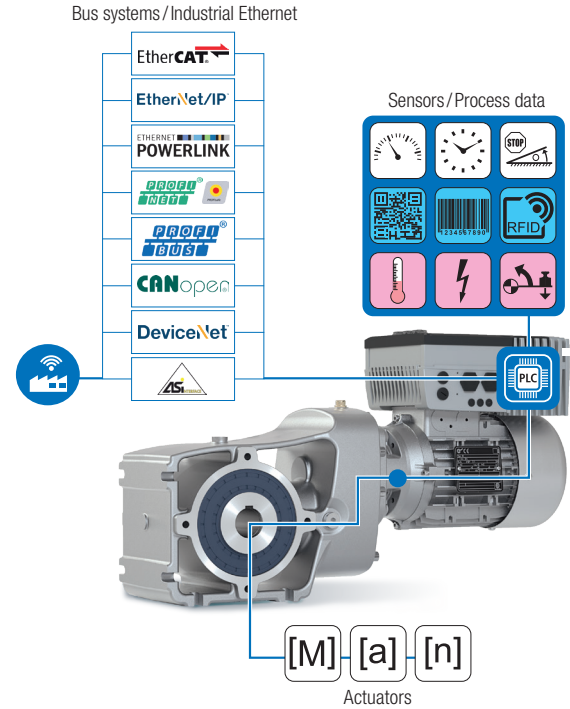



## Correct connection technology – pre-assembled (Catalogue E3000)



NORD DRIVESYSTEMS supplies an extensive range of connection and control cables.

- ▶ Depending on the version, connecting cables include power connection cables (mains and motor) and if necessary cables for thermistors as well as 24VDC control voltage
- ▶ Control cables are exclusively used for transmitting control signals (encoder, bus, I/O signals)

Connection and control cables are supplied pre-assembled. They are available in various lengths and can be optionally provided with open ends or plug connectors.

- ▶ Cables for motor and frequency inverter connection
- ▶ Mains connection and Daisy-Chain cables
- ▶ Signal and brake resistor cables

## Correct connection technology – pre-assembled

### SC H4G2.5 HQ8SMM H10E1SMF 1.5 UL

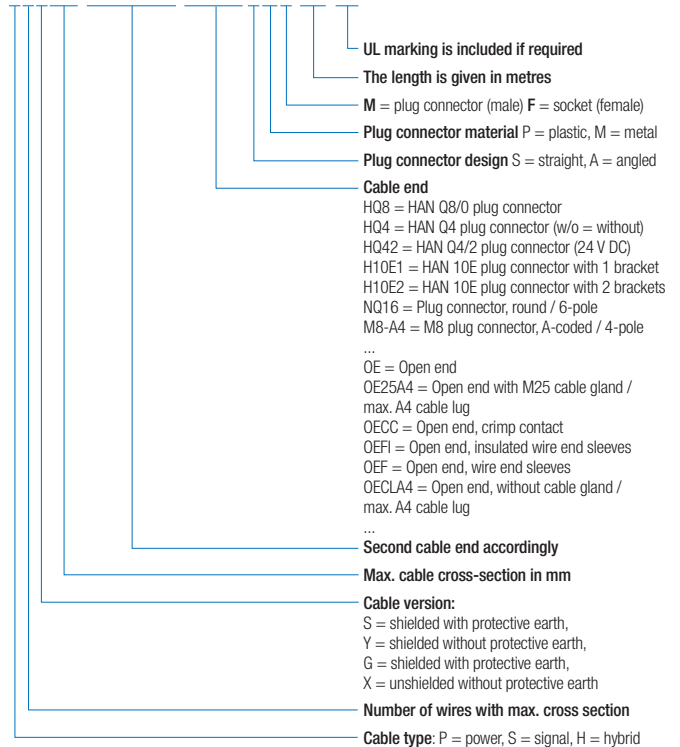

## Condition Monitoring for Predictive Maintenance (Flyer S9091)

For Condition Monitoring, drive and status data are recorded periodically or continuously in order to optimise the operational safety and efficiency of machines and plants. Condition Monitoring can provide major information for Predictive Maintenance. The objective is to maintain machines and plants proactively, to reduce downtimes and to increase the efficiency of the entire plant.

The INDUSTRIAL INTERNET of THINGS (IIoT) focuses on internet usage in industrial processes and procedures. IIoT aims at increasing the operational efficiency, reducing costs and speeding up processes. Sensors and sensor data play a central role to provide the basis for Condition Monitoring and Predictive Maintenance.

- ▶ Condition Monitoring solutions for Predictive Maintenance systems integrated into the frequency inverter
- ▶ System is IIoT / INDUSTRY 4.0 READY!
- ▶ Available for decentralised and control cabinet solutions

## Temperature curve of the oil in the gear unit

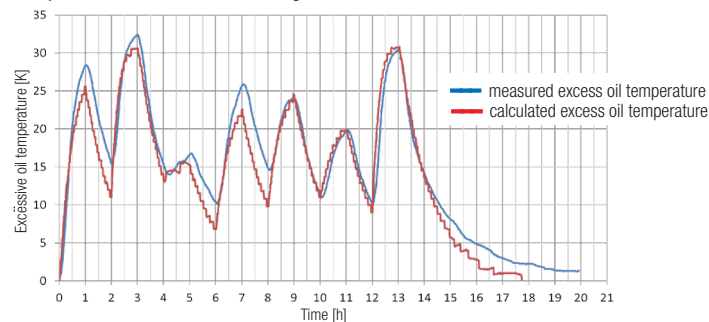

### Sensors

- ▶ Virtual sensors – the internal PLC can calculate information such as the optimal oil change time
- ▶ Interface for digital / analogue sensors

### Communication interfaces

- ▶ Threshold values or general status information can be communicated externally (via normal Industrial Ethernet dialects)

### Integrated PLC

- ▶ Local pre-processing of data with the integrated PLC
- ▶ Pre-processing of threshold values

## Condition Monitoring for Predictive Maintenance (Flyer S9091)



### System vibration sensor

- ▶ NORD qualified sensors
- ▶ Connection of customised sensors (analogue/digital)



### Temperature sensor

- ▶ PT1000-based motor temperature sensor
- ▶ Ambient or system temperature



### Oil change

- ▶ Determination of the optimal time for oil change on the basis of the virtual oil temperature
- ▶ The algorithm is executed in the integrated PLC



### Drive parameters

- ▶ Readout of drive system parameters
- ▶ Basis for virtual sensors



### Integrated PLC

- ▶ Pre-processing of drive-specific parameters and sensors related to the drive
- ▶ Evaluation of drive conditions



### Signal beacon

- ▶ Local display of drive conditions
- ▶ Scalable display



### Local data management (IPC)

- ▶ Processing of drive data for drive and system analysis
- ▶ Condition Monitoring



### Local dashboard

- ▶ Display of drive and system data



### Higher level PLC

- ▶ Processing of Condition Monitoring information by the customer
- ▶ Combination of collected Condition Monitoring data with process data

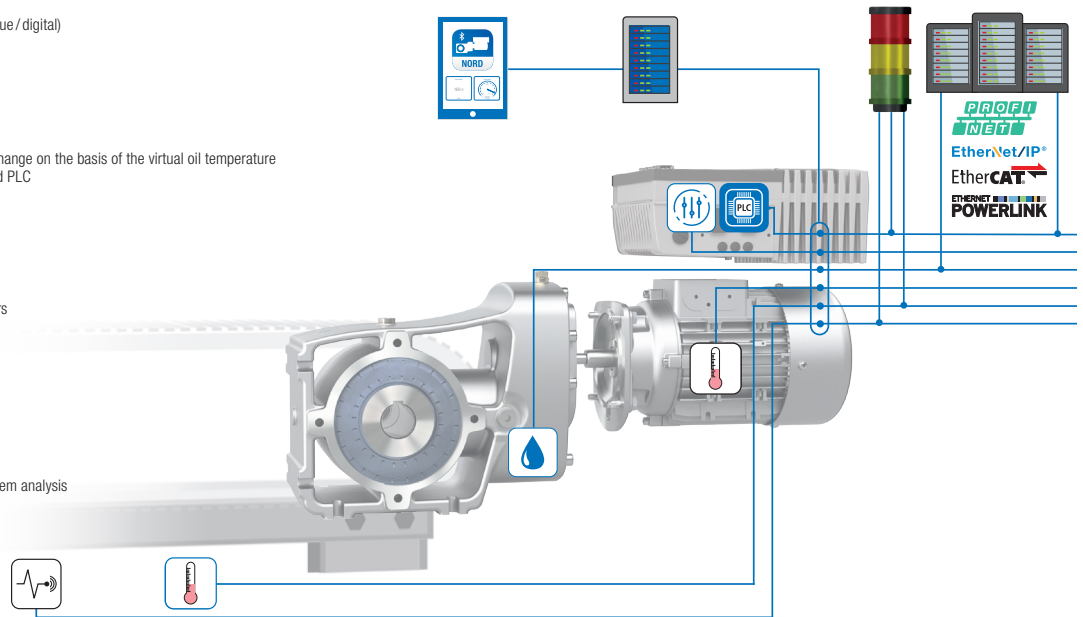

[Surface protection for NORD drive solutions](#)

[Energy saving directives for motors](#)

[Nominal operating modes](#)

[International Protection Codes](#)

[Labels](#)

[Installation orientations](#)

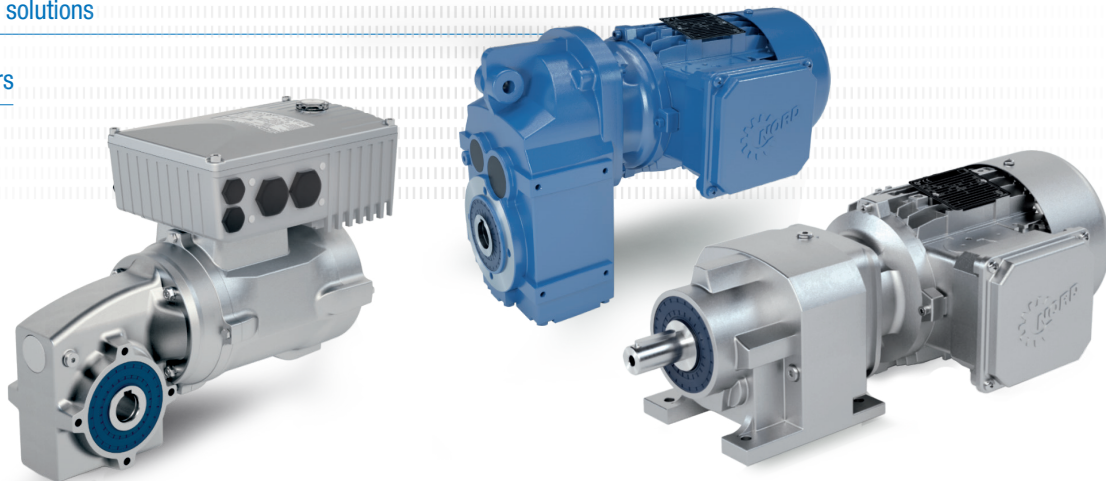

## Surface protection for NORD drive solutions

Coating/Application range	Class**	Structure	Coating thickness*
Basic Basic+ Indoor installation Formerly F2	C2		50–90 µm
NORD Severe Duty 2 NORD Severe Duty 2+ Indoor installation and protected outdoor installation (e.g. in open, unheated halls) Formerly F3.0	C2		110–150 µm
NORD Severe Duty 3 NORD Severe Duty 3+ Outdoor installation, city and industrial environment with low contamination Formerly F3.1	C3		160–200 µm
NORD Severe Chem Duty 3 Normal chemical loads Formerly F3.4	C3		100–140 µm
NORD Severe Food Duty 3 NORD Severe Food Duty 3+ Areas for food packaging Formerly F3.5	C3		100–140 µm











Coating/Application range	Class**	Structure	Coating thickness*
NORD Severe Duty 4 NORD Severe Duty 4+ Outdoor installation, city and industrial environment with moderate contamination Formerly F3.2	C4		220–260 µm
NORD Severe Duty 5 NORD Severe Duty 5+ Outdoor installation, city and industrial environment with high contamination Formerly F3.3	C5		200–240 µm
A	Optional antimicrobial coating lacquer (+ variants), coating thickness + 25 µm		
Z	Filling of contour recesses and crevices with polyurethane-based sealant possible with NSD2, NSD3 and NSD4, included in NSD5		
T	2-component polyurethane coating lacquer		
E	2-component-EP zinc phosphate primer		
P	2-component polyurethane primer		
D	1-component dip primer (for grey-cast iron housings only)		

\*\*Comparable to the classification of ambient conditions according to DIN EN ISO 12944-2

\*Protocol of coating thickness following ISO 19840 available on request

## Overview of energy saving directives for motors

Region	Efficiency standard/ Directives	Minimum energy efficiency
 Europe	IEC 60034-30	IE3
 United Kingdom	IEC 60034-30	IE3
 Schwitterland	IEC 60034-30	IE3
 Turkey	IEC 60034-30	IE3
 Egypt	ES 2623-3	IE3
 USA	NEMA MG-1	Premium Efficiency (IE3)
 Canada	CSA C390-10	Premium Efficiency (IE3)
 China	GB 18613-2012; GB 25958-2010	IE3
 Brasil	INMETRO NBR 17094-1	Alto Rendimento Plus (IE3)
 Mexico	NOM-016-ENER-2016	Premium Efficiency (IE3)
 Columbia	Resolución no 1012 : 2015	IE3
 Chile	PE N° 7/01/2; IEC 60034-30-1	IE2

Region	Efficiency standard/ Directives	Minimum energy efficiency
 Ecuador	NTE INEN 2498 : 2009	IE2
 Australia New Zealand	AS/NZS 1359.5 : 2004	IE2
 India	IS 12615 : 2018	IE2
 South Korea	KS C IEC 60034	IE3
 Singapore	S602 : 2018	IE3
 Taiwan	IEC 60034-2-1	IE3
 Japan	JIS C 4034-30 : 2011	IE3
 Saudi Arabia	IEC 60034-30 : 2013	IE3
 Eurasian Economic Union	IEC 60034-2-1	IE2 from 01. September 2022
 Ukraine	IEC 60034-2-1	IE3



Please note that the standards and guidelines are subject to constant change and this excerpt is only a rough overview. More detailed information can be found on our homepage.

Efficiency regulations for motors

## Nominal operating modes according to IEC 60034-1

Power increase in short-term and intermittent operation: In short-term (S2) and intermittent operation (S3), electric motors can be subjected to greater loads than in continuous operation (S1). (See motor catalogue M7000)

- ▶ In case of S2 the operating time in minutes must be stated as follows: "S2 15 minutes"
- ▶ In case of S3, S4, S5 and S6 a percentage value must be stated as follows: "S3 40%", i.e.: 40% operating time on the basis of 10 minutes



Product catalogue:  
Asynchronous motors M7000

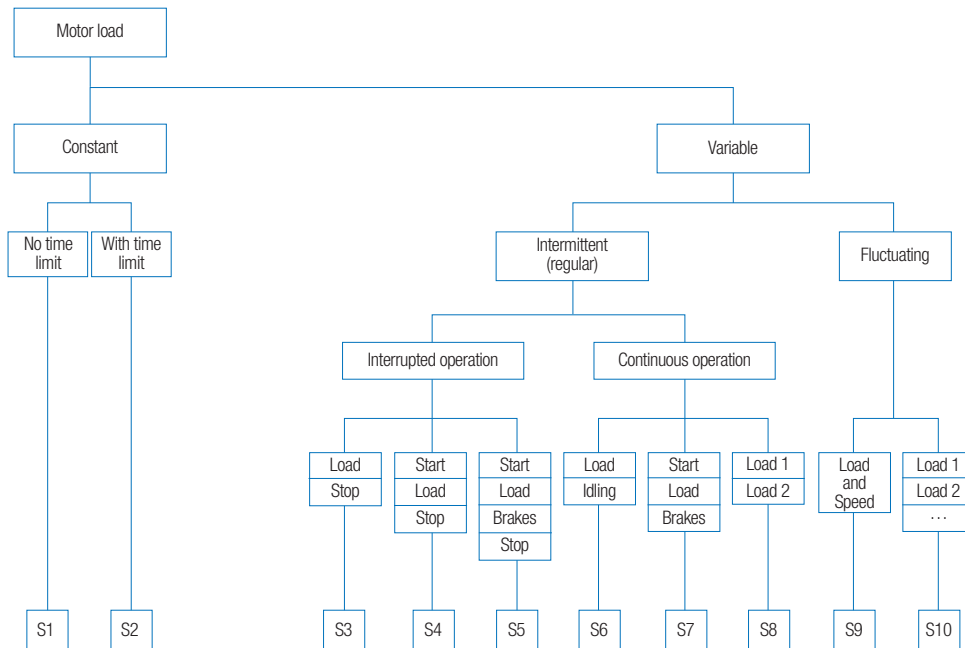

## Cooling types for NORD motors according to IEC 60034-6 and NEMA

### IC411 “TEFC” – Totally enclosed fan cooled motor



- ▶ Ribbed or smooth housing
- ▶ Fan on the motor shaft
- ▶ Fan speed and air volume directly depend on the motor speed
- ▶ Air flow also cools driven components such as gear units
- ▶ Most common cooling method for electric motors

#### NORD products

- ▶ All NORD motors with ribbed housing

### IC410 “TENV” – Totally enclosed non ventilated motor



- ▶ Ribbed or smooth housing
- ▶ No fan
- ▶ Quiet running – Fan noise is eliminated
- ▶ Reduced length with option OL/H
- ▶ No ambient air turbulences
- ▶ Widely used in the hygiene sector as well as in theatre and stage applications

#### NORD products

- ▶ NORD option OL or OL/H
- ▶ Asynchronous smooth-surface motor
- ▶ Unventilated IE5+ synchronous motor

### IC416 “TEBC” or “TEFV” – Totally enclosed blower cooled motor



- ▶ Ribbed or smooth housing
- ▶ External fan directly mounted on the motor
- ▶ Fan speed and air volume are independent of the motor speed
- ▶ External fan is a standalone unit with separate voltage supply
- ▶ Air flow also cools driven components such as gear units
- ▶ Preferentially used during inverter operation, if full motor torque is required with low speed

#### NORD products

- ▶ NORD option F



## International Protection Codes IP protection class (IEC 60529)

Digit 1	Protection against foreign bodies	Digit 2	Protection against humidity
0	No protection	0	No protection
1	Protected against solid foreign bodies with diameter above 50 mm	1	Protection against dripping water
2	Protected against solid foreign bodies with diameter above 12.5 mm	2	Protection against falling dripping water if the housing is inclined by up to 15°
3	Protected against solid foreign bodies with diameter above 2.5 mm	3	Protection against falling sprayed water up to 60° from vertical
4	Protected against solid foreign bodies with diameter above 1.0 mm	4	Protection against splashed water from all sides
5	Protected against damaging amounts of dust	5	Protection against water jets (nozzle) from any angle
6	Dust-proof	6	Protection against strong water jets
		7	Protection against temporary immersion
		8	Protection against permanent immersion
		9K (according to ISO 20653)	Protection against water for high pressure water jet and steam cleaning, specifically for road vehicles

- ▶ If one of the numbers is not stated, this is indicated with an "X", e.g.: IP4X (protection against foreign bodies > 1.0 mm no details of protection against moisture)
- ▶ For IPX7 the immersion depth and the immersion time must also be stated
- ▶ Up to IPX6 the lower protection classes are included

## Overview labels

Region	Label	Abbr.	Meaning
 Europe		CE	Conformité Européenne, Europäische Konformität
 United Kingdom		UKCA	UK Conformity Assessed
 China		CCC	China Compulsory Certification
 USA		UL	Underwriters Laboratories
 Canada		CSA	Canadian Standards Association
 Eurasian Economic Union		EAC	Eurasian Conformity
 India		BIS	Bureau of Indian Standards
 Ukraine		UA	UkrSEPRO
 Mexico		NOM	Normas Oficiales Mexicanas
 Brasil		ABNT	Associação Brasileira de Normas Técnicas
 South Korea		KC	Korea Certification
 Australia		RCM	Regulatory Compliance Mark
 Morocco		VOC	Verification of Conformity

The NORD UNIVERSAL motor has many of the above-mentioned certifications and can therefore be used flexibly.

## Installation orientations helical gear units

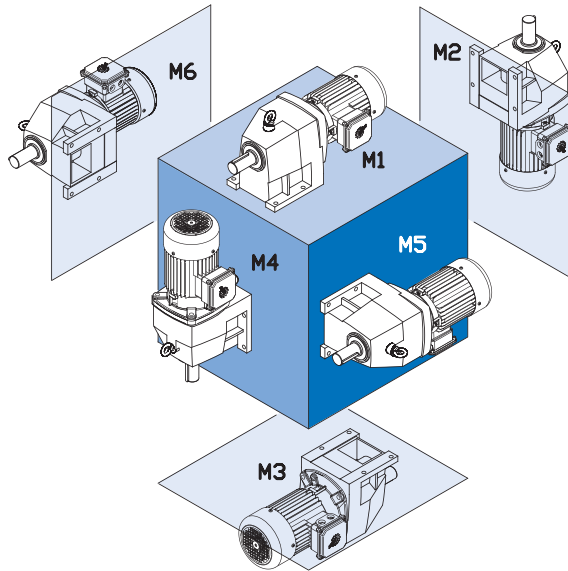

## Installation orientations parallel shaft gear units

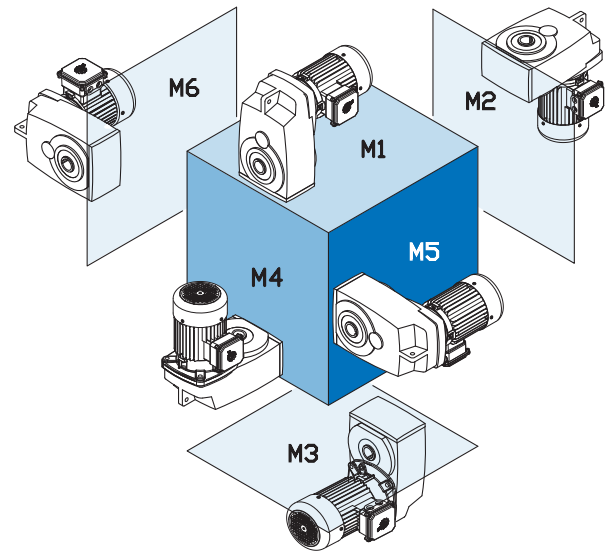

## Installation orientations bevel gear units

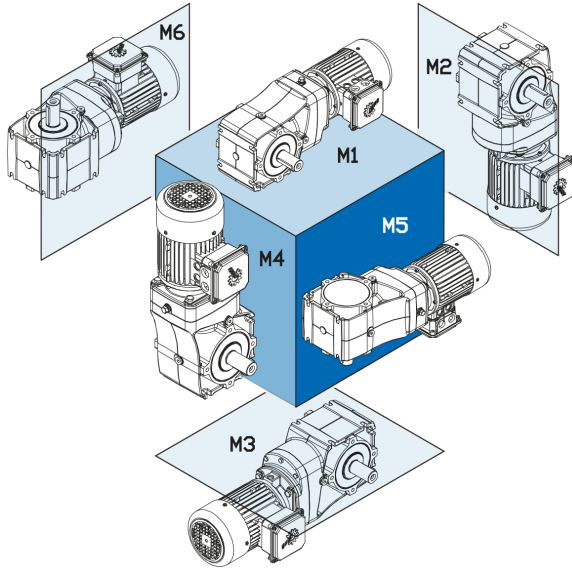

## Installation orientations worm gear units

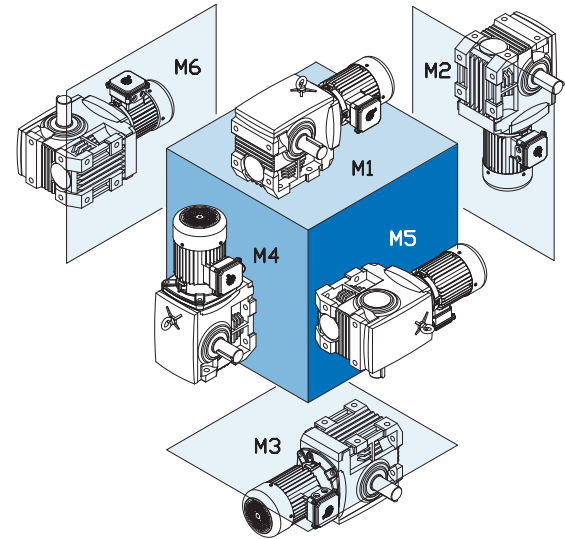





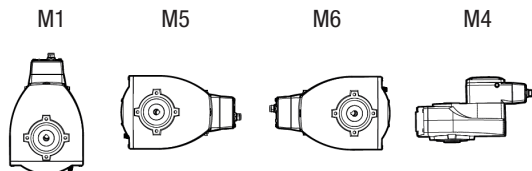



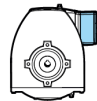

## Installation positions and cable glands DuoDrive

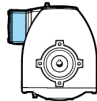
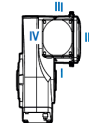
### Designs

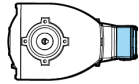

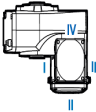
### Cable gland

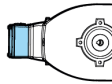
Device type	Cable gland
SK EVO 80	1 x M25 x 1.5 2 x M16 x 1.5
SK EVO 200	1 x M25 x 1.5 2 x M16 x 1.5

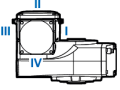
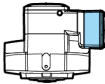
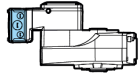
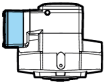
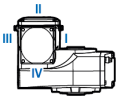
Designs	Position of electrical connection			Position of cable gland
	1	2	3	
M1				
M5				
M6				
M4				

## Installation orientations MAXXDRIVE® parallel gear units

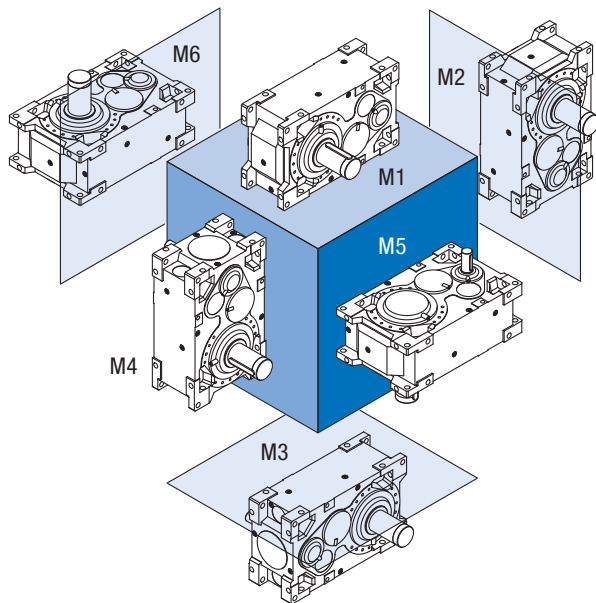

Standard mounting positions:

- SKx207: M1
- SKx307: M3
- SKx321: M1
- SKx421: M1

## Installation orientations MAXXDRIVE® right-angle gear units

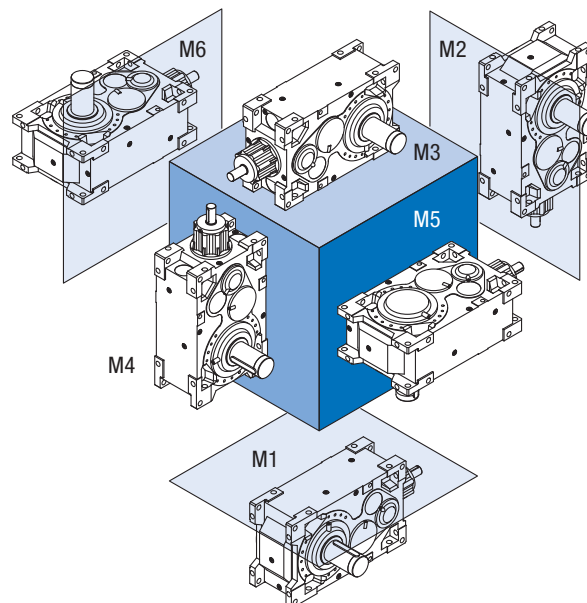

Standard mounting positions:

- SKx407: M1
- SKx507: M3
- SKx418: M1
- SKx217: M1

## Installation orientations for motors and terminal boxes

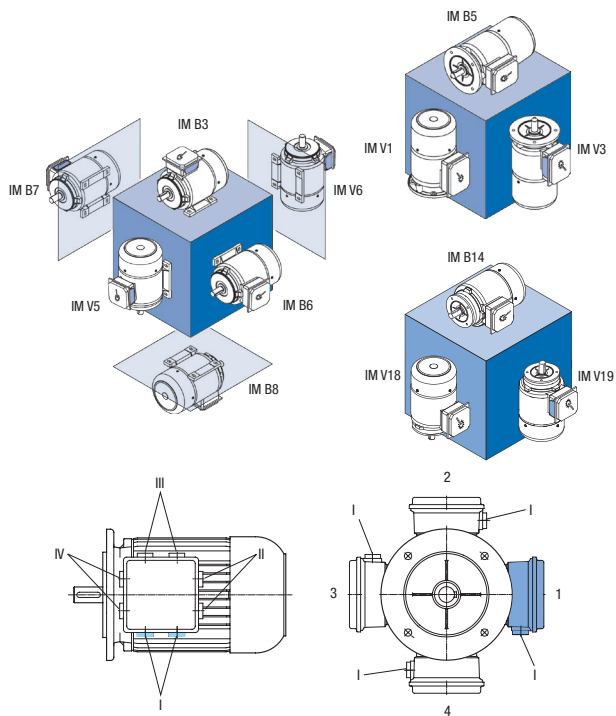

## Enquiry process



Configurator for precisely tailored drives



Generate CAD data (3D models, dimensional sheets, outline drawings)



Generate offer with purchase prices



Track order status

### myNORD

The online product configurator in the myNORD customer portal ([www.mynord.com](http://www.mynord.com)) enables convenient selection of the drive unit. Ex drives including options can also be selected.

- ▶ Precise configuration
- ▶ Direct generation of CAD data (3D models, dimensional sheets, outline drawings)
- ▶ Creation of offers online

It must be emphasised that the configurator indicates whether or not a selected drive unit is Ex compliant. Price information as well as an enquiry / order form are also included.

If configuration with myNORD is not possible, an enquiry form is available ([www.nord.com](http://www.nord.com) > Forms > General Enquiry Form). Selection of the drive unit and checking of conformity will then be carried out by your technical contact partner.



NORD enquiry form

The nomenclature is also available as a poster (Part No. 6091985).

Headquarters:  
Getriebebau NORD GmbH & Co. KG  
Getriebebau-Nord-Str. 1  
22941 Bargteheide, Germany  
T: +49 45 32 / 289 0  
F: +49 45 32 / 289 22 53  
info@nord.com