

JACKSON  
SAFETY

Canadian Catalog





For 75 years, men and women have wanted Jackson Safety on the job for their safety needs. The reason is simple. When it comes to providing superior protection and durability, we set the standards. Jackson Safety has truly become a leading source for welding safety, traffic safety products and personal protective equipment. This single source approach to fulfilling multiple safety solutions has resonated with customers and resulted in a broadened identification of Jackson Safety.

Every Jackson Safety product is guaranteed to deliver long-lasting value. Because your customers need the tools they work with, you always want Jackson Safety on the Job.

JACKSON SAFETY IS PROUD TO BE AN ACTIVE MEMBER OF THE SAFETY COMMUNITY



Construction/Industrial Supply Distribution Network



## PATENTS

Jackson Safety's welding helmets and lenses are covered by one or more of the following US patents: D310,432; D349,588; D353,692; D431,328; 5,208,688; 5,248,880; 5,252,817; 5,347,383; 5,377,032; 5,515,186; 5,519,522; 5,533,206; 5,751,258; 5,959,705; 6,067,129; 6,070,264; 6,151,711; 6,260,197; 6,341,382; and related foreign patents. Jackson Safety floor signs are covered by US patent D.395,334 and Canadian design registration No.83761. Other US and foreign patents pending. For additional patent numbers, contact Jackson Safety.

## WARNING

Read this section completely before selecting your Jackson Safety products. Our products are tested to meet the standards of the American National Standards Institute (ANSI) and other applicable standards. All warning statements, operating instructions and industry standards should be complied with at all times. Please read any and all warning statements attached to or associated with any Jackson Safety product prior to use. Failure to use only Jackson Safety designed, produced and tested components, attachments and replacement parts can adversely affect product performance resulting in serious injury. Installing generic parts or components voids all standards compliances, all guarantees and warranties and makes the installer solely liable for the consequences.

# TABLE OF CONTENTS



jacksonsafety

## PERSONAL PROTECTION EQUIPMENT

Safety Eyewear	6
Safety Goggles	14
Face Protection	18
Head Protection	22
Hearing Protection	30
Seasonal	36
Respiratory	40

## WELDING

Welding Safety	42
Electric Line	64
Contour	68
Welding Curtains	76
Roll Goods	80
Stur-D-Screens	82
Welding Blankets	96
Strip Curtains	88
Track Hardware	90
Specialty Products	91

## TRAFFIC SAFETY

Safety Apparel	96
Traffic Cones	99
Delineators	103
Impact Recovery Systems	104
Drums	108
Barricades	110
Barricade Lights	112
Sign Stands	113
Stop/Slow Paddles	113
Roll-Up Signs	115
Flags	116
Motor Safety	118
Fencing	122
Floor Warning	124

personalsafety

## PERSONAL PROTECTION EQUIPMENT THAT YOU CAN TRUST

The Jackson Safety® name has continuously been identified with quality personal protective equipment that provides safety and comfort to workers in a wide variety of industries. Whether the need is for eye and face protection in food processing applications, head protection on a construction job site, or hearing protection at an airport, Jackson Safety® provides the widest range of safety choices for every worker.

With respected market-leading brand names as Smith & Wesson® in eyewear and the pioneering Monogoggle brand of safety goggles, Jackson Safety® is on the job in terms of product innovation, striving to always provide safety product style and comfort for both work and leisure situations. The trend-setting style of our Nemesis family of safety eyewear exemplifies the approach of styles that cross a broad range of applications.

Customization is a key element in today's personal protective equipment, and Jackson Safety® is proud to offer custom identification with logos and designs on a wide variety of products, ranging from hardhats to safety glasses to hearing protectors. We want your identity to be known, as well as your market brand.

Pulling together all of your safety needs into one integrated system has become the trademark of Jackson Safety products, best illustrated in our ATS (Above The Shoulder) safety systems that combine the best in head, hearing, and face protection in a single unit. Add our new line of respiratory products, and workers have complete flexibility and confidence in any industrial application.





## STANDARDS

**ANSI Z87.1+:** The American National Standards Institute (ANSI) set forth requirements for the design, construction, testing, and use of eye protection devices, including standards for impact and penetration resistance. Requirements include, but are not limited to, durability, easy to clean, reasonably comfortable, secure fit, fit over, or incorporate, prescription eyewear and, most importantly, provide adequate protection against the hazards for which they are designed.

**ANSI Z89.1:** The American National Standards Institute (ANSI) provides performance and testing requirements for hard hats. This specification includes requirements for protection from lateral impact or top-only impact, giving employers and users the flexibility to specify the helmet that best meets the needs of their specific workplace. Type I hard hats provide top protection and Type II hard hats provide lateral impact protection. The three classes indicate the helmets electrical insulation rating: Class E (electrical), Class G (general) and Class C (conductive).

**NRR:** Noise Reduction Rating (NRR) is the measure, in decibels, of how well a hearing protection reduces noise, as specified by the Environmental Protection Agency (EPA). The higher the number, the greater the noise reduction.

**NIOSH:** The National Institute for Occupational Safety and Health is the US federal agency responsible for conducting research and making recommendations for the prevention of work-related injury and illness. NIOSH issues recommendations for respirator use. Industrial type approvals are in accordance to the NIOSH federal respirator regulations 42 CFR Part 84.

**OSHA:** Occupational Safety and Health Administration (OSHA) is an agency of the United States Department of Labor. Their mission is to prevent work-related injuries, illnesses and deaths by issuing and enforcing standards for workplace safety and health.

**ISEA:** The International Safety Equipment Association is the trade association in the United States for companies that manufacture safety and personal protective equipment. Its member companies are world leaders in the design and manufacture of protective clothing and equipment used in factories, construction sites, hospitals and clinics, farms, schools, laboratories, emergency response and in the home.



## BASE CURVE

Base curve is the measurement of an eyewear lens or curvature. The higher the base curve, the greater the sweep of the eyewear. A higher base curve provides more wrap-around protection, peripheral vision and can reduce the need for side shields.

## MARKINGS – ANSI, CSA, CE

**ANSI:** The American National Standards Institute (ANSI) is a private, non-profit organization that administers and coordinates the US voluntary standardization and conformity assessment system.

**CSA:** The Canadian Standards Association is a not-for-profit membership-based association serving business, industry, government and consumers in Canada and the global marketplace. CSA develops standards that address real needs, such as enhancing public safety and health.

**CE:** A mandatory European product marking and certification system that indicates the product complies with all applicable European product safety, health and environmental requirements within the CE marking system.

## ANTI-FOG LENS COATING

We've subjected our lenses to extensive testing. We froze them. Heated them. Soaked them. Cleaned them. We put them through humidity and anti-static tests. No matter what we tried, our anti-fog lenses wouldn't fog up. In fact, these tests, combined with on-the-job field evaluations, indicate that our anti-fog coating will eliminate lens fogging in 99% of workplace applications.



## LENS OPTIONS

JACKSON SAFETY'S EYEWEAR LENSES ARE MADE OF A POLYCARBONATE MATERIAL THAT PROVIDE 99.9% UV PROTECTION.















### LENS COATINGS:

- Polarized Lens: Protection from glare reduces eye fatigue
- Hard Coat: For scratch resistant
- Anti-fog for humid environments and extreme temperature variances
- Uncoated: for economical budgets
- Visiclear™ : Prevents flash fogging

### STANDARD LENS TINTS:

-  Clear Lens: Allows maximum visible light transmission, this safety lens is used for indoor applications where impact protection is required.
-  Smoke Lens: Worn on bright, sunny days, these lenses provide maximum glare reduction and are ideal when eye strain is a major factor.
-  Amber/Yellow Lens: Light gathering properties make this lens ideal for low light environments in which contrast is low.

### SPECIALTY LENS TINTS:

-  Blue Shield and Copper Blue Block: Filters out blue light for enhanced contrast and is ideal for medium to bright outdoor conditions.
-  IRUV 3.0 Lens: Protects against infrared (IRUV) and ultraviolet radiation. Perfect for light cutting and brazing applications.
-  IRUV 5.0 Lens: Protects against infrared (IRUV) and ultraviolet radiation. Perfect for medium to heavy cutting and brazing applications.
-  Smoke Mirror Lens: Smoke tint sunglass with outer mirror finish coating, for outdoor use where sunlight can cause eyestrain and fatigue.
-  Silver Mirror Lens: Smoke tint sunglass with outer silver finish coating, for outdoor use where sunlight can cause eyestrain and fatigue.
-  Gold Mirror Lens: Smoke tint sunglass with outer gold mirror finish coating, for outdoor use where sunlight can cause eyestrain and fatigue.
-  Blue Mirror and Metallic Blue Lens: Smoke tint sunglass with outer blue mirror finish coating, for outdoor use where sunlight can cause eyestrain.
-  Red Mirror Lens: Smoke tint sunglass with outer red mirror finish coating, for outdoor use where sunlight can cause eyestrain and fatigue.
-  Metallic Rainbow Lens: Smoke tint sunglass with outer rainbow mirror finish coating, for outdoor use where sunlight can cause eyestrain.
-  Bronze Lens: Superior visual definition with increased contrast and enhanced contours in most light conditions.
-  Copper and Brown Lens: Effective at filtering light in hazy, foggy, or low light conditions by enhancing contrast.
-  Orange Lens: Filters out blue and green light to reduce eye fatigue, improves visual acuity during curing and inspection processes.
-  Indoor/Outdoor Lens: Comfortable solution for moving from indoor or shaded locations to direct sunlight and back.
-  Teal Lens: Commonly used for indoor applications where there is an excessive amount of yellow or sodium vapor light, offers a high level of contrast. This lens is not recommended for driving situations.
-  Light Blue Lens: Commonly used in indoor or low light outdoor applications for enhanced contrast.

\*\*Actual lens colors may vary according to each style\*\*

Shown in image  
 #3016308 - Equalizer, Smoke Lens  
 #3013362 - Charger, White



**NEW**

## EQUALIZER™

BASE CURVE  
**8**



**Smith & Wesson®**

Stylized frame features a cutting edge design that is ideal for work and play. Sport grip temples help to eliminate slippage and anti-scratch, dual lenses offer wrap-around protection. Every glass comes with a Smith & Wesson® micro-fiber carry pouch that doubles as a cleaning cloth. Standard Pack: 12

FRAME/LENS	PART#
GUNMETAL/CLEAR	3016306
GUNMETAL/CLEAR ANTI-FOG	3016307
GUNMETAL/SMOKE ANTI-FOG	3016308
GUNMETAL/IN/OUTDOOR	3016309
RED/AMBER	3016310
BLUE/BLUE MIRROR	3016311



Shown above  
 #3016308 - Smoke Lens



Shown above  
 #3016311 - Blue Mirror Lens

**NEW**

## ELITE™

BASE CURVE  
**8**



**Smith & Wesson®**

Lightweight "retro-style" design provides the latest fashion statement in eyewear. Wide temple provides structural integrity and stability and an anti-scratch, dual lenses offers wrap-around protection. Every glass comes with a Smith & Wesson® micro-fiber carry pouch that doubles as a cleaning cloth. Standard Pack: 12

FRAME/LENS	PART#
BLACK/CLEAR ANTI-FOG	3016312
BLACK/SMOKE ANTI-FOG	3016313
BLACK/IN/OUTDOOR	3016315
BLACK/AMBER ANTI-FOG	3016314
BLACK/BLUE MIRROR	3016316

## NEMESIS™

BASE CURVE  
8

Sleek, sporty, lightweight design with soft touch temples for added comfort. Single lens wrap-around protection. Every glass includes a neck cord. Available in reader style lenses (see page 12). Standard Pack: 12

FRAME/LENS	PART#
BLACK/CLEAR	3000354* [19804]
BLACK/CLEAR ANTI-FOG	3000355* [19805]
BLACK/SMOKE	3000356* [19806]
BLACK/IN/OUTDOOR	3000357* [19807]
BLACK/BLUE MIRROR	3000358* [19808]
BLACK/AMBER	3000359* [19809]
BLUE/LIGHT BLUE	3011373* [19859]
BLACK/BLUESHIELD	3011374* [19860]
CAMO/BRONZE	3011375*
BLACK/IRUV 3.0	3004762*
BLACK/IRUV 5.0	3004761*

## NEMESIS VL™

BASE CURVE  
8

Frameless ultra-lightweight, **33% lighter than Nemesis**. No-brow design increases upward and peripheral vision. Slip-stop temples. Compact profile accommodates smaller faces. Every glass includes a neck cord. Standard Pack: 12

FRAME/LENS	PART#
GUN METAL/CLEAR	3013536*
GUN METAL/CLEAR ANTI-FOG	3013537*
GUN METAL/SMOKE	3013538*
GUN METAL/IN/OUTDOOR	3013539*
GUN METAL/BLUE MIRROR	3013540*
CAMO/BRONZE	3013542
GUN METAL/IRUV 5.0	3013544

## NEMESIS™ CSA

BASE CURVE  
8

Sleek, sporty lightweight design with soft touch temples. Large, single lens wrap-around protection for added protection. Every glass includes a neck cord. Meets CSA standards. Standard Pack: 12

FRAME/LENS	PART#
<b>MEETS CSA STANDARDS</b>	
BLACK/CLEAR	3013296**
BLACK/SMOKE MIRROR	3013298**
BLACK/IN/OUTDOOR	3013299**
BLACK/IRUV 5.0	3014556**
<b>Z94.3 COMPLIANT</b>	
BLACK/CLEAR ANTI-FOG	3013297*
BLACK/BLUE MIRROR	3013300*
BLUE/LIGHT BLUE	3013301*
BLACK/BLUESHIELD	3013302*
GUN METAL/SMOKE	3013303*
CAMO/BRONZE	3013304*
BLACK/IRUV 3.0	3014555*

## ENVISION™

BASE CURVE  
9

Adjustable temples create a custom fit with wrap-around protection. Soft grip comfort temples. Meets CSA standards. Standard Pack: 12

FRAME/LENS	PART#
BLACK/CLEAR	3000337** [19741]
BLACK/CLEAR ANTI-FOG	3000338** [19742]
BLACK/SMOKE	3000339** [19743]
BLACK/IN/OUTDOOR	3000341** [19745]



## VISIO™

BASE CURVE  
8



One-piece polycarbonate lens with adjustable temples and wrap-around protection. Unique duo-tone frame, lightweight design and comfortable fit. Standard Pack: 12

FRAME/LENS	PART#
SILVER/CLEAR	3000303 [19492]
SILVER/CLEAR ANTI-FOG	3000304 [19493]
SILVER/SMOKE	3000305 [19494]
SILVER-BLACK/SMOKE ANTI-FOG	3000306 [19495]
BLACK/IN/OUTDOOR	3000309 [19498]
BLACK/AMBER	3000307 [19496]
BLACK/BLUE MIRROR	3000308 [19497]

## OTG™

NEW

BASE CURVE  
4



Streamlined, stylish and comfortable. The new standard in over-the-glass safety eyewear. Fits over most prescription eyewear. Integral side shields provide added protection. Z94.3 compliant. Standard Pack: 12

FRAME/LENS	PART#
BLACK/CLEAR ANTI-FOG	3015022*
BLACK/SMOKE MIRROR ANTI-FOG	3015023*
BLACK/IN/OUTDOOR	3015024*
BLACK/IRUV 5.0	3018175

## UNISPEC™

BASE CURVE  
4



Low cost wrap-around protection with one-piece polycarbonate lens and uncoated frame. Fits over most prescription eyewear. Side shields provide added protection. Standard Pack: 12

FRAME/LENS	PART#
CLEAR UNCOATED	3000285* [18832]
CLEAR HARD COATED	3005206 [18333]
IRUV 3.0	3000323 [19630]
IRUV 5.0	3000324 [19631]

## CUDAS™

BASE CURVE  
6



Lens curve provides for peripheral vision and protection. Durable, modified nylon frame with Cudaslide adjustable temples for an individual fit with 5 different lengths. Standard Pack: 12

FRAME/LENS	PART#
BLACK/CLEAR	3000287 [19142]
BLACK/CLEAR ANTI-FOG	3000288 [19143]
BLACK/SMOKE	3000289 [19144]
BLACK/SMOKE ANTI-FOG	3000290 [19145]
BLACK/AMBER	3000293 [19149]

## NEMESIS RX™



'Cheaters' style with integral diopters for vision assistance. Larger lens for a more complete wrap-around impact protection. Enhanced nose piece design to channel away sweat. Every glass includes a neck cord. Z94.3 compliant. Standard Pack: 6

FRAME/LENS	PART#
BLACK/CLEAR +1.0	3013305**
BLACK/CLEAR +1.5	3013306**
BLACK/CLEAR +2.0	3013307**
BLACK/CLEAR +2.5	3013308**
BLACK/CLEAR +3.0	3013309**

## 30-06™ READERS



Stylish, ergonomic, nylon frame combined with high performance polycarbonate lenses for ultimate protection. Soft, comfortable self-adjusting rubber nose pad. Precise placement of lens inserts helps prevent accidents, headaches and eyestrain.

Standard Pack: 6



FRAME/LENS	PART#	FRAME/LENS	PART#
TORT/BROWN +1.5	3011712	BLACK/YELLOW +1.5	3011724
TORT/BROWN +2.0	3011713	BLACK/YELLOW +2.0	3011725
TORT/BROWN +2.5	3011714	BLACK/YELLOW+2.5	3011726
BLACK/CLEAR +1.0	3011716	BLACK/IRUV 5.0 +1.5	3013933
BLACK/CLEAR +1.5	3011717	BLACK/IRUV 5.0 +2.0	3013968
BLACK/CLEAR +2.0	3011718	BLACK/IRUV 5.0 +2.5	3013969
BLACK/CLEAR +2.5	3011719		
BLACK/CLEAR +3.0	3011720		

## DUAL SEGMENT READERS



Perfect for individuals who work overhead or upside down and need to look up for near vision as well as down. Helps prevent neck and eye strain, as well as headaches. Standard Pack: 6

FRAME/LENS	PART#
BLACK/CLEAR +1.5	3013327
BLACK/CLEAR +2.0	3013328
BLACK/CLEAR +2.5	3013329

safetyeyewear





safety eyewear



## DIOPTR SELECTION CHART

If this line is difficult to read, use power	+1.0
If this line is difficult to read, use power	+1.5
If this line is difficult to read, use power	+2.0
If this line is difficult to read, use power	+2.5
If this line is difficult to read, use power	+3.0

\*Z94.3 COMPLIANT \*CE CERTIFIED

JACKSON SAFETY EYEWEAR PROVIDES 99.9% UV PROTECTION AND MEETS ANSI Z87.1+ STANDARDS

## EYEWEAR DISPLAYS

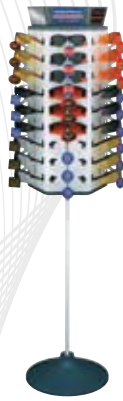

### S&W® 54 PAIR FLOOR DISPLAY

Smith & Wesson® revolving floor stand  
Capacity: 54 pair of glasses  
Dimensions: 71" Height, 18" Diameter

DESCRIPTION	PART#
54 PAIR SPINNER	3011828



### S&W® COUNTER DISPLAYS

Smith & Wesson® revolving counter stand  
Capacity: 24 or 36 pair of glasses  
Dimensions: (24) 22" Height, 13" Diameter  
(36) 32" Height, 14" Diameter

DESCRIPTION	PART#
24 PAIR SPINNER	3012156
36 PAIR SPINNER	3011827



### 6 PAIR STACKING DISPLAY

Stationary 6 pair stacking display. Some assembly required.  
Capacity: 6 pair of glasses  
Dimensions: 22" Height, 5" Diameter

DESCRIPTION	PART#
6 PAIR EYEWEAR DISPLAY	3014039

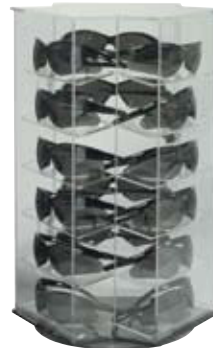

### LOCKING DISPLAYS

Locking, rotating counter display eliminates theft.  
Capacity: 18 or 24 pair of glasses  
Dimensions: (18) 17" Height, 11.5" Diameter  
(24) 17" Height, 12" Diameter

DESCRIPTION	PART#
18 PAIR LOCKING SPINNER	3014038
24 PAIR LOCKING DISPLAY	3014037

## LENS CLEANING



Sturdy, corrugate construction with easy wall mount design. For glass, plastic and polycarbonate lenses, goggles and faceshields. Anti-fog, anti-static formula. Towelettes are available in 100 individually packaged (per box). Cleaning station includes spray bottle with 100 low lint tissues.

DESCRIPTION	PART#
LENS CLEANING TOWELETTES	3000555
DELUXE LENS CLEANING STATION	3000554

safetyeyewear



## EYEWEAR NECK CORDS



Eyewear not included



Eyewear not included

### EYEWEAR CORDS

Conveniently fits any eyewear. Standard Pack: 12/bag

DESCRIPTION	PART#
BLACK EYEWEAR CORDS	3000283

### CHUMS® ORIGINAL

Fits standard frames, adjustable fit. Available in small and large. Standard Pack: 25/bag

DESCRIPTION	PART#
ASSORTED COLORS, CHUMS®	3005243
BLACK, CHUMS®	3005244

## EYEWEAR CUSTOMIZATION PROGRAM



### CUSTOM EYEWEAR DECORATING DIMENSIONS

FRAME STYLE	FRAME SIDE - DIMENSIONS	LENS DIMENSIONS
S&W® EQUALIZER™	RIGHT - 1"W x 1/8"H	NOT AVAILABLE
S&W® ELITE™	RIGHT - 1"W x 1/4"H	NOT AVAILABLE
S&W® MAGNUM™ MINI	RIGHT - 5/16" W x 3/8" H	3/4" W x 3/8" H
S&W® VIEWMASTER™	RIGHT - 3/4"W x 3/8"H	NOT AVAILABLE
S&W® 38 SPECIAL™	RIGHT - 7/8" W x 1/8" H	3/4" W x 3/8" H
S&W® PHANTOM™	NOT AVAILABLE	RIGHT ONLY - 1"W x 1/4"H
S&W® CODE 4™	RIGHT - 7/8" W x 1/8" H	3/4" W x 3/8" H
NEMESIS™	LEFT - 3/4" W x 1/8" H	3/4" W x 3/8" H
NEMESIS™ VL	LEFT - 3/4"W x 3/16"H	3/4" W x 3/8" H
ENVISION™	RIGHT - 1/2" W x 1/4" H	NOT AVAILABLE
HELLRAISER™	RIGHT - 1/2"W x 3/16"H	NOT AVAILABLE
VISIO™	RIGHT & LEFT - 3/4"W x 1/8" H	1/2" W x 1/2"H
ELEMENT™	RIGHT - 1/2" W x 1/4" H	3/4" W x 3/8" H
CUDAS™	RIGHT - 5/8"W x 1/8"H	1/2" W x 1/2"H
OTG™	LEFT - 7/8"W x 1/4"H	NOT AVAILABLE

**DECORATING ON LEFT OR RIGHT ONLY**

- Minimum Order 72 safety eyewear
- In order to provide superior screening, we require camera ready artwork (black on glossy white or film positive with sharp images) and color separated
- A charge may be invoiced for artwork that requires redrawing or typesetting and may add 10-15 business days to lead time
- Delivery of pad printed eyewear will take approximately 5-7 business days upon receipt of distributor approval of final artwork
- A cliché charge reflects the cost of creating the custom cliché. Cliché remains the property of Jackson Safety®
- For more information, call customer service at 800-428-8185 or email us [info@jacksonsafety.com](mailto:info@jacksonsafety.com)
- ONLY EYEWEAR MENTIONED ARE AVAILABLE FOR DECORATING

## MONOGOGGLE® HISTORY

The history of our protective safety goggles began over 30 years ago with an anti-fog model designed to protect against chemical splash. This model went on to become the staple of millions of safety programs throughout the industry, and is now synonymous with on-the-job eye protection. You can be confident about the protection that Jackson Safety® goggles provide. Today our line still meets ANSI Z87.1-2003 performance criteria. Jackson Safety's unique Visiclear™ coating has been scientifically formulated after a series of on-the-job evaluations eliminating lens fogging in 99% of workplace applications.

All lenses are made with an optical grade polycarbonate material and provide 99.9% UV protection.

### MONOGOGGLE® 201

#### DUST & IMPACT GOGGLE



Frame provides impact protection and direct ventilation where chemical splashes and fumes are not primary hazards. Separate, pliable plastic nosepiece for a comfortable seal. .060" polycarbonate lens. Standard Pack: 36

FRAME/LENS	PART #
GREEN/CLEAR	3005051** [10013]

### MONOGOGGLE® 202

#### DUST & IMPACT GOGGLE



Unventilated design provides protection against fumes, dust, and chemical splashes. Lightweight two-piece frame with separate nosepiece for better fit and comfort. Can be worn over most prescription eyeglasses. .066" polycarbonate lens. Standard Pack: 36

FRAME/LENS	PART #
GREEN/CLEAR	3005052 [10024]
GREEN/CLEAR VISICLEAR™	3005055 [10097]

### MONOGOGGLE® 211

#### CHEMICAL SPLASH GOGGLE



Patented indirect ventilation system provides increased air flow, minimizes condensation and fogging, and protects against chemical splash. Soft frame design with pantoscopic angle to improve work area visibility and assist bifocal wearers. Soft, pliable plastic nosepiece for a snug, comfortable seal. .066" polycarbonate lens. Standard Pack: 36

FRAME/LENS	PART #
GREEN/CLEAR	3000005*** [10032]
GREEN/CLEAR VISICLEAR™	3000013*** [10115]
COMFORT FOAM/VISICLEAR™	3005056** [10116]
SMOKE/CLEAR VISICLEAR™	3005058 [10148]

safetygoggles



## MONOGOGGLE® VPC

CHEMICAL SPLASH GOGGLE



Indirect ventilation ideal for chemical splash protection. Fits over most prescription eyewear. Pantoscopic design assists bifocal wearers and improves work area visibility. Soft, pliable nosepiece. Headband buckle located towards rear of goggle, so that it will not interfere with peripheral vision. .060" polycarbonate lens. Standard Pack: 36

FRAME/LENS	PART #
GRAY/CLEAR VISICLEAR™	3003414** [10195]

## MONOGOGGLE® XTR™

CHEMICAL SPLASH GOGGLE



Extreme visual clarity in all conditions! This lightweight, stylish goggle protects against chemical splashes, while providing increased visibility due to its cylindrical lens. A soft pliable frame conforms to the face for comfort and is easy to clean and sanitize. Goggle only weighs 9.2 ounces! 5.0 model features flame retardant headband. .060" polycarbonate lens. Standard Pack: 6

FRAME/LENS	PART #
BLUE/CLEAR ANTI-FOG	3010334
BLUE/SMOKE ANTI-FOG	3010335
BLACK/IRUV 5.0 ANTI-FOG	3010338

## THE SHIELD™

CHEMICAL SPLASH GOGGLE



Features the Monogoggle XTR™ with a polycarbonate shield for full face protection. Shield detaches from the goggle. Curved faceshield conforms to shape of face offering better protection. 5.0 model features flame retardant headband. The Shield only weighs 14.1 ounces! Standard Pack: 6

FRAME/LENS	PART #
BLUE/CLEAR ANTI-FOG	3010343
BLACK/IRUV 3.0 AF	3010345
BLACK/IRUV 5.0 AF	3010346

## MONOSHIELD™

CHEMICAL SPLASH GOGGLE



Distortion-free vision because it attaches to the MonoGoggle® 211 with PVC gaskets. Can be worn with caps and disposable respirators. Clear see-through material allows for easy wearer identification. Polycarbonate shield provides face protection. Standard Pack: 12

FRAME/LENS	PART #
GREEN/CLEAR	3005059 [10179]

## RESPIRATOR FIT



### CHEMICAL SPLASH GOGGLE

Indirect ventilation with wider nosepiece fits over most half mask respirators. Internal baffles maximize splash protection. Trusted Monogoggle® design. .060" polycarbonate lens. Standard Pack: 36

FRAME/LENS	PART#
GREEN/CLEAR VISICLEAR™	3005057 [10140]

## REVOLUTION™



### CHEMICAL SPLASH GOGGLE

Cross Vent™ technology keeps air flowing in and moisture out. VisiClear™ anti-fog, anti-scratch, anti-static lens coating. Accommodates large Rx insert (sold separately). Expanded visual field. .080" polycarbonate lens provides impact protection. Standard Pack 30

FRAME/LENS	PART #
BLUE/CLEAR VISICLEAR™	3000048 [10500]
BLUE/SMOKE VISICLEAR™	3000049 [10501]
BLUE/AMBER VISICLEAR™	3000050 [10501]
BLACK/CLEAR VISICLEAR™	3009654 [10541]
BLACK/SMOKE VISICLEAR™	3005121 [10542]
REVOLUTION RX INSERT (25/BAG)	3000052 [10505]



## WILDCAT™



### EXTREME PERFORMANCE VISION PROTECTION

Features extreme heat resistance - will not melt, drip, or ignite at 350°F for five minutes. Adjustable side vents to ensure increased air flow. Fits naturally to the contour of your face in order to block out airborne contaminants. Lightweight and comfortable with a pivot headband that allows for optimal placement. Meets NFPA 1977 standards and is Z94.3 compliant. Standard Pack: 12



LENS	PART #
CLEAR ANTI-FOG	3013710*
SMOKE ANTI-FOG	3013711*
AMBER ANTI-FOG	3013712*
IRUV 3.0 ANTI-FOG	3013713*
IRUV 5.0 ANTI-FOG	3013714*

## SG30



### DUST & IMPACT GOGGLE

Economical dust and impact protection with .060 polycarbonate lens and direct ventilation. .060" polycarbonate lens.

FRAME/LENS	PART #
GREEN/CLEAR, 200 PACK	3005067* [10260]
GREEN/CLEAR, 50 PACK	3009541 [10468]

safetygoggles





## SG34

### CHEMICAL SPLASH GOGGLE



Economical chemical splash protection with .060 polycarbonate lens and button vents that provide indirect venting. .060" polycarbonate lens.

FRAME/LENS	PART #
GREEN/CLEAR, 200 PACK	3005066 [10258]
GREEN/CLEAR, 50 PACK	3003415* [10257]

## MRXV™

### CHEMICAL SPLASH GOGGLE



Spherical lens provides more than 360 degrees of vision. .090 polycarbonate lens has indirect vents that offer splash protection. .090" polycarbonate lens. Standard Pack: 36

FRAME/LENS	PART #
BLUE/CLEAR	3005068 [10276]
BLUE/CLEAR VISICLEAR™	3005069 [10277]
SMOKE/CLEAR	3005070 [10280]
SMOKE/CLEAR VISICLEAR™	3005071 [10281]

## GOGGLE TOGGLE™



Snaps into universal hard hat slots on most safety caps. Ideal for storage of goggles in front of cap and back of cap. Perfect for when goggles are worn occasionally or only in certain applications, but must be kept with workers at all times.



DESCRIPTION	PART #
GOGGLE TOGGLE, 50 PACK	3005127 [14420]

## GOGGLE RETAINER



Ideal for use with non-slotted hard hats. Goggle Retainer holds goggle firmly in place on safety hats when not in use. Standard Pack: 1

DESCRIPTION	PART #
GOGGLE RETAINER	3000057 [10511]

\*Z94.3 COMPLIANT



Shown in image: #3000001 - Model K Headgear

### FACESHIELD FEATURE

- Larger sizes provide additional protection from top, bottom and sides.
- All Jackson Safety® and Huntsman® faceshields meet or exceed ANSI Z87.1 standards for secondary eye protection. Primary eye protection (safety eyewear) required with use of these products in accordance with ANSI Z87.1.
- Available in Polycarbonate, Propionate, Acetate, APCP™, PETG and Mesh.
- Excellent with the 170-SB headgear or Huntsman® Model K.

### MATERIAL SELECTOR GUIDE

MATERIAL	SHAPE	IMPACT RESISTANCE	SCRATCH RESISTANCE	HEAT RESISTANCE	OPTICS
POLYCARBONATE	MOLDED/SHEET	BEST	BETTER	BEST	BEST
PROPIONATE	MOLDED	LIMITED	GOOD	GOOD	BETTER
ACETATE	SHEET	LIMITED	BEST	BETTER	BEST
APCP™	SHEET	LIMITED	BETTER	BETTER	GOOD
PETG	SHEET	LIMITED	BETTER	BETTER	GOOD

#### POLYCARBONATE

Optical-grade .060" thick polycarbonate from extruded sheets or injection molded resin provide superior secondary impact protection and increased scratch resistance. Available molded or flat - 15.5" x 8". Clear, IRUV 3.0 and IRUV 5.0. Meets or exceeds ANSI Z87.1+

#### PROPIONATE

Injection molded, .060" thick propionate offers distortion-free optics. Available in clear, dark green and IRUV 5.0.

#### ACETATE

High-grade cast sheet acetate available in .040" and .060" thickness protects against dust and chemical splash. Available in clear, light green and dark green with the option of aluminum bound or unbound.

#### APCP™

.040" thick polyester based resin offers lightweight comfort and economical protection. Low haze and high gloss optics. Available in clear with option of aluminum bound or unbound.

#### PETG

Provides quality protection at an economical price. Ideal for any worker who needs protection and is not exposed to high heat applications. Offers good scratch resistance and distortion free optics. Available un-molded in clear and dark green.

#### 40-MESH BLACK STEEL SCREEN

Not intended for impact protection. Apply over a faceshield to dissipate heat, preventing faceshield from warping in high heat applications.

WARNING: APPLICATIONS & SAFETY  
FACESHIELDS DO NOT PROVIDE UNLIMITED EYE AND FACE PROTECTION - PRIMARY EYE PROTECTION (SAFETY EYEWEAR OR GOGGLES) MUST BE WORN.

## JACKSON SAFETY FACESHIELDS

PART #	OLD #	DESCRIPTION	DIMENSIONS	PK	BOUND/UNBOUND
<b>POLYCARBONATE</b>					
3002835*	0754-9975	34-60 CLEAR BULK	8" X 15.5" X .060"	50	UNBOUND
3002832**	0754-0415	34-60-PC CLEAR, MOLDED	8" X 15.5" X .060"	12	UNBOUND
3009492*	0754-0048	34-60 CLEAR	8" X 15.5" X .060"	12	UNBOUND
3002813**	0754-0034	34-63 IRUV 3.0	8" X 15.5" X .060"	12	UNBOUND
3002810*	0754-0031	34-65 IRUV 5.0	8" X 15.5" X .060"	12	UNBOUND
3002838*	0754-9979	34-65 IRUV 5.0 BULK	8 X 15.5" X .060"	50	UNBOUND
<b>PROPIONATE</b>					
3002828	0754-0205	812-60 CLEAR	8" X 12" X .060"	12	UNBOUND
3002844	0754-9990	812-60 CLEAR, BULK	8" X 12" X .060"	50	UNBOUND
3002830	0754-0215	915-60 CLEAR	9" X 15.5" X .060"	12	BOUND
3002843	0754-9988	915-60 CLEAR, BULK	9" X 15.5" X .060"	50	UNBOUND
3002831	0754-0218	915-63 DARK GREEN	9" X 15.5" X .060"	12	UNBOUND

All faceshields meet ANSI Z87.1 standards for secondary eye protection. Primary eye protection is required with use of these products in accordance with ANSI Z87.1.



faceprotection

## JACKSON SAFETY FACESHIELDS

PART #	OLD #	DESCRIPTION	DIMENSIONS	PK	BOUND/UNBOUND
<b>ACETATE</b>					
3002805	0754-0017	6040 CLEAR	6" X 12" X .040"	12	BOUND
3002806*	0754-0018	8040 CLEAR	8" X 12" X .040"	24	UNBOUND
3002824	0754-0118	8040-U CLEAR	8" X 12" X .040"	50	UNBOUND
3002815	0754-0037	8041 LIGHT GREEN	8" X 12" X .040"	12	BOUND
3002816*	0754-0038	8042 DARK GREEN	8" X 12" X .040"	12	BOUND
3002846*	0754-9993	8042 DARK GREEN, BULK	8" X 12" X .040"	50	BOUND
3002808*	0754-0029	34-40 CLEAR	9" X 15.5" X .040"	24	BOUND
3002848*	0754-9996	34-40 CLEAR, BULK	9" X 15.5" X .040"	50	BOUND
3002825*	0754-0129	34-40-U CLEAR	9" X 15.5" X .040"	12	UNBOUND
3002817*	0754-0039	34-41 LIGHT GREEN	9" X 15.5" X .040"	12	BOUND
3002818*	0754-0040	34-42 DARK GREEN	9" X 15.5" X .040"	24	BOUND
3002845*	0754-9992	34-42 DARK GREEN, BULK	9" X 15.5" X .040"	50	BOUND
3002826	0754-0132	1940-U CLEAR	9" X 19.5" X .040"	12	UNBOUND
3002807	0754-0020	8060 CLEAR	8" X 12" X .060"	12	BOUND
3002809*	0754-0030	34-60 CLEAR	9" X 15.5" X .060"	12	BOUND
3002847*	0754-9994	8040 CLEAR, BULK	9" X 15.5" X .040"	50	BOUND
<b>APCP™</b>					
3002821	0754-0047	34-40-AP CLEAR	9" X 15.5" X .040"	50	BOUND
3002836	0754-9977	34-40-AP-U CLEAR	9" X 15.5" X .040"	50	UNBOUND
<b>BLACK MESH STEEL SCREEN</b>					
3002812	0754-0033	40-MESH STEEL SCREEN	9" X 15.5"	12	BOUND
<b>39 FIBRE</b>					
3002811	0754-0032	39 FIBRE FILTER PLATE HOLDER	6.5" X 12"	12	UNBOUND

## HUNTSMAN® FACESHIELDS

PART #	OLD #	DESCRIPTION	DIMENSIONS	PK	BOUND/UNBOUND
<b>POLYCARBONATE</b>					
3005377	22655	4200 LB CLEAR	10" X 20" X .040"	36	UNBOUND
3005378	22663	8140 LB CLEAR	8" X 15.5" X .040"	36	UNBOUND
3009531	15057	8154 PLF	8" X 15.5" X .040"	12	UNBOUND
3005371	22643	8154 LB CLEAR	8" X 15.5" X .040"	25	BOUND
3005372	22644	8154 LB CLEAR	8" X 15.5" X .040"	36	UNBOUND
3000169	15133	8156P CLEAR, MOLDED	8" X 15.5" X .060"	24	UNBOUND
3005381	22677	8156 CLEAR, MOLDED	8" X 15.5" X .070"	50	UNBOUND
3005374	22646	8156 LB CLEAR	8" X 15.5" X .060"	25	BOUND
3005375	22647	8156 LB CLEAR	8" X 15.5" X .060"	36	UNBOUND
3005385	22701	9196 LB CLEAR	9" X 19.25" X .060"	36	UNBOUND
3000171	15137	10206P CLEAR, MOLDED	10" X 20" X .060"	24	UNBOUND
3000162	15095	10206G GOLD, MOLDED	10" X 20" X .060"	1	UNBOUND
3005379	22667	8154 LB DARK GREEN	8" X 15.5" X .040"	36	UNBOUND
3005373	22645	8154 LB MEDIUM GREEN	8" X 15.5" X .040"	36	UNBOUND
3000449	22690	8154 WITH CHIN CUP, CLEAR	8" X 15.5" X .040"	12	UNBOUND
3005386	22702	9194 LB CLEAR	9" X 19.25" X .060"	36	UNBOUND
<b>PROPIONATE</b>					
3000173	15039	8156PP CLEAR	8" X 15.5" X .060"	24	UNBOUND
3000159	15092	H9156-5 IRUV 5.0	9" X 15.5" X .060"	12	UNBOUND

# HUNTSMAN® FACESHIELDS

PART #	OLD #	DESCRIPTION	DIMENSIONS	PK	BOUND/UNBOUND
<b>ACETATE</b>					
3000117*	15012	8124 CLEAR	8" X 12" X .040"	24	BOUND
3000152*	15085	8124 CLEAR, BULK	8" X 12" X .040"	50	BOUND
3000121	15023	6154 CLEAR	6" X 15.5" X .040"	24	BOUND
3000122*	15026	8154 CLEAR	8" X 15.5" X .040"	24	BOUND
3000155*	15088	8154 CLEAR, BULK	8" X 15.5" X .040"	75	BOUND
3000128*	15033	8154 LB CLEAR	8" X 15.5" X .040"	24	UNBOUND
3000129	15035	8154MLF MEDIUM GREEN FLAT	8" X 15.5" X .040"	12	BOUND
3000124*	15028	8154D DARK GREEN	8" X 15.5" X .040"	24	BOUND
3000156*	15089	8154D DARK GREEN, BULK	8" X 15.5" X .040"	75	BOUND
3000130	15036	8154 LB DARK GREEN	8" X 15.5" X .040"	12	UNBOUND
3000125	15030	8156 CLEAR	8" X 15.5" X .060"	24	BOUND
3000143	15069	8156M MEDIUM GREEN	8" X 15.5" X .060"	24	BOUND
3000133*	15039	H9154 CLEAR	9" X 15.5" X .040"	24	BOUND
3000157*	15090	H9154 CLEAR, BULK	9" X 15.5" X .040"	75	BOUND
3000134	15040	H9154M MEDIUM GREEN	9" X 15.5" X .040"	24	BOUND
3000135	15041	H9154D DARK GREEN	9" X 15.5" X .040"	24	BOUND
3000158	15091	H9154D DARK GREEN, BULK	9" X 15.5" X .040"	75	BOUND
3000136	15051	H9194 CLEAR	9" X 19.5" X .040"	24	UNBOUND
3000411	22029	9154 CHIN CLEAR	9" X 15.5" X .040"	24	UNBOUND
3000146	15076	9204 CHIN CLEAR	9" X 20" X .040"	12	UNBOUND
3000450*	22740	9154 CLEAR	9" X 15.5" X .040"	24	BOUND
3000451	22741	8124 DARK GREEN	8" X 12" X .040"	24	BOUND
3000452	22742	9154 DARK GREEN	9" X 15.5" X .040"	50	BOUND
3000115	15009	6124 CLEAR	6" X 12" X .040"	24	BOUND
3000123	15027	8154M MEDIUM GREEN	8" X 15.5" X .040"	24	BOUND
3000422	22046	H9194D DARK GREEN	9" X 19" X .040"	60	UNBOUND
<b>PETG</b>					
3000151	15084	8154PETGLF CLEAR	8" X 15.5" X .040"	100	UNBOUND
3005376	22648	8154LB CLEAR	8" X 15.5" X .040"	36	UNBOUND
3005382	22681	8154LB MEDIUM GREEN	8" X 15.5" X .040"	36	UNBOUND
3005384	22699	8154LB CLEAR, BULK	8" X 15.5" X .040"	100	UNBOUND
3005399	22761	ECONOMY 8154LB CLEAR	8" X 15.5" X .040"	100	UNBOUND
<b>MESH</b>					
3000127	15032	815 WIRE SCREEN	8" X 15.5" X .020"	12	BOUND
3005383	22692	6513 WIRE SCREEN	15" X .009"	30	BOUND

## MODEL K HEADGEAR



Model K ratchet headgear with spark deflector secures 12" or 15.5" faceshields. Soft, absorbent wrap-around foam cushioned sweatband gently hugs the natural shape of the head. Model K-10 features pinlock size adjustment. Faceshields sold separately.

DESCRIPTION	PART #	STANDARD PACK
MODEL K	3000001 [10000]	6
MODEL K BULK	3000006 [10042]	60
MODEL K W/ 8124 CLEAR	3000002 [10003]	12
MODEL K10	3000012 [10050]	6
MODEL K10 BULK	3000011 [10049]	60
MODEL K10 W/8124 CLEAR	3000420 [22042]	12

## 170-SB & 131-B HEADGEAR



Universal hole pattern. Enables attachment of all Jackson Safety® faceshields to your safety cap. Headgear features large spark deflector and 170-SB has ratchet suspension. 131-B is an economical headgear with non-ratchet suspension. Faceshield sold separately.

DESCRIPTION	PART #	STANDARD PACK
170-SB	3002436* [0742-0020]	12
170-SB BULK	3002447* [0742-9802]	40
131-B	3002437 [0742-0021]	12

## A-F3000



Economical headgear has a universal hole pattern that holds faceshield firmly in place. Easy ratchet headband for precise fit. Wrap-around cushioned headband gently hugs the natural shape of the head. Both crown and faceshield easily pivot up. Faceshield sold separately. 19-1/2" x 9-1/2" x 14".

DESCRIPTION	PART #
A-F3000	3005840 [27910]

## CHEMICAL SPLASH PROTECTION

The type of lens material you will need depends on many factors such as strength and the temperature of the chemical. Below is a basic guide for what may be suitable. \*Always consult your safety director for the best determination.

CHEMICAL	ACETATE	POLYCARBONATE	CHEMICAL	ACETATE	POLYCARBONATE
Aromatic Hydrocarbons	Good	Limited Protection	Mineral Spirits	Good	Good
Calcium Chloride	Good	Good	Motor Fuel	Good	Limited Protection
Carbon Tetrachloride	Good	No Protection	Nitric Acid 10% - 20%	No Protection	Limited Protection
Chlorine 10%	Good	No Protection	Nitric Acid 10%	No Protection	Good
Citric Acid	Limited Protection	Good	Oil of Turpentine	Good	Good
Concentrated Acid	No Protection	Limited Protection	Organic Acids	Limited Protection	Limited Protection
Dry Halogen	Limited Protection	Good	Oxidized Acids	Limited Protection	Limited Protection
Ether	Good	No Protection	Paraffin Oil	Limited Protection	Good
Glycerine	Good	Good	Perchloroethylene	Good	No Protection
Greases and Oils	Good	Good	Petrol	Good	Limited Protection
Heptane	Good	Good	Potassium Hydroxide	No Protection	No Protection
Hydrocarbons	Limited Protection	Limited Protection	Sulfuric Acid 70%	No Protection	Limited Protection
Hydrochloric Acid 10%	No Protection	Limited Protection	Sulfuric Acid 50%	No Protection	Good
Hydrofluoric Acid 5%	Limited Protection	Good	Toluene	No Protection	No Protection
Inorganic bases	Good	No Protection	Trichloroethylene	No Protection	No Protection
Iodine	Good	No Protection	Turpentine	Good	Good
Methylene Chloride	No Protection	No Protection	Xylene	Good	No Protection

Above is a limited list of chemicals, please visit our website at [www.jacksonsafety.com](http://www.jacksonsafety.com) for a complete listing.

**WARNING:** Faceshields do not provide complete chemical protection. Faceshields provide chemical resistance. Exposing a facshield to contact with chemicals and solvents or their vapors can severely reduce the level of face and eye protection.

A hard hat is the most unappreciated piece of protection on a job site, when it should be the most desired. It is an amazing piece of equipment with enormous performance expectations, protection for your brain - your life! Jackson Safety offers unmatched protection, meeting all ANSI Type 1 safety classes (G, E and C) to protect you. No matter what dangers you may encounter, Jackson Safety is on the job. Jackson Safety caps are only the second line of defense, you must be the first. Searching for and understanding potential dangers, and eliminating them are the first line of defense. If head hazards still exist, you can count on Jackson Safety to offer a proven line of products that are specially suited to protect you.

### TYPES & CLASSES STANDARDS

Protective helmets are classified according to the specific impact and electrical performance requirements they are designed to meet. All protective helmets in accordance with this standard shall meet either Type I or Type II impact requirements. In addition, all helmets are further classified as meeting Class G, Class E, or Class C electrical requirements.

#### IMPACT TYPES

Type I: Helmets intended to reduce the force of impact resulting from a blow only to the top of the head.

Type II: Helmets intended to reduce the force of impact resulting from a blow which may receive limited protection off center, lateral or to the top of the head.

#### ELECTRICAL CLASSES

Class G (General): Class G helmets are intended to reduce the danger of contact exposure to low voltage conductors. Test samples are proof-tested at 2200 volts (phase to ground). However, this voltage is not intended as an indication of the voltage at which the helmet protects the wearer.

Class E (Electrical): Class E helmets are intended to reduce the danger of exposure to high voltage conductors. Test samples are proof-tested at 20,000 volts (phase to ground). However, this voltage is not intended as an indication of the voltage at which the helmet protects the wearer.

Class C (Conductive): Class C helmets are not intended to provide protection against contact with electrical conductors.

### COLOR SELECTION CHART

COLORS	SC-6	SB6	SENTRY III	CHARGER	CHARGER VAC	BLOCKHEAD	SC-16	BC 100
BLACK				X				
BLUE [PMS 2935C]	X	X	X	X	X	X	X	X
BROWN [462C]	X							
GRAY [PMS 430C]	X	X	X	X				X
GREEN [PMS 3425C]	X	X	X	X		X		X
HI-VIZ ORANGE [PMS 1655C]			X	X		X		X
LIME [PMS 381C]	X		X	X				
NEON PINK [PMS 225C]				X				
ORANGE [PMS 1165C]	X	X	X	X	X	X		X
PURPLE [2685C]	X							
RED [PMS 1797C]	X	X	X	X	X	X		X
SKY BLUE [PMS 291C]			X	X				
TAN [PMS 468C]	X							
YELLOW [PMS 107C]	X	X	X	X	X	X	X	X
WHITE	X	X	X	X	X	X	X	X



Shown in image  
 #3013372 - Charger, Neon Pink  
 #3016316 - Elite, Blue Mirror Lens

headprotection



## SC-6

THE INDUSTRY HAS SPOKEN!



Meets ANSI Z89.1, Class G, C & E. Smooth dome design. Lightweight, molded from dielectric High Density Polyethylene (HDPE) -- only 12.4 oz. Slotted, impact absorbing design. Accessory slots for attaching additional protection options. Deep nape strap and absorbent cloth sweatband for comfortable fit. 4 pt. ratchet or pinlock suspensions. Can be worn backwards when suspension is reversed. Attaches to 137 Capshield, Model P, 337 Capshield and the 437 Capshield. Standard Pack: 12

DESCRIPTION	PART# RATCHET	PART# PINLOCK
YELLOW	3001987* [0740-0441]	3001952 [0740-0241]
WHITE	3001988* [0740-0442]	3001953 [0740-0242]
GREEN	3001990* [0740-0444]	3001954 [0740-0244]
BLUE	3001991* [0740-0445]	3001955 [0740-0245]
ORANGE	3001992* [0740-0446]	3001956 [0740-0246]
RED	3001993* [0740-0447]	3001957 [0740-0247]
GRAY	3001994* [0740-0448]	3001958 [0740-0248]
BROWN	3020132	N/A
HI-VIZ LIME	3001998 [0740-0456]	N/A
PURPLE	3001997 [0740-0451]	N/A
TAN	3001999 [0740-0463]	N/A

### SB-6 STUBBY

Short bill design of the SC-6. Ideal for use with welding helmets. 4 pt. ratchet suspension. Standard Pack 12

DESCRIPTION	PART #
YELLOW	3001928* [0740-0081]
WHITE	3001929* [0740-0082]
GREEN	3001930* [0740-0084]
BLUE	3001931* [0740-0085]
ORANGE	3001932* [0740-0086]
RED	3001933* [0740-0087]
GRAY	3001934* [0740-0088]



REPLACEMENT PARTS			
4 PT SUSPENSION	3002428 [0741-0003]	3004233 [0741-0021]	
SWEATBAND	3000105 [14739]	3000105 [14739]	
4 PT CHINSTRAP	3009653 [15597]	3009653 [15597]	
2 PT CHINSTRAP	3002430 [0741-0012]	3002430 [0741-0012]	



3002428 [0741-0003]  
4PT RATCHET



3002433 [0741-0021]  
4PT PINLOCK

## SENTRY III™

TRANSCEND THE CONVENTIONAL



Meets ANSI Z89.1, Class G, C & E. Low profile, silhouette styled cap. Low riding nape strap prevents cap from slipping. Lightweight, molded from High Density Polyethylene (HDPE) - only weighs 12.5 oz! Accessory slots for attaching additional protection options. 6 pt. ratchet and 6 pt. pinlock suspensions offer two additional points of impact absorbance. Attaches to 137 Capshield, Model C, Model P, A-5500X, 337 Capshield and 437 Capshield. Standard Pack: 12

DESCRIPTION	PART# RATCHET	PART# PINLOCK
WHITE	3000064 [14024]	3000063 [14022]
BLUE	3000072 [14055]	3000071 [14053]
RED	3000075 [14065]	3000074 [14063]
HI VIZ ORANGE	3000085 [14101]	3000084 [14199]
LIME	3000204 [15549]	3000203 [15548]
GRAY	3000067 [14033]	3000066 [14031]
ORANGE	3000078 [14073]	3000077 [14071]
GREEN	3000070 [14047]	3000069 [14045]
SKY BLUE	3000206 [15551]	3000205 [15550]
YELLOW	3000061 [14011]	3000060 [14009]

REPLACEMENT PARTS			
6 PT SUSPENSION	3000095 [14431]	3000094 [14429]	
SWEATBAND	3000105 [14739]	3000105 [14739]	
2 PT CHINSTRAP	3002430 [15597]	3002430 [15597]	
4 PT CHINSTRAP	3009653 [0741-0012]	3009653 [0741-0012]	



3000095 [14431]  
SENTRY 6PT RATCHET



3000094 [14429]  
SENTRY 6PT PINLOCK

# CHARGER™

SUPERIOR PROTECTION AT AN ECONOMICAL PRICE



## CHARGER™ VAC

Meets ANSI Z89.1, Class C. Vented design of the popular Charger™. 12 cooling vents that provide the maximum in air circulation for comfort. 4 pt. ratchet suspensions. Attaches to 137 Capshield, Model P, Model C, 337 Capshield, A-5500SN and A-5500X. Standard Pack 12

DESCRIPTION	PART #
WHITE	3013392
BLUE	3013393
RED	3013394
ORANGE	3013398
YELLOW	3013400



Meets ANSI Z89.1, Class G, C & E. Lightweight for comfort, molded from High Density Polyethylene (HDPE) - only 13.5 oz. Contoured dome maximized protection while providing a sleek, low profile. Griptec™ coated bill helps to improve gripping. Trim bill style for greater upward vision, ideal for vision attachment. Low nape strap, and rain trough. Universal slots allow easy attachment of hearing, welding and faceshield accessories. 4 pt. ratchet, pinlock or plastic suspensions. Attaches to 137 Capshield, Model P, Model C, 337 Capshield, A-5500SN and A-5500X. Standard Pack: 12

DESCRIPTION	PART# RATCHET	PART# PINLOCK	PART# PLASTIC
WHITE	3013362	3013374	3013409
BLUE	3013663	3013375	3013412
RED	3013364	3013376	3013413
GRAY	3013367	3013379	3013417
ORANGE	3013368	3013380	3013414
GREEN	3013369	3013381	3013415
YELLOW	3013370	3013382	3013411
HI-VIZ ORANGE	3013365	3013377	3013416
HI-VIZ LIME	3013366	3013378	3013410
NEON PINK	3013372	3013384	3013420
SKY BLUE	3013371	3013383	3013418
BLACK	3014571	3014572	3014709

### REPLACEMENT PARTS

4 PT SUSPENSION	3013403	3013404	3013405
SWEATBAND	3000105	3000105	3000105
4 PT CHINSTRAP	3009653	3009653	3009653
2 PT CHINSTRAP	3002430	3002430	3002430



3013403  
CHARGER 4PT RATCHET



3013404  
CHARGER 4PT PINLOCK



3013405  
CHARGER 4PT PLASTIC

# BLOCKHEAD™

BETTER BY DESIGN



Meets ANSI Z89.1, Class G, C & E. Full 360° brim protects wearer from nature's elements. Lightweight for comfort, molded from High Density Polyethylene (HDPE) - only 16.3 oz. Smooth dome leaves no crevices for buildup. Reinforced brim ensuring longevity and safety. Anti-glare bill. Griptec™ coated bill improves gripping. Soft, absorbent cloth absorbs sweat keeping you safe and comfortable. 8 pt. ratchet suspension. Attaches to 37 Hatshield. Standard Pack: 10



3014879  
BLOCKHEAD 8PT RATCHET

DESCRIPTION	PART# RATCHET
WHITE	3014874
BLUE	3014876
RED	3014878
ORANGE	3014877
YELLOW	3014875
HI-VIZ ORANGE	3014982
GREEN	3014902
SUNSHADE	3000188

### REPLACEMENT PARTS

8 PT SUSPENSION	3014879
SWEATBAND	3000105
4 PT CHINSTRAP	3009653
2 PT CHINSTRAP	3002430



headprotection





## HEADTURNERS™

YOUR STYLE, YOUR HAT

Meets ANSI Z89.1, Class G, C & E. Smooth dome design with low profile that's desired most by industry professionals. Graphics designed to withstand temperature variances, humidity, and exposure to UV light for long-lasting wear. 4 pt. ratchet suspensions. Attaches to Model H, Model P, Model C and the 137 Capshield. Standard Pack: 12



INFERNO  
#3011126



HELLRAISER  
#3004888



HELLRAISER  
#3013040

DESCRIPTION	PART# RATCHET
HELLRAISER	3004888*
INFERNO	3011126*

FULL BRIM STYLE	
HELLRAISER	3013040

REPLACEMENT PARTS	
4 PT SUSPENSION	3002428
SWEATBAND	3002459



3002428 [0741-0003]  
4PT RATCHET

## SC 16 - FIBERGLASS CAP

Meets ANSI Z89.1, Class G & C. Fiberglass protection for high heat applications. Smooth dome design, the most desirable by industry professionals. Firm, comfortable fit with low profile. Padded, absorbent brow pad. Accessory slots offer additional protection options. Only weighs 16.8 oz! 4 pt. ratchet suspension. Attaches to 137 Capshield, Model C, 337 Capshield and A-5500SN. Standard Pack: 12



3002428 [0741-0003]  
4PT RATCHET

DESCRIPTION	PART# RATCHET
YELLOW	3001980* [0740-0411]
WHITE	3001981* [0740-0412]
BLUE	3001983* [0740-0415]

REPLACEMENT PARTS	
4 PT SUSPENSION	3002428 [0741-0003]
SWEATBAND	3000105 [14739]

## WESTERN OUTLAW™ HARD HAT

Meets ANSI Z89.1, Class G, C & E. Stylish, comfortable and fits all head sizes. Wide brim for protection against sunlight. 4 pt. ratchet suspension. Standard Pack: 4



DESCRIPTION	PART# RATCHET
BLACK	3007313
GRAY	3010945
TAN	3010944
WHITE	3010943

REPLACEMENT PARTS	
4 PT SUSPENSION	3000187
SWEATBAND	3000105

# BC 100 BUMP CAP



*CAUTION: Bump caps are not designed for protection against impact from falling or glancing objects. Does not meet ANSI Z89.1 requirements.*

Protection from minor bumps where ANSI standards are not required. Lightweight for comfort, molded from High Density Polyethylene (HDPE) - only 8 oz. Smooth dome leaves no crevices for buildup. Comfortable, low profile design. Available with faceshield attachment knobs. Absorbent, terry cloth brow pad. 4-point injection molded suspension. Pinlock sizing from head sizes 6-1/2 to 8-1/4. Standard Pack: 12

DESCRIPTION	PART NO	DESCRIPTION	PART NO
YELLOW	3001936	<b>BUMP CAP WITH HEADGEAR ATTACHMENT</b>	
WHITE	3001937	WHITE	3012332
GREEN	3001938	YELLOW	3012333
BLUE	3001939	BLUE	3012334
ORANGE	3001940	GREEN	3012335
RED	3001941	RED	3012336
HI-VIZ ORANGE	3012323	ORANGE	3012337
GRAY	3001942	HI-VIZ ORANGE	3012338
		GRAY	3012339

**REPLACEMENT PARTS**

4 PT SUSPENSION	3012340
SWEATBAND	3009543



BUMP CAP WITH HEADGEAR ATTACHMENT

**FACESHIELDS FOR BUMP CAP**

- FACESHIELD PETG 6X15.5X.040" 3005392
- FACESHIELD PETG 8X15.5X.040" 3005391



3012340  
4 PT PINLOCK BUMP CAP

headprotection



## HARD HAT CUSTOMIZATION PROGRAM



Jackson Safety utilizes the most technologically advanced and innovative pad-printing machine on the market. As with most methods of reproducing process-color images, the creation of near-photographic quality separates the novices from the experts. Jackson Safety pad printing processes utilizes only the highest quality ink to produce fine-line detailing and brilliant color depicting your concise company image, every time. The ability to pad print is only limited by your imagination.

### HARD HAT CUSTOMIZATION PROGRAM DETAILS:

- Minimum order of 24 hard hats of the same style
- Up to a maximum of 5 colors per printed location (solid pantones only)  
\*Ink color may vary based on color of hat being printed on.
- 4 locations per hat/cap: Front, Back, Left Side, Right Side
- Vector artwork is preferred in a .EPS, .PDF, or .AI artwork format
- One measurement at least 5" with a resolution of 600 DPI is acceptable (3000 pixels x 3000 pixels)

These specifications are required and provide you with the best possible results. Supplying camera-ready artwork benefits you by avoiding additional fees and longer lead times. Images may be subject to an artwork fee if they are not production ready. For more information, please contact our Customer Service team at (800)428-8185.

HAT	FRONT		BACK		SIDE	
	HEIGHT	WIDTH	HEIGHT	WIDTH	HEIGHT	WIDTH
SC-6	2"	3"	2"	2"	2"	3"
SENTRY III	2"	2"	2"	2"	1-1/4"	3-1/4"
CHARGER	2"	3"	2"	1-7/8"	2"	3"
BLOCKHEAD	2"	3"	2"	2"	2"	3"
SC-16	2"	3"	2"	2"	2"	3"
BC 100	2"	3"	2"	2"	2"	3"

## HEADGEAR ATTACHMENTS



	SC-6/16	HEADTURNER FULL BRIM	SENTRY III	CHARGER	BLOCKHEAD
37 HATSHIELD #3002442					✓
MODEL H #3000038		✓			
137 CAPSHIELD #3002445	✓		✓	✓	
MODEL P #3000034	✓ SC-6 ONLY		✓	✓	
MODEL C #3000032	✓ SC-16 ONLY		✓	✓	
337 CAPSHIELD #3002443	✓		✓	✓	
A-5500SN #3000447	✓			✓	
437 CAPSHIELD #3002444	✓ SC-6 ONLY		✓		
A-5500X #3000448	✓ SC-6 ONLY		✓	✓	

## BLADE MOUNTED



### 437 CAPSHIELD

3002444 [0742-0037]

Totally dielectric, all plastic device for slotted caps. Curved plastic channel fits over the bill of the cap and includes pivoting blades that snap easily into cap slots. Faceshields are secured with integral plastic lugs. Ideal for bill forward user. Attaches to SC-6 and Sentry III. Standard Pack: 12



### HUNTSMAN® A-5500X

3000448 [22640]

Lightweight 100% nylon bracket. Pivots up and secures in 3 different positions. Attaches to SC-6, Sentry III, Charger and Charger VAC.



### 382 B CAP ADAPTER

3002441 [0742-0025]

2002449 40/BOX, BULK

Totally dielectric for slotted caps. Easiest, least costly adapter. Includes an integral spark deflector and pivoting blades. Polyethylene spark deflector. Faceshields secured with integral plastic lugs. Standard Pack: 12



### 82 B CAPMOUNT ADAPTER

3002438 [0742-0022]

Totally dielectric for slotted caps. Quick detach brackets that join any faceshield and spark deflector with plastic pins to any cap equipped with 87 mounting blades. Polyethylene spark deflector. Standard Pack: 12



### 82 BM CAPMOUNT ADAPTER

3002446 [0742-0099]

Metal, quick detach brackets join any faceshield and spark deflector with plastic pins to any cap equipped with 87 mounting blades. Polyethylene spark deflector. Standard Pack: 12

## CORD MOUNTED



### 337 CAPSHIELD

3002443 [0742-0036]

Totally dielectric device for non-slotted caps. Curved plastic channel fits over the bill and secures with adjustable rubber headband that stretches around the exterior cap crown. Faceshields are secured with integral plastic lugs. Ideal for bill forward user. Attaches to SC-6, Sentry III, Charger, Charger VAC and SC-16. Standard Pack: 12



### HUNTSMAN® A-5500SN

3000447 [22639]

Dielectric. Heavy-duty rubber cord holds bracket in place. Attaches to SC-6, Charger, Charger VAC and SC-16.



### 282 B CAPMOUNT ADAPTER

3002440 [0742-0024]

2002450 40/BOX, BULK

Mounts faceshield instantly on a wide variety of non-slotted caps with integral plastic lugs. Uses clips pressed over the cap rim for firm fit; removes with thumb pressure. Not to be used on caps with slots and rain troughs. Polyethylene spark deflector. Standard Pack: 12



### MODEL K-4 CAP ADAPTER

DESCRIPTION	PART #	STANDARD PACK
MODEL K-4	3000046 [10350]	6
MODEL K-4 BULK	3000045 [10343]	60

Model K-4 cap adapter holds faceshield firmly on safety caps with heavy duty clips and springs. Features a spark guard with pivoting double slots to hold faceshield in down position. Fits most safety caps. Faceshield sold separately.

**\*\*DIELECTRIC MEANS ALL EXPOSED PARTS ARE EITHER PLASTIC OR RUBBER\*\***

## CAP COIL SPRING ATTACHMENTS



### 137 CAPSHIELD

3002445 [0742-0049]

Cap coil spring attachment. Metal device for non-slotted caps. Curved aluminum channel and coil spring attachment. Ideal for bill forward user. Attaches to the SC-6, Sentry III, SC-16, Charger and Charger VAC. Standard Pack: 12



### HUNTSMAN® MODEL P CAP ADAPTER

3000034 [10217]

Model P cap adaptor easily attaches faceshield to most safety caps. Huntsman® locking device holds faceshield securely in the up or down position. Turn button attachment will secure faceshield and provide fast, easy attachment and replacement for bill forward facing hats. Faceshield sold separately. Attaches to SC-6, Sentry III, Charger and Charger VAC. Standard Pack: 24

*Used with bill forward facing hats*



### HUNTSMAN® MODEL C CAP ADAPTER

3000032 [10200]

Model C cap adaptor easily attaches faceshield to most safety caps. Huntsman® locking device holds faceshield securely in the up or down position. Ideal for bill backward facing hats. Faceshield sold separately. Attaches to Sentry III, Charger, Charger VAC and SC-16. Standard Pack: 24

*Used with bill backward facing hats*



### 182 B CAPMOUNT ADAPTER

3002439 [0742-0023]

Permits attachment of any faceshield and spark deflector combination to any non-slotted cap. Faceshield secured with integral plastic lugs. Polyethylene spark deflector. Standard Pack: 12

## HAT COIL SPRING ATTACHMENT



### 37 HATSHIELD

3002442 [0742-0035]

Metal device for non-slotted hats. Curved aluminum channel and coil spring attachment or allows for attachment of any Jackson Safety faceshield to protective full brim hat. Ideal for bill forward user. Attaches to Blockhead. Standard Pack: 12



### MODEL H HAT ADAPTER

3000038 [10250]

Model H Hat Adapter attaches faceshield to most full brim safety hats. Huntsman® locking device holds faceshield securely in the up or down position. Turn button attachment secures faceshield and provides fast easy attachment and replacement. Attaches to Full Brim Headturner Hat. Faceshield sold separately. Standard Pack: 24



## TYPES & CLASS STANDARDS

### TECHNICAL DATA

All product packaging provides attenuation data and NRR (Noise Reduction Rating).

The following definitions are used in the measurement of noise:

- Hertz - A unit of frequency equal to 1 cycle per second.
- Mean attenuation - The average data derived from all tested subjects.
- Standard deviation - The difference in attenuation between the tested subjects or how well the protection "fits" the individual.

### OSHA APPROVAL RULES

1. No agency approves hearing protection.
2. OSHA approves the hearing protector only in accordance to the noise level where it is used. A protector may be approved in one noisy work area but not another because of the level or type (frequency) of noise present.
3. For complete OSHA hearing protection recommendations, see OSHA Occupational Noise Exposure Standard 29 CFR 1910.95 at [www.osha.com](http://www.osha.com)

## WHAT LEVEL OF PROTECTION DO YOU NEED?

All hearing protectors sold by Jackson Safety are tested to the American National Standards Institute (ANSI) S3.19-1974 Standard to receive a Noise Reduction Rating (NRR), which is labeled on all such products as required by the US Environmental Protection Agency (EPA).

This number gives the consumer a method to judge performance among different models of hearing protectors - a higher NRR indicating more effective protection against sound. Some models of hearing protectors have multiple NRR numbers. This reflects the fact that these hearing protectors may be worn with their headbands in different positions.

**HIGH**  
NRR 27-33

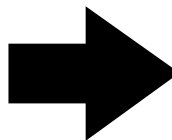

**MEDIUM**  
NRR 25-26

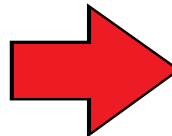

**LOW**  
NRR 21-24

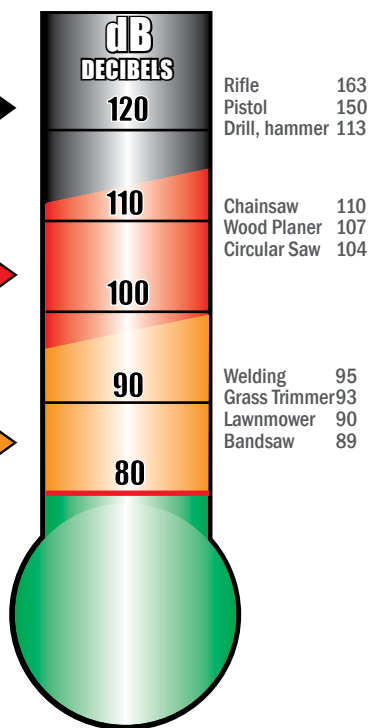
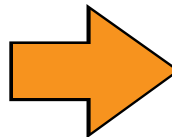

With the numerous options available, the function of a hearing protection device can only be surpassed by alluring colors and trendy shapes. Hearing protection should be taken very seriously and protectors, either muffs or plugs, should be comfortable to wear and offer sufficient attenuation to prevent hearing loss based on individual protection needed.

### MUFFS VERSUS PLUGS:

Earplugs as a form of hearing protection are widely accepted and proven. It has been proven time and time again that when worn properly, ear muffs and earplugs offer consistent protection, how then do you choose one from the other? The answer is very specific to your work environment. When Plant conditions such as dust, temperature, and humidity can cause one type of protector to be more suitable than another. For example, ear plugs can be more comfortable in a hot, humid environment, than ear muffs. Also, individual ear canals come in all shapes and sizes. For people with unusually shaped ear canals, fitting may be difficult, and commonly-used insert protectors may be very uncomfortable.

## FALCON™ WITH ACTIVE LISTENING

### ELECTRONIC HEARING PROTECTION

**NRR  
22**



Active listening breaks isolation and offers variable attenuations while still protecting the wearer. Amplifies low level sounds while limiting speaker output to a safe 82 dB. It takes a single AAA battery in each side (included) which lasts up to 250 hours. External battery compartments for easy battery replacement. Dual microphones, volume controls and speakers provide natural directional hearing and compensation for hearing differences between ears.

DESCRIPTION	PART #
FALCON ELECTRONIC EARMUFF	3010513

## VIBE EARMUFF™ & CAPMOUNT

**NRR  
23**



Shown left  
#3015087 - VIBE 23 Headband

**NRR  
26**



Shown above  
#3015089 - VIBE 26 Headband

**NRR  
29**



Shown left  
#3015090 - VIBE 29 Headband

New, innovative design with soft padded headband that adjusts to fit all head shapes and sizes. Dielectric components and durable thermoplastic material retains its shape and pressure for consistent noise reduction. Three levels of protection available. For low, medium and extremely noisy environments.

VIBE 23 is ideal for use with low level noise environments; VIBE 26 is ideal for use with medium level noise environments; VIBE 29 is ideal for use with high level noise environments. All noise levels are available in headband and capmount style.

DESCRIPTION	PART #
VIBE 23 HEADBAND, 9.3 OZ, NRR 23	3015087
VIBE CAPMOUNT, NRR 22	3015091
VIBE 26 HEADBAND, 9.8 OZ, NRR 26	3015089
VIBE CAPMOUNT, NRR 25	3015092
VIBE 29 HEADBAND, 10.9 OZ, NRR 29	3015090
VIBE CAPMOUNT, NRR 27	3015093

## SILENCIO® RBW ORIGINAL EARMUFF

- NRR 23**  
UNDER CHIN
- NRR 24**  
BEHIND HEAD
- NRR 25**  
OVER HEAD



Shown left  
#3010417 - ORIGINAL EARMUFF, RED

The RBW Original Earmuff has been protecting people for over 30 years and is still one of the best values around! Fully adjustable steel headband can be worn in 3-positions: over-head, behind-head or under-chin. Individually adjustable ear cups can be removed for sanitation and easy maintenance. Cups can be adjusted vertically and horizontally ensuring the perfect fit for all users.

DESCRIPTION	PART #
ORIGINAL EARMUFF, ORANGE	3010415
ORIGINAL EARMUFF, RED	3005516
ORIGINAL EARMUFF, BLUE	3005517

## SILENCIO® RBW LIQUID EARMUFF

- NRR 21**  
UNDER CHIN
- NRR 23**  
BEHIND HEAD
- NRR 27**  
OVER HEAD



Shown right  
#3010450 - LIQUID EARMUFF, RED

The RBW Original Earmuff with liquid filled cushions for added comfort and increased protection. Fully adjustable steel headband can be worn in 3-positions: over-head, behind-head or under-chin. Individually adjustable ear cups can be removed for sanitation and easy maintenance. Cups can be adjusted vertically and horizontally ensuring the perfect fit for all users.

DESCRIPTION	PART #
LIQUID EARMUFF, RED	3005521
LIQUID EARMUFF, BLUE	3005522

## ONYX™ EARMUFF

- NRR 23**
- NRR 26**



Shown left  
#3015085 - ONYX-23  
Headband Earmuff



- NRR 26**

Shown left  
#3015086 - ONYX-26  
Headband Earmuff

Lightweight, durable & economical protection for low or medium level noise environments. Ultra-soft ear cushions for comfort and extended wear. Ball & socket pivoting cup attachment provides optimum pressure distribution for maximum noise reduction. Available in 2 different levels of protection.

DESCRIPTION	PART #
ONYX 23 HEADBAND	3015085
ONYX 26 HEADBAND	3015086

## SILENCIO® STINGER™

- NRR 23**



Economical and lightweight with ultra-soft cushions for extra comfort. Ball and socket pivoting cup attachment for optimum pressure distribution. Cupslides that ratchet for quick and easy adjustment. Slim, lightweight design - only weights 8.1 oz!

DESCRIPTION	PART #
STINGER, BLACK	3014960





## ABOVE-THE-SHOULDER PROTECTION SYSTEM

**NRR  
24**



Shown right  
#3005132 [14764]  
ATS Protection System

Complete forestry system includes orange Sentry III™ cap pin-lock suspension, 24 NRR Muff, faceshield carrier and clear polycarbonate face shield. Lightweight and low profile. Snug, comfortable fit. Dielectric for protection against electrical hazards. Component parts also available separately.



Shown right  
#3005524 [23463]  
Capmate Earmuffs

DESCRIPTION	PART #
ATS PROTECTION SYSTEM	3005132 [14764]
<b>COMPONENT PARTS</b>	
ORANGE SENTRY III CAP	3000077 [14071]
FACE SHIELD BRACKET	3005410 [23291]
CLEAR POLYCARBONATE FACE SHIELD	3005401 [22763]
CAPMATE EARMUFFS	3005524 [23463]

## CAP ADAPTER SYSTEM

**NRR  
22**

Shown right  
#3002716 [0748-0027]  
HFS-22 Sytem



Earmuffs, mounting brackets and cap adapter system provide complete hearing, head and face protection when used with Jackson safety cap, faceshield and safety eyewear. Cap and faceshield sold separately.



Shown left  
#3002711 [0748-0022]  
HP-22-MB Earmuffs

DESCRIPTION	PART #
HFS-22 SYSTEM	3002716 [0748-0028]
HP-22-MB EARMUFFS	3002711 [0748-0022]

## SAFE 2/3 PROTECTION SYSTEMS

### SAFE 2 PROTECTION SYSTEM



Shown above  
Complete Safe 2 System

Dielectric faceshield system fits most safety caps. Faceshield bracket features an encapsulated stainless steel spring which ensures that the faceshield stays in the selected position. Bracket fits most slotted safety caps and fits most cap-mount earmuffs. Faceshields are shaped to follow the contours of the face for maximum protection. Safety cap, faceshield and earmuffs sold separately.



Shown right  
Safe 3 Headgear  
with Faceshield

### SAFE 3 FACESHIELD HEADGEAR

Faceshield headgear features adjustable headband and unique design that allows the use of earmuffs without interfering with the faceshield. High impact grade of ABS-plastic provides excellent protection. Easy to raise into the rest position when not in use. Faceshields are shaped to follow the contours of the face to provide maximum protection. Faceshields sold separately.

DESCRIPTION	PART NO
SAFE 2 FACESHIELD BRACKET	3005410 [23291]
SAFE 3 FACESHIELD HEADGEAR	3005411 [23292]
CLEAR POLYCARBONATE FACESHIELD, 8 X 13 X .040	3005401 [22763]
NYLON MESH FACESHIELD	3005415 [23296]
STEEL MESH FACESHIELD	3005413 [23294]

#### FACESHIELD OPTIONS

Shown left  
Clear Polycarbonate Faceshield

Shown right  
Steel Mesh Faceshield



## SILENCIO® RED-E-FIT™ EARPLUGS

**NRR  
32**



Shown left  
#3005542 - RED-E-FIT  
Uncorded Earplugs



Soft foam and comfortable design conforms to ear for extended wear. Ideal for high noise environments. Tapered shape offers easy insertion for any ear canal. Brilliant orange in color for quick compliance checks. Individually bagged, one pair per bag. Available in corded, non-corded and economy package. (Contains latex.)

**DESCRIPTION**

RED-E-FIT EARPLUGS (6 PAIR BLISTER CARD)  
RED-E-FIT CORDED EARPLUGS (INDIVIDUALLY WRAPPED, 100/BOX) 3004904  
RED-E-FIT UNCORDED EARPLUGS (INDIVIDUALLY WRAPPED, 200/BOX) 3005542 [23530]

**PART #**

3003321  
3004904  
3005542 [23530]



Shown left  
#3004904 - RED-E-FIT  
Corded Earplugs

## SILENCIO® ECONOMY EARPLUGS

**NRR  
26**

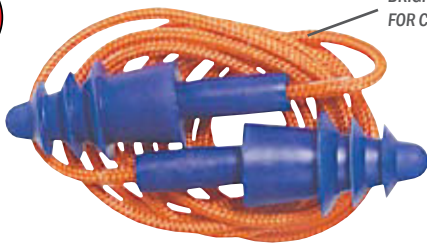

BRIGHT ORANGE CORD IDEAL  
FOR COMPLIANCE CHECKS

Shown above  
#3010526 - Corded Earplugs



Shown left  
#3010522 - Uncorded Earplugs

Soft, silicone rubber with an internal air cushion for added comfort. Triple flanged for superior fit and seal. Reusable and easy to clean. Available corded and uncorded. Includes carry case that can be Private Branded. Blister card packaging.

**DESCRIPTION**

ECONOMY UNCORDED EARPLUGS (PAIR) 3010522  
ECONOMY CORDED EARPLUGS (PAIR) 3010526

**PART #**

3010522  
3010526

## SILENCIO® SILENT PARTNER

**NRR  
25**



BRIGHT ORANGE STEM IDEAL  
FOR COMPLIANCE CHECKS

Soft silicone rubber conforms to the ear canal for an extremely comfortable fit. Reusable and easy to clean. Includes carry case that can be Private Branded. Blister card packaging, sold in pairs.

**DESCRIPTION**

SILENT PARTNER EARPLUGS (PAIR) 3010520

**PART #**

3010520

hearingprotection



## SILENCIO® HEARSAFE™ T230

**NRR  
22**

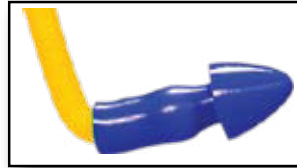

BRIGHT YELLOW STEM IDEAL FOR COMPLIANCE CHECKS

.5 oz. dielectric band with silicone plugs are designed comfortably to quickly mold to the ear canal for custom fit. Low profile band does not interfere with hardhats or eyewear. Excellent value and durability, compared to competitive "name-brands". Blister packaging.

DESCRIPTION	PART #
HEARSAFE T230	3000460 [23268]

## SILENCIO® SILENT BAND-IT

**NRR  
25**

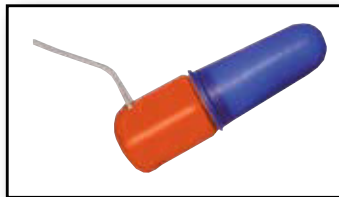
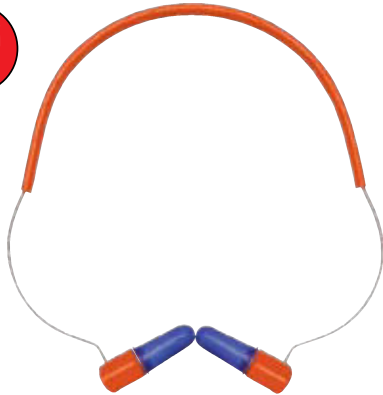

BRIGHT ORANGE STEM IDEAL FOR COMPLIANCE CHECKS

Features an adjustable headband for three position wear to fit over-head, behind-head or under-chin. Durable stainless steel headband fitted with hypo-allergenic silicone earplugs for a reusable and easy to maintain protector. Blister packaging.

DESCRIPTION	PART #
SILENT BAND-IT	3010543

## NOISE LEVELS AND DURATION

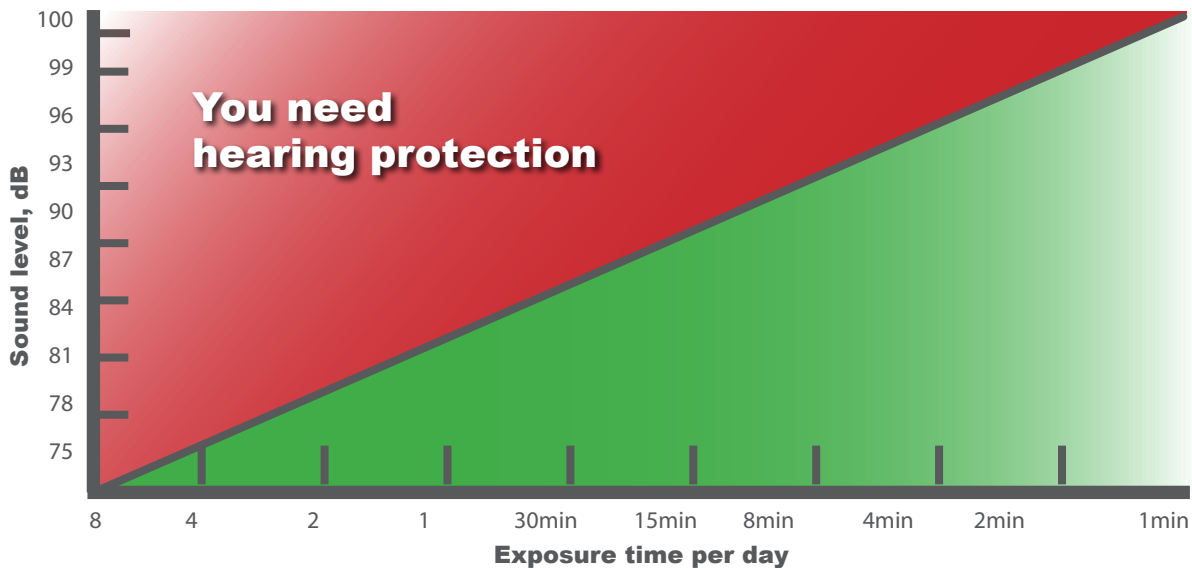

Even a very short exposure to noise is harmful to hearing if hearing protection is not worn. If you are exposed to noise levels and durations indicated by the red area, you must use hearing protectors - in the green area, you may still wish to use protection. High levels of noise exposure over a short period affect the level of sound energy much more than lower levels over longer periods.

## DRYBROW® SWEATBAND

Keep cool and prevent perspiration from running into your eyes in hot and humid conditions with Jackson Safety's specialized sweatbands. Ideal for all applications that workers need to be kept cool and comfortable.

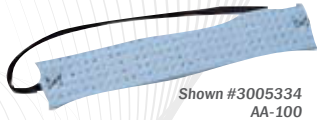

Shown #3005334  
AA-100

### AA-100

Individually sleeved for increased shelf life.

### AA-101

Packaged 100/bag. Not individually sleeved.

### AA-103

Packaged 25/bag. Individually sleeved for increased shelf life.

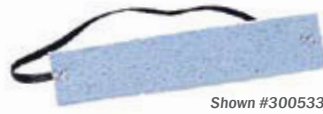

Shown #3005338  
DB-801

### DB-801

Packaged 100/bag. Economy price.

### DB-803

Packaged 25/bag.



Shown #3005336  
AA-102

### AA-102

Packaged 25/bag. Deluxe clip-on.

DESCRIPTION	PART #	
AA-100	3005334	[22008]
AA-101	3005335	[22009]
AA-103	3005337	[22011]
DB-801	3005338	[22013]
DB-803	3009557	[22017]
AA-102	3005336	[22010]

## ICY BLUE ONES™ COOLING PRODUCTS

Soak in cold water or chill in freezer for ultimate cooling relief that lasts up to a few hours. Interior polymer crystals absorb up to 200 times their weight in water. A high quality fabric keeps crystals inside and protects against leakage.



Shown #3009560  
IB-902E

### IB-902E

Headband style keeps brow cool and keeps sweat from dripping into eyes. Wraps around brow with convenient hook and loop fasteners. 27.5" long, 2.5" wide.



Shown #3009561  
IB-901C

### IB-901C

Bandanna style. Fast, cool relief from heat. Tie around neck or forehead.

DESCRIPTION	PART #	
IB-902E, ECONOMY BLUE	3009560	[22041]
IB901F, AMERICAN FLAG	3009559	[22038]
IB901E, ECONOMY BLUE	3005339	[22039]
IB901C, RED/WHITE	3009561	[22046]



## SKULL CAPS



### SMITH & WESSON® SKULL CAP

Washable flame retardant fabric. Air cushioned, sweat absorbent insert acts as built-in sweatband. Athletic mesh lining keeps your head cooler. One size fits most with tie closer for a secure fit. Standard Pack: 12



### HELLRAISER™ SKULL CAP

Mesh lining to help keep head cool. Guaranteed low profile fit. Athletic mesh lining keeps your head cooler. Excellent craftsmanship. Washable flame retardant fabric. Standard Pack: 12

DESCRIPTION	PART #
S&W® SKULL CAP	3013052
HELLRAISER SKULL CAP	3016261

## WINDGARD™

Keeps wind out, traps warmth and prevents moisture build-up. Knitted flame resistant treated polyester meets IGCFR 1610 Class 1. High visibility colors utilize dielectric material so that it can be worn near electrical hazards. Standard Pack: 12



Shown #3000435  
AA-7

### AA-7

Warmth for temps 32° to 0°F (0° to -20°C). Snug fitting cap-style fits over most hard hats.



Shown #3000436  
AA-8

### AA-8

Warmth for temps 32° to 0°F (0° to -20°C). Fits over most safety caps and full-brim styles.



Shown #3005342  
AA-9

### AA-9

Warmth for temps 0° to -20°F (-20° to -40°C). Full face and neck model protects mouth and cheeks. Fits over most safety caps.

DESCRIPTION	PART #	
AA-7, RED	3005341	[22207]
AA-7, NAVY BLUE	3000434	[22201]
AA-7, ORANGE	3000435	[22204]
AA-8, RED	3000436	[22221]
AA-9, RED	3005342	[22225]
AA-9, NAVY BLUE	3000437	[22223]

seasonal



## WINTERLINERS

Through cold and chill, snow, rain and sleet, Jackson Safety offers the industry's most comprehensive line of thermal winterwear that gives workers full protection from the elements. Our winter liners are made from the most technologically advanced fabrics that combine the best of performance features with a number of comfort options.

16 CFR 1610, Class I: "Textiles meeting these requirements are generally accepted by the trade as having no unusual burning characteristics." Windgard, Windjammer™ II, IV, 2-N-1 Sport meet 16 CFR 1610, Class I

### TEMPERATURE RANGE CODING



45° to 32°F or 8° to 0°C



32° to 0°F or 0° to -20°C



0° to -20°F or -20° to -28°C

The above suggested ranges are to assist in choosing an appropriate liner for various climates.

#### IMPORTANT

All models are flame retardant treated unless otherwise noted. Flame retardant treated models meet the Federal NFPA701 Standard. Flame resistance is the fabric's ability to self extinguish when source of flame or thermal ignition is removed. Flame resistance is meaningful only when applied to specific tests used to measure the characteristic.

### 165



Lightweight protection that can be worn under caps and hats. Two string ties for comfortable, close fit. Dielectric material can be worn near electrical hazards. Inner Liner: Napped Flannel. Standard Pack: 12

DESCRIPTION	PART #
165 WINTERLINER	3000438 [22251]

### 200



Medium protection that can be worn under caps and hats. Hook and loop fastener for a comfortable, close fit. Dielectric material can be worn near electrical hazards. Outer Fabric: 8 oz. cotton twill; Lining: Acrylic Fleece; Thread: Spun Poly. Standard Pack: 12

DESCRIPTION	PART #
200 WINTERLINER	3000440 [22294]

### 225 PLUS



Medium protection that can be worn under caps and hats. Meets requirements Class 1 CFR 1610 Flammability of General Apparel. Hook and loop fastener for a comfortable, close fit. Dielectric material can be worn near electrical hazards. Water resistant material. Outer Fabric: Quilted nylon with extra thick foam fill; Lining: Polyester fleece. Standard Pack: 12

DESCRIPTION	PART #
225 PLUS WINTERLINER	3000442 [22295]

### 250M



Medium protection that can be worn under caps and hats. Hook and loop fastener for a comfortable, close fit. Dielectric material can be worn near electrical hazards. Outer fabric: 8 oz. cotton twill; Lining: Acrylic Fleece. Standard Pack: 12

DESCRIPTION	PART #
250M WINTERLINER	3005348 [22295]

### 305 TSL



Ideal for cold weather environments. Full head and neck coverage with extra-wide wrapped collar. Shoulder-length liner can be tucked into jacket. Hook and loop fastener straps. Outer Fabric: 8 oz. 100% Cotton Twill; Inner Panels: Thinsulate®; Inner shell: Heavy-weight Fleece. Standard Pack: 3

DESCRIPTION	PART #
305 TSL WINTERLINER	3000443 [22383]

## 325 ULTRA



Ideal for cold weather environments. Can be worn over hearing products. Top section is flame retardant. Bottom section is flame resistant. Plastic zipper for dielectric protection. Detachable bottom section is double layered, heavy spun polyester. Nape piece closes with two buttons. Top Piece: 8 oz. Cotton Twill; Bottom Piece: Nylon Knit; Lining: Brushed 100% Acrylic Fleece (Top Only). Standard Pack: 3

DESCRIPTION	PART #
325 ULTRA WINTERLINER	3000439 [22293]

## 375



Ideal for cold weather environments. Long nape offered for extra neck coverage from wind. Dielectric material that can be worn near electrical hazards. Outer Fabric: 8 oz. Cotton Twill; Lining: 16 oz Sherpa. Standard Pack: 3

DESCRIPTION	PART #
375 WINTERLINER	3005349 [22300]

## 400



Ideal for cold weather environments. Full head and neck coverage with extra-long nape and wrap-around collar. Shoulder length that can be tucked into jacket. Dielectric material can be worn near electrical hazards. Outer Fabric: 8 oz. cotton twill; Lining: 16 oz Sherpa. Standard Pack: 3

DESCRIPTION	PART #
400 WINTERLINER	3000441 [22297]

## 440 MAX WITH MOUTHPIECE



Ideal for cold weather environments. Can be worn under most caps and hats. Wide neck piece. Lower forehead coverage. Detachable face piece (not shown) for extra cold temperatures. Dielectric material can be worn near electrical hazards. Outer Fabric: Nylon quilt meets Federal Fabric Act 16 CFR Class 1; Lining: 16 oz. Sherpa. Standard Pack: 3

DESCRIPTION	PART #
440 MAX WINTERLINER	3005351 [22308]

## WIND JAMMER II



Ideal for cold weather environments. Heavy-duty with lightweight comfort and warmth. Silver with black trim and fastener straps. Nylon quilt meets Federal Fabric Act 16 CFR Class 1. Standard Pack: 12

DESCRIPTION	PART #
WIND JAMMER II	3005347 [22278]

## WIND JAMMER IV



Ideal for cold weather environments. Long nape and wrap-around design provides extra warmth and a snug fit. Silver with black fastener straps and elastic border stitching. Nylon quilt meets Federal Fabric Act 16 CFR Class 1. Standard Pack: 6

DESCRIPTION	PART #
WIND JAMMER IV	3005346 [22277]

## ARCTIC 2-IN-1 SPORT™



Great coverage with reduced drafting. Top section made of fleece with elastic around the face; Bottom section made of spun polyester. Standard Pack: 3

DESCRIPTION	PART #
ARCTIC 2-IN-1, ROYAL BLUE/RED	3004789 [22311]
ARCTIC 2-IN-1, SILVER/NAVY BLUE	3004788 [22316]

## 650 NPR

MEETS NFPA 1975



Ideal for cold weather environments. Leather chin-strap Leather/Nomex® tabs to attach to hard hats. Longer nape for neck and lower forehead protection. Dielectric material can be worn near electrical hazards. Retains FR protection throughout life of the product. Outer Shell: 100% Nomex IIIA; Inner Shell: 100% Proban Cotton. Standard Pack: 6

DESCRIPTION	PART #
650 NPR WINTERLINER	3005354 [22329]

## 695 NPR

MEETS NFPA 1975



Ideal for cold weather environments. Full head and neck liner with wide wrap-around collar. Universal to fit all head sizes. Leather/Nomex tabs attach to hard hats. Dielectric material can be worn near electrical hazards. Retains FR protection throughout life of the product. Outer Shell: 100% Nomex IIIA; Inner Shell: 100% Proban Cotton. Standard Pack: 3

DESCRIPTION	PART #
695 NPR WINTERLINER	3005355 [22337]

## NOMEX® HOOD



100% Nomex® knitted hood. Double-layered with 100% Nomex® for extra protection around the face. Full head and neck coverage with extra-wide collar. Shoulder length collar can be tucked into jacket. Can be worn under a hard hat or welding helmet as protection against flame and electrical arcs. Retains FR protection throughout life of the product. Standard Pack: 12

DESCRIPTION	PART #
NOMEX HOOD	3000444 [22402]

### ARC ENERGY EXPOSURES

OUTER	INNER
96 **Cal/Cm2/Second	76 **Cal/Cm2/Second

\* The length of brittle residue when material is exposed to thermal energy.  
 \*\*CAL=Calorie=Measure of heat energy.

Flash-Tex™ liners will assist in complying with OSHA 1910.269.

FLASH-TEX™	FLAME RESISTANT		LAUNDERING DATA		*CHAR LENGTH	
	OUTER SHELL	INNER SHELL	OUTER SHELL	INNER SHELL	OUTER	INNER
650 NPR 695 NPR	Nomex® inherently flame resistant NFPA 1975	Proban® durable flame resistant NFPA 1975	FR properties last lifetime	Retains FR properties up to 25 industrial washes and 50 domestic washes	2.4	3.5

Note: Above data obtained from material manufacturers' testing. For additional technical information, contact Customer Service.

## DISPOSABLE RESPIRATOR



Not NIOSH approved. Maintenance-free disposable respirator. Low profile design ensures clear vision. Lightweight fiber for comfort and clear communication. Adjustable nose piece for proper fit. Standard Pack: 50 masks per box

DESCRIPTION	PART #
DISPOSABLE RESPIRATOR	3005847 [28082]

## N95 DISPOSABLE RESPIRATOR



Features durable, latex-free head straps to withstand tough use. Adjustable metal nose piece helps ensure proper fit. Ideal for dusty environments. Lightweight for comfort and extended wear. Use for protection against non-oil-based solids or liquid particulates. Standard Pack: 20 masks per box

DESCRIPTION	PART #
N95 DISPOSABLE RESPIRATOR	3000559 [28083]

## N95 PARTICULATE MASK



Features durable, latex-free head straps to withstand tough use. Adjustable nose piece and a soft foam nose cushion helps ensure proper fit. Lightweight for comfort and extended wear. Inner coating repels moisture that allows workers to breath easier. Easier breathing and less fatigue for workers means better compliance. NIOSH N95 approved. Standard Pack: 20 masks per box

DESCRIPTION	PART #
N95 PARTICULATE RESPIRATOR	3010941

## N95 PARTICULATE W/VALVE



A new valve design that helps provide workers a cooler and more comfortable experience. Features durable, latex-free head straps to withstand tough use. Adjustable metal nose piece and soft foam nose cushion helps ensure proper fit. Lightweight for extended wear. Easier breathing and less fatigue for your workers means better compliance. NIOSH N95 approved. Standard Pack: 10 masks per box

DESCRIPTION	PART #
N95 PARTICULATE RESPIRATOR W/ VALVE	3010947



Chromium exists in a number of different valence states and the hexavalent form has been associated with significant adverse health effects including cancer, damage to the nasal tissues, asthma and allergic skin reactions. As of February 28, 2006, OSHA published a new standard on hexavalent chromium lowering the PEL (Permissible Exposure Limit) to .005 mg/m<sup>3</sup> (5 ug/m<sup>3</sup>) and established an Action Limit of 0.0025 mg/m<sup>3</sup> (2.5ug/m<sup>3</sup>). This new standard only covers exposure to the hexavalent form of chromium but it covers any chromium species with this valence state.

Jackson Safety recommends contacting an Industrial Hygienist to have the air at your facility evaluated to determine the proper application of the ShadowAire system to meet the requirements of your environments.

## SHADOWAIRE II™ POWERED AIR PURIFYING RESPIRATOR

Jackson Safety's Powered Air Purifying Respirator - ShadowAire II features tough industrial strength construction with a flame retardant and crush resistant hose -- the ONLY one in the industry. The airflow exceeds NIOSH standard by over 25%. The NiMh battery is 40% lighter than NiCad battery. Sleek plenum design allows for more head room and attaches to helmet instead of headgear for comfort. Available with the NexGen™ EQC, latest in auto-darkening technology. Audible alarm alert low battery and low airflow. Adjustable belt with lumbar support. Fast Charger provides quick, reliable battery charging. Meets OSHA requirements & NIOSH approved. Includes carry bag.

DESCRIPTION	PART #	
PAPR AND P3 FILTERS, NEXGEN EQC W/ 2-4 HOUR BATTERIES	3002551	[0744-1045]
PAPR AND P3 FILTERS, NEXGEN EQC W/ 8 HOUR BATTERY	3002552	[0744-1050]
PAPR AND P3 FILTERS, SHADE 10 W/ 2-4 HOUR BATTERIES	3002544	[0744-1024]
PAPR AND P3 FILTERS, SHADE 10 W/ 8 HOUR BATTERY	3002550	[0744-1032]

Note: The ShadowAire II protects against radio nuclids, asbestos and other dusts, mists and fumes with time weighted averages less than 0.05 Milligrams per cubic meter when used properly with P3 filters. Always consult with a safety specialist before choosing a PAPR.



### REPLACEMENT PARTS

DESCRIPTION	PART #	DESCRIPTION	PART #
COMPLETE BLOWER UNIT (INCLUDES BLOWER UNIT, BELT, AIR FLOW INDICATOR & BREATHING HOSE)	3002856 [0744-0518]	8HR NIMH BATTERY	3002871 [0756-0536]
P3 FILTER (6PK)	3002861 [0756-0523]	BLOWER UNIT	3002857 [0756-0519]
FAST CHARGE BATTERY CHARGER (4 HR)	3002862 [0756-0525]	BREATHING HOSE	3002859 [0756-0521]
OVERNIGHT BATTERY CHARGER (8 HR)	3002873 [0756-0538]	AIR FLOW INDICATOR	3002860 [0756-0522]
PLENUM ASSEMBLY	3002863 [0756-0526]	BELT	3002865 [0756-0528]
FACE SEAL (3PK)	3002864 [0756-0527]	GASKET SEAL FOR BREATHING HOSE	3002866 [0756-0529]
4HR NIMH BATTERY	3002858 [0756-0520]	BELT BRACKET	3002867 [0756-0530]
592 SAIL HELMET ASSEMBLY	3010546	SHADOWAIRE II SHELL WITH VELCRO STRIPS	3002868 [0756-0532]

weldingsafety



## EXCLUSIVE AUTO-DARKENING TECHNOLOGY

Exclusive, cutting-edge technology empowers Jackson Safety to provide superior auto-darkening units. Innovative technology includes unparalleled features such as: 3N1 technology for three modes of operation (grind, cut, and weld), ClimaSensor™ technology, EMI coating, and Intellisense™. Jackson Safety battery operated EQCs also have the fastest switching speed in the industry by utilizing the same surface mode (Pi) technology in the EQCs as seen in advanced aircraft cockpit displays, 3-D viewing systems and nuclear flash protection devices. With state-of-the-art technology that can perform in these extreme environments, rest assured it will withstand your extreme environment as well.

Not only does the cutting edge technology allow Jackson Safety to stand apart from the competition, our Two-Year Performance Guarantee offers our customers a performance promise that can't be beaten. And, with our exclusive EQC Upgrade Program, our customers always have the option to upgrade to a newer lens should their welding needs change or new technology is introduced.



**DELAY ADJUSTMENT:** used to keep the ADF dark until the bright light from the hot steel has time to decay or drop. It controls the amount of time the lens will stay dark before moving back to the light state, after you have stopped the arc. Beneficial when making several consecutive welds in the same area where the light state is not necessary to get set for the next weld. The higher the number, the longer the unit will stay dark after the arc before moving to the light state.

**SENSITIVITY ADJUSTMENT:** allows user to fine tune the unit depending on ambient light (such as the sun, overhead lighting or other welders in close proximity) or arc intensity. This feature allows low amp, DC TIG welding that other units cannot accomplish. The higher the number, the more sensitive the unit will be to ambient light or arc intensity, thereby moving to dark with a less intense light.

**SOLAR BATTERY LIFE EXTENDER:** solar panel that extends the welding hours provided by a set of batteries, thus decreasing battery replacement costs and downtime

**INTELLISENSE™:** allows the unit to detect welds less than 5 amps. This feature is useful for those who are performing low-amperage welds, primarily low-amp TIG welding.

**3N1:** provides three modes of operation for the lens: grind (shade 3), oxyfuel gas cutting (shade 5), and weld (shades 9-13). This allows the welder the ability to wear one hood for every welding process, thus eliminating downtime.

**AMBER VIEW:** the soothing amber color provides greater visibility of the weld with less strain on the eyes.

**INDEPENDENT REDUNDANT SENSORS:** in units of two or more sensors, if one sensor is blocked or damaged, the unit's performance will not be compromised. Therefore, welders can work in tight areas, where a sensor may be blocked, without any interruptions.

**AUTO-OFF:** battery maximizing feature that manually shuts-down the unit when not in use or 20 minutes after the last arc is struck.

**CLIMASENSOR™ TECHNOLOGY:** tests the ambient air temperature three times per minute and automatically adjusts the lens accordingly to ensure a true shade when welding. ClimaSensor™ technology is useful to those who are welding in extremely hot or cold environments.

**EMI COATING:** a special coating applied to protect the electronics against extreme electromagnetic interference. This coating is essential for welders who generate higher than normal electromagnetic interference, such as TIG welding, particularly AC TIG, and other alternating current welding applications, or are in an environment with a concentration of this interference.

**BANDPASS FILTER:** a chemical treatment applied to one side of glass inserted in all Jackson EQCs. The chemical treatment only allows visible light to pass, and does not allow Ultraviolet or Infrared radiation to pass thru it. Jackson EQCs bandpass protects to a shade 14, even in the "off" state.

**LOW VOLTAGE INDICATOR:** when lit, alerts the welder to change the batteries in their EQC. Replacement batteries must be alkaline batteries for optimal performance. Jackson recommends the same battery brand as supplied to ensure a proper fit and connection with the unit.

## EASILY SELECT THE RIGHT EQC FOR YOUR APPLICATION

With Jackson Safety's full range of auto-darkening line, there is an auto-darkening option to suit every welders needs.

Welding Processes	BOSS	Nex Gen	Executive	Master	Pro Variable	Journey Man Variable	Apprentice	Nitro	Solera	Turbo	AutoView 1105VXL	AutoView 1100IVXL	AutoView 1105VLS	1100BVL Variable
STICK ELECTRODE A/C. & D/C.	X	X	X	X	X	X	X	X	X	X	X	X	X	X
MIG AND PULSE MIG (DELAY)	X	X	X	X	X	X	X	X	X	X	X	X	X	X
TIG - A/C. & D/C.	X	X	X	X	X			X		X	X	X	X	
LOW AMP TIG (20-50AMP)	X	X	X	X	X					X	X	X	X	
EXTREME LOW AMP TIG (<20 AMP)	X	X	X	X	X					X	X	X	X	
PULSE TIG A/C. & D/C	X	X	X	X	X					X	X	X	X	
INVERTER POWER SUPPLY	X	X	X	X	X					X	X	X	X	
PLASMA ARC	X	X	X	X	X					X	X	X	X	
FLUX CORE	X	X	X	X	X	X		X		X	X	X	X	X
METAL CORE	X	X	X	X	X	X		X		X	X	X	X	X
CARBON ARC GOUGING	X	X	X	X	X	X		X		X	X	X	X	X
TORCH AND GRIND FUNCTION	X	X	AVAIL.	AVAIL.										

Shown in image: #3018230 Nitro



Shown in image: #3013593 I2 HXL100 with Pro V



Shown in image: #3013586 Yellow Flame HXL100 with NexGen EQC

## JACKSON SAFETY AUTO-DARKENING QUICK REFERENCE GUIDE

Jackson Safety offers a wide range of options at competitive prices to fit your needs. Look for the “Good, Better, Best” for our most popular values. All are backed by Jackson’s 2 year performance guarantee and meet ANSI Z87.1 standards.

		JACKSON						HUNTSMAN							
		BEST		BETTER		GOOD									
		BOSS	Nex Gen	Executive	Master Variable	Pro Variable	Journey Man Variable	Apprentice	Nitro	Solera	Turbo	Autoview 1105VXL	Autoview 1100IVXL	Autoview 1105VLS	1100BVL Variable
Viewing Area	3-1/2" X 3-7/8" Window	X													
	2-3/8" x 3-3/4" Window		X	X								X	X		
	1-3/4" x 3-3/4" Window				X	X								X	
	42 x 96 mm Window								X		X				
	1-1/5" x 3-3/4" Window						X	X		X					X
User Adjustments	Sensitivity Adjustment	X	X	X	X	X			X		X	X	X	X	
	Fixed Shade 10					AVAIL.	AVAIL.	X		X					
	Variable Shade	X	X	X	X	X	X		X		X	X	X	X	X
	Delay Adjustment	X	X	X	X	X			X		X	X	X	X	
	3N1 Grind, Cut, Weld	X	X	AVAIL.	AVAIL.										
Power Supply	Solar Powered							X	X	X					
	Auto-Off Feature	X	X	X	X	X	X			X	X	X	X	X	X
	On/Off Switch w/ auto-off			X	X	X						X	X	X	X
	Uses 2 "AAA" Batteries	X		X	X	X	X				X	X	X	X	X
	Uses 2 Lithium "Coin" Batteries		X												
	Solar Battery Life Extender		X	X	X										
	Low Voltage Indicator Lamp	X	X	X	X	X					X	X	X	X	
Helmets	Fits HSL 100 or Halo X	X	X	X	X	X					X				
	Fits HSL 1 Series Hoods						X	X		X					X
	Fits 900 Series									X	X	X	X	X	X
	Fits 90 x 110 Window								X		X				
Features	Intellisense	X	X	X	X	X					X	X	X	X	
	Single Sensor						X								X
	Two Independent Sensors	X		X	X	X		X	X	X	X	X	X	X	
	Four Independent Sensors		X									X			
	Climasensor Technology		X												
	EMI Coating		X												

**BEST**



weldingsafety



Shown in image: #3014755- HLX100 with BOSS EQC mounted on a white charger hard hat

**BOSS™ BIG WINDOW EQC®**

The BOSS™ by Jackson Safety features 13 square inches of viewing area, the largest in the market! With Jackson's exclusive amber view lens, the BOSS™ allows greater visibility of the weld with less strain on the eyes. The BOSS™ is paired with the following must-have features for welding:

- Versatile: 3N1 Weld (9-12), Grind (3), and Cut (5) mode
- Sensitivity & delay adjustments
- Variable shade 9-12
- Intellisense technology allows unit to detect welds less than 5 amps-ideal for low amp tig
- Two independent sensors
- Mag lens adaptable
- 4 x 5 cartridge fits Shadow and Halo X helmets



HSL100 GUN METAL  
3014754



HLX100 BLADE RUNNER  
3016340



HLX100 I²  
3016263



HLX100 YELLOW FLAME  
3016262

DESCRIPTION	PART #
BOSS EQC CARTRIDGE ONLY	3014753*
HSL100 GUN METAL W/BOSS	3014754*
HLX100 HEAVY METAL W/BOSS	3014755**
HLX100 YELLOW FLAME W/BOSS	3016262**
HLX100 I² W/ BOSS	3016263**
HLX100 BLADE RUNNER W/BOSS	3016340**
HLX100 SPEED W/BOSS	3016336**
BOSS RETAINER FOR HLX100, HSL100	3015040
BOSS BACK COVER PLATE	3015039
270-S HEADGEAR	3002669
WELDING HELMET BAG	3010811
REPLACEMENT SWEATBAND, 2 PACK	3011537

**NEED VISION ASSISTANCE?  
ADD A MAG LENS!**

2 X 4 FOCAL POWER 1.00	3002741	[0752-0063]
2 X 4 FOCAL POWER 1.25	3002742	[0752-0064]
2 X 4 FOCAL POWER 1.50	3002743	[0752-0065]
2 X 4 FOCAL POWER 1.75	3002744	[0752-0066]
2 X 4 FOCAL POWER 2.00	3002745	[0752-0067]
2 X 4 FOCAL POWER 2.25	3002746	[0752-0068]
2 X 4 FOCAL POWER 2.50	3002747	[0752-0069]

\*Z94.3 COMPLIANT \*CE CERTIFIED

JACKSON SAFETY ADF HELMETS CARRY A TWO YEAR PERFORMANCE GUARANTEE AND MEETS ANSI Z87.1+ STANDARDS



Shown in image  
#3002515 - HSL100 with NexGen EQC

## NEXGEN™ EQC®

The NexGen™ by Jackson Safety is truly the next generation of auto-darkening for the welding specialist. Featuring four sensors in a staggered design to eliminate blocked sensors and soft touch controls to eliminate contaminants, protect from harsh welding environments, Smart View LCD provides fingertip control adjustments and an easy to read digital readout.

weldingsafety



HXL100 SPEED  
3016335



HSL100 BLACK  
3002515

- Amber view lens provides greater visibility of the weld with less strain on the eyes
- Intellisense technology allows unit to detect welds less than 5 amps - ideal for low amp tig
- Versatile: 3N1 Weld (9-13), Grind (3), and Torch (5) mode
- Protective coating shields EQC from extreme electromagnetic interference
- Integrated ClimaSensors™ register ambient temperature three times per minute and adjusts EQC shade accordingly to ensure a true welding shade
- Variable shade 9-13
- Sensitivity and delay adjustments
- Auto shut-off after 60 minutes in torch and grind modes and 20 minutes after weld mode
- Replaceable lithium batteries with low battery indicator
- Four independent sensors
- Mag lens adaptable



HSL100 HELLRAISER  
3004628

### DESCRIPTION

NEXGEN EQC CARTRIDGE ONLY  
HSL100 W/ NEXGEN  
HSL100 W/ NEXGEN, BULK -10 PACK  
HLX100 YELLOW FLAME W/ NEXGEN  
HLX100 RAZOR W/ NEXGEN  
HLX100 F W/ NEXGEN  
HLX100 HEAVY METAL W/ NEXGEN  
HLX100 BLADE RUNNER W/ NEXGEN  
HLX100 SPEED W/ NEXGEN  
HSL100 HELLRAISER W/ NEXGEN  
HSL100 GLORY W/ NEXGEN  
  
NEXGEN RETAINER FOR HSL100 & HLX100  
NEXGEN BACK COVER PLATE  
270-S HEADGEAR  
WELDING HELMET BAG  
REPLACEMENT SWEATBAND, 2 PACK

### PART #

3004384\* [0752-0106]  
3002515\* [0744-0705]  
3002585 [0744-9668]  
3013586\*\*  
3013589\*\*  
3013592\*\*  
3013595\*\*  
3016339\*\*  
3016335\*\*  
3004628\*  
3011006\*  
  
3002670 [0745-0074]  
3002739 [0752-0054]  
3002669  
3010811  
3011537

### NEED VISION ASSISTANCE? ADD A MAG LENS!

2 X 4 FOCAL POWER 1.00	3002741	[0752-0063]
2 X 4 FOCAL POWER 1.25	3002742	[0752-0064]
2 X 4 FOCAL POWER 1.50	3002743	[0752-0065]
2 X 4 FOCAL POWER 1.75	3002744	[0752-0066]
2 X 4 FOCAL POWER 2.00	3002745	[0752-0067]
2 X 4 FOCAL POWER 2.25	3002746	[0752-0068]
2 X 4 FOCAL POWER 2.50	3002747	[0752-0069]



## BETTER



### EXECUTIVE EQC®

Features variable shade 9-12, sensitivity and delay adjustments. Intellisense™ technology ideal for low amp tig. Two independent sensors. Requires 2 AAA batteries (included). 3N1 model includes grind, cut and weld modes.

DESCRIPTION	PART #
EXECUTIVE CARTRIDGE ONLY	3004391 [0752-0201]
HSL100 W/ EXECUTIVE	3002521 [0744-0751]
EXECUTIVE 3N1 CARTRIDGE ONLY	3004400 [0752-0227]
HSL100 W/ EXECUTIVE 3N1	3002518 [0744-0750]



### MASTER EQC®

Features variable shade 9-12, sensitivity and delay adjustments. Intellisense™ technology ideal for low amp tig. Two independent sensors. Requires 2 AAA batteries (included). 3N1 model includes grind, cut and weld modes.

DESCRIPTION	PART #
MASTER CARTRIDGE ONLY	3004386 [0752-0141]
HSL100 W/ MASTER	3002513* [0744-0660]
MASTER 3N1 CARTRIDGE ONLY	3004399 [0752-0225]
HSL100 W/ MASTER 3N1	3002519 [0744-0747]

## GOOD



HSL100 BLACK  
3004387



HXL100 RAZOR  
3013590

### PROFESSIONAL EQC®

Features variable shade 9-12, sensitivity and delay adjustments. Also available with a fixed shade 10. Pro Variable also offers Intellisense technology ideal for low amp tig. Two independent sensors. Requires 2 AAA batteries (included).

DESCRIPTION	PART #
PRO SHADE 10 CARTRIDGE ONLY	3002769 [0744-0761]
HSL100 W/ PRO SHADE 10	3002530* [0744-0665]
PRO V CARTRIDGE ONLY	3004387* [0752-0142]
HSL100 W/ PRO V	3002514* [0752-0211]
HSL100 HELLRAISER W/ PRO V	3011636*
HSL100 GLORY W/ PRO V	3011640*
HLX100 YELLOW FLAME W/ PRO V	3013587*
HLX100 I <sup>2</sup> W/ PRO V	3013593*
HLX100 RAZOR W/ PRO V	3013590*
HLX100 HEAVY METAL W/ PRO V	3013596*



### JOURNEYMAN EQC®

Available with variable shade 9-12 or fixed shade 10. Single sensor with auto-off feature. Requires 2 AAA batteries (included).

DESCRIPTION	PART #
JOURNEY MAN VARIABLE 9-12 CARTRIDGE ONLY	3004394 [0752-0214]
HSL1 W/ JOURNEYMAN VARIABLE	3002533* [0744-0764]
JOURNEYMAN SHADE 10 CARTRIDGE ONLY	3004396 [0752-0216]
HSL1 W/ JOURNEYMAN SHADE 10	3002535* [0744-0766]



### APPRENTICE EQC®

IDEAL FOR THE HOBBYIST WELDER!  
Features fixed shade 10/11. Solar powered - always on and ready to weld. Two independent sensors.

DESCRIPTION	PART #
HSL1 W/ APPRENTICE	3002516* [0744-0706]

Huntsman's history is rich in tradition, trust and value for welders. From welding helmets to auto-darkening technology, Huntsman has your welding safety needs covered.

**AUTOVIEW 1105VXL 4X4**



Variable shade 9-12, sensitivity and delay adjustments. Intellisense™ technology for low amp tig. Four independent sensors with low voltage indicator lamp. Auto-off feature. Requires 2 AAA batteries (included).

DESCRIPTION	PART #
1105VXL CARTRIDGE ONLY	3004015 [33097]
951P W/1105VXL	3000523 [25140]

**AUTOVIEW 1100IVXL**



The AutoView 1100IVXL features a Big Window™ viewing area. Variable shade 9-12, sensitivity and delay adjustments. Intellisense™ technology for low amp tig. Two independent sensors with low voltage indicator lamp. Auto-off feature. Requires 2 AAA batteries (included).

DESCRIPTION	PART #
1100IVXL CARTRIDGE ONLY	3004005 [30089]

**AUTOVIEW 1105VLS**



Variable shade 9-12, sensitivity and delay adjustments. 1105VLS features Intellisense™ technology for low amp tig. Two independent sensors. Low voltage indicator lamp. Auto-off feature. Requires 2 AAA batteries (included).

DESCRIPTION	PART #
1105VLS CARTRIDGE ONLY	3004016 [33098]
1105VS CARTRIDGE ONLY	3004017 [33099]
951P W/ 1105VS	3000522 [25139]

**AUTOVIEW BASIC 1100BVL**



Variable shade 9-12 with one sensor and auto-off feature. Requires 2 AAA batteries (included).

DESCRIPTION	PART #
1100BVL CARTRIDGE ONLY	3004004 [30085]
911P W/1100BVL	3000524 [25141]

weldingsafety





**NEW**

## NITRO™

The newest member of the Huntsman family, the NITRO offers welders outstanding features at an economical price point.

- Infinitely variable shade 9-13
- Sensitivity and delay adjustments
- Lightweight - only weighs 1 pound fully assembled
- Two independent sensors - ideal for tight spaces
- Always on and ready to weld
- Solar powered - no batteries to replace

DESCRIPTION	PART #
BLUE NITRO	3018230*
SMITH & WESSON GHOST FLAME	3016157

NITRO CARTRIDGE ONLY	3018384
90110 PC POLYCARBONATE SAFETY PLATE	3015038
24 PC BACK SAFETY PLATE	3016169
REPLACEMENT HEADGEAR	3002669
WELDING HELMET BAG	3010811
REPLACEMENT SWEATBAND, 2 PACK	3011537



**ALSO AVAILABLE IN  
EYE-CATCHING GRAPHICS**



**Smith & Wesson®  
GHOST FLAME**

Smith & Wesson® is a registered trademark of Smith & Wesson Corp used under license by Jackson Safety



weldingsafety

## TURBO



Variable shade 9-12, sensitivity and delay adjustments. Two independent sensors with auto-off feature. Low voltage indicator lamp. Requires 2 AAA batteries (included).

DESCRIPTION	PART #
TURBO CARTRIDGE ONLY	3004013 [30107]
951P W/ TURBO	3000534 [25209]

## SOLERA



Features an economical lens for the consumer welder. Solar powered - always on and ready to weld! Easy to use, no batteries to change. Fixed shade 10/11 lens with two independent sensors.

DESCRIPTION	PART #
SOLERA CARTRIDGE ONLY	3004006 [30090]
981P W/SOLERA	3000504 [25049]

\*Z94.3 COMPLIANT

**HUNTSMAN®**

www.jacksonsafety.com | 49

## HLX SERIES - HALO X



Shown in image: #3013592 - Halo X F with NexGen EQC

### ULTRA LIGHTWEIGHT SHELL - ONLY 6 OUNCES!

Ergonomic, lightweight design reduces neck tension and fatigue. Sleek, balanced design and weight reduces “top-heavy” effect. Hydraflex™ shell provides the ultimate in flexibility and durability. Easily attaches to safety caps for added head protection. High impact, seamless graphic designs. Duralogic™ high index metallic paint.



### BLADE RUNNER

BLADE RUNNER W/ BOSS 3016340\*\*  
 BLADE RUNNER W/ NEXGEN 3016339\*\*  
 BLADE RUNNER W/ SHADE 10 3016337\*



### SPEED

SPEED W/ BOSS 3016336\*\*  
 SPEED W/ NEXGEN 3016335\*\*  
 SPEED W/ SHADE 10 3016333\*

## HSL SERIES - SHADOW®

### THE BEST SELLING WELDING HELMET IN THE INDUSTRY!

The narrow shell design is perfect for work in tight spaces, and the Shadow® helmets extended front increases throat protection against sparks, slag, and fumes. The Shadow® helmet also can stand up to radiant heat of 350°F, a minimum 50% improvement over most other thermoplastic shells. All Shadow® helmets come complete with cover plate and shade 10 polycarbonate filter plate. Also available with 187 blades or 386 capmount adapter for attachment to safety caps.



**HSL 100**  
 (4.5" X 5.25" FIXED FRONT)

HSL100 BLACK 3002498\*\* [0744-0504]  
 HSL100 BLACK (BULK) 3002581\* [0744-9459]  
 HSL100-B BLUE 3002499\* [0744-0505]  
 HSL100-R RED 3002500\* [0744-0506]  
 HSL100-187 3002502\* [0744-0508]  
 HSL100-386 3002491\* [0744-0352]



**HSL 1**  
 (2" X 4.25" FIXED FRONT)

HSL1 BLACK 3002503\*\* [0744-0512]  
 HSL1 BLACK (BULK) 3002579\* [0744-9452]  
 HSL1-B BLUE 3002504\* [0744-0513]  
 HSL1-R RED 3002505\* [0744-0514]  
 HSL1-187 3002511\* [0744-0522]



**HSL 2**  
 (2" X 4.25" LIFT FRONT)

HSL2 BLACK 3002507\*\* [0744-0516]  
 HSL2 BLACK (BULK) 3002580\* [0744-9453]  
 HSL2-B BLUE 3002508\* [0744-0517]  
 HSL2-R RED 3002509\* [0744-0518]  
 HSL2-187 3002512\* [0744-0523]  
 HSL2-386 3002490\* [0744-0351]  
 HSL2-86M 3002481\* [0744-0139]

weldingsafety





## I<sup>2</sup>

I<sup>2</sup> W/ BOSS  
I<sup>2</sup> W/ NEXGEN  
I<sup>2</sup> W/ PRO V  
I<sup>2</sup> W/ SHADE 10

3016263\*\*  
3013592\*\*  
3013593\*  
3013594\*



## YELLOW FLAME

YELLOW FLAME W/ BOSS  
YELLOW FLAME W/NEXGEN  
YELLOW FLAME W/ PRO V  
YELLOW FLAME W/ SHADE 10

3016262\*\*  
3013586\*\*  
3013587\*  
3013588\*



## RAZOR

RAZOR W/ NEXGEN  
RAZOR W/ PRO V  
RAZOR W/ SHADE 10

3013589\*\*  
3013590\*  
3013591



## HEAVY METAL

HEAVY METAL W/ BOSS  
HEAVY METAL W/ NEXGEN  
HEAVY METAL W/ PRO V  
HEAVY METAL W/ SHADE 10

3014755\*\*  
3013595\*  
3013596\*  
3013597\*

## REPLACEMENT PARTS

270-S HEADGEAR	3002669	[0745-0036]
54-PC CLEAR SAFETY PLATE	3002759	[0752-0040]
427 SHADE 10 4.5X5.25 FILTER LENS	3000645	[40037]
1127 SHADE 10 2X4.25 FILTER LENS	3000652	[40061]
SWEATBAND, 2 PACK	3011537	
WELDING HELMET BAG	3010811	

## ALSO AVAILABLE IN HEAD TURNING GRAPHICS

Shown in image: #3002515- HSL100 with NexGen EQC



## HELLRAISER

HSL100 HELLRAISER W/ SHADE 10  
HSL100 HELLRAISER W/ PRO V  
HSL100 HELLRAISER W/ NEXGEN

3004629\*  
3011636\*  
3004628\*



## H SERIES - HANDSHIELDS



H-500



HM-5

Handshields features fiberglass helmet with injection-molded plastic handle. Available in two curved shell models: H-500 large window and HM-5 Integral 2" x 4.25" front.

**DESCRIPTION**  
H-500 HANDSHIELD  
HM-5 HANDSHIELD

**PART #**  
3002469 [0744-0016]  
3002474 [0744-0037]

## H SERIES



### H100-A: LARGE WINDOW

H100-A features 19 square inches of viewing area. To prevent entry of harmful rays, the plate holder is molded into shell with a folded neoprene gasket that seals both the cover and filter plate. Maximum clearance for nose, chin and largest prescription glasses or goggles.

**DESCRIPTION**  
H100-A  
170 HEADGEAR

**PART #**  
3002463 [0744-0001]  
3002454 [0743-0010]



### HM1-A & HM1-PW: 2" X 4.25"

HM1-A features a lightweight helmet design with an inclined top surface of the plate holder which helps resist weld splatter. Shell and plate holder are molded in a single piece.



Also available in a pipe line version, the HM1-PW, that features a white coating on the exterior shell.

**DESCRIPTION**  
HM1-A  
HM1-PW  
170 HEADGEAR  
170-P HEADGEAR

**PART #**  
3002465 [0744-0005]  
3002476 [0744-0081]  
3002454 [0743-0010]  
3002661 [0745-0047]



### H9-A: NARROW SHELL

H9-A features a straight front design that provides extended protection to the throat area and better ventilation. Lift front provides flexibility so user does not have to raise hood.

**DESCRIPTION**  
H9-A  
170 HEADGEAR

**PART #**  
3002468 [0744-0009]  
3002454 [0743-0010]



### H2-A: 2" X 4.25"

H2-A features a lightweight helmet design with inclined top surface of plate folder to help resist weld splatter. Lift front provides flexibility so user does not have to raise hood.

**DESCRIPTION**  
H2-A  
170 HEADGEAR

**PART #**  
3002464 [0744-0004]  
3002454 [0743-0010]



### H4-A: NARROW SHELL

H4-A features compact design for use in welding in close quarters.

**DESCRIPTION**  
H4-A  
170 HEADGEAR

**PART #**  
3002466 [0744-0009]  
3002454 [0743-0010]



### HR-2A: RESPIRATOR FIT

HR-2A features a 'bubble' front to accommodate a mask-type respirator for greater worker convenience. NOTE: Welding fumes are not reduced unless accompanied by the proper respirator.

**DESCRIPTION**  
HR-2A  
170 HEADGEAR

**PART #**  
3002475 [0744-0069]  
3002454 [0743-0010]

## "FORTY-NINER"



The "forty-niner" welding helmet features a large window lift-front design with a ratchet headgear. Durable and lightweight design provides a comfortable fit. Comes standard with a shade 10 filter plate.

DESCRIPTION	PART #	
493 BLACK	3002882*	[0800-0009]
493 BLUE	3002885	[0800-0021]
270-S HEADGEAR	3002669	[0745-0036]

## ACCESSORIES

### PROTECT YOUR GEAR! WELDING HELMET BAG

Made of heavy-duty denier fabric with drawstring closure. Features velcro close front lens pocket and two side mesh tool pockets. Throw the bag over your shoulder when you are ready to go! Fits all Jackson Safety helmets.



DESCRIPTION	PART #
WELDING HELMET BAG	3010811

### BLACK QUILTED SHOP CAP

High grade quilted cotton with sateen sweatband. Available in sizes 6-3/4" to 7-3/4". Not fire retardant.



DESCRIPTION	PART #
365 SHOP CAP 6-3/4"	3000699
365 SHOP CAP 6-7/8"	3000700
365 SHOP CAP 7"	3000701
365 SHOP CAP 7-1/8"	3000702
365 SHOP CAP 7-1/4"	3000703
365 SHOP CAP 7-3/8"	3000704
365 SHOP CAP 7-1/2"	3000705
365 SHOP CAP 7-5/8"	3000706
365 SHOP CAP 7-3/4"	3000707

### ALUMINIZED WELD-O-GLASS BACK HAND PAD

Protects the back of welder's glove from weld spatter and high radiant heat. Increases the life of your glove. Helps you to weld longer when exposed to high radiant heat. Provides good mobility for gloved hand. Double layer protection, Wilson Weld-O-Glass 2600 AMA on top and a high temperature glass fabric on the bottom. Sewn and riveted for added durability.

DESCRIPTION	STOCK ITEM	PART #
BACK HAND PAD (MIN. ORDER 6)	3018810	BHP06



### WELDING UMBRELLA

Provides great protection from rain or sunlight. Features a lightweight aluminum frame and tilt mechanism. Cover made of Rip-Stop vinyl, which is water resistant, fire retardant and very tear resistant. 6' diameter and 7'; high (diameter may vary by 3").



DESCRIPTION	PART #
BLUE WELDING UMBRELLA	UM6500
YELLOW WELDING UMBRELLA	UM8500
GREEN WELDING UMBRELLA	UM9500
RED, WHITE & BLUE WELDING UMBRELLA	UB7500
SUPPORT BASE	21127

The Huntsman 900 series welding helmets features a lightweight, durable, washable thermoplastic shell. Contour Comfort™ double-lock headgear with Zahnlock™ size adjustment system. All helmets come complete with standard shade 10 filter plate.



**951P**  
Big Window™ 4x5.25  
951P 3000512\*\* [25066]



**981P**  
2x4.25 Fixed front  
981P 3000513\*\* [25067]



**930P**  
2x4.25 Lift front  
930P 3000511 [25065]



**911P**  
2x4.25 Fixed front with aluminum frame filter plate holder  
Ideal for higher heat applications  
911P 3000510 [25064]



**990P**  
2x4.25 Quick-slide filter plate holder  
Ideal for tight work environments.  
990P 3000514 [25068]



**929P**  
2x4.25 Inspectors model  
No headgear included  
929P 3000515 [25070]

**800 SERIES LEATHER**

The Huntsman 800 series welding helmets features a tough, pliable, breathable leather covering. Ideal for use in overhead welding applications or when working in tight spaces. [Does not include headgear]



**860P**  
2x4.25 window  
860P LIFT FRONT 3000506\*\* [25052]  
860-2 FIXED FRONT 3000507 [25055]



**851P**  
4x5.25 Big Window™  
851P 3000508 [25056]



**870 INSPECTION SHIELD**  
Ideal for those who occasionally observe welding  
870 INSPECTION SHIELD 3000697 [45004]

## 400 SERIES

The Huntsman 400 series welding helmets features a heat-resistant vulcanized fiber shell for comfortable, cool, heavy duty welding. "Contour Comfort" double-lock headgear with Zahnlock™ size adjustment system. All helmets come complete with standard shade 10 filter plate. (NOTE: In some damp or wet environments, scotch guarding will prolong useful life. Not to be used for overhead welding.)

Shown in image: #3000496- 411P



**451P**  
Big Window™ 4x5.25  
451P 3000500\*\* [25030]



**411P**  
2x4.25 Fixed front with aluminum frame filter plate holder  
Ideal for higher heat applications  
411P 3000496 [25023]



**430P**  
2x4 Lift front  
430P 3000499 [25029]



**490P**  
2x4.25 Quick-slide filter plate holder  
Ideal for tight work environments.  
490P 3000509 [25062]



## 700 SERIES



The Huntsman 700 series welding helmets feature a lightweight, heat-resistant vulcanized fiber shell designed for use in acetylene welding and cutting applications. 711P features an aluminum frame filter plate holder - ideal for higher heat applications Shipped without filter plates.

711P -2"x4.25" 3000503 [25048]  
751P-4.25"x5.25" 3000516 [25071]



### PROTECT YOUR GEAR! WELDING HELMET BAG

Made of heavy-duty denier fabric with drawstring closure. Features velcro close front lens pocket and two side mesh tool pockets. Throw the bag over your shoulder when you are ready to go! Fits all Jackson Safety helmets.

WELDING HELMET BAG 3010811

## 187-S MOUNTING BLADES



Securely attaches a welding helmet safely to safety cap. Positive locking device keeps the helmet in any position.

187-S MOUNTING KIT 3002634

### 187-S MOUNTING BLADES CAN BE USED WITH:

	SC6	SENTRY	CHARGER	SC16	SB6-STUBBY
HLX SERIES HALO X	✓	✓	✓	✓	✓
HSL SERIES SHADOW	✓	✓	✓	✓	✓

## 187-K MOUNTING BLADES



Securely attaches a welding helmet safely to safety cap. Positive locking device keeps the helmet in any position.

187-S MOUNTING KIT 3002634

### 187-K MOUNTING BLADES CAN BE USED WITH:

	SC6	SENTRY	CHARGER	SC16	SB6-STUBBY
H SERIES	✓	✓	✓		✓

## ROTO-CLIP



Lets you attach almost any Huntsman welding helmet safely and securely to a hard hat. Positive locking device keeps the helmet in any position.

1906 JACKSON CAPS 3000629  
1908 4 PT SUS 3000631

### ROTO-CLIP MOUNTING BLADES CAN BE USED WITH:

	SC6	SENTRY	CHARGER	SC16	SB6-STUBBY
900 & 400 SERIES	✓		✓	✓	✓



## 87 MOUNTING BLADES



Attaches to almost any H series welding helmet safely and securely to a hard hat. Must use with 86 quick detach pins (not included), available in metal and plastic.

87 MOUNTING BLADES	3002435	[0741-0061]
86-M METAL PINS	3002462	[0743-9998]
86 PLASTIC PINS	3002453	[0743-0007]

87 MOUNTING BLADES & 86 PINS CAN BE USED WITH:

	SC6	SENTRY	CHARGER	SC16	SB6-STUBBY
H SERIES				✓	

## 386 CAPMOUNT ADAPTER



Lets you attach any H series fiberglass or HSL welding helmet safely and securely to a hard hat.

386 CAPMOUNT ADAPTER	3002645	[0745-0027]
----------------------	---------	-------------

386 CAPMOUNT ADAPTER CAN BE USED WITH:

	SC6	SENTRY	CHARGER	SC3	SB6-STUBBY
H SERIES				✓	

\*Can we used on most non-slotted safety caps

## 4000 UNIMATE



Attaches the 400 series welding helmet to most safety caps without slots. Quick and easy release.

4000 UNIMATE	3000577	[30058]
--------------	---------	---------

4000 UNIMATE CAN BE USED WITH:

	SC6	SENTRY	CHARGER	SC3	SB6-STUBBY
400 SERIES				✓	

\*Can we used on most non-slotted safety caps

## FILTER SELECTION GUIDE

Jackson Safety has a large selection of top-quality polycarbonate lenses for welding helmets and cutting goggles. To prevent surface damage to welding filter plates and auto darkening lenses, clear safety plates should always be inserted in front for protection. For your protection and comfort, be sure to use the correct filter shade for the job. Refer to the suggested shade guide.

### GUIDE FOR SHADE NUMBERS (ADAPTED FROM ANSI TABLE Z89.1)

OPERATION	ELECTRODE SIZE 1/32 IN. (MM)	ARC CURRENT (A)	SUGGESTED SHADE NO. (COMFORT)
Shielded metal arc welding	Less than 3 (2.5)	Less than 60	9
	3-5 (2.5-4)	60-160	10
	5-8 (4-6,4)	160-350	12
	More than 8 (6,4)	250-500	14
Gas metal arc welding and flux cored arc welding		Less than 60	9
		60-160	11
		160-350	12
		250-500	14
Gas tungsten arc welding		Less than 50	10
		50-150	12
Air carbon Arc cutting	(light)	150-500	14
	(heavy)	Less than 500	12
		500-1000	14
Plasma arc welding		Less than 20	6 to 8
		20-100	10
		100-400	12
		400-800	14
Plasma Arc cutting	(light)	Less than 300	9
	(medium)	300-400	12
	(heavy)	400-800	14

## FILTER LENS

PART #		DESCRIPTION	SIZE	MATERIAL
3000691	[40173]	427 FILTER LENS SH. 5	2" X 4.25"	POLYCARBONATE
3000644	[40035]	427 FILTER LENS SH. 9	2" X 4.25"	POLYCARBONATE
3000645	[40037]	427 FILTER LENS SH. 10	2" X 4.25"	POLYCARBONATE
3000690	[40171]	427 FILTER LENS SH. 11	2" X 4.25"	POLYCARBONATE
3000646	[40041]	427 FILTER LENS SH. 12	2" X 4.25"	POLYCARBONATE
3000649	[40058]	1127 FILTER LENS SH. 9	4.5" X 5.25"	POLYCARBONATE
3000650	[40059]	1127 FILTER LENS SH. 10	4.5" X 5.25"	POLYCARBONATE
3000651	[40060]	1127 FILTER LENS SH. 11	4.5" X 5.25"	POLYCARBONATE
3000652	[40061]	1127 FILTER LENS SH. 12	4.5" X 5.25"	POLYCARBONATE
3000684	[40156]	1227 FILTER LENS SH. 4	50 MM ROUND	POLYCARBONATE
3000685	[40157]	1227 FILTER LENS SH. 5	50 MM ROUND	POLYCARBONATE
3000686	[40158]	1227 FILTER LENS SH. 6	50 MM ROUND	POLYCARBONATE

## SAFETY PLATES/COVER LENS

PART #		DESCRIPTION	SIZE	MATERIAL	TYPE
3015039		BOSS BACK COVER LENS		POLYCARBONATE	COVER LENS
3015038		90110 PC FRONT SAFETY PLATE	90 X 110	POLYCARBONATE	SAFETY PLATE
3016169		24 PC SAFETY PLATE	2" X 4.25"	POLYCARBONATE	SAFETY PLATE
3000658	[40089]	339 COVER LENS	2" X 4.25"	THERMALLY SET PLASTIC	COVER LENS
3000660	[40093]	339-L COVER LENS	4.5" X 5.25"	THERMALLY SET PLASTIC	COVER LENS
3002739	[0752-0054]	NEXGEN BACK COVER LENS		POLYCARBONATE	COVER LENS
3000638	[40015]	235-6 COVER LENS	4.5" X 5.25" X .060"	POLYCARBONATE	SAFETY PLATE
3000689	[40168]	435-6 COVER LENS	2" X 4.25" X .060"	POLYCARBONATE	SAFETY PLATE
3002760	[0752-0161]	97-PC SAFETY PLATE	4.5" X 5.25"	POLYCARBONATE	SAFETY PLATE
3002759	[0752-0151]	54-PC SAFETY PLATE	2" X 4.25"	POLYCARBONATE	SAFETY PLATE
3002740	[0752-0055]	335-6 SAFETY PLATE/67 EXEC	EXECUTIVE	POLYCARBONATE	COVER LENS

## MAGNIFYING PLATES

Jackson Safety has an array of "Mag" plates to fit the needs of any welder. While providing close vision without glasses, the 2x4 mag plates are also adaptable to all EQC Filters. Select focal power by comparing prescription lenses.

PART #		FOCAL POWER	MAG PLATE ADAPTER KITS
3002741	[0752-0063]	1.00	3002656 [0745-0040] 98-2 EXECUTIVE EQC MAG LENS HOLDER
3002742	[0752-0064]	1.25	3002647 [0745-0029] 98-3 LARGE WINDOW MAG LENS HOLDER (FOR HSL-100)
3002743	[0752-0065]	1.50	
3002744	[0752-0066]	1.75	
3002745	[0752-0067]	2.00	
3002746	[0752-0068]	2.25	
3002747	[0752-0069]	2.50	

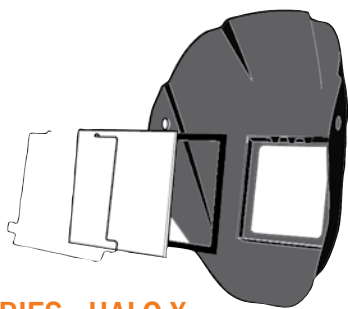

## HLX SERIES - HALO X

### DESCRIPTION

- A. 853 RETAINER SPRING
- B. 1127 FILTER LENS SHADE 10
- C. 97-PC SAFETY PLATE
- D. 251 LIGHT SEAL

PART #	
3002648	[0745-0031]
3000650	[40059]
3002760	[0752-0161]
3004736	[0745-0045]

### NOT SHOWN:

270-S HEADGEAR	3002669	[0745-0036]
----------------	---------	-------------

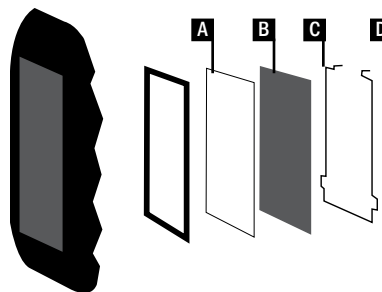

## SHADOW® HSL 100

### DESCRIPTION

- A. 251 LIGHT SEAL GASKET
- B. 97-PC SAFETY PLATE
- C. 1127 FILTER LENS SHADE 10
- D. 853 RETAINER SPRING

PART #	
3004736	[0745-0045]
3002760	[0752-0161]
3000650	[0752-0082]
3002648	[0745-0031]

### NOT SHOWN:

270-S HEADGEAR	3002669	[0745-0036]
----------------	---------	-------------

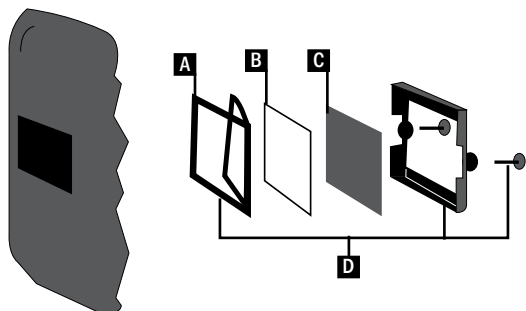

## SHADOW® HSL 1

### DESCRIPTION

- A. 224 LIGHT SEAL GASKET
- B. 54-PC SAFETY PLATE
- C. 427 FILTER LENS SHADE 10
- D. LENS RETAINER KIT

PART #	
3002653	[0745-0036]
3002759	[0752-0151]
3000645	[40037]
3002641	[0745-0017]

### NOT SHOWN:

270-S HEADGEAR	3002669	[0745-0036]
----------------	---------	-------------

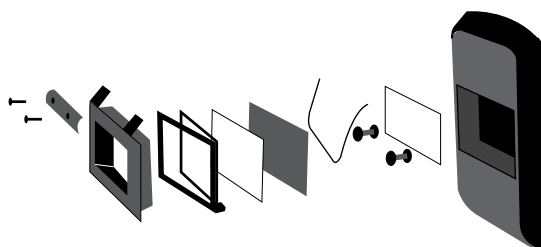

## SHADOW® HSL 2

### DESCRIPTION

- A. 224 LIGHT SEAL GASKET
- B. 54-PC SAFETY PLATE
- C. 427 FILTER LENS SHADE 10
- D. 63 RETAINER SPRING
- E. 54-PC SAFETY PLATE
- F. HSL 2 LIFT FRONT KIT

PART #	
3002653	[0745-0036]
3002759	[0752-0151]
3000645	[40037]
3002640	[0745-0013]
3002759	[0752-0151]
3002642	[0745-0018]

### NOT SHOWN:

270-S HEADGEAR	3002669	[0745-0036]
----------------	---------	-------------

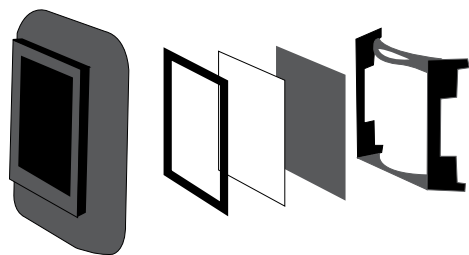

## H100-A & H-500

### DESCRIPTION

- A. 251 LIGHT SEAL GASKET
- B. 97-PC SAFETY PLATE
- C. 427 FILTER LENS SHADE 10
- D. 220-P LARGE LENS SPRING

PART #	
3004736	[0745-0045]
3002760	[0752-0161]
3000645	[40037]
3002639	[0745-0010]

### NOT SHOWN:

170 HEADGEAR	3002454	[0743-0010]
--------------	---------	-------------

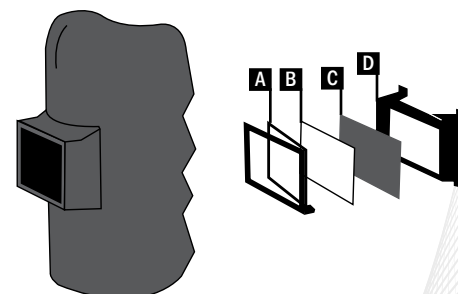

## HM1-A & HM-5 HANDSHIELD

### DESCRIPTION

- A. 224 LIGHT SEAL GASKET
- B. 54-PC SAFETY PLATE
- C. 427 FILTER LENS SHADE 10
- D. 258 LENS SPRING

PART #	
3002653	[0745-0036]
3002759	[0752-0151]
3000645	[40037]
3002638	[0745-0009]

### NOT SHOWN:

170 HEADGEAR	3002454	[0743-0010]
--------------	---------	-------------

# PARTS GUIDE

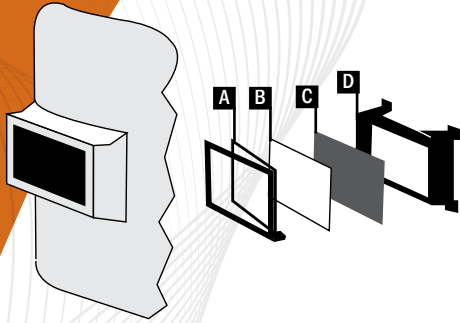

## HM1-PW PIPE LINE STYLE

DESCRIPTION	PART #	
A. 224 LIGHT SEAL GASKET	3002653	[0745-0036]
B. 54-PC SAFETY PLATE	3002759	[0752-0151]
C. 427 FILTER LENS SHADE 10	3000645	[40037]
D. 258 LENS SPRING	3002638	[0745-0009]
<b>NOT SHOWN:</b>		
170-P HEADGEAR	3002661	[0745-0047]

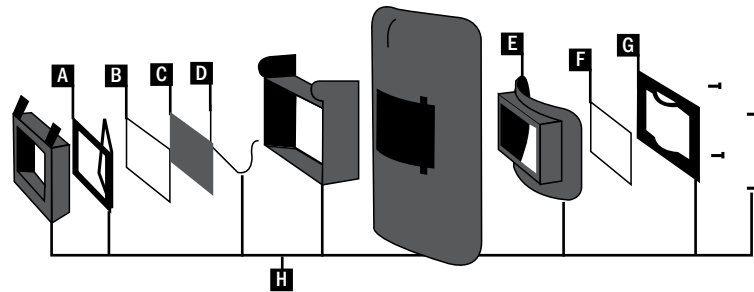

## H9-A, H2-A, H4-A, & HR-2A

DESCRIPTION	PART #	
A. 224 LIGHT SEAL GASKET	3002653	[0745-0036]
B. 54-PC SAFETY PLATE	3002759	[0752-0151]
C. 427 FILTER LENS SHADE 10	3000645	[40037]
D. 63 RETAINER SPRING	3002640	[0745-0013]
E. 66-7 INNER LENS RETAINER	3002651	[0745-0034]
F. 54-PC SAFETY PLATE	3002759	[0752-0151]
G. 58 RETAINER SPRING	3002636	[0745-0006]
H. 66 LIFT-FRONT UNIT	3002635	[0745-0005]
<b>NOT SHOWN:</b>		
170 HEADGEAR	3002454	[0743-0010]



## 930P, 860-2 & 430P

DESCRIPTION	PART #	
A. 4158-1 BACK PLATE	3000620	[35082]
B. 441 SPRING GASKET	3000601	[35040]
C. 421 FIBRE GASKET	3000596	[35031]
D. 54-PC SAFETY PLATE	3002759	[0752-0151]
E. 433P RETAINING SPRING	3000610	[35067]
F. 54-PC SAFETY PLATE	3002759	[0752-0151]
G. 427 FILTER LENS SHADE 10	3000645	[40037]
H. 421 FIBRE GASKET	3000596	[35031]
I. 54-PC SAFETY PLATE	3002759	[0752-0151]
J. 434-1 LIFT FRONT	3000598	[35034]
<b>NOT SHOWN:</b>		
170 HEADGEAR	3002454	[35083]

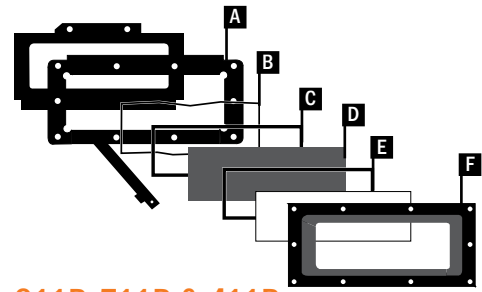

## 911P, 711P & 411P

DESCRIPTION	PART #	
A. 4158-1 BACK PLATE	3000620	[35082]
B. 441 SPRING GASKET	3000601	[35031]
C. 421 FIBRE GASKET	3000596	[35040]
D. 54-PC SAFETY PLATE	3002759	[0752-0151]
E. 421 FIBRE GASKET	3000596	[35040]
F. 415-1 ALUMINUM GLASSHOLDER	3000623	[35085]
<b>NOT SHOWN:</b>		
170 HEADGEAR	3002454	[35083]

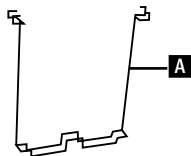

## 951P

DESCRIPTION	PART #	
A. 444-2 RETAINER SPRING	3000615	[35073]
B. 445-1 & 1A GASKET SET	3000614	[35072]
<b>NOT SHOWN:</b>		
170 HEADGEAR	3002454	[35083]

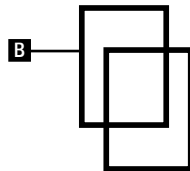

## 981P

DESCRIPTION	PART #	
A. 433A RETAINING SPRING	3000610	[35067]
B. 421-1 & 1A PLASTIC GASKETS	3000613	[35071]
<b>NOT SHOWN:</b>		
170 HEADGEAR	3002454	[35083]

weldingsafety



## 990P & 490P QUICK-SLIDE

DESCRIPTION	PART #	
A. 415A FRONT PLATE	3000595	[35028]
B. 54-PC SAFETY PLATE	3002759	[0752-0151]
C. 421 FIBRE GASKET	3000596	[35031]
D. 452 ALUMINUM BACK PLATE	3000609	[35062]
E. 449 PLASTIC BACK PLATE	3000605	[35058]
F. 450 GLASS RET CLIP FOR 490P	3000606	[35059]
G. 427 FILTER LENS SHADE 10	3000645	[0752-0151]
H. 451A TENSION PLATE	3000607	[35060]

NOT SHOWN:		
170 HEADGEAR	3002454	[35083]
447 QUICK-SLIDE ASSEMBLY	3000603	[35055]
448 PLASTIC SLIDE GUIDE	3000604	[35057]

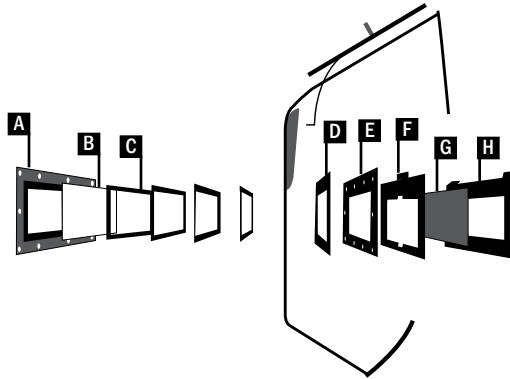
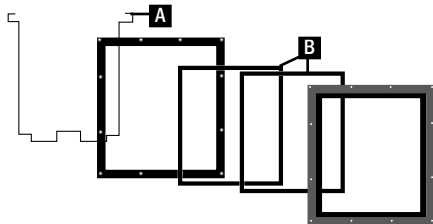

## 451P & 751P

DESCRIPTION	PART #	
A. 444-2 RETAINER SPRING	3000615	[35073]
B. 445-1 & 1A GASKET SET	3000614	[35072]

NOT SHOWN:		
170 HEADGEAR	3002454	[35083]

## 860P

DESCRIPTION	PART #	
A. 434C BACK COVER PLATE	3000600	[35036]
B. 433A RETAINING SPRING	3000610	[35067]
C. 421 FIBRE GASKET	3000596	[35031]
D. 54-PC SAFETY PLATE	3002759	[0752-0151]
E. 433A RETAINING SPRING	3000610	[35067]
F. 54-PC SAFETY PLATE	3002759	[0752-0151]
G. 427 FILTER LENS SHADE 10	3000645	[40037]
H. 421 FIBRE GASKET	3000596	[35031]
I. 54-PC SAFETY PLATE	3002759	[0752-0151]

NOT SHOWN:		
170 HEADGEAR	3002454	[35083]

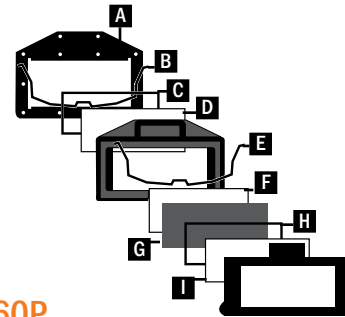

## REPLACEMENT HEADGEAR

### 270-S HEADGEAR



270-S features an ergonomically designed, streamlined ratchet for easy adjustments and increased shell clearance. Six crown adjustments with comfortable strap and absorbent sweatband. For use with Shadow, Halo X and HML series helmets produced after May 2000.

DESCRIPTION	PART #	
270-S HEADGEAR	3002669	[0745-0073]

### 170 HEADGEAR



170 features 45 head size adjustments and 5 crown adjustments. Lower ratchet strap for added comfort and strength. Ratchet eliminates "backing off" with push and turn design. For use with H series fiberglass helmets, [excluding HSL series.]

DESCRIPTION	PART #	
170 HEADGEAR	3002454	[0743-0010]

### 117A HEADGEAR



Plastic headgear fits all Huntsman helmets. Teeth are automatically disengaged during adjustment. Air cushioned cloth sweatband is washable and durable.

DESCRIPTION	PART NO	
117A HEADGEAR	3000621	[35083]

### 170-P HEADGEAR



170-P features 45 head size adjustments and 5 crown adjustment. Rubber strap sits across the back of the head. For use with HM1-PW pipe line style helmet only.

DESCRIPTION	PART #	
170-P	3002661	[0745-0047]

## WILDCAT™ CUTTING GOGGLES



Extreme performance vision protection. Lightweight and comfortable with a pivoting headband that allows custom fit. Adjustable side vents ensure increased air flow. Material does not melt, drip, or ignite at 350°F for five minutes. Anti-fog lenses. Meets NFPA 1977 standards. Standard Pack: 12

DESCRIPTION	PART #
IRUV 3.0 ANTI-FOG	3013713*
IRUV 5.0 ANTI-FOG	3013714*

## THE SHIELD™ CUTTING GOGGLES



Features the Monogoggle® XTR goggle with a polycarbonate shield for full face protection. Shield detaches from the goggle. Curved faceshield conforms to shape of face offering better protection. Indentations in face seal to fit over most prescription glasses. Flame retardant headband. IRUV goggle lens with dark green shield. Standard Pack: 6

DESCRIPTION	PART #
THE SHIELD, IRUV 3.0 AF	3010345
THE SHIELD, IRUV 5.0 AF	3010346
MONOGOGGLE XTR, IRUV 3.0 AF	3010337
MONOGOGGLE XTR, IRUV 5.0 AF	3010338

Shown in image: #3008175- OTG IRUV 5.0



## IRUV FACESHIELDS FOR CUTTING /GRINDING

Ideal for cutting, grinding or chipping, these polycarbonate faceshields attach easily to safety caps or can be used with a stand alone headgear.

DESCRIPTION	SIZE	PART #
34-63 IRUV 3.0	15.5" X 8" X .060"	3002813 [0754-0034]
34-65 IRUV 5.0	15.5" X 8" X .060"	3002810 [0754-0031]



Shown in image: #3002436 - 170SB Headgear

## CUTTING & GRINDING EYEWEAR



**OTG™**  
Stylish over-the-glass design that fits over most prescription eyewear. Standard Pack: 12

FRAME/LENS	PART #
BLACK/IRUV 5.0	3018175



**30-06™ READERS**  
Features a precisely placed diopter for easy magnifying during use. Standard Pack: 12

FRAME/LENS	PART #
BLACK/IRUV 5.0 +1.5	3013933
BLACK/IRUV 5.0 +2.0	3013968
BLACK/IRUV 5.0 +2.5	3013969



**NEMESIS™**  
Sleek, sporty design with soft touch temples for added comfort. Standard Pack: 12

FRAME/LENS	PART #
BLACK/IRUV 3.0	3004762 [19859]
BLACK/IRUV 5.0	3004761 [19860]
BLACK/IRUV 3.0	3014555**
BLACK/IRUV 5.0	3014556**



## 2" X 4.25" CUTTING GOGGLES



### WS SERIES

Flexible frame with shade 5.0 lens and an adjustable elastic strap. Available in a fixed or lift front design.  
Standard Pack: 24

DESCRIPTION	PART #
WS-80 FIXED FRONT	3002695* [0746-0505]
WS-85 LIFT FRONT	3002696* [0746-0515]



### WR SERIES

Rigid frame with shade 5.0 fixed front and adjustable elastic strap. Also available in a deep frame to fit over most prescription glasses.  
Standard Pack: 24

DESCRIPTION	PART #
WR-60	3002687 [0746-0223]
WR-600 DEEP FRAME	3002688* [0746-0235]



### WA SERIES

Rigid frame with shade 5.0 fixed front. Features adjust-o-lock™ headgear. Also available in a deep frame to fit over most prescription glasses.  
Standard Pack: 12

DESCRIPTION	PART #
WA-60	3002689 [0746-0315]
WA-600 DEEP FRAME	3002690 [0746-0325]

## 50MM ROUND CUTTING GOGGLES



### WR-70

Rigid frame with shade 5.0, 50mm round lens. Features an adjustable elastic strap.  
Standard Pack: 24

DESCRIPTION	PART #
WR-70	3002686 [0746-0209]



### WR-40

Rigid eye cup style with shade 5.0, 50 mm round lens. Features an adjustable elastic strap.  
Standard Pack: 24

DESCRIPTION	PART #
WR-40	3002681 [0746-0103]



### JP-150

Flexible frame with shade 5.0, 50 mm round lens. Features an adjustable elastic strap.  
Standard Pack: 24

DESCRIPTION	PART #
JP-150	3002684 [0746-0125]



### NEMESIS VL™

Frameless ultra-lightweight design increases upward & peripheral vision.  
Standard Pack: 12

FRAME/LENS	PART #
BLACK/IRUV 5.0	3013544



### HELLRAISER™

Extreme lightweight design with flex point temples for comfort & stability.  
Standard Pack: 12

FRAME/LENS	PART #
BLACK/IRUV 3.0	3013859
BLACK/IRUV 5.0	3013860



### MAGNUM® 3G Smith & Wesson

Ergonomic self-adjusting rubber nose pad & fingers for added comfort.  
Standard Pack: 12

FRAME/LENS	PART #
BLACK/IRUV 3.0	3011668
BLACK/IRUV 5.0	3011669

## JACKSON SAFETY ELECTRODE HOLDERS

Units feature integrated slots for convenient angled holding, fully insulated pivots and springs for maximum dielectric integrity. Large dome screw cable connectors are designed for near unbreakable connection and copper wrap to ensure maximum conductivity. Integral grooves allow for efficient heat dissipation and extended handle with integral ribs that act as a cable support system, eliminating play, reducing wear. Available in heavy duty copper or aluminum alloy.

### JH-1 & JH-2 ELECTRODE HOLDER



JH-1 HOLDER

3001793 [0700-0011]

**JH-1:** Features 3/16" electrode capacity and 50% duty cycle rating. Rated 250 Amperes with No. 4 through 1/0 cable capacity. Lightweight design - only 12 oz.

**JH-2:** Features 5/32" electrode capacity with 45% duty cycle rating. Rated for 200 Amperes with No.4 through 1/0 cable capacity. Aluminium alloy construction and lightweight 10 oz. design.

JH-2 HOLDER

3001797 [0700-0022]

### AW-C & A-W ELECTRODE HOLDER



AW-C HOLDER

3001794 [0700-0012]

**AW-C:** Features 1/4" electrode capacity and 45% duty cycle rating. Rated for 300 Amperes with No. 2 through 2/0 cable capacity. Aluminum alloy construction. Weighs 19 oz.

**A-W:** Features 1/4" electrode capacity and 45% duty cycle rating. Rated for 300 Amperes with No. 2 through 2/0 cable capacity. Aluminum alloy construction. Weighs 14 oz.

A-W HOLDER

3001796 [0700-0019]

### A3-S ELECTRODE HOLDER



A3-S HOLDER

3001795 [0700-0016]

**A3-S:** Features 3/8" electrode capacity with 60% duty cycle rating. Rated 500 Amperes with 2/0 through 4/0 cable capacity. Copper alloy construction. Weighs 30 oz.

### J-4 ELECTRODE HOLDER



J-4 HOLDER

3001798 [0700-0034]

**J-4:** Features 1/4" electrode capacity with 60% duty cycle rating. Rated 400 Amperes with No. 2 through 1/0 cable capacity. Handle size adjusts to electrode sizes with 45 degree head angle. Weighs 16 oz.



## JACKSON SAFETY GROUND CLAMPS

Forged copper alloy ground clamps have higher conductivity, fewer resistances, and run at a cooler temperature at higher Amps for better arc starting. The extra-large contact areas provide superior conductivity and higher clamping pressure, and the long-lever, finger-grip contoured handle allows for easy jaw opening.

### GROUND CLAMPS



**GC-2:** 200 Amperes rating with 1-1/4" jaw capacity. No. 4 through 1/0 cable capacity. Weighs 16 oz.

**GC-3:** 300 Amperes rating with 1-5/8" jaw capacity. 1/0 and 2/0 cable capacity. Weighs 23 oz.

**GC-5:** 500 Amperes with 2" jaw capacity. 3/0 and 4/0 cable capacity. Weighs 34 oz.

GC-2 CLAMP	3001834	[0702-0001]
GC-3 CLAMP	3001835	[0702-0002]
GC-5 CLAMP	3001836	[0702-0003]

### ELECTRODE/CABLE SIZE GUIDE

A.W.G. Size Copper Welding Cable	Diameter over bare conductor	* Recommended Max. Amperage	** Normal Max. Electrode Size
No. 6	.210"	85	3/32"
No. 4	.275"	150	1/8"
No. 2	.335"	200	5/32"
No. 1	.400"	250	5/32" - 3/16"
1/0	.440"	300	3/16" - 7/32"
2/0	.490"	375	7/32" - 1/4"
3/0	.545"	450	1/4" - 5/16"
4/0	.635"	550	5/16" - 3/8"

\* Recommended Maximum Amperage is based on normal shop conditions for manual welding with its approximate 40 to 50% duty cycle (arc time). On automatic welding where the duty cycle is high it is recommended that one size larger cable be used.

\*\* Normal Maximum Electrode Size recommendation varies with the wide permissible amperage range with iron powder electrodes. If electrodes are to be used at the outer range for peak deposition rates it is advisable to increase cable by one size.

### CROSS REFERENCE CHARTS

#### ELECTRODE HOLDERS

Jackson	Tweco	Lenco
JH-1	A-316	AF-2
JH-2	N/A	N/A
A-W	N/A	N/A
AW-C	A-732	AF-3
J-4	4-TT	TT-4-B
A3-S	A-38-HD	AF-50

#### GROUND CLAMPS

Jackson	Tweco	Lenco
GC-2	FGC-200	200
GC-3	FGC-300	300
GC-5	FGC-500	500

#### CABLE CONNECTORS

Jackson	Tweco	Lenco
UB-1-BP	1-MBP or 1-MPC	LC-10
UB-3-BP	2-MBP or 2-MPC	LC-40
UB-4-BP	4-MBP or 4-MPC	LC-40HD

\*DUTY CYCLE RATING IS THE MAXIMUM PERCENTAGE OF ARC TIME (OUT OF ANY 10-MINUTE PERIOD) THAT A HOLDER SHOULD BE EXPECTED TO PERFORM COMFORTABLY.

## UNI-TRIK® CABLE CONNECTORS

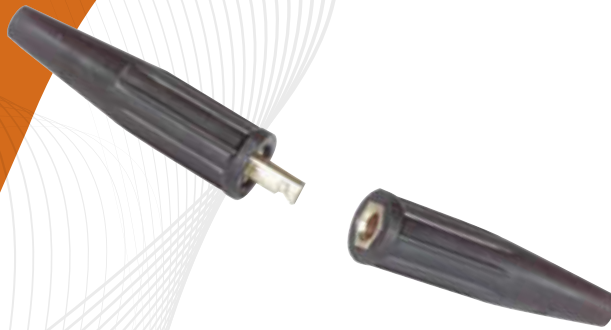

UNI-TRIK® cable connectors are completely insulated, with no exposed metal and feature large, dome-nose cable screws to ensure a virtually unbreakable, high conductivity connection. A form fitting rubber outer jacket prevents screws from shorting out and tapered ends lock out moisture, oil and dirt.

- UB-1-BP: For cables No. 4 through No. 1
- UB-3-BP: For cables 1/0 through 3/0
- UB-4-BP: For cables 3/0 through 4/0

UB-1-BP	3001848 [0704-0020]
UB-3-BP	3001849 [0704-0210]
UB-4-BP	3001852 [0704-0213]

## QUIK-TRIK® CABLE CONNECTORS



QUIK-TRIK® top-of-the-line cable connector halves have morse-tapered sections that are drawn together with a cam and locking bar, for maximum conductivity. Tapered ends that cover the cable jacket and lock out moisture, oil and dirt.

- QNB-2-BP: For cables 1/0 and 2/0
- QNB-4-BP: For cables 3/0 and 4/0
- QB-2-BP: For cables 1/0 and 2/0

QNB-2-BP	3001840 [0704-0001]
QNB-4-BP	3001841 [0704-0202]
QB-2-BP	3001842 [0704-0204]

## INSULATED CABLE LUGS



Cable lugs give you completely insulated welding machine terminal connections, plus quick-connect convenience. Sold in pairs.

QLB-45 QUIK-TRIK LUG	3001855 [0706-0034]
ULB-45 UNI-TRIK LUG	3001854 [0706-0030]

## TERMINAL COVERS



The easiest, least costly way to protect against electrical shock from exposed welding machine terminal connections. Sold in pairs.

TERMINAL COVERS	3001853 [0706-0029]
-----------------	---------------------

# ELECTRIC LINE: PARTS GUIDES

## JH-1 HOLDER

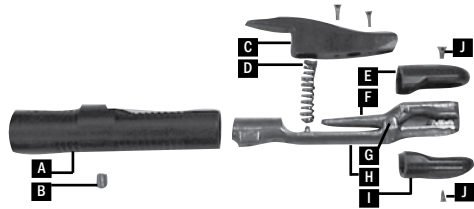

DESCRIPTION	PART #	
A. 1306 HANDLE	3001830	[0701-0071]
B. 2302 HANDLE SCREW	3004753	[0701-0073]
C. 206 LEVER	3001825	[0701-0063]
D. 1006 SPRING	3001812	[0701-0044]
E. 103 INSULATOR	3001815	[0701-0050]
F. 514 UPPER TONG	3001803	[0701-0009]
G. 619 LOWER TONG	3001804	[0701-0018]
H. 1503 INSULATOR SCREW	3001822	[0701-0059]
<b>NOT SHOWN:</b>		
1617 CABLE CLAMP KIT (INCLUDES COPPER WRAP & 2 SET SCREWS)	3001832	[0701-0074]

## JH-2 HOLDER

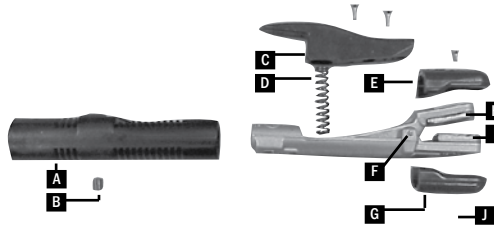

DESCRIPTION	PART #	
A. 1306 HANDLE	3001830	[0701-0071]
B. 2302 HANDLE SCREW	3004753	[0701-0073]
C. 206 LEVER	3001825	[0701-0063]
D. 1006 SPRING	3001812	[0701-0044]
E. 103 INSULATOR	3001815	[0701-0050]
F. 3106 TONG PIN	3001807	[0701-0034]
G. 103 INSULATOR	3001815	[0701-0050]
H. 1703 UPPER JAW	3001809	[0701-0039]
I. 1803 LOWER JAW	3001810	[0701-0040]
J. 1503 INSULATOR SCREW	3001822	[0701-0059]
<b>NOT SHOWN:</b>		
1616 CABLE CLAMP KIT (INCLUDES COPPER WRAP & 2 SET SCREWS)	3001833	[0701-0075]

## AW-C HOLDER

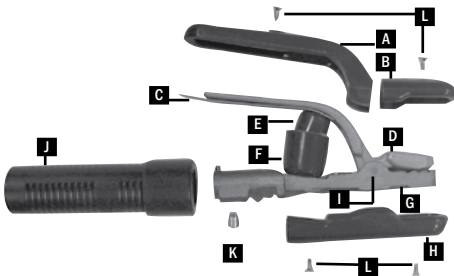

DESCRIPTION	PART #	
A. 203 INSULATOR LEVER	3001817	[0701-0053]
B. 103 INSULATOR	3001815	[0701-0050]
C. 904 INSULATOR STRIP	3001823	[0701-0061]
D. 513 UPPER TONG	3001801	[0701-0007]
E. 1101 SMALL SPRING CUP	3001813	[0701-0047]
F. 1201 LARGE SPRING CUP	3001814	[0701-0049]
G. 618 LOWER TONG	3001805	[0701-0019]
H. 403 INSULATOR LOWER NOSE	3001820	[0701-0057]
I. 3101 TONG PIN	3001806	[0701-0032]
J. 1301 HANDLE	3001827	[0701-0068]
K. 2302 HANDLE SCREW	3004753	[0701-0073]
I. 1503 INSULATOR SCREW	3001822	[0701-0059]
<b>NOT SHOWN:</b>		
1616 CABLE CLAMP KIT (INCLUDES COPPER WRAP & 2 SET SCREWS)	3001833	[0701-0075]
1001 INNER SPRING	3001811	[0701-0043]

## AW HOLDER

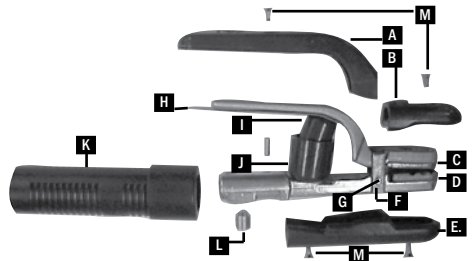

DESCRIPTION	PART #	
A. 203 INSULATOR LEVER	3001817	[0701-0053]
B. 103 INSULATOR	3001815	[0701-0050]
C. 1703 UPPER JAW	3001809	[0701-0039]
D. 1803 LOWER JAW	3001810	[0701-0040]
E. 403 INSULATOR	3001820	[0701-0057]
F. 3202 YOKE	3001808	[0701-0036]
G. 3101 TONG PIN	3001806	[0701-0032]
H. 904 INSULATOR, STRIP	3001823	[0701-0061]
I. 1101 SMALL SPRING CUP	3001813	[0701-0047]
J. 1201 LARGE SPRING CUP	3001814	[0701-0049]
K. 1301 HANDLE	3001827	[0701-0068]
I. 2302 HANDLE SCREW	3004753	[0701-0073]
M. 1503 INSULATOR SCREW	3001822	[0701-0059]
<b>NOT SHOWN:</b>		
1616 CABLE CLAMP KIT (INCLUDES COPPER WRAP & 2 SET SCREWS)	3001833	[0701-0075]
1001 INNER SPRING	3001811	[0701-0043]

## A3-S HOLDER

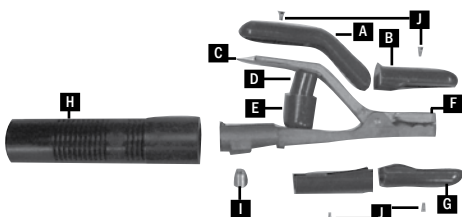

DESCRIPTION	PART #	
A. 201 INSULATOR LEVER	3001818	[0701-0054]
B. 102 UPPER NOSE	3001816	[0701-0051]
C. 903 INSULATOR STRIP	3001824	[0701-0062]
D. 1101 SMALL SPRING CUP	3001813	[0701-0047]
E. 1201 LARGE SPRING CUP	3001814	[0701-0049]
F. 501 UPPER TONG	3001802	[0701-0008]
G. 303 INSULATOR	3001826	[0701-0067]
H. 1305 HANDLE	3001828	[0701-0069]
I. 2302 HANDLE SCREW	3004753	[0701-0073]
J. 1503 INSULATOR SCREW	3001822	[0701-0059]
<b>NOT SHOWN:</b>		
1614 CABLE CLAMP KIT (INCLUDES COPPER WRAP & 2 SET SCREWS)	3001829	[0701-0070]
1001 INNER SPRING	3001811	[0701-0043]

## CURV-O-MARK®

Curv-O-Mark® layout systems have earned a reputation for quality and consistency over a wide range of industries. Easy to use, long-lasting and durable tools, Curv-O-Mark® tools help bring precision to most any layout task.

### CONTOUR WORKER KIT



Contour Worker Kit features the top selling precision pipe marking tools with a heavy-duty metal locking case for convenient storage. These tools are durable, long lasting and provide a timesaving solution to the precision marking applications. Kit includes:

- #1 Contour Marker
- #7 Centering Head
- #8 Pro Mag Level
- Standard Radius Marker
- Square Soap Stone & Holder
- Lockable metal carrying case

CONTOUR WORKER KIT

3014807

### #1 CONTOUR MARKER



#1 Contour Marker is a compact design, time-saving tool used to lay out pipe and structural steel joints. Ideal for quick, precise layout of laterals at any angle, tees, wyes, crosses, elbows -- any type or size of joint (for use on same size pipe intersections). Eliminates complicated mathematical formulas, cut and try, and needless material waste. Can be used to lay out pipe from 1-1/2" to 18" diameter, or structural steel members up to 18" in a right side up or upside down position. Consists of an X-shaped frame, calibrated protractor, and a triple-jointed marking arm and holder. Protractor is calibrated on both sides -- one in degrees, the other in rise-inches-per-foot -- to service any type of measurement need. Holder accepts a soapstone crayon (included), felt pen or pencil.

#1 CONTOUR MARKER

3001874 [0721-0000]

contour

## #4 JUMBO CONTOUR MARKER

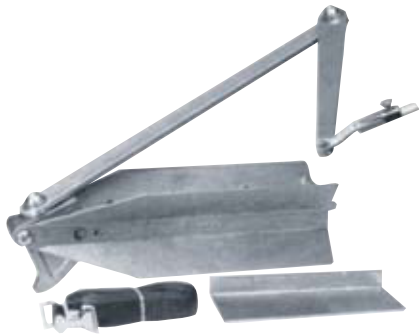

Developed for use in the layout of large diameter pipe, from 8" to 48" and structural seal joints, of the same size pipe. Comes complete with a durable web strap (included) to help hold the unit in place during layout. Built-in adjustable dial set level (DSL) ensures accurate center-line location. A soapstone crayon is included.

#4 JUMBO CONTOUR MARKER 3001877 [0721-0003]

## COMBO ADAPTOR ACCESSORY



Designed for use with the Standard and Jumbo Contour Markers, the adaptor simplifies handling and increases layout flexibility. Permits use of all four sides of the Contour Marker and allows marking on small diameter pipe, over nipples, old weld or on wrapped pipe. Also provides layouts with compound angles Using a single setting, or any degree of take-off on elbows and turns up to 90°.

#2 STANDARD 3001875 [0721-0003]  
#5 JUMBO 3001878 [0721-0004]

## #14 CIRCLE ELLIPSE PROJECTOR



Ideal for creating perfect circles, ellipses or oblong circles on any irregular flat or round surface. Can be used to lay out lateral intersections of different diameter pipes, or to project circles from 1-1/2" to 18" diameter on flat surfaces intersecting at angles from 0 to 70° from vertical. Features a protractor with sliding rod and an adjustable lever to lock in the specified layout. Strong, 20-pound pull magnetic base holds the Projector in position during layout. Durable web strap (included) holds the unit secure on non-magnetic surfaces and can be used on either side of the vertical column. The Projector is equipped with a soapstone crayon and also works with chalk, pencil or steel scribe.

#14 CIRCLE ELLIPSE PROJECTOR 3001888 [0721-0014]

## CENTERING HEAD



Aids in the setting of center lines, establishing angles and marks for butt-ins, locating points inside pipes and tanks, laying out keyways and measuring declivity. Standard Model is used on pipe 1/2" diameter and larger and has a 4" Y-type head fitted with an adjustable dial set level (DSL) and a manually operated hardened centering pin. Jumbo Centering Head is ideal for pipe 1" diameter and up and has an 8" Y-type head and a DSL. A spring-loaded hardened centering pin eliminates the need for a hammer.

#6 STANDARD 3001879 [0721-0005]  
#7 JUMBO 3001880 [0721-0006]

## #9 FITTER WELDER PROTRACTOR



90° protractor has a matching locking lever to set and hold the tool at the desired angle. Equipped with a 5.8" by 10" tapered arm to complete finding of angles or desired bends, or to determine any portions of elbows. Tool is mounted in a 3/4" wide frame with a 3/8" by 6" cast-in rod and comes with a 25-pound pull magnetic base for holding the protractor frame in position. Can be used manually or with a magnetic base.

#9 FITTER WELDER PROTRACTOR 3001882 [0721-0008]

## #32 FLANGE ALIGNER BASE



Removes the difficulty of flange aligning and squaring. Tool holds a square in the needed position without tying up one's hands. Base is notched at either end for ease in aligning on the center line of the pipe. Two 25-pound pull, cast-in magnets for holding either a flat horizontal or vertical position. Base accepts either leg of a standard or combination aluminum square and works on pipe diameters from 1"+, requiring only the extension of the legs of the square being used to accommodate larger diameters.

#32 FLANGE ALIGNER BASE 3001903 [0721-0029]

## #10 PIPE FLANGE ALIGNER

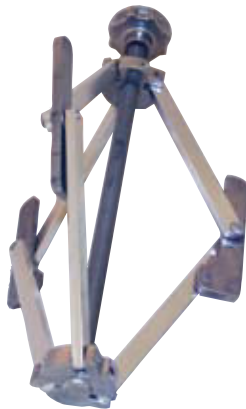

Aids in fast, accurate pipe construction with self-determining flange aligning tool. Inserts easily into pipe, centers snugly against the inside pipe diameter and automatically aligns with the pipe axis. Quickly adjustable for all types of flanges or pipe sizes ranging from 3" to 12" diameter.

#10 PIPE FLANGE ALIGNER 3001883 [0721-0009]

## RADIUS MARKERS



Models available in four sizes for scribing circles up to 80" in diameter. Folding type design--three smallest models will fit conveniently into a shirt pocket. Sturdy friction joints maintain rigidity and accuracy, and are made from lightweight, rustproof aluminum for long wear. Soapstone crayon is included. The scribe holder will accept round, square or flat soap stone crayon, pencil or steel point scribe.

MINI - UP TO 8 IN RADIUS 3001884 [0721-0010]  
 SMALL - UP TO 20 IN RADIUS 3001885 [0721-0011]  
 STANDARD - UP TO 24 IN RADIUS 3001886 [0721-0012]  
 JUMBO - UP TO 40 IN RADIUS 3001887 [0721-0013]

## #19 MULTI-TRAMMEL HEADS



Using standard half inch pipe as a trammel bar, heads feature radius set points cast in alignment with marking pointers for easy setting. Equipped with 1/4" screws and squared on the back side of perpendicular alignment. The stationary head holds a 1/4" case hardened center point. Moveable head has a 1/8" steel scribe hardened. Marks from 1-1/2" circle to any diameter needed, depending on length of pipe used as a trammel bar. Allen wrench, soapstone, scribe and pointer also included.

#19 MULTI-TRAMMEL HEADS

3001890 [0721-0016]

## #21 VERSI-MAG & HOLDER



Versatile magnetic aids free up hands for other work. Versi-Mag features a single 25-pound magnet cast in a square end body that can be used for the line up of steel parts for welding or machining. Versi-Mag Holder works as a jig or line-up fixture, and can hold leads, hoses, torches or other devices. Includes two 25-pound pull magnets, each cast in an aluminum body and machined with square ends. Each one hinged to swing through a 90° angle and the bodies are fitted with either a holding pin or clamp to receive various tools.

#21 VERSI-MAG  
VERSI-MAG HOLDER

3001892 [0721-0018]  
3001893 [0721-0019]

## #20 DIAL-ANGLE-FLANGE LEVEL



A versatile tool that can be used as a dial degree utility level or, with attachments, for two-holding flange alignment. Constructed of cast aluminum with a protective housing containing an adjustable DSL. Fitted with a threaded, self-aligning conical spacer and conical nut and bolt units for fastening the Level to a pipe flange. One of the nut and bold units is stationary, while the other slides up to 5-1/2" along a slot in the level to accommodate various flange bolt hold spacings from 2" to 5-1/2".

#20 DIAL-ANGLE-FLANGE LEVEL

3001891 [0721-0017]

## #8 PRO-MAG LEVEL

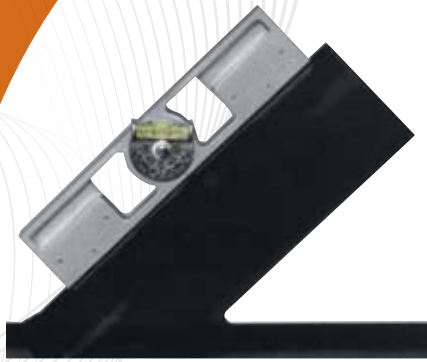

A lightweight, easy to use tool for determining angles. Unit is ideal for the pipe fitter, welder, jig builder or anyone who has to determine angles or do setup work. Includes two cast-in 25-pound pull magnets that hold securely to any steel surface. Unit has a 360° adjustable DSL with two 90° quadrants graduated in 2-1/2° increments. Cast in tables are used to convert degree-of-angle to rise-in-inches-per-foot or millimeters-per-meter. A groove on the bottom edge permits use on a small pipe.

#8 PRO-MAG LEVEL

3001881 [0721-0007]

## #22 PRO-MAG BURNING SQUARE

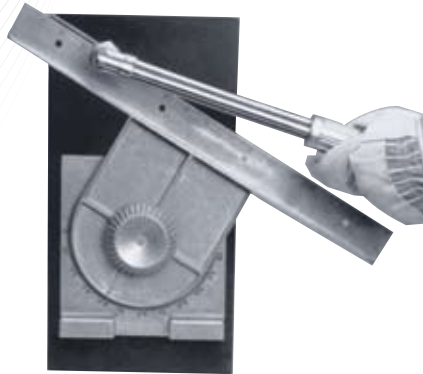

Precise tool used in structural thermal cutting and layout. Tool base is a perfect square containing powerful cast-in magnets, permitting placement in any position. Tool surface is embossed with a protractor inscribed with two 90° quadrants graduated in 1° increments. Top of the tool carries an 18" ruler blade divided in 1/8" increments and can be locked in place at the desired angle setting by hand tightening of the adjustment knob. Ruler blade is on a raised plane for use as a straight edge when flame cutting, without distortion or marring. Blade will also accept attachments or extensions that allow an overall length up to 72". Made of cast aluminum.

#22 PRO-MAG BURNING SQUARE

3001894 [0721-0020]

## #28 MAGNETIC BURNING GUIDE

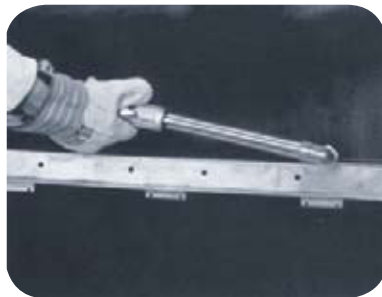

Designed for use with a burning torch or plasma cutter as straight edge, the Burning Guide is cast of strong, durable material to withstand heat spatter. Tool's base has three 30-pound pull cast-in magnets for use in any position.

#28 MAGNETIC BURNING GUIDE

3001899 [0721-0025]

## ATTACHMENTS FOR #22 & #28



Attachments for #22 Pro-Mag Burning Square and #28 Magnetic Burning Guide.

#31 ATTACHMENT - 72" OVERALL LENGTH  
 #30 ATTACHMENT - 48" OVERALL LENGTH  
 #29 ATTACHMENT - 34" OVERALL LENGTH

3001902 [0721-0028]  
 3001901 [0721-0027]  
 3001900 [0721-0026]



## #33 UNIVERSAL LEVEL



Designed primarily for pipe fitting applications, the Universal Level is a valuable tool for any craft required to use a level or a plumb bob:

- For structural ironworkers, the powerful holding magnets provide an extra hand.
- Electricians will find the Level useful in laying out and lining up heavy conduit.
- With the aid of a handy conversion chart, carpenters can use the Level for the layout of roof rafters.
- Multi-purpose tool features a 360-degree adjustable dial set level (DSL) that ensures accurate leveling and permits the following additional uses: setting a predetermined pitch of a string of pipe, setting the angle of laterals to a precise degree, trueing vertical runs, & two-holding flanges.

Includes two cast-in 25-pound magnets (exerting a 50-pound pull) to securely hold the unit in place on any steel surface, including the underside of a pipe or beam. This permits hands-free leveling, a welcome aid in tight spots. Bubble is mounted on a protector dial, the level may be used in any position and still read accurately. Magnets are cast in and do not interfere with the use of the Level on nonmagnetic materials, such as aluminum, copper, lumber or stone requiring leveling. For aligning pipe flanges (two-holding), the level comes with a two-threaded, self-aligning conical spacer and conical nut and bolt units, designed to fit any size bolt hole spaced between 2-1/4" and 8" centers on flanges. Permits the orientation of flange bolt holds for any size pipe.

#33 UNIVERSAL LEVEL

3001904 [0721-0030]

## WRAP-A-ROUND



Economical tool for marking straight lines around pipe, or for use of a straight edge. Made out of flexible gasket material, with good resistance to heat and cold. Available in two colors, designating material type and service temperature. Gray material is used high temperature applications up to 550°F. Black material has a service temperature up to 350°F. Both are asbestos free. Wrap-A-Rounds in 3.88" and 5.00" feature a metric scale and pitch chart. All sizes are printed with a scale in inches, pitch chart, tangent chart and other useful markings. Extra small, small and special order sizes are unmarked.

SIZE	DIMENSIONS WIDTH/LENGTH	PIPE DIAMETER	BLACK ITEM NUMBER	GRAY ITEM NUMBER
EX-SMALL	1.94" X 2'	1" TO 3"	3001856 [0720-0001]	3001865 [0720-0027]
SMALL	2.50" X 2'	1" TO 3"	3001857 [0720-0004]	3001866 [0720-0028]
MEDIUM	3.88" X 4'	3" TO 6"	3001858 [0720-0007]	3001867 [0720-0029]
LARGE	3.88" X 6'	3" TO 10"	3001859 [0720-0010]	3001868 [0720-0030]
EX-LARGE	5.00" X 7'	4" TO 12"	3001860 [0720-0013]	3001869 [0720-0031]
EX-LARGE	5.00" X 9'	6" TO 16"	3001861 [0720-0016]	3001870 [0720-0032]
SPECIAL	3.88" X LENGTH DESIRED*		3001862 [0720-0019]	3001871 [0720-0033]
SPECIAL	5.00" X LENGTH DESIRED*		3001863 [0720-0022]	3001872 [0720-0034]
SPECIAL	7.00" X LENGTH DESIRED*		3001864 [0720-0025]	3001873 [0720-0035]

\*SPECIAL LENGTHS AVAILABLE UP TO A MAXIMUM OF 375'

## STRESS RELIEF PADS

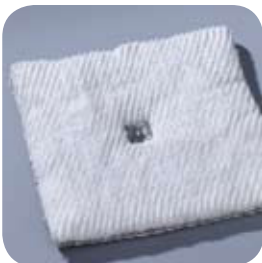

These flexible pads are made from special non-asbestos, resilient, high temperature materials. Non-combustible and chemically inert, they provide temporary insulation of welds during stress relieving of large diameter piping, ducts, vessels, or tanks. Available in 12", 24" or 48" widths and 1", 1.5", and 2" thicknesses.

DESCRIPTION	PART NO
STRESS RELIEF PADS	HTFM

### ACCESSORIES & REPLACEMENT PARTS

#24 SOAPSTONE 1/4 IN X 5 IN ROUND	3001895 [0721-0021]
#26 ROUND SOAPSTONE HOLDER	3001897 [0721-0023]
#25 SOAPSTONE 3/16 IN X 1/2 IN X 5 IN FLAT	3001896 [0721-0022]
#27 FLAT SOAPSTONE HOLDER	3001898 [0721-0024]
#6 CENTERING PIN	3001906 [0722-0001]
CENTERING BUSHING SET #20, #30	3001907 [0722-0002]
DIAL SET LEVEL (DSL)	3001905 [0722-0000]

wilsonindustries



### THE HISTORY OF WILSON INDUSTRIES

Since 1957, Wilson has prided itself on being at the forefront of technology. By researching today's scientific and engineering developments and applying them to tomorrow's safety needs. Wilson has consistently produced a superior line of quality safety products.

Wilson products are designed to improve the overall working environment and assist in increasing productivity . All of our products meet or exceed OSHA specifications. Through our leadership in the safety field, the complete Wilson line has played an important part in the safety programs of various companies. When you specify Wilson products, you are assured excellent quality supported by years of experience, family pride and commitment to customer satisfaction.

# WILSON

QUALITY SAFETY PRODUCTS

## CUSTOMIZATION EXPERTS

**Special made to order curtains and blankets are our specialty!**

Wilson makes custom curtains, shrouds, covers or traps in virtually any size from our wide variety of fire resistant specialty fabrics. We electronically weld or securely sew all products to provide superior quality and long lasting protection. You design it and we will make it; or we are happy to assist you with a design. Cutouts, conveyor belt openings, machine shrouds, weighted hems, wind relief vents and doorways are just a few of the many custom features offered.

When designing a custom curtain, choose the proper fabric for the application (contact Wilson customer service for assistance at 1-800-423-4277), take into consideration special design features (cut-outs, dimensions, etc.) and determine how the curtain will be supported. Add 10% to the width dimension, if the product is intended for hanging



## NOW IN STOCK!

Now that Jackson Safety and Wilson Industries have become one, we are stocking a select number of products in both of our warehouse facilities. When you see a part number in **blue** it is stocked at both our east and west warehouse facilities for your convenience.

## PIONEER OF SPECTRA™ ORANGE SEE-THRU

Since 1968 the traditional Wilson Spectra brand has been the industry standard in transparent welding curtains. The development of the unique absorption scattering and filtering properties of Spectra™ curtain was based on scientific principles similar to those used by scientists who studied the Voyager probe's response to radiation exposure during its exploration of the planet Saturn.

In an independent study conducted by the United States Army at its Aberdeen Proving Grounds, Spectra™ Curtain proved to be superior to all other semitransparent welding curtains on the market today. Wilson holds three patents for the unique properties of its Spectra Curtain: its orange color that cuts dangerous blue light; its fluorescent and white pigments scatter light; and its dimpled texture refracts and enlarges light.

Insist on a Wilson's Spectra Curtain, DO NOT be confused by other orange imitations, there is only one Spectra™ Curtains, look for the Spectra label.



### SPECTRA™ SEE THRU: NO OTHER TRANSPARENT WELDING CURTAIN MANIPULATES LIGHT WAVES LIKE THE SPECTRA CURTAIN!

With its scientifically engineered, special patented PVC formula, the Spectra™ curtain absorbs, scatters and filters the light spectrum to create a safer and better working environment for the welder, surrounding co-workers, and supervisors.

The Spectra™ See-Thru Curtain constitutes the "NEAR IDEAL" transparent welding curtain:

- Eliminates dangerous Ultra Violet Radiation
- Provides good visibility like the yellow transparent welding curtain
- Minimizes the arc glare better than all other transparent curtains
- Puts light back into the welding booth to assist the welder with his work like no other welding curtain!

Each Wilson Spectra™ curtain is embossed with our distinctive trademark Wilson logo throughout the curtain. DO NOT BE CONFUSED BY OTHER ORANGE IMITATIONS, specify Spectra and look for the trademark embossed on the curtain with label.

### HOW SPECTRA™ COMPARES IN 5 ZONES OF THE OPTICAL WELDING SPECTRUM

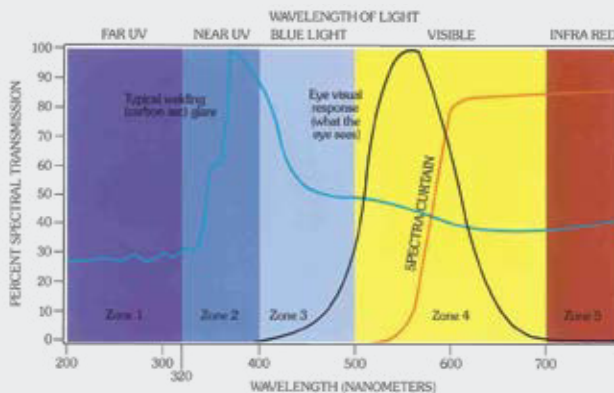

#### Zone 1 200-320 nm. (far u.v., flash burns)

This zone cannot be seen by the naked eye, yet the powerful and dangerous far Ultra Violet Rays within this zone can have damaging and permanent effect on the eye. Spectra™ curtain prevents the transmission of this zone, preventing flash burns.

#### Zone 2 320-400 nm. (near u.v.)

This zone cannot be seen by the naked eye, yet may cause such harmful effects as lens fluorescence, cataracts, and skin problems. Spectra™ curtain prevents the transmission of this zone, thus preventing these harmful effects.

#### Zone 3 400-500 nm. (Blue Light)

Within this zone, welding arcs product their highest percent of concentrated energy. This zone is either not seen or very dimly seen by the naked eye. However, this zone emits a blue light that may annoy or irritate the eye. Conventional transparent welding curtains usually start to transmit in this range. Spectra™ Curtain prevents the transmission of this zone, thus preventing blue light annoyance or irritation.

#### Zone 4 500-700 nm. (good visible light)

Within this zone, the eye has its maximum capabilities of vision. Spectra™ Curtain begins transmission in this zone and allows ample light for a safety supervised and enjoyable working environment.

#### Zone 5 Above 700 nm.

This zone is not seen by the naked eye and studies indicate that most welding curtain applications are not influenced within this range.

## ORIGINATOR OF THE TRANSPARENT WELDING CURTAINS

Wilson Industries originated the concept of the transparent welding curtains in 1968.

- All four sides are securely hemmed by our electronic welding process for added strength and durability (except Canvas which are sewn)
- Plastic grommets provide better wearability with less possibility of separation from the curtain
- Grommets are placed 8" apart on one width side and 16" apart on both height sides
- Durable curtain materials - resists tearing
- Wide Variety of transparent welding curtains tailored to your particular welding and safety needs
- All Wilson welding curtains meet or exceed California State Fire Marshall and NFPA 701 requirements for flame resistance.



### SPECTRA™ ORANGE SEE-THRU

### SEE-THRU WELDING CURTAINS

Heavy duty vinyl. Filters 100% of far/near UV radiation and blue light. Arc image dispersed throughout the curtain. Puts light back into the welding booth. Use: low to high amperage. Thickness: 14 mil or 40 mil



#### SPECTRA SEE THRU CURTAIN - 14 MIL

DESCRIPTION	STOCK ITEM	PART #
4' X 5'		4520-25
4' X 6'	3018914	4624-25
4' X 8'	3018919	4832-25
4' X 10'		41040-25
5' X 5'		5525-25
5' X 6'	3018944	5630-25
5' X 8'	3018948	5840-25
5' X 10'	3018924	51050-25
6' X 6'	3018979	6636-25
6' X 8'	3018985	6848-25
6' X 9'		6954-25
6' X 10'	3018955	61060-25
6' X 12'	3018959	61272-25
6' X 15'		61590-25

#### SPECTRA SEE THRU CURTAIN - 40 MIL

DESCRIPTION	PART #
4' X 5'	4520-28
4' X 6'	4624-28
4' X 8'	4832-28
4' X 10'	41040-28
5' X 5'	5525-28
5' X 6'	5630-28
5' X 8'	5840-28
5' X 10'	51050-28
6' X 6'	6636-28
6' X 8'	6848-28
6' X 9'	6954-28
6' X 10'	61060-28
6' X 12'	61272-28
6' X 15'	61590-28

\*CUT SIZE: ACTUAL FINISHED SIZE MAY VARY 3" IN HEIGHT AND WIDTHS. CUSTOM SIZES AVAILABLE. CLEAR/COLORLESS SEE-THRU IS AVAILABLE IN 14 AND 40 MIL, BUT IS NOT TO BE USED FOR WELDING OR U.V. FILTRATION.

\*ITEMS IN BLUE ARE STOCKED IN BOTH OUR DISTRIBUTION FACILITIES

## GOLD SEE-THRU

## SEE-THRU WELDING CURTAINS

Heavy duty vinyl. Stops far/near U.V. radiation. Excellent blue light protection. Arc image dispersed throughout the curtain. Allows supervision and a bright work environment. Use: low to medium amperage. Thickness: 14 mil or 40 mil



Gold See-Thru

### GOLD SEE THRU CURTAIN - 14 MIL

DESCRIPTION	STOCK ITEM	PART #
4' X 5'		4520-50
4' X 6'		4624-50
4' X 8'		4832-50
4' X 10'		41040-50
5' X 5'		5525-50
5' X 6'		5630-50
5' X 8'	3018945	5840-50
5' X 10'		51050-50
6' X 6'	3018975	6636-50
6' X 8'	3018981	6848-50
6' X 9'		6954-50
6' X 10'		61060-50
6' X 12'		61272-50
6' X 15'		61590-50

### GOLD SEE THRU CURTAIN - 40 MIL

DESCRIPTION	PART #
4' X 5'	4520-54
4' X 6'	4624-54
4' X 8'	4832-54
4' X 10'	41040-54
5' X 5'	5525-54
5' X 6'	5630-54
5' X 8'	5840-54
5' X 10'	51050-54
6' X 6'	6636-54
6' X 8'	6848-54
6' X 9'	6954-54
6' X 10'	61060-54
6' X 12'	61272-54
6' X 15'	61590-54

## GREEN & GRAY SEE-THRU

## SEE-THRU WELDING CURTAINS

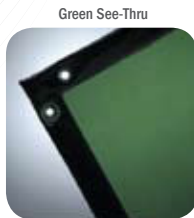

Green See-Thru



Gray See-Thru

Heavy duty vinyl. Stops far U.V. radiation. Good blue light protection. Decreases total light from welding arc. Good visibility into higher amperage welding areas. Use: medium to medium high amperage in electric arc welding. Thickness: 14 mil

### GREEN SEE THRU CURTAIN - 14 MIL

DESCRIPTION	STOCK ITEM	PART #
4' X 5'		4520-60
4' X 6'		4624-60
4' X 8'		4832-60
4' X 10'		41040-60
5' X 5'		5525-60
5' X 6'	3018941	5630-60
5' X 8'	3018946	5840-60
5' X 10'	3018922	51050-60
6' X 6'	3018976	6636-60
6' X 8'	3018982	6848-60
6' X 9'		6954-60
6' X 10'	3018952	61060-60
6' X 12'	3018957	61272-60
6' X 15'		61590-60

### GRAY SEE THRU CURTAIN - 14 MIL

DESCRIPTION	PART #
4' X 5'	4520-80
4' X 6'	4624-80
4' X 8'	4832-80
4' X 10'	41040-80
5' X 5'	5525-80
5' X 6'	5630-80
5' X 8'	5840-80
5' X 10'	51050-80
6' X 6'	6636-80
6' X 8'	6848-80
6' X 9'	6954-80
6' X 10'	61060-80
6' X 12'	61272-80
6' X 15'	61590-80

## PLASMA SEE-THRU

## SEE-THRU WELDING CURTAINS

Extra dark green (shade 8) Heavy-duty vinyl . Stops far U.V. radiation. Superior blue light protection. Excellent for plasma cutting or extremely bright welding arcs. Thickness: 14 mil



Plasma See-Thru

### PLASMA SEE THRU CURTAIN - (DINS #32504)

DESCRIPTION	PART#
4' X 5'	4520-90
4' X 6'	4624-90
4' X 8'	4832-90
4' X 10'	41040-90
5' X 5'	5525-90
5' X 6'	5630-90
5' X 8'	5840-90

DESCRIPTION	PART #
5' X 10'	51050-90
6' X 6'	6636-90
6' X 8'	6848-90
6' X 9'	6954-90
6' X 10'	61060-90
6' X 12'	61272-90
6' X 15'	61590-90

## GREEN CANVAS

### OPAQUE WELDING CURTAINS

Medium weight, resistant to fire, water and mildew. Recommended for most welding applications.

#### GREEN CANVAS

DESCRIPTION	STOCK ITEM	PART #	DESCRIPTION	STOCK ITEM	PART #
4' X 5'		4520-15	5' X 10'		51050-15
4' X 6'		4624-15	6' X 6'	3018857	6636-15
4' X 8'		4832-15	6' X 8'	3018858	6848-15
4' X 10'		41040-15	6' X 9'		6954-15
5' X 5'		5525-15	6' X 10'		61060-15
5' X 6'	3018852	5630-15	6' X 12'		61272-15
5' X 8'	3018853	5840-15	6' X 15'		61590-15

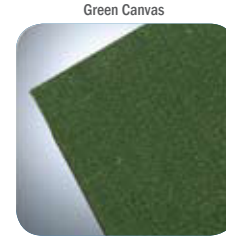

## RIP-STOP

### OPAQUE WELDING CURTAINS

Vinyl laminated polyester scrim. Withstands heavy abrasion and abuse, resists oil, water and most acids. Recommended for most welding applications. May be combined with any transparent vinyl for visibility and strength. Colors: yellow (85), green (95), orange (75), blue (65), and black (55)

RIP-STOP \*ADD COLOR CODE AFTER EACH PART NO. PREFIX FOR ORDERING. (EX. 4520-85)

DESCRIPTION	PART #	DESCRIPTION	PART #
4' X 5'	4520-*	5' X 10'	51050-*
4' X 6'	4624-*	6' X 6'	6636-*
4' X 8'	4832-*	6' X 8'	6848-*
4' X 10'	41040-*	6' X 9'	6954-*
5' X 5'	5525-*	6' X 10'	61060-*
5' X 6'	5630-*	6' X 12'	61272-*
5' X 8'	5840-*	6' X 15'	61590-*

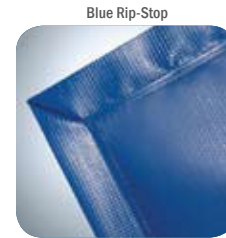

## INSTANT CURTAIN

### SEE-THRU WELDING CURTAINS



#### CUSTOMIZE YOUR OWN CURTAIN.

Simply cut off the amount of curtain you need and hang it. Transparent welding curtain material with grommets every 8" on one width side (no hems). 75' wide (long).

DESCRIPTION	PART #
SPECTRA ORANGE SEE-THRU 14 MIL, HEIGHT 5'	IC60-25
SPECTRA ORANGE SEE-THRU 14 MIL, HEIGHT 6'	IC72-25
GOLD (YELLOW) SEE-THRU 14 MIL, HEIGHT 5'	IC60-50
GOLD (YELLOW) SEE-THRU 14 MIL, HEIGHT 6'	IC72-50
GREEN SEE-THRU 14 MIL, HEIGHT 6'	IC72-60
GRAY SEE-THRU 14 MIL, HEIGHT 6'	IC72-80

## GLIDE - N - FOLD



Accordion style folding curtains offer a space saving configuration with a sharp, clean appearance. Sold in 24" width multiples.

(Add 10% to widths for proper hanging)

DESCRIPTION	PART #
SPECTRA ORANGE SEE-THRU 12" FOLD SECTIONS, 45 MIL	SP-28GF
CLR (COLORLESS) SEE-THRU 12" FOLD SECTIONS, 45 MIL	SP-44GF
RIP-STOP, VINYL LAMINATE 12" FOLD SECTIONS	SP-**GF

(ADD COLOR CODE AFTER EACH PART NO. PREFIX FOR ORDERING RIP STOP  
 COLORS: GREEN-95, YELLOW-85, ORANGE-75, BLUE-65, OR BLACK-55)

\*CUT SIZE: ACTUAL FINISHED SIZE MAY VARY 3" IN HEIGHT AND WIDTHS. CUSTOM SIZES AVAILABLE.  
 CLEAR/COLORLESS SEE-THRU IS AVAILABLE IN 14 AND 40 MIL, BUT IS NOT TO BE USED FOR WELDING OR U.V. FILTRATION.

## ROLL GOODS

Spectra Orange See-Thru



Gold See-Thru



Green See-Thru



Gray See-Thru



Plasma See-Thru



Blue Rip-Stop

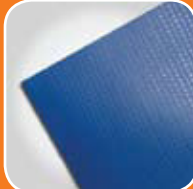

Green Canvas



Electro-Safe



**SPECTRA™ ORANGE SEE-THRU\*** The “Ideal” transparent welding curtain material. Patented formula, heavy duty 14 mil vinyl film. Stops dangerous U.V. radiation and minimizes arc glare.

PART NO	COLOR	WIDTH	APPROX. YDS/ROLL	APPROX. WT/ROLL
250-72	SPECTRA ORANGE	72"	100	165 LBS
250-60	SPECTRA ORANGE	60"	100	135 LBS

**SPECTRA™ ORANGE SEE-THRU FORTY\*** Extra thick (40 mil) patented Spectra. Provides extra strength, longevity and added abrasion resistance.

PART NO	COLOR	WIDTH	APPROX. YDS/ROLL	APPROX. WT/ROLL
280-48	ORANGE/RED	48"	50	160 LBS

**SEE-THRU WELDING MATERIAL\*** Heavy duty 14 mil vinyl film. Stops dangerous U.V. radiation.

PART NO	COLOR	WIDTH	APPROX. YDS/ROLL	APPROX. WT/ROLL
500-60	GOLD	60"	100	135 LBS
500-72	GOLD	72"	100	165 LBS
600-72	GREEN	72"	100	165 LBS
800-72	GRAY	72"	100	165 LBS

**SEE-THRU FORTY\*** Stops dangerous U.V. radiation. 40 mil thickness provides extra strength, longevity and added abrasion resistance.

PART NO	COLOR	WIDTH	APPROX. YDS/ROLL	APPROX. WT/ROLL
540-48	GOLD	48"	50	160 LBS

**PLASMA SEE-THRU\*** Heavy duty 14 mil vinyl. Stops dangerous U.V. radiation.

PART NO	COLOR	WIDTH	APPROX. YDS/ROLL	APPROX. WT/ROLL
900-72	EXTRA DARK GREEN	72"	100	165 LBS

**RIP-STOP\*** Vinyl laminated polyester scrim. Resists tearing ripping, oil, mildew, water and most acids.

PART NO	COLOR	WIDTH	APPROX. YDS/ROLL	APPROX. WT/ROLL
550-61	BLACK	61"	75	105 LBS
650-61	BLUE	61"	75	105 LBS
750-61	ORANGE	61"	75	105 LBS
850-72	YELLOW	72"	75	130 LBS
950-72	GREEN	72"	75	130 LBS

**CANVAS\*** Medium weight, resistant to fire, water and mildew.

PART NO	COLOR	WIDTH	APPROX. YDS/ROLL	APPROX. WT/ROLL
110-60	GREEN	60"	100	200 LBS
150-60	YELLOW	60"	100	200 LBS

**CLEAR VINYL\*** Heavy duty 14 mil colorless vinyl film. Excellent for draft curtain, chipping, grinding, paint and general use (not to be used for welding). U.V. absorbers inhibit cracking.

PART NO	COLOR	WIDTH	APPROX. YDS/ROLL	APPROX. WT/ROLL
400-60	CLR/COLORLESS	60"	100	135 LBS
400-72	CLR/COLORLESS	72"	100	165 LBS

**CLEAR FORTY\*** heavy duty 40 mil colorless vinyl film. Excellent for extra protection and abrasion resistance (not to be used for welding). U.V. absorbers inhibit cracking.

PART NO	COLOR	WIDTH	APPROX. YDS/ROLL	APPROX. WT/ROLL
440-48	CLR/COLORLESS	48"	50	160 LBS

**SEE-THRU HEAVY GAUGE\*** Vinyls. Transparent - welding, sound reduction, chip control.

PART NO	COLOR	WIDTH	APPROX. YDS/ROLL	APPROX. WT/ROLL
S848-40	CLEAR	48"	40	240 LBS
S1648-40	CLEAR	48"	20	240 LBS
S848-50	AMBER	48"	40	240 LBS

**ELECTRO-SAFE** heavy duty 12 mil transparent vinyl film. Grounding scrim eliminates static electricity. Grounds to 0 kv. Excellent for clean rooms, dust-free environments, computer enclosures.

PART NO	COLOR	WIDTH	APPROX. YDS/ROLL	APPROX. WT/ROLL
450-54	CLR/COLORLESS	54"	94	100 LBS

\*Meets California Fire Marshal Requirements.



## CUSTOM FABRICATION

Wilson makes custom curtains, shrouds, covers or tarps in virtually any size from our wide variety of fire resistant specialty fabrics. We electronically weld or securely sew all products to provide superior quality and long lasting protection. You design it and we will make it; or we're happy to assist you with a design. Cutouts, conveyor belt openings, machine shrouds, weighted hems, wind relief vents and doorways are just a few of the many custom features offered. When designing a custom curtain, choose the proper fabric for the application (contact Wilson customer service for assistance), take into consideration special design features (cut-outs, dimensions, etc.) and determine how the curtain will be supported. Add 10% to the width dimension, if the product is intended for hanging. Special made to order curtains are our specialty!



wilsonindustries

## WILSON'S PREMIUM SCREEN: STUR-D-SCREEN

Stur-D-Screen features a freestanding, strong square tubing that provides neat appearance and sturdy platform legs. No curtain gapping between posts ensures a secure and safe area. Easy to assemble with interchangeable parts. Available in multi-panel screens or cubicles.

\*The complete package includes square steel frame, brackets, platform "T" legs, lacing ties, and safety curtain - all shipped disassembled.\*



### FREESTANDING, PORTABLE SAFETY SCREENS OFFER A UNIQUE COMBINATION OF STRENGTH, STURDINESS AND SAFETY.

- **STRENGTH** - Solid square steel tubing eliminates slipping and twisting. Exclusive bolted corner clamps assure a tight, secure fit.
- **SAFETY** - Combined with Wilson safety fabrics, Wilson Stur-D-Screens ensure optimal protection for welding areas, machine shop chip control and many other applications.
- **STURDINESS** - Square steel tubing, bolted corner clamps and platform legs minimize frame wobble and sway.



Shown in image:  
Platform legs minimize frame wobble and sway



Shown in image:  
Square steel tubing provide strength and exclusive bolted corner clamps assure a tight, secure fit

The remarkable strength of the Stur-D-Screen frame is demonstrated here. Solid square steel tubing, exclusive bolted corner clamps and platform legs provide exceptional strength and sturdiness - enough to support these 200 pound welding tanks.



wilsonindustries



- **VARIETY** - Allows for a variety of configurations to fit any work environment without having to worry about stability of the frame. Creating a work environment with more than one screen is easy, it only takes one extra connector, SDSH02.

The Stur-D-Screen frame (R106668-00) adjusts to 5'x6', 6'x6' and 6'x8' in size to fit 85% of the most common size of welding screen curtains for convenience and ease.



**DESCRIPTION**  
FRAME ONLY - FITS 5' X 5', 5' X 6' 6' X 8'  
CONNECTOR FOR STUR-D-SCREENS

**PART #**  
R106668-00  
SDSH02

FRAME SIZE	STOCK ITEM SPECTRA	PART # W/ SPECTRA 14 MIL	PART # W/ GOLD 14 MIL	PART # W/ GREEN 14 MIL	PART # W/ GRAY 14 MIL	PART # W/ PLASMA 14 MIL	PART # W/ RIP-STOP*	PART # W/ GREEN CANVAS	STOCK ITEM FRAME	PART # FRAME ONLY
4' X 5' - SINGLE PANEL		R1045-25	R1045-50	R1045-60	R1045-80	R1045-60	R1045-*	R1045-15		R1045-00
5' X 5' - SINGLE PANEL		R1055-25	R1055-50	R1055-60	R1055-80	R1055-60	R1055-*	R1055-15		R1055-00
6' X 4' - SINGLE PANEL		R1064-25	R1064-50	R1064-60	R1064-80	R1064-60	R1064-*	R1064-15		R1064-00
6' X 6' - SINGLE PANEL	3019240	R1066-25	R1066-50	R1066-60	R1066-80	R1066-60	R1066-*	R1066-15	3019175	R1066-00
6' X 8' - SINGLE PANEL	3019248	R1068-25	R1068-50	R1068-60	R1068-80	R1068-60	R1068-*	R1068-15	3019176	R1068-00
6' X 10' - SINGLE PANEL		R10610-25	R10610-50	R10610-60	R10610-80	R10610-60	R10610-*	R10610-15		R10610-00
6' X 12' - SINGLE PANEL		R10612-25	R10612-50	R10612-60	R10612-80	R10612-60	R10612-*	R10612-15		R10612-00
5' X 5' - TWO PANEL		R2055-25	R2055-50	R2055-60	R2055-80	R2055-60	R2055-*	R2055-15		R2055-00
6' X 4' - TWO PANEL		R2064-25	R2064-50	R2064-60	R2064-80	R2064-60	R2064-*	R2064-15		R2064-00
6' X 6' - TWO PANEL		R2066-25	R2066-50	R2066-60	R2066-80	R2066-60	R2066-*	R2066-15		R2066-00
6' X 8' - TWO PANEL		R2068-25	R2068-50	R2068-60	R2068-80	R2068-60	R2068-*	R2068-15		R2068-00
5' X 5' - THREE PANEL		R3055-25	R3055-50	R3055-60	R3055-80	R3055-60	R3055-*	R3055-15		R3055-00
6' X 4' - THREE PANEL		R3064-25	R3064-50	R3064-60	R3064-80	R3064-60	R3064-*	R3064-15		R3064-00
6' X 6' - THREE PANEL		R3066-25	R3066-50	R3066-60	R3066-80	R3066-60	R3066-*	R3066-15		R3066-00
6' X 8' - THREE PANEL		R3068-25	R3068-50	R3068-60	R3068-80	R3068-60	R3068-*	R3068-15		R3068-00
6' X 6' - FOUR PANEL		R4066-25	R4066-50	R4066-60	R4066-80	R4066-60	R4066-*	R4066-15		R4066-00
6' X 8' - FOUR PANEL		R4068-25	R4068-50	R4068-60	R4068-80	R4068-60	R4068-*	R4068-15		R4068-00

\*ADD COLOR CODE AFTER EACH PART NO. PREFIX FOR ORDERING. RIP-STOP IS AVAILABLE IN GREEN-95, YELLOW-85, BLUE-65, RED-35 OR BLACK-55. (EX. 4520-85)  
RE-COVERS (SAFETY CURTAINS) ARE AVAILABLE UPON REQUEST.  
PER OSHA RECOMMENDATIONS, ALL CURTAINS ALLOW 1FT. CLEARANCE AT FLOOR.

## STUR-D-SHIELD



Lightweight, compact and easy to assemble, the portable Stur-D-Shield folds flat when not in use. Provides all the features of Stur-D-Screen and is perfect as a tabletop welding screen, portable maintenance screen or compact safety screen. Fits easily into a truck or van. Shipped disassembled.

Available with Spectra See-Thru, Gold See-Thru, Green See-Thru, Green Canvas, Weld-O-Glass 3330R (Red Silicone), Weld-O-Glass 900FC (Uncoated white fiberglass).

H" X W"	PART # W/ SPECTRA 14 MIL	PART # W/ GOLD 14 MIL	PART # W/ GREEN 14 MIL	PART # W/ GREEN CANVAS	PART # W/ W-O-G 900FC	PART # W/ W-O-G 3000R
36"H X 48"W	B342-25	B342-50	B342-60	B342-15	B342-900	B342-3000
36"H X 60"W	B521-25	B521-50	B521-60	B521-15	B521-900	B521-3000
36"H X 72"W	B631-25	B631-50	B631-60	B631-15	B631-900	B631-3000
60"H X 144"W	B754-25	B754-50	B754-60	B754-15	B754-900	B754-3000
72"H X 144"W	B864-25	B864-50	B864-60	B864-15	B864-900	B864-3000

# MODULAR SCREEN

This industrial-grade modular frame can be configured to fit 85% of all welding screen size requirements. The highly adaptable, push button splice-tubing steel construction allows for this single frame to adjust from **6' wide to 8' wide**. The frame adjusts to 5'x6', 6'x6' and 6'x8' in size to fit the most common size of welding screen curtains for convenience and ease. Simply snap spring-pins into place. The Modular Screen is designed to be used individually or quickly hinged together to form multiple panel units. The modular screen is durable, lightweight and easy to assemble.

- Adjust to sizes: 5'x6', 6'x6' and 6'x8'
- Steel tubing with an outside diameter of 7/8"
- 24" crossbar legs standard with all screens
- Exclusive corner clamp and hinge assembly
- Packaged to ship UPS standard and store on warehouse pallet racks

DESCRIPTION	STOCK ITEM	PART #
FRAME ONLY - 1 PANEL	3019148	M66-68



Shown in image:  
Simply snap spring pins into place for easy assemble

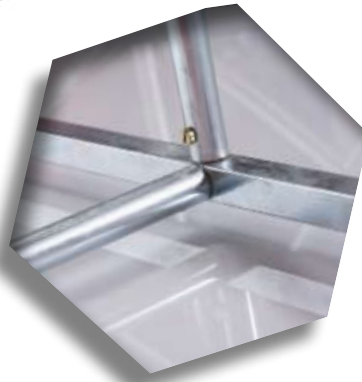

Shown in image:  
Crossbar legs standard with all screens for stability



Shown in image:  
7/8" round steel tubing for a durability

## KITS INCLUDE WELDING SCREEN OF YOUR CHOICE!

The new Modular Screen is available in kits for your ordering convenience. The kits are designed to meet the most common welding screen requirements and include a Modular Screen frame and your choice of screen material size to either 5'x6', 6'x6' or 6'x8'. You can also purchase the standard size screen material separately. Kits are packaged to meet UPS specifications to reduce shipping cost.

H' X W'	PART # W/ SPECTRA 14 MIL	PART # W/ GOLD 14 MIL	PART # W/ GREEN 14 MIL	PART # W/ GRAY 14 MIL	PART # W/ PLASMA 14 MIL	PART # W/ CANVAS DUCK	PART # W/ RIP-STOP*
5' X 6'	M56-25	M56-50	M56-60	M56-80	M56-90	M56-15	M56-**
6' X 6'	M66-25	M66-50	M66-60	M66-80	M66-90	M66-15	M66-**
6' X 8'	M68-25	M68-50	M68-60	M68-80	M68-90	M68-15	M68-**

\*\*ADD COLOR CODE AFTER EACH PART# PREFIX FOR ORDERING. RIP-STOP IS AVAILABLE IN GREEN-95, YELLOW-85, BLUE-65, RED-35) OR BLACK-55). RE-COVERS (SAFETY CURTAINS) ARE AVAILABLE UPON REQUEST. PER OSHA RECOMMENDATIONS, ALL CURTAINS ALLOW 1FT. CLEARANCE AT FLOOR.

wilsonindustries



## TRI-FOLD SCREEN

Wilson Tri-Fold Screen offers flexible, lightweight and durable protection for a variety of welding and industrial applications. Our unique swing arm feature adapts to any angle or shape. Wilson Tri-Fold consists of sturdy 1" square steel tubing, compression brackets, platform legs and wrap-around safety curtain. This screen measures 6' high with a 6' wide center panel and 4' wide side panels. Available in all Wilson See-Thru fabrics.



DESCRIPTION	PART #
SPECTRA ORANGE SEE-THRU	T36464-25
GOLD (YELLOW) SEE-THRU	T36464-50

Per OSHA recommendations, all curtains allow 1ft. clearance at floor.

## ACCESSORIES



### WIND CONTROL VALVE

Valve allows bottom hem to be filled with water, sand, etc. Provides curtain ballast. One valve every 10' recommended.

PART #	DESCRIPTION
WC-1	WIND CONTROL VALVE



### NYLON TIES

Adjustable nylon ties. Fit 3/4" to 2" outside diameter pipe.

PART #	DESCRIPTION
800	NYLON TIES



### HEM WEIGHT CHAIN

Flexible link chain. Weights and stabilizes safety/welding curtains. Factory installed into bottom hem of fabric.

PART #	DESCRIPTION
BC015	HEM WEIGHT CHAIN



### PATCH KIT

30 in. by 36 in. material with adhesive backing.

PART #	DESCRIPTION
PK-25	SPECTRA
PK-50	GOLD
PK-60	GREEN
PK-80	GRAY



### GROMMETS

Additional heavy-duty vinyl or brass grommets may be incorporated into any curtain or blanket material.

PART #	DESCRIPTION
GR15	VINYL
GR20	BRASS

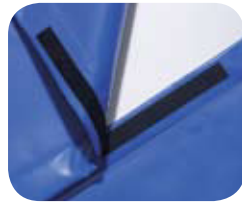

### E-Z FAS'N FASTENER

1-inch wide nylon hook and loop material for joining sections of curtains or other materials together. Press together to close, and pull apart to open.

PART #	DESCRIPTION
EZ005	E-Z FAS'N



### CURTAIN HOOKS

Heavy-duty hooks for use with welding curtains. Fit 1-1/2" to 2" outside diameter pipe.

STOCKED IN BELMONT	PART #	DESCRIPTION
3019060	100	CURTAIN HOOKS



### AIR VENT MESH

Heavy-duty vinyl mesh allows air circulation and ventilation. Does not filter UV radiation. CFM approved.

PART #	DESCRIPTION
AVM-10	AIR VENT MESH



### CASTERS

Two-inch diameter rubber wheel, swivel casters provide rolling portability for tubular frame screens. Adjustable.

PART #	DESCRIPTION
CAS-1	SINGLE-PANEL
CAS-2	TWO-PANEL
CAS-3	THREE-PANEL
CAS-4	FOUR-PANEL



### INSPECTION WINDOW

Shade 8, 20" x 25" flexible window permits viewing of weld puddle through welding screens or shields. Attaches with E-Z FAS'N Fastener.

PART #	DESCRIPTION
IW007	INSPECTION WINDOW

## WELD-O-GLASS BLANKETS



### HIGH TEMPERATURE FABRICS

Recognizing the need for a replacement for harmful asbestos, Wilson Industries turned to the science of metallurgy in order to perfect their fiberglass, high-temperature fabric, Weld-O-Glass.

Wilson Weld-O-Glass fabrics are used to protect equipment and personnel near hazardous operations, such as welding, flame cutting, grinding or spraying. The Weld-O-Glass family of fabrics is made up of fiberglass and silica materials with working temperatures ranging from 600°F to 2000°F. These fabrics can be made into blankets, hanging curtains or are available as roll goods.

#### Weld-O-Glass Uses

- Welding Slag Protection, Stress Relief, Oven Door Insulation, Pig-tails, Gaskets Low Coiling/Tempering, Heat Containment, Personnel Heat Protection, Machine Covers, Pipe and Weld Wrapping

Wilson recommends the use of welding blankets in multiple layers to attain proper molten metal and radiant heat protection. Blankets are hemmed on all four sides and have grommets in each corner and on 36" centers. Actual finished size of blanket may vary 3" in height and width.

### 18 OZ FIBERGLASS - UNCOATED

#### FOR LIGHT USE

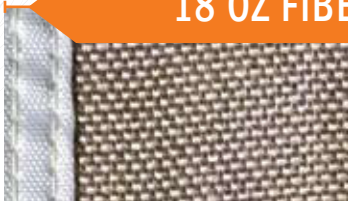

Heat-treating up to 800°F. Pipe wrap. Not recommended for molten metal slag protection. Color: White

DESCRIPTION	PART NO
3' X 3'	3309-1850
5' X 5'	5525-1850
5' X 10'	51050-1850
6' X 6'	6636-1850
6' X 8'	6848-1850
6' X 9'	6954-1850
ROLL-60" X 50 YARDS	1850

### 15 OZ FIBERGLASS - ACRYLIC COATED

#### FOR LIGHT USE



Light spark and spatter protection. To be used on a vertical or angles plane. Working temperature 600°F. (VP) Color: Gray

DESCRIPTION	PART NO
ROLL-60" X 50 YARDS	3001

### 16 OZ FIBERGLASS - NEOPRENE COATED

#### FOR LIGHT USE

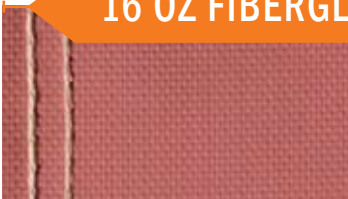

Light spark and spatter protection. To be used on a vertical or angled plane. Working temperature 600°F (VP) Color: Salmon

DESCRIPTION	PART NO
3' X 3'	3309-2000TP
5' X 5'	5525-2000TP
5' X 10'	51050-2000TP
6' X 6'	6636-2000TP
6' X 8'	6848-2000TP
6' X 9'	6954-2000TP
ROLL-38" X 50 YARDS	2000TP

### 24 & 35 OZ FIBERGLASS - UNCOATED

#### FOR MEDIUM TO HEAVY USE



Heat treating up to 800°F. 35 oz. provides extra weight for added durability. Color: White

DESCRIPTION	PART NO 24 OZ	PART NO 35 OZ
3' X 3'	3309-900	3309-1000
5' X 5'	5525-900	5525-1000
5' X 10'	51050-900	51050-1000
6' X 6'	6636-900	6636-1000
6' X 8'	6848-900	6848-1000
6' X 9'	6954-900	6954-1000
ROLL-40" X 50 YARDS	900FC	
ROLL-60" X 50 YARDS	900FC	1000FC

## 24 & 30 OZ FIBERGLASS - NEOPRENE COATED

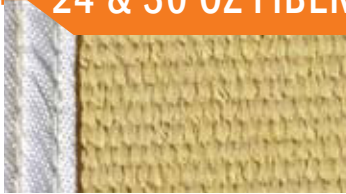

One side coated with neoprene. Good spark and spatter protection. 24 oz. medium duty and 30 oz. heavy duty welding blanket. Working temperature 600°F. (VP) Color: Yellow

DESCRIPTION	PART NO	STOCK ITEM	PART NO
	24 OZ		30 OZ
3' X 3'	3309-2624		3309-2600
5' X 5'	5525-2624		5525-2600
5' X 10'	51050-2624		51050-2600
6' X 6'	6636-2624	3018750	6636-2600
6' X 8'	6848-2624	3018751	6848-2600
6' X 9'	6954-2624		6954-2600
ROLL-40" X 50 YARDS	2624		2600
ROLL-60" X 50 YARDS	2624		2600
ROLL-72" X 50 YARDS	2624		2600

FOR MEDIUM TO HEAVY USE

## 24 OZ FIBERGLASS - VERMICULITE COATED

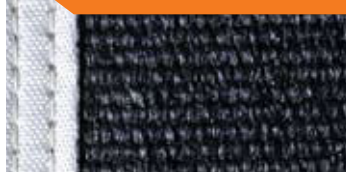

Good spark and spatter protection. Medium to heavy duty welding blanket. Good for heat treating. Working temperature 1000°F. Color: Black

DESCRIPTION	STOCK ITEM	PART NO
3' X 3'		3309-906
5' X 5'		5525-906
5' X 10'		51050-906
6' X 6'	3018803	6636-906
6' X 8'	3018805	6848-906
6' X 9'		6954-906
ROLL-40" X 50 YARDS		906
ROLL-60" X 50 YARDS		906
ROLL-72" X 50 YARDS		906

FOR MEDIUM TO HEAVY USE

## 32 OZ FIBERGLASS - SILICONE COATED



Good spark and spatter protection. To be used on a vertical or angled plane. No halides or chlorides. Working temperature 600°F. (VP) Color: Red

DESCRIPTION	PART NO
3' X 3'	3309-3000
5' X 5'	5525-3000
5' X 10'	51050-3000
6' X 6'	6636-3000
6' X 8'	6848-3000
6' X 9'	6954-3000
ROLL-38" X 50 YARDS	3000R
ROLL-60" X 50 YARDS	3000R

FOR HEAVY USE

## 15 OZ CARBONIZED ACRYLIC FELT



Light all purpose welding blankets. Extremely heat and fire resistant. Melting temperature up to 3000°F

DESCRIPTION	STOCK ITEM	PART NO
3' X 3'		3309-5180
5' X 5'		5525-5180
5' X 10'		51050-5180
6' X 6'	3018788	6636-5180
6' X 8'		6848-5180
6' X 9'		6954-5180
ROLL-72" X 50 YARDS		5180

FOR HEAVY USE

## 18 & 36 OZ SILICA - UNCOATED



Good spark and spatter protection. 18 oz. medium duty and 36 oz. heavy welding blanket. Good for heat treating. Work temperature 1700°F. Color: Tan

DESCRIPTION	PART NO	PART NO
	18 OZ	36 OZ
3' X 3'	3309-21900	3309-23700
5' X 5'	5525-21900	5525-23700
5' X 10'	51050-21900	51050-23700
6' X 6'	6636-21900	6636-23700
6' X 8'	6848-21900	6848-23700
6' X 9'	6954-21900	6954-23700
ROLL-36" X 50 YARDS	2-1900	2-3700

FOR MEDIUM TO HEAVY USE



### HOW TO ORDER

- Select appropriate fabric for application
  - Fire/Welding Blanket** - (a)1000FC, (b)2600, (c)906, (d)900FC, (e)2624
  - Slag Protection** - (a)3000R, (b) 3001, (c)906, (d)2600, (e)2000G
  - Furnace Blanket** - (a)2-3700, (b)2600AMA
  - Stress Relief to 800°F** - (a)1000FC, (b)900FC, (c)906
  - Extra High Temperature & Stress Relief over 1000°F** - (a)HTFM, (b)2-3700, (c)2-1900
  - Arc Gouging/Grinding** - (a)3000R, (b)2000G
- Determine dimensions of area to be protected
- Choose roll goods or size of finished blankets.

Temperature ratings are based on recommended usages and presented without guarantee or responsibility on our part. Information given herein is intended to be used as a guideline only.

As the industry leader in strip curtains, Wilson now offers our quality strip curtains in a made-to-order package. Just by following a few steps you can custom order curtains to fit your exact needs. Wilson products are designed to improve the overall working environment and increase productivity. All of our products meet or exceed OSHA specifications.

Easily pass into and out of noisy, hazardous or energy-wasting work areas. No struggling with heavy, awkward doors. Wilson See-Thru Strip Curtains automatically reseal with non-gap closure after pass through.

**CLARITY** Wilson clear vinyl strips allow added safety of a less obstructed view with outstanding clarity. Stabilizers added to the vinyl compound help reduce fading and yellowing.

**ROUND EDGES** Round edges help prevent snagging of products or clothes, with no sharp edges that harm personnel.

**CONCAVE/CONVEX** When hung, Wilson strips have a curved profile. By alternating and overlapping the strips, the opening has a built-in sealing ability, improving effectiveness.

**STRONG/FLEXIBLE** All Wilson vinyl products are available in a variety of thicknesses and widths to suit your applications.

Sound Transmission - Loss dB

FREQUENCY	80 MIL SHEET	160 MIL SHEET
100 HZ	7	13
125 HZ	8	14
160 HZ	6	12
200 HZ	4	10
250 HZ	13	19
315 HZ	13	19
400 HZ	16	22
500 HZ	17	23
630 HZ	19	25
800 HZ	20	26
1000 HZ	22	28
1250 HZ	23	29
3100 HZ	30	36
4000 HZ	31	37
5000 HZ	33	39

FULL OVERLAP IS RECOMMENDED FOR MAXIMUM SOUND REDUCTION.

## HOW TO ORDER IN A FEW EASY STEPS

### 1 Identify your safety and comfort needs.

Take a look at your whole work area. Are these areas that could be broken up in to specific stations?

- Welding, sanding, heavy traffic
- Temperature control to regulate wide fluctuation changes in temperature
- Refrigeration containment
- Dust control...storage areas for sensitive work areas

Now look at the shapes below and see if these can work for you. Enclosures and doors can be designed in any configuration and combination of: Beam Mount, Vertical Suspension, Wall Mount, Floor Mount, Automatic/Robotic.

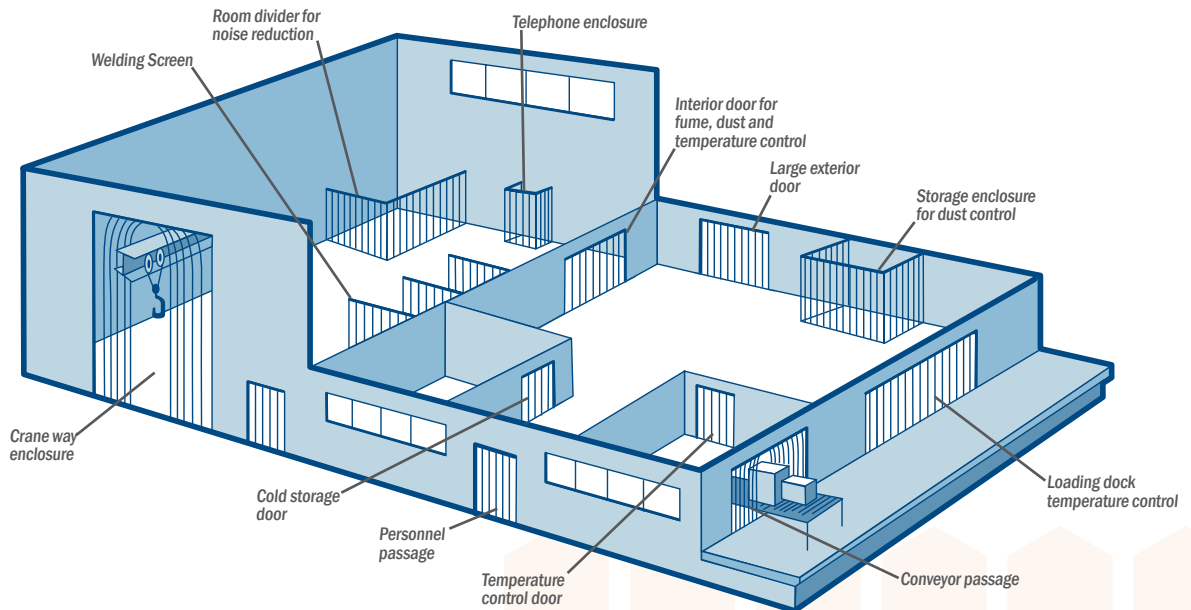
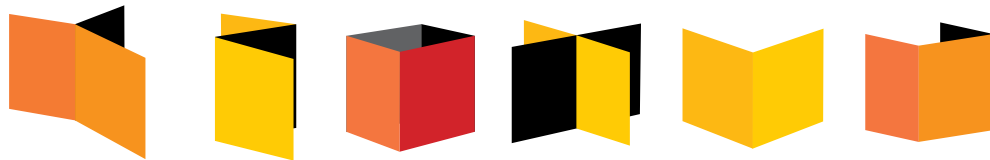



## 2

### Sketch out your design and list the hardware components needed.

Sketch out the design you want and refer to that track hardware system to see all components offered.

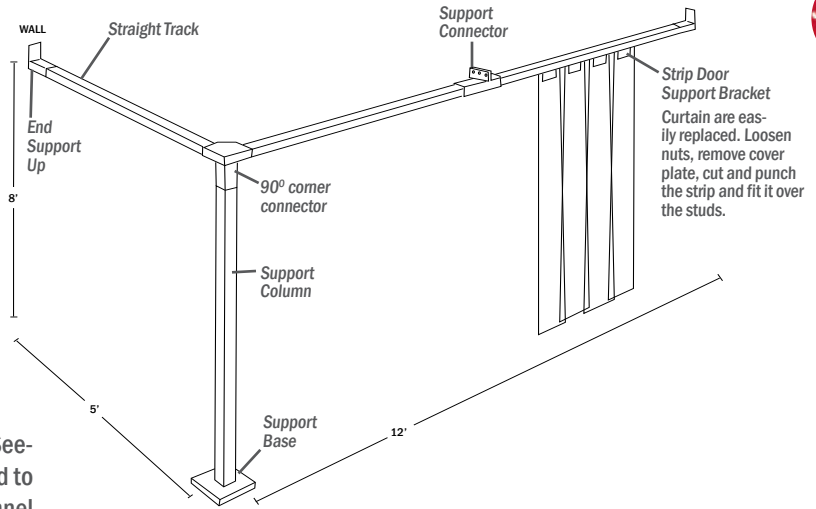

#### UNIVERSAL MOUNT

SUB100. 14 gauge, galvanized steel. Punched strips fit over studs welded to bracket and are secured in place with cover plates and nuts. Design allows Header Mount to overhead surface inside doorway, Wall Mount over doorway, or Threaded Rod. Call Customer Service at 1-800-423-4277 with dimensions.

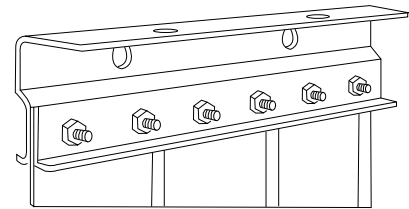

#### SB500 SUPPORT BRACKET/CHANNEL TRACK

One person can easily install or individually replace See-Thru Strip Curtains. They are hung on 1/4" studs welded to a support bracket which is inserted into a modular channel track. A sectionalized front bar is used to compress the strip material to the support bracket.

SB500 support brackets can be mounted to the ceiling, lintel bar, suspended from chain, cable, threaded rod, angle iron, or supported from the floor. Support brackets also integrate with Track Hardware on page 96.

- Please specify exact lengths needed. Standard support spacing is approximately 5-7 feet.

## 3

### Choose strip curtain for your specific application.

Considerations in choosing strip width, thickness and type of curtains:

#### 1. How do I determine what size strip I need?

Wilson recommends using the following guidelines:

DOOR HEIGHT	STRIP SIZE
UP TO 8' HIGH	6" - 40 MIL STRIP
8' TO 10'	8" - 80 MIL STRIP
10' TO 12'	12" - 120 MIL STRIP
12' AND HIGHER	16" - 160 MIL STRIP

#### 2. How do I determine the overlap I need?

A rule of thumb would be: If you have only pedestrian traffic, use a partial overlap. If you have forklift traffic, need protection from nose and /or temperatures, use a full overlap.

#### 3. Do I need a ribbed or reinforced strip curtain?

You would only need the ribbed or reinforced strip if you have a high traffic area using pallet jacks, forklifts, highly abrasive materials, etc.

#### 4. What if I need strips in a low temp or food grade area?

Wilson does offer both low temp and USDA approved strip materials.

#### 5. Do the strip curtains offer light protection from Welding?

Wilson has strip curtains available in see-thru amber and spectra orange. These materials offer the same protection from dangerous UV radiation and arc glare as Wilson's innovative welding curtains and screens.

#### 6. Do you want to order extra replacement strips?

Strip curtains are easily replaced. Just loosen nuts, remove cover plate, cut and punch the strip and fit it over the studs. All Wilson strip curtains are also sold in roll lengths. If you need to replace your strips it's great to have a roll around. You will just cut the length you need and replace any number of strip.

#### SEE-THRU STRIP CURTAIN MATERIAL, STRIP WIDTH, & THICKNESS

		PARTIAL OVERLAP PART NO	FULL OVERLAP PART NO
SEE-THRU CLEAR	6" W .040	S666-40	N/A
SEE-THRU CLEAR	8" W .080	S850-40	S810-40
SEE-THRU CLEAR	12" W .120	S1266-40	S1210-40
SEE-THRU CLEAR	16" W .160	S1650-40	S1610-40
SEE-THRU AMBER	6" W .040	S666-50	N/A
SEE-THRU AMBER	8" W .080	S850-50	S810-50
SEE-THRU AMBER	12" W .120	S1266-50	S1210-50
SEE-THRU AMBER	16" W .160	S1650-50	S1610-50
SEE-THRU ORANGE	6" W .040	S666-25	N/A
SEE-THRU ORANGE	8" W .080	S850-25	S810-25
SEE-THRU ORANGE	12" W .120	S1266-25	S1210-25

\*1/2" OVERLAP FOR 8" AND 16" STRIPS, 2/3" OVERLAP FOR 6" AND 12" STRIPS USDA, REINFORCED OR RIBBED MATERIALS AVAILABLE. CONTACT FACTORY FOR PRICE.

#### REPLACEMENT STRIPS MATERIAL, STRIP WIDTH, & THICKNESS

		APPROX. WEIGHT & FT PER ROLL	PART NO
SEE-THRU CLEAR	6" W .040	62 LBS, 300'	S406-40
SEE-THRU CLEAR	8" W .080	100 LBS, 300'	S808-40
SEE-THRU CLEAR	12" W .120	150 LBS, 200'	S1212-40
SEE-THRU CLEAR	16" W .160	200 LBS, 150'	S1610-40
SEE-THRU AMBER	6" W .040	62 LBS, 300'	S406-50
SEE-THRU AMBER	8" W .080	100 LBS, 300'	S808-50
SEE-THRU AMBER	12" W .120	150 LBS, 200'	S1212-50
SEE-THRU AMBER	16" W .160	200 LBS, 150'	S1610-50
SEE-THRU ORANGE	6" W .040	62 LBS, 300'	S406-25
SEE-THRU ORANGE	8" W .080	100 LBS, 300'	S808-25
SEE-THRU ORANGE	12" W .120	150 LBS, 200'	S1212-25

## TRACK HARDWARE SYSTEM

Wilson's track hardware system forms quick, economical walls at a fraction of the cost of standard construction. Break up large areas into smaller compartments for safety, privacy and convenience. Track Hardware moves on quiet nylon rollers set in steel track. All components are hot-dipped galvanized or zinc plated to prevent rusting.

Available in five suspension methods (may be used in any combination): Beam/Vertical Suspension, Wall Mounting, Ceiling Mounting, Floor Mounting or Thread Rod Mounting

### HOW TO ORDER

The experts in customer service at Wilson Industries can help you design work areas within a space using the Wilson Track Hardware System. You can be sure that layout of the space, the suspension method and connectors they suggest are the best for your application.





- Determine dimension of each side
- Choose suspension system
- Order all necessary parts based on
  - A. suspension system B. type of corners (deduct 2 feet from adjacent track sections for curved corner)
  - C. length of sides (sides should be supported at maximum 10' intervals)
- Select Wilson fabric and order curtains). Add 10% to width for proper drape. Specify height and width.

Note: Wilson Track Hardware is shipped disassembled. Nuts and bolts not included.

## COMPONENTS

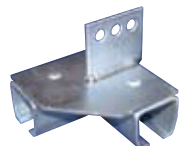
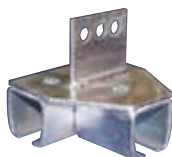
 STRIP DOOR SUPPORT BRACKET (4" LONG) 21132	 HINGED STRIP DOOR TROLLEY 21130	 PULL ROPE WITH BRACKET 21131	 STRAIGHT TRACK 5 FEET 21101-5 6 FEET 21101-6 7 FEET 21101-7 8 FEET 21101-8 9 FEET 21101-9 10 FEET 21101-10 SPECIAL LENGTHS AVAILABLE UPON REQUEST (20 FEET MAXIMUM)		
 STRAIGHT CONNECTOR 211102	 END STOP 21103	 SUPPORT CONNECTOR 21104	 END SUPPORT UP 21105	 END SUPPORT DOWN 21106	 OVERLAPPING TROLLEY 21129

## BEAM MOUNTED





 SUPPORT CONNECTOR 21115	 90° CORNER CONNECTOR 21116	 3-WAY T-CONNECTOR 21117	 THREADED ROD SUPPORT CONNECTOR 21135	 SUPPORT COLUMN 6 FEET 21124 7 FEET 21125 8 FEET 21126	 90° CURVE/24" R (3 SUPPORTS) 21114	 THREADED ROD ADAPTER 21134
---	--	---	--	---	--	--

## FLOOR MOUNTED

 SUPPORT CONNECTOR 21120	 90° CORNER CONNECTOR 21121	 3 WAY T-CONNECTOR 21122	 SUPPORT BASE 21127	 90° CURVE/24" R 21119
---	--	---	---	---

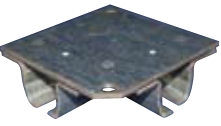
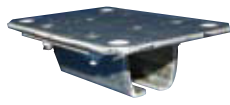
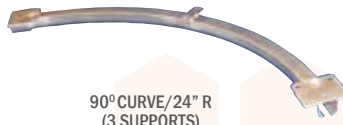
## CEILING MOUNTED

## 2 WAY ROLLER

 90° CORNER CONNECTOR 21110	 SUPPORT CONNECTOR 21109	 90° CURVE/24" R (3 SUPPORTS) 21108	 STEEL WHEEL 21133	 NYLON WHEEL 21128
 3 WAY T-CONNECTOR 21111				

## CURTAIN WALLS



Wilson Curtain Walls offer the most economical solution for the segmentation of a facility. The multi-task environments demand the most efficient utilization of floor space. The thoughtful separation of functions such as metal repair, welding, body prep, washing or detailing can add productivity to your operation.



Wall Curtain Systems combine the highest quality opaque and clear vinyl materials with the integrity of high tensile steel roller track and hardware parts to deliver the finest wall curtain product available. Our curtains are electronically sealed, not sewn, to assure a strong seam for long service life. The side seams are reinforced for strength and the ballast chain weight is secured in a secondary containment hem pocket for added durability. The two-wheel roller hooks assure a smooth action for easy movement of the curtains.

Curtain designs are available in floor-mounted configurations, as well as ceiling suspended styles or flush mounted to prep station or other framework. Curtains are available in a variety of color combinations for a custom coordinated look.

Contact Customer Service for more information at 1-800-423-4277.

### TIE-DOWN STRAPS

Replaceable straps and flush mounting D-ring hardware comprise the tie-down accessory package. Easily attached to the curtain, tie-downs prevent unnecessary curtain movement in draft prone work areas.



DESCRIPTION	PART #
TIE-DOWN STRAP	TD-15

## ANTI-FATIGUE SPATTER MAT



The ultimate anti-fatigue mat for welding areas! The Spatter-Mat's specially formulated rubber surface repels sparks and hot metal shards. Designed for worker comfort, the buoyant sponge base alleviates leg and back stress and minimizes overall body fatigue. Edges are beveled for safety. 1/2" overall thickness. Pebbled surface also provides extra traction in industrial areas.

PART #	DESCRIPTION
2306-SM	2' X 3'
3515-SM	3' X 5'
CUSTOM SIZES UP TO 75' IN LENGTH	

## STRESS RELIEF PADS

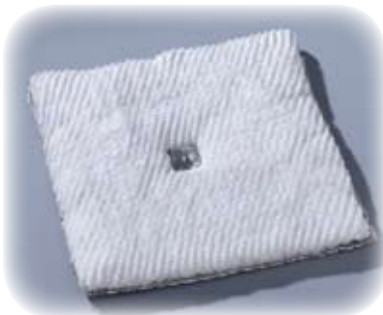

Flexible pads made from special non-asbestos, resilient, high temperature materials. Non-combustible & chemically inert, provides temporary insulation of welds during stress relieving of large diameter piping.

PART #	DESCRIPTION
HTFM	STRESS RELIEF PADS

## STAINLESS STEEL SAFETY MESH



Used as a machine guard to protect personnel and equipment from high velocity flying chips or shrapnel, such as broken carbide cutters and grinding wheels, or large cuts of metal. Excellent as a protective screen around mills, routers, spar mills, lathe, grinders and forges, and as a safety barrier for various types of testing applications.

Stainless steel Safety Mesh is secured at the top and hangs free at both sides and bottom. Safety Mesh not only stops dangerous flying debris, but also protects those within the confines of the work area. Upon contact, the Safety Mesh wraps around the debris and drops it onto the floor, preventing it from leaving the work area or ricocheting back toward the machine operator. Allows for good visibility and airflow into the protected work environment.

- Fire resistant
- Will not absorb oil
- Easily cleaned

For maximum chip protection, mesh should have 50% additional drape or fullness. Mesh should have 100% additional drape for test applications

**DESCRIPTION**

1/8" - 19 GAUGE STAINLESS STEEL MESH (100 LBS/SQ FT)  
 3/16" - 19 GAUGE STAINLESS STEEL MESH (80 LBS/SQ FT)

**PART #**

SSM018  
 SSM316

\*PLEASE SPECIFY WIDTH AND HEIGHT WHEN ORDERING. (BE SURE TO INCLUDE PROPER DRAPE.) MINIMUM HEIGHT 2 FEET - MAXIMUM HEIGHT 20 FEET



## STAINLESS STEEL MESH HOOKS

Each hook "locks in" three strands of steel mesh, creating full draping effect which surrounds flying objects on impact. Should be placed on 3" centers.

**DESCRIPTION**

FITS OVER 1" STANDARD PIPE - DEDUCT 2" ON OVERALL HEIGHT  
 FITS OVER 1.5" STANDARD PIPE - DEDUCT 3" ON OVERALL HEIGHT

**PART #**

1516  
 2000

## STAINLESS STEEL MESH WITH STUR-D-SCREEN

3/16" - 19 gauge mesh with 50% drape. Free standing frame of sturdy square steel tubing. Easy to assemble. 1/8" - 19 gauge and/or additional drape available.

**FRAME SIZE SINGLE PANEL**

5' X 5'  
 5' X 6'  
 5' X 7'  
 5' X 8'  
 6' X 6'  
 6' X 7'  
 6' X 8'

**PART #**

R1055-SSM  
 R1056-SSM  
 R1057-SSM  
 R1058-SSM  
 R1066-SSM  
 R1067-SSM  
 R1068-SSM

**FRAME SIZE TWO PANEL**

5' X 5'  
 5' X 6'  
 5' X 7'  
 5' X 8'  
 6' X 6'  
 6' X 7'  
 6' X 8'

**PART #**

R2055-SSM  
 R2056-SSM  
 R2057-SSM  
 R2058-SSM  
 R2066-SSM  
 R2067-SSM  
 R2068-SSM

**FRAME SIZE THREE PANEL**

5' X 5'  
 5' X 6'  
 5' X 7'  
 5' X 8'  
 6' X 6'  
 6' X 7'  
 6' X 8'

**PART #**

R3055-SSM  
 R3056-SSM  
 R3057-SSM  
 R3058-SSM  
 R3066-SSM  
 R3067-SSM  
 R3068-SSM

Wilson applied the knowledge gained by the military in impact physics, tank armor design and projectile impact science when developing their unique Stainless Steel Safety Mesh.

Boeing engineers used **Wilson Stainless Steel Mesh** when they pressure tested an aircraft. The stainless steel mesh was wrapped around the entire aircraft. It safely captured the flying debris when the wing ruptured, dropping the shrapnel harmlessly to the ground.

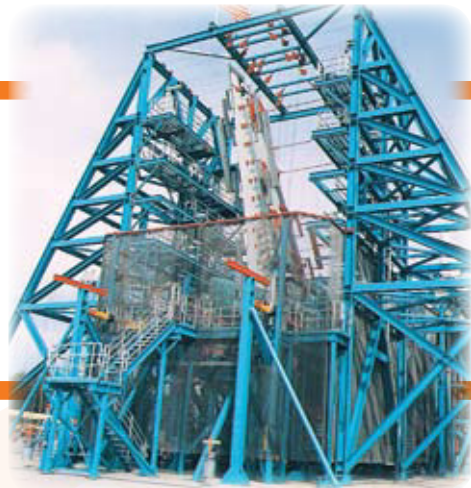

## FLAMESHIELD

## SOLDERING & WELDING PAD

Protects walls, joints and wall studs from burn damage associated with low temperature soldering. Also an excellent blanket for weld sparks and spatter. Flameshield is a must for every toolbox and maintenance service vehicle. Made of Wilson Weld-O-Glass 906 fabric. One grommet in each of the top corners.



DESCRIPTION	PART NO
9" X 12" COATED FIBERGLASS	912FS
18" X 20" COATED FIBERGLASS	1820FS
9" X 12" CARBON FELT	912FS-5180
18" X 20" CARBON FELT	1820FS-5180

## BACK HAND PAD

## ALUMINIZED WELD-O-GLASS

Protects the back of welder's glove from weld spatter and high radiant heat. Increases the life of your glove. Helps you to weld longer when exposed to high radiant heat. Provides good mobility for gloved hand. Double layer protection, Wilson Weld-O-Glass 2600 AMA on top and a high temperature glass fabric on the bottom. Sewn and riveted for added durability.



DESCRIPTION	STOCK ITEM	PART NO
BACK HAND PAD (MIN. ORDER 6)	3018810	BHP06

## ELECTRO-SAFE ANTI-STATIC

## SEE-THRU VINYL CURTAIN

A SUPERIOR ANTI-STATIC, See-Thru vinyl curtain. A carbon scrim grounds out electrical charges, bringing the curtain down to zero voltage. Static free, ideal anywhere a dust-free environment is vital. Fire retardant.

Contact customer service for ordering information at 800-423-4277



## WELDING UMBRELLA

Provides great protection from rain or sunlight. Features a lightweight aluminum frame and tilt mechanism. Cover made of fire retardant, Rip-Stop vinyl for water and tear resistance.

PART #	DESCRIPTION
UM6500	BLUE
UM8500	YELLOW
UM9500	GREEN
UB750	RED, WHITE & BLUE

trafficsafety



## PROTECTING OUR ROAD WARRIORS

For work zone related safety products, Jackson Safety is truly the most complete safety solution.

In the area of temporary traffic control, we provide high visibility safety products that not only meet or exceed federal and state standards, but offer solutions for motorists and pedestrians in both high speed and low speed work zones.

Worker safety and visibility is the ultimate goal in the Jackson Safety line of Road Warrior safety apparel. This quality line of apparel combines comfort and breathability in garments with a high degree of visibility that meets ANSI/ISEA requirements and provides workers with full 360° visibility in all types of light and weather conditions.

As the leading manufacturer of traffic cones, Jackson Safety offers the broadest array of products in the industry and provides custom stenciling for high visibility identification.

Whether the work zone specifications call for barricades, cones, channelizers, roll-up signs, sign stands or a broad variety of other highway and traffic safety products, Jackson Safety has the experience and the products that are necessary to provide a complete solution for every need.

In a broad sense, traffic control for Jackson Safety also means crowd management in non-highway settings, such as public buildings, restaurants, and other venues, where maintenance and control products such as floor cones become a necessity. The Jackson line of products, with its long standing Lamba® line, meets and exceeds this need.





## STANDARDS

**ANSI 107:** The American National Standards Institute (ANSI) publishes a regulatory safety standard for high visibility clothing. The standard defines three classes of successively more visible garments that protect workers exposed to increasingly higher levels of risk from motor vehicles and heavy equipment.

**MUTCD:** The Manual on Uniform Traffic Control Devices (MUTCD) is a document issued by the Federal Highway Administration (FHWA) of the United States Department of Transportation (USDOT) to specify the standards by which traffic signs, road markings, and signals are designed, installed and used. These specifications include the shapes, colors, and fonts used in road markings and signs. All of Jackson Safety's traffic products meet MUTCD standards.

**NCHRP 350:** The National Cooperative Highway Research Program (NCHRP) represents uniform guidelines for conducting full-scale crash tests for permanent and temporary highway safety features. The crash performance is judged on structural adequacy, occupant risk and vehicle trajectory. Products addressed in these guidelines include longitudinal barriers, transitions, end terminals, crash cushions, breakaway/yielding supports, truck mounted attenuators and work zone traffic control devices. All of Jackson Safety's traffic products meet or exceed NCHRP 350 regulations.

**ITE:** The Institute of Transportation Engineers (ITE) is an international educational and scientific association of transportation professionals who attempt to meet mobility and safety standards. ITE facilitates the application of technology and scientific principles to research, plan, functional design, implementation, operation, policy development and management for any mode of transportation. Jackson Safety's line of barricade lights have all been awarded ITE certification.

**FMVSS 125:** Federal Motor Vehicle Safety Standards (FMVSS) is a standard that applies to the shape, size, and performance requirements for reusable day and night warning devices that can be erected on or near the roadway to warn approaching motorists of the presence of a stopped vehicle. Our safety triangles conform to FMVSS standards.

**OSHA:** Occupational Safety and Health Administration (OSHA) is a division of the United States Department of Labor. Their mission is to prevent work-related injuries, illnesses and deaths by issuing and enforcing standards for workplace safety and health.

**ISEA:** The International Safety Equipment Association (ISEA) is the primary trade association in the U.S. for companies that manufacture safety and personal protective equipment. The member companies are world leaders in the design and manufacturing of protective clothing and equipment used in factories, construction sites, hospitals, clinics, farms, schools, laboratories, emergency response and in the home.

## ANSI STORM APPAREL

360° visibility with reflective tape. Machine washable.



Shown #3009694

### ANSI CLASS 3 STORM JACKET

Meets ANSI/ISEA 107-2004 Class 3 standards. Velcro adjustable cuffs. Convenient stow away hood folds inside collar. Non-ANSI fleece lined inner vest can be zipped out and worn alone.



Shown #3009702



### ANSI CLASS E STORM PANTS

Meets ANSI/ISEA 107 Class E standards. Unlined storm pants. Side zipper for coverage over boots. Side slit pockets, single rear pocket with flap and zipper. Belted waist and zipper fly.

DESCRIPTION	PART #
ORANGE JACKET W/SILVER REFLECTIVE - L	3009694 [9150000]
ORANGE JACKET W/SILVER REFLECTIVE - XL	3009298 [9150001]
ORANGE JACKET W/SILVER REFLECTIVE - 2X	3009695 [9150002]
ORANGE JACKET W/SILVER REFLECTIVE - 3X	3009696 [9150003]
LIME JACKET W/SILVER REFLECTIVE - L	3009698 [9150100]
LIME JACKET W/SILVER REFLECTIVE - XL	3009699 [9150101]
LIME JACKET W/SILVER REFLECTIVE - 2X	3009700 [9150102]
LIME JACKET W/SILVER REFLECTIVE - 3X	3009701 [9150103]

DESCRIPTION	PART #
ORANGE PANTS W/SILVER REFLECTIVE - L	3009702 [9151000]
ORANGE PANTS W/SILVER REFLECTIVE - XL	3009299 [9151001]
ORANGE PANTS W/SILVER REFLECTIVE - 2X	3009704 [9151002]
ORANGE PANTS W/SILVER REFLECTIVE - 3X	3009705 [9151003]
LIME PANTS W/SILVER REFLECTIVE - L	3009706 [9151100]
LIME PANTS W/SILVER REFLECTIVE - XL	3009707 [9151101]
LIME PANTS W/SILVER REFLECTIVE - 2X	3009708 [9151102]
LIME PANTS W/SILVER REFLECTIVE - 3X	3009710 [9151103]

## ANSI RAINWEAR

360° visibility with reflective tape. Machine washable.

HydroGARD™ coated polyester outer shell provides a waterproof and breathable system. Two outside front pockets with flip over snap closure and one inside pocket. Under arm vents for added circulation and cooling. Convenient stow away hood inside collar. Snap closure on sleeve cuff closes the space around the hands.



Shown #3012931



Shown #3012927

### ANSI CLASS 3 RAIN JACKET

DESCRIPTION	PART #
ANSI CLASS 3 RAIN JACKET	
ORANGE CLASS 3 RAIN JACKET - L	3012926
ORANGE CLASS 3 RAIN JACKET - XL	3012927
ORANGE CLASS 3 RAIN JACKET - 2X	3012928
ORANGE CLASS 3 RAIN JACKET - 3X	3012929
LIME CLASS 3 RAIN JACKET - L	3012930
LIME CLASS 3 RAIN JACKET - XL	3012931
LIME CLASS 3 RAIN JACKET - 2X	3012932
LIME CLASS 3 RAIN JACKET - 3X	3012933

### ANSI CLASS E RAIN PANTS

DESCRIPTION	PART #
ANSI CLASS E RAIN PANTS	
ORANGE CLASS E RAIN PANTS - L	3012935
ORANGE CLASS E RAIN PANTS - XL	3012936
ORANGE CLASS E RAIN PANTS - 2X	3012937
ORANGE CLASS E RAIN PANTS - 3X	3012938
LIME CLASS E RAIN PANTS - L	3012939
LIME CLASS E RAIN PANTS - XL	3012940
LIME CLASS E RAIN PANTS - 2X	3012941
LIME CLASS E RAIN PANTS - 3X	3012942



Shown #3012940



Shown #3012936



safety apparel



MEETS ANSI/ISEA 107-2004 STANDARDS



## ANSI CLASS 3 CONVERTIBLE PARKA

360° visibility with reflective tape. Machine washable.



Shown #3009724  
CL3 with sleeves



Shown #3009724  
CL2 without sleeves

Meets ANSI/ISEA 107-2004 Class 3 with sleeves and converts to meet ANSI/ISEA 107-2004 Class 2 without sleeves. Convenient stow away hood inside collar. Zipper travels through extended collar for full insulation. Zips into the All Weather System Jacket (shown below) for additional warmth and versatile style.

DESCRIPTION	PART #	
ORANGE WITH SILVER REFLECTIVE - L	3009724	[9153000]
ORANGE WITH SILVER REFLECTIVE - XL	3009726	[9153001]
ORANGE WITH SILVER REFLECTIVE - 2X	3009727	[9153002]
ORANGE WITH SILVER REFLECTIVE - 3X	3009728	[9153003]
LIME WITH SILVER REFLECTIVE - L	3009729	[9153100]
LIME WITH SILVER REFLECTIVE - XL	3009301	[9153101]
LIME WITH SILVER REFLECTIVE - 2X	3009731	[9153102]
LIME WITH SILVER REFLECTIVE - 3X	3009733	[9153103]

## ANSI ALL WEATHER APPAREL

360° visibility with reflective tape. Machine washable.



### ANSI CLASS 3 ALL WEATHER SYSTEM JACKET

Meets ANSI/ISEA 107-2004 Class 3 standards. ANSI Class 3 Convertible parka (shown above) may be zipped inside for additional protection and warmth. Convenient snap-on hood. Insulated patch pockets with flaps. Elastic cuffs with adjustable closure.



Shown #3009712



### ANSI CLASS E ALL WEATHER PANTS

Meets ANSI/ISEA 107 Class E standards. Fleece lined storm pants. Bottom side zipper for coverage over boots. Side slit pockets and single rear pocket with flap and zipper. Belted waist and zipper fly.



Shown #3009739

DESCRIPTION	PART #	
ORANGE WITH SILVER REFLECTIVE - L	3009712	[9150000]
ORANGE WITH SILVER REFLECTIVE - XL	3009713	[9150001]
ORANGE WITH SILVER REFLECTIVE - 2X	3009716	[9150002]
ORANGE WITH SILVER REFLECTIVE - 3X	3009719	[9150003]
LIME WITH SILVER REFLECTIVE - L	3009718	[9150100]
LIME WITH SILVER REFLECTIVE - XL	3009300	[9150101]
LIME WITH SILVER REFLECTIVE - 2X	3009720	[9150102]
LIME WITH SILVER REFLECTIVE - 3X	3009722	[9150103]

DESCRIPTION	PART #	
ORANGE WITH SILVER REFLECTIVE - L	3009734	[9152000]
ORANGE WITH SILVER REFLECTIVE - XL	3009736	[9152001]
ORANGE WITH SILVER REFLECTIVE - 2X	3009737	[9152002]
ORANGE WITH SILVER REFLECTIVE - 3X	3009738	[9152003]
LIME WITH SILVER REFLECTIVE - L	3009739	[9152100]
LIME WITH SILVER REFLECTIVE - XL	3009302	[9152101]
LIME WITH SILVER REFLECTIVE - 2X	3009740	[9152102]
LIME WITH SILVER REFLECTIVE - 3X	3009741	[9152103]



Shown in image: #3009729 - Lime Parka, #3009298 - Orange Storm Jacket

Jackson Safety uses only the most durable finest materials to produce our traffic safety products. We promise that all of our collars fit specific to the style of the cone in order to meet all of the necessary standards required to provide you with the ultimate protection in any work environment.

## STANDARDS & REGULATIONS

### MUTCD (Manual on Uniform Traffic Control Devices)

The Manual on Uniform Traffic Control Devices (MUTCD) is a document issued by the Federal Highway Administration (FHWA) of the United States Department of Transportation (USDOT) to specify the standards by which traffic signs, road markings and signals are designed, installed and used. In the United States, all traffic control devices must generally conform to these standards. The manual is used by state and local agencies as well as private construction firms to ensure that the traffic control devices they use conform to the national standard. While some state agencies have developed their own set of standards, their standards must be in substantial conformance with the MUTCD.

### NCHRP 350 (National Cooperative Highway Research Program)

The National Cooperative Highway Research Program represents uniform guidelines for conducting full-scale crash tests for permanent and temporary highway safety features along with recommended evaluation criteria to assess the test results. The crash performance is judged on structural adequacy, occupant risk and vehicle trajectory. Category I devices may be self-certified and include traffic cones, channelizer drums (without lights) and delineators. Category II devices must be crash-tested include channelizer drums (with lights), vertical panels, barricades (Types I, II and III) and sign stands.

### ITE (Institute of Transportation Engineers)

The Institute of Transportation Engineers is an international educational and scientific association of transportation professionals who attempt to meet mobility and safety needs and was founded in 1930. ITE is a standards development organization designated by the U.S. Department of Transportation. Traffic barricade lights must also adhere to ITE testing standards.



As the market leader in traffic cones, we manufacture all of our traffic cones in the United States to meet NCHRP 350 Category 1 and MUTCD standards.



trafficsafety

## CUSTOM IMPRINTING

Imprinting and silk screening are available for all traffic cones. 100 cone minimum per order. Lead time required. Only available in black ink.

### STENCILING

Stenciling available for both the outside of the cone and the inside liner. One-time stencil set-up fee applies. Per cone additional charge applies for inner and outer stencil. Standard legends for imprinted cones require no set-up charge and include the following: WET FLOOR, CAUTION, DANGER, KEEP OUT, NO PARKING, NO SMOKING.

### SILK SCREEN

Silk screen available on the outside of cone only. Film charge applies for silk screen. Camera-ready artwork must be provided for all silk screens. Camera-ready artwork is defined as "digital form, 1-bit format, true black on white (no gray scale) of imprint. Image must be the same size for the graphic to be printed.

### CUSTOM IMPRINTS: AVAILABLE SPACE PER SCREEN

CONES WITHOUT COLLARS		CONES WITH COLLARS	
18"	5"W x 10"H	18"	5"W x 6"H
28"	10"W x 18"H	28"	10"W x 9"H
36"	11"W x 22"H	36"	11"W x 17"H



## DW SERIES



Wide body design with rugged black base. Flow molded, dayglow orange PVC with white inner liner.

DESCRIPTION	PART #	
6" DW CONE - 1.0 LBS	3004101	[0100680]
12" DW CONE - 2 LBS	3004020	[0100032]
18" DW CONE - 3 LBS	3004023	[0100109]
18" DW CONE - 5 LBS	3004174	[2058609]
18" DW CONE - 6" COLLAR, 3 LBS, 3M	3004319	[2215283]
18" DW CONE - CONE 18DW 4" REFLECTIVE COLLAR	3004345	[2202539]
28" DW CONE - 7 LBS	3004057	[0100355]
28" DW CONE - 4" COLLAR	3015901	
28" DW CONE - 6" & 4" COLLARS, 7 LBS, 3M	3004236	[2193643]
28" DW CONE - 10 LBS	3004176	[2058647]
28" DW CONE - 6" & 4" COLLARS, 10 LBS, 3M	3004256	[2202353]
36" DW CONE - 10 LBS	3004159	[2058116]
36" DW CONE - 36DW 4" REFLECTIVE COLLAR	3015918	

## W SERIES



Wide body design with rugged orange base. Flow molded, dayglow orange PVC with white inner liner.

DESCRIPTION	PART #	
4" W CONE - .38 LBS	3004094	[0100666]
12" W CONE - 2 LBS	3004019	[0100006]
18" W CONE - 2.5 LBS	3004042	[0100238]
18" W CONE - 3 LBS W 4" REFLECTIVE COLLAR	3004043	
28" W CONE - 6.5 LBS	3004158	[2058087]
28" W CONE - 6" & 4" COLLARS, 6.5 LBS, 3M	3004245	[2196970]
28" W CONE - CONE 28W 4U AV	3015919	
28" W CONE - 7 LBS	3004181	[2068000]
28" W CONE - 10 LBS	3004175	[2058635]
28" W CONE - CONE 28W 7 LBS 6U4L 3M	3004183	
36" W CONE - 10 LBS	3004160	[2058130]

## W SERIES: RECESSED CONES



Shown right  
#3004604

One piece wide body design and construction. Easier stacking with no pinch points for collars. Increased durability for reflective sheeting; recessed collars resist direct wear. Protected reflective translates into longer service life lowering overall usage costs.

DESCRIPTION	PART #	
28" W CONE RECESSED - 6" & 4" COLLARS, 7 LBS, 3M	3004604	[2069001]

## FLUORESCENT LIME



W Series, wide body design. Flow molded, dayglow fluorescent lime with white inner liner. Differentiates work zone for added measure of safety. Fluorescent color increases pedestrian and driver awareness.

**DESCRIPTION**

18" W CONE FLUORESCENT LIME - 2.5 LBS	3004283	[2212126]
18" W CONE FLUORESCENT LIME - 2.5 LBS W/ 4" REFLECTIVE COLLAR	3008843	
28" W CONE FLUORESCENT LIME - 6.5 LBS	3004286	[2212138]
28" W CONE FLUORESCENT LIME - 6.5 LBS W/ 4" REFLECTIVE COLLAR	3013043	
36" W CONE FLUORESCENT LIME - 10 LBS	3004287	[2212140]

**PART #**

## F SERIES



Shown left #3004179

Heavy, slim line body design to enhance wind resistance. Flow molded, dayglow red/orange with white inner liner.

**DESCRIPTION**

28" F CONE - 10 LBS	3004179	[2058659]
28" F CONE - 6" & 4" COLLARS, 10 LBS, REFLEXITE	3004262	[2202391]
28" F CONE - 6" & 4" COLLARS, 10 LBS, 3M	3004252	[2197390]
28" F CONE - 6" & 4" COLLARS, 10 LBS, AVERY	3004263	[2202395]

**PART #**

## FL SERIES



Shown left #3004085 & #3004071

Narrow wind resistant profile with orange base. Flow molded, dayglow red/orange PVC with white inner liner.

**DESCRIPTION**

18" FL CONE - 2.4 LBS	3004034	[0100185]
18" FL CONE - 4" COLLAR, 2.4 LBS	3004322	[2215611]
28" FL CONE - 5.5 LBS	3004071	[0100484]
36" FL CONE - 8 LBS	3004085	[0100604]

**PART #**

## PACK AND POP COLLAPSIBLE CONE



Internal cone light features 2 settings: steady burn and flashing. Operates on 2 'AAA' batteries (included) and endures 100,000 flashes or 36 hours of steady burn. Constructed with orange waterproof nylon that assures visibility in all weather environments.

**DESCRIPTION**

18" PACK & POP COLLAPSIBLE SAFETY CONE KIT	3012918	
28" PACK & POP COLLAPSIBLE SAFETY CONE KIT	3018159	3012917

**PART #**

4 Pack and Pop cones fit in 1 carrying bag when fully collapsed

NEW PART #	OLD PART #	MATERIAL DESCRIPTION	BASE WIDTH (INCHES)	BASE LENGTH (INCHES)	UNIT WEIGHT (LBS)	PALLET QTY (UNITS)
<b>DW SERIES TRAFFIC CONES</b>						
3004101	0100680	DW CONE - 6"	8	8	1.5	500
3004020	0100032	DW CONE - 12"	8	8	1.5	500
3004023	0100109	DW CONE - 18"	10.75	10.75	3	500
3004174	2058609	DW CONE - 18"	11	11	5	400
3004319	2215283	DW CONE - 18" W/6" UPPER 3M	11	11	3	500
3004345	2202539	DW CONE - 18" 4U AVERY	11	11	3	500
3004057	0100355	DW CONE - 28"	14	14	7	250
3015901	N/A	DW CONE - 28" W/4" COLLARS	14	14	7	250
3004236	2193643	DW CONE - 28" W/6" & 4" COLLARS	14	14	7	200
3004176	2058647	DW CONE - 28"	14	14	10	200
3004256	2202353	DW CONE - 28" W/6" & 4" COLLARS, 3M	14	14	10	250
3004159	2058116	DW CONE - 36"	14	14	10	150
3015918	N/A	DW CONE - 36" 4U AVERY	14	14	10	150
<b>W SERIES TRAFFIC CONES</b>						
3004094	0100666	W CONE - 4"	9	9	.38	500
3004019	0100006	W CONE - 12"	9	9	2	500
3004042	0100238	W CONE - 18"	10.75	10.75	2.5	500
3004158	2058087	W CONE - 28"	14.5	14.5	6.5	250
3004245	2196970	W CONE - 28" W/6" UPPER 4" LOWER 3M	14.5	14.5	6.5	250
3015919	N/A	W CONE - 28" 4U AVERY	14.5	14.5	6.5	250
3004181	2068000	W CONE - 28"	14.5	14.5	7	250
3004175	2058635	W CONE - 28"	14.5	14.5	10	200
3004183	N/A	W CONE - 28" 6U4L 3M	14.5	14.5	7	200
3004160	2058130	W CONE - 36"	14.5	14.5	10	150
<b>W SERIES: RECESSED TRAFFIC CONES</b>						
3004604	2069001	W CONE - 28" RECESSED, 6"UPPER 4"LOWER, 3M	14.5	14.5	6.5	250
<b>W SERIES: FLUORESCENT LIME TRAFFIC CONES</b>						
3004283	2212126	W CONE - 18" FLUORESCENT LIME	10.75	10.75	2.5	500
3004286	2212138	W CONE - 28" FLUORESCENT LIME	14.5	14.5	6.5	250
3004287	2212140	W CONE - 36" FLUORESCENT LIME	14.5	14.5	10	150
<b>FL SERIES TRAFFIC CONES</b>						
3004034	100185	FL CONE - 18"	10	10	2.4	500
3004322	2215611	FL CONE - 18" w/ 4" COLLAR	10	10	2.4	500
3004071	0100484	FL CONE - 28"	13	13	5.5	250
3004085	0100604	FL CONE - 36"	13	13	8	150
<b>F SERIES TRAFFIC CONES</b>						
3004179	2058659	F CONE - 28"	14.5	14.5	10	200
3004252	2197390	F CONE - 28" W/6"UPPER 4"LOWER 3M	14.5	14.5	10	200
3004262	2202391	F CONE - 28" W/6"UPPER 4"LOWER REFLX	14.5	14.5	10	200
3004263	2202395	F CONE - 28" W/6"UPPER 4" LOWER AVERY	14.5	14.5	10	200



## SPORT CONES



Ideal for sporting events, parking lots, festivals and temporary (off highway) traffic delineation. Made from lightweight and durable injection-molded polyethylene. Sold in standard packs of 25 cones.

DESCRIPTION	PART #
18" RED SPORT CONE	3001764 [2027193]
18" BLUE SPORT CONE	3001766 [2027210]
18" YELLOW SPORT CONE	3001765 [2027208]
18" WHITE SPORT CONE	3001767 [2027222]
18" ORANGE SPORT CONE	3001761 [2008733]
18" GREEN SPORT CONE	3001768 [2027753]

## BARRICONE SYSTEM



Cones sold separately

Attaches to your existing 28" or 36" traffic cones to form a highly visible, continuous, rigid barrier that will safely guide vehicles and pedestrians past short duration work sites. High grade yellow polyvinyl chloride (PVC). Lightweight and easy to handle. Panels are stackable for compact storage. Quick and easy set-up and knockdown - no tools required. Reflective models available for day and night roadway use.

DESCRIPTION	PART #
4' YELLOW BARRICONE	3007963 [2191932]
4' YELLOW BARRICONE C/W HI-INT GRADE REFLECTIVE TAPE, ORANGE/BLACK WITH CAUTION DECAL	3015658 [2183399]
4' YELLOW BARRICONE C/W ENG GRADE REFLECTIVE TAPE, ORANGE/WHITE WITH CAUTION DECAL	3007965
6' YELLOW BARRICONE	3007964 [2191944]
6' YELLOW BARRICONE C/W HI-INT GRADE REFLECTIVE TAPE, ORANGE/BLACK WITH CAUTION DECAL	3015660 [2191968]
6' YELLOW BARRICONE C/W ENG GRADE REFLECTIVE TAPE, ORANGE/BLACK WITH CAUTION DECAL	3015659

## MICROLITE FLASHING CONE LIGHT



Sits on any style 18", 28" or 36" traffic cone. Available in yellow case with 360° amber or red lens, with and without photo cell. Mounting bracket included. Powered by a single 6V lantern battery (not included). Flash rate of 120 - 150 flashes per minute. Dimensions: 8" high x 3-1/4" diameter.

DESCRIPTION	PART #
MICROLITE WITH PHOTOCELL, AMBER LENS	3007647 [2095594]
MICROLITE - AMBER LENS	3007533 [2083173]
MICROLITE WITH PHOTOCELL, RED LENS	3008108 [2195421]
LANTERN BATTERY - 12/BOX	3001752 [0118144]

## CONE HOLDER

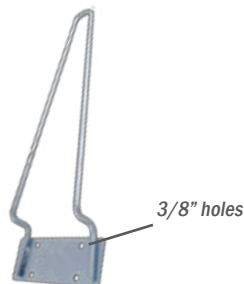

Ideal for vehicular use. Holds no more than (10) 18" cones or (5) 28" cones only. Mounting plate is 6.75" wide. Height of unit = 22" from bottom of mounting plate to top of holder. Hardware not included.

DESCRIPTION	PART #
CONE HOLDER	3001749 [0116976]

## GRIP AND GO™ CHANNELIZER CONE



Shown left  
#3014083 (cone)  
#3014089 (base)

Channelizer cone utilizes less space than traditional barrels or drums. 42" tiered cone design with the easy Grip and Go handle. 47" to the handle top. Available with various reflective sheeting and recessed areas for protection when stacking. Handle accommodates most barricade lights and barrier tape products. Low density polyethylene with UV inhibitors minimizes fading. Exterior handle dimensions: 3-1/2"W x 5"L. Rubber bases have 8" interior opening.

DESCRIPTION	PART #
42" CHANNELIZER WITH NO SHEETING	3014081
42" CHANNELIZER (1) 4" & (1) 6" HI SHEETING	3014082
42" CHANNELIZER (4) 4" HI SHEETING	3014083
42" CHANNELIZER (4) 6" HI SHEETING	3014084
42" CHANNELIZER (2) 6" DG & (2) 6" HI SHEETING	3014085
CHANNELIZER 10LB 16" OCTAGONAL BASE	3009066
CHANNELIZER 15LB 16" OCTAGONAL BASE	3007532
CHANNELIZER 20LB 26" X 12" RECTANGULAR BASE	3014088
CHANNELIZER 30LB 26" X 12" RECTANGULAR BASE	3014089

## DELUXE DELINEATOR POST



Shown above #3008102 (post)  
& #3006195 (base)

Standard 4" x 42" high post, overall height 47". Optional 3" round yellow reflective dot on both sides of post for additional safety. 16"W x 1-1/2"H octagonal base with interlocking high-density polyethylene post.

DESCRIPTION	PART #
42" POST, WHITE HI INTENSITY STRIPES	3007642 [2094294]
42" POST, WHITE HI INTENSITY STRIPES, YELLOW REFL. DOT	3008102 [2195366]
RUBBER DELINEATOR BASE - 10 LB	3001742 [0102391]
RUBBER DELINEATOR BASE - 15 LB	3006195 [0102406]
YELLOW REFLECTIVE DOT ONLY	3008121 [2195902]

## STACKABLE DELUXE DELINEATOR POST

TOP SELLER



Shown above #3008102 (post)  
& #3006195 (base)

Durable, 42" high, linear low density polyethylene post comes complete with two 4" hi-intensity reflective bands. Comfortable grip handle make posts easy to move. Posts are stackable for space preservation. Bases are 100% recycled rubber, octagonal shape.

DESCRIPTION	PART #
42" POST DELINEATOR W/ 2 REFLECTIVE STRIPES	3016118 [2094295]
42" DELINEATOR PLAIN NON-REFLECTIVE	3015476
RUBBER DELINEATOR BASE - 10 LB	3001742 [0102391]
RUBBER DELINEATOR BASE - 15 LB	3006195 [0102406]

## MAXI-POST COMPONENTS

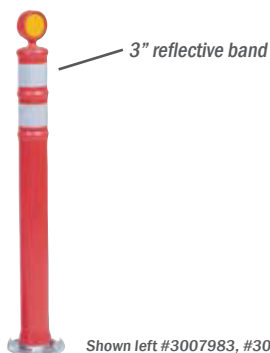

Shown left #3007983, #3007302, #3006196

Standard 4" x 38" high post, overall height 43". Requires 8" diameter cast aluminum base with clamp. Order optional 3" round yellow reflective dot on both sides of post for additional safety or add later. Anchor bolts not included.

DESCRIPTION	PART #
POST ONLY WITH REFLECTIVE STRIPES, 42" X 3"	3007643 [2094307]
POST ONLY, 42" X 3" WITH YELLOW REFLECTIVE DOT	3007983 [2193578]
METAL DELINEATOR BASE - PERMANENT MOUNT	3007302 [2057576]
DELINEATOR BASE CLAMP 8" - CLAMP ONLY	3006196 [0102468]
YELLOW REFLECTIVE DOT ONLY, 2-7/8"	3008121 [2195902]

## IMPACT RECOVERY SYSTEMS

Impact Recovery Systems are temporary and permanent flexible high impact delineation devices for use in construction work zones, highways, streets and parking lots.

The heart of the Impact Recovery System is a unique reactive spring with the strength to support not only a flexible post, but an information panel as well. This unit gives upon impact and is designed to reorient the panel towards traffic. The introduction of the new "Anti-Twist Feature" assures the sign will return to its' original position.



### BASE TYPES (Bases sold separately)

What makes the Portable One Base™ System so unique is virtually every portable channeling device required in today's work zone. This system allows you to move channeling devices to areas needed.

Fixed Bases are for more permanent or extended use in a certain area. Fixed bases require installation materials such as epoxy, anchor bolts, or Super Bundy.

Both bases come with a quick-release option. Quick-release design allows you to change and repair devices in less than 10 seconds. To remove the device, you simply pull the keeper pin and rotate the assembly 15°, then lift and remove. This system is ideal for applications where changeable and/or movable work zone devices are required.





## IMPACT RECOVERY TUBULAR MARKERS



Wall Thickness: 6mm  
 Base Height: 1-1/2"  
 Base Diameter: 4-1/2"  
 Base Material: High Density Polyethelene

Flexible, high-impact delineation devices are designed with energy absorbing mechanics producing a longer lasting traffic control device. Constructed with a unique reactive spring to give with impact and rebound towards traffic. Withstands tested speeds up to 30 mph. Comes with a 'fixed' 8"x8" base designed for concrete median barriers or road surface application using bolts or epoxy (not included).

**DESCRIPTION**

36" ORANGE TUBULAR MARKER - WHITE SHEETING  
 42" ORANGE TUBULAR MARKER - WHITE SHEETING  
 48" ORANGE TUBULAR MARKER - WHITE SHEETING  
 36" ORANGE TUBULAR MARKER - PLAIN  
 42" ORANGE TUBULAR MARKER - PLAIN  
 48" ORANGE TUBULAR MARKER - PLAIN

**PART #**

3020749  
 3020750  
 3020752  
 3015405  
 3015412  
 3015417

36" WHITE TUBULAR MARKER - ORANGE SHEETING  
 42" WHITE TUBULAR MARKER - ORANGE SHEETING  
 48" WHITE TUBULAR MARKER - ORANGE SHEETING  
 36" WHITE TUBULAR MARKER - PLAIN  
 42" WHITE TUBULAR MARKER - PLAIN  
 48" WHITE TUBULAR MARKER - PLAIN

3020753  
 3020754  
 3020755  
 3015406  
 3015413  
 3020742

36" YELLOW TUBULAR MARKER - ORANGE SHEETING  
 42" YELLOW TUBULAR MARKER - ORANGE SHEETING  
 48" YELLOW TUBULAR MARKER - ORANGE SHEETING  
 36" YELLOW TUBULAR MARKER - PLAIN  
 42" YELLOW TUBULAR MARKER - PLAIN  
 48" YELLOW TUBULAR MARKER - PLAIN

3020756  
 3020757  
 3020758  
 3015408  
 3015414  
 3020744

## OPPOSING TRAFFIC LANE DIVIDERS



The opposing traffic lane dividers an help to both minimize a workers' exposure in the roadway and reduce the damage to your decives. They are durable and easy to maintain. Opposing traffic lane dividers have an overall height of 36" with 12" x 18" high intensity or diamond grade panels.

**DESCRIPTION**

OPPOSING TRAFFIC LANE DIVIDER

**PART #**

3016072



## PORTABLE STOP SLOW SIGN



The portable stop sign is great for emergency situations. It can be assembled on location and installed in seconds. It comes with a 24" x 24" durable plastic panel and has an overall viewing height of 60" for great visibility. Not MUTCD compliant as a permanent stop sign.

**DESCRIPTION**  
24" X 24" STOP SIGN

**PART #**  
3015421 [2184862]

## HANDICAP PARKING SIGN



Our handicap parking signs are 12" x 18" with engineer grade sheeting. They have a 5' 6" post and have an overall height of 66".

**DESCRIPTION**  
HANDICAP SIGN ON 5'6" POST ONTARIO SPEC  
5'6" POST ONLY

**PART #**  
3015452 [2191360]  
3015422



## SIGN POSTS

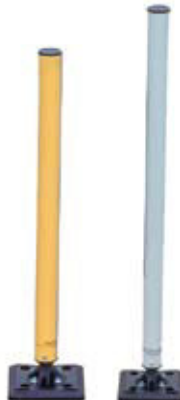

All posts are constructed of flexible polyethylene plastics that are resistant to ultraviolet light, ozone, and hydrocarbons. All parking lot products are available in either portable or fixed bases.

**DESCRIPTION**  
36" YELLOW SIGN POST  
36" ORANGE SIGN POST  
36" WHITE SIGN POST

**PART #**  
3020745  
3017734  
3020760

48" YELLOW SIGN POST  
48" ORANGE SIGN POST  
48" WHITE SIGN POST

3015466  
3015464  
3020761

60" YELLOW SIGN POST  
60" ORANGE SIGN POST  
60" WHITE SIGN POST

3015446  
3020759  
3015447



## HAZARD MARKERS

Hazard markers can help reduce your property damage liability and improve the life of your traffic control equipment. Hazard markers are 12" x 45".

Shown right  
#3015434



Shown left  
#3015436

Shown right  
#3015448



**DESCRIPTION**

HAZARD MARKER, HI-INTENSITY YELLOW/BLACK (RIGHT)  
HAZARD MARKER, HI-INTENSITY YELLOW/BLACK (LEFT)  
ISLAND MARKER, 5' POST HI INTENSITY

**PART #**

3015434 [2184898]  
3015436 [2184903]  
3015448 [2184692]

Ideal for marking exit gores and medians or any area where traffic is directed around two sides of an object. Available in two sizes: small (12" x 24" panels with an overall height of 36") and large (18" x 36" panels with an overall height of 48")

Shown right  
#3015432



**DESCRIPTION**

SERGEANT STRIPES (WA-133)

**PART #**

3015432

## BASES

All bases allow for interchangeable systems. 8" x 8" plastic fixed bases are designed for permanent road surface while portable bases allow mobility.

Shown right  
Portable Base with  
Quick Release  
#3015820



Shown left  
Fixed Base with  
Quick Release  
#3015428



Shown left  
Fixed Base without  
Quick Release  
#3007584



Shown left  
Driveable Base  
#3015426



**DESCRIPTION**

PORTABLE BASE WITH QUICK RELEASE  
FIXED BASE WITH QUICK RELEASE  
FIXED BASE WITHOUT QUICK RELEASE  
DRIVEABLE BASE

**PART #**

3015820 [2088834]  
3015428 [2087313]  
3007584 [2088977]  
3015426 [2088977]

## TWO GALLON EPOXY KIT

Fixed bases require epoxy application. One kit installs approximately 12 bases.



**DESCRIPTION**

TWO GALLON EPOXY KIT

**PART #**

3016268 [2183832]



Shown in image: #3007649 - TrailBoss Drum, #3007669 - 25 LB Base

## TRAILBLAZER™ VERTICAL PANEL



Shown left  
#3007677 (top) and  
#3007674 (base)

Engineer Grade or Hi-Intensity reflective sheeting available. Only weighs 3.4 lbs sheeted excluding rubber base. Stackable. Extreme heat and cold weather durability. Recessed panels protect reflective sheeting. Impact resistant polyethylene. 15 lb, 20 lb and 30 lb recycled rubber bases available.

### DESCRIPTION

NO SHEETING, TOP ONLY  
ENGINEER GRADE SHEETING, BOTH SIDES, TOP ONLY  
ENGINEER GRADE 3M SHEETING, BOTH SIDES, TOP ONLY  
HI INTENSITY SHEETING, BOTH SIDES, TOP ONLY  
15 LB RUBBER BASE, 18.5"W X 22"L X 1.3"H  
20 LB RUBBER BASE, 18.5"W X 22"L X 1.8"H  
30 LB RUBBER BASE, 18.5W X 22"L X 2.6"H

### PART #

3007676 [2161003]  
3007677 [2161004]  
3007678 [2161005]  
3007679 [2161006]  
3007681 [2161008]  
3007674 [2161001]  
3007675 [2161002]

## TRAILBOSS™ CHANNELIZER DRUM



Shown left  
#3007649 (top) and  
#3007668 (base)

Accommodates most barricade lights. Patented handle design allows for easy pickup. Five panels available for sheeting. Choice of two bases: 25 lb. and 35 lb. recycled rubber. Anti-roll foot design. Base incorporates a waffle pattern on bottom to eliminate 'walking' or 'creeping'. Tapered design enables nesting for storage or transportation. Dimensions - 39.7"H x 20.5"W at base. 1600 models are constructed of linear low density polyethylene. 1610 models are constructed of high density polyethylene.

### DESCRIPTION

1600 TOP ONLY, 4 ENGINEER GRADE 4" STRIPES, 3M  
1600 TOP ONLY, 4 ENGINEER GRADE 6" STRIPES, 3M  
1600 TOP ONLY, 4 HI INTENSITY, 4" STRIPES, 3M  
1600 TOP ONLY, 4 HI INTENSITY 6" STRIPES, 3M  
1610 TOP ONLY, 4 ENGINEER GRADE 4" STRIPES, 3M  
1610 TOP ONLY, 4 ENGINEER GRADE 6" STRIPES, 3M  
1610 TOP ONLY, 4 HI INTENSITY 4" STRIPES, 3M  
25 LB RECYCLED RUBBER BASE  
35 LB RECYCLED RUBBER BASE

### PART #

3007649 [2110001]  
3007650 [2110002]  
3007652 [2110004]  
3007654 [2110006]  
3007658 [2110101]  
3007659 [2110102]  
3007661 [2110104]  
3007668 [2111001]  
3007669 [2111002]

## CHANNELIZER DRUM



Shown left  
#3007442 (top) and  
#3007725 (base)

Accommodates most barricade lights. Unique anti-roll drum design with one flat side. Base incorporates waffle pattern on bottom to eliminate 'walking' or 'creeping'. Tapered design enables nesting for storage or transport. 1500 models are constructed of linear low density polyethylene. 1510 models are constructed of high density polyethylene.

### DESCRIPTION

1500 TOP ONLY WITH 4 ENGINEER GRADE 4" STRIPES, 3M  
1500 TOP ONLY WITH 4 ENGINEER GRADE 6" STRIPES, 3M  
1500 TOP ONLY WITH 4 DIAMOND GRADE 6" STRIPES  
1500 TOP ONLY WITH 4 HI INTENSITY 6" STRIPES, 3M  
1500 PLASTIC SNAP ON BASE (REQUIRES SANDBAG)  
1510 TOP ONLY WITH 4 ENGINEER GRADE 4" STRIPES, 3M  
1510 TOP ONLY WITH 4 ENGINEER GRADE 6" STRIPES, 3M  
1510 TOP ONLY WITH 4 HI INTENSITY 4" STRIPES, 3M  
1510 TOP ONLY WITH 4 HI INTENSITY 6" STRIPES, 3M  
25 LB RECYCLED RUBBER BASE  
35 LB RECYCLED RUBBER BASE

### PART #

3007442 [2070188]  
3007443 [2070190]  
3008629 [2204715]  
3007441 [2070177]  
3001773 [2070413]  
3007449 [2070229]  
3007450 [2070231]  
3007446 [2070206]  
3007448 [2070218]  
3007725 [2173459]  
3007605 [2088262]



## T-TOP CHANNELIZER CONE



Shown left  
#3015480 (top) and  
#3015479 (base)

Low density fluorescent orange polyethylene cone can be used as a sleeved cone, tubular delineator post or channelizer device. Unique T-shaped handle with mounting hole for light. Can be stacked with base for confined storage. Bases made from 100% recycled rubber, sold separately. Optional 13" reflexite hi-intensity reflectivity. Cones are 42" in height plus 3" handle and weigh 3 lbs.

**DESCRIPTION**

- 42" T-TOP CHANNELIZER CONE WITH 13" REFLECTIVE COLLAR
- 42" PLAIN CHANNELIZER CONE
- 11 LB BASE FOR CHANNELIZER CONE
- 15 LB BASE FOR CHANNELIZER CONE

**PART #**

- 3015480 [2081457]
- 3001791 [2215532]
- 3015479 [2082893]
- 3007532 [2082880]

## B54A CHANNELIZER



Molded from linear low density polyethylene. Channelizer meets or exceeds M.T.O. TC-54 specifications. Two piece channelizer drum is stackable and available in orange or black. Rubber sidewall tire base sold separately.

**DESCRIPTION**

- B54A BLACK CHANNELIZER - PLAIN
- B54A BLACK CHANNELIZER C/W (4) 4" ORANGE HI-INT GRADE STRIPES
- B54A ORANGE CHANNELIZER - PLAIN
- B54A ORANGE CHANNELIZER C/W (4) 4" ORANGE/WHT HI-INT GRADE STRIPES
- 15" SIDEWALL TIRE BASE FOR B52A CHANNELIZERS

**PART #**

- 3015571 [2081613]
- 3015573 [2186339]
- 3015574 [2081626]
- 3015577 [2197819]
- 3015575 [2186353]

## B54Q CHANNELIZER



As above, orange drum.

**DESCRIPTION**

- B54Q ORANGE CHANNELIZER - PLAIN
- CHAN-B54Q ORG 5-4 HI WHI & 5-4 DG OR
- CHAN-B54Q ORG 5-4 HI WHI STRIPES
- 16" 23 LB RUBBER SIDEWALL TIRE BASE FOR B54Q
- 16" 35 LB RUBBER SIDEWALL TIRE BASE FOR B54Q

**PART #**

- 3015578 [2199532]
- 3020723
- 3020724
- 3015579 [2199037]
- 3015576 [2199038]

## B52A TRAFFIC DELINEATORS



Manufactured from linear low density polyethylene. Delineators meet or exceed M.T.O. specifications. Tube portion is designed to separate from the base in case of collision with little or no damage to the vehicle. The tube actually pastes itself to the front of the vehicle rather than flying like a missile and striking workers or other vehicles. Units stack efficiently and are easily transported to the job site. Available in black or orange and can be striped with engineer or high intensity grade reflective material. Unit will accommodate any Jackson Safety Barricade Flasher (not included). 15" tire base sold separately.

**DESCRIPTION**

- 52A BLACK POST WITH ORANGE HI-INTENSITY STRIPES
- 52A ORANGE POST WITH ORANGE/WHITE HI-INTENSITY STRIPES
- 15" RUBBER SIDEWALL TIRE BASE
- OPTIONAL BARRICADE FLASHER

**PART #**

- 3015566 [2185426]
- 3015558 [2197833]
- 3015575 [2186353]
- (SEE PAGE 112)

## B52 TRAFFIC DELINEATORS



Manufactured from recycled plastic. Conforms to Ontario Standard for TC-52 Delineators. Tube portion is designed to separate from the base in case of collision with little or no damage to the vehicle. The tube actually pastes itself to the front of the vehicle rather than flying like a missile and striking workers or other vehicles. Base slips over the tube and is easily filled with sand ballast through a 2" opening. B52 units stack efficiently and are easily transported to the job site. Available in black or orange and can be striped with Hi-Intensity Grade Reflective Strips. Unit will accommodate any Jackson Safety Barricade Flasher (not included).

**DESCRIPTION**

B52 BLACK DELINEATOR C/W PLASTIC BASE AND ORANGE HI-INTENSITY STRIPES  
 B52 ORANGE DELINEATOR C/W PLASTIC BASE WITH ORANGE/WHITE HI-INTENSITY STRIPES  
 OPTIONAL BARRICADE FLASHER

**PART #**

3015561 [2185385]  
 3015564 [2185347]  
 (SEE PAGE 112)

## B-53A BARRICADE SYSTEM



Barricades stack for easy transportation

Traffic and crowd control, ideal for construction, airports, police, parking etc. Excellent visibility and easy to install. Convenient to store and transport, a 3/4 tone pick-up can carry 10-12. Lower section of container can be filled with water or sand. Other colors available, please inquire.

**DESCRIPTION**

B-53A BARRICADE, PLAIN, YELLOW  
 B-53A BARRICADE, PLAIN, ORANGE

**PART #**

3015569  
 3015570

Weight Empty: 22kg.  
 Filled with Sand: 100kg.  
 Filled with Water: 220kg.



Barricades interlock for a secure, stable barrier

## PLASTIC BARRICADES

**TYPE 1**



**TYPE 1 AND TYPE 2 BARRICADES**

Only weighs 15 lbs. Low profile - folded dimensions are 2.5"H x 24"W x 45.5"L. Closed hinge feature prevents pinched fingers during placement and retrieval.

**DESCRIPTION**

DESCRIPTION	PART #	
TYPE 1		
TYPE 1, 24" X 8" X 8", EG SHEETING	3001783	[2181000]
TYPE 1, 24" X 8" X 8", HI INTENSITY SHEETING	3007828	[2181001]
TYPE 1, 24" X 12" X 8", EG SHEETING	3007829	[2181002]
TYPE 1, 24" X 12" X 8", HI INTENSITY SHEETING	3007830	[2181003]
TYPE 2		
TYPE 2, 24" X 8" X 8", EG SHEETING	3007831	[2181005]
TYPE 2, 24" X 8" X 8", HI INTENSITY SHEETING	3007832	[2181006]
TYPE 2, 24" X 12" X 8", EG SHEETING	3007833	[2181007]
TYPE 2, 24" X 12" X 8", HI INTENSITY SHEETING	3007834	[2181008]

**TYPE 2**



Barricade lights sold separately

Sand ballast system (sold separately)



## PLASTIC A-FRAME BARRICADE



Top rail is 36.5" above the ground

Shown above (2) #3001784 [A-Frame Legs] and (1) #3007871

Second leg can be inserted to make Type 2 Barricade

Impact-resistant polypropylene is weather resistant in extreme conditions. Barricade can be Type 1 (single rail) or Type 2 (2 rails). Rails are reinforced to resist bowing in hot weather conditions and are angled at 15° for greater stability. Lightweight and easy to handle with reflective sheeting for maximum adhesion. Individual leg weighs 6 lbs. each.

### DESCRIPTION

DESCRIPTION	PART #
PLASTIC BARRICADE A-FRAME LEG - SINGLE LEG	3001784 [2181048]
PLASTIC BARR 2" X 6' RAIL, NON-REFLECTIVE	3007869 [2181049]
PLASTIC BARR 2" X 6' RAIL, EG SHEETING - 2 SIDES	3007871 [2181051]
PLASTIC BARR 2" X 6' RAIL, HI SHEETING - 2 SIDES	3007873 [2181053]
PLASTIC BARR 2" X 8' RAIL, NON-REFLECTIVE	3007874 [2181055]
PLASTIC BARR 2" X 8' RAIL, EG SHEETING - 2 SIDES	3007876 [2181057]
PLASTIC BARR 2" X 8' RAIL, HI SHEETING - 2 SIDES	3007878 [2181059]



Shown above (2) #3001784 [A-Frame Legs] and (1) #3006225 [Stop/Slow paddle]

### UNIQUE DUAL USE

A-Frame legs can be joined with hinge pin (included) to use as rigid sign stand.

## BARRICADE ACCESSORIES



### SAND BALLAST SYSTEM

Used as a weight with Type 1 & 2 plastic barricades only. Unique alternative to sandbags. Adds up to 10 lbs of ballast with hollow high impact plastic panel that can be filled with sand or water. 5.75" x 15" panels, sold as a set of 2. Mounts with two bolts and nuts (included) to barricade legs below lower panel for low profile fit (shown on previous page).

#### DESCRIPTION

SAND BALLAST SYSTEM

#### PART #

3007835 [2181009]

### SANDBAGS

Used as a weight with Type 1 Barricades only. Hemmed top polypropylene sandbags have tie cord attached. Orange UV rating: 1,200 hours. White UV rating: 500 hours. Mildew resistant. Sold in bundles of 100 only. 10 lbs. per bundle.



#### DESCRIPTION

SANDBAG - WHITE 14" X 26", HOLDS UP TO 40 LBS  
 SANDBAG - ORANGE 14" X 26", HOLDS UP TO 40 LBS  
 SANDBAG - WHITE 18" X 27", HOLDS UP TO 50 LBS  
 SANDBAG - ORANGE 18" X 27", HOLDS UP TO 50 LBS

#### PART #

3006693 [0119174]  
 3007298 [2057320]  
 3007297 [2057318]  
 3007299 [2057332]



Shown in image:  
 #3007833 - Plastic Type 2 Barricades  
 #3004280 - W Series Traffic Cone  
 #3012872 - Class 2 Two-Tone deluxe orange vest  
 #3012874 - Class 2 Two-Tone deluxe lime vest



## L.E.D. SUNDOWNER®



90° angle lens

New configuration operates with 4 D-cell batteries. 3-Way (flashing, steady burn, off) L.E.D. lights located in the strongest area of the case for protection. Simple, one piece battery compartment with battery contacts that work with gravity for greater conductivity. Durable protected L.E.D. lighting assembly with break away feature during impact. A case housing, with proven durability, and a neck that is almost unbreakable. Standard Pack: 10

DESCRIPTION	PART #
SUNDOWNER - AMBER BODY / AMBER LENS	3019298
BOLT KIT (10 BOLTS, 1 WRENCH, 1 WIRE KEY)	3019496
AMBER L.E.D. AND HOLDER (STD PK 10)	3019833
REPLACEMENT AMBER LENS (SET OF 2)	3019834
REPLACEMENT CIRCUIT PLATE (STD PK 10)	3019499
REPLACEMENT WRENCH (STD PK 10)	3019497
REPLACEMENT WIRE KEY (STD PK 100)	3019498



## NIGHTFLASHER\*



6V battery (not included) configuration. 7" polycarbonate lens. Dependable circuitry coated for protection against weather. Standard Pack: 10 (\*Parts are not interchangeable with old light)

DESCRIPTION	PART #
NIGHTFLASHER - AMBER BODY/AMBER LENS	3016221
BOLT KIT (10 BOLTS, 1 WRENCH, 1 WIRE KEY)	3019496
REPLACEMENT AMBER LENS	2005495
REPLACEMENT CIRCUIT PLATE (STD PK 10)	2005254
REPLACEMENT WRENCH (STD PK 10)	3019497
REPLACEMENT WIRE KEY (STD PK 100)	3019498



## PARALTA\*



6V battery (not included) configuration. 7" polycarbonate lens. High density polyethylene case, UV stabilized. Standard Pack: 10 (\*Parts are not interchangeable with old light)

DESCRIPTION	PART #
PARALTA - AMBER BODY/AMBER LENS	3016222
BOLT KIT (10 BOLTS, 1 WRENCH, 1 WIRE KEY)	3019496
REPLACEMENT AMBER LENS	2005495
REPLACEMENT CIRCUIT PLATE (STD PK 10)	2005254
REPLACEMENT WRENCH (STD PK 10)	3019497
REPLACEMENT WIRE KEY (STD PK 100)	3019498



## A-FRAME SIGN STAND



Manufactured in Canada. Painted steel frame designed to hold 24" or 36" signs. Equipped with a double flag holder. Unit folds for easy storage. Compact and easy to set up. Aluminum signs extra, please specify. 36" A-Frame meets new M.T.O. standards.

### DESCRIPTION

24" A-FRAME (STAND ONLY)  
 24" SIGN, MEN AT WORK, ALUMINUM, ENG GRADE  
 24" SIGN, TRAFFIC CONTROL PERSON, ALUMINUM, ENG GRADE  
 36" A-FRAME STAND INCLUDES 2 FLAGS & 2 36" DOWELS  
 36" SIGN, MEN AT WORK, DIAMOND GRADE  
 36" SIGN, TRAFFIC CONTROL, DIAMOND GRADE

### PART #

3015528 [2060418]  
 3015642 [2060420]  
 3015646 [2080833]  
 3015526 [2060419]  
 3015552 [2060421]  
 3015553 [2060423]



Shown left  
 #3015642 aluminum  
 Men At Work sign



Shown right  
 #3015646 aluminum  
 Traffic Control Person

## STOP/SLOW PADDLES

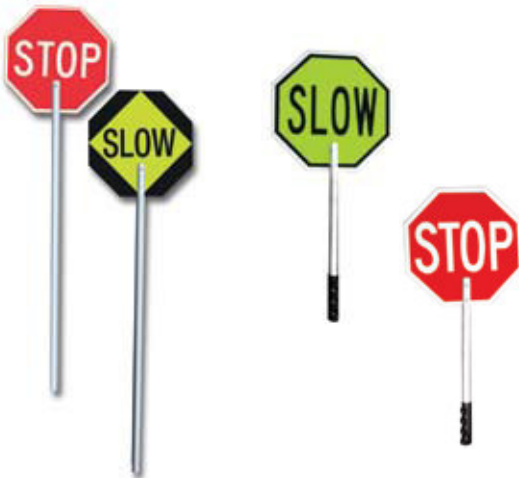

Exceeds M.T.O. spec TC-22. 18" x 18" combination Stop/Slow hand held sign conforms to highway specifications. Available with 5' plastic PVC handle (Sold Separately). Both sign faces are retro reflective. Also available in a reflective hand held version for school crossing guards and lower speed construction zones. Octagon shape, 12" across the flats - comes with a 15" aluminum handle with comfortable rubber grip.

### DESCRIPTION

18" X 18" STOP/SLOW SIGN  
 5' PLASTIC HANDLE FOR ABOVE  
 12" STOP/STOP C/W HANDLE  
 12" STOP/SLOW C/W HANDLE

### PART #

3015541 [2058752]  
 3015547 [2060511]  
 3015546 [2183856]  
 3015544 [2060468]

## QUADRA FLEX RIGID QFVR



Shown left  
 #3015819  
 QFV-R Sign Stand

Meets MUTCD specifications. Supports 30", 36" and 48" rigid signs. Optional brackets allows stand to accept roll-up signs. Kicklock attachment allows legs to unfold into position and individually adjust to uneven terrain. Exclusive base, spring and leg design reduces need for sandbags and prevents creeping and shifting from high-speed traffic. Absorbs winds up to 80 km/hr. Lightweight aluminum legs and durable steel parts for less maintenance, longer service life and easier handling. Maximum height to top of flag holder: 82". Base dimensions folded: 57" x 8-1/2" x 8-1/2". Weight :28 lbs.

### DESCRIPTION

QFV-R SIGN STAND  
 ROLL-UP ADAPTER BRACKET

### PART #

3015819 [0119057]  
 3006664 [0118261]

Shown left  
 #3006664  
 Roll-Up Adapter Bracket

# QUADRA-FLEX V SIGN SYSTEM

trafficsafety



Ideal as a temporary sign around road construction sites and for specialty applications.



NCHRP-350 Approved

The Quadra-Flex V Sign Stand System is ideal as a temporary sign around road construction sites. It meets all standards in the manual uniform traffic control devices.

**The Quadra-Flex V Complete Sign System includes:**

sign base, telescoping mast, fiberglass sign support rib set, 3 flags c/w dowels and sign case.

**Features:**

Supports 24", 30", 36", 48" & 36" X 48" roll-up signs. Kicklock attachment allows legs to unfold into position and individually adjust to uneven terrain. Heavy-duty spring design incorporates anti-rotational device and positive stops to prevent spring fatigue. Exclusive base, spring and leg design reduces need for sandbags. Withstands winds up to 100 km/hr, preventing creeping and shifting from high speed traffic. Lightweight aluminum legs, combined with durable steel parts provide less maintenance, longer service life, and easier handling.

**DESCRIPTION**  
QFV 36 SET  
QFV 36 x 48 SET

**PART #**  
3015529  
3015530



Compact and easily transported, the Quadra-Flex V Sign System sets up in minutes...



...compact and easily transportable, the Quadra-Flex V fits easily into the trunk of a car.

...the kicklock attachment allows legs to unfold into position and individually adjust to uneven terrain.

...roll-up sign and mast set up in a snap.

...flexible cross-pieces accommodate 28", 30" & 36" signs.

...withstands winds up to 100 km/hr, preventing creeping and shifting from high speed traffic.



# REFLECTIVE ROLL-UP SIGN

Super Bright Reflective  
Roll-Up Signs



Lightweight, compact and rugged. Good for both day and night time use. Best protection and the highest reflectivity available. Available in white 36" x 48". All standard symbols and legends are kept in stock for quick delivery. Sewn rib pockets, standard. Lexan pockets available.



**MEN AT WORK SYMBOL**  
30" 3015723  
36" 3015729  
36" D/G 3015767



**ARROW**  
30" 3015734  
36" 3015741  
36" D/G 3015771



**TRAFFIC CONTROL**  
30" 3015740  
36" 3015747  
36" D/G 3015768



**RIGHT LANE CLOSED**  
30" 3015724  
36" 3015730  
36" D/G 3015706



**LEFT LANE CLOSED**  
24" H/I 3015718  
30" 3015733  
36" 3015728  
36" D/G 3015702



**CONSTRUCTION AHEAD**  
36" H/I 3015726  
36" D/G 3015766



**PREPARE TO STOP**  
36" D/G 3016270



**TRUCK ENTRANCE RIGHT**  
36" H/I 3015759  
36" D/G 3015701



**TRUCK ENTRANCE LEFT**  
36" H/I 3015758  
36" D/G 3015769



**MAN IN BUCKET**  
30" 3015736  
36" 3015744  
36" D/G 3015669



**SURVEYOR**  
30" 3015725  
36" 3015731  
36" D/G 3015673



**T-60**  
24" 3015757  
30" 3016198



**YIELD TO ONCOMING TRAFFIC**  
36" X 48" 3015703



**ROAD CLOSED SYMBOL**  
36" X 48" 3015705



**DO NOT PASS**  
24" D/G 3015715  
30" H/I 3015737  
30" D/G 3015716



**NO RIGHT TURN**  
24" H/I 3015773



**NO LEFT TURN**  
24" H/I 3015751

Custom Signs  
Available!

Please Inquire!



**T-100-1-G**  
24" 3015754  
30" 3016197



**T-100-1-D**  
24" 3015859  
30" 3015753



**T-100-2-G**  
30" 3015756



**T-100-2-D**  
30" 3015755



**T-D-130-1**  
24" 2005450  
30" 3015761



**T-D-210-2-D**  
24" 3015762  
30" 3015763



**T-D-210-2-G**  
30" 3015764



**T-D-210-1**  
24" 3015765



**P-60-D**  
24" X 30" 3015708



**P-60-G**  
24" X 30" 3015709

## STANDARD VINYL KNITTED WARNING FLAGS



Heat sealed hem. Non-fouling feature. Available with unique diagonal plastic stay which holds flag open. Vinyl-coated nylon blend material. 3/4" diameter hardwood dowel. Standard Pack: 50

DESCRIPTION	PART #
VINYL WARNING FLAG (18" FLAG / 24" DOWEL)	3006648 [0117152]
VINYL WARNING FLAG (18" FLAG / 30" DOWEL)	3006654 [0117229]
VINYL WARNING FLAG (18" FLAG / 36" DOWEL)	3006651 [0117176]
VINYL WARNING FLAG (18" FLAG / 36" DOWEL WITH STAY)	3006218 [0103254]
VINYL WARNING FLAG (18" FLAG ONLY)	3006650 [0117164]
VINYL WARNING FLAG (24" FLAG / 30" DOWEL)	3006219 [0103266]
VINYL WARNING FLAG (24" FLAG / 36" DOWEL)	3006652 [0117205]
VINYL WARNING FLAG (24" FLAG / 36" DOWEL WITH STAY)	3006220 [0103292]

## THROW AWAY WARNING FLAGS



Economy style. Nail or staple to overhanging load. Bright red plastic material. No hems, grommets or dowels. Standard Pack: 100/bag

DESCRIPTION	PART #
THROW AWAY FLAG - 12" FLAG	3006197 [0102729]
THROW AWAY FLAG - 18" FLAG	3006655 [0117243]

## HEAVY DUTY KNITTED WARNING FLAGS

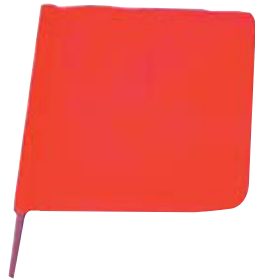

Vinyl trim. Polyester yarn covered in vinyl. Red knitted flag with vinyl trim. 3/4" diameter hard wood dowel. Standard Pack: 50

DESCRIPTION	PART #
KNITTED VINYL WARNING FLAG (18" FLAG/24" DOWEL)	3006201 [0102822]
KNITTED VINYL WARNING FLAG (18" FLAG/30" DOWEL)	3001743 [0102734]
KNITTED VINYL WARNING FLAG (18" FLAG/36" DOWEL)	3006202 [0102846]
KNITTED VINYL WARNING FLAG (18" FLAG/NO DOWEL)	3007303 [2057629]
KNITTED VINYL WARNING FLAG (24" FLAG/30" DOWEL)	3006203 [0102858]
KNITTED VINYL WARNING FLAG (24" FLAG/36" DOWEL)	3006204 [0102860]

## PLAIN WEAVE MESH WARNING FLAGS



18" x 18". Vinyl-coated mesh material. 3/4" diameter hard wood dowel. Standard Pack: 50

DESCRIPTION	PART #
MESH WARNING FLAG (18" FLAG / 24" DOWEL)	3006205 [0102896]
MESH WARNING FLAG (18" FLAG / 30" DOWEL)	3006206 [0102913]
MESH WARNING FLAG (18" FLAG/NO DOWEL)	3006210 [0102951]

## FLAGMAN'S FLAG



24" flag with weighted edge. Available in silver reflective or non-reflective material. 36" long dowel. Standard Pack: 50

DESCRIPTION	PART #
WARNING FLAG - 24" FLAG (NON-REFLECTIVE)	3006215 [0103151]
WARNING FLAG - 24" FLAG (REFLECTIVE)	3006216 [0103163]

## AIRPORT FLAGS



36" x 36" nylon flag with pocket to mount on your existing staff. Alternating checkerboard 12" x 12" squares in orange and white. Sleeve opening is 2-3/4". Dowel not included.

DESCRIPTION	PART #
AIRPORT TRUCK SIGNAL FLAG, 36" X 36" ORANGE/WHITE CHECKERBOARD	3006235 [0103644]

## COLOURED PENNANTS



9' x 12' available on 60' or 100' strings. Standard package 50 strings. Available in red, orange, yellow, alternating red/white and multi-colour.

DESCRIPTION	PART #
MULTI-COLOURED - 60 FT STRING	3006683 [0118895]
MULTI-COLOURED - 100 FT STRING	3006632 [0111615]
ORANGE - 60 FT STRING	3006681 [0118871]
ORANGE - 100 FT STRING	3007349 [2058336]
RED - 60 FT STRING	3006679 [0118845]
RED - 100 FT STRING	3006634 [0111653]

## WINDSOCKS



Strong vinyl-coated nylon fabric in dayglow orange color. Reinforced at both ends with extra stitching. Begins to open at 3 MPH, fully extended at 21 MPH. Windsock and hardware kits sold separately. 3' opening, 8' long, 11" opening at end.

DESCRIPTION	PART #
AIRPORT WINDSOCK 3' X 8' X 11'	3006697 [0119239]
WINDSOCK HARDWARE	3006663 [0118209]

## SPEED BUMP



Will not warp, crack, chip or rot. Withstands 120,000 lbs. Yellow polyurethane glass-beaded paint for maximum reflectivity. Channeled bottom (two 1-1/4" channels) allows for cabling or piping and facilitates drainage. Epoxy or rebar spikes can be used to hold speed bump in place. Three rebar spikes on 48", four rebar spikes on 72" speed bumps. Spikes sold separately. Made of 100% recycled rubber.

DESCRIPTION	PART #
STRIPED SPEED BUMP 2.5" X 12" X 48" (34 LBS.)	3007916 [2185050]
STRIPED SPEED BUMP 2.5" X 12" X 72" (51 LBS.)	3007917 [2185074]
14" REBAR SPIKE	3007973 [2192326]

## PARKING CURB



Will not warp, crack, chip or rot. 1/10 the weight of concrete. Yellow polyurethane glass-beaded paint for maximum reflectivity. Resistant to UV rays, moisture, paint, oil and extreme temperature variations. Epoxy or rebar spikes can be used to hold parking curb in place. Two rebar spikes on 36", four rebar spikes on 72" parking curbs. Spikes sold separately. Made of 100% recycled rubber.

DESCRIPTION	PART #
PARKING CURB 4" X 6" X 36" (17 LBS.)	3007914 [2185024]
PARKING CURB 4" X 6" X 72" (34 LBS.)	3007915 [2185036]
14" REBAR SPIKE	3007973 [2192326]



## TEMPORARY PAVEMENT MARKER



1.6" square inches of reflective area on each side. For temporary use in construction zones with or in place of conventional tape. 3/4" x 4" x 4".

DESCRIPTION	PART #
2 WAY AMBER	3015594 [2078831]
1 WAY AMBER	3015592 [2078843]
2 WAY WHITE	3015595 [2078855]
1 WAY WHITE	3015593 [2078867]



## FLEXIBLE PAVEMENT MARKER



Body retains its original shape after being hit repeatedly. Working hinge and PVC body make this marker virtually vandal proof. Large reflective area.

DESCRIPTION	PART #
2 WAY YELLOW	3015583 [2186743]
1 WAY YELLOW	3015582 [2186690]

## VEHICLE CONSPICUITY REFLECTIVE TAPE



DOT C2 approved. High adhesive pressure sensitive tape with 11" red and 7" white stripes. Also available in white (silver), yellow, red, orange, blue & green and in 1" to 12" widths.

DESCRIPTION	PART #
VEHICLE CONSPICUITY TAPE 2" X 150' ROLL	3015388 [2186573]

## BARRIER TAPE



Provides warning of temporary safety hazards. Economical, strong and disposable. 3 inches wide x 1000 feet long x 2 mm thick. Special legends available with minimums and plate charge. Call Customer Service for details at 800-265-7661.

DESCRIPTION	PART #
CAUTION - YELLOW	3006620 [0110843]
POLICE LINE DO NOT CROSS - YELLOW	3006627 [0111029]
FIRE LINE DO NOT CROSS - YELLOW	3006625 [0110972]
CAUTION CONSTRUCTION AREA - YELLOW	3006621 [0110855]
CAUTION DO NOT ENTER - YELLOW	3006622 [0110867]
DANGER DO NOT ENTER - RED	3006618 [0110805]
DANGER - RED	3006619 [0110817]

## HIGHWAY BANNERS



Available in Wide Load, Oversize Load or Wide Load/Oversize Load, 2-sided combination. Bright yellow with 12" black letters. 18" x 8' with 5' rope ties. 10 oz. non-reflective nylon material.

DESCRIPTION	PART #
WIDE LOAD	3006691 [0119150]
OVERSIZE LOAD	3006601 [0109820]
WIDE LOAD/OVERSIZE LOAD COMBO	3006692 [0119162]

## RUBBER WHEEL CHOCK



Built to meet OSHA requirements. Designed with a friction base for maximum traction on practically any surface, wet or dry. Metal "O" hook imbedded in back. Fluted, hollow design causes downward pressure to lock chock into place. SVR rubber compound material.

DESCRIPTION	PART #
RUBBER WHEEL CHOCK, 8 LBS (6"H X 10"L X 8"D)	3006598 [0109765]

## HEAVY DUTY WHEEL CHOCK



Fifteen pound chock is made from 95% recycled rubber. Will not gouge or cut tires if run over. Resistant to sun, salt, oil and ozone. Chain hole in main body, insurance against loss. Superior traction on any surface. Curved tire support - for weight of trailer on leading edge will hold chock in place.

DESCRIPTION	PART #
HEAVY DUTY WHEEL CHOCK, 15 LBS	3016023 [2185220]

## NON-SKID TAPE



Self adhesive backing applies in seconds and adheres to any smooth, clean, dry surface. High-traction surface stands up to heavy pedestrian traffic. Works indoor and outdoors. Recommend using POL Contact Primer for all permanent applications.

DESCRIPTION	PART #
NON-SKID TAPE 2"X60', BLACK	3015814 [2194776]
NON-SKID TAPE 4"X60', BLACK	3015812 [2194764]
NON-SKID TAPE 6"X60', BLACK	3015811 [2194752]
FOL CONTACT PRIMER, 1 GALLON US	3015834 [2066620]
FOL CONTACT PRIMER, 2 GALLON US	3007412 [2066618]

## FIREBOLT SERIES STROBE LIGHT



Ideal for fork lifts, electric vehicles, industrial trucks & equipment. Operates in multiple voltages from 12 to 72 volts. Available with amber, red, clear, green and blue lenses. Magnetic mount kit available with cigarette lighter cord. Various mount kits and 115 vac operation also available.

DESCRIPTION	PART #
FIREBOLT 12-72 V DC, AMBER LENS	3015343 [2060975]
FIREBOLT 115 V DC, AMBER LENS	3015342 [2060999]
MAGNETIC MOUNT KIT WITH CIGARETTE LIGHTER CORD	3015335 [2090628]

## MODEL 951



High profile lens, longer flash-on time and a powerful Helical Flash Tube. Six times brighter than Model 651. 8-1/2" high and 6-5/8" in diameter.

DESCRIPTION	PART #
MODEL 951 AMBER 12 VOLT	3015341 [2061084]

## 550 SERIES REVOLVING LIGHT



Self lube bronze bearing on rotator assembly. 6" high x 6" diameter. Lamp: 55 watt quartz halogen. Lens color: red, amber, blue, and green. Weight: 2 lbs. Permanent or magnetic mounts available. 100 flashes per minute. 12 volt DC, 4 amp. draw.

DESCRIPTION	PART #
550 SERIES REVOLVING LIGHT PERMANENT MOUNT	3015343 [2061486]
550 SERIES REVOLVING LIGHT MAGNETIC MOUNT WITH HD COILED CORD & CIGARETTE ADAPTER	3015342 [2060999]



## SAFETY FLARES



Visible in fog, rain or snow. Easy to ignite with self-contained striker. Approved by Underwriter's Labs. 20 minute flare is 11.5" and 30 minute flare is 15.5" in length. 70-80 candles bright. Available spikeless, with spike, and with wire. Sold by case quantity only.

DESCRIPTION	PART #
20 MIN. NON-SPIKE (CASE QTY 72)	3006660 [0117944]
20 MIN. SPIKE (CASE QTY 72)	3006661 [0117956]
20 MIN. WIRE (CASE QTY 72)	3006659 [0117932]
30 MIN. NON-SPIKE (CASE QTY 36)	3001750 [0117279]
30 MIN. SPIKE (CASE QTY 36)	3004843 [0117267]
30 MIN. WIRE (CASE QTY 36)	3006658 [0117920]

## CYALUME LIGHT STICKS



Ideal for traffic control, utility operation and in-plant use. 7" length. 12-hour green, 30 minute hi-intensity red and 30 minute hi-intensity yellow. Just bend, snap and shake for instant light. Sold by standard pack of 10 only.

DESCRIPTION	PART #
12 HOUR GREEN	3015078 [2057655]
30 MINUTE HI-INT RED	3015077 [2056601]
30 MINUTE HI-INT YELLOW	3015076 [2056596]

## SAFETY TRIANGLES



Shown left \$3006007 with 3 red triangles in case

Meets Federal Motor Vehicle Standard No. 125. Constructed on molded polypropylene plastic with red acrylic plastic reflectors. Air-flow design helps reduce wind resistance. Kit includes three triangles in one red, hard plastic case.

DESCRIPTION	PART #
HIGHWAY TRIANGLE - SINGLE	3006010 [0100036]
HIGHWAY TRIANGLE KIT - 3 TRIANGLES IN POLY BOX	3006007 [0100031]

## SLOW MOVING VEHICLE



Heavy duty aluminum backed triangle mounts easily using screw holes provided. Meets all Provincial & Federal specifications.

DESCRIPTION	PART #
SLOW MOVING VEHICLE ALUMINUM TRIANGLE	3006009 [0100035]

## SAFETY FENCING

Jackson Safety fences are produced with a material consisting of a UV stabilized high density polyethylene (HDPE) with a freezing point of approximately -112°F. For added convenience, every item is rolled, labeled, bagged, pelletized and stretch-wrapped. We offer fences for a variety of classifications: economy, mid-grade, diamond, speciality and erosion control silt fences.

### GENERAL PURPOSE 12 LB. FENCE

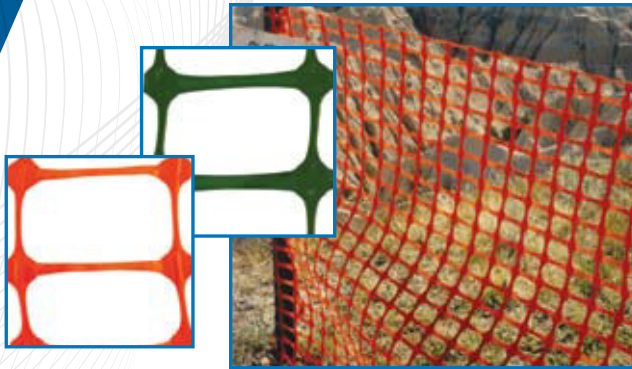

Mono-oriented safety fencing with horizontal openings. Size/Color: 4'x100', Orange; 4'x100' Green, Weight: 12 lbs. 48 rolls per pallet. Tensile Strength - MD: 240 lbs/ft, TD: 90 lbs/ft.

DESCRIPTION	PART #
ORANGE 12 LBS	3007305 [2057679]
GREEN 12 LBS	3007813 [2180153]

### LIGHT DUTY DIAMOND FENCE



Diamond mesh safety fence with smooth top and bottom. Size/Color: 4'x50' Orange, 4'x100' Green. Weight: 4'x50'/11 lbs; 4'x100'/23 lbs, 4'x50'/42 rolls per pallet; 4'x100'/20 rolls per pallet. Tensile Strength - MD: 100 lbs/ft, TD: 85 lbs/ft. Lower cost alternative to Mid Grade Diamond Fence

DESCRIPTION	PART #
4X50 ORANGE 11 LBS	3014744
4X100 GREEN 23 LBS	3014745

### MID GRADE DIAMOND FENCE



Diamond mesh safety fence with smooth top and bottom. Size/Color: 4'x50' Orange, 5'x50' Orange. Weight: 4'x50'/14 lbs; 5'x50'/18 lbs 30 rolls per pallet. Tensile Strength - MD: 160 lbs/ft TD: 100 lbs/ft. Heavier and more visible than Light Duty Diamond Safety Fence

DESCRIPTION	PART #
4X50 ORANGE 14 LBS	3007606 [2088353]
5X50 ORANGE 23 LBS	3006612 [0110283]

### HEAVY DUTY DIAMOND FENCE

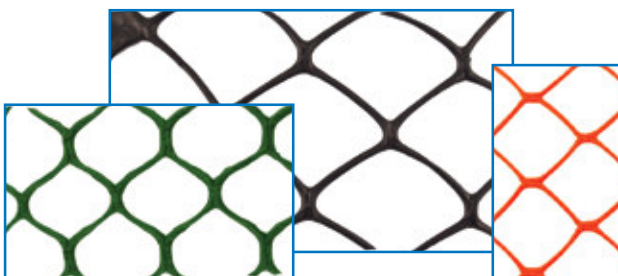

Diamond mesh safety fence with smooth top and bottom. Size/Color: 4'x50' Black; 4'x50' Green; 4'x50' Orange; 4'x100' Orange. Weight: 50'/16 lbs; 100'/32 lbs. 48 rolls per pallet. Tensile Strength - MD: 180 lbs/ft TD: 175 lbs/ft. Strongest and heaviest diamond mesh fence.

DESCRIPTION	PART #
BLACK 16 LBS	3006609 [0110245]
GREEN 16 LBS	3006610 [0110257]
ORANGE 16 LBS	3011239
ORANGE 32 LBS	3006607 [0110221]

## ECONOMY FENCE



Lightweight safety fence with oval openings. Size/Color: 4'x100' Orange. Weight: 8.5 lbs. 48 rolls per pallet. Used as a visual barrier for crowd control and around job sites.

DESCRIPTION	PART #
ORANGE 8.5 LBS	3014742

## EROSION CONTROL SILT FENCE



100 ft woven silt fence with 42" hardwood stakes that are spaced 10' apart. Size/Color: 3x100 Black. Weight: 22.5 lbs. 25 rolls per pallet. Tensile Strength - MD: 20 lbs/ft TD: 20 lbs/ft.

DESCRIPTION	PART #
BLACK 22.5 LBS	3007594 [2087651]

## BARGARD® PROTECTOR CAPS

Low Density Polyethylene Material



### CAL-OSHA

Fits rebar #3-7, 3/8" to 7/8" diameter. Lightweight and chemical resistant. Stands up to weather and temperature conditions. Bright orange for visibility. Standard package 100.

DESCRIPTION	PART #
CAL-OSHA ORANGE REBAR CAP	3011839



### A-10

Fits rebar 3/8" to 1-1/4" diameter. Also fits inside 1-3/4" ID pipe. Standard Package: 100

DESCRIPTION	PART #
A-10 LIME REBAR CAP	3005543 [23700]



### A-5

Fits rebar 3/8" to 3/4" diameter. Also fits inside 1" ID pipe. Standard package 200.

DESCRIPTION	PART #
A-5 LIME REBAR CAP	3005547 [23704]



### A-20

Fits rebar 1" to 2-1/4" diameter. Standard package 100.

DESCRIPTION	PART #
A-20 LIME REBAR CAP	3005545 [23702]
A-20 WHITE REBAR CAP	3005546 [23703]

**WARNING** – BARGARD® caps are not designed or intended to provide impact or impalement protection. They are not a substitute for covering vertical reinforcing steel with timber, as recommended by OSHA, and are not recommended for use when protection from falls is required. For additional information on acceptable methods of guarding against impact or impalement, consult OSHA CFR TITLE 29, PART 19120, ANSI A10.9-1983, and your state regulations for specific requirements.

**WARNING** – DISC-10 BARGARD® PROTECTOR CAPS

DISC-10 meets the testing requirements of CAL OSHA Construction Safety Orders Section 1712 on impalement protection from concrete reinforcing bars (#3-9, 3/8 - 1-1/4") for heights up to 7-1/2" and 250 lbs. (CAL OSHA Approval Code #C-1716-AG) when properly installed. Failure to properly install DISC-10 will significantly decrease any impalement protection that may otherwise be provided by the DISC-10 and may result in injury. If positioning fins are missing or damaged, the DISC-10 must be discarded. For information on the requirements of guarding against impalement, consult OSHA CFR Title 29, Sect. 1928.701 et. seq.

For additional information on fall protection, consult OSHA CFR Title 29, Part 1926 - Safety and Health Regulations for Construction, Subpart M - Fall Protection, and your state regulations for specific requirements.

Protect yourself from liability issues with the first name in slip, trip and fall protection. Lamba® products offer the original four-sided cone with a variety of messages and languages. Accessories include chain links and lock-in signs.

## LAMBA® CONES



25" and 36" yellow and lime green models. Available plain or imprinted with stock legends. International languages and styles. 25" cone dimensions: 10" base, 4-3/4" middle, 3-1/4" top. 36" cone dimensions: 12" base, 6" middle, 3-1/2" top. Custom imprinting available. Standard

DESCRIPTION	Pack: 5	PART #	DESCRIPTION	PART #
25" YELLOW FLOOR CONES			36" YELLOW FLOOR CONES	
PLAIN		3000479 [23820]	PLAIN	3000485 [23888]
CAUTION		3005557 [23819]	CAUTION	3000484 [23887]
NO PARKING		3010288 [23801]	DANGER PEOPLE WORKING ABOVE	3005563 [23834]
SAFETY FIRST		3000478 [23809]	FLOOR MAY BE SLIPPERY	3005564 [23836]
WET FLOOR		3005553 [23812]	HAZARDOUS MATERIAL	3009773 [23911]
CUIDADO PISO MOJADO		3005584 [23935]	ICY AREAS	3005591 [23983]
CUIDADO PISO MOJADO/WET FLOOR		3005555 [23816]	NO ENTRY - RESTROOM CLOSED	3005565 [23838]
CUIDADO/SEGURIDAD AUTE TODO/SAFETY FIRST		3005552 [23811]	NO PARKING	3005566 [23839]
CUIDADO/WET FLOOR		3005556 [23817]	RESTRICTED AREA	3005571 [23861]
PLANCHER MOUILLE/WET FLOOR		3005554 [23815]	SAFETY FIRST	3000481 [23863]
			WET FLOOR	3000482 [23870]
			DRIVE UP SERVICE	3019461
			CUIDADO PISO MOJADO/WET FLOOR	3000483 [23879]
			CUIDADO/SEGURIDAD AUTE TODO/SAFETY FIRST	3005575 [23868]
			36" LIME FLOOR CONES	
			WET FLOOR	3005661 [24238]

## CONE SYSTEMS

### THREE CONE SYSTEM

25" or 36" cone systems include: 3 yellow cones, 1 red flashing lights, 1-20' yellow plastic chain, 2 lock-in signs (red) and 4 message labels. International system available only in 36".



### FIVE CONE SYSTEM

25" or 36" cone systems include 5 yellow cones, 3 red flashing lights, 2-20' yellow plastic chains, 2 lock-in signs (red) and 4 message labels.



DESCRIPTION	PART #
25" WET FLOOR	3005558 [23824]
36" WET FLOOR	3005579 [23891]
36" SAFETY FIRST	3005578 [23890]
36" WET FLOOR (ENGLISH/SPANISH)	3005590 [23980]

DESCRIPTION	PART #
25" WET FLOOR	3005559 [23826]
36" WET FLOOR	3005581 [23893]
36" SAFETY FIRST	3005580 [23892]
36" WET FLOOR (ENGLISH/SPANISH)	3005586 [23946]

## 2" YELLOW PLASTIC CHAIN



Helps to expand the effectiveness of the Lamba cones or 2x4™. Attach either slide link into the side of Lamba cone or to the custom hooks on our 2x4™ to create a safety system.



DESCRIPTION	PART #
20' CHAIN	3000539 [26407]
100' CHAIN	3000540 [26408]

## LAMBA CUSTOMIZATION PROGRAM

### LAMBA CONES

- Minimum order = 75 cones per imprint size (may not combine 25" and 36" cones); No silk-screening charge on orders exceeding 200 cones
- Images can be one color, silk-screened as follows: Same message on all four sides; 2 different messages on two sides

### 2X4 FLOOR WARNING SIGNS

- Minimum order = 30 floor warning signs; 12 labels per message
- Logo imprint area measures 2" H x 4" W; Image is silk-screened on both sides of 2x4

PLEASE NOTE: Jackson Safety requires camera-ready artwork. Minimum of 3 week lead-time after approval of artwork. Definition of camera ready/photo reproducible artwork is black on glossy white background with sharp images (photocopies, business cards, drawings, letterhead and decals are not camera-ready and require additional charges). Screen printing only available in black ink. One time silk-screen charge per screen applies.

## LAMBA CONE ACCESSORIES



### RING WEIGHTS

Black metal. Slides over cone and rests on base.  
Weight for 25" cones inner dimensions: 8" x 8"  
Weight for 36" cones inner dimensions: 10" x 10"

DESCRIPTION	PART #
25" CONE WEIGHT 7 LBS	3005687 [26413]
36" CONE WEIGHT 9 LBS.	3000541 [26414]



### LOCK-IN SIGNS

8" x 8" plastic sign that can be placed in top of Lamba cones to display message labels.

DESCRIPTION	PART #
BLACK SIGN	3000537 [26400]
RED SIGN	3000538 [26401]



### LOCK-IN FLASHING LIGHTS

Flashing light has convenient on/off switch and lasts up to 300 hours. Requires 2 AA batteries (not included).

DESCRIPTION	PART #
LOCK-IN FLASHING LIGHT	3000549 [26649]

## MESSAGE LABELS

Yellow 8" x 8" adhesive backed vinyl for use on our lock-in signs.



DESCRIPTION	PART #	DESCRIPTION	PART #
ENGLISH		ENGLISH	
PLAIN (NO VERBAGE)	3005709 [26483]	WET FLOOR PLEASE WALK TO THE RIGHT	3000544 [26490]
SECTION CLOSED	3005694 [26449]	WET FLOOR PLEASE WALK TO THE LEFT	3000545 [26491]
SLIPPERY	3005699 [26469]	CAUTION FLOOR MAY BE SLIPPERY	3005718 [26501]
OUT OF SERVICE	3005702 [26473]	CAUTION - WET FLOOR	3005719 [26502]
ELECTRICAL HAZARD	3005704 [26475]	DANGER PEOPLE WORKING ABOVE	3005721 [26505]
HARD HAT AREA	3005705 [26477]	BLACK ARROW	3005713 [26489]
NO ENTRY - CONSTRUCTION	3005706 [26478]	CAUTION - FALLING ICE	3005730 [26559]
WATCH YOUR STEP	3005708 [26480]	INTERNATIONAL	
RESTROOM CLOSED - NO ENTRY	3000543 [26481]	WET FLOOR (ENGLISH/SPANISH)	3000546 [26498]
PEOPLE WORKING	3005710 [26485]	OUT OF SERVICE (ENGLISH/SPANISH)	3005726 [26536]
NO ENTRY - RESTRICTED AREA	3005711 [26487]	WATCH YOUR STEP (ENGLISH/SPANISH)	3005727 [26539]

## 2X4 SAFETY FLOOR SIGNS



The Lamba® 2x4 safety floor sign helps corporations control the environment and dramatically reduce liability programs. Featuring our Lockin'Arm™ technology for easy set-up and extra stability. Four-sided caution messages display clear warnings from every angle. The 25" high, bright yellow plastic signs fold up quickly and store in spaces as narrow as 3". Standard Pack: 5

DESCRIPTION - ALL YELLOW UNLESS OTHERWISE INDICATED	PART #
YELLOW, PLAIN	3005622
CAUTION, WET FLOOR	3000488 [24102]
SAFETY MAN, LARGE, WET FLOOR	3005605 [24103]
WET FLOOR, WALK RIGHT/LEFT	3005606 [24105]
WET FLOOR, CUIDADA PISO MOJADO (LIME)	3000489 [24106]
NO ENTRY, RESTROOM CLOSED	3005609 [24109]
CAUTION, WATCH YOUR STEP	3005610 [24110]
CAUTION WET FLOOR/CUIDADO PISO MOJADO (LIME)	3005825 [26815]

## ECONOMY FLOOR STANDS



Lightweight, corrosion resistant and moisture proof. Wide, 'easy-grip' handle ensures easier transportation. Larger printing area provides greater visibility for your message. Folds flat for easy storage. Standard legends only. 11-3/4" W x 24-1/8" H (open).

DESCRIPTION	PART #
YELLOW, PLAIN	3017717 [3005898]
CAUTION WATCH YOUR STEP	3017718 [3005899]
CAUTION WET FLOOR/CUIDADO PISO MOJADO	3017719 [3005900]
CLOSED/CERRADO FERMÉ	3017720 [3005901]
NO ENTRY RESTROOM CLOSED	3017721 [3005902]
OUT OF SERVICE	3017722 [3005903]
CAUTION WET FLOOR	3017723 [3000585]



**WWW.JACKSONSAFETY.COM**  
**143 BORDEN AVE, BELMONT, ONTARIO N0L 1B0**  
**PHONE: 800.265.7661 FAX: 800.267.3265**