

# AT-GS950/48PS AT-GS950/16PS AT-GS950/10PS

Gigabit Ethernet PoE+ Switches

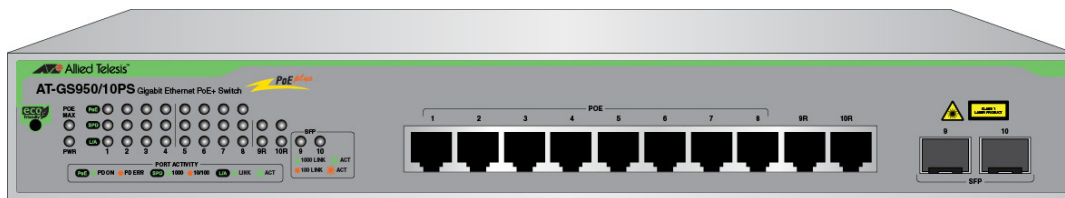
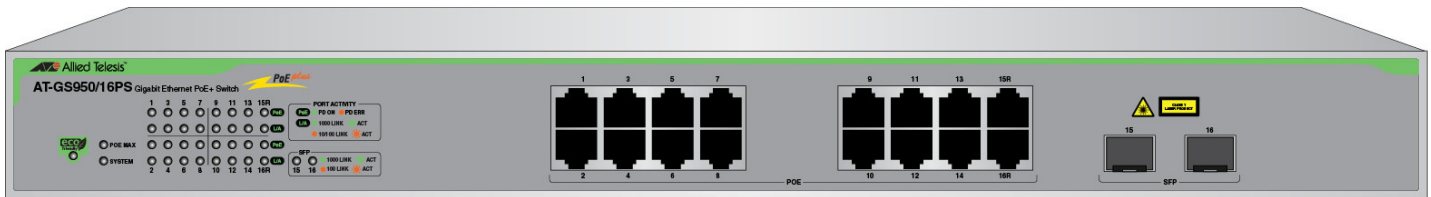
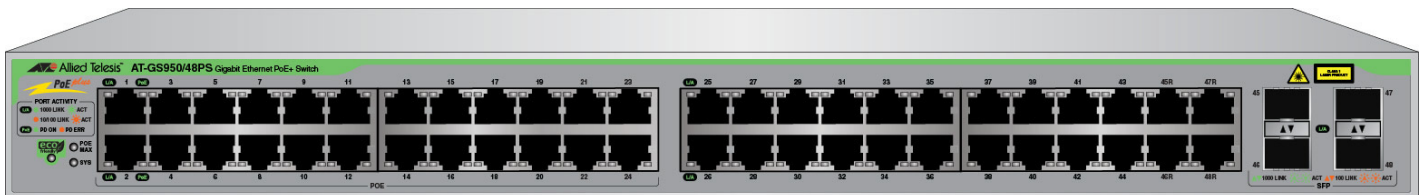

## Installation Guide

Copyright © 2013 Allied Telesis, Inc.

All rights reserved. No part of this publication may be reproduced without prior written permission from Allied Telesis, Inc.

Allied Telesis and the Allied Telesis logo are trademarks of Allied Telesis, Incorporated. All other product names, company names, logos or other designations mentioned herein are trademarks or registered trademarks of their respective owners.

Allied Telesis, Inc. reserves the right to make changes in specifications and other information contained in this document without prior written notice. The information provided herein is subject to change without notice. In no event shall Allied Telesis, Inc. be liable for any incidental, special, indirect, or consequential damages whatsoever, including but not limited to lost profits, arising out of or related to this manual or the information contained herein, even if Allied Telesis, Inc. has been advised of, known, or should have known, the possibility of such damages.

# Electrical Safety and Emissions Standards

---

This product meets the following standards.

## U.S. Federal Communications Commission

### Radiated Energy

Note: This equipment has been tested and found to comply with the limits for a Class A digital device pursuant to Part 15 of FCC Rules. These limits are designed to provide reasonable protection against harmful interference when the equipment is operated in a commercial environment. This equipment generates, uses, and can radiate radio frequency energy and, if not installed and used in accordance with this instruction manual, may cause harmful interference to radio communications. Operation of this equipment in a residential area is likely to cause harmful interference in which case the user will be required to correct the interference at his own expense.

Note: Modifications or changes not expressly approved of by the manufacturer or the FCC, can void your right to operate this equipment.

## Industry Canada

This Class A digital apparatus meets all requirements of the Canadian Interference-Causing Equipment Regulations.

Cet appareil numérique de la classe A respecte toutes les exigences du Règlement sur le matériel brouilleur du Canada.

RFI Emissions      FCC Class A, EN55022 Class A, EN61000-3-2, EN61000-3-3, C-TICK, CE

**Warning:** In a domestic environment this product may cause radio interference in which case the user may be required to take adequate measures.

Immunity            EN55024

Electrical Safety    EN60950 (TUV), UL 60950 (CUL-US)



Laser Safety        EN60825

# Translated Safety Statements

---

**Important:** The  indicates that a translation of the safety statement is available in a PDF document titled ***Translated Safety Statements*** posted on the Allied Telesis website at **[www.alliedtelesis.com](http://www.alliedtelesis.com)**.

# Contents

---

<b>Preface</b> .....	3
Symbol Conventions .....	4
Contacting Allied Telesis.....	5
<b>Chapter 1: Features</b> .....	8
Twisted Pair Ports .....	8
SFP Slots.....	8
LEDs .....	8
Installation Options .....	9
Power Conservation .....	9
MAC Address Table .....	9
Front and Back Panels.....	10
Management Software .....	12
Twisted Pair Ports .....	13
Power over Ethernet (PoE) .....	14
.....	14
Combo Ports .....	15
LEDs .....	16
PWR/SYS LEDs .....	16
10/100/1000 BaseT Link Activity LEDs .....	18
SFP LEDs .....	20
PoE LEDs .....	22
eco-Friendly Button .....	25
eco-Friendly Button Operation.....	25
Reboot/Reset the Switch .....	26
Power Supply .....	27
Fans .....	28
<b>Chapter 2: Reviewing Safety Precautions</b> .....	30
Selecting a Site for the Switch .....	32
Cable Specifications.....	33
Unpacking the Switch.....	34
Installing the Switch on a Desktop .....	36
Installing the Switch in an Equipment Rack .....	37
Installing the Switch on a Wall .....	39
Installing Optional SFP Transceivers .....	42
Cabling the Switch .....	45
Powering On the Switch.....	46
<b>Chapter 3: Appendix A: Physical Specifications</b> .....	51
Dimensions .....	51
Weight .....	51
Environmental Specifications .....	51
Power Specifications.....	52
PoE Specifications .....	52
Safety and Electromagnetic Emissions Certifications .....	52
Connectors and Port Pinouts .....	53



# Figures

---

Figure 1: AT-GS950/10PS, AT-GS950/16PS, and AT-GS950/48PS Front Panels.....	10
Figure 2: AT-GS950/10PS Back Panel.....	11
Figure 3: AT-GS950/16PS Back Panel.....	11
Figure 4: AT-GS950/48PS Back Panel.....	11
Figure 5: PWR LED on AT-GS950/10PS .....	16
Figure 6: SYSTEM LED on AT-GS950/16PS .....	17
Figure 7: SYS LED on AT-GS950/48PS.....	17
Figure 8: AT-GS950/10PS Link/Activity and Speed LEDs.....	18
Figure 9: AT-GS950/16PS Link/Activity/Speed LEDs.....	19
Figure 10: AT-GS950/48PS Link/Activity/Speed Port LED.....	19
Figure 11: AT-GS950/10PS SFP Speed and Link/Activity LEDs.....	20
Figure 12: AT-GS950/16PS SFP Status LEDs.....	21
Figure 13: AT-GS950/48PS SFP Status LEDs.....	21
Figure 14: AT-GS950/10PS PoE and PoE MAX LEDs.....	23
Figure 15: AT-GS950/16PS PoE and PoE MAX LEDs.....	23
Figure 16: AT-GS950/48PS PoE and PoE MAX LEDs.....	23
Figure 17: eco-Friendly Button .....	25
Figure 18: Shipping Package Contents .....	35
Figure 19: Attaching the Rubber Feet .....	36
Figure 20: Attaching the Rack-Mount Brackets to the Switch.....	37
Figure 21: Attaching the Rack-Mount Brackets to the Switch (Continued).....	38
Figure 22: Mounting the Switch in an Equipment Rack .....	38
Figure 23: Attaching the Brackets to Install the Switch on a Wall.....	39
Figure 24: Marking the Screw Hole Locations .....	40
Figure 25: Securing the Switch to the Wall.....	41
Figure 26: Removing the Dust Plug from an SFP Slot .....	42
Figure 27: Inserting the SFP.....	43
Figure 28: Positioning the SFP Handle in the Upright Position .....	43
Figure 29: Plugging in the AC Power Cord.....	46
Figure 30: RJ-45 Connector and Port Pin Layout.....	53





# Tables

---

Table 1. Max Ports Supported per PoE Class .....	14
Table 2. Combo Ports .....	15
Table 3. AT-GS950/10PS PWR LED Functional Descriptions .....	16
Table 4. AT-GS950/16PS and AT-GS950/48PS SYS LED Functional Descriptions .....	17
Table 5. AT-GS950/10PS L/A and SPD LEDs Functional Descriptions .....	18
Table 6. AT-GS950/16PS and AT-GS950/48PS L/A LED Functional Descriptions .....	20
Table 7. SFP Slot LED Functional Descriptions .....	22
Table 8. PoE Status LED Functional Descriptions .....	23
Table 9. Twisted Pair Cabling and Distances .....	33
Table 10. Chassis Dimensions .....	51
Table 11. Chassis Weight .....	51
Table 12. Environmental Specifications .....	51
Table 13. Power Specifications .....	52
Table 14. Max Ports Supported per PoE Class .....	52
Table 15. Safety and Electromagnetic Emissions Certifications .....	52
Table 16. MDI Pin Signals (10Base-T or 100Base-TX) .....	53
Table 17. MDI-X Pin Signals (10Base-T or 100Base-TX) .....	53
Table 18. RJ-45 1000Base-T Connector Pinouts .....	54



# Preface

---

This guide contains the installation instructions for the AT-GS950/10PS, AT-GS950/16PS, and AT-GS950/48PS Gigabit Ethernet PoE+ Switches. This preface contains the following sections:

- “Symbol Conventions” on page 4
- “Contacting Allied Telesis” on page 5

# Symbol Conventions

---

This document uses the following conventions:

---

**Note**

Notes provide additional information.

---

**Caution**

Cautions inform you that performing or omitting a specific action may result in equipment damage or loss of data.

---

**Warning**

Warnings inform you that performing or omitting a specific action may result in bodily injury.

---

**Warning**

Warnings inform you that an eye and skin hazard exists due to the presence of a Class 1 laser device.

---

## Contacting Allied Telesis

---

If you need assistance with this product, you may contact Allied Telesis technical support by going to the Support & Services section of the Allied Telesis web site at **[www.alliedtelesis.com/support](http://www.alliedtelesis.com/support)**. You can find links for the following services on this page:

- 24/7 Online Support - Enter our interactive support center to search for answers to your questions in our knowledge database, check support tickets, learn about RMAs, and contact Allied Telesis technical experts.
- USA and EMEA phone support - Select the phone number that best fits your location and customer type.
- Hardware warranty information - Learn about Allied Telesis warranties and register your product online.
- Replacement Services - Submit a Return Merchandise Authorization (RMA) request via our interactive support center.
- Documentation - View the most recent installation guides, user guides, software release notes, white papers and data sheets for your product.
- Software Updates - Download the latest software releases for your product.

For sales or corporate contact information, go to **[www.alliedtelesis.com/purchase](http://www.alliedtelesis.com/purchase)** and select your region.



## Chapter 1

# Overview

---

This chapter provides descriptions of the AT-GS950/10PS, AT-GS950/

16PS, and AT-GS950/48PS Layer 2 Gigabit Ethernet Switches and contains the following sections:

- “Features” on page 8
- “Front and Back Panels” on page 10
- “Management Software” on page 12
- “Twisted Pair Ports” on page 13
- “Power over Ethernet (PoE)” on page 14
- “Combo Ports” on page 15
- “LEDs” on page 16
- “eco-Friendly Button” on page 25
- “Power Supply” on page 27
- “Fans” on page 28

## Features

---

Here are the hardware features of the AT-GS950/10PS, AT-GS950/16PS and AT-GS950/48PS Gigabit Ethernet Switches.

### Twisted Pair Ports

Here are the basic features of the 10/100/1000 Mbps twisted-pair ports:

- 10, 16, or 48 ports per switch
- 10, 16, or 24 PoE ports per switch
- 10Base-TX, 100Base-T and 1000Base-T compliant
- IEEE 802.3u Auto-Negotiation compliant
- Auto-MDI/MDIX
- 100 meters (328 feet) maximum operating distance
- IEEE 802.3x Flow Control in 10/100Base-TX full-duplex operation
- IEEE 802.3x Back Pressure in 10/100Base-TX half-duplex operation
- IEEE803.3z 1000Base-T Flow Control
- Support for Jumbo frames up to 10KB
- RJ-45 connectors

### SFP Slots

All three switches support both 100Base-FX and 1000Base-SX/LX transceivers. The switches support either two or four slots for SFPs:

- Two SFP slots on the AT-GS950/10PS and AT-GS950/16PS Switches
- Four SFP slots on the AT-GS950/48PS Switch

---

#### Note

The SFP slots are paired with twisted pair ports on the switch to form combo ports. For more information, see “Combo Ports” on page 15.

---

---

#### Note

You must purchase SFP transceivers separately. For a list of supported transceivers, contact your Allied Telesis distributor or reseller.

---

---

#### Note

See the product data sheets for the specific ATI SFP modules supported by the AT-GS950 series switches.

---

### LEDs

Here is a brief description of the port LEDs:



- Power LED/SYS; refer to “PWR/SYS LEDs” on page 16.
- Speed and link/activity LEDs for the twisted pair ports; see “10/100/1000 BaseT Link Activity LEDs” on page 18.
- Link/activity LEDs for the SFP slots; see “SFP LEDs” on page 20.
- ecoFriendly button turns off the LEDs to conserve electricity; see “PoE LEDs” on page 22.

**Installation Options**

The AT-GS950/10PS, AT-GS950/16PS, and AT-GS950/48PS switches can be installed in the following ways:

- Rack mounted in a 19-inch equipment rack
- Mounted on a Desk or tabletop
- Wall mounted for the AT-GS950/10PS and AT-GS950/16PS only.

**Power Conservation**

The AT-GS950/10PS, AT-GS950/16PS, and AT-GS950/48PS switches have the following power conservation features:

- eco-Friendly button to turn off the port LEDs when the system is not being monitored
- High-efficiency power supply
- Power scaling based on traffic loads on ports operating at 1000 Mbps (Port power scaling not available at 10 or 100 Mbps)
- Power shutdown on unused ports

**MAC Address Table**

Here are the basic features of the MAC address table:

- Storage capacity up to 16KB MAC address entries
- Automatic learning and aging

# Front and Back Panels

Figure 1 illustrates the front panels of the AT-GS950/10PS, AT-GS950/16PS, and AT-GS950/48PS Gigabit Ethernet Switches.

## AT-GS950/10PS

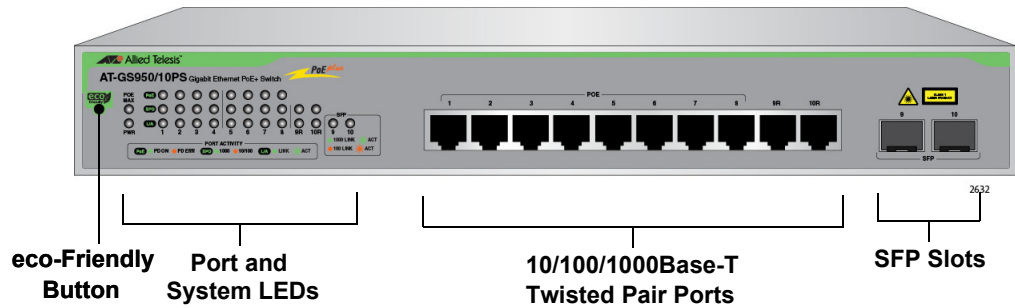

## AT-GS950/16PS

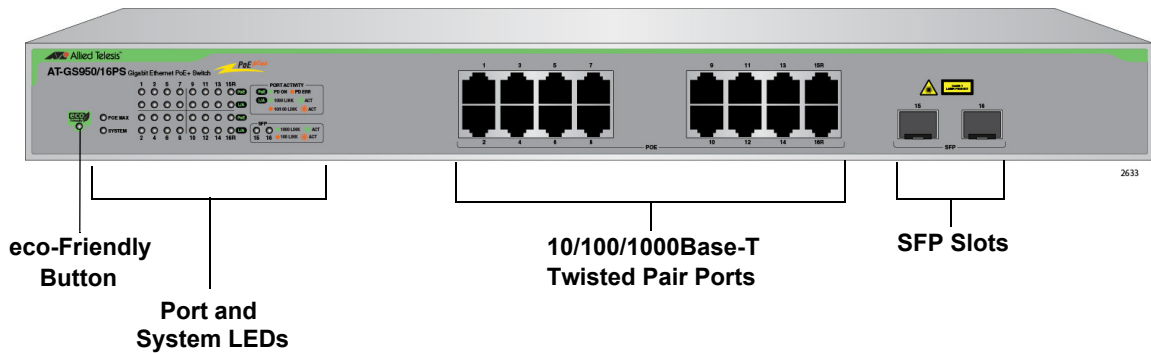

## AT-GS950/48PS

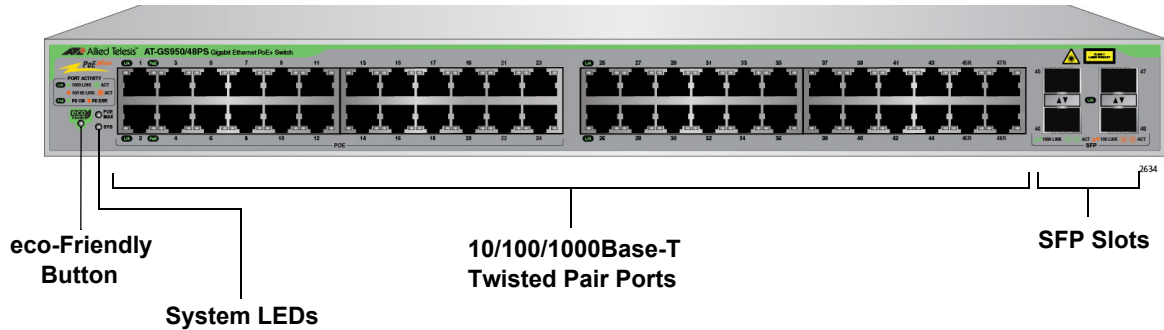

Figure 1. AT-GS950/10PS, AT-GS950/16PS, and AT-GS950/48PS Front Panels

See Figure 2 for an example of the AT-GS950/10PS back panel.

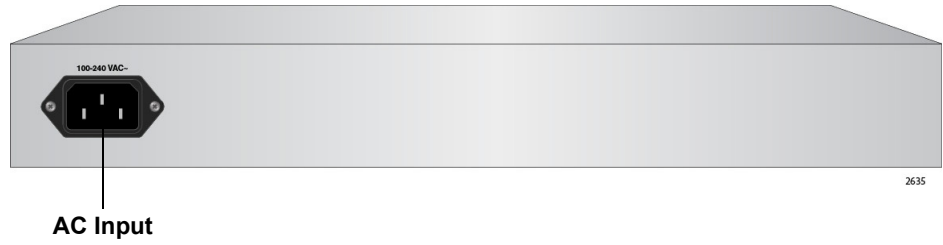

Figure 2. AT-GS950/10PS Back Panel

See Figure 3 for an example of the AT-GS950/16PS back panel.

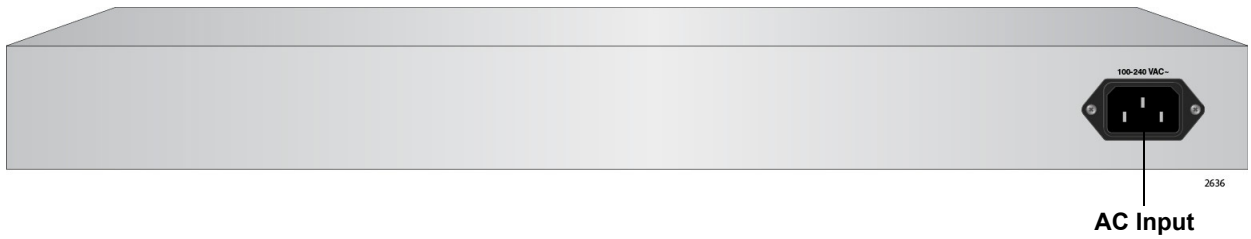

Figure 3. AT-GS950/16PS Back Panel

See Figure 4 for an example of the AT-GS950/48PS back panel.

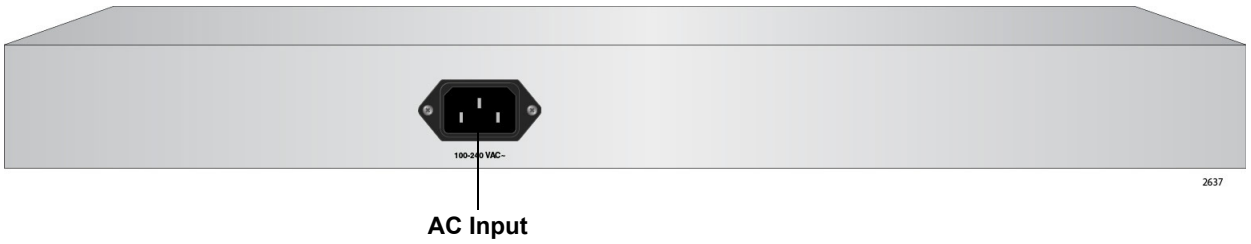

Figure 4. AT-GS950/48PS Back Panel

## Management Software

---

The switches are shipped with the management software pre-installed. The software provides a web-browser interface for in-band, over-the-network management. Although the three models have the same features, each has a different management software program. The programs are:

- AT-S110 Management Software Web User's Guide for the AT-GS950/10PS Switch
- AT-S111 Management Software Web User's Guide for the AT-GS950/48PS Switch
- AT-S112 Management Software Web User's Guide for the AT-GS950/16PS Switch

In the unlikely event that the management software becomes corrupted or damaged on the switch, you can download the software from the Allied Telesis corporate web site and reinstall it on the switch. For instructions on how to install new management software, see the product documentation.

## Twisted Pair Ports

---

The AT-GS950/10PS, AT-GS950/16PS, and AT-GS950/48PS Layer 2 Gigabit Ethernet Switches feature 10, 16, and 48 twisted pair ports, respectively. All ports are 10Base-T, 100Base-TX, and 1000Base-TX compliant. You can set the port speeds and duplex modes either automatically with IEEE 802.3u Auto-Negotiation or manually with the management software.

The twisted pair ports feature 8-pin RJ-45 connectors. For the port pinouts, see “Connectors and Port Pinouts” on page 52.

The ports have a maximum operating distance of 100 m (328 feet). For 10 Mbps operation, the ports require Category 3 or better 100 ohm shielded or unshielded twisted pair cabling. For 100 or 1000 Mbps operation, the ports require Category 5 or Enhanced Category 5 (5E) 100 ohm shielded or unshielded twisted pair cabling.

The ports feature auto-MDI, which automatically configures the ports as MDI or MDI-X. This feature allows you to use straight-through twisted pair cables regardless of the wiring configurations of the ports on the end nodes.

---

### Note

A switch port connected to an end node that is not using Auto-Negotiation should not use Auto-Negotiation to set the speed and duplex mode, because a duplex mode mismatch may occur. In this case, disable Auto-Negotiation and set the port's speed and duplex mode manually.

---

## Power over Ethernet (PoE)

---

Power over Ethernet technology permits both power and data to be transmitted over an Ethernet cable. Both PoE (IEEE802.3af) and PoE+ (IEEE802.3at) are supported on the 10/100/1000T ports on the AT-GS950/10PS, AT-GS950/16PS, and AT-GS950/48PS switches. Here is a summary of the PoE feature:

- Powered device classes 0,1, 2, 3 and 4 are supported.
- Port prioritization is provided on all PoE ports.
- The default configuration is DISABLED on all PoE switch ports.
- The PoE configuration parameters can be set through the switch's web management interface.

The maximum number of ports that the AT-GS950xx/PS switches will support when only one class of service is required from the powered devices connected to the PoE ports is shown in Table 1.

---

### Note

Each switch can support any combination of PoE classes 0 - 4 simultaneously up to the maximum PoE power that is available from the switch.

---

Table 1. Max Ports Supported per PoE Class

Switch	PoE Ports	Max PoE Power Available	Class 2 IEEE 802.3af (7W per Port)	Class 3 IEEE 802.3af (15.4W per Port)	Class 4 IEEE 802.3at (30W per Port)
AT-GS950/10PS	Ports 1 - 8	75 W	8 Ports	4 Ports	2 Ports
AT-GS950/16PS	Ports 1 - 16	150W	16 Ports	12 Ports	6 ports
AT-GS950/48PS	Ports 1 - 24	370W	24 Ports	24 Ports	12 ports

### Port Power Priority

When the power budget for the switch is reached, each port is allotted power according to its priority level. You can set the power priority of each PoE port to one of three levels: Low, High, and Critical. The default is Low.

If the priority level of all the ports is set to the same value, the lowest port number has the highest port power priority. For instance, if you connect eight class 4 powered devices to ports 1 - 8 on a AT-GS950/16PS switch, the PoE power budget is exceeded and some ports will have the PoE power turned off. The ports allowed to transmit power are determined by the Port Priority feature. In this case, port 1 has the highest power priority level and transmits PoE power followed by port 2, etc. through port 6 while ports 7 and 8 are not allowed to transmit any PoE power.

## Combo Ports

---

The AT-GS950/8 and AT-GS950/48PS Switches have two combo ports and the AT-GS950/16PS Switch has four combo ports. Each combo port consists of one 10/100/1000Base-T twisted pair port and one slot for an optional 100Base-FX or 1000Base-SX/LX SFP transceiver. The twisted pair ports are identified with the letter “R” for “Redundant” on the front faceplates of the units. The ports and slots are listed in Table 2.

Table 2. Combo Ports

Switch	Twisted Pair Port	SFP Slot
AT-GS950/10PS	9R	9
	10R	10
AT-GS950/16PS	15R	15
	16R	16
AT-GS950/48PS	45R	45
	46R	46
	47R	47
	48R	48

The combo ports have the guidelines listed here:

- Only one port in a pair, either the twisted pair port or a corresponding SFP module, can be active at a time.
- The twisted pair port is the active port when its SFP slot is empty, or when an SFP module is installed but has not established a link to an end node.
- The twisted pair port automatically changes to the redundant status mode when an SFP module establishes a link with an end node.
- A twisted pair port automatically transitions back to the active status when the link is lost on the SFP module.
- In nearly all cases, a twisted pair port and an SFP module share the same configuration settings, including port settings, VLAN assignments, access control lists, and spanning tree.
- An exception to the shared settings is port speed. If you disable Auto-Negotiation on a twisted pair port and set the speed and duplex mode manually, the speed reverts to Auto-Negotiation when an SFP module establishes a link with an end node.

# LEDs

There are four types of LEDs on the AT-GS950 Switches:

- “PWR/SYS LEDs” on page 16
- “10/100/1000 BaseT Link Activity LEDs” on page 18
- “PoE LEDs” on page 22
- “SFP LEDs” on page 20

## PWR/SYS LEDs

The PWR LED reports the status of AC power and is located on the left side of the front panel of the AT-GS950/10PS switch. See Figure 5.

**Note**

All of the port LEDs are off when the switch is operating in the low power mode. To toggle on the LEDs, use the eco-Friendly button. See “eco-Friendly Button” on page 25 for more information.

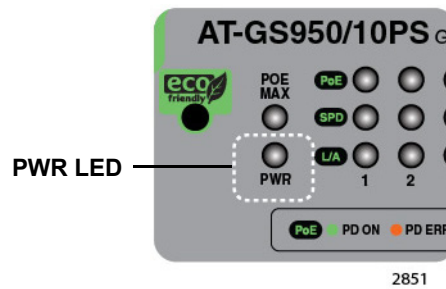

Figure 5. PWR LED on AT-GS950/10PS

Table 3 describes the PWR LEDs for the AT-GS950/10PS switch.

Table 3. AT-GS950/10PS PWR LED Functional Descriptions

LED	State	Description
PWR	Off	Indicates either the switch is not receiving AC power or the AC input power is operating outside the normal range.
	Steady Green	The switch is receiving AC input power and is operating normally.

On the AT-GS950/16PS and AT-GS950/48PS switches, the power and FAN status is indicated with a system or SYS LED. See Figure 6 and Figure 7.



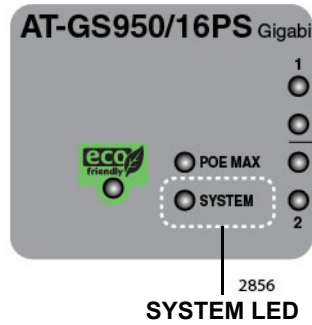

Figure 6. SYSTEM LED on AT-GS950/16PS

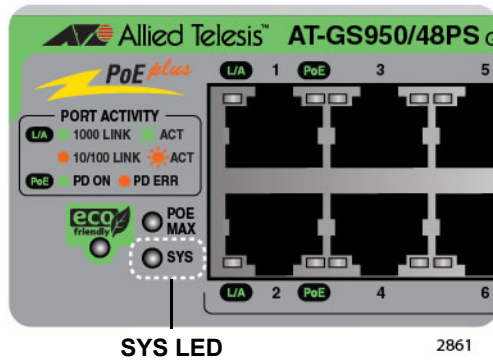

Figure 7. SYS LED on AT-GS950/48PS

Table 4 describes the functions for the SYS LED for the AT-GS950/16PS and AT-GS950/48PS switches.

Table 4. AT-GS950/16PS and AT-GS950/48PS SYS LED Functional Descriptions

LED	State	Description
SYS	Off	Indicates either the switch is not receiving power or the AC input power is operating outside the normal range.
	Steady Green	The switch is receiving AC input power and is operating normally.
	Steady Red	Indicates the system is experiencing a fan failure.

## 10/100/1000 BaseT Link Activity LEDs

The Link Activity (L/A) LEDs provide information about the 10/100/1000Base-T ports.

### AT-GS950/10PS Link/Activity and Speed LEDs

The AT-GS950/10PS switch indicates L/A (link activity) and SPD (speed) with two LEDs for each port. See Figure 8.

**Note**

All of the port LEDs are off when the switch is operating in the low power mode. To toggle on the LEDs, use the eco-Friendly button. See “eco-Friendly Button” on page 25 for more information.

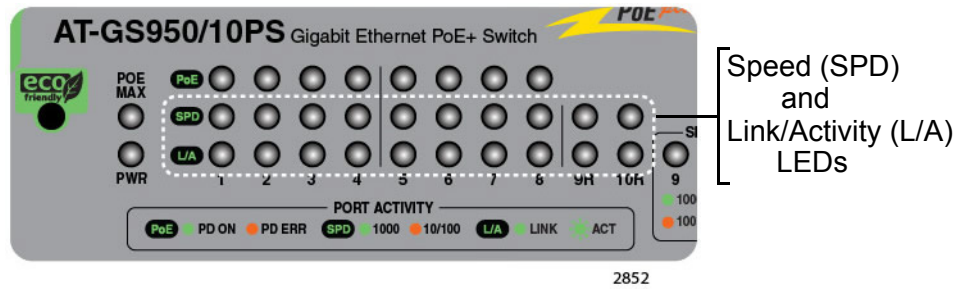

Figure 8. AT-GS950/10PS Link/Activity and Speed LEDs

See Table 5 for a description for the AT-GS950/10PS Link/Activity and Speed LEDs.

Table 5. AT-GS950/10PS L/A and SPD LEDs Functional Descriptions

LED	State	Description
Link/Activity (L/A)	Off	The port has not established a link with a network device.
	Blinking Green	The port is transmitting or receiving network packets.
Speed (SPD)	Off	The port has not established a link with a network device.
	Steady Amber	The maximum operating speed of the port is 10 or 100 Mbps.
	Steady Green	The maximum operating speed of the port is 1000 Mbps.

### AT-GS950/16PS Link/Activity LEDs

The AT-GS950/16PS switch has one LED per port on the front panel to indicate link, activity and speed status. See Figure 9.

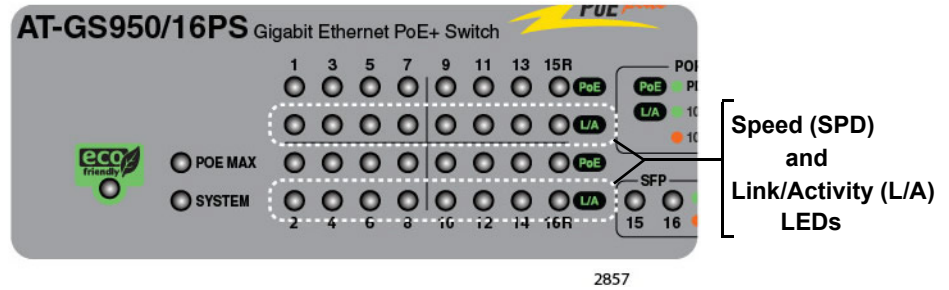

Figure 9. AT-GS950/16PS Link/Activity/Speed LEDs

The AT-GS950/48PS switch has one LED per port to indicate port's link, activity and speed status. These LEDs are located next to each port. See Figure 10.

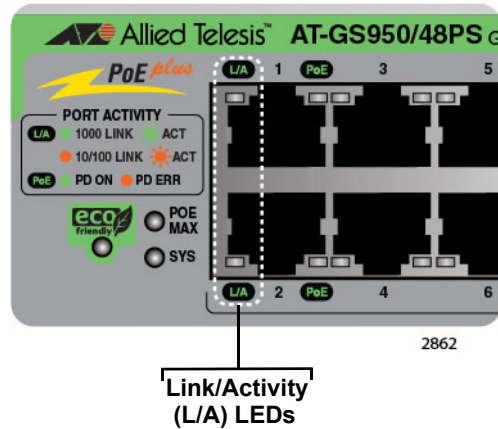

Figure 10. AT-GS950/48PS Link/Activity/Speed Port LED

See Table 6 for a description for the AT-GS950/16PS and AT-GS950/48PS Link/Activity and Speed LEDs.

Table 6. AT-GS950/16PS and AT-GS950/48PS L/A LED Functional Descriptions

LED	State	Description
L/A (link/activity)	Off	The port on the has not established a link.
	Steady Green	The port has established a 1000Mbps link to a network device, but it is not transmitting or receiving network packets.
	Blinking Green	Indicates the port transmitting or receiving network packets at 1000 Mbps.
	Steady Amber	The SFP transceiver has established a link at either 10 or 100 Mbps with a network device, but is not transmitting or receiving network packets.
	Blinking Amber	Indicates the port is transmitting or receiving network packets at 10 or 100 Mbps.

**SFP LEDs**

The SFP LEDs indicate the Link/Activity and Speed status of each SFP slot.

**Note**

All of the port LEDs are off when the switch is operating in the low power mode. To toggle on the LEDs, use the eco-Friendly button. See “eco-Friendly Button” on page 25 for more information.

The AT-GS950/10PS and AT-GS950/16PS switches have the SFP LEDs on the front panel. See Figure 11 and Figure 12.

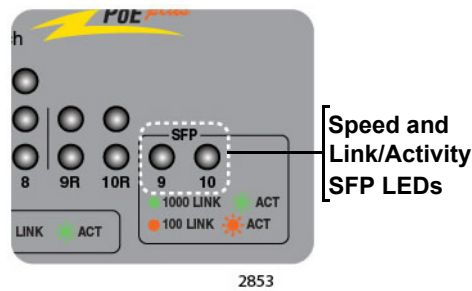

Figure 11. AT-GS950/10PS SFP Speed and Link/Activity LEDs

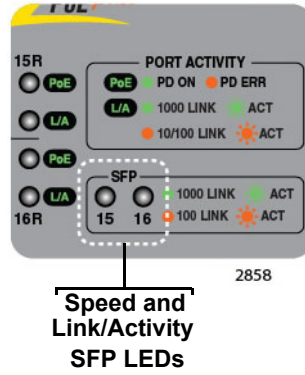

Figure 12. AT-GS950/16PS SFP Status LEDs

The AT-GS950/48PS SFP LEDs can be found on between the upper and lower SFP slots. See Figure 13.

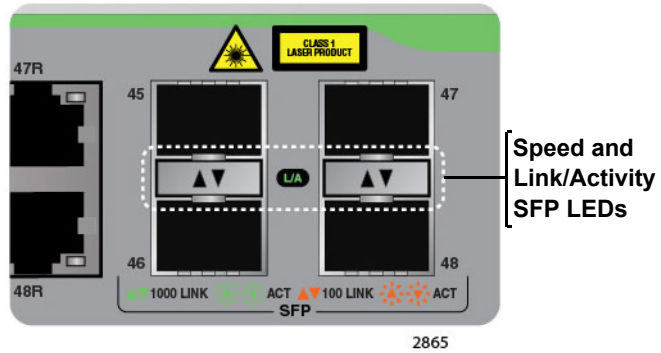

Figure 13. AT-GS950/48PS SFP Status LEDs

Table 7 describes the Link LEDs for the SFP slots.

Table 7. SFP Slot LED Functional Descriptions

LED	State	Description
SFP	Off	The port on the SFP transceiver has not established a link with an end node or the transceiver slot is empty.
	Blinking Green	The SFP transceiver is transmitting or receiving network packets at 1000 Mbps.
	Steady Green	The SFP transceiver has established a link with a network device at 1000 Mbps, but is not transmitting or receiving network packets.
	Blinking Amber	The SFP transceiver is transmitting or receiving network packets at 100 Mbps.
	Steady Amber	The SFP transceiver has established a link with a network device at 100 Mbps, but is not transmitting or receiving network packets.

## PoE LEDs

All three PoE switches have two types of PoE LEDs indicating the PoE status for each port and maximum power limit of the switch's PoE power supply.

Each switch model has individual PoE LEDs indicating the PoE status of each individual port. Each chassis also has one PoE MAX LED which is used to determine if you have exceeded the maximum power that the chassis is capable of supplying to the powered devices (PDs).

### AT-GS950/10PS and AT-GS950/16PS PoE Status LEDs

The AT-GS950/10PS switch can supply PoE power to PDs on ports 1 - 8. See Figure 14 on page 23 for the locations of the PoE LEDs.

The AT-GS950/16PS switch can supply PoE power to PDs on ports 1 - 16. See Figure 15 on page 23 for the location of the PoE LEDs.

The AT-GS950/48PS switch can supply PoE power to PDs on ports 1 - 24. See Figure 16 on page 23 for the location of the PoE status LEDs.

---

#### Note

See "Power over Ethernet (PoE)" on page 14 for more information about this PoE feature.

---



---

#### Note

All of the port LEDs are off when the switch is operating in the low power mode. To toggle on the LEDs, use the eco-Friendly button. See "eco-Friendly Button" on page 25 for more information.

---

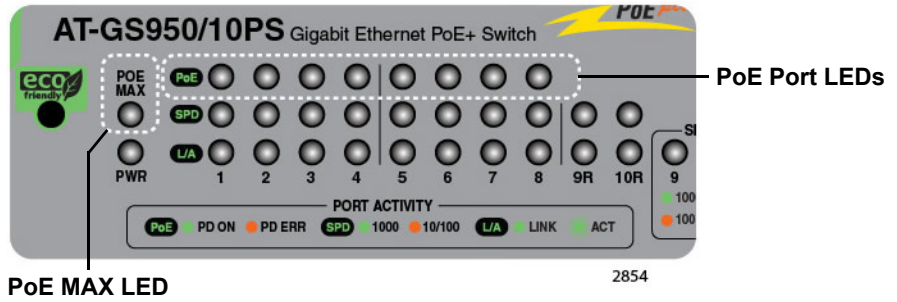

Figure 14. AT-GS950/10PS PoE and PoE MAX LEDs

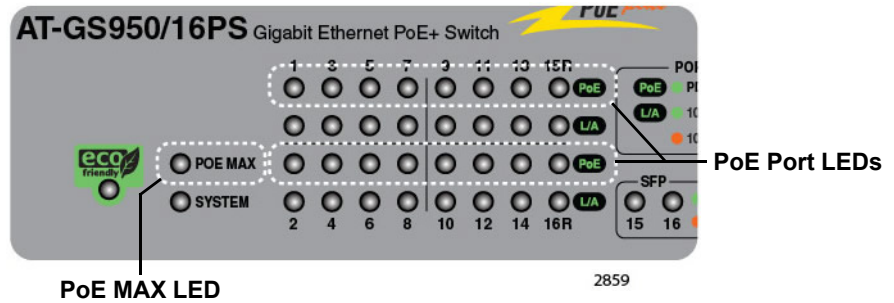

Figure 15. AT-GS950/16PS PoE and PoE MAX LEDs

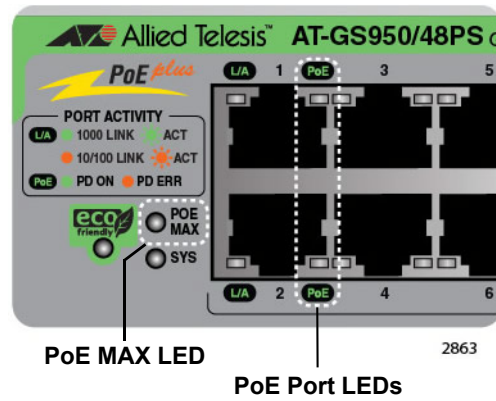

Figure 16. AT-GS950/48PS PoE and PoE MAX LEDs

See Table 8 for a functional description of the PoE status LEDs.

Table 8. PoE Status LED Functional Descriptions

LEDs	State	Description
PoE MAX	Red	Indicates the total PoE output power for all ports on the switch exceeds the maximum PoE power that the switch can deliver.
	Off	Indicates the switch has spare power for a new PD.

Table 8. PoE Status LED Functional Descriptions

<b>LEDs</b>	<b>State</b>	<b>Description</b>
PoE	Green	PoE power is being supplied to the PD normally.
	Amber	Indicates the total PoE output power for this port exceeds the maximum power budget for the switch.
	Off	PoE power is not being supplied.



## eco-Friendly Button

---

The eco-Friendly button serves multiple functions. See Figure 17 for its location.

By pressing this button, you can:

- Toggle the front panel LEDs on and off to conserve electricity when you are not physically monitoring the switch.
- Reboot your switch while maintaining the current configuration
- Reset your switch configuration to the factory default values.

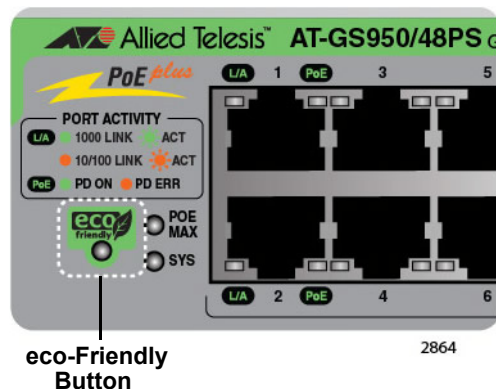

Figure 17. eco-Friendly Button

---

### Note

The eco-Friendly button does not control the Power LED.

---

### eco-Friendly Button Operation

The button operates as follows:

- **Conserve energy:** When you press the eco-Friendly button for 1 to 4 seconds, the front panel port LEDs are disabled. You may use the button to turn off the LEDs when you are not monitoring the switch. To turn the port LEDs on, press the eco-Friendly button for 1 to 4 seconds again. Toggling the LEDs does not affect the network operations of the switch.
- **Reboot the switch:** By pressing the button for 5 to 9 seconds, you can initiate a software reboot of the switch.
- **Reset the switch to factory default settings:** By pressing the button for more than 10 seconds, you initiate a software reboot of the switch followed by a reset of the switch to its factory settings.  
Rebooting the Switch and Resetting Factory Defaults

## Reboot/Reset the Switch

Use the following procedure to reboot the switch or reboot the switch and reset the switch to its factory default settings with the eco-Friendly button:



### Caution

This procedure causes the switch to reboot. The switch does not forward network traffic during the reboot process. Some network traffic may be lost.

---

1. To reset the switch, press the eco-Friendly button for 5 to 9 seconds.

Rebooting takes approximately 1 to 2 minutes before the switch comes back on line and is ready to transmit Ethernet traffic again.

2. To reboot the switch and reset the switch to its factory default settings, press the eco-Friendly button for more than 10 seconds.

This initiates a software reboot of the switch and resets all of the configuration parameters of the switch to the factory default settings, including the management IP address which reverts to 192.168.1.1. If your browser is configured for another IP address, you must reconfigure your browser and workstation before you can connect to the switch again.

---

### Note

In the management software, you can disable both the reboot and factory default reset functions for the eco-Friendly button. For more information, see “Management Software” on page 12 for a list of the manuals.

---

## Power Supply

---

Each switch has an internal power supply with a single AC power supply socket on the back panel. To power the switch on or off, connect or disconnect the power cord provided with the switch. A power cord is supplied with the switch.

---

**Note**

For the power requirements, see the “Power Specifications” on page 52.

---

## Fans

---

Both the AT-GS950/16PS and AT-GS950/48PS switches have internal fans. You cannot remove or replace these fans in the field. The fan status is indicated with the SYSTEM LED. See “PWR/SYS LEDs” on page 16 for more information.

---

**Note**

The AT-GS950/10PS switch does not have a fan.

---

## Chapter 2

# Installation

---

This chapter contains the following sections:

- “Reviewing Safety Precautions” on page 30
- “Selecting a Site for the Switch” on page 32
- “Cable Specifications” on page 33
- “Unpacking the Switch” on page 34
- “Installing the Switch on a Desktop” on page 36
- “Installing the Switch in an Equipment Rack” on page 37
- “Installing the Switch on a Wall” on page 39
- “Installing Optional SFP Transceivers” on page 42
- “Cabling the Switch” on page 45
- “Powering On the Switch” on page 46

## Reviewing Safety Precautions

---

Please review the following safety precautions before you begin to install the chassis or any of its components.

---

### Note

The  indicates that a translation of the safety statement is available in a PDF document titled **Translated Safety Statements**.

---



### Warning

To prevent electric shock, do not remove the cover. No user-serviceable parts inside. This unit contains hazardous voltages and should only be opened by a trained and qualified technician. To avoid the possibility of electric shock, disconnect electric power to the product before connecting or disconnecting the cables.  E1

---



### Warning

Do not work on equipment or cables during periods of lightning activity.  E2

---



### Warning

Power cord is used as a disconnection device. To de-energize equipment, disconnect the power cord.  E3

---



### Warning

Class I Equipment. This equipment must be earthed. The power plug must be connected to a properly wired earth ground socket outlet. An improperly wired socket outlet could place hazardous voltages on accessible metal parts.  E4

---

Pluggable Equipment. The socket outlet shall be installed near the equipment and shall be easily accessible.  E5

---



### Caution

Air vents must not be blocked and must have free access to the room ambient air for cooling.  E6

---

Operating Temperature. This product is designed for a maximum ambient temperature of 40° degrees C.  E7

---

---

All Countries: Install product in accordance with local and National Electrical Codes. ⚡ E8

---

---

Circuit Overloading: Consideration should be given to the connection of the equipment to the supply circuit and the effect that overloading of circuits might have on overcurrent protection and supply wiring. Appropriate consideration of equipment nameplate ratings should be used when addressing this concern. ⚡ E21

---



**Warning**

Mounting of the equipment in the rack should be such that a hazardous condition is not created due to uneven mechanical loading. ⚡ E25

---

---

If installed in a closed or multi-unit rack assembly, the operating ambient temperature of the rack environment may be greater than the room ambient temperature. Therefore, consideration should be given to installing the equipment in an environment compatible with the manufacturer's maximum rated ambient temperature ( $T_{mra}$ ). ⚡ E35

---



**Caution**

Installation of the equipment in a rack should be such that the amount of air flow required for safe operation of the equipment is not compromised. ⚡ E36

---



**Warning**

Reliable earthing of rack-mounted equipment should be maintained. Particular attention should be given to supply connections other than direct connections to the branch circuits (e.g., use of power strips). ⚡ E37

---

## Selecting a Site for the Switch

---

Observe the following requirements when choosing a site for your switch:

- If you plan to install the switch in an equipment rack, verify that the rack is safely secured and will not tip over. Devices in a rack should be installed starting at the bottom, with the heavier devices near the bottom of the rack.
- If you are installing the switch on a table, verify that the table is level and secure.
- The power outlet for the switch should be located near the unit and should be easily accessible.
- The site should provide for easy access to the ports on the front of the switch. This will make it easier for you to connect and disconnect cables, as well as view the switch's LEDs.
- Air flow around the unit and through its vents on the side and rear should not be restricted so that the switch can maintain adequate cooling.
- Do not place objects on top of the switch.
- Do not expose the switch to moisture or water.
- Ensure that the site is a dust-free environment.
- You should use dedicated power circuits or power conditioners to supply reliable electrical power to the network devices.



## Cable Specifications

---

Table 9 contains the cable specifications for the twisted pair ports.

Table 9. Twisted Pair Cabling and Distances

Speed	Type of Cable	Maximum Operating Distance
10 Mbps	Standard TIA/EIA 568-B-compliant Category 3 or better shielded or unshielded cabling with 100 ohm impedance and a frequency of 16 MHz.	100 m (328 ft)
100 Mbps	Standard TIA/EIA 568-A-compliant Category 5 or TIA/EIA 568-B-compliant Enhanced Category 5 (Cat 5e) shielded or unshielded cabling with 100 ohm impedance and a frequency of 100 MHz.	100 m (328 ft)
1000 Mbps	Standard TIA/EIA 568-A-compliant Category 5 or TIA/EIA 568-B-compliant Enhanced Category 5 (Cat 5e) shielded or unshielded cabling with 100 ohm impedance and a frequency of 100 MHz.	100 m (328 ft)

---

**Note**

The twisted pair ports on the switch feature auto-MDI when operating at 10, 100, or 1000 Mbps. A port is configured as MDI or MDI-X when it is connected to an end node. Consequently, you can use a straight-through twisted pair cable when connecting any type of network device to a port on the switch.

---

## Unpacking the Switch

---

To unpack the switch, perform the following procedure:

1. Remove all of the components from the shipping package.

---

**Note**

Store the packaging material in a safe location. You must use the original shipping material if you need to return the unit to Allied Telesis.

---

2. Place the switch on a level, secure surface.
3. In addition to an AT-GS950/10PS, AT-GS950/16PS, or AT-GS950/48PS switch, verify that the shipping container includes the following items shown in Figure 18 on page 35.

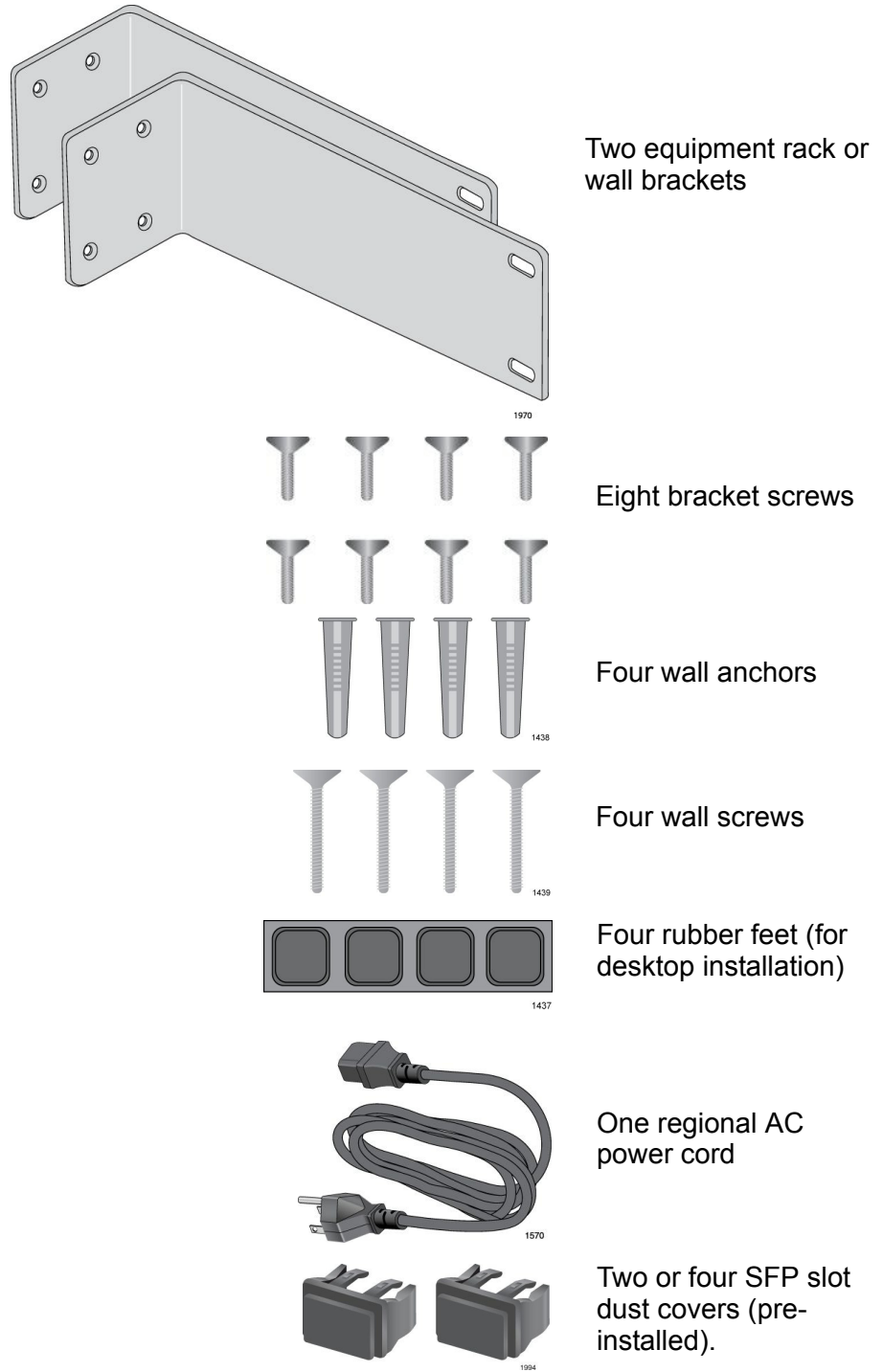

Figure 18. Shipping Package Contents

## Installing the Switch on a Desktop

---

You may install the switches on a desktop, in a standard 19-inch equipment rack, or on a wall. To install the switch in a rack, see “Installing the Switch in an Equipment Rack” on page 37. To install the switch on a wall, see “Installing the Switch on a Wall” on page 39.

To place the switch on a desktop, perform the following procedure:

1. Remove all equipment from the package and store the packaging material in a safe place.
2. Turn the switch over and place it on a table.
3. Attach the four rubber feet to the bottom of the switch as shown in Figure 19.

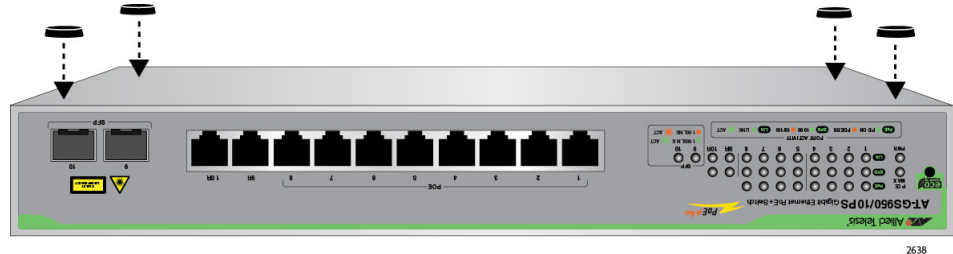

Figure 19. Attaching the Rubber Feet

4. Turn the switch over again and place it on a flat, secure surface (such as a desk or table) leaving ample space around the unit for ventilation.
5. Go to “Installing Optional SFP Transceivers” on page 42 or “Cabling the Switch” on page 45.

## Installing the Switch in an Equipment Rack

---

To install the switch in a standard 19-inch equipment rack, perform the following procedure:

1. If the rubber feet are attached to the bottom of the switch, remove them using a flat-head screwdriver.
2. Attach the two rack mount brackets to the sides of the switch using the eight bracket screws that come with the unit. There are four possible positions in which the brackets may be installed.

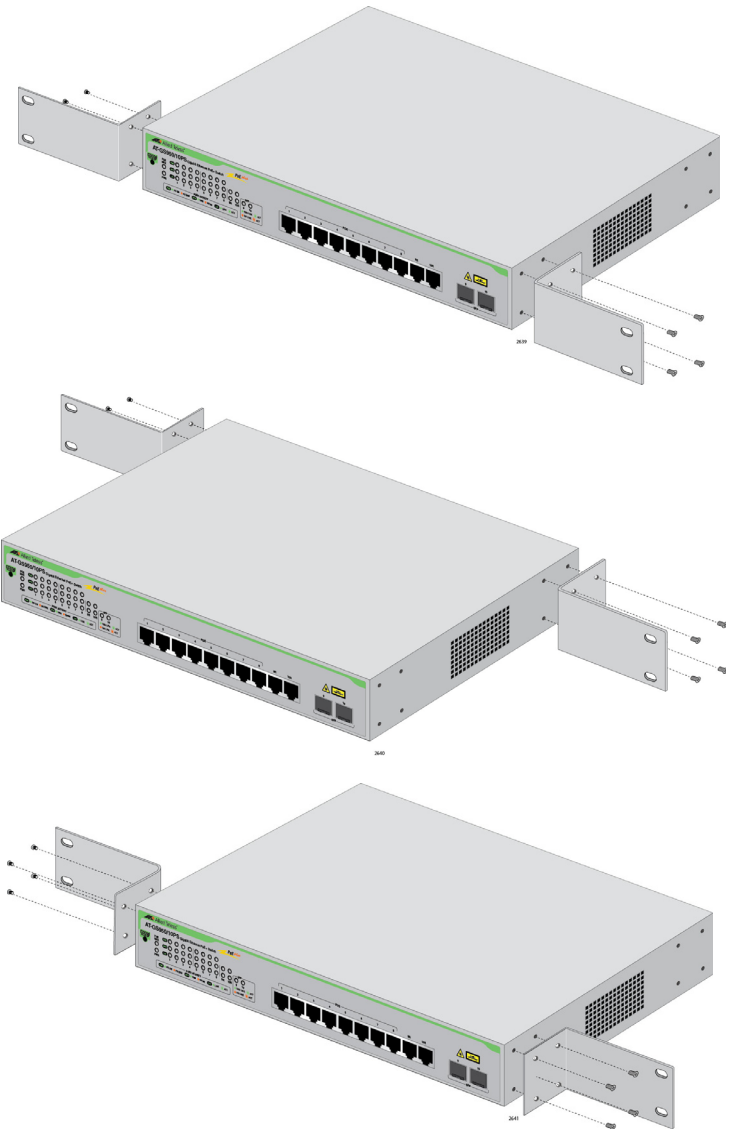

Figure 20. Attaching the Rack-Mount Brackets to the Switch

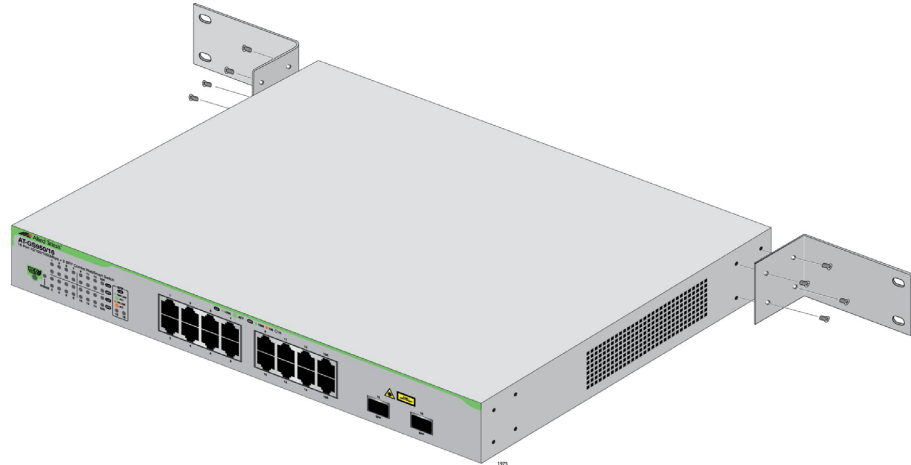

Figure 21. Attaching the Rack-Mount Brackets to the Switch (Continued)

3. Mount the switch in a standard 19-inch equipment rack using four equipment rack screws (not provided with the switch).

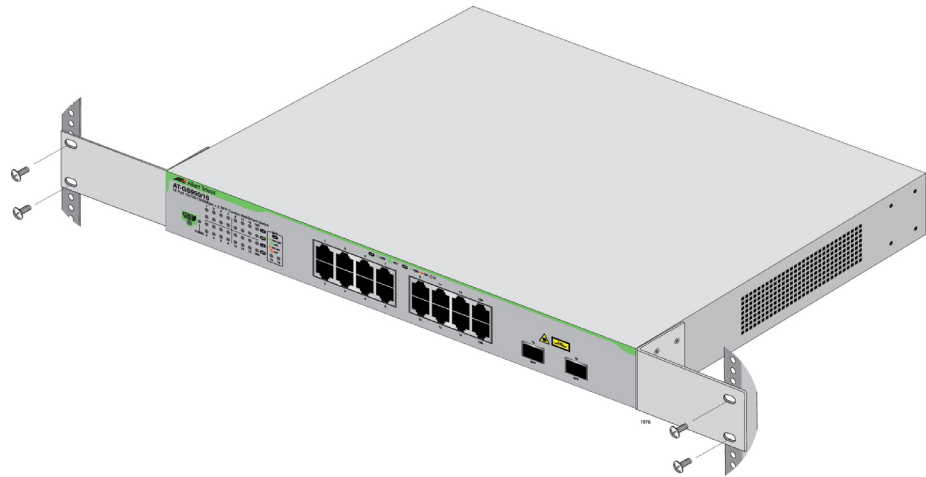

Figure 22. Mounting the Switch in an Equipment Rack

4. Go to “Installing Optional SFP Transceivers” on page 42 or “Cabling the Switch” on page 45.

## Installing the Switch on a Wall

---

Only the AT-GS950/10PS and AT-GS950/16PS switches can be installed on a wall.



---

**Caution**

The AT-GS950/48PS is too heavy to be safely installed on a wall.

---

To AT-GS950/10PS or AT-GS950/16PS install the switch on a wall, perform the following procedure:

1. Turn the switch over and place it on a table.
2. If the rubber feet are attached to the bottom of the switch, remove them using a flat-head screwdriver.
3. Orient the brackets against the sides of the switch as shown in Figure 23, and secure them to the unit with the eight brackets screws included with the switch.

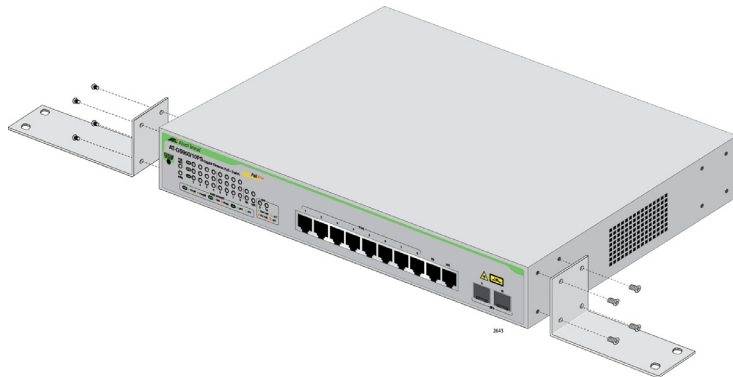

Figure 23. Attaching the Brackets to Install the Switch on a Wall

4. Have another person hold the switch at the wall location where the switch is to be installed, while you use a pencil or pen to mark the wall with the locations of the four holes in the brackets. The switch should be oriented such that its front faceplate is facing up and is level to the floor. See Figure 24 on page 40.

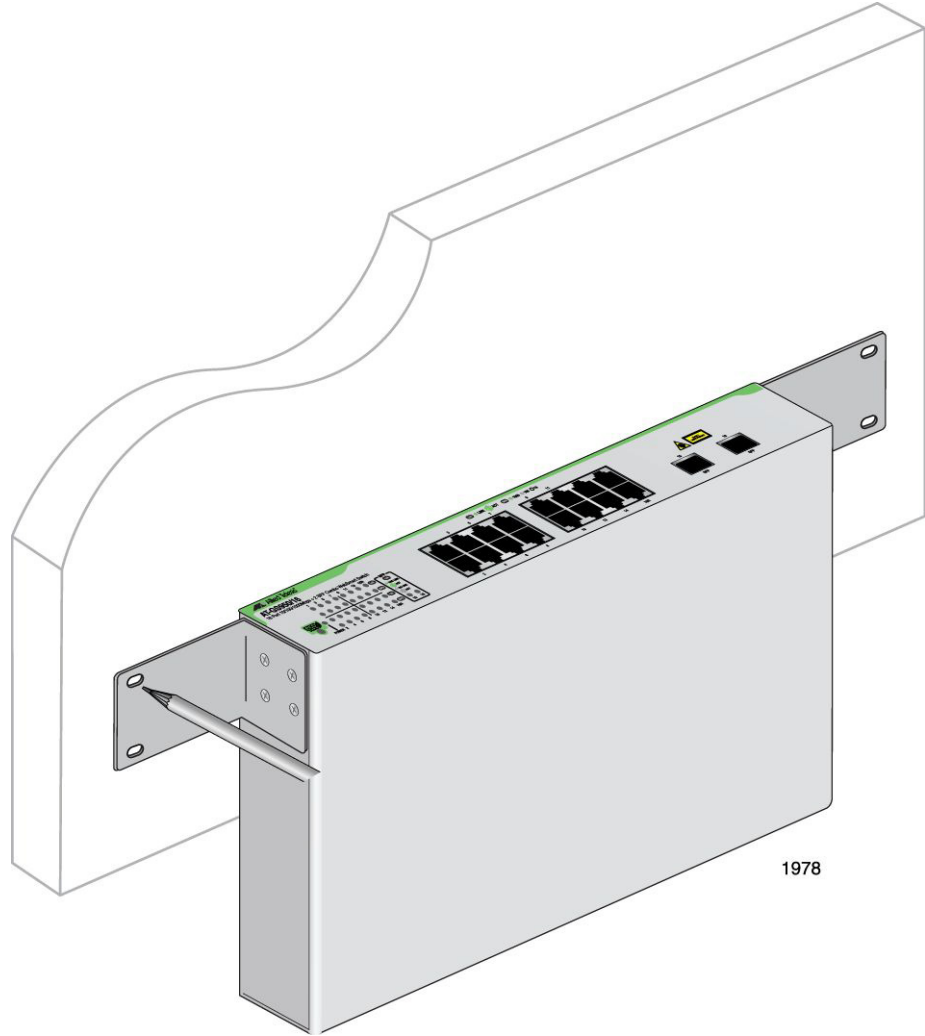

Figure 24. Marking the Screw Hole Locations

5. Install the four plastic anchors included with the switch into the wall, at the locations marked in the previous step. The anchors require 0.635 mm (0.25 in.) holes.



6. While another person holds the switch at the wall location, secure it to the wall using the four wall mounting screws. See Figure 25.

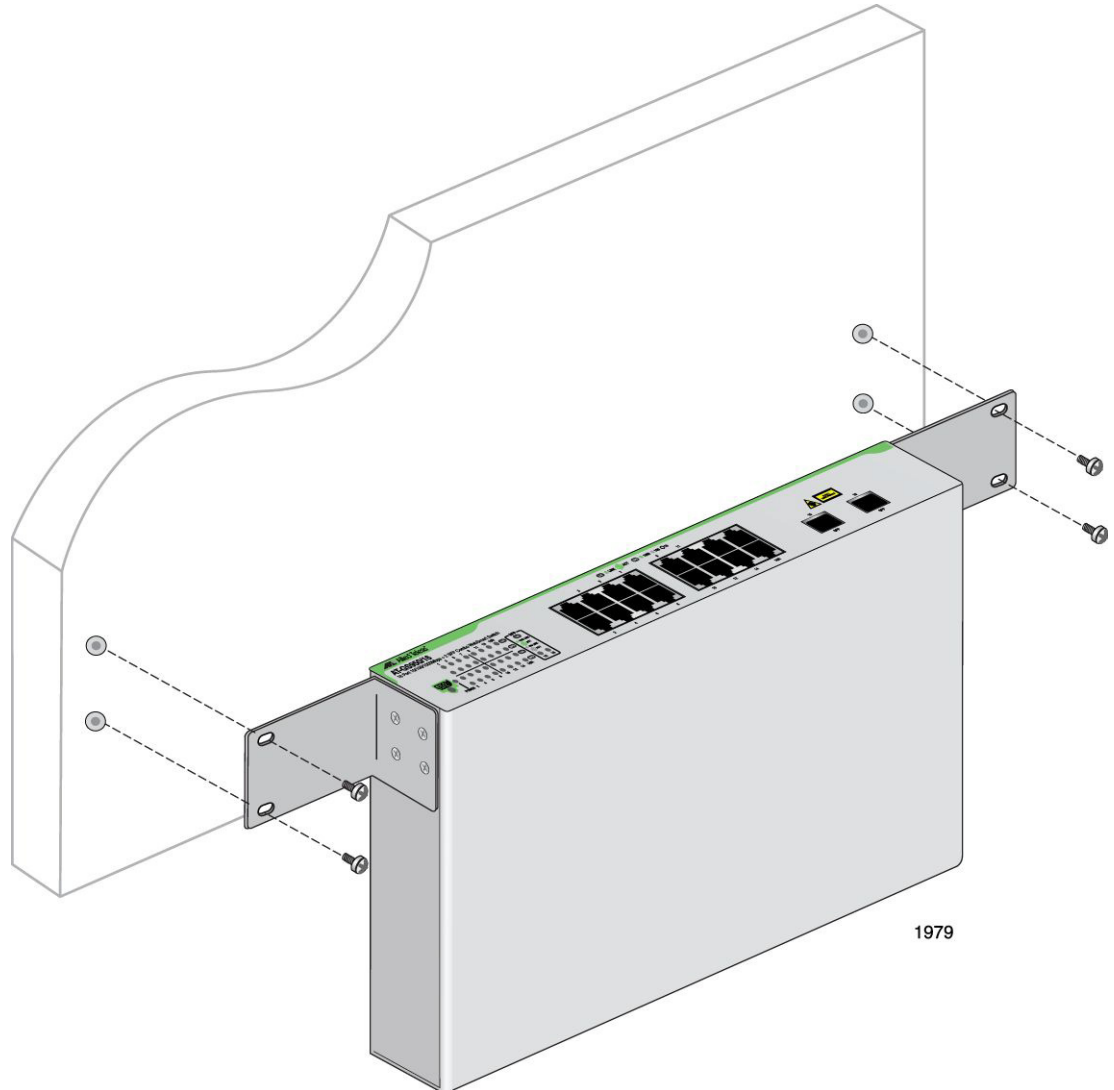

Figure 25. Securing the Switch to the Wall

7. Go to “Installing Optional SFP Transceivers” on page 42 or “Cabling the Switch” on page 45.

## Installing Optional SFP Transceivers

---

To install an SFP transceiver, perform the following procedure:

---

**Note**

The transceiver can be hot-swapped; you do not need to power off the switch to install a transceiver. However, always remove the cables before removing the transceiver.

---

---

**Note**

You should always install the transceiver before connecting the fiber optic cables to it.

---

1. Remove the transceiver from its shipping container and store the packaging material in a safe location.

**Warning**

An SFP transceiver can be damaged by static electricity. Be sure to observe all standard electrostatic discharge (ESD) precautions, such as wearing an antistatic wrist strap, to avoid damaging the transceiver.

---

2. Remove the dust plug from an SFP slot. See Figure 26.

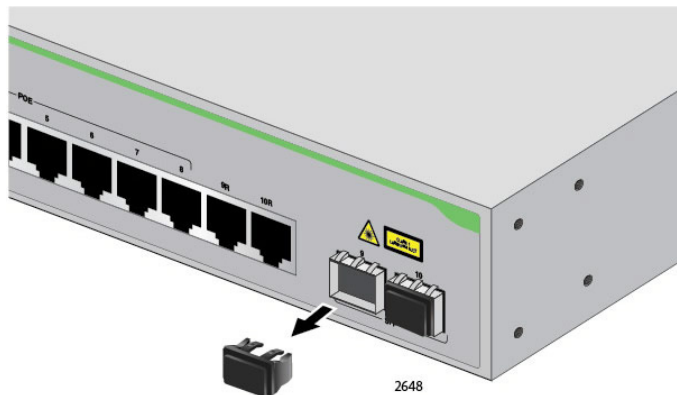

Figure 26. Removing the Dust Plug from an SFP Slot

3. Position the SFP transceiver with the label facing up.

4. Slide the transceiver into the SFP slot until it clicks into place. See Figure 27

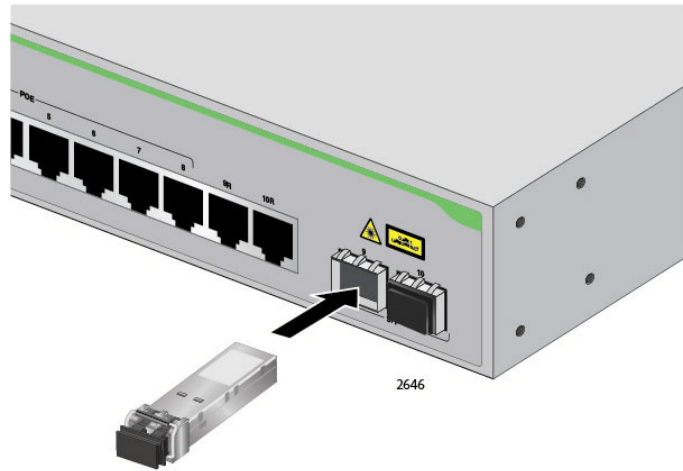

Figure 27. Inserting the SFP

5. Verify that the handle on the transceiver is in the upright position, as shown in Figure 28. This secures the transceiver and prevents it from being dislodged from the slot.

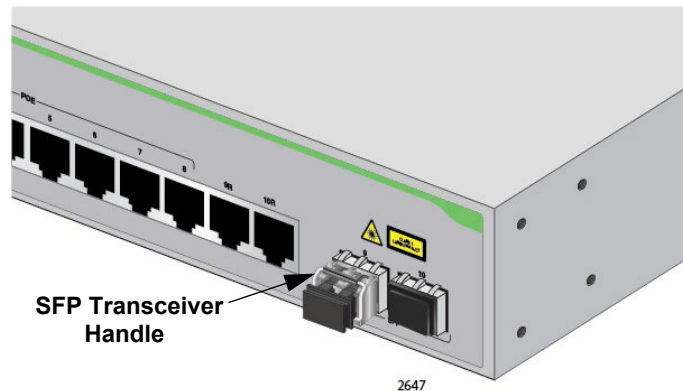

Figure 28. Positioning the SFP Handle in the Upright Position

6. Repeat steps 2 through 5 to install additional SFP transceivers.

---

**Note**

SFP transceivers are dust sensitive. Always keep the plug in the optical bores when a fiber optic cable is not installed, or when storing the SFP. When you do remove the plug, keep it for future use.

---

**Note**

Unnecessary removal and insertion of an SFP can lead to premature failure.

---

For information on the cable specifications of the SFP, consult the documentation shipped with the SFP.

7. Go to “Cabling the Switch” on page 45.

## Cabling the Switch

---

Observe the following guidelines when connecting twisted pair and fiber optic cables to the ports on the switch:

- The connector on the cable should fit snugly into the port on the switch. The tab on the connector should lock the connector into place.
- Because the twisted pair ports have auto-MDI/MDI-X, you may use straight-through twisted pair cable to connect any type of network device to the switch.
- If your network topology contains a loop where two or more network devices can communicate with each other over more than one network path, do not connect the network cables that form the loop until after you activate a spanning tree protocol on the switch. Data loops can adversely affect network performance.
- If you are creating a port trunk, do not connect the cables of the trunk to the switch until after you have created the trunk in the switch's management software. Otherwise, a network loop will result which can adversely affect network performance.

## Powering On the Switch

---

To power on the switch, perform the following procedure:

1. Plug the power cord into the AC power connector on the back of the switch, as shown in Figure 29.

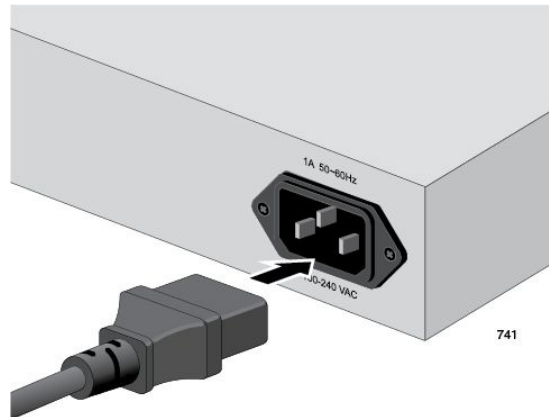

Figure 29. Plugging in the AC Power Cord

2. Plug the other end of the power cord into a wall outlet.



### Warning

Power cord is used as a disconnection device. To de-energize equipment, disconnect the power cord. ⚡ E3

---

Pluggable Equipment. The socket outlet shall be installed near the equipment and shall be easily accessible. ⚡ E5

---

3. Verify that the POWER LED is green. If the LED is OFF, see Chapter 3, “Troubleshooting” on page 47.

The switch is now powered on and ready for network operations. For information on how to manage the switch, see one of the following manuals:

- AT-S110 Management Software Web User’s Guide for the AT-GS950/10PS Switch
- AT-S111 Management Software Web User’s Guide for the AT-GS950/48PS Switch
- AT-S112 Management Software Web User’s Guide for the AT-GS950/16PS Switch

## Chapter 3

# Troubleshooting

---

This chapter contains information on how to troubleshoot the switch if a problem occurs.

---

**Note**

For further assistance, please contact Allied Telesis Technical Support at [www.alliedtelesis.com/support](http://www.alliedtelesis.com/support).

---

**Problem 1:** The POWER LED on the front of the switch is off.

**Solutions:** The unit is not receiving power. Try the following:

- Verify that the power cord is securely connected to the power source and to the AC connector on the back panel of the switch.
- Verify that the power outlet has power by connecting another device to it.
- Try connecting the unit to another power source.
- Try a different power cord.
- Verify that the voltage from the power source is within the required levels for your region.

**Problem 2:** All of the port LEDs are off even though the ports are connected to active network devices.

**Solution:** The switch is probably operating in low power mode. To toggle on the LEDs, press the eco-friendly button on the front panel between to 4 seconds.

**Caution**

Pressing the eco-friendly button for more than 4 seconds causes the switch to reboot. The switch does not forward network traffic during the reboot process. Some network traffic may be lost. Pressing the eco-friendly button for more than 10 seconds causes the switch to reset to factory defaults.

---

**Problem 3:** A twisted pair port on the switch is connected to a network device but the port's LINK/ACT LED is off.

**Solutions:** The port is unable to establish a link to a network device. Try the following:

- Verify that the network device connected to the twisted pair port is

powered on and is operating properly.

- Verify that the twisted pair cable is securely connected to the port on the media converter channel and to the port on the remote network device.
- Verify that the port is connected to the correct twisted pair cable. This is to eliminate the possibility that the port is connected to the wrong network device, such as a powered off device.
- Try connecting another network device to the twisted pair port with a different cable. If the twisted pair port is able to establish a link, then the problem is with the cable or the other network device.
- Verify that the twisted pair cable does not exceed 100 meters (328 feet).
- Verify that you are using the appropriate category of twisted pair cable: Category 3 or better for 10 Mbps operation and Category 5 and Category 5E for 100 and 1000 Mbps operation.

---

**Note**

A 1000Base connection may require five to ten seconds to establish a link.

---

**Problem 4:** The LINK/ACT LED for an SFP transceiver is off.

**Solutions:** The fiber optic port on the transceiver is unable to establish a link to a network device. Try the following:

- Verify that the network device connected to the fiber optic port is operating properly.
- Verify that the fiber optic cable is securely connected to the port on the media converter channel and to the port on the remote network device.
- Check that the SFP module is fully inserted in the slot.
- Verify that the operating specifications of the fiber optic ports on the SFP transceiver and the remote network device are compatible.
- Verify that the correct type of fiber optic cabling is being used.
- Verify that the port is connected to the correct fiber optic cable. This is to eliminate the possibility that the port is connected to the wrong remote network device, such as a powered off device.
- Try connecting another network device to the fiber optic port using a different cable. If the port is able to establish a link, then the problem is with the cable or with the other network device.
- Use the switch's management software to verify that the port is enabled.
- If the remote network device is a management device, use its



management firmware to determine whether its port is enabled.

- Test the attenuation on the fiber optic cable with a fiber optic tester to determine whether the optical signal is too weak (sensitivity) or too strong (maximum input power).

**Problem 5:** Network performance between a twisted pair port on the switch and a network device is slow.

**Solution:** There might be a duplex mode mismatch between the port and the network device. This occurs when a twisted pair port using Auto-Negotiation is connected to a device with a fixed duplex mode of full duplex. If this is the cause of the problem, adjust the duplex mode of the port on the network device or on the switch so that both ports are using the same duplex mode.

**Problem 6:** A port's LINK/ACT LED is blinking.

**Solutions:** The link between the port and the network device is intermittent. Try the following:

- Connect another network device with a different cable to the port. If the Link LED remains steady on, then the problem is with the original cable or the network device.
- If the problem is with an SFP transceiver, check that the transceiver is fully inserted in the slot.



## Appendix A

# Technical Specifications

---

## Physical Specifications

---

### Dimensions

Table 10. Chassis Dimensions

Model	W x D x H mm (in)
AT-GS950/10PS	330 mm x 200 mm x 44 mm (13.0 in x 7.9 in x 1.7 in)
AT-GS950/16PS	430 mm x 250 mm x 44 mm (17.0 in x 9.4 in x 1.7 in)
AT-GS950/48PS	440 mm x 430 mm x 44 mm (17.32 in x 17.0 in x 1.7 in)

### Weight

Table 11. Chassis Weight

Model	W x D x H mm (in)
AT-GS950/10PS	1.90 kg (4.20 lbs)
AT-GS950/16PS	3.56 kg (7.85 lbs)
AT-GS950/48PS	6.62 kg (14.60 lbs)

## Environmental Specifications

---

Table 12. Environmental Specifications

Operating Temperature	0° C to 45° C (32° F to 113° F)
Storage Temperature	-25° C to 70° C (-13° F to 158° F)
Operating Humidity	5% to 90% non-condensing
Storage Humidity	5% to 95% non-condensing
Operating Altitude Range	Up to 3,000 m (9,843 ft)

## Power Specifications

---

Input Supply Voltage - 100-240 VAC, 50 - 60 Hz

Table 13. Power Specifications

AT-GS950/10PS	92.7 W
AT-GS950/16PS	228.5 W
AT-GS950/48PS	446.0 W

## PoE Specifications

---

The maximum number of ports that the AT-GS950xx/PS switches will support when only one class of service is required from the powered devices connected to the PoE ports is shown in Table 14.

Table 14. Max Ports Supported per PoE Class

Switch	PoE Ports	Max PoE Power Available	Class 2 IEEE 802.3af (7W per Port)	Class 3 IEEE 802.3af (15.4W per Port)	Class 4 IEEE 802.3at (30W per Port)
AT-GS950/10PS	Ports 1 - 8	75 W	8 Ports	4 Ports	2 Ports
AT-GS950/16PS	Ports 1 - 16	150W	16 Ports	12 Ports	6 ports
AT-GS950/48PS	Ports 1 - 24	370W	24 Ports	24 Ports	12 ports

## Safety and Electromagnetic Emissions Certifications

---

Table 15. Safety and Electromagnetic Emissions Certifications

RFI Emissions	FCC Part 15 Class A CISPR Class A EN55022:2006/A:2007 Class A
Immunity	EN55024
Electrical Safety	EN60950 (TUV) T-Mark, UL 60950 (CULUS), C-TICK, CE

Table 15. Safety and Electromagnetic Emissions Certifications

Environmental Compliance	EU-RoHS compliant, WEEE China RoHS compliant
--------------------------	-------------------------------------------------

## Connectors and Port Pinouts

This section lists the connectors and connector pinouts.

Figure 30 illustrates the pin layout for an RJ-45 connector and port.

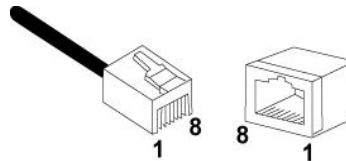

Figure 30. RJ-45 Connector and Port Pin Layout

Table 16 lists the RJ-45 pin signals when a twisted pair port is operating in the MDI configuration.

Table 16. MDI Pin Signals (10Base-T or 100Base-TX)

Pin	Signal
1	TX+
2	TX-
3	RX+
6	RX-

Table 17 lists the RJ-45 port pin signals when a twisted pair port is operating in the MDI-X configuration.

Table 17. MDI-X Pin Signals (10Base-T or 100Base-TX)

Pin	Signal
1	RX+
2	RX-
3	TX+
6	TX-

Table 18 lists the RJ-45 connector pins and their signals when a 1000Base-T port is operating at 1000 Mbps.

Table 18. RJ-45 1000Base-T Connector Pinouts

<b>Pin</b>	<b>Pair</b>	<b>Signal</b>
1	1	TX and RX+
2	1	TX and RX-
3	2	TX and RX+
4	3	TX and RX+
5	3	TX and RX-
6	2	TX and RX-
7	4	TX and RX+
8	4	TX and RX-