

Neosys Technology Inc.

Nuvo-5100VTC Series

User Manual

Rev. 1.0

Table of Contents

Table of Contents	2
Legal Information	5
Contact Information	6
Declaration of Conformity	6
Copyright Notice	7
Safety Precautions	8
Service and Maintenance	9
ESD Precautions	9
About This Manual	10

1 Introduction

1.1 Nuvo-5100VTC Series Overview	11
1.2 Nuvo-5100VTC Series Specifications	12
1.2.1 Nuvo-5100VTC Specification	12
1.2.2 Nuvo-5104VTC Specification	14
1.2.3 Nuvo-5108VTC Specification	16
1.3 Isolated DIO Specifications	18
1.4 Supported CPUs	18
1.5 Dimension	19
1.5.1 Superior View	19
1.5.2 Front Panel View	20
1.5.3 Side View	20
1.5.4 Bottom View	21
1.5.5 Dimensions with Mount Bracket/ Anti-vibration Grommet	22

2 System Overview

2.1 Nuvo-5100VTC Series Packing List	23
2.2 Nuvo-5100VTC Series Front Panel	24
2.2.1 DisplayPort	25
2.2.2 DVI Port	26
2.2.3 VGA Port	27
2.2.4 USB3.0 Port	28
2.2.5 Ethernet Port / PoE	29
2.2.6 On/ Off Ctrl & Status Output	30
2.2.7 2.5" HDD Tray Lock/ HDD Tray	31
2.2.8 System Status LED	31
2.2.9 Power Button	32
2.2.10 Reset Button	32
2.3 Nuvo-5100 VTC Series Rear Panel	33
2.3.1 SIM Slot	34
2.3.2 Ignition Control Switch	34
2.3.3 CAN Bus Port	35
2.3.4 M12 Power over Ethernet Port (Nuvo-5100 VTC)	36
2.3.5 RJ-45 Power over Ethernet Port (Nuvo-5104VTC / 5108VTC)	37
2.3.6 3.5mm Speaker-out / Microphone-in Jack	38
2.3.7 Digital Input/ Output	39
2.3.8 COM Ports	41
2.3.9 USB2.0 Ports	42
2.3.10 3-Pin Terminal Block for DC and Ignition Input	42
2.4 Internal I/O Components	43
2.4.1 DDR4 SO-DIMM Slots	43
2.4.2 Dual Mode mSATA/ mini-PCIe socket	44
2.4.3 mini-PCIe Socket	46
2.4.4 SATA Ports	48
2.4.5 Internal USB Port	49
2.4.6 mini-PCIe Socket on MezIO™ -V510	50

3	System Installation	
3.1	Disassembling the System Enclosure.....	53
3.2	CPU Installation Procedure	54
3.3	Memory Module Installation	57
3.4	mini-PCIe Module Installation.....	58
3.5	Reinstalling the System Enclosure.....	60
3.6	Internal 2.5" SATA HDD/ SSD Installation.....	62
3.7	External 2.5" HDD/ SSD Installation.....	64
3.8	DC Power Connection.....	66
3.9	Wall Mount/ Anti-Vibration Bracket Installation	67
3.9.1	Anti-vibration Bracket Installation.....	67
3.9.2	Wall Mount Bracket Installation.....	68
3.10	DIN Rail Installation (Optional)	69
3.11	Powering On the System	70
3.11.1	Powering On Using the Power Button.....	70
3.11.2	Powering On Using External Non-latched Switch	71
3.11.3	Powering On Using Wake-on-LAN.....	72
3.12	Ignition Power Control	74
3.12.1	Principles of Ignition Power Control	74
3.12.2	Additional Features of Ignition Power Control	75
3.12.3	Wiring Ignition Signal.....	76
3.12.4	Configure your Windows system.....	77
3.12.5	Operation Modes of Ignition Power Control	78
4	System Configuration	
4.1	BIOS Settings	82
4.1.1	COM1 & COM3 Operating Mode	83
4.1.2	CAN bus Termination.....	85
4.1.3	SATA Configuration	86
4.1.4	Configure Hot-Swappable HDD Tray	88
4.1.5	TPM Availability.....	89
4.1.6	CPU SKU Power Configuration.....	90
4.1.7	Wake on LAN Option	91
4.1.8	Power On after Power Failure Option	92
4.1.9	Boot Type (Legacy/ UEFI).....	93
4.1.10	Boot Option for Newly Added Device	94
4.1.11	Watchdog Timer for Booting.....	95
4.1.12	Selecting Legacy/ UEFI Boot Device	97
4.2	AMT Configuration	98
4.3	RAID Volume Configuration.....	99
5	OS Support and Driver Installation	
5.1	Operating System Compatibility	100
5.2	Install Drivers Automatically	101
5.3	Install Drivers Manually	102
5.3.1	For Windows 7 (x86).....	102
5.3.2	For Windows 7 (x64).....	102
5.3.3	For Windows 8/ 8.1/ 10 (x64).....	102
5.4	Install WDT_DIO Driver Package.....	103
5.4.1	For Windows 7 (x86).....	103
5.4.2	For Windows 7/ 8/ 10 (x64).....	103
5.4.3	For Windows 7/ 8/ 10 (WOW64).....	103
	Appendix A Windows 7 Installation	
	xHCI Driver Support in Microsoft OS.....	104
	User Provided Items For Windows 7 Installation	104
	Creating Windows 7 Installation USB Flash Drive	105
	Step 1 - Create .ISO File From Windows 7 DVD.....	105

Step 2 - Create USB Flash Drive Installer From .ISO.....	106
Step 3 - Create Folder and Copy Files for Patching Process	108
Step 4 - Execute .bat File to Patch .wim Files	109
Step 5 - Install Windows 7 Using USB Flash Drive Installer	111

Appendix B Using WDT & DIO

WDT and DIO Library Installation	113
WDT Function Reference	115
InitWDT	115
SetWDT.....	115
StartWDT.....	116
ResetWDT.....	116
StopWDT.....	116
Using DIO Function.....	117
Wiring for DIO.....	117
DIO Pin Definition.....	118
DIO Function Reference	119
InitDIO	119
DIReadLine	119
DIReadPort	119
DOWriteLine.....	120
DOWritePort	120
DOWriteLineChecked.....	121
DOWritePortChecked.....	121
COS Function Reference.....	122
SetupDICOS	122
RegisterCallbackDICOS.....	123
StartDICOS.....	123
StopDICOS.....	124
DI COS Example	124

Appendix C CAN bus Function

CAN Bus Function Reference	127
CAN_RegisterReceived	127
CAN_RegisterStatus	129
CAN_Setup	130
CAN_Start	131
CAN_Stop	131
CAN_Send	132

Appendix D Ignition Control Function

Ignition Control Function Reference.....	133
IGN_GetState	133
IGN_GetBatteryVoltage.....	134
IGN_GetSetting.....	135

Appendix E PoE On/ Off Control

GetStatusPoEPort	137
EnablePoEPort	138
DisablePoEPort	139

Legal Information

All Neosys Technology Inc. products shall be subject to the latest Standard Warranty Policy

Neosys Technology Inc. may modify, update or upgrade the software, firmware or any accompanying user documentation without any prior notice. Neosys Technology Inc. will provide access to these new software, firmware or documentation releases from download sections of our website or through our service partners.

Before installing any software, applications or components provided by a third party, customer should ensure that they are compatible and interoperable with Neosys Technology Inc. product by checking in advance with Neosys Technology Inc.. Customer is solely responsible for ensuring the compatibility and interoperability of the third party's products. Customer is further solely responsible for ensuring its systems, software, and data are adequately backed up as a precaution against possible failures, alternation, or loss.

For questions in regards to hardware/ software compatibility, customers should contact Neosys Technology Inc. sales representative or technical support.

To the extent permitted by applicable laws, Neosys Technology Inc. shall NOT be responsible for any interoperability or compatibility issues that may arise when (1) products, software, or options not certified and supported; (2) configurations not certified and supported are used; (3) parts intended for one system is installed in another system of different make or model.

Contact Information

Headquarters
(Taipei, Taiwan)

Neosys Technology Inc.
15F, No.868-3, Zhongzheng Rd., Zhonghe Dist., New Taipei City, 23586, Taiwan
Tel: +886-2-2223-6182 Fax: +886-2-2223-6183 [Email](#), [Website](#)

Americas
(Illinois, USA)

Neosys Technology America Inc.
3384 Commercial Avenue, Northbrook, IL 60062, USA
Tel: +1-847-656-3298 [Email](#), [Website](#)

China

Neosys Technology (China) Ltd.
Room 612, Building 32, Guiping Road 680, Shanghai
Tel: +86-2161155366 [Email](#), [Website](#)

Declaration of Conformity

FCC

This equipment has been tested and found to comply with the limits for a Class A digital device, pursuant to part 15 of the FCC Rules. These limits are designed to provide reasonable protection against harmful interference when the equipment is operated in a commercial environment. This equipment generates, uses, and can radiate radio frequency energy and, if not installed and used in accordance with the instruction manual, may cause harmful interference to radio communications. Operation of this equipment in a residential area is likely to cause harmful interference in which case the user will be required to correct the interference at own expense.

CE

The product(s) described in this manual complies with all applicable European Union (CE) directives if it has a CE marking. For computer systems to remain CE compliant, only CE-compliant parts may be used. Maintaining CE compliance also requires proper cable and cabling techniques.

Copyright Notice

All rights reserved. This publication may not be reproduced, transmitted, transcribed, stored in a retrieval system, or translated into any language or computer language, in any form or by any means, electronic, mechanical, magnetic, optical, chemical, manual or otherwise, without the prior written consent of Neosys Technology, Inc.

Disclaimer

This manual is intended to be used as an informative guide only and is subject to change without prior notice. It does not represent commitment from Neosys Technology Inc. Neosys Technology Inc. shall not be liable for any direct, indirect, special, incidental, or consequential damages arising from the use of the product or documentation, nor for any infringement on third party rights.

Patents and Trademarks

Neosys, the Neosys logo, Expansion Cassette, MezIO™ are registered patents and trademarks of Neosys Technology, Inc.

Windows is a registered trademark of Microsoft Corporation.

Intel®, Core™ is a registered trademark of Intel Corporation

NVIDIA®, GeForce® is a registered trademark of NVIDIA Corporation

Texas Instruments (TI) and Sitara are registered trademarks of Texas Instruments Incorporated.

All other names, brands, products or services are trademarks or registered trademarks of their respective owners.

Safety Precautions

- Read these instructions carefully before you install, operate, or transport the system.
- Install the system or DIN rail associated with, at a sturdy location
- Install the power socket outlet near the system where it is easily accessible
- Secure each system module(s) using its retaining screws
- Place power cords and other connection cables away from foot traffic. Do not place items over power cords and make sure they do not rest against data cables
- Shutdown, disconnect all cables from the system and ground yourself before touching internal modules
- Ensure that the correct power range is being used before powering the device
- Should a module fail, arrange for a replacement as soon as possible to minimize down-time
- If the system is not going to be used for a long time, disconnect it from mains (power socket) to avoid transient over-voltage

Service and Maintenance

- ONLY qualified personnel should service the system
- Shutdown the system, disconnect the power cord and all other connections before servicing the system
- When replacing/ installing additional components (expansion card, memory module, etc.), insert them as gently as possible while assuring connectors are properly engaged

ESD Precautions

- Handle add-on module, motherboard by their retention screws or the module's frame/ heat sink. Avoid touching the PCB circuit board or add-on module connector pins
- Use a grounded wrist strap and an anti-static work pad to discharge static electricity when installing or maintaining the system
- Avoid dust, debris, carpets, plastic, vinyl and styrofoam in your work area.
- Do not remove any module or component from its anti-static bag before installation

About This Manual

This manual introduces Neosys Technology Nuvo-5100VTC series in-vehicle systems that are designed for in-vehicle and railway applications with EN 50155 certification. The fanless systems support Intel 6th generation quad-core CPUs to provide exceptional performance for emerging high-end in-vehicle applications.

Applicable systems: Nuvo-5100VTC, Nuvo-5104VTC, Nuvo-5108VTC

Revision History

Version	Date	Description
1.0	Jan. 2018	Initial release

1 Introduction

Neosys' Nuvo-5100VTC series in-vehicle fanless computers support 6th Gen Intel® Core™ i7/ i5 quad-core CPUs to provide extraordinary performance for emerging high-end in-vehicle applications.

1.1 Nuvo-5100VTC Series Overview

Nuvo-5100VTC series is a fanless PC with EN 50155 (Nuvo-5100VTC) and E-mark (Nuvo-5108VTC) certification for in-vehicle & railway applications. The series features integrated IEEE 802.3at PoE+ ports in RJ45 socket/ M12 connectors. The RJ45 connectors offer compatibility and ease of connection while the M12 connectors offer rugged Ethernet connectivity while both can supply power to IP cameras for surveillance applications. By using X-coded M12 connectors, they offer higher rated voltage (60V), higher rated surge voltage (1.5kV) and higher data bandwidth (up to 10Gbps) to meet higher safety regulation requirements and in turn boost Gigabit Ethernet connection stability and reliability.

The Nuvo-5100VTC series platform offers dual DisplayPort outputs, dual Gigabit Ethernet, 4 or 8 PoE+, 4 USB 3.0, SATA, 3 COM ports, mini-PCIe, CAN bus and isolation digital I/O. Nuvo-5100VTC series supports 8~35V DC input and is suitable to be deployed in wide temperature operating conditions ranging from -25°C to 70°C.

Designed for in-vehicle deployment and has EN 50155 certification for railway applications, Nuvo-5100VTC series also features intelligent ignition power control and an easy-swap HDD tray. The derivative model, Nuvo-5108VTC, carries E-Mark to meet the requirements of European UN regulations for in-vehicle use.



Nuvo-5100/ 5104VTC



Nuvo-5108VTC



MX12 connectors on Nuvo-5100VTC



PoE ports on Nuvo-5108VTC

1.2 Nuvo-5100VTC Series Specifications

1.2.1 Nuvo-5100VTC Specification

System Platform	
Processor	Supports 6 th -Gen Intel® Core™ LGA1151 CPU <ul style="list-style-type: none"> ● Intel® Core™ i7-6700TE (2.4/ 3.4 GHz, 8MB cache, 35W TDP) ● Intel® Core™ i5-6500TE (2.3/ 3.3 GHz, 6MB cache, 35W TDP) ● Intel® Core™ i3-6100TE (2.7 GHz, 4MB cache, 35W TDP)
Chipset	Intel® Q170 Platform
Graphics	Integrated Intel® HD Graphics 530
Memory	2x 260-pin SO-DIMM sockets, up to 32 GB DDR4 2133 MHz SDRAM
I/O Interface	
Ethernet	2x Ethernet ports by Intel® I219 and I210
PoE+	4x IEEE 802.3at (25.5W) Gigabit PoE+ ports (M12 x-coded) by Intel® I210
Video Port	1x VGA supporting maximum 1920 x 1200 resolution 1x DVI-D supporting maximum 1920 x 1200 resolution 2x DisplayPort outputs, supporting maximum 4096 x 2304 resolution
USB	4x USB 3.0 ports via native xHCI controller 4x USB 2.0 ports
Serial Port	2x software-programmable RS-232/422/485 (COM1 & COM3) 1x RS-232 port (COM2)
CAN	1x CAN 2.0 port
Isolated DIO	4x isolated DI with COS interrupt and 4x isolated DO
Audio	1x microphone-in and 1x speaker-out
Storage Interface	
SATA HDD	1x internal SATA port for 2.5" HDD/SSD 1x hot-swappable HDD tray for 2.5" HDD/SSD (support RAID0/ 1)
mSATA	1x full-size mSATA (mux with mini-PCIe)
Expansion Bus	
Mini PCI-E	1x full-size mini-PCIe socket with panel-accessible SIM socket 1x full-size mini-PCIe socket with internal SIM socket (mux. with mSATA) 2x full-size mini-PCIe sockets (USB signals only) with internal SIM sockets
Power Supply & Ignition Control	
DC Input	1x 3-pin pluggable terminal block for 8~35VDC DC input
Ignition Control	Ignition power control with user-selectable on/ off delay
Remote Ctrl. &	1x 10-pin (2x5) wafer connector for remote on/off control and status LED

Status Output	output
Max. Power Consumption	With Core™ i7-6700TE: 49.2W (2.05A@24V)* With Core™ i5-6500TE: 47.8W (1.99A@24V)* With Core™ i3-6100TE: 39.4W (1.64A@24V)*
Mechanical	
Dimension	240 mm (W) x 225 mm (D) x 79 mm (H)
Weight	3.3 kg (approx.)
Mounting	Neousys' patented damping bracket (standard) or DIN-Rail mounting (optional)
Environmental	
Operating Temperature	-40°C ~ 70°C */** (EN 50155 Tx Class)
Storage Temperature	-40°C ~85°C
Humidity	10%~90% , non-condensing
Vibration	Operating, 5 Grms, 5-500 Hz, 3 Axes (w/ SSD, according to IEC60068-2-64)
Shock	Operating, 50 Grms, Half-sine 11 ms Duration (w/ SSD, according to IEC60068-2-27)
Certification	EN 50155 / EN 50121-3-2 / EN 50121-2-1/ EN50121-2-2 / EN 61373 CE/FCC Class A, according to EN 55022 & EN 55024

* Maximal power consumption is measured with 100% CPU and 3D loading applied using Passmark® BurnInTest™ v8.0. No Ethernet connection and external PoE devices are connected. For detail testing criteria, please contact Neousys Technology.

** For sub-zero operating temperature, a wide temperature HDD drive or Solid State Disk (SSD) is required.



NOTE

When running CPUs with greater than 35W TDP, the maximum operating temperature shall be limited to 50°C and thermal throttling may occur when sustained full-load is applied. Users can configure CPU power in BIOS to obtain higher operating temperature.

1.2.2 Nuvo-5104VTC Specification

System Platform	
Processor	Supports 6 th -Gen Intel® Core™ LGA1151 CPU <ul style="list-style-type: none"> ● Intel® Core™ i7-6700TE (2.4/ 3.4 GHz, 8MB cache, 35W TDP) ● Intel® Core™ i5-6500TE (2.3/ 3.3 GHz, 6MB cache, 35W TDP) ● Intel® Core™ i3-6100TE (2.7 GHz, 4MB cache, 35W TDP)
Chipset	Intel® Q170 Platform
Graphics	Integrated Intel® HD Graphics 530
Memory	2x 260-pin SO-DIMM sockets, up to 32 GB DDR4 2133 MHz SDRAM
I/O Interface	
Ethernet	2x Ethernet ports by Intel® I219 and I210
PoE+	4x IEEE 802.3at (25.5W) Gigabit PoE+ ports (RJ45) by Intel® I210
Video Port	1x VGA supporting maximum 1920 x 1200 resolution 1x DVI-D supporting maximum 1920 x 1200 resolution 2x DisplayPort outputs, supporting maximum 4096 x 2304 resolution
USB	4x USB 3.0 ports via native xHCI controller 4x USB 2.0 ports
Serial Port	2x software-programmable RS-232/422/485 (COM1 & COM3) 1x RS-232 port (COM2)
CAN	1x CAN 2.0 port
Isolated DIO	4x isolated DI with COS interrupt and 4x isolated DO
Audio	1x microphone-in and 1x speaker-out
Storage Interface	
SATA HDD	1x internal SATA port for 2.5" HDD/SSD 1x hot-swappable HDD tray for 2.5" HDD/SSD (support RAID0/ 1)
mSATA	1x full-size mSATA (mux with mini-PCIe)
Expansion Bus	
Mini PCI-E	1x full-size mini-PCIe socket with panel-accessible SIM socket 1x full-size mini-PCIe socket with internal SIM socket (mux. with mSATA) 2x full-size mini-PCIe sockets (USB signals only) with internal SIM sockets
Power Supply & Ignition Control	
DC Input	1x 3-pin pluggable terminal block for 8~35VDC DC input
Ignition Control	Ignition power control with user-selectable on/ off delay
Remote Ctrl. & Status Output	1x 10-pin (2x5) wafer connector for remote on/off control and status LED output
Max. Power Consumption	With Core™ i7-6700TE: 49.2W (2.05A@24V)* With Core™ i5-6500TE: 47.8W (1.99A@24V)*

	With Core™ i3-6100TE: 39.4W (1.64A@24V)*
Mechanical	
Dimension	240 mm (W) x 225 mm (D) x 79 mm (H)
Weight	3.3 kg (approx.)
Mounting	Neousys' patented damping bracket (standard) or DIN-Rail mounting (optional)
Environmental	
Operating Temperature	-40°C ~ 70°C */**
Storage Temperature	-40°C ~85°C
Humidity	10%~90% , non-condensing
Vibration	Operating, 5 Grms, 5-500 Hz, 3 Axes (w/ SSD, according to IEC60068-2-64)
Shock	Operating, 50 Grms, Half-sine 11 ms Duration (w/ SSD, according to IEC60068-2-27)
Certification	CE/FCC Class A, according to EN 55022 & EN 55024

* Maximal power consumption is measured with 100% CPU and 3D loading applied using Passmark® BurnInTest™ v8.0. No Ethernet connection and external PoE devices are connected. For detail testing criteria, please contact Neousys Technology.

** For sub-zero operating temperature, a wide temperature HDD drive or Solid State Disk (SSD) is required.



NOTE

When running CPUs with greater than 35W TDP, the maximum operating temperature shall be limited to 50°C and thermal throttling may occur when sustained full-load is applied. Users can configure CPU power in BIOS to obtain higher operating temperature.

1.2.3 Nuvo-5108VTC Specification

System Platform	
Processor	Supports 6 th -Gen Intel® Core™ LGA1151 CPU <ul style="list-style-type: none"> ● Intel® Core™ i7-6700TE (2.4/ 3.4 GHz, 8MB cache, 35W TDP) ● Intel® Core™ i5-6500TE (2.3/ 3.3 GHz, 6MB cache, 35W TDP) ● Intel® Core™ i3-6100TE (2.7 GHz, 4MB cache, 35W TDP)
Chipset	Intel® Q170 Platform
Graphics	Integrated Intel® HD Graphics 530
Memory	2x 260-pin SO-DIMM sockets, up to 32 GB DDR4 2133 MHz SDRAM
I/O Interface	
Ethernet	2x Ethernet ports by Intel® I219 and I210
PoE+	8x IEEE 802.3at (25.5W) Gigabit PoE+ ports (RJ45) by Intel® I210
Video Port	1x VGA supporting maximum 1920 x 1200 resolution 1x DVI-D supporting maximum 1920 x 1200 resolution 2x DisplayPort outputs, supporting maximum 4096 x 2304 resolution
USB	4x USB 3.0 ports via native xHCI controller 4x USB 2.0 ports
Serial Port	2x software-programmable RS-232/422/485 (COM1 & COM3) 1x RS-232 port (COM2)
CAN	1x CAN 2.0 port
Isolated DIO	4x isolated DI with COS interrupt and 4x isolated DO
Audio	1x microphone-in and 1x speaker-out
Storage Interface	
SATA HDD	1x internal SATA port for 2.5" HDD/SSD 1x hot-swappable HDD tray for 2.5" HDD/SSD (support RAID0/ 1)
mSATA	1x full-size mSATA (mux with mini-PCIe)
Expansion Bus	
Mini PCI-E	1x full-size mini-PCIe socket with panel-accessible SIM socket 1x full-size mini-PCIe socket with internal SIM socket (mux. with mSATA) 2x full-size mini-PCIe sockets (USB signals only) with internal SIM sockets
Power Supply & Ignition Control	
DC Input	1x 3-pin pluggable terminal block for 8~35VDC DC input
Ignition Control	Ignition power control with user-selectable on/ off delay
Remote Ctrl. & Status Output	1x 10-pin (2x5) wafer connector for remote on/off control and status LED output
Max. Power Consumption	With Core™ i7-6700TE: 49.2W (2.05A@24V)* With Core™ i5-6500TE: 47.8W (1.99A@24V)*

	With Core™ i3-6100TE: 39.4W (1.64A@24V)*
Mechanical	
Dimension	240 mm (W) x 225 mm (D) x 79 mm (H)
Weight	3.3 kg (approx.)
Mounting	Neousys' patented damping bracket (standard) or DIN-Rail mounting (optional)
Environmental	
Operating Temperature	-40°C ~ 70°C */**
Storage Temperature	-40°C ~85°C
Humidity	10%~90% , non-condensing
Vibration	Operating, 5 Grms, 5-500 Hz, 3 Axes (w/ SSD, according to IEC60068-2-64)
Shock	Operating, 50 Grms, Half-sine 11 ms Duration (w/ SSD, according to IEC60068-2-27)
Certification	E-mark E13 10R-0514321 CE/FCC Class A, according to EN 55022 & EN 55024

* Maximal power consumption is measured with 100% CPU and 3D loading applied using Passmark® BurnInTest™ v8.0. No Ethernet connection and external PoE devices are connected. For detail testing criteria, please contact Neousys Technology.

** For sub-zero operating temperature, a wide temperature HDD drive or Solid State Disk (SSD) is required.



NOTE

When running CPUs with greater than 35W TDP, the maximum operating temperature shall be limited to 50°C and thermal throttling may occur when sustained full-load is applied. Users can configure CPU power in BIOS to obtain higher operating temperature.

1.3 Isolated DIO Specifications

Isolated Digital Input	
No. of Channel	4-CH Isolated Digital Input Channels
Logic Level	Logic High: 5 to 24V Logic Low: 0 to 1.5V
Isolated Voltage	2500 Vrms
Input Resistance	1kΩ
Operation Mode	Polling I/O, Change-of-State Interrupt
Isolated Digital Output	
No. of Channel	4-CH Isolated Digital Output Channels
Sink Current (per channel)	100 mA (sustained loading) 250 mA (peak loading)
Isolated Voltage	2500 Vrms
Operation Mode	Polling, Change-of-State Interrupt
Output Type	Power MOSFET + Analog Device iCoupler®
Operation Mode	Polling I/O and Change-of-State interrupt for DI

1.4 Supported CPUs

Nuvo-5100VTC series accepts Intel® 6th Gen. i7/ i5/ i3 processor via the LGA1151 CPU socket. Nuvo-5100VTC series support

- Intel® Core™ i7-6700TE Processor (8M Cache, 2.4/ 3.4 GHz, 35W TDP)
- Intel® Core™ i5-6500TE Processor (6M Cache, 2.3/ 3.3 GHz, 35W TDP)
- Intel® Core™ i3-6100TE Processor (4M Cache, 2.7 GHz, 35W TDP)

Alternatively, you may also select a processor from Intel’s Embedded solution “[Products formerly Skylake](#)” that utilizes LGA1151 CPU socket.



NOTE

Other processors may result in different overall system power consumption or generate excess heat.

Avoid using CPUs not tested by Neosys Technology, as Neosys Technology may not be able guarantee the system’s stability and functionality under its designated working environment.

If in doubt, please contact Neosys technical support!

1.5 Dimension

1.5.1 Superior View

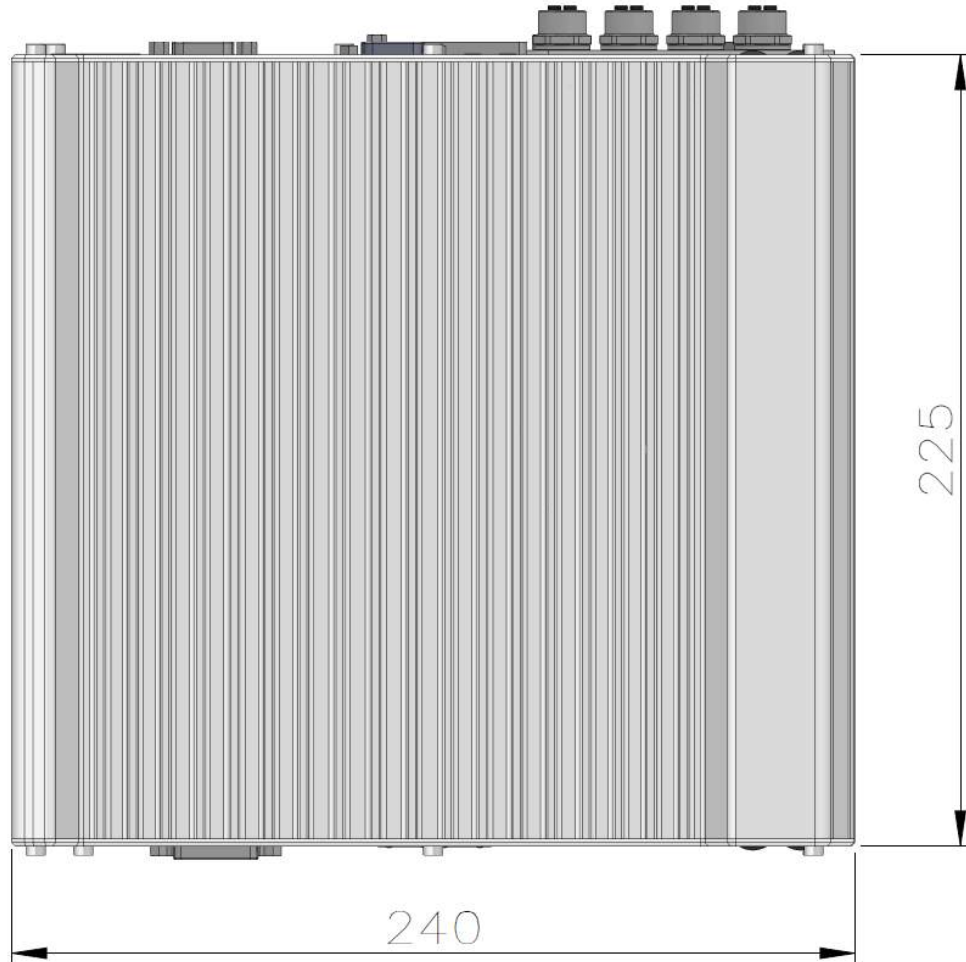

1.5.2 Front Panel View

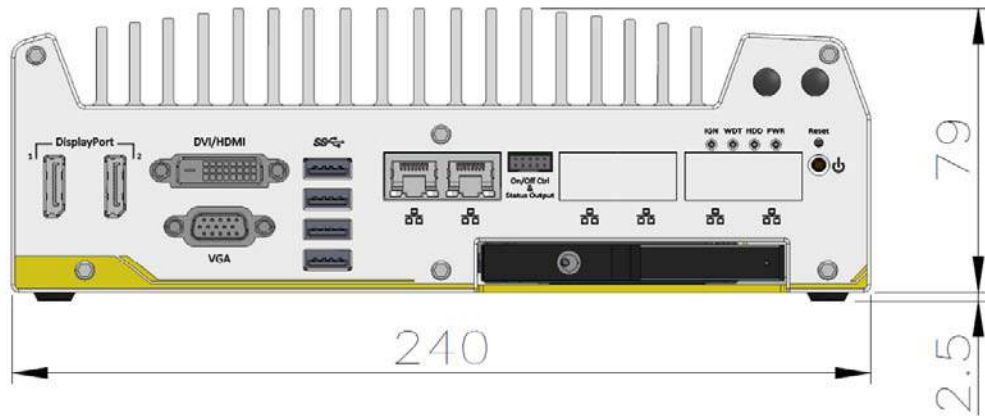

1.5.3 Side View

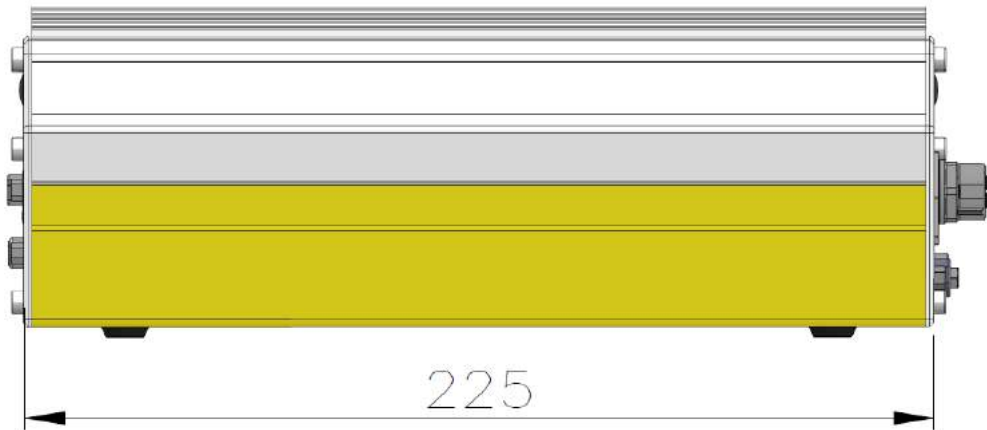

1.5.4 Bottom View

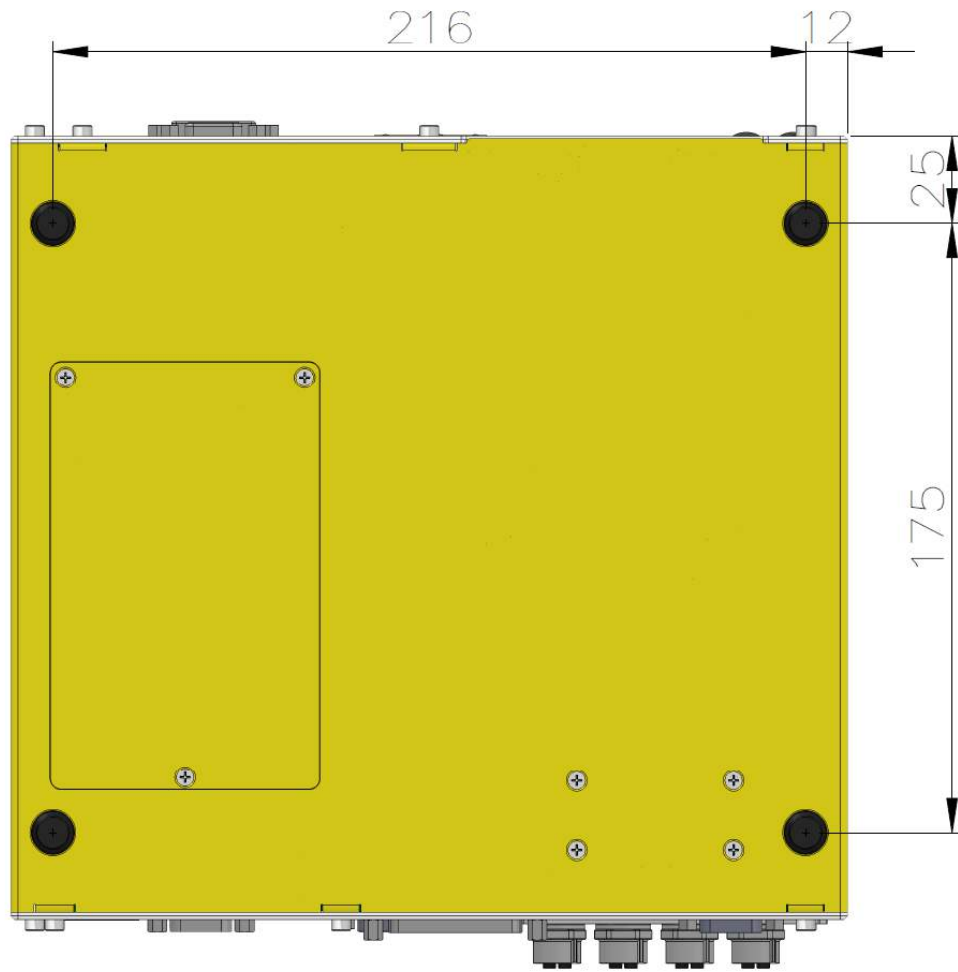

1.5.5 Dimensions with Mount Bracket/ Anti-vibration Grommet

Anterior View

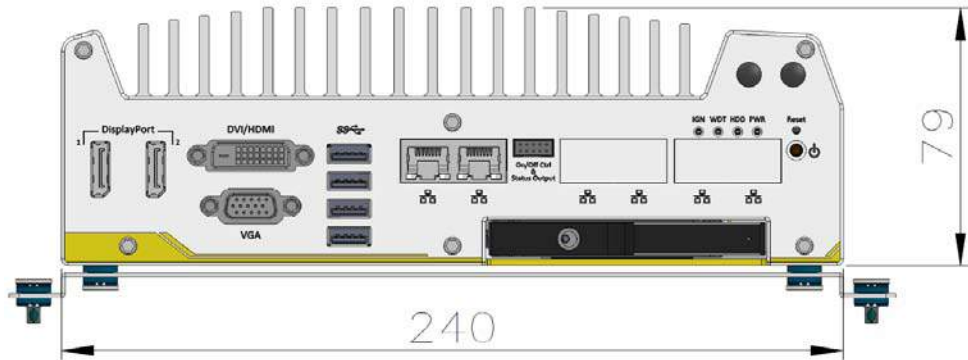

Bottom View

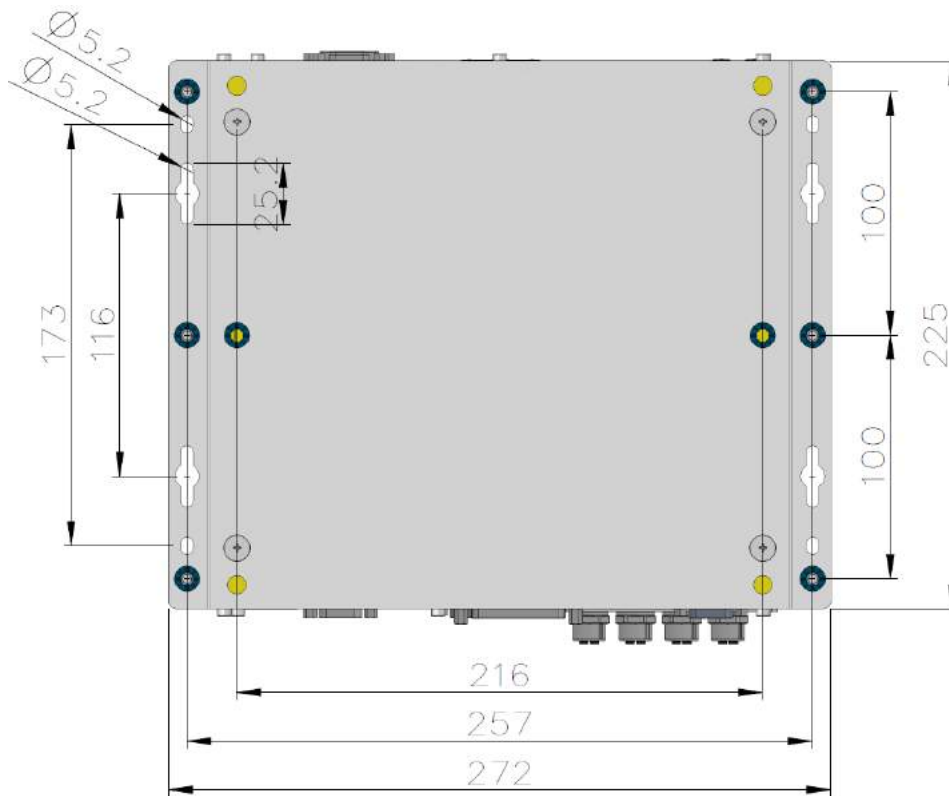

2 System Overview

Upon receiving and unpacking your Nuvo-5100VTC series, please check immediately if the package contains all the items listed in the following table. If any item(s) are missing or damaged, please contact your local dealer or Neousys Technology.

2.1 Nuvo-5100VTC Series Packing List

System Pack	Nuvo-5100VTC	Nuvo-5104VTC	Nuvo-5108VTC	Qty
1	Fanless in-vehicle controller / computer (If you ordered CPU/ RAM/ HDD, please verify these items)			1
2	Accessory box, which contains <ul style="list-style-type: none"> ● Neousys drivers & utilities DVD ● Damping bracket for in-vehicle deployment (with shock-absorbing grommets) ● 3-pin power terminal block ● Key for hot-swappable HDD tray ● HDD thermal pad for 2.5" HDD/SSD (if HDD is not installed) ● Screw pack 			1 1 1 1 1 1

2.2 Nuvo-5100VTC Series Front Panel

Neousys Nuvo-5100VTC series front panel offer plenty of I/O ports. For demonstration purposes, Nuvo-5108VTC will be used in most illustrations.

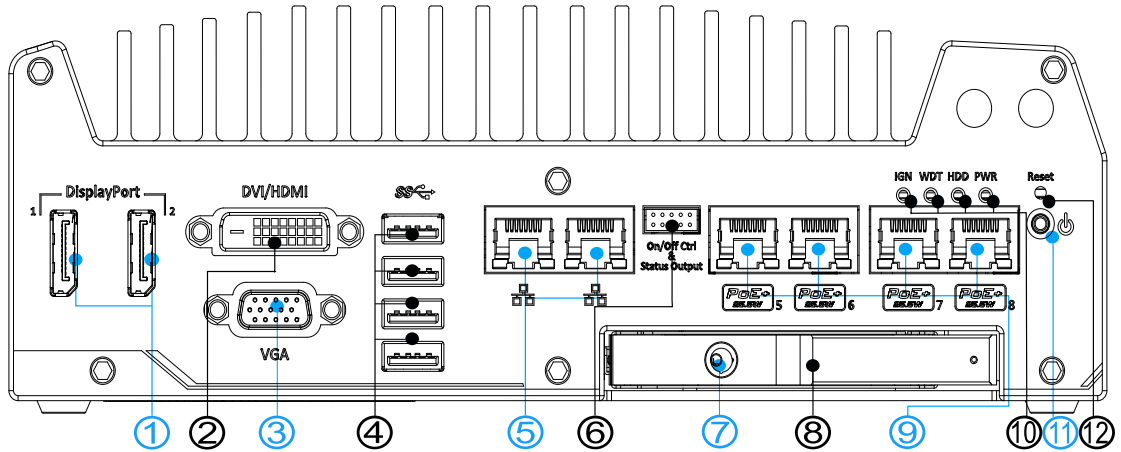

No.	Item	Description
1	DisplayPort 1 & 2	Support display resolutions up to 4096 x 2304. Compatible with HDMI/ DVI via respective adapter/ cable (support resolution may vary).
2	DVI port	DVI-D output supports resolution up to 1920x1200@60Hz and is compatible with other digital connections via an adapter
3	VGA port	VGA output supports resolution up to 1920x1200@60Hz
4	USB 3.0 port	USB 3.0 port supports up to 5 Gbit/s data transfer bandwidth.
5	GbE ports	Gigabit Ethernet ports offer fast network access.
6	On/ off control & status output	Allows for external switch extension when the system is placed inside a cabinet.
7	2.5" HDD tray key lock	The lock prevents unauthorized or accidental HDD removal
8	2.5" HDD tray	The HDD expansion tray offer storage expansion capabilities.
9	PoE+ GbE port	Applicable to 5108VTC system only, Power over Ethernet (PoE) port can provide both data connection and electric power to devices (eg. IP camera).
10	System status LEDs	Four system LEDs, Ignition control (IGN), Watchdog Timer (WDT), Hard Disk Drive (HDD) and Power (PWR).
11	Power button	Use this button to turn on or shutdown the system.
12	Reset button	Use this button to manually reset the system.

2.2.1 DisplayPort

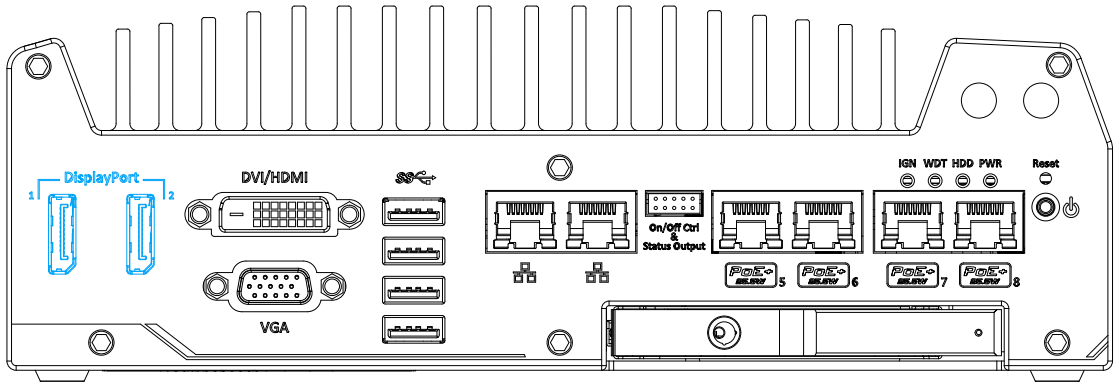

The system has dual DisplayPort (DP) outputs which are digital display interfaces that mainly connect video source and carry audio to a display device. When connecting a single DP, it can deliver up to 4096 x 2304 resolution and each port can deliver up to 2880 x 1800 resolution when both DPs are connected in conjunction. The system is designed to support passive DP adapter/ cable. You can connect to other display devices using DP-to-HDMI cable or DP-to-DVI cable.



DP-to-HDMI



DP-to-DVI

The system supports triple independent display outputs in the following combination of VGA, DVI/ HDMI and DisplayPort. To support multiple display outputs and achieve best DVI/ HDMI output resolution in Windows, you need to install corresponding graphics driver. Please refer to section [OS Support and Driver Installation](#) for details.

Triple Independent Display Configuration (resolution may be limited)

Active display 1	Active display 2	Active display 3
DisplayPort	DisplayPort	DVI or VGA
DisplayPort	DVI	VGA

2.2.2 DVI Port

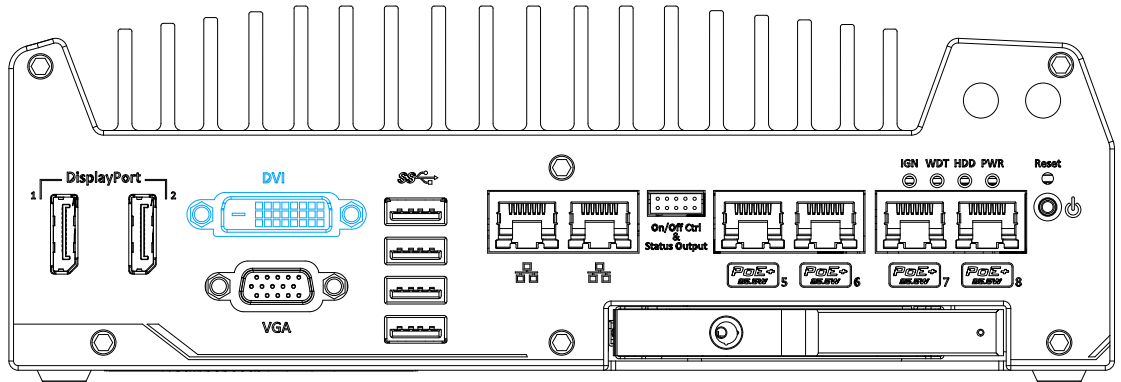

DVI-D transmits graphics data in digital format and therefore can deliver better image quality at high resolution. The DVI connector on the front panel can either output DVI signals or other digital signals (via an adapter/ cable) depending on the display device connected. It supports resolutions up to 1920x1200@60Hz.

The system supports triple independent display outputs in the following combination of VGA, DVI and DisplayPort. To support multiple display outputs and achieve best DVI output resolution in Windows, you need to install corresponding graphics driver. Please refer to section [OS Support and Driver Installation](#) for details.

Triple Independent Display Configuration (resolution may be limited)

Active display 1	Active display 2	Active display 3
DisplayPort	DisplayPort	DVI or VGA
DisplayPort	DVI	VGA

2.2.3 VGA Port

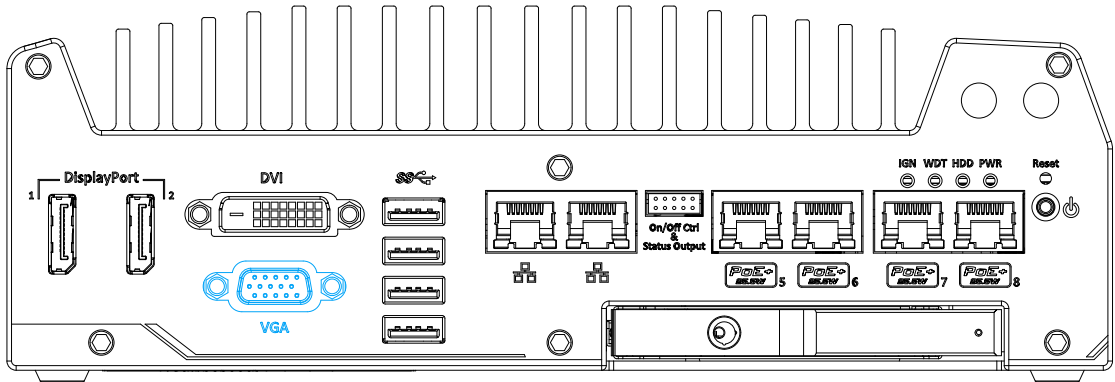

VGA connector is the most common video display connection. The VGA output supports up to 1920x1200@60Hz resolution. By default, the VGA output is set to “always-on”. For users who want to use only digital display interface (eg. DVI or DP), the VGA Output setting can be disabled. To disable, press F2 upon system startup, go to “**Advanced > System Agent (SA) Configuration > Graphics Configuration > VGA Output > [Disable]**”.

The system supports triple independent display outputs in the following combination of VGA, DVI/ HDMI and DisplayPort. To support multiple display outputs and achieve best DVI/ HDMI output resolution in Windows, you need to install corresponding graphics driver. Please refer to section [OS Support and Driver Installation](#) for details.

Triple Independent Display Configuration (resolution may be limited)

Active display 1	Active display 2	Active display 3
DisplayPort	DisplayPort	DVI or VGA
DisplayPort	DVI	VGA



NOTE

Please make sure your VGA cable includes SDA and SCL (DDC clock and data) signals for correct communication with monitor to get resolution/timing information. A cable without SDA/ SCL can cause blank screen on your VGA monitor due to incorrect resolution/timing output.

2.2.4 USB3.0 Port

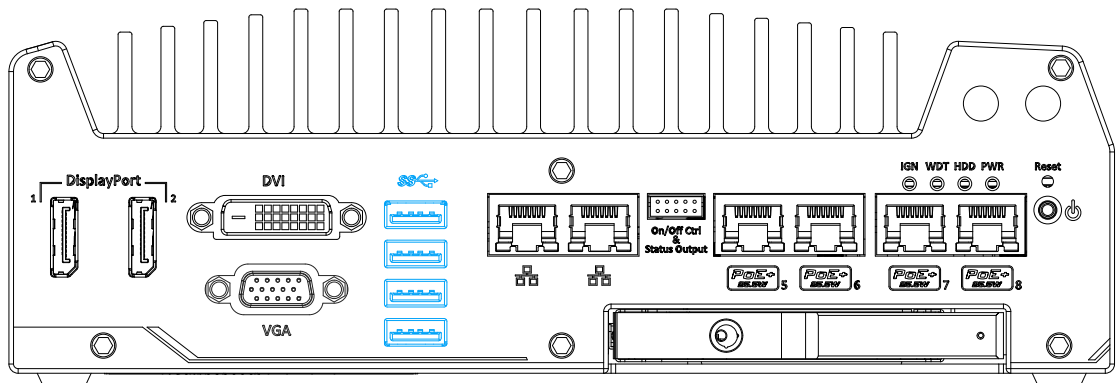

The system offers four USB 3.0 (SuperSpeed USB) ports on its front panel. They are implemented via native xHCI (eXtensible Host Controller Interface) controller in Q170 chipset and are backward compatible with USB 2.0, USB 1.1 and USB 1.0 devices. Legacy USB support is also provided so you can use USB keyboard/mouse in DOS environment.

Due to the nature that XHCI driver is not included natively in Windows 7, you may encounter the issue of USB keyboard/mouse not working when installing Windows 7. Neousys offers a Windows-based batch file and step-by-step guide to help you. Please refer to [Appendix A Windows 7 Installation](#) for information on installing Windows 7 on Nuvo-5100VTC series.

2.2.5 Ethernet Port / PoE

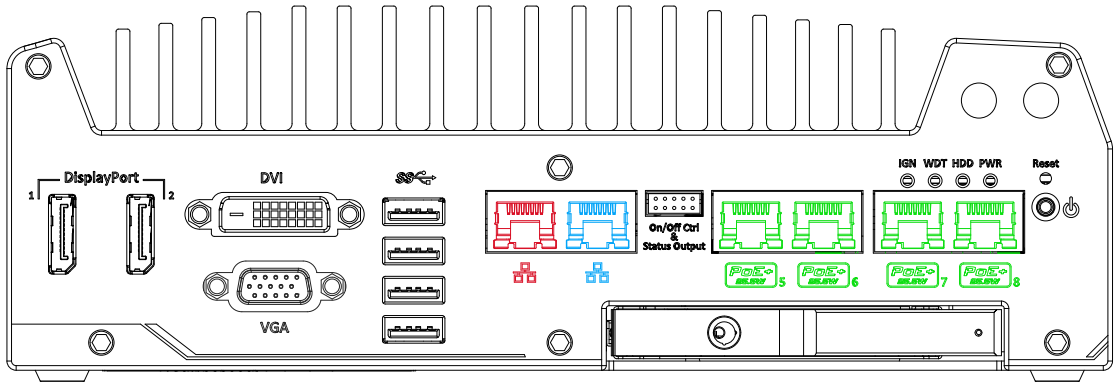

All Nuvo-5100VTC series offer two GbE ports (in red and blue) while Nuvo-5108VTC has four additional PoE (Power over Ethernet) ports marked in green on the front panel. The port marked in blue is implemented using Intel® I219-LM controller that supports Wake-on-LAN and is also compatible with [Intel® AMT \(Active Management Technology\)](#) to support advanced features such as remote SOL desktop and remote on/ off control.

Power over Ethernet (PoE) supplies electrical power and data on a standard CAT-5/CAT-6 Ethernet cable. Acting as a PoE PSE (Power Sourcing Equipment), compliant with IEEE 802.3at, each PoE port delivers up to 25W to a Powered Device (PD). PoE can automatically detect and determine if the connected device requires power or not, so it is compatible with standard Ethernet devices as well.

Each port has one dedicated PCI Express link for maximum network performance. Please refer to the table below for LED connection statuses.

Active/Link LED (Right)

LED Color	Status	Description
Yellow	Off	Ethernet port is disconnected
	On	Ethernet port is connected and no data transmission
	Flashing	Ethernet port is connected and data is transmitting/receiving

Speed LED (Left)

LED Color	Status	Description
Green or Orange	Off	10 Mbps
	Green	100 Mbps
	Orange	1000 Mbps

To utilize the GbE port in Windows, you need to install corresponding driver for Intel® I210-IT/ I219-LM GbE controller.

2.2.6 On/ Off Ctrl & Status Output

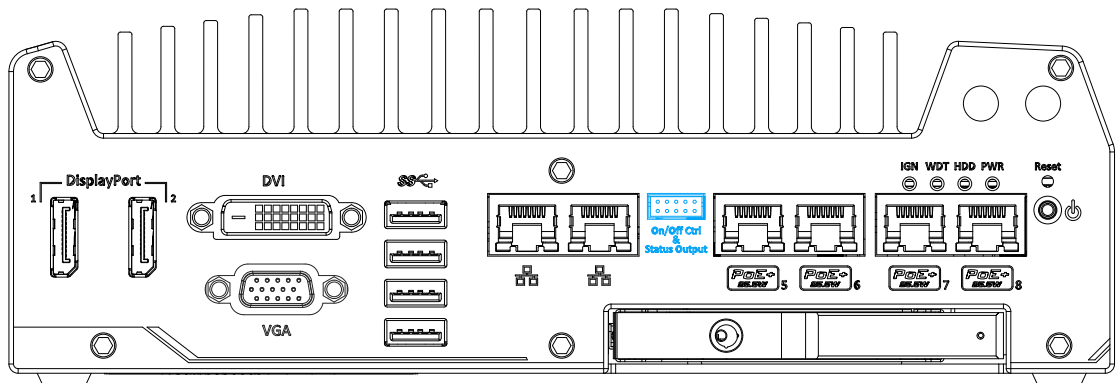

The “On/ Off Control Ctrl & Status Output” connection allows for external switch and LED indicator extension. It is useful when the system is placed in a cabinet or a not easily accessed location. This function is provided via a 2x5 2.0mm pitch wafer connector.

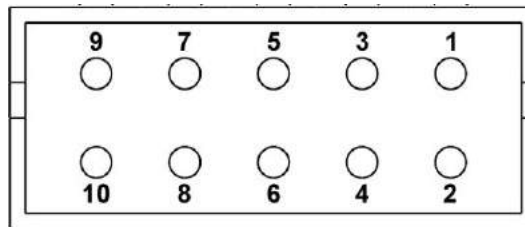

Pin#	Definition	Description
1	Ctrl+	[Input] Remote on/off control, connecting to an external switch to turn on/off the system (polarity is negligible).
2	Ctrl-	
3	Power+	[Output] System power indicator, on if system is turned on, off if system is turned off.
4	Power-	
5	HDD+	[Output] Hard drive indicator, flashing when SATA hard drive is active.
6	HDD-	
7	Standby Power+	[Output] Standby power indicator, lighting up when DC power is applied and system is in S5 (standby) mode.
8	Standby Power-	
9	WDT+	[Output] Watchdog timer indicator, flashing when watchdog timer is started.
10	WDT-	



NOTE

Please make sure the polarity is correct when you connect the external LED indicator to the Status LED Output.

2.2.7 2.5” HDD Tray Lock/ HDD Tray

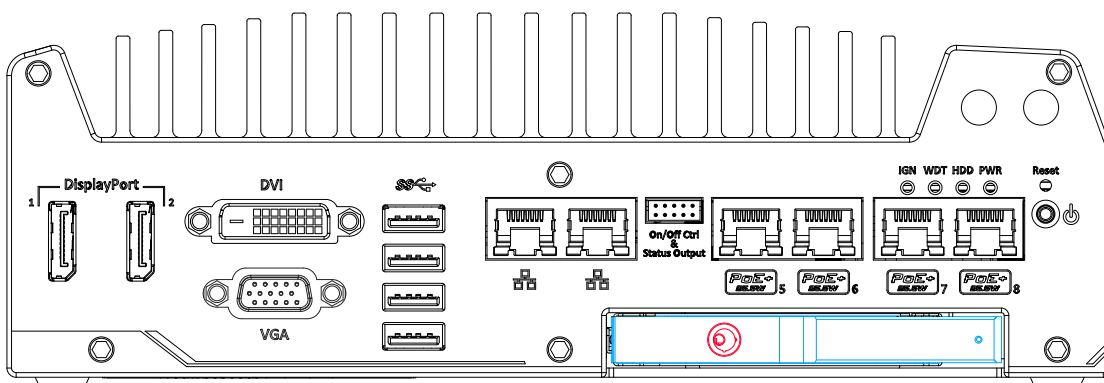

Nuvo-5100VTC series support an external 2.5” HDD via a hot-swappable tray. Designed for easy access, the HDD tray is secured by a lock (indicated in red) and it supports RAID modes 0/ 1 configuration combining with internal HDD/ SSD drive for OS installation (coupled with the internal HDD). To set up RAID, please refer to [RAID Volume Configuration](#) section for details.

2.2.8 System Status LED

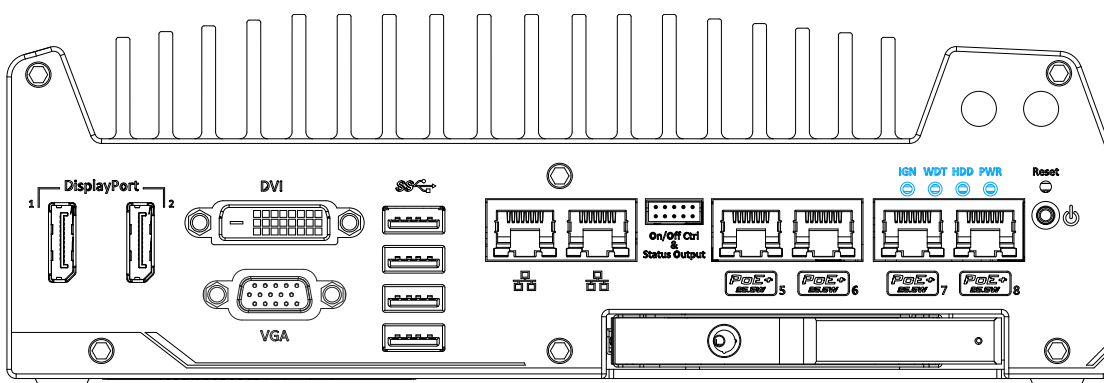

There are four LED indicators on the front panel: PWR, HDD, WDT and IGN. The descriptions of these four LEDs are listed in the following table.

Indicator	Color	Description
IGN	Green	Ignition signal indicator, lid when IGN is high (12V/ 24V).
WDT	Yellow	Watchdog timer indicator, flashing when WDT is active
HDD	Red	Hard drive indicator, flashing when SATA drive is active
PWR	Green	Power indicator, lid when system is on

2.2.9 Power Button

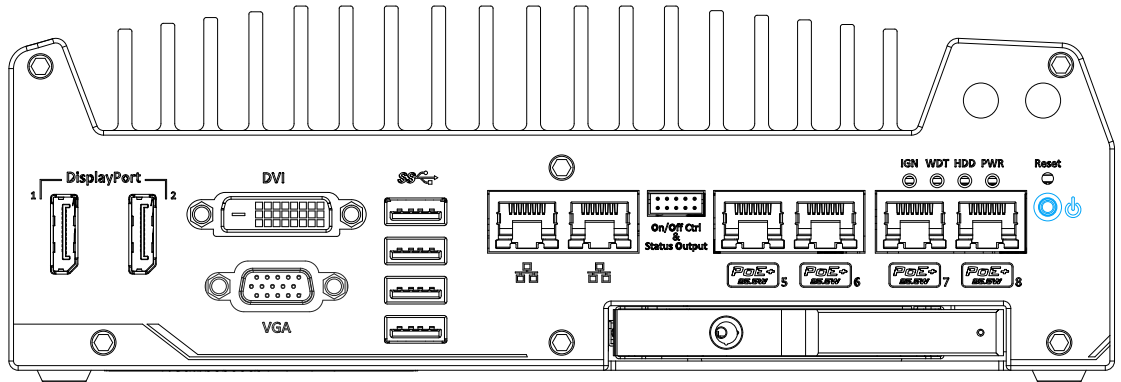

The power button is a non-latched switch for ATX mode on/off operation. To turn on the Nuvo-5100VTC series, press the power button and the PWR LED should light-up green. To turn off Nuvo-5100VTC, issuing a shutdown command in OS is preferred, or you can simply press the power button. To force shutdown when the system freezes, press and hold the power button for 5 seconds. Please note that there is a 5-second interval between on/off operations (i.e. once turning off the system, there is a 5-second wait before you can power-on the system).

2.2.10 Reset Button

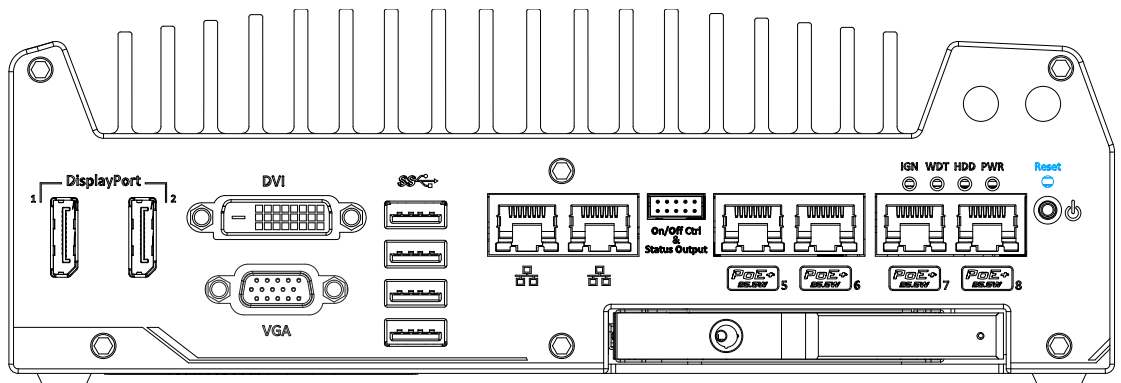

The reset button is used to manually reset the system in case of system halt or malfunction. To avoid unexpected reset, the button is purposely placed behind the panel. To reset, please use a pin-like object (eg. tip of a pen) to access the reset button.

2.3 Nuvo-5100 VTC Series Rear Panel

Neosys Nuvo-5100VTC series offers additional expansion I/O ports on its rear panel. For demonstration purposes, Nuvo-5108VTC is shown in illustrations.

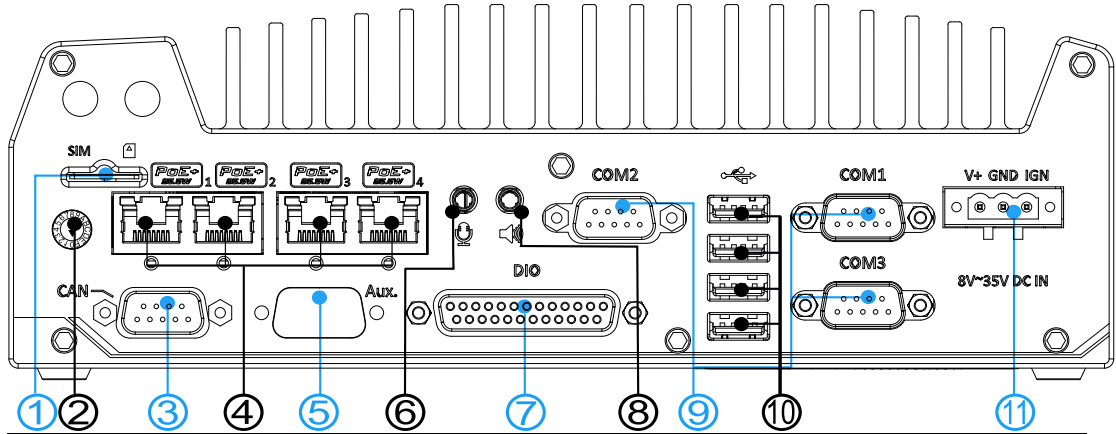

No.	Item	Description
1	SIM card slot	With a 3G/ 4G module installed, insert a SIM card to access the operator's network.
2	Ignition control switch	The switch allows for the configuration of ignition power on/ off delay by adjusting switch position.
3	CAN bus port	Allows controller to communicate with other in-vehicle CAN device(s).
4	PoE+ GbE ports	M12 x-coded connector is applicable to Nuvo-5100VTC only. The rugged connection guarantees signal integrity while providing both data and electric power to devices. RJ45 PoE+ is applicable to Nuvo-5104VTC / 5108VTC systems. The Power over Ethernet (PoE) port can provide both data connection and electric power to devices.
5	Aux	Reserved for additional DB9 connector.
6	Microphone-in jack	Microphone-in jack for voice (microphone) input.
7	DIO	The DIO port provides 4x isolated digital input and 4x isolate output channels.
8	Speaker-out jack	Speaker-out jack for sound output.
9	COM ports	There are 3 COM ports for communicating with external devices.
10	USB 2.0	The USB 2.0 ports are backward with USB 1.1 / 1.0.
11	3-pin terminal block (DC/ ignition input)	Compatible with DC power input from 8~35V, the terminal block is also used for ignition signal input.

2.3.1 SIM Slot

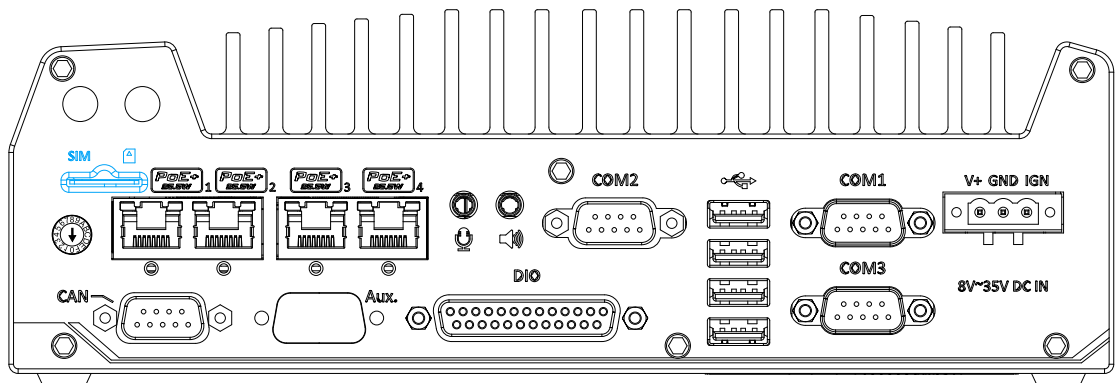

On the rear panel, there is a panel-accessible SIM socket. By installing a 3G/4G module onto the internal mini-PCIe port, you can have Internet access via telecom operator's network. The SIM socket is a push-push type. The push-push mechanism means the SIM card is push-to-install and push-to-retrieve. Please note that the SIM card must be inserted upside down (gold fingers facing upward).

2.3.2 Ignition Control Switch



Nuvo-5100VTC



Nuvo-5104/ 5108 VTC

The ignition power control switch features multiple modes for pre and post ignition settings. Please refer to the section [Ignition Power Control](#) for details.

The ignition switch on **Nuvo-5100VTC** is covered by M12 connector's face plate. Use a Philips screw driver to remove the four screws (location shown in **red**), gently pull off the face plate to expose the ignition switch.

The ignition power control switch on **Nuvo-5104/ 5108VTC** can be located on the rear panel. Please use a flathead screwdriver to adjust the position of the ignition power control switch.

2.3.3 CAN Bus Port

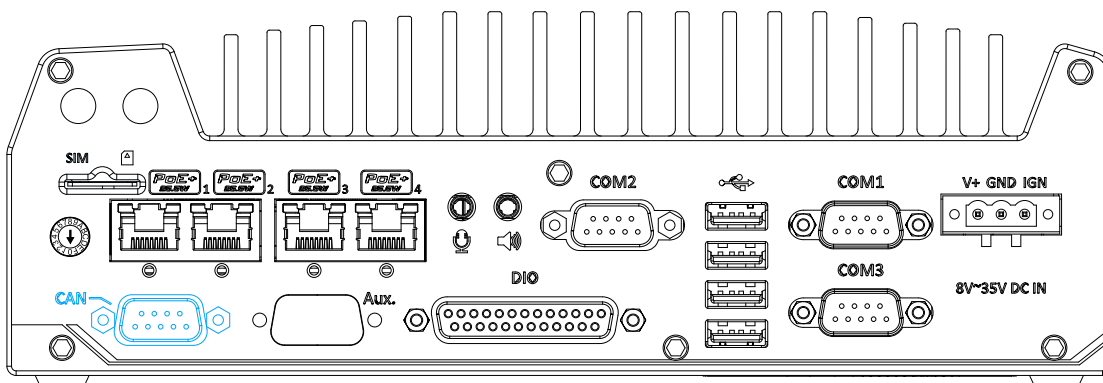

CAN bus is a robust industrial bus with a pair of differential signals and is commonly used in various industrial and in-vehicles applications. The system is equipped with a CAN bus DB9 port that is compatible with both industrial and in-vehicle applications. The CAN bus port supports CAN2.0A and CAN2.0B up to 1Mbps.

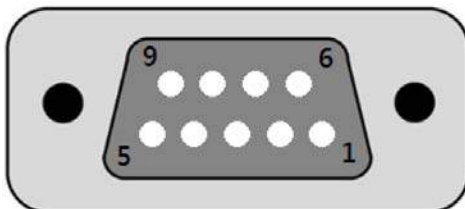

Pin No.	Definition	I/O	Description
1	GND	-	GND
2	Reserved	-	Reserved pin. Keep unconnected
3	CAN_H	I/O	CAN Bus High-level voltage
4	Reserved	-	Reserved pin. Keep unconnected
5	CAN_L	I/O	CAN Bus Low-level voltage
6	Reserved	-	Reserved pin. Keep unconnected
7	Reserved	-	Reserved pin. Keep unconnected
8	Reserved	-	Reserved pin. Keep unconnected
9	Reserved	-	Reserved pin. Keep unconnected

2.3.4 M12 Power over Ethernet Port (Nuvo-5100 VTC)

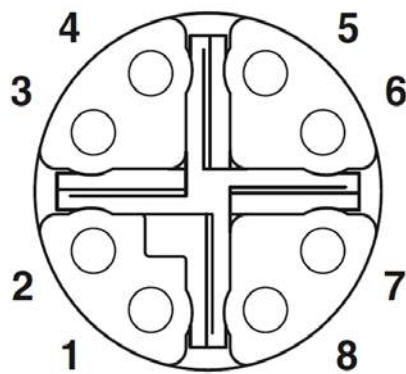
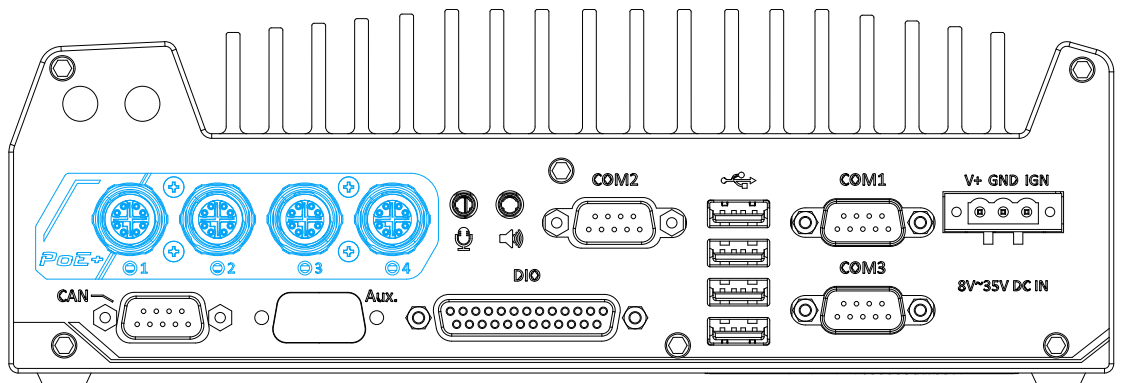



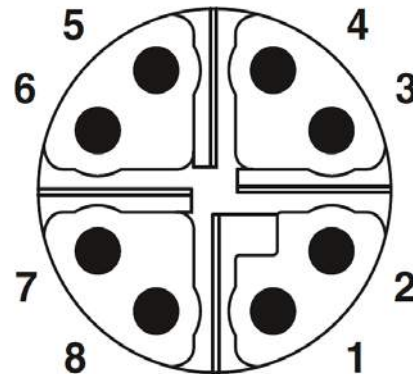





M12 socket (panel side)



M12 plug (cable side)

M12 Pin and Corresponding RJ45 Wire Connection

Wire color	Signal	M12 Pin	RJ45 Wire
	D1+	1	1
	D1-	2	2
	D2+	3	3
	D3+	8	4
	D3-	7	5
	D2-	4	6
	D4+	5	7
	D4-	6	8

PoE ports on Nuvo-5100VTC are provided via 8-pole, x-coded M12 connectors, offering extraordinary reliability for Ethernet connection. Power over Ethernet (PoE) supplies electrical power along with data on a standard Ethernet cable. As an IEEE 802.3at compliant PSE (Power Sourcing Equipment), each PoE port can deliver up to 25W of power to a Powered Device (PD), such as an IP camera. PoE is able to automatically detect the device connected and determine whether to dispatch power thus it is also compatible with traditional Ethernet devices.

2.3.5 RJ-45 Power over Ethernet Port (Nuvo-5104VTC / 5108VTC)

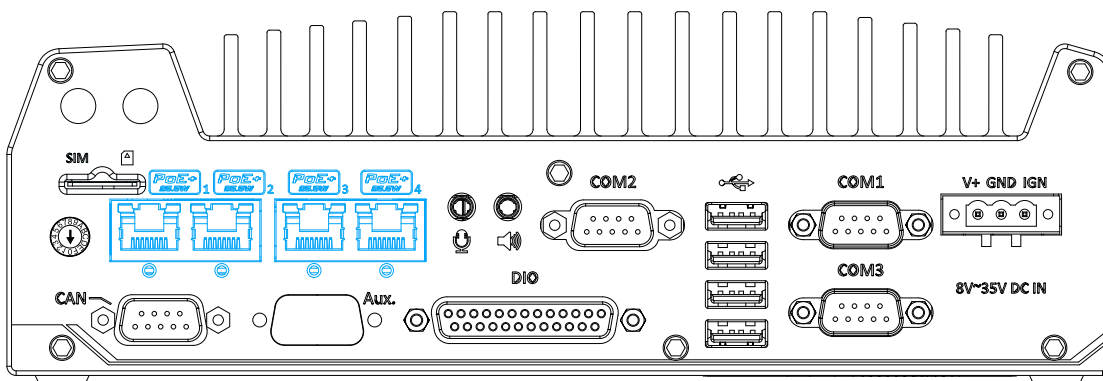

PoE ports on Nuvo-5104VTC and Nuvo-5108VTC are provided via RJ-45 connectors. Power over Ethernet (PoE) is an Ethernet technology that supplies electrical power along with data on a standard CAT-6 Ethernet cable. Acting as a Power Source Equipment (PSE), compliant with IEEE 802.3at standard, each port can deliver up to 25W of power to a Powered Device (PD), such as a PoE IP camera. PoE is able to automatically detect the device connected and determine whether to dispatch power thus it is also compatible with traditional Ethernet devices. Each port is linked to a dedicated PCI Express for maximum network performance. When plugged in, the Ethernet connection status and speed are shown on RJ45 LED indicators.

Active/Link LED



LED Color	Status	Description
Yellow	Off	Ethernet port is disconnected
	On	Ethernet port is connected and no data transmission
	Flashing	Ethernet port is connected and data is transmitting/receiving

Speed LED

LED Color	Status	Description
Green or Orange	Off	10 Mbps
	Green	100 Mbps
	Orange	1000 Mbps

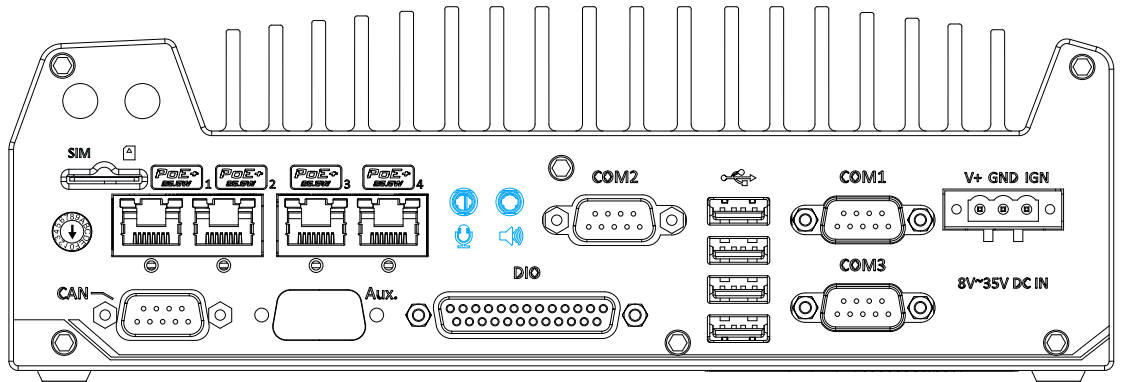
2.3.6 3.5mm Speaker-out / Microphone-in Jack



The audio function on Nuvo-5100VTC series uses Intel® High Definition Audio in Q170 chipset and Realtek ALC262 codec. There are two audio function jacks, the  port is used for microphone input, and the  port is used for speaker / headphone output. To utilize the audio function in Windows, you need to install corresponding drivers for both Intel® Q170 chipset and Realtek ALC262 codec.

2.3.7 Digital Input/ Output

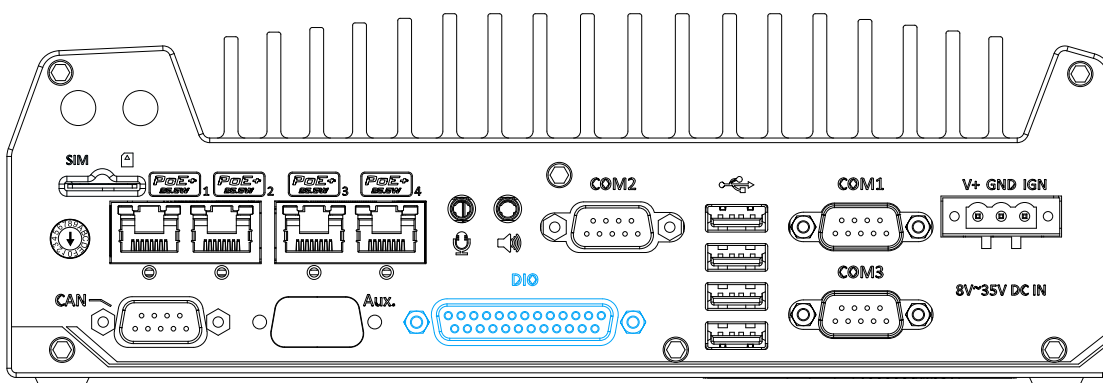

The system provides 4x isolated digital input channels and 4x isolated digital output channels. The DIO functions support polling mode I/O access and DI change-of-state interrupt. Please refer to [Watchdog Timer & Isolated DIO](#) for information on wiring and programming the isolated DIO channels.

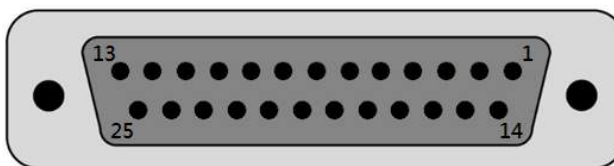

Pin No.	Definition	I/O	Description
1	ISO_DI3H	I	Digital input channel 3
2	ISO_DI2H	I	Digital input channel 2
3	ISO_DI1H	I	Digital input channel 1
4	ISO_DI0H	I	Digital input channel 0
5	Reserved	-	Reserved pin. Keep unconnected
6	Reserved	-	Reserved pin. Keep unconnected
7	ISO_DO3	O	Digital output channel 3
8	ISO_DO2	O	Digital output channel 2
9	ISO_DO1	O	Digital output channel 1
10	ISO_DO0	O	Digital output channel 0
11	VDD	-	DO voltage source input for inductive load
12	ISO5V	-	Isolated 5V power supply
13	Reserved	-	Reserved pin. Keep unconnected
14	ISO_DI3L	-	Digital input channel 3 GND
15	ISO_DI2L	-	Digital input channel 2 GND
16	ISO_DI1L	-	Digital input channel 1 GND
17	ISO_DI0L	-	Digital input channel 0 GND
18	Reserved	-	Reserved pin. Keep unconnected
19	Reserved	-	Reserved pin. Keep unconnected

20	DOGND	-	Digital output GND
21	DOGND	-	Digital output GND
22	DOGND	-	Digital output GND
23	DOGND	-	Digital output GND
24	DOGND	-	Digital output GND
25	DOGND	-	Digital output GND

2.3.8 COM Ports

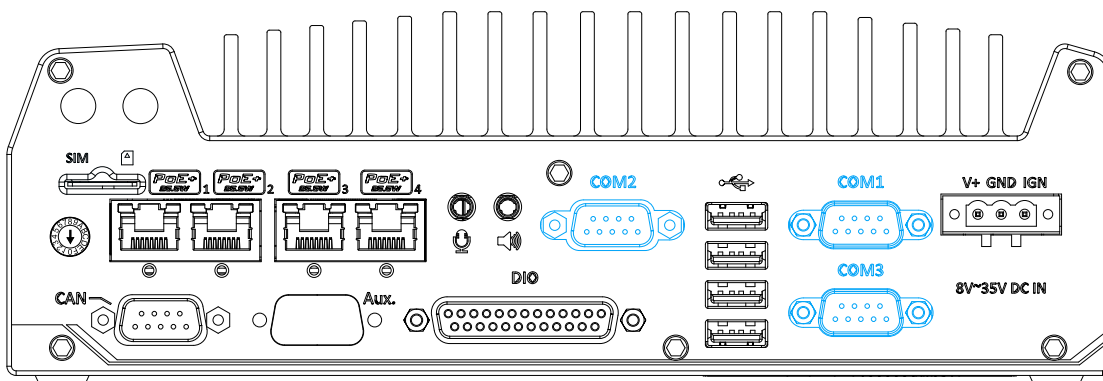

The system has three COM ports for communicating with external devices. COM1, COM2 and COM3 ports are located on the rear panel via 9-pin D-Sub male connectors. They are implemented using industrial-grade ITE8786 Super IO chip (-40 to 85°C) and provide up to 115200 bps baud rate.

COM1 and COM3 are software-configurable RS-232/422/485 ports and COM2 is a standard 9-wire RS-232 port. The operation mode, slew rate and termination of COM1 and COM3 can be set in BIOS setup utility. The following table describes the pin definition of COM ports.

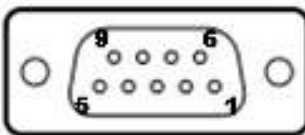

Pin#	COM1 / COM3			COM2
	RS-232 Mode	RS-422 Mode	RS-485 Mode (Two-wire 485)	RS-232 Mode
1	DCD	-	-	DCD
2	RX	422 TXD+	485 TXD+/RXD+	RX
3	TX	422 RXD+	-	TX
4	DTR	422 RXD-	-	DTR
5	GND	GND	GND	GND
6	DSR	-	-	DSR
7	RTS	-	-	RTS
8	CTS	422 TXD-	485 TXD-/RXD-	CTS
9	RI	-	-	RI

2.3.9 USB2.0 Ports

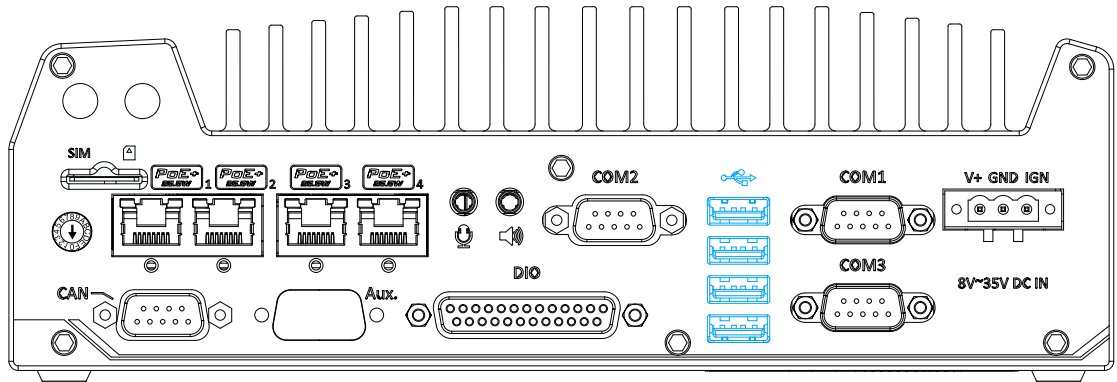

The USB2.0 ports are implemented via native xHCI (eXtensible Host Controller Interface) controller in Q170 chipset and are backward compatible with USB 1.1 and USB 1.0 devices. Legacy USB support is also provided so you can use USB keyboard/mouse in DOS environment.

Due to the nature that XHCI driver is not included natively in Windows 7, you may encounter the issue of USB keyboard/mouse not working when installing Windows 7.

Neousys offers a Windows-based batch file and step-by-step guide to help you.

Please refer to [Appendix A Windows 7 Installation](#) for information on installing Windows 7 on Nuvo-5100VTC series.

2.3.10 3-Pin Terminal Block for DC and Ignition Input

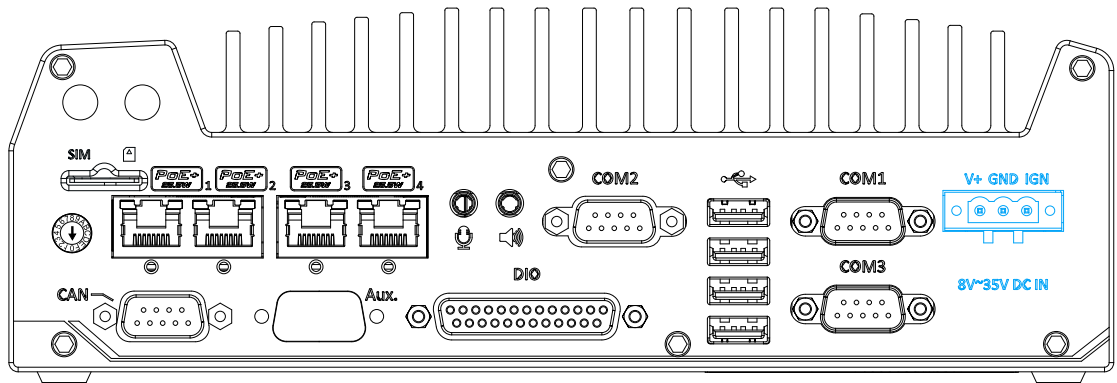

The system allows an 8 to 35V DC power input from via a 3-pin pluggable terminal block. The screw clamping mechanism is a reliable way to wire DC power. In addition to DC power, this terminal block also accepts ignition signal input (IGN).



WARNING

Please make sure the voltage of DC power is correct before you connect it to the system. Supplying a voltage over 35V will damage the system.

2.4 Internal I/O Components

The internal components of Nuvo-5100VTC series include two SODIMM sockets, SATA ports, mSATA, mini-PCIe sockets and an internal USB port.

2.4.1 DDR4 SO-DIMM Slots

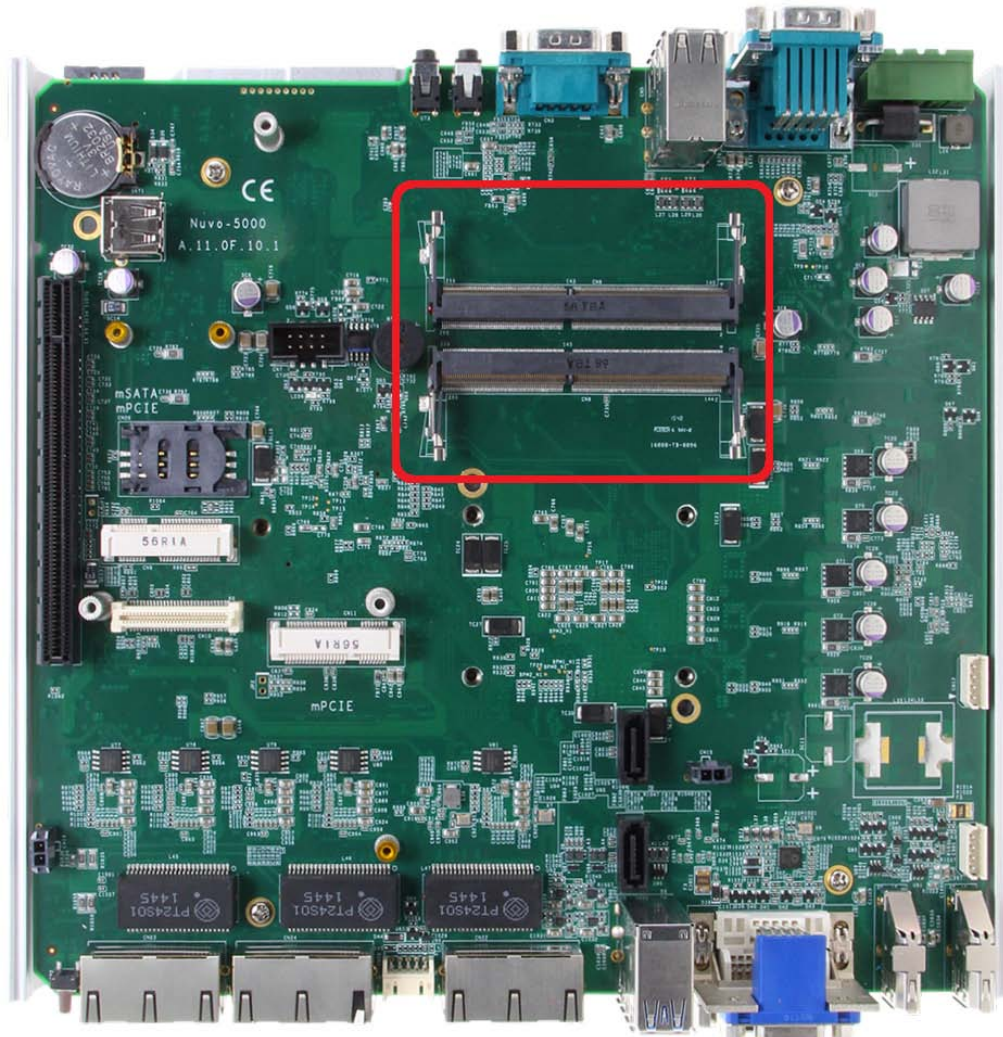

The system provides two 260-pin DDR4 memory SO-DIMM sockets. It can support up to 32GB maximum capacity by installing two 16GB DDR4 2133 MHz SODIMM modules.

2.4.2 Dual Mode mSATA/ mini-PCle socket

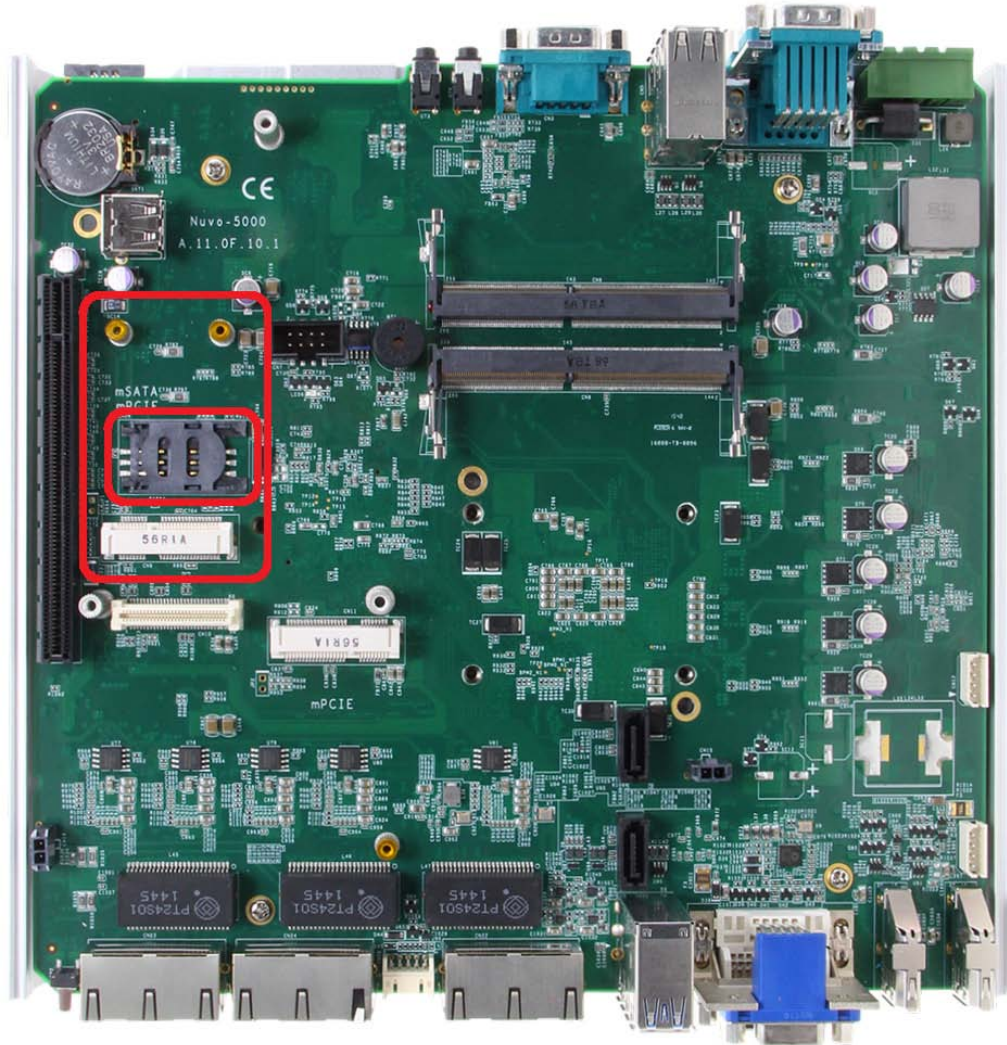

The system provides a dual mode mSATA/ mini-PCle socket that is in compliance with mini-PCle specification rev. 1.2. You can install either an mSATA SSD or mini-PCle module into this socket and the system will automatically detect and configure it to run PCIe or SATA signals. This mini-PCle socket is designed with SIM card support. With a SIM card installed, your system can access the internet via your network provider's 3G/ 4G network.

For wireless (WIFI/ 3G/ 4G) communication, multiple SMA antenna apertures can be located on the front and rear panel.



Dual mode mSATA/ mini-PCle socket definition

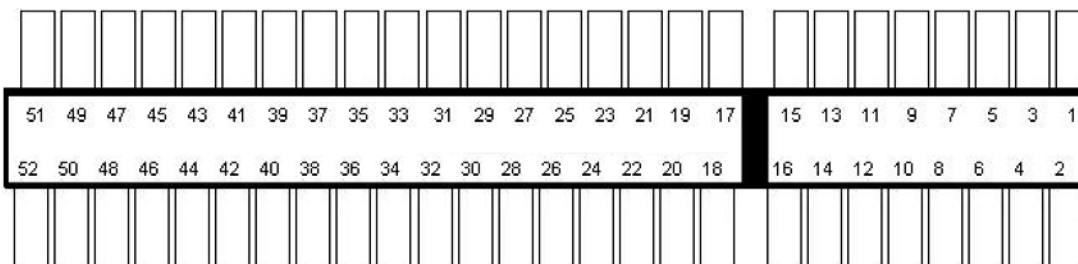

Pin	Signal (mPCle)	Signal (mSATA)	Pin #	Signal (mPCle)	Signal (mSATA)
1	WAKE#	-	2	+3.3Vaux	+3.3Vaux
3	COEX1	-	4	GND	GND
5	COEX2	-	6	+1.5V	+1.5V
7	CLKREQ#	-	8	UIM PWR	-
9	GND	GND	10	UIM DATA	-
11	REFCLK-	-	12	UIM CLK	-
13	REFCLK+	-	14	UIM RESET	-
15	GND	GND	16	UIM VPP	-
Mechanical Key					
17	Reserved*	-	18	GND	GND
19	Reserved*	-	20	W_DISABLE#	-
21	GND	GND	22	PERST#	-
23	PERn0	SATA Rxp	24	+3.3Vaux	+3.3Vaux
25	PERp0	SATA Rxn	26	GND	GND
27	GND	GND	28	+1.5V	+1.5V
29	GND	GND	30	SMB CLK	SMB CLK
31	PETn0	SATA Txn	32	SMB DATA	SMB DATA
33	PETp0	SATA Txp	34	GND	GND
35	GND	GND	36	USB D-	-
37	GND	GND	38	USB D+	-
39	+3.3Vaux	+3.3Vaux	40	GND	GND
41	+3.3Vaux	+3.3Vaux	42	LED WWAN#	-
43	GND	-	44	LED WLAN#	-
45	Reserved	-	46	LED WPAN#	-
47	Reserved	-	48	+1.5V	+1.5V
49	Reserved	-	50	GND	GND
51	Reserved	-	52	+3.3Vaux	+3.3Vaux



WARNING

*Some off-the-shelf mini-PCle 4G modules are not compliant to standard mini-PCle interface. They use 1.8V I/O signals instead of standard 3.3V I/O and may have signal conflict. Please consult with Neousys for compatibility when in doubt!
Installing an incompatible 4G module may damage the system or the module itself may be damaged.*

2.4.3 mini-PCle Socket

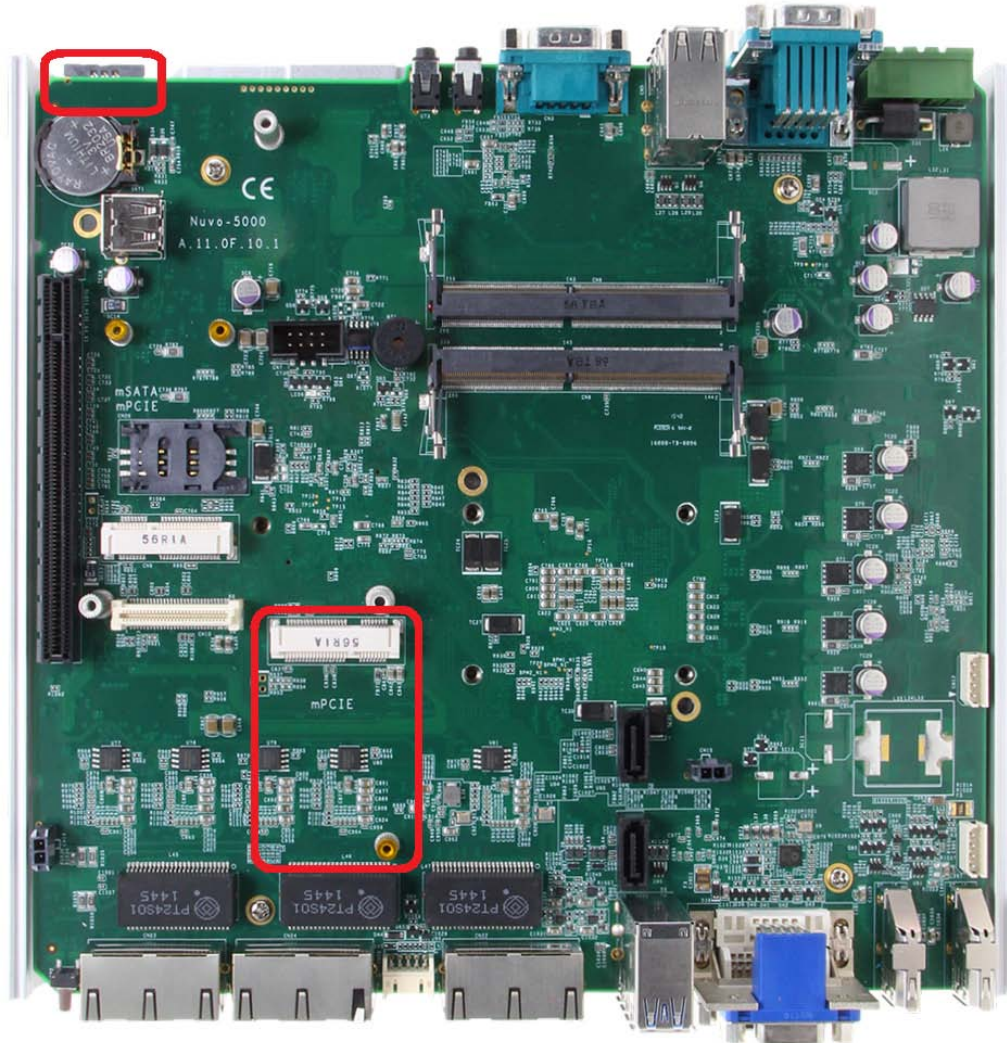

This mini-PCle socket works in cooperation with the panel-accessible SIM slot. By installing a mini-PCle module, you can add additional features to your system such as WIFI, GPS, CAN bus, analog frame grabber, etc. You can also install a 3G/4G module and SIM card for internet via your service provider's 3G/ 4G network.

For wireless (WIFI/ 3G/ 4G) communication, multiple SMA antenna apertures can be located on the front and rear panel.



mini-PCle Pin Definition

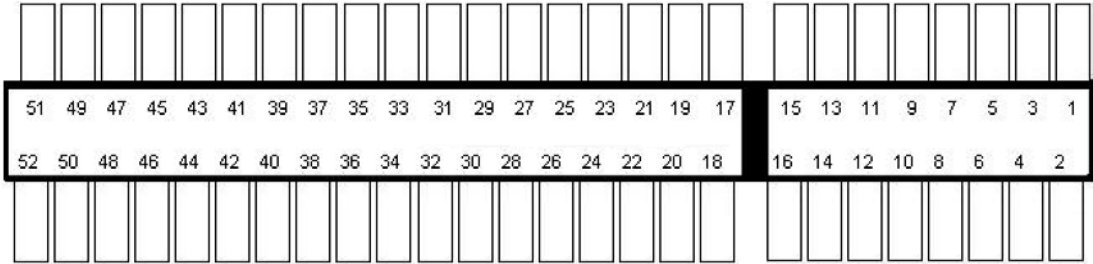

Pin #	Signal	Pin #	Signal
1	WAKE#	2	+3.3Vaux
3	COEX1	4	GND
5	COEX2	6	+1.5V
7	CLKREQ#	8	UIM PWR
9	GND	10	UIM DATA
11	REFCLK-	12	UIM CLK
13	REFCLK+	14	UIM RESET
15	GND	16	UIM VPP
Mechanical Key			
17	Reserved* (UIM C8)	18	GND
19	Reserved* (UIM C4)	20	W DISABLE#
21	GND	22	PERST#
23	PERn0	24	+3.3Vaux
25	PERp0	26	GND
27	GND	28	+1.5V
29	GND	30	SMB CLK
31	PETn0	32	SMB DATA
33	PETp0	34	GND
35	GND	36	USB D-
37	GND	38	USB D+
39	+3.3Vaux	40	GND
41	+3.3Vaux	42	LED WWAN#
43	GND	44	LED WLAN#
45	Reserved	46	LED WPAN#
47	Reserved	48	+1.5V
49	Reserved	50	GND
51	Reserved	52	+3.3Vaux



WARNING

Some off-the-shelf mini-PCle 4G modules are not compliant to standard mini-PCle interface. They use 1.8V I/O signals instead of standard 3.3V I/O and may have signal conflict. Please consult with Neousys for compatibility when in doubt!

Installing an incompatible 4G module may damage the system or the module itself may be damaged.

2.4.4 SATA Ports

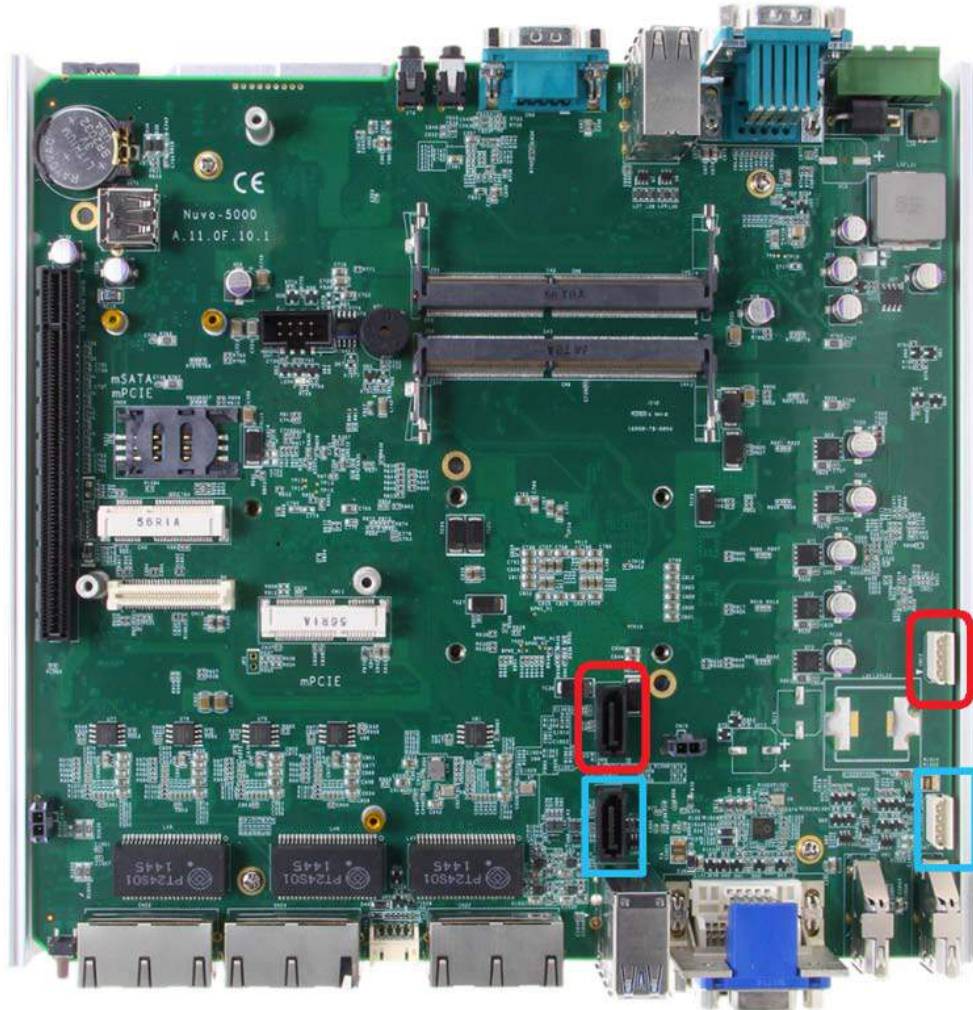

The system provides two SATA ports which support Gen3, 6 Gb/s SATA signals. Each SATA port features a 7-pin SATA connector and a 4-pin power connector.

The SATA port and power plug indicated in **red** is used in conjunction with the hot plug HDD tray to accommodate a 2.5" HDD/SSD. Standard 22-pin SATA connectors are provided with the system. You may enable the Hot Plug function in the [SATA Configuration](#) section.

The SATA port and power plug indicated in **blue** accommodates a 2.5" HDD/SSD in internal HDD bracket. Standard 22-pin SATA connectors are provided with the system. You may refer to the [SATA Configuration](#) section for SATA settings.

2.4.5 Internal USB Port

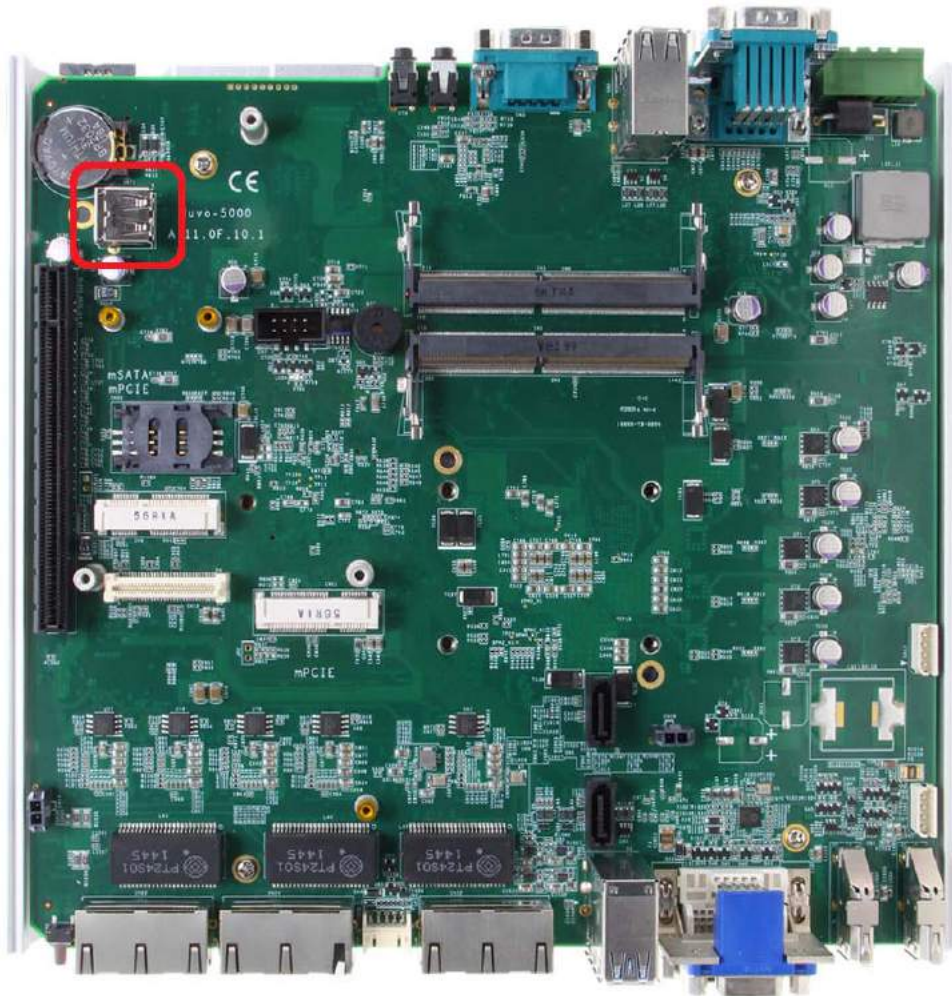

The system has an internal USB2.0 port on the PCBA. You can utilize this USB port to connect a USB protection dongle inside the chassis of the system.

2.4.6 mini-PCIe Socket on MezIO™ -V510

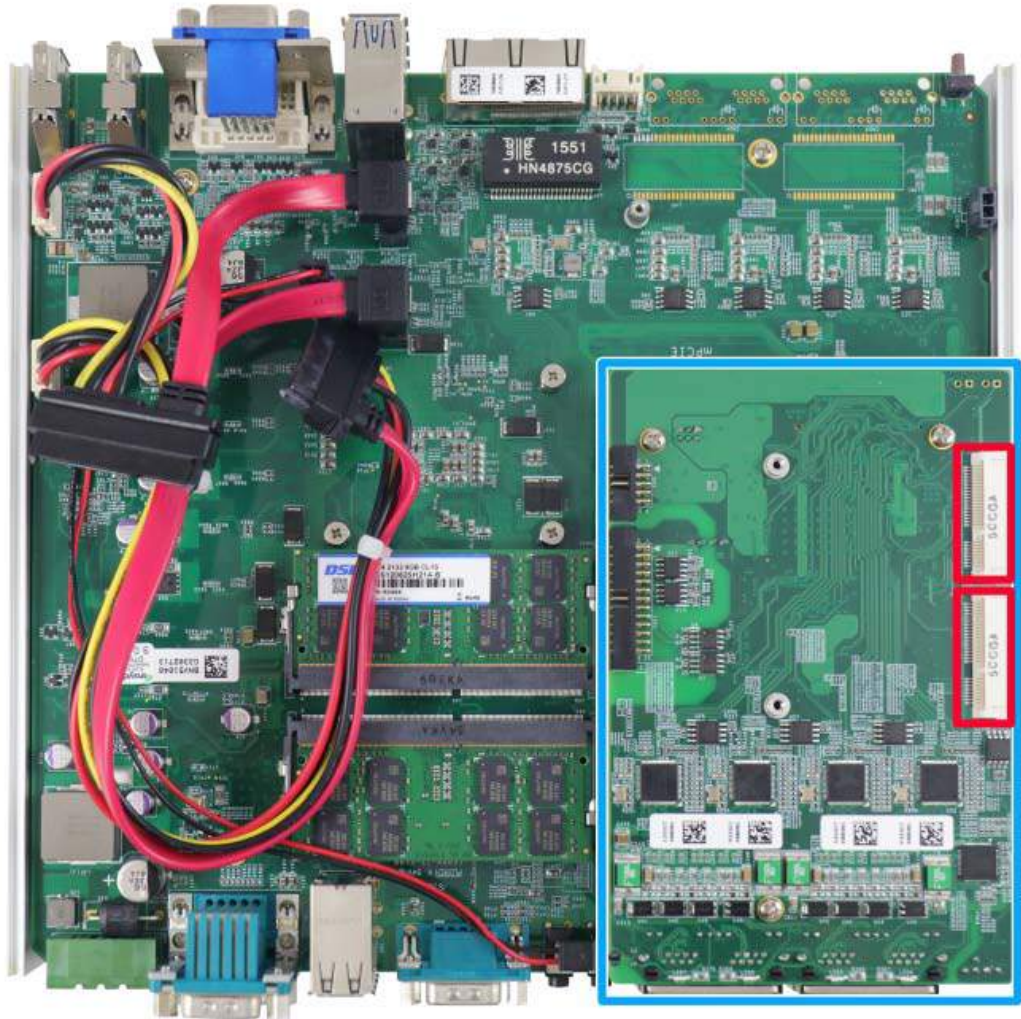

There are two additional full-size mini-PCIe sockets available on MezIO™-V50. They are implemented with USB signals only and have better compatibility with off-the-shelf 3G/4G mini-PCIe modules. For customers who want to install 3G/ 4G module(s), please take advantage of these two mini-PCIe sockets and the associated SIM slots.

For wireless (3G/ 4G) communication, multiple SMA antenna apertures can be located on the front and rear panel.



MezIO™-V510 mini-PCIe Pin Definition

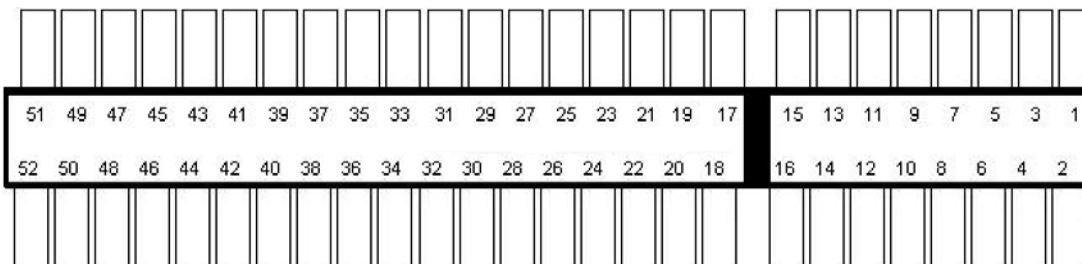

Pin #	Signal	Pin #	Signal
1	Reserved	2	+3.3Vaux
3	Reserved	4	GND
5	Reserved	6	+1.5V
7	Reserved	8	UIM PWR
9	GND	10	UIM DATA
11	Reserved	12	UIM CLK
13	Reserved	14	UIM RESET
15	GND	16	UIM VPP
Mechanical Key			
17	Reserved	18	GND
19	Reserved	20	W DISABLE#
21	GND	22	PERST#
23	Reserved	24	+3.3Vaux
25	Reserved	26	GND
27	GND	28	+1.5V
29	GND	30	Reserved
31	Reserved	32	Reserved
33	Reserved	34	GND
35	GND	36	USB D-
37	GND	38	USB D+
39	+3.3Vaux	40	GND
41	+3.3Vaux	42	LED WWAN#
43	GND	44	LED WLAN#
45	Reserved	46	LED WPAN#
47	Reserved	48	+1.5V
49	Reserved	50	GND
51	Reserved	52	+3.3Vaux

3 System Installation

Before disassembling the system enclosure and installing components and modules, please make sure you have done the following:

- It is recommended that only qualified service personnel should install and service this product to avoid injury or damage to the system.
- Please observe all ESD procedures at all times to avoid damaging the equipment.
- Before disassembling your system, please make sure the system has powered off, all cables and antennae (power, video, data, etc.) are disconnected.
- Place the system on a flat and sturdy surface (remove from mounts or out of server cabinets) before proceeding with the installation/ replacement procedure.

3.1 Disassembling the System Enclosure

1. Turn the system upside-down.
2. Unscrew the six (6) screws indicated below on the front panel.



3. On the rear panel, remove the ten (10) screws indicated.



4. Gently lift the bottom enclosure cover and disconnect any cables connected to the rear panel. Once disconnected, remove the rear panel.
5. Remove the three (3) screws on the MezIO™ card and gently lift the MezIO™ card (if you need to install mini-PCIe or mSATA module on PCBA).

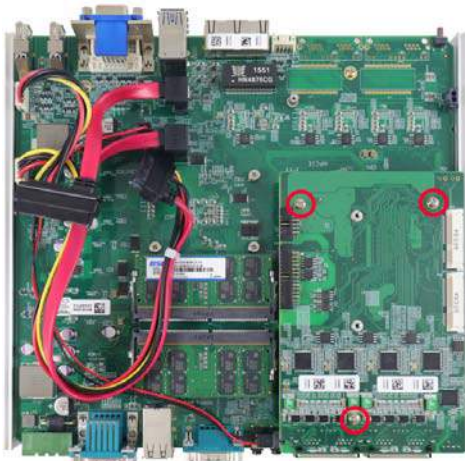

3.2 CPU Installation Procedure

1. DO NOT remove the CPU from its container / tray before it is ready to be installed.
2. Once the enclosure panels have been removed and to install a CPU into the system, remove the four (4) M3 P-head screws in the illustration below.

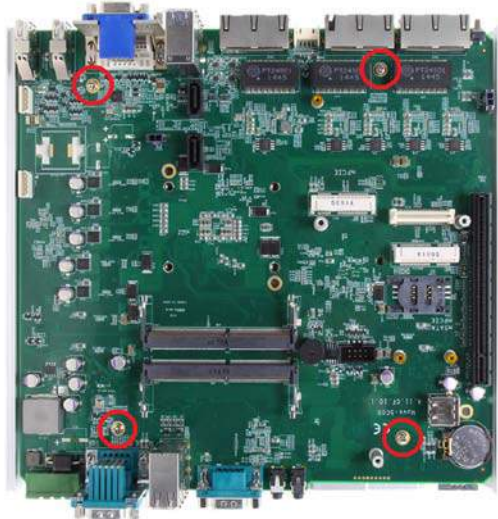

3. Gently lift the motherboard off the heatsink and turn the motherboard upside-down. You'll see the CPU socket protective cover, place finger tips under the sign "REMOVE" for leverage. Gently lift the cover.



WARNING

With the protective cover removed, please be careful when handling the motherboard. DO NOT touch the pins in the LGA socket!

- Remove the CPU from its container/ tray. Match the two notches on the side to the protrusions in the socket, gently lower the CPU into the socket.



- Locate the CPU retention bracket in the accessory box. Place the retention bracket on the CPU and hold it in place, turn the motherboard around and secure the bracket by tightening two (2) M3 P-head screws.

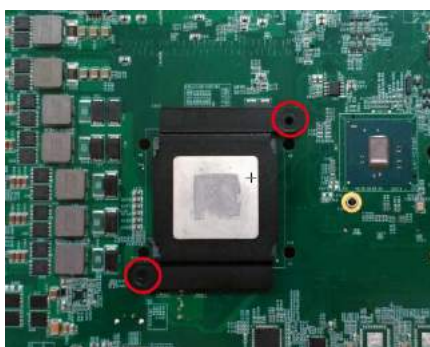

Retention bracket screw location

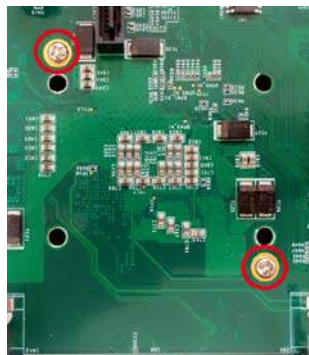

Secure two M3 P-head screws on the opposite side

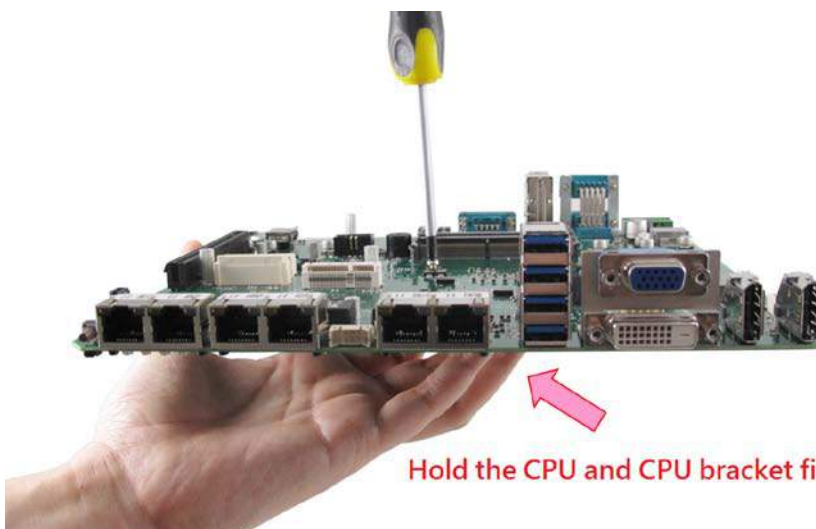

Hold bracket/ CPU in place along with the motherboard

6. Remove all thermal pad protective films pre-placed on the heatsink.

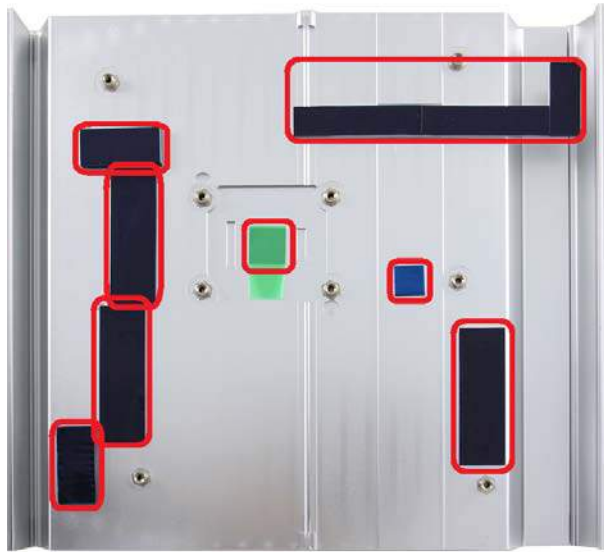

7. With the four (4) motherboard standoffs aligned (please refer to step 2), gently lower the motherboard onto the heatsink
8. Secure the four (4) M3 P-head motherboard screws (indicated in yellow) and from the accessory box, five (5) M3 spring screws (indicated in red). Gradually tighten the five screws in the following order for even pressure.

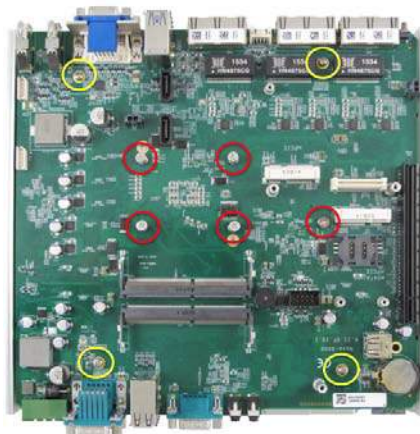

Securing the motherboard

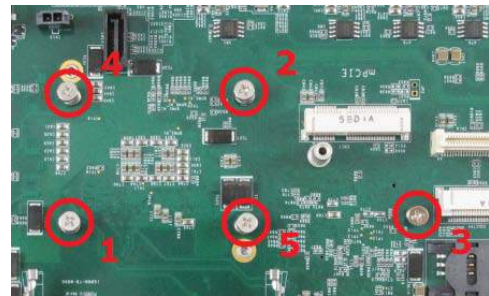

Secure five CPU/ heatsink spring screws in order

9. [Reinstall the system enclosure](#) and panel when done.
10. If you need to install other components, please refer to respective sections.

3.3 Memory Module Installation

There are two memory SO-DIMM slots on the motherboard that support a total maximum of 32GB DDR4-2133. Please follow the procedures below to replace or install the memory modules.

1. [Disassemble the system enclosure according to steps described in section 3.1.](#)
2. The SO-DIMM slots can be located once the bottom cover of the enclosure has been removed.
3. To install the memory module, insert gold fingers of the module into the slot at 45 degree angle, push down on the edge of the module and the clips on the side should clip the module into place.



Insert module at 45 degree angle



Press down on outer edge of the memory module

4. Repeat steps above to install the other module.
5. [Reinstall the system enclosure](#) and panel when done.
6. If you need to install other components, please refer to respective sections.

3.4 mini-PCle Module Installation

There are two full size mini-PCle sockets with SIM card support on the PCBA and another two on the MeziO™ module. It supports off-the-shelf mini-PCle modules. Please refer to the following procedures on how to install a mini-PCle module.



WARNING

It is recommended to install 4G SIM mini-PCle modules onto the MeziO™ module's mini-PCle socket (in red) to avoid signal conflict issues.

1. [Disassemble the system enclosure according to steps described in section 3.1.](#)
2. Location of the mini-PCle sockets on the motherboard shown below. The SIM slot of mini-PCle socket (in red) is situated on the rear panel.

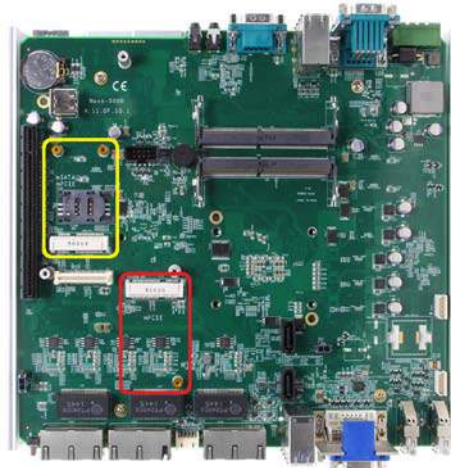

mini-PCle on motherboard

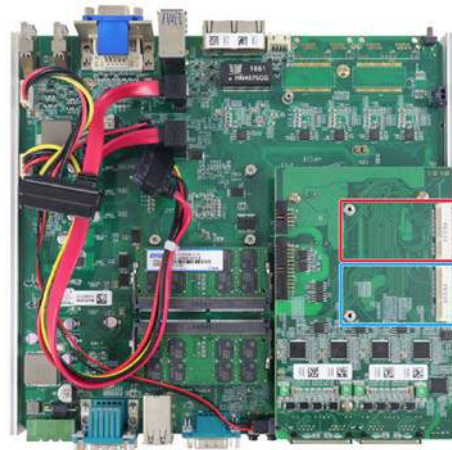

mini-PCle on MeziO Module

3. Inset the mini-PCle module's gold finger on a 45 degree angle into the socket, gently press the module down and secure it with an M2.5 P-head screw.



45 degree insertion angle



Secured with M2.5 P-head screw

- Clip on the IPEX-to-SMA cable to the module and attach the antenna onto the front or rear panel.

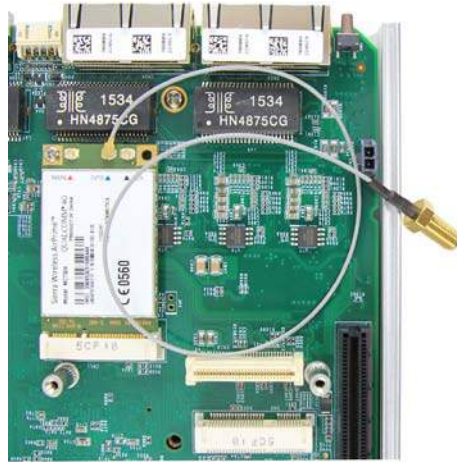

Clip on IPEX-to-SMA cable

Attach antenna to panel

- Insert the SIM card (if necessary) situated underneath the mini-PCle slot on the MezIO™ module.

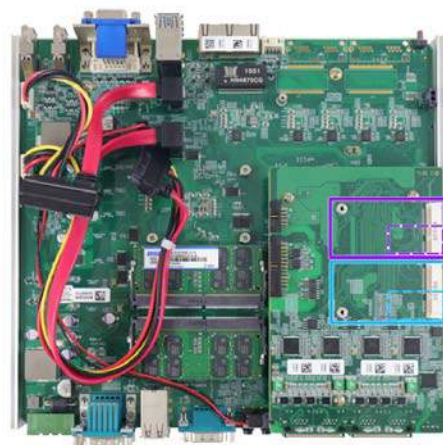
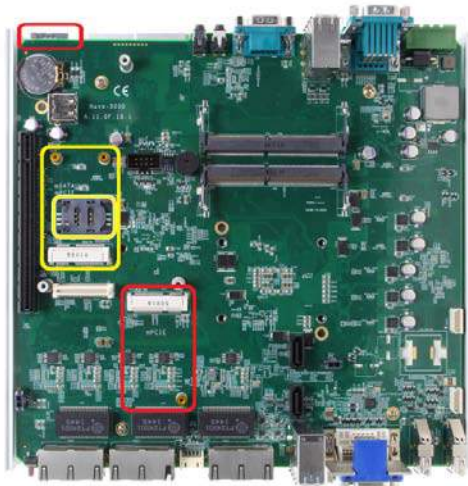

SIM slots for onboard mini-PCle modules

SIM slots for mini-PCle sockets on MezIO modules (on the opposite side)

- The mini-PCle socket (in **red**) works in conjunction with the panel-accessible SIM slot on the rear panel, while other mini-PCle sockets work with internal SIM slots. Insert the SIM upside down for 3G/ 4G access via your provider's network. Push the SIM card into the panel, make sure it clicks into the slot and is seated firmly (not protruding) in the slot.
- [Reinstall the system enclosure](#) and panel when done.
- If you need to install other components, please refer to respective sections.

3.5 Reinstalling the System Enclosure

Once you have installed or replace the component(s), to reinstall the enclosure, please refer to the following procedure:

1. Fit the front panel on and secure using the three (3) screws shown below.



2. Secure the DIO and CAN bus connector onto the panel with two (2) hex nut standoff each (indicated in red). Then fit the rear panel onto heatsink fins and secure using the three (3) screws shown below.

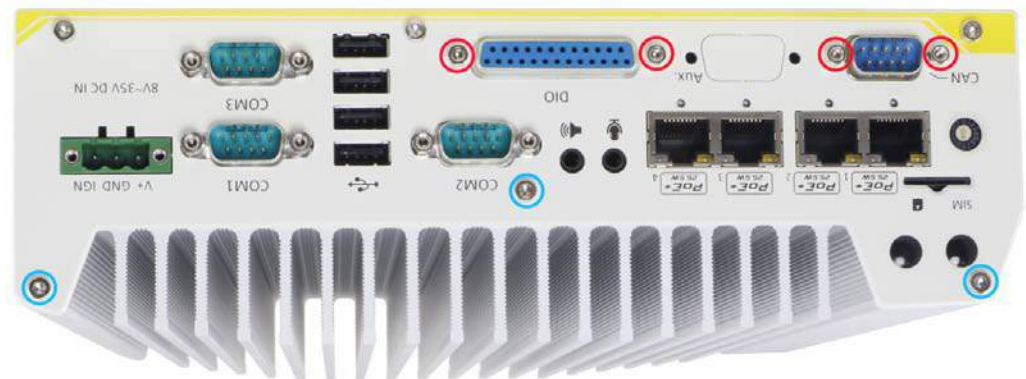

3. Secure three (3) screws at the bottom of the rear panel.

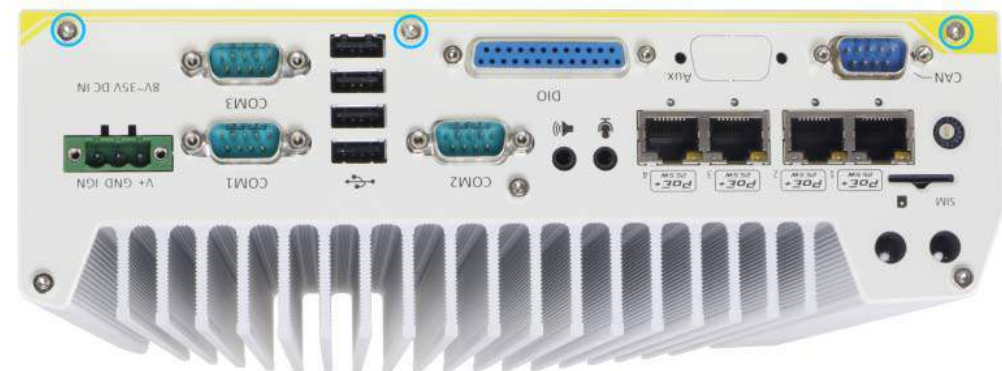

- Secure three (3) screws at the bottom of the front panel.



3.6 Internal 2.5" SATA HDD/ SSD Installation

The system has two SATA ports for connecting SATA HDD/ SSD, one internal and one external. Please follow the procedures below to install or replace the hard drives.

1. Place the system upside down on a flat surface and loosen the three (3) screws show below.

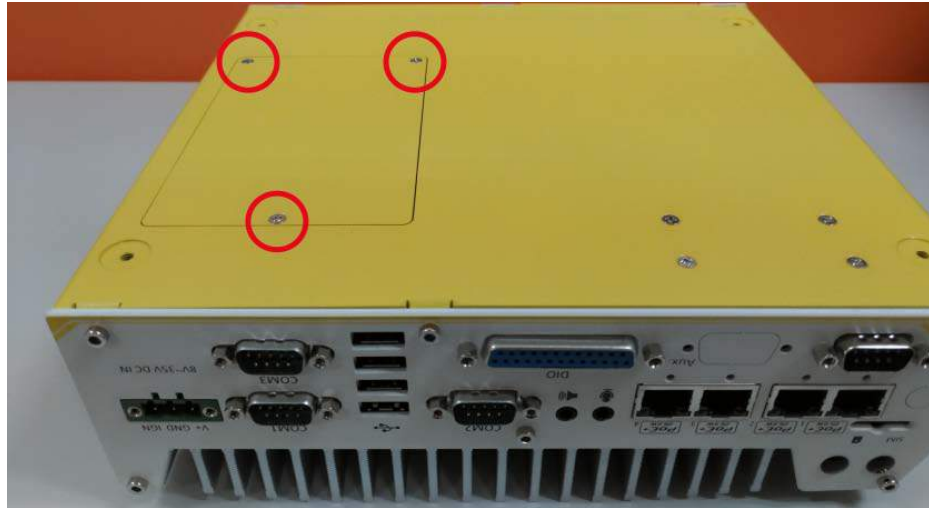

2. Remove the protective films on the thermal pad situated in the center of the bracket.



- Place the HDD/ SSD on the bracket, gently press it down against the thermal pad. From the accessory box, use M3 flat-head screws to secure the HDD/ SSD. Make sure the HDD/ SSD is secured in the same orientation as shown in the illustration below.



- Connect the SATA cable inside the enclosure to the HDD/ SSD



- Gently wiggle the bracket back into the enclosure and secure it with three (3) M3 flat-head screws.



3.7 External 2.5" HDD/ SSD Installation

1. Location of the hot-swappable HDD tray is shown in the illustration below.



2. Pull the handle of the tray door to open the hot-swappable HDD tray.



3. With HDD/ SSD label facing upwards, insert the gold finger end of the 2.5" HDD/SSD into the tray.



4. Push the handle into the HDD tray with HDD until it snaps into position.



5. A key is provided (in accessory box) to lock the tray door.



3.8 DC Power Connection

The system uses a 3-pin pluggable terminal block to accept 8~35V DC power input. It is a reliable, convenient and easy method to directly wire cables to the DC power connector. The pluggable terminal block is also used to accept ignition signal. To connect DC power via the 3-pin pluggable terminal block, please refer to the procedures described below.

1. Before connecting the cables, please make sure the DC power supply is unplugged!
2. Take the 3-pin pluggable terminal block out of the accessory box. The terminal block fits the wires with a gauge of 12~24 AWG.
3. Carefully identify the positive and negative contacts of your DC power supply and the pluggable terminal block. The polarities between DC power supply and terminal block must be positive (+) to positive (+) and ground (GND) to ground (GND).
4. Insert the wires to the matching pluggable terminal block contacts and tighten clamping screws using a Philips screwdriver.
5. Plug in the terminal plug into the 3-pin pluggable terminal block on the system enclosure and secure the plug using a flat-head screwdriver.



WARNING

The system accepts 8~35 VDC when using terminal block for DC input. Please make sure the voltage and polarity of DC power is correct before you connect and power on the system. Supplying a voltage over 35V or incorrect polarity will damage the system!

3.9 Wall Mount/ Anti-Vibration Bracket Installation

Nuvo-5100VTC series is shipped with dedicated wall mount/ anti-vibration for in-vehicle installation. The patented anti-vibration damping bracket offers superior vibration resistance (up to 1Grm with HDD and 5Grms with SSD, operating). To install the bracket, please refer to the following installation procedure.

 **NOTE**

You will need to remove the four (4) rubber stands at the bottom of the enclosure if they have been attached.

3.9.1 Anti-vibration Bracket Installation

1. Take the anti-vibration damping bracket, ten (10) M4 step screws and six (6) shock-absorbing grommets from the accessory box. There are four (4) shock-absorbing grommets (indicated in **red**) pre-installed on the bracket.
2. Insert the shock-absorbing grommets (indicated in **blue**) into the brackets shown in the illustration below and fix the anti-vibration damping bracket to the system using four (4) M4 step screws.

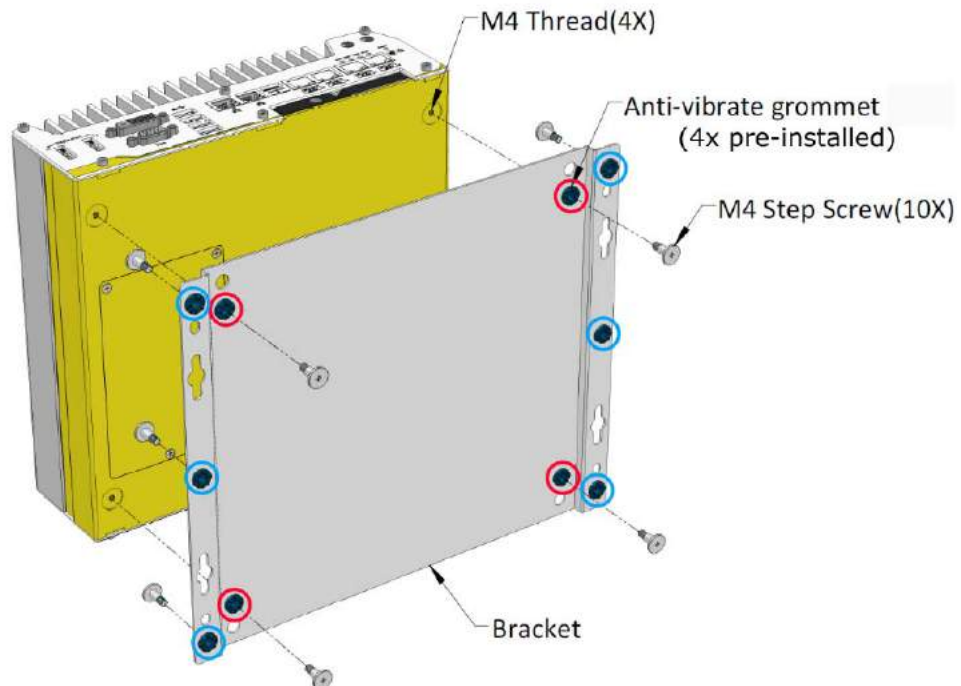

The damping bracket performs best when the system is installed horizontally.

3. Once the bracket has been secured onto the system, place the system at the desired location on a flat surface, secure it with the other six (6) M4 screws.

3.9.2 Wall Mount Bracket Installation

The included bracket can also be wall mounted. To install the system as a wall mount device, please refer to the following illustration.

1. Take the wall mount bracket, four (4) M4 step screws and four (4) shock-absorbing grommets from the accessory box. Fix the mounting brackets to the system enclosure using M4 step screws.

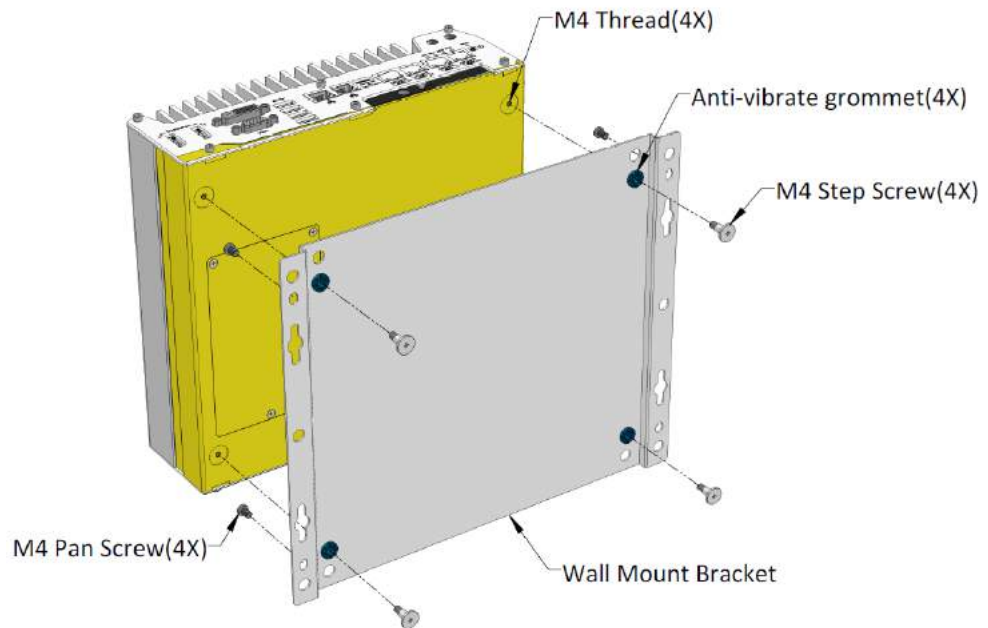

2. Place the system on a flat surface portion of the wall and secure it with four (4) M4 pan screws.

3.10 DIN Rail Installation (Optional)

The system also comes with an optional DIN-rail mounting kit. The kit includes a bracket and a DIN-rail mounting clip. By fixing the clip to the bracket using four M4 flat-head screws and fixing the bracket assembly to the system four M4 screws, complete the installation by clipping the system onto the DIN rail. This option may be useful if you want to deploy it inside an equipment cabinet where DIN rail is available.

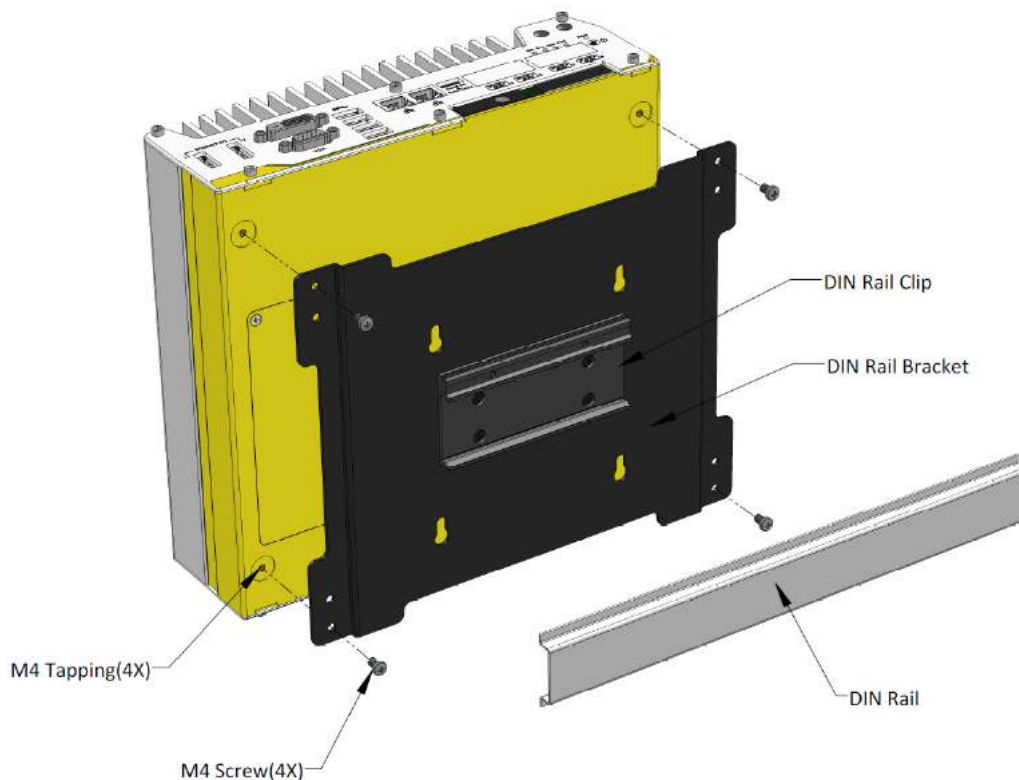

3.11 Powering On the System

There are four methods to power on the system

- Using the ignition signal input
- Pressing the power button
- Via an external non-latched switch
- Sending a LAN packet via Ethernet (Wake-on-LAN)

Powering on using the [ignition power control](#) is described in a designated section. We will describe the other three processes involved in this section

3.11.1 Powering On Using the Power Button

This is the simplest way to turn on your system. The power button on the front panel is a non-latched switch and behaves as the ATX-mode on/off control. With DC power connected, pushing the power button will turn on the system and the PWR LED indicator will light up. Pushing the button when system is on will turn off the system. If your operating system supports ATX power mode (i.e. Microsoft Windows or Linux), pushing the power button while the system is in operation will result in a pre-defined system behavior, such as shutdown or hibernation.



3.11.2 Powering On Using External Non-latched Switch

If your application demands the system to be placed inside a cabinet, you may use an external non-latched switch to power on/ off the system. The system provides a [“On/ Off Control Ctrl & Status Output”](#) connection (a 2x5, 2.0mm pitch wafer connector) for connecting a non-latched switch and acts as the ATX-mode power on/off control switch. The external non-latched switch acts exactly the same as the power button on the front panel. To setup and power on/ off the system using an external non-latched switch (ATX-mode), please follow the steps described below.

1. Acquire a non-latched switch with a 2x5, 2.0mm pitch wafer terminal and the switch must be connected to pin#1 and pin #2 (polarity is negligible).



2. Connect the wafer terminal to the “On/Off Control Ctrl & Status Output” connector on the system

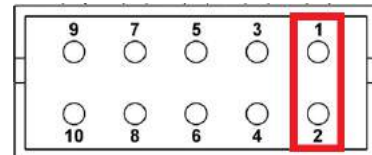

On/Off Control Ctrl & Status Output

Pin #1 and Pin #2

3. With DC power connected, pushing the power button will turn on the system and the PWR LED indicator will light up. Pushing the button when system is on will turn off the system. If your operating system supports ATX power mode (i.e. Microsoft Windows or Linux), pushing the power button while the system is in operation will result in a pre-defined system behavior, such as shutdown or hibernation.

3.11.3 Powering On Using Wake-on-LAN

Wake-on-LAN (WOL) is a mechanism to wake up a computer system from a S5 (system off with standby power) state via issuing a magic packet. The system's Wake-on-LAN compatible GbE port is shown below.



 **NOTE**

Please make sure the Intel chipset and Ethernet driver has been properly installed prior to setting up WOL function.

To enable WOL function, please set up WOL settings in the BIOS and in the operating system by follow the steps described below.

1. When the system boots up, press F2 to enter BIOS setup utility.
2. Go to the **[Power] > [Wake On LAN]** and set it to **[Enabled]**.
3. Press F10 to **“Save changes and exit BIOS”** and allow the system boot into the operating system.

4. Once booted into the Windows system, press **“Windows key + E”**, right-click on **“Network > Properties > Change adapter settings”**. Locate and double-click on the adapter Intel® I219 Gigabit Network Connection, click on **Configure...**

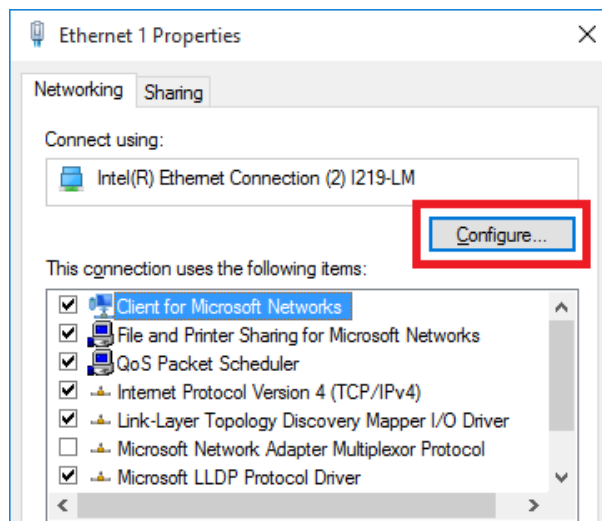

- Click on the **Power Management** tab and check the following options. Click on OK when done.

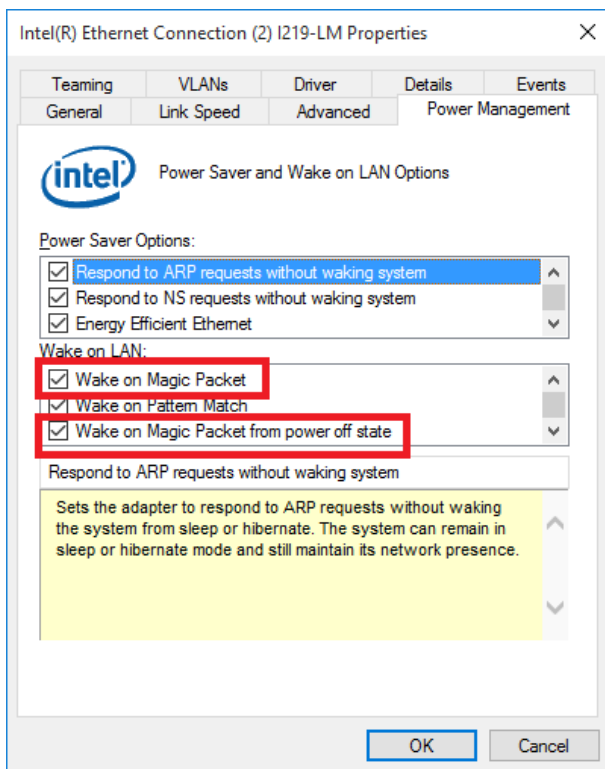

Magic Packet

The magic packet is a broadcast frame containing anywhere within its payload 6 bytes of all 255 (FF FF FF FF FF FF in hexadecimal), followed by sixteen repetitions of the target computer's 48-bit MAC address.

For example, NIC's 48-bit MAC Address is 78h D0h 04h 0Ah 0Bh 0Ch

DESTINATION SOURCE MISC

FF FF FF FF FF FF

78 D0 04 0A 0B 0C 78 D0 04 0A 0B 0C

78 D0 04 0A 0B 0C 78 D0 04 0A 0B 0C

78 D0 04 0A 0B 0C 78 D0 04 0A 0B 0C

78 D0 04 0A 0B 0C 78 D0 04 0A 0B 0C

78 D0 04 0A 0B 0C 78 D0 04 0A 0B 0C

78 D0 04 0A 0B 0C 78 D0 04 0A 0B 0C

78 D0 04 0A 0B 0C 78 D0 04 0A 0B 0C

78 D0 04 0A 0B 0C 78 D0 04 0A 0B 0C

MISC CRC

There are some free tools available on Internet that can be used to send a magic packet. Please refer to the following link to understand more about [Magic Packet](#).

3.12 Ignition Power Control

The ignition power control module for in-vehicle applications is a MCU-based implementation that monitors the ignition signal and reacts to turn on/off the system according to predefined on/off delay. Its built-in algorithm supports other features such as ultra-low power standby, battery-low protection, system hard-off, etc. In this section, we'll illustrate the principle of ignition power control and operation modes. For the location of your system's ignition control switch, please go [here](#).

3.12.1 Principles of Ignition Power Control

The basic concept of ignition power control module is to control the timing correlation between ignition signal and system power status. A typical timing correlation is described in following diagram.

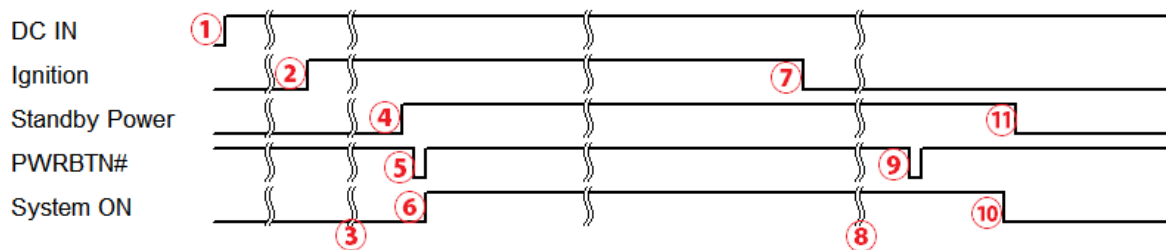

1. When DC power is supplied to the system, MCU starts to periodically detect ignition signal. Note that only MCU is working at this moment and the overall power consumption is less than 2 mW.
2. Ignition signal is active (both 12VDC and 24VDC ignition signals are accepted).
3. MCU starts to count a pre-defined power-on delay.
4. Once power-on delay expired, MCU turns on necessary standby power for the system (3.3VSB & 5VSB).
5. A PWRBTN# pulse is then issued to turn on the system (equivalent to one pressing the power button on the front panel).
6. The system is booting and becomes operational.
7. After a period of time, the ignition signal becomes inactive.
8. MCU starts to count a pre-defined power-off delay.
9. Once power-off delay expired, another PWRBTN# pulse is issued to perform a soft-off for the system (ex. a normal shutdown process for Windows system).
10. The system is completely shut down.
11. As MCU detects system is off, it turns off the standby power for the system, and operates in low power mode again (< 2mW power consumption).

3.12.2 Additional Features of Ignition Power Control

In addition to the typical timing correlation, the ignition power control module offers additional features to provide additional reliability for in-vehicle applications.

1. Low battery detection

The ignition power control module continuously monitors the voltage of DC input when the system is operational. If input voltage is less than 9V (for 12VDC input) or less than 18V (for 24VDC input) over a 60-second duration, it will shut down the system automatically.

2. Guarded power-on/ power-off delay duration

If ignition signal goes inactive during the power-on delay duration, the ignition power control module will cancel the power-on delay process and go back to idle status. Likewise if ignition signal goes active during the power-off delay duration, the ignition power control module will cancel the power-off delay process and keep the system running.

3. System hard-off

In some cases, system may fail to shutdown via a soft-off operation due to system/ application halts. The ignition power control module offers a mechanism called “hard-off” to handle this unexpected condition. By detecting the system status, it can determine whether the system is shutting down normally. If not, the ignition power control module will force cut-off the system power 10 minutes after the power-off delay duration.

4. Smart off-delay

The ignition power control module offers two modes (mode 13 & mode 14) which have very long power-off delay duration for applications require additional off-line time to process after the vehicle has stopped. In these two modes, the ignition power control module will automatically detect the system status during the power-off delay duration. If the system has shutdown (by the application software) prior to power-off delay expiring, it will cut off the system power immediately to prevent further battery consumption.

3.12.3 Wiring Ignition Signal



To have ignition power control for in-vehicle usage, you need to supply IGN signal to the system. The IGN input is located on the 3-pin pluggable terminal block (shared with DC power input). Below is the typical wiring configuration for in-vehicle applications.

1. Connect car Battery+ line (12V for sedan, 24V for bus/truck) to V+.
2. Connect car Batter-/ GND line to GND.
3. Connect ACC line to IGN.



WARNING

Please make sure your DC power source and IGN signal share the same ground.

IGN input accepts 8~35VDC. Supply a voltage higher than 35VDC may damage the system.

3.12.4 Configure your Windows system

When applying ignition power control to your system, please make sure you've configured your Windows system to initiate a shutdown process when pressing the power button. By default, Windows 7/ 8/ 10 goes to sleep (S3) mode when power button is pressed. As sleep (S3) is not a complete shutdown behavior, the ignition control function does not recognize the finish of a normal shut down process and thus users will encounter a system hard-off (power cut-off after 10 minutes). Please configure "When I press the power button" to "Shut down" in your Windows system settings.

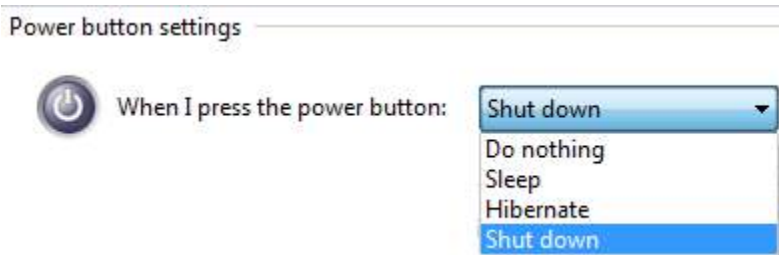

3.12.5 Operation Modes of Ignition Power Control

You can use the rotary switch to configure the operation mode. The system offers 16 (0~15) operation modes with different power-on/power-off delay configurations.

The ignition control module is also BIOS-configurable. When rotary switch is set to mode 15 (0xF), the ignition power control is set to executed according to parameters configured in BIOS setup menu, which allows richer combination of power-on/power-off delay and more detailed control parameters.



- **Mode 0**

Mode 0 is the ATX mode without power-on and power-off delay. User can only use the power button on the front panel to turn on or turn off the system.

Mode	Power-on Delay	Power-off Delay	Hard-off Timeout
0	N/A	N/A	N/A

- **Mode 1**

Mode 1 is AT mode without power-on and power-off delay. The system automatically turns on when DC power is applied. A retry mechanism is designed to repeat the power-on cycle if the system fails to boot up.

Mode	Power-on Delay	Power-off Delay	Hard-off Timeout
1	N/A	N/A	N/A

- **Mode 2**

Mode 2 is designed to have a very minor power on/ off delay of 160ms for applications that requires the system to start up almost at the same as the rest of the equipment it is working in collaboration with.

Mode	Power-on Delay	Power-off Delay	Hard-off Timeout
2	160ms	160ms	10 minutes

- **Mode 3 ~ Mode 12**

Mode 3 ~ Mode 12 have various power-on delay and power-off delay. Each mode supports a hard-off timeout of 10 minutes.

Mode	Power-on Delay	Power-off Delay	Hard-off Timeout
3	10 seconds	10 seconds	10 minutes
4	10 seconds	1 minute	10 minutes
5	10 seconds	5 minutes	10 minutes
6	30 seconds	1 minute	10 minutes
7	30 seconds	5 minutes	10 minutes
8	30 seconds	10 minutes	10 minutes
9	3 minutes	1 minute	10 minutes
10 (A)	3 minutes	10 minutes	10 minutes
11 (B)	3 minutes	30 minutes	10 minutes
12 (C)	10 minutes	30 minutes	10 minutes

- **Mode 13 (D) / Mode 14 (E)**

Mode 13 and Mode 14 are ignition power control modes with very long power-off delay. Both modes support the feature of “smart off-delay”, which automatically detect system status during power-off delay duration and cut off system power if system is off in prior to power-off delay expired.

Mode	Power-on Delay	Power-off Delay	Hard-off Timeout
13 (D)	30 seconds	2 hours	10 minutes
14 (E)	3 minutes	2 hours	10 minutes

- **Mode 15 (F)**

The ignition control module is implemented to support BIOS-configurable ignition parameters. When the rotary switch is set to 15 (0xF), users can configure ignition parameters in BIOS setup menu.

To configure ignition parameters in BIOS, please follow the steps below.

1. Make sure you have set the rotary switch to position 15 (0xF).
2. When system boots up, press F2 to enter BIOS setup menu.
3. Go to **[Power]** → **[Ignition Power Control]**.

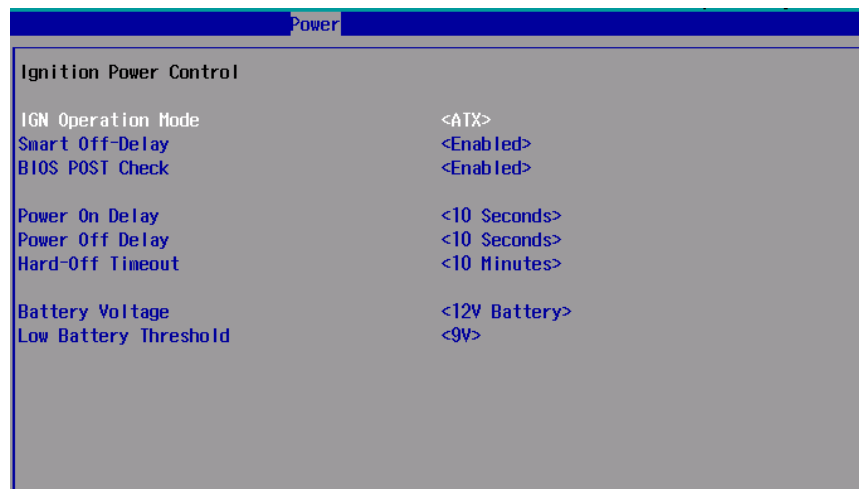

4. You can configure parameters for ignition power control according to your application.

[IGN Operation Mode]

ATX	ATX mode without power-on and power-off delay. Same operation as rotary switch set to 0.
AUTO-ON	Automatically turns on the system when DC power is applied. Same operation as rotary switch set to 1.
IGN	Ignition power control mode. Ignition control is executed according to the specified parameters.

[Smart Off-Delay]

Enabled	If system is manually shutdown during the power-off delay period, ignition control module will cut off system power in prior to expiration of power-off delay to save battery power.
Disabled	Ignition control module cut off system power only after power-off delay expired.

[BIOS POST Check]

Enabled	This option secures a boot-to-OS operation. If the system is failed to boot to OS (e.g. disk failure or no bootable device) within 60 seconds, ignition control module will cut off system power and retry another power on cycle.
Disabled	BIOS POST check is skipped.

[Power On Delay]

Specifies the power-on delay duration. Once IGN signal goes active and sustains for the duration of power-on delay, ignition control module turns on system power and boot up the system.

[Power Off Delay]

Specifies the power-off delay duration. Once IGN signal goes inactive and sustains for the duration of power-off delay, ignition control module performs system shutdown (soft-off) and then cut off system power.

[Hard-off Timeout]

Specifies system hard-off timeout. Once system failed to normally shutdown via a soft-off operation due to system/application halts (e.g. Windows BSOD), ignition control module can compulsively cut off system power after the given hard-off timeout.

[Battery Voltage]

Specifies the battery voltage of the vehicle where System VTC is deployed. Typically it's 12 VDC for sedan and 24 VDC for bus/truck.

[Low Battery Threshold]

When system is running, ignition control module continuously monitors the battery voltage. Once the battery voltage is lower than the specified threshold, it performs system shutdown (soft-off) and cut off system power to prevent battery drain-out. You should specify the low battery threshold according to the given battery voltage.

5. Press F10 to "Save Changes and Exit". The ignition control module will be reset and operate according to parameters configured in BIOS setup menu.

4 System Configuration

4.1 BIOS Settings

The system is shipped with factory-default BIOS settings meticulously programmed for optimum performance and compatibility. In this section, we'll illustrate some of the BIOS settings you may need to modify. Please always make sure you understand the effect of change before you proceed with any modification. If you are unsure of the function you are changing, it is recommended to change one setting at a time to see its effect(s).

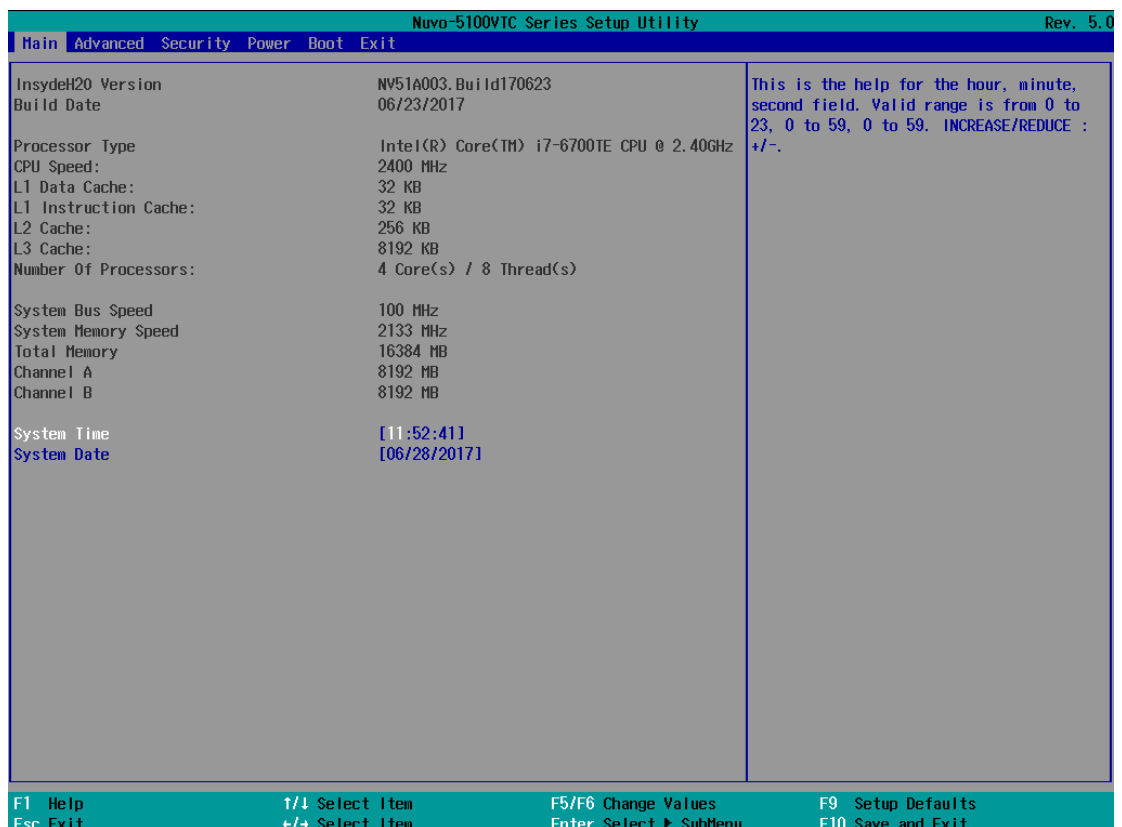

 **NOTE**

Not all BIOS settings will be discussed in this section. If a particular setting/ function you are after requires specific BIOS settings but is not discussed in this section, please contact Neousys Technical Support staff.

4.1.1 COM1 & COM3 Operating Mode

COM1 and COM3 of System series support RS-232 (full-duplex), RS-422 (full-duplex) and RS-485 (half-duplex) mode. You can set the COM1/ COM3 operating mode via BIOS settings.



Another option in BIOS called “*Slew Rate*” defines how sharp the rising/falling edge is for the output signal of COM1/ COM3. For long-distance RS-422/485 transmission, you may set the “*Slew Rate*” option as “High” to improve signal quality.

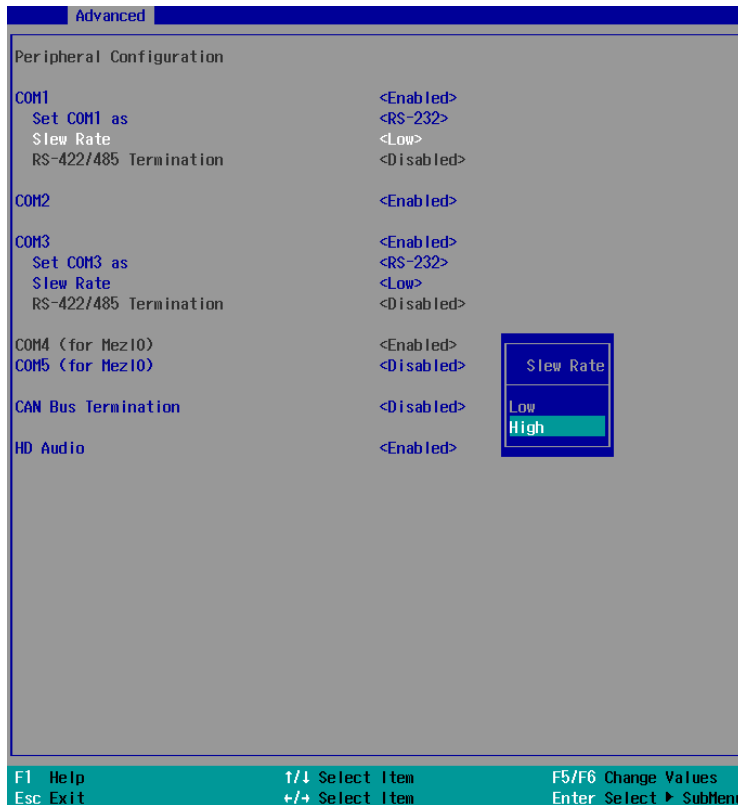

To set COM port operating mode:

1. When system boots up, press F2 to enter BIOS setup utility.
2. Go to **[Advanced] > [Peripheral Configuration]**.
3. Highlight the COM port you wish to set and press Enter to bring up setting options. Use up/ down arrow to highlight your selection and press Enter.
4. Repeat step 2 to set other COM ports.
5. Press F10 to "Exit Saving Changes".

4.1.2 CAN bus Termination

The CAN bus is a communication bus running at differential signal pair and it must be terminated. Nuvo-5100VTC series features built-in termination to suppress signal reflection. You should enable the built-in CAN Bus Termination if no external resistor is added to the connection.

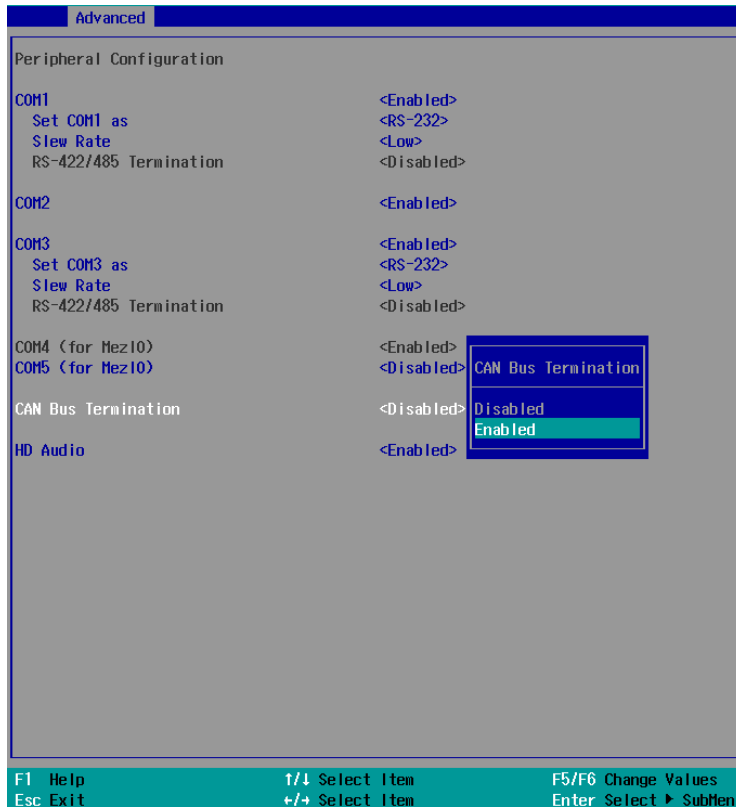

1. When system boots up, press F2 to enter BIOS setup utility.
2. Go to **[Advanced] > [Peripheral Configuration]**.
3. Highlight CAN bus Termination and press Enter to bring up options, Disabled/ Enabled, use up/ down arrow to highlight your selection and press Enter.
4. Press F10 to "Exit Saving Changes".

4.1.3 SATA Configuration

The system SATA controller supports two (2) operating modes: **AHCI** and **RAID** mode. **AHCI** mode, which exposes SATA's advanced capabilities such as hot swapping and native command queuing, is supported in several later version of operating systems. **RAID** mode provides redundant data storage (RAID 1) or a higher throughput (RAID 0). Nuvo-5100VTC series features built-in hardware RAID. No additional H/W or driver is needed to use RAID function.

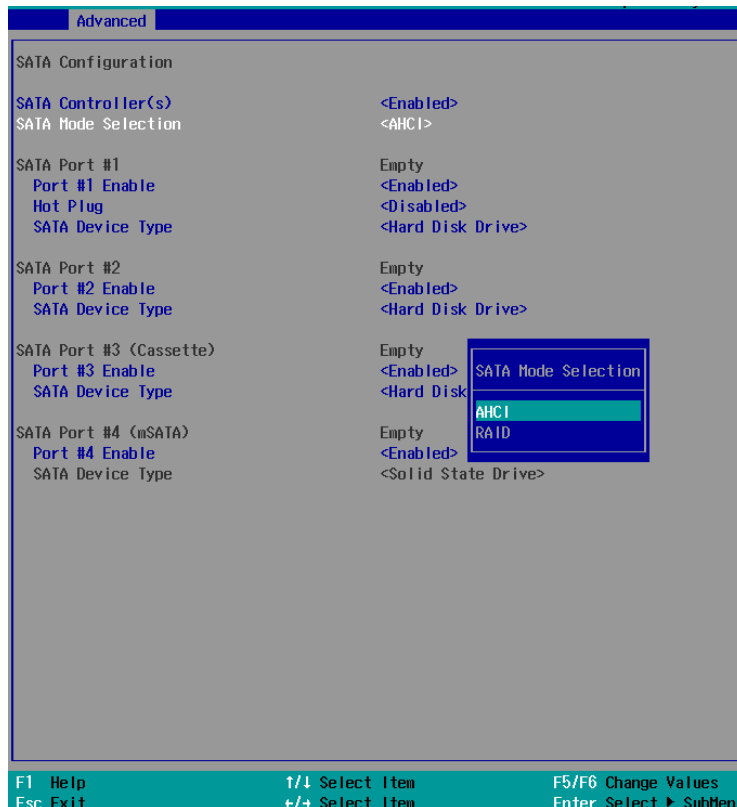

Recommended SATA controller mode settings:

- If you're using Windows Vista, Windows 7/ 8/ 10, or Linux kernel 2.6.19 or later, you can select **AHCI** mode for better performance.
- If you're installing two 2.5" HDD/ SSD and looking for data striping (RAID 0) or data mirroring (RAID 1), you can select **RAID** mode to utilize built-in RAID.

To set SATA controller mode:

1. When system boots up, press F2 to enter BIOS setup utility.
2. Go to **[Advanced] > [SATA Configuration]**.
3. Highlight the SATA port you wish to set and press Enter to bring up setting options. Use up/ down arrow to highlight your selection and press Enter.

4. Repeat step 3 to set other SATA ports.
5. Press F10 to “Exit Saving Changes”.

**NOTE**

By enabling Hot Plug function for SATA Port #1, the front accessible 2.5” HDD/SSD tray may be removed while the system is in operation, please avoid installing operating system onto this drive!

4.1.4 Configure Hot-Swappable HDD Tray

The system has a hot pluggable SATA port (#1) connected to the hot-swappable HDD tray on the front panel. The HDD tray can be configured as removable storage device so you can insert/ remove a HDD/ SSD while the system is in operation without shutting down the system. If it is used for OS installation (single drive or RAID), it is recommended that the drive be configured as a fixed storage device by disabling the hot-plug function.



To enable/ disable hot-swap for HDD tray:

1. When system boots up, press F2 to enter BIOS setup utility.
2. Go to **[Advanced] > [SATA Configuration]**.
3. Go to **[SATA Port #1] > [Hot Plug]**, press Enter to bring up setting options. Highlight **[Enable]** for removable drive or **[Disable]** for fixed drive, and press Enter.
4. Press F10 to "Exit Saving Changes".

4.1.5 TPM Availability

Trusted Platform Module (TPM) is a hardware-based cryptoprocessor to secure hardware by integrating cryptographic keys into devices. Nuvo-5100VTC series is designed with on-board TPM 2.0 module. As TPM 2.0 requires 64-bit Windows 7/8/10 with UEFI boot mode, it is disabled in BIOS by default. For customers who want to utilize TPM feature, you will need to enable TPM in BIOS as well as install Windows with UEFI mode.



To enable TPM availability:

1. When system boots up, press F2 to enter BIOS setup utility.
2. Go to **[Security] > [TPM Availability]**, press Enter to bring up Options, Available/ Hidden.
3. Highlight your selection, press Enter and press F10 to "Exit Saving Changes".

4.1.6 CPU SKU Power Configuration

The system supports various 6th-Gen Skylake LGA1151 CPUs. A unique feature, “**SKU Power Config**” is implemented in BIOS to allow users to specify user-defined SKU power limit. Although the system is designed to have best thermal performance with CPUs of 35W TDP, you can install a 65W CPU and limit its SKU power to obtain more computing power. This feature gives you the flexibility of CPU selection and great balance between computing power and operating temperature range.

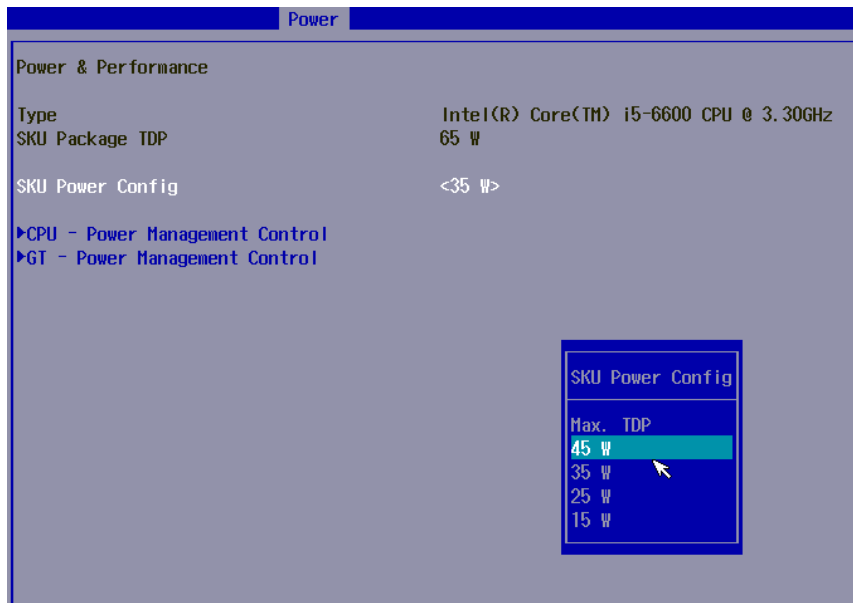

Here is our suggestion regarding specifying SKU power for system with 65W/ 54W/ 51W CPUs.

- For system running at up to 70°C ambient, specify SKU power to 35 W.
- For system running at up to 60°C ambient, specify SKU power to 45 W.
- For system running at up to 50°C ambient, specify SKU power to Max. TDP.

To configure the CPU SKU power limit:

1. When the system boots up, press F2 to enter BIOS setup utility.
2. Go to **[Power]** → **[Power & Performance]**.

Select a proper value of SKU power limit for **[SKU Power Config]** option.

4.1.7 Wake on LAN Option

Wake-on-LAN (WOL) is a mechanism which allows you to turn on your System series via Ethernet connection. To utilize Wake-on-LAN function, you have to enable this option first in BIOS settings. Please refer "[Powering On Using Wake-on-LAN](#)" to set up the system.



To enable/disable "Wake on LAN" option:

1. When system boots up, press F2 to enter BIOS setup utility.
2. Go to **[Power] > [Wake on LAN]**.
3. Press Enter to bring up setting options, scroll to the setting you desire and press Enter to set.
4. Press F10 to "Exit Saving Changes."

4.1.8 Power On after Power Failure Option

This option defines the behavior of system when DC power is supplied.

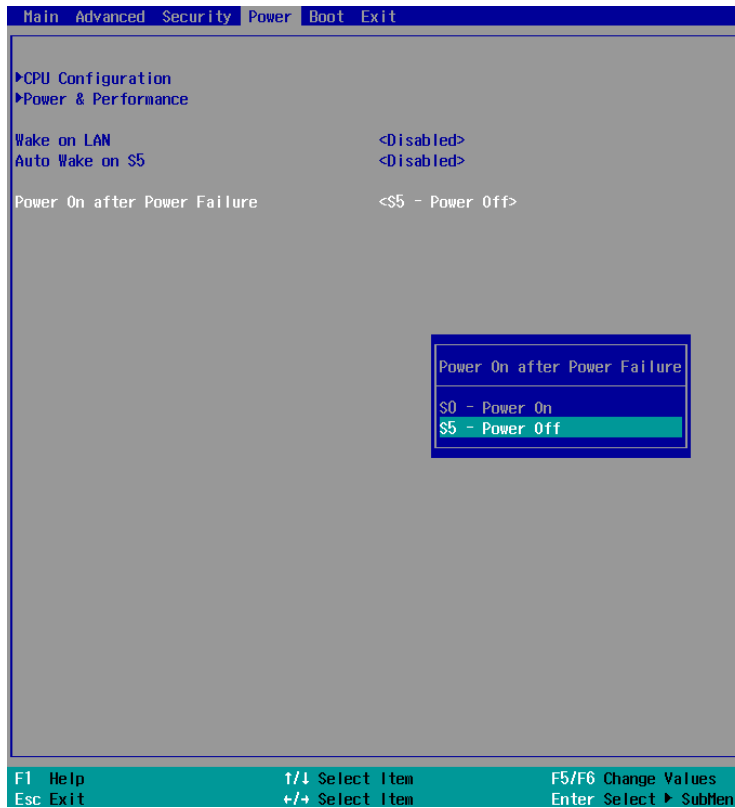

Value	Description
S0 – Power On	System is powered on when DC power is supplied.
S5 – Power Off	System is kept in off state when DC power is supplied.

To set “Power On after Power Failure” option:

1. When system boots up, press F2 to enter BIOS setup utility.
2. Go to **[Power] > [Power On after Power Failure]**.
3. Scroll down to highlight **[Power On after Power Failure]**, press Enter to bring up setting options, S0 – Power On or S5 – Power Off, and press Enter to select the setting.
4. Press F10 to “Exit Saving Changes”

4.1.9 Boot Type (Legacy/ UEFI)

The system supports both Legacy and Unified Extensible Firmware Interface (UEFI) boot modes. UEFI is a specification proposed by Intel to define a software interface between operating system and platform firmware. Most modern operating systems, such as Windows 7/ 8/ 10 and Linux support both Legacy and UEFI boot modes. The Legacy boot mode uses MBR partition for disk and VBIOS for video initialization, the UEFI boot mode uses GPT partition which supports greater than 2TB partition size and GOP driver for faster video initialization.



It is recommended that:

- If you need greater than 2TB disk partition or want to use TPM 2.0 function, you shall choose UEFI boot mode and install operating system accordingly.
- Otherwise you can choose Legacy boot mode for most cases.

To configure Boot Type:

1. When system boots up, press F2 to enter BIOS setup utility.
2. Go to **[Boot] > [Boot Type]**, press Enter to bring up options, Dual Boot (Legacy+UEFI), Legacy Boot Type, UEFI Boot Type.
3. Highlight your selection and press Enter.
4. Press F10 to “Exit Saving Changes”.

4.1.10 Boot Option for Newly Added Device

The Add Boot Options dedicates the boot sequence order of a newly added device (eg. USB flash drive). The setting allows you to set the newly added device as the first device or as the last device to boot.

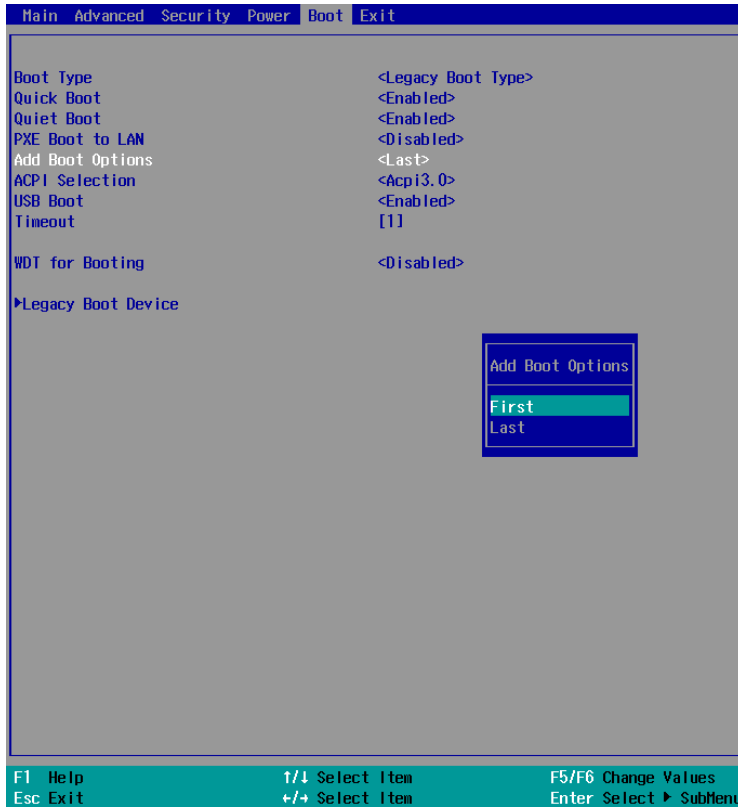

To set Add Boot Options:

1. When system boots up, press F2 to enter BIOS setup utility.
2. Go to [Boot] > [Add Boot Options], press Enter to bring up options, First or Last.
3. Highlight your selection and press Enter, press F10 to "Exit Saving Changes".

4.1.11 Watchdog Timer for Booting

The system BIOS has a useful feature which allows users to use watchdog timer to ensure a successful boot process. You can specify the timeout value for watchdog timer. Once the watchdog timer expires, BIOS issues a reset command to initiate another boot process. You can also set the behavior of how to stop the watchdog timer. There are two options in BIOS menu, “**Automatically after POST**” and “**Manually after Entering OS**”. When “**Automatically after POST**” is selected, the BIOS automatically stop the watchdog timer after POST (Power-On Self Test) OK. When “**Manually after Entering OS**” is selected, it’s user’s liability to stop the watchdog timer when entering OS. This guarantees the system can always boot to OS, otherwise another booting process will be initiated. For information about programming watchdog timer, please refer to [Watchdog Timer & Isolated DIO](#).



To set the watchdog timer for boot in BIOS:

1. When system boots up, press F2 to enter BIOS setup utility.
2. Go to **[Boot]** menu.
3. Disable or select timeout value for **[WDT for Booting]** option.
4. Once you give a timeout value, the **[WDT Stop Option]** option appears. You can select “*Automatically after POST*” or “*Manually after Entering OS*”.

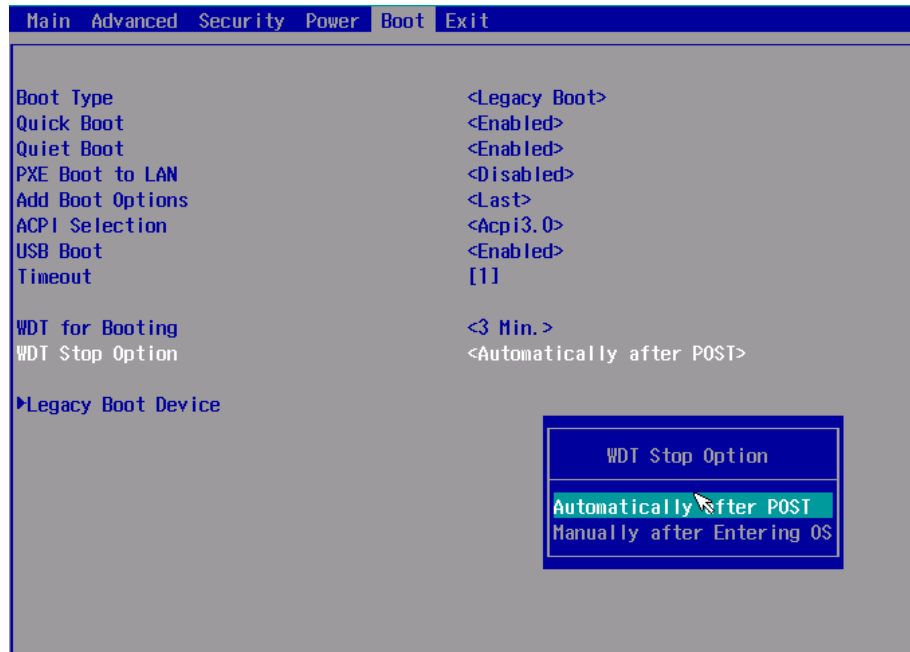

5. Press F10 to "Exit Saving Changes.

4.1.12 Selecting Legacy/ UEFI Boot Device

When multiple bootable devices are connected (e.g. HDD, mSATA, USB flash disk, USB DVD-drive), you may need to select one of them as the boot device. There are two ways to select the device. You can either, press F12 when system boots up to go to Boot Manager and then select one of the devices, or select the boot device in BIOS settings.



To set boot order for devices in UEFI Boot Device:

1. When system boots up, press F2 to enter BIOS setup utility
2. Go to **[Boot] > [UEFI Boot Device]**
3. Highlight the device you wish to make boot order changes to and press F5/ F6 or +/- to change device boot order.

To select boot order for devices in Legacy Boot Device:

1. When system boots up, press F2 to enter BIOS setup utility
2. Go to **[Boot] > [Legacy Boot Device]**, you can choose the type of device to list by selecting “**By Device**” or “**By Device Type**”.
3. Highlight the device or device category you wish to make boot order changes to and press F5/ F6 or +/- to change device boot order.

4.2 AMT Configuration

Intel® AMT (Active Management Technology) is a hardware-based technology for remotely managing target PCs via Ethernet connection. Nuvo-5100VTC series supports AMT function via its Ethernet port implemented with Intel I219-LM. Prior to using AMT to remotely control Nuvo-5100VTC series, you need to configure AMT password and network settings.

1. Make sure you have connected the proper Ethernet port (via I219-LM).



2. When the system boots up, press F10 to enter the MEBx configuration menu.

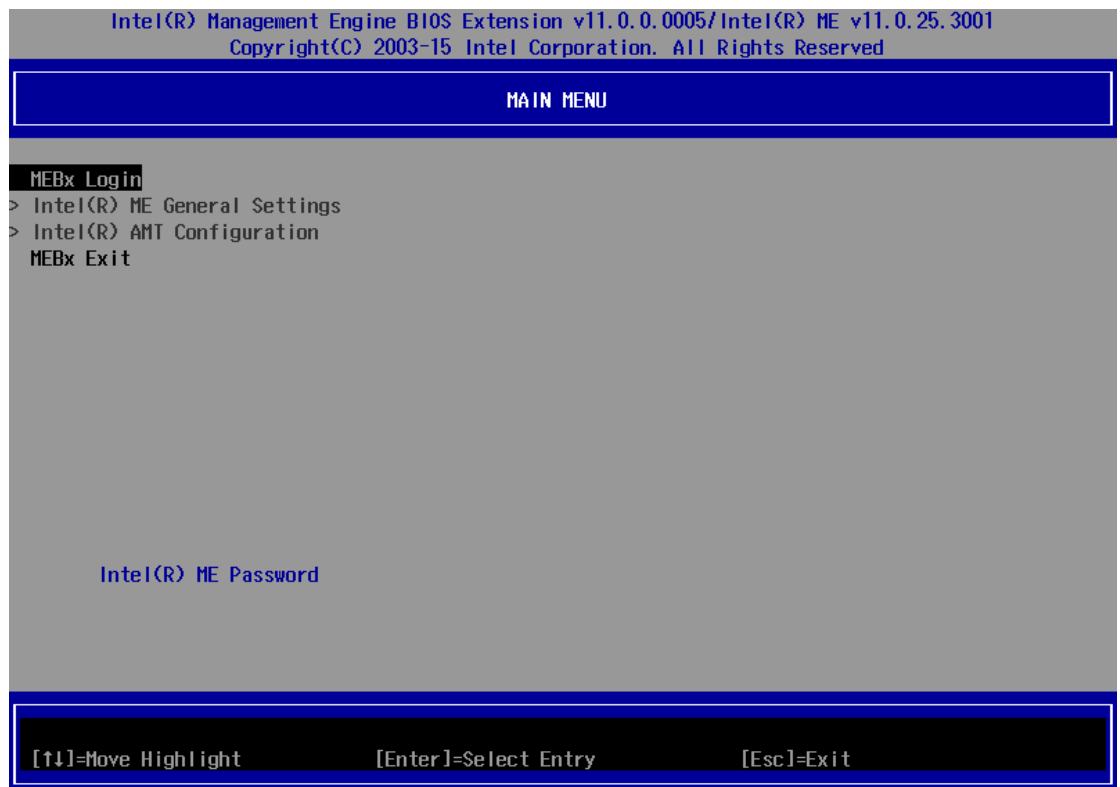

3. Highlight MEBx Login and press Enter, a prompt will appear asking for password. The default password is “admin”. For further MEBx configuration details, please refer to [Intel® MEBX User Guide](#).

4.3 RAID Volume Configuration

The system supports hardware RAID function for more reliable and efficient disk access. The built-in RAID supports RAID 0 (data striping) and RAID 1 (data mirroring). You can configure RAID mode according to your needs by following steps listed below.

1. Configure the SATA controller by going to **[Advanced] > [SATA Configuration] > [SATA Mode Selection]** and select **[RAID]** (refer to [section 4.3](#) for details).
2. Reboot the system once RAID mode has been set, upon reboot, you will see a UI banner for RAID configuration.

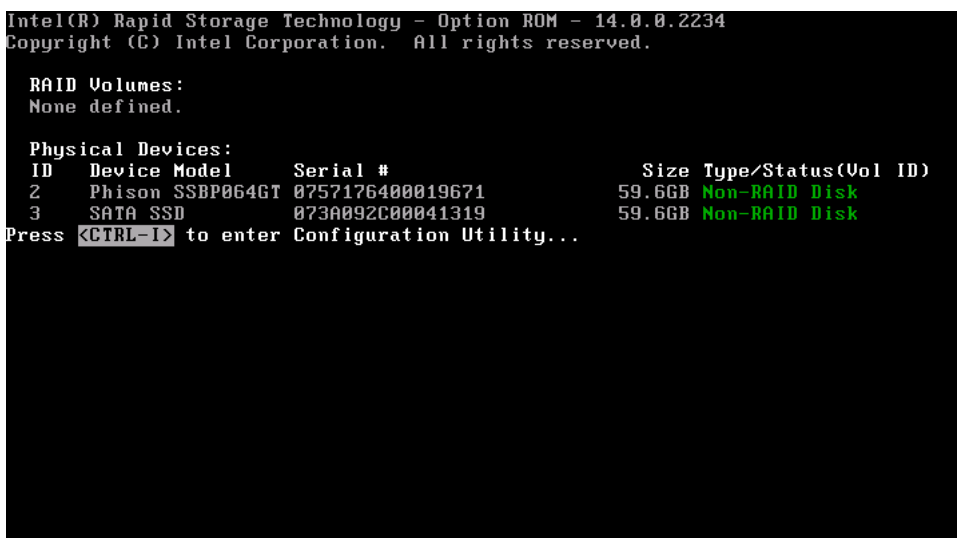

3. Press **[Ctrl + I]** to enter the RAID configuration menu. Follow the on-screen instructions to create, delete or configure the RAID volume.

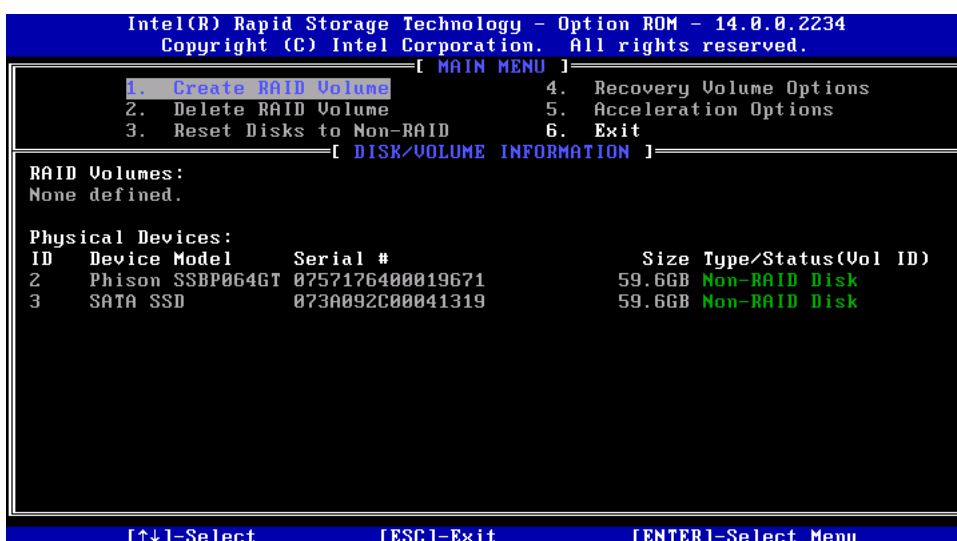

5 OS Support and Driver Installation

5.1 Operating System Compatibility

Nuvo-5100VTC series support most operating system developed for Intel® x86 architecture. The following list contains the operating systems which have been tested by Neosys Technology.

- Microsoft Window 7 (x86*/ x64*)
- Microsoft Window 8 (x64)
- Microsoft Window 10 (x64)
- Microsoft Embedded Standard 7
- CentOS 7
- Debian 8.7**
- Fedora 24**
- OpenSUSE 42.1**
- Ubuntu 14.04.4 LTS and 16.04 LTS**



NOTE

** Due to XHCI driver is not included natively in Windows 7, you may encounter Keyboard/ mouse issues when installing Windows 7. Neosys offers a Windows-based batch file and step-by-step installation guide.*

*** For distributions, graphics driver and RAID function may not be completely implemented in its kernel. You may encounter restrictions when using these features, such as triple independent display and RAID. For optimum operation, it is the users' responsibility to manually check for new drivers and upgrades!*

Neosys may remove or update operating system compatibility without prior notice. Please contact us if your operating system of choice is not on the list.

5.2 Install Drivers Automatically

The system comes with a “Drivers & Utilities” DVD that offers “one-click” driver installation process. It automatically detects your Windows operating system and installs all necessary drivers for you system with a single click.

To install drivers automatically, please refer to the following procedures.

1. Insert the “Drivers & Utilities” DVD into a USB DVD-drive connect to your system. A setup utility launches and the following dialog appears.



2. Click on “**Automatic Driver Installation**” and the setup utility will automatically detect your Windows operating system and install all necessary drivers. The installation process takes about 6~8 minutes depending on your Windows version. Once driver installation is done, the setup utility reboots your Windows and you may begin using your system.

5.3 Install Drivers Manually

You can also manually install each driver for the system. Please note when installing drivers manually, you need to install the drivers in the following sequence mentioned below.

5.3.1 For Windows 7 (x86)

The recommended driver installation sequence is

1. Chipset driver (x:\Driver_Pool\Chipset_10_Series\Win_ALL\SetupChipset.exe)
2. Graphics driver (x:\Driver_Pool\Graphics_6th_i7\Win_7_32\Setup.exe)
3. Audio driver (x:\Driver_Pool\Audio_ALC262\Win_ALL_32\Setup.exe)
4. LAN driver
(x:\Driver_Pool\GbE_I210_I350\Win_ALL_32\APPS\PROSETDX\Win32\DxSetup.exe)
5. ME driver (x:\Driver_Pool\ME_10_Series\Win_ALL_AMT\SetupME.exe)

5.3.2 For Windows 7 (x64)

The recommended driver installation sequence is

1. Chipset driver (x:\Driver_Pool\Chipset_10_Series\Win_ALL\SetupChipset.exe)
2. Graphics driver (x:\Driver_Pool\Graphics_6th_i7\Win_7_8_10_64\Setup.exe)
3. Audio driver (x:\Driver_Pool\Audio_ALC262\Win_ALL_64\Setup.exe)
4. LAN driver
(x:\Driver_Pool\GbE_I210_I350\Win_ALL_64\APPS\PROSETDX\Winx64\DxSetup.exe)
5. TPM 2.0 driver
(x:\Driver_Pool\TPM2\Win7_64\Windows6.1-KB2920188-v7-x64.msu)
6. ME driver (x:\Driver_Pool\ME_10_Series\Win_ALL_AMT\SetupME.exe)

5.3.3 For Windows 8/ 8.1/ 10 (x64)

The recommended driver installation sequence is

1. Chipset driver (x:\Driver_Pool\Chipset_10_Series\Win_ALL\SetupChipset.exe)
2. Graphics driver (x:\Driver_Pool\Graphics_6th_i7\Win_7_8_10_64\Setup.exe)
3. Audio driver (x:\Driver_Pool\Audio_ALC262\Win_ALL_64\Setup.exe)
4. LAN driver
(x:\Driver_Pool\GbE_I210_I350\Win_ALL_64\APPS\PROSETDX\Winx64\DxSetup.exe)
5. ME driver (x:\Driver_Pool\ME_10_Series\Win_ALL_AMT\SetupME.exe)

5.4 Install WDT_DIO Driver Package

Neosys provides a driver package which contains function APIs for watchdog timer, digital I/O, per-port PoE power on/off control and other platform-related functions. You should install the driver package (WDT_DIO_Setup.exe) in prior to use these functions.



NOTE

Please install WDT_DIO_Setup_v2.2.5 or later versions for Nuvo-5100VTC Series.

5.4.1 For Windows 7 (x86)

Please execute the driver setup program in the following directory.

x:\Driver_Pool\WDT_DIO\XP_Win7_8_32\WDT_DIO_Setup_v2.2.5.exe

5.4.2 For Windows 7/ 8/ 10 (x64)

Please execute the driver setup program in the following directory.

x:\Driver_Pool\WDT_DIO\Win7_8_64\WDT_DIO_Setup_v2.2.5(x64).exe

5.4.3 For Windows 7/ 8/ 10 (WOW64)

Please execute the driver setup program in the following directory.

x:\Driver_Pool\WDT_DIO\Win7_8_WOW64\WDT_DIO_Setup_v2.2.5(wow64).exe

Appendix A Windows 7 Installation

xHCI Driver Support in Microsoft OS

Intel Skylake platform removed EHCI controller and supports USB 2.0 and USB 3.0 connectivity only through its xHCI controller. For **Windows 8/ 8.1** and **Windows 10**, xHCI controller is natively supported. To install Windows 8/ 8.1/ 10, please follow the recommended installation procedure by Microsoft. However, **Windows 7** does not natively support xHCI thus the xHCI driver needs to be manually patched in order to support both USB storage device and USB keyboard/mouse during the OS installation process.

If you would like to install Windows 7, the simplest way is to create a USB thumb drive with Windows 7 installation files and Intel xHCI driver included. Please follow instructions in the following sections to install Windows 7 on your system.

Please refer to the following procedures to create an installation flash drive to aid in smooth installation of Windows 7.

User Provided Items For Windows 7 Installation

Before we proceed with the creation of USB flash drive for installation, please make sure you have the following items.

1. Windows 7 original installation DVD
2. USB thumb drive with at least 4 GB capacity
3. Software utility to create ISO image from DVD, e.g.
 - ImgBurn (<http://www.imgburn.com>)
 - Nero (<http://www.nero.com>)
4. Software utility to create bootable USB drive from ISO file, e.g.
 - Microsoft Windows USB/DVD Download Tool
(<https://www.microsoft.com/en-us/download/windows-usb-dvd-download-tool>)
 - ISO to USB (<http://www.isotousb.com>)
5. You should have at least 10 GB disk space on your local drive.

Creating Windows 7 Installation USB Flash Drive

Once you have all the “user provided items”, please follow the steps below to create a Windows 7 Installation USB flash drive.

Step 1 - Create .ISO File From Windows 7 DVD

The first step is to create a .iso file from the Windows 7 DVD. Here we use ImgBurn (<http://www.imgburn.com>) to create the .iso file and save it to local drive.

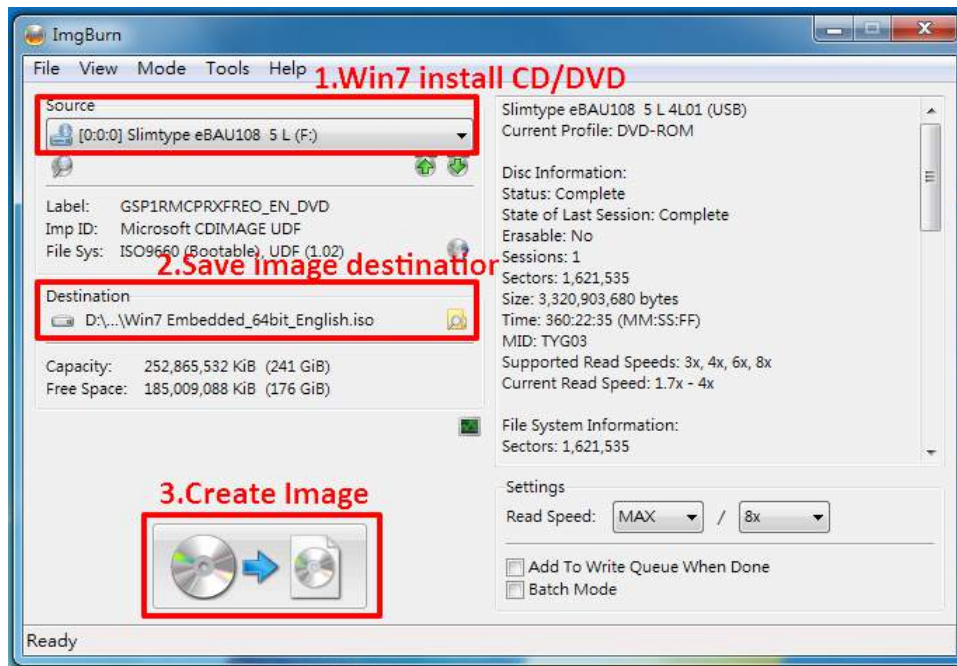

Step 2 - Create USB Flash Drive Installer From .ISO

The next step is to create a bootable USB flash drive using the .iso file created in step 1. Here we use Microsoft Windows USB/DVD Download Tool to create the USB flash drive

(<https://www.microsoft.com/en-us/download/windows-usb-dvd-download-tool>).

Please note that the content of USB flash drive will be destroyed.

1. Right-click on the 'Windows 7 USB DVD Download Tool' and select 'Run as administrator'.
2. Follow the instructions below to create the USB flash drive installer.

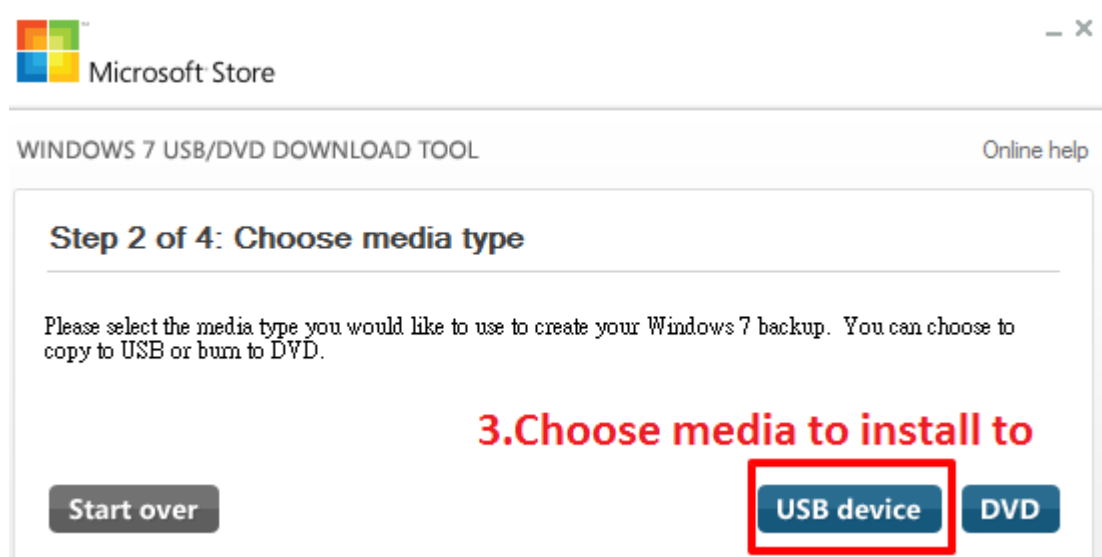
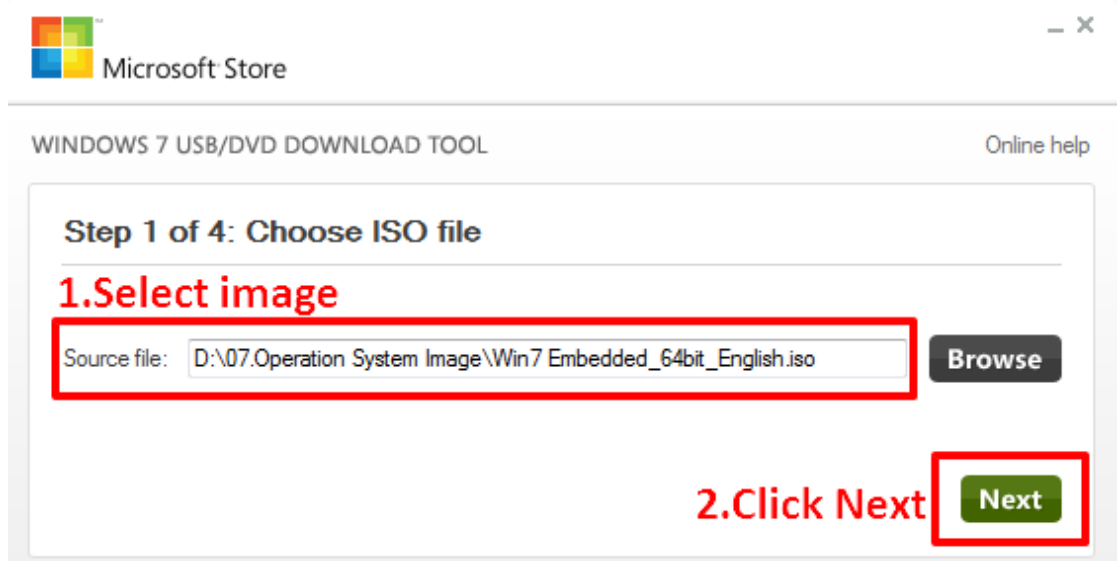

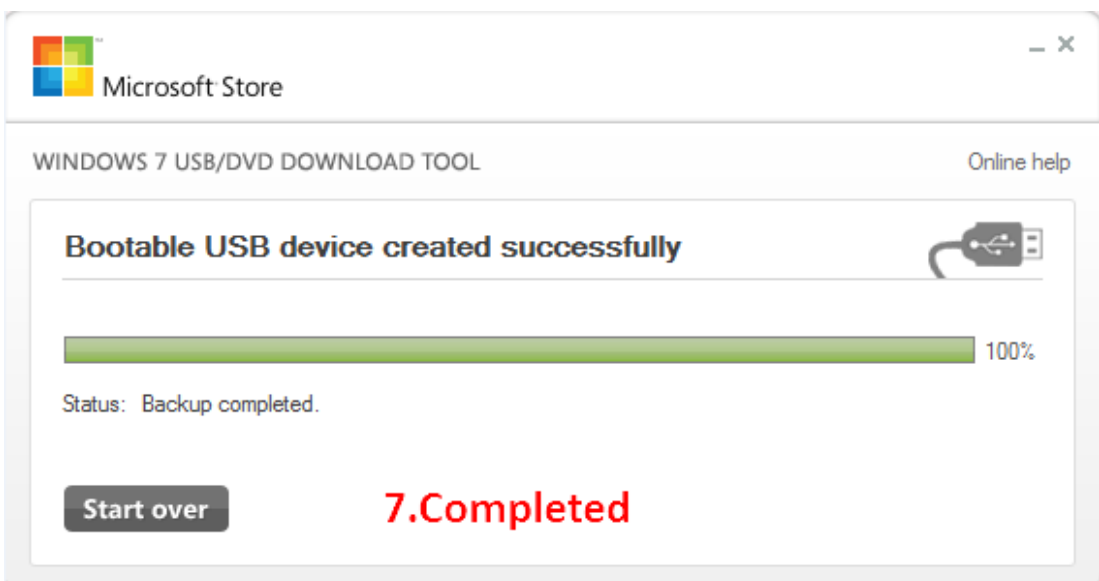
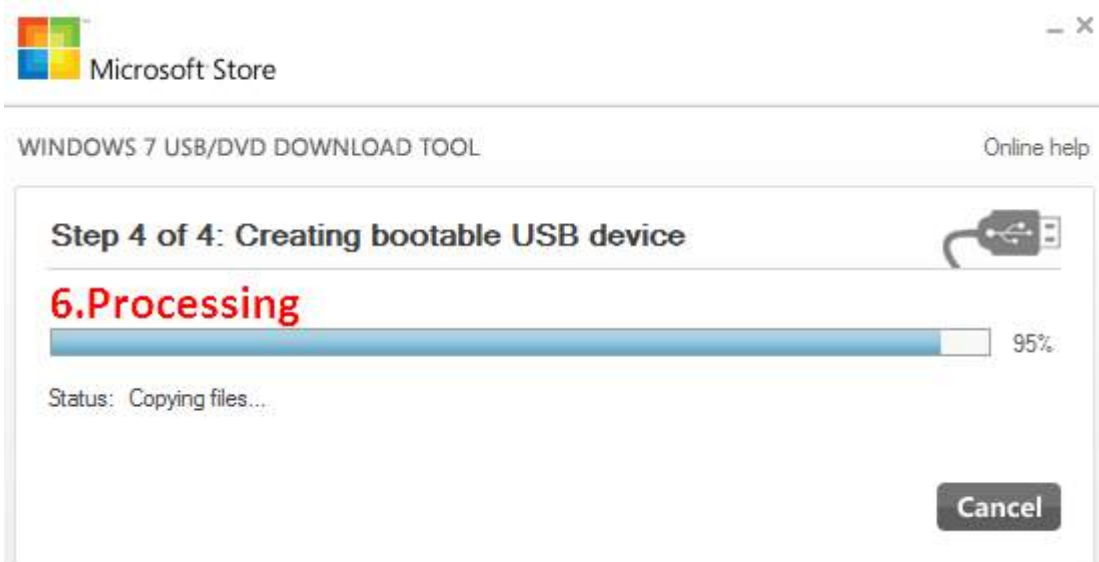

Step 3 - Create Folder and Copy Files for Patching Process

In this step, we need to create a working folder on your local drive and copy necessary files to it. Please follow the steps below.

1. Create a temporary working folder on your local drive. Here we use D:\WIM as an example.
2. Create another folder under D:\WIM for Intel xHCI driver files. Here we use \x86 for Win7 32-bit and \x64 for Win7 64-bit.
3. Copy xHCI driver files to the corresponding folder. You can find the driver files from Neousys Driver DVD.
 - For Win7 32-bit, copy all files from x:\Driver_Pool\USB3_10_Series\Win7_ALL\x86 to D:\WIM\x86
 - For Win7 64-bit, copy all files from x:\Driver_Pool\USB3_10_Series\Win7_ALL\x64 to D:\WIM\x64

(where x: denotes the drive of your DVD drive)

4. Copy **install.wim** and **boot.wim** from \sources folder of your USB flash drive to D:\WIM.

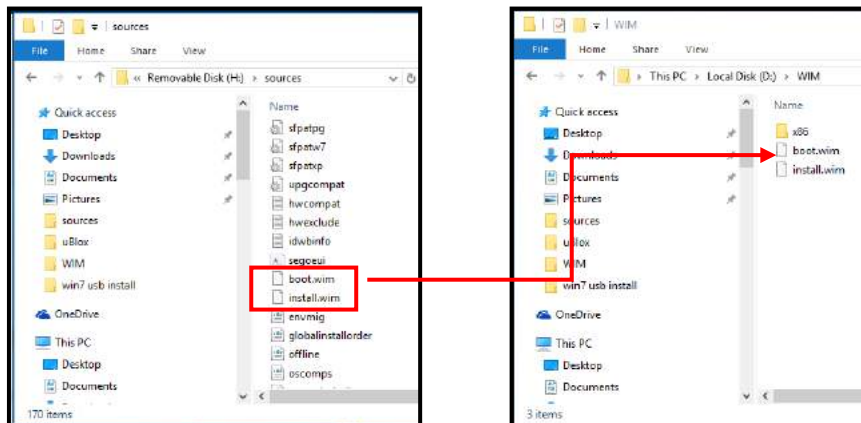

5. On the created USB drive, locate the folder "x:\Driver_Pool\USB3_10_Series\Win7_ALL", copy the batch file (**Win7_USB3_Patch_x86.bat** or **Win7_USB3_Patch_x64.bat**) to the working folder "D:\WIM".

Step 4 - Execute .bat File to Patch .wim Files

To support xHCI for Windows 7 installation, both install.wim and boot.wim need to be patched to include xHCI driver files. Neosys offers Windows-based batch files

(**Win7_USB3_Patch_x86.bat** for Windows 7 32-bit and

Win7_USB3_Patch_x64.bat for Windows 7 64-bit) to simplify this process.

1. Before executing the batch file, please make sure folders specified in the batch file are identical to your working folders.

```
SET IMAGE_PATH=D:\WIM
```

```
SET DRIVER_PATH=D:\WIM\x86
```

```
SET DRIVER_PATH=D:\WIM\x64
```

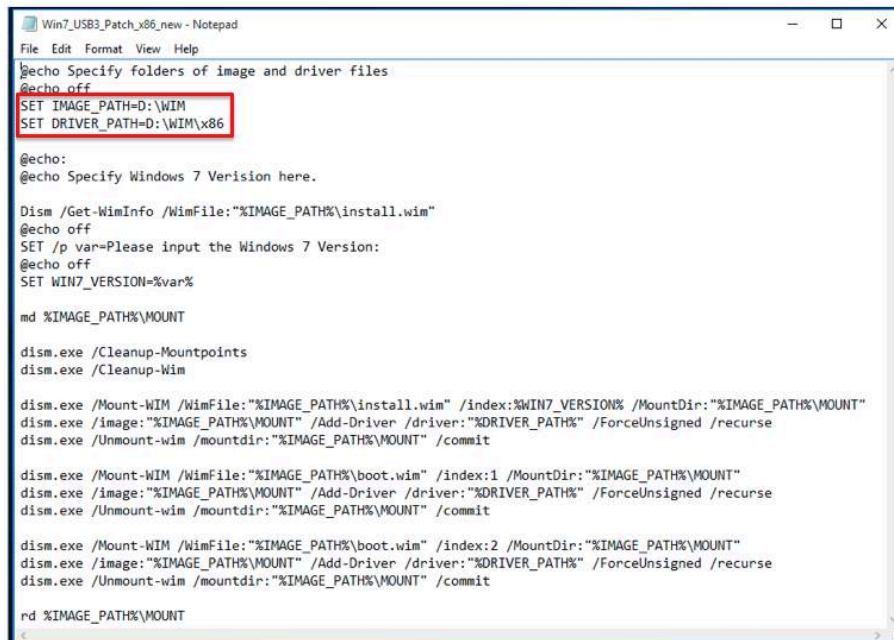

```
Win7_USB3_Patch_x86_new - Notepad
File Edit Format View Help
@echo Specify folders of image and driver files
@echo off
SET IMAGE_PATH=D:\WIM
SET DRIVER_PATH=D:\WIM\x86

@echo:
@echo Specify Windows 7 Verision here.

Dism /Get-WimInfo /WimFile:"%IMAGE_PATH%\install.wim"
@echo off
SET /p var=Please input the Windows 7 Version:
@echo off
SET WIN7_VERSION=%var%

md %IMAGE_PATH%\MOUNT

dism.exe /Cleanup-Mountpoints
dism.exe /Cleanup-Wim

dism.exe /Mount-WIM /WimFile:"%IMAGE_PATH%\install.wim" /index:%WIN7_VERSION% /MountDir:"%IMAGE_PATH%\MOUNT"
dism.exe /image:"%IMAGE_PATH%\MOUNT" /Add-Driver /driver:"%DRIVER_PATH%" /ForceUnsigned /recurse
dism.exe /Unmount-wim /mountdir:"%IMAGE_PATH%\MOUNT" /commit

dism.exe /Mount-WIM /WimFile:"%IMAGE_PATH%\boot.wim" /index:1 /MountDir:"%IMAGE_PATH%\MOUNT"
dism.exe /image:"%IMAGE_PATH%\MOUNT" /Add-Driver /driver:"%DRIVER_PATH%" /ForceUnsigned /recurse
dism.exe /Unmount-wim /mountdir:"%IMAGE_PATH%\MOUNT" /commit

dism.exe /Mount-WIM /WimFile:"%IMAGE_PATH%\boot.wim" /index:2 /MountDir:"%IMAGE_PATH%\MOUNT"
dism.exe /image:"%IMAGE_PATH%\MOUNT" /Add-Driver /driver:"%DRIVER_PATH%" /ForceUnsigned /recurse
dism.exe /Unmount-wim /mountdir:"%IMAGE_PATH%\MOUNT" /commit

rd %IMAGE_PATH%\MOUNT
```

- Right click on the batch file, select “Run as administrator” and click on “Yes” to continue. A menu of various Windows 7 version options will appear, please enter the corresponding index number for your Windows 7 version and press Enter.

```

C:\Windows\System32\cmd.exe
Specify folders of image and driver files

Specify Windows 7 Verision here.

Deployment Image Servicing and Management tool
Version: 10.0.10240.16384

Details for image : D:\WIM\install.wim

Index : 1
Name : Windows 7 STARTER
Description : Windows 7 STARTER
Size : 8,067,003,725 bytes

Index : 2
Name : Windows 7 HOMEBASIC
Description : Windows 7 HOMEBASIC
Size : 8,127,590,116 bytes

Index : 3
Name : Windows 7 HOMEPREMIUM
Description : Windows 7 HOMEPREMIUM
Size : 8,569,006,173 bytes

Index : 4
Name : Windows 7 PROFESSIONAL
Description : Windows 7 PROFESSIONAL
Size : 8,442,573,362 bytes

Index : 5
Name : Windows 7 ULTIMATE
Description : Windows 7 ULTIMATE
Size : 8,610,128,720 bytes

The operation completed successfully.
Please input the Windows 7 Version: 
  
```

- This will automatically patch both install.wim and boot.wim to include xHCI drivers. The patch process may take a few minutes to complete.
- Once the patch process has finished, please copy the patched “install.wim” and “boot.wim” files from your local drive to the USB flash drives’ \sources folder. A prompt may appear asking if you want to overwrite existing files, please click “Yes” and continue.

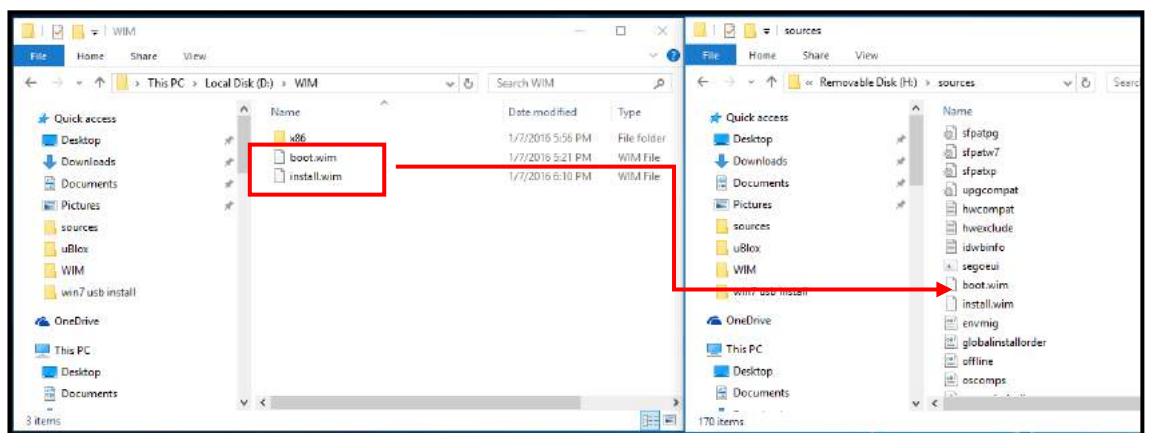

Step 5 - Install Windows 7 Using USB Flash Drive Installer

Now you can use the USB flash drive to install Windows 7 on your system.

1. Plug the USB flash drive to USB port.
2. Power on the system and press F12 to select USB flash drive as boot device.
3. Follow regular installation process to install Windows 7 on your system. The xHCI driver is included in the newly-installed system.



NOTE

If it appears a warning message of "Setup was unable to create a new system partition or locate an existing system partition", please unplug and re-plug the USB flash drive, click 'Refresh' and try again.

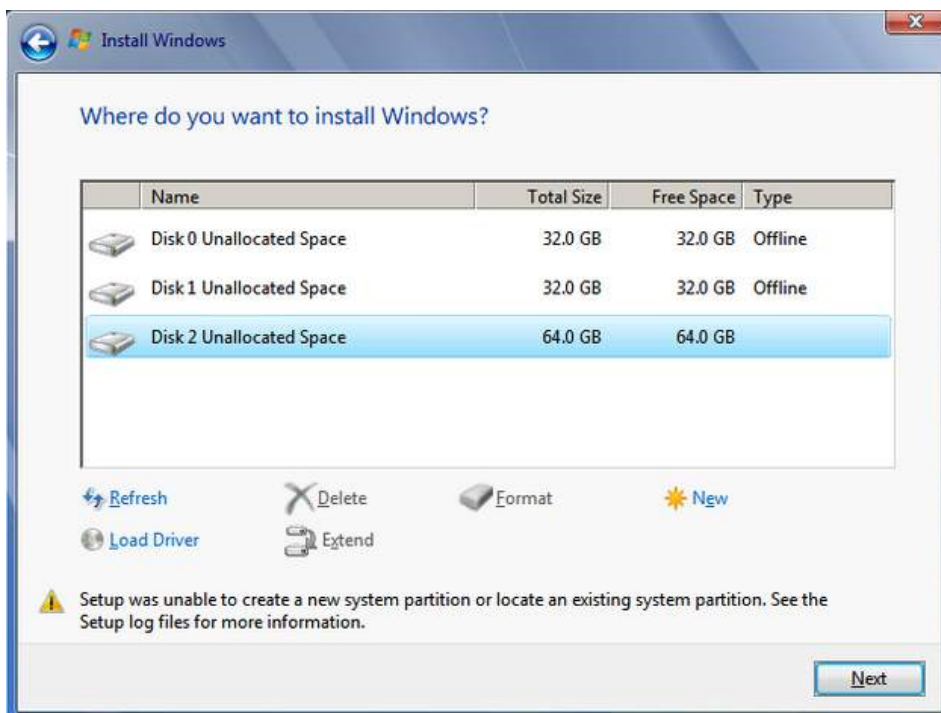

Appendix B Using WDT & DIO

The watchdog timer (WDT) function ensures reliable system operation. The WDT is a hardware mechanism to reset the system if the watchdog timer expires. Users can start the WDT and keep resetting the timer to make sure the system or program is running. Otherwise, the system shall be reset.

In this section, we'll illustrate how to use the function library provided by Neosys to program WDT functions. Currently, WDT driver library supports Windows 7/ 8.1/ 10 32-bit and 64-bit versions. For other OS support, please contact Neosys Technology for further information.

Installing WDT_DIO Library

The WDT_DIO function library is delivered in the form of a setup package named **WDT_DIO_Setup.exe**. Prior to programming WDT, you should execute the setup program and install the WDT library. Please use the following WDT_DIO_Setup packages according to your operating system and application.

- For Windows 7/ 8.1/ 10 32-bit OS, please install WDT_DIO_Setup_v2.2.5.exe or later version.
- For Windows 7/ 8.1/ 10 64-bit OS with 64-bit application (x64 mode), please install WDT_DIO_Setup_v2.2.5(x64).exe or later version.
- For Windows 7/ 8.1/ 10 64-bit OS with 32-bit application (WOW64 mode), please install WDT_DIO_Setup_v2.2.5(wow64).exe or later version.

WDT and DIO Library Installation

To setup WDT & DIO Library, please follow instructions below.

1. Execute **WDT_DIO_Setup.2.2.5.exe**. and the following dialog appears.

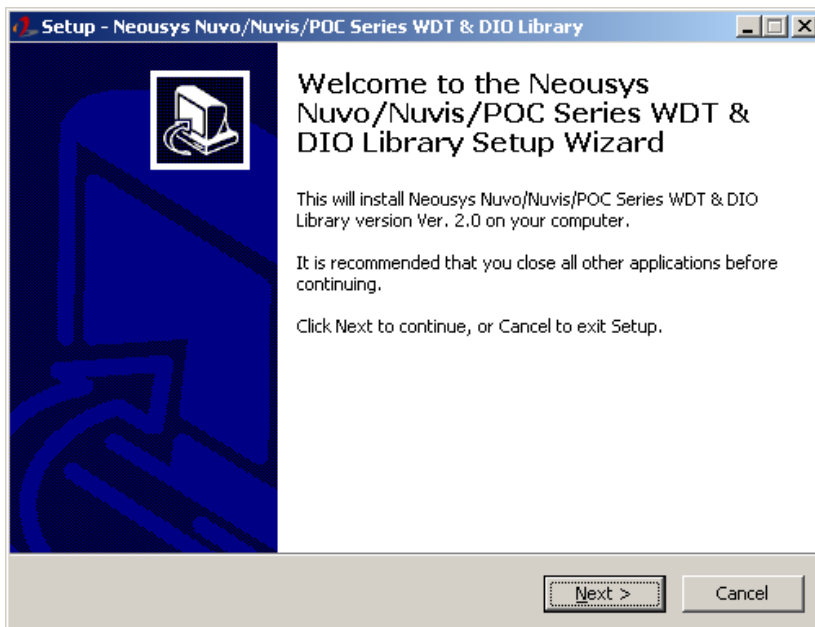

2. Click "Next >" and specify the directory of installing related files. The default directory is *C:\Neousys\WDT_DIO*.

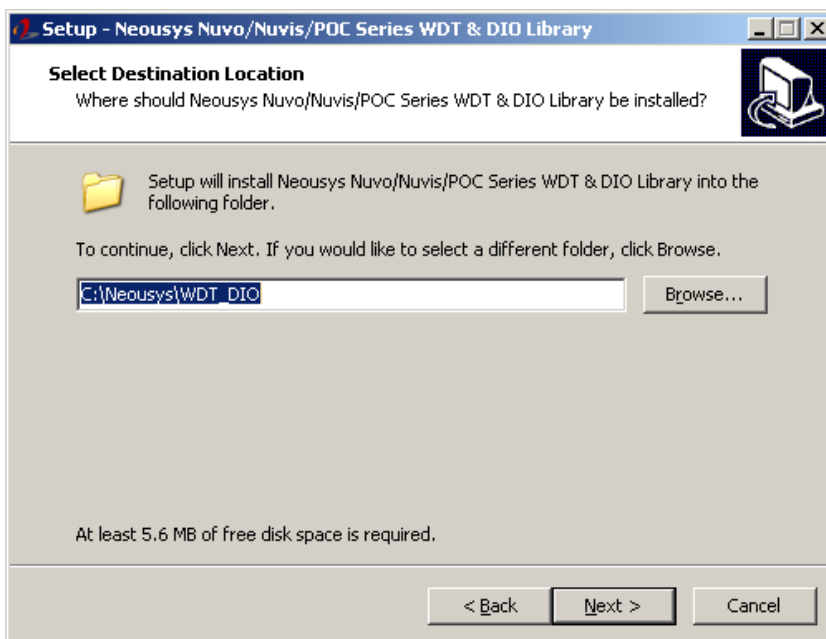

- Once the installation has finished, a dialog will appear to prompt you to reboot the system. The WDT & DIO library will take effect after the system has rebooted.

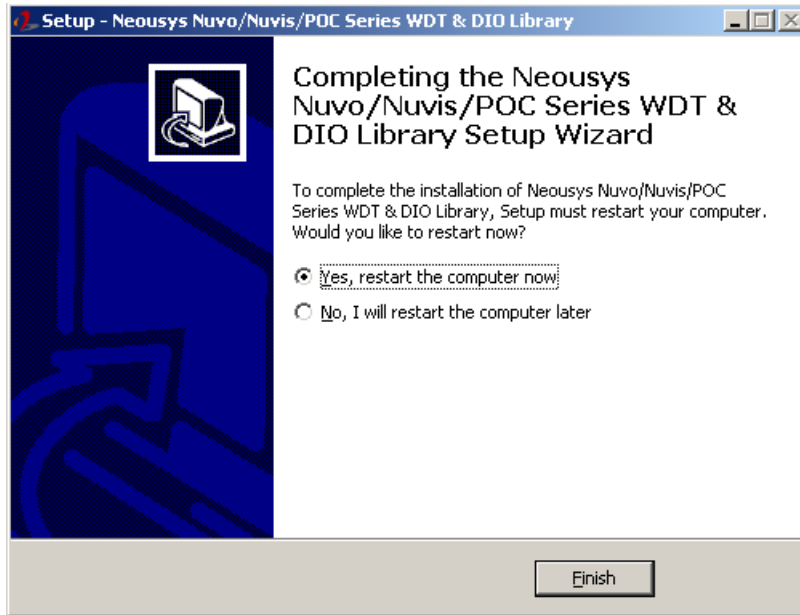

- When programming your WDT or DIO program, the related files are located in

Header File:	\Include
Library File:	\Lib
Function Reference:	\Manual
Sample Code:	\Sample\WDT_Demo (Demo for Watchdog Timer) \Sample\DIO_Demo (Demo for DIO Control) \Sample\COS_Demo (Demo for change-of-state DI) \Sample\CAN_Demo (Demo for CAN bus manipulation) \Sample\IGN_Demo (Demo for ignition status manipulation) \Sample\POE_Demo (Demo for PoE per-port on/off control)



WDT Function Reference

InitWDT

Syntax	BOOL InitWDT(void);
Description:	Initialize the WDT function. You should always invoke InitWDT() before set or start watchdog timer.
Parameter	None
Return Value	TRUE: Successfully initialized FALSE: Failed to initialize
Usage	BOOL bRet = InitWDT()

SetWDT

Syntax	BOOL SetWDT(WORD tick, BYTE unit);
Description	Set timeout value and unit for watchdog timer. When InitWDT() is invoked, a default timeout value of 255 seconds is assigned.
Parameter	<i>tick</i> WORD value (1 ~ 65535) to indicate timeout ticks. <i>unit</i> BYTE value (0 or 1) to indicate unit of timeout ticks. 0 : unit is minute 1: unit is second
Return Value	If value of unit is correct (0 or 1), this function returns TRUE, otherwise FALSE.
Usage	WORD tick=255; BYTE unit=1; //unit is second. BOOL bRet = SetWDT(tick, unit); //timeout value is 255 seconds

StartWDT

Syntax	BOOL StartWDT(void);
Description	Starts WDT countdown. Once started, the WDT LED indicator will begin blinking. If ResetWDT() or StopWDT is not invoked before WDT countdowns to 0, the WDT expires and the system resets.
Parameter	None
Return Value	If the timeout value is given in correct format (WDT started), this function returns TRUE, otherwise FALSE
Usage	BOOL bRet = StartWDT();

ResetWDT

Syntax	BOOL ResetWDT(void);
Description	Reset the timeout value to the value given by SetWDT().If ResetWDT() or StopWDT is not invoked before WDT countdowns to 0, the WDT expires and the system resets.
Parameter	None
Return Value	Always returns TRUE
Usage	BOOL bRet = ResetWDT();

StopWDT

Syntax	BOOL StopWDT(void);
Description	Stops the countdown of WDT. When WDT has stopped, the WDT LED indicator stops blinking.
Parameter	None
Return Value	Always returns TRUE
Usage	BOOL bRet = StopWDT();

Using DIO Function

Wiring for DIO

The digital input function of System series is implemented using a photo-coupler with an internally series-connected 1kΩ resistor. You need to provide a voltage to specify the logic high/low state. The input voltage for logic high is 5~24V, and the input voltage for logic low is 0~1.5V.

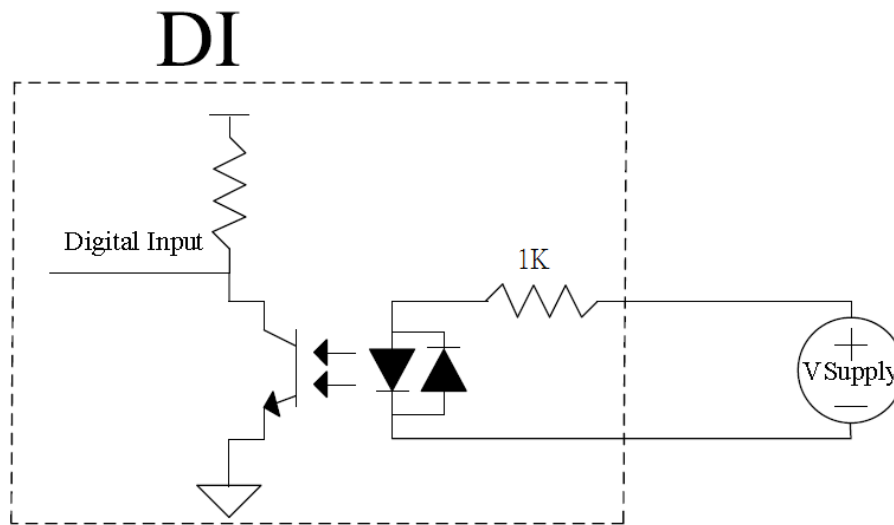

The digital output function of System series is implemented using Power MOSFET + Analog Device iCoupler® component. The DO channels are configured as NO (normally-open) configuration. When you turn on system, all DO channels have a deterministic state of logic 0 (circuit disconnected from GND return). When logic 1 is specified, MOSFET is activated and GND return path is established. The digital output function on System series supports sinking current connection. The following diagrams are the suggested wiring for DO:

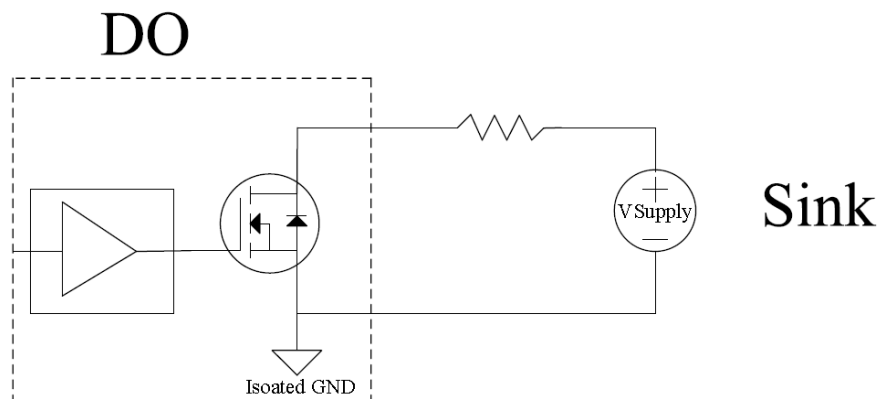

DIO Pin Definition

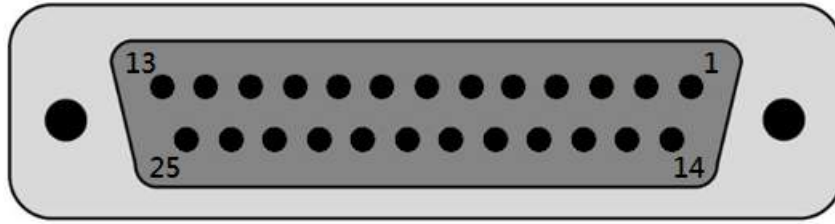

Pin No.	Definition	I/O	Description
1	ISO_DI3H	I	Digital input channel 3
2	ISO_DI2H	I	Digital input channel 2
3	ISO_DI1H	I	Digital input channel 1
4	ISO_DI0H	I	Digital input channel 0
5	Reserved	-	Reserved pin. Keep unconnected
6	Reserved	-	Reserved pin. Keep unconnected
7	ISO_DO3	O	Digital output channel 3
8	ISO_DO2	O	Digital output channel 2
9	ISO_DO1	O	Digital output channel 1
10	ISO_DO0	O	Digital output channel 0
11	VDD	-	DO voltage source input for inductive load
12	ISO5V	-	Isolated 5V power supply
13	Reserved	-	Reserved pin. Keep unconnected
14	ISO_DI3L	-	Digital input channel 3 GND
15	ISO_DI2L	-	Digital input channel 2 GND
16	ISO_DI1L	-	Digital input channel 1 GND
17	ISO_DI0L	-	Digital input channel 0 GND
18	Reserved	-	Reserved pin. Keep unconnected
19	Reserved	-	Reserved pin. Keep unconnected
20	DOGND	-	Digital output GND
21	DOGND	-	Digital output GND
22	DOGND	-	Digital output GND
23	DOGND	-	Digital output GND
24	DOGND	-	Digital output GND
25	DOGND	-	Digital output GND

DIO Function Reference

InitDIO

Syntax	BOOL InitDIO(void);
Description:	Initialize the DIO function. You should always invoke InitDIO() before write/read any DIO port/channel.
Parameter	None
Return Value	TRUE: Successfully initialized FALSE: Failed to initialize
Usage	BOOL bRet = InitWDT();

DIReadLine

Syntax	BOOL DIReadLine(BYTE ch);
Description:	Read a single channel of isolated digital input.
Parameter	<i>ch</i> BYTE value specifies the DI channel to be read. <i>ch</i> should be a value of 0 ~ 3.
Return Value	The status (TRUE or FALSE) of the specified DI channel.
Usage	BYTE ch=3; //DI channel #3 BOOL DIChValue = DIReadLine(ch); //read DI channel #3

DIReadPort

Syntax	WORD DIReadPort(void);
Description:	Read the entire isolated digital input port (4 channels).
Parameter	None
Return Value	The status (TRUE or FALSE) of the specified DI channel.
Usage	WORD DIPortValue = DIReadPort ();

DOWriteLine

Syntax	void DOWriteLine(BYTE ch, BOOL value);
Description:	Write a single channel of isolated digital output.
Parameter	<p><i>ch</i> BYTE value specifies the DO channel to be written. <i>ch</i> should be a value of 0 ~ 3.</p> <p><i>value</i> BOOL value (TRUE or FALSE) specifies the status of DO channel.</p>
Return Value	None
Usage	<pre> BYTE ch=3; //DI channel #3 BOOL DOChValue=TRUE; DOWriteLine(ch, DOChValue); //write DO channel #3 as TRUE </pre>

DOWritePort

Syntax	void DOWritePort(WORD value);
Description:	Write the entire isolated digital output port (4 channels).
Parameter	<p><i>value</i> WORD value specifies the status of the DO port. <i>value</i> should be a value of 0~15.</p>
Return Value	None
Usage	<pre> WORD DOPortValue=0x0C; //1100b DOWritePort(DOPortValue); //write DO port as 1100b </pre>

DOWriteLineChecked

Syntax	void DOWriteLineChecked(BYTE ch, BOOL value);
Description:	Write a single channel of isolated digital output and read-back the value of DO register. Note that this function is not returned until the DO register is checked and identical to the written value.
Parameter	<p><i>ch</i> BYTE value specifies the DO channel to be written. <i>ch</i> should be a value of 0 ~ 3.</p> <p><i>value</i> BOOL value (TRUE or FALSE) specifies the status of DO channel.</p>
Return Value	None
Usage	<pre> BYTE ch=3; //DI channel #3 BOOL DOChValue=TRUE; DOWriteLineChecked(ch, DOChValue); //write DO channel #3 as TRUE </pre>

DOWritePortChecked

Syntax	void DOWritePortChecked(WORD value);
Description:	Write the entire isolated digital output port (8 channels) and check it has been done. Note that this function is not returned until the write value has been checked the same with the device registry.
Parameter	<p><i>value</i> WORD value specifies the status of the DO port. <i>value</i> should be a value of 0~15.</p>
Return Value	None
Usage	<pre> WORD DOPortValue=0x0C; //1100b DOWritePortChecked(DOPortValue); //write DO port as 1100b </pre>

COS Function Reference

SetupDICOS

Syntax	<pre>BOOL SetupDICOS(COS_INT_SETUP *lpSetup, DWORD cbSetup);</pre>
Description	Setup Digital-Input(DI) Change-of-State(COS) interrupt parameters.
Parameter	<p><i>lpSetup</i> [in] A pointer to a COS_INT_SETUP structure that contains the COS configuration information for the DI device. This data structure contains the following variables:</p> <p><i>portMask</i> WORD value specifies the interrupt mask for corresponding channel(s).</p> <p><i>edgeMode</i> WORD value specifies that interrupt is generated when level change (set to 0) or on rising/falling edge (set to 1) for the corresponding channel(s).</p> <p><i>edgeType</i> WORD value specifies that interrupt is generated on rising edge (set to 0) or falling (set to 1) edge for corresponding channel(s). This value is neglected if <i>edgeMode</i> is set to 0 for the corresponding channel(s).</p> <p><i>cbSetup</i> [in] The length of the structure, in bytes. The caller must set this member to size of (COS_INT_SETUP).</p>
Return Value	<p>TRUE if setup successes</p> <p>FALSE if setup failed</p>
Usage	<pre>COS_INT_SETUP setup; memset(&setup, 0, sizeof(setup)); setup.portMask = 0x0f; // enable ch.0~3 setup.edgeMode = 0; // level setup.edgeType = 0x00; // Lo/Hi BOOL bRet = SetupDICOS(&setup, sizeof(setup));</pre>

RegisterCallbackDICOS

Syntax	<pre> BOOL RegisterCallbackDICOS(COS_INT_CALLBACK callback); </pre>
Description:	Registers a callback function, which is called when the DICOS interrupt occurred.
Parameter	<p>callback [in]</p> <p>Specifies the callback function. The prototype for this function is described as follow.</p> <pre> void __stdcall callback_func(COS_INT_CALLBACK_ARG* arg); </pre>
Return Value	<p>TRUE if setup successes,</p> <p>FALSE if setup failed.</p>
Usage	<pre> void __stdcall callback_func(COS_INT_CALLBACK_ARG* arg) { printf("data=0x%02x, flag=0x%02x, seq=%02d\n", arg->portData, arg->intrFlag, arg->intrSeq); } BOOL bRet = RegisterCallbackDICOS(callback_func); </pre>

StartDICOS

Syntax	<pre> BOOL StartDICOS(void); </pre>
Description	Start DI Change-of-State interrupt
Parameter	None
Return Value	<p>TRUE if start procedure successes</p> <p>FALSE if start procedure failed</p>
Usage	<pre> BOOL bRet = StartDICOS(); </pre>

StopDICOS

Syntax	BOOL StopDICOS(void);
Description	Stop DI Change-of-State interrupt
Parameter	None
Return Value	TRUE if stop procedure successes FALSE if stop procedure failed
Usage	BOOL bRet = StopDICOS();

DI COS Example

```

#include <stdio.h>
#include <stdlib.h>
#include <windows.h>
#include "WDT_DIO.h"

//Step 0, define a Change-of-State Interrupt callback function
void __stdcall callback_function(COS_INT_CALLBACK_ARG* arg)
{
    printf("data=0x%02x, flag=0x%02x, seq=%02d\n",
        arg->portData, arg->intrFlag, arg->intrSeq);
}

int main(int argc, char* argv[])
{
    //Step 1, initialize DIO library by invoking InitDIO()
    if ( ! InitDIO() )
    {
        printf("InitDIO --> FAILED\n");
        return -1;
    }
    printf("InitDIO --> PASSED\n");

    //Step 2, setup Change-of-State Interrupt mask and level/edge mode
    COS_INT_SETUP setup;

```



```
memset(&setup, 0, sizeof(setup));

setup.portMask = 0x0f;      // 00001111b, enable ch.0~3
setup.edgeMode = 0x00;     // generate interrupt on level change
setup.edgeType = 0x00;     // rising/falling edge, only effective when
edgeMode = 1

if ( ! SetupDICOS(&setup, sizeof(setup)) )
{
    printf("SetupDICOS --> FAILED\n");
    return -2;
}
printf("SetupDICOS --> PASSED\n");

//Step 3, register the callback function
if ( ! RegisterCallbackDICOS(callback_function) )
{
    printf("RegisterCallbackDICOS --> FAILED\n");
    return -3;
}
printf("RegisterCallbackDICOS --> PASSED\n");

//Step 4, start the DI Change-of-State Interrupt
if ( ! StartDICOS() )
{
    printf("StartDICOS --> FAILED\n");
    return -4;
}
printf("StartDICOS --> PASSED\n");

printf("\npress any key to stop...\n");
system("pause >nul");

//Step 5, stop the DI Change-of-State Interrupt operation
if ( ! StopDICOS() )
{
    printf("StopDICOS --> FAILED\n");
```

```
        return -5;
    }
    printf("StopDICOS --> PASSED\n");

    printf("\npress any key to exit...\n");
    system("pause >nul");
    return 0;
}
```

Appendix C CAN bus Function

Users can configure the CAN Bus, as well as get access to the bus, via APIs included in the WDT_DIO driver package. This section provides API functions, parameters and definitions for users to create their own software applications.

CAN Bus Function Reference

CAN_RegisterReceived

Syntax	<pre> BOOL CAN_RegisterReceived(DWORD idx, void (__stdcall *pfnHandler)(CAN_MSG *lpMsg, DWORD cbMsg)); </pre>
Description	Registers a callback function. It is called when the CAN controller has received a message object
Parameter	<p><i>idx</i> [in] Specifies the index of CAN bus controllers. Currently there are only one CAN bus controller.</p> <p><i>pfnHandler</i> [in] Specifies the callback function. The prototype for this function is described as follow.</p> <pre> void __stdcall CAN0_Received(CAN_MSG *lpMsg, DWORD cbMsg); </pre>
Return Value	<p>TRUE if registration successes</p> <p>FALSE if registration failed</p>
Usage	<pre> void __stdcall CAN0_Received(CAN_MSG *lpMsg, DWORD cbMsg) { printf("%08x, %d, %02x %02x %02x %02x %02x %02x %02x %02x\r\n", lpMsg->id, lpMsg->len, lpMsg->data[0], lpMsg->data[1], lpMsg->data[2], lpMsg->data[3], lpMsg->data[4], lpMsg->data[5], lpMsg->data[6], lpMsg->data[7]); } void main(int argc, char *argv[]) { if (! CAN_RegisterReceived(0, AN0_Received)) </pre>

```
{  
    printf("CAN_RegisterReceived is FAILED !\r\n");  
}  
}
```

CAN_RegisterStatus

Syntax	<pre> BOOL CAN_RegisterStatus(DWORD idx, void (__stdcall *pfnHandler)(DWORD status)); </pre>
Description	Registers a callback function, which is called when the CAN controller has received a status interrupt.
Parameter	<p>idx [in] Specifies the index of CAN bus controllers. Currently there are only one CAN bus controller.</p> <p>pfnHandler [in] Specifies the callback function. The prototype for this function is described as follow. void __stdcall CAN0_Status(DWORD status);</p>
Return Value	<p>TRUE if registration successes</p> <p>FALSE if registration failed</p>
Usage	<pre> void __stdcall CAN0_Status(DWORD status) { printf("%08x\r\n", status); } void main(int argc, char *argv[]) { if (! CAN_RegisterStatus(0, CAN0_Status)) { printf("CAN_RegisterStatus is FAILED !\r\n"); } } </pre>

CAN_Setup

Syntax	<pre> BOOL CAN_Setup(DWORD idx, CAN_SETUP *lpSetup, DWORD cbSetup); </pre>
Description	Setup timing correlation of trigger source input (DI) and pulse target output (DO) for Deterministic Trigger Fan-Out function.
Parameter	<p><i>idx</i> [in] Specifies the index of CAN bus controllers. Currently there are only one CAN bus controller.</p> <p><i>lpSetup</i> [in] A pointer to a CAN_SETUP structure that contains the CAN-Bus configuration. This data structure contains the following variables:</p> <p><i>Bitrate</i> DWORD value specifies the bit rate of the specified CAN controller.</p> <p><i>recvConfig</i> DWORD value specifies the received message configuration.</p> <p><i>recvId</i> DWORD value specifies the received identity number.</p> <p><i>recvMask</i> DWORD value specifies the mask for received identity number.</p> <p><i>cbSetup</i> [in] The length of the structure, in bytes. The caller must set this member to size of (CAN_SETUP).</p>
Return Value	<p>TRUE if setup successes, FALSE if setup failed.</p>
Usage	

CAN_Start

Syntax	BOOL CAN_Start(DWORD idx);
Description	Start CAN Bus transmit and receive operation.
Parameter	<i>idx</i> [in] Specifies the index of CAN bus controllers. Currently there are only one CAN bus controller.
Return Value	TRUE if start procedure successes FALSE if start procedure failed
Usage	BOOL bRet = CAN_Start(0);

CAN_Stop

Syntax	BOOL CAN_Stop(DWORD idx);
Description	Stop CAN Bus controller operation.
Parameter	<i>idx</i> [in] Specifies the index of CAN bus controllers. Currently there are only one CAN bus controller.
Return Value	TRUE if stop procedure successes FALSE if stop procedure failed
Usage	BOOL bRet = CAN_Stop(0);

CAN_Send

Syntax	<pre> BOOL CAN_Send(DWORD idx , CAN_MSG *lpMsg, DWORD cbMsg); </pre>
Description	Put message object into CAN Bus controller.
Parameter	<p><i>idx</i> [in] Specifies the index of CAN bus controllers. Currently there are only one CAN bus controller.</p> <p><i>lpMsg</i> [in] A pointer to a CAN_MSG structure that contains the CAN-Bus message object. This data structure contains the following variables:.</p> <p><i>id</i> DWORD value specifies the identity number of the message object.</p> <p><i>flags</i> WORD value specifies the status or configuration of the message object.</p> <p><i>extra</i> BYTE value specifies nothing but does reserved.</p> <p><i>len</i> BYTE value specifies the length of the message object.</p> <p><i>data</i> BYTE array specifies the data of the message object.</p> <p><i>cbMsg</i> [in] The length of the structure, in bytes. The caller must set this member to size of (CAN_MSG).</p>
Return Value	<p>TRUE if stop procedure successes</p> <p>FALSE if stop procedure failed</p>
Usage	<pre> void main(int argc, char *argv[]) { CAN_MSG canMsg; memset(&canMsg, 0, sizeof(canMag)); if (! CAN_Send(0, &canMsg, sizeof(canMsg))) { printf("CAN_Send is FAILED !\r\n"); } } </pre>

Appendix D Ignition Control

Function

The system supports ignition control. This is a hardware functionality and control by the on-board micro controller. However, the following APIs enable users to check the status and configuration. Therefore, actions in users' software applications are possible according to different ignition status.

Ignition Control Function Reference

IGN_GetState

Syntax	BOOL IGN_GetState(DWORD *lpState);
Description	Get current ignition input status
Parameter	<i>lpState</i> [in] pointer to DWORD value which represents the state of ignition input.
Return Value	TRUE if stop procedure successes FALSE if stop procedure failed
Usage	<pre>void main(int argc, char *argv[]) { DWORD state; state = 0; if (! IGN_GetState(&state)) { printf("IGN_GetState is FAILED !\r\n"); } }</pre>

IGN_GetBatteryVoltage

Syntax	BOOL IGN_GetBatteryVoltage(double *lpVoltage);
Description	Get current DC input voltage
Parameter	<i>lpVoltage</i> [in] pointer to double value which represents the input voltage.
Return Value	TRUE if procedure successful FALSE if procedure failed
Usage	<pre>void main(int argc, char *argv[]) { double voltage; voltage = 0; if (! IGN_GetBatteryVoltage(&voltage)) { printf("IGN_GetBatteryVoltage is FAILED !\r\n"); } }</pre>

IGN_GetSetting

Syntax	<pre> BOOL IGN_GetSetting(IGN_SETTING *lpSetting, DWORD cbSetting); </pre>
Description	Get ignition BIOS setting information
Parameter	<p><i>lpSetting</i> [in]</p> <p>A pointer to an IGN_SETTING structure that contains the ignition setting from BIOS. This data structure contains the following variables:</p> <p><i>mode</i></p> <p>BYTE value specifies the operation mode of the ignition controller. (0: atx, 1: at, 2~7: ignition mode)</p> <p><i>batteryType</i></p> <p>BYTE value specifies the battery type. (0: 12v, 1: 24v)</p> <p><i>isSmartOff</i></p> <p>BYTE value specifies the smart off function is enabled or not. (0: disabled, 1: enabled)</p> <p><i>isPostCheck</i></p> <p>BYTE value specifies the post check function is enabled or not. (0: disabled, 1: enabled)</p> <p><i>onDelay</i></p> <p>DWORD value specifies the delay count in seconds until ignition controller turn on the machine.</p> <p><i>offDelay</i></p> <p>DWORD value specifies the delay count in seconds until ignition controller turn off the machine.</p> <p><i>hardOffTimeout</i></p> <p>DWORD value specifies the limit count in seconds while ignition controller could not turn off the machine.</p> <p><i>lowVolThreshold</i></p> <p>DOUBLE precision floating point number specifies the low voltage limit then ignition controller will turn off the machine.</p>
Return Value	<p>TRUE if procedure successful</p> <p>FALSE if procedure failed</p>
Usage	<pre> int main(int argc, char *argv[]) { IGN_SETTING setting; memset(&setting, 0, sizeof(setting)); if (! IGN_GetSetting(&setting, sizeof(setting))) </pre>

```
{  
    printf("IGN_GetSetting is FAILED !\r\n");  
    return -1;  
}  
return 0;  
}
```

Appendix E PoE On/ Off Control

Nuvo-5108VTC series offers 802.3at PoE+ ports with a unique feature to allow users manually turn on or off the power supply of each PoE port. This function can be useful in power device (PD) fault-recovery or power reset.

The APIs are part of Neosys WDT_DIO driver package. Please follow the instructions in [Appendix B Watchdog Timer & Isolated DIO](#) to install the driver package prior to programming PoE on/off control function.

GetStatusPoEPort

Syntax	BYTE GetStatusPoEPort (Byte port);
Description	Get current on/off status of designated PoE port.
Parameter	<i>port</i> BYTE value specifies the index of PoE port. Please refer to the following illustration, <i>port</i> should be a value of 1 ~ 4 (Nuvo-5100VTC/ 5104VTC) or 1 ~ 8 (Nuvo-5108VTC).
Return Value	BYTE value indicating PoE on/off status 0 if port is disabled (off) 1 if port is enabled (on)
Usage	BYTE bEnabled = GetStatusPoEPort (1); //Get on/off status of PoE Port#1

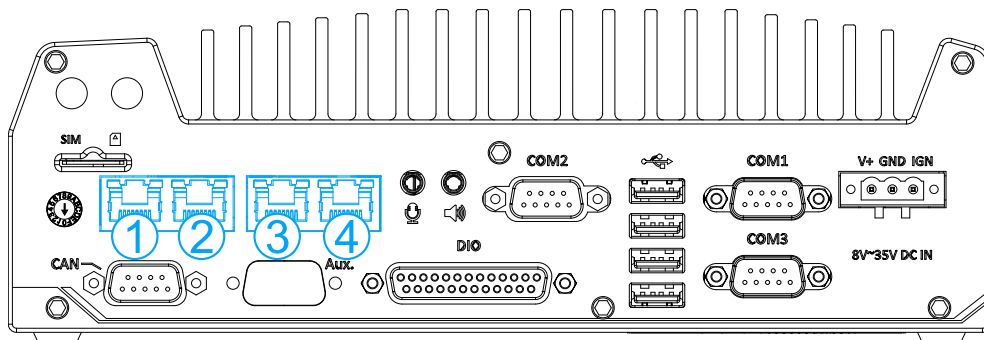

PoE ports 1/ 2/ 3/ 4 are on the rear panel of Nuvo-5100VTC series

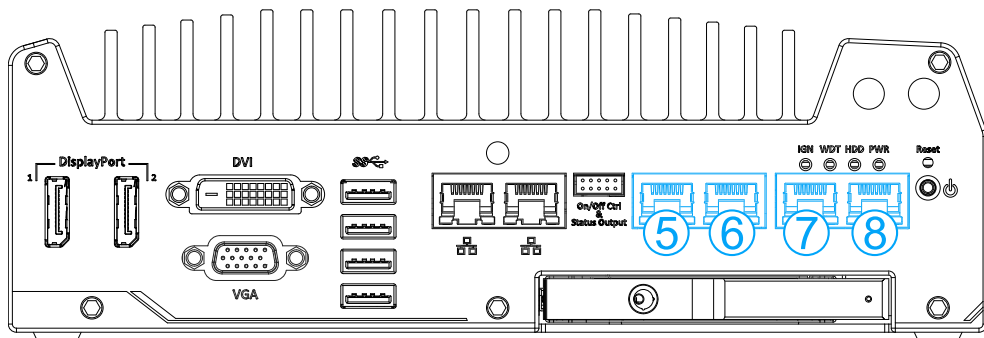

PoE ports 5/ 6/ 7/ 8 are on the front panel of Nuvo-5108VTC

EnablePoEPort

Syntax	BOOL EnablePoEPort (BYTE port);
Description	Turn on PoE power of designated PoE port.
Parameter	<i>port</i> BYTE value specifies the index of PoE port. Please refer to the following illustration, <i>port</i> should be a value of 1 ~ 4 (Nuvo-5100VTC/ 5104VTC) or 1 ~ 8 (Nuvo-5108VTC).
Return Value	TRUE if enabled success FALSE if fail to enable.
Usage	BOOL bRet = EnablePoEPort (1); //Turn on PoE Port#1

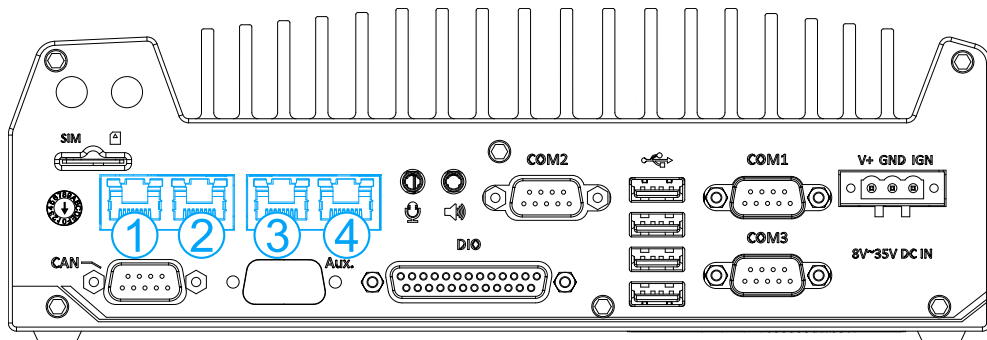

PoE ports 1/ 2/ 3/ 4 are on the rear panel of Nuvo-5100VTC series

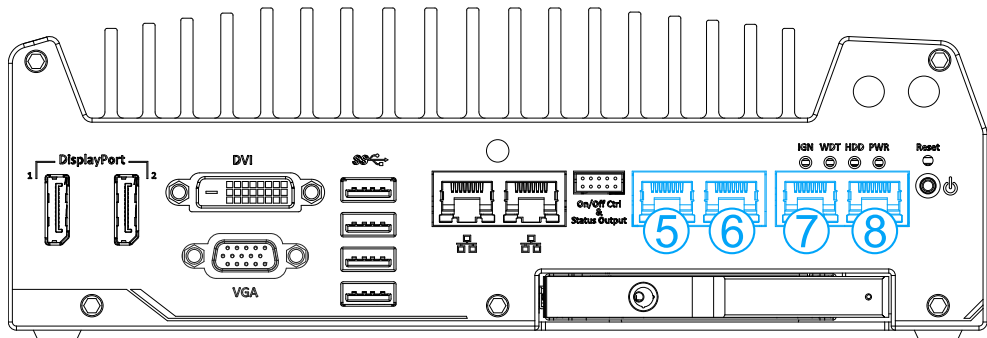

PoE ports 5/ 6/ 7/ 8 are on the front panel of Nuvo-5108VTC

DisablePoEPort

Syntax	BOOL DisablePoEPort (BYTE port);
Description	Turn off PoE power of designated PoE port
Parameter	<i>port</i> BYTE value specifies the index of PoE port. Please refer to the following illustration, <i>port</i> should be a value of 1 ~ 4 (Nuvo-5100VTC/ 5104VTC) or 1 ~ 8 (Nuvo-5108VTC).
Return Value	TRUE if disabled success FALSE if fail to disable
Usage	BOOL bRet = DisablePoEPort (1); //Turn off PoE Port#1

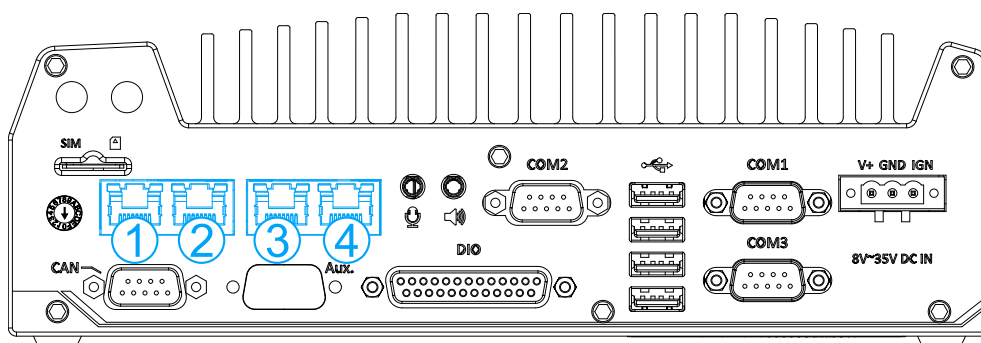

PoE ports 1/ 2/ 3/ 4 are on the back panel of Nuvo-5100VTC series

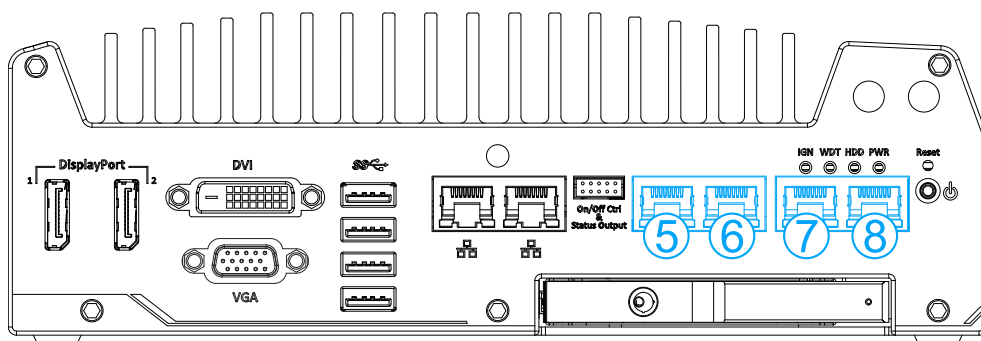

PoE ports 5/ 6/ 7/ 8 are on the front panel of Nuvo-5108VTC