

Dell EMC PowerEdge T340

Installation and Service Manual

Notes, cautions, and warnings

 **NOTE:** A NOTE indicates important information that helps you make better use of your product.

 **CAUTION:** A CAUTION indicates either potential damage to hardware or loss of data and tells you how to avoid the problem.

 **WARNING:** A WARNING indicates a potential for property damage, personal injury, or death.

| | |
|--|-----------|
| 1 About this document | 7 |
| 2 Dell EMC PowerEdge T340 system overview | 8 |
| Front view of the system | 9 |
| Rear view of the system | 11 |
| Inside the system | 12 |
| Locating the information tag of your system | 14 |
| System information label | 14 |
| 3 PowerEdge T340 initial system setup and configuration | 17 |
| Setting up your system | 17 |
| iDRAC configuration | 17 |
| Options to set up iDRAC IP address | 17 |
| Log in to iDRAC | 17 |
| Options to install the operating system | 18 |
| Methods to download firmware and drivers | 18 |
| Downloading drivers and firmware | 19 |
| 4 PowerEdge T340 Pre-operating system management applications | 20 |
| Options to manage the pre-operating system applications | 20 |
| System Setup | 20 |
| Viewing System Setup | 20 |
| System Setup details | 21 |
| System BIOS | 21 |
| iDRAC Settings utility | 37 |
| Device Settings | 37 |
| Dell Lifecycle Controller | 37 |
| Embedded system management | 37 |
| Boot Manager | 38 |
| Viewing Boot Manager | 38 |
| Boot Manager main menu | 38 |
| One-shot UEFI boot menu | 38 |
| System Utilities | 38 |
| PXE boot | 38 |
| 5 Installing and removing system components | 40 |
| Safety instructions | 40 |
| Before working inside your system | 40 |
| After working inside your system | 40 |
| Recommended tools | 40 |
| Front bezel | 41 |
| Removing the front bezel | 41 |
| Installing the front bezel | 41 |
| System feet | 42 |

| | |
|--|----|
| Removing the system feet..... | 42 |
| Installing the system feet..... | 43 |
| Caster wheels – optional..... | 44 |
| Removing caster wheels..... | 44 |
| Installing caster wheels..... | 45 |
| System cover..... | 46 |
| Removing the system cover..... | 46 |
| Installing the system cover..... | 47 |
| Air shroud..... | 48 |
| Removing the air shroud..... | 48 |
| Installing the air shroud..... | 49 |
| Intrusion switch..... | 50 |
| Removing the intrusion switch..... | 50 |
| Installing the intrusion switch..... | 51 |
| Drives..... | 52 |
| Removing a drive blank..... | 52 |
| Installing a drive blank..... | 52 |
| Removing a drive carrier..... | 53 |
| Installing the drive carrier..... | 54 |
| Removing the drive from the drive carrier..... | 55 |
| Installing the drive into the drive carrier..... | 56 |
| Removing a 2.5-inch drive from the 3.5-inch drive adapter..... | 57 |
| Installing a 2.5-inch drive into the 3.5-inch drive adapter..... | 58 |
| Removing a 3.5-inch drive adapter from a 3.5-inch drive carrier..... | 59 |
| Installing a 3.5-inch adapter into a 3.5-inch drive carrier..... | 60 |
| Optical drive and tape drives..... | 61 |
| Removing the optical or tape drive blank..... | 61 |
| Installing the optical or tape drive blank..... | 62 |
| Removing the optical drive..... | 62 |
| Installing the optical drive..... | 63 |
| Removing the tape drive..... | 64 |
| Installing the tape drive..... | 65 |
| Drive backplane..... | 66 |
| Drive backplane details..... | 66 |
| Removing the drive backplane..... | 67 |
| Installing the drive backplane..... | 68 |
| Backplane cable routing..... | 69 |
| Four-slot drive blank..... | 70 |
| Removing a four-slot drive blank..... | 70 |
| Installing a four-slot drive blank..... | 71 |
| System memory..... | 72 |
| System memory guidelines..... | 72 |
| General memory module installation guidelines..... | 73 |
| Removing a memory module..... | 73 |
| Installing a memory module..... | 74 |
| Cooling fan..... | 75 |
| Removing the internal cooling fan..... | 75 |
| Installing the internal cooling fan..... | 76 |
| Optional internal USB memory key..... | 77 |
| Replacing the optional internal USB memory key..... | 77 |

| | |
|--|------------|
| Expansion cards | 78 |
| Expansion card guidelines..... | 78 |
| Removing an expansion card..... | 78 |
| Installing an expansion card..... | 80 |
| M.2 SSD module..... | 81 |
| Removing the M.2 SSD module..... | 81 |
| Installing the M.2 SSD module..... | 82 |
| Optional IDSDM or vFlash module..... | 83 |
| Removing the optional IDSDM or vFlash card..... | 83 |
| Installing optional IDSDM or vFlash card..... | 84 |
| Removing the MicroSD card..... | 84 |
| Installing the MicroSD card..... | 85 |
| Processor and heat sink..... | 86 |
| Removing the heat sink..... | 86 |
| Removing the processor..... | 87 |
| Installing the processor..... | 88 |
| Installing the heat sink..... | 89 |
| Power supply unit..... | 90 |
| Removing the power supply unit blank..... | 90 |
| Installing the power supply unit blank..... | 91 |
| Removing a redundant AC power supply unit..... | 92 |
| Installing a redundant AC power supply unit..... | 92 |
| Removing a cabled power supply unit..... | 93 |
| Installing a cabled power supply unit..... | 94 |
| Power interposer board..... | 95 |
| Removing the power interposer board..... | 95 |
| Installing the power interposer board..... | 96 |
| System battery | 97 |
| Replacing the system battery..... | 97 |
| System board..... | 98 |
| Removing the system board..... | 98 |
| Installing the system board..... | 100 |
| Trusted Platform Module..... | 102 |
| Upgrading the Trusted Platform Module..... | 102 |
| Initializing TPM for BitLocker users..... | 103 |
| Initializing the TPM 1.2 for TXT users..... | 103 |
| Initializing the TPM 2.0 for TXT users..... | 103 |
| Control panel..... | 104 |
| Removing the control panel assembly..... | 104 |
| Installing the control panel assembly..... | 104 |
| 6 PowerEdge T340 jumpers and connectors | 106 |
| System board jumpers and connectors..... | 106 |
| System board jumper settings..... | 107 |
| Disabling forgotten password..... | 107 |
| 7 Technical specifications..... | 109 |
| Chassis dimensions..... | 109 |
| System weight..... | 110 |

| | |
|--|------------|
| Processor specifications..... | 110 |
| Supported operating systems..... | 110 |
| PSU specifications..... | 110 |
| Cooling fan specifications..... | 111 |
| System battery specifications..... | 111 |
| Expansion card specifications..... | 111 |
| Memory specifications..... | 111 |
| Storage controller specifications..... | 112 |
| Drive specifications..... | 112 |
| Drives..... | 112 |
| Optical drives..... | 112 |
| Tape drives..... | 112 |
| Ports and connectors specifications..... | 112 |
| USB ports specifications..... | 112 |
| NIC ports specifications..... | 113 |
| Serial connector specifications..... | 113 |
| VGA ports specification..... | 113 |
| IDSDM module..... | 113 |
| Video specifications..... | 113 |
| Environmental specifications..... | 114 |
| Standard operating temperature..... | 115 |
| Expanded operating temperature..... | 115 |
| Particulate and gaseous contamination specifications..... | 116 |
| 8 System diagnostics and indicator codes | 117 |
| System health and system ID indicator codes..... | 117 |
| iDRAC Direct LED indicator codes..... | 117 |
| NIC indicator codes..... | 118 |
| Non-redundant cabled power supply unit indicator codes..... | 118 |
| Power supply unit indicator codes..... | 119 |
| Drive indicator codes..... | 120 |
| PowerEdge T340 system diagnostics..... | 121 |
| Dell Embedded System Diagnostics..... | 121 |
| 9 Getting help..... | 123 |
| Recycling or End-of-Life service information..... | 123 |
| Contacting Dell..... | 123 |
| Accessing system information by using QRL..... | 123 |
| Quick Resource Locator for Dell EMC PowerEdge T340 system..... | 124 |
| Receiving automated support with SupportAssist | 124 |
| 10 Documentation resources..... | 125 |

About this document

This document provides an overview about the system, information about installing and replacing components, technical specifications, diagnostic tools, and guidelines to be followed while installing certain components.

Dell EMC PowerEdge T340 system overview

The Dell EMC PowerEdge T340 system is a tower server that supports:

- One Intel Xeon, Core i3, Pentium, or Celeron processor
- Four DIMM slots
- Redundant and cabled AC power supply units
- Up to eight 3.5-inch or four 3.5-inch SAS, SATA drives, or SSDs.

For more information, see the [Technical specifications](#) section.

i **NOTE: All instances of SAS, SATA drives, and SSDs are referred to as drives in this document, unless specified otherwise.**

Topics:

- [Front view of the system](#)
- [Rear view of the system](#)
- [Inside the system](#)
- [Locating the information tag of your system](#)
- [System information label](#)

Front view of the system

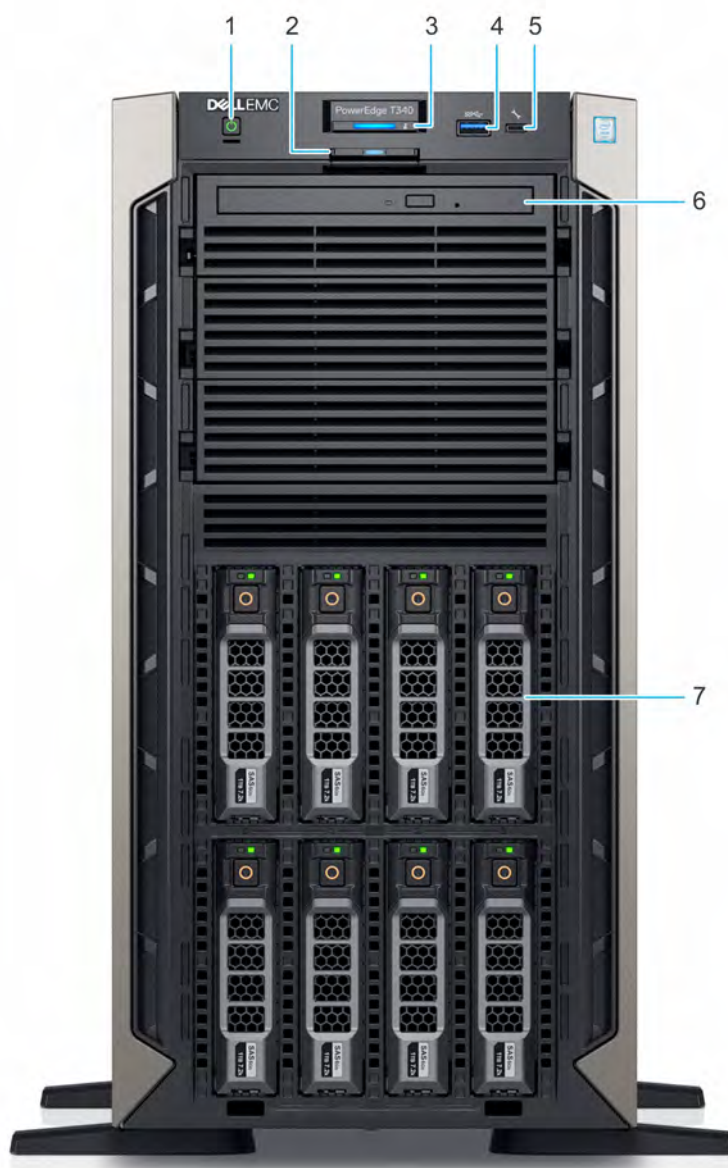

Figure 1. Front view of 8 x 3.5-inch drive system

- | | |
|--|-----------------------------|
| 1. Power button | 2. Information tag |
| 3. System health and system ID indicator | 4. USB 3.0 port |
| 5. iDRAC direct micro USB port | 6. Optical drive (optional) |
| 7. Drive (8) | |

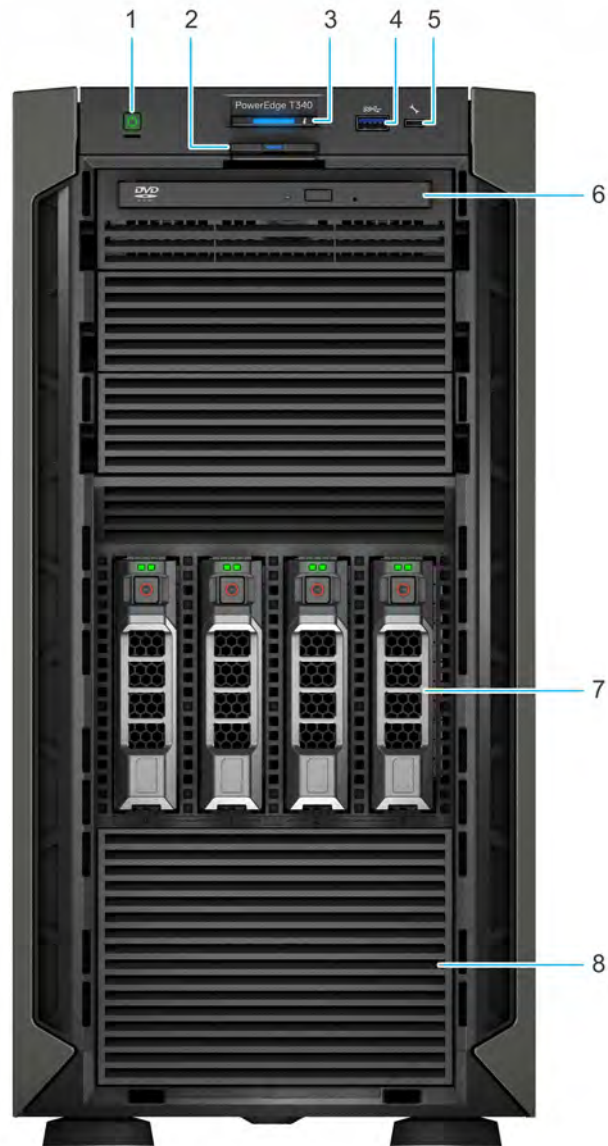

Figure 2. Front view of 4 x 3.5-inch drive system

- | | |
|--|-----------------------------|
| 1. Power button | 2. Information tag |
| 3. System health and system ID indicator | 4. USB 3.0 port |
| 5. iDRAC direct micro USB port | 6. Optical drive (optional) |
| 7. Drive (4) | 8. Four-slot drive blank |

For more information about the ports, see the [Ports and connectors specifications](#) section.

Rear view of the system

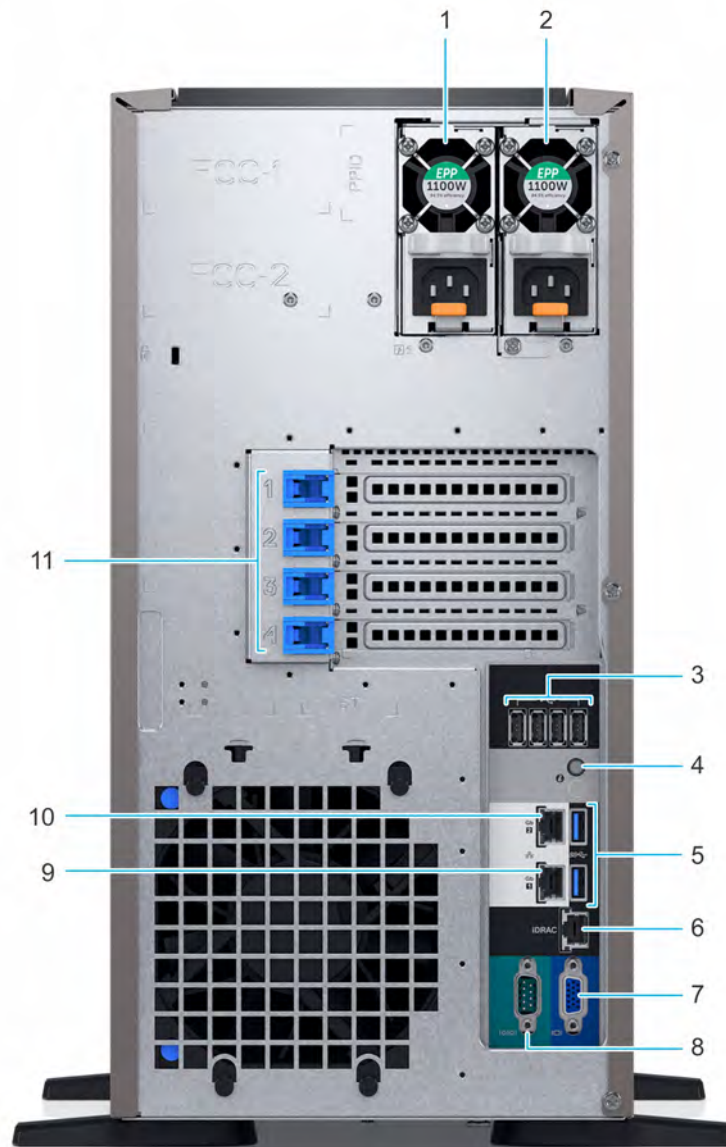

Figure 3. Rear view of 8 x 3.5-inch drive system

- | | |
|-----------------------------------|---------------------------------|
| 1. Power supply unit (PSU 1) | 2. Power supply unit (PSU 2) |
| 3. USB 2.0 port (4) | 4. System Identification button |
| 5. USB 3.0 port (2) | 6. iDRAC dedicated NIC port |
| 7. VGA port | 8. Serial port |
| 9. NIC port (Gb1) | 10. NIC port (Gb2) |
| 11. PCIe expansion card slots (4) | |

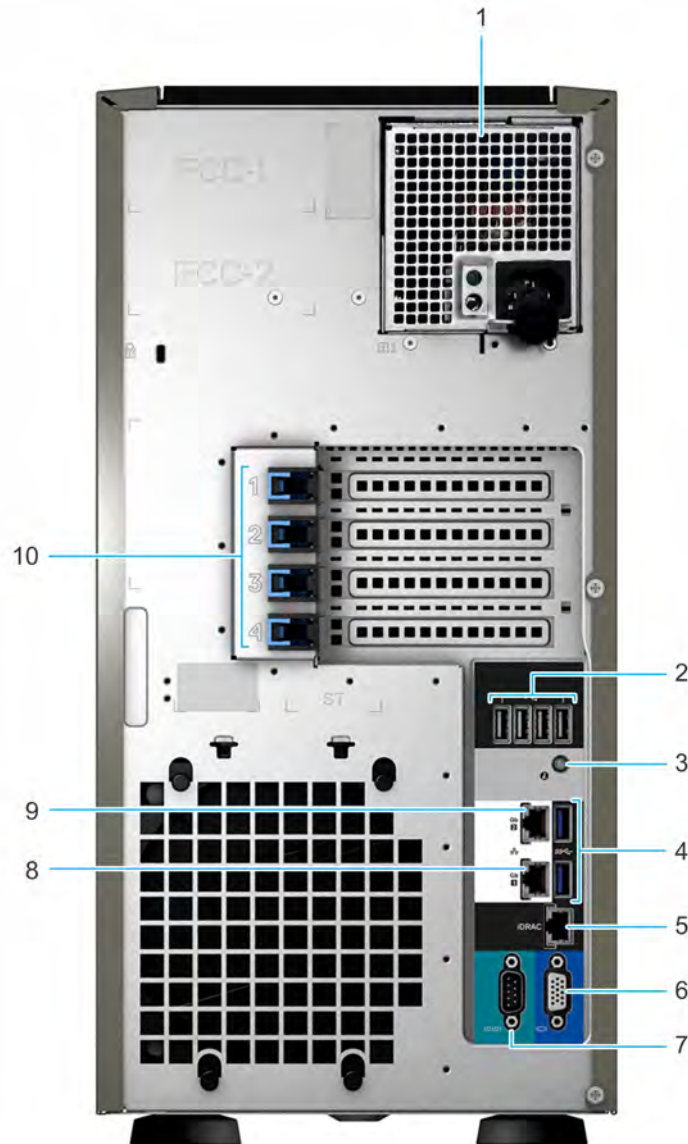

Figure 4. Rear view of 4 x 3.5-inch drive system

- | | |
|-----------------------------------|-----------------------------------|
| 1. Cabled power supply unit (PSU) | 2. USB 2.0 port (4) |
| 3. System identification button | 4. USB 3.0 port (2) |
| 5. iDRAC dedicated NIC port | 6. VGA port |
| 7. Serial port | 8. NIC port (Gb1) |
| 9. NIC port (Gb2) | 10. PCIe expansion card slots (4) |

NOTE: For more information about the ports and connectors, see the [Ports and connectors specifications](#) section.

Inside the system

NOTE: Components that are hot swappable are marked orange and touch points on the components are marked blue.

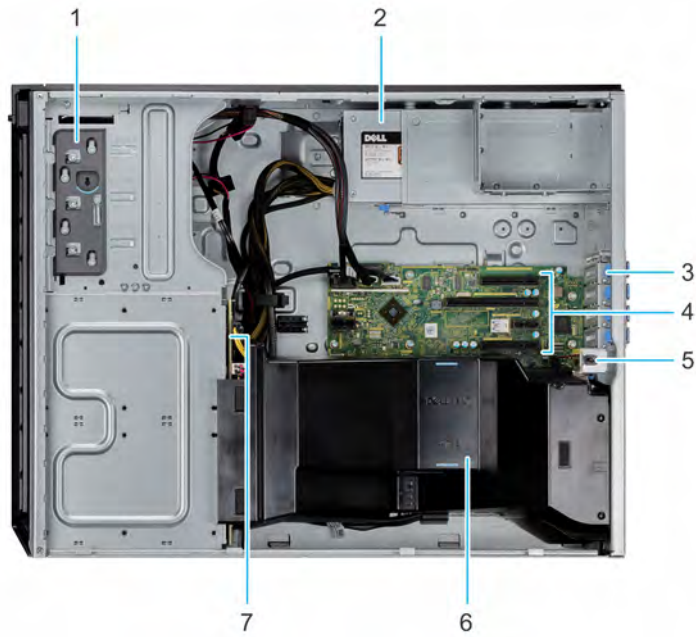

Figure 5. Inside the system with cabled power supply unit (PSU)

- | | |
|----------------------------------|----------------------------------|
| 1. Optical drive or tape drive | 2. Power supply unit (cabled) |
| 3. PCIe Expansion card latch (4) | 4. PCIe Expansion card slots (4) |
| 5. Intrusion switch | 6. Air shroud |
| 7. Drive backplane | |

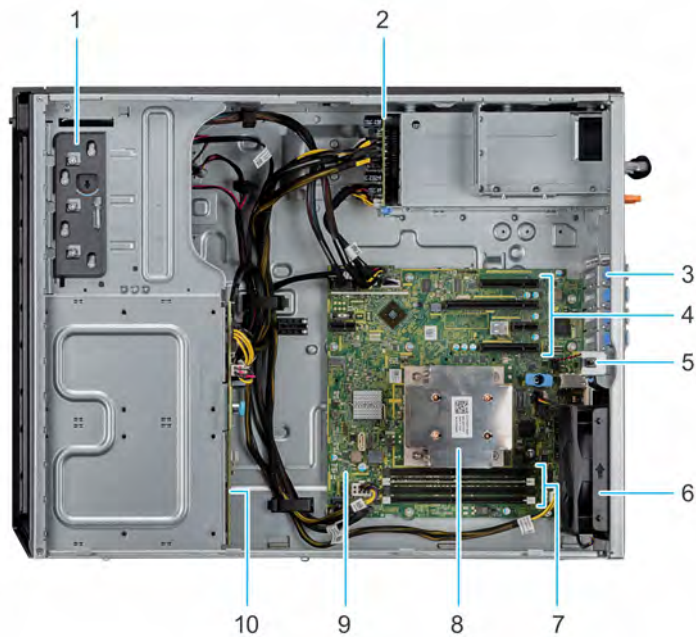

Figure 6. Inside the system with redundant power supply unit (PSU)

- | | |
|----------------------------------|----------------------------------|
| 1. Optical drive or tape drive | 2. Power interposer board |
| 3. PCIe Expansion card latch (4) | 4. PCIe Expansion card slots (4) |
| 5. Intrusion switch | 6. Fan |
| 7. Memory module socket (4) | 8. Processor and heat sink |
| 9. System board | 10. Drive backplane |

Locating the information tag of your system

Your system is identified by a unique Express Service Code and Service Tag number. You can view the Express Service Code and Service Tag by pulling out the information tag located on the front of the system. Alternatively, the information may be on the Mini Enterprise Service Tag (MEST) label on the chassis, on the rear of the system. This information is used by Dell to route support calls to the appropriate personnel.

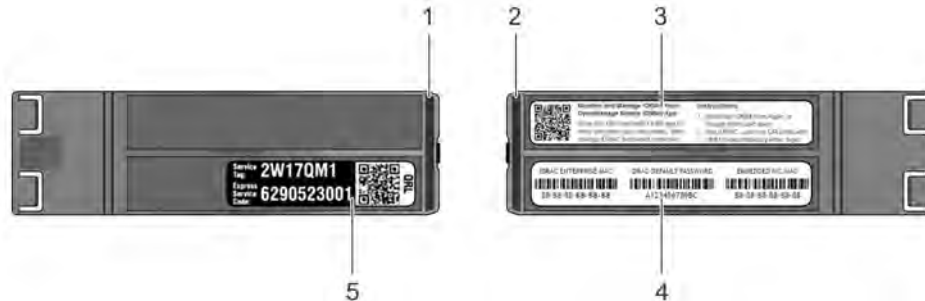

Figure 7. Locating Service Tag of your system

1. Information tag (top view)
2. Information tag (back view)
3. OpenManage Mobile (OMM) label
4. iDRAC MAC address and iDRAC secure password label
5. Service Tag, Express Service Code, QRL label

System information label

PowerEdge T340 – System information label

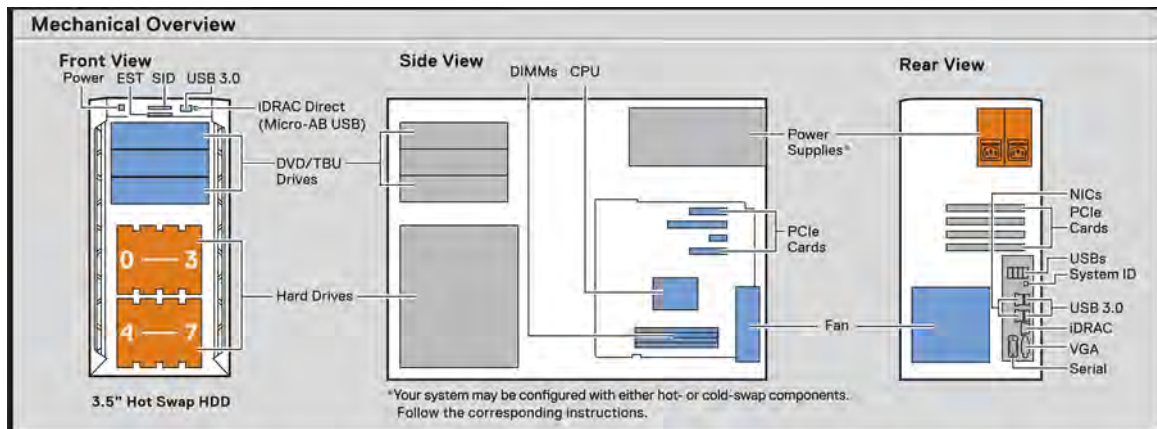

Figure 8. Mechanical overview

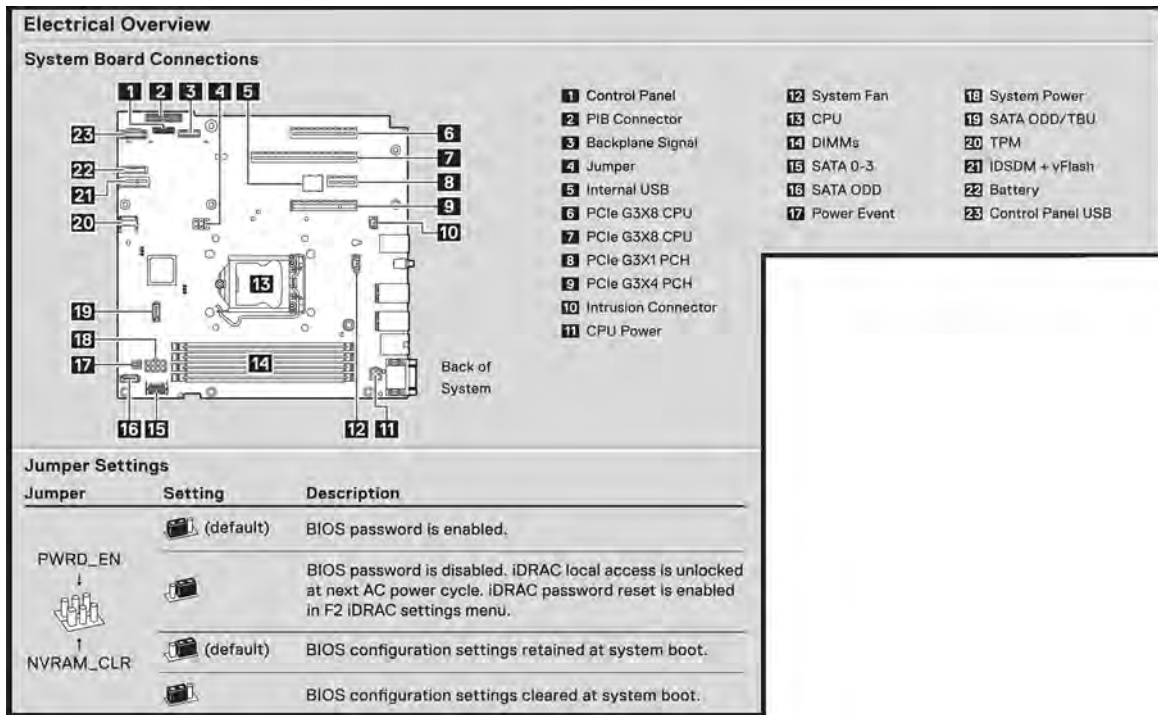

Figure 9. Electrical overview

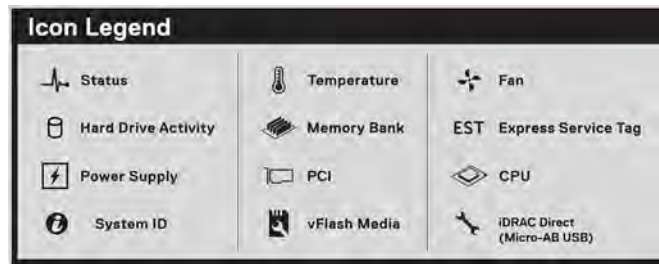

Figure 10. Icon legend

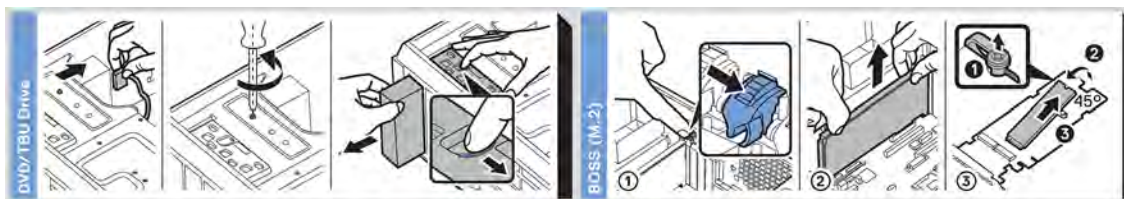

Figure 11. DVD and BOSS installation

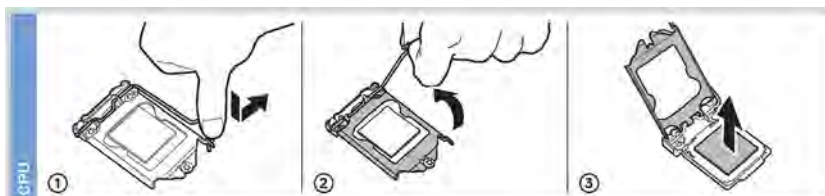

Figure 12. CPU installation

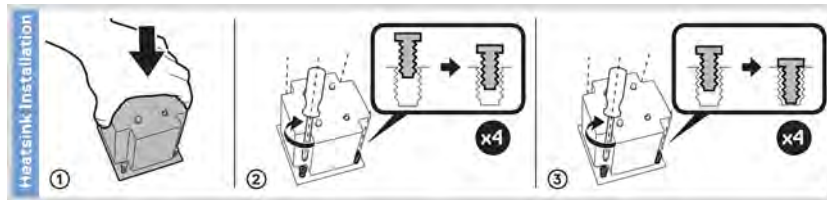

Figure 13. Heat sink installation

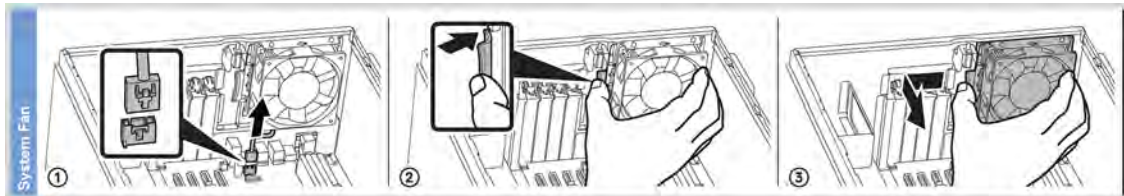

Figure 14. Internal cooling fan installation

Memory Information

Caution: Memory (DIMMs) and CPUs may be hot during servicing.

A3 →

A1 →

A4 →

A2 →

Memory Population

| Configuration | Sequence |
|------------------|------------|
| Memory-Optimized | 1, 2, 3, 4 |

Figure 15. Memory population

Scan to see hardware servicing and software setup videos, how-to's, and documentation.

Quick Resource Locator
Dell.com/QRL/Server/PET340

Figure 16. Quick resource locator

PowerEdge T340 initial system setup and configuration

Setting up your system

Perform the following steps to set up your system:

Steps

1. Unpack the system.
2. Connect the peripherals to the system.
3. Connect the system to its electrical outlet.
4. Power on the system by pressing the power button or by using iDRAC.
5. Power on the attached peripherals.

For more information about setting up your system, see the *Getting Started Guide* that shipped with your system.

iDRAC configuration

The Integrated Dell Remote Access Controller (iDRAC) is designed to make system administrators more productive and improve the overall availability of Dell systems. iDRAC alerts administrators about system issues and enables them to perform remote system management. This reduces the need for physical access to the system.

Options to set up iDRAC IP address

To enable communication between your system and iDRAC, you must first configure the network settings based on your network infrastructure.

NOTE: For static IP configuration, you must request for it at the time of purchase.

This option is set to **DHCP** by Default. You can set up the IP address by using one of the following interfaces:

| Interfaces | Document/Section |
|----------------------------------|---|
| iDRAC Settings utility | <i>Dell Integrated Dell Remote Access Controller User's Guide</i> at www.dell.com/poweredgemanuals |
| Dell Deployment Toolkit | <i>Dell Deployment Toolkit User's Guide</i> at www.dell.com/openmanagemanuals > OpenManage Deployment Toolkit |
| Dell Lifecycle Controller | <i>Dell Lifecycle Controller User's Guide</i> at www.dell.com/poweredgemanuals |

NOTE: To access iDRAC, ensure that you connect the ethernet cable to the iDRAC9 dedicated network port. You can also access iDRAC through the shared LOM mode, if you have opted for a system that has the shared LOM mode enabled.

Log in to iDRAC

You can log in to iDRAC as:

- iDRAC user
- Microsoft Active Directory user
- Lightweight Directory Access Protocol (LDAP) user

If you have opted for secure default access to iDRAC, you must use the iDRAC secure default password available on the system Information tag. If you have not opted for secure default access to iDRAC, then use the default user name and password `-root` and `calvin`. You can also log in by using your Single Sign-On or Smart Card.

NOTE: You must have the iDRAC credentials to log in to iDRAC.

NOTE: Ensure that you change the default user name and password after setting up the iDRAC IP address.

For more information about logging in to the iDRAC and iDRAC licenses, see the latest *Integrated Dell Remote Access Controller User's Guide* at www.dell.com/poweredgemanuals.

You can also access iDRAC by using RACADM. For more information, see the *RACADM Command Line Interface Reference Guide* at www.dell.com/poweredgemanuals.

Options to install the operating system

If the system is shipped without an operating system, install a supported operating system by using one of the following resources:

Table 1. Resources to install the operating system

| Resources | Location |
|---|--|
| iDRAC | www.dell.com/idracmanuals |
| Lifecycle Controller | www.dell.com/idracmanuals > Lifecycle Controller |
| OpenManage Deployment Toolkit | www.dell.com/openmanagemanuals > OpenManage Deployment Toolkit |
| Dell certified VMware ESXi | www.dell.com/virtualizationsolutions |
| Installation and How-to videos for supported operating systems on PowerEdge systems | Supported Operating Systems for Dell EMC PowerEdge systems |

Methods to download firmware and drivers

You can download the firmware and drivers by using any of the following methods:

Table 2. Firmware and drivers

| Methods | Location |
|--|--|
| From the Dell EMC support site | www.dell.com/support/home |
| Using Dell Remote Access Controller Lifecycle Controller (iDRAC with LC) | www.dell.com/idracmanuals |
| Using Dell Repository Manager (DRM) | www.dell.com/openmanagemanuals > Repository Manager |
| Using Dell OpenManage Essentials | www.dell.com/openmanagemanuals > OpenManage Essentials |
| Using Dell OpenManage Enterprise | www.dell.com/openmanagemanuals > OpenManage Enterprise |
| Using Dell Server Update Utility (SUU) | www.dell.com/openmanagemanuals > Server Update Utility |
| Using Dell OpenManage Deployment Toolkit (DTK) | www.dell.com/openmanagemanuals > OpenManage Deployment Toolkit |
| Using iDRAC virtual media | www.dell.com/idracmanuals |

Downloading drivers and firmware

Dell EMC recommends that you download and install the latest BIOS, drivers, and systems management firmware on your system.

Prerequisites

Ensure that you clear the web browser cache before downloading the drivers and firmware.

Steps

1. Go to www.dell.com/support/home.
2. In the **Drivers & Downloads** section, type the Service Tag of your system in the **Enter a Service Tag or product ID** box, and then click **Submit**.



NOTE: If you do not have the Service Tag, select Detect Product to allow the system to automatically detect the Service Tag, or click View products, and navigate to your product.

3. Click **Drivers & Downloads**.
The drivers that are applicable to your system are displayed.
4. Download the drivers to a USB drive, CD, or DVD.

PowerEdge T340 Pre-operating system management applications

You can manage basic settings and features of a system without booting to the operating system by using the system firmware.

Topics:

- [Options to manage the pre-operating system applications](#)
- [System Setup](#)
- [Dell Lifecycle Controller](#)
- [Boot Manager](#)
- [PXE boot](#)

Options to manage the pre-operating system applications

Your system has the following options to manage the pre-operating system applications:

- System Setup
- Dell Lifecycle Controller
- Boot Manager
- Preboot Execution Environment (PXE)

System Setup

By using the **System Setup** screen, you can configure the BIOS settings, iDRAC settings, and device settings of your system.

 **NOTE: Help text for the selected field is displayed in the graphical browser by default. To view the help text in the text browser, press F1.**

You can access system setup by one of the following:

- Standard graphical browser—The browser is enabled by default.
- Text browser—The browser is enabled by using Console Redirection.

Viewing System Setup

To view the **System Setup** screen, perform the following steps:

Steps

1. Power on, or restart your system.
2. Press F2 immediately after you see the following message:

```
F2 = System Setup
```

 **NOTE: If your operating system begins to load before you press F2, wait for the system to finish booting, and then restart your system and try again.**

System Setup details

The **System Setup Main Menu** screen details are explained as follows:

| Option | Description |
|------------------------|--|
| System BIOS | Enables you to configure BIOS settings. |
| iDRAC Settings | Enables you to configure the iDRAC settings. The iDRAC settings utility is an interface to set up and configure the iDRAC parameters by using UEFI (Unified Extensible Firmware Interface). You can enable or disable various iDRAC parameters by using the iDRAC settings utility. For more information about this utility, see <i>Integrated Dell Remote Access Controller User's Guide</i> at www.dell.com/poweredgemanuals . |
| Device Settings | Enables you to configure device settings. |

System BIOS

You can use the **System BIOS** screen to edit specific functions such as boot order, system password, setup password, set the SATA mode, and enable or disable USB ports.

Viewing System BIOS

To view the **System BIOS** screen, perform the following steps:

Steps

1. Power on, or restart your system.
2. Press F2 immediately after you see the following message:

```
F2 = System Setup
```

NOTE: If the operating system begins to load before you press F2, wait for the system to finish booting, and then restart the system and try again.

3. On the **System Setup Main Menu** screen, click **System BIOS**.

System BIOS Settings details

About this task

The **System BIOS Settings** screen details are explained as follows:

| Option | Description |
|-----------------------------|--|
| System Information | Specifies information about the system such as the system model name, BIOS version, and Service Tag. |
| Memory Settings | Specifies information and options related to the installed memory. |
| Processor Settings | Specifies information and options related to the processor such as speed and cache size. |
| SATA Settings | Specifies options to enable or disable the integrated SATA controller and ports. |
| Boot Settings | Specifies options to specify the Boot mode (BIOS or UEFI). Enables you to modify UEFI and BIOS boot settings. |
| Network Settings | Specifies options to manage the UEFI network settings and boot protocols. Legacy network settings are managed from the Device Settings menu. |
| Integrated Devices | Specifies options to manage integrated device controllers and ports, specifies related features and options. |
| Serial Communication | Specifies options to manage the serial ports, its related features and options. |

| Option | Description |
|--------------------------------|---|
| System Profile Settings | Specifies options to change the processor power management settings, memory frequency. |
| System Security | Specifies options to configure the system security settings, such as system password, setup password, Trusted Platform Module (TPM) security, and UEFI secure boot. It also manages the power button on the system. |
| Redundant OS Control | Sets the redundant OS info for redundant OS control. |
| Miscellaneous Settings | Specifies options to change the system date and time. |

System Information

You can use the **System Information** screen to view system properties such as Service Tag, system model name, and BIOS version.

Viewing System Information

To view the **System Information** screen, perform the following steps:

Steps

1. Power on, or restart your system.
2. Press F2 immediately after you see the following message:

```
F2 = System Setup
```

NOTE: If your operating system begins to load before you press F2, wait for the system to finish booting, and then restart your system and try again.

3. On the **System Setup Main Menu** screen, click **System BIOS**.
4. On the **System BIOS** screen, click **System Information**.

System Information details

About this task

The **System Information** screen details are explained as follows:

| Option | Description |
|--|--|
| System Model Name | Specifies the system model name. |
| System BIOS Version | Specifies the BIOS version installed on the system. |
| System Management Engine Version | Specifies the current version of the Management Engine firmware. |
| System Service Tag | Specifies the system Service Tag. |
| System Manufacturer | Specifies the name of the system manufacturer. |
| System Manufacturer Contact Information | Specifies the contact information of the system manufacturer. |
| System CPLD Version | Specifies the current version of the system complex programmable logic device (CPLD) firmware. |

| Option | Description |
|-------------------------|---|
| UEFI Compliance Version | Specifies the UEFI compliance level of the system firmware. |

Memory Settings

You can use the **Memory Settings** screen to view all the memory settings and enable or disable specific memory functions, such as system memory testing and node interleaving.

Viewing Memory Settings

To view the **Memory Settings** screen, perform the following steps:

Steps

1. Power on, or restart your system.
2. Press F2 immediately after you see the following message:

```
F2 = System Setup
```

NOTE: If the operating system begins to load before you press F2, wait for the system to finish booting, and then restart the system and try again.

3. On the **System Setup Main Menu** screen, click **System BIOS**.
4. On the **System BIOS** screen, click **Memory Settings**.

Memory Settings details

About this task

The **Memory Settings** screen details are explained as follows:

| Option | Description |
|---|---|
| System Memory Size | Specifies the memory size in the system. |
| System Memory Type | Specifies the type of memory installed in the system. |
| System Memory Speed | Specifies the system memory speed. |
| System Memory Voltage | Specifies the system memory voltage. |
| Video Memory | Specifies the amount of video memory. |
| System Memory Testing | Specifies whether the system memory tests are run during system boot. Options are Enabled and Disabled . This option is set to Disabled by default. |
| Memory Operating Mode | Specifies the memory operating mode. This option is set to Optimizer Mode by default. NOTE: The Memory Operating Mode option can have different default and available options based on the memory configuration of your system. |
| Current State of Memory Operating Mode | Specifies the current state of the memory operating mode. |

Processor Settings

You can use the **Processor Settings** screen to view the processor settings, and perform specific functions such as enabling virtualization technology, hardware prefetcher, and logical processor idling.

Viewing Processor Settings

To view the **Processor Settings** screen, perform the following steps:

Steps

1. Power on, or restart your system.
2. Press F2 immediately after you see the following message:

```
F2 = System Setup
```

NOTE: If your operating system begins to load before you press F2, wait for the system to finish booting, and then restart your system and try again.

3. On the **System Setup Main Menu** screen, click **System BIOS**.
4. On the **System BIOS** screen, click **Processor Settings**.

Processor Settings details

About this task

The **Processor Settings** screen details are explained as follows:

| Option | Description |
|--------------------------------------|--|
| Logical Processor | Enables or disables the logical processors and displays the number of logical processors. If this option is set to Enabled , the BIOS displays all the logical processors. If this option is set to Disabled , the BIOS displays only one logical processor per core. This option is set to Enabled by default. |
| Virtualization Technology | Enables or disables the virtualization technology for the processor. This option is set to Enabled by default. |
| Adjacent Cache Line Prefetch | Optimizes the system for applications that need high utilization of sequential memory access. This option is set to Enabled by default. You can disable this option for applications that need high utilization of random memory access. |
| Hardware Prefetcher | Enables or disables the hardware prefetcher. This option is set to Enabled by default. |
| Logical Processor Idling | Enables you to improve the energy efficiency of a system. It uses the operating system core parking algorithm and parks some of the logical processors in the system which in turn allows the corresponding processor cores to transition into a lower power idle state. This option can only be enabled if the operating system supports it. It is set to Disabled by default. |
| x2APIC Mode | Enables or disables the x2APIC mode. This option is set to Disabled by default. |
| Number of Cores per Processor | Controls the number of enabled cores in each processor. This option is set to All by default. |
| Processor Core Speed | Specifies the maximum core frequency of the processor. |
| Processor 1 | The following settings are displayed for each processor installed in the system: |
| Option | Description |
| Family-Model-Stepping | Specifies the family, model, and stepping of the processor as defined by Intel. |
| Brand | Specifies the brand name. |
| Level 2 Cache | Specifies the total L2 cache. |

| Option | Description |
|------------------------|--|
| Option | Description |
| Level 3 Cache | Specifies the total L3 cache. |
| Number of Cores | Specifies the number of cores per processor. |
| Microcode | Specifies the microcode. |

SATA Settings

You can use the **SATA Settings** screen to view the SATA settings of SATA devices and enable SATA on your system.

Viewing SATA Settings

To view the **SATA Settings** screen, perform the following steps:

Steps

1. Power on, or restart your system.
2. Press F2 immediately after you see the following message:

```
F2 = System Setup
```

NOTE: If your operating system begins to load before you press F2, wait for the system to finish booting, and then restart your system and try again.

3. On the **System Setup Main Menu** screen, click **System BIOS**.
4. On the **System BIOS** screen, click **SATA Settings**.

SATA Settings details

About this task

The **SATA Settings** screen details are explained as follows:

| Option | Description |
|-----------------------------|---|
| Embedded SATA | Enables the embedded SATA option to be set to Off , AHCI , or RAID modes. This option is set to AHCI Mode by default. |
| Security Freeze Lock | Sends Security Freeze Lock command to the embedded SATA drives during POST. This option is applicable only for AHCI Mode. This option is set to Enabled by default. |
| Write Cache | Enables or disables the command for the embedded SATA drives during POST. This option is set to Disabled by default. |
| Port n | Sets the drive type of the selected device. For AHCI Mode or RAID Mode , BIOS support is always enabled. |
| Option | Description |
| Model | Specifies the drive model of the selected device. |
| Drive Type | Specifies the type of drive attached to the SATA port. |
| Capacity | Specifies the total capacity of the drive. This field is undefined for removable media devices such as optical drives. |

Boot Settings

You can use the **Boot Settings** screen to set the boot mode to either **BIOS** or **UEFI**. It also enables you to specify the boot order.

- **UEFI:** The Unified Extensible Firmware Interface (UEFI) is a new interface between operating systems and platform firmware. The interface consists of data tables with platform related information, boot and runtime service calls that are available to the operating system and its loader. The following benefits are available when the **Boot Mode** is set to **UEFI**:
 - Support for drive partitions larger than 2 TB.
 - Enhanced security (e.g., UEFI Secure Boot).
 - Faster boot time.
- **BIOS:** The **BIOS Boot Mode** is the legacy boot mode. It is maintained for backward compatibility.

Viewing Boot Settings

To view the **Boot Settings** screen, perform the following steps:

Steps

1. Power on, or restart your system.
2. Press F2 immediately after you see the following message:

```
F2 = System Setup
```

NOTE: If your operating system begins to load before you press F2, wait for the system to finish booting, and then restart your system and try again.

3. On the **System Setup Main Menu** screen, click **System BIOS**.
4. On the **System BIOS** screen, click **Boot Settings**.

Boot Settings details

About this task

The **Boot Settings** screen details are explained as follows:

| Option | Description |
|------------------------------------|---|
| Boot Mode | <p>Enables you to set the boot mode of the system.</p> <p>CAUTION: Switching the boot mode may prevent the system from booting if the operating system is not installed in the same boot mode.</p> <p>If the operating system supports UEFI, you can set this option to UEFI. Setting this field to BIOS allows compatibility with non-UEFI operating systems. This option is set to UEFI by default.</p> <p>NOTE: Setting this field to UEFI disables the BIOS Boot Settings menu.</p> |
| Boot Sequence Retry | <p>Enables or disables the Boot Sequence Retry feature. If this option is set to Enabled and the system fails to boot, the system re-attempts the boot sequence after 30 seconds. This option is set to Enabled by default.</p> |
| Hard-Disk Failover | <p>Specifies the drive that is booted in the event of a drive failure. The devices are selected in the Hard-Disk Drive Sequence on the Boot Option Setting menu. When this option is set to Disabled, only the first drive in the list is attempted to boot. When this option is set to Enabled, all drives are attempted to boot in the order selected in the Hard-Disk Drive Sequence. This option is not enabled for UEFI Boot Mode. This option is set to Disabled by default.</p> |
| Generic USB boot | <p>Enables or disables generic USB boot. This option is set to Disabled by default.</p> |
| Hard-disk Drive Placeholder | <p>Enables or disables Hard-disk Drive Placeholder.</p> |
| UEFI Boot Settings | <p>Enables or disables UEFI Boot options.</p> <p>The Boot options include IPv4 PXE and IPv6 PXE. This option is set to IPv4 by default.</p> <p>NOTE: This option is enabled only if the boot mode is UEFI.</p> |

| Option | Description |
|-----------------------------|---|
| UEFI Boot Sequence | Enables you to change the boot device order. |
| Boot Options Enable/Disable | Enables you to select the enabled or disabled boot devices. |

Network Settings

You can use the **Network Settings** screen to modify UEFI PXE, iSCSI, and HTTP boot settings. The network settings option is available only in the UEFI mode.

NOTE: BIOS does not control network settings in the BIOS mode. For the BIOS boot mode, the optional Boot ROM of the network controllers handles the network settings.

Viewing Network Settings

To view the **Network Settings** screen, perform the following steps:

Steps

1. Power on, or restart your system.
2. Press F2 immediately after you see the following message:

```
F2 = System Setup
```

NOTE: If your operating system begins to load before you press F2, wait for the system to finish booting, and then restart your system and try again.

3. On the **System Setup Main Menu** screen, click **System BIOS**.
4. On the **System BIOS** screen, click **Network Settings**.

Network Settings screen details

The **Network Settings** screen details are explained as follows:

About this task

| Option | Description |
|-------------------------------------|--|
| PXE Device n (n = 1 to 4) | Enables or disables the device. When enabled, a UEFI PXE boot option is created for the device. |
| PXE Device n Settings(n = 1 to 4) | Enables you to control the configuration of the PXE device. |
| HTTP Device n (n = 1 to 4) | Enables or disables the device. When enabled, a UEFI HTTP boot option is created for the device. |
| HTTP Device n Settings (n = 1 to 4) | Enables you to control the configuration of the HTTP device. |
| UEFI iSCSI Settings | Enables you to control the configuration of the iSCSI device. |

Table 3. UEFI iSCSI Settings screen details

| Option | Description |
|----------------------|---|
| iSCSI Initiator Name | Specifies the name of the iSCSI initiator in IQN format. |
| iSCSI Device1 | Enables or disables the iSCSI device. When enabled, a UEFI boot option is created for the iSCSI device automatically. This is set to Enabled by default. |

| Option | Description |
|--------|-------------|
|--------|-------------|

Table 3. UEFI iSCSI Settings screen details(continued)

| Option | Description |
|------------------------|---|
| iSCSI Device1 Settings | Enables you to control the configuration of the iSCSI device. |

Integrated Devices

You can use the **Integrated Devices** screen to view and configure the settings of all integrated devices including the video controller, integrated RAID controller, and the USB ports.

Viewing Integrated Devices

To view the **Integrated Devices** screen, perform the following steps:

Steps

1. Power on, or restart your system.
2. Press F2 immediately after you see the following message:

```
F2 = System Setup
```

NOTE: If your operating system begins to load before you press F2, wait for the system to finish booting, and then restart your system and try again.

3. On the **System Setup Main Menu** screen, click **System BIOS**.
4. On the **System BIOS** screen, click **Integrated Devices**.

Integrated Devices details

About this task

The **Integrated Devices** screen details are explained as follows:

| Option | Description |
|--------|-------------|
|--------|-------------|

| | |
|----------------------------------|---|
| User Accessible USB Ports | Configures the user accessible USB ports. Selecting Only Back Ports On disables the front USB ports; selecting All Ports Off disables all front and back USB ports; |
|----------------------------------|---|

The USB keyboard and mouse still function in certain USB ports during the boot process, depending on the selection. After the boot process is complete, the USB ports will be enabled or disabled as per the setting.

NOTE: Selecting **Only Back Ports On** and **All Ports Off** disables the USB management port and also restricts access to the iDRAC features.

| | |
|--------------------------|--|
| Internal USB Port | Enables or disables the internal USB port. This option is set to On or Off . This option is set to On by default. |
|--------------------------|--|

| | |
|------------------------------|---|
| iDRAC Direct USB Port | The iDRAC Direct USB port is managed by iDRAC exclusively with no host visibility. This option is set to ON or OFF . When set to OFF , iDRAC does not detect any USB devices installed in this managed port. This option is set to On by default. |
|------------------------------|---|

| | |
|-------------------------------|---|
| Embedded NIC1 and NIC2 | NOTE: The Embedded NIC1 and NIC2 options are only available on systems that do not have Integrated Network Card 1 . |
|-------------------------------|---|

Enables or disables the Embedded NIC1 and NIC2 options. If set to **Disabled**, the NIC may still be available for shared network access by the embedded management controller. The embedded NIC1 and NIC2 options are only available on systems that do not have Network Daughter Cards (NDCs). The Embedded NIC1 and NIC2 option is mutually exclusive with the Integrated Network Card 1 option. Configure the Embedded NIC1 and NIC2 option by using the NIC management utilities of the system.

| Option | Description |
|---|--|
| I/OAT DMA Engine | Enables or disables the I/O Acceleration Technology (I/OAT) option. I/OAT is a set of DMA features designed to accelerate network traffic and lower CPU utilization. Enable only if the hardware and software support the feature. |
| Embedded Video Controller | <p>Enables or disables the use of Embedded Video Controller as the primary display. When set to Enabled, the Embedded Video Controller will be the primary display even if add-in graphic cards are installed. When set to Disabled, an add-in graphics card will be used as the primary display. BIOS will output displays to both the primary add-in video and the embedded video during POST and pre-boot environment. The embedded video will then be disabled right before the operating system boots. This option is set to Enabled by default.</p> <p>NOTE: When there are multiple add-in graphic cards installed in the system, the first card discovered during PCI enumeration is selected as the primary video. You might have to re-arrange the cards in the slots in order to control which card is the primary video.</p> |
| Current State of Embedded Video Controller | Displays the current state of the embedded video controller. The Current State of Embedded Video Controller option is a read-only field. If the Embedded Video Controller is the only display capability in the system (that is, no add-in graphics card is installed), then the Embedded Video Controller is automatically used as the primary display even if the Embedded Video Controller setting is set to Enabled . |
| OS Watchdog Timer | If your system stops responding, this watchdog timer aids in the recovery of your operating system. When this option is set to Enabled , the operating system initializes the timer. When this option is set to Disabled (the default), the timer does not have any effect on the system. |
| Memory Mapped I/O above 4 GB | Enables or disables the support for the PCIe devices that need large amounts of memory. Enable this option only for 64-bit operating systems. This option is set to Enabled by default. |
| Slot Disablement | Enables or disables the available PCIe slots on your system. The slot disablement feature controls the configuration of the PCIe cards installed in the specified slot. Slots must be disabled only when the installed peripheral card prevents booting into the operating system or causes delays in system startup. If the slot is disabled, both the Option ROM and UEFI drivers are disabled. Only slots that are present on the system will be available for control. |

Table 4. Slot Disablement

| Option | Description |
|---------------|---|
| Slot 1 | Enables or disables or only the boot driver is disabled for the PCIe slot 1. This option is set to Enabled by default. |
| Slot 2 | Enables or disables or only the boot driver is disabled for the PCIe slot 2. This option is set to Enabled by default. |
| Slot 3 | Enables or disables or only the boot driver is disabled for the PCIe slot 3. This option is set to Enabled by default. |
| Slot 4 | Enables or disables or only the boot driver is disabled for the PCIe slot 4. This option is set to Enabled by default. |

Serial Communication

You can use the **Serial Communication** screen to view the properties of the serial communication port.

Viewing Serial Communication

To view the **Serial Communication** screen, perform the following steps:

Steps

1. Power on, or restart your system.

- Press F2 immediately after you see the following message:

F2 = System Setup

NOTE: If your operating system begins to load before you press F2, wait for the system to finish booting, and then restart your system and try again.

- On the **System Setup Main Menu** screen, click **System BIOS**.
- On the **System BIOS** screen, click **Serial Communication**.

Serial Communication details

About this task

The **Serial Communication** screen details are explained as follows:

| Option | Description |
|----------------------------------|---|
| Serial Communication | Selects serial communication devices (Serial Device 1 and Serial Device 2) in BIOS. BIOS console redirection can also be enabled, and the port address can be specified. This option is set to Auto by default. |
| Serial Port Address | Enables you to set the port address for serial devices. This field sets the serial port address to either COM1 or COM2 (COM1=0x3F8, COM2=0x2F8). This option is set to Serial Device1=COM2 or Serial Device 2=COM1 by default. <p>NOTE: You can use only Serial Device 2 for the Serial Over LAN (SOL) feature. To use console redirection by SOL, configure the same port address for console redirection and the serial device.</p> <p>NOTE: Every time the system boots, the BIOS syncs the serial MUX setting saved in iDRAC. The serial MUX setting can independently be changed in iDRAC. Loading the BIOS default settings from within the BIOS setup utility may not always revert the serial MUX setting to the default setting of Serial Device 1.</p> |
| External Serial Connector | Enables you to associate the External Serial Connector to Serial Device 1 , Serial Device 2 , or the Remote Access Device by using this option. This option is set to Serial Device 1 by default. <p>NOTE: Only Serial Device 2 can be used for Serial Over LAN (SOL). To use console redirection by SOL, configure the same port address for console redirection and the serial device.</p> <p>NOTE: Every time the system boots, the BIOS syncs the serial MUX setting saved in iDRAC. The serial MUX setting can independently be changed in iDRAC. Loading the BIOS default settings from within the BIOS setup utility may not always revert this setting to the default setting of Serial Device 1.</p> |
| Failsafe Baud Rate | Specifies the failsafe baud rate for console redirection. The BIOS attempts to determine the baud rate automatically. This failsafe baud rate is used only if the attempt fails, and the value must not be changed. This option is set to 115200 by default. |
| Remote Terminal Type | Sets the remote console terminal type. This option is set to ANSI/VT100/VT220 by default. |
| Redirection After Boot | Enables or disables the BIOS console redirection when the operating system is loaded. This option is set to Enabled by default. |

System Profile Settings

You can use the **System Profile Settings** screen to enable specific system performance settings such as power management.

Viewing System Profile Settings

To view the **System Profile Settings** screen, perform the following steps:

Steps

- Power on, or restart your system.

- Press F2 immediately after you see the following message:

F2 = System Setup

NOTE: If your operating system begins to load before you press F2, wait for the system to finish booting, and then restart your system and try again.

- On the **System Setup Main Menu** screen, click **System BIOS**.
- On the **System BIOS** screen, click **System Profile Settings**.

System Profile Settings details

About this task

The **System Profile Settings** screen details are explained as follows:

| Option | Description |
|--|--|
| System Profile | Sets the system profile. If you set the System Profile option to a mode other than Custom , the BIOS automatically sets the rest of the options. You can only change the rest of the options if the mode is set to Custom . This option is set to Performance Per Watt (OS) by default. NOTE: All the parameters on the system profile setting screen are available only when the System Profile option is set to Custom. |
| CPU Power Management | Sets the CPU power management. This option is set to OS DBPM by default. |
| Memory Frequency | Sets the speed of the system memory. You can select Maximum Performance , Maximum Reliability , or a specific speed. This option is set to Maximum Performance by default. |
| Turbo Boost | Enables or disables the processor to operate in the turbo boost mode. This option is set to Enabled by default. |
| C1E | Enables or disables the processor to switch to a minimum performance state when it is idle. This option is set to Enabled by default. |
| C States | Enables or disables the processor to operate in all available power states. This option is set to Enabled by default. |
| Memory Refresh Rate | Sets the memory refresh rate to either 1x or 2x. This option is set to 1x by default. |
| Uncore Frequency | Enables you to select the Processor Uncore Frequency option. Dynamic mode enables the processor to optimize power resources across the cores and uncore during runtime. The optimization of the uncore frequency to either save power or optimize performance is influenced by the setting of the Energy Efficiency Policy option. |
| Number of Turbo Boost Enabled Cores for Processor 1 | NOTE: If there are two processors installed in the system, you will see an entry for Number of Turbo Boost Enabled Cores for Processor 2 . Controls the number of turbo boost enabled cores for Processor 1. The maximum number of cores is enabled by default. |
| Monitor/Mwait | Enables the Monitor/Mwait instructions in the processor. This option is set to Enabled for all system profiles, except Custom by default. NOTE: This option can be disabled only if the C States option in the Custom mode is set to disabled. NOTE: When C States is set to Enabled in the Custom mode, changing the Monitor/Mwait setting does not impact the system power or performance. |
| PCI ASPM L1 Link Power Management | Enables or disables the PCI ASPM L1 Link Power Management. This option is set to Enabled by default. |

System Security

You can use the **System Security** screen to perform specific functions such as setting the system password, setup password and disabling the power button.

Viewing System Security

To view the **System Security** screen, perform the following steps:

Steps

1. Power on, or restart your system.
2. Press F2 immediately after you see the following message:

F2 = System Setup

NOTE: If your operating system begins to load before you press F2, wait for the system to finish booting, and then restart your system and try again.



3. On the **System Setup Main Menu** screen, click **System BIOS**.
4. On the **System BIOS** screen, click **System Security**.

System Security Settings details

About this task

The **System Security Settings** screen details are explained as follows:

| Option | Description |
|------------------------|---|
| CPU AES-NI | Improves the speed of applications by performing encryption and decryption by using the Advanced Encryption Standard Instruction Set (AES-NI). This option is set to Enabled by default. |
| System Password | Sets the system password. This option is set to Enabled by default and is read-only if the password jumper is not installed in the system. |
| Setup Password | Sets the setup password. This option is read-only if the password jumper is not installed in the system. |
| Password Status | Locks the system password. This option is set to Unlocked by default. |
| TPM Security | <p>NOTE: The TPM menu is available only when the TPM module is installed.</p> <p>Enables you to control the reporting mode of the TPM. The TPM Security option is set to Off by default. You can only modify the TPM Status, and TPM Activation fields if the TPM Status field is set to either On with Pre-boot Measurements or On without Pre-boot Measurements.</p> |
| TPM Information | Changes the operational state of the TPM. This option is set to No Change by default. |
| TPM Status | Specifies the TPM status. |
| TPM Command | <p>Controls the Trusted Platform Module (TPM). When set to None, no command is sent to the TPM. When set to Activate, the TPM is enabled and activated. When set to Deactivate, the TPM is disabled and deactivated. When set to Clear, all the contents of the TPM are cleared. This option is set to None by default.</p> <p>CAUTION: Clearing the TPM results in the loss of all keys in the TPM. The loss of TPM keys may affect booting to the operating system.</p> <p>This field is read-only when TPM Security is set to Off. The action requires an additional reboot before it can take effect.</p> |
| Intel(R) TXT | <p>Enables or disables the Intel Trusted Execution Technology (TXT) option. To enable the Intel TXT option, virtualization technology and TPM Security must be enabled with Pre-boot measurements. This option is set to Off by default.</p> <p>When TPM 2.0 is installed, TPM 2 Algorithm option is available. It enables you to select a hash algorithm from those supported by the TPM (SHA1, SHA256). TPM 2 Algorithm option must be set to SHA256, to enable TXT.</p> |
| Intel(R) SGX | Enables or disables the Intel Software Guard Extension (SGX) option. This option is set to Software by default. |

| Option | Description | | | | | | | | |
|---|---|---------|-------------|------------------|--|-------------------|--|----------------------|---|
| | <p> NOTE: The SGX menu is available, only when the SGX supported processor is installed.</p> | | | | | | | | |
| SGX Launch Control Policy | Allows controlling the Launch Control Policy (LCP) of Software Guard Extensions (SGX) technology. This option is set to Unlocked by default. | | | | | | | | |
| Power Button | Enables or disables the power button on the front of the system. This option is set to Enabled by default. | | | | | | | | |
| AC Power Recovery | Sets how the system behaves after AC power is restored to the system. This option is set to Last by default. | | | | | | | | |
| AC Power Recovery Delay | Sets the time delay for the system to power up after AC power is restored to the system. This option is set to Immediate by default. | | | | | | | | |
| User Defined Delay (60 s to 240 s) | Sets the User Defined Delay option when the User Defined option for AC Power Recovery Delay is selected. | | | | | | | | |
| UEFI Variable Access | Provides varying degrees of securing UEFI variables. When set to Standard (the default), UEFI variables are accessible in the operating system per the UEFI specification. When set to Controlled , selected UEFI variables are protected in the environment and new UEFI boot entries are forced to be at the end of the current boot order. | | | | | | | | |
| In-Band Manageability Interface | When set to Disabled , this setting will hide the Management Engine's (ME), HECI devices, and the system's IPMI devices from the operating system. This prevents the operating system from changing the ME power capping settings, and blocks access to all in-band management tools. All management should be managed through out-of-band. This option is set to Enabled by default. <p> NOTE: BIOS update requires HECI devices to be operational and DUP updates require IPMI interface to be operational. This setting needs to be set to Enabled to avoid updating errors.</p> | | | | | | | | |
| Secure Boot | Enables Secure Boot, where the BIOS authenticates each pre-boot image by using the certificates in the Secure Boot Policy. Secure Boot is set to Disabled by default. | | | | | | | | |
| Secure Boot Policy | When Secure Boot policy is set to Standard , the BIOS uses the system manufacturer's key and certificates to authenticate pre-boot images. When Secure Boot policy is set to Custom , the BIOS uses the user-defined key and certificates. Secure Boot policy is set to Standard by default. | | | | | | | | |
| Secure Boot Mode | Configures how the BIOS uses the Secure Boot Policy Objects (PK, KEK, db, dbx). <p>If the current mode is set to Deployed Mode, the available options are User Mode and Deployed Mode. If the current mode is set to User Mode, the available options are User Mode, Audit Mode, and Deployed Mode.</p> <table border="1"> <thead> <tr> <th>Options</th> <th>Description</th> </tr> </thead> <tbody> <tr> <td>User Mode</td> <td>In User Mode, PK must be installed, and BIOS performs signature verification on programmatic attempts to update policy objects. The BIOS allows unauthenticated programmatic transitions between modes.</td> </tr> <tr> <td>Audit Mode</td> <td>In Audit mode, PK is not present. The BIOS does not authenticate programmatic updates to the policy objects, and transitions between modes. Audit Mode is useful for programmatically determining a working set of policy objects. BIOS performs signature verification on pre-boot images and logs results in the image Execution Information Table, but executes the images whether they pass or fail verification.</td> </tr> <tr> <td>Deployed Mode</td> <td>Deployed Mode is the most secure mode. In Deployed Mode, PK must be installed and the BIOS performs signature verification on programmatic attempts to update policy objects. Deployed Mode restricts the programmatic mode transitions.</td> </tr> </tbody> </table> | Options | Description | User Mode | In User Mode , PK must be installed, and BIOS performs signature verification on programmatic attempts to update policy objects. The BIOS allows unauthenticated programmatic transitions between modes. | Audit Mode | In Audit mode , PK is not present. The BIOS does not authenticate programmatic updates to the policy objects, and transitions between modes. Audit Mode is useful for programmatically determining a working set of policy objects. BIOS performs signature verification on pre-boot images and logs results in the image Execution Information Table, but executes the images whether they pass or fail verification. | Deployed Mode | Deployed Mode is the most secure mode. In Deployed Mode , PK must be installed and the BIOS performs signature verification on programmatic attempts to update policy objects. Deployed Mode restricts the programmatic mode transitions. |
| Options | Description | | | | | | | | |
| User Mode | In User Mode , PK must be installed, and BIOS performs signature verification on programmatic attempts to update policy objects. The BIOS allows unauthenticated programmatic transitions between modes. | | | | | | | | |
| Audit Mode | In Audit mode , PK is not present. The BIOS does not authenticate programmatic updates to the policy objects, and transitions between modes. Audit Mode is useful for programmatically determining a working set of policy objects. BIOS performs signature verification on pre-boot images and logs results in the image Execution Information Table, but executes the images whether they pass or fail verification. | | | | | | | | |
| Deployed Mode | Deployed Mode is the most secure mode. In Deployed Mode , PK must be installed and the BIOS performs signature verification on programmatic attempts to update policy objects. Deployed Mode restricts the programmatic mode transitions. | | | | | | | | |
| Secure Boot Policy Summary | Specifies the list of certificates and hashes that secure boot uses to authenticate images. | | | | | | | | |

| Option | Description |
|---|--|
| Secure Boot Custom Policy Settings | Configures the Secure Boot Custom Policy. To enable this option, set the Secure Boot Policy to Custom option. |

Creating a system and setup password

Prerequisites

Ensure that the password jumper is enabled. The password jumper enables or disables the system password and setup password features. For more information, see the System board jumper settings section.

NOTE: If the password jumper setting is disabled, the existing system password and setup password are deleted and you need not provide the system password to boot the system.

Steps

1. To enter System Setup, press F2 immediately after turning on or rebooting your system.
2. On the **System Setup Main Menu** screen, click **System BIOS > System Security**.
3. On the **System Security** screen, verify that **Password Status** is set to **Unlocked**.
4. In the **System Password** field, type your system password, and press Enter or Tab.

Use the following guidelines to assign the system password:

- A password can have up to 32 characters.
- The password can contain the numbers 0 through 9.
- Only the following special characters are allowed: space, ("), (+), (,), (-), (.), (/), (:), ([), (\), (]), (').

A message prompts you to reenter the system password.

5. Reenter the system password, and click **OK**.
6. In the **Setup Password** field, type your setup password and press Enter or Tab. A message prompts you to reenter the setup password.
7. Reenter the setup password, and click **OK**.
8. Press Esc to return to the System BIOS screen. Press Esc again.

A message prompts you to save the changes.

NOTE: Password protection does not take effect until the system reboots.

Using your system password to secure the system

About this task

If you have assigned a setup password, the system accepts your setup password as an alternate system password.

Steps

1. Power on or reboot your system.
2. Type the system password and press Enter.

Next steps

When **Password Status** is set to **Locked**, type the system password and press Enter when prompted at reboot.

NOTE: If an incorrect system password is typed, the system displays a message and prompts you to reenter your password. You have three attempts to type the correct password. After the third unsuccessful attempt, the system displays an error message that the system has stopped functioning and must be turned off. Even after you turn off and restart the system, the error message is displayed until the correct password is entered.

Deleting or changing system and setup password

Prerequisites

NOTE: You cannot delete or change an existing system or setup password if the Password Status is set to Locked.

Steps

1. To enter System Setup, press F2 immediately after turning on or restarting your system.
2. On the **System Setup Main Menu** screen, click **System BIOS > System Security**.
3. On the **System Security** screen, ensure that **Password Status** is set to **Unlocked**.
4. In the **System Password** field, change or delete the existing system password, and then press Enter or Tab.
5. In the **Setup Password** field, alter or delete the existing setup password, and then press Enter or Tab.
NOTE: If you change the system password or setup password, a message prompts you to reenter the new password. If you delete the system password or setup password, a message prompts you to confirm the deletion.
6. Press Esc to return to the **System BIOS** screen. Press Esc again, and a message prompts you to save the changes.
7. Select **Setup Password**, change, or delete the existing setup password and press Enter or Tab.
NOTE: If you change the system password or setup password, a message prompts you to reenter the new password. If you delete the system password or setup password, a message prompts you to confirm the deletion.

Operating with setup password enabled

If **Setup Password** is set to **Enabled**, type the correct setup password before modifying the system setup options.

If you do not type the correct password in three attempts, the system displays the following message:

```
Invalid Password! Number of unsuccessful password attempts: <x> System Halted! Must power down.
```

```
Password Invalid. Number of unsuccessful password attempts: <x> Maximum number of password attempts exceeded. System halted.
```

Even after you turn off and restart the system, the error message is displayed until the correct password is typed. The following options are exceptions:

- If **System Password** is not set to **Enabled** and is not locked through the **Password Status** option, you can assign a system password. For more information, see the System Security Settings screen section.
- You cannot disable or change an existing system password.

NOTE: You can use the password status option with the setup password option to protect the system password from unauthorized changes.

Redundant OS Control

In the **Redundant OS Control** screen you can set the redundant OS information. This enables you to set up a physical recovery disk on the system.

Viewing Redundant OS Control

To view the **Redundant OS Control** screen, perform the following steps:

Steps

1. Power on, or restart your system.
2. Press F2 immediately after you see the following message:

```
F2 = System Setup
```

NOTE: If your operating system begins to load before you press F2, wait for the system to finish booting, and then restart your system and try again.

3. On the **System Setup Main Menu** screen, click **System BIOS**.
4. On the **System BIOS** screen, click **Redundant OS Control**.

Redundant OS Control screen details

The **Redundant OS Control** screen details are explained as follows:

About this task

| Option | Description |
|------------------------------|---|
| Redundant OS Location | <p>Enables you to select a backup disk from the following devices:</p> <ul style="list-style-type: none">· None· IDSDM· SATA Ports in AHCI mode· BOSS PCIe Cards (Internal M.2 Drives)· Internal USB <p>NOTE: RAID configurations and NVMe cards not are included as BIOS does not have the ability to distinguish between individual drives in those configurations.</p> |
| Redundant OS State | <p>NOTE: This option is disabled if Redundant OS Location is set to None.</p> <p>When set to Visible, the backup disk is visible to the boot list and OS. When set to Hidden, the backup disk is disabled and is not visible to the boot list and OS. This option is set to Visible by default.</p> <p>NOTE: BIOS will disable the device in hardware, so it cannot be accessed by the OS.</p> |
| Redundant OS Boot | <p>NOTE: This option is disabled if Redundant OS Location is set to None or if Redundant OS State is set to Hidden.</p> <p>When set to Enabled, BIOS boots to the device specified in Redundant OS Location. When set to Disabled, BIOS preserves the current boot list settings. This option is set to Disabled by default.</p> |

Miscellaneous Settings

You can use the **Miscellaneous Settings** screen to perform specific functions such as updating the asset tag and changing the system date and time.

Viewing Miscellaneous Settings

To view the **Miscellaneous Settings** screen, perform the following steps:

Steps

1. Power on, or restart your system.
2. Press F2 immediately after you see the following message:

```
F2 = System Setup
```

NOTE: If your operating system begins to load before you press F2, wait for the system to finish booting, and then restart your system and try again.

3. On the **System Setup Main Menu** screen, click **System BIOS**.
4. On the **System BIOS** screen, click **Miscellaneous Settings**.

Miscellaneous Settings details

About this task

The **Miscellaneous Settings** screen details are explained as follows:

| Option | Description |
|--------------------------------------|---|
| System Time | Enables you to set the time on the system. |
| System Date | Enables you to set the date on the system. |
| Asset Tag | Specifies the asset tag and enables you to modify it for security and tracking purposes. |
| Keyboard NumLock | Enables you to set whether the system boots with the NumLock enabled or disabled. This option is set to On by default.  NOTE: This option does not apply to 84-key keyboards. |
| F1/F2 Prompt on Error | Enables or disables the F1/F2 prompt on error. This option is set to Enabled by default. The F1/F2 prompt also includes keyboard errors. |
| Load Legacy Video Option ROM | Enables you to determine whether the system BIOS loads the legacy video (INT 10H) option ROM from the video controller. Selecting Enabled in the operating system does not support UEFI video output standards. This field is available only for UEFI boot mode. You cannot set the option to Enabled if UEFI Secure Boot mode is enabled. This option is set to Disabled by default. |
| Dell Wyse P25/P45 BIOS Access | Enables or disables the Dell Wyse P25/P45 BIOS Access. This option is set to Enabled by default. |
| Power Cycle Request | Enables or disables the Power Cycle Request. This option is set to None by default. |

iDRAC Settings utility

The iDRAC settings utility is an interface to set up and configure the iDRAC parameters by using UEFI. You can enable or disable various iDRAC parameters by using the iDRAC settings utility.

 **NOTE: Accessing some of the features on the iDRAC settings utility needs the iDRAC Enterprise License upgrade.**

For more information about using iDRAC, see *Dell Integrated Dell Remote Access Controller User's Guide* at www.dell.com/poweredgemanuals.

Device Settings

Device Settings enables you to configure the below device parameters:

- Controller Configuration Utility
- Embedded NIC Port1-X Configuration
- NICs in slotX, Port1-X Configuration
- BOSS Card configuration

Dell Lifecycle Controller

Dell Lifecycle Controller (LC) provides advanced embedded systems management capabilities including system deployment, configuration, update, maintenance, and diagnosis. LC is delivered as part of the iDRAC out-of-band solution and Dell system embedded Unified Extensible Firmware Interface (UEFI) applications.

Embedded system management

The Dell Lifecycle Controller provides advanced embedded system management throughout the lifecycle of the system. The Dell Lifecycle Controller can be started during the boot sequence and can function independently of the operating system.

 **NOTE:** Certain platform configurations may not support the full set of features provided by the Dell Lifecycle Controller.

For more information about setting up the Dell Lifecycle Controller, configuring hardware and firmware, and deploying the operating system, see the Dell Lifecycle Controller documentation at www.dell.com/poweredgemanuals.

Boot Manager

The **Boot Manager** screen enables you to select boot options and diagnostic utilities.

Viewing Boot Manager

About this task

To enter Boot Manager:

Steps

1. Power on, or restart your system.
2. Press F11 when you see the following message:

F11 = Boot Manager

If your operating system begins to load before you press F11, allow the system to complete the booting, and then restart your system and try again.

Boot Manager main menu

| Menu item | Description |
|------------------------------------|---|
| Continue Normal Boot | The system attempts to boot to devices starting with the first item in the boot order. If the boot attempt fails, the system continues with the next item in the boot order until the boot is successful or no more boot options are found. |
| One-shot Boot Menu | Enables you to access boot menu, where you can select a one-time boot device to boot from. |
| Launch System Setup | Enables you to access System Setup. |
| Launch Lifecycle Controller | Exits the Boot Manager and invokes the Dell Lifecycle Controller program. |
| System Utilities | Enables you to launch System Utilities menu such as System Diagnostics and UEFI shell. |

One-shot UEFI boot menu

One-shot UEFI boot menu enables you to select a boot device to boot from.

System Utilities

System Utilities contains the following utilities that can be launched:

- Launch Diagnostics
- BIOS Update File Explorer
- Reboot System







PXE boot

You can use the Preboot Execution Environment (PXE) option to boot and configure the networked systems, remotely.

To access the **PXE boot** option, boot the system and then press F12 during POST instead of using standard Boot Sequence from BIOS Setup. It does not pull any menu or allows managing of network devices.

Installing and removing system components

Safety instructions

-  **NOTE:** Whenever you need to lift the system, get others to assist you. To avoid injury, do not attempt to lift the system by yourself.
-  **WARNING:** Opening or removing the system cover while the system is powered on may expose you to a risk of electric shock.
-  **CAUTION:** Do not operate the system without the cover for a duration exceeding five minutes. Operating the system without the system cover can result in component damage.
-  **CAUTION:** Many repairs may only be done by a certified service technician. You should only perform troubleshooting and simple repairs as authorized in your product documentation, or as directed by the online or telephone service and support team. Damage due to servicing that is not authorized by Dell is not covered by your warranty. Read and follow the safety instructions that are shipped with your product.
-  **CAUTION:** To ensure proper operation and cooling, all bays in the system and system fans must be always populated with a component or a blank.
-  **NOTE:** It is recommended that you always use an antistatic mat and antistatic strap while working on components inside the system.

Before working inside your system

Prerequisites

Follow the safety guidelines listed in [Safety instructions](#).

Steps

1. Power off the system and all attached peripherals.
2. Disconnect the system from the electrical outlet, and disconnect the peripherals.
3. Remove the system cover.

After working inside your system

Prerequisites

Follow the safety guidelines listed in [Safety instructions](#) on page 40.

Steps

1. [Install the system cover](#).
2. Place the system upright on a flat, stable surface.
3. Reconnect the peripherals and connect the system to the electrical outlet.
4. Power on the attached peripherals and then power on the system.

Recommended tools

You need the following tools to perform the removal and installation procedures:

- Key to the bezel lock
The key is required only if your system includes a bezel.
- Phillips #1 screwdriver
- Phillips #2 screwdriver
- 5mm hex nut screwdriver
- Plastic scribe
- Wrist grounding strap connected to the ground
- ESD mat

Front bezel

Removing the front bezel

Prerequisites

1. Follow the safety guidelines listed in [Safety instructions](#).
2. Keep the bezel key handy.

Steps

1. Unlock the bezel.
2. Press the blue release latch at the top of the bezel to release the bezel from the system.
3. Unhook the bezel tabs from the slots at the bottom, and lift the bezel.



Figure 17. Removing the front bezel

Next steps

1. [Replace the front bezel](#).

Installing the front bezel

Prerequisites

1. Follow the safety guidelines listed in [Safety instructions](#).

2. Locate and remove the bezel key.

NOTE: The bezel key is part of the bezel package.

Steps

1. Align and insert the bezel tabs into the slots in the system.
2. Press the release latch, and push the bezel toward the system until the bezel locks into place.
3. Lock the bezel.



Figure 18. Installing the front bezel

System feet

Removing the system feet

Prerequisites

NOTE: It is recommended that you remove the system feet only when you are replacing the system feet with the wheel assembly.

1. Follow the safety guidelines listed in [Safety instructions](#).
2. Place the system on its side on a flat, stable surface.
3. Rotate the system feet inward.

Steps

1. Using the Phillips #2 screwdriver, remove the screw that secures the foot to the base of the system.
2. Repeat the preceding step to remove the remaining system feet.



Figure 19. Removing the system feet

Next steps

1. [Replace the system feet](#) or [install the caster wheels](#).

Installing the system feet

Prerequisites

CAUTION: Install the feet on a stand-alone tower system to provide stability to the system. An unstable system might tip over and cause injury to the user or damage to the system.

1. Follow the safety guidelines listed in [Safety instructions](#).
2. Place the system on its side on a flat, stable surface.

Steps

1. Align the three tabs on the system foot with the three slots on the base of the system.
2. Using the Phillips #2 screwdriver, secure the screw that secures the foot to the base of the system.
3. Repeat the above steps to install the remaining system feet.



Figure 20. Installing the system feet

Next steps

1. Place the system upright on a flat, stable surface, and rotate the system feet outward.
2. Follow the procedure listed in [After working inside your system](#).

Caster wheels – optional

Removing caster wheels

Prerequisites

1. Follow the safety guidelines listed in [Safety instructions](#).
2. Place the system on its side on a flat, stable surface.

Steps

1. Using the Phillips #2 screwdriver, loosen the captive screw that secures the front wheel unit to the base of the system.
2. Push the front wheel unit toward the rear of the system to release the retention hooks, and pull out the front wheel unit.
3. Loosen the screw that secures the back wheel unit to the base of the system.
4. Push the rear wheel unit toward the front of the system to release the retention hooks, and pull out the rear wheel unit.



Next steps

1. [Replace the caster wheels](#) or [replace the system feet](#), as applicable.

Installing caster wheels

Prerequisites

1. Follow the safety guidelines listed in [Safety instructions](#).
2. Place the system on its side on a flat, stable surface.
3. If installed, [remove the system feet](#).

Steps

1. Align the two retention hooks on the rear wheel unit with the two slots on the base of the system, and insert the hooks into the slots.
2. Push the rear wheel unit toward the back of the system and using a Phillips #2 screwdriver secure the unit in place using a single screw.
3. Align the two retention hooks on the front wheel unit with the two slots on the base of the system, and insert the hooks into the slots.
4. Push the front wheel unit toward the front of the system and using a Phillips #2 screwdriver secure the unit in place using a single screw.



Figure 21. Installing castor wheels

Next steps

1. Follow the procedure listed in [After working inside your system.](#)

System cover

Removing the system cover

Prerequisites

1. Follow the safety guidelines listed in [Safety instructions.](#)
2. Power off the system and all attached peripherals.
3. Disconnect the system from the electrical outlet and disconnect the peripherals.
4. Place the system on a flat, stable surface.
5. [Remove the front bezel.](#)

Steps

1. Use a 1/4-inch flat head or a Phillips #2 screwdriver to turn the cover release latch counterclockwise to the unlock position.
2. Press the cover release latch, and remove the system cover.

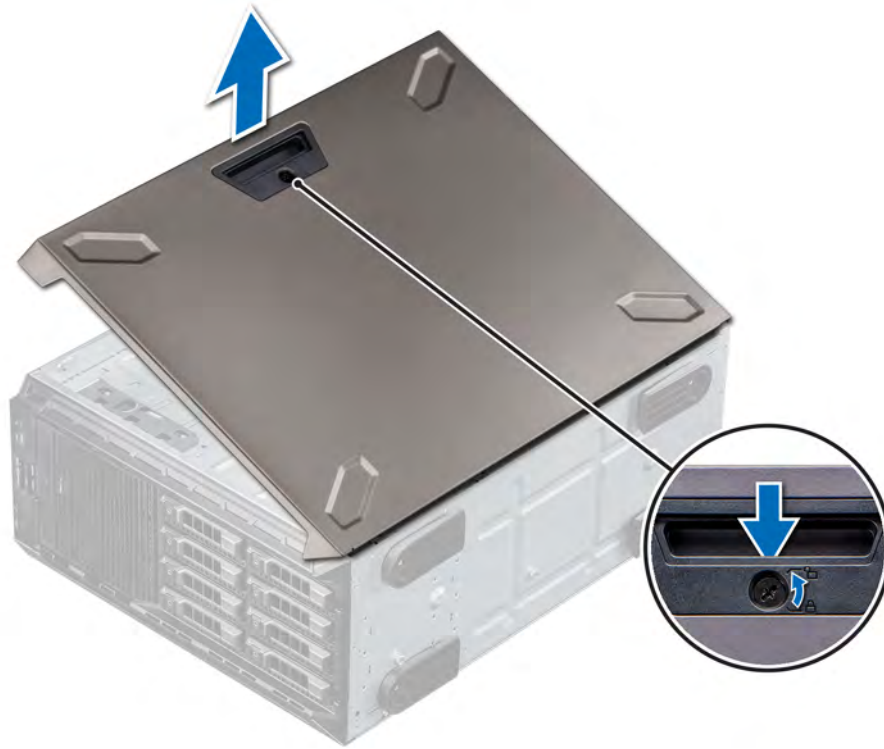

Figure 22. Removing the system cover

Installing the system cover

Prerequisites

1. Follow the safety guidelines listed in [Safety instructions](#).
2. [Remove the front bezel](#).
3. Power off the system and all attached peripherals.
4. Disconnect the system from the electrical outlet and disconnect the peripherals.
5. Ensure that all internal cables are connected and placed out of the way and no tools or extra parts are left inside the system.

Steps

1. Align the tabs on the system cover with the slots on the system.
2. Press the cover release latch, and push the cover toward the system until the latch locks into place.
3. Using a 1/4-inch flat head or a Phillips #2 screwdriver, rotate the cover release latch lock clockwise to the locked position.



Figure 23. Installing the system cover

Next steps

1. Place the system upright on its feet on a flat, stable surface.
2. [Install the front bezel.](#)
3. Reconnect the peripherals, and connect the system to the electrical outlet.
4. Power on the system and all attached peripherals.

Air shroud

Removing the air shroud

Prerequisites

CAUTION: Never operate your system with the air shroud removed. The system may get overheated quickly, resulting in shutdown of the system and loss of data.

1. Follow the safety guidelines listed in [Safety instructions.](#)
2. Follow the procedure listed in [Before working inside your system.](#)
3. [Remove the system cover.](#)

Steps

Holding the blue touch points, lift the air shroud out of the system.

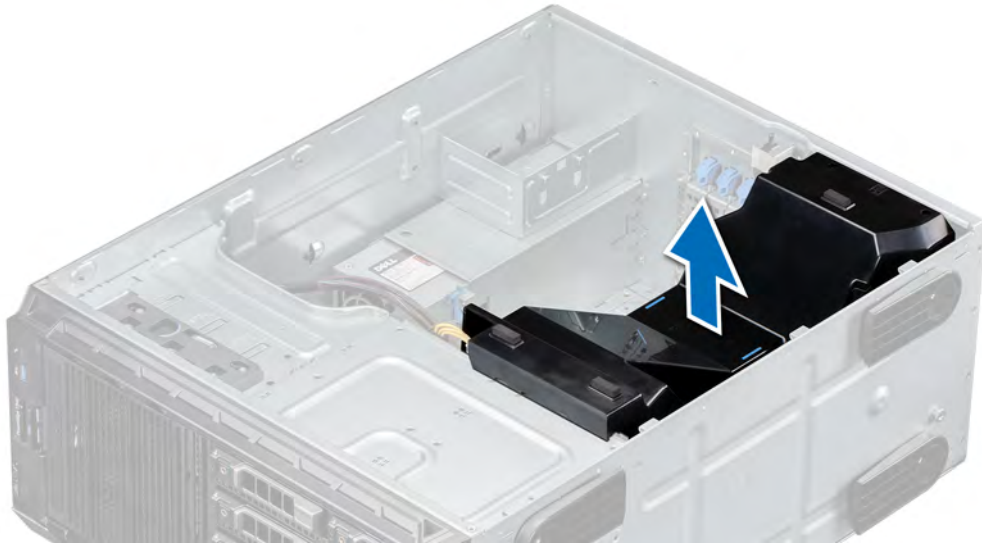

Figure 24. Removing the air shroud

Next steps

1. [Replace the air shroud.](#)

Installing the air shroud

Prerequisites

1. Follow the safety guidelines listed in [Safety instructions.](#)
2. Follow the procedure listed in [Before working inside your system.](#)
3. If applicable, route the cables inside the system along the system wall and secure the cables by using the cable-securing bracket.

Steps

1. Align the tabs on the air shroud with the slots on the system.
2. Lower the air shroud into the system until it is firmly seated.

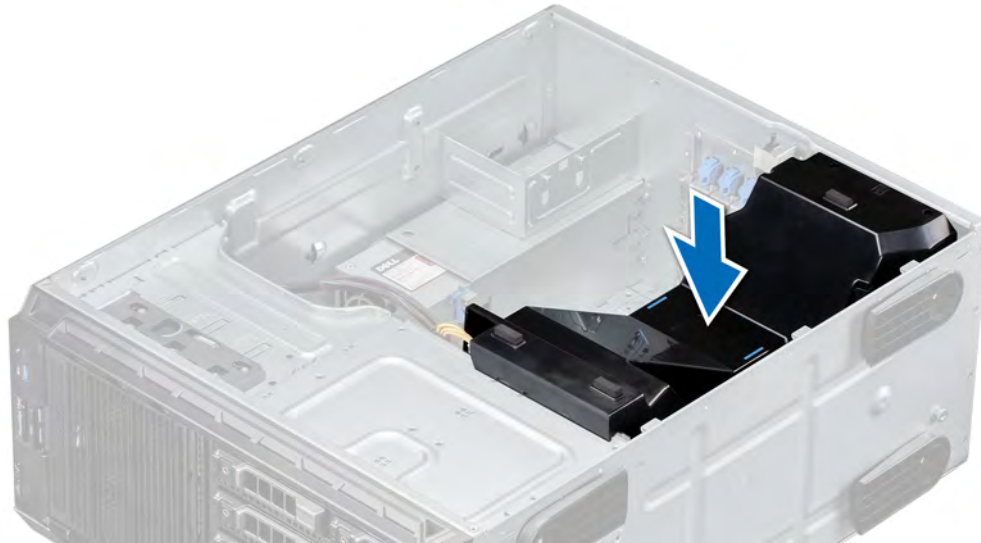

Figure 25. Installing the air shroud

Next steps

1. [Install the system cover.](#)
2. Follow the procedure listed in [Before working inside your system.](#)

Intrusion switch

Removing the intrusion switch

Prerequisites

1. Follow the safety guidelines listed in [Safety instructions.](#)
2. Follow the procedure listed in [Before working inside your system.](#)
3. Keep the plastic scribe ready.

Steps

1. Disconnect the intrusion switch cable connector from the system board.

i **NOTE:** Observe the routing of the cable as you remove it from the system. Route the cable properly when you replace it to prevent the cable from being pinched or crimped.

2. Using the plastic scribe, slide the intrusion switch out of the intrusion switch slot.

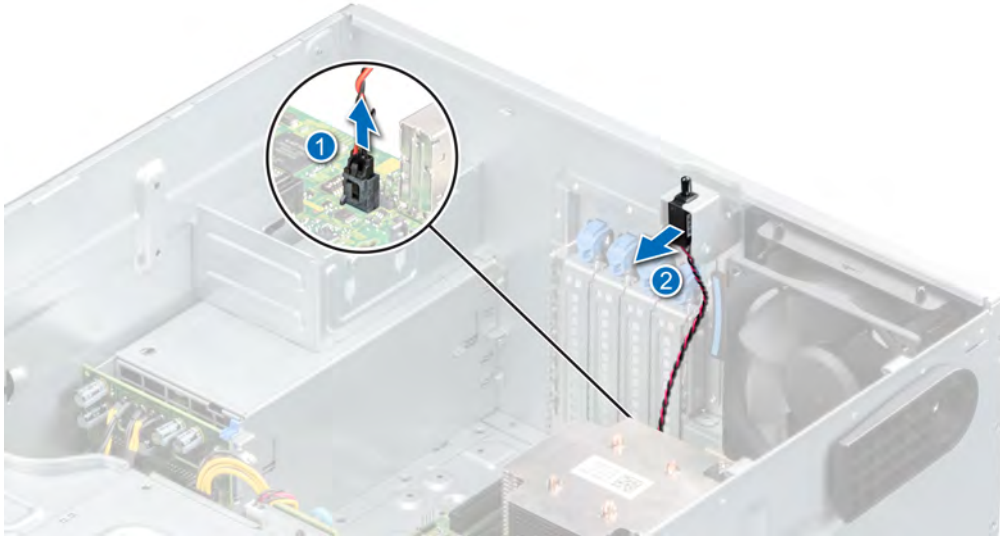

Figure 26. Removing the intrusion switch

Next steps

1. [Replace the intrusion switch.](#)

Installing the intrusion switch

Prerequisites

1. Follow the safety guidelines listed in [Safety instructions](#).
2. Follow the procedure listed in [Before working inside your system](#).

Steps

1. Align and slide the intrusion switch into the slot in the system.
2. Connect the intrusion switch cable connector to the intrusion switch connector on the system board.

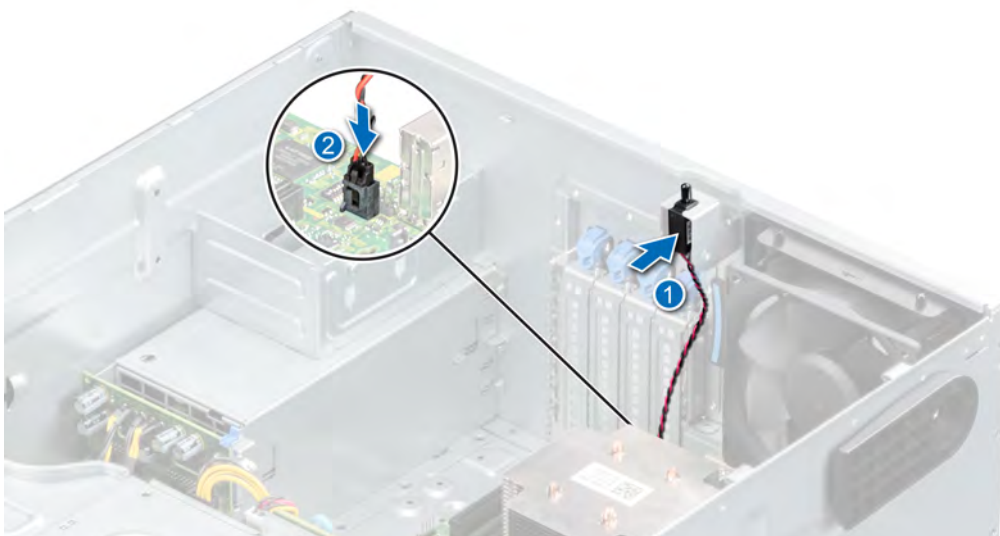

Figure 27. Installing the intrusion switch

Next steps

1. [Install the air shroud.](#)
2. Follow the procedure that is listed in [After working inside your system.](#)

Drives

Removing a drive blank

Prerequisites

1. Follow the safety guidelines listed in [Safety instructions.](#)
2. Follow the procedure listed in [Before working inside your system.](#)
3. [Remove the front bezel.](#)

CAUTION: To maintain proper system cooling, drive blanks must be installed in all empty drive slots.

CAUTION: Mixing drive blanks from previous generations of PowerEdge servers is not supported.

Steps

Press the release tab, and slide the drive blank out.

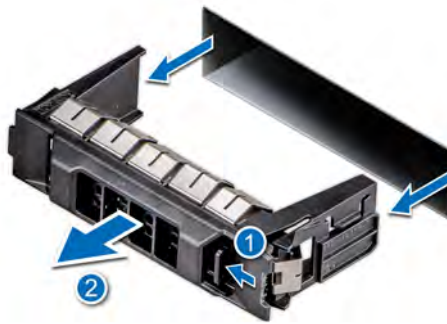

Figure 28. Removing a drive blank

NOTE: The procedure to remove a 2.5-inch or a 3.5-inch drive blank is the same.

Next steps

1. [Replace the drive](#) or a [drive blank.](#)

Installing a drive blank

Prerequisites

1. Follow the safety guidelines listed in [Safety instructions.](#)
2. Follow the procedure in [Before working inside your system.](#)
3. [Remove the front bezel.](#)

CAUTION: To maintain proper system cooling, drive blanks must be installed in all empty drive slots.

CAUTION: Mixing drive blanks from previous generations of PowerEdge servers is not supported.

Steps

Slide the drive blank into the drive slot until the release tab clicks into place.

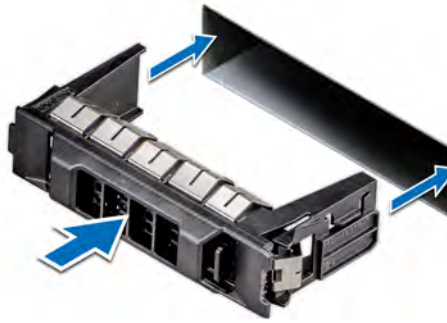

Figure 29. Installing a drive blank

Next steps

1. [Replace the front bezel.](#)
2. Follow the procedure listed in [After working inside your system.](#)

Removing a drive carrier

Prerequisites

1. Follow the safety guidelines listed in [Safety instructions.](#)
2. [Remove the front bezel.](#)
3. Using the management software, prepare the drive for removal.

If the drive is online, the green activity or fault indicator flashes while the drive is turning off. When the drive indicators are off, the drive is ready for removal. For more information, see the storage controller documentation.

CAUTION: Before attempting to remove or install a drive while the system is running, see the documentation for the storage controller card to ensure that the host adapter is configured correctly to support drive removal and insertion.

CAUTION: To prevent data loss, ensure that your operating system supports drive installation. See the documentation supplied with your operating system.

Steps

1. Press the release button to open the drive carrier release handle.
2. Holding the handle, slide the drive carrier out of the drive slot.

NOTE: If you are not replacing the drive immediately, install a drive blank in the empty drive slot to maintain proper system cooling.



Figure 30. Removing a drive carrier

Next steps

Replace the drive or a drive blank.

Installing the drive carrier

Prerequisites

- ⚠ **CAUTION:** Before removing or installing a drive while the system is running, see the documentation for the storage controller card to ensure that the host adapter is configured correctly to support drive removal and insertion.
- ⚠ **CAUTION:** Combining SAS and SATA drives in the same RAID volume is not supported.
- ⚠ **CAUTION:** When installing a drive, ensure that the adjacent drives are fully installed. Inserting a drive carrier and attempting to lock its handle next to a partially installed carrier can damage the partially installed carrier's shield spring and make it unusable.
- ℹ **NOTE:** Ensure that the drive carrier's release handle is in the open position before inserting the carrier into the slot.
- ⚠ **CAUTION:** To prevent data loss, ensure that your operating system supports hot-swap drive installation. See the documentation supplied with your operating system.
- ⚠ **CAUTION:** When a replacement hot swappable drive is installed and the system is powered on, the drive automatically begins to rebuild. Ensure that the replacement drive is blank or contains data that you wish to overwrite. Any data on the replacement drive is immediately lost after the drive is installed.

1. Follow the safety guidelines listed in [Safety instructions](#).
2. Follow the procedure listed in [Before working inside your system](#).
3. [Remove the front bezel](#).
4. If installed, [remove a drive blank](#).

Steps

1. Press the release button on the front of the drive carrier to open the release handle.
2. Insert the drive carrier into the drive slot and push until the drive connects with the backplane.
3. Close the drive carrier release handle to lock the drive in place.

NOTE: The procedure to install a 2.5-inch or a 3.5-inch drive are the same.



Figure 31. Installing a drive carrier

Next steps

1. [Install the front bezel.](#)
2. Follow the procedure listed in [After working inside your system.](#)

Removing the drive from the drive carrier

Prerequisites

1. Follow the safety guidelines listed in [Safety instructions.](#)

CAUTION: Mixing drive carriers from previous generations of PowerEdge servers is not supported.

2. Follow the procedure listed in [Before working inside your system.](#)
3. [Remove the front bezel.](#)
4. [Remove the drive carrier.](#)

Steps

1. Using a Phillips #1 screwdriver, remove the screws from the slide rails on the drive carrier.
2. Lift the drive out of the drive carrier.



Figure 32. Removing the drive from the drive carrier

Next steps

1. [Replace the drive into the drive carrier.](#)

Installing the drive into the drive carrier

Prerequisites

1. Follow the safety guidelines listed in [Safety instructions](#).
2. Follow the procedure listed in [Before working inside your system](#).
3. [Remove the front bezel.](#)
4. [Remove the drive carrier.](#)

CAUTION: Mixing drive carriers from other generations of PowerEdge servers is not supported.

Steps

1. Insert the drive into the drive carrier with the connector end of the drive towards the back of the carrier.
2. Align the screw holes on the drive with the screws holes on the drive carrier. When aligned correctly, the back of the drive is flush with the back of the drive carrier.
3. Using a Phillips #1 screwdriver, replace the screws to secure the drive to the drive carrier.

NOTE: When installing a drive into the drive carrier, ensure that the screws are torqued to 4 in-pounds.

NOTE: Use the screws shipped with the drive carrier to secure the drive to the drive carrier.



Figure 33. Installing a drive into the drive carrier

Next steps

1. [Replace the drive carrier.](#)
2. [Install the front bezel.](#)
3. Follow the procedure listed in [After working inside your system.](#)

Removing a 2.5-inch drive from the 3.5-inch drive adapter

Prerequisites

1. Follow the safety guidelines listed in [Safety instructions.](#)
2. Follow the procedure listed in [Before working inside your system.](#)
3. [Remove 3.5-inch drive adapter from the 3.5-inch drive carrier.](#)

NOTE: A 2.5 inch hot swappable drive is installed in a 3.5-inch drive adapter, which is then installed in the 3.5-inch hot swappable drive carrier.

Steps

1. Using a Phillips #1 screwdriver, remove the screws from the side of the 3.5-inch drive adapter.
2. Remove the drive from the 3.5-inch drive adapter.

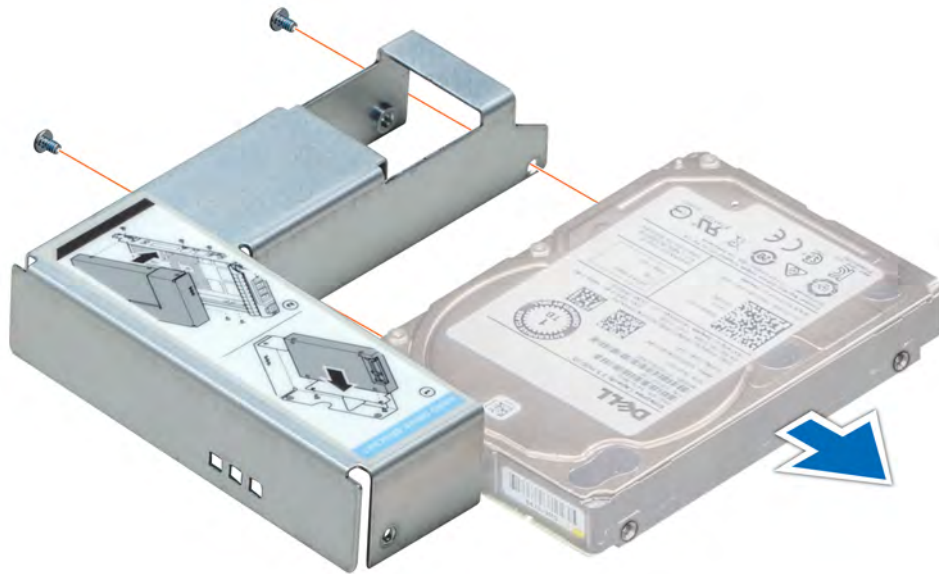

Figure 34. Removing a 2.5-inch drive from the 3.5-inch drive adapter

Next steps

Replace a 2.5-inch drive into the 3.5-inch drive adapter.

Installing a 2.5-inch drive into the 3.5-inch drive adapter

Prerequisites

Follow the safety guidelines listed in [Safety instructions](#).

Steps

1. Align the screw holes on the 2.5-inch drive with the screw holes on the 3.5-inch drive adapter.
2. Using a Phillips #1 screwdriver, install the screws to secure the drive to the 3.5-inch drive adapter.

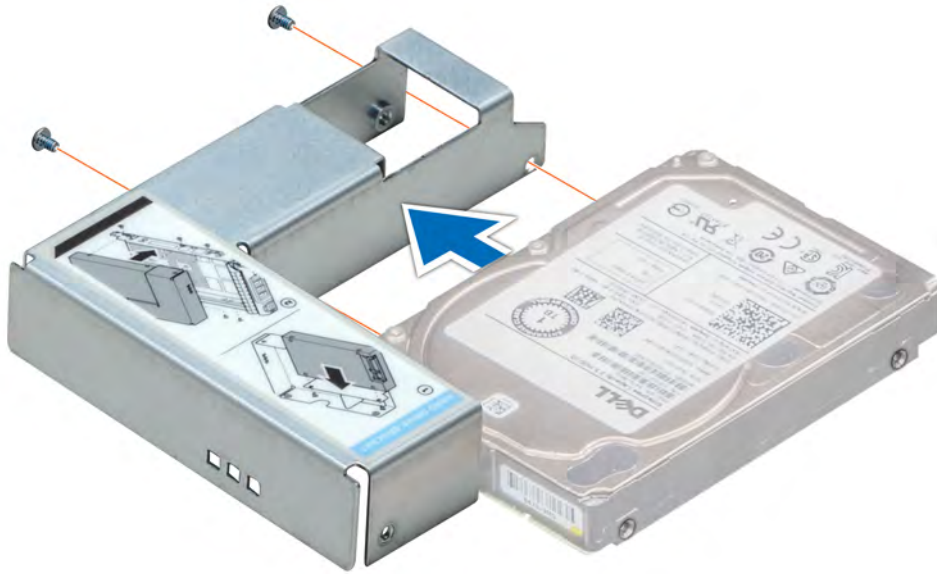

Figure 35. Installing a 2.5-inch drive into the 3.5-inch drive adapter

Next steps

1. [Replace a 3.5-inch adapter into the 3.5-inch drive carrier.](#)
2. Follow the procedure listed in [After working inside your system.](#)

Removing a 3.5-inch drive adapter from a 3.5-inch drive carrier

Prerequisites

1. Follow the safety guidelines listed in [Safety instructions.](#)
2. Follow the procedure listed in [Before working inside your system.](#)
3. [Remove the 3.5-inch drive carrier from the system.](#)

Steps

1. Remove the screws from the rails on the drive carrier.
2. Lift the 3.5 inch drive adapter out of the drive carrier.

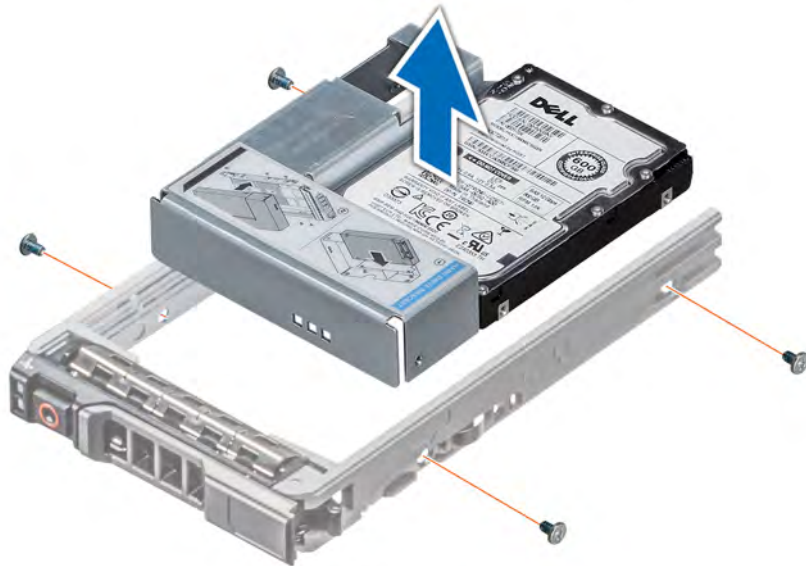

Figure 36. Removing a 3.5-inch drive adapter from a 3.5-inch drive carrier

Next steps

Replace a 3.5-inch adapter into a 3.5-inch drive carrier.

Installing a 3.5-inch adapter into a 3.5-inch drive carrier

Prerequisites

Follow the safety guidelines listed in [Safety instructions](#).

Steps

1. Insert the 3.5 inch drive adapter into the drive carrier with the connector end of the drive toward the back of the drive carrier.
2. Align the screw holes on the drive with the holes on the drive carrier.
3. Install the screws to secure the drive to the drive carrier.

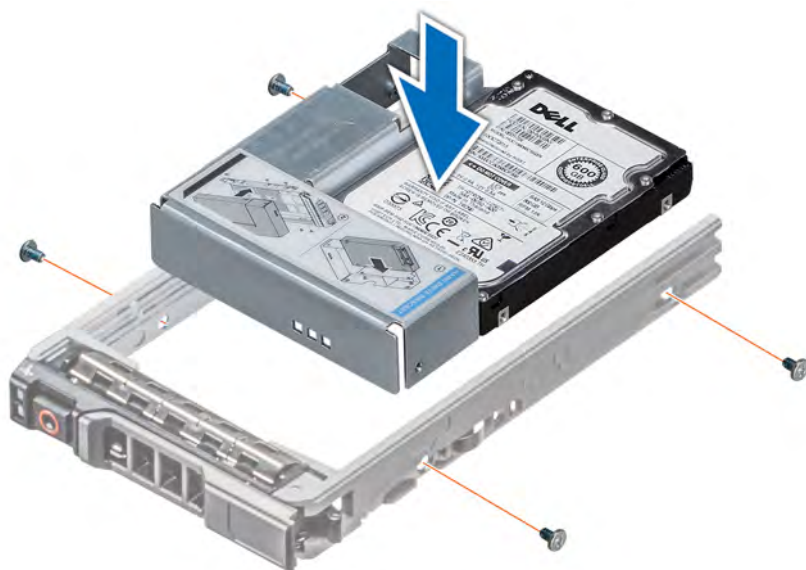

Figure 37. Installing a 3.5-inch drive adapter into the 3.5-inch drive carrier

Next steps

1. [Replace a 3.5-inch drive carrier into the system.](#)
2. Follow the procedure listed in [After working inside your system.](#)

Optical drive and tape drives

Removing the optical or tape drive blank

Prerequisites

i **NOTE:** The procedure to remove the optical drive blank is identical to removing a tape drive blank.

1. Follow the safety guidelines listed in [Safety instructions.](#)
2. Follow the procedure listed in [Before working inside your system.](#)
3. [Remove the front bezel.](#)

Steps

1. Slide the release latch downwards to remove the drive blank.
2. Push the drive blank to slide it out of the drive bay.



Figure 38. Removing the optical drive or tape drive blank

i **NOTE:** Blanks must be installed on empty optical drive or tape drive slots to maintain FCC certification of the system. The brackets also keep dust and dirt out of the system and aid in proper cooling and airflow inside the system. Perform the same steps to install blanks.

Next steps

[Replace the optical drive blank, or an optical drive, or a tape drive.](#)

Installing the optical or tape drive blank

Prerequisites

1. Follow the safety guidelines listed in [Safety instructions](#).
2. [Remove the front bezel](#).

Steps

1. Align the guide on the drive blank with the slot on drive bay.
2. Slide the drive into the slot until the latch snaps into place.



Figure 39. Installing the optical or tape drive blank

Next steps

1. [Install the front bezel](#).
2. Follow the procedure listed in [After working inside your system](#).

Removing the optical drive

Prerequisites

1. Follow the safety guidelines listed in [Safety instructions](#).
2. Follow the procedure listed in [Before working inside your system](#).
3. [Remove the front bezel](#).

Steps

1. Disconnect the power and data cable connectors from the connectors on the optical drive.

NOTE: Observe the routing of the power and data cable inside the chassis as you remove them from the system board and the drive. You must route these cables properly when you replace them to prevent them from being pinched or crimped.

2. To remove the drive, slide the release latch downwards to release the drive.
3. Slide the drive out of the drive bay.
4. If you are not immediately replacing the tape drive, install the blank.

NOTE: Blanks must be installed on empty optical drive or tape drive slots to maintain FCC certification of the system. The brackets also keep dust and dirt out of the system and aid in proper cooling and airflow inside the system. Perform the same steps to install blanks.



Figure 40. Removing the optical drive

Next steps

1. [Replace the optical drive.](#)
2. Follow the procedure listed in [After working inside your system.](#)

Installing the optical drive

Prerequisites

1. Ensure that you follow the procedure listed in [Safety instructions.](#)
2. Follow the procedure listed in [Before working inside your system.](#)
3. [Remove the front bezel.](#)
4. If applicable, [remove the optical drive blank.](#)

NOTE: The procedure to remove the optical drive blank and the optical drive is similar.

Steps

1. Align the slide the optical drive into the slot until the latch clicks into place.
2. Connect the power and data cable connectors to the connectors on the optical drive.
3. Connect the power and data cable connectors to the backplane and the system board.

NOTE: Route the cables properly to prevent them from being pinched or crimped.



Figure 41. Installing the optical drive

Next steps

1. [Install the front bezel.](#)
2. Follow the procedure listed in [After working inside your system.](#)

Removing the tape drive

Prerequisites

1. Follow the safety guidelines listed in [Safety instructions.](#)
2. Follow the procedure listed in [Before working inside your system.](#)
3. [Remove the front bezel.](#)

Steps

1. Disconnect the power and data cable connectors from the connectors on the tape drive.

NOTE: Observe the routing of the power and data cable connectors inside the chassis as you remove them from the system board and the drive. You must route these cables properly when you replace them to prevent them from being pinched or crimped.

2. Using the Phillips #2 screwdriver, remove the screw that secures the tape drive.
3. Push the release latch to release the drive.
4. Slide the drive out of the drive bay.
5. If you are not immediately replacing the tape drive, install the blank.

NOTE: Blanks must be installed on empty tape drive slots to maintain FCC certification of the system. The brackets also keep dust and dirt out of the system and aid in proper cooling and airflow inside the system. Perform the same steps to install blanks.

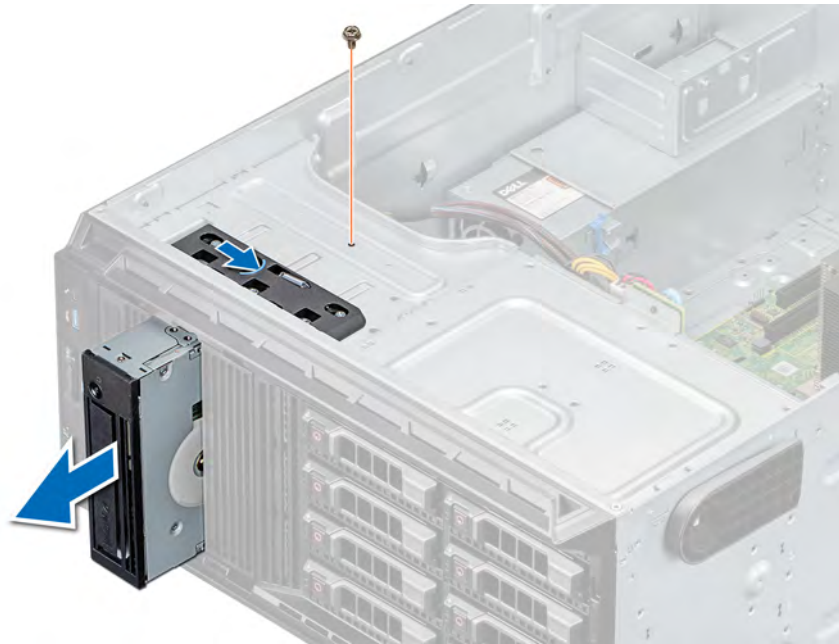

Figure 42. Removing the tape drive

Next steps

1. [Replace the tape drive.](#)
2. Follow the procedure listed in [After working inside your system.](#)

Installing the tape drive

Prerequisites

1. Ensure that you follow the procedure listed in [Safety instructions.](#)
2. Follow the procedure listed in [Before working inside your system.](#)
3. [Remove the front bezel.](#)
4. If applicable, [remove the tape drive blank.](#)

i **NOTE:** The procedure to remove the tape drive blank and the tape drive is similar.

Steps

1. Align and slide the tape drive into the tape drive bay until it clicks into place.
2. Using the Phillips #2 screwdriver, secure the tape drive to the drive bay.
3. Connect the power and data cable connectors to the connectors on the tape drive.
4. Connect the power and data cable connectors to the backplane and the system board.

i **NOTE:** Route the cables properly to prevent them from being pinched or crimped.

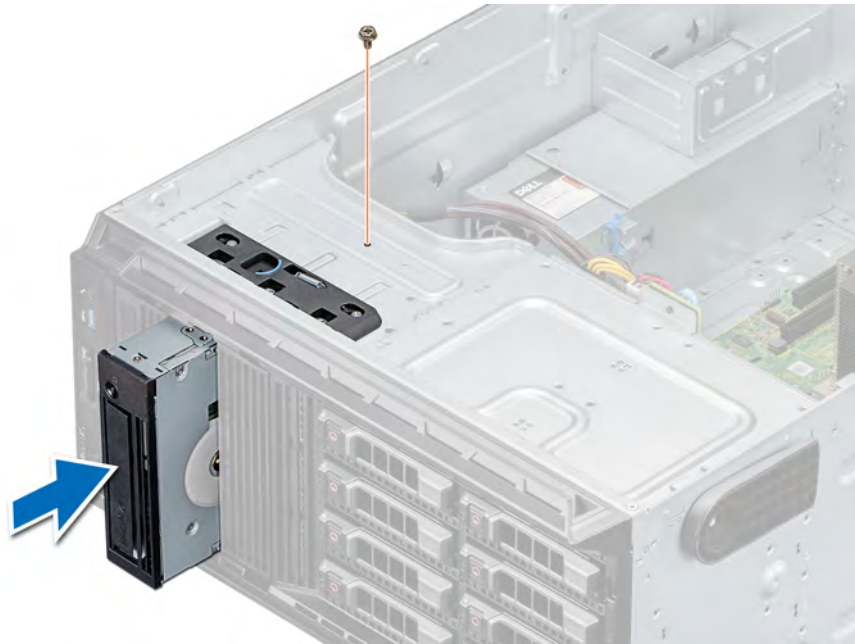

Figure 43. Installing the tape drive

Next steps

1. [Install the front bezel.](#)
2. Follow the procedure listed in [After working inside your system.](#)

Drive backplane

Drive backplane details

Your system supports the following backplane configuration:

- x8 SAS/SATA backplane for 3.5-inch drives

i **NOTE:** The x8 backplane also supports up to eight 2.5-inch (SAS, SATA, or SSD) hot swappable drives that can be installed in 3.5-inch drive adapters, which can be installed in the 3.5-inch drive carriers.

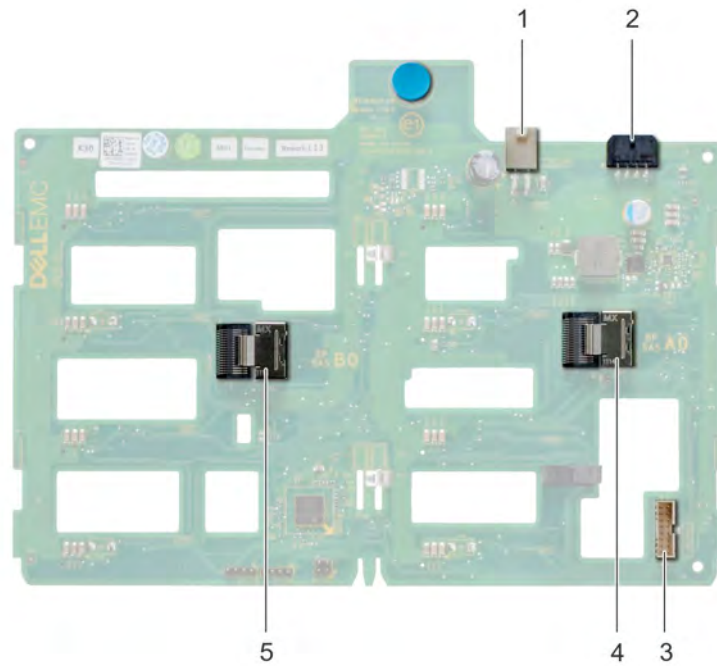

Figure 44. x8 SAS/SATA backplane for 3.5-inch drives

1. ODD power connector (P1)
2. Backplane P4 power connector (BP_PWR)
3. Backplane sideband signal connector (BP_SIG)
4. Mini SAS SAS_A0
5. Mini SAS SAS_B0

Removing the drive backplane

Prerequisites

CAUTION: Note the number of each drive and temporarily label them before you remove the drive so that you can replace them in the same location.

1. Follow the safety guidelines listed in [Safety instructions](#).
2. Follow the procedure listed in [Before working inside your system](#).
3. [Remove the front bezel](#).
4. [Remove all the drives](#).

CAUTION: To prevent damage to the drives and backplane, remove the drives from the system before removing the backplane.

5. [Remove the air shroud](#).

Steps

1. Disconnect the data, signal, and power cables from the backplane.
2. Pull the release pin to disengage the backplane from the system.
3. Lift the backplane out of the system.



Figure 45. Removing the drive backplane

Next steps

1. [Replace a drive backplane.](#)
2. Follow the procedure listed in [After working inside your system.](#)

Installing the drive backplane

Prerequisites

1. Follow the safety guidelines listed in [Safety instructions.](#)
2. Follow the procedure listed in [Before working inside your system.](#)
3. [Remove the front bezel.](#)
4. [Remove the air shroud.](#)
5. [Remove all the drives.](#)

Steps

1. Align the slots on the backplane with the hooks on the system.
2. Lower the drive backplane into the system until the release pin locks in place, securing the drive backplane to the system.
3. Connect the data, signal, and power cables to the backplane.



Figure 46. Installing the drive backplane

Next steps

1. Install the air shroud.
2. Install the drives.
3. Install the front bezel.
4. Follow the procedure listed in [After working inside your system](#).

Backplane cable routing



Figure 47. Cable routing - 8 x 3.5-inch, SATA drive backplane

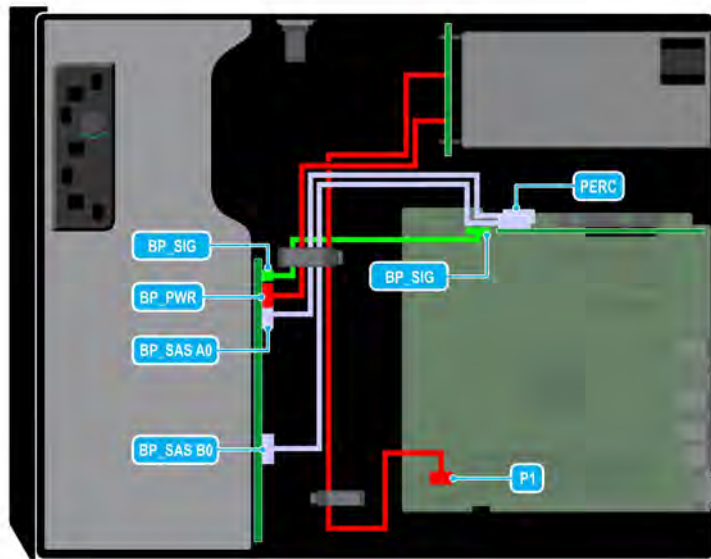

Figure 48. Cable routing - 8 x 3.5-inch SAS/SATA drive backplane with PERC card

Four-slot drive blank

Systems with x8 drive backplanes configured for software RAID support only four drives. The remaining drive slots are pre-installed with the four-slot drive blank, and cannot be upgraded for additional storage.

Removing a four-slot drive blank

Prerequisites

CAUTION: To maintain proper system cooling, all empty drive slots must have drive blanks installed.

1. Follow the safety guidelines listed in [Safety instructions](#).
2. Follow the procedure listed in [Before working inside your system](#).

CAUTION: To prevent damage to the drives and backplane, you must remove the drives from the system before removing the backplane.

CAUTION: Note the slot number of each drive and temporarily label the slots before removing the drives so that you can replace them in the same locations.

3. [Remove the air shroud](#).
4. [Remove all the drives](#).
5. [Remove the drive backplane](#).

Steps

1. Using a screwdriver, push the release tabs on the corners of the blank from inside the system, to unlock the four-slot hard drive blank from the chassis.
2. From the front of the system, pull the four-slot hard drive blank at the corners until it is free of the hard drive slot.

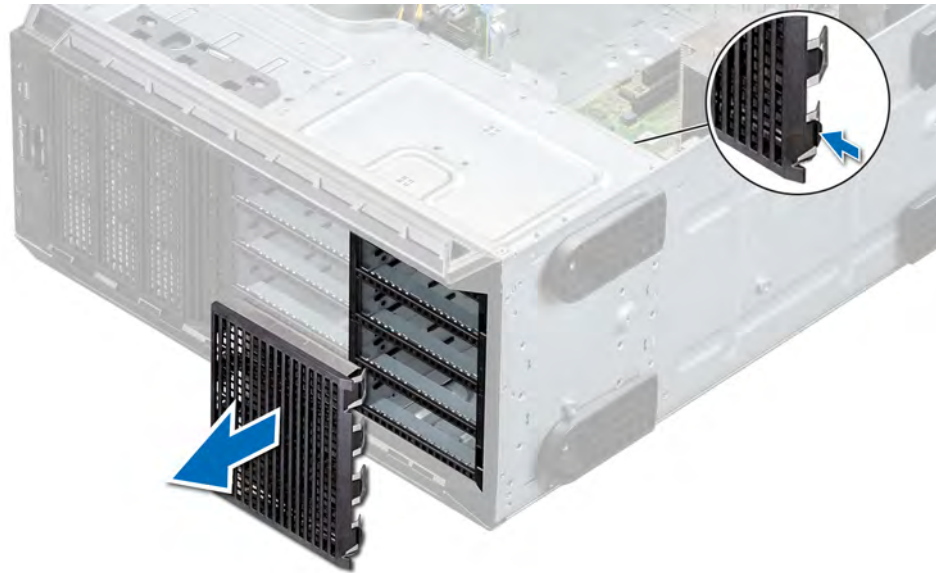

Figure 49. Removing a four-slot drive blank

Next steps

1. [Replace a four-slot drive blank.](#)

Installing a four-slot drive blank

Prerequisites

1. Follow the safety guidelines listed in [Safety instructions](#).
2. Follow the procedure listed in [Before working inside your system](#).

Steps

1. Locate the drive slots numbered from four to seven.
2. Insert the four-slot drive blank into the drive slot, and push it until the release tabs click into place.

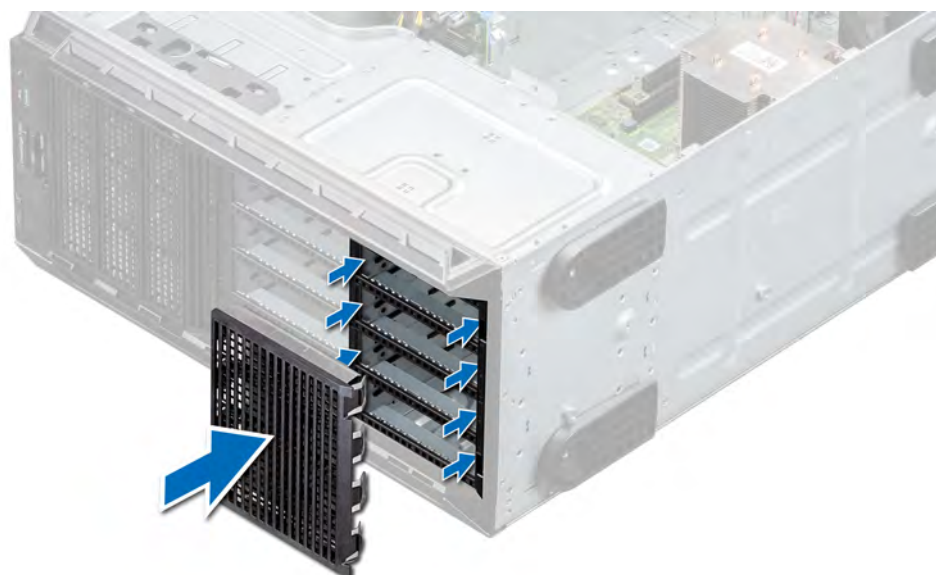

Figure 50. Installing a four-slot drive blank

Next steps

1. [Install the drive backplane.](#)
2. [Install the drives.](#)
3. [Install the air shroud.](#)
4. Follow the procedure listed in [After working inside your system.](#)

System memory

System memory guidelines

The system supports DDR4 unbuffered DIMMs (UDIMMs). System memory holds the instructions that are executed by the processor.

Your system contains 4 memory sockets. Two memory channels are allocated to the processor.

Memory channels are organized as follows:

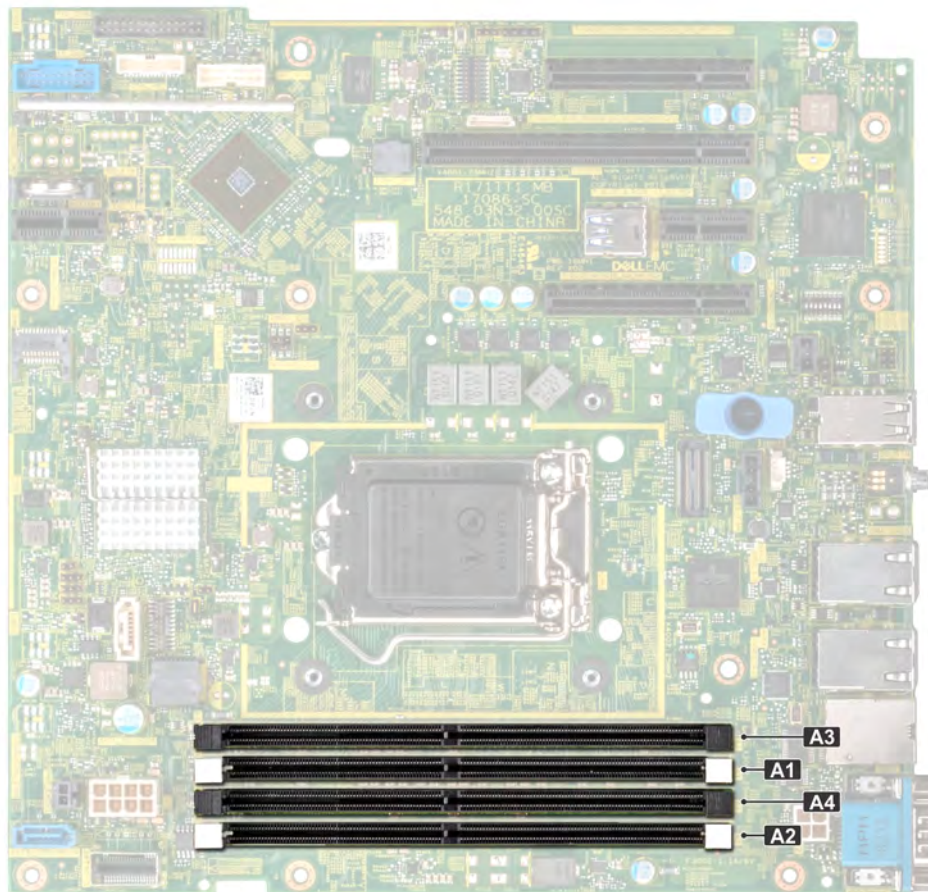

Figure 51. System memory view

Table 5. Memory channels

| Processor | Channel 0 | Channel 1 |
|-------------|--------------|--------------|
| Processor 1 | Slots A1, A3 | Slots A2, A4 |

The following table shows the memory populations and operating frequencies for the supported configurations:

Table 6. Memory population

| DIMM Type | DIMMs Populated/ Channel | Voltage | Operating Frequency (in MT/s) | Maximum DIMM Rank/ Channel |
|-----------|--------------------------|---------|-------------------------------|----------------------------|
| UDIMM | 1 | 1.2 V | 2133, 2400, 2666 | Dual rank or single rank |
| | 2 | | 2133, 2400, 2666 | Dual rank or single rank |

General memory module installation guidelines

To ensure optimal performance of your system, observe the following general guidelines when configuring your system memory. If your system's memory configurations fail to observe these guidelines, your system might not boot, stop responding during memory configuration, or operate with reduced memory.

The memory bus may operate at frequency can be 2666 MT/s, 2400 MT/s, or 2133 MT/s depending on the following factors:

- System profile selected (for example, Performance Optimized, or Custom [can be run at high speed or lower])
- Maximum supported DIMM speed of the processors.
- Maximum supported speed of the DIMMs

 **NOTE: MT/s indicates DIMM speed in MegaTransfers per second.**

The system supports Flexible Memory Configuration, enabling the system to be configured and run in any valid chipset architectural configuration. The following are the recommended guidelines for installing memory modules:

- All DIMMs must be DDR4.
- A maximum of two different ranked DIMMs can be populated in a channel regardless of rank count.
- If memory modules with different speeds are installed, they will operate at the speed of the slowest installed memory module(s).
- Populate memory module sockets only if a processor is installed.
 - For single-processor systems, sockets A1 to A4 are available.
 - In **Optimizer Mode**, the DRAM controllers operate independently in the 64-bit mode and provide optimized memory performance.

Table 7. Memory population rules

| Processor | Configuration | Memory population | Memory population information |
|------------------|--|-------------------|--|
| Single processor | Optimizer (Independent channel) population order | 1, 2, 3, 4 | Odd amount of DIMMs per processor allowed. |

- Populate all the sockets with white release tabs first, followed by the black release tabs.
- When mixing memory modules with different capacities, populate the sockets with memory modules with the highest capacity first.

For example, if you want to mix 8 GB and 16 GB memory modules, populate 16 GB memory modules in the sockets with white release tabs and 8 GB memory modules in the sockets with black release tabs.
- Memory modules of different capacities can be mixed provided other memory population rules are followed.

For example, 8 GB and 16 GB memory modules can be mixed.
- Mixing of more than two memory module capacities in a system is not supported.
- Unbalanced memory configurations will result in a performance loss so always populate memory channels identically with identical DIMMs for best performance.
- To ensure proper system cooling, memory module blanks must be installed in memory sockets that are not occupied.

Removing a memory module

Prerequisites

 **WARNING: Allow the memory modules to cool after you power off the system. Handle the memory modules by the edges and avoid touching the components or metallic contacts on the memory module.**

 **CAUTION: To ensure proper system cooling, when processor 1 and processor 2 are installed, memory module blanks must be installed in memory sockets that are not occupied. Remove memory module blanks only if you intend to install memory modules in those sockets.**

1. Follow the safety guidelines listed in [Safety instructions](#).

2. Follow the procedure listed in [Before working inside your system](#).
3. [Remove the air shroud](#).

Steps

1. Locate the appropriate memory module socket.

CAUTION: Handle each memory module only by the edges, ensuring not to touch the middle of the memory module or metallic contacts.

2. Push the ejectors outward on both ends of the memory module socket to release the memory module from the socket.
3. Lift and remove the memory module from the system.

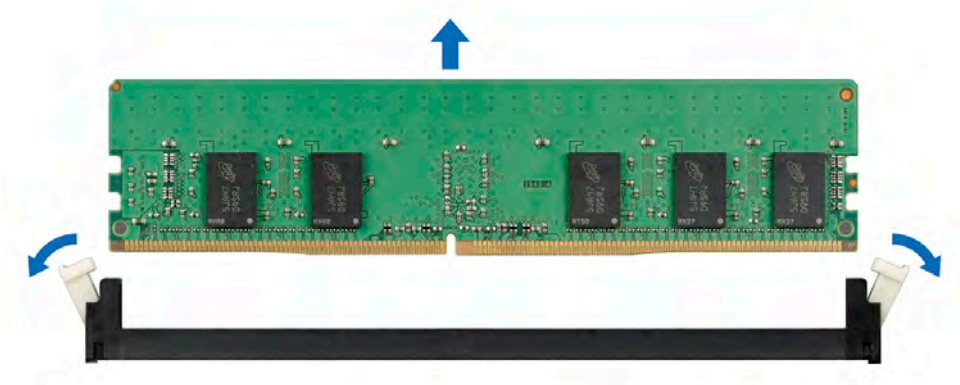

Figure 52. Removing a memory module

NOTE: If you are removing the memory module permanently, install a memory module blank. The procedure to install a memory module blank is similar to that of the memory module.

Next steps

1. [Replace the memory module](#).

Installing a memory module

Prerequisites

1. Follow the safety guidelines listed in [Safety instructions](#).
2. Follow the procedure listed in [Before working inside your system](#).
3. [Install the air shroud](#).

Steps

1. Locate the appropriate memory module socket.

CAUTION: Handle each memory module only by the edges, ensuring not to touch the middle of the memory module or metallic contacts.

CAUTION: To prevent damage to the memory module or the memory module socket during installation, do not bend or flex the memory module. You must insert both ends of the memory module simultaneously.

2. Open the ejectors on the memory module socket outward to allow the memory module to be inserted into the socket.
3. Align the edge connector of the memory module with the alignment key of the memory module socket, and insert the memory module in the socket.

CAUTION: Do not apply pressure at the center of the memory module. Apply pressure at both ends of the memory module evenly.

NOTE: The memory module socket has an alignment key that enables you to install the memory module in the socket in only one orientation.

4. Press the memory module with your thumbs until the ejectors firmly click into place.

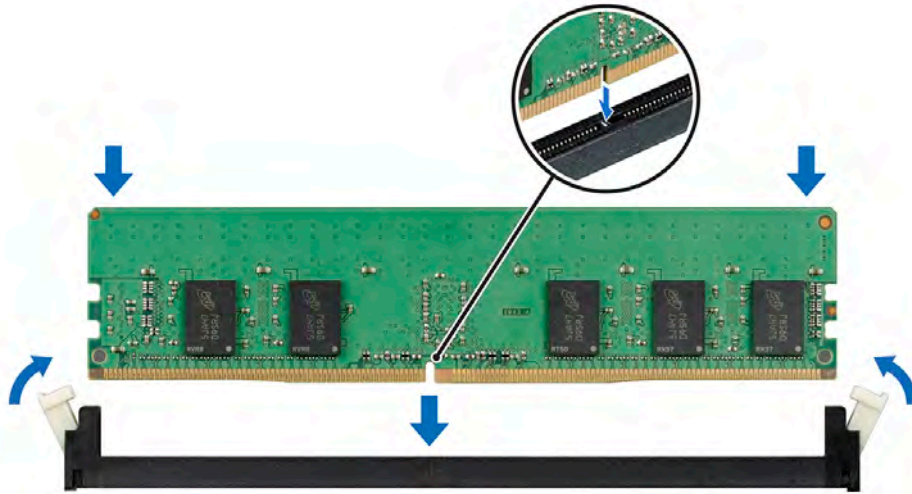

Figure 53. Installing a memory module

Next steps

1. [Install the air shroud.](#)
2. Follow the procedure listed in [After working inside your system.](#)
3. Verify if the memory module has been installed properly, by pressing F2 and navigating to System Setup Main Menu > System BIOS > Memory Settings . In the Memory Settings screen, the System Memory Size must reflect the updated capacity of the installed memory. If the value is incorrect, one or more of the memory modules may not be installed properly. Ensure that the memory module is firmly seated in the memory module socket. Run the system memory test in system diagnostics.

Cooling fan

Removing the internal cooling fan

Prerequisites

CAUTION: Never operate your system cover with the internal fan removed. The system can overheat and result in shutdown of the system and loss of data.

CAUTION: Do not operate the system with the system cover removed for more than 5 minutes.

1. Follow the safety guidelines listed in [Safety instructions.](#)
2. Follow the procedure listed in [Before working inside your system.](#)
3. [Remove the air shroud.](#)

Steps

1. Press the release tabs on the fan cable connector and disconnect it from the connector on the system board.
2. Holding the fan, press the release tab, and slide the fan out in the direction of the arrow marked on the fan.

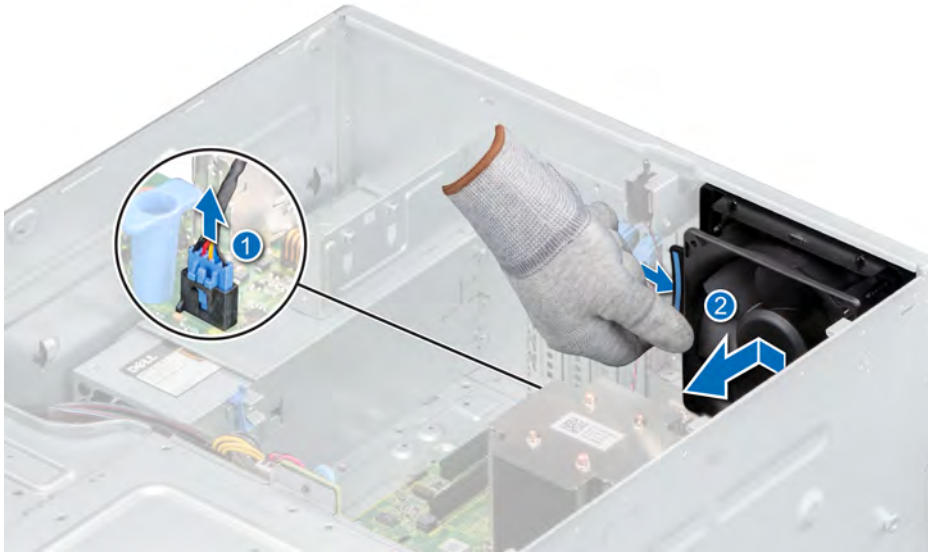

Figure 54. Removing the internal cooling fan

CAUTION: Do not remove or install the fan by holding the fan blades.

Next steps

1. [Replace the internal fan.](#)

Installing the internal cooling fan

Prerequisites

1. Follow the safety guidelines listed in [Safety instructions](#).
2. Follow the procedure listed in [Before working inside your system](#).
3. [Remove the air shroud](#)

Steps

1. Align the four tabs on the fan with the four slots on the system wall.
2. Press and slide the fan into the slots until the release tab locks into place.
3. Connect the fan power cable connector to the connector on the system board.

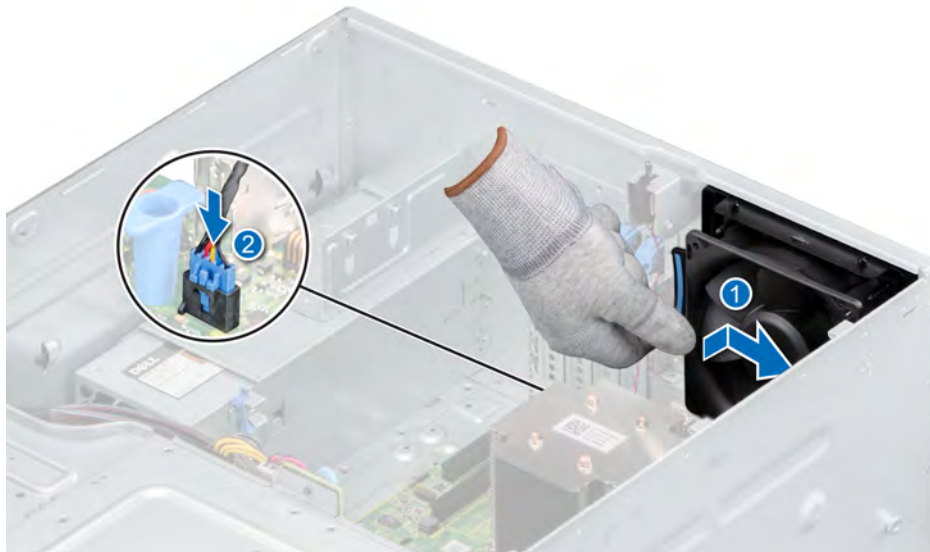

Figure 55. Installing the internal cooling fan

Next steps

1. [Install the air shroud.](#)
2. Follow the procedure listed in [After working inside your system.](#)

Optional internal USB memory key

NOTE: To locate the internal USB port on the system board, see the [System board jumpers and connectors](#) section.

Replacing the optional internal USB memory key

Prerequisites

CAUTION: To avoid interference with other components in the server, the maximum permissible dimensions of the USB memory key: 15.9 mm width x 57.15 mm length x 7.9 mm height.

1. Follow the safety guidelines listed in the [Safety instructions.](#)
2. Follow the procedure listed in the [Before working inside your system.](#)
3. [Remove the air shroud.](#)

Steps

1. Locate the USB port or USB memory key on the system board.
To locate the USB port, see the [System board jumpers and connectors](#) section.
2. If installed, remove the USB memory key from the USB port.
3. Insert the replacement USB memory key into the USB port.

Next steps

1. Follow the procedure that is listed in [After working inside your system.](#)
2. While booting, press F2 to enter System Setup and verify that the system detects the USB memory key.

Expansion cards

NOTE: A System Event Log (SEL) event is logged if an expansion card riser is not supported or missing. It does not prevent your system from turning on. However, if a F1/F2 pause occurs with an error message, see *Troubleshooting expansion cards* section in the *Dell EMC PowerEdge Servers Troubleshooting Guide* at www.dell.com/poweredgemanuals.

Expansion card guidelines

The following table describes the installation order for installing expansion cards to ensure proper cooling and mechanical fit. The expansion cards with the highest priority must be installed first by using the slot priority indicated.

NOTE: The expansion card slots are not hot-swappable.

Table 8. Expansion card slots supported on the system board

| PCIe slot | Processor Connection | PCIe slot height | PCIe slot length | Slot width |
|---------------|-------------------------|------------------|------------------|---------------------|
| Slot 1 (Gen3) | Processor | Full Height | Half Length | x8 link in x8 slot |
| Slot 2 (Gen3) | Processor | Full Height | Half Length | x8 link in x16 slot |
| Slot 3 (Gen3) | Platform Controller Hub | Full Height | Half Length | x1 |
| Slot 4 (Gen3) | Platform Controller Hub | Full Height | Half Length | x4 link in x8 slot |

Table 9. Expansion card installation order

| Card Priority | Category | Card Type | Form Factor | Slot Priority | Maximum Allowed |
|---------------|------------------|---|-------------|---------------|-----------------|
| 1 | Internal Adapter | PowerEdge RAID Controller (PERC) H730P+ | Full Height | 1,2 | 1 |
| 2 | Internal Adapter | PowerEdge RAID Controller (PERC) H330+ | Full Height | 1,2 | 1 |
| 4 | Internal Adapter | HBA330 | Full Height | 1,2 | 1 |
| 6 | External Adapter | 12 GB SAS HBA | Full Height | 1,2 | 2 |
| 7 | NIC | 10 G NICs Dual Port (Intel) | Full Height | 1,2 | 2 |
| 8 | NIC | 10 GBT NICs (Intel) | Full Height | 1,2 | 2 |
| 9 | HBA | FC8 HBAs | Full Height | 1,2 | 2 |
| 10 | Internal storage | BOSS | Full Height | 1,2,4 | 1 |
| 11 | Internal storage | BOSS2 | Full height | 1,2,4 | 1 |
| 12 | NIC | 1 Gb NICs Quad Port (Broadcom) | Full Height | 1,2,4 | 3 |
| 13 | NIC | 1 Gb NICs Quad Port (Intel) | Full Height | 1,2,4 | 3 |
| 14 | NIC | 1 Gb NICs Dual Port (Broadcom) | Full Height | 1,2,3,4 | 4 |
| 15 | NIC | 1 Gb NICs Quad Port (Intel) | Full Height | 1,2,4 | 3 |

Removing an expansion card

Prerequisites

1. Follow the safety guidelines listed in [Safety instructions](#).
2. Follow the procedure listed in [Before working inside your system](#).
3. [Remove the air shroud](#).

4. Disconnect any cables connected to the expansion card.

Steps

1. If installed, disconnect the data cables from the PERC card.
2. Press the expansion card retention latch and push the latch downwards to open it.

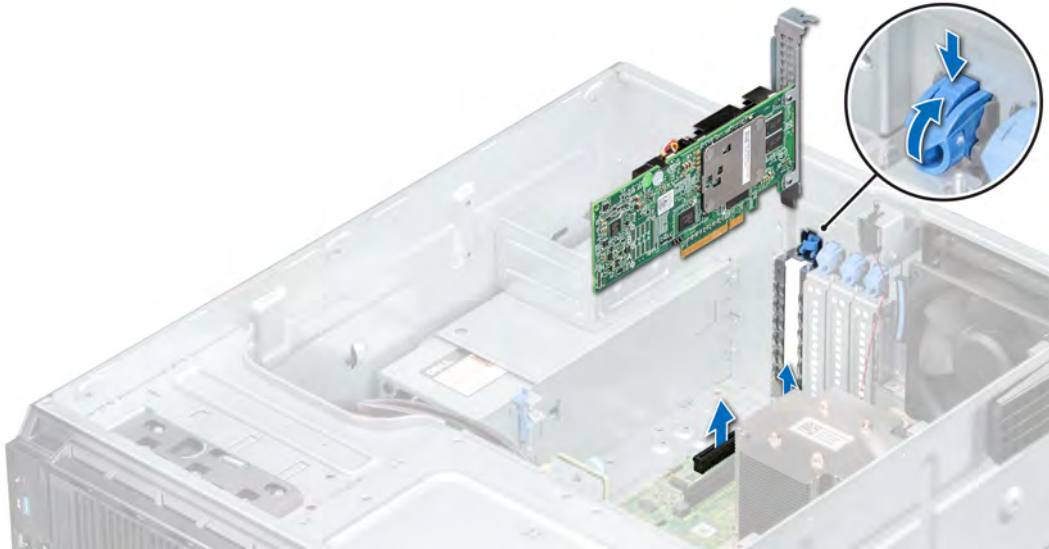

Figure 56. Removing an expansion card



Figure 57. Removing the filler bracket

3. Hold the expansion card by its edges, and pull the card up to remove it from the expansion card connector and the system.
4. Install the filler bracket by performing the following steps:
 - a. Align the expansion card filler bracket with the slot on the system.
 - b. Push the expansion card filler bracket downwards until firmly seated.
 - c. Close the blue expansion card retention latch by pushing the latch up until the latch snaps into place.

NOTE: Filler brackets must be installed in empty expansion-card slots to maintain FCC certification of the system. The brackets also keep dust and dirt out of the system and aid in proper cooling and airflow inside the system.

Next steps

1. [Replace an expansion card.](#)
2. [Install the air shroud.](#)

Installing an expansion card

Prerequisites

1. Follow the safety guidelines listed in [Safety instructions](#).
2. Follow the procedure listed in [Before working inside your system](#).

Steps

1. Open the expansion card retention latch.
2. Remove the existing expansion card or filler bracket from the slot.

i **NOTE: Store this bracket for future use. Filler brackets must be installed in empty expansion-card slots to maintain FCC certification of the system. The brackets also keep dust and dirt out of the system and aid in proper cooling and airflow inside the system.**

3. Holding the card by its edges, align the card with the expansion card connector on the system board.
4. Insert the card firmly into the expansion card connector until the card is firmly seated.
5. Close the expansion card retention latch by pushing the latch down until the latch snaps into place.

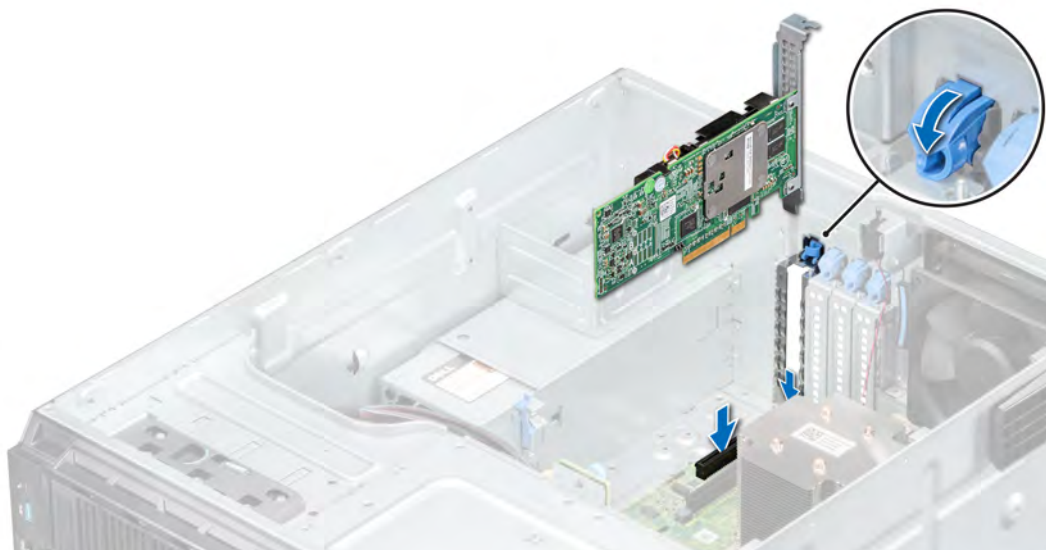

Figure 58. Installing an expansion card



Figure 59. Installing the filler bracket

6. Connect the data cables to the expansion card.

Next steps

1. [Install the air shroud.](#)
2. Connect the cables to the expansion card.
3. Follow the procedure listed in [After working inside your system.](#)

M.2 SSD module

Removing the M.2 SSD module

Prerequisites

1. Follow the safety guidelines listed in [Safety instructions.](#)
2. Follow the procedure listed in [Before working inside your system.](#)
3. [Remove the air shroud.](#)
4. Remove the BOSS card.

NOTE: The procedure to remove the BOSS card is similar to removing an expansion card.

Steps

1. Using the Phillips #1 screwdriver, remove the screws securing the M.2 SSD module to the BOSS card.
2. Pull the M.2 SSD module to disconnect from the BOSS card connector.

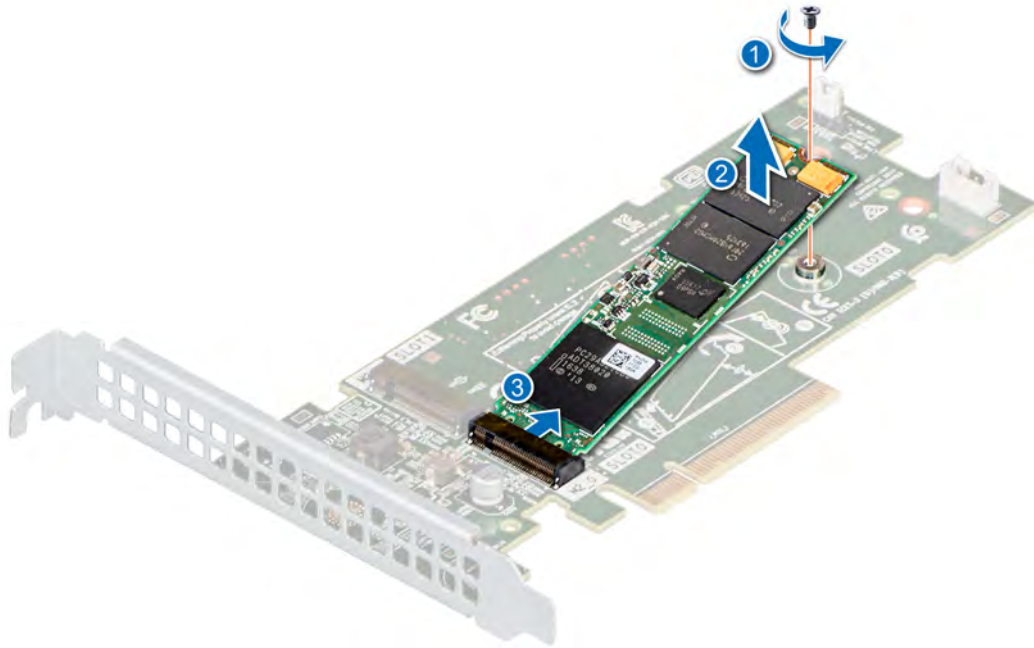

Figure 60. Removing the M.2 SSD module

Next steps

Replace the M.2 SSD module.

Installing the M.2 SSD module

Prerequisites

1. Follow the safety guidelines listed in [Safety instructions](#).
2. Follow the procedure listed in [Before working inside your system](#).
3. [Remove the air shroud](#).
4. Remove the BOSS card.

NOTE: The procedure to remove the BOSS card is similar to the removing an expansion card.

Steps

1. Align the M.2 SSD module at an angle with the BOSS card connector.
2. Insert the M.2 SSD module until it is firmly seated in the BOSS card connector.
3. Using the Phillips #1 screwdriver, secure the M.2 SSD module on the BOSS card with the screw.

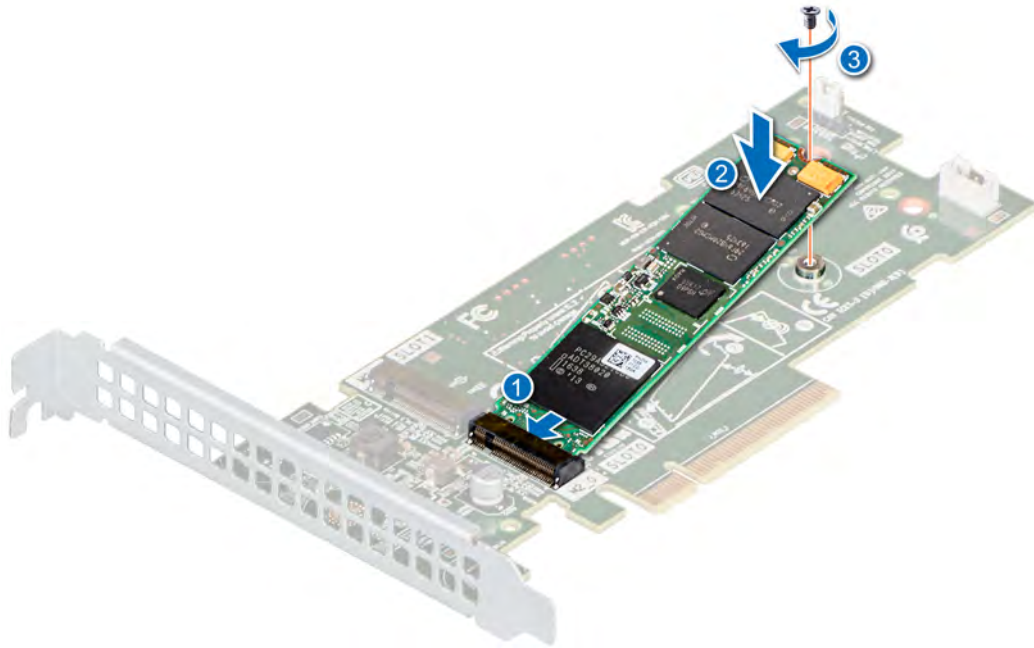

Figure 61. Installing the M.2 SSD module

Next steps

1. Install the BOSS card.
NOTE: The procedure to install the BOSS card is similar to removing an expansion card.
2. Install the air shroud.
3. Follow the procedure listed in the [After working inside your system](#).

Optional IDSDM or vFlash module

The IDSDM or vFlash module combines the IDSDM and/or vFlash features into a single module.

NOTE: The write-protect switch is on the IDSDM or vFlash module.

Removing the optional IDSDM or vFlash card

Prerequisites

1. Follow the safety guidelines listed in [Safety instructions](#).
2. Follow the procedure listed in [Before working inside your system](#).
3. Remove the air shroud.
4. If you are replacing the IDSDM/vFlash card, remove the MicroSD cards.
NOTE: Temporarily label each SD card with its corresponding slot number before removal. Reinstall the SD cards into the corresponding slots.

Steps

Holding the pull tab, lift the IDSDM/vFlash card out of the system.

Next steps

- NOTE:** If you are replacing the IDSDM or vFlash module, remove the MicroSD cards.
1. Replace the IDSDM/vFlash module.

Installing optional IDSDM or vFlash card

Prerequisites

1. Follow the safety guidelines listed in the [Safety instructions](#).
2. Follow the procedure listed in the [Before working inside your system](#).
3. [Remove the air shroud](#).

Steps

1. Locate the IDSDM/vFlash connector on the system board. To locate IDSDM/vFlash connector, see [System board jumpers and connectors](#) section.
2. Align the IDSDM/vFlash card with the connector on the system board.
3. Push the IDSDM/vFlash card until it is firmly seated on the system board.

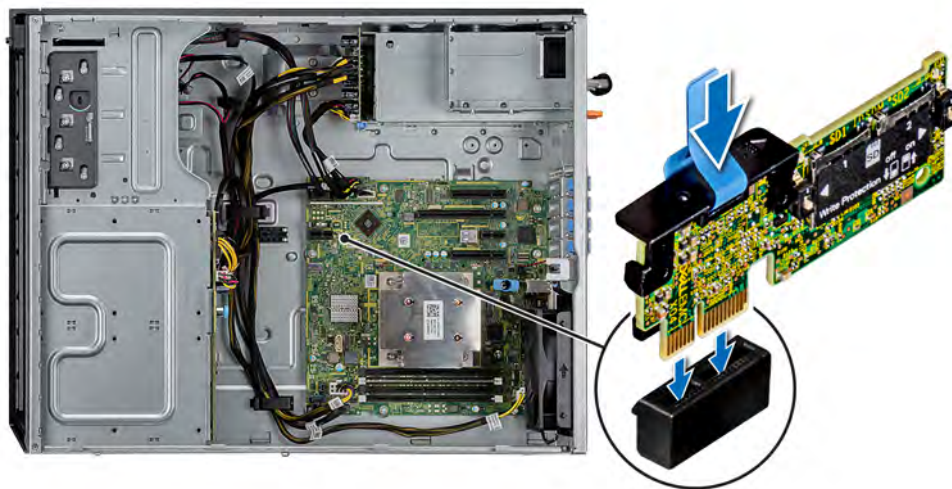

Figure 62. Installing optional IDSDM or vFlash card

Next steps

1. [Install the MicroSD cards](#).
NOTE: Reinstall the MicroSD cards into the same slots that are based on the labels you had marked on the cards during removal.
2. [Install the air shroud](#).
3. Follow the procedure that is listed in [After working inside your system](#).

Removing the MicroSD card

Prerequisites

1. Follow the safety guidelines listed in the [Safety instructions](#).
2. Follow the procedure listed in the [Before working inside your system](#).
3. [Remove the air shroud](#).
4. [Remove the IDSDM or vFlash module](#).

Steps

1. Locate the MicroSD card slot on the vFlash/IDSDM module, and press the card to partially release it from the slot. To locate IDSDM/vFlash module, see the [System board jumpers and connectors](#) section.
2. Hold the MicroSD card and remove it from the slot.

NOTE: Temporarily label each MicroSD card with its corresponding slot number after removal.

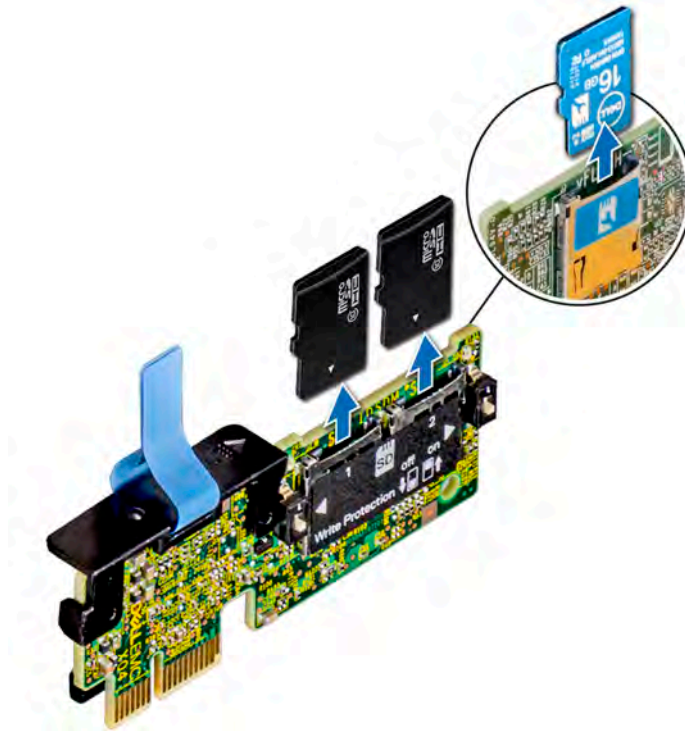

Figure 63. Removing the MicroSD card

Next steps

1. Replace the MicroSD cards.

Installing the MicroSD card

Prerequisites

1. Follow the safety guidelines listed in the [Safety instructions](#).
2. Follow the procedure listed in the [Before working inside your system](#).
3. [Remove the air shroud](#).
4. [Remove the IDSDM or vFlash module](#).

NOTE: To use a MicroSD card with your system, ensure that the Internal SD Card Port is enabled in System Setup.

NOTE: If reinstalling, ensure that you install the MicroSD cards into the same slots based on the labels you had marked on the cards during removal.

Steps

1. Locate the MicroSD card connector on the IDSDM/vFlash module. Orient the MicroSD card appropriately and insert the contact-pin end of the card into the slot. To locate IDSDM/vFlash, see the [System board jumpers and connectors](#) section.

NOTE: The slot is keyed to ensure correct insertion of the card.

2. Press the card into the card slot to lock it into place.

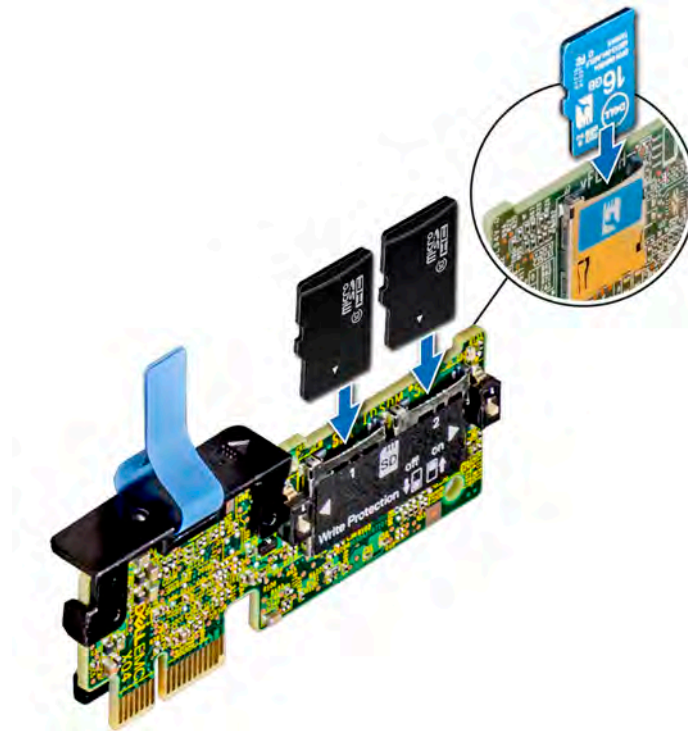

Figure 64. Installing the MicroSD card

Next steps

1. [Install the IDSDM or vFlash module.](#)
2. Follow the procedure listed in the [After working inside your system.](#)

Processor and heat sink

Removing the heat sink

Prerequisites

⚠ WARNING: The heat sink may be hot to touch for some time after the system is powered down. Allow the heat sink to cool before removing it.

1. Follow the safety guidelines listed in [Safety instructions.](#)
2. Follow the procedure listed in [Before working inside your system.](#)
3. [Remove the air shroud](#)

Steps

1. Using a Phillips #2 screwdriver, loosen the screws on the heat sink in the order below:
 - a. Loosen the first screw three turns.
 - b. Loosen the second screw completely.
 - c. Return to the first screw and loosen it completely.
2. Repeat the procedure for the remaining screws.
3. Lift the heat sink from the system.

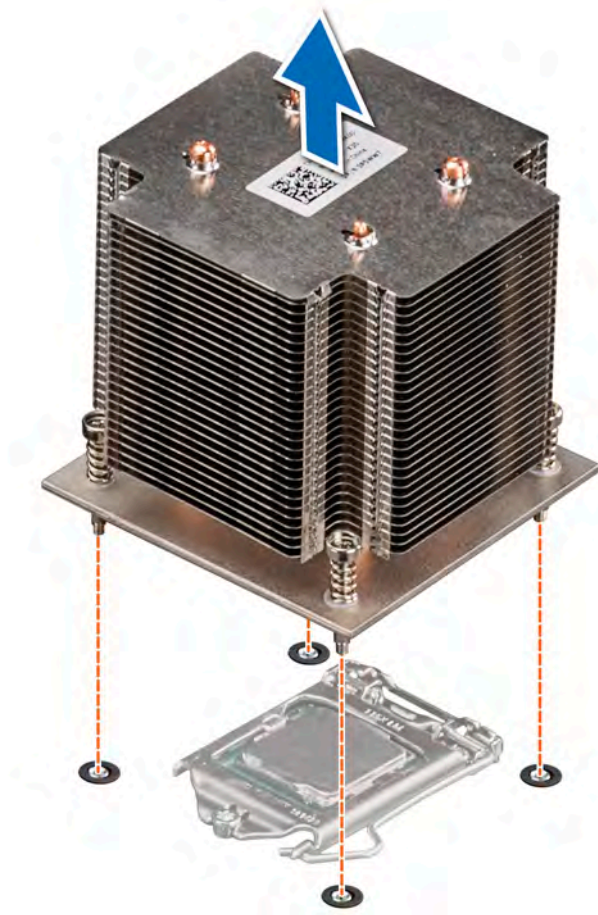

Figure 65. Removing the heat sink

Next steps

1. If you are removing a faulty heat sink, [Replace the heat sink](#). Else, [remove the processor](#).
2. Follow the procedure listed in [After working inside your system](#).

Removing the processor

Prerequisites

⚠ WARNING: The heat sink may be hot to touch for some time after the system has been powered down. Allow the heat sink to cool before removing it.

1. Follow the safety guidelines listed in [Safety instructions](#).
2. Follow the procedure listed in [Before working inside your system](#).
3. [Remove the air shroud](#).
4. [Remove the heat sink](#).

Steps

1. Release the socket lever by pushing the lever down and out from under the tab on the processor shield.
2. Lift the lever until the processor shield is fully open.
3. Lift the processor from the socket.



Figure 66. Removing the processor

CAUTION: Do not touch the processor socket pins, they are fragile and can be permanently damaged. Be careful not to bend the pins in the processor socket when removing the processor out of the socket.

Next steps

1. Replace the processor into the processor and heat sink.
2. Follow the procedure listed in [After working inside your system](#).

Installing the processor

Prerequisites

Follow the safety guidelines listed in [Safety instructions](#).

Steps

1. Align the pin1-indicator of the processor with the triangle on the system board.

CAUTION: Do not use force to seat the processor. When the processor is positioned correctly, it engages easily into the socket.

2. Place the processor in the socket.
3. Close the processor shield by sliding it under the retention screw on the system board.
4. Lower the lever and push it under the tab to lock the processor shield.

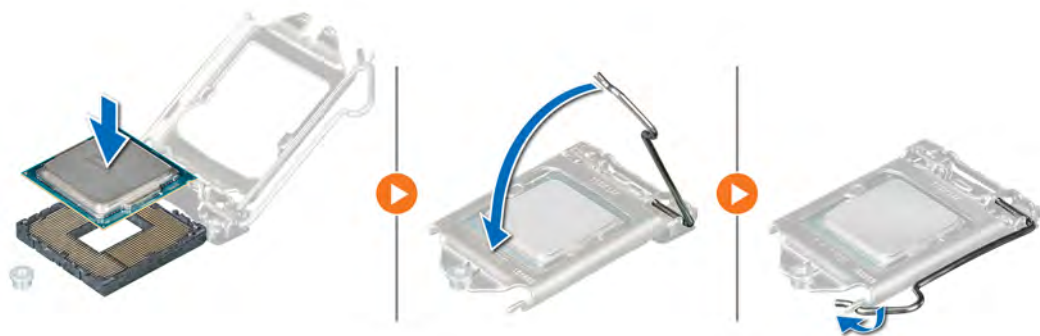

Figure 67. Installing the processor

Next steps

1. Replace the heat sink.
2. Replace the air shroud.
3. Follow the procedure listed in [After working inside your system](#).

Installing the heat sink

Prerequisites

1. Follow the safety guidelines listed in [Safety instructions](#).
2. Follow the procedure listed in [Before working inside your system](#).
3. [Install the processor](#).

Steps

1. If you are using an existing heat sink, remove the thermal grease from the heat sink by using a clean lint-free cloth.
2. Use the thermal grease syringe included with your processor kit to apply the grease in a thin spiral on the top of the processor as shown in the following figure.



Figure 68. Applying thermal grease on top of the processor

CAUTION: Applying too much thermal grease can result in excess grease coming in contact with and contaminating the processor socket.

NOTE: The thermal grease syringe is intended for one-time use only. Dispose of the syringe after you use it.

3. Align the screws on the heat sink with the standoffs on the system board.

CAUTION: When installing the heat sink, ensure that the airflow arrow is pointed towards the rear of the system.

4. Use a Phillips #2 screwdriver to tighten the screws to secure the heat sink to the system board.
 - a. Tighten the first screw three turns.
 - b. Tighten the screw diagonally opposite to the screw you tightened.
 - c. Return to the first screw and tighten it completely.
5. Repeat the procedure for the remaining screws.

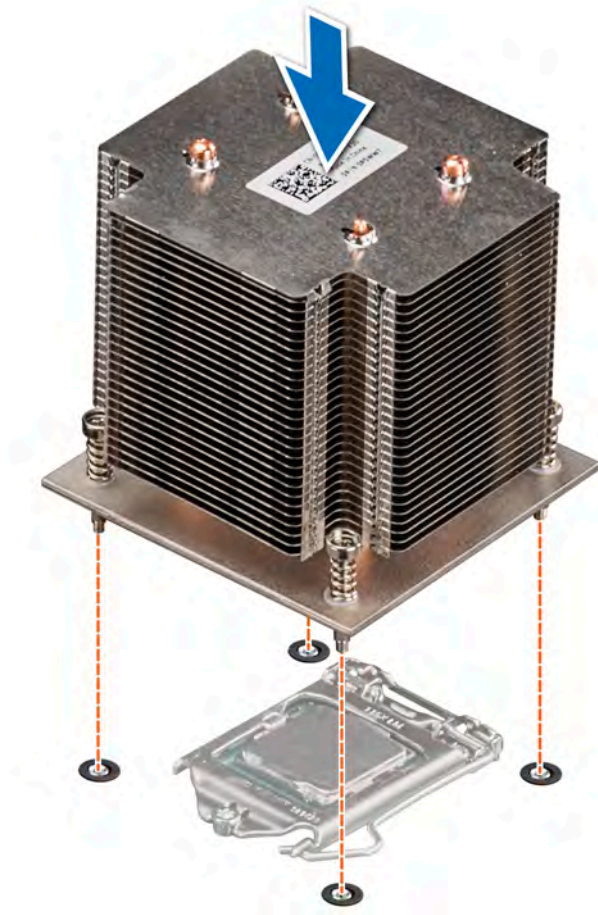



Figure 69. Installing the heat sink

Next steps

1. [Replace the air shroud.](#)
2. Follow the procedure listed in [After working inside your system.](#)
3. While booting, press F2 to enter System Setup and verify that the processor information matches the new system configuration.
4. Run the system diagnostics to verify that the new processor operates correctly.

Power supply unit

 **NOTE:** For more information, see the [Technical specifications](#) section.

Removing the power supply unit blank

Prerequisites

1. Follow the safety guidelines listed in [Safety instructions.](#)

Steps

Remove the PSU blank in the bay by pulling the blank outward.

 **CAUTION:** To ensure proper system cooling, the PSU blank must be installed in the second PSU bay in a non-redundant configuration. Remove the PSU blank only if you are installing a second PSU.



Figure 70. Removing the power supply unit blank

Next steps

Install the PSU or PSU blank.

Installing the power supply unit blank

Prerequisites

1. Follow the safety guidelines listed in [Safety instructions](#).
i **NOTE:** Install the power supply unit (PSU) blank only in the second PSU bay.
2. [Remove the PSU](#).

Steps

Align the PSU blank with the PSU slot and push it into the PSU slot until it clicks into place.



Figure 71. Installing the power supply unit blank

Removing a redundant AC power supply unit

Prerequisites

1. Follow the safety guidelines listed in [Safety instructions](#).
2. Disconnect the power cable from the power outlet and from the PSU you want to remove, then remove the cable from the strap on the PSU handle.

Steps

Press the orange release latch and slide the PSU out of the system using the PSU handle.

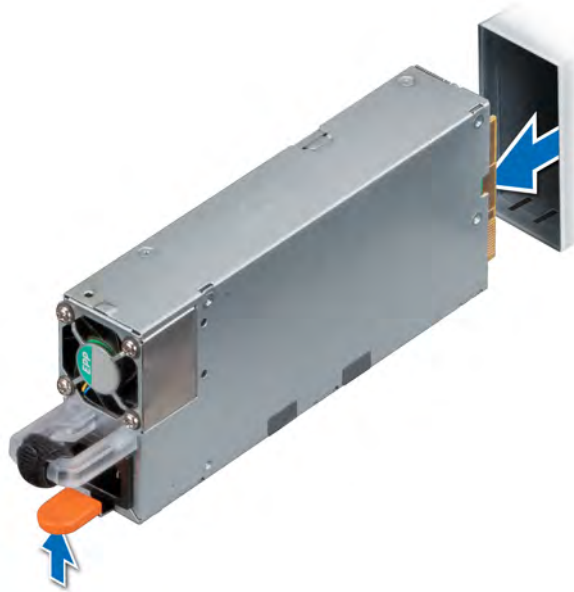

Figure 72. Removing a redundant power supply unit

Next steps

Install the PSU or PSU blank.

Installing a redundant AC power supply unit

Prerequisites

1. Follow the safety guidelines listed in [Safety instructions](#).
2. For systems that support redundant PSU, ensure that both the PSUs are of the same type and have the same maximum output power.

NOTE: The maximum output power (shown in watts) is listed on the PSU label.

3. [Remove the PSU blank](#).

Steps

Slide the PSU into the system until the PSU is fully seated.

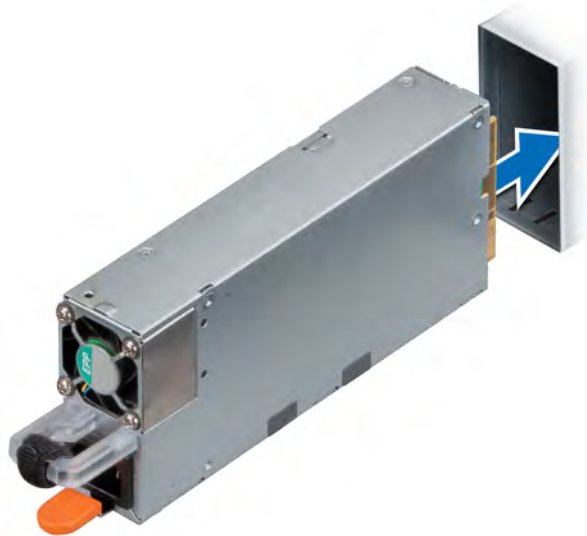

Figure 73. Installing a redundant power supply unit

Next steps

1. Connect the power cable to the PSU, and plug the cable into a power outlet.

CAUTION: When connecting the power cable to the PSU, secure the cable to the PSU with the strap.

NOTE: When installing, hot swapping, or hot adding a new PSU, wait for 15 seconds for the system to recognize the PSU and determine its status. The PSU redundancy may not occur until discovery is complete. The PSU status indicator turns green to indicate that the PSU is functioning properly.

Removing a cabled power supply unit

Prerequisites

1. Follow the safety guidelines listed in [Safety instructions](#).
2. Follow the procedure listed in [Before working inside your system](#).

Steps

1. Disconnect all the power cables of the PSU from the system board and the drive backplane.
2. Remove the screw securing the PSU to the system and slide the PSU out of the PSU bay in the chassis.

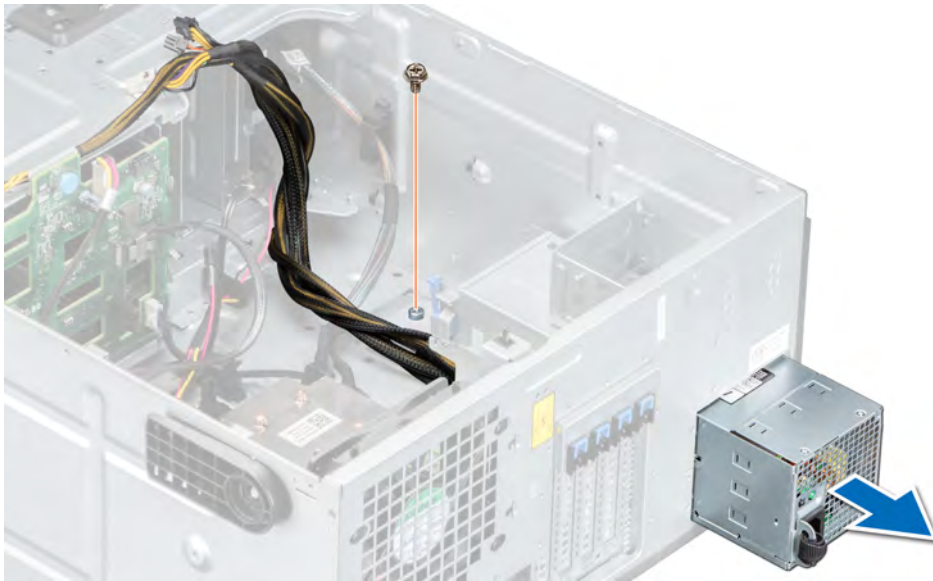

Figure 74. Removing a cabled power supply unit

Next steps

1. [Replace a cabled PSU.](#)

Installing a cabled power supply unit

Prerequisites

1. Follow the safety guidelines listed in [Safety instructions.](#)
2. Unpack the replacement power supply unit (PSU).

Steps

1. Slide the PSU into the PSU bay in the chassis until the PSU is fully seated.
2. Tighten the screw to secure the PSU to the system.
3. Connect all the power cables from the PSU to the system board and the drive backplane.

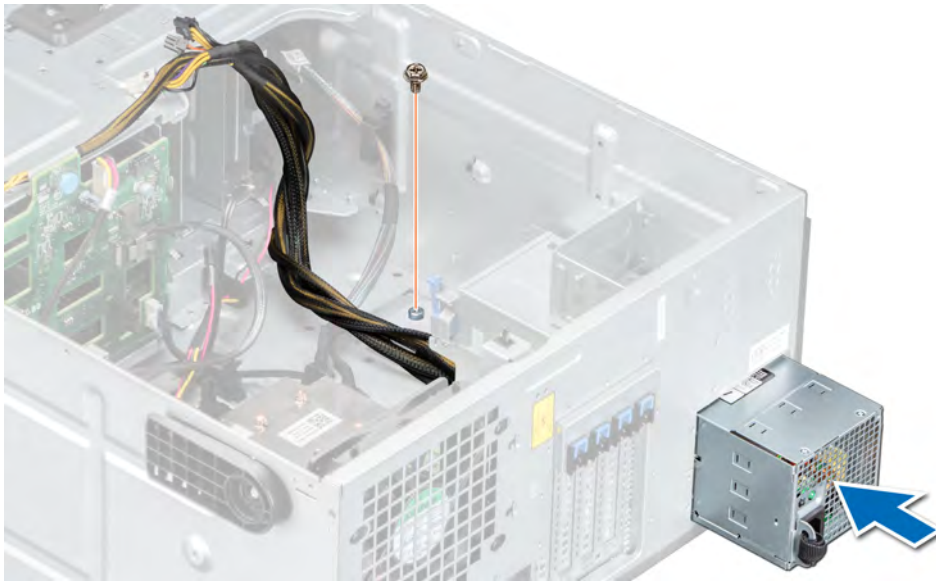

Figure 75. Installing a cabled power supply unit

Next steps

1. Follow the procedure listed in [After working inside your system](#).

Power interposer board

Removing the power interposer board

Prerequisites

1. Follow the safety guidelines listed in [Safety instructions](#).
2. Follow the procedure listed in [Before working inside your system](#).
3. [Remove the power supply units \(PSUs\)](#).

CAUTION: To prevent damage to the power interposer board, you must remove the power supply units or PSU blank from the system before removing the power interposer board (PIB).

Steps

1. Disconnect all cables connected from the power interposer board (PIB) to the system board, and remove the cables from the cable retention brackets.

NOTE: Observe the routing of the cable as you remove it from the system. Route the cable properly when you replace it to prevent the cable from being pinched or crimped.

2. Pressing the release latch on the PIB, lift the PIB to release it from the hooks on the PSU cage.
3. Lift the board and slide it out at an angle to disengage the guide pins on the board.



Figure 76. Removing the power interposer board

Next steps

1. [Replace the power interposer board \(PIB\).](#)

Installing the power interposer board

Prerequisites

1. Follow the safety guidelines listed in [Safety instructions](#).
2. Follow the procedure listed in [Before working inside your system](#).
3. [Remove the power supply units.](#)
4. [Remove the air shroud.](#)

Steps

1. Align the slots on the power interposer board (PIB) with the hooks on the power supply unit (PSU) cage and slide the PIB until it snaps into place.
2. Route the P3 power cable through the securing clip on the system board and connect the power cable to the drive backplane.

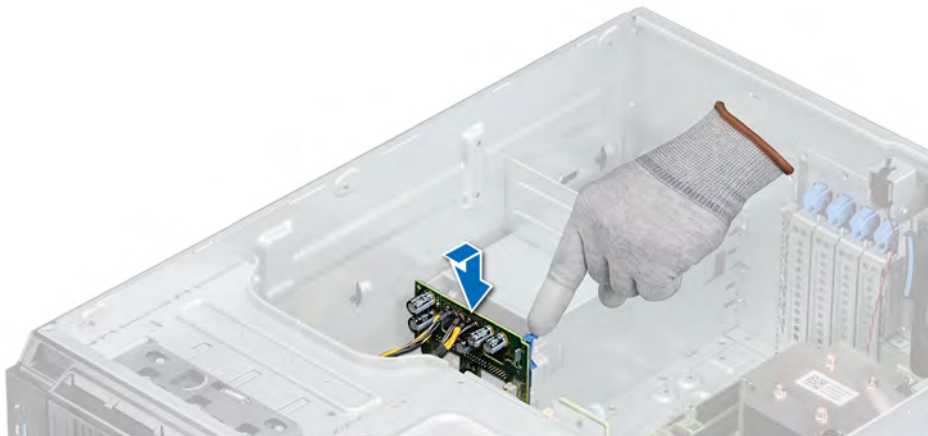

Figure 77. Installing the power interposer board

Next steps

1. [Install the air shroud](#)
2. [Replace the PSUs.](#)
3. Follow the procedure that is listed in [After working inside your system](#).

System battery

Replacing the system battery

Prerequisites

NOTE: There is a danger of a new battery exploding if it is incorrectly installed. Replace the battery only with the same or equivalent type that the manufacturer recommends. Discard used batteries according to the manufacturer's instructions. See the safety instructions that came with your system for more information.

1. Follow the safety guidelines listed in [Safety instructions](#).
2. Follow the procedure listed in [Before working inside your system](#).

Steps

1. Locate the system battery on the system.
2. To remove the battery:
 - a. Push the battery toward the positive side of the battery until the battery disengages from the connector.
 - b. Lift the battery away from the system.

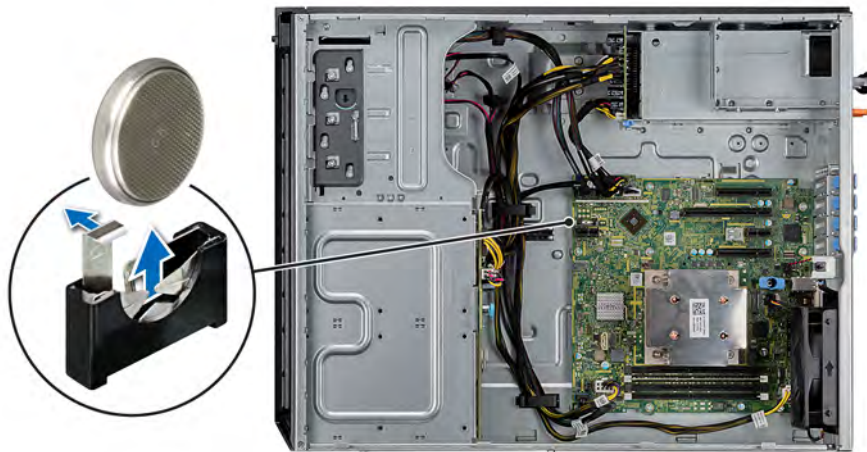

Figure 78. Removing the system battery

3. To install a new system battery:
 - a. Hold the battery with the + sign facing the positive side of the battery connector.

NOTE: Ensure that you do not push the battery clip more than 3.2 millimeters or you might risk damaging the part.
 - b. Insert the battery down into the connector until the battery snaps into place.

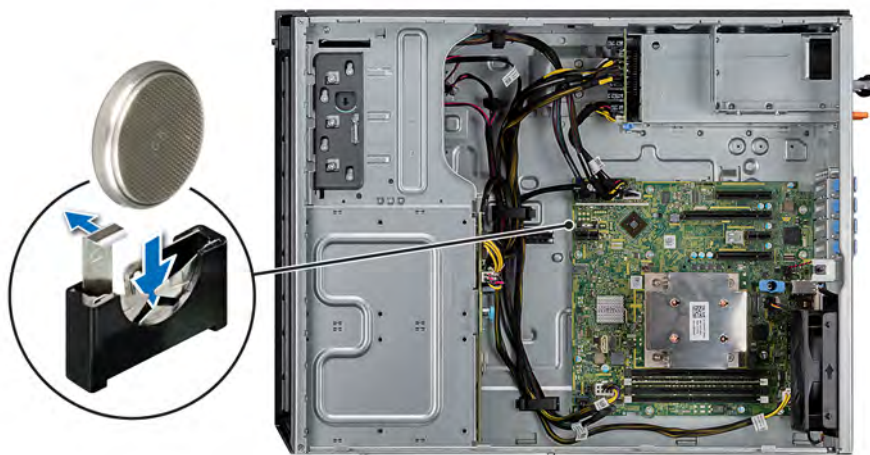

Figure 79. Installing the system battery

Next steps

1. Follow the procedure listed in [After working inside your system](#).
2. Enter the System Setup to confirm that the battery is operating properly.
3. Enter the correct time and date in the System Setup's **Time** and **Date** fields.
4. Exit the System Setup.
5. To test the newly installed battery, remove the system from the enclosure, for at least an hour.
6. Reinstall the system into the enclosure, after an hour.
7. Enter the System Setup and if the time and date are still incorrect, see [Getting help](#).

System board

Removing the system board

Prerequisites

CAUTION: If you are using the Trusted Platform Module (TPM) with an encryption key, you may be prompted to create a recovery key during program or System Setup. Be sure to create and safely store this recovery key. If you replace this system board, you must supply the recovery key when you restart your system or program before you can access the encrypted data on your hard drives.

CAUTION: Do not attempt to remove the TPM plug-in module from the system board. Once the TPM plug-in module is installed, it is cryptographically bound to that specific system board. Any attempt to remove an installed TPM plug-in module breaks the cryptographic binding, and it cannot be reinstalled or installed on another system board.

1. Follow the safety guidelines listed in [Safety instructions](#).
2. Follow the procedure listed in [Before working inside your system](#).
3. Remove the following:
 - a. [Air shroud](#)
 - b. [Internal cooling fan](#)
 - c. [Expansion cards](#), if installed
 - d. [vFlash/IDSDM module](#)
 - e. [Internal USB key](#), if installed
 - f. [Processors and heat sink](#)

CAUTION: To prevent damage to the processor pins when replacing a faulty system board, ensure that you cover the processor socket with the processor protective cap.

g. [Memory modules](#)

Steps

1. Disconnect all cables from the system board.

CAUTION: Take care not to damage the system identification button while removing the system board from the system.

CAUTION: Do not lift the system board by holding a memory module, processor, or other components.

2. Using a Phillips #2 screwdriver, remove the screws that secure the system board to the system.

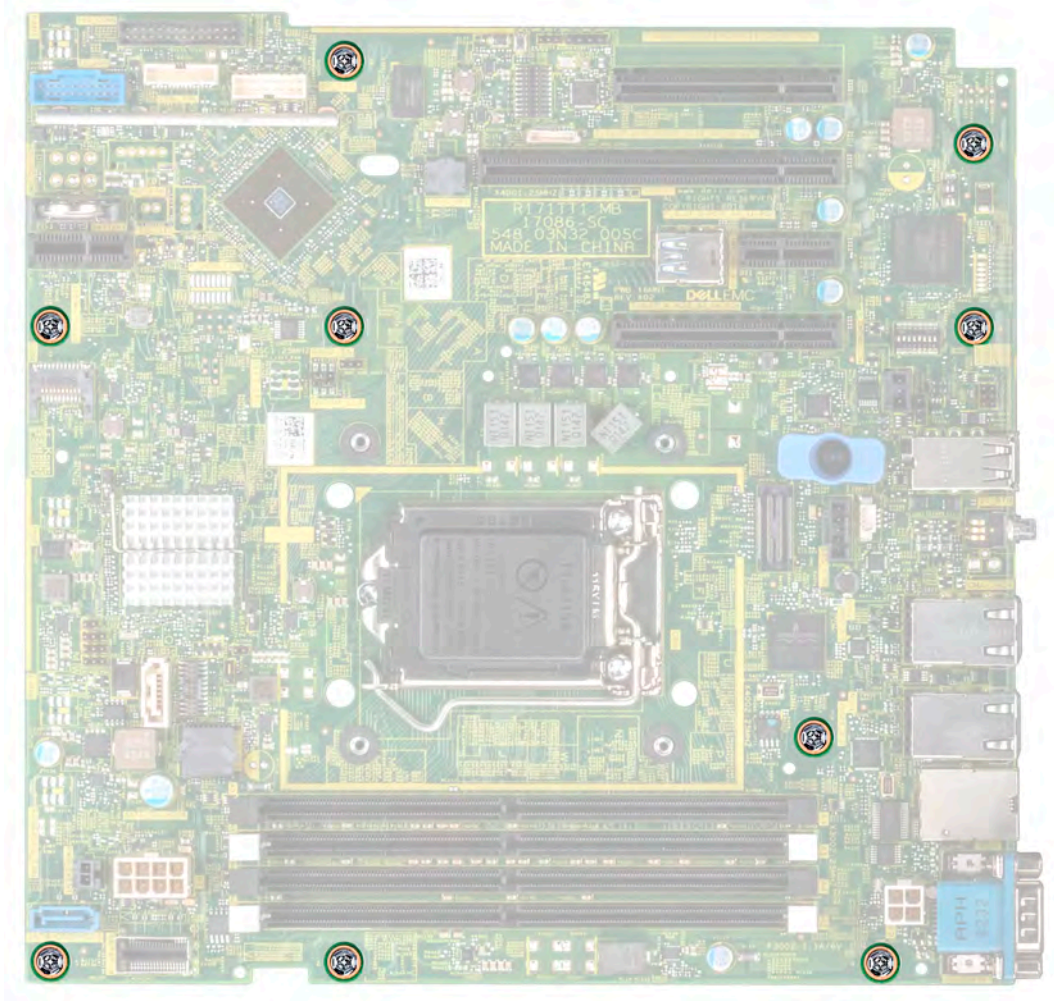
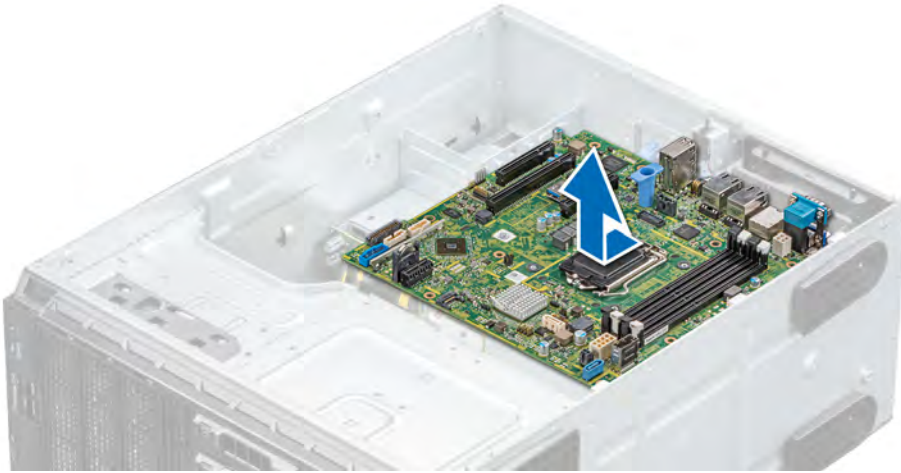

Figure 80. Removing the screws from the system board

3. Holding the post, incline the system board at an angle, and lift the system board out of the system.

Figure 81. Removing the system board



Next steps

1. [Replace or install the system board.](#)

Installing the system board

Prerequisites

Follow the safety guidelines listed in [Safety instructions](#).

Steps

1. Unpack the new system board assembly.

CAUTION: Do not lift the system board by holding a memory module, processor, or other components.

CAUTION: Take care not to damage the system identification button while placing the system board into the system.

2. Holding the post, incline the system board, and lower the system board into the system.
3. Holding the system board holder, push the system board toward the back of the system such that the ports on the system board align with the corresponding slots on the system.
4. Using the Phillips #2 screwdriver, secure the system board to the system with screws.

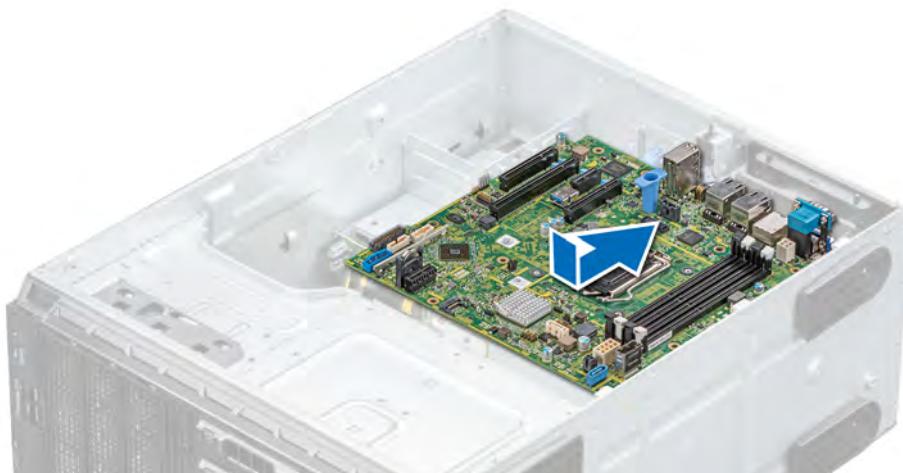

Figure 82. Installing the system board

Next steps

1. Replace the following:

- a. [Trusted Platform Module \(TPM\)](#)

i **NOTE:** The TPM plug-in module is attached to the system board and cannot be removed. A replacement TPM plug-in module is provided for all system board replacements, where a TPM plug-in module was installed.

- b. [Memory modules](#)
c. [Processors and heat sink](#)
d. [Internal USB key](#), if installed
e. [vFlash/iDSDM module](#)
f. [Expansion cards](#), if installed
g. [Internal cooling fan](#)
h. [Air shroud](#)

2. Reconnect all cables to the system board.

i **NOTE:** Ensure that the cables inside the system are routed along the chassis wall and secured by using the cable securing bracket.

3. Follow the procedure that is listed in [Safety instructions](#).

4. Ensure that you:

- a. Use the Easy Restore feature to restore the Service Tag. For more information, see the [Restoring the system using Easy Restore](#) section.
b. If the Service Tag is not backed up in the backup flash device, enter the Service Tag manually. For more information, see the [Manually update the Service Tag](#) section.
c. Update the BIOS and iDRAC versions.
d. Reenable the Trusted Platform Module (TPM). For more information, see the [Upgrading the Trusted Platform Module](#) section.

5. Import your new or existing iDRAC Enterprise license.

For more information, see iDRAC User's Guide, at www.dell.com/poweredgemanuals

Restoring the system using Easy Restore

The easy restore feature enables you to restore your service tag, license, UEFI configuration, and the system configuration data after replacing the system board. All data is backed up in a backup flash device automatically. If BIOS detects a new system board, and the service tag in the backup flash device, BIOS prompts the user to restore the backup information.

About this task

Below is a list of options available:

- Restore the service tag, license, and diagnostics information, press **Y**
- Navigate to the Lifecycle Controller based restore options, press **N**.
- Restore data from a previously created **Hardware Server Profile**, press **F10**

i **NOTE:** When the restore process is complete, BIOS prompts to restore the system configuration data.

- To restore the system configuration data, press **Y**
- To use the default configuration settings, press **N**

i **NOTE:** After the restore process is complete, system reboots.

Manually update the Service Tag

After replacing a system board, if Easy Restore fails, follow this process to manually enter the Service Tag, using **System Setup**.

About this task

If you know the system service tag, use the **System Setup** menu to enter the service tag.

Steps

1. Power on the system.
2. To enter the **System Setup**, press **F2**.
3. Click **Service Tag Settings**.
4. Enter the service tag.

NOTE: You can enter the service tag only when the Service Tag field is empty. Ensure that you enter the correct service tag. Once the service tag is entered, it cannot be updated or changed.

5. Click **OK**.

Trusted Platform Module

Upgrading the Trusted Platform Module

Prerequisites

NOTE:

- Ensure that your operating system supports the version of the TPM module being installed.
- Ensure that you download and install the latest BIOS firmware on your system.
- Ensure that the BIOS is configured to enable UEFI boot mode.

About this task

CAUTION: Once the TPM plug-in module is installed, it is cryptographically bound to that specific system board. Any attempt to remove an installed TPM plug-in module breaks the cryptographic binding, the removed TPM cannot be reinstalled or installed on another system board.

Removing the TPM

Steps

1. Locate the TPM connector on the system board.
2. Press to hold the module down and remove the screw using the security Torx 8-bit shipped with the TPM module.
3. Slide the TPM module out from its connector.
4. Push the plastic rivet away from the TPM connector and rotate it 90° counterclockwise to release it from the system board.
5. Pull the plastic rivet out of its slot on the system board.

Installing the TPM

Steps

1. To install the TPM, align the edge connectors on the TPM with the slot on the TPM connector.
2. Insert the TPM into the TPM connector such that the plastic rivet aligns with the slot on the system board.
3. Press the plastic rivet until the rivet snaps into place.
4. Replace the screw that secures the TPM to the system board.



Figure 83. Installing the TPM

Next steps

1. [Replace the system board.](#)
2. Follow the procedure listed in [After working inside your system.](#)
3. To verify if the memory module has been installed properly, press F2 and navigate to **System Setup Main Menu > System BIOS > Memory Settings**. In the **Memory Settings** screen, the System Memory Size must reflect the updated capacity of the installed memory.
4. If the value is incorrect, one or more of the memory modules may not be installed properly. Ensure that the memory module is firmly seated in the memory module socket.
5. Run the system memory test in system diagnostics.

Initializing TPM for BitLocker users

Steps

1. Initialize the TPM.
For more information, see [initializing the TPM for Intel TXT users.](#)
2. The **TPM Status** changes to **Enabled, Activated**.

Initializing the TPM 1.2 for TXT users

Steps

1. While booting your system, press F2 to enter System Setup.
2. On the **System Setup Main Menu** screen, click **System BIOS > System Security Settings**.
3. From the **TPM Security** option, select **On with Preboot Measurements**.
4. From the **TPM Command** option, select **Activate**.
5. Save the settings.
6. Restart your system.
7. Enter **System Setup** again.
8. On the **System Setup Main Menu** screen, click **System BIOS > System Security Settings**.
9. From the **Intel TXT** option, select **On**.

Initializing the TPM 2.0 for TXT users

Steps

1. While booting your system, press F2 to enter System Setup.
2. On the **System Setup Main Menu** screen, click **System BIOS > System Security Settings**.
3. From the **TPM Security** option, select **On**.
4. Save the settings.
5. Restart your system.
6. Enter **System Setup** again.
7. On the **System Setup Main Menu** screen, click **System BIOS > System Security Settings**.
8. Select the **TPM Advanced Settings** option.
9. From the **TPM2 Algorithm Selection** option, select **SHA256**, then go back to **System Security Settings** screen.
10. On the **System Security Settings** screen, from the **Intel TXT** option, select **On**.
11. Save the settings.
12. Restart your system.

Control panel

Removing the control panel assembly

Prerequisites

1. Follow the safety guidelines listed in [Safety instructions](#).
2. Follow the procedure listed in [Before working inside your system](#).

Steps

1. Using the Phillips #2 screwdriver, remove the screw that secures control panel to the system.
2. Disconnect the control panel cable and the control panel USB cable from the system board.

CAUTION: Do not use excessive force when removing the control panel cables as it can damage the connectors.

3. Slide the control panel out of the system.
4. To remove the information tag, perform the following steps:
 - a. Locate and press the tabs on the information tag.
 - b. Push the information tag out of the slot to remove it from the control panel.

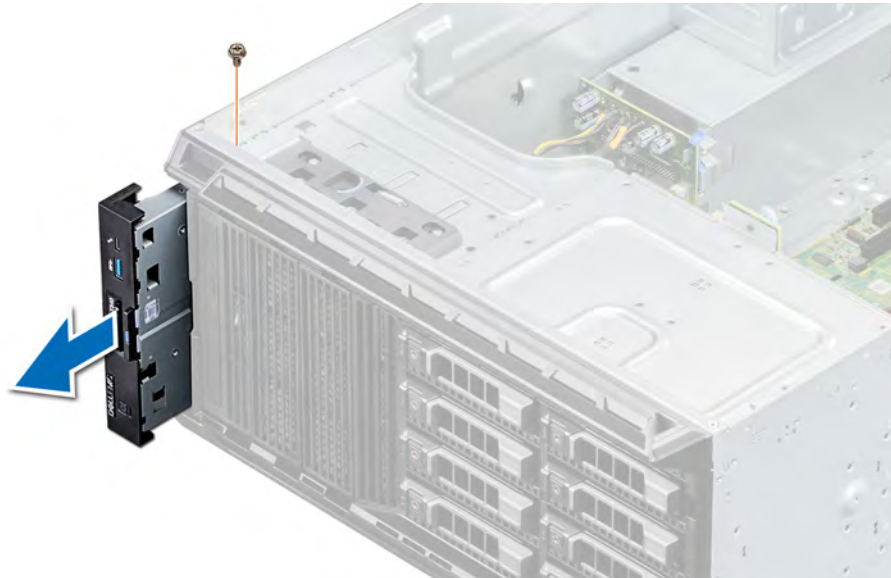

Figure 84. Removing the control panel assembly

NOTE: Retain the information tag to replace it in the new control panel.

Next steps

1. [Replace the control panel assembly](#).

Installing the control panel assembly

Prerequisites

Follow the safety guidelines listed in [Safety instructions](#).

Steps

1. Replace the blank information tag in the new control panel with the information tag retained from the old control panel.

2. To install the information tag, push the information tag into the control-panel slot.
3. Connect the control panel cable and the control panel USB cable to the control panel assembly.
4. Align and insert the control panel into the control panel slot in the system.
5. Secure the control panel to the system by using the screw.
6. Connect the control panel cable and the control panel USB cable to the system board.

Figure 85. Installing the control panel assembly

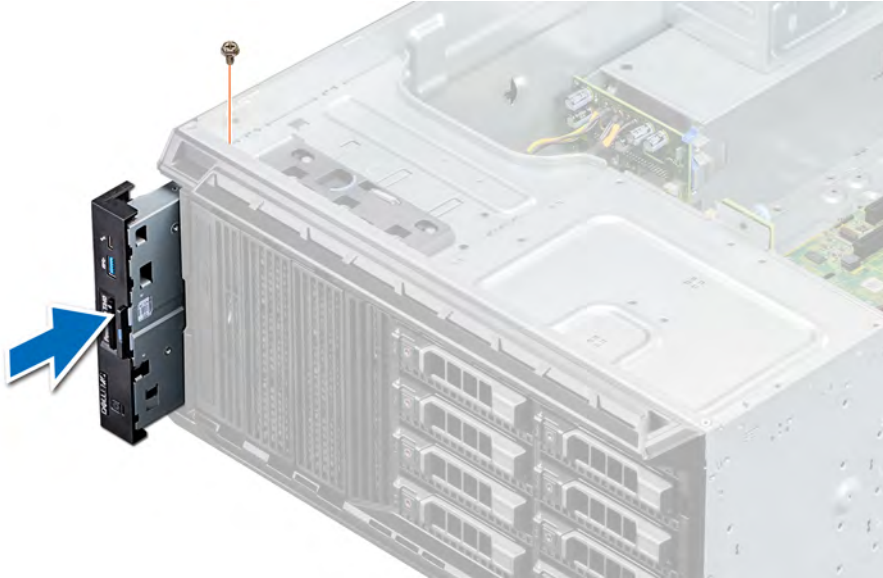

Next steps

1. Follow the procedure listed in [After working inside your system](#).

PowerEdge T340 jumpers and connectors

This topic provides specific information about the jumpers. It also provides some basic information about jumpers and switches and describes the connectors on the various boards in the system. Jumpers on the system board help to disable the system and setup passwords. You must know the connectors on the system board to install components and cables correctly.

Topics:

- System board jumpers and connectors
- System board jumper settings
- Disabling forgotten password

System board jumpers and connectors

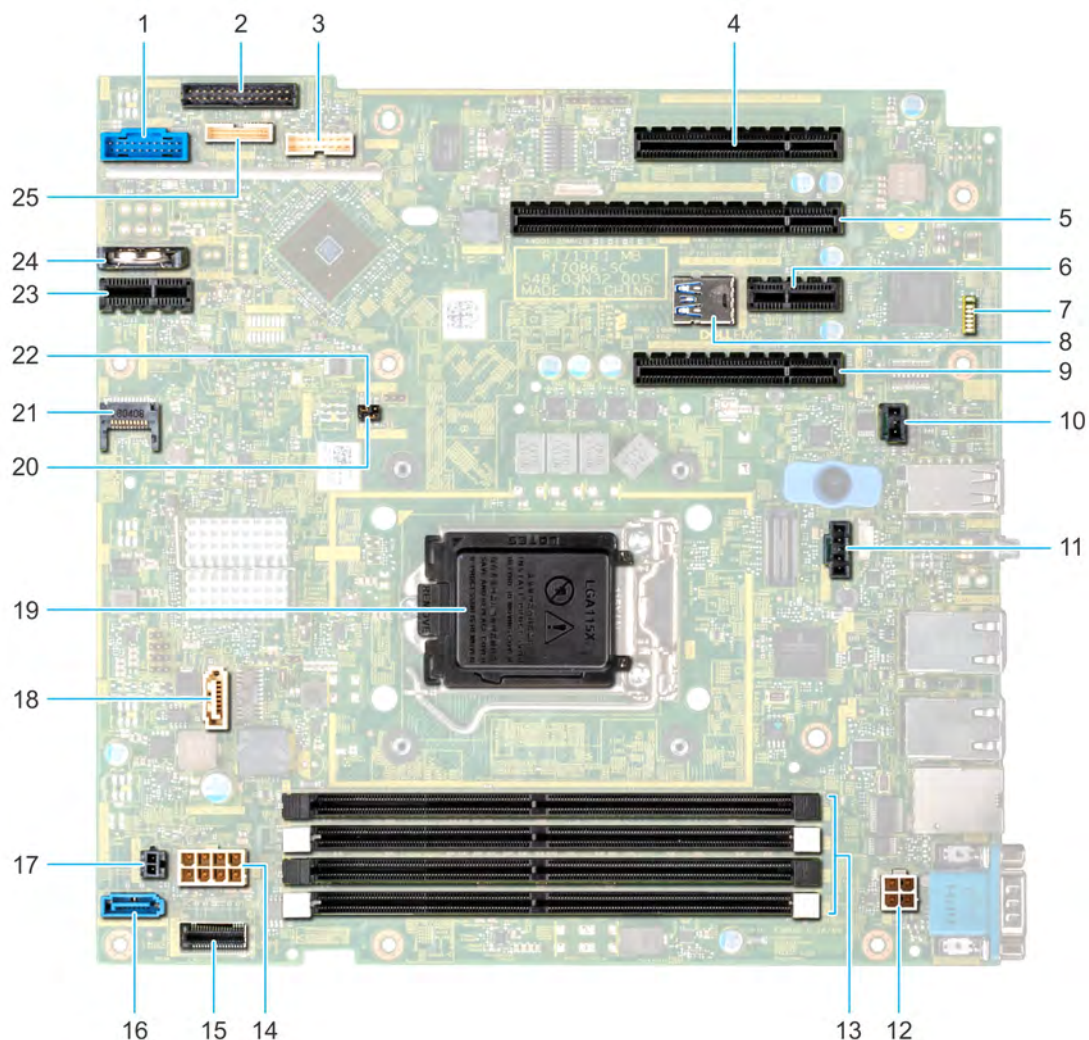

Figure 86. T340 system board jumpers and connectors

Table 10. System board connectors

| Item | Connector | Description |
|------|-----------------------|---|
| 1 | FP_USB | Front panel USB connector |
| 2 | PIB_CONN | Power interposer board signal connector |
| 3 | BP_SIG | Backplane signal connector |
| 4 | Slot 1 PCIE_G3_X8 CPU | PCIe card connector 1 |
| 5 | Slot 2 PCIE_G3_X8 CPU | PCIe card connector 2 |
| 6 | Slot 3 PCIE_G3_X1 PCH | PCIe card connector 3 |
| 7 | LEDs (7) | System board diagnostic LED indicators |
| 8 | INT_USB_3.0 | Internal USB |
| 9 | Slot 4 PCIE_G3_X4 PCH | PCIe card connector 4 |
| 10 | T_INTRUSION | Intrusion switch connector |
| 11 | SYS_FAN | Fan |
| 12 | P2 | CPU power connector P2 |
| 13 | A1, A2, A3, A4 | Memory module sockets |
| 14 | P1 | System power P1 |
| 15 | SATA 0-3 | Mini SAS connector |
| 16 | SATA_ODD/SSD | Optical disk drive connector |
| 17 | PWR_EVNT | Power event |
| 18 | J_SATA_2 | SATA connector 2 |
| 19 | CPU | Processor |
| 20 | NVRAM_CLR | NVRAM password Jumper |
| 21 | TPM | Trusted Platform Module connector |
| 22 | PWRD_EN | Reset BIOS password jumper |
| 23 | IDSDM+ vFlash | IDSDM+VFlash connector |
| 24 | Coin cell battery | Coin cell battery |
| 25 | CTRL_PNL | Control panel |

System board jumper settings

For information on resetting the password jumper to disable a password, see the [Disabling a forgotten password](#) section.

Disabling forgotten password

The software security features of the system include a system password and a setup password. The password jumper enables or disables password features and clears any password(s) currently in use.

Prerequisites

CAUTION: Many repairs may only be done by a certified service technician. You should only perform troubleshooting and simple repairs as authorized in your product documentation, or as directed by the online or telephone service and support team. Damage due to servicing that is not authorized by Dell is not covered by your warranty. Read and follow the safety instructions that are shipped with your product.

Steps

1. Power off the system, including any attached peripherals, and disconnect the system from the electrical outlet.
2. Remove the system cover.
3. Move the jumper on the system board jumper from pins 2 and 4 to pins 4 and 6.
4. Install the system cover.

The existing passwords are not disabled (erased) until the system boots with the jumper on pins 4 and 6. However, before you assign a new system and/or setup password, you must move the jumper back to pins 2 and 4.

 **NOTE: If you assign a new system and/or setup password with the jumper on pins 4 and 6, the system disables the new password(s) the next time it boots.**

5. Reconnect the system to its electrical outlet and power on the system, including any attached peripherals.
6. Power off the system, including any attached peripherals, and disconnect the system from the electrical outlet.
7. Remove the system cover.
8. Move the jumper on the system board jumper from pins 4 and 6 to pins 2 and 4.
9. Install the system cover.
10. Reconnect the system to its electrical outlet and power on the system, including any attached peripherals.
11. Assign a new system and/or setup password.

Technical specifications

The technical and environmental specifications of your system are outlined in this section.

Topics:

- Chassis dimensions
- System weight
- Processor specifications
- Supported operating systems
- PSU specifications
- Cooling fan specifications
- System battery specifications
- Expansion card specifications
- Memory specifications
- Storage controller specifications
- Drive specifications
- Ports and connectors specifications
- Video specifications
- Environmental specifications

Chassis dimensions

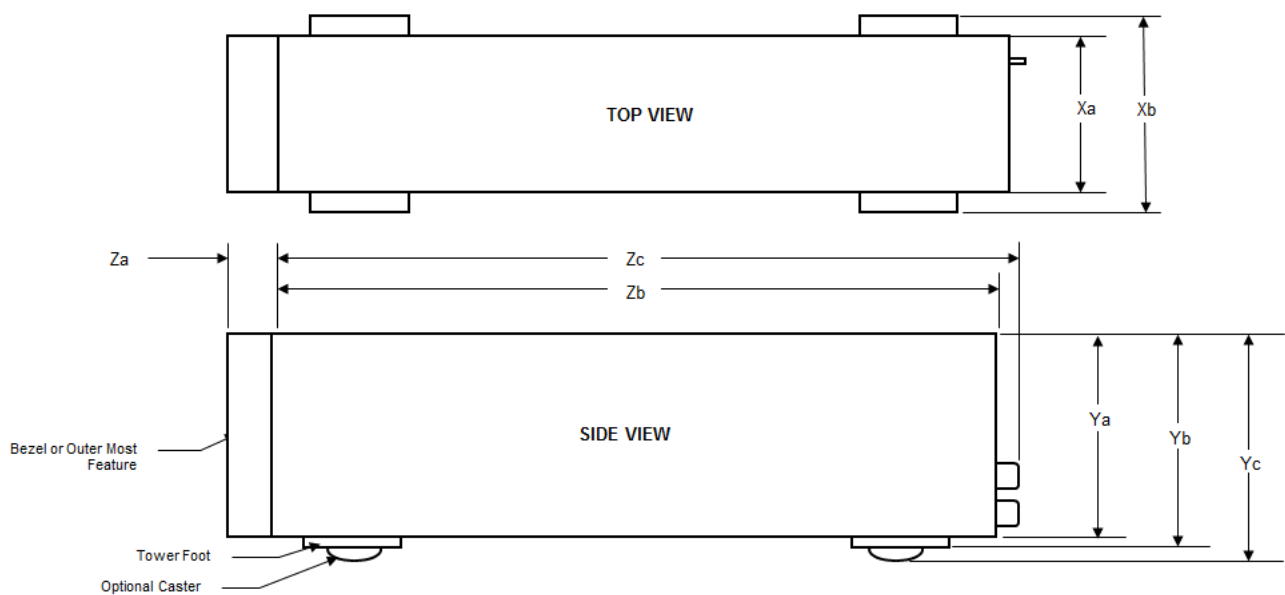

Figure 87. Chassis dimensions

Table 11. Dell EMC PowerEdge T340 chassis dimensions

| Xa | Xb | Ya | Yb | Yc | Za | Zb | Zc |
|----------------------|-------------------------|-------------------------|-------------------------|-------------------------|-----------------------------------|-------------------------|-------------------------|
| 218 mm (8.58 inches) | 307.9 mm (12.12 inches) | 430.3 mm (16.94 inches) | 443.3 mm (17.45 inches) | 471.3 mm (18.56 inches) | With bezel: 14.1 mm (0.56 inches) | 545.4 mm (21.47 inches) | 589.1 mm (23.19 inches) |

System weight

Table 12. Dell EMC PowerEdge T340 system chassis weight

| System configuration | Maximum weight (with all drives/SSDs) |
|----------------------|---------------------------------------|
| 8 x 3.5-inch drives | 26 Kg (57.32 lb) |

Processor specifications

Table 13. Dell EMC PowerEdge T340 processor specifications

| Supported processor | Number of processors supported |
|--|--------------------------------|
| Intel Xeon processor E-2200 product family | One |
| Intel Core i3 9100 processor | |
| Intel Pentium G5420 processor | |
| Intel Celeron G4930 processor | |
| Intel Xeon processor E-2100 product family | |
| Intel Core i3 8100 processor | |
| Intel Pentium G5500 processor | |
| Intel Celeron G4900 processor | |

Supported operating systems

The Dell EMC PowerEdge T340 supports the following operating systems:

- Canonical Ubuntu LTS
- Citrix Hypervisor
- Microsoft Windows Server
- Red Hat Enterprise Linux
- SUSE Linux Enterprise Server
- VMware ESXi

NOTE: For more information, go to www.dell.com/ossupport.

PSU specifications

The Dell EMC PowerEdge T340 system supports up to two AC power supply units (PSUs).

Table 14. Dell EMC PowerEdge T340 PSU specifications

| PSU | Class | Heat dissipation (maximum) | Frequency | Voltage | AC | | DC | Current |
|----------|----------|----------------------------|-----------|---------------------------|-----------------------|----------------------|-----|-----------|
| | | | | | High line (100–240 V) | Low line (100–120 V) | | |
| 495 W AC | Platinum | 1908 BTU/hr | 50/60 Hz | 100–240 V AC, autoranging | 495 W | NA | N/A | 6.5 A–3 A |
| 350 W AC | Bronze | 1455 BTU/hr | 50/60 Hz | 100–240 V AC, autoranging | 350 W | NA | N/A | 5.5 A–3 A |

Cooling fan specifications

The Dell EMC PowerEdge T340 system supports one system cooling fan.

NOTE: When selecting or upgrading the system configuration, to ensure optimum power utilization, verify the system power consumption with the Dell Energy Smart Solution Advisor available at Dell.com/ESSA.

System battery specifications

The Dell EMC PowerEdge T340 system supports CR 2032 3.0-V lithium coin cell system battery.

Expansion card specifications

The Dell EMC PowerEdge T340 system supports up to four PCI express (PCIe) Generation 3.

Table 15. Expansion card slots supported on the system board

| PCIe slot | Processor Connection | PCIe slot height | PCIe slot length | Slot width |
|---------------|-------------------------|------------------|------------------|---------------------|
| Slot 1 (Gen3) | Processor | Full Height | Half Length | x8 link in x8 slot |
| Slot 2 (Gen3) | Processor | Full Height | Half Length | x8 link in x16 slot |
| Slot 3 (Gen3) | Platform Controller Hub | Full Height | Half Length | x1 |
| Slot 4 (Gen3) | Platform Controller Hub | Full Height | Half Length | x4 link in x8 slot |

NOTE: The expansion cards are not hot swappable.

Memory specifications

The Dell EMC PowerEdge T340 system supports the following memory specifications for optimized operation:

Table 16. Memory specifications

| DIMM type | DIMM rank | DIMM capacity | Minimum RAM | Maximum RAM |
|-----------|-------------|---------------|-------------|-------------|
| UDIMM | Single rank | 8 GB | 8 GB | 32 GB |
| | | 16 GB | 16 GB | 64 GB |
| | Dual rank | 8 GB | 8 GB | 32 GB |
| | | 16 GB | 16 GB | 64 GB |

Table 16. Memory specifications

| Memory module sockets | Speed |
|-----------------------|-------------------------------------|
| Four 288-pin | 2666 MT/s 2400 MT/s 2133 MT/s |

Storage controller specifications

The Dell EMC PowerEdge T340 system supports the following controller cards:

Table 17. Dell EMC PowerEdge T340 system controller cards

| Internal controllers | External controllers |
|--|---|
| <ul style="list-style-type: none">PERC H730PPERC H330S140HBA330 | <ul style="list-style-type: none">12Gbps SAS Ext. HBA |

Drive specifications

Drives

The Dell EMC PowerEdge T340 system supports:

- 4 x 3.5-inch SAS, SATA drives, 2.5-inch hotplug drives
- 8 x 3.5-inch SAS, SATA drives, 2.5-inch hotplug drives

 **NOTE: 2.5-inch drives in 3.5-inch carriers are supported for SAS, and SATA SSD drives.**

Optical drives

The Dell EMC PowerEdge T340 system supports the following optical drives.

Table 18. Supported optical drive type

| Supported drive type | Supported number of drives |
|---|----------------------------|
| Dedicated SATA DVD-ROM drive or DVD +/-RW drive | One |

Tape drives

The Dell EMC PowerEdge T340 system supports up to two dedicated 5.25-inch tape drives.

Ports and connectors specifications

USB ports specifications

Table 19. Dell EMC PowerEdge T340 system USB port specifications

| Front panel | Back panel | Internal USB |
|--|---|---|
| <ul style="list-style-type: none">One USB 3.0-compliant port | <ul style="list-style-type: none">Two USB 3.0-compliant ports | <ul style="list-style-type: none">One internal USB 3.0-compliant port |

Table 19. Dell EMC PowerEdge T340 system USB port specifications

| Front panel | Back panel | Internal USB |
|--|--|--------------|
| <ul style="list-style-type: none"> One iDRAC USB MGMT port (USB 2.0) <p>NOTE: The micro USB 2.0 compliant port can only be used as an iDRAC Direct or a management port.</p> | <ul style="list-style-type: none"> Four USB 2.0-compliant ports | |

NIC ports specifications

The Dell EMC PowerEdge T340 system supports up to two 10/100/1000 Mbps Network Interface Controller (NIC) ports that are located on the back panel.

Serial connector specifications

The Dell EMC PowerEdge T340 system supports one serial connector on the back panel, which is a 9-pin connector, Data Terminal Equipment (DTE), 16550-compliant.

VGA ports specification

The Dell EMC PowerEdge T340 system supports one 15-pin VGA port, on the back of the system.

IDSDM module

The Dell EMC PowerEdge T340 system supports optional Internal Dual SD module (IDSDM) module.

The module supports three microSD cards; two cards for IDSDM and one card for vFlash. In 14th generation of PowerEdge servers, the IDSDM or vFlash module is combined into a single card module, and is available in the following configurations:

- vFlash or
- vFlash and IDSDM

Table 20. Supported microSD card storage capacity

| IDSDM card | vFlash card |
|---|---|
| <ul style="list-style-type: none"> 16 GB 32 GB 64 GB | <ul style="list-style-type: none"> 16 GB |

NOTE: There are two dip switches on the IDSDM or vFlash module for write-protection.

NOTE: One IDSDM card slot is dedicated for redundancy.

NOTE: Use Dell EMC branded microSD cards that are associated with the IDSDM or vFlash configured systems.

Video specifications

The Dell EMC PowerEdge T340 system supports Matrox G200eR2 graphics card with 16 MB capacity.

Table 21. Supported video resolution options

| Resolution | Refresh rate | Color depth (bits) |
|------------|--------------|--------------------|
| 640x480 | 60, 70 | 8, 16, 24 |

Table 21. Supported video resolution options(continued)

| Resolution | Refresh rate | Color depth (bits) |
|------------|--------------|--------------------|
| 800x600 | 60, 75, 85 | 8, 16, 24 |
| 1024x768 | 60, 75, 85 | 8, 16, 24 |
| 1152x864 | 60, 75, 85 | 8, 16, 24 |
| 1280x1024 | 60, 75 | 8, 16, 24 |

Environmental specifications

NOTE: For additional information about environmental certifications, refer to the *Product Environmental Datasheet* located with the Manuals & Documents on www.dell.com/support/home.

Table 22. Temperature specifications

| Temperature | Specifications |
|--|--|
| Storage | -40–65°C (-40–149°F) |
| Continuous operation (for altitude less than 950 m or 3117 ft) | 10–35°C (50–95°F) with no direct sunlight on the equipment |
| Fresh air | For information about fresh air, see the Expanded operating temperature section. |
| Maximum temperature gradient (operating and storage) | 20°C/h (68°F/h) |

Table 23. Relative humidity specifications

| Relative humidity | Specifications |
|-------------------|--|
| Storage | 5% to 95% RH with 33°C (91°F) maximum dew point. Atmosphere must be noncondensing at all times. |
| Operating | 10% to 80% RH with 29°C (84.2°F) maximum dew point. |

Table 24. Maximum vibration specifications

| Maximum vibration | Specifications |
|-------------------|--|
| Operating | 0.26 G _{rms} at 5 Hz to 350 Hz (all operation orientations) |
| Storage | 1.88 G _{rms} at 10 Hz to 500 Hz for 15 minutes (all six sides tested) |

Table 25. Maximum shock pulse specifications

| Maximum shock pulse | Specifications |
|---------------------|--|
| Operating | Six consecutively executed shock pulses in the positive and negative x, y, and z axis of 6 G for up to 11 ms. |
| Storage | Six consecutively executed shock pulses in the positive and negative x, y, and z axis (one pulse on each side of the system) of 71 G for up to 2 ms. |

Table 26. Maximum altitude specifications

| Maximum altitude | Specifications |
|------------------|----------------------|
| Operating | 3048 m (10,000 ft) |
| Storage | 12,000 m (39,370 ft) |

Table 27. Operating temperature derating specifications

| Operating temperature derating | Specifications |
|--------------------------------|---|
| Up to 35°C (95°F) | Maximum temperature is reduced by 1°C/300 m (1°F/547 ft), above 950 m (3,117 ft). |
| 35–40°C (95–104°F) | Maximum temperature is reduced by 1°C/175 m (1°F/319 ft), above 950 m (3,117 ft). |
| 40–45°C (104–113°F) | Maximum temperature is reduced by 1°C/125 m (1°F/228 ft), above 950 m (3,117 ft). |

Standard operating temperature

Table 28. Standard operating temperature specifications

| Standard operating temperature | Specifications |
|--|---|
| Continuous operation (for altitude less than 950 m or 3117 ft) | 10–35°C (50–95°F) with no direct sunlight on the equipment. |

Expanded operating temperature

Table 29. Expanded operating temperature specifications

| Expanded operating temperature | Specifications |
|--------------------------------|--|
| Continuous operation | <p>5°C–40°C at 5% to 85% RH with 29°C dew point.</p> <p>i NOTE: Outside the standard operating temperature (10°C–35°C), the system can operate continuously in temperatures as low as 5°C and as high as 40°C.</p> <p>For temperatures 35°C– 40°C, derate maximum allowable temperature by 1°C per 175 m (1°F per 319 ft) above 950 m (3,1171 ft).</p> |
| ≤ 1% of annual operating hours | <p>-5°C–45°C at 5% to 90% RH with 29°C dew point.</p> <p>i NOTE: Outside the standard operating temperature (10°C–35°C), the system can operate down to -5°C or up to 45°C for a maximum of 1% of its annual operating hours.</p> <p>For temperatures 40°C– 45°C, derate maximum allowable temperature by 1°C per 125 m (1°F per 228 ft) above 950 m (3.117 ft).</p> |

i **NOTE: When operating in the expanded temperature range, the performance of the system may be impacted.**

i **NOTE: When operating in the expanded temperature range, ambient temperature warnings may be reported on the System Event Log.**

Expanded operating temperature restrictions

- Do not perform a cold startup of the system below 5°C.
- The operating temperature specified is for a maximum altitude of 950 m for Fresh Air cooling.
- Two redundant power supply units are required.
- Cooling redundancy is not supported due to single fan only in system.
- Support up to 80 W processor.
- One system fan is required.
- Non-Dell qualified peripheral cards and/or peripheral cards greater than 25 W are not supported.
- GPU is not supported.

- Tape backup unit is supported.

Particulate and gaseous contamination specifications

The following table defines the limitations that help avoid any damages to the IT equipment and/or, or both failure from particulate and gaseous contamination. If the levels of particulate or gaseous pollution exceed the specified limitations and results in equipment damage or failure, you must rectify the environmental conditions. Remediation of environmental conditions is the responsibility of the customer.

Table 30. Particulate contamination specifications

| Particulate contamination | Specifications |
|---------------------------|---|
| Air filtration | <p>Data center air filtration as defined by ISO Class 8 per ISO 14644-1 with a 95% upper confidence limit.</p> <p>i NOTE: This condition applies to data center environments only. Air filtration requirements do not apply to IT equipment designed to be used outside a data center, in environments such as an office or factory floor.</p> <p>i NOTE: Air entering the data center must have MERV11 or MERV13 filtration.</p> |
| Conductive dust | <p>Air must be free of conductive dust, zinc whiskers, or other conductive particles.</p> <p>i NOTE: This condition applies to data center and non-data center environments.</p> |
| Corrosive dust | <ul style="list-style-type: none"> · Air must be free of corrosive dust. · Residual dust present in the air must have a deliquescent point less than 60% relative humidity. <p>i NOTE: This condition applies to data center and non-data center environments.</p> |

Table 31. Gaseous contamination specifications

| Gaseous contamination | Specifications |
|-------------------------|---|
| Copper Coupon Corrosion | <300 Å/month per Class G1 as defined by ANSI/ISA71.04-1985. |
| Silver Coupon Corrosion | <200 Å/month as defined by AHSRAE TC9.9. |

i **NOTE: Maximum corrosive contaminant levels measured at ≤50% relative humidity.**

System diagnostics and indicator codes

The diagnostic indicators on the system front panel display system status during system startup.

Topics:

- System health and system ID indicator codes
- iDRAC Direct LED indicator codes
- NIC indicator codes
- Non-redundant cabled power supply unit indicator codes
- Power supply unit indicator codes
- Drive indicator codes
- PowerEdge T340 system diagnostics

System health and system ID indicator codes

The system health and system ID indicator is located on the front panel of your system.



Figure 88. System health and system ID indicator

Table 32. System health and system ID indicator codes

| System health and system ID indicator code | Condition |
|--|--|
| Solid blue | Indicates that the system is turned on, system is healthy, and system ID mode is not active. Press the system health and system ID button to switch to system ID mode. |
| Blinking blue | Indicates that the system ID mode is active. Press the system health and system ID button to switch to system health mode. |
| Solid amber | Indicates that the system is in fail-safe mode. If the problem persists, see the Getting help section. |
| Blinking amber | Indicates that the system is experiencing a fault. Check the System Event Log for specific error messages. For information about the event and error messages generated by the system firmware and agents that monitor system components, see the Error Code Lookup page at qrl.dell.com |

iDRAC Direct LED indicator codes

The iDRAC Direct LED indicator lights up to indicate that the port is connected and is being used as a part of the iDRAC subsystem.

You can configure iDRAC Direct by using a USB to micro USB (type AB) cable, which you can connect to your laptop or tablet. The following table describes iDRAC Direct activity when the iDRAC Direct port is active:

Table 33. iDRAC Direct LED indicator codes

| iDRAC Direct LED indicator code | Condition |
|---|--|
| Solid green for two seconds | Indicates that the laptop or tablet is connected. |
| Flashing green (on for two seconds and off for two seconds) | Indicates that the laptop or tablet connected is recognized. |

Table 33. iDRAC Direct LED indicator codes(continued)

| iDRAC Direct LED indicator code | Condition |
|---------------------------------|---|
| Powers off | Indicates that the laptop or tablet is unplugged. |

NIC indicator codes

Each NIC on the back of the system has indicators that provide information about the activity and link status. The activity LED indicator indicates if data is flowing through the NIC, and the link LED indicator indicates the speed of the connected network.

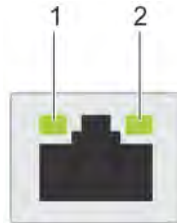

Figure 89. NIC indicator codes

1. Link LED indicator
2. Activity LED indicator

Table 34. NIC indicator codes

| Status | Condition |
|--|--|
| Link and activity indicators are off. | The NIC is not connected to the network. |
| Link indicator is green, and activity indicator is blinking green. | The NIC is connected to a valid network at its maximum port speed, and data is being sent or received. |
| Link indicator is amber, and activity indicator is blinking green. | The NIC is connected to a valid network at less than its maximum port speed, and data is being sent or received. |
| Link indicator is green, and activity indicator is off. | The NIC is connected to a valid network at its maximum port speed, and data is not being sent or received. |
| Link indicator is amber, and activity indicator is off. | The NIC is connected to a valid network at less than its maximum port speed, and data is not being sent or received. |
| Link indicator is blinking green, and activity is off. | NIC identify is enabled through the NIC configuration utility. |

Non-redundant cabled power supply unit indicator codes

Press the self-diagnostic button to perform a quick health check on the non-redundant cabled power supply unit (PSU) of the system.

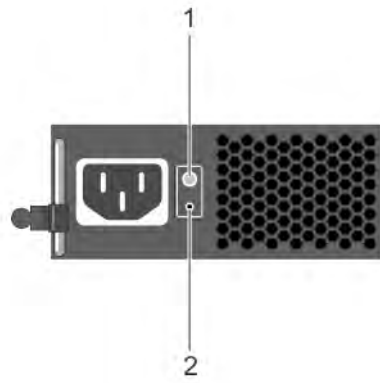

Figure 90. Non-redundant cabled AC PSU status indicator and self-diagnostic button

1. Self-diagnostic button
2. AC PSU status indicator

Table 35. Non-redundant AC PSU status indicator

| Power Indicator Pattern | Condition |
|-------------------------|--|
| Not lit | Power is not connected or PSU is faulty. |
| Green | A valid power source is connected to the PSU and the PSU is operational. |

Power supply unit indicator codes

AC power supply units (PSUs) have an illuminated translucent handle that serves as an indicator. The indicator shows whether power is present or if a power fault has occurred.

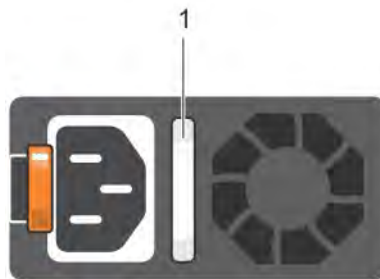

Figure 91. AC PSU status indicator

1. AC PSU status indicator/handle

Table 36. AC PSU status indicator codes

| Power indicator codes | Condition |
|------------------------------|---|
| Green | A valid power source is connected to the PSU and the PSU is operational. |
| Blinking amber | Indicates a problem with the PSU. |
| Not illuminated | Power is not connected to the PSU. |
| Blinking green | When the firmware of the PSU is being updated, the PSU handle blinks green. CAUTION: Do not disconnect the power cord or unplug the PSU when updating firmware. If firmware update is interrupted, the PSUs do not function. |
| Blinking green and turns off | When hot-plugging a PSU, the PSU handle blinks green five times at a rate of 4 Hz and turns off. This indicates a PSU mismatch with respect to efficiency, feature set, health status, or supported voltage. CAUTION: If two PSUs are installed, both the PSUs must have the same type of label; for example, Extended Power Performance (EPP) label. Mixing PSUs from previous generations |

Table 36. AC PSU status indicator codes(continued)

| Power indicator codes | Condition |
|-----------------------|---|
| | of PowerEdge servers is not supported, even if the PSUs have the same power rating. This results in a PSU mismatch condition or failure to power on the system. |
| △ | CAUTION: When correcting a PSU mismatch, replace only the PSU with the blinking indicator. Swapping the PSU to make a matched pair can result in an error condition and unexpected system shutdown. To change from a high output configuration to a low output configuration or vice versa, you must power off the system. |
| △ | CAUTION: AC PSUs support both 240 V and 120 V input voltages with the exception of Titanium PSUs, which support only 240 V. When two identical PSUs receive different input voltages, they can output different wattages, and trigger a mismatch. |
| △ | CAUTION: If two PSUs are used, they must be of the same type and have the same maximum output power. |

Drive indicator codes

The LEDs on the drive carrier indicates the state of each drive. Each drive carrier in your system has two LEDs: an activity LED (green) and a status LED (bicolor, green/amber). The activity LED flashes whenever the drive is accessed.



Figure 92. Drive indicators on the drive and the mid drive tray backplane

1. Drive activity LED indicator
2. Drive status LED indicator
3. Drive Capacity Label

NOTE: If the drive is in the Advanced Host Controller Interface (AHCI) mode, the status LED indicator does not turn on.

Table 37. Drive indicator codes

| Drive status indicator code | Condition |
|--|--|
| Flashes green twice per second | Identifying drive or preparing for removal. |
| Off | Drive ready for removal. NOTE: The drive status indicator remains off until all drives are initialized after the system is turned on. Drives are not ready for removal during this time. |
| Flashes green, amber, and then turns off | Predicted drive failure. |

Table 37. Drive indicator codes(continued)

| Drive status indicator code | Condition |
|--|-------------------|
| Flashes amber four times per second | Drive failed. |
| Flashes green slowly | Drive rebuilding. |
| Solid green | Drive online. |
| Flashes green for three seconds, amber for three seconds, and then turns off after six seconds | Rebuild stopped. |

PowerEdge T340 system diagnostics

If you experience a problem with your system, run the system diagnostics before contacting Dell for technical assistance. The purpose of running system diagnostics is to test your system hardware without using additional equipment or risking data loss. If you are unable to fix the problem yourself, service and support personnel can use the diagnostics results to help you solve the problem.

Dell Embedded System Diagnostics

 **NOTE: The Dell Embedded System Diagnostics is also known as Enhanced Pre-boot System Assessment (ePSA) diagnostics.**

The Embedded System Diagnostics provides a set of options for particular device groups or devices allowing you to:

- Run tests automatically or in an interactive mode
- Repeat tests
- Display or save test results
- Run thorough tests to introduce additional test options to provide extra information about the failed device(s)
- View status messages that inform you if tests are completed successfully
- View error messages that inform you of problems encountered during testing

Running the Embedded System Diagnostics from Boot Manager

Run the Embedded System Diagnostics (ePSA) if your system does not boot.

Steps

1. When the system is booting, press F11.
2. Use the up arrow and down arrow keys to select **System Utilities > Launch Diagnostics**.
3. Alternatively, when the system is booting, press F10, select **Hardware Diagnostics > Run Hardware Diagnostics**.
The **ePSA Pre-boot System Assessment** window is displayed, listing all devices detected in the system. The diagnostics starts executing the tests on all the detected devices.

Results

Running the Embedded System Diagnostics from the Dell Lifecycle Controller

Steps

1. As the system boots, press F10.
2. Select **Hardware Diagnostics → Run Hardware Diagnostics**.
The **ePSA Pre-boot System Assessment** window is displayed, listing all devices detected in the system. The diagnostics starts executing the tests on all the detected devices.

System diagnostic controls

| Menu | Description |
|----------------------|---|
| Configuration | Displays the configuration and status information of all detected devices. |
| Results | Displays the results of all tests that are run. |
| System health | Provides the current overview of the system performance. |
| Event log | Displays a time-stamped log of the results of all tests run on the system. This is displayed if at least one event description is recorded. |

Getting help

Topics:

- [Recycling or End-of-Life service information](#)
- [Contacting Dell](#)
- [Accessing system information by using QRL](#)
- [Receiving automated support with SupportAssist](#)

Recycling or End-of-Life service information

Take back and recycling services are offered for this product in certain countries. If you want to dispose of system components, visit www.dell.com/recyclingworldwide and select the relevant country.

Contacting Dell

Dell provides several online and telephone based support and service options. If you do not have an active internet connection, you can find contact information about your purchase invoice, packing slip, bill, or Dell product catalog. Availability varies by country and product, and some services may not be available in your area. To contact Dell for sales, technical assistance, or customer service issues:

Steps

1. Go to www.dell.com/support/home
2. Select your country from the drop-down menu on the lower right corner of the page.
3. For customized support:
 - a. Enter your system Service Tag in the **Enter your Service Tag** field.
 - b. Click **Submit**.
The support page that lists the various support categories is displayed.
4. For general support:
 - a. Select your product category.
 - b. Select your product segment.
 - c. Select your product.
The support page that lists the various support categories is displayed.
5. For contact details of Dell Global Technical Support:
 - a. Click [Global Technical Support](#)
 - b. The **Contact Technical Support** page is displayed with details to call, chat, or e-mail the Dell Global Technical Support team.

Accessing system information by using QRL

You can use the Quick Resource Locator (QRL) located on the information tag in the front of the T340, to access the information about the Dell EMC PowerEdge T340.

Prerequisites

Ensure that your smartphone or tablet has the QR code scanner installed.

The QRL includes the following information about your system:

- How-to videos
- Reference materials, including the Installation and Service Manual, and mechanical overview
- Your system service tag to quickly access your specific hardware configuration and warranty information
- A direct link to Dell to contact technical assistance and sales teams

Steps

1. Go to www.dell.com/qrl and navigate to your specific product or
2. Use your smartphone or tablet to scan the model-specific Quick Resource (QR) code on your system or in the Quick Resource Locator section.

Quick Resource Locator for Dell EMC PowerEdge T340 system



Figure 93. Quick Resource Locator for Dell EMC PowerEdge T340 system

Receiving automated support with SupportAssist

Dell EMC SupportAssist is an optional Dell EMC Services offering that automates technical support for your Dell EMC server, storage, and networking devices. By installing and setting up a SupportAssist application in your IT environment, you can receive the following benefits:

- **Automated issue detection** — SupportAssist monitors your Dell EMC devices and automatically detects hardware issues, both proactively and predictively.
- **Automated case creation** — When an issue is detected, SupportAssist automatically opens a support case with Dell EMC Technical Support.
- **Automated diagnostic collection** — SupportAssist automatically collects system state information from your devices and uploads it securely to Dell EMC. This information is used by Dell EMC Technical Support to troubleshoot the issue.
- **Proactive contact** — A Dell EMC Technical Support agent contacts you about the support case and helps you resolve the issue.

The available benefits vary depending on the Dell EMC Service entitlement purchased for your device. For more information about SupportAssist, go to www.dell.com/supportassist.

Documentation resources

This section provides information about the documentation resources for your system.

To view the document that is listed in the documentation resources table:

- From the Dell EMC support site:
 1. Click the documentation link that is provided in the Location column in the table.
 2. Click the required product or product version.
 3. On the Product Support page, click **Manuals & documents**.
- Using search engines:
 - Type the name and version of the document in the search box.

 **NOTE: To locate the product name and model, see the front of your system.**

Table 38. Additional documentation resources for your system

| Task | Document | Location |
|-------------------------|---|--|
| Setting up your system | For more information about installing and securing the system into a rack, see the Rail Installation Guide included with your rack solution. For information about setting up your system, see the <i>Getting Started Guide</i> document that is shipped with your system. | www.dell.com/poweredgemanuals |
| Configuring your system | For information about the iDRAC features, configuring and logging in to iDRAC, and managing your system remotely, see the Integrated Dell Remote Access Controller User's Guide. For information about understanding Remote Access Controller Admin (RACADM) subcommands and supported RACADM interfaces, see the RACADM CLI Guide for iDRAC. For information about Redfish and its protocol, supported schema, and Redfish Eventing are implemented in iDRAC, see the Redfish API Guide. For information about iDRAC property database group and object descriptions, see the Attribute Registry Guide. | www.dell.com/poweredgemanuals |
| | For information about earlier versions of the iDRAC documents, see the iDRAC documentation. To identify the version of iDRAC available on your system, on the iDRAC web interface, click ? > About . | www.dell.com/idracmanuals |
| | For information about installing the operating system, see the operating system documentation. | www.dell.com/operatingsystemmanuals |
| | For information about updating drivers and firmware, see the Methods to download firmware and drivers section in this document. | www.dell.com/support/drivers |
| Managing your system | For information about systems management software offered by Dell, see the Dell | www.dell.com/poweredgemanuals |

Table 38. Additional documentation resources for your system(continued)

| Task | Document | Location |
|--|--|--|
| | OpenManage Systems Management Overview Guide. | |
| | For information about setting up, using, and troubleshooting OpenManage, see the Dell OpenManage Server Administrator User's Guide. | www.dell.com/openmanagemanuals > OpenManage Server Administrator |
| | For information about installing, using, and troubleshooting Dell OpenManage Essentials, see the Dell OpenManage Essentials User's Guide. | www.dell.com/openmanagemanuals > OpenManage Essentials |
| | For information about installing, using, and troubleshooting Dell OpenManage Enterprise, see the Dell OpenManage Enterprise User's Guide. | www.dell.com/openmanagemanuals > OpenManage Enterprise |
| | For information about installing and using Dell SupportAssist, see the Dell EMC SupportAssist Enterprise User's Guide. | www.dell.com/serviceabilitytools |
| | For information about partner programs enterprise systems management, see the OpenManage Connections Enterprise Systems Management documents. | www.dell.com/openmanagemanuals |
| Working with the Dell PowerEdge RAID controllers | For information about understanding the features of the Dell PowerEdge RAID controllers (PERC), Software RAID controllers, or BOSS card and deploying the cards, see the Storage controller documentation. | www.dell.com/storagecontrollermanuals |
| Understanding event and error messages | For information about the event and error messages that are generated by the system firmware and agents that monitor system components, see the Error Code Lookup. | www.dell.com/qrl |
| Troubleshooting your system | For information about identifying and troubleshooting the PowerEdge server issues, see the Server Troubleshooting Guide. | www.dell.com/poweredgemanuals |