



***Rolko Products Are Available
Through MK Battery***



Product Catalog

**Mobility &
Positioning
Products**

**Customized
Products**

Daily Aids

CONTENTS

About	3
Commitment	4
Information Key	5

MOBILITY

Frog Legs Casters/LED Wheels	6-7
Manual Tires iMPAC	8
Manual Tires Schwalbe	9
Tubes, Inlets and RimBands	10
Poly Tires	11
Push Rims Vega	12
Push Rims Perigon and Accessories	13
Wheel Accessories	14
Wheel Brakes and Accessories	15
Power Chair Casters And Wheels	16-18
Power Chair Tires	19

POSITIONING

Seatbelts	20-22
Arm Supports	23
Modular Arm Shell System HEMI	24-25
Leg Supports	26
Abductor Wedges and Supports	27
Head Supports	28

ACCESSORIES

Hand Grips Easy Push	29
Transfer Aids EasyTRANSFER <small>Rolko</small>	30
Umbrella and Walker Belts PROTEKTOR	31
Bags and Wheel Bags BAG <small>Rolko</small>	32
Scooter Accessories	33
Thermo Wear Thermo <small>Rolko</small>	34-35

Rolko North America Inc. is a subsidiary of Rolko Kohlgrüber GmbH, a leading manufacturer and supplier of components and accessories for the rehabilitation market as well as mobility solutions for companies from various industrial sectors. Rolko's headquarters is in Germany, with subsidiaries in Denmark, the Netherlands and the USA as well as a production plant in Asia. The company ensures advice, support and delivery around the globe.

Manufacturers and specialist retailers from over 80 countries rely on the product offering of Rolko, which includes wheels, tires, puncture-proof solutions and other components for wheelchairs and rehabilitation equipment. Rolko also offers rehabilitations aids such as wheelchair ramps, weather protection, transfer aids, seating and positioning aids, and accessories for scooters, power and manual wheelchairs. With over 30 years of industry experience, Rolko is here to meet your wheelchair needs.

Rolko has joined forces with MK Battery to provide enhanced logistics and distribution services throughout the U.S.

MK Battery is stocking select Rolko products, making them available via its nationwide order processing and route delivery system. MK customers are now able to add Rolko accessories, such as wheels, tires, seatbelts, arm-rests, etc. onto their orders. Rolko products not stocked in MK distribution centers are available to order from MK Battery for drop shipment.

Route delivery of certain products available through MK Battery

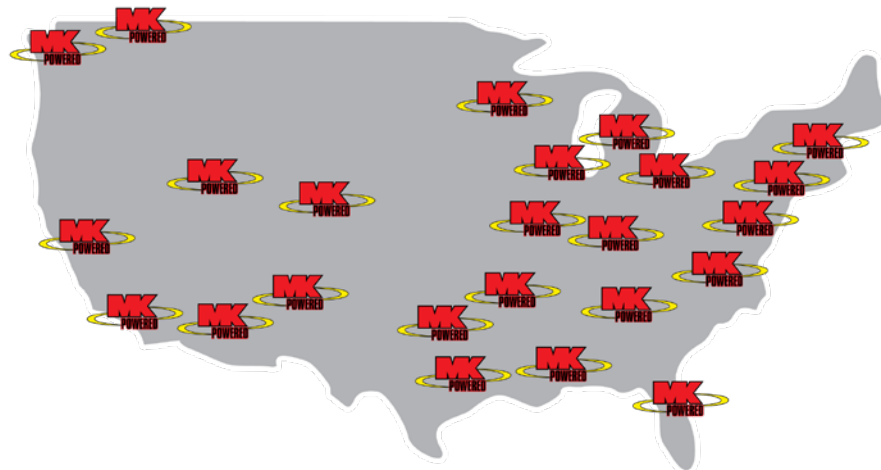

MK Battery Supports the HME Industry

MK Battery is committed to helping our HME business partners succeed in today's challenging environment. We offer an array of training and merchandising tools specifically designed for the HME dealer. From our accredited technical training programs to our retail marketing pieces, MK Battery provides the tools you need.



1.

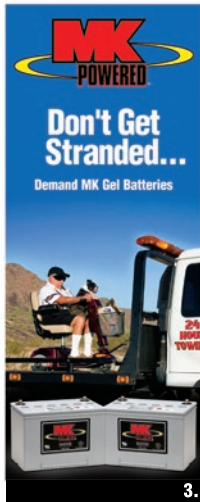

3.



4.



5.

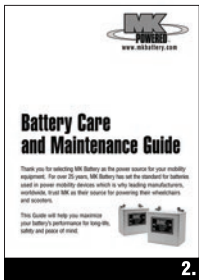

2.

1. Attractive "Recharge Every Night" reminder stickers are available to MK customers free of charge for placement on dispensed power mobility equipment. Authorized dealer decals also available.

2. The Battery Care & Maintenance Guide provides consumers with concise tips on proper care, charging, storage & maintenance and safety aspects associated with batteries used in their mobility equipment.

3. Full-color, retail display with takeaway insert. A visual accent to any dealer showroom with a clear message that quality batteries make a big difference in the performance of wheelchairs and scooters.

4. MK Battery offers an assortment of technical and educational support, specifically designed for the HME industry. Accredited in-service presentations and a host of other technical and training tools are available to authorized dealers.

5. MK Battery is committed to supporting the strategic industry initiatives at the national, state and local levels. Through educational programs, participation in global wheelchair standards committees, direct lobbying efforts, and financial support of industry associations, MK Battery is your partner in protecting the interests of the HME community.

MK Battery proudly supports:

AA HOMECARE | NRRTS | NCART | RESNA

Your Partner In Power and Parts

MK Battery is one of the world's largest specialty Sealed VRLA, deep-cycle battery suppliers. Trusted globally by mobility products manufacturers and HME providers, our mission to supply the highest quality battery products to the mobility industry has kept us at the forefront of providing unsurpassed battery performance and dependability.

Extended cycle life and high capacity sealed batteries are MK's hallmark. This means greater service life and performance for your customers. Our ongoing R&D efforts ensure you the most effective technology to meet your unique requirements.

MK Battery ships fresh inventory fast, often within 24 hours, from a stock of more than 100,000 batteries in multiple distribution centers throughout the world, and assists our customers with proper spent battery disposal thru EPA permitted smelters. (Please note that violation of hazardous waste disposal laws can place heavy penalties on offenders).

Educational literature. Training videos. Lobbying support for reimbursement. These are some of the things that set MK Battery apart from other battery sellers. MK Battery supports mobility manufacturers, HME providers, and consumers with extensive battery care, maintenance and safety information. We have worked to further the application of new technologies for the continued improvement of mobility through groups such as ANSI/RESNA Wheelchair Standards Committee, on which we proudly serve. With MK Battery, you know that you can expect our total commitment to keep you at the forefront of new technology and to provide the greatest value in power.



MK Battery is a proud sponsor and the official battery of the United States Power Soccer Association and TEAM USA National Power Soccer Team.

www.powersoccerusa.org



Tire Color



Rim Color



Bore / Inner Diameter

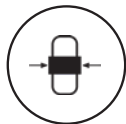

Hub Length

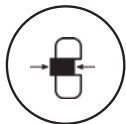

Mounting Length



Rim Base Width



Tire Tread



Gap Between Tabs



Net Weight (LB)

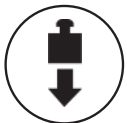

Load Capacity (Lb)



Max. Air Pressure (Psi)



Color



Depth



Installation Length



Tire Width / Inner Diameter



Height



Length



Reference



Seat Width



Width





Max. Speed Miles per hour

All specified dimensions are approximate. All illustrations are non-binding.
We reserve the right to make unpublished/unannounced modifications.

All images, graphics and texts in our catalog are copyright © protected.
Any use requires our prior written permission.





Silver Aluminum Lightweight Rim
With Poly Tire

SIZE			Product Number
3x1.4"	1"	8mm	RLK-MCLT3SB
4x1"	1"	8mm	RLK-MCC24SB
4x1.25"	1"	8mm	RLK-MCOE4SB
4x1.4"	1"	8mm	RLK-MCLT4SB
5x1"	1"	8mm	RLK-MCC25SB
5x1.25"	1"	8mm	RLK-MCOE5SB
5x1.4"	1"	8mm	RLK-MCLT5SB
6x1.4"	1"	8mm	RLK-MCLT6SB





Black Aluminum Lightweight Rim
With Poly Tire

SIZE			Product Number
3x1.4"	1"	8mm	RLK-MCLT3BB
4x1"	1"	8mm	RLK-MCC24BB
4x1.25"	1"	8mm	RLK-MCOE4BB
4x1.4"	1"	8mm	RLK-MCLT4BB
5x1"	1"	8mm	RLK-MCC25BB
5x1.25"	1"	8mm	RLK-MCOE5BB
5x1.4"	1"	8mm	RLK-MCLT5BB
6x1.4"	1"	8mm	RLK-MCLT6BB





Ti-Lite Wheels Aluminum Lightweight Rim
With Poly Tire

SIZE				Product Number
4x1.4"	1"	3/8"	Silver	RLK-MCTL4SB
5x1.4"	1"	3/8"	Silver	RLK-MCTL5SB
6x1.4"	1"	3/8"	Silver	RLK-MCTL6SB
4x1.4"	1"	3/8"	Black	RLK-MCTL4BB
5x1.4"	1"	3/8"	Black	RLK-MCTL5BB
6x1.4"	1"	3/8"	Black	RLK-MCTL6BB



Composite Lightweight Rims
With Poly Tire

SIZE			Product Number
4x1.4"	1"	8mm	RLK-MCAG4BB
5x1.4"	1"	8mm	RLK-MCAG5BB
6x1.4"	1"	8mm	RLK-MCAG6BB

Technician Notes

Three-spoke ultralight aluminum caster wheels.

Custom-made 6061-T6 aircraft grade aluminum wheel that is machine-lathed for a perfect balance.

Priority, highly-resilient solid urethane tread is designed to minimize energy loss and absorb vibration.

Spherical arched-tread design improves pivotability for effortless turns and enhanced stability.

Extra width better distributes downward pressure allowing the wheel to maintain higher flotation and significantly reduces immersion into carpet, gravel, etc.

Technician Notes



Same great benefits of traditional Frog Legs wheels but specially designed for Ti-Lite wheels

Technician Notes

An economic alternative made with composite. Still with all the benefits of the Frog Legs wheel design.

Frog Legs and Skate Wheels



Blue Aluminum Lightweight Rim With Poly Tire

SIZE			Product Number
4x1"	1"	8mm	RLK-MCC24UB
4x1.4"	1"	8mm	RLK-MCLT4UB
5x1"	1"	8mm	RLK-MCC25UB
5x1.4"	1"	8mm	RLK-MCLT5UB

**Available in other colors. Contact us for more details.





Red Aluminum Lightweight Rim With Poly Tire

SIZE			Product Number
4x1"	1"	8mm	RLK-MCC24RB
4x1.4"	1"	8mm	RLK-MCLT4RB
5x1"	1"	8mm	RLK-MCC25RB
5x1.4"	1"	8mm	RLK-MCLT5RB

**Available in other colors. Contact us for more details.



Orange Aluminum Lightweight Rim With Poly Tire

SIZE			Product Number
4x1"	1"	8mm	RLK-MCC24OB
4x1.4"	1"	8mm	RLK-MCLT4OB
5x1"	1"	8mm	RLK-MCC25OB
5x1.4"	1"	8mm	RLK-MCLT5OB

**Available in other colors. Contact us for more details.









Skate Wheels With Plastic Rim and Poly Tire With Four LED Lights

SIZE			Product Number
80mm	1"	8mm	RLK-MCLED3
100mm	1"	8mm	RLK-MCLED4
125mm	1"	8mm	RLK-MCLED5









IMPAC

Grey Tires, Standard

Size	ETRTO		BAR			Product Number
20x1.3/8"	37-451	60 kg	60 psi		R-124	RLK-MD20WG
22x1.3/8"	37-501	65 kg	60 psi		R-124	RLK-MD22WG
24x1.3/8"	37-540	75 kg	60 psi		R-124	RLK-MD24WG

Black Tire, Non-Marking

Size	ETRTO		BAR			Product Number
20x1.3/8"	37-451	60 kg	60 psi		R-124	RLK-MD20WB
22x1.3/8"	37-501	65 kg	60 psi		R-124	RLK-MD22WB
24x1.3/8"	37-540	75 kg	60 psi		R-124	RLK-MD24WB

Grey Tire, Super Light Tread

Size	ETRTO		BAR			Product Number
24x1"	25-540	60 kg	100 psi		R-103	RLK-MD24NHPG

Black Tire, Non-Marking, Super Light Tread

Size	ETRTO		BAR			Product Number
24x1"	25-540	60 kg	100 psi		R-103	RLK-MD24NHPB

Tread Patterns

R-103

R-103

R-124

R-124





Rolko: Official Supplier of Schwalbe Tires in North America

Contact us for additional sizes and colors.

RightRun: Entry level model with effective puncture protection layer, Easy grip, hand-friendly 2grip side walls, and attractive two color compound.

Size	ETRTO	TIRE COLOR	BAR	Weight	Product Number
24x1"	25-540	● / ●	6-10	130lbs	RLK-MD24RRG
24x1"	25-540	● / ●	6-10	130lbs	RLK-MD24RRB
25x1"	23-559	● / ●	6-10	130lbs	RLK-MD25RRG
26x1"	25-590	● / ●	6-10	143lbs	RLK-MD26RRG



Marathon Plus Evolution: Punctures are a thing of the past! Flat-less smart guard. Durable rubber compound that does not leave marks with easy grip. The tire with the lowest rolling resistance on the market!

Size	ETRTO	TIRE COLOR	BAR	Weight	Product Number
24x1"	25-540	●	6-10	130lbs	RLK-MD24MP
24x1"	25-540	●/Reflex	6-10	130lbs	RLK-MD24MPR
24x1.3/8"	37-540	●	3, 5-6	165lbs	RLK-MD24MPW
25x1"	25-559	●	6-10	130lbs	RLK-MD25MP
26x1"	25-590	●	6-10	143lbs	RLK-MD26MP



One: Fast and reliable folding Schwalbe tire. Stylish design and Wheelstar rubber compound, high level of puncture resistance due to the V-Guard fiber.

Size	ETRTO	TIRE COLOR	BAR	Weight	Product Number
24x1"	25-540	●/Reflex	6-9	154lbs	RLK-MD24ONE
25x1"	25-559	●/Reflex	6-9	154lbs	RLK-MD25ONE



DownTown: All-rounder with grip and comfort. Puncture protection belt kevlar guard and easy grip.

Size	ETRTO	TIRE COLOR	BAR	Weight	Product Number
24x1"	25-540	●	6-10	130lbs	RLK-MD24DTS
24x1.3/8"	37-540	● / ●	3, 5-6	165lbs	RLK-MD24DTW



Tubes

Tire Tubes With Car or French Valve

SIZE	ETRTO	VALVE	Product Number
7x1.3/4"	47-93	Car Valve 90 degree	RLK-CS8X290
20x1"	25-451	Car Valve Schrader	RLK-MS20NAV
20x1.3/8"	37-451	Car Valve Schrader	RLK-MS20WAV
22x1.3/8"	37-489	Car Valve Schrader	RLK-MS22WAV
24x1"	25-540	Car Valve Schrader	RLK-MS24NAV
24x1"	25-540	Presta/French Valve	RLK-MS24NFV
24x1.3/8"	37-540	Car Valve Schrader	RLK-MS24WAV
25x1"	25-559	Car Valve Schrader	RLK-MS25NAV
25x1"	20-559	Presta/French Valve	RLK-MS25NFV
26x1"	25-590	Car Valve Schrader	RLK-MS26NAV
26x1"	25-590	Presta/French Valve	RLK-MS26NFV
26x1.3/8"	37-590	Car Valve Schrader	RLK-MS26WAV

Please Contact Us For Additional Sizes



Presta / French Valve



Car Valve Schrader

Tire Inlays

Polyurethane Foam Inlay To Insert Into Tires

SIZE	Product Number
24x1"	23 - 24mm RLK-MA24N
24x1.3/8"	27 - 29mm RLK-MA24W

Please Contact Us For Additional Sizes



Rolko Inlet

Rim Bands









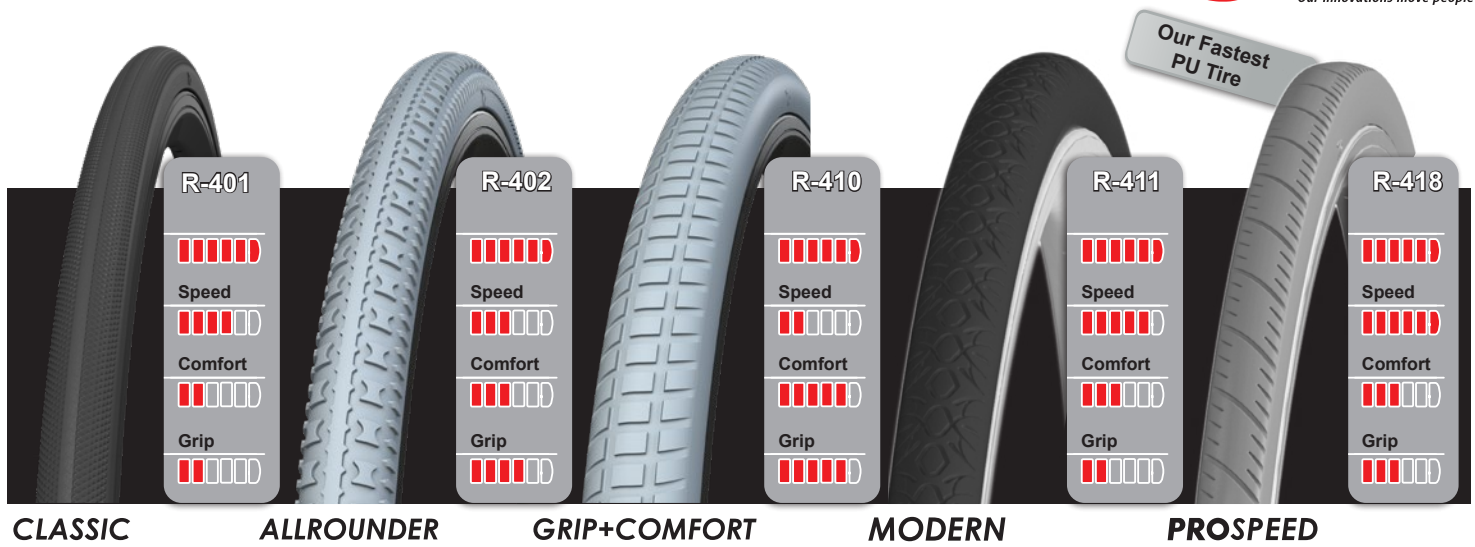











Rim Bands Protect The Inner Tubes Against Damages From The Spoke Ends In The Inner Rim. Width Size In Milimeters. Sold Individually.

SIZE	ETRTO	W	Product Number
Standard	22-406	13mm	RLK-FB20W
Standard	20-89/507	12mm	RLK-FB22W
Standard	18-540	14mm	RLK-FB24W
Standard	20-590	13mm	RLK-FB26W
Polyurethane	16-540	16mm	RLK-FB24N
Polyurethane	20-559	19mm	RLK-FB25N



Polyurethane Tires For Manual Wheelchairs



SIZE	ETRTO				Product Number
20x1"	25-451		R-401	16	RLK-MU20NG16
20x1"	25-451		R-401	21	RLK-MU20NG21
20x1.3/8"	37-451		R-402	21	RLK-MU20WG
22x1"	25-489		R-401	16	RLK-MU22NB16
22x1"	25-489		R-411	16	RLK-MU22YB16
22x1.3/8"	37-501		R-402	19	RLK-MU22WG
22x1.3/8"	37-501		R-401	19	RLK-MU22WB
24x1"	25-540		R-401	16	RLK-MU24NB16
24x1"	25-540		R-411	16	RLK-MU24YB16
24x1"	25-540		R-401	20	RLK-MU24NB20
24x1"	25-540		R-418 PROSPEED	20	RLK-MU24PSB
24x1.3/8"	37-540		R-410	21	RLK-MU24WB
24x1.3/8"	37-540		R-402	21	RLK-MU24WG
25x1"	25-559		R-401	19	RLK-MU25NB
25x1"	25-559		R-418 PROSPEED	21	RLK-MU25PSB
25x1"	25-559		R-418 PROSPEED	21	RLK-MU25PSG
26x1"	25-590		R-401	19	RLK-MU26NB
26x1.3/8"	37-590		R-402	21	RLK-MU26WG

Tire Accessories

Plastic Tire Lever For An Easy Assembly of PU and Pneumatic Tires on Rims



VEGA Push Rims



Technician Notes

Soft Rims have a coating for easy grip and comfort.



Push Rim, Ergonomic, Oval, Anodized Aluminum, Black

	SIZE	TABS	Product Number
Natural Fit	24"	6	RLK-GF24EV
Natural Fit	25"	6	RLK-GF25EV
Natural Fit, Vinyl Dip	24"	6	RLK-GF24QV
Natural Fit, Vinyl Dip	25"	6	RLK-GF25QV



Push Rim Made Of Aluminum, Extra-Soft Coating For More Grip

Size			TABS	Ø1	Product Number
24"	545	523*	6	20	RLK-GF24QG

*Space between tabs



Size			TABS	Ø1	Product Number
24"	545	523*	5	20	RLK-G24AL5S

*Space between tabs

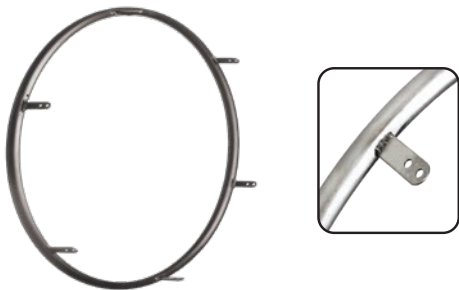

Push Rim Made of Aluminum, Silver or Black Anodized

Size			TABS	Ø1	COLOR	Product Number
24"	542	523*	6	20	Silver	RLK-GF24SA
24"	542	523*	6	20	Black	RLK-GF24BA

*Space between tabs



Push Rim Made of Stainless Steel

Size			TABS	Ø1	Product Number
24"	540	524*	6	20	RLK-GF24SS

*Space between tabs

Push Rims And Accessories

Fixation Kit:
6 Pan Head Screws
M5x10 mm, 6 Hexagon
Nuts M5

Product Number
RLK-UM5GFKIT



Comfortable Push Rim Covers Made Of Silicone,
Supersoft, Smooth. Sold Individually

Size		$\varnothing 1$	Product Number
20"	412-424	16-21	RLK-SGR201
22"	486-501	16-21	RLK-SGR221
24"	519-532	16-21	RLK-SGR241
25"	533-559	16-21	RLK-SGR251
26"	571-590	16-21	RLK-SGR261

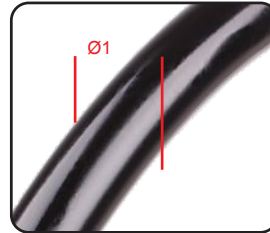



Perigon



36 SPOKE WHEEL



Black Aluminum Double Wall Rim, With 36 Black Spokes.
Black Aluminum Push Rims, Available With A Variety of Tire
Options Compatible with TiLite, Ki Mobility and Sunrise

Pneumatic Tire Schwalbe RunRight

	SIZE				Product Number
Black	24x1"	540	2"	1/2"	RLK-H224BBB2



Pneumatic Tire With Airless Insert

	SIZE				Product Number
Black	24x1.3/8"	540	2"	1/2"	RLK-H224BBB1
Grey	24x1.3/8"	540	2"	1/2"	RLK-H224BBB3



Quick Release Axle FLY, Large Button, Easy Release For Those With Limited Dexterity

L	Ø	Product Number
3.9"	1/2"	RLK-QRA99FLY
4"	1/2"	RLK-QRA104FLY
4.3"	1/2"	RLK-QRA110FLY
4.6"	1/2"	RLK-QRA116FLY

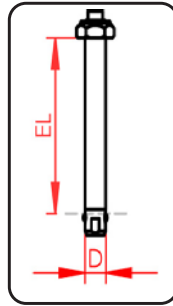

Button Back



Button Front

Quick Release Axle

L	Ø	Product Number
4"	1/2"	RLK-QRA104VA
4.3"	1/2"	RLK-QRA110VA
1.8"	1/2"	RLK-QRA123VA



ABEC 3, Double Sealed Precision Bearings

Ø	W	W	Type	Product Number
28mm	12mm	8mm	6001-2RS	RLK-KG6001
1 1/8"	1/2"	5/16"	R8-2RS	RLK-KGR82RS
7/8"	3/8"	9/32"	R6-2RS	RLK-KGR62RS
22mm	8mm	7mm	608-2RS	RLK-KG6083
29/32"	7/16"	5/16"	1607-2RS	RLK-KG1607



Spoke Reflector. Approximately 3"

W	Product Number
3"	RLK-REF2



Bearing Cap

W	Product Number
1"	RLK-KNROCAP



Wheel Brakes and Accessories

Composite Brakes Push To Lock

	Product Number
Right	RLK-WL20R
Left	RLK-WL20L
Kit	RLK-WL20KIT

Kit: Left & Right Brake, Clamps Sold Separately.



Composite Brakes Scissor Lock

	Product Number
Right	RLK-WL01R
Left	RLK-WL01L
Kit	RLK-WL01KIT

Kit: Left & Right Brake, Clamps Sold Separately.



Aluminum Parking Brakes Compatible With Lever Extension WLV1

	Product Number
Right	RLK-WLLEVR
Left	RLK-WLLEVL
Kit	RLK-WLLEVKIT

Kit: Left & Right Brake, Two 1" Clamps Included.



Lever Extension For Parking Brakes, 18x8mm, Length 60mm

Product Number
RLK-WLV1

Compatible ONLY With RLK-WLLEVR & RLK-WLLEVL



Brake Clamp, silver anodized

SIZE	Product Number
1"	RLK-WLAL4025

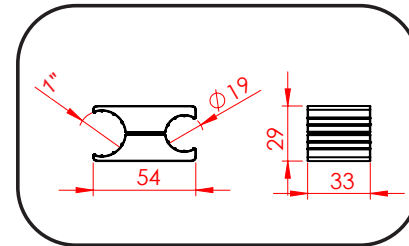

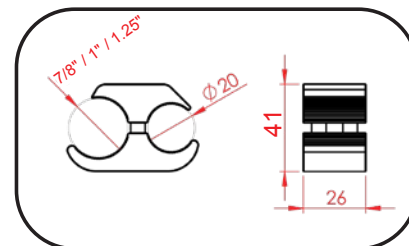

Brake Clamps, black

SIZE	Product Number
7/8"	RLK-WL22LP
1"	RLK-WL25LP
1.25"	RLK-WL30LP



Pride & Quantum



Composite Hub With Poly Tire, Specially Designed Bearing Spacer Makes Installation Quick And Easy, No Washers Necessary.

Size	 HUB COLOR	 TIRE COLOR	Product Number
5x1.75"	Black	Black	RLK-PC1745BB
5x1.75"	Black	Grey	RLK-PC1745BG
5x1.75"	Silver	Black	RLK-PC1745SB
5x1.75"	Silver	Grey	RLK-PC0381SG



Invacare, Pride, Quantum, Sunrise



Split Hub With Poly Tire

Size	 HUB COLOR	 TIRE COLOR	REF	Product Number
6x2"	Black	Black	Invacare 7/16"	RLK-PC2604BB
6x2"	Black	Grey	Invacare 7/16"	RLK-PC5036BG
6x2"	Silver	Black	Pride/Quantum/ Sunrise	RLK-PC2047SB



Pride & Quantum

Composite Hub With Poly Tire



Size	 HUB COLOR	 TIRE COLOR	Product Number
6x2"	Black	Black	RLK-PC0039BB
6x2"	Black	Grey	RLK-PC1762BG
6x2"	Silver	Black	RLK-PC0011SB

Rolko Design



Pride & Quantum

Composite Hub With Poly Tire



Size	 HUB COLOR	 TIRE COLOR	Product Number
6x2"	Black	Black	RLK-PC0039BB1
6x2"	Black	Grey	RLK-PC2130BG1
6x2"	Black	Dark Grey	RLK-PC0040DG1
6x2"	Silver	Black	RLK-PC2131SB1

OEM Design



Permobil



Wheel Hardware And Plugs/Caps Included

			REF	Product Number
180mm	68mm	Black	Permobil 1832937 for the M3	RLK-PC725BB
210mm	65mm	Black	Permobil 1830780 for the F3, F5, M5	RLK-PC720BB



Rovi

Aluminum Split Hub With Poly Tire For Mono Fork, Axle Cap Included

Size			Product Number
6x2"	Black	Black	RLK-PCROVIBB
6x2"	Black	Grey	RLK-PCROVIBG



Invacare

Split Hub With Poly Tire

Size			REF	Product Number
8x2"	Black	Black	Invacare 7/16"	RLK-PC0811BB
8x2"	Black	Grey	Invacare 7/16"	RLK-PC0811BG



Invacare

Split Hub With Poly Tire, Specially Designed Bearing Spacer Makes Installation Quick And Easy. No Washers Necessary.

Size			REF	Product Number
8x2.2"	Black	Black	Invacare 7/16"	RLK-PC1108BB
8x2.2"	Black	Grey	Invacare 7/16"	RLK-PC1108BG





Technician Notes

Rolko foam filled wheels are puncture proof.
All black tires are non-marking (NM).



Pride & Quantum



Drive Wheels With Foam Filled Tires, Compatible with Pride & Quantum: Jazzy 600 ES, Aspen, Lightning, Q4, Q6 Edge 3, Stretto, Edge Z, Edge HD 4 Front 2

Size	 RIM COLOR	 TIRE COLOR	Product Number
14x3"	Black	Black	RLK-PWPQ14BB
14x3"	Black	Grey	RLK-PWPQ14BG
14x3"	Silver	Black	RLK-PWPQ14SB
14x3"	Silver	Grey	RLK-PWPQ14SG



Permobil

Drive Wheels With Foam Filled Tires, Compatible with Permobil: C300, 350, 400, 500, 500S, K300, M300, 400

Size	 RIM COLOR	 TIRE COLOR	Product Number
14x3"	Silver	Black	RLK-PWPM14SB
14x3"	Silver	Grey	RLK-PWPB14SG



Pride

Drive Wheels With Foam Filled Tires, Compatible With Pride PN WHLASMB1418

 RIM COLOR	 TIRE COLOR	Product Number	
260mm	85mm	Grey	RLK-PW26085G

Power Chair Tires

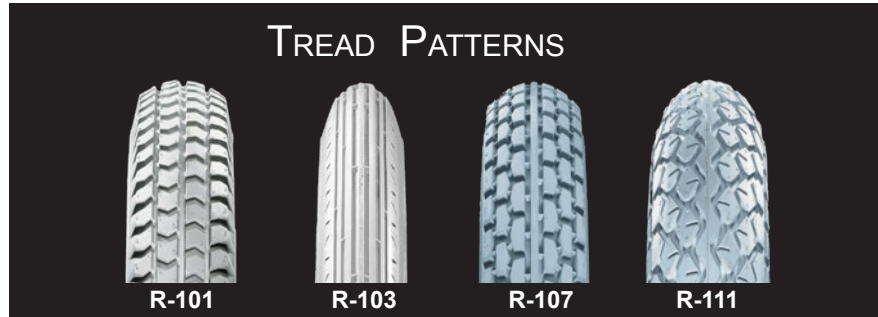

RolkoFill: Foam Filled Tires, All Black Tires Are Non-Marking (NM)

Size	TIRE COLOR			MPH	REF	Product Number	
8x2"	●	R-103	28	110	7.45	-	RLK-AA20050G
8x2"	●	R-103	28	110	7.45	-	RLK-AA20050B
2.80/2.50-4"	●	R-103	55	145	7.45	-	RLK-AA28254G
3.00-4"	●	R-101	55	200	7.45	-	RLK-AA2685G
3.00-4"	●	R-101	55	200	7.45	-	RLK-AA2685B
12.1/2x2.1/4"	●	R-107	46	132	7.45	-	RLK-AA125225G
3.00-8"	●	R-101	38	200	7.45	Permobil/Invacare	RLK-AA3008NG
3.00-8"	●	R-101	55	200	7.45	Sunrise	RLK-AA3008WG
3.00-8"	●	R-101	38	200	7.45	Permobil/Invacare	RLK-AA3008NB
3.00-8"	●	R-101	55	200	7.45	Sunrise	RLK-AA3008WB
3.00-8"	●	R-101	55	200	7.45	Pride/Quantum	RLK-AA3008ZG
3.00-8"	●	R-101	60	200	7.45	Pride/Quantum	RLK-AA3008ZDG
3.00-8"	●	R-101	55	200	7.45	Pride/Quantum	RLK-AA3008ZB
4.00-5"	●	R-111	65	200	7.45	-	RLK-AA4005G



RolkoFILL

Pneumatic Tires, All Tires Are Puncture-Proof (PP), Black Tires Are Non-Marking (NM)

Size	TIRE COLOR			Product Number
8x2"	●	R-103	132	RLK-PD20050G
8x2"	●	R-103	132	RLK-PD20050B
2.80/2.50-4"	●	R-103	265	RLK-PD280250G
2.80/2.50-4"	●	R-103	265	RLK-PD280250B
3.00-4"	●	R-101	375	RLK-PD26085G
3.00-4"	●	R-101	375	RLK-PD26085B
3.00-8"	●	R-101	395	RLK-PD3008G
3.00-8"	●	R-101	395	RLK-PD3008B
3.00-8"	●	R-101	395	RLK-PD3008DG

Depending on the floor material and color as well as braking effect, black pneumatic tires may rarely leave marks in the flooring. Note the instructions for use from the flooring manufacturer.

2-Point, Metal Buckle For Manual Chairs

L	W	GROMMET	Product Number
48"	2"	7/16"	RLK-SB548M
60"	2"	7/16"	RLK-SB560M
72"	2"	7/16"	RLK-SB572M



Belt Fixation

2-Point, Light Metal Buckle

L	W	GROMMET	Product Number
63"	1.6"	7/16"	RLK-SB463M

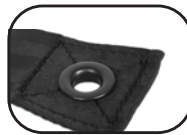

Belt Fixation

2-Point, Metal Buckle For Power Chairs

L	W	GROMMET	Product Number
48"	2"	5/8"	RLK-SB548P
60"	2"	5/8"	RLK-SB560P
82"	2"	5/8"	RLK-SB582P



Belt Fixation

2-Point, Light Metal Buckle

L	W	Product Number
70"	2"	RLK-SB570K
88"	2"	RLK-SB588K



Belt Fixation



2-Point, Light Metal Buckle, Belt Ends With Triglides

L	W	Product Number
70"	2"	RLK-SB570K4



Auto Standard Buckle Without Fixation/Grommet

L	W	Product Number
70"	1.6"	RLK-SB470J
70"	2"	RLK-SB572J



Aircraft Seatbelt

L	W	GROMMET	Product Number
36"	2"	7/16"	RLK-SB536FS
48"	2"	7/16"	RLK-SB548FS
60"	2"	7/16"	RLK-SB559FS



Flat Iron On The Tongue Side

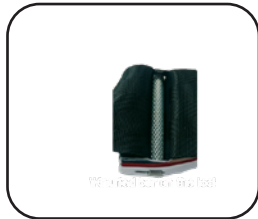

Knurled Bar On The Lock



Belt Fixations

2-Point, Snap Buckle Made of Plastic

L	W	Product Number
62"	1.6"	RLK-SB4P62K



Belt Fixation



2-Point, Light Metal Buckle

L	W	Product Number
70"	1.6"	RLK-SB470K



Belt Fixation



2-Point, Light Metal Buckle, With Pin Lock

L	W	Product Number
70"	2"	RLK-SBPL70K



Belt Fixation



4-Point Belt Without Fixation To The Belt Ends Diagonal Belts 1" And Hip Cushion 7.5x2"

L	W	Product Number
55"	2"	RLK-SB3554P



4-Point Belt, Metal Eyelet Fixation Belt Ends Diagonal Belts 1" And Hip Cushion 9x2.8"

L	W	Product Number
67"	1.6"	RLK-SB4674P



Tube Clamps

Product Number
RLK-RH2225

Technician Notes

Tube clamps for attaching snap locks to round tube, includes spacers for 19, 22 + 25 mm. Price per each set. One set required for each side of chair.



Positioning

Arm Supports

Soft Synthetic Leather Cover, Light Plastic
Lower Part With 6 Threaded Sockets M5

L	W	H	Product Number
10.5"	2.37"	1.5"	RLK-AG240HD
14.6"	2.37"	1.5"	RLK-AG370HD

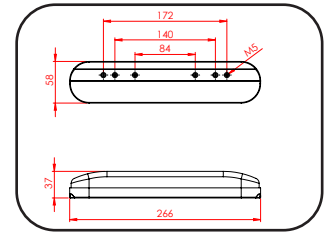

PU Foam, Wood Core

L	W	Product Number
15"	9"	RLK-AGPU375

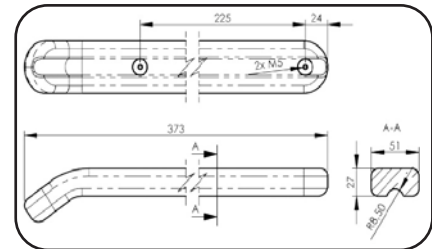

Permobil

PU Foam, Aluminum Core,
Cable Fixation Kit Included

L	W	Product Number
13"	3.5"	RLK-AGPU335S
16"	3.5"	RLK-AGPU406S

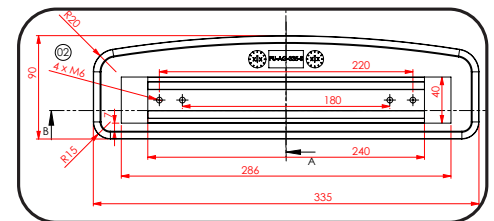

AGPU335S

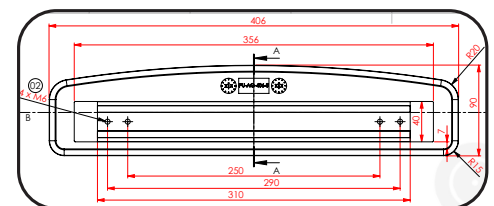

AGPU406S

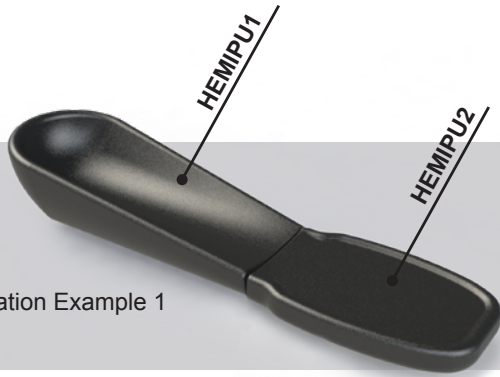

Combination Example 1

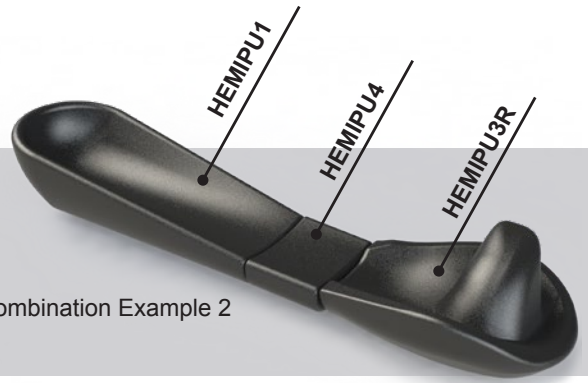

Combination Example 2

Premium High Density, Closed Cell Polyurethane

Support With Slot Nuts For An Optimal Forearm Stabilization And Positioning.

Product Number
RLK-HEMIPU1

Universal Comfort Hand Rest. Includes Connecting Plate With 4 Set Screws.

Product Number
RLK-HEMIPU5

Arm Rest. Includes Connecting Plate With 4 Set Screws.

Product Number
RLK-HEMIPU2

Comfort Hand Rest. Includes Connecting Plate With 4 Set Screws.

Product Number
Left **RLK-HEMIPU3L**
Right **RLK-HEMIPU3R**

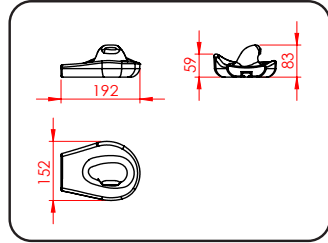
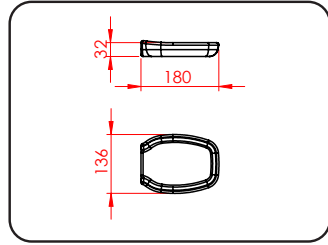
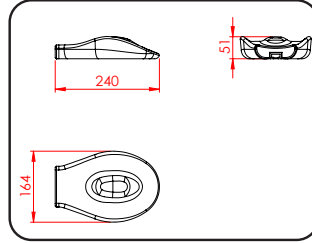
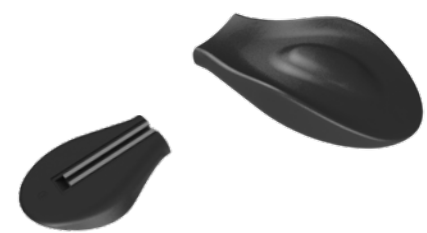
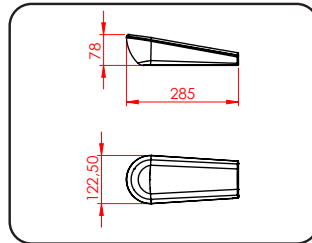

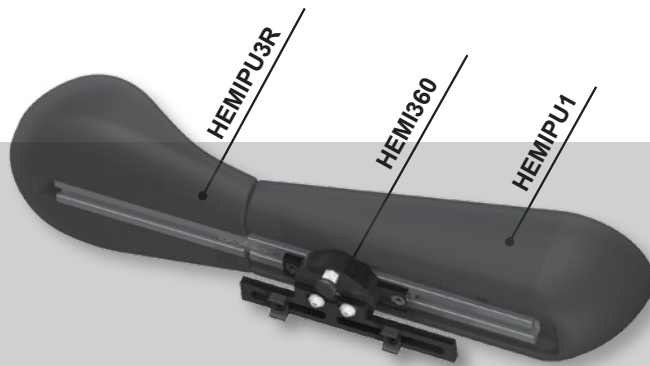

Premium High Density, Closed Cell Polyurethane

Extension Piece. Includes Connecting Plates With 4 Set Screws.

Product Number
RLK-HEMIPU4

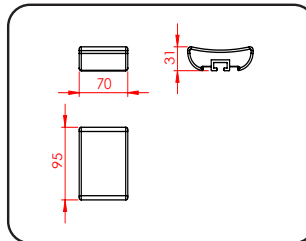

Technician Notes

Low profile fixation unit, 60° turnable swivel arm, with round tube adapter for attachment on wheelchair side parts, mountable on the left or right side, includes 2 slot nuts, outreach 17.5mm, hole distance 141mm.

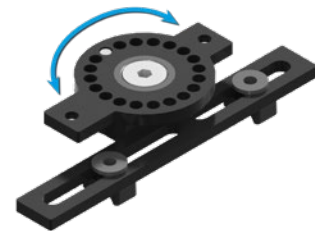
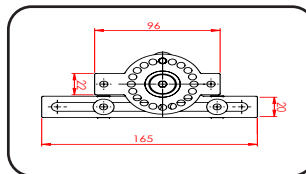

Upper side

360° Fixation Unit

Product Number
RLK-HEMI360

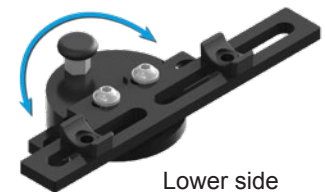
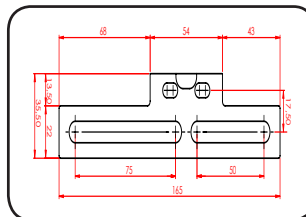

Lower side

Additional Support Plate, Outreach 37.5mm, Hole Distance 141mm

Product Number
RLK-HEMIRBP

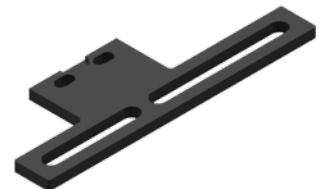
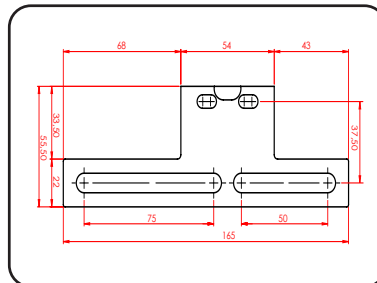

Hook And Loop Straps For Foot Rests,
Includes 4 Straps only, Foot Plate Not Included.

L	W	Product Number
28"	1.5"	RLK-FGFS700



Foot Rest With Slots And Thread-Holes, Set With
2 Piece Foot Plate, Straps Are Not Included.

L	B	B1	Product Number
7"	2.7"	8"	RLK-FSK180
8.22"	3"	8 2/3"	RLK-FSK215
9.3"	3.5"	9 1/6"	RLK-FSK240
11.3"	4.3"	11"	RLK-FSK280
13"	5"	12 2/3"	RLK-FSK320

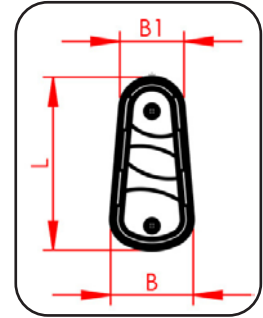

Foot Straps: FG250KB: 2-Piece, Each With One
Loop (Ø 13mm) And One Hook And Loop Tape.
FG450KB: 1-Piece With One Loop And One
Hook And Loop Tape, Color: Black. Foot Plate
And Assembly Not Included.

L	W	Product Number
9.5"-17"	2"	RLK-FG250K
18"	2"	RLK-FG450KB

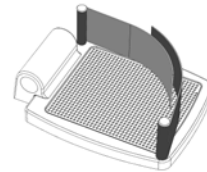

FG250KB

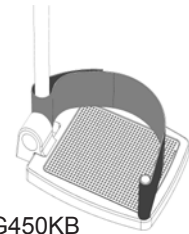

FG450KB

Foot Board For Tube Diameter 1"

L	W	Product Number
6.8"	5.5"	RLK-FBK173S



Foot Belt With Fixation, 1 Pair

Size	Product Number
Medium	RLK-FGM
Large	RLK-FGL



Calf Strap With Hook And Loop Tape

	L	W	Product Number
Standard	27.5"	2"	RLK-WG700K
Standard	32"	2"	RLK-WG820K
Smooth	33.5"	3"	RLK-WG850SK



Smooth



Standard

Abductor Wedges And Restraining System

Restraining System For Abductor Wedges, Height And Depth Adjustable, Steel Mounting Plate With 8 Holes, Bore 1/5", For Fixation Below The Wheelchair Seat Area.

L	Product Number
3.1"	RLK-AKHA1
6.3"	RLK-AKHA2



Abductor Wedges In Polyurethane Foam With Wood Core

	L	W	H	Product Number
Small	3.6"	2.6"	3.5"	RLK-AKPUS
Medium	4.4"	3.2"	3.9"	RLK-AKPUM
Large	5"	3.6"	3.9"	RLK-AKPUL



Restraining system for head supports, in aluminum with gooseneck for back rest attachment. Up to 13.8" height adjustable. Mounting plate and ball head Ø 1" with clamp included.

Product Number
RLK-HRHAALR

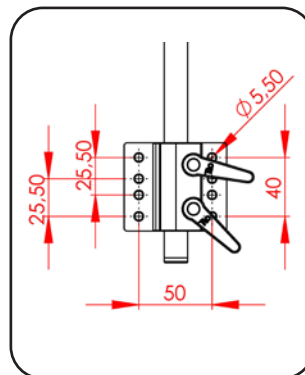

Mounting Plate Measurements In mm





Aluminum Core,
Back Side: For 25mm
Ball Head Mount.
96x225x100mm

**Product
Number**

RLK-HRPU5

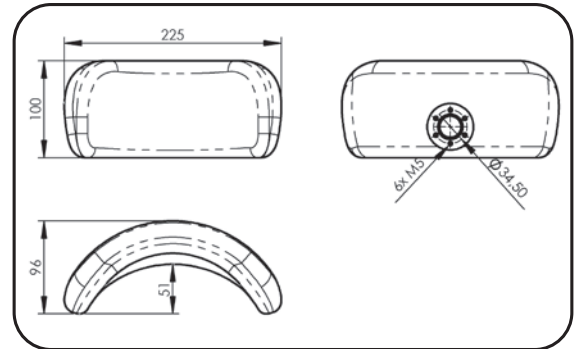

Aluminum Core,
Back Side: For 25mm
Ball Head Mount.
110.5x300x150mm

**Product
Number**

RLK-HRPU7

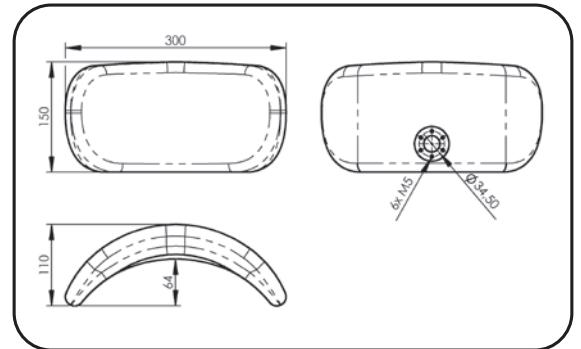

Hand Grips

Soft Foam Rubber Hand Grip,
Sold in Pairs

		Product Number
7/8"	4.33"	RLK-GR120



Ergonomic Hand Grip With Soft
Grip Surface, Sold in Pairs

		Product Number
7/8"	4.33"	RLK-GRERG



Standard Composite Hand Grip,
Sold in Pairs

		Product Number
7/8"	4.33"	RLK-GRKS





Ergonomic Composite Hand Grip,
Sold In Pairs

		Product Number
7/8"	4.33"	RLK-GRS





Comfort Composite Hand Grip,
Sold in Pairs

		Product Number
7/8"	4.72"	RLK-GRER22
1"	4.72"	RLK-GRER25



Tube Cover, Smooth

		Product Number
7/8"	8"	RLK-GR210G
7/8"	10"	RLK-GR260G
7/8"	27"	RLK-GR680G



Additional comfort for wheelchair companions, quick-release levers for an easy usage and fixation on a wheelchair, height adjustable without tools, incl. mounting kit for tube Ø 7/8" or 1".

Pipe Ø		Product Number
7/8"/1"	9"	RLK-SGE2
7/8"/1"	8"	RLK-SGE3

*Max. height adjustment

Easy Push

Push Handle Elevations



Model: SGE2



Model: SGE3



Additional Mounting Kit With
1 Quick-Release Lever, 2
Screws M6 And 1 Tube Clamp.

Product Number
RLK-USEG2



Rolko EasyTRANSFER Transfer Boards

Facilitates The Transfer Of Persons From Wheelchair To Bed Or Car, Independent Usage Without External Help, Can Be Combined With Our Transfer Disc.

W	L	H			Product Number
9"	28"	0.5"	360 lbs	287 lbs	RLK-RBK700
8"	27"	0.4"	275 lbs	287 lbs	RLK-RBKKV

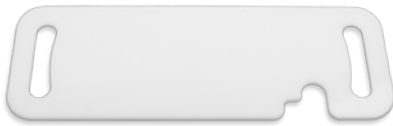

Standard
RLK-RBK-700



Curved
RLK-RBK-KV



Rolko EasyTRANSFER Transfer Disc

Allows A Convenient Transfer Of Persons From The Wheelchair To The Bed Or Into Another Sitting Position, Independent Usage Without External Help, Can Be Combined With Our Transfer Boards.

	H			Product Number
16"	1.5"	37 lbs	287 lbs	RLK-DRT400



Anti-Tip Wheel

Anti-Tip Wheel With Adapter For Tube Diameter 22 + 25 mm, One Horizontal And One Vertical Bore

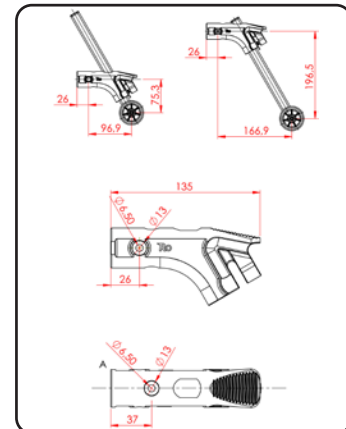

	Product Number
22+25	RLK-KSH2225





Umbrellas

Rolko Umbrellas Offer Optimal Protection Against Rain and Sun, While Leaving Both Hands Free To Push the Walker. Wheelchair Compatible. Height Adjustable, User-Friendly Automatic Opening, Windproof Due To Overlapping Fabric Construction, Easy To Attach/Remove From Walker or Chair. Includes Mounting Kit For Common Walkers With Round Tube Ø 18-25mm (0.71"-1") or Oval Tube up to 60mm (2.36"), Umbrella Diameter: 1.000mm (39.37").

C	Product Number
	RLK-UMR
	RLK-UMGG
	RLK-UMBG

Additional Mounting Kit

For a Second Medical Aid, Wheelchair, or Scooter, Includes: 90° Angle Support With Clamps (Ø 18 - 25mm), Wedge Clamps, Screws, Allen Wrench and Star Grip.

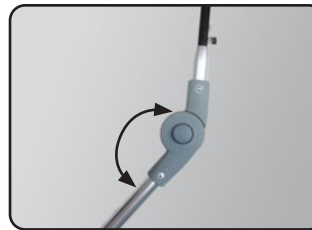

Articulated Joints For Multiple Positions.

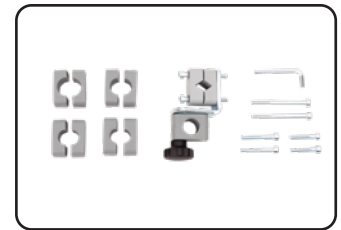

Hardware Included.

Mounting Kit

Product Number
RLK-UMU90



Technician Notes
Includes Fixation For Round Tube Ø 18-25mm, Oval Tube Up to 60mm

Stable and Padded, For Common Walkers With Round Tube 22mm, Easy Assembly With Tube Clamps.

	L	W	Product Number
7/8"	22.65" up to 25.2"	2.56"	RLK-RGROL01



Rolko BAG

Wheelchair Bag

Practical Belt System For Easy Attachment To Manual And Electric Wheelchairs. Comfortable Grip Loops On The Zippers, Holding System For Bottles And Openings For Cable. Waterproof And Dirt Resistant.

W	H	D	Product Number
14"	18.5"	6"	RLK-BAG01G



Docking Station For Straps



Side Pocket With Cable Eyelet



Main Bag With Straps For Bottles



WHEELBAG

Transport Bag for Spoke Wheels

Three Separated Compartments For Spoke Wheels 20" Up To 26", E.g. For A Wheel Set And A Spare Wheel, Incl. Hub Pads, Carrying Handles, Shoulder Strap And Inner Pocket For Accessories Such As Quick-Release Axles.

W	D	Product Number
27"	8"	RLK-BAGWH1B



Inner pocket for accessories



3 separated compartments



2 hub pads per compartment



Rolko Thermo Wrap-up Blankets



With a water-repellant outer material and a quilted, lint-free polar fleece lining, the wrap-up blanket rolko-thermo is the perfect companion in autumn and winter ensuring that you stay dry and comfortably warm. Easy to use due to hook and loop fasteners.

Size	L	W	Product Number
L	5 ft	4 ft	RLK-WBL
XXL	6 ft	4 ft	RLK-WBXXL

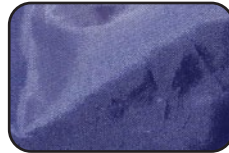

Water-repellent material



Warm polar fleece, quilt lining



With hook & loop straps



Rolko rainPRO Scooter Cover For Mobility Scooters

Consisting of a water, uv and frost resistant material, our scooter garage rolko-rainpro offers protection against weather and dust, with reflective strips marking the longitudinal direction and thus simplifying handling, including weight strap and loops.

Size	L	W	Product Number
XL	5 ft	2 ft	RLK-WRGXL
XXL	6 ft	2 ft	RLK-WRGXXL

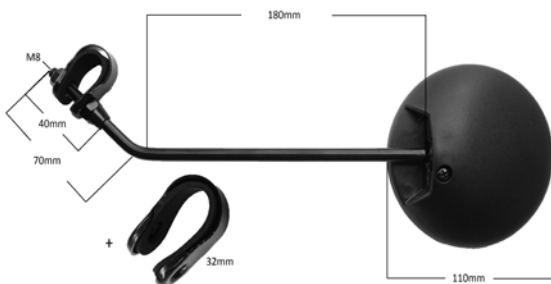

Scooter Rear Mirror

With Clamp and Hexagon Bolt M8 For Fixation, Universal Fit, Sold In Pairs.

Product Number
RLK-USMX2

Rolko Thermo Body Warmers

Our body warmers are made from a water-repellant outer material, being perfect for cold and rainy weather. The non-lint polar fleece liner provides a pleasant warmth and comfort. Easy to use due to circumferential zipper with large handle loops.



Size	Body Size	Product Number
S	up to 1600mm/63"	RLK-WWS
M	up to 1700mm/67"	RLK-WWM
L	up to 1800mm/71"	RLK-WWL
XXL	up to 1950mm/77"	RLK-WWXXL



Front pocket with reflective stripe



Fixation loops for push handles

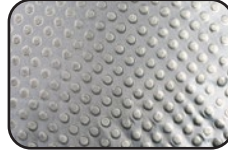

Non-slip bottom

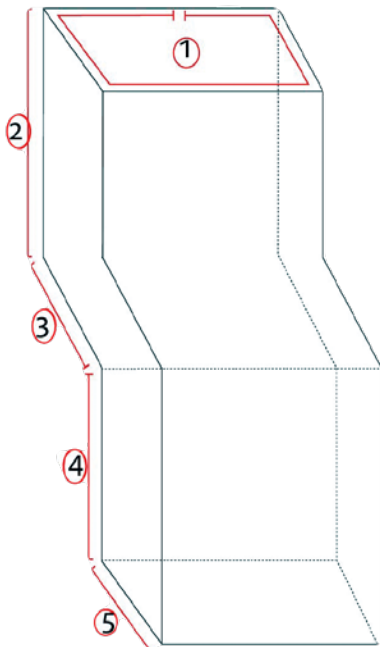

	Adults							
	S WW-S	Approx.	M WW-M	Approx.	L WW-L	Approx.	XXL WW-XXL	Approx.
1	1300	51"	1420	56"	1590	63"	1850	73"
2	410	16.1"	440	17"	470	19"	500	20"
3	430	17"	460	18"	490	19.2"	510	20"
4	400	16"	425	17"	470	19"	500	20"
5	300	12"	315	12.4"	320	13"	350	14"

	Children			
	XXS WW-KID-1	Approx.	XS WW-KID-2	Approx.
1	850	33.4"	1050	41"
2	260	10.2"	300	12"
3	280	11"	340	13.3"
4	270	11"	380	15"
5	180	7"	220	9"

Rolko Thermo

Body Warmer For Children



Our children body warmers are made from a non-lint polar fleece liner and a water-repellant outer material, being optimal for cold and rainy weather. Suitable for belt systems of common wheelchairs and strollers: simply cut into the stitched strips. Circumferential zipper with handle loops. Back strap for the attachment on the wheelchair/stroller. Washable up to 86°F.

Size	Age	Body Size	Product Number
XXS	1-3 years	31"-35"	RLK-WWKID1
XS	4-8 years	39"-50"	RLK-WWKID2



With reflective stripes

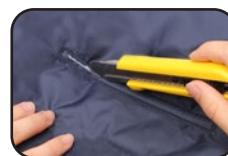

Suitable for common belt systems



Non-slip bottom

Rolko Thermo

Thermo Leg Protection

Due to the water-repellent outer material, our leg protection offers an optimal protection during wet and cold conditions. Straps with push buttons allow easy installation to the wheelchair. Washable up to 86°F.

Size	Body Size	Product Number
L	45"	RLK-WWAL



Easy fixation on wheelchair



Reflective stripe for more safety



Polar fleece inner lining





***Rolko Products Are Available
Through MK Battery***



MK Battery
1631 South Sinclair Street
Anaheim, California 92806

Toll Free: 800-372-9253
Phone: 714-937-1033
Fax: 714-937-0818
Email: info@mkbattery.com
Website: www.mkbattery.com