

ABB MACHINERY DRIVES

# ACS380 machinery control program Firmware manual



---

# List of related manuals

## Drive hardware manuals and guides

Drive/converter/inverter safety instructions	3AXD50000037978
ACS380 Hardware manual	3AXD50000029274

## Drive firmware manuals and guides

ACS380 Firmware manual	3AXD50000029275
ACS380 Quick installation and start-up guide	3AXD50000018553
ACS380 User interface guide	3AXD50000022224

## Option manuals and guides

ACS-AP-x Assistant control panels user's manual	3AUA0000085685
ACS-BP-S Basic control panel user's manual	3AXD50000032527
FCAN-01 CANopen adapter module user's manual	3AFE68615500
FECA-01 EtherCAT adapter module user's manual	3AUA0000068940
FENA-01/-11/-21 Ethernet adapter module user's manual	3AUA0000093568
FPBA-01 PROFIBUS DP adapter module user's manual	3AFE68573271
FEPL-02 Ethernet POWERLINK adapter module user's manual	3AUA0000123527

## Tool and maintenance manuals and guides

Drive composer PC tool user's manual	3AUA0000094606
Converter module capacitor reforming instructions	38FE64059629
Adaptive Programming Application guide	3AXD50000028574
NETA-21 remote monitoring tool user's manual	3AUA0000096939
NETA-21 remote monitoring tool installation and start-up guide	3AUA0000096881

You can find manuals and other product documents in PDF format on the Internet. See section Document library on the Internet on the inside of the back cover. For manuals not available in the Document library, contact your local ABB representative.

The code below opens an online listing of the manuals applicable to the product:



# Firmware manual

## ACS380 machinery control program

Table of contents



3. Start-up, ID run and use





# Table of contents

---

## 1. Introduction to the manual

Contents .....	11
Applicability .....	11
Safety instructions .....	11
Target audience .....	12
Purpose of the manual .....	12
Contents of the manual .....	12
Terms and abbreviations .....	13
Related manuals .....	15
Cybersecurity disclaimer .....	15

## 2. Control panel

Contents .....	17
Control panel .....	17
Home view and Message view .....	18
Options menu and Main menu .....	19
Options menu .....	19
Main menu .....	19



## 3. Start-up, ID run and use

Contents .....	23
Start up the drive .....	23
Do the identification (ID) run .....	25
Background information .....	25
ID run steps .....	25
Start and stop the drive .....	27
Change the rotation direction .....	27
Set the speed or frequency reference .....	27
Set the drive parameters .....	28
Open Diagnostics .....	28
Change the units .....	29

## 4. Control macros

Contents .....	31
ABB standard macro .....	32
Default control connections for the ABB standard macro .....	33
ABB limited macro .....	35
Default control connections for the ABB limited macro .....	35
Fieldbus control macro .....	36
Default control connections for the Fieldbus macro .....	36
Alternate macro .....	38
Default control connections for the Alternate macro .....	39

---

## 6 Table of contents

Motor potentiometer macro	41
Default control connections for the Motor potentiometer macro	42
PID control macro	44
Default control connections for PID control macro	44
Modbus macro	46
Default control connections for the Modbus macro	47
Parameter default values for different macros	49

## 5. Program features

Contents	51
Local and external control locations	52
Local control	52
External control	53
Operating modes and motor control modes	54
Overview diagram of control hierarchy	54
Speed control mode	56
Torque control mode	56
Frequency control mode	56
Special control modes	56
Settings	57
Autophasing	57
Drive configuration and programming	60
Programming via parameters	60
Adaptive programming	61
Control interfaces	64
Programmable analog inputs	64
Programmable analog outputs	64
Programmable digital inputs and outputs	64
Programmable relay outputs	65
Programmable I/O extensions	65
Fieldbus control	65
Motor control	66
Motor types	66
Motor identification	66
Power loss ride-through	66
Vector control	66
Reference ramping	67
Constant speeds/frequencies	68
Critical speeds/frequencies	68
Rush control	70
Encoder echo support	70
Jogging	70
Speed control performance figures	73
Torque control performance figures	73
Scalar motor control	74
User load curve	75
U/f ratio	76
Flux braking	76
DC magnetization	77
Energy optimization	79



Switching frequency	79
Speed compensated stop	80
Application control	81
Control macros	81
Process PID control	81
Mechanical brake control	84
DC voltage control	90
Overvoltage control	90
Undervoltage control (power loss ride-through)	90
Voltage control and trip limits	91
Settings	92
Brake chopper	93
Limit to limit control	94
Limit to limit control function	95
Limitations	95
Tips	96
Safety and protections	97
Fixed/Standard protections	97
Emergency stop	97
Motor thermal protection	98
Programmable protection functions	101
Automatic fault resets	103
Diagnostics	104
Signal supervision	104
Energy saving calculators	104
Load analyzer	104
Miscellaneous	106
Backup and restore	106
User parameter sets	106
Data storage parameters	107
Parameter checksum calculation	107
Motor potentiometer	108
User lock	109



## 6. Parameters

Contents	111
Terms and abbreviations	112
Fieldbus addresses	112
Summary of parameter groups	113
Parameter listing	115
01 Actual values	115
03 Input references	118
04 Warnings and faults	119
05 Diagnostics	120
06 Control and status words	123
07 System info	128
09 Crane application signals	130
10 Standard DI, RO	131
11 Standard DIO, FI, FO	135
12 Standard AI	141

## 8 Table of contents

13 Standard AO	146
15 I/O extension module	149
19 Operation mode	153
20 Start/stop/direction	155
21 Start/stop mode	169
22 Speed reference selection	177
23 Speed reference ramp	190
24 Speed reference conditioning	194
25 Speed control	195
26 Torque reference chain	199
28 Frequency reference chain	203
30 Limits	215
31 Fault functions	223
32 Supervision	232
34 Timed functions	239
35 Motor thermal protection	245
36 Load analyzer	252
37 User load curve	255
40 Process PID set 1	259
41 Process PID set 2	273
43 Brake chopper	276
44 Mechanical brake control	278
45 Energy efficiency	284
46 Monitoring/scaling settings	289
47 Data storage	292
49 Panel port communication	293
50 Fieldbus adapter (FBA)	295
51 FBA A settings	299
52 FBA A data in	300
53 FBA A data out	301
58 Embedded fieldbus	301
71 External PID1	320
76 Application features	322
90 Feedback selection	327
91 Encoder adapter settings	328
92 Encoder 1 configuration	329
95 HW configuration	329
96 System	330
97 Motor control	340
98 User motor parameters	345
99 Motor data	347
Differences in the default values between 50 Hz and 60 Hz supply frequency settings	354

## 7. Additional parameter data

Contents	355
Terms and abbreviations	355
Fieldbus addresses	356
Parameter groups 1...9	357
Parameter groups 10...99	360

---



## 8. Fault tracing

Contents	389
Safety	389
Indications	390
Warnings and faults	390
Pure events	390
Warning/fault history	390
Event log	390
Viewing warning/fault information	390
QR Code generation for mobile service application	391
Warning messages	392
Fault messages	402

## 9. Fieldbus control through the embedded fieldbus interface (EFB)

Contents	416
System overview	416
Modbus	417
CANopen	441



## 10. Fieldbus control through a fieldbus adapter

Contents	481
System overview	481
Basics of the fieldbus control interface	483
Control word and Status word	484
References	485
Actual values	486
Contents of the fieldbus Control word (ABB Drives profile)	487
Contents of the fieldbus Status word (ABB Drives profile)	488
The state diagram (valid for ABB drives profile only)	489
Automatic drive configuration for fieldbus control	491
Automatically changed parameters (all adapters)	492
Specific fieldbus adapter parameters	492
Setting up the drive for fieldbus control manually	494

## 11. Control chain diagrams

Contents of this chapter	495
Frequency reference selection	496
Frequency reference modification	497
Speed reference source selection I	498
Speed reference source selection II	499
Speed reference ramping and shaping	500
Speed error calculation	501
Speed controller	502
Torque reference source selection and modification	503
Reference selection for torque controller	504
Torque limitation	505
Process PID setpoint and feedback source selection	506
Process PID controller	507

External PID setpoint and feedback source selection .....	508
External PID controller .....	509
Direction lock .....	510

## **12. Appendix A - ACS380 in crane applications**

Contents .....	511
Overview of the crane control program .....	512
Quick start-up .....	513
Control through the I/O interface using a joystick .....	514
Control through the I/O interface using the step reference logic/pendant control .....	518
Control through the fieldbus interface using the fieldbus control word .....	522
Configuring speed feedback using a HTL/TTL pulse encoder .....	525
Configuring slowdown with two limits and stop limit logic .....	527
Configuring Mechanical brake control .....	531
Crane mechanical brake control .....	533
Crane brake control timing diagram .....	533
Brake system checks – overview .....	534
Brake system checks – Torque proving .....	536
Brake system checks – Brake slip .....	537
Brake safe closure .....	538
Extended run time .....	539
Speed matching .....	540
Crane warning masking .....	542
Dead-band function .....	542
Start/stop interlocking .....	543
Joystick zero position interlocking .....	543
Joystick reference interlocking .....	544
Crane stop limit function .....	546
Crane slowdown function .....	548
Slowdown with two limit inputs .....	548
Fast stop .....	550
Power on acknowledgment .....	551
Speed reference handling .....	554
Unipolar joysticks .....	554
Parabolic speed reference .....	554
Step reference speed selection/Pendant control .....	556
Crane motor potentiometer .....	557
Conical motor control .....	563



### **Further information**

# 1

## Introduction to the manual

---

### Contents

- [Applicability](#)
- [Safety instructions](#)
- [Target audience](#)
- [Purpose of the manual](#)
- [Contents of the manual](#)
- [Terms and abbreviations](#)
- [Related manuals](#)

### Applicability

The manual applies to the ACS380 machinery control program 2.05 or later.

To check the version of the control program, see parameter [07.05 Firmware version](#).

### Safety instructions

Follow all safety instructions.

- Read the complete safety instructions in the Hardware manual of the drive before you install, commission, or use the drive.
  - Read the firmware function-specific warnings before changing parameter values. Chapter [Parameters](#) lists the relevant parameters and related warnings.
-

## Target audience

The reader is expected to know the fundamentals of electricity, wiring, electrical components and electrical schematic symbols.

The manual is written for readers worldwide. Both SI and imperial units are shown.

## Purpose of the manual

This manual provided information for designing, commissioning, or operating the drive system.

## Contents of the manual

- Introduction to the manual (this chapter) describes the applicability, purpose and content of the manual, and terms and conditions.
  - *Control panel* (page 17) introduces the internal control panel.
  - *Start-up, ID run and use* (page 23) contains instructions on how to start up the drive and perform the ID run, and descriptions of the main use cases.
  - *Control macros* (page 31) contains a short description of each macro together with a connection diagram. Macros are pre-defined applications and saves the user time when configuring the drive.
  - *Program features* (page 51) describes the program features and parameters.
  - *Parameters* (page 111) describes the parameters used to program the drive.
  - *Additional parameter data* (page 355) contains further information on the parameters.
  - *Fault tracing* (page 389) lists the warning and fault messages with possible causes and remedies.
  - *Fieldbus control through the embedded fieldbus interface (EFB)* (page 415) describes the communication to and from a fieldbus network using the embedded fieldbus interface of the drive.
  - *Fieldbus control through a fieldbus adapter* (page 481) describes the communication to and from a fieldbus network using an optional fieldbus module.
  - *Control chain diagrams* (page 495) presents the reference chains of the drive.
  - *Appendix A - ACS380 in crane applications* (page 511) describes the functions that are specific to the crane application. If required, these functions can be used for other applications.
-

## Terms and abbreviations

Term/abbreviation	Explanation
ACS-AP-x	Assistant control panel, advanced operator keypad for communication with the drive. The ACS380 support types ACS-AP-1, ACS-AP-S and ACS-AP-W (with a Bluetooth interface).
ACS-BP-S	Basic control panel, basic operator keypad for communication with the drive.
AI	Analog input; interface for analog input signals
AO	Analog output; interface for analog output signals
AsynM	Asynchronous motor
BAPO-01	Optional side-mounted auxiliary power extension module
BCAN-11	CANopen interface
BCBL-01	Optional USB to RJ45 cable
BMIO-01	I/O and Modbus module
Brake chopper	Conducts the surplus energy from the intermediate circuit of the drive to the brake resistor when necessary. The chopper operates when the DC link voltage exceeds a certain maximum limit. The voltage rise is typically caused by deceleration (braking) of a high inertia motor.
Brake resistor	Dissipates the drive surplus braking energy conducted by the brake chopper to heat. Essential part of the brake circuit. See chapter <i>Resistor breaking</i> in the hardware manual of the drive.
BREL-01	Optional side-mounted relay output extension module
BTAC-02	Optional side-mounted pulse encoder interface module
Capacitor bank	See <a href="#">DC link capacitors</a> .
CCA-01	Optional cold configuration adapter
Control board	Circuit board in which the control program runs
DC link	DC circuit between rectifier and inverter
DC link capacitors	Energy storage which stabilizes the intermediate circuit DC voltage
DI	Digital input; interface for digital input signals
DO	Digital output; interface for digital output signals
Drive	Frequency converter for controlling AC motors
EFB	Embedded fieldbus
FBA	Fieldbus adapter
FCAN-01 / -01-M	Optional CANopen adapter module
FCNA-01	Optional ControlNet adapter module
FDNA-01	Optional DeviceNet adapter module
FECA-01/-01-M	Optional EtherCAT adapter module

FENA -21/-21-M	Optional Ethernet adapter module for EtherNet/IP, Modbus TCP and PROFINET IO protocols
FEPL-02	Ethernet POWERLINK adapter module
FPBA-01/-01-M	Optional PROFIBUS DP adapter module
Frame (size)	Refers to the drive physical size, for example R0 and R1. The type designation label attached to the drive shows the frame of the drive, see the hardware manual of the drive.
ID run	Motor identification run. During the identification run, the drive will identify the characteristics of the motor for optimum motor control.
Hexadecimal	Describes binary numbers using a numbering system that has 16 sequential numbers as base units. The hexadecimal numbers are 0-9 and the letters A-F.
IGBT	Insulated gate bipolar transistor
Intermediate circuit	See <a href="#">DC link</a> .
Inverter	Converts direct current and voltage to alternating current and voltage.
I/O	Input/Output
LSW	Least significant word
Macro	Pre-defined default values of parameters in a drive control program. Each macro is intended for a specific application. See chapter <a href="#">Control macros</a> .
NETA-21	Optional remote monitoring tool
Network control	With fieldbus protocols based on the Common Industrial Protocol (CIP™), such as DeviceNet and Ethernet/IP, denotes the control of the drive using the Net Ctrl and Net Ref objects of the ODVA AC/DC Drive Profile. For more information, see <a href="http://www.odva.org">www.odva.org</a> , and the following manuals: <ul style="list-style-type: none"> <li>• <i>FDNA-01 DeviceNet adapter module user's manual</i> (3AFE68573360 [English]), and</li> <li>• <i>FENA-01/-11/-21 Ethernet adapter module user's manual</i> (3AUA0000093568 [English])</li> </ul>
Parameter	User-adjustable operation instruction to the drive, or signal measured or calculated by the drive
PDO	Process data object
PID controller	Proportional–integral–derivative controller
PLC	Programmable logic controller
PMSM	Permanent magnet synchronous motor
PM	Permanent magnet
PROFIBUS, PROFIBUS DP, PROFINET IO	Registered trademarks of PI - PROFIBUS & PROFINET International
R0, R1,...	Frame (size)

RCD	Residual current device
Rectifier	Converts alternating current and voltage to direct current and voltage.
RFI	Radio frequency interference
RO	Relay output; interface for a digital output signal. Implemented with a relay.
SDO	Service data object
SIL	Safety integrity level. See chapter <i>Safe torque off function</i> in the drive hardware manual.
STO	Safe torque off. See chapter <i>Safe torque off function</i> in the drive hardware manual.

## Related manuals

The related manuals are listed behind the front cover under [List of related manuals](#).

## Cybersecurity disclaimer

This product is designed to be connected to and to communicate information and data via a network interface. It is Customer's sole responsibility to provide and continuously ensure a secure connection between the product and Customer network or any other network (as the case may be). Customer shall establish and maintain any appropriate measures (such as but not limited to the installation of firewalls, application of authentication measures, encryption of data, installation of anti-virus programs, etc) to protect the product, the network, its system and the interface against any kind of security breaches, unauthorized access, interference, intrusion, leakage and/or theft of data or information. ABB and its affiliates are not liable for damages and/or losses related to such security breaches, any unauthorized access, interference, intrusion, leakage and/or theft of data or information.

See also section [User lock](#) (page 109).





## 2

# Control panel

---

## Contents

- [Control panel](#)
- [Home view and Message view](#)
- [Options menu](#)
- [Main menu](#)
- [Submenus](#)

## Control panel

By default, ACS 380 has an integrated panel. If required, you can use external control panels such as assistant control panel or a basic panel. For more information, refer *ACX-AP-x assistant control panel's user's manual* (3AUA0000085685 [English]) or *ACS-BP-S basic control panel's user's manual* (3AXD50000032527 [English])



1. Display - shows the *Home* view as default.
2. Main menu.
3. OK button - open the Main menu, select and save settings.
4. Start button - start the drive.
5. Menu navigation buttons - move in the menus and set values.
6. Stop button - stop the drive.
7. Back button - open the Options menu, and move back in the menu.
8. Options menu.
9. Status light - green and red colors indicate the state and potential problems.

## Home view and Message view

The *Home* view is the main view. Open the Main menu and Options menu from the *Home* view.

Home view



1. Control selection - local or remote  
2. Local start/stop control - enabled  
3. Rotation direction - forward or reverse  
4. Local reference setting - enabled  
5. Speed - target  
6. Speed - current  
7. Main menu - menu list  
8. Options menu - quick access menu

The *Message* view shows fault and warning messages. If there is an active fault or warning, the panel shows the *Message* view directly.

You can open the *Message* view from the Options menu or Diagnostics submenu.

Message view: Fault



Fault messages require your immediate attention.

Check the code in the Fault messages table on page [402](#) to troubleshoot the problem.

Message view: Warning

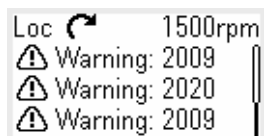

Warning messages show possible problems.

Check the code in the Warning messages table on page [392](#) to troubleshoot the problem.

## Options menu and Main menu

### Options menu

1. To open: press the Back button in the *Home* view.



### Main menu

2. To open: press the OK button in the *Home* view.

### Options menu

The Options menu is a quick access menu.

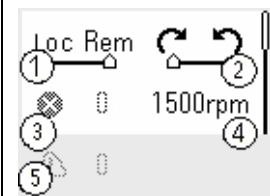

1. Control location - set to local or remote control
2. Rotation direction - set to forward or reverse
3. Active faults - view possible faults
4. Reference speed - set the reference speed
5. Active warnings - view possible warnings

### Main menu

The Main menu is a scroll menu. The menu icons represent specific groups. The groups have submenus.

**Note:** You can define which Main menu items are visible (see parameter [49.30](#)).

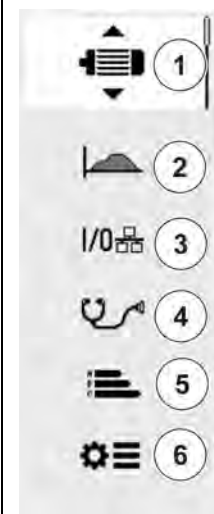

1. Motor data - motor parameters
2. Motor control - motor settings
3. Control macros
4. Diagnostics - faults, warnings, fault log and connection status
5. Energy efficiency - energy savings
6. Parameters - parameters

**Submenus**

The Main menu items have submenus. Some submenus also have menus and/or option lists. The content of the submenu depend on the drive type.

**Motor Data**

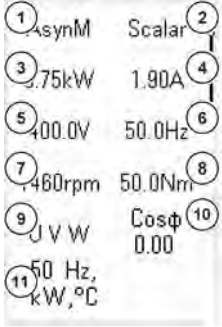

1. Motor type - AsynM, PMSM, SynRM  
 2. Control mode - Scalar, Vector  
 3. Nominal power  
 4. Nominal current  
 5. Nominal voltage  
 6. Nominal frequency  
 7. Nominal speed  
 8. Nominal torque  
 9. Phase order - U V W, U W V  
 10. Nominal Cosphi  
 11. Unit selection - SI or US units

**Motor Data: Motor type**

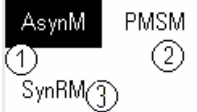

- 1. AsynM
- 2. PMSM
- 3. SynRM

**Motor Data: Control mode**



- 1. Scalar
- 2. Vector

**Motor Data: Phase order**



- 1. U V W
- 2. U W V

**Motor Data: Unit selection**

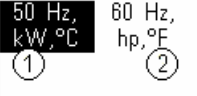

- 1. SI units
- 2. US units

## Motor Control



1. Start mode - Const time, Automatic
2. Stop mode - Coast, Ramp, DC hold
3. Acceleration time
4. Deceleration time
5. Maximum allowed speed
6. Maximum allowed current
7. Minimum allowed speed

## Motor Control: Start modes

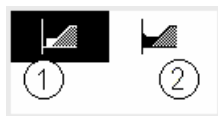

1. Const time
2. Automatic

## Motor Control: Stop modes

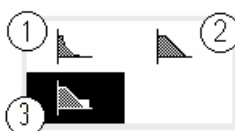

1. Coast
2. Ramp
3. DC hold

## Control macros

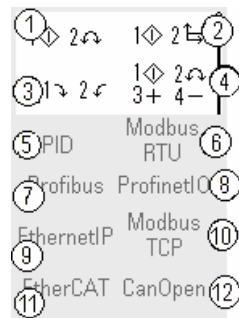

The control macros available depends on the option module installed.

1. ABB standard (2-wire)
2. ABB limited (2-wire)
3. Alternate
4. Motor potentiometer
5. PID
6. Modbus RTU
7. PROFIBUS
8. PROFINET IO
9. EthernetIP
10. Modbus TCP
11. EtherCAT
12. CANopen

### Diagnostics



1. Active Fault - shows the fault code
2. Fault History - list of latest fault codes (newest first)
3. Active Warnings - shows the warning code
4. Connection Status - Fieldbus and I/O signals

### Energy Efficiency

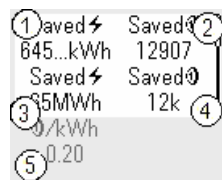

1. Saved energy in kWh
2. Saved money
3. Saved energy in MW
4. Saved money x 1000
5. Cost per kWh h

### Parameters

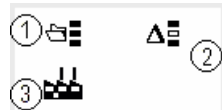

1. Complete parameter list - groups menu with complete parameters and parameter levels
2. Modified parameter list
3. Parameter restore - reset to factory default parameters

# 3

## Start-up, ID run and use

---

### Contents

- [Start up the drive](#)
- [Do the identification \(ID\) run](#)
- [Start and stop the drive](#)
- [Change the rotation direction](#)
- [Set the speed or frequency reference](#)
- [Set the drive parameters](#)
- [Open Diagnostics](#)
- [Change the units](#)

**Note:** In this chapter the drive uses an integrated panel to perform the start-up, ID run, and other actions. You can also perform these functions using an external control panel or a drive composer PC tool.

### Start up the drive

1. Select the unit (international or US) and press OK.  
The drive recognizes the connected adapter and sets the correct settings. This may take a few seconds depending on the adapter.
  2. In the *Motor data* view, set the motor type:  
**AsynM:** Asynchronous motor  
**PMSM:** Permanent magnet motor, or  
**SynRM:** Synchronous reluctance motor
  3. Set the motor control mode:  
**Vector:** Speed reference. This is suitable for most cases. The drive does an automatic stand-still ID run.
- 



**Scalar:** Frequency reference.

Use this mode when:

- The number of motors can change.
- The nominal motor current is less than 20% of the nominal drive current.

Scalar mode is not recommended for permanent magnet motors.

4. Set the nominal motor values:

- Nominal power
- Nominal current
- Nominal voltage
- Nominal frequency
- Nominal speed
- Nominal torque (optional)
- Nominal cosphi

5. Examine the direction of the motor.

If it is necessary, set the motor direction with the **Phase order** setting or with the phase order of the motor cable.

6. In the *Motor control* view, set the start and stop mode.

7. Set the acceleration time and the deceleration time.

**Note:** The speed acceleration and deceleration ramp times are based on the value in parameter [46.01 Speed scaling](#)/[46.02 Frequency scaling](#).

8. Set the maximum and minimum speed or frequency. For more information, see parameters [30.11 Minimum speed](#) /[30.13 Minimum frequency](#) and [30.12 Maximum speed](#)/[30.14 Maximum frequency](#) on page 218.

9. In the *Control macros* view, select the applicable macro.

For units with a fieldbus adapter connected: you can see the fieldbus in the *Control macros* view. There are certain parameters that you need to change, eg. the station ID. See chapter [Fieldbus control through a fieldbus adapter](#).

10. Tune the drive parameters to the application. You can use the Assistant control panel (ACS-AP-x), or the Drive Composer PC tool with the drive.





## Do the identification (ID) run

### ■ Background information

The drive automatically estimates motor characteristics using Standstill ID run when the drive is started for the first time, and after any motor parameter (group [99 Motor data](#)) is changed. This is valid when:

- parameter [99.13 ID run requested](#) selection is *Standstill* and
- parameter [99.04 Motor control mode](#) selection is *Vector*.

In most applications there is no need to perform a separate ID run. Select the ID run for demanding motor control connections. For example:

- permanent magnet motor (PMSM) is used
- drive operates near zero speed references, or
- operation at torque range above the motor nominal torque, over a wide speed range is needed.

**Note:** If you change the motor parameters after the ID run, you need to repeat the run.

**Note:** If you have already parameterized your application using scalar motor control mode and you need to change to vector:

- in the *Motor data* submenu, set *Motor control* to *Vector*, or set parameter [99.04 Motor control mode](#) selection to *Vector*.
- for I/O controlled drive, check parameters in groups [22 Speed reference selection](#), [23 Speed reference ramp](#), [12 Standard AI](#), [30 Limits](#) and [46 Monitoring/scaling settings](#).
- for torque controlled drive, check also parameters in group [26 Torque reference chain](#).

### ■ ID run steps



**Warning!** Make sure it is safe to run the procedure.

1. Open the *Main* menu.
2. Select the *Parameters* submenu.
3. Select *All parameters*.
4. Select [99 Motor data](#) and press OK.
5. Select [99.13 ID run requested](#), select the wanted ID mode and press OK.  
An [AFF6 Identification run](#) warning message is shown before you press Start.  
The panel LED starts to blink green to indicate an active warning.
6. Press Start to start the ID run.



Do not to press any control panel keys during the ID run. If you need to stop the ID run, press Stop.

After the ID run is completed, the status light stops blinking.

If the ID run fails, the panel shows the fault *FF61 ID run*.



## Start and stop the drive



1. Press the Start button to start the drive.
2. Press the Stop button to stop the drive.

## Change the rotation direction



1. In the *Options* menu, move to the rotation direction item with the arrow buttons.
2. Press the OK button to change the rotation direction.

## Set the speed or frequency reference



1. In the *Options* menu, move to the speed or frequency reference item and press OK.
2. Press the arrow buttons to edit the value.
3. Press the OK button to confirm the new value.



## Set the drive parameters

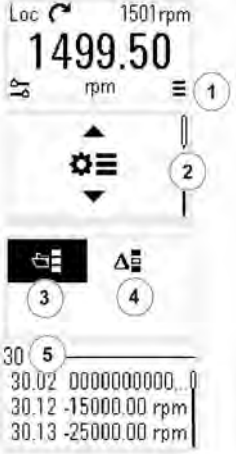

The screenshot shows a drive parameter menu. At the top, it displays 'Loc' with a refresh icon and '1501 rpm'. Below this is a large digital display showing '1499.50 rpm'. To the right of the display is a menu icon (three horizontal lines) with a circled '1' next to it. Below the display are two arrow buttons (up and down) with a gear icon between them, and a circled '2' next to them. Below the arrows are two icons: a gear with a checkmark and a gear with a warning triangle, with circled '3' and '4' next to them respectively. At the bottom, there is a scrollable list of parameters starting with '30', with a circled '5' next to the first parameter '30.02 0000000000'. The list includes:
 

- 30.02 0000000000
- 30.12 -15000.00 rpm
- 30.13 -25000.00 rpm

1. Select the Main menu from the *Home* view.
2. Scroll to Parameters, and press the OK button to open the submenu.
3. Select the complete parameters list with the arrow button and press the OK button, or
4. Select the modified parameters list with the arrow button and press the OK button.
5. Select the parameter and press the OK button.

The parameters are shown in respective groups. The first two digits of the parameter number represent the parameter group. For example, parameters starting with 30 are in the Limits group.

See chapter [Parameters](#) for more information.



## Open Diagnostics



The screenshot shows a drive diagnostics menu. At the top, it displays 'Loc' with a refresh icon and '1501 rpm'. Below this is a large digital display showing '1499.50 rpm'. To the right of the display is a menu icon (three horizontal lines) with a circled '1' next to it. Below the display are two arrow buttons (up and down) with a warning icon (a lightning bolt in a triangle) between them, and a circled '2' next to them. Below the arrows are two icons: a warning icon with a circled 'x' and a gear with a warning triangle, with circled '3' next to them. The list of diagnostics includes:
 

- x 1001
- ! 2009
- ! 0

1. Select the Main menu from the *Home* view.
2. Scroll to Diagnostics and press the OK button to open the submenu.
3. Select the warning or fault with the arrow button and press the OK button.

See chapter [Fault tracing](#) for more information.

## Change the units

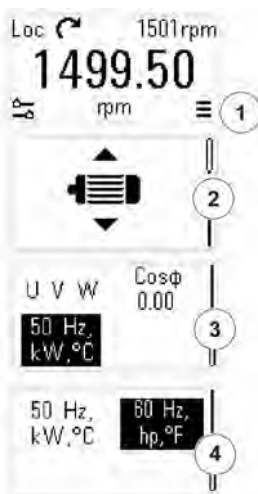

The screenshot shows a motor data menu with the following elements:

- Top left: "Loc" with a refresh icon and "1501 rpm".
- Top center: A large digital display showing "1499.50".
- Below the display: "rpm" and a menu icon (three horizontal lines) with a circled "1" next to it.
- Below the menu icon: A vertical scroll bar with a motor icon in the center and a circled "2" at the bottom.
- Below the scroll bar: "U V W" and "Cosφ 0.00".
- Below "U V W": A box containing "50 Hz, kW, °C" with a circled "3" to its right.
- Below "Cosφ": A box containing "50 Hz, kW, °C" and "60 Hz, hp, °F" with a circled "4" to its right.

1. Select the Main menu from the *Home* view.
2. Scroll to Motor data and press the OK button to open the submenu.
3. Scroll to the unit selection item and press the OK button.
4. Select the unit with the arrow button, then press the OK button.

You can see the selected unit on the *Home* view.







# Control macros

---

## Contents

- [\*ABB standard macro\*](#)
- [\*ABB limited macro\*](#)
- [\*Fieldbus control macro\*](#)
- [\*Alternate macro\*](#)
- [\*Motor potentiometer macro\*](#)
- [\*PID control macro\*](#)
- [\*Modbus macro\*](#)
- [\*Parameter default values for different macros\*](#)

Control macros are sets of default parameter values that apply to a specific control configuration. They make it faster and easier to set up a drive for use.

By default, macro for I/O controlled drive is set as ABB standard macro and macro for Fieldbus controlled drive is set as Fieldbus control macro.

---

## **ABB standard macro**

ABB standard macro is suitable for an IO-controlled drive. Digital inputs control start/stop (2-wire), direction and constant speed selection (3 speeds) and acceleration and deceleration ramp selection.

You can activate the macro from the *Control macros* view, or by setting parameter [96.04 Macro select](#) to value *ABB standard*.

This is the default macro for the standard drive variant (ACS380-04xS) and configured drive variant ACS380-4xC +L538.

---



## ■ Default control connections for the ABB standard macro

This connection diagram is valid for the standard drive variant ACS380-04xS and the configured drive variant ACS380-04xC +L538 (with the ABB standard macro selected).

Terminals	Description
<b>Digital I/O connections</b>	
+24V	Aux. +24 V DC, max 200 mA
DGND	Aux. voltage output common
DCOM	Digital input common
DI1	Stop (0) / Start (1)
DI2	Forward (0) / Reverse (1)
DI3	Constant frequency / speed selection <sup>1)</sup>
DI4	Constant frequency / speed selection <sup>1)</sup>
DIO1	Ramp set 1 input (0) / Ramp set 2 input (1) <sup>2)</sup>
DIO2	Ready run output(0) / Not ready output (1)
DIO SRC	Digital output auxiliary voltage
DIO COM	Digital input/output common
<b>Analog I/O</b>	
AI1	Speed / freq.(0...10V) <sup>4)</sup>
AGND	Analog input circuit common
AI2	Not configured <sup>4)</sup>
AGND	Analog input circuit common
AO	Output frequency (0...20 mA)
AGND	Analog output circuit common
SCR	Signal cable shield (screen)
+10V	Ref. voltage +10 V DC
<b>Safe torque off (STO)</b>	
S+	Safe torque off. Connected at factory.
SGND	Drive starts only if both circuits are closed.
S1	
S2	
<b>Relay output 1</b>	
RC	No fault [Fault (-1)]
RA	
RB	

### Notes:

Terminal sizes: 0.14 mm<sup>2</sup> ... 1.5 mm<sup>2</sup>

Tightening torques: 0.5 N·m (0.4 lbf·ft).

Terminals DGND, AGND and SGND are internally connected to same reference potential.

Reference from the integrated panel.

- 1) In scalar control (default): See parameter group [28 Frequency reference chain](#).  
In vector control: See parameter group [22 Speed reference selection](#).

Select the correct control mode from the *Motor data* view or with parameter [99.04 Motor control mode](#).

DI3	DI4	Operation/Parameter	
		Scalar control (default)	Vector control
0	0	Set frequency through AI1	Set speed through AI1
1	0	<a href="#">28.26 Constant frequency 1</a>	<a href="#">22.26 Constant speed 1</a>
0	1	<a href="#">28.27 Constant frequency 2</a>	<a href="#">22.27 Constant speed 2</a>
1	1	<a href="#">28.28 Constant frequency 3</a>	<a href="#">22.28 Constant speed 3</a>

2)

DIO1	Ramp set	Parameters
0	1	<a href="#">28.71 Freq ramp set selection</a> ,...
1	2	<a href="#">28.74 Freq acceleration time 2</a>

3) Ground the outer shield of the cable 360 degrees under the grounding clamp on the grounding shelf for the control cables.

4) Select the unit for analog input AI1 in the parameter [12.15](#) and for AI2 in the parameter [12.25](#).

Input signals

- Start/Stop selection (DI1)
- Forward (0) / Reverse (1) (DI2)
- Speed selection (DI3)
- Speed selection (DI4)
- Ramp set 1 (0) / Ramp set 2 (1) selection (DIO1)
- Output frequency or motor speed reference (AI1)

Output signals

- Output frequency (AO)
- Ready to run (0) / Not ready (1) (DIO2)
- No Fault [Fault (-1)]

## ABB limited macro

The ABB limited macro is suitable for an IO-controlled drive which has the minimum number of I/O available.

The ABB limited macro is optimized for the base drive variant (ACS380-04xN) with no optional module connected.

You can activate the macro from the *Control macros* view, or by setting parameter [96.04 Macro select](#) to value *ABB limited 2-wire*.

### ■ Default control connections for the ABB limited macro

This is the default control connection diagram for the base drive variant (ACS380-04xN) with the ABB limited macro selected.

Terminals	Description
	<b>Digital I/O connections</b>
	Aux. +24 V DC, max 200 mA
	Aux. voltage output common
	Digital input common
	Stop (0) / Start (1)
	Speed (1) / freq selection (2)
	<b>Safe torque off (STO)</b>
	Safe torque off. Connected at factory.
	Drive starts only if both circuits are closed.
	Relay output 1
No fault [Fault (-1)]	

#### Notes:

Terminal sizes: 0.14 mm<sup>2</sup> ... 1.5 mm<sup>2</sup>

Tightening torque: 0.5 N·m (0.4 lbf·ft).

Terminals DGND and SGND are internally connected to same reference potential.

Input signals

- Start / Stop (DI1)
- Output frequency or motor speed reference (DI2)

Output signals

- Relay output 1: Fault (-1)
- No Fault [Fault (-1)]

## Fieldbus control macro

Fieldbus control macro is suitable for a fieldbus-controlled drive. The I/O signal interface is not in use as default.

In the initial start-up of the drive, the fieldbus control macro activates automatically whenever it detects a fieldbus adapter. For more information, see [Automatic drive configuration for fieldbus control](#) on page 491.

You can activate the macro manually from the *Control macros* view, or by setting parameter [96.04 Macro select](#) to the correct value based on the selected fieldbus.

The macro is optimal for the configured variant (ACS380-04xC) which is equipped with a fieldbus adapter module.

### ■ Default control connections for the Fieldbus macro

This is the default control connection diagram for the configured variant (ACS380-04xC) with the Fieldbus macro selected.

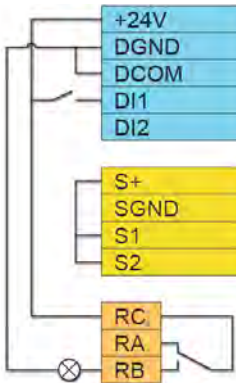
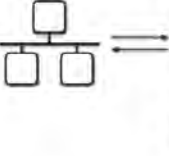
Terminals	Description
<b>Digital I/O connections</b>	
	Aux. +24 V DC, max 200 mA
	Aux. voltage output common
	Digital input common
	Fault reset
	Not configured
<b>Safe torque off (STO)</b>	
	Safe torque off. Connected at factory.
	Drive starts only if both circuits are closed.
<b>Relay output 1</b>	
	No fault [Fault (-1)]
<b>Fieldbus module connections</b>	
	+K457 FCAN-01-M CANopen
	+K454 FPBA-01-M PROFIBUS DP
	+K469 FECA-01-M EtherCAT
	+K475 FENA-21-M Ethernet/IP, PROFINET, Modbus TCP
	+K495 BCAN-11 CANopen interface
DSUB9	CANopen
DSUB9	Profibus DP
RJ45 X 2	EtherCAT
RJ45 X 2	Ethernet IP
RJ45 X 2	Profinet
RJ45 X 2	Modbus TCP
Terminal Block	CANopen

#### Notes:

Terminal sizes: 0.14 mm<sup>2</sup> ... 1.5 mm<sup>2</sup>

Tightening torque: 0.5 N·m (0.4 lbf·ft).

Terminals DGND and SGND are internally connected to same reference potential.

When the fieldbus adapter module is connected, the drive control signals are expected to come from the fieldbus typically.

When taking the drive variant ACS380-04xC +K495 (with the BCAN-11 CANopen interface module) into use, it is recommended that the cord is not connected during the first start. This is to avoid disturbing the CANopen bus when the drive attempts to recognize the attached module.

The software automatically sets the relevant parameters when the fieldbus adapter module is connected to the drive. For more information, see [Automatic drive configuration for fieldbus control](#) on page 491. For CANopen parameters, see [CANopen parameter settings for embedded fieldbus interface](#) on page 443.

#### Input signals

- Fault reset (DI1)
- Control words and reference words through the fieldbus adapter module

#### Output signals

- Status words and status signals through the fieldbus adapter module
  - No Fault [Fault (-1)]
-

## **Alternate macro**

This macro provides an I/O configuration where one signal starts the motor in the forward direction and another signal starts the motor in the reverse direction.

You can activate the macro from the *Control macros* view, or by setting parameter [96.04 Macro select](#) to value *Alternate*.

The macro is optimized for the standard drive variant (ACS380-04xS) and configured drive variant ACS380-04xC +L538. You can use it also with the base drive variant (ACS380-04xN) but then you cannot use all the I/O available in the macro.

---

## Default control connections for the Alternate macro

This connection diagram is valid for the standard drive variant ACS380-04xS and the configured drive variant ACS380-04xC +L538 (with the Alternate macro selected).

Terminals	Description
<b>Digital I/O connections</b>	
+24V	Aux. +24 V DC, max 200 mA
DGND	Aux. voltage output common
DCOM	Digital input common
DI 1	Start forward; If DI1 = DI2: stop
DI 2	Start reverse
DI 3	Constant speed / frequency selection <sup>1)</sup>
DI 4	Constant speed / frequency selection <sup>1)</sup>
DIO 1	Ramp set 1 (0) / Ramp set 2 (1) <sup>2)</sup>
DIO 2	Ready run (0) / not ready run
DIO SRC	Digital output auxiliary voltage
DIO COM	Digital input/output common
<b>Analog I/O</b>	
AI 1	Output freq./Speed ref.(0...10V) <sup>4)</sup>
AGND	Analog input circuit common
AI 2	Not configured <sup>4)</sup>
AGND	Analog input circuit common
AO	Output frequency (0...20 mA)
AGND	Analog output circuit common
SCR	Signal cable shield (screen)
+10V	Ref. voltage +10 V DC
<b>Safe torque off (STO)</b>	
S+	Safe torque off. Connected at factory.
SGND	Safe torque off. Connected at factory.
S 1	Drive starts only if both circuits are closed.
S 2	Drive starts only if both circuits are closed.
<b>Relay output</b>	
RC	No Fault [Fault (-1)]
RA	
RB	
<b>EIA-485 Modbus RTU</b>	
B+	Embedded Modbus RTU (EIA-485). See chapter <a href="#">Fieldbus control through the embedded fieldbus interface (EFB)</a> .
A-	
BGND	
Shield	
Termination	

### Notes:

Terminal sizes: 0.14 mm<sup>2</sup> ... 1.5 mm<sup>2</sup>

Tightening torque: 0.5 N·m (0.4 lbf·ft).

Terminals DGND, AGND and SGND are internally connected to same reference potential.

- 1) In scalar control (default): See parameter group [28 Frequency reference chain](#).  
In vector control: See parameter group [22 Speed reference selection](#).

Select the correct control mode from the *Motor data* view or with parameter [99.04 Motor control mode](#).

DI3	DI4	Operation/Parameter	
		Scalar control (default)	Vector control
0	0	Set frequency through AI1	Set speed through AI1
1	0	<a href="#">28.26 Constant frequency 1</a>	<a href="#">22.26 Constant speed 1</a>
0	1	<a href="#">28.27 Constant frequency 2</a>	<a href="#">22.27 Constant speed 2</a>
1	1	<a href="#">28.28 Constant frequency 3</a>	<a href="#">22.28 Constant speed 3</a>

- 2) In scalar control (default): See parameter group [28 Frequency reference chain](#).  
In vector control: See parameter group [23 Speed reference ramp](#).

Select the correct control mode from the *Motor data* view or with parameter [99.04 Motor control mode](#).

DIO2	Ramp set	Parameters	
		Scalar control (default)	Vector control
0	1	<a href="#">28.72 Freq acceleration time 1</a>	<a href="#">23.12 Acceleration time 1</a>
		<a href="#">28.73 Freq deceleration time 1</a>	<a href="#">23.13 Deceleration time 1</a>
1	2	<a href="#">28.74 Freq acceleration time 2</a>	<a href="#">23.14 Acceleration time 2</a>
		<a href="#">28.75 Freq deceleration time 2</a>	<a href="#">23.15 Deceleration time 2</a>

- 3) Ground the outer shield of the cable 360 degrees under the grounding clamp on the grounding shelf for the control cables.
- 4) Select the unit for analog input AI1 in the parameter [12.15](#) and for AI2 in the parameter [12.25](#).

#### Input signals

- Start motor forward (DI1)
- Start motor in reverse (DI2)
- Constant output frequency / motor speed selection (DI3)
- Constant output frequency / motor speed selection (DI4)
- Ramp set selection (DIO1)

#### Output signals

- Output frequency or motor speed reference (AI1)
- Output frequency (AO1)
- No Fault [Fault (-1)]



## Motor potentiometer macro

This macro provides a way to adjust the speed with the help of two push buttons, or a cost-effective interface for PLCs that vary the speed of the motor using only digital signals.

You can activate the macro from the *Control macros* view, or by setting parameter [96.04 Macro select](#) to value *Motor potentiometer*.

For more information on the motor potentiometer counter, see section [Motor potentiometer](#) on page [108](#).

The macro is optimized for the standard drive variant (ACS380-04xS) and configured drive variant ACS380-04xC +L538.

---

**Default control connections for the Motor potentiometer macro**

This connection diagram is valid for drives with the standard drive variant ACS380-04xS and the configured drive variant ACS380-04xC +L538 (with the Motor potentiometer macro selected).

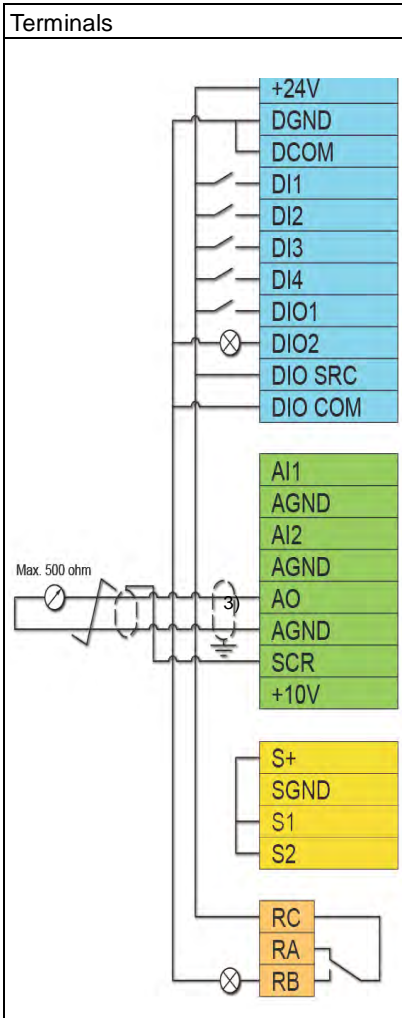
Terminals	Description
<b>Digital I/O connections</b>	
	Aux. +24 V DC, max 200 mA
DGND	Aux. voltage output common
DCOM	Digital input common
DI1	Stop (0) / Start (1)
DI2	Forward (0) / Reverse (1)
DI3	Frequency / speed up <sup>1)</sup>
DI4	Frequency / speed down <sup>1)</sup>
DIO1	Constant speed sel 1 <sup>2)</sup>
DIO2	Ready run (0) / Not ready run (1)
DIO SRC	Digital output auxiliary voltage
DIO COM	Digital input/output common
<b>Analog I/O</b>	
AI1	Not configured <sup>4)</sup>
AGND	Analog input circuit common
AI2	Not configured <sup>4)</sup>
AGND	Analog input circuit common
AO	Not configured
AGND	Analog output circuit common
SCR	Signal cable shield (screen)
+10V	Ref. voltage +10 V DC
<b>Safe torque off (STO)</b>	
S+	Safe torque off. Connected at factory.
SGND	Drive starts only if both circuits are closed.
S1	
S2	
<b>Relay output</b>	
RC	No Fault [Fault (-1)]
RA	
RB	

**Notes:**

Terminal sizes: 0.14 mm<sup>2</sup> ... 1.5 mm<sup>2</sup>

Tightening torque: 0.5 N·m (0.4 lbf·ft).

Terminals DGND, AGND and SGND are internally connected to same reference potential.

1) When the input signal is on, the speed/frequency increase or decrease along a parameter-defined change rate. See parameters [22.75](#), [22.76](#), and [22.77](#). If DI3 and DI4 are both active or inactive, the frequency/speed reference is unchanged. The existing frequency/speed reference is stored during stop and power down.

2) In scalar control (default): See parameter group [28 Frequency reference chain](#).  
In vector control: See parameter group [23 Speed reference ramp](#).

Select the correct control mode from the *Motor data* view or with parameter [99.04 Motor control mode](#).

DIO1	Ramp set	Parameters	
		Scalar control (default)	Vector control
0	1	<a href="#">28.72 Freq acceleration time 1</a> <a href="#">28.73 Freq deceleration time 1</a>	<a href="#">23.12 Acceleration time 1</a> <a href="#">23.13 Deceleration time 1</a>
1	2	<a href="#">28.74 Freq acceleration time 2</a> <a href="#">28.75 Freq deceleration time 2</a>	<a href="#">23.14 Acceleration time 2</a> <a href="#">23.15 Deceleration time 2</a>

3) Ground the outer shield of the cable 360 degrees under the grounding clamp on the grounding shelf for the control cables.

4) Select the unit for analog input AI1 in the parameter [12.15](#) and for AI2 in the parameter [12.25](#).

Input signals

- Stop (0) / Start (1) (DI1)
- Forward (0) / Reverse (1) (DI2)
- Frequency / speed up (DI3)
- Frequency / speed down (DI4)
- Constant speed selection 1 (DIO1)

Output signals

- No Fault [Fault (-1)]

## PID control macro

This macro is suitable for applications where the drive is always controlled by PID and the reference comes from analog input AI1.

You can activate the macro from the *Control macros* view, or by setting parameter [96.04 Macro select](#) to value *PID*.

The macro is optimized for the standard drive variant ACS380-04xS and the configured drive variant ACS380-04xC +L538.

### Default control connections for PID control macro

This connection diagram is valid for the standard drive variant ACS380-04xS and the configured drive variant ACS380-04xC +L538 (with the PID control macro selected).

Terminals	Description
<b>Digital I/O connections</b>	
+24V	Aux. +24 V DC, max 200 mA
DGND	Aux. voltage output common
DCOM	Digital input common
DI 1	Stop (0) / Start (1)
DI 2	Internal setpoint sel1 <sup>1)</sup>
DI 3	Internal setpoint sel2 <sup>1)</sup>
DI 4	Constant speed / frequency selection <sup>2)</sup>
DIO 1	Run enable 1 source
DIO 2	Ready run
DIO SRC	Digital output auxiliary voltage
DIO COM	Digital input/output common
<b>Analog I/O</b>	
AI 1	External PID ref <sup>3) 6)</sup>
AGND	Analog input circuit common
AI 2	Actual PID feedback <sup>4) 6)</sup>
AGND	Analog input circuit common
AO	Output frequency (0...20 mA)
AGND	Analog output circuit common
SCR	Signal cable shield (screen)
+10V	Ref. voltage +10 V DC
<b>Safe torque off (STO)</b>	
S+	Safe torque off. Connected at factory.
SGND	Drive starts only if both circuits are closed.
S 1	
S 2	
<b>Relay output</b>	
RC	No Fault [Fault (-1)]
RA	
RB	

#### Notes:

Terminal sizes: 0.14 mm<sup>2</sup> ... 1.5 mm<sup>2</sup>

Tightening torque: 0.5 N·m (0.4 lbf·ft).

Terminals DGND, AGND and SGND are internally connected to same reference potential.

1) See parameters [40.19 Set 1 internal setpoint sel1](#) and [40.20 Set 1 internal setpoint sel2](#) source table.

Source defined by par. <a href="#">40.19</a> DI2	Source defined by par. <a href="#">40.20</a> DI3	Internal setpoint active
0	0	Setpoint source: AI1 (par. <a href="#">40.16</a> )
1	0	1 (par. <a href="#">40.21</a> )
0	1	2 (par. <a href="#">40.22</a> )
1	1	3 (par. <a href="#">40.23</a> )

2) Select the correct control mode from the *Motor data* view or with parameter [99.04 Motor control mode](#).

DI4	Operation/Parameter	
	Scalar control (default)	Vector control
0	Set frequency through AI1	Set speed through AI1
1	<a href="#">28.26 Constant frequency 1</a>	<a href="#">22.26 Constant speed 1</a>

3) PID: 0...10 V -> 0...100% PID setpoint.

4) The signal source is powered externally. See the manufacturer's instructions. To use sensors supplied by the drive aux. voltage output, see connection examples of two-wire and three-wire sensors in the hardware manual of the drive.

5) Ground the outer shield of the cable 360 degrees under the grounding clamp on the grounding shelf for the control cables.

6) Select the unit for analog input AI1 in the parameter [12.15](#) and for AI2 in the parameter [12.25](#).

Input signals

- External PID ref (AI1)
- Actual feedback from PID (AI2)
- Start/Stop selection (DI1)
- Constant setpoint 1 (DI2)
- Constant setpoint 2 (DI3)
- Speed/freq selection (DI4)
- Ramp pair selection (DIO1)

Output signals

- Output frequency (AO)
  - No Fault [Fault (-1)]
-

## **Modbus macro**

Modbus macro is suitable for a Modbus-controlled drive.

You can activate the macro from the *Control macros* view, or by setting parameter [96.04 Macro select](#) to value *Modbus TCP*.

The macro is optimized for the standard drive variant ACS380-04xS and the configured drive variant ACS380-04xC +L538.

---

## ■ Default control connections for the Modbus macro

This connection diagram is valid for the standard drive variant ACS380-04xS and the configured drive variant ACS380-04xC +L538 (with the Modbus macro selected).

Terminals	Description
<b>Digital I/O connections</b>	
+24V	Aux. +24 V DC, max 200 mA
DGND	Aux. voltage output common
DCOM	Digital input common
DI1	Fault reset
DI2	Not configured
DI3	Not configured
DI4	Not configured
DIO1	Not configured
DIO2	Not configured
DIO SRC	Digital output auxiliary voltage
DIO COM	Digital input/output common
<b>Analog I/O</b>	
AI1	Not configured <sup>1)</sup>
AGND	Analog input circuit common
AI2	Not configured <sup>1)</sup>
AGND	Analog input circuit common
AO	Not configured
AGND	Analog output circuit common
SCR	Signal cable shield (screen)
+10V	Ref. voltage +10 V DC
<b>Safe torque off (STO)</b>	
S+	Safe torque off. Connected at factory.
SGND	Drive starts only if both circuits are closed.
S1	
S2	
<b>Relay output</b>	
RC	No Fault [Fault (-1)]
RA	
RB	
<b>EIA-485 Modbus RTU</b>	
B+	Embedded Modbus RTU (EIA-485). See chapter <a href="#">Fieldbus control through the embedded fieldbus interface (EFB)</a> .
A-	
BGND	
Shield	
Termination	

### Notes:

Terminal sizes: 0.14 mm<sup>2</sup> ... 1.5 mm<sup>2</sup>

Tightening torque: 0.5 N·m (0.4 lbf·ft).

Terminals DGND, AGND and SGND are internally connected to same reference potential.

The embedded parameters also change, see the embedded macros [20.03 Ext1 in1 source](#) (Not selected).

<sup>1)</sup> Select the unit for analog input AI1 in the parameter [12.15](#) and for AI2 in the parameter [12.25](#).

Input signals

- Fault reset (DI1)
- Output frequency / speed reference (AI1)

Output signals

- Output frequency (AO)
  - No Fault [Fault (-1)]
-



## Parameter default values for different macros

Chapter [Parameters](#) shows the default values of all parameters for the ABB standard macro (factory macro). Some parameters have different default values for other macros. The tables below lists the default values for those parameters for each macro.

<b>96.04</b>	<b>Macro select</b>	<b>1 = ABB standard</b>	<b>12 = Alternate</b>	<b>13 = Motor potenti- ometer</b>	<b>14 = PID</b>
10.24	RO1 source	15 = Fault (-1)	15 = Fault (-1)	15 = Fault (-1)	15 = Fault (-1)
12.20	AI1 scaled at AI1 max	50.0	50.0	50.0	50.0
13.12	AO1 source	2 = Output frequency	2 = Output frequency	2 = Output frequency	2 = Output frequency
13.18	AO1 source max	50.0	50.0	50.0	50.0
19.11	Ext1/Ext2 selection	0 = EXT1	0 = EXT1	0 = EXT1	0 = EXT1
20.01	Ext1 commands	2 = In1 Start; In2 Dir	3 = In1 Start fwd; In2 Start	2 = In1 Start; In2 Dir	1 = In1 Start
20.03	Ext1 in1 source	2 = DI1	2 = DI1	2 = DI1	2 = DI1
20.04	Ext1 in2 source	3 = DI2	3 = DI2	3 = DI2	0 = Always off
20.05	Ext1 in3 source	0 = Always off	0 = Always off	0 = Always off	0 = Always off
20.06	Ext2 commands	0 = Not selected	0 = Not selected	0 = Not selected	0 = Not selected
20.08	Ext2 in1 source	0 = Always off	0 = Always off	0 = Always off	0 = Always off
20.09	Ext2 in2 source	0 = Always off	0 = Always off	0 = Always off	0 = Always off
20.12	Run enable 1 source	1 = Selected	1 = Selected	1 = Selected	10 = DIO1
21.05	Emergency stop source	1 = Inactive (true)	1 = Inactive (true)	1 = Inactive (true)	1 = Inactive (true)
22.11	Ext1 speed ref1	1 = AI1 scaled	1 = AI1 scaled	15 = Motor potentiometer	16 = PID
22.18	Ext2 speed ref1	0 = Zero	0 = Zero	0 = Zero	0 = Zero
22.22	Constant speed sel1	4 = DI3	4 = DI3	10 = DIO1	5 = DI4
22.23	Constant speed sel2	5 = DI4	5 = DI4	0 = Always off	0 = Always off

<b>96.04 Macro select</b>	<b>1 = ABB standard</b>	<b>12 = Alternate</b>	<b>13 = Motor potenti- ometer</b>	<b>14 = PID</b>
22.71 Motor potentiometer function	0 = Disabled	0 = Disabled	1 = Enabled (init at power-up)	0 = Disabled
22.73 Motor potentiometer up source	0 = Not selected	0 = Not selected	4 = DI3	0 = Not selected
22.74 Motor potentiometer down source	0 = Not selected	0 = Not selected	5 = DI4	0 = Not selected
23.11 Ramp set selection	10 = DIO1	10 = DIO1	0 = Acc/Dec time 1	0 = Acc/Dec time 1
28.11 Ext1 frequency ref1	1 = AI1 scaled	1 = AI1 scaled	15 = Motor potentiometer	16 = PID
28.15 Ext1 frequency ref2	0 = Zero	0 = Zero	0 = Zero	0 = Zero
28.22 Constant frequency sel1	4 = DI3	4 = DI3	10 = DIO1	5 = DI4
28.23 Constant frequency sel2	5 = DI4	5 = DI4	0 = Always off	0 = Always off
28.71 Freq ramp set selection	10 = DIO1	10 = DIO1	0 = Acc/Dec time 1	0 = Acc/Dec time 1
40.07 Process PID operation mode	0 = Off	0 = Off	0 = Off	2 = On when drive running
40.16 Set 1 setpoint 1 source	11 = AI1 percent	11 = AI1 percent	11 = AI1 percent	11 = AI1 percent
40.17 Set 1 setpoint 2 source	0 = Not selected	0 = Not selected	0 = Not selected	2 = Internal setpoint
40.19 Set 1 internal setpoint sel1	0 = Not selected	0 = Not selected	0 = Not selected	3 = DI2
40.20 Set 1 internal setpoint sel2	0 = Not selected	0 = Not selected	0 = Not selected	4 = DI3
40.32 Set 1 gain	1.00	1.00	1.00	1.00
40.33 Set 1 integration time	60.0	60.0	60.0	60.0



# Program features

---

## Contents

- *Local and external control locations*
  - *Operating modes and motor control modes*
  - *Drive configuration and programming*
  - *Control interfaces*
  - *Motor control*
  - *Application control*
  - *DC voltage control*
  - *Limit to limit control*
  - *Safety and protections*
  - *Diagnostics*
  - *Miscellaneous*
-

## Local and external control locations

There are two main control locations: local and external. Select the control by pressing the Loc/Rem key on the panels, or from the Drive composer PC tool.

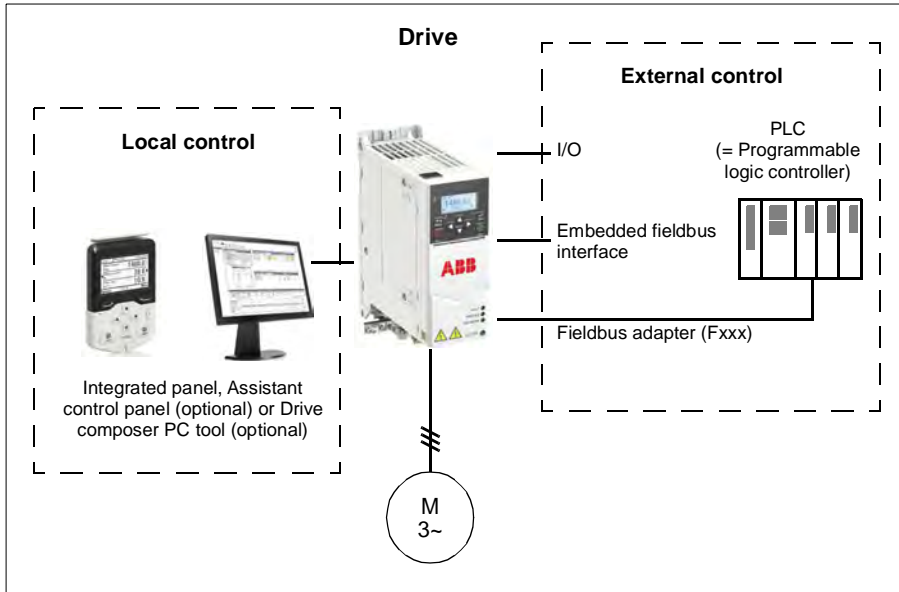

### Local control

The control commands are given from the integrated control panel or from a PC equipped with Drive composer when the drive is in local control. Local control is mainly used during commissioning and maintenance. The control panel always overrides the external control signal sources when used in local control.

Changing the control location to local can be prevented by parameter [19.17 Local control disable](#).

**Note:** You can use both assistant control panel/drive composer tool at the same time, but only one can be in local control at a time.

### Settings

Parameters [19.17 Local control disable](#) (page [155](#)) and [49.05 Communication loss action](#) page ([293](#)).

## External control

When the drive is in external control, control commands are given through:

- the I/O terminals (digital and analog inputs)
- the fieldbus interface (via the embedded fieldbus interface or an optional fieldbus adapter module)
- external panel (assistant panel).

Two external control locations, EXT1 and EXT2, are available. You can select the sources of the start and stop commands separately for each location by setting parameters [20.01...20.10](#). The operating mode can be selected separately for each location, which enables quick switching between different operating modes, for example speed and torque control. Selection between EXT1 and EXT2 is done via any binary source such as a digital input or fieldbus control word by parameter [19.11 Ext1/Ext2 selection](#). You can also select the source of reference for each operating mode separately, and the operation mode.

### Settings

Parameters [20.01... 20.10](#) and [19.11 Ext1/Ext2 selection](#) (page [154](#)).

### Block diagram: Run enable source for EXT1

The figure below shows the parameters that select the interface for run enable for external control location [EXT1](#).

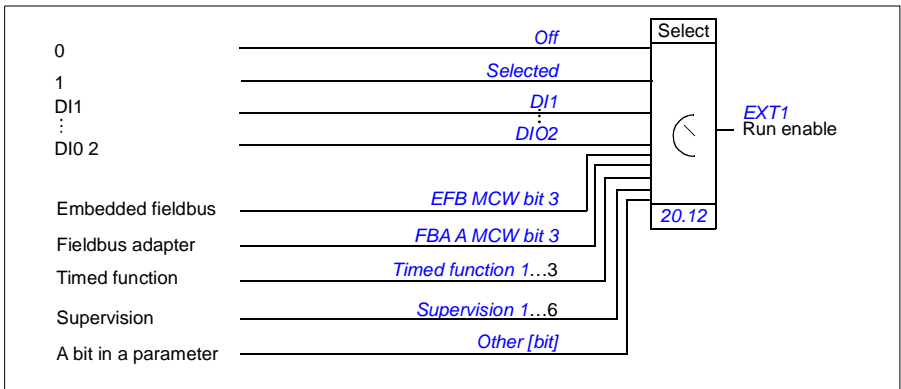

### Settings

Parameters [19.11 Ext1/Ext2 selection](#) (page [154](#)) and [20.01...20.10](#).

## Operating modes and motor control modes

The drive can operate in several operating modes with different types of reference. The operating mode is selectable for each control location (*Local*, *EXT1* and *EXT2*) when the motor control mode is *Vector* (99.04). If the motor control mode is *Scalar*, the drive operation mode is fixed to frequency control mode.

An overview of the control hierarchy and different reference types and control chains is shown below.

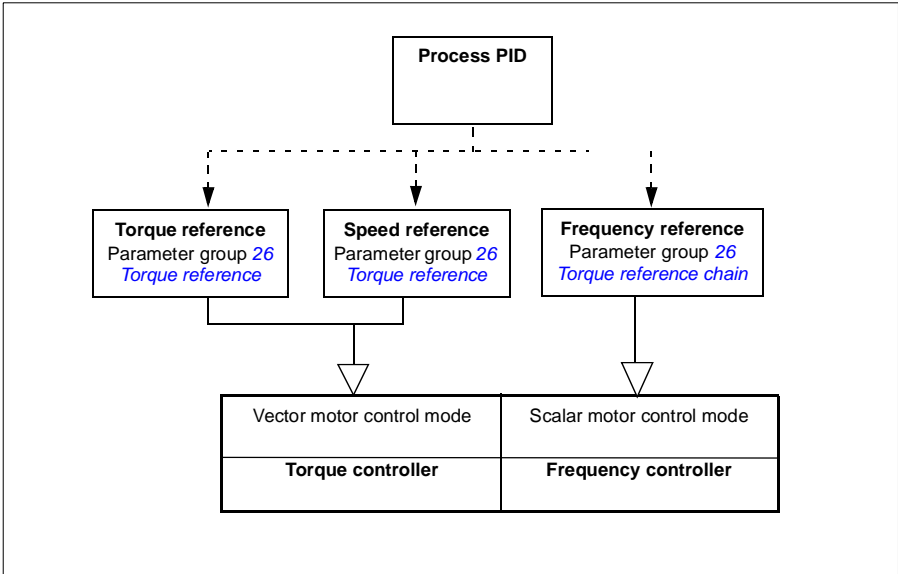

### Settings

Parameter group [19 Operation mode](#) (page [153](#)).

### ■ Overview diagram of control hierarchy

The following is a more detailed representation of the drive control hierarchy reference types and control chains.

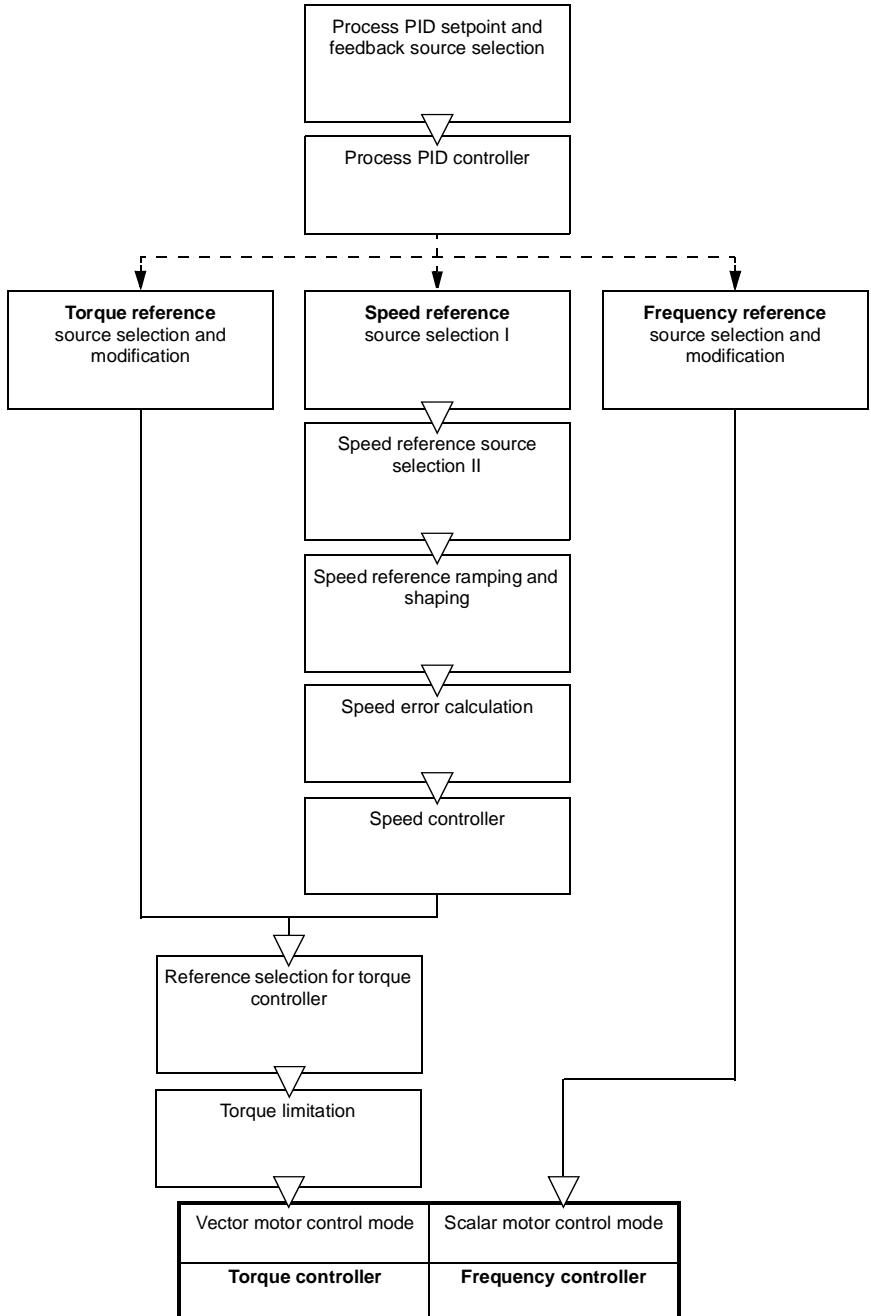

## ■ Speed control mode

In speed control mode, the motor follows a speed reference given to the drive. This mode can be used with either estimated or measured speed used as feedback.

Speed control mode is available in both local and external control locations. It is supported in vector motor control only.

Speed control uses speed reference chain. Select speed reference with parameters in group [22 Speed reference selection](#) on page [177](#).

## ■ Torque control mode

In torque control mode, the motor torque follows a torque reference given to the drive. Torque control mode is available in both local and external control locations. It is supported in vector motor control only.

Torque control uses torque reference chain. Select torque reference with parameters in group [26 Torque reference chain](#) on page [199](#).

## ■ Frequency control mode

In frequency control mode, the motor follows the drive output frequency reference. Frequency control is available in both local and external control location. It is supported in scalar motor control only.

Frequency control uses frequency reference chain. Select frequency reference with parameters in group [28 Frequency reference chain](#) on page [203](#).

## ■ Special control modes

In addition to the above-mentioned operating modes, the following special operating modes are available:

- Process PID control. For more information, see section [Process PID control](#) on page [81](#).
  - Emergency stop modes OFF1 and OFF3: Drive stops along the defined deceleration ramp and drive modulation stops.
  - Jogging mode: Drive starts and accelerates to the defined speed when the jogging signal is activated. For more information, see section [Jogging](#) on page [70](#).
  - Pre-magnetization: DC magnetization of the motor before start. For more information, see section [Pre-magnetization](#) on page [77](#).
  - DC hold: Locking the rotor at (near) zero speed in the middle of normal operation. For more information, see section [DC hold](#) on page [77](#).
  - Pre-heating (motor heating): Keeping the motor warm when the drive is stopped. For more information, see section [Pre-heating \(Motor heating\)](#) on page [78](#).
-



## ■ Settings

Parameter groups [19 Operation mode](#) (page 153) and [99.04 Motor control mode](#) (page 347).

## ■ Autophasing

Autophasing is an automatic measurement routine to determine the angular position of the magnetic flux of a permanent magnet synchronous motor or the magnetic axis of a synchronous reluctance motor. The motor control requires the absolute position of the rotor flux in order to control motor torque accurately.

Sensors like absolute encoders and resolvers indicate the rotor position at all times after the offset between the zero angle of rotor and that of the sensor has been established. On the other hand, a standard pulse encoder determines the rotor position when it rotates but the initial position is not known. However, a pulse encoder can be used as an absolute encoder if it is equipped with Hall sensors, albeit with coarse initial position accuracy. Hall sensors generate so-called commutation pulses that change their state six times during one revolution, so it is only known within which 60° sector of a complete revolution the initial position is.

Many encoders give a zero pulse (also called Z-pulse) once during each rotation. The position of the zero pulse is fixed. If this position is known with respect to zero position used by motor control, the rotor position at the instant of the zero pulse is also known.

Using the zero pulse improves the robustness of the rotor position measurement. The rotor position must be determined during starting because the initial value given by the encoder is zero. The autophasing routine determines the position, but there is a risk of some position error. If the zero pulse position is known in advance, the position found by autophasing can be corrected as soon as the zero pulse is detected for the first time after starting.

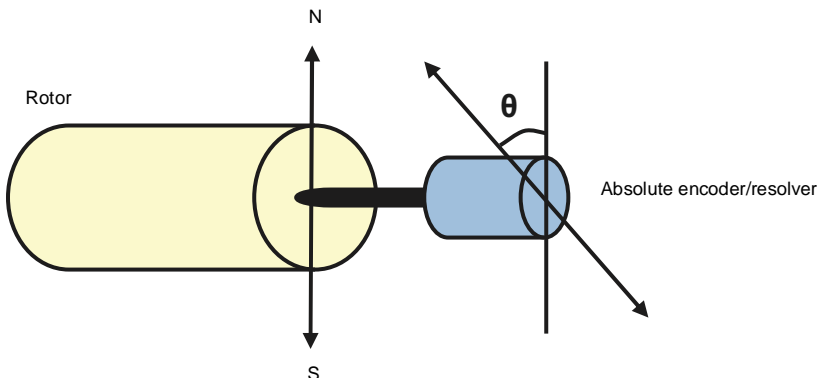

The autophasing routine is performed with permanent magnet synchronous motors and synchronous reluctance motors in the following cases:

1. One-time measurement of the rotor and encoder position difference when an absolute encoder, a resolver, or an encoder with commutation signals is used
2. At every power-up when an incremental encoder is used
3. With open-loop motor control, repetitive measurement of the rotor position at every start
4. When the position of the zero pulse must be measured before the first start after power-up.

**Note:** In closed-loop control, autophasing is performed automatically after the motor identification run (ID run). Autophasing is also performed automatically before starting when necessary.

In open-loop control, the zero angle of the rotor is determined before starting. In closed-loop control, the actual angle of the rotor is determined with autophasing when the sensor indicates zero angle. The offset of the angle must be determined because the actual zero angles of the sensor and the rotor do not usually match. The autophasing mode determines how this operation is done both in open-loop and closed-loop control.

The rotor position offset used in motor control can also be given by the user – see parameter [98.15 Position offset user](#). Note that the autophasing routine also writes its result into this parameter. The results are updated even if user settings are not enabled by [98.01 User motor model mode](#).

**Note:** In open-loop control, the motor always turns when it is started as the shaft is turned towards the remanence flux.

Bit 4 of [06.21 Drive status word 3](#) indicates if the rotor position has already been determined.

### Autophasing modes

The ACS380 uses turning mode (see parameter [21.13 Autophasing mode](#)).

The turning mode ([Turning](#)) is the most robust and accurate method. In turning mode, the motor shaft is turned back and forward ( $\pm 360/\text{polepairs}$ )° in order to determine the rotor position. In case 3 (open-loop control), the shaft is turned only in one direction and the angle is smaller.

The drive is capable of determining the rotor position when started into a running motor in open-loop or closed-loop control. In this situation, the setting of [21.13 Autophasing mode](#) has no effect.

The autophasing routine can fail and therefore it is recommended to perform the routine several times and check the value of parameter [98.15 Position offset user](#).

---

An autophasing fault ([3385 Autophasing](#)) can occur with a running motor if the estimated angle of the motor differs too much from the measured angle. This could be caused by, for example, the following:

- The encoder is slipping on the motor shaft
- An incorrect value has been entered into [98.15 Position offset user](#)
- The motor is already turning before the autophasing routine is started
- [Turning](#) mode is selected in [21.13 Autophasing mode](#) but the motor shaft is locked
- The wrong motor type is selected in [99.03 Motor type](#)
- Motor ID run has failed.

### Settings

Parameters [06.21 Drive status word 3](#) (page [128](#)), [21.13 Autophasing mode](#) (page [173](#)), [98.15 Position offset user](#) (page [347](#)) and [99.13 ID run requested](#) (page [350](#)).

---

## Drive configuration and programming

The drive control program is divided into two parts:

- firmware program
- application program

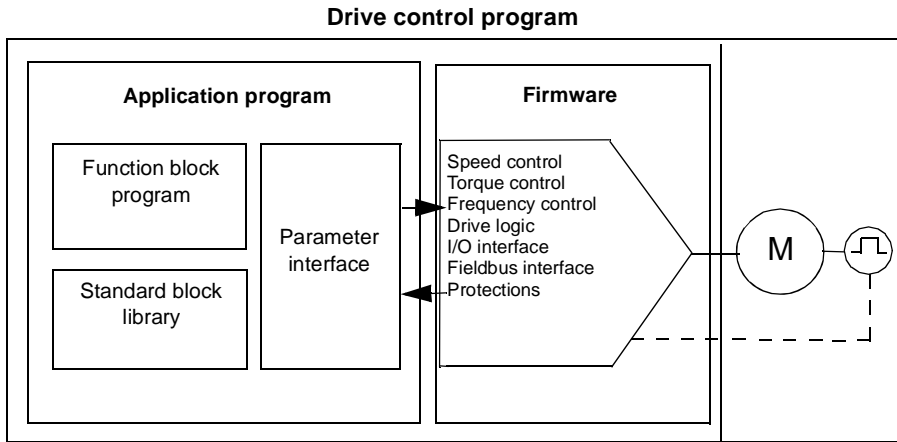

The firmware program performs the main control functions, including speed, torque and frequency control, drive logic (start/stop), I/O, feedback, communication and protection functions. Firmware functions are configured and programmed with parameters, and can be extended by application programming

### ■ Programming via parameters

Parameters configure all of the standard drive operations and can be set via

- the integrated panel, as described in chapter [Control panel](#)
- an external panel
- the Drive composer PC tool, as described in *Drive composer PC tool user's manual* (3AUA0000094606 [English]), or
- the fieldbus interface, as described in chapters [Fieldbus control through the embedded fieldbus interface \(EFB\)](#) and [Fieldbus control through a fieldbus adapter](#).

All parameter settings are stored automatically to the permanent memory of the drive. However, if an external +24 V DC power supply is used for the drive control unit, it is highly recommended to force a save by using parameter [96.07 Parameter save manually](#) before powering down the control unit after any parameter changes have been made.

If necessary, the default parameter values can be restored by parameter [96.06 Parameter restore](#).

## ■ Adaptive programming

Conventionally, you can control the operation of the drive by parameters. However, the standard parameters have a fixed set of choices or a setting range. To further customize the operation of the drive, an adaptive program can be constructed out of a set of function blocks.

The Drive composer pro PC tool (version 1.11 or later, available separately) has an Adaptive programming feature with a graphical user interface for building the custom program. The function blocks include the usual arithmetic and logical functions, as well as e.g., selection, comparison and timer blocks.

The physical inputs, drive status information, actual values, constants and parameters can be used as the input for the program. The output of the program can be used e.g., as a start signal, external event or reference, or connected to the drive outputs. See the table below for a listing of the available inputs and outputs.

If you connect the output of the adaptive program to a selection parameter that is a pointer parameter, the selection parameter will be write-protected.

### Example:

If parameter *31.01 External event 1 source* is connected to an adaptive programming block output, the parameter value is shown as *Adaptive program* on a control panel or PC-tool. The parameter is write-protected (= the selection cannot be changed).

The status of the adaptive program is shown by parameter *07.30 Adaptive program status*.

For more information, see the *Adaptive programming application guide* (3AXD50000028574 [English]).

Inputs available to the adaptive program	
Input	Source
I/O	
DI1	<a href="#">10.02 DI delayed status</a> , bit 0
DI2	<a href="#">10.02 DI delayed status</a> , bit 1
DI3	<a href="#">10.02 DI delayed status</a> , bit 2 1)
DI4	<a href="#">10.02 DI delayed status</a> , bit 3 1)
AI1	<a href="#">12.11 AI1 actual value</a> 1)
AI2	<a href="#">12.21 AI2 actual value</a> 1)
DIO1	<a href="#">11.02 DIO delayed status</a> , bit 0 1)
DIO2	<a href="#">11.02 DIO delayed status</a> , bit 1 1)
<i>Actual signals</i>	
Motor speed	<a href="#">01.01 Motor speed used</a>
Output frequency	<a href="#">01.06 Output frequency</a>
Motor current	<a href="#">01.07 Motor current</a>
Motor torque	<a href="#">01.10 Motor torque</a>
Motor shaft power	<a href="#">01.17 Motor shaft power</a>
<i>Status</i>	
Enabled	<a href="#">06.16 Drive status word</a> 1, bit 0

<b>Inputs available to the adaptive program</b>	
<i>Input</i>	<i>Source</i>
Inhibited	<a href="#">06.16 Drive status word 1, bit 1</a>
Ready to start	<a href="#">06.16 Drive status word 1, bit 3</a>
Tripped	<a href="#">06.11 Main status word, bit 3</a>
At setpoint	<a href="#">06.11 Main status word, bit 8</a>
Limiting	<a href="#">06.16 Drive status word 1, bit 7</a>
Ext1 active	<a href="#">06.16 Drive status word 1, bit 10</a>
Ext2 active	<a href="#">06.16 Drive status word 1, bit 11</a>
<i>Data storage</i>	
Data storage 1 real32	<a href="#">47.01 Data storage 1 real32</a>
Data storage 2 real32	<a href="#">47.02 Data storage 2 real32</a>
Data storage 3 real32	<a href="#">47.03 Data storage 3 real32</a>
Data storage 4 real32	<a href="#">47.04 Data storage 4 real32</a>

1) Available only if I/O and Modbus module is connected and in use.

<b>Outputs available to the adaptive program</b>	
<i>Output</i>	<i>Target</i>
<i>I/O</i>	
RO1	<a href="#">10.24 RO1 source</a>
AO1	<a href="#">13.12 AO1 source 2)</a>
DIO1	<a href="#">11.06 DIO1 output source 2)</a>
DIO2	<a href="#">11.10 DIO2 output source 2)</a>
<i>Start control</i>	
Ext1/Ext2 selection	<a href="#">19.11 Ext1/Ext2 selection</a>
Run enable 1	<a href="#">20.12 Run enable 1 source</a>
Ext1 in1 cmd	<a href="#">20.03 Ext1 in1 source</a>
Ext1 in2 cmd	<a href="#">20.04 Ext2 in2 source</a>
Ext1 in3 cmd	<a href="#">20.05 Ext1 in3 source</a>
Ext2 in1 cmd	<a href="#">20.08 Ext2 in1 source</a>
Ext2 in2 cmd	<a href="#">20.09 Ext2 in2 source</a>
Ext2 in3 cmd	<a href="#">20.10 Ext2 in3 source</a>
Fault reset	<a href="#">31.11 Fault reset selection</a>
<i>Speed control</i>	
Ext1 speed reference	<a href="#">22.11 Ext1 speed ref1</a>
Speed proportional gain	<a href="#">25.02 Speed proportional gain</a>
Speed integration time	<a href="#">25.03 Speed integration time</a>
Acceleration time 1	<a href="#">23.12 Acceleration time 1</a>
Deceleration time 1	<a href="#">23.13 Deceleration time 1</a>
<i>Frequency control</i>	
Ext1 frequency reference	<a href="#">28.11 Ext1 frequency ref1</a>
<i>Torque control</i>	
Ext1 torque reference	<a href="#">26.11 Torque ref1 source</a>
Ext2 torque reference	<a href="#">26.12 Torque ref2 source</a>
<i>Limit function</i>	
Minimum torque 2	<a href="#">30.21 Min torque 2 source</a>
Maximum torque 2	<a href="#">30.22 Max torque 2 source</a>
<i>Events</i>	
External event 1	<a href="#">31.01 External event 1 source</a>
External event 2	<a href="#">31.03 External event 2 source</a>
External event 3	<a href="#">31.05 External event 3 source</a>

<b>Outputs available to the adaptive program</b>	
<i>Output</i>	<i>Target</i>
External event 4	<a href="#">31.07 External event 4 source</a>
External event 5	<a href="#">31.09 External event 5 source</a>
<i>Data Storage</i>	
Data storage 1 real32	<a href="#">47.01 Data storage 1 real32</a>
Data storage 2 real32	<a href="#">47.02 Data storage 2 real32</a>
Data storage 3 real32	<a href="#">47.03 Data storage 3 real32</a>
Data storage 4 real32	<a href="#">47.04 Data storage 4 real32</a>
<i>Process PID</i>	
Set 1 setpoint 1	<a href="#">40.16 Set 1 setpoint 1 source</a>
Set 1 setpoint 2	<a href="#">40.17 Set 1 setpoint 2 source</a>
Set 1 feedback 1	<a href="#">40.08 Set 1 feedback 1 source</a>
Set 1 feedback 2	<a href="#">40.09 Set 1 feedback 2 source</a>
Set 1 gain	<a href="#">40.32 Set 1 gain</a>
Set 1 integration time	<a href="#">40.33 Set 1 integration time</a>
Set 1 tracking mode	<a href="#">40.49 Set 1 tracking mode</a>
Set 1 track reference	<a href="#">40.50 Set 1 tracking ref selection</a>

2) Available only if I/O and Modbus module is connected and in use.

### **Adaptive program fault and aux code formats**

The format of the aux code:

Bits 24-31: State number	Bits 16-23: block number	Bits 0-15: error code
--------------------------	--------------------------	-----------------------

If the state number is zero but the block number has a value, the fault is related to a function block in the base program. If both state number and block number are zero, the fault is a generic fault that is not related to a specific block.

### **Sequence program**

An adaptive program can contain base program and sequence program parts. Base program is run continuously when adaptive program is in running mode. The functionality of the base program is programmed using function blocks and system inputs and outputs.

Sequence program is a state machine. This means that only one state of the sequence program is run at a time. You can create a sequence program by adding states and programming the state programs using the same program elements as in the base program. You can program state transitions by adding state transition outputs to the state programs. The state transition rules are programmed using function blocks.

The number of the active state of the sequence program is shown by parameter [07.31 AP sequence state](#).

## Control interfaces

The number of inputs and outputs depend on the product variant and if the drive is equipped with any optional I/O extension modules.

S variant:

- 4 x Digital Inputs
- 2 x Digital Inputs/Outputs
- 2 x Analog Inputs
- 1 x Analog Output
- 1 x Relay Output

C variant:

- 2 x Digital Inputs
- 1 x Relay Output

### ■ Programmable analog inputs

There are max two programmable analog inputs. Each of the inputs can be independently set as a voltage (0/2...10 V) or current (0/4...20 mA) input by a switch on the control unit. Each input can be filtered, inverted and scaled.

#### Settings

Parameter group [12 Standard AI](#) (page [141](#)).

### ■ Programmable analog outputs

There is max one current (0...20mA) analog output. The output can be filtered, inverted and scaled.

#### Settings

Parameter group [13 Standard AO](#) (page [146](#)).

### ■ Programmable digital inputs and outputs

There are max four digital inputs, and two digital inputs/outputs (I/O that can be set as either an input or an output).

Digital inputs DI3 and DI4 can be used as frequency input and digital outputs DIO1 and DIO2 can be used as frequency output.

#### Settings

Parameter groups [10 Standard DI, RO](#) (page [131](#)) and [11 Standard DIO, FI, FO](#) (page [135](#)).

---



## ■ Programmable relay outputs

There is one relay output as standard. The signal indicated by the output can be selected by parameters.

### Settings

Parameter groups [10 Standard DI, RO](#) (page [131](#)).

## ■ Programmable I/O extensions

Inputs and outputs can be added by using I/O extension modules.

The table below shows the number of I/O on the control unit as well as optional I/O extension modules.

Location	Digital inputs (DI)	Digital outputs (DO)	Digital I/Os (DIO)	Analog inputs (AI)	Analog outputs (AO)	Relay outputs (RO)
Base unit	2	-	-	-	-	1
BREL	-	-	-	-	-	4
BIO-01	3	1	-	1	-	-

**Note:** The configuration parameter group contains parameters that display the values of the inputs on the extension module. These parameters are the only way of utilizing the inputs on an I/O extension module as signal sources.

### Settings

Parameter groups [15 I/O extension module](#) (page [149](#)).

## ■ Fieldbus control

The drive can be connected to several different automation systems through its fieldbus interfaces. See chapters [Fieldbus control through the embedded fieldbus interface \(EFB\)](#) and [Fieldbus control through a fieldbus adapter](#).

### Settings

Parameter groups [50 Fieldbus adapter \(FBA\)](#) (page [295](#)), [51 FBA A settings](#) (page [299](#)), [52 FBA A data in](#) (page [300](#)), [53 FBA A data out](#) (page [301](#)) and [58 Embedded fieldbus](#) (page [301](#)).

## Motor control

### ■ Motor types

The drive supports the following motor types:

- Asynchronous AC induction motors
- Permanent magnet (PM) motors
- Synchronous reluctance motors (SynRM).

### Settings

Parameter [99.03 Motor type](#) (page [347](#)).

### ■ Motor identification

The performance of vector control is based on an accurate motor model determined during the motor start-up.

A motor Identification magnetization is automatically performed the first time the start command is given. During this first start-up, the motor is magnetized at zero speed for several seconds to allow the motor model to be created. This identification method is suitable for most applications.

In demanding applications a separate Identification run (ID run) can be performed.

### Settings

Parameter [99.13 ID run requested](#) (page [350](#)).

### ■ Power loss ride-through

See section [Undervoltage control \(power loss ride-through\)](#) on page [90](#).

### ■ Vector control

Vector control is the motor control mode which is intended for applications where high control accuracy is needed. It requires an identification run at startup. Vector control cannot be used in all applications.

The switching of the output semiconductors is controlled to achieve the required stator flux and motor torque. The switching frequency is changed only if the actual torque and stator flux values differ from their reference values by more than the allowed hysteresis. The reference value for the torque controller comes from the speed controller or directly from an external torque reference source.

Motor control requires measurement of the DC voltage and two motor phase currents. Stator flux is calculated by integrating the motor voltage in vector space. Motor torque is calculated as a cross product of the stator flux and the rotor current. By utilizing the identified motor model, the stator flux estimate is improved. Actual motor shaft speed is not needed for the motor control.

---

The main difference between traditional control and vector control is that torque control operates at the same time level as the power switch control. There is no separate voltage and frequency controlled PWM modulator; the output stage switching is wholly based on the electromagnetic state of the motor.

The best motor control accuracy is achieved by activating a separate motor identification run (ID run).

See also section [Speed control performance figures](#) on page 73.

## Settings

Parameters [99.04 Motor control mode](#) (page 347) and [99.13 ID run requested](#) (page 350).

### ■ Reference ramping

Acceleration and deceleration ramping times can be set individually for speed, torque and frequency reference.

With a speed or frequency reference, the ramps are defined as the time it takes for the drive to accelerate or decelerate between zero speed or frequency and the value defined by parameter [46.01 Speed scaling](#) or [46.02 Frequency scaling](#). The user can switch between two preset ramp sets using a binary source such as a digital input. For speed reference, also the shape of the ramp can be controlled.

With a torque reference, the ramps are defined as the time it takes for the reference to change between zero and nominal motor torque ([01.30 Nominal torque scale](#)).

### Variable slope

Variable slope controls the slope of the speed ramp during a reference change. With this feature a constantly variable ramp can be used.

Variable slope is only supported in remote control.

## Settings

Parameters [23.28 Variable slope enable](#) (page 192) and [23.29 Variable slope rate](#) (page 192).

### Special acceleration/deceleration ramps

The acceleration/deceleration times for the jogging function can be defined separately; see section [Jogging](#) on page 70.

The change rate of the motor potentiometer function (page 108) is adjustable. The same rate applies in both directions.

A deceleration ramp can be defined for emergency stop (“Off3” mode).

## Settings

- Speed reference ramping - Parameters [23.11...23.15](#), [23.32 Shape time 1](#) (page [193](#)), [23.33 Shape time 2](#) (page [193](#)) and [46.01 Speed scaling](#) (page [289](#)).
- Torque reference ramping - Parameters [01.30 Nominal torque scale](#) (page [117](#)), [26.18 Torque ramp up time](#) (page [202](#)) and [26.19 Torque ramp down time](#) (page [202](#)).
- Frequency reference ramping - Parameters [28.71...28.75](#) and [46.02 Frequency scaling](#) (page [289](#)).
- Jogging - Parameters [23.20 Acc time jogging](#) (page [191](#)) and [23.21 Dec time jogging](#) (page [191](#)).
- Motor potentiometer - Parameter [22.75 Motor potentiometer ramp time](#) (page [187](#)).
- Emergency stop (“Off3” mode) - Parameter [23.23 Emergency stop time](#) (page [192](#)).

### ■ Constant speeds/frequencies

Constant speeds and frequencies are predefined references that can be quickly activated, for example, through digital inputs. It is possible to define up to 7 speeds for speed control and 7 constant frequencies for frequency control.



**WARNING:** Speeds and frequencies override the normal reference irrespective of where the reference is coming from.

---

## Settings

Parameter groups [22 Speed reference selection](#) (page [177](#)) and [28 Frequency reference chain](#) (page [203](#)).

### ■ Critical speeds/frequencies

Critical speeds (sometimes called “skip speeds”) can be predefined for applications where it is necessary to avoid certain motor speeds or speed ranges because of, for example, mechanical resonance problems.

The critical speeds function prevents the reference from dwelling within a critical band for extended times. When a changing reference enters a critical range, the output of the function freezes until the reference exits the range. Any instant change in the output is smoothed out by the ramping function further in the reference chain.

When the drive is limiting the allowed output speeds/frequencies, it limits to the absolutely lowest critical speed (critical speed low or critical frequency low) when accelerating from standstill, unless the speed reference is over the upper critical speed/ frequency limit.

---

## Example

A fan has vibrations in the range of 540 to 690 rpm and 1380 to 1560 rpm. To make the drive avoid these speed ranges,

- enable the critical speeds function by turning on bit 0 of parameter [22.51](#), and
- set the critical speed ranges as in the figure below.

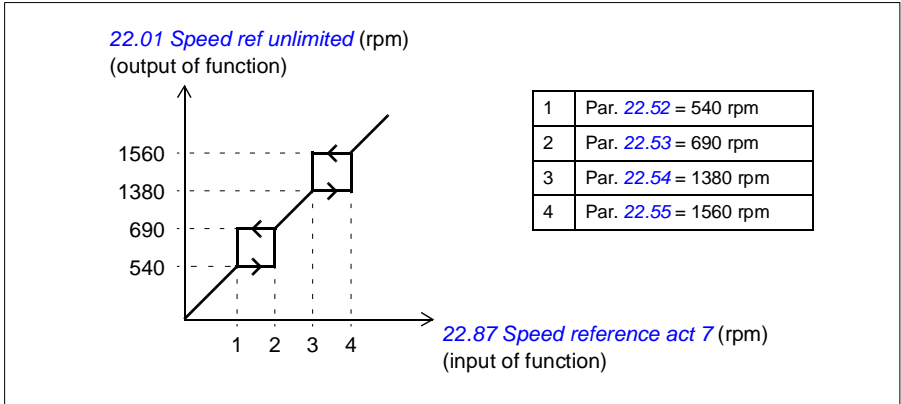

## Settings

- Critical speeds - Parameters [22.51](#)...[22.57](#).
- Critical frequencies - Parameters [28.51](#)...[28.57](#).
- Function input (speed) - Parameter [22.01 Speed ref unlimited](#) (page [177](#)).
- Function output (speed) - Parameter [22.87 Speed reference act 7](#) (page [188](#)).
- Function input (frequency) - Parameter [28.96 Frequency ref act 7](#) (page [215](#)).
- Function output (frequency) - Parameter [28.97 Frequency ref unlimited](#) (page [215](#)).

## ■ Rush control

Rush control is automatically on when the operation mode is torque. In torque control, the motor could potentially rush if the load were suddenly lost. The control program has a rush control function that decreases the torque reference whenever the motor speed exceeds the set minimum speed or maximum speed.

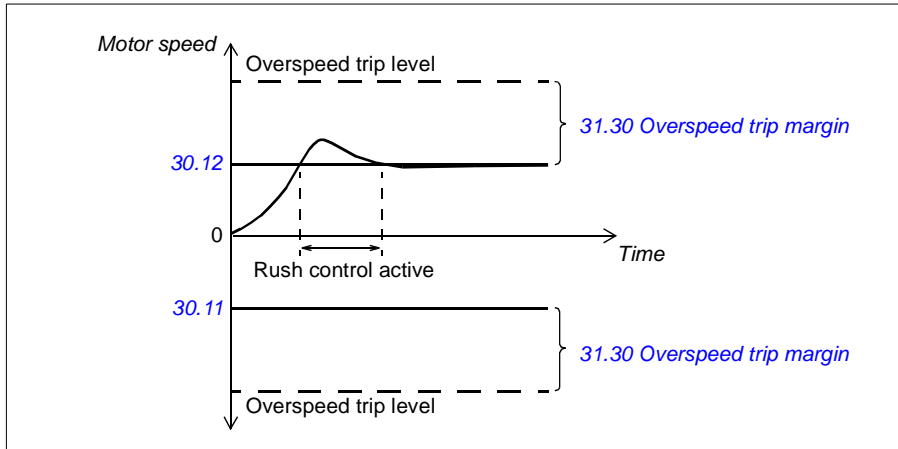

The function is based on a PI controller. The program sets the proportional gain to 10.0 and integration time to 2.0 s.

### Settings

Parameters [30.11 Minimum speed](#) (page 217), [30.12 Maximum speed](#) (page 217) and [31.30 Overspeed trip margin](#) (page 229).

## ■ Encoder echo support

The connection of one encoder to several drives with the BTAC-02 encoder interface module can be done by using a daisy chain wiring scheme. This means wiring channels A, B, Z and GND of multiple encoder modules together with the encoder.

### Settings

Parameter groups [90 Feedback selection](#) (page 327), [91 Encoder adapter settings](#) (page 328) and [92 Encoder 1 configuration](#) (page 329).

## ■ Jogging

The jogging function enables the use of a momentary switch to briefly rotate the motor. The jogging function is typically used during servicing or commissioning to control the machinery locally.

Two jogging functions (1 and 2) are available, each with their own activation sources and references. The signal sources are selected by parameters [20.26](#) and [20.27](#).

When jogging is activated, the drive starts and accelerates to the defined jogging speed along the defined jogging acceleration ramp. After the activation signal switches off, the drive decelerates to a stop along the defined jogging deceleration ramp.

The figure and table below provide an example of how the drive operates during jogging. In the example, the ramp stop mode is used ([21.03 Stop mode](#)).

Jog cmd = State of source set by [20.26](#) or [20.27](#)

Jog enable = State of source set by [20.25](#)

Start cmd = State of drive start command.

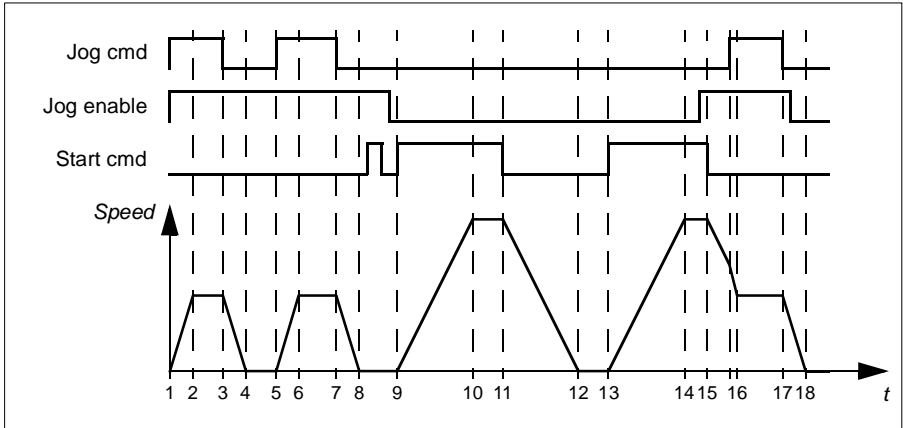

Phase	Jog cmd	Jog enable	Start cmd	Description
1-2	1	1	0	Drive accelerates to the jogging speed along the acceleration ramp of the jogging function.
2-3	1	1	0	Drive follows the jog reference.
3-4	0	1	0	Drive decelerates to zero speed along the deceleration ramp of the jogging function.
4-5	0	1	0	Drive is stopped.
5-6	1	1	0	Drive accelerates to the jogging speed along the acceleration ramp of the jogging function.
6-7	1	1	0	Drive follows the jog reference.
7-8	0	1	0	Drive decelerates to zero speed along the deceleration ramp of the jogging function.
8-9	0	1->0	0	Drive is stopped. As long as the jog enable signal is on, start commands are ignored. After jog enable switches off, a fresh start command is required.
9-10	x	0	1	Drive accelerates to the speed reference along the selected acceleration ramp (parameters <a href="#">23.11</a> ... <a href="#">23.15</a> ).

Phase	Jog cmd	Jog enable	Start cmd	Description
10-11	x	0	1	Drive follows the speed reference.
11-12	x	0	0	Drive decelerates to zero speed along the selected deceleration ramp (parameters <a href="#">23.11...23.15</a> ).
12-13	x	0	0	Drive is stopped.
13-14	x	0	1	Drive accelerates to the speed reference along the selected acceleration ramp (parameters <a href="#">23.11...23.15</a> ).
14-15	x	0>1	1	Drive follows the speed reference. As long as the start command is on, the jog enable signal is ignored. If the jog enable signal is on when the start command switches off, jogging is enabled immediately.
15-16	0>1	1	0	Start command switches off. The drive starts to decelerate along the selected deceleration ramp (parameters <a href="#">23.11...23.15</a> ). When the jog command switches on, the decelerating drive adopts the deceleration ramp of the jogging function.
16-17	1	1	0	Drive follows the jog reference.
17-18	0	1>0	0	Drive decelerates to zero speed along the deceleration ramp of the jogging function.

**Notes:**

- Jogging is not available when the drive is in local control.
- Jogging cannot be enabled when the drive start command is on, or the drive started when jogging is enabled. Starting the drive after the jog enable switches off requires a fresh start command.



**WARNING!** If jogging is enabled and activated while the start command is on, jogging will activate as soon as the start command switches off.

- If both jogging functions are activated, the one that was activated first has priority.
- Jogging uses vector control.
- The inching functions activated through fieldbus ([06.01](#) bits 8...9) use the references and ramp times defined for jogging, but do not require the jog enable signal.

**Settings**

Parameters [20.25 Jog enable](#) (page [164](#)), [20.26 Jog 1 start](#) (page [165](#)), [20.27 Jog 2 start](#) (page [166](#)), [22.42 Jogging 1 ref](#) (page [185](#)), [22.43 Jogging 2 ref](#) (page [185](#)), [23.20 Acc time jogging](#) (page [191](#)) and [23.21 Dec time jogging](#) (page [191](#)).



### Speed control performance figures

The table below shows typical performance figures for speed control.

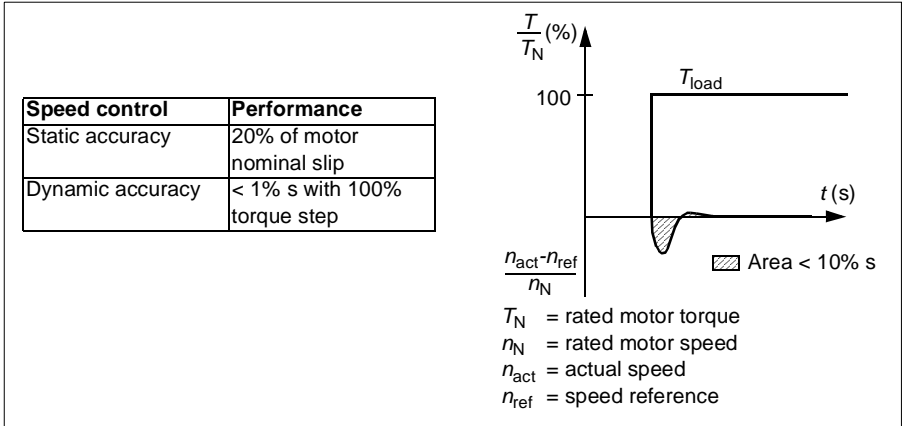

### Torque control performance figures

The drive can perform precise torque control without any speed feedback from the motor shaft. The table below shows typical performance figures for torque control.

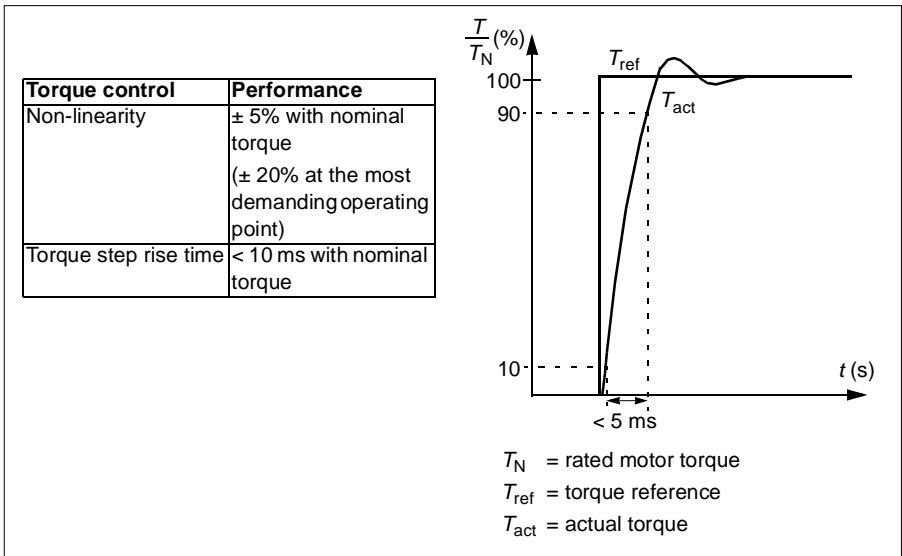

## ■ Scalar motor control

Scalar motor control is the default motor control method. It is suitable for applications which do not require the control accuracy available in vector control. In scalar control, you control the drive output frequency reference, and you do not need to do any motor identification run at the first start.

It is recommended to activate scalar motor control mode in the following special situations:

- In multimotor drives: 1) if the load is not equally shared between the motors, 2) if the motors are of different sizes, or 3) if the motors are going to be changed after motor identification (ID run)
- If the nominal current of the motor is less than 1/6 of the nominal output current of the drive  
**Note:** During this time, do not activate the motor phase loss fault ([31.19 Motor phase loss](#)) as the drive cannot measure the motor current accurately.
- If the drive is used without a motor connected (for example, for test purposes)
- If the drive runs a medium-voltage motor through a step-up transformer.

In scalar control, some features are not available.

See also section [Operating modes and motor control modes](#) on page 54.

### IR compensation for scalar motor control

IR compensation (also known as voltage boost) is available only when the motor control mode is scalar. When IR compensation is activated, the drive gives an extra voltage boost to the motor at low speeds. IR compensation is useful in applications that require a high break-away torque.

In vector control, no IR compensation is possible or needed as it is applied automatically.

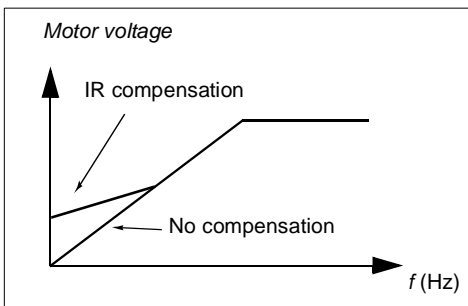

### Settings

Parameter group [28 Frequency reference chain](#) (page 203).

Parameters [97.13 IR compensation](#) (page 343) and [99.04 Motor control mode](#) (page 347).

## ■ User load curve

The User load curve provides a supervisory function that monitors an input signal as a function of frequency or speed, and load. It shows the status of the monitored signal and can give a warning or fault based on the violation of a user defined profile.

The user load curve consists of an overload and an underload curve, or just one of them. Each curve is formed by five points that represent the monitored signal as a function of frequency or speed.

In the example below, the user load curve is constructed from the motor nominal torque to which a 10% margin is added and subtracted. The margin curves define a working envelope for the motor so that excursions outside the envelope can be supervised, timed and detected.

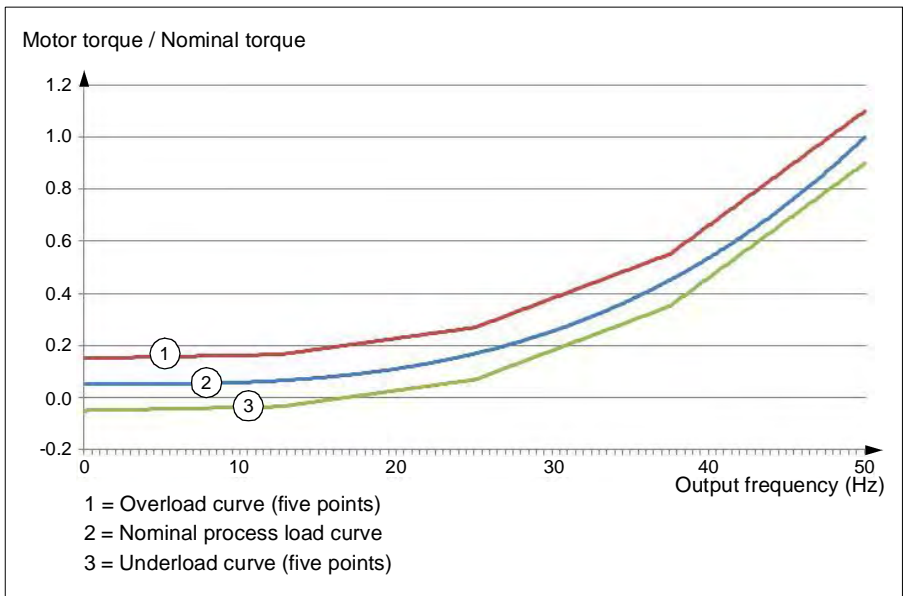

An overload warning and/or fault can be set to occur if the monitored signal stays continuously over the overload curve for a defined time. An underload warning and/or fault can be set to occur if the monitored signal stays continuously under the underload for a defined time.

Overload can be for example used to monitor for a saw blade hitting a knot or fan load profiles becoming too high.

Underload can be for example used to monitor for load dropping and breaking of conveyer belts or fan belts.

## Settings

Parameter group [37 User load curve](#) (page [255](#)).

### ■ U/f ratio

The *U/f* function is only available in scalar motor control mode, which uses frequency control.

The function has two modes: linear and squared.

In linear mode, the ratio of voltage to frequency is constant below the field weakening point. This is used in constant torque applications where it may be necessary to produce torque at or near the rated torque of the motor throughout the frequency range

In squared mode, the ratio of the voltage to frequency increases as the square of the frequency below the field weakening point. This is typically used in centrifugal pump or fan applications. For these applications, the torque required follows the square relationship with frequency. Therefore, if the voltage is varied using the square relationship, the motor operates at improved efficiency and lower noise levels in these applications.

The *U/f* function cannot be used with energy optimization; if parameter [45.11 Energy optimizer](#) is set to *Enable*, parameter [97.20 U/F ratio](#) is ignored.

## Settings

Parameter [97.20 U/F ratio](#) (page [344](#)).

### ■ Flux braking

The drive can provide greater deceleration by raising the level of magnetization in the motor. By increasing the motor flux, the energy generated by the motor during braking can be converted to motor thermal energy.

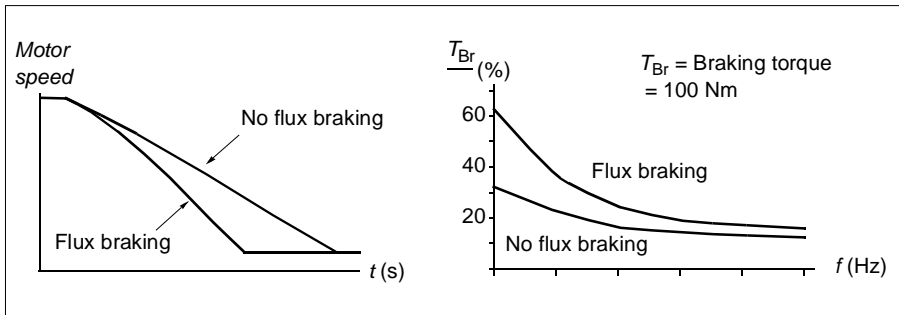

The drive monitors the motor status continuously, also during flux braking. Therefore, flux braking can be used both for stopping the motor and for changing the speed. The other benefits of flux braking are:

- The braking starts immediately after a stop command is given. The function does not need to wait for the flux reduction before it can start the braking.
- The cooling of the induction motor is efficient. The stator current of the motor increases during flux braking, not the rotor current. The stator cools much more efficiently than the rotor.
- Flux braking can be used with induction motors and permanent magnet motors.

Two braking power levels are available:

- Moderate braking provides faster deceleration compared to a situation where flux braking is disabled. The flux level of the motor is limited to prevent excessive heating of the motor.
- Full braking exploits almost all available current to convert the mechanical braking energy to motor thermal energy. Braking time is shorter compared to moderate braking. In cyclic use, motor heating may be significant.



**WARNING:** The motor needs to be rated to absorb the thermal energy generated by flux braking.

---

## Settings

Parameter [97.05 Flux braking](#) (page [341](#)).

## ■ DC magnetization

The drive has different magnetization functions for different phases of motor start/rotation/stop: pre-magnetization, DC hold, post-magnetization and pre-heating (motor heating).

### Pre-magnetization

Pre-magnetization refers to DC magnetization of the motor before start. Depending on the selected start mode (vector or scalar) pre-magnetization can be applied to guarantee the highest possible breakaway torque, up to 200% of the nominal torque of the motor. By adjusting the pre-magnetization time, it is possible to synchronize the motor start and, for example, the release of a mechanical brake.

## Settings

Parameters [21.01 Vector start mode](#) (page [169](#)), [21.19 Scalar start mode](#) (page [175](#)) and [21.02 Magnetization time](#) (page [170](#)).

### DC hold

The function makes it possible to lock the rotor at (near) zero speed in the middle of normal operation. DC hold is activated by parameter [21.08](#). When both the reference and motor speed drop below a certain level, the drive will stop generating sinusoidal

---

current and start to inject DC into the motor. The current is set by parameter [21.10](#). When the reference exceeds parameter [21.09](#), normal drive operation continues.

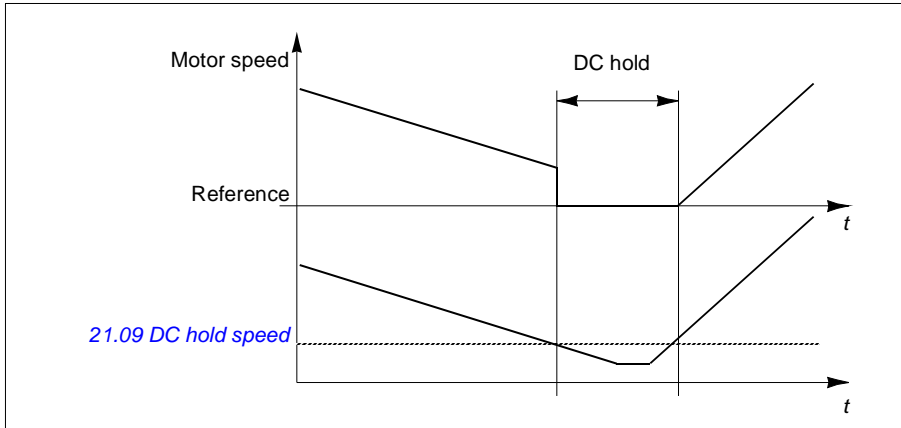

## Settings

Parameters [21.08 DC current control](#) (page [173](#)), [21.09 DC hold speed](#) (page [173](#)) and [21.10 DC current reference](#) (page [173](#)).

## Post-magnetization

The function keeps the motor magnetized for a certain period after stopping. This is to prevent the machinery from moving under load, for example before a mechanical brake can be applied. Post-magnetization is activated by parameter [21.08](#). The magnetization current is set by parameter [21.10](#).

**Note:** Post-magnetization is only available when ramping is the selected stop mode.

## Settings

Parameters [21.01 Vector start mode](#) (page [169](#)), [21.02 Magnetization time](#) (page [170](#)), [21.03 Stop mode](#) (page [170](#)), [21.08 DC current control](#) (page [173](#)), [21.09 DC hold speed](#) (page [173](#)) and [21.11 Post magnetization time](#) (page [173](#)).

## Pre-heating (Motor heating)

The pre-heating function keeps the motor warm and prevents condensation inside the motor by feeding it with DC current when the drive has been stopped. The heating can only be activated when the drive is in the stopped state, and starting the drive stops the heating.

When pre-heating is activated and the stop command is given, pre-heating starts immediately if the drive is running below the zero speed limit (see bit 0 in parameter [06.19 Speed control status word](#)). If the drive is running above the zero speed limit,

pre-heating is delayed by the time defined by parameter [21.15 Pre-heating time delay](#) to prevent excessive current.

The function can be defined to be always active when the drive is stopped or it can be activated by a digital input, fieldbus, timed function or supervision function. For example, with the help of signal supervision function, the heating can be activated by a thermal measurement signal from the motor.

The pre-heating current fed to the motor can be defined as 0...30% of the nominal motor current.

#### Notes:

- In applications where the motor keeps rotating for a long time after the modulation is stopped, it is recommended to use ramp stop with pre-heating to prevent a sudden pull at the rotor when the pre-heating is activated.
- The heating function requires that STO is not triggered.
- The heating function requires that the drive is not faulted.
- Pre-heating uses DC hold to produce current.

#### Settings

Parameters [21.14 Pre-heating input source](#) (page 174), [21.15 Pre-heating time delay](#) and [21.16 Pre-heating current](#) (page 174).

### ■ Energy optimization

The Energy optimization function optimizes the motor flux so that total energy consumption and motor noise level are reduced when the drive operates below the nominal load. The total efficiency (motor and drive) can be improved by 1...20% depending on load torque and speed.

**Note:** With a permanent magnet motor and synchronous reluctance motor, energy optimization is always enabled.

#### Settings

Parameter [45.11 Energy optimizer](#) (page 286).

### ■ Switching frequency

The drive has two switching frequencies: reference switching frequency and minimum switching frequency. The drive tries to keep the highest allowed switching frequency (= reference switching frequency) if thermally possible, and then adjusts dynamically between the reference and minimum switching frequencies depending on the drive temperature. When the drive reaches the minimum switching frequency (= lowest allowed switching frequency), it starts to limit output current as the heating up continues.

For derating, see the hardware manual of the drive.

---

**Example 1:** If you need to fix the switching frequency to a certain value as with some external filters, e.g. with EMC C1 filters (see the hardware manual), set both the reference and the minimum switching frequency to this value and the drive will retain this switching frequency.

**Example 2:** If the reference switching frequency is set to 12 kHz and the minimum switching frequency is set to 1.5 kHz (or 1 kHz), the drive maintains the highest possible switching frequency to reduce motor noise and only when the drive heats it will decrease the switching frequency. This is useful, for example, in applications where low noise is necessary but higher noise can be tolerated when the full output current is needed.

## Settings

Parameters [97.01 Switching frequency reference](#) (page 340) and [97.02 Minimum switching frequency](#) (page 340).

### Speed compensated stop

Speed compensation stop is available for example for applications where a conveyer needs to travel a certain distance after receiving the stop command. At maximum speed, the motor is stopped normally along the defined deceleration ramp, after the application of a user defined delay to adjust the distance traveled. Below maximum speed, stop is delayed still more by running the drive at current speed before the motor is ramped to a stop. As shown in the figure, the distance traveled after the stop command is the same in both cases, that is, area A + area B equals area C.

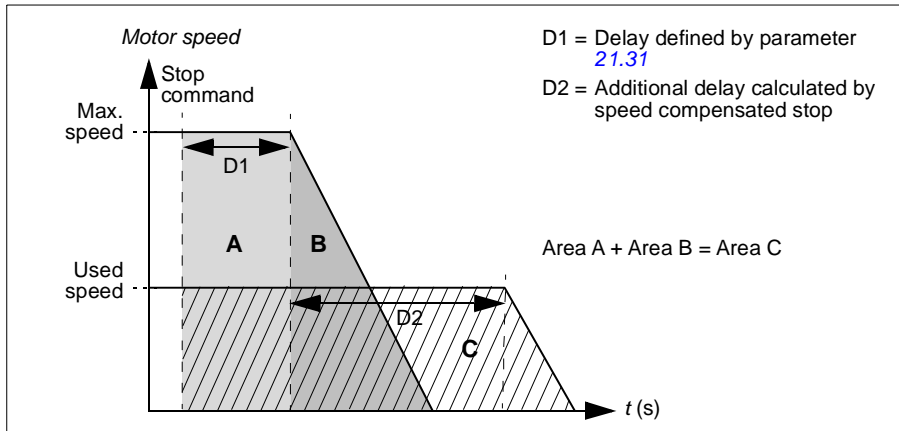

Speed compensation does not take into account shape times (parameters [23.32 Shape time 1](#) and [23.33 Shape time 2](#)). Positive shape times lengthen the distance traveled.



Speed compensation can be restricted to forward or reverse rotating direction. Speed compensation is supported in both vector and scalar motor control.

## Settings

Parameters [21.30 Speed compensated stop mode](#) (page 176), [21.31 Speed compensated stop delay](#) (page 177) and [21.32 Speed comp stop threshold](#) (page 177).

## Application control

### Control macros

Control macros are predefined parameter edits and I/O configurations. See chapter [Control macros](#).

### Process PID control

There is a built-in process PID controller in the drive. The controller can be used to control process such as pressure or flow in the pipe or fluid level in the container.

In process PID control, a process reference (setpoint) is connected to the drive instead of a speed reference. An actual value (process feedback) is also brought back to the drive. The process PID control adjusts the drive speed in order to keep the measured process quantity (actual value) at the desired level (setpoint). This means that user does not need to set a frequency/speed/torque reference to the drive but the drive adjust its operation according to the process PID.

The simplified block diagram below illustrates the process PID control.

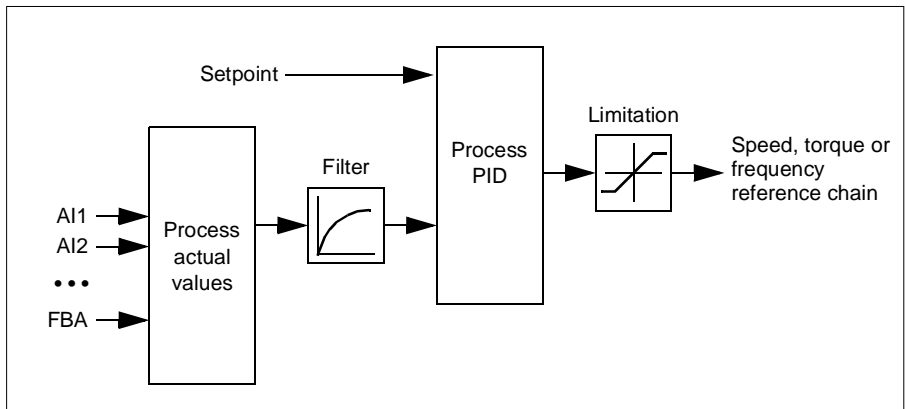

The drive contains two complete sets of process PID controller settings that can be alternated whenever necessary; see parameter [40.57 PID set1/set2 selection](#).

**Note:** Process PID control is only available in external control; see section [Local and external control locations](#) on page 52.

### **Sleep and boost functions for process PID control**

The sleep function is suitable for PID control applications where the consumption varies, such as clean water pumping systems. When used, it stops the pump completely during low demand, instead of running the pump slowly below its efficient operating range. The following example visualizes the operation of the function.

**Example:** The drive controls a pressure boost pump. The water consumption falls at night. As a consequence, the process PID controller decreases the motor speed. However, due to natural losses in the pipes and the low efficiency of the centrifugal pump at low speeds, the motor would never stop rotating. The sleep function detects the slow rotation and stops the unnecessary pumping after the sleep delay has passed. The drive shifts into sleep mode, still monitoring the pressure. The pumping resumes when the pressure falls under the predefined minimum level and the wake-up delay has passed.

The user can extend the PID sleep time by the boost functionality. The boost functionality increases the process setpoint for a predetermined time before the drive enters the sleep mode.

---

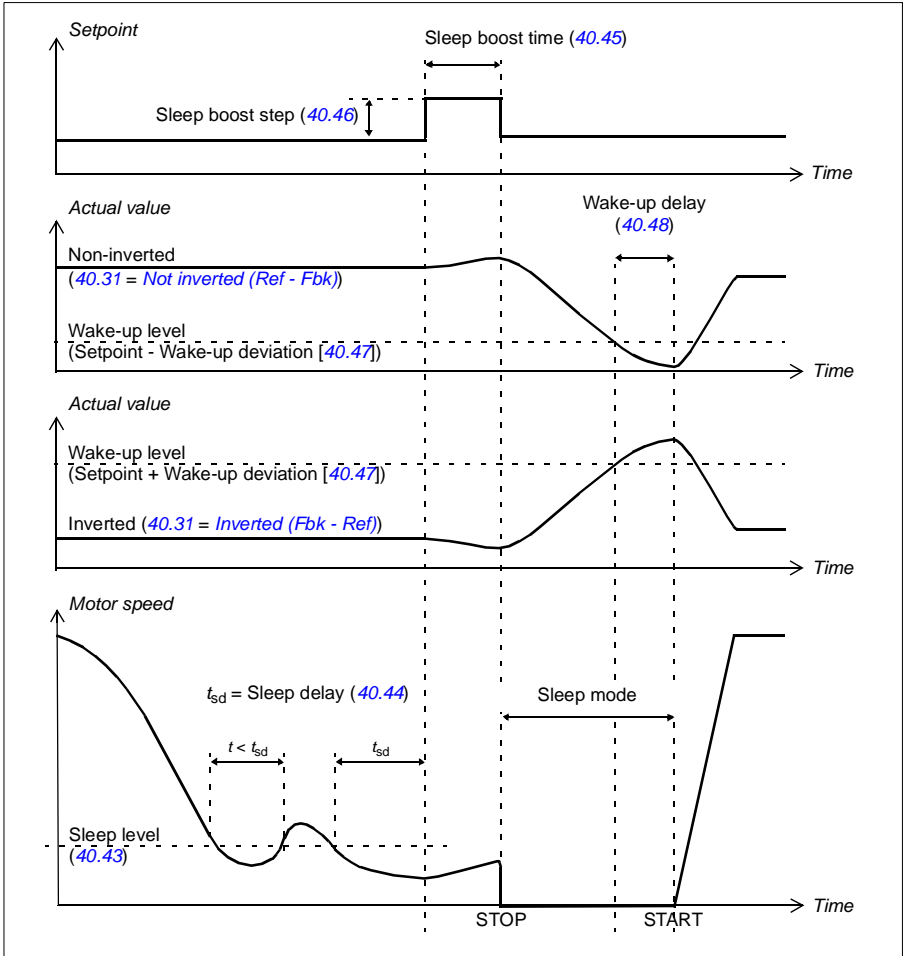

## Tracking

In tracking mode, the PID block output is set directly to the value of parameter [40.50 Set 1 tracking ref selection](#) (or [41.50 Set 2 tracking ref selection](#)). The internal I term of the PID controller is set so that no transient is allowed to pass on to the output, so when the tracking mode is left, normal process control operation can be resumed without a significant bump.

## Settings

Parameter [96.04 Macro select](#) (page [332](#)).

Parameter groups [40 Process PID set 1](#) (page [259](#)) and [41 Process PID set 2](#) (page [273](#)).

## ■ Mechanical brake control

A mechanical brake can be used for holding the motor and driven machinery at zero speed when the drive is stopped, or not powered. The brake control logic observes the settings of parameter group [44 Mechanical brake control](#) as well as several external signals, and moves between the states presented in the diagram on page [85](#). The tables below the state diagram detail the states and transitions. The timing diagram on page [87](#) shows an example of a close-open-close sequence.

For application example, see section [Crane mechanical brake control](#) on page [533](#).

## Inputs of the brake control logic

The start command of the drive (bit 5 of [06.16 Drive status word 1](#)) is the main control source of the brake control logic. An optional external open/close signal can be selected by [44.12 Brake close request](#). The two signals interact as follows:

- Start command = 1 **AND** signal selected by [44.12 Brake close request](#) = 0  
→ Request brake to **open**
- Start command = 0 **OR** signal selected by [44.12 Brake close request](#) = 1  
→ Request brake to **close**

Another external signal – for example, from a higher-level control system – can be connected via parameter [44.11 Keep brake closed](#) to prevent the brake from opening.

Other signals that affect the state of the control logic are

- brake status acknowledgment (optional, defined by parameter [44.07 Brake acknowledge selection](#)),
  - bit 2 of [06.11 Main status word](#) (indicates whether the drive is ready to follow the given reference or not),
  - bit 6 of [06.16 Drive status word 1](#) (indicates whether the drive is modulating or not).
-

### Outputs of the brake control logic

The mechanical brake is controlled by bit 0 of parameter [44.01 Brake control status](#). This bit should be selected as the source of a relay output (or a digital input/output in output mode) which is then wired to the brake actuator through a relay. See the wiring example on page [88](#).

The brake control logic, in various states, will request the drive control logic to hold the motor, increase the torque, or ramp down the speed. These requests are visible in parameter [44.01 Brake control status](#).

### Brake state diagram

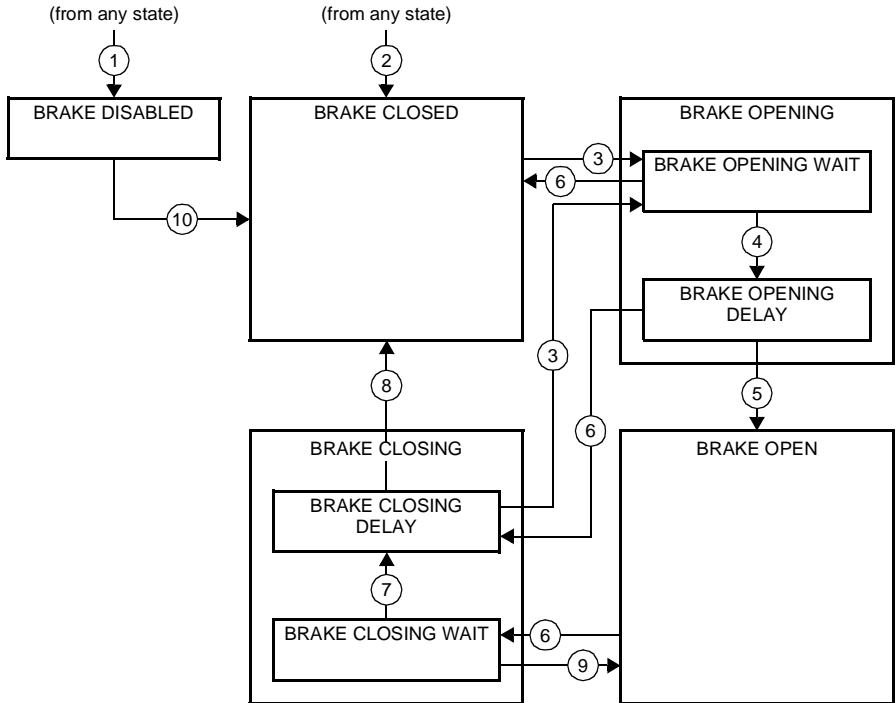

#### State descriptions

State name	Description
<a href="#">BRAKE DISABLED</a>	Brake control is disabled (parameter <a href="#">44.06 Brake control enable</a> = 0, and <a href="#">44.01 Brake control status</a> b4 = 0). The open signal is active ( <a href="#">44.01 Brake control status</a> b0 = 1).
<a href="#">BRAKE OPENING</a>	
<a href="#">BRAKE OPENING WAIT</a>	Brake has been requested to open. The drive logic is requested to increase the torque up to opening torque to hold the load in place ( <a href="#">44.01 Brake control status</a> b1 = 1 and b2 = 1). The state of <a href="#">44.11 Keep brake closed</a> is checked; if it is not 0 within a reasonable time, the drive trips on a <a href="#">71A5 Mechanical brake opening not allowed</a> fault.

State name	Description
<a href="#">BRAKE OPENING DELAY</a>	Opening conditions have been met and open signal activated ( <a href="#">44.01 Brake control status</a> b0 is set). The opening torque request is removed ( <a href="#">44.01 Brake control status</a> b1 → 0). The load is held in place by the speed control of the drive until <a href="#">44.08 Brake open delay</a> elapses. At this point, if <a href="#">44.07 Brake acknowledge selection</a> is set to <i>No acknowledge</i> , the logic proceeds to BRAKE OPEN state. If an acknowledgement signal source has been selected, its state is checked; if the state is not "brake open", the drive trips on a <a href="#">71A3 Mechanical brake opening failed</a> fault <sup>*)</sup> .
<a href="#">BRAKE OPEN</a>	The brake is open ( <a href="#">44.01 Brake control status</a> b0 = 1). Hold request is removed ( <a href="#">44.01 Brake control status</a> b2 = 0), and the drive is allowed to follow the reference.
<a href="#">BRAKE CLOSING</a>	
<a href="#">BRAKE CLOSING WAIT</a>	Brake has been requested to close. The drive logic is requested to ramp down the speed to a stop ( <a href="#">44.01 Brake control status</a> b3 = 1). The open signal is kept active ( <a href="#">44.01 Brake control status</a> b0 = 1). The brake logic will remain in this state until the motor speed is below <a href="#">44.14 Brake close level</a> for the time defined by <a href="#">44.15 Brake close level delay</a> .
<a href="#">BRAKE CLOSING DELAY</a>	Closing conditions have been met. The open signal is deactivated ( <a href="#">44.01 Brake control status</a> b0 → 0). The ramp-down request is maintained ( <a href="#">44.01 Brake control status</a> b3 = 1). The brake logic will remain in this state until <a href="#">44.13 Brake close delay</a> has elapsed. At this point, if <a href="#">44.07 Brake acknowledge selection</a> is set to <i>No acknowledge</i> , the logic proceeds to BRAKE CLOSED state. If an acknowledgment signal source has been selected, its state is checked; if the state is not "brake closed", the drive generates an <a href="#">ATA1 Mechanical brake closing failed</a> warning. If <a href="#">44.17 Brake fault function</a> = Fault, the drive will trip on a <a href="#">71A2 Mechanical brake closing failed</a> fault after <a href="#">44.18 Brake fault delay</a> .
<a href="#">BRAKE CLOSED</a>	The brake is closed ( <a href="#">44.01 Brake control status</a> b0 = 0). The drive is not necessarily modulating. <b>Note concerning open-loop (encoder-less) applications:</b> If the brake is kept closed by a brake close request (either from parameter <a href="#">44.12</a> ) against a modulating drive for longer than 5 seconds, the brake is forced to closed state and the drive trips on a fault, <a href="#">71A5 Mechanical brake opening not allowed</a> .
*) A warning can alternatively be selected by parameter <a href="#">44.17 Brake fault function</a> ; if so, the drive will keep modulating and remain in this state.	

### State change conditions ( $\odot$ n )

- 1 Brake control disabled (parameter [44.06 Brake control enable](#) → 0).
- 2 [06.11 Main status word](#), bit 2 = 0.
- 3 Brake has been requested to open and [44.16 Brake reopen delay](#) has expired.
- 4 Brake open conditions (such as [44.10 Brake open torque](#)) fulfilled and [44.11 Keep brake closed](#) = 0.
- 5 [44.08 Brake open delay](#) has elapsed and brake open acknowledgement (if chosen by [44.07 Brake acknowledge selection](#)) has been received.
- 6 Brake has been requested to close.
- 7 Motor speed has remained below closing speed [44.14 Brake close level](#) for the duration of [44.15 Brake close level delay](#).
- 8 [44.13 Brake close delay](#) has elapsed and brake close acknowledgement (if chosen by [44.07 Brake acknowledge selection](#)) has been received.
- 9 Brake has been requested to open.
- 10 Brake control enabled (parameter [44.06 Brake control enable](#) → 1).

## Timing diagram

The simplified timing diagram below illustrates the operation of the brake control function. Refer to the Brake state diagram on page 85.

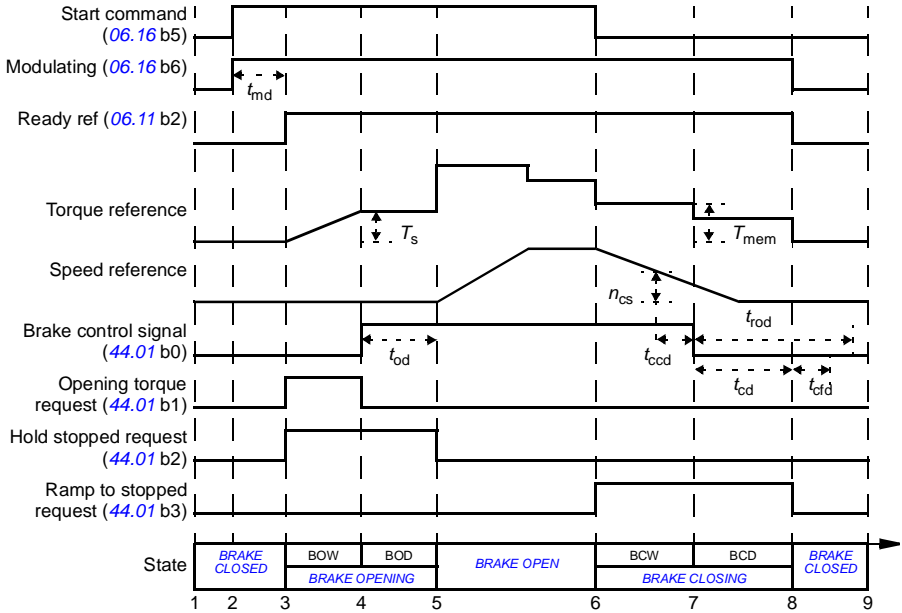

- $T_s$  Start torque at brake open (parameter 44.03 Brake open torque reference)
- $T_{mem}$  Stored torque value at brake close (44.02 Brake torque memory)
- $t_{md}$  Motor magnetization delay
- $t_{od}$  Brake open delay (parameter 44.08 Brake open delay)
- $n_{cs}$  Brake close speed (parameter 44.14 Brake close level)
- $t_{ccd}$  Brake close command delay (parameter 44.15 Brake close level delay)
- $t_{cd}$  Brake close delay (parameter 44.13 Brake close delay)
- $t_{cfd}$  Brake close fault delay (parameter 44.18 Brake fault delay)
- $t_{rod}$  Brake reopen delay (parameter 44.16 Brake reopen delay)
- BOW **BRAKE OPENING WAIT**
- BOD **BRAKE OPENING DELAY**
- BCW **BRAKE CLOSING WAIT**
- BCD **BRAKE CLOSING DELAY**

## Wiring example

The figure below shows a brake control wiring example. The brake control hardware and wiring is to be sourced and installed by the customer.

**⚠ WARNING!** Make sure that the machinery into which the drive with brake control function is integrated fulfills the personnel safety regulations. Note that the frequency converter (a Complete Drive Module or a Basic Drive Module, as defined in IEC/EN 61800-2), is not considered as a safety device mentioned in the European Machinery Directive and related harmonized standards. Thus, the personnel safety of the complete machinery must not be based on a specific frequency converter feature (such as the brake control function), but it has to be implemented as defined in the application specific regulations.

The brake is controlled by bit 0 of parameter [44.01 Brake control status](#). The source of brake acknowledge (status supervision) is selected by parameter [44.07 Brake acknowledge selection](#). In this example,

- parameter [10.24 RO1 source](#) is set to *Open brake command* (ie. bit 0 of [44.01 Brake control status](#)), and
- parameter [44.07 Brake acknowledge selection](#) is set to *DIO1*.

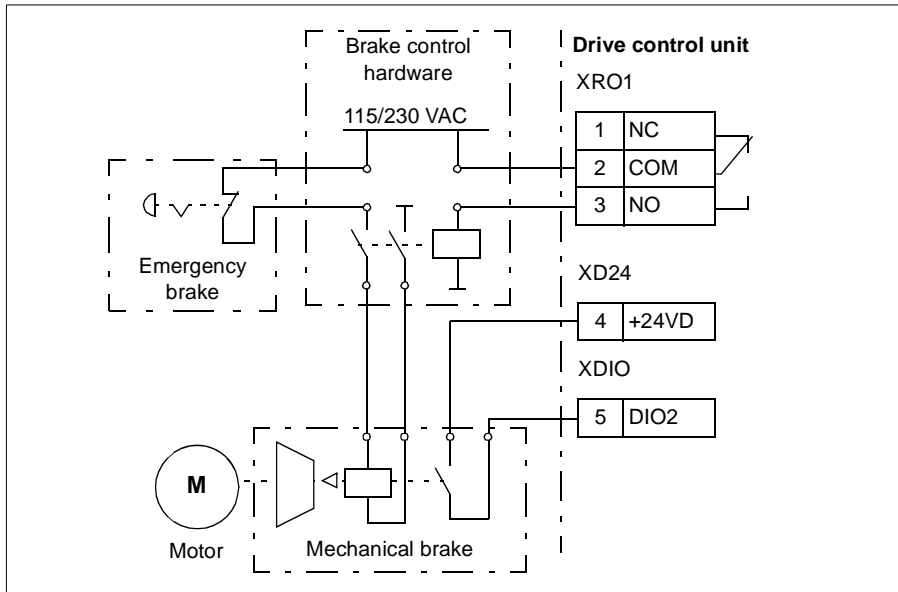



## Settings

Parameters [06.11 Main status word](#) (page 124), [06.16 Drive status word 1](#) (page 125) and parameter group [44 Mechanical brake control](#) (page 278).

Events [A7A1 Mechanical brake closing failed](#) (page 396), [71A2 Mechanical brake closing failed](#) (page 407), [71A3 Mechanical brake opening failed](#) (page 408) and [71A5 Mechanical brake opening not allowed](#) (page 408).

---

## DC voltage control

### Overvoltage control

Overvoltage control of the intermediate DC link is typically needed when the motor is in generating mode. The motor can generate when it decelerates or when the load overhauls the motor shaft, causing the shaft to turn faster than the applied speed or frequency. To prevent the DC voltage from exceeding the overvoltage control limit, the overvoltage controller automatically decreases the generating torque when the limit is reached. The overvoltage controller also increases any programmed deceleration times if the limit is reached; to achieve shorter deceleration times, a brake chopper and resistor may be required.

### Undervoltage control (power loss ride-through)

If the incoming supply voltage is cut off, the drive will continue to operate by utilizing the kinetic energy of the rotating motor. The drive will be fully operational as long as the motor rotates and generates energy to the drive. The drive can continue operation after the break if the main contactor (if present) remained closed.

**Note:** Units equipped with a main contactor must be equipped with a hold circuit (e.g. UPS) to keep the contactor control circuit closed during a short supply break.

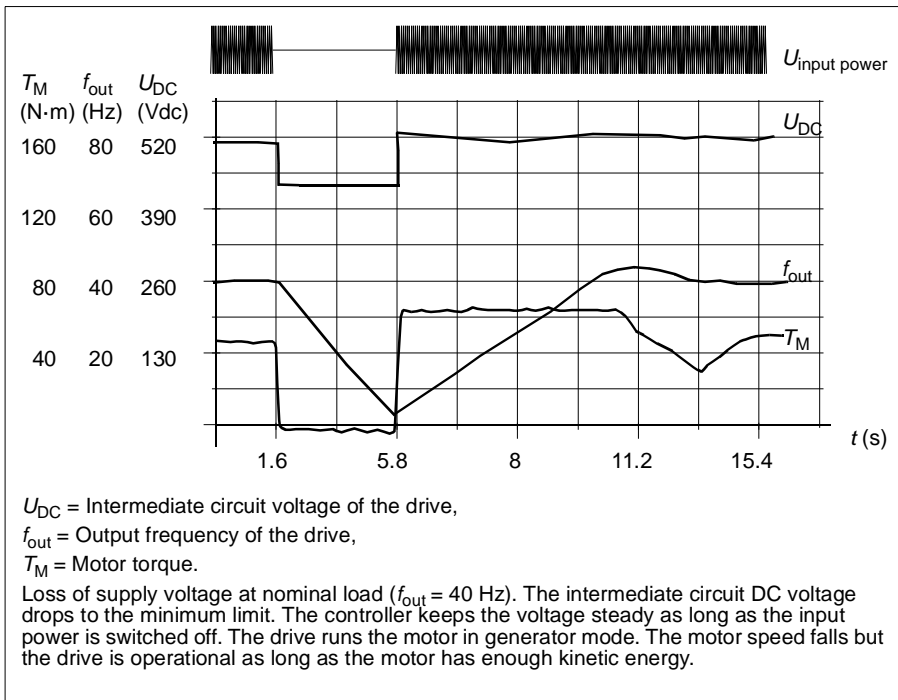

## Implementing the undervoltage control (power loss ride-through)

Implement the undervoltage control function as follows:

- Check that the undervoltage control function of the drive is enabled with parameter [30.31 Undervoltage control](#).
- Parameter [21.01 Vector start mode](#) must be set to *Automatic* (in vector mode) or parameter [21.19 Scalar start mode](#) to *Automatic* (in scalar mode) to make flying start (starting into a rotating motor) possible.

If the installation is equipped with a main contactor, prevent its tripping at the input power break. For example, use a time delay relay (hold) in the contactor control circuit.



**WARNING!** Make sure that the flying restart of the motor will not cause any danger. If you are in doubt, do not implement the undervoltage control function.

---

## Automatic restart

It is possible to restart the drive automatically after a short (max. 10 seconds) power supply failure by using the Automatic restart function, provided that the drive is allowed to run for 10 seconds without the cooling fans operating.

When enabled, the function takes the following actions upon a supply failure to enable a successful restart:

- The undervoltage fault is suppressed (but a warning is generated).
- Modulation and cooling is stopped to conserve any remaining energy.
- DC circuit pre-charging is enabled.

If the DC voltage is restored before the expiration of the period defined by parameter [21.18 Auto restart time](#) and the start signal is still on, normal operation will continue. However, if the DC voltage remains too low at that point, the drive trips on a fault, [3220 DC link undervoltage](#).



**WARNING!** Before you activate the function, make sure that no dangerous situations can occur. The function restarts the drive automatically and continues operation after a supply break.

---

## ■ Voltage control and trip limits

The control and trip limits of the intermediate DC voltage regulator are relative to the supply voltage as well as drive/inverter type. The DC voltage ( $U_{DC}$ ) is approximately 1.35 times the line-to-line supply voltage, and is displayed by parameter [01.11 DC voltage](#).

---

The following table shows the values of the selected DC voltage levels in volts. Note that the absolute voltages vary according to drive/inverter type and AC supply voltage range.

	DC voltage level [V]	
	Supply voltage range [V] 380...415	Supply voltage range [V] 440...480
See <a href="#">95.01 Supply voltage</a> .		
Overvoltage fault limit	840	840
Overvoltage control limit	780	780
Internal brake chopper start limit	780	780
Internal brake chopper stop limit	760	760
Overvoltage warning limit	745	745
Undervoltage warning limit	$0.85 \times 1.41 \times \text{par } 95.03 \text{ value } ^{1)}$ $0.85 \times 1.41 \times 380 = 455 \text{ } ^{2)}$	$0.85 \times 1.41 \times \text{par } 95.03 \text{ value } ^{1)}$ $0.85 \times 1.41 \times 440 = 527 \text{ } ^{2)}$
Undervoltage control limit	$0.75 \times 1.41 \times \text{par } 95.03 \text{ value } ^{1)}$ $0.75 \times 1.41 \times 380 = 402 \text{ } ^{2)}$	$0.75 \times 1.41 \times \text{par } 95.03 \text{ value } ^{1)}$ $0.75 \times 1.41 \times 440 = 465 \text{ } ^{2)}$
Charging relay closing limit	$0.75 \times 1.41 \times \text{par } 95.03 \text{ value } ^{1)}$ $0.75 \times 1.41 \times 380 = 402 \text{ } ^{2)}$	$0.75 \times 1.41 \times \text{par } 95.03 \text{ value } ^{1)}$ $0.75 \times 1.41 \times 440 = 465 \text{ } ^{2)}$
Charging relay opening limit	$0.65 \times 1.41 \times \text{par } 95.03 \text{ value } ^{1)}$ $0.65 \times 1.41 \times 380 = 348 \text{ } ^{2)}$	$0.65 \times 1.41 \times \text{par } 95.03 \text{ value } ^{1)}$ $0.65 \times 1.41 \times 440 = 403 \text{ } ^{2)}$
DC voltage at upper bound of supply voltage range ( $U_{DCmax}$ )	560	648
DC voltage at lower bound of supply voltage range ( $U_{DCmin}$ )	513	594
Charging activation/standby limit	$0.65 \times 1.41 \times \text{par } 95.03 \text{ value } ^{1)}$ $0.65 \times 1.41 \times 380 = 348 \text{ } ^{2)}$	$0.65 \times 1.41 \times \text{par } 95.03 \text{ value } ^{1)}$ $0.65 \times 1.41 \times 440 = 403 \text{ } ^{2)}$
Undervoltage fault limit	$0.45 \times 1.41 \times \text{par } 95.03 \text{ value } ^{1)}$ $0.45 \times 1.41 \times 380 = 241 \text{ } ^{2)}$	$0.45 \times 1.41 \times \text{par } 95.03 \text{ value } ^{1)}$ $0.45 \times 1.41 \times 440 = 279 \text{ } ^{2)}$
<sup>1)</sup> If parameter <a href="#">95.01 Supply voltage</a> is set to <i>Automatic</i> / <i>not selected</i> and <a href="#">95.02 Adaptive voltage limits</a> is set to <i>Enable</i> , the value of parameter <a href="#">95.03 Estimated AC supply voltage</a> is used, <sup>2)</sup> otherwise the lower limit of the range selected with parameter <a href="#">95.01 Supply voltage</a> is used.		

## ■ Settings

Parameters [01.11 DC voltage](#) (page 116), [30.30 Overvoltage control](#) (page 221), [30.31 Undervoltage control](#) (page 221), [95.01 Supply voltage](#) (page 329) and [95.02 Adaptive voltage limits](#) (page 329).

## ■ Brake chopper

A brake chopper can be used to handle the energy generated by a decelerating motor. When the DC voltage rises high enough, the chopper connects the DC circuit to an external brake resistor. The chopper operation is based on hysteresis.

The internal brake choppers in the drive (in frames R0...R3) start conducting at internal brake chopper start limit 780 V and stop conducting at internal brake chopper stop limit 760 V (AC supply 380...480 V).

For information on external brake choppers, refer to the respective user manual.

**Note:** Overvoltage control needs to be disabled for the chopper to operate.

### Settings

Parameters [01.11 DC voltage](#) (page 116), [30.30 Overvoltage control](#) (page 221) and parameter group [43 Brake chopper](#) (page 276).

---

## Limit to limit control

The Limit to limit control function restricts the forward and reverse movement of a load inside two extreme points. The function supports the monitoring of two sensors at both ends of the movement range: one for the slow down point and the other for the stop point. The system installer must install the sensors (eg, limit switches) and connect them to the drive.

In the forward direction, the function allows normal operation of the drive until the movement reaches the forward limiting points:

- When the drive receives the forward slow down signal, it decelerates the speed to the slow down speed. Slow down speed allows smooth transition to stop at a later stage. Vector mode uses the Speed reference ramp (23.11... 23.15) and Scalar mode the Freq reference ramp (28.71... 28.75).
- When the drive receives the forward stop signal, it stops the motor. It uses the drive stop mode selection (21.03). The function allows start only in the reverse direction.

In the reverse direction, the function monitors reverse slow down and reverse stop signals. The operation is similar as in the forward direction.

You can enable the function by a parameter, and define the signal sources for the forward slow down, forward stop, reverse slow down and reverse stop. You can also define the slow down speed by a parameter.

The Limit to limit function detects the signal status changes only when the function is active, and the load is moved by the drive and motor. The function does not update the signal states in its state machine despite of the actual status changes:

1. when the user has deactivated or disabled the function
2. when the function has stopped the motor but the load is moved by a force other than the drive and motor (e.g., by a gravity).

For application example, see sections [Crane stop limit function](#) on page 546, [Crane slowdown function](#) on page 548, and [Fast stop](#) on page 550.

---

## Limit to limit control function

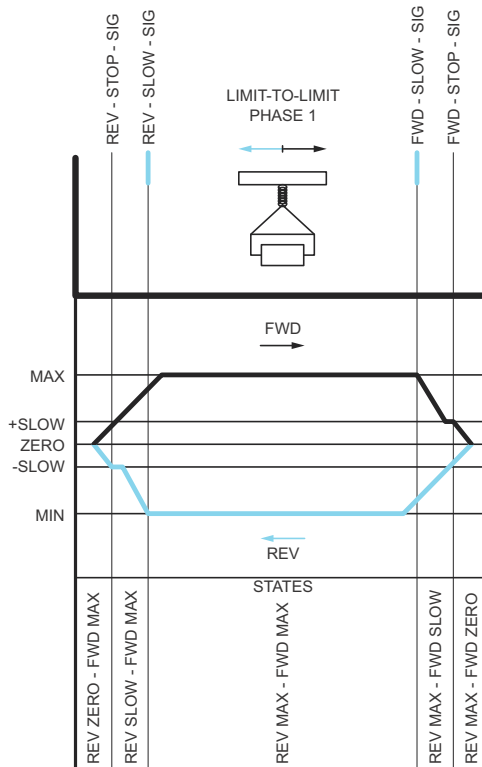

## Limitations

- The external stop or slow down signals (in either direction) must not be on when the Limit to limit function is activated for the first time. If that is not possible, change the state manually to match the actual status in the Limit to limit state parameter (76.01).
- When drive is stopped, the load must not be moved with external force (the drive cannot monitor direction). If this happens, the Limit to limit state can be manually changed to the correct one in parameter Limit to limit state parameter (76.01).
- Coast stop without mechanical brake may cause load moving without Limit to limit control (drive is not controlling load movement). If this happens, the Limit to limit state can be manually changed to the correct one in parameter Limit to limit state parameter (76.01).
- When Limit to limit control is in Pulse mode then the state is saved over power cycle. The load must not be moved when the drive is powered off. If this happens, then Limit to limit state can be manually changed to the correct one in parameter Limit to limit state parameter (76.01).

## ■ Tips

- You can connect Slow down and Stop signals into the same signal source by setting the Stop limit and Slow down parameters to the same digital input ([76.01 Forward stop limit = DI2](#) and [76.05 Forward slow down limit = DI2](#)).
- You can change the Limit to limit state machine state with the parameter Limit to limit state parameter ([76.01](#)), in case of maintenance.

## Settings

Parameter groups [21 Start/stop mode](#) (page 169), [23 Speed reference ramp](#) (page 190) and [28 Frequency reference chain](#) (page 203).

Parameters [76.01 Limit to limit control status](#) (page 322), [76.02 Enable limit to limit control](#) (page 322), [76.03 Limit to limit trigger type](#) (page 323), [76.04 Forward stop limit](#) (page 323), [76.05 Forward slow down limit](#) (page 324), [76.06 Reverse stop limit](#) (page 325), [76.07 Reverse slow down limit](#) (page 325), [76.08 Slow down speed](#) (page 325) and [76.09 Slow down frequency](#) (page 325).

---



## Safety and protections

### ■ Fixed/Standard protections

#### Overcurrent

If the output current exceeds the internal overcurrent limit, the IGBTs are shut down immediately to protect the drive.

#### DC overvoltage

See section [Overvoltage control](#) on page 90.

#### DC undervoltage

See section [Undervoltage control \(power loss ride-through\)](#) on page 90.

#### Drive temperature

If the temperature rises high enough, the drive first starts to limit the switching frequency and then the current to protect itself. If it is still keeps heating up, for example because of a fan failure, an overtemperature fault is generated.

#### Short circuit

In case of a short circuit, the IGBTs are shut down immediately to protect the drive.

### ■ Emergency stop

The emergency stop signal is connected to the input selected by parameter [21.05 Emergency stop source](#). An emergency stop can also be generated through fieldbus (parameter [06.01 Main control word](#), bits 0...2).

The mode of the emergency stop is selected by parameter [21.04 Emergency stop mode](#). The following modes are available:

- Off1: Stop along the standard deceleration ramp defined for the particular reference type in use
- Off2: Stop by coasting
- Off3: Stop by the emergency stop ramp defined by parameter [23.23 Emergency stop time](#).
- Stop torque.

With Off1 or Off3 emergency stop modes, the ramp-down of the motor speed can be supervised by parameters [31.32 Emergency ramp supervision](#) and [31.33 Emergency ramp supervision delay](#).

---

### Notes:

- The installer of the equipment is responsible for installing the emergency stop devices and all additional devices needed for the emergency stop function to fulfill the required emergency stop categories.
- After an emergency stop signal is detected, the emergency stop function cannot be canceled even though the signal is canceled.
- If the minimum (or maximum) torque limit is set to 0%, the emergency stop function may not be able to stop the drive.
- During an emergency stop, the speed and torque reference parameters such as reference ramp shapes ([23.32 Shape time 1](#) and [23.33 Shape time 2](#)) are not considered.

### Settings

Parameters [21.04 Emergency stop mode](#) (page 170), [21.05 Emergency stop source](#) (page 171), [23.23 Emergency stop time](#) (page 192), [31.32 Emergency ramp supervision](#) (page 230) and [31.33 Emergency ramp supervision delay](#) (page 231).

### ■ Motor thermal protection

The control program features two separate motor temperature monitoring functions. The temperature data sources and warning/trip limits can be set up independently for each function.

The motor temperature can be monitored using

- the motor thermal protection model (estimated temperature derived internally inside the drive), or
- sensors installed in the windings. This will result in a more accurate motor model.

### Motor thermal protection model

The drive calculates the temperature of the motor on the basis of the following assumptions:

1. When power is applied to the drive for the first time, the motor is assumed to be at ambient temperature (defined by parameter [35.50 Motor ambient temperature](#)). After this, when power is applied to the drive, the motor is assumed to be at the estimated temperature.
2. Motor temperature is calculated using the user-adjustable motor thermal time and motor load curve. The load curve should be adjusted in case the ambient temperature exceeds 30 °C.

**Note:** The motor thermal model can be used when only one motor is connected to the inverter.

---

## Motor temperature measurement through the standard I/O

This section describes the temperature measurement of one motor when the drive I/O terminals are used as the connection interface.

Motor temperature can be measured using Pt100 or PTC sensors connected to analog input and output.

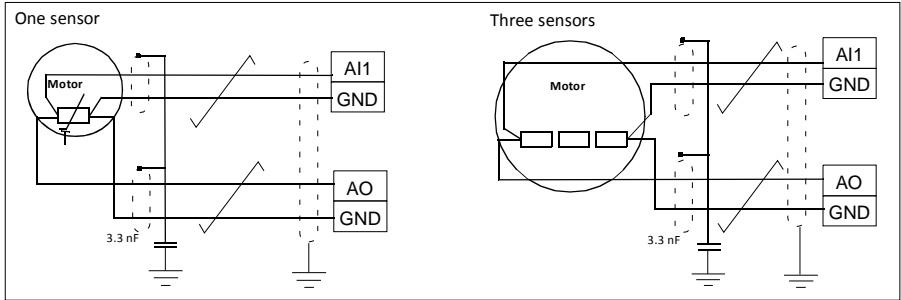

**Warning!** According to IEC 60664, the connection of the motor temperature sensor requires double or reinforced insulation between motor live parts and the sensor. Reinforced insulation entails a clearance and creepage distance of 8 mm (0.3 in) (400/500 V AC equipment).

If the assembly does not fulfill the requirement, the I/O board terminals must be protected against contact and they may not be connected to other equipment, or the temperature sensor must be isolated from the I/O terminals.

## Temperature monitoring using Pt100 sensors

1...3 Pt100 sensors can be connected in series to an analog input and an analog output.

The analog output feeds a constant excitation current of 9.1 mA through the sensor. The sensor resistance increases as the motor temperature rises, as does the voltage over the sensor. The temperature measurement function reads the voltage through the analog input and converts it into degrees Celsius.

It is possible to adjust the motor temperature supervision limits and select how the drive reacts when overtemperature is detected.

For the wiring of the sensor, see chapter *Electrical installation, AI1 and AI2 as Pt100, Pt1000, Ni1000, KTY83 and KTY84 sensor inputs (X1)* in the *Hardware manual* of the drive.

### **Temperature monitoring using Pt1000 sensors**

1...3 Pt1000 sensors can be connected in series to an analog input and an analog output.

The analog output feeds a constant excitation current of 0.1 mA through the sensor. The sensor resistance increases as the motor temperature rises, as does the voltage over the sensor. The temperature measurement function reads the voltage through the analog input and converts it into degrees Celsius.

For the wiring of the sensor, see chapter *Electrical installation, AI1 and AI2 as Pt100, Pt1000, Ni1000, KTY83 and KTY84 sensor inputs (X1)* in the *Hardware manual* of the drive.

### **Temperature monitoring using Ni1000 sensors**

One Ni1000 sensor can be connected to an analog input and an analog output on the control unit.

The analog output feeds a constant excitation current of 9.1 mA through the sensor. The sensor resistance increases as the motor temperature rises, as does the voltage over the sensor. The temperature measurement function reads the voltage through the analog input and converts it into degrees Celsius.

For the wiring of the sensor, see chapter *Electrical installation, AI1 and AI2 as Pt100, Pt1000, Ni1000, KTY83 and KTY84 sensor inputs (X1)* in the *Hardware manual* of the drive.

### **Temperature monitoring using KTY84 sensors**

One KTY84 sensor can be connected to an analog input and an analog output on the control unit.

The analog output feeds a constant excitation current of 2.0 mA through the sensor. The sensor resistance increases as the motor temperature rises, as does the voltage over the sensor. The temperature measurement function reads the voltage through the analog input and converts it into degrees Celsius.

The figure and table on page 146 show typical KTY84 sensor resistance values as a function of the motor operating temperature.

For the wiring of the sensor, see chapter *Electrical installation, AI1 and AI2 as Pt100, Pt1000, Ni1000, KTY83 and KTY84 sensor inputs (X1)* in the *Hardware manual* of the drive.

### **Temperature monitoring using KTY83 sensors**

One KTY83 sensor can be connected to an analog input and an analog output on the control unit.

The analog output feeds a constant excitation current of 1.0 mA through the sensor. The sensor resistance increases as the motor temperature rises, as does the voltage

---

over the sensor. The temperature measurement function reads the voltage through the analog input and converts it into degrees Celsius.

The figure and table below show typical KTY83 sensor resistance values as a function of the motor operating temperature.

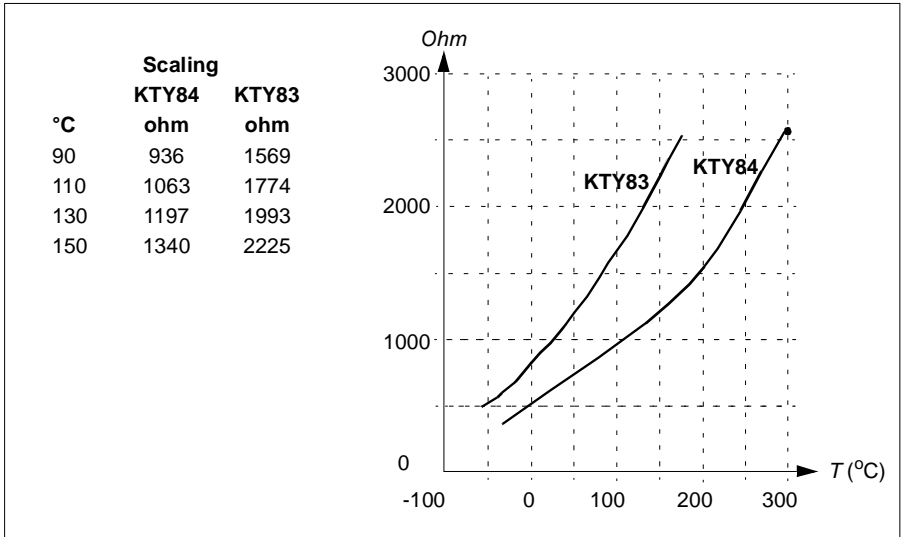

It is possible to adjust the motor temperature supervision limits and select how the drive reacts when overtemperature is detected.

For the wiring of the sensor, see chapter *Electrical installation, AI1 and AI2 as Pt100, Pt1000, Ni1000, KTY83 and KTY84 sensor inputs (X1)* in the *Hardware manual* of the drive.

## Settings

Parameter group [35 Motor thermal protection](#) (page 245).

### ■ Programmable protection functions

#### External events (parameters [31.01...31.10](#))

Five different event signals from the process can be connected to selectable inputs to generate trips and warnings for the driven equipment. When the signal is lost, an external event (fault, warning, or a mere log entry) is generated.

#### Motor phase loss detection (parameter [31.19](#))

The parameter selects how the drive reacts whenever a motor phase loss is detected.

The motor phase loss detection is enabled by default and displays fault [3381 Output phase loss](#) whenever the drive detects a phase loss. The motor phase loss detection

needs to be enabled or disabled based on the motor control mode and the nominal current as follows:

- With the vector control, the motor phase loss detection is always on and there are no operational limits.
- With the scalar control, the motor phase loss detection activates when the motor frequency is above 10% of the motor nominal frequency. This limit cannot be changed.
- With motors having nominal current below 1/6 of drive nominal current, the supervision must be disabled as the drive cannot measure the motor current accurately.

### **Earth (Ground) fault detection (parameter 31.20)**

Note that

- an earth fault in the supply cable does not activate the protection
- in a grounded supply, the protection activates within 2 milliseconds
- in an ungrounded supply, the supply capacitance must be 1 microfarad or more
- the capacitive currents caused by shielded motor cables up to 300 meters will not activate the protection
- the protection is deactivated when the drive is stopped.

### **Supply phase loss detection (parameter 31.20)**

The parameter selects how the drive reacts whenever a supply phase loss is detected.

### **Safe torque off detection (parameter 31.22)**

The drive monitors the status of the Safe torque off input, and this parameter selects which indications are given when the signals are lost. (The parameter does not affect the operation of the Safe torque off function itself). For more information on the Safe torque off function, see the hardware manual of the drive.

### **Swapped supply and motor cabling (parameter 31.23)**

The drive can detect if the supply and motor cables have accidentally been swapped (for example, if the supply is connected to the motor connection of the drive). The parameter selects if a fault is generated or not.

### **Stall protection (parameters 31.24...31.28)**

The drive protects the motor in a stall situation. It is possible to adjust the supervision limits (current, frequency and time) and choose how the drive reacts to a motor stall condition.

### **Overspeed protection (parameter 31.30)**

The user can set overspeed (and overfrequency) limits by specifying a margin that is added to the currently-used maximum and minimum speed (or frequency) limits.

---

**Local control loss detection (parameter [49.05](#))**

The parameter selects how the drive reacts to a control panel or PC tool communication break.

**AI supervision (parameters [12.03](#)... [12.04](#))**

The parameters select how the drive reacts when an analog input signal moves out of the minimum and/or maximum limits specified for the input.

**■ Automatic fault resets**

The drive can automatically reset itself after overcurrent, overvoltage, undervoltage and external faults. The user can also specify a fault that is automatically reset.

By default, automatic resets are off and must be specifically activated by the user.

**Settings**

Parameters [31.12](#)...[31.16](#).

---

## Diagnostics

### ■ Signal supervision

Six signals can be selected to be supervised by this function. Whenever a supervised signal exceeds or falls below predefined limits, a bit in [32.01 Supervision status](#) is activated, and a warning or fault generated.

The supervised signal is low-pass filtered.

### Settings

Parameter group [32 Supervision](#) (page [232](#)).

### ■ Energy saving calculators

This feature consists of the following functionalities:

- An energy optimizer that adjusts the motor flux in such a way that the total system efficiency is maximized
- A counter that monitors used and saved energy by the motor and displays them in kWh, currency or volume of CO<sub>2</sub> emissions, and
- A load analyzer showing the load profile of the drive (see section [Load analyzer](#) on page [104](#)).

In addition, there are counters that show energy consumption in kWh of the current and previous hour as well as the current and previous day.

**Note:** The accuracy of the energy savings calculation is directly dependent on the accuracy of the reference motor power given in parameter [45.19 Comparison power](#).

### Settings

Parameter group [45 Energy efficiency](#) (page [284](#)).

Parameters [01.50 Current hour kWh](#) (page [117](#)), [01.51 Previous hour kWh](#) (page [117](#)), [01.52 Current day kWh](#) (page [117](#)) and [01.53 Previous day kWh](#) (page [117](#)).

### ■ Load analyzer

#### Peak value logger

The user can select a signal to be monitored by a peak value logger. The logger records the peak value of the signal along with the time the peak occurred, as well as motor current, DC voltage and motor speed at the time of the peak. The peak value is sampled at 2 ms intervals.

#### Amplitude loggers

The control program has two amplitude loggers.

---



For amplitude logger 2, the user can select a signal to be sampled at 200 ms intervals, and specify a value that corresponds to 100%. The collected samples are sorted into 10 read-only parameters according to their amplitude.

- Parameter 1 shows the share of samples that have fallen in range 0... 10% of the reference value during the time that the logging has been active.
- Parameter 2 shows that share of samples that have fallen in range 10...20% of the reference value during the time that the logging has been active
- etc.

You can view this graphically with the assistant panel or the Drive composer PC tool.

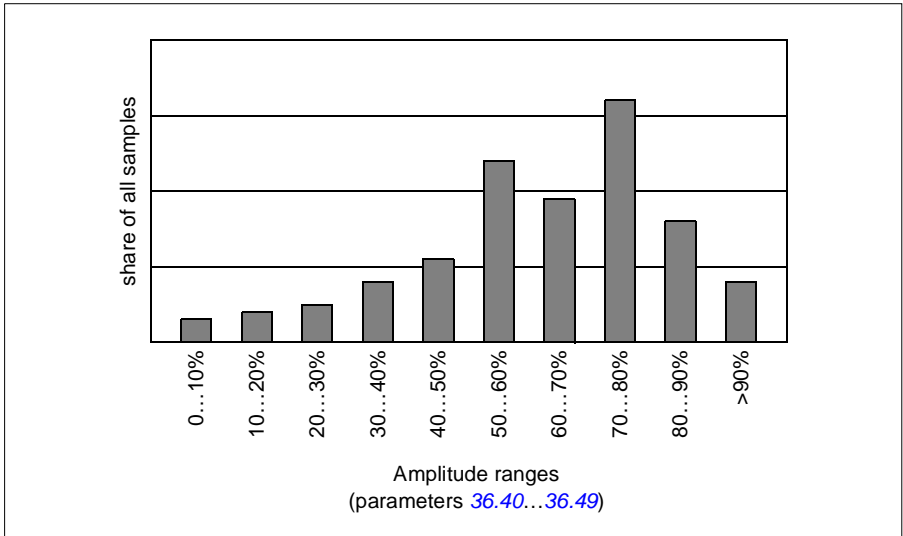

Amplitude logger 1 is fixed to monitor motor current, and cannot be reset. With amplitude logger 1, 100% corresponds to the maximum output current of the drive ( $I_{\max}$ ). The maximum output current values are listed in the section *Rated* in the *Hardware manual* of the drive. The measured current is logged continuously. The distribution of samples is shown by parameters [36.20...36.29](#).

## Settings

Parameter group [36 Load analyzer](#) (page [252](#)).

## Miscellaneous

### ■ Backup and restore

You can make backups of the settings manually to the assistant panel. The panel also keeps one automatic backup. You can restore a backup to another drive, or a new drive replacing a faulty one. You can make backups and restore on the panel, or with the Drive composer PC tool.

See the relevant assistant control panel for more information on backing up and settings.

### Backup

#### Manual backup

Make a backup when necessary, for example, after you have started up the drive or when you want to copy the settings to another drive.

Parameter changes from fieldbus interfaces are ignored unless you have forced parameter saving.

#### Automatic backup

The assistant panel has space for one automatic backup. An automatic backup is created two hours after the last parameter change. After completing the backup, the panel waits for 24 hours before checking if there are additional parameter changes. If there are, it creates a new backup overwriting the previous one when two hours have passed after the latest change.

You cannot adjust the delay time or disable the automatic backup function.

Parameter changes from fieldbus interfaces are ignored unless you have forced parameter saving.

### Restore

The backups are shown on the panel. Automatic and manual backups are separately marked.

**Note:** To restore a backup, the drive has to be in Local control.

### Settings

Parameter [96.07 Parameter save manually](#) (page 333).

### ■ User parameter sets

The drive supports four user parameter sets that can be saved to the permanent memory and recalled using drive parameters. It is also possible to use digital inputs to switch between user parameter sets. To change a user parameter set, the drive has to be stopped.

---

A user parameter set contains all editable values in parameter groups 10...99 except

- I/O extension module settings ([15 I/O extension module](#))
- Data storage parameters ([47 Data storage](#))
- Fieldbus communication settings ([50 Fieldbus adapter \(FBA\)](#)...[53 FBA A data out](#) and [58 Embedded fieldbus](#)).

As the motor settings are included in the user parameter sets, make sure the settings correspond to the motor used in the application before recalling a user set. In an application where different motors are used with the drive, the motor ID run needs to be performed with each motor and the results saved to different user sets. The appropriate set can then be recalled when the motor is switched.

## Settings

Parameters [96.10](#)...[96.13](#).

### ■ Data storage parameters

Twelve (eight 32-bit, four 16-bit) parameters are reserved for data storage. These parameters are unconnected by default and can be used for linking, testing and commissioning purposes. They can be written to and read from using other parameters' source or target selections.

## Settings

Parameter group [47 Data storage](#) (page [292](#)).

### ■ Parameter checksum calculation

Parameter checksums A and B can be calculated from a set of parameters to monitor changes in the drive configuration. The parameter sets are different for A and B. Each of the calculated checksum is compared to corresponding reference checksum. If a mismatch occurs, the drive generates an event (a pure event, warning or fault). The calculated checksum can be set as the new reference checksum.

The set of parameters for checksum A does not include fieldbus settings parameters.

The parameters included in the checksum A calculation are user editable parameters in parameter groups 10, 15, 19, 20, 21, 22, 23, 24, 25, 28, 30, 31, 32, 34, 35, 36, 37, 40, 41, 43, 45, 46, 71, 76, 90, 91, 92, 95, 96, 97, 98, and 99.

The set of parameters for checksum B does not include:

- fieldbus settings
- motor data settings, and
- energy data settings parameters.

The parameters included in the checksum B calculation are user editable parameters in parameter groups 10, 15, 19, 20, 21, 22, 23, 24, 25, 28, 30, 31, 32, 34, 35, 36, 37, 40, 41, 43, 46, 71, 76, 90, 91, 92, 95, 96, and 97.

---

## Settings

Parameters [96.54...96.55](#), [96.68...96.69](#) and [96.71...96.72](#).

Events [A686 Checksum mismatch](#) (page [395](#)), [B686 Checksum mismatch](#) (page [400](#)) and [6200 Checksum mismatch](#) (page [405](#)).

### Motor potentiometer

The motor potentiometer is a counter whose value can be adjusted up and down using two digital signals selected by parameters.

When enabled, the motor potentiometer assumes a set value. Depending on the mode selected, the motor potentiometer value is either retained or reset over a power cycle.

The change rate is defined as the time it would take for the value to change from the minimum to the maximum, or vice versa. If the up and down signals are simultaneously on, the motor potentiometer value does not change.

The output of the function is shown, and it can be directly set as the reference source in the main selector parameters, or used as an input by other source selector parameters.

The following example shows the behavior of the motor potentiometer value.

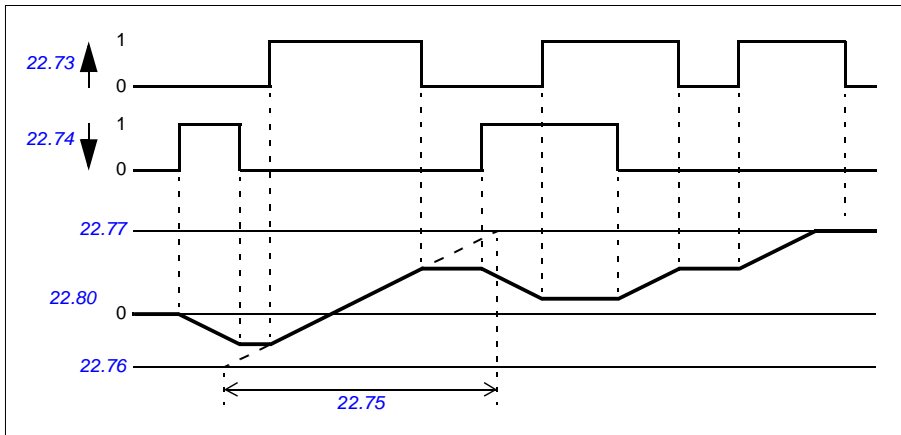

For application example, see section [Crane motor potentiometer](#) on page [557](#).

## Settings

Parameters [22.71...22.80](#).

## ■ User lock

For better cybersecurity, you can set a master password to prevent eg. the changing of parameter values and/or the loading of firmware and other files.



**WARNING!** ABB will not be liable for damages or losses caused by the failure to activate the user lock using a new pass code. See [Cybersecurity disclaimer](#) (page 15).

---

To activate the user lock for the first time, enter the default pass code, 10000000, into [96.02 Pass code](#). This will make parameters [96.100...96.102](#) visible. Then enter a new pass code into [96.100 Change user pass code](#), and confirm the code in [96.101 Confirm user pass code](#). In [96.102 User lock functionality](#), define the actions that you want to prevent.

To close the user lock, enter an invalid pass code into [96.02 Pass code](#), activate [96.08 Control board boot](#), or cycle the power. With the lock closed, parameters [96.100...96.102](#) are hidden.

To reopen the lock, enter your pass code into [96.02 Pass code](#). This will again make parameters [96.100...96.102](#) visible.

### Settings

Parameters [96.02 Pass code](#) (page 331) and [96.100...96.102](#).

---





# Parameters

---

## Contents

- [\*Terms and abbreviations\*](#)
  - [\*Fieldbus addresses\*](#)
  - [\*Summary of parameter groups\*](#)
  - [\*Parameter listing\*](#)
  - [\*Differences in the default values between 50 Hz and 60 Hz supply frequency settings\*](#)
-

## Terms and abbreviations

Term	Definition
Actual signal	Signal measured or calculated by the drive. Usually can only be monitored but not adjusted; some counter-type signals can however be reset.
Analog src	Analog source: the parameter can be set to the value of another parameter by choosing "Other", and selecting the source parameter from a list. In addition to the "Other" selection, the parameter may offer other pre-selected settings. Not in this version.
Binary src	Binary source: the value of the parameter can be taken from a specific bit in another parameter value ("Other"). Sometimes the value can be fixed to 0 (false) or 1 (true). In addition, the parameter may offer other pre-selected settings. Not in this version.
Default	The default is shown on the same row as the parameter name. The default value of a parameter for the Factory macro. For information on other macro-specific parameter values, see chapter <a href="#">Control macros</a> .
FbEq16/32	The fieldbus equivalent for 16-bit and 32-bit. They are shown on the same row as the parameter range, or for each selection. 16-bit fieldbus equivalent: The scaling between the value shown on the panel and the integer used in fieldbus communication when the user selects a 16-bit value in parameter group <a href="#">52 FBA A data in</a> or <a href="#">53 FBA A data out</a> . A dash (-) indicates that the user cannot access the parameter in 16-bit format. 32-bit fieldbus equivalent: The scaling between the value shown on the panel and the integer used in communication when a 32-bit value is selected for transmission to an external system.
List	Selection list.
No.	Parameter number.
PB	Packed Boolean (bit list).
Real	Real number.
Type	Type (analogue src, binary src, list, PPB, real).
Other	The value is taken from another parameter. Choosing "Other" displays a parameter list in which the user can specify the source parameter.
Other [bit]	The value is taken from a specific bit in another parameter. The user selects the source from a parameter list.
Parameter	Either a user-adjustable operating instruction for the drive, or an <i>Actual signal</i> .
p.u.	Per unit
[parameter number]	Value of the parameter

## Fieldbus addresses

Refer to the user's manual of the fieldbus adapter.



## Summary of parameter groups

Group	Contents	Page
<a href="#">01 Actual values</a>	Basic signals for monitoring the drive.	115
<a href="#">03 Input references</a>	Values of references received from various sources.	118
<a href="#">04 Warnings and faults</a>	Information on warnings and faults that occurred last.	119
<a href="#">05 Diagnostics</a>	Various run-time-type counters and measurements related to drive maintenance.	120
<a href="#">06 Control and status words</a>	Drive control and status words.	123
<a href="#">07 System info</a>	Drive hardware and firmware information.	128
<a href="#">09 Crane application signals</a>	Signals related to crane applications.	130
<a href="#">10 Standard DI, RO</a>	Configuration of digital inputs and relay outputs.	131
<a href="#">11 Standard DIO, FI, FO</a>	Configuration of the digital input/outputs.	135
<a href="#">12 Standard AI</a>	Configuration of standard analog inputs.	141
<a href="#">13 Standard AO</a>	Configuration of standard analog outputs.	146
<a href="#">15 I/O extension module</a>	Configuration of the I/O extension module.	149
<a href="#">19 Operation mode</a>	Selection of local and external control location sources and operating modes.	153
<a href="#">20 Start/stop/direction</a>	Start/stop/direction and run/start/jog enable signal source selection; positive/negative reference enable signal source selection.	155
<a href="#">21 Start/stop mode</a>	Start and stop modes; emergency stop mode and signal source selection; DC magnetization settings.	169
<a href="#">22 Speed reference selection</a>	Speed reference selection; motor potentiometer settings.	177
<a href="#">23 Speed reference ramp</a>	Speed reference ramp settings (programming of the acceleration and deceleration rates for the drive).	190
<a href="#">24 Speed reference conditioning</a>	Speed error calculation; speed error window control configuration; speed error step.	194
<a href="#">25 Speed control</a>	Speed controller settings.	195
<a href="#">26 Torque reference chain</a>	Settings for the torque reference chain.	199
<a href="#">28 Frequency reference chain</a>	Settings for the frequency reference chain.	203
<a href="#">30 Limits</a>	Drive operation limits.	215
<a href="#">31 Fault functions</a>	Configuration of external events; selection of behavior of the drive upon fault situations.	223
<a href="#">32 Supervision</a>	Configuration of signal supervision functions 1...3.	232
<a href="#">34 Timed functions</a>	Configuration of the timed functions.	239
<a href="#">35 Motor thermal protection</a>	Motor thermal protection settings such as temperature measurement configuration, load curve definition and motor fan control configuration.	245
<a href="#">36 Load analyzer</a>	Peak value and amplitude logger settings.	252
<a href="#">37 User load curve</a>	Settings for user load curve.	255
<a href="#">40 Process PID set 1</a>	Parameter values for process PID control.	259
<a href="#">41 Process PID set 2</a>	A second set of parameter values for process PID control.	273
<a href="#">43 Brake chopper</a>	Settings for the internal brake chopper.	276
<a href="#">44 Mechanical brake control</a>	Configuration of mechanical brake control.	278
<a href="#">45 Energy efficiency</a>	Settings for the energy saving calculators.	284

<b>Group</b>	<b>Contents</b>	<b>Page</b>
<a href="#">46 Monitoring/scaling settings</a>	Speed supervision settings; actual signal filtering; general scaling settings.	<a href="#">289</a>
<a href="#">47 Data storage</a>	Data storage parameters that can be written to and read from using other parameters' source and target settings.	<a href="#">292</a>
<a href="#">49 Panel port communication</a>	Communication settings for the control panel port on the drive.	<a href="#">293</a>
<a href="#">50 Fieldbus adapter (FBA)</a>	Fieldbus communication configuration.	<a href="#">295</a>
<a href="#">51 FBA A settings</a>	Fieldbus adapter A configuration.	<a href="#">299</a>
<a href="#">52 FBA A data in</a>	Selection of data to be transferred from drive to fieldbus controller through fieldbus adapter A.	<a href="#">300</a>
<a href="#">53 FBA A data out</a>	Selection of data to be transferred from fieldbus controller to drive through fieldbus adapter A.	<a href="#">301</a>
<a href="#">58 Embedded fieldbus</a>	Configuration of the embedded fieldbus (EFB) interface.	<a href="#">301</a>
<a href="#">71 External PID1</a>	Configuration of external PID.	<a href="#">320</a>
<a href="#">76 Application features</a>	Application parameters for, e.g., Limit to limit control configuration.	<a href="#">322</a>
<a href="#">90 Feedback selection</a>	Motor and load feedback configuration.	<a href="#">327</a>
<a href="#">91 Encoder adapter settings</a>	Configuration of encoder interface modules.	<a href="#">328</a>
<a href="#">92 Encoder 1 configuration</a>	Settings for encoder 1.	<a href="#">329</a>
<a href="#">95 HW configuration</a>	Various hardware-related settings.	<a href="#">329</a>
<a href="#">96 System</a>	Language selection; access levels; macro selection; parameter save and restore; control unit reboot; user parameter sets; unit selection; parameter checksum calculation; user lock.	<a href="#">330</a>
<a href="#">97 Motor control</a>	Switching frequency; slip gain; voltage reserve; flux braking; anti-cogging (signal injection); IR compensation.	<a href="#">340</a>
<a href="#">98 User motor parameters</a>	Motor values supplied by the user that are used in the motor model.	<a href="#">345</a>
<a href="#">99 Motor data</a>	Motor configuration settings.	<a href="#">347</a>

## Parameter listing

No.	Name/Value	Description	Default FbEq 16
<b>01 Actual values</b>			
Basic signals for monitoring the drive. All parameters in this group are read-only unless otherwise noted. <b>Note:</b> Values of these actual signals are filtered with the filter time defined in group <a href="#">46 Monitoring/scaling settings</a> . The selection lists for parameters in other groups mean the raw value of the actual signal instead. For example, if a selection is "Output frequency" it does not point to the value of parameter <a href="#">01.06 Output frequency</a> but to the raw value.			
<a href="#">01.01</a>	<a href="#">Motor speed used</a>	Measured or Estimated motor speed depending on the type of feedback used in parameter <a href="#">96.01 Motor feedback selection</a> . A filter time constant for this signal can be defined by parameter <a href="#">46.11 Filter time motor speed</a> .	-
	-30000.00... 30000.00 rpm	Measured or estimated motor speed.	See par. <a href="#">46.01</a>
<a href="#">01.02</a>	<a href="#">Motor speed estimated</a>	Estimated motor speed in rpm. A filter time constant for this signal can be defined by parameter <a href="#">46.11 Filter time motor speed</a> .	-
	-30000.00... 30000.00 rpm	Estimated motor speed.	See par. <a href="#">46.01</a>
<a href="#">01.03</a>	<a href="#">Motor speed %</a>	Actual speed in percent of the motor synchronous speed. The filter time constant can be adjusted by parameter <a href="#">46.11 Filter time motor speed</a> .	-
	-1000.00... 1000.00%	Motor speed.	See par. <a href="#">46.01</a>
<a href="#">01.04</a>	<a href="#">Encoder 1 speed filtered</a>	Measured motor speed from Encoder 1. The filter time constant can be adjusted by parameter <a href="#">46.11 Filter time motor speed</a> .	-
	-30000 ... 30000		1=1
<a href="#">01.06</a>	<a href="#">Output frequency</a>	Estimated drive output frequency in Hz. A filter time constant for this signal can be defined by parameter <a href="#">46.12 Filter time output frequency</a> .	-
	-500.00...500.00 Hz	Estimated output frequency.	See par. <a href="#">46.02</a>
<a href="#">01.07</a>	<a href="#">Motor current</a>	Measured (absolute) motor current in A.	-
	0.00...30000.00	Motor current.	See par. <a href="#">46.05</a>
<a href="#">01.08</a>	<a href="#">Motor current % of motor nom</a>	Motor current (drive output current) in percent of the nominal motor current.	-
	0.0...1000.0%	Motor current.	1=1%
<a href="#">01.09</a>	<a href="#">Motor current % of drive nom</a>	Motor current (drive output current) in percent of the nominal drive current.	-
	0.0...1000.0%	Motor current.	1=1%

No.	Name/Value	Description	Default FbEq 16
01.10	<i>Motor torque</i>	Motor torque in percent of the nominal motor torque. See also parameter <i>01.30 Nominal torque scale</i> . A filter time constant for this signal can be defined by parameter <i>46.13 Filter time motor torque</i> .	-
	-1600.0...1600.0%	Motor torque.	See par. <i>46.03</i>
01.11	<i>DC voltage</i>	Measured intermediate circuit DC Link voltage.	-
	0.00...2000.00 V	DC link voltage.	10 = 1 V
01.13	<i>Output voltage</i>	Calculated motor voltage in V AC.	-
	0...2000 V	Motor voltage.	1 = 1 V
01.14	<i>Output power</i>	Measured output power in kW or hp, depending on setting of parameter Power unit. The filter time constant can be adjusted by parameter <i>46.14 Filter time power</i> .	-
	-32768.00... 32767.00 kW or hp	Output power.	See par. <i>46.04</i>
01.15	<i>Output power % of motor nom</i>	Measured output power in % of nominal motor power.	-
	-300.00... 300.00%	Output power.	10 = 1%
01.16	<i>Output power % of drive nom</i>	Measured output power in % of drive nominal power. The filter time constant can be adjusted by parameter <i>46.14 Filter time power</i> .	-
	-300.00... 300.00%	Output power.	10 = 1%
01.17	<i>Motor shaft power</i>	Estimated mechanical power at motor shaft in kW or hp. The unit is selected by parameter <i>96.16 Unit selection</i> . The filter time constant can be adjusted by parameter <i>46.14 Filter time power</i> .	-
	-32768.00... 32767.00 kW or hp	Motor shaft power.	See par. <i>46.04</i>
01.18	<i>Inverter GWh counter</i>	Amount of energy that has passed through the drive (in either direction) in full gigawatt-hours. The minimum value is zero.	-
	0...65535 GWh	Energy in GWh.	1 = 1 GWh
01.19	<i>Inverter MWh counter</i>	Amount of energy that has passed through the drive (in either direction) in full megawatt-hours. Whenever the counter rolls over, <i>01.18 Inverter GWh counter</i> is incremented. The minimum value is zero.	-
	0...1000 MWh	Energy in MWh.	1 = 1 MWh
01.20	<i>Inverter kWh counter</i>	Amount of energy that has passed through the drive (in either direction) in full kilowatt-hours. Whenever the counter rolls over, <i>01.19 Inverter MWh counter</i> is incremented. The minimum value is zero.	-
	0...1000 kWh	Energy in kWh.	10 = 1 kWh
01.24	<i>Flux actual %</i>	Used flux reference in percent of nominal flux of motor.	-
	0...200%	Flux reference.	1 = 1%

No.	Name/Value	Description	Default FbEq 16
01.30	<i>Nominal torque scale</i>	Nominal torque in N•m which corresponds to 100%. Note: This parameter is copied from parameter <a href="#">99.12 Motor nominal torque</a> if given. Otherwise the value is calculated from other motor data.	0
	0.000...4000000 N•m or lb•ft	Nominal torque.	1 = 100 unit
01.50	<i>Current hour kWh</i>	Current hour energy consumption. This is the energy of the last 60 minutes (not necessarily continuous) the drive has been running, not the energy of a calendar hour. The value is set to the value before the power cycle when the drive is again up and running.	- / -
	0.00...1000000.00 kWh	Energy.	1 = 1 kWh
01.51	<i>Previous hour kWh</i>	Previous hour energy consumption. The value <i>Current hour kWh</i> is stored here when its values has been cumulated for 60 minutes. The value is set to the value before the power cycle when the drive is again up and running.	-
	0.00...1000000.00 kWh	Energy.	1 = 1 kWh
01.52	<i>Current day kWh</i>	Current day energy consumption. This is the energy of the last 24 hours (not necessarily continuous) the drive has been running, not the energy of a calendar day. The value is set to the value before the power cycle when the drive is again up and running.	-
	0.00...1000000.00 kWh	Energy.	1 = 1 kWh
01.53	<i>Previous day kWh</i>	Previous day energy consumption. The value is set to the value before the power cycle when the drive is again up and running.	-
	0.00 ... 1000000.00 kWh	Energy.	1 = 1 kWh
01.54	<i>Cumulative inverter energy</i>	Amount of energy that has passed through the drive (in either direction) in full kilowatt-hours. The minimum value is zero.	-
	-200000000.0... 200000000.0 kWh	Energy in kWh.	10 = 1 kWh
01.55	<i>Inverter GWh counter (resettable)</i>	Amount of energy that has passed through the drive (in either direction) in full gigawatt-hours. The minimum value is zero. You can reset the value by setting it to zero. Resetting any of parameters <a href="#">01.55...01.58</a> resets all of them.	-
	0...65535 GWh	Energy in GWh.	1 = 1 GWh
01.56	<i>Inverter MWh counter (resettable)</i>	Amount of energy that has passed through the drive (in either direction) in full megawatt-hours. Whenever the counter rolls over, <a href="#">01.55 Inverter GWh counter (resettable)</a> is incremented. The minimum value is zero. You can reset the value by setting it to zero. Resetting any of parameters <a href="#">01.55...01.58</a> resets all of them.	-
	0...1000 MWh	Energy in MWh.	1 = 1 MWh

No.	Name/Value	Description	Default FbEq 16
01.57	<i>Inverter kWh counter (resettable)</i>	Amount of energy that has passed through the drive (in either direction) in full kilowatt-hours. Whenever the counter rolls over, <i>01.56 Inverter MWh counter (resettable)</i> is incremented. The minimum value is zero. You can reset the value by setting it to zero. Resetting any of parameters <i>01.55...01.58</i> resets all of them.	-
	0...1000 kWh	Energy in kWh.	10 = 1 kWh
01.58	<i>Cumulative inverter energy (resettable)</i>	Amount of energy that has passed through the drive (in either direction) in full kilowatt-hours. The minimum value is zero. You can reset the value by setting it to zero. Resetting any of parameters <i>01.55...01.58</i> resets all of them.	-
	-200000000.0... 200000000.0 kWh	Energy in kWh.	10 = 1 kWh
01.61	<i>Abs motor speed used</i>	Absolute value of the motor speed used <i>01.01 Motor speed used</i> .	-
	0.00... 30000.00 rpm		1 = 1 rpm
01.62	<i>Abs motor speed %</i>	Absolute value of the motor speed % <i>01.03 Motor speed %</i>	-
	0.00... 1000.00%		10 = 1%
01.63	<i>Abs output frequency</i>	Absolute value of the output frequency <i>01.06 Output frequency</i>	-
	0.00...500.00 Hz		1 = 1 Hz
01.64	<i>Abs motor torque</i>	Absolute value of the motor torque <i>01.10 Motor torque</i> .	-
	0.0...1600.0%		1 = 1%
01.65	<i>Abs output power</i>	Absolute value of the output power <i>01.14 Output power</i> .	-
	0.00...32767.00 kW		1 = 1 kW
01.66	<i>Abs output power % mot nom</i>	Absolute value of the output power % of motor nominal <i>01.15 Output power % of motor nom</i> .	-
	0.00... 300.00%		1 = 1%
01.67	<i>Abs output power % drive nom</i>	Absolute value of the output power % of drive nominal <i>01.16 Output power % of drive nom</i> .	-
	0.00... 300.00%		1 = 1%
01.68	<i>Abs motor shaft power</i>	Absolute value of the motor shaft power <i>01.17 Motor shaft power</i> .	-
	0.00...332767.00 kW		1 = 1 kW
<b>03 Input references</b>		Values of references received from various sources. All parameters in this group are read-only unless otherwise noted.	
03.01	<i>Panel reference</i>	Local mode reference is given from the control panel.	0
	-100000.00... 100000.00 rpm, Hz or %	Control panel or PC tool reference.	1 = 10 unit
03.02	<i>Panel reference remote</i>	Remote mode reference given from the control panel.	-

No.	Name/Value	Description	Default FbEq 16
	-100000.00... 100000.00 rpm, Hz or %	Control panel or PC tool reference.	1 = 10 unit
03.05	<i>FB A reference 1</i>	Scaled fieldbus A reference 1. See parameter <a href="#">50.14 FBA A reference 1</a> .	0
	-100000.00 ... 100000.00	Reference from fieldbus adapter A.	1 = 10
03.06	<i>FB A reference 2</i>	Scaled fieldbus A reference 2. See parameter <a href="#">50.15 FBA A reference 2</a> .	0
	-100000.00 ... 100000.00	Reference 2 from fieldbus adapter A.	1 = 10
03.09	<i>EFB reference 1</i>	Scaled reference 1 received through the embedded fieldbus interface. The scaling is defined by <a href="#">58.26 EFB ref1 type</a>	-
	-30000.00 ... 30000.00	Scaled reference 1 received through the embedded fieldbus interface.	1 = 10
03.10	<i>EFB reference 2</i>	Scaled embedded fieldbus reference 2.	-
	-30000.00 ... 30000.00	Scaled reference 2 received through the embedded fieldbus interface. The scaling is defined by <a href="#">58.27 EFB ref2 type</a>	1 = 10
03.17	<i>Integrated Panel ref</i>	Local mode reference given from the integrated control panel. Unit (rpm, Hz or %) is set from parameter	0
	-100000.00 ... 100000.00 rpm, Hz or %	Integrated control panel reference.	1 = 10
03.18	<i>Integrated Panel ref remote</i>	Remote mode reference given from the integrated control panel.	0
	-100000.00 ... 100000.00 rpm, Hz or %	Integrated control panel reference.	1 = 10
<b>04 Warnings and faults</b>		Information on warnings and faults that occurred last. For explanations of individual warning and fault codes, see chapter <a href="#">Fault tracing</a> . All parameters in this group are read-only unless otherwise noted.	
04.01	<i>Tripping fault</i>	Code of the 1st active fault (the fault that caused the drive to trip as it arrived at the trip register).	-
	0000h...FFFFh	Fault code.	1=1
04.02	<i>Active fault 2</i>	2nd active fault in the trip register.	-
	0000h...FFFFh	Fault code.	1=1
04.03	<i>Active fault 3</i>	3rd active fault in the trip register.	-
	0000h...FFFFh	Fault code.	1=1
04.06	<i>Active warning 1</i>	1st active warning in warning register.	-
	0000h...FFFFh	Warning code.	1=1
04.07	<i>Active warning 2</i>	2nd active warning in warning register.	-
	0000h...FFFFh	Warning code.	1=1

## 120 Parameters

No.	Name/Value	Description	Default FbEq 16
<a href="#">04.08</a>	<a href="#">Active warning 3</a>	3rd active warning in warning register.	-
	0000h...FFFFh	Warning code.	1=1
<a href="#">04.11</a>	<a href="#">Latest fault</a>	Latest fault in the trip log store. The trip log store is loaded with the active faults in the order they occur.	-
	0000h...FFFFh	Fault code.	1=1
<a href="#">04.12</a>	<a href="#">2nd latest fault</a>	2nd fault in trip log store.	-
	0000h...FFFFh	Fault code.	1=1
<a href="#">04.13</a>	<a href="#">3rd latest fault</a>	3rd fault in trip log store.	-
	0000h...FFFFh	Fault code.	1=1
<a href="#">04.16</a>	<a href="#">Latest warning</a>	Latest warning in the warning log store. The warning log store is loaded with the active warnings in the order they occur.	-
	0000h...FFFFh	Warning code.	1=1
<a href="#">04.17</a>	<a href="#">2nd latest warning</a>	2nd warning in trip log store.	-
	0000h...FFFFh	Warning code.	1=1
<a href="#">04.18</a>	<a href="#">3rd latest warning</a>	3rd warning in trip log store.	-
	0000h...FFFFh	Warning code.	1=1
<a href="#">05 Diagnostics</a>		Various run-time-type counters and measurements related to drive maintenance. All parameters in this group are read-only unless otherwise noted.	
<a href="#">05.01</a>	<a href="#">On-time counter</a>	Drive on-time counter. The counter runs when the drive is powered.	-
	0...65535 d	On-time counter (number of days).	1 = 1 d
<a href="#">05.02</a>	<a href="#">Run-time counter</a>	Motor run-time counter. The counter runs when the inverter modulates.	-
	0...65535 d	Motor run-time counter.	1 = 1 d
<a href="#">05.03</a>	<a href="#">Hours run</a>	Corresponding parameter to <a href="#">05.02 Run-time counter</a> in hours, that is, 24 * <a href="#">05.02</a> value + fractional part of a day.	-
	0.0... 429496729.5 h	Hours.	10 = 1 h
<a href="#">05.04</a>	<a href="#">Fan on-time counter</a>	Running time of the drive cooling fan. Can be reset from the control panel by keeping Reset down for over 3 seconds.	-
	0...65535 d	Cooling fan run-time.	1 = 1 d
<a href="#">05.10</a>	<a href="#">Control board temperature</a>	Measured temperature of the control board.	-
	-100... 300 °C or °F	Temperature in degrees Celsius for Fahrenheit.	1 = unit
<a href="#">05.11</a>	<a href="#">Inverter temperature</a>	Estimated drive temperature in percent of fault limit. The fault limit varies according to the type of the drive. 0.0% = 0 °C (32 °F) 100.0% = Fault limit	-
	-40.0...160.0%	Temperature in percent.	1 = 1%



No.	Name/Value	Description	Default FbEq 16
05.20	<i>Diagnostic word 1</i>	Diagnostic word 1. For possible causes and remedies, see chapter <i>Fault tracing</i> .	0b0000
<b>Bit</b>	<b>Name</b>	<b>Value</b>	
0	Any warning or fault	Yes = Drive has generated a warning or tripped on a fault.	
1	Any warning	Yes = Drive has generated a warning.	
2	Any fault	Yes = Drive has tripped on a fault.	
3	Reserved		
4	Overcurrent fault	Yes = Drive has tripped on fault <i>2310 Overcurrent</i> .	
5	Reserved		
6	DC overvoltage	Yes = Drive has tripped on fault <i>3210 DC link overvoltage</i> .	
7	DC undervoltage	Yes = Drive has tripped on fault <i>3220 DC link undervoltage</i> .	
8	Reserved		
9	Device overtemp flt	Yes = Drive has tripped on fault <i>4310 Excess temperature</i> .	
10...15	Reserved		
0b0000...0b1111		Diagnostic word 1.	1 = 1
05.21	<i>Diagnostic word 2</i>	Diagnostic word 2 For possible causes and remedies, see chapter <i>Fault tracing</i> .	0b0000
<b>Bit</b>	<b>Name</b>	<b>Value</b>	
0...9	Reserved		
10	Motor overtemp flt	Yes = Drive has tripped on fault <i>4981 External temperature 1</i> or <i>4982 External temperature 2</i> .	
11...15	Reserved		
0b0000...0b1111		Diagnostic word 2.	1 = 1
05.22	<i>Diagnostic word 3</i>	Diagnostic word 3. For possible causes and remedies, see chapter <i>Fault tracing</i> .	0b0000
<b>Bit</b>	<b>Name</b>	<b>Value</b>	
0...8	Reserved		
9	kWh pulse	1 = kWh pulse is active.	
10	Reserved		
11	Fan command	1 = Drive fan is rotating above idle speed.	
12...15	Reserved		
0b0000...0b1111		Diagnostic word 3.	1 = 1
05.80	<i>Motor speed at fault</i>	Displays the motor speed ( <i>01.01</i> ) at which fault occurred.	-
-30000.00... 30000.00 rpm		Motor speed at fault.	See par. <i>46.01</i>
05.81	<i>Output frequency at fault</i>	Displays the output frequency ( <i>01.06</i> ) at which fault occurred.	-
-500.00...500.00 Hz		Output frequency at fault.	See par. <i>46.02</i>
05.82	<i>DC voltage at fault</i>	Displays the DC link volt age ( <i>01.11</i> ) at which fault occurred.	-
0.00...2000.00 V		DC voltage at fault.	10 = 1 V

## 122 Parameters

No.	Name/Value	Description	Default FbEq 16																																		
05.83	<i>Motor current at fault</i>	Displays the motor current (01.07) at which fault occurred.	-																																		
	0.00...30000.00 A	Motor current at fault.	See par. 46.05																																		
05.84	<i>Motor torque at fault</i>	Displays the motor torque (01.10) at which fault occurred	-																																		
	-1600.0...1600.0%	Motor torque at fault.	See par. 46.03																																		
05.85	<i>Main status word at fault</i>	Displays the main status word (06.11) at which fault occurred. For the bit list, see parameter 06.11 <i>Main status word</i> .	0000h																																		
		<table border="1"> <thead> <tr> <th>Bit</th> <th>Name</th> </tr> </thead> <tbody> <tr><td>0</td><td>Ready to switch ON</td></tr> <tr><td>1</td><td>Ready run</td></tr> <tr><td>2</td><td>Ready ref</td></tr> <tr><td>3</td><td>Tripped</td></tr> <tr><td>4</td><td>Not in use</td></tr> <tr><td>5</td><td>Not in use</td></tr> <tr><td>6</td><td>Not in use</td></tr> <tr><td>7</td><td>Warning</td></tr> <tr><td>8</td><td>Modulating</td></tr> <tr><td>9</td><td>Remote</td></tr> <tr><td>10</td><td>Net OK</td></tr> <tr><td>11</td><td>User bit 0</td></tr> <tr><td>12</td><td>User bit 1</td></tr> <tr><td>13</td><td>User bit 2</td></tr> <tr><td>14</td><td>Charging</td></tr> <tr><td>15</td><td>User bit 3</td></tr> </tbody> </table>	Bit	Name	0	Ready to switch ON	1	Ready run	2	Ready ref	3	Tripped	4	Not in use	5	Not in use	6	Not in use	7	Warning	8	Modulating	9	Remote	10	Net OK	11	User bit 0	12	User bit 1	13	User bit 2	14	Charging	15	User bit 3	
Bit	Name																																				
0	Ready to switch ON																																				
1	Ready run																																				
2	Ready ref																																				
3	Tripped																																				
4	Not in use																																				
5	Not in use																																				
6	Not in use																																				
7	Warning																																				
8	Modulating																																				
9	Remote																																				
10	Net OK																																				
11	User bit 0																																				
12	User bit 1																																				
13	User bit 2																																				
14	Charging																																				
15	User bit 3																																				
	0000h...FFFFh	Main status word at fault.	1 = 1																																		
05.86	<i>DI delayed status at fault</i>	Displays the DI delayed status (10.02) at which fault occurred. For the bit list, see parameter 10.02 <i>DI delayed status</i> .	0000h																																		
	0000h...FFFFh	DI delayed status at fault.	1 = 1																																		
05.87	<i>Inverter temperature at fault</i>	Displays the inverter temperature (05.11) at which fault occurred.	-																																		
	-40...160°C	Inverter temperature at fault.	1 = 1°C																																		
05.88	<i>Reference used at fault</i>	Displays the reference used (28.01/26.73/23.01) at which fault occurred. The type of the reference depends on the selected operation mode (19.01).	-																																		
	-500.00...500.00 Hz/ -1600.0...1600.0%/	Reference used at fault.	See par. 46.02/ See par. 46.03/ See par. 46.01																																		
	30000.00... 30000.00 rpm																																				

No.	Name/Value	Description	Default FbEq 16																																		
<b>06 Control and status words</b>		Drive control and status words.																																			
06.01	<i>Main control word</i>	<p>The main control word of the drive. This parameter shows the control signals as received from the selected sources (such as digital inputs, the fieldbus interfaces and the application program).</p> <p>The bit assignments of the word are as described on page 487. The related status word and state diagram are presented on pages 488 and 489 respectively.</p> <p>This parameter is read-only.</p> <p><b>Note:</b> With the fieldbus control, the parameter value is not same as the value that it receives from the PLC. For the correct value, see parameter <i>50.12 FBA A debug mode</i>.</p>	0000h																																		
<table border="1" data-bbox="412 552 650 1007"> <thead> <tr> <th>Bit</th> <th>Name</th> </tr> </thead> <tbody> <tr><td>0</td><td><i>Off1 control</i></td></tr> <tr><td>1</td><td><i>Off2 control</i></td></tr> <tr><td>2</td><td><i>Off3 control</i></td></tr> <tr><td>3</td><td><i>Run</i></td></tr> <tr><td>4</td><td><i>Ramp out zero</i></td></tr> <tr><td>5</td><td><i>Ramp hold</i></td></tr> <tr><td>6</td><td><i>Ramp in zero</i></td></tr> <tr><td>7</td><td><i>Reset</i></td></tr> <tr><td>8</td><td><i>Inching 1</i></td></tr> <tr><td>9</td><td><i>Inching 2</i></td></tr> <tr><td>10</td><td><i>Remote cmd</i></td></tr> <tr><td>11</td><td><i>Ext ctrl loc</i></td></tr> <tr><td>12</td><td><i>User bit 0</i></td></tr> <tr><td>13</td><td><i>User bit 1</i></td></tr> <tr><td>14</td><td><i>User bit 2</i></td></tr> <tr><td>15</td><td><i>User bit 3</i></td></tr> </tbody> </table>				Bit	Name	0	<i>Off1 control</i>	1	<i>Off2 control</i>	2	<i>Off3 control</i>	3	<i>Run</i>	4	<i>Ramp out zero</i>	5	<i>Ramp hold</i>	6	<i>Ramp in zero</i>	7	<i>Reset</i>	8	<i>Inching 1</i>	9	<i>Inching 2</i>	10	<i>Remote cmd</i>	11	<i>Ext ctrl loc</i>	12	<i>User bit 0</i>	13	<i>User bit 1</i>	14	<i>User bit 2</i>	15	<i>User bit 3</i>
Bit	Name																																				
0	<i>Off1 control</i>																																				
1	<i>Off2 control</i>																																				
2	<i>Off3 control</i>																																				
3	<i>Run</i>																																				
4	<i>Ramp out zero</i>																																				
5	<i>Ramp hold</i>																																				
6	<i>Ramp in zero</i>																																				
7	<i>Reset</i>																																				
8	<i>Inching 1</i>																																				
9	<i>Inching 2</i>																																				
10	<i>Remote cmd</i>																																				
11	<i>Ext ctrl loc</i>																																				
12	<i>User bit 0</i>																																				
13	<i>User bit 1</i>																																				
14	<i>User bit 2</i>																																				
15	<i>User bit 3</i>																																				
0000h...FFFFh		Main control word.	1 = 1																																		

No.	Name/Value	Description	Default FbEq 16																																		
06.11	<i>Main status word</i>	<p>ABB Drives Profile Main status word. Reflects the status of the drive irrespective of control source e.g. a fieldbus system, control panel (keypad), PC-Tool, standard I/O, application program or sequence programming, and irrespective of the actual control profile which is used to control the drive.</p> <p>The bit assignments are described on page 487 (Contents of the fieldbus control word). The state diagram (valid for ABB drives profile) is on page 489.</p> <p>This parameter is read-only.</p> <p><b>Note:</b> With the fieldbus control, the parameter value is not same as the value that it receives from the PLC. For the correct value, see parameter 50.12 <i>FBA A debug mode</i>.</p>	0000h																																		
<table border="1" style="width: 100%; border-collapse: collapse;"> <thead> <tr> <th style="width: 10%;">Bit</th> <th style="width: 90%;">Name</th> </tr> </thead> <tbody> <tr><td>0</td><td><i>Ready to switch ON</i></td></tr> <tr><td>1</td><td><i>Ready run</i></td></tr> <tr><td>2</td><td><i>Ready ref</i></td></tr> <tr><td>3</td><td><i>Tripped</i></td></tr> <tr><td>4</td><td><i>Off 2 inactive</i></td></tr> <tr><td>5</td><td><i>Off 3 inactive</i></td></tr> <tr><td>6</td><td><i>Switch-on inhibited</i></td></tr> <tr><td>7</td><td><i>Warning</i></td></tr> <tr><td>8</td><td><i>At setpoint</i></td></tr> <tr><td>9</td><td><i>Remote</i></td></tr> <tr><td>10</td><td><i>Above limit</i></td></tr> <tr><td>11</td><td><i>User bit 0</i></td></tr> <tr><td>12</td><td><i>User bit 1</i></td></tr> <tr><td>13</td><td><i>User bit 2</i></td></tr> <tr><td>14</td><td><i>User bit 3</i></td></tr> <tr><td>15</td><td><i>Reserved</i></td></tr> </tbody> </table>				Bit	Name	0	<i>Ready to switch ON</i>	1	<i>Ready run</i>	2	<i>Ready ref</i>	3	<i>Tripped</i>	4	<i>Off 2 inactive</i>	5	<i>Off 3 inactive</i>	6	<i>Switch-on inhibited</i>	7	<i>Warning</i>	8	<i>At setpoint</i>	9	<i>Remote</i>	10	<i>Above limit</i>	11	<i>User bit 0</i>	12	<i>User bit 1</i>	13	<i>User bit 2</i>	14	<i>User bit 3</i>	15	<i>Reserved</i>
Bit	Name																																				
0	<i>Ready to switch ON</i>																																				
1	<i>Ready run</i>																																				
2	<i>Ready ref</i>																																				
3	<i>Tripped</i>																																				
4	<i>Off 2 inactive</i>																																				
5	<i>Off 3 inactive</i>																																				
6	<i>Switch-on inhibited</i>																																				
7	<i>Warning</i>																																				
8	<i>At setpoint</i>																																				
9	<i>Remote</i>																																				
10	<i>Above limit</i>																																				
11	<i>User bit 0</i>																																				
12	<i>User bit 1</i>																																				
13	<i>User bit 2</i>																																				
14	<i>User bit 3</i>																																				
15	<i>Reserved</i>																																				
0000h...FFFh		Main status word.	1 = 1																																		

No.	Name/Value	Description	Default FbEq 16
06.16	<i>Drive status word 1</i>	Drive status word 1. This parameter is read-only.	-
<b>Bit</b>	<b>Name</b>	<b>Description</b>	
0	Enabled	1 = Both run enable (see par. <a href="#">20.12</a> ) and start enable ( <a href="#">20.19</a> ) signals are present. <b>Note:</b> This bit is not affected by the presence of a fault.	
1	Inhibited	1 = Start inhibited. To start the drive, the inhibiting signal (see par. <a href="#">06.18</a> ) must be removed and the start signal cycled.	
2	DC charged	1 = DC circuit has been charged	
3	Ready to start	1 = Drive is ready to receive a start command	
4	Following reference	1 = Drive is ready to follow given reference	
5	Started	1 = Drive has been started	
6	Modulating	1 = Drive is modulating (output stage is being controlled)	
7	Limiting	1 = Any operating limit (speed, torque, etc.) is active	
8	Local control	1 = Drive is in local control	
9	Network control	1 = Drive is in <i>Network control</i> (see page <a href="#">14</a> ).	
10	Ext1 active	1 = Control location EXT1 active	
11	Ext2 active	1 = Control location EXT2 active	
12	Reserved		
13	Start request	1 = Start requested. 0 = When Enable to rotate signal (see par. <a href="#">20.22</a> ) is 0 (rotating of the motor is disabled).	
14...15	Reserved		
	0000h...FFFFh	Drive status word 1.	1 = 1
06.17	<i>Drive status word 2</i>	Drive status word 2. This parameter is read-only.	-
<b>Bit</b>	<b>Name</b>	<b>Description</b>	
0	Identification run done	1 = Motor identification (ID) run has been performed	
1	Magnetized	1 = The motor has been magnetized	
2	Torque control	1 = Torque control mode active	
3	Speed control	1 = Speed control mode active	
4	Reserved		
5	Safe reference active	1 = A "safe" reference is applied by functions such as parameters <a href="#">49.05</a> and <a href="#">50.02</a>	
6	Last speed active	1 = A "last speed" reference is applied by functions such as parameters <a href="#">49.05</a> and <a href="#">50.02</a>	
7	Reserved		
8	Emergency stop failed	1 = Emergency stop failed (see parameters <a href="#">31.32</a> and <a href="#">31.33</a> )	
9	Jogging active	1 = Jogging enable signal is on	
10...12	Reserved		
13	Start delay active	1 = Start delay (par. <a href="#">21.22</a> ) active.	
14...15	Reserved		
	0000h...FFFFh	Drive status word 2.	1 = 1

No.	Name/Value	Description	Default FbEq 16
06.18	<i>Start inhibit status word</i>	<p>Start inhibit status word. This word specifies the source of the inhibiting signal that is preventing the drive from starting.</p> <p>The conditions marked with an asterisk (*) only require that the start command is cycled. In all other instances, the inhibiting condition must be removed first.</p> <p>See also parameter <i>06.16 Drive status word 1</i>, bit 1.</p> <p>This parameter is read-only.</p>	-

Bit	Name	Description
0	Not ready run	1 = DC voltage is missing or drive has not been parametrized correctly. Check the parameters in groups 95 and 99.
1	Ctrl location changed	* 1 = Control location has changed
2	SSW inhibit	1 = Control program is keeping itself in inhibited state
3	Fault reset	* 1 = A fault has been reset
4	Lost start enable	1 = Start enable signal missing
5	Lost run enable	1 = Run enable signal missing
6	Reserved	
7	STO	1 = Safe torque off function active
8	Current calibration ended	* 1 = Current calibration routine has finished
9	ID run ended	* 1 = Motor identification run has finished
10	Reserved	-
11	Em Off1	1 = Emergency stop signal (mode off1)
12	Em Off2	1 = Emergency stop signal (mode off2)
13	Em Off3	1 = Emergency stop signal (mode off3)
14	Auto reset inhibit	1 = The autoreset function is inhibiting operation
15	Jogging active	1 = The jogging enable signal is inhibiting operation

0000h...FFFFh	Start inhibit status word.	1 = 1
---------------	----------------------------	-------

No.	Name/Value	Description	Default FbEq 16																																				
06.19	<i>Speed control status word</i>	Speed control status word. This parameter is read-only.	--																																				
<table border="1"> <thead> <tr> <th>Bit</th> <th>Name</th> <th>Description</th> </tr> </thead> <tbody> <tr> <td>0</td> <td>Zero speed</td> <td>1 = Drive has been running below zero speed limit (par. 21.06) for a time defined by parameter 21.07 <i>Zero speed delay</i></td> </tr> <tr> <td>1</td> <td>Forward</td> <td>1 = Drive is running in forward direction above zero speed limit (par. 21.06)</td> </tr> <tr> <td>2</td> <td>Reverse</td> <td>1 = Drive is running in reverse direction above zero speed limit (par. 21.06)</td> </tr> <tr> <td>3</td> <td>Out of window</td> <td>Speed out of speed window</td> </tr> <tr> <td>4</td> <td>Internal speed feedback</td> <td>Estimate used for motor control</td> </tr> <tr> <td>5</td> <td>Encoder 1 feedback</td> <td>Encoder 1 feedback used for motor control</td> </tr> <tr> <td>6</td> <td>Encoder 2 feedback</td> <td>Encoder 2 feedback used for motor control</td> </tr> <tr> <td>7</td> <td>Any constant speed request</td> <td>1 = A constant speed or frequency has been selected; see par. 06.20 below.</td> </tr> <tr> <td>8</td> <td>Follower speed correction min lim</td> <td>Minimum limit of speed correction is reached by speed controlled follower application.</td> </tr> <tr> <td>9</td> <td>Follower speed correction max lim</td> <td>Maximum limit of speed correction is reached by speed controlled follower application.</td> </tr> <tr> <td>10...15</td> <td>Reserved</td> <td></td> </tr> </tbody> </table>				Bit	Name	Description	0	Zero speed	1 = Drive has been running below zero speed limit (par. 21.06) for a time defined by parameter 21.07 <i>Zero speed delay</i>	1	Forward	1 = Drive is running in forward direction above zero speed limit (par. 21.06)	2	Reverse	1 = Drive is running in reverse direction above zero speed limit (par. 21.06)	3	Out of window	Speed out of speed window	4	Internal speed feedback	Estimate used for motor control	5	Encoder 1 feedback	Encoder 1 feedback used for motor control	6	Encoder 2 feedback	Encoder 2 feedback used for motor control	7	Any constant speed request	1 = A constant speed or frequency has been selected; see par. 06.20 below.	8	Follower speed correction min lim	Minimum limit of speed correction is reached by speed controlled follower application.	9	Follower speed correction max lim	Maximum limit of speed correction is reached by speed controlled follower application.	10...15	Reserved	
Bit	Name	Description																																					
0	Zero speed	1 = Drive has been running below zero speed limit (par. 21.06) for a time defined by parameter 21.07 <i>Zero speed delay</i>																																					
1	Forward	1 = Drive is running in forward direction above zero speed limit (par. 21.06)																																					
2	Reverse	1 = Drive is running in reverse direction above zero speed limit (par. 21.06)																																					
3	Out of window	Speed out of speed window																																					
4	Internal speed feedback	Estimate used for motor control																																					
5	Encoder 1 feedback	Encoder 1 feedback used for motor control																																					
6	Encoder 2 feedback	Encoder 2 feedback used for motor control																																					
7	Any constant speed request	1 = A constant speed or frequency has been selected; see par. 06.20 below.																																					
8	Follower speed correction min lim	Minimum limit of speed correction is reached by speed controlled follower application.																																					
9	Follower speed correction max lim	Maximum limit of speed correction is reached by speed controlled follower application.																																					
10...15	Reserved																																						
	0000h...FFFFh	Speed control status word.	1 = 1																																				
06.20	<i>Constant speed status word</i>	Constant speed/frequency status word. Indicates which constant speed or frequency is active (if any). See also parameter 06.19 <i>Speed control status word</i> , bit 7, and section Constant speeds/frequencies. This parameter is read-only.	-																																				
<table border="1"> <thead> <tr> <th>Bit</th> <th>Name</th> <th>Description</th> </tr> </thead> <tbody> <tr> <td>0</td> <td>Constant speed 1</td> <td>1 = Constant speed or frequency 1 selected</td> </tr> <tr> <td>1</td> <td>Constant speed 2</td> <td>1 = Constant speed or frequency 2 selected</td> </tr> <tr> <td>2</td> <td>Constant speed 3</td> <td>1 = Constant speed or frequency 3 selected</td> </tr> <tr> <td>3</td> <td>Constant speed 4</td> <td>1 = Constant speed or frequency 4 selected</td> </tr> <tr> <td>4</td> <td>Constant speed 5</td> <td>1 = Constant speed or frequency 5 selected</td> </tr> <tr> <td>5</td> <td>Constant speed 6</td> <td>1 = Constant speed or frequency 6 selected</td> </tr> <tr> <td>6</td> <td>Constant speed 7</td> <td>1 = Constant speed or frequency 7 selected</td> </tr> <tr> <td>7...15</td> <td>Reserved</td> <td></td> </tr> </tbody> </table>				Bit	Name	Description	0	Constant speed 1	1 = Constant speed or frequency 1 selected	1	Constant speed 2	1 = Constant speed or frequency 2 selected	2	Constant speed 3	1 = Constant speed or frequency 3 selected	3	Constant speed 4	1 = Constant speed or frequency 4 selected	4	Constant speed 5	1 = Constant speed or frequency 5 selected	5	Constant speed 6	1 = Constant speed or frequency 6 selected	6	Constant speed 7	1 = Constant speed or frequency 7 selected	7...15	Reserved										
Bit	Name	Description																																					
0	Constant speed 1	1 = Constant speed or frequency 1 selected																																					
1	Constant speed 2	1 = Constant speed or frequency 2 selected																																					
2	Constant speed 3	1 = Constant speed or frequency 3 selected																																					
3	Constant speed 4	1 = Constant speed or frequency 4 selected																																					
4	Constant speed 5	1 = Constant speed or frequency 5 selected																																					
5	Constant speed 6	1 = Constant speed or frequency 6 selected																																					
6	Constant speed 7	1 = Constant speed or frequency 7 selected																																					
7...15	Reserved																																						
	0000h...FFFFh	Constant speed/frequency status word.	1 = 1																																				

No.	Name/Value	Description	Default FbEq 16															
06.21	<i>Drive status word 3</i>	Drive status word 3. This parameter is read-only.	-															
		<table border="1"> <thead> <tr> <th>Bit</th> <th>Name</th> <th>Description</th> </tr> </thead> <tbody> <tr> <td>0</td> <td>DC hold active</td> <td>1 = DC hold is active</td> </tr> <tr> <td>1</td> <td>Post-magnetizing active</td> <td>1 = Post-magnetizing is active</td> </tr> <tr> <td>2</td> <td>Motor pre-heating active</td> <td>1 = Motor pre-heating is active</td> </tr> <tr> <td>3...15</td> <td>Reserved</td> <td></td> </tr> </tbody> </table>	Bit	Name	Description	0	DC hold active	1 = DC hold is active	1	Post-magnetizing active	1 = Post-magnetizing is active	2	Motor pre-heating active	1 = Motor pre-heating is active	3...15	Reserved		
Bit	Name	Description																
0	DC hold active	1 = DC hold is active																
1	Post-magnetizing active	1 = Post-magnetizing is active																
2	Motor pre-heating active	1 = Motor pre-heating is active																
3...15	Reserved																	
	0000h...FFFFh	Drive status word 1.	1 = 1															
06.30	<i>MSW bit 11 selection</i>	Selects a binary source whose status is transmitted as bit 11 (User bit 0) of <i>06.11 Main status word</i> .	<i>Ext ctrl loc</i>															
	False	0.	0															
	True	1.	1															
	Ext ctrl loc	Bit 11 of <i>06.01 Main control word</i> .	2															
	<i>Other [bit]</i>	Source selection (see <i>Terms and abbreviations</i> ).	-															
06.31	<i>MSW bit 12 selection</i>	Selects a binary source whose status is transmitted as bit 12 (User bit 1) of <i>06.11 Main status word</i> .	<i>Ext run enable</i>															
	False	0.	0															
	True	1.	1															
	Ext run enable	Status of the external run enable signal (see parameter <i>20.12 Run enable 1 source</i> ).	2															
	<i>Other [bit]</i>	Source selection (see <i>Terms and abbreviations</i> ).	-															
06.32	<i>MSW bit 13 selection</i>	Selects a binary source whose status is transmitted as bit 13 (User bit 2) of <i>06.11 Main status word</i> .	<i>False</i>															
	False	0.	0															
	True	1.	1															
	<i>Other [bit]</i>	Source selection (see <i>Terms and abbreviations</i> ).	-															
06.33	<i>MSW bit 14 selection</i>	Selects a binary source whose status is transmitted as bit 14 (User bit 3) of <i>06.11 Main status word</i> .	<i>False</i>															
	False	0.	0															
	True	1.	1															
	<i>Other [bit]</i>	Source selection (see <i>Terms and abbreviations</i> ).	-															
<b>07 System info</b>		Drive hardware and firmware information. All parameters in this group are read-only.																
07.03	<i>Drive rating id</i>	Type of the drive/inverter unit.	-															
07.04	<i>Firmware name</i>	Firmware identification.	-															
07.05	<i>Firmware version</i>	Version number of the firmware.	-															
07.06	<i>Loading package name</i>	Name of the firmware loading package.	-															
07.07	<i>Loading package version</i>	Version number of the firmware loading package.	-															



No.	Name/Value	Description	Default FbEq 16																												
07.11	<i>Cpu usage</i>	Microprocessor load in percent.	-																												
	0...100%	Microprocessor load.	1 = 1-																												
07.25	<i>Customization package name</i>	First five ASCII letters of the name given to the customization package. The full name is visible under System info on the control panel or the Drive composer PC tool. _N/A_ = None.	-																												
07.26	<i>Customization package version</i>	Customization package version number. Also visible under System info on the control panel or the Drive composer PC tool.	-																												
07.30	<i>Adaptive program status</i>	Shows the status of the adaptive program. See section <i>Adaptive programming</i> on page 61.	-																												
		<table border="1"> <thead> <tr> <th>Bit</th> <th>Name</th> <th>Description</th> </tr> </thead> <tbody> <tr> <td>0</td> <td>Initialized</td> <td>Adaptive program initialized.</td> </tr> <tr> <td>1</td> <td>Editing</td> <td>Adaptive program in editing state.</td> </tr> <tr> <td>2</td> <td>Edit done</td> <td>Editing of the adaptive program finished.</td> </tr> <tr> <td>3</td> <td>Running</td> <td>Adaptive program running.</td> </tr> <tr> <td>4-13</td> <td>Reserved</td> <td></td> </tr> <tr> <td>14</td> <td>State changing</td> <td>State changing on-going in the adaptive programming engine.</td> </tr> <tr> <td>15</td> <td>Faulted</td> <td>Adaptive program faulted.</td> </tr> </tbody> </table>	Bit	Name	Description	0	Initialized	Adaptive program initialized.	1	Editing	Adaptive program in editing state.	2	Edit done	Editing of the adaptive program finished.	3	Running	Adaptive program running.	4-13	Reserved		14	State changing	State changing on-going in the adaptive programming engine.	15	Faulted	Adaptive program faulted.					
Bit	Name	Description																													
0	Initialized	Adaptive program initialized.																													
1	Editing	Adaptive program in editing state.																													
2	Edit done	Editing of the adaptive program finished.																													
3	Running	Adaptive program running.																													
4-13	Reserved																														
14	State changing	State changing on-going in the adaptive programming engine.																													
15	Faulted	Adaptive program faulted.																													
	0000h...FFFFh	Adaptive program status	1 = 1																												
07.31	<i>AP sequence state</i>	Shows the number of the active state of the sequence program part of the adaptive program (AP). If adaptive programming is not running, or it does not contain a sequence program, the parameter is zero.																													
	0...20		1 = 1																												
07.35	<i>Drive configuration</i>	Plug 'n' play configuration. Performs HW initialization, and shows the detected module configuration of the drive. During the HW initialization, if the drive is not able to detect any module, the value is set to 1, Base unit. For more information, see section <i>Automatic drive configuration for fieldbus control</i> on page 491.	0x0000																												
		<table border="1"> <thead> <tr> <th>Bit</th> <th>Name</th> <th>Bit</th> <th>Name</th> </tr> </thead> <tbody> <tr> <td>0</td> <td>Reserved</td> <td>5</td> <td>FPBA-01</td> </tr> <tr> <td>1</td> <td>Base unit</td> <td>6</td> <td>FCAN-01</td> </tr> <tr> <td>2</td> <td>BMIO-01</td> <td>7</td> <td>BCAN-01</td> </tr> <tr> <td>3</td> <td>FENA-21</td> <td>8</td> <td>BIO-01</td> </tr> <tr> <td>4</td> <td>FECA-01</td> <td>9</td> <td>RIIO-01</td> </tr> <tr> <td></td> <td></td> <td>10...15</td> <td>Reserved</td> </tr> </tbody> </table>	Bit	Name	Bit	Name	0	Reserved	5	FPBA-01	1	Base unit	6	FCAN-01	2	BMIO-01	7	BCAN-01	3	FENA-21	8	BIO-01	4	FECA-01	9	RIIO-01			10...15	Reserved	
Bit	Name	Bit	Name																												
0	Reserved	5	FPBA-01																												
1	Base unit	6	FCAN-01																												
2	BMIO-01	7	BCAN-01																												
3	FENA-21	8	BIO-01																												
4	FECA-01	9	RIIO-01																												
		10...15	Reserved																												
	0x0000...oxfff	Drive configuration.	1 = 1																												

No.	Name/Value	Description	Default FbEq 16
<b>09 Crane application signals</b>		Signals related to crane applications. All parameters in this group are read-only.	
09.01	<i>Crane SW1</i>	Shows the crane status word 1.	0000h
<b>Bit</b>	<b>Name</b>	<b>Description</b>	
0	Brake slip at standstill	1 = Speed matching function detected a brake slip when the motor was not running.	
1	Slowdown activated	1 = Slowdown command is active either in the forward or reverse direction.	
2	Forward slowdown limit	1 = Slowdown command is inactive in the forward direction.	
3	Reverse slowdown limit	1 = Slowdown command is inactive in the reverse direction.	
4	Reserved		
5	Reserved		
6	Reserved		
7	Forward stop limit	1 = Forward limit command is inactive.	
8	Reverse stop limit	1 = Reverse limit command is inactive.	
9	Reserved		
10	Joystick reference check	1 = Reference is greater than +/- 10% of the minimum or maximum scaled value of the used joystick reference, and the joystick zero position input is active.	
11	Joystick zero position	1 = Drive does not accept a start command because of a wrong state of the joystick zero position input.	
12	Brake control selected	1 = Mechanical brake control is selected.	
13	Torque prove ok	1 = Torque proving has been successfully performed or Torque proving has been disabled.	
14	Fast stop	1 = Fast stop command is active.	
15	Power on acknowledge warning	1 = Power on acknowledgment circuit is open, main contactor is open, warning <i>D20B Power on acknowledge</i> is generated. 0 = Power on acknowledgment circuit is closed, main contactor is closed. See parameter <i>20.2.12 Power on acknowledge</i> (page 166) and section <i>Power on acknowledgment</i> (page 551).	
0000h...FFFFh		Crane status word 1.	1 = 1

No.	Name/Value	Description	Default FbEq 16																																	
09.03	<i>Crane FW1</i>	Shows the crane fault status word 1 with fault bits.	0000h																																	
		<table border="1"> <thead> <tr> <th>Bit</th> <th>Name</th> <th>Description</th> </tr> </thead> <tbody> <tr> <td>0</td> <td>Reserved</td> <td></td> </tr> <tr> <td>1</td> <td>Speed match</td> <td>1 = <i>D105 Speed match</i> (page 413)</td> </tr> <tr> <td>2</td> <td>Reserved</td> <td></td> </tr> <tr> <td>3</td> <td>Reserved</td> <td></td> </tr> <tr> <td>4</td> <td>Stops limits IO error</td> <td>1 = <i>D108 Stop limits I/O error</i> (page 413)</td> </tr> <tr> <td>5</td> <td>Reserved</td> <td></td> </tr> <tr> <td>6</td> <td>Torque prove</td> <td>1 = <i>D100 Torque prove</i> (page 412)</td> </tr> <tr> <td>7</td> <td>Brake slip</td> <td>1 = <i>D101 Brake slip</i> (page 413)</td> </tr> <tr> <td>8</td> <td>Brake safe closure</td> <td>1 = <i>D102 Brake safe closure</i> (page 413)</td> </tr> <tr> <td>9...15</td> <td>Reserved</td> <td></td> </tr> </tbody> </table>	Bit	Name	Description	0	Reserved		1	Speed match	1 = <i>D105 Speed match</i> (page 413)	2	Reserved		3	Reserved		4	Stops limits IO error	1 = <i>D108 Stop limits I/O error</i> (page 413)	5	Reserved		6	Torque prove	1 = <i>D100 Torque prove</i> (page 412)	7	Brake slip	1 = <i>D101 Brake slip</i> (page 413)	8	Brake safe closure	1 = <i>D102 Brake safe closure</i> (page 413)	9...15	Reserved		
Bit	Name	Description																																		
0	Reserved																																			
1	Speed match	1 = <i>D105 Speed match</i> (page 413)																																		
2	Reserved																																			
3	Reserved																																			
4	Stops limits IO error	1 = <i>D108 Stop limits I/O error</i> (page 413)																																		
5	Reserved																																			
6	Torque prove	1 = <i>D100 Torque prove</i> (page 412)																																		
7	Brake slip	1 = <i>D101 Brake slip</i> (page 413)																																		
8	Brake safe closure	1 = <i>D102 Brake safe closure</i> (page 413)																																		
9...15	Reserved																																			
	0000h...FFFFh	Crane fault status word 1 with fault bits.	1 = 1																																	
09.06	<i>Crane speed reference</i>	Shows the final speed reference received from the signal source.	0.00 rpm																																	
	-30000.00 ... 30000.00 rpm	Final crane speed reference.	1 = 1 rpm																																	
09.16	<i>Crane frequency reference</i>	Shows the final frequency received from the signal source.	0.00 Hz																																	
	-500.00...500.00	Final crane frequency reference.	10 = 1 Hz																																	
<b>10 Standard DI, RO</b>		Configuration of digital inputs and relay outputs.																																		
10.02	<i>DI delayed status</i>	Displays the status of digital inputs. This word is updated only after activation / deactivation delays.	0000h																																	
		<table border="1"> <thead> <tr> <th>Bit</th> <th>Value</th> </tr> </thead> <tbody> <tr> <td>0</td> <td>DI1 = Delayed status of digital input 1.</td> </tr> <tr> <td>1</td> <td>DI2 = Delayed status of digital input 2.</td> </tr> <tr> <td>2</td> <td>DI3 = Delayed status of digital input 3.</td> </tr> <tr> <td>3</td> <td>DI4 = Delayed status of digital input 4.</td> </tr> <tr> <td>4</td> <td>DI5 = Delayed status of digital input 5.</td> </tr> <tr> <td>5</td> <td>DI6 = Delayed status of digital input 6.</td> </tr> <tr> <td>6...15</td> <td>Reserved.</td> </tr> </tbody> </table>	Bit	Value	0	DI1 = Delayed status of digital input 1.	1	DI2 = Delayed status of digital input 2.	2	DI3 = Delayed status of digital input 3.	3	DI4 = Delayed status of digital input 4.	4	DI5 = Delayed status of digital input 5.	5	DI6 = Delayed status of digital input 6.	6...15	Reserved.																		
Bit	Value																																			
0	DI1 = Delayed status of digital input 1.																																			
1	DI2 = Delayed status of digital input 2.																																			
2	DI3 = Delayed status of digital input 3.																																			
3	DI4 = Delayed status of digital input 4.																																			
4	DI5 = Delayed status of digital input 5.																																			
5	DI6 = Delayed status of digital input 6.																																			
6...15	Reserved.																																			
	0000h...FFFFh	Delayed status of digital inputs.	1 = 1																																	

No.	Name/Value	Description	Default FbEq 16																
10.03	<i>DI force selection</i>	Selects the digital inputs, states of which will be controlled by parameter <a href="#">10.04 DI forced data</a> . A bit in parameter <a href="#">10.04 DI forced data</a> is provided for each digital input, and its value is applied whenever the corresponding bit in this parameter is 1. <b>Note:</b> Boot and power cycle reset the force selections (parameters <a href="#">10.03</a> and <a href="#">10.04</a> ).	0000h																
<table border="1"> <thead> <tr> <th>Bit</th> <th>Value</th> </tr> </thead> <tbody> <tr> <td>0</td> <td>1 = Force DI1 to value of bit 0 of parameter <a href="#">10.04 DI forced data</a>.</td> </tr> <tr> <td>1</td> <td>1 = Force DI2 to value of bit 1 of parameter <a href="#">10.04 DI forced data</a>.</td> </tr> <tr> <td>2</td> <td>1 = Force DI3 to value of bit 2 of parameter <a href="#">10.04 DI forced data</a>.</td> </tr> <tr> <td>3</td> <td>1 = Force DI4 to value of bit 3 of parameter <a href="#">10.04 DI forced data</a>.</td> </tr> <tr> <td>4</td> <td>1 = Force DI5 to value of bit 4 of parameter <a href="#">10.04 DI forced data</a>.</td> </tr> <tr> <td>5</td> <td>1 = Force DI6 to value of bit 5 of parameter <a href="#">10.04 DI forced data</a>.</td> </tr> <tr> <td>6...15</td> <td>Reserved.</td> </tr> </tbody> </table>				Bit	Value	0	1 = Force DI1 to value of bit 0 of parameter <a href="#">10.04 DI forced data</a> .	1	1 = Force DI2 to value of bit 1 of parameter <a href="#">10.04 DI forced data</a> .	2	1 = Force DI3 to value of bit 2 of parameter <a href="#">10.04 DI forced data</a> .	3	1 = Force DI4 to value of bit 3 of parameter <a href="#">10.04 DI forced data</a> .	4	1 = Force DI5 to value of bit 4 of parameter <a href="#">10.04 DI forced data</a> .	5	1 = Force DI6 to value of bit 5 of parameter <a href="#">10.04 DI forced data</a> .	6...15	Reserved.
Bit	Value																		
0	1 = Force DI1 to value of bit 0 of parameter <a href="#">10.04 DI forced data</a> .																		
1	1 = Force DI2 to value of bit 1 of parameter <a href="#">10.04 DI forced data</a> .																		
2	1 = Force DI3 to value of bit 2 of parameter <a href="#">10.04 DI forced data</a> .																		
3	1 = Force DI4 to value of bit 3 of parameter <a href="#">10.04 DI forced data</a> .																		
4	1 = Force DI5 to value of bit 4 of parameter <a href="#">10.04 DI forced data</a> .																		
5	1 = Force DI6 to value of bit 5 of parameter <a href="#">10.04 DI forced data</a> .																		
6...15	Reserved.																		
0000h...FFFFh		Override selection for digital inputs.	1 = 1																
10.04	<i>DI forced data</i>	Defines the forced values for the digital inputs selected by parameter <a href="#">10.03 DI force selection</a> . It is only possible to force an input that has been selected in parameter <a href="#">10.03 DI force selection</a> . Bit 0 is the forced value for DI1.	0000h																
<table border="1"> <thead> <tr> <th>Bit</th> <th>Value</th> </tr> </thead> <tbody> <tr> <td>0</td> <td>Force the value of this bit to D1, if so defined in parameter <a href="#">10.03 DI force selection</a>.</td> </tr> <tr> <td>1</td> <td>Force the value of this bit to D2, if so defined in parameter <a href="#">10.03 DI force selection</a>.</td> </tr> <tr> <td>2</td> <td>Force the value of this bit to D3, if so defined in parameter <a href="#">10.03 DI force selection</a>.</td> </tr> <tr> <td>3</td> <td>Force the value of this bit to D4, if so defined in parameter <a href="#">10.03 DI force selection</a>.</td> </tr> <tr> <td>4</td> <td>Force the value of this bit to D5, if so defined in parameter <a href="#">10.03 DI force selection</a>.</td> </tr> <tr> <td>5</td> <td>Force the value of this bit to D6, if so defined in parameter <a href="#">10.03 DI force selection</a>.</td> </tr> <tr> <td>6...15</td> <td>Reserved.</td> </tr> </tbody> </table>				Bit	Value	0	Force the value of this bit to D1, if so defined in parameter <a href="#">10.03 DI force selection</a> .	1	Force the value of this bit to D2, if so defined in parameter <a href="#">10.03 DI force selection</a> .	2	Force the value of this bit to D3, if so defined in parameter <a href="#">10.03 DI force selection</a> .	3	Force the value of this bit to D4, if so defined in parameter <a href="#">10.03 DI force selection</a> .	4	Force the value of this bit to D5, if so defined in parameter <a href="#">10.03 DI force selection</a> .	5	Force the value of this bit to D6, if so defined in parameter <a href="#">10.03 DI force selection</a> .	6...15	Reserved.
Bit	Value																		
0	Force the value of this bit to D1, if so defined in parameter <a href="#">10.03 DI force selection</a> .																		
1	Force the value of this bit to D2, if so defined in parameter <a href="#">10.03 DI force selection</a> .																		
2	Force the value of this bit to D3, if so defined in parameter <a href="#">10.03 DI force selection</a> .																		
3	Force the value of this bit to D4, if so defined in parameter <a href="#">10.03 DI force selection</a> .																		
4	Force the value of this bit to D5, if so defined in parameter <a href="#">10.03 DI force selection</a> .																		
5	Force the value of this bit to D6, if so defined in parameter <a href="#">10.03 DI force selection</a> .																		
6...15	Reserved.																		
0000h...FFFFh		Forced values of digital inputs.	1 = 1																
10.21	<i>RO status</i>	Status of relay outputs R01...R03.	-																
<table border="1"> <thead> <tr> <th>Bit</th> <th>Value</th> </tr> </thead> <tbody> <tr> <td>0</td> <td>1 = RO1 is energized.</td> </tr> <tr> <td>1</td> <td>1 = RO2 is energized.</td> </tr> <tr> <td>2</td> <td>1 = RO3 is energized.</td> </tr> <tr> <td>3...15</td> <td>Reserved.</td> </tr> </tbody> </table>				Bit	Value	0	1 = RO1 is energized.	1	1 = RO2 is energized.	2	1 = RO3 is energized.	3...15	Reserved.						
Bit	Value																		
0	1 = RO1 is energized.																		
1	1 = RO2 is energized.																		
2	1 = RO3 is energized.																		
3...15	Reserved.																		
0000h...FFFFh		Status of relay outputs.	1 = 1																

No.	Name/Value	Description	Default FbEq 16										
10.22	<i>RO force selection</i>	Selects the relay outputs that will be controlled by parameter <i>10.23</i> . The signals connected to the relay outputs can be overridden for eg. testing purposes. A bit in parameter <i>10.23 RO forced data</i> is provided for each relay output, and its value is applied whenever the corresponding bit in this parameter is 1. <b>Note:</b> Boot and power cycle reset the force selections (parameters <i>10.22</i> and <i>10.23</i> ).	0000h										
<table border="1"> <thead> <tr> <th>Bit</th> <th>Value</th> </tr> </thead> <tbody> <tr> <td>0</td> <td>1 = Force RO1 to value of bit 0 of parameter <i>10.23 RO forced data</i> (0 = Normal mode).</td> </tr> <tr> <td>1</td> <td>1 = Force RO2 to value of bit 0 of parameter <i>10.23 RO forced data</i> (0 = Normal mode).</td> </tr> <tr> <td>2</td> <td>1 = Force RO3 to value of bit 0 of parameter <i>10.23 RO forced data</i> (0 = Normal mode).</td> </tr> <tr> <td>3...15</td> <td>Reserved</td> </tr> </tbody> </table>				Bit	Value	0	1 = Force RO1 to value of bit 0 of parameter <i>10.23 RO forced data</i> (0 = Normal mode).	1	1 = Force RO2 to value of bit 0 of parameter <i>10.23 RO forced data</i> (0 = Normal mode).	2	1 = Force RO3 to value of bit 0 of parameter <i>10.23 RO forced data</i> (0 = Normal mode).	3...15	Reserved
Bit	Value												
0	1 = Force RO1 to value of bit 0 of parameter <i>10.23 RO forced data</i> (0 = Normal mode).												
1	1 = Force RO2 to value of bit 0 of parameter <i>10.23 RO forced data</i> (0 = Normal mode).												
2	1 = Force RO3 to value of bit 0 of parameter <i>10.23 RO forced data</i> (0 = Normal mode).												
3...15	Reserved												
	0000h...FFFFh	Override selection for relay outputs.	1 = 1										
10.23	<i>RO forced data</i>	Contains the values of relay outputs that are used instead of the connected signals if selected in parameter <i>10.22 RO force selection</i> . Bit 0 is the forced value for RO1. This provides the possibility to test the drive functionality without the plant wiring. Ton and Toff delays are passed.											
<table border="1"> <thead> <tr> <th>Bit</th> <th>Value</th> </tr> </thead> <tbody> <tr> <td>0</td> <td>1 = Force the value of this bit to RO1, if so defined in parameter <i>10.22 RO force selection</i>.</td> </tr> <tr> <td>1</td> <td>1 = Force the value of this bit to RO2, if so defined in parameter <i>10.22 RO force selection</i>.</td> </tr> <tr> <td>2</td> <td>1 = Force the value of this bit to RO3, if so defined in parameter <i>10.22 RO force selection</i>.</td> </tr> <tr> <td>3...15</td> <td>Reserved</td> </tr> </tbody> </table>				Bit	Value	0	1 = Force the value of this bit to RO1, if so defined in parameter <i>10.22 RO force selection</i> .	1	1 = Force the value of this bit to RO2, if so defined in parameter <i>10.22 RO force selection</i> .	2	1 = Force the value of this bit to RO3, if so defined in parameter <i>10.22 RO force selection</i> .	3...15	Reserved
Bit	Value												
0	1 = Force the value of this bit to RO1, if so defined in parameter <i>10.22 RO force selection</i> .												
1	1 = Force the value of this bit to RO2, if so defined in parameter <i>10.22 RO force selection</i> .												
2	1 = Force the value of this bit to RO3, if so defined in parameter <i>10.22 RO force selection</i> .												
3...15	Reserved												
	0000h...FFFFh	Forced RO values.	1 = 1										
10.24	<i>RO1 source</i>	Selects a drive signal to be connected to relay output RO1.	<i>Fault (-1)</i>										
	Not energized	Output is not energized.	0										
	Energized	Output is energized.	1										
	Ready run	Bit 1 of <i>06.11 Main status word</i> .	2										
	Enabled	Bit 0 of <i>06.16 Drive status word 1</i> .	4										
	Started	Bit 5 of <i>06.16 Drive status word 1</i> .	5										
	Magnetized	Bit 1 of <i>06.17 Drive status word 2</i> .	6										
	Running	Bit 6 of <i>06.16 Drive status word 1</i> .	7										
	Ready ref	Bit 2 of <i>06.11 Main status word</i> .	8										
	At setpoint	Bit 8 of <i>06.11 Main status word</i> .	9										
	Reverse	Bit 2 of <i>06.19 Speed control status word</i> .	10										
	Zero speed	Bit 0 of <i>06.19 Speed control status word</i> .	11										
	Above limit	Bit 10 of <i>06.17 Drive status word 2</i> .	12										
	Warning	Bit 7 of <i>06.11 Main status word</i> .	13										
	Fault	Bit 3 of <i>06.11 Main status word</i> .	14										

No.	Name/Value	Description	Default FbEq 16
	Fault (-1)	Inverted bit 3 of <a href="#">06.11 Main status word</a> .	15
	Fault/Warning	A warning or fault is active.	16
	Overcurrent	A drive is tripped to overcurrent fault.	17
	Overvoltage	A drive is tripped to overvoltage fault.	18
	Drive temp	A drive is tripped to drive temperature fault.	19
	Undervoltage	A drive is tripped to undervoltage fault.	20
	Motor temp	A drive is tripped to motor temperature fault.	21
	Brake command	Bit 0 of <a href="#">44.01 Brake control status</a> .	22
	Ext2 active	Bit 11 of <a href="#">06.16 Drive status word 1</a> .	23
	Remote control	Bit 9 of <a href="#">06.11 Main status word</a> .	24
	Timed function 1	Bit 0 of <a href="#">34.01 Timed functions status</a> .	27
	Timed function 2	Bit 1 of <a href="#">34.01 Timed functions status</a> .	28
	Timed function 3	Bit 2 of <a href="#">34.01 Timed functions status</a> .	29
	Reserved	Bit 3 of <a href="#">34.01 Timed functions status</a> .	30
	Reserved	Bit 4 of <a href="#">34.01 Timed functions status</a> .	31
	Reserved	Bit 5 of <a href="#">34.01 Timed functions status</a> .	32
	Supervision 1	Bit 0 of <a href="#">32.01 Supervision status</a> .	33
	Supervision 2	Bit 1 of <a href="#">32.01 Supervision status</a> .	34
	Supervision 3	Bit 2 of <a href="#">32.01 Supervision status</a> .	35
	Start delay	Bit 13 of <a href="#">06.17 Drive status word 2</a> .	39
	RO/DIO control word bit0	Bit 0 of <a href="#">10.99 RO/DIO control word</a> .	40
	RO/DIO control word bit1	Bit 1 of <a href="#">10.99 RO/DIO control word</a> .	41
	RO/DIO control word bit2	Bit 2 of <a href="#">10.99 RO/DIO control word</a> .	42
	User load curve	Bit 3 (Outside load limit) of <a href="#">37.01 ULC output status word</a> (see page 255).	61
	RO/DIO control word	Maps to corresponding bit in parameter <a href="#">10.99 RO/DIO control word</a> . For example, Bit 0 of <a href="#">10.99 RO/DIO control word</a> controls RO1, Bit 1 of <a href="#">10.99 RO/DIO control word</a> controls RO2, and so on.	62
	<i>Other [bit]</i>	Source selection (see <a href="#">Terms and abbreviations</a> ).	-

No.	Name/Value	Description	Default FbEq 16																		
10.25	<i>RO1 ON delay</i>	Defines the activation delay for relay output RO1.	0.0 -																		
<p> <math>t_{on} = 10.25 \text{ RO1 ON delay}</math>  <math>t_{off} = 10.26 \text{ RO1 OFF delay}</math> </p>																					
	0.0 ... 3000.0 s	Activation delay for RO1.	10 = 1 -																		
10.26	<i>RO1 OFF delay</i>	Defines the deactivation delay for relay output RO1. See parameter <a href="#">10.25 RO1 ON delay</a> .	0.0 -																		
	0.0 ... 3000.0 s	Deactivation delay for RO1.	10 = 1 -																		
10.99	<i>RO/DIO control word</i>	Storage parameter for controlling the relay outputs eg. through the embedded fieldbus interface. To control the relay outputs (RO) of the drive, send a control word with the bit assignments shown below as Modbus I/O data. Set the target selection parameter of that particular data ( <a href="#">58.101...58.114</a> ) to <i>RO/DIO control word</i> . In the source selection parameter of the desired output, select the appropriate bit of this word.	0000h																		
<table border="1"> <thead> <tr> <th>Bit</th> <th>Name</th> <th>Description</th> </tr> </thead> <tbody> <tr> <td>0</td> <td>RO1</td> <td rowspan="8">Source bits for relay outputs RO1...RO3 (see parameter <a href="#">10.24</a>).</td> </tr> <tr> <td>1</td> <td>RO2</td> </tr> <tr> <td>2</td> <td>RO3</td> </tr> <tr> <td>3</td> <td>RO4</td> </tr> <tr> <td>4</td> <td>RO5</td> </tr> <tr> <td>5...7</td> <td>RO6-8</td> </tr> <tr> <td>8...15</td> <td>DIO1-8</td> </tr> </tbody> </table>				Bit	Name	Description	0	RO1	Source bits for relay outputs RO1...RO3 (see parameter <a href="#">10.24</a> ).	1	RO2	2	RO3	3	RO4	4	RO5	5...7	RO6-8	8...15	DIO1-8
Bit	Name	Description																			
0	RO1	Source bits for relay outputs RO1...RO3 (see parameter <a href="#">10.24</a> ).																			
1	RO2																				
2	RO3																				
3	RO4																				
4	RO5																				
5...7	RO6-8																				
8...15	DIO1-8																				
	0000h...FFFFh		RO control word.	1 = 1																	
10.101	<i>RO1 toggle counter</i>	Displays the number of times relay output RO1 has changed states.	-																		
	0...4294967000	State change count.	1 = 1																		
<b>11 Standard DIO, FI, FO</b>		Configuration of the digital inputs/outputs (DIO) for use as digital inputs,																			
11.02	<i>DIO delayed status</i>	Displays the delayed status of digital input/outputs DIO2 and DIO1. This word is updated only after activation/deactivation delays (if any are specified). <b>Example:</b> 0010 = DIO2 is on, DIO1 is off. This parameter is read-only.	-																		
	0000b...0011b	Status of digital input/outputs.	1 = 1																		

No.	Name/Value	Description	Default FbEq 16								
11.03	<i>DIO force selection</i>	Selects the digital inputs, states which will be controlled by parameter 11.04. A bit in parameter 11.04 is provided for each digital input, and its value is applied whenever the corresponding bit in this parameter is 1.	0000h								
<table border="1"> <thead> <tr> <th>Bit</th> <th>Value</th> </tr> </thead> <tbody> <tr> <td>0</td> <td>1 = Force DIO1 to value of bit 0 of parameter 11.04 <i>DIO force data</i>.</td> </tr> <tr> <td>1</td> <td>1 = Force DIO2 to value of bit 1 of parameter 11.04 <i>DIO force data</i>.</td> </tr> <tr> <td>2...15</td> <td>Reserved</td> </tr> </tbody> </table>				Bit	Value	0	1 = Force DIO1 to value of bit 0 of parameter 11.04 <i>DIO force data</i> .	1	1 = Force DIO2 to value of bit 1 of parameter 11.04 <i>DIO force data</i> .	2...15	Reserved
Bit	Value										
0	1 = Force DIO1 to value of bit 0 of parameter 11.04 <i>DIO force data</i> .										
1	1 = Force DIO2 to value of bit 1 of parameter 11.04 <i>DIO force data</i> .										
2...15	Reserved										
0000h...FFFFh		Forced selections of digital inputs/outputs.	1=1								
11.04	<i>DIO force data</i>	Defines the forced values for the digital inputs selected by parameter 11.03 <i>DIO force selection</i> . It is only possible to force an input that has been selected in parameter 10.03 <i>DI force selection</i> . Bit 0 is the forced value for DIO1.	0000h								
<table border="1"> <thead> <tr> <th>Bit</th> <th>Value</th> </tr> </thead> <tbody> <tr> <td>0</td> <td>Set state of DIO1.</td> </tr> <tr> <td>1</td> <td>Set state of DIO2.</td> </tr> <tr> <td>2...15</td> <td>Reserved</td> </tr> </tbody> </table>				Bit	Value	0	Set state of DIO1.	1	Set state of DIO2.	2...15	Reserved
Bit	Value										
0	Set state of DIO1.										
1	Set state of DIO2.										
2...15	Reserved										
0000h...FFFFh		Forced values of digital inputs/outputs.	1=1								
11.05	<i>DIO1 configuration</i>	Selects whether DIO1 is used as a digital output, digital input, or frequency output. <b>Note:</b> DIOs cannot be used as frequency inputs.	<i>Input</i>								
Digital output		DIO1 is used as a digital output.	0								
Input		Digital input.	1								
Frequency output		DIO1 is used as frequency output.	2								
11.06	<i>DIO1 output source</i>	Selects a drive signal to be connected to digital input/output DIO1 when it is configured to digital output by parameter 11.05.	<i>Not energized</i>								
Not energized		Output is not energized.	0								
Energized		Output is energized.	1								
Ready run		Bit 1 of 06.11 <i>Main status word</i> .	2								
Enabled		Bit 0 of 06.16 <i>Drive status word 1</i> .	4								
Started		Bit 5 of 06.16 <i>Drive status word 1</i> .	5								
Magnetized		Bit 1 of 06.17 <i>Drive status word 2</i> .	6								
Running		Bit 6 of 06.16 <i>Drive status word 1</i> .	7								
Ready ref		Bit 2 of 06.11 <i>Main status word</i> .	8								
At setpoint		Bit 8 of 06.11 <i>Main status word</i> .	9								
Reverse		Bit 2 of 06.19 <i>Speed control status word</i> .	10								
Zero speed		Bit 0 of 06.19 <i>Speed control status word</i> .	11								
Above limit		Bit 10 of 06.17 <i>Drive status word 2</i> .	12								
Warning		Bit 7 of 06.11 <i>Main status word</i> .	13								
Fault		Bit 3 of 06.11 <i>Main status word</i> .	14								



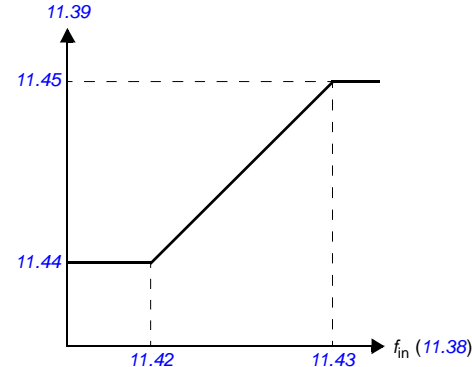

No.	Name/Value	Description	Default FbEq 16
	Fault (-1)	Inverted bit 3 of <a href="#">06.11 Main status word</a> .	15
	Fault/Warning	A warning or fault is active.	16
	Overcurrent	A drive is tripped to overcurrent fault.	17
	Overvoltage	A drive is tripped to overvoltage fault.	18
	Drive temp	A drive is tripped to drive temperature fault.	19
	Undervoltage	A drive is tripped to undervoltage fault.	20
	Motor temp	A drive is tripped to motor temperature fault.	21
	Brake command	Bit 0 of <a href="#">44.01 Brake control status</a> .	22
	Ext2 active	Bit 11 of <a href="#">06.16 Drive status word 1</a> .	23
	Remote control	Bit 9 of <a href="#">06.11 Main status word</a> .	24
	Timed function 1	Bit 0 of <a href="#">34.01 Timed functions status</a> .	27
	Timed function 2	Bit 1 of <a href="#">34.01 Timed functions status</a> .	28
	Timed function 3	Bit 2 of <a href="#">34.01 Timed functions status</a> .	29
	Reserved	Bit 3 of <a href="#">34.01 Timed functions status</a> .	30
	Reserved	Bit 4 of <a href="#">34.01 Timed functions status</a> .	31
	Reserved	Bit 5 of <a href="#">34.01 Timed functions status</a> .	32
	Supervision 1	Bit 0 of <a href="#">32.01 Supervision status</a> .	33
	Supervision 2	Bit 1 of <a href="#">32.01 Supervision status</a> .	34
	Supervision 3	Bit 2 of <a href="#">32.01 Supervision status</a> .	35
	Start delay	Bit 13 of <a href="#">06.17 Drive status word 2</a> .	39
	RO/DIO control word bit0	Bit 0 of <a href="#">10.99 RO/DIO control word</a> .	40
	RO/DIO control word bit1	Bit 1 of <a href="#">10.99 RO/DIO control word</a> .	41
	RO/DIO control word bit2	Bit 2 of <a href="#">10.99 RO/DIO control word</a> .	42
	User load curve	Bit 3 (Outside load limit) of <a href="#">37.01 ULC output status word</a> (see page 255).	61
	RO/DIO control word	Maps to corresponding bit in parameter <a href="#">10.99 RO/DIO control word</a> . For example, Bit 0 of <a href="#">10.99 RO/DIO control word</a> controls RO1, Bit 1 of <a href="#">10.99 RO/DIO control word</a> controls RO2, and so on.	62
	<i>Other [bit]</i>	Source selection (see <a href="#">Terms and abbreviations</a> ).	-
<a href="#">11.07</a>	<a href="#">DIO1 ON delay</a>	Defines the on (activation) delay for digital input/output DIO1 (when used as a digital output or digital input).	0.00 s
	0.0 ... 3000.0 s	Activation delay for DIO1.	10 = 1 s
<a href="#">11.08</a>	<a href="#">DIO1 OFF delay</a>	Defines the deactivation delay for digital input/output DIO1 (when used as a digital output or digital input). See parameter <a href="#">11.07 DIO1 ON delay</a> .	0.00 s
	0.0 ... 3000.0 s	Deactivation delay for DIO1.	10 = 1 s
<a href="#">11.09</a>	<a href="#">DIO2 configuration</a>	Selects whether DIO2 is used as a digital output or input, or a frequency output. <b>Note:</b> DIOs cannot be used as frequency inputs.	<i>Digital output</i>
	Digital output	DIO2 is used as a digital output.	0

No.	Name/Value	Description	Default FbEq 16
	Input	DIO2 is used as a digital input.	1
	Frequency output	DIO2 is used as frequency output.	2
11.10	<i>DIO2 output source</i>	Selects a drive signal to be connected to digital input/output DIO2 when parameter <a href="#">11.09 DIO2 configuration</a> is set to <i>Digital output</i> . For the available selections, see parameter <a href="#">11.06 DIO1 output source</a> .	<i>Ready run</i>
11.11	<i>DIO2 ON delay</i>	Defines the activation delay for digital input/output DIO2 (when used as a digital output or digital input).	0.00 s
	0.0 ... 300.0 s	Activation delay for DIO2	10 = 1 s
11.12	<i>DIO2 OFF delay</i>	Defines the deactivation delay for digital input/output DIO2 (when used as a digital output or digital input). See parameter <a href="#">11.11 DIO1 ON delay</a> .	0.00 s
	0.0 ... 3000.0 s	Deactivation delay for DIO2.	10 = 1 s
11.13	<i>DI3 configuration</i>	Selects the type of digital input DI3: normal digital input or frequency input.	<i>Digital input</i>
	Digital input	Digital input. See parameter <a href="#">11.42</a> for more information.	0
	Frequency input	Frequency input.	1
11.17	<i>DI4 configuration</i>	Selects the type of digital input DI4: normal digital input or frequency input.	
	Digital input	Digital input.	0
	Frequency input	Frequency input.	1
11.38	<i>Freq in 1 actual value</i>	Displays the value of frequency input 1 before scaling. See parameter <a href="#">11.42 Freq in 1 min</a> . This parameter is read-only.	-
	0 ... 16000 Hz	Unscaled value of frequency input 1.	1 = 1 Hz
11.39	<i>Freq in 1 scaled value</i>	Displays the value of frequency input 1 after scaling. See parameter <a href="#">11.42 Freq in 1 min</a> . This parameter is read-only.	-
	-32768.000... 32767.000	Scaled value of frequency input 1.	1 = 1

No.	Name/Value	Description	Default FbEq 16
11.42	<i>Freq in 1 min</i>	<p>Defines the minimum for the frequency actually arriving at frequency input 1.</p> <p>The incoming frequency signal (<i>11.38 Freq in 1 actual value</i>) is scaled into an internal signal (<i>11.39 Freq in 1 scaled value</i>) by parameters 11.42...11.45 as follows:</p> 	0 Hz
	0 ... 16000 Hz	Minimum frequency of frequency input 1.	1 = 1 Hz
11.43	<i>Freq in 1 max</i>	Defines the maximum value of the frequency signal actually arriving at frequency input 1. See parameter <i>11.42 Freq in 1 min</i> .	16000 Hz
	0 ... 16000 Hz	Maximum frequency of frequency input 1.	1 = 1 Hz
11.44	<i>Freq in 1 at scaled min</i>	Defines the value that corresponds to the actual minimum input frequency defined by parameter <i>11.42 Freq in 1 min</i> .	0.000
	-32768.000... 32767.000	Value corresponding to minimum of frequency input 1.	1 = 1
11.45	<i>Freq in 1 at scaled max</i>	Defines the value that corresponds to the actual maximum input frequency defined by parameter <i>11.43 Freq in 1 max</i> . See parameter <i>11.42 Freq in 1 min</i> .	1500.000
	-32768.000... 32767.000	Value corresponding to maximum of frequency input 1.	1 = 1
11.46	<i>Freq in 2 actual value</i>	Displays the value of frequency input 2 before scaling. See parameter <i>11.50 Freq in 2 min</i> . This parameter is read-only.	-
	0 ... 16000 Hz	Unscaled value of frequency input 2.	1 = 1 Hz
11.47	<i>Freq in 2 scaled</i>	Displays the value of frequency input 2 after scaling. See parameter <i>11.50 Freq in 2 min</i> . This parameter is read-only.	-
	-32768.000... 32767.000	Scaled value of frequency input 2.	1 = 1
11.50	<i>Freq in 2 min</i>	Defines the minimum value for frequency input 2.	0 Hz
	0 ... 16000 Hz	Minimum frequency of frequency input 2.	1 = 1 Hz
11.51	<i>Freq in 2 max</i>	Defines the maximum value for frequency input 2.	16000 Hz
	0 ... 16000 Hz	Maximum frequency for frequency input 2.	1 = 1 Hz

No.	Name/Value	Description	Default FbEq 16
11.52	<i>Freq in 2 at scaled min</i>	Defines the real value that corresponds to the minimum frequency input 2 value defined by parameter <i>Freq in 2 min.</i>	0.000
	-32768.000 ... 32767.000	Value corresponding to minimum of frequency input 2.	1 = 1
11.53	<i>Freq in 2 at scaled max</i>	Defines the real value that corresponds to the maximum frequency input 2 value defined by parameter <i>Freq in 2 max.</i>	1500.000
	-32768.000 ... 32767.000	Value corresponding to maximum of frequency input 2.	1 = 1
11.54	<i>Freq out 1 actual value</i>	Displays the value of frequency output 1 after scaling. See parameter <i>11.58 Freq out 1 src min.</i> This parameter is read-only.	-
	0 ... 16000 Hz	Unscaled value of frequency input 2.	1 = 1 Hz
11.55	<i>Freq out 1 source</i>	Selects a signal to be connected to frequency output 1.	<i>Motor speed used</i>
	Not selected	None	0
	Motor speed used	<i>01.01 Motor speed used</i>	1
	Output frequency	<i>01.06 Output frequency</i>	3
	Motor current	<i>01.07 Motor current</i>	4
	Motor torque	<i>01.10 Motor torque</i>	6
	DC voltage	<i>01.11 DC voltage</i>	7
	Output power	<i>01.13 Output power</i>	8
	Speed ref ramp in	<i>23.02 Speed ref ramp input</i>	10
	Speed ref ramp out	<i>23.01 Speed ref ramp output</i>	11
	Speed ref used	<i>24.01 Used speed reference</i>	12
	Torque ref used	<i>26.02 Torque reference used</i>	13
	Freq ref used	<i>28.02 Frequency ref ramp output</i>	14
	Process PID out	<i>40.04 Process PID deviation actual</i>	16
	<i>Other</i>	Source selection (see <i>Terms and abbreviations</i> ).	-
11.58	<i>Freq out 1 src min</i>	Defines the real value of the signal (selected by parameter <i>11.55 Freq out 1 source</i> and shown by parameter <i>11.54 Freq out 1 actual value</i> ) that corresponds to the minimum value of frequency output 1 (defined by parameter <i>11.60 Freq out 1 at src min</i> ).	0.000
	-32768.000 ... 32767.000	Real signal value corresponding to minimum value of frequency output 1.	1 = 1
11.59	<i>Freq out 1 src max</i>	Defines the minimum value for frequency output 1.	1500.000
	-32768.000 ... 32767.000	Real signal value corresponding to maximum value of frequency output 1.	1 = 1
11.60	<i>Freq out 1 at src min</i>	Defines the real value that corresponds to the minimum frequency output 1 value defined by parameter <i>Freq out 1 min.</i>	0 Hz
	0 ... 16000 Hz	Minimum value of frequency output 1.	1 = 1 Hz
11.61	<i>Freq out 1 at src max</i>	Defines the real value that corresponds to the maximum frequency output 1 value defined by parameter <i>Freq out 1 max.</i>	16000 Hz

No.	Name/Value	Description	Default FbEq 16								
	0 ... 16000 Hz	Maximum value of frequency output 1.	1 = 1 Hz								
11.62	<i>Freq out 2 actual value</i>	Displays the value of frequency output 2 after scaling. See parameter <a href="#">11.66 Freq out 2 source min</a> . This parameter is read-only.	-								
	0 ... 16000 Hz	Unscaled value of frequency input 2.	1 = 1 Hz								
11.63	<i>Freq out 2 source</i>	Selects a drive signal to be connected to the frequency output 2. For the available selections, see parameter <a href="#">11.55 Freq out 1 source</a> .	<i>Not selected</i>								
11.66	<i>Freq out 2 source min</i>	Defines the minimum value for frequency output 2.	0.000								
	-32768.000 ... 32767.000	Real signal value corresponding to minimum value of frequency output 2.	1 = 1								
11.67	<i>Freq out 2 source max</i>	Defines the minimum value for frequency output 2.	1500.000								
	-32768.000 ... 32767.000	Real signal value corresponding to maximum value of frequency output 2.	1 = 1								
11.68	<i>Freq out 2 at src min</i>	Defines the real value that corresponds to the minimum frequency output 2 value defined by parameter <a href="#">Freq out 2 min</a> .	0 Hz								
	0 ... 16000 Hz	Minimum value of frequency output 2.	1 = 1 Hz								
11.69	<i>Freq out 2 at src max</i>	Defines the real value that corresponds to the maximum frequency output 2 value defined by parameter <a href="#">Freq out 2 max</a> .	16000 Hz								
	0 ... 16000 Hz	Maximum value of frequency output 2.	1 = 1 Hz								
<b>12 Standard AI</b>		Configuration of standard analog inputs.									
12.02	<i>AI force selection</i>	The true readings of the analog inputs can be overridden for e.g. testing purposes. A forced value parameter is provided for each analog input, and its value is applied whenever the corresponding bit in this parameter is 1. <b>Note:</b> AI filter times (parameters <a href="#">12.16 AI1 filter time</a> and <a href="#">12.26 AI1 filter time</a> ) have no effect on forced AI values (parameters <a href="#">12.13 AI1 forced value</a> and <a href="#">12.23 AI2 forced value</a> ). <b>Note:</b> Boot and power cycle reset the force selections (parameter <a href="#">12.02</a> ).	0000h								
		<table border="1"> <thead> <tr> <th>Bit</th> <th>Value</th> </tr> </thead> <tbody> <tr> <td>0</td> <td>1 = Force AI1 to value of parameter <a href="#">12.13 AI1 forced value</a>.</td> </tr> <tr> <td>1</td> <td>1 = Force AI2 to value of parameter <a href="#">12.23 AI2 forced value</a>.</td> </tr> <tr> <td>2...15</td> <td>Reserved</td> </tr> </tbody> </table>	Bit	Value	0	1 = Force AI1 to value of parameter <a href="#">12.13 AI1 forced value</a> .	1	1 = Force AI2 to value of parameter <a href="#">12.23 AI2 forced value</a> .	2...15	Reserved	
Bit	Value										
0	1 = Force AI1 to value of parameter <a href="#">12.13 AI1 forced value</a> .										
1	1 = Force AI2 to value of parameter <a href="#">12.23 AI2 forced value</a> .										
2...15	Reserved										
0000h...FFFFh		Forced values selector for analog inputs AI1 and AI2.	1 = 1								

No.	Name/Value	Description	Default FbEq 16																		
12.03	<i>AI supervision function</i>	<p>Selects how the drive reacts when an analog input signal moves out of the minimum and/or maximum limits specified for the input.</p> <p>The supervision applies a margin of 0.5 V or 1.0 mA to the limits. For example, if the maximum limit for the input is 7.000 V, the maximum limit supervision activates at 7.500 V.</p> <p>The inputs and the limits to be observed are selected by parameter <i>12.04 AI supervision selection</i>.</p>	<i>No action</i>																		
	No action	No action taken.	0																		
	Fault	Drive trips on <i>80A0 AI supervision</i> .	1																		
	Warning	Drive generates an <i>A8A0 AI supervision</i> warning.	2																		
	Last speed	<p>Drive generates a warning (<i>A8A0 AI supervision</i>) and freezes the speed (or frequency) to the level the drive was operating at. The speed/frequency is determined on the basis of actual speed using 850 ms low-pass filtering.</p> <p> <b>WARNING!</b> Make sure that it is safe to continue operation in case of a communication break.</p>	3																		
	Speed ref safe	<p>Drive generates a warning (<i>A8A0 AI supervision</i>) and sets the speed to the speed defined by parameter <i>22.41 Speed ref safe</i> (or <i>28.41 Frequency ref safe</i> when frequency reference is being used).</p> <p> <b>WARNING!</b> Make sure that it is safe to continue operation in case of a communication break.</p>	4																		
12.04	<i>AI supervision selection</i>	Specifies the analog input limits to be supervised. See parameter <i>12.03 AI supervision function</i> .	0000h																		
		<table border="1"> <thead> <tr> <th>Bit</th> <th>Name</th> <th>Description</th> </tr> </thead> <tbody> <tr> <td>0</td> <td>AI1 &lt; MIN</td> <td>1 = Minimum limit supervision of AI1 active.</td> </tr> <tr> <td>1</td> <td>AI1 &gt; MAX</td> <td>1 = Maximum limit supervision of AI1 active.</td> </tr> <tr> <td>2</td> <td>AI2 &lt; MIN</td> <td>1 = Minimum limit supervision of AI2 active.</td> </tr> <tr> <td>3</td> <td>AI2 &gt; MAX</td> <td>1 = Maximum limit supervision of AI2 active.</td> </tr> <tr> <td>4...15</td> <td>Reserved</td> <td></td> </tr> </tbody> </table>	Bit	Name	Description	0	AI1 < MIN	1 = Minimum limit supervision of AI1 active.	1	AI1 > MAX	1 = Maximum limit supervision of AI1 active.	2	AI2 < MIN	1 = Minimum limit supervision of AI2 active.	3	AI2 > MAX	1 = Maximum limit supervision of AI2 active.	4...15	Reserved		
Bit	Name	Description																			
0	AI1 < MIN	1 = Minimum limit supervision of AI1 active.																			
1	AI1 > MAX	1 = Maximum limit supervision of AI1 active.																			
2	AI2 < MIN	1 = Minimum limit supervision of AI2 active.																			
3	AI2 > MAX	1 = Maximum limit supervision of AI2 active.																			
4...15	Reserved																				
	0000h...FFFh	Activation of analog input supervision.	1 = 1																		
12.11	<i>AI1 actual value</i>	<p>Displays the value of analog input AI1 in mA or V (depending on whether the input is set to current or voltage by a hardware setting).</p> <p>This parameter is read-only.</p>	-																		
	0.000...20.000 mA or 0.000...10.000 V	Value of analog input AI1.	1000 = 1 unit																		
12.12	<i>AI1 scaled value</i>	<p>Displays the value of analog input AI1 after scaling. See parameters <i>12.19 AI1 scaled at AI1 min</i> and <i>12.20 AI1 scaled at AI1 max</i>.</p> <p>This parameter is read-only.</p>	-																		
	-32768 ... 32767	Scaled value of analog input AI1.	1 = 1																		
12.13	<i>AI1 forced value</i>	Defines the forced value that can be used instead of the true reading of the input. See parameter <i>12.02 AI force selection</i> .	-																		
	-		1000 = 1 -																		

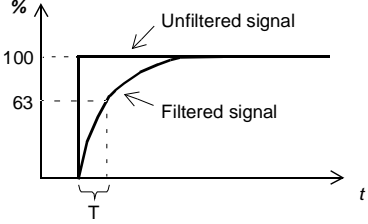
No.	Name/Value	Description	Default FbEq 16
12.15	<i>AI1 unit selection</i>	Selects the unit for readings and settings related to analog input AI1. See the default control connections of the macro in use, in chapter <i>Control macros</i> (page 31).	V
	V	Volts.	0
	mA	Milliamperes.	1
12.16	<i>AI1 filter time</i>	Defines the filter time constant for analog input AI1.  $O = I \times (1 - e^{-t/T})$ I = filter input (step) O = filter output t = time T = filter time constant <b>Note:</b> The signal is also filtered due to the signal interface hardware (approximately 0.25 ms time constant). This cannot be changed by any parameter.	0.100 s
	0.000...30.000 s	Filter time constant.	1000 = 1 s
12.17	<i>AI1 min</i>	Defines the minimum site value for analog input AI1. Set the value actually sent to the drive when the analog signal from plant is wound to its minimum setting.	4.000 mA or 0.000 V
	0.000...20.000 mA or 0.000...10.00 V	Minimum value of AI1.	1000 = 1 mA or V
12.18	<i>AI1 max</i>	Defines the maximum site value for analog input AI1. Set the value actually sent to the drive when the analog signal from plant is wound to its maximum setting.	20.000 mA or 10.00 V
	0.000...20.000 mA or 0.000...10.00 V	Maximum value of AI1.	1000 = 1 mA or V

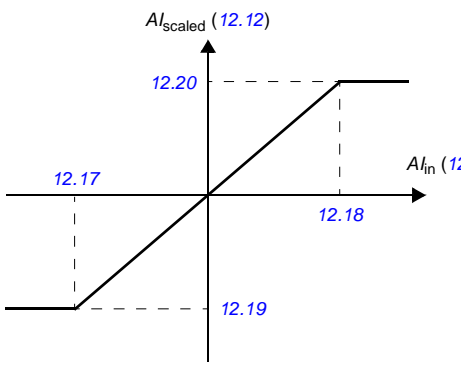
No.	Name/Value	Description	Default FbEq 16
12.19	<i>AI1 scaled at AI1 min</i>	Defines the real internal value that corresponds to the minimum analog input AI1 value defined by parameter <a href="#">12.17 AI1 min</a> . (Changing the polarity settings of <a href="#">12.19</a> and <a href="#">12.20</a> can effectively invert the analog input.) 	0
	-32768.000... 32767.000		1 = 1
12.20	<i>AI1 scaled at AI1 max</i>	Defines the real internal value that corresponds to the maximum analog input AI1 value defined by parameter <a href="#">12.18 AI1 max</a> . See the drawing at parameter <a href="#">12.19 AI1 scaled at AI1 min</a> .	50.000
	-32768.000... 32767.000	Real value corresponding to maximum AI1 value.	1 = 1
12.21	<i>AI2 actual value</i>	Displays the value of analog input AI2 in mA or V (depending on whether the input is set to current or voltage by a hardware setting). This parameter is read-only.	-
	0.000...20.000 mA or 0.000...10.000 V	Value of analog input AI2.	1000 = 1 mA or V
12.22	<i>AI2 scaled value</i>	Displays the value of analog input AI2 after scaling. See parameters <a href="#">12.29 AI2 scaled at AI2 min</a> and <a href="#">12.101 AI1 percent value</a> . This parameter is read-only.	-
	-32768.000... 32767.000	Scaled value of analog input AI2.	1 = 1
12.23	<i>AI2 forced value</i>	Forced value that can be used instead of the true reading of the input. See parameter <a href="#">12.02 AI force selection</a> .	-
	0.000...20.000 mA or 0.000...10.000 V	Forced value of analog input AI2.	1000 = 1 mA or V
12.25	<i>AI2 unit selection</i>	Selects the unit for readings and settings related to analog input AI2. See the default control connections of the macro in use, in chapter <a href="#">Control macros</a> (page 31).	mA
	V	Volts.	2
	mA	Milliamperes.	1

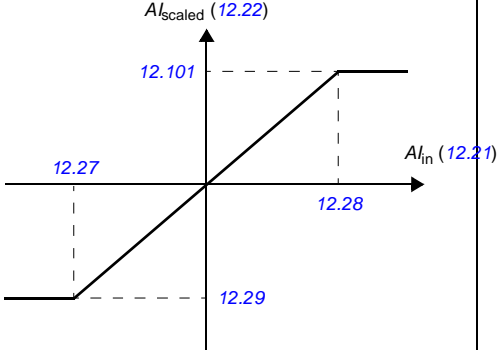

No.	Name/Value	Description	Default FbEq 16
12.26	<i>AI2 filter time</i>	Defines the filter time constant for analog input AI2. See parameter <a href="#">12.16 AI1 filter time</a> . Note: The signal is also filtered due to the signal interface hardware (approximately 0.25 ms time constant). This cannot be changed by any parameter.	0.100 s
	0.000...30.000 s	Filter time constant.	1000 = 1 s
12.27	<i>AI2 min</i>	Defines the minimum site value for analog input AI2. Set the value actually sent to the drive when the analog signal from plant is wound to its minimum setting.	4.000 mA or 0.000 V
	0.000...20.000 mA or 0.000...10.000 V	Minimum value of AI2.	1000 = 1 mA or V
12.28	<i>AI2 max</i>	Defines the maximum site value for analog input AI2. Set the value actually sent to the drive when the analog signal from plant is wound to its maximum setting.	20.000 mA or 10.000 V
	0.000...20.000 mA or 0.000...10.000 V	Maximum value of AI2.	1000 = 1 mA or V
12.29	<i>AI2 scaled at AI2 min</i>	Defines the real value that corresponds to the minimum analog input AI2 value defined by parameter <a href="#">12.27 AI2 min</a> . (Changing the polarity settings of <a href="#">12.29</a> and <a href="#">12.101</a> can effectively invert the analog input.) 	0.000
	-32768.000... 32767.000	Real value corresponding to minimum AI2 value.	1 = 1
12.30	<i>AI2 scaled at AI2 max</i>	Defines the real value that corresponds to the maximum analog input AI2 value defined by parameter <a href="#">12.28 AI2 max</a> . See the drawing at parameter of <a href="#">12.29 AI2 scaled at AI2 min</a>	50.000
	-32768.000... 32767.000	Real value corresponding to maximum AI2 value.	1 = 1
12.101	<i>AI1 percent value</i>	Value of analog input AI1 in percent of AI1 scaling ( <a href="#">12.18 AI1 max</a> - <a href="#">12.17 AI1 min</a> ).	-
	0.00... 100.00	AI1 value	100 = 1%
12.102	<i>AI2 percent value</i>	Value of analog input AI2 in percent of AI1 scaling ( <a href="#">12.28 AI2 max</a> - <a href="#">12.27 AI2 min</a> ).	-
	0.00... 100.00	AI2 value	100 = 1%

No.	Name/Value	Description	Default FbEq 16						
<b>13 Standard AO</b>		Configuration of standard analog outputs.							
13.02	<i>AO force selection</i>	<p>Selects the analog outputs that will be forced to values defined by parameters.</p> <p>The true source signals of the analog outputs can be overridden for eg. testing purposes. A forced value parameter is provided for each analog output, and its value is applied whenever the corresponding bit in this parameter is 1.</p> <p><b>Note:</b> Boot and power cycle reset the force selections (parameters <a href="#">13.02</a> and <a href="#">13.11</a>).</p>	0000h						
		<table border="1"> <thead> <tr> <th>Bit</th> <th>Value</th> </tr> </thead> <tbody> <tr> <td>0</td> <td>1 = Force AO1 to value of parameter <a href="#">13.13 AO1 forced value</a>.</td> </tr> <tr> <td>1...15</td> <td>Reserved.</td> </tr> </tbody> </table>	Bit	Value	0	1 = Force AO1 to value of parameter <a href="#">13.13 AO1 forced value</a> .	1...15	Reserved.	
Bit	Value								
0	1 = Force AO1 to value of parameter <a href="#">13.13 AO1 forced value</a> .								
1...15	Reserved.								
	0000h...FFFFh	Forced values selector for analog output AO1.	1 = 1						
13.11	<i>AO1 actual value</i>	<p>Displays the value of AO1 in mA.</p> <p>This parameter is read-only.</p>	-						
	0.000...22.000 mA	Value of AO1.	1 = 1 mA						
13.12	<i>AO1 source</i>	Selects a signal to be connected to analog output AO1.	<i>Output frequency</i>						
	Zero	None.	0						
	Motor speed used	<a href="#">01.01 Motor speed used</a>	1						
	Output frequency	<a href="#">01.06 Output frequency</a>	3						
	Motor current	<a href="#">01.07 Motor current</a>	4						
	Motor current % of motor nom	<a href="#">01.08 Motor current % of motor nom</a>	5						
	Motor torque	<a href="#">01.10 Motor torque</a>	6						
	DC voltage	<a href="#">01.11 DC voltage</a>	7						
	Output power	<a href="#">01.14 Output power</a>	8						
	Speed ref ramp in	<a href="#">23.01 Speed ref ramp input</a>	10						
	Speed ref ramp out	<a href="#">23.02 Speed ref ramp output</a>	11						
	Speed ref used	<a href="#">24.01 Used speed reference</a>	12						
	Freq ref used	<a href="#">28.02 Frequency ref ramp output</a>	14						
	Process PID out	<a href="#">40.01 Process PID output actual</a>	16						
	Temp sensor 1 excitation	The output is used to feed an excitation current to the temperature sensor 1, see parameter <a href="#">35.11 Temperature 1 source</a> . See also section <a href="#">Motor thermal protection</a> .	20						
	Temp sensor 2 excitation	The output is used to feed an excitation current to the temperature sensor 2, see parameter <a href="#">35.21 Temperature 2 source</a> . See section <a href="#">Motor thermal protection</a> in chapter <a href="#">Program features</a> .	21						
	Abs motor speed used	<a href="#">01.61 Abs motor speed used</a>	26						
	Abs motor speed %	<a href="#">01.62 Abs motor speed %</a>	27						
	Abs output frequency	<a href="#">01.63 Abs output frequency</a>	28						
	Abs motor torque	<a href="#">01.64 Abs motor torque</a>	30						

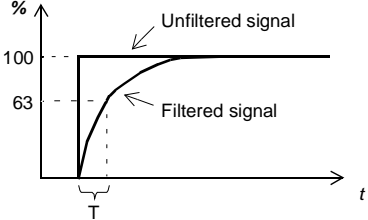
No.	Name/Value	Description	Default FbEq 16
	Abs output power	<a href="#">01.65 Abs output power</a>	31
	Abs motor shaft power	<a href="#">01.68 Abs motor shaft power</a>	32
	External PID1 out	<a href="#">71.01 External PID act value</a>	33
	AO1 data storage	<a href="#">13.91 AO1 data storage</a>	37
	<i>Other</i>	Source selection (see <a href="#">Terms and abbreviations</a> ).	-
13.13	<a href="#">AO1 forced value</a>	Forced value that can be used instead of the selected output signal. See parameter <a href="#">13.02 AO force selection</a> .	0.000 mA
	-		1000 = 1 -
13.15	<a href="#">AO1 unit selection</a>	Selects the unit for readings and settings related to analog input AO1. <b>Note:</b> This setting must match the corresponding hardware setting on the drive control unit (see the drive hardware manual). See the default control connections for the macro in use in chapter <a href="#">Control macros</a> . Control board reboot (either by cycling the power or through parameter <a href="#">96.08 Control board boot</a> ) is required to validate any changes in the hardware settings.	<i>mA</i>
	V	Volts.	0
	mA	Milliamperes.	1
13.16	<a href="#">AO1 filter time</a>	Defines the filtering time constant for analog output AO1.   $O = I \times (1 - e^{-t/T})$ I = filter input (step) O = filter output t = time T = filter time constant	0.100 s
	0.000 ... 30.000 s	Filter time constant.	1000 = 1 s

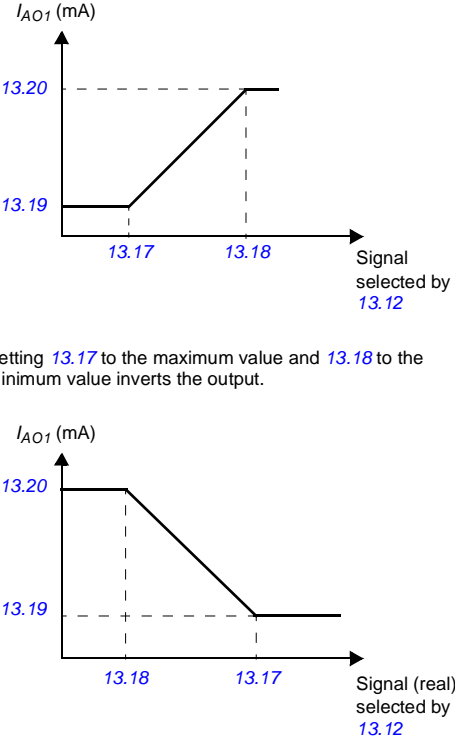
No.	Name/Value	Description	Default FbEq 16
13.17	<i>AO1 source min</i>	<p>Defines the real minimum value of the signal (selected by parameter <a href="#">13.12 AO1 source</a>) that corresponds to the minimum required AO1 output value (defined by parameter <a href="#">13.19 AO1 out at AO1 src min</a>).</p>  <p>Setting <a href="#">13.17</a> to the maximum value and <a href="#">13.18</a> to the minimum value inverts the output.</p>	0.0
	-32768.0...32767.0	Real signal value corresponding to minimum AO1 output value.	1 = 1
13.18	<i>AO1 source max</i>	<p>Defines the real maximum value of the signal (selected by parameter <a href="#">13.12 AO1 source</a>) that corresponds to the maximum required AO1 output value (defined by parameter <a href="#">13.20 AO1 out at AO1 src max</a>). See parameter <a href="#">13.17 AO1 source min</a>.</p>	50.0
	-32768.0...32767.0	Real signal value corresponding to maximum AO1 output value.	1 = 1
13.19	<i>AO1 out at AO1 src min</i>	<p>Defines the minimum output value for analog output AO1. See also drawing at parameter <a href="#">13.17 AO1 source min</a>.</p>	0.000 mA
	0.000...22.00 mA 0.000...11.000 V	Minimum AO1 output value.	1000 = 1 mA

No.	Name/Value	Description	Default FbEq 16												
13.20	<i>AO1 out at AO1 src max</i>	Defines the maximum output value for analog output AO1. See also drawing at parameter <i>13.17 AO1 source min</i> .	20.000 mA												
	0.000...22.000 mA 0.000...11.000 V	Maximum AO1 output value.	1000 = 1 mA												
13.91	<i>AO1 data storage</i>	Storage parameter for controlling analog output AO1 eg. through the embedded fieldbus interface. In parameter <i>13.12 AO1 source</i> , select <i>AO1 data storage</i> . Then set this parameter as the target of the incoming value data. With the embedded fieldbus interface, set the target selection parameter of that particular data ( <i>58.101...58.114</i> to <i>AO1 data storage</i> ).	0.00												
	-327.68 ... 327.67	Storage parameter for AO1.	100 = 1												
<b>15 I/O extension module</b>		Configuration of the I/O extension module. <b>Note:</b> The contents of the parameter group vary according to the selected I/O extension module type.													
15.01	<i>Extension module type</i>	Activates (and specifies the type of) I/O extension module. If the value is <i>None</i> , when an extension module has been installed and the drive is powered, the drive automatically sets the value to the type it has detected (= value of parameter <i>15.02 Detected extension module</i> ); otherwise warning <i>A7AB Extension I/O configuration failure</i> is generated and you have to set the value of this parameter manually.	<i>None</i>												
	None	Inactive.	0												
	BREL	External relay option BREL-01.	5												
	BAPO-01	Auxiliary power extension module option BAPO-01.	6												
	BTAC-02	BTAC-02 pulse encoder interface module option BTAC-02.	7												
15.02	<i>Detected extension module</i>	Shows the I/O extension module that the control program has automatically detected on the drive.	<i>None</i>												
	None	Inactive.	0												
	BREL	External relay option BREL-01.	5												
	BAPO-01	Auxiliary power extension module option BAPO-01.	6												
	BTAC-02	Pulse encoder interface module option BTAC-02.	7												
15.04	<i>RO status</i>	Displays the status of the relay outputs RO2, RO3, RO4 and RO5 on the extension module.	-												
<table border="1"> <thead> <tr> <th>Bit</th> <th>Value</th> </tr> </thead> <tbody> <tr> <td>0</td> <td>Status of RO2 (1= relay closed, 0=relay open)</td> </tr> <tr> <td>1</td> <td>Status of RO3 (1= relay closed, 0=relay open)</td> </tr> <tr> <td>2</td> <td>Status of RO4 (1= relay closed, 0=relay open)</td> </tr> <tr> <td>3</td> <td>Status of RO5 (1= relay closed, 0=relay open)</td> </tr> <tr> <td>4...15</td> <td>Reserved</td> </tr> </tbody> </table>				Bit	Value	0	Status of RO2 (1= relay closed, 0=relay open)	1	Status of RO3 (1= relay closed, 0=relay open)	2	Status of RO4 (1= relay closed, 0=relay open)	3	Status of RO5 (1= relay closed, 0=relay open)	4...15	Reserved
Bit	Value														
0	Status of RO2 (1= relay closed, 0=relay open)														
1	Status of RO3 (1= relay closed, 0=relay open)														
2	Status of RO4 (1= relay closed, 0=relay open)														
3	Status of RO5 (1= relay closed, 0=relay open)														
4...15	Reserved														
	0000h...FFFFh	Status of relay outputs.	1 = 1												

No.	Name/Value	Description	Default FbEq 16												
15.05	<i>RO force selection</i>	The electrical statuses of the relay outputs can be overridden for e.g. testing purposes. A bit in parameter <i>15.06 RO forced data</i> is provided for each relay output, and its value is applied whenever the corresponding bit in this parameter is 1. <b>Note:</b> Boot and power cycle reset the force selections (parameters <i>15.05</i> and <i>15.06</i> ).	0000h												
<table border="1"> <thead> <tr> <th>Bit</th> <th>Value</th> </tr> </thead> <tbody> <tr> <td>0</td> <td>1= Force RO2 to value of bit 0 of parameter <i>15.06 RO forced data</i>.</td> </tr> <tr> <td>1</td> <td>1= Force RO3 to value of bit 1 of parameter <i>15.06 RO forced data</i>.</td> </tr> <tr> <td>2</td> <td>1= Force RO4 to value of bit 2 of parameter <i>15.06 RO forced data</i>.</td> </tr> <tr> <td>3</td> <td>1= Force RO5 to value of bit 3 of parameter <i>15.06 RO forced data</i>.</td> </tr> <tr> <td>4...15</td> <td>Reserved</td> </tr> </tbody> </table>				Bit	Value	0	1= Force RO2 to value of bit 0 of parameter <i>15.06 RO forced data</i> .	1	1= Force RO3 to value of bit 1 of parameter <i>15.06 RO forced data</i> .	2	1= Force RO4 to value of bit 2 of parameter <i>15.06 RO forced data</i> .	3	1= Force RO5 to value of bit 3 of parameter <i>15.06 RO forced data</i> .	4...15	Reserved
Bit	Value														
0	1= Force RO2 to value of bit 0 of parameter <i>15.06 RO forced data</i> .														
1	1= Force RO3 to value of bit 1 of parameter <i>15.06 RO forced data</i> .														
2	1= Force RO4 to value of bit 2 of parameter <i>15.06 RO forced data</i> .														
3	1= Force RO5 to value of bit 3 of parameter <i>15.06 RO forced data</i> .														
4...15	Reserved														
0000h...FFFFh		Override selection for relay outputs.	1 = 1												
15.06	<i>RO forced data</i>	Allows the data value of a forced relay or relay output to be changed from 0 to 1. It is only possible to force an output that has been selected in parameter <i>15.05 RO force selection</i> Bits 0...3 are the forced values for RO2...RO5.	0000h												
<table border="1"> <thead> <tr> <th>Bit</th> <th>Value</th> </tr> </thead> <tbody> <tr> <td>0</td> <td>1= Force RO2 to value of bit 0 of parameter <i>15.05 RO force selection</i></td> </tr> <tr> <td>1</td> <td>1= Force RO3 to value of bit 1 of parameter <i>15.05 RO force selection</i></td> </tr> <tr> <td>2</td> <td>1=Force RO4 to value of bit 2 of parameter <i>15.05 RO force selection</i></td> </tr> <tr> <td>3</td> <td>1= Force RO5 to value of bit 3 of parameter <i>15.05 RO force selection</i></td> </tr> <tr> <td>4...15</td> <td>Reserved</td> </tr> </tbody> </table>				Bit	Value	0	1= Force RO2 to value of bit 0 of parameter <i>15.05 RO force selection</i>	1	1= Force RO3 to value of bit 1 of parameter <i>15.05 RO force selection</i>	2	1=Force RO4 to value of bit 2 of parameter <i>15.05 RO force selection</i>	3	1= Force RO5 to value of bit 3 of parameter <i>15.05 RO force selection</i>	4...15	Reserved
Bit	Value														
0	1= Force RO2 to value of bit 0 of parameter <i>15.05 RO force selection</i>														
1	1= Force RO3 to value of bit 1 of parameter <i>15.05 RO force selection</i>														
2	1=Force RO4 to value of bit 2 of parameter <i>15.05 RO force selection</i>														
3	1= Force RO5 to value of bit 3 of parameter <i>15.05 RO force selection</i>														
4...15	Reserved														
0000h...FFFFh		Forced values of relay outputs.	1 = 1												
15.07	<i>RO2 source</i>	Selects a drive signal to be connected to relay output RO2.	<i>Not energized</i>												
Not energized		Output is not energized.	0												
Energized		Output is energized.	1												
Ready run		Bit 1 of <i>06.11 Main status word</i>	2												
Enabled		Bit 0 of <i>06.16 Drive status word 1</i> .	4												
Started		Bit 5 of <i>06.16 Drive status word 1</i> .	5												
Magnetized		Bit 1 of <i>06.17 Drive status word 2</i> .	6												
Running		Bit 6 of <i>06.16 Drive status word 1</i> .	7												
Ready ref		Bit 2 of <i>06.11 Main status word</i> .	8												
At setpoint		Bit 8 of <i>06.11 Main status word</i> .	9												
Reverse		Bit 2 of <i>06.19 Speed control status word</i> .	10												
Zero speed		Bit 0 of <i>06.19 Speed control status word</i> .	11												
Above limit		Bit 10 of <i>06.17 Drive status word 2</i> .	12												
Warning		Bit 7 of <i>06.11 Main status word</i> .	13												
Fault		Bit 3 of <i>06.11 Main status word</i> .	14												
Fault (-1)		Inverted bit 3 of <i>06.11 Main status word</i> .	15												

No.	Name/Value	Description	Default FbEq 16
	Fault/Warning	Bit 3 OR bit 7 of <a href="#">06.11 Main status word</a> .	16
	Overcurrent	Relay is energized when drive is tripped to overcurrent fault.	17
	Overvoltage	Relay is energized when drive is tripped to overvoltage fault.	18
	Drive temp	Relay is energized when drive is tripped to drive temperature fault.	19
	Undervoltage	Relay is energized when drive is tripped to undervoltage fault.	20
	Motor temp	Relay is energized when drive is tripped to motor temperature fault.	21
	Brake command	Bit 0 of <a href="#">44.01 Brake control status</a> .	22
	Ext2 active	Bit 11 of <a href="#">06.16 Drive status word 1</a> .	23
	Remote control	Bit 9 of <a href="#">06.11 Main status word</a> .	24
	Timed function 1	Bit 0 of <a href="#">34.01 Timed functions status</a> .	27
	Timed function 2	Bit 1 of <a href="#">34.01 Timed functions status</a> .	28
	Timed function 3	Bit 2 of <a href="#">34.01 Timed functions status</a> .	29
	Supervision 1	Bit 0 of <a href="#">32.01 Supervision status</a> .	33
	Supervision 2	Bit 1 of <a href="#">32.01 Supervision status</a> .	34
	Supervision 3	Bit 2 of <a href="#">32.01 Supervision status</a> .	35
	Start delay		39
	RO/DIO control word bit0	Bit 0 of <a href="#">10.99 RO/DIO control word</a> .	40
	RO/DIO control word bit1	Bit 1 of <a href="#">10.99 RO/DIO control word</a> .	41
	RO/DIO control word bit2	Bit 2 of <a href="#">10.99 RO/DIO control word</a> .	42
	User load curve	Bit 3 (Outside load limit) of <a href="#">37.01 ULC output status word</a> (see page 255).	61
	RO/DIO control word	Maps to corresponding bit in parameter <a href="#">10.99 RO/DIO control word</a> . For example, Bit 0 of <a href="#">10.99 RO/DIO control word</a> controls RO1, Bit 1 of <a href="#">10.99 RO/DIO control word</a> controls RO2, and so on.	62
	<i>Other [bit]</i>	Source selection (see <a href="#">Terms and abbreviations</a> ).	-

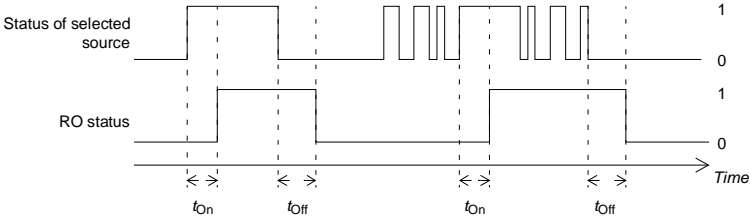
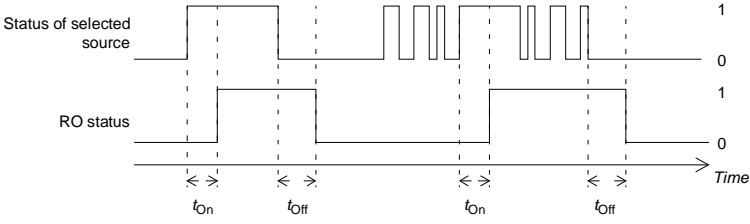
No.	Name/Value	Description	Default FbEq 16
15.08	<i>RO2 ON delay</i>	Defines the activation delay for relay output RO2.	0.0 s
 <p data-bbox="165 507 360 549"><math>t_{On} = 15.08</math> RO2 ON delay <math>t_{Off} = 15.09</math> RO2 OFF delay</p>			
0.0 ... 3000.0 s		Activation delay for RO2.	1 = 1 s
15.09	<i>RO2 OFF delay</i>	Defines the deactivation delay for relay output RO2. See parameter <a href="#">15.08 RO2 ON delay</a> .	0.0 s
0.0 ... 3000.0 s		Deactivation delay for RO2.	1 = 1 s
15.10	<i>RO3 source</i>	Selects a drive signal to be connected to relay output RO3.	<i>Not energized</i>
		See parameter <a href="#">15.07 RO2 source</a> for the available selections.	
15.11	<i>RO3 ON delay</i>	Defines the activation delay for relay output RO3.	0.0 s
 <p data-bbox="165 1066 360 1107"><math>t_{On} = 15.11</math> RO3 ON delay <math>t_{Off} = 15.12</math> RO3 OFF delay</p>			
0.0 ... 3000.0 s		Activation delay for RO5.	1 = 1 s
15.12	<i>RO3 OFF delay</i>	Defines the deactivation delay for relay output RO5. See parameter <a href="#">15.11 RO3 ON delay</a> .	0.0 s
0.0 ... 3000.0 s		Deactivation delay for RO3.	1 = 1 s
15.13	<i>RO4 source</i>	Selects a drive signal to be connected to relay output RO4.	<i>Not energized</i>
		See parameter <a href="#">15.07 RO2 source</a> for the available selections.	
15.14	<i>RO4 ON delay</i>	Defines the activation delay for relay output RO4.	0.0 s



No.	Name/Value	Description	Default FbEq 16
<p><math>t_{on} = 15.08</math> RO4 ON delay <math>t_{off} = 15.09</math> RO4 OFF delay</p>			
	0.0 ... 3000.0 s	Activation delay for RO4.	1 = 1 s
15.15	RO4 OFF delay	Defines the deactivation delay for relay output RO4. See parameter 15.14 RO4 ON delay.	0.0 s
	0.0 ... 3000.0 s	Deactivation delay for RO4.	1 = 1 s
15.16	RO5 source	Selects a drive signal to be connected to relay output RO5.	Not energized
		See parameter 15.07 RO2 source for the available selections.	
15.17	RO5 ON delay	Defines the activation delay for relay output RO5.	0.0 s
<p><math>t_{on} = 15.17</math> RO3 ON delay <math>t_{off} = 15.18</math> RO5 OFF delay</p>			
	0.0 ... 3000.0 s	Activation delay for RO5.	1 = 1 s
15.18	RO5 OFF delay	Defines the deactivation delay for relay output RO5. See parameter 15.17 RO3 ON delay.	0.0 s
	0.0 ... 3000.0 s	Deactivation delay for RO5.	1 = 1 s
<b>19 Operation mode</b>			
		Selection of local and external control location sources and operating modes. See section <i>Operating modes and motor control modes</i> in chapter <i>Program features</i> .	
19.01	Actual operation mode	Displays the operating mode currently used. See parameters 19.11...19.14. This parameter is read-only.	-
	Zero	Zero.	1
	Speed	Speed control (in vector motor control mode).	2
	Torque	Torque control (in vector motor control mode).	3

No.	Name/Value	Description	Default FbEq 16
	Min	The torque selector is comparing the output of the speed controller (25.01) and torque reference (26.74) and the smaller of the two is used (in vector motor control mode).	4
	Max	The torque selector is comparing the output of the speed controller (25.01) and torque reference (26.74) and the greater of the two is used (in vector motor control mode).	5
	Scalar (Hz)	Frequency control in scalar motor control mode (in scalar motor control mode).	10
	Forced magn.	Motor is in magnetizing mode.	20
19.11	<i>Ext1/Ext2 selection</i>	Selects the source for external control location EXT1/EXT2 selection. 0 = EXT1 1 = EXT2	<i>EXT1</i>
	EXT1	EXT1 (permanently selected).	0
	EXT2	EXT2 (permanently selected).	1
	FBA A MCW bit 11	Control word bit 11 received through fieldbus interface A.	2
	DI1	Digital input DI1 (10.02 <i>DI delayed status</i> , bit 0).	3
	DI2	Digital input DI2 (10.02 <i>DI delayed status</i> , bit 1).	4
	DI3	Digital input DI3 (10.02 <i>DI delayed status</i> , bit 2).	5
	DI4	Digital input DI4 (10.02 <i>DI delayed status</i> , bit 3).	6
	DIO1	Digital input/output DIO1 (11.02 <i>DIO delayed status</i> , bit 0)	11
	DIO2	Digital input/output DIO2 (11.02 <i>DIO delayed status</i> , bit 1)	12
	Timed function 1	Bit 0 of 34.01 <i>Timed functions status</i> .	19
	Timed function 2	Bit 1 of 34.01 <i>Timed functions status</i> .	20
	Timed function 3	Bit 2 of 34.01 <i>Timed functions status</i> .	21
	Supervision 1	Bit 0 of 32.01 <i>Supervision status</i> .	25
	Supervision 2	Bit 1 of 32.01 <i>Supervision status</i> .	26
	Supervision 3	Bit 2 of 32.01 <i>Supervision status</i> .	27
	Supervision 4	Bit 3 of 32.01 <i>Supervision status</i> .	28
	Supervision 5	Bit 4 of 32.01 <i>Supervision status</i> .	29
	Supervision 6	Bit 5 of 32.01 <i>Supervision status</i> .	30
	EFB MCW bit 11	Control word bit 11 received through the embedded fieldbus interface.	32
	FBA A connection loss	Detected communication loss of fieldbus interface A changes control mode to EXT2.	33
	EFB connection loss	Detected communication loss of embedded fieldbus interface changes control mode to EXT2.	35
	<i>Other [bit]</i>	Source selection (see <i>Terms and abbreviations</i> ).	-
19.12	<i>Ext1 control mode</i>	Selects the operating mode for external control location EXT1 in vector motor control mode.	<i>Speed</i>
	Zero	None.	1
	Speed	Speed control. The torque reference used is 25.01 <i>Torque reference speed control</i> (output of the speed reference chain).	2

No.	Name/Value	Description	Default FbEq 16
	Torque	Torque control. The torque reference used is <a href="#">26.74 Torque ref ramp out</a> (output of the torque reference chain).	3
	Minimum	Combination of selections <a href="#">Speed</a> and <a href="#">Torque</a> : the torque selector compares the speed controller output ( <a href="#">25.01 Torque reference speed control</a> ) and the torque reference ( <a href="#">26.74 Torque ref ramp out</a> ) and selects the smaller of the two. If speed error becomes negative, the drive follows the speed controller output until speed error becomes positive again. This prevents the drive from accelerating uncontrollably if the load is lost in torque control.	4
	Maximum	Combination of selections <a href="#">Speed</a> and <a href="#">Torque</a> : the torque selector compares the speed controller output ( <a href="#">25.01 Torque reference speed control</a> ) and the torque reference ( <a href="#">26.74 Torque ref ramp out</a> ) and selects the greater of the two. If speed error becomes positive, the drive follows the speed controller output until speed error becomes negative again. This prevents the drive from accelerating uncontrollably if the load is lost in torque control.	5
<a href="#">19.14</a>	<a href="#">Ext2 control mode</a>	Selects the operating mode for external control location EXT2 in vector motor control mode. For the selections, see parameter <a href="#">19.12 Ext1 control mode</a> .	<a href="#">Speed</a>
<a href="#">19.16</a>	<a href="#">Local control mode</a>	Selects the operating mode for local control in vector motor control mode.	<a href="#">Speed</a>
	Speed	Speed control. The torque reference used is <a href="#">25.01 Torque reference speed control</a> (output of the speed reference chain).	0
	Torque	Torque control. The torque reference used is <a href="#">26.74 Torque ref ramp out</a> (output of the torque reference chain).	1
<a href="#">19.17</a>	<a href="#">Local control disable</a>	Enables/disables local control (start and stop buttons on the control panel, and the local controls on the PC tool).  <b>WARNING!</b> Before disabling local control, ensure that the control panel is not needed for stopping the drive.	<a href="#">No</a>
	No	Local control enabled.	0
	Yes	Local control disabled.	1
<b>20 Start/stop/direction</b>		Start/stop/direction and run/start/jog enable signal source selection; positive/negative reference enable signal source selection. For information on control locations, see section <a href="#">Local and external control locations</a> (page 52).	
<a href="#">20.01</a>	<a href="#">Ext1 commands</a>	Selects the source of start, stop and direction commands for external control location 1 (EXT1). See also parameters <a href="#">20.02...20.05</a> . See parameter <a href="#">20.21</a> for the determination of the actual direction.	<a href="#">In1 Start; In2 Dir</a>
	Not selected	No start or stop command sources selected.	0

No.	Name/Value	Description	Default FbEq 16															
	In1 Start	<p>The source of the start and stop commands is selected by parameter <a href="#">20.03 Ext1 in1 source</a>. The state transitions of the source bits are interpreted as follows:</p> <table border="1" data-bbox="362 280 710 389"> <thead> <tr> <th>State of source 1 (<a href="#">20.03</a>)</th> <th>Command</th> </tr> </thead> <tbody> <tr> <td>0 → 1 (<a href="#">20.02 = Edge</a>)</td> <td>Start</td> </tr> <tr> <td>1 (<a href="#">20.02 = Level</a>)</td> <td>Stop</td> </tr> </tbody> </table>	State of source 1 ( <a href="#">20.03</a> )	Command	0 → 1 ( <a href="#">20.02 = Edge</a> )	Start	1 ( <a href="#">20.02 = Level</a> )	Stop	1									
State of source 1 ( <a href="#">20.03</a> )	Command																	
0 → 1 ( <a href="#">20.02 = Edge</a> )	Start																	
1 ( <a href="#">20.02 = Level</a> )	Stop																	
	In1 Start; In2 Dir	<p>The source selected by <a href="#">20.03 Ext1 in1 source</a> is the start signal; the source selected by <a href="#">20.04 Ext1 in2 source</a> determines the direction. The state transitions of the source bits are interpreted as follows:</p> <table border="1" data-bbox="362 512 855 644"> <thead> <tr> <th>State of source 1 (<a href="#">20.03</a>)</th> <th>State of source 2 (<a href="#">20.04</a>)</th> <th>Command</th> </tr> </thead> <tbody> <tr> <td>0</td> <td>Any</td> <td>Stop</td> </tr> <tr> <td>0 → 1 (<a href="#">20.02 = Edge</a>)</td> <td>0</td> <td>Start forward</td> </tr> <tr> <td>1 (<a href="#">20.02 = Level</a>)</td> <td>1</td> <td>Start reverse</td> </tr> </tbody> </table>	State of source 1 ( <a href="#">20.03</a> )	State of source 2 ( <a href="#">20.04</a> )	Command	0	Any	Stop	0 → 1 ( <a href="#">20.02 = Edge</a> )	0	Start forward	1 ( <a href="#">20.02 = Level</a> )	1	Start reverse	2			
State of source 1 ( <a href="#">20.03</a> )	State of source 2 ( <a href="#">20.04</a> )	Command																
0	Any	Stop																
0 → 1 ( <a href="#">20.02 = Edge</a> )	0	Start forward																
1 ( <a href="#">20.02 = Level</a> )	1	Start reverse																
	In1 Start fwd; In2 Start rev	<p>The source selected by <a href="#">20.03 Ext1 in1 source</a> is the forward start signal; the source selected by <a href="#">20.04 Ext1 in2 source</a> is the reverse start signal. The state transitions of the source bits are interpreted as follows:</p> <table border="1" data-bbox="362 780 855 986"> <thead> <tr> <th>State of source 1 (<a href="#">20.03</a>)</th> <th>State of source 2 (<a href="#">20.04</a>)</th> <th>Command</th> </tr> </thead> <tbody> <tr> <td>0</td> <td>0</td> <td>Stop</td> </tr> <tr> <td>0 → 1 (<a href="#">20.02 = Edge</a>)</td> <td>0</td> <td>Start forward</td> </tr> <tr> <td>1 (<a href="#">20.02 = Level</a>)</td> <td>0 → 1 (<a href="#">20.02 = Edge</a>)</td> <td>Start reverse</td> </tr> <tr> <td>1</td> <td>1 (<a href="#">20.02 = Level</a>)</td> <td>Stop</td> </tr> </tbody> </table>	State of source 1 ( <a href="#">20.03</a> )	State of source 2 ( <a href="#">20.04</a> )	Command	0	0	Stop	0 → 1 ( <a href="#">20.02 = Edge</a> )	0	Start forward	1 ( <a href="#">20.02 = Level</a> )	0 → 1 ( <a href="#">20.02 = Edge</a> )	Start reverse	1	1 ( <a href="#">20.02 = Level</a> )	Stop	3
State of source 1 ( <a href="#">20.03</a> )	State of source 2 ( <a href="#">20.04</a> )	Command																
0	0	Stop																
0 → 1 ( <a href="#">20.02 = Edge</a> )	0	Start forward																
1 ( <a href="#">20.02 = Level</a> )	0 → 1 ( <a href="#">20.02 = Edge</a> )	Start reverse																
1	1 ( <a href="#">20.02 = Level</a> )	Stop																
	In1P Start; In2 Stop	<p>The sources of the start and stop commands are selected by parameters <a href="#">20.03 Ext1 in1 source</a> and <a href="#">20.04 Ext1 in2 source</a>. The state transitions of the source bits are interpreted as follows:</p> <table border="1" data-bbox="362 1118 818 1222"> <thead> <tr> <th>State of source 1 (<a href="#">20.03</a>)</th> <th>State of source 2 (<a href="#">20.04</a>)</th> <th>Command</th> </tr> </thead> <tbody> <tr> <td>0 → 1</td> <td>1</td> <td>Start</td> </tr> <tr> <td>Any</td> <td>0</td> <td>Stop</td> </tr> </tbody> </table> <p><b>Notes:</b></p> <ul style="list-style-type: none"> <li>Parameter <a href="#">20.02 Ext1 start trigger type</a> has no effect with this setting.</li> <li>When source 2 is 0, the Start and Stop keys on the control panel are disabled.</li> </ul>	State of source 1 ( <a href="#">20.03</a> )	State of source 2 ( <a href="#">20.04</a> )	Command	0 → 1	1	Start	Any	0	Stop	4						
State of source 1 ( <a href="#">20.03</a> )	State of source 2 ( <a href="#">20.04</a> )	Command																
0 → 1	1	Start																
Any	0	Stop																

No.	Name/Value	Description	Default FbEq 16																
	In1P Start; In2 Stop; In3 Dir	<p>The sources of the start and stop commands are selected by parameters <a href="#">20.03 Ext1 in1 source</a> and <a href="#">20.04 Ext1 in2 source</a>. The source selected by <a href="#">20.05 Ext1 in3 source</a> determines the direction. The state transitions of the source bits are interpreted as follows:</p> <table border="1" data-bbox="421 325 883 475"> <thead> <tr> <th>State of source 1 (<a href="#">20.03</a>)</th> <th>State of source 2 (<a href="#">20.04</a>)</th> <th>State of source 3 (<a href="#">20.05</a>)</th> <th>Command</th> </tr> </thead> <tbody> <tr> <td>0 -&gt; 1</td> <td>1</td> <td>0</td> <td>Start forward</td> </tr> <tr> <td>0 -&gt; 1</td> <td>1</td> <td>1</td> <td>Start reverse</td> </tr> <tr> <td>Any</td> <td>0</td> <td>Any</td> <td>Stop</td> </tr> </tbody> </table> <p><b>Notes:</b></p> <ul style="list-style-type: none"> <li>Parameter <a href="#">20.02 Ext1 start trigger type</a> has no effect with this setting.</li> <li>When source 2 is 0, the Start and Stop keys on the control panel are disabled.</li> </ul>	State of source 1 ( <a href="#">20.03</a> )	State of source 2 ( <a href="#">20.04</a> )	State of source 3 ( <a href="#">20.05</a> )	Command	0 -> 1	1	0	Start forward	0 -> 1	1	1	Start reverse	Any	0	Any	Stop	5
State of source 1 ( <a href="#">20.03</a> )	State of source 2 ( <a href="#">20.04</a> )	State of source 3 ( <a href="#">20.05</a> )	Command																
0 -> 1	1	0	Start forward																
0 -> 1	1	1	Start reverse																
Any	0	Any	Stop																
	In1P Start fwd; In2P Start rev; In3 Stop	<p>The sources of the start and stop commands are selected by parameters <a href="#">20.03 Ext1 in1 source</a>, <a href="#">20.04 Ext1 in2 source</a> and <a href="#">20.05 Ext1 in3 source</a>. The source selected by <a href="#">20.05 Ext1 in3 source</a> determines the direction. The state transitions of the source bits are interpreted as follows:</p> <table border="1" data-bbox="421 740 883 890"> <thead> <tr> <th>State of source 1 (<a href="#">20.03</a>)</th> <th>State of source 2 (<a href="#">20.04</a>)</th> <th>State of source 3 (<a href="#">20.05</a>)</th> <th>Command</th> </tr> </thead> <tbody> <tr> <td>0 -&gt; 1</td> <td>Any</td> <td>1</td> <td>Start forward</td> </tr> <tr> <td>Any</td> <td>0 -&gt; 1</td> <td>1</td> <td>Start reverse</td> </tr> <tr> <td>Any</td> <td>Any</td> <td>0</td> <td>Stop</td> </tr> </tbody> </table> <p><b>Note:</b> Parameter <a href="#">20.02 Ext1 start trigger type</a> has no effect with this setting.</p>	State of source 1 ( <a href="#">20.03</a> )	State of source 2 ( <a href="#">20.04</a> )	State of source 3 ( <a href="#">20.05</a> )	Command	0 -> 1	Any	1	Start forward	Any	0 -> 1	1	Start reverse	Any	Any	0	Stop	6
State of source 1 ( <a href="#">20.03</a> )	State of source 2 ( <a href="#">20.04</a> )	State of source 3 ( <a href="#">20.05</a> )	Command																
0 -> 1	Any	1	Start forward																
Any	0 -> 1	1	Start reverse																
Any	Any	0	Stop																
	Control panel	Start; stop and direction commands through control panel; when EXT1 is active. Applies also for PC-Tool when it is connected via panel port.	11																
	Fieldbus A	<p>The start and stop commands are taken from fieldbus adapter A.</p> <p><b>Note:</b> The start signal is always level-triggered with this setting regardless of parameter <a href="#">20.02 Ext1 start trigger type</a>.</p>	12																
	Embedded fieldbus	<p>The start and stop commands are taken from the embedded fieldbus interface.</p> <p><b>Note:</b> The start signal is always level-triggered with this setting regardless of parameter <a href="#">20.02 Ext1 start trigger type</a>.</p>	14																
	Integrated Panel	Start; stop and direction commands from Integrated Panel	23																
	<a href="#">20.02 Ext1 start trigger type</a>	<p>Defines whether the start signal for external control location EXT1 is edge-triggered or level-triggered.</p> <p><b>Note:</b> This parameter is not effective if a pulse-type start signal is selected. See the descriptions of the selections of parameter <a href="#">20.01 Ext1 commands</a>.</p>	<a href="#">Level</a>																
	Edge	The start signal is edge-triggered.	0																
	Level	The start signal is level-triggered.	1																

No.	Name/Value	Description	Default FbEq 16								
<a href="#">20.03</a>	<a href="#">Ext1 in1 source</a>	Selects source 1 for parameter <a href="#">20.01 Ext1 commands</a> .	<a href="#">DI1</a>								
	Always off	0 (always off).	0								
	Always on	1 (always on).	1								
	DI1	Digital input DI1 ( <a href="#">10.02 DI delayed status</a> , bit 0).	2								
	DI2	Digital input DI2 ( <a href="#">10.02 DI delayed status</a> , bit 1).	3								
	DI3	Digital input DI3 ( <a href="#">10.02 DI delayed status</a> , bit 2).	4								
	DI4	Digital input DI4 ( <a href="#">10.02 DI delayed status</a> , bit 3).	5								
	DIO1	Digital input/output DIO1 ( <a href="#">11.02 DIO delayed status</a> , bit 0).	10								
	DIO2	Digital input/output ( <a href="#">11.02 DIO delayed status</a> , bit 1).	11								
	Timed function 1	Bit 0 of <a href="#">34.01 Timed functions status</a> .	18								
	Timed function 2	Bit 1 of <a href="#">34.01 Timed functions status</a> .	19								
	Timed function 3	Bit 2 of <a href="#">34.01 Timed functions status</a> .	20								
	Supervision 1	Bit 0 of <a href="#">32.01 Supervision status</a> .	24								
	Supervision 2	Bit 1 of <a href="#">32.01 Supervision status</a> .	25								
	Supervision 3	Bit 2 of <a href="#">32.01 Supervision status</a> .	26								
	Supervision 4	Bit 3 of <a href="#">32.01 Supervision status</a> .	27								
	Supervision 5	Bit 4 of <a href="#">32.01 Supervision status</a> .	28								
	Supervision 6	Bit 5 of <a href="#">32.01 Supervision status</a> .	29								
	<a href="#">Other [bit]</a>	Source selection (see <a href="#">Terms and abbreviations</a> ).	-								
<a href="#">20.04</a>	<a href="#">Ext1 in2 source</a>	Selects source 2 for parameter <a href="#">20.01 Ext1 commands</a> . For the available selections, see parameter <a href="#">20.03 Ext1 in1 source</a> .	<a href="#">DI2</a>								
<a href="#">20.05</a>	<a href="#">Ext1 in3 source</a>	Selects source 3 for parameter <a href="#">20.01 Ext1 commands</a> . For the available selections, see parameter <a href="#">20.03 Ext1 in1 source</a> .	<a href="#">Always off</a>								
<a href="#">20.06</a>	<a href="#">Ext2 commands</a>	Selects the source of start, stop and direction commands for external control location 2 (EXT2). See also parameters <a href="#">20.07</a> ... <a href="#">20.10</a> . See parameter <a href="#">20.21</a> for the determination of the actual direction.	<a href="#">Not selected</a>								
	Not selected	No start or stop command sources selected.	0								
	In1 Start	The source of the start and stop commands is selected by parameter <a href="#">20.08 Ext2 in1 source</a> . The state transitions of the source bits are interpreted as follows: <table border="1" data-bbox="370 1177 717 1283"> <thead> <tr> <th>State of source 1 (<a href="#">20.08</a>)</th> <th>Command</th> </tr> </thead> <tbody> <tr> <td>0 -&gt; 1 (<a href="#">20.07</a> = <i>Edge</i>)</td> <td>Start</td> </tr> <tr> <td>1 (<a href="#">20.07</a> = <i>Level</i>)</td> <td>Stop</td> </tr> <tr> <td>0</td> <td>Stop</td> </tr> </tbody> </table>	State of source 1 ( <a href="#">20.08</a> )	Command	0 -> 1 ( <a href="#">20.07</a> = <i>Edge</i> )	Start	1 ( <a href="#">20.07</a> = <i>Level</i> )	Stop	0	Stop	1
State of source 1 ( <a href="#">20.08</a> )	Command										
0 -> 1 ( <a href="#">20.07</a> = <i>Edge</i> )	Start										
1 ( <a href="#">20.07</a> = <i>Level</i> )	Stop										
0	Stop										

No.	Name/Value	Description	Default FbEq 16															
	In1 Start; In2 Dir	<p>The source selected by <a href="#">20.08 Ext2 in1 source</a> is the start signal; the source selected by <a href="#">20.09 Ext2 in2 source</a> determines the direction. The state transitions of the source bits are interpreted as follows:</p> <table border="1" data-bbox="423 300 897 427"> <thead> <tr> <th data-bbox="427 304 617 349">State of source 1 (20.08)</th> <th data-bbox="617 304 792 349">State of source 2 (20.09)</th> <th data-bbox="792 304 897 349">Command</th> </tr> </thead> <tbody> <tr> <td data-bbox="427 349 617 370">0</td> <td data-bbox="617 349 792 370">Any</td> <td data-bbox="792 349 897 370">Stop</td> </tr> <tr> <td data-bbox="427 370 617 391">0 -&gt; 1 (20.07 = Edge)</td> <td data-bbox="617 370 792 391">0</td> <td data-bbox="792 370 897 391">Start forward</td> </tr> <tr> <td data-bbox="427 391 617 427">1 (20.07 = Level)</td> <td data-bbox="617 391 792 427">1</td> <td data-bbox="792 391 897 427">Start reverse</td> </tr> </tbody> </table>	State of source 1 (20.08)	State of source 2 (20.09)	Command	0	Any	Stop	0 -> 1 (20.07 = Edge)	0	Start forward	1 (20.07 = Level)	1	Start reverse	2			
State of source 1 (20.08)	State of source 2 (20.09)	Command																
0	Any	Stop																
0 -> 1 (20.07 = Edge)	0	Start forward																
1 (20.07 = Level)	1	Start reverse																
	In1 Start fwd; In2 Start rev	<p>The source selected by <a href="#">20.08 Ext2 in1 source</a> is the forward start signal; the source selected by <a href="#">20.09 Ext1 in2 source</a> is the reverse start signal. The state transitions of the source bits are interpreted as follows:</p> <table border="1" data-bbox="423 552 897 759"> <thead> <tr> <th data-bbox="427 557 605 601">State of source 1 (20.08)</th> <th data-bbox="605 557 792 601">State of source 2 (20.09)</th> <th data-bbox="792 557 897 601">Command</th> </tr> </thead> <tbody> <tr> <td data-bbox="427 601 605 622">0</td> <td data-bbox="605 601 792 622">0</td> <td data-bbox="792 601 897 622">Stop</td> </tr> <tr> <td data-bbox="427 622 605 676">0 -&gt; 1 (20.07 = Edge) 1 (20.07 = Level)</td> <td data-bbox="605 622 792 676">0</td> <td data-bbox="792 622 897 676">Start forward</td> </tr> <tr> <td data-bbox="427 676 605 730">0</td> <td data-bbox="605 676 792 730">0 -&gt; 1 (20.07 = Edge) 1 (20.07 = Level)</td> <td data-bbox="792 676 897 730">Start reverse</td> </tr> <tr> <td data-bbox="427 730 605 751">1</td> <td data-bbox="605 730 792 751">1</td> <td data-bbox="792 730 897 751">Stop</td> </tr> </tbody> </table>	State of source 1 (20.08)	State of source 2 (20.09)	Command	0	0	Stop	0 -> 1 (20.07 = Edge) 1 (20.07 = Level)	0	Start forward	0	0 -> 1 (20.07 = Edge) 1 (20.07 = Level)	Start reverse	1	1	Stop	3
State of source 1 (20.08)	State of source 2 (20.09)	Command																
0	0	Stop																
0 -> 1 (20.07 = Edge) 1 (20.07 = Level)	0	Start forward																
0	0 -> 1 (20.07 = Edge) 1 (20.07 = Level)	Start reverse																
1	1	Stop																
	In1P Start; In2 Stop	<p>The sources of the start and stop commands are selected by parameters <a href="#">20.08 Ext2 in1 source</a> and <a href="#">20.09 Ext1 in2 source</a>. The state transitions of the source bits are interpreted as follows:</p> <table border="1" data-bbox="423 887 885 991"> <thead> <tr> <th data-bbox="427 892 591 936">State of source 1 (20.08)</th> <th data-bbox="591 892 756 936">State of source 2 (20.09)</th> <th data-bbox="756 892 885 936">Command</th> </tr> </thead> <tbody> <tr> <td data-bbox="427 936 591 957">0 -&gt; 1</td> <td data-bbox="591 936 756 957">1</td> <td data-bbox="756 936 885 957">Start</td> </tr> <tr> <td data-bbox="427 957 591 991">Any</td> <td data-bbox="591 957 756 991">0</td> <td data-bbox="756 957 885 991">Stop</td> </tr> </tbody> </table> <p data-bbox="423 1007 482 1027"><b>Notes:</b></p> <ul data-bbox="423 1034 882 1118" style="list-style-type: none"> <li>Parameter <a href="#">20.07 Ext2 start trigger type</a> has no effect with this setting.</li> <li>When source 2 is 0, the Start and Stop keys on the control panel are disabled.</li> </ul>	State of source 1 (20.08)	State of source 2 (20.09)	Command	0 -> 1	1	Start	Any	0	Stop	4						
State of source 1 (20.08)	State of source 2 (20.09)	Command																
0 -> 1	1	Start																
Any	0	Stop																

No.	Name/Value	Description	Default FbEq 16																
	In1P Start; In2 Stop; In3 Dir	<p>The sources of the start and stop commands are selected by parameters <a href="#">20.08 Ext2 in1 source</a> and <a href="#">20.09 Ext1 in2 source</a>. The source selected by <a href="#">20.10 Ext2 in3 source</a> determines the direction. The state transitions of the source bits are interpreted as follows:</p> <table border="1"> <thead> <tr> <th>State of source 1 (<a href="#">20.08</a>)</th> <th>State of source 2 (<a href="#">20.09</a>)</th> <th>State of source 3 (<a href="#">20.10</a>)</th> <th>Command</th> </tr> </thead> <tbody> <tr> <td>0 -&gt; 1</td> <td>1</td> <td>0</td> <td>Start forward</td> </tr> <tr> <td>0 -&gt; 1</td> <td>1</td> <td>1</td> <td>Start reverse</td> </tr> <tr> <td>Any</td> <td>0</td> <td>Any</td> <td>Stop</td> </tr> </tbody> </table> <p><b>Notes:</b></p> <ul style="list-style-type: none"> <li>Parameter <a href="#">20.07 Ext2 start trigger type</a> has no effect with this setting.</li> <li>When source 2 is 0, the Start and Stop keys on the control panel are disabled.</li> </ul>	State of source 1 ( <a href="#">20.08</a> )	State of source 2 ( <a href="#">20.09</a> )	State of source 3 ( <a href="#">20.10</a> )	Command	0 -> 1	1	0	Start forward	0 -> 1	1	1	Start reverse	Any	0	Any	Stop	5
State of source 1 ( <a href="#">20.08</a> )	State of source 2 ( <a href="#">20.09</a> )	State of source 3 ( <a href="#">20.10</a> )	Command																
0 -> 1	1	0	Start forward																
0 -> 1	1	1	Start reverse																
Any	0	Any	Stop																
	In1P Start fwd; In2P Start rev; In3 Stop	<p>The sources of the start and stop commands are selected by parameters <a href="#">20.08 Ext2 in1 source</a>, <a href="#">20.09 Ext1 in2 source</a> and <a href="#">20.10 Ext2 in3 source</a>. The source selected by <a href="#">20.10 Ext2 in3 source</a> determines the direction. The state transitions of the source bits are interpreted as follows:</p> <table border="1"> <thead> <tr> <th>State of source 1 (<a href="#">20.08</a>)</th> <th>State of source 2 (<a href="#">20.09</a>)</th> <th>State of source 3 (<a href="#">20.10</a>)</th> <th>Command</th> </tr> </thead> <tbody> <tr> <td>0 -&gt; 1</td> <td>Any</td> <td>1</td> <td>Start forward</td> </tr> <tr> <td>Any</td> <td>0 -&gt; 1</td> <td>1</td> <td>Start reverse</td> </tr> <tr> <td>Any</td> <td>Any</td> <td>0</td> <td>Stop</td> </tr> </tbody> </table> <p><b>Note:</b> Parameter <a href="#">20.07 Ext2 start trigger type</a> has no effect with this setting.</p>	State of source 1 ( <a href="#">20.08</a> )	State of source 2 ( <a href="#">20.09</a> )	State of source 3 ( <a href="#">20.10</a> )	Command	0 -> 1	Any	1	Start forward	Any	0 -> 1	1	Start reverse	Any	Any	0	Stop	6
State of source 1 ( <a href="#">20.08</a> )	State of source 2 ( <a href="#">20.09</a> )	State of source 3 ( <a href="#">20.10</a> )	Command																
0 -> 1	Any	1	Start forward																
Any	0 -> 1	1	Start reverse																
Any	Any	0	Stop																
	Control panel	Start; stop and direction commands through control panel; when EXT1 is active. Applies also for PC-Tool when it is connected via panel port.	11																
	Fieldbus A	The start and stop commands are taken from fieldbus adapter A. <b>Note:</b> The start signal is always level-triggered with this setting regardless of parameter <a href="#">20.02 Ext1 start trigger type</a> .	12																
	Embedded fieldbus	Start; stop and direction commands through embedded fieldbus protocol when EXT1 is active. <b>Note:</b> The start signal is always level-triggered with this setting regardless of parameter <a href="#">20.02 Ext1 start trigger type</a> .	14																
	Integrated Panel	Start; stop and direction commands from Integrated Panel	23																
	<a href="#">20.07 Ext2 start trigger type</a>	Defines whether the start signal for external control location EXT2 is edge-triggered or level-triggered. <b>Note:</b> This parameter is not effective if a pulse-type start signal is selected. See the descriptions of the selections of parameter <a href="#">20.06 Ext2 commands</a> .	<i>Level</i>																
	Edge	The start signal is edge-triggered.	0																
	Level	The start signal is level-triggered.	1																



No.	Name/Value	Description	Default FbEq 16
20.08	<i>Ext2 in1 source</i>	Selects source 1 for parameter <i>20.06 Ext2 commands</i> . For the available selections, see parameter <i>20.03 Ext1 in1 source</i> .	<i>Always off</i>
20.09	<i>Ext2 in2 source</i>	Selects source 2 for parameter <i>20.06 Ext2 commands</i> . For the available selections, see parameter <i>20.03 Ext1 in1 source</i> .	<i>Always off</i>
20.10	<i>Ext2 in3 source</i>	Selects source 3 for parameter <i>20.06 Ext2 commands</i> . For the available selections, see parameter <i>20.03 Ext1 in1 source</i> .	<i>Always off</i>
20.11	<i>Run enable stop mode</i>	Selects the way the motor is stopped when the run enable signal switches off. The source of the run enable signal is selected by parameter <i>20.12 Run enable 1 source</i> .	<i>Coast</i>
	Coast	Stop by switching off the output semiconductors of the drive. The motor coasts to a stop.  <b>WARNING!</b> If a mechanical brake is used, ensure it is safe to stop the drive by coasting.	0
	Ramp	Stop along the active deceleration ramp. See parameter group <i>23 Speed reference ramp</i> .	1
	Torque limit	Stop according to torque limits (parameters <i>30.19</i> and <i>30.20</i> ).	2
20.12	<i>Run enable 1 source</i>	Selects the source of the external run enable signal. If the run enable signal is switched off, the drive will not start. If already running, the drive will stop according to the setting of parameter <i>20.11 Run enable stop mode</i> . 1 = Run enable signal on. <b>Note:</b> This parameter cannot be changed while the drive is running. See also parameter <i>20.19 Enable start signal</i>	<i>Selected</i>
	Not selected	0.	0
	Selected	1.	1
	DI1	Digital input DI1 ( <i>10.02 DI delayed status</i> , bit 0).	2
	DI2	Digital input DI2 ( <i>10.02 DI delayed status</i> , bit 1).	3
	DI3	Digital input DI3 ( <i>10.02 DI delayed status</i> , bit 2).	4
	DI4	Digital input DI4 ( <i>10.02 DI delayed status</i> , bit 3).	5
	DIO1	Digital input/output DIO1 ( <i>11.02 DIO delayed status</i> , bit 0)	10
	DIO2	Digital input/output DIO2 ( <i>11.02 DIO delayed status</i> , bit 0)	11
	Timed function 1	Bit 0 of <i>34.01 Timed functions status</i> .	18
	Timed function 2	Bit 1 of <i>34.01 Timed functions status</i> .	19
	Timed function 3	Bit 2 of <i>34.01 Timed functions status</i> .	20
	Supervision 1	Bit 0 of <i>32.01 Supervision status</i> .	24
	Supervision 2	Bit 1 of <i>32.01 Supervision status</i> .	25
	Supervision 3	Bit 2 of <i>32.01 Supervision status</i> .	26
	Supervision 4	Bit 3 of <i>32.01 Supervision status</i> .	27
	Supervision 5	Bit 4 of <i>32.01 Supervision status</i> .	28
	Supervision 6	Bit 5 of <i>32.01 Supervision status</i> .	29
	FBA A MCW bit 3	Control word bit 3 received through fieldbus interface A.	30

No.	Name/Value	Description	Default FbEq 16
	EFB MCW bit 3	Control word bit 3 received through the embedded fieldbus interface.	32
	<i>Other [bit]</i>	Source selection (see <i>Terms and abbreviations</i> ).	-
20.19	<i>Enable start signal</i>	Selects the source for the start enable signal. 1 = Start enable. With the signal switched off, any drive start command is inhibited. (Switching the signal off while the drive is running will not stop the drive.) See also parameter <i>20.12 Run enable 1 source</i> .	<i>On</i>
	Off	0.	0
	On	1.	1
	DI1	Digital input DI1 ( <i>10.02 DI delayed status</i> , bit 0).	2
	DI2	Digital input DI2 ( <i>10.02 DI delayed status</i> , bit 1).	3
	DI3	Digital input DI3 ( <i>10.02 DI delayed status</i> , bit 2).	4
	DI4	Digital input DI4 ( <i>10.02 DI delayed status</i> , bit 3).	5
	DIO1	Digital input/output DIO1 ( <i>11.02 DIO delayed status</i> , bit 0).	11
	DIO2	Digital input/output DIO2 ( <i>11.02 DIO delayed status</i> , bit 1).	12
	Timed function 1	Bit 0 of <i>34.01 Timed functions status</i> .	18
	Timed function 2	Bit 1 of <i>34.01 Timed functions status</i> .	19
	Timed function 3	Bit 2 of <i>34.01 Timed functions status</i> .	20
	Supervision 1	Bit 0 of <i>32.01 Supervision status</i> .	24
	Supervision 2	Bit 1 of <i>32.01 Supervision status</i> .	25
	Supervision 3	Bit 2 of <i>32.01 Supervision status</i> .	26
	Supervision 4	Bit 3 of <i>32.01 Supervision status</i> .	27
	Supervision 5	Bit 4 of <i>32.01 Supervision status</i> .	28
	Supervision 6	Bit 5 of <i>32.01 Supervision status</i> .	29
	<i>Other [bit]</i>	Source selection (see <i>Terms and abbreviations</i> ).	-

No.	Name/Value	Description	Default FbEq 16																
20.21	<i>Direction</i>	Reference direction lock. Defines the direction of the drive rather than the sign of the reference, except in some cases. In the table the actual drive rotation is shown as a function of parameter <i>20.21 Direction</i> and Direction command (from parameter <i>20.01 Ext2 commands</i> or <i>20.06 Ext2 commands</i> ).	<i>Request</i>																
		<table border="1"> <thead> <tr> <th></th> <th>Direction command = Forward</th> <th>Direction command = Reverse</th> <th>Direction command not defined</th> </tr> </thead> <tbody> <tr> <td>Par. <i>20.21 Direction</i> = <i>Forward</i></td> <td>Forward</td> <td>Forward</td> <td>Forward</td> </tr> <tr> <td>Par. <i>20.21 Direction</i> = <i>Reverse</i></td> <td>Reverse</td> <td>Reverse</td> <td>Reverse</td> </tr> <tr> <td>Par. <i>20.21 Direction</i> = <i>Request</i></td> <td>Forward, but <ul style="list-style-type: none"> <li>If reference from Constant, Motor potentiometer, PID, Safe speed, Last, Jogging or Panel reference, reference used as is.</li> <li>If reference from the network, reference used as is.</li> </ul> </td> <td>Reverse, but <ul style="list-style-type: none"> <li>If reference from Constant, PID or Jogging reference, reference used as is.</li> <li>If reference from the network, Panel, Analog input, Motor potentiometer, Safe speed or Last reference, reference multiplied by -1.</li> </ul> </td> <td>Forward</td> </tr> </tbody> </table>		Direction command = Forward	Direction command = Reverse	Direction command not defined	Par. <i>20.21 Direction</i> = <i>Forward</i>	Forward	Forward	Forward	Par. <i>20.21 Direction</i> = <i>Reverse</i>	Reverse	Reverse	Reverse	Par. <i>20.21 Direction</i> = <i>Request</i>	Forward, but <ul style="list-style-type: none"> <li>If reference from Constant, Motor potentiometer, PID, Safe speed, Last, Jogging or Panel reference, reference used as is.</li> <li>If reference from the network, reference used as is.</li> </ul>	Reverse, but <ul style="list-style-type: none"> <li>If reference from Constant, PID or Jogging reference, reference used as is.</li> <li>If reference from the network, Panel, Analog input, Motor potentiometer, Safe speed or Last reference, reference multiplied by -1.</li> </ul>	Forward	
	Direction command = Forward	Direction command = Reverse	Direction command not defined																
Par. <i>20.21 Direction</i> = <i>Forward</i>	Forward	Forward	Forward																
Par. <i>20.21 Direction</i> = <i>Reverse</i>	Reverse	Reverse	Reverse																
Par. <i>20.21 Direction</i> = <i>Request</i>	Forward, but <ul style="list-style-type: none"> <li>If reference from Constant, Motor potentiometer, PID, Safe speed, Last, Jogging or Panel reference, reference used as is.</li> <li>If reference from the network, reference used as is.</li> </ul>	Reverse, but <ul style="list-style-type: none"> <li>If reference from Constant, PID or Jogging reference, reference used as is.</li> <li>If reference from the network, Panel, Analog input, Motor potentiometer, Safe speed or Last reference, reference multiplied by -1.</li> </ul>	Forward																
	Request	In external control the direction is selected by a direction command (parameter <i>20.01 Ext2 commands</i> or <i>20.06 Ext2 commands</i> ). If the reference comes from Constant (constant speeds/frequencies), Motor potentiometer, PID, Fail, Last (last speed reference), Jogging (jogging speed) or Panel reference, the reference is used as is. If the reference comes from a fieldbus: <ul style="list-style-type: none"> <li>if the direction command is forward, the reference is used as is</li> <li>if the direction command is reverse, the reference is multiplied by -1.</li> </ul>	0																
	Forward	Motor rotates forward regardless of the sign of the external reference. (Negative reference values are replaced by zero. Positive reference values are used as is.)	1																
	Reverse	Motor rotates reverse regardless of the sign of the external reference. (Negative reference values are replaced by zero. Positive reference values are multiplied by -1.)	2																

No.	Name/Value	Description	Default FbEq 16
20.22	<i>Enable to rotate</i>	Setting this parameter to 0 stops motor rotating but does not affect any other conditions for rotating. Setting the parameter back to 1 starts motor rotating again. This parameter can be used for example with a signal from some external equipment to prevent the motor rotating before the equipment is ready. When this parameter is 0 (rotating of the motor is disabled), bit 13 of parameter <i>06.16 Drive status word 1</i> is set to 0.	<i>Selected</i>
	Not selected	0 (always off).	0
	Selected	1 (always on).	1
	DI1	Digital input DI1 ( <i>10.02 DI delayed status</i> , bit 0).	2
	DI2	Digital input DI2 ( <i>10.02 DI delayed status</i> , bit 1).	3
	DI3	Digital input DI3 ( <i>10.02 DI delayed status</i> , bit 2).	4
	DI4	Digital input DI4 ( <i>10.02 DI delayed status</i> , bit 3).	5
	DIO1	Digital input/output DIO1 ( <i>11.02 DIO delayed status</i> , bit 0).	11
	DIO2	Digital input/output DIO2 ( <i>11.02 DIO delayed status</i> , bit 1).	12
	Timed function 1	Bit 0 of <i>34.01 Timed functions status</i> .	18
	Timed function 2	Bit 1 of <i>34.01 Timed functions status</i> .	19
	Timed function 3	Bit 2 of <i>34.01 Timed functions status</i> .	20
	Supervision 1	Bit 0 of <i>32.01 Supervision status</i> .	24
	Supervision 2	Bit 1 of <i>32.01 Supervision status</i> .	25
	Supervision 3	Bit 2 of <i>32.01 Supervision status</i> .	26
	Supervision 4	Bit 3 of <i>32.01 Supervision status</i> .	27
	Supervision 5	Bit 4 of <i>32.01 Supervision status</i> .	28
	Supervision 6	Bit 5 of <i>32.01 Supervision status</i> .	29
	<i>Other [bit]</i>	Source selection (see <i>Terms and abbreviations</i> ).	-
20.25	<i>Jog enable</i>	Selects the source for a jog enable signal. (The sources for jogging activation signals are selected by parameters <i>20.26 Jog 1 start</i> and <i>20.27 Jog 2 start</i> ) 1 = Jogging is enabled. 0 = Jogging is disabled. <b>Notes:</b> <ul style="list-style-type: none"> <li>Jogging is supported in vector control mode only.</li> <li>Jogging can be enabled only when no start command from an external control location is active. On the other hand, if jogging is already enabled, the drive cannot be started from an external control location (apart from inching commands through fieldbus).</li> </ul> See section <i>Rush control</i> on page 70.	<i>Not selected</i>
	Not selected	0.	0
	Selected	1.	1
	DI1	Digital input DI1 ( <i>10.02 DI delayed status</i> , bit 0).	2
	DI2	Digital input DI2 ( <i>10.02 DI delayed status</i> , bit 1).	3
	DI3	Digital input DI3 ( <i>10.02 DI delayed status</i> , bit 2).	4
	DI4	Digital input DI4 ( <i>10.02 DI delayed status</i> , bit 3).	5

No.	Name/Value	Description	Default FbEq 16
	DIO1	Digital input/output DIO1 ( <i>11.02 DIO delayed status</i> , bit 0).	11
	DIO2	Digital input/output DIO2 ( <i>11.02 DIO delayed status</i> , bit 1).	12
	Timed function 1	Bit 0 of <i>34.01 Timed functions status</i> .	18
	Timed function 2	Bit 1 of <i>34.01 Timed functions status</i> .	19
	Timed function 3	Bit 2 of <i>34.01 Timed functions status</i> .	20
	Supervision 1	Bit 0 of <i>32.01 Supervision status</i> .	24
	Supervision 2	Bit 1 of <i>32.01 Supervision status</i> .	25
	Supervision 3	Bit 2 of <i>32.01 Supervision status</i> .	26
	Supervision 4	Bit 3 of <i>32.01 Supervision status</i> .	27
	Supervision 5	Bit 4 of <i>32.01 Supervision status</i> .	28
	Supervision 6	Bit 5 of <i>32.01 Supervision status</i> .	29
	<i>Other [bit]</i>	Source selection (see <i>Terms and abbreviations</i> ).	-
<b>20.26</b>	<b>Jog 1 start</b>	<p>If enabled by parameter <i>20.25 Jog enable</i>, selects the source for the activation of jogging function 1. (Jogging function 1 can also be activated through fieldbus regardless of parameter <i>20.25</i>.)</p> <p>1 = Jogging 1 active.</p> <p><b>Notes:</b></p> <ul style="list-style-type: none"> <li>• Jogging is supported in vector control mode only.</li> <li>• If both jogging 1 and 2 are activated, the one that was activated first has priority.</li> <li>• This parameter cannot be changed while the drive is running.</li> </ul>	<i>Not selected</i>
	Not selected	0.	0
	Selected	1.	1
	DI1	Digital input DI1 ( <i>10.02 DI delayed status</i> , bit 0).	2
	DI2	Digital input DI2 ( <i>10.02 DI delayed status</i> , bit 1).	3
	DI3	Digital input DI3 ( <i>10.02 DI delayed status</i> , bit 2).	4
	DI4	Digital input DI4 ( <i>10.02 DI delayed status</i> , bit 3).	5
	DIO1	Digital input/output DIO1 ( <i>11.02 DIO delayed status</i> , bit 0).	11
	DIO2	Digital input/output DIO2 ( <i>11.02 DIO delayed status</i> , bit 1).	12
	Timed function 1	Bit 0 of <i>34.01 Timed functions status</i> .	18
	Timed function 2	Bit 1 of <i>34.01 Timed functions status</i> .	19
	Timed function 3	Bit 2 of <i>34.01 Timed functions status</i> .	20
	Supervision 1	Bit 0 of <i>32.01 Supervision status</i> .	24
	Supervision 2	Bit 1 of <i>32.01 Supervision status</i> .	25
	Supervision 3	Bit 2 of <i>32.01 Supervision status</i> .	26
	Supervision 4	Bit 3 of <i>32.01 Supervision status</i> .	27
	Supervision 5	Bit 4 of <i>32.01 Supervision status</i> .	28
	Supervision 6	Bit 5 of <i>32.01 Supervision status</i> .	29
	<i>Other [bit]</i>	Source selection (see <i>Terms and abbreviations</i> ).	-

No.	Name/Value	Description	Default FbEq 16
20.27	<i>Jog 2 start</i>	If enabled by parameter <i>20.25 Jog enable</i> , selects the source for the activation of jogging function 2. (Jogging function 2 can also be activated through fieldbus regardless of parameter <i>20.25</i> .) 1 = Jogging 2 active. For the selections, see parameter <i>20.26 Jog 1 start</i> . <b>Notes:</b> <ul style="list-style-type: none"> <li>Jogging is supported in vector control mode only.</li> <li>If both jogging 1 and 2 are activated, the one that was activated first has priority.</li> <li>This parameter cannot be changed while the drive is running.</li> </ul> For the selections, see parameter <i>20.26 Jog 1 start</i> .	<i>Not selected</i>
20.210	<i>Fast stop input</i>	Selects the source for activating the Fast stop command. 0 = Fast stop command is active. 1 = Fast stop command is inactive (normal operation). When the command is active, the drive decelerates according to the value of parameter <i>23.206 Fast stop deceleration time</i> .	<i>Inactive (true)</i>
	Active (false)	Fast stop command is enabled.	0
	Inactive (true)	Fast stop command is disabled.	1
	DI1	Digital input DI1 ( <i>10.02 DI delayed status</i> , bit 0).	3
	DI2	Digital input DI2 ( <i>10.02 DI delayed status</i> , bit 1).	4
	DI3	Digital input DI3 ( <i>10.02 DI delayed status</i> , bit 2).	5
	DI4	Digital input DI4 ( <i>10.02 DI delayed status</i> , bit 3).	6
	DIO1	Digital input/output DIO1 ( <i>11.02 DIO delayed status</i> , bit 0).	11
	DIO2	Digital input/output DIO2 ( <i>11.02 DIO delayed status</i> , bit 1)	12
	<i>Other [bit]</i>	Source selection (see <i>Terms and abbreviations</i> on page 112).	-
20.211	<i>Fast stop mode</i>	Selects the mode of the Fast stop function.	<i>Ramp</i>
	Ramp	The drive decelerates to zero speed according to a defined ramp time. The mechanical brake closes when the drive reaches the brake close speed.	1
	Torque limit	The drive decelerates to zero speed against the drive torque limits. The mechanical brake closes when the drive reaches the brake close speed.	2
	Mechanical brake	The function forces the mechanical brake to close.	3
20.212	<i>Power on acknowledge</i>	Selects the source for activating the Power on acknowledgment signal. 1 = Power on acknowledgment circuit is closed, main contactor is closed. 0 = Power on acknowledgment circuit is open, main contactor is open, warning <i>D20B Power on acknowledge</i> generated. For more information on the function, see section <i>Power on acknowledgment</i> on page 551.	<i>Selected</i>
	Not Selected	Power on acknowledge function is disabled.	0
	Selected	Power on acknowledge function is enabled.	1
	DI1	Digital input DI1 ( <i>10.02 DI delayed status</i> , bit 0).	2

No.	Name/Value	Description	Default FbEq 16
	DI2	Digital input DI2 ( <i>10.02 DI delayed status</i> , bit 1).	3
	DI3	Digital input DI3 ( <i>10.02 DI delayed status</i> , bit 2).	4
	DI4	Digital input DI4 ( <i>10.02 DI delayed status</i> , bit 3).	5
	DIO1	Digital input/output DIO1 ( <i>11.02 DIO delayed status</i> , bit 0)	10
	DIO2	Digital input/output DIO2 ( <i>11.02 DIO delayed status</i> , bit 0)	11
	Timed function 1	Bit 0 of <i>34.01 Timed functions status</i> .	18
	Timed function 2	Bit 1 of <i>34.01 Timed functions status</i> .	19
	Timed function 3	Bit 2 of <i>34.01 Timed functions status</i> .	20
	Supervision 1	Bit 0 of <i>32.01 Supervision status</i> .	24
	Supervision 2	Bit 1 of <i>32.01 Supervision status</i> .	25
	Supervision 3	Bit 2 of <i>32.01 Supervision status</i> .	26
	Supervision 4	Bit 3 of <i>32.01 Supervision status</i> .	27
	Supervision 5	Bit 4 of <i>32.01 Supervision status</i> .	28
	Supervision 6	Bit 5 of <i>32.01 Supervision status</i> .	29
	<i>Other [bit]</i>	Source selection (see <i>Terms and abbreviations</i> on page 112).	-
<i>20.213</i>	<i>Power on ackn reset delay</i>	Defines the time delay for a fault reset after the Power on acknowledgment signal is activated.	1000 ms
	0...30000 ms	Time delay.	1 = 1 ms
<i>20.214</i>	<i>Joystick zero position</i>	Selects the source for activating the joystick zero position input. 0 = Joystick is not at zero position. 1 = Joystick is at zero position. For more information, see section <i>Start/stop interlocking</i> on page 543.	<i>Not selected</i>
	Not selected	0.	0
	Selected	1.	1
	DI1	Digital input DI1 ( <i>10.02 DI delayed status</i> , bit 0).	2
	DI2	Digital input DI2 ( <i>10.02 DI delayed status</i> , bit 1).	3
	DI3	Digital input DI3 ( <i>10.02 DI delayed status</i> , bit 2).	4
	DI4	Digital input DI4 ( <i>10.02 DI delayed status</i> , bit 3).	5
	DIO1	Digital input/output DIO1 ( <i>11.02 DIO delayed status</i> , bit 0)	10
	DIO2	Digital input/output DIO2 ( <i>11.02 DIO delayed status</i> , bit 0)	11
	Timed function 1	Bit 0 of <i>34.01 Timed functions status</i> .	18
	Timed function 2	Bit 1 of <i>34.01 Timed functions status</i> .	19
	Timed function 3	Bit 2 of <i>34.01 Timed functions status</i> .	20
	Supervision 1	Bit 0 of <i>32.01 Supervision status</i> .	24
	Supervision 2	Bit 1 of <i>32.01 Supervision status</i> .	25
	Supervision 3	Bit 2 of <i>32.01 Supervision status</i> .	26
	Supervision 4	Bit 3 of <i>32.01 Supervision status</i> .	27
	Supervision 5	Bit 4 of <i>32.01 Supervision status</i> .	28
	Supervision 6	Bit 5 of <i>32.01 Supervision status</i> .	29

No.	Name/Value	Description	Default FbEq 16
	<i>Other [bit]</i>	Source selection (see <i>Terms and abbreviations</i> on page 112).	-
20.215	<i>Joystick warning delay</i>	Defines the time delay for generating warning <i>D208 Joystick reference check</i> . The warning is generated if <i>20.214 Joystick zero position</i> is active and the speed reference is greater than +/- 10% of the minimum or maximum scaled value of the joystick reference used.	1000 ms
	0...30000 ms	Time delay.	1 = 1 ms
20.216	<i>Crane control word 1</i>	Shows the control signals as received from the selected sources. The parameter updates based on the parameter group <i>53 FBA A data out</i> selections. <b>Note:</b> These bits are not connected to any functions by default. The bit names exists already for which you need to make connections separately.	0000h

  

Bit	Name	Description
0	Start forward	1 = Start command in the forward direction.
1	Start reverse	1 = Start command in the reverse direction.
2	Fault reset	1 = Activate a fault reset.
3	Step reference mode	1 = Enable the Step reference mode.
4	Step reference select 2	1 = Enable step reference selection pointer 2.
5	Step reference select 3	1 = Enable step reference selection pointer 3.
6	Step reference select 4	1 = Enable step reference selection pointer 4.
7	Slowdown forward	1 = Deactivate the Slowdown command in the forward direction.
8	Slowdown reverse	1 = Deactivate the Slowdown command in the reverse direction.
9	Forward stop limit	1 = Deactivate the forward stop limit command.
10	Reverse stop limit	1 = Deactivate the reverse stop limit command.
11	Fast stop	1 = Activate the Fast stop command.
12	Reserved	
13	Reserved	
14	Reserved	
15	Reserved	

0000h...FFFh	Crane control program control word 1.	1 = 1
--------------	---------------------------------------	-------



No.	Name/Value	Description	Default FbEq 16
<b>21 Start/stop mode</b>			
21.01	<i>Vector start mode</i>	<p>Start and stop modes; emergency stop mode and signal source selection; DC magnetization settings.</p> <p>Selects the motor start function for the vector motor control mode, ie. when <i>99.04 Motor control mode</i> is set to <i>Vector</i>.</p> <p><b>Notes:</b></p> <ul style="list-style-type: none"> <li>• The start function for the scalar motor control mode is selected by parameter <i>21.19 Scalar start mode</i>.</li> <li>• Starting into a rotating motor is not possible when DC magnetizing is selected (<i>Fast</i> or <i>Const time</i>).</li> <li>• With permanent magnet motors, <i>Automatic</i> start mode must be used.</li> <li>• This parameter cannot be changed while the drive is running.</li> </ul> <p>See also section <i>DC magnetization</i> on page 77.</p>	<i>Const time</i>
	Fast	The drive pre-magnetizes the motor before start. The pre-magnetizing time is determined automatically, typically 200 ms to 2 s depending on motor size. Select this mode if a high break-away torque is required.	0
	Const time	<p>The drive pre-magnetizes the motor before start. The pre-magnetizing time is defined by parameter <i>21.02 Magnetization time</i>. This mode should be selected if constant pre-magnetizing time is required (e.g. if the motor start must be synchronized with the release of a mechanical brake). This setting also guarantees the highest possible break-away torque when the pre-magnetizing time is set long enough.</p> <p> <b>WARNING!</b> The drive will start after the set magnetizing time has passed even if motor magnetization is not completed. In applications where a full break-away torque is essential, ensure that the constant magnetizing time is long enough to allow generation of full magnetization and torque.</p>	1
	Automatic	<p>Automatic start guarantees optimal motor start in most cases. It includes the flying start function (starting into a rotating motor) and the automatic restart function. The drive motor control program identifies the flux as well as the mechanical state of the motor and starts the motor instantly under all conditions.</p> <p><b>Note:</b> If parameter <i>99.04 Motor control mode</i> is set to <i>Scalar</i>, no flying start or automatic restart is possible unless parameter <i>21.19 Scalar start mode</i> is set to <i>Automatic</i>.</p>	2

No.	Name/Value	Description	Default FbEq 16										
21.02	<i>Magnetization time</i>	<p>Defines the pre-magnetization time when</p> <ul style="list-style-type: none"> <li>parameter <a href="#">21.01 Vector start mode</a> is set to <i>Const time</i> (in vector motor control mode), or</li> <li>parameter <a href="#">21.19 Scalar start mode</a> is set to <i>Const time</i> (in scalar motor control mode).</li> </ul> <p>After the start command, the drive automatically premagnetizes the motor for the set time. To ensure full magnetizing, set this parameter to the same value as, or higher than, the rotor time constant. If not known, use the rule-of-thumb value given in the table below:</p> <table border="1"> <thead> <tr> <th>Motor rated power</th> <th>Constant magnetizing time</th> </tr> </thead> <tbody> <tr> <td>&lt; 1 kW</td> <td>≥ 50 to 100 ms</td> </tr> <tr> <td>1 to 10 kW</td> <td>≥ 100 to 200 ms</td> </tr> <tr> <td>10 to 200 kW</td> <td>≥ 200 to 1000 ms</td> </tr> <tr> <td>200 to 1000 kW</td> <td>≥ 1000 to 2000 ms</td> </tr> </tbody> </table> <p><b>Note:</b> This parameter cannot be changed while the drive is running.</p>	Motor rated power	Constant magnetizing time	< 1 kW	≥ 50 to 100 ms	1 to 10 kW	≥ 100 to 200 ms	10 to 200 kW	≥ 200 to 1000 ms	200 to 1000 kW	≥ 1000 to 2000 ms	500 ms
Motor rated power	Constant magnetizing time												
< 1 kW	≥ 50 to 100 ms												
1 to 10 kW	≥ 100 to 200 ms												
10 to 200 kW	≥ 200 to 1000 ms												
200 to 1000 kW	≥ 1000 to 2000 ms												
	0...10000 ms	Constant DC magnetizing time.	1 = 1 ms										
21.03	<i>Stop mode</i>	<p>Selects the way the motor is stopped when a stop command is received.</p> <p>Additional braking is possible by selecting flux braking (see parameter <a href="#">97.05 Flux braking</a>).</p>	Ramp										
	Coast	<p>Stop by switching off the output semiconductors of the drive. The motor coasts to a stop.</p> <p> <b>WARNING!</b> If a mechanical brake is used, make sure it is safe to stop the drive by coasting.</p>	0										
	Ramp	<p>Stop along the active deceleration ramp. See parameter group <a href="#">23 Speed reference ramp</a> or <a href="#">28 Frequency reference chain</a>.</p>	1										
	Torque limit	<p>Stop according to torque limits (parameters <a href="#">30.19</a> and <a href="#">30.20</a>). This mode is only possible in vector motor control mode.</p>	2										
21.04	<i>Emergency stop mode</i>	<p>Selects the way the motor is stopped when an emergency stop command is received.</p> <p>The source of the emergency stop signal is selected by parameter <a href="#">21.05 Emergency stop source</a>.</p>	<i>Ramp stop (Off1)</i>										
	Ramp stop (Off1)	<p>With the drive running:</p> <ul style="list-style-type: none"> <li>1 = Normal operation.</li> <li>0 = Normal stop along the standard deceleration ramp defined for the particular reference type (see section <a href="#">Reference ramping</a> on page <a href="#">67</a>). After the drive has stopped, it can be restarted by removing the emergency stop signal and switching the start signal from 0 to 1.</li> </ul> <p>With the drive stopped:</p> <ul style="list-style-type: none"> <li>1 = Starting allowed.</li> <li>0 = Starting not allowed.</li> </ul>	0										

No.	Name/Value	Description	Default FbEq 16
	Coast stop (Off2)	With the drive running: <ul style="list-style-type: none"> <li>• 1 = Normal operation.</li> <li>• 0 = Stop by coasting.</li> </ul> With the drive stopped: <ul style="list-style-type: none"> <li>• 1 = Starting allowed.</li> <li>• 0 = Starting not allowed.</li> </ul>	1
	Eme ramp stop (Off3)	With the drive running: <ul style="list-style-type: none"> <li>• 1 = Normal operation</li> <li>• 0 = Stop by ramping along emergency stop ramp defined by parameter <a href="#">23.23 Emergency stop time</a>. After the drive has stopped, it can be restarted by removing the emergency stop signal and switching the start signal from 0 to 1.</li> </ul> With the drive stopped: <ul style="list-style-type: none"> <li>• 1 = Starting allowed</li> <li>• 0 = Starting not allowed</li> </ul>	2
<a href="#">21.05</a>	<a href="#">Emergency stop source</a>	Selects the source of the emergency stop signal. The stop mode is selected by parameter <a href="#">21.04 Emergency stop mode</a> . 0 = Emergency stop active 1 = Normal operation <b>Note:</b> This parameter cannot be changed while the drive is running.	<i>Inactive (true)</i>
	Active (false)	0.	0
	Inactive (true)	1.	1
	DI1	Digital input DI1 ( <a href="#">10.02 DI delayed status</a> , bit 0).	3
	DI2	Digital input DI2 ( <a href="#">10.02 DI delayed status</a> , bit 1).	4
	DI3	Digital input DI3 ( <a href="#">10.02 DI delayed status</a> , bit 2).	5
	DI4	Digital input DI4 ( <a href="#">10.02 DI delayed status</a> , bit 3).	6
	DIO1	Digital input DIO1 ( <a href="#">11.02 DIO delayed status</a> bit 0).	10
	DIO2	Digital input DIO2 ( <a href="#">11.02 DIO delayed status</a> bit 0).	11
<a href="#">21.06</a>	<a href="#">Zero speed limit</a>	Defines the zero speed limit. The motor is stopped along a speed ramp (when ramped stop is selected or emergency stop time is used) until the defined zero speed limit is reached. After the zero speed delay, the motor coasts to a stop.	30.00 rpm
	0.00...30000.00 rpm	Zero speed limit.	See par. <a href="#">46.01</a>

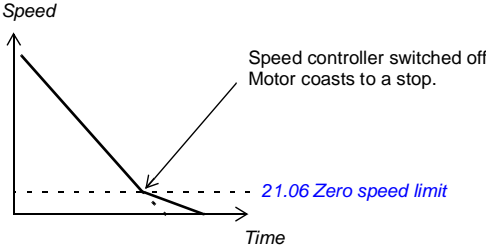
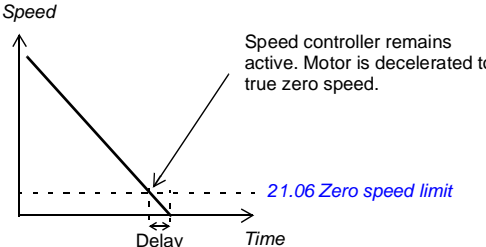
No.	Name/Value	Description	Default FbEq 16
21.07	<i>Zero speed delay</i>	<p>Defines the delay for the zero speed delay function. The function is useful in applications where a smooth and quick restarting is essential. During the delay, the drive knows the rotor position accurately.</p> <p><u>Without zero speed delay:</u> The drive receives a stop command and decelerates along a ramp. When actual motor speed falls below the value of parameter <i>21.06 Zero speed limit</i>, inverter modulation is stopped and the motor coasts to a standstill.</p>  <p><u>With zero speed delay:</u> The drive receives a stop command and decelerates along a ramp. When actual motor speed falls below the value of parameter <i>21.06 Zero speed limit</i>, the zero speed delay function activates. During the delay the function keeps the speed controller live: the inverter modulates, motor is magnetized and the drive is ready for a quick restart. Zero speed delay can be used e.g. with the jogging function.</p> 	0 ms
	0...30000 ms	Zero speed delay.	1 = 1 ms

No.	Name/Value	Description	Default FbEq 16								
21.08	<i>DC current control</i>	Activates/deactivates the DC hold and post-magnetization functions. See section <i>DC magnetization</i> on page 77. <b>Note:</b> DC magnetization causes the motor to heat up. In applications where long DC magnetization times are required, externally ventilated motors should be used. If the DC magnetization period is long, DC magnetization cannot prevent the motor shaft from rotating if a constant load is applied to the motor.	0b0000								
		<table border="1"> <thead> <tr> <th>Bit</th> <th>Value</th> </tr> </thead> <tbody> <tr> <td>0</td> <td>1 = DC hold. See section <i>DC hold</i> on page 77. <b>Note:</b> The DC hold function has no effect if the start signal is switched off.</td> </tr> <tr> <td>1</td> <td>1 = Post-magnetization. See section <i>Post-magnetization</i> on page 78. <b>Note:</b> Post-magnetization is only available when ramping is the selected stop mode (see parameter <i>21.03 Stop mode</i>).</td> </tr> <tr> <td>2...15</td> <td>Reserved</td> </tr> </tbody> </table>	Bit	Value	0	1 = DC hold. See section <i>DC hold</i> on page 77. <b>Note:</b> The DC hold function has no effect if the start signal is switched off.	1	1 = Post-magnetization. See section <i>Post-magnetization</i> on page 78. <b>Note:</b> Post-magnetization is only available when ramping is the selected stop mode (see parameter <i>21.03 Stop mode</i> ).	2...15	Reserved	
Bit	Value										
0	1 = DC hold. See section <i>DC hold</i> on page 77. <b>Note:</b> The DC hold function has no effect if the start signal is switched off.										
1	1 = Post-magnetization. See section <i>Post-magnetization</i> on page 78. <b>Note:</b> Post-magnetization is only available when ramping is the selected stop mode (see parameter <i>21.03 Stop mode</i> ).										
2...15	Reserved										
	0b0000...0b1111	DC magnetization selection.	1 = 1								
21.09	<i>DC hold speed</i>	Defines the DC hold speed in speed control mode. See parameter <i>21.08 DC current control</i> , and section <i>DC hold</i> on page 77.	5.00 rpm								
	0.00...1000.00 rpm	DC hold speed.	See par. <i>46.01</i>								
21.10	<i>DC current reference</i>	Defines the DC hold current in percent of the motor nominal current. See parameter <i>21.08 DC current control</i> , and section <i>DC magnetization</i> on page 77. After 100 s post-magnetization time, the maximum magnetization current is limited to the magnetization current corresponding to the actual flux reference.	30.0%								
	0.0...100.0%	DC hold current.	1 = 1%								
21.11	<i>Post magnetization time</i>	Defines the length of time for which post-magnetization is active after stopping the motor. The magnetization current is defined by parameter <i>21.10 DC current reference</i> . See parameter <i>21.08 DC current control</i>	0 s								
	0...3000 s	Post-magnetization time.	1 = 1 s								
21.13	<i>Autophasing mode</i>	Selects the way autophasing is performed. See section Autophasing on page 59.	<i>Turning</i>								
	Turning	This mode gives the most accurate autophasing result. This mode can be used, and is recommended, if the motor is allowed to rotate during the ID run and the start-up is not time-critical. <b>Note:</b> This mode will cause the motor to rotate. The load torque must be less than 5%.	0								

No.	Name/Value	Description	Default FbEq 16
21.14	<i>Pre-heating input source</i>	Selects the source for triggering pre-heating for the motor. The status of the pre-heating is shown as bit 2 of <a href="#">06.21 Drive status word 3</a> . <b>Notes:</b> <ul style="list-style-type: none"> <li>The heating function requires that STO is not triggered.</li> <li>The heating function requires that the drive is not faulted.</li> <li>Pre-heating uses DC hold to produce current.</li> </ul>	Off
	Off	0. Pre-heating is always deactivated.	0
	On	1. Pre-heating is always activated when the drive is stopped.	1
	DI1	Digital input DI1 ( <a href="#">10.02 DI delayed status</a> , bit 0).	2
	DI2	Digital input DI2 ( <a href="#">10.02 DI delayed status</a> , bit 1).	3
	DI3	Digital input DI3 ( <a href="#">10.02 DI delayed status</a> , bit 2).	4
	DI4	Digital input DI4 ( <a href="#">10.02 DI delayed status</a> , bit 3).	5
	Supervision 1	Bit 0 of <a href="#">32.01 Supervision status</a> (see page 232).	8
	Supervision 2	Bit 1 of <a href="#">32.01 Supervision status</a> (see page 232).	9
	Supervision 3	Bit 2 of <a href="#">32.01 Supervision status</a> (see page 232).	10
	Timed function 1	Bit 0 of <a href="#">34.01 Timed functions status</a> (see page 239)	11
	Timed function 2	Bit 1 of <a href="#">34.01 Timed functions status</a> (see page 239).	12
	Timed function 3	Bit 2 of <a href="#">34.01 Timed functions status</a> (see page 239)	13
	DIO1	Digital input/output DIO1 ( <a href="#">11.02 DIO delayed status</a> , bit 0).	14
	DIO2	Digital input/output DIO2 ( <a href="#">11.02 DIO delayed status</a> , bit 1).	15
	<i>Other [bit]</i>	Source selection (see <a href="#">Terms and abbreviations</a> ).	-
21.15	<i>Pre-heating time delay</i>	Time delay before pre-heating starts after the drive is stopped.	60 s
	10...3000 s	Pre-heating time delay.	1 = 1 s
21.16	<i>Pre-heating current</i>	Defines the DC current used to heat the motor. The value is in percent of the nominal motor current.	0.0%
	0.0...30.0%	Pre-heating current.	1 = 1%
21.18	<i>Auto restart time</i>	The motor can be automatically started after a short supply power failure using the automatic restart function. See section <a href="#">Automatic restart</a> on page 91. When this parameter is set to 0.0 seconds, automatic restarting is disabled. Otherwise, the parameter defines the maximum duration of the power failure after which restarting is attempted. Note that this time also includes the DC pre-charging delay.  <b>WARNING!</b> Before you activate the function, make sure that no dangerous situations can occur. The function restarts the drive automatically and continues operation after a supply break.	10.0 s
	0.0 s	Automatic restart disabled.	0
	0.0...10.0 s	Maximum power failure duration.	1 = 1 s

No.	Name/Value	Description	Default FbEq 16
21.19	<i>Scalar start mode</i>	<p>Selects the motor start function for the scalar motor control mode, ie. when <a href="#">99.04 Motor control mode</a> is set to <a href="#">Scalar</a>.</p> <p><b>Notes:</b></p> <ul style="list-style-type: none"> <li>The start function for the vector motor control mode is selected by parameter <a href="#">21.01 Vector start mode</a>.</li> <li>With permanent magnet motors, <a href="#">Automatic</a> start mode must be used.</li> <li>This parameter cannot be changed while the drive is running.</li> </ul> <p>See also section <a href="#">DC magnetization</a> on page <a href="#">77</a>.</p>	<i>Const time</i>
	Normal	Immediate start from zero speed.	0
	Const time	<p>The drive pre-magnetizes the motor before start. The pre-magnetizing time is defined by parameter <a href="#">21.02 Magnetization time</a>. This mode should be selected if constant pre-magnetizing time is required (e.g. if the motor start must be synchronized with the release of a mechanical brake). This setting also guarantees the highest possible break-away torque when the pre-magnetizing time is set long enough.</p> <p><b>Note:</b> This mode cannot be used to start into a rotating motor.</p> <p> <b>WARNING!</b> The drive will start after the set magnetizing time has passed even if motor magnetization is not completed. In applications where a full break-away torque is essential, ensure that the constant magnetizing time is long enough to allow generation of full magnetization and torque.</p>	1
	Automatic	<p>The drive automatically selects the correct output frequency to start a rotating motor. This is useful for flying starts: if the motor is already rotating, the drive will start smoothly at the current frequency.</p> <p><b>Note:</b> Cannot be used in multimotor systems.</p>	2
	Torque boost	Torque boost is applied at start, ending when output frequency exceeds 40% of nominal frequency or when output frequency is equal to reference.	3
	Automatic + boost	If the Flystart routine does not detect rotating motor, torque boost is applied.	4
	Flying start	<p>The drive automatically selects the correct output frequency to start a rotating motor. If the motor is already rotating, drive will start smoothly at the current frequency. The mode will start the motor with vector control and switch to scalar control on the fly when the motor speed has been found. Compared to the Automatic start mode, Flying start detects the motor speed faster. Flying start requires more accurate information about motor model. Therefore standstill ID run is done automatically when the drive is started for the first time after selecting Flying start. Motor plate values should be accurate. Wrong plate values may decrease the starting performance.</p> <p><b>Note:</b> Flying start cannot be used in multimotor systems.</p>	5
	Flying start+boost	<p>Flying start with torque boost.</p> <p>Flying start is performed first and the motor is magnetized. If the speed is found to be zero, torque boost is applied.</p>	6

No.	Name/Value	Description	Default FbEq 16
21.21	<i>DC hold frequency</i>	Defines the DC hold frequency, which is used instead of parameter <i>21.09 DC hold speed</i> when the operating mode in use is <i>Scalar frequency mode</i> . See parameters <i>19.01 Actual operation mode</i> , <i>21.08 DC current control</i> , and section <i>DC hold</i> on page 77.	5.00 Hz
	0.00...1000.00 Hz	DC hold frequency.	1 = 1 Hz
21.22	<i>Start delay</i>	Defines the start delay. After the conditions for start have been fulfilled, the drive waits until the delay has elapsed and then starts the motor. During the delay, warning <i>AFE9 Start delay</i> is shown. Start delay can be used with all start modes.	0.00 s
	0.00...60.00 s	Start delay	1 = 1 s
21.23	<i>Smooth start</i>	Enables smooth start function. Smooth start function restricts the motor current below the limit defined by parameter <i>21.24 Smooth start current</i> when the motor speed is below <i>21.25 Smooth start speed</i> .	<i>Disabled</i>
	Disabled	Smooth start disabled	0
	Enabled always	Smooth start function is always active when speed is below limit.	1
	Start only	Smooth start function is only active after start while the speed is below limit.	2
21.24	<i>Smooth start current</i>	Current applied to motor when the smooth start is active.	50.0%
	10.0... 100.0%		1=1%
21.25	<i>Smooth start speed</i>	Set the smooth start speed when the current is applied.	10.0%
	2.0... 100.0%		1=1%
21.26	<i>Torque boost current</i>	Defines the maximum supplied current to motor during 'Torque boost' –starting mode. Parameter value is in percent of the motor nominal current. Nominal value of the parameter is 100.0%. 'Torque boost' –starting mode can be used only when motor control mode is 'Scalar'. Torque boost is only applied at start, ending when output frequency exceeds 40% of nominal frequency or when output frequency is equal to reference.	100.0%
	15.0... 300.0%		0.01 = 1%
21.30	<i>Speed compensated stop mode</i>	Selects the method used to stop the drive. See also section <i>Speed compensated stop</i> on page 80. Speed compensated stop is active only if <ul style="list-style-type: none"> <li>the operation mode is not torque, and <ul style="list-style-type: none"> <li>parameter <i>21.03 Stop mode</i> is <i>Ramp</i>, or</li> <li>parameter <i>20.11 Run enable stop mode</i> is <i>Ramp</i> (in case Run enable is missing).</li> </ul> </li> </ul>	<i>Off</i>
	Off	Stop according parameter <i>21.03 Stop mode</i> , no speed compensated stop.	0
	Speed comp FWD	If the direction of rotation is forward, speed compensation is used for constant distance braking. Speed difference (between used speed and maximum speed) is compensated by running the drive with current speed before the motor is stopped along a ramp. If the direction of rotation is reverse, the drive is stopped along a ramp.	1



No.	Name/Value	Description	Default FbEq 16
	Speed comp REV	If the direction of rotation is reverse, speed compensation is used for constant distance braking. Speed difference (between used speed and maximum speed) is compensated by running the drive with current speed before the motor is stopped along a ramp. If the direction of rotation is forward, the drive is stopped along a ramp.	2
	Speed comp bipolar	Regardless of the direction of rotation, speed compensation is used for constant distance braking. Speed difference (between used speed and maximum speed) is compensated by running the drive with current speed before the motor is stopped along a ramp.	3
21.31	<i>Speed compensated stop delay</i>	This delay adds distance to the total distance traveled during a stop from maximum speed. It is used to adjust the distance to match requirements so that the distance traveled is not solely determined by the deceleration rate.	0.00 s
	0.00...1000.00 s	Speed delay.	1 = 1 s
21.32	<i>Speed comp stop threshold</i>	This parameter sets a speed threshold below which the Speed compensated stop feature is disabled. In this speed region, the speed compensated stop is not attempted and the drive stops as it would, using the ramp option.	10%
	0...100%	Speed threshold as a percent of the motor nominal speed.	1 = 1%
21.34	<i>Force auto restart</i>	Forces automatic restart. The parameter is applicable only if parameter <i>95.04 Control board supply</i> is set to <i>External 24V</i> .	<i>Disable</i>
	Disable	Force auto restart disabled. Parameter <i>21.18 Auto restart time</i> is in effect if its value is more than 0.0 s.	0
	Enable	Force auto restart enabled. Parameter <i>21.18 Auto restart time</i> is ignored. The drive never trips on the undervoltage fault and the start signal is on forever. When the DC voltage is restored, the normal operation continues.	1
<b>22 Speed reference selection</b>		Speed reference selection; motor potentiometer settings. See the control chain diagrams on pages 498...502.	
22.01	<i>Speed ref unlimited</i>	Displays the output of the speed reference selection block. See the control chain diagram on page 498. This parameter is read-only.	0.00 rpm
	-30000.00... 30000.00 rpm	Value of the selected speed reference.	See par. <i>46.01</i>

No.	Name/Value	Description	Default FbEq 16
22.11	<i>Ext1 speed ref1</i>	<p>Selects Ext1 speed reference source 1.</p> <p>Two signal sources can be defined by this parameter and <a href="#">22.12 Ext1 speed ref2</a>. A mathematical function (<a href="#">22.13 Ext1 speed function</a>) applied to the two signals creates an Ext1 reference (A in the figure below).</p> <p>A digital source selected by <a href="#">19.11 Ext1/Ext2 selection</a> can be used to switch between Ext1 reference and the corresponding Ext2 reference defined by parameters <a href="#">22.18 Ext2 speed ref1</a>, <a href="#">22.19 Ext2 speed ref2</a> and <a href="#">22.20 Ext2 speed function</a> (B in the figure below).</p> <p><b>Note:</b> The default value depends on the selected macro. See <a href="#">Control macros</a> on page 31.</p>	<i>Integrated panel (ref saved)</i>
<p>The diagram illustrates the configuration for Ext1 and Ext2 speed references. It shows four input blocks (22.11, 22.12, 22.18, 22.19) each receiving signals from 0, AI, FB, and Other sources. These signals are processed by function blocks 22.13 and 22.20, which contain Ref1 and Ref2 outputs. The Ref1 outputs are connected to Ext1 and Ext2. A switch block 19.11 selects between Ext1 and Ext2, with output 22.86.</p>			
Zero	None.		0
AI1 scaled	<a href="#">12.12 AI1 scaled value</a> .		1
AI2 scaled	<a href="#">12.22 AI2 scaled value</a> .		2
FB A ref1	<a href="#">03.05 FB A reference 1</a>		4
FB A ref2	<a href="#">03.06 FB A reference 2</a> .		5
EFB ref1	<a href="#">03.09 EFB reference 1</a> .		8
EFB ref2	<a href="#">03.10 EFB reference 2</a> .		9
Motor potentiometer	<a href="#">22.80 Motor potentiometer ref act</a> (output of the motor potentiometer).		15

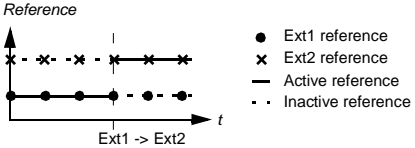
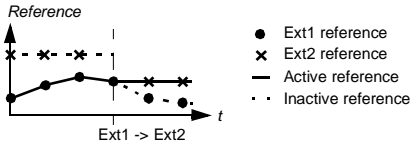
No.	Name/Value	Description	Default FbEq 16
	PID	<a href="#">40.01 Process PID output actual</a> (output of the process PID controller).	16
	Frequency input 1	<a href="#">11.38 Freq in 1 actual value</a> (when DI3 or DI4 is used as a frequency input).	17
	Control panel (ref saved)	Panel reference ( <a href="#">03.01 Panel reference</a> , see page 118) saved by the control system for the location where the control returns is used as the reference.  <i>Reference</i> 	18
	Control panel (ref copied)	Panel reference ( <a href="#">03.01 Panel reference</a> for the previous control location is used as the reference when the control location changes if the references for the two locations are of the same type (eg frequency/speed/torque/PID); otherwise, the actual signal is used as the new reference.  <i>Reference</i> 	19
	Integrated panel (ref saved)	See above Control panel (ref saved).	20
	Integrated panel (ref copied)	See above Control panel (ref copied).	21
	Frequency input 2	<a href="#">11.46 Freq in 2 actual value</a> (when DI3 or DI4 is used as a frequency input).	22
	MotPot Crane	Output of the crane motor potentiometer. See <a href="#">22.230 Crane motpot ref act</a> .	31
	<i>Other</i>	Source selection (see <a href="#">Terms and abbreviations</a> ).	-
<a href="#">22.12</a>	<a href="#">Ext1 speed ref2</a>	Selects Ext1 speed reference source 2. For the diagram of reference source selection, see parameter <a href="#">22.11 Ext1 speed ref1</a> .	<a href="#">Zero</a>
	Zero	None.	0
	AI1 scaled	<a href="#">12.12 AI1 scaled value</a> .	1
	AI2 scaled	<a href="#">12.22 AI2 scaled value</a> .	2
	FB A ref1	<a href="#">03.05 FB A reference 1</a>	4
	FB A ref2	<a href="#">03.06 FB A reference 2</a> .	5
	EFB ref1	<a href="#">03.09 EFB reference 1</a> .	8
	EFB ref2	<a href="#">03.10 EFB reference 2</a> .	9
	Motor potentiometer	<a href="#">22.80 Motor potentiometer ref act</a> (output of the motor potentiometer).	15
	PID	<a href="#">40.01 Process PID output actual</a> (output of the process PID controller).	16

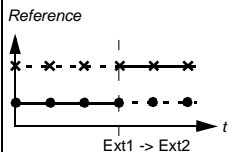
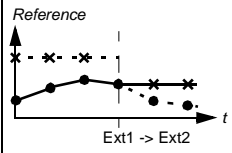
No.	Name/Value	Description	Default FbEq 16
	Frequency input 1	<a href="#">11.38 Freq in 1 actual value</a> (when DI3 or DI4 is used as a frequency input).	17
	Control panel (ref saved)	Panel reference ( <a href="#">03.01 Panel reference</a> , see page <a href="#">118</a> ) saved by the control system for the location where the control returns is used as the reference. <i>Reference</i>  <ul style="list-style-type: none"> <li>● Ext1 reference</li> <li>× Ext2 reference</li> <li>— Active reference</li> <li>· · Inactive reference</li> </ul>	18
	Control panel (ref copied)	Panel reference ( <a href="#">03.01 Panel reference</a> for the previous control location is used as the reference when the control location changes if the references for the two locations are of the same type (eg frequency/speed/torque/PID); otherwise, the actual signal is used as the new reference. <i>Reference</i>  <ul style="list-style-type: none"> <li>● Ext1 reference</li> <li>× Ext2 reference</li> <li>— Active reference</li> <li>· · Inactive reference</li> </ul>	19
	Integrated panel (ref saved)	See above Control panel (ref saved).	20
	Integrated panel (ref copied)	See above Control panel (ref copied).	21
	Frequency input 2	<a href="#">11.46 Freq in 2 actual value</a> (when DI3 or DI4 is used as a frequency input).	22
	<i>Other</i>	Source selection (see <a href="#">Terms and abbreviations</a> ).	-
22.13	<a href="#">Ext1 speed function</a>	Selects a mathematical function between the reference sources selected by parameters <a href="#">22.11 Ext1 speed ref1</a> and <a href="#">22.12 Ext1 speed ref2</a> . See diagram at <a href="#">22.11 Ext1 speed ref1</a> .	<a href="#">Ref1</a>
	Ref1	Signal selected by <a href="#">22.11 Ext1 speed ref1</a> is used as speed reference 1 as such (no function applied).	0
	Add (ref1 + ref2)	The sum of the reference sources is used as speed reference 1.	1
	Sub (ref1 - ref2)	The subtraction ( <a href="#">[22.11 Ext1 speed ref1]</a> - <a href="#">[22.12 Ext1 speed ref2]</a> ) of the reference sources is used as speed reference 1.	2
	Mul (ref1 × ref2)	The multiplication of the reference sources is used as speed reference 1.	3
	Min (ref1, ref2)	The smaller of the reference sources is used as speed reference 1.	4
	Max (ref1, ref2)	The greater of the reference sources is used as speed reference 1.	5
	Abs (ref1)	The absolute value of the reference sources is used as speed reference 1	6

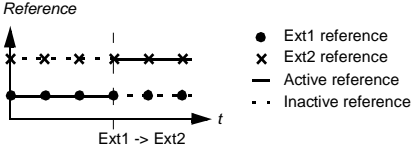
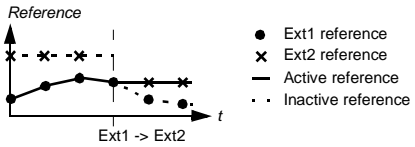
No.	Name/Value	Description	Default FbEq 16
22.18	<i>Ext2 speed ref1</i>	Selects Ext2 speed reference source 1. Two signal sources can be defined by this parameter and <a href="#">22.19 Ext2 speed ref2</a> . A mathematical function ( <a href="#">22.20 Ext2 speed function</a> ) applied to the two signals creates an Ext2 reference. See diagram at <a href="#">28.11 Ext1 frequency ref1</a> .	Zero
	Zero	None.	0
	AI1 scaled	<a href="#">12.12 AI1 scaled value</a> .	1
	AI2 scaled	<a href="#">12.22 AI2 scaled value</a> .	2
	FB A ref1	<a href="#">03.05 FB A reference 1</a> .	4
	FB A ref2	<a href="#">03.06 FB A reference 2</a>	5
	EFB ref1	<a href="#">03.09 EFB reference 1</a> .	8
	EFB ref2	<a href="#">03.10 EFB reference 2</a> .	9
	Motor potentiometer	<a href="#">22.19 Motor potentiometer ref act</a> (output of the motor potentiometer).	15
	PID	<a href="#">40.01 Process PID output actual</a> (output of the process PID controller).	16
	Frequency input 1	<a href="#">11.38 Freq in 1 actual value</a> (when DI3 or DI4 is used as a frequency input).	17
	Control panel (ref saved)	Panel reference ( <a href="#">03.01 Panel reference</a> , see page <a href="#">118</a> ) saved by the control system for the location where the control returns is used as the reference.  	18
	Control panel (ref copied)	Panel reference ( <a href="#">03.01 Panel reference</a> , see page <a href="#">118</a> ) for the previous control location is used as the reference when the control location changes if the references for the two locations are of the same type (eg frequency/speed/torque/PID); otherwise, the actual signal is used as the new reference.  	19
	Integrated panel (ref saved)	See above Control panel (ref saved).	20
	Integrated panel (ref copied)	See above Control panel (ref copied).	21
	Frequency input 2	<a href="#">11.46 Freq in 2 actual value</a> (when DI3 or DI4 is used as a frequency input).	22
	<i>Other</i>	Source selection (see <a href="#">Terms and abbreviations</a> ).	-

No.	Name/Value	Description	Default FbEq 16
22.19	<i>Ext2 speed ref2</i>	Selects Ext2 speed reference source 2. For the selections, and a diagram of reference source selection, see parameter <a href="#">22.18 Ext2 speed ref1</a> .	Zero
22.20	<i>Ext2 speed function</i>	Selects a mathematical function between the reference sources selected by parameters <a href="#">22.18 Ext2 speed ref1</a> and <a href="#">22.19 Ext2 speed ref2</a> . See diagram at <a href="#">22.18 Ext2 speed ref1</a> .	Ref1
	Ref1	Signal selected by <i>Ext2 speed ref1</i> is used as speed reference 1 as such (no function applied).	0
	Add (ref1 + ref2)	The sum of the reference sources is used as speed reference 1.	1
	Sub (ref1 - ref2)	The subtraction ( <a href="#">22.11 Ext1 speed ref1</a> - <a href="#">22.12 Ext1 speed ref2</a> ) of the reference sources is used as speed reference 1.	2
	Mul (ref1 × ref2)	The multiplication of the reference sources is used as speed reference 1.	3
	Min (ref1, ref2)	The smaller of the reference sources is used as speed reference 1.	4
	Max (ref1, ref2)	The greater of the reference sources is used as speed reference 1.	5
	Abs (ref1)	The absolute value of the reference sources is used as speed reference 1	6
22.21	<i>Constant speed function</i>	Determines how constant speeds are selected, and whether the rotation direction signal is considered or not when applying a constant speed.	0b0001

Bit	Name	Information
0	Constant speed mode	1 = Packed: 7 constant speeds are selectable using the three sources defined by parameters <a href="#">22.22</a> , <a href="#">22.23</a> and <a href="#">22.24</a> . 0 = Separate: Constant speeds 1, 2 and 3 are separately activated by the sources defined by parameters <a href="#">22.22</a> , <a href="#">22.23</a> and <a href="#">22.24</a> respectively. In case of conflict, the constant speed with the smaller number takes priority.
1	Direction enable	1 = Start dir: To determine running direction for a constant speed, the sign of the constant speed setting (parameters <a href="#">22.26...22.32</a> ) is multiplied by the direction signal (forward: +1, reverse: -1). This effectively allows the drive to have 14 (7 forward, 7 reverse) constant speeds if all values in <a href="#">22.26...22.32</a> are positive.  <b>WARNING:</b> If the direction signal is reverse and the active constant speed is negative, the drive will run in the forward direction. 0 = According to Par: The running direction for the constant frequency is determined by the sign of the constant speed setting (parameters <a href="#">28.26...28.32</a> ).
2	Speed step	1 = Speed step enable; 0 = Speed step disable
3...15	Reserved	

0b0000...0b1111	Constant speed configuration word.	1 = 1
-----------------	------------------------------------	-------

No.	Name/Value	Description	Default FbEq 16																																				
22.22	<i>Constant speed sel1</i>	<p>When bit 0 of parameter <a href="#">22.21 Constant speed function</a> is 0 (Separate), selects a source that activates constant speed 1.</p> <p><b>Note:</b> The default value depends on the selected macro. See <a href="#">Control macros</a> on page 31.</p> <p>When bit 0 of parameter <a href="#">22.21 Constant speed function</a> is 1 (Packed), this parameter and parameters <a href="#">22.23 Constant speed sel2</a> and <a href="#">22.24 Constant speed sel3</a> select three sources whose states activate constant speeds as follows:</p>	<i>DI2</i>																																				
<table border="1"> <thead> <tr> <th>Source defined by par. <a href="#">22.22</a></th> <th>Source defined by par. <a href="#">22.23</a></th> <th>Source defined by par. <a href="#">22.24</a></th> <th>Constant speed active</th> </tr> </thead> <tbody> <tr> <td>0</td> <td>0</td> <td>0</td> <td>None</td> </tr> <tr> <td>1</td> <td>0</td> <td>0</td> <td>Constant speed 1</td> </tr> <tr> <td>0</td> <td>1</td> <td>0</td> <td>Constant speed 2</td> </tr> <tr> <td>1</td> <td>1</td> <td>0</td> <td>Constant speed 3</td> </tr> <tr> <td>0</td> <td>0</td> <td>1</td> <td>Constant speed 4</td> </tr> <tr> <td>1</td> <td>0</td> <td>1</td> <td>Constant speed 5</td> </tr> <tr> <td>0</td> <td>1</td> <td>1</td> <td>Constant speed 6</td> </tr> <tr> <td>1</td> <td>1</td> <td>1</td> <td>Constant speed 7</td> </tr> </tbody> </table>				Source defined by par. <a href="#">22.22</a>	Source defined by par. <a href="#">22.23</a>	Source defined by par. <a href="#">22.24</a>	Constant speed active	0	0	0	None	1	0	0	Constant speed 1	0	1	0	Constant speed 2	1	1	0	Constant speed 3	0	0	1	Constant speed 4	1	0	1	Constant speed 5	0	1	1	Constant speed 6	1	1	1	Constant speed 7
Source defined by par. <a href="#">22.22</a>	Source defined by par. <a href="#">22.23</a>	Source defined by par. <a href="#">22.24</a>	Constant speed active																																				
0	0	0	None																																				
1	0	0	Constant speed 1																																				
0	1	0	Constant speed 2																																				
1	1	0	Constant speed 3																																				
0	0	1	Constant speed 4																																				
1	0	1	Constant speed 5																																				
0	1	1	Constant speed 6																																				
1	1	1	Constant speed 7																																				
	Always off	0 (always off).	0																																				
	Always on	1 (always on).	1																																				
	DI1	Digital input DI1 ( <a href="#">10.02 DI delayed status</a> , bit 0).	2																																				
	DI2	Digital input DI2 ( <a href="#">10.02 DI delayed status</a> , bit 1).	3																																				
	DI3	Digital input DI3 ( <a href="#">10.02 DI delayed status</a> , bit 2).	4																																				
	DI4	Digital input DI4 ( <a href="#">10.02 DI delayed status</a> , bit 3).	5																																				
	DIO1	Digital input/output DIO1 ( <a href="#">11.02 DIO delayed status</a> , bit 0)	10																																				
	DIO2	Digital input/output DIO2 ( <a href="#">11.02 DIO delayed status</a> , bit 0)	11																																				
	Timed function 1	Bit 0 of <a href="#">34.01 Timed functions status</a> .	18																																				
	Timed function 2	Bit 1 of <a href="#">34.01 Timed functions status</a> .	19																																				
	Timed function 3	Bit 2 of <a href="#">34.01 Timed functions status</a> .	20																																				
	Supervision 1	Bit 0 of <a href="#">32.01 Supervision status</a> .	24																																				
	Supervision 2	Bit 1 of <a href="#">32.01 Supervision status</a> .	25																																				
	Supervision 3	Bit 2 of <a href="#">32.01 Supervision status</a> .	26																																				
	Supervision 4	Bit 3 of <a href="#">32.01 Supervision status</a> .	27																																				
	Supervision 5	Bit 4 of <a href="#">32.01 Supervision status</a> .	28																																				
	Supervision 6	Bit 5 of <a href="#">32.01 Supervision status</a> .	29																																				
	<i>Other [bit]</i>	Source selection (see <a href="#">Terms and abbreviations</a> ).	-																																				

No.	Name/Value	Description	Default FbEq 16
22.23	<a href="#">Constant speed sel2</a>	When bit 0 of parameter <a href="#">22.21 Constant speed function</a> is 0 (Separate), selects a source that activates constant speed 2. When bit 0 of parameter <a href="#">22.21 Constant speed function</a> is 1 (Packed), this parameter and parameters <a href="#">22.22 Constant speed sel1</a> and <a href="#">22.24 Constant speed sel3</a> select three sources that are used to activate constant speeds. For the selections, see parameter <a href="#">22.22 Constant speed sel1</a> . <b>Note:</b> The default value depends on the selected macro. See <a href="#">Control macros</a> on page 31.	<i>Always off</i>
22.24	<a href="#">Constant speed sel3</a>	When bit 0 of parameter <a href="#">22.21 Constant speed function</a> is 0 (Separate), selects a source that activates constant speed 3. When bit 0 of parameter <a href="#">22.21 Constant speed function</a> is 1 (Packed), this parameter and parameters <a href="#">22.22 Constant speed sel1</a> and <a href="#">22.23 Constant speed sel2</a> select three sources that are used to activate constant speeds. See table at parameter <a href="#">22.22 Constant speed sel1</a> . For the selections, see parameter <a href="#">22.22 Constant speed sel1</a> .	<i>Always off</i>
22.26	<a href="#">Constant speed 1</a>	Defines constant speed 1 (the speed the motor will turn when constant speed 1 is selected).	300.00 rpm
	-30000.00... 30000.00 rpm	Constant speed 1.	See par. <a href="#">46.01</a>
22.27	<a href="#">Constant speed 2</a>	Defines constant speed 2.	600.00 rpm
	-30000.00... 30000.00 rpm	Constant speed 2.	See par. <a href="#">46.01</a>
22.28	<a href="#">Constant speed 3</a>	Defines constant speed 3.	900.00 rpm
	-30000.00... 30000.00 rpm	Constant speed 3.	See par. <a href="#">46.01</a>
22.29	<a href="#">Constant speed 4</a>	Defines constant speed 4.	1200.00 rpm
	-30000.00... 30000.00 rpm	Constant speed 4.	See par. <a href="#">46.01</a>
22.30	<a href="#">Constant speed 5</a>	Defines constant speed 5.	1500.00 rpm
	-30000.00... 30000.00 rpm	Constant speed 5.	See par. <a href="#">46.01</a>
22.31	<a href="#">Constant speed 6</a>	Defines constant speed 6.	2400.00 rpm
	-30000.00... 30000.00 rpm	Constant speed 6.	See par. <a href="#">46.01</a>
22.32	<a href="#">Constant speed 7</a>	Defines constant speed 7.	3000.00 rpm
	-30000.00... 30000.00 rpm	Constant speed 7.	See par. <a href="#">46.01</a>



No.	Name/Value	Description	Default FbEq 16														
22.41	<i>Speed ref safe</i>	Defines a safe speed reference value that is used with supervision functions such as <ul style="list-style-type: none"> <li>• <a href="#">12.03 AI supervision function</a></li> <li>• <a href="#">49.05 Communication loss action</a></li> <li>• <a href="#">50.02 FBA A comm loss func.</a></li> </ul>	0.00 rpm														
	-30000.00... 30000.00 rpm	Safe speed reference.	See par. <a href="#">46.01</a>														
22.42	<i>Jogging 1 ref</i>	Defines the speed reference for jogging function 1. For more information on jogging, see page <a href="#">70</a> .	0.00 rpm														
	-30000.00... 30000.00 rpm	Speed reference for jogging function 1.	See par. <a href="#">46.01</a>														
22.43	<i>Jogging 2 ref</i>	Defines the speed reference for jogging function 2. For more information on jogging, see page <a href="#">70</a> .	0.00 rpm														
	-30000.00... 30000.00 rpm	Speed reference for jogging function 2.	See par. <a href="#">46.01</a>														
22.51	<i>Critical speed function</i>	Enables/disables the critical speeds function. Also determines whether the specified ranges are effective in both rotating directions or not. See also section <a href="#">Critical speeds/frequencies</a> on page <a href="#">68</a> .	0000h														
<table border="1"> <thead> <tr> <th>Bit</th> <th>Name</th> <th>Information</th> </tr> </thead> <tbody> <tr> <td rowspan="2">0</td> <td rowspan="2">Enable</td> <td>1 = Enable: Critical speeds enabled.</td> </tr> <tr> <td>0 = Disable: Critical speeds disabled.</td> </tr> <tr> <td rowspan="2">1</td> <td rowspan="2">Sign mode</td> <td>1 = Signed: The signs of parameters <a href="#">22.52... 22.57</a> are taken into account.</td> </tr> <tr> <td>0 = Absolute: Parameters <a href="#">22.52... 22.57</a> are handled as absolute values. Each range is effective in both directions of rotation.</td> </tr> <tr> <td>2...15</td> <td>Reserved</td> <td></td> </tr> </tbody> </table>				Bit	Name	Information	0	Enable	1 = Enable: Critical speeds enabled.	0 = Disable: Critical speeds disabled.	1	Sign mode	1 = Signed: The signs of parameters <a href="#">22.52... 22.57</a> are taken into account.	0 = Absolute: Parameters <a href="#">22.52... 22.57</a> are handled as absolute values. Each range is effective in both directions of rotation.	2...15	Reserved	
Bit	Name	Information															
0	Enable	1 = Enable: Critical speeds enabled.															
		0 = Disable: Critical speeds disabled.															
1	Sign mode	1 = Signed: The signs of parameters <a href="#">22.52... 22.57</a> are taken into account.															
		0 = Absolute: Parameters <a href="#">22.52... 22.57</a> are handled as absolute values. Each range is effective in both directions of rotation.															
2...15	Reserved																
	0000h...FFFFh	Critical speeds configuration word.	1 = 1														
22.52	<i>Critical speed 1 low</i>	Defines the low limit for critical speed range 1. <b>Note:</b> This value must be less than or equal to the value of <a href="#">22.53 Critical speed 1 high</a> .	0.00 rpm														
	-30000.00... 30000.00 rpm	Low limit for critical speed 1.	See par. <a href="#">46.01</a>														
22.53	<i>Critical speed 1 high</i>	Defines the high limit for critical speed range 1. <b>Note:</b> This value must be greater than or equal to the value of <a href="#">22.52</a> .	0.00 rpm														
	-30000.00... 30000.00 rpm	High limit for critical speed 1.	See par. <a href="#">46.01</a>														
22.54	<i>Critical speed 2 low</i>	Defines the low limit for critical speed range 2. <b>Note:</b> This value must be less than or equal to the value of parameter <a href="#">22.55</a> .	0.00 rpm														
	-30000.00... 30000.00 rpm	Low limit for critical speed 2.	See par. <a href="#">46.01</a>														
22.55	<i>Critical speed 2 high</i>	Defines the high limit for critical speed range 2. <b>Note:</b> This value must be greater than or equal to the value of parameter <a href="#">22.54</a> .	0.00 rpm														
	-30000.00... 30000.00 rpm	High limit for critical speed 2.	See par. <a href="#">46.01</a>														

No.	Name/Value	Description	Default FbEq 16
22.56	<i>Critical speed 3 low</i>	Defines the low limit for critical speed range 3. <b>Note:</b> This value must be less than or equal to the value of parameter <a href="#">22.57</a> .	0.00 rpm
	-30000.00... 30000.00 rpm	Low limit for critical speed 3.	See par. <a href="#">46.01</a>
22.57	<i>Critical speed 3 high</i>	Defines the high limit for critical speed range 3. <b>Note:</b> This value must be greater than or equal to the value of parameter <a href="#">22.56</a> .	0.00 rpm
	-30000.00... 30000.00 rpm	High limit for critical speed 3.	See par. <a href="#">46.01</a>
22.71	<i>Motor potentiometer function</i>	Activates and selects the mode of the motor potentiometer. See section <a href="#">Speed control performance figures</a> in chapter <a href="#">Program features</a> .	<i>Disabled</i>
	Disabled	Motor potentiometer is disabled and its value set to 0.	0
	Enabled (init at power-up)	When enabled, the motor potentiometer first adopts the value defined by parameter <a href="#">22.72</a> . The value can then be adjusted from the up and down sources defined by parameters <a href="#">22.73</a> and <a href="#">22.74</a> . A power cycle will reset the motor potentiometer to the predefined initial value ( <a href="#">22.72</a> ).	1
	Enabled (resume always)	As <i>Enabled (init at power-up)</i> , but the motor potentiometer value is retained over a power cycle.	2
	Enabled (init to actual)	Whenever another reference source is selected, the value of the motor potentiometer follows that reference. After the source of reference returns to the motor potentiometer, its value can again be changed by the up and down sources (defined by <a href="#">22.73</a> and <a href="#">22.74</a> ).	3
22.72	<i>Motor potentiometer initial value</i>	Defines an initial value (starting point) for the motor potentiometer. See the selections of parameter <a href="#">22.71</a> .	0.00
	-32768.00... 32767.00	Initial value for motor potentiometer.	1 = 1
22.73	<i>Motor potentiometer up source</i>	Selects the source of motor potentiometer up signal. 0 = No change 1 = Increase motor potentiometer value. (If both the up and down sources are on, the potentiometer value will not change.)	<i>Not selected</i>
	Not selected	0.	0
	Selected	1.	1
	DI1	Digital input DI1 ( <a href="#">10.02 DI delayed status</a> , bit 0).	2
	DI2	Digital input DI2 ( <a href="#">10.02 DI delayed status</a> , bit 1).	3
	DI3	Digital input DI3 ( <a href="#">10.02 DI delayed status</a> , bit 2).	4
	DI4	Digital input DI4 ( <a href="#">10.02 DI delayed status</a> , bit 3).	5
	DIO1	Digital input/output DIO1 ( <a href="#">11.02 DIO delayed status</a> , bit 0)	10
	DIO2	Digital input/output DIO2 ( <a href="#">11.02 DIO delayed status</a> , bit 0)	11
	Timed function 1	Bit 0 of <a href="#">34.01 Timed functions status</a> .	18
	Timed function 2	Bit 1 of <a href="#">34.01 Timed functions status</a> .	19
	Timed function 3	Bit 2 of <a href="#">34.01 Timed functions status</a> .	20
	Supervision 1	Bit 0 of <a href="#">32.01 Supervision status</a> .	24

No.	Name/Value	Description	Default FbEq 16
	Supervision 2	Bit 1 of <a href="#">32.01 Supervision status</a> .	25
	Supervision 3	Bit 2 of <a href="#">32.01 Supervision status</a> .	26
	Supervision 4	Bit 3 of <a href="#">32.01 Supervision status</a> .	27
	Supervision 5	Bit 4 of <a href="#">32.01 Supervision status</a> .	28
	Supervision 6	Bit 5 of <a href="#">32.01 Supervision status</a> .	29
	<i>Other [bit]</i>	Source selection (see <a href="#">Terms and abbreviations</a> ).	-
22.74	<i>Motor potentiometer down source</i>	Selects the source of motor potentiometer down signal. 0 = No change 1 = Decrease motor potentiometer value. (If both the up and down sources are on, the potentiometer value will not change.) For the selections, see parameter <a href="#">22.73</a> .	<i>Not selected</i>
22.75	<i>Motor potentiometer ramp time</i>	Defines the change rate of the motor potentiometer. This parameter specifies the time required for the motor potentiometer to change from minimum (parameter <a href="#">22.76</a> ) to maximum (parameter <a href="#">22.77</a> ). The same change rate applies in both directions.	40.0 s
	0.0...3600.0 s	Motor potentiometer change time.	1 = 1 s
22.76	<i>Motor potentiometer min value</i>	Defines the minimum value of the motor potentiometer. <b>Note:</b> If vector control mode is used, the value of this parameter must be changed.	-50.00
	-32768.00... 32767.00	Motor potentiometer minimum.	1 = 1
22.77	<i>Motor potentiometer max value</i>	Defines the maximum value of the motor potentiometer. <b>Note:</b> If vector control mode is used, the value of this parameter must be changed.	50.00
	-32768.00... 32767.00	Motor potentiometer maximum.	1 = 1
22.80	<i>Motor potentiometer ref act</i>	Shows the output of the motor potentiometer function. (The motor potentiometer is configured using parameters <a href="#">22.71...22.74</a> .) This parameter is read-only.	-
	-32768.00... 32767.00	Value of motor potentiometer.	1 = 1
22.86	<i>Speed reference act 6</i>	Displays the value of the speed reference (Ext1 or Ext2) that has been selected by <a href="#">19.11 Ext1/Ext2 selection</a> . See diagram at <a href="#">22.11 Ext1 speed ref1</a> or the control chain diagram on page <a href="#">498</a> . This parameter is read-only.	0.00 rpm
	-30000.00... 30000.00 rpm	Speed reference after additive 2.	See par. <a href="#">46.01</a>

No.	Name/Value	Description	Default FbEq 16
22.87	<a href="#">Speed reference act 7</a>	Displays the value of speed reference before application of critical speeds. See the control chain diagram on page <a href="#">498</a> . The value is received from <a href="#">22.86 Speed reference act 6</a> unless overridden by <ul style="list-style-type: none"> <li>any constant speed</li> <li>a jogging reference</li> <li>network control reference</li> <li>control panel reference</li> <li>safe speed reference.</li> </ul> This parameter is read-only.	0.00 rpm
	-30000.00... 30000.00 rpm	Speed reference before application of critical speeds.	See par. <a href="#">46.01</a>
22.211	<a href="#">Speed reference shape</a>	Defines the speed reference shape. See also section <a href="#">Parabolic speed reference</a> on page <a href="#">554</a> .	<i>Linear</i>
	Linear	Linear speed reference.	0
	Parabolic 1	X <sup>2</sup> speed reference.	1
	Parabolic 2	X <sup>3</sup> speed reference.	2
22.220	<a href="#">Crane motpot enable</a>	Enables or selects the source to activate the Crane motor potentiometer function. See section <a href="#">Crane motor potentiometer</a> on page <a href="#">557</a> .	<i>Not selected</i>
	Not selected	Crane motor potentiometer function is disabled.	0
	Selected	Crane motor potentiometer function is enabled.	1
	DI1	Digital input DI1 ( <a href="#">10.02 DI delayed status</a> , bit 0).	2
	DI2	Digital input DI2 ( <a href="#">10.02 DI delayed status</a> , bit 1).	3
	DI3	Digital input DI3 ( <a href="#">10.02 DI delayed status</a> , bit 2).	4
	DI4	Digital input DI4 ( <a href="#">10.02 DI delayed status</a> , bit 3).	5
	DIO1	Digital input/output DIO1 ( <a href="#">11.02 DIO delayed status</a> , bit 0)	10
	DIO2	Digital input/output DIO2 ( <a href="#">11.02 DIO delayed status</a> , bit 0)	11
	Timed function 1	Bit 0 of <a href="#">34.01 Timed functions status</a> .	18
	Timed function 2	Bit 1 of <a href="#">34.01 Timed functions status</a> .	19
	Timed function 3	Bit 2 of <a href="#">34.01 Timed functions status</a> .	20
	Supervision 1	Bit 0 of <a href="#">32.01 Supervision status</a> .	24
	Supervision 2	Bit 1 of <a href="#">32.01 Supervision status</a> .	25
	Supervision 3	Bit 2 of <a href="#">32.01 Supervision status</a> .	26
	Supervision 4	Bit 3 of <a href="#">32.01 Supervision status</a> .	27
	Supervision 5	Bit 4 of <a href="#">32.01 Supervision status</a> .	28
	Supervision 6	Bit 5 of <a href="#">32.01 Supervision status</a> .	29
	<i>Other [bit]</i>	Source selection (see <a href="#">Terms and abbreviations</a> on page <a href="#">112</a> ).	-
22.223	<a href="#">Crane motpot accel sel</a>	Selects the source of Crane motor potentiometer accelerate signal. See section <a href="#">Crane motor potentiometer</a> on page <a href="#">557</a> .	<i>Not selected</i>
	Not selected	No change.	0

No.	Name/Value	Description	Default FbEq 16																		
	Selected	Increases the motor potentiometer value depending on the selected direction. The possible effect can be seen in parameter <a href="#">22.225 Crane motpot sw</a> , bits 3 and 4.	1																		
	DI1	Digital input DI1 ( <a href="#">10.02 DI delayed status</a> , bit 0).	2																		
	DI2	Digital input DI2 ( <a href="#">10.02 DI delayed status</a> , bit 1).	3																		
	DI3	Digital input DI3 ( <a href="#">10.02 DI delayed status</a> , bit 2).	4																		
	DI4	Digital input DI4 ( <a href="#">10.02 DI delayed status</a> , bit 3).	5																		
	DIO1	Digital input/output DIO1 ( <a href="#">11.02 DIO delayed status</a> , bit 0)	10																		
	DIO2	Digital input/output DIO2 ( <a href="#">11.02 DIO delayed status</a> , bit 0)	11																		
	Timed function 1	Bit 0 of <a href="#">34.01 Timed functions status</a> .	18																		
	Timed function 2	Bit 1 of <a href="#">34.01 Timed functions status</a> .	19																		
	Timed function 3	Bit 2 of <a href="#">34.01 Timed functions status</a> .	20																		
	Supervision 1	Bit 0 of <a href="#">32.01 Supervision status</a> .	24																		
	Supervision 2	Bit 1 of <a href="#">32.01 Supervision status</a> .	25																		
	Supervision 3	Bit 2 of <a href="#">32.01 Supervision status</a> .	26																		
	Supervision 4	Bit 3 of <a href="#">32.01 Supervision status</a> .	27																		
	Supervision 5	Bit 4 of <a href="#">32.01 Supervision status</a> .	28																		
	Supervision 6	Bit 5 of <a href="#">32.01 Supervision status</a> .	29																		
	<i>Other [bit]</i>	Source selection (see <a href="#">Terms and abbreviations</a> on page 112).	-																		
<a href="#">22.224 Crane motpot min speed</a>		Defines an initial value (starting point) for the motor potentiometer at start. See section <a href="#">Crane motor potentiometer</a> on page 557.	0.00																		
	0.00...30000	Minimum speed.	1 = 1																		
<a href="#">22.225 Crane motpot sw</a>		Crane motor potentiometer status word.	0000h																		
<table border="1"> <thead> <tr> <th>Bit</th> <th>Name</th> <th>Description</th> </tr> </thead> <tbody> <tr> <td>0</td> <td>Crane motpot enabled</td> <td>Status of the Crane motor potentiometer function. 1 = Crane motor potentiometer enabled. 0 = Crane motor potentiometer disabled.</td> </tr> <tr> <td>1...2</td> <td>Reserved</td> <td></td> </tr> <tr> <td>3</td> <td>Crane motpot up source</td> <td>Used as source for four inputs of the motor potentiometer to increase the output value. 1 = Crane motor potentiometer with increased output reference. 0 = Crane motor potentiometer without increased output reference.</td> </tr> <tr> <td>4</td> <td>Crane motpot dn source</td> <td>Used as source for four inputs of the motor potentiometer to decrease the output value. 1 = Crane motor potentiometer with decreased output reference. 0 = Crane motor potentiometer without decreased output reference.</td> </tr> <tr> <td>5...15</td> <td>Reserved</td> <td></td> </tr> </tbody> </table>				Bit	Name	Description	0	Crane motpot enabled	Status of the Crane motor potentiometer function. 1 = Crane motor potentiometer enabled. 0 = Crane motor potentiometer disabled.	1...2	Reserved		3	Crane motpot up source	Used as source for four inputs of the motor potentiometer to increase the output value. 1 = Crane motor potentiometer with increased output reference. 0 = Crane motor potentiometer without increased output reference.	4	Crane motpot dn source	Used as source for four inputs of the motor potentiometer to decrease the output value. 1 = Crane motor potentiometer with decreased output reference. 0 = Crane motor potentiometer without decreased output reference.	5...15	Reserved	
Bit	Name	Description																			
0	Crane motpot enabled	Status of the Crane motor potentiometer function. 1 = Crane motor potentiometer enabled. 0 = Crane motor potentiometer disabled.																			
1...2	Reserved																				
3	Crane motpot up source	Used as source for four inputs of the motor potentiometer to increase the output value. 1 = Crane motor potentiometer with increased output reference. 0 = Crane motor potentiometer without increased output reference.																			
4	Crane motpot dn source	Used as source for four inputs of the motor potentiometer to decrease the output value. 1 = Crane motor potentiometer with decreased output reference. 0 = Crane motor potentiometer without decreased output reference.																			
5...15	Reserved																				
	0000h...FFFFh	Status word.	1 = 1																		
<a href="#">22.226 Crane motpot min value</a>		Defines the minimum value of the Crane motor potentiometer.	-50.00																		
	-30000.00... 30000.00	Minimum value	1 = 1																		

No.	Name/Value	Description	Default FbEq 16
22.227	<i>Crane motpot max value</i>	Defines the maximum value of Crane motor potentiometer.	50.00
	-30000.00... 30000.00	Maximum value	1 = 1
22.230	<i>Crane motpot ref act</i>	Displays the output of the motor potentiometer function.	0.00
	-30000.00... 30000.00		1 = 1

<b>23 Speed reference ramp</b>			
		Speed reference ramp settings (programming of the acceleration and deceleration rates for the drive). See the control chain diagram on page 500.	
23.01	<i>Speed ref ramp input</i>	Displays the used speed reference (in rpm) before it enters the ramping and shaping functions. See the control chain diagram on page 500. This parameter is read-only.	-
	-30000.00... 30000.00 rpm	Speed reference before ramping and shaping.	See par. <a href="#">46.01</a>
23.02	<i>Speed ref ramp output</i>	Displays the ramped and shaped speed reference in rpm. See the control chain diagram on page 500. This parameter is read-only.	-
	-30000.00... 30000.00 rpm	Speed reference after ramping and shaping.	See par. <a href="#">46.01</a>
23.11	<i>Ramp set selection</i>	Selects the source that switches between the two sets of acceleration/deceleration ramp times defined by parameters <a href="#">23.12</a> ... <a href="#">23.15</a> 0 = Acceleration time 1 and deceleration time 1 are active 1 = Acceleration time 2 and deceleration time 2 are active.	<a href="#">DIO1</a>
	Acc/Dec time 1	0.	0
	Acc/Dec time 2	1.	1
	DI1	Digital input DI1 ( <a href="#">10.02 DI delayed status</a> , bit 0).	2
	DI2	Digital input DI2 ( <a href="#">10.02 DI delayed status</a> , bit 1).	3
	DI3	Digital input DI3 ( <a href="#">10.02 DI delayed status</a> , bit 2).	4
	DI4	Digital input DI4 ( <a href="#">10.02 DI delayed status</a> , bit 3).	5
	DIO1	Digital input/output DIO1 ( <a href="#">11.02 DIO delayed status</a> , bit 0)	10
	DIO2	Digital input/output DIO2 ( <a href="#">11.02 DIO delayed status</a> , bit 0)	11
	FBA A	Only for the Transparent16 or Transparent32 profile. Transparent16 or Transparent32 control word bit received through the fieldbus A interface.	18
	EFB DCU CW bit 10	Only for the DCU profile. DCU control word bit 10 received through the embedded fieldbus interface.	20
	<i>Other [bit]</i>	Source selection (see <a href="#">Terms and abbreviations</a> ).	-

No.	Name/Value	Description	Default FbEq 16
23.12	<i>Acceleration time 1</i>	<p>Defines acceleration time 1 as the time required for the speed to change from zero to the speed defined by parameter <a href="#">46.01 Speed scaling</a> (not to parameter <a href="#">30.12 Maximum speed</a>).</p> <p>If the speed reference increases faster than the set acceleration rate, the motor speed will follow the acceleration rate.</p> <p>If the speed reference increases slower than the set acceleration rate, the motor speed will follow the reference.</p> <p>If the acceleration time is set too short, the drive will automatically prolong the acceleration in order not to exceed the drive torque limits.</p>	3.000 s
	0.000 ...1800.000 s	Acceleration time 1.	10 = 1 s
23.13	<i>Deceleration time 1</i>	<p>Defines deceleration time 1 as the time required for the speed to change from the speed defined by parameter <a href="#">46.01 Speed scaling</a> (not from parameter <a href="#">30.12 Maximum speed</a>) to zero.</p> <p>If the speed reference decreases slower than the set deceleration rate, the motor speed will follow the reference.</p> <p>If the reference changes faster than the set deceleration rate, the motor speed will follow the deceleration rate.</p> <p>If the deceleration rate is set too short, the drive will automatically prolong the deceleration in order not to exceed drive torque limits (or not to exceed a safe DC link voltage). If there is any doubt about the deceleration time being too short, ensure that DC overvoltage control is on (parameter <a href="#">30.30 Overvoltage control</a>).</p> <p><b>Note:</b> If a short deceleration time is needed for a high inertia application, the drive should be equipped with braking equipment such as a brake chopper and brake resistor.</p>	3.000 s
	0.000 ...1800.000 s	Deceleration time 1.	10 = 1 s
23.14	<i>Acceleration time 2</i>	Defines acceleration time 2. See parameter <a href="#">23.12 Acceleration time 1</a> .	60.000 s
	0.000 ...1800.000 s	Acceleration time 2.	10 = 1 s
23.15	<i>Deceleration time 2</i>	Defines deceleration time 2. See parameter <a href="#">23.13 Deceleration time 1</a> .	60.000 s
	0.000 ...1800.000 s	Deceleration time 2.	10 = 1 s
23.20	<i>Acc time jogging</i>	Defines the acceleration time for the jogging function ie. the time required for the speed to change from zero to the speed value defined by parameter <a href="#">46.01 Speed scaling</a> . See section <a href="#">Rush control</a> on page <a href="#">70</a> .	60.000 s
	0.000 ...1800.000 s	Acceleration time for jogging.	10 = 1 s
23.21	<i>Dec time jogging</i>	Defines the deceleration time for the jogging function ie. the time required for the speed to change from the speed value defined by parameter <a href="#">46.01 Speed scaling</a> to zero. See section <a href="#">Rush control</a> on page <a href="#">70</a> .	60.000 s
	0.000 ...1800.000 s	Deceleration time for jogging.	10 = 1 s

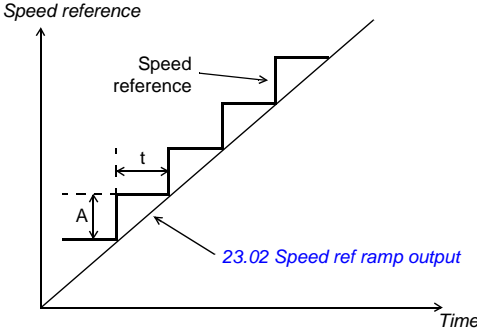
No.	Name/Value	Description	Default FbEq 16
23.23	<a href="#">Emergency stop time</a>	<p>Defines the time inside which the drive is stopped if an emergency stop Off3 is activated (ie. the time required for the speed to change from the speed value defined by parameter <a href="#">46.01 Speed scaling</a> or <a href="#">46.02 Frequency scaling</a> to zero). Emergency stop mode and activation source are selected by parameters <a href="#">21.04 Emergency stop mode</a> and <a href="#">21.05 Emergency stop source</a> respectively. Emergency stop can also be activated through fieldbus.</p> <p><b>Note:</b></p> <ul style="list-style-type: none"> <li>Emergency stop Off1 uses the standard deceleration ramp as defined by parameters <a href="#">23.11...23.15</a>.</li> <li>The same parameter value is also used in frequency control mode (ramp parameters <a href="#">28.71...28.75</a>).</li> </ul>	3.000 s
	0.000 ...1800.000 s	Emergency stop Off3 deceleration time.	10 = 1 s
23.28	<a href="#">Variable slope enable</a>	<p>Activates the variable slope function, which controls the slope of the speed ramp during a speed reference change. This allows for a constantly variable ramp rate to be generated, instead of just the standard two ramps normally available.</p> <p>If the update interval of the signal from an external control system and the variable slope rate (<a href="#">23.32 Variable slope rate</a>) are equal, speed reference (<a href="#">23.02 Speed ref ramp output</a>) is a straight line.</p>  <p><math>t</math> = update interval of signal from external control system  <math>A</math> = speed reference change during <math>t</math></p> <p>This function is only active in remote control.</p>	<a href="#">Off</a>
	Off	Variable slope disabled.	0
	On	Variable slope enabled (not available in local control).	1
23.29	<a href="#">Variable slope rate</a>	<p>Defines the rate of the speed reference change when variable slope is enabled by parameter <a href="#">23.28 Variable slope enable</a>.</p> <p>For the best result, enter the reference update interval into this parameter.</p>	50 ms
	2...30000 ms	Variable slope rate.	1 = 1 ms

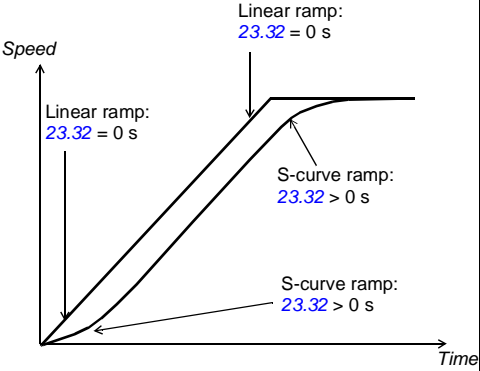
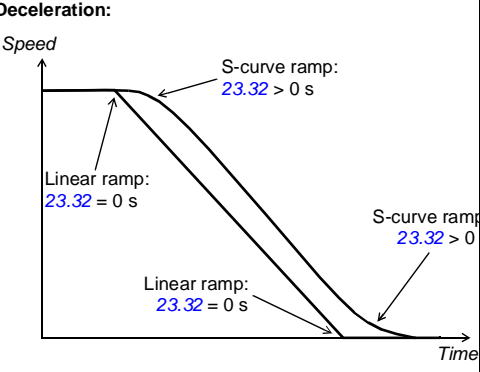

No.	Name/Value	Description	Default FbEq 16
23.32	<i>Shape time 1</i>	<p>Defines the shape of the acceleration and deceleration ramps used with the set 1.</p> <p>0.000 s: Linear ramp. Suitable for steady acceleration or deceleration and for slow ramps.</p> <p>0.001...1000.000 s: S-curve ramp. S-curve ramps are ideal for lifting applications. The S-curve consists of symmetrical curves at both ends of the ramp and a linear part in between.</p> <p><b>Acceleration:</b></p>  <p><b>Deceleration:</b></p> 	0.000 s
	0.100...1800.000 s	Ramp shape at start and end of acceleration and deceleration.	10 = 1 s
23.33	<i>Shape time 2</i>	Defines the shape of the acceleration and deceleration ramps used with the set 2. See parameter <a href="#">23.32 Shape time 1</a> .	0.000 s
	0.100...1800.000 s	Ramp shape at start and end of acceleration and deceleration.	10 = 1 s

No.	Name/Value	Description	Default FbEq 16
23.201	<i>Crane motpot acc time 1</i>	(Visible only when parameter 22.220 is selected) Defines acceleration time 1 as the time required for the speed to change from zero to the speed defined by parameter 46.01 <i>Speed scaling</i> (not to parameter 30.12 <i>Maximum speed</i> ).	40.000 s
	0.00 ...3600.000 s	Acceleration time 1.	10 = 1 s
23.202	<i>Crane motpot dec time 1</i>	(Visible only when parameter 22.220 is selected) Defines deceleration time 1 as the time required for the speed to change from the speed defined by parameter 46.01 <i>Speed scaling</i> (not from parameter 30.12 <i>Maximum speed</i> ) to zero.	40.000 s
	0.00 ...3600.000 s	Deceleration time 1.	10 = 1 s
23.206	<i>Fast stop deceleration time</i>	Defines the time within which the drive stops if the drive receives a Fast stop command (20.210 <i>Fast stop input</i> ).	0.500 s
	0.00 ...3000.000 s	Fast stop deceleration time.	10 = 1 s
<b>24 Speed reference conditioning</b>		Speed error calculation; speed error window control configuration; speed error step. See the control chain diagram on page 498.	
24.01	<i>Used speed reference</i>	Displays the ramped and corrected speed reference (before speed error calculation). See the control chain diagram on page 498. This parameter is read-only.	-
	-30000.00... 30000.00 rpm	Speed reference used for speed error calculation.	See par. 46.01
24.02	<i>Used speed feedback</i>	Displays the speed feedback used for speed error calculation. See the control chain diagram on page 498. This parameter is read-only.	-
	-30000.00... 30000.00 rpm	Speed feedback used for speed error calculation.	See par. 46.01
24.03	<i>Speed error filtered</i>	Displays the filtered speed error. See the control chain diagram on page 498. This parameter is read-only.	-
	-30000.0... 30000.0 rpm	Filtered speed error.	See par. 46.01
24.04	<i>Speed error inverted</i>	Displays the inverted (unfiltered) speed error. See the control chain diagram on page 498. This parameter is read-only.	-
	-30000.0... 30000.0 rpm	Inverted speed error.	See par. 46.01
24.11	<i>Speed correction</i>	Defines a speed reference correction, ie. a value added to the existing reference between ramping and limitation. This is useful to trim the speed if necessary, for example to adjust draw between sections of a paper machine. See the control chain diagram on page 498.	0.00 rpm
	-10000.00... 10000.00 rpm	Speed reference correction.	See par. 46.01

No.	Name/Value	Description	Default FbEq 16
24.12	<i>Speed error filter time</i>	Defines the time constant of the speed error low-pass filter. If the used speed reference changes rapidly, the possible interferences in the speed measurement can be filtered with the speed error filter. Reducing the ripple with this filter may cause speed controller tuning problems. A long filter time constant and fast acceleration time contradict one another. A very long filter time results in unstable control.	0 ms
	0...10000 ms	Speed error filtering time constant. 0 = filtering disabled.	1 = 1 ms
<b>25 Speed control</b>		Speed controller settings. See the control chain diagram on page 502.	
25.01	<i>Torque reference speed control</i>	Displays the speed controller output that is transferred to the torque controller. See the control chain diagram on page 502. This parameter is read-only.	-
	-1600.0...1600.0%	Limited speed controller output torque.	See par. 46.03
25.02	<i>Speed proportional gain</i>	Defines the proportional gain ( $K_p$ ) of the speed controller. Too high a gain may cause speed oscillation. The figure below shows the speed controller output after an error step when the error remains constant.	10.00
		<p>Gain = <math>K_p = 1</math>  <math>T_l</math> = Integration time = 0  <math>T_d</math> = Derivation time = 0</p> <p>Controller output = <math>K_p \times e</math></p> <p><math>e</math> = Error value</p>	
	0.00 ...250.00	Proportional gain for speed controller.	100 = 1

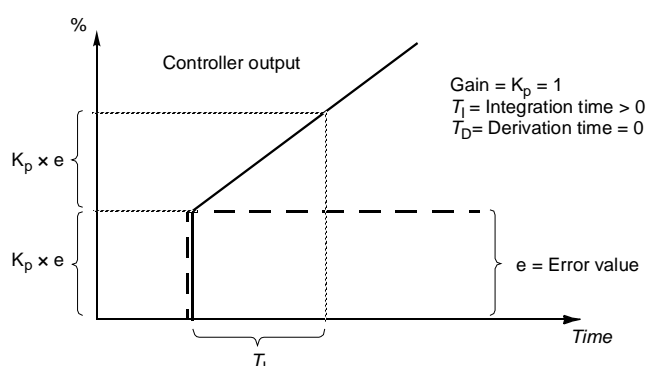
No.	Name/Value	Description	Default FbEq 16
25.03	<i>Speed integration time</i>	<p>Defines the integration time of the speed controller. The integration time defines the rate at which the controller output changes when the error value is constant and the proportional gain of the speed controller is 1. The shorter the integration time, the faster the continuous error value is corrected. This time constant must be set to the same order of magnitude as the time constant (time to respond) of the actual mechanical system being controlled, otherwise instability will result.</p> <p>Setting the integration time to zero disables the I-part of the controller. This is useful to do when tuning the proportional gain; adjust the proportional gain first, then return the integration time.</p> <p>Anti-windup (the integrator just integrates up to 100%) stops the integrator if the controller output is limited. See 06.05 Limit word1.</p> <p>The figure below shows the speed controller output after an error step when the error remains constant.</p> 	2.50 s
0.00...1000.00 s	Integration time for speed controller.		10 = 1 s

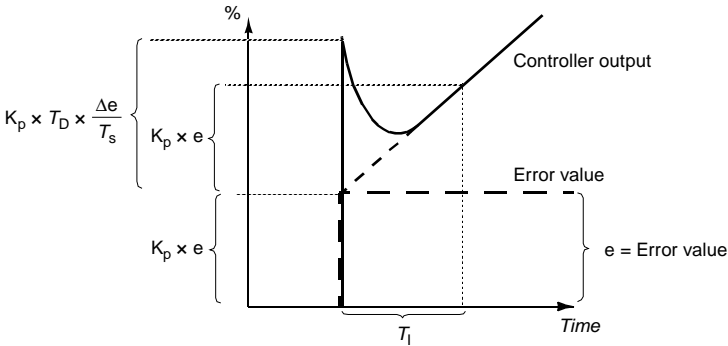
No.	Name/Value	Description	Default FbEq 16
25.04	<i>Speed derivation time</i>	<p>Defines the derivation time of the speed controller. Derivative action boosts the controller output if the error value changes. The longer the derivation time, the more the speed controller output is boosted during the change. If the derivation time is set to zero, the controller works as a PI controller, otherwise as a PID controller. The derivation makes the control more responsive for disturbances. For simple applications (especially those without a pulse encoder), derivative time is not normally required and should be left at zero.</p> <p>The speed error derivative must be filtered with a low pass filter to eliminate disturbances.</p> <p>The figure below shows the speed controller output after an error step when the error remains constant.</p>  <p>Gain = <math>K_p = 1</math>  <math>T_I</math> = Integration time &gt; 0  <math>T_D</math> = Derivation time &gt; 0  <math>T_s</math> = Sample time period = 250 <math>\mu</math>s  <math>\Delta e</math> = Error value change between two samples</p>	0.000 s
	0.000...10.000 s	Derivation time for speed controller.	1000 = 1 s
25.05	<i>Derivation filter time</i>	Defines the derivation filter time constant. See parameter <a href="#">25.04 Speed derivation time</a> .	8 ms
	0...10000 ms	Derivation filter time constant.	1 = 1 ms

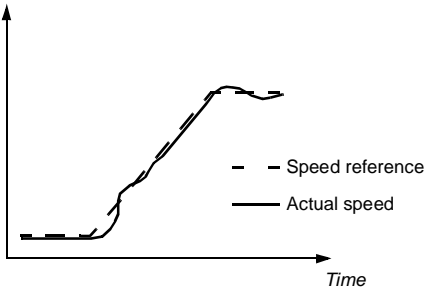
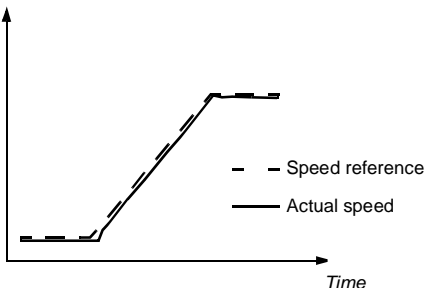
No.	Name/Value	Description	Default FbEq 16
25.06	<i>Acc comp derivation time</i>	<p>Defines the derivation time for acceleration(/deceleration) compensation. In order to compensate for a high inertia load during acceleration, a derivative of the reference is added to the output of the speed controller. The principle of a derivative action is described under parameter <a href="#">25.04 Speed derivation time</a>.</p> <p><b>Note:</b> As a general rule, set this parameter to the value between 50 and 100% of the sum of the mechanical time constants of the motor and the driven machine.</p> <p>The figure below shows the speed responses when a high inertia load is accelerated along a ramp.</p> <p><b>No acceleration compensation:</b></p>  <p><b>Acceleration compensation:</b></p> 	0.00 s
	0.00...1000.00 s	Acceleration compensation derivation time.	10 = 1 s
25.07	<i>Acc comp filter time</i>	Defines the acceleration (or deceleration) compensation filter time constant. See parameters <a href="#">25.04 Speed derivation time</a> and <a href="#">25.06 Acc comp derivation time</a> .	8.0 ms
	0.0...1000.0 ms	Acceleration/deceleration compensation filter time.	1 = 1 ms
25.15	<i>Proportional gain em stop</i>	Defines the proportional gain for the speed controller when an emergency stop is active. See parameter <a href="#">25.02 Speed proportional gain</a> .	10.00
	1.00...250.00	Proportional gain upon an emergency stop.	100 = 1

No.	Name/Value	Description	Default FbEq 16
25.53	<i>Torque prop reference</i>	Displays the output of the proportional (P) part of the speed controller. See the control chain diagram on page 502. This parameter is read-only.	-
	-30000.0... 30000.0%	P-part output of speed controller.	See par. 46.03
25.54	<i>Torque integral reference</i>	Displays the output of the integral (I) part of the speed controller. See the control chain diagram on page 502. This parameter is read-only.	-
	-30000.0... 30000.0%	I-part output of speed controller.	See par. 46.03
25.55	<i>Torque deriv reference</i>	Displays the output of the derivative (D) part of the speed controller. See the control chain diagram on page 502. This parameter is read-only.	-
	-30000.0... 30000.0%	D-part output of speed controller.	See par. 46.03
25.56	<i>Torque acc compensation</i>	Displays the output of the acceleration compensation function. See the control chain diagram on page 502. This parameter is read-only.	-
	-30000.0... 30000.0%	Output of acceleration compensation function.	See par. 46.03
<b>26 Torque reference chain</b>			
		Settings for the torque reference chain. See the control chain diagrams on pages 503 and 504.	
26.01	<i>Torque reference to TC</i>	Displays the final torque reference given to the torque controller in percent. This reference is then acted upon by various final limiters, like power, torque, load etc. See the control chain diagrams on pages 503 and 504. This parameter is read-only.	-
	-1600.0...1600.0%	Torque reference for torque control.	See par. 46.03
26.02	<i>Torque reference used</i>	Displays the final torque reference (in percent of motor nominal torque) given to the torque controller, and comes after frequency, voltage and torque limitation. See the control chain diagram on page 503. This parameter is read-only.	-
	-1600.0...1600.0%	Torque reference for torque control.	See par. 46.03
26.08	<i>Minimum torque ref</i>	Defines the minimum torque reference. Allows for local limiting of the torque reference before it is passed on to the torque ramp controller. For absolute torque limiting, refer to parameter 30.19 <i>Minimum torque 1</i> .	-300.0%
	-1000.0...0.0%	Minimum torque reference.	See par. 46.03
26.09	<i>Maximum torque ref</i>	Defines the maximum torque reference. Allows for local limiting of the torque reference before it is passed on to the torque ramp controller. For absolute torque limiting, refer to parameter 30.20 <i>Maximum torque 1</i> .	300.0%
	0.0...1000.0%	Maximum torque reference.	See par. 46.03

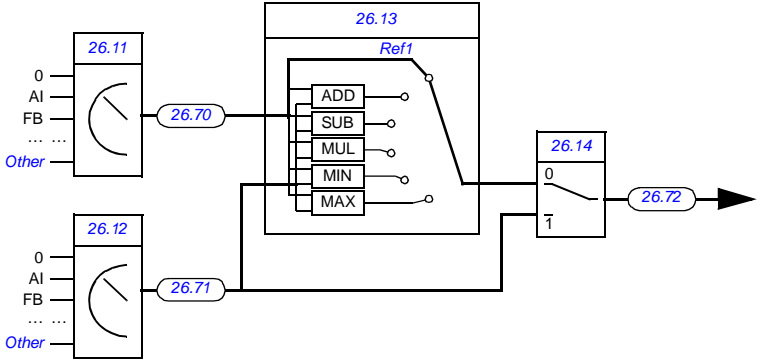
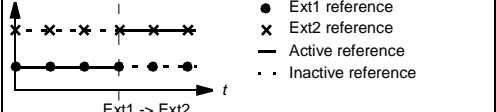
No.	Name/Value	Description	Default FbEq 16
26.11	<i>Torque ref1 source</i>	<p>Selects torque reference source 1.</p> <p>Two signal sources can be defined by this parameter and <a href="#">26.12 Torque ref2 source</a>. A digital source selected by <a href="#">26.14 Torque ref1/2 selection</a> can be used to switch between the two sources, or a mathematical function (<a href="#">26.13 Torque ref1 function</a>) applied to the two signals to create the reference.</p> 	Zero
Zero	None.	0	
AI1 scaled	<a href="#">12.12 AI1 scaled value</a> (see page <a href="#">142</a> ).	1	
AI2 scaled	<a href="#">12.22 AI2 scaled value</a> (see page <a href="#">144</a> ).	2	
FB A ref1	<a href="#">03.05 FB A reference 1</a> (see page <a href="#">119</a> ).	4	
FB A ref2	<a href="#">03.06 FB A reference 2</a> (see page <a href="#">119</a> ).	5	
EFB ref1	<a href="#">03.09 EFB reference 1</a> (see page <a href="#">119</a> ).	8	
EFB ref2	<a href="#">03.10 EFB reference 2</a> (see page <a href="#">119</a> ).	9	
Motor potentiometer	<a href="#">22.80 Motor potentiometer ref act</a> (output of the motor potentiometer).	15	
PID	<a href="#">40.01 Process PID output actual</a> (output of the process PID controller).	16	
Frequency input	<a href="#">11.38 Freq in 1 actual value</a> (when DI3 or DI4 is used as a frequency input).	17	
Control panel (ref saved)	<p>Panel reference (<a href="#">03.01 Panel reference</a>, see page <a href="#">118</a>) saved by the control system for the location where the control returns is used as the reference.</p> <p><i>Reference</i></p> 	18	



No.	Name/Value	Description	Default FbEq 16
	Control panel (ref copied)	<p>Panel reference (<a href="#">03.01 Panel reference</a>, see page 118) for the previous control location is used as the reference when the control location changes if the references for the two locations are of the same type (eg frequency/speed/torque/PID); otherwise, the actual signal is used as the new reference.</p> <p>● Ext1 reference  x Ext2 reference  — Active reference  ... Inactive reference</p>	19
	Integrated panel (ref saved)	See above Control panel (ref saved)	20
	Integrated panel (ref copied)	See above Control panel (ref copied).	21
	Frequency input 2	<a href="#">11.46 Freq in 2 actual value</a> (when DI3 or DI4 is used as a frequency input).	22
	<i>Other</i>	Source selection (see <a href="#">Terms and abbreviations</a> ).	-
26.12	<a href="#">Torque ref2 source</a>	Selects torque reference source 2. For the selections, and a diagram of reference source selection, see parameter <a href="#">26.11 Torque ref1 source</a> .	Zero
26.13	<a href="#">Torque ref1 function</a>	Selects a mathematical function between the reference sources selected by parameters <a href="#">26.11 Torque ref1 source</a> and <a href="#">26.12 Torque ref2 source</a> . See diagram at <a href="#">26.11 Torque ref1 source</a> .	Ref1
	Ref1	Signal selected by <a href="#">26.11 Torque ref1 source</a> is used as torque reference 1 as such (no function applied).	0
	Add (ref1 + ref2)	The sum of the reference sources is used as torque reference 1.	1
	Sub (ref1 - ref2)	The subtraction ( <a href="#">[26.11 Torque ref1 source]</a> - <a href="#">[26.12 Torque ref2 source]</a> ) of the reference sources is used as torque reference 1.	2
	Mul (ref1 x ref2)	The multiplication of the reference sources is used as torque reference 1.	3
	Min (ref1, ref2)	The smaller of the reference sources is used as torque reference 1.	4
	Max (ref1, ref2)	The greater of the reference sources is used as torque reference 1.	5
26.14	<a href="#">Torque ref1/2 selection</a>	Configures the selection between torque references 1 and 2. See diagram at <a href="#">26.11 Torque ref1 source</a> . 0 = Torque reference 1 1 = Torque reference 2	<a href="#">Torque reference 1</a>
	Torque reference 1	0.	0
	Torque reference 2	1.	1
	Follow Ext1/Ext2 selection	Torque reference 1 is used when external control location EXT1 is active. Torque reference 2 is used when external control location EXT2 is active. See also parameter <a href="#">19.11 Ext1/Ext2 selection</a> .	2
	DI1	Digital input DI1 ( <a href="#">10.02 DI delayed status</a> , bit 0).	3

## 202 Parameters

No.	Name/Value	Description	Default FbEq 16
	DI2	Digital input DI2 ( <i>10.02 DI delayed status</i> , bit 1).	4
	DI3	Digital input DI3 ( <i>10.02 DI delayed status</i> , bit 2).	5
	DI4	Digital input DI4 ( <i>10.02 DI delayed status</i> , bit 3).	6
	DIO1	Digital input/output DIO1 ( <i>11.02 DIO delayed status</i> , bit 0).	11
	DIO2	Digital input/output DIO2 ( <i>11.02 DIO delayed status</i> , bit 1).	12
	<i>Other [bit]</i>	Source selection (see <i>Terms and abbreviations</i> ).	-
<i>26.17</i>	<i>Torque ref filter time</i>	Defines a low-pass filter time constant for the torque reference.	0.000 s
	0.000...30.000 s	Filter time constant for torque reference.	1000 = 1 s
<i>26.18</i>	<i>Torque ramp up time</i>	Defines the torque reference ramp-up time, ie. the time for the reference to increase from zero to nominal motor torque.	0.000 s
	0.000...60.000 s	Torque reference ramp-up time.	100 = 1 s
<i>26.19</i>	<i>Torque ramp down time</i>	Defines the torque reference ramp-down time, ie. the time for the reference to decrease from nominal motor torque to zero.	0.000 s
	0.000...60.000 s	Torque reference ramp-down time.	100 = 1 s
<i>26.21</i>	<i>Torque sel torque in</i>	Selects the source for <i>26.74 Torque ref ramp out</i> .	<i>Torque ref torq ctrl</i>
	Not selected	None.	0
	Torque ref torq ctrl	Torque reference from the torque chain.	1
	<i>Other</i>	Source selection (see <i>Terms and abbreviations</i> ).	-
<i>26.22</i>	<i>Torque sel speed in</i>	Selects the source for <i>25.01 Torque reference speed control</i> .	<i>Torque ref torq ctrl</i>
	Not selected	None.	0
	Torque ref speed ctrl	Torque reference from the speed chain.	1
	<i>Other</i>	Source selection (see <i>Terms and abbreviations</i> ).	-
<i>26.70</i>	<i>Torque reference act 1</i>	Displays the value of torque reference source 1 (selected by parameter <i>26.11 Torque ref1 source</i> ). See the control chain diagram on page 503. This parameter is read-only.	-
	-1600.0...1600.0%	Value of torque reference source 1.	See par. <i>46.03</i>
<i>26.71</i>	<i>Torque reference act 2</i>	Displays the value of torque reference source 2 (selected by parameter <i>26.12 Torque ref2 source</i> ). See the control chain diagram on page 503. This parameter is read-only.	-
	-1600.0...1600.0%	Value of torque reference source 2.	See par. <i>46.03</i>
<i>26.72</i>	<i>Torque reference act 3</i>	Displays the torque reference after the function applied by parameter <i>26.13 Torque ref1 function</i> (if any), and after selection ( <i>26.14 Torque ref1/2 selection</i> ). See the control chain diagram on page 503. This parameter is read-only.	-
	-1600.0...1600.0%	Torque reference after selection.	See par. <i>46.03</i>

No.	Name/Value	Description	Default FbEq 16
26.73	<i>Torque reference act 4</i>	Displays the torque reference after application of reference additive 1. See the control chain diagram on page 503. This parameter is read-only.	-
	-1600.0...1600.0%	Torque reference after application of reference additive 1.	See par. 46.03
26.74	<i>Torque ref ramp out</i>	Displays the torque reference after limiting and ramping. See the control chain diagram on page 503. This parameter is read-only.	-
	-1600.0...1600.0%	Torque reference after limiting and ramping.	See par. 46.03
26.75	<i>Torque reference act 5</i>	Displays the torque reference after control mode selection. See the control chain diagram on page 504. This parameter is read-only.	-
	-1600.0...1600.0%	Torque reference after control mode selection.	See par. 46.03
26.81	<i>Rush control gain</i>	Rush controller gain term. See section <i>Rush control</i> (page 70).	10.0
	0.0 ...10000.0	Rush controller gain (0.0 = disabled).	1 = 1
26.82	<i>Rush control integration time</i>	Rush controller integration time term.	2.0 s
	0.0 ...10.0 s	Rush controller integration time (0.0 = disabled).	1 = 1 s
<b>28 Frequency reference chain</b>		Settings for the frequency reference chain. See the control chain diagrams on pages 503 and 504.	
28.01	<i>Frequency ref ramp input</i>	Displays the used frequency reference before ramping. See the control chain diagram on page 503. This parameter is read-only.	-
	-500.00...500.00 Hz	Frequency reference before ramping.	See par. 46.02
28.02	<i>Frequency ref ramp output</i>	Displays the final frequency reference (after selection, limitation and ramping). See the control chain diagram on page 503. This parameter is read-only.	-
	-500.00...500.00 Hz	Final frequency reference.	See par. 46.02

No.	Name/Value	Description	Default FbEq 16
28.11	<i>Ext1 frequency ref1</i>	<p>Selects Ext1 frequency reference source 1.</p> <p>Two signal sources can be defined by this parameter and <a href="#">28.12 Ext1 frequency ref2</a>. A mathematical function (<a href="#">28.13 Ext1 frequency function</a>) applied to the two signals creates an Ext1 reference (A in the figure below).</p> <p>A digital source selected by <a href="#">19.11 Ext1/Ext2 selection</a> can be used to switch between Ext1 reference and the corresponding Ext2 reference defined by parameters <a href="#">28.15 Ext2 frequency ref1</a>, <a href="#">28.16 Ext2 frequency ref2</a> and <a href="#">28.17 Ext2 frequency function</a> (B in the figure below).</p> <p><b>Note:</b> The default value depends on the selected macro. See chapter <a href="#">Control macros</a> on page 31.</p>	<i>Integrated panel (ref saved)</i>
Zero	None.		0
AI1 scaled	<a href="#">12.12 AI1 scaled value</a> (see page 142).		1
AI2 scaled	<a href="#">12.22 AI2 scaled value</a> (see page 144).		2
FB A ref1	<a href="#">03.05 FB A reference 1</a> (see page 119).		4
FB A ref2	<a href="#">03.06 FB A reference 2</a> (see page 119).		5
EFB ref1	<a href="#">03.09 EFB reference 1</a> (see page 119).		8
EFB ref2	<a href="#">03.10 EFB reference 2</a> (see page 119).		9
Motor potentiometer	<a href="#">22.80 Motor potentiometer ref act</a> (output of the motor potentiometer).		15

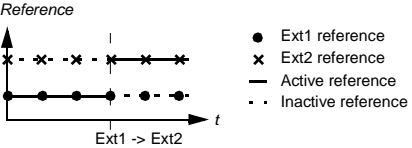
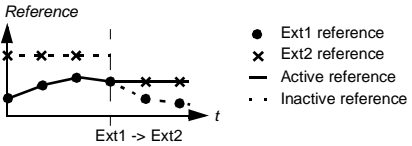
No.	Name/Value	Description	Default FbEq 16
	PID	<a href="#">40.01 Process PID output actual</a> (output of the process PID controller).	16
	Frequency input 1	<a href="#">11.38 Freq in 1 actual value</a> (when DI3 or DI4 is used as a frequency input).	17
	Control panel (ref saved)	Panel reference ( <a href="#">03.01 Panel reference</a> , see page 118) saved by the control system for the location where the control returns is used as the reference.  <i>Reference</i>  ● Ext1 reference × Ext2 reference — Active reference - - Inactive reference Ext1 -> Ext2	18
	Control panel (ref copied)	Panel reference ( <a href="#">03.01 Panel reference</a> , see page 118) for the previous control location is used as the reference when the control location changes if the references for the two locations are of the same type (eg frequency/speed/torque/PID); otherwise, the actual signal is used as the new reference.  <i>Reference</i>  ● Ext1 reference × Ext2 reference — Active reference - - Inactive reference Ext1 -> Ext2	19
	Integrated panel (ref saved)	See above Control panel (ref saved).	20
	Integrated panel (ref copied)	See above Control panel (ref copied).	21
	Frequency input 2	<a href="#">11.46 Freq in 2 actual value</a> (when DI3 or DI4 is used as a frequency input).	22
	MotPot Crane	Output of the crane motor potentiometer. See <a href="#">22.230</a> .	31
	<i>Other</i>	Source selection (see <a href="#">Terms and abbreviations</a> ).	-
<a href="#">28.12</a>	<a href="#">Ext1 frequency ref2</a>	Selects Ext1 frequency reference source 2. For the diagram of reference source selection, see parameter <a href="#">28.11 Ext1 frequency ref1</a> .	<i>Zero</i>
	Zero	None.	0
	AI1 scaled	<a href="#">12.12 AI1 scaled value</a> (see page 142).	1
	AI2 scaled	<a href="#">12.22 AI2 scaled value</a> (see page 144).	2
	FB A ref1	<a href="#">03.05 FB A reference 1</a> (see page 119).	4
	FB A ref2	<a href="#">03.06 FB A reference 2</a> (see page 119).	5
	EFB ref1	<a href="#">03.09 EFB reference 1</a> (see page 119).	8
	EFB ref2	<a href="#">03.10 EFB reference 2</a> (see page 119).	9
	Motor potentiometer	<a href="#">22.80 Motor potentiometer ref act</a> (output of the motor potentiometer).	15
	PID	<a href="#">40.01 Process PID output actual</a> (output of the process PID controller).	16

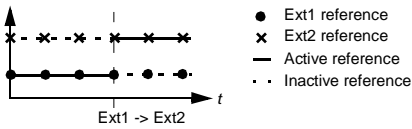
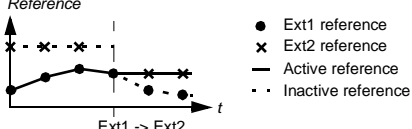
No.	Name/Value	Description	Default FbEq 16
	Frequency input 1	<a href="#">11.38 Freq in 1 actual value</a> (when DI3 or DI4 is used as a frequency input).	17
	Control panel (ref saved)	Panel reference ( <a href="#">03.01 Panel reference</a> , see page <a href="#">118</a> ) saved by the control system for the location where the control returns is used as the reference. <i>Reference</i> 	18
	Control panel (ref copied)	Panel reference ( <a href="#">03.01 Panel reference</a> , see page <a href="#">118</a> ) for the previous control location is used as the reference when the control location changes if the references for the two locations are of the same type (eg frequency/speed/torque/PID); otherwise, the actual signal is used as the new reference. <i>Reference</i> 	19
	Integrated panel (ref saved)	See above Control panel (ref saved).	20
	Integrated panel (ref copied)	See above Control panel (ref copied).	21
	Frequency input 2	<a href="#">11.46 Freq in 2 actual value</a> (when DI3 or DI4 is used as a frequency input).	22
	<i>Other</i>	Source selection (see <a href="#">Terms and abbreviations</a> ).	-
<a href="#">28.13</a>	<a href="#">Ext1 frequency function</a>	Selects a mathematical function between the reference sources selected by parameters <a href="#">28.11 Ext1 frequency ref1</a> and <a href="#">28.12 Ext1 frequency ref2</a> . See diagram at <a href="#">28.11 Ext1 frequency ref1</a> .	<a href="#">Ref1</a>
	Ref1	Signal selected by <a href="#">28.11 Ext1 frequency ref1</a> is used as frequency reference 1 as such (no function applied).	0
	Add (ref1 + ref2)	The sum of the reference sources is used as frequency reference 1.	1
	Sub (ref1 - ref2)	The subtraction ( <a href="#">[28.11 Ext1 frequency ref1] - [28.12 Ext1 frequency ref2]</a> ) of the reference sources is used as frequency reference 1.	2
	Mul (ref1 × ref2)	The multiplication of the reference sources is used as frequency reference 1.	3
	Min (ref1, ref2)	The smaller of the reference sources is used as frequency reference 1.	4
	Max (ref1, ref2)	The greater of the reference sources is used as frequency reference 1.	5
	Abs (ref1)	The absolute value of the reference sources is used as frequency reference 1.	6

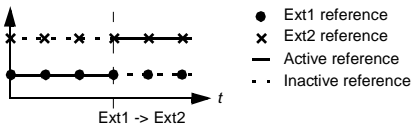
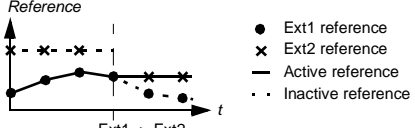
No.	Name/Value	Description	Default FbEq 16
28.15	<i>Ext2 frequency ref1</i>	Selects Ext2 frequency reference source 1. Two signal sources can be defined by this parameter and <a href="#">28.16 Ext2 frequency ref2</a> . A mathematical function ( <a href="#">28.17 Ext2 frequency function</a> ) applied to the two signals creates an Ext2 reference. See diagram at <a href="#">28.11 Ext1 frequency ref1</a> .	Zero
	Zero	None.	0
	AI1 scaled	<a href="#">12.12 AI1 scaled value</a> (see page 142).	1
	AI2 scaled	<a href="#">12.22 AI2 scaled value</a> (see page 144).	2
	FB A ref1	<a href="#">03.05 FB A reference 1</a> (see page 119).	4
	FB A ref2	<a href="#">03.06 FB A reference 2</a> (see page 119).	5
	EFB ref1	<a href="#">03.09 EFB reference 1</a> (see page 119).	8
	EFB ref2	<a href="#">03.10 EFB reference 2</a> (see page 119).	9
	Motor potentiometer	<a href="#">22.80 Motor potentiometer ref act</a> (output of the motor potentiometer).	15
	PID	<a href="#">40.01 Process PID output actual</a> (output of the process PID controller).	16
	Frequency input 1	<a href="#">11.38 Freq in 1 actual value</a> (when DI3 or DI4 is used as a frequency input).	17
	Control panel (ref saved)	Panel reference ( <a href="#">03.01 Panel reference</a> , see page 118) saved by the control system for the location where the control returns is used as the reference.  <i>Reference</i> 	18
	Control panel (ref copied)	Panel reference ( <a href="#">03.01 Panel reference</a> , see page 118) for the previous control location is used as the reference when the control location changes if the references for the two locations are of the same type (eg frequency/speed/torque/PID); otherwise, the actual signal is used as the new reference.  <i>Reference</i> 	19
	Integrated panel (ref saved)	See above Control panel (ref saved).	20
	Integrated panel (ref copied)	See above Control panel (ref copied).	21
	Frequency input 2	<a href="#">11.46 Freq in 2 actual value</a> (when DI3 or DI4 is used as a frequency input).	22
	<i>Other</i>	Source selection (see <a href="#">Terms and abbreviations</a> ).	-

No.	Name/Value	Description	Default FbEq 16
28.16	<i>Ext2 frequency ref2</i>	Selects Ext2 frequency reference source 2. For the selections, and a diagram of reference source selection, see parameter <a href="#">28.15 Ext2 frequency ref1</a> .	<i>Zero</i>
28.17	<i>Ext2 frequency function</i>	Selects a mathematical function between the reference sources selected by parameters <a href="#">28.15 Ext2 frequency ref1</a> and <a href="#">28.16 Ext2 frequency ref2</a> . See diagram at <a href="#">28.15 Ext2 frequency ref1</a> .	<i>Ref1</i>
	Ref1	Signal selected by <a href="#">28.15 Ext2 frequency ref1</a> is used as frequency reference 1 as such (no function applied).	0
	Add (ref1 + ref2)	The sum of the reference sources is used as frequency reference 1.	1
	Sub (ref1 - ref2)	The subtraction ( <a href="#">28.15 Ext2 frequency ref1</a> - <a href="#">28.16 Ext2 frequency ref2</a> ) of the reference sources is used as frequency reference 1.	2
	Mul (ref1 × ref2)	The multiplication of the reference sources is used as frequency reference 1.	3
	Min (ref1, ref2)	The smaller of the reference sources is used as frequency reference 1.	4
	Max (ref1, ref2)	The greater of the reference sources is used as frequency reference 1.	5
	Abs (ref1)	Selects a mathematical function between the frequency reference sources.	6
28.21	<i>Constant frequency function</i>	Determines how constant frequencies are selected, and whether the rotation direction signal is considered or not when applying a constant frequency.	0b00001

Bit	Name	Information
0	Const freq mode	1 = Packed: 7 constant frequencies are selectable using the three sources defined by parameters <a href="#">28.22</a> , <a href="#">28.23</a> and <a href="#">28.24</a> . 0 = Separate: Constant frequencies 1, 2 and 3 are separately activated by the sources defined by parameters <a href="#">28.22</a> , <a href="#">28.23</a> and <a href="#">28.24</a> respectively. In case of conflict, the constant frequency with the smaller number takes priority.
1	Direction enable	1 = Start dir: To determine running direction for a constant frequency, the sign of the constant frequency setting (parameters <a href="#">28.26...28.32</a> ) is multiplied by the direction signal (forward: +1, reverse: -1). This effectively allows the drive to have 14 (7 forward, 7 reverse) constant frequencies if all values in <a href="#">28.26...28.32</a> are positive.  <b>WARNING:</b> If the direction signal is reverse and the active constant frequency is negative, the drive will run in the forward direction. 0 = According to Par: The running direction for the constant frequency is determined by the sign of the constant speed setting (parameters <a href="#">28.26...28.32</a> ).
2	Frequency step	Frequency step: 1 = Freq step enable; 0 = Freq step disable
3...15	Reserved	

0b0000...0b1111	Constant frequency configuration word.	1 = 1
-----------------	--	-------



No.	Name/Value	Description	Default FbEq 16																																				
28.22	<i>Constant frequency sel1</i>	<p>When bit 0 of parameter <i>28.21 Constant frequency function</i> is 0 (Separate), selects a source that activates constant frequency 1.</p> <p><b>Note:</b> The default value depends on the selected macro. See chapter <i>Control macros</i> on page 31.</p> <p>When bit 0 of parameter <i>28.21 Constant frequency function</i> is 1 (Packed), this parameter and parameters <i>28.23 Constant frequency sel2</i> and <i>28.24 Constant frequency sel3</i> select three sources whose states activate constant frequencies as follows:</p>	<i>DI2</i>																																				
<table border="1"> <thead> <tr> <th>Source defined by par. 28.22</th> <th>Source defined by par. 28.23</th> <th>Source defined by par. 28.24</th> <th>Constant frequency active</th> </tr> </thead> <tbody> <tr> <td>0</td> <td>0</td> <td>0</td> <td>None</td> </tr> <tr> <td>1</td> <td>0</td> <td>0</td> <td>Constant frequency 1</td> </tr> <tr> <td>0</td> <td>1</td> <td>0</td> <td>Constant frequency 2</td> </tr> <tr> <td>1</td> <td>1</td> <td>0</td> <td>Constant frequency 3</td> </tr> <tr> <td>0</td> <td>0</td> <td>1</td> <td>Constant frequency 4</td> </tr> <tr> <td>1</td> <td>0</td> <td>1</td> <td>Constant frequency 5</td> </tr> <tr> <td>0</td> <td>1</td> <td>1</td> <td>Constant frequency 6</td> </tr> <tr> <td>1</td> <td>1</td> <td>1</td> <td>Constant frequency 7</td> </tr> </tbody> </table>				Source defined by par. 28.22	Source defined by par. 28.23	Source defined by par. 28.24	Constant frequency active	0	0	0	None	1	0	0	Constant frequency 1	0	1	0	Constant frequency 2	1	1	0	Constant frequency 3	0	0	1	Constant frequency 4	1	0	1	Constant frequency 5	0	1	1	Constant frequency 6	1	1	1	Constant frequency 7
Source defined by par. 28.22	Source defined by par. 28.23	Source defined by par. 28.24	Constant frequency active																																				
0	0	0	None																																				
1	0	0	Constant frequency 1																																				
0	1	0	Constant frequency 2																																				
1	1	0	Constant frequency 3																																				
0	0	1	Constant frequency 4																																				
1	0	1	Constant frequency 5																																				
0	1	1	Constant frequency 6																																				
1	1	1	Constant frequency 7																																				
	Always off	0 (always off).	0																																				
	Always on	1 (always on).	1																																				
	DI1	Digital input DI1 ( <i>10.02 DI delayed status</i> , bit 0).	2																																				
	DI2	Digital input DI2 ( <i>10.02 DI delayed status</i> , bit 1).	3																																				
	DI3	Digital input DI3 ( <i>10.02 DI delayed status</i> , bit 2).	4																																				
	DI4	Digital input DI4 ( <i>10.02 DI delayed status</i> , bit 3).	5																																				
	DIO1	Digital input/output DIO1 ( <i>11.02 DIO delayed status</i> , bit 0)	10																																				
	DIO2	Digital input/output DIO2 ( <i>11.02 DIO delayed status</i> , bit 0)	11																																				
	Timed function 1	Bit 0 of <i>34.01 Timed functions status</i> .	18																																				
	Timed function 2	Bit 1 of <i>34.01 Timed functions status</i> .	19																																				
	Timed function 3	Bit 2 of <i>34.01 Timed functions status</i> .	20																																				
	Supervision 1	Bit 0 of <i>32.01 Supervision status</i> .	24																																				
	Supervision 2	Bit 1 of <i>32.01 Supervision status</i> .	25																																				
	Supervision 3	Bit 2 of <i>32.01 Supervision status</i> .	26																																				
	Supervision 4	Bit 3 of <i>32.01 Supervision status</i> .	27																																				
	Supervision 5	Bit 4 of <i>32.01 Supervision status</i> .	28																																				
	Supervision 6	Bit 5 of <i>32.01 Supervision status</i> .	29																																				
	<i>Other [bit]</i>	Source selection (see <i>Terms and abbreviations</i> ).	-																																				

No.	Name/Value	Description	Default FbEq 16
28.23	<a href="#">Constant frequency sel2</a>	When bit 0 of parameter <a href="#">28.21 Constant frequency function</a> is 0 (Separate), selects a source that activates constant frequency 2. When bit 0 of parameter <a href="#">28.21 Constant frequency function</a> is 1 (Packed), this parameter and parameters <a href="#">28.22 Constant frequency sel1</a> and <a href="#">28.24 Constant frequency sel3</a> select three sources that are used to activate constant frequencies. See table at parameter <a href="#">28.22 Constant frequency sel1</a> . For the selections, see parameter <a href="#">28.22 Constant frequency sel1</a> . <b>Note:</b> The default value depends on the selected macro. See <a href="#">Control macros</a> on page 31.	<i>Always off</i>
28.24	<a href="#">Constant frequency sel3</a>	When bit 0 of parameter <a href="#">28.21 Constant frequency function</a> is 0 (Separate), selects a source that activates constant frequency 3. When bit 0 of parameter <a href="#">28.21 Constant frequency function</a> is 1 (Packed), this parameter and parameters <a href="#">28.22 Constant frequency sel1</a> and <a href="#">28.23 Constant frequency sel2</a> select three sources that are used to activate constant frequencies. See table at parameter <a href="#">28.22 Constant frequency sel1</a> . For the selections, see parameter <a href="#">28.22 Constant frequency sel1</a> .	<i>Always off</i>
28.26	<a href="#">Constant frequency 1</a>	Defines constant frequency 1 (the frequency the motor will turn when constant frequency 1 is selected).	5.00 Hz
	-500.00...500.00 Hz	Constant frequency 1.	See par. <a href="#">46.02</a>
28.27	<a href="#">Constant frequency 2</a>	Defines constant frequency 2.	10.00 Hz
	-500.00...500.00 Hz	Constant frequency 2.	See par. <a href="#">46.02</a>
28.28	<a href="#">Constant frequency 3</a>	Defines constant frequency 3.	15.00 Hz
	-500.00...500.00 Hz	Constant frequency 3.	See par. <a href="#">46.02</a>
28.29	<a href="#">Constant frequency 4</a>	Defines constant frequency 4.	20.00 Hz
	-500.00...500.00 Hz	Constant frequency 4.	See par. <a href="#">46.02</a>
28.30	<a href="#">Constant frequency 5</a>	Defines constant frequency 5.	25.00 Hz
	-500.00...500.00 Hz	Constant frequency 5.	See par. <a href="#">46.02</a>
28.31	<a href="#">Constant frequency 6</a>	Defines constant frequency 6.	40.00 Hz
	-500.00...500.00 Hz	Constant frequency 6.	See par. <a href="#">46.02</a>
28.32	<a href="#">Constant frequency 7</a>	Defines constant frequency 7.	50.00 Hz
	-500.00...500.00 Hz	Constant frequency 7.	See par. <a href="#">46.02</a>

No.	Name/Value	Description	Default FbEq 16											
28.41	<i>Frequency ref safe</i>	Defines a safe frequency reference value that is used with supervision functions such as <ul style="list-style-type: none"> <li>• <a href="#">12.03 AI supervision function</a></li> <li>• <a href="#">49.05 Communication loss action</a></li> <li>• <a href="#">50.02 FBA A comm loss func.</a></li> </ul>	0.00 Hz											
	-500.00...500.00 Hz	Safe frequency reference.	See par. <a href="#">46.02</a>											
28.51	<i>Critical frequency function</i>	Enables/disables the critical frequencies function. Also determines whether the specified ranges are effective in both rotating directions or not. See also section <a href="#">Critical speeds/frequencies</a> on page <a href="#">68</a> .	0000h											
		<table border="1"> <thead> <tr> <th>Bit</th> <th>Name</th> <th>Information</th> </tr> </thead> <tbody> <tr> <td rowspan="2">0</td> <td rowspan="2">Crit freq</td> <td>1 = Enable: Critical frequencies enabled.</td> </tr> <tr> <td>0 = Disable: Critical frequencies disabled.</td> </tr> <tr> <td rowspan="2">1</td> <td rowspan="2">Sign mode</td> <td>1 = According to par: The signs of parameters <a href="#">28.52...28.57</a> are taken into account.</td> </tr> <tr> <td>0 = Absolute: Parameters <a href="#">28.52...28.57</a> are handled as absolute values. Each range is effective in both directions of rotation.</td> </tr> </tbody> </table>	Bit	Name	Information	0	Crit freq	1 = Enable: Critical frequencies enabled.	0 = Disable: Critical frequencies disabled.	1	Sign mode	1 = According to par: The signs of parameters <a href="#">28.52...28.57</a> are taken into account.	0 = Absolute: Parameters <a href="#">28.52...28.57</a> are handled as absolute values. Each range is effective in both directions of rotation.	
Bit	Name	Information												
0	Crit freq	1 = Enable: Critical frequencies enabled.												
		0 = Disable: Critical frequencies disabled.												
1	Sign mode	1 = According to par: The signs of parameters <a href="#">28.52...28.57</a> are taken into account.												
		0 = Absolute: Parameters <a href="#">28.52...28.57</a> are handled as absolute values. Each range is effective in both directions of rotation.												
	0000h...FFFFh	Critical frequencies configuration word.	1 = 1											
28.52	<i>Critical frequency 1 low</i>	Defines the low limit for critical frequency 1. <b>Note:</b> This value must be less than or equal to the value of <a href="#">28.53 Critical frequency 1 high</a> .	0.00 Hz											
	-500.00...500.00 Hz	Low limit for critical frequency 1.	See par. <a href="#">46.02</a>											
28.53	<i>Critical frequency 1 high</i>	Defines the high limit for critical frequency 1. <b>Note:</b> This value must be greater than or equal to the value of <a href="#">28.52 Critical frequency 1 low</a> .	0.00 Hz											
	-500.00...500.00 Hz	High limit for critical frequency 1.	See par. <a href="#">46.02</a>											
28.54	<i>Critical frequency 2 low</i>	Defines the low limit for critical frequency 2. <b>Note:</b> This value must be less than or equal to the value of <a href="#">28.55 Critical frequency 2 high</a> .	0.00 Hz											
	-500.00...500.00 Hz	Low limit for critical frequency 2.	See par. <a href="#">46.02</a>											
28.55	<i>Critical frequency 2 high</i>	Defines the high limit for critical frequency 2. <b>Note:</b> This value must be greater than or equal to the value of <a href="#">28.54 Critical frequency 2 low</a> .	0.00 Hz											
	-500.00...500.00 Hz	High limit for critical frequency 2.	See par. <a href="#">46.02</a>											
28.56	<i>Critical frequency 3 low</i>	Defines the low limit for critical frequency 3. <b>Note:</b> This value must be less than or equal to the value of <a href="#">28.57 Critical frequency 3 high</a> .	0.00 Hz											
	-500.00...500.00 Hz	Low limit for critical frequency 3.	See par. <a href="#">46.02</a>											

No.	Name/Value	Description	Default FbEq 16
28.57	<i>Critical frequency 3 high</i>	Defines the high limit for critical frequency 3. <b>Note:</b> This value must be greater than or equal to the value of <a href="#">28.56 Critical frequency 3 low</a> .	0.00 Hz
	-500.00...500.00 Hz	High limit for critical frequency 3.	See par. <a href="#">46.02</a>
28.71	<i>Freq ramp set selection</i>	Selects a source that switches between the two sets of acceleration/deceleration times defined by parameters <a href="#">28.72...28.75</a> . 0 = Acceleration time 1 and deceleration time 1 are in force. 1 = Acceleration time 2 and deceleration time 2 are in force. <b>Note:</b> The default value depends on the selected macro. See chapter <a href="#">Control macros</a> on page 31.	<a href="#">Acc/Dec time 1</a>
	Acc/Dec time 1	0	0
	Acc/Dec time 2	1	1
	DI1	Digital input DI1 ( <a href="#">10.02 DI delayed status</a> , bit 0).	2
	DI2	Digital input DI2 ( <a href="#">10.02 DI delayed status</a> , bit 1).	3
	DI3	Digital input DI3 ( <a href="#">10.02 DI delayed status</a> , bit 2).	4
	DI4	Digital input DI4 ( <a href="#">10.02 DI delayed status</a> , bit 3).	5
	DIO1	Digital input/output DIO1 ( <a href="#">11.02 DIO delayed status</a> , bit 0).	10
	DIO2	Digital input/output DIO2 ( <a href="#">11.02 DIO delayed status</a> , bit 1).	11
	FBA A	Only for the Transparent16 or Transparent32 profile. Transparent16 or Transparent32 control word bit received through the fieldbus A interface.	18
	EFB DCU CW bit 10	Only for the DCU profile. DCU control word bit 10 received through the embedded fieldbus interface.	20
	<i>Other [bit]</i>	Source selection (see <a href="#">Terms and abbreviations</a> ).	-
28.72	<i>Freq acceleration time 1</i>	Defines acceleration time 1 as the time required for the frequency to change from zero to the frequency defined by parameter <a href="#">46.02 Frequency scaling</a> . After this frequency has been reached, the acceleration continues with the same rate to the value defined by parameter <a href="#">30.14 Maximum frequency</a> . If the reference increases faster than the set acceleration rate, the motor will follow the acceleration rate. If the reference increases slower than the set acceleration rate, the motor frequency will follow the reference. If the acceleration time is set too short, the drive will automatically prolong the acceleration in order not to exceed the drive torque limits.	3.000 s
	0.000...1800.000 s	Acceleration time 1.	10 = 1 s

No.	Name/Value	Description	Default FbEq 16
28.73	<i>Freq deceleration time 1</i>	Defines deceleration time 1 as the time required for the frequency to change from the frequency defined by parameter <a href="#">46.02 Frequency scaling</a> (not from parameter <a href="#">30.14 Maximum frequency</a> ) to zero. If there is any doubt about the deceleration time being too short, ensure that DC overvoltage control ( <a href="#">30.30 Overvoltage control</a> ) is on. <b>Note:</b> If a short deceleration time is needed for a high inertia application, the drive should be equipped with braking equipment such as a brake chopper and brake resistor.	3.000 s
	0.000...1800.000 s	Deceleration time 1.	10 = 1 s
28.74	<i>Freq acceleration time 2</i>	Defines acceleration time 2. See parameter <a href="#">28.72 Freq acceleration time 1</a> .	60.000 s
	0.000...1800.000 s	Acceleration time 2.	10 = 1 s
28.75	<i>Freq deceleration time 2</i>	Defines deceleration time 2. See parameter <a href="#">28.73 Freq deceleration time 1</a> .	60.000 s
	0.000...1800.000 s	Deceleration time 2.	10 = 1 s
28.76	<i>Freq ramp in zero source</i>	Selects a source that forces the frequency reference to zero. 0 = Force frequency reference to zero 1 = Normal operation	<i>Inactive</i>
	Active	0.	0
	Inactive	1.	1
	DI1	Digital input DI1 ( <a href="#">10.02 DI delayed status</a> , bit 0).	2
	DI2	Digital input DI2 ( <a href="#">10.02 DI delayed status</a> , bit 1).	3
	DI3	Digital input DI3 ( <a href="#">10.02 DI delayed status</a> , bit 2).	4
	DI4	Digital input DI4 ( <a href="#">10.02 DI delayed status</a> , bit 3).	5
	DIO1	Digital input/output DIO1 ( <a href="#">11.02 DIO delayed status</a> , bit 0).	10
	DIO2	Digital input/output DIO2 ( <a href="#">11.02 DIO delayed status</a> , bit 1).	11
	<i>Other [bit]</i>	Source selection (see <a href="#">Terms and abbreviations</a> ).	-

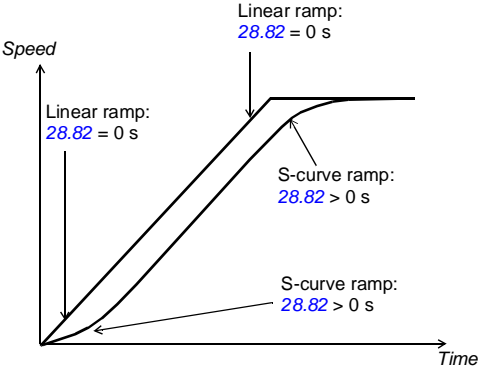
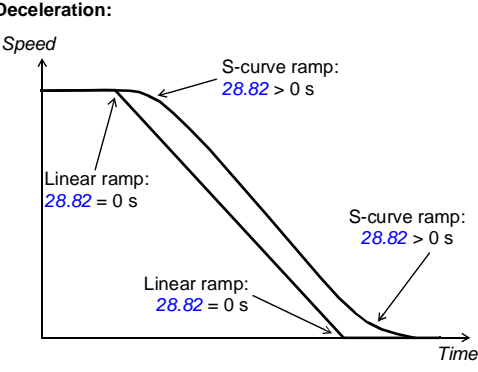
No.	Name/Value	Description	Default FbEq 16
28.82	<i>Shape time 1</i>	<p>Defines the shape of the acceleration and deceleration ramps used with the set 1.</p> <p>0.000 s: Linear ramp. Suitable for steady acceleration or deceleration and for slow ramps.</p> <p>0.001...1000.000 s: S-curve ramp. S-curve ramps are ideal for lifting applications. The S-curve consists of symmetrical curves at both ends of the ramp and a linear part in between.</p> <p><b>Acceleration:</b></p>  <p><b>Deceleration:</b></p> 	0.000 s
	0.000...1800.000 s	Ramp shape at start and end of acceleration and deceleration.	10 = 1 s
28.83	<i>Shape time 2</i>	Defines the shape of the acceleration and deceleration ramps used with the set 2. See parameter <a href="#">28.82 Shape time 1</a> .	0.000 s
	0.000...1800.000 s	Ramp shape at start and end of acceleration and deceleration.	10 = 1 s

No.	Name/Value	Description	Default FbEq 16
28.92	<i>Frequency ref act 3</i>	Displays the frequency reference after the function applied by parameter <i>28.13 Ext1 frequency function</i> (if any), and after selection ( <i>19.11 Ext1/Ext2 selection</i> ). See the control chain diagram on page 496. This parameter is read-only.	0.00 Hz
	-500.00...500.00 Hz	Frequency reference after selection.	See par. <a href="#">46.02</a>
28.96	<i>Frequency ref act 7</i>	Displays the frequency reference after application of constant frequencies, control panel reference, etc. See the control chain diagram on page 496. This parameter is read-only.	0.00 Hz
	-500.00...500.00 Hz	Frequency reference 7.	See par. <a href="#">46.02</a>
28.97	<i>Frequency ref unlimited</i>	Displays the frequency reference after application of critical frequencies, but before ramping and limiting. See the control chain diagram on page 496. This parameter is read-only.	0.00 Hz
	-500.00...500.00 Hz	Frequency reference before ramping and limiting.	See par. <a href="#">46.02</a>
28.211	<i>Frequency reference shape</i>	Defines the Frequency reference shape.	<i>Linear</i>
	Linear	Linear frequency reference.	0
	Parabolic 1	X <sup>2</sup> frequency reference.	1
	Parabolic 2	X <sup>3</sup> frequency reference.	2

30 Limits		Drive operation limits.	
30.01	<i>Limit word 1</i>	Displays limit word 1. This parameter is read-only.	-
<b>Bit</b>	<b>Name</b>	<b>Description</b>	
0	Torq lim	1 = Drive torque is being limited by the motor control (undervoltage control, current control, load angle control or pull-out control), or by the torque limits defined by parameters.	
1...2	Reserved		
3	Torq ref max	1 = Torque reference is being limited by <a href="#">26.09 Maximum torque ref</a> or <a href="#">30.20 Maximum torque 1</a>	
4	Torq ref min	1 = Torque reference is being limited by <a href="#">26.08 Minimum torque ref</a> or <a href="#">30.19 Minimum torque 1</a>	
5	Tlim max speed	1 = Torque reference is being limited by the rush control because of maximum speed limit ( <a href="#">30.12 Maximum speed</a> )	
6	Tlim min speed	1 = Torque reference is being limited by the rush control because of minimum speed limit ( <a href="#">30.11 Minimum speed</a> )	
7	Max speed ref lim	1 = Speed reference is being limited by <a href="#">30.12 Maximum speed</a>	
8	Min speed ref lim	1 = Speed reference is being limited by <a href="#">30.11 Minimum speed</a>	
9	Max freq ref lim	1 = Frequency reference is being limited by <a href="#">30.14 Maximum frequency</a>	
10	Min freq ref lim	1 = Frequency reference is being limited by <a href="#">30.13 Minimum frequency</a>	
11...15	Reserved		
0000h...FFFFh	Limit word 1.		1 = 1

## 216 Parameters

No.	Name/Value	Description	Default FbEq 16																																										
30.02	<i>Torque limit status</i>	Displays the torque controller limitation status word. This parameter is read-only.	-																																										
<table border="1"> <thead> <tr> <th>Bit</th> <th>Name</th> <th>Description</th> </tr> </thead> <tbody> <tr> <td>0</td> <td>Undervoltage</td> <td>*1 = Intermediate DC circuit undervoltage</td> </tr> <tr> <td>1</td> <td>Overvoltage</td> <td>*1 = Intermediate DC circuit overvoltage</td> </tr> <tr> <td>2</td> <td>Minimum torque</td> <td>*1 = Torque is being limited by <a href="#">30.19 Minimum torque 1</a>, <a href="#">30.26 Power motoring limit</a> or <a href="#">30.27 Power generating limit</a></td> </tr> <tr> <td>3</td> <td>Maximum torque</td> <td>*1 = Torque is being limited by <a href="#">30.20 Maximum torque 1</a>, <a href="#">30.26 Power motoring limit</a> or <a href="#">30.27 Power generating limit</a></td> </tr> <tr> <td>4</td> <td>Internal current</td> <td>1 = An inverter current limit (identified by bits 8...11) is active</td> </tr> <tr> <td>5</td> <td>Load angle</td> <td>(With permanent magnet motors and reluctance motors only) 1 = Load angle limit is active, ie. the motor cannot produce any more torque</td> </tr> <tr> <td>6</td> <td>Motor pullout</td> <td>(With asynchronous motors only) Motor pull-out limit is active, ie. the motor cannot produce any more torque</td> </tr> <tr> <td>7</td> <td>Reserved</td> <td></td> </tr> <tr> <td>8</td> <td>Thermal</td> <td>1 = Input current is being limited by the main circuit thermal limit</td> </tr> <tr> <td>9</td> <td>Max current</td> <td>*1 = Maximum output current (<math>I_{MAX}</math>) is being limited</td> </tr> <tr> <td>10</td> <td>User current</td> <td>*1 = Output current is being limited by <a href="#">30.17 Maximum current</a></td> </tr> <tr> <td>11</td> <td>Thermal IGBT</td> <td>*1 = Output current is being limited by a calculated thermal current value</td> </tr> <tr> <td>12...15</td> <td>Reserved</td> <td></td> </tr> </tbody> </table> <p>*Only one out of bits 0...3, and one out of bits 9...11 can be on simultaneously. The bit typically indicates the limit that is exceeded first.</p>				Bit	Name	Description	0	Undervoltage	*1 = Intermediate DC circuit undervoltage	1	Overvoltage	*1 = Intermediate DC circuit overvoltage	2	Minimum torque	*1 = Torque is being limited by <a href="#">30.19 Minimum torque 1</a> , <a href="#">30.26 Power motoring limit</a> or <a href="#">30.27 Power generating limit</a>	3	Maximum torque	*1 = Torque is being limited by <a href="#">30.20 Maximum torque 1</a> , <a href="#">30.26 Power motoring limit</a> or <a href="#">30.27 Power generating limit</a>	4	Internal current	1 = An inverter current limit (identified by bits 8...11) is active	5	Load angle	(With permanent magnet motors and reluctance motors only) 1 = Load angle limit is active, ie. the motor cannot produce any more torque	6	Motor pullout	(With asynchronous motors only) Motor pull-out limit is active, ie. the motor cannot produce any more torque	7	Reserved		8	Thermal	1 = Input current is being limited by the main circuit thermal limit	9	Max current	*1 = Maximum output current ( $I_{MAX}$ ) is being limited	10	User current	*1 = Output current is being limited by <a href="#">30.17 Maximum current</a>	11	Thermal IGBT	*1 = Output current is being limited by a calculated thermal current value	12...15	Reserved	
Bit	Name	Description																																											
0	Undervoltage	*1 = Intermediate DC circuit undervoltage																																											
1	Overvoltage	*1 = Intermediate DC circuit overvoltage																																											
2	Minimum torque	*1 = Torque is being limited by <a href="#">30.19 Minimum torque 1</a> , <a href="#">30.26 Power motoring limit</a> or <a href="#">30.27 Power generating limit</a>																																											
3	Maximum torque	*1 = Torque is being limited by <a href="#">30.20 Maximum torque 1</a> , <a href="#">30.26 Power motoring limit</a> or <a href="#">30.27 Power generating limit</a>																																											
4	Internal current	1 = An inverter current limit (identified by bits 8...11) is active																																											
5	Load angle	(With permanent magnet motors and reluctance motors only) 1 = Load angle limit is active, ie. the motor cannot produce any more torque																																											
6	Motor pullout	(With asynchronous motors only) Motor pull-out limit is active, ie. the motor cannot produce any more torque																																											
7	Reserved																																												
8	Thermal	1 = Input current is being limited by the main circuit thermal limit																																											
9	Max current	*1 = Maximum output current ( $I_{MAX}$ ) is being limited																																											
10	User current	*1 = Output current is being limited by <a href="#">30.17 Maximum current</a>																																											
11	Thermal IGBT	*1 = Output current is being limited by a calculated thermal current value																																											
12...15	Reserved																																												
0000h...FFFFh		Torque limitation status word.	1 = 1																																										

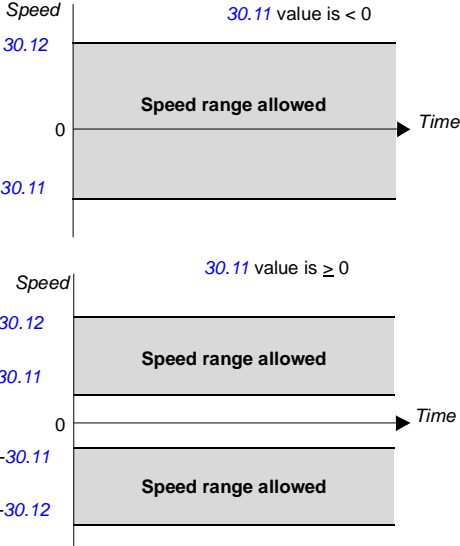

No.	Name/Value	Description	Default FbEq 16
30.11	<i>Minimum speed</i>	<p>Defines together with <a href="#">30.12 Maximum speed</a> allowed speed range. See the figure below.</p> <p>A positive (or zero) minimum speed value defines two ranges, one positive and one negative.</p> <p>A negative minimum speed value defines one range.</p> <p><b>⚠ WARNING!</b> The absolute value of <a href="#">30.11 Minimum speed</a> must not be higher than the <a href="#">30.12 Maximum speed</a>.</p> <p><b>⚠ WARNING!</b> In speed control mode only. In frequency control mode, use frequency limits (<a href="#">30.13</a> and <a href="#">30.14</a>).</p> 	-1500.00 rpm
	-30000.00...30000.00 rpm	Minimum allowed speed.	See par. <a href="#">46.01</a>
30.12	<i>Maximum speed</i>	<p>Defines together with <a href="#">30.11 Minimum speed</a> allowed speed range. See parameter <a href="#">30.11 Minimum speed</a>.</p> <p><b>Note:</b> This parameter does not affect the speed acceleration and deceleration ramp times. See parameter <a href="#">46.01 Speed scaling</a>.</p> <p><b>⚠ WARNING!</b> The absolute value of <a href="#">30.12 Maximum speed</a> must not be lower than <a href="#">30.11 Minimum speed</a>.</p> <p><b>⚠ WARNING!</b> In speed control mode only. In frequency control mode, use frequency limits (<a href="#">30.13</a> and <a href="#">30.14</a>).</p>	1500.00 rpm
	-30000.00... 30000.00 rpm	Maximum speed.	See par. <a href="#">46.01</a>

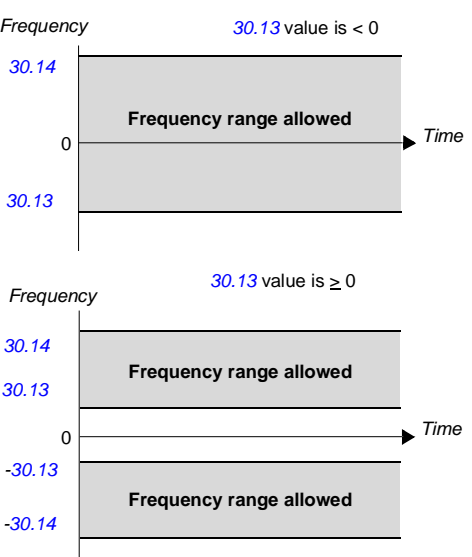

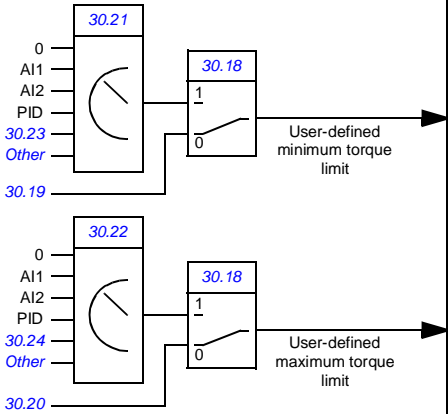
No.	Name/Value	Description	Default FbEq 16
30.13	<i>Minimum frequency</i>	<p>Defines together with <a href="#">30.14 Maximum frequency</a> allowed frequency range. See the figure below.</p> <p>A positive (or zero) minimum frequency value defines two ranges, one positive and one negative.</p> <p>A negative minimum frequency value defines one range.</p> <p><b>WARNING!</b> The absolute value of <a href="#">30.13 Minimum frequency</a> must not be higher than <a href="#">30.14 Maximum frequency</a>.</p> <p><b>WARNING!</b> In frequency control mode only.</p> 	-50.00 Hz
	-500.00...500.00 Hz	Minimum frequency.	See par. <a href="#">46.02</a>
30.14	<i>Maximum frequency</i>	<p>Defines together with <a href="#">30.13 Minimum frequency</a> allowed frequency range. See <a href="#">30.13 Minimum frequency</a>.</p> <p><b>Note:</b> This parameter does not affect the speed acceleration and deceleration ramp times. See parameter <a href="#">46.02 Frequency scaling</a>.</p> <p><b>WARNING!</b> This absolute value of <a href="#">30.14 Maximum frequency</a> must not be lower than <a href="#">30.13 Minimum frequency</a>.</p> <p><b>WARNING!</b> In frequency control mode only.</p>	50.00 Hz
	-500.00...500.00 Hz	Maximum frequency.	See par. <a href="#">46.02</a>

No.	Name/Value	Description	Default FbEq 16
30.17	<i>Maximum current</i>	<p>Defines the maximum allowed motor current. The system sets the default value to 90% of the rated current. If required, you can increase the parameter value by 10%.</p> <p><b>Note:</b> The maximum current range and default value depends on the drive type.</p>	2.88 A
	0.00...3.20 A	Maximum motor current.	1 = 1 A
30.18	<i>Torq lim sel</i>	<p>Selects a source that switches between two different predefined minimum torque limit sets.</p> <p>0 = minimum torque limit defined by 30.19 and maximum torque limit defined by 30.20 are active 1 = minimum torque limit selected by 30.21 and maximum torque limit defined by 30.22 are active</p> <p>The user can define two sets of torque limits, and switch between the sets using a binary source such as a digital input.</p> <p>The first set of limits is defined by parameters 30.19 and 30.20. The second set has selector parameters for both the minimum (30.21) and maximum (30.22) limits that allows the use of a selectable analog source (such as an analog input).</p>  <p><b>Note:</b> In addition to the user-defined limits, torque may be limited for other reasons (such as power limitation). Refer to the block diagram on page 439.</p>	<i>Torque limit set 1</i>
	Torque limit set 1	0 (minimum torque limit defined by 30.19 and maximum torque limit defined by 30.20 are active).	0
	Torque limit set 2	1 (minimum torque limit selected by 30.21 and maximum torque limit defined by 30.22 are active).	1
	DI1	Digital input DI1 ( <i>10.02 DI delayed status</i> , bit 0).	2
	DI2	Digital input DI2 ( <i>10.02 DI delayed status</i> , bit 1).	3
	DI3	Digital input DI3 ( <i>10.02 DI delayed status</i> , bit 2).	4
	DI4	Digital input DI4 ( <i>10.02 DI delayed status</i> , bit 3).	5
	DIO1	Digital input/output DIO1 ( <i>11.02 DIO delayed status</i> , bit 0).	6

No.	Name/Value	Description	Default FbEq 16
	DIO2	Digital input/output DIO2 ( <i>11.02 DIO delayed status</i> , bit 1)	7
	EFB	Only for the DCU profile. DCU control word bit 15 received through the embedded fieldbus interface.	11
	<i>Other [bit]</i>	Source selection (see <i>Terms and abbreviations</i> ).	-
30.19	<i>Minimum torque 1</i>	<p>Defines a minimum torque limit for the drive (in percent of nominal motor torque). See diagram at parameter <i>30.18 Torq lim sel</i>.</p> <p>The limit is effective when</p> <ul style="list-style-type: none"> <li>the source selected by <i>30.18 Torq lim sel</i> is 0, or</li> <li><i>30.18</i> is set to <i>Torque limit set 1</i>.</li> </ul> <p> <b>WARNING!</b> Do not use minimum torque to stop reverse rotation of the motor. Usage of minimum torque limits disables the drive to reach zero speed and fails to stop the motor.</p>	-300.0%
	-1600.0...0.0%	Minimum torque limit 1.	See par. <i>46.03</i>
30.20	<i>Maximum torque 1</i>	<p>Defines a maximum torque limit for the drive (in percent of nominal motor torque). See diagram at parameter <i>30.18 Torq lim sel</i>.</p> <p>The limit is effective when</p> <ul style="list-style-type: none"> <li>the source selected by <i>30.18 Torq lim sel</i> is 0, or</li> <li><i>30.18</i> is set to <i>Torque limit set 1</i>.</li> </ul>	300.0%
	0.0...1600.0%	Maximum torque 1.	See par. <i>46.03</i>
30.21	<i>Min torque 2 source</i>	<p>Defines the source of the minimum torque limit for the drive (in percent of nominal motor torque) when</p> <ul style="list-style-type: none"> <li>the source selected by parameter <i>30.18 Torq lim sel</i> is 1, or</li> <li><i>30.18</i> is set to <i>Torque limit set 2</i>.</li> </ul> <p>See diagram at <i>30.18 Torq lim sel</i>.</p> <p><b>Note:</b> Any positive values received from the selected source are inverted.</p>	<i>Minimum torque 2</i>
	Zero	None.	0
	AI1 scaled	<i>12.12 AI1 scaled value</i> (see page <i>142</i> ).	1
	AI2 scaled	<i>12.22 AI2 scaled value</i> (see page <i>144</i> ).	2
	PID	<i>40.01 Process PID output actual</i> (output of the process PID controller).	15
	Minimum torque 2	<i>30.23 Minimum torque 2</i> .	16
	<i>Other</i>	Source selection (see <i>Terms and abbreviations</i> ).	-
30.22	<i>Max torque 2 source</i>	<p>Defines the source of the maximum torque limit for the drive (in percent of nominal motor torque) when</p> <ul style="list-style-type: none"> <li>the source selected by parameter <i>30.18 Torq lim sel</i> is 1, or</li> <li><i>30.18</i> is set to <i>Torque limit set 2</i>.</li> </ul> <p>See diagram at <i>30.18 Torq lim sel</i>.</p> <p><b>Note:</b> Any negative values received from the selected source are inverted.</p>	<i>Maximum torque 2</i>
	Zero	None.	0
	AI1 scaled	<i>12.12 AI1 scaled value</i> (see page <i>142</i> ).	1
	AI2 scaled	<i>12.22 AI2 scaled value</i> (see page <i>144</i> ).	2

No.	Name/Value	Description	Default FbEq 16
	PID	<a href="#">40.01 Process PID output actual</a> (output of the process PID controller).	15
	Maximum torque 2	<a href="#">30.24 Maximum torque 2</a> .	16
	<i>Other</i>	Source selection (see <a href="#">Terms and abbreviations</a> ).	-
<a href="#">30.23</a>	<a href="#">Minimum torque 2</a>	Defines the minimum torque limit for the drive (in percent of nominal motor torque) when <ul style="list-style-type: none"> <li>the source selected by <a href="#">30.18 Torq lim sel</a> is 1, or</li> <li><a href="#">30.18</a> is set to <a href="#">Torque limit set 2</a></li> </ul> and <ul style="list-style-type: none"> <li><a href="#">30.21 Min torque 2 source</a> is set to <a href="#">Minimum torque 2</a>.</li> </ul> See diagram at <a href="#">30.18 Torq lim sel</a> .	-300.0%
	-1600.0...0.0%	Minimum torque limit 2.	See par. <a href="#">46.03</a>
<a href="#">30.24</a>	<a href="#">Maximum torque 2</a>	Defines the maximum torque limit for the drive (in percent of nominal motor torque) when The limit is effective when <ul style="list-style-type: none"> <li>the source selected by <a href="#">30.18 Torq lim sel</a> is 1, or</li> <li><a href="#">30.18</a> is set to <a href="#">Torque limit set 2</a></li> </ul> and <ul style="list-style-type: none"> <li><a href="#">30.22 Max torque 2 source</a> is set to <a href="#">Maximum torque 2</a>.</li> </ul> See diagram at <a href="#">30.18 Torq lim sel</a> .	300.0%
	0.0...1600.0%	Maximum torque limit 2.	See par. <a href="#">46.03</a>
<a href="#">30.26</a>	<a href="#">Power motoring limit</a>	Defines the maximum allowed power fed by the inverter to the motor in percent of nominal motor power.	300.00%
	0.00...600.00%	Maximum motoring power.	1 = 1%
<a href="#">30.27</a>	<a href="#">Power generating limit</a>	Defines the maximum allowed power fed by the motor to the inverter in percent of nominal motor power.	-300.00%
	-600.00...0.00%	Maximum generating power.	1 = 1%
<a href="#">30.30</a>	<a href="#">Overvoltage control</a>	Enables the overvoltage control of the intermediate DC link. Fast braking of a high inertia load causes the voltage to rise to the overvoltage control limit. To prevent the DC voltage from exceeding the limit, the overvoltage controller automatically decreases the braking torque. <b>Note:</b> If the drive is equipped with a brake chopper and resistor, or a regenerative supply unit, the controller must be disabled.	<a href="#">Enable</a>
	Disable	Overvoltage control disabled.	0
	Enable	Overvoltage control enabled.	1
<a href="#">30.31</a>	<a href="#">Undervoltage control</a>	Enables the undervoltage control of the intermediate DC link. If the DC voltage drops due to input power cut off, the undervoltage controller will automatically decrease the motor torque in order to keep the voltage above the lower limit. By decreasing the motor torque, the inertia of the load will cause regeneration back to the drive, keeping the DC link charged and preventing an undervoltage trip until the motor coasts to a stop. This will act as a power-loss ride-through functionality in systems with high inertia, such as a centrifuge or a fan.	<a href="#">Enable</a>
	Disable	Undervoltage control disabled.	0

No.	Name/Value	Description	Default FbEq 16
	Enable	Undervoltage control enabled.	1
30.35	<i>Thermal current limitation</i>	Enables/disables temperature-based output current limitation. The limitation should only be disabled if required by the application.	<i>Enable</i>
	Disable	Thermal current limitation disabled.	0
	Enable	Thermal current limitation enabled.	1
30.36	<i>Speed limit selection</i>	<p>Selects a source that switches between two different predefined adjustable speed limit sets.</p> <p>0 = minimum speed limit defined by 30.11 and maximum speed limit defined by 30.12 are active</p> <p>1 = minimum speed limit selected by 30.37 and maximum speed limit defined by 30.38 are active.</p> <p>The user can define two sets of speed limits, and switch between the sets using a binary source such as a digital input.</p> <p>The user can define two sets of speed limits, and switch between the sets using a binary source such as a digital input.</p> <p>The first set of limits is defined by parameters 30.11 <i>Minimum speed</i> and 30.12 <i>Maximum speed</i>. The second set has selector parameters for both the minimum (30.37) and maximum (30.38) limits that allows the use of a selectable analog source (such as an analog input).</p>	<i>Not selected</i>
	Not selected	Adjustable speed limits are disabled. (Minimum speed limit defined by 30.11 <i>Minimum speed</i> and maximum speed limit defined by 30.12 <i>Maximum speed</i> are active).	0
	Selected	Adjustable speed limits are enabled. (Minimum speed limit defined by 30.37 <i>Min speed source</i> and maximum speed limit defined by 30.38 <i>Max speed source</i> are active).	1
	Ext1 active	Adjustable speed limits are enabled if EXT1 is active.	2
	Ext2 active	Adjustable speed limits are enabled if EXT2 is active.	3

No.	Name/Value	Description	Default FbEq 16
	Torque control	Adjustable speed limits are enabled if Torque control mode (vector motor control) is active.	4
	DI1	Digital input DI1 ( <i>10.02 DI delayed status</i> , bit 0).	5
	DI2	Digital input DI2 ( <i>10.02 DI delayed status</i> , bit 1).	6
	DI3	Digital input DI2 ( <i>10.02 DI delayed status</i> , bit 2).	7
	DI4	Digital input DI2 ( <i>10.02 DI delayed status</i> , bit 3).	8
	<i>Other [bit]</i>	Source selection (see <i>Terms and abbreviations</i> ).	-
<b>30.37</b>	<b><i>Min speed source</i></b>	Defines the source of a minimum speed limit for the drive when the source is selected by <b>30.36 Speed limit selection</b> .  <b>WARNING!</b> In vector motor control mode only. In scalar motor control mode, use frequency limits <b>30.13</b> and <b>30.14</b> .	<b><i>Minimum speed</i></b>
	Zero	None.	0
	AI1 scaled	<b>12.12 AI1 scaled value</b>	1
	AI2 scaled	<b>12.22 AI2 scaled value</b>	2
	Minimum speed	<b>30.11 Minimum speed</b> .	11
	<i>Other</i>	Source selection (see <i>Terms and abbreviations</i> ).	-
<b>30.38</b>	<b><i>Max speed source</i></b>	Defines the source of a maximum speed limit for the drive when the source is selected by <b>30.36 Speed limit selection</b> .  <b>WARNING!</b> In vector motor control mode only. In scalar motor control mode, use frequency limits <b>30.13</b> and <b>30.14</b> .	<b><i>Maximum speed</i></b>
	Zero	None.	0
	AI1 scaled	<b>12.12 AI1 scaled value</b>	1
	AI2 scaled	<b>12.22 AI2 scaled value</b>	2
	Maximum speed	<b>30.12 Maximum speed</b> .	12
	<i>Other</i>	Source selection (see <i>Terms and abbreviations</i> ).	-
<b>30.203</b>	<b><i>Deadband forward</i></b>	Defines the dead-band area for the positive speed reference when the speed reference is taken from an analog input.	0.00%
	0.00...100.00%		10=1%
<b>30.204</b>	<b><i>Deadband reverse</i></b>	Defines the dead-band area for the negative speed reference when the speed reference is taken from an analog input.	0.00%
	0.00...100.00%		10=1%
<b>31 Fault functions</b>		Configuration of external events; selection of behavior of the drive upon fault situations.	
<b>31.01</b>	<b><i>External event 1 source</i></b>	Defines the source of external event 1. See also parameter <b>31.02 External event 1 type</b> . 0 = Trigger event 1 = Normal operation	<b><i>Inactive (true)</i></b>
	Active (false)	0.	0
	Inactive (true)	1.	1
	DI1	Digital input DI1 ( <i>10.02 DI delayed status</i> , bit 0).	3

No.	Name/Value	Description	Default FbEq 16
	DI2	Digital input DI2 ( <i>10.02 DI delayed status</i> , bit 1).	4
	DI3	Digital input DI3 ( <i>10.02 DI delayed status</i> , bit 2).	5
	DI4	Digital input DI4 ( <i>10.02 DI delayed status</i> , bit 3).	6
	DIO1	Digital input/output DIO1 ( <i>11.02 DIO delayed status</i> , bit 0).	11
	DIO2	Digital input/output DIO2 ( <i>11.02 DIO delayed status</i> , bit 1)	12
	<i>Other [bit]</i>	Source selection (see <i>Terms and abbreviations</i> ).	-
<i>31.02</i>	<i>External event 1 type</i>	Selects the type of external event 1.	<i>Fault</i>
	Fault	The external event generates a fault.	0
	Warning	The external event generates a warning.	1
<i>31.03</i>	<i>External event 2 source</i>	Defines the source of external event 2. See also parameter <i>31.04 External event 2 type</i> . For the selections, see parameter <i>31.01 External event 1 source</i> .	<i>Inactive (true)</i>
<i>31.04</i>	<i>External event 2 type</i>	Selects the type of external event 2.	<i>Fault</i>
	Fault	The external event generates a fault.	0
	Warning	The external event generates a warning.	1
<i>31.05</i>	<i>External event 3 source</i>	Defines the source of external event 3. See also parameter <i>31.06 External event 3 type</i> . For the selections, see parameter <i>31.01 External event 1 source</i> .	<i>Inactive (true)</i>
<i>31.06</i>	<i>External event 3 type</i>	Selects the type of external event 3.	
	Fault	The external event generates a fault.	0
	Warning	The external event generates a warning.	1
<i>31.07</i>	<i>External event 4 source</i>	Defines the source of external event 4. See also parameter <i>31.08 External event 4 type</i> . For the selections, see parameter <i>31.01 External event 1 source</i> .	<i>Inactive (true)</i>
<i>31.08</i>	<i>External event 4 type</i>	Selects the type of external event 4.	
	Fault	The external event generates a fault.	0
	Warning	The external event generates a warning.	1
<i>31.09</i>	<i>External event 5 source</i>	Defines the source of external event 5. See also parameter <i>31.10 External event 5 type</i> . For the selections, see parameter <i>31.01 External event 1 source</i> .	<i>Inactive (true)</i>
<i>31.10</i>	<i>External event 5 type</i>	Selects the type of external event 5.	<i>Fault</i>
	Fault	The external event generates a fault.	0
	Warning	The external event generates a warning.	1
<i>31.11</i>	<i>Fault reset selection</i>	Selects the source of an external fault reset signal. The signal resets the drive after a fault trip if the cause of the fault no longer exists. 0 -> 1 = Reset <b>Note:</b> A fault reset from the fieldbus interface is always observed regardless of this parameter.	<i>Not used</i>
	Not used	Not used	0
	Not used	Not used	1



No.	Name/Value	Description	Default FbEq 16																								
	DI1	Digital input DI1 ( <i>10.02 DI delayed status</i> , bit 0).	2																								
	DI2	Digital input DI2 ( <i>10.02 DI delayed status</i> , bit 1).	3																								
	DI3	Digital input DI3 ( <i>10.02 DI delayed status</i> , bit 2).	4																								
	DI4	Digital input DI4 ( <i>10.02 DI delayed status</i> , bit 3).	5																								
	DIO1	Digital input/output DIO1 ( <i>11.02 DIO delayed status</i> , bit 0).	10																								
	DIO2	Digital input/output DIO2 ( <i>11.02 DIO delayed status</i> , bit 1)	11																								
	Timed function 1	Bit 0 of <i>34.01 Timed functions status</i> .	18																								
	Timed function 2	Bit 1 of <i>34.01 Timed functions status</i> .	19																								
	Timed function 3	Bit 2 of <i>34.01 Timed functions status</i> .	20																								
	Supervision 1	Bit 0 of <i>32.01 Supervision status</i> .	24																								
	Supervision 2	Bit 1 of <i>32.01 Supervision status</i> .	25																								
	Supervision 3	Bit 2 of <i>32.01 Supervision status</i> .	26																								
	Supervision 4	Bit 3 of <i>32.01 Supervision status</i> .	27																								
	Supervision 5	Bit 4 of <i>32.01 Supervision status</i> .	28																								
	Supervision 6	Bit 5 of <i>32.01 Supervision status</i> .	29																								
	<i>Other [bit]</i>	Source selection (see <i>Terms and abbreviations</i> ).	-																								
<b>31.12</b>	<b><i>Autoreset selection</i></b>	<p>Selects faults that are automatically reset. The parameter is a 16-bit word with each bit corresponding to a fault type. Whenever a bit is set to 1, the corresponding fault is automatically reset.</p> <p> <b>WARNING!</b> Before you activate the function, make sure that no dangerous situations can occur. The function restarts the drive automatically and continues operation after a fault.</p> <p>The bits of this binary number correspond to the following faults:</p>	0000h																								
		<table border="1"> <thead> <tr> <th>Bit</th> <th>Fault</th> </tr> </thead> <tbody> <tr> <td>0</td> <td>Overcurrent</td> </tr> <tr> <td>1</td> <td>Overvoltage</td> </tr> <tr> <td>2</td> <td>Undervoltage</td> </tr> <tr> <td>3</td> <td>AI supervision fault</td> </tr> <tr> <td>4...9</td> <td>Reserved</td> </tr> <tr> <td>10</td> <td>Selectable fault (see parameter <i>31.13 Selectable fault</i>)</td> </tr> <tr> <td>11</td> <td>External fault 1 (from source selected by parameter <i>31.01 External event 1 source</i>)</td> </tr> <tr> <td>12</td> <td>External fault 2 (from source selected by parameter <i>31.03 External event 2 source</i>)</td> </tr> <tr> <td>13</td> <td>External fault 3 (from source selected by parameter <i>31.05 External event 3 source</i>)</td> </tr> <tr> <td>14</td> <td>External fault 4 (from source selected by parameter <i>31.07 External event 4 source</i>)</td> </tr> <tr> <td>15</td> <td>External fault 5 (from source selected by parameter <i>31.09 External event 5 source</i>)</td> </tr> </tbody> </table>	Bit	Fault	0	Overcurrent	1	Overvoltage	2	Undervoltage	3	AI supervision fault	4...9	Reserved	10	Selectable fault (see parameter <i>31.13 Selectable fault</i> )	11	External fault 1 (from source selected by parameter <i>31.01 External event 1 source</i> )	12	External fault 2 (from source selected by parameter <i>31.03 External event 2 source</i> )	13	External fault 3 (from source selected by parameter <i>31.05 External event 3 source</i> )	14	External fault 4 (from source selected by parameter <i>31.07 External event 4 source</i> )	15	External fault 5 (from source selected by parameter <i>31.09 External event 5 source</i> )	
Bit	Fault																										
0	Overcurrent																										
1	Overvoltage																										
2	Undervoltage																										
3	AI supervision fault																										
4...9	Reserved																										
10	Selectable fault (see parameter <i>31.13 Selectable fault</i> )																										
11	External fault 1 (from source selected by parameter <i>31.01 External event 1 source</i> )																										
12	External fault 2 (from source selected by parameter <i>31.03 External event 2 source</i> )																										
13	External fault 3 (from source selected by parameter <i>31.05 External event 3 source</i> )																										
14	External fault 4 (from source selected by parameter <i>31.07 External event 4 source</i> )																										
15	External fault 5 (from source selected by parameter <i>31.09 External event 5 source</i> )																										
	0000h...FFFFh	Automatic reset configuration word.	1 = 1																								
<b>31.13</b>	<b><i>Selectable fault</i></b>	<p>Defines the fault that can be automatically reset using parameter <i>31.12 Autoreset selection</i>, bit 10.</p> <p>Faults are listed in chapter <i>Fault tracing</i> (page 389).</p> <p><b>Note:</b> The fault codes are in hexadecimal. The selected code must be converted to decimal for this parameter.</p>	0																								
	0000h...FFFFh	Fault code.	10 = 1																								

No.	Name/Value	Description	Default FbEq 16																	
31.14	<i>Number of trials</i>	Defines the number of automatic fault resets the drive performs within the time defined by parameter <i>31.15 Total trials time</i> .	0																	
	0...5	Number of automatic resets.	10 = 1																	
31.15	<i>Total trials time</i>	Defines the time the automatic reset function will attempt to reset the drive. During this time, it will perform the number of automatic resets defined by <i>31.14 Number of trials</i> .	30.0 s																	
	1.0...600.0 s	Time for automatic resets.	10 = 1 s																	
31.16	<i>Delay time</i>	Defines the time that the drive will wait after a fault before attempting an automatic reset. See parameter <i>31.12 Autoreset selection</i> .	0.0 s																	
	0.0...120.0 s	Autoreset delay.	10 = 1 s																	
31.19	<i>Motor phase loss</i>	Selects how the drive reacts when a motor phase loss is detected. See section <i>Motor phase loss detection (parameter 31.19)</i> on page 101.	<i>Fault</i>																	
	No action	No action taken.	0																	
	Fault	The drive trips on fault <i>3381 Output phase loss</i> .	1																	
31.20	<i>Earth fault</i>	Selects how the drive reacts when an earth (ground) fault or current unbalance is detected in the motor or the motor cable.	<i>Fault</i>																	
	No action	No action taken.	0																	
	Warning	The drive generates an <i>A2B3 Earth leakage</i> warning.	1																	
	Fault	The drive trips on fault <i>2330 Earth leakage</i> .	2																	
31.22	<i>STO indication run/stop</i>	Selects which indications are given when one or both Safe torque off (STO) signals are switched off or lost. The indications also depend on whether the drive is running or stopped when this occurs. The tables at each selection below show the indications generated with that particular setting. <b>Notes:</b> <ul style="list-style-type: none"> <li>This parameter does not affect the operation of the STO function itself. The STO function will operate regardless of the setting of this parameter: a running drive will stop upon removal of one or both STO signals, and will not start until both STO signals are restored and all faults reset.</li> <li>The loss of only one STO signal always generates a fault as it is interpreted as a malfunction.</li> </ul> For more information on the STO, see chapter <i>The Safe torque off function</i> in the hardware manual of the drive.	<i>Fault/Fault</i>																	
	Fault/Fault	<table border="1"> <thead> <tr> <th colspan="2">Inputs</th> <th rowspan="2">Indication (running or stopped)</th> </tr> <tr> <th>IN1</th> <th>IN2</th> </tr> </thead> <tbody> <tr> <td>0</td> <td>0</td> <td>Fault <i>5091 Safe torque off</i></td> </tr> <tr> <td>0</td> <td>1</td> <td>Fault <i>FA81 Safe torque off 1</i></td> </tr> <tr> <td>1</td> <td>0</td> <td>Fault <i>FA82 Safe torque off 2</i></td> </tr> <tr> <td>1</td> <td>1</td> <td>(Normal operation)</td> </tr> </tbody> </table>	Inputs		Indication (running or stopped)	IN1	IN2	0	0	Fault <i>5091 Safe torque off</i>	0	1	Fault <i>FA81 Safe torque off 1</i>	1	0	Fault <i>FA82 Safe torque off 2</i>	1	1	(Normal operation)	0
Inputs		Indication (running or stopped)																		
IN1	IN2																			
0	0	Fault <i>5091 Safe torque off</i>																		
0	1	Fault <i>FA81 Safe torque off 1</i>																		
1	0	Fault <i>FA82 Safe torque off 2</i>																		
1	1	(Normal operation)																		

No.	Name/Value	Description	Default FbEq 16																								
	Fault/Warning	<table border="1"> <thead> <tr> <th colspan="2">Inputs</th> <th colspan="2">Indication</th> </tr> <tr> <th>IN1</th> <th>IN2</th> <th>Running</th> <th>Stopped</th> </tr> </thead> <tbody> <tr> <td>0</td> <td>0</td> <td>Fault <i>5091 Safe torque off</i></td> <td>Warning <i>A5A0 Safe torque off</i></td> </tr> <tr> <td>0</td> <td>1</td> <td>Fault <i>FA81 Safe torque off 1</i></td> <td>Fault <i>FA81 Safe torque off 1</i></td> </tr> <tr> <td>1</td> <td>0</td> <td>Fault <i>FA82 Safe torque off 2</i></td> <td>Fault <i>FA82 Safe torque off 2</i></td> </tr> <tr> <td>1</td> <td>1</td> <td colspan="2">(Normal operation)</td> </tr> </tbody> </table>	Inputs		Indication		IN1	IN2	Running	Stopped	0	0	Fault <i>5091 Safe torque off</i>	Warning <i>A5A0 Safe torque off</i>	0	1	Fault <i>FA81 Safe torque off 1</i>	Fault <i>FA81 Safe torque off 1</i>	1	0	Fault <i>FA82 Safe torque off 2</i>	Fault <i>FA82 Safe torque off 2</i>	1	1	(Normal operation)		1
Inputs		Indication																									
IN1	IN2	Running	Stopped																								
0	0	Fault <i>5091 Safe torque off</i>	Warning <i>A5A0 Safe torque off</i>																								
0	1	Fault <i>FA81 Safe torque off 1</i>	Fault <i>FA81 Safe torque off 1</i>																								
1	0	Fault <i>FA82 Safe torque off 2</i>	Fault <i>FA82 Safe torque off 2</i>																								
1	1	(Normal operation)																									
	Fault/Event	<table border="1"> <thead> <tr> <th colspan="2">Inputs</th> <th colspan="2">Indication</th> </tr> <tr> <th>IN1</th> <th>IN2</th> <th>Running</th> <th>Stopped</th> </tr> </thead> <tbody> <tr> <td>0</td> <td>0</td> <td>Fault <i>5091 Safe torque off</i></td> <td>Event <i>B5A0 Safe torque off</i></td> </tr> <tr> <td>0</td> <td>1</td> <td>Fault <i>FA81 Safe torque off 1</i></td> <td>Fault <i>FA81 Safe torque off 1</i></td> </tr> <tr> <td>1</td> <td>0</td> <td>Fault <i>FA82 Safe torque off 2</i></td> <td>Fault <i>FA82 Safe torque off 2</i></td> </tr> <tr> <td>1</td> <td>1</td> <td colspan="2">(Normal operation)</td> </tr> </tbody> </table>	Inputs		Indication		IN1	IN2	Running	Stopped	0	0	Fault <i>5091 Safe torque off</i>	Event <i>B5A0 Safe torque off</i>	0	1	Fault <i>FA81 Safe torque off 1</i>	Fault <i>FA81 Safe torque off 1</i>	1	0	Fault <i>FA82 Safe torque off 2</i>	Fault <i>FA82 Safe torque off 2</i>	1	1	(Normal operation)		2
Inputs		Indication																									
IN1	IN2	Running	Stopped																								
0	0	Fault <i>5091 Safe torque off</i>	Event <i>B5A0 Safe torque off</i>																								
0	1	Fault <i>FA81 Safe torque off 1</i>	Fault <i>FA81 Safe torque off 1</i>																								
1	0	Fault <i>FA82 Safe torque off 2</i>	Fault <i>FA82 Safe torque off 2</i>																								
1	1	(Normal operation)																									
	Warning/Warning	<table border="1"> <thead> <tr> <th colspan="2">Inputs</th> <th rowspan="2">Indication (running or stopped)</th> </tr> <tr> <th>IN1</th> <th>IN2</th> </tr> </thead> <tbody> <tr> <td>0</td> <td>0</td> <td>Warning <i>A5A0 Safe torque off</i></td> </tr> <tr> <td>0</td> <td>1</td> <td>Fault <i>FA81 Safe torque off 1</i></td> </tr> <tr> <td>1</td> <td>0</td> <td>Fault <i>FA82 Safe torque off 2</i></td> </tr> <tr> <td>1</td> <td>1</td> <td>(Normal operation)</td> </tr> </tbody> </table>	Inputs		Indication (running or stopped)	IN1	IN2	0	0	Warning <i>A5A0 Safe torque off</i>	0	1	Fault <i>FA81 Safe torque off 1</i>	1	0	Fault <i>FA82 Safe torque off 2</i>	1	1	(Normal operation)	3							
Inputs		Indication (running or stopped)																									
IN1	IN2																										
0	0	Warning <i>A5A0 Safe torque off</i>																									
0	1	Fault <i>FA81 Safe torque off 1</i>																									
1	0	Fault <i>FA82 Safe torque off 2</i>																									
1	1	(Normal operation)																									
	Event/Event	<table border="1"> <thead> <tr> <th colspan="2">Inputs</th> <th rowspan="2">Indication (running or stopped)</th> </tr> <tr> <th>IN1</th> <th>IN2</th> </tr> </thead> <tbody> <tr> <td>0</td> <td>0</td> <td>Event <i>B5A0 Safe torque off</i></td> </tr> <tr> <td>0</td> <td>1</td> <td>Event <i>B5A0 Safe torque off</i> and fault <i>FA81 Safe torque off 1</i></td> </tr> <tr> <td>1</td> <td>0</td> <td>Event <i>B5A0 Safe torque off</i> and fault <i>FA82 Safe torque off 2</i></td> </tr> <tr> <td>1</td> <td>1</td> <td>(Normal operation)</td> </tr> </tbody> </table>	Inputs		Indication (running or stopped)	IN1	IN2	0	0	Event <i>B5A0 Safe torque off</i>	0	1	Event <i>B5A0 Safe torque off</i> and fault <i>FA81 Safe torque off 1</i>	1	0	Event <i>B5A0 Safe torque off</i> and fault <i>FA82 Safe torque off 2</i>	1	1	(Normal operation)	4							
Inputs		Indication (running or stopped)																									
IN1	IN2																										
0	0	Event <i>B5A0 Safe torque off</i>																									
0	1	Event <i>B5A0 Safe torque off</i> and fault <i>FA81 Safe torque off 1</i>																									
1	0	Event <i>B5A0 Safe torque off</i> and fault <i>FA82 Safe torque off 2</i>																									
1	1	(Normal operation)																									
	No Indication/No Indication	<table border="1"> <thead> <tr> <th colspan="2">Inputs</th> <th rowspan="2">Indication (running or stopped)</th> </tr> <tr> <th>IN1</th> <th>IN2</th> </tr> </thead> <tbody> <tr> <td>0</td> <td>0</td> <td>None</td> </tr> <tr> <td>0</td> <td>1</td> <td>Fault <i>FA81 Safe torque off 1</i></td> </tr> <tr> <td>1</td> <td>0</td> <td>Fault <i>FA82 Safe torque off 2</i></td> </tr> <tr> <td>1</td> <td>1</td> <td>(Normal operation)</td> </tr> </tbody> </table>	Inputs		Indication (running or stopped)	IN1	IN2	0	0	None	0	1	Fault <i>FA81 Safe torque off 1</i>	1	0	Fault <i>FA82 Safe torque off 2</i>	1	1	(Normal operation)	5							
Inputs		Indication (running or stopped)																									
IN1	IN2																										
0	0	None																									
0	1	Fault <i>FA81 Safe torque off 1</i>																									
1	0	Fault <i>FA82 Safe torque off 2</i>																									
1	1	(Normal operation)																									

## 228 Parameters

No.	Name/Value	Description	Default FbEq 16
<a href="#">31.23</a>	<a href="#">Wiring or earth fault</a>	Selects how the drive reacts to incorrect input power and motor cable connection (ie. input power cable is connected to drive motor connection).	<a href="#">Fault</a>
	No action	No action taken.	0
	Fault	The drive trips on fault <a href="#">3181 Cross connection</a> .	1
<a href="#">31.24</a>	<a href="#">Stall function</a>	Selects how the drive reacts to a motor stall condition. A stall condition is defined as follows: <ul style="list-style-type: none"> <li>• The drive exceeds the stall current limit (<a href="#">31.25 Stall current limit</a>), and</li> <li>• the output frequency is below the level set by parameter <a href="#">31.27 Stall frequency limit</a> or the motor speed is below the level set by parameter <a href="#">31.26 Stall speed limit</a>, and</li> <li>• the conditions above have been true longer than the time set by parameter <a href="#">31.28 Stall time</a>.</li> </ul>	<a href="#">No action</a>
	No action	None (stall supervision disabled).	0
	Warning	The drive generates an <a href="#">A780 Motor stall</a> warning.	1
	Fault	The drive trips on fault <a href="#">7121 Motor stall</a> .	2
<a href="#">31.25</a>	<a href="#">Stall current limit</a>	Stall current limit in percent of the nominal current of the motor. See parameter <a href="#">31.24 Stall function</a> .	200.0%
	0.0...1600.0%	Stall current limit.	-
<a href="#">31.26</a>	<a href="#">Stall speed limit</a>	Stall speed limit in rpm. See parameter <a href="#">31.24 Stall function</a> .	150.00 rpm
	0.00...10000.00 rpm	Stall speed limit.	See par. <a href="#">46.01</a>
<a href="#">31.27</a>	<a href="#">Stall frequency limit</a>	Stall frequency limit. See parameter <a href="#">31.24 Stall function</a> . <b>Note:</b> Setting the limit below 10 Hz is not recommended.	15.00 Hz
	0.00...1000.00 Hz	Stall frequency limit.	See par. <a href="#">46.02</a>
<a href="#">31.28</a>	<a href="#">Stall time</a>	Stall time. See parameter <a href="#">31.24 Stall function</a> .	20 s
	0...3600 s	Stall time.	-

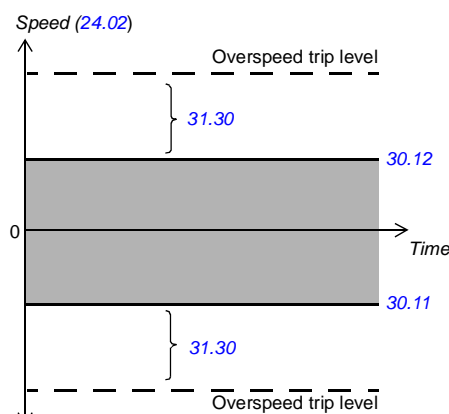
No.	Name/Value	Description	Default FbEq 16
31.30	<i>Overspeed trip margin</i>	<p>Defines, together with <a href="#">30.11 Minimum speed</a> and <a href="#">30.12 Maximum speed</a>, the maximum allowed speed of the motor (overspeed protection). If the speed (<a href="#">24.02 Used speed feedback</a>) exceeds the speed limit defined by parameter <a href="#">30.11</a> or <a href="#">30.12</a> by more than the value of this parameter, the drive trips on the <a href="#">7310 Overspeed</a> fault.</p> <p><b>⚠ WARNING!</b> This function only supervises the speed in vector motor control mode. The function is not effective in scalar motor control mode.</p> <p><b>Example:</b> If the maximum speed is 1420 rpm and speed trip margin is 300 rpm, the drive trips at 1720 rpm.</p> 	500.00 rpm
	0.00...10000.00 rpm	Overspeed trip margin.	See par. <a href="#">46.01</a>

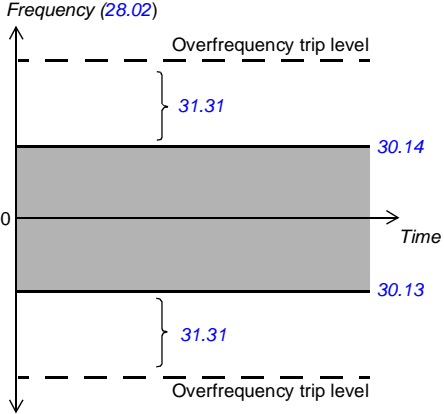
No.	Name/Value	Description	Default FbEq 16
31.31	<p><i>Frequency trip margin</i></p> <p>Defines, together with <a href="#">30.13 Minimum frequency</a> and <a href="#">30.14 Maximum frequency</a>, the maximum allowed frequency of the motor. If the speed (<a href="#">28.01 Frequency ref ramp input</a>) exceeds the frequency limit defined by parameter <a href="#">30.13</a> or <a href="#">30.14</a> by more than the value of this parameter, the drive trips on the <a href="#">73F0 Overfrequency</a> fault.</p> <p> <b>WARNING!</b> This function only supervises the speed in scalar motor control mode. The function is not effective in vector motor control mode.</p> <p><b>Example:</b> If the maximum speed is 40 Hz and speed trip margin is 10 Hz, the drive trips at 50 Hz.</p> <p><i>Frequency (28.02)</i></p>  <p>The graph plots Frequency (28.02) on the vertical axis against Time on the horizontal axis. A shaded gray band represents the allowed frequency range, bounded by parameter 30.14 at the top and 30.13 at the bottom. Dashed horizontal lines above and below this band represent the 'Overfrequency trip level'. Brackets labeled '31.31' indicate the vertical distance from the top and bottom edges of the shaded band to their respective trip levels.</p>	15.00 Hz	
	0.00...10000.00 Hz	Overfrequency trip margin.	See par. <a href="#">46.02</a>
31.32	<p><i>Emergency ramp supervision</i></p> <p>Parameters <a href="#">31.32 Emergency ramp supervision</a> and <a href="#">31.33 Emergency ramp supervision delay</a>, together with the derivative of <a href="#">24.02 Used speed feedback</a>, provide a supervision function for emergency stop modes Off1 and Off3.</p> <p>The supervision is based on either</p> <ul style="list-style-type: none"> <li>observing the time within which the motor stops, or</li> <li>comparing the actual and expected deceleration rates.</li> </ul> <p>If this parameter is set to 0%, the maximum stop time is directly set in parameter <a href="#">31.33</a>. Otherwise, <a href="#">31.32</a> defines the maximum allowed deviation from the expected deceleration rate, which is calculated from parameters <a href="#">23.11... 23.15</a> (Off1) or <a href="#">23.23 Emergency stop time</a> (Off3). If the actual deceleration rate (<a href="#">24.02</a>) deviates too much from the expected rate, the drive trips on <a href="#">73B0 Emergency ramp failed</a>, sets bit 8 of <a href="#">06.17 Drive status word 2</a>, and coasts to a stop.</p> <p>If <a href="#">31.32</a> is set to 0% and <a href="#">31.33</a> is set to 0 s, the emergency stop ramp supervision is disabled. See also parameter <a href="#">21.04 Emergency stop mode</a>.</p>	0%	
	0...300%	Maximum deviation from expected deceleration rate.	1 = 1%

No.	Name/Value	Description	Default FbEq 16																																							
31.33	<i>Emergency ramp supervision delay</i>	If parameter <i>31.32 Emergency ramp supervision</i> is set to 0%, this parameter defines the maximum time an emergency stop (mode Off1 or Off3) is allowed to take. If the motor has not stopped when the time elapses, the drive trips on <i>73B0 Emergency ramp failed</i> , sets bit 8 of <i>06.17 Drive status word 2</i> , and coasts to a stop. If <i>31.32</i> is set to a value other than 0%, this parameter defines a delay between the receipt of the emergency stop command and the activation of the supervision. It is recommended to specify a short delay to allow the speed change rate to stabilize.	0 s																																							
	0...100 s	Maximum ramp-down time, or supervision activation delay.	1 = 1 s																																							
31.205	<i>Crane warning masking</i>	Selects which crane warnings trigger events to the drive. Whenever a bit of this parameter is set to 1, the corresponding warning can trigger an event. If a bit is set to 0, the warning does not appear in the event logger or control panel, and the warning can be read only from parameters <i>09.01 Crane SW1</i> . The bits of this binary number correspond to the following warnings:	FFFFh																																							
		<table border="1"> <thead> <tr> <th>Bit</th> <th>Name</th> <th>Description</th> </tr> </thead> <tbody> <tr> <td>0</td> <td>Brake slip at standstill</td> <td>D200 Brake slip at standstill2</td> </tr> <tr> <td>1</td> <td>Slowdown forward/reverse</td> <td>D201 Forward slowdown limit, D202 Reverse slowdown limit</td> </tr> <tr> <td>2</td> <td>Reserved</td> <td></td> </tr> <tr> <td>3</td> <td>Reserved</td> <td></td> </tr> <tr> <td>4</td> <td>End limit forward/reverse</td> <td>D205 Forward stop limit, D206 Reverse stop limit</td> </tr> <tr> <td>5</td> <td>Reserved</td> <td></td> </tr> <tr> <td>6</td> <td>Joystick reference check</td> <td>D208 Joystick reference check</td> </tr> <tr> <td>7</td> <td>Joystick zero position</td> <td>D209 Joystick zero position2</td> </tr> <tr> <td>8</td> <td>Power on acknowledge</td> <td>D20B Power on acknowledge</td> </tr> <tr> <td>9</td> <td>Reserved</td> <td></td> </tr> <tr> <td>10</td> <td>Fast stop</td> <td>D20A Fast stop</td> </tr> <tr> <td>11...15</td> <td>Reserved</td> <td></td> </tr> </tbody> </table>	Bit	Name	Description	0	Brake slip at standstill	D200 Brake slip at standstill2	1	Slowdown forward/reverse	D201 Forward slowdown limit, D202 Reverse slowdown limit	2	Reserved		3	Reserved		4	End limit forward/reverse	D205 Forward stop limit, D206 Reverse stop limit	5	Reserved		6	Joystick reference check	D208 Joystick reference check	7	Joystick zero position	D209 Joystick zero position2	8	Power on acknowledge	D20B Power on acknowledge	9	Reserved		10	Fast stop	D20A Fast stop	11...15	Reserved		
Bit	Name	Description																																								
0	Brake slip at standstill	D200 Brake slip at standstill2																																								
1	Slowdown forward/reverse	D201 Forward slowdown limit, D202 Reverse slowdown limit																																								
2	Reserved																																									
3	Reserved																																									
4	End limit forward/reverse	D205 Forward stop limit, D206 Reverse stop limit																																								
5	Reserved																																									
6	Joystick reference check	D208 Joystick reference check																																								
7	Joystick zero position	D209 Joystick zero position2																																								
8	Power on acknowledge	D20B Power on acknowledge																																								
9	Reserved																																									
10	Fast stop	D20A Fast stop																																								
11...15	Reserved																																									
	0000h...FFFFh	Crane warning masking status word	1 = 1																																							

No.	Name/Value	Description	Default FbEq 16																								
<b>32 Supervision</b>																											
		Configuration of signal supervision functions 1...3. Three values can be chosen to be monitored; a warning or fault is generated whenever predefined limits are exceeded. See also section <a href="#">Signal supervision</a> (page 104).																									
32.01	<i>Supervision status</i>	Signal supervision status word. Indicates whether the values monitored by the signal supervision functions are within or outside their respective limits. <b>Note:</b> This word is independent of the drive actions defined by parameters <a href="#">32.06</a> , <a href="#">32.16</a> , <a href="#">32.26</a> , <a href="#">32.36</a> , <a href="#">32.46</a> and <a href="#">32.56</a> .	0000h																								
<table border="1"> <thead> <tr> <th>Bit</th> <th>Name</th> <th>Description</th> </tr> </thead> <tbody> <tr> <td>0</td> <td>Supervision 1 active</td> <td>1 = Signal selected by <a href="#">32.07</a> is outside its limits.</td> </tr> <tr> <td>1</td> <td>Supervision 2 active</td> <td>1 = Signal selected by <a href="#">32.17</a> is outside its limits.</td> </tr> <tr> <td>2</td> <td>Supervision 3 active</td> <td>1 = Signal selected by <a href="#">32.27</a> is outside its limits.</td> </tr> <tr> <td>3</td> <td>Supervision 4 active</td> <td>1 = Signal selected by <a href="#">32.37</a> is outside its limits.</td> </tr> <tr> <td>4</td> <td>Supervision 5 active</td> <td>1 = Signal selected by <a href="#">32.47</a> is outside its limits.</td> </tr> <tr> <td>5</td> <td>Supervision 6 active</td> <td>1 = Signal selected by <a href="#">32.57</a> is outside its limits.</td> </tr> <tr> <td>6...15</td> <td>Reserved</td> <td></td> </tr> </tbody> </table>				Bit	Name	Description	0	Supervision 1 active	1 = Signal selected by <a href="#">32.07</a> is outside its limits.	1	Supervision 2 active	1 = Signal selected by <a href="#">32.17</a> is outside its limits.	2	Supervision 3 active	1 = Signal selected by <a href="#">32.27</a> is outside its limits.	3	Supervision 4 active	1 = Signal selected by <a href="#">32.37</a> is outside its limits.	4	Supervision 5 active	1 = Signal selected by <a href="#">32.47</a> is outside its limits.	5	Supervision 6 active	1 = Signal selected by <a href="#">32.57</a> is outside its limits.	6...15	Reserved	
Bit	Name	Description																									
0	Supervision 1 active	1 = Signal selected by <a href="#">32.07</a> is outside its limits.																									
1	Supervision 2 active	1 = Signal selected by <a href="#">32.17</a> is outside its limits.																									
2	Supervision 3 active	1 = Signal selected by <a href="#">32.27</a> is outside its limits.																									
3	Supervision 4 active	1 = Signal selected by <a href="#">32.37</a> is outside its limits.																									
4	Supervision 5 active	1 = Signal selected by <a href="#">32.47</a> is outside its limits.																									
5	Supervision 6 active	1 = Signal selected by <a href="#">32.57</a> is outside its limits.																									
6...15	Reserved																										
0000h...FFFFh		Signal supervision status word.	1 = 1																								
32.05	<i>Supervision 1 function</i>	Selects the mode of signal supervision function 1. Determines how the monitored signal (see parameter <a href="#">32.07</a> ) is compared to its lower and upper limits ( <a href="#">32.09</a> and <a href="#">32.10</a> respectively). The action to be taken when the condition is fulfilled is selected by <a href="#">32.06</a> .	<i>Disabled</i>																								
Disabled		Signal supervision 1 not in use.	0																								
Low		Action is taken whenever the signal falls below its lower limit.	1																								
High		Action is taken whenever the signal rises above its upper limit.	2																								
Abs low		Action is taken whenever the absolute value of the signal falls below its (absolute) lower limit.	3																								
Abs high		Action is taken whenever the absolute value of the signal rises above its (absolute) upper limit.	4																								
Both		Action is taken whenever the signal falls below its low limit or rises above its high limit.	5																								
Abs both		Action is taken whenever the absolute value of the signal falls below its (absolute) low limit or rises above its (absolute) high limit.	6																								
Hysteresis		Action is taken whenever the signal rises above the value defined by the limit + 0.5 · hysteresis range ( <a href="#">32.11 Supervision 1 hysteresis</a> ). The action is deactivated when the signal falls below the value defined by the limit - 0.5 · hysteresis range.	7																								



No.	Name/Value	Description	Default FbEq 16
32.06	<i>Supervision 1 action</i>	Selects whether the drive generates a fault, warning or neither when the value monitored by signal supervision 1 exceeds its limits. <b>Note:</b> This parameter does not affect the status indicated by <i>32.01 Supervision status</i> .	<i>No action</i>
	No action	No warning or fault generated.	0
	Warning	Warning <i>A8B0 Signal supervision</i> is generated.	1
	Fault	The drive trips on fault <i>80B0 Signal supervision</i> .	2
	Fault if running	The drive trips on fault <i>80B0 Signal supervision</i> if running.	3
32.07	<i>Supervision 1 signal</i>	Selects the signal to be monitored by signal supervision function 1.	<i>Frequency</i>
	Zero	None.	0
	Speed	<i>01.01 Motor speed used</i> .	1
	Frequency	<i>01.06 Output frequency</i> .	3
	Current	<i>01.07 Motor current</i> .	4
	Torque	<i>01.10 Motor torque</i> .	6
	DC voltage	<i>01.11 DC voltage</i> .	7
	Output power	<i>01.14 Output power</i> .	8
	AI1	<i>12.11 AI1 actual value</i> .	9
	AI2	<i>12.21 AI2 actual value</i> .	10
	Speed ref ramp in	<i>23.01 Speed ref ramp input</i> .	18
	Speed ref ramp out	<i>23.02 Speed ref ramp output</i> .	19
	Speed ref used	<i>24.01 Used speed reference</i> .	20
	Torque ref used	<i>26.02 Torque reference used</i> .	21
	Freq ref used	<i>28.02 Frequency ref ramp output</i> .	22
	Inverter temperature	<i>05.11 Inverter temperature</i> .	23
	Process PID output	<i>40.01 Process PID output actual</i> .	24
	Process PID feedback	<i>40.02 Process PID feedback actual</i> .	25
	Process PID setpoint	<i>40.03 Process PID setpoint actual</i> .	26
	Process PID deviation	<i>40.04 Process PID deviation actual</i> .	27
	<i>Other</i>	Source selection (see <i>Terms and abbreviations</i> ).	-
32.08	<i>Supervision 1 filter time</i>	Defines a filter time constant for the signal monitored by signal supervision 1.	0.000 s
	0.000 ... 30.000 s	Signal filter time.	1000 = 1 s
32.09	<i>Supervision 1 low</i>	Defines the lower limit for signal supervision 1.	0.00
	-21474830.00... 21474830.00	Low limit.	-
32.10	<i>Supervision 1 high</i>	Defines the upper limit for signal supervision 1.	0.00
	-21474830.00... 21474830.00	Upper limit.	-
32.11	<i>Supervision 1 hysteresis</i>	Defines the hysteresis for the signal monitored by signal supervision 1.	0.00
	0.00...100000.00	Hysteresis.	-

No.	Name/Value	Description	Default FbEq 16
32.15	<i>Supervision 2 function</i>	Selects the mode of signal supervision function 2. Determines how the monitored signal (see parameter 32.17) is compared to its lower and upper limits (32.19 and 32.20 respectively). The action to be taken when the condition is fulfilled is selected by 32.16.	<i>Disabled</i>
	Disabled	Signal supervision 2 not in use.	0
	Low	Action is taken whenever the signal falls below its lower limit.	1
	High	Action is taken whenever the signal rises above its upper limit.	2
	Abs low	Action is taken whenever the absolute value of the signal falls below its (absolute) lower limit.	3
	Abs high	Action is taken whenever the absolute value of the signal rises above its (absolute) upper limit.	4
	Both	Action is taken whenever the signal falls below its low limit or rises above its high limit.	5
	Abs both	Action is taken whenever the absolute value of the signal falls below its (absolute) low limit or rises above its (absolute) high limit.	6
	Hysteresis	Action is taken whenever the signal rises above the value defined by the limit + 0.5 · hysteresis range (32.21 <i>Supervision 2 hysteresis</i> ). The action is deactivated when the signal falls below the value defined by the limit - 0.5 · hysteresis range.	7
32.16	<i>Supervision 2 action</i>	Selects whether the drive generates a fault, warning or neither when the value monitored by signal supervision 2 exceeds its limits. <b>Note:</b> This parameter does not affect the status indicated by 32.01 <i>Supervision status</i> .	<i>No action</i>
	No action	No warning or fault generated.	0
	Warning	Warning <i>A8B0 Signal supervision</i> is generated.	1
	Fault	The drive trips on fault <i>80B0 Signal supervision</i> .	2
	Fault if running	The drive trips on fault <i>80B0 Signal supervision</i> if running.	3
32.17	<i>Supervision 2 signal</i>	Selects the signal to be monitored by signal supervision function 2. For the available selections, see parameter 32.07 <i>Supervision 1 signal</i> .	<i>Current</i>
32.18	<i>Supervision 2 filter time</i>	Defines a filter time constant for the signal monitored by signal supervision 2.	0.000 s
	0.000 ... 30.000 s	Signal filter time.	1000 = 1 s
32.19	<i>Supervision 2 low</i>	Defines the lower limit for signal supervision 2.	0.00
	-21474830.00... 21474830.00	Low limit.	-
32.20	<i>Supervision 2 high</i>	Defines the upper limit for signal supervision 2.	0.00
	-21474830.00... 21474830.00	Upper limit.	-
32.21	<i>Supervision 2 hysteresis</i>	Defines the hysteresis for the signal monitored by signal supervision 2.	0.00
	0.00...100000.00	Hysteresis.	-

No.	Name/Value	Description	Default FbEq 16
<a href="#">32.25</a>	<a href="#">Supervision 3 function</a>	Selects the mode of signal supervision function 3. Determines how the monitored signal (see parameter <a href="#">32.27</a> ) is compared to its lower and upper limits ( <a href="#">32.29</a> and <a href="#">32.30</a> respectively). The action to be taken when the condition is fulfilled is selected by <a href="#">32.26</a> .	<a href="#">Disabled</a>
	Disabled	Signal supervision 3 not in use.	0
	Low	Action is taken whenever the signal falls below its lower limit.	1
	High	Action is taken whenever the signal rises above its upper limit.	2
	Abs low	Action is taken whenever the absolute value of the signal falls below its (absolute) lower limit.	3
	Abs high	Action is taken whenever the absolute value of the signal rises above its (absolute) upper limit.	4
	Both	Action is taken whenever the signal falls below its low limit or rises above its high limit.	5
	Abs both	Action is taken whenever the absolute value of the signal falls below its (absolute) low limit or rises above its (absolute) high limit.	6
	Hysteresis	Action is taken whenever the signal rises above the value defined by the limit + 0.5 · hysteresis range ( <a href="#">32.31 Supervision 3 hysteresis</a> ). The action is deactivated when the signal falls below the value defined by the limit - 0.5 · hysteresis range.	7
<a href="#">32.26</a>	<a href="#">Supervision 3 action</a>	Selects whether the drive generates a fault, warning or neither when the value monitored by signal supervision 3 exceeds its limits. <b>Note:</b> This parameter does not affect the status indicated by <a href="#">32.01 Supervision status</a> .	<a href="#">No action</a>
	No action	No warning or fault generated.	0
	Warning	Warning <a href="#">A8B0 Signal supervision</a> is generated.	1
	Fault	The drive trips on fault <a href="#">80B0 Signal supervision</a> .	2
	Fault if running	The drive trips on fault <a href="#">80B0 Signal supervision</a> if running.	3
<a href="#">32.27</a>	<a href="#">Supervision 3 signal</a>	Selects the signal to be monitored by signal supervision function 3. For the available selections, see parameter <a href="#">32.07 Supervision 1 signal</a> .	<a href="#">Torque</a>
<a href="#">32.28</a>	<a href="#">Supervision 3 filter time</a>	Defines a filter time constant for the signal monitored by signal supervision 3.	0.000 s
	0.000 ... 30.000 s	Signal filter time.	1000 = 1 s
<a href="#">32.29</a>	<a href="#">Supervision 3 low</a>	Defines the lower limit for signal supervision 3.	0.00
	-21474830.00... 21474830.00	Low limit.	-
<a href="#">32.30</a>	<a href="#">Supervision 3 high</a>	Defines the upper limit for signal supervision 3.	0.00
	-21474830.00... 21474830.00	Upper limit.	-
<a href="#">32.31</a>	<a href="#">Supervision 3 hysteresis</a>	Defines the hysteresis for the signal monitored by signal supervision 3.	0.00
	0.00...100000.00	Hysteresis.	-

No.	Name/Value	Description	Default FbEq 16
32.35	<i>Supervision 4 function</i>	Selects the mode of signal supervision function 4. Determines how the monitored signal (see parameter 32.37 is compared to its lower and upper limits (32.39 and 32.30 respectively). The action to be taken when the condition is fulfilled is selected by 32.36.	<i>Disabled</i>
	Disabled	Signal supervision 4 not in use.	0
	Low	Action is taken whenever the signal falls below its lower limit.	1
	High	Action is taken whenever the signal rises above its upper limit.	2
	Abs low	Action is taken whenever the absolute value of the signal falls below its (absolute) lower limit.	3
	Abs high	Action is taken whenever the absolute value of the signal rises above its (absolute) upper limit.	4
	Both	Action is taken whenever the signal falls below its low limit or rises above its high limit.	5
	Abs both	Action is taken whenever the absolute value of the signal falls below its (absolute) low limit or rises above its (absolute) high limit.	6
	Hysteresis	Action is taken whenever the signal rises above the value defined by the limit + 0.5 · hysteresis range (32.41 <i>Supervision 4 hysteresis</i> ). The action is deactivated when the signal falls below the value defined by the limit - 0.5 · hysteresis range.	7
32.36	<i>Supervision 4 action</i>	Selects whether the drive generates a fault, warning or neither when the value monitored by signal supervision 4 exceeds its limits. <b>Note:</b> This parameter does not affect the status indicated by 32.01 <i>Supervision status</i> .	<i>No action</i>
	No action	No warning or fault generated.	0
	Warning	Warning <i>A8B0 Signal supervision</i> is generated.	1
	Fault	The drive trips on fault <i>80B0 Signal supervision</i> .	2
	Fault if running	The drive trips on fault <i>80B0 Signal supervision</i> if running.	3
32.37	<i>Supervision 4 signal</i>	Selects the signal to be monitored by signal supervision function 4. For the available selections, see parameter 32.07 <i>Supervision 1 signal</i> .	<i>Zero</i>
32.38	<i>Supervision 4 filter time</i>	Defines a filter time constant for the signal monitored by signal supervision 4.	0.000 s
	0.000 ... 30.000 s	Signal filter time.	1000 = 1 s
32.39	<i>Supervision 4 low</i>	Defines the lower limit for signal supervision 4.	0.00
	-21474830.00... 21474830.00	Low limit.	-
32.40	<i>Supervision 4 high</i>	Defines the upper limit for signal supervision 4.	0.00
	-21474830.00... 21474830.00	Upper limit.	-
32.41	<i>Supervision 4 hysteresis</i>	Defines the hysteresis for the signal monitored by signal supervision 4.	0.00
	0.00...100000.00	Hysteresis.	-

No.	Name/Value	Description	Default FbEq 16
32.45	<i>Supervision 5 function</i>	Selects the mode of signal supervision function 5. Determines how the monitored signal (see parameter 32.47) is compared to its lower and upper limits (32.49 and 32.40 respectively). The action to be taken when the condition is fulfilled is selected by 32.46.	<i>Disabled</i>
	Disabled	Signal supervision 5 not in use.	0
	Low	Action is taken whenever the signal falls below its lower limit.	1
	High	Action is taken whenever the signal rises above its upper limit.	2
	Abs low	Action is taken whenever the absolute value of the signal falls below its (absolute) lower limit.	3
	Abs high	Action is taken whenever the absolute value of the signal rises above its (absolute) upper limit.	4
	Both	Action is taken whenever the signal falls below its low limit or rises above its high limit.	5
	Abs both	Action is taken whenever the absolute value of the signal falls below its (absolute) low limit or rises above its (absolute) high limit.	6
	Hysteresis	Action is taken whenever the signal rises above the value defined by the limit + 0.5 · hysteresis range (32.51 <i>Supervision 5 hysteresis</i> ). The action is deactivated when the signal falls below the value defined by the limit - 0.5 · hysteresis range.	7
32.46	<i>Supervision 5 action</i>	Selects whether the drive generates a fault, warning or neither when the value monitored by signal supervision 5 exceeds its limits. <b>Note:</b> This parameter does not affect the status indicated by 32.01 <i>Supervision status</i> .	<i>No action</i>
	No action	No warning or fault generated.	0
	Warning	Warning <i>A8B0 Signal supervision</i> is generated.	1
	Fault	The drive trips on fault <i>80B0 Signal supervision</i> .	2
	Fault if running	The drive trips on fault <i>80B0 Signal supervision</i> if running.	3
32.47	<i>Supervision 5 signal</i>	Selects the signal to be monitored by signal supervision function 5. For the available selections, see parameter 32.07 <i>Supervision 1 signal</i> .	<i>Zero</i>
32.48	<i>Supervision 5 filter time</i>	Defines a filter time constant for the signal monitored by signal supervision 5.	0.000 s
	0.000 ... 30.000 s	Signal filter time.	1000 = 1 s
32.49	<i>Supervision 5 low</i>	Defines the lower limit for signal supervision 5.	0.00
	-21474830.00... 21474830.00	Low limit.	-
32.50	<i>Supervision 5 high</i>	Defines the upper limit for signal supervision 5.	0.00
	-21474830.00... 21474830.00	Upper limit.	-
32.51	<i>Supervision 5 hysteresis</i>	Defines the hysteresis for the signal monitored by signal supervision 5.	0.00
	0.00...100000.00	Hysteresis.	-

No.	Name/Value	Description	Default FbEq 16
<a href="#">32.55</a>	<a href="#">Supervision 6 function</a>	Selects the mode of signal supervision function 6. Determines how the monitored signal (see parameter <a href="#">32.57</a> ) is compared to its lower and upper limits ( <a href="#">32.59</a> and <a href="#">32.50</a> respectively). The action to be taken when the condition is fulfilled is selected by <a href="#">32.56</a> .	<i>Disabled</i>
	Disabled	Signal supervision 6 not in use.	0
	Low	Action is taken whenever the signal falls below its lower limit.	1
	High	Action is taken whenever the signal rises above its upper limit.	2
	Abs low	Action is taken whenever the absolute value of the signal falls below its (absolute) lower limit.	3
	Abs high	Action is taken whenever the absolute value of the signal rises above its (absolute) upper limit.	4
	Both	Action is taken whenever the signal falls below its low limit or rises above its high limit.	5
	Abs both	Action is taken whenever the absolute value of the signal falls below its (absolute) low limit or rises above its (absolute) high limit.	6
	Hysteresis	Action is taken whenever the signal rises above the value defined by the limit + 0.5 · hysteresis range ( <a href="#">32.61 Supervision 6 hysteresis</a> ). The action is deactivated when the signal falls below the value defined by the limit - 0.5 · hysteresis range.	7
<a href="#">32.56</a>	<a href="#">Supervision 6 action</a>	Selects whether the drive generates a fault, warning or neither when the value monitored by signal supervision 6 exceeds its limits. <b>Note:</b> This parameter does not affect the status indicated by <a href="#">32.01 Supervision status</a> .	<i>No action</i>
	No action	No warning or fault generated.	0
	Warning	Warning <a href="#">A8B0 Signal supervision</a> is generated.	1
	Fault	The drive trips on fault <a href="#">80B0 Signal supervision</a> .	2
	Fault if running	The drive trips on fault <a href="#">80B0 Signal supervision</a> if running.	3
<a href="#">32.57</a>	<a href="#">Supervision 6 signal</a>	Selects the signal to be monitored by signal supervision function 6. For the available selections, see parameter <a href="#">32.07 Supervision 1 signal</a> .	<i>Zero</i>
<a href="#">32.58</a>	<a href="#">Supervision 6 filter time</a>	Defines a filter time constant for the signal monitored by signal supervision 6.	0.000 s
	0.000 ... 30.000 s	Signal filter time.	1000 = 1 s
<a href="#">32.59</a>	<a href="#">Supervision 6 low</a>	Defines the lower limit for signal supervision 6.	0.00
	-21474830.00... 21474830.00	Low limit.	-
<a href="#">32.60</a>	<a href="#">Supervision 6 high</a>	Defines the upper limit for signal supervision 6.	0.00
	-21474830.00... 21474830.00	Upper limit.	-
<a href="#">32.61</a>	<a href="#">Supervision 6 hysteresis</a>	Defines the hysteresis for the signal monitored by signal supervision 6.	0.00
	0.00...100000.00	Hysteresis.	-

No.	Name/Value	Description	Default FbEq 16
<b>34 Timed functions</b>		Configuration of the timed functions.	
34.01	<i>Timed functions status</i>	Status of the timed functions. The status of a timed function is the logical OR of all timers connected to it. This parameter is read-only.	-
<b>Bit</b>	<b>Name</b>	<b>Description</b>	
0	Timed function 1	1 = Active.	
1	Timed function 2	1 = Active.	
2	Timed function 3	1 = Active.	
3...15	Reserved		
0000h...0FFFh		Status of combined timers 1...3.	1 = 1
34.02	<i>Timer status</i>	Status of timers 1...12. This parameter is read-only.	-
<b>Bit</b>	<b>Name</b>	<b>Description</b>	
0	Timer 1	1 = Active.	
1	Timer 2	1 = Active.	
2	Timer 3	1 = Active.	
3	Timer 4	1 = Active.	
4	Timer 5	1 = Active.	
5	Timer 6	1 = Active.	
6	Timer 7	1 = Active.	
7	Timer 8	1 = Active.	
8	Timer 9	1 = Active.	
9	Timer 10	1 = Active.	
10	Timer 11	1 = Active.	
11	Timer 12	1 = Active.	
12...15	Reserved		
0000h...FFFFh		Timer status.	1 = 1
34.04	<i>Season/exception day status</i>	Status of seasons 1...3, exception workday and exception holiday. Only one season can be active at a time. A day can be a workday and a holiday at the same time. This parameter is read-only.	-
<b>Bit</b>	<b>Name</b>	<b>Description</b>	
0	Status of season 1	1 = Active.	
1	Status of season 2	1 = Active.	
2	Status of season 3	1 = Active.	
3	Status of season 4	1 = Active.	
4...9	Reserved		
10	Status of exception workday	1 = Active.	
11	Status of exception holiday	1 = Active.	
12...15	Reserved		
0000h...FFFFh		Status of the seasons and exception workday and holiday.	1 = 1

No.	Name/Value	Description	Default FbEq 16
34.10	<i>Timed functions enable</i>	Selects the source for the timed functions enable signal. 0 = Disabled. 1 = Enabled. <b>Note:</b> The ACS380 drives do not have an inbuilt timer. Time needs to be provided through an external assistant control panel or PLC.	<i>Disabled</i>
	Disabled	0.	0
	Enabled	1.	1
	DI1	Digital input DI1 ( <i>10.02 DI delayed status</i> , bit 0).	2
	DI2	Digital input DI2 ( <i>10.02 DI delayed status</i> , bit 1).	3
	DI3	Digital input DI3 ( <i>10.02 DI delayed status</i> , bit 2).	4
	DI4	Digital input DI4 ( <i>10.02 DI delayed status</i> , bit 3).	5
	DIO1	Digital input/output DIO1 ( <i>11.02 DIO delayed status</i> , bit 0).	10
	DIO2	Digital input/output DIO2 ( <i>11.02 DIO delayed status</i> , bit 1)	11
	<i>Other [bit]</i>	Source selection (see <i>Terms and abbreviations</i> ).	-
34.11	<i>Timer 1 configuration</i>	Defines when timer 1 is active.	0000011110 000000

Bit	Name	Description
0	Monday	1 = Monday is an active start day.
1	Tuesday	1 = Tuesday is an active start day.
2	Wednesday	1 = Wednesday is an active start day.
3	Thursday	1 = Thursday is an active start day.
4	Friday	1 = Friday is an active start day.
5	Saturday	1 = Saturday is an active start day.
6	Sunday	1 = Sunday is an active start day.
7	Season 1	1 = Timer is active in season 1.
8	Season 2	1 = Timer is active in season 2.
9	Season 3	1 = Timer is active in season 3.
10	Season 4	1 = Timer is active in season 4.
11	Exceptions	0 = Exceptions days are disabled. 1 = Exception days are enabled. Bits 12 and 13 are taken into account.
12	Holidays	0 = Timer is inactive on exception days configured as "Holiday". 1 = Timer is active on exception days configured as "Holiday".
13	Workdays	0 = Timer is inactive on exception days configured as "Workday". 1 = Timer is active on exception days configured as "Workday".
14...15	Reserved	

0000h...FFFh	Configuration of timer 1.	1 = 1
--------------	---------------------------	-------



No.	Name/Value	Description	Default FbEq 16
34.12	<a href="#">Timer 1 start time</a>	Defines the daily start time of timer 1. The time can be changed in second steps. The timer can be started at an other time than the start time. E.g. if the timer's duration is more than one day and the active session starts during the time, the timer is started at 00:00 and stopped when there is no duration left.	00:00:00
	00:00:00...23:59:59	Daily start time of the timer.	1 = 1
34.13	<a href="#">Timer 1 duration</a>	Defines the duration of timer 1. The duration can be changed in minute steps. The duration can extend over the change of the day but if an exception day becomes active, the period is interrupted at midnight. In the same way the period started on an exception day stays active only until the end of the day, even if the duration is longer. The timer will continue after a break if there is duration left.	00 00:00
	00 00:00...07 00:00	Timer duration.	1 = 1
34.14	<a href="#">Timer 2 configuration</a>	See <a href="#">34.11 Timer 1 configuration</a> .	0000011110 000000
34.15	<a href="#">Timer 2 start time</a>	See <a href="#">34.12 Timer 1 start time</a> .	00:00:00
34.16	<a href="#">Timer 2 duration</a>	See <a href="#">34.13 Timer 1 duration</a> .	00 00:00
34.17	<a href="#">Timer 3 configuration</a>	See <a href="#">34.11 Timer 1 configuration</a> .	0000011110 000000
34.18	<a href="#">Timer 3 start time</a>	See <a href="#">34.12 Timer 1 start time</a> .	00:00:00
34.19	<a href="#">Timer 3 duration</a>	See <a href="#">34.13 Timer 1 duration</a> .	00 00:00
34.20	<a href="#">Timer 4 configuration</a>	See <a href="#">34.11 Timer 1 configuration</a> .	0000011110 000000
34.21	<a href="#">Timer 4 start time</a>	See <a href="#">34.12 Timer 1 start time</a> .	00:00:00
34.22	<a href="#">Timer 4 duration</a>	See <a href="#">34.13 Timer 1 duration</a> .	00 00:00
34.23	<a href="#">Timer 5 configuration</a>	See <a href="#">34.11 Timer 1 configuration</a> .	0000011110 000000
34.24	<a href="#">Timer 5 start time</a>	See <a href="#">34.12 Timer 1 start time</a> .	00:00:00
34.25	<a href="#">Timer 5 duration</a>	See <a href="#">34.13 Timer 1 duration</a> .	00 00:00
34.26	<a href="#">Timer 6 configuration</a>	See <a href="#">34.11 Timer 1 configuration</a> .	0000011110 000000
34.27	<a href="#">Timer 6 start time</a>	See <a href="#">34.12 Timer 1 start time</a> .	00:00:00
34.28	<a href="#">Timer 6 duration</a>	See <a href="#">34.13 Timer 1 duration</a> .	00 00:00
34.29	<a href="#">Timer 7 configuration</a>	See <a href="#">34.11 Timer 1 configuration</a> .	0000011110 000000
34.30	<a href="#">Timer 7 start time</a>	See <a href="#">34.12 Timer 1 start time</a> .	00:00:00
34.31	<a href="#">Timer 7 duration</a>	See <a href="#">34.13 Timer 1 duration</a> .	00 00:00
34.32	<a href="#">Timer 8 configuration</a>	See <a href="#">34.11 Timer 1 configuration</a> .	0000011110 000000
34.33	<a href="#">Timer 8 start time</a>	See <a href="#">34.12 Timer 1 start time</a> .	00:00:00
34.34	<a href="#">Timer 8 duration</a>	See <a href="#">34.13 Timer 1 duration</a> .	00 00:00
34.35	<a href="#">Timer 9 configuration</a>	See <a href="#">34.11 Timer 1 configuration</a> .	0000011110 000000

## 242 Parameters

No.	Name/Value	Description	Default FbEq 16
34.36	<a href="#">Timer 9 start time</a>	See <a href="#">34.12 Timer 1 start time</a> .	00:00:00
34.37	<a href="#">Timer 9 duration</a>	See <a href="#">34.13 Timer 1 duration</a> .	00 00:00
34.38	<a href="#">Timer 10 configuration</a>	See <a href="#">34.11 Timer 1 configuration</a> .	0000011110 000000
34.39	<a href="#">Timer 10 start time</a>	See <a href="#">34.12 Timer 1 start time</a> .	00:00:00
34.40	<a href="#">Timer 10 duration</a>	See <a href="#">34.13 Timer 1 duration</a> .	00 00:00
34.41	<a href="#">Timer 11 configuration</a>	See <a href="#">34.11 Timer 1 configuration</a> .	0000011110 000000
34.42	<a href="#">Timer 11 start time</a>	See <a href="#">34.12 Timer 1 start time</a> .	00:00:00
34.43	<a href="#">Timer 11 duration</a>	See <a href="#">34.13 Timer 1 duration</a> .	00 00:00
34.44	<a href="#">Timer 12 configuration</a>	See <a href="#">34.11 Timer 1 configuration</a> .	0000011110 000000
34.45	<a href="#">Timer 12 start time</a>	See <a href="#">34.12 Timer 1 start time</a> .	00:00:00
34.46	<a href="#">Timer 12 duration</a>	See <a href="#">34.13 Timer 1 duration</a> .	00 00:00
34.60	<a href="#">Season 1 start date</a>	<p>Defines the start date of season 1 in format dd.mm, where dd is the number of the day and mm is the number of the month.</p> <p>The season changes at midnight. One season can be active at a time. Timers are started on exception days even if they are not inside the active season.</p> <p>The season start dates (1...4) must be given in increasing order to use all seasons. The default value is interpreted that the season is not configured. If the season start dates are not in increasing order and the value is something else than the default value, a season configuration warning is given.</p>	01.01.
	01.01...31.12	Season start date.	
34.61	<a href="#">Season 2 start date</a>	<p>Defines the start date of season 2.</p> <p>See <a href="#">34.60 Season 1 start date</a>.</p>	01.01.
34.62	<a href="#">Season 3 start date</a>	<p>Defines the start date of season 3.</p> <p>See <a href="#">34.60 Season 1 start date</a>.</p>	01.01.
34.63	<a href="#">Season 4 start date</a>	<p>Defines the start date of season 4.</p> <p>See <a href="#">34.60 Season 1 start date</a>.</p>	01.01.
34.70	<a href="#">Number of active exceptions</a>	<p>Defines how many of the exceptions are active by specifying the last active one. All preceding exceptions are active.</p> <p>Exceptions 1...3 are periods (duration can be defined) and exceptions 4...16 are days (duration is always 24 hours).</p> <p><b>Example:</b> If the value is 4, exceptions 1...4 are active, and exceptions 5...16 are not active.</p>	3
	0...16	Number of active exception periods or days.	-
34.71	<a href="#">Exception types</a>	<p>Defines the types of exceptions 1...16 as workday or holiday.</p> <p>Exceptions 1...3 are periods (duration can be defined) and exceptions 4...16 are days (duration is always 24 hours).</p>	0b0000

No.	Name/Value	Description	Default FbEq 16																																																			
<table border="1"> <thead> <tr> <th data-bbox="217 220 288 242">Bit</th> <th data-bbox="294 220 518 242">Name</th> <th data-bbox="524 220 1029 242">Description</th> </tr> </thead> <tbody> <tr><td>0</td><td>Exception 1</td><td>0 = Workday. 1 = Holiday</td></tr> <tr><td>1</td><td>Exception 2</td><td>0 = Workday. 1 = Holiday</td></tr> <tr><td>2</td><td>Exception 3</td><td>0 = Workday. 1 = Holiday</td></tr> <tr><td>3</td><td>Exception 4</td><td>0 = Workday. 1 = Holiday</td></tr> <tr><td>4</td><td>Exception 5</td><td>0 = Workday. 1 = Holiday</td></tr> <tr><td>5</td><td>Exception 6</td><td>0 = Workday. 1 = Holiday</td></tr> <tr><td>6</td><td>Exception 7</td><td>0 = Workday. 1 = Holiday</td></tr> <tr><td>7</td><td>Exception 8</td><td>0 = Workday. 1 = Holiday</td></tr> <tr><td>8</td><td>Exception 9</td><td>0 = Workday. 1 = Holiday</td></tr> <tr><td>9</td><td>Exception 10</td><td>0 = Workday. 1 = Holiday</td></tr> <tr><td>10</td><td>Exception 11</td><td>0 = Workday. 1 = Holiday</td></tr> <tr><td>11</td><td>Exception 12</td><td>0 = Workday. 1 = Holiday</td></tr> <tr><td>12</td><td>Exception 13</td><td>0 = Workday. 1 = Holiday</td></tr> <tr><td>13</td><td>Exception 14</td><td>0 = Workday. 1 = Holiday</td></tr> <tr><td>14</td><td>Exception 15</td><td>0 = Workday. 1 = Holiday</td></tr> <tr><td>15</td><td>Exception 16</td><td>0 = Workday. 1 = Holiday</td></tr> </tbody> </table>				Bit	Name	Description	0	Exception 1	0 = Workday. 1 = Holiday	1	Exception 2	0 = Workday. 1 = Holiday	2	Exception 3	0 = Workday. 1 = Holiday	3	Exception 4	0 = Workday. 1 = Holiday	4	Exception 5	0 = Workday. 1 = Holiday	5	Exception 6	0 = Workday. 1 = Holiday	6	Exception 7	0 = Workday. 1 = Holiday	7	Exception 8	0 = Workday. 1 = Holiday	8	Exception 9	0 = Workday. 1 = Holiday	9	Exception 10	0 = Workday. 1 = Holiday	10	Exception 11	0 = Workday. 1 = Holiday	11	Exception 12	0 = Workday. 1 = Holiday	12	Exception 13	0 = Workday. 1 = Holiday	13	Exception 14	0 = Workday. 1 = Holiday	14	Exception 15	0 = Workday. 1 = Holiday	15	Exception 16	0 = Workday. 1 = Holiday
Bit	Name	Description																																																				
0	Exception 1	0 = Workday. 1 = Holiday																																																				
1	Exception 2	0 = Workday. 1 = Holiday																																																				
2	Exception 3	0 = Workday. 1 = Holiday																																																				
3	Exception 4	0 = Workday. 1 = Holiday																																																				
4	Exception 5	0 = Workday. 1 = Holiday																																																				
5	Exception 6	0 = Workday. 1 = Holiday																																																				
6	Exception 7	0 = Workday. 1 = Holiday																																																				
7	Exception 8	0 = Workday. 1 = Holiday																																																				
8	Exception 9	0 = Workday. 1 = Holiday																																																				
9	Exception 10	0 = Workday. 1 = Holiday																																																				
10	Exception 11	0 = Workday. 1 = Holiday																																																				
11	Exception 12	0 = Workday. 1 = Holiday																																																				
12	Exception 13	0 = Workday. 1 = Holiday																																																				
13	Exception 14	0 = Workday. 1 = Holiday																																																				
14	Exception 15	0 = Workday. 1 = Holiday																																																				
15	Exception 16	0 = Workday. 1 = Holiday																																																				
0b0000...0b1111		Types of exception period or days.	1 = 1																																																			
34.72	<a href="#">Exception 1 start</a>	<p>Defines the start date of the exception period in format dd.mm, where dd is the number of the day and mm is the number of the month.</p> <p>The timer started on an exception day is always stopped at 23:59:59 even if it has duration left.</p> <p>The same date can be configured to be holiday and workday. The date is active if any of exception days are active.</p>	01.01.																																																			
01.01....31.12.		Start date of exception period 1.																																																				
34.73	<a href="#">Exception 1 length</a>	<p>Defines the length of the exception period in days.</p> <p>Exception period is handled the same as a number of consecutive exception days.</p>	0																																																			
0...60		Length of exception period 1.	1 = 1																																																			
34.74	<a href="#">Exception 2 start</a>	See <a href="#">34.72 Exception 1 start</a> .	01.01.																																																			
34.75	<a href="#">Exception 2 length</a>	See <a href="#">34.73 Exception 1 length</a> .	0																																																			
34.76	<a href="#">Exception 3 start</a>	See <a href="#">34.72 Exception 1 start</a> .	01.01.																																																			
34.77	<a href="#">Exception 3 length</a>	See <a href="#">34.73 Exception 1 length</a> .	0																																																			
34.78	<a href="#">Exception day 4</a>	Defines the date of exception day 4.	01.01.																																																			
01.01....31.12.		<p>Start date of exception day 4.</p> <p>The timer started on an exception day is always stopped at 23:59:59 even if it has duration left.</p>																																																				
34.79	<a href="#">Exception day 5</a>	See <a href="#">34.79 Exception day 4</a> .	01.01																																																			
34.80	<a href="#">Exception day 6</a>	See <a href="#">34.79 Exception day 4</a> .	01.01																																																			
34.81	<a href="#">Exception day 7</a>	See <a href="#">34.79 Exception day 4</a> .	01.01																																																			
34.82	<a href="#">Exception day 8</a>	See <a href="#">34.79 Exception day 4</a> .	01.01																																																			
34.83	<a href="#">Exception day 9</a>	See <a href="#">34.79 Exception day 4</a> .	01.01																																																			
34.84	<a href="#">Exception day 10</a>	See <a href="#">34.79 Exception day 4</a> .	01.01																																																			

No.	Name/Value	Description	Default FbEq 16																																										
34.85	<i>Exception day 11</i>	See <a href="#">34.79 Exception day 4.</a>	01.01																																										
34.86	<i>Exception day 12</i>	See <a href="#">34.79 Exception day 4.</a>	01.01																																										
34.87	<i>Exception day 13</i>	See <a href="#">34.79 Exception day 4.</a>	01.01																																										
34.88	<i>Exception day 14</i>	See <a href="#">34.79 Exception day 4.</a>	01.01																																										
34.89	<i>Exception day 15</i>	See <a href="#">34.79 Exception day 4.</a>	01.01																																										
34.90	<i>Exception day 16</i>	See <a href="#">34.79 Exception day 4.</a>	01.01																																										
34.100	<i>Timed function 1</i>	Defines which timers are connected to timed function 1. 0 = Not connected. 1 = Connected. See parameter <a href="#">34.01 Timed functions status.</a>	0b0000																																										
<table border="1"> <thead> <tr> <th>Bit</th> <th>Name</th> <th>Description</th> </tr> </thead> <tbody> <tr> <td>0</td> <td>Timer 1</td> <td>0 = Inactive. 1 = Active.</td> </tr> <tr> <td>1</td> <td>Timer 2</td> <td>0 = Inactive. 1 = Active.</td> </tr> <tr> <td>2</td> <td>Timer 3</td> <td>0 = Inactive. 1 = Active.</td> </tr> <tr> <td>3</td> <td>Timer 4</td> <td>0 = Inactive. 1 = Active.</td> </tr> <tr> <td>4</td> <td>Timer 5</td> <td>0 = Inactive. 1 = Active.</td> </tr> <tr> <td>5</td> <td>Timer 6</td> <td>0 = Inactive. 1 = Active.</td> </tr> <tr> <td>6</td> <td>Timer 7</td> <td>0 = Inactive. 1 = Active.</td> </tr> <tr> <td>7</td> <td>Timer 8</td> <td>0 = Inactive. 1 = Active.</td> </tr> <tr> <td>8</td> <td>Timer 9</td> <td>0 = Inactive. 1 = Active.</td> </tr> <tr> <td>9</td> <td>Timer 10</td> <td>0 = Inactive. 1 = Active.</td> </tr> <tr> <td>10</td> <td>Timer 11</td> <td>0 = Inactive. 1 = Active.</td> </tr> <tr> <td>11</td> <td>Timer 12</td> <td>0 = Inactive. 1 = Active.</td> </tr> <tr> <td>12...15</td> <td>Reserved</td> <td></td> </tr> </tbody> </table>				Bit	Name	Description	0	Timer 1	0 = Inactive. 1 = Active.	1	Timer 2	0 = Inactive. 1 = Active.	2	Timer 3	0 = Inactive. 1 = Active.	3	Timer 4	0 = Inactive. 1 = Active.	4	Timer 5	0 = Inactive. 1 = Active.	5	Timer 6	0 = Inactive. 1 = Active.	6	Timer 7	0 = Inactive. 1 = Active.	7	Timer 8	0 = Inactive. 1 = Active.	8	Timer 9	0 = Inactive. 1 = Active.	9	Timer 10	0 = Inactive. 1 = Active.	10	Timer 11	0 = Inactive. 1 = Active.	11	Timer 12	0 = Inactive. 1 = Active.	12...15	Reserved	
Bit	Name	Description																																											
0	Timer 1	0 = Inactive. 1 = Active.																																											
1	Timer 2	0 = Inactive. 1 = Active.																																											
2	Timer 3	0 = Inactive. 1 = Active.																																											
3	Timer 4	0 = Inactive. 1 = Active.																																											
4	Timer 5	0 = Inactive. 1 = Active.																																											
5	Timer 6	0 = Inactive. 1 = Active.																																											
6	Timer 7	0 = Inactive. 1 = Active.																																											
7	Timer 8	0 = Inactive. 1 = Active.																																											
8	Timer 9	0 = Inactive. 1 = Active.																																											
9	Timer 10	0 = Inactive. 1 = Active.																																											
10	Timer 11	0 = Inactive. 1 = Active.																																											
11	Timer 12	0 = Inactive. 1 = Active.																																											
12...15	Reserved																																												
0b0000...0b1111		Timers connected to timed function 1.	1 = 1																																										
34.101	<i>Timed function 2</i>	Defines which timers are connected to timed function 2. See <a href="#">34.01 Timed functions status.</a>	0b0000																																										
34.102	<i>Timed function 3</i>	Defines which timers are connected to timed function 3. See <a href="#">34.01 Timed functions status.</a>	0b0000																																										
34.110	<i>Boost time function</i>	Defines which timed functions (that is, timers that are connected to the timed functions) are activated with the boost time function.	0b0000																																										
<table border="1"> <thead> <tr> <th>Bit</th> <th>Name</th> <th>Description</th> </tr> </thead> <tbody> <tr> <td>0</td> <td>Timed function 1</td> <td>0 = Inactive. 1 = Active.</td> </tr> <tr> <td>1</td> <td>Timed function 2</td> <td>0 = Inactive. 1 = Active.</td> </tr> <tr> <td>2</td> <td>Timed function 3</td> <td>0 = Inactive. 1 = Active.</td> </tr> <tr> <td>3...15</td> <td>Reserved</td> <td></td> </tr> </tbody> </table>				Bit	Name	Description	0	Timed function 1	0 = Inactive. 1 = Active.	1	Timed function 2	0 = Inactive. 1 = Active.	2	Timed function 3	0 = Inactive. 1 = Active.	3...15	Reserved																												
Bit	Name	Description																																											
0	Timed function 1	0 = Inactive. 1 = Active.																																											
1	Timed function 2	0 = Inactive. 1 = Active.																																											
2	Timed function 3	0 = Inactive. 1 = Active.																																											
3...15	Reserved																																												
0000h...FFFFh		Timed functions including the boost timer.	1 = 1																																										
34.111	<i>Boost time activation source</i>	Selects the source of boost time activation signal. 0 = Disabled. 1 = Enabled.	Off																																										
Off		0.	0																																										

No.	Name/Value	Description	Default FbEq 16
	On	1.	1
	DI1	Digital input DI1 ( <i>10.02 DI delayed status</i> , bit 0).	2
	DI2	Digital input DI2 ( <i>10.02 DI delayed status</i> , bit 1).	3
	DI3	Digital input DI3 ( <i>10.02 DI delayed status</i> , bit 2).	4
	DI4	Digital input DI4 ( <i>10.02 DI delayed status</i> , bit 3).	5
	DIO1	Digital input/output DIO1 ( <i>11.02 DIO delayed status</i> , bit 0).	10
	DIO2	Digital input/output DIO2 ( <i>11.02 DIO delayed status</i> , bit 1)	11
	<i>Other [bit]</i>	Source selection (see <i>Terms and abbreviations</i> ).	-
<i>34.112</i>	<i>Boost time duration</i>	Defines the time inside which the boost time is deactivated after boost time activation signal is switched off. <b>Example:</b> If parameter <i>34.111 Boost time activation source source</i> is set to <i>DI1</i> and <i>34.112</i> is set to 00 01:30, the boost time is active for 1 hour and 30 minutes after digital input DI is deactivated.	00 00:00
	00 00:00...00 00:00	Boost time duration.	1 = 1
<b>35 Motor thermal protection</b>		Motor thermal protection settings such as temperature measurement configuration, load curve definition and motor fan control configuration. See also section <i>Motor thermal protection</i> (page 98).	
<i>35.01</i>	<i>Motor estimated temperature</i>	Displays the motor temperature as estimated by the internal motor thermal protection model (see parameters <i>35.50...35.55</i> ). The unit is selected by parameter <i>96.16 Unit selection</i> . This parameter is read-only.	-
	-60...1000 °C	Estimated motor temperature.	1 = 1°
<i>35.02</i>	<i>Measured temperature 1</i>	Displays the temperature received through the source defined by parameter <i>35.11 Temperature 1 source</i> . The unit is selected by parameter <i>96.16 Unit selection</i> . <b>Note:</b> With a PTC sensor, either 0 ohm (normal temperature) or the value of parameter <i>35.12 Temperature 1 fault limit</i> (excessive temperature) is shown. This parameter is read-only.	-
	-60...5000 °C	Measured temperature 1.	1 = 1 unit
<i>35.03</i>	<i>Measured temperature 2</i>	Displays the temperature received through the source defined by parameter <i>35.21 Temperature 2 source</i> . The unit is selected by parameter <i>96.16 Unit selection</i> . <b>Note:</b> With a PTC sensor, either 0 ohm (normal temperature) or the value of parameter <i>35.22 Temperature 2 fault limit</i> (excessive temperature) is shown. This parameter is read-only.	-
	-60...5000 °C	Measured temperature 2.	1 = 1 unit

No.	Name/Value	Description	Default FbEq 16
35.11	<i>Temperature 1 source</i>	Selects the source from which measured temperature 1 is read. Usually this source is from a sensor connected to the motor controlled by the drive, but it could be used to measure and monitor a temperature from other parts of the process as long as a suitable sensor is used as per the selection list.	<i>Estimated temperature</i>
	Disabled	None. Temperature monitoring function 1 is disabled.	0
	Estimated temperature	Estimated motor temperature (see parameter <i>35.01 Motor estimated temperature</i> ). The temperature is estimated from an internal drive calculation. It is important to set up the ambient temperature of the motor in <i>35.50 Motor ambient temperature</i> .	1
	KTY84 analog I/O	KTY84 sensor connected to the analog input selected by parameter <i>35.14 Temperature 1 AI source</i> and an analog output. The following settings are required: <ul style="list-style-type: none"> <li>Set the hardware jumper or switch related to the analog input to U (voltage). Any change must be validated by a control unit reboot.</li> <li>Set the appropriate analog input unit selection parameter in group <i>12 Standard AI</i> to V (volt).</li> <li>In parameter group <i>13 Standard AO</i>, set the source selection parameter of the analog output to <i>Temp sensor 1 excitation</i>.</li> </ul> The analog output feeds a constant current through the sensor. As the resistance of the sensor increases along with its temperature, the voltage over the sensor increases. The voltage is read by the analog input and converted into degrees.	2
	1 x Pt100 analog I/O	Pt100 sensor connected to a standard analog input selected by parameter <i>35.14 Temperature 1 AI source</i> and an analog output. The following settings are required: <ul style="list-style-type: none"> <li>Set the hardware jumper or switch related to the analog input to U (voltage). Any change must be validated by a control unit reboot.</li> <li>Set the appropriate analog input unit selection parameter in group <i>12 Standard AI</i> to V (volt).</li> <li>In parameter group <i>13 Standard AO</i>, set the source selection parameter of the analog output to <i>Temp sensor 1 excitation</i>.</li> </ul> The analog output feeds a constant current through the sensor. As the resistance of the sensor increases along with its temperature, the voltage over the sensor increases. The voltage is read by the analog input and converted into degrees.	5
	2 x Pt100 analog I/O	As selection <i>1 x Pt100 analog I/O</i> , but with two sensors connected in series. Using multiple sensors improves measurement accuracy significantly.	6
	3 x Pt100 analog I/O	As selection <i>1 x Pt100 analog I/O</i> , but with three sensors connected in series. Using multiple sensors improves measurement accuracy significantly.	7

No.	Name/Value	Description	Default FbEq 16
	Direct temperature	The temperature is taken from the source selected by parameter <a href="#">35.14</a> . The value of the source is assumed to be degrees Celsius.	11
	KTY83 analog I/O	<p>KTY83 sensor connected to the analog input selected by parameter <a href="#">35.14 Temperature 1 AI source</a> and an analog output.</p> <p>The following settings are required:</p> <ul style="list-style-type: none"> <li>• Set the hardware jumper or switch related to the analog input to <b>U</b> (voltage). Any change must be validated by a control unit reboot.</li> <li>• Set the appropriate analog input unit selection parameter in group <a href="#">12 Standard AI to V</a> (volt).</li> <li>• In parameter group <a href="#">13 Standard AO</a>, set the source selection parameter of the analog output to <a href="#">Temp sensor 1 excitation</a>.</li> </ul> <p>The analog output feeds a constant current through the sensor. As the resistance of the sensor increases along with its temperature, the voltage over the sensor increases. The voltage is read by the analog input and converted into degrees.</p>	12
	1 × Pt1000 analog I/O	<p>Pt1000 sensor connected to a standard analog input selected by parameter <a href="#">35.14 Temperature 1 AI source</a> and an analog output.</p> <p>The following settings are required:</p> <ul style="list-style-type: none"> <li>• Set the hardware jumper or switch related to the analog input to <b>U</b> (voltage). Any change must be validated by a control unit reboot.</li> <li>• Set the appropriate analog input unit selection parameter in group <a href="#">12 Standard AI to V</a> (volt).</li> <li>• In parameter group <a href="#">13 Standard AO</a>, set the source selection parameter of the analog output to <a href="#">Temp sensor 1 excitation</a>.</li> </ul> <p>The analog output feeds a constant current through the sensor. As the resistance of the sensor increases along with its temperature, the voltage over the sensor increases. The voltage is read by the analog input and converted into degrees.</p>	13
	2 × Pt1000 analog I/O	As selection <a href="#">1 × Pt1000 analog I/O</a> , but with two sensors connected in series. Using multiple sensors improves measurement accuracy significantly.	14
	3 × Pt1000 analog I/O	As selection <a href="#">1 × Pt1000 analog I/O</a> , but with three sensors connected in series. Using multiple sensors improves measurement accuracy significantly.	15

No.	Name/Value	Description	Default FbEq 16
	Ni1000	Ni1000 sensor connected to the analog input selected by parameter <a href="#">35.14 Temperature 1 AI source</a> and an analog output. The following settings are required: <ul style="list-style-type: none"> <li>Set the hardware jumper or switch related to the analog input to <b>U</b> (voltage). Any change must be validated by a control unit reboot.</li> <li>Set the appropriate analog input unit selection parameter in group <a href="#">12 Standard AI</a> to <b>V</b> (volt).</li> <li>In parameter group <a href="#">13 Standard AO</a>, set the source selection parameter of the analog output to <a href="#">Temp sensor 1 excitation</a>.</li> </ul> The analog output feeds a constant current through the sensor. As the resistance of the sensor increases along with its temperature, the voltage over the sensor increases. The voltage is read by the analog input and converted into degrees.	16
<a href="#">35.12</a>	<a href="#">Temperature 1 fault limit</a>	Defines the fault limit for temperature supervision function 1. The unit is selected by parameter <a href="#">96.16 Unit selection</a> . <b>Note:</b> With a PTC sensor, the unit is ohms.	130 °C
	-60...5000 °C	Fault limit for temperature monitoring function 1.	1 = 1 unit
<a href="#">35.13</a>	<a href="#">Temperature 1 warning limit</a>	Defines the warning limit for temperature supervision function 1. The unit is selected by parameter <a href="#">96.16 Unit selection</a> . <b>Note:</b> With a PTC sensor, the unit is ohms.	110 °C
	-60...5000 °C	Warning limit for temperature monitoring function 1.	1 = 1 unit
<a href="#">35.14</a>	<a href="#">Temperature 1 AI source</a>	Selects the input for parameter <a href="#">35.11 Temperature 1 source</a> selections <a href="#">1 x Pt100 analog I/O</a> , <a href="#">2 x Pt100 analog I/O</a> , <a href="#">3 x Pt100 analog I/O</a> , and <a href="#">Direct temperature</a> .	<i>Not selected</i>
	Not selected	None.	0
	AI1 actual value	Analog input AI1.	1
	AI2 actual value	Analog input AI2.	2
	<i>Other</i>	Source selection (see <a href="#">Terms and abbreviations</a> ).	-
<a href="#">35.21</a>	<a href="#">Temperature 2 source</a>	Selects the source from which measured temperature 2 is read. Usually this source is from a sensor connected to the motor controlled by the drive, but it could be used to measure and monitor a temperature from other parts of the process as long as a suitable sensor is used as per the selection list.	<i>Disabled</i>
	Disabled	None. Temperature monitoring function 2 is disabled.	0
	Estimated temperature	Estimated motor temperature (see parameter <a href="#">35.01 Motor estimated temperature</a> ). The temperature is estimated from an internal drive calculation. It is important to set up the ambient temperature of the motor in <a href="#">35.50 Motor ambient temperature</a> .	1
	Direct temperature	The temperature is taken from the source selected by parameter <a href="#">35.24 Temperature 2 AI source</a> . The value of the source is assumed to be degrees Celsius.	11

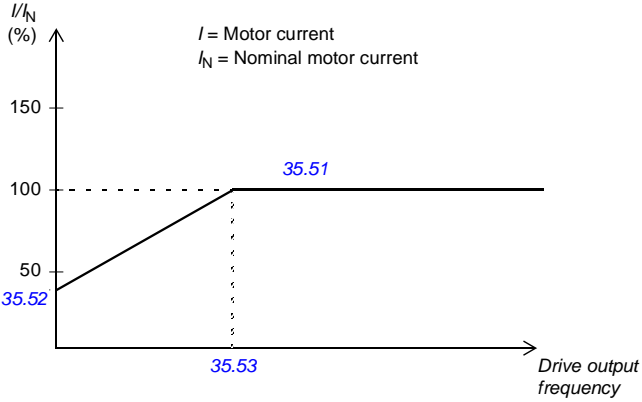

No.	Name/Value	Description	Default FbEq 16
35.22	<i>Temperature 2 fault limit</i>	Defines the fault limit for temperature supervision function 2. The unit is selected by parameter <a href="#">96.16 Unit selection</a> . <b>Note:</b> With a PTC sensor, the unit is ohms.	130 °C
	-60...5000 °C	Fault limit for temperature monitoring function 2.	1 = 1 unit
35.23	<i>Temperature 2 warning limit</i>	Defines the warning limit for temperature supervision function 2. The unit is selected by parameter <a href="#">96.16 Unit selection</a> . <b>Note:</b> With a PTC sensor, the unit is ohms.	110 °C
	-60...5000 °C	Warning limit for temperature monitoring function 2.	1 = 1 unit
35.24	<i>Temperature 2 AI source</i>	Selects the input for parameter <a href="#">35.21 Temperature 2 source</a> selection <i>Direct temperature</i> .	<i>Not selected</i>
	Not selected	None.	0
	AI1 actual value	Analog input AI1 on the control unit.	1
	AI2 actual value	Analog input AI2 on the control unit.	2
	<i>Other</i>	Source selection (see <a href="#">Terms and abbreviations</a> ).	-
35.50	<i>Motor ambient temperature</i>	Defines the ambient temperature of the motor for the motor thermal protection model. The unit is selected by parameter <a href="#">96.16 Unit selection</a> . The motor thermal protection model estimates the motor temperature on the basis of parameters <a href="#">35.50 ... 35.55</a> . The motor temperature increases if it operates in the region above the load curve, and decreases if it operates in the region below the load curve.  <b>WARNING!</b> The model cannot protect the motor if the motor does not cool properly because of dust, dirt, etc.	20 °C or 68 °F
	-60...100 °C or -75 ... 212 °F	Ambient temperature.	1 = 1°

No.	Name/Value	Description	Default FbEq 16
35.51	<i>Motor load curve</i>	<p>Defines the motor load curve together with parameters <a href="#">35.52 Zero speed load</a> and <a href="#">35.53 Break point</a>. The load curve is used by the motor thermal protection model to estimate the motor temperature.</p> <p>When the parameter is set to 100%, the maximum load is taken as the value of parameter <a href="#">99.06 Motor nominal current</a> (higher loads heat up the motor). The load curve level should be adjusted if the ambient temperature differs from the nominal value set in <a href="#">35.50 Motor ambient temperature</a>.</p>	110%
 <p style="text-align: center;"> <math>I</math> = Motor current  <math>I_N</math> = Nominal motor current         </p>			
50...150%		Maximum load for the motor load curve.	1 = 1%
35.52	<i>Zero speed load</i>	<p>Defines the motor load curve together with parameters <a href="#">35.51 Motor load curve</a> and <a href="#">35.53 Break point</a>. Defines the maximum motor load at zero speed of the load curve. A higher value can be used if the motor has an external motor fan to boost the cooling. See the motor manufacturer's recommendations.</p> <p>See parameter <a href="#">35.51 Motor load curve</a>.</p>	70%
25...150%		Zero speed load for the motor load curve.	1 = 1%
35.53	<i>Break point</i>	<p>Defines the motor load curve together with parameters <a href="#">35.51 Motor load curve</a> and <a href="#">35.52 Zero speed load</a>.</p> <p>Defines the break point frequency of the load curve ie. the point at which the motor load curve begins to decrease from the value of parameter <a href="#">35.51 Motor load curve</a> towards the value of parameter <a href="#">35.52 Zero speed load</a>.</p> <p>See parameter <a href="#">35.51 Motor load curve</a>.</p>	45.00 Hz
1.00...500.00 Hz		Break point for the motor load curve.	See par. <a href="#">46.02</a>

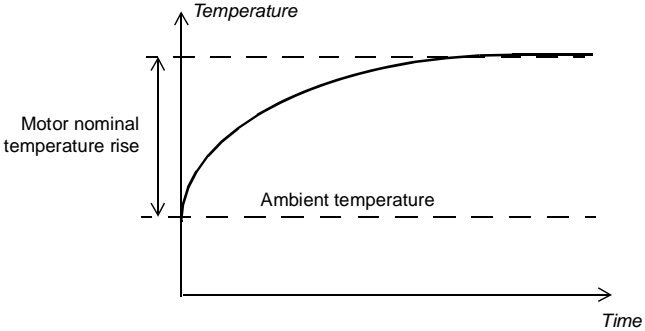
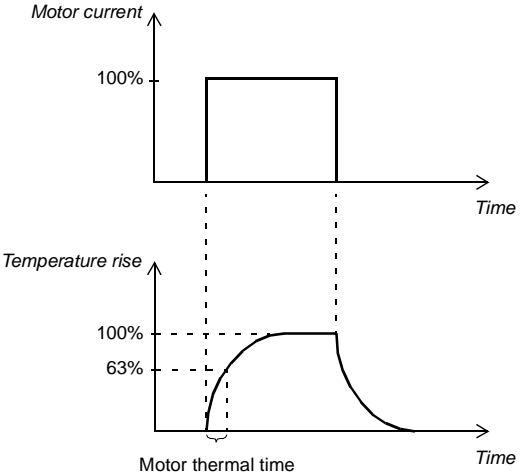
No.	Name/Value	Description	Default FbEq 16
35.54	<i>Motor nominal temperature rise</i>	Defines the temperature rise of the motor above ambient when the motor is loaded with nominal current. See the motor manufacturer's recommendations. The unit is selected by parameter <a href="#">96.16 Unit selection</a> .	80 °C or 176 °F
			
	0...300 °C or 32...572 °F	Temperature rise.	1 = 1°
35.55	<i>Motor thermal time constant</i>	Defines the thermal time constant for use with the motor thermal protection model, defined as the time to reach 63% of the nominal motor temperature. See the motor manufacturer's recommendations.	256 s
			
	100...10000 s	Motor thermal time constant.	1 = 1 s

No.	Name/Value	Description	Default FbEq 16
<b>36 Load analyzer</b>			
Peak value and amplitude logger settings. See also section <i>Load analyzer</i> (page 104).			
36.01	<i>PVL signal source</i>	Selects the signal to be monitored by the peak value logger. The signal is filtered using the filtering time specified by parameter <i>36.02 PVL filter time</i> . The peak value is stored, along with other pre-selected signals at the time, into parameters <i>36.10 ... 36.15</i> . The peak value logger can be reset using parameter <i>36.09 Reset loggers</i> . The date and time of the last reset are stored into parameters <i>36.16</i> and <i>36.17</i> respectively.	<i>Output power</i>
	Not selected	None (peak value logger disabled).	0
	Motor speed used	<i>01.01 Motor speed used</i> .	1
	Output frequency	<i>01.06 Output frequency</i> .	3
	Motor current	<i>01.07 Motor current</i> .	4
	Motor torque	<i>01.10 Motor torque</i> .	6
	DC voltage	<i>01.11 DC voltage</i> .	7
	Output power	<i>01.14 Output power</i> .	8
	Speed ref ramp in	<i>23.01 Speed ref ramp input</i> .	10
	Speed ref ramp out	<i>23.02 Speed ref ramp output</i> .	11
	Speed ref used	<i>24.01 Used speed reference</i> .	12
	Torque ref used	<i>26.02 Torque reference used</i> .	13
	Freq ref used	<i>28.02 Frequency ref ramp output</i> .	14
	Process PID out	<i>40.01 Process PID output actual</i> .	16
	<i>Other</i>	Source selection (see <i>Terms and abbreviations</i> ).	-
36.02	<i>PVL filter time</i>	Peak value logger filtering time. See parameter <i>36.01 PVL signal source</i> .	2.00 s
	0.00...120.00 s	Peak value logger filtering time.	100 = 1 s
36.06	<i>AL2 signal source</i>	Selects the signal to be monitored by amplitude logger 2. The signal is sampled at 200 ms intervals. The results are displayed by parameters <i>36.40 ... 36.49</i> . Each parameter represents an amplitude range, and shows what portion of the samples fall within that range. The signal value corresponding to 100% is defined by parameter <i>36.07 AL2 signal scaling</i> . Amplitude logger 2 can be reset using parameter <i>36.09 Reset loggers</i> . The date and time of the last reset are stored into parameters <i>36.50</i> and <i>36.51</i> respectively. For the selections, see parameter <i>36.01 PVL signal source</i> .	<i>Motor torque</i>
		See parameter <i>36.01</i> for the selections.	
36.07	<i>AL2 signal scaling</i>	Defines the monitored signal value for the amplitude logger AL2 that corresponds to 100% sample value.	100.00
	0.00...32767.00	Signal value corresponding to 100%.	1 = 1
36.09	<i>Reset loggers</i>	Resets the peak value logger and/or amplitude logger 2. (Amplitude logger 1 cannot be reset.)	<i>Done</i>
	Done	Reset completed or not requested (normal operation).	0

No.	Name/Value	Description	Default FbEq 16
	All	Reset both the peak value logger and amplitude logger 2.	1
	PVL	Reset the peak value logger.	2
	AL2	Reset amplitude logger 2.	3
36.10	<i>PVL peak value</i>	Shows the peak value recorded by the peak value logger.	0.00
	-32768.00... 32767.00	Peak value.	1 = 1
36.11	<i>PVL peak date</i>	Shows the date when the peak value was recorded.	01/01/1980
	1/1/1980...6/5/2159	Peak occurrence date.	-
36.12	<i>PVL peak time</i>	Shows the time when the peak value was recorded.	00:00:00
	-	Peak occurrence time.	-
36.13	<i>PVL current at peak</i>	Shows the Motor current at the moment the peak value was recorded.	0.00 A
	-32768.00... 32767.00 A	Motor current at peak.	1 = 1 A
36.14	<i>PVL DC voltage at peak</i>	Shows the voltage in the intermediate DC circuit of the drive at the moment the peak value was recorded.	0.00 V
	0.00...2000.00 V	DC voltage at peak.	10 = 1 V
36.15	<i>PVL speed at peak</i>	Shows the Motor speed at the moment the peak value was recorded.	0.00 rpm
	-30000... 30000 rpm	Motor speed at peak.	See par. <a href="#">46.01</a>
36.16	<i>PVL reset date</i>	Shows the date on which the peak value logger was last reset.	01/01/1980
	1/1/1980...6/5/2159	Last reset date of the peak value logger.	-
36.17	<i>PVL reset time</i>	Shows the time when the peak value logger was last reset.	00:00:00
	-	Last reset time of the peak value logger.	-
36.20	<i>AL1 0 to 10%</i>	Shows the percentage of samples recorded by amplitude logger 1 that fall between 0 and 10%. 100% corresponds to the $I_{max}$ value given in the ratings table in chapter Technical data in the hardware manual.	0.00%
	0.00...100.00%	Amplitude logger 1 samples between 0 and 10%.	1 = 1%
36.21	<i>AL1 10 to 20%</i>	Shows the percentage of samples recorded by amplitude logger 1 that fall between 10 and 20%.	0.00%
	0.00...100.00%	Amplitude logger 1 samples between 10 and 20%.	1 = 1%
36.22	<i>AL1 20 to 30%</i>	Shows the percentage of samples recorded by amplitude logger 1 that fall between 20 and 30%.	0.00%
	0.00...100.00%	Amplitude logger 1 samples between 20 and 30%.	1 = 1%
36.23	<i>AL1 30 to 40%</i>	Shows the percentage of samples recorded by amplitude logger 1 that fall between 30 and 40%.	0.00%
	0.00...100.00%	Amplitude logger 1 samples between 30 and 40%.	1 = 1%
36.24	<i>AL2 40 to 50%</i>	Shows the percentage of samples recorded by amplitude logger 1 that fall between 40 and 50%.	0.00%
	0.00...100.00%	Amplitude logger 1 samples between 40 and 50%.	1 = 1%

No.	Name/Value	Description	Default FbEq 16
36.25	<i>AL1 60 to 70%</i>	Percentage of samples recorded by amplitude logger 1 that fall between 50 and 60%.	0.00%
	0.00...100.00%	Amplitude logger 1 samples between 50 and 60%.	1 = 1%
36.26	<i>AL1 60 to 70%</i>	Percentage of samples recorded by amplitude logger 1 that fall between 60 and 70%.	0.00%
	0.00...100.00%	Amplitude logger 1 samples between 60 and 70%.	1 = 1%
36.27	<i>AL1 70 to 80%</i>	Percentage of samples recorded by amplitude logger 1 that fall between 70 and 80%.	0.00%
	0.00...100.00%	Amplitude logger 1 samples between 70 and 80%.	1 = 1%
36.28	<i>AL1 80 to 90%</i>	Percentage of samples recorded by amplitude logger 1 that fall between 80 and 90%.	0.00%
	0.00...100.00%	Amplitude logger 1 samples between 80 and 90%.	1 = 1%
36.29	<i>AL1 over 90%</i>	Percentage of samples recorded by amplitude logger 1 that exceed 90%.	0.00%
	0.00...100.00%	Amplitude logger 1 samples over 90%.	1 = 1%
36.40	<i>AL2 0 to 10%</i>	Percentage of samples recorded by amplitude logger 2 that fall between 0 and 10%.	0.00%
	0.00...100.00%	Amplitude logger 2 samples between 0 and 10%.	1 = 1%
36.41	<i>AL2 10 to 20%</i>	Percentage of samples recorded by amplitude logger 2 that fall between 10 and 20%.	0.00%
	0.00...100.00%	Amplitude logger 2 samples between 10 and 20%.	1 = 1%
36.42	<i>AL2 20 to 30%</i>	Percentage of samples recorded by amplitude logger 2 that fall between 20 and 30%.	0.00%
	0.00...100.00%	Amplitude logger 2 samples between 20 and 30%.	1 = 1%
36.43	<i>AL2 30 to 40%</i>	Percentage of samples recorded by amplitude logger 2 that fall between 30 and 40%.	0.00%
	0.00...100.00%	Amplitude logger 2 samples between 30 and 40%.	1 = 1%
36.44	<i>AL2 40 to 50%</i>	Percentage of samples recorded by amplitude logger 2 that fall between 40 and 50%.	0.00%
	0.00...100.00%	Amplitude logger 2 samples between 40 and 50%.	1 = 1%
36.45	<i>AL2 50 to 60%</i>	Percentage of samples recorded by amplitude logger 2 that fall between 50 and 60%.	0.00%
	0.00...100.00%	Amplitude logger 2 samples between 50 and 60%.	1 = 1%
36.46	<i>AL2 60 to 70%</i>	Percentage of samples recorded by amplitude logger 2 that fall between 60 and 70%.	0.00%
	0.00...100.00%	Amplitude logger 2 samples between 60 and 70%.	1 = 1%
36.47	<i>AL2 70 to 80%</i>	Percentage of samples recorded by amplitude logger 2 that fall between 70 and 80%.	0.00%
	0.00...100.00%	Amplitude logger 2 samples between 70 and 80%.	1 = 1%
36.48	<i>AL2 80 to 90%</i>	Percentage of samples recorded by amplitude logger 2 that fall between 80 and 90%.	0.00%
	0.00...100.00%	Amplitude logger 2 samples between 80 and 90%.	1 = 1%
36.49	<i>AL2 over 90%</i>	Percentage of samples recorded by amplitude logger 2 that exceed 90%.	0.00%
	0.00...100.00%	Amplitude logger 2 samples over 90%.	1 = 1%

No.	Name/Value	Description	Default FbEq 16
36.50	<i>AL2 reset date</i>	The date on which amplitude logger 2 was last reset.	01/01/1980
	1/1/1980...6/5/2159	Last reset date of amplitude logger 2.	-
36.51	<i>AL2 reset time</i>	The time at which amplitude logger 2 was last reset.	00:00:00
	-	Last reset time of amplitude logger 2.	-

<b>37 User load curve</b>		Settings for user load curve. See also section <i>User load curve</i> (page 75).																			
37.01	<i>ULC output status word</i>	Displays the status of the monitored signal (37.02). The status is shown only while the drive is running. (The status word is independent of the actions and delays selected by parameters 37.03, 37.04, 37.41 and 37.42.) This parameter is read-only.	0000h																		
<table border="1"> <thead> <tr> <th>Bit</th> <th>Name</th> <th>Description</th> </tr> </thead> <tbody> <tr> <td>0</td> <td>Under load limit</td> <td>1 = Signal lower than the underload curve.</td> </tr> <tr> <td>1</td> <td>Within load range</td> <td>1 = Signal between the underload and overload curve.</td> </tr> <tr> <td>2</td> <td>Overload limit</td> <td>1 = Signal higher than the overload curve.</td> </tr> <tr> <td>3</td> <td>Outside load limit</td> <td>1 = Signal lower than the underload curve or higher than the overload curve.</td> </tr> <tr> <td>4...15</td> <td>Reserved</td> <td></td> </tr> </tbody> </table>				Bit	Name	Description	0	Under load limit	1 = Signal lower than the underload curve.	1	Within load range	1 = Signal between the underload and overload curve.	2	Overload limit	1 = Signal higher than the overload curve.	3	Outside load limit	1 = Signal lower than the underload curve or higher than the overload curve.	4...15	Reserved	
Bit	Name	Description																			
0	Under load limit	1 = Signal lower than the underload curve.																			
1	Within load range	1 = Signal between the underload and overload curve.																			
2	Overload limit	1 = Signal higher than the overload curve.																			
3	Outside load limit	1 = Signal lower than the underload curve or higher than the overload curve.																			
4...15	Reserved																				
0000h...FFFFh		Status of the monitored signal.	1 = 1																		
37.02	<i>ULC supervision signal</i>	Selects the signal to be monitored. The function compares the absolute value of the signal against the load curve.	<i>Motor torque %</i>																		
Not selected		No signal selected. Monitoring disabled.	0																		
Motor speed %		<i>01.03 Motor speed %.</i>	1																		
Motor current %		<i>01.08 Motor current % of motor nom.</i>	2																		
Motor torque %		<i>01.10 Motor torque.</i>	3																		
Output power % of motor nom		<i>01.15 Output power % of motor nom.</i>	4																		
Output power % of drive nom		<i>01.16 Output power % of drive nom.</i>	5																		
<i>Other</i>		Source selection (see <i>Terms and abbreviations</i> ).	-																		
37.03	<i>ULC overload actions</i>	Selects how the drive reacts if the absolute value of the monitored signal stays continuously above the overload curve for longer than the value of 37.41 <i>ULC overload timer</i> .	<i>Disabled</i>																		
Disabled		No warnings or fault generated.	0																		
Warning		The drive generates an <i>A8C1 ULC overload warning</i> if the signal has been continuously over the overload curve for a time defined by parameter 37.41 <i>ULC overload timer</i> .	1																		
Fault		The drive trips on <i>8002 ULC overload fault</i> if the signal has been continuously over the overload curve for a time defined by parameter 37.41 <i>ULC overload timer</i> .	2																		

No.	Name/Value	Description	Default FbEq 16
	Warning/Fault	The drive generates an <i>A8C1 ULC overload warning</i> if the signal has been continuously over the overload curve for half of the time defined by parameter <i>37.41 ULC overload timer</i> . The drive trips on <i>8002 ULC overload fault</i> if the signal has been continuously over the overload curve for a time defined by parameter <i>37.41 ULC overload timer</i> .	3
<i>37.04</i>	<i>ULC underload actions</i>	Selects an action taken if the signal ( <i>37.02</i> ) stays under the underload curve for a defined time.	<i>Disabled</i>
	Disabled	No warnings or fault generated.	0
	Warning	The drive generates an <i>A8C4 ULC underload warning</i> if the signal has been continuously under the underload curve for a time defined by parameter <i>37.42 ULC underload timer</i> .	1
	Fault	The drive trips on <i>8001 ULC underload fault</i> if the signal has been continuously under the underload curve for a time defined by parameter <i>37.42 ULC underload timer</i> .	2
	Warning/Fault	The drive generates an <i>A8C4 ULC underload warning</i> if the signal has been continuously under the underload curve for half of the time defined by parameter <i>37.42 ULC underload timer</i> . The drive trips on <i>8001 ULC underload fault</i> if the signal has been continuously under the underload curve for a time defined by parameter <i>37.42 ULC underload timer</i> .	3
<i>37.11</i>	<i>ULC speed table point 1</i>	Defines the first of the five speed points on the X-axis of the user load curve. The values of the parameters must satisfy: $-30000.0 \text{ rpm} \leq 37.11 \text{ ULC speed table point 1} < 37.12 \text{ ULC speed table point 2} < 37.13 \text{ ULC speed table point 3} < 37.14 \text{ ULC speed table point 4} < 37.15 \text{ ULC speed table point 5} \leq 30000.0 \text{ rpm}$ . Speed points are used if parameter <i>99.04 Motor control mode</i> is set to <i>Vector</i> or if <i>99.04 Motor control mode</i> is set to <i>Scalar</i> and the reference unit is rpm. The five points must be in order from lowest to highest. The points are defined as positive values, but the range is symmetrically effective also in the negative direction. The monitoring is not active outside these two areas.	150.0 rpm
	-30000.0...30000.0 rpm	Speed.	1 = 1 rpm
<i>37.12</i>	<i>ULC speed table point 2</i>	Defines the second speed point. See parameter <i>37.11 ULC speed table point 1</i> .	750.0 rpm
	-30000.0...30000.0 rpm	Speed.	1 = 1 rpm
<i>37.13</i>	<i>ULC speed table point 3</i>	Defines the third speed point. See parameter <i>37.11 ULC speed table point 1</i> .	1290.0 rpm
	-30000.0...30000.0 rpm	Speed.	1 = 1 rpm
<i>37.14</i>	<i>ULC speed table point 4</i>	Defines the fourth speed point. See parameter <i>37.11 ULC speed table point 1</i> .	1500.0 rpm
	-30000.0...30000.0 rpm	Speed.	1 = 1 rpm



No.	Name/Value	Description	Default FbEq 16
37.15	<a href="#">ULC speed table point 5</a>	Defines the fifth speed point. See parameter <a href="#">37.11 ULC speed table point 1</a> .	1800.0 rpm
	-30000.0...30000.0 rpm	Speed.	1 = 1 rpm
37.16	<a href="#">ULC frequency table point 1</a>	Defines the first of the five frequency points on the X-axis of the user load curve. The values of the parameters must satisfy: $-500.0 \text{ Hz} \leq \text{37.16 ULC frequency table point 1} < \text{37.17 ULC frequency table point 2} < \text{37.18 ULC frequency table point 3} < \text{37.19 ULC frequency table point 4} < \text{37.20 ULC frequency table point 5} \leq 500.0 \text{ Hz}$ . Frequency points are used if parameter <a href="#">99.04 Motor control mode</a> is set to <i>Scalar</i> and the reference unit is Hz. The five points must be in order from lowest to highest. The points are defined as positive values, but the range is symmetrically effective also in the negative direction. The monitoring is not active outside these two areas.	5.0 Hz
	-500.0...500.0 Hz	Frequency.	1 = 1 Hz
37.17	<a href="#">ULC frequency table point 2</a>	Defines the second frequency point. See parameter <a href="#">37.16 ULC frequency table point 1</a> .	25.0 Hz
	-500.0...500.0 Hz	Frequency.	1 = 1 Hz
37.18	<a href="#">ULC frequency table point 3</a>	Defines the third frequency point. See parameter <a href="#">37.16 ULC frequency table point 1</a> .	43.0 Hz
	-500.0...500.0 Hz	Frequency.	1 = 1 Hz
37.19	<a href="#">ULC frequency table point 4</a>	Defines the fourth frequency point. See parameter <a href="#">37.16 ULC frequency table point 1</a> .	50.0 Hz
	-500.0...500.0 Hz	Frequency.	1 = 1 Hz
37.20	<a href="#">ULC frequency table point 5</a>	Defines the fifth frequency point. See parameter <a href="#">37.16 ULC frequency table point 1</a> .	60.0 Hz
	-500.0...500.0 Hz	Frequency.	1 = 1 Hz
37.21	<a href="#">ULC underload point 1</a>	Defines the first of the five points on the Y-axis that together with the corresponding point on the X-axis ( <a href="#">37.11 ULC speed table point 1</a> ... <a href="#">37.15 ULC speed table point 5</a> or <a href="#">37.15 ULC speed table point 5</a> ... <a href="#">37.15 ULC frequency table point 5</a> ) define the underload (lower) curve. The following conditions must be fulfilled: <ul style="list-style-type: none"> <li>• <a href="#">37.21 ULC underload point 1</a> <math>\leq</math> <a href="#">37.31 ULC overload point 1</a></li> <li>• <a href="#">37.22 ULC underload point 2</a> <math>\leq</math> <a href="#">37.32 ULC overload point 2</a></li> <li>• <a href="#">37.23 ULC underload point 3</a> <math>\leq</math> <a href="#">37.33 ULC overload point 3</a></li> <li>• <a href="#">37.24 ULC underload point 4</a> <math>\leq</math> <a href="#">37.34 ULC overload point 4</a></li> <li>• <a href="#">37.25 ULC underload point 5</a> <math>\leq</math> <a href="#">37.35 ULC overload point 5</a></li> </ul>	10.0%
	-1600.0...1600.0%	Underload point.	1 = 1%
37.22	<a href="#">ULC underload point 2</a>	Defines the second underload point. See parameter <a href="#">37.21 ULC underload point 1</a> .	15.0%
	-1600.0...1600.0%	Underload point.	1 = 1%

No.	Name/Value	Description	Default FbEq 16
37.23	<i>ULC underload point 3</i>	Defines the third underload point. See parameter <i>37.21 ULC underload point 1</i> .	25.0%
	-1600.0...1600.0%	Underload point.	1 = 1%
37.24	<i>ULC underload point 4</i>	Defines the fourth underload point. See parameter <i>37.21 ULC underload point 1</i> .	30.0%
	-1600.0...1600.0%	Underload point.	1 = 1%
37.25	<i>ULC underload point 5</i>	Defines the fifth underload point. See parameter <i>37.21 ULC underload point 1</i> .	30.0%
	-1600.0...1600.0%	Underload point.	1 = 1%
37.31	<i>ULC overload point 1</i>	Defines the first of the five points on the Y-axis that together with the corresponding point on the X-axis ( <i>37.11 ULC speed table point 1...37.15 ULC frequency table point 5</i> or <i>37.15 ULC frequency table point 5...37.20 ULC frequency table point 5</i> ) define the overload (higher) curve. At each of the five points the value of the underload curve point must be equal to or smaller than the value of the overload curve point. See parameter <i>37.21 ULC underload point 1</i> .	300.0%
	-1600.0...1600.0%	Overload point.	1 = 1%
37.32	<i>ULC overload point 2</i>	Defines the second overload point. See parameter <i>37.31 ULC overload point 1</i> .	300.0%
	-1600.0...1600.0%	Overload point.	1 = 1%
37.33	<i>ULC overload point 3</i>	Defines the third overload point. See parameter <i>37.31 ULC overload point 1</i> .	300.0%
	-1600.0...1600.0%	Overload point.	1 = 1%
37.34	<i>ULC overload point 4</i>	Defines the fourth overload point. See parameter <i>37.31 ULC overload point 1</i> .	300.0%
	-1600.0...1600.0%	Overload point.	1 = 1%
37.35	<i>ULC overload point 5</i>	Defines the fifth overload point. See parameter <i>37.31 ULC overload point 1</i> .	300.0%
	-1600.0...1600.0%	Overload point.	1 = 1%
37.41	<i>ULC overload timer</i>	Defines the time for which the monitored signal must continuously stay above the overload curve before the drive takes the action selected by <i>37.03 ULC overload actions</i> .	20.0 s
	0.0...10000.0 s	Time.	1 = 1 s
37.42	<i>ULC underload timer</i>	Defines the time for which the monitored signal must continuously stay below the underload curve before the drive takes the action selected by <i>37.04 ULC underload actions</i> .	20.0 s
	0.0...10000.0 s	Time.	1 = 1 s

No.	Name/Value	Description	Default FbEq 16
<b>40 Process PID set 1</b>		<p>Parameter values for process PID control.</p> <p>The drive output can be controlled by the process PID. When the process PID control is enabled, the drive controls the process feedback to the reference value.</p> <p>Two different parameter sets can be defined for the process PID. One parameter set is in use at a time. The first set is made up of parameters <a href="#">40.07...40.50</a>, the second set is defined by the parameters in group <a href="#">41 Process PID set 2</a>. The binary source that defines which set is used is selected by parameter <a href="#">40.57 PID set1/set2 selection</a>.</p> <p>See also the PID control chain diagrams in chapter <a href="#">Control chain diagrams</a>.</p>	
40.01	<i>Process PID output actual</i>	<p>Displays the output of the process PID controller. See the control chain diagram on page <a href="#">507</a>.</p> <p>This parameter is read-only.</p>	0.00
	-200000.00... 200000.00%	Process PID controller output.	1 = 1%
40.02	<i>Process PID feedback actual</i>	<p>Displays the value of process feedback after source selection, mathematical function (parameter <a href="#">40.10 Set 1 feedback function</a>), and filtering. See the control chain diagram on page <a href="#">507</a>.</p> <p>This parameter is read-only.</p>	0.00
	-200000.00... 200000.00 PID customer units	Process feedback.	1 = 1 PID customer unit
40.03	<i>Process PID setpoint actual</i>	<p>Displays the value of process PID setpoint after source selection, mathematical function (<a href="#">40.18 Set 1 setpoint function</a>), limitation and ramping. See the control chain diagram on page <a href="#">507</a>.</p> <p>This parameter is read-only.</p>	0.00
	-200000.00... 200000.00 PID customer units	Setpoint for process PID controller.	1 = 1 PID customer unit
40.04	<i>Process PID deviation actual</i>	<p>Displays the process PID deviation. By default, this value equals setpoint - feedback, but deviation can be inverted by parameter <a href="#">40.31 Set 1 deviation inversion</a>. See the control chain diagram on page <a href="#">507</a>.</p> <p>This parameter is read-only.</p>	0.00
	-200000.00... 200000.00 PID customer units	PID deviation.	1 = 1 PID customer unit
40.05	<i>Process PID trim output act</i>	<p>Displays the trimmed reference output.</p> <p>This parameter is read-only.</p>	-
	-32768...32767	Trimmed reference.	1 = 1 unit

No.	Name/Value	Description	Default FbEq 16																																													
40.06	<a href="#">Process PID status word</a>	Displays status information on process PID control. This parameter is read-only.	0000h																																													
		<table border="1"> <thead> <tr> <th>Bit</th> <th>Name</th> <th>Value</th> </tr> </thead> <tbody> <tr> <td>0</td> <td>PID active</td> <td>1 = Process PID control active.</td> </tr> <tr> <td>1</td> <td>Setpoint frozen</td> <td>1 = Process PID setpoint frozen.</td> </tr> <tr> <td>2</td> <td>Output frozen</td> <td>1 = Process PID controller output frozen.</td> </tr> <tr> <td>3</td> <td>PID sleep mode</td> <td>1 = Sleep mode active.</td> </tr> <tr> <td>4</td> <td>Sleep boost</td> <td>1 = Sleep boost active.</td> </tr> <tr> <td>5</td> <td>Trim mode</td> <td>1 = Trim function active.</td> </tr> <tr> <td>6</td> <td>Tracking mode</td> <td>1 = Tracking function active.</td> </tr> <tr> <td>7</td> <td>Output limit high</td> <td>1 = PID output is being limited by parameter <a href="#">40.37</a>.</td> </tr> <tr> <td>8</td> <td>Output limit low</td> <td>1 = PID output is being limited by parameters <a href="#">40.36</a></td> </tr> <tr> <td>9</td> <td>Deadband active</td> <td>1 = Deadband active (see parameter <a href="#">40.39</a>)</td> </tr> <tr> <td>10</td> <td>PID set</td> <td>0 = Parameter set 1 in use. 1 = Parameter set 2 in use.</td> </tr> <tr> <td>11</td> <td>Reserved</td> <td></td> </tr> <tr> <td>12</td> <td>Internal setpoint active</td> <td>1 = Internal setpoint active (see parameters <a href="#">40.16...40.23</a>)</td> </tr> <tr> <td>13...15</td> <td>Reserved</td> <td></td> </tr> </tbody> </table>	Bit	Name	Value	0	PID active	1 = Process PID control active.	1	Setpoint frozen	1 = Process PID setpoint frozen.	2	Output frozen	1 = Process PID controller output frozen.	3	PID sleep mode	1 = Sleep mode active.	4	Sleep boost	1 = Sleep boost active.	5	Trim mode	1 = Trim function active.	6	Tracking mode	1 = Tracking function active.	7	Output limit high	1 = PID output is being limited by parameter <a href="#">40.37</a> .	8	Output limit low	1 = PID output is being limited by parameters <a href="#">40.36</a>	9	Deadband active	1 = Deadband active (see parameter <a href="#">40.39</a> )	10	PID set	0 = Parameter set 1 in use. 1 = Parameter set 2 in use.	11	Reserved		12	Internal setpoint active	1 = Internal setpoint active (see parameters <a href="#">40.16...40.23</a> )	13...15	Reserved		
Bit	Name	Value																																														
0	PID active	1 = Process PID control active.																																														
1	Setpoint frozen	1 = Process PID setpoint frozen.																																														
2	Output frozen	1 = Process PID controller output frozen.																																														
3	PID sleep mode	1 = Sleep mode active.																																														
4	Sleep boost	1 = Sleep boost active.																																														
5	Trim mode	1 = Trim function active.																																														
6	Tracking mode	1 = Tracking function active.																																														
7	Output limit high	1 = PID output is being limited by parameter <a href="#">40.37</a> .																																														
8	Output limit low	1 = PID output is being limited by parameters <a href="#">40.36</a>																																														
9	Deadband active	1 = Deadband active (see parameter <a href="#">40.39</a> )																																														
10	PID set	0 = Parameter set 1 in use. 1 = Parameter set 2 in use.																																														
11	Reserved																																															
12	Internal setpoint active	1 = Internal setpoint active (see parameters <a href="#">40.16...40.23</a> )																																														
13...15	Reserved																																															
	0000h...FFFh	Process PID control status word.	1 = 1																																													
40.07	<a href="#">Process PID operation mode</a>	Activates/deactivates process PID control. <b>Note:</b> Process PID control is only available in external control; see section <a href="#">Local and external control locations</a> (page <a href="#">52</a> ).	<i>Off</i>																																													
	Off	Process PID control inactive.	0																																													
	On	Process PID control active.	1																																													
	On when drive running	Process PID control is active when the drive is running.	2																																													
40.08	<a href="#">Set 1 feedback 1 source</a>	Selects the primary source of process feedback. See the control chain diagram on page <a href="#">506</a> .	<i>Not selected</i>																																													
	Not selected	None.	0																																													
	AI1 scaled	<a href="#">12.12 AI1 scaled value</a>	1																																													
	AI2 scaled	<a href="#">12.22 AI2 scaled value</a>	2																																													
	Freq in scaled	<a href="#">11.39 Freq in 1 scaled value</a>	3																																													
	AI1 percent	<a href="#">12.101 AI1 percent value</a>	8																																													
	AI2 percent	<a href="#">12.102 AI2 percent value</a>	9																																													
	Feedback storage	<a href="#">40.91 Feedback data storage</a>	9																																													
	<i>Other</i>	Source selection (see <a href="#">Terms and abbreviations</a> ).	-																																													
40.09	<a href="#">Set 1 feedback 2 source</a>	Selects the second source of process feedback. The second source is used only if the setpoint function requires two inputs. For the selections, see parameter <a href="#">40.08 Set 1 feedback 1 source</a> .	<i>Not selected</i>																																													
40.10	<a href="#">Set 1 feedback function</a>	Defines how process feedback is calculated from the two feedback sources selected by parameters <a href="#">40.08 Set 1 feedback 1 source</a> and <a href="#">40.09 Set 1 feedback 2 source</a> .	<i>In1</i>																																													
	In1	Source 1.	0																																													

No.	Name/Value	Description	Default FbEq 16						
	In1+In2	Sum of sources 1 and 2.	1						
	In1-In2	Source 2 subtracted from source 1.	2						
	In1*In2	Source 1 multiplied by source 2.	3						
	In1/In2	Source 1 divided by source 2.	4						
	MIN(In1,In2)	Smaller of the two sources.	5						
	MAX(In1,In2)	Greater of the two sources.	6						
	AVE(In1,In2)	Average of the two sources.	7						
	sqrt(In1)	Square root of source 1.	8						
	sqrt(In1-In2)	Square root of (source 1 - source 2).	9						
	sqrt(In1+In2)	Square root of (source 1 + source 2).	10						
	sqrt(In1)+sqrt(In2)	Square root of source 1 + square root of source 2.	11						
40.11	<i>Set 1 feedback filter time</i>	Defines the filter time constant for process feedback.	0.000 s						
	0.000...30.000 s	Feedback filter time.	1 = 1 s						
40.14	<i>Set 1 setpoint scaling</i>	<p>Defines, together with parameter <a href="#">40.15 Set 1 output scaling</a>, a general scaling factor for the process PID control chain.</p> <p>If the parameter is set to zero, automatic setpoint scaling is activated, where suitable setpoint scale is calculated according to selected setpoint source. Actual setpoint scale is shown in parameter <a href="#">40.61 Setpoint scaling actual</a>.</p> <p>The scaling can be utilized when, for example, the process setpoint is input in Hz, and the output of the PID controller is used as an rpm value in speed control. In this case, this parameter might be set to 50, and parameter <a href="#">40.15</a> to the nominal motor speed at 50 Hz.</p> <p>In effect, the output of the PID controller = [<a href="#">40.15</a>] when deviation (setpoint - feedback) = [<a href="#">40.14</a>] and [<a href="#">40.32</a>] = 1.</p> <p><b>Note:</b> The scaling is based on the ratio between <a href="#">40.14</a> and <a href="#">40.15</a>. For example, the values 50 and 1500 would produce the same scaling as 1 and 30.</p>	0.00						
	-200000.00... 200000.00	Scaling.	1 = 1						
40.15	<i>Set 1 output scaling</i>	<p>See parameter <a href="#">40.14 Set 1 setpoint scaling</a>.</p> <p>If the parameter is set to zero, scaling is automatic:</p> <table border="1" data-bbox="420 1141 907 1244"> <thead> <tr> <th>Operation mode (see par. <a href="#">19.01</a>)</th> <th>Scaling</th> </tr> </thead> <tbody> <tr> <td>Speed control</td> <td><a href="#">46.01 Speed scaling</a></td> </tr> <tr> <td>Frequency control</td> <td><a href="#">46.02 Frequency scaling</a></td> </tr> </tbody> </table>	Operation mode (see par. <a href="#">19.01</a> )	Scaling	Speed control	<a href="#">46.01 Speed scaling</a>	Frequency control	<a href="#">46.02 Frequency scaling</a>	0.00
Operation mode (see par. <a href="#">19.01</a> )	Scaling								
Speed control	<a href="#">46.01 Speed scaling</a>								
Frequency control	<a href="#">46.02 Frequency scaling</a>								
	-200000.00... 200000.00	Process PID controller output base.	1 = 1						
40.16	<i>Set 1 setpoint 1 source</i>	Selects the primary source of process PID setpoint. See the control chain diagram on page <a href="#">506</a> .	<i>Not selected</i>						
	Not selected	None.	0						
	Internal setpoint	Internal setpoint. See parameter <a href="#">40.19 Set 1 internal setpoint sel1</a> .	2						
	A11 scaled	<a href="#">12.12 A11 scaled value</a>	3						

No.	Name/Value	Description	Default FbEq 16
	AI2 scaled	<a href="#">12.22 AI2 scaled value</a>	4
	Motor potentiometer	<a href="#">22.80 Motor potentiometer ref act</a> (output of the motor potentiometer).	8
	Freq in scaled	<a href="#">11.39 Freq in 1 scaled value</a>	10
	AI1 percent	<a href="#">12.101 AI1 percent value</a>	11
	AI2 percent	<a href="#">12.102 AI2 percent value</a>	12
	Control panel (ref saved)	<p>Panel reference (<a href="#">03.01 Panel reference</a>, see page 118) saved by the control system for the location where the control returns is used as the reference.</p> <p>Reference</p> <p>● Ext1 reference                      × Ext2 reference                      — Active reference                      ·· Inactive reference</p> <p>Ext1 -&gt; Ext2</p>	13
	Control panel (ref copied)	<p>Panel reference (<a href="#">03.01 Panel reference</a>, see page 118) for the previous control location is used as the reference when the control location changes if the references for the two locations are of the same type (eg frequency/speed/torque/PID); otherwise, the actual signal is used as the new reference.</p> <p>Reference</p> <p>● Ext1 reference                      × Ext2 reference                      — Active reference                      ·· Inactive reference</p> <p>Ext1 -&gt; Ext2</p>	14
	FB A ref1	<a href="#">03.05 FB A reference 1</a>	15
	FB A ref2	<a href="#">03.06 FB A reference 2</a>	16
	EFB ref1	<a href="#">03.09 EFB reference 1</a>	19
	EFB ref2	<a href="#">03.10 EFB reference 2</a>	20
	Setpoint data storage	<a href="#">40.92 Setpoint data storage</a>	24
	Integrated panel (ref saved)	See above Control panel (ref saved).	26
	Integrated panel (ref copied)	See above Control panel (ref copied).	27
	<i>Other</i>	Source selection (see <a href="#">Terms and abbreviations</a> ).	-
40.17	<a href="#">Set 1 setpoint 2 source</a>	<p>Selects the second source of process setpoint. The second source is used only if the setpoint function requires two inputs.</p> <p>For the selections, see parameter <a href="#">40.16 Set 1 setpoint 1 source</a>.</p>	<i>Not selected</i>
40.18	<a href="#">Set 1 setpoint function</a>	<p>Selects a function between the setpoint sources selected by parameters <a href="#">40.16 Set 1 setpoint 1 source</a> and <a href="#">40.17 Set 1 setpoint 2 source</a>.</p>	<i>In1</i>
	In1	Source 1.	0
	In1+In2	Sum of sources 1 and 2.	1

No.	Name/Value	Description	Default FbEq 16															
	In1-In2	Source 2 subtracted from source 1.	2															
	In1*In2	Source 1 multiplied by source 2.	3															
	In1/In2	Source 1 divided by source 2.	4															
	MIN(In1,In2)	Smaller of the two sources.	5															
	MAX(In1,In2)	Greater of the two sources.	6															
	AVE(In1,In2)	Average of the two sources.	7															
	sqrt(In1)	Square root of source 1.	8															
	sqrt(In1-In2)	Square root of (source 1 - source 2).	9															
	sqrt(In1+In2)	Square root of (source 1 + source 2).	10															
	sqrt(In1)+sqrt(In2)	Square root of source 1 + square root of source 2.	11															
40.19	<i>Set 1 internal setpoint sel1</i>	Selects together with <i>40.20 Set 1 internal setpoint sel2</i> the internal setpoint out of the presets defined by parameters <i>40.21...40.23</i> . <b>Note:</b> Parameters <i>40.16 Set 1 setpoint 1 source</i> and <i>40.17 Set 1 setpoint 2 source</i> must be set to <i>Internal setpoint</i>	<i>Not selected</i>															
		<table border="1"> <thead> <tr> <th>Source defined by par. 40.19</th> <th>Source defined by par. 40.20</th> <th>Internal setpoint active</th> </tr> </thead> <tbody> <tr> <td>0</td> <td>0</td> <td>Setpoint source</td> </tr> <tr> <td>1</td> <td>0</td> <td>1 (par. 40.21)</td> </tr> <tr> <td>0</td> <td>1</td> <td>2 (par. 40.22)</td> </tr> <tr> <td>1</td> <td>1</td> <td>3 (par. 40.23)</td> </tr> </tbody> </table>	Source defined by par. 40.19	Source defined by par. 40.20	Internal setpoint active	0	0	Setpoint source	1	0	1 (par. 40.21)	0	1	2 (par. 40.22)	1	1	3 (par. 40.23)	
Source defined by par. 40.19	Source defined by par. 40.20	Internal setpoint active																
0	0	Setpoint source																
1	0	1 (par. 40.21)																
0	1	2 (par. 40.22)																
1	1	3 (par. 40.23)																
	Not selected	0.	0															
	Selected	1.	1															
	DI1	Digital input DI1 ( <i>10.02 DI delayed status</i> , bit 0).	2															
	DI2	Digital input DI2 ( <i>10.02 DI delayed status</i> , bit 1).	3															
	DI3	Digital input DI3 ( <i>10.02 DI delayed status</i> , bit 2).	4															
	DI4	Digital input DI4 ( <i>10.02 DI delayed status</i> , bit 3).	5															
	DIO1	Digital input/output DIO1 ( <i>11.02 DIO delayed status</i> , bit 0).	10															
	DIO2	Digital input/output DIO2 ( <i>11.02 DIO delayed status</i> , bit 1).	11															
	Timed function 1	Bit 0 of <i>34.01 Timed functions status</i> .	18															
	Timed function 2	Bit 1 of <i>34.01 Combined timer status</i> .	19															
	Timed function 3	Bit 2 of <i>34.01 Combined timer status</i> .	20															
	Supervision 1	Bit 0 of <i>32.01 Supervision status</i> .	21															
	Supervision 2	Bit 1 of <i>32.01 Supervision status</i> .	22															
	Supervision 3	Bit 2 of <i>32.01 Supervision status</i> .	23															
	<i>Other [bit]</i>	Source selection (see <i>Terms and abbreviations</i> ).	-															
40.20	<i>Set 1 internal setpoint sel2</i>	Selects together with <i>40.19 Set 1 internal setpoint sel1</i> the internal setpoint used out of the three internal setpoints defined by parameters <i>40.21...40.23</i> . See table at <i>40.19 Set 1 internal setpoint sel1</i> .	<i>Not selected</i>															
	Not selected	0.	0															

No.	Name/Value	Description	Default FbEq 16
	Selected	1.	1
	DI1	Digital input DI1 ( <i>10.02 DI delayed status</i> , bit 0).	2
	DI2	Digital input DI2 ( <i>10.02 DI delayed status</i> , bit 1).	3
	DI3	Digital input DI3 ( <i>10.02 DI delayed status</i> , bit 2).	4
	DI4	Digital input DI4 ( <i>10.02 DI delayed status</i> , bit 3).	5
	DIO1	Digital input/output DIO1 ( <i>11.02 DIO delayed status</i> , bit 0).	10
	DIO2	Digital input/output DIO2 ( <i>11.02 DIO delayed status</i> , bit 1)	11
	Timed function 1	Bit 0 of <i>34.01 Timed functions status</i> .	18
	Timed function 2	Bit 1 of <i>34.01 Timed functions status</i> .	19
	Timed function 3	Bit 2 of <i>34.01 Timed functions status</i> .	20
	Supervision 1	Bit 0 of <i>32.01 Supervision status</i>	21
	Supervision 2	Bit 1 of <i>32.01 Supervision status</i>	22
	Supervision 3	Bit 2 of <i>32.01 Supervision status</i>	23
	<i>Other [bit]</i>	Source selection (see <i>Terms and abbreviations</i> ).	-
<i>40.21</i>	<i>Set 1 internal setpoint 1</i>	Internal process setpoint 1. See parameter <i>40.19 Set 1 internal setpoint sel1</i> .	0.00 PID customer units
	-200000.00... 200000.00 PID customer units	Internal process setpoint 1.	1 = 1 PID customer unit
<i>40.22</i>	<i>Set 1 internal setpoint 2</i>	Internal process setpoint 2. See parameter <i>40.19 Set 1 internal setpoint sel1</i> .	0.00 PID customer units
	-200000.00... 200000.00 PID customer units	Internal process setpoint 2.	1 = 1 PID customer unit
<i>40.23</i>	<i>Set 1 internal setpoint 3</i>	Internal process setpoint 3. See parameter <i>40.19 Set 1 internal setpoint sel1</i> .	0.00 PID customer units
	-200000.00... 200000.00 PID customer units	Internal process setpoint 3.	1 = 1 PID customer unit
<i>40.24</i>	<i>Set 1 internal setpoint 0</i>	Internal process setpoint 0. See parameter <i>40.19 Set 1 internal setpoint sel1</i> .	0.00 PID customer units
	-200000.00... 200000.00 PID customer units	Internal process setpoint 0.	1 = 1 PID customer unit
<i>40.26</i>	<i>Set 1 setpoint min</i>	Defines a minimum limit for the process PID controller setpoint.	0.00
	-200000.00... 200000.00	Minimum limit for process PID controller setpoint.	1 = 1
<i>40.27</i>	<i>Set 1 setpoint max</i>	Defines a maximum limit for the process PID controller setpoint.	200000.00
	-200000.00... 200000.00	Maximum limit for process PID controller setpoint.	1 = 1

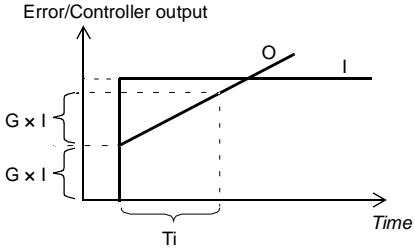

No.	Name/Value	Description	Default FbEq 16
40.28	<a href="#">Set 1 setpoint increase time</a>	Defines the minimum time it takes for the setpoint to increase from 0% to 100%.	0.0 s
	0.0...1800.0 s	Setpoint increase time.	1 = 1
40.29	<a href="#">Set 1 setpoint decrease time</a>	Defines the minimum time it takes for the setpoint to decrease from 100% to 0%.	0.0 s
	0.0...1800.0 s	Setpoint decrease time.	1 = 1
40.30	<a href="#">Set 1 setpoint freeze enable</a>	Freezes, or defines a source that can be used to freeze, the setpoint of the process PID controller. This feature is useful when the reference is based on a process feedback connected to an analog input, and the sensor must be serviced without stopping the process. 1 = Process PID controller setpoint frozen See also parameter <a href="#">40.38 Set 1 output freeze enable</a>	<i>Not selected</i>
	Not selected	Process PID controller setpoint not frozen.	0
	Selected	Process PID controller setpoint frozen.	1
	DI1	Digital input DI1 ( <a href="#">10.02 DI delayed status</a> , bit 0).	2
	DI2	Digital input DI2 ( <a href="#">10.02 DI delayed status</a> , bit 1).	3
	DI3	Digital input DI3 ( <a href="#">10.02 DI delayed status</a> , bit 2).	4
	DI4	Digital input DI4 ( <a href="#">10.02 DI delayed status</a> , bit 3).	5
	DIO1	Digital input/output DIO1 ( <a href="#">11.02 DIO delayed status</a> , bit 0).	10
	DIO2	Digital input/output DIO2 ( <a href="#">11.02 DIO delayed status</a> , bit 1).	11
	Timed function 1	Bit 0 of <a href="#">34.01 Timed functions status</a> .	18
	Timed function 2	Bit 1 of <a href="#">34.01 Timed functions status</a> .	19
	Timed function 3	Bit 2 of <a href="#">34.01 Timed functions status</a> .	20
	Supervision 1	Bit 0 of <a href="#">32.01 Supervision status</a>	21
	Supervision 2	Bit 1 of <a href="#">32.01 Supervision status</a>	22
	Supervision 3	Bit 2 of <a href="#">32.01 Supervision status</a> .	23
	<i>Other [bit]</i>	Source selection (see <a href="#">Terms and abbreviations</a> ).	-
40.31	<a href="#">Set 1 deviation inversion</a>	Inverts the input of the process PID controller. 0 = Deviation not inverted (Deviation = Setpoint - Feedback) 1 = Deviation inverted (Deviation = Feedback - Setpoint) See also section <a href="#">Sleep and boost functions for process PID control</a> (page 82).	<i>Not inverted (Ref - Fbk)</i>
	Not inverted (Ref - Fbk)	0.	0
	Inverted (Fbk - Ref)	1.	1
	<i>Other [bit]</i>	Source selection (see <a href="#">Terms and abbreviations</a> ).	-
40.32	<a href="#">Set 1 gain</a>	Defines the gain for the process PID controller. See parameter <a href="#">40.33 Set 1 integration time</a> .	1.00
	0.01...100.00	Gain for PID controller.	100 = 1

No.	Name/Value	Description	Default FbEq 16
40.33	Set 1 integration time	<p>Defines the integration time for the process PID controller. This time needs to be set to the same order of magnitude as the reaction time of the process being controlled, otherwise instability will result.</p>  <p>I = controller input (error) O = controller output G = gain Ti = integration time</p> <p><b>Note:</b> Setting this value to 0 disables the "I" part, turning the PID controller into a PD controller.</p>	60.0 s
	0.0...9999.0 s	Integration time.	1 = 1 s
40.34	Set 1 derivation time	<p>Defines the derivation time of the process PID controller. The derivative component at the controller output is calculated on basis of two consecutive error values (<math>E_{K-1}</math> and <math>E_K</math>) according to the following formula:  <math>PID\ DERIV\ TIME \times (E_K - E_{K-1}) / T_S</math>, in which  <math>T_S = 2\ ms</math> sample time  <math>E = Error = Process\ reference - process\ feedback</math>.</p>	0.000 s
	0.000...10.000 s	Derivation time.	1000 = 1 s

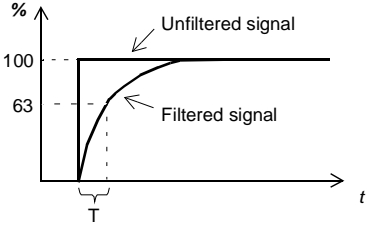
No.	Name/Value	Description	Default FbEq 16
40.35	<i>Set 1 derivation filter time</i>	Defines the time constant of the 1-pole filter used to smooth the derivative component of the process PID controller. <div style="text-align: center;">  <p data-bbox="493 528 628 552"><math>O = I \times (1 - e^{-t/T})</math></p> <p data-bbox="493 580 656 604">I = filter input (step)</p> <p data-bbox="493 608 624 632">O = filter output</p> <p data-bbox="493 635 557 659">t = time</p> <p data-bbox="493 662 680 686">T = filter time constant</p> </div>	0.0 s
	0.0...10.0 s	Filter time constant.	10 = 1 s
40.36	<i>Set 1 output min</i>	Defines the minimum limit for the process PID controller output. Using the minimum and maximum limits, it is possible to restrict the operation range.	0.00
	-200000.00... 200000.00	Minimum limit for process PID controller output.	1 = 1
40.37	<i>Set 1 output max</i>	Defines the maximum limit for the process PID controller output. See parameter <a href="#">40.36 Set 1 output min</a> .	100.00
	-200000.00... 200000.00	Maximum limit for process PID controller output.	1 = 1
40.38	<i>Set 1 output freeze enable</i>	Freezes (or defines a source that can be used to freeze) the output of the process PID controller, keeping the output at the value it was before freeze was enabled. This feature can be used when, for example, a sensor providing process feedback must to be serviced without stopping the process. 1 = Process PID controller output frozen See also parameter <a href="#">40.30 Set 1 setpoint freeze enable</a> .	<i>Not selected</i>
	Not selected	Process PID controller output not frozen.	0
	Selected	Process PID controller output frozen.	1
	DI1	Digital input DI1 ( <a href="#">10.02 DI delayed status</a> , bit 0).	2
	DI2	Digital input DI2 ( <a href="#">10.02 DI delayed status</a> , bit 1).	3
	DI3	Digital input DI3 ( <a href="#">10.02 DI delayed status</a> , bit 2).	4
	DI4	Digital input DI4 ( <a href="#">10.02 DI delayed status</a> , bit 3).	5
	DIO1	Digital input/output DIO1 ( <a href="#">11.02 DIO delayed status</a> , bit 0).	10
	DIO2	Digital input/output DIO2 ( <a href="#">11.02 DIO delayed status</a> , bit 1)	11
	Timed function 1	Bit 0 of <a href="#">34.01 Timed functions status</a> .	18

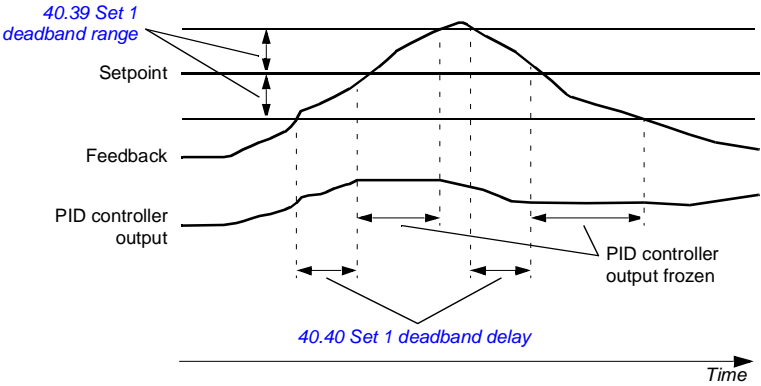
No.	Name/Value	Description	Default FbEq 16
	Timed function 2	Bit 1 of <a href="#">34.01 Timed functions status</a> .	19
	Timed function 3	Bit 2 of <a href="#">34.01 Timed functions status...</a>	20
	Supervision 1	Bit 0 of <a href="#">32.01 Supervision status</a>	21
	Supervision 2	Bit 1 of <a href="#">32.01 Supervision status</a>	22
	Supervision 3	Bit 2 of <a href="#">32.01 Supervision status</a> .	23
	<a href="#">Other [bit]</a>	Source selection (see <a href="#">Terms and abbreviations</a> ).	-
40.39	<a href="#">Set 1 deadband range</a>	<p>Defines a deadband around the setpoint. Whenever process feedback enters the deadband, a delay timer starts. If the feedback remains within the deadband longer than the delay (<a href="#">40.40 Set 1 deadband delay</a>), the PID controller output is frozen. Normal operation resumes after the feedback value leaves the deadband.</p> 	0.0
	0.....200000.0	Deadband range.	1 = 1
40.40	<a href="#">Set 1 deadband delay</a>	Delay for the deadband. See parameter <a href="#">40.39 Set 1 deadband range</a> .	0.0 s
	0.0 ... 3600.0 s	Delay for deadband area.	1 = 1 s
40.43	<a href="#">Set 1 sleep level</a>	<p>Defines the start limit for the sleep function. If the value is 0.0, set 1 sleep mode is disabled.</p> <p>The sleep function compares the motor speed to the value of this parameter. If the motor speed remains below this value longer than the sleep delay defined by <a href="#">40.44 Set 1 sleep delay</a>, the drive enters the sleep mode and stops the motor.</p>	0.0
	0.0...200000.0	Sleep start level.	1 = 1
40.44	<a href="#">Set 1 sleep delay</a>	<p>Defines a delay before the sleep function actually becomes enabled, to prevent nuisance sleeping.</p> <p>The delay timer starts when the sleep mode is enabled by parameter <a href="#">40.43 Set 1 sleep level</a>, and resets when the sleep mode is disabled.</p>	60.0 s
	0.0...3600.0 s	Sleep start delay.	1 = 1 s

No.	Name/Value	Description	Default FbEq 16
40.45	<i>Set 1 sleep boost time</i>	Defines a boost time for the sleep boost step. See parameter <a href="#">40.46 Set 1 sleep boost step</a> .	0.0 s
	0.0...3600.0 s	Sleep boost time.	1 = 1 s
40.46	<i>Set 1 sleep boost step</i>	When the drive is entering sleep mode, the process setpoint is increased by this value for the time defined by parameter <a href="#">40.45 Set 1 sleep boost time</a> . If active, sleep boost is aborted when the drive wakes up.	0.0 PID customer units
	0.0...200000.0 PID customer units	Sleep boost step.	1 = 1 PID customer unit
40.47	<i>Set 1 wake-up deviation</i>	Defines the wake-up level as deviation between process setpoint and feedback. When the deviation exceeds the value of this parameter, and remains there for the duration of the wake-up delay ( <a href="#">40.48 Set 1 wake-up delay</a> ), the drive wakes up. See also parameter <a href="#">40.31 Set 1 deviation inversion</a> .	0.00 PID customer units
	-200000.00...200000.0 PID customer units	Wake-up level (as deviation between process setpoint and feedback).	1 = 1 PID customer unit
40.48	<i>Set 1 wake-up delay</i>	Defines a wake-up delay for the sleep function to prevent nuisance wake-ups. See parameter <a href="#">40.47 Set 1 wake-up deviation</a> . The delay timer starts when the deviation exceeds the wake-up level ( <a href="#">40.47 Set 1 wake-up deviation</a> ), and resets if the deviation falls below the wake-up level.	0.50 s
	0.00...60.00 s	Wake-up delay.	1 = 1 s
40.49	<i>Set 1 tracking mode</i>	Activates (or selects a source that activates) tracking mode. In tracking mode, the value selected by parameter <a href="#">40.50 Set 1 tracking ref selection</a> is substituted for the PID controller output. See also section <a href="#">Tracking</a> (page 84). 1 = Tracking mode enabled	<i>Not selected</i>
	Not selected	0.	0
	Selected	1.	1
	DI1	Digital input DI1 ( <a href="#">10.02 DI delayed status</a> , bit 0).	2
	DI2	Digital input DI2 ( <a href="#">10.02 DI delayed status</a> , bit 1).	3
	DI3	Digital input DI3 ( <a href="#">10.02 DI delayed status</a> , bit 2).	4
	DI4	Digital input DI4 ( <a href="#">10.02 DI delayed status</a> , bit 3).	5
	DIO1	Digital input/output DIO1 ( <a href="#">11.02 DIO delayed status</a> , bit 0).	10
	DIO2	Digital input/output DIO2 ( <a href="#">11.02 DIO delayed status</a> , bit 1)	11
	Timed function 1	Bit 0 of <a href="#">34.01 Timed functions status</a> .	18
	Timed function 2	Bit 1 of <a href="#">34.01 Timed functions status</a> .	19
	Timed function 3	Bit 2 of <a href="#">34.01 Timed functions status</a> .	20
	Supervision 1	Bit 0 of <a href="#">32.01 Supervision status</a> .	21
	Supervision 2	Bit 1 of <a href="#">32.01 Supervision status</a> .	22
	Supervision 3	Bit 2 of <a href="#">32.01 Supervision status</a> .	23
	Supervision 4	Bit 3 of <a href="#">32.01 Supervision status</a> .	24
	Supervision 5	Bit 4 of <a href="#">32.01 Supervision status</a> .	25

No.	Name/Value	Description	Default FbEq 16
	Supervision 6	Bit 5 of <a href="#">32.01 Supervision status</a>	26
	<i>Other [bit]</i>	Source selection (see <a href="#">Terms and abbreviations</a> ).	-
<b>40.50</b>	<b><i>Set 1 tracking ref selection</i></b>	Selects the value source for tracking mode. See parameter <a href="#">40.49 Set 1 tracking mode</a> .	<i>Not selected</i>
	Not selected	None.	0
	AI1 scaled	<a href="#">12.12 AI1 scaled value</a>	1
	AI2 scaled	<a href="#">12.22 AI2 scaled value</a> .	2
	FB A ref1	<a href="#">03.05 FB A reference 1</a>	3
	FB A ref2	<a href="#">03.06 FB A reference 2</a>	4
	<i>Other</i>	Source selection (see <a href="#">Terms and abbreviations</a> ).	-
<b>40.51</b>	<b><i>Set 1 trim mode</i></b>	Activates the trim function and selects between direct and proportional trimming (or a combination of both). With trimming, it is possible to apply a corrective factor to the drive reference (setpoint). The output after trimming is available as parameter <a href="#">40.05 Process PID trim output act</a> .	<i>Off</i>
	Off	The trim function is inactive.	0
	Direct	The trim function is active. The trimming factor is relative to the maximum speed, torque or frequency; the selection between these is made by parameter <a href="#">40.52 Set 1 trim selection</a> .	1
	Proportional	The trim function is active. The trimming factor is relative to the reference selected by parameter <a href="#">40.53 Set 1 trimmed ref pointer</a> .	2
	Combined	The trim function is active. The trimming factor is a combination of both <i>Direct</i> and <i>Proportional</i> modes; the proportions of each are defined by parameter <a href="#">40.54 Set 1 trim mix</a> .	3
<b>40.52</b>	<b><i>Set 1 trim selection</i></b>	Selects whether trimming is used for correcting the speed, torque or frequency reference.	<i>Torque</i>
	Torque	Torque reference trimming.	1
	Speed	Speed reference trimming.	2
	Frequency	Frequency reference trimming.	3
<b>40.53</b>	<b><i>Set 1 trimmed ref pointer</i></b>	Selects the signal source for the trim reference.	<i>Not selected</i>
	Not selected	None.	0
	FBA ref1	<a href="#">03.05 FB A reference 1</a> (see page <a href="#">119</a> ).	3
	FBA ref2	<a href="#">03.06 FB A reference 2</a> (see page <a href="#">119</a> ).	4
	<i>Other</i>	Source selection (see <a href="#">Terms and abbreviations</a> ).	-
<b>40.54</b>	<b><i>Set 1 trim mix</i></b>	When parameter <a href="#">40.51 Set 1 trim mode</a> is set to <i>Combined</i> , defines the effect of direct and proportional trim sources in the final trimming factor. 0.000 = 100% proportional 0.500 = 50% proportional, 50% direct 1.000 = 100% direct	0.000
	0.000...1.000	Trim mix.	1 = 1

No.	Name/Value	Description	Default FbEq 16
40.55	<i>Set 1 trim adjust</i>	Defines a multiplier for the trimming factor. This value is multiplied by the result of parameter <a href="#">40.51 Set 1 trim mode</a> . Consequently, the result of the multiplication is used to multiply the result of parameter <a href="#">40.56 Set 1 trim source</a> .	1.000
	-100.000...100.000	Multiplier for trimming factor.	1 = 1
40.56	<i>Set 1 trim source</i>	Selects the reference to be trimmed.	<i>PID ref</i>
	PID ref	PID setpoint.	1
	PID output	PID controller output.	2
40.57	<i>PID set1/set2 selection</i>	Selects the source that determines whether process PID parameter set 1 (parameters <a href="#">40.07...40.50</a> ) or set 2 (group <a href="#">41 Process PID set 2</a> ) is used. 0 = PID set 1 in use 1 = PID set 2 in use	<i>PID set 1</i>
	PID set 1	PID set 1.	0
	PID set 2	PID set 2.	1
	DI1	Digital input DI1 ( <a href="#">10.02 DI delayed status</a> , bit 0).	2
	DI2	Digital input DI2 ( <a href="#">10.02 DI delayed status</a> , bit 1).	3
	DI3	Digital input DI3 ( <a href="#">10.02 DI delayed status</a> , bit 2).	4
	DI4	Digital input DI4 ( <a href="#">10.02 DI delayed status</a> , bit 3).	5
	DIO1	Digital input/output DIO1 ( <a href="#">11.02 DIO delayed status</a> , bit 0).	10
	DIO2	Digital input/output DIO2 ( <a href="#">11.02 DIO delayed status</a> , bit 1).	11
	Timed function 1	Bit 0 of <a href="#">34.01 Timed functions status</a> .	18
	Timed function 2	Bit 1 of <a href="#">34.01 Timed functions status</a> .	19
	Timed function 3	Bit 2 of <a href="#">34.01 Timed functions status</a> .	20
	Supervision 1	Bit 0 of <a href="#">32.01 Supervision status</a>	21
	Supervision 2	Bit 1 of <a href="#">32.01 Supervision status</a>	22
	Supervision 3	Bit 2 of <a href="#">32.01 Supervision status</a> .	23
	<i>Other [bit]</i>	Source selection (see <a href="#">Terms and abbreviations</a> ).	-
40.58	<i>Set 1 increase prevention</i>	Prevention of PID integration term increase for PID set 1.	<i>No</i>
	No	Increase prevention not in use.	0
	Limiting	The PID integration term is not increased if the maximum value for the PID output is reached. This parameter is valid for the PID set 1.	1
	Ext PID min lim	The process PID integration term is not increased when the output of the external PID has reached its minimum limit. In this setup, the external PID is used as a source for the process PID. This parameter is valid for the PID set 1.	2
	Ext PID max lim	The process PID integration term is not increased when the output of the external PID has reached its maximum limit. In this setup, the external PID is used as a source for the process PID. This parameter is valid for the PID set 1.	3
40.59	<i>Set 1 decrease prevention</i>	Prevention of PID integration term decrease for PID set 1.	<i>No</i>
	No	Decrease prevention not in use.	0

No.	Name/Value	Description	Default FbEq 16
	Limiting	The PID integration term is not decreased if the minimum value for the PID output is reached. This parameter is valid for the PID set 1.	1
	Ext PID min lim	The process PID integration term is not decreased when the output of the external PID has reached it's minimum limit. In this setup, the external PID is used as a source for the process PID. This parameter is valid for the PID set 1.	2
	Ext PID max lim	The process PID integration term is not decreased when the output of the external PID has reached it's maximum limit. In this setup, the external PID is used as a source for the process PID. This parameter is valid for the PID set 1.	3
40.60	<i>Set 1 PID activation source</i>	Selects the source of process PID set 1 activation.	<i>On</i>
	Off	Set 1 PID activation source is Off.	0
	On	Set 1 PID activation source is On.	1
	Follow Ext1/Ext2 selection	Selection follows the value of parameter <a href="#">19.11 Ext1/Ext2 selection</a> . By changing to Ext2 control location, Process PID set 1 is activated.	2
	DI1	Digital input DI1 ( <a href="#">10.02 DI delayed status</a> , bit 0).	3
	DI2	Digital input DI2 ( <a href="#">10.02 DI delayed status</a> , bit 1).	4
	DI3	Digital input DI3 ( <a href="#">10.02 DI delayed status</a> , bit 2).	5
	DI4	Digital input DI4 ( <a href="#">10.02 DI delayed status</a> , bit 3).	6
	DIO2	Digital input/output DIO2 ( <a href="#">11.02 DIO delayed status</a> , bit 1)	10
	<i>Other [bit]</i>	Source selection (see <a href="#">Terms and abbreviations</a> on page 112).	-
40.61	<i>Setpoint scaling actual</i>	Actual setpoint scaling. See parameter <a href="#">40.14 Set 1 setpoint scaling</a> .	0.00
	-200000.00... 200000.00 PID customer units	Scaling.	1 = 1 PID customer unit
40.62	<i>PID internal setpoint actual</i>	Displays the value of the internal setpoint. See the control chain diagram on page <a href="#">506</a> . This parameter is read-only.	0.00 PID unit 1
	-200000.00... 200000.00 PID customer units	Process PID internal setpoint.	1 = 1 PID customer unit
40.80	<i>Set 1 PID output min source</i>	Selects the source for set 1 PID output minimum.	<i>Set1 output min</i>
	None	None.	0
	Set1 output min	<a href="#">40.36 Set 1 output min</a> .	1
	<i>Other</i>	Source selection (see <a href="#">Terms and abbreviations</a> on page 112).	-
40.81	<i>Set 1 PID output max source</i>	Selects the source for set 1 PID output maximum.	<i>Set1 output max</i>
	None	None.	0
	Set1 output max	<a href="#">40.37 Set 1 output max</a>	1



No.	Name/Value	Description	Default FbEq 16
	<i>Other</i>	Source selection (see <i>Terms and abbreviations</i> on page 112).	-
40.89	<i>Set 1 setpoint multiplier</i>	Defines the multiplier with which the result of the function specified by parameter <i>40.18 Set 1 setpoint function</i> is multiplied.	1.00
	-200000.00... 200000.00	Multiplier.	1 = 1
40.90	<i>Set 1 feedback multiplier</i>	Defines the multiplier with which the result of the function specified by parameter <i>40.10 Set 1 feedback function</i> is multiplied.	1.00
	-200000.00... 200000.00	Multiplier.	1 = 1
40.91	<i>Feedback data storage</i>	Storage parameter for receiving a process feedback value eg. through the embedded fieldbus interface. The value can be sent to the drive as Modbus I/O data. Set the target selection parameter of that particular data ( <i>58.101...58.114</i> ) to <i>Feedback data storage</i> . In <i>40.08 Set 1 feedback 1 source</i> (or <i>40.09 Set 1 feedback 2 source</i> ), select <i>Feedback storage</i> .	0.00
	-327.68 ... 327.67	Storage parameter for process feedback.	100 = 1
40.92	<i>Setpoint data storage</i>	Storage parameter for receiving a process setpoint value eg. through the embedded fieldbus interface. The value can be sent to the drive as Modbus I/O data. Set the target selection parameter of that particular data ( <i>58.101...58.114</i> ) to <i>Setpoint data storage</i> . In <i>40.16 Set 1 setpoint 1 source</i> (or <i>40.17 Set 1 setpoint 2 source</i> ), select <i>Setpoint data storage</i> .	0.00
	-327.68 ... 327.67	Storage parameter for process setpoint.	100 = 1
40.96	<i>Process PID output %</i>	Percentage scaled signal of parameter <i>40.01 Process PID feedback actual</i> .	0.00%
	-100.00...100.00%	Percentage.	100 = 1%
40.97	<i>Process PID feedback %</i>	Percentage scaled signal of parameter <i>40.02 Process PID feedback actual</i> .	0.00%
	-100.00...100.00%	Percentage.	100 = 1%
40.98	<i>Process PID setpoint %</i>	Percentage scaled signal of parameter <i>40.03 Process PID setpoint actual</i> .	0.00%
	-100.00...100.00%	Percentage.	100 = 1%
40.99	<i>Process PID deviation %</i>	Percentage scaled signal of parameter <i>40.04 Process PID deviation actual</i> .	0.00%
	-100.00...100.00%	Percentage.	100 = 1%
<b>41 Process PID set 2</b>		A second set of parameter values for process PID control. The selection between this set and first set (parameter group <i>40 Process PID set 1</i> ) is made by parameter <i>40.57 PID set1/set2 selection</i> . See also parameters <i>40.01...40.06</i> , and the control chain diagrams on pages 506 and 507.	
41.08	<i>Set 2 feedback 1 source</i>	See parameter <i>40.08 Set 1 feedback 1 source</i> .	<i>Not selected</i>

## 274 Parameters

No.	Name/Value	Description	Default FbEq 16
41.09	Set 2 feedback 2 source	See parameter <a href="#">40.09 Set 1 feedback 2 source.</a>	<i>Not selected</i>
41.10	Set 2 feedback function	See parameter <a href="#">40.10 Set 1 feedback function.</a>	<i>In1</i>
41.11	Set 2 feedback filter time	See parameter <a href="#">40.11 Set 1 feedback filter time.</a>	0.000 s
41.14	Set 2 setpoint scaling	See parameter <a href="#">40.14 Set 1 setpoint scaling.</a>	0.00
41.15	Set 2 output scaling	See parameter <a href="#">40.15 Set 1 output scaling.</a>	0.00
41.16	Set 2 setpoint 1 source	See parameter <a href="#">40.16 Set 1 setpoint 1 source.</a>	<i>Not selected</i>
41.17	Set 2 setpoint 2 source	See parameter <a href="#">40.17 Set 1 setpoint 2 source.</a>	<i>Not selected</i>
41.18	Set 2 setpoint function	See parameter <a href="#">40.18 Set 1 setpoint function.</a>	<i>In1</i>
41.19	Set 2 internal setpoint sel1	See parameter <a href="#">40.19 Set 1 internal setpoint sel1.</a>	<i>Not selected</i>
41.20	Set 2 internal setpoint sel2	See parameter <a href="#">40.20 Set 1 internal setpoint sel2.</a>	<i>Not selected</i>
41.21	Set 2 internal setpoint 1	See parameter <a href="#">40.21 Set 1 internal setpoint 1.</a>	0.00 PID customer units
41.22	Set 2 internal setpoint 2	See parameter <a href="#">40.22 Set 1 internal setpoint 2.</a>	0.00 PID customer units
41.23	Set 2 internal setpoint 3	See parameter <a href="#">40.23 Set 1 internal setpoint 3.</a>	0.00 PID customer units
41.24	Set 2 internal setpoint 0	<a href="#">40.24 Set 1 internal setpoint 0.</a>	0.00 PID customer units
41.26	Set 2 setpoint min	See parameter <a href="#">40.26 Set 1 setpoint min.</a>	0.00
41.27	Set 2 setpoint max	See parameter <a href="#">40.27 Set 1 setpoint max.</a>	200000.00
41.28	Set 2 setpoint increase time	See parameter <a href="#">40.28 Set 1 setpoint increase time.</a>	0.0 s
41.29	Set 2 setpoint decrease time	See parameter <a href="#">40.29 Set 1 setpoint decrease time.</a>	0.0 s
41.30	Set 2 setpoint freeze enable	See parameter <a href="#">40.30 Set 1 setpoint freeze enable.</a>	<i>Not selected</i>
41.31	Set 2 deviation inversion	See parameter <a href="#">40.31 Set 1 deviation inversion.</a>	<i>Not inverted (Ref - Fbk)</i>
41.32	Set 2 gain	See parameter <a href="#">40.32 Set 1 gain.</a>	1.00
41.33	Set 2 integration time	See parameter <a href="#">40.33 Set 1 integration time.</a>	60.0 s
41.34	Set 2 derivation time	See parameter <a href="#">40.34 Set 1 derivation time.</a>	0.000 s
41.35	Set 2 derivation filter time	See parameter <a href="#">40.35 Set 1 derivation filter time.</a>	0.0 s
41.36	Set 2 output min	See parameter <a href="#">40.36 Set 1 output min.</a>	0.00
41.37	Set 2 output max	See parameter <a href="#">40.37 Set 1 output max.</a>	100.00

No.	Name/Value	Description	Default FbEq 16
41.38	<i>Set 2 output freeze enable</i>	See parameter <i>40.38 Set 1 output freeze enable.</i>	<i>Not selected</i>
41.39	<i>Set 2 deadband range</i>	See parameter <i>40.39 Set 1 deadband range.</i>	0.0
41.40	<i>Set 2 deadband delay</i>	See parameter <i>40.40 Set 1 deadband delay.</i>	0.0 s
41.43	<i>Set 2 sleep level</i>	See parameter <i>40.43 Set 1 sleep level.</i>	0.0
41.44	<i>Set 2 sleep delay</i>	See parameter <i>40.44 Set 1 sleep delay.</i>	60.0 s
41.45	<i>Set 2 sleep boost time</i>	See parameter <i>40.45 Set 1 sleep boost time.</i>	0.0 s
41.46	<i>Set 2 sleep boost step</i>	See parameter <i>40.46 Set 1 sleep boost step.</i>	0.0 PID customer units
41.47	<i>Set 2 wake-up deviation</i>	See parameter <i>40.47 Set 1 wake-up deviation.</i>	0.00 PID customer units
41.48	<i>Set 2 wake-up delay</i>	See parameter <i>40.48 Set 1 wake-up delay.</i>	0.50 s
41.49	<i>Set 2 tracking mode</i>	See parameter <i>40.49 Set 1 tracking mode.</i>	<i>Not selected</i>
41.50	<i>Set 2 tracking ref selection</i>	See parameter <i>40.50 Set 1 tracking ref selection.</i>	<i>Not selected</i>
41.51	<i>Set 2 trim mode</i>	See parameter <i>40.51 Set 1 trim mode.</i>	<i>Off</i>
41.52	<i>Set 2 trim selection</i>	See parameter <i>40.52 Set 1 trim selection.</i>	<i>Torque</i>
41.53	<i>Set 2 trimmed ref pointer</i>	See parameter <i>40.53 Set 1 trimmed ref pointer.</i>	<i>Not selected</i>
41.54	<i>Set 2 trim mix</i>	See parameter <i>40.54 Set 1 trim mix.</i>	0.000
41.55	<i>Set 2 trim adjust</i>	See parameter <i>40.55 Set 1 trim adjust.</i>	1.000
41.56	<i>Set 2 trim source</i>	See parameter <i>40.56 Set 1 trim source.</i>	<i>PID ref</i>
41.58	<i>Set 2 increase prevention</i>	See parameter <i>40.58 Set 1 increase prevention.</i>	<i>No</i>
41.59	<i>Set 2 decrease prevention</i>	See parameter <i>40.59 Set 1 decrease prevention.</i>	<i>No</i>
41.60	<i>Set 2 PID activation source</i>	See parameter <i>40.60 Set 1 PID activation source.</i>	<i>On</i>
41.80	<i>Set 2 PID output min source</i>	Selects the source for set 2 PID output minimum.	<i>Set2 output min</i>
	None	None.	0
	Set2 output min	<i>41.36 Set 2 output min.</i>	1
41.81	<i>Set 2 PID output max source</i>	Selects the source for set 2 PID output maximum.	<i>Set2 output max</i>
	None	None.	0
	Set2 output max	<i>40.47 Set 2 output max</i>	1
41.89	<i>Set 2 setpoint multiplier</i>	See parameter <i>40.89 Set 1 setpoint multiplier.</i>	1.00
41.90	<i>Set 2 feedback multiplier</i>	Defines the multiplier k used in formulas of parameter <i>41.10 Set 2 feedback function.</i> See parameter <i>40.90 Set 1 feedback multiplier.</i>	1.00

No.	Name/Value	Description	Default FbEq 16
<b>43 Brake chopper</b>		Settings for the internal brake chopper.	
43.01	<i>Braking resistor temperature</i>	Displays the estimated temperature of the brake resistor, or how close the brake resistor is to being too hot. The value is given in percent where 100% is the eventual temperature the resistor would reach when loaded long enough with its rated maximum load capacity ( <a href="#">43.09 Brake resistor Pmax conf</a> ). The temperature calculation is based on the values of parameters <a href="#">43.08</a> , <a href="#">43.09</a> and <a href="#">43.10</a> , and on the assumption that the resistor is installed as instructed by the manufacturer (ie, it cools down as expected).	-
	0.0...120.0%	Estimated brake resistor temperature.	1 = 1%
43.06	<i>Brake chopper enable</i>	Enables brake chopper control and selects the brake resistor overload protection method (calculation or measurement). <b>Note:</b> Before enabling brake chopper control, ensure that <ul style="list-style-type: none"> <li>a brake resistor is connected</li> <li>overvoltage control is switched off (parameter <a href="#">30.30 Overvoltage control</a>)</li> <li>the supply voltage range (parameter <a href="#">95.01 Supply voltage</a>) has been selected correctly.</li> </ul>	<i>Disabled</i>
	Disabled	Brake chopper control disabled.	0
	Enabled with thermal model	Brake chopper control enabled with the brake resistor protection based on the thermal model. If you select this, you must also specify the values needed by the model, ie. parameters <a href="#">43.08</a> , and <a href="#">43.09</a> , <a href="#">43.10</a> , <a href="#">43.11</a> and <a href="#">43.12</a> . See the resistor manufacturer data sheet.	1
	Enabled without thermal model	Brake chopper control enabled without resistor overload protection based on the thermal model if the resistor is equipped with a thermal switch that is wired to open the main contactor of the drive if the resistor overheats. For more information, see chapter <i>Resistor braking</i> in the hardware manual.	2
	Overvoltage peak protection	Brake chopper control enabled in an overvoltage condition. This setting is intended for situations where <ul style="list-style-type: none"> <li>the braking chopper is not needed for runtime operation, ie. to dissipate the inertial energy of the motor,</li> <li>the motor is able to store a considerable amount magnetic energy in its windings, and</li> <li>the motor might, deliberately or inadvertently, be stopped by coasting.</li> </ul> In such a situation, the motor would potentially discharge enough magnetic energy towards the drive to cause damage. To protect the drive, the brake chopper can be used with a small resistor dimensioned merely to handle the magnetic energy (not the inertial energy) of the motor. With this setting, the brake chopper is activated only whenever the DC voltage exceeds the overvoltage limit. During normal use, the brake chopper is not operating.	3

No.	Name/Value	Description	Default FbEq 16
43.07	<i>Brake chopper runtime enable</i>	Selects the source for quick brake chopper on/off control. 0 = Brake chopper IGBT pulses are cut off 1 = Normal brake chopper IGBT modulation allowed. This parameter can be used to enable the chopper operation only when the supply is missing from a drive with a regenerative supply unit.	<i>On</i>
	Off	0.	0
	On	1.	1
	<i>Other [bit]</i>	Source selection (see <i>Terms and abbreviations</i> ).	-
43.08	<i>Brake resistor thermal tc</i>	Defines the thermal time constant of the brake resistor thermal model.	0 s
	0...10000 s	Brake resistor thermal time constant, ie, the rated time to achieve 63% temperature.	1 = 1 s
43.09	<i>Brake resistor Pmax cont</i>	Defines the maximum continuous load of the brake resistor which will eventually raise the resistor temperature to the maximum allowed value (= continuous heat dissipation capacity of the resistor in kW) but not above it. The value is used in the resistor overload protection based on the thermal model. See parameter <i>43.06 Brake chopper enable</i> . See the data sheet of the brake resistor used.	0.00 kW
	0.00... 10000.00 kW	Maximum continuous load of the brake resistor.	1 = 1 kW
43.10	<i>Brake resistance</i>	Defines the resistance value of the brake resistor. The value is used for the brake resistor protection based on the thermal model. See parameter <i>43.06 Brake chopper enable</i> .	0.0 ohm
	0.0...1000.0 ohm	Brake resistor resistance value.	1 = 1 ohm
43.11	<i>Brake resistor fault limit</i>	Selects the fault limit for the brake resistor protection based on the thermal model. See parameter <i>43.06 Brake chopper enable</i> . When the limit is exceeded, the drive trips on fault <i>7183 BR excess temperature</i> . The value is given in percent of the temperature the resistor reaches when loaded with the power defined by parameter <i>43.09 Brake resistor Pmax cont</i> .	105%
	0...150%	Brake resistor temperature fault limit.	1 = 1%
43.12	<i>Brake resistor warning limit</i>	Selects the warning limit for the brake resistor protection based on the thermal model. See parameter <i>43.06 Brake chopper enable</i> . When the limit is exceeded, the drive generates a <i>A793 BR excess temperature</i> warning. The value is given in percent of the temperature the resistor reaches when loaded with the power defined by parameter <i>43.09 Brake resistor Pmax cont</i> .	95%
	0...150%	Brake resistor temperature warning limit.	1 = 1%

No.	Name/Value	Description	Default FbEq 16																																	
<b>44 Mechanical brake control</b>		Configuration of mechanical brake control. See also parameter groups <a href="#">40 Process PID set 1</a> and <a href="#">41 Process PID set 2</a> .																																		
44.01	<i>Brake control status</i>	Displays the mechanical brake control status word. This parameter is read-only.	0000h																																	
<table border="1"> <thead> <tr> <th>Bit</th> <th>Name</th> <th>Information</th> </tr> </thead> <tbody> <tr> <td>0</td> <td>Open command</td> <td>Close/open command to brake actuator (0 = close, 1 = open). Connect this bit to desired output.</td> </tr> <tr> <td>1</td> <td>Opening torque request</td> <td>1 = Opening torque requested from drive logic</td> </tr> <tr> <td>2</td> <td>Hold stopped request</td> <td>1 = Hold requested from drive logic</td> </tr> <tr> <td>3</td> <td>Ramp to stopped</td> <td>1 = Ramping down to zero speed requested from drive logic</td> </tr> <tr> <td>4</td> <td>Enabled</td> <td>1 = Brake control is enabled</td> </tr> <tr> <td>5</td> <td>Closed</td> <td>1 = Brake control logic in <a href="#">BRAKE CLOSED</a> state</td> </tr> <tr> <td>6</td> <td>Opening</td> <td>1 = Brake control logic in <a href="#">BRAKE OPENING</a> state</td> </tr> <tr> <td>7</td> <td>Open</td> <td>1 = Brake control logic in <a href="#">BRAKE OPEN</a> state</td> </tr> <tr> <td>8</td> <td>Closing</td> <td>1 = Brake control logic in <a href="#">BRAKE CLOSING</a> state</td> </tr> <tr> <td>9...15</td> <td>Reserved</td> <td></td> </tr> </tbody> </table>				Bit	Name	Information	0	Open command	Close/open command to brake actuator (0 = close, 1 = open). Connect this bit to desired output.	1	Opening torque request	1 = Opening torque requested from drive logic	2	Hold stopped request	1 = Hold requested from drive logic	3	Ramp to stopped	1 = Ramping down to zero speed requested from drive logic	4	Enabled	1 = Brake control is enabled	5	Closed	1 = Brake control logic in <a href="#">BRAKE CLOSED</a> state	6	Opening	1 = Brake control logic in <a href="#">BRAKE OPENING</a> state	7	Open	1 = Brake control logic in <a href="#">BRAKE OPEN</a> state	8	Closing	1 = Brake control logic in <a href="#">BRAKE CLOSING</a> state	9...15	Reserved	
Bit	Name	Information																																		
0	Open command	Close/open command to brake actuator (0 = close, 1 = open). Connect this bit to desired output.																																		
1	Opening torque request	1 = Opening torque requested from drive logic																																		
2	Hold stopped request	1 = Hold requested from drive logic																																		
3	Ramp to stopped	1 = Ramping down to zero speed requested from drive logic																																		
4	Enabled	1 = Brake control is enabled																																		
5	Closed	1 = Brake control logic in <a href="#">BRAKE CLOSED</a> state																																		
6	Opening	1 = Brake control logic in <a href="#">BRAKE OPENING</a> state																																		
7	Open	1 = Brake control logic in <a href="#">BRAKE OPEN</a> state																																		
8	Closing	1 = Brake control logic in <a href="#">BRAKE CLOSING</a> state																																		
9...15	Reserved																																			
0000h...FFFFh		Mechanical brake control status word.	1 = 1																																	
44.02	<i>Brake torque memory</i>	Displays the torque (in percent) at the instant of the previous brake close command. This value can be used as a reference for the brake open torque. See parameters <a href="#">44.09 Brake open torque source</a> and <a href="#">44.10 Brake open torque</a> .	-																																	
-1600.0 ... 1600.0%		Torque at brake closure.	See par. <a href="#">46.03</a>																																	
44.03	<i>Brake open torque reference</i>	Displays the currently active brake open torque. See parameters <a href="#">44.09 Brake open torque source</a> and <a href="#">44.10 Brake open torque</a> . This parameter is read-only.	-																																	
-1600.0 ... 1600.0%		Currently active brake open torque.	See par. <a href="#">46.03</a>																																	
44.06	<i>Brake control enable</i>	Activates/deactivates (or selects a source that activates/deactivates) the mechanical brake control logic. 0 = Brake control inactive 1 = Brake control active	<i>Not selected</i>																																	
Not selected		The brake control function is disabled.	0																																	
Selected		The brake control function is enabled.	1																																	
DI1		Digital input DI1 ( <a href="#">10.02 DI delayed status</a> , bit 0).	2																																	
DI2		Digital input DI2 ( <a href="#">10.02 DI delayed status</a> , bit 1).	3																																	
DI3		Digital input DI3 ( <a href="#">10.02 DI delayed status</a> , bit 2).	4																																	
DI4		Digital input DI4 ( <a href="#">10.02 DI delayed status</a> , bit 3).	5																																	
DIO1		Digital input/output DIO1 ( <a href="#">11.02 DIO delayed status</a> , bit 0).	10																																	
DIO2		Digital input/output DIO2 ( <a href="#">11.02 DIO delayed status</a> , bit 1)	11																																	

No.	Name/Value	Description	Default FbEq 16
	Timed function 1	Bit 0 of <a href="#">34.01 Timed functions status</a> .	18
	Timed function 2	Bit 1 of <a href="#">34.01 Timed functions status</a> .	19
	Timed function 3	Bit 2 of <a href="#">34.01 Timed functions status</a> .	20
	Supervision 1	Bit 0 of <a href="#">32.01 Supervision status</a>	24
	Supervision 2	Bit 1 of <a href="#">32.01 Supervision status</a>	25
	Supervision 3	Bit 2 of <a href="#">32.01 Supervision status</a> .	26
	Supervision 4	Bit 3 of <a href="#">32.01 Supervision status</a> .	27
	Supervision 5	Bit 4 of <a href="#">32.01 Supervision status</a> .	28
	Supervision 6	Bit 5 of <a href="#">32.01 Supervision status</a> .x	29
	<i>Other [bit]</i>	Source selection (see <a href="#">Terms and abbreviations</a> ).	-
<b>44.07</b>	<b><i>Brake acknowledge selection</i></b>	Activates/deactivates (and selects the source for) brake open/close status (acknowledgment) supervision. When a brake control error (unexpected state of the acknowledgment signal) is detected, the drive reacts as defined by parameter <a href="#">44.17 Brake fault function</a> . 0 = Brake closed 1 = Brake open	<b><i>No acknowledge</i></b>
	Off	The brake acknowledge function is disabled.	0
	On	The brake acknowledge function is enabled.	1
	No acknowledge	Brake open/closed supervision disabled.	2
	DI1	Digital input DI1 ( <a href="#">10.02 DI delayed status</a> , bit 0).	3
	DI2	Digital input DI2 ( <a href="#">10.02 DI delayed status</a> , bit 1).	4
	DI3	Digital input DI3 ( <a href="#">10.02 DI delayed status</a> , bit 2).	5
	DI4	Digital input DI4 ( <a href="#">10.02 DI delayed status</a> , bit 3).	6
	DIO1	Digital input/output DIO1 ( <a href="#">11.02 DIO delayed status</a> , bit 0).	11
	DIO2	Digital input/output DIO2 ( <a href="#">11.02 DIO delayed status</a> , bit 1)	12
	<i>Other [bit]</i>	Source selection (see <a href="#">Terms and abbreviations</a> ).	-
<b>44.08</b>	<b><i>Brake open delay</i></b>	Defines the brake open delay, ie. the delay between the internal open brake command and the release of motor speed control. The delay timer starts when the drive has magnetized the motor. Simultaneously with the timer start, the brake control logic energizes the brake control output and the brake starts to open. Set this parameter to the value of mechanical opening delay specified by the brake manufacturer.	0.00 s
	0.00...5.00 s	Brake open delay.	100 = 1 s
<b>44.09</b>	<b><i>Brake open torque source</i></b>	Defines a source that is used as a brake opening torque reference if <ul style="list-style-type: none"> <li>its absolute value is greater than the setting of parameter <a href="#">44.10 Brake open torque</a>, and</li> <li>its sign is the same as the setting of <a href="#">44.10 Brake open torque</a>.</li> </ul> See parameter <a href="#">44.10 Brake open torque</a> .	<b><i>Brake open torque</i></b>
	Zero	Zero.	0
	AI1 scaled	<a href="#">12.12 AI1 scaled value</a> .	1
	AI2 scaled	<a href="#">12.22 AI2 scaled value</a> .	2

No.	Name/Value	Description	Default FbEq 16
	FBA ref1	<a href="#">03.05 FB A reference 1.</a>	3
	FBA ref2	<a href="#">03.06 FB A reference 2.</a>	4
	Brake torque memory	Parameter <a href="#">44.02 Brake torque memory.</a>	7
	Brake open torque	Parameter <a href="#">44.10 Brake open torque.</a>	8
<a href="#">44.10</a>	<a href="#">Brake open torque</a>	Defines the sign (ie. direction of rotation) and minimum absolute value of the brake open torque (motor torque requested at brake release in percent of motor nominal torque). The value of the source selected by parameter <a href="#">44.09 Brake open torque source</a> is used as the brake open torque only if it has the same sign as this parameter and has a greater absolute value. <b>Note:</b> This parameter is not effective in scalar motor control mode.	0.0%
	-1600.0 ... 1600.0%	Minimum torque at brake release.	See par. <a href="#">46.03</a>
<a href="#">44.11</a>	<a href="#">Keep brake closed</a>	Selects a source that prevents the brake from opening. 0 = Normal brake operation 1 = Keep brake closed <b>Note:</b> This parameter cannot be changed while the drive is running.	<i>Not selected</i>
	Not selected	0.	0
	Selected	1.	1
	DI1	Digital input DI1 ( <a href="#">10.02 DI delayed status</a> , bit 0).	2
	DI2	Digital input DI2 ( <a href="#">10.02 DI delayed status</a> , bit 1).	3
	DI3	Digital input DI3 ( <a href="#">10.02 DI delayed status</a> , bit 2).	4
	DI4	Digital input DI4 ( <a href="#">10.02 DI delayed status</a> , bit 3).	5
	DIO1	Digital input/output DIO1 ( <a href="#">11.02 DIO delayed status</a> , bit 0).	10
	DIO2	Digital input/output DIO2 ( <a href="#">11.02 DIO delayed status</a> , bit 1)	11
	Timed function 1	Bit 0 of <a href="#">34.01 Timed functions status.</a>	18
	Timed function 2	Bit 1 of <a href="#">34.01 Timed functions status.</a>	19
	Timed function 3	Bit 2 of <a href="#">34.01 Timed functions status.</a>	20
	Supervision 1	Bit 0 of <a href="#">32.01 Supervision status</a>	24
	Supervision 2	Bit 1 of <a href="#">32.01 Supervision status</a>	25
	Supervision 3	Bit 2 of <a href="#">32.01 Supervision status.</a>	26
	Supervision 4	Bit 3 of <a href="#">32.01 Supervision status.</a>	27
	Supervision 5	Bit 4 of <a href="#">32.01 Supervision status.</a>	28
	Supervision 6	Bit 5 of <a href="#">32.01 Supervision status.</a>	29
	<a href="#">Other [bit]</a>	Source selection (see <a href="#">Terms and abbreviations</a> ).	-



No.	Name/Value	Description	Default FbEq 16
44.12	<i>Brake close request</i>	<p>Selects the source of an external brake close request signal. When on, the signal overrides the internal logic and closes the brake.</p> <p>0 = Normal operation/No external close signal connected 1 = Close brake</p> <p><b>Notes:</b></p> <ul style="list-style-type: none"> <li>In an open-loop (encoderless) application, if the brake is kept closed by a brake close request against a modulating drive for longer than 5 seconds, the brake is forced to close and the drive trips on a fault, <a href="#">71A5 Mechanical brake opening not allowed</a></li> <li>This parameter cannot be changed while the drive is running.</li> </ul>	<i>Not selected</i>
	Not selected	0.	0
	Selected	1.	1
	DI1	Digital input DI1 ( <a href="#">10.02 DI delayed status</a> , bit 0).	2
	DI2	Digital input DI2 ( <a href="#">10.02 DI delayed status</a> , bit 1).	3
	DI3	Digital input DI3 ( <a href="#">10.02 DI delayed status</a> , bit 2).	4
	DI4	Digital input DI4 ( <a href="#">10.02 DI delayed status</a> , bit 3).	5
	DIO1	Digital input/output DIO1 ( <a href="#">11.02 DIO delayed status</a> , bit 0).	10
	DIO2	Digital input/output DIO2 ( <a href="#">11.02 DIO delayed status</a> , bit 1)	11
	Timed function 1	Bit 0 of <a href="#">34.01 Timed functions status</a> .	18
	Timed function 2	Bit 1 of <a href="#">34.01 Timed functions status</a> .	19
	Timed function 3	Bit 2 of <a href="#">34.01 Timed functions status</a> .	20
	Supervision 1	Bit 0 of <a href="#">32.01 Supervision status</a>	24
	Supervision 2	Bit 1 of <a href="#">32.01 Supervision status</a>	25
	Supervision 3	Bit 2 of <a href="#">32.01 Supervision status</a> .	26
	Supervision 4	Bit 3 of <a href="#">32.01 Supervision status</a> .	27
	Supervision 5	Bit 4 of <a href="#">32.01 Supervision status</a> .	28
	Supervision 6	Bit 5 of <a href="#">32.01 Supervision status</a> .	29
	<i>Other [bit]</i>	Source selection (see <a href="#">Terms and abbreviations</a> ).	-
44.13	<i>Brake close delay</i>	<p>Specifies a delay between a close command (that is, when the brake control output is de-energized) and when the drive stops modulating. This is to keep the motor live and under control until the brake actually closes.</p> <p>Set this parameter equal to the value specified by the brake manufacturer as the mechanical make-up time of the brake.</p>	0.00 s
	0.00...60.00 s	Brake close delay.	100 = 1 s
44.14	<i>Brake close level</i>	<p>Defines the brake close speed as an absolute value.</p> <p>After motor speed has decelerated to this level, a close command is given.</p>	10.00 rpm
	0.00...1000.00 rpm	Brake close speed.	See par. <a href="#">46.01</a>
44.15	<i>Brake close level delay</i>	Defines a brake close level delay. See parameter <a href="#">44.14 Brake close level</a> .	0.00 s
	0.00 ... 10.00 s	Brake close level delay.	100 = 1 s

No.	Name/Value	Description	Default FbEq 16
44.16	<i>Brake reopen delay</i>	Defines a minimum time between brake closure and a subsequent open command.	0.00 s
	0.00 ... 10.00 s	Brake reopen delay.	100 = 1 s
44.17	<i>Brake fault function</i>	Determines how the drive reacts upon a mechanical brake control error. <b>Note:</b> If parameter <i>44.07 Brake acknowledge selection</i> is set to <i>No acknowledge</i> , acknowledgment status supervision is disabled altogether and will generate no warnings or faults. However, the brake open conditions are always supervised.	<i>Fault</i>
	Fault	The drive trips on a <i>71A2 Mechanical brake closing failed</i> The drive trips on a <i>A7A5 Mechanical brake opening not allowed</i> fault if the brake open conditions cannot be fulfilled (for example, the required motor starting torque is not achieved).	0
	Warning	The drive generates a <i>A7A1 Mechanical brake closing failed</i> The drive generates a <i>A7A5 Mechanical brake opening not allowed</i> warning if the brake open conditions cannot be fulfilled (for example, the required motor starting torque is not achieved).	1
	Open fault	Upon closing the brake, the drive generates a <i>A7A1 Mechanical brake closing failed</i> warning if the status of the acknowledgment does not match the status presumed by the brake control logic. The drive trips on a <i>71A5 Mechanical brake opening not allowed</i> fault if the brake open conditions cannot be fulfilled (for example, the required motor starting torque is not achieved).	2
44.18	<i>Brake fault delay</i>	Defines a close fault delay, ie. time between brake closure and brake close fault trip.	0.00 s
	0.00 ... 60.00 s	Brake close fault delay.	100 = 1 s
44.202	<i>Torque proving</i>	Selects whether Torque proving (electrical test) is active or not. For more information on the function, see section <i>Brake system checks – Torque proving</i> on page 536. <b>Note:</b> For scalar motor control, disable Torque proving and Brake open torque. Select the following: <i>44.09 Brake open torque source = Zero</i> <i>44.10 Brake open torque = 0%</i> <i>44.202 Torque proving = Not selected</i>	<i>Not selected</i>
	Not selected	Torque proving is inactive.	0
	Selected	Torque proving is active.	1
	DI1	Digital input DI1 ( <i>10.02 DI delayed status</i> , bit 0).	2
	DI2	Digital input DI2 ( <i>10.02 DI delayed status</i> , bit 1).	3
	DI3	Digital input DI3 ( <i>10.02 DI delayed status</i> , bit 2).	4
	DI4	Digital input DI4 ( <i>10.02 DI delayed status</i> , bit 3).	5
	DIO1	Digital input/output DIO1 ( <i>11.02 DIO delayed status</i> , bit 0).	10
	DIO2	Digital input/output DIO2 ( <i>11.02 DIO delayed status</i> , bit 1)	11
	Timed function 1	Bit 0 of <i>34.01 Timed functions status</i> .	18
	Timed function 2	Bit 1 of <i>34.01 Timed functions status</i> .	19

No.	Name/Value	Description	Default FbEq 16
	Timed function 3	Bit 2 of <a href="#">34.01 Timed functions status</a> .	20
	Supervision 1	Bit 0 of <a href="#">32.01 Supervision status</a>	21
	Supervision 2	Bit 1 of <a href="#">32.01 Supervision status</a>	22
	Supervision 3	Bit 2 of <a href="#">32.01 Supervision status</a> .	23
	Supervision 4	Bit 3 of <a href="#">32.01 Supervision status</a> .	24
	Supervision 5	Bit 4 of <a href="#">32.01 Supervision status</a> .	25
	Supervision 6	Bit 5 of <a href="#">32.01 Supervision status</a> .	26
	<i>Other [bit]</i>	Source selection (see <a href="#">Terms and abbreviations</a> on page 112).	-
<b>44.203</b>	<b><i>Torque proving reference</i></b>	Defines the Torque proving (electrical test) reference to be used when the Torque proving function is enabled.	25.0%
	0.0 ... 300.0%	Torque proving (electrical test) reference in percentage of the motor nominal torque ( <a href="#">01.10 Motor torque</a> ).	1 = 1%
<b>44.204</b>	<b><i>Brake system check time</i></b>	Defines the time delay during which Torque proving is active and the electrical and mechanical tests of the crane system are done against a closed brake. If the actual torque cannot be reached during this check time, the drive trips on fault <a href="#">D100 Torque prove</a> .	0.30 s
	0.10....30.00 s	Time delay.	1000 = 1 s
<b>44.205</b>	<b><i>Brake slip speed limit</i></b>	Defines the speed limit used for examining the system for brake slips during Torque proving (mechanical test). For more information on the function, see section <a href="#">Brake system checks – Brake slip</a> on page 537.	30.00 rpm
	0.00 ... 30000.00 rpm	Brake slip speed limit.	1 = 1 rpm
<b>44.206</b>	<b><i>Brake slip fault delay</i></b>	Defines the time delay before the drive trips on fault <a href="#">D101 Brake slip</a> during Torque proving (mechanical test). If a brake slip is detected during the system check time ( <a href="#">44.204 Brake system check time</a> ), the fault is generated immediately, even if the check time had not yet elapsed.	300 ms
	0...30000 ms	Time delay.	1 = 1 ms
<b>44.207</b>	<b><i>Safety close select</i></b>	Selects whether the Brake safe closure function is active or not. For more information on the function, see section <a href="#">Brake safe closure</a> on page 538.	<i>Not selected</i>
	Not selected	Brake safe closure function is inactive.	0
	Selected	Brake safe closure function is active.	1
	DI1	Digital input DI1 ( <a href="#">10.02 DI delayed status</a> , bit 0).	2
	DI2	Digital input DI2 ( <a href="#">10.02 DI delayed status</a> , bit 1).	3
	DI3	Digital input DI3 ( <a href="#">10.02 DI delayed status</a> , bit 2).	4
	DI4	Digital input DI4 ( <a href="#">10.02 DI delayed status</a> , bit 3).	5
	DIO1	Digital input/output DIO1 ( <a href="#">11.02 DIO delayed status</a> , bit 0).	10
	DIO2	Digital input/output DIO2 ( <a href="#">11.02 DIO delayed status</a> , bit 1)	11
	Timed function 1	Bit 0 of <a href="#">34.01 Timed functions status</a> .	18
	Timed function 2	Bit 1 of <a href="#">34.01 Timed functions status</a> .	19
	Timed function 3	Bit 2 of <a href="#">34.01 Timed functions status</a> .	20
	Supervision 1	Bit 0 of <a href="#">32.01 Supervision status</a>	24
	Supervision 2	Bit 1 of <a href="#">32.01 Supervision status</a>	25

No.	Name/Value	Description	Default FbEq 16												
	Supervision 3	Bit 2 of <a href="#">32.01 Supervision status</a> .	26												
	Supervision 4	Bit 3 of <a href="#">32.01 Supervision status</a> .	27												
	Supervision 5	Bit 4 of <a href="#">32.01 Supervision status</a> .	28												
	Supervision 6	Bit 5 of <a href="#">32.01 Supervision status</a> .	29												
	<a href="#">Other [bit]</a>	Source selection (see <a href="#">Terms and abbreviations</a> on page 112).	-												
<a href="#">44.208</a>	<a href="#">Safety close speed</a>	Defines the speed limit for the Brake safe closure function.	50.00 rpm												
	0.00 ... 30000.00 rpm	Brake safe closure speed.	1 = 1 rpm												
<a href="#">44.209</a>	<a href="#">Safety close delay</a>	Defines the time delay before the drive trips on fault <a href="#">D102 Brake safe closure</a> .	2000 ms												
	0...30000 ms	Time delay.	1 = 1 ms												
<a href="#">44.211</a>	<a href="#">Extended runtime</a>	Defines the time period during which drive keeps the motor magnetized after the brake is closed. The Extended run time function is enabled if this value is less than 3600 seconds or greater than 0 seconds. <b>Note:</b> The extended run time function is active only when all these conditions are satisfied: <ul style="list-style-type: none"> <li>the drive is set to vector motor control mode (see page <a href="#">54</a>)</li> <li>the drive is in Remote control</li> </ul>  <b>WARNING!</b> Extended runtime causes the motor to heat up. In cases where long magnetization time is required, make sure to use motors with external ventilation.	0.0 s												
	0.0...3600.0 s	Time period.	10 = 1 s												
<a href="#">44.212</a>	<a href="#">Extended runtime sw</a>	Shows the status of the Extended runtime function. This parameter is read-only.	0000h												
		<table border="1"> <thead> <tr> <th>Bit</th> <th>Name</th> <th>Description</th> </tr> </thead> <tbody> <tr> <td>0</td> <td>Extended run in operation</td> <td>0 = Extended run time is active. 1 = Extended run time is not active.</td> </tr> <tr> <td>1</td> <td>Extended run enabled</td> <td>1 = Extended run time function is enabled. 0 = Extended run time function is disabled.</td> </tr> <tr> <td>2...15</td> <td>Reserved</td> <td></td> </tr> </tbody> </table>	Bit	Name	Description	0	Extended run in operation	0 = Extended run time is active. 1 = Extended run time is not active.	1	Extended run enabled	1 = Extended run time function is enabled. 0 = Extended run time function is disabled.	2...15	Reserved		
Bit	Name	Description													
0	Extended run in operation	0 = Extended run time is active. 1 = Extended run time is not active.													
1	Extended run enabled	1 = Extended run time function is enabled. 0 = Extended run time function is disabled.													
2...15	Reserved														
	0000h...FFFFh	Extended runtime status.	-												
<a href="#">45 Energy efficiency</a>		Settings for the energy saving calculators. See also section <a href="#">Energy saving calculators</a> (page 104).													
<a href="#">45.01</a>	<a href="#">Saved GW hours</a>	Energy saved in GWh compared to direct-on-line motor connection. This parameter is incremented when <a href="#">45.02 Saved MW hours</a> rolls over. This parameter is read-only (see parameter <a href="#">45.21 Energy calculations reset</a> ).	-												
	0...65535 GWh	Energy savings in GWh.	1 = 1 GWh												

No.	Name/Value	Description	Default FbEq 16
45.02	<i>Saved MW hours</i>	Energy saved in MWh compared to direct-on-line motor connection. This parameter is incremented when <a href="#">45.03 Saved kW hours</a> rolls over. When this parameter rolls over, parameter <a href="#">45.01 Saved GW hours</a> is incremented. This parameter is read-only (see parameter <a href="#">45.21 Energy calculations reset</a> ).	-
	0...999 MWh	Energy savings in MWh.	1 = 1 MWh
45.03	<i>Saved kW hours</i>	Energy saved in kWh compared to direct-on-line motor connection. If the internal brake chopper of the drive is enabled, all energy fed by the motor to the drive is assumed to be converted into heat, but the calculation still records savings made by controlling the speed. If the chopper is disabled, then regenerated energy from the motor is also recorded here. When this parameter rolls over, parameter <a href="#">45.02 Saved MW hours</a> is incremented. This parameter is read-only (see parameter <a href="#">45.21 Energy calculations reset</a> ).	-
	0.0...999.9 kWh	Energy savings in kWh.	10 = 1 kWh
45.04	<i>Saved energy</i>	Energy saved in kWh compared to direct-on-line motor connection. This parameter is read-only (see parameter <a href="#">45.21 Energy calculations reset</a> ).	-
	0.0...214748364.7 kWh	Energy savings in kWh.	1 = 1 kWh
45.05	<i>Saved money x1000</i>	Monetary savings in thousands compared to direct-on-line motor connection. This parameter is incremented when <a href="#">45.06 Saved money</a> rolls over. This parameter is read-only (see parameter <a href="#">45.21 Energy calculations reset</a> ).	-
	0...4294967295 thousands	Monetary savings in thousands of units.	1 = 1 unit
45.06	<i>Saved money</i>	Monetary savings compared to direct-on-line motor connection. This value is a calculated by multiplying the saved energy in kWh by the currently active energy tariff ( <a href="#">45.14 Tariff selection</a> ). When this parameter rolls over, parameter <a href="#">45.05 Saved money x1000</a> is incremented. This parameter is read-only (see parameter <a href="#">45.21 Energy calculations reset</a> ).	-
	0.00...999.99 units	Monetary savings.	1 = 1 unit
45.07	<i>Saved amount</i>	Monetary savings compared to direct-on-line motor connection. This value is a calculated by multiplying the saved energy in kWh by the currently active energy tariff ( <a href="#">45.14 Tariff selection</a> ). This parameter is read-only (see parameter <a href="#">45.21 Energy calculations reset</a> ).	-
	0.00... 21474836.47 units	Monetary savings.	1 = 1 unit

No.	Name/Value	Description	Default FbEq 16
45.08	<i>CO2 reduction in kilotons</i>	Reduction in CO <sub>2</sub> emissions in metric kilotons compared to direct-on-line motor connection. This value is incremented when parameter <i>45.09 CO2 reduction in tons</i> rolls over. This parameter is read-only (see parameter <i>45.21 Energy calculations reset</i> ).	-
	0...65535 metric kilotons	Reduction in CO <sub>2</sub> emissions in metric kilotons.	1 = 1 metric kiloton
45.09	<i>CO2 reduction in tons</i>	Reduction in CO <sub>2</sub> emissions in metric tons compared to direct-on-line motor connection. This value is calculated by multiplying the saved energy in MWh by the value of parameter <i>45.18 CO2 conversion factor</i> (by default, 0.5 metric tons/MWh). When this parameter rolls over, parameter <i>45.08 CO2 reduction in kilotons</i> is incremented. This parameter is read-only (see parameter <i>45.21 Energy calculations reset</i> ).	-
	0.0...999.9 metric tons	Reduction in CO <sub>2</sub> emissions in metric tons.	1 = 1 metric ton
45.10	<i>Total saved CO2</i>	Reduction in CO <sub>2</sub> emissions in metric tons compared to direct-on-line motor connection. This value is calculated by multiplying the saved energy in MWh by the value of parameter <i>45.18 CO2 conversion factor</i> (by default, 0.5 metric tons/MWh). This parameter is read-only (see parameter <i>45.21 Energy calculations reset</i> ).	-
	0.0...214748364.7 metric tons	Reduction in CO <sub>2</sub> emissions in metric tons.	1 = 1 metric ton
45.11	<i>Energy optimizer</i>	Enables/disables the energy optimization function. The function optimizes the motor flux so that total energy consumption and motor noise level are reduced when the drive operates below the nominal load. The total efficiency (motor and drive) can be improved by 1...20% depending on load torque and speed. <b>Note:</b> With a permanent magnet motor or a synchronous reluctance motor, energy optimization is always enabled regardless of this parameter.	<i>Disable</i>
	Disable	Energy optimization disabled.	0
	Enable	Energy optimization enabled.	1
45.12	<i>Energy tariff 1</i>	Defines energy tariff 1 (price of energy per kWh). Depending on the setting of parameter <i>45.14 Tariff selection</i> , either this value or <i>45.13 Energy tariff 2</i> is used for reference when monetary savings are calculated. <b>Note:</b> Tariffs are read only at the instant of selection, and are not applied retroactively.	0.100 units
	0.000... 4294967.295 units	Energy tariff 1.	-
45.13	<i>Energy tariff 2</i>	Defines energy tariff 2 (price of energy per kWh). See parameter <i>45.12 Energy tariff 1</i> .	0.200 units
	0.000... 4294967.295 units	Energy tariff 2.	-

No.	Name/Value	Description	Default FbEq 16
45.14	<i>Tariff selection</i>	Selects (or defines a source that selects) which pre-defined energy tariff is used. 0 = <a href="#">45.12 Energy tariff 1</a> 1 = <a href="#">45.13 Energy tariff 2</a>	<a href="#">Energy tariff 1</a>
	Energy tariff 1	0.	0
	Energy tariff 2	1.	1
	DI1	Digital input DI1 ( <a href="#">10.02 DI delayed status</a> , bit 0).	2
	DI2	Digital input DI2 ( <a href="#">10.02 DI delayed status</a> , bit 1).	3
	DI3	Digital input DI3 ( <a href="#">10.02 DI delayed status</a> , bit 2).	4
	DI4	Digital input DI4 ( <a href="#">10.02 DI delayed status</a> , bit 3).	5
	<i>Other [bit]</i>	Source selection (see <a href="#">Terms and abbreviations</a> ).	-
45.18	<i>CO2 conversion factor</i>	Defines a factor for conversion of saved energy into CO <sub>2</sub> emissions (kg/kWh or tn/MWh). For example, <a href="#">45.10 Total saved CO2</a> = <a href="#">45.02 Saved kW hours</a> × <a href="#">45.18 CO2 conversion factor</a> (tn/MWh).	0.500 tn/MWh
	0.000...65.535 tn/MWh	Factor for conversion of saved energy into CO <sub>2</sub> emissions.	1 = 1 tn/MWh
45.19	<i>Comparison power</i>	Actual power that the motor absorbs when connected direct-on-line and operating the application. The value is used for reference when energy savings are calculated. <b>Note:</b> The accuracy of the energy savings calculation is directly dependent on the accuracy of this value. If nothing is entered here, then the nominal motor power is used by the calculation, but that may inflate the energy savings reported as many motors do not absorb nameplate power.	0.00 kW
	0.00...100000.00 kW	Motor power.	1 = 1 kW
45.21	<i>Energy calculations reset</i>	Resets the savings counter parameters <a href="#">45.01...45.10</a> .	<a href="#">Done</a>
	Done	Reset not requested (normal operation), or reset complete.	0
	Reset	Reset the savings counter parameters. The value reverts automatically to <a href="#">Done</a> .	1
45.24	<i>Hourly peak power value</i>	Value of the peak power during the last hour, that is, the most recent 60 minutes after the drive has been powered up. The parameter is updated once every 10 minutes unless the hourly peak is found in the most recent 10 minutes. In that case, the values is shown immediately.	0.00 kW
	-3000.00 ... 3000.00 kW	Peak power value.	10 = 1 kW
45.25	<i>Hourly peak power time</i>	Time of the peak power value during the last hour.	00:00:00
		Time.	N/A
45.26	<i>Hourly total energy (resettable)</i>	Total energy consumption during the last hour, that is, the most recent 60 minutes. You can reset the value by setting it to zero.	0.00 kWh
	-3000.00 ... 3000.00 kWh	Total energy.	10 = 1 kWh

No.	Name/Value	Description	Default FbEq 16
45.27	<i>Daily peak power value (resettable)</i>	Value of the peak power since midnight of the present day. You can reset the value by setting it to zero.	0.00 kW
	-3000.00 ... 3000.00 kW	Peak power value.	10 = 1 kW
45.28	<i>Daily peak power time</i>	Time of the peak power since midnight of the present day.	00:00:00
		Time.	N/A
45.29	<i>Daily total energy (resettable)</i>	Total energy consumption since midnight of the present day. You can reset the value by setting it to zero.	0.00 kWh
	-30000.00 ... 30000.00 kWh	Total energy.	1 = 1 kWh
45.30	<i>Last day total energy</i>	Total energy consumption during the previous day, that is, between midnight of the previous day and midnight of the present day	0.00 kWh
	-30000.00 ... 30000.00 kWh	Total energy.	1 = 1 kWh
45.31	<i>Monthly peak power value (resettable)</i>	Value of the peak power during the present month, that is, since midnight of the first day of the present month. You can reset the value by setting it to zero.	0.00 kW
	-3000.00 ... 3000.00 kW	Peak power value.	10 = 1 kW
45.32	<i>Monthly peak power date</i>	Date of the peak power during the present month.	1/1/1980
	1/1/1980...6/5/2159	Date.	N/A
45.33	<i>Monthly peak power time</i>	Time of the peak power during the present month.	00:00:00
		Time.	N/A
45.34	<i>Monthly total energy (resettable)</i>	Total energy consumption from the beginning of the present month. You can reset the value by setting it to zero.	0.00 kWh
	-1000000.00 ... 1000000.00 kWh	Total energy.	0.01 = 1 kWh
45.35	<i>Last month total energy</i>	Total energy consumption during the previous month, that is, between midnight of the first day or the previous month and midnight of the first day of the present month.	0.00 kWh
	-1000000.00 ... 1000000.00 kWh		0.01 = 1 kWh
45.36	<i>Lifetime peak power value</i>	Value of the peak power over the drive lifetime.	0.00 kW
	-3000.00 ... 3000.00 kW	Peak power value.	10 = 1 kW
45.37	<i>Lifetime peak power date</i>	Date of the peak power over the drive lifetime.	1/1/1980
		Date.	N/A
45.38	<i>Lifetime peak power time</i>	Time of the peak power over the drive lifetime.	00:00:00
		Time.	N/A



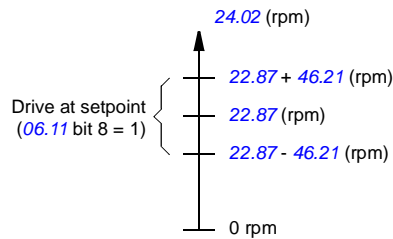

No.	Name/Value	Description	Default FbEq 16
<b>46 Monitoring/scaling settings</b>			
Speed supervision settings; actual signal filtering; general scaling settings.			
46.01	<i>Speed scaling</i>	Defines the maximum speed value used to define the acceleration ramp rate and the initial speed value used to define the deceleration ramp rate (see parameter group <a href="#">23 Speed reference ramp</a> ). The speed acceleration and deceleration ramp times are therefore related to this value ( <b>not</b> to parameter <a href="#">30.12 Maximum speed</a> ). Also defines the 16-bit scaling of speed-related parameters. The value of this parameter corresponds to 20000 in eg. fieldbus communication.	1500.00 rpm
	0.10...30000.00 rpm	Acceleration/deceleration terminal/initial speed.	1 = 1 rpm
46.02	<i>Frequency scaling</i>	Defines the maximum frequency value used to define the acceleration ramp rate and the initial frequency value used to define deceleration ramp rate (see parameter group <a href="#">28 Frequency reference chain</a> ). The frequency acceleration and deceleration ramp times are therefore related to this value ( <b>not</b> to parameter <a href="#">30.14 Maximum frequency</a> ). Also defines the 16-bit scaling of frequency-related parameters. The value of this parameter corresponds to 20000 in eg. fieldbus communication.	50.00 Hz
	0.10...1000.00 Hz	Acceleration/deceleration terminal/initial frequency.	10 = 1 Hz
46.03	<i>Torque scaling</i>	Defines the 16-bit scaling of torque parameters. The value of this parameter (in percent of nominal motor torque) corresponds to 10000 in eg. fieldbus communication.	100.0%
	0.1...1000.0%	Torque corresponding to 10000 on fieldbus.	10 = 1%
46.04	<i>Power scaling</i>	Defines the output power value that corresponds to 10000 in eg. fieldbus communication. The unit is selected by parameter <a href="#">96.16 Unit selection</a> .	1000.00
	0.10...30000.00	Power corresponding to 10000 on fieldbus.	1 = 1 unit
46.05	<i>Current scaling</i>	Defines the 16-bit scaling of current parameters. The value of this parameter corresponds to 10000 in fieldbus communication.	10000 A
	0...30000 A		
46.06	<i>Speed ref zero scaling</i>	Defines a speed corresponding to a zero reference received from fieldbus (either the embedded fieldbus interface, or interface FBA A). For example, with a setting of 500, the fieldbus reference range of 0...20000 would correspond to a speed of 500...[ <a href="#">46.01</a> ] rpm. <b>Note:</b> This parameter is effective only with the ABB Drives communication profile.	0.00 rpm
	0.00 ... 30000.00 rpm	Speed corresponding to minimum fieldbus reference.	1 = 1 rpm
46.07	<i>Frequency ref zero scaling</i>	Defines a frequency corresponding to a zero reference received from fieldbus (either the embedded fieldbus interface, or interface FBA A or FBA B). For example, with a setting of 30, the fieldbus reference range of 0...20000 would correspond to a speed of 30...[ <a href="#">46.02</a> ] Hz. <b>Note:</b> This parameter is effective only with the ABB Drives communication profile.	0.00 Hz
	0.00 ... 1000.00 Hz	Speed corresponding to minimum fieldbus reference.	10 = 1 Hz

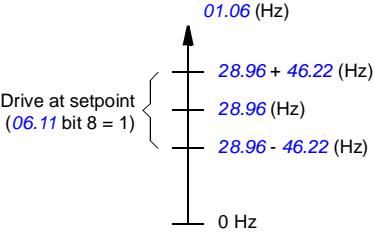
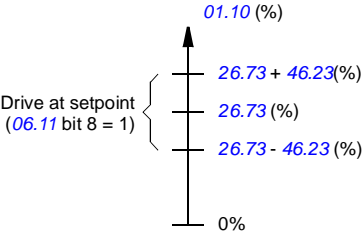

No.	Name/Value	Description	Default FbEq 16
46.11	<i>Filter time motor speed</i>	Defines a filter time for signals <i>01.01 Motor speed used</i> and <i>01.02 Motor speed estimated</i> .	500 ms
	2...20000 ms	Motor speed signal filter time.	1 = 1 ms
46.12	<i>Filter time output frequency</i>	Defines a filter time for signal <i>01.06 Output frequency</i> .	500 ms
	2...20000 ms	Output frequency signal filter time.	1 = 1 ms
46.13	<i>Filter time motor torque</i>	Defines a filter time for signal <i>01.10 Motor torque</i> .	100 ms
	2...20000 ms	Motor torque signal filter time.	1 = 1 ms
46.14	<i>Filter time power</i>	Defines a filter time for signal <i>01.14 Output power</i> .	100 ms
	2...20000 ms	Output power signal filter time.	1 = 1 ms
46.21	<i>At speed hysteresis</i>	<p>Defines the “at setpoint” limits for speed control of the drive.</p> <p>When the difference between reference (<i>22.87 Speed reference act 7</i>) and the speed (<i>24.02 Used speed feedback</i>) is smaller than <i>46.21 At speed hysteresis</i>, the drive is considered to be “at setpoint”. This is indicated by bit 8 of <i>06.11 Main status word</i>.</p> 	50.00 rpm
	0.00...30000.00 rpm	Limit for “at setpoint” indication in speed control.	See par. <i>46.01</i>

No.	Name/Value	Description	Default FbEq 16
46.22	<i>At frequency hysteresis</i>	<p>Defines the “at setpoint” limits for frequency control of the drive. When the absolute difference between reference (28.96 <i>Frequency ref ramp input</i>) and actual frequency (01.06 <i>Output frequency</i>) is smaller than 46.22 <i>At frequency hysteresis</i>, the drive is considered to be “at setpoint”. This is indicated by bit 8 of 06.11 <i>Main status word</i>.</p> 	2.00 Hz
	0.00...1000.00 Hz	Limit for “at setpoint” indication in frequency control.	See par. 46.02
46.23	<i>At torque hysteresis</i>	<p>Defines the “at setpoint” limits for torque control of the drive. When the absolute difference between reference (26.73 <i>Torque reference act 4</i>) and actual torque (01.10 <i>Motor torque</i>) is smaller than 46.23 <i>At torque hysteresis</i>, the drive is considered to be “at setpoint”. This is indicated by bit 8 of 06.11 <i>Main status word</i></p> 	5.0%
	0.0...300.0%	Limit for “at setpoint” indication in torque control.	See par. 46.03
46.31	<i>Above speed limit</i>	Defines the trigger level for “above limit” indication in speed control. When actual speed exceeds the limit, bit 10 of 06.17 <i>Drive status word 2</i> is set.	0.00 rpm
	0.00...30000.00 rpm	“Above limit” indication trigger level for speed control.	See par. 46.01
46.32	<i>Above frequency limit</i>	Defines the trigger level for “above limit” indication in frequency control. When actual frequency exceeds the limit, bit 10 of 06.17 <i>Drive status word 2</i> is set.	0.00 Hz
	0.00...1000.00 Hz	“Above limit” indication trigger level for frequency control.	See par. 46.02

No.	Name/Value	Description	Default FbEq 16
46.33	<i>Above torque limit</i>	Defines the trigger level for "above limit" indication in torque control. When actual torque exceeds the limit, bit 10 of <i>06.17 Drive status word 2</i> is set.	0.0%
	0.0...1600.0%	"Above limit" indication trigger level for torque control.	See par. <a href="#">46.03</a>
46.41	<i>kWh pulse scaling</i>	Defines the trigger level for the "kWh pulse" on for 50 ms. The output of the pulse is bit 9 of <i>05.22 Diagnostic word 3</i> .	1.000 kWh
	0.001... 1000.000 kWh	"kWh pulse" on trigger level.	1 = 1 kWh
<b>47 Data storage</b>		Data storage parameters that can be written to and read from using other parameters' source and target settings. Note that there are different storage parameters for different data types. See also section <i>Data storage parameters</i> (page 107).	
47.01	<i>Data storage 1 real32</i>	Data storage parameter 1.	0.000
	-2147483.008... 2147483.008	32-bit data.	-
47.02	<i>Data storage 2 real32</i>	Data storage parameter 2.	0.000
	-2147483.008... 2147483.008	32-bit data.	-
47.03	<i>Data storage 3 real32</i>	Data storage parameter 3.	0.000
	-2147483.008... 2147483.008	32-bit data.	-
47.04	<i>Data storage 4 real32</i>	Data storage parameter 4.	0.000
	-2147483.008... 2147483.008	32-bit data.	-
47.11	<i>Data storage 1 int32</i>	Data storage parameter 9.	0
	-2147483648... 2147483647	32-bit data.	-
47.12	<i>Data storage 2 int32</i>	Data storage parameter 10.	0
	-2147483648... 2147483647	32-bit data.	-
47.13	<i>Data storage 3 int32</i>	Data storage parameter 11.	0
	-2147483648... 2147483647	32-bit data.	-
47.14	<i>Data storage 4 int32</i>	Data storage parameter 12.	0
	-2147483648... 2147483647	32-bit data.	-
47.21	<i>Data storage 1 int16</i>	Data storage parameter 17.	0
	-32768...32767	16-bit data.	1 = 1
47.22	<i>Data storage 2 int16</i>	Data storage parameter 18.	0
	-32768...32767	16-bit data.	1 = 1
47.23	<i>Data storage 3 int16</i>	Data storage parameter 19.	0
	-32768...32767	16-bit data.	1 = 1

No.	Name/Value	Description	Default FbEq 16
47.24	<a href="#">Data storage 4 int16</a>	Data storage parameter 20.	0
	-32768...32767	16-bit data.	1 = 1
<b>49 Panel port communication</b>		Communication settings for the control panel port on the drive.	
49.01	<a href="#">Node ID number</a>	Defines the node ID of the drive. All devices connected to the network must have a unique node ID. <b>Note:</b> For networked drives, it is advisable to reserve ID 1 for spare/replacement drives.	1
	1...32	Node ID.	1 = 1
49.03	<a href="#">Baud rate</a>	Defines the transfer rate of the link.	<a href="#">115.2 kbps</a>
	38.4 kbps	38.4 kbit/s.	1
	57.6 kbps	57.6 kbit/s.	2
	86.4 kbps	86.4 kbit/s.	3
	115.2 kbps	115.2 kbit/s.	4
	230.4 kbps	230.4 kbit/s.	5
49.04	<a href="#">Communication loss time</a>	Sets a timeout for control panel (or PC tool) communication. If a communication break lasts longer than the timeout, the action specified by parameter <a href="#">49.05 Communication loss action</a> is taken.	10.0 s
	0.3...3000.0 s	Panel/PC tool communication timeout.	10 = 1 s
49.05	<a href="#">Communication loss action</a>	Selects how the drive reacts to a control panel (or PC tool) communication break.	<a href="#">Fault</a>
	No action	No action taken.	0
	Fault	Drive trips on <a href="#">7081 Control panel loss</a> .	1
	Last speed	Drive generates an <a href="#">A7EE Panel loss</a> warning and freezes the speed to the level the drive was operating at. The speed is determined on the basis of actual speed using 850 ms low-pass filtering.  <b>WARNING!</b> Make sure that it is safe to continue operation in case of a communication break.	2
	Speed ref safe	Drive generates an <a href="#">A7EE Panel loss</a> warning and sets the speed to the speed defined by parameter <a href="#">22.41 Speed ref safe</a> (or <a href="#">28.41 Frequency ref safe</a> when frequency reference is being used).  <b>WARNING!</b> Make sure that it is safe to continue operation in case of a communication break.	3
49.06	<a href="#">Refresh settings</a>	Applies the settings of parameters <a href="#">49.01...49.05</a> . <b>Note:</b> Refreshing may cause a communication break, so reconnecting the drive may be required.	<a href="#">Done</a>
	Done	Refresh done or not requested.	0
	Configure	Refresh parameters <a href="#">49.01...49.05</a> . The value reverts automatically to <a href="#">Done</a> .	1
49.19	<a href="#">Basic panel home view 1</a>	Selects the parameters that are shown in <i>Home view 1</i> of the integrated or Basic panel (ACS-BP-S).	<a href="#">Zero</a>
	Zero	Shows the factory default parameters.	0
	Motor speed used	<a href="#">01.01 Motor speed used</a>	1
	Output frequency	<a href="#">01.06 Output frequency</a>	3

No.	Name/Value	Description	Default FbEq 16
	Motor current	<a href="#">01.07 Motor current</a>	4
	Motor current % of motor nominal	<a href="#">01.08 Motor current % of motor nom</a>	5
	Motor torque	<a href="#">01.10 Motor torque</a>	6
	DC voltage	<a href="#">01.11 DC voltage</a>	7
	Output power	<a href="#">01.14 Output power</a>	8
	Speed ref ramp in	<a href="#">23.01 Speed ref ramp input</a>	10
	Speed ref ramp out	<a href="#">23.02 Speed ref ramp output</a>	11
	Speed ref used	<a href="#">24.01 Used speed reference</a>	12
	Freq ref used	<a href="#">28.02 Frequency ref ramp output</a>	14
	Process PID out	<a href="#">40.01 Process PID output actual</a>	16
	Temp sensor 1 excitation	The output is used to feed an excitation current to the temperature sensor 1, see parameter <a href="#">35.11 Temperature 1 source</a> . See also section <a href="#">Motor thermal protection</a> (page 98).	20
	Temp sensor 2 excitation	The output is used to feed an excitation current to the temperature sensor 2, see parameter <a href="#">35.21 Temperature 2 source</a> . See also section <a href="#">Motor thermal protection</a> (page 98).	21
	Abs motor speed used	<a href="#">01.61 Abs motor speed used</a>	26
	Abs motor speed %	<a href="#">01.62 Abs motor speed %</a>	27
	Abs output frequency	<a href="#">01.63 Abs output frequency</a>	28
	Abs motor torque	<a href="#">01.64 Abs motor torque</a>	30
	Abs output power	<a href="#">01.66 Abs output power</a>	31
	Abs motor shaft power	<a href="#">01.68 Abs motor shaft power</a>	32
	External PID1 out	<a href="#">71.01 External PID act value</a>	33
	AO1 data storage	<a href="#">13.91 AO1 data storage.</a>	37
	<i>Other</i>		
<a href="#">49.20</a>	<a href="#">Basic panel home view 2</a>	Selects the parameters that are shown in <i>Home view 2</i> of the integrated or Basic panel (ACS-BP-S). See parameter <a href="#">49.19</a> for the selection.	<i>Zero</i>
<a href="#">49.21</a>	<a href="#">Basic panel home view 3</a>	Selects the parameters that are shown in <i>Home view 3</i> of the integrated or Basic panel (ACS-BP-S). See parameter <a href="#">49.19</a> for the selection.	<i>Zero</i>
<a href="#">49.30</a>	<a href="#">Basic panel menu hiding</a>	Parameter to hide main level menus in the integrated or Basic panel (ACS-BP-S). Values are: 0 = Menu visible 1 = Menu hidden	0000h

No.	Name/Value	Description	Default FbEq 16																
	<table border="1"> <thead> <tr> <th>Bit</th> <th>Value</th> </tr> </thead> <tbody> <tr> <td>0</td> <td>Motor data</td> </tr> <tr> <td>1</td> <td>Motor control</td> </tr> <tr> <td>2</td> <td>Control macros</td> </tr> <tr> <td>3</td> <td>Diagnostics</td> </tr> <tr> <td>4</td> <td>Energy efficiency</td> </tr> <tr> <td>5</td> <td>Parameters</td> </tr> <tr> <td>6...15</td> <td>Reserved</td> </tr> </tbody> </table>	Bit	Value	0	Motor data	1	Motor control	2	Control macros	3	Diagnostics	4	Energy efficiency	5	Parameters	6...15	Reserved		
Bit	Value																		
0	Motor data																		
1	Motor control																		
2	Control macros																		
3	Diagnostics																		
4	Energy efficiency																		
5	Parameters																		
6...15	Reserved																		
	000h...FFFh		1=1																
	<b>50 Fieldbus adapter (FBA)</b>	Fieldbus communication configuration. See also chapter <i>Fieldbus control through a fieldbus adapter</i> (page 481).																	
50.01	<i>FBA A enable</i>	Enables/disables communication between the drive and fieldbus adapter A, and specifies the slot the adapter is installed into.	<i>Disable</i>																
	Disable	Communication between drive and fieldbus adapter A disabled.	0																
	Enable	Communication between drive and fieldbus adapter A enabled. The adapter is in slot 1.	1																
50.02	<i>FBA A comm loss func</i>	Selects how the drive reacts upon a fieldbus communication break. The time delay is defined by parameter <i>50.03 FBA A comm loss t out</i> .	<i>No action</i>																
	No action	No action taken.	0																
	Fault	Communication break detection active. Upon a communication break, the drive trips on a <i>7510 FBA A communication</i> fault and coasts to a stop.	1																
	Last speed	Communication break detection active. Upon a communication break, the drive generates a warning ( <i>A7C1 FBA A communication</i> ) and freezes the speed to the level the drive was operating at. The speed is determined on the basis of actual speed using 850 ms low-pass filtering.  <b>WARNING!</b> Make sure that it is safe to continue operation in case of a communication break.	2																
	Speed ref safe	Communication break detection active. Upon a communication break, the drive generates a warning ( <i>A7C1 FBA A communication</i> ) and sets the speed to the value defined by parameter <i>22.41 Speed ref safe</i> (or <i>28.41 Frequency ref safe</i> when frequency reference is being used).  <b>WARNING!</b> Make sure that it is safe to continue operation in case of a communication break.	3																
	Fault always	The machinery control unit trips on a communication fault even though no control is expected from the fieldbus.	4																
	Warning	The machinery control unit generates a communication warning even though no control is expected from the fieldbus.	5																

No.	Name/Value	Description	Default FbEq 16								
50.03	<i>FBA A comm loss t out</i>	Defines the time delay before the action defined by parameter <i>50.02 FBA A comm loss func</i> is taken. Time count starts when the communication link fails to update the message. <b>Note:</b> There is a 60-second boot-up delay immediately after power-up. During the delay, the communication break monitoring is disabled (but communication itself can be active).	0.3 s								
	0.3...6553.5 s	Time delay.	1 = 1 s								
50.04	<i>FBA A ref1 type</i>	Selects the type and scaling of reference 1 received from fieldbus adapter A. The scaling of the reference is defined by parameters <i>46.01...46.04</i> , depending on which reference type is selected by this parameter.	<i>Speed or frequency</i>								
	Speed or frequency	Type and scaling is chosen automatically according to the currently active operation mode as follows:	0								
		<table border="1"> <thead> <tr> <th>Operation mode (see par. 19.01)</th> <th>Reference 1 type</th> </tr> </thead> <tbody> <tr> <td>Speed control</td> <td><i>Speed</i></td> </tr> <tr> <td>Torque control</td> <td><i>Speed</i></td> </tr> <tr> <td>Frequency control</td> <td><i>Frequency</i></td> </tr> </tbody> </table>	Operation mode (see par. 19.01)	Reference 1 type	Speed control	<i>Speed</i>	Torque control	<i>Speed</i>	Frequency control	<i>Frequency</i>	
Operation mode (see par. 19.01)	Reference 1 type										
Speed control	<i>Speed</i>										
Torque control	<i>Speed</i>										
Frequency control	<i>Frequency</i>										
	Transparent	No scaling is applied.	1								
	General	Generic reference without a specific unit.	2								
	Torque	The scaling is defined by parameter <i>46.03 Torque scaling</i> .	3								
	Speed	The scaling is defined by parameter <i>46.01 Speed scaling</i> .	4								
	Frequency	The scaling is defined by parameter <i>46.02 Frequency scaling</i> .	5								
50.05	<i>FBA A ref2 type</i>	Selects the type and scaling of reference 2 received from fieldbus adapter A. The scaling of the reference is defined by parameters <i>46.01...46.04</i> , depending on which reference type is selected by this parameter.	<i>Speed or frequency</i>								
	Speed or frequency	Type and scaling is chosen automatically according to the currently active operation mode as follows:	0								
		<table border="1"> <thead> <tr> <th>Operation mode (see par. 19.01)</th> <th>Reference 2 type</th> </tr> </thead> <tbody> <tr> <td>Speed control</td> <td><i>Torque</i></td> </tr> <tr> <td>Torque control</td> <td><i>Torque</i></td> </tr> <tr> <td>Frequency control</td> <td><i>Torque</i></td> </tr> </tbody> </table>	Operation mode (see par. 19.01)	Reference 2 type	Speed control	<i>Torque</i>	Torque control	<i>Torque</i>	Frequency control	<i>Torque</i>	
Operation mode (see par. 19.01)	Reference 2 type										
Speed control	<i>Torque</i>										
Torque control	<i>Torque</i>										
Frequency control	<i>Torque</i>										
	Transparent	No scaling is applied.	1								
	General	Generic reference without a specific unit.	2								
	Torque	The scaling is defined by parameter <i>46.03 Torque scaling</i> .	3								
	Speed	The scaling is defined by parameter <i>46.01 Speed scaling</i> .	4								
	Frequency	The scaling is defined by parameter <i>46.02 Frequency scaling</i> .	5								
50.06	<i>FBA A SW sel</i>	Selects the source of the status word to be sent to the fieldbus network through fieldbus adapter A.	<i>Auto</i>								
	Auto	Source of the status word is chosen automatically.	0								



No.	Name/Value	Description	Default FbEq 16												
	Transparent mode	The source selected by parameter <a href="#">50.09 FBA A SW transparent source</a> is transmitted as the status word to the fieldbus network through fieldbus adapter A.	1												
<a href="#">50.07</a>	<a href="#">FBA A actual 1 type</a>	Selects the type and scaling of actual value 1 transmitted to the fieldbus network through fieldbus adapter A. The scaling of the value is defined by parameters <a href="#">46.01...46.04</a> , depending on which actual value type is selected by this parameter.	<a href="#">Speed or frequency</a>												
	Speed or frequency	Type and scaling is chosen automatically according to the currently active operation mode as follows:	0												
<table border="1"> <thead> <tr> <th>Operation mode (see par. <a href="#">19.01</a>)</th> <th>Actual value 1 type (source)</th> <th>Scaling</th> </tr> </thead> <tbody> <tr> <td>Speed control</td> <td><a href="#">Speed</a> (<a href="#">01.01 Motor speed used</a>)</td> <td><a href="#">46.01 Speed scaling</a></td> </tr> <tr> <td>Torque control</td> <td></td> <td></td> </tr> <tr> <td>Frequency control</td> <td><a href="#">Frequency</a> (<a href="#">01.06 Output frequency</a>)</td> <td><a href="#">46.02 Frequency scaling</a></td> </tr> </tbody> </table>				Operation mode (see par. <a href="#">19.01</a> )	Actual value 1 type (source)	Scaling	Speed control	<a href="#">Speed</a> ( <a href="#">01.01 Motor speed used</a> )	<a href="#">46.01 Speed scaling</a>	Torque control			Frequency control	<a href="#">Frequency</a> ( <a href="#">01.06 Output frequency</a> )	<a href="#">46.02 Frequency scaling</a>
Operation mode (see par. <a href="#">19.01</a> )	Actual value 1 type (source)	Scaling													
Speed control	<a href="#">Speed</a> ( <a href="#">01.01 Motor speed used</a> )	<a href="#">46.01 Speed scaling</a>													
Torque control															
Frequency control	<a href="#">Frequency</a> ( <a href="#">01.06 Output frequency</a> )	<a href="#">46.02 Frequency scaling</a>													
	Transparent	No scaling is applied.	1												
	General	Generic reference without a specific unit.	2												
	Torque	The scaling is defined by parameter <a href="#">46.03 Torque scaling</a> .	3												
	Speed	The scaling is defined by parameter <a href="#">46.01 Speed scaling</a> .	4												
	Frequency	The scaling is defined by parameter <a href="#">46.02 Frequency scaling</a> .	5												
<a href="#">50.08</a>	<a href="#">FBA A actual 2 type</a>	Selects the type and scaling of actual value 2 transmitted to the fieldbus network through fieldbus adapter A. The scaling of the value is defined by parameters <a href="#">46.01...46.04</a> , depending on which actual value type is selected by this parameter.	<a href="#">Speed or frequency</a>												
	Speed or frequency	Type and scaling is chosen automatically according to the currently active operation mode as follows:	0												
<table border="1"> <thead> <tr> <th>Operation mode (see par. <a href="#">19.01</a>)</th> <th>Actual value 2 type</th> <th>Scaling</th> </tr> </thead> <tbody> <tr> <td>Speed control</td> <td><a href="#">Speed</a> (<a href="#">01.01 Motor speed used</a>)</td> <td><a href="#">46.01 Speed scaling</a></td> </tr> <tr> <td>Torque control</td> <td></td> <td></td> </tr> <tr> <td>Frequency control</td> <td><a href="#">Frequency</a> (<a href="#">01.06 Output frequency</a>)</td> <td><a href="#">46.02 Frequency scaling</a></td> </tr> </tbody> </table>				Operation mode (see par. <a href="#">19.01</a> )	Actual value 2 type	Scaling	Speed control	<a href="#">Speed</a> ( <a href="#">01.01 Motor speed used</a> )	<a href="#">46.01 Speed scaling</a>	Torque control			Frequency control	<a href="#">Frequency</a> ( <a href="#">01.06 Output frequency</a> )	<a href="#">46.02 Frequency scaling</a>
Operation mode (see par. <a href="#">19.01</a> )	Actual value 2 type	Scaling													
Speed control	<a href="#">Speed</a> ( <a href="#">01.01 Motor speed used</a> )	<a href="#">46.01 Speed scaling</a>													
Torque control															
Frequency control	<a href="#">Frequency</a> ( <a href="#">01.06 Output frequency</a> )	<a href="#">46.02 Frequency scaling</a>													
	Transparent	The value selected by parameter <a href="#">50.11 FBA A act2 transparent source</a> is sent as actual value 2. No scaling is applied (the 16-bit scaling is 1=1 unit).	1												
	General	The value selected by parameter <a href="#">50.11 FBA A act2 transparent source</a> is sent as actual value 2 with a 16-bit scaling of 100=1 unit (i.e. integer and two decimals).	2												
	Torque	<a href="#">01.01 Motor speed used</a> is sent as actual value 2. The scaling is defined by parameter <a href="#">46.03 Torque scaling</a> .	3												

No.	Name/Value	Description	Default FbEq 16
	Speed	<a href="#">01.01 Motor speed used</a> is sent as actual value 2. The scaling is defined by parameter <a href="#">46.01 Speed scaling</a> .	4
	Frequency	<a href="#">01.06 Output frequency</a> is sent as actual value 2. The scaling is defined by parameter <a href="#">46.02 Frequency scaling</a> .	5
<a href="#">50.09</a>	<a href="#">FBA A SW transparent source</a>	Selects the source of the fieldbus status word when parameter <a href="#">50.06 FBA A SW sel</a> is set to <a href="#">Transparent mode</a> .	<a href="#">Not selected</a>
	Not selected	No source selected.	-
	<a href="#">Other</a>	Source selection (see <a href="#">Terms and abbreviations</a> ).	-
<a href="#">50.10</a>	<a href="#">FBA A act1 transparent source</a>	When parameter <a href="#">50.07 FBA A actual 1 type</a> is set to <a href="#">Transparent</a> , this parameter selects the source of actual value 1 transmitted to the fieldbus network through fieldbus adapter A.	<a href="#">Not selected</a>
	Not selected	No source selected.	-
	<a href="#">Other</a>	Source selection (see <a href="#">Terms and abbreviations</a> ).	-
<a href="#">50.11</a>	<a href="#">FBA A act2 transparent source</a>	When parameter <a href="#">50.08 FBA A actual 2 type</a> is set to <a href="#">Transparent</a> , this parameter selects the source of actual value 2 transmitted to the fieldbus network through fieldbus adapter A.	<a href="#">Not selected</a>
	Not selected	No source selected.	-
	<a href="#">Other</a>	Source selection (see <a href="#">Terms and abbreviations</a> ).	-
<a href="#">50.12</a>	<a href="#">FBA A debug mode</a>	This parameter enables debug mode. Displays raw (unmodified) data received from and sent to fieldbus adapter A in parameters <a href="#">50.13...50.18</a> .	<a href="#">Disable</a>
	Disable	Debug mode disabled.	0
	Fast	Debug mode enabled. Cyclical data update is as fast as possible which increases CPU load on the drive.	1
<a href="#">50.13</a>	<a href="#">FBA A control word</a>	Displays the raw (unmodified) control word sent by the master (PLC) to fieldbus adapter A if debugging is enabled by parameter <a href="#">50.12 FBA A debug mode</a> . This parameter is read-only.	-
	0000000h... FFFFFFFh	Control word sent by master to fieldbus adapter A.	-
<a href="#">50.14</a>	<a href="#">FBA A reference 1</a>	Displays raw (unmodified) reference REF1 sent by the master (PLC) to fieldbus adapter A if debugging is enabled by parameter <a href="#">50.12 FBA A debug mode</a> . This parameter is read-only.	-
	-2147483648... 2147483647	Raw REF1 sent by master to fieldbus adapter A.	-
<a href="#">50.15</a>	<a href="#">FBA A reference 2</a>	Displays raw (unmodified) reference REF2 sent by the master (PLC) to fieldbus adapter A if debugging is enabled by parameter <a href="#">50.12 FBA A debug mode</a> . This parameter is read-only.	-
	-2147483648... 2147483647	Raw REF2 sent by master to fieldbus adapter A.	-

No.	Name/Value	Description	Default FbEq 16
50.16	<i>FBA A status word</i>	Displays the raw (unmodified) status word sent by fieldbus adapter A to the master (PLC) if debugging is enabled by parameter <a href="#">50.12 FBA A debug mode</a> . This parameter is read-only.	-
	00000000h... FFFFFFFFh	Status word sent by fieldbus adapter A to master.	-
50.17	<i>FBA A actual value 1</i>	Displays raw (unmodified) actual value ACT1 sent by fieldbus adapter A to the master (PLC) if debugging is enabled by parameter <a href="#">50.12 FBA A debug mode</a> . This parameter is read-only.	-
	-2147483648... 2147483647	Raw ACT1 sent by fieldbus adapter A to master.	-
50.18	<i>FBA A actual value 2</i>	Displays raw (unmodified) actual value ACT2 sent by fieldbus adapter A to the master (PLC) if debugging is enabled by parameter <a href="#">50.12 FBA A debug mode</a> . This parameter is read-only.	-
	-2147483648... 2147483647	Raw ACT2 sent by fieldbus adapter A to master.	-
<b>51 FBA A settings</b>		Fieldbus adapter A configuration.	
51.01	<i>FBA A type</i>	Displays the type of the connected fieldbus adapter module. <b>0</b> = Module is not found or is not properly connected, or is disabled by parameter <a href="#">50.01 FBA A enable</a> ; <b>0</b> = None; <b>1</b> = PROFIBUS DP; <b>32</b> = CANopen; <b>37</b> = DeviceNet; <b>128</b> = Ethernet; <b>132</b> = PROFINET IO; <b>135</b> = EtherCAT; <b>136</b> = ETH Pwrlink; <b>485</b> = RS-485 comm; <b>101</b> = ControlNet; This parameter is read-only.	-
51.02	<i>FBA A Par2</i>	Parameters <a href="#">51.02</a> ... <a href="#">51.26</a> are adapter module-specific. For more information, see the documentation of the fieldbus adapter module. Note that not all of these parameters are necessarily in use.	-
	0...65535	Fieldbus adapter configuration parameter.	1 = 1
	...	...	...
51.26	<i>FBA A Par26</i>	See parameter <a href="#">51.02 FBA A Par2</a> .	-
	0...65535	Fieldbus adapter configuration parameter.	1 = 1
51.27	<i>FBA A par refresh</i>	Validates any changed fieldbus adapter module configuration settings. After refreshing, the value reverts automatically to <a href="#">Done</a> . <b>Note:</b> This parameter cannot be changed while the drive is running.	<i>Done</i>
	Done	Refreshing done.	0
	Configure	Refreshing.	1
51.28	<i>FBA A par table ver</i>	Displays the parameter table revision of the fieldbus adapter module mapping file (stored in the memory of the drive). In format axyz, where ax = major table revision number; yz = minor table revision number. This parameter is read-only.	-
		Parameter table revision of adapter module.	-

No.	Name/Value	Description	Default FbEq 16
51.29	<i>FBA A drive type code</i>	Displays the drive type code in the fieldbus adapter module mapping file (stored in the memory of the drive). This parameter is read-only.	-
	0...65535	Drive type code stored in the mapping file.	1 = 1
51.30	<i>FBA A mapping file ver</i>	Displays the fieldbus adapter module mapping file revision stored in the memory of the drive in decimal format. This parameter is read-only.	-
	0...65535	Mapping file revision.	1 = 1
51.31	<i>D2FBA A comm status</i>	Displays the status of the fieldbus adapter module communication.	<i>Not configured</i>
	Not configured	Adapter is not configured.	0
	Initializing	Adapter is initializing.	1
	Time out	A timeout has occurred in the communication between the adapter and the drive.	2
	Configuration error	Adapter configuration error: mapping file not found in the file system of the drive, or mapping file upload has failed more than three times.	3
	Off-line	Fieldbus communication is off-line.	4
	On-line	Fieldbus communication is on-line, or fieldbus adapter has been configured not to detect a communication break. For more information, see the documentation of the fieldbus adapter.	5
	Reset	Adapter is performing a hardware reset.	6
51.32	<i>FBA A comm SW ver</i>	Displays the common program revision of the adapter module in format axyz, where a = major revision number, xy = minor revision number, z = correction number or letter. Example: 190A = revision 1.90A.	
		Common program revision of adapter module.	-
51.33	<i>FBA A appl SW ver</i>	Displays the application program revision of the adapter module in format axyz, where a = major revision number, xy = minor revision number, z = correction number or letter. Example: 190A = revision 1.90A.	
		Application program version of adapter module.	-
<b>52 FBA A data in</b>		Selection of data to be transferred from drive to fieldbus controller through fieldbus adapter A. <b>Note:</b> 32-bit values require two consecutive parameters. Whenever a 32-bit value is selected in a data parameter, the next parameter is automatically reserved.	
52.01	<i>FBA A data in1</i>	Parameters <a href="#">52.01</a> ... <a href="#">52.12</a> select data to be transferred from the drive to the fieldbus controller through fieldbus adapter A.	<i>None</i>
	None	None.	0
	CW 16bit	Control Word (16 bits)	1
	Ref1 16bit	Reference REF1 (16 bits)	2
	Ref2 16bit	Reference REF2 (16 bits)	3
	SW 16bit	Status Word (16 bits)	4

No.	Name/Value	Description	Default FbEq 16
	Act1 16bit	Actual value ACT1 (16 bits)	5
	Act2 16bit	Actual value ACT2 (16 bits)	6
	CW 32bit	Control Word (32 bits)	11
	Ref1 32bit	Reference REF1 (32 bits)	12
	Ref2 32bit	Reference REF2 (32 bits)	13
	SW 32bit	Status Word (32 bits)	14
	Act1 32bit	Actual value ACT1 (32 bits)	15
	Act2 32bit	Actual value ACT2 (32 bits)	16
	SW2 16bit	Status Word 2 (16 bits)	24
	<i>Other</i>	Source selection (see <a href="#">Terms and abbreviations</a> ).	-
...	...	...	...
<b>52.12</b>	<b>FBA A data in12</b>	See parameter <a href="#">52.01 FBA A data in1</a> .	<i>None</i>

<b>53 FBA A data out</b>		Selection of data to be transferred from fieldbus controller to drive through fieldbus adapter A. <b>Note:</b> 32-bit values require two consecutive parameters. Whenever a 32-bit value is selected in a data parameter, the next parameter is automatically reserved.	
<b>53.01</b>	<b>FBA A data out1</b>	Parameters <a href="#">53.01</a> ... <a href="#">53.12</a> select data to be transferred from the fieldbus controller to the drive through fieldbus adapter A.	<i>None</i>
	None	None.	0
	CW 16bit	Control Word (16 bits)	1
	Ref1 16bit	Reference REF1 (16 bits)	2
	Ref2 16bit	Reference REF2 (16 bits)	3
	CW 32bit	Control Word (32 bits)	11
	Ref1 32bit	Reference REF1 (32 bits)	12
	Ref2 32bit	Reference REF2 (32 bits)	13
	CW2 16bit	Control Word 2 (16 bits)	21
	<i>Other</i>	Source selection (see <a href="#">Terms and abbreviations</a> ).	-
...	...	...	...
<b>53.12</b>	<b>FBA A data out12</b>	See parameter <a href="#">53.01 FBA A data out1</a> .	<i>None</i>



<b>58 Embedded fieldbus</b>		Configuration of the embedded fieldbus (EFB) interface. See chapter <a href="#">Fieldbus control through the embedded fieldbus interface (EFB)</a> . <b>NOTE:</b> Different embedded fieldbus protocols (Modbus or CANopen) require different hardware options.	
<b>58.01</b>	<b>Protocol enable</b>	Enables/disables the embedded fieldbus interface and selects the protocol to use.	<i>None</i>
	None	None (communication disabled).	0
	Modbus RTU	Embedded fieldbus interface is enabled and uses the Modbus RTU protocol.	1
	CANopen	Embedded fieldbus interface is enabled and uses the CANopen protocol.	3

No.	Name/Value	Description	Default FbEq 16
58.02	<i>Protocol ID</i>	Displays the protocol ID and revision. This parameter is read-only.	-
		Protocol ID and revision.	1 = 1
58.03	<i>Node address</i>	Defines the node address of the drive on the fieldbus link. Values 1...247 are allowable. Two devices with the same address are not allowed on-line. Changes to this parameter take effect after the control unit is rebooted or the new settings validated by parameter <a href="#">58.06 Communication control (Refresh settings)</a> .  <b>Note:</b> If parameter <a href="#">58.01</a> = [3] CANopen, the name of this parameter, <a href="#">58.03</a> is <b>Node ID</b> (see below).	1
	0...255	Node address (values 1...247 are allowed).	1 = 1
58.03	<i>Node ID</i>	Defines the node address for the drive on the CANopen bus. Values 1...127 are allowable. Two devices with the same address are not allowed on-line. Changes to this parameter take effect after the control unit is rebooted or the new settings are validated by parameter <a href="#">58.06 Communication control (Refresh settings)</a> .  <b>Note:</b> If <a href="#">58.01</a> = [1] Modbus RTU, the name of this parameter <a href="#">58.03</a> is <b>Node address</b> (see above).	3
	0...255	Node address (values 1...127 are allowed).	1=1
58.04	<i>Baud rate</i>	Selects the transfer rate of the Modbus fieldbus link. Changes to this parameter take effect after the control unit is rebooted or the new settings validated by parameter <a href="#">58.06 Communication control (Refresh settings)</a> .  <b>Note:</b> If parameter <a href="#">58.01</a> = [3] CANopen, the Baud rate range and the selection list item names change. See <a href="#">Baud rate</a> below.	<a href="#">19.2 kbps</a>
	4.8 kbps	4.8 kbit/s.	1
	9.6 kbps	9.6 kbit/s.	2
	19.2 kbps	19.2 kbit/s.	3
	38.4 kbps	38.4 kbit/s.	4
	57.6 kbps	57.6 kbit/s.	5
	76.8 kbps	76.8 kbit/s.	6
	115.2 kbps	115.2 kbit/s.	7
58.04	<i>Baud rate</i>	Defines the communication speed of the CANopen bus. Changes to this parameter take effect after the control unit is rebooted or the new settings validated by parameter <a href="#">58.06 Communication control (Refresh settings)</a> .	<a href="#">125 kbps</a>
	50 kbps	50 kbit/s.	1
	100 kbps	100 kbit/s.	2
	125 kbps	125 kbit/s.	3
	250 kbps	250 kbit/s.	4
	500 kbps	500 kbit/s.	5
	1 Mbps	1 Mbit/s.	6

No.	Name/Value	Description	Default FbEq 16
<a href="#">58.05</a>	<a href="#">Parity</a>	<p>Selects the type of parity bit and number of stop bits. Changes to this parameter take effect after the control unit is rebooted or the new settings validated by parameter <a href="#">58.06 Communication control (Refresh settings)</a>.</p> <p><b>Note:</b> If parameter <a href="#">58.01</a> = [3] CANopen, this parameter is hidden.</p>	<a href="#">8 EVEN 1</a>
	8 NONE 1	Eight data bits, no parity bit, one stop bit.	0
	8 NONE 2	Eight data bits, no parity bit, two stop bits.	1
	8 EVEN 1	Eight data bits, even parity bit, one stop bit.	2
	8 ODD 1	Eight data bits, odd parity bit, one stop bit.	3
<a href="#">58.06</a>	<a href="#">Communication control</a>	Takes changed EFB settings in use, or activates silent mode.	<a href="#">Enabled</a>
	Enabled	Normal operation.	0
	Refresh settings	<p>Refreshes settings (Modbus parameters <a href="#">58.01...58.05</a>, <a href="#">58.14...58.17</a>, <a href="#">58.25</a>, <a href="#">58.28...58.34</a>, CANopen parameters <a href="#">58.03</a>, <a href="#">58.04</a>, <a href="#">58.06</a>, <a href="#">58.14</a>, <a href="#">58.23...58.29</a>, <a href="#">58.70...58.93</a> and <a href="#">58.101...58.124</a>) and takes changed EFB configuration settings in use.</p> <p>Reverts automatically to <a href="#">Enabled</a>.</p>	1
	Silent mode	<p>Activates silent mode (no messages are transmitted). Silent mode can be terminated by activating the <a href="#">Refresh settings</a> selection of this parameter.</p> <p><b>Note:</b> If parameter <a href="#">58.01</a> = [3] CANopen, this option is not available.</p>	2

No.	Name/Value	Description	Default FbEq 16																																																					
58.07	<i>Communication diagnostics</i>	<p>Displays the status of the EFB communication. This parameter is read-only. Note that the name is only visible when the error is present (bit value is 1).</p> <p><b>Note:</b> If parameter 58.01 = [3] CANopen, this parameter is hidden.</p>	-																																																					
		<table border="1"> <thead> <tr> <th>Bit</th> <th>Name</th> <th>Description</th> </tr> </thead> <tbody> <tr> <td>0</td> <td>Init failed</td> <td>1 = EFB initialization failed</td> </tr> <tr> <td>1</td> <td>Addr config err</td> <td>1 = Node address not allowed by protocol</td> </tr> <tr> <td>2</td> <td rowspan="2">Silent mode</td> <td>1 = Drive not allowed to transmit</td> </tr> <tr> <td></td> <td>0 = Drive allowed to transmit</td> </tr> <tr> <td>3</td> <td colspan="2">Autobauding</td> </tr> <tr> <td>4</td> <td>Wiring error</td> <td>1 = Errors detected (A/B wires possibly swapped)</td> </tr> <tr> <td>5</td> <td>Parity error</td> <td>1 = Error detected: check parameters 58.04 and 58.05</td> </tr> <tr> <td>6</td> <td>Baud rate error</td> <td>1 = Error detected: check parameters 58.05 and 58.04</td> </tr> <tr> <td>7</td> <td>No bus activity</td> <td>1 = 0 bytes received during last 5 seconds</td> </tr> <tr> <td>8</td> <td>No packets</td> <td>1 = 0 packets (addressed to any device) detected during last 5 seconds</td> </tr> <tr> <td>9</td> <td>Noise or addressing error</td> <td>1 = Errors detected (interference, or another device with the same address on line)</td> </tr> <tr> <td>10</td> <td>Comm loss</td> <td>1 = 0 packets addressed to the drive received within timeout (58.16)</td> </tr> <tr> <td>11</td> <td>CW/Ref loss</td> <td>1 = No control word or references received within timeout (58.16)</td> </tr> <tr> <td>12</td> <td>Not active</td> <td>Reserved</td> </tr> <tr> <td>13</td> <td>Protocol 1</td> <td>Reserved</td> </tr> <tr> <td>14</td> <td>Protocol 2</td> <td>Reserved</td> </tr> <tr> <td>15</td> <td>Internal error</td> <td>1 = Internal errors detected</td> </tr> </tbody> </table>	Bit	Name	Description	0	Init failed	1 = EFB initialization failed	1	Addr config err	1 = Node address not allowed by protocol	2	Silent mode	1 = Drive not allowed to transmit		0 = Drive allowed to transmit	3	Autobauding		4	Wiring error	1 = Errors detected (A/B wires possibly swapped)	5	Parity error	1 = Error detected: check parameters 58.04 and 58.05	6	Baud rate error	1 = Error detected: check parameters 58.05 and 58.04	7	No bus activity	1 = 0 bytes received during last 5 seconds	8	No packets	1 = 0 packets (addressed to any device) detected during last 5 seconds	9	Noise or addressing error	1 = Errors detected (interference, or another device with the same address on line)	10	Comm loss	1 = 0 packets addressed to the drive received within timeout (58.16)	11	CW/Ref loss	1 = No control word or references received within timeout (58.16)	12	Not active	Reserved	13	Protocol 1	Reserved	14	Protocol 2	Reserved	15	Internal error	1 = Internal errors detected	
Bit	Name	Description																																																						
0	Init failed	1 = EFB initialization failed																																																						
1	Addr config err	1 = Node address not allowed by protocol																																																						
2	Silent mode	1 = Drive not allowed to transmit																																																						
		0 = Drive allowed to transmit																																																						
3	Autobauding																																																							
4	Wiring error	1 = Errors detected (A/B wires possibly swapped)																																																						
5	Parity error	1 = Error detected: check parameters 58.04 and 58.05																																																						
6	Baud rate error	1 = Error detected: check parameters 58.05 and 58.04																																																						
7	No bus activity	1 = 0 bytes received during last 5 seconds																																																						
8	No packets	1 = 0 packets (addressed to any device) detected during last 5 seconds																																																						
9	Noise or addressing error	1 = Errors detected (interference, or another device with the same address on line)																																																						
10	Comm loss	1 = 0 packets addressed to the drive received within timeout (58.16)																																																						
11	CW/Ref loss	1 = No control word or references received within timeout (58.16)																																																						
12	Not active	Reserved																																																						
13	Protocol 1	Reserved																																																						
14	Protocol 2	Reserved																																																						
15	Internal error	1 = Internal errors detected																																																						
	0000h...FFFh	EFB communication status.	1 = 1																																																					
58.08	<i>Received packets</i>	<p>Displays a count of valid packets addressed to the drive. During normal operation, this number increases constantly. Can be reset from the control panel by keeping Reset down for over 3 seconds.</p> <p><b>Note:</b> If parameter 58.01 = [3] CANopen, this parameter is hidden.</p>	-																																																					
	0...4294967295	Number of received packets addressed to the drive.	1 = 1																																																					
58.09	<i>Transmitted packets</i>	<p>Displays a count of valid packets transmitted by the drive. During normal operation, this number increases constantly. Can be reset from the control panel by keeping Reset down for over 3 seconds.</p> <p><b>Note:</b> If parameter 58.01 = [3] CANopen, this parameter is hidden.</p>	-																																																					
	0...4294967295	Number of transmitted packets.	1 = 1																																																					



No.	Name/Value	Description	Default FbEq 16
58.10	<i>All packets</i>	Displays a count of valid packets addressed to any device on the bus. During normal operation, this number increases constantly. Can be reset from the control panel by keeping Reset down for over 3 seconds.  <b>Note:</b> If parameter <i>58.01</i> = [3] CANopen, this parameter is hidden.	-
	0...4294967295	Number of all received packets.	1 = 1
58.11	<i>UART errors</i>	Displays a count of character errors received by the drive. An increasing count indicates a configuration problem on the bus. Can be reset from the control panel by keeping Reset down for over 3 seconds.  <b>Note:</b> If parameter <i>58.01</i> = [3] CANopen, this parameter is hidden.	-
	0...4294967295	Number of UART errors.	1 = 1
58.12	<i>CRC errors</i>	Displays a count of packets with a CRC error received by the drive. An increasing count indicates interference on the bus. Can be reset from the control panel by keeping Reset down for over 3 seconds.  <b>Note:</b> If parameter <i>58.01</i> = [3] CANopen, this parameter, is hidden.	-
	0...4294967295	Number of CRC errors.	1 = 1
58.14	<i>Communication loss action</i>	Selects how the drive reacts to an EFB communication break. The drive does not trip if only reference is coming from EFB and the communication is lost. Changes to this parameter take effect after the control unit is rebooted or the new settings validated by parameter <i>58.06 Communication control (Refresh settings)</i> . See also parameters <i>58.15 Communication loss mode</i> and <i>58.16 Communication loss time</i> .	<i>Fault</i>
	No action	No action taken (monitoring disabled).	0
	Fault	Drive trips on <i>6681 EFB comm loss</i> . This occurs only if control in the currently active control location is expected from the EFB.	1
	Last speed	Drive generates an <i>A7CE EFB comm loss</i> warning and freezes the speed to the level the drive was operating at. The speed is determined on the basis of actual speed using 850 ms low-pass filtering. This occurs only if control is expected from the EFB.   <b>WARNING!</b> Make sure that it is safe to continue operation in case of a communication break.	2
	Speed ref safe	Drive generates an <i>A7CE EFB comm loss</i> warning and sets the speed to the speed defined by parameter <i>22.41 Speed ref safe</i> (or <i>28.41 Frequency ref safe</i> when frequency reference is being used). This occurs only if control is expected from the EFB.   <b>WARNING!</b> Make sure that it is safe to continue operation in case of a communication break.	3

No.	Name/Value	Description	Default FbEq 16
	Fault always	Drive trips on <a href="#">6681 EFB comm loss</a> . This happens even though the drive is in a control location where the EFB start/stop or reference is not used.	4
	Warning	Drive generates an <a href="#">A7CE EFB comm loss</a> warning. This occurs even though no control is expected from the EFB.  <b>WARNING!</b> Make sure that it is safe to continue operation in case of a communication break.	5
<a href="#">58.15</a>	<a href="#">Communication loss mode</a>	Defines which message types reset the timeout counter for detecting an EFB communication loss. Changes to this parameter take effect after the control unit is rebooted or the new settings validated by parameter <a href="#">58.06 Communication control (Refresh settings)</a> . See also parameters <a href="#">58.14 Communication loss action</a> and <a href="#">58.16 Communication loss time</a>  <b>Note:</b> If parameter <a href="#">58.01</a> = [3] CANopen, this parameter is hidden.	<a href="#">Cw / Ref1 / Ref2</a>
	Any message	Any message addressed to the drive resets the timeout.	1
	Cw / Ref1 / Ref2	A write of the control word or a reference resets the timeout.	2
<a href="#">58.16</a>	<a href="#">Communication loss time</a>	Sets a timeout for EFB communication. If a communication break lasts longer than the timeout, the action specified by parameter <a href="#">58.14 Communication loss action</a> is taken. Changes to this parameter take effect after the control unit is rebooted or the new settings validated by parameter <a href="#">58.06 Communication control (Refresh settings)</a> . See also parameter <a href="#">58.15 Communication loss mode</a> . <b>Notes:</b> <ul style="list-style-type: none"> <li>• There is a 30-second boot-up delay immediately after power-up. During the delay, the communication break monitoring is disabled (but communication itself can be active).</li> <li>• If parameter <a href="#">58.01</a> = [3] CANopen, the default value is set as 0.3 seconds.</li> </ul>	3.0 s
	0.0...6000.0 s	EFB communication timeout.	1 = 1
<a href="#">58.17</a>	<a href="#">Transmit delay</a>	Defines a minimum response delay in addition to any fixed delay imposed by the protocol. Changes to this parameter take effect after the control unit is rebooted or the new settings validated by parameter <a href="#">58.06 Communication control (Refresh settings)</a> . <b>Note:</b> If parameter <a href="#">58.01</a> = [3] CANopen, this parameter is hidden.	0 ms
	0...65535 ms	Minimum response delay.	1 = 1
<a href="#">58.18</a>	<a href="#">EFB control word</a>	Displays the raw (unmodified) status word sent by the drive to the Modbus controller. For debugging purposes. This parameter is read-only.	-
	0...FFFFFFFh	Control word sent by the controller to the drive.	1 = 1
<a href="#">58.19</a>	<a href="#">EFB status word</a>	Displays the raw (unmodified) status word for debugging purposes. This parameter is read-only.	-
	0...FFFFFFFh	Status word sent by the drive to the controller.	1 = 1

No.	Name/Value	Description	Default FbEq 16
58.22	<i>CANopen NMT state</i>	This parameter tells the CANopen NMT state of the drive.  <b>Note:</b> If parameter <a href="#">58.01</a> = [1] Modbus RTU, this parameter is hidden.	<i>Uninitialized</i>
	Uninitialized	Node is not initialized	0
	Stopped	Node is in STOPPED state.	4
	Operational	Node is in OPERATIONAL state.	5
	Pre-operational	Node is in PRE-OPERATIONAL state.	127
58.23	<i>Configuration location</i>	This parameter defines where communication configuration for the device comes from. Changes to this parameter take effect after the control unit is rebooted or the new settings validated by parameter <a href="#">58.06 Communication control (Refresh settings)</a> .  <b>Note:</b> If parameter <a href="#">58.01</a> = [1] Modbus RTU, this parameter is hidden.	<i>CAN objects</i>
	Drive parameters		0
	CAN objects	Communication configuration is written by CANopen master to CANopen objects. The configuration can be saved into the drive's non-volatile memory. In that case, the parameters don't need to be set every time the system is powered on	1
58.24	<i>Transparent 16 scale</i>	Defines the scaling value for Transparent 16 communication profile. Changes to this parameter take effect after the control unit is rebooted or the new settings validated by parameter <a href="#">58.06 Communication control (Refresh settings)</a> .  <b>Note:</b> If parameter <a href="#">58.01</a> = [1] Modbus RTU, this parameter is hidden.	99
	0..65535	Actual values and reference values are multiplied by this value + 1 in the object dictionary.	1 = 1
58.25	<i>Control profile</i>	Defines the communication profile used by the protocol. Changes to this parameter take effect after the control unit is rebooted or the new settings validated by parameter <a href="#">58.06 Communication control (Refresh settings)</a> .	<i>ABB Drives</i>
	ABB Drives	ABB Drives control profile (with a 16-bit control word)	0
	DCU Profile	DCU control profile (with a 16 or 32-bit control word)	5
	CiA 402	CiA 402 control profile	7
	Transparent 16	Transparent control profile (with a 16-bit control word).	8
	Transparent 32	Transparent control profile (with a 32-bit control word).	9

No.	Name/Value	Description	Default FbEq 16											
58.26	<i>EFB ref1 type</i>	Selects the type and scaling of reference 1 received through the embedded fieldbus interface. The scaled reference is displayed by <a href="#">03.09 EFB reference 1</a> .	<i>Speed or frequency</i>											
	Speed or frequency	Type and scaling is chosen automatically according to the currently active operation mode as follows.	0											
		<table border="1"> <thead> <tr> <th>Operation mode (see par. 19.01)</th> <th>Reference 1 type</th> </tr> </thead> <tbody> <tr> <td>Speed control</td> <td><i>Speed</i></td> </tr> <tr> <td>Torque control</td> <td><i>Speed</i></td> </tr> <tr> <td>Frequency control</td> <td><i>Frequency</i></td> </tr> </tbody> </table>	Operation mode (see par. 19.01)	Reference 1 type	Speed control	<i>Speed</i>	Torque control	<i>Speed</i>	Frequency control	<i>Frequency</i>				
Operation mode (see par. 19.01)	Reference 1 type													
Speed control	<i>Speed</i>													
Torque control	<i>Speed</i>													
Frequency control	<i>Frequency</i>													
	Transparent	No scaling is applied.	1											
	General	Generic reference without a specific unit. Scaling: 1 = 100.	2											
	Torque	Torque reference. The scaling is defined by parameter <a href="#">46.03 Torque scaling</a> .	3											
	Speed	Speed reference. The scaling is defined by parameter <a href="#">46.01 Speed scaling</a> .	4											
	Frequency	Frequency reference. The scaling is defined by parameter <a href="#">46.02 Frequency scaling</a> .	5											
58.27	<i>EFB ref2 type</i>	Selects the type and scaling of reference 2 received through the embedded fieldbus interface. The scaled reference is displayed by <a href="#">03.10 EFB reference 2</a> .	<i>Speed or frequency</i>											
58.28	<i>EFB act1 type</i>	Selects the type/source and scaling of actual value 1 transmitted to the fieldbus.network through the embedded fieldbus interface.	<i>Speed or frequency</i>											
	Speed or frequency	Type and scaling is chosen automatically according to the currently active operation mode as follows:	0											
		<table border="1"> <thead> <tr> <th>Operation mode (see par. 19.01)</th> <th>Actual 1 type (source)</th> <th>Scaling</th> </tr> </thead> <tbody> <tr> <td>Speed control</td> <td><i>Speed</i></td> <td rowspan="2"><i>46.01 Speed scaling</i></td> </tr> <tr> <td>Torque control</td> <td><i>(01.01 Motor speed used)</i></td> </tr> <tr> <td>Frequency control</td> <td><i>Frequency</i> <i>(01.06 Output frequency)</i></td> <td><i>46.02 Frequency scaling</i></td> </tr> </tbody> </table>	Operation mode (see par. 19.01)	Actual 1 type (source)	Scaling	Speed control	<i>Speed</i>	<i>46.01 Speed scaling</i>	Torque control	<i>(01.01 Motor speed used)</i>	Frequency control	<i>Frequency</i> <i>(01.06 Output frequency)</i>	<i>46.02 Frequency scaling</i>	
Operation mode (see par. 19.01)	Actual 1 type (source)	Scaling												
Speed control	<i>Speed</i>	<i>46.01 Speed scaling</i>												
Torque control	<i>(01.01 Motor speed used)</i>													
Frequency control	<i>Frequency</i> <i>(01.06 Output frequency)</i>	<i>46.02 Frequency scaling</i>												
	Transparent	The value selected by parameter <a href="#">58.31 EFB act1 transparent source</a> is sent as actual value 1. No scaling is applied (the 16-bit scaling is 1 = 1 unit).	1											
	General	The value selected by parameter <a href="#">58.31 EFB act1 transparent source</a> is sent as actual value 1 with a 16-bit scaling of 100 = 1 unit (ie. integer and two decimals).	2											
	Torque	<a href="#">01.10 Motor torque</a> is sent as actual value 1. Scaling is defined by parameter <a href="#">46.03 Torque scaling</a> .	3											
	Speed	<a href="#">01.01 Motor speed used</a> is sent as actual value 1. Scaling is defined by parameter <a href="#">46.01 Speed scaling</a> .	4											
	Frequency	<a href="#">01.06 Output frequency</a> is sent as actual value 1. Scaling is defined by parameter <a href="#">46.02 Frequency scaling</a> .	5											

No.	Name/Value	Description	Default FbEq 16												
58.29	<i>EFB act2 type</i>	Selects the type/source and scaling of actual value 2 transmitted to the fieldbus network through the embedded fieldbus interface. <b>Note:</b> If parameter <i>58.01</i> = [3] CANopen, default value is set as <i>Speed or frequency</i> .	<i>Transparent</i>												
	Speed or frequency	Type/source and scaling are chosen automatically according to the currently active operation mode as follows:	0												
		<table border="1"> <thead> <tr> <th>Operation mode (see par. 19.01)</th> <th>Actual 1 type (source)</th> <th>Scaling</th> </tr> </thead> <tbody> <tr> <td>Speed control</td> <td><i>Speed</i> (<i>01.01 Motor speed used</i>)</td> <td><i>46.01 Speed scaling</i></td> </tr> <tr> <td>Torque control</td> <td><i>Frequency</i> (<i>01.06 Output frequency</i>)</td> <td><i>46.02 Frequency scaling</i></td> </tr> <tr> <td>Frequency control</td> <td></td> <td></td> </tr> </tbody> </table>	Operation mode (see par. 19.01)	Actual 1 type (source)	Scaling	Speed control	<i>Speed</i> ( <i>01.01 Motor speed used</i> )	<i>46.01 Speed scaling</i>	Torque control	<i>Frequency</i> ( <i>01.06 Output frequency</i> )	<i>46.02 Frequency scaling</i>	Frequency control			
Operation mode (see par. 19.01)	Actual 1 type (source)	Scaling													
Speed control	<i>Speed</i> ( <i>01.01 Motor speed used</i> )	<i>46.01 Speed scaling</i>													
Torque control	<i>Frequency</i> ( <i>01.06 Output frequency</i> )	<i>46.02 Frequency scaling</i>													
Frequency control															
	Transparent	The value selected by parameter <i>58.32 EFB act2 transparent source</i> is sent as actual value 2. No scaling is applied (the 16-bit scaling is 1 = 1 unit).	1												
	General	The value selected by parameter <i>58.32 EFB act2 transparent source</i> is sent as actual value 2 with a 16-bit scaling of 100 = 1 unit (i.e. integer and two decimals).	2												
	Torque	<i>01.10 Motor torque</i> is sent as actual value 2. Scaling is defined by parameter <i>46.03 Torque scaling</i> .	3												
	Speed	<i>01.01 Motor speed used</i> is sent as actual value 2. Scaling is defined by parameter <i>46.01 Speed scaling</i> .	4												
	Frequency	<i>01.06 Output frequency</i> is sent as actual value 2. Scaling is defined by parameter <i>46.02 Frequency scaling</i> .	5												
58.31	<i>EFB act1 transparent source</i>	Selects the source of actual value 1 when parameter <i>58.28 EFB act1 type</i> is set to <i>Transparent</i> .	<i>Not selected</i>												
	Not selected	None.	0												
	<i>Other</i>	Source selection (see <i>Terms and abbreviations</i> ).	-												
58.32	<i>EFB act2 transparent source</i>	Selects the source of actual value 1 when parameter <i>58.29 EFB act2 type</i> is set to <i>Transparent</i> .	<i>Not selected</i>												
	Not selected	None.	0												
	<i>Other</i>	Source selection (see <i>Terms and abbreviations</i> ).	-												

No.	Name/Value	Description	Default FbEq 16
58.33	<i>Addressing mode</i>	<p>Defines the mapping between parameters and holding registers in the 400101...465535 Modbus register range. Changes to this parameter take effect after the control unit is rebooted or the new settings validated by parameter <a href="#">58.06 Communication control (Refresh settings)</a>.</p> <p><b>Note:</b> If parameter <a href="#">58.01</a> = [3] CANopen, this parameter is hidden.</p>	<i>Mode 0</i>
	Mode 0	<p><b>16-bit values (groups 1...99, indexes 1...99):</b> Register address = 400000 + 100 × parameter group + parameter index. For example, parameter 22.80 would be mapped to register 400000 + 2200 + 80 = 402280.</p> <p><b>32-bit values (groups 1...99, indexes 1...99):</b> Register address = 420000 + 200 × parameter group + 2 × parameter index. For example, parameter 22.80 would be mapped to register 420000 + 4400 + 160 = 424560.</p>	0
	Mode 1	<p><b>16-bit values (groups 1...255, indexes 1...255):</b> Register address = 400000 + 256 × parameter group + parameter index. For example, parameter 22.80 would be mapped to register 400000 + 5632 + 80 = 405712.</p>	1
	Mode 2	<p><b>32-bit values (groups 1...127, indexes 1...255):</b> Register address = 400000 + 512 × parameter group + 2 × parameter index. For example, parameter 22.80 would be mapped to register 400000 + 11264 + 160 = 411424.</p>	2
58.34	<i>Word order</i>	<p>Selects in which order 16-bit registers of 32-bit parameters are transferred. For each register, the first byte contains the high order byte and the second byte contains the low order byte. Changes to this parameter take effect after the control unit is rebooted or the new settings validated by parameter <a href="#">58.06 Communication control (Refresh settings)</a>.</p> <p><b>Note:</b> If parameter <a href="#">58.01</a> = [3] CANopen, this parameter is hidden.</p>	<i>LO-HI</i>
	HI-LO	The first register contains the high order word, the second contains the low order word.	0
	LO-HI	The first register contains the low order word, the second contains the high order word.	1
58.70	<i>EFB debug mode</i>	<p>This parameter enables debug mode. RAW-data is echoed to drive parameters <a href="#">58.18 EFB control word</a>, <a href="#">58.71 EFB reference 1</a>, <a href="#">58.72 EFB reference 2</a>, <a href="#">58.19 EFB status word</a>, <a href="#">58.73 EFB actual value 1</a> and <a href="#">58.74 EFB actual value 2</a></p> <p>Changes to this parameter take effect after the control unit is rebooted or the new settings validated by parameter <a href="#">58.06 Communication control (Refresh settings)</a>.</p> <p><b>Note:</b> If parameter <a href="#">58.01</a> = [1] Modbus RTU, this parameter is hidden.</p>	1
	Disable	Debug mode disabled. <a href="#">58.18 EFB control word</a> , <a href="#">58.71 EFB reference 1</a> , <a href="#">58.72 EFB reference 2</a> , <a href="#">58.19 EFB status word</a> , <a href="#">58.73 EFB actual value 1</a> and <a href="#">58.74 EFB actual value 2</a> are not updated.	0

No.	Name/Value	Description	Default FbEq 16
	Enable	Debug mode enabled. <a href="#">58.18 EFB control word</a> , <a href="#">58.71 EFB reference 1</a> , <a href="#">58.72 EFB reference 2</a> , <a href="#">58.19 EFB status word</a> , <a href="#">58.73 EFB actual value 1</a> and <a href="#">58.74 EFB actual value 2</a> are updated.	1
<a href="#">58.71</a>	<a href="#">EFB reference 1</a>	Displays the raw (unmodified) reference value 1 for debugging purposes. This parameter is read-only.  <b>Note:</b> If parameter <a href="#">58.01</a> = [1] Modbus RTU, this parameter is hidden.	0
	-100000...100000	Reference value 1	1=1
<a href="#">58.72</a>	<a href="#">EFB reference 2</a>	Displays the raw (unmodified) reference value 2 for debugging purposes. This parameter is read-only.  <b>Note:</b> If parameter <a href="#">58.01</a> = [1] Modbus RTU, this parameter is hidden.	0
	-100000...100000	Reference value 2	1=1
<a href="#">58.73</a>	<a href="#">EFB actual value 1</a>	Displays the raw (unmodified) actual value 1 for debugging purposes. This parameter is read-only.  <b>Note:</b> If parameter <a href="#">58.01</a> = [1] Modbus RTU, this parameter is hidden.	0
	-100000...100000	Actual value 1	1=1
<a href="#">58.74</a>	<a href="#">EFB actual value 2</a>	Displays the raw (unmodified) actual value 2 for debugging purposes. This parameter is read-only.  <b>Note:</b> If parameter <a href="#">58.01</a> = [1] Modbus RTU, this parameter is hidden.	0
	-100000...100000	Actual value 2	1=1
<a href="#">58.76</a>	<a href="#">RPDO1 COB-ID</a>	Set the COB-ID of the PDO. Changing this parameter has an effect only if <a href="#">58.23 Configuration location</a> is <a href="#">Drive parameters</a> and after the control unit is rebooted or the new settings validated by parameter <a href="#">58.06 Communication control (Refresh settings)</a> .  <b>Note:</b> If parameter <a href="#">58.01</a> = [1] Modbus RTU, this parameter is hidden.	0x0001
	0x0000...0x07ff	COB-ID. 0 = RPDO disabled, 1 = use COB-ID from CiA 301 pre-defined connection set, <other value> = use selected COB-ID.	1=1

No.	Name/Value	Description	Default FbEq 16
58.77	<i>RPDO1 transmission type</i>	<p>Set the transmission type of the PDO. Changing this parameter has an effect only if <a href="#">58.23 Configuration location</a> is <i>Drive parameters</i> and after the control unit is rebooted or the new settings validated by parameter <a href="#">58.06 Communication control (Refresh settings)</a>.</p> <p><b>Note:</b> If parameter <a href="#">58.01</a> = [1] Modbus RTU, this parameter is hidden.</p>	255
	0...255	<p>Transmission type. 0 = acyclic synchronous 1...240 = cyclic synchronous 252 = synchronous RTR only 253 = asynchronous RTR only 254...255 = asynchronous</p>	1=1
58.78	<i>RPDO1 event timer</i>	<p>Set the event timer of the PDO. Changing this parameter has an effect only if <a href="#">58.23 Configuration location</a> is <i>Drive parameters</i> and after the control unit is rebooted or the new settings validated by parameter <a href="#">58.06 Communication control (Refresh settings)</a>.</p> <p><b>Note:</b> If parameter <a href="#">58.01</a> = [1] Modbus RTU, this parameter is hidden.</p>	0
	0...65535	<p>Defines the time-out time for the PDO. 0 = no timeout other = if this PDO is enabled and not received for event timer milliseconds, <a href="#">58.14 Communication loss time</a> is performed. <b>Note:</b> The timeout supervision is activated upon a successful reception of the RPDO.</p>	1=1 ms
58.79	<i>TPDO1 COB-ID</i>	<p>Set the COB-ID of the PDO. Changing this parameter has an effect only if <a href="#">58.23 Configuration location</a> is <i>Drive parameters</i> and after the control unit is rebooted or the new settings validated by parameter <a href="#">58.06 Communication control (Refresh settings)</a>.</p> <p><b>Note:</b> If parameter <a href="#">58.01</a> = [1] Modbus RTU, this parameter is hidden.</p>	0x0001
	0x0000...0x07ff	<p>COB-ID. 0 = RPDO disabled, 1 = use COB-ID from CiA 301 pre-defined connection set, &lt;other value&gt; = use selected COB-ID.</p>	1=1
58.80	<i>TPDO1 transmission type</i>	<p>Set the transmission type of the PDO. Changing this parameter has an effect only if <a href="#">58.23 Configuration location</a> is <i>Drive parameters</i> and after the control unit is rebooted or the new settings validated by parameter <a href="#">58.06 Communication control (Refresh settings)</a>.</p> <p><b>Note:</b> If parameter <a href="#">58.01</a> = [1] Modbus RTU, this parameter is hidden.</p>	255



No.	Name/Value	Description	Default FbEq 16
	0...255	Transmission type. 0 = acyclic synchronous 1...240 = cyclic synchronous 252 = synchronous RTR only 253 = asynchronous RTR only 254...255 = asynchronous	1=1
<a href="#">58.81</a>	<a href="#">TPDO1 event timer</a>	Set the event timer of the PDO. Changing this parameter has an effect only if <a href="#">58.23 Configuration location</a> is <a href="#">Drive parameters</a> and after the control unit is rebooted or the new settings validated by parameter <a href="#">58.06 Communication control (Refresh settings)</a> .  <b>Note:</b> If parameter <a href="#">58.01</a> = [1] Modbus RTU, this parameter is hidden.	0
	0...65535	Event timer 0 = no timeout other = if this PDO is enabled and has not been transmitted for event timer milliseconds, a transmission is forced	1=1 ms
<a href="#">58.82</a>	<a href="#">RPDO6 COB-ID</a>	Set the COB-ID of the PDO. Changing this parameter has an effect only if <a href="#">58.23 Configuration location</a> is <a href="#">Drive parameters</a> and after the control unit is rebooted or the new settings validated by parameter <a href="#">58.06 Communication control (Refresh settings)</a> .  <b>Note:</b> If parameter <a href="#">58.01</a> = [1] Modbus RTU, this parameter is hidden.	0x0000
	0x0000...0x07ff	COB-ID. 0 = RPDO disabled, 1 = use COB-ID from CiA 301 pre-defined connection set, <other value> = use selected COB-ID.	1=1
<a href="#">58.83</a>	<a href="#">RPDO6 transmission type</a>	Set the transmission type of the PDO. Changing this parameter has an effect only if <a href="#">58.23 Configuration location</a> is <a href="#">Drive parameters</a> and after the control unit is rebooted or the new settings validated by parameter <a href="#">58.06 Communication control (Refresh settings)</a> .  <b>Note:</b> If parameter <a href="#">58.01</a> = [1] Modbus RTU, this parameter is hidden.	255
	0...255	Transmission type. 0 = acyclic synchronous 1...240 = cyclic synchronous 252 = synchronous RTR only 253 = asynchronous RTR only 254...255 = asynchronous	1=1

No.	Name/Value	Description	Default FbEq 16
58.84	<i>RPDO6 event timer</i>	<p>Set the event timer of the PDO. Changing this parameter has an effect only if <a href="#">58.23 Configuration location</a> is <a href="#">Drive parameters</a> and after the control unit is rebooted or the new settings validated by parameter <a href="#">58.06 Communication control (Refresh settings)</a>.</p> <p><b>Note:</b> If parameter <a href="#">58.01</a> = [1] Modbus RTU, this parameter is hidden.</p>	0
	0...65535	<p>Defines the time-out time for the PDO. 0 = no timeout other = if this PDO is enabled and not received for event timer milliseconds, <a href="#">58.14 Communication loss time</a> is performed.</p> <p><b>Note:</b> The timeout supervision is activated upon a successful reception of the RPDO.</p>	1=1 ms
58.85	<i>TPDO6 COB-ID</i>	<p>Set the COB-ID of the PDO. Changing this parameter has an effect only if <a href="#">58.23 Configuration location</a> is <a href="#">Drive parameters</a> and after the control unit is rebooted or the new settings validated by parameter <a href="#">58.06 Communication control (Refresh settings)</a>.</p> <p><b>Note:</b> If parameter <a href="#">58.01</a> = [1] Modbus RTU, this parameter is hidden.</p>	0x0000
	0x0000...0x07ff	<p>COB-ID. 0 = RPDO disabled, 1 = use COB-ID from CiA 301 pre-defined connection set, &lt;other value&gt; = use selected COB-ID.</p>	1=1
58.86	<i>TPDO6 transmission type</i>	<p>Set the transmission type of the PDO. Changing this parameter has an effect only if <a href="#">58.23 Configuration location</a> is <a href="#">Drive parameters</a> and after the control unit is rebooted or the new settings validated by parameter <a href="#">58.06 Communication control (Refresh settings)</a>.</p> <p><b>Note:</b> If parameter <a href="#">58.01</a> = [1] Modbus RTU, this parameter is hidden.</p>	255
	0...255	<p>Transmission type. 0 = acyclic synchronous 1...240 = cyclic synchronous 252 = synchronous RTR only 253 = asynchronous RTR only 254...255 = asynchronous</p>	1=1
58.87	<i>TPDO6 event timer</i>	<p>Set the event timer of the PDO. Changing this parameter has an effect only if <a href="#">58.23 Configuration location</a> is <a href="#">Drive parameters</a> and after the control unit is rebooted or the new settings validated by parameter <a href="#">58.06 Communication control (Refresh settings)</a>.</p> <p><b>Note:</b> If parameter <a href="#">58.01</a> = [1] Modbus RTU, this parameter is hidden.</p>	0

No.	Name/Value	Description	Default FbEq 16
	0..65535	Event timer 0 = no timeout other = if this PDO is enabled and has not been transmitted for event timer milliseconds, a transmission is forced	1=1 ms
58.88	<i>RPDO21 COB-ID</i>	Set the COB-ID of the PDO. Changing this parameter has an effect only if <a href="#">58.23 Configuration location</a> is <i>Drive parameters</i> and after the control unit is rebooted or the new settings validated by parameter <a href="#">58.06 Communication control (Refresh settings)</a> .  <b>Note:</b> If parameter <a href="#">58.01</a> = [1] Modbus RTU, this parameter is hidden.	0x0000
	0x0000...0x07ff	COB-ID. 0 = RPDO disabled, 1 = use COB-ID from CiA 301 pre-defined connection set, <other value> = use selected COB-ID.	1=1
58.89	<i>RPDO21 transmission type</i>	Set the transmission type of the PDO. Changing this parameter has an effect only if <a href="#">58.23 Configuration location</a> is <i>Drive parameters</i> and after the control unit is rebooted or the new settings validated by parameter <a href="#">58.06 Communication control (Refresh settings)</a> .  <b>Note:</b> If parameter <a href="#">58.01</a> = [1] Modbus RTU, this parameter is hidden.	255
	0...255	Transmission type. 0 = acyclic synchronous 1...240 = cyclic synchronous 252 = synchronous RTR only 253 = asynchronous RTR only 254...255 = asynchronous	1=1
58.90	<i>RPDO21 event timer</i>	Set the event timer of the PDO. Changing this parameter has an effect only if <a href="#">58.23 Configuration location</a> is <i>Drive parameters</i> and after the control unit is rebooted or the new settings validated by parameter <a href="#">58.06 Communication control (Refresh settings)</a> .  <b>Note:</b> If parameter <a href="#">58.01</a> = [1] Modbus RTU, this parameter is hidden.	0
	0..65535	Defines the time-out time for the PDO. 0 = no timeout other = if this PDO is enabled and not received for event timer milliseconds, <a href="#">58.14 Communication loss time</a> is performed.  <b>Note:</b> The timeout supervision is activated upon a successful reception of the RPDO.	1=1 ms

## 316 Parameters

No.	Name/Value	Description	Default FbEq 16
58.91	<i>RPDO21 COB-ID</i>	<p>Set the COB-ID of the PDO. Changing this parameter has an effect only if <a href="#">58.23 Configuration location</a> is <i>Drive parameters</i> and after the control unit is rebooted or the new settings validated by parameter <a href="#">58.06 Communication control (Refresh settings)</a>.</p> <p><b>Note:</b> If parameter <a href="#">58.01</a> = [1] Modbus RTU, this parameter is hidden.</p>	0x0000
	0x0000...0x07ff	<p>COB-ID. 0 = RPDO disabled, 1 = use COB-ID from CiA 301 pre-defined connection set, &lt;other value&gt; = use selected COB-ID.</p>	1=1
58.92	<i>TPDO21 transmission type</i>	<p>Set the transmission type of the PDO. Changing this parameter has an effect only if <a href="#">58.23 Configuration location</a> is <i>Drive parameters</i> and after the control unit is rebooted or the new settings validated by parameter <a href="#">58.06 Communication control (Refresh settings)</a>.</p> <p><b>Note:</b> If parameter <a href="#">58.01</a> = [1] Modbus RTU, this parameter is hidden.</p>	255
	0...255	<p>Transmission type. 0 = acyclic synchronous 1...240 = cyclic synchronous 252 = synchronous RTR only 253 = asynchronous RTR only 254...255 = asynchronous</p>	1=1
58.93	<i>TPDO21 event timer</i>	<p>Set the event timer of the PDO. Changing this parameter has an effect only if <a href="#">58.23 Configuration location</a> is <i>Drive parameters</i> and after the control unit is rebooted or the new settings validated by parameter <a href="#">58.06 Communication control (Refresh settings)</a>.</p> <p><b>Note:</b> If parameter <a href="#">58.01</a> = [1] Modbus RTU, this parameter is hidden.</p>	0
	0...65535	<p>Event timer 0 = no timeout other = if this PDO is enabled and has not been transmitted for event timer milliseconds, a transmission is forced</p>	1=1 ms

No.	Name/Value	Description	Default FbEq 16
58.101	<i>Data I/O 1</i>	Defines the address in the drive which the Modbus master accesses when it reads from or writes to the register address corresponding to Modbus register 1 (400001). The master defines the type of the data (input or output). The value is transmitted in a Modbus frame consisting of two 16-bit words. If the value is 16-bit, it is transmitted in the LSW (least significant word). If the value is 32-bit, the subsequent parameter is also reserved for it and must be set to <i>None</i> .	<i>CW 16bit</i>
	<i>TPDO1 word 1</i>	Selects a parameter that is mapped to TPDO1 word 1. Changing this parameter has an effect only if <a href="#">58.23 Configuration location</a> is <i>Drive parameters</i> and after the control unit is rebooted or the new settings validated by parameter <a href="#">58.06 Communication control (Refresh settings)</a> .	<i>SW 16bit</i>
	None	No mapping, register is always zero.	0
	CW 16bit	<i>ABB Drives</i> , CiA402 and Transparent 16 profiles: 16-bit control word; <i>DCU Profile</i> : lower 16 bits of the DCU control word	1
	Ref1 16bit	Reference REF1 (16 bits)	2
	Ref2 16bit	Reference REF2 (16 bits)	3
	SW 16bit	<i>ABB Drives</i> profile: 16-bit ABB drives status word; <i>DCU Profile</i> : lower 16 bits of the DCU status word	4
	Act1 16bit	Actual value ACT1 (16 bits)	5
	Act2 16bit	Actual value ACT2 (16 bits)	6
	CW 32bit	Control Word (32 bits)	11
	Ref1 32bit	Reference REF1 (32 bits)	12
	Ref2 32bit	Reference REF2 (32 bits)	13
	SW 32bit	Status Word (32 bits)	14
	Act1 32bit	Actual value ACT1 (32 bits)	15
	Act2 32bit	Actual value ACT2 (32 bits)	16
	CW2 16bit	<i>ABB Drives</i> profile, CANopen: not used; <i>DCU Profile</i> : upper 16 bits of the DCU control word	21
	SW2 16bit	CANopen: Error code <i>ABB Drives</i> profile: not used / always zero; <i>DCU Profile</i> : upper 16 bits of the DCU status word.	24
	RO/DIO control word	CANopen: not used. Parameter <a href="#">10.99 RO/DIO control word</a> .	31
	AO1 data storage	CANopen: not used. Parameter <a href="#">13.91 AO1 data storage</a> .	32
	Feedback data storage	CANopen: not used. Parameter <a href="#">40.91 Feedback data storage</a> .	40
	Setpoint data storage	CANopen: not used. Parameter <a href="#">40.92 Setpoint data storage</a>	41
	<i>Other</i>	Source selection (see <a href="#">Terms and abbreviations</a> ).	-

No.	Name/Value	Description	Default FbEq 16
58.102	Data I/O 2	Defines the address in the drive which the Modbus master accesses when it reads from or writes to register address 400002. For the selections, see parameter 58.101 Data I/O 1.	Ref1 16bit
	TPDO1 word 2	Selects a parameter that is mapped to TPDO1 word 2. For selections, see parameter 58.101 TPDO1 word 1.	Act1 16bit
58.103	Data I/O 3	Defines the address in the drive which the Modbus master accesses when it reads from or writes to register address 400003. For the selections, see parameter 58.101 Data I/O 1.	Ref2 16bit
	TPDO1 word 3	Selects a parameter that is mapped to TPDO1 word 3. For selections, see parameter 58.101 TPDO1 word 1.	Act2 16bit
58.104	Data I/O 4	Defines the address in the drive which the Modbus master accesses when it reads from or writes to register address 400004. For the selections, see parameter 58.101 Data I/O 1.	SW 16bit
	TPDO1 word 4	Selects a parameter that is mapped to TPDO1 word 4. For selections, see parameter 58.101 TPDO1 word 1.	None
58.105	Data I/O 5	Defines the address in the drive which the Modbus master accesses when it reads from or writes to register address 400005. For the selections, see parameter 58.101 Data I/O 1.	Act1 16bit
	RPDO1 word 1	Selects a parameter that is mapped to RPDO1 word 1. For selections, see parameter 58.101 TPDO1 word 1.	CW 16bit
58.106	Data I/O 6	Defines the address in the drive which the Modbus master accesses when it reads from or writes to register address 400006. For the selections, see parameter 58.101 Data I/O 1.	Act2 16bit
	RPDO1 word 2	Selects a parameter that is mapped to RPDO1 word 2. For selections, see parameter 58.101 TPDO1 word 1.	Ref1 16bit
58.107	Data I/O 7	Parameter selector for Modbus register address 400007. For the selections, see parameter 58.101 Data I/O 1.	None
	RPDO1 word 3	Selects a parameter that is mapped to RPDO1 word 3. For selections, see parameter 58.101 TPDO1 word 1.	Ref2 16bit
58.108	Data I/O 8	Parameter selector for Modbus register address 400008. For the selections, see parameter 58.101 Data I/O 1.	None
	RPDO1 word 4	Selects a parameter that is mapped to RPDO1 word 4. For selections, see parameter 58.101 TPDO1 word 1.	None
58.109	Data I/O 9	Parameter selector for Modbus register address 400009. For the selections, see parameter 58.101 Data I/O 1.	None
	TPDO6 word 1	Selects a parameter that is mapped to TPDO6 word 1. For selections, see parameter 58.101 TPDO1 word 1.	None
58.110	Data I/O 10	Parameter selector for Modbus register address 400010. For the selections, see parameter 58.101 Data I/O 1.	None
	TPDO6 word 2	Selects a parameter that is mapped to TPDO6 word 2. For selections, see parameter 58.101 TPDO1 word 1.	None

No.	Name/Value	Description	Default FbEq 16
58.111	<i>Data I/O 11</i>	Parameter selector for Modbus register address 400011. For the selections, see parameter <a href="#">58.101 Data I/O 1</a> .	None
	<i>TPDO6 word 3</i>	Selects a parameter that is mapped to TPDO6 word 3. For selections, see parameter <a href="#">58.101 TPDO1 word 1</a> .	None
58.112	<i>Data I/O 12</i>	Parameter selector for Modbus register address 400012. For the selections, see parameter <a href="#">58.101 Data I/O 1</a> .	None
	<i>TPDO6 word 4</i>	Selects a parameter that is mapped to TPDO6 word 4. For selections, see parameter <a href="#">58.101 TPDO1 word 1</a> .	None
58.113	<i>Data I/O 13</i>	Parameter selector for Modbus register address 400013. For the selections, see parameter <a href="#">58.101 Data I/O 1</a> .	None
	<i>RPDO6 word 1</i>	Selects a parameter that is mapped to RPDO6 word 1. For selections, see parameter <a href="#">58.101 TPDO1 word 1</a> .	None
58.114	<i>Data I/O 14</i>	Parameter selector for Modbus register address 400014. For the selections, see parameter <a href="#">58.101 Data I/O 1</a> .	None
	<i>RPDO6 word 2</i>	Selects a parameter that is mapped to RPDO6 word 2. For selections, see parameter <a href="#">58.101 TPDO1 word 1</a> .	None
58.115	<i>RPDO6 word 3</i>	Selects a parameter that is mapped to RPDO6 word 3. For selections, see parameter <a href="#">58.101 TPDO1 word 1</a> .  <b>Note:</b> If parameter <a href="#">58.01</a> = [1] Modbus RTU, this parameter is hidden.	None
58.116	<i>RPDO6 word 4</i>	Selects a parameter that is mapped to RPDO6 word 4. For selections, see parameter <a href="#">58.101 TPDO1 word 1</a> .  <b>Note:</b> If parameter <a href="#">58.01</a> = [1] Modbus RTU, this parameter is hidden.	None
58.117	<i>TPDO21 word 1</i>	Selects a parameter that is mapped to TPDO21 word 1. For selections, see parameter <a href="#">58.101 TPDO1 word 1</a> .  <b>Note:</b> If parameter <a href="#">58.01</a> = [1] Modbus RTU, this parameter is hidden.	None
58.118	<i>TPDO21 word 2</i>	Selects a parameter that is mapped to TPDO21 word 2. For selections, see parameter <a href="#">58.101 TPDO1 word 1</a> .  <b>Note:</b> If parameter <a href="#">58.01</a> = [1] Modbus RTU, this parameter is hidden.	None
58.119	<i>TPDO21 word 3</i>	Selects a parameter that is mapped to TPDO21 word 3. For selections, see parameter <a href="#">58.101 TPDO1 word 1</a> .  <b>Note:</b> If parameter <a href="#">58.01</a> = [1] Modbus RTU, this parameter is hidden.	None
58.120	<i>TPDO21 word 4</i>	Selects a parameter that is mapped to TPDO21 word 4. For selections, see parameter <a href="#">58.101 TPDO1 word 1</a> .  <b>Note:</b> If parameter <a href="#">58.01</a> = [1] Modbus RTU, this parameter is hidden.	None
58.121	<i>RPDO21 word 1</i>	Selects a parameter that is mapped to RPDO21 word 1. For selections, see parameter <a href="#">58.101 TPDO1 word 1</a> .  <b>Note:</b> If parameter <a href="#">58.01</a> = [1] Modbus RTU, this parameter is hidden.	None

No.	Name/Value	Description	Default FbEq 16
58.122	RPDO21 word 2	Selects a parameter that is mapped to RPDO21 word 2. For selections, see parameter <a href="#">58.101 TPDO1 word 1</a> .  <b>Note:</b> If parameter <a href="#">58.01</a> = [1] Modbus RTU, this parameter is hidden.	None
58.123	RPDO21 word 3	Selects a parameter that is mapped to RPDO21 word 3. For selections, see parameter <a href="#">58.101 TPDO1 word 1</a> .  <b>Note:</b> If parameter <a href="#">58.01</a> = [1] Modbus RTU, this parameter is hidden.	None
58.124	RPDO21 word 4	Selects a parameter that is mapped to RPDO21 word 4. For selections, see parameter <a href="#">58.101 TPDO1 word 1</a> .  <b>Note:</b> If parameter <a href="#">58.01</a> = [1] Modbus RTU, this parameter is hidden.	None

71 External PID1		Configuration of external PID.	
71.01	External PID act value	See parameter <a href="#">40.01 Process PID output actual</a> .	-
71.02	Feedback act value	See parameter <a href="#">40.02 Process PID feedback actual</a> .	-
71.03	Setpoint act value	See parameter <a href="#">40.03 Process PID setpoint actual</a> .	-
71.04	Deviation act value	See parameter <a href="#">40.04 Process PID deviation actual</a> .	-
71.06	PID status word	Displays status information on process external PID control. This parameter is read-only.	-

Bit	Name	Value
0	PID active	1 = Process PID control active.
1	Reserved	
2	Output frozen	1 = Process PID controller output frozen. Bit is set if parameter <a href="#">71.38 Output freeze enable</a> is TRUE, or the deadband function is active (bit 9 is set).
3...6	Reserved	
7	Output limit high	1 = PID output is being limited by par. <a href="#">40.37</a> .
8	Output limit low	1 = PID output is being limited by par. <a href="#">40.36</a> .
9	Deadband active	1 = Deadband is active.
10...11	Reserved	
12	Internal setpoint active	1 = Internal setpoint active (see par. <a href="#">40.16...40.16</a> )
13...15	Reserved	

0000h...FFFFh	Process PID control status word.	1 = 1
71.07	PID operation mode	See parameter <a href="#">40.07 Process PID operation mode</a> . <i>Off</i>
71.08	Feedback 1 source	See parameter <a href="#">40.08 Set 1 feedback 1 source</a> . <i>Not selected</i>
71.11	Feedback filter time	See parameter <a href="#">40.11 Set 1 feedback filter time</a> . 0.000 s



No.	Name/Value	Description	Default FbEq 16
71.14	<i>Setpoint scaling</i>	Defines, together with parameter <i>71.15 Output scaling</i> , a general scaling factor for the external PID control chain. The scaling can be utilized when, for example, the process setpoint is input in Hz, and the output of the PID controller is used as an rpm value in speed control. In this case, this parameter might be set to 50, and parameter <i>71.15</i> to the nominal motor speed at 50 Hz. In effect, the output of the PID controller [ <i>71.15</i> ] when deviation (setpoint - feedback) = [ <i>71.14</i> ] and [ <i>71.32</i> ] = 1. <b>Note:</b> The scaling is based on the ratio between <i>71.14</i> and <i>71.15</i> . For example, the values 50 and 1500 would produce the same scaling as 1 and 3.	1500.00
	-200000.00... 200000.00	Process setpoint base.	1 = 1
71.15	<i>Output scaling</i>	See parameter <i>71.14 Setpoint scaling</i> .	1500.00
	-200000.00... 200000.00	Process PID controller output base.	1 = 1
71.16	<i>Setpoint 1 source</i>	See parameter <i>40.16 Set 1 setpoint 1 source</i> .	<i>Not selected</i>
71.19	<i>Internal setpoint sel1</i>	See parameter <i>40.19 Set 1 internal setpoint sel1</i> .	<i>Not selected</i>
71.20	<i>Internal setpoint sel2</i>	See parameter <i>40.20 Set 1 internal setpoint sel2</i> .	<i>Not selected</i>
71.21	<i>Internal setpoint 1</i>	See parameter <i>40.21 Set 1 internal setpoint 1</i> .	0.00 PID customer units
71.22	<i>Internal setpoint 2</i>	See parameter <i>40.22 Set 1 internal setpoint 2</i> .	0.00 PID customer units
71.23	<i>Internal setpoint 3</i>	See parameter <i>40.23 Set 1 internal setpoint 3</i> .	0.00 PID customer units
71.26	<i>Setpoint min</i>	See parameter <i>40.26 Set 1 setpoint min</i> .	0.00
71.27	<i>Setpoint max</i>	See parameter <i>40.27 Set 1 setpoint max</i> .	200000.00
71.31	<i>Deviation inversion</i>	See parameter <i>40.31 Set 1 deviation inversion</i> .	<i>Not inverted (Ref - Fbk)</i>
71.32	<i>Gain</i>	See parameter <i>40.32 Set 1 gain</i> .	1.00
71.33	<i>Integration time</i>	See parameter <i>40.33 Set 1 integration time</i> .	60.0 s
71.34	<i>Derivation time</i>	See parameter <i>40.34 Set 1 derivation time</i> .	0.000 s
71.35	<i>Derivation filter time</i>	See parameter <i>40.35 Set 1 derivation filter time</i> .	0.0 s
71.36	<i>Output min</i>	See parameter <i>40.36 Set 1 output min</i> .	-200000.00
71.37	<i>Output max</i>	See parameter <i>40.37 Set 1 output max</i> .	200000.00
71.38	<i>Output freeze enable</i>	See parameter <i>40.38 Set 1 output freeze enable</i> .	<i>Not selected</i>
71.39	<i>Deadband range</i>	The control program compares the absolute value of parameter <i>71.04 Deviation act value</i> to the deadband range defined by this parameter. If the absolute value is within the deadband range for the time period defined by parameter <i>71.40 Deadband delay</i> , PID's deadband mode is activated and <i>71.06 PID status word</i> bit 9 <i>Deadband active</i> is set. Then PID's output is frozen and <i>71.06 PID status word</i> bit 2 <i>Output frozen</i> is set. If the absolute value is equal or greater than the deadband range, PID's deadband mode is deactivated.	0.0

No.	Name/Value	Description	Default FbEq 16
	0.0...200000.0	Range	1 = 1
71.40	<i>Deadband delay</i>	Defines the deadband delay for the deadband function. See parameter <a href="#">71.39 Deadband range</a> .	0.0 s
	0.0...3600.0 s	Delay	1 = 1 s
71.58	<i>Increase prevention</i>	See parameter <a href="#">40.58 Set 1 increase prevention</a> .	No
71.59	<i>Decrease prevention</i>	See parameter <a href="#">40.59 Set 1 decrease prevention</a> .	No
71.62	<i>Internal setpoint actual</i>	See parameter <a href="#">40.62 PID internal setpoint actual</a> .	-

<b>76 Application features</b>		Application parameters. See also section <a href="#">Limit to limit control</a> on page 94 and <a href="#">Conical motor control</a> on page 563.	
76.01	<i>Limit to limit control status</i>	Displays the state of the Limit to limit control state machine.	<i>Not initialized</i>
	Not initialized	The initial value of the state machine.	0
	Rev zero, Fwd max speed	The reverse speed is limited to zero speed, and the forward direction speed is not limited by Limit to limit control.	1
	Rev safe, Fwd max speed	The reverse speed is limited to safe speed, and the forward direction speed is not limited by Limit to limit control.	2
	Rev max, Fwd max speed	The reverse speed is not limited, and the forward direction speed is not limited by Limit to limit control.	3
	Rev max, Fwd safe speed	The reverse speed is not limited, and the forward direction speed is limited to safe speed by Limit to limit control.	4
	Rev max, Fwd zero speed	The reverse speed is not limited, and the forward direction speed is limited to zero speed by Limit to limit control.	5
	Rev safe, Fwd zero speed	The reverse speed is limited to safe speed, and the forward direction speed is limited to zero speed by Limit to limit control.	6
	Rev zero, Fwd safe speed	The reverse speed is limited to zero speed, and the forward direction speed is limited to safe speed by Limit to limit control.	7
	Rev safe, Fwd safe speed	The reverse speed is limited to safe speed, and the forward direction speed is limited to safe speed by Limit to limit control.	8
	Rev zero, Fwd zero speed	The reverse speed is limited to zero speed, and the forward direction speed is limited to zero speed by Limit to limit control.	9
	0...9		1 = 1
76.02	<i>Enable limit to limit control</i>	Enables the Limit to limit control or selects the source for limit to limit control function. For more information on the function, see section <a href="#">Limit to limit control</a> on page 94.	<i>Not selected</i>
	Not selected	The Limit to limit control function is disabled.	0
	Selected	The Limit to limit control function is enabled.	1
	DI1	Digital input DI1 ( <a href="#">10.02 DI delayed status</a> , bit 0)	2
	DI2	Digital input DI2 ( <a href="#">10.02 DI delayed status</a> , bit 1)	3
	DI3	Digital input DI3 ( <a href="#">10.02 DI delayed status</a> , bit 2)	4
	DI4	Digital input DI4 ( <a href="#">10.02 DI delayed status</a> , bit 3)	5

No.	Name/Value	Description	Default FbEq 16
	DIO1	Digital input/output DIO1 ( <i>11.02 DIO delayed status</i> , bit 0)	10
	DIO2	Digital input/output DIO2 ( <i>11.02 DIO delayed status</i> , bit 1)	11
	Timed function 1	Bit 0 of <i>34.01 Timed functions status</i>	18
	Timed function 2	Bit 1 of <i>34.01 Timed functions status</i>	19
	Timed function 3	Bit 2 of <i>34.01 Timed functions status</i>	20
	Supervision 1	Bit 0 of <i>32.01 Supervision status</i>	24
	Supervision 2	Bit 1 of <i>32.01 Supervision status</i>	25
	Supervision 3	Bit 2 of <i>32.01 Supervision status</i>	26
	Supervision 4	Bit 3 of <i>32.01 Supervision status</i>	27
	Supervision 5	Bit 4 of <i>32.01 Supervision status</i>	28
	Supervision 6	Bit 5 of <i>32.01 Supervision status</i>	29
	<i>Other [bit]</i>	Source selection (see <i>Terms and abbreviations</i> ).	-
<i>76.03</i>	<i>Limit to limit trigger type</i>	Selects the Limit to limit control trigger type.	<i>Rising Edge</i>
	Rising Edge	Safe and stop limits are handled as pulses. Limit to limit state machine changes states due to rising edge.	0
	Falling edge	Safe and stop limits are handled as pulses. Limit to limit state machine changes states due to falling edge.	1
	Level high	Safe and stop limits are handled as static signals. Limit to limit state machine changes states due state of high signal.	2
	Level low	Safe and stop limits are handled as static signals. Limit to limit state machine changes states due state of low signal.	3
	<i>Other [bit]</i>	Source selection (see <i>Terms and abbreviations</i> ).	
<i>76.04</i>	<i>Forward stop limit</i>	Selects the source to activate the Forward stop limit function. When the you enable the Forward stop command, the function activates an stop command in the forward direction, and the drive stops as per the stop mode defined in the parameter <i>76.12</i> . For more information on the function, see section <i>Crane stop limit function</i> on page <i>546</i> .	<i>Not selected</i>
	Not selected	Disables the stop limit function if the Limit to limit trigger type ( <i>76.03</i> ) is Rising edge or Level high. Enables the function if the trigger type is Falling edge or Level low.	0
	Selected	Enables the stop limit function if the Limit to limit trigger type ( <i>76.03</i> ) is Rising edge or Level high. Disables the function if the trigger type is Falling edge or Level low.	1
	DI1	Digital input DI1 ( <i>10.02 DI delayed status</i> , bit 0)	2
	DI2	Digital input DI2 ( <i>10.02 DI delayed status</i> , bit 1)	3
	DI3	Digital input DI3 ( <i>10.02 DI delayed status</i> , bit 2)	4
	DI4	Digital input DI4 ( <i>10.02 DI delayed status</i> , bit 3)	5
	DIO1	Digital input/output DIO1 ( <i>11.02 DIO delayed status</i> , bit 0)	10
	DIO2	Digital input/output DIO2 ( <i>11.02 DIO delayed status</i> , bit 1)	11

## 324 Parameters

No.	Name/Value	Description	Default FbEq 16
	Timed function 1	Bit 0 of <a href="#">34.01 Timed functions status</a>	18
	Timed function 2	Bit 1 of <a href="#">34.01 Timed functions status</a>	19
	Timed function 3	Bit 2 of <a href="#">34.01 Timed functions status</a>	20
	Supervision 1	Bit 0 of <a href="#">32.01 Supervision status</a>	24
	Supervision 2	Bit 1 of <a href="#">32.01 Supervision status</a>	25
	Supervision 3	Bit 2 of <a href="#">32.01 Supervision status</a>	26
	Supervision 4	Bit 3 of <a href="#">32.01 Supervision status</a>	27
	Supervision 5	Bit 4 of <a href="#">32.01 Supervision status</a>	28
	Supervision 6	Bit 5 of <a href="#">32.01 Supervision status</a>	29
	<a href="#">Other [bit]</a>	Source selection (see <a href="#">Terms and abbreviations</a> ).	-
<a href="#">76.05</a>	<a href="#">Forward slow down limit</a>	<p>Selects the source to activate the Forward slowdown function.</p> <p>When the command is active, the drive limits the speed reference to the value of parameter <a href="#">76.08 Slow down speed</a>. The slowdown frequency is read from parameter <a href="#">76.09 Slow down frequency</a>.</p> <p>For more information on the function, see section <a href="#">Crane slowdown function</a> on page <a href="#">548</a>.</p>	<i>Not selected</i>
	Not selected	<p>Disables the slowdown function if the Limit to limit trigger type (<a href="#">76.03</a>) is Rising edge or Level high.</p> <p>Enables the function if the trigger type is Falling edge or Level low.</p>	0
	Selected	<p>Enables the slowdown function if the Limit to limit trigger type (<a href="#">76.03</a>) is Rising edge or Level high.</p> <p>Disables the function if the trigger type is Falling edge or Level low.</p>	1
	DI1	Digital input DI1 ( <a href="#">10.02 DI delayed status</a> , bit 0)	2
	DI2	Digital input DI2 ( <a href="#">10.02 DI delayed status</a> , bit 1)	3
	DI3	Digital input DI3 ( <a href="#">10.02 DI delayed status</a> , bit 2)	4
	DI4	Digital input DI4 ( <a href="#">10.02 DI delayed status</a> , bit 3)	5
	DIO1	Digital input/output DIO1 ( <a href="#">11.02 DIO delayed status</a> , bit 0)	10
	DIO2	Digital input/output DIO2 ( <a href="#">11.02 DIO delayed status</a> , bit 1)	11
	Timed function 1	Bit 0 of <a href="#">34.01 Timed functions status</a>	18
	Timed function 2	Bit 1 of <a href="#">34.01 Timed functions status</a>	19
	Timed function 3	Bit 2 of <a href="#">34.01 Timed functions status</a>	20
	Supervision 1	Bit 0 of <a href="#">32.01 Supervision status</a>	24
	Supervision 2	Bit 1 of <a href="#">32.01 Supervision status</a>	25
	Supervision 3	Bit 2 of <a href="#">32.01 Supervision status</a>	26
	Supervision 4	Bit 3 of <a href="#">32.01 Supervision status</a>	27
	Supervision 5	Bit 4 of <a href="#">32.01 Supervision status</a>	28
	Supervision 6	Bit 5 of <a href="#">32.01 Supervision status</a>	29
	<a href="#">Other [bit]</a>	Source selection (see <a href="#">Terms and abbreviations</a> ).	-

No.	Name/Value	Description	Default FbEq 16
76.06	<i>Reverse stop limit</i>	Selects the source to activate the Reverse stop limit function. When the command is enabled, the function activates an stop command in the reverse direction, and the drive stops as per the stop mode defined in the parameter <a href="#">76.12</a> . For more information on the function, see section <a href="#">Crane stop limit function</a> on page <a href="#">546</a> .	<i>Not selected</i>
		For the available selections, see parameter <a href="#">76.04 Forward stop limit</a> .	
76.07	<i>Reverse slow down limit</i>	Selects the source to activate the Reverse slowdown function. When the command is active, the drive limits the speed reference to the value of parameter <a href="#">76.08 Slow down speed</a> . The Slowdown frequency is read from parameter <a href="#">76.09 Slow down frequency</a> . For more information on the function, see section <a href="#">Crane slowdown function</a> on page <a href="#">548</a> .	<i>Not selected</i>
		For the available selections, see parameter <a href="#">76.05 Forward slow down limit</a> .	
76.08	<i>Slow down speed</i>	Defines the slowdown speed.	0.00
	0.00...30000.00 rpm	Slowdown speed	1 = 1
76.09	<i>Slow down frequency</i>	Defines the slowdown frequency.	0.00
	0.00...500.00 Hz	Slowdown frequency	1 = 1
76.11	<i>Limit stop mode</i>	Selects the stop ramp mode when a limit stop command is activated.	<i>Normal stop mode</i>
	Normal stop mode	The motor takes the same stop mode as the mode set by <a href="#">21.03 Stop mode</a> .	0
	Limit ramp stop mode	The motor takes ramp stop mode, and the ramp time is defined by <a href="#">76.12 Limit stop ramp time</a> .	1
76.12	<i>Limit stop ramp time</i>	Defines the time inside which the drive is stopped if <a href="#">76.11</a> is <i>Limit ramp stop mode</i> . (ie. the time required for the speed to change from the speed value defined by parameter <a href="#">46.01 Speed scaling</a> or <a href="#">46.02 Frequency scaling</a> to zero).	3.000 s
	0.000...3000.000 s		10 = 1 s
76.21	<i>Conical motor control</i>	Enables the Conical motor control function. <b>Note:</b> Mechanical brake control must be enabled when the Conical motor control function is used. See parameter <a href="#">44.06 Brake control enable</a> .	<i>Disable</i>
	Disable	Conical motor control function is disabled.	0
	Enable	Conical motor control function is enabled.	1
	<i>Other [bit]</i>	Source selection (see <a href="#">Terms and abbreviations</a> ).	-
76.22	<i>Start flux level</i>	Defines the start flux level, that is, the flux level for opening the brake. The drive uses this value as the flux reference when the Conical motor function is activated and the drive is started. See also parameter <a href="#">76.24 Start flux hold time</a> .	125 %
	0...150 %	Start flux level in percentage of the motor nominal flux.	1 = 1 %

## 326 Parameters

No.	Name/Value	Description	Default FbEq 16
76.23	<i>Start stop level</i>	Defines the stop flux level, that is, the flux level for closing the brake. The drive uses this value as the flux reference when the stop command is given and the motor actual speed is below <a href="#">21.06 Zero speed limit</a> .	75 %
	0...100 %	Stop flux level in percentage of the motor nominal flux.	1 = 1 %
76.24	<i>Start flux hold time</i>	Defines the hold time for the start flux level as the flux reference. This hold time makes sure that the start flux level is active for the time required for the brake to open.	2000 ms
	0...10000 ms	Start flux hold time.	1 = 1 ms
76.25	<i>Flux ramp up time</i>	Defines the time for the flux reference to ramp up from the normal flux level (100%) to the start flux level, and from the stop flux level to the normal level (100%).	2000 ms
	0...10000 ms	Flux ramp-up time.	1 = 1 ms
76.26	<i>Flux ramp down time</i>	Defines the time for the flux reference to ramp down from the normal flux level (100%) to the stop flux level, and from the start flux level to the normal level (100%).	2000 ms
	0...10000 ms	Flux ramp-down time.	1 = 1 ms
76.27	<i>Flux reference</i>	Shows the crane flux reference in percent of the nominal flux of the motor. This parameter is read-only and used in the crane application for Conical motor control. See section <a href="#">Conical motor control</a> on page 563.	0 %
	0...200 %	Crane flux reference.	1 = 1 %
76.31	<i>Motor speed match</i>	Enables the speed matching function or selects the source for enable/disable signal.	<i>Not selected</i>
	Not selected	The motor speed matching function is disabled.	0
	Selected	The motor speed matching function is enabled.	1
	DI1	Digital input DI1 ( <a href="#">10.02 DI delayed status</a> , bit 0)	2
	DI2	Digital input DI1 ( <a href="#">10.02 DI delayed status</a> , bit 0)	3
	DI3	Digital input DI1 ( <a href="#">10.02 DI delayed status</a> , bit 0)	4
	DI4	Digital input DI4 ( <a href="#">10.02 DI delayed status</a> , bit 3)	5
	DIO1	Digital input/output DIO1 ( <a href="#">11.02 DIO delayed status</a> , bit 0)	10
	DIO2	Digital input/output DIO2 ( <a href="#">11.02 DIO delayed status</a> , bit 1)	11
	Timed function 1	Bit 0 of <a href="#">34.01 Timed functions status</a>	18
	Timed function 2	Bit 1 of <a href="#">34.01 Timed functions status</a>	19
	Timed function 3	Bit 2 of <a href="#">34.01 Timed functions status</a>	20
	Supervision 1	Bit 0 of <a href="#">32.01 Supervision status</a>	24
	Supervision 2	Bit 1 of <a href="#">32.01 Supervision status</a>	25
	Supervision 3	Bit 2 of <a href="#">32.01 Supervision status</a>	26
	Supervision 4	Bit 3 of <a href="#">32.01 Supervision status</a>	27
	Supervision 5	Bit 4 of <a href="#">32.01 Supervision status</a>	28
	Supervision 6	Bit 5 of <a href="#">32.01 Supervision status</a>	29
	<i>Other</i>	Source selection (see <a href="#">Terms and abbreviations</a> ).	

No.	Name/Value	Description	Default FbEq 16
76.32	<i>Motor speed steady deviation level</i>	Defines the allowed motor speed deviation level (absolute value) for the steady state operation (motor started and running).	30.00
	0.00....30000.00 rpm		1 = 1
76.33	<i>Motor speed ramp deviation level</i>	Defines the allowed motor speed deviation level (absolute value) for the ramping state (acceleration/deceleration) operation (motor started and running).	70.00
	0.00....30000.00 rpm		1 = 1
76.34	<i>Speed match fault delay</i>	Defines the time delay for generating fault <i>D105 Speed match</i> and warning <i>D200 Brake slip at standstill2</i> .	1000 ms
	0....30000 ms		1 = 1

<b>90 Feedback selection</b>		Motor and load feedback configuration. See also sections <i>Rush control</i> (page 70) and <i>Jogging</i> (page 70).	
90.01	<i>Motor speed for control</i>	Displays the estimated or measured motor speed that is used for motor control, ie. final motor speed feedback selected by parameter <i>90.41 Motor feedback selection</i> and filtered by <i>90.42 Motor speed filter time</i> . This parameter is read-only.	-
	-32768.00 ... 32767.00 rpm	Motor speed used for control.	See par. <a href="#">46.01</a>
90.02	<i>Motor position</i>	Displays the motor position (within one revolution) received from the source selected by parameter <i>90.41 Motor feedback selection</i> . This parameter is read-only.	-
	0.00000000 ... 1.00000000 rev	Motor position.	32767 = 1 rev
90.10	<i>Encoder 1 speed</i>	Displays encoder 1 speed in rpm. This parameter is read-only.	-
	-32768.00 ... 32767.00 rpm	Encoder 1 speed.	See par. <a href="#">46.01</a>
90.11	<i>Encoder 1 position</i>	Displays the actual position of encoder 1 within one revolution. This parameter is read-only.	-
	0.00000000 ... 1.00000000 rev	Encoder 1 position within one revolution.	32767 = 1 rev
90.13	<i>Encoder 1 revolution extension</i>	Displays the revolution count extension for encoder 1. With a single-turn encoder, the counter is incremented when encoder position (parameter <i>90.11</i> ) wraps around in the positive direction, and decremented in the negative direction. This parameter is read-only.	-
	-2147483648... 2147483647	Encoder 1 revolution count extension.	-

No.	Name/Value	Description	Default FbEq 16
90.41	<i>Motor feedback selection</i>	Selects the motor speed feedback value used during motor control. <b>Note:</b> With a permanent magnet motor, make sure an autophasing routine (see page 57) is performed using the selected encoder. If necessary, set parameter 99.13 <i>ID run requested</i> requested to <i>Autophasing</i> to request a fresh autophasing routine.	<i>Estimate</i>
	Estimate	A calculated speed estimate generated from the vector control is used.	0
	Encoder 1	Actual speed measured by encoder 1. The encoder is set up by the parameters in group 92 <i>Encoder 1 configuration</i> .	1
90.42	<i>Motor speed filter time</i>	Defines a filter time for motor speed feedback used for control (90.01 <i>Motor speed for control</i> ).	3 ms
	0 ... 10000 ms	Motor speed filter time.	1=1
90.45	<i>Motor feedback fault</i>	Selects how the drive reacts to loss of measured motor feedback.	<i>Fault</i>
	Fault	Drive trips on a 7301 <i>Motor speed feedback</i> . or 7381 <i>Encoder</i> fault.	0
	Warning	Drive generates a A7B0 <i>Motor speed feedback</i> or A7E1 <i>Encoder</i> warning and continues operation using estimated feedbacks. <b>Note:</b> Before using this setting, test the stability of the speed control loop with estimated feedback by running the drive on estimated feedback (see 90.41 <i>Motor feedback selection</i> ).	1
90.46	<i>Force open loop</i>	Defines the speed feedback used by the vector motor model.	<i>No</i>
	No	The motor model uses the feedback selected by 90.41 <i>Motor feedback selection</i> .	0
	Yes	The motor model uses the calculated speed estimate (regardless of the setting of 90.41 <i>Motor feedback selection</i> , which in this case only selects the source of the feedback for the speed controller).	1
90.47	<i>Enable motor encoder drift detection</i>	Enables/disables the motor encoder drift detection. When drift is detected, fault 7301 <i>Motor speed feedback</i> and AUX code 4 Drift detected are set.	<i>Yes</i>
	No	Drift detection is disabled.	0
	Yes	Drift detection is enabled.	1
<b>91 Encoder adapter settings</b>		Configuration of encoder interface modules.	
91.10	<i>Encoder parameter refresh</i>	Validates any changed encoder interface module parameters. This is needed for any parameter changes in groups 90...93 to take effect. After refreshing, the value reverts automatically to <i>Done</i> . <b>Notes:</b> <ul style="list-style-type: none"> <li>Permanent magnet motors only: The drive will perform a fresh autophasing routine (see page 57) at next start if the motor feedback encoder settings have been changed.</li> <li>The parameter cannot be changed while the drive is running.</li> </ul>	<i>Done</i>



No.	Name/Value	Description	Default FbEq 16
	Done	The refreshing is completed.	0
	Refresh	Refresh function is running.	1
<b>92 Encoder 1 configuration</b>		Settings for encoder 1. <b>Notes:</b> <ul style="list-style-type: none"> <li>The contents of the parameter group vary according to the selected encoder type.</li> <li>It is recommended that encoder connection 1 (this group) is used whenever possible.</li> </ul>	
92.10	<i>Pulses/revolution</i>	(Visible when a TTL, TTL + HTL encoder is selected) Defines the pulse number per revolution.	2048
	0...65535	Number of pulses.	-
<b>95 HW configuration</b>		Various hardware-related settings.	
95.01	<i>Supply voltage</i>	Selects the supply voltage range. This parameter is used by the drive to determine the nominal voltage of the supply network. The parameter also affects the current ratings and the DC voltage control functions (trip and brake chopper activation limits) of the drive.  <b>WARNING!</b> An incorrect setting may cause the motor to rush uncontrollably, or the brake chopper or resistor to overload. <b>Note:</b> The selections shown depend on the hardware of the drive. If only one voltage range is valid for the drive in question, it is selected by default.	<i>Automatic / not selected</i>
	Automatic / not selected	No voltage range selected. The drive will not start modulating before a range is selected, unless parameter <i>95.02 Adaptive voltage limits</i> is set to <i>Enable</i> , in which case the drive estimates the supply voltage itself.	0
	208...240 V	200...240 V, available for ACS380-04-xxxx-1/-2 drives	1
	380...480 V	380...480 V, available for ACS380-04-xxxx-4 drives	2
95.02	<i>Adaptive voltage limits</i>	Enables adaptive voltage limits. Adaptive voltage limits can be used if, for example, an IGBT supply unit is used to raise the DC voltage level. If the communication between the inverter and IGBT supply unit is active, the voltage limits are related to the DC voltage reference from the IGBT supply unit. Otherwise the limits are calculated based on the measured DC voltage at the end of the pre-charging sequence. This function is also useful if the AC supply voltage to the drive is high, as the warning levels are raised accordingly.	<i>Enable</i>
	Disable	Adaptive voltage limits disabled.	0
	Enable	Adaptive voltage limits enabled.	1
95.03	<i>Estimated AC supply voltage</i>	AC supply voltage estimated by calculation. Estimation is done every time the drive is powered up and is based on the rise speed of voltage level of the DC bus while the drive charges the DC bus.	-
	0.0...65535.0 V	Voltage.	10 = 1 V
95.04	<i>Control board supply</i>	Specifies how the control board of the drive is powered.	<i>Internal 24V</i>
	Internal 24V	The drive control board is powered from the drive power unit it is connected to.	0

No.	Name/Value	Description	Default FbEq 16															
	External 24V	The drive control board is powered from an external power supply.	1															
95.15	<i>Special HW settings</i>	Contains hardware-related settings that can be enabled and disabled by toggling the specific bits. <b>Note:</b> The installation of the hardware specified by this parameter may require derating of drive output, or impose other limitations. Refer to the hardware manual of the drive.	-															
<table border="1"> <thead> <tr> <th>Bit</th> <th>Name</th> <th>Information</th> </tr> </thead> <tbody> <tr> <td>0</td> <td>Reserved</td> <td>-</td> </tr> <tr> <td>1</td> <td>ABB Sine filter</td> <td>1 = An ABB sine filter is connected to the output of the drive/inverter</td> </tr> <tr> <td>2...15</td> <td>Reserved</td> <td>-</td> </tr> </tbody> </table>				Bit	Name	Information	0	Reserved	-	1	ABB Sine filter	1 = An ABB sine filter is connected to the output of the drive/inverter	2...15	Reserved	-			
Bit	Name	Information																
0	Reserved	-																
1	ABB Sine filter	1 = An ABB sine filter is connected to the output of the drive/inverter																
2...15	Reserved	-																
	0...1	Hardware options configuration word.	1 = 1															
95.20	<i>HW options word 1</i>	Specifies hardware-related options that require differentiated parameter defaults. This parameter is not affected by a parameter restore.	-															
<table border="1"> <thead> <tr> <th>Bit</th> <th>Name</th> <th>Value</th> </tr> </thead> <tbody> <tr> <td>0</td> <td>Supply frequency 60 Hz</td> <td>If you change the value of this bit, you have to do a complete reset to the drive after the change. After reset you have to reselect the macro to be used. See section <i>Differences in the default values between 50 Hz and 60 Hz supply frequency settings</i> on page 354. 0 = 50 Hz. 1 = 60 Hz.</td> </tr> <tr> <td>1...12</td> <td>Reserved</td> <td></td> </tr> <tr> <td>13</td> <td>du/dt filter activation</td> <td>When active, an external du/dt filter is connected to the drive/inverter output. The setting will limit the output switching frequency, and force the fan of the drive/inverter module to full speed. 0 = du/dt filter inactive. 1 = du/dt filter active.</td> </tr> <tr> <td>14...15</td> <td>Reserved</td> <td></td> </tr> </tbody> </table>				Bit	Name	Value	0	Supply frequency 60 Hz	If you change the value of this bit, you have to do a complete reset to the drive after the change. After reset you have to reselect the macro to be used. See section <i>Differences in the default values between 50 Hz and 60 Hz supply frequency settings</i> on page 354. 0 = 50 Hz. 1 = 60 Hz.	1...12	Reserved		13	du/dt filter activation	When active, an external du/dt filter is connected to the drive/inverter output. The setting will limit the output switching frequency, and force the fan of the drive/inverter module to full speed. 0 = du/dt filter inactive. 1 = du/dt filter active.	14...15	Reserved	
Bit	Name	Value																
0	Supply frequency 60 Hz	If you change the value of this bit, you have to do a complete reset to the drive after the change. After reset you have to reselect the macro to be used. See section <i>Differences in the default values between 50 Hz and 60 Hz supply frequency settings</i> on page 354. 0 = 50 Hz. 1 = 60 Hz.																
1...12	Reserved																	
13	du/dt filter activation	When active, an external du/dt filter is connected to the drive/inverter output. The setting will limit the output switching frequency, and force the fan of the drive/inverter module to full speed. 0 = du/dt filter inactive. 1 = du/dt filter active.																
14...15	Reserved																	
	0000h...FFFh	Hardware options configuration word.	1 = 1															
<b>96 System</b>		Language selection; access levels; macro selection; parameter save and restore; control unit reboot; user parameter sets; unit selection; parameter checksum calculation; user lock.																
96.01	<i>Language</i>	Selects the language of the parameter interface and other displayed information when viewed on the control panel. <b>Notes:</b> <ul style="list-style-type: none"> <li>Not all languages listed below are necessarily supported.</li> <li>This parameter does not affect the languages visible in the Drive composer PC tool. (Those are specified under <b>View – Settings – Drive default language.</b>)</li> </ul>	<i>Not selected</i>															
	Not selected	Select a language.	0															
	English	English.	1033															
	Deutsch	German.	1031															
	Italiano	Italian.	1040															

No.	Name/Value	Description	Default FbEq 16																				
	Español	Spanish.	3082																				
	Portugues	Portuguese.	2070																				
	Nederlands	Dutch.	1043																				
	Français	French.	1036																				
	Suomi	Finnish.	1035																				
	Svenska	Swedish.	1053																				
	Russki	Russian.	1049																				
	Polski	Polish.	1045																				
	Türkçe	Turkish.	1055																				
	Chinese (Simplified, PRC)	Simplified Chinese.	2052																				
96.02	<i>Pass code</i>	<p>Pass codes can be entered into this parameter to activate further access levels, for example additional parameters, parameter lock, etc. See parameter <a href="#">96.03 Access levels status</a>.</p> <p>Entering "358" toggles the parameter lock, which prevents the changing of all other parameters through the control panel or the Drive composer PC tool.</p> <p>Entering the user pass code (by default, "10000000") enables parameters <a href="#">96.100...96.102</a>, which can be used to define a new user pass code and to select the actions that are to be prevented.</p> <p>Entering an invalid pass code will close the user lock if open, ie. hide parameters <a href="#">96.100...96.102</a>. After entering the code, check that the parameters are in fact hidden.</p> <p><b>Note:</b> We recommend that you change the default user pass code.</p> <p>See also section <a href="#">User lock</a> (page <a href="#">109</a>).</p>	0																				
	0...99999999	Pass code.	-																				
96.03	<i>Access levels status</i>	Shows which access levels have been activated by pass codes entered into parameter <a href="#">96.02 Pass code</a> .	0b0000																				
	<table border="1"> <thead> <tr> <th>Bit</th> <th>Name</th> </tr> </thead> <tbody> <tr> <td>0</td> <td>End user</td> </tr> <tr> <td>1</td> <td>Service</td> </tr> <tr> <td>2</td> <td>Advanced users</td> </tr> <tr> <td>3...10</td> <td>Reserved</td> </tr> <tr> <td>11</td> <td>OEM access level 1</td> </tr> <tr> <td>12</td> <td>OEM access level 2</td> </tr> <tr> <td>13</td> <td>OEM access level 3</td> </tr> <tr> <td>14</td> <td>Parameter lock</td> </tr> <tr> <td>15</td> <td>Reserved</td> </tr> </tbody> </table>	Bit	Name	0	End user	1	Service	2	Advanced users	3...10	Reserved	11	OEM access level 1	12	OEM access level 2	13	OEM access level 3	14	Parameter lock	15	Reserved		
Bit	Name																						
0	End user																						
1	Service																						
2	Advanced users																						
3...10	Reserved																						
11	OEM access level 1																						
12	OEM access level 2																						
13	OEM access level 3																						
14	Parameter lock																						
15	Reserved																						
	0b0000...0b1111	Active access levels.	-																				

No.	Name/Value	Description	Default FbEq 16
96.04	<i>Macro select</i>	<p>Selects the control macro. See chapter <i>Control macros</i> for more information.</p> <p>After a selection is made, the parameter reverts automatically to <i>Done</i>.</p> <p>Note: When you change the default parameter values of a macro, the new settings become valid immediately and stay valid even if the power of the drive is switched off and on. However, backup of the default parameter settings (factory settings) of each standard macro is still available.</p>	<i>Done</i>
	Done	Macro selection complete; normal operation.	0
	ABB standard	<i>ABB standard macro</i> . For scalar motor control.	1
	AC500 Modbus RTU	AC500 Modbus RTU	5
	Ethernet IP	Ethernet IP	8
	Modbus TCP	Modbus TCP	9
	Alternate	<i>Alternate macro</i>	12
	Motor potentiometer	<i>Motor potentiometer macro</i>	13
	PID	<i>PID control macro</i>	14
96.05	<i>Macro active</i>	<p>Shows which control macro is currently selected. See chapter <i>Control macros</i> for more information.</p> <p>To change the macro, use parameter <i>96.04 Macro select</i>.</p>	<i>ABB standard</i>
	Done	Macro selection complete; normal operation.	0
	ABB standard	<i>ABB standard macro</i> . For scalar motor control.	1
	AC500 Modbus RTU	AC500 Modbus RTU	5
	Ethernet IP	Ethernet IP	8
	Modbus TCP	Modbus TCP	9
	Alternate	<i>Alternate macro</i>	12
	Motor potentiometer	<i>Motor potentiometer macro</i>	13
	PID	<i>PID control macro</i>	14
96.06	<i>Parameter restore</i>	<p>Restores the original settings of the control program, ie. parameter default values.</p> <p><b>Note:</b> This parameter cannot be changed while the drive is running.</p>	<i>Done</i>
	Done	Restoring is completed.	0
	Restore defaults	<p>All editable parameter values are restored to default values, except</p> <ul style="list-style-type: none"> <li>• motor data and ID run results</li> <li>• I/O extension module settings</li> <li>• end user texts, such as customized warnings and faults (external faults and changed), and the drive name</li> <li>• control panel/PC communication settings</li> <li>• fieldbus adapter settings</li> <li>• control macro selection and the parameter defaults implemented by it</li> <li>• parameter <i>95.20 HW options word 1</i> and the differentiated defaults implemented by it.</li> <li>• user lock configuration parameters <i>96.100...96.102</i>.</li> </ul>	8

No.	Name/Value	Description	Default FbEq 16
	Clear all	All editable parameter values are restored to default values, except <ul style="list-style-type: none"> <li>• end user texts, such as customized warnings and faults (external faults and changed), and the drive name</li> <li>• control panel/PC communication settings</li> <li>• fieldbus adapter settings (clears entire existing settings)</li> <li>• control macro selection and the parameter defaults implemented by it</li> <li>• parameter <a href="#">95.20 HW options word 1</a> and the differentiated defaults implemented by it.</li> <li>• user lock configuration parameters <a href="#">96.100...96.102</a>.</li> </ul> PC tool communication is interrupted during the restoring.	62
	Reset all fieldbus settings	Restores all fieldbus and communication related settings to default values. <b>Note:</b> Fieldbus, control panel and PC tool communication are interrupted during the restore.	32
	Reset home view	Restores the Home view layout to show the values of the default parameters defined by the control macro use.	512
	Reset end user texts	Restores all end user texts to default values, including the drive name, contact info, customized fault and warning texts, PID unit and currency unit.	1024
	Reset motor data	Restores all motor nominal values and motor ID run results to default values.	2
	All to factory defaults	Restores all drive parameters and settings back to initial factory values, except <ul style="list-style-type: none"> <li>• parameter <a href="#">95.20 HW options word 1</a> and the differentiated defaults implemented by it.</li> </ul>	34560
<a href="#">96.07</a>	<a href="#">Parameter save manually</a>	Saves the valid parameter values to the permanent memory on the drive control board to ensure that operation can continue after cycling the power. Save the parameters with this parameter <ul style="list-style-type: none"> <li>• to store values sent from the fieldbus</li> <li>• when using external +24 V DC power supply to the control unit: to save parameter changes before you power down the control unit. The supply has a very short hold-up time when powered off.</li> </ul> <b>Note:</b> A new parameter value is saved automatically when changed from the PC tool or control panel but not when altered through a fieldbus adapter connection.	<a href="#">Done</a>
	Done	Save completed.	0
	Save	Save in progress.	1
<a href="#">96.08</a>	<a href="#">Control board boot</a>	Changing the value of this parameter to 1 reboots the control unit (without requiring a power off/on cycle of the complete drive module). The value reverts to 0 automatically.	0
	0	No action	1 = 1
	1	Reboot the control unit.	
<a href="#">96.10</a>	<a href="#">User set status</a>	Shows the status of the user parameter sets. This parameter is read-only. See also section <a href="#">User parameter sets</a> (page 106).	-
	n/a	No user parameter sets have been saved.	0

No.	Name/Value	Description	Default FbEq 16
	Loading	A user set is being loaded.	1
	Saving	A user set is being saved.	2
	Faulted	Invalid or empty parameter set.	3
	User1 IO active	User set 1 has been selected by parameters <a href="#">96.12 User set I/O mode in1</a> and <a href="#">96.13 User set I/O mode in2</a> .	4
	User2 IO active	User set 2 has been selected by parameters <a href="#">96.12 User set I/O mode in1</a> and <a href="#">96.13 User set I/O mode in2</a> .	5
	User3 IO active	User set 3 has been selected by parameters <a href="#">96.12 User set I/O mode in1</a> and <a href="#">96.13 User set I/O mode in2</a> .	6
	User4 IO active	User set 4 has been selected by parameters <a href="#">96.12 User set I/O mode in1</a> and <a href="#">96.13 User set I/O mode in2</a> .	7
	User1 backup	User set 1 has been saved or loaded.	20
	User2 backup	User set 2 has been saved or loaded.	21
	User3 backup	User set 3 has been saved or loaded.	22
	User4 backup	User set 4 has been saved or loaded.	23
<a href="#">96.11</a>	<a href="#">User set save/load</a>	<p>Enables the saving and restoring of up to four custom sets of parameter settings.</p> <p>The set that was in use before powering down the drive is in use after the next power-up.</p> <p><b>Notes:</b></p> <ul style="list-style-type: none"> <li>Some hardware configuration settings, such as I/O extension module, fieldbus and encoder configuration parameters (groups 14...16, 47, 50...58 and 92...93) are not included in user parameter sets.</li> <li>Parameter changes made after loading a set are not automatically stored – they must be saved using this parameter.</li> <li>This parameter cannot be changed while the drive is running</li> </ul>	<i>No action</i>
	No action	Load or save operation complete; normal operation.	0
	User set I/O mode	Load user parameter set using parameters <a href="#">96.12 User set I/O mode in1</a> and <a href="#">96.13 User set I/O mode in2</a> .	1
	Load set 1	Load user parameter set 1.	2
	Load set 2	Load user parameter set 2.	3
	Load set 3	Load user parameter set 3.	4
	Load set 4	Load user parameter set 4.	5
	Save to set 1	Save user parameter set 1.	18
	Save to set 2	Save user parameter set 2.	19
	Save to set 3	Save user parameter set 3.	20
	Save to set 4	Save user parameter set 4.	21

No.	Name/Value	Description	Default FbEq 16															
96.12	<i>User set I/O mode in1</i>	When parameter <a href="#">96.11 User set save/load</a> is set to <i>User set I/O mode</i> , selects the user parameter set together with parameter <a href="#">96.13 User set I/O mode in2</a> as follows:	<i>Not selected</i>															
		<table border="1"> <thead> <tr> <th data-bbox="427 279 580 341">Status of source defined by par. <a href="#">96.12</a></th> <th data-bbox="584 279 736 341">Status of source defined by par. <a href="#">96.13</a></th> <th data-bbox="741 279 896 341">User parameter set selected</th> </tr> </thead> <tbody> <tr> <td data-bbox="499 357 508 379">0</td> <td data-bbox="663 357 672 379">0</td> <td data-bbox="799 357 844 379">Set 1</td> </tr> <tr> <td data-bbox="499 392 508 414">1</td> <td data-bbox="663 392 672 414">0</td> <td data-bbox="799 392 844 414">Set 2</td> </tr> <tr> <td data-bbox="499 427 508 450">0</td> <td data-bbox="663 427 672 450">1</td> <td data-bbox="799 427 844 450">Set 3</td> </tr> <tr> <td data-bbox="499 462 508 485">1</td> <td data-bbox="663 462 672 485">1</td> <td data-bbox="799 462 844 485">Set 4</td> </tr> </tbody> </table>	Status of source defined by par. <a href="#">96.12</a>	Status of source defined by par. <a href="#">96.13</a>	User parameter set selected	0	0	Set 1	1	0	Set 2	0	1	Set 3	1	1	Set 4	
Status of source defined by par. <a href="#">96.12</a>	Status of source defined by par. <a href="#">96.13</a>	User parameter set selected																
0	0	Set 1																
1	0	Set 2																
0	1	Set 3																
1	1	Set 4																
	Not selected	0.	0															
	Selected	1.	1															
	DI1	Digital input DI1 ( <a href="#">10.02 DI delayed status</a> , bit 0).	2															
	DI2	Digital input DI2 ( <a href="#">10.02 DI delayed status</a> , bit 1).	3															
	DI3	Digital input DI3 ( <a href="#">10.02 DI delayed status</a> , bit 2).	4															
	DI4	Digital input DI4 ( <a href="#">10.02 DI delayed status</a> , bit 3).	5															
	DIO1	Digital input/output DIO1 ( <a href="#">11.02 DIO delayed status</a> , bit 0).	10															
	DIO2	Digital input/output DIO2 ( <a href="#">11.02 DIO delayed status</a> , bit 1)	11															
	Timed function 1	Bit 0 of <a href="#">34.01 Timed functions status</a>	18															
	Timed function 2	Bit 1 of <a href="#">34.01 Timed functions status</a> .	19															
	Timed function 3	Bit 2 of <a href="#">34.01 Timed functions status</a> .	20															
	Supervision 1	Bit 0 of <a href="#">32.01 Supervision status</a> .	24															
	Supervision 2	Bit 1 of <a href="#">32.01 Supervision status</a> .	25															
	Supervision 3	Bit 2 of <a href="#">32.01 Supervision status</a> .	26															
	Supervision 4	Bit 3 of <a href="#">32.01 Supervision status</a>	27															
	Supervision 5	Bit 4 of <a href="#">32.01 Supervision status</a> .	28															
	Supervision 6	Bit 5 of <a href="#">32.01 Supervision status</a> .	29															
	<i>Other [bit]</i>	Source selection (see <a href="#">Terms and abbreviations</a> ).	-															
96.13	<i>User set I/O mode in2</i>	See parameter <a href="#">96.12 User set I/O mode in1</a> .	<i>Not selected</i>															

No.	Name/Value	Description	Default FbEq 16																								
96.16	<a href="#">Unit selection</a>	Selects the unit of parameters indicating power, temperature and torque.	0b0000																								
		<table border="1"> <thead> <tr> <th>Bit</th> <th>Name</th> <th>Information</th> </tr> </thead> <tbody> <tr> <td rowspan="2">0</td> <td rowspan="2">Power unit</td> <td>0 = kW</td> </tr> <tr> <td>1 = hp</td> </tr> <tr> <td>1</td> <td>Reserved</td> <td></td> </tr> <tr> <td rowspan="2">2</td> <td rowspan="2">Temperature unit</td> <td>0 = °C</td> </tr> <tr> <td>1 = °F</td> </tr> <tr> <td>3</td> <td>Reserved</td> <td></td> </tr> <tr> <td rowspan="2">4</td> <td rowspan="2">Torque unit</td> <td>0 = Nm (N·m)</td> </tr> <tr> <td>1 = lbft (lb·ft)</td> </tr> <tr> <td>5...15</td> <td>Reserved</td> <td></td> </tr> </tbody> </table>	Bit	Name	Information	0	Power unit	0 = kW	1 = hp	1	Reserved		2	Temperature unit	0 = °C	1 = °F	3	Reserved		4	Torque unit	0 = Nm (N·m)	1 = lbft (lb·ft)	5...15	Reserved		
Bit	Name	Information																									
0	Power unit	0 = kW																									
		1 = hp																									
1	Reserved																										
2	Temperature unit	0 = °C																									
		1 = °F																									
3	Reserved																										
4	Torque unit	0 = Nm (N·m)																									
		1 = lbft (lb·ft)																									
5...15	Reserved																										
	0b0000...0b1111	Unit selection word.	1 = 1																								
96.20	<a href="#">Time sync primary source</a>	Defines the 1st priority external source for synchronization of the drive's time and date.	<a href="#">Panel link</a>																								
	Internal	No external source selected.	0																								
	Fieldbus A	Fieldbus interface A.	3																								
	Embedded FB	Embedded fieldbus interface.	6																								
	Panel link	Control panel, or Drive composer PC tool connected to the control panel.	8																								
	Ethernet tool link	Drive composer PC tool through FENA module.	9																								
96.51	<a href="#">Clear fault and event logger</a>	Clears all events from the drive's fault and event logs.	<a href="#">Done</a>																								
	Done	0 = No action.	0																								
	Reset	1 = Resets (clears) fault and event logger.	1																								
96.54	<a href="#">Checksum action</a>	<p>Selects how the drive reacts</p> <ul style="list-style-type: none"> <li>when <a href="#">96.55 Checksum control word</a>, bit 8 = 1 (<a href="#">Approved checksum A</a>): if the parameter checksum <a href="#">96.68 Actual checksum A</a> does not match <a href="#">96.71 Approved checksum A</a>, and/or</li> <li>when <a href="#">96.55 Checksum control word</a>, bit 9 = 1 (<a href="#">Approved checksum B</a>): if the parameter checksum <a href="#">96.69 Actual checksum B</a> does not match <a href="#">96.72 Approved checksum B</a>.</li> </ul>	<a href="#">No action</a>																								
	No action	No action taken. (The checksum feature is not in use.)	0																								
	Pure event	The drive generates an event log entry ( <a href="#">B686 Checksum mismatch</a> ).	1																								
	Warning	The drive generates a warning ( <a href="#">A686 Checksum mismatch</a> ).	2																								
	Warning and prevent start	The drive generates a warning ( <a href="#">A686 Checksum mismatch</a> ). Starting the drive is prevented.	3																								
	Fault	The drive trips on <a href="#">6200 Checksum mismatch</a> .	4																								



No.	Name/Value	Description	Default FbEq 16																								
96.55	<i>Checksum control word</i>	<p>Bits 8...9 select which comparison(s) are made:</p> <ul style="list-style-type: none"> <li>• <b>Bit 8 = 1 (Approved checksum A):</b> 96.68 <i>Actual checksum A</i> is compared to 96.71 <i>Approved checksum A</i>, and/or</li> <li>• <b>Bit 9 = 1 (Approved checksum A):</b> if 96.69 <i>Actual checksum B</i> is compared to 96.72 <i>Approved checksum B</i>.</li> </ul> <p>Bits 12...13 select approved (reference) checksum parameter(s) into which the actual checksum(s) from parameter(s) are copied:</p> <ul style="list-style-type: none"> <li>• <b>Bit 12 = 1 (Set approved checksum A):</b> Value of 96.68 <i>Actual checksum A</i> is copied into 96.71 <i>Approved checksum A</i> and/or</li> <li>• <b>Bit 13 = 1 (Set approved checksum B):</b> Value of 96.69 <i>Actual checksum B</i> copied into 96.72 <i>Approved checksum B</i>.</li> </ul>	0b0000																								
<table border="1"> <thead> <tr> <th>Bit</th> <th>Name</th> <th>Information</th> </tr> </thead> <tbody> <tr> <td>0...7</td> <td>Reserved</td> <td></td> </tr> <tr> <td>8</td> <td>Approved checksum A</td> <td>1 = Enabled: Checksum A (96.71) is observed. 0 = Disabled.</td> </tr> <tr> <td>9</td> <td>Approved checksum B</td> <td>1 = Enabled: Checksum B (96.72) is observed. 0 = Disabled.</td> </tr> <tr> <td>10...11</td> <td>Reserved</td> <td></td> </tr> <tr> <td>12</td> <td>Set approved checksum A</td> <td>1 = Set: Copy value of 96.68 into 96.71. 0 = Done (copy has been made).</td> </tr> <tr> <td>13</td> <td>Set approved checksum B</td> <td>1 = Set: Copy value of 96.69 into 96.72. 0 = Done (copy has been made).</td> </tr> <tr> <td>14...15</td> <td>Reserved</td> <td></td> </tr> </tbody> </table>				Bit	Name	Information	0...7	Reserved		8	Approved checksum A	1 = Enabled: Checksum A (96.71) is observed. 0 = Disabled.	9	Approved checksum B	1 = Enabled: Checksum B (96.72) is observed. 0 = Disabled.	10...11	Reserved		12	Set approved checksum A	1 = Set: Copy value of 96.68 into 96.71. 0 = Done (copy has been made).	13	Set approved checksum B	1 = Set: Copy value of 96.69 into 96.72. 0 = Done (copy has been made).	14...15	Reserved	
Bit	Name	Information																									
0...7	Reserved																										
8	Approved checksum A	1 = Enabled: Checksum A (96.71) is observed. 0 = Disabled.																									
9	Approved checksum B	1 = Enabled: Checksum B (96.72) is observed. 0 = Disabled.																									
10...11	Reserved																										
12	Set approved checksum A	1 = Set: Copy value of 96.68 into 96.71. 0 = Done (copy has been made).																									
13	Set approved checksum B	1 = Set: Copy value of 96.69 into 96.72. 0 = Done (copy has been made).																									
14...15	Reserved																										
	0b0000...0b1111	Checksum control word.	1 = 1																								
96.68	<i>Actual checksum A</i>	<p>Displays the actual parameter configuration checksum A. The checksum A is generated and updated whenever an action is selected in 96.54 <i>Checksum action</i> and 96.55 <i>Checksum control word</i>, bit 8 = 1 (Approved checksum A)</p> <p>The set of parameters for checksum A calculation does not include fieldbus settings parameters.</p> <p>The parameters included in the checksum A calculation are user editable parameters in parameter groups 10, 15, 19, 20, 21, 22, 23, 24, 25, 28, 30, 31, 32, 34, 35, 36, 37, 40, 41, 43, 45, 46, 71, 76, 90, 91, 92, 95, 96, 97, 98, and 99.</p> <p>See also section <i>Parameter checksum calculation</i> (page 107).</p>	0x0000																								
	0x0000...0xffff	Actual checksum A.	1 = 1																								

No.	Name/Value	Description	Default FbEq 16
96.69	<i>Actual checksum B</i>	Displays the actual parameter configuration checksum B. The checksum B is generated and updated whenever an action is selected in <a href="#">96.54 Checksum action</a> and <a href="#">96.55 Checksum control word</a> , bit 9 = 1 (Approved checksum B) The set of parameters for checksum B does not include: <ul style="list-style-type: none"> <li>• fieldbus settings</li> <li>• motor data settings, and</li> <li>• energy data settings parameters.</li> </ul> The parameters included in the checksum B calculation are user editable parameters in parameter groups 10, 15, 19, 20, 21, 22, 23, 24, 25, 28, 30, 31, 32, 34, 35, 36, 37, 40, 41, 43, 46, 71, 76, 90, 91, 92, 95, 96, and 97. See also section <a href="#">Parameter checksum calculation</a> (page <a href="#">107</a> ).	0x0000
	0x0000...0xffff	Actual checksum B.	1 = 1
96.70	<i>Disable adaptive program</i>	Selects if the adaptive program is enabled or disabled	
	No	Adaptive program is enabled. Adaptive program is set to running mode automatically when drive is powered on. Commanding adaptive program to running mode is possible from PC tool.	0
	Yes	Adaptive program is disabled. Setting adaptive program to running mode is not possible. If adaptive program was running when disabled, then adaptive program is stopped and set to init state.	1
96.71	<i>Approved checksum A</i>	Approved (reference) checksum A.	0x0000
	0x0000...0xffff	Approved checksum A.	-
96.72	<i>Approved checksum B</i>	Approved (reference) checksum B.	0x0000
	0x0000...0xffff	Approved checksum B.	-
96.100	<i>Change user pass code</i>	<i>(Visible when user lock is open)</i> To change the current user pass code, enter a new code into this parameter as well as <a href="#">96.101 Confirm user pass code</a> . A warning will be active until the new pass code is confirmed. To cancel changing the pass code, close the user lock without confirming. To close the lock, enter an invalid pass code in parameter <a href="#">96.02 Pass code</a> , activate parameter <a href="#">96.08 Control board boot</a> , or cycle the power. See also section <a href="#">User lock</a> (page <a href="#">109</a> ).	10000000
	10000000... 99999999	New user pass code.	-
96.101	<i>Confirm user pass code</i>	<i>(Visible when user lock is open)</i> Confirms the new user pass code entered in <a href="#">96.100 Change user pass code</a> .	
	10000000... 99999999	Confirmation of new user pass code.	-

No.	Name/Value	Description	Default FbEq 16
96.102	User lock functionality	(Visible when user lock is open) Selects the actions or functionalities to be prevented by the user lock. Note that the changes made take effect only when the user lock is closed. See parameter <a href="#">96.02 Pass code</a> .	0000h
<b>Bit</b>	<b>Name</b>	<b>Information</b>	
0	Disable ABB access levels	1 = ABB access levels (service, advanced programmer, etc.; see <a href="#">96.03</a> ) disabled	
1	Freeze parameter lock state	1 = Changing the parameter lock state prevented, ie. pass code 358 has no effect	
2	Disable file download	1 = Loading of files to drive prevented. This applies to <ul style="list-style-type: none"> <li>• firmware upgrades</li> <li>• parameter restore</li> <li>• loading of adaptive or application programs</li> <li>• changing home view of control panel</li> <li>• editing drive texts</li> <li>• editing the favorite parameters list on control panel</li> <li>• configuration settings made through control panel such as time/date formats and enabling/disabling clock display.</li> </ul>	
3	Disable FB write to hidden	1 = Disable fieldbus write to closed access level.	
4	Disable backups	1 = Disable backup file download.	
5...10	Reserved		
11	Disable OEM access level 1	1 = Disable OEM access level 1.	
12	Disable OEM access level 2	1 = Disable OEM access level 2.	
13	Disable OEM access level 3	1 = Disable OEM access level 3.	
14, 15	Reserved		
0000h...FFFFh		Selection of actions to be prevented by user lock.	-

No.	Name/Value	Description	Default FbEq 16
<b>97 Motor control</b>			
Switching frequency; slip gain; voltage reserve; flux braking; anti-cogging (signal injection); IR compensation.			
97.01	<i>Switching frequency reference</i>	Defines the switching frequency of the drive that is used as long as the drive does not heat too much. See section <i>Switching frequency</i> on page 79. Higher switching frequency results in lower acoustic noise. In multimotor systems, do not change the switching frequency from the default value.	4 kHz
	4 kHz	4 kHz.	4
	8 kHz	8 kHz.	8
	12 kHz	12 kHz.	12
97.02	<i>Minimum switching frequency</i>	Lowest switching frequency that is allowed. Depends on the frame size.	1.5 kHz
	1.5 kHz	1.5 kHz. In some larger frame sizes 1 kHz is used instead.	1.5
	2 kHz	2 kHz.	2
	4 kHz	4 kHz.	4
	8 kHz	8 kHz.	8
	12 kHz	12 kHz.	12
97.03	<i>Slip gain</i>	Defines the slip gain which is used to improve the estimated motor slip. 100% means full slip gain; 0% means no slip gain. The default value is 100%. Other values can be used if a static speed error is detected despite having the setting at full slip gain. <b>Example</b> (with nominal load and nominal slip of 40 rpm): A 1000 rpm constant speed reference is given to the drive. Despite having full slip gain (= 100%), a manual tachometer measurement from the motor axis gives a speed value of 998 rpm. The static speed error is 1000 rpm - 998 rpm = 2 rpm. To compensate the error, the slip gain should be increased to 105% (2 rpm / 40 rpm = 5%).	100%
	0...200%	Slip gain.	1 = 1%
97.04	<i>Voltage reserve</i>	Defines the minimum allowed voltage reserve. When the voltage reserve has decreased to the set value, the drive enters the field weakening area. <b>Note:</b> This is an expert level parameter and should not be adjusted without appropriate skill. If the intermediate circuit DC voltage $U_{dc} = 550$ V and the voltage reserve is 5%, the RMS value of the maximum output voltage in steady-state operation is $0.95 \times 550$ V / $\sqrt{2} = 369$ V The dynamic performance of the motor control in the field weakening area can be improved by increasing the voltage reserve value, but the drive enters the field weakening area earlier.	-2%
	-4...50%	Voltage reserve.	1 = 1%

No.	Name/Value	Description	Default FbEq 16
97.05	<i>Flux braking</i>	Defines the level of flux braking power. (Other stopping and braking modes can be configured in parameter group <a href="#">21 Start/stop mode</a> ). <b>Note:</b> This is an expert level parameter and should not be adjusted without appropriate skill.	<i>Disabled</i>
	Disabled	Flux braking is disabled.	0
	Moderate	Flux level is limited during the braking. Deceleration time is longer compared to full braking.	1
	Full	Maximum braking power. Almost all available current is used to convert the mechanical braking energy to thermal energy in the motor.  <b>WARNING!</b> Using full flux braking heats up the motor especially in cyclic operation. Make sure that the motor can withstand this if you have a cyclic application.	2
97.06	<i>Flux reference select</i>	Defines the source of flux reference. <b>Notes:</b> <ul style="list-style-type: none"> <li>This parameter is not effective if parameter <a href="#">76.21 Conical motor control</a> is enabled.</li> <li>This is an expert level parameter and should not be adjusted without appropriate skill.</li> <li>Do not use this parameter in scalar control mode, if the parameter <a href="#">97.20 U/F ratio</a> is set to <i>Squared</i>.</li> </ul>	<i>User flux reference</i>
	Zero	Minimum value of parameter <a href="#">97.07 User flux reference</a> .	0
	User flux reference	Parameter <a href="#">97.07 User flux reference</a> .	1
	<i>Other</i>	Source selection (see <a href="#">Terms and abbreviations</a> ).	-
97.07	<i>User flux reference</i>	Defines the flux reference when parameter <a href="#">97.06 Flux reference select</a> is set to <i>User flux reference</i> . <b>Note:</b> This parameter is not effective if parameter <a href="#">76.21 Conical motor control</a> is enabled.	100.00%
	0.00...200.00%	User-defined flux reference.	100 = 1%
97.08	<i>Optimizer minimum torque</i>	This parameter can be used to improve the control dynamics of a synchronous reluctance motor or a salient permanent magnet synchronous motor. As a rule of thumb, define a level to which the output torque must rise with minimum delay. This will increase the motor current and improve the torque response at low speeds.	0.0%
	0.0...1600.0%	Optimizer torque limit.	10 = 1%

No.	Name/Value	Description	Default FbEq 16
97.10	<i>Signal injection</i>	<p>Enables the anti-cogging function: a high-frequency alternating signal is injected to the motor in the low speed region to improve the stability of torque control. This removes the “cogging” that can sometimes be seen as the rotor passes the motor magnetic poles. Anti-cogging can be enabled with different amplitude levels.</p> <p><b>Notes:</b></p> <ul style="list-style-type: none"> <li>• This is an expert level parameter and should not be adjusted without appropriate skill.</li> <li>• Use as low a level as possible that gives satisfactory performance.</li> <li>• Signal injection cannot be applied to asynchronous motors.</li> </ul>	<i>Disabled</i>
	Disabled	Anti-cogging disabled.	0
	Enabled (5%)	Anti-cogging enabled with amplitude level of 5%.	1
	Enabled (10%)	Anti-cogging enabled with amplitude level of 10%.	2
	Enabled (15%)	Anti-cogging enabled with amplitude level of 15%.	3
	Enabled (20%)	Anti-cogging enabled with amplitude level of 20%.	4
97.11	<i>TR tuning</i>	<p>Rotor time constant tuning.</p> <p>This parameter can be used to improve torque accuracy in closed-loop control of an induction motor. Normally, the motor identification run provides sufficient torque accuracy, but manual fine-tuning can be applied in exceptionally demanding applications to achieve optimal performance.</p> <p><b>Note:</b> This is an expert level parameter and should not be adjusted without appropriate skill.</p>	100%
	25...400%	Rotor time constant tuning.	1 = 1%

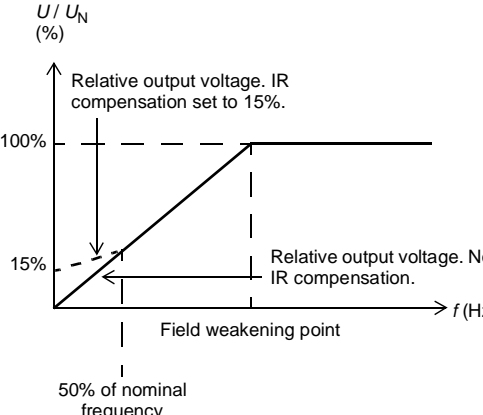
No.	Name/Value	Description	Default FbEq 16																																																																											
97.13	<i>IR compensation</i>	<p>Defines the relative output voltage boost at zero speed (IR compensation). The function is useful in applications with a high break-away torque where vector control cannot be applied.</p>  <p>See also section <a href="#">IR compensation for scalar motor control</a> on page 74. Typical IR compensation values are shown below.</p> <table border="1" data-bbox="423 829 901 973"> <thead> <tr> <th colspan="9">3-phase 380...480V drives</th> </tr> </thead> <tbody> <tr> <td>P<sub>N</sub> (kW)</td> <td>0, 37</td> <td>0, 75</td> <td>1, 1</td> <td>2, 2</td> <td>4</td> <td>7, 5</td> <td>15</td> <td>22</td> </tr> <tr> <td>IR compens-ation (%)</td> <td>3, 5</td> <td>3, 5</td> <td>3, 2</td> <td>2, 5</td> <td>2</td> <td>1, 5</td> <td>1, 25</td> <td>1, 2</td> </tr> </tbody> </table> <table border="1" data-bbox="423 981 901 1125"> <thead> <tr> <th colspan="9">3-phase 200...240V drives</th> </tr> </thead> <tbody> <tr> <td>P<sub>N</sub> (kW)</td> <td>0, 37</td> <td>0, 75</td> <td>1, 1</td> <td>2, 2</td> <td>3</td> <td>7, 5</td> <td>11</td> <td></td> </tr> <tr> <td>IR compens-ation (%)</td> <td>3, 5</td> <td>3, 5</td> <td>2, 6</td> <td>2, 4</td> <td>2, 2</td> <td>1, 7</td> <td>1, 5</td> <td></td> </tr> </tbody> </table> <table border="1" data-bbox="423 1133 901 1268"> <thead> <tr> <th colspan="7">1-phase 200...240V drives</th> </tr> </thead> <tbody> <tr> <td>P<sub>N</sub> (kW)</td> <td>0, 37</td> <td>0, 75</td> <td>1, 1</td> <td>1, 5</td> <td>2, 2</td> <td></td> </tr> <tr> <td>IR compens-ation (%)</td> <td>3, 0</td> <td>2, 3</td> <td>2, 0</td> <td>1, 7</td> <td>1, 5</td> <td></td> </tr> </tbody> </table> <p><b>⚠ WARNING!</b> Set IR compensation value as low as possible. Large IR compensation value can lead to overheating of the motor and damage to the drive, if operated for longer periods at low speed.</p>	3-phase 380...480V drives									P <sub>N</sub> (kW)	0, 37	0, 75	1, 1	2, 2	4	7, 5	15	22	IR compens-ation (%)	3, 5	3, 5	3, 2	2, 5	2	1, 5	1, 25	1, 2	3-phase 200...240V drives									P <sub>N</sub> (kW)	0, 37	0, 75	1, 1	2, 2	3	7, 5	11		IR compens-ation (%)	3, 5	3, 5	2, 6	2, 4	2, 2	1, 7	1, 5		1-phase 200...240V drives							P <sub>N</sub> (kW)	0, 37	0, 75	1, 1	1, 5	2, 2		IR compens-ation (%)	3, 0	2, 3	2, 0	1, 7	1, 5		3.20%
3-phase 380...480V drives																																																																														
P <sub>N</sub> (kW)	0, 37	0, 75	1, 1	2, 2	4	7, 5	15	22																																																																						
IR compens-ation (%)	3, 5	3, 5	3, 2	2, 5	2	1, 5	1, 25	1, 2																																																																						
3-phase 200...240V drives																																																																														
P <sub>N</sub> (kW)	0, 37	0, 75	1, 1	2, 2	3	7, 5	11																																																																							
IR compens-ation (%)	3, 5	3, 5	2, 6	2, 4	2, 2	1, 7	1, 5																																																																							
1-phase 200...240V drives																																																																														
P <sub>N</sub> (kW)	0, 37	0, 75	1, 1	1, 5	2, 2																																																																									
IR compens-ation (%)	3, 0	2, 3	2, 0	1, 7	1, 5																																																																									
	0.00...50.00%	Voltage boost at zero speed in percent of nominal motor voltage.	1 = 1%																																																																											

### 344 Parameters

No.	Name/Value	Description	Default FbEq 16
97.15	<i>Motor model temperature adaptation</i>	Selects whether the temperature-dependent parameters (such as stator or rotor resistance) of the motor model adapt to actual (measured or estimated) temperature or not. See parameter group <a href="#">35 Motor thermal protection</a> for selection of temperature measurement sources.	<i>Disabled</i>
	Disabled	Temperature adaptation of motor model disabled.	0
	Estimated temperature	Estimated temperature ( <a href="#">35.01 Motor estimated temperature</a> ) used for adaptation of motor model.	1
97.16	<i>Stator temperature factor</i>	Tunes the motor temperature dependence of stator parameters (stator resistance).	50
	0...200 %	Tuning factor.	
97.17	<i>Rotor temperature factor</i>	Tunes the motor temperature dependence of rotor parameters (eg. rotor resistance).	100
	0...200 %	Tuning factor.	
97.20	<i>U/F ratio</i>	Selects the form for the U/f (voltage to frequency) ratio below field weakening point. For scalar control only.	<i>Disabled</i>
	Linear	Linear ratio for constant torque applications.	0
	Squared	Squared ratio for centrifugal pump and fan applications. With squared U/f ratio the noise level is lower for most operating frequencies. Not recommended for permanent magnet motors.	1
97.33	<i>Speed estimate filter time</i>	Defines a filtering time for estimated speed.	5.00
	0.00...100.00 ms	Filtering time for estimated speed.	1 = 1 ms
97.49	<i>Slip gain for scalar</i>	Sets gain for slip compensation (in %) while drive is operating in scalar control mode. <ul style="list-style-type: none"> <li>A squirrel-cage motor slips under load. Increasing the frequency as the motor torque increases compensates for the slip.</li> <li>Requires parameter <a href="#">99.04 Motor control mode</a> = <i>Scalar</i>.</li> </ul> 0 = No slip compensation. 1...200 = Increasing slip compensation. 100% means full slip compensation according to parameters <a href="#">99.08 Motor nominal frequency</a> and <a href="#">99.09 Motor nominal speed</a> .	0
	0...200 %	Slip compensation in %.	1 = 1%

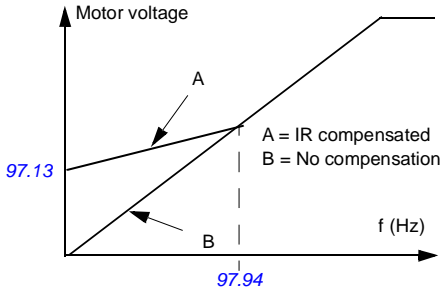

No.	Name/Value	Description	Default FbEq 16
97.94	<i>IR comp max frequency</i>	<p>Sets the frequency at which IR compensation (set by parameter <a href="#">97.13 IR compensation</a>) reaches 0 V. The unit is % of motor nominal frequency.</p> <p>IR compensation</p> <p>When enabled, IR compensation provides an extra voltage boost to the motor at low speeds. Use IR compensation, for example, in applications that require a high breakaway torque.</p> 	80.0
	1.0...200.0 %	IR compensation maximum frequency in %.	1 = 1%

<b>98 User motor parameters</b>		<p>Motor values supplied by the user that are used in the motor model.</p> <p>These parameters are useful for non-standard motors, or to just get more accurate motor control of the motor on site. A better motor model always improves the shaft performance.</p>	
98.01	<i>User motor model mode</i>	<p>Activates the motor model parameters <a href="#">98.02...98.12</a> and <a href="#">98.14</a>.</p> <p><b>Notes:</b></p> <ul style="list-style-type: none"> <li>Parameter value is automatically set to zero when ID run is selected by parameter <a href="#">99.13 ID run requested</a>. The values of parameters <a href="#">98.02...98.12</a> are then updated according to the motor characteristics identified during the ID run.</li> <li>Measurements made directly from the motor terminals during the ID run are likely to produce slightly different values than those on a data sheet from a motor manufacturer.</li> <li>This parameter cannot be changed while the drive is running.</li> </ul>	<i>Not selected</i>
	Not selected	Parameters <a href="#">98.02...98.12</a> inactive.	0
	Motor parameters	The values of parameters <a href="#">98.02...98.12</a> are used as the motor model.	1
98.02	<i>Rs user</i>	<p>Defines the stator resistance <math>R_S</math> of the motor model.</p> <p>With a star-connected motor, <math>R_S</math> is the resistance of one winding. With a delta-connected motor, <math>R_S</math> is one-third of the resistance of one winding.</p>	0.00000 p.u.
	0.00000...0.50000 p.u.	Stator resistance in per unit.	-

No.	Name/Value	Description	Default FbEq 16
98.03	<i>Rr user</i>	Defines the rotor resistance $R_R$ of the motor model. <b>Note:</b> This parameter is valid only for asynchronous motors.	0.00000 p.u.
	0.00000...0.50000 p.u.	Rotor resistance in per unit.	-
98.04	<i>Lm user</i>	Defines the main inductance $L_M$ of the motor model. <b>Note:</b> This parameter is valid only for asynchronous motors.	0.00000 p.u.
	0.00000... 10.00000 p.u.	Main inductance in per unit.	-
98.05	<i>SigmaL user</i>	Defines the leakage inductance $\sigma L_S$ . <b>Note:</b> This parameter is valid only for asynchronous motors.	0.00000 p.u.
	0.00000...1.00000 p.u.	Leakage inductance in per unit.	-
98.06	<i>Ld user</i>	Defines the direct axis (synchronous) inductance. <b>Note:</b> This parameter is valid only for permanent magnet motors.	0.00000 p.u.
	0.00000 ... 10.00000 p.u	Direct axis inductance in per unit.	-
98.07	<i>Lq user</i>	Defines the quadrature axis (synchronous) inductance. <b>Note:</b> This parameter is valid only for permanent magnet motors.	0.00000 p.u.
	0.00000 ... 10.00000 p.u	Quadrature axis inductance in per unit.	-
98.08	<i>PM flux user</i>	Defines the permanent magnet flux. <b>Note:</b> This parameter is valid only for permanent magnet motors.	0.00000 p.u.
	0.00000 ... 2.00000 p.u	Permanent magnet flux in per unit.	-
98.09	<i>Rs user SI</i>	Defines the stator resistance $R_S$ of the motor model.	0.00000 ohm
	0.00000... 100.00000 ohm	Stator resistance.	-
98.10	<i>Rs user SI</i>	Defines the rotor resistance $R_R$ of the motor model. <b>Note:</b> This parameter is valid only for asynchronous motors.	0.00000 ohm
	0.00000... 100.00000 ohm	Rotor resistance.	-
98.11	<i>Lm user SI</i>	Defines the main inductance $L_M$ of the motor model. <b>Note:</b> This parameter is valid only for asynchronous motors.	0.00 mH
	0.00...100000.00 mH	Main inductance.	1 = 10000 mH
98.12	<i>SigmaL user SI</i>	Defines the leakage inductance $\sigma L_S$ . <b>Note:</b> This parameter is valid only for asynchronous motors.	0.00 mH
	0.00...100000.00 mH	Leakage inductance.	1 = 10000 mH



No.	Name/Value	Description	Default FbEq 16
98.13	<i>Ld user SI</i>	Defines the direct axis (synchronous) inductance. <b>Note:</b> This parameter is valid only for permanent magnet motors.	0.00 mH
	0.00 ...100000.00 mH	Direct axis inductance.	1 = 10000 mH
98.14	<i>Lq user SI</i>	Defines the quadrature axis (synchronous) inductance. <b>Note:</b> This parameter is valid only for permanent magnet motors.	0.00 mH
	0.00 ...100000.00 mH	Quadrature axis inductance.	1 = 10000 mH
98.15	<i>Position offset user</i>	Defines an angle offset between the zero position of the synchronous motor and the zero position of the position sensor. <b>Notes:</b> <ul style="list-style-type: none"> <li>The value is in electrical degrees. The electrical angle equals the mechanical angle multiplied by the number of motor pole pairs.</li> <li>This parameter is valid only for permanent magnet motors.</li> </ul>	0.0 deg
	0.0...360.0 deg	Angle offset.	1 = 1 deg

<b>99 Motor data</b>		Motor configuration settings.	
99.03	<i>Motor type</i>	Selects the motor type. <b>Note:</b> This parameter cannot be changed while the drive is running.	<i>Asynchronous motor</i>
	Asynchronous motor	Standard squirrel cage AC induction motor (asynchronous induction motor).	0
	Permanent magnet motor	Permanent magnet motor. Three-phase AC synchronous motor with permanent magnet rotor and sinusoidal BackEMF voltage. <b>Note:</b> With permanent magnet motors special attention must be paid on setting the motor nominal values correctly in this parameter group ( <i>99 Motor data</i> ). You must use vector control. If the nominal BackEMF voltage of the motor is not available, a full ID run should be performed for improving performance.	1
	SynRM motor	Synchronous reluctance motor. Three-phase AC synchronous motor with salient pole rotor without permanent magnets.	
99.04	<i>Motor control mode</i>	Selects the motor control mode.	<i>Scalar</i>
	Vector	Vector control. Vector control has better accuracy than scalar control but cannot be used in all situations (see selection Scalar below). Requires motor identification run (ID run). See parameter <i>99.13 ID run requested</i> . <b>Note:</b> In vector control the drive performs a standstill ID run at the first start if ID run has not been previously performed. A new start command is required after standstill ID run. <b>Note:</b> To achieve a better motor control performance, you can perform a normal ID run without load. See also section <i>Operating modes and motor control modes</i> (page 54).	0

No.	Name/Value	Description	Default FbEq 16
	Scalar	Scalar control. Suitable for most applications, if top performance is not required. Motor identification run is not required. <b>Note:</b> Scalar control must be used in the following situations: <ul style="list-style-type: none"> <li>• with multimotor applications 1) if the load is not equally shared between the motors, 2) if the motors are of different sizes, or 3) if the motors are going to be changed after the motor identification (ID run)</li> <li>• if the nominal current of the motor is less than 1/6 of the nominal output current of the drive</li> <li>• if the drive is used with no motor connected (for example, for test purposes).</li> </ul> <b>Note:</b> Correct motor operation requires that the magnetizing current of the motor does not exceed 90% of the nominal current of the inverter. See also section <a href="#">Speed control performance figures</a> (page 73), and section <a href="#">Operating modes and motor control modes</a> (page 54).	1
99.06	<a href="#">Motor nominal current</a>	Defines the nominal motor current. Must be equal to the value on the motor rating plate. If multiple motors are connected to the drive, enter the total current of the motors. <b>Notes:</b> <ul style="list-style-type: none"> <li>• Correct motor operation requires that the magnetizing current of the motor does not exceed 90% of the nominal current of the drive.</li> <li>• This parameter cannot be changed while the drive is running.</li> </ul>	4.0 A
	0.0...4.8 A	Nominal current of the motor. The allowable range is $1/6 \dots 2 \times I_N$ of the drive ( $0 \dots 2 \times I_N$ with scalar control mode).	1 = 1 A
99.07	<a href="#">Motor nominal voltage</a>	Defines the nominal motor voltage supplied to the motor. This setting must match the value on the rating plate of the motor. <b>Notes:</b> <ul style="list-style-type: none"> <li>• With permanent magnet motors, the nominal voltage is the BackEMF voltage at nominal speed of the motor. If the voltage is given as voltage per rpm, e.g. 60 V per 1000 rpm, the voltage for a nominal speed of 3000 rpm is <math>3 \times 60 \text{ V} = 180 \text{ V}</math>. Note that the nominal voltage is not equal to the equivalent DC motor voltage (EDCM) specified by some motor manufacturers. The nominal voltage can be calculated by dividing the EDCM voltage by 1.7 (or square root of 3).</li> <li>• The stress on the motor insulation is always dependent on the drive supply voltage. This also applies to the case where the motor voltage rating is lower than that of the drive and the supply.</li> <li>• This parameter cannot be changed while the drive is running.</li> </ul>	230.0 V
	40.0...480.0	Nominal voltage of the motor.	10 = 1 V

No.	Name/Value	Description	Default FbEq 16
99.08	<i>Motor nominal frequency</i>	Defines the nominal motor frequency. This setting must match the value on the rating plate of the motor. <b>Note:</b> This parameter cannot be changed while the drive is running.	50.00 Hz
	0.00...500.00 Hz	Nominal frequency of the motor.	10 = 1 Hz
99.09	<i>Motor nominal speed</i>	Defines the nominal motor speed. The setting must match the value on the rating plate of the motor. <b>Note:</b> This parameter cannot be changed while the drive is running.	1435 rpm
	0...30000 rpm	Nominal speed of the motor.	1 = 1 rpm
99.10	<i>Motor nominal power</i>	Defines the nominal motor power. The setting must match the value on the rating plate of the motor. If multiple motors are connected to the drive, enter the total power of the motors. The unit is selected by parameter <a href="#">96.16 Unit selection</a> . <b>Note:</b> This parameter cannot be changed while the drive is running.	1.10 kW or hp
	0.00... 10000.00 kW or 0.00... 13404.83 hp	Nominal power of the motor.	1 = 1 unit
99.11	<i>Motor nominal cos <math>\Phi</math></i>	Defines the cosphi of the motor for a more accurate motor model. This value is not obligatory, but is useful with an asynchronous motor, especially when performing a standstill identification run. With a permanent magnet or synchronous reluctance motor, this value is not needed. <b>Notes:</b> <ul style="list-style-type: none"> <li>Do not enter an estimated value. If you do not know the exact value, leave the parameter at zero.</li> <li>This parameter cannot be changed while the drive is running.</li> </ul>	0.00
	0.00...1.00	Cosphi of the motor.	100 = 1
99.12	<i>Motor nominal torque</i>	Defines the nominal motor shaft torque for a more accurate motor model. Not obligatory. The unit is selected by parameter <a href="#">96.16 Unit selection</a> . <b>Note:</b> This parameter cannot be changed while the drive is running.	0.000 N·m or lb-ft
	0.000...4000000.000 N·m or 0.000...2950248.597 lb-ft	Nominal motor torque.	1 = 100 unit

No.	Name/Value	Description	Default FbEq 16
99.13	<i>ID run requested</i>	<p>Selects the type of the motor identification routine (ID run) performed at the next start of the drive. During the ID run, the drive will identify the characteristics of the motor for optimum motor control.</p> <p>If no ID run has been performed yet (or if default parameter values have been restored using parameter <a href="#">96.06 Parameter restore</a>), this parameter is automatically set to <i>Standstill</i>, signifying that an ID run must be performed.</p> <p>After the ID run, the drive stops and this parameter is automatically set to <i>None</i>.</p> <p><b>Notes:</b></p> <ul style="list-style-type: none"> <li>To ensure that the ID run can work properly, the drive limits in group <a href="#">30 Limits</a> (maximum speed and minimum speed, and maximum torque and minimum torque) must be large enough (the range specified by the limits must be wide enough. If eg. speed limits are less than the motor nominal speed, the ID run cannot be completed.</li> <li>For the <i>Advanced</i> ID run, the machinery must always be de-coupled from the motor.</li> <li>With a permanent magnet or synchronous reluctance motor, a <i>Normal</i>, <i>Reduced</i> or <i>Standstill</i> ID run requires that the motor shaft is NOT locked and the load torque is less than 10%.</li> <li>Once the ID run is activated, it can be canceled by stopping the drive.</li> <li>The ID run must be performed every time any of the motor parameters (<a href="#">99.04</a>, <a href="#">99.06</a>...<a href="#">99.12</a>) have been changed.</li> <li>With scalar control mode (<a href="#">99.04 Motor control mode</a> = <i>Scalar</i>), the ID run is not requested automatically. However, an ID run can be performed for more accurate torque estimation.</li> <li>Ensure that the Safe torque off and emergency stop circuits (if any) are closed during the ID run.</li> <li>Mechanical brake (if present) is not opened by the logic for the ID run.</li> <li>This parameter cannot be changed while the drive is running.</li> </ul>	<i>None</i>
	None	No motor ID run is requested. This mode can be selected only if the ID run ( <i>Normal/Reduced/Standstill/Advanced</i> ) has already been performed once.	0

No.	Name/Value	Description	Default FbEq 16
	Normal	<p>Normal ID run. Guarantees good control accuracy for all cases. The ID run takes about 90 seconds. This mode should be selected whenever it is possible.</p> <p><b>Notes:</b></p> <ul style="list-style-type: none"> <li>• If the load torque will be higher than 20% of motor nominal torque, or if the machinery is not able to withstand the nominal torque transient during the ID run, then the driven machinery must be de-coupled from the motor during a Normal ID run.</li> <li>• Check the direction of rotation of the motor before starting the ID run. During the run, the motor will rotate in the forward direction.</li> </ul> <p> <b>WARNING!</b> The motor will run at up to approximately 50...100% of the nominal speed during the ID run. ENSURE THAT IT IS SAFE TO RUN THE MOTOR BEFORE PERFORMING THE ID RUN!</p>	1
	Reduced	<p>Reduced ID run. This mode should be selected instead of the <i>Normal</i> or <i>Advanced</i> ID Run if</p> <ul style="list-style-type: none"> <li>• mechanical losses are higher than 20% (ie. the motor cannot be de-coupled from the driven equipment), or if</li> <li>• flux reduction is not allowed while the motor is running (ie. in case of a motor with an integrated brake supplied from the motor terminals).</li> </ul> <p>With this ID run mode, the resultant motor control in the field weakening area or at high torques is not necessarily as accurate as motor control following a Normal ID run. Reduced ID run is completed faster than the Normal ID Run (&lt; 90 seconds).</p> <p><b>Note:</b> Check the direction of rotation of the motor before starting the ID run. During the run, the motor will rotate in the forward direction.</p> <p> <b>WARNING!</b> The motor will run at up to approximately 50...100% of the nominal speed during the ID run. ENSURE THAT IT IS SAFE TO RUN THE MOTOR BEFORE PERFORMING THE ID RUN!</p>	2
	Standstill	<p>Standstill ID run. The motor is injected with DC current. With an AC induction (asynchronous) motor, the motor shaft is not rotated. With a permanent magnet motor, the shaft can rotate up to half a revolution.</p> <p><b>Note:</b> This mode should be selected only if the <i>Normal</i>, <i>Reduced</i> or <i>Advanced</i> ID run is not possible due to the restrictions caused by the connected mechanics (e.g. with lift or crane applications).</p>	3

No.	Name/Value	Description	Default FbEq 16
	Autophasing	<p>The autophasing routine determines the start angle of a permanent magnet or synchronous reluctance motor (see page 57). Autophasing does not update the other motor model values.</p> <p>Autophasing is automatically performed as part of the <i>Normal</i>, <i>Reduced</i>, <i>Standstill</i>, or <i>Advanced</i> ID runs. Using this setting, it is possible to perform autophasing alone. This is useful after changes in the feedback configuration, such as the replacement or addition of an absolute encoder, resolver, or pulse encoder with commutation signals.</p> <p><b>Notes:</b></p> <ul style="list-style-type: none"> <li>• This setting can only be used after a <i>Normal</i>, <i>Reduced</i>, <i>Standstill</i>, or <i>Advanced</i> ID run has already been performed.</li> <li>• Depending on the selected autophasing mode, the shaft can rotate during autophasing. See parameter <a href="#">21.13 Autophasing mode</a>.</li> </ul>	4
	Advanced	<p>Advanced ID run.</p> <p>Guarantees the best possible control accuracy. The ID run takes a very long time to complete. This mode should be selected when top performance is needed across the whole operating area.</p> <p><b>Note:</b> The driven machinery must be de-coupled from the motor because of high torque and speed transients that are applied.</p> <p> <b>WARNING!</b> The motor may run at up to the maximum (positive) and minimum (negative) allowed speed during the ID run. Several accelerations and decelerations are done. The maximum torque, current and speed allowed by the limit parameters may be utilized. ENSURE THAT IT IS SAFE TO RUN THE MOTOR BEFORE PERFORMING THE ID RUN!</p>	6
99.14	<i>Last ID run performed</i>	Shows the type of ID run that was performed last.	<i>None</i>
	None	No ID run has been performed.	0
	Normal	<i>Normal</i> ID run.	1
	Reduced	<i>Reduced</i> ID run.	2
	Standstill	<i>Standstill</i> ID run.	3
	Autophasing	<i>Autophasing</i> ID run.	4
	Advanced	<i>Advanced</i> ID run.	6
99.15	<i>Motor polepairs calculated</i>	Calculated number of pole pairs in the motor.	0
	0...1000	Number of pole pairs.	1 = 1



No.	Name/Value	Description	Default FbEq 16
99.16	<i>Motor phase order</i>	<p>Switches the rotation direction of motor. This parameter can be used if the motor turns in the wrong direction (for example, because of the wrong phase order in the motor cable), and correcting the cabling is considered impractical.</p> <p><b>Notes:</b></p> <ul style="list-style-type: none"> <li>Changing this parameter does not affect speed reference polarities, so positive speed reference will rotate the motor forward. The phase order selection just ensures that "forward" is in fact the correct direction.</li> </ul>	<i>U V W</i>
	U V W	Normal.	0
	U W V	Reversed rotation direction.	1

## Differences in the default values between 50 Hz and 60 Hz supply frequency settings

Parameter [95.20 HW options word 1](#) bit 0 changes the drive parameter default values according to the supply frequency, 50 Hz or 60 Hz. The bit is set according to the market before the drive is delivered.

If you need to change from 50 Hz to 60 Hz, or vice versa, change the value of the bit and then do a complete reset to the drive ([96.06 Parameter restore](#)). After that you have to reselect the macro to be used.

The table below shows the parameters whose default values depend on the supply frequency setting. The supply frequency setting, with the type designation of the drive, also affects group [99 Motor data](#) parameter values (not listed in the table).

No	Name	95.20 HW options word 1 bit 0 Supply frequency 60 Hz = 50 Hz	95.20 HW options word 1 bit 0 Supply frequency 60 Hz = 60 Hz
11.45	<i>Freq in 1 at scaled max</i>	1500.000	1800.000
12.20	<i>AI1 scaled at AI1 max</i>	1500.000	1800.000
13.18	<i>AO1 source max</i>	1500.0	1800.0
22.26	<i>Constant speed 1</i>	300.00 rpm	360.00 rpm
22.27	<i>Constant speed 2</i>	600.00 rpm	720.00 rpm
22.28	<i>Constant speed 3</i>	900 .00 rpm	1080.00 rpm
22.29	<i>Constant speed 4</i>	1200.00 rpm	1440.00 rpm
22.30	<i>Constant speed 5</i>	1500.00 rpm	1800.00 rpm
22.31	<i>Constant speed 6</i>	2400.00 rpm	2880.00 rpm
22.32	<i>Constant speed 7</i>	3000.00 rpm	3600.00 rpm
28.26	<i>Constant frequency 1</i>	5.00 Hz	6.00 Hz
28.27	<i>Constant frequency 2</i>	10.00 Hz	12.00 Hz
28.28	<i>Constant frequency 3</i>	15.00 Hz	18.00 Hz
28.29	<i>Constant frequency 4</i>	20.00 Hz	24.00 Hz
28.30	<i>Constant frequency 5</i>	25.00 Hz	30.00 Hz
28.31	<i>Constant frequency 6</i>	40.00 Hz	48.00 Hz
28.32	<i>Constant frequency 7</i>	50.00 Hz	60.00 Hz
30.11	<i>Minimum speed</i>	-1500.00 rpm	-1800.00 rpm
30.12	<i>Maximum speed</i>	1500.00 rpm	1800.00 rpm
30.13	<i>Minimum frequency</i>	-50.00 Hz	-60.00 Hz
30.14	<i>Maximum frequency</i>	50.00 Hz	60.00 Hz
31.26	<i>Stall speed limit</i>	150.00 rpm	180.00 rpm
31.27	<i>Stall frequency limit</i>	15.00 Hz	18.00 Hz
31.30	<i>Overspeed trip margin</i>	500.00 rpm	500.00 rpm
46.01	<i>Speed scaling</i>	1500.00 rpm	1800.00 rpm
46.02	<i>Frequency scaling</i>	50.00 Hz	60.00 Hz

## 7

# Additional parameter data

---

## Contents

- [Terms and abbreviations](#)
- [Fieldbus addresses](#)
- [Parameter groups 1...9](#)
- [Parameter groups 10...99](#)

## Terms and abbreviations

Term	Definition
Actual signal	Signal measured or calculated by the drive. Usually can only be monitored but not adjusted; some counter-type signals can however be reset.
Analog src	Analog source: the parameter can be set to the value of another parameter by choosing "Other", and selecting the source parameter from a list. In addition to the "Other" selection, the parameter may offer other pre-selected settings.
Binary src	Binary source: the value of the parameter can be taken from a specific bit in another parameter value ("Other"). Sometimes the value can be fixed to 0 (false) or 1 (true). In addition, the parameter may offer other pre-selected settings.
Data	Data parameter.
FbEq32	32-bit fieldbus equivalent: The scaling between the value shown on the panel and the integer used in communication when a 32-bit value is selected for transmission to an external system. The corresponding 16-bit scalings are listed in chapter <a href="#">Parameters</a> .

---

<b>Term</b>	<b>Definition</b>
List	Selection list.
No.	Parameter number.
PB	Packed Boolean (bit list).
Real	Real number.
Type	Parameter type. See <a href="#">Analog src</a> , <a href="#">Binary src</a> , <a href="#">List</a> , <a href="#">PB</a> , <a href="#">Real</a> .

## **Fieldbus addresses**

Refer to the user's manual of the fieldbus adapter.

---

## Parameter groups 1...9

No.	Name	Type	Range	Unit	FbEq32
<b>01 Actual values</b>					
01.01	Motor speed used	Real	-30000.00...30000.00	rpm	100 = 1 rpm
01.02	Motor speed estimated	Real	-30000.00...30000.00	rpm	100 = 1 rpm
01.03	Motor speed %	Real	-1000.00...1000.00	%	100 = 1%
01.04	Encoder 1 speed filtered	Real	-30000 ... 30000	rpm	100 = 1
01.06	Output frequency	Real	-500.00...500.00	Hz	100 = 1 Hz
01.07	Motor current	Real	0.00...30000.00	A	100 = 1 A
01.08	Motor current % of motor nom	Real	0.0...1000.0	%	10 = 1%
01.09	Motor current % of drive nom	Real	0.0...1000.0	%	10 = 1%
01.10	Motor torque	Real	-1600.0...1600.0	%	10 = 1%
01.11	DC voltage	Real	0.00...2000.00	V	100 = 1 V
01.13	Output voltage	Real	0...2000	V	1 = 1 V
01.14	Output power	Real	-32768.00...32767.00	kW or hp	100 = 1 unit
01.15	Output power % of motor nom	Real	-300.00...300.00	%	100 = 1%
01.16	Output power % of drive nom	Real	-300.00...300.00	%	100 = 1%
01.17	Motor shaft power	Real	-32768.00...32767.00	kW or hp	100 = 1 unit
01.18	Inverter GWh counter	Real	0...65535	GWh	1 = 1 GWh
01.19	Inverter MWh counter	Real	0...1000	MWh	1 = 1 MWh
01.20	Inverter kWh counter	Real	0...1000	kWh	1 = 1 kWh
01.24	Flux actual %	Real	0...200	%	1 = 1%
01.30	Nominal torque scale	Real	0.000...4000000	N·m or lb-ft	1000 = 1 unit
01.50	Current hour kWh	Real	-21474836.48... 21474836.47	kWh	100 = 1 kWh
01.51	Previous hour kWh	Real	-21474836.48... 21474836.47	kWh	100 = 1 kWh
01.52	Current day kWh	Real	-21474836.48... 21474836.47	kWh	100 = 1 kWh
01.53	Previous day kWh	Real	-21474836.48... 21474836.47	kWh	100 = 1 kWh
01.54	Cumulative inverter energy	Real	-200000000.0... 200000000.0	kWh	1 = 1 kWh
01.55	Inverter GWh counter (resettable)	Real	0...65535	GWh	1 = 1 GWh
01.56	Inverter MWh counter (resettable)	Real	0...1000	MWh	1 = 1 MWh
01.57	Inverter kWh counter (resettable)	Real	0...1000	kWh	1 = 1 kWh
01.58	Cumulative inverter energy (resettable)	Real	-200000000.0... 200000000.0	kWh	1 = 1 kWh
01.61	Abs motor speed used	Real	0.00... 30000.00	rpm	100 = 1 rpm
01.62	Abs motor speed %	Real	0.00... 100.00%	%	100 = 1%
01.63	Abs output frequency	Real	0.00...500.00 Hz	Hz	100 = 1 Hz

No.	Name	Type	Range	Unit	FbEq32
01.64	Abs motor torque	<i>Real</i>	0.00...1600.0	%	10 = 1%
01.65	Abs output power	<i>Real</i>	0.00... 32767.00	kW	100 = 1 kW
01.66	Abs output power % mot nom	<i>Real</i>	0.00...300.00	%	100 = 1%
01.67	Abs output power % drive nom	<i>Real</i>	0.00...300.00	%	100 = 1%
01.68	Abs motor shaft power	<i>Real</i>	0.00... 32767.00	kW	100 = 1 kW
<b>03 Input references</b>					
03.01	Panel reference	<i>Real</i>	-100000.00...100000.00	-	100 = 1
03.02	Panel reference remote	<i>Real</i>	-100000.00...100000.00	-	100 = 1 unit
03.05	FB A reference 1	<i>Real</i>	-100000.00...100000.00	-	100 = 1
03.06	FB A reference 2	<i>Real</i>	-100000.00...100000.00	-	100 = 1
03.09	EFB reference 1	<i>Real</i>	-30000.00...30000.00	-	100 = 1
03.10	EFB reference 2	<i>Real</i>	-30000.00...30000.00	-	100 = 1
03.17	Integrated Panel ref	<i>Real</i>	-100000.00...100000.00	-	100 = 1
03.18	Integrated Panel ref remote	<i>Real</i>	-100000.00...100000.00	-	100 = 1
<b>04 Warnings and faults</b>					
04.01	Tripping fault	<i>Data</i>	0000h...FFFFh	-	1 = 1
04.02	Active fault 2	<i>Data</i>	0000h...FFFFh	-	1 = 1
04.03	Active fault 3	<i>Data</i>	0000h...FFFFh	-	1 = 1
04.06	Active warning 1	<i>Data</i>	0000h...FFFFh	-	1 = 1
04.07	Active warning 2	<i>Data</i>	0000h...FFFFh	-	1 = 1
04.08	Active warning 3	<i>Data</i>	0000h...FFFFh	-	1 = 1
04.11	Latest fault	<i>Data</i>	0000h...FFFFh	-	1 = 1
04.12	2nd latest fault	<i>Data</i>	0000h...FFFFh	-	1 = 1
04.13	3rd latest fault	<i>Data</i>	0000h...FFFFh	-	1 = 1
04.16	Latest warning	<i>Data</i>	0000h...FFFFh	-	1 = 1
04.17	2nd latest warning	<i>Data</i>	0000h...FFFFh	-	1 = 1
04.18	3rd latest warning	<i>Data</i>	0000h...FFFFh	-	1 = 1
<b>05 Diagnostics</b>					
05.01	On-time counter	<i>Real</i>	0...65535	d	1 = 1 d
05.02	Run-time counter	<i>Real</i>	0...65535	d	1 = 1 d
05.03	Hours run	<i>Real</i>	0.0...429496729.5	h	10 = 1 h
05.04	Fan on-time counter	<i>Real</i>	0...65535	d	1 = 1 d
05.10	Control board temperature	<i>Real</i>	-100...300 °C	°C or °F	10 = 1 °C
05.11	Inverter temperature	<i>Real</i>	-40.0...160.0	%	10 = 1%
05.20	Diagnostic word 1	<i>PB</i>	0b0000...0b1111	-	-
05.21	Diagnostic word 2	<i>PB</i>	0b0000...0b1111	-	-
05.22	Diagnostic word 3	<i>PB</i>	0b0000...0b1111	-	-
05.80	Motor speed at fault	<i>Real</i>	-30000.00...30000.00	rpm	100 = 1 rpm
05.81	Output frequency at fault	<i>Real</i>	-500.00...500.00	Hz	100 = 1 Hz
05.82	DC voltage at fault	<i>Real</i>	0.00...2000.00	V	100 = 1 V
05.83	Motor current at fault	<i>Real</i>	0.00...30000.00	A	100 = 1 A

No.	Name	Type	Range	Unit	FbEq32
05.84	Motor torque at fault	<i>Real</i>	-1600.0...1600.0	%	10 = 1%
05.85	Main status word at fault	<i>PB</i>	0000h...FFFFh	-	1 = 1
05.86	DI delayed status at fault	<i>PB</i>	0000h...FFFFh	-	1 = 1
05.87	Inverter temperature at fault	<i>PB</i>	-40.0...160.0	°C	10 = 1°C
05.88	Reference used at fault	<i>Real</i>	-500.00...500.00 Hz/ -1600.0...1600.0%/ 30000.00...30000.00 rpm	Hz/ %/ rpm	100 = 1 Hz/ 10 = 1%/ 100 = 1 rpm
<b>06 Control and status words</b>					
06.01	Main control word	<i>PB</i>	0000h...FFFFh	-	1 = 1
06.11	Main status word	<i>PB</i>	0000h...FFFFh	-	1 = 1
06.16	Drive status word 1	<i>PB</i>	0000h...FFFFh	-	1 = 1
06.17	Drive status word 2	<i>PB</i>	0000h...FFFFh	-	1 = 1
06.18	Start inhibit status word	<i>PB</i>	0000h...FFFFh	-	1 = 1
06.19	Speed control status word	<i>PB</i>	0000h...FFFFh	-	1 = 1
06.20	Constant speed status word	<i>PB</i>	0000h...FFFFh	-	1 = 1
06.21	Drive status word 3	<i>PB</i>	0000h...FFFFh	-	1 = 1
06.30	MSW bit 11 selection	<i>Binary src</i>	-	-	1 = 1
06.31	MSW bit 12 selection	<i>Binary src</i>	-	-	1 = 1
06.32	MSW bit 13 selection	<i>Binary src</i>	-	-	1 = 1
06.33	MSW bit 14 selection	<i>Binary src</i>	-	-	1 = 1
<b>07 System info</b>					
07.03	Drive rating id	<i>List</i>	-	-	1 = 1
07.04	Firmware name	<i>List</i>	-	-	1 = 1
07.05	Firmware version	<i>Data</i>	-	-	1 = 1
07.06	Loading package name	<i>List</i>	-	-	1 = 1
07.07	Loading package version	<i>Data</i>	-	-	1 = 1
07.11	Cpu usage	<i>Real</i>	0...100	%	1 = 1%
07.25	Customization package name	<i>Data</i>	-	-	1 = 1
07.26	Customization package version	<i>Data</i>	-	-	1 = 1
07.30	Adaptive program status	<i>PB</i>	0000h...FFFFh	-	1 = 1
07.31	AP sequence state	<i>Data</i>	0...20	-	1 = 1
07.35	Drive configuration	<i>Binary src</i>	0x0000...0xffff	-	1 = 1
<b>09 Crane application signals</b>					
09.01	Crane SW1	<i>PB</i>	0000h...FFFFh	-	1 = 1
09.03	Crane FW1	<i>PB</i>	0000h...FFFFh	-	1 = 1
09.06	Crane speed reference	<i>Real</i>	-30000...30000.00	rpm	100 = 1 rpm
09.16	Crane frequency reference	<i>Real</i>	-500...500	Hz	100 = 1 Hz

## Parameter groups 10...99

No.	Name	Type	Range	Unit	FbEq32
<b>10 Standard DI, RO</b>					
10.02	DI delayed status	<i>PB</i>	0000h...FFFFh	-	1 = 1
10.03	DI force selection	<i>PB</i>	0000h...FFFFh	-	1 = 1
10.04	DI forced data	<i>PB</i>	0000h...FFFFh	-	1 = 1
10.21	RO status	<i>PB</i>	0000h...FFFFh	-	1 = 1
10.22	RO force selection	<i>PB</i>	0000h...FFFFh	-	1 = 1
10.23	RO forced data	<i>PB</i>	0000h...FFFFh	-	1 = 1
10.24	RO1 source	<i>Binary src</i>	-	-	1 = 1
10.25	RO1 ON delay	<i>Real</i>	0.0...3000.0	s	10 = 1 s
10.26	RO1 OFF delay	<i>Real</i>	0.0...3000.0	s	10 = 1 s
10.99	RO/DIO control word	<i>PB</i>	0000h...FFFFh	-	1 = 1
10.101	RO1 toggle counter	<i>Real</i>	0...4294967000	-	1 = 1
<b>11 Standard DIO, FI, FO</b>					
11.02	DIO delayed status	<i>List</i>	0000h...FFFFh	-	1 = 1
11.03	DIO force selection	<i>PB</i>	0000h...FFFFh	-	1 = 1
11.04	DIO force data	<i>PB</i>	0000h...FFFFh	-	1 = 1
11.05	DIO1 configuration	<i>List</i>	0...2	-	1 = 1
11.06	DIO1 output source	<i>Binary src</i>	-	-	1 = 1
11.07	DIO1 ON delay	<i>Real</i>	0.0...3000.0	s	10 = 1 s
11.08	DIO1 OFF delay	<i>Real</i>	0.0...3000.0	s	10 = 1 s
11.09	DIO2 configuration	<i>List</i>	0...2	-	1 = 1
11.10	DIO2 output source	<i>Binary src</i>	-	-	1 = 1
11.11	DIO2 ON delay	<i>Real</i>	0.0...3000.0	s	10 = 1 s
11.12	DIO2 OFF delay	<i>Real</i>	0.0...3000.0	s	10 = 1 s
11.13	DI3 configuration	<i>List</i>	0, 1	-	1 = 1
11.17	DI4 configuration	<i>List</i>	0, 1	-	1 = 1
11.38	Freq in 1 actual value	<i>Real</i>	0...16000	Hz	1 = 1 Hz
11.39	Freq in 1 scaled value	<i>Real</i>	-32768.000...32767.000	-	1000 = 1
11.42	Freq in 1 min	<i>Real</i>	0...16000	Hz	1 = 1 Hz
11.43	Freq in 1 max	<i>Real</i>	0...16000	Hz	1 = 1 Hz
11.44	Freq in 1 at scaled min	<i>Real</i>	-32768.000...32767.000	-	1000 = 1
11.45	Freq in 1 at scaled max	<i>Real</i>	-32768.000...32767.000	-	1000 = 1
11.46	Freq in 2 actual value	<i>Real</i>	0...16000	Hz	1 = 1
11.47	Freq in 2 scaled	<i>Real</i>	-32768.000...32767.000	-	1000 = 1
11.50	Freq in 2 min	<i>Real</i>	0...16000	Hz	1 = 1
11.51	Freq in 2 max	<i>Real</i>	0...16000	Hz	1 = 1
11.52	Freq in 2 at scaled min	<i>Real</i>	-32768.000...32767.000	-	1 = 1
11.53	Freq in 2 at scaled max	<i>Real</i>	-32768.000...32767.000	-	1 = 1
11.54	Freq out 1 actual value	<i>Real</i>	0...16000	Hz	1 = 1



No.	Name	Type	Range	Unit	FbEq32
11.55	Freq out 1 source	<i>List</i>	0, 1, 3, 4, 6...8, 10...14, 16	-	1 = 1
11.58	Freq out 1 src min	<i>Real</i>	-32768.000...32767.000	-	1 = 1
11.59	Freq out 1 src max	<i>Real</i>	-32768.000...32767.000	-	1 = 1
11.60	Freq out 1 at src min	<i>Real</i>	0...16000	Hz	1 = 1
11.61	Freq out 1 at src max	<i>Real</i>	0...16000	Hz	1 = 1
11.62	Freq out 2 actual value	<i>Real</i>	0...16000	Hz	1 = 1
11.63	Freq out 2 source	<i>List</i>	0, 1, 3, 4, 6...8, 10...14, 16	-	1 = 1
11.66	Freq out 2 source min	<i>Real</i>	-32768.000...32767.000	-	1 = 1
11.67	Freq out 2 source max	<i>Real</i>	-32768.000...32767.000	-	1 = 1
11.68	Freq out 2 at src min	<i>Real</i>	0...16000	Hz	1 = 1
11.69	Freq out 2 at src max	<i>Real</i>	0...16000	Hz	1 = 1
<b>12 Standard AI</b>					
12.02	AI force selection	<i>PB</i>	0000h...FFFFh	-	1 = 1
12.03	AI supervision function	<i>List</i>	0...4	-	1 = 1
12.04	AI supervision selection	<i>PB</i>	0000h...FFFFh	-	1 = 1
12.11	AI1 actual value	<i>Real</i>	4.000...20.000 mA or 0.000...10.000 V	mA or V	1000 = 1 unit
12.12	AI1 scaled value	<i>Real</i>	-32768.000...32767.000	-	1000 = 1
12.13	AI1 forced value	<i>Real</i>	4.000...20.000 mA or 0.000...10.000 V	mA or V	1000 = 1 unit
12.15	AI1 unit selection	<i>List</i>	2, 10	-	1 = 1
12.16	AI1 filter time	<i>Real</i>	0.000...30.000	s	1000 = 1 s
12.17	AI1 min	<i>Real</i>	4.000...20.000 mA or 0.000...10.000 V	mA or V	1000 = 1 unit
12.18	AI1 max	<i>Real</i>	0.000...20.000 mA or 0.000...10.000 V	mA or V	1000 = 1 unit
12.19	AI1 scaled at AI1 min	<i>Real</i>	-32768.000...32767.000	-	1000 = 1
12.20	AI1 scaled at AI1 max	<i>Real</i>	-32768.000...32767.000	-	1000 = 1
12.21	AI2 actual value	<i>Real</i>	4.000...20.000 mA or 0.000...10.000 V	mA or V	1000 = 1 unit
12.22	AI2 scaled value	<i>Real</i>	-32768.000...32767.000	-	1000 = 1
12.23	AI2 forced value	<i>Real</i>	4.000...20.000 mA or 0.000...10.000 V	mA or V	1000 = 1 unit
12.25	AI2 unit selection	<i>List</i>	2, 10	-	1 = 1
12.26	AI2 filter time	<i>Real</i>	0.000...30.000	s	1000 = 1 s
12.27	AI2 min	<i>Real</i>	4.000...20.000 mA or 0.000...10.000 V	mA or V	1000 = 1 unit
12.28	AI2 max	<i>Real</i>	4.000...20.000 mA or 0.000...10.000 V	mA or V	1000 = 1 unit
12.29	AI2 scaled at AI2 min	<i>Real</i>	-32768.000...32767.000	-	1000 = 1
12.30	AI2 scaled at AI2 max	<i>Real</i>	-32768.000...32767.000	-	1000 = 1
12.101	AI1 percent value	<i>Real</i>	0.00...100.00	%	100 = 1%
12.102	AI2 percent value	<i>Real</i>	0.00...100.00	%	100 = 1%

No.	Name	Type	Range	Unit	FbEq32
<b>13 Standard AO</b>					
13.02	AO force selection	<i>PB</i>	0000h...FFFFh	-	1 = 1
13.11	AO1 actual value	<i>Real</i>	0.000...22.000	mA	1000 = 1 mA
13.12	AO1 source	<i>Analog src</i>	-	-	1 = 1
13.13	AO1 forced value	<i>Real</i>	0.000...22.000	mA	1000 = 1 mA
13.15	AO1 unit selection	<i>List</i>	2, 10	-	1 = 1
13.16	AO1 filter time	<i>Real</i>	0.000...30.000	s	1000 = 1 s
13.17	AO1 source min	<i>Real</i>	-32768.0...32767.0	-	10 = 1
13.18	AO1 source max	<i>Real</i>	-32768.0...32767.0	-	10 = 1
13.19	AO1 out at AO1 src min	<i>Real</i>	0.000...22.000	mA	1000 = 1 mA
13.20	AO1 out at AO1 src max	<i>Real</i>	0.000...22.000	mA	1000 = 1 mA
13.91	AO1 data storage	<i>Real</i>	-327.68 ... 327.67	-	100 = 1
<b>15 I/O extension module</b>					
15.01	Extension module type	<i>List</i>	0, 5...7	-	1 = 1
15.02	Detected extension module	<i>List</i>	0...3	-	1 = 1
15.04	RO status	<i>PB</i>	0000h...FFFFh	-	1 = 1
15.05	RO force selection	<i>PB</i>	0000h...FFFFh	-	1 = 1
15.06	RO forced data	<i>PB</i>	0000h...FFFFh	-	1 = 1
15.07	RO2 source	<i>Binary src</i>	-	-	1 = 1
15.08	RO2 ON delay	<i>Real</i>	0.0...3000.0	s	10 = 1 s
15.09	RO2 OFF delay	<i>Real</i>	0.0...3000.0	s	10 = 1 s
15.10	RO3 source	<i>Binary src</i>	-	-	1 = 1
15.11	RO3 ON delay	<i>Real</i>	0.0...3000.0	s	10 = 1 s
15.12	RO3 OFF delay	<i>Real</i>	0.0...3000.0	s	10 = 1 s
15.13	RO4 source	<i>Binary src</i>	-	-	1 = 1
15.14	RO4 ON delay	<i>Real</i>	0.0...3000.0	s	10 = 1 s
15.15	RO4 OFF delay	<i>Real</i>	0.0...3000.0	s	10 = 1 s
15.16	RO5 source	<i>Binary src</i>	-	-	1 = 1
15.17	RO5 ON delay	<i>Real</i>	0.0...3000.0	s	10 = 1 s
15.18	RO5 OFF delay	<i>Real</i>	0.0...3000.0	s	10 = 1 s
<b>19 Operation mode</b>					
19.01	Actual operation mode	<i>List</i>	1...5, 10, 20	-	1 = 1
19.11	Ext1/Ext2 selection	<i>Binary src</i>	-	-	1 = 1
19.12	Ext1 control mode	<i>List</i>	1...5	-	1 = 1
19.14	Ext2 control mode	<i>List</i>	1...5	-	1 = 1
19.16	Local control mode	<i>List</i>	0...1	-	1 = 1
19.17	Local control disable	<i>List</i>	0...1	-	1 = 1
<b>20 Start/stop/direction</b>					
20.01	Ext1 commands	<i>List</i>	0...6, 11...12, 14...16, 21...23	-	1 = 1
20.02	Ext1 start trigger type	<i>List</i>	0...1	-	1 = 1

No.	Name	Type	Range	Unit	FbEq32
20.03	Ext1 in1 source	<i>Binary src</i>	-	-	1 = 1
20.04	Ext1 in2 source	<i>Binary src</i>	-	-	1 = 1
20.05	Ext1 in3 source	<i>Binary src</i>	-	-	1 = 1
20.06	Ext2 commands	<i>List</i>	0...6, 11...12, 14, 21...23	-	1 = 1
20.07	Ext2 start trigger type	<i>List</i>	0...1	-	1 = 1
20.08	Ext2 in1 source	<i>Binary src</i>	-	-	1 = 1
20.09	Ext2 in2 source	<i>Binary src</i>	-	-	1 = 1
20.10	Ext2 in3 source	<i>Binary src</i>	-	-	1 = 1
20.11	Run enable stop mode	<i>List</i>	0...2	-	1 = 1
20.12	Run enable 1 source	<i>Binary src</i>	-	-	1 = 1
20.13	Run enable 2	<i>Binary src</i>	-	-	1 = 1
20.14	Run enable 3	<i>Binary src</i>	-	-	1 = 1
20.15	Run enable 4	<i>Binary src</i>	-	-	1 = 1
20.19	Enable start signal	<i>Binary src</i>	-	-	1 = 1
20.21	Direction	<i>List</i>	0...2	-	1 = 1
20.22	Enable to rotate	<i>Binary src</i>	-	-	1 = 1
20.25	Jog enable	<i>Binary src</i>	-	-	1 = 1
20.26	Jog 1 start	<i>Binary src</i>	-	-	1 = 1
20.27	Jog 2 start	<i>Binary src</i>	-	-	1 = 1
20.210	Fast stop input	<i>Binary src</i>	-	-	1 = 1
20.211	Fast stop mode	<i>List</i>	1...3	-	1 = 1
20.212	Power on acknowledge	<i>Binary src</i>	-	-	1 = 1
20.213	Power on ackn reset delay	<i>Real</i>	0...30000	ms	1 = 1
20.214	Joystick zero position	<i>Binary src</i>	-	-	1 = 1
20.215	Joystick warning delay	<i>Real</i>	0...30000	ms	1 = 1
20.216	Crane control word 1	<i>PB</i>	0000h...FFFFh	-	1 = 1
<b>21 Start/stop mode</b>					
21.01	Vector start mode	<i>List</i>	0...2	-	1 = 1
21.02	Magnetization time	<i>Real</i>	0...10000	ms	1 = 1 ms
21.03	Stop mode	<i>List</i>	0...2	-	1 = 1
21.04	Emergency stop mode	<i>List</i>	0...3	-	1 = 1
21.05	Emergency stop source	<i>Binary src</i>	-	-	1 = 1
21.06	Zero speed limit	<i>Real</i>	0.00...30000.00	rpm	100 = 1 rpm
21.07	Zero speed delay	<i>Real</i>	0...30000	ms	1 = 1 ms
21.08	DC current control	<i>PB</i>	0b0000...0b1111	-	1 = 1
21.09	DC hold speed	<i>Real</i>	0.00...1000.00	rpm	100 = 1 rpm
21.10	DC current reference	<i>Real</i>	0.0...100.0	%	10 = 1%
21.11	Post magnetization time	<i>Real</i>	0...3000	s	1 = 1 s
21.13	Autophasing mode	<i>List</i>	0	-	1 = 1
21.14	Pre-heating input source	<i>Binary src</i>	-	-	1 = 1
21.15	Pre-heating time delay	<i>Real</i>	10...3000	s	1 = 1 s

No.	Name	Type	Range	Unit	FbEq32
21.16	Pre-heating current	<i>Real</i>	0.0...30.0	%	10 = 1%
21.18	Auto restart time	<i>Real</i>	0.0, 0.1 ... 10.0	s	10 = 1 s
21.19	Scalar start mode	<i>List</i>	0...6	-	1 = 1
21.21	DC hold frequency	<i>Real</i>	0.00...1000.00	Hz	100 = 1 Hz
21.22	Start delay	<i>Real</i>	0.00...60.00	s	100 = 1 s
21.23	Smooth start	<i>Real</i>	0...2	-	1 = 1
21.24	Smooth start current	<i>Real</i>	10.0...100.0	%	100 = 1%
21.25	Smooth start speed	<i>Real</i>	2.0...100.0	%	100 = 1%
21.26	Torque boost current	<i>Real</i>	15.0...300.0	%	100 = 1%
21.30	Speed compensated stop mode	<i>Real</i>	0...3	-	1 = 1
21.31	Speed compensated stop delay	<i>Real</i>	0.00...1000.00	s	100 = 1 s
21.32	Speed comp stop threshold	<i>Real</i>	0...100	%	1 = 1%
21.34	Force auto restart	<i>List</i>	0...1	-	1 = 1
<b>22 Speed reference selection</b>					
22.01	Speed ref unlimited	<i>Real</i>	-30000.00...30000.00	rpm	100 = 1 rpm
22.11	Ext1 speed ref1	<i>Analog src</i>	-	-	1 = 1
22.12	Ext1 speed ref2	<i>Analog src</i>	-	-	1 = 1
22.13	Ext1 speed function	<i>List</i>	0...6	-	1 = 1
22.18	Ext2 speed ref1	<i>Analog src</i>	-	-	1 = 1
22.19	Ext2 speed ref2	<i>Analog src</i>	-	-	1 = 1
22.20	Ext2 speed function	<i>List</i>	0...6	-	1 = 1
22.21	Constant speed function	<i>PB</i>	0b0000...0b1111	-	1 = 1
22.22	Constant speed sel1	<i>Binary src</i>	-	-	1 = 1
22.23	Constant speed sel2	<i>Binary src</i>	-	-	1 = 1
22.24	Constant speed sel3	<i>Binary src</i>	-	-	1 = 1
22.26	Constant speed 1	<i>Real</i>	-30000.00...30000.00	rpm	100 = 1 rpm
22.27	Constant speed 2	<i>Real</i>	-30000.00...30000.00	rpm	100 = 1 rpm
22.28	Constant speed 3	<i>Real</i>	-30000.00...30000.00	rpm	100 = 1 rpm
22.29	Constant speed 4	<i>Real</i>	-30000.00...30000.00	rpm	100 = 1 rpm
22.30	Constant speed 5	<i>Real</i>	-30000.00...30000.00	rpm	100 = 1 rpm
22.31	Constant speed 6	<i>Real</i>	-30000.00...30000.00	rpm	100 = 1 rpm
22.32	Constant speed 7	<i>Real</i>	-30000.00...30000.00	rpm	100 = 1 rpm
22.41	Speed ref safe	<i>Real</i>	-30000.00...30000.00	rpm	100 = 1 rpm
22.42	Jogging 1 ref	<i>Real</i>	-30000.00...30000.00	rpm	100 = 1 rpm
22.43	Jogging 2 ref	<i>Real</i>	-30000.00...30000.00	rpm	100 = 1 rpm
22.51	Critical speed function	<i>PB</i>	0000h...FFFFh	-	1 = 1
22.52	Critical speed 1 low	<i>Real</i>	-30000.00...30000.00	rpm	100 = 1 rpm
22.53	Critical speed 1 high	<i>Real</i>	-30000.00...30000.00	rpm	100 = 1 rpm
22.54	Critical speed 2 low	<i>Real</i>	-30000.00...30000.00	rpm	100 = 1 rpm
22.55	Critical speed 2 high	<i>Real</i>	-30000.00...30000.00	rpm	100 = 1 rpm

No.	Name	Type	Range	Unit	FbEq32
22.56	Critical speed 3 low	<i>Real</i>	-30000.00...30000.00	rpm	100 = 1 rpm
22.57	Critical speed 3 high	<i>Real</i>	-30000.00...30000.00	rpm	100 = 1 rpm
22.71	Motor potentiometer function	<i>List</i>	0...3, 5	-	1 = 1
22.72	Motor potentiometer initial value	<i>Real</i>	-32768.00...32767.00	-	100 = 1
22.73	Motor potentiometer up source	<i>Binary src</i>	-	-	1 = 1
22.74	Motor potentiometer down source	<i>Binary src</i>	-	-	1 = 1
22.75	Motor potentiometer ramp time	<i>Real</i>	0.0...3600.0	s	10 = 1 s
22.76	Motor potentiometer min value	<i>Real</i>	-32768.00...32767.00	-	100 = 1
22.77	Motor potentiometer max value	<i>Real</i>	-32768.00...32767.00	-	100 = 1
22.80	Motor potentiometer ref act	<i>Real</i>	-32768.00...32767.00	-	100 = 1
22.86	Speed reference act 6	<i>Real</i>	-30000.00...30000.00	rpm	100 = 1 rpm
22.87	Speed reference act 7	<i>Real</i>	-30000.00...30000.00	rpm	100 = 1 rpm
22.211	Speed reference shape	<i>List</i>	0...2	-	1 = 1
22.220	Crane motpot enable	<i>List</i>	0...7	-	1 = 1
22.223	Crane motpot accel sel	<i>List</i>	0...7	-	1 = 1
22.224	Crane motpot min speed	<i>Real</i>	0...30000	rpm	100 = 1 rpm
22.225	Crane motpot sw	<i>PB</i>	0000h...FFFFh	-	100 = 1
22.226	Crane motpot min value	<i>Real</i>	-30000.00...30000.00	-	100 = 1
22.227	Crane motpot max value	<i>Real</i>	-30000.00...30000.00	-	100 = 1
22.230	Crane motpot ref act	<i>Real</i>	-30000.00...30000.00	-	100 = 1
<b>23 Speed reference ramp</b>					
23.01	Speed ref ramp input	<i>Real</i>	-30000.00...30000.00	rpm	100 = 1 rpm
23.02	Speed ref ramp output	<i>Real</i>	-30000.00...30000.00	rpm	100 = 1 rpm
23.11	Ramp set selection	<i>Binary src</i>	-	-	1 = 1
23.12	Acceleration time 1	<i>Real</i>	0.000 ...1800.000	s	1000 = 1 s
23.13	Deceleration time 1	<i>Real</i>	0.000 ...1800.000	s	1000 = 1 s
23.14	Acceleration time 2	<i>Real</i>	0.000 ...1800.000	s	1000 = 1 s
23.15	Deceleration time 2	<i>Real</i>	0.000 ...1800.000	s	1000 = 1 s
23.20	Acc time jogging	<i>Real</i>	0.000 ...1800.000	s	1000 = 1 s
23.21	Dec time jogging	<i>Real</i>	0.000 ...1800.000	s	1000 = 1 s
23.23	Emergency stop time	<i>Real</i>	0.000 ...1800.000	s	1000 = 1 s
23.28	Variable slope enable	<i>List</i>	0...1	-	1 = 1
23.29	Variable slope rate	<i>Real</i>	2...30000	ms	1 = 1 ms
23.32	Shape time 1	<i>Real</i>	0.000 ...1800.000	s	1000 = 1 s
23.33	Shape time 2	<i>Real</i>	0.000 ...1800.000	s	1000 = 1 s
23.201	Crane motpot acc time 1	<i>Real</i>	0.00 ...3600.000	s	1000 = 1 s
23.202	Crane motpot dec tme 1	<i>Real</i>	0.00 ...3600.000	s	1000 = 1 s

No.	Name	Type	Range	Unit	FbEq32
23.206	Fast stop deceleration time	<i>Real</i>	0.00 ...3000.000	s	1000 = 1 s
<b>24 Speed reference conditioning</b>					
24.01	Used speed reference	<i>Real</i>	-30000.00...30000.00	rpm	100 = 1 rpm
24.02	Used speed feedback	<i>Real</i>	-30000.00...30000.00	rpm	100 = 1 rpm
24.03	Speed error filtered	<i>Real</i>	-30000.0...30000.0	rpm	100 = 1 rpm
24.04	Speed error inverted	<i>Real</i>	-30000.0...30000.0	rpm	100 = 1 rpm
24.11	Speed correction	<i>Real</i>	-10000.00...10000.00	rpm	100 = 1 rpm
24.12	Speed error filter time	<i>Real</i>	0...10000	ms	1 = 1 ms
<b>25 Speed control</b>					
25.01	Torque reference speed control	<i>Real</i>	-1600.0...1600.0	%	10 = 1%
25.02	Speed proportional gain	<i>Real</i>	0.00...250.00	-	100 = 1
25.03	Speed integration time	<i>Real</i>	0.00...1000.00	s	100 = 1 s
25.04	Speed derivation time	<i>Real</i>	0.000...10.000	s	1000 = 1 s
25.05	Derivation filter time	<i>Real</i>	0...10000	ms	1 = 1 ms
25.06	Acc comp derivation time	<i>Real</i>	0.00...1000.00	s	100 = 1 s
25.07	Acc comp filter time	<i>Real</i>	0.0...1000.0	ms	10 = 1 ms
25.15	Proportional gain em stop	<i>Real</i>	1.00...250.00	-	100 = 1
25.53	Torque prop reference	<i>Real</i>	-30000.0...30000.0	%	10 = 1%
25.54	Torque integral reference	<i>Real</i>	-30000.0...30000.0	%	10 = 1%
25.55	Torque deriv reference	<i>Real</i>	-30000.0...30000.0	%	10 = 1%
25.56	Torque acc compensation	<i>Real</i>	-30000.0...30000.0	%	10 = 1%
<b>26 Torque reference chain</b>					
26.01	Torque reference to TC	<i>Real</i>	-1600.0...1600.0	%	10 = 1%
26.02	Torque reference used	<i>Real</i>	-1600.0...1600.0	%	10 = 1%
26.08	Minimum torque ref	<i>Real</i>	-1000.0...0.0	%	10 = 1%
26.09	Maximum torque ref	<i>Real</i>	0.0...1000.0	%	10 = 1%
26.11	Torque ref1 source	<i>Analog src</i>	-	-	1 = 1
26.12	Torque ref2 source	<i>Analog src</i>	-	-	1 = 1
26.13	Torque ref1 function	<i>List</i>	0...5	-	1 = 1
26.14	Torque ref1/2 selection	<i>Binary src</i>	-	-	1 = 1
26.17	Torque ref filter time	<i>Real</i>	0.000...30.000	s	1000 = 1 s
26.18	Torque ramp up time	<i>Real</i>	0.000...60.000	s	1000 = 1 s
26.19	Torque ramp down time	<i>Real</i>	0.000...60.000	s	1000 = 1 s
26.21	Torque sel torque in	<i>Binary src</i>	-	-	1 = 1
26.22	Torque sel speed in	<i>Binary src</i>	-	-	1 = 1
26.70	Torque reference act 1	<i>Real</i>	-1600.0...1600.0	%	10 = 1%
26.71	Torque reference act 2	<i>Real</i>	-1600.0...1600.0	%	10 = 1%
26.72	Torque reference act 3	<i>Real</i>	-1600.0...1600.0	%	10 = 1%
26.73	Torque reference act 4	<i>Real</i>	-1600.0...1600.0	%	10 = 1%
26.74	Torque ref ramp out	<i>Real</i>	-1600.0...1600.0	%	10 = 1%

No.	Name	Type	Range	Unit	FbEq32
26.75	Torque reference act 5	<i>Real</i>	-1600.0...1600.0	%	10 = 1%
26.81	Rush control gain	<i>Real</i>	0.0 ... 10000.0	-	10 = 1
26.82	Rush control integration time	<i>Real</i>	0.0 ... 10.0	s	10 = 1 s
<b>28 Frequency reference chain</b>					
28.01	Frequency ref ramp input	<i>Real</i>	-500.00...500.00	Hz	100 = 1 Hz
28.02	Frequency ref ramp output	<i>Real</i>	-500.00...500.00	Hz	100 = 1 Hz
28.11	Ext1 frequency ref1	<i>Analog src</i>	-	-	1 = 1
28.12	Ext1 frequency ref2	<i>Analog src</i>	-	-	1 = 1
28.13	Ext1 frequency function	<i>List</i>	0...6	-	1 = 1
28.15	Ext2 frequency ref1	<i>Analog src</i>	-	-	1 = 1
28.16	Ext2 frequency ref2	<i>Analog src</i>	-	-	1 = 1
28.17	Ext2 frequency function	<i>List</i>	0...6	-	1 = 1
28.21	Constant frequency function	<i>PB</i>	0000h...FFFFh	-	1 = 1
28.22	Constant frequency sel1	<i>Binary src</i>	-	-	1 = 1
28.23	Constant frequency sel2	<i>Binary src</i>	-	-	1 = 1
28.24	Constant frequency sel3	<i>Binary src</i>	-	-	1 = 1
28.26	Constant frequency 1	<i>Real</i>	-500.00...500.00	Hz	100 = 1 Hz
28.27	Constant frequency 2	<i>Real</i>	-500.00...500.00	Hz	100 = 1 Hz
28.28	Constant frequency 3	<i>Real</i>	-500.00...500.00	Hz	100 = 1 Hz
28.29	Constant frequency 4	<i>Real</i>	-500.00...500.00	Hz	100 = 1 Hz
28.30	Constant frequency 5	<i>Real</i>	-500.00...500.00	Hz	100 = 1 Hz
28.31	Constant frequency 6	<i>Real</i>	-500.00...500.00	Hz	100 = 1 Hz
28.32	Constant frequency 7	<i>Real</i>	-500.00...500.00	Hz	100 = 1 Hz
28.41	Frequency ref safe	<i>Real</i>	-500.00...500.00	Hz	100 = 1 Hz
28.51	Critical frequency function	<i>PB</i>	00b...11b	-	1 = 1
28.52	Critical frequency 1 low	<i>Real</i>	-500.00...500.00	Hz	100 = 1 Hz
28.53	Critical frequency 1 high	<i>Real</i>	-500.00...500.00	Hz	100 = 1 Hz
28.54	Critical frequency 2 low	<i>Real</i>	-500.00...500.00	Hz	100 = 1 Hz
28.55	Critical frequency 2 high	<i>Real</i>	-500.00...500.00	Hz	100 = 1 Hz
28.56	Critical frequency 3 low	<i>Real</i>	-500.00...500.00	Hz	100 = 1 Hz
28.57	Critical frequency 3 high	<i>Real</i>	-500.00...500.00	Hz	100 = 1 Hz
28.71	Freq ramp set selection	<i>Binary src</i>	-	-	1 = 1
28.72	Freq acceleration time 1	<i>Real</i>	0.000...1800.000	s	1000 = 1 s
28.73	Freq deceleration time 1	<i>Real</i>	0.000...1800.000	s	1000 = 1 s
28.74	Freq acceleration time 2	<i>Real</i>	0.000...1800.000	s	1000 = 1 s
28.75	Freq deceleration time 2	<i>Real</i>	0.000...1800.000	s	1000 = 1 s
28.76	Freq ramp in zero source	<i>Binary src</i>	-	-	1 = 1
28.82	Shape time 1	<i>Real</i>	0.000...1800.000	s	1000 = 1 s
28.83	Shape time 2	<i>Real</i>	0.000...1800.000	s	1000 = 1 s
28.92	Frequency ref act 3	<i>Real</i>	-500.00...500.00	Hz	100 = 1 Hz
28.96	Frequency ref act 7	<i>Real</i>	-500.00...500.00	Hz	100 = 1 Hz

No.	Name	Type	Range	Unit	FbEq32
28.97	Frequency ref unlimited	<i>Real</i>	-500.00 ... 500.00	Hz	100 = 1 Hz
28.211	Frequency reference shape	<i>List</i>	0...2	-	1 = 1
<b>30 Limits</b>					
30.01	Limit word 1	<i>PB</i>	0000h...FFFFh	-	1 = 1
30.02	Torque limit status	<i>PB</i>	0000h...FFFFh	-	1 = 1
30.11	Minimum speed	<i>Real</i>	-30000.00...30000.00	rpm	100 = 1 rpm
30.12	Maximum speed	<i>Real</i>	-30000.00...30000.00	rpm	100 = 1 rpm
30.13	Minimum frequency	<i>Real</i>	-500.00...500.00	Hz	100 = 1 Hz
30.14	Maximum frequency	<i>Real</i>	-500.00...500.00	Hz	100 = 1 Hz
30.17	Maximum current	<i>Real</i>	0.00...30000.00	A	100 = 1 A
30.18	Torq lim sel	<i>Binary src</i>	-	-	1 = 1
30.19	Minimum torque 1	<i>Real</i>	-1600.0...0.0	%	10 = 1%
30.20	Maximum torque 1	<i>Real</i>	0.0...1600.0	%	10 = 1%
30.21	Min torque 2 source	<i>Analog src</i>	-	-	1 = 1
30.22	Max torque 2 source	<i>Analog src</i>	-	-	1 = 1
30.23	Minimum torque 2	<i>Real</i>	-1600.0...0.0	%	10 = 1%
30.24	Maximum torque 2	<i>Real</i>	0.0...1600.0	%	10 = 1%
30.26	Power motoring limit	<i>Real</i>	0.00...600.00	%	100 = 1%
30.27	Power generating limit	<i>Real</i>	-600.00...0.00	%	100 = 1%
30.30	Overvoltage control	<i>List</i>	0...1	-	1 = 1
30.31	Undervoltage control	<i>List</i>	0...1	-	1 = 1
30.35	Thermal current limitation	<i>List</i>	0...1	-	1 = 1
30.36	Speed limit selection	<i>Binary src</i>	-	-	1 = 1
30.37	Min speed source	<i>Analog src</i>	-	-	1 = 1
30.38	Max speed source	<i>Analog src</i>	-	-	1 = 1
30.203	Deadband forward	<i>Real</i>	0.00...100.00	%	100 = 1%
30.204	Deadband reverse	<i>Real</i>	0.00...100.00	%	100 = 1%
<b>31 Fault functions</b>					
31.01	External event 1 source	<i>Binary src</i>	-	-	1 = 1
31.02	External event 1 type	<i>List</i>	0...1	-	1 = 1
31.03	External event 2 source	<i>Binary src</i>	-	-	1 = 1
31.04	External event 2 type	<i>List</i>	0...1	-	1 = 1
31.05	External event 3 source	<i>Binary src</i>	-	-	1 = 1
31.06	External event 3 type	<i>List</i>	0...1	-	1 = 1
31.07	External event 4 source	<i>Binary src</i>	-	-	1 = 1
31.08	External event 4 type	<i>List</i>	0...1	-	1 = 1
31.09	External event 5 source	<i>Binary src</i>	-	-	1 = 1
31.10	External event 5 type	<i>List</i>	0...1	-	1 = 1
31.11	Fault reset selection	<i>Binary src</i>	-	-	1 = 1
31.12	Autoreset selection	<i>PB</i>	0000h...FFFFh	-	1 = 1
31.13	Selectable fault	<i>Real</i>	0000h...FFFFh	-	1 = 1



No.	Name	Type	Range	Unit	FbEq32
31.14	Number of trials	<i>Real</i>	0...5	-	1 = 1
31.15	Total trials time	<i>Real</i>	1.0...600.0	s	10 = 1 s
31.16	Delay time	<i>Real</i>	0.0...120.0	s	10 = 1 s
31.19	Motor phase loss	<i>List</i>	0...1	-	1 = 1
31.20	Earth fault	<i>List</i>	0...2	-	1 = 1
31.22	STO indication run/stop	<i>List</i>	0...5	-	1 = 1
31.23	Wiring or earth fault	<i>List</i>	0...1	-	1 = 1
31.24	Stall function	<i>List</i>	0...2	-	1 = 1
31.25	Stall current limit	<i>Real</i>	0.0...1600.0	%	10 = 1%
31.26	Stall speed limit	<i>Real</i>	0.00...10000.00	rpm	100 = 1 rpm
31.27	Stall frequency limit	<i>Real</i>	0.00...1000.00	Hz	100 = 1 Hz
31.28	Stall time	<i>Real</i>	0...3600	s	1 = 1 s
31.30	Overspeed trip margin	<i>Real</i>	0.00...10000.00	rpm	100 = 1 rpm
31.31	Frequency trip margin	<i>Real</i>	0.00...10000.00	Hz	100 = 1 Hz
31.32	Emergency ramp supervision	<i>Real</i>	0...300	%	1 = 1%
31.33	Emergency ramp supervision delay	<i>Real</i>	0...100	s	1 = 1 s
31.205	Crane warning masking	<i>Analog src</i>	0, 1, 4, 6...10, 11...15	-	1 = 1
<b>32 Supervision</b>					
32.01	Supervision status	<i>PB</i>	0000h...FFFFh	-	1 = 1
32.05	Supervision 1 function	<i>List</i>	0...7	-	1 = 1
32.06	Supervision 1 action	<i>List</i>	0...2	-	1 = 1
32.07	Supervision 1 signal	<i>Analog src</i>	-	-	1 = 1
32.08	Supervision 1 filter time	<i>Real</i>	0.000...30.000	s	1000 = 1 s
32.09	Supervision 1 low	<i>Real</i>	-21474830.00... 21474830.00	-	100 = 1
32.10	Supervision 1 high	<i>Real</i>	-21474830.00... 21474830.00	-	100 = 1
32.11	Supervision 1 hysteresis	<i>Real</i>	0.00...100000.00	-	100 = 1
32.15	Supervision 2 function	<i>List</i>	0...7	-	1 = 1
32.16	Supervision 2 action	<i>List</i>	0...2	-	1 = 1
32.17	Supervision 2 signal	<i>Analog src</i>	-	-	1 = 1
32.18	Supervision 2 filter time	<i>Real</i>	0.000...30.000	s	1000 = 1 s
32.19	Supervision 2 low	<i>Real</i>	-21474830.00... 21474830.00	-	100 = 1
32.20	Supervision 2 high	<i>Real</i>	-21474830.00... 21474830.00	-	100 = 1
32.21	Supervision 2 hysteresis	<i>Real</i>	0.00...100000.00	-	100 = 1
32.25	Supervision 3 function	<i>List</i>	0...7	-	1 = 1
32.26	Supervision 3 action	<i>List</i>	0...2	-	1 = 1
32.27	Supervision 3 signal	<i>Analog src</i>	-	-	1 = 1
32.28	Supervision 3 filter time	<i>Real</i>	0.000...30.000	s	1000 = 1 s

## 370 Additional parameter data

No.	Name	Type	Range	Unit	FbEq32
32.29	Supervision 3 low	<i>Real</i>	-21474830.00... 21474830.00	-	100 = 1
32.30	Supervision 3 high	<i>Real</i>	-21474830.00... 21474830.00	-	100 = 1
32.31	Supervision 3 hysteresis	<i>Real</i>	0.00...100000.00	-	100 = 1
32.35	Supervision 4 function	<i>List</i>	0...7	-	1 = 1
32.36	Supervision 4 action	<i>List</i>	0...2	-	1 = 1
32.37	Supervision 4 signal	<i>Analog src</i>	-	-	1 = 1
32.38	Supervision 4 filter time	<i>Real</i>	0.000...30.000	s	1000 = 1 s
32.39	Supervision 4 low	<i>Real</i>	-21474830.00... 21474830.00	-	100 = 1
32.40	Supervision 4 high	<i>Real</i>	-21474830.00... 21474830.00	-	100 = 1
32.41	Supervision 4 hysteresis	<i>Real</i>	0.00...100000.00	-	100 = 1
32.45	Supervision 5 function	<i>List</i>	0...7	-	1 = 1
32.46	Supervision 5 action	<i>List</i>	0...2	-	1 = 1
32.47	Supervision 5 signal	<i>Analog src</i>	-	-	1 = 1
32.48	Supervision 5 filter time	<i>Real</i>	0.000...30.000	s	1000 = 1 s
32.49	Supervision 5 low	<i>Real</i>	-21474830.00... 21474830.00	-	100 = 1
32.50	Supervision 5 high	<i>Real</i>	-21474830.00... 21474830.00	-	100 = 1
32.51	Supervision 5 hysteresis	<i>Real</i>	0.00...100000.00	-	100 = 1
32.55	Supervision 6 function	<i>List</i>	0...7	-	1 = 1
32.56	Supervision 6 action	<i>List</i>	0...2	-	1 = 1
32.57	Supervision 6 signal	<i>Analog src</i>	-	-	1 = 1
32.58	Supervision 6 filter time	<i>Real</i>	0.000...30.000	s	1000 = 1 s
32.59	Supervision 6 low	<i>Real</i>	-21474830.00... 21474830.00	-	100 = 1
32.60	Supervision 6 high	<i>Real</i>	-21474830.00... 21474830.00	-	100 = 1
32.61	Supervision 6 hysteresis	<i>Real</i>	0.00...100000.00	-	100 = 1
<b>34 Timed functions</b>					
34.01	Timed functions status	<i>PB</i>	0000h...FFFFh	-	1 = 1
34.02	Timer status	<i>PB</i>	0000h...FFFFh	-	1 = 1
34.04	Season/exception day status	<i>PB</i>	0000h...FFFFh	-	1 = 1
34.10	Timed functions enable	<i>Binary src</i>	-	-	1 = 1
34.11	Timer 1 configuration	<i>PB</i>	0000h...FFFFh	-	1 = 1
34.12	Timer 1 start time	Time	00:00:00...23:59:59	s	1 = 1 s
34.13	Timer 1 duration	Duration	00 00:00...07 00:00	min	1 = 1 min
34.14	Timer 2 configuration	<i>PB</i>	0000h...FFFFh	-	1 = 1
34.15	Timer 2 start time	Time	00:00:00...23:59:59	s	1 = 1 s
34.16	Timer 2 duration	Duration	00 00:00...07 00:00	min	1 = 1 min
34.17	Timer 3 configuration	<i>PB</i>	0000h...FFFFh	-	1 = 1

No.	Name	Type	Range	Unit	FbEq32
34.18	Timer 3 start time	Time	00:00:00...23:59:59	s	1 = 1 s
34.19	Timer 3 duration	Duration	00 00:00...07 00:00	min	1 = 1 min
34.20	Timer 4 configuration	<i>PB</i>	0000h...FFFFh	-	1 = 1
34.21	Timer 4 start time	Time	00:00:00...23:59:59	s	1 = 1 s
34.22	Timer 4 duration	Duration	00 00:00...07 00:00	min	1 = 1 min
34.23	Timer 5 configuration	<i>PB</i>	0000h...FFFFh	-	1 = 1
34.24	Timer 5 start time	Time	00:00:00...23:59:59	s	1 = 1 s
34.25	Timer 5 duration	Duration	00 00:00...07 00:00	min	1 = 1 min
34.26	Timer 6 configuration	<i>PB</i>	0000h...FFFFh	-	1 = 1
34.27	Timer 6 start time	Time	00:00:00...23:59:59	s	1 = 1 s
34.28	Timer 6 duration	Duration	00 00:00...07 00:00	min	1 = 1 min
34.29	Timer 7 configuration	<i>PB</i>	0000h...FFFFh	-	1 = 1
34.30	Timer 7 start time	Time	00:00:00...23:59:59	s	1 = 1 s
34.31	Timer 7 duration	Duration	00 00:00...07 00:00	min	1 = 1 min
34.32	Timer 8 configuration	<i>PB</i>	0000h...FFFFh	-	1 = 1
34.33	Timer 8 start time	Time	00:00:00...23:59:59	s	1 = 1 s
34.34	Timer 8 duration	Duration	00 00:00...07 00:00	min	1 = 1 min
34.35	Timer 9 configuration	<i>PB</i>	0000h...FFFFh	-	1 = 1
34.36	Timer 9 start time	Time	00:00:00...23:59:59	s	1 = 1 s
34.37	Timer 9 duration	Duration	00 00:00...07 00:00	min	1 = 1 min
34.38	Timer 10 configuration	<i>PB</i>	0000h...FFFFh	-	1 = 1
34.39	Timer 10 start time	Time	00:00:00...23:59:59	s	1 = 1 s
34.40	Timer 10 duration	Duration	00 00:00...07 00:00	min	1 = 1 min
34.41	Timer 11 configuration	<i>PB</i>	0000h...FFFFh	-	1 = 1
34.42	Timer 11 start time	Time	00:00:00...23:59:59	s	1 = 1 s
34.43	Timer 11 duration	Duration	00 00:00...07 00:00	min	1 = 1 min
34.44	Timer 12 configuration	<i>PB</i>	0000h...FFFFh	-	1 = 1
34.45	Timer 12 start time	Time	00:00:00...23:59:59	s	1 = 1 s
34.46	Timer 12 duration	Duration	00 00:00...07 00:00	min	1 = 1 min
34.60	Season 1 start date	Date	01.01...31.12	d	1 = 1 d
34.61	Season 2 start date	Date	01.01...31.12	d	1 = 1 d
34.62	Season 3 start date	Date	01.01...31.12	d	1 = 1 d
34.63	Season 4 start date	Date	01.01...31.12	d	1 = 1 d
34.70	Number of active exceptions	<i>Real</i>	0...16	-	1 = 1
34.71	Exception types	<i>PB</i>	0b0000...0b1111	-	1 = 1
34.72	Exception 1 start	Date	01.01...31.12	d	1 = 1 d
34.73	Exception 1 length	<i>Real</i>	0...60	d	1 = 1 d
34.74	Exception 2 start	Date	01.01...31.12	d	1 = 1 d
34.75	Exception 2 length	<i>Real</i>	0...60	d	1 = 1 d
34.76	Exception 3 start	Date	01.01...31.12	d	1 = 1 d
34.77	Exception 3 length	<i>Real</i>	0...60	d	1 = 1 d

No.	Name	Type	Range	Unit	FbEq32
34.78	Exception day 4	Date	01.01...31.12	d	1 = 1 d
34.79	Exception day 5	Date	01.01...31.12	d	1 = 1 d
34.80	Exception day 6	Date	01.01...31.12	d	1 = 1 d
34.81	Exception day 7	Date	01.01...31.12	d	1 = 1 d
34.82	Exception day 8	Date	01.01...31.12	d	1 = 1 d
34.83	Exception day 9	Date	01.01...31.12	d	1 = 1 d
34.84	Exception day 10	Date	01.01...31.12	d	1 = 1 d
34.85	Exception day 11	Date	01.01...31.12	d	1 = 1 d
34.86	Exception day 12	Date	01.01...31.12	d	1 = 1 d
34.87	Exception day 13	Date	01.01...31.12	d	1 = 1 d
34.88	Exception day 14	Date	01.01...31.12	d	1 = 1 d
34.89	Exception day 15	Date	01.01...31.12	d	1 = 1 d
34.90	Exception day 16	Date	01.01...31.12	d	1 = 1 d
34.100	Timed function 1	<i>PB</i>	0b0000...0b1111	-	1 = 1
34.101	Timed function 2	<i>PB</i>	0b0000...0b1111	-	1 = 1
34.102	Timed function 3	<i>PB</i>	0b0000...0b1111	-	1 = 1
34.110	Boost time function	<i>PB</i>	0b0000...0b1111	-	
34.111	Boost time activation source	<i>Binary src</i>	-	-	1 = 1
34.112	Boost time duration	Duration	00 00:00...07 00:00	min	1 = 1 min
<b>35 Motor thermal protection</b>					
35.01	Motor estimated temperature	<i>Real</i>	-60...1000 °C	°C or °F	1 = 1°
35.02	Measured temperature 1	<i>Real</i>	-60...5000 °C	°C, °F or ohm	1 = 1 unit
35.03	Measured temperature 2	<i>Real</i>	-60...5000 °C	°C, °F or ohm	1 = 1 unit
35.11	Temperature 1 source	<i>List</i>	0...2, 5...7, 11...16	-	1 = 1
35.12	Temperature 1 fault limit	<i>Real</i>	-60 ... 5000 °C	°C, °F or ohm	1 = 1 unit
35.13	Temperature 1 warning limit	<i>Real</i>	-60 ... 5000 °C	°C, °F or ohm	1 = 1 unit
35.14	Temperature 1 AI source	<i>Analog src</i>	-	-	1 = 1
35.21	Temperature 2 source	<i>List</i>	0, 1, 11	-	1 = 1
35.22	Temperature 2 fault limit	<i>Real</i>	-60 ... 5000 °C	°C, °F or ohm	1 = 1 unit
35.23	Temperature 2 warning limit	<i>Real</i>	-60 ... 5000 °C	°C, °F or ohm	1 = 1 unit
35.24	Temperature 2 AI source	<i>Analog src</i>	-	-	1 = 1
35.50	Motor ambient temperature	<i>Real</i>	-60...100 °C or -75 ... 212 °F	°C or °F	1 = 1 °
35.51	Motor load curve	<i>Real</i>	50...150	%	1 = 1%
35.52	Zero speed load	<i>Real</i>	25...150	%	1 = 1%
35.53	Break point	<i>Real</i>	1.00 ... 500.00	Hz	100 = 1 Hz
35.54	Motor nominal temperature rise	<i>Real</i>	0...300 °C	°C or °F	1 = 1°

No.	Name	Type	Range	Unit	FbEq32
35.55	Motor thermal time constant	<i>Real</i>	100...10000	s	1 = 1 s
<b>36 Load analyzer</b>					
36.01	PVL signal source	<i>Analog src</i>	-	-	1 = 1
36.02	PVL filter time	<i>Real</i>	0.00...120.00	s	100 = 1 s
36.06	AL2 signal source	<i>Analog src</i>	-	-	1 = 1
36.07	AL2 signal scaling	<i>Real</i>	0.00...32767.00	-	100 = 1
36.09	Reset loggers	<i>List</i>	0...3	-	1 = 1
36.10	PVL peak value	<i>Real</i>	-32768.00...32767.00	-	100 = 1
36.11	PVL peak date	<i>Data</i>	1/1/1980...6/5/2159	-	1 = 1
36.12	PVL peak time	<i>Data</i>	-	-	1 = 1
36.13	PVL current at peak	<i>Real</i>	-32768.00...32767.00	A	100 = 1 A
36.14	PVL DC voltage at peak	<i>Real</i>	0.00...2000.00	V	100 = 1 V
36.15	PVL speed at peak	<i>Real</i>	-30000... 30000	rpm	100 = 1 rpm
36.16	PVL reset date	<i>Data</i>	1/1/1980...6/5/2159	-	1 = 1
36.17	PVL reset time	<i>Data</i>	-	-	1 = 1
36.20	AL1 0 to 10%	<i>Real</i>	0.00...100.00	%	100 = 1%
36.21	AL1 10 to 20%	<i>Real</i>	0.00...100.00	%	100 = 1%
36.22	AL1 20 to 30%	<i>Real</i>	0.00...100.00	%	100 = 1%
36.23	AL1 30 to 40%	<i>Real</i>	0.00...100.00	%	100 = 1%
36.24	AL1 40 to 50%	<i>Real</i>	0.00...100.00	%	100 = 1%
36.25	AL1 50 to 60%	<i>Real</i>	0.00...100.00	%	100 = 1%
36.26	AL1 60 to 70%	<i>Real</i>	0.00...100.00	%	100 = 1%
36.27	AL1 70 to 80%	<i>Real</i>	0.00...100.00	%	100 = 1%
36.28	AL1 80 to 90%	<i>Real</i>	0.00...100.00	%	100 = 1%
36.29	AL1 over 90%	<i>Real</i>	0.00...100.00	%	100 = 1%
36.40	AL2 0 to 10%	<i>Real</i>	0.00...100.00	%	100 = 1%
36.41	AL2 10 to 20%	<i>Real</i>	0.00...100.00	%	100 = 1%
36.42	AL2 20 to 30%	<i>Real</i>	0.00...100.00	%	100 = 1%
36.43	AL2 30 to 40%	<i>Real</i>	0.00...100.00	%	100 = 1%
36.44	AL2 40 to 50%	<i>Real</i>	0.00...100.00	%	100 = 1%
36.45	AL2 50 to 60%	<i>Real</i>	0.00...100.00	%	100 = 1%
36.46	AL2 60 to 70%	<i>Real</i>	0.00...100.00	%	100 = 1%
36.47	AL2 70 to 80%	<i>Real</i>	0.00...100.00	%	100 = 1%
36.48	AL2 80 to 90%	<i>Real</i>	0.00...100.00	%	100 = 1%
36.49	AL2 over 90%	<i>Real</i>	0.00...100.00	%	100 = 1%
36.50	AL2 reset date	<i>Data</i>	1/1/1980...6/5/2159	-	1 = 1
36.51	AL2 reset time	<i>Data</i>	-	-	1 = 1
<b>37 User load curve</b>					
37.01	ULC output status word	<i>PB</i>	0000h...FFFFh	-	1 = 1
37.02	ULC supervision signal	<i>Analog src</i>	-	-	1 = 1
37.03	ULC overload actions	<i>List</i>	0...3	-	1 = 1

374 Additional parameter data

No.	Name	Type	Range	Unit	FbEq32
37.04	ULC underload actions	<i>List</i>	0...3	-	1 = 1
37.11	ULC speed table point 1	<i>Real</i>	-30000.0...30000.0	rpm	10 = 1 rpm
37.12	ULC speed table point 2	<i>Real</i>	-30000.0...30000.0	rpm	10 = 1 rpm
37.13	ULC speed table point 3	<i>Real</i>	-30000.0...30000.0	rpm	10 = 1 rpm
37.14	ULC speed table point 4	<i>Real</i>	-30000.0...30000.0	rpm	10 = 1 rpm
37.15	ULC speed table point 5	<i>Real</i>	-30000.0...30000.0	rpm	10 = 1 rpm
37.16	ULC frequency table point 1	<i>Real</i>	-500.0...500.0	Hz	10 = 1 Hz
37.17	ULC frequency table point 2	<i>Real</i>	-500.0...500.0	Hz	10 = 1 Hz
37.18	ULC frequency table point 3	<i>Real</i>	-500.0...500.0	Hz	10 = 1 Hz
37.19	ULC frequency table point 4	<i>Real</i>	-500.0...500.0	Hz	10 = 1 Hz
37.20	ULC frequency table point 5	<i>Real</i>	-500.0...500.0	Hz	10 = 1 Hz
37.21	ULC underload point 1	<i>Real</i>	-1600.0...1600.0	%	10 = 1%
37.22	ULC underload point 2	<i>Real</i>	-1600.0...1600.0	%	10 = 1%
37.23	ULC underload point 3	<i>Real</i>	-1600.0...1600.0	%	10 = 1%
37.24	ULC underload point 4	<i>Real</i>	-1600.0...1600.0	%	10 = 1%
37.25	ULC underload point 5	<i>Real</i>	-1600.0...1600.0	%	10 = 1%
37.31	ULC overload point 1	<i>Real</i>	-1600.0...1600.0	%	10 = 1%
37.32	ULC overload point 2	<i>Real</i>	-1600.0...1600.0	%	10 = 1%
37.33	ULC overload point 3	<i>Real</i>	-1600.0...1600.0	%	10 = 1%
37.34	ULC overload point 4	<i>Real</i>	-1600.0...1600.0	%	10 = 1%
37.35	ULC overload point 5	<i>Real</i>	-1600.0...1600.0	%	10 = 1%
37.41	ULC overload timer	<i>Real</i>	0.0...10000.0	s	10 = 1 s
37.42	ULC underload timer	<i>Real</i>	0.0...10000.0	s	10 = 1 s
<b>40 Process PID set 1</b>					
40.01	Process PID output actual	<i>Real</i>	-200000.00...200000.00	%	100 = 1%
40.02	Process PID feedback actual	<i>Real</i>	-200000.00...200000.00	PID customer units	100 = 1 PID customer unit
40.03	Process PID setpoint actual	<i>Real</i>	-200000.00...200000.00	PID customer units	100 = 1 PID customer unit
40.04	Process PID deviation actual	<i>Real</i>	-200000.00...200000.00	PID customer units	100 = 1 PID customer unit
40.05	Process PID trim output act	<i>Real</i>	-32768...32767	PID customer units	100 = 1 PID customer unit
40.06	Process PID status word	<i>PB</i>	0000h...FFFFh	-	1 = 1
40.07	Process PID operation mode	<i>List</i>	0...2	-	1 = 1
40.08	Set 1 feedback 1 source	<i>Analog src</i>	-	-	1 = 1
40.09	Set 1 feedback 2 source	<i>Analog src</i>	-	-	1 = 1
40.10	Set 1 feedback function	<i>List</i>	0...11	-	1 = 1
40.11	Set 1 feedback filter time	<i>Real</i>	0.000...30.000	s	1000 = 1 s
40.14	Set 1 setpoint scaling	<i>Real</i>	-200000.00...200000.00	-	100 = 1

No.	Name	Type	Range	Unit	FbEq32
40.15	Set 1 output scaling	<i>Real</i>	-200000.00...200000.00	-	100 = 1
40.16	Set 1 setpoint 1 source	<i>Analog src</i>	-	-	1 = 1
40.17	Set 1 setpoint 2 source	<i>Analog src</i>	-	-	1 = 1
40.18	Set 1 setpoint function	<i>List</i>	0...11	-	1 = 1
40.19	Set 1 internal setpoint sel1	<i>Binary src</i>	-	-	1 = 1
40.20	Set 1 internal setpoint sel2	<i>Binary src</i>	-	-	1 = 1
40.21	Set 1 internal setpoint 1	<i>Real</i>	-200000.00...200000.00	PID customer units	100 = 1 PID customer unit
40.22	Set 1 internal setpoint 2	<i>Real</i>	-200000.00...200000.00	PID customer units	100 = 1 PID customer unit
40.23	Set 1 internal setpoint 3	<i>Real</i>	-200000.00...200000.00	PID customer units	100 = 1 PID customer unit
40.24	Set 1 internal setpoint 0	<i>Real</i>	-200000.00...200000.00	PID customer units	100 = 1 PID customer unit
40.26	Set 1 setpoint min	<i>Real</i>	-200000.00...200000.00	-	100 = 1
40.27	Set 1 setpoint max	<i>Real</i>	-200000.00...200000.00	-	100 = 1
40.28	Set 1 setpoint increase time	<i>Real</i>	0.0...1800.0	s	10 = 1 s
40.29	Set 1 setpoint decrease time	<i>Real</i>	0.0...1800.0	s	10 = 1 s
40.30	Set 1 setpoint freeze enable	<i>Binary src</i>	-	-	1 = 1
40.31	Set 1 deviation inversion	<i>Binary src</i>	-	-	1 = 1
40.32	Set 1 gain	<i>Real</i>	0.10...100.00	-	100 = 1
40.33	Set 1 integration time	<i>Real</i>	0.0...9999.0	s	10 = 1 s
40.34	Set 1 derivation time	<i>Real</i>	0.000...10.000	s	1000 = 1 s
40.35	Set 1 derivation filter time	<i>Real</i>	0.0...10.0	s	10 = 1 s
40.36	Set 1 output min	<i>Real</i>	-200000.00...200000.00	-	10 = 1
40.37	Set 1 output max	<i>Real</i>	-200000.00...200000.00	-	10 = 1
40.38	Set 1 output freeze enable	<i>Binary src</i>	-	-	1 = 1
40.39	Set 1 deadband range	<i>Real</i>	0.....200000.0	-	10 = 1
40.40	Set 1 deadband delay	<i>Real</i>	0.0 .... 3600.0	s	10 = 1 s
40.43	Set 1 sleep level	<i>Real</i>	0.....200000.0	-	10 = 1
40.44	Set 1 sleep delay	<i>Real</i>	0.0...3600.0	s	10 = 1 s
40.45	Set 1 sleep boost time	<i>Real</i>	0.0...3600.0	s	10 = 1 s
40.46	Set 1 sleep boost step	<i>Real</i>	-0.....200000.0	PID customer units	100 = 1 PID customer unit
40.47	Set 1 wake-up deviation	<i>Real</i>	-200000.00...200000.00	PID customer units	100 = 1 PID customer unit
40.48	Set 1 wake-up delay	<i>Real</i>	0.00...60.00	s	100 = 1 s
40.49	Set 1 tracking mode	<i>Binary src</i>	-	-	1 = 1
40.50	Set 1 tracking ref selection	<i>Analog src</i>	-	-	1 = 1

376 Additional parameter data

No.	Name	Type	Range	Unit	FbEq32
40.51	Set 1 trim mode	List	0...3	-	1 = 1
40.52	Set 1 trim selection	List	1...3	-	1 = 1
40.53	Set 1 trimmed ref pointer	Analog src	-	-	1 = 1
40.54	Set 1 trim mix	Real	0.000...1.000	-	1 = 1
40.55	Set 1 trim adjust	Real	-100.000...100.000	-	1 = 1
40.56	Set 1 trim source	List	1...2	-	1 = 1
40.57	PID set1/set2 selection	Binary src	-	-	1 = 1
40.58	Set 1 increase prevention	List	0...3	-	1 = 1
40.59	Set 1 decrease prevention	List	0...3	-	1 = 1
40.60	Set 1 PID activation source	Binary src	-	-	1 = 1
40.61	Setpoint scaling actual	Real	-200000.00...200000.00	-	100 = 1
40.62	PID internal setpoint actual	Real	-200000.00...200000.00	PID customer units	100 = 1 PID customer unit
40.80	Set 1 PID output min source	Analog src	-	-	1 = 1
40.81	Set 1 PID output max source	Analog src	-	-	1 = 1
40.89	Set 1 setpoint multiplier	Real	-200000.00...200000.00	-	100 = 1
40.90	Set 1 feedback multiplier	Real	--200000.00...200000.00	-	100 = 1
40.91	Feedback data storage	Real	-327.68 ... 327.67	-	100 = 1
40.92	Setpoint data storage	Real	-327.68 ... 327.67	-	100 = 1
40.96	Process PID output %	Real	-100.00...100.00	%	100 = 1
40.97	Process PID feedback %	Real	-100.00...100.00	%	100 = 1
40.98	Process PID setpoint %	Real	-100.00...100.00	%	100 = 1
40.99	Process PID deviation %	Real	-100.00...100.00	%	100 = 1
<b>41 Process PID set 2</b>					
41.08	Set 2 feedback 1 source	Analog src	-	-	1 = 1
41.09	Set 2 feedback 2 source	Analog src	-	-	1 = 1
41.10	Set 2 feedback function	List	0...11	-	1 = 1
41.11	Set 2 feedback filter time	Real	0.000...30.000	s	1000 = 1 s
41.14	Set 2 setpoint scaling	Real	-200000.00...200000.00	-	100 = 1
41.15	Set 2 output scaling	Real	-200000.00...200000.00	-	100 = 1
41.16	Set 2 setpoint 1 source	Analog src	-	-	1 = 1
41.17	Set 2 setpoint 2 source	Analog src	-	-	1 = 1
41.18	Set 2 setpoint function	List	0...11	-	1 = 1
41.19	Set 2 internal setpoint sel1	Binary src	-	-	1 = 1
41.20	Set 2 internal setpoint sel2	Binary src	-	-	1 = 1
41.21	Set 2 internal setpoint 1	Real	-200000.00...200000.00	PID customer units	100 = 1 PID customer unit
41.22	Set 2 internal setpoint 2	Real	-200000.00...200000.00	PID customer units	100 = 1 PID customer unit



No.	Name	Type	Range	Unit	FbEq32
41.23	Set 2 internal setpoint 3	<i>Real</i>	-200000.00...200000.00	PID customer units	100 = 1 PID customer unit
41.24	Set 2 internal setpoint 0	<i>Real</i>	-200000.00...200000.00	PID customer units	100 = 1 PID customer unit
41.26	Set 2 setpoint min	<i>Real</i>	-200000.00...200000.00	-	100 = 1
41.27	Set 2 setpoint max	<i>Real</i>	-200000.00...200000.00	-	100 = 1
41.28	Set 2 setpoint increase time	<i>Real</i>	0.0...1800.0	s	10 = 1 s
41.29	Set 2 setpoint decrease time	<i>Real</i>	0.0...1800.0	s	10 = 1 s
41.30	Set 2 setpoint freeze enable	<i>Binary src</i>	-	-	1 = 1
41.31	Set 2 deviation inversion	<i>Binary src</i>	-	-	1 = 1
41.32	Set 2 gain	<i>Real</i>	0.01...100.00	-	100 = 1
41.33	Set 2 integration time	<i>Real</i>	0.0...9999.0	s	10 = 1 s
41.34	Set 2 derivation time	<i>Real</i>	0.000...10.000	s	1000 = 1 s
41.35	Set 2 derivation filter time	<i>Real</i>	0.0...10.0	s	10 = 1 s
41.36	Set 2 output min	<i>Real</i>	-200000.00... 200000.00	-	10 = 1
41.37	Set 2 output max	<i>Real</i>	-200000.00... 200000.00	-	10 = 1
41.38	Set 2 output freeze enable	<i>Binary src</i>	-	-	1 = 1
41.39	Set 2 deadband range	<i>Real</i>	0.....200000.0	-	10 = 1
41.40	Set 2 deadband delay	<i>Real</i>	0.0 ... 3600.0	s	10 = 1 s
41.43	Set 2 sleep level	<i>Real</i>	0.0...20000.00	-	10 = 1
41.44	Set 2 sleep delay	<i>Real</i>	0.0...3600.0	s	10 = 1 s
41.45	Set 2 sleep boost time	<i>Real</i>	0.0...3600.0	s	10 = 1 s
41.46	Set 2 sleep boost step	<i>Real</i>	0.0...20000.00	PID customer units	100 = 1 PID customer unit
41.47	Set 2 wake-up deviation	<i>Real</i>	-200000.00... 200000.00	PID customer units	100 = 1 PID customer unit
41.48	Set 2 wake-up delay	<i>Real</i>	0.00...60.00	s	100 = 1 s
41.49	Set 2 tracking mode	<i>Binary src</i>	-	-	1 = 1
41.50	Set 2 tracking ref selection	<i>Analog src</i>	-	-	1 = 1
41.51	Set 2 trim mode	<i>List</i>	0...3	-	1 = 1
41.52	Set 2 trim selection	<i>List</i>	1...3	-	1 = 1
41.53	Set 2 trimmed ref pointer	<i>Analog src</i>	-	-	1 = 1
41.54	Set 2 trim mix	<i>Real</i>	0.000...1.000	-	1 = 1
41.55	Set 2 trim adjust	<i>Real</i>	-100.000...100.000	-	1 = 1
41.56	Set 2 trim source	<i>List</i>	1...2	-	1 = 1
41.58	Set 2 increase prevention	<i>List</i>	0...3	-	1 = 1
41.59	Set 2 decrease prevention	<i>List</i>	0...3	-	1 = 1
41.60	Set 2 PID activation source	<i>Binary src</i>	-	-	1 = 1
41.80	Set 2 PID output min source	<i>List</i>	0...1	-	1 = 1
41.81	Set 2 PID output max source	<i>List</i>	0...1	-	1 = 1

No.	Name	Type	Range	Unit	FbEq32
41.89	Set 2 setpoint multiplier	<i>Real</i>	-200000.00...200000.00	-	100 = 1
41.90	Set 2 feedback multiplier	<i>Real</i>	-200000.00...200000.00	-	100 = 1
<b>43 Brake chopper</b>					
43.01	Braking resistor temperature	<i>Real</i>	0.0...120.0	%	10 = 1%
43.06	Brake chopper enable	<i>List</i>	0...2	-	1 = 1
43.07	Brake chopper runtime enable	<i>Binary src</i>	-	-	1 = 1
43.08	Brake resistor thermal tc	<i>Real</i>	0...10000	s	1 = 1 s
43.09	Brake resistor Pmax cont	<i>Real</i>	0.00...10000.00	kW	100 = 1 kW
43.10	Brake resistance	<i>Real</i>	0.0...1000.0	ohm	10 = 1 ohm
43.11	Brake resistor fault limit	<i>Real</i>	0...150	%	1 = 1%
43.12	Brake resistor warning limit	<i>Real</i>	0...150	%	1 = 1%
<b>44 Mechanical brake control</b>					
44.01	Brake control status	<i>PB</i>	0000h...FFFFh	-	1 = 1
44.02	Brake torque memory	<i>Real</i>	-1600.0...1600.0	%	10 = 1%
44.03	Brake open torque reference	<i>Real</i>	-1600.0...1600.0	%	10 = 1%
44.06	Brake control enable	<i>Binary src</i>	-	-	1 = 1
44.07	Brake acknowledge selection	<i>Binary src</i>	-	-	1 = 1
44.08	Brake open delay	<i>Real</i>	0.00...5.00	s	100 = 1 s
44.09	Brake open torque source	<i>Analog src</i>	-	-	1 = 1
44.10	Brake open torque	<i>Real</i>	-1000...1000	%	10 = 1%
44.11	Keep brake closed	<i>Binary src</i>	-	-	1 = 1
44.12	Brake close request	<i>Binary src</i>	-	-	1 = 1
44.13	Brake close delay	<i>Real</i>	0.00...60.00	s	100 = 1 s
44.14	Brake close level	<i>Real</i>	0.0...1000.0	rpm	100 = 1 rpm
44.15	Brake close level delay	<i>Real</i>	0.00...10.00	s	100 = 1 s
44.16	Brake reopen delay	<i>Real</i>	0.00...10.00	s	100 = 1 s
44.17	Brake fault function	<i>List</i>	0...2	-	1 = 1
44.18	Brake fault delay	<i>Real</i>	0.00...60.00	s	100 = 1 s
44.202	Torque proving	<i>Binary src</i>	-	-	1 = 1
44.203	Torque proving reference	<i>Real</i>	0.0...300.0	%	10 = 1.0%
44.204	Brake system check time	<i>Real</i>	0.10...30	ms	10 = 1 s
44.205	Brake slip speed limit	<i>Real</i>	0.0 ... 30000.0	rpm	1 = 1 rpm
44.206	Brake slip fault delay	<i>Real</i>	0...30000	ms	1 = 1 ms
44.207	Safety close select	<i>Binary src</i>	-	-	1 = 1
44.208	Safety close speed	<i>Real</i>	0.00 ... 30000.00	rpm	1 = 1 rpm
44.209	Safety close delay	<i>Real</i>	0...30000	ms	1 = 1 ms
44.211	Extended runtime	<i>Real</i>	0.0...3600.0	s	1000 = 1 s
44.212	Extended runtime sw	<i>Binary src</i>	0000h...FFFFh	-	-
<b>45 Energy efficiency</b>					
45.01	Saved GW hours	<i>Real</i>	0...65535	GWh	1 = 1 GWh

No.	Name	Type	Range	Unit	FbEq32
45.02	Saved MW hours	<i>Real</i>	0...999	MWh	1 = 1 MWh
45.03	Saved kW hours	<i>Real</i>	0.0...999.0	kWh	10 = 1 kWh
45.04	Saved energy	<i>Real</i>	0.0...214748364.7	kWh	10 = 1 kWh
45.05	Saved money x1000	<i>Real</i>	0...4294967295 thousands	(selectable)	1 = 1 unit
45.06	Saved money	<i>Real</i>	0.00...999.99	(selectable)	100 = 1 unit
45.07	Saved amount	<i>Real</i>	0.00...21474836.47	(selectable)	100 = 1 unit
45.08	CO2 reduction in kilotons	<i>Real</i>	0...65535	metric kiloton	1 = 1 metric kiloton
45.09	CO2 reduction in tons	<i>Real</i>	0.0...999.9	metric ton	10 = 1 metric ton
45.10	Total saved CO2	<i>Real</i>	0.0...214748365.7	metric ton	10 = 1 metric ton
45.11	Energy optimizer	<i>List</i>	0...1	-	1 = 1
45.12	Energy tariff 1	<i>Real</i>	0.000...4294967.295	(selectable)	1000 = 1 unit
45.13	Energy tariff 2	<i>Real</i>	0.000...4294967.295	(selectable)	1000 = 1 unit
45.14	Tariff selection	<i>Binary src</i>	-	-	1 = 1
45.18	CO2 conversion factor	<i>Real</i>	0.000...65.535	metric ton/MWh	1000 = 1 metric ton/MWh
45.19	Comparison power	<i>Real</i>	0.00...100000.00	kW	10 = 1 kW
45.21	Energy calculations reset	<i>List</i>	0...1	-	1 = 1
45.24	Hourly peak power value	<i>Real</i>	-3000.00 ... 3000.00	kW	1 = 1 kW
45.25	Hourly peak power time	<i>Real</i>			N/A
45.26	Hourly total energy (resettable)	<i>Real</i>	-3000.00 ... 3000.00	kWh	1 = 1 kWh
45.27	Daily peak power value (resettable)	<i>Real</i>	-3000.00 ... 3000.00	kW	1 = 1 kW
45.28	Daily peak power time	<i>Real</i>			N/A
45.29	Daily total energy (resettable)	<i>Real</i>	-30000.00 ... 30000.00	kWh	1 = 1 kWh
45.30	Last day total energy	<i>Real</i>	-30000.00 ... 30000.00	kWh	1 = 1 kWh
45.31	Monthly peak power value (resettable)	<i>Real</i>	-3000.00 ... 3000.00	kW	1 = 1 kW
45.32	Monthly peak power date	<i>Real</i>	1/1/1980...6/5/2159		N/A
45.33	Monthly peak power time	<i>Real</i>			N/A
45.34	Monthly total energy (resettable)	<i>Real</i>	-1000000.00 ... 1000000.00	kWh	1 = 1 kWh
45.35	Last month total energy	<i>Real</i>	-1000000.00 ... 1000000.00	kWh	1 = 1 kWh
45.36	Lifetime peak power value	<i>Real</i>	-3000.00 ... 3000.00	kW	1 = 1 kW
45.37	Lifetime peak power date	<i>Real</i>			N/A
45.38	Lifetime peak power time	<i>Real</i>			N/A

No.	Name	Type	Range	Unit	FbEq32
<b>46 Monitoring/scaling settings</b>					
46.01	Speed scaling	<i>Real</i>	0.00...30000.00	rpm	100 = 1 rpm
46.02	Frequency scaling	<i>Real</i>	0.10...1000.00	Hz	100 = 1 Hz
46.03	Torque scaling	<i>Real</i>	0.1...1000.0	%	10 = 1%
46.04	Power scaling	<i>Real</i>	0.10...30000.00	-	10 = 1 unit
46.05	Current scaling	<i>Real</i>	0...30000	A	1 = 1 A
46.06	Speed ref zero scaling	<i>Real</i>	0.00 ... 30000.00	rpm	100 = 1 rpm
46.07	Frequency ref zero scaling	<i>Real</i>	0.00 ... 1000.00	Hz	100 = 1 Hz
46.11	Filter time motor speed	<i>Real</i>	2...20000	ms	1 = 1 ms
46.12	Filter time output frequency	<i>Real</i>	2...20000	ms	1 = 1 ms
46.13	Filter time motor torque	<i>Real</i>	2...20000	ms	1 = 1 ms
46.14	Filter time power	<i>Real</i>	2...20000	ms	1 = 1 ms
46.21	At speed hysteresis	<i>Real</i>	0.00...30000.00	rpm	100 = 1 rpm
46.22	At frequency hysteresis	<i>Real</i>	0.00...1000.00	Hz	100 = 1 Hz
46.23	At torque hysteresis	<i>Real</i>	0.00...300.00	%	1 = 1%
46.31	Above speed limit	<i>Real</i>	0.00...30000.00	rpm	100 = 1 rpm
46.32	Above frequency limit	<i>Real</i>	0.00...1000.00	Hz	100 = 1 Hz
46.33	Above torque limit	<i>Real</i>	0.0...1600.0	%	10 = 1%
46.41	kWh pulse scaling	<i>Real</i>	0.001...1000.000	kWh	1000 = 1 kWh
<b>47 Data storage</b>					
47.01	Data storage 1 real32	<i>Real</i>	-2147483.008... 2147483.008	-	1000 = 1
47.02	Data storage 2 real32	<i>Real</i>	-2147483.008... 2147483.008	-	1000 = 1
47.03	Data storage 3 real32	<i>Real</i>	-2147483.008... 2147483.008	-	1000 = 1
47.04	Data storage 4 real32	<i>Real</i>	-2147483.008... 2147483.008	-	1000 = 1
47.11	Data storage 1 int32	<i>Real</i>	-2147483648... 2147483647	-	1 = 1
47.12	Data storage 2 int32	<i>Real</i>	-2147483648... 2147483647	-	1 = 1
47.13	Data storage 3 int32	<i>Real</i>	-2147483648... 2147483647	-	1 = 1
47.14	Data storage 4 int32	<i>Real</i>	-2147483648... 2147483647	-	1 = 1
47.21	Data storage 1 int16	<i>Real</i>	-32768...32767	-	1 = 1
47.22	Data storage 2 int16	<i>Real</i>	-32768...32767	-	1 = 1
47.23	Data storage 3 int16	<i>Real</i>	-32768...32767	-	1 = 1
47.24	Data storage 4 int16	<i>Real</i>	-32768...32767	-	1 = 1
<b>49 Panel port communication</b>					
49.01	Node ID number	<i>Real</i>	1...32	-	1 = 1
49.03	Baud rate	<i>List</i>	1...5	-	1 = 1

No.	Name	Type	Range	Unit	FbEq32
49.04	Communication loss time	<i>Real</i>	0.3...3000.0	s	10 = 1 s
49.05	Communication loss action	<i>List</i>	0...3	-	1 = 1
49.06	Refresh settings	<i>List</i>	0...1	-	1 = 1
49.19	Basic panel home view 1		-	-	
49.20	Basic panel home view 2		-	-	
49.21	Basic panel home view 3		-	-	
49.30	Basic panel menu hiding		0000h...FFFFh	-	
<b>50 Fieldbus adapter (FBA)</b>					
50.01	FBA A enable	<i>List</i>	0...1	-	1 = 1
50.02	FBA A comm loss func	<i>List</i>	0...3	-	1 = 1
50.03	FBA A comm loss t out	<i>Real</i>	0.3...6553.5	s	10 = 1 s
50.04	FBA A ref1 type	<i>List</i>	0...5	-	1 = 1
50.05	FBA A ref2 type	<i>List</i>	0...5	-	1 = 1
50.06	FBA A SW sel	<i>List</i>	0...1	-	1 = 1
50.07	FBA A actual 1 type	<i>List</i>	0...5	-	1 = 1
50.08	FBA A actual 2 type	<i>List</i>	0...5	-	1 = 1
50.09	FBA A SW transparent source	<i>Analog src</i>	-	-	1 = 1
50.10	FBA A act1 transparent source	<i>Analog src</i>	-	-	1 = 1
50.11	FBA A act2 transparent source	<i>Analog src</i>	-	-	1 = 1
50.12	FBA A debug mode	<i>List</i>	0...2	-	1 = 1
50.13	FBA A control word	<i>Data</i>	00000000h...FFFFFFFFh	-	1 = 1
50.14	FBA A reference 1	<i>Real</i>	-2147483648... 2147483647	-	1 = 1
50.15	FBA A reference 2	<i>Real</i>	-2147483648... 2147483647	-	1 = 1
50.16	FBA A status word	<i>Data</i>	00000000h...FFFFFFFFh	-	1 = 1
50.17	FBA A actual value 1	<i>Real</i>	-2147483648... 2147483647	-	1 = 1
50.18	FBA A actual value 2	<i>Real</i>	-2147483648... 2147483647	-	1 = 1
<b>51 FBA A settings</b>					
51.01	FBA A type	<i>List</i>	-	-	1 = 1
51.02	FBA A Par2	<i>Real</i>	0...65535	-	1 = 1
...	...	...	...	...	
51.26	FBA A Par26	<i>Real</i>	0...65535	-	1 = 1
51.27	FBA A par refresh	<i>List</i>	0...1	-	1 = 1
51.28	FBA A par table ver	<i>Data</i>	-	-	1 = 1
51.29	FBA A drive type code	<i>Real</i>	0...65535	-	1 = 1
51.30	FBA A mapping file ver	<i>Real</i>	0...65535	-	1 = 1
51.31	D2FBA A comm status	<i>List</i>	0...6	-	1 = 1
51.32	FBA A comm SW ver	<i>Data</i>	-	-	1 = 1

No.	Name	Type	Range	Unit	FbEq32
51.33	FBA A appl SW ver	<i>Data</i>	-	-	1 = 1
<b>52 FBA A data in</b>					
52.01	FBA A data in1	<i>List</i>	-	-	1 = 1
...	...	...	...	...	
52.12	FBA A data in12	<i>List</i>	-	-	1 = 1
<b>53 FBA A data out</b>					
53.01	FBA A data out1	<i>List</i>	-	-	1 = 1
...	...	...	...	...	
53.12	FBA A data out12	<i>List</i>	-	-	1 = 1
<b>58 Embedded fieldbus</b>					
58.01	Protocol enable	<i>List</i>	0, 1, 3	-	1 = 1
58.02	Protocol ID	<i>Real</i>	0..65535	-	1 = 1
58.03	Node address Node ID	<i>Real</i>	0...255	-	1 = 1
58.04	Baud rate	<i>List</i>	0...7	-	1 = 1
58.05	Parity	<i>List</i>	0...3	-	1 = 1
58.06	Communication control	<i>List</i>	0...2	-	1 = 1
58.07	Communication diagnostics	<i>PB</i>	0000h...FFFFh	-	1 = 1
58.08	Received packets	<i>Real</i>	0..4294967295	-	1 = 1
58.09	Transmitted packets	<i>Real</i>	0..4294967295	-	1 = 1
58.10	All packets	<i>Real</i>	0..4294967295	-	1 = 1
58.11	UART errors	<i>Real</i>	0..4294967295	-	1 = 1
58.12	CRC errors	<i>Real</i>	0..4294967295	-	1 = 1
58.14	Communication loss action	<i>List</i>	0...4	-	1 = 1
58.15	Communication loss mode	<i>List</i>	0...2	-	1 = 1
58.16	Communication loss time	<i>Real</i>	0.0...6000.0	s	10 = 1 s
58.17	Transmit delay	<i>Real</i>	0...65535	ms	1 = 1 ms
58.18	EFB control word	<i>PB</i>	0...FFFFFFFFh	-	1 = 1
58.19	EFB status word	<i>PB</i>	0...FFFFFFFFh	-	1 = 1
58.22	CANopen NMT state	<i>List</i>	0...127	-	1 = 1
58.23	Configuration location	<i>List</i>	0...1	-	1 = 1
58.24	Transparent 16 scale	<i>Real</i>	0..65535	-	1 = 1
58.25	Control profile	<i>List</i>	0, 5, 7, 8, 9	-	1 = 1
58.26	EFB ref1 type	<i>List</i>	0...5	-	1 = 1
58.27	EFB ref2 type	<i>List</i>	0...5	-	1 = 1
58.28	EFB act1 type	<i>List</i>	0...5	-	1 = 1
58.29	EFB act2 type	<i>List</i>	0...5	-	1 = 1
58.31	EFB act1 transparent source	<i>Analog src</i>	-	-	1 = 1
58.32	EFB act2 transparent source	<i>Analog src</i>	-	-	1 = 1
58.33	Addressing mode	<i>List</i>	0...2	-	1 = 1
58.34	Word order	<i>List</i>	0...1	-	1 = 1

No.	Name	Type	Range	Unit	FbEq32
58.70	EFB debug mode	<i>List</i>	-100000...100000	-	1 = 1
58.71	EFB reference 1	<i>Real</i>	-100000...100000	-	1 = 1
58.72	EFB reference 2	<i>Real</i>	-100000...100000	-	1 = 1
58.73	EFB actual value 1	<i>Real</i>	-100000...100000	-	1 = 1
58.74	EFB actual value 2	<i>Real</i>	-100000...100000	-	1 = 1
58.76	RPDO1 COB-ID	<i>Real</i>	0...7FFh	-	1 = 1
58.77	RPDO1 transmission type	<i>Real</i>	0...255	-	1 = 1
58.78	RPDO1 event timer	<i>Real</i>	0...65535	ms	1 = 1 ms
58.79	TPDO1 COB-ID	<i>Real</i>	0...7FFh	-	1 = 1
58.80	TPDO1 transmission type	<i>Real</i>	0...255	-	1 = 1
58.81	TPDO1 event timer	<i>Real</i>	0...65535	ms	1 = 1 ms
58.82	RPDO6 COB-ID	<i>Real</i>	0...7FFh	-	1 = 1
58.83	RPDO6 transmission type	<i>Real</i>	0...255	-	1 = 1
58.84	RPDO6 event timer	<i>Real</i>	0...65535	ms	1 = 1 ms
58.85	TPDO6 COB-ID	<i>Real</i>	0...7FFh	-	1 = 1
58.86	TPDO6 transmission type	<i>Real</i>	0...255	-	1 = 1
58.87	TPDO6 event timer	<i>Real</i>	0...65535	ms	1 = 1 ms
58.88	RPDO21 COB-ID	<i>Real</i>	0...7FFh	-	1 = 1
58.89	RPDO21 transmission type	<i>Real</i>	0...255	-	1 = 1
58.90	RPDO21 event timer	<i>Real</i>	0...65535	ms	1 = 1 ms
58.91	TPDO21 COB-ID	<i>Real</i>	0...7FFh	-	1 = 1
58.92	TPDO21 transmission type	<i>Real</i>	0...255	-	1 = 1
58.93	TPDO21 event timer	<i>Real</i>	0...65535	ms	1 = 1 ms
58.101	Data I/O 1	<i>Analog src</i>	-	-	1 = 1
	TPDO1 word 1	<i>Analog src</i>	-	-	1 = 1
58.102	Data I/O 2	<i>Analog src</i>	-	-	1 = 1
	TPDO1 word 2	<i>Analog src</i>	-	-	1 = 1
58.103	Data I/O 3	<i>Analog src</i>	-	-	1 = 1
	TPDO1 word 3	<i>Analog src</i>	-	-	1 = 1
58.104	Data I/O 4	<i>Analog src</i>	-	-	1 = 1
	TPDO1 word 4	<i>Analog src</i>	-	-	1 = 1
58.105	Data I/O 5	<i>Analog src</i>	-	-	1 = 1
	RPDO1 word 1	<i>Analog src</i>	-	-	1 = 1
58.106	Data I/O 6	<i>Analog src</i>	-	-	1 = 1
	RPDO1 word 2	<i>Analog src</i>	-	-	1 = 1
58.107	Data I/O 7	<i>Analog src</i>	-	-	1 = 1
	RPDO1 word 3	<i>Analog src</i>	-	-	1 = 1
58.108	Data I/O 8	<i>Analog src</i>	-	-	1 = 1
	RPDO1 word 4	<i>Analog src</i>	-	-	1 = 1
58.109	Data I/O 9	<i>Analog src</i>	-	-	1 = 1
	TPDO6 word 1	<i>Analog src</i>	-	-	1 = 1

## 384 Additional parameter data

No.	Name	Type	Range	Unit	FbEq32
58.110	Data I/O 10	<i>Analog src</i>	-	-	1 = 1
	TPDO6 word 2	<i>Analog src</i>	-	-	1 = 1
58.111	Data I/O 11	<i>Analog src</i>	-	-	1 = 1
	TPDO6 word 3	<i>Analog src</i>	-	-	1 = 1
58.112	Data I/O 12	<i>Analog src</i>	-	-	1 = 1
	TPDO6 word 4	<i>Analog src</i>	-	-	1 = 1
58.113	Data I/O 13	<i>Analog src</i>	-	-	1 = 1
	RPDO6 word 1	<i>Analog src</i>	-	-	1 = 1
58.114	Data I/O 14	<i>Analog src</i>	-	-	1 = 1
	RPDO6 word 2	<i>Analog src</i>	-	-	1 = 1
58.115	RPDO6 word 3	<i>Analog src</i>	-	-	1 = 1
58.116	RPDO6 word 4	<i>Analog src</i>	-	-	1 = 1
58.117	TPDO21 word 1	<i>Analog src</i>	-	-	1 = 1
58.118	TPDO21 word 2	<i>Analog src</i>	-	-	1 = 1
58.119	TPDO21 word 3	<i>Analog src</i>	-	-	1 = 1
58.120	TPDO21 word 4	<i>Analog src</i>	-	-	1 = 1
58.121	RPDO21 word 1	<i>Analog src</i>	-	-	1 = 1
58.122	RPDO21 word 2	<i>Analog src</i>	-	-	1 = 1
58.123	RPDO21 word 3	<i>Analog src</i>	-	-	1 = 1
58.124	RPDO21 word 4	<i>Analog src</i>	-	-	1 = 1
<b>71 External PID1</b>					
71.01	External PID act value	<i>Real</i>	-200000.00...200000.00	rpm, % or Hz	100 = 1 unit
71.02	Feedback act value	<i>Real</i>	-200000.00...200000.00	rpm, % or Hz	100 = 1 unit
71.03	Setpoint act value	<i>Real</i>	-200000.00...200000.00	rpm, % or Hz	100 = 1 unit
71.04	Deviation act value	<i>Real</i>	-200000.00...200000.00	rpm, % or Hz	100 = 1 unit
71.06	PID status word	<i>PB</i>	0000h...FFFFh	-	1 = 1
71.07	PID operation mode	<i>List</i>	0...2	-	1 = 1
71.08	Feedback 1 source	<i>Analog src</i>	-	-	1 = 1
71.11	Feedback filter time	<i>Real</i>	0.000...30.000	s	1000 = 1 s
71.14	Setpoint scaling	<i>Real</i>	-200000.00...200000.00	-	100 = 1
71.15	Output scaling	<i>Real</i>	-200000.00...200000.00	-	100 = 1
71.16	Setpoint 1 source	<i>Analog src</i>	-	-	1 = 1
71.19	Internal setpoint sel1	<i>Binary src</i>	-	-	1 = 1
71.20	Internal setpoint sel2	<i>Binary src</i>	-	-	1 = 1
71.21	Internal setpoint 1	<i>Real</i>	-200000.00...200000.00	rpm, % or Hz	100 = 1 unit
71.22	Internal setpoint 2	<i>Real</i>	-200000.00...200000.00	rpm, % or Hz	100 = 1 unit



No.	Name	Type	Range	Unit	FbEq32
71.23	Internal setpoint 3	<i>Real</i>	-200000.00...200000.00	rpm, % or Hz	100 = 1 unit
71.26	Setpoint min	<i>Real</i>	-200000.00...200000.00	-	100 = 1
71.27	Setpoint max	<i>Real</i>	-200000.00...200000.00	-	100 = 1
71.31	Deviation inversion	<i>Binary src</i>	-	-	1 = 1
71.32	Gain	<i>Real</i>	0.10...100.00	-	100 = 1
71.33	Integration time	<i>Real</i>	0.0...9999.0	s	10 = 1 s
71.34	Derivation time	<i>Real</i>	0.000...10.000	s	1000 = 1 s
71.35	Derivation filter time	<i>Real</i>	0.0...10.0	s	10 = 1 s
71.36	Output min	<i>Real</i>	-200000.00...200000.00	-	10 = 1
71.37	Output max	<i>Real</i>	-200000.00...200000.00	-	10 = 1
71.38	Output freeze enable	<i>Binary src</i>	-	-	1 = 1
71.39	Deadband range	<i>Real</i>	0.0...200000.0	-	10 = 1
71.40	Deadband delay	<i>Real</i>	0.0...3600.0	s	10 = 1 s
71.58	Increase prevention	<i>List</i>	0...3	-	1 = 1
71.59	Decrease prevention	<i>List</i>	0...3	-	1 = 1
71.62	Internal setpoint actual	<i>Real</i>	-200000.00...200000.00	rpm,% or Hz	100 = 1 unit
<b>76 Application features</b>					
76.01	Limit to limit control status	<i>List</i>	0...9	-	1 = 1
76.02	Enable limit to limit control	<i>Binary src</i>	-	-	1 = 1
76.03	Limit to limit trigger type	<i>List</i>	0...3	-	1 = 1
76.04	Forward stop limit	<i>Binary src</i>	-	-	1 = 1
76.05	Forward slow down limit	<i>Binary src</i>	-	-	1 = 1
76.06	Reverse stop limit	<i>Binary src</i>	-	-	1 = 1
76.07	Reverse slow down limit	<i>Binary src</i>	-	-	1 = 1
76.08	Slow down speed	<i>Real</i>	0.00...30000.00	rpm	1 = 1
76.09	Slow down frequency	<i>Real</i>	0.00...500.00	Hz	1 = 1
76.11	Limit stop mode	<i>List</i>	0...1	-	1 = 1
76.12	Limit stop ramp time	<i>Real</i>	0.000...3000.000 s	S	1000 = 1
76.21	Conical motor control	<i>Binary src</i>	-	-	1 = 1 %
76.22	Start flux level	<i>Real</i>	0...150	%	1 = 1 %
76.23	Start stop level	<i>Real</i>	0...100	%	1 = 1 %
76.24	Start flux hold time	<i>Real</i>	0...10000	ms	1 = 1 ms
76.25	Flux ramp up time	<i>Real</i>	0...10000	ms	1 = 1 ms
76.26	Flux ramp down time	<i>Real</i>	0...10000	ms	1 = 1 ms
76.27	Flux reference	<i>Real</i>	0...200	%	1 = 1 %
76.31	Motor speed match	<i>Binary src</i>	-	-	1 = 1
76.32	Motor speed steady deviation level	<i>Real</i>	0.00...30000.00	rpm	1 = 1
76.33	Motor speed ramp deviation level	<i>Real</i>	0.00...30000.00	rpm	1 = 1

No.	Name	Type	Range	Unit	FbEq32
76.34	Speed match fault delay	<i>Real</i>	0...30000	ms	1 = 1
<b>90 Feedback selection</b>					
90.01	Motor speed for control	<i>Real</i>	-32768.00 ... 32767.00	rpm	100 = 1 rpm
90.02	Motor position	<i>Real</i>	0.00000000 ... 1.00000000	rev	100000000 = 1 rev
90.10	Encoder 1 speed	<i>Real</i>	-32768.00 ... 32767.00	rpm	100 = 1 rpm
90.11	Encoder 1 position	<i>Real</i>	0.00000000 ... 1.00000000	rev	100000000 = 1 rev
90.13	Encoder 1 revolution extension	<i>Real</i>	-2147483648 ... 2147483647	-	1 = 1
90.41	Motor feedback selection	<i>List</i>	0...2	-	1 = 1
90.42	Motor speed filter time	<i>Real</i>	0...10000	ms	1 = 1 ms
90.45	Motor feedback fault	<i>List</i>	0...1	-	1 = 1
90.46	Force open loop	<i>List</i>	0...1	-	1 = 1
90.47	Enable motor encoder drift detection	<i>List</i>	0...1	-	1 = 1
<b>91 Encoder adapter settings</b>					
91.10	Encoder parameter refresh	<i>List</i>	0...1	-	1 = 1
<b>92 Encoder 1 configuration</b>					
92.10	Pulses/revolution	<i>Real</i>	0...65535	-	1 = 1
<b>95 HW configuration</b>					
95.01	Supply voltage	<i>List</i>	0...5	-	1 = 1
95.02	Adaptive voltage limits	<i>List</i>	0...1	-	1 = 1
95.03	Estimated AC supply voltage	<i>Real</i>	0...65535	-	1 = 1 V
95.04	Control board supply	<i>List</i>	0...1	-	1 = 1
95.15	Special HW settings	<i>List</i>	0...1	.	1 = 1
95.20	HW options word 1	<i>PB</i>	0000h...FFFFh	-	1 = 1
<b>96 System</b>					
96.01	Language	<i>List</i>	-	-	1 = 1
96.02	Pass code	<i>Data</i>	0...99999999	-	1 = 1
96.03	Access levels status	<i>PB</i>	0b0000...0b1111	-	1 = 1
96.04	Macro select	<i>List</i>	0, 1, 5, 8, 9, 12...14	-	1 = 1
96.05	Macro active	<i>List</i>	0, 1, 5, 8, 9, 12...14	-	1 = 1
96.06	Parameter restore	<i>List</i>	0, 8, 62	-	1 = 1
96.07	Parameter save manually	<i>List</i>	0...1	-	1 = 1
96.08	Control board boot	<i>Real</i>	0...1	-	1 = 1
96.10	User set status	<i>List</i>	0...7, 20...23	-	-
96.11	User set save/load	<i>List</i>	0...5, 18...21	-	-
96.12	User set I/O mode in1	<i>Binary src</i>	-	-	-
96.13	User set I/O mode in2	<i>Binary src</i>	-	-	-
96.16	Unit selection	<i>PB</i>	0b0000...0b1111	-	1 = 1
96.20	Time sync primary source	<i>List</i>	0, 2, 6, 8, 9	-	1 = 1

No.	Name	Type	Range	Unit	FbEq32
96.51	Clear fault and event logger	<i>Real</i>	0...1	-	1 = 1
96.54	Checksum action	<i>List</i>	0...4	-	1 = 1
96.55	Checksum control word	<i>PB</i>	0b0000...0b1111	-	1 = 1
96.68	Actual checksum A	<i>Real</i>	0x0000...0xffff	-	1 = 1
96.69	Actual checksum B	<i>Real</i>	0x0000...0xffff	-	1 = 1
96.70	Disable adaptive program	<i>Real</i>	0...1	-	1 = 1
96.71	Approved checksum A	<i>Real</i>	0x0000...0xffff	-	1 = 1
96.72	Approved checksum B	<i>Real</i>	0x0000...0xffff	-	1 = 1
<i>(Parameters 96.100...96.102 only visible when enabled by parameter 96.02)</i>					
96.100	Change user pass code	<i>Data</i>	10000000...99999999	-	1 = 1
96.101	Confirm user pass code	<i>Data</i>	10000000...99999999	-	1 = 1
96.102	User lock functionality	<i>PB</i>	0000h...FFFFh	-	1 = 1
<b>97 Motor control</b>					
97.01	Switching frequency reference	<i>List</i>	4...12	kHz	1 = 1
97.02	Minimum switching frequency	<i>List</i>	1...12	kHz	1 = 1
97.03	Slip gain	<i>Real</i>	0...200	%	1 = 1%
97.04	Voltage reserve	<i>Real</i>	-4...50	%	1 = 1%
97.05	Flux braking	<i>List</i>	0...2	-	1 = 1
97.06	Flux reference select	<i>Binary src</i>	-	-	1 = 1
97.07	User flux reference	<i>Real</i>	0.0...200.0	%	100 = 1%
97.08	Optimizer minimum torque	<i>Real</i>	0.0...1600.0	%	10 = 1%
97.10	Signal injection	<i>List</i>	0...4	-	1 = 1
97.11	TR tuning	<i>Real</i>	25...400	%	1 = 1%
97.13	IR compensation	<i>Real</i>	0.00...50.00	%	100 = 1%
97.15	Motor model temperature adaptation	<i>List</i>	0...1	-	1 = 1
97.16	Stator temperature factor	<i>Real</i>	0...200	%	1=1%
97.17	Rotor temperature factor	<i>Real</i>	0...200	%	1=1%
97.20	U/F ratio	<i>List</i>	0...1	-	1 = 1
97.33	Speed estimate filter time	<i>Real</i>	0.00...100.00	ms	5.00
97.49	Slip gain for scalar	<i>Real</i>	0...200	%	1 = 1%
97.94	IR comp max frequency	<i>Real</i>	1.0...200.0	%	10 = 1%
<b>98 User motor parameters</b>					
98.01	User motor model mode	<i>List</i>	0...1	-	1 = 1
98.02	Rs user	<i>Real</i>	0.0000...0.50000	p.u.	100000 = 1 p.u.
98.03	Rr user	<i>Real</i>	0.0000...0.50000	p.u.	100000 = 1 p.u.
98.04	Lm user	<i>Real</i>	0.00000...10.00000	p.u.	100000 = 1 p.u.
98.05	SigmaL user	<i>Real</i>	0.00000...1.00000	p.u.	100000 = 1 p.u.

No.	Name	Type	Range	Unit	FbEq32
98.06	Ld user	<i>Real</i>	0.00000...10.00000	p.u.	100000 = 1 p.u.
98.07	Lq user	<i>Real</i>	0.00000...10.00000	p.u.	100000 = 1 p.u.
98.08	PM flux user	<i>Real</i>	0.00000...2.00000	p.u.	100000 = 1 p.u.
98.09	Rs user SI	<i>Real</i>	0.00000...100.00000	ohm	100000 = 1 p.u.
98.10	Rr user SI	<i>Real</i>	0.00000...100.00000	ohm	100000 = 1 p.u.
98.11	Lm user SI	<i>Real</i>	0.00...100000.00	mH	100 = 1 mH
98.12	SigmaL user SI	<i>Real</i>	0.00...100000.00	mH	100 = 1 mH
98.13	Ld user SI	<i>Real</i>	0.00...100000.00	mH	100 = 1 mH
98.14	Lq user SI	<i>Real</i>	0.00...100000.00	mH	100 = 1 mH
98.15	Position offset user	<i>Real</i>	0.0...360	deg	1 = 1
<b>99 Motor data</b>					
99.03	Motor type	<i>List</i>	0...1	-	1 = 1
99.04	Motor control mode	<i>List</i>	0...1	-	1 = 1
99.06	Motor nominal current	<i>Real</i>	0.0...6400.0	A	10 = 1 A
99.07	Motor nominal voltage	<i>Real</i>	0.0...800.0	V	10 = 1 V
99.08	Motor nominal frequency	<i>Real</i>	0.00 ... 500.00	Hz	100 = 1 Hz
99.09	Motor nominal speed	<i>Real</i>	0 ... 30000	rpm	1 = 1 rpm
99.10	Motor nominal power	<i>Real</i>	-10000.00...10000.00 kW or -13405.83 ... 13405.83 hp	kW or hp	100 = 1 unit
99.11	Motor nominal cos $\Phi$	<i>Real</i>	0.00 ... 1.00	-	100 = 1
99.12	Motor nominal torque	<i>Real</i>	0.000...	N·m or lb-ft	1000 = 1 unit
99.13	ID run requested	<i>List</i>	0...4, 6	-	1 = 1
99.14	Last ID run performed	<i>List</i>	0...4, 6	-	1 = 1
99.15	Motor polepairs calculated	<i>Real</i>	0...1000	-	1 = 1
99.16	Motor phase order	<i>List</i>	0...1	-	1 = 1



# Fault tracing

---

## Contents

- [Safety](#)
- [Indications](#)
- [Warning/fault history](#)
- [QR Code generation for mobile service application](#)
- [Warning messages](#)
- [Fault messages](#)

If the warnings and faults cannot be identified and corrected using the information in this chapter, contact an ABB service representative. If you use the Drive composer PC tool, send the Support package created by the Drive composer to the ABB service representative.

Warnings and faults are listed in separate tables. Each table is sorted by a warning/fault code.

## Safety

---



**WARNING!** Only qualified electricians are allowed to service the drive. Read the instructions in chapter *Safety instructions* at the beginning of the hardware manual of the drive before working on the drive.

---

## Indications

### ■ Warnings and faults

Warnings and faults indicate an abnormal drive status. The codes and names of active warnings and faults are displayed on the control panel of the drive as well as in the Drive composer PC tool. Only the codes of warnings and faults are available over fieldbus.

Warnings do not need to be reset; they stop showing when the cause of the warning ceases. Warnings do not latch and the drive will continue to operate the motor.

Faults latch inside the drive and cause the drive to trip, and the motor stops. After the cause of a fault has been removed, the fault can be reset from parameter [31.11 Fault reset selection](#)) such as the control panel, Drive composer PC tool, the digital inputs of the drive, or fieldbus. Resetting the fault creates an event [64FF Fault reset](#). After the reset, the drive can be restarted.

Note that some faults require a reboot of the control unit either by switching the power off and on, or using parameter [96.08 Control board boot](#) – this is mentioned in the fault listing wherever appropriate.

### ■ Pure events

In addition to warnings and faults, there are pure events that are only recorded in the event log of the drive. The codes of these events are included in the [Warning messages](#) table on page [392](#).

## Warning/fault history

### ■ Event log

All indications are stored in the event log. The event log stores information on

- the last 8 fault recordings, that is, faults that tripped the drive or fault resets
- the last 10 warnings or pure events that occurred.

See section [Viewing warning/fault information](#) on page [390](#).

### Auxiliary codes

Some events generate an auxiliary code that often helps in pinpointing the problem. On the control panel, the auxiliary code is stored as part of the details of the event; in the Drive composer PC tool, the auxiliary code is shown in the event listing.

### ■ Viewing warning/fault information

The drive is able to store a list of the active faults actually causing the drive to trip at the present time. The drive also stores a list of faults and warnings that have previously occurred.

---

For each stored fault, the panel shows the fault code, time and values of nine parameters (actual signals and status words) stored at the time of the fault. The values of the parameters for the latest fault are in parameters [05.80...05.88](#).

For active faults and warnings, see

- **Main menu - Diagnostics - Active faults**
- **Main menu - Diagnostics - Active warnings**
- **Options menu - Active faults**
- **Options menu - Active warnings**
- parameters in group [04 Warnings and faults](#) (page [119](#)).

For previously occurred faults and warnings, see

- **Main menu - Diagnostics - Fault & event log**
  - Note:** Active faults are also stored in the fault and event log.
- parameters in group [04 Warnings and faults](#) (page [119](#)).

The event log can also be accessed (and reset) using the Drive composer PC tool. See *Drive composer PC tool user's manual* (3AUA0000094606 [English]).

## QR Code generation for mobile service application

A QR Code (or a series of QR Codes) can be generated by the drive for display on the assistant control panel. The QR Code contains drive identification data, information on the latest events, and values of status and counter parameters. The code can be read with a mobile device containing the ABB service application, which then sends the data to ABB for analysis. For more information on the application, contact your local ABB service representative.

---

## Warning messages

**Note:** The list also contains events that only appear in the Event log.

Code (hex)	Warning / Aux. code	Cause	What to do
64FF	Fault reset	A fault has been reset from the panel, Drive composer PC tool, fieldbus or I/O.	Event. Informative only.
A2A1	Current calibration	Current offset and gain measurement calibration will occur at next start.	Informative warning. (See parameter <a href="#">99.13 ID run requested.</a> )
A2B1	Overcurrent	Output current has exceeded internal fault limit. In addition to an actual overcurrent situation, this warning may also be caused by an earth fault or supply phase loss.	<p>Check motor load.</p> <p>Check acceleration times in parameter group <a href="#">23 Speed reference ramp</a> (speed control), <a href="#">26 Torque reference chain</a> (torque control) or <a href="#">28 Frequency reference chain</a> (frequency control). Also check parameters <a href="#">46.01 Speed scaling</a>, <a href="#">46.02 Frequency scaling</a> and <a href="#">46.03 Torque scaling</a>.</p> <p>Check motor and motor cable (including phasing and delta/star connection).</p> <p>Check for an earth fault in motor or motor cables by measuring the insulation resistances of motor and motor cable. See chapter <i>Electrical installation</i>, section <i>Checking the insulation of the assembly</i> in the hardware manual of the drive.</p> <p>Check there are no contactors opening and closing in motor cable.</p> <p>Check that the start-up data in parameter group <a href="#">99 Motor data</a> corresponds to the motor rating plate.</p> <p>Check that there are no power factor correction capacitors or surge absorbers in motor cable.</p>
A2B3	Earth leakage	Drive has detected load unbalance typically due to earth fault in motor or motor cable.	<p>Check there are no power factor correction capacitors or surge absorbers in motor cable.</p> <p>Check for an earth fault in motor or motor cables by measuring the insulation resistances of motor and motor cable. See chapter <i>Electrical installation</i>, section <i>Checking the insulation of the assembly</i> in the hardware manual of the drive. If an earth fault is found, fix or change the motor cable and/or motor. If no earth fault can be detected, contact your local ABB representative.</p>



Code (hex)	Warning / Aux. code	Cause	What to do
A2B4	Short circuit	Short-circuit in motor cable(s) or motor.	<p>Check motor and motor cable for cabling errors.</p> <p>Check motor and motor cable (including phasing and delta/star connection).</p> <p>Check for an earth fault in motor or motor cables by measuring the insulation resistances of motor and motor cable.</p> <p>See chapter <i>Electrical installation</i>, section <i>Checking the insulation of the assembly</i> in the hardware manual of the drive.</p> <p>Check there are no power factor correction capacitors or surge absorbers in motor cable.</p>
A2BA	IGBT overload	Excessive IGBT junction to case temperature. This warning protects the IGBT(s) and can be activated by a short circuit in the motor cable.	<p>Check motor cable.</p> <p>Check ambient conditions.</p> <p>Check air flow and fan operation.</p> <p>Check heatsink fins for dust pick-up.</p> <p>Check motor power against drive power.</p>
A3A1	DC link overvoltage	Intermediate circuit DC voltage too high (when the drive is stopped).	<p>Check the supply voltage setting (parameter <i>95.01 Supply voltage</i>). Note that the wrong setting of the parameter may cause the motor to rush uncontrollably, or may overload the brake chopper or resistor.</p> <p>Check the supply voltage.</p> <p>If the problem persists, contact your local ABB representative.</p>
A3A2	DC link undervoltage	Intermediate circuit DC voltage too low (when the drive is stopped).	
A3AA	DC not charged	The voltage of the intermediate DC circuit has not yet risen to operating level.	
A490	Incorrect temperature sensor setup	Sensor type mismatch.	Check the settings of temperature source parameters <i>35.11</i> and <i>35.21</i> .
A491	External temperature 1 (Editable message text)	Measured temperature 1 has exceeded warning limit.	<p>Check the value of parameter <i>35.02 Measured temperature 1</i>.</p> <p>Check the cooling of the motor (or other equipment whose temperature is being measured).</p> <p>Check the value of <i>35.13 Temperature 1 warning limit</i>.</p>
A492	External temperature 2 (Editable message text)	Measured temperature 2 has exceeded warning limit.	<p>Check the value of parameter <i>35.03 Measured temperature 2</i>.</p> <p>Check the cooling of the motor (or other equipment whose temperature is being measured).</p> <p>Check the value of <i>35.23 Temperature 2 warning limit</i>.</p>
A4A1	IGBT overtemperature	Estimated drive IGBT temperature is excessive.	<p>Check ambient conditions.</p> <p>Check air flow and fan operation.</p> <p>Check heatsink fins for dust pick-up.</p> <p>Check motor power against drive power.</p>

Code (hex)	Warning / Aux. code	Cause	What to do
A4A9	Cooling	Drive module temperature is excessive.	Check ambient temperature. If it exceeds 50 °C /122 °F, ensure that load current does not exceed derated load capacity of drive. See chapter <i>Technical data</i> , section <i>Derating</i> in the hardware manual of the drive. Check drive module cooling air flow and fan operation. Check inside of cabinet and heatsink of drive module for dust pick-up. Clean whenever necessary.
A4B0	Excess temperature	Power unit module temperature is excessive.	Check ambient conditions. Check air flow and fan operation. Check heatsink fins for dust pick-up. Check motor power against drive power.
A4B1	Excess temperature difference	High temperature difference between the IGBTs of different phases.	Check the motor cabling. Check cooling of drive module(s).
A4F6	IGBT temperature	Drive IGBT temperature is excessive.	Check ambient conditions. Check air flow and fan operation. Check heatsink fins for dust pick-up. Check motor power against drive power.
A580	PU communication	Communication errors detected between the drive control unit and the power unit.	Check the connections between the drive control unit and the power unit. Check the value of parameter <a href="#">95.04 Control board supply</a> .
A591	Drive HW initialization	Initialization of the drive hardware.	Check the auxiliary code. See actions for each code below.
	0000	Drive hardware setup is initializing.	Wait for the setup to initialize.
	0001	Initializing HW settings for the first time.	Wait for the setup to initialize.
A5A0	Safe torque off Programmable warning: <a href="#">31.22 STO indication run/stop</a>	Safe torque off function is active, ie safety circuit signal(s) connected to connector STO is lost.	Check safety circuit connections. For more information, chapter <i>The Safe torque off function</i> in the hardware manual of the drive and description of parameter <a href="#">31.22 STO indication run/stop</a> (page 226). Check the value of parameter <a href="#">95.04 Control board supply</a> .
A5EA	Measurement circuit temperature	Problem with internal temperature measurement of the drive.	Contact your local ABB representative.
A5EB	PU board powerfail	Power unit power supply failure.	Contact your local ABB representative.
A5EC	PU communication internal	Communication errors detected between the drive control unit and the power unit.	Check the connections between the drive control unit and the power unit.
A5ED	Measurement circuit ADC	Measurement circuit fault.	Contact your local ABB representative.
A5EE	Measurement circuit DFF	Measurement circuit fault.	Contact your local ABB representative.

Code (hex)	Warning / Aux. code	Cause	What to do
A5EF	PU state feedback	State feedback from output phases does not match control signals.	Contact your local ABB representative.
A5F0	Charging feedback	Charging feedback signal missing.	Check the feedback signal coming from the charging system.
A686	Checksum mismatch Programmable warning: <a href="#">96.54 Checksum action</a>	The calculated parameter checksum does not match any enabled reference checksum.	Check that all necessary approved (reference) checksums ( <a href="#">96.71...96.72</a> ) are enabled in <a href="#">96.55 Checksum control word</a> . Check the parameter configuration. Using <a href="#">96.55 Checksum control word</a> , enable a checksum parameter and copy the actual checksum into that parameter.
A687	Checksum configuration	An action has been defined for a parameter checksum mismatch but the feature has not been configured.	Contact your local ABB representative for configuring the feature, or disable the feature in <a href="#">96.54 Checksum action</a> .
A6A4	Motor nominal value	The motor parameters are set incorrectly.	Check the settings of the motor configuration parameters in group 99.
		The drive is not dimensioned correctly.	Check that the drive is sized correctly for the motor.
A6A5	No motor data	Parameters in group 99 have not been set.	Check that all the required parameters in group 99 have been set. <b>Note:</b> It is normal for this warning to appear during the start-up and continue until the motor data is entered.
A6A6	Voltage category unselected	The voltage category has not been defined.	Set voltage category in parameter <a href="#">95.01 Supply voltage</a> .
A6B0	User lock is open	The user lock is open, ie. user lock configuration parameters <a href="#">96.100...96.102</a> are visible.	Close the user lock by entering an invalid pass code in parameter <a href="#">96.02 Pass code</a> . See section <a href="#">User lock</a> (page 109).
A6D1	FBA A parameter conflict	The drive does not have a functionality requested by a PLC, or requested functionality has not been activated.	Check PLC programming. Check settings of parameter groups <a href="#">50 Fieldbus adapter (FBA)</a> .
A6E5	AI parametrization	The current/voltage hardware setting of an analog input does not correspond to parameter settings.	Check the event log for an auxiliary code. The code identifies the analog input whose settings are in conflict. Adjust parameter <a href="#">12.15/12.25</a> . <b>Note:</b> Control board reboot (either by cycling the power or through parameter <a href="#">96.08 Control board boot</a> ) is required to validate any changes in the hardware settings.
A6E6	ULC configuration	User load curve configuration error.	Check the auxiliary code. See actions for each code below.
	0000	Speed points inconsistent.	Check that each speed point (parameters <a href="#">37.11...37.15</a> ) has a higher value than the previous point.
	0001	Frequency points inconsistent.	Check that each frequency point ( <a href="#">37.16...37.20</a> ) has a higher value than the previous point.

Code (hex)	Warning / Aux. code	Cause	What to do
	0002	Underload point above overload point.	Check that each overload point ( <a href="#">37.31...</a> <a href="#">37.35</a> ) has a higher value than the corresponding underload point ( <a href="#">37.21...</a> <a href="#">37.25</a> ).
	0003	Overload point below underload point.	
A7A1	Mechanical brake closing failed	Mechanical brake control warning.	Check mechanical brake connection. Check mechanical brake settings in parameter group <a href="#">44 Mechanical brake control</a> . Check that acknowledgment signal matches the actual status of the brake.
A7A5	Mechanical brake opening not allowed	Open conditions of mechanical brake cannot be fulfilled (e.g., brake has been prevented from opening by parameter <a href="#">44.11</a> )	Check mechanical brake settings in parameter group <a href="#">44 Mechanical brake control</a> (especially <a href="#">44.11</a> ). Check that the acknowledgment signal (if used) matches the actual status of the brake.
A7B0	Motor speed feedback Programmable warning: <a href="#">90.45 Motor feedback fault</a>	Motor speed feedback has failed and drive continues operation with open loop control.	Check the settings of the parameters in groups <a href="#">90 Feedback selection</a> , <a href="#">91 Encoder adapter settings</a> and <a href="#">92 Encoder 1 configuration</a> . Check encoder installation.
A780	Motor stall Programmable warning: <a href="#">31.24 Stall function</a>	Motor is operating in stall region because of e.g. excessive load or insufficient motor power.	Check motor load and drive ratings. Check fault function parameters.
A791	Brake resistor	Brake resistor broken or not connected.	Check that a brake resistor has been connected. Check the condition of the brake resistor.
A793	BR excess temperature	Brake resistor temperature has exceeded warning limit defined by parameter <a href="#">43.12 Brake resistor warning limit</a> .	Stop drive. Let resistor cool down. Check resistor overload protection function settings (parameter group <a href="#">43 Brake chopper</a> ). Check warning limit setting, parameter <a href="#">43.12 Brake resistor warning limit</a> . Check that the resistor has been dimensioned correctly. Check that braking cycle meets allowed limits.
A794	BR data	Brake resistor data has not been given.	Check the resistor data settings (parameters <a href="#">43.08...</a> <a href="#">43.10</a> ).

Code (hex)	Warning / Aux. code	Cause	What to do
A79C	BC IGBT excess temperature	Brake chopper IGBT temperature has exceeded internal warning limit.	Let chopper cool down. Check for excessive ambient temperature. Check for cooling fan failure. Check for obstructions in the air flow. Check the dimensioning and cooling of the cabinet. Check resistor overload protection function settings (parameters <a href="#">43.06...43.10</a> ). Check minimum allowed resistor value for the chopper being used. Check that braking cycle meets allowed limits. Check that drive supply AC voltage is not excessive.
A7AB	Extension I/O configuration failure	The I/O module is not connected to the device or parameterization conflict with currently connected I/O-module.  For example, if the drive is connected to an I/O & Modbus module and removed later, the drive displays a warning if connection between any of the parameter and the configured digital/analog output signal is lost.	Make sure that the I/O module is connected to the device and no parameters are connected to non-existing I/O parameters.
A7C1	FBA A communication Programmable warning: <a href="#">50.02 FBA A comm loss func</a>	Cyclical communication between drive and fieldbus adapter module A or between PLC and fieldbus adapter module A is lost.	Check status of fieldbus communication. See user documentation of fieldbus interface. Check settings of parameter groups <a href="#">50 Fieldbus adapter (FBA)</a> , <a href="#">51 FBA A settings</a> , <a href="#">52 FBA A data in</a> and <a href="#">53 FBA A data out</a> . Check cable connections. Check if communication master is able to communicate.
A7CE	EFB comm loss Programmable warning: <a href="#">58.14 Communication loss action</a>	Communication break in embedded fieldbus (EFB) communication.	Check the status of the fieldbus master (online/offline/error etc.). Check cable connections to the EIA-485/X5 terminals 29, 30 and 31 on the control unit.
A7E1	Encoder Programmable warning: <a href="#">90.45 Motor feedback fault</a>	Encoder error.	Check the auxiliary code. See below for actions.
	0001	Cable fault.	Check the encoder cable connection. If the encoder was working previously, check the encoder, encoder cable, and encoder interface module for damage.

<b>Code (hex)</b>	<b>Warning / Aux. code</b>	<b>Cause</b>	<b>What to do</b>
A7EE	Panel loss Programmable warning: <a href="#">49.05 Communication loss action</a>	Control panel or PC tool selected as active control location for drive has ceased communicating.	Check PC tool or control panel connection. Check control panel connector. Check mounting platform if being used. Disconnect and reconnect the control panel.
A71C	I/O Module internal error	Calibration data is not stored in the IO module. Analog signals are not working with full accuracy.	Replace IO module.
A8A0	AI supervision Programmable warning: <a href="#">12.03 AI supervision function</a>	An analog signal is outside the limits specified for the analog input.	Check signal level at the analog input. Check the wiring connected to the input. Check the minimum and maximum limits of the input in parameter group <a href="#">12 Standard AI</a> .
A8A1	RO life warning	The relay has changed states more than the recommended number of times.	Change the control board or stop using the relay output.
	0001	Relay output 1	Change the control board or stop using relay output 1.
A8A2	RO toggle warning	The relay output is changing states faster than recommended, eg. if a fast changing frequency signal is connected to it. The relay lifetime will be exceeded shortly.	Replace the signal connected to the relay output source with a less frequently changing signal.
	0001	Relay output 1	Select a different signal with parameter <a href="#">10.24 RO1 source</a> .
A8B0	Signal supervision (Editable message text) Programmable warning: <a href="#">32.06 Supervision 1 action</a>	Warning generated by a signal supervision function.	Check the source of the warning (parameter <a href="#">32.07 Supervision 1 signal</a> ).
A8B1	Signal supervision (Editable message text) Programmable warning: <a href="#">32.16 Supervision 2 action</a>	Warning generated by a signal supervision function.	Check the source of the warning (parameter <a href="#">32.17 Supervision 2 signal</a> ).
A8B2	Signal supervision (Editable message text) Programmable warning: <a href="#">32.26 Supervision 3 action</a>	Warning generated by a signal supervision function.	Check the source of the warning (parameter <a href="#">32.27 Supervision 3 signal</a> ).
A8B3	Signal supervision (Editable message text) Programmable warning: <a href="#">32.36 Supervision 4 action</a>	Warning generated by a signal supervision function.	Check the source of the warning (parameter <a href="#">32.37 Supervision 4 signal</a> ).
A8B4	Signal supervision (Editable message text) Programmable warning: <a href="#">32.46 Supervision 5 action</a>	Warning generated by a signal supervision function.	Check the source of the warning (parameter <a href="#">32.47 Supervision 5 signal</a> ).
A8B5	Signal supervision (Editable message text) Programmable warning: <a href="#">32.56 Supervision 6 action</a>	Warning generated by a signal supervision function.	Check the source of the warning (parameter <a href="#">32.57 Supervision 6 signal</a> ).

Code (hex)	Warning / Aux. code	Cause	What to do
A8C0	ULC invalid speed table	User load curve: X-axis points (speed) are not valid.	Check that points fulfill conditions. See parameter <a href="#">37.11 ULC speed table point 1</a> .
A8C1	ULC overload warning	User load curve: Signal has been too long over the overload curve.	See parameter <a href="#">37.03 ULC overload actions</a> .
A8C4	ULC underload warning	User load curve: Signal has been too long under the underload curve.	See parameter <a href="#">37.04 ULC underload actions</a> .
A8C5	ULC invalid underload table	User load curve: Underload curve points are not valid.	Check that points fulfill conditions. See parameter <a href="#">37.21 ULC underload point 1</a> .
A8C6	ULC invalid overload table	User load curve: Overload curve points are not valid.	Check that points fulfill conditions. See parameter <a href="#">37.31 ULC overload point 1</a> .
A8C8	ULC invalid frequency table	User load curve: X-axis points (frequency) are not valid.	Check that points fulfill conditions. - $500.0 \text{ Hz} \leq 37.16 < 37.17 < 37.18 < 37.19 < 37.20 \leq 500.0 \text{ Hz}$ . See parameter <a href="#">37.16 ULC frequency table point 1</a> .
A981	External warning 1 (Editable message text) Programmable warning: <a href="#">31.01 External event 1 source</a> <a href="#">31.02 External event 1 type</a>	Fault in external device 1.	Check the external device. Check setting of parameter <a href="#">31.01 External event 1 source</a> .
A982	External warning 2 (Editable message text) Programmable warning: <a href="#">31.03 External event 2 source</a> <a href="#">31.04 External event 2 type</a>	Fault in external device 2.	Check the external device. Check setting of parameter <a href="#">31.03 External event 2 source</a> .
A983	External warning 3 (Editable message text) Programmable warning: <a href="#">31.05 External event 3 source</a> <a href="#">31.06 External event 3 type</a>	Fault in external device 3.	Check the external device. Check setting of parameter <a href="#">31.05 External event 3 source</a> .
A984	External warning 4 (Editable message text) Programmable warning: <a href="#">31.07 External event 4 source</a> <a href="#">31.08 External event 4 type</a>	Fault in external device 5.	Check the external device. Check setting of parameter <a href="#">31.07 External event 4 source</a> .
A985	External warning 5 (Editable message text) Programmable warning: <a href="#">31.09 External event 5 source</a> <a href="#">31.10 External event 5 type</a>	Fault in external device 5.	Check the external device. Check setting of parameter <a href="#">31.09 External event 5 source</a> .
AF88	Season configuration warning	You have configured a season which starts before the previous season.	Configure the seasons with increasing start dates, see parameters <a href="#">34.60 Season 1 start date...</a> <a href="#">34.63 Season 4 start date</a> .

Code (hex)	Warning / Aux. code	Cause	What to do
AF8C	Process PID sleep mode	The drive is entering sleep mode.	Informative warning. See section <a href="#">Sleep and boost functions for process PID control</a> , and parameters <a href="#">40.43...40.48</a> .
AFAA	Autoreset	A fault is about to be autoreset.	Informative warning. See the settings in parameter group <a href="#">31 Fault functions</a> .
AFE1	Emergency stop (off2)	Drive has received an emergency stop (mode selection off2) command.	Check that it is safe to continue operation. Then return emergency stop push button to normal position. Restart drive.
AFE2	Emergency stop (off1 or off3)	Drive has received an emergency stop (mode selection off1 or off3) command.	If the emergency stop was unintentional, check the source selected by parameter <a href="#">21.05 Emergency stop source</a> .
AFEA	Enable start signal missing (Editable message text)	No enable start signal received.	Check the setting of (and the source selected by) parameter <a href="#">20.19 Enable start signal</a> .
AFE9	Start delay	The start delay is active and the drive will start the motor after a predefined delay.	Informative warning. See parameter <a href="#">21.22 Start delay</a> .
AFEB	Run enable missing	No run enable signal is received.	Check setting of parameter <a href="#">20.12 Run enable 1 source</a> . Switch signal on (e.g. in the fieldbus Control Word) or check wiring of selected source.
AFEC	External power signal missing	<a href="#">95.04 Control board supply</a> is set to <i>External 24V</i> but no voltage is connected to the control unit.	Check the external 24 V DC power supply to the control unit, or change the setting of parameter <a href="#">95.04</a> .
AFED	Enable to rotate	Signal enable to rotate has not been received within a fixed time delay of 240s.	Switch enable to rotate signal on (eg. in digital inputs). Check the setting of (and source selected by) parameter <a href="#">20.22 Enable to rotate</a> .
AFF6	Identification run	Motor ID run will occur at next start.	Informative warning.
AFF7	Autophasing	Autophasing will occur at next start.	Informative warning.
B5A0	STO event Programmable event: <a href="#">31.22 STO indication run/stop</a>	Safe torque off function is active, ie. safety circuit signal(s) connected to connector STO is lost.	Check safety circuit connections. For more information, see chapter <i>The Safe torque off function</i> in the hardware manual of the drive and description of parameter <a href="#">31.22 STO indication run/stop</a> (page <a href="#">226</a> ).
B686	Checksum mismatch Programmable event: <a href="#">96.54 Checksum action</a>	The calculated parameter checksum does not match any enabled reference checksum.	See <a href="#">A686 Checksum mismatch</a> (page <a href="#">395</a> ).
D200	Brake slip at standstill2	Brake is slipping when the motor is not running.	Check the mechanical brake. Check the parameter settings in group <a href="#">76.31 Motor speed match</a> .
D201	Forward slow down limit	Slowdown command is active in the forward (up) direction based on the selection in parameter <a href="#">76.05 Forward slow down limit</a> .	Run the motor in the opposite direction and deactivate the Slowdown command, or let the drive run with the limited speed reference.



Code (hex)	Warning / Aux. code	Cause	What to do
D202	Reverse slow down limit	Slowdown command is active in the reverse (down) direction based on the selection in parameter <a href="#">76.07 Reverse slow down limit</a> .	Run the motor in the opposite direction and deactivate the Slowdown command, or let the drive run with the limited speed reference.
D205	Forward stop limit	Stop limit command is active based on the selection in parameter <a href="#">76.04 Forward stop limit</a> .	Check the wiring of the forward stop limit connection. Run the motor in the opposite direction and deactivate the forward stop limit command.
D206	Reverse stop limit	Stop limit command is active in the reverse direction based on the selection of <a href="#">76.06 Reverse stop limit</a> .	Check the wiring of the reverse stop limit connection. Run the motor in the opposite direction and deactivate the reverse stop limit command.
D208	Joystick reference check	Speed reference is greater than +/- 10% of the minimum or maximum scaled value of the used joystick reference, the joystick zero position input ( <a href="#">20.214 Joystick zero position</a> ) is active, and the delay defined with parameter <a href="#">20.215 Joystick warning delay</a> has elapsed.	Check the wiring of the joystick zero position input. Check the wiring of the analog input reference signal of the joystick.
D209	Joystick zero position	Drive does not accept a start command because of a wrong state of the joystick zero position input ( <a href="#">20.214 Joystick zero position</a> ).	Check the wiring of the joystick zero position input.
D20A	Fast stop	Fast stop command ( <a href="#">20.210 Fast stop input</a> ) is activated.	Deactivate the Fast stop command.
D20B	Power on acknowledge	Power on acknowledge circuit is open.	Check the wiring and the setting of parameter <a href="#">20.212 Power on acknowledge</a> .

## Fault messages

Code (hex)	Fault / Aux. code	Cause	What to do
1080	Backup/Restore timeout	Panel or PC tool has failed to communicate with the drive when backup was being made or restored.	Request backup or restore again.
1081	Rating ID fault	Drive software has not been able to read the rating ID of the drive.	Reset the fault to make the drive try to reread the rating ID. If the fault reappears, cycle the power to the drive. You may have to repeat this. If the fault persists, contact your local ABB representative.
2281	Calibration	Measured offset of output phase current measurement or difference between output phase U2 and W2 current measurement is too great (the values are updated during current calibration).	Try performing the current calibration again. If the fault persists, contact your local ABB representative.
2310	Overcurrent	Output current has exceeded internal fault limit. In addition to an actual overcurrent situation, this fault may also be caused by an earth fault or supply phase loss.	Check motor load. Check acceleration times in parameter group <i>23 Speed reference ramp</i> (speed control), <i>26 Torque reference chain</i> (torque control) or <i>28 Frequency reference chain</i> (frequency control). Also check parameters <i>46.01 Speed scaling</i> , <i>46.02 Frequency scaling</i> and <i>46.03 Torque scaling</i> . Check motor and motor cable (including phasing and delta/star connection). Check there are no contactors opening and closing in motor cable. Check that the start-up data in parameter group <i>99 Motor data</i> corresponds to the motor rating plate. Check that there are no power factor correction capacitors or surge absorbers in motor cable. Check for an earth fault in motor or motor cables by measuring the insulation resistances of motor and motor cable. See chapter <i>Electrical installation</i> , section <i>Checking the insulation of the assembly</i> in the hardware manual of the drive.
2330	Earth leakage Programmable fault: <i>31.20 Earth fault</i>	Drive has detected load unbalance typically due to earth fault in motor or motor cable.	Check there are no power factor correction capacitors or surge absorbers in motor cable. Check for an earth fault in motor or motor cables by measuring the insulation resistances of motor and motor cable. Try running the motor in scalar control mode if allowed. (See parameter <i>99.04 Motor control mode</i> .) If no earth fault can be detected, contact your local ABB representative.

Code (hex)	Fault / Aux. code	Cause	What to do
2340	Short circuit	Short-circuit in motor cable(s) or motor	Check motor and motor cable for cabling errors. Check there are no power factor correction capacitors or surge absorbers in motor cable. Cycle the power to the drive.
2381	IGBT overload	Excessive IGBT junction to case temperature. This fault protects the IGBT(s) and can be activated by a short circuit in the motor cable.	Check motor cable. Check ambient conditions. Check air flow and fan operation. Check heatsink fins for dust pick-up. Check motor power against drive power.
3130	Input phase loss	Intermediate circuit DC voltage is oscillating due to missing input power line phase or blown fuse.	Check input power line fuses. Check for loose power cable connections. Check for input power supply imbalance.
3181	Cross connection Programmable fault: <a href="#">31.23 Wiring or earth fault</a>	Incorrect input power and motor cable connection (ie. input power cable is connected to drive motor connection).	Check input power connections.
3210	DC link overvoltage	Excessive intermediate circuit DC voltage.	Check that overvoltage control is on (parameter <a href="#">30.30 Overvoltage control</a> ). Check that the supply voltage matches the nominal input voltage of the drive. Check the supply line for static or transient overvoltage. Check brake chopper and resistor (if present). Check deceleration time. Use coast-to-stop function (if applicable). Retrofit drive with brake chopper and brake resistor. Check that the brake resistor is dimensioned properly and the resistance is between acceptable range for the drive.
3220	DC link undervoltage	Intermediate circuit DC voltage is not sufficient because of a missing supply phase, blown fuse or fault in the rectifier bridge.	Check supply cabling, fuses and switchgear.
3385	Autophasing	Autophasing routine (see section <a href="#">Autophasing</a> on page <a href="#">57</a> ) has failed.	Try other autophasing modes (see parameter <a href="#">21.13 Autophasing mode</a> ) if possible.  Check that the motor ID run has been successfully completed. Clear parameter <a href="#">98.15 Position offset user</a> . Check that the encoder is not slipping on the motor shaft. Check that the motor is not already turning when the autophasing routine starts. Check the setting of parameter <a href="#">99.03 Motor type</a> .

Code (hex)	Fault / Aux. code	Cause	What to do
3381	Output phase loss Programmable fault: <a href="#">31.19 Motor phase loss</a>	Motor circuit fault due to missing motor connection (any of the three phases not connected). In scalar control mode, the drive detects fault only when the output frequency is above 10% of the motor nominal frequency.	Connect motor cable. If the drive is in scalar mode and nominal current of the motor is less than 1/6 of the nominal output current of the drive, set parameter <a href="#">31.19 Motor phase loss</a> to <i>No action</i> .
4110	Control board temperature	Control board temperature is too high.	Check proper cooling of the drive. Check the auxiliary cooling fan.
4210	IGBT overtemperature	Estimated drive IGBT temperature is excessive.	Check ambient conditions. Check air flow and fan operation. Check heatsink fins for dust pick-up. Check motor power against drive power.
4290	Cooling	Drive module temperature is excessive.	Check ambient temperature. If it exceeds 50 °C /122 °F, ensure that load current does not exceed derated load capacity of drive. See chapter <i>Technical data</i> , section <i>Derating</i> in the hardware manual of the drive. Check drive module cooling air flow and fan operation. Check inside of cabinet and heatsink of drive module for dust pick-up. Clean whenever necessary.
42F1	IGBT temperature	Drive IGBT temperature is excessive.	Check ambient conditions. Check air flow and fan operation. Check heatsink fins for dust pick-up. Check motor power against drive power.
4310	Excess temperature	Power unit module temperature is excessive.	Check ambient conditions. Check air flow and fan operation. Check heatsink fins for dust pick-up. Check motor power against drive power.
4380	Excess temperature difference	High temperature difference between the IGBTs of different phases.	Check the motor cabling. Check cooling of drive module(s).
4981	External temperature 1 (Editable message text)	Measured temperature 1 has exceeded fault limit.	Check the value of parameter <a href="#">35.02 Measured temperature 1</a> . Check the cooling of the motor (or other equipment whose temperature is being measured). Check the value of parameter <a href="#">35.12 Temperature 1 fault limit</a> .
4982	External temperature 2 (Editable message text)	Measured temperature 2 has exceeded fault limit.	Check the value of parameter <a href="#">35.03 Measured temperature 2</a> . Check the cooling of the motor (or other equipment whose temperature is being measured). Check the value of parameter <a href="#">35.22 Temperature 2 fault limit</a> .
5090	STO hardware failure	STO hardware diagnostics has detected hardware failure.	Contact your local ABB representative for hardware replacement.

Code (hex)	Fault / Aux. code	Cause	What to do
5091	Safe torque off Programmable fault: <a href="#">31.22 STO indication run/stop</a>	Safe torque off function is active, ie. safety circuit signal(s) connected to connector STO is broken during start or run.	Check safety circuit connections. For more information, see chapter <i>The Safe torque off function</i> in the hardware manual of the drive and description of parameter <a href="#">31.22 STO indication run/stop</a> (page 226). Check the value of parameter <a href="#">95.04 Control board supply</a> .
5092	PU logic error	Power unit memory has cleared.	Contact your local ABB representative.
5093	Rating ID mismatch	The hardware of the drive does not match the information stored in the memory. This may occur eg. after a firmware update.	Cycle the power to the drive. You may have to repeat this.
5094	Measurement circuit temperature	Problem with internal temperature measurement of the drive.	Contact your local ABB representative.
5098	I/O communication loss	Communication failure to standard I/O.	Try resetting the fault or cycle the power to the drive.
50A0	Fan	Cooling fan stuck or disconnected.	Check fan operation and connection. Replace fan if faulty.
5681	PU communication	Communication errors detected between the drive control unit and the power unit.	Check the connection between the drive control unit and the power unit. Check the value of parameter <a href="#">95.04 Control board supply</a> .
5682	Power unit lost	Connection between the drive control unit and the power unit is lost.	Check the connection between the control unit and the power unit.
5690	PU communication internal	Internal communication error.	Contact your local ABB representative.
5691	Measurement circuit ADC	Measurement circuit fault.	Contact your local ABB representative.
5692	PU board powerfail	Power unit power supply failure.	Contact your local ABB representative.
5693	Measurement circuit DFF	Measurement circuit fault.	Contact your local ABB representative.
5696	PU state feedback	State feedback from output phases does not match control signals.	Contact your local ABB representative.
5697	Charging feedback	Charging feedback signal missing.	Check the feedback signal coming from the charging system.
6181	FPGA version incompatible	Firmware and FPGA versions are incompatible.	Reboot the control unit (using parameter <a href="#">96.08 Control board boot</a> ) or by cycling power. If the problem persists, contact your local ABB representative
6200	Checksum mismatch Programmable event: <a href="#">96.54 Checksum action</a>	The calculated parameter checksum does not match any enabled reference checksum.	See <a href="#">A686 Checksum mismatch</a> (page 395).
6306	FBA A mapping file	Fieldbus adapter A mapping file read error.	Contact your local ABB representative.

Code (hex)	Fault / Aux. code	Cause	What to do
6481	Task overload	Internal fault.	Reboot the control unit (using parameter <a href="#">96.08 Control board boot</a> ) or by cycling power. If the problem persists, contact your local ABB representative
6487	Stack overflow	Internal fault.	Reboot the control unit (using parameter <a href="#">96.08 Control board boot</a> ) or by cycling power. If the problem persists, contact your local ABB representative
64A1	Internal file load	File read error.	Reboot the control unit (using parameter <a href="#">96.08 Control board boot</a> ) or by cycling power. If the problem persists, contact your local ABB representative
64A6	Adaptive program file incompatible or corrupted	Adaptive program has faulted.	Check the auxiliary code. See actions for each code below.
	000A	Program corrupted or block non-existent.	Restore the template program or download the program to the drive.
	000C	Required block input missing.	Check the inputs of the block.
	000E	Program corrupted or block non-existent.	Restore the template program or download the program to the drive.
	0011	Program too large.	Remove blocks until the error stops.
	0012	Program is empty.	Correct the program and download it to the drive.
	001C	A non-existing parameter or block is used in the parameter.	Edit the program to correct the parameter reference, or use an existing block.
	001E	Output to parameter failed because the parameter was write-protected.	Check the parameter reference in the program. Check for other sources affecting the target parameter.
	0023	Program file incompatible with current firmware version.	Adapt the program to current block library and firmware version.
	0024	Program file incompatible with current firmware version.	Adapt the program to current block library and firmware version.
	Other	-	Contact your local ABB representative, quoting the auxiliary code.
64B2	User set fault	Loading of user parameter set failed because <ul style="list-style-type: none"> <li>• requested set does not exist</li> <li>• set is not compatible with control program</li> <li>• drive was switched off during loading.</li> </ul>	Ensure that a valid user parameter set exists. Reload if uncertain.
64E1	Kernel overload	Operating system error.	Reboot the control unit (using parameter <a href="#">96.08 Control board boot</a> ) or by cycling power. If the problem persists, contact your local ABB representative
6581	Parameter system	Parameter load or save failed.	Try forcing a save using parameter <a href="#">96.07 Parameter save manually</a> . Retry.

Code (hex)	Fault / Aux. code	Cause	What to do
65A1	FBA A parameter conflict	The drive does not have a functionality requested by PLC, or requested functionality has not been activated.	Check PLC programming. Check settings of parameter groups <a href="#">50 Fieldbus adapter (FBA)</a> and <a href="#">51 FBA A settings</a> .
6681	EFB comm loss Programmable fault: <a href="#">58.14 Communication loss action</a>	Communication break in embedded fieldbus (EFB) communication.	Check the status of the fieldbus master (online/offline/error etc.). Check cable connections to the EIA-485/X5 terminals 29, 30 and 31 on the control unit.
6682	EFB config file	Embedded fieldbus (EFB) configuration file could not be read.	Contact your local ABB representative.
6683	EFB invalid parameterization	Embedded fieldbus (EFB) parameter settings inconsistent or not compatible with selected protocol.	Check the settings in parameter group <a href="#">58 Embedded fieldbus</a> .
6684	EFB load fault	Embedded fieldbus (EFB) protocol firmware could not be loaded.	Contact your local ABB representative.
		Version mismatch between EFB protocol firmware and drive firmware.	
6685	EFB fault 2	Fault reserved for the EFB protocol application.	Check the documentation of the protocol.
6686	EFB fault 3	Fault reserved for the EFB protocol application.	Check the documentation of the protocol.
6882	Text 32-bit table overflow	Internal fault.	Reset the fault. Contact your local ABB representative if the fault persists.
6885	Text file overflow	Internal fault.	Reset the fault. Contact your local ABB representative if the fault persists.
7081	Control panel loss Programmable fault: <a href="#">49.05 Communication loss action</a>	Control panel or PC tool selected as active control location for drive has ceased communicating.	Check PC tool or control panel connection. Check control panel connector. Disconnect and reconnect the control panel.
7082	I/O module comm loss	Communication between IO module and drive is not working properly.	Check the IO module installation.
7086	I/O module AI Over voltage	Overvoltage detected in AI. AI is changed to voltage mode. AI will return automatically back to mA mode when the AI signal level is in accepted limits.	Check AI signal levels.
71A2	Mechanical brake closing failed Programmable fault: <a href="#">44.17 Brake fault function</a>	Mechanical brake control fault. Activated e.g., if brake acknowledgment is not as expected during brake closing.	Check mechanical brake connection. Check mechanical brake settings in parameter group <a href="#">44 Mechanical brake control</a> . Check that the acknowledgment signal matches the actual status of the brake.

Code (hex)	Fault / Aux. code	Cause	What to do
71A3	Mechanical brake opening failed Programmable fault: <a href="#">44.17 Brake fault function</a>	Mechanical brake control fault. Activated e.g. if brake acknowledgement is not as expected during brake opening.	Check mechanical brake connection. Check mechanical brake settings in parameter group <a href="#">44 Mechanical brake control</a> . Check that acknowledgement signal matches actual status of brake.
71A5	Mechanical brake opening not allowed	Open conditions of mechanical brake cannot be fulfilled (e.g., the brake has been prevented from opening by parameter 44.11).	Check mechanical brake settings in parameter group <a href="#">44 Mechanical brake control</a> (especially <a href="#">44.11</a> ). Check that the acknowledgment signal (if used) matches the actual status of the brake.
7121	Motor stall Programmable fault: <a href="#">31.24 Stall function</a>	Motor is operating in stall region because of e.g. excessive load or insufficient motor power.	Check motor load and drive ratings. Check fault function parameters.
7181	Brake resistor	Brake resistor broken or not connected.	Check that a brake resistor has been connected. Check the condition of the brake resistor. Check the dimensioning of the brake resistor.
7183	BR excess temperature	Brake resistor temperature has exceeded fault limit defined by parameter <a href="#">43.11 Brake resistor fault limit</a> .	Stop drive. Let resistor cool down. Check resistor overload protection function settings (parameter group <a href="#">43 Brake chopper</a> ). Check fault limit setting, parameter <a href="#">43.11 Brake resistor fault limit</a> . Check that braking cycle meets allowed limits.
7184	Brake resistor wiring	Brake resistor short circuit or brake chopper control fault.	Check brake chopper and brake resistor connection. Ensure brake resistor is not damaged.
7191	BC short circuit	Short circuit in brake chopper IGBT.	Ensure brake resistor is connected and not damaged. Check the electrical specifications of the brake resistor against chapter <i>Resistor braking</i> in the hardware manual of the drive. Replace brake chopper (if replaceable).
7192	BC IGBT excess temperature	Brake chopper IGBT temperature has exceeded internal fault limit.	Let chopper cool down. Check for excessive ambient temperature. Check for cooling fan failure. Check for obstructions in the air flow. Check resistor overload protection function settings (parameter group <a href="#">43 Brake chopper</a> ). Check that braking cycle meets allowed limits. Check that drive supply AC voltage is not excessive.



Code (hex)	Fault / Aux. code	Cause	What to do
7301	Motor speed feedback Programmable fault: <a href="#">90.45 Motor feedback fault</a>	No motor speed feedback received. Encoder speed differs too much from internal speed estimate. Aux code 4 = Drift detected. Aux code 3FC = Incorrect motor feedback configuration.	Check the parameter <a href="#">90.41</a> setting and the actual source selected. Check electrical connection of the encoder and pulse sin/cos nr.
7310	Overspeed	Motor is turning faster than highest allowed speed due to incorrectly set minimum/maximum speed, insufficient braking torque or changes in load when using torque reference.	Check minimum/maximum speed settings, parameters <a href="#">30.11 Minimum speed</a> and <a href="#">30.12 Maximum speed</a> . Check adequacy of motor braking torque. Check applicability of torque control. Check need for brake chopper and resistor(s).
7381	Encoder Programmable fault: <a href="#">90.45 Motor feedback fault</a>	Encoder feedback fault.	See <a href="#">A7E1 Encoder</a> (page <a href="#">397</a> ).
73F0	Overfrequency	Maximum allowed output frequency exceeded.	Check minimum/maximum frequency settings, parameters <a href="#">30.13 Minimum frequency</a> and <a href="#">30.14 Maximum frequency</a> . Check adequacy of motor braking torque. Check applicability of torque control. Check need for brake chopper and resistor(s).
	00FA	Motor is turning faster than the highest allowed frequency due to incorrectly set minimum/maximum frequency or the motor rushes because of too high supply voltage or incorrect supply voltage selection in parameter <a href="#">95.01 Supply voltage</a> .	Check minimum/maximum frequency settings, parameters <a href="#">30.13 Minimum frequency</a> and <a href="#">30.14 Maximum frequency</a> . Check used supply voltage and voltage selection parameter <a href="#">95.01 Supply voltage</a> .
	Other	-	Contact your local ABB representative, quoting the auxiliary code.
73B0	Emergency ramp failed	Emergency stop did not finish within expected time.	Check the settings of parameters <a href="#">31.32 Emergency ramp supervision</a> and <a href="#">31.33 Emergency ramp supervision delay</a> . Check the predefined ramp times ( <a href="#">23.11...23.15</a> for mode Off1, <a href="#">23.23</a> for mode Off3).

Code (hex)	Fault / Aux. code	Cause	What to do
7510	FBA A communication Programmable fault: <a href="#">50.02 FBA A comm loss func</a>	Cyclical communication between drive and fieldbus adapter module A or between PLC and fieldbus adapter module A is lost.	Check status of fieldbus communication. See user documentation of fieldbus interface. Check settings of parameter groups <a href="#">50 Fieldbus adapter (FBA)</a> , <a href="#">51 FBA A settings</a> , <a href="#">52 FBA A data in</a> and <a href="#">53 FBA A data out</a> . Check cable connections. Check if communication master is able to communicate.
8001	ULC underload fault	User load curve: Signal has been too long under the underload curve.	See parameter <a href="#">37.04 ULC underload actions</a> .
8002	ULC overload fault	User load curve: Signal has been too long over the overload curve.	See parameter <a href="#">37.03 ULC overload actions</a> .
80A0	AI supervision Programmable fault: <a href="#">12.03 AI supervision function</a>	An analog signal is outside the limits specified for the analog input.	Check signal level at the analog input. Check the wiring connected to the input. Check the minimum and maximum limits of the input in parameter group <a href="#">12 Standard AI</a> .
80B0	Signal supervision (Editable message text) Programmable fault: <a href="#">32.06 Supervision 1 action</a>	Fault generated by the signal supervision 1 function.	Check the source of the fault (parameter <a href="#">32.07 Supervision 1 signal</a> ).
80B1	Signal supervision (Editable message text) Programmable fault: <a href="#">32.16 Supervision 2 action</a>	Fault generated by the signal supervision 2 function.	Check the source of the fault (parameter <a href="#">32.17 Supervision 2 signal</a> ).
80B2	Signal supervision (Editable message text) Programmable fault: <a href="#">32.26 Supervision 3 action</a>	Fault generated by the signal supervision 3 function.	Check the source of the fault (parameter <a href="#">32.27 Supervision 3 signal</a> ).
80B3	Signal supervision (Editable message text) Programmable fault: <a href="#">32.36 Supervision 4 action</a>	Fault generated by the signal supervision 4 function.	Check the source of the fault (parameter <a href="#">32.37 Supervision 4 signal</a> ).
80B4	Signal supervision (Editable message text) Programmable fault: <a href="#">32.46 Supervision 5 action</a>	Fault generated by the signal supervision 5 function.	Check the source of the fault (parameter <a href="#">32.47 Supervision 5 signal</a> ).
80B5	Signal supervision (Editable message text) Programmable fault: <a href="#">32.56 Supervision 6 action</a>	Fault generated by the signal supervision 6 function.	Check the source of the fault (parameter <a href="#">32.57 Supervision 6 signal</a> ).
9081	External fault 1 (Editable message text) Programmable fault: <a href="#">31.01 External event 1 source</a> <a href="#">31.02 External event 1 type</a>	Fault in external device 1.	Check the external device. Check setting of parameter <a href="#">31.01 External event 1 source</a> .
9082	External fault 2 (Editable message text) Programmable fault: <a href="#">31.03 External event 2 source</a> <a href="#">31.04 External event 2 type</a>	Fault in external device 2.	Check the external device. Check setting of parameter <a href="#">31.03 External event 2 source</a> .

Code (hex)	Fault / Aux. code	Cause	What to do
9083	External fault 3 (Editable message text) Programmable fault: <a href="#">31.05 External event 3 source</a> <a href="#">31.06 External event 3 type</a>	Fault in external device 3.	Check the external device. Check setting of parameter <a href="#">31.05 External event 3 source</a> .
9084	External fault 4 (Editable message text) Programmable fault: <a href="#">31.07 External event 4 source</a> <a href="#">31.08 External event 4 type</a>	Fault in external device 5.	Check the external device. Check setting of parameter <a href="#">31.07 External event 4 source</a> .
9085	External fault 5 (Editable message text) Programmable fault: <a href="#">31.09 External event 5 source</a> <a href="#">31.10 External event 5 type</a>	Fault in external device 5.	Check the external device. Check setting of parameter <a href="#">31.09 External event 5 source</a> .
FA81	Safe torque off 1	Safe torque off function is active, ie. STO circuit 1 is broken.	Check safety circuit connections. For more information, see chapter <i>The Safe torque off function</i> in the hardware manual of the drive and description of parameter <a href="#">31.22 STO indication run/stop</a> (page <a href="#">226</a> ). Check the value of parameter <a href="#">95.04 Control board supply</a> .
FA82	Safe torque off 2	Safe torque off function is active, ie. STO circuit 2 is broken.	
FF61	ID run	Motor ID run was not completed successfully.	Check the nominal motor values in parameter group <a href="#">99 Motor data</a> . Check that no external control system is connected to the drive. Cycle the power to the drive (and its control unit, if powered separately). Check that no operation limits prevent the completion of the ID run. Restore parameters to default settings and try again. Check that the motor shaft is not locked.
	0001	Maximum current limit too low.	Check settings of parameters <a href="#">99.06 Motor nominal current</a> and <a href="#">30.17 Maximum current</a> . Make sure that $30.17 > 99.06$ . Check that the drive is dimensioned correctly according to the motor.
	0002	Maximum speed limit or calculated field weakening point too low.	Check settings of parameters <ul style="list-style-type: none"> <li>• <a href="#">30.11 Minimum speed</a></li> <li>• <a href="#">30.12 Maximum speed</a></li> <li>• <a href="#">99.07 Motor nominal voltage</a></li> <li>• <a href="#">99.08 Motor nominal frequency</a></li> <li>• <a href="#">99.09 Motor nominal speed</a>.</li> </ul> Make sure that <ul style="list-style-type: none"> <li>• <math>30.12 &gt; (0.55 \times 99.09) &gt; (0.50 \times \text{synchronous speed})</math></li> <li>• <math>30.11 \leq 0</math>, and</li> <li>• supply voltage <math>\geq (0.66 \times 99.07)</math>.</li> </ul>

Code (hex)	Fault / Aux. code	Cause	What to do
	0003	Maximum torque limit too low.	Check settings of parameter <a href="#">99.12 Motor nominal torque</a> , and the torque limits in group <a href="#">30 Limits</a> . Make sure that the maximum torque limit in force is greater than 100%.
	0004	Current measurement calibration did not finish within reasonable time	Contact your local ABB representative.
	0005...0008	Internal error.	Contact your local ABB representative.
	0009	(Asynchronous motors only) Acceleration did not finish within reasonable time.	Contact your local ABB representative.
	000A	(Asynchronous motors only) Deceleration did not finish within reasonable time.	Contact your local ABB representative.
	000B	(Asynchronous motors only) Speed dropped to zero during ID run.	Contact your local ABB representative.
	000C	(Permanent magnet motors only) First acceleration did not finish within reasonable time.	Contact your local ABB representative.
	000D	(Permanent magnet motors only) Second acceleration did not finish within reasonable time.	Contact your local ABB representative.
	000E...0010	Internal error.	Contact your local ABB representative.
	0011	(Synchronous reluctance motors only) Pulse test error.	Contact your local ABB representative.
	0012	Motor too large for advanced standstill ID run.	Check that the motor and drive sizes are compatible. Contact your local ABB representative.
	0013	(Asynchronous motors only) Motor data error.	Check that the motor nominal value settings in the drive are the same as in the motor nameplate. Contact your local ABB representative.
FF81	FB A force trip	A fault trip command has been received through fieldbus adapter A.	Check the fault information provided by the PLC.
FF8E	EFB force trip	A fault trip command has been received through the embedded fieldbus interface.	Check the fault information provided by the PLC.
D100	Torque prove	Drive was not able to provide sufficient torque during Torque proving. The pre-magnetizing time mode is wrong or too short.	Check the motor and motor cables. Check that the parameter settings are as follows: <ul style="list-style-type: none"> <li>• <a href="#">21.01 Vector start mode = Const time</a></li> <li>• <a href="#">21.02 Magnetization time</a> = Setting is not fixed. Enter an appropriate value.</li> </ul>

Code (hex)	Fault / Aux. code	Cause	What to do
D101	Brake slip	Brake slipped during Torque proving.	Check the brake. Check whether the brake is slipping when it is in the closed state.
D102	Brake safe closure	Start command is active, the actual speed is below the limit defined with parameter <a href="#">44.208 Safety close speed</a> , and the delay defined with parameter <a href="#">44.209 Safety close delay</a> has elapsed.	Check whether it is necessary to drive the application at a low speed. If it is not, change the values of parameters <a href="#">44.208 Safety close speed</a> and <a href="#">44.209 Safety close delay</a> to correspond to the application. In trolley or long-travel applications, disable the Brake safe closure function with parameter <a href="#">44.207 Safety close select</a> .
D105	Speed match	Motor speed has exceeded the steady state deviation level (par. <a href="#">76.32</a> ) or the ramping state deviation level (par. <a href="#">76.33</a> ), and the delay defined with parameter <a href="#">76.34 Speed match fault delay</a> has elapsed.	Check the torque and current limit settings. If an encoder is used, check the encoder settings.d205
D108	Stop limits I/O error	Both the forward stop limit and reverse stop limit inputs are active simultaneously.	Check the forward stop limit and reverse stop limit wiring.
D10A	Brake not selected	Mechanical brake control was inactive when the Conical motor control function was enabled.	Activate mechanical brake control with parameter <a href="#">44.06 Brake control enable</a> .





# 9

## **Fieldbus control through the embedded fieldbus interface (EFB)**

---

## **Contents**

- [System overview](#)
- [Modbus](#)
  - [Connecting the fieldbus to the drive](#)
  - [Setting up the embedded fieldbus interface \(Modbus\)](#)
  - [Setting the drive control parameters](#)
  - [Basics of the embedded fieldbus interface](#)
  - [About the control profiles](#)
  - [Control Word](#)
  - [Status Word](#)
  - [State transition diagrams](#)
  - [References](#)
  - [Actual values](#)
  - [Modbus holding register addresses](#)
  - [Modbus function codes](#)
  - [Exception codes](#)
  - [Coils \(0xxxx reference set\)](#)
  - [Discrete inputs \(1xxxx reference set\)](#)
  - [Error code registers \(holding registers 400090...400100\)](#)
  - [CANopen](#)
    - [Connecting the fieldbus to the drive](#)
    - [Setting up the embedded fieldbus interface \(CANopen\)](#)
    - [Setting the drive control parameters](#)
    - [Basics of the embedded fieldbus interface](#)
    - [About the control profiles](#)
    - [CiA 402 profile](#)
    - [ABB drives profile](#)
    - [Transparent 16 profile](#)
    - [Transparent 32 profile](#)
    - [Object dictionary](#)
    - [CANopen status indicators](#)

## **System overview**

The drive can be connected to an external control system through a communication link using either a fieldbus adapter or the embedded fieldbus interface.

---



Two protocols are supported by the embedded fieldbus interface: Modbus and CANopen.

### ■ **Modbus**

Embedded fieldbus is for the following instruments:

- Standard variant ACS380-04xS
- Configured variant (ACS380-04xC) with the I/O and Modbus extension module (option +L538).

The embedded fieldbus interface supports the Modbus RTU protocol. The drive control program can handle 10 Modbus registers in a 10-millisecond time level. For example, if the drive receives a request to read 20 registers, it will start its response within 22 ms of receiving the request – 20 ms for processing the request and 2 ms overhead for handling the bus. The actual response time depends on other factors as well, such as the baud rate (a parameter setting in the drive).

The drive can be set to receive all of its control information through the fieldbus interface, or the control can be distributed between the embedded fieldbus interface and other available sources, for example, digital and analog inputs.

### Connecting the fieldbus to the drive

Connect the fieldbus to the EIA-485 Modbus RTU terminal on the BMIO-01 module which is attached on the control unit of the drive. The connection diagram is shown below.

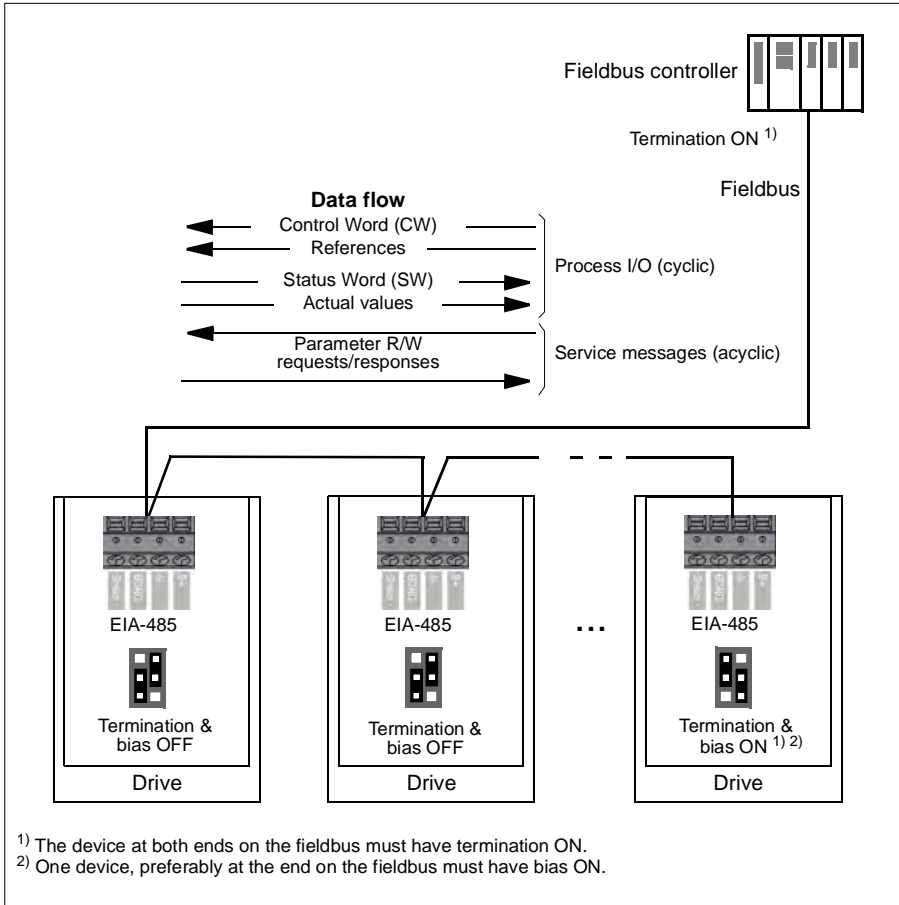

## Setting up the embedded fieldbus interface (Modbus)

To take the Modbus into use

1. Select *Modbus RTU* from the Control macros menu (see section [Submenus](#) on page 20).

The following parameters change automatically.

Parameter	Setting
20.01 Ext1 commands	Embedded fieldbus
20.03 Ext1 in1	Not selected
20.04 Ext1 in2	Not selected
22.11 Ext1 speed ref1	EFB ref1
22.22 Constant speed sel1	Not selected
22.23 Constant speed sel2	Not selected
23.11 Ramp set selection	Acc/Dec time 1
28.11 Ext1 frequency ref1	EFB ref1
28.22 Constant frequency sel1	Not selected
28.23 Constant frequency sel2	Not selected
28.71 Freq ramp set sel	Acc/Dec time 1
31.11 Fault reset selection	DI1
58.01 Protocol enable	Modbus RTU

You can manually set the drive up for the embedded fieldbus communication with the parameters shown in the table below. The **Setting for fieldbus control** column gives either the value to use or the default value. The **Function/Information** column gives a description of the parameter.

### Modbus parameter settings for embedded fieldbus interface

Parameter	Setting for fieldbus control	Function/Information
COMMUNICATION INITIALIZATION		
<a href="#">58.01</a> <i>Protocol enable</i>	<i>Modbus RTU</i>	Initializes embedded fieldbus communication.
EMBEDDED MODBUS CONFIGURATION		
<a href="#">58.03</a> <i>Node address</i>	1 (default)	Node address. There must be no two nodes with the same node address online.
<a href="#">58.04</a> <i>Baud rate</i>	<i>19.2 kbps</i> (default)	Defines the communication speed of the link. Use the same setting as in the master station.
<a href="#">58.05</a> <i>Parity</i>	<i>8 EVEN 1</i> (default)	Selects the parity and stop bit setting. Use the same setting as in the master station.
<a href="#">58.14</a> <i>Communication loss action</i>	<i>Fault</i> (default)	Defines the action taken when a communication loss is detected.

Parameter	Setting for fieldbus control	Function/Information
58.15 <i>Communication loss mode</i>	<i>Cw / Ref1 / Ref2</i> (default)	Enables/disables communication loss monitoring and defines the means for resetting the counter of the communication loss delay.
58.16 <i>Communication loss time</i>	3.0 s (default)	Defines the timeout limit for the communication monitoring.
58.17 <i>Transmit delay</i>	0 ms (default)	Defines a response delay for the drive.
58.25 <i>Control profile</i>	<i>ABB Drives</i> (default)	Selects the control profile used by the drive. See section <i>Basics of the embedded fieldbus interface</i> (page 423).
58.26 <i>EFB ref1 type</i> 58.27 <i>EFB ref2 type</i>	<i>Speed or frequency</i> (default for 58.26), <i>Transparent, General, Torque</i> (default for 58.27), <i>Speed, Frequency</i>	Defines the types of fieldbus references 1 and 2. The scaling for each reference type is defined by parameters 46.01...46.03. With the <i>Speed or frequency</i> setting, the type is selected automatically according to the currently active drive control mode.
58.28 <i>EFB act1 type</i> 58.29 <i>EFB act2 type</i>	<i>Speed or frequency</i> (default for 58.28), <i>Transparent</i> (default for 58.29), <i>General, Torque, Speed, Frequency</i>	Defines the types of actual values 1 and 2. The scaling for each actual value type is defined by parameters 46.01...46.03. With the <i>Speed or frequency</i> setting, the type is selected automatically according to the currently active drive control mode.
58.31 <i>EFB act1 transparent source</i> 58.32 <i>EFB act2 transparent source</i>	<i>Other</i>	Defines the source of actual values 1 and 2 when the 58.26 <i>EFB ref1 type</i> (58.27 <i>EFB ref2 type</i> ) is set to <i>Transparent</i> .
58.33 <i>Addressing mode</i>	<i>Mode 0</i> (default)	Defines the mapping between parameters and holding registers in the 400001...465536 (100...65535) Modbus register range.
58.34 <i>Word order</i>	<i>LO-HI</i> (default)	Defines the order of the data words in the Modbus message frame.
58.101 <i>Data I/O 1</i> ... 58.114 <i>Data I/O 14</i>	For example, the default settings (I/Os 1...6 contain the control word, the status word, two references and two actual values)	Defines the address of the drive parameter which the Modbus master accesses when it reads from or writes to the register address corresponding to Modbus In/Out parameters. Select the parameters that you want to read or write through the Modbus I/O words.
	<i>RO/DIO control word, AO1 data storage, Feedback data storage, Setpoint data storage</i>	These settings write the incoming data into storage parameters 10.99 <i>RO/DIO control word</i> , 13.91 <i>AO1 data storage</i> , 40.91 <i>Feedback data storage</i> or 40.92 <i>Setpoint data storage</i> .

Parameter	Setting for fieldbus control	Function/Information
<i>58.06 Communication control</i>	<i>Refresh settings</i>	Validates the settings of the configuration parameters.

The new settings will take effect when the drive is powered up the next time, or when they are validated by parameter *58.06 Communication control (Refresh settings)*.

### Setting the drive control parameters

After the embedded fieldbus interface has been set up, check and adjust the drive control parameters listed in the table below. The **Setting for fieldbus control** column gives the value or values to use when the embedded fieldbus signal is the desired source or destination for that particular drive control signal. The **Function/Information** column gives a description of the parameter.

Parameter	Setting for fieldbus control	Function/Information
CONTROL COMMAND SOURCE SELECTION		
<i>20.01 Ext1 commands</i>	<i>Embedded fieldbus</i>	Selects fieldbus as the source for the start and stop commands when EXT1 is selected as the active control location.
<i>20.02 Ext2 commands</i>	<i>Embedded fieldbus</i>	Selects fieldbus as the source for the start and stop commands when EXT2 is selected as the active control location.
SPEED REFERENCE SELECTION		
<i>22.11 Ext1 speed ref1</i>	<i>EFB ref1</i>	Selects a reference received through the embedded fieldbus interface as speed reference 1.
<i>22.18 Ext2 speed ref1</i>	<i>EFB ref1</i>	Selects a reference received through the embedded fieldbus interface as speed reference 2.
TORQUE REFERENCE SELECTION		
<i>26.11 Torque ref1 source</i>	<i>EFB ref1</i>	Selects a reference received through the embedded fieldbus interface as torque reference 1.
<i>26.12 Torque ref2 source</i>	<i>EFB ref1</i>	Selects a reference received through the embedded fieldbus interface as torque reference 2.
FREQUENCY REFERENCE SELECTION		
<i>28.11 Ext1 frequency ref1</i>	<i>EFB ref1</i>	Selects a reference received through the embedded fieldbus interface as frequency reference 1.
<i>28.15 Ext2 frequency ref1</i>	<i>EFB ref1</i>	Selects a reference received through the embedded fieldbus interface as frequency reference 2.

Parameter	Setting for fieldbus control	Function/Information
-----------	------------------------------	----------------------

OTHER SELECTIONS		
EFB references can be selected as the source at virtually any signal selector parameter by selecting <i>Other</i> , then either <a href="#">03.09 EFB reference 1</a> or <a href="#">03.10 EFB reference 2</a> .		

SYSTEM CONTROL INPUTS		
<a href="#">96.07 Parameters save manually</a>	<i>Save</i> (reverts to <i>Done</i> )	Saves parameter value changes (including those made through fieldbus control) to permanent memory.

**Basics of the embedded fieldbus interface**

The cyclic communication between a fieldbus system and the drive consists of 16-bit data words or 32-bit data words (with a transparent control profile).

The diagram below illustrates the operation of the embedded fieldbus interface. The signals transferred in the cyclic communication are explained further below the diagram.

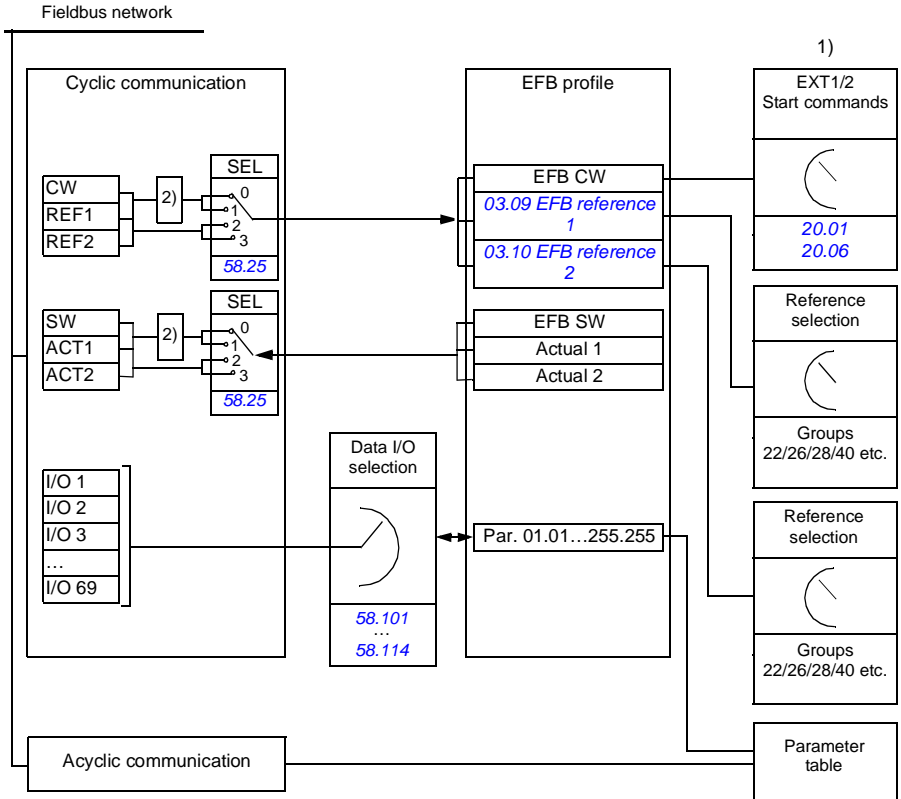

1. See also other parameters which can be controlled through fieldbus.
2. Data conversion if parameter **58.25 Control profile** is set to **ABB Drives**. See section *About the control profiles* on page **425**.

## **Control word and Status word**

The Control Word (CW) is a 16-bit or 32-bit packed boolean word. It is the principal means of controlling the drive from a fieldbus system. The CW is sent by the fieldbus controller to the drive. With drive parameters, the user selects the EFB CW as the source of drive control commands (such as start/stop, emergency stop, selection between external control locations 1/2, or fault reset). The drive switches between its states according to the bit-coded instructions of the CW.

The fieldbus CW is either written to the drive as it is or the data is converted. See section [About the control profiles](#) on page 425.

The fieldbus Status Word (SW) is a 16-bit or 32-bit packed boolean word. It contains status information from the drive to the fieldbus controller. The drive SW is either written to the fieldbus SW as it is or the data is converted. See section [About the control profiles](#) on page 425.

## **References**

EFB references 1 and 2 are 16-bit or 32-bit signed integers. The contents of each reference word can be used as the source of virtually any signal, such as the speed, frequency, torque or process reference. In embedded fieldbus communication, references 1 and 2 are displayed by [03.09 EFB reference 1](#) and [03.10 EFB reference 2](#) respectively. Whether the references are scaled or not depends on the settings of [58.26 EFB ref1 type](#) and [58.27 EFB ref2 type](#). See section [About the control profiles](#) on page 425.

## **Actual values**

Fieldbus actual signals (ACT1 and ACT2) are 16-bit or 32-bit signed integers. They convey selected drive parameter values from the drive to the master. Whether the actual values are scaled or not depends on the settings of [58.28 EFB act1 type](#) and [58.29 EFB act2 type](#). See section [About the control profiles](#) on page 425.

## **Data input/outputs**

Data input/outputs are 16-bit or 32-bit words containing selected drive parameter values. Parameters [58.101 Data I/O 1 ... 58.114 Data I/O 14](#) define the addresses from which the master either reads data (input) or to which it writes data (output).

## **Register addressing**

The address field of Modbus requests for accessing holding registers is 16 bits. This allows the Modbus protocol to support addressing of 65536 holding registers.

Historically, Modbus master devices used 5-digit decimal addresses from 40001 to 49999 to represent holding register addresses. The 5-digit decimal addressing limited to 9999 the number of holding registers that could be addressed.

---



Modern Modbus master devices typically provide a means to access the full range of 65536 Modbus holding registers. One of these methods is to use 6-digit decimal addresses from 400001 to 465536. This manual uses 6-digit decimal addressing to represent Modbus holding register addresses.

Modbus master devices that are limited to the 5-digit decimal addressing may still access registers 400001 to 409999 by using 5-digit decimal addresses 40001 to 49999. Registers 410000-465536 are inaccessible to these masters. For more information, see parameter [58.33 Addressing mode](#).

**Note:** Register addresses of 32-bit parameters cannot be accessed by using 5-digit register numbers.

### About the control profiles

A control profile defines the rules for data transfer between the drive and the fieldbus master, for example:

- if packed boolean words are converted and how
- if signal values are scaled and how
- how drive register addresses are mapped for the fieldbus master.

You can configure the drive to receive and send messages according to one of the two profiles:

- [ABB Drives](#)
- [DCU Profile](#).

For the ABB Drives profile, the embedded fieldbus interface of the drive converts the fieldbus data to and from the native data used in the drive. The DCU Profile involves no data conversion or scaling. The figure below illustrates the effect of the profile selection.

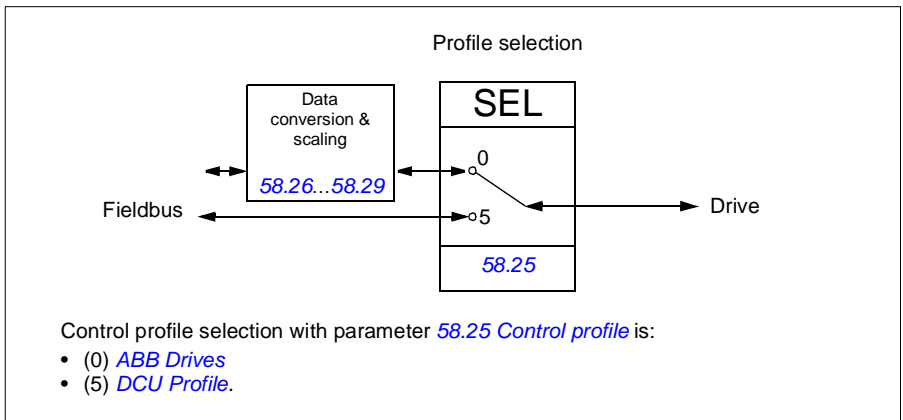

## Control Word

Control Word for the ABB Drives profile

The table below shows the contents of the fieldbus Control Word for the ABB Drives control profile. The embedded fieldbus interface converts this word to the form in which it is used in the drive. The upper case boldface text refers to the states shown in [State transition diagram for the ABB Drives profile](#) on page 431.

Bit	Name	Value	STATE/Description
0	OFF1_ CONTROL	1	Proceed to <b>READY TO OPERATE</b> .
		0	Stop along currently active deceleration ramp. Proceed to <b>OFF1 ACTIVE</b> ; proceed to <b>READY TO SWITCH ON</b> unless other interlocks (OFF2, OFF3) are active.
1	OFF2_ CONTROL	1	Continue operation (OFF2 inactive).
		0	Emergency OFF, coast to stop. Proceed to <b>OFF2 ACTIVE</b> , proceed to <b>SWITCH-ON INHIBITED</b> .
2	OFF3_ CONTROL	1	Continue operation (OFF3 inactive).
		0	Emergency stop, stop within time defined by drive parameter. Proceed to <b>OFF3 ACTIVE</b> ; proceed to <b>SWITCH-ON INHIBITED</b> . <b>Warning:</b> Ensure that the motor and driven machine can be stopped using this stop mode.
3	INHIBIT_ OPERATION	1	Proceed to <b>OPERATION ENABLED</b> . <b>Note:</b> Run enable signal must be active; see the drive documentation. If the drive is set to receive the Run enable signal from the fieldbus, this bit activates the signal. See also parameter <i>06.18 Start inhibit status word</i> (page 126).
		0	Inhibit operation. Proceed to <b>OPERATION INHIBITED</b> .
4	RAMP_OUT_ ZERO	1	Normal operation. Proceed to <b>RAMP FUNCTION GENERATOR: OUTPUT ENABLED</b> .
		0	Force Ramp Function Generator output to zero. Drive ramps to stop (current and DC voltage limits in force).
5	RAMP_HOLD	1	Enable ramp function. Proceed to <b>RAMP FUNCTION GENERATOR: ACCELERATOR ENABLED</b> .
		0	Halt ramping (Ramp Function Generator output held).
6	RAMP_IN_ ZERO	1	Normal operation. Proceed to <b>OPERATING</b> . <b>Note:</b> This bit is effective only if the fieldbus interface is set as the source for this signal by drive parameters.
		0	Force Ramp Function Generator input to zero.
7	RESET	0=>1	Fault reset if an active fault exists. Proceed to <b>SWITCH-ON INHIBITED</b> . <b>Note:</b> This bit is effective only if the fieldbus interface is set as the source for this signal by drive parameters.
		0	Continue normal operation.

Bit	Name	Value	STATE/Description
8	JOGGING_1	1	Request running at Jogging 1 speed. <b>Note:</b> This bit is effective only if the fieldbus interface is set as the source for this signal by drive parameters.
		0	Continue normal operation.
9	JOGGING_2	1	Request running at Jogging 2 speed. <b>Note:</b> This bit is effective only if the fieldbus interface is set as the source for this signal by drive parameters.
		0	Continue normal operation.
10	REMOTE_CMD	1	Fieldbus control enabled.
		0	Control Word <> 0 or Reference <> 0: Retain last Control Word and Reference. Control Word = 0 and Reference = 0: Fieldbus control enabled. Reference and deceleration/acceleration ramp are locked.
11	EXT_CTRL_LOC	1	Select External Control Location EXT2. Effective if the control location is parameterized to be selected from the fieldbus.
		0	Select External Control Location EXT1. Effective if the control location is parameterized to be selected from the fieldbus.
12	USER_0		Writable control bits that can be combined with drive logic for application-specific functionality.
13	USER_1		
14	USER_2		
15	USER_3		

### Control Word for the DCU Profile

The embedded fieldbus interface writes the fieldbus Control Word as is to the drive Control Word bits 0 to 15. Bits 16 to 32 of the drive Control Word are not in use.

Bit	Name	Value	State/Description
0	STOP	1	Stop according to the Stop Mode parameter or the stop mode request bits (bits 7...9).
		0	(no op)
1	START	1	Start the drive.
		0	(no op)
2	REVERSE	1	Reverse direction of motor rotation.
		0	(no op)
3	Reserved		
4	RESET	0=>1	Fault reset if an active fault exists.
		0	(no op)

Bit	Name	Value	State/Description
5	EXT2	1	Select External control location EXT2. Effective if the control location is parameterized to be selected from the fieldbus.
		0	Select External control location EXT1. Effective if the control location is parameterized to be selected from the fieldbus.
6	RUN_DISABLE	1	Run disable. If the drive is set to receive the run enable signal from the fieldbus, this bit deactivates the signal.
		0	Run enable. If the drive is set to receive the run enable signal from the fieldbus, this bit activates the signal.
7	STOPMODE_RAMP	1	Normal ramp stop mode
		0	(no op) Default to parameter stop mode if bits 7...9 are all 0.
8	STOPMODE_EMERGENCY_RAMP	1	Emergency ramp stop mode.
		0	(no op) Default to parameter stop mode if bits 7...9 are all 0.
9	STOPMODE_COAST	1	Coast stop mode.
		0	(no op) Default to parameter stop mode if bits 7...9 are all 0.
10	Reserved for RAMP_PAIR_2		Not yet implemented.
11	RAMP_OUT_ZERO	1	Force Ramp Function Generator output to zero. Drive ramps to stop (current and DC voltage limits in force).
		0	Normal operation.
12	RAMP_HOLD	1	Halt ramping (Ramp Function Generator output held).
		0	Normal operation.
13	RAMP_IN_ZERO	1	Force Ramp Function Generator input to zero.
		0	Normal operation.
14	REQ_LOCAL_LOCK	1	
		0	
15	Reserved for TORQ_LIM_PAIR_2		Not yet implemented.
16	FB_LOCAL_CTL	1	Local mode for control from the fieldbus is requested. Steal control from the active source.
		0	(no op)
17	FB_LOCAL_REF	1	Local mode for reference from the fieldbus is requested. Steal reference from the active source.
		0	(no op)
18	Reserved for RUN_DISABLE_1		Not yet implemented.
19	Reserved		
20	Reserved		

Bit	Name	Value	State/Description
21	Reserved		
22	USER_0		Writable control bits that can be combined with drive logic for application-specific functionality.
23	USER_1		
24	USER_2		
25	USER_3		
26 ...31	Reserved		

## Status Word

### Status Word for the ABB Drives profile

The table below shows the fieldbus Status Word for the ABB Drives control profile. The embedded fieldbus interface converts the drive Status Word into this form for the fieldbus. The upper case boldface text refers to the states shown in [State transition diagram for the ABB Drives profile](#) on page 431.

Bit	Name	Value	STATE/Description
0	RDY_ON	1	<b>READY TO SWITCH ON.</b>
		0	<b>NOT READY TO SWITCH ON.</b>
1	RDY_RUN	1	<b>READY TO OPERATE.</b>
		0	<b>OFF1 ACTIVE.</b>
2	RDY_REF	1	<b>OPERATION ENABLED.</b>
		0	<b>OPERATION INHIBITED.</b> See also parameter <a href="#">06.18 Start inhibit status word</a> (page 126).
3	TRIPPED	1	<b>FAULT.</b>
		0	No fault.
4	OFF_2_STATUS	1	OFF2 inactive.
		0	<b>OFF2 ACTIVE.</b>
5	OFF_3_STATUS	1	OFF3 inactive.
		0	<b>OFF3 ACTIVE.</b>
6	SWC_ON_INHIB	1	<b>SWITCH-ON INHIBITED.</b>
		0	–
7	ALARM	1	Warning/Alarm.
		0	No warning/alarm.
8	AT_SETPOINT	1	<b>OPERATING.</b> Actual value equals Reference (is within tolerance limits, e.g. in speed control, speed error is 10% max. of nominal motor speed).
		0	Actual value differs from Reference (is outside tolerance limits).
9	REMOTE	1	Drive control location: REMOTE (EXT1 or EXT2).
		0	Drive control location: LOCAL.

Bit	Name	Value	STATE/Description
10	ABOVE_LIMIT	1	Actual frequency or speed equals or exceeds supervision limit (set by drive parameter). Valid in both directions of rotation.
		0	Actual frequency or speed within supervision limit.
11	USER_0		Status bits that can be combined with drive logic for application-specific functionality.
12	USER_1		
13	USER_2		
14	USER_3		
15	Reserved		

### Status Word for the DCU Profile

The embedded fieldbus interface writes the drive Status Word bits 0 to 15 to the fieldbus Status Word as is. Bits 16 to 32 of the drive Status Word are not in use.

Bit	Name	Value	State/Description
0	READY	1	Drive is ready to receive the start command.
		0	Drive is not ready.
1	ENABLED	1	External run enable signal is active.
		0	External run enable signal is not active.
2	Reserved for ENABLED_TO_ROTATE		Not yet implemented.
3	RUNNING	1	Drive is modulating.
		0	Drive is not modulating.
4	ZERO_SPEED	1	Drive is at zero speed.
		0	Drive is not at zero speed.
5	ACCELERATING	1	Not yet implemented.
		0	Not yet implemented.
6	DECELERATING	1	Not yet implemented.
		0	Not yet implemented.
7	AT_SETPOINT	1	Drive is at setpoint.
		0	Drive is not at setpoint.
8	LIMIT	1	Drive operation is limited.
		0	Drive operation is not limited.
9	SUPERVISION	1	Actual value (speed, frequency or torque) is above a limit. Limit is set with parameters 46.31...46.33
		0	Actual value (speed, frequency or torque) is within limits.
10	REVERSE_REF	1	Not yet implemented.
		0	Not yet implemented.

Bit	Name	Value	State/Description
11	REVERSE_ACT	1	Not yet implemented.
		0	Not yet implemented.
12	PANEL_LOCAL	1	Panel/keypad (or PC tool) is in local control mode.
		0	Panel/keypad (or PC tool) is not in local control mode.
13	FIELDBUS_LOCAL	1	Fieldbus is in local control mode.
		0	Fieldbus is not in local control mode.
14	EXT2_ACT	1	External control location EXT2 is active.
		0	External control location EXT1 is active.
15	FAULT	1	Drive is faulted.
		0	Drive is not faulted.
16	ALARM	1	Warning/Alarm is active.
		0	No warning/alarm.
17	Reserved		
18	Reserved for DIRECTION_LOCK		Not yet implemented.
19	Reserved		
20	Reserved		
21	Reserved		
22	USER_0		Status bits that can be combined with drive logic for application-specific functionality.
23	USER_1		
24	USER_2		
25	USER_3		
26	REQ_CTL	1	Control is requested in this channel.
		0	Control is not requested in this channel.
27 ... 31	Reserved		

## State transition diagrams

### State transition diagram for the ABB Drives profile

The diagram below shows the state transitions in the drive when the drive is using the ABB Drives profile and the drive is configured to follow the commands of the control word from the embedded fieldbus interface. The upper case texts refer to the states which are used in the tables representing the fieldbus Control and Status words.

See sections [Control Word for the ABB Drives profile](#) on page 426 and [Status Word for the ABB Drives profile](#) on page 429.





A control word sequence example is given below:

Start:

- 476h --> NOT READY TO SWITCH ON

If MSW bit 0 = 1 then

- 477h --> READY TO SWITCH ON (Stopped)
- 47Fh --> OPERATION (Running)

Stop:

- 477h = Stop according to [21.03 Stop mode](#)
- 47Eh = OFF1 ramp stop (**Note:** uninterpretable ramp stop)

Fault reset:

- Rising edge of MCW bit 7

Start after STO:

- If [31.22 STO indication run/stop](#) is not fault/fault make sure that [06.18 Start inhibit status word](#), bit 7 STO = 0 before giving a start command.
-

## References

### References for the ABB Drives profile and DCU Profile

The ABB Drives profile supports the use of two references, EFB reference 1 and EFB reference 2. The references are 16-bit words each containing a sign bit and a 15-bit integer. A negative reference is formed by calculating the two's complement from the corresponding positive reference.

The references are scaled as defined by parameters [46.01...46.04](#); which scaling is in use depends on the setting of [58.26 EFB ref1 type](#) and [58.27 EFB ref2 type](#) (see page [308](#)).

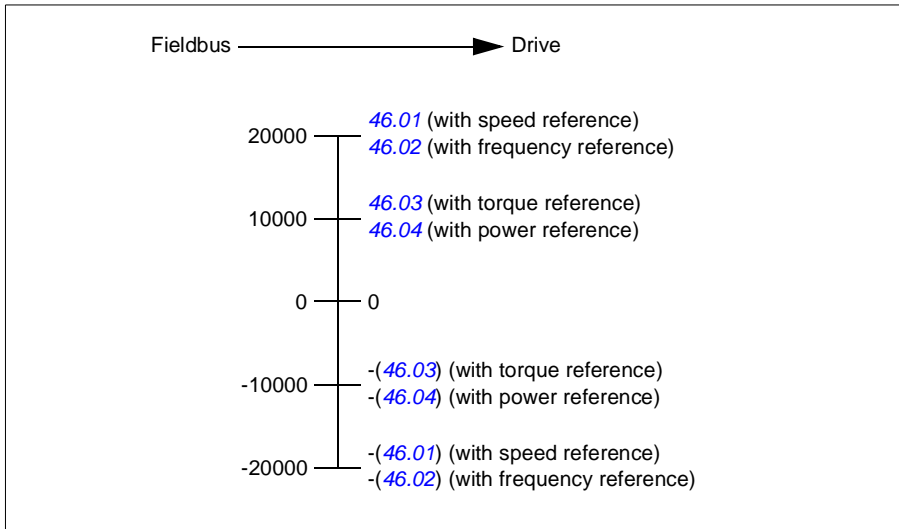

The scaled references are shown by parameters [03.09 EFB reference 1](#) and [03.10 EFB reference 2](#).

## Actual values

### Actual values for the ABB Drives profile and DCU Profile

The ABB Drives profile supports the use of two fieldbus actual values, ACT1 and ACT2. The actual values are 16-bit words each containing a sign bit and a 15-bit integer. A negative value is formed by calculating the two's complement from the corresponding positive value.

The actual values are scaled as defined by parameters [46.01...46.04](#); which scaling is in use depends on the setting of parameters [58.28 EFB act1 type](#) and [58.29 EFB act2 type](#) (see page [308](#)).

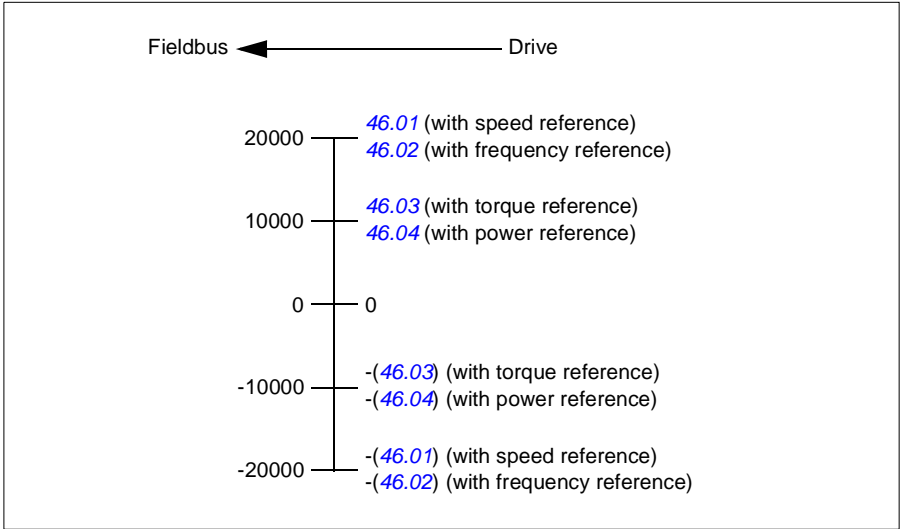

**Modbus holding register addresses**

**Modbus holding register addresses for the ABB Drives profile and DCU Profile**

The table below shows the default Modbus holding register addresses for the drive data with the ABB Drives profile. This profile provides a converted 16-bit access to the drive data.

**Note:** Only the 16 least significant bits of the drive’s 32-bit Control and Status Words can be accessed.

**Note:** Bits 16 through 32 of the DCU Control/Status word are not in use if 16-bit control/status word is used with the DCU Profile.

Register address	Register data (16-bit words)
400001	Default: Control word ( <i>CW 16bit</i> ). See sections <i>Control Word for the ABB Drives profile</i> (page 426) and <i>Control Word for the DCU Profile</i> (page 427). The selection can be changed using parameter <i>58.101 Data I/O 1</i> .
400002	Default: Reference 1 ( <i>Ref1 16bit</i> ). The selection can be changed using parameter <i>58.102 Data I/O 2</i> .
400003	Default: Reference 2 ( <i>Ref2 16bit</i> ). The selection can be changed using parameter <i>58.102 Data I/O 2</i> .
400004	Default: Status Word ( <i>SW 16bit</i> ). See sections <i>Status Word for the ABB Drives profile</i> (page 429) and <i>Status Word for the DCU Profile</i> (page 430). The selection can be changed using parameter <i>58.102 Data I/O 2</i> .

400005	Default: Actual value 1 ( <i>Act1 16bit</i> ). The selection can be changed using parameter <i>58.105 Data I/O 5</i> .
400006	Actual value 2 ( <i>Act2 16bit</i> ). The selection can be changed using parameter <i>58.106 Data I/O 6</i> .
400007...400014	Data in/out 7...14. Selected by parameters <i>58.107 Data I/O 7 ... 58.114 Data I/O 14</i> .
400015...400089	Unused
400090...400100	Error code access. See section <i>Error code registers (holding registers 400090...400100)</i> (page 440).
400101...465536	Parameter read/write. Parameters are mapped to register addresses according to parameter <i>58.33 Addressing mode</i> .

### Modbus function codes

The table below shows the Modbus function codes supported by the embedded fieldbus interface.

Code	Function name	Description
01h	Read Coils	Reads the 0/1 status of coils (0X references).
02h	Read Discrete Inputs	Reads the 0/1 status of discrete inputs (1X references).
03h	Read Holding Registers	Reads the binary contents of holding registers (4X references).
05h	Write Single Coil	Forces a single coil (0X reference) to 0 or 1.
06h	Write Single Register	Writes a single holding register (4X reference).
08h	Diagnostics	Provides a series of tests for checking the communication, or for checking various internal error conditions. Supported subcodes: <ul style="list-style-type: none"> <li>• 00h Return Query Data: Echo/loopback test.</li> <li>• 01h Restart Comm Option: Restarts and initializes the EFB, clears communications event counters.</li> <li>• 04h Force Listen Only Mode</li> <li>• 0Ah Clear Counters and Diagnostic Register</li> <li>• 0Bh Return Bus Message Count</li> <li>• 0Ch Return Bus Comm. Error Count</li> <li>• 0Dh Return Bus Exception Error Count</li> <li>• 0Eh Return Slave Message Count</li> <li>• 0Fh Return Slave No Response Count</li> <li>• 10h Return Slave NAK (negative acknowledge) Count</li> <li>• 11h Return Slave Busy Count</li> <li>• 12h Return Bus Character Overrun Count</li> <li>• 14h Clear Overrun Counter and Flag</li> </ul>

Code	Function name	Description
0Bh	Get Comm Event Counter	Returns a status word and an event count.
0Fh	Write Multiple Coils	Forces a sequence of coils (0X references) to 0 or 1.
10h	Write Multiple Registers	Writes the contents of a contiguous block of holding registers (4X references).
16h	Mask Write Register	Modifies the contents of a 4X register using a combination of an AND mask, an OR mask, and the register's current contents.
17h	Read/Write Multiple Registers	Writes the contents of a contiguous block of 4X registers, then reads the contents of another group of registers (the same or different than those written) in a server device.
2Bh / 0Eh	Encapsulated Interface Transport	Supported subcodes: <ul style="list-style-type: none"> <li>• 0Eh Read Device Identification: Allows reading the identification and other information.</li> </ul> Supported ID codes (access type): <ul style="list-style-type: none"> <li>• 00h: Request to get the basic device identification (stream access)</li> <li>• 04h: Request to get one specific identification object (individual access)</li> </ul> Supported Object IDs: <ul style="list-style-type: none"> <li>• 00h: Vendor Name ("ABB")</li> <li>• 01h: Product Code (for example, "ASCCL")</li> <li>• 02h: Major Minor Revision (combination of contents of parameters <a href="#">07.05 Firmware version</a> and <a href="#">58.02 Protocol ID</a>).</li> <li>• 03h: Vendor URL ("www.abb.com")</li> <li>• 04h: Product name: ("ACS380").</li> </ul>

### Exception codes

The table below shows the Modbus exception codes supported by the embedded fieldbus interface.

Code	Name	Description
01h	ILLEGAL FUNCTION	The function code received in the query is not an allowable action for the server.
02h	ILLEGAL ADDRESS	The data address received in the query is not an allowable address for the server.
03h	ILLEGAL VALUE	The requested quantity of registers is larger than the device can handle. This error does not mean that a value written to the device is outside of the valid range.
04h	DEVICE FAILURE	An unrecoverable error occurred while the server was attempting to perform the requested action. See section <a href="#">Error code registers (holding registers 400090...400100)</a> on page 440.

**Coils (0xxxx reference set)**

Coils are 1-bit read/write values. Control Word bits are exposed with this data type. The table below summarizes the Modbus coils (0xxxx reference set). Note that the references are 1-based index which match the address transmitted on the wire.

Reference	ABB Drives profile	DCU Profile
000001	OFF1_CONTROL	STOP
000002	OFF2_CONTROL	START
000003	OFF3_CONTROL	Reserved
000004	INHIBIT_OPERATION	Reserved
000005	RAMP_OUT_ZERO	RESET
000006	RAMP_HOLD	EXT2
000007	RAMP_IN_ZERO	RUN_DISABLE
000008	RESET	STOPMODE_RAMP
000009	JOGGING_1	STOPMODE_EMERGENCY_RAMP
000010	JOGGING_2	STOPMODE_COAST
000011	REMOTE_CMD	Reserved
000012	EXT_CTRL_LOC	RAMP_OUT_ZERO
000013	USER_0	RAMP_HOLD
000014	USER_1	RAMP_IN_ZERO
000015	USER_2	Reserved
000016	USER_3	Reserved
000017	Reserved	FB_LOCAL_CTL
000018	Reserved	FB_LOCAL_REF
000019	Reserved	Reserved
000020	Reserved	Reserved
000021	Reserved	Reserved
000022	Reserved	Reserved
000023	Reserved	USER_0
000024	Reserved	USER_1
000025	Reserved	USER_2
000026	Reserved	USER_3
000027	Reserved	Reserved
000028	Reserved	Reserved
000029	Reserved	Reserved
000030	Reserved	Reserved
000031	Reserved	Reserved
000032	Reserved	Reserved

Reference	ABB Drives profile	DCU Profile
000033	Control for relay output RO1 (parameter <a href="#">10.99 RO/DIO control word</a> , bit 0)	Control for relay output RO1 (parameter <a href="#">10.99 RO/DIO control word</a> , bit 0)
000034	Control for relay output RO2 (parameter <a href="#">10.99 RO/DIO control word</a> , bit 1)	Control for relay output RO2 (parameter <a href="#">10.99 RO/DIO control word</a> , bit 1)
000035	Control for relay output RO3 (parameter <a href="#">10.99 RO/DIO control word</a> , bit 2)	Control for relay output RO3 (parameter <a href="#">10.99 RO/DIO control word</a> , bit 2)
000036	Control for relay output RO4 (parameter <a href="#">10.99 RO/DIO control word</a> , bit 3)	Control for relay output RO4 (parameter <a href="#">10.99 RO/DIO control word</a> , bit 3)
000037	Control for relay output RO5 (parameter <a href="#">10.99 RO/DIO control word</a> , bit 4)	Control for relay output RO5 (parameter <a href="#">10.99 RO/DIO control word</a> , bit 4)

### Discrete inputs (1xxxx reference set)

Discrete inputs are 1-bit read-only values. Status Word bits are exposed with this data type. The table below summarizes the Modbus discrete inputs (1xxxx reference set). Note that the references are 1-based index which match the address transmitted on the wire.

Reference	ABB Drives profile	DCU Profile
0	RDY_ON	READY
1	RDY_RUN	ENABLED
2	RDY_REF	Reserved
3	TRIPPED	RUNNING
4	OFF_2_STATUS	ZERO_SPEED
5	OFF_3_STATUS	Reserved
6	SWC_ON_INHIB	Reserved
7	ALARM	AT_SETPOINT
8	AT_SETPOINT	LIMIT
9	REMOTE	SUPERVISION
10	ABOVE_LIMIT	Reserved
11	USER_0	Reserved
12	USER_1	PANEL_LOCAL
13	USER_2	FIELDBUS_LOCAL
14	USER_3	EXT2_ACT
15	Reserved	FAULT
16	Reserved	ALARM
17	Reserved	Reserved
18	Reserved	Reserved

Reference	ABB Drives profile	DCU Profile
19	Reserved	Reserved
20	Reserved	Reserved
21	Reserved	Reserved
22	Reserved	USER_0
23	Reserved	USER_1
24	Reserved	USER_2
25	Reserved	USER_3
26	Reserved	REQ_CTL
27	Reserved	Reserved
28	Reserved	Reserved
29	Reserved	Reserved
30	Reserved	Reserved
31	Reserved	Reserved
32	Delayed status of digital input DI1 (parameter <a href="#">10.02 DI delayed status</a> , bit 0)	Delayed status of digital input DI1 (parameter <a href="#">10.02 DI delayed status</a> , bit 0)
33	Delayed status of digital input DI2 (parameter <a href="#">10.02 DI delayed status</a> , bit 1)	Delayed status of digital input DI2 (parameter <a href="#">10.02 DI delayed status</a> , bit 1)
34	Delayed status of digital input DI3 (parameter <a href="#">10.02 DI delayed status</a> , bit 2)	Delayed status of digital input DI3 (parameter <a href="#">10.02 DI delayed status</a> , bit 2)
35	Delayed status of digital input DI4 (parameter <a href="#">10.02 DI delayed status</a> , bit 3)	Delayed status of digital input DI4 (parameter <a href="#">10.02 DI delayed status</a> , bit 3)
36	Delayed status of digital input DIO1 (parameter <a href="#">11.02 DIO delayed status</a> , bit 4)	Delayed status of digital input DIO1 (parameter <a href="#">11.02 DIO delayed status</a> , bit 4)
37	Delayed status of digital input DIO2 (parameter <a href="#">11.02 DIO delayed status</a> , bit 5)	Delayed status of digital input DIO2 (parameter <a href="#">11.02 DIO delayed status</a> , bit 5)

### Error code registers (holding registers 400090...400100)

These registers contain information about the last query. The error register is cleared when a query has finished successfully.

Reference	Name	Description
89	Reset Error Registers	1 = Reset internal error registers (91...95). 0 = Do nothing.
90	Error Function Code	Function code of the failed query.



Reference	Name	Description
91	Error Code	Set when exception code 04h is generated (see table above). <ul style="list-style-type: none"> <li>• 00h No error</li> <li>• 02h Low/High limit exceeded</li> <li>• 03h Faulty Index: Unavailable index of an array parameter</li> <li>• 05h Incorrect Data Type: Value does not match the data type of the parameter</li> <li>• 65h General Error: Undefined error when handling query</li> </ul>
92	Failed Register	The last register (discrete input, coil, input register or holding register) that failed to be read or written.
93	Last Register Written Successfully	The last register (discrete input, coil, input register or holding register) that was written successfully.
94	Last Register Read Successfully	The last register (discrete input, coil, input register or holding register) that was read successfully.

### ■ CANopen

Embedded fieldbus with CANopen protocol is for the following instrument:

- Configured variant (ACS380-04xC) with the BCAN-11 CANopen extension module (option+K495).

The embedded CANopen operates on multiple time levels. High priority cyclical data (control word, references, status word and actual values), and most of CANopen message handling are processed at 2ms time level. SDO messages and drive parameter access are processed at 10ms time level. Saving objects into non-volatile memory and restoring objects from non-volatile memory are processed in the background task.

The drive can be set to receive all of its control information through the fieldbus interface, or the control can be distributed between the embedded fieldbus interface and other available sources, for example, digital and analog inputs.

### Connecting the fieldbus to the drive

Connect the fieldbus to terminal X1 on the BCAN-11, which is attached to the control unit of the drive.

The pins in the connector are identified on the BCAN-11 sticker.

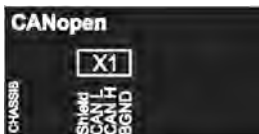

**Note:** When taking the CANopen module into use, it is recommended that the cord is not connected during the first start. This is to avoid disturbing the CAN bus when the drive attempts to recognize the attached module.

**CANopen network example**

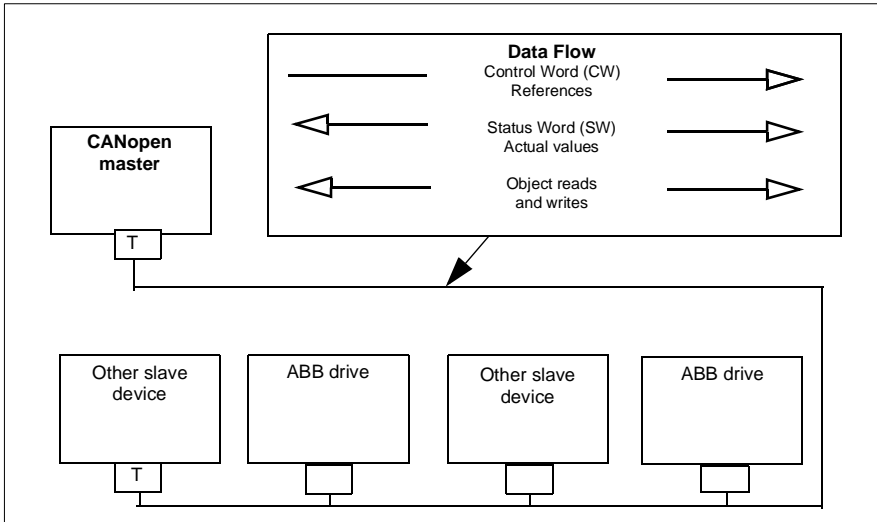

**Setting up the embedded fieldbus interface (CANopen)**

Set up the drive automatically

1. Power up the drive.  
The software recognizes the CANopen interface module that is connected to the drive. The software checks that the CANopen adapter is attached.
2. Press OK. The parameters listed in the table [CANopen parameters](#) are automatically set.

*CANopen parameters*

Parameter	Setting
20.01 Ext1 commands	Embedded fieldbus
20.03 Ext1 in1	Not selected
20.04 Ext1 in2	Not selected
22.11 Ext1 speed ref1	EFB ref1
22.22 Constant speed sel1	Not selected
22.23 Constant speed sel2	Not selected
23.11 Ramp set selection	Acc/Dec time 1
28.11 Ext1 frequency ref1	EFB ref1
28.22 Constant frequency sel1	Not selected

Parameter	Setting
28.23 Constant frequency sel2	Not selected
28.71 Freq ramp set sel	Acc/Dec time 1
31.11 Fault reset selection	DI1
58.01 Protocol enable	CANopen

Set up the drive manually.

1. Power up the drive.

The software recognizes the CANopen interface module that is connected to the drive. The software checks that the CANopen adapter is attached.

2. Do not press OK. Set up the parameters listed in the table [CANopen parameters](#).
3. Set up the drive for the embedded fieldbus communication with the parameters shown in the table below ([CANopen parameter settings for embedded fieldbus interface](#)).

The *Setting for fieldbus control* column shows either the value to use, or the default value. The *Function/Information* column describes the parameter.

**Note:** The CANopen module must be connected to the drive for the CANopen parameters to be visible (58.01 = [3] CANopen).

#### *CANopen parameter settings for embedded fieldbus interface*

Parameter	Setting for fieldbus control	Function/Information
COMMUNICATION INITIALIZATION		
58.01 <i>Protocol enable</i>	<i>CANopen</i>	Initializes embedded fieldbus communication.
EMBEDDED MODBUS CONFIGURATION		
58.03 <i>Node ID</i>	3 (default)	Node address. There must be no two nodes with the same node address online.
58.04 <i>Baud rate</i>	125 kbps (default)	Defines the communication speed of the link. Use the same setting as in the master station.
58.14 <i>Communication loss action</i>	<i>Fault</i> (default)	Defines the action taken when a communication loss is detected.
58.23 <i>Configuration location</i>	CAN objects	Bus: PDOs are configured by the fieldbus master with SDO. Drive parameters: PDO configuration is determined by drive parameters 58.76, 58.93, and 58.101...58.124.
58.25 <i>Control profile</i>	CiA 402 (default)	Selects the control profile used by the drive. See section Basics of the user interface.

Parameter	Setting for fieldbus control	Function/Information
<p>58.26 <i>EFB ref1 type</i> 58.27 <i>EFB ref2 type</i></p>	<p><i>Speed or frequency</i> (default for 58.26), <i>Transparent, General, Torque</i> (default for 58.27), <i>Speed, Frequency</i></p>	<p>Defines the types of fieldbus references 1 and 2. The scaling for each reference type is defined by parameters 46.01...46.03. With the <i>Speed or frequency</i> setting, the type is selected automatically according to the currently active drive control mode.</p>
<p>58.28 <i>EFB act1 type</i> 58.29 <i>EFB act2 type</i></p>	<p><i>Speed or frequency</i> (default for 58.28), <i>Transparent</i> (default for 58.29), <i>General, Torque, Speed, Frequency</i></p>	<p>Defines the types of actual values 1 and 2. The scaling for each actual value type is defined by parameters 46.01...46.03. With the <i>Speed or frequency</i> setting, the type is selected automatically according to the currently active drive control mode.</p>
<p>58.76 <i>RPDO1 COB-ID</i> 58.82 <i>RPDO6 COB-ID</i> 58.88 <i>RPDO21 COB-ID</i></p>	<p>1 (default) for 58.76), 0 (default for 58.82 and 58.88)</p>	<p>Defines the COB-ID for the PDO and also enables or disables it. 0= Disable this PDO 1= Enable this PDO with default COB-ID other= Enable this PDO with given (COB-ID)</p>
<p>58.77 <i>RPDO1 transmission type</i> 58.83 <i>RPDO6 transmission type</i> 58.89 <i>RPDO21 transmission type</i></p>	<p>255 (default)</p>	<p>Defines the transmission type of the PDO. 0 = acyclic synchronous 1...240 = cyclic synchronous 254...255 = asynchronous</p>
<p>58.78 <i>RPDO1 event timer</i> 58.84 <i>RPDO6 event timer</i> 58.90 <i>RPDO21 event timer</i></p>	<p>0 (default)</p>	<p>Defines the time-out time for the PDO. 0 = no timeout other = if this PDO is enabled and not received for event timer milliseconds, 58.14 Communication loss action is performed Note: The timeout supervision is activated upon a successful reception of the RPDO.</p>
<p>58.79 <i>TPDO1 COB-ID</i> 58.85 <i>TPDO6 COB-ID</i> 58.91 <i>RPDO21 COB-ID</i></p>	<p>1 (default for 58.79), 0 (default for 58.85 and 58.91)</p>	<p>Defines the COB-ID for the PDO and also enables or disables it. 0 = Disable this PDO 1 = Enable this PDO with default COB-ID other = Enable this PDO with given COB-ID</p>

Parameter	Setting for fieldbus control	Function/Information
<a href="#">58.80 TPDO1 transmission type</a> <a href="#">58.86 TPDO6 transmission type</a> <a href="#">58.92 TPDO21 transmission type</a>	255 (default)	Defines the transmission type of the PDO. 0 = acyclic synchronous 1...240 = cyclic synchronous 252 = synchronous RTR only 253 = asynchronous RTR only 254...255 = asynchronous
<a href="#">58.81 TPDO1 event timer</a> <a href="#">58.87 TPDO6 event timer</a> <a href="#">58.93 TPDO21 event timer</a>	100 (default for <a href="#">58.81</a> ) 0 (default for <a href="#">58.87</a> , <a href="#">58.93</a> )	Defines the time-out time for the PDO. 0 = no timeout other = if this PDO is enabled and has not been transmitted for event timer milliseconds, a transmission is forced
<a href="#">58.101 TPDO1 word 1</a> ... .. <a href="#">58.114 RPDO21 word 4</a>	With the default settings, TPDO1 contains 16-bit status word and two 16-bit actual values and RPDO1 contains 16-bit control word and two 16-bit reference values.	Defines the objects mapped to PDOs to and from the drive.
<a href="#">58.06 Communication control</a>	<a href="#">Refresh settings</a>	Validates the settings of the configuration parameters.

The new settings will take effect when the drive is powered up the next time, or when they are validated by parameter [58.06 Communication control \(Refresh settings\)](#).

### Setting the drive control parameters

After the embedded fieldbus interface has been set up, check and adjust the drive control parameters listed in the table below. The **Setting for fieldbus control** column gives the value or values to use when the embedded fieldbus signal is the desired source or destination for that particular drive control signal. The **Function/Information** column gives a description of the parameter.

Parameter	Setting for fieldbus control	Function/Information
CONTROL COMMAND SOURCE SELECTION		
<a href="#">20.01 Ext1 commands</a>	<a href="#">Embedded fieldbus</a>	Selects fieldbus as the source for the start and stop commands when EXT1 is selected as the active control location.
<a href="#">20.02 Ext2 commands</a>	<a href="#">Embedded fieldbus</a>	Selects fieldbus as the source for the start and stop commands when EXT2 is selected as the active control location.

Parameter	Setting for fieldbus control	Function/Information
<b>SPEED REFERENCE SELECTION</b>		
<a href="#">22.11 Ext1 speed ref1</a>	<a href="#">EFB ref1</a>	Selects a reference received through the embedded fieldbus interface as speed reference 1.
<a href="#">22.18 Ext2 speed ref1</a>	<a href="#">EFB ref1</a>	Selects a reference received through the embedded fieldbus interface as speed reference 2.
<b>TORQUE REFERENCE SELECTION</b>		
<a href="#">26.11 Torque ref1 source</a>	<a href="#">EFB ref1</a>	Selects a reference received through the embedded fieldbus interface as torque reference 1.
<a href="#">26.12 Torque ref2 source</a>	<a href="#">EFB ref1</a>	Selects a reference received through the embedded fieldbus interface as torque reference 2.
<b>FREQUENCY REFERENCE SELECTION</b>		
<a href="#">28.11 Ext1 frequency ref1</a>	<a href="#">EFB ref1</a>	Selects a reference received through the embedded fieldbus interface as frequency reference 1.
<a href="#">28.15 Ext2 frequency ref1</a>	<a href="#">EFB ref1</a>	Selects a reference received through the embedded fieldbus interface as frequency reference 2.
<b>OTHER SELECTIONS</b>		
EFB references can be selected as the source at virtually any signal selector parameter by selecting <i>Other</i> , then either <a href="#">03.09 EFB reference 1</a> or <a href="#">03.10 EFB reference 2</a> .		
<b>SYSTEM CONTROL INPUTS</b>		
<a href="#">96.07 Parameter save manually</a>	<a href="#">Save</a> (reverts to <a href="#">Done</a> )	Saves parameter value changes (including those made through fieldbus control) to permanent memory.

### Basics of the embedded fieldbus interface

The cyclic communication between a fieldbus system and the drive consists of 16-bit data words or 32-bit data words. The diagram below illustrates the operation of the CANopen embedded fieldbus interface. The signals transferred in the cyclic communication are explained further below the diagram.

CANopen embedded fieldbus interface operation

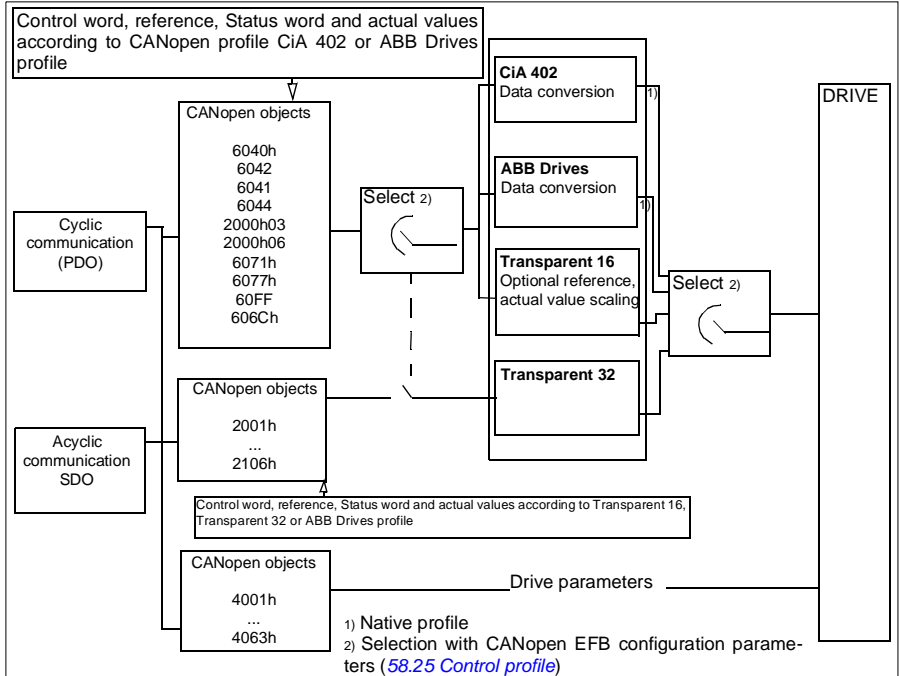

**Control word and Status word**

The Control Word (CW) is a 16-bit or 32-bit packed boolean word. It is the principal means of controlling the drive from a fieldbus system. The CW is sent by the fieldbus controller to the drive. With drive parameters, the user selects the EFB CW as the source of drive control commands (such as start/stop, emergency stop, selection between external control locations 1/2, or fault reset). The drive switches between its states according to the bit-coded instructions of the CW. The fieldbus CW is either written to the drive as it is or the data is converted. See section [About the control profiles](#) on page 425.

The fieldbus Status Word (SW) is a 16-bit or 32-bit packed boolean word. It contains status information from the drive to the fieldbus controller. The drive SW is either written to the fieldbus SW as it is or the data is converted. See section [About the control profiles](#) on page 425.

**References**

EFB references 1 and 2 are 16-bit or 32-bit signed integers. The contents of each reference word can be used as the source of virtually any signal, such as the speed, frequency, torque or process reference. In embedded fieldbus communication, references 1 and 2 are displayed by [03.09 EFB reference 1](#) and [03.10 EFB reference 2](#) respectively. Whether the references are scaled or not depends on the settings of

[58.26 EFB ref1 type](#) and [58.27 EFB ref2 type](#). See section [About the control profiles](#) on page [425](#).

### Actual values

Fieldbus actual signals (ACT1 and ACT2) are 16-bit or 32-bit signed integers. They convey selected drive parameter values from the drive to the master. Whether the actual values are scaled or not depends on the settings of [58.28 EFB act1 type](#) and [58.29 EFB act2 type](#). See section [About the control profiles](#) on page [425](#).

### About the control profiles

A control profile defines the rules for data transfer between the drive and the fieldbus master, for example:

- if control word and status word are converted and how
- if signal values are scaled and how
- functionality and content of certain objects in section [Object dictionary](#) on page [465](#).

You can configure the drive to receive and send messages according to one of the four profiles:

- CiA 402
- ABB Drives
- Transparent 16
- Transparent 32

For the ABB Drives and CiA 402 profiles, the embedded fieldbus interface of the drive converts the fieldbus data to and from the native data used in the drive. The Transparent profiles perform no data conversion, but the Transparent 16 profile may optionally scale the reference and actual values with a configured scaling value ([58.24 Transparent 16 scale](#)).

### CiA 402 profile

Control Word for the CiA 402 profile

Control word of the CiA 402 profile can be written to the object 6040h.

The table below shows the contents of the fieldbus Control Word for the CiA 402 control profile. The embedded fieldbus interface converts this word to the form in which it is used in the drive.

Bit	Name
0	Switch on
1	Enable voltage
2	Quick stop
3	Enable operation
4...6	Operation -mode specific

---



Bit	Name
7	Fault reset
8	Halt
9...10	Reserved
11...15	Drive specific

Operation mode specific bits

Bit	Velocity mode	Profile velocity mode	Profile torque
4	Ramp function generator enable	Reserved	Reserved
5	Ramp function generator unlock	Reserved	Reserved
6	Ramp function generator use ref	Reserved	Reserved

Device commands are triggered by the Control word bits as follows:

Command	Control word bit 1)					
	Fault reset, bit 7	Enable operation, bit 3	Quick stop, bit 2	Enable voltage, bit 1	Switch on, bit 0	State transitions
Shut down	0	x	1	1	0	2,6,8
Switch on	0	0	1	1	1	3 2)
Switch on	0	1	1	1	1	3 2)
Disable voltage	0	x	x	0	x	7,9,10,12
Quick stop	0	x	0	1	x	7,10,11
Disable operation	0	0	1	1	1	5
Enable operation	0	1	1	1	1	4
Fault reset	0=>1	x	x	x	x	15

1) Bits marked as x are irrelevant

2) When Control word bit 3 (Enable operation) is 1, the drive does not perform any tasks in the *Switched on* state. When bit 3 is 0, the state *Switched on* tasks are performed.

The states and state transitions refer to those shown in the [State transition diagram for the CiA 402 profile](#) on page 452.

The following stop modes are associated with the control commands and other events:

Command/Event	Drive stop mode
Quick stop	Emergency stop
Shut down	Coast stop
Disable voltage	Ramp stop
Halt	Ramp stop (configurable with CANopen object 605Dh)

Command/Event	Drive stop mode
Fault	Fault reaction specified by the drive. Typically a Coast stop.

The halt mode is controlled with bit 8 of the CiA 402 control word. When the halt bit is set during the OPERATION ENABLED state, the drive stops and the state machine remains in the OPERATION ENABLED state. When the bit is reset, the drive starts running again. In all modes supporting the halt function, CiA 402 Status Word bit 10 (target reached) is set when the drive is stopped.

**Note:** The drive may not necessarily stop completely as it is still in the running (OPERATION ENABLED) state.

The following table summarizes the drive features used to perform the ramp stop during the halt function, as well as the different halt option codes supported by each CiA 402 operating mode. The halt option code is selected by CANopen object 605Dh.

Mode	Description	Halt option codes
Profile velocity	Dynamic limiter ramp	1
Profile torque	Sets the torque reference to 0. Ramp depends on the drive parameters	1
Velocity	Halt mode1: Ramp input is set to 0. Halt mode 2,3,4: Ramp output is set to 0.	1, 2, 3, 4
Other modes	Halt bit has no effect.	N/A

### Status Word for the CiA 402 profile

Status word of the CiA 402 profile can be read from the object 6041h. The table below shows the fieldbus Status Word for the CiA 402 control profile. The embedded fieldbus interface converts the drive Status Word into this form for the fieldbus.

Bit	Name
0	Ready to switch on
1	Switched on
2	Operation enabled
3	Fault
4	Voltage enabled
5	Quick stop
6	Switch on disabled
7	Warning
8	Drive-specific bit
9	Remote
10	Target reached
11	Internal limit active
12...13	Operation mode specific
14...15	Drive specific

Operation mode specific bits:

Bit	Velocity mode	Profile velocity mode	Profile torque mode
12	Reserved	Speed is zero	Reserved
13	Reserved	Max slippage reached	Reserved

### Modes of operation

The operation mode defines the behavior of the drive. The following CiA 402 operation modes are supported:

- Profile velocity mode
- Profile torque mode
- Velocity mode
- Cyclic synchronous velocity mode
- Cyclic synchronous torque mode

The ACS380 CANopen implementation supports minimal implementation of the operation modes. In this chapter scalings of the reference and actual values are described for each operation mode. Operation-mode-specific objects are defined in section [Object dictionary](#) on page [465](#).

The mode of operation is automatically selected to be either velocity mode or profile torque mode according to the control mode configured with parameter [19.12 Ext1 control mode](#) or [19.14 Ext2 control mode](#) (depending on the current control location). The correct reference scaling must be selected with parameters [58.26 EFB ref1 type](#) and [58.27 EFB ref2 type](#). When in Velocity mode, the drive can be switched to Profile velocity mode or Cyclic synchronous velocity mode with the object 6060h. When in Profile torque mode, the drive can be switched to Cyclic synchronous torque mode with the object 6060h.

### Velocity mode

Velocity mode is a basic mode to control the velocity of the drive with limits and ramp functions. Target velocity is set with the object 6042h and velocity actual value can be read from the object 6044h. Velocity values are scaled with the dimension factor given in object 604Ch. By default the dimension factor is 1, and the velocity values are given in rpm, e.g. 1 = 1 rpm.

### Profile velocity mode

The profile velocity mode is used to control the velocity of the drive with no special regard of the position. Target velocity is set with the object 60FFh and the velocity actual value can be read from the object 606Ch. Velocity values are given in increments per second. Increment resolution is defined by the object 608Fh. The default values in object 608Fh are 65536 increments per 1 revolution. This means that 1 rpm equals 1 [rpm] \* 65536 [inc/s] / 60 [s/min] = 1092 inc/s.

### **Cyclic synchronous velocity mode**

In cyclic synchronous velocity mode, the trajectory generator is in the control device and not in the drive. The control device delivers a new target velocity value to the drive periodically at a fixed interval. Target velocity is set with the object 60FFh and the velocity actual value can be read from the object 606Ch. Velocity values are given in increments per second. Increment resolution is defined by the object 608Fh. The default values in object 608Fh are 65536 increments per 1 revolution. This means that 1 rpm equals  $1 \text{ [rpm]} * 65536 \text{ [inc/s]} / 60 \text{ [s/min]} = 1092 \text{ inc/s}$ .

### **Profile torque mode**

The profile torque mode enables the drive torque to be controlled directly. Target torque is set with the object 6071h and the torque actual value can be read from the object 6077h. Torque values are given in per thousand of the rated torque, e.g. 10 = 1%.

### **Cyclic synchronous torque mode**

In cyclic synchronous torque mode, the trajectory generator is in the control device and not in the drive. The control device delivers a new target torque value to the drive periodically at a fixed interval. Target torque is set with the object 6071h and the torque actual value can be read from the object 6077h. Torque values are given in per thousand of the rated torque, e.g. 10 = 1%.

### **State transition diagram for the CiA 402 profile**

The diagram below shows the state transitions in the drive when the drive is using the CiA 402 profile and the drive is configured to follow the commands of the control word from the embedded fieldbus interface.

---



**ABB drives profile**

Control Word for the ABB Drives profile

Control word of the ABB Drives profile can be written to the object 2101h, or alternatively to the object 6040h.

The table below shows the contents of the fieldbus Control Word for the ABB Drives control profile. The embedded fieldbus interface converts this word to the form in which it is used in the drive. The upper case boldface text refers to the states shown in [State transition diagram for the ABB Drives profile](#) on page 458.

Bit	Name	Value	State/Description
0	OFF1 CONTROL	1	Proceed to READY TO OPERATE.
		0	Stop along currently active deceleration ramp. Proceed to OFF1 ACTIVE; proceed to READY TO SWITCH ON unless other interlocks (OFF2, OFF3) are active.
1	OFF2 CONTROL	1	Continue operation (OFF2 inactive).
		0	Emergency OFF, coast to stop. Proceed to OFF2 ACTIVE, proceed to SWITCH ON INHIBITED.
2	OFF3 CONTROL	1	Continue operation (OFF3 inactive).
		0	Emergency stop. Emergency stop, stop within time defined by drive parameter. Proceed to OFF3 ACTIVE; proceed to SWITCH-ON INHIBITED.  <b>Warning:</b> Ensure that the motor and driven machine can be stopped using this stop mode.
3	INHIBIT OPERATION	1	Proceed to OPERATION ENABLED. <b>Note:</b> Run enable signal must be active; see the drive documentation. If the drive is set to receive the Run enable signal from the fieldbus, this bit activates the signal.
		0	Inhibit operation. Proceed to OPERATION INHIBITED.
4	RAMP OUT ZERO	1	Normal operation. Proceed to RAMP FUNCTION GENERATOR: OUTPUT ENABLED.
		0	Force Ramp Function Generator output to zero. Drive ramps to stop (current and DC voltage limits in force).
5	RAMP HOLD	1	Enable ramp function. Proceed to RAMP FUNCTION GENERATOR: ACCELERATOR ENABLED.
		0	Halt ramping (Ramp Function Generator output held).
6	RAMP IN ZERO	1	Proceed to <b>OPERATING</b> . <b>Note:</b> This bit is effective only if the fieldbus interface is set as the source for this signal by drive parameters.
		0	Force Ramp Function Generator input to zero.

Bit	Name	Value	State/Description
7	RESET	0=>1	Fault reset if an active fault exists. Proceed to <b>SWITCH-ON INHIBITED</b> . <b>Note:</b> This bit is effective only if the fieldbus interface is set as the source for this signal by drive parameters.
		0	No warning/alarm.
8	JOGGING 1	1	Request running at Jogging 1 speed. <b>Note:</b> This bit is effective only if the fieldbus interface is set as the source for this signal by drive parameters.
		0	Continue normal operation.
9	JOGGING 2	1	Request running at Jogging 2 speed. <b>Note:</b> This bit is effective only if the fieldbus interface is set as the source for this signal by drive parameters.
		0	Continue normal operation.
10	REMOTE CMD	1	Fieldbus control enabled.
		0	Control Word <> 0 or Reference <> 0: Retain last Control Word and Reference. Control Word = 0 and Reference = 0: Fieldbus control enabled. Reference and deceleration/acceleration ramp are locked.
11	EXT CTRL LOC	1	Select External Control Location EXT2. Effective if the control location is parameterized to be selected from the fieldbus.
		0	Select External Control Location EXT1. Effective if the control location is parameterized to be selected from the fieldbus.
12	USER_0		Writable control bits that can be combined with drive logic for application-specific functionality.
13	USER_1		
14	USER_2		
15	USER_3		

### Status Word for the ABB Drives profile

Status word of the ABB Drives profile can be read from the object 2104h, or alternatively from the object 6041h.

The table below shows the fieldbus Status Word for the ABB Drives control profile. The embedded fieldbus interface converts the drive Status Word into this form for the fieldbus. The upper case boldface text refers to the states shown in [State transition diagram for the ABB Drives profile](#) on page 431.

Bit	Name	Value	State/Description
0	RDY_ON	1	<b>READY TO SWITCH ON.</b>
		0	<b>NOT READY TO SWITCH ON.</b>
1	RDY_RUN	1	<b>READY TO OPERATE.</b>
		0	<b>OFF1 ACTIVE.</b>

Bit	Name	Value	State/Description
2	RDY_REF	1	<b>OPERATION ENABLED.</b>
		0	<b>OPERATION INHIBITED.</b>
3	TRIPPED	1	<b>FAULT.</b>
		0	No fault.
4	OFF_2_STATUS	1	OFF2 inactive.
		0	<b>OFF2 ACTIVE.</b>
5	OFF_3_STATUS	1	OFF3 inactive.
		0	<b>OFF3 ACTIVE.</b>
6	SWC_ON_INHIB	1	<b>SWITCH-ON INHIBITED.</b>
		0	–
7	ALARM	1	Warning/Alarm.
		0	No warning/alarm.
8	AT_SETPOINT	1	<b>OPERATING.</b> Actual value equals Reference (is within tolerance limits, e.g. in speed control, speed error is 10% max. of nominal motor speed).
		0	Actual value differs from Reference (is outside tolerance limits).
9	REMOTE	1	Drive control location: REMOTE (EXT1 or EXT2).
		0	Drive control location: LOCAL.
10	ABOVE_LIMIT	1	Actual frequency or speed equals or exceeds supervision limit (set by drive parameter). Valid in both directions of rotation.
		0	Actual frequency or speed within supervision limit.
11	USER_0		Status bits that can be combined with drive logic for application-specific functionality.
12	USER_1		
13	USER_2		
14	USER_3		
15	Reserved		

### References for the ABB Drives profile

The ABB Drives profile supports the use of two references, EFB reference 1 and EFB reference 2. The references are 16-bit signed integers.

The reference values can be written to the objects 2102h and 2103h, or alternatively to corresponding objects in the CiA 402 profile object area, see [Object dictionary](#) (p. 465).

The references are scaled as defined by parameters [46.01...46.04](#); which scaling is in use depends on the setting of [58.26 EFB ref1 type](#) and [58.27 EFB ref2 type](#) (see the table [CANopen parameter settings for embedded fieldbus interface](#)).



### ABB Drives profile scaling from fieldbus to drive

The scaled references are shown by parameters [03.09 EFB reference 2](#) and [03.10 EFB reference 2](#).

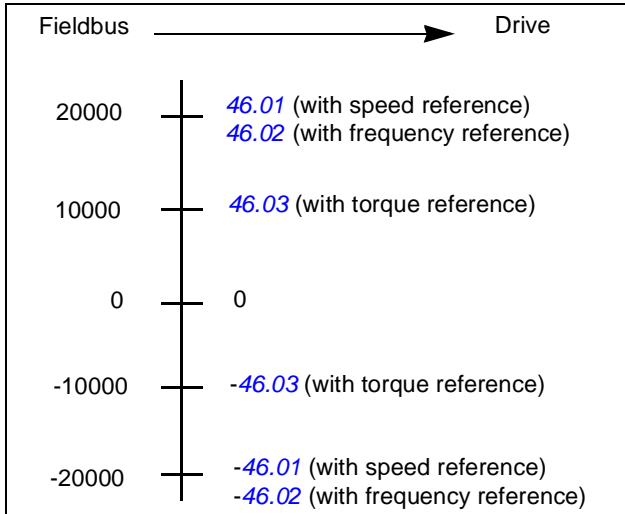

### Actual values for the ABB Drives profile

The ABB Drives profile supports the use of two fieldbus actual values, ACT1 and ACT2. The actual values are 16-bit words each containing a sign bit and a 15-bit integer. A negative value is formed by calculating the two's complement from the corresponding positive value.

The actual values can be read from the objects 2105h and 2106h, or alternatively from corresponding objects in the CiA 402 profile object area, see section [Object dictionary](#) on page [465](#).

The actual values are scaled as defined by parameters [46.01...46.04](#); which scaling is in use depends on the setting of parameters [58.28 EFB act1 type](#) and [58.29 EFB act2 type](#).

**ABB Drives profile scaling from drive to fieldbus**

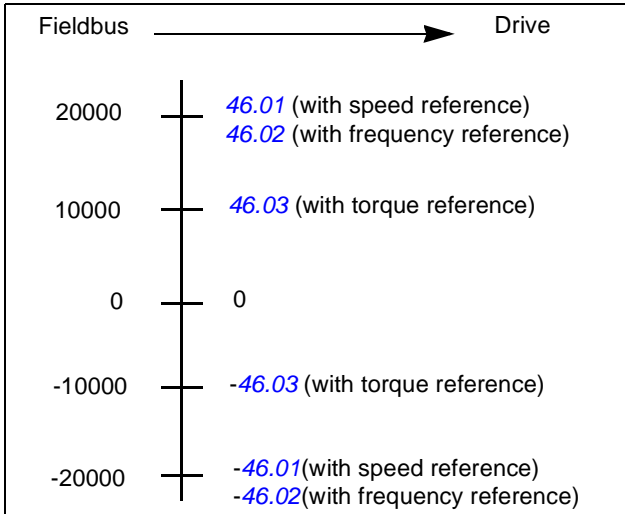

**State transition diagram for the ABB Drives profile**

The diagram below shows the state transitions in the drive when the drive is using the ABB Drives profile and the drive is configured to follow the commands of the control word from the embedded fieldbus interface. The upper case texts refer to the states which are used in the tables representing the fieldbus Control and Status words. See sections [Control Word for the ABB Drives profile](#) on page 426 and [Status Word for the ABB Drives profile](#) on page 429.

**ABB Drives profile state machine**

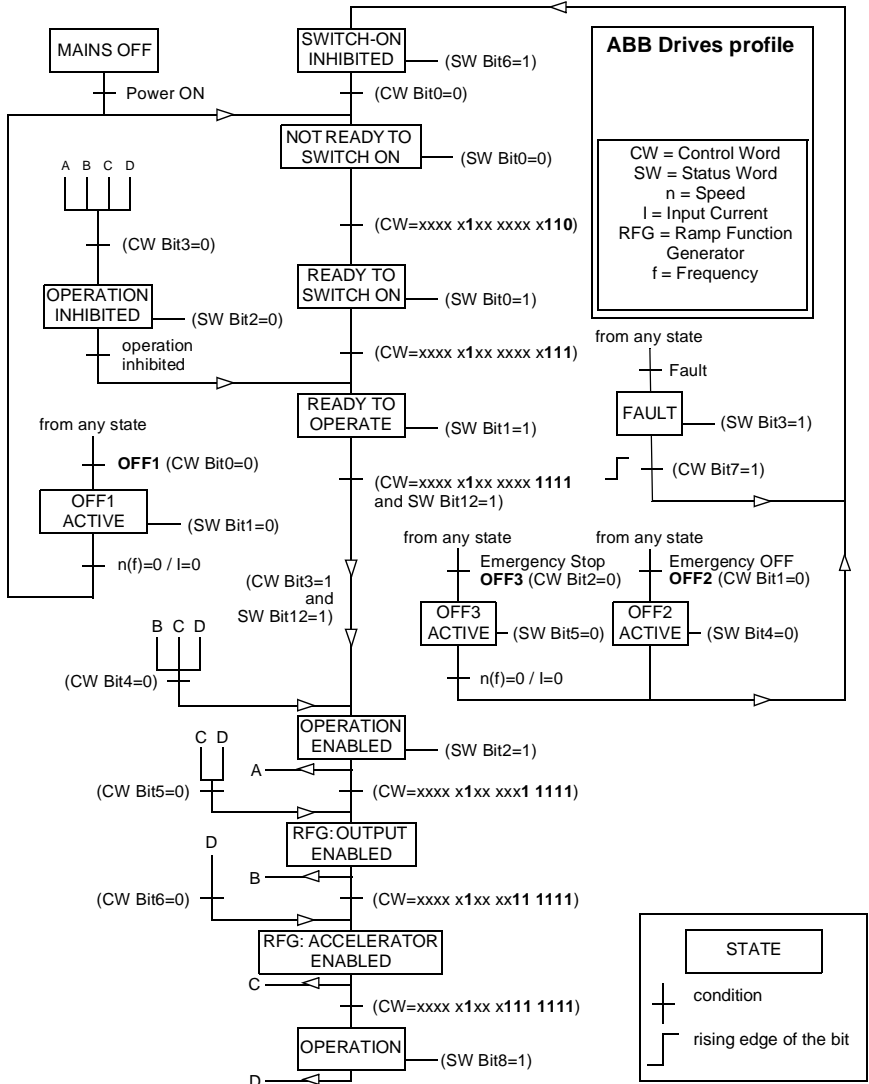

**Transparent 16 profile****Control Word for the Transparent 16 Profile**

Control word of the Transparent 16 profile can be written to the object 2051h. The embedded fieldbus interface writes the fieldbus Control Word as is to the drive.

Bit	Name	Value	State/Description
0	STOP	1	Stop according to the Stop Mode parameter or the stop mode request bits (bits 7...9).
		0	(no op)
1	START	1	Start the drive.
		0	(no op)
2	REVERSE	1	Reverse direction of motor rotation.
		0	(no op)
3	Reserved		
4	RESET	0=>1	Fault reset if an active fault exists.
		0	(no op)
5	EXT2	1	Select External control location EXT2. Effective if the control location is parameterized to be selected from the fieldbus.
		0	Select External control location EXT1. Effective if the control location is parameterized to be selected from the fieldbus.
6	RUN_DISABLE	1	Run disable. If the drive is set to receive the run enable signal from the fieldbus, this bit deactivates the signal.
		0	Run enable. If the drive is set to receive the run enable signal from the fieldbus, this bit activates the signal.
7	STOPMODE_RAMP	1	Normal ramp stop mode
		0	(no op) Default to parameter stop mode if bits 7...9 are all 0.
8	STOPMODE_EMERGENCY_RAMP	1	Emergency ramp stop mode.
		0	(no op) Default to parameter stop mode if bits 7...9 are all 0.
9	STOPMODE_COAST	1	Coast stop mode.
		0	(no op) Default to parameter stop mode if bits 7...9 are all 0.
10	Reserved for RAMP_PAIR_2		Not yet implemented.
11	RAMP_OUT_ZERO	1	Force Ramp Function Generator output to zero. Drive ramps to stop (current and DC voltage limits in force).
		0	Normal operation.
12	RAMP_HOLD	1	Halt ramping (Ramp Function Generator output held).
		0	Normal operation.

Bit	Name	Value	State/Description
13	RAMP_IN_ZERO	1	Force Ramp Function Generator input to zero.
		0	Normal operation.
14	REQ_LOCAL_LOCK	1	Not yet implemented.
		0	Not yet implemented.
15	Reserved for TORQ_LIM_PAIR_2		Not yet implemented.

### Status Word for the Transparent 16 Profile

Status word of the Transparent 16 profile can be read from the object 2054h.

Bit	Name	Value	State/Description
0	READY	1	Drive is ready to receive the start command.
		0	Drive is not ready.
1	ENABLED	1	External run enable signal is active.
		0	External run enable signal is not active.
2	Reserved for ENABLED_TO_ROTATE		Not yet implemented.
3	RUNNING	1	Drive is modulating.
		0	Drive is not modulating.
4	ZERO_SPEED	1	Drive is at zero speed.
		0	Drive is not at zero speed.
5	ACCELERATING	1	Not yet implemented.
		0	Not yet implemented.
6	DECELERATING	1	Not yet implemented.
		0	Not yet implemented.
7	AT_SETPOINT	1	Drive is at setpoint.
		0	Drive is not at setpoint.
8	LIMIT	1	Drive operation is limited.
		0	Drive operation is not limited.
9	SUPERVISION	1	Actual value (speed, frequency or torque) is above a limit. Limit is set with parameters 46.31...46.33
		0	Actual value (speed, frequency or torque) is within limits.
10	REVERSE_REF	1	Not yet implemented.
		0	Not yet implemented.
11	REVERSE_ACT	1	Not yet implemented.
		0	Not yet implemented.

Bit	Name	Value	State/Description
12	PANEL_LOCAL	1	Panel/keypad (or PC tool) is in local control mode.
		0	Panel/keypad (or PC tool) is not in local control mode.
13	FIELDBUS_LOCAL	1	Fieldbus is in local control mode.
		0	Fieldbus is not in local control mode.
14	EXT2_ACT	1	External control location EXT2 is active.
		0	External control location EXT1 is active.
15	FAULT	1	Drive is faulted.
		0	Drive is not faulted.
		0	No warning/alarm

### References for the Transparent 16 profile

The reference values can be written to the objects 2052h and 2053h. The references are scaled with the scaling value defined in [58.24 Transparent 16 scale](#).

### Actual values for the Transparent 16 profile

The actual values can be read from the objects 2055h and 2056h. The actual values are scaled with the scaling value defined in [58.24 Transparent 16 scale](#).

### Transparent 32 profile

#### Control Word for the Transparent 32 Profile

Control word of the Transparent 32 profile can be written to the object 2001h. The embedded fieldbus interface writes the fieldbus Control Word as is to the drive.

Bit	Name	Value	State/Description
0	STOP	1	Stop according to the Stop Mode parameter or the stop mode request bits (bits 7...9).
		0	(no op)
1	START	1	Start the drive.
		0	(no op)
2	REVERSE	1	Reverse direction of motor rotation.
		0	(no op)
3	Reserved		
4	RESET	0=>1	Fault reset if an active fault exists.
		0	(no op)
5	EXT2	1	Select External control location EXT2. Effective if the control location is parameterized to be selected from the fieldbus.
		0	Select External control location EXT1. Effective if the control location is parameterized to be selected from the fieldbus.

Bit	Name	Value	State/Description
6	RUN_DISABLE	1	Run disable. If the drive is set to receive the run enable signal from the fieldbus, this bit deactivates the signal.
		0	Run enable. If the drive is set to receive the run enable signal from the fieldbus, this bit activates the signal.
7	STOPMODE_RAMP	1	Normal ramp stop mode
		0	(no op) Default to parameter stop mode if bits 7...9 are all 0.
8	STOPMODE_EMERGENCY_RAMP	1	Emergency ramp stop mode.
		0	(no op) Default to parameter stop mode if bits 7...9 are all 0.
9	STOPMODE_COAST	1	Coast stop mode.
		0	(no op) Default to parameter stop mode if bits 7...9 are all 0.
10	Reserved for RAMP_PAIR_2		Not yet implemented.
11	RAMP_OUT_ZERO	1	Force Ramp Function Generator output to zero. Drive ramps to stop (current and DC voltage limits in force).
		0	Normal operation.
12	RAMP_HOLD	1	Halt ramping (Ramp Function Generator output held).
		0	Normal operation.
13	RAMP_IN_ZERO	1	Force Ramp Function Generator input to zero.
		0	Normal operation.
14	REQ_LOCAL_LOCK	1	Not yet implemented.
		0	Not yet implemented.
15	Reserved for TORQ_LIM_PAIR_2		Not yet implemented.
16	FB_LOCAL_CTL	1	Local mode for reference from the fieldbus is requested. Steal control from the active source.
		0	(no op)
17	FB_LOCAL_REF	1	Local mode for reference from the fieldbus is requested. Steal reference from the active source.
		0	(no op)
18	Reserved for RUN_DISABLE_1		Not yet implemented.
19	Reserved		
20	Reserved		
21	Reserved		
22	USER_0		Writable control bits that can be combined with drive logic for application-specific functionality.
23	USER_1		
24	USER_2		
25	USER_3		

Bit	Name	Value	State/Description
26... 31	Reserved		

### Status Word for the Transparent 32 Profile

Status word of the Transparent 32 profile can be read from the object 2004h.

Bit	Name	Value	State/Description
0	READY	1	Drive is ready to receive the start command.
		0	Drive is not ready.
1	ENABLED	1	External run enable signal is active.
		0	External run enable signal is not active.
2	Reserved for ENABLED_TO_R OTATE		Not yet implemented.
3	RUNNING	1	Drive is modulating.
		0	Drive is not modulating.
4	ZERO_SPEED	1	Drive is at zero speed.
		0	Drive is not at zero speed.
5	ACCELERATING	1	Not yet implemented.
		0	Not yet implemented.
6	DECELERATING	1	Not yet implemented.
		0	Not yet implemented.
7	AT_SETPOINT	1	Drive is at setpoint.
		0	Drive is not at setpoint.
8	LIMIT	1	Drive operation is limited.
		0	Drive operation is not limited.
9	SUPERVISION	1	Actual value (speed, frequency or torque) is above a limit. Limit is set with parameters 46.31...46.33
		0	Actual value (speed, frequency or torque) is within limits.
10	REVERSE_REF	1	Not yet implemented.
		0	Not yet implemented.
11	REVERSE_ACT	1	Not yet implemented.
		0	Not yet implemented.
12	PANEL_LOCAL	1	Panel/keypad (or PC tool) is in local control mode.
		0	Panel/keypad (or PC tool) is not in local control mode.
13	FIELDBUS_LOCAL	1	Fieldbus is in local control mode.
		0	Fieldbus is not in local control mode.



Bit	Name	Value	State/Description
14	EXT2_ACT	1	External control location EXT2 is active.
		0	External control location EXT1 is active.
15	FAULT	1	Drive is faulted.
		0	Drive is not faulted.
16	ALARM	1	Warning/Alarm is active.
		0	No warning/alarm.
17	Reserved		
18	Reserved for DIRECTION_LOCK		Not yet implemented.
19...21	Reserved		
22	USER_0		Status bits that can be combined with drive logic for application-specific functionality.
23	USER_1		
24	USER_2		
25	USER_3		
26	REQ_CTL		
26	REQ_CTL	1	Control is requested in this channel.
		0	Control is not requested in this channel.
27...31	Reserved		

### References for the Transparent 32 profile

The reference values can be written to the objects 2002h and 2003h.

### Actual values for the Transparent 32 profile

The actual values can be read from the objects 2005h and 2006h.

### Object dictionary

The Object dictionary consists of objects. Each object within the dictionary is addressed using a 16-bit index (hexadecimal values 0000h-FFFFh). The object addresses are divided in this manual into three categories:

1. *Communication profile area (1000...1FFF)*  
Lists the communication related objects.
2. *Manufacturer specific profile area (2000...5FFF)*  
Lists the manufacturer specific objects.
3. *Standardized profile area (6000...9FFF)*  
Lists the CiA standard profile objects.

**Communication profile area (1000...1FFF)**

Index	Sub-index	Name	Type	Access	Description
1000h	0	Device Type	U32	RO	The device type specifies the kind of device. The lower 16 bits contain the device profile number and the upper 16 bits additional information depending on the profile.
1001h	0	Error Register	U8	RO	The error register is a field of 8 bits, each for a certain error type. If an error occurs the bit is set. Bit Meaning 0 generic error, always set on error 1 current 2 voltage 3 temperature 4 communication error (overrun, error state) 5 device profile specific 6 reserved 7 manufacturer specific
1003h	0	Number of Errors	U8	RW	This object holds errors that have occurred on the device and have been signaled via Emergency Object. The most recent error is at sub-index 1. When a new error occurs, the previous errors move down the list. See <a href="#">Fault tracing</a> on page 389 for details on the meaning of error codes. Writing 0 to sub index 0 deletes the entire error history.  <b>NOTE:</b> Only sub-indices up to 1001h:0h (Number of Errors) can be read. E.g. if Number of Errors is 2, reading 1001h:2h is possible, but attempting to read 1001h:3h causes an SDO abort.
	1	Standard Error Field	U32	RO	
	2	Standard Error Field	U32	RO	
	3	Standard Error Field	U32	RO	
	4	Standard Error Field	U32	RO	
	5	Standard Error Field	U32	RO	
1005h	0	COB-ID Sync Message	U32	RW	
1008h	0	Manufacturer Device Name	Visible string	Const	Contains the device name.
1009h	0	Manufacturer Software Version	Visible string	RW	Contains the device software version.
100Ch	0	Guard Time	U6	RW	This entry contains the guard time in ms. The value 0 means, that the guard time is not used.
100Dh	0	Life Time Factor	U8	RW	The life time factor multiplied with the guard time gives the life time for the device. If it is 0, it is not used.

Index	Sub-index	Name	Type	Access	Description
1010h	0	Largest Subindex Supported	U8	RO	<p>This entry supports saving of parameters in non-volatile memory. With read access the device provides information about its saving capabilities. Several parameter groups are distinguished.</p> <p>Sub index 1: all parameters                      Sub index 2: communication parameters (1000h...1FFFh)                      Sub index 3: application parameters (6000h...9FFFh)                      Sub index 4: request drive to perform parameter save function                      For saving the signature 'save' (65766173h) must be written.</p>
	1	Save All Parameters	U32	RW	
	2	Save Communication parameters	U32	RW	
	3	Save Application parameters	U32	RW	
	4	Save Drive parameters	U32	RW	
1011h	0	Largest Subindex Supported	U8	RO	<p>This entry supports restoring of default parameters. With read access the device provides information about its capabilities to restore these values. Several parameter groups are distinguished.</p> <p>Sub index 1: all parameters                      Sub index 2: communication parameters (1000h...1FFFh)                      Sub index 3: application parameters (6000h...9FFFh)                      Sub index 4: request drive to perform parameter restore function                      For restoring, the signature 'load' (64616F6Ch) must be written.</p>
	1	Restore All Default Parameters	U32	RW	
	2	Restore Communication Default Parameters	U32	RW	
	3	Restore Application Default Parameters	U32	RW	
	4	Restore Drive Default Parameters	U32	RW	
1014h	0	COB-ID Emergency Message	U32	RW	COB-ID used for emergency message (Emergency Producer).
1016h	0	Number Of Entries	U8	RO	<p>The consumer heartbeat time defines the expected heartbeat cycle time and thus has to be higher than the corresponding producer heartbeat time configured on the device producing this heartbeat.</p> <p>The bits 31-24 of each sub-index have to be 0.                      The bits 23-16 contain the node-id.                      The lower 16 bits contain the heartbeat time</p>
	1	Consumer Heartbeat Time	U32	RW	

Index	Sub-index	Name	Type	Access	Description
1017h	0	Producer Heartbeat Time	U16	RW	The producer heartbeat time defines the cycle time of the heartbeat. If the time is 0 it is not used. The time has to be a multiple of 1 ms.
1018h	0	Number of Entries	U8	RO	This object contains general information about the device.
	1	Vendor ID	U32	RO	Sub-Index 1 contains the vendor ID (B7h = ABB)
	2	Product Code	U32	RO	Sub-Index 2 identifies the drive type.
	3	Module revision	U32	RO	Sub-Index 3 contains the revision number. Bit 31-16 is the major revision number and Bit 15-0 the minor revision number.
	4	Serial number	U32	RO	Sub-Index 4 contains a numerical representation of the drive's serial number.
1400h	0	Number Of Entries	U8	RO	Contain the communication parameters of the PDOs the device is able to receive.
	1	COB-ID	U32	RW	Sub-index 0 contains the number of PDO-parameters implemented.
	2	Transmission Type	U8	RW	Sub-index 1 describes the COB-ID for the PDO. If bit 31 is set the PDO is disabled.
	3	Inhibit Time	U6	RW	Sub-index 2 defines the transmission mode.
	5	Event Timer	U6	RW	Sub-index 3 is not used with RPDOs. Sub-index 5 defines a timeout for asynchronous PDOs.
1405h	0	Number Of Entries	U8	RO	
	1	COB-ID	U32	RW	
	2	Transmission Type	U8	RW	
	3	Inhibit Time	U6	RW	
	5	Event Timer	U6	RW	
1414h	0	Number Of Entries	U8	RO	
	1	COB-ID	U32	RW	
	2	Transmission Type	U8	RW	
	3	Inhibit Time	U6	RW	
	5	Event Timer	U6	RW	

Index	Sub-index	Name	Type	Access	Description
1600h	0	Number Of Entries	U8	RW	Contain the mapping of data in PDOs to objects in the object dictionary. Sub-index 0 defines the number of objects mapped to the PDO. The other sub-indices each map one object to the PDO. Their structure is as follows: Index (top 16bits) Sub-index (8bits) Length in bits (bottom 8bits)
	1	PDO Mapping Entry 1	U32	RW	
	2	PDO Mapping Entry 2	U32	RW	
	3	PDO Mapping Entry 3	U32	RW	
	4	PDO Mapping Entry 4	U32	RW	
1605h	0	Number Of Entries	U8	RW	
	1	PDO Mapping Entry 1	U32	RW	
	2	PDO Mapping Entry 2	U32	RW	
	3	PDO Mapping Entry 3	U32	RW	
	4	PDO Mapping Entry 4	U32	RW	
1614h	0	Number Of Entries	U8	RW	
	1	PDO Mapping Entry 1	U32	RW	
	2	PDO Mapping Entry 2	U32	RW	
	3	PDO Mapping Entry 3	U32	RW	
	4	PDO Mapping Entry 4	U32	RW	

470 *Fieldbus control through the embedded fieldbus interface (EFB)*

Index	Sub-index	Name	Type	Access	Description
1800h	0	Number Of Entries	U8	RO	<p>Contain the communication parameters of the PDOs the device sends.</p> <p>Sub-index 0 contains the number of PDO-parameters implemented.</p> <p>Sub-index 1 describes the COB-ID for the PDO. If bit 31 is set the PDO is disabled.</p> <p>Sub-index 2 defines the transmission mode.</p> <p>Sub-index 3 defines inhibit time (10 = 1ms).</p> <p>Sub-index 5 defines a timeout for asynchronous PDOs.</p>
	1	COB-ID	U32	RW	
	2	Transmission Type	U8	RW	
	3	Inhibit Time	U6	RW	
	5	Event Timer	U6	RW	
1805h	0	Number Of Entries	U8	RO	
	1	COB-ID	U32	RW	
	2	Transmission Type	U8	RW	
	3	Inhibit Time	U6	RW	
	5	Event Timer	U6	RW	
1814h	0	Number Of Entries	U8	RO	
	1	COB-ID	U32	RW	
	2	Transmission Type	U8	RW	
	3	Inhibit Time	U6	RW	
	5	Event Timer	U6	RW	

Index	Sub-index	Name	Type	Access	Description	
1A00h	0	Number Of Entries	U8	RW	Contain the mapping of data in PDOs to objects in the object dictionary. Sub-index 0 defines the number of objects mapped to the PDO. The other sub-indices each map one object to the PDO. Their structure is as follows: Index (top 16bits) Sub-index (8bits) Length in bits (bottom 8bits)	
	1	PDO Mapping Entry 1	U32	RW		
	2	PDO Mapping Entry 2	U32	RW		
	3	PDO Mapping Entry 3	U32	RW		
	4	PDO Mapping Entry 4	U32	RW		
1A05h	0	Number Of Entries	U8	RW		
	1	PDO Mapping Entry 1	U32	RW		
	2	PDO Mapping Entry 2	U32	RW		
	3	PDO Mapping Entry 3	U32	RW		
	4	PDO Mapping Entry 4	U32	RW		
1A14h	0	Number Of Entries	U8	RW		
	1	PDO Mapping Entry 1	U32	RW		
	2	PDO Mapping Entry 2	U32	RW		
	3	PDO Mapping Entry 3	U32	RW		
	4	PDO Mapping Entry 4	U32	RW		
2000h	0	Number Of Entries	U8	RO		
	3	REFERENCE 2	INT16	RWW		Transparent 16 and ABB Drives profile reference value 2 (alternative)
	6	ACTUAL VALUE 2	INT16	RO		Transparent 16 and ABB Drives profile actual value 2 (alternative)

**Manufacturer specific profile area (2000...5FFF)**

Index	Sub-index	Name	Type	Access	Description
2000h	0	Number Of Entries	U8	RO	
	3	REFERENCE 2	INT16	RWW	Transparent 16 and ABB Drives profile reference value 2 (alternative)
	6	ACTUAL VALUE 2	INT16	RO	Transparent 16 and ABB Drives profile actual value 2 (alternative)
2001h	0	T32 CW	U32	RWW	Transparent 32 profile command word
2002h	0	T32 Ref1	INT32	RWW	Transparent 32 profile
2003h	0	T32 Ref2	INT32	RWW	Transparent 32 profile reference value 1
2004h	0	T32 SW	U32	RO	Transparent 32 profile reference value 2
2005h	0	T32 Act1	INT32	RO	Transparent 32 profile actual value 1
2006h	0	T32 Act2	INT32	RO	Transparent 32 profile actual value 2
2051h	0	T16 CW	U6	RWW	Transparent 16 profile command word
2052h	0	T16 Ref1	INT16	RWW	Transparent 16 profile reference value 1
2053h	0	T16 Ref2	INT16	RWW	Transparent 16 profile reference value 2
2054h	0	T16 SW	U6	RO	Transparent 16 profile status word
2055h	0	T16 Act1	INT16	RO	Transparent 16 profile actual value 1
2056h	0	T16 Act2	INT16	RO	Transparent 16 profile actual value 2
2100h	0	Number Of Entries	U8	RO	Maximum sub-index in the object
	1		U6	RO	Alarm code 1
	2		U6	RO	Alarm code 2
	3		U6	RO	Alarm code 3
	4		U6	RO	Alarm code 4
	5		U6	RO	Alarm code 5
2101h	0	ABB CW	U6	RWW	ABB Drives profile command word
2102h	0	ABB Ref1	INT16	RWW	ABB Drives profile reference value 1
2103h	0	ABB Ref2	INT16	RWW	ABB Drives profile reference value 2
2104h	0	ABB SW	U6	RO	ABB Drives profile status word
2105h	0	ABB Act1	INT16	RO	ABB Drives profile actual value 1
2106h	0	ABB Act2	INT16	RO	ABB Drives profile actual value 2



Index	Sub-index	Name	Type	Access	Description
4001h - 4063h					The objects 4001h-4063h provide access to the drive parameters. Each object corresponds to a parameter group and each sub-index in the object corresponds to a single parameter in the group, e.g., 4001h.01 corresponds to parameter <i>01.01</i> and 400Ah.04 corresponds to parameter <i>10.04</i> .

**Standardized profile area (6000...9FFF)**

Index	Sub-index	Name	Type	Access	Description
603Fh	0	Error code	U6	RO	This object provides the error code of the last error occurred in the drive device.
6040h	0	Control Word	U6	RWW	See <a href="#">CiA 402 profile</a> on page 448 and <a href="#">ABB drives profile</a> on page 454 for details.
6041h	0	Status Word	U6	RO	
6042h	0	VI Target Velocity	INT16	RWW	This object is the required velocity of the system in velocity mode. The value is multiplied by VI Dimension Factor Numerator and divided by VI Dimension Factor Denominator. If both of these are 1 (default), the velocity is given in rpm.
6043h	0	VI Velocity Demand	INT16	RO	This object provides the velocity generated by the ramp function. It is an internal value of the drive. The value shall be given in the same unit as the VI Target Velocity. Positive values indicate forward direction and negative values indicate reverse direction.
6044h	0	VI Control Effort	INT16	RO	This object provides the actual velocity. The value shall be given in the same unit as the VI Target Velocity. Positive values indicate forward direction and negative values indicate reverse direction.
6046h	0	Number of Entries	U8	RO	The values shall be given in rotations per minute (rpm) or in user-defined velocity unit if the VI Dimension Factor object is not set to 1.
	1	VI Velocity Min Amount	U32	RWW	Always zero.
	2	VI Velocity Max Amount	U32	RWW	Mapped internally to the VI Velocity Max Pos and VI Velocity Max Neg values.

Index	Sub-index	Name	Type	Access	Description
6048h	0	Number of Entries	U8	RO	This object indicates the configured delta speed and delta time of the slope of the acceleration ramp: VI Velocity Acceleration = Delta Speed / Delta Time
	1	Delta Speed	U32	RWW	The value shall be given in rotations per minute (rpm) or in user-defined velocity unit if the VI Dimension Factor object is not set to 1.
	2	Delta Time	U6	RWW	Value shall be given in seconds.
6049h	0	Number of Entries	U8	RO	This object indicates the configured delta speed and delta time of the slope of the deceleration ramp: VI Velocity Deceleration = Delta Speed / Delta Time
	1	Delta Speed	U32	RWW	The value shall be given in rotations per minute (rpm) or in user-defined velocity unit if the VI Dimension Factor object is not set to 1.
	2	Delta Time	U6	RWW	Value shall be given in seconds.
604Ch	0	Highest sub-index supported	U8	Const	This object indicates the configured numerator and denominator of the VI Dimension Factor. The VI Dimension Factor serves to include gearing in calculation or serves to scale the frequencies or specific units of the user. It influences the VI Target Velocity, VI Velocity Demand, VI Velocity Actual Value as well as the velocity limit function and the ramp function.
	1	VI Dimension Factor Numerator	INT32	RW	Multiplier for VI velocity values. Shall not be 0.
	2	VI Dimension Factor Denominator	INT32	RW	Divider for VI velocity values. Shall not be 0.

Index	Sub-index	Name	Type	Access	Description
605Dh	0	Halt option code	INT16	RW	<p>This object indicates what action is performed when the halt function is executed, i.e. when the halt bit in the Control word is set.</p> <p>The slow down ramp is the deceleration value of the used mode of operations.</p> <p>The following value definition is valid:                      1 = slow down on slow down ramp and stay in OPERATION ENABLED                      2 = slow down on quick stop ramp and stay in OPERATION ENABLED                      3 = slow down on the current limit and stay in OPERATION ENABLED                      4 = slow down on voltage limit and stay in OPERATION ENABLED</p>
6060h	0	Mode of Operation	INT8	RW	<p>The operational mode is selectable by this object. This object shows only the value of the requested operation mode, the actual operation mode of the PDS is reflected in the object 6061h.</p> <p>The following value definition is valid:                      0 = no mode change / no mode assigned                      1 = profile position mode (not supported)                      2 = velocity mode                      3 = profile velocity mode                      4 = profile torque mode                      5 = reserved                      6 = homing mode (not supported)                      7 = interpolated position mode (not supported)                      8 = cyclic synchronous position mode (not supported)                      9 = cyclic synchronous velocity mode                      10 = cyclic synchronous torque mode</p>

Index	Sub-index	Name	Type	Access	Description
6061h	0	Mode of Operation Display	INT8	RO	This object provides the actual operation mode. The following value definition is valid: 0 = no mode change / no mode assigned 1 = profile position mode (not supported) 2 = velocity mode 3 = profile velocity mode 4 = profile torque mode 5 = reserved 6 = homing mode (not supported) 7 = interpolated position mode (not supported) 8 = cyclic synchronous position mode (not supported) 9 = cyclic synchronous velocity mode 10 = cyclic synchronous torque mode
6069h	0	Velocity sensor actual value	INT32	RO	This object provides the value read from a velocity sensor.
606Bh	0	Velocity demand value	INT32	RO	This object provides the output value of the trajectory generator.
606Ch	0	Velocity actual value	INT32	RO	This object provides the actual velocity value derived either from the velocity sensor or the position sensor.
6071h	0	Target torque	INT16	RWW	This object indicates the input value for the torque controller in profile torque mode.
6072h	0	Max torque	U6	RWW	This object indicates the maximum permissible torque in the motor. 10 = 1%
6073h	0	Max current	U6	RWW	This object indicates the maximum permissible torque creating current in the motor. 10 = 1%
6077h	0	Torque actual value	INT16	RO	This object provides the actual value of the torque. It shall correspond to the instantaneous torque in the motor. 10 = 1%
6083h	0	Profile acceleration	U32	RWW	This object defines the commanded acceleration. This object is used in the profile velocity mode.
6084h	0	Profile deceleration	U32	RWW	This object defines the deceleration. This object is used in the profile velocity mode.
6087h	0	Torque slope	U32	RW	This object indicates the rate of change of torque.



Index	Sub-index	Name	Type	Access	Description
608Fh	0	Highest sub-index supported	U8	Const	This object indicates the configured encoder increments and number of motor revolutions. The position encoder resolution is calculated by the following formula: position encoder resolution = encoder increments / motor revolutions
	1	Encoder Increments	U32	RW	
	2	Motor Revolutions	U32	RW	
60C2h	0	Highest sub-index supported.	U8	Const	This object indicates the interpolation cycle time.
	1	Interpolation time period value	U8	RW	Value of the time.
	2	Interpolation time index	INT8	RW	Dimension index to the time value in sub-index 1
60FFh	0	Target velocity	INT32	RWW	This object indicates the configured target velocity.
6402h	0	Motor type	U6	RO	This object indicates the type of motor attached to and driven by the drive device.  The following value definition is valid: 0000h = non-standard motor 0001h = phase modulated DC motor 0002h = frequency controlled DC motor 0003h = PM synchronous motor 0004h = FC synchronous motor 0005h = switched reluctance motor 0006h = wound rotor induction motor 0007h = squirrel cage induction motor 0008h = stepper motor 0009h = micro-step stepper motor 0010h = sinusoidal PM BL motor 0011h = trapezoidal PM BL motor 0012h = AC synchronous reluctance sync 0013h = DC commutator PM 0014h = DC commutator wound field series 0015h = DC commutator wound field compound 7FFFh = no motor type assigned 8000h-FFFFh = manufacturer-specific

Index	Sub-index	Name	Type	Access	Description
6502h	0	Supported drive modes	U32	RO	<p>This object provides information on the supported drive modes.</p> <p>This object is organized bit-wise. The bits have the following meaning:  bit 0: profile position mode  bit 1: velocity mode  bit 2: profile velocity mode  bit 3: profile torque mode  bit 4: reserved  bit 5: homing mode  bit 6: interpolated position mode  bit 7: cyclic synchronous position mode  bit 8: cyclic synchronous velocity mode  bit 9: cyclic synchronous torque mode  bit 10-15: reserved  bit 16-31: manufacturer-specific</p> <p>The bit values have the following meaning:  bit value = 0: mode is not supported  bit value = 1: mode is supported</p>
6504h	0	Drive manufacturer	Visible string	Const	This object indicates the manufacturer: ABB Drives
6505h		http drive catalog address	Visible string	Const	This object indicates the assigned web address of the drive manufacturer: www.abb.com

### CANopen status indicators

The status of CANopen communication can be determined from virtual LEDs which are displayed on the integrated panel. The two CANopen virtual LEDs, RUN and ERROR, can be found on Connection Status View of the integrated panel.

Both LEDs can be either ON or OFF. The following table defines the image shown for a LED that is ON and for a LED that is OFF.

LED	State
	Off
	On

LED blinking descriptions.

<b>Name</b>	<b>State</b>	<b>Description</b>
ERROR	Off	No error
	Blinking	General configuration error
	Single flash	CANopen controller error counters have reached the warning limit (too many error frames).
	Double flash	A guard event or a receive heartbeat time-out has occurred.
	Quadruple flash	An expected PDO has not been received before the event-timer elapsed.
	On	The CAN controller is bus off.
RUN	Blinking	The device is in PRE-OPERATIONAL state.
	Single flash	The device is in STOPPED state.
	On	The device is in OPERATIONAL state.





# 10

## Fieldbus control through a fieldbus adapter

---

### Contents

- [System overview](#)
- [Basics of the fieldbus control interface](#)
- [Automatic drive configuration for fieldbus control](#)
- [Setting up the drive for fieldbus control manually](#)

### System overview

For the following instrument:

- ACS380-04xC with fieldbus adapter connected (excluding BCAN-11 CANopen interface +K405)

The drive can be controlled by external devices over a communication network (fieldbus) through an optional fieldbus adapter module.

The drive can be connected to an external control system through an optional fieldbus adapter (“fieldbus adapter A” = FBA A) mounted onto the control unit of the drive. The drive can be configured to receive all of its control information through the fieldbus interface, or other available sources such as digital and analog inputs, depending on how control locations EXT1 and EXT2 are configured.

---

Fieldbus adapters are available as loose options for ACS380 base variants (ACS380-04xN-xxAx-x) or as built-in options for ACS380 configured variants (ACS380-04xC-xxAx-x types). For example following protocols are supported:

- PROFIBUS DP
- CANopen
- EtherNet/IP™
- EtherCAT™

When you use loose option, make sure that the adapter is compatible.

**Note:** The text and examples in this chapter describe the configuration of one fieldbus adapter (FBA A) by parameters [50.01...50.18](#) and parameter groups [51 FBA A settings...53 FBA A data out](#).

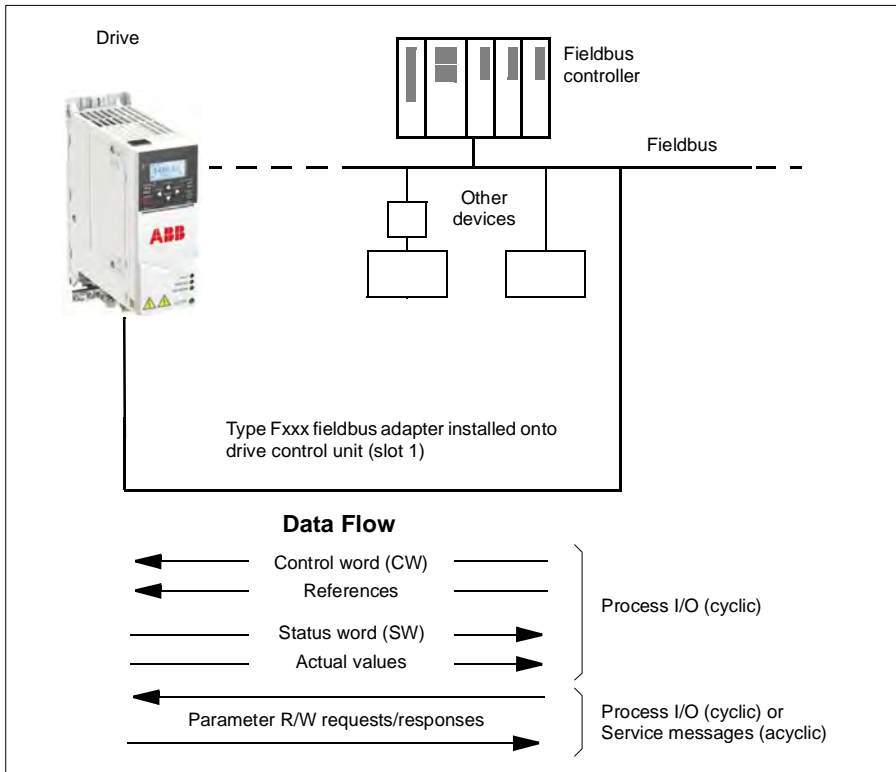

## Basics of the fieldbus control interface

The cyclic communication between a fieldbus system and the drive consists of 16- or 32-bit input and output data words. The drive is able to support a maximum of 12 data words (16 bits) in each direction.

Data transmitted from the drive to the fieldbus controller is defined by parameters [52.01 FBA A data in1](#) ... [52.12 FBA A data in12](#). The data transmitted from the fieldbus controller to the drive is defined by parameters [53.01 FBA A data out1](#) ... [53.12 FBA A data out12](#).

Fieldbus network

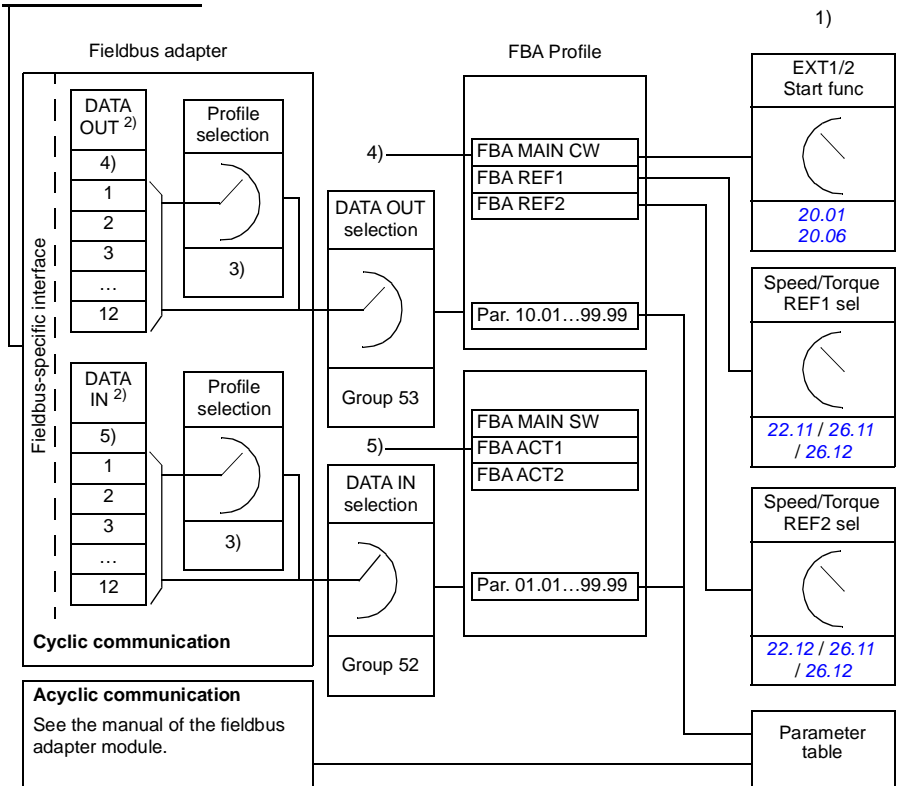

- 1) See also other parameters which can be controlled from fieldbus.
- 2) The maximum number of data words used is protocol-dependent.
- 3) Profile/instance selection parameters. Fieldbus module specific parameters. For more information, see the user's manual of the appropriate fieldbus adapter module.
- 4) With DeviceNet, the control part is transmitted directly.
- 5) With DeviceNet, the actual value part is transmitted directly.

## ■ Control word and Status word

The Control word is the principal means for controlling the drive from a fieldbus system. It is sent by the fieldbus master station to the drive through the adapter module. The drive switches between its states according to the bit-coded instructions in the Control word, and returns status information to the master in the Status word.

For the ABB Drives communication profile, the contents of the Control word and the Status word are detailed on pages [487](#) and [488](#) respectively. The drive states are presented in the state diagram (page [489](#)). For other fieldbus-specific communication profiles, see the manual of the fieldbus adapter.

For more details on the Control word, go to page [487](#), and on the Status word, go to page [488](#). The drive states are presented in the state diagram on page [489](#).

### **Debugging the network words**

If parameter [50.12 FBA A debug mode](#) is set to *Fast*, the Control word received from the fieldbus is shown by parameter [50.13 FBA A control word](#), and the Status word transmitted to the fieldbus network by [50.16 FBA A status word](#). This “raw” data is very useful to determine if the fieldbus master is transmitting the correct data before handing control to the fieldbus network.

---

## References

References are 16-bit words containing a sign bit and a 15-bit integer. A negative reference (indicating reversed direction of rotation) is formed by calculating the two's complement from the corresponding positive reference.

ABB drives can receive control information from multiple sources including analog and digital inputs, the drive control panel and a fieldbus adapter module. In order to have the drive controlled through the fieldbus, the module must be defined as the source for control information such as reference. This is done using the source selection parameters in groups [22 Speed reference selection](#), [26 Torque reference chain](#) and [28 Frequency reference chain](#).

### Debugging the network words

If parameter [50.12 FBA A debug mode](#) is set to *Fast*, the references received from the fieldbus are displayed by [50.14 FBA A reference 1](#) and [50.15 FBA A reference 2](#).

### Scaling of references

**Note:** The scalings described below are for the ABB Drives communication profile. Fieldbus-specific communication profiles may use different scalings. For more information, see the manual of the fieldbus adapter.

The references are scaled as defined by parameters [46.01...46.04](#); which scaling is in use depends on the setting of [50.04 FBA A ref1 type](#) and [50.05 FBA A ref2 type](#).

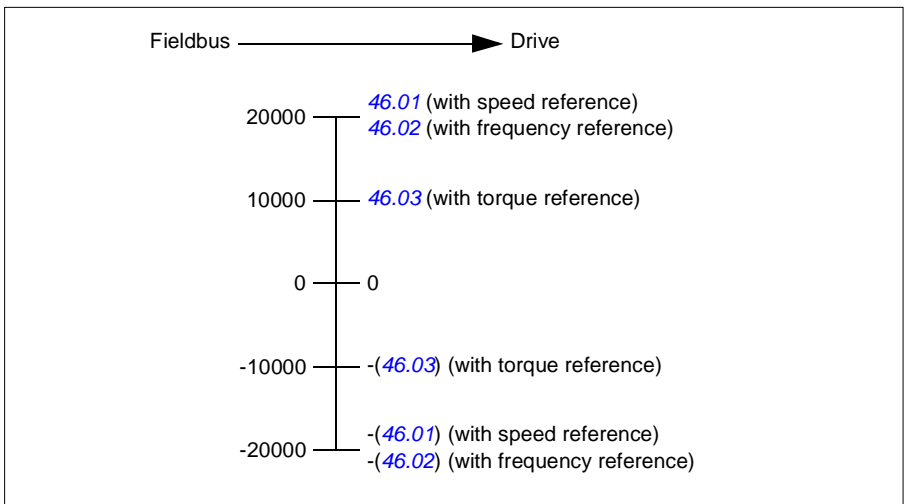

The scaled references are shown by parameters [03.05 FB A reference 1](#) and [03.06 FB A reference 2](#).

## Actual values

Actual values are 16-bit words containing information on the operation of the drive. The types of the monitored signals are selected by parameters [50.07 FBA A actual 1 type](#) and [50.08 FBA A actual 2 type](#).

### Debugging the network words

If parameter [50.12 FBA A debug mode](#) is set to *Fast* the actual values sent to the fieldbus are displayed by [50.17 FBA A actual value 1](#) and [50.18 FBA A actual value 2](#).

### Scaling of actual values

**Note:** The scalings described below are for the ABB Drives communication profile. Fieldbus-specific communication profiles may use different scalings. For more information, see the manual of the fieldbus adapter.

The actual values are scaled as defined by parameters [46.01...46.04](#); which scaling is in use depends on the setting of parameters [50.07 FBA A actual 1 type](#) and [50.08 FBA A actual 2 type](#).

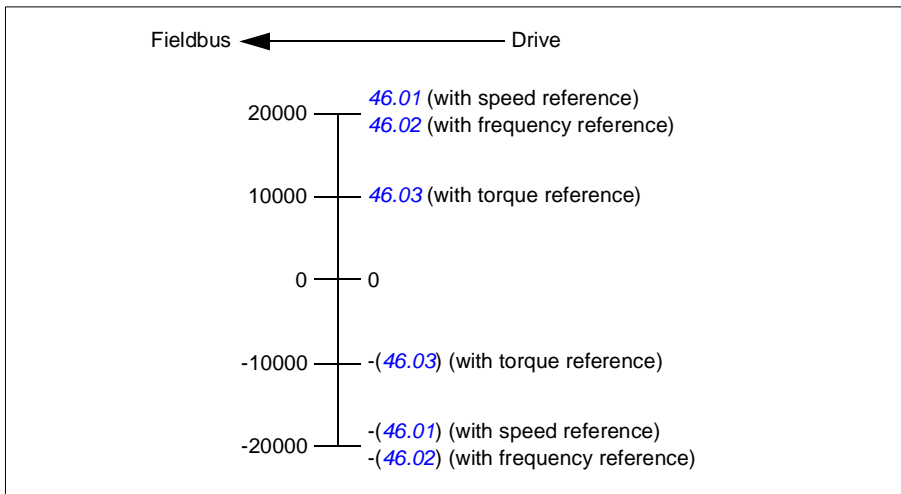

## ■ Contents of the fieldbus Control word (ABB Drives profile)

The upper case boldface text refers to the states shown in the state diagram on page 489.

Bit	Name	Value	State/Description
0	Off1 control	1	Proceed to <b>READY TO OPERATE</b> .
		0	Stop along currently active deceleration ramp. Proceed to <b>OFF1 ACTIVE</b> ; proceed to <b>READY TO SWITCH ON</b> unless other interlocks (OFF2, OFF3) are active.
1	Off2 control	1	Continue operation (OFF2 inactive).
		0	Emergency OFF, coast to a stop. Proceed to <b>OFF2 ACTIVE</b> , proceed to <b>SWITCH-ON INHIBITED</b> .
2	Off3 control	1	Continue operation (OFF3 inactive).
		0	Emergency stop, stop within time defined by drive parameter. Proceed to <b>OFF3 ACTIVE</b> ; proceed to <b>SWITCH-ON INHIBITED</b> .  <b>WARNING:</b> Ensure motor and driven machine can be stopped using this stop mode.
3	Run	1	Proceed to <b>OPERATION ENABLED</b> . <b>Note:</b> Run enable signal must be active; see drive documentation. If the drive is set to receive the Run enable signal from the fieldbus, this bit activates the signal. See also parameter <i>06.18 Start inhibit status word</i> (page 126).
		0	Inhibit operation. Proceed to <b>OPERATION INHIBITED</b> .
4	Ramp out zero	1	Normal operation. Proceed to <b>RAMP FUNCTION GENERATOR: OUTPUT ENABLED</b> .
		0	Force Ramp function generator output to zero. The drive will immediately decelerate to zero speed (observing the torque limits).
5	Ramp hold	1	Enable ramp function. Proceed to <b>RAMP FUNCTION GENERATOR: ACCELERATOR ENABLED</b> .
		0	Halt ramping (Ramp Function Generator output held).
6	Ramp in zero	1	Normal operation. Proceed to <b>OPERATING</b> . <b>Note:</b> This bit is effective only if the fieldbus interface is set as the source for this signal by drive parameters.
		0	Force Ramp function generator input to zero.
7	Reset	0=>1	Fault reset if an active fault exists. Proceed to <b>SWITCH-ON INHIBITED</b> . <b>Note:</b> This bit is effective only if the fieldbus interface is set as the source of the reset signal by drive parameters.
		0	Continue normal operation.
8	Inching 1	1	Accelerate to inching (jogging) setpoint 1. <b>Notes:</b> • Bits 4...6 must be 0. • See also section <i>Jogging</i> on page 70.
		0	Inching (jogging) 1 disabled.
9	Inching 2	1	Accelerate to inching (jogging) setpoint 2. See notes at bit 8.
		0	Inching (jogging) 2 disabled.
10	Remote cmd	1	Fieldbus control enabled.
		0	Control word and reference not getting through to the drive, except for bits 0...2.

Bit	Name	Value	State/Description
11	Ext ctrl loc	1	Select External Control Location EXT2. Effective if control location is parameterized to be selected from fieldbus.
		0	Select External Control Location EXT1. Effective if control location is parameterized to be selected from fieldbus.
12	User bit 0	1	User configurable.
		0	
13	User bit 1	1	
		0	
14	User bit 2	1	
		0	
15	User bit 3	1	
		0	

### ■ Contents of the fieldbus Status word (ABB Drives profile)

The upper case boldface text refers to the states shown in the state diagram on page [489](#).

Bit	Name	Value	State/Description
0	Ready to switch ON	1	<b>READY TO SWITCH ON.</b>
		0	<b>NOT READY TO SWITCH ON.</b>
1	Ready run	1	<b>READY TO OPERATE.</b>
		0	<b>OFF1 ACTIVE.</b>
2	Ready ref	1	<b>OPERATION ENABLED.</b>
		0	<b>OPERATION INHIBITED.</b> See also parameter <a href="#">06.18 Start inhibit status word</a> (page <a href="#">126</a> ).
3	Tripped	1	<b>FAULT.</b>
		0	No fault.
4	Off 2 inactive	1	OFF2 inactive.
		0	<b>OFF2 ACTIVE.</b>
5	Off 3 inactive	1	OFF3 inactive.
		0	<b>OFF3 ACTIVE.</b>
6	Switch-on inhibited	1	<b>SWITCH-ON INHIBITED.</b>
		0	–
7	Warning	1	Warning active.
		0	No warning active.
8	At setpoint	1	<b>OPERATING.</b> Actual value equals reference = is within tolerance limits (see parameters <a href="#">46.21...46.23</a> ).
		0	Actual value differs from reference = is outside tolerance limits.
9	Remote	1	Drive control location: REMOTE (EXT1 or EXT2).
		0	Drive control location: LOCAL.
10	Above limit	-	See bit 10 of <a href="#">06.17 Drive status word 2</a> .
11	User bit 0	-	See parameter <a href="#">06.30 MSW bit 11 selection</a> .
12	User bit 1	-	See parameter <a href="#">06.31 MSW bit 12 selection</a> .
13	User bit 2	-	See parameter <a href="#">06.32 MSW bit 13 selection</a> .
14	User bit 3	-	See parameter <a href="#">06.33 MSW bit 14 selection</a> .
15	Reserved		



■ The state diagram (valid for ABB drives profile only)

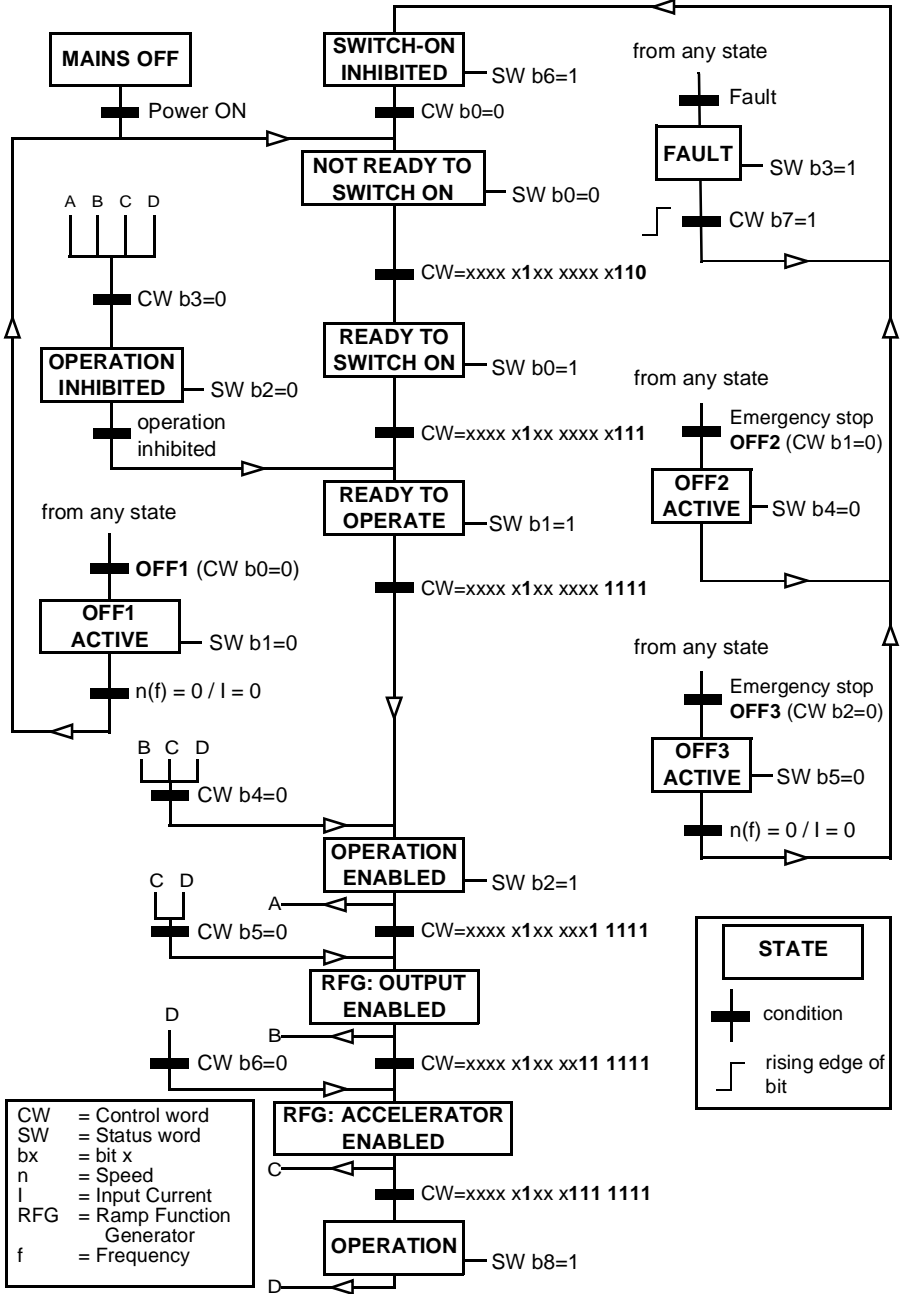

A control word sequence example is given below:

Start:

- 476h --> NOT READY TO SWITCH ON

If MSW bit 0 = 1 then

- 477h --> READY TO SWITCH ON (Stopped)
- 47Fh --> OPERATION (Running)

Stop:

- 477h = Stop according to [21.03 Stop mode](#)
- 47Eh = OFF1 ramp stop (**Note:** uninterpretable ramp stop)

Fault reset:

- Rising edge of MCW bit 7

Start after STO:

If [31.22 STO indication run/stop](#) is not Fault/Fault make sure that [06.18 Start inhibit status word](#), bit 7 STO = 0 before giving a start command.

## Automatic drive configuration for fieldbus control

The software automatically sets the relevant parameters when the fieldbus adapter module is connected to the drive. The preset settings apply to the CANopen, EtherCAT, PROFIBUS and PROFINET (default in the FENA-21-M module) protocols.



**Warning!** The drive needs to be unpowered for five (5) minutes before electrical installation.

---

To configure fieldbus communications:

1. Power up the drive.
2. The drive software recognizes the connected fieldbus adapter and selects the correct connection macro.  
The changed parameters are listed in the [Automatically changed parameters \(all adapters\)](#) and [Specific fieldbus adapter parameters](#).
3. You can see the selected macro in the Connection macros submenu or from parameter [96.05](#). You can also change the node number from the Connection macros submenu.
4. If you need to change other parameters, you can set them manually.

If the relevant parameters are not automatically set, follow the instructions under [Setting up the drive for fieldbus control manually](#) on page [494](#).

Automatic configuration is a minimum configuration, and you can change parameters after it. There are certain parameters that you need to change, e.g. station ID.

The fieldbus autosetting function is activated automatically after power boot if parameter [07.35](#) is set to 0. It also activates again if you change to another adapter and parameter [07.35](#) is 0.

*Example:* If you change to another adapter you need to configure parameter [07.35 Drive configuration](#) again. Select *0 Not initialized*, go to parameter [96.07](#) and save the parameter. Stop and start the drive, and the drive starts again with the new configuration.

The fieldbus autosetting function is not activated automatically after fieldbus parameter changes, or after changing the fieldbus module.

When the fieldbus adapter is connected to the drive, the drive control program sets the applicable parameters. The preset settings apply to the CANopen, EtherCAT, PROFIBUS and PROFINET (default in the FENA-21 module) protocols. If you have a BCAN-11 adapter, refer to the exceptions in the table.

---

### ■ Automatically changed parameters (all adapters)

Parameter	Setting (general)	Setting (BCAN-11)
20.01 Ext1 commands	Fieldbus A	Embedded fieldbus
20.03 Ext1 in1	Not selected	Not selected
20.04 Ext1 in2	Not selected	Not selected
22.11 Ext1 speed ref1	FB A ref1	EFB ref1
22.22 Constant speed sel1	Not selected	Not selected
22.23 Constant speed sel2	Not selected	Not selected
23.11 Ramp set selection	Acc/Dec time 1	Acc/Dec time 1
28.11 Ext1 frequency ref1	FB A ref1	EFB ref1
28.22 Constant frequency sel1	Not selected	Not selected
28.23 Constant frequency sel2	Not selected	Not selected
28.71 Freq ramp set sel	Acc/Dec time 1	Acc/Dec time 1
31.11 Fault reset selection	DI1	DI2
50.01 FBA A enable	Enable	N/A
50.02 FBA A comm loss func	Fault	N/A

### ■ Specific fieldbus adapter parameters

Parameter	Setting
<b>CANopen (FCAN-01-M)</b>	
51.05 Profile	CiA 402
<b>EtherCAT</b>	
51.02 Profile	CiA 402
<b>PROFIBUS</b>	
51.02 Node address	3
51.05 Profile	ABB Drives
52.01 FBA A data in1	SW 16bit
52.02 FBA A data in2	Act1 16bit
53.01 FBA A data out1	CW 16bit
53.02 FBA A data out2	Ref1 16bit
<b>PROFINET (default in FENA-21)</b>	
51.02 Protocol/profile	11 = PNIO ABB Pro (PROFINET IO protocol: ABB Drives profile).
51.04 IP configuration	0 (Static IP)
52.01 Data In	4 (SW 16 bit (Status word (16 bit)))
52.02 Data In 2	5 (Act 1 16 bit)
53.01 Data Out 1	1 (CW 16 bit)
53.02 Data Out 2	2 (ref 1 16-bit)
<b>Modbus TCP/IP</b>	
51.02 Protocol / Profile	1 = MB/TCP T16. (Modbus/TCP: ABB Drives profile - Enhanced)

<b>Parameter</b>	<b>Setting</b>
<b>Ethernet IP</b>	
51.02 Protocol / Profile	EIP ABB Pro. (EtherNet/IP protocol: ABB Drives profile.)
<b>CANopen (BCAN-11)</b>	
58.01 Protocol enable	CANopen

---

## Setting up the drive for fieldbus control manually

The fieldbus adapter module is typically pre-installed. The device automatically recognizes the module.

If the adapter is not pre-installed, you can install it mechanically and electrically.

1. Install the fieldbus adapter module mechanically and electrically according to the instructions given in the user's manual of the module.
  2. Power up the drive.
  3. Enable the communication between the drive and the fieldbus adapter module with parameter [50.01 FBA A enable](#).
  4. With [50.02 FBA A comm loss func](#), select how the drive should react to a fieldbus communication break.  
**Note:** This function monitors both the communication between the fieldbus master and the adapter module and the communication between the adapter module and the drive.
  5. With [50.03 FBA A comm loss t out](#), define the time between communication break detection and the selected action.
  6. Select application-specific values for the rest of the parameters in group [50 Fieldbus adapter \(FBA\)](#), starting from [50.04](#). Examples of appropriate values are shown in the tables below.
  7. Set the fieldbus adapter module configuration parameters in group [51 FBA A settings](#). As a minimum, set the required node address and the communication profile.
  8. Define the process data transferred to and from the drive in parameter groups [52 FBA A data in](#) and [53 FBA A data out](#).  
**Note:** Depending on the communication protocol and profile being used, the Control word and Status word may already be configured to be sent/received by the communication system.
  9. Save the valid parameter values to permanent memory by setting parameter [96.07 Parameter save manually](#) to [Save](#).
  10. Validate the settings made in parameter groups 51, 52 and 53 by setting parameter [51.27 FBA A par refresh](#) to [Configure](#).
  11. Configure control locations EXT1 and EXT2 to allow control and reference signals to come from the fieldbus.
-

11

# Control chain diagrams

---

## Contents of this chapter

This chapter presents the reference chains of the drive. The control chain diagrams can be used to trace how parameters interact and where parameters have an effect within the drive parameter system.

For a more general diagram, see section [Operating modes and motor control modes](#) on page [54](#).

**Note:** The panel references in the diagrams refer to ACX-AP-x Assistant control panels and the Drive composer PC tool.

---

# Frequency reference selection

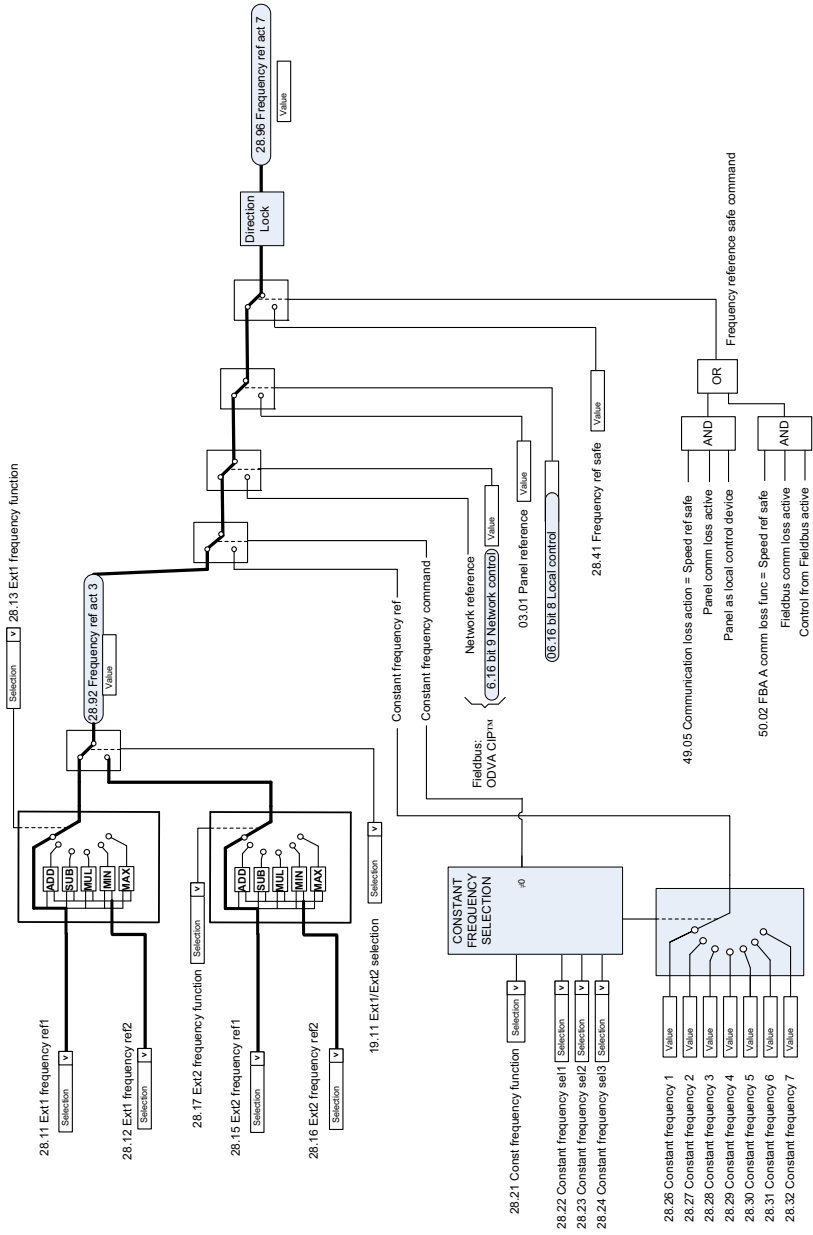



# Frequency reference modification

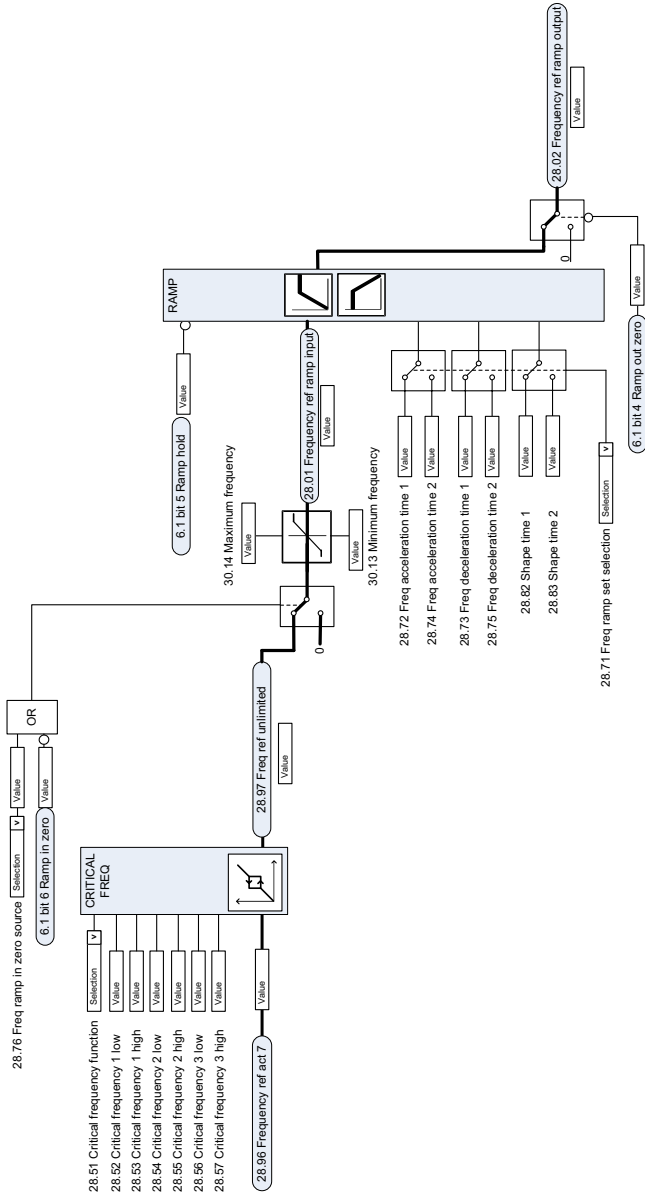

# Speed reference source selection I

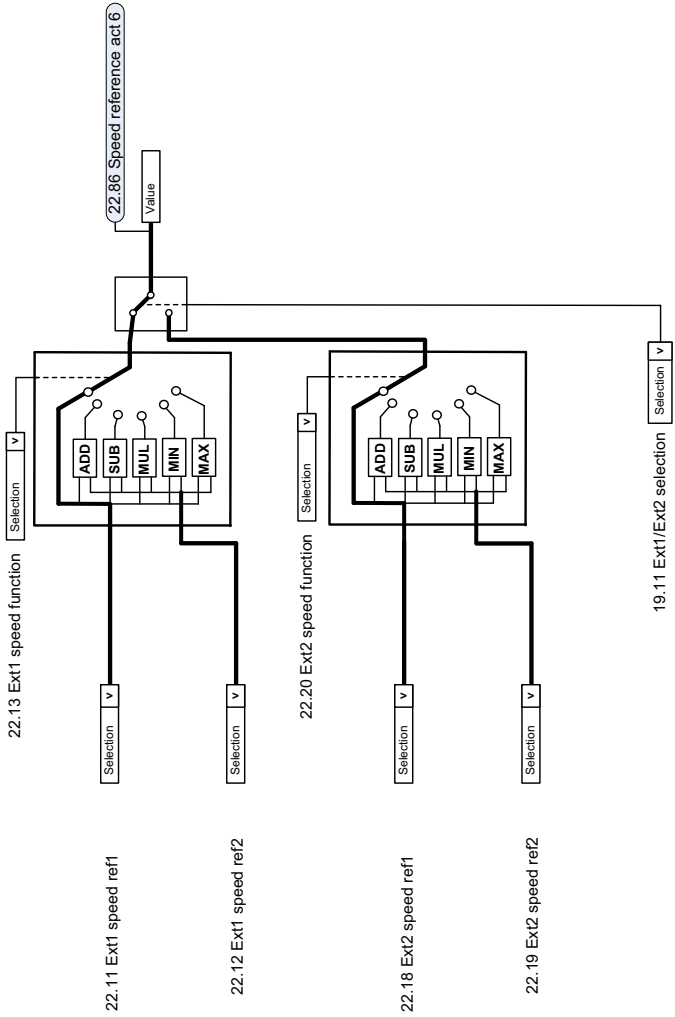

# Speed reference source selection II

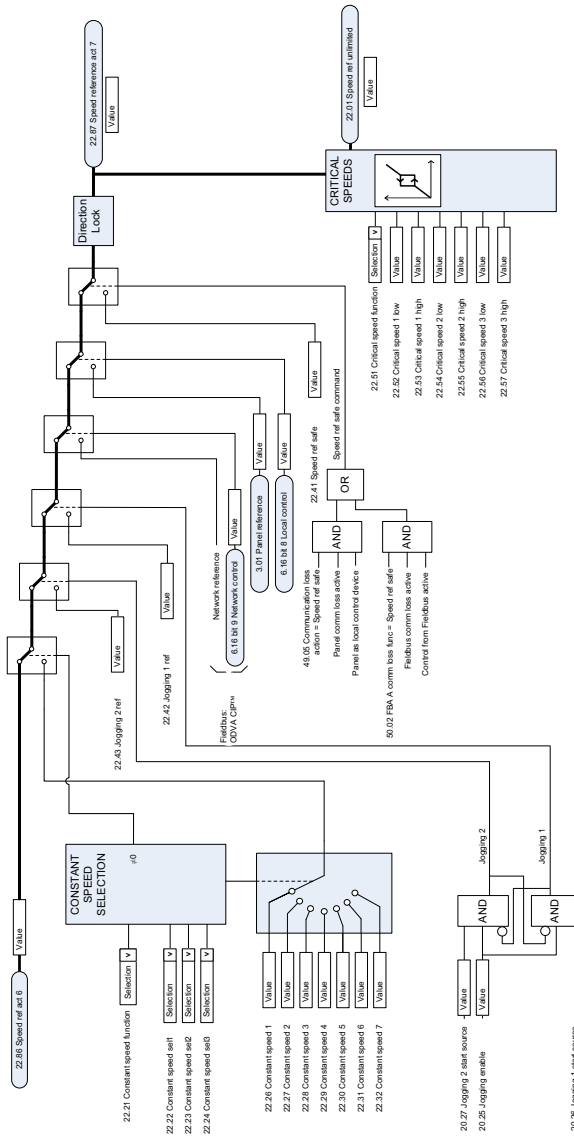

# Speed reference ramping and shaping

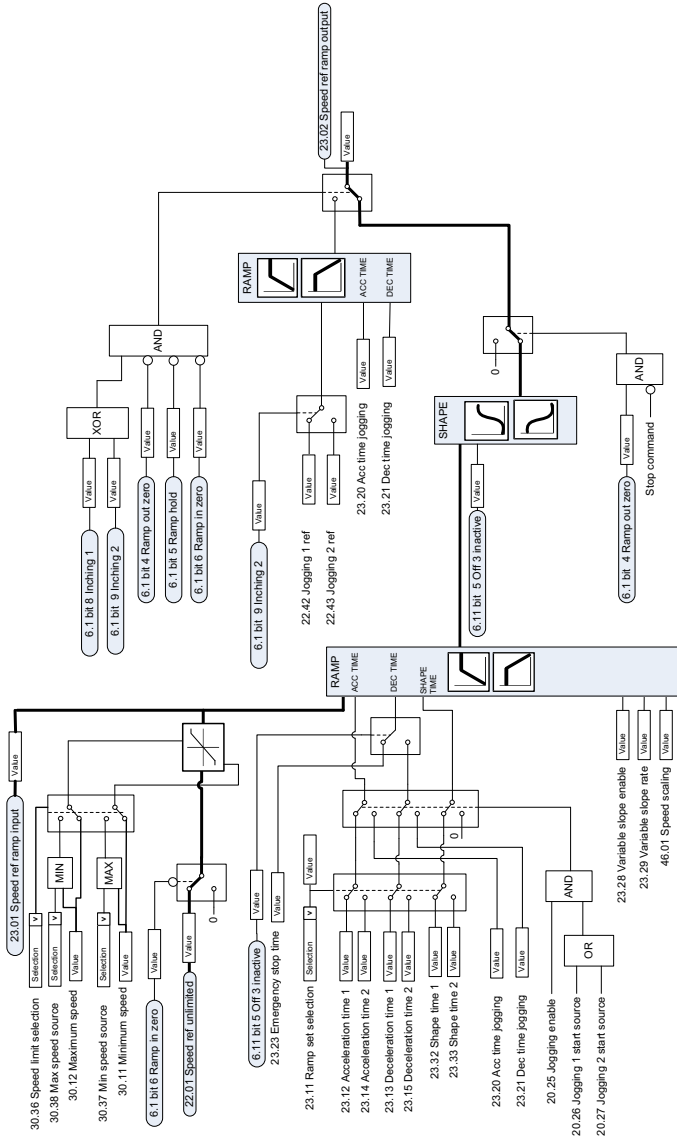

# Speed error calculation

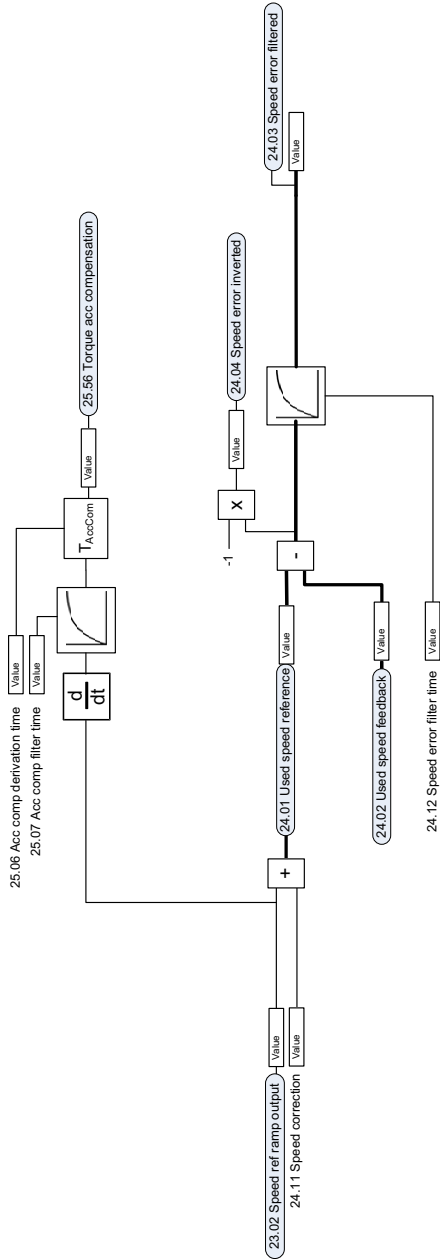

# Speed controller

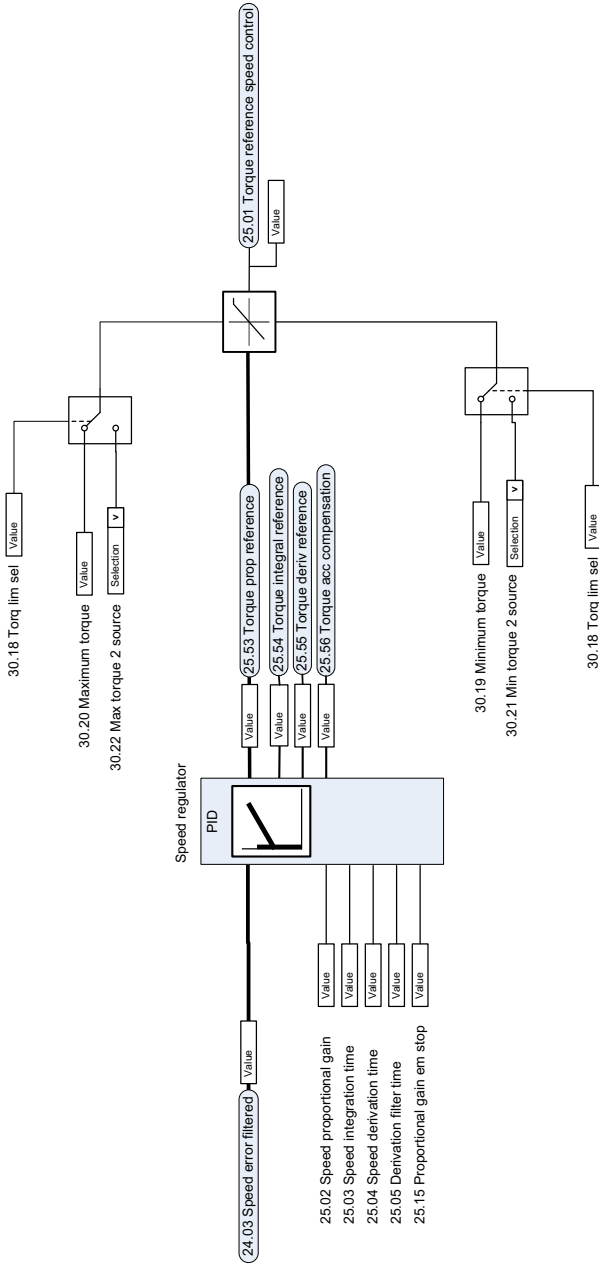

# Torque reference source selection and modification

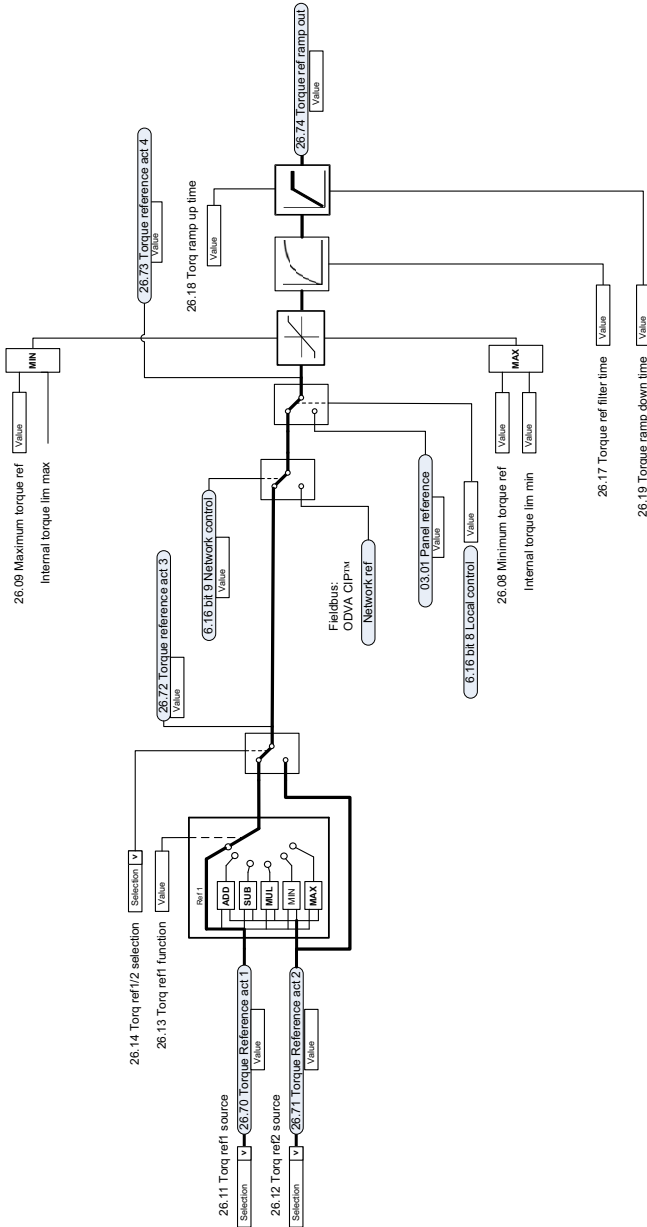

## Reference selection for torque controller

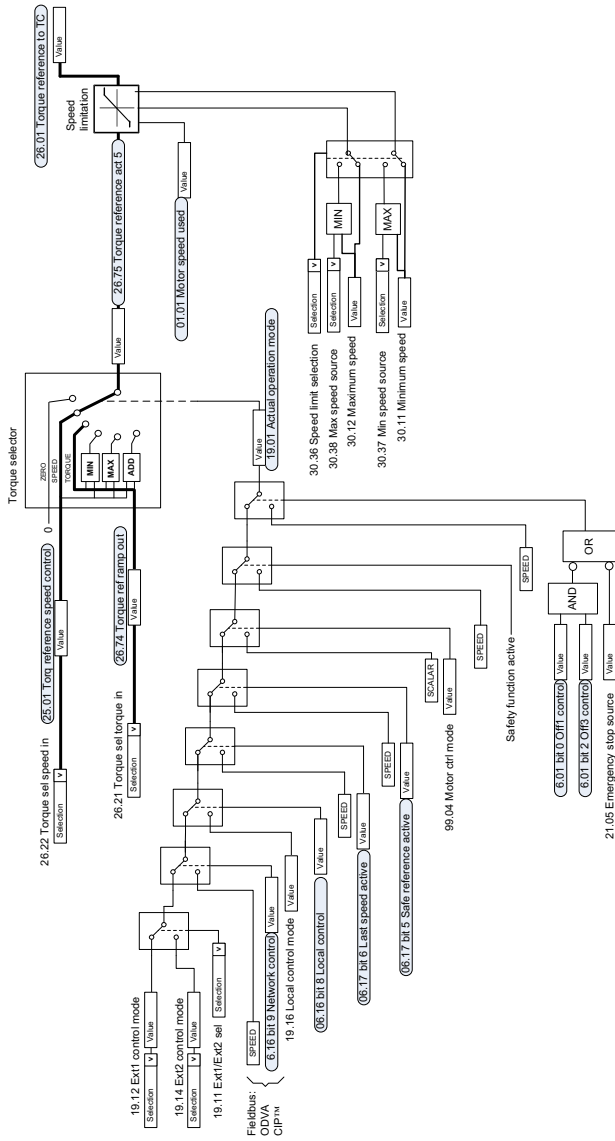





# Process PID setpoint and feedback source selection

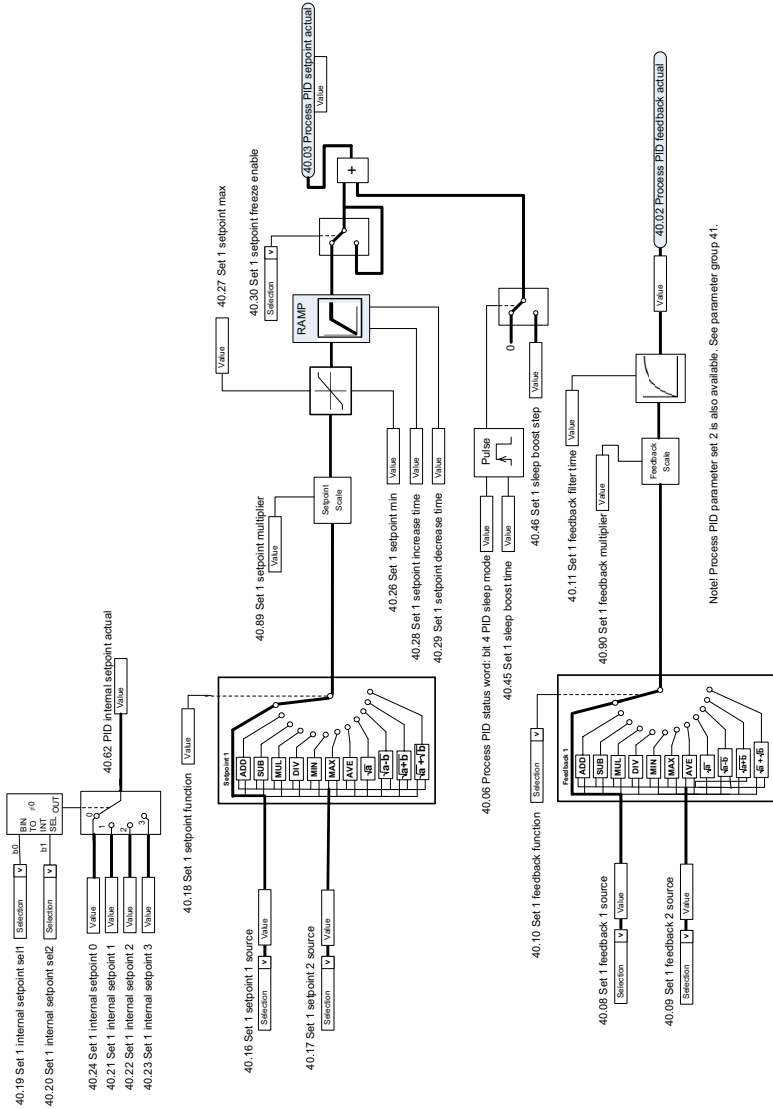

# Process PID controller

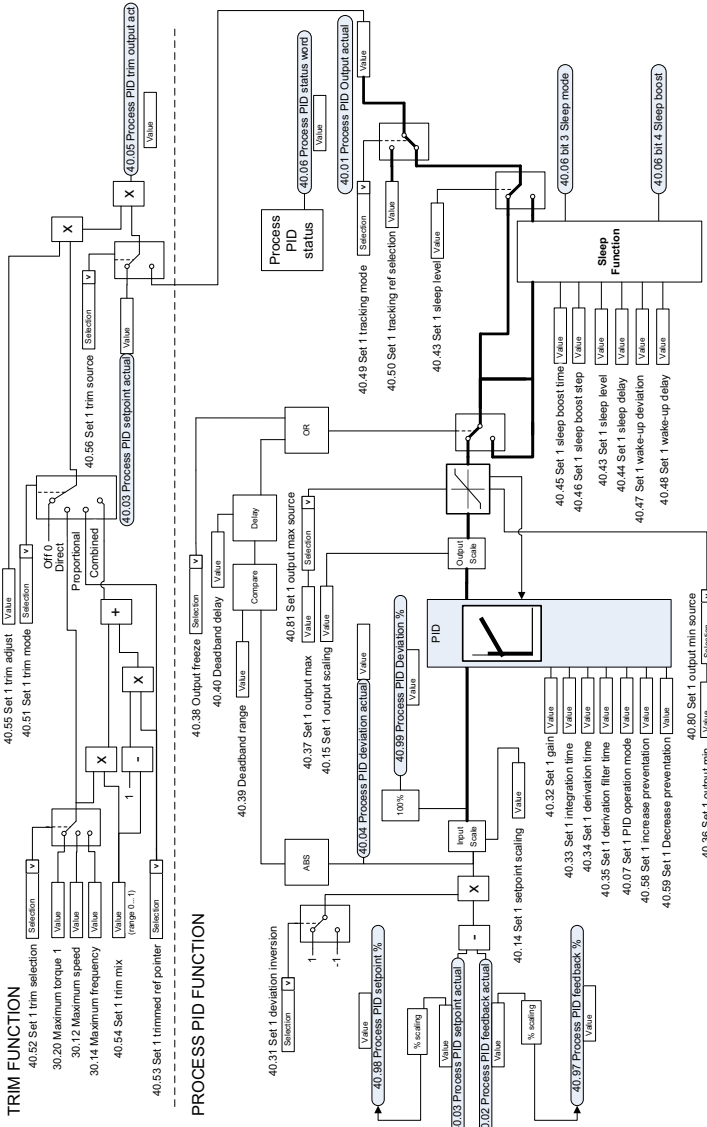

## External PID setpoint and feedback source selection

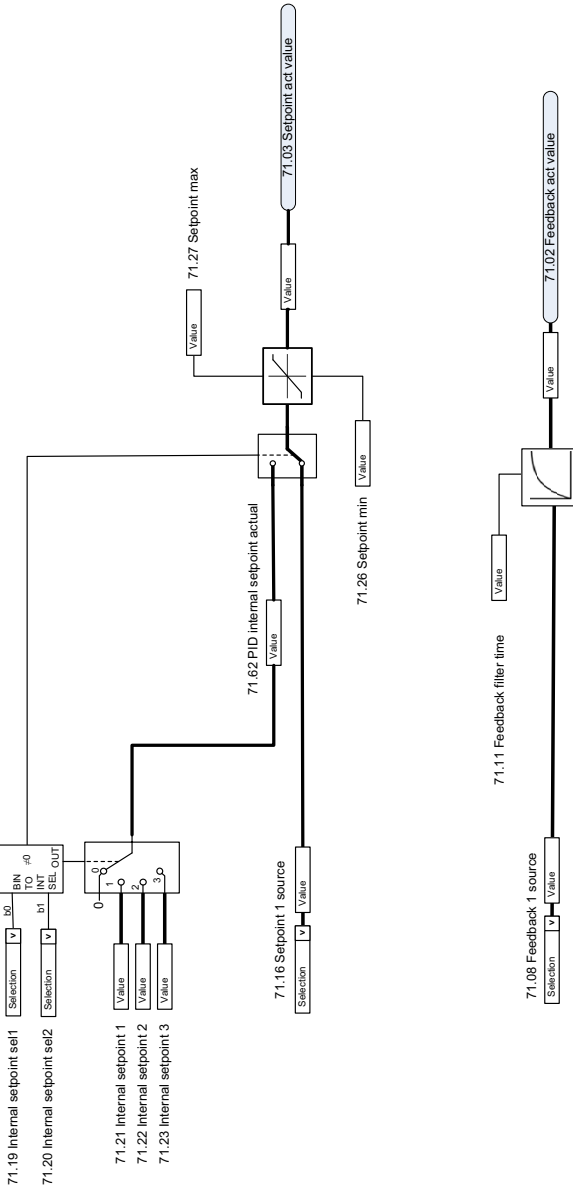

# External PID controller

## EXTERNAL PID FUNCTION

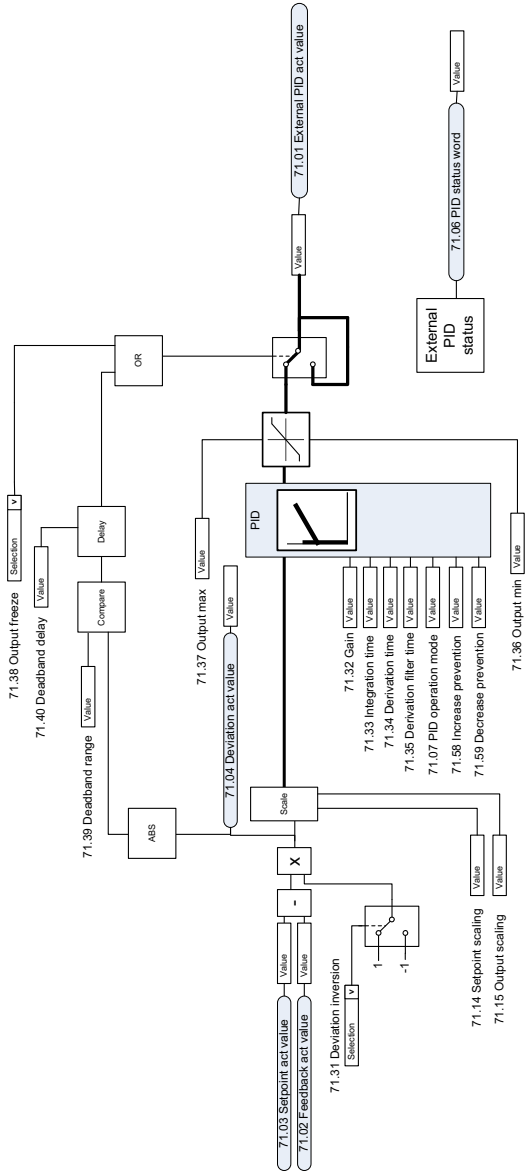

# Direction lock

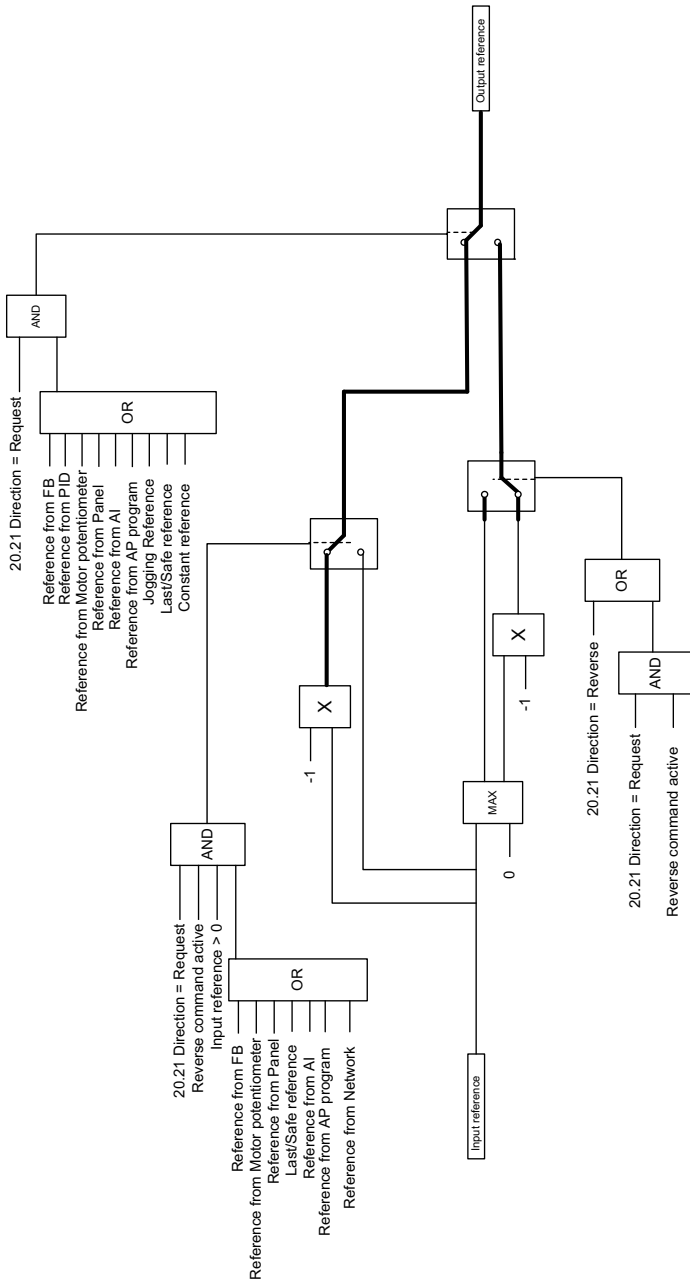

# 12

## Appendix A - ACS380 in crane applications

---

This chapter describes the functions within the control program that are specific to the crane application, how to use them, and how to configure them to operate. If required, you can use these functions for other applications also.

### Contents

- [\*Overview of the crane control program\*](#)
  - [\*Quick start-up\*](#)
  - [\*Crane mechanical brake control\*](#)
  - [\*Speed matching\*](#)
  - [\*Crane warning masking\*](#)
  - [\*Dead-band function\*](#)
  - [\*Start/stop interlocking\*](#)
  - [\*Crane stop limit function\*](#)
  - [\*Crane slowdown function\*](#)
  - [\*Fast stop\*](#)
  - [\*Power on acknowledgment\*](#)
  - [\*Speed reference handling\*](#)
  - [\*Crane motor potentiometer\*](#)
  - [\*Conical motor control\*](#)
-

## Overview of the crane control program

The ACS380 drives can be used in cranes such as

- indoor electric overhead traveling (EOT) cranes,
- outdoor tower cranes, and
- Tower cranes.

These cranes require independent movements. Indoor EOT cranes and tower cranes have motions such as hoist, trolley and long travel. Outdoor tower cranes typically have motions such as hoist, trolley, and slew.

The start, stop and control signals can be analog, digital, or fieldbus-based from a programmable logic controller (PLC) or a manual control device such as joystick. For a typical crane control interface, see section [Control connections](#) on page [552](#).

ABB product offering for cranes highlights safety and performance and every component that increases safety must be used with the crane drives. For example, in hoist drives, closed loop control (encoder or external supervision) must be used for safe speed supervision.

---



## Quick start-up

This section contains the following alternative control schemes for starting up the drive with the control program:

- [Control through the I/O interface using a joystick](#) (page 514)
- [Control through the I/O interface using the step reference logic/pendant control](#) (page 518)
- [Control through the fieldbus interface using the fieldbus control word](#) (page 522).

In addition, this section describes how to configure the following program features:

- [Configuring slowdown with two limits and stop limit logic](#) (page 527)
- [Configuring speed feedback using a HTL/TTL pulse encoder](#) (page 525)
- [Configuring Mechanical brake control](#) (page 531).

Before the start-up, perform the following:

1. Make sure that the necessary IO connections are available. To configure necessary I/O connections, set the below parameters:

No.	Name	Value
11.09	<a href="#">DIO2 configuration</a>	<a href="#">Input</a>
22.22	<a href="#">Constant speed sel1</a>	<a href="#">Always off</a>
22.23	<a href="#">Constant speed sel2</a>	<a href="#">Always off</a>
23.11	<a href="#">Ramp set selection</a>	<a href="#">Acc/Dec time 1</a>

2. In scalar motor control or in trolley and long travel movements, disable torque proving and brake open torque. See [Configuring Mechanical brake control](#) on page 531.

## ■ Control through the I/O interface using a joystick

This section describes how to set up the drive for control through the I/O interface with a joystick.

Safety	
	<b>WARNING!</b> Obey all safety instructions for the drive. Only qualified electricians are allowed to start up the drive.
Preliminary actions	
<input type="checkbox"/>	Make sure that you have completed the basic start-up sequence of the drive. See <a href="#">Start-up, ID run and use</a> on page 23. Make sure that the motor control method is selected as vector control (99.04).
<input type="checkbox"/>	Power up the drive and wait for 10 seconds. This is to make sure that all the boards are powered and the application is running.
<input type="checkbox"/>	Switch to local control.
Brake circuit check	
<input type="checkbox"/>	Make sure that you can safely do the brake circuit check. For example, make sure that the load is not hanging from a hook.
<input type="checkbox"/>	Make sure that the brake circuit is working as expected according to the command given by the default brake control signal interface (relay output RO1): <ul style="list-style-type: none"> <li>• Open the brake temporarily by setting parameter <a href="#">10.24 RO1 source</a> to <a href="#">Energized</a>. Verify that the break opens.</li> <li>• Set parameter <a href="#">10.24 RO1 source</a> to <a href="#">Brake command</a> to use the default brake control signal interface.</li> </ul>
Control signal settings	
<input type="checkbox"/>	Select the signal sources for start and stop control. <a href="#">20.01 Ext1 commands</a> = <a href="#">In1 Start fwd</a> ; <a href="#">In2 Start rev</a> <a href="#">20.02 Ext1 start trigger type</a> = <a href="#">Edge</a> <a href="#">20.03 Ext1 in1 source</a> = <a href="#">DI1</a> <a href="#">20.04 Ext1 in2 source</a> = <a href="#">DI2</a>
<input type="checkbox"/>	Select the signal source for speed reference 1. <a href="#">22.11 Ext1 speed ref1</a> = <a href="#">AI1 scaled</a> <a href="#">22.13 Ext1 speed function</a> = <a href="#">Abs (ref1)</a>
<input type="checkbox"/>	Define the analog input AI1 scales. <a href="#">12.15 AI1 unit selection</a> = <a href="#">V</a> <a href="#">12.17 AI1 min</a> = 0 V <a href="#">12.18 AI1 max</a> = 10 V <a href="#">12.19 AI1 scaled at AI1 min</a> = The required maximum speed for reverse direction <a href="#">12.20 AI1 scaled at AI1 max</a> = The required maximum speed for forward direction

<input type="checkbox"/>	Set the required ramp times. <i>23.11 Ramp set selection</i> <i>23.12 Acceleration time 1</i> <i>23.13 Deceleration time 1</i> <i>23.14 Acceleration time 2</i> <i>23.15 Deceleration time 2</i>
<input type="checkbox"/>	Set the speed limits. <i>30.11 Minimum speed</i> = The same value as for <i>12.19 A11 scaled at A11 min</i> <i>30.12 Maximum speed</i> = The same value as for <i>12.20 A11 scaled at A11 max</i>
<input type="checkbox"/>	Set the torque and current limits. <i>30.17 Maximum current</i> = Nominal motor current [A] <i>30.19 Minimum torque 1</i> = Nominal motor torque (for example, -100%) <i>30.20 Maximum torque 1</i> = Nominal motor torque (for example, 100%) <b>Note:</b> After the trial run, you must set the above limits according to the application requirements.
<b>Brake control settings</b>	
<input type="checkbox"/>	Make sure that the brake control logic is activated. <i>44.06 Brake control enable</i> = <i>Selected</i> <i>10.24 RO1 source</i> = <i>Brake command</i>
<input type="checkbox"/>	Define brake opening and closing delays. <i>44.08 Brake open delay</i> = eg. 1 s <i>44.13 Brake close delay</i> = eg. 1 s
<input type="checkbox"/>	Select the source for the brake acknowledgment signal. <i>44.07 Brake acknowledge selection</i> = as per the application requirements (eg. <i>No acknowledge</i> )
<input type="checkbox"/>	If you set up a hoist drive, set the parameters as below: <i>44.09 Brake open torque source</i> = <i>Brake open torque</i> <i>44.10 Brake open torque</i> = 30% (this value works as minimum value when <i>Brake torque memory</i> is selected) <i>44.202 Torque proving</i> = <i>Selected</i> <i>44.203 Torque proving reference</i> = 25.0 <i>44.204 Brake system check time</i> = 0.30 If you set up a trolley or long travel drive, set the parameters as below: <i>44.09 Brake open torque source</i> = <i>Zero</i> <i>44.10 Brake open torque</i> = 0% <i>44.202 Torque proving</i> = <i>Not selected</i> <b>Note:</b> These values are also recommended when you use scalar control mode ( <i>99.04</i> ) for the hoist drive.
<b>Trial run</b>	
<input type="checkbox"/>	Do a trial run with no load.
<input type="checkbox"/>	Make sure that the brake and safety circuits are working.
<input type="checkbox"/>	Do a trial run with real load.

### Control connections

The diagram shows the control connections for the joystick set-up described on page 514.

Terminals	Description
<b>Digital I/O connections</b>	
	<b>+24V</b> Aux. +24 V DC, max 200 mA
	<b>DGND</b> Aux. voltage output common
	<b>DCOM</b> Digital input common
	<b>DI1</b> Start forward
	<b>DI2</b> Start reverse
	<b>DI3</b> Stop limit 1 (forward)
	<b>DI4</b> Stop limit 2 (reverse)
	<b>DIO1</b> Slowdown
	<b>DIO2</b> Not configured
	<b>DIO SRC</b> Digital output auxiliary voltage
<b>DIO COM</b> Digital input/output common	
<b>Analog I/O</b>	
	<b>AI1</b> Speed / freq (0...10V)
	<b>AGND</b> Analog input circuit common
	<b>AI2</b> Not configured
	<b>AGND</b> Analog input circuit common
	<b>AO</b> Output frequency (0...20 mA)
	<b>AGND</b> Analog output circuit common
	<b>SCR</b> Signal cable shield (screen)
<b>+10V</b> Ref. voltage +10 V DC	
<b>Safe torque off (STO)</b>	
	<b>S+</b>
	<b>SGND</b>
	<b>S1</b>
	<b>S2</b>
<b>Relay output 1</b>	
	<b>RC</b>
	<b>RA</b>
	<b>RB</b>
Brake command (10.24 RO1 source = Brake command)	

**Notes:**

Terminal sizes: 0.14 mm<sup>2</sup> ... 1.5 mm<sup>2</sup>.

Tightening torque: 0.5 N·m (0.4 lbf·ft).

Terminals DGND, AGND and SGND are internally connected to same reference potential.

Input signals

- Start forward (DI1)
- Start reverse (DI2)
- Stop limit 1 (forward) (DI3)
- Stop limit 2 (reverse) (DI4)
- Slowdown (DIO1)

Output signals

- Speed / freq (0...10V) (AI1)
  - Output frequency (0...20mA) (AO)
  - Brake command (RO1)
-

## ■ Control through the I/O interface using the step reference logic/pendant control

This section describes how to set up the drive for control through the I/O interface using the step reference logic/pendant control.

<b>Safety</b>	
	<b>WARNING!</b> Obey all safety instructions for the drive. Only qualified electricians are allowed to start up the drive.
<b>Preliminary actions</b>	
<input type="checkbox"/>	Make sure that you have completed the basic start-up sequence of the drive. See <a href="#">Start-up, ID run and use</a> on page 23. Make sure that the motor control method is selected as vector control (99.04).
<input type="checkbox"/>	Power up the drive and wait for 10 seconds. This is to make sure that all the boards are powered and the application is running.
<input type="checkbox"/>	Switch to local control.
<b>Brake circuit check</b>	
<input type="checkbox"/>	Make sure that you can safely do the brake circuit check. For example, make sure that the load is not hanging from a hook.
<input type="checkbox"/>	Make sure that the brake circuit is working as expected according to the command given by the default brake control signal interface (relay output RO1): <ul style="list-style-type: none"> <li>• Open the brake temporarily by setting parameter <a href="#">10.24 RO1 source</a> to <a href="#">Energized</a>. Verify that the brake opens.</li> <li>• Set parameter <a href="#">10.24 RO1 source</a> to <a href="#">Brake command</a> to use the default brake control signal interface.</li> </ul>
<b>Control signal settings</b>	
<input type="checkbox"/>	Select the signal sources for start and stop control. <a href="#">20.01 Ext1 commands</a> = <a href="#">In1 Start fwd</a> ; <a href="#">In2 Start rev</a> <a href="#">20.02 Ext1 start trigger type</a> = <a href="#">Edge</a> <a href="#">20.03 Ext1 in1 source</a> = <a href="#">DI1</a> <a href="#">20.04 Ext1 in2 source</a> = <a href="#">DI2</a>
<input type="checkbox"/>	Define the step reference logic (4 steps). <a href="#">22.21 Constant speed function</a> = Set speed step bit 2 = 1 (0b0100) <a href="#">22.22 Constant speed sel1</a> = <a href="#">DI3</a> <a href="#">22.23 Constant speed sel2</a> = <a href="#">DI4</a> <a href="#">22.24 Constant speed sel3</a> = <a href="#">DIO1</a> ( <a href="#">11.05 DIO1 configuration</a> = <a href="#">Input</a> ) <a href="#">22.26 Constant speed 1</a> = 300.00 <a href="#">22.27 Constant speed 2</a> = 600.00 <a href="#">22.28 Constant speed 3</a> = 1000.00 <a href="#">22.29 Constant speed 4</a> = 1500.00

<input type="checkbox"/>	Set the required ramp times. <i>23.11 Ramp set selection</i> <i>23.12 Acceleration time 1</i> <i>23.13 Deceleration time 1</i> <i>23.14 Acceleration time 2</i> <i>23.15 Deceleration time 2</i>
<input type="checkbox"/>	Set the speed limits. <i>30.11 Minimum speed</i> = The same value as for <i>12.19 A11 scaled at A11 min</i> <i>30.12 Maximum speed</i> = The same value as for <i>12.20 A11 scaled at A11 max</i>
<input type="checkbox"/>	Set the torque and current limits. <i>30.17 Maximum current</i> = Nominal motor current [A] <i>30.19 Minimum torque 1</i> = Nominal motor torque (for example, -100%) <i>30.20 Maximum torque 1</i> = Nominal motor torque (for example, 100%) <b>Note:</b> After the trial run, you must set the above limits according to the application requirements.
<b>Brake control settings</b>	
<input type="checkbox"/>	Make sure that the brake control logic is activated. <i>44.06 Brake control enable</i> = <i>Selected</i> <i>10.24 RO1 source</i> = <i>Brake command</i>
<input type="checkbox"/>	Define brake opening and closing delays. <i>44.08 Brake open delay</i> = eg. 1 s <i>44.13 Brake close delay</i> = eg. 1 s
<input type="checkbox"/>	Select the source for the brake acknowledgment signal. <i>44.07 Brake acknowledge selection</i> = as per the application requirements (eg. <i>No acknowledge</i> )
<input type="checkbox"/>	If you set up a hoist drive, set the parameters as below: <i>44.09 Brake open torque source</i> = <i>Brake open torque</i> <i>44.10 Brake open torque</i> = 30% (this value works as minimum value when <i>Brake torque memory</i> is selected) <i>44.202 Torque proving</i> = <i>Selected</i> <i>44.203 Torque proving reference</i> = 25.0 <i>44.204 Brake system check time</i> = 0.30 If you set up a trolley or a long travel drive, set the parameters as below: <i>44.09 Brake open torque source</i> = <i>Zero</i> <i>44.10 Brake open torque</i> = 0% <i>44.202 Torque proving</i> = <i>Not selected</i> <b>Note:</b> These values are also recommended when you use scalar control mode ( <i>99.04</i> ) for the hoist drive.
<b>Trial run</b>	
<input type="checkbox"/>	Do a trial run with no load.
<input type="checkbox"/>	Make sure that the brake and safety circuits are working.
<input type="checkbox"/>	Do a trial run with real load.

### Control connections

The diagram shows the control connections for the step reference set-up described on page 562.

Terminals	Description	
<b>Digital I/O connections</b>		
	+24V	Aux. +24 V DC, max 200 mA
	DGND	Aux. voltage output common
	DCOM	Digital input common
	DI1	Start forward (Serial with stop limit 1)
	DI2	Start reverse (Serial with stop limit 2)
	DI3	Speed step sel 2
	DI4	Speed step sel 3
	DIO1	Speed step sel 4
	DIO2	Not configured
	DIO SRC	Digital output auxiliary voltage
	DIO COM	Digital input/output common
	<b>Analog I/O</b>	
	AI1	Speed / freq.(0...10V)
	AGND	Analog input circuit common
AI2	Not configured	
AGND	Analog input circuit common	
AO	Output frequency (0...20 mA)	
AGND	Analog output circuit common	
SCR	Signal cable shield (screen)	
+10V	Ref. voltage +10 V DC	
<b>Safe torque off (STO)</b>		
	S+	Safe torque off. Connected at factory.
	SGND	Drive starts only if both circuits are closed.
	S1	Status from <a href="#">06.18 Start inhibit status word</a> (1 = STO active, circuits are open), <a href="#">20.2.12 Power on acknowledge</a> , and <a href="#">20.12 Run enable 1 source</a> .
	S2	
<b>Relay output 1</b>		
	RC	Brake command ( <a href="#">10.24 RO1 source</a> = <i>Brake command</i> )
	RA	
	RB	



**Notes:**

Terminal sizes: 0.14 mm<sup>2</sup> ... 1.5 mm<sup>2</sup>.

Tightening torque: 0.5 N·m (0.4 lbf·ft).

Terminals DGND, AGND and SGND are internally connected to same reference potential.

Input signals

- Start forward (Serial with stop limit 1) (DI1)
- Start reverse (Serial with stop limit 2) (DI2)
- Speed step sel 2 (DI3)
- Speed step sel 3 (DI4)
- Speed step sel 4 (DIO1)

Output signals

- Speed / freq (0...10V) (AI1)
  - Output frequency (0...20 mA) (AO)
  - Brake command (RO1)
-

## ■ Control through the fieldbus interface using the fieldbus control word

This section describes how to set up the drive for control through the fieldbus interface using the fieldbus control word.

Safety	
	<b>WARNING!</b> Obey all safety instructions for the drive. Only qualified electricians are allowed to start up the drive.
Preliminary actions	
<input type="checkbox"/>	Make sure that you have completed the basic start-up sequence of the drive. See <a href="#">Start-up, ID run and use</a> on page 23. <b>Note:</b> While performing the start up procedures, make sure that the motor control method is selected as vector control (99.04).
<input type="checkbox"/>	Power up the drive and wait for 10 seconds. This is to make sure that all the boards are powered and the application is running.
<input type="checkbox"/>	Switch to local control.
Brake circuit check	
<input type="checkbox"/>	Make sure that you can safely do the brake circuit check. For example, make sure that the load is not hanging from a hook.
<input type="checkbox"/>	Make sure that the brake circuit is working as expected according to the command given by the default brake control signal interface (relay output RO1): <ul style="list-style-type: none"> <li>• Open the brake temporarily by setting parameter <a href="#">10.24 RO1 source</a> to <a href="#">Energized</a>. Verify that the break opens.</li> <li>• Set parameter <a href="#">10.24 RO1 source</a> to <a href="#">Brake command</a> to use the default brake control signal interface.</li> </ul>
Basic fieldbus adapter settings	
<input type="checkbox"/>	See chapter <a href="#">Automatic drive configuration for fieldbus control</a> on page 491.
Control signal settings	
<input type="checkbox"/>	Select the signal sources for start and stop control. <a href="#">20.01 Ext1 commands</a> = <a href="#">Fieldbus A</a> <a href="#">20.02 Ext1 start trigger type</a> = <a href="#">Level</a>
<input type="checkbox"/>	Select the signal source for speed reference 1. <a href="#">22.11 Ext1 speed ref1</a> = <a href="#">FB A ref1</a>
<input type="checkbox"/>	Set the required ramp times. <a href="#">23.11 Ramp set selection</a> <a href="#">23.12 Acceleration time 1</a> <a href="#">23.13 Deceleration time 1</a> <a href="#">23.14 Acceleration time 2</a> <a href="#">23.14 Deceleration time 2</a>

<input type="checkbox"/>	Set the speed limits. <i>30.11 Minimum speed</i> <i>30.12 Maximum speed</i> <i>46.01 Speed scaling</i>
<input type="checkbox"/>	Set the torque and current limits. <i>30.17 Maximum current</i> = Nominal motor current [A] <i>30.19 Minimum torque 1</i> = Nominal motor torque (for example, -100%) <i>30.20 Maximum torque 1</i> = Nominal motor torque (for example, 100%) <b>Note:</b> After the trial run, you must set the above limits according to the application requirements.
<b>Brake control settings</b>	
<input type="checkbox"/>	Make sure that the brake control logic is activated. <i>44.06 Brake control enable</i> = <i>Selected</i> <i>10.24 RO1 source</i> = <i>Brake command</i>
<input type="checkbox"/>	Define brake opening and closing delays. <i>44.08 Brake open delay</i> = eg. 1 s <i>44.13 Brake close delay</i> = eg. 1 s
<input type="checkbox"/>	Select the source for the brake acknowledgment signal. <i>44.07 Brake acknowledge selection</i> = as per the application requirements (eg. DI3 or No acknowledge)
<input type="checkbox"/>	If you set up a hoist drive, set the parameters as below: <i>44.09 Brake open torque source</i> = <i>Brake open torque</i> <i>44.10 Brake open torque</i> = 30% (this value works as minimum value when <i>Brake torque memory</i> is selected) <i>44.202 Torque proving</i> = <i>Selected</i> <i>44.203 Torque proving reference</i> = 25.0 <i>44.204 Brake system check time</i> = 0.30 If you set up a trolley or long travel drive, set the parameters as below: <i>44.09 Brake open torque source</i> = <i>Zero</i> <i>44.10 Brake open torque</i> = 0% <i>44.202 Torque proving</i> = <i>Not selected</i> <b>Note:</b> These values are also recommended when you use scalar control mode ( <i>99.04</i> ) for the hoist drive.
<b>Trial run</b>	
<input type="checkbox"/>	Do a trial run with an empty hook.
<input type="checkbox"/>	Make sure that the brake and safety circuits are working.
<input type="checkbox"/>	Do a trial run with real load.

### Control connection for the fieldbus control set-up

The diagram below shows the control connections for the fieldbus control word set-up described on page 522.

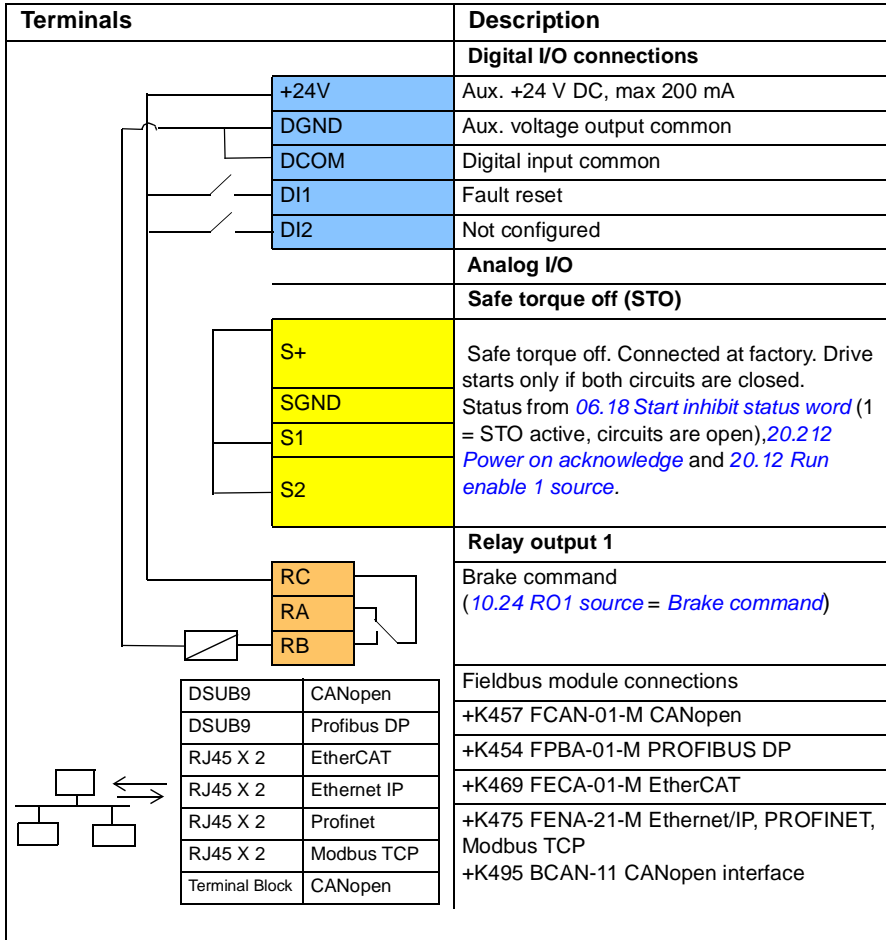

**Notes:**

Terminal sizes: 0.14 mm<sup>2</sup> ... 1.5 mm<sup>2</sup>.

Tightening torque: 0.5 N·m (0.4 lbf·ft).

Terminals DGND, AGND and SGND are internally connected to same reference potential.

## Input signals

- Fault reset (DI1)
- Control words and reference words through the fieldbus adapter module

## Output signals

- Status words and status signals through the fieldbus adapter module
- Brake command (RO1)

### ■ Configuring speed feedback using a HTL/TTL pulse encoder

You can configure the speed feedback with a BTAC pulse encoder interface module (option +L535). This adds a digital pulse encoder interface to the drive and provides accurate speed or position (angle) feedback from the motor shaft.

**Note:** ABB product offering for cranes highlights safety and performance. You should use components that increases safety. For example, in hoist crane application drives, closed loop control (encoder or external supervision) must be used for safe speed supervision.

The figure below shows the ACS380 drive with BTAC module.



For information related to mechanical and electrical installation, see the hardware manual of the drive.

Safety	
<input type="checkbox"/>	 <b>WARNING!</b> Obey all safety instructions for the drive. Only qualified electricians are allowed to start up the drive.
Parameter settings	
<input type="checkbox"/>	Power up the BTAC module and the drive (if external supply).
<input type="checkbox"/>	Set the feedback selection. <i>90.41 Motor feedback selection = Encoder 1</i> <i>90.45 Motor feedback fault = Fault</i>
<input type="checkbox"/>	Set the number of pulses according to encoder nameplate ( <i>92.10 Pulses/revolution</i> ).

<input type="checkbox"/>	Set parameter <i>91.10 Encoder parameter refresh</i> to <i>Refresh</i> , to apply the new parameter settings. The parameter automatically changes to <i>Done</i> after application of the new settings. This must be performed whenever you change the encoder parameters.
<b>Trial run</b>	
<input type="checkbox"/>	Temporarily set parameter <i>90.41</i> to <i>Estimate</i> . Perform a trial run. Observe encoder feedback from signal <i>90.10 Encoder 1 speed</i> and compare with <i>01.02 Motor speed estimated</i> . If the difference between values are not high, set <i>90.41 90.41</i> to <i>Encoder 1</i> .

## ■ Configuring slowdown with two limits and stop limit logic

### Slowdown limit inputs

Safety	
<input type="checkbox"/>	 <b>WARNING!</b> Obey all safety instructions for the drive. Only qualified electricians are allowed to start up the drive.
Parameter settings	
<input type="checkbox"/>	Enable limit control. <i>76.02 Enable limit to limit control = Selected</i>
<input type="checkbox"/>	Set triggering type for signals. <i>76.03 Limit to limit trigger type = Level low</i>
<input type="checkbox"/>	Select slowdown inputs. <i>76.05 Forward slow down limit</i> <i>76.07 Reverse slow down limit</i> Either select one incoming signal in both directions, or two inputs, one input for each direction. See section <i>Crane slowdown function</i> on page 548.
<input type="checkbox"/>	Select slowdown speed or frequency according to the selected reference. <i>76.08 Slow down speed</i> or <i>76.09 Slow down frequency</i>
Trial run	
<input type="checkbox"/>	Test the connected inputs and outputs in the local control mode before the final trial run. <b>Note:</b> If digital input/output (DIO1 or DIO2) is in use, set correct configuration. <i>11.05 DIO1 configuration = Input</i> or <i>11.09 DIO2 configuration = Input</i>

### Stop limit

Safety	
<input type="checkbox"/>	 <b>WARNING!</b> Obey all safety instructions for the drive. Only qualified electricians are allowed to start up the drive.
Parameter settings	
<input type="checkbox"/>	Enable limit control. <i>76.02 Enable limit to limit control = Selected</i>
<input type="checkbox"/>	Set triggering type for signals to be level. <i>76.03 Limit to limit trigger type = Level low</i>
<input type="checkbox"/>	Select stop limit inputs <i>76.04 Forward stop limit</i> <i>76.06 Reverse stop limit</i>

<input type="checkbox"/>	Select stop ramp mode. <i>76.11 Limit stop mode</i>
<input type="checkbox"/>	If <i>76.11 Limit stop mode</i> = <i>Limit ramp stop mode</i> , enter required ramp time to stop. <i>76.12 Limit stop ramp time</i> = e.g 0.500 s
<b>Trial run</b>	
<input type="checkbox"/>	Test the connected inputs and outputs in the local control mode before the final trial run. <b>Note:</b> Instead of stop limit logic, the switches can be connected serial with start orders



### Control connection diagram

The diagram below shows the control connection example for the slowdown limit and stop limit function described on page 527.

Terminals	Description	
<b>Digital I/O connections</b>		
	<b>+24V</b>	Aux. +24 V DC, max 200 mA
	<b>DGND</b>	Aux. voltage output common
	<b>DCOM</b>	Digital input common
	<b>DI1</b>	Start forward
	<b>DI2</b>	Start reverse
	<b>DI3</b>	Stop limit 1 (forward)
	<b>DI4</b>	Stop limit 2 (reverse)
	<b>DIO1</b>	Slowdown
	<b>DIO2</b>	Not configured
	<b>DIO SRC</b>	Digital output auxiliary voltage
<b>DIO COM</b>	Digital input/output common	
<b>Analog I/O</b>		
	<b>AI1</b>	Speed / freq.(0...10V)
	<b>AGND</b>	Analog input circuit common
	<b>AI2</b>	Not configured
	<b>AGND</b>	Analog input circuit common
	<b>AO</b>	Output frequency (0...20 mA)
	<b>AGND</b>	Analog output circuit common
	<b>SCR</b>	Signal cable shield (screen)
<b>+10V</b>	Ref. voltage +10 V DC	
<b>Safe torque off (STO)</b>		
	<b>S+</b>	Safe torque off. Connected at factory.
	<b>SGND</b>	Drive starts only if both circuits are closed.
	<b>S1</b>	Status from <a href="#">06.18 Start inhibit status word</a>
	<b>S2</b>	(1 = STO active, circuits are open).
<b>Relay output 1</b>		
	<b>RC</b>	Brake command ( <a href="#">10.24 RO1 source</a> = Brake command)
	<b>RA</b>	
	<b>RB</b>	

**Notes:**

Terminal sizes: 0.14 mm<sup>2</sup> ... 1.5 mm<sup>2</sup>.

Tightening torque: 0.5 N·m (0.4 lbf·ft).

Terminals DGND, AGND and SGND are internally connected to same reference potential.

Input signals

- Start forward (DI1)
- Start reverse (DI2)
- Stop limit 1 (forward) (DI3)
- Stop limit 2 (reverse) (DI4)
- Slowdown (DIO1)

Output signals

- Speed/freq(0...10V) (AI1)
  - Output frequency (0...20 mA) (AO)
  - Brake command (RO1)
-

## ■ Configuring Mechanical brake control

Safety	
<input type="checkbox"/>	 <b>WARNING!</b> Obey all safety instructions for the drive. Only qualified electricians are allowed to start up the drive.
Parameter settings	
<input type="checkbox"/>	Activate the brake control logic. <i>44.06 Brake control enable = Selected</i>
<input type="checkbox"/>	Select the source for the brake acknowledgment signal. <i>44.07 Brake acknowledge selection = as per the application requirements (eg. DI3 or No acknowledge)</i>
<input type="checkbox"/>	Define the brake open and close delay. <i>44.08 Brake open delay = eg. 1 s</i> <i>44.13 Brake close delay = eg. 1 s</i> <b>Notes:</b> <ul style="list-style-type: none"> <li>• Close delay time can be longer than the mechanical delay time provided by the mechanical brake manufacturer.</li> <li>• Longer delay time can cause small roll back, and short delay time can cause wear of the brake pads.</li> </ul>
<input type="checkbox"/>	Select the source for the brake opening torque. At first, select the following: <i>44.09 Brake open torque source = Brake open torque</i> <i>44.10 Brake open torque = 30%</i> <b>Notes:</b> <ul style="list-style-type: none"> <li>• The break opening torque is meant for hoisting application only, and is not necessary to use it with trolley and long travel movement applications. If used for trolley or long travel movement applications, set the value of both parameters as 0%.</li> <li>• In scalar motor control or in trolley and long travel movements, disable Torque proving and Brake open torque. Select the following:  <i>44.09 Brake open torque source = Zero</i>  <i>44.10 Brake open torque = 0%</i>  <i>44.202 Torque proving = Not selected</i>  <i>44.203 Torque proving reference = 0%</i> </li> </ul>
<input type="checkbox"/>	Set the brake close level. <i>44.14 Brake close level = 30 rpm or 60 rpm</i> When an encoder is used, the value needs to be set as 10-30 rpm else set the value as 60 rpm.
<input type="checkbox"/>	Set break fault function to fault. <i>44.17 Brake fault function = Fault</i>
<input type="checkbox"/>	For hoist drives, set the parameters as below: <i>44.202 Torque proving = Selected</i> <i>44.203 Torque proving reference = 30%</i>

<input type="checkbox"/>	Set the extended runtime to keep the drive modulating after the brake is closed. This magnetizes the drive before the next start and enables faster response to the control commands. <a href="#">44.211 Extended runtime</a>
<input type="checkbox"/>	If a pulse encoder does not exist in the system, activate the Brake safe closure function in parameter <a href="#">44.207 Safety close select</a> .
<b>Trial run</b>	
<input type="checkbox"/>	Tune the brake control parameters during final testing and when you monitor the actual speed and torque. This helps to get the fastest possible response for the control commands without any jerk or roll-back in the actual speed while opening or closing the brake.

## Crane mechanical brake control

In addition to the existing mechanical brake control function (see page 84), the crane mechanical brake control function consists of brake system check (see page 534) and extended run time (see page 539) functions.

The *Crane brake control timing diagram* below shows an example of a close-open-close sequence and illustrates the operation of the crane brake control function.

### Crane brake control timing diagram

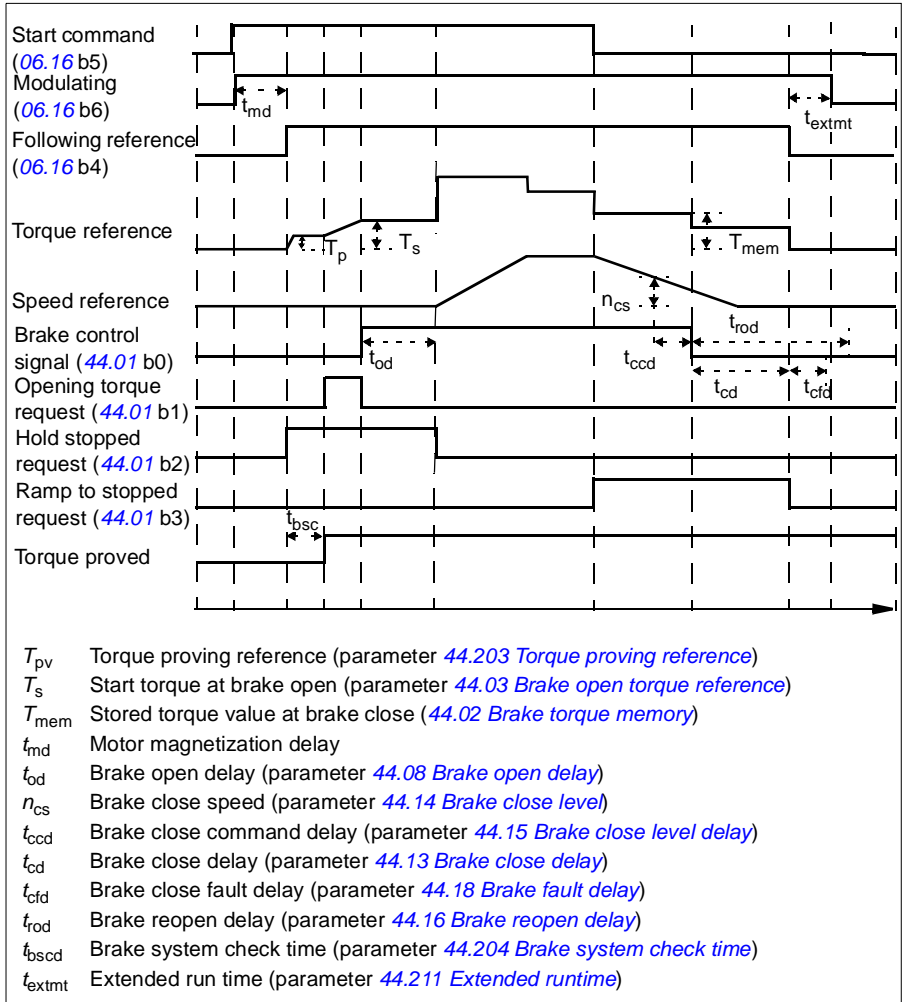

**Note:** In case of any fault, the brake closes immediately. By default, the brake control uses relay output RO1.

## ■ Brake system checks – overview

The brake system checks consist of electrical and mechanical tests.

- The electrical test makes sure that the drive can produce torque before it releases the brake and starts the crane operation. That is, electrical components like the drive, motor cable, and motor itself are ready to start.
- The mechanical test makes sure that the motor brake is not slipping.

Both tests are done in parallel (at the same time) during a check time ([44.204](#)). If both tests are performed successfully during the check time, the drive opens the brake, and the crane hoist motion starts.

For more detailed information on the tests, see sections:

- [Brake system checks – Torque proving](#) on page [536](#)
- [Brake system checks – Brake slip](#) on page [537](#).

**Note:** In scalar motor control or in trolley and long travel movements, disable Torque proving and Brake open torque. Select the following:

- [44.09 Brake open torque source](#) = Zero
  - [44.10 Brake open torque](#) = 0%
  - [44.202 Torque proving](#) = *Not selected*
-

This flowchart shows the brake system check sequence.

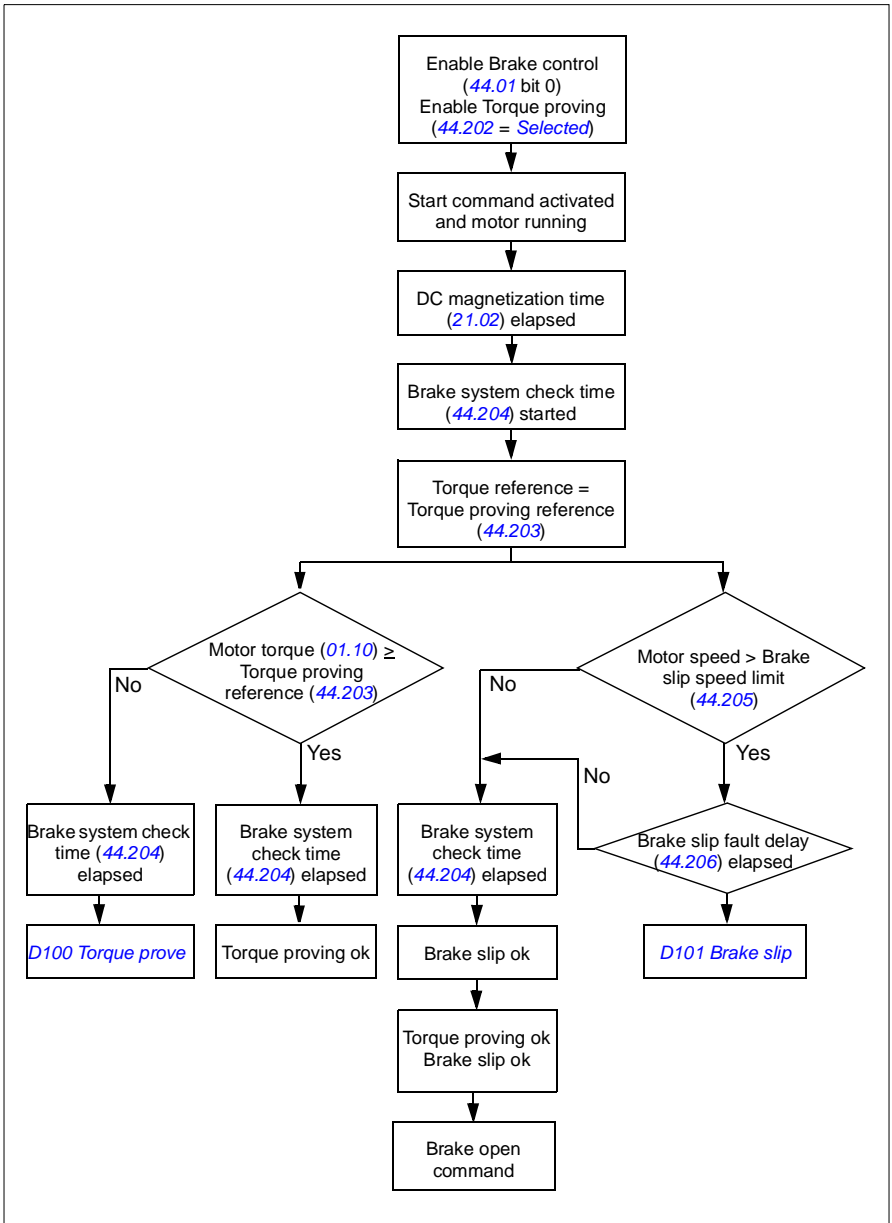

### Timing diagram

This timing diagram shows the operation of the Torque proving and Brake system check functions.

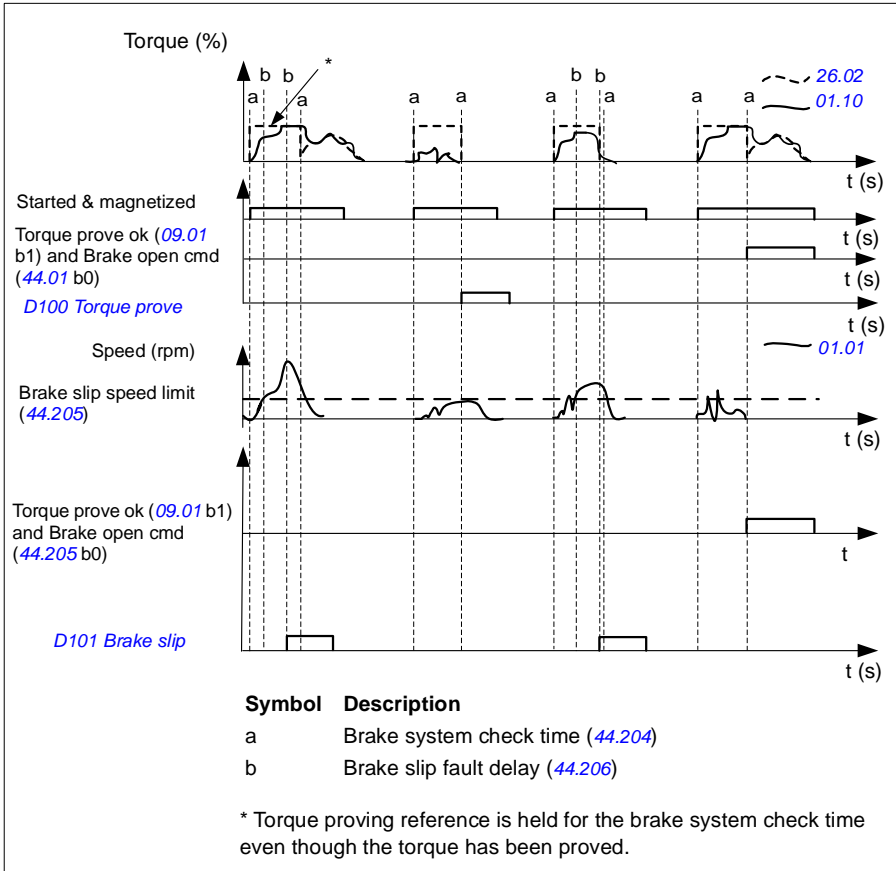

### ■ Brake system checks – Torque proving

Torque proving makes sure that the drive can produce torque before it releases the brake and starts the crane operation. The function is mainly intended for hoist drives, but you can also activate it in drives that control other crane motions if the drives uses encoder feedback.

Torque proving gives a positive or negative torque reference against a closed mechanical brake. If torque proving is successful, in other words, the actual torque of the drive reaches the reference level (44.203), the drive lets the brake open and starts the next step in the starting sequence.



A time delay ([44.204](#)) defines the time during which the torque reference ([44.203](#)) is active and completes the electrical and mechanical tests of the crane system. Unsuccessful torque proving trips the drive ([D100](#)).

See also the *Timing diagram* on page [536](#).

### Settings

Parameters: [44.202 Torque proving](#), [44.203 Torque proving reference](#), [44.204 Brake system check time](#)

Signals: [09.01 Crane SW1](#), [09.03 Crane FW1](#)

Warnings: -

Faults: [D100 Torque prove](#)

### ■ Brake system checks – Brake slip

The Brake slip function examines the system for brake slips while the control program performs Torque proving with the brake closed. If the motor actual speed exceeds speed limit ([44.205](#)) during a check time ([44.204](#)), and stays there for longer than a time delay ([44.206](#)), the drive trips on a fault ([D101](#)).

See, *Timing diagram* on page [536](#).

**Note:** In scalar motor control or in trolley and long travel movements, disable Torque proving and Brake open torque. Select the following:

- [44.09 Brake open torque source](#) = *Zero*
- [44.10 Brake open torque](#) = 0%
- [44.202 Torque proving](#) = *Not selected*

### Settings

Parameters: [44.204 Brake system check time](#), [44.205 Brake slip speed limit](#), [44.206 Brake slip fault delay](#)

Signals: [09.03 Crane FW1](#)

Warnings: -

Faults: [D101 Brake slip](#)

## ■ Brake safe closure

The Brake safe closure function performs a forced closure of the brake and prevents the end-user from operating the drive at very low speeds. We recommend this function especially in hoist drives which, for some reason, have no pulse encoder. (As a safety measure, a speed feedback device is highly recommended in hoist drives.)

The Brake safe closure function monitors the motor speed estimate when the drive is running. When both the estimated motor speed (01.01) and the ramped and shaped speed reference (23.02) are below a user-defined speed limit (44.208) longer than a user-defined delay (44.209), the drive trips on a fault (D102) and closes the motor brake.

### Timing diagram

The below diagram shows the operation of the *Brake safe closure* fault.

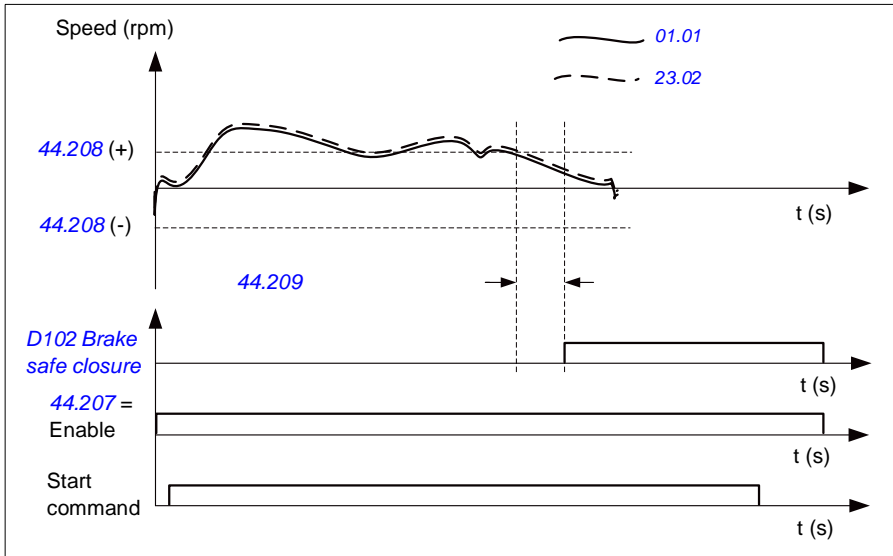

### Settings

Parameters: *44.207 Safety close select*, *44.208 Safety close speed*, *44.209 Safety close delay*

Signals: *09.03 Crane FW1*

Warnings: -

Faults: *D102 Brake safe closure*

## Extended run time

The Extended run time function minimizes the delay between consecutive start commands. After the brake closes and the brake close delay time elapses, the extended run time function keeps the motor magnetized for a defined time period. During the delay period, the motor is kept magnetized (modulating), to be ready for immediate restart. Because of this action, the next start can be considerably faster by skipping certain start sequence steps, such as magnetization (page 77) and torque proving (page 536).

The function activates when the following parameters are set:

- *44.06 Brake control enable* = *Selected*
- *44.211 Extended runtime* > 0.
- *44.212 Extended runtime sw* (Bit 0) = 1. After the brake closes, this modulates the drive for the defined time in parameter *44.211 Extended runtime*.

If the drive trips during the extended run time operation, the function timer resets.

Refer the *Crane brake control timing diagram* (page 533), to see the operation of the Extended run time function.

### Notes:

- The Extended run time function is available only in vector control mode (see page 54) when the drive is in Remote mode and only when parameter *21.03 Stop mode* is set as *Ramp*.
- If you enable Post magnetization function at the same time, post magnetization function executes first, and when post magnetization time elapses, the extended runtime should be set for the remaining time if extended runtime is longer than post magnetization time.



**WARNING:** Make sure the motor is capable of absorbing or dissipating the thermal energy generated by continuous magnetization, for example by forced ventilation.

---

### Settings

Parameters: *44.211 Extended runtime*

Signals: *44.01 Brake control status*, *44.212 Extended runtime sw*

Warnings: -

Faults: -

---

## Speed matching

The Speed matching function compares the crane speed reference continuously to the actual motor speed to detect any differences. The function makes sure that the motor follows the speed reference when stopped, during acceleration or deceleration, and when running at the constant speed. The function also makes sure that the brake does not slip when the drive has stopped with the brake closed.

The function has two deviation levels:

- one for checking the speed deviation during a ramping state, that is, acceleration and deceleration (76.33)
- one for checking the speed deviation during a constant speed (76.32).

The drive trips on a fault (D105) if the drive is running, and

- the motor is running in a steady state, and the difference between the motor actual speed (90.01) and the ramped and shaped speed reference (24.01) is greater than the steady state deviation level for longer than a delay (76.34)  
or
- the motor is accelerating or decelerating, and the difference between the motor actual speed (90.01) and the ramped and shaped speed reference (24.01) is greater than the ramping state deviation level for longer than a delay (76.34).

The drive generates a warning (D200) if the drive stops, and

- the difference between the motor actual speed (90.01) and the speed reference is greater than the steady state deviation level for longer than a delay (76.34)  
and
  - the brake control is active and the brake is closed.
-

### Timing diagrams

The diagram shows the operation of the *Speed match* fault.

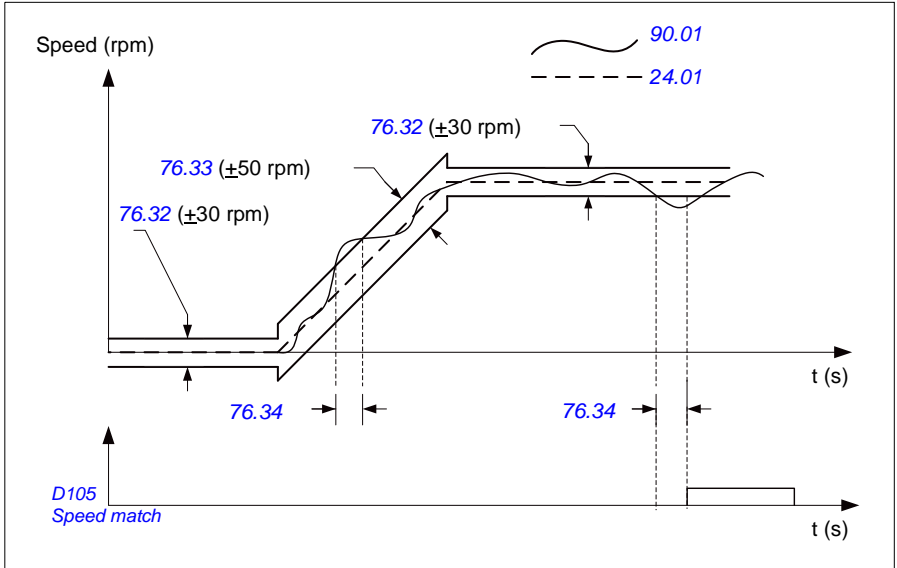

The diagram shows the operation of the *Brake slip at standstill2* warning.

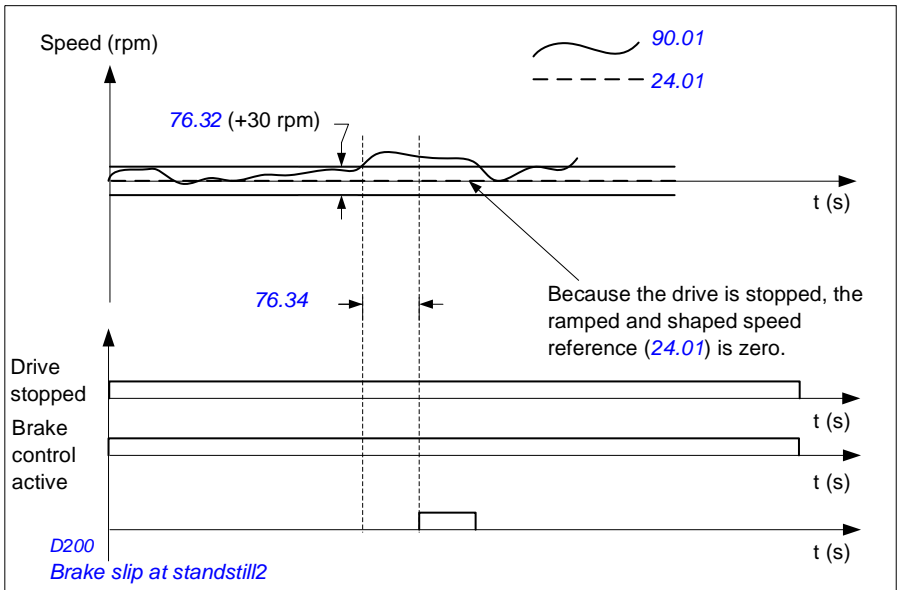

## Settings

Parameters: [76.31 Motor speed match](#)

Signals: [09.01 Crane SW1](#), [09.03 Crane FW1](#)

Warnings: [D200 Brake slip at standstill2](#)

Faults: [D105 Speed match](#)

## Crane warning masking

The Crane warning masking function masks the predefined crane control warnings. The masked warnings do not appear in the event logger or on the control panel

Parameter: [31.205 Crane warning masking](#)

Signals: [09.01 Crane SW1](#)

Warnings: -

Faults: -

## Dead-band function

The accuracy of an analog input signal near zero is poor. With the Dead-band function, you can freeze the speed reference for a defined band area (that is, dead band) or ignore a low speed reference caused by possible crane vibrations on the joystick.

The function re-scales the analog signal based on the dead-band settings, and then calculates a new speed reference.

### Example

In the example:

- Analog input reference (AI1) comes from the joystick:
    - Par. [12.18 AI1 max](#) = 10 V
    - Par. [12.17 AI1 min](#) = 0 V
    - Par. [12.20 AI1 scaled at AI1 max](#) = 1500
  - 0...5 V gives the reverse speed reference.
  - 5 V is the joystick zero position.
  - 5...10 V gives the forward speed reference.
-

When parameter [30.203 Deadband forward](#) is set to 2%, it means that there is a deadband area of 30 rpm (2% of par. [12.20 AI1 scaled at AI1 max](#) = 1500 rpm) in the forward direction. Inside this deadband area, the resulting speed reference is zero. Actual signal [09.06 Crane speed reference](#) shows the final speed reference used, and when the speed reference is outside this dead-band area. In this case, actual signal [09.06](#) starts to show a positive reference starting from the point where the scaled value of analog input AI1 ([12.12 AI1 scaled value](#)) exceeds 30 rpm.

## Settings

Parameters: [30.203 Deadband forward](#), [30.204 Deadband reverse](#)

Signals: [09.06 Crane speed reference](#), [09.16 Crane frequency reference](#)

Warnings: -

Faults: -

## Start/stop interlocking

The Start/stop interlocking function of the control program lets the end-user start the crane only when the drive is ready to operate.

The function includes the following features:

- [Joystick zero position interlocking](#) (page [543](#))
- [Joystick reference interlocking](#) (page [544](#))

### ■ Joystick zero position interlocking

This function supervises the zero position of the joystick while the drive is running and a stop command is given, or if the drive trips on a fault. A falling edge of the zero position input ([20.214](#)) must occur before the end-user can give a new start command after stopping or tripping. If the drive logic does not detect a falling edge (that is, the signal remains high) before a new start command is given, the drive generates a warning ([D209](#)).

This figure shows how the joystick works with NO (normally open) contact elements for start/stop in the forward and reverse directions and one NC (normally closed) contact element for the zero position.

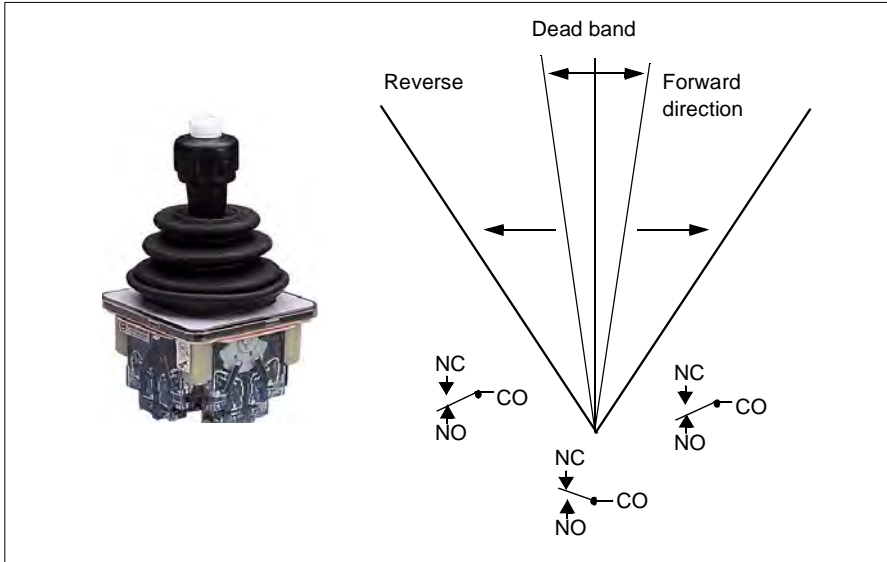

### Joystick reference interlocking

You can use this function to check the analog reference that comes from the joystick. If the joystick zero position input (20.214) is active and the speed reference or torque reference is greater than +/- 10% of the minimum or maximum scaled value of the used reference, the drive generates a warning (D208) after a time delay (20.215).



## Timing diagram

The diagram shows the operation of the *Joystick reference check* warning.

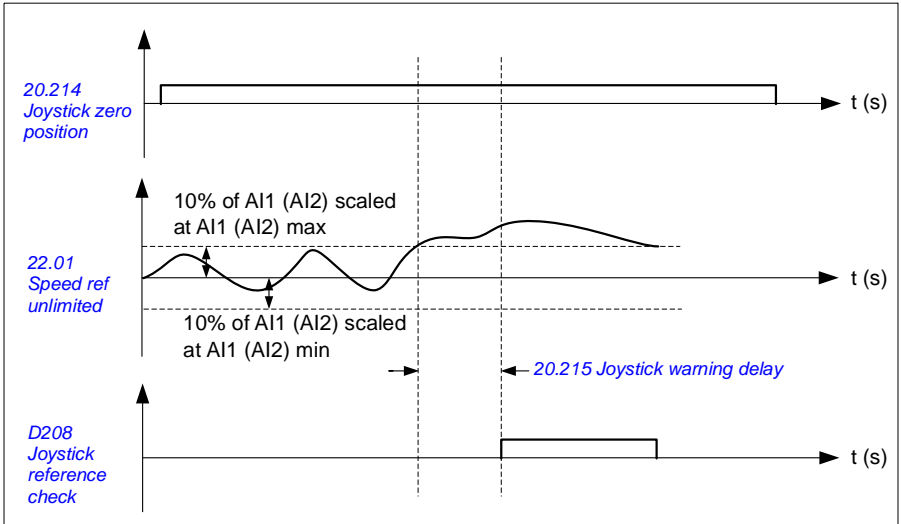

## Settings

Parameters: *20.214 Joystick zero position*, *20.215 Joystick warning delay*

Signals: *09.01 Crane SW1*

Warnings: *D208 Joystick reference check*, *D209 Joystick zero position*

Faults: -

## Crane stop limit function

The crane stop limit function stops the crane movement safely when it reaches the end position. You can use the stop limit function in both horizontal (long travel trolley) and vertical (hoist) movement.

The stop limit function has two stop limits:

1. Forward stop limit (76.04) – for forward (positive) direction.
2. Reverse stop limit (76.06) – for reverse (negative) direction.

For forward and reverse stop limit, the input is wired to the forward and reverse limit switch respectively.

If one of the two limits is active, the function activates a stop command and stops the movement according to the stop mode selection (76.11). The two limits are independent of each other.

For both forward and reverse limit, the active and inactive conditions are applicable as follows:

- The limits are active when the limit input to the drive is False (0), i.e. when the normally-closed limit switch is open.
- The limits are inactive when the limit input to the drive is True (1), i.e. the normally-closed limit switch is closed. This condition is valid when the crane movement has not reached the limit.

The following steps describe the forward stop limit operation in the forward lifting (positive) direction. The same can be applied for reverse stop limit in the reverse lowering (negative) direction:

- If the forward stop limit is activated while the drive is running in the forward (up) direction, the function stops the motor according to the selected stop mode (76.11)
  - If limit ramp stop mode is selected (76.11), the drive decelerates according to the defined limit ramp stop time (76.12)
  - If limit normal stop mode is selected (76.11), the drive stops according to the selected stop mode (21.03).
- When the forward stop limit is active, the drive generates a warning *D205 Forward stop limit*.
- You can run the motor only in the reverse direction when the forward stop limit is active.

Typically, for the crane stop limit function, the parameters are set as follows:

No.	Name	Value
76.01	<i>Limit to limit control status</i>	(Actual status of limit control)
76.02	<i>Enable limit to limit control</i>	<i>Selected</i>
76.03	<i>Limit to limit trigger type</i>	<i>Level low</i>

No.	Name	Value
76.04	<i>Forward stop limit</i>	<i>DI3</i> (sample value)
76.05	<i>Forward slow down limit</i>	<i>Selected</i>
76.06	<i>Reverse stop limit</i>	<i>DI4</i> (sample value)
76.07	<i>Reverse slow down limit</i>	<i>Selected</i>
76.11	<i>Limit stop mode</i>	<i>Limit ramp stop mode</i>
76.12	<i>Limit stop ramp time</i>	0.5 s (sample value)

### Settings

Parameters: *76.01 Limit to limit control status*, *76.02 Enable limit to limit control*, *76.03 Limit to limit trigger type*, *76.04 Forward stop limit*, *76.06 Reverse stop limit*, *76.11 Limit stop mode*, *76.12 Limit stop ramp time*

Signals: *09.01 Crane SW1*, *09.03 Crane FW1*

Warnings: *D205 Forward stop limit*, *D206 Reverse stop limit*

Faults: *D108 Stop limits I/O error*

---

## Crane slowdown function

The slowdown function limits the forward and reverse movements of the load between two points.

The function supports monitoring of the slowdown sensors in the movement area and reduces the speed accordingly. The system installer must install the sensors and connect them to the drive.

You can use the crane slowdown function in both horizontal (long travel and trolley) and vertical (hoist) movements of the crane.

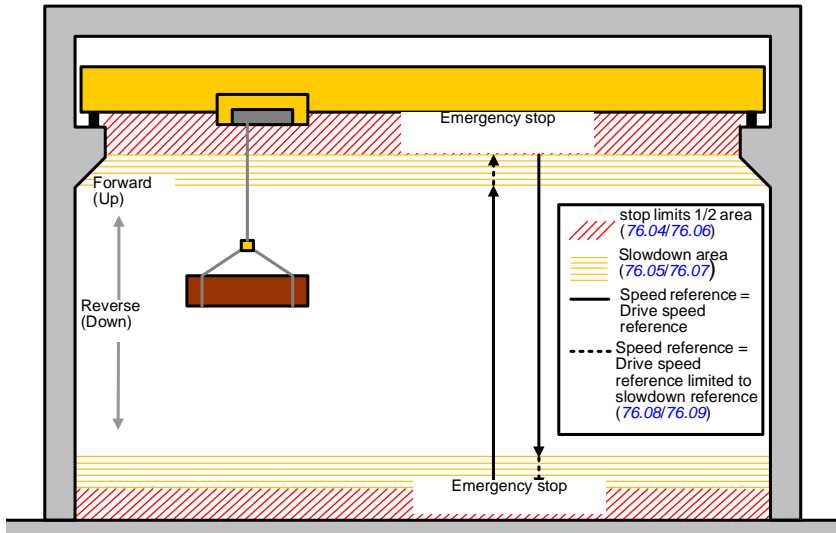

The crane slowdown function uses Limit to limit trigger type Level low (76.03) and has two modes:

1. Slowdown with two limit inputs.
2. Slowdown with direction.

### ■ Slowdown with two limit inputs

The two limit inputs of slowdown function are (see figure above):

1. Forward slowdown limit (76.05) – for forward (positive) direction.
2. Reverse slowdown limit (76.07) – for reverse (negative) direction.

For both forward and reverse limit, the active and inactive conditions are applicable as follows:

- The limits are active when the limit input to the drive is False (0), i.e. when the normally-closed limit switch is open.
- The limits are inactive when the limit input to the drive is True (1), i.e. the normally-closed limit switch is closed. This condition is applicable for the normal operation of the crane.

### Slowdown with direction

The control program activates this mode when you have the same signal source in the parameters [76.05 Forward slow down limit](#) and [76.07 Reverse slow down limit](#) and any of these source signals is set to False (0).

On activation of slowdown with direction, the function limits the speed reference to the slowdown reference limit ([76.08/76.09](#)) in the direction of motion at the time of activation. As long as the supply voltage is not switched off, the drive remembers the direction of motion and allows full speed in the opposite direction.

If you activate the slowdown command after the drive stops, the function allows only slow speed in both directions. The function also limits the speed reference in both directions if you activate the slowdown command when the drive powers up.

Typically, for the crane slowdown function, parameters are set as follows:

No.	Name	Value
<a href="#">76.01</a>	<a href="#">Limit to limit control status</a>	(Actual status of limit control)
<a href="#">76.02</a>	<a href="#">Enable limit to limit control</a>	<a href="#">Selected</a>
<a href="#">76.03</a>	<a href="#">Limit to limit trigger type</a>	<a href="#">Level low</a>
<a href="#">76.05</a>	<a href="#">Forward slow down limit</a>	<a href="#">DIO1</a>
<a href="#">76.07</a>	<a href="#">Reverse slow down limit</a>	<a href="#">DIO1</a>
<a href="#">76.08</a>	<a href="#">Slow down speed</a>	300 rpm
<a href="#">76.09</a>	<a href="#">Slow down frequency</a>	0.00 Hz

### Settings

Parameters: [76.01 Limit to limit control status](#), [76.02 Enable limit to limit control](#), [76.03 Limit to limit trigger type](#), [76.05 Forward slow down limit](#), [76.07 Reverse slow down limit](#), [76.08 Slow down speed](#), [76.09 Slow down frequency](#)

Signals: [09.01 Crane SW1](#), [09.03 Crane FW1](#)

Warnings: [D201 Forward slow down limit](#), [D202 Reverse slow down limit](#)

Faults: -

For control connection diagram, see [Configuring slowdown with two limits and stop limit logic](#) on page [527](#).

## Fast stop

The Fast stop function stops the drive immediately, even if the drive is at high speed. For example, the function can be used to stop the swift downward movement of a bucket crane before the ropes unwind and pile up on top of the crane. The Fast stop function is not an emergency stop function.

The fast stop mode activates when the fast stop input changes to false (0). The drive stops the motor according to the selected fast stop mode ([20.211](#)) and displays warning [D20A Fast stop](#). The function reverts to normal operation once the fast stop input is changed to 1 (true).

The function has three modes:

- **Ramping and mechanical braking** – drive decelerates to zero speed according to a defined ramp time. The mechanical brake closes when the drive reaches the brake close speed.
- **Torque limit and mechanical braking** – drive decelerates to zero speed against the drive torque limits. The mechanical brake closes when the drive reaches the brake close speed.
- **Mechanical braking only** – the function forces the mechanical brake to close.

Typically, for the crane fast stop feature, parameters are set as follows:

No.	Name	Value
<a href="#">20.210</a>	<a href="#">Fast stop input</a>	<a href="#">DIO2</a>
<a href="#">20.211</a>	<a href="#">Fast stop mode</a>	<a href="#">Ramp</a>
<a href="#">23.206</a>	<a href="#">Fast stop deceleration time</a>	0.5 s

### Settings

Parameters: [20.210 Fast stop input](#), [20.211 Fast stop mode](#), [23.206 Fast stop deceleration time](#)

Signals: [09.01 Crane SW1](#)

Warnings: [D20A Fast stop](#)

Faults: -

---

## Power on acknowledgment

The Power on acknowledgment function makes sure that the main power is connected and the drive is ready for operation. You can use this function, for example, to automatically reset faults that are generated during the drive in standby.

The source to Power on acknowledgment signal (20.212) can be from the following sources:

- From the Safe torque off (STO), parameter [06.18 Start inhibit status word](#), bit 7 inverted.
- or
- Digital input. For example parameter [20.212 Power on acknowledge](#), [DIO2](#).

If the drive trips on a fault, and you activate the Power on acknowledgment signal (a rising edge), the drive generates an internal fault reset after a time delay (20.213).

If the Power on acknowledgment circuit is open (20.212 = False), then the drive shows the warning [D20B Power on acknowledge](#).

### Timing diagram

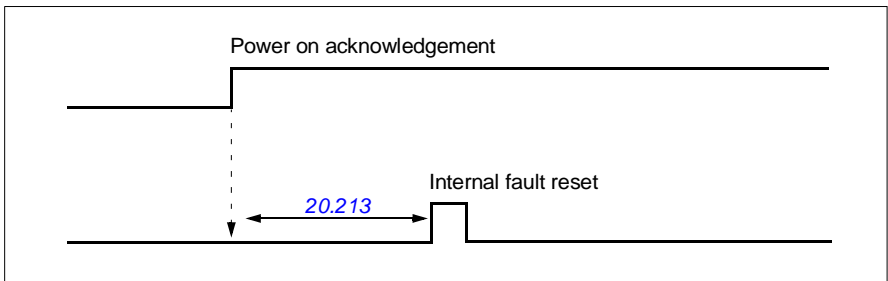

Typically, for the crane power acknowledgment feature, parameters are set as follows:

No.	Name	Value
<a href="#">20.12</a>	<a href="#">Run enable 1 source</a>	value of parameter <a href="#">06.18</a> bit 7. (if run enabled is used)
<a href="#">20.212</a>	<a href="#">Power on acknowledge</a>	value of parameter <a href="#">06.18</a> bit 7.
<a href="#">20.213</a>	<a href="#">Power on ackn reset delay</a>	500 ms

### Settings

Parameters: [20.212 Power on acknowledge](#), [20.213 Power on ackn reset delay](#)

Signals: [09.01 Crane SW1](#)

Warnings: [D20B Power on acknowledge](#)

Faults: -

### Control connections

The diagram below shows control connection diagram to enable the power acknowledge feature (through STO or DIO2) with external 24V supply.

Terminals	Description	
<b>Digital I/O connections</b>		
		<b>BTAC</b>
	<b>+24V</b> Aux. +24 V DC, max 200 mA	X103
	<b>DGND</b> Aux. voltage output common	
	<b>DCOM</b> Digital input common	VIN
	<b>DI1</b> Start forward	VOUT
	<b>DI2</b> Start reverse	
	<b>DI3</b> Stop limit 1 (forward)	
	<b>DI4</b> Stop limit 2 (reverse)	
	<b>DIO1</b> Slowdown	GND
	<b>DIO2</b> Power acknowledge	
	<b>DIO SRC</b> Digital output auxiliary voltage	
	<b>DIO COM</b> Digital input/output common	
<b>Analog I/O</b>		
	<b>AI1</b> Speed / freq (0...10V)	
	<b>AGND</b> Analog input circuit common	
	<b>AI2</b> Not configured	
	<b>AGND</b> Analog input circuit common	
	<b>AO</b> Output frequency (0...20 mA)	
	<b>AGND</b> Analog output circuit common	
	<b>SCR</b> Signal cable shield (screen)	
	<b>+10V</b> Ref. voltage +10 V DC	
<b>Safe torque off (STO)</b>		
	<b>S+</b>	Safe torque off. Connected at factory. Drive starts only if both circuits are closed. Status from <a href="#">06.18 Start inhibit status word</a> (1 = STO active, circuits are open)
	<b>SGND</b>	
	<b>S1</b>	
	<b>S2</b>	
<b>Relay output 1</b>		
	<b>RC</b> Brake command	<i>(10.24 RO1 source = Brake command)</i>
	<b>RA</b>	
	<b>RB</b>	

External 24V supply



**Notes:**

Terminal sizes: 0.14 mm<sup>2</sup> ... 1.5 mm<sup>2</sup>.

Tightening torque: 0.5 N·m (0.4 lbf·ft).

Terminals DGND, AGND and SGND are internally connected to same reference potential.

Input signals

- Start forward (DI1)
- Start reverse (DI2)
- Stop limit 1 (forward) (DI3)
- Stop limit 2 (reverse) (DI4)
- Slowdown (DIO1)
- Power acknowledge (DIO2)

Output signals

- Speed / freq (0...10V) (AI1)
  - Output frequency (0...20mA) (AO)
  - Brake command
-

## Speed reference handling

The crane speed reference can be provided through any of the following sources:

- Joystick connected through digital and analog I/O
- PLC device connected to a fieldbus
- Pendant control connected to digital inputs or the step references
- Crane motor potentiometer.

### ■ Unipolar joysticks

Unipolar joysticks give the speed reference value with analog signal 0...10 V where 0 V is -maximum speed, 5 V is zero speed, and +10 V is +maximum speed. The direction commands are specified with two digital inputs. For example, digital input DI1 can be used for Start forward and DI2 for Start reverse.

Typically, for unipolar joysticks, parameters are set as follows:

No.	Name	Value
12.17	<i>AI1 min</i>	0.000
12.18	<i>AI1 max</i>	10.000
12.19	<i>AI1 scaled at AI1 min</i>	-1500
12.20	<i>AI1 scaled at AI1 max</i>	1500
22.11	<i>Ext1 speed ref1</i>	<i>AI1 scaled</i>
22.13	<i>Ext1 speed function</i>	<i>Abs (ref1)</i>

### Settings

Parameters: *12.17 AI1 min*, *12.18 AI1 max*, *12.19 AI1 scaled at AI1 min*, *12.20 AI1 scaled at AI1 max*, *22.11 Ext1 speed ref1*, *22.13 Ext1 speed function*

Signals: -

Warnings: -

Faults: -

For control connection diagram, see [Control through the I/O interface using a joystick](#) on page 514.

### ■ Parabolic speed reference

In general, joystick movements cause a linear change to the speed reference: a 50% change in position gives a 50% speed reference.

Often, accurate load handling is needed in lower speed areas. For example, when the end-user needs to position the load manually, or when the lack of space causes limitations. In such situations, the end-user can control joystick movements more accurately with a parabolic speed reference instead of a linear reference.

The Parabolic speed reference function (par. 22.211) changes the interrelationship of the incoming signal (joystick movement) and the speed reference according to a mathematical function. The mathematical functions available are X2 (*Parabolic 1*), X3 (*Parabolic 2*) and linear interrelationship (Linear). The joystick has parameters for setting the deadband in the forward (30.203) and reverse (30.204) directions.

Besides the joystick, the source of a parabolic speed reference can also be an analog signal from an external device.

### Operation chart

This graph shows the parabolic reference curves compared to the linear speed reference curve.

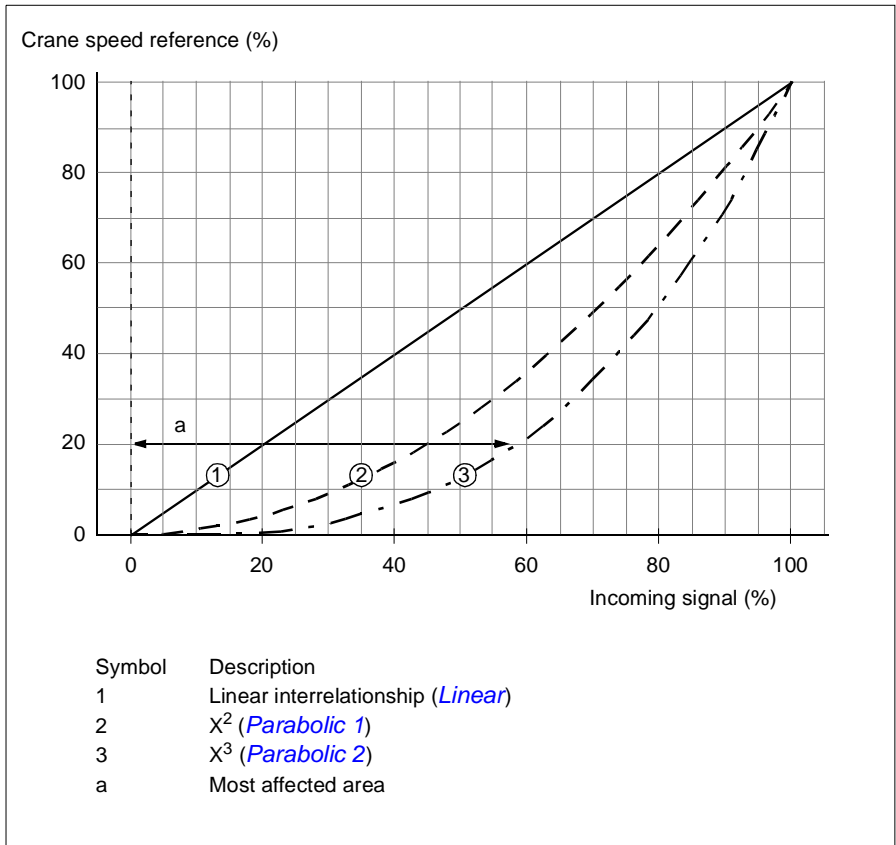

### Settings

Parameters: 22.211 *Speed reference shape*

Signals: [09.06 Crane speed reference](#)

Warnings: -

Faults: -

### ■ Step reference speed selection/Pendant control

In step reference, you can select speed between four step reference speeds. A pendant controller is commonly used with the step reference logic.

The figure below shows a pendant controller.



To activate a pendant control/step control, set parameter [22.21 Constant speed function](#), bit 2 to 1. The polarity of the references depends on the direction in which the end-user gives the start command using digital inputs ([20.03](#) and [20.04](#))

The table below shows how the control program determines which step reference speed is used. To activate the subsequent speed step, the previous speed step must be retained.

<a href="#">22.21 Constant speed function</a>	<a href="#">22.22 Constant speed sel1</a>	<a href="#">22.23 Constant speed sel2</a>	<a href="#">22.24 Constant speed sel3</a>	Used reference
1	0	0	0	<a href="#">22.26 Constant speed 1</a>
1	1	0	0	<a href="#">22.27 Constant speed 2</a>
1	1	1	0	<a href="#">22.28 Constant speed 3</a>
1	1	1	1	<a href="#">22.29 Constant speed 4</a>
1	0	1	1	<a href="#">22.26 Constant speed 1</a>
1	1	0	1	<a href="#">22.27 Constant speed 2</a>
1	0	0	1	<a href="#">22.26 Constant speed 1</a>
1	0	1	0	<a href="#">22.26 Constant speed 1</a>

Typically, for the step reference logic, parameters are set as follows:

No.	Name	Value
<a href="#">22.21</a>	<a href="#">Constant speed function</a>	0b0100 (Bit 2 = 1)
<a href="#">22.22</a>	<a href="#">Constant speed sel1</a>	<a href="#">DI3</a>
<a href="#">22.23</a>	<a href="#">Constant speed sel2</a>	<a href="#">DI4</a>
<a href="#">22.24</a>	<a href="#">Constant speed sel3</a>	<i>Always off</i>
<a href="#">22.26</a>	<a href="#">Constant speed 1</a>	300.00

No.	Name	Value
<a href="#">22.27</a>	<a href="#">Constant speed 2</a>	750
<a href="#">22.28</a>	<a href="#">Constant speed 3</a>	1500
<a href="#">22.29</a>	<a href="#">Constant speed 4</a>	1500

## Settings

Parameters: [22.21 Constant speed function](#), [22.22 Constant speed sel1](#), [22.23 Constant speed sel2](#), [22.24 Constant speed sel3](#), [22.26 Constant speed 1](#), [22.27 Constant speed 2](#), [22.28 Constant speed 3](#), [22.29 Constant speed 4](#)

Signals: -

Warnings: -

Faults: -

## Crane motor potentiometer

The crane motor potentiometer function can be used in retrofit cases with older controllers. For example, a pendant controller with push-buttons for start forward, start reverse, and increase speed (three buttons). The function is used instead of the normal motor potentiometer which contains separate incoming signals for increasing and decreasing the reference. These signals are not effective when the drive is stopped.

To activate crane potentiometer, use parameter [22.220 Crane motpot enable](#).

### Forward direction

You can increase the motor potentiometer reference ([22.230](#)) with any of these two methods:

- Activating the forward command: When you activate the forward command, the motor potentiometer reference ([22.230](#)) increases to the crane motor potentiometer minimum speed ([22.224](#)).
- or
- Activating the crane motor potentiometer acceleration command ([22.223](#)) together with forward command: This increases the motor potentiometer reference ([22.230](#)).

When you activate a forward command,

- when the motor potentiometer reference (22.230) is less than the crane motor potentiometer minimum speed (22.224), the crane accelerates to the crane motor potentiometer minimum speed (22.224).
- when the motor potentiometer reference (22.230) is higher than the crane motor potentiometer minimum speed (22.224) and the crane travels in forward direction the speed reference remains at the last speed before the forward command.
- when the motor potentiometer reference (22.230) is higher than the crane motor potentiometer minimum speed (22.224) and the crane travels in reverse direction, the crane decelerates to zero speed, changes direction and then accelerates to the crane motor potentiometer minimum speed (22.224).

**Notes:**

1. When you release the acceleration command (22.223), the motor potentiometer reference (22.230) remains in the last reached level. To accelerate further, you need to activate the acceleration command (22.223) again.
2. When you release the forward command, the motor potentiometer reference (22.230) decreases to zero as per the deceleration time (23.202).

**Reverse direction**

You can increase the motor potentiometer reference (22.230) to the reverse direction with any of these two methods:

- Activating the reverse command: The motor potentiometer reference (22.230) increases to the crane motor potentiometer minimum speed (22.224).
- or
- Activating the crane motor potentiometer acceleration command (22.223) together with the reverse command: This increases the motor potentiometer reference (22.230).

When you activate a reverse command,

- when the motor potentiometer reference (22.230) is less than the crane motor potentiometer minimum speed (22.224), the crane accelerates to the crane motor potentiometer minimum speed (22.224).
  - when the motor potentiometer reference (22.230) is higher than the crane motor potentiometer minimum speed (22.224) and the crane travels in reverse direction the speed reference remains at the last speed before the reverse command.
  - when the motor potentiometer reference (22.230) is higher than the crane motor potentiometer minimum speed (22.224) and the crane travels in the forward direction, the crane decelerates to zero speed, changes direction and then accelerates to the crane motor potentiometer minimum speed (22.224).
-

**Notes:**

1. When you release the acceleration command (22.223), the motor potentiometer reference (22.230) remains in the last reached level. To accelerate further, you need to activate the acceleration command (22.223) again.
2. When you release the reverse command immediately, the motor potentiometer reference (22.230) decreases to zero as per the deceleration time (23.202). On activating the acceleration command again (22.223), the motor potentiometer reference (22.230) remains in the last reached level.

The following example shows the behavior of the motor potentiometer value:

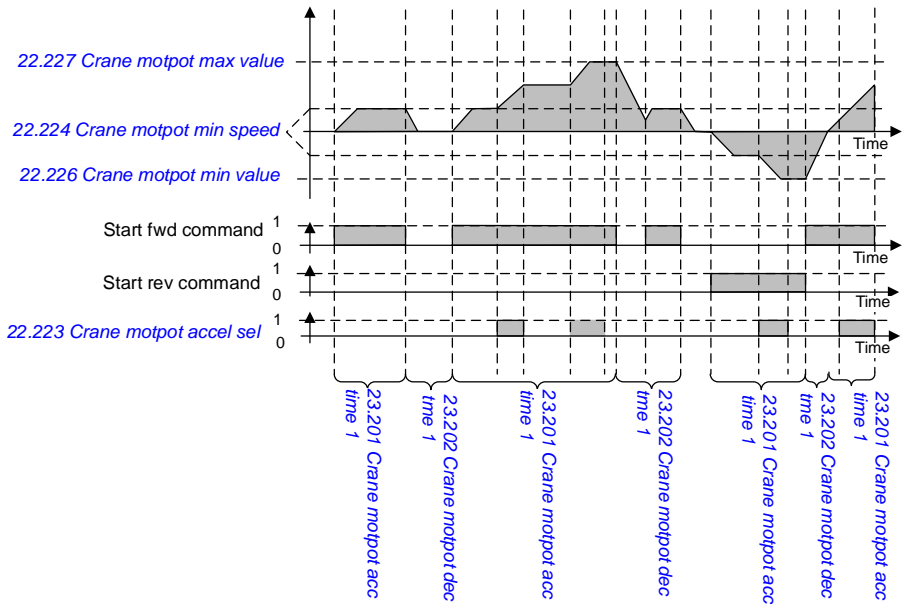

Typically, for the motor potentiometer function, parameters are set as follows:

No.	Name	Value
22.11	Ext1 speed ref1	MotPot Crane
22.220	Crane motpot enable	Selected
22.223	Crane motpot accel sel	DIO2
22.224	Crane motpot min speed	300.00
22.226	Crane motpot min value	-1500.00
22.227	Crane motpot max value	1500.00
23.201	Crane motpot acc time 1	4.0 (visible only if parameter 22.220 Crane motpot enable is set to Selected)
23.202	Crane motpot dec tme 1	4.0 (visible only if parameter 22.220 Crane motpot enable is set to Selected)

The start forward and start reverse commands are defined in parameter group [20 Start/stop/direction](#).

### **Settings**

Parameters: [22.11 Ext1 speed ref1](#), [28.11 Ext1 frequency ref1](#), [22.220 Crane motpot enable](#), [22.223 Crane motpot accel sel](#), [22.224 Crane motpot min speed](#), [22.226 Crane motpot min value](#), [22.227 Crane motpot max value](#), [23.201 Crane motpot acc time 1](#), [23.202 Crane motpot dec tme 1](#), group [20 Start/stop/direction](#)

Signals: - [22.230 Crane motpot ref act](#), [22.225 Crane motpot sw](#)

Warnings: -

Faults: -

---



### Control connections

The diagram below shows the I/O control connection diagram for the crane motor potentiometer.

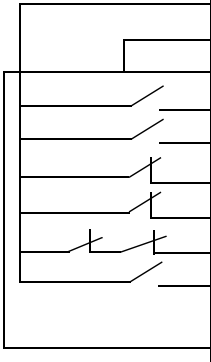
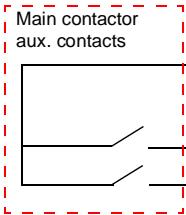
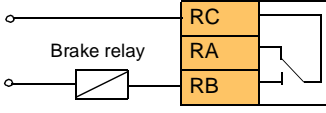
Terminals	Description
<b>Digital I/O connections</b>	
	<b>+24V</b> Aux. +24 V DC, max 200 mA
	<b>DGND</b> Aux. voltage output common
	<b>DCOM</b> Digital input common
	<b>DI1</b> Start forward
	<b>DI2</b> Start reverse
	<b>DI3</b> Stop limit 1 (forward)
	<b>DI4</b> Stop limit 2 (reverse)
	<b>DIO1</b> Slowdown
	<b>DIO2</b> Accelerate ( <a href="#">22.223</a> )
	<b>DIO SRC</b> Digital output auxiliary voltage
	<b>DIO COM</b> Digital input/output common
<b>Analog I/O</b>	
	<b>AI1</b> Not configured
	<b>AGND</b> Analog input circuit common
	<b>AI2</b> Not configured
	<b>AGND</b> Analog input circuit common
	<b>AO</b> Output frequency (0...20 mA)
	<b>AGND</b> Analog output circuit common
	<b>SCR</b> Signal cable shield (screen)
	<b>+10V</b> Ref. voltage +10 V DC
<b>Safe torque off (STO)</b>	
	<b>S+</b> Safe torque off. Connected at factory.
	<b>SGND</b> Drive starts only if both circuits are closed.
	<b>S1</b> Status from <a href="#">06.18 Start inhibit status word</a> (1 = STO active, circuits are open), <a href="#">20.212 Power on acknowledge</a> , and <a href="#">20.12 Run enable 1 source</a> .
	<b>S2</b>
<b>Relay output 1</b>	
	<b>RC</b> Brake command
	<b>RA</b>
	<b>RB</b> ( <a href="#">10.24 RO1 source</a> = Brake command)

**Notes:**

Terminal sizes: 0.14 mm<sup>2</sup> ... 1.5 mm<sup>2</sup>.

Tightening torque: 0.5 N·m (0.4 lbf·ft).

Terminals DGND, AGND and SGND are internally connected to same reference potential.

Input signals

- Start forward (DI1)
- Start reverse (DI2)
- Stop limit 1 (forward) (DI3)
- Stop limit 2 (reverse) (DI4)
- Slowdown (DIO1)
- Accelerate (DIO2)

Output signals

- Output frequency (AO)
  - Brake command
-

## Conical motor control

This function handles the brake control for conical motors, which do not have an external mechanical brake. A conical motor has an internal brake, which opens or closes according to the motor flux level. The brake opens when the motor flux level is higher than the normal flux level and closes when the flux is below the normal flux level. You can find the opening and closing flux levels on the motor rating plate or ask the motor manufacturer for the levels. The opening flux level has to be kept active for a certain period of time. The time depends on the motor.

When a conical motor is switched on, axial force is created as a result of the electromagnetic field (flux) and the air gap between the cone-shaped rotor and stator. This axial force overcomes the return force of the brake spring and moves the rotor shaft and brake disc in an axial direction. The brake is then released, allowing the motor to start up. After the motor is switched off or if the voltage fails, the magnetic force collapses, and the motor mechanically brakes to a standstill by the return force of the brake spring.

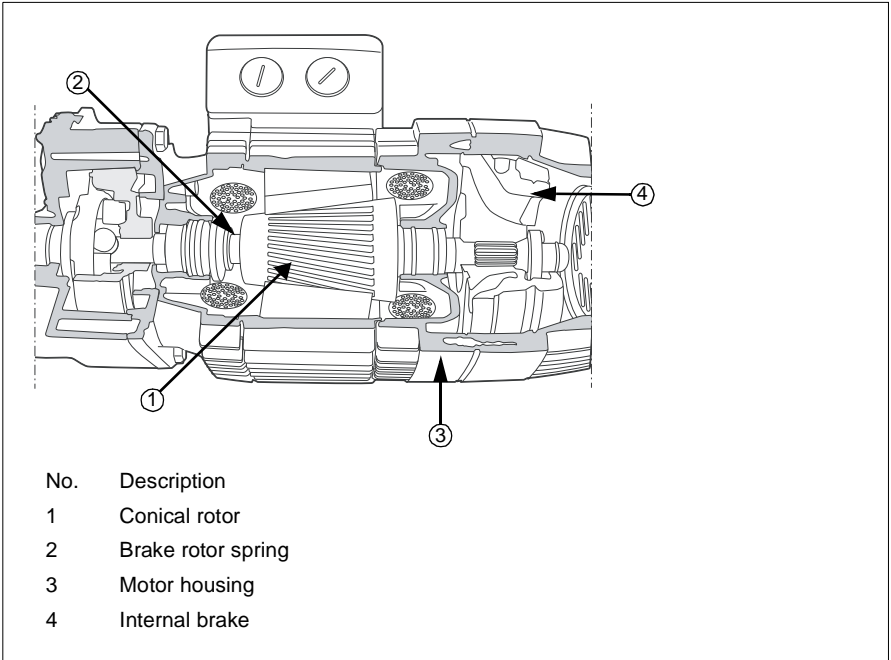

### Notes:

- Mechanical brake control ([44.06](#)) must be active when the Conical motor control function is used. If mechanical brake control is not active, the drive trips on a fault ([D10A](#)).
- Brake close delay ([44.13](#)) must be greater than 0 seconds.

When the Conical motor control function is enabled and the start command is given, the motor flux ramps up over the normal level (100%) to the start flux level (76.22) during a flux ramp-up time (76.25). The ramp-up time makes sure that the brake opens faster and there is minimal roll-back that can cause a load dip. The start flux level is kept as the reference for a hold time (76.24) to make sure that there is enough time for the brake to open.

After the start flux hold time is over, the normal flux level (100%) is activated for normal running. The flux ramps down from the start flux level to the normal level (100%) during a flux ramp-down time (76.26).

When the stop command is given, the drive decelerates the motor. When the motor speed (01.01) decreases below the zero speed limit (21.06), the motor starts to use the stop flux level (76.23) as the flux reference. The flux ramps down from the normal level (100%) to the stop flux level during the ramp-down time. When the actual motor flux reaches the stop flux level, the brake closes.

### Timing diagram

This diagram shows brake opening and closing as well as the normal running flux levels.

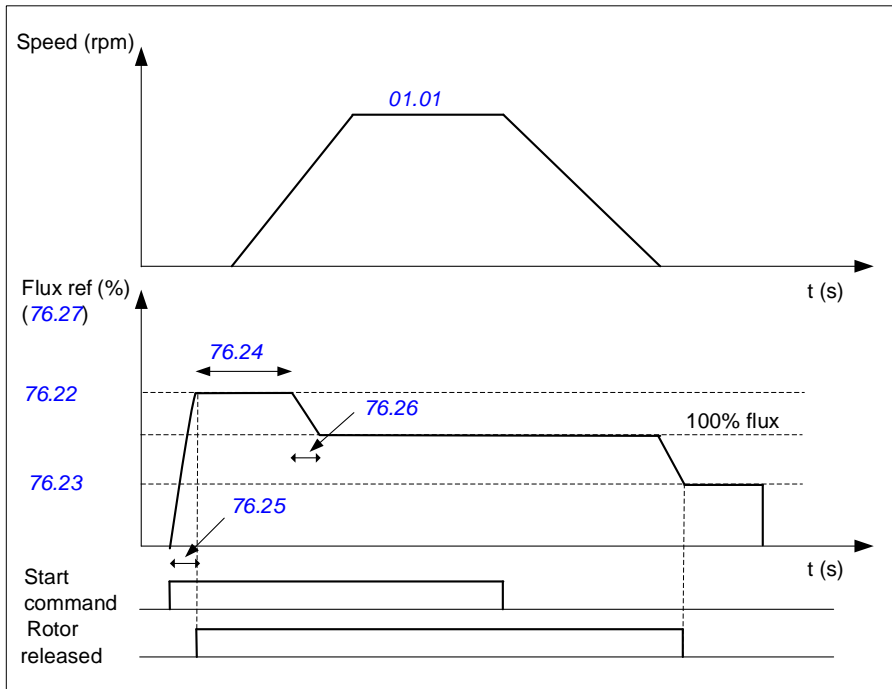

## Settings

Parameters: [76.21...76.26](#)

Signals: [09.01 Crane SW1](#), [76.27 Flux reference](#)

Warnings: -

Faults: [D10A Brake not selected](#)

---



---

# Further information

## **Product and service inquiries**

Address any inquiries about the product to your local ABB representative, quoting the type designation and serial number of the unit in question. A listing of ABB sales, support and service contacts can be found by navigating to [abb.com/searchchannels](http://abb.com/searchchannels).

## **Product training**

For information on ABB product training, navigate to [new.abb.com/service/training](http://new.abb.com/service/training).

## **Providing feedback on ABB Drives manuals**

Your comments on our manuals are welcome. Navigate to [new.abb.com/drives/manuals-feedback-form](http://new.abb.com/drives/manuals-feedback-form).

## **Document library on the Internet**

You can find manuals and other product documents in PDF format on the Internet at [abb.com/drives/documents](http://abb.com/drives/documents).



[abb.com/drives](http://abb.com/drives)



3AXD5000029275E