

Tire & Wheel Service >>

Lubricants | Markers | Tire Branders | Bead Breakers
Bead Seating Devices | Hydraulic Rams | Pumps
OTR Service Tools | Tire Irons | Hammers & Wedges
Wrenches & Lug Wrenches | Tire Changers
Inflation Systems | Safety Inflation Cages





TSI
TIRE SERVICE EQUIPMENT



THERE'S ONLY ONE ORIGINAL!



Available in

5, 10, 13 and 60 gallon tank sizes

Tire Lubricants & Sealants >>



Ascot Tire and Tube Mounting Compound

- Now with rust inhibitor • **Makes tire mounting and dismounting faster and easier** • Approved by major rubber companies • Lubricates all rubber parts, stops rubber squeaks



432-02028

432-02029

ASCOT NO.	MFG. NO.	DESCRIPTION
432-02012	2012	Tire/Tube Mounting Compound, 125 Lbs. Drum
432-02022	2022	Tire/Tube Mounting Compound, 445 Lbs. Drum
432-02028	2028	Tire/Tube Mounting Compound, 8 Lbs. Pail
432-02029	2029	Tire/Tube Mounting Compound, 25 Lbs. Pail
432-02035	2035	Tire/Tube Mounting Compound, 40 Lbs. Pail

Black Rim Rust Retardant & Tire Lube

- Now with rust inhibitor • **Makes tire mounting and dismounting faster and easier** • Approved by major rubber companies • Lubricates all rubber parts, stops rubber squeaks



435-06001

435-06002

435-07002

435-08002

ASCOT NO.	MFG. NO.	DESCRIPTION
435-06001	065-2539	Black Rim Rust Retardant Tire Lube, 6 - 5 Lbs.
435-06008	048-2539	Black Rim Rust Retardant Tire Lube, 4 - 8 Lbs.
435-06002	025-2539	Black Rim Rust Retardant Tire Lube, 25 Lbs.
435-06003	040-2539	Black Rim Rust Retardant Tire Lube, 40 Lbs.
435-06004	120-2539	Black Rim Rust Retardant Tire Lube, 120 Lbs.
435-07001	041-2541	Tire Mounting & Rubber Lubricant, 4 Gal.
435-07002	005-2541	Tire Mounting & Rubber Lubricant, 5 Gal.
435-08001	048-2540	Tire Mounting & Rubber Lubricant Paste, 8 Lbs.
435-08002	025-2540	Tire Mounting & Rubber Lubricant Paste, 25 Lbs.
435-08003	040-2540	Tire Mounting & Rubber Lubricant Paste, 40 Lbs.

Miscellaneous Tire Swabs and Brushes



437-00001

437-00002

437-00003

437-40006

437-13014

ASCOT NO.	MFG. NO.	DESCRIPTION
437-00001	TS-1	Tire Swab - 11" OAL X 2" Diameter
437-00002	TS-2	Tire Swab - 15" OAL X 2" Diameter
437-00003	TS-3	Tire Swab - 18" OAL X 3" Diameter
437-40006	40006	Tire Lubricating Brush
437-13014	313014	Hunter-Style Tire Lubricating Brush

Tire & Wheel Service >> TIRE SERVICE SUPPLIES

Tire Lubricants & Sealants >>

Tire & Wheel Service >> TIRE SERVICE SUPPLIES

Murphy's Non-Rust Rim-Kote

- Contains no petroleum - prevents rim rust and scale
- **Acts as tire mounting lubricant - prevents tire bead "freezing"**
- Great for seating tubeless bias, belted and radial tires
- **APPLICATIONS:** Recommended for mounting tires on heavy duty trucks, buses and off-the-road vehicles



434-02120

ASCOT NO.	MFG. NO.	DESCRIPTION
434-02020	2020	Liquid-Lube, 1-Gallon
434-02105	2105	Non-Rust Rim-Kote, 7 Lbs. Can
434-02110	2110	Non-Rust Rim-Kote, 25 Lbs. Pail
434-02120	2120	Non-Rust Rim-Kote, 40 Lbs. Pail

Murphy's Concentrated Extra Slippery Liquid Lubricant

- **A concentrated liquid made from the finest raw materials available**
- Contains improved super lubricity polymers
- Economical: dilutes 2 to 1
- Rust inhibitor added to help fight rim rust
- **Formulated for super fast mounting of passenger tires**



433-01950

ASCOT NO.	MFG. NO.	DESCRIPTION
433-01950	1950	1-Gallon (4 per Case)
433-01957	1957	5-Gallon Pail
433-01958	1958	55-Gallon Drum

No Rim Rust

- **Protects tires. Tire bead won't fuse to rim**
- Helps prevent corrosion on rims and rigs
- Helps you comply with OSHA Regulation 3086



435-00125

ASCOT NO.	MFG. NO.	DESCRIPTION
435-00015	FL4-1	No Rim Rust, 4-1/2 Lbs. Pail
435-00125	FL25-1	No Rim Rust, 25 Lbs. Pail
435-01120	FL120-1	No Rim Rust, 120 Lbs. Drum



Universal Mounting Paste

- **Makes mounting and demounting tires easier and faster and helps alleviate stress on and damage to the bead area of tires**
- Tire mounting paste applies with a sponge and will not corrode or discolor aluminum or alloy wheels, won't freeze or harden
- Rubber Lubricant is a liquid concentrate that makes one gallon of rust-inhibiting water-based mounting lubricant



ASCOT NO.	MFG. NO.	DESCRIPTION	QTY./BOX
432-00720	72	Rema Rubber Lubricant, 16 Oz. Can, Concentrate	12
432-00730	73	Mounting Paste Brush for Car/Light Truck	1
432-00731	73T	Mounting Paste Brush for Trucks	1
432-00740	74	Universal Mounting Paste, 22 Lbs.	1
432-00750	75	High Profile Universal Mounting Paste, 7.7 Lbs.	1
432-01750	75N	Low Profile Universal Mounting Paste, 7.7 Lbs.	1
432-00751	75B	Bracket For Mounting Paste	1
437-00001	TS-1	Swab - 11" OAL x 2" Diameter	1
437-00002	TS-2	Swab - 15" OAL x 2" Diameter	1
437-00003	TS-3	Swab - 18" OAL x 3" Diameter	2

OTR Mounting/Packing Compound

- **Extra thick for Superior Bead Packing on OTR tires**
- Makes OTR Tire Mounting Faster and Easier
- Will not separate or liquefy



432-12490

ASCOT NO.	MFG. NO.	DESCRIPTION
432-12490	2490	OTR Mounting/Packing Compound, 25 Lbs.
432-12492	2492	OTR Mounting/Packing Compound, 40 Lbs.

Tire Lubricants & Sealants >>



Tire Mounting Compounds

- **Excellent Lubrication** • Will not separate or liquefy • Superior for tire bead packing • Concentrated; water soluble, can be diluted



432-12180



432-12280

ASCOT NO.	MFG. NO.	DESCRIPTION
432-12178	2178	Tire Mounting Compound (Honey Color), 8 Lbs. (4 per Case)
432-12180	2180X	Tire Mounting Compound (Honey Color), 25 Lbs.
432-12183	2183	Tire Mounting Compound (Honey Color), 40 Lbs.
432-12012	2012	Tire Mounting Compound (Honey Color), 125 Lbs.
432-12014	2014	Tire Mounting Compound (Honey Color), 55 Gal.
432-12278	2278	Tire Mounting Compound (Brown Color), 8 Lbs. (4 per Case)
432-12280	2280	Tire Mounting Compound (Brown Color), 25 Lbs.
432-12282	2282	Tire Mounting Compound (Brown Color), 40 Lbs.
432-12214	2214	Tire Mounting Compound (Brown Color), 55 Gal.

Bead Butter Blue Tire Mounting Liquid Lube

- **Excellent Lubrication** • No Residue
- Concentrated; water soluble, can be diluted



433-02054

ASCOT NO.	MFG. NO.	DESCRIPTION
433-02053	2053B	Bead Butter Blue Tire Mounting Liquid Lube, 1 Gal. (4 per Case)
433-02054	2054B	Bead Butter Blue Tire Mounting Liquid Lube, 5 Gal.
433-02055	2055B	Bead Butter Blue Tire Mounting Liquid Lube, 55 Gal.

Liquid Lube Blue Tire Mounting Liquid

- **Excellent Lubrication** • **Superior "Tack" and Bead Sealing qualities** • Reduces tire/rim slippage
- Concentrated; water soluble, can be diluted • Near neutral pH factor



433-81505

ASCOT NO.	MFG. NO.	DESCRIPTION
433-81505	81505	Liquid Lube Blue Tire Mounting Liquid, 2 Gal. (5 Gal. Mixing Pail)
433-81511	81511	Liquid Lube Blue Tire Mounting Liquid, 1 Gal. (4 per Case)
433-81515	81515	Liquid Lube Blue Tire Mounting Liquid, 5 Gal.
433-81555	81555	Liquid Lube Blue Tire Mounting Liquid, 55 Gal.

Black-Ice Stop Rust Rim Release

- **Lubricates rim and tire for easy mounting & demounting** • Protects against rust & corrosion • Prevents rim and bead from bonding



435-02480

ASCOT NO.	MFG. NO.	DESCRIPTION
435-02480	2480	Black-Ice Stop Rust Rim Release, 25 Lbs. Pail

Bead Release

- Ready-to-Use • Non-Flammable, Retread Safe • Safe to handle • **Superior penetration between Bead and Rim flange** • No back-breaking effort required
- Prevents Bead Rubber damage



431-00005

ASCOT NO.	MFG. NO.	DESCRIPTION
431-00001	BR-1	Bead Release, 1 Gal.
431-00005	BR-5	Bead Release, 5 Gal.
431-00055	BR-55	Bead Release, 55 Gal.

Tire & Wheel Service >> TIRE SERVICE SUPPLIES

Tire Lubricants & Sealants >>

Tire & Wheel Service >> TIRE SERVICE SUPPLIES

Sure Shot Pressure Sprayers

- Air pressurized and refillable
- Environmentally safe, eliminates aerosol usage
- For brake and parts cleaner, penetrating oils, lubricants, degreasers, solvents
- **MADE IN USA**



632-01002

ASCOT NO.	MFG. NO.	DESCRIPTION
632-00005	K-5	Partial Repair Kit for Model A Sure Shot Sprayers
632-00010	K-10	Complete Repair Kit for Model A Sure Shot Sprayers
632-01002	A1002	Sure Shot Black Enameled Steel Sprayer w/ Adjustable Nozzle
632-10001	A1000R	Sure Shot Enameled Steel Sprayer - Red

Anodized Aluminum Sprayer

- Adjustable pistol-grip nozzle
- Features a chemical resistant anodized finish
- Will work with water, solvent & oil-based materials
- Replaces Model "A" plated brass sprayers
- 24 oz. capacity
- Max pressure: 200 PSI
- **MADE IN USA**



632-02400

ASCOT NO.	MFG. NO.	DESCRIPTION
632-02400	M2400S	Anodized Aluminum Sprayer

Spray Bottle



632-00922

ASCOT NO.	MFG. NO.	DESCRIPTION
632-00922	TS-922	16 Oz. Poly Trigger Sprayer

Penetrants/Air Leak Detector

- PB Blaster quickly breaks loose the surface tension of frozen parts and protects against further and corrosion



433-35805

408-00016

ASCOT NO.	MFG. NO.	DESCRIPTION
328-05001	022-1071	Ultra Pen Lube 2000 Penetrant Lubricant, 1- 22 Oz.
328-05003	001-1071	Ultra Pen Lube 2000 Penetrant Lubricant, 1 Gal.
328-05005	005-1071	Ultra Pen Lube 2000 Penetrant Lubricant, 5 Gal.
408-00016	16PB	Blaster Penetrating Catalyst, 11 Oz.
433-35805	35805	Detecto Mist Air Leak Locator, 1 Qt.

EcoSeal

- Permanently seals punctures up to 1/4"
- Prevents wheel corrosion
- Uses recycled rubber and 100 percent biodegradable ingredients
- Non-combustible by NFPA standards (flashpoint over 700°F)
- Low freeze point (-10°F)
- Freeze/thaw stable



ASCOT NO.	MFG. NO.	DESCRIPTION
451-05510	ST-XM55	5 Gal. EcoSeal Hand Pump
504-00005	EC05G	5 Gal. Pail
504-00055	EC055G	55 Gal. Drum
504-00275	EC0275G	275 Gal. Tote

Tire Lubricants & Sealants >>



STS Tire Sealant

ASCOT NO.	MFG. NO.	DESCRIPTION
STS Tire Sealant		
451-04128	STS-CS4-128	1 Gal. (4 per Case)
451-00640	STS-640	5 Gal. Pail
451-00006	STS-6G	6 Gal. Pail
451-00055	STS-55G	55 Gal. Drum
STS Concentrate Tire Sealant		
451-14128	STS-CON-CS4-128	1 Gal. (4 per Case)
451-01640	STS-CON-640	5 Gal. Pail
451-00026	STSCON-6G	6 Gal. Pail
451-00155	STS-CON--55G	55 Gal. Drum
STS OTR Tire Sealant		
451-24128	STS-OTR-CS4-128	1 Gal. (4 per Case)
451-02640	STS-OTR-640	5 Gal. Pail
451-00036	STSOTR-6G	6 Gal. Pail
451-00255	STS-OTR--55G	55 Gal. Drum

STS Tools and Accessories



451-00101

ASCOT NO.	MFG. NO.	DESCRIPTION
451-00101	ST-XM-1	1 Gal. Hand Pump
451-00440	ST-XM-44	5 Gal. Hand Pump
451-00551	STXM55	55 Gal. Transfer Pump
451-00707	ST-TTS-WW	STS Display Stand
469-02311	VCR-A	Auto Valve Core Tool
469-02312	VCR-F	Farm Valve Core Tool



Chemical Flat Stop

• **Instant puncture protection:**
Repairs any pneumatic, tubeless or tube tire • Prevents flats from cactus needles, thorns, stickers and most small nails • Prevents high pressure and rim leaks • Not harmful to rubber or cord and will not affect wheel balance



504-30050

ASCOT NO.	MFG. NO.	DESCRIPTION
504-30035	FS-35	1 Gal. Plastic Container (4 per Case)
504-30050	FS-50	5 Gal. Pail
504-30065	FS-65	55 Gal. Drum
504-30010	FS-15	Applicator Pump w/16" Hose
504-20505	MR-50-5	Pump Fits 5 Gal. Pail With 1 Ft. Hose
504-20050	MR-50	Barrel Pump Fits 55 Gal. Drum

Chemical Shur Seal

• **For tubeless tires** • Seals rim, bead leaks, hard-to-find slow leaks • Reduces ply separation in new and recapped tubeless tires • Ends need for tubes in recapped tubeless tires • Helps keep tires fully inflated



504-20024



504-20060

ASCOT NO.	MFG. NO.	DESCRIPTION
504-20024	SS-24	4 Oz. Bottles (24 per Case)
504-20060	SS-60	1 Gal. Plastic Containers (4 per Case)
504-20053	SS-53	5 Gal. Pail
504-20070	SS-70	55 Gal. Drum
504-20010	CR-10	Applicator Pump w/16" Hose & Choke Valve
504-20505	MR-50-5	Applicator Pump Fits 5 Gal. Pail With 1 Ft. Hose
504-20050	MR-50	Barrel Pump Fits 55 Gal. Drum

Chemical Bead Boss

• **Very slippery for easy mounting or dismounting** • Contains anti-rust chemicals for preventing rim rust at the bead area • Easy release of the bead for removing the tire • Can be diluted with water up to 1 to 8 (1:8) for lubricant purposes only • Does not damage the bead • Used as a sealant to seat and seal bead on tire beads



504-10085

504-10080

ASCOT NO.	MFG. NO.	DESCRIPTION
504-10080	CS-80	1 Gal. Plastic Containers (4 per Case)
504-10085	CS-85	5 Gal. Pail
504-10090	CS-90	55 Gal. Drum

Markers >>



Paintstik® Markers

- Real paint in stick form
- Ideal for coding tire casings • Marks are long lasting, water resistant and weather resistant • Marks will withstand vulcanizing and recap temperatures • Non-toxic, contains no lead • Marking range -50°F to 150°F (-46°C to 66°C) • **INCLUDES:** 12 sticks per box, 12 boxes per case



ASCOT NO.	COLOR	ASCOT NO.	COLOR	ASCOT NO.	COLOR
459-80222	Red	459-80228	Purple	459-80257	White
459-80223	Black	459-80229	Brown	459-80258	Yellow
459-80225	Blue	459-80230	Gray	459-80271	Orange
459-80226	Green	459-80231	Gold		
459-80227	Pink	459-80232	Aluminum		

Paintstik® Marker Holder



ASCOT NO.	MFG. NO.	DESCRIPTION
459-85000	85000	5" Metal Holder for Paintstik Marker
459-85100	85100	6" Push-Button Metal Holder for B-Paintstik

Quik Stik Mini

- Fast-drying, vibrant paint marks dry in 5 to 7 minutes • Compact plastic holder with clip cap stores easily in pocket and keeps hands and clothing clean • Marks on virtually any surface; wet, smooth, rough, or hot • Weather- and UV-resistant paint for long-lasting marks • Solid paint marker advances and retracts by turning twist-up knob • Xylene and 2-Butoxyethanol free formula to reduce health risks • Marking range: 0°F to 392°F (-18°C to 200°C)



ASCOT NO.	MFG. NO.	DESCRIPTION	QTY./ BOX
459-61126	61126	Mini Quik Stik Marker (White)	12
459-61127	61127	Mini Quik Stik Marker (Yellow)	12
459-61128	61128	Mini Quik Stik Marker (Red)	12
459-61129	61129	Mini Quik Stik Marker (Black)	12

Markal Crayon

- Ideal for temporary marking of tires • Marks easily on wet or cold surfaces • Lead-free, zinc-free marks can be painted over • Size: 1/2" X 4-5/8" • Marking range: -20°F to 130°F (-29°C to 24°C) • **INCLUDES:** 12 sticks per box, 12 boxes per case

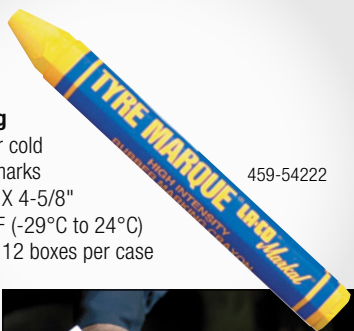

ASCOT NO.	MFG. NO.	COLOR
459-54220	51420	White
459-54221	51422	Red
459-54222	51421	Yellow



The White Markal Crayon in use.

B Hex White Tire Paintstik

- Ideal for temporary marking of tires • Marks easily on wet or cold surfaces • **INCLUDES:** 12 sticks per box, 12 boxes per case



ASCOT NO.	MFG. NO.	DESCRIPTION
459-80250	80250	B Hex White Tire Paintstik

E-Z Break Anti-Seize Compound-Copper Grade

- Copper-based anti-seize and lubricating compound
- Prevents seizing of aluminum wheels to steel brake drums or rotors • Will not wash off in rain or snow
- Other applications include head bolts, exhaust manifolds and muffler connections, brackets and engine bolts
- Withstands temperatures to 1800°F (982°C)



ASCOT NO.	MFG. NO.	DESCRIPTION
494-01010	08910	10 Oz. Can With Brush in Cap
494-08907	08907	16 Oz. Can with Brush in Cap
494-08916	08916	14 Oz. Aerosol Can
494-08930	8930	2.25 Oz. Stick

Tire Branders >>

Electric Tire Branders

• 110 volt and 220 volt electric, and propane versions available • Hardwood handle • 1" letters (A-Z) & numbers (0-9) sold separately • Comparable to Myers 32A brander



452-01200

452-01201



452-00300



Letters and numbers sold separately

ASCOT NO.	MFG. NO.	DESCRIPTION
Electric Tire Branders		
452-00100	BI-CC-1BZ-0	Tire Brander 1" Insert - 0
452-00101	BI-CC-1BZ-1	Tire Brander 1" Insert - 1
452-00102	BI-CC-1BZ-2	Tire Brander 1" Insert - 2
452-00103	BI-CC-1BZ-3	Tire Brander 1" Insert - 3
452-00104	BI-CC-1BZ-4	Tire Brander 1" Insert - 4
452-00105	BI-CC-1BZ-5	Tire Brander 1" Insert - 5
452-00106	BI-CC-1BZ-6	Tire Brander 1" Insert - 6
452-00107	BI-CC-1BZ-7	Tire Brander 1" Insert - 7
452-00108	BI-CC-1BZ-8	Tire Brander 1" Insert - 8
452-00109	BI-CC-1BZ-9	Tire Brander 1" Insert - 9
452-00201	BI-CC-1BZ-A	Tire Brander 1" Insert - A
452-00202	BI-CC-1BZ-B	Tire Brander 1" Insert - B
452-00203	BI-CC-1BZ-C	Tire Brander 1" Insert - C
452-00204	BI-CC-1BZ-D	Tire Brander 1" Insert - D
452-00205	BI-CC-1BZ-E	Tire Brander 1" Insert - E
452-00206	BI-CC-1BZ-F	Tire Brander 1" Insert - F
452-00207	BI-CC-1BZ-G	Tire Brander 1" Insert - G
452-00208	BI-CC-1BZ-H	Tire Brander 1" Insert - H
452-00209	BI-CC-1BZ-I	Tire Brander 1" Insert - I
452-00210	BI-CC-1BZ-J	Tire Brander 1" Insert - J
452-00211	BI-CC-1BZ-K	Tire Brander 1" Insert - K

ASCOT NO.	MFG. NO.	DESCRIPTION
Electric Tire Branders		
452-00212	BI-CC-1BZ-L	Tire Brander 1" Insert - L
452-00213	BI-CC-1BZ-M	Tire Brander 1" Insert - M
452-00214	BI-CC-1BZ-N	Tire Brander 1" Insert - N
452-00215	BI-CC-1BZ-O	Tire Brander 1" Insert - O
452-00216	BI-CC-1BZ-P	Tire Brander 1" Insert - P
452-00217	BI-CC-1BZ-Q	Tire Brander 1" Insert - Q
452-00218	BI-CC-1BZ-R	Tire Brander 1" Insert - R
452-00219	BI-CC-1BZ-S	Tire Brander 1" Insert - S
452-00220	BI-CC-1BZ-T	Tire Brander 1" Insert - T
452-00221	BI-CC-1BZ-U	Tire Brander 1" Insert - U
452-00222	BI-CC-1BZ-V	Tire Brander 1" Insert - V
452-00223	BI-CC-1BZ-W	Tire Brander 1" Insert - W
452-00224	BI-CC-1BZ-X	Tire Brander 1" Insert - X
452-00225	BI-CC-1BZ-Y	Tire Brander 1" Insert - Y
452-00226	BI-CC-1BZ-Z	Tire Brander 1" Insert - Z
452-00300	END LOCK	End Lock for Tire Brander Slot
452-01200	BI-NTC-1000-TB-120	Electric Tire Brander 120 volts
452-01201	BI-NTC-1000-TB-120WH	Electric Tire Brander w/ Aux. Handle, 110 volts*
452-02400	BI-NTC-1000-TB-240	Electric Tire Brander 240 volts

Propane Tire Brander

• Same branding head as electric branders but heated with a propane flame • Use bar-b-que or larger propane tank • **INCLUDES:** branding head, torch head, 10' hose, handle, valve and propane fitting



452-03000

ASCOT NO.	MFG. NO.	DESCRIPTION
452-03000	BI-Propane	Propane Tire Brander

Serial Number Remover Tool



531-95002

531-95001

ASCOT NO.	MFG. NO.	DESCRIPTION
531-95001	TTHB-1	Serial Number Remover Tool
531-95002	RRB-1	12-Pack Replacement Blades

Tire Regrooving Tools & Accessories

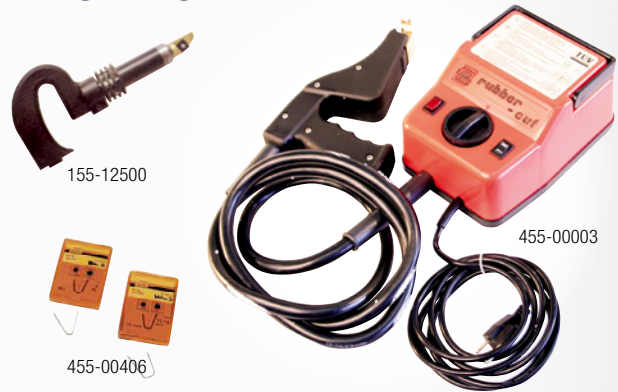

155-12500

455-00406

455-00003

ASCOT NO.	MFG. NO.	DESCRIPTION
Electric Tire Branders		
455-00003	RC400	Rubber Cut 400 Rema Regroover
455-00129	N/A	Set Screw for PS-15 Regroover
455-00401	W-1	Regroover Blades 20-Pack
455-00402	W-2	Regroover Blades 20-Pack
455-00403	W-3	Regroover Blades 20-Pack
455-00404	W-4	Regroover Blades 20-Pack
455-00405	W-5	Regroover Blades 20-Pack

ASCOT NO.	MFG. NO.	DESCRIPTION
Electric Tire Branders		
455-00406	W-6	Regroover Blades 10-Pack
455-00444	No. 4 Head	Replacement Head for 125 Groover
455-04444	No. 4 Bld.	Replacement Blades for 125 Groover
455-12500	125	Heavy Duty Pistol Grip Tire Groover
455-15017	N/A	Transformer for PS-15 Regroover
455-15019	N/A	Rotative Switch for PS-15 Regroover

Bead Breakers >>



"Combi" Tire Bead Breaker

- Works on a single, two and three-piece truck, agricultural and earthmover tire/rim
- Breaks beads in seconds using 10,000 lbs. of force
- No screws, bolts or attachments
- "Combi" bead breaker will not work on five-piece earth mover giant wheel/rim



422-11010



422-16200



422-12000

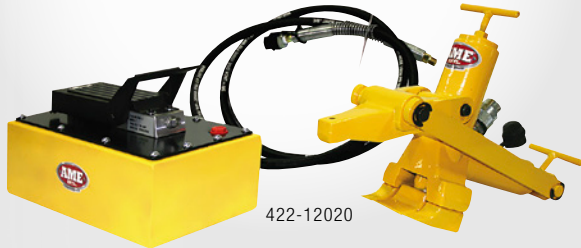

422-12020

ASCOT NO.	MFG. NO.	DESCRIPTION
422-11010	11010	Bead Breaker
422-12000	12000	Bead Breaker Kit. INCLUDES: 11010 Bead Breaker, 15000 Pump and 16040 Hose Assembly
422-12020	12020	Bead Breaker Kit. INCLUDES: 11010 Bead Breaker, 15920 Pump and 16040 Hose Assembly
422-16200	16200	Conversion Kit for Combi Bead Breaker

Modified "Combi" Tire Bead Breaker

- Modified 11010, the most popular tool for breaking beads on all agriculture wheels
- Most affordable bead breaker for new 3 piece wheel assemblies
- Modified jaw and feet allow for larger grab on larger wheel assemblies
- Can be used on the front and back side of the wheel assembly
- All parts (except for modified feet and jaw) can be interchanged with 11010



422-11020

ASCOT NO.	MFG. NO.	DESCRIPTION
422-11020	11020	Modified "Combi" Tire Bead Breaker

Giant Tire/Earthmover Tire Bead Breaker

- Use on 5-piece rims 15" to 51" without pry bar/bead loosening pockets
- Model 15000, 15920 or 15040 air/hydraulic pump recommended for operation
- Replaces Goodyear TO-100-HA



422-11040

ASCOT NO.	MFG. NO.	DESCRIPTION
422-11040	11040	Giant Tire/Earthmover Tire Bead Breaker

Giant Tire/Earthmover Tire Bead Breaker

- Use on 5-piece rim 25" to 51" with pry bar/bead loosening pocket
- Replaces Goodyear TO-1600-HA
- 4-1/4" stroke, 14-ton ram will break the toughest beads
- Same as IMT-1800
- Model 15000, 15020 or 15040 air/hydraulic pump recommended



The Giant Tire/Earthmover Tire Bead Breaker in use.



422-11000

ASCOT NO.	MFG. NO.	DESCRIPTION
422-11000	11000	Bead Breaker
422-12070	12070	Bead Breaker Kit. INCLUDES: 11000 Bead Breaker, 15000 Pump, 16040 Hose Assembly
422-12090	12090	Bead Breaker Kit. INCLUDES: 11000 Bead Breaker, 15920 Pump, 16040 Hose Assembly

Titan Earthmover Bead Breaker

- Ideal for tire dealer who requires occasional use of bead breaker
- 10 ton cylinder has enough force to break most beads
- 4" (10 cm) stroke length
- Unit will work on 5 piece wheels with bead loosening pockets
- Weight: 34 lbs. (15.5 kg)



422-11005

ASCOT NO.	MFG. NO.	DESCRIPTION
422-11005	11005	Titan Earthmover Bead Breaker

Tire & Wheel Service >> BEAD BREAKERS, BEAD SEATING DEVICES & PUMPS

Bead Breakers (Cont.) >>

OTR Giant Tire Bead Breaker

- Compact, lightweight tool used primarily on 25" and 29" earthmover wheels
- Originally marketed as Goodyear TO-1600-HA
- Works only on 5 piece wheels with bead loosening pockets
- 2 1/8" (5.4 cm) stroke
- 10 tons of hydraulic force
- Used with 10,000 PSI (700 bar) air/hydraulic pump
- Weight: 23 lbs. (10 kg)

ASCOT NO.	MFG. NO.	DESCRIPTION
422-11050	11050	OTR Giant Tire Bead Breaker



422-11050

Dual Agricultural Tractor Tire Bead Breaker

- Heavy duty: 10-tons of force breaks the toughest beads
- Breaks inside bead on outside dual farm tractor tires
- Requires just 3" of operating space between dual tractor tires
- Use with 10,000 PSI air/hydraulic pump
- No need to remove outside wheel to change tire on outside dual

ASCOT NO.	MFG. NO.	DESCRIPTION
422-11060	11060	Dual Agricultural Tractor Tire Bead Breaker



422-11060

OTR 3000 Giant Tire Bead Breaker

- Designed specifically to work on Topy and Rimex OE wheels found on Terex, Komatsu, Liebherr and Le Tourneau
- Designed to prevent the tool from kicking out while under load
- 6' Stroke ram delivers maximum force
- New Universal Jaw design works on ALL wheels 51" – 63"
- Weight: 54 lbs. (24.5 kg)

ASCOT NO.	MFG. NO.	DESCRIPTION
422-11044	11044	OTR 3000 Giant Tire Bead Breaker



422-11044

Dual Agricultural 300 Tire Bead Breaker

- Lightweight and easy to handle
- Requires only 4 1/2" (11.5 cm) operating space
- Designed for all agricultural applications
- 5 Tons of pushing force
- Opens to 12" (30.5 cm) wide
- Weight: 20 lbs. (9kg)

ASCOT NO.	MFG. NO.	DESCRIPTION
422-11065	11065	Dual Agricultural 300 Tire Bead Breaker



422-11065

Giant Tire/Earthmover Tire Bead Breaker

- Use on all 39", 45", 49", 51", 57" and 63" wheel sizes
- In most cases you must first use Model 10105 or 10100 bead breaker to start the movement of the rim flange. Model 11030 can then be used
- Model 15020 or 15040 air/hydraulic pump recommended for operation
- Replaces Goodyear TO-2000-HA

ASCOT NO.	MFG. NO.	DESCRIPTION
422-10103	11030	Giant Tire Earthmover Bead Breaker
422-12110	12110	Kit Contains 11030 Bead Breaker, 15040 Pump And 16020 Hose Assembly



422-10103

Titan Farm Tire Bead Breaker

- Ideal for tire dealer who requires occasional use of bead breaker
- 10-ton cylinder has enough force to break most beads
- 4" (10 cm) stroke length
- Unit will break all single and 2-piece and most 3-piece wheels
- Weight: 34 lbs (15.5 kg)

ASCOT NO.	MFG. NO.	DESCRIPTION
422-11015	11015	Titan Farm Tire Bead Breaker



422-11015

Tire & Wheel Service >> BEAD BREAKERS, BEAD SEATING DEVICES & PUMPS

Bead Breakers (Cont.) >>

Tire & Wheel Service >> BEAD BREAKERS, BEAD SEATING DEVICES & PUMPS



"Maxi" Bead Breaker

- Newly redesigned bead breaker, works on ALL 3-piece wheels that replace older 5-piece wheels
- Designed to work on front or back of wheel with no attachments or accessories
- Unit clamps easily to wheel – no setup time



318-11020

ASCOT NO.	MFG. NO.	DESCRIPTION
318-11020	11020	"Maxi" Bead Breaker

Stinger Bead Breaker

- OTR Bead Breaker for heavy duty • 3-piece rims that replace standard 5-piece rims
- Works on both front and back of wheel without dismounting wheel from vehicle • Works on all new 3-piece 25" wheels or larger • Works on all wheels with CAT "Shur-Lok" safety feature



The Stinger Bead Breaker in use.

ASCOT NO.	MFG. NO.	DESCRIPTION
318-11090	11090	Stinger Bead Breaker

Truck Tire Bead Breaker

- Break both tire beads at the same time
- Works on all truck tire sizes: 19.5-24.5 + Super Singles & X-One wide base types • No more back injuries from lifting 300+ lb. tires • Simple Operation • Compact Storage • Breaks the Bead with 5,000 lbs. of Force • Helps Comply With OSHA 29CFR1910.177 - Reg: Striking of Tire with Steel Hammers • Limits Workman's Compensation Claims • Made in the USA



422-20425

ASCOT NO.	MFG. NO.	DESCRIPTION
422-20425	20425	Truck Tire Bead Breaker

Diamondback Aluminum Bead Breaker Kit

- Lightweight Aluminum reduces weight by 40% • Longer feet allow better fit onto wheel/rim • Feet fully engage rim flange and push against the bead of the tire
- Weight: 31 lbs. (14kg)



422-11076

ASCOT NO.	MFG. NO.	DESCRIPTION
422-11076	11076	Diamondback Aluminum Bead Breaker Kit

Diamondback Bead Breaker Upgrade Kit

- Will work with existing Aluminum Bead Breakers, including AME model 11070 and IMT-1000 • Longer feet allow the tool to fully engage the bead of the tire • Helps tool to push on the bead, not the sidewall
- Installation instructions included



422-17200

ASCOT NO.	MFG. NO.	DESCRIPTION
422-17200	17200	Diamondback Bead Breaker Upgrade Kit



Pneumatic Bead Breaker

- Recommended for agricultural, small OTR and most truck tires
- Extremely fast: saves time over conventional hydraulic bead breakers
- Lighter weight than conventional bead breakers: only 17 lbs.
- Includes storage case • Requires a minimum of 85 psi



423-00101

ASCOT NO.	MFG. NO.	DESCRIPTION
423-00101	GTABB-01	Pneumatic Bead Breaker

Bead Breakers (Cont.) >>



Winntec Wheel Breaker Set

• Provides a safe and easy way to loosen oxidized (stuck) wheels • Simply place the ram between the duals or between the inside wheel & frame • The manual pump allows the technician to feel how much pressure is being applied • Adaptors included for wider work spaces



The Winntec Wheel Breaker Set in use.

ASCOT NO.	MFG. NO.	DESCRIPTION
422-47180	G471180	Winntec Wheel Breaker Set

Slide Hammer Bead Breaker

• Protect your expensive wheels from swinging hammers by breaking the bead loose with this slide hammer • Use only on wheels without a hump



427-12026

ASCOT NO.	MFG. NO.	DESCRIPTION
427-12026	12026B	Slide Hammer Bead Breaker

Platinum Demount Tool

• Demounts tire sizes 17.5" - 24.5" • Only a single tool needed to demount tires • Eliminates the need to lift the tire and wheel making a hard job easy and protecting against insurance claims • Unique design protects valuable tire casings for retreading • Handle design protects against damage to the tool and other objects that may come in contact



448-12100

ASCOT NO.	MFG. NO.	DESCRIPTION
448-12100	12100	Platinum Demount Tool

Impact Bead Breaker

• Loosens the most stubborn beads with floating bead breaking foot and ram bar • Forces wedge foot between head and rim flange • Delivers blow directly to the tip • Designed for shop or road use



427-35926

427-45926

ASCOT NO.	MFG. NO.	DESCRIPTION	LENGTH	LENGTH EXT.	WEIGHT
427-35924	T24B	Economy	46"	72"	13.5 Lbs.
427-35926	T26B	Heavy Duty	50"	80"	23 Lbs.
427-45926	35926-11	Impact Bead Breaker Replacement Grips			

Floor Type Bead Breaker

• Use on custom wheels, without center holes, wide based motorcycle tires, ATV tires • Used to prevent bending of wheels



421-00098

ASCOT NO.	MFG. NO.	DESCRIPTION	TREAD WIDTH	WEIGHT
421-00098	T98	Deluxe	Up to 11"	28.5 Lbs.

Portable Bead Breaker

• Breaks beads on most sizes of passenger tires & light trucks



421-00100

ASCOT NO.	MFG. NO.	DESCRIPTION	HANDLE LENGTH	WEIGHT
421-00100	T100	Portable Bead Breaker	36"	5.2 Lbs.

Driving Iron

• Used for loosening rusted truck and bus beads



427-26000

ASCOT NO.	MFG. NO.	DESCRIPTION	LENGTH	STOCK	WEIGHT
427-26000	T26A	Driving Iron	11-3/4"	1-1/4"	4.4 Lbs.

Tire & Wheel Service >> BEAD BREAKERS, BEAD SEATING DEVICES & PUMPS

Bead Breakers (Cont.) >>

"Swan Neck" Bead Breaking Tools

- Portable tools: great alternative to handled bead breaking wedges or hydraulic bead breakers



ASCOT NO.	MFG. NO.	LENGTH	STOCK	WEIGHT
427-00041	T41	30"	7/8"	5.3 Lbs.
427-00042	T42	30"	7/8"	4.8 Lbs.
427-00052	T52	33"	7/8"	5.5 Lbs.

ATV Bead Breaker

- Constructed of heavy duty steel • Works with any center-post tire changing machine and adjusts to sizes of 6" to 12" ATV rims • No hammers, wrenches or additional tools required

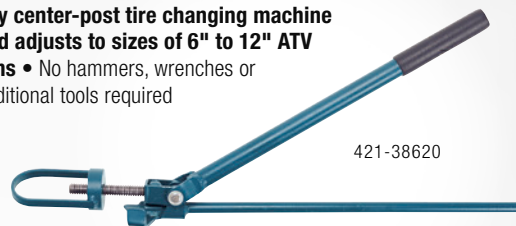

ASCOT NO.	MFG. NO.	DESCRIPTION	WEIGHT
421-38620	38620	ATV Bead Breaker	7 Lbs.

Hydraulic Pumps >>

Economy Air Hydraulic Pump

- Provides up to 10,000 PSI with standard shop air supply • Reservoir made of durable aluminum • Built-in pressure bypass system to prevent overload of operation • User-friendly foot-actuated design for easy control of moving fluid



ASCOT NO.	MFG. NO.	DESCRIPTION
422-22903	22903	1.39-Quart Capacity
422-22905	22905	1.75-Quart Capacity

Recommended fluid for all hydraulic pumps: AW32

Turbo II Air Hydraulic Pump (3.5-Quart Oil Capacity)

- Rugged polyglass reservoir with sight gauge • 10,000 PSI hydraulic pressure • Easily works on rams and bead breakers with oil to spare • Unique design easily fits truck storage bins • Turbo II pump-fastest pump available • Redesigned air motor is inexpensive to service • User-friendly foot-actuated design for easy control of moving fluid



ASCOT NO.	MFG. NO.	DESCRIPTION
318-15000	15000	3.5-Quart Air Hydraulic Pump
318-15010	15010	Above Pump With Hydraulic Hose
318-15020	15020	5-Quart Air Hydraulic Pump



Air Hydraulic Pump (5-Quart Oil Capacity)

- Rugged 5-quart metal reservoir • Air inlet filter keeps air clean • All metal air motor • 10,000 PSI hydraulic pressure



ASCOT NO.	MFG. NO.	DESCRIPTION
318-15920	15920	5-Quart Air Hydraulic Pump
318-15930	15930C	Air Hydraulic Pump w/Hose & Coupler

Miller Mud Flap

- Fits AME 15920 and IMT style pumps • Prevents dirt from getting into the release valve assembly • Inexpensive solution to lengthen the life of your pumps



ASCOT NO.	MFG. NO.	DESCRIPTION
318-15901	15901	Miller Mud Flap

Air Hydraulic Pump (2-Gallon Oil Capacity)

- Rugged 2-gallon metal reservoir • Air inlet filter keeps air clean • All metal air motor • 10,000 PSI hydraulic pressure



ASCOT NO.	MFG. NO.	DESCRIPTION
318-15940	15940	2-Gallon Air Hydraulic Pump
318-15950	15950C	2-Gallon Air Hydraulic Pump w/Hose & Coupler

Tire & Wheel Service >> BEAD BREAKERS, BEAD SEATING DEVICES & PUMPS

Hydraulic Rams & Accessories >>



Single Acting Aluminum Lock Nut Cylinder

- Safety lock nut for mechanical load holding
- Low weight and good portability • High flow quick coupler • Overflow port functions as a stroke limiter
- Spring return • Features a carrying handle



ASCOT NO.	MFG. NO.	CAPACITY (TONS)	COLLAPSED HEIGHT	EXTENDED HEIGHT	WEIGHT (LBS.)
318-10808	10808	50	12-1/2"	18-3/4"	26.4
318-10809	10809	100	13-1/3"	19-3/4"	66

318-10808

55-Ton and 100-Ton Aluminum Rams

- Lightweight yet durable • For use with 10,000 PSI pumps • Ships completely assembled with valve, coupler and base
- Perfect for off highway truck work • The preferred jack for road service



318-13000



318-13080



318-13120



318-13140

ASCOT NO.	MFG. NO.	RECOMMENDED PUMP	CAP. (TONS)	COLLAPSED HEIGHT	EXTENDED HEIGHT	WEIGHT (LBS.)
318-13081	13081	15930C	55	11-1/4"	17-1/4"	24.5
318-13120	13120	15930C	55	12-1/4"	18-1/4"	29
318-13000	13000	15930C	100	11-3/4"	17-3/4"	38
318-13140	13140	15930C	55	16-1/4"	26-1/4"	53

Low Profile Cylinder Kit

- Compact Design for use in confined spaces • Convenient storage case to keep cylinders and adapters together
- Specially designed return spring ensures a quick retraction and extends the lift of the spring
- INCLUDES: Stackable 1", 2" & 3" aluminum adapters that conveniently snap into the base of the ram; high flow ball coupler and dust cap • Rod wiper helps seal out dirt and contamination



318-72101

ASCOT NO.	MFG. NO.	CAP. (TONS)	STROKE	CYLINDER EFFECTIVE AREA	COLLAPSED HEIGHT	EXTENDED HEIGHT	OPERATING PRESSURE	CYLINDER HOUSING DIAMETER	RAM PLUNGING DIAMETER	WEIGHT (LBS.)
318-72101	72101	10	1-1/2"	2.35"	3-3/8"	4-7/8"	8.5 PSI	2-3/4"	1-1/2"	10

Hydraulic Rams

- Used to push off rear rim flange and tire bead on earthmover wheels • For all earthmover tires, trucks and perfect for construction



422-13050 422-13040 422-13030 422-13020 422-13010

ASCOT NO.	MFG. NO.	CAP. (TONS)	COLLAPSED HEIGHT	STROKE
422-13010	13010	10	4-3/4"	2-1/8"
422-13020	13020	10	6-3/4"	4"
422-13030	13030	10	9-3/4"	6-1/8"
422-13040	13040	10	11-3/4"	8"
422-13050	13050	10	13-3/4"	10-1/8"
422-13060	13060	30	4-5/8"	2-7/16"
422-13090	13090	25	12-3/4"	8-1/4"
422-13100	13100	25	10"	6-1/4"

3/8" Hydraulic Hoses

- 10,000 PSI Working Pressure, 20,000 PSI Burst Pressure • High flow valve for fast inflation • Includes half coupler and plastic dust cover



ASCOT NO.	MFG. NO.	DESCRIPTION
318-04960	9010-08	8' Hydraulic Hose Assembly
318-04120	9010-10	10' Hydraulic Hose Assembly

Tire & Wheel Service >> BEAD BREAKERS, BEAD SEATING DEVICES & PUMPS

Hydraulic Rams & Accessories (Cont.) >>

Hy-Flo Hydraulic Coupler

- **Lightweight yet durable**
- Includes ram and hose portions
- Interchanges with OTC, Power Team and ESCO hydraulic products

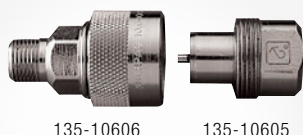

135-10606 135-10605



135-16000

ASCOT NO.	MFG. NO.	DESCRIPTION
135-10605	16050	Hose Male Half Coupler
135-10606	16060	Ram Female Half Coupler
135-16000	16000	Hy-Flo Hydraulic Coupler

Hydraulic Quick Connect Coupler/Plug

- **10,000 PSI maximum operating pressure**
- Safety sleeve lock prevents accidental disconnection
- Heavy duty back-up ring prevents o-ring extrusion
- Heat treated and plated steel for greater wear and corrosion resistance
- Self-sealing poppet valves provide excellent high and low pressure seating



135-11606 135-12606

ASCOT NO.	MFG. NO.	DESCRIPTION
135-11606	FD35-1001-0606	Hydraulic Quick Connect Coupler
135-12606	FD35-1002-0606	Hydraulic Quick Connect Plug

Quick Couplers

- **Precision built and designed for high pressure**
- Permits disconnecting without loss of oil
- 3/8" NPTF



318-09795 318-09796

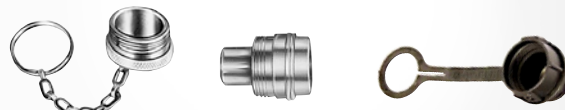

318-09797 318-09798 318-09866

ASCOT NO.	MFG. NO.	DESCRIPTION
318-09795	9795	Complete Quick Coupler
318-09796	9796	Ram Half Coupler And Dust Cap
318-09797	9797	Ram Half Coupler Dust Cap Only
318-09798	9798	Hose Half Coupler Only
318-09799	9799	Hose Half Coupler Dust Cap Only
318-09866	9866	Hose or Ram Half Dust Cap

OTR Service Tools & Accessories >>

Flange Ring Puller

- **Lifts the rim base and bead seat band from the tire**
- Aids in bead seating during inflation
- Attaches to a standard boom style service truck
- 4-point hook/chain assembly for optimal lifting
- Chain lengths of 30" (76.2 cm)
- Includes 2 flat hooks and 2 tapered hooks to allow use on all rim styles
- Weight: 32 Lbs.



402-08029

ASCOT NO.	MFG. NO.	CAPACITY
402-08029	93000	5,000 Lbs.

2-Way Push Bar

- **Two-way push bar allows for quick and easy depression of the bead seat band flange ring and rim for removal of the lock ring and O-ring**
- Can also be used to retain the tire during inflation



429-08837

ASCOT NO.	MFG. NO.	CAPACITY
429-06661	92005	33" to 57"
429-08837	92000	25" to 51"

Bead Push Off Tool

- **Lightweight tool for removing combine and tractor tires after breaking the bead**
- Pushing force of 8,000 lbs. and a 5.5" stroke, a removable handle for compact storage and uses hydraulic pressure to force the tire off the rim
- Hooks between the rim and the tire bead



429-10108

ASCOT NO.	MFG. NO.	DESCRIPTION
429-10108	11080	Bead Push Off Tool

Tire & Wheel Service >> BEAD BREAKERS, BEAD SEATING DEVICES & PUMPS

OTR Service Tools & Accessories (Cont.) >>

Bead Hooks

• Adjustable locking sling for dismantling single or dual assembly tires • With locking mechanism so tires don't rotate



429-00441

429-01601

ASCOT NO.	MFG. NO.	DESCRIPTION	CAPACITY
429-00441	B0441PC	Bead Hook	12,000 Lbs.
429-01601	D1601PC	Bead Hook	16,000 Lbs.

Earthmover Tire Bead Hooks

• Used to connect with hydraulic boom on tire service truck for transport of tires • Model 94000 has slim design which will fit inside all tires, even ones that have been stacked



429-00441

429-00441

429-00441

ASCOT NO.	MFG. NO.	DESCRIPTION	CAPACITY
429-90401	94010	Earthmover Tire Bead Hook	16,000 Lbs.
429-90402	94020	Earthmover Tire Bead Hook	12,000 Lbs.
429-90403	94000	Earthmover Tire Bead Hook	4,000 Lbs.

Tire Sling

• Adjustable locking sling for dismantling single or dual assembly tires • With locking mechanism so tires don't rotate



402-06662

ASCOT NO.	MFG. NO.	DESCRIPTION	CAPACITY
402-06662	91000	Small Sling Assembly	6,500 Lbs.

Ring Master O-Ring and Lock Ring Installer

- Lightweight and easy to use
- Pushes & Holds rim flange & tire back for easy O-ring and lock ring installation
- Portable: fits in tire truck tool box
- Eliminates use of boom crane & cumbersome tire tools
- Easy one-man operation
- Works on all 3-piece and 5-piece rim/wheels up to 30" in diameter
- Great for tough to handle forestry tires/wheels
- Eliminates danger of pushing equipment off jack with crane



The Ring Master O-Ring and Lock Ring Installer in use.



429-70162

ASCOT NO.	MFG. NO.	DESCRIPTION
429-70162	70162	Ring Master O-Ring and Lock Ring Installer

Tire & Wheel Service >> BEAD BREAKERS, BEAD SEATING DEVICES & PUMPS

Cribbing Sets >>

Cribbing Set for 55-Ton Ram Nesting

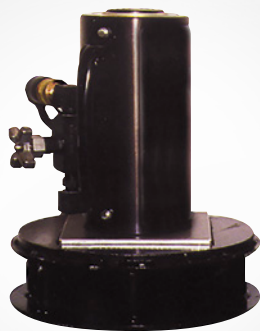

429-08075

ASCOT NO.	MFG. NO.	DESCRIPTION	SIZE
429-08075	15012	Cribbing Set	3"
429-08076	15022	Cribbing Set	6"
429-08077	15032	Cribbing Set	9"

Super Stacker Cribbing

- Industrial cribbing blocks made from 100% recycled plastic
- Provide superior strength compared to hardwood or softwood
- Provide visual warning of overload
- Interlocking and aggressive non-slip surfaces
- Non-conductive plastic construction
- Carry lanyards provided on all 6x7 and 4x4 blocks
- Rated up to 298,000 lbs., depending on configuration
- Testing paperwork available and can be filed on service truck

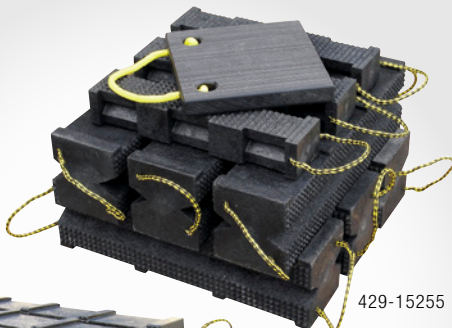

429-15255

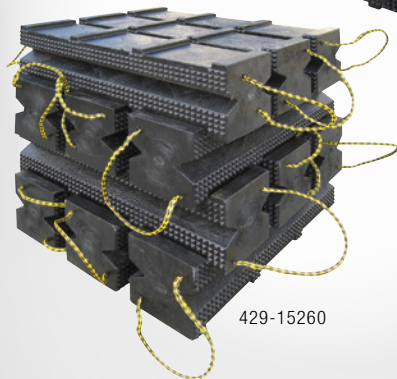

429-15260

ASCOT NO.	MFG. NO.	DESCRIPTION
429-15255	15255	KIT INCLUDES: (6) 15230, (3) 15210 and (1) 14465
429-15260	15260	KIT INCLUDES: (12) 15230 150T Capacity when Used in 3-Block Configuration

Steel Crib Kit



- Durable Steel Cribbing, will not bend or warp
- Model 15002 is a complete set: 3", 6" and 9" stands
- Units can be nested together for 18" of total lift
- Recessed area on cribbing fits 7" square plate on 55-Ton Cylinders
- Each unit has carry handle

429-08074

ASCOT NO.	MFG. NO.	DESCRIPTION
429-08074	15002	Steel Crib Kit

Off-Road Urethane Wheel Chocks

- Specifically designed for the mining and construction industries
- Tough Urethane Construction
- Resistant to Oils, Fuels and Solvents
- Mounting Hole for Ropes, Chains or Brackets
- Replaceable Rubber Anti-slip Traction Pads
- Molded-in "How to Use" Guidelines
- Safety Yellow Caution Color
- Recessed Carrying Handle



396-15305



396-15310



396-15315



396-15320



ASCOT NO.	MFG. NO.	DESCRIPTION	DIMENSIONS	WEIGHT
396-15305	15305	For Mine Support Equipment such as Lubrication Trucks and Heavy Maintenance Vehicles	15" x 15.1" x 11"	19 Lbs.
396-15310	15310	For Mine Haul Trucks with Tire Sizes up to 105" Diameter and Load Capacities up to 120-Ton	17.7" x 15.2" x 10"	28 Lbs.
396-15315	15315	For Mine Haul Trucks with Tire Sizes up to 105" Diameter and Load Capacities up to 400-Ton (A Minimum of 4 Chocks Must be Used when Chocking Haul Trucks with Load Capacities from 240- to 400-Ton)	24.6" x 14.5" x 16"	42 Lbs.
396-15320	15320	For Mine Haul Trucks with Tire Sizes over 105" Diameter and Load Capacities up to 240-Ton	21.9" x 14.9" x 10.6"	39 Lbs.

Tire & Wheel Service >> BEAD BREAKERS, BEAD SEATING DEVICES & PUMPS

UNINFLATABLE TIRES
NO LONGER EXIST!



WATCH THE GAITHER
BAZOOKA™ DEMO VIDEO

HEAVY ON DURABILITY,
LIGHT ON PRICE!
3 YEAR WARRANTY!



Gaither
GT3531

Capacity 35 t.	Entrance height 7.28"
Net Weight 93 lbs.	Working air pressure 115 psi - 205 psi



Gaither
GT3531AG

Capacity 35 t.	Entrance height 14.17"
Net Weight 154 lbs.	Working air pressure 115 psi - 205 psi



Gaither
GT4532

Capacity 45/20 t.	Entrance height 5.91"
Net Weight 99 lbs.	Working air pressure 115 psi - 205 psi



INCLUSIVE GTPANEXT
AND 3 ADAPTORS



Gaither
12100



Bead Seating Devices >>



5-Gallon Cheetah Bead Seater

- Makes seating the most difficult bead safe and simple • 5-gallon capacity
- **APPLICATIONS:** Designed for commercial use on large truck tires, passenger and ATV tires to 24.5" • Fill tank from any service station chuck or service truck air compressor



473-00500

ASCOT NO.	MFG. NO.	DESCRIPTION
473-00500	CH-5	Cheetah Bead Seater, 5-Gallon
473-00501	CH5AL	Same As Above With Aluminum Tank

10-Gallon Cheetah Bead Seater

- 10-gallon capacity with ASME certified tank
- **APPLICATIONS:** Designed for small rear agri/grader or smaller tires; Standard for fleet work, farm and service trucks



473-00010

ASCOT NO.	MFG. NO.	DESCRIPTION
473-00010	CH-10	10-Gallon
473-00011	CH-10AL	10-Gallon With Aluminum Tank

Easy-Lift™ Bead Seating Stand

- With hub facing out, simply roll mounted tire and wheel assembly to front of stand • Push assembly onto crown – tire and wheel will automatically fall onto center of stand and rest with bead centered on bottom wheel flange • Seat beads by inflating tire to 4 PSI (max.) • Step around stand and easily lift assembly into vertical position • Roll assembly into tire inflation safety cage for final inflation • **Portable for field service, or can be bolted to the floor**
- 24"H x 26"W x 27"L • Made of high grade steel



473-36016

ASCOT NO.	MFG. NO.	DESCRIPTION	WEIGHT
473-36016	36016	Std. Crown for 8-3/4" Dia. Hubs	16,000 Lbs.
473-36017	36017	Large Crown for 11" Euro Hubs	12,000 Lbs.

13-Gallon Cheetah Bead Seater

- 13-gallon capacity with ASME certified tank
- **APPLICATIONS:** Seats bead on tractor & heavy equipment tires from 24.5" to 54"
- Includes a straight barrel, new Magnum barrel (for larger tires) and safety goggles as standard equipment • Extends tire service capability not possible with portable unit



473-00010

ASCOT NO.	MFG. NO.	DESCRIPTION
473-00012	CH-13	13-Gallon
473-00013	CH-13AL	13-Gallon With Aluminum Tank

CHEETAH REPLACEMENT PARTS

Ascot No.	Mfg. No.	Description	Ascot No.	Mfg. No.	Description
473-01109	'1.109	Cheetah Air Hose Assembly	473-02103	'2.103	Threaded Barrel
473-01106	'1.106	Pressure Gauge	473-02107	'2.107	Lock Nut
473-01107	'1.107	3/4" - 1/4" Bushing	473-03104	'3.104	90 Degree NPT
473-01230	'1.230	Handle & Nut	473-04103	'4.103	Ball Valve
473-02102	'2.102	Discharge Valve	473-05102	'5.102	Safety release Valve

Cheetah Cannon Bead Seaters

- Available in 12 liter or 20 liter • Available in Steel or Aluminum • ASME Certified • Fully automatic discharge (Push Button) • Fast, simple and economical



473-00120

ASCOT NO.	MFG. NO.	DESCRIPTION
473-00120	CH-12	12-Liter Steel Cheetah Cannon
473-00121	CH-12AL	12-Liter Aluminum Cheetah Cannon
473-00220	CH-20AL	20-Liter Aluminum Cheetah Cannon

Bead Seat Band Installer

- Uses hydraulic force to install bead seat bands in earthmover tires • 25 tons of hydraulic force to ensure that all bead seat bands are installed effortlessly
- The angled plate rests against a large section of the tire, ensuring protection of the bead during installation • Weight: 40 lbs (18.1 kg)



ASCOT NO.	MFG. NO.	DESCRIPTION
429-11900	11900	Bead Seat Band Installer

Tire & Wheel Service >> BEAD BREAKERS, BEAD SEATING DEVICES & PUMPS

Bead Seating Devices (Cont.) >>

B&J Standard Duty Bead Seating System



- Provides an efficient and quick way to seat the beads of truck tires • Easy to operate-twist valve with man-size handle • **INCLUDES:** 8 feet of 1" diameter hose, hand-operated valve and choice of one ring-specifying ring part number



474-21371

ASCOT NO.	MFG. NO.	DESCRIPTION
474-21371	31210	For Rim Sizes 20" To 24.5"
474-21372	31211	For Rim Sizes 17.5" To 19.5"
474-21373	31212	For Rim Sizes 14.5" To 16.5"
474-21374	31213	For Rim Sizes 17.5" Only
474-21375	31214	For Rim Sizes 22.5" Only
474-31303	31303	8 ft. Hose
474-31401	31401	1" Valve
474-31701	31701	20 Gallon Surge Tank

Air Blast Bead Seater for Small Tires

- Fast and easy way to seat beads in one simple operation • Seat the bead on most small tubeless tires with rims ranging from 4" to 12"
- One-man operation: just point and release



473-31440

ASCOT NO.	MFG. NO.	WEIGHT
473-31440	31440	5.6 Lbs.

Pneumatic Bead Expanders

- Fits most bias ply passenger tires • Pliable neoprene rubber tube encased in tough nylon cover • Withstands contact with oil, grease, solvents and acid



471-31432

ASCOT NO.	MFG. NO.	MIN./MAX. DIAM.	TUBE DIAM.	WEIGHT
471-31432	31432	24"-34"	2-1/4"	2.8 Lbs.
471-31433	31433	22"-32"	3/4"	.75 Lbs.



Bead Bazooka with Auto Release System

- Automatic Rapid Air Release System makes it the most powerful bead-seating device in the market • Smaller tank allows for easier handling in shop and service truck
- Light weight (14 lbs.) reduces stress on technician
- Push-button trigger allows technician to keep both hands on the tank for more control, making it safer than manual-release tanks • "Slotted" Double Barrel directs the air for best overall lift • New, more ergonomic grip design



473-00006

ASCOT NO.	MFG. NO.	DESCRIPTION
473-00006	BB6L	Bead Bazooka with Auto Release System

Bead Bazooka XL with Auto Release System

- The Bazooka XL offers the same technology the Bazooka 6L delivers, but is suited for use with larger trucks and AG wheels
- Automatic Rapid Air Release System makes it the most powerful bead-seating device in the market • Smaller tank allows for easier handling in shop and service truck • Light weight reduces stress on technician • Push-button trigger allows technician to keep both hands on the tank for more control, making it safer than manual-release tanks • "Slotted" Double Barrel directs the air for best overall lift • New, more ergonomic grip design



473-00009

ASCOT NO.	MFG. NO.	DESCRIPTION
473-00009	BBL9XL	Bead Bazooka XL with Auto Release System

Bead Bazooka Charging Station

- Allows techs to store the Bead Bazooka near the working area without leaving it on the floor • Protects the tool from dropping, being kicked, broken components, etc. • Helps keep the shop clean and safer • Allows tech to fill the tank while it's in the holster and offers a direct view of the pressure gauge • Accessory hooks are convenient for airlines, tire wedges, etc.

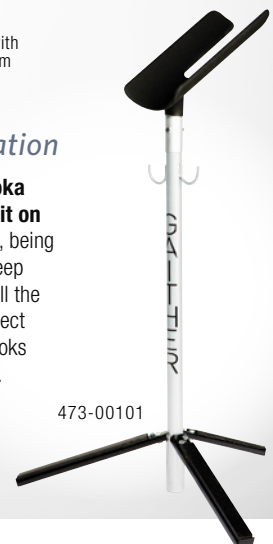

473-00101

ASCOT NO.	MFG. NO.	DESCRIPTION
473-00101	BBH-01	Bead Bazooka Charging Station

Bead Seating Devices (Cont.) >>



Gaither's Bead Saver System

• Patented design • **By using simple principles of leverage, the Bead Saver System actually works with tire and rim to do the work for you** • Safest, fastest, easiest way ever invented to change tubeless truck tires • Guaranteed not to damage tire beads



ASCOT NO. 448-12880 MFG. NO. 12880 DESCRIPTION Bead Saver System

GAITHER'S BEAD SAVER SYSTEM: PARTS

ITEM	ASCOT NO.	DESCRIPTION
A	448-12902	Clevis (Demounting Tool)
B	448-12883	Right Wing For Clevis
C	448-12884	Left Wing For Clevis
D	448-12897	Bolts For Clevis Wing (Set Of 2)
E	448-12903	Rollers For Clevis (Black & White Roller Including Pins)
F	448-12909	Wire Handle For Clevis (Includes Screws)
G	448-12892	On/Off Plate
H	448-12893	Wedge
I	448-12899	Beavertail
J	448-12901	Rollers For Beavertail (Set Of 2 Includes Screws)
K	448-12886	Lever Bar
L	448-22886	Crook End For Lever Bar
M	448-32886	Spoon End For Lever Bar
N	448-12894	Beadkeeper (1 Included In Standard Set)
O	448-12898	Clevis Assist (Not Included In Standard Set)
P	448-12900	Heavy Duty Carrying Case
Q	448-12904	Gaither's Super Slick'em (Replacement Sold by The Case) - 4 Gallons w/Applicator
R	448-12905	Instructional Video (Available in PAL Also)

Gaither J1 Mount/Demount Tool

• Slightly altered and condensed version of the original Bead Saver System • 2-piece system that mounts and dismounts all standard 19.5", 22.5" and 24.5" tubeless tires up to a 315/80R22.5, including those mounted on aluminum wheels • Differs from the original system in that each process is done completely while the tire is flat on the ground • The first Bead is dismounted with the clevis & crook/spoon end • The second Bead is dismounted with the J-1 end without picking the tire up • The first bead can be mounted with the J-1 end • The second Bead is mounted with the spoon end • Two Beadkeepers can be used to assist with mounting

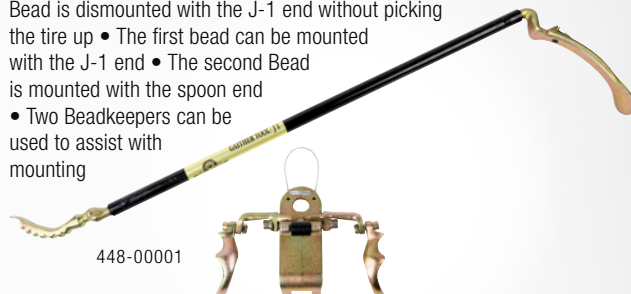

ASCOT NO. 448-00001 MFG. NO. J1 DESCRIPTION Mount/Demount Tool

5-Gallon Bead Booster

• Creates a blast of air used for seating tubeless tire beads • Release valve safety lock prevents inadvertent discharge • Powder-coated inside and out to protect from rust and deterioration caused by moisture • Double Barrel directs the air around the tire for a better "lift" • Safety pop-off valve prevents overloading with too much air pressure



ASCOT NO. 473-00005 MFG. NO. GB-5Z DESCRIPTION 5-Gallon Bead Booster

Boa Constrictor

• Hammerless bead breaking system • Uses a high pressure vacuum to literally "squeeze" the tire away from the wheel • Eliminates the need for a hammer in the tire break-down process • **APPLICATIONS:** Ideal for aluminum & steel wheels • Connects to any standard air line - perfect for on-the-road service

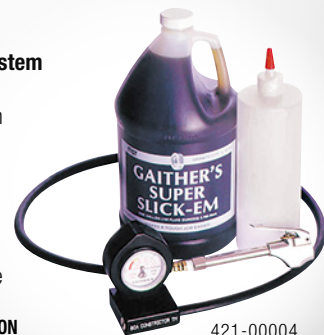

ASCOT NO. 421-00004 MFG. NO. BC-04 DESCRIPTION Bead Breaking System

Tire & Wheel Service >> BEAD BREAKERS, BEAD SEATING DEVICES & PUMPS

Beadkeepers >>



A

448-12894
Yellow Rubber
Coated Beadkeeper



A. Yellow Rubber Coated Beadkeeper

- Keeps truck tire bead from slipping during mounting of top bead
- Rubber coated steel construction
- Will not scratch aluminum wheels
- Great for hard to mount tires, a must for all super singles
- **Equivalent**

ASCOT NO.	MFG. NO.	DESCRIPTION
448-12894	12894C	Yellow Rubber Coated Beadkeeper

B

448-32894
Blue Wide Mouth
Rubber Coated
Beadkeeper



B. Blue Wide Mouth Rubber Coated Beadkeeper

- **Wider mouth works on newer, wider Alcoa wheels**
- Keeps truck tire bead from slipping during mounting of top bead
- Rubber coated steel construction
- Will not scratch aluminum wheels
- Great for hard to mount tires, a must for all super singles
- **Equivalent to Gaither 12894-CW**

ASCOT NO.	MFG. NO.	DESCRIPTION
448-32894	12894-CW	Wide Mouth Blue Rubber Coated Beadkeeper

C

448-22894
Steel Beadkeeper



448-42894

C. Steel Beadkeeper

- **THE ORIGINAL BEADKEEPER®**
- Used to hold a tire bead in place during the mounting process
- Eliminates the need to stand on the tire and/or use a second mounting bar

ASCOT NO.	MFG. NO.	DESCRIPTION
448-22894	12894	Steel Beadkeeper

D

448-42894
Beadkeepers-
On-A-Rope



D. Beadkeepers-On-A-Rope

- **Used to hold the tire in place while mounting the second bead**
- These tools eliminate the dangerous job of standing on the tire in order to mount it
- After the first bead is mounted, simply place two Beadkeepers on the flange of the wheel and spread them apart as far as possible; Use the Spoon End of the bar to mount a small part of the bead and slide the closest Beadkeeper to the bar; Repeat this step until the entire second bead is mounted

ASCOT NO.	MFG. NO.	DESCRIPTION
448-42894	12894-P	Beadkeepers-On-A-Rope

Tire & Wheel Service >> BEAD BREAKERS, BEAD SEATING DEVICES & PUMPS

Chloride Pumps >>



Valve Adapter Gun

- 1/2" female pipe thread
- Will attach to any calcium tire filling pump
- Will extract valve core from a standard bore valve or core housing from tractor valve
- Securely holds valve core or core housing up in the gun body during the filling or evacuation of liquid from tire



ASCOT NO.	MFG. NO.	DESCRIPTION
464-00310	310	Valve Adapter Gun

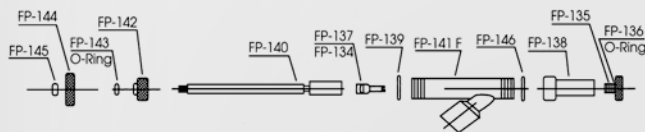

VALVE ADAPTER GUN: PARTS

Ascot No.	Mfg. No.	Description	Ascot No.	Mfg. No.	Description
464-00134	FP-134	Large Bore Core Remover	464-00139	FP-139	Gasket
464-00135	FP-135	Adapter For Standard Valve	464-00140	FP-140	Stem
464-00136	FP-136	O-Ring For FP-135	464-00141	FP-141F	Adapter Body
464-00137	FP-137	Standard Valve Core Remover	464-00142	FP-142	Stem Sealing Nut
464-00138	FP-138	Ejector Union With FP-136 O-Ring	464-00143	FP-143	O-Ring For FP-142
			464-00144	FP-144	Hand Wheel
			464-00145	FP-145	Lock Nut
			464-00146	FP-146	Teflon Gasket

"Wonder Pump" Pneumatic Double Diaphragm Calcium Chloride Pump

- No lubrication required
- Self-priming; non-stalling; low noise level
- Diaphragms have no stress points and "less flex" for longer life
- No gradual loss of pump performance due to wear
- Can run dry indefinitely
- Protected by an air filter/regulator
- 4-way valve : 1/4 turn reverses the flow - no need to change hoses
- 35 gallon per minute free flow

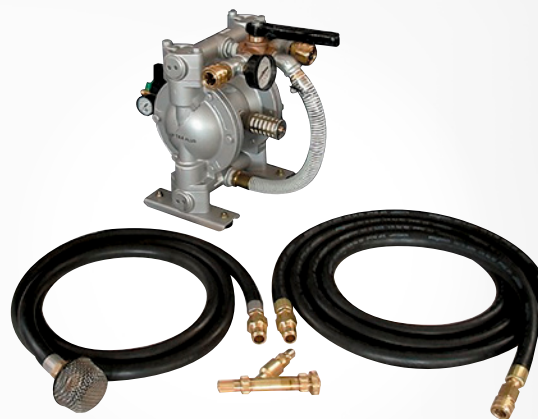

ASCOT NO.	MFG. NO.	DESCRIPTION
475-18001	30A Plus	1" Capacity Standard Package

"WONDER PUMP" PARTS & ACCESSORIES

Ascot No.	Mfg. No.	Description
475-13011	30A-11	310 Calcium Gun
475-13018	30A-18	3/4" Brass Quick Coupler-Hose Saver
475-13019	30A-19	3/4" Brass Plug - Hose Saver (Needed for 30A-18)
475-13021	30A-21	1/2" Brass Quick Coupler - Calcium Gun
475-13022	30A-22	1/2" Brass Plug - Calcium Gun (Needed for 30A-21)
475-13026	30A-26	1/8" Back Mount Air Gauge - 0-100 PSI
475-13027	30A-27	2-1/2" Dia. S.S. 1/4" Back Mount Press/Vac Gauge - 30/0/150 Glycerin Filled
475-82515	682515	Extra Large Exhaust Muffler
475-13028	30A-28	3/4" Brass 4-Way Directional Valve w/ O-Ring Seals w/ Handle
475-13029	30A-29	Handle for 30A-28
475-13030	30A-30	10' Supply Hose (3/4" x 1" MPT Ends) 300 PSI - Wingfoot
475-13031	30A-31	15' Fill/Evac Hose (3/4" x 1/2" MPT Ends) 300 PSI - Wingfoot
475-13032	30A-32	PVC Suction Bypass Hose for Silver Pump
475-13033	30A-33	1" FPT Stainless Steel Strainer for 30A-30 Prior to 2002
475-13034	30A-34	3/4" FPT Stainless Steel Strainer for Current 30A-Plus
475-12532	25A-32	PVC Bypass Hose for Black Pump

Calcium Chloride Pump

- Now available with polyvinyl valve (Model #10509) or anodized aircraft aluminum valve (Model #10509M)

• Pumps 34 gallons of calcium chloride per minute

• Newly designed valve will not leak

• Spring reinforced hoses for fill and evacuate

• Comes complete with valve adapters for all valves (large bore and standard)

• Gauges are protected

• Unit is portable or can be mounted in tire service trucks

• Double diaphragm pump, 1 to 1 ratio

• 10' hoses gives plenty of room to operate

• Includes hoses & calcium tire filled gun

• USA MADE PUMP



ASCOT NO.	MFG. NO.	DESCRIPTION
475-10509	10509	Calcium Chloride Pump with Polyvinyl Valve
475-11590	10509M	Calcium Chloride Pump with Aircraft Aluminum Valve

Tire & Wheel Service >> BEAD BREAKERS, BEAD SEATING DEVICES & PUMPS

Tire Irons >>

Golden Tool Tubeless Truck Tire Mount/ Demount Tool

- Demounts most tubeless tires in 8 seconds with ease - remount them in 20 seconds with equal ease - all without the need to lift tire and rim to remove rear bead • Demounts/mounts 17.5" to 24.5" tires • **APPLICATIONS:** Use on all tubeless truck tires including super single/ duplex tires, radial and bias
- For Dayton-type wheels (centerless) and Budd type disc wheels • Eliminates the need to lift tire and rim to remove the bottom bead, preventing possible strain or even serious injury



ASCOT NO.	MFG. NO.	DESCRIPTION
448-00100	TNT-100	Tire Mount/ Demout Tool Complete
448-00101	TNT-100-1	Demount Tool Only
448-01008	TNT-100-8	Roll Pins for TNT-9 (Need 2)
448-01009	TNT-100-9	Small Tire Roller (Need 2)
448-10010	TNT-100-10	Main Roller
448-10011	TNT-100-11	Roll Pin For TNT-100-1 (Need 1)
448-00200	TNT-200	Super Single Tire Mount/ Demount Tool
448-00201	TNT-200D	Super Demount Tool
448-00202	TNT200M	Single Mount Tool
448-00301	TNT-300-1	New 445 Super Single Demount Tool

Blue Cobra™ Truck Tire Demount Tool

- Ergonomic shaped steel handle with no-slip grip for optimum leverage • **APPLICATIONS:** Change nearly any 20", 22.5" and 24.5" tube-type and tubeless truck tires, up to a 13" wide one-piece wheel

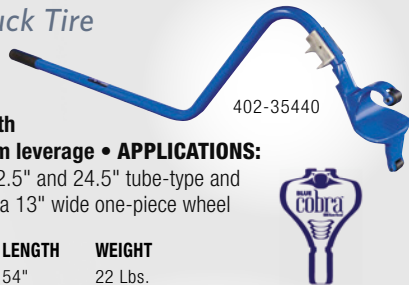

ASCOT NO.	MFG. NO.	LENGTH	WEIGHT
402-35440	35440	54"	22 Lbs.

Easy-Way™ Tubeless Truck Tire Demounting System

- Demount tubeless truck tire in 8 seconds • Never lift tire to demount rear or bottom bead • Eliminates bead damage
- **APPLICATIONS:** Handles all tubeless truck tires 16.5"-24.5" diameter and some super single "floats"
- No damage to aluminum or painted wheels

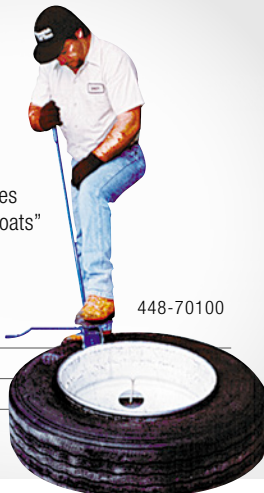

ASCOT NO.	MFG. NO.	DESCRIPTION
402-70100	70100	Complete Kit
402-70101	70101	Top Bead Tool
402-70102	70102	Bottom Bead Tool
402-70103	70103	Rim Protector



Classic Tubeless Tire Iron

- Ken-Tool's patented designs offer one-piece construction and assure long life for many tire changing applications • Tip ends insert easily and will not cut or rip bead or sidewall • These designs make it easier to mount and demount tires without changing the way the tool is used • Mount end: Precision-forged knob grips rim. Tip designs won't slip during tire mounting. Special curve design always grabs the bead edge
- Demount end: Precision-forged angled tip slides between bead and rim easily. Forged design won't slip when demounting the second bead



ASCOT NO.	MFG. NO.	LENGTH	STOCK	WEIGHT
402-34645	T45AC	37"	3/4"	4.6 Lbs.
402-34649	T45AS	52"	7/8"	8.25 Lbs.

Tire Mount/ Demount Irons

- Many sizes for use on truck, agricultural and industrial tires • **APPLICATIONS:** Straight and offset tire irons for use on large, wide-base tires; T45 series for use on standard truck tires • New 402-45005 allows the professional to lift the bead over the rim with less effort than conventional methods

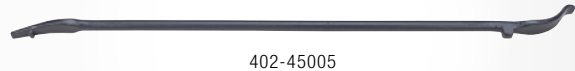

ASCOT NO.	MFG. NO.	LENGTH	STOCK	WEIGHT
402-45003	T45A	37"	3/4"	4.6 Lbs.
402-45005	T45A-2000K	38"	3/4"	5 Lbs.
402-45004	T45HD	41"	7/8"	7 Lbs.
402-47001	T47A	52"	1"	11 Lbs.

Tire Demount Tool

- Demounts both beads on most truck tires with the need for lifting the tire/wheel assembly off the ground and then dropping it • Heat-treated alloy steel for maximum durability and strength

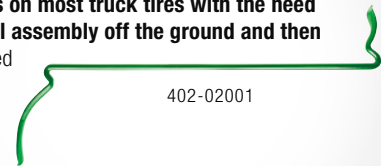

ASCOT NO.	MFG. NO.	LENGTH	STOCK	WEIGHT
402-02001	T2001	39"	3/4"	6.5 Lbs.

Tire Mount Tool

- Wing shaped designed to stop against rim, remove itself from between rim and bead • Small end gets under stretched bead for last pull

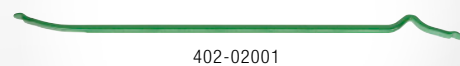

ASCOT NO.	MFG. NO.	LENGTH	STOCK	WEIGHT
402-02001	T2001	39"	3/4"	6.5 Lbs.

Tire & Wheel Service >> MOUNT/DEMOUNT TOOLS & ACCESSORIES

Tire Irons (Cont.) >>



Super Serpent Mount Tool

- It may seem funny looking, but every inch of this innovative design is purely serious
- **Delivers Twice the leverage of any "Straight-type" tire mounting tool**



402-02005

ASCOT NO.	MFG. NO.	LENGTH	STOCK	WEIGHT
402-02005	T2005	37"	3/4"	6.6 Lbs.

Super Serpent Demount Tool

- **At only 5-1/2 pounds, this unique, lightweight demount tool for super singles can be lugged around on a fingertip**
- Delivers incredible leverage right where it's needed

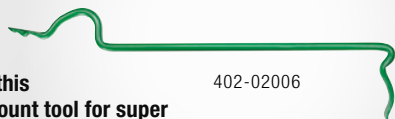

402-02006

ASCOT NO.	MFG. NO.	LENGTH	STOCK	WEIGHT
402-02006	T2006	37"	3/4"	5.5 Lbs.

Tire Spoons

- **General purpose tire irons for all mounting and demounting needs** • **APPLICATIONS:** Use 18" and 24" spoons to mount or demount passenger car, motorcycle, ATV and light truck tires; 30" spoons provide enough strength and leverage to work on large truck, bus, off-road vehicle, tractor and aircraft tires

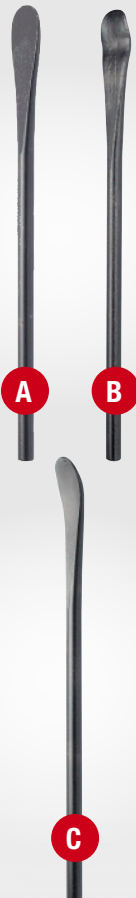

ASCOT NO.	MFG. NO.	LENGTH	STOCK	WEIGHT
-----------	----------	--------	-------	--------

A. Straight

402-32101	T1X	18"	11/16"	1.8 Lbs.
402-32119	T19	24"	11/16"	2.5 Lbs.
402-33022	33022	30"	3/4"	3.4 Lbs.
402-33219	T19A	30"	11/16"	3 Lbs.
402-33238	T38	30"	7/8"	4.8 Lbs.

B. Drop-Center

402-02100	T21R	18"	11/16"	1.8 Lbs.
402-02101	T21F	24"	11/16"	2.5 Lbs.
402-02102	T21HD	30"	7/8"	4.5 Lbs.
402-33020	33020	30"	11/16"	3.1 Lbs.
402-33024	33024	30"	3/4"	3.4 Lbs.

C. Curved

402-31820	31820	18"	11/16"	1.8 Lbs.
402-32102	T2X	18"	11/16"	1.8 Lbs.
402-32120	T20	24"	11/16"	2.4 Lbs.
402-32420	32420	24"	11/16"	2.5 Lbs.
402-33021	33021	30"	11/16"	3.1 Lbs.
402-33052	33052	30"	3/4"	3.1 Lbs.
402-33062	33062	30"	7/8"	3.4 Lbs.
402-33220	T20A	30"	11/16"	3.1 Lbs.
402-33239	T39	30"	7/8"	4.5 Lbs.

Tubeless Tire Iron Sets

- **Sets provide all irons necessary for a variety of tire changing applications**
- **APPLICATIONS:** Use C bar with the B extension bar for easier use on large, wide-base truck tires; Use on standard and large truck tires, including industrial, farm, buses and tractors

ASCOT NO.	MFG. NO.	DESCR.	LENGTH	STOCK	WEIGHT
-----------	----------	--------	--------	-------	--------

Adapter Plugs

402-46000	T46	Tire Iron Set. INCLUDES: T46A, T46B, T46C	—	3/4"	12 Lbs.
402-46001	T46A	Med. Duty Mount/Demount Iron	36"	3/4"	4.5 Lbs.
402-46002	T46B	Mount/Demount Iron	36"	3/4"	4.5 Lbs.
402-46003	T46C	Offset Bar For Deep Well Tires	22"	3/4"	3 Lbs.

Heavy

402-47000	T47	Tire Iron Set. INCLUDES: T47A, T47B, T47C	—	1"	29 Lbs.
402-47001	T47A	Ultra Duty Mount/Demount Iron	52"	1"	11 Lbs.
402-47002	T47B	Mount/Demount Iron	49-1/2"	1"	11 Lbs.
402-47003	T47C	Offset Bar For Deep Well Tires	27"	1"	6.66 Lbs.



Ironman™ Ergonomic Wheel Lifting Bar

- **Easily and safely lift heavy, awkward truck tire and wheel assemblies** • Extremely useful in outdoor conditions when truck tire and wheel assemblies can become wet & slippery • Protect your workers and yourself: reduce injuries & claims, keep insurance premiums down • Specially designed forged ends work from either side of the wheel assembly as it lays flat • **APPLICATIONS:** Lift all sizes and types of small and large heavy truck wheels: Standard sizes including 22.5" and 24.5" wheels, plus European (which have 1" lug holes), Super Wide and even the Super Single (a 340 Lb. assembly) size



The Ironman™ Ergonomic Wheel Lifting Bar in use.

ASCOT NO.	MFG. NO.	LENGTH	WEIGHT
402-34950	34950	58"	10 Lbs.

Tire & Wheel Service >> MOUNT/DEMOUNT TOOLS & ACCESSORIES

Tire Irons (Cont.) >>



Nineteen-Five™ Tire Mounting & Demounting Tool Set for 19.5" Truck Tires

- New tire bar uniquely designed to work on hub side of wheel, where hub protrudes above rim
- Specially designed ends manipulate tire with less effort
- Tools are powder coated to protect from rust and corrosion
- Forged from high-grade carbon steel and heat-treated for longlasting strength and durability
- **APPLICATIONS:** Specially designed Bead Holder to hold bead on 19.5" aluminum wheels • Solid brass Bead Holder for steel wheels
- Aluminum Wheel Protector - thick leather pad helps protect rims from marring and scratching

ASCOT NO. MFG. NO. DESCRIPTION LENGTH WEIGHT

Nineteen-Five™ Tire Mounting & Demounting Tool Set				
402-33195	33195	Nineteen-Five™ Tire Mounting and Demounting Set. INCLUDES: 31710, 31810, 33196, 33199		
472-31710	31710	Bead Holder for Steel Wheels - Solid Brass	4-1/2"	2.5 Lbs.
472-31810	31810	Aluminum Wheel Protector - Leather	6"	3.4 Lbs.
402-33196	33196	Bead Holder for 19.5" Aluminum Wheels	7-1/2"	3 Lbs.
402-33199	33199	Tire Mounting/ Demounting Tool	38"	2.5 Lbs.

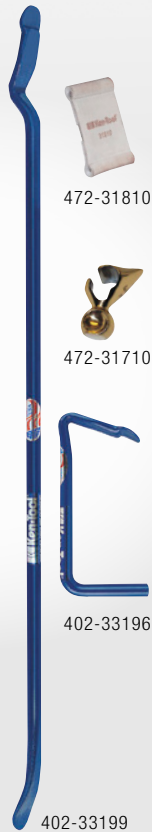

Bead Holder

- Holds the bead in place against the wheel when mounting the tire on the wheel
- 31713 Bead Holder works on Super Singles and Super Wides



ASCOT NO.	MFG. NO.	MATERIAL	STOCK	WEIGHT
472-31710	31710	Solid Brass	1.4 Lbs.	1.8 Lbs.
472-31713	31713	Aluminum Bead Holder - Works on Super Singles		

Aluminum Wheel Protector

- Protects wheel rims from damage
- U.S. Patent No. 6,991,018

ASCOT NO.	MFG. NO.	WEIGHT
472-31810	31810	12 Lbs. (5.4 kg)



Small Mount/ Demount Tools

Design based on popular European styles. Extended length of the flat curved sliding surface provides comparable mounting ability of much longer traditional tire irons.

Tire Irons - Small Tire

- Pro tire changing tools for small tires
- **APPLICATIONS:** Ideal for mounting and demounting motorcycle, ATV, lawn, golf cart and small tires by hand
- Rounded ends will not pinch tube

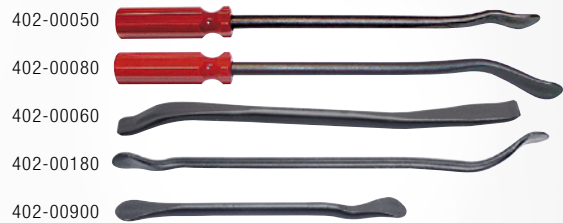

ASCOT NO.	MFG. NO.	LENGTH	STOCK	WEIGHT
402-00050	T5	16"	.8 Lbs	
402-00060	T6A	16-1/2"	5/8"	1.5 Lbs.
402-00080	T8	16"	.8 Lbs	
402-00160	T16A	16"	7/16"	.7 Lbs.
402-00900	T9A	9"	7/16"	.4 Lbs.
402-01160	T16C	2 Piece Set. INCLUDES: (2) T16A 16" Bars		
402-01900	T9C	2 Piece Set. INCLUDES: (2) T9A 9" Bars		

Motorcycle/Small Wheel



ASCOT NO.	MFG. NO.	LENGTH	STOCK	WEIGHT
402-04311	T43A	15"	3/4"	1.8 Lbs.

European Style Tools

- **APPLICATIONS:** Use on car, motorcycle, truck and agricultural tires
- Designed for mounting and demounting tires
- Best if used in pairs

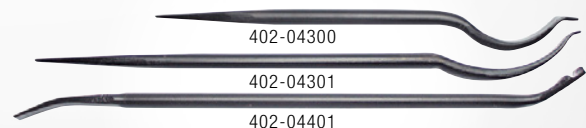

ASCOT NO.	MFG. NO.	LENGTH	STOCK	WEIGHT
402-04300	T43C	21"	7/8"	3.1 Lbs.
402-04301	T43D	30"	7/8"	4.5 Lbs.
402-04401	T44	31"	7/8"	5.3 Lbs.

Tire & Wheel Service >> MOUNT/DEMOUNT TOOLS & ACCESSORIES

Lock Ring Tools >>



Truck Lock Ring Remover

• **APPLICATIONS:** Designed for small diameter wheels



402-32123

ASCOT NO.	MFG. NO.	LENGTH	DIAMETER	WEIGHT
402-32123	T23	24"	11/16"	2.4 Lbs.
402-33223	T23A	30"	11/16"	3.1 Lbs.

Combination Rim/Ring Tool

• Flat tapered end • **APPLICATIONS:** Ideal for all around ring and rim work



402-33224

ASCOT NO.	MFG. NO.	LENGTH	DIAMETER	WEIGHT
402-33224	T23B	23-1/2"	11/16"	2.4 Lbs.

Rim Lock Tool

• **APPLICATIONS:** For servicing wide base rims



402-32125

ASCOT NO.	MFG. NO.	LENGTH	DIAMETER	WEIGHT
402-32125	T25	18"	5/8"	1.8 Lbs.

Special Lock Ring Tool

• Long tapered curved end • **APPLICATIONS:** For continuous side rings



402-32127

ASCOT NO.	MFG. NO.	LENGTH	DIAMETER	WEIGHT
402-32127	T27	18"	11/16"	1.8 Lbs.

Lock Ring Tool

• **APPLICATIONS:** Removes continuous side rings on two-piece truck rims



402-32128

ASCOT NO.	MFG. NO.	LENGTH	DIAMETER	WEIGHT
402-32128	T27A	18"	11/16"	1.8 Lbs.

Heavy Duty Lock Ring Tool

• **APPLICATIONS:** Use for multi-piece wheels, especially hub type



402-34648

ASCOT NO.	MFG. NO.	LENGTH	DIAMETER	WEIGHT
402-34648	T48A	37"	3/4"	4.6 Lbs.

Industrial Wheel Lock Ring Tool Set

• **Helps prevent injury, easier to keep hands safely outside of press cage** • Tools are powder coated to protect from rust and corrosion; bright orange color helps prevent lost tools • Forged from high-grade carbon steel and heat-treated for long lasting strength and durability • **SET INCLUDES: #3130 Mount/Demount Tool:** Demount end lifts split ring progressively around wheel until fully demounted, mount end used to mount split ring; **#3132 Demount Prep Tool:** Separator end separates split ring from solid flange ring to form gap, pry-out end reaches behind slotted end of split ring to pry in out and over the flange of the wheel

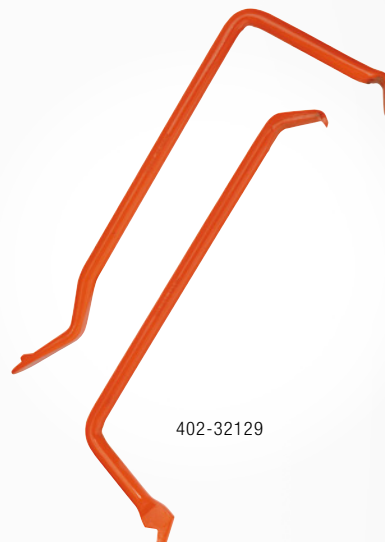

402-32129

ASCOT NO.	MFG. NO.	DESCRIPTION
402-32129	32129	2 Pc. Industrial Wheel Lock Ring Set

INDUSTRIAL WHEEL LOCK RING TOOL SET: PARTS

Ascot No.	Mfg. No.	Description	Length	Weight
402-32130	32130	Mount/Demount Tool	15-3/4"	1.8 Lbs.
402-32131	32131	Demount Prep Tool	15-1/2"	1.5 Lbs.



Tire & Wheel Service >> MOUNT/DEMOUNT TOOLS & ACCESSORIES

Hammers & Wedges >>

Heavy Duty Hammers

Wooden Handle Hammers

- Used for mounting and demounting tires
- **APPLICATIONS:** Makes tire changing easier for passenger car, truck, bus, farm tractor and aircraft tires



ASCOT NO.	MFG. NO.	HANDLE NO.	LENGTH	WEIGHT
425-35321	T34	T11CH	17"	4.8 Lbs.
425-35323	T35	T11CH	16-1/2"	5.5 Lbs.
425-35325	T36	T11CH	16-1/2"	5.8 Lbs.
425-35105	T34RH	Rubberhead Replacement		

Fiberglass Handle Hammers



ASCOT NO.	MFG. NO.	HANDLE NO.	LENGTH	HEAD WEIGHT	WEIGHT
425-35421	TG34	TG11CH	18"	5.5 Lbs.	6 Lbs.
425-35423	TG35	TG11CH	18"	4.8 Lbs.	6.6 Lbs.
425-35425	TG36	TG11CH	18"	5.8 Lbs.	6 Lbs.



All-Weather Heavy Duty Hammers

- Handles are constructed with a solid core with thousands of fiberglass strands and a unique resin to make them super strong, all-weather, chemical and insect-resistant
- Ergonomic non-slip grips for slippery conditions
- **MADE IN THE USA**



Ascot No.	Mfg. No.	Description	Details
426-10062	10062	2 lb. Dead Blow Hammer	Engineered to perform better than rubber or plastic face hammers. Shot-loaded composite interior cavities of these Dead Blow hammers are fullyencased in a tough polymer outer jacket. Free flowing inner shot concentrates striking power and increases driving force creating a dead blow effect.
426-10064	10064	4 lb. Dead Blow Hammer	
426-10066	10066	2 lb. Dead Blow Hammer w/Steel face	
426-27804	27804	8 lb. Slugging Hammer	Features drop forged, heat treated and tempered carbon steel sledge heads with dual machined striking faces and chamfers.
426-28045	28045	4 lb. Hand Drilling Hammer	High quality drop forged, heat treated and tempered carbon steel heads with a black crown and polished striking faces.
426-29045	29045	4 lb. Cross-Pein Hammer	High quality forged, heat treated and tempered heads with one radiused pein.
426-30025	30025	2.5 lb. Brass Hammer	High quality cast brass head with polished striking face.

Tire & Wheel Service >> TIRE SERVICING TOOLS

Hammers & Wedges (Cont.) >>

General Purpose Hammers & Wedges

Wooden Handle Hammers

- Designed for tire service in variety of sizes



ASCOT NO.	MFG. NO.	HANDLE NO.	LENGTH	WEIGHT
426-35311	T11B	T11BH	14-1/2"	4.5 Lbs.
426-35317	T33R	T11HN	14"	2.3 Lbs.

Fiberglass Handle Hammers



ASCOT NO.	MFG. NO.	HANDLE NO.	LENGTH	WEIGHT
426-35411	TG11B	TG11BH	16"	4.8 Lbs.
426-35417	TG33R	TG31H	16"	2.5 Lbs.

Double Faced Sledge Hammer

- High carbon steel, heat treated
- Machined, polished face • Top grade U.S. hickory handle



ASCOT NO.	MFG. NO.	HANDLE LENGTH.	FACE	EYE SIZE	WEIGHT
428-37302	84H-2	15"	1-1/2"	3/4" x 1"	2 Lbs.
428-37304	84H-4	15"	1-3/4"	3/4" x 1"	4 Lbs.
428-37308	84H-8	32"	2"	1" x 1-3/8"	8 Lbs.
428-37310	84H-10	36"	2-1/8"	1" x 1-3/8"	10 Lbs.
428-37312	84H-12	36"	2-1/8"	1" x 1-3/8"	12 Lbs.
428-37316	84H-16	36"	2-3/8"	1" x 1-3/8"	16 Lbs.
428-37320	84H-20	36"	3"	2" x 1-1/2"	20 Lbs.

Duck Billed Bead Breaking Wedges - Wood Handled



ASCOT NO.	MFG. NO.	HANDLE NO.	LENGTH	WEIGHT
424-35327	T11D	T11DH	17"	4.8 Lbs.
424-35329	T11E	T11EH	30"	9.2 Lbs.

Duck Billed Bead Breaking Wedges-Fiberglass Handled



ASCOT NO.	MFG. NO.	HANDLE NO.	LENGTH	WEIGHT
424-35427	TG11D	TG11DH	18"	4.8 Lbs.
424-35429	TG11E	TG11EH	32"	9.1 Lbs.

Duck Billed Polymer Handled Bead Breaking Wedge

- Hump design prevents tool from wedging between rim and bead
- Breaks bead with little or no prying
- New polymer handle design with fiberglass core



ASCOT NO.	MFG. NO.	HANDLE NO.	LENGTH	WEIGHT
424-35460	T11K	T11KH	32"	10.5 Lbs.
429-35230	T11KH	Replacement Handle for T11K		

2 Lb. Rubber Mallet

- Rubber head prevents marring surfaces



ASCOT NO.	MFG. NO.	HANDLE LENGTH	WEIGHT
426-35310	T32	17"	2 Lbs.

Hammers & Wedges (Cont.) >>

Cross-Pein/Blacksmith Hammer



426-37103

ASCOT NO.	MFG. NO.	HANDLE LENGTH.	FACE	EYE SIZE	WEIGHT
426-37103	85H-3	16"	1-5/8"	1" x 1-3/4"	3 Lbs.

New England Pattern Hand-Drilling Hammers



426-37003

ASCOT NO.	MFG. NO.	HANDLE LENGTH.	FACE	EYE SIZE	WEIGHT
426-37003	80H-3	10-1/2"	1-1/2"	1"x 3/4"	3 Lbs.
426-37004	80H-4	10-1/2"	1-5/8"	1"x 3/4"	4 Lbs.

Tire Knocker



426-35110

ASCOT NO.	MFG. NO.	HANDLE LENGTH.	FACE	EYE SIZE	WEIGHT
426-35110	35110	18"	.7 Lbs.	1"x 3/4"	3 Lbs.

Dead Blow Hammers

• **Economy version for DIYers or home workshops** • One-piece polypropylene outer jacket provides a lifetime of use • Head is shot-filled for maximum force with no bounce effect



426-35310

ASCOT NO.	MFG. NO.	LENGTH	WEIGHT
426-35335	T335	12"	1.5 Lbs.

Professional Dead Blow Hammers



426-35332

426-35337

ASCOT NO.	MFG. NO.	DESCRIPTION	LENGTH	WEIGHT
426-35331	TG331	1 lb. Head	12-1/4"	1.8 Lbs.
426-35332	TG332	2 lb. Head	13-1/2"	1.9 Lbs.
426-35333	TG333	3 lb. Head	14-1/2"	2.7 Lbs.
426-35334	TG334	4 lb. Head	15-1/2"	3.4 Lbs.
426-35337	TG337	Steel Face/Soft Face	13-1/2"	2.2 Lbs.

Replacement Handles



Fiberglass Replacement Handles



ASCOT NO.	MFG. NO.	FOR HAMMER NO.	LENGTH	WEIGHT
429-35206	TG31H	TG11R, TG31, TG33R	16"	1 Lb.
429-35211	TG11BH	TG11B	16"	1.3 Lbs.
429-35219	TG11CH	TG11C, TG34, TG35, TG36	18"	2.5 Lbs.
429-35227	TG11DH	TG11D	18"	1.2 Lbs.
429-35229	TG11EH	TG11E	32"	2.3 Lbs.

Aluminum Replacement Handles



ASCOT NO.	MFG. NO.	FOR HAMMER NO.	LENGTH	WEIGHT
429-35529	T11AH	T11E, TG11E	32"	4.3 Lbs.

Hickory Replacement Handles



ASCOT NO.	MFG. NO.	FOR HAMMER NO.	LENGTH	WEIGHT
429-35111	T11BH	T11B	15"	.75 Lbs.
429-35113	T11HN	T11R, T31, T33R	15"	.75 Lbs.
429-35119	T11CH	T11C, T34, T35, T36	17"	.75 Lbs.
429-35127	T11DH	T11D	17"	.75 Lbs.
429-35129	T11EH	T11E	30"	1.2 Lbs.

Fiberglass Replacement Handles for Duck-Billed Bead Breaking Wedges

• **Handles are constructed with a solid core which has thousands of fiberglass strands and a unique resin making them super strong all-weather, chemical and insect-resistant**



• Ergonomic non-slip grips for slippery conditions
• Replacement Adapters available • **MADE IN THE USA**



429-35227



429-35229

ASCOT NO.	MFG. NO.	DESCRIPTION
429-35227	TG11DH	19" Fiberglass Hammer Handle
429-35229	TG11EH	33" Fiberglass Hammer Handle

Tire & Wheel Service >> TIRE SERVICING TOOLS

Wrenches & Lug Wrenches >>

KenTool Porkchop™ Wrenches

- Holds outer cap nut on dual wheels while turning inner nut
- Lip fits in hole to secure wrench in place
- Fits standard and metric cap nuts



ASCOT NO.	MFG. NO.	DESCRIPTION	SIZE	WEIGHT
406-30609	TX9	SAE	1-1/2"	.4 Lbs.
406-30610	TX10	Metric	35mm	.4 Lbs.
406-30612	TX12	Metric	41mm	.4 Lbs.

Combination Cap Nut Wrenches

- Combination wrench offers you the versatility of two wrenches in one
- Fit one end onto the outer cap nut with other end through center hole
- Slides underneath center disc of wheel reducing slipping during nut removals



ASCOT NO.	MFG. NO.	DESCRIPTION	SIZE	WEIGHT
406-30620	TX50	SAE & Metric	41mm	1.3 Lbs.

Heavy Duty Nut Wrenches

- Heavy duty design will not slip out of position
- Rests snugly against the center hole reducing the possibility of rim damage
- Great for aluminum rims



ASCOT NO.	MFG. NO.	DESCRIPTION	SIZE	WEIGHT
406-30618	TX200	SAE	1-1/2"	2.6 Lbs.
406-30619	TX241	Metric	41mm	2.6 Lbs.

Budd Nut Wrenches

- New design won't slip out of rim hole
- Will not damage aluminum/chrome rim
- Holds outer cap nut securely
- This adaptation of an old product solves the problem of damage to wheels, as well as broken toes and injuries to the feet
- Model 60301 has a replaceable polymer covered tail that locks the tool securely in place



ASCOT NO.	MFG. NO.	DESCRIPTION
406-60301	60301	Budd Nut Wrench
406-60302	60302	Budd Nut Wrench - 35mm
406-60303	60303	Budd Nut Wrench - 41mm
406-60908	60908	Replaceable Polymer Tail

Budd Nut Wrenches

- Eliminates the need for hand and foot aid in separating the nuts, therefore reducing needless injury
- Reduces the work and potential for back strain because there is no need to lay down the tire
- Will not lose its grip on the outer cap nut so there is no loss of torque, which will give the impact wrench maximum power and efficiency



The Budd Nut Wrench in use.

ASCOT NO.	MFG. NO.	DESCRIPTION
406-60300	60300	Budd Nut Wrench



Power Wrench

- Designed for dual nut systems
- Has 13/16" square end to hold inner nut, with a 1-1/2" hex drive to spin outer nut off



The Budd Wheel Set in use.

ASCOT NO.	MFG. NO.	DESCRIPTION
404-34543	TR43	BASIC SET INCLUDES: Power Drive And Two Handles (Solid Bar - 20-1/2" Long And Tube - 20" Long)
404-34545	TR44X	BUDD WHEEL SET INCLUDES: Power Drive, One Bar, One Tube Handle, A 3/4" Service Adapter And One 13/16" Square Adapter
404-34547	TR44SW	UNIVERSAL SET INCLUDES: Power Drive, One 20-1/2" Bar, One 36" Tube Handle, A 3/4" Service Adapter, A 13/16" Square Adapter, And Six 3/4" Impact Sockets (7/8", 15/16", 1-1/16", 1-1/8", 1-3/16", 1-1/2")

Wrenches & Lug Wrenches (Cont.) >>

Double End Truck Wrenches

• **Double end truck wrenches for on-the-road service** • Sizes available for all standard lug nuts • Constructed from 1" high quality steel for greatest strength and durability • **All will take our standard TR5 (ASCOT Order No. 405-32318) leverage handle.** Handle hex opening: 3/4" • Length: 16"; Weight: 4-1/2 Lbs.



ASCOT NO.	MFG. NO.	SOCKET SIZE	WEIGHT
SAE			
405-32501	TR1	1-1/8", 13/16" Square, 1-1/2"	4.6 Lbs.
405-32502	TR2	1, 1-1/4", 5/8" Square	4.3 Lbs.
405-32504	TR2X	15/16", 7/8"	4.5 Lbs.
405-32503	TR3	7/8", 1-1/16"	4.5 Lbs.
405-32505	TR3A	1-1/8", 1-1/16"	4.5 Lbs.
405-32506	TR3X	1-1/16", 1-3/16"	4.5 Lbs.
405-32509	TR9	1-1/4", 1-1/16"	4.5 Lbs.
405-32508	TR98	1-1/2", 13/16" Square	4.5 Lbs.
METRIC			
405-32551	TRM1	35mm Sq. x 17mm Square	4.5 Lbs.
405-32552	TRM2	24mm x 33mm	4.4 Lbs.
405-32553	TRM3	27mm x 30mm	4.5 Lbs.
405-32556	TRM6	41mm x 21mm Square	4.5 Lbs.
405-32557	TRM7	33mm x 30mm Square	4.5 Lbs.

Heavy Duty Truck Wrenches

• **Use for off-the-road Budd-type wheels** • Use TR11 handle



ASCOT NO.	MFG. NO.	LENGTH	STOCK	WEIGHT
405-34401	TR10	29-1/2"	1-3/4" Hex x 15/16" Square	12.2 Lbs.
402-34402	TR11	30"	1-1/4"	6.5 Lbs.

Dual Wheel Lug Stud Remover

• **Special self-tapping splines provide maximum grip to remove stripped lug studs** • Use with TR1 and TR98 truck wrenches
• Also used with open end wrench • Use with soft-faced hammer



ASCOT NO.	MFG. NO.	DESCRIPTION	WEIGHT
492-30165	30165	Fits 13/16" Sq. Inner Nut	1 Lb.



Heavy Duty Truck Four-Way Lug Wrenches

• **Drop-forged center** • **APPLICATIONS:** Heavy duty truck, bus, tractor four-way • Center hole for leverage bar • T96 with heavy duty solid center

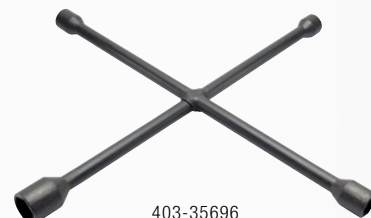

ASCOT NO.	MFG. NO.	LENGTH	STOCK	SOCKET SIZE	WEIGHT
403-35595	TC95	27-1/2"	1"	1-1/2", 13/16" Sq., 30, 33mm	14.2 Lbs.
403-35695	T95	27-1/2"	1"	1-1/16", 1-1/4", 1-1/2", 13/16" Sq.	13.8 Lbs.
403-35696	T96	27-1/2"	1"	1-1/16", 1-1/4", 1-1/2", 13/16" Sq.	13.5 Lbs.
403-35697	T95A	27-1/2"	1"	1-1/4", 1-1/2", 13/16" Sq., 3/4" Service Arm (will take any standard 3/4" drive socket)	13.5 Lbs.
403-35795	TM95	27-1/2"	1"	24, 27, 30, 33mm	13.5 Lbs.

Wrenches & Lug Wrenches (Cont.) >>



Professional Lug Wrenches

• Most popular 4-way lug wrench, polished sockets • APPLICATIONS: For passenger cars



403-35656

ASCOT NO.	MFG. NO.	LENGTH	STOCK	SOCKET SIZE	WEIGHT
403-35656	T56	20"	5/8"	17, 19, 21, 22mm	4 Lbs.
403-35657	T57	23"	5/8"	3/4", 13/16", 7/8", 15/16"	4-1/2 Lbs.

Standard Lug Wrenches

• Welded center construction for strength and durability • Premium grade, special bar quantity steel for extra strength • APPLICATIONS: T59 series for passenger cars and T90 series for light truck



403-35659

ASCOT NO.	MFG. NO.	LENGTH	STOCK	SOCKET SIZE	WEIGHT
403-35659	T59	22"	5/8"	3/4", 13/16", 7/8", 15/16"	4.5 Lbs.
405-35690	T90	25"	3/4"	7/8", 15/16", 1", 1-1/16"	7.2 Lbs.

Economy Lug Wrenches

• Designed with welded centers which stand up to everyday use • APPLICATIONS: For passenger cars



403-35620

ASCOT NO.	MFG. NO.	LENGTH	STOCK	SOCKET SIZE	WEIGHT
403-35620	T9520	20"	9/16"	3/4", 13/16", 7/8", 17mm	3.4 Lbs.
403-35661	T61	22"	9/16"	3/4", 13/16", 7/8", 17mm	3.8 Lbs.
403-35662	T62	18"	9/16"	3/4", 13/16", 7/8", 17mm	3.2 Lbs.
403-35663	T63	18"	9/16"	17, 19, 21, 22mm	3.2 Lbs.



Shop Service Tools >>

Wheel Cover Pullers/Replacers

• Remove wheel covers quickly and easily without gouging or scratching • Rubber head T11RH prevents damage to hubcap and is replaceable



402-31567

402-31568

ASCOT NO.	MFG. NO.	LENGTH	STOCK	WEIGHT
402-31567	T67	17-1/2"	9/16"	1.8 Lbs.
402-31568	T68	14"	7/16"	1.3 Lbs.

Center Cap Removers



402-31565

402-31566

ASCOT NO.	MFG. NO.	LENGTH	STOCK	WEIGHT
402-31565	T65	7-3/4"	5/16"	.2 Lbs.
402-31566	T66	7-3/4"	5/16"	.2 Lbs.

Tire Changers, Dual Wheel Separator >>

Small Tire Snake

- Included with T600 Tire Changer



402-34672

ASCOT NO.	MFG. NO.	LENGTH	STOCK	WEIGHT
402-34672	34672	22"	5/8"	2 Lbs.

Medium Tire Snake

- Included with T601 Tire Changer • **APPLICATIONS:** Designed for wheels from 4" to 13" • Longer length provides greater strength



402-34674

ASCOT NO.	MFG. NO.	LENGTH	STOCK	WEIGHT
402-34674	34674	28"	5/8"	2.5 Lbs.

Large Tire Snake

- Included with T600 Tire Changer



402-34678

ASCOT NO.	MFG. NO.	LENGTH	STOCK	WEIGHT
402-34678	34678	40"	3/4"	5.3 Lbs.

Dual Wheel Separator

- Makes removing stuck or frozen dual steel wheels quick and easy • **APPLICATIONS:** Ideal for use on nearly any truck, bus, van or trailer that has dual steel wheels • Innovative "One-piece" Pusher won't fall apart during use • Pusher is ball bearing-driven for near-zero turning resistance • Pusher is heat treated for long-lasting strength and durability • Forcing Screw and Pullers have powerful • 1-1/8" diameter x 11 threads for years of reliable service • Includes two pullers to cover large and small dual wheel applications • Components have black oxide or bright nickel plating for rust and corrosion resistance

- Use with air impact wrench
- Components are laser-etched for easy identification • Comes in a sturdy, compact, easy-to-store case • Weight: 6.5" x 9.5" x 2.5", 5.3 lbs. • **MADE IN USA**



The Dual Wheel Separator in use.

422-34549

ASCOT NO.	MFG. NO.	DESCRIPTION
422-34549	34549	Dual Wheel Separator



Floor Mount Manual Tire Changer

- **APPLICATIONS:** Mounts and demounts a full range of tires on rim diameters from 4" to 15" • **Tapered bearing guide positively centers straight shaft hubs of all diameters** • Built-in adjustable bead breaker works on rims up to 13" in diameters and 24" in width without disassembly • Includes a 28" tire snake mount/demount tool

ASCOT NO.	MFG. NO.	HEIGHT	WEIGHT
441-38601	T601	32"	31 Lbs.



441-38601

Bench Mount Rim-Clamp Manual Tire Changer

- **APPLICATIONS:** Mounts and demounts a full range of tires on rim diameters from 4" to 12" • **Mounts easily to a bench or in any standard, four-position rim-clamp tire changer** • Built-in, three-fin centering device mounts standard lug-type rims with 2" and larger center hole • Square base prevents turning in the changer during use • Includes a 22" tire snake mount/demount tool

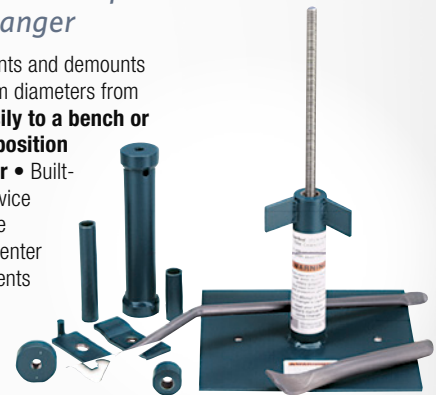

441-38600

ASCOT NO.	MFG. NO.	HEIGHT	WEIGHT
441-38600	T600	16.5"	21.7 Lbs.

Multi Tire Changer

- **APPLICATIONS:** For changing small tires and wheels
- **INCLUDES:** Everything needed to change 4" to 16.5" tires including rim • Rim clamp mechanism • 2 center posts (for open or hub type wheels and bearing type wheels) • Also includes the CH-4 Mongoose tire tool • Can be mounted on a bench, tire stand or tire changer



441-00220

ASCOT NO.	MFG. NO.	DESCRIPTION	WEIGHT
441-00220	CH-22	Multi-Tire Changer	23 Lbs.
441-00230	CH-23	Tire Stand	70 Lbs.

Inflation Systems & Accessories >>

Automatic Tire Inflation Systems

All systems feature an operating range of 5-145 PSI, accurate within .3 PSI. Units are housed in weather resistant aluminum casings. All provide an easy to use and affordable way to assure precise inflation. Units available with 110 volt AC electric or battery hook up. Optional heater available for outdoor units.

Multiple Tire Inflator

• For Fleet Operations, Service Centers, or Mounters • **APPLICATIONS:** For 19.5" and larger rims • Capable of inflating four 22.5" tires from 5 to 100 PSI in 5 minutes

ASCOT NO.	MFG. NO.	DESCRIPTION
475-89003	89 XDB	Multiple Tire Inflation System



475-89003

Multiple Tire Inflation Hoses & Accessories

ASCOT NO.	MFG. NO.	DESCRIPTION
475-00891	89HKC-LM	Straight Hose w/ CH-360S Air Chuck
475-00892	89HKT-LM	Straight Hose w/Coupler & CH-330-LO Air Chuck
475-00893	89HKL-25	Straight Hose w/Coupler & IN-20 Tool (Single Tire)
475-00894	89-HMVN	4-Way Manifold
475-00895	89-3W	Air Flow Control Valve
475-00896	SVL-STD	4' Mounting Steel Swivel Stand
478-00360	CH-360S	Chip-On Style Air Chuck (Closed) w/Spring
478-03300	CH-330-LO	Lock-On Style Air Chuck (Dual Wheels)

Specify Hose length when ordering. Components available separately.



478-00360

Portable Tire Inflator

• Easy to maneuver! • Perfect in service bay or on truck • High capacity battery means long life between recharges • Walk right up to the point of inflation!

ASCOT NO.	MFG. NO.	DESCRIPTION
475-01891	89 PIU	Portable Tire Inflator



475-01891

Single Tire Inflator

• For Dealerships, Rental Facilities, Service Centers and Quick Lubes

ASCOT NO.	MFG. NO.	DESCRIPTION
475-89001	89 XDA	Single Tire Inflation System



475-89001

Single Tire Inflation Hoses & Accessories

ASCOT NO.	MFG. NO.	DESCRIPTION
475-00896	SVL-STD	4' Mounting Steel Swivel Stand
475-01892	89HKC-L	Straight Hose w/Coupler & CH3600P Chuck
475-01893	89HKC-LC	Coil Hose w/ Coupler and CH-3600P Chuck
475-01894	89HKT-L	Straight Hose w/Coupler & CH 330-LO-OP Chuck
475-01895	89HK1-25	Straight Hose w/Coupler & IN-20 Tool
475-01896	89-2 WASV	2 Way Automatic Switching Valve (2 Hoses)
475-01897	89-3 WASV	3 Way Automatic Switching Valve (3 Hoses)
475-01898	89-3 WTK	3 Way Automatic Switching Valve Kit
478-00820	IN20	Core Removal and Inflation Tire Chuck

Specify Hose length when ordering. Components available separately.



478-00820

475-01898

Over Inflation & High Volume

• For Retreaders, Fleets or Mounters • Inflate single or multiple tires to a preset over-pressure setting • Unit then performs a leak test for "zipper leaks" • Deflates to final preset required PSI setting • Features 3 preset PSI settings

ASCOT NO.	MFG. NO.	DESCRIPTION
475-89004	89 XDZ	Over Inflation & High Volume System



475-89004

Nitrogen Tire Inflation System

• For any service center inflating with nitrogen • Use with any nitrogen generator • Convert up to 4 tires at once • Optional heater available

ASCOT NO.	MFG. NO.	DESCRIPTION
475-89005	89 XDB-G	Nitrogen Tire Inflation System



475-89005

Mobile Inflation System

• Nitrogen or air • Trolley design provides mobility • Nitrogen software will purge the air out of any size tire, re-inflate with nitrogen, while maintaining .3 PSI accuracy • Designate the number of purge cycles needed to obtain the benefits of nitrogen

ASCOT NO.	MFG. NO.	DESCRIPTION
475-89106	89 TRL-6B	Mobile Inflation System



475-89106

Tire & Wheel Service >> TIRE SERVICING TOOLS

Safety Inflation Cages & Accessories >>

Safety Inflation Cages

A safety inflation cage is mandatory in any shop for tubeless and multi-piece rims. Ascot offers a size and design for all your needs. Constructed of heavy gauge steel welded to a steel base. Guards against blown lock rings, exploding rims and ruptured tire explosions when used properly. These cages meet OSHA safety requirements (29-CFR Part 1910.177).

2-BAR



479-02220

3-BAR



479-36006

4-BAR



479-02240

5-BAR



479-36005



479-36011



479-36013



479-36002



479-36015

ASCOT NO.	MFG. NO.	DESCRIPTION	HANDLES TIRES	BASE PLATE	INSIDE HEIGHT	INSIDE DIMENSIONS	WEIGHT
2-Bar Safety Inflation Cages							
479-02220	2220	Portable 2-Bar Safety Cage	Up to 22"	—	—	—	70 Lbs.
479-36001	MIC-2	Portable 2-Bar Safety Cage	12" - 24"	6" x 21-1/2"	54"	41" H x 16" W	60 Lbs.
479-36011	MIC-2WB	Portable 2-Bar Safety Cage (Super Single)	12" - 24"	-	43"	-	70 Lbs.
3-Bar Safety Inflation Cages							
479-36006	MIC-3	3-Bar Safety Cage	14" - 24"	26" x 22"	43-1/2"	43-1/2" H x 20-1/2" W	134 Lbs.
479-36013	MIC-3SUV	3-Bar Passenger-SUV Safety Cage	Up to 20"	20-1/4" x 27-3/4"	37-3/32"	27-3/32" H x 20-1/4" W	110 Lbs.
4-Bar Safety Inflation Cages							
479-02240	2240NM	4-Bar Safety Cage with No Mar Coating	Up to 21.5"	—	—	—	170 Lbs.
479-36002	MIC-4	4-Bar Safety Cage (Super Single)	—	31-1/2" x 26"	43-1/2"	43-1/2" H x 20-1/2" W	146 Lbs.
5-Bar Safety Inflation Cages							
479-36005	MIC-5	5-Bar Safety Cage	—	41" x 26"	43-1/2"	43-1/2" H x 20-1/2" W	182 Lbs.
479-36015	MIC-OTR	5-Bar Safety Cage	39-3/8" x 41"	39-3/8" x 41"	63-15/16"	39-3/8" H x 63-15/16" W	310 Lbs.



Work safely. Always use an inflation cage when inflating tires.
Follow OSHA regulation 29-CFR Part 1910.177 whenever changing tires.

Safety Inflation Cages & Accessories (Cont.) >>

Ken-Tool® Safety Inflation Cages



A safety inflation cage is mandatory in any shop for tubeless and multi-piece rims. Ascot offers a size and design for all your needs. Constructed of heavy gauge steel welded to a steel base. Guards against blown lock rings, exploding rims and ruptured tire explosions when used properly. These cages meet OSHA safety requirements (29-CFR Part 1910.177). Designed to meet OSHA regulation requirements for medium, heavy duty truck, OTR, tractor & Super Singles.

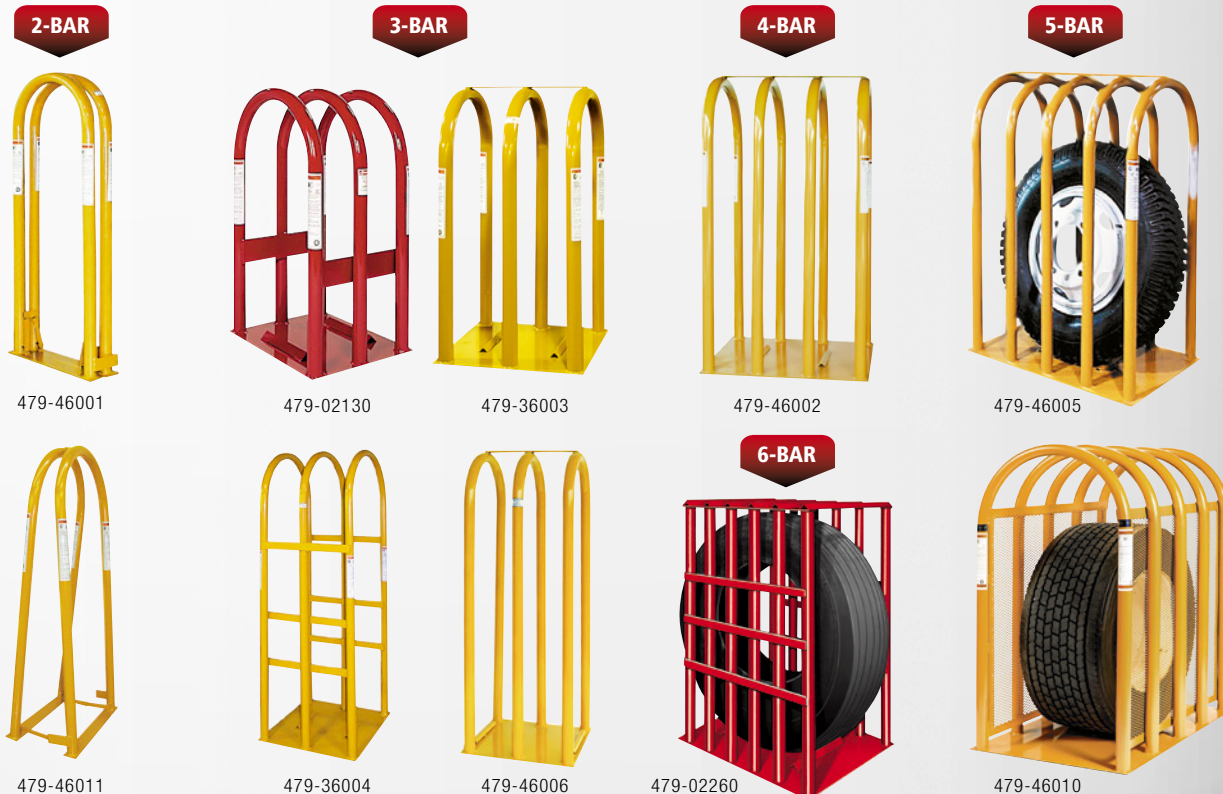

ASCOT NO.	MFG. NO.	DESCRIPTION	HANDLES TIRES	BASE PLATE	INSIDE HEIGHT	INSIDE DIMENSIONS	WEIGHT
2-Bar Safety Inflation Cages							
479-46001	36001	2-Bar Safety Cage	—	7" x 21-1/2"	41"	41" H x 16" W	60 Lbs.
479-46011	36007	2-Bar Wide Base Safety Cage	—	7" x 27"	43.5"	43.5" H x 20.5" W	72 Lbs.
3-Bar Safety Inflation Cages							
479-02130	2130	3-Bar Passenger/Light Truck Cage	Up to 27"	—	—	—	100 Lbs.
479-36003	T103	3-Bar Safety Cage/Light Truck Cage	—	21-1/2" x 22"	30"	30" H x 16" W	80 Lbs.
479-36004	T104	3-Bar Safety Cage for Off Road	—	30" x 27"	65"	65" H x 24" W	158 Lbs.
479-46006	36006	3-Bar Tire Inflation Cage	—	31.5" x 26"	43.5"	43.5" H x 20.5" W	146 Lbs.
4-Bar Safety Inflation Cages							
479-46002	36002	4-Bar Safety Cage	—	31.5" x 26"	43.5"	43.5 H x 20.5 W	146 Lbs.
5-Bar Safety Inflation Cages							
479-46005	36005	5-Bar Safety Cage	—	41" x 26"	43.5"	43.5" H x 20.5" W	182 Lbs.
479-46010	36010	5-Bar Super Magnum	—	48" x 30"	41.5"	41.5" H x 24" W	248 Lbs.
6-Bar Safety Inflation Cages							
479-02260	2260	6-Bar Safety Cage	14"- 24" or 54" Super Single	—	—	—	275 Lbs.



Work safely. Always use an inflation cage when inflating tires. Follow OSHA regulation 29-CFR Part 1910.177 whenever changing tires.

Tire & Wheel Service >> TIRE SERVICING TOOLS

Safety Inflation Cages & Accessories (Cont.) >>



Earthmover Tire Inflation Cage

- **APPLICATIONS:** For large Earthmover & Agricultural tires
- New design with 10-bar construction • **Fits up to 29.5R25 L-3 Earthmover** • For maximum tire inflation pressure up to 100-psi
- Cage dimensions: 48" x 72" x 89" • ships on skid • **PROUDLY MADE IN USA** • Designed to meet OSHA reg. 29-CFR Part 1910.177



479-46111

ASCOT NO.	MFG. NO.	DESCRIPTION
479-46111	T111	Earthmover Tire Inflation Cage



Heavy Duty Inflation Chamber

- **Fast accurate inflation using pressure limiter** • Liquid filled pressure gauges • Automatic shut-off when desired pressure is reached • Bleed valve for releasing air in the tire if defect is found while inflating • Complies with federal law covering the service of single or multi-piece wheels • **Max. tire diameter: 51"; Max. tire width: 23"**

ASCOT NO.	MFG. NO.	DESCRIPTION
479-06160	6160	Heavy Duty Inflation Chamber



479-06160



Work safely. Always use an inflation cage when inflating tires.
Follow OSHA regulation 29-CFR Part 1910.177 whenever changing tires.

Safety Inflation Cages & Accessories (Cont.) >>



Truck Tire Changing Stand

- **APPLICATIONS:** Handles wheels or open rims 16.5" to 24"
- **Double-slide adjustment with locking device prevents twisting so it stays aligned with the wheel or rim**
- Ideal height for driving off beads or demounting tire



479-36115

ASCOT NO.	MFG. NO.	DESCRIPTION
479-36115	T115	Truck Tire Changing Stand

EZ Tire Rotator for Inflation Cages

- **APPLICATIONS:** EZ Tire Rotator fits any Ken-Tool 3-Bar, 4-Bar and 5-Bar Inflation Cage, plus many competitive cages
- **No need to lift or remove rim/wheel assembly from cage when repositioning valve stem for access through the cage tubes**
- Allows tire tech to easily and quickly rotate rim/wheel assembly inside the safety cage in order to adjust position of valve stem
- Reduces handling, back strain and user fatigue; increases safety
- Easily installed or moved to another cage - no fastening required
- No assembly required; simply place in the center of the cage
- Features heavy-duty 2" ball-bearing steel rollers and 1/4" thick steel stock for long service
- Boxed and UPS shippable
- **MADE IN USA**



479-36014

ASCOT NO.	MFG. NO.	DESCRIPTION
479-36014	T114	EZ Tire Rotator for Inflation Cages

Roller for Tire Inflation Cages

- **Used to roll the tires easily directly into the inflation cage**
- Allows an easy access to the tire valve because it is easy to turn the tire to have the valve to any position
- For use with all 3-bar, 4-bar & 5-bar inflation cages
- Prevent back injuries when handling heavy tires
- Weight: 12 lbs.



479-36111

ASCOT NO.	MFG. NO.	DESCRIPTION
479-36111	MIC-ROLLER	Roller for Tire Inflation Cages

Tire Cage Stand for Automatic Inflators

- **Used to support automatic inflators to tire inflation cages**
- Reduces movement of automatic and allows for faster inflation of tires
- Install directly on the top of one of the inflation cage bars with the mounting bracket
- Weight: 8 lbs.



479-36112

ASCOT NO.	MFG. NO.	DESCRIPTION
479-36112	MW-STAND	Tire Cage Stand for Automatic Inflators

Contact us for more information about Safety Inflation Cages