



Where **high performance**
is the **standard**[®]



Including

 **M.A. FORD**[®]
High Performance Cutting Tools
ADVANCED PRODUCT GROUP

GP End Mill Section
Product Catalog
2020

www.maford.com



Where **high performance** is the **standard**®



For 100 years, M.A. FORD® has been at the cutting edge of tooling design and manufacturing and has developed an enviable global reputation for performance and precision in advanced solid carbide tooling, serving over 60 countries worldwide.

Our innovative cutting geometries, materials and coating technologies are providing effective manufacturing solutions to an expanding and increasingly diverse range of industries from agriculture and construction to aerospace, power generation and automotive, to name but a few.

M.A. FORD® – Where *high performance* is the *standard*.®





⚠ WARNING: This product can expose you to chemicals including nickel, cobalt, and lead, which are known to the State of California to cause cancer, and chemicals including lead which are known to the State of California to cause birth defects or other reproductive harm. For more information go to www.P65Warnings.ca.gov.

Series Number by Page













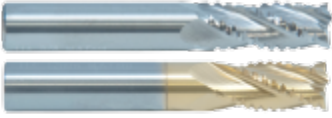























GP End Mills		
Series No.	Cat. Pg.	Tech Pg.
111	266	376
114	272	376
116	281	376
116C	284	376
117	273	376
121	289	376
122	279	376
132	280	376
140	299	376
150	303	376
163	275	376
164	295	376
165	301	376
166	307	376
169	285	376
169C	288	376

Tuff-Cut® GP End Mills Page 265-308

Series	Tool Illustration	Z	Size Range	Length	Corner Type	Helix Angle	Material Group	Page
111	 <p>Center Cutting</p> <p>• Micro sizes available.</p>	4	.0050" - 1" 0.2mm - 25.0mm		Square End Corner Radius	30°		266-270

For product information, call your local distributor.

Tuff-Cut® GP End Mills Page 265-308 (continued)

Series	Tool Illustration	Z	Size Range	Length	Corner Type	Helix Angle	Material Group	Page
111 Coated	 Center Cutting	4	1/8" - 1" 1.0mm - 25.0mm		Square End	30°		271
114	 Center Cutting	4	1/8" - 1" 3.0mm - 25.0mm		Square End Chipbreaker	30°		272
117	 Center Cutting	4	1/8" - 1/2"		Square End	30°		273-274
163	 Center Cutting • Micro sizes available.	4	.0050" - 3/4" 1.0mm - 20.0mm		Square End	30°		275-277
163 Coated	 Center Cutting	4	1/8" - 3/4" 3.0mm - 20.0mm		Square End	30°		278
122	 Center Cutting	4	1/8" - 1" 3.0mm - 25.0mm		Square End	30°		279
132	 Center Cutting	4	1/8" - 1" 3.0mm - 25.0mm		Square End Chipbreaker	30°		280
116	 Center Cutting	3	1/64" - 1" 1.0mm - 25.0mm		Square End Corner Radius	30°		281-282
116 Coated	 Center Cutting	3	1/16" - 1" 1.0mm - 25.0mm		Square End Corner Radius	30°		283
116C Workhorse	 Center Cutting	3	1/8" - 1"		Corner Radius	30°		284
169	 Center Cutting	3	1/64" - 3/4" 1.0mm - 20.0mm		Square End Corner Radius	30°		285-286
169 Coated	 Center Cutting	3	1/16" - 3/4" 3.0mm - 20.0mm		Square End Corner Radius	30°		287
169C Workhorse	 Center Cutting	3	1/8" - 3/4"		Corner Radius	30°		288

Tuff-Cut® GP End Mills Page 265-308 (continued)

Series	Tool Illustration	Z	Size Range	Length	Corner Type	Helix Angle	Material Group	Page
121	 Center Cutting • Micro sizes available.	2	.0050" - 1" 0.2mm - 25.0mm		Square End Corner Radius	30°		289-293
121 Coated	 Center Cutting	2	1/8" - 1" 1.0mm - 25.0mm		Square End	30°		294
164	 Center Cutting • Micro sizes available.	2	.0050" - 3/4" 0.2mm - 20.0mm		Square End	30°		295-297
164 Coated	 Center Cutting	2	1/8" - 3/4" 3.0mm - 20.0mm		Square End	30°		298
140	 Center Cutting	4	1/32" - 1" 1.0mm - 25.0mm		Ball Nose	30°		299
140 Coated	 Center Cutting	4	1/8" - 1" 1.0mm - 25.0mm		Ball Nose	30°		300
165	 Center Cutting	4	1/64" - 3/4" 1.0mm - 20.0mm		Ball Nose	30°		301-302
165 Coated	 Center Cutting	4	1/8" - 3/4" 3.0mm - 20.0mm		Ball Nose	30°		302
150	 Center Cutting • Micro sizes available.	2	.0150" - 1" 0.4mm - 25.0mm		Ball Nose	30°		303-305
150 Coated	 Center Cutting	2	1/8" - 1" 1.0mm - 25.0mm		Ball Nose	30°		306
166	 Center Cutting	2	1/64" - 3/4" 1.0mm - 20.0mm		Ball Nose	30°		307-308
166 Coated	 Center Cutting	2	1/8" - 3/4" 3.0mm - 20.0mm		Ball Nose	30°		308
Technical Information								310-396

TuffCut®

General Purpose End Mills

Square End/Corner Radius

4 Flute TuffCut® GP Series 111
TuffCut® GP Series 114
TuffCut® GP Series 117
TuffCut® GP Series 163
TuffCut® GP Series 122
TuffCut® GP Series 132

3 Flute TuffCut® GP Series 116
TuffCut® GP Series 169

2 Flute TuffCut® GP Series 121
TuffCut® GP Series 164

Ball Nose

4 Flute TuffCut® GP Series 140
TuffCut® GP Series 165

2 Flute TuffCut® GP Series 150
TuffCut® GP Series 166

• All uncoated standard tools are available coated upon request. Contact customer service for details.



Made in USA



ISO 9001:2015 Certified



**TuffCut® GP
Series 111**

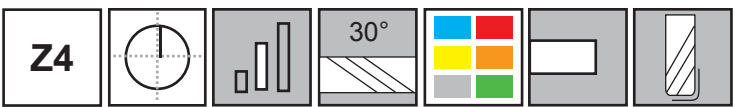

Designed for aggressive milling of most materials.

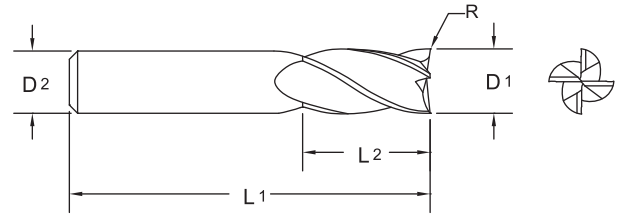

• Micro sizes available.

Tool No.	EDP	Diameter			Shank		OAL		Flute Length		Corner Radius	
		D1			D2		L1		L2		R	
		Inch	mm	Decimal	Inch	mm	Inch	mm	Inch	mm	Inch	mm
11100500	51001			.0050*	1/8		1-1/2		.015			
11100780	51003		0.2	.0078*		3.0		38		0.6		
11101000	51005			.0100*	1/8		1-1/2		.030			
11101180	51007		0.3	.0118*		3.0		38		0.9		
11101500	51009			.0150*	1/8		1-1/2		.045			
11101560	11011	1/64		.0156	1/8		1-1/2		1/32			
11101570	51013		0.4	.0157		3.0		38		1.2		
11101960	51015		0.5	.0196		3.0		38		1.5		
11102000	51017			.0200	1/8		1-1/2		.060			
11102360	51019		0.6	.0236		3.0		38		1.8		
11102500	51021			.0250	1/8		1-1/2		.075			
11102750	51023		0.7	.0275		3.0		38		2.1		
11103000	51025			.0300	1/8		1-1/2		.090			
11103120	11027	1/32		.0312	1/8		1-1/2		5/64			
11103150	51029		0.8	.0315		3.0		38		2.4		
11103500	51031			.0350	1/8		1-1/2		.105			
11103540	51033		0.9	.0354		3.0		38		2.7		
11103940	11035		1.0	.0394		3.0		38		3.0		
11104000	51039			.0400	1/8		1-1/2		.120			
11104330	51041		1.1	.0433		3.0		38		3.3		
11104500	51043			.0450	1/8		1-1/2		.135			
11104680	11045	3/64		.0468	1/8		1-1/2		7/64			
11104720	51047		1.2	.0472		3.0		38		3.6		
11105000	51049			.0500	1/8		1-1/2		.150			
11105120	51051		1.3	.0512		3.0		38		3.9		
11105500	51053			.0550	1/8		1-1/2		.165			
11105510	51055		1.4	.0551		3.0		38		4.2		
11105910	11057		1.5	.0591		3.0		38		6.0		
11105911	51057		1.5	.0591		3.0		38		4.5		
11106000	51061			.0600	1/8		1-1/2		.180			
11106250	11063	1/16		.0625	1/8		1-1/2		3/16			
11106300	51065		1.6	.0630		3.0		38		4.8		
11106500	51067			.0650	1/8		1-1/2		.195			
11106690	51069		1.7	.0669		3.0		38		5.1		

*End mills 0.015" (0.3mm) and smaller are non-center cutting.

Inch	
D1	Tolerance
1/64	+ .000/- .001
1/32 - 1/4	+ .000/- .002
>1/4 - 1	+ .000/- .003
D1 Micro Sizes*	Tolerance
.005 - .100	+ .0005/- .0005

*Inch decimal size range .005 - .100 only.

Metric (mm)	
D1	Tolerance h10
0.20 - 0.50	+ .000/- .025
0.60 - 3.00	+ .000/- .040
>3.00 - 6.00	+ .000/- .048
>6.00 - 10.00	+ .000/- .058
>10.00 - 18.00	+ .000/- .070
>18.00 - 25.00	+ .000/- .084

Inch	
R	Tolerance
1/8 - 1	+ .002/- .002

Metric (mm)	
R	Tolerance
3.0 - 25.0	+ .05/- .05

Series 111 coated tools on page 271.



Series 111 Continued

Tool No.	EDP	Diameter			Shank		OAL		Flute Length		Corner Radius	
		D1			D2		L1		L2		R	
		Inch	mm	Decimal	Inch	mm	Inch	mm	Inch	mm	Inch	mm
11107000	51071			.0700	1/8		1-1/2		.210			
11107090	51073		1.8	.0709		3.0		38		5.4		
11107480	51075		1.9	.0748		3.0		38		5.7		
11107500	51077			.0750	1/8		1-1/2		.225			
11107810	11079	5/64		.0781	1/8		1-1/2		3/16			
11107870	11081		2.0	.0787		3.0		38		9.0		
11107871	51081		2.0	.0787		3.0		38		6.0		
11108000	51085			.0800	1/8		1-1/2		.240			
11108500	51087			.0850	1/8		1-1/2		.255			
11109000	51089			.0900	1/8		1-1/2		.270			
11109370	11091	3/32		.0937	1/8		1-1/2		9/32			
11109500	51093			.0950	1/8		1-1/2		.285			
11109840	11095		2.5	.0984		3.0		38		12.0		
11110010	51099			.1000	1/8		1-1/2		.300			
11110930	11101	7/64		.1093	1/8		1-1/2		3/8			
11111810	11103		3.0	.1181		3.0		38		12.0		
11111811	51402		3.0	.1181		3.0		38		12.0		0.50
11112500	11105	1/8		.1250	1/8		1-1/2		3/8			
11112501	11108	1/8		.1250	1/8		1-1/2		1/2			
11112511	51401	1/8		.1250	1/8		1-1/2		3/8		0.015	
11112512	51403	1/8		.1250	1/8		1-1/2		3/8		0.020	
11113780	11111		3.5	.1378		4.0		51		12.0		
11114060	11112	9/64		.1406	3/16		2		1/2			
11115620	11113	5/32		.1562	3/16		2		1/2			
11115750	11115		4.0	.1575		4.0		51		14.0		
11115751	51404		4.0	.1575		4.0		51		14.0		0.50
11115752	51422		4.0	.1575		4.0		51		14.0		0.75
11117190	11116	11/64		.1719	3/16		2		5/8			
11117720	11117		4.5	.1772		5.0		51		14.0		
11118750	11119	3/16		.1875	3/16		2		5/8			
11118751	51405	3/16		.1875	3/16		2		5/8		0.015	
11118752	51407	3/16		.1875	3/16		2		5/8		0.020	
11118753	51409	3/16		.1875	3/16		2		5/8		0.030	
11119680	11121		5.0	.1968		5.0		51		20.0		
11119681	51406		5.0	.1968		5.0		51		20.0		0.50
11119682	51424		5.0	.1968		5.0		51		20.0		0.75
11119683	51440		5.0	.1968		5.0		51		20.0		1.00
11120310	11122	13/64		.2031	1/4		2-1/2		5/8			
11121650	11123		5.5	.2165		6.0		64		20.0		
11121870	11125	7/32		.2187	1/4		2-1/2		5/8			
11123440	11126	15/64		.2344	1/4		2-1/2		3/4			
11123620	11127		6.0	.2362		6.0		64		20.0		
11123621	51408		6.0	.2362		6.0		64		20.0		0.50
11123622	51426		6.0	.2362		6.0		64		20.0		0.75

Series 111 coated tools on page 271.



4
Flute

Series 111 Continued

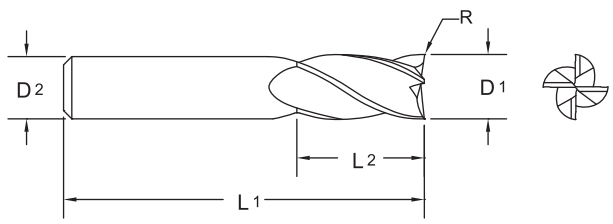
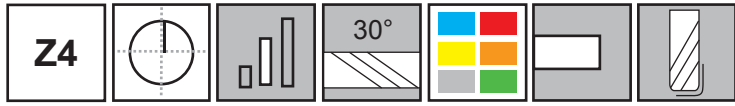

Tool No.	EDP	Diameter			Shank		OAL		Flute Length		Corner Radius	
		D1			D2		L1		L2		R	
		Inch	mm	Decimal	Inch	mm	Inch	mm	Inch	mm	Inch	mm
11123623	51442		6.0	.2362		6.0		64		20.0		1.00
11125000	11129	1/4		.2500	1/4		2-1/2		3/4			
11125001	51411	1/4		.2500	1/4		2-1/2		3/4		0.015	
11125002	51413	1/4		.2500	1/4		2-1/2		3/4		0.020	
11125003	51415	1/4		.2500	1/4		2-1/2		3/4		0.030	
11125004	51417	1/4		.2500	1/4		2-1/2		3/4		0.045	
11127560	11131		7.0	.2756		8.0		64		20.0		
11128120	11133	9/32		.2812	5/16		2-1/2		3/4			
11131250	11135	5/16		.3125	5/16		2-1/2		13/16			
11131251	51419	5/16		.3125	5/16		2-1/2		13/16		0.015	
11131252	51421	5/16		.3125	5/16		2-1/2		13/16		0.020	
11131253	51423	5/16		.3125	5/16		2-1/2		13/16		0.030	
11131254	51425	5/16		.3125	5/16		2-1/2		13/16		0.045	
11131500	11137		8.0	.3150		8.0		64		20.0		
11131501	51410		8.0	.3150		8.0		64		20.0		0.50
11131502	51428		8.0	.3150		8.0		64		20.0		0.75
11131503	51444		8.0	.3150		8.0		64		20.0		1.00
11131504	51456		8.0	.3150		8.0		64		20.0		1.50
11135430	11139		9.0	.3543		9.0		64		20.0		
11137500	11141	3/8		.3750	3/8		2-1/2		1			
11137501	51427	3/8		.3750	3/8		2-1/2		1		0.015	
11137502	51429	3/8		.3750	3/8		2-1/2		1		0.020	
11137503	51431	3/8		.3750	3/8		2-1/2		1		0.030	
11137504	51433	3/8		.3750	3/8		2-1/2		1		0.045	
11139370	11143		10.0	.3937		10.0		70		25.0		
11139371	51412		10.0	.3937		10.0		70		25.0		0.50
11139372	51430		10.0	.3937		10.0		70		25.0		0.75
11139373	51446		10.0	.3937		10.0		70		25.0		1.00
11139374	51458		10.0	.3937		10.0		70		25.0		1.50
11143310	11145		11.0	.4331		11.0		70		25.0		
11143750	11147	7/16		.4375	7/16		2-3/4		1			
11147240	11149		12.0	.4724		12.0		76		25.0		
11147241	51414		12.0	.4724		12.0		76		25.0		0.50
11147242	51432		12.0	.4724		12.0		76		25.0		0.75
11147243	51448		12.0	.4724		12.0		76		25.0		1.00
11147244	51460		12.0	.4724		12.0		76		25.0		1.50
11147245	51468		12.0	.4724		12.0		76		25.0		2.00
11150000	11151	1/2		.5000	1/2		3		1			

Series 111 coated tools on page 271.



Series 111 Continued

Tool No.	EDP	Diameter			Shank		OAL		Flute Length		Corner Radius	
		D1			D2		L1		L2		R	
		Inch	mm	Decimal	Inch	mm	Inch	mm	Inch	mm	Inch	mm
11150001	51435	1/2		.5000	1/2		3		1		0.015	
11150002	51437	1/2		.5000	1/2		3		1		0.020	
11150003	51439	1/2		.5000	1/2		3		1		0.030	
11150004	51441	1/2		.5000	1/2		3		1		0.045	
11150005	51443	1/2		.5000	1/2		3		1		0.060	
11155120	11153		14.0	.5512		14.0		89		30.0		
11156250	11155	9/16		.5625	9/16		3-1/2		1-1/8			
11162500	11157	5/8		.6250	5/8		3-1/2		1-1/4			
11162501	51445	5/8		.6250	5/8		3-1/2		1-1/4		0.015	
11162502	51447	5/8		.6250	5/8		3-1/2		1-1/4		0.020	
11162503	51449	5/8		.6250	5/8		3-1/2		1-1/4		0.030	
11162504	51451	5/8		.6250	5/8		3-1/2		1-1/4		0.045	
11162505	51453	5/8		.6250	5/8		3-1/2		1-1/4		0.060	
11162506	51455	5/8		.6250	5/8		3-1/2		1-1/4		0.090	
11162990	11159		16.0	.6299		16.0		89		30.0		
11162991	51416		16.0	.6299		16.0		89		30.0		0.50
11162992	51434		16.0	.6299		16.0		89		30.0		0.75
11162993	51450		16.0	.6299		16.0		89		30.0		1.00
11162994	51462		16.0	.6299		16.0		89		30.0		1.50
11162995	51470		16.0	.6299		16.0		89		30.0		2.00
11162996	51476		16.0	.6299		16.0		89		30.0		2.50
11162997	51482		16.0	.6299		16.0		89		30.0		3.00
11170870	11161		18.0	.7087		18.0		102		35.0		
11175000	11163	3/4		.7500	3/4		4		1-1/2			
11175001	51457	3/4		.7500	3/4		4		1-1/2		0.015	
11175002	51459	3/4		.7500	3/4		4		1-1/2		0.020	
11175003	51461	3/4		.7500	3/4		4		1-1/2		0.030	
11175004	51463	3/4		.7500	3/4		4		1-1/2		0.045	
11175005	51465	3/4		.7500	3/4		4		1-1/2		0.060	
11175006	51467	3/4		.7500	3/4		4		1-1/2		0.090	
11175007	51469	3/4		.7500	3/4		4		1-1/2		0.125	
11178740	11165		20.0	.7874		20.0		102		38.0		
11178741	51418		20.0	.7874		20.0		102		38.0		0.50
11178742	51436		20.0	.7874		20.0		102		38.0		0.75
11178743	51452		20.0	.7874		20.0		102		38.0		1.00
11178744	51464		20.0	.7874		20.0		102		38.0		1.50
11178745	51472		20.0	.7874		20.0		102		38.0		2.00
11178746	51478		20.0	.7874		20.0		102		38.0		2.50
11178747	51484		20.0	.7874		20.0		102		38.0		3.00
11186620	11167		22.0	.8662		22.0		102		40.0		
11187500	11169	7/8		.8750	7/8		4		1-1/2			
11198430	11171		25.0	.9843		25.0		102		40.0		
11198431	51420		25.0	.9843		25.0		102		40.0		0.50
11198432	51438		25.0	.9843		25.0		102		40.0		0.75

Series 111 coated tools on page 271.



Page 376

4
Flute

Series 111 Continued

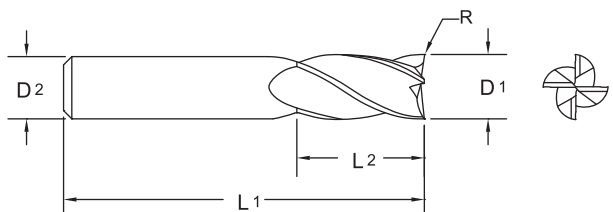
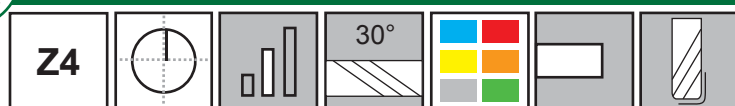

Tool No.	EDP	Diameter			Shank		OAL		Flute Length		Corner Radius	
		D1			D2		L1		L2		R	
		Inch	mm	Decimal	Inch	mm	Inch	mm	Inch	mm	Inch	mm
11198433	51454		25.0	.9843		25.0		102		40.0		1.00
11198434	51466		25.0	.9843		25.0		102		40.0		1.50
11198435	51474		25.0	.9843		25.0		102		40.0		2.00
11198436	51480		25.0	.9843		25.0		102		40.0		2.50
11198437	51486		25.0	.9843		25.0		102		40.0		3.00
11110000	11097	1.0		1.0000	1		4		1-1/2			
11110001	51471	1.0		1.0000	1		4		1-1/2		0.015	
11110002	51473	1.0		1.0000	1		4		1-1/2		0.020	
11110003	51475	1.0		1.0000	1		4		1-1/2		0.030	
11110004	51477	1.0		1.0000	1		4		1-1/2		0.045	
11110005	51479	1.0		1.0000	1		4		1-1/2		0.060	
11110006	51481	1.0		1.0000	1		4		1-1/2		0.090	
11110007	51483	1.0		1.0000	1		4		1-1/2		0.125	



Series 111 coated tools on page 271.



Made in USA

ISO 9001:2015 Certified



TuffCut® GP Series 111 Coated



4
Flute

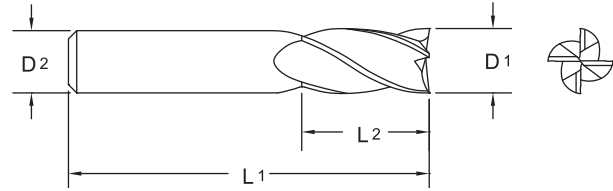

TiN		ALtima®		TiCN		Diameter			Shank		OAL		Flute Length		
Tool No.		EDP		Tool No.		EDP		Tool No.		EDP		Inch		mm	
		11103940A	11036				1.0	.0394		3.0		38		3.0	
		11105910A	11058				1.5	.0591		3.0		38		6.0	
		11107870A	11082				2.0	.0787		3.0		38		9.0	
		11109840A	11096				2.5	.0984		3.0		38		12.0	
11111810T	11104	11111810A	11003	11111810C	11004		3.0	.1181		3.0		38		12.0	
11112500T	11106	11112500A	11005	11112500C	11006	1/8		.1250	1/8		1-1/2		3/8		
11115750T	11118	11115750A	11007	11115750C	11008		4.0	.1575		4.0		51		14.0	
11118750T	11120	11118750A	11009	11118750C	11010	3/16		.1875	3/16		2		5/8		
11119680T	11124	11119680A	11013	11119680C	11014		5.0	.1968		5.0		51		20.0	
11123620T	11128	11123620A	11015	11123620C	11016		6.0	.2362		6.0		64		20.0	
11125000T	11130	11125000A	11017	11125000C	11018	1/4		.2500	1/4		2-1/2		3/4		
11131250T	11136	11131250A	11019	11131250C	11020	5/16		.3125	5/16		2-1/2		13/16		
11131500T	11138	11131500A	11021	11131500C	11022		8.0	.3150		8.0		64		20.0	
11137500T	11142	11137500A	11023	11137500C	11024	3/8		.3750	3/8		2-1/2		1		
11139370T	11144	11139370A	11025	11139370C	11026		10.0	.3937		10.0		70		25.0	
11143750T	11148	11143750A	11029	11143750C	11030	7/16		.4375	7/16		2-3/4		1		
11147240T	11150	11147240A	11031	11147240C	11032		12.0	.4724		12.0		76		25.0	
11150000T	11152	11150000A	11033	11150000C	11034	1/2		.5000	1/2		3		1		
11162500T	11158	11162500A	11037	11162500C	11038	5/8		.6250	5/8		3-1/2		1-1/4		
11162990T	11160	11162990A	11039	11162990C	11040		16.0	.6299		16.0		89		30.0	
11175000T	11164	11175000A	11041	11175000C	11042	3/4		.7500	3/4		4		1-1/2		
11178740T	11166	11178740A	11043	11178740C	11044		20.0	.7874		20.0		102		38.0	
11198430T	11172	11198430A	11047	11198430C	11048		25.0	.9843		25.0		102		40.0	
11110000T	11098	11110000A	11001	11110000C	11002	1.0		1.0000	1		4		1-1/2		

Series 111 uncoated tools on page 266.



Page 376

111 / 111 Coated
TuffCut® GP

GENERAL PURPOSE

4
Flute

**TuffCut® GP
Series 114**

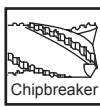
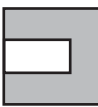
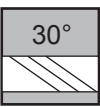
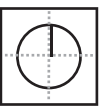

Chipbreaker end mill designed for aggressive milling of most materials.

- Allows high feed rates when roughing.
- Designed to minimize cutting forces, reduce or eliminate chatter and prolong tool life.
- Designed with tooth overlap to produce smooth part finish.

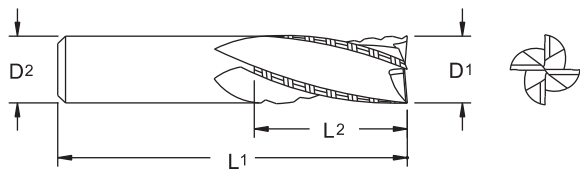

Uncoated		TiN		Diameter			Shank		OAL		Flute Length	
Tool No.	EDP	Tool No.	EDP	D1			D2		L1		L2	
				Inch	mm	Decimal	Inch	mm	Inch	mm	Inch	mm
11411810	11403	11411810T	11404		3.0	.1181		3.0		38		12.0
11412500	11405	11412500T	11406	1/8		.1250	1/8		1-1/2		3/8	
11413780	11407				3.5	.1378		4.0		51		12.0
11415620	11409			5/32		.1562	3/16		2		1/2	
11415750	11411				4.0	.1575		4.0		51		14.0
11417720	11413				4.5	.1772		5.0		51		14.0
11418750	11415	11418750T	11416	3/16		.1875	3/16		2		5/8	
11419680	11417	11419680T	11418		5.0	.1968		5.0		51		20.0
11421650	11419				5.5	.2165		6.0		64		20.0
11421870	11421			7/32		.2187	1/4		2-1/2		5/8	
11423620	11423	11423620T	11424		6.0	.2362		6.0		64		20.0
11425000	11425	11425000T	11426	1/4		.2500	1/4		2-1/2		3/4	
11427560	11427				7.0	.2756		8.0		64		20.0
11428120	11429			9/32		.2812	5/16		2-1/2		3/4	
11431250	11431	11431250T	11432	5/16		.3125	5/16		2-1/2		13/16	
11431500	11433	11431500T	11434		8.0	.3150		8.0		64		20.0
11435430	11435				9.0	.3543		9.0		64		20.0
11437500	11437	11437500T	11438	3/8		.3750	3/8		2-1/2		1	
11439370	11439	11439370T	11440		10.0	.3937		10.0		70		25.0
11443310	11441				11.0	.4331		11.0		70		25.0
11443750	11443	11443750T	11444	7/16		.4375	7/16		2-3/4		1	
11447240	11445	11447240T	11446		12.0	.4724		12.0		76		25.0
11450000	11447	11450000T	11448	1/2		.5000	1/2		3		1	
11455120	11449				14.0	.5512		14.0		89		30.0
11456250	11451			9/16		.5625	9/16		3-1/2		1-1/8	
11462500	11453	11462500T	11454	5/8		.6250	5/8		3-1/2		1-1/4	
11462990	11455	11462990T	11456		16.0	.6299		16.0		89		30.0
11470870	11457	11470870T	11458		18.0	.7087		18.0		102		35.0
11475000	11459	11475000T	11460	3/4		.7500	3/4		4		1-1/2	
11478740	11461	11478740T	11462		20.0	.7874		20.0		102		38.0
11486620	11463				22.0	.8662		22.0		102		40.0
11487500	11465			7/8		.8750	7/8		4		1-1/2	
11498430	11467				25.0	.9843		25.0		102		40.0
11410000	11401			1		1.0000	1		4		1-1/2	

Inch	
D1	Tolerance
1/8 - 1/4	+0.000/-0.002
> 1/4 - 1	+0.000/-0.003

Metric (mm)	
D1	Tolerance h10
3.00	+0.000/-0.040
>3.00 - 6.00	+0.000/-0.048
>6.00 - 10.00	+0.000/-0.058
>10.00 - 18.00	+0.000/-0.070
>18.00 - 25.00	+0.000/-0.084



TuffCut® GP Series 117



4
Flute

Recommended for use on close tolerance milling.

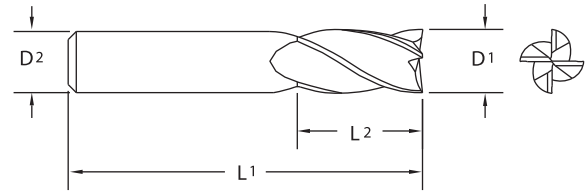

- NC tolerances on cutting diameter:
Imperial $+.001"/-0.000"$
Metric $+.025\text{mm}/-.000\text{mm}$
- TiN and ALtima® coatings available.

Tool No.	EDP	Diameter			Shank		OAL		Flute Length		Stock Status
		D1			D2		L1		L2		• Stocked
		Inch	mm	Decimal	Inch	mm	Inch	mm	Inch	mm	○ Non-Stocked
11701560	11701	1/64		.0156	1/8		1-1/2		.040		○
11703120	11703	1/32		.0312	1/8		1-1/2		5/64		○
11703940	11705		1.0	.0394		3.0		38		3.0	○
11704680	11707	3/64		.0468	1/8		1-1/2		7/64		○
11705910	11709		1.5	.0591		3.0		38		6.0	○
11706250	11711	1/16		.0625	1/8		1-1/2		3/16		○
11707810	11713	5/64		.0781	1/8		1-1/2		15/64		○
11707870	11715		2.0	.0787		3.0		38		9.0	○
11709370	11717	3/32		.0937	1/8		1-1/2		9/32		○
11709840	11719		2.5	.0984		3.0		38		12.0	○
11710930	11723	7/64		.1093	1/8		1-1/2		21/64		○
11711810	11725		3.0	.1181		3.0		38		12.0	○
11712500	11727	1/8		.1250	1/8		1-1/2		3/8		•
11713780	11729		3.5	.1378		4.0		51		12.0	○
11715620	11731	5/32		.1562	3/16		2		1/2		•
11715750	11733		4.0	.1575		4.0		51		14.0	○
11717720	11735		4.5	.1772		5.0		51		14.0	○
11718750	11737	3/16		.1875	3/16		2		9/16		•
11719680	11739		5.0	.1968		5.0		51		20.0	○
11721650	11741		5.5	.2165		6.0		64		20.0	○
11721870	11743	7/32		.2187	1/4		2-1/2		5/8		•
11723620	11745		6.0	.2362		6.0		64		20.0	○
11725000	11747	1/4		.2500	1/4		2-1/2		3/4		•
11727560	11749		7.0	.2756		8.0		64		20.0	○
11728120	11751	9/32		.2812	5/16		2-1/2		3/4		•
11731250	11753	5/16		.3125	5/16		2-1/2		13/16		•
11731500	11755		8.0	.3150		8.0		64		20.0	○
11735430	11757		9.0	.3543		9.0		64		20.0	○
11737500	11759	3/8		.3750	3/8		2-1/2		7/8		•
11739370	11761		10.0	.3937		10.0		70		25.0	○
11743310	11763		11.0	.4331		11.0		70		25.0	○
11743750	11765	7/16		.4375	7/16		2-3/4		1		•
11747240	11767		12.0	.4724		12.0		76		25.0	○
11750000	11769	1/2		.5000	1/2		3		1		•

Inch	
D1	Tolerance
1/64 - 1	$+.001"/-0.000$

Metric (mm)	
D1	Tolerance
1.00 - 25.00	$+.025/-0.000$



Page 376

114 / 117
TuffCut® GP

GENERAL PURPOSE

4
Flute

Series 117 Continued

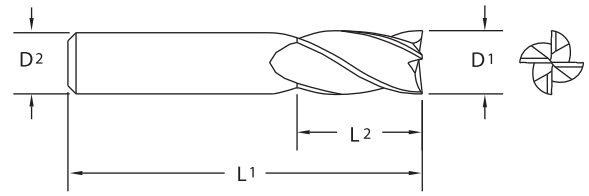
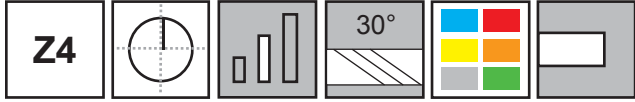

Tool No.	EDP	Diameter			Shank		OAL		Flute Length		Stock Status
		D1			D2		L1		L2		● Stocked
		Inch	mm	Decimal	Inch	mm	Inch	mm	Inch	mm	○ Non-Stocked
11755120	11771		14.0	.5512		14.0		89		30.0	○
11756250	11773	9/16		.5625	9/16		3-1/2		1-1/8		○
11762500	11775	5/8		.6250	5/8		3-1/2		1-1/4		○
11762990	11777		16.0	.6299		16.0		89		30.0	○
11770870	11779		18.0	.7087		18.0		102		35.0	○
11775000	11781	3/4		.7500	3/4		4		1-1/2		○
11778740	11783		20.0	.7874		20.0		102		38.0	○
11786620	11785		22.0	.8662		22.0		102		40.0	○
11787500	11787	7/8		.8750	7/8		4		1-1/2		○
11798430	11789		25.0	.9843		25.0		102		40.0	○
11710000	11721	1		1.0000	1		4		1-1/2		○



ISO 9001:2015 Certified

**TuffCut® GP
Series 163**

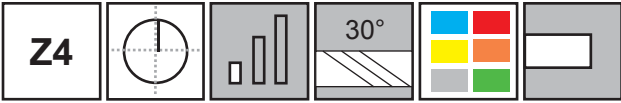

Designed for aggressive milling of most materials with reduced deflection, improved tool life and overall economy.

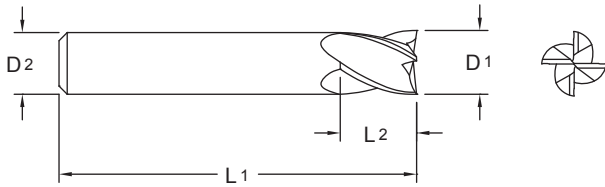

• Micro sizes available.

Tool No.	EDP	Diameter			Shank		OAL		Flute Length	
		D1			D2		L1		L2	
		Inch	mm	Decimal	Inch	mm	Inch	mm	Inch	mm
16300500	16302			.0050	1/8		1-1/2		.010	
16300600	16304			.0060	1/8		1-1/2		.012	
16300700	16306			.0070	1/8		1-1/2		.014	
16300800	16308			.0080	1/8		1-1/2		.016	
16300900	16312			.0090	1/8		1-1/2		.018	
16301000	16314			.0100	1/8		1-1/2		.020	
16301100	16318			.0110	1/8		1-1/2		.022	
16301200	16320			.0120	1/8		1-1/2		.024	
16301300	16328			.0130	1/8		1-1/2		.026	
16301400	16330			.0140	1/8		1-1/2		.028	
16301500	16334			.0150	1/8		1-1/2		.030	
16301560	16300	1/64		.0156	1/8		1-1/2		.023	
16301600	16338			.0160	1/8		1-1/2		.032	
16301700	16340			.0170	1/8		1-1/2		.034	
16301800	16344			.0180	1/8		1-1/2		.036	
16301900	16346			.0190	1/8		1-1/2		.038	
16302000	16348			.0200	1/8		1-1/2		.040	
16302100	16350			.0210	1/8		1-1/2		.042	
16302200	16352			.0220	1/8		1-1/2		.044	
16302300	16354			.0230	1/8		1-1/2		.046	
16302400	16356			.0240	1/8		1-1/2		.048	
16302500	16358			.0250	1/8		1-1/2		.050	
16302600	16360			.0260	1/8		1-1/2		.052	
16302700	16362			.0270	1/8		1-1/2		.054	
16302800	16364			.0280	1/8		1-1/2		.056	
16302900	16366			.0290	1/8		1-1/2		.058	
16303000	16368			.0300	1/8		1-1/2		.060	
16303100	16370			.0310	1/8		1-1/2		.062	
16303120	16301	1/32		.0312	1/8		1-1/2		1/16	
16303200	16372			.0320	1/8		1-1/2		.064	
16303300	16373			.0330	1/8		1-1/2		.066	
16303400	16374			.0340	1/8		1-1/2		.068	
16303500	16375			.0350	1/8		1-1/2		.070	
16303600	16376			.0360	1/8		1-1/2		.072	
16303700	16377			.0370	1/8		1-1/2		.074	
16303800	16378			.0380	1/8		1-1/2		.076	

Inch	
D1	Tolerance
1/64	+ .000/- .001
1/32 - 1/4	+ .000/- .002
>1/4 - 3/4	+ .000/- .003
D1 Micro Sizes*	Tolerance
.005 - .060	+ .0005/- .0005

* Inch decimal size range .005 - .060" only.

Metric (mm)	
D1	Tolerance h10
1.00 - 3.00	+ .000/- .040
>3.00 - 6.00	+ .000/- .048
>6.00 - 10.00	+ .000/- .058
>10.00 - 18.00	+ .000/- .070
>18.00 - 20.00	+ .000/- .084

Series 163 coated tools on page 278.



4
Flute

Series 163 Continued

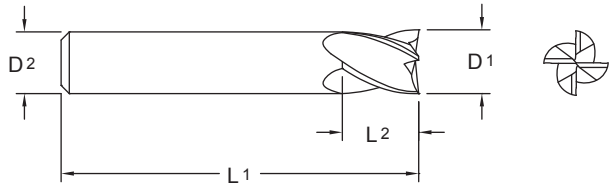
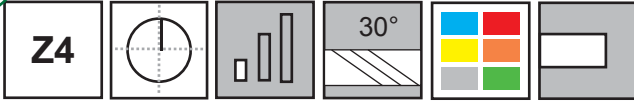

Tool No.	EDP	Diameter			Shank		OAL		Flute Length	
		D1			D2		L1		L2	
		Inch	mm	Decimal	Inch	mm	Inch	mm	Inch	mm
16303900	16379			.0390	1/8		1-1/2		.078	
16303940	16303		1.0	.0394		3.0		38		2.0
16304000	16380			.0400	1/8		1-1/2		.080	
16304100	16381			.0410	1/8		1-1/2		.082	
16304200	16382			.0420	1/8		1-1/2		.084	
16304300	16383			.0430	1/8		1-1/2		.086	
16304400	16384			.0440	1/8		1-1/2		.088	
16304500	16385			.0450	1/8		1-1/2		.090	
16304600	16386			.0460	1/8		1-1/2		.092	
16304680	16305	3/64		.0468	1/8		1-1/2		3/32	
16304700	16387			.0470	1/8		1-1/2		.094	
16304800	16388			.0480	1/8		1-1/2		.096	
16304900	16389			.0490	1/8		1-1/2		.098	
16305000	16390			.0500	1/8		1-1/2		.100	
16305100	16391			.0510	1/8		1-1/2		.102	
16305200	16392			.0520	1/8		1-1/2		.104	
16305300	16393			.0530	1/8		1-1/2		.106	
16305400	16394			.0540	1/8		1-1/2		.108	
16305500	16395			.0550	1/8		1-1/2		.110	
16305600	16396			.0560	1/8		1-1/2		.112	
16305700	16397			.0570	1/8		1-1/2		.114	
16305800	16398			.0580	1/8		1-1/2		.116	
16305900	16399			.0590	1/8		1-1/2		.118	
16305910	16307		1.5	.0591		3.0		38		3.0
16306000	16324			.0600	1/8		1-1/2		.120	
16306250	16309	1/16		.0625	1/8		1-1/2		1/8	
16307810	16310	5/64		.0781	1/8		1-1/2		5/32	
16307870	16311		2.0	.0787		3.0		38		4.0
16309370	16313	3/32		.0937	1/8		1-1/2		3/16	
16309840	16315		2.5	.0984		3.0		38		5.0
16310930	16316	7/64		.1093	1/8		1-1/2		7/32	
16311810	16317		3.0	.1181		3.0		38		6.0
16312500	16319	1/8		.1250	1/8		1-1/2		1/4	
16313780	16321		3.5	.1378		4.0		51		7.0
16314060	16322	9/64		.1406	3/16		2		5/16	
16315620	16323	5/32		.1562	3/16		2		5/16	
16315750	16325		4.0	.1575		4.0		51		8.0
16317180	16326	11/64		.1718	3/16		2		3/8	
16317720	16327		4.5	.1772		5.0		51		9.0
16318750	16329	3/16		.1875	3/16		2		3/8	

Series 163 coated tools on page 278.



Series 163 Continued

Tool No.	EDP	Diameter			Shank		OAL		Flute Length	
		D1			D2		L1		L2	
		Inch	mm	Decimal	Inch	mm	Inch	mm	Inch	mm
16319680	16331		5.0	.1968		5.0		51		11.0
16320310	16332	13/64		.2031	1/4		2		1/2	
16321650	16333		5.5	.2165		6.0		51		12.0
16321870	16335	7/32		.2187	1/4		2		1/2	
16323430	16336	15/64		.2343	1/4		2		1/2	
16323620	16337		6.0	.2362		6.0		51		13.0
16325000	16339	1/4		.2500	1/4		2		1/2	
16327560	16341		7.0	.2756		8.0		51		13.0
16328120	16342	9/32		.2812	5/16		2		1/2	
16331250	16343	5/16		.3125	5/16		2		1/2	
16331500	16345		8.0	.3150		8.0		51		13.0
16335430	16347		9.0	.3543		9.0		51		14.0
16337500	16349	3/8		.3750	3/8		2		5/8	
16339370	16351		10.0	.3937		10.0		51		14.0
16343310	16353		11.0	.4331		11.0		64		16.0
16343750	16355	7/16		.4375	7/16		2-1/2		5/8	
16347240	16357		12.0	.4724		12.0		64		16.0
16350000	16359	1/2		.5000	1/2		2-1/2		5/8	
16355120	16361		14.0	.5512		14.0		70		18.0
16362500	16363	5/8		.6250	5/8		3		3/4	
16362990	16365		16.0	.6299		16.0		76		20.0
16370870	16367		18.0	.7087		18.0		76		25.0
16375000	16369	3/4		.7500	3/4		3		1	
16378740	16371		20.0	.7874		20.0		76		25.0



Page 376

Series 163 coated tools on page 278.



Made in USA



For product information, call your local distributor.

4
Flute

**TuffCut® GP
Series 163 Coated**

Z4



TiN

ALtima®

TiCN

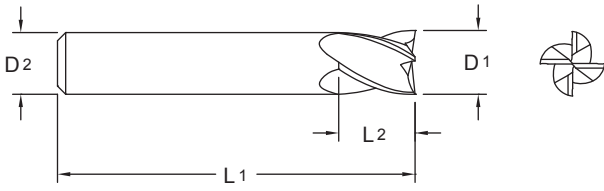

TiN		ALtima®		TiCN		Diameter			Shank		OAL		Flute Length	
Tool No.	EDP	Tool No.	EDP	Tool No.	EDP	D1			D2		L1		L2	
						Inch	mm	Decimal	Inch	mm	Inch	mm	Inch	mm
16311810T	56300	16311810A	56333	16311810C	56366		3.0	.1181		3.0		38		6.0
16312500T	56301	16312500A	56334	16312500C	56367	1/8		.1250	1/8		1-1/2		1/4	
16315750T	56305	16315750A	56338	16315750C	56371		4.0	.1575		4.0		51		8.0
16318750T	56308	16318750A	56341	16318750C	56374	3/16		.1875	3/16		2		3/8	
16319680T	56309	16319680A	56342	16319680C	56375		5.0	.1968		5.0		51		11.0
16323620T	56314	16323620A	56347	16323620C	56380		6.0	.2362		6.0		51		13.0
16325000T	56315	16325000A	56348	16325000C	56381	1/4		.2500	1/4		2		1/2	
16331250T	56318	16331250A	56351	16331250C	56384	5/16		.3125	5/16		2		1/2	
16331500T	56319	16331500A	56352	16331500C	56385		8.0	.3150		8.0		51		13.0
16337500T	56321	16337500A	56354	16337500C	56387	3/8		.3750	3/8		2		5/8	
16339370T	56322	16339370A	56355	16339370C	56388		10.0	.3937		10.0		51		14.0
16343750T	56324	16343750A	56357	16343750C	56390	7/16		.4375	7/16		2-1/2		5/8	
16347240T	56325	16347240A	56358	16347240C	56391		12.0	.4724		12.0		64		16.0
16350000T	56326	16350000A	56359	16350000C	56392	1/2		.5000	1/2		2-1/2		5/8	
16362500T	56328	16362500A	56361	16362500C	56394	5/8		.6250	5/8		3		3/4	
16362990T	56329	16362990A	56362	16362990C	56395		16.0	.6299		16.0		76		20.0
16375000T	56331	16375000A	56364	16375000C	56397	3/4		.7500	3/4		3		1	
16378740T	56332	16378740A	56365	16378740C	56398		20.0	.7874		20.0		76		25.0

Series 163 uncoated tools on page 275.



**TuffCut® GP
Series 122**

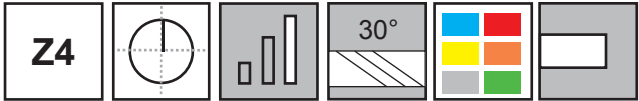

Designed for deep pocket milling and other applications where standard flute lengths are too short.

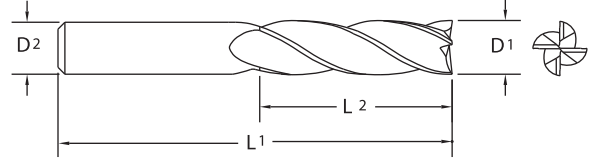

Tool No.	EDP	Diameter			Shank		OAL		Flute Length	
		D1			D2		L1		L2	
		Inch	mm	Decimal	Inch	mm	Inch	mm	Inch	mm
12211810	12203		3.0	.1181		3.0		64		25.0
12212500	12205	1/8		.1250	1/8		2-1/2		1	
12215750	12206		4.0	.1575		4.0		64		25.0
12218750	12207	3/16		.1875	3/16		3		1-1/8	
12219680	12208		5.0	.1968		5.0		64		25.0
12223620	12209		6.0	.2362		6.0		76		30.0
12225000	12211	1/4		.2500	1/4		3		1-1/4	
12227560	12212		7.0	.2756		8.0		83		30.0
12231250	12213	5/16		.3125	5/16		3-1/4		1-3/8	
12231500	12215		8.0	.3150		8.0		83		35.0
12235430	12216		9.0	.3543		10.0		89		35.0
12237500	12217	3/8		.3750	3/8		3-1/2		1-1/2	
12239370	12219		10.0	.3937		10.0		89		40.0
12243310	12220		11.0	.4331		12.0		102		40.0
12243750	12221	7/16		.4375	7/16		4		1-3/4	
12247240	12223		12.0	.4724		12.0		102		50.0
12250000	12225	1/2		.5000	1/2		4		2	
12262500	12227	5/8		.6250	5/8		4-5/8		2-1/2	
12262990	12229		16.0	.6299		16.0		117		65.0
12275000	12231	3/4		.7500	3/4		5-1/4		3	
12278740	12233		20.0	.7874		20.0		133		80.0
12298430	12235		25.0	.9843		25.0		152		80.0
12210000	12201	1		1.0000	1		6		3	

Inch	
D1	Tolerance
1/8 - 1/4	+ .000/- .002
> 1/4 - 1	+ .000/- .003

Metric (mm)	
D1	Tolerance
3.00 - 6.00	+ .000/- .051
7.00 - 25.00	+ .000/- .076



Page 376

4
Flute

**TuffCut® GP
Series 132**

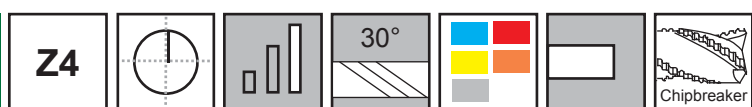

Chipbreakers are designed to minimize cutting forces, reduce or eliminate chatter and prolong tool life.

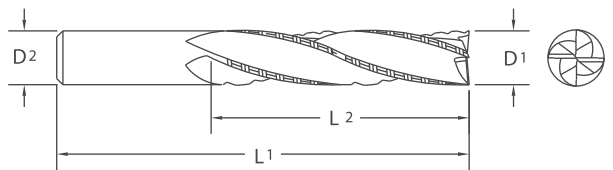

Tool No.	EDP	Diameter			Shank		OAL		Flute Length	
		D1			D2		L1		L2	
		Inch	mm	Decimal	Inch	mm	Inch	mm	Inch	mm
13211810	13203		3.0	.1181		3.0		64		25.0
13212500	13205	1/8		.1250	1/8		2-1/2		1	
13218750	13207	3/16		.1875	3/16		3		1-1/8	
13223620	13209		6.0	.2362		6.0		76		30.0
13225000	13211	1/4		.2500	1/4		3		1-1/4	
13231250	13213	5/16		.3125	5/16		3-1/4		1-3/8	
13231500	13215		8.0	.3150		8.0		83		35.0
13237500	13217	3/8		.3750	3/8		3-1/2		1-1/2	
13239370	13219		10.0	.3937		10.0		89		40.0
13243750	13221	7/16		.4375	7/16		4		1-3/4	
13247240	13223		12.0	.4724		12.0		102		50.0
13250000	13225	1/2		.5000	1/2		4		2	
13262500	13227	5/8		.6250	5/8		4-5/8		2-1/2	
13262990	13229		16.0	.6299		16.0		117		65.0
13275000	13231	3/4		.7500	3/4		5-1/4		3	
13278740	13233		20.0	.7874		20.0		133		80.0
13298430	13235		25.0	.9843		25.0		152		80.0
13210000	13201	1		1.0000	1		6		3	

Inch	
D1	Tolerance
1/8 - 1/4	+0.000/-0.002
> 1/4 - 1.00	+0.000/-0.003

Metric (mm)	
D1	Tolerance
3.00 - 6.00	+0.000/-0.051
8.00 - 25.00	+0.000/-0.076

- Chipbreaker geometry permits extremely high feed rates in roughing operations. Tools designed with tooth overlap to produce fairly smooth part finish.
- Designed for deep pocket milling and other applications where standard flute lengths are too short.
- TiN coating available.



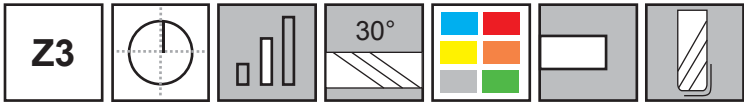

**Corner Radius Options
Now Available As Standards!**

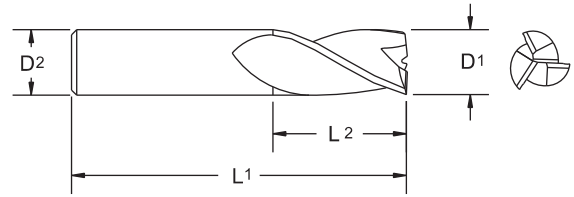

Tool No.	EDP	Diameter			Shank		OAL		Flute Length		Corner Radius
		D1			D2		L1		L2		R
		Inch	mm	Decimal	Inch	mm	Inch	mm	Inch	mm	Inch
11601560	11601	1/64		.0156	1/8		1-1/2		1/32		
11603120	11603	1/32		.0312	1/8		1-1/2		5/64		
11603940	11605		1.0	.0394		3.0		38		3.0	
11604680	11607	3/64		.0468	1/8		1-1/2		7/64		
11605910	11609		1.5	.0591		3.0		38		6.0	
11606250	11611	1/16		.0625	1/8		1-1/2		3/16		
11606250R.005	16197	1/16		.0625	1/8		1-1/2		3/16		.005
11606250R.010	16102	1/16		.0625	1/8		1-1/2		3/16		.010
11606250R.015	16104	1/16		.0625	1/8		1-1/2		3/16		.015
11606250R.020	16106	1/16		.0625	1/8		1-1/2		3/16		.020
11607810	11613	5/64		.0781	1/8		1-1/2		3/16		
11607810R.005	16198	5/64		.0781	1/8		1-1/2		3/16		.005
11607810R.010	16108	5/64		.0781	1/8		1-1/2		3/16		.010
11607810R.015	16110	5/64		.0781	1/8		1-1/2		3/16		.015
11607810R.020	16112	5/64		.0781	1/8		1-1/2		3/16		.020
11607870	11615		2.0	.0787		3.0		38		9.0	
11609370	11617	3/32		.0937	1/8		1-1/2		9/32		
11609370R.005	16199	3/32		.0937	1/8		1-1/2		9/32		.005
11609370R.010	16114	3/32		.0937	1/8		1-1/2		9/32		.010
11609370R.015	16116	3/32		.0937	1/8		1-1/2		9/32		.015
11609370R.020	16118	3/32		.0937	1/8		1-1/2		9/32		.020
11609840	11619		2.5	.0984		3.0		38		12.0	
11610930	11623	7/64		.1093	1/8		1-1/2		3/8		
11611810	11625		3.0	.1181		3.0		38		12.0	
11612500	11627	1/8		.1250	1/8		1-1/2		3/8		
11612500R.005	16202	1/8		.1250	1/8		1-1/2		3/8		.005
11612500R.010	16120	1/8		.1250	1/8		1-1/2		3/8		.010
11612500R.015	16122	1/8		.1250	1/8		1-1/2		3/8		.015
11612500R.020	16124	1/8		.1250	1/8		1-1/2		3/8		.020
11612501	11630	1/8		.1250	1/8		1-1/2		1/2		
11613780	11633		3.5	.1378		4.0		51		12.0	
11614060	11634	9/64		.1406	3/16		2		1/2		
11615620	11635	5/32		.1562	3/16		2		1/2		
11615750	11637		4.0	.1575		4.0		51		14.0	
11617190	11638	11/64		.1719	3/16		2		5/8		
11617720	11639		4.5	.1772		5.0		51		14.0	

Inch	
D1	Tolerance
1/64	+0.000/-0.001
1/32 - 1/4	+0.000/-0.002
>1/4 - 1	+0.000/-0.003

Metric (mm)	
D1	Tolerance h10
1.00 - 3.00	+0.000/-0.040
>3.00 - 6.00	+0.000/-0.048
>6.00 - 10.00	+0.000/-0.058
>10.00 - 18.00	+0.000/-0.070
>18.00 - 25.00	+0.000/-0.084

Series 116 coated tools on page 283.



3
Flute

Series 116 Continued

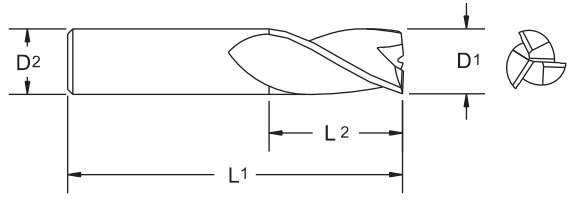
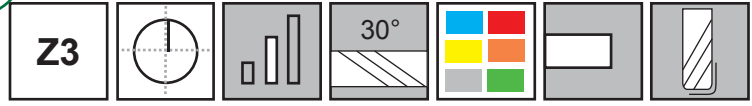

Tool No.	EDP	Diameter			Shank		OAL		Flute Length		Corner Radius
		D1			D2		L1		L2		R
		Inch	mm	Decimal	Inch	mm	Inch	mm	Inch	mm	Inch
11618750	11641	3/16		.1875	3/16		2		5/8		
11619680	11643		5.0	.1968		5.0		51		20.0	
11620310	11644	13/64		.2031	1/4		2-1/2		5/8		
11621650	11645		5.5	.2165		6.0		64		20.0	
11621870	11647	7/32		.2187	1/4		2-1/2		5/8		
11623440	11648	15/64		.2344	1/4		2-1/2		3/4		
11623620	11649		6.0	.2362		6.0		64		20.0	
11625000	11651	1/4		.2500	1/4		2-1/2		3/4		
11627560	11653		7.0	.2756		8.0		64		20.0	
11628120	11655	9/32		.2812	5/16		2-1/2		3/4		
11631250	11657	5/16		.3125	5/16		2-1/2		13/16		
11631500	11659		8.0	.3150		8.0		64		20.0	
11635430	11661		9.0	.3543		9.0		64		20.0	
11637500	11663	3/8		.3750	3/8		2-1/2		1		
11639370	11665		10.0	.3937		10.0		70		25.0	
11643310	11667		11.0	.4331		11.0		70		25.0	
11643750	11669	7/16		.4375	7/16		2-3/4		1		
11647240	11671		12.0	.4724		12.0		76		25.0	
11650000	11673	1/2		.5000	1/2		3		1		
11655120	11675		14.0	.5512		14.0		89		30.0	
11656250	11677	9/16		.5625	9/16		3-1/2		1-1/8		
11662500	11679	5/8		.6250	5/8		3-1/2		1-1/4		
11662990	11681		16.0	.6299		16.0		89		30.0	
11670870	11683		18.00	.7087		18.0		102		35.0	
11675000	11685	3/4		.7500	3/4		4		1-1/2		
11678740	11687		20.0	.7874		20.0		102		38.0	
11686620	11689		22.0	.8662		22.0		102		40.0	
11687500	11691	7/8		.8750	7/8		4		1-1/2		
11698430	11693		25.0	.9843		25.0		102		40.0	
11610000	11621	1		1.0000	1		4		1-1/2		



Series 116 coated tools on page 283.

**TuffCut® GP
Series 116
Coated**



**3
Flute**

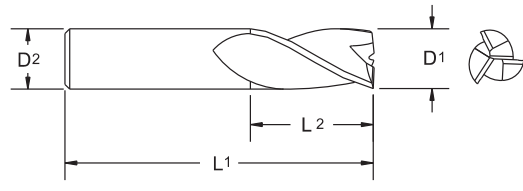

TiN		ALtima®		TiCN		Fordlube		Diameter			Shank	OAL	Flute Length	Corner Radius
Tool No.	EDP	Tool No.	EDP	Tool No.	EDP	Tool No.	EDP	Inch	mm	Decimal				
		11603940A	11606						1.0	.0394	3.0	38	3.0	
		11606250R.005A	16204			11606250R.005F	16210	1/16		.0625	1/8	1-1/2	3/16	.005
		11606250R.010A	16150			11606250R.010F	16212	1/16		.0625	1/8	1-1/2	3/16	.010
		11606250R.015A	16128			11606250R.015F	16214	1/16		.0625	1/8	1-1/2	3/16	.015
		11606250R.020A	16130			11606250R.020F	16216	1/16		.0625	1/8	1-1/2	3/16	.020
		11605910A	11610						1.5	.0591	3.0	38	6.0	
		11607810R.005A	16206			11607810R.005F	16218	5/64		.0781	1/8	1-1/2	3/16	.005
		11607810R.010A	16132			11607810R.010F	16220	5/64		.0781	1/8	1-1/2	3/16	.010
		11607810R.015A	16134			11607810R.015F	16222	5/64		.0781	1/8	1-1/2	3/16	.015
		11607810R.020A	16136			11607810R.020F	16224	5/64		.0781	1/8	1-1/2	3/16	.020
		11607870A	11616						2.0	.0787	3.0	38	9.0	
		11609370R.005A	16208			11609370R.005F	16227	3/32		.0937	1/8	1-1/2	9/32	.005
		11609370R.010A	16138			11609370R.010F	16228	3/32		.0937	1/8	1-1/2	9/32	.010
		11609370R.015A	16140			11609370R.015F	16230	3/32		.0937	1/8	1-1/2	9/32	.015
		11609370R.020A	16142			11609370R.020F	16232	3/32		.0937	1/8	1-1/2	9/32	.020
		11609840A	11620						2.5	.0984	3.0	38	12.0	
11611810T	11626	11611810A	51603	11611810C	51604				3.0	.1181	3.0	38	12.0	
11612500T	11628	11612500A	51605	11612500C	51606			1/8		.1250	1/8	1-1/2	3/8	
		11612500R.005A	16242			11612500R.005F	16234	1/8		.1250	1/8	1-1/2	3/8	.005
		11612500R.010A	16144			11612500R.010F	16238	1/8		.1250	1/8	1-1/2	3/8	.010
		11612500R.015A	16146			11612500R.015F	16239	1/8		.1250	1/8	1-1/2	3/8	.015
		11612500R.020A	16148			11612500R.020F	16240	1/8		.1250	1/8	1-1/2	3/8	.020
11615750T	11636	11615750A	51607	11615750C	51608				4.0	.1575	4.0	51	14.0	
11618750T	11642	11618750A	51609	11618750C	51610			3/16		.1875	3/16	2	5/8	
11619680T	11646	11619680A	51611	11619680C	51612				5.0	.1968	5.0	51	20.0	
11623620T	11650	11623620A	51613	11623620C	51614				6.0	.2362	6.0	64	20.0	
11625000T	11652	11625000A	51615	11625000C	51616			1/4		.2500	1/4	2-1/2	3/4	
11631250T	11658	11631250A	51617	11631250C	51618			5/16		.3125	5/16	2-1/2	13/16	
11631500T	11660	11631500A	51619	11631500C	51620				8.0	.3150	8.0	64	20.0	
11637500T	11664	11637500A	51621	11637500C	51622			3/8		.3750	3/8	2-1/2	1	
11639370T	11666	11639370A	51623	11639370C	51624				10.0	.3937	10.0	70	25.0	
11643750T	11670	11643750A	51625	11643750C	51626			7/16		.4375	7/16	2-3/4	1	
11647240T	11672	11647240A	51627	11647240C	51628				12.0	.4724	12.0	76	25.0	
11650000T	11674	11650000A	51629	11650000C	51630			1/2		.5000	1/2	3	1	
11662500T	11680	11662500A	51631	11662500C	51632			5/8		.6250	5/8	3-1/2	1-1/4	
11662990T	11682	11662990A	51633	11662990C	51634				16.0	.6299	16.0	89	30.0	
11675000T	11686	11675000A	51635	11675000C	51636			3/4		.7500	3/4	4	1-1/2	
11678740T	11688	11678740A	51637	11678740C	51638				20.0	.7874	20.0	102	38.0	
11698430T	11694	11698430A	51639	11698430C	51640				25.0	.9843			40.0	
11610000T	11622	11610000A	51601	11610000C	51602			1		1.0000	1	4	1-1/2	

Series 116 uncoated tools on page 281.

For product information, call your local distributor.

116 / 116 Coated
TuffCut® GP

GENERAL PURPOSE

3
Flute

**TuffCut® GP
Series 116C Workhorse**

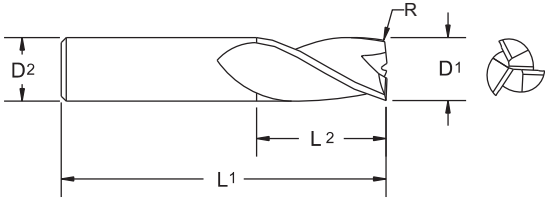
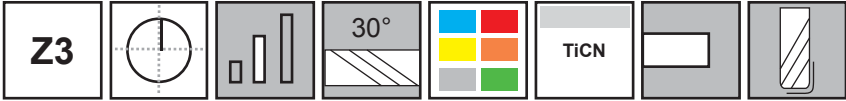

- Performs well in all materials including Stainless Steel, Inconel and Stellite.
- Produces long cuts at reasonable speeds on everyday equipment.
- Exceptional tool life at moderate speeds and feeds.
- Ideal for long cuts requiring accuracy and minimal tool wear deflection.
- Perfect Job Shop Tool.

TiCN		Diameter		Shank	OAL	Flute Length		Corner Radius
		D1		D2	L1	L2		R
Tool No.	EDP	Inch	Decimal	Inch	Inch	Inch		
11612508C	11695	1/8	.1250	1/8	1-1/2	1/2		0.01
11615628C	11696	5/32	.1562	3/16	2	9/16		0.01
11618758C	11697	3/16	.1875	3/16	2	5/8		0.01
11621872C	11698	7/32	.2187	1/4	2-1/2	3/4		0.02
11625002C	11699	1/4	.2500	1/4	2-1/2	3/4		0.02
11628122C	11468	9/32	.2812	5/16	2-1/2	3/4		0.02
11631252C	11469	5/16	.3125	5/16	2-1/2	13/16		0.02
11634382C	11500	11/32	.3438	3/8	2-1/2	7/8		0.02
11637502C	11369	3/8	.3750	3/8	2-1/2	1		0.02
11640622C	11370	13/32	.4062	7/16	2-3/4	1		0.02
11643752C	11382	7/16	.4375	7/16	2-3/4	1		0.02
11646882C	11383	15/32	.4688	1/2	3	1-1/4		0.02
11650002C	11371	1/2	.5000	1/2	3	1-1/4		0.02
11650003C	11372	1/2	.5000	1/2	3	1-1/4		0.03
11662502C	11373	5/8	.6250	5/8	3-1/2	1-5/8		0.02
11662503C	11374	5/8	.6250	5/8	3-1/2	1-5/8		0.03
11675002C	11375	3/4	.7500	3/4	4	1-1/2		0.02
11675003C	11376	3/4	.7500	3/4	4	1-1/2		0.03
11610002C	11379	1	1.0000	1	4	1-1/2		0.02
11610003C	11380	1	1.0000	1	4	1-1/2		0.03
11610012C	11377	1	1.0000	1	4	2		0.02
11610013C	11378	1	1.0000	1	4	2		0.03

Inch	
D1	Tolerance
1/8 - 1/4	+0.000/-0.002
>1/4 - 1	+0.000/-0.003

Inch	
R	Tolerance
1/8 - 1	+0.002/-0.002



**TuffCut® GP
Series 169**

Z3

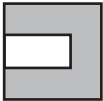
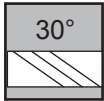
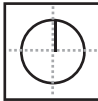

**Corner Radius
Options Now
Available As
Standards!**

**3
Flute**

Designed for aggressive milling of most materials. Provides reduced deflection, improved tool life and overall economy.

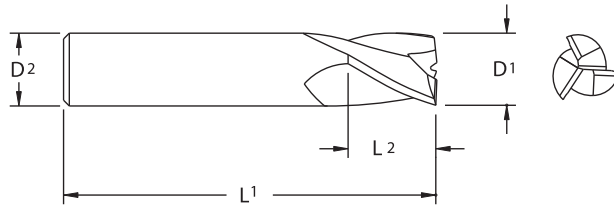

Tool No.	EDP	Diameter			Shank		OAL		Flute Length		Corner Radius
		D1			D2		L1		L2		R
		Inch	mm	Decimal	Inch	mm	Inch	mm	Inch	mm	Inch
16901560	16900	1/64		.0156	1/8		1-1/2		.023		
16903120	16901	1/32		.0312	1/8		1-1/2		1/16		
16903940	16903		1.0	.0394		3.0		38		2.0	
16904680	16905	3/64		.0468	1/8		1-1/2		3/32		
16905910	16907		1.5	.0591		3.0		38		3.0	
16906250	16909	1/16		.0625	1/8		1-1/2		1/8		
16906250R.005	16966	1/16		.0625	1/8		1-1/2		1/8		.005
16906250R.010	16910	1/16		.0625	1/8		1-1/2		1/8		.010
16906250R.015	16912	1/16		.0625	1/8		1-1/2		1/8		.015
16906250R.020	16914	1/16		.0625	1/8		1-1/2		1/8		.020
16907810	16911	5/64		.0781	1/8		1-1/2		5/32		
16907810R.005	16968	5/64		.0781	1/8		1-1/2		5/32		.005
16907810R.010	16916	5/64		.0781	1/8		1-1/2		5/32		.010
16907810R.015	16918	5/64		.0781	1/8		1-1/2		5/32		.015
16907810R.020	16920	5/64		.0781	1/8		1-1/2		5/32		.020
16907870	16913		2.0	.0787		3.0		38		4.0	
16909370	16915	3/32		.0937	1/8		1-1/2		3/16		
16909370R.005	16970	3/32		.0937	1/8		1-1/2		3/16		.005
16909370R.010	16922	3/32		.0937	1/8		1-1/2		3/16		.010
16909370R.015	16924	3/32		.0937	1/8		1-1/2		3/16		.015
16909370R.020	16928	3/32		.0937	1/8		1-1/2		3/16		.020
16909840	16917		2.5	.0984		3.0		38		5.0	
16910930	16919	7/64		.1093	1/8		1-1/2		7/32		
16911810	16921		3.0	.1181		3.0		38		6.0	
16912500	16923	1/8		.1250	1/8		1-1/2		1/4		
16912500R.005	16972	1/8		.1250	1/8		1-1/2		1/4		.005
16912500R.010	16932	1/8		.1250	1/8		1-1/2		1/4		.010
16912500R.015	16934	1/8		.1250	1/8		1-1/2		1/4		.015
16912500R.020	16938	1/8		.1250	1/8		1-1/2		1/4		.020
16913780	16925		3.5	.1378		4.0		51		7.0	
16914060	16926	9/64		.1406	3/16		2		5/16		
16915620	16927	5/32		.1562	3/16		2		5/16		

Inch	
D1	Tolerance
1/64	+0.000/-0.001
1/32 - 1/4	+0.000/-0.002
>1/4 - 3/4	+0.000/-0.003

Metric (mm)	
D1	Tolerance h10
1.00 - 3.00	+0.000/-0.040
>3.00 - 6.00	+0.000/-0.048
>6.00 - 10.00	+0.000/-0.058
>10.00 - 18.00	+0.000/-0.070
>18.00 - 20.00	+0.000/-0.084

Series 169 coated tools on page 287.



Page 376

116C Workhorse / 169
TuffCut® GP

GENERAL PURPOSE

3
Flute

Series 169 Continued

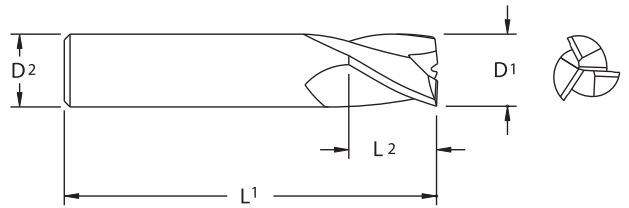
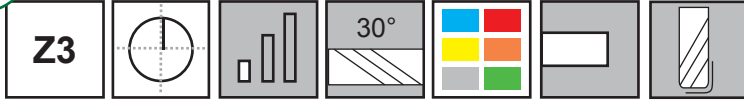

Tool No.	EDP	Diameter			Shank		OAL		Flute Length		Corner Radius
		D1			D2		L1		L2		R
		Inch	mm	Decimal	Inch	mm	Inch	mm	Inch	mm	Inch
16915750	16929		4.0	.1575		4.0		51		8.0	
16917180	16930	11/64		.1718	3/16		2		3/8		
16917720	16931		4.5	.1772		5.0		51		9.0	
16918750	16933	3/16		.1875	3/16		2		3/8		
16919680	16935		5.0	.1968		5.0		51		11.0	
16920310	16936	13/64		.2031	1/4		2		1/2		
16921650	16937		5.5	.2165		6.0		51		12.0	
16921870	16939	7/32		.2187	1/4		2		1/2		
16923430	16940	15/64		.2343	1/4		2		1/2		
16923620	16941		6.0	.2362		6.0		51		13.0	
16925000	16943	1/4		.2500	1/4		2		1/2		
16927560	16945		7.0	.2756		8.0		51		13.0	
16928120	16947	9/32		.2812	5/16		2		1/2		
16931250	16949	5/16		.3125	5/16		2		1/2		
16931500	16951		8.0	.3150		8.0		51		13.0	
16935430	16953		9.0	.3543		9.0		51		14.0	
16937500	16955	3/8		.3750	3/8		2		5/8		
16939370	16957		10.0	.3937		10.0		51		14.0	
16943310	16959		11.0	.4331		11.0		64		16.0	
16943750	16961	7/16		.4375	7/16		2-1/2		5/8		
16947240	16963		12.0	.4724		12.0		64		16.0	
16950000	16965	1/2		.5000	1/2		2-1/2		5/8		
16955120	16967		14.0	.5512		14.0		70		18.0	
16962500	16969	5/8		.6250	5/8		3		3/4		
16962990	16971		16.0	.6299		16.0		76		20.0	
16970870	16973		18.0	.7087		18.0		76		25.0	
16975000	16975	3/4		.7500	3/4		3		1		
16978740	16977		20.0	.7874		20.0		76		25.0	



Page 376

Series 169 coated tools on page 287.



Made in USA

ISO 9001:2015 Certified

**TuffCut® GP
Series 169
Coated**



**3
Flute**

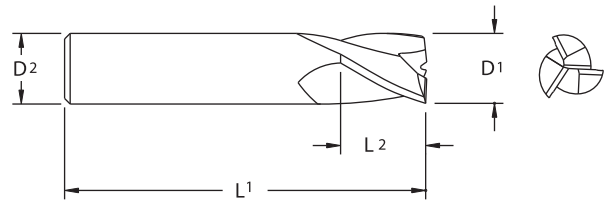

TiN		ALtima®		TiCN		Fordlube		Diameter			Shank D2	OAL L1	Flute Length L2	Corner Radius R
Tool No.	EDP	Tool No.	EDP	Tool No.	EDP	Tool No.	EDP	Inch	mm	Decimal				
		16906250R.005A	16974			16906250R.005F	16997	1/16		.0625	1/8	1-1/2	1/8	.005
		16906250R.010A	16942			16906250R.010F	16998	1/16		.0625	1/8	1-1/2	1/8	.010
		16906250R.015A	16944			16906250R.015F	16999	1/16		.0625	1/8	1-1/2	1/8	.015
		16906250R.020A	16946			16906250R.020F	17000	1/16		.0625	1/8	1-1/2	1/8	.020
		16907810R.005A	16976			16907810R.005F	17001	5/64		.0781	1/8	1-1/2	5/32	.005
		16907810R.010A	16948			16907810R.010F	17002	5/64		.0781	1/8	1-1/2	5/32	.010
		16907810R.015A	16950			16907810R.015F	17003	5/64		.0781	1/8	1-1/2	5/32	.015
		16907810R.020A	16952			16907810R.020F	17004	5/64		.0781	1/8	1-1/2	5/32	.020
		16909370R.005A	16995			16909370R.005F	17005	3/32		.0937	1/8	1-1/2	3/16	.005
		16909370R.010A	16954			16909370R.010F	17006	3/32		.0937	1/8	1-1/2	3/16	.010
		16909370R.015A	16956			16909370R.015F	17007	3/32		.0937	1/8	1-1/2	3/16	.015
		16909370R.020A	16958			16909370R.020F	17008	3/32		.0937	1/8	1-1/2	3/16	.020
16911810T	56900	16911810A	56933	16911810C	56966				3.0	.1181	3.0	38	6.0	
16912500T	56901	16912500A	56934	16912500C	56967			1/8		.1250	1/8	1-1/2	1/4	
		16912500R.005A	16996			16912500R.005F	17009	1/8		.1250	1/8	1-1/2	1/4	.005
		16912500R.010A	16960			16912500R.010F	17010	1/8		.1250	1/8	1-1/2	1/4	.010
		16912500R.015A	16962			16912500R.015F	17011	1/8		.1250	1/8	1-1/2	1/4	.015
		16912500R.020A	16964			16912500R.020F	17012	1/8		.1250	1/8	1-1/2	1/4	.020
16915750T	56905	16915750A	56938	16915750C	56971				4.0	.1575	4.0	51	8.0	
16918750T	56908	16918750A	56941	16918750C	56974			3/16		.1875	3/16	2	3/8	
16919680T	56909	16919680A	56942	16919680C	56975				5.0	.1968	5.0	51	11.0	
16923620T	56914	16923620A	56947	16923620C	56980				6.0	.2362	6.0	51	13.0	
16925000T	56915	16925000A	56948	16925000C	56981			1/4		.2500	1/4	2	1/2	
16931250T	56918	16931250A	56951	16931250C	56984			5/16		.3125	5/16	2	1/2	
16931500T	56919	16931500A	56952	16931500C	56985				8.0	.3150	8.0	51	13.0	
16937500T	56921	16937500A	56954	16937500C	56987			3/8		.3750	3/8	2	5/8	
16939370T	56922	16939370A	56955	16939370C	56988				10.0	.3937	10.0	51	14.0	
16943750T	56924	16943750A	56957	16943750C	56990			7/16		.4375	7/16	2-1/2	5/8	
16947240T	56925	16947240A	56958	16947240C	56991				12.0	.4724	12.0	64	16.0	
16950000T	56926	16950000A	56959	16950000C	56992			1/2		.5000	1/2	2-1/2	5/8	
16962500T	56928	16962500A	56961	16962500C	56994			5/8		.6250	5/8	3	3/4	
16962990T	56929	16962990A	56962	16962990C	56995				16.0	.6299	16.0	76	20.0	
16975000T	56931	16975000A	56964	16975000C	56997			3/4		.7500	3/4	3	1	
16978740T	56932	16978740A	56965	16978740C	56998				20.0	.7874	20.0	76	25	

Series 169 uncoated tools on page 285.



For product information, call your local distributor.

169 / 169 Coated
TuffCut® GP

GENERAL PURPOSE

3
Flute

**TuffCut® GP
Series 169C Workhorse**

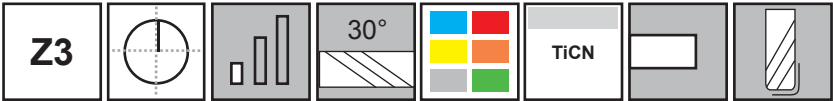

Designed for aggressive milling of most materials.

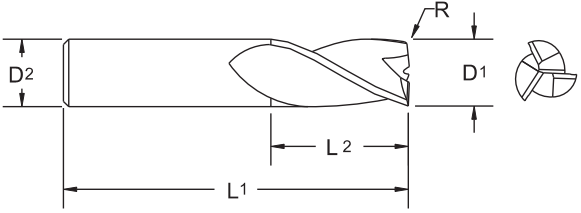

- Performs well in all materials including Stainless Steel, Inconel and Stellite.
- Produces long cuts at reasonable speeds on everyday equipment.
- Exceptional tool life at moderate speeds and feeds.
- Ideal for long cuts requiring accuracy and minimal tool wear deflection.
- Perfect Job Shop Tool.

TICN		Diameter		Shank	OAL	Flute Length		Corner Radius
Tool No.	EDP	Inch	Decimal	D1	D2	L1	L2	
16912508C	16978	1/8	.1250	1/8	1-1/2	1/4	0.01	
16915628C	16979	5/32	.1562	3/16	2	5/16	0.01	
16918758C	16980	3/16	.1875	3/16	2	3/8	0.01	
16921872C	16981	7/32	.2187	1/4	2	1/2	0.02	
16925002C	16982	1/4	.2500	1/4	2	1/2	0.02	
16928122C	11381	9/32	.2812	5/16	2	1/2	0.02	
16931252C	16983	5/16	.3125	5/16	2	1/2	0.02	
16934382C	16984	11/32	.3438	3/8	2	1/2	0.02	
16937502C	16985	3/8	.3750	3/8	2	5/8	0.02	
16940622C	16986	13/32	.4062	7/16	2-1/2	9/16	0.02	
16943752C	16987	7/16	.4375	7/16	2-1/2	5/8	0.02	
16946882C	16988	15/32	.4688	1/2	2-1/2	1/2	0.02	
16950002C	16989	1/2	.5000	1/2	2-1/2	5/8	0.02	
16950003C	16990	1/2	.5000	1/2	2-1/2	5/8	0.03	
16962502C	16991	5/8	.6250	5/8	3	3/4	0.02	
16962503C	16992	5/8	.6250	5/8	3	3/4	0.03	
16975002C	16993	3/4	.7500	3/4	3	1	0.02	
16975003C	16994	3/4	.7500	3/4	3	1	0.03	

Inch	
D1	Tolerance
1/8 - 1/4	+ .000/- .002
> 1/4 - 3/4	+ .000/- .003

Inch	
R	Tolerance
1/8 - 3/4	+ .002/- .002



Page 376



**TuffCut® GP
Series 121**

Z2

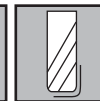
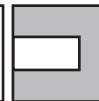
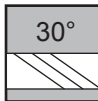
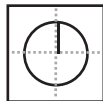

Designed for aggressive milling of most materials.

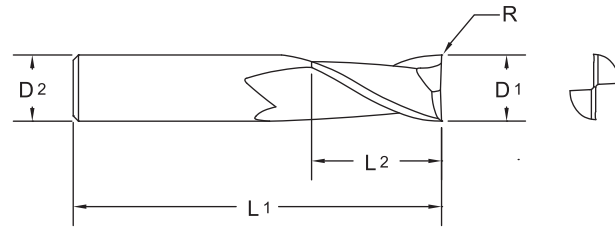

- Micro sizes available.

Tool No.	EDP	Diameter			Shank		OAL		Flute Length		Corner Radius	
		D1			D2		L1		L2		R	
		Inch	mm	Decimal	Inch	mm	Inch	mm	Inch	mm	Inch	mm
12100500	52101			.0050	1/8		1-1/2		.015			
12100600	52191			.0060	1/8		1-1/2		.018			
12100700	52192			.0070	1/8		1-1/2		.021			
12100780	52102		0.2	.0078		3.0		38		0.6		
12100800	52193			.0080	1/8		1-1/2		.024			
12100900	52194			.0090	1/8		1-1/2		.027			
12101000	52103			.0100	1/8		1-1/2		.030			
12101100	52195			.0110	1/8		1-1/2		.033			
12101180	52104		0.3	.0118		3.0		38		0.9		
12101200	52196			.0120	1/8		1-1/2		.036			
12101300	52197			.0130	1/8		1-1/2		.039			
12101400	52198			.0140	1/8		1-1/2		.042			
12101500	52105			.0150	1/8		1-1/2		.045			
12101560	12106	1/64		.0156	1/8		1-1/2		1/32			
12101570	52107		0.4	.0157		3.0		38		1.2		
12101600	52199			.0160	1/8		1-1/2		.048			
12101700	52250			.0170	1/8		1-1/2		.051			
12101800	52251			.0180	1/8		1-1/2		.054			
12101900	52252			.0190	1/8		1-1/2		.057			
12101960	52108		0.5	.0196		3.0		38		1.5		
12102000	52109			.0200	1/8		1-1/2		.060			
12102100	52253			.0210	1/8		1-1/2		.063			
12102200	52254			.0220	1/8		1-1/2		.066			
12102300	52255			.0230	1/8		1-1/2		.069			
12102360	52110		0.6	.0236		3.0		38		1.8		
12102400	52256			.0240	1/8		1-1/2		.072			
12102500	52111			.0250	1/8		1-1/2		.075			
12102600	52257			.0260	1/8		1-1/2		.078			
12102700	52258			.0270	1/8		1-1/2		.081			
12102750	52112		0.7	.0275		3.0		38		2.1		
12102800	52259			.0280	1/8		1-1/2		.084			
12102900	52260			.0290	1/8		1-1/2		.087			
12103000	52113			.0300	1/8		1-1/2		.090			
12103120	12114	1/32		.0312	1/8		1-1/2		5/64			

Inch	
D1	Tolerance
1/64	+ .000/- .001
1/32 - 1/4	+ .000/- .002
>1/4 - 1-1/4	+ .000/- .003
D1 Micro Sizes*	Tolerance
.005 - .100	+ .0005/- .0005

*Inch decimal size range
.005-.100" only.

Metric (mm)	
D1	Tolerance h10
0.20 - 0.50	+ .000/- .025
0.60 - 3.00	+ .000/- .040
>3.00 - 6.00	+ .000/- .048
>6.00 - 10.00	+ .000/- .058
>10.00 - 18.00	+ .000/- .070
>18.00 - 30.00	+ .000/- .084
32.00	+ .000/- .100

Inch	
R	Tolerance
1/8 - 1	+ .002/- .002

Metric (mm)	
R	Tolerance
3.0 - 25.0	+ .05/- .05

Series 121 coated tools
on page 294.



Page 376

2
Flute

Series 121 Continued

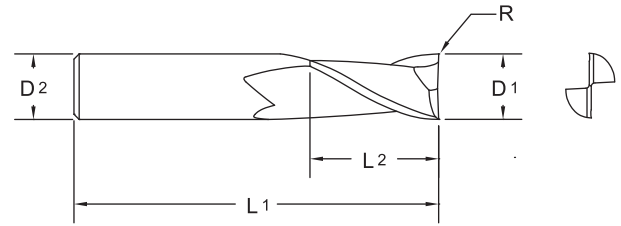
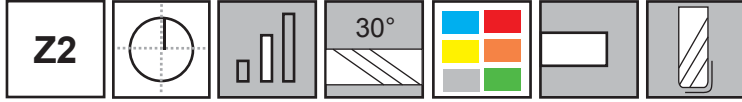

Tool No.	EDP	Diameter			Shank		OAL		Flute Length		Corner Radius	
		D1			D2		L1		L2		R	
		Inch	mm	Decimal	Inch	mm	Inch	mm	Inch	mm	Inch	mm
12103150	52115		0.8	.0315		3.0		38		2.4		
12103500	52116			.0350	1/8		1-1/2		.105			
12103540	52117		0.9	.0354		3.0		38		2.7		
12103940	12118		1.0	.0394		3.0		38		3.0		
12104000	52120			.0400	1/8		1-1/2		.120			
12104330	52121		1.1	.0433		3.0		38		3.3		
12104500	52122			.0450	1/8		1-1/2		.135			
12104680	12123	3/64		.0468	1/8		1-1/2		7/64			
12104720	52124		1.2	.0472		3.0		38		3.6		
12105000	52125			.0500	1/8		1-1/2		.150			
12105120	52126		1.3	.0512		3.0		38		3.9		
12105500	52127			.0550	1/8		1-1/2		.165			
12105510	52128		1.4	.0551		3.0		38		4.2		
12105910	12129		1.5	.0591		3.0		38		6.0		
12105911	52129		1.5	.0591		3.0		38		4.5		
12106000	52131			.0600	1/8		1-1/2		.180			
12106250	12132	1/16		.0625	1/8		1-1/2		3/16			
12106300	52133		1.6	.0630		3.0		38		4.8		
12106500	52134			.0650	1/8		1-1/2		.195			
12106690	52135		1.7	.0669		3.0		38		5.1		
12107000	52136			.0700	1/8		1-1/2		.210			
12107090	52137		1.8	.0709		3.0		38		5.4		
12107480	52138		1.9	.0748		3.0		38		5.7		
12107500	52139			.0750	1/8		1-1/2		.225			
12107810	12140	5/64		.0781	1/8		1-1/2		3/16			
12107870	12141		2.0	.0787		3.0		38		9.0		
12107871	52141		2.0	.0787		3.0		38		6.0		
12108000	52143			.0800	1/8		1-1/2		.240			
12108500	52144			.0850	1/8		1-1/2		.255			
12109000	52145			.0900	1/8		1-1/2		.270			
12109370	12146	3/32		.0937	1/8		1-1/2		9/32			
12109500	52147			.0950	1/8		1-1/2		.285			
12109840	12148		2.5	.0984		3.0		38		12.0		
12110010	52150			.1000	1/8		1-1/2		.300			
12110930	12151	7/64		.1093	1/8		1-1/2		3/8			
12111810	12152		3.0	.1181		3.0		38		12.0		
12111811	52402		3.0	.1181		3.0		38		12.0		0.500
12112500	12153	1/8		.1250	1/8		1-1/2		3/8			
12112511	52401	1/8		.1250	1/8		1-1/2		3/8			0.015
12112512	52403	1/8		.1250	1/8		1-1/2		3/8			0.020

Series 121 coated tools on page 294.



Series 121 Continued

Tool No.	EDP	Diameter			Shank		OAL		Flute Length		Corner Radius	
		D1			D2		L1		L2		R	
		Inch	mm	Decimal	Inch	mm	Inch	mm	Inch	mm	Inch	mm
12112501	12150	1/8		.1250	1/8		1-1/2		1/2			
12113780	12156		3.5	.1378		4.0		51		12.0		
12114060	12187	9/64		.1406	3/16		2		1/2			
12115620	12157	5/32		.1562	3/16		2		1/2			
12115750	12158		4.0	.1575		4.0		51		14.0		
12115751	52404		4.0	.1575		4.0		51		14.0		0.500
12115752	52422		4.0	.1575		4.0		51		14.0		0.750
12117190	12188	11/64		.1719	3/16		2		5/8			
12117720	12159		4.5	.1772		5.0		51		14.0		
12118750	12160	3/16		.1875	3/16		2		5/8			
12118751	52405	3/16		.1875	3/16		2		5/8			0.015
12118752	52407	3/16		.1875	3/16		2		5/8			0.020
12118753	52409	3/16		.1875	3/16		2		5/8			0.030
12119680	12161		5.0	.1968		5.0		51		20.0		
12119681	52406		5.0	.1968		5.0		51		20.0		0.500
12119682	52424		5.0	.1968		5.0		51		20.0		0.750
12119683	52440		5.0	.1968		5.0		51		20.0		1.000
12120310	12189	13/64		.2031	1/4		2-1/2		5/8			
12121650	12162		5.5	.2165		6.0		64		20.0		
12121870	12163	7/32		.2187	1/4		2-1/2		5/8			
12123440	12190	15/64		.2344	1/4		2-1/2		3/4			
12123620	12164		6.0	.2362		6.0		64		20.0		
12123621	52408		6.0	.2362		6.0		64		20.0		0.500
12123622	52426		6.0	.2362		6.0		64		20.0		0.750
12123623	52442		6.0	.2362		6.0		64		20.0		1.000
12125000	12165	1/4		.2500	1/4		2-1/2		3/4			
12125001	52411	1/4		.2500	1/4		2-1/2		3/4		0.015	
12125002	52413	1/4		.2500	1/4		2-1/2		3/4		0.020	
12125003	52415	1/4		.2500	1/4		2-1/2		3/4		0.030	
12125004	52417	1/4		.2500	1/4		2-1/2		3/4		0.045	
12127560	12166		7.0	.2756		8.0		64		20.0		
12128120	12167	9/32		.2812	5/16		2-1/2		3/4			
12131250	12168	5/16		.3125	5/16		2-1/2		13/16			
12131251	52419	5/16		.3125	5/16		2-1/2		13/16		0.015	
12131252	52421	5/16		.3125	5/16		2-1/2		13/16		0.020	
12131253	52423	5/16		.3125	5/16		2-1/2		13/16		0.030	
12131254	52425	5/16		.3125	5/16		2-1/2		13/16		0.045	
12131500	12169		8.0	.3150		8.0		64		20.0		
12131501	52410		8.0	.3150		8.0		64		20.0		0.500
12131502	52428		8.0	.3150		8.0		64		20.0		0.750
12131503	52444		8.0	.3150		8.0		64		20.0		1.000
12131504	52456		8.0	.3150		8.0		64		20.0		1.500
12135430	12170		9.0	.3543		9.0		64		20.0		
12137500	12171	3/8		.3750	3/8		2-1/2		1			

Series 121 coated tools on page 294.



Page 376

2
Flute

Series 121 Continued

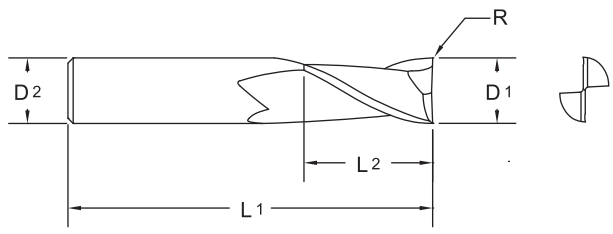
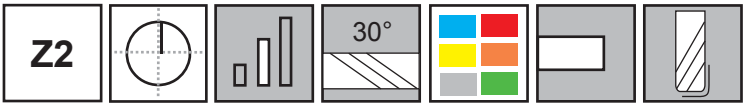

Tool No.	EDP	Diameter			Shank		OAL		Flute Length		Corner Radius	
		D1			D2		L1		L2		R	
		Inch	mm	Decimal	Inch	mm	Inch	mm	Inch	mm	Inch	mm
12137501	52427	3/8		.3750	3/8		2-1/2		1		0.015	
12137502	52429	3/8		.3750	3/8		2-1/2		1		0.020	
12137503	52431	3/8		.3750	3/8		2-1/2		1		0.030	
12137504	52433	3/8		.3750	3/8		2-1/2		1		0.045	
12139370	12172		10.0	.3937		10.0		70		25.0		
12139371	52412		10.0	.3937		10.0		70		25.0		0.500
12139372	52430		10.0	.3937		10.0		70		25.0		0.750
12139373	52446		10.0	.3937		10.0		70		25.0		1.000
12139374	52458		10.0	.3937		10.0		70		25.0		1.500
12143310	12173		11.0	.4331		11.0		70		25.0		
12143750	12174	7/16		.4375	7/16		2-3/4		1			
12147240	12175		12.0	.4724		12.0		76		25.0		
12147241	52414		12.0	.4724		12.0		76		25.0		0.500
12147242	52432		12.0	.4724		12.0		76		25.0		0.750
12147243	52448		12.0	.4724		12.0		76		25.0		1.000
12147244	52460		12.0	.4724		12.0		76		25.0		1.500
12147245	52468		12.0	.4724		12.0		76		25.0		2.000
12150000	12176	1/2		.5000	1/2		3		1			
12150001	52435	1/2		.5000	1/2		3		1		0.015	
12150002	52437	1/2		.5000	1/2		3		1		0.020	
12150003	52439	1/2		.5000	1/2		3		1		0.030	
12150004	52441	1/2		.5000	1/2		3		1		0.045	
12150005	52443	1/2		.5000	1/2		3		1		0.060	
12155120	12177		14.0	.5512		14.0		89		30.0		
12156250	12178	9/16		.5625	9/16		3-1/2		1-1/8			
12162500	12179	5/8		.6250	5/8		3-1/2		1-1/4			
12162501	52445	5/8		.6250	5/8		3-1/2		1-1/4		0.015	
12162502	52447	5/8		.6250	5/8		3-1/2		1-1/4		0.020	
12162503	52449	5/8		.6250	5/8		3-1/2		1-1/4		0.030	
12162504	52451	5/8		.6250	5/8		3-1/2		1-1/4		0.045	
12162505	52453	5/8		.6250	5/8		3-1/2		1-1/4		0.060	
12162506	52455	5/8		.6250	5/8		3-1/2		1-1/4		0.090	
12162990	12180		16.0	.6299		16.0		89		30.0		
12162991	52416		16.0	.6299		16.0		89		30.0		0.500
12162992	52434		16.0	.6299		16.0		89		30.0		0.750
12162993	52450		16.0	.6299		16.0		89		30.0		1.000
12162994	52462		16.0	.6299		16.0		89		30.0		1.500
12162995	52470		16.0	.6299		16.0		89		30.0		2.000

Series 121 coated tools on page 294.



Series 121 Continued

Tool No.	EDP	Diameter			Shank		OAL		Flute Length		Corner Radius	
		D1			D2		L1		L2		R	
		Inch	mm	Decimal	Inch	mm	Inch	mm	Inch	mm	Inch	mm
12162996	52476		16.0	.6299		16.0		89		30.0		2.500
12162997	52482		16.0	.6299		16.0		89		30.0		3.000
12170870	12181		18.00	.7087		18.00		102		35.0		
12175000	12182	3/4		.7500	3/4		4		1-1/2			
12175001	52457	3/4		.7500	3/4		4		1-1/2		0.015	
12175002	52459	3/4		.7500	3/4		4		1-1/2		0.020	
12175003	52461	3/4		.7500	3/4		4		1-1/2		0.030	
12175004	52463	3/4		.7500	3/4		4		1-1/2		0.045	
12175005	52465	3/4		.7500	3/4		4		1-1/2		0.060	
12175006	52467	3/4		.7500	3/4		4		1-1/2		0.090	
12175007	52469	3/4		.7500	3/4		4		1-1/2		0.125	
12178740	12183		20.0	.7874		20.0		102		38.0		
12178741	52418		20.0	.7874		20.0		102		38.0		0.500
12178742	52436		20.0	.7874		20.0		102		38.0		0.750
12178743	52452		20.0	.7874		20.0		102		38.0		1.000
12178744	52464		20.0	.7874		20.0		102		38.0		1.500
12178745	52472		20.0	.7874		20.0		102		38.0		2.000
12178746	52478		20.0	.7874		20.0		102		38.0		2.500
12178747	52484		20.0	.7874		20.0		102		38.0		3.000
12186620	12184		22.0	.8662		22.0		102		40.0		
12187500	12185	7/8		.8750	7/8		4		1-1/2			
12198430	12186		25.0	.9843		25.0		102		40.0		
12198431	52420		25.0	.9843		25.0		102		40.0		0.500
12198432	52438		25.0	.9843		25.0		102		40.0		0.750
12198433	52454		25.0	.9843		25.0		102		40.0		1.000
12198434	52466		25.0	.9843		25.0		102		40.0		1.500
12198435	52474		25.0	.9843		25.0		102		40.0		2.000
12198436	52480		25.0	.9843		25.0		102		40.0		2.500
12198437	52486		25.0	.9843		25.0		102		40.0		3.000
12110000	12149	1		1.0000	1		4		1-1/2			
12110001	52471	1		1.0000	1		4		1-1/2		0.015	
12110002	52473	1		1.0000	1		4		1-1/2		0.020	
12110003	52475	1		1.0000	1		4		1-1/2		0.030	
12110004	52477	1		1.0000	1		4		1-1/2		0.045	
12110005	52479	1		1.0000	1		4		1-1/2		0.060	
12110006	52481	1		1.0000	1		4		1-1/2		0.090	
12110007	52483	1		1.0000	1		4		1-1/2		0.125	

Series 121 coated tools on page 294.



Page 376

2
Flute

**TuffCut® GP
Series 121 Coated**

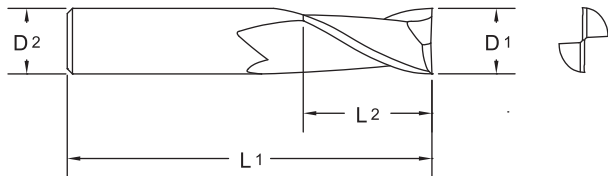

TiN		ALtima®		TiCN		Diameter			Shank		OAL		Flute Length	
Tool No.	EDP	Tool No.	EDP	Tool No.	EDP	D1			D2		L1		L2	
						Inch	mm	Decimal	Inch	mm	Inch	mm	Inch	mm
		12103940A	12119				1.0	.0394		3.0		38		3.0
		12105910A	12130				1.5	.0591		3.0		38		6.0
		12107870A	12142				2.0	.0787		3.0		38		9.0
		12109840A	12147				2.5	.0984		3.0		38		12.0
12111810T	12270	12111810A	52153	12111810C	52154		3.0	.1181		3.0		38		12.0
12112500T	12261	12112500A	52155	12112500C	52156	1/8		.1250	1/8		1-1/2		3/8	
12115750T	12278	12115750A	52157	12115750C	52158		4.0	.1575		4.0		51		14.0
12118750T	12262	12118750A	52159	12118750C	52160	3/16		.1875	3/16		2		5/8	
12119680T	12271	12119680A	52161	12119680C	52162		5.0	.1968		5.0		51		20.0
12123620T	12272	12123620A	52163	12123620C	52164		6.0	.2362		6.0		64		20.0
12125000T	12263	12125000A	52165	12125000C	52166	1/4		.2500	1/4		2-1/2		3/4	
12131250T	12264	12131250A	52167	12131250C	52168	5/16		.3125	5/16		2-1/2		13/16	
12131500T	12273	12131500A	52169	12131500C	52170		8.0	.3150		8.0		64		20.0
12137500T	12265	12137500A	52171	12137500C	52172	3/8		.3750	3/8		2-1/2		1	
12139370T	12274	12139370A	52173	12139370C	52174		10.0	.3937		10.0		70		25.0
12143750T	12266	12143750A	52175	12143750C	52176	7/16		.4375	7/16		2-3/4		1	
12147240T	12275	12147240A	52177	12147240C	52178		12.0	.4724		12.0		76		25.0
12150000T	12267	12150000A	52179	12150000C	52180	1/2		.5000	1/2		3		1	
12162500T	12268	12162500A	52181	12162500C	52182	5/8		.6250	5/8		3-1/2		1-1/4	
12162990T	12276	12162990A	52183	12162990C	52184		16.0	.6299		16.0		89		30.0
12175000T	12269	12175000A	52185	12175000C	52186	3/4		.7500	3/4		4		1-1/2	
12178740T	12277	12178740A	52187	12178740C	52188		20.0	.7874		20.0		102		38.0
12198430T	12280	12198430A	52189	12198430C	52190		25.0	.9843		25.0		102		40.0
12110000T	12279	12110000A	52151	12110000C	52152	1		1.0000	1		4		1-1/2	

Series 121 uncoated tools on page 289.



Page 376



TuffCut® GP Series 164

Z2

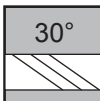
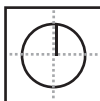

2
Flute

Designed for aggressive milling of most materials with reduced deflection, improved tool life and overall economy.

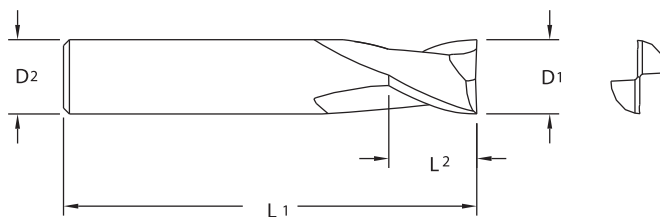

• Micro sizes available.

Tool No.	EDP	Diameter			Shank		OAL		Flute Length	
		D1			D2		L1		L2	
		Inch	mm	Decimal	Inch	mm	Inch	mm	Inch	mm
16400500	16468			.0050	1/8		1-1/2		.010	
16400600	16469			.0060	1/8		1-1/2		.012	
16400700	16470			.0070	1/8		1-1/2		.014	
16400780	16402		0.2	.0078		3.0		38		0.4
16400800	16471			.0080	1/8		1-1/2		.016	
16400900	16472			.0090	1/8		1-1/2		.018	
16401000	16473			.0100	1/8		1-1/2		.020	
16401100	16474			.0110	1/8		1-1/2		.022	
16401180	16404		0.3	.0118		3.0		38		0.6
16401200	16475			.0120	1/8		1-1/2		.024	
16401300	16476			.0130	1/8		1-1/2		.026	
16401400	16477			.0140	1/8		1-1/2		.028	
16401500	16478			.0150	1/8		1-1/2		.030	
16401560	16400	1/64		.0156	1/8		1-1/2		.023	
16401570	16406		0.4	.0157		3.0		38		0.8
16401600	16479			.0160	1/8		1-1/2		.032	
16401700	16480			.0170	1/8		1-1/2		.034	
16401800	16481			.0180	1/8		1-1/2		.036	
16401900	16482			.0190	1/8		1-1/2		.038	
16401960	16408		0.5	.0196		3.0		38		1.0
16402000	16483			.0200	1/8		1-1/2		.040	
16402100	16484			.0210	1/8		1-1/2		.042	
16402200	16485			.0220	1/8		1-1/2		.044	
16402300	16486			.0230	1/8		1-1/2		.046	
16402360	16412		0.6	.0236		3.0		38		1.2
16402400	16487			.0240	1/8		1-1/2		.048	
16402500	16488			.0250	1/8		1-1/2		.050	
16402600	16489			.0260	1/8		1-1/2		.052	
16402700	16490			.0270	1/8		1-1/2		.054	
16402750	16414		0.7	.0275		3.0		38		1.4
16402800	16491			.0280	1/8		1-1/2		.056	
16402900	16492			.0290	1/8		1-1/2		.058	
16403000	16493			.0300	1/8		1-1/2		.060	
16403100	16572			.0310	1/8		1-1/2		.062	

Inch	
D1	Tolerance
1/64	+ .000/- .001
1/32 - 1/4	+ .000/- .002
>1/4 - 3/4	+ .000/- .003
D1 Micro Sizes*	Tolerance
.005 - .060	+ .0005/- .0005

*Inch decimal size range .005-.060" only.

Metric (mm)	
D1	Tolerance h10
0.20 - 0.50	+ .000/- .025
0.60 - 3.00	+ .000/- .040
>3.00 - 6.00	+ .000/- .048
>6.00 - 10.00	+ .000/- .058
>10.00 - 18.00	+ .000/- .070
>18.00 - 20.00	+ .000/- .084

Series 164 coated tools on page 298.



121 Coated / 164
TuffCut® GP

GENERAL PURPOSE

Series 164 Continued

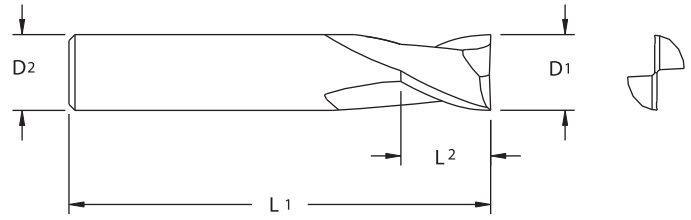
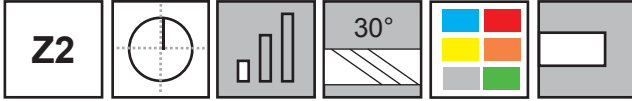

Tool No.	EDP	Diameter			Shank		OAL		Flute Length	
		D1			D2		L1		L2	
		Inch	mm	Decimal	Inch	mm	Inch	mm	Inch	mm
16403120	16401	1/32		.0312	1/8		1-1/2		1/16	
16403150	16418		0.8	.0315		3.0		38		1.6
16403200	16573			.0320	1/8		1-1/2		.064	
16403300	16574			.0330	1/8		1-1/2		.066	
16403400	16575			.0340	1/8		1-1/2		.067	
16403500	16494			.0350	1/8		1-1/2		.070	
16403540	16420		0.9	.0354		3.0		38		1.8
16403600	16576			.0360	1/8		1-1/2		.072	
16403700	16577			.0370	1/8		1-1/2		.074	
16403800	16578			.0380	1/8		1-1/2		.076	
16403900	16579			.0390	1/8		1-1/2		.078	
16403940	16403		1.0	.0394		3.0		38		2.0
16404000	16495			.0400	1/8		1-1/2		.080	
16404100	16580			.0410	1/8		1-1/2		.082	
16404200	16581			.0420	1/8		1-1/2		.084	
16404300	16582			.0430	1/8		1-1/2		.086	
16404330	16428		1.1	.0433		3.0		38		2.2
16404400	16583			.0440	1/8		1-1/2		.088	
16404500	16496			.0450	1/8		1-1/2		.090	
16404600	16584			.0460	1/8		1-1/2		.092	
16404680	16405	3/64		.0468	1/8		1-1/2		3/32	
16404700	16585			.0470	1/8		1-1/2		.094	
16404720	16430		1.2	.0472		3.0		38		2.4
16404800	16586			.0480	1/8		1-1/2		.096	
16404900	16587			.0490	1/8		1-1/2		.098	
16405000	16497			.0500	1/8		1-1/2		.100	
16405100	16588			.0510	1/8		1-1/2		.102	
16405120	16434		1.3	.0512		3.0		38		2.6
16405200	16589			.0520	1/8		1-1/2		.104	
16405300	16590			.0530	1/8		1-1/2		.106	
16405400	16591			.0540	1/8		1-1/2		.108	
16405500	16498			.0550	1/8		1-1/2		.110	
16405510	16438		1.4	.0551		3.0		38		2.8
16405600	16592			.0560	1/8		1-1/2		.112	
16405700	16593			.0570	1/8		1-1/2		.114	
16405800	16594			.0580	1/8		1-1/2		.116	
16405900	16595			.0590	1/8		1-1/2		.118	
16405910	16407		1.5	.0591		3.0		38		3.0
16406000	16499			.0600	1/8		1-1/2		.120	
16406250	16409	1/16		.0625	1/8		1-1/2		1/8	

Series 164 coated tools on page 298.



Series 164 Continued

Tool No.	EDP	Diameter			Shank		OAL		Flute Length	
		D1			D2		L1		L2	
		Inch	mm	Decimal	Inch	mm	Inch	mm	Inch	mm
16406300	16444		1.6	.0630		3.0		38		3.2
16406690	16446		1.7	.0669		3.0		38		3.4
16407090	16448		1.8	.0709		3.0		38		3.6
16407480	16450		1.9	.0748		3.0		38		3.8
16407810	16410	5/64		.0781	1/8		1-1/2		5/32	
16407870	16411		2.0	.0787		3.0		38		4.0
16409370	16413	3/32		.0937	1/8		1-1/2		3/16	
16409840	16415		2.5	.0984		3.0		38		5.0
16410930	16416	7/64		.1093	1/8		1-1/2		7/32	
16411810	16417		3.0	.1181		3.0		38		6.0
16412500	16419	1/8		.1250	1/8		1-1/2		1/4	
16413780	16421		3.5	.1378		4.0		51		7.0
16414060	16422	9/64		.1406	3/16		2		5/16	
16415620	16423	5/32		.1562	3/16		2		5/16	
16415750	16425		4.0	.1575		4.0		51		8.0
16417180	16426	11/64		.1718	3/16		2		3/8	
16417720	16427		4.5	.1772		5.0		51		9.0
16418750	16429	3/16		.1875	3/16		2		3/8	
16419680	16431		5.0	.1968		5.0		51		11.0
16420310	16432	13/64		.2031	1/4		2		1/2	
16421650	16433		5.5	.2165		6.0		51		12.0
16421870	16435	7/32		.2187	1/4		2		1/2	
16423430	16436	15/64		.2343	1/4		2		1/2	
16423620	16437		6.0	.2362		6.0		51		13.0
16425000	16439	1/4		.2500	1/4		2		1/2	
16427560	16441		7.0	.2756		8.0		51		13.0
16428120	16442	9/32		.2812	5/16		2		1/2	
16431250	16443	5/16		.3125	5/16		2		1/2	
16431500	16445		8.0	.3150		8.0		51		13.0
16435430	16447		9.0	.3543		9.0		51		14.0
16437500	16449	3/8		.3750	3/8		2		5/8	
16439370	16451		10.0	.3937		10.0		51		14.0
16443310	16453		11.0	.4331		11.0		64		16.0
16443750	16455	7/16		.4375	7/16		2-1/2		5/8	
16447240	16457		12.0	.4724		12.0		64		16.0
16450000	16459	1/2		.5000	1/2		2-1/2		5/8	
16455120	16461		14.0	.5512		14.0		70		18.0
16462500	16463	5/8		.6250	5/8		3		3/4	
16462990	16465		16.0	.6299		16.0		76		20.0
16470870	16466		18.0	.7087		18.0		76		25.0
16475000	16467	3/4		.7500	3/4		3		1	
16478740	16462		20.0	.7874		20.0		76		25.0

Series 164 coated tools on page 298.



Page 376

2
Flute

**TuffCut® GP
Series 164 Coated**

Z2     TiN ALtima® TiCN 

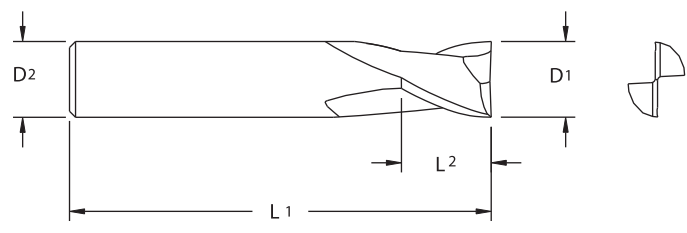

TiN		ALtima®		TiCN		Diameter			Shank		OAL		Flute Length	
Tool No.	EDP	Tool No.	EDP	Tool No.	EDP	D1			D2		L1		L2	
						Inch	mm	Decimal	Inch	mm	Inch	mm	Inch	mm
16411810T	56400	16411810A	56433	16411810C	56466		3.0	.1181		3.0		38		6.0
16412500T	56401	16412500A	56434	16412500C	56467	1/8		.1250	1/8		1-1/2		1/4	
16415750T	56405	16415750A	56438	16415750C	56471		4.0	.1575		4.0		51		8.0
16418750T	56408	16418750A	56441	16418750C	56474	3/16		.1875	3/16		2		3/8	
16419680T	56409	16419680A	56442	16419680C	56475		5.0	.1968		5.0		51		11.0
16423620T	56414	16423620A	56447	16423620C	56480		6.0	.2362		6.0		51		13.0
16425000T	56415	16425000A	56448	16425000C	56481	1/4		.2500	1/4		2		1/2	
16431250T	56418	16431250A	56451	16431250C	56484	5/16		.3125	5/16		2		1/2	
16431500T	56419	16431500A	56452	16431500C	56485		8.0	.3150		8.0		51		13.0
16437500T	56421	16437500A	56454	16437500C	56487	3/8		.3750	3/8		2		5/8	
16439370T	56422	16439370A	56455	16439370C	56488		10.0	.3937		10.0		51		14.0
16443750T	56424	16443750A	56457	16443750C	56490	7/16		.4375	7/16		2-1/2		5/8	
16447240T	56425	16447240A	56458	16447240C	56491		12.0	.4724		12.0		64		16.0
16450000T	56426	16450000A	56459	16450000C	56492	1/2		.5000	1/2		2-1/2		5/8	
16462500T	56428	16462500A	56461	16462500C	56494	5/8		.6250	5/8		3		3/4	
16462990T	56429	16462990A	56462	16462990C	56495		16.0	.6299		16.0		76		20.0
16475000T	56431	16475000A	56464	16475000C	56497	3/4		.7500	3/4		3		1	
16478740T	56432	16478740A	56465	16478740C	56498		20.0	.7874		20.0		76		25.0

Series 164 uncoated tools on page 295.



**TuffCut® GP
Series 140**

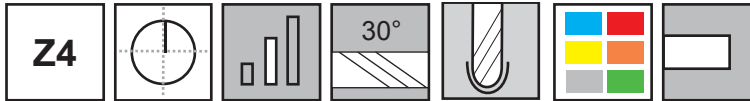

Manufactured with a full ball radius end. Designed for milling fillets or similar rounded corners in the bottom of a cut.

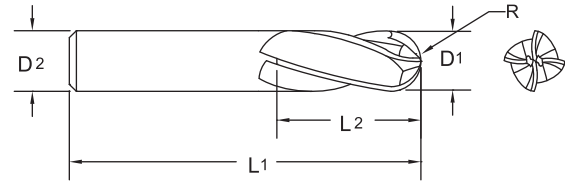

- Ideal for most ferrous metal applications.

Tool No.	EDP	Diameter			Shank		OAL		Flute Length	
		D1			D2		L1		L2	
		Inch	mm	Decimal	Inch	mm	Inch	mm	Inch	mm
14003120	14001	1/32		.0312	1/8		1-1/2		5/64	
14003940	14003		1.0	.0394		3.0		38		3.0
14004680	14005	3/64		.0468	1/8		1-1/2		7/64	
14005910	14007		1.5	.0591		3.0		38		6.0
14006250	14009	1/16		.0625	1/8		1-1/2		3/16	
14007810	14011	5/64		.0781	1/8		1-1/2		3/16	
14007870	14013		2.0	.0787		3.0		38		9.0
14009370	14015	3/32		.0937	1/8		1-1/2		9/32	
14009840	14017		2.5	.0984		3.0		38		12.0
14010930	14021	7/64		.1093	1/8		1-1/2		3/8	
14011810	14023		3.0	.1181		3.0		38		12.0
14012500	14025	1/8		.1250	1/8		1-1/2		3/8	
14013780	14027		3.5	.1378		4.0		51		12.0
14015620	14029	5/32		.1562	3/16		2		1/2	
14015750	14031		4.0	.1575		4.0		51		14.0
14017720	14033		4.5	.1772		5.0		51		14.0
14018750	14035	3/16		.1875	3/16		2		5/8	
14019680	14037		5.0	.1968		5.0		51		20.0
14021650	14039		5.5	.2165		6.0		64		20.0
14021870	14041	7/32		.2187	1/4		2-1/2		5/8	
14023620	14043		6.0	.2362		6.0		64		20.0
14025000	14045	1/4		.2500	1/4		2-1/2		3/4	
14027560	14047		7.0	.2756		8.0		64		20.0
14028120	14049	9/32		.2812	5/16		2-1/2		3/4	
14031250	14051	5/16		.3125	5/16		2-1/2		13/16	
14031500	14053		8.0	.3150		8.0		64		20.0
14035430	14055		9.0	.3543		9.0		64		20.0
14037500	14057	3/8		.3750	3/8		2-1/2		1	
14039370	14059		10.0	.3937		10.0		70		25.0
14043310	14061		11.0	.4331		11.0		70		25.0
14043750	14063	7/16		.4375	7/16		2-3/4		1	
14047240	14065		12.0	.4724		12.0		76		25.0
14050000	14067	1/2		.5000	1/2		3		1	
14055120	14069		14.0	.5512		14.0		89		30.0
14056250	14071	9/16		.5625	9/16		3-1/2		1-1/8	
14062500	14073	5/8		.6250	5/8		3-1/2		1-1/4	
14062990	14075		16.0	.6299		16.0		89		30.0
14068750	14077	11/16		.6875	3/4		4		1-3/8	
14070870	14079		18.0	.7087		18.0		102		35.0
14075000	14081	3/4		.7500	3/4		4		1-1/2	
14078740	14083		20.0	.7874		20.0		102		38.0
14086620	14085		22.0	.8662		22.0		102		40.0
14087500	14087	7/8		.8750	7/8		4		1-1/2	
14098430	14089		25.0	.9843		25.0		102		40.0
14010000	14019	1		1.0000	1		4		1-1/2	

Inch	
D1	Tolerance
1/32 - 1/4	+ .000/- .002
> 1/4 - 1	+ .000/- .003

Metric (mm)	
D1	Tolerance h10
1.00 - 3.00	+ .000/- .040
> 3.00 - 6.00	+ .000/- .048
> 6.00 - 10.00	+ .000/- .058
> 10.00 - 18.00	+ .000/- .070
> 18.00 - 25.00	+ .000/- .084

Inch	
R	Tolerance
≤ 1/16	+ .001/- .001
> 1/16 - 1/8	+ .002/- .002
> 1/8	+ .003/- .003

Metric (mm)	
R	Tolerance
≤ 1.5	+ .025/- .025
1.6 - 3.0	+ .050/- .050
> 3.0	+ .075/- .075

Series 140 coated tools on page 300.



4
Flute
Ball

**TuffCut® GP
Series 140 Coated**

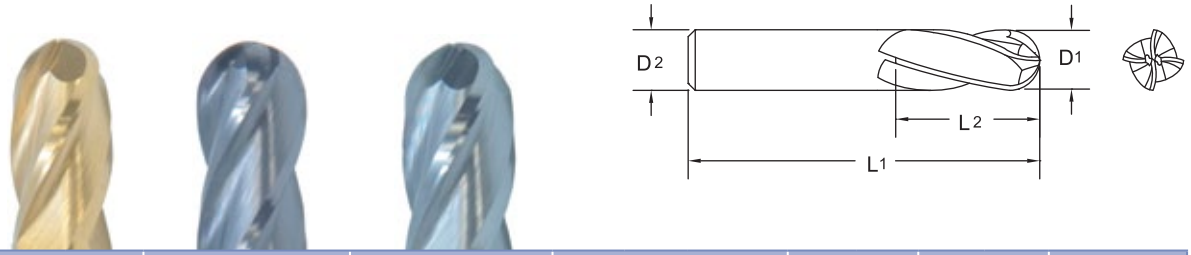

TiN		ALtima®		TiCN		Diameter			Shank		OAL		Flute Length	
						D1			D2		L1		L2	
Tool No.	EDP	Tool No.	EDP	Tool No.	EDP	Inch	mm	Decimal	Inch	mm	Inch	mm	Inch	mm
		14003940A	14108				1.0	.0394		3.0		38		3.0
		14005910A	14109				1.5	.0591		3.0		38		6.0
		14007870A	14110				2.0	.0787		3.0		38		9.0
		14009840A	14111				2.5	.0984		3.0		38		12.0
14011810T	14072	14011810A	14000	14011810C	14036		3.0	.1181		3.0		38		12.0
14012500T	14074	14012500A	14002	14012500C	14038	1/8		.1250	1/8		1-1/2		3/8	
14015750T	14076	14015750A	14004	14015750C	14040		4.0	.1575		4.0		51		14.0
14018750T	14078	14018750A	14006	14018750C	14042	3/16		.1875	3/16		2		5/8	
14019680T	14080	14019680A	14008	14019680C	14044		5.0	.1968		5.0		51		20.0
14023620T	14082	14023620A	14010	14023620C	14046		6.0	.2362		6.0		64		20.0
14025000T	14084	14025000A	14012	14025000C	14048	1/4		.2500	1/4		2-1/2		3/4	
14031250T	14086	14031250A	14014	14031250C	14050	5/16		.3125	5/16		2-1/2		13/16	
14031500T	14088	14031500A	14016	14031500C	14052		8.0	.3150		8.0		64		20.0
14037500T	14090	14037500A	14018	14037500C	14054	3/8		.3750	3/8		2-1/2		1	
14039370T	14091	14039370A	14020	14039370C	14056		10.0	.3937		10.0		70		25.0
14043750T	14092	14043750A	14022	14043750C	14058	7/16		.4375	7/16		2-3/4		1	
14047240T	14093	14047240A	14024	14047240C	14060		12.0	.4724		12.0		76		25.0
14050000T	14094	14050000A	14026	14050000C	14062	1/2		.5000	1/2		3		1	
14062500T	14095	14062500A	14028	14062500C	14064	5/8		.6250	5/8		3-1/2		1-1/4	
14062990T	14096	14062990A	14030	14062990C	14066		16.0	.6299		16.0		89		30.0
14075000T	14097	14075000A	14032	14075000C	14068	3/4		.7500	3/4		4		1-1/2	
14078740T	14098	14078740A	14034	14078740C	14070		20.0	.7874		20.0		102		38.0
14098430T	54003	14098430A	54004	14098430C	54005		25.0	.9843		25.0		102		40.0
14010000T	54000	14010000A	54001	14010000C	54002	1		1.0000	1		4		1-1/2	

Series 140 uncoated tools on page 299.



**TuffCut® GP
Series 165**

Z4

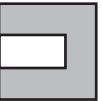
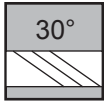
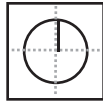

Manufactured with full ball radius end.

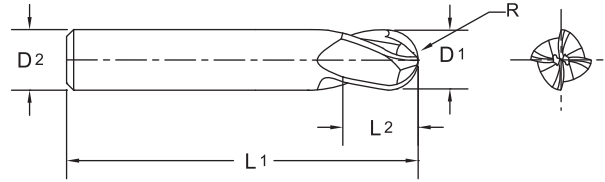

- Ideal for most ferrous metal applications

Tool No.	EDP	Diameter			Shank		OAL		Flute Length	
		D1			D2		L1		L2	
		Inch	mm	Decimal	Inch	mm	Inch	mm	Inch	mm
16501560	16500	1/64		.0156	1/8		1-1/2		.023	
16503120	16501	1/32		.0312	1/8		1-1/2		1/16	
16503940	16503		1.0	.0394		3.0		38		2.0
16504680	16505	3/64		.0468	1/8		1-1/2		3/32	
16505910	16507		1.5	.0591		3.0		38		3.0
16506250	16509	1/16		.0625	1/8		1-1/2		1/8	
16507810	16510	5/64		.0781	1/8		1-1/2		5/32	
16507870	16511		2.0	.0787		3.0		38		4.0
16509370	16513	3/32		.0937	1/8		1-1/2		3/16	
16509840	16515		2.5	.0984		3.0		38		5.0
16510930	16516	7/64		.1093	1/8		1-1/2		7/32	
16511810	16517		3.0	.1181		3.0		38		6.0
16512500	16519	1/8		.1250	1/8		1-1/2		1/4	
16513780	16521		3.5	.1378		4.0		51		7.0
16514060	16522	9/64		.1406	3/16		2		5/16	
16515620	16523	5/32		.1562	3/16		2		5/16	
16515750	16525		4.0	.1575		4.0		51		8.0
16517180	16526	11/64		.1718	3/16		2		3/8	
16517720	16527		4.5	.1772		5.0		51		9.0
16518750	16529	3/16		.1875	3/16		2		3/8	
16519680	16531		5.0	.1968		5.0		51		11.0
16520310	16532	13/64		.2031	1/4		2		1/2	
16521650	16533		5.5	.2165		6.0		51		12.0
16521870	16535	7/32		.2187	1/4		2		1/2	
16523430	16536	15/64		.2343	1/4		2		1/2	
16523620	16537		6.0	.2362		6.0		51		13.0
16525000	16539	1/4		.2500	1/4		2		1/2	
16527560	16541		7.0	.2756		8.0		51		13.0
16528120	16542	9/32		.2812	5/16		2		1/2	
16531250	16543	5/16		.3125	5/16		2		1/2	
16531500	16545		8.0	.3150		8.0		51		13.0
16535430	16547		9.0	.3543		9.0		51		14.0
16537500	16549	3/8		.3750	3/8		2		5/8	
16539370	16551		10.0	.3937		10.0		51		14.0
16543310	16553		11.0	.4331		11.0		64		16.0
16543750	16555	7/16		.4375	7/16		2-1/2		5/8	

Inch	
D1	Tolerance
1/64	+ .000/- .001
1/32 - 1/4	+ .000/- .002
>1/4 - 3/4	+ .000/- .003

Metric (mm)	
D1	Tolerance h10
1.00 - 3.00	+ .000/- .040
>3.00 - 6.00	+ .000/- .048
>6.00 - 10.00	+ .000/- .058
>10.00 - 18.00	+ .000/- .070
>18.00 - 20.00	+ .000/- .084

Inch	
R	Tolerance
≤ 1/16	+ .001/- .001
>1/16 - 1/8	+ .002/- .002
>1/8	+ .003/- .003

Metric (mm)	
R	Tolerance
≤ 1.5	+ .025/- .025
1.6 - 3.0	+ .050/- .050
> 3.0	+ .075/- .075

Series 165 coated tools on page 302.



140 Coated / 165
TuffCut® GP

GENERAL PURPOSE

4
Flute
Ball

Series 165 Continued

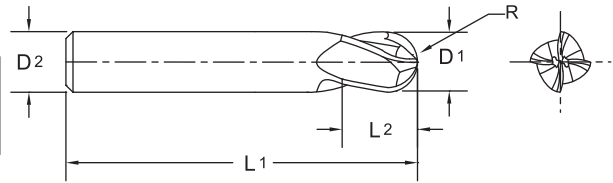
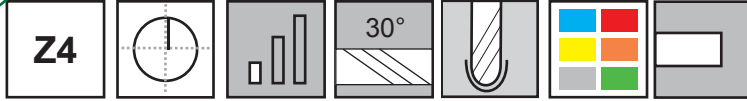

Tool No.	EDP	Diameter			Shank		OAL		Flute Length	
		D1			D2		L1		L2	
		Inch	mm	Decimal	Inch	mm	Inch	mm	Inch	mm
16547240	16557		12.0	.4724		12.0		64		16.0
16550000	16559	1/2		.5000	1/2		2-1/2		5/8	
16555120	16561		14.0	.5512		14.0		70		18.0
16562500	16563	5/8		.6250	5/8		3		3/4	
16562990	16565		16.0	.6299		16.0		76		20.0
16570870	16567		18.0	.7087		18.0		76		25.0
16575000	16569	3/4		.7500	3/4		3		1	
16578740	16571		20.0	.7874		20.0		76		25.0



Page 376

4
Flute
Ball

TuffCut® GP
Series 165 Coated

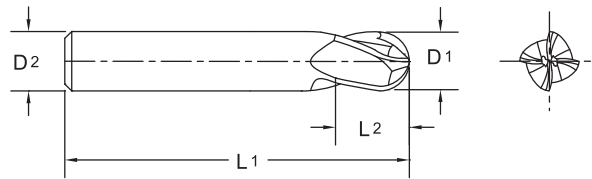

TiN		ALtima®		TiCN		Diameter			Shank		OAL		Flute Length	
D1		D2		L1		L2								
Tool No.	EDP	Tool No.	EDP	Tool No.	EDP	Inch	mm	Decimal	Inch	mm	Inch	mm	Inch	mm
16511810T	56500	16511810A	56533	16511810C	56566		3.0	.1181		3.0		38		6.0
16512500T	56501	16512500A	56534	16512500C	56567	1/8		.1250	1/8		1-1/2		1/4	
16515750T	56505	16515750A	56538	16515750C	56571		4.0	.1575		4.0		51		8.0
16518750T	56508	16518750A	56541	16518750C	56574	3/16		.1875	3/16		2		3/8	
16519680T	56509	16519680A	56542	16519680C	56575		5.0	.1968		5.0		51		11.0
16523620T	56514	16523620A	56547	16523620C	56580		6.0	.2362		6.0		51		13.0
16525000T	56515	16525000A	56548	16525000C	56581	1/4		.2500	1/4		2		1/2	
16531250T	56518	16531250A	56551	16531250C	56584	5/16		.3125	5/16		2		1/2	
16531500T	56519	16531500A	56552	16531500C	56585		8.0	.3150		8.0		51		13.0
16537500T	56521	16537500A	56554	16537500C	56587	3/8		.3750	3/8		2		5/8	
16539370T	56522	16539370A	56555	16539370C	56588		10.0	.3937		10.0		51		14.0
16543750T	56524	16543750A	56557	16543750C	56590	7/16		.4375	7/16		2-1/2		5/8	
16547240T	56525	16547240A	56558	16547240C	56591		12.0	.4724		12.0		64		16.0
16550000T	56526	16550000A	56559	16550000C	56592	1/2		.5000	1/2		2-1/2		5/8	
16562500T	56528	16562500A	56561	16562500C	56594	5/8		.6250	5/8		3		3/4	
16562990T	56529	16562990A	56562	16562990C	56595		16.0	.6299		16.0		76		20.0
16575000T	56531	16575000A	56564	16575000C	56597	3/4		.7500	3/4		3		1	
16578740T	56532	16578740A	56565	16578740C	56598		20.0	.7874		20.0		76		25.0



Page 376

Series 165 uncoated tools on page 301.

TuffCut® GP Series 150

Z2

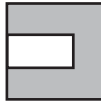
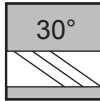
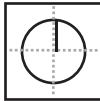

2
Flute
Ball

Manufactured with a full ball radius end. Designed for milling fillets or similar rounded corners in the bottom of a cut. Ideal for most ferrous metal applications.

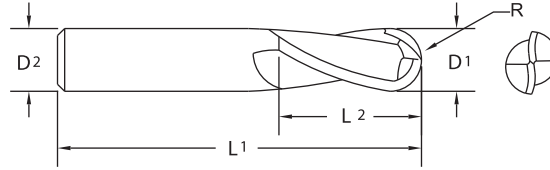

• Micro sizes available.

Tool No.	EDP	Diameter			Shank		OAL		Flute Length	
		D1			D2		L1		L2	
		Inch	mm	Decimal	Inch	mm	Inch	mm	Inch	mm
15001500	15002			.0150	1/8		1-1/2		.045	
15001570	15038		0.4	.0157		3		38		1.2
15001960	15040		0.5	.0196		3		38		1.5
15002000	15004			.0200	1/8		1-1/2		.060	
15002360	15042		0.6	.0236		3		38		1.8
15002500	15006			.0250	1/8		1-1/2		.075	
15002750	15044		0.7	.0275		3		38		2.1
15003000	15008			.0300	1/8		1-1/2		.090	
15003120	15001	1/32		.0312	1/8		1-1/2		5/64	
15003150	15046		0.8	.0315		3		38		2.4
15003350	15010			.0350	1/8		1-1/2		.105	
15003540	15048		0.9	.0354		3		38		2.7
15003940	15003		1.0	.0394		3		38		3.0
15004000	15012			.0400	1/8		1-1/2		.120	
15004330	15052		1.1	.0433		3		38		3.3
15004500	15014			.0450	1/8		1-1/2		.135	
15004680	15005	3/64		.0468	1/8		1-1/2		7/64	
15004720	15054		1.2	.0472		3		38		3.6
15005000	15016			.0500	1/8		1-1/2		.150	
15005120	15056		1.3	.0512		3		38		3.9
15005500	15018			.0550	1/8		1-1/2		.165	
15005510	15058		1.4	.0551		3		38		4.2
15005910	15007		1.5	.0591		3		38		6.0
15005911	15060		1.5	.0591		3		38		4.5
15006000	15020			.0600	1/8		1-1/2		.180	
15006250	15009	1/16		.0625	1/8		1-1/2		3/16	
15006300	15062		1.6	.0630		3		38		4.8
15006500	15022			.0650	1/8		1-1/2		.195	
15006690	15064		1.7	.0669		3		38		5.1
15007000	15024			.0700	1/8		1-1/2		.210	
15007090	15066		1.8	.0709		3		38		5.4
15007480	15068		1.9	.0748		3		38		5.7

Inch	
D1	Tolerance
1/32 - 1/4	+ .000/- .002
> 1/4 - 1	+ .000/- .003
D1 Micro Sizes*	Tolerance
.015 - .100	+ .0005/- .0005

*Inch decimal size range .015-.100" only.

Metric (mm)	
D1	Tolerance h10
0.40 - 0.50	+ .000/- .025
0.60 - 3.00	+ .000/- .040
> 3.00 - 6.00	+ .000/- .048
> 6.00 - 10.00	+ .000/- .058
> 10.00 - 18.00	+ .000/- .070
> 18.00 - 25.00	+ .000/- .084

Inch	
R	Tolerance
≤ 1/16	+ .001/- .001
> 1/16 - 1/8	+ .002/- .002
> 1/8	+ .003/- .003

Metric (mm)	
R	Tolerance
≤ 1.5	+ .025/- .025
1.6 - 3.0	+ .050/- .050
> 3.0	+ .075/- .075

Series 150 coated tools on page 306.



Page 376

165 / 165 Coated / 150
TuffCut® GP

GENERAL PURPOSE

Series 150 Continued

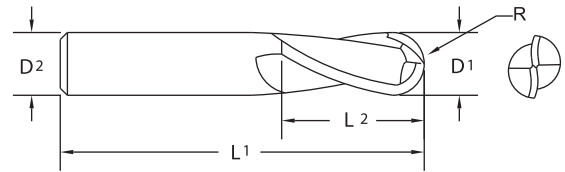
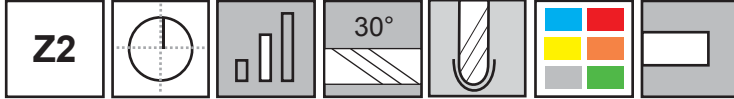

Tool No.	EDP	Diameter			Shank		OAL		Flute Length	
		D1			D2		L1		L2	
		Inch	mm	Decimal	Inch	mm	Inch	mm	Inch	mm
15007500	15026			.0750	1/8		1-1/2		.225	
15007810	15011	5/64		.0781	1/8		1-1/2		3/16	
15007870	15013		2.0	.0787		3	38		9.0	
15007871	15070		2.0	.0787		3	38		6.0	
15008000	15028			.0800	1/8		1-1/2		.240	
15008500	15030			.0850	1/8		1-1/2		.255	
15009000	15032			.0900	1/8		1-1/2		.270	
15009370	15015	3/32		.0937	1/8		1-1/2		9/32	
15009500	15034			.0950	1/8		1-1/2		.285	
15009840	15017		2.5	.0984		3	38		12.0	
15010010	15036			.1000	1/8		1-1/2		.300	
15010930	15021	7/64		.1093	1/8		1-1/2		3/8	
15011810	15023		3.0	.1181		3	38		12.0	
15012500	15025	1/8		.1250	1/8		1-1/2		3/8	
15013780	15027		3.5	.1378		4	51		12.0	
15015620	15029	5/32		.1562	3/16		2		1/2	
15015750	15031		4.0	.1575		4	51		14.0	
15017720	15033		4.5	.1772		5	51		14.0	
15018750	15035	3/16		.1875	3/16		2		5/8	
15019680	15037		5.0	.1968		5	51		20.0	
15021650	15039		5.5	.2165		6	64		20.0	
15021870	15041	7/32		.2187	1/4		2-1/2		5/8	
15023620	15043		6.0	.2362		6	64		20.0	
15025000	15045	1/4		.2500	1/4		2-1/2		3/4	
15027560	15047		7.0	.2756		8	64		20.0	
15028120	15049	9/32		.2812	5/16		2-1/2		3/4	
15031250	15051	5/16		.3125	5/16		2-1/2		13/16	
15031500	15053		8.0	.3150		8	64		20.0	
15035430	15055		9.0	.3543		9	64		20.0	
15037500	15057	3/8		.3750	3/8		2-1/2		1	
15039370	15059		10.0	.3937		10	70		25.0	
15043310	15061		11.0	.4331		11	70		25.0	
15043750	15063	7/16		.4375	7/16		2-3/4		1	
15047240	15065		12.0	.4724		12	76		25.0	
15050000	15067	1/2		.5000	1/2		3		1	
15055120	15069		14.0	.5512		14	89		30.0	
15056250	15071	9/16		.5625	9/16		3-1/2		1-1/8	
15062500	15073	5/8		.6250	5/8		3-1/2		1-1/4	
15062990	15075		16.0	.6299		16	89		30.0	
15068750	15077	11/16		.6875	3/4		4		1-3/8	

Series 150 coated tools on page 306.



Series 150 Continued

Tool No.	EDP	Diameter			Shank		OAL		Flute Length	
		D1			D2		L1		L2	
		Inch	mm	Decimal	Inch	mm	Inch	mm	Inch	mm
15070870	15079		18.0	.7087		18		102		35.0
15075000	15081	3/4		.7500	3/4		4		1-1/2	
15078740	15083		20.0	.7874		20		102		38.0
15086620	15085		22.0	.8662		22		102		40.0
15087500	15087	7/8		.8750	7/8		4		1-1/2	
15098430	15089		25.0	.9843		25		102		40.0
15010000	15019	1		1.0000	1		4		1-1/2	

Series 150 coated tools on page 306.



Page 376



Made in USA

ISO 9001:2015 Certified



For product information, call your local distributor.

**TuffCut® GP
Series 150 Coated**

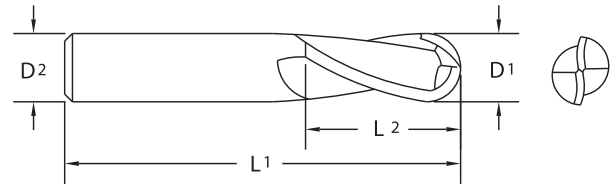

TiN		ALtima®		TiCN		Diameter			Shank		OAL		Flute Length	
Tool No.	EDP	Tool No.	EDP	Tool No.	EDP	D1			D2		L1		L2	
						Inch	mm	Decimal	Inch	mm	Inch	mm	Inch	mm
		15003940A	15050				1.0	.0394		3.0		38		3.0
		15005910A	15080				1.5	.0591		3.0		38		6.0
		15007870A	15082				2.0	.0787		3.0		38		9.0
		15009840A	15084				2.5	.0984		3.0		38		12.0
15011810T	55076	15011810A	55040	15011810C	55058		3.0	.1181		3.0		38		12.0
15012500T	55077	15012500A	55041	15012500C	55059	1/8		.1250	1/8		1-1/2		3/8	
15015750T	55078	15015750A	55042	15015750C	55060		4.0	.1575		4.0		51		14.0
15018750T	55079	15018750A	55043	15018750C	55061	3/16		.1875	3/16		2		5/8	
15019680T	55080	15019680A	55044	15019680C	55062		5.0	.1968		5.0		51		20.0
15023620T	55081	15023620A	55045	15023620C	55063		6.0	.2362		6.0		64		20.0
15025000T	55082	15025000A	55046	15025000C	55064	1/4		.2500	1/4		2-1/2		3/4	
15031250T	55083	15031250A	55047	15031250C	55065	5/16		.3125	5/16		2-1/2		13/16	
15031500T	55084	15031500A	55048	15031500C	55066		8.0	.3150		8.0		64		20.0
15037500T	55085	15037500A	55049	15037500C	55067	3/8		.3750	3/8		2-1/2		1	
15039370T	55086	15039370A	55050	15039370C	55068		10.0	.3937		10.0		70		25.0
15043750T	55087	15043750A	55051	15043750C	55069	7/16		.4375	7/16		2-3/4		1	
15047240T	55088	15047240A	55052	15047240C	55070		12.0	.4724		12.0		76		25.0
15050000T	55089	15050000A	55053	15050000C	55071	1/2		.5000	1/2		3		1	
15062500T	55090	15062500A	55054	15062500C	55072	5/8		.6250	5/8		3-1/2		1-1/4	
15062990T	55091	15062990A	55055	15062990C	55073		16.0	.6299		16.0		89		30.0
15075000T	55092	15075000A	55056	15075000C	55074	3/4		.7500	3/4		4		1-1/2	
15078740T	55093	15078740A	55057	15078740C	55075		20.0	.7874		20.0		102		38.0
15098430T	55097	15098430A	55098	15098430C	55099		25.0	.9843		25.0		102		40.0
15010000T	55094	15010000A	55095	15010000C	55096	1		1.0000	1		4		1-1/2	

Series 150 uncoated tools on page 303.



TuffCut® GP Series 166

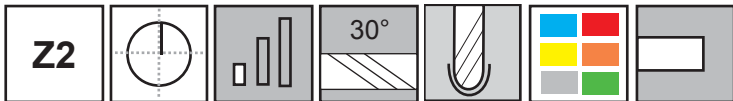

2 Flute Ball

Manufactured with a full ball radius end. Designed for milling fillets or similar rounded corners in the bottom of a cut. Ideal for most ferrous metal applications.

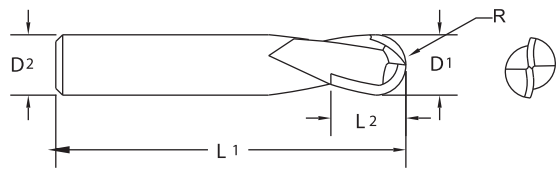

Tool No.	EDP	Diameter			Shank		OAL		Flute Length	
		D1			D2		L1		L2	
		Inch	mm	Decimal	Inch	mm	Inch	mm	Inch	mm
16601560	16600	1/64		.0156	1/8		1-1/2		.023	
16603120	16601	1/32		.0312	1/8		1-1/2		1/16	
16603940	16603		1.0	.0394		3.0		38		2.0
16604680	16605	3/64		.0468	1/8		1-1/2		3/32	
16605910	16607		1.5	.0591		3.0		38		3.0
16606250	16609	1/16		.0625	1/8		1-1/2		1/8	
16607810	16610	5/64		.0781	1/8		1-1/2		5/32	
16607870	16611		2.0	.0787		3.0		38		4.0
16609370	16613	3/32		.0937	1/8		1-1/2		3/16	
16609840	16615		2.5	.0984		3.0		38		5.0
16610930	16616	7/64		.1093	1/8		1-1/2		7/32	
16611810	16617		3.0	.1181		3.0		38		6.0
16612500	16619	1/8		.1250	1/8		1-1/2		1/4	
16613780	16621		3.5	.1378		4.0		51		7.0
16614060	16622	9/64		.1406	3/16		2		5/16	
16615620	16623	5/32		.1562	3/16		2		5/16	
16615750	16625		4.0	.1575		4.0		51		8.0
16617180	16626	11/64		.1718	3/16		2		3/8	
16617720	16627		4.5	.1772		5.0		51		9.0
16618750	16629	3/16		.1875	3/16		2		3/8	
16619680	16631		5.0	.1968		5.0		51		11.0
16620310	16632	13/64		.2031	1/4		2		1/2	
16621650	16633		5.5	.2165		6.0		51		12.0
16621870	16635	7/32		.2187	1/4		2		1/2	
16623430	16636	15/64		.2343	1/4		2		1/2	
16623620	16637		6.0	.2362		6.0		51		13.0
16625000	16639	1/4		.2500	1/4		2		1/2	
16627560	16641		7.0	.2756		8.0		51		13.0
16628120	16642	9/32		.2812	5/16		2		1/2	
16631250	16643	5/16		.3125	5/16		2		1/2	
16631500	16645		8.0	.3150		8.0		51		13.0
16635430	16647		9.0	.3543		9.0		51		14.0
16637500	16649	3/8		.3750	3/8		2		5/8	
16639370	16651		10.0	.3937		10.0		51		14.0
16643310	16653		11.0	.4331		11.0		64		16.0
16643750	16655	7/16		.4375	7/16		2-1/2		5/8	

Inch	
D1	Tolerance
1/64	+ .000/- .001
1/32 - 1/4	+ .000/- .002
> 1/4 - 3/4	+ .000/- .003

Metric (mm)	
D1	Tolerance h10
1.00 - 3.00	+ .000/- .040
> 3.00 - 6.00	+ .000/- .048
> 6.00 - 10.00	+ .000/- .058
> 10.00 - 18.00	+ .000/- .070
> 18.00 - 20.00	+ .000/- .084

Inch	
R	Tolerance
≤ 1/16	+ .001/- .001
> 1/16 - 1/8	+ .002/- .002
> 1/8	+ .003/- .003

Metric (mm)	
R	Tolerance
≤ 1.5	+ .025/- .025
1.6 - 3.0	+ .050/- .050
> 3.0	+ .075/- .075

Series 166 coated tools on page 308.



Page 376

150 Coated / 166 TuffCut® GP

GENERAL PURPOSE

2
Flute
Ball

Series 166 Continued

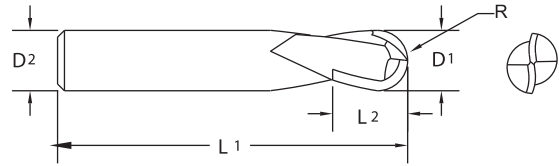
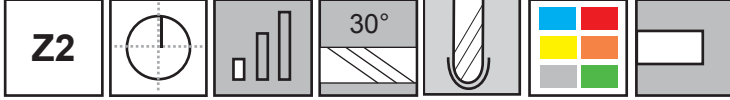

Tool No.	EDP	Diameter			Shank		OAL		Flute Length	
		D1			D2		L1		L2	
		Inch	mm	Decimal	Inch	mm	Inch	mm	Inch	mm
16647240	16657		12.0	.4724		12.0		64		16.0
16650000	16659	1/2		.5000	1/2		2-1/2		5/8	
16655120	16661		14.0	.5512		14.0		70		18.0
16662500	16663	5/8		.6250	5/8		3		3/4	
16662990	16665		16.0	.6299		16.0		76		20.0
16670870	16667		18.0	.7087		18.0		76		25.0
16675000	16669	3/4		.7500	3/4		3		1	
16678740	16671		20.0	.7874		20.0		76		25.0



Page 376

2
Flute
Ball

TuffCut® GP Series 166 Coated

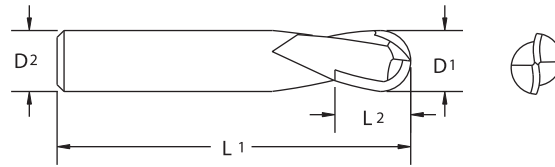

TiN		ALtima®		TiCN		Diameter			Shank		OAL		Flute Length	
D1		D2		L1		L2								
Tool No.	EDP	Tool No.	EDP	Tool No.	EDP	Inch	mm	Decimal	Inch	mm	Inch	mm	Inch	mm
16611810T	56600	16611810A	56633	16611810C	56666		3.0	.1181		3.0		38		6.0
16612500T	56601	16612500A	56634	16612500C	56667	1/8		.1250	1/8		1-1/2		1/4	
16615750T	56605	16615750A	56638	16615750C	56671		4.0	.1575		4.0		51		8.0
16618750T	56608	16618750A	56641	16618750C	56674	3/16		.1875	3/16		2		3/8	
16619680T	56609	16619680A	56642	16619680C	56675		5.0	.1968		5.0		51		11.0
16623620T	56614	16623620A	56647	16623620C	56680		6.0	.2362		6.0		51		13.0
16625000T	56615	16625000A	56648	16625000C	56681	1/4		.2500	1/4		2		1/2	
16631250T	56618	16631250A	56651	16631250C	56684	5/16		.3125	5/16		2		1/2	
16631500T	56619	16631500A	56652	16631500C	56685		8.0	.3150		8.0		51		13.0
16637500T	56621	16637500A	56654	16637500C	56687	3/8		.3750	3/8		2		5/8	
16639370T	56622	16639370A	56655	16639370C	56688		10.0	.3937		10.0		51		14.0
16643750T	56624	16643750A	56657	16643750C	56690	7/16		.4375	7/16		2-1/2		5/8	
16647240T	56625	16647240A	56658	16647240C	56691		12.0	.4724		12.0		64		16.0
16650000T	56626	16650000A	56659	16650000C	56692	1/2		.5000	1/2		2-1/2		5/8	
16662500T	56628	16662500A	56661	16662500C	56694	5/8		.6250	5/8		3		3/4	
16662990T	56629	16662990A	56662	16662990C	56695		16.0	.6299		16.0		76		20.0
16675000T	56631	16675000A	56664	16675000C	56697	3/4		.7500	3/4		3		1	
16678740T	56632	16678740A	56665	16678740C	56698		20.0	.7874		20.0		76		25.0



Page 376

Series 166 uncoated tools on page 307.



Where **high performance**
is the **standard**[®]

166 / 166 Coated
TuffCut[®] GP



GENERAL PURPOSE







End Mill Icon Glossary

Z3 Number of Flutes  Workpiece Material Group

 Center Cutting **P** Steels

 Lengths **M** Stainless Steels

Coatings

K Cast Iron

S Special Alloys

H Hardened Steels (35-65Rc)

N Non-Ferrous

 30° Helix Angle

 Ball Nose



 Neck Relief

 Corner Radius

 Shank

 Shank/DIN
HB
DIN6535

 Chipbreaker

Coolant **Maximum**
 Max. Coolant
 Coolant **Minimal**
 MMS Coolant

Cutting Calculations And Definitions		Metric	U.S.
ae	= Width of cut, radial depth of cut	(mm)	(inch)
ap	= Depth of cut, axial depth of cut	(mm)	(inch)
Dc	= Cutter diameter	(mm)	(inch)
f	= Feed per revolution	(mm/rev)	(IPR)
fz	= Feed per tooth	(mm/tooth)	(IPT)
zn	= Number of teeth	Number	
n	= RPM	(rev/min)	(rev/min)
Q	= Metal removal rate	(cm ³ /min)	(in ³ /min)
vc	= Cutting speed	(m/min)	(SFM)
vf	= Feed speed	(mm/min)	(IPM)
Dw	= Working diameter	(mm)	(inch)

Formulas

Inch

$$\text{RPM (n)} = \text{SFM (vc)} \times 3.82 / \text{Tool Diam.}$$

$$\text{IPM (vf)} = \text{RPM (n)} \times \text{IPR (f)}$$

Conversion Inch to Metric

$$\text{SFM (vc) to m/min (vc)} = \text{SFM (vc)} \times .3048$$

$$\text{IPM (vf) to mm/min (vf)} = \text{IPM (vf)} \times 25.4$$

Metric

$$\text{RPM (n)} = \text{m/min (vc)} \times 318.057 / \text{Tool Diam.}$$

$$\text{mm/min (vf)} = \text{RPM (n)} \times \text{mm/Revolution (f)}$$

Conversion Metric to Inch

$$\text{m/min (vc) to SFM (vc)} = (\text{m/min}) / .3048$$

$$\text{mm/min (vf) to IPM (vf)} = (\text{mm/min}) / 25.4$$



Made in USA



Safety Note

Always wear the appropriate personal protective equipment such as safety glasses and protective clothing when using solid carbide or HSS cutting tools. Machines should be fully guarded. Technical data provided should be considered advisory only as variations may be necessary depending on the particular application.

End Mill Troubleshooting

PROBLEM	POSSIBLE CAUSE	POSSIBLE SOLUTION
Excessive Flank Wear	Speed too high	Reduce the cutting speed RPM's (n).
	Improper feed speed (too slow)	Increase feed per tooth (fz).
	Hard workpiece material > 55 Rc	Try 90-100 SFM (vc) with multi-fluted tool (5 flutes+). Use ALtima® 52 hard coating.
	Recutting Chips	Change feed speed to change chip size or clear chips with coolant or air pressure.
	Milling Strategy	Ensure you are climb milling unless workpiece material has hard/abrasive outer skin or high impact tool steel like D2, then conventional milling technique is preferred for breakthrough (see pg 314).
	Improper cutting angle	Change to correct cutting angle, tilt tool at 15 degrees.
	Too low a primary relief angle	Change to larger relief angle.
PROBLEM	POSSIBLE CAUSE	POSSIBLE SOLUTION
Excessive Corner Wear	No Corner Radius	Implementing corner radius on tool adds strength and increases tool life.
	Speed too high	Reduce the cutting speed RPM's (n).
	Tool Runout	Check tool runout in holder/spindle, <.0003" (.0076mm) desired. Hand ground flats can be suspect and common cause. Use collet, milling chuck, or shrink fit holders if possible.
	Tool Overhang	Ensure you are using shortest OAL possible, stub tool in holder. Utilize stronger necked tool for longer reaches.
PROBLEM	POSSIBLE CAUSE	POSSIBLE SOLUTION
Cutting Edge Chipping	Lack of rigidity (tool)	Use shortest end mill available, hold shank deeper in holder, investigate for tool slippage. Use short gage length holder.
	Lack of rigidity (workpiece)	Tighten workpiece fixture - a common problem.
	Feed too high	Decrease feed per tooth (fz)
	Feed too high on first pass	Decrease feed per tooth (fz) on first pass through workpiece skin or reduce radial width of cut (ae) first pass.
	Part Entry	Reduce FPT on entry - implement radius in or sweeping entrances - avoid 90° (perpendicular) entry.
	Milling Strategy	Ensure you are climb milling unless workpiece material has hard/abrasive outer skin or high impact tool steel like D2, then conventional milling technique is preferred for breakthrough (see pg 314).
	Tool Overhang	Ensure you are using shortest OAL possible, stub tool in holder. Utilize stronger necked tool for longer reaches.
	Tool Runout	Check tool runout in holder/spindle, <.0003" (.0076mm) desired. Hand ground flats can be suspect and common cause. Use collet, milling chuck, or shrink fit holders if possible.
	Not enough rigidity of machine tool & holder	Change rigid machine tool or holder.
	Cutting Edge Prep	Ensure tool has proper edge prep for workpiece material.
	Teeth too sharp	Change to lower cutting angle, primary relief.

Technical data provided should be considered advisory only as variations may be necessary depending on the particular application.

[For product information, call your local distributor.](#)

End Mill Troubleshooting Continued

PROBLEM	POSSIBLE CAUSE	POSSIBLE SOLUTION
Breakage	Lack of rigidity (workpiece)	Tighten workpiece fixture - a common problem.
	Speed too low	Increase the cutting speed RPM's (n).
	Feed too high	Decrease feed per tooth (fz).
	Heavy depth of cut	Reduce width of cut, radial depth of cut (ae) & depth of cut, axial depth of cut (ap).
	Part Entry	Reduce FPT on entry - implement radius in or sweeping entrances - avoid 90° (perpendicular) entry.
	Milling Strategy	Review tool path and ensure there are no arbitrary moves, extreme arc of engagement increases & undesirable situations for the tool. Keep constant radial engagement. See tool path diagrams on page 317.
	Tool Overhang	Ensure you are using shortest OAL possible, stub tool in holder. Utilize stronger necked tool for longer reaches.
	Tool Runout	Check tool runout in holder/spindle, <.0003" (.0076mm) desired. Hand ground flats can be suspect and common cause. Use collet, milling chuck, or shrink fit holders if possible.
	Excessive edge wear	Recondition at earlier stage. Factory recondition service is recommended. See M.A. Ford's® RED BOX reconditioning program on page 471.
PROBLEM	POSSIBLE CAUSE	POSSIBLE SOLUTION
Built Up Edge (BUE)	Chip Welding to cutting edge	Utilize proper tool coating for workpiece material being cut. Climb mill preferred.
	Feed too low	Increase feed per tooth (fz).
	Speed too low	Increase the cutting speed RPM's (n).
	Coolant Strategy	Add coolant or readjust coolant flow, use through tool coolant if available. Check coolant mixture concentration.
PROBLEM	POSSIBLE CAUSE	POSSIBLE SOLUTION
Chip Packing	Insufficient chip room	Use end mill with fewer flutes.
	Feed too high	Decrease feed per tooth (fz).
	Heavy depth of cut	Reduce width of cut, radial depth of cut (ae) & depth of cut, axial depth of cut (ap).
	Not enough coolant	Apply more coolant to flush chips. Use air pressure or op. stop to clear chips away.
	Large heavy chip	Utilize chipbreaker style tool to cut chip size.
PROBLEM	POSSIBLE CAUSE	POSSIBLE SOLUTION
Poor Surface Finish	Feed too high	Decrease feed per tooth (fz).
	Speed too low	Increase the cutting speed RPM's (n).
	Too light width of cut	Increase width of cut, radial depth of cut (ae) to stabilize tool in cut.
	Tool Runout	Check tool runout in holder/spindle, <.0003" (.0076mm) desired. Hand ground flats can be suspect and common cause. Use collet, milling chuck, or shrink fit holders if possible.
	Built up Edge	Use Flood Coolant.
	Recutting Chips	Redirect/Evaluate coolant flush - or use fewer number of flutes.
	No end tooth concavity	Add margin (touch primary with oilstone).

Technical data provided should be considered advisory only as variations may be necessary depending on the particular application.

End Mill Troubleshooting Continued

PROBLEM	POSSIBLE CAUSE	POSSIBLE SOLUTION
Chatter/Vibration	Lack of rigidity (workpiece)	Tighten workpiece fixture - a common problem.
	Lack of rigidity (machine & holder)	Use better machine tool, holder or change condition. Ask your M.A. Ford® representative about BlueSwarf harmonic testing.
	Tool Runout	Check tool runout in holder/spindle, <.0003" (.0076mm) desired. Hand ground flats can be suspect and common cause. Use collet, milling chuck, or shrink fit holders if possible.
	Speed too high	Reduce the cutting speed RPM's (n).
	Feed too low	Increase feed per tooth (fz).
	Chip too thin	Utilize chip thinning adjustment multiplier.
	Arc of engagement violation	Use smaller tools and generate corner radii in pockets. Avoid tools that diameter matches workpiece corner radius, or rough plunge corners.
	Milling Strategy	Ensure you are climb milling unless workpiece material has hard/abrasive outer skin or high impact tool steel like D2 then conventional milling technique is preferred for breakthrough.
PROBLEM	POSSIBLE CAUSE	POSSIBLE SOLUTION
Tool Deflection	Tool Overhang	Ensure you are using shortest OAL possible, stub tool in holder. Utilize stronger necked tool for longer reaches.
	End mill Diameter	Increase diameter of end mill for higher strength to length ratio.
	Increase number of flutes	Higher number of flutes = larger core diameter = increased strength.
	Feed too high	Decrease feed per tooth (fz).
	Too high width of cut	Decrease width of cut, radial depth of cut (ae).
	Milling Strategy	Climb milling can help reduce the amount of deflection in some cases.
PROBLEM	POSSIBLE CAUSE	POSSIBLE SOLUTION
No Dimensional Accuracy (Wall Tapered)	Coolant Strategy	Add coolant or readjust coolant flow, use through tool coolant if available. Check coolant mixture concentration.
	Tool Deflection	See Tool Deflection above.
	Feed too high	Decrease feed per tooth (fz).
	Too high width of cut	Decrease width of cut, radial depth of cut (ae).
	Tool Runout	Check tool runout in holder/spindle, <.0003" (.0076mm) desired. Hand ground flats can be suspect and common cause. Use collet, milling chuck, or shrink fit holders if possible.

Milling Strategy Comparison



Conventional Machining

- Reduced Axial Depths Of Cut (ap) - Normally 1 x Tool Diameter
- Higher Radial Depths Of Cut (ae) - Normally 0.5 x Tool Diameter
- Lower Spindle Speed RPM (n)
- Lower Feed Rate (vf) (inch/min or mm/min)
- Slower Machining Time
- Low Metal Removal Rate (Q - in³/min or cm³/min)

High Speed Machining (HSM)

- Increased Axial Depths Of Cut (ap) - up to 2 x Tool Diameter
- Reduced Radial Depths Of Cut (ae) - 0.1/0.2 x Tool Diameter
- Higher Spindle Speed RPM (n)
- Higher Feed Rate (vf) (inch/min or mm/min)
- Faster Machining Time
- High Metal Removal Rate (Q - in³/min or cm³/min)

Contact Your Local M.A. Ford®
Representative For More Information On The Right
Milling Strategy For Your Application.

Milling Strategy Comparison continued

Conventional

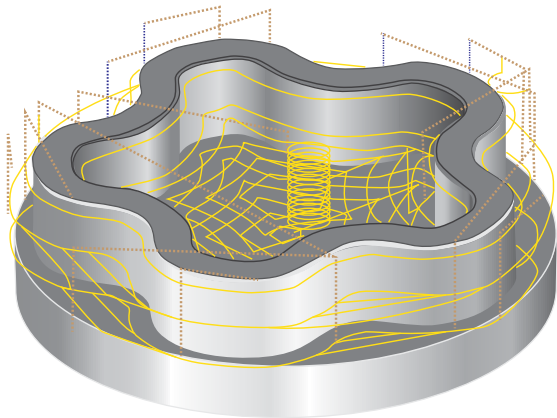

Tool Ø 12.0mm (.4724") 4 Flute

vc - 150m/min (5,905 in/min)

n - 3,975 RPM

fz - 0.06mm/z (.0024 in/z)

vf - 954mm/min (37.6 in/min)

ap - 2 x 12.0mm (.4724") 1xD

ae - 6.0mm (.2362") 0.5xD

Metal Removal Rate (MRR)

68.7 cm³/min (4.2 in³/min)

Machining Time

7 minutes 45 Seconds

High Speed

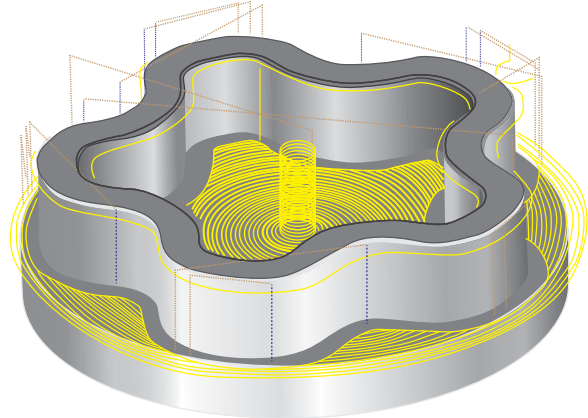

Tool Ø 12.0mm (.4724") 5 Flute

vc - 300m/min (11,811 in/min)

n - 8,000 RPM

fz - 0.15mm/z (.006 in/z)

vf - 6,000mm/min (240 in/min)

ap - 24.0mm (.945") 2xD

ae - 1.2mm (.047") 0.1xD

Metal Removal Rate (MRR)

172.8 cm³/min (10.5 in³/min)

Machining Time

3 minutes 35 Seconds

Contact Your Local M.A. Ford®
Representative For More Information On The Right
Milling Strategy For Your Application.

Technical data provided should be considered advisory only as variations may be necessary depending on the particular application.

For product information, call your local distributor.

Radial Chip Thinning

During profile or side milling with a solid carbide end mill at 50% (a_e) radial width of cut, the chip formed is at full programmed thickness. When your radial depth of cut decreases to something less than 50%, the chip formed is not as thick. This is known as "radial chip thinning". When less than 50% (a_e) radial depths are used, it becomes necessary to increase your feed to achieve full chip thickness. This means a higher programmed feed rate is needed to achieve the recommended chip thickness.

Programmers and Machinists have a tendency to lower feed rate due to previous experience. With the utilization of new programming methods, such as trochoidal and peel milling, manufacturers can increase productivity and tool life. These methods take advantage of much deeper (a_p) axial cuts with less (a_e) radial width of cut. With these methods, it's possible to run higher surface footages (SFM or m/min) along with these higher feed rates (IPM or mm/min) because less heat is generated at the cutting zone. Plus, you're utilizing chip thinning.

With the introduction of M.A. Ford®'s variable pitch tools, harmonics have virtually been eliminated, thus easing Programmers and Machinists fears of previous experiences. Advancements in our hard coatings enable our tools to withstand 900 degrees F, thus eliminating heat concerns. In addition, machine tools have advanced greatly to take advantage of these new methods. Use the following chart as a reference to increase feed rates by multiplying recommended feed rate by the increase feed factor, according to your (a_e) radial depth of cut as % of (D_c) cutter diameter.

(a_e) Radial Depth of Cut as to % of (D_c) Cutter Diameter	Increase Feed Factor
30%	1.10
25%	1.20
20%	1.20
15%	1.41
10%	1.80
7%	2.00
5%	2.30
3%	2.93
2%	3.60
1%	5.00

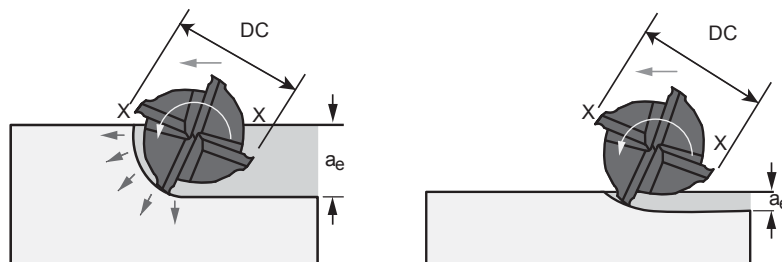

Technical data provided should be considered advisory only as variations may be necessary depending on the particular application.

Tool Engagement Angle

Sometimes referred to as "Arc of Engagement", this is the degrees of engagement the end mill will contact the part during cut depths in the radial direction. Ideally you would like to engage the end mill at a constant engagement angle of 30-40 degrees. At this degree of engagement the tool will perform best because of acceptable loading while not exceeding deflection limits.

As the tool travels around the geometrical shape of the part features, it will encounter areas where it could exceed the acceptable engagement angle. Software manufacturers have created methods to calculate algorithms to avoid these situations. One such case would be the entry into a pocket corner. At 50% radial depth of cut (ae), the cutter runs along the pocket side with a tool engagement angle of 90 degrees. As it enters the corner, it can quickly jump to 180 degrees as shown in the example below.

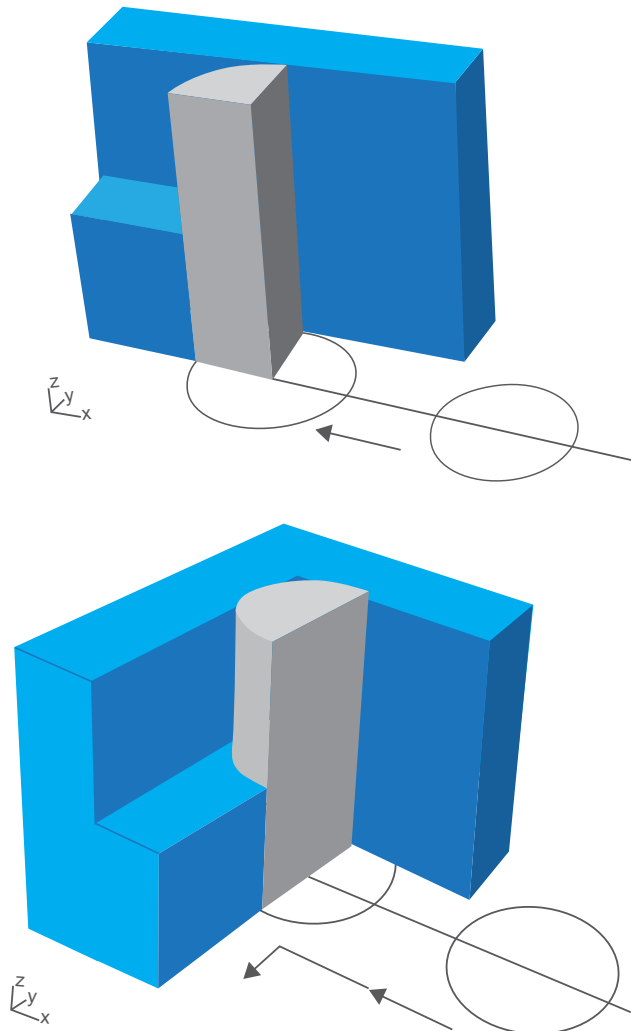

At this intersection, large engagement would cause tool chatter and even breakage. Using CAD CAM software to generate the corner avoids an abrupt stop and change of direction. It also keeps a constant arc of engagement while providing smooth chatter free cutting and long tool life.

Deflection

During the machining process, high cutting forces are directed on the end mill causing it to deflect. How much the end mill deflects depends on cutting parameters, tool diameter, tool stick out, and the elasticity coefficient (PSI) of the cutting tool material. The cutting tool strength will vary from different suppliers. At M.A. Ford®, we use only raw material of the highest quality and strength.

During roughing, deflection can be slightly higher than finishing. Deflection may be tolerable when roughing because at some point you will come back and finish cut your part. On larger carbide tools, deflection less than .001" (.025mm) is acceptable. However, on small micro end mills, deflection of less than .0005" (.0127mm) is acceptable.

Depending whether you are conventional milling or climb milling, deflection will be in different directions. With climb milling, deflection is in the direct opposite of the cut, but with conventional milling its direction is more parallel with the cut. This difference in direction will impart a different pattern finish on the wall of the workpiece. In climb milling, the tool engagement lines are more vertical and distinct. With conventional milling, your chip starts out thin and then gets thicker as your end mill continues through the cut; tool engagement lines are not as distinctly vertical.

M.A. Ford® has designed computer software to perform the many calculations required to determine tool deflection. All M.A. Ford® tools carry a Lot Number which can be traced back to that tool's DNA. With this information, we can plug the exact carbide TRS number into our software. How does this benefit you? We can increase cutting parameters to the point of maximum deflection, thus optimizing your operation parameters.

Please contact M.A. Ford®'s Tech Line (1-800-553-8024 or maftech@maford.com) with your tooling application questions.

ISO 9001:2015 Certified



Pocket Corners

Inside or pocket corners present a different challenge in two ways. First, if the corner radius is proportionally smaller than the related pocket size, it is necessary to use a much smaller diameter end mill to achieve the necessary radius. With a small diameter end mill there are restrictions from a cut depth standpoint; a small end mill will deflect when axial depth of cut (ap) exceeds the end mills limits and breakage can occur.

Secondly, to rough the pocket the programmer may use a much larger end mill to remove large amounts of stock. If you plow into the rough corner with the small end mill, your tool engagement angle can cause the small end mill to deflect and chip or break. To avoid these problems, you must use one of two methods: peck milling or rest milling. Software packages again ease this procedure by maintaining low tool engagement angle.

Peck milling is a series of axial plunge moves to remove much of the stock remaining in the corner. Plunging directs forces axially on the machine spindle, thus eliminating radial force and deflection. This is particularly beneficial for light duty machines.

Rest milling is a series of circular moves while traveling in the Z direction, very similar to helical milling. This removes the remaining stock much like trochoidal milling but with the addition of Z movements.

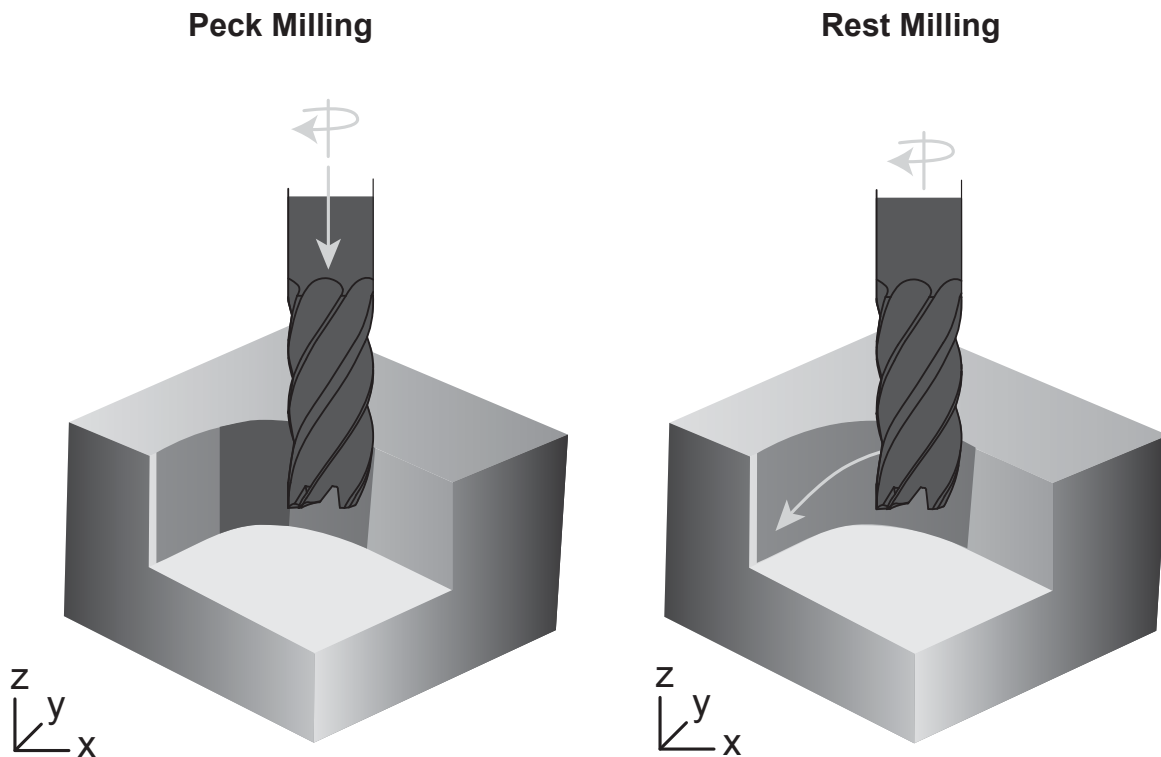

General Purpose End Mill Recommended Cutting Data - Profile Milling

Length	2 Flute Series		3 Flute Series	4 Flute Series			
Stub	164	166	169	163		165	
Standard	121	150	116	111	140	117	114
Long Length				122*			132*

*Chip thinning may not be possible with 122 and 132 series if radial width of cut exceeds 20%.

For ball nose end mills - If axial depth (ap) is less than the ball diameter, the speed is figured using the effective cutting diameter.

Inch

For diameters 1/4" and below, see Micro Charts starting on page 385.

Workpiece Material Group	ISO	Hardness	Profile Milling (ae)					End Mill Diameters										
			Coolant ● Preferred ○ Possible x Not Possible										5/16	3/8	1/2	5/8	3/4	1
								5%	10%	20%	30%	50%	ae > .3D use < 1D ap ae < .2D use < 2D ap					
								2.3	1.8	1.2	1.1	1	← Multiply fz by this Factor based on ae. When finishing, use the standard fz per chart below. Only add chip thinning when roughing or semi-finishing.					
			Max.	Air	MMS	vc - SFM Increase speeds by 30% for ALtima® coated tools					fz - in/tooth							
Free Machining & Low Carbon Steels 1006, 1008, 1015, 1018, 1020, 1022, 1025, 1117, 1140, 1141, 11L08, 11L14, 1213, 12L13, 12L14, 1215, 1330	P	up to 28 Rc	●	●	●	1050	700	385	375	350	.0027	.0032	.0045	.0054	.0063	.0090		
Medium Carbon & High Carbon Steels, Alloy Steels & Easy to Machine Tool Steels 1030, 1035, 1040, 1045, 1050, 1052, 1055, 1060, 1085, 1095, 1541, 1551, 9255, 2515, 3135, 3415, 4130, 4137, 4140, 4150, 4320, 4340, 4520, 5015, 5115, 5120, 5132, 5140, 5155, 6150, 8620, 9262, 9840, 52100, O1, O2, O6, S2, W1 to W310	P	28 to 38 Rc	●	●	●	630	420	320	250	210	.0027	.0032	.0045	.0054	.0063	.0090		
Tool Steels & Die Steels O7, M1, M2, M3, M4, M7, T1, T2, T4, T5, T8, T15, A2, A3, A6, A7, H10, H11, H12, H13, H19, H21, L3, L6, L7, P2, P20, S1, S5, S7, 52100, A 128, D2, D3, D4, D5, D7	P	28 to 44 Rc	●	●	●	525	350	300	275	250	.0027	.0032	.0045	.0054	.0063	.0090		
Hardened Steels	H	45-55 Rc	●	○	○	250	240	230	210	200	.0018	.0021	.0030	.0036	.0042	.0060		
Hardened Steels		55-65 Rc	●	○	○	200	180	160	150	100	.0013	.0014	.0021	.0024	.0029	.0041		
Stainless Steel - Easy to Machine 430F, 301, 303, 410, 416 Annealed, 420F, 430, 430F	M	up to 28 Rc	●	x	○	650	600	550	500	450	.0027	.0032	.0045	.0054	.0063	.0090		
Stainless Steel - Moderately Difficult 301, 302, 303 High Tensile, 304, 304L, 305, 420, 15-5PH, 17-4PH, 17-7PH	M	up to 28 Rc	●	x	○	525	400	350	300	250	.0027	.0032	.0045	.0054	.0063	.0090		
Stainless Steel - Difficult to Machine 302B, 304B, 309, 310, 316, 316B, 316L, 316Ti, 317, 317L, 321, PH13-8Mo, Nitronics	M	over 28 Rc	●	x	○	525	400	350	300	250	.0027	.0032	.0045	.0054	.0063	.0090		

Technical data provided should be considered advisory only as variations may be necessary depending on the particular application.

General Purpose End Mill Recommended Cutting Data - Profile Milling

Length	2 Flute Series		3 Flute Series	4 Flute Series			
Stub	164	166	169	163		165	
Standard	121	150	116	111	140	117	114
Long Length				122*			132*

*Chip thinning may not be possible with 122 and 132 series if radial width of cut exceeds 20%.

For ball nose end mills - If axial depth (ap) is less than the ball diameter, the speed is figured using the effective cutting diameter.

Inch Continued

For diameters 1/4" and below, see Micro Charts starting on page 385.

Workpiece Material Group	ISO	Hardness	Coolant			Profile Milling (ae)					End Mill Diameter					
			• Preferred ○ Possible x Not Possible								5/16	3/8	1/2	5/8	3/4	1
			Max.	Air	MMS	5%	10%	20%	30%	50%	ae > .3D use < 1D ap ae < .2D use < 2D ap					
						vc - SFM Increase speeds by 30% for ALtima® coated tools					← Multiply fz by this Factor based on ae. When finishing, use the standard fz per chart below. Only add chip thinning when roughing or semi-finishing.					
											fz - in/tooth					
High Temp Alloys Nimonic, Inconel, Monel, Hastelloy	S	up to 42 Rc	•	x	x	265	200	175	150	100	.0014	.0016	.0023	.0027	.0032	.0045
Titanium Alloys 6Al-4V, 5Al-2.5 Sn, 6Al-2 Sn-4Zr-6Mo, 3Al-8V-6Cr4Mo-4Zr, 10V-2Fe-3Al, 13V-11Cr-3Al	S	up to 42 Rc	•	x	x	230	200	175	150	125	.0014	.0016	.0023	.0027	.0032	.0045
Cast-Iron - Gray CG, ASTM A48, CLASS 20, 25, 30, 35, SAE J431C, GRADES G1800, G3000, G3500, GG 10, 15, 20, 25, 30, 35, 40	K	up to 240 HB	•	○	○	425	400	375	350	300	.0027	.0032	.0045	.0054	.0063	.0090
Cast Iron - Ductile & Malleable CGI 60-40-18, 65-45-12, D4018, D4512, D5506, 32510, 35108, M3210, M4504, M5503, 250, 300, 350, 400, 450	K	over 240 HB	•	○	○	320	300	250	225	200	.0027	.0032	.0045	.0054	.0063	.0090
Non-Ferrous, Plastics, Graphite	N		•			1000	960	920	880	840	.0027	.0032	.0045	.0054	.0063	.0090

General Purpose End Mill Recommended Cutting Data - Profile Milling

Length	2 Flute Series		3 Flute Series	4 Flute Series			
Stub	164	166	169	163		165	
Standard	121	150	116	111	140	117	114
Long Length				122*			132*

*Chip thinning may not be possible with 122 and 132 series if radial width of cut exceeds 20%.

For ball nose end mills - If axial depth (ap) is less than the ball diameter, the speed is figured using the effective cutting diameter.

Metric

For diameters 1/4" and below, see Micro Charts starting on page 385.

Workpiece Material Group	ISO	Hardness	Coolant			Profile Milling (ae)					End Mill Diameter (mm)					
			• Preferred o Possible x Not Possible								8	10	12	16	20	25
						5%	10%	20%	30%	50%	ae > .3D use < 1D ap ae < .2D use < 2D ap					
			Max.	Air	MMS	vc - m/min Increase speeds by 30% for ALtima® coated tools					← Multiply fz by this Factor based on ae. When finishing, use the standard fz per chart below. Only add chip thinning when roughing or semi-finishing.					
			fz - mm/tooth													
Free Machining & Low Carbon Steels 1006, 1008, 1015, 1018, 1020, 1022, 1025, 1117, 1140, 1141, 11L08, 11L14, 1213, 12L13, 12L14, 1215, 1330	P	up to 28 Rc	•	•	•	320	215	120	115	110	.0690	.0810	.1140	.1370	.1600	.2290
Medium Carbon & High Carbon Steels, Alloy Steels & Easy to Machine Tool Steels 1030, 1035, 1040, 1045, 1050, 1052, 1055, 1060, 1085, 1095, 1541, 1551, 9255, 2515, 3135, 3415, 4130, 4137, 4140, 4150, 4320, 4340, 4520, 5015, 5115, 5120, 5132, 5140, 5155, 6150, 8620, 9262, 9840, 52100, O1, O2, O6, S2, W1 to W310	P	28 to 38 Rc	•	•	•	200	130	100	75	65	.0690	.0810	.1140	.1370	.1600	.2290
Tool Steels & Die Steels O7, M1, M2, M3, M4, M7, T1, T2, T4, T5, T8, T15, A2, A3, A6, A7, H10, H11, H12, H13, H19, H21, L3, L6, L7, P2, P20, S1, S5, S7, 52100, A 128, D2, D3, D4, D5, D7	P	28 to 44 Rc	•	•	•	160	110	90	85	75	.0690	.0810	.1140	.1370	.1600	.2290
Hardened Steels	H	45-55 Rc	•	o	o	75	73	70	65	60	.0460	.0530	.0760	.0910	.1070	.1520
Hardened Steels		55-65 Rc	•	o	o	60	55	50	45	30	.0330	.0360	.0530	.0610	.0740	.1040
Stainless Steel - Easy to Machine 430F, 301, 303, 410, 416 Annealed, 420F, 430, 430F	M	up to 28 Rc	•	x	o	200	185	170	150	140	.0690	.0810	.1140	.1370	.1600	.2290
Stainless Steel - Moderately Difficult 301, 302, 303 High Tensile, 304, 304L, 305, 420, 15-5PH, 17-4PH, 17-7PH	M	up to 28 Rc	•	x	o	160	125	110	90	75	.0690	.0810	.1140	.1370	.1600	.2290
Stainless Steel - Difficult to Machine 302B, 304B, 309, 310, 316, 316B, 316L, 316Ti, 317, 317L, 321, PH13-8Mo, Nitronics	M	over 28 Rc	•	x	o	160	125	110	90	75	.0690	.0810	.1140	.1370	.1600	.2290

Technical data provided should be considered advisory only as variations may be necessary depending on the particular application.

General Purpose End Mill Recommended Cutting Data - Profile Milling

Length	2 Flute Series		3 Flute Series	4 Flute Series			
Stub	164	166	169	163		165	
Standard	121	150	116	111	140	117	114
Long Length				122*			132*

*Chip thinning may not be possible with 122 and 132 series if radial width of cut exceeds 20%.

For ball nose end mills - If axial depth (ap) is less than the ball diameter, the speed is figured using the effective cutting diameter.

Metric Continued

For diameters 6mm and below, see Micro Charts starting on page 385.

Workpiece Material Group	ISO	Hardness	Coolant					Profile Milling (ae)					End Mill Diameter (mm)					
			• Preferred o Possible x Not Possible								8	10	12	16	20	25		
			Max.	Air	MMS	5%	10%	20%	30%	50%	ae > .3D use < 1D ap ae < .2D use < 2D ap							
						2.3	1.8	1.2	1.1	1	← Multiply fz by this Factor based on ae. When finishing, use the standard fz per chart below. Only add chip thinning when roughing or semi-finishing.							
			vc - m/min Increase speeds by 30% for ALtima® coated tools					fz - mm/tooth										
High Temp Alloys Nimonic, Inconel, Monel, Hastelloy	S	up to 42 Rc	•	x	x	80	60	50	45	30	.0360	.0410	.0580	.0690	.0810	.1140		
Titanium Alloys 6Al-4V, 5Al-2.5 Sn, 6Al-2 Sn-4Zr-6Mo, 3Al-8V-6Cr4Mo-4Zr, 10V-2Fe-3Al, 13V-11Cr-3Al	S	up to 42 Rc	•	x	x	70	60	55	45	35	.0360	.0410	.0580	.0690	.0810	.1140		
Cast-Iron - Gray CG, ASTM A48, CLASS 20, 25, 30, 35, SAE J431C, GRADES G1800, G3000, G3500, GG 10, 15, 20, 25, 30, 35, 40	K	up to 240 HB	•	o	o	130	125	115	110	90	.0690	.0810	.1140	.1370	.1600	.2290		
Cast Iron - Ductile & Malleable CGI 60-40-18, 65-45-12, D4018, D4512, D5506, 32510, 35108, M3210, M4504, M5503, 250, 300, 350, 400, 450	K	over 240 HB	•	o	o	100	90	75	65	60	.0690	.0810	.1140	.1370	.1600	.2290		
Non-Ferrous, Plastic, Graphite	N		•			300	290	280	260	255	.0690	.0810	.1140	.1370	.1600	.2290		







General Purpose End Mill Recommended Cutting Data - Slotting

Length	2 Flute Series		3 Flute Series	4 Flute Series			
Stub	164	166	169	163	165		
Standard	121	150	116	111	140	117	114

For ball nose end mills - If axial depth (ap) is less than the ball diameter, the speed is figured using the effective cutting diameter.

Inch

For diameters 1/4" and below, see Micro Charts starting on page 385.

Workpiece Material Group	ISO	Hardness	Coolant			Slotting			End Mill Diameter					
			● Preferred ○ Possible x Not Possible						5/16	3/8	1/2	5/8	3/4	1
						25%	50%	100%	fz - in/tooth					
			Max.	Air	MMS	vc - SFM Increase speeds by 30% for ALtima® coated tools								
Free Machining & Low Carbon Steels 1006, 1008, 1015, 1018, 1020, 1022, 1025, 1117, 1140, 1141, 11L08, 11L14, 1213, 12L13, 12L14, 1215, 1330	P	up to 28 Rc	●	●	●	385	370	350	.0016	.0019	.0025	.0031	.0038	.0050
Medium Carbon & High Carbon Steels, Alloy Steels & Easy to Machine Tool Steels 1030, 1035, 1040, 1045, 1050, 1052, 1055, 1060, 1085, 1095, 1541, 1551, 9255, 2515, 3135, 3415, 4130, 4137, 4140, 4150, 4320, 4340, 4520, 5015, 5115, 5120, 5132, 5140, 5155, 6150, 8620, 9262, 9840, 52100, O1, O2, O6, S2, W1 to W310	P	28 to 38 Rc	●	●	●	245	230	210	.0016	.0019	.0025	.0031	.0038	.0050
Tool Steels & Die Steels O7, M1, M2, M3, M4, M7, T1, T2, T4, T5, T8, T15, A2, A3, A6, A7, H10, H11, H12, H13, H19, H21, L3, L6, L7, P2, P20, S1, S5, S7, 52100, A 128, D2, D3, D4, D5, D7	P	28 to 44 Rc	●	●	●	210	195	175	.0016	.0019	.0025	.0031	.0038	.0050
Hardened Steels	H	35-45 Rc	●	○	○	245	230	210	.0016	.0019	.0025	.0031	.0038	.0050
Hardened Steels		45-55 Rc	●	○	○	175	160	140	.0008	.0010	.0013	.0016	.0020	.0025
Hardened Steels		55-65 Rc	●	○	○	150	125	100	.0004	.0005	.0008	.0008	.0010	.0012
Stainless Steel - Easy to Machine 430F, 301, 303, 410, 416 Annealed, 420F, 430, 430F	M	up to 28 Rc	●	x	○	385	370	350	.0016	.0019	.0025	.0031	.0038	.0050
Stainless Steel - Moderately Difficult 301, 302, 303 High Tensile, 304, 304L, 305, 420, 15-5PH, 17-4PH, 17-7PH	M	up to 28 Rc	●	x	○	245	210	175	.0016	.0019	.0025	.0031	.0038	.0050
Stainless Steel - Difficult to Machine 302B, 304B, 309, 310, 316, 316B, 316L, 316Ti, 317, 317L, 321, PH13-8Mo, Nitronics	M	over 28 Rc	●	x	○	210	195	175	.0016	.0019	.0025	.0031	.0038	.0050

Technical data provided should be considered advisory only as variations may be necessary depending on the particular application.





General Purpose End Mill Recommended Cutting Data - Slotting

Length	2 Flute Series		3 Flute Series	4 Flute Series			
	Stub	164	166	169	163	165	
Standard	121	150	116	111	140	117	114

For ball nose end mills - If axial depth (ap) is less than the ball diameter, the speed is figured using the effective cutting diameter.

Inch Continued

For diameters 1/4" and below, see Micro Charts starting on page 385.

Workpiece Material Group	ISO	Hardness	Coolant			Slotting			End Mill Diameter					
			● Preferred ○ Possible x Not Possible						5/16	3/8	1/2	5/8	3/4	1
						25%	50%	100%						
			Max.	Air	MMS	vc - SFM Increase speeds by 30% for ALtima® coated tools			fz - in/tooth					
High Temp Alloys Nimonic, Inconel, Monel, Hastelloy	S	up to 42 Rc	●	x	x	125	105	90	.0008	.0010	.0013	.0016	.0017	.0026
Titanium Alloys 6Al-4V, 5Al-2.5 Sn, 6Al-2 Sn-4Zr-6Mo, 3Al-8V-6Cr4Mo-4Zr, 10V-2Fe-3Al, 13V-11Cr-3Al	S	up to 42 Rc	●	x	x	100	90	80	.0008	.0010	.0013	.0016	.0017	.0026
Cast-Iron - Gray CG, ASTM A48, CLASS 20, 25, 30, 35, SAE J431C, GRADES G1800, G3000, G3500, GG 10, 15, 20, 25, 30, 35, 40	K	up to 240 HB	●	○	○	450	400	350	.0016	.0019	.0025	.0031	.0038	.0050
Cast Iron - Ductile & Malleable CGI 60-40-18, 65-45-12, D4018, D4512, D5506, 32510, 35108, M3210, M4504, M5503, 250, 300, 350, 400, 450	K	over 240 HB	●	○	○	300	250	225	.0016	.0019	.0025	.0031	.0038	.0050
Non-Ferrous, Plastic, Graphite	N		●			750	600	450	.0016	.0019	.0025	.0031	.0038	.0050







General Purpose End Mill Recommended Cutting Data - Slotting

Length	2 Flute Series		3 Flute Series	4 Flute Series			
Stub	164	166	169	163		165	
Standard	121	150	116	111	140	117	114

For ball nose end mills - If axial depth (ap) is less than the ball diameter, the speed is figured using the effective cutting diameter.

Metric

For diameters 6 mm and below, see Micro Charts starting on page 385.

Workpiece Material Group	I S O	Hardness	Coolant			Slotting			End Mill Diameter (mm)					
			● Preferred ○ Possible x Not Possible						8	10	12	16	20	25
						25%	50%	100%	fz - mm/tooth					
			Max.	Air	MMS	vc - m/min Increase speeds by 30% for ALtima® coated tools								
Free Machining & Low Carbon Steels 1006, 1008, 1015, 1018, 1020, 1022, 1025, 1117, 1140, 1141, 11L08, 11L14, 1213, 12L13, 12L14, 1215, 1330	P	up to 28 Rc	●	●	●	120	110	107	.0400	.0500	.0600	.0800	.1000	.1250
Medium Carbon & High Carbon Steels, Alloy Steels & Easy to Machine Tool Steels 1030, 1035, 1040, 1045, 1050, 1052, 1055, 1060, 1085, 1095, 1541, 1551, 9255, 2515, 3135, 3415, 4130, 4137, 4140, 4150, 4320, 4340, 4520, 5015, 5115, 5120, 5132, 5140, 5155, 6150, 8620, 9262, 9840, 52100, O1, O2, O6, S2, W1 to W310	P	28 to 38 Rc	●	●	●	75	70	65	.0400	.0500	.0600	.0800	.1000	.1250
Tool Steels & Die Steels O7, M1, M2, M3, M4, M7, T1, T2, T4, T5, T8, T15, A2, A3, A6, A7, H10, H11, H12, H13, H19, H21, L3, L6, L7, P2, P20, S1, S5, S7, 52100, A 128, D2, D3, D4, D5, D7	P	28 to 44 Rc	●	●	●	65	60	55	.0400	.0500	.0600	.0800	.1000	.1250
Hardened Steels	H	35-45 Rc	●	○	○	55	50	45	.0400	.0500	.0600	.0800	.1000	.1250
Hardened Steels		45-55 Rc	●	○	○	55	50	45	.0200	.0250	.0300	.0400	.0500	.0620
Hardened Steels		55-65 Rc	●	○	○	50	45	40	.0100	.0120	.0150	.0200	.0250	.0300
Stainless Steel - Easy to Machine 430F, 301, 303, 410, 416 Annealed, 420F, 430, 430F	M	up to 28 Rc	●	x	○	120	115	110	.0400	.0500	.0600	.0800	.1000	.1250
Stainless Steel - Moderately Difficult 301, 302, 303 High Tensile, 304, 304L, 305, 420, 15-5PH, 17-4PH, 17-7PH	M	up to 28 Rc	●	x	○	75	65	55	.0400	.0500	.0600	.0800	.1000	.1250
Stainless Steel - Difficult to Machine 302B, 304B, 309, 310, 316, 316B, 316L, 316Ti, 317, 317L, 321, PH13-8Mo, Nitronics	M	over 28 Rc	●	x	○	65	60	55	.0400	.0500	.0600	.0800	.1000	.1250

Technical data provided should be considered advisory only as variations may be necessary depending on the particular application.







General Purpose End Mill Recommended Cutting Data - Slotting

Length	2 Flute Series		3 Flute Series	4 Flute Series			
Stub	164	166	169	163	165		
Standard	121	150	116	111	140	117	114

For ball nose end mills - If axial depth (ap) is less than the ball diameter, the speed is figured using the effective cutting diameter.

Metric Continued

For diameters 6 mm and below, see Micro Charts starting on page 385.

Workpiece Material Group	ISO	Hardness	Coolant			Slotting			End Mill Diameter (mm)					
			• Preferred o Possible x Not Possible						8	10	12	16	20	25
						25%	50%	100%	fz - mm/tooth					
			Max.	Air	MMS	vc - m/min Increase speeds by 30% for ALtima® coated tools								
High Temp Alloys Nimonic, Inconel, Monel, Hastelloy	S	up to 42 Rc	•	x	x	40	35	30	.0100	.0120	.0150	.0200	.0250	.0300
Titanium Alloys 6Al-4V, 5Al-2.5 Sn, 6Al-2 Sn-4Zr-6Mo, 3Al-8V-6Cr4Mo-4Zr, 10V-2Fe-3Al, 13V-11Cr-3Al	S	up to 42 Rc	•	x	x	30	25	25	.0100	.0120	.0150	.0200	.0250	.0300
Cast Iron - Gray CG, ASTM A48, CLASS 20, 25, 30, 35, SAE J431C, GRADES G1800, G3000, G3500, GG 10, 15, 20, 25, 30, 35, 40	K	up to 240 HB	•	o	o	135	125	110	.0400	.0500	.0600	.0800	.1000	.1250
Cast Iron - Ductile & Malleable CGI 60-40-18, 65-45-12, D4018, D4512, D5506, 32510, 35108, M3210, M4504, M5503, 250, 300, 350, 400, 450	K	over 240 HB	•	o	o	90	75	70	.0400	.0500	.0600	.0800	.1000	.1250
Non-Ferrous, Plastic, Graphite	N		•			230	180	140	.0400	.0500	.0600	.0800	.1000	.1250

End Mill Terminology

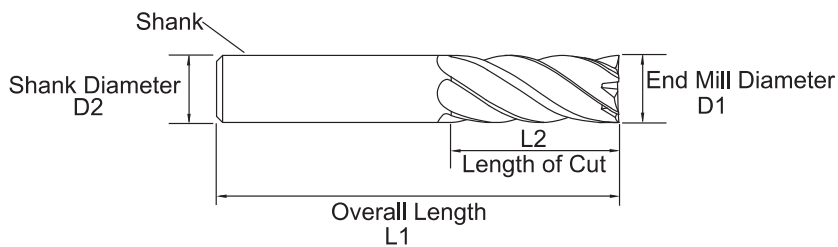

Length of Cut (Flute Length) – Always select the shortest Flute Length possible for your application. By selecting the shortest Flute Length, you can increase rigidity and allow for higher feed rates.

End Mill Diameter – Always select the largest diameter possible for your milling operation. Increasing your diameter by just 10%, can increase your rigidity by 25%.

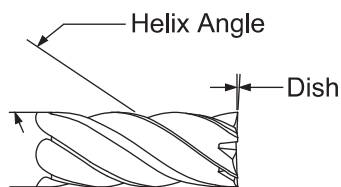

Helix Angle – Varies from 0 to 60 degrees. Higher helix angles can increase the number of teeth in a cut, and help in redirecting cutting forces. This is beneficial in harder to machine materials in particular. Changes in helix angle can also greatly affect the flute form of an end mill, and affect chip evacuation.

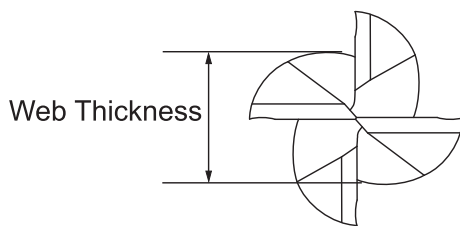

Web Thickness – The cross section of the fluting of the end mill. Larger webs allow for more rigidity, while smaller webs allow for better chip evacuation. This feature is highly dependent on the material being machined.

Rake Angle – The measurement of the curvature of the cutting edge in the face of the flute. A high rake angle will cut more aggressively, while a lower rake angle will increase the strength of the cutting edge.

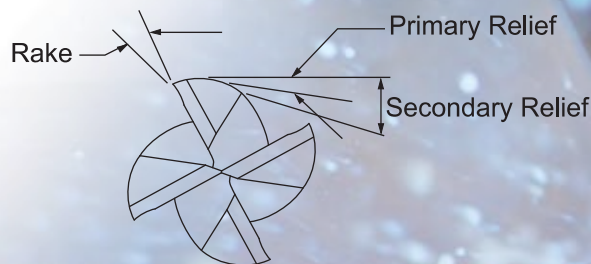

Primary Relief – The clearance directly behind the cutting edge. High primary relief angles will allow for more aggressive milling, while lower relief angles will increase the strength of the cutting edge. The primary relief will also affect the wear on a cutting edge. Lower primary relief angles can tend to develop larger wear lands.





Micro End Mill Recommended Cutting Data - Profile Milling

Length	2 Flute Series		3 Flute Series	4 Flute Series			
Standard	121	150	116	111	140	117	114
Long Length				122			132

Inch - Standard / Long Length

Ball Nose End Mills - If axial depth (ap) is less than the ball diameter, the speed is figured using the effective cutting diameter.

For diameters > 1/4", see Charts Starting on page 376.

Workpiece Material Group	ISO	Hardness	Coolant			Profile Milling 	End Mill Diameter (Inch)								
			• Preferred	o Possible	x Not Possible		.0150	.0310	.0470	.0620	.0780	.0930	.1250	.1870	.2500
							13% Dia. ae				25% Dia. ae				
			Max.	Air	MMS		<2 Dia. ap				<2 Dia. ap				
						vc - SFM Increase speed by 30% for ALtima® coated tools.									
						fz - in/tooth									
Free Machining & Low Carbon Steels 1006, 1008, 1015, 1018, 1020, 1022, 1025, 1117, 1140, 1141, 11L08, 11L14, 1213, 12L13, 12L14, 1215, 1330	P	up to 28 Rc	•	•	•	400	0.00007	0.00015	0.00023	0.00027	0.00034	0.00040	0.00054	0.00081	0.00100
Medium Carbon & High Carbon Steels, Alloy Steels & Easy to Machine Tool Steels 1030, 1035, 1040, 1045, 1050, 1052, 1055, 1060, 1085, 1095, 1541, 1551, 9255, 2515, 3135, 3415, 4130, 4137, 4140, 4150, 4320, 4340, 4520, 5015, 5115, 5120, 5132, 5140, 5155, 6150, 8620, 9262, 9840, 52100, O1, O2, O6, S2, W1 to W310	P	28 to 38 Rc	•	•	•	300	0.00007	0.00015	0.00023	0.00027	0.00034	0.00040	0.00054	0.00081	0.00100
Tool Steels & Die Steels O7, M1, M2, M3, M4, M7, T1, T2, T4, T5, T8, T15, A2, A3, A6, A7, H10, H11, H12, H13, H19, H21, L3, L6, L7, P2, P20, S1, S5, S7, 52100, A 128, D2, D3, D4, D5, D7	P	28 to 44 Rc	•	•	•	200	0.00007	0.00015	0.00023	0.00027	0.00034	0.00040	0.00054	0.00081	0.00100
Hardened Steels	H	45-55 Rc	•	o	o	100	0.00010	0.00030	0.00050	0.00140	0.00180	0.00210	0.00300	0.00360	0.00420
Stainless Steel - Easy to Machine 430F, 301, 303, 410, 416 Annealed, 420F, 430, 430F	M	up to 28 Rc	•	x	o	400	0.00007	0.00015	0.00023	0.00027	0.00034	0.00040	0.00054	0.00081	0.00100
Stainless Steel - Moderately Difficult 301, 302, 303 High Tensile, 304, 304L, 305, 420, 15-5PH, 17-4PH, 17-7PH	M	up to 28 Rc	•	x	o	200	0.00007	0.00015	0.00023	0.00027	0.00034	0.00040	0.00054	0.00081	0.00100
Stainless Steel - Difficult to Machine 302B, 304B, 309, 310, 316, 316B, 316L, 316Ti, 317, 317L, 321, PH13-8Mo, Nitronics	M	over 28 Rc	•	x	o	150	0.00007	0.00015	0.00023	0.00027	0.00034	0.00040	0.00054	0.00081	0.00100
Cast Iron	K	160-200 HB	•	o	o	400	0.00007	0.00015	0.00023	0.00027	0.00034	0.00040	0.00054	0.00081	0.00100
Malleable / Ductile Cast Iron	K	200-250 HB	•	o	o	250	0.00007	0.00015	0.00023	0.00027	0.00034	0.00040	0.00054	0.00081	0.00100
High Temp Alloys Nimonics, Inconel, Monel, Hastelloy	S	up to 42 Rc	•	x	x	70	0.00004	0.00008	0.00015	0.00023	0.00027	0.00034	0.00040	0.00054	0.00080
Titanium Alloys 6Al-4V, 5Al-2.5 Sn, 6Al-2 Sn-4Zr-6Mo, 3Al-8V-6Cr4Mo-4Zr, 10V-2Fe-3Al, 13V-11Cr-3Al	S	up to 42 Rc	•	x	x	150	0.00004	0.00008	0.00015	0.00023	0.00027	0.00034	0.00040	0.00054	0.00080
Aluminum < 10 % Si	N		•			750	0.00007	0.00015	0.00023	0.00027	0.00034	0.00040	0.00054	0.00081	0.00100
Aluminum > 10 % Si	N		•				0.00007	0.00015	0.00023	0.00027	0.00034	0.00040	0.00054	0.00081	0.00100

Technical data provided should be considered advisory only as variations may be necessary depending on the particular application.

For product information, call your local distributor.





Micro End Mill Recommended Cutting Data - Profile Milling

Length	2 Flute Series		3 Flute Series	4 Flute Series			
Standard	121	150	116	111	140	117	114
Long Length				122			132

Metric - Standard / Long Length

Ball Nose End Mills - If axial depth (ap) is less than the ball diameter, the speed is figured using the effective cutting diameter.

For diameters > 6mm, see Charts Starting on page 376.

Workpiece Material Group	ISO	Hardness	Coolant			Profile Milling 	End Mill Diameter (mm)								
			• Preferred	o Possible	x Not Possible		.4	.8	1.2	1.6	2.0	2.5	3.0	5.0	6.0
							13% Dia. ae				25% Dia. ae				
			Max.	Air	MMS		<2 Dia. ap				<2 Dia. ap				
vc - m/min Increase speed by 30% for ALtima® coated tools.						fz - mm/tooth									
Free Machining & Low Carbon Steels 1006, 1008, 1015, 1018, 1020, 1022, 1025, 1117, 1140, 1141, 11L08, 11L14, 1213, 12L13, 12L14, 1215, 1330	P	up to 28 Rc	•	•	•	122	0.00170	0.00380	0.00580	0.00680	0.00860	0.01010	0.01370	0.02050	0.02540
Medium Carbon & High Carbon Steels, Alloy Steels & Easy to Machine Tool Steels 1030, 1035, 1040, 1045, 1050, 1052, 1055, 1060, 1085, 1095, 1541, 1551, 9255, 2515, 3135, 3415, 4130, 4137, 4140, 4150, 4320, 4340, 4520, 5015, 5115, 5120, 5132, 5140, 5155, 6150, 8620, 9262, 9840, 52100, O1, O2, O6, S2, W1 to W310	P	28 to 38 Rc	•	•	•	92	0.00170	0.00380	0.00580	0.00680	0.00860	0.01010	0.01370	0.02050	0.02540
Tool Steels & Die Steels O7, M1, M2, M3, M4, M7, T1, T2, T4, T5, T8, T15, A2, A3, A6, A7, H10, H11, H12, H13, H19, H21, L3, L6, L7, P2, P20, S1, S5, S7, 52100, A 128, D2, D3, D4, D5, D7	P	28 to 44 Rc	•	•	•	60	0.00170	0.00380	0.00580	0.00680	0.00860	0.01010	0.01370	0.02050	0.02540
Hardened Steels	H	45-55 Rc	•	o	o	30	0.00250	0.00760	0.01270	0.03500	0.04500	0.05300	0.07600	0.09100	0.10600
Stainless Steel - Easy to Machine 430F, 301, 303, 410, 416 Annealed, 420F, 430, 430F	M	up to 28 Rc	•	x	o	122	0.00170	0.00360	0.00580	0.00680	0.00860	0.01010	0.01370	0.02050	0.02540
Stainless Steel - Moderately Difficult 301, 302, 303 High Tensile, 304, 304L, 305, 420, 15-5PH, 17-4PH, 17-7PH	M	up to 28 Rc	•	x	o	61	0.00170	0.00360	0.00580	0.00680	0.00860	0.01010	0.01370	0.02050	0.02540
Stainless Steel - Difficult to Machine 302B, 304B, 309, 310, 316, 316B, 316L, 316Ti, 317, 317L, 321, PH13-8Mo, Nitronics	M	over 28 Rc	•	x	o	45	0.00170	0.00360	0.00580	0.00680	0.00860	0.01010	0.01370	0.02050	0.02540
Cast Iron	K	160-200 HB	•	o	o	120	0.00170	0.00360	0.00580	0.00680	0.00860	0.01010	0.01370	0.02050	0.02540
Malleable / Ductile Cast Iron	K	200-250 HB	•	o	o	76	0.00170	0.00360	0.00580	0.00680	0.00860	0.01010	0.01370	0.02050	0.02540
High Temp Alloys Nimonic, Inconel, Monel, Hastelloy	S	up to 42 Rc	•	x	x	22	0.00100	0.00200	0.00380	0.00580	0.00680	0.00860	0.01010	0.01370	0.02000
Titanium Alloys 6Al-4V, 5Al-2.5 Sn, 6Al-2 Sn-4Zr-6Mo, 3Al-8V-6Cr-4Mo-4Zr, 10V-2Fe-3Al, 13V-11Cr-3Al	S	up to 42 Rc	•	x	x	45	0.00100	0.00200	0.00380	0.00580	0.00680	0.00860	0.01010	0.01370	0.02000
Aluminum < 10 % Si	N		•			228	0.00170	0.00360	0.00580	0.00680	0.00860	0.01010	0.01370	0.02050	0.02540
Aluminum > 10 % Si	N		•												

Technical data provided should be considered advisory only as variations may be necessary depending on the particular application.





Micro End Mill Recommended Cutting Data - Profile Milling

Length	2 Flute Series		3 Flute Series	4 Flute Series	
Stub	164	166	169	163	165

Inch - Stub Length

Ball Nose End Mills - If axial depth (ap) is less than the ball diameter, the speed is figured using the effective cutting diameter.

For diameters > 1/4", see Charts Starting on page 376.

Workpiece Material Group	ISO	Hardness	Coolant			Profile Milling 	End Mill Diameter (Inch)									
			● Preferred ○ Possible x Not Possible				vc - SFM Increase speed by 30% for ALtima® coated tools.	.0150	.0310	.0470	.0620	.0780	.0930	.1250	.1870	.2500
								13% Dia. ae			25% Dia. ae					
			Max.	Air	MMS			<1 Dia. ap			<1 Dia. ap					
fz - in/tooth																
Free Machining & Low Carbon Steels 1006, 1008, 1015, 1018, 1020, 1022, 1025, 1117, 1140, 1141, 11L08, 11L14, 1213, 12L13, 12L14, 1215, 1330	P	up to 28 Rc	●	●	●	400	0.00007	0.00015	0.00023	0.00027	0.00034	0.00040	0.00054	0.00081	0.00100	
Medium Carbon & High Carbon Steels, Alloy Steels & Easy to Machine Tool Steels 1030, 1035, 1040, 1045, 1050, 1052, 1055, 1060, 1085, 1095, 1541, 1551, 9255, 2515, 3135, 3415, 4130, 4137, 4140, 4150, 4320, 4340, 4520, 5015, 5115, 5120, 5132, 5140, 5155, 6150, 8620, 9262, 9840, 52100, O1, O2, O6, S2, W1 to W310	P	28 to 38 Rc	●	●	●	300	0.00007	0.00015	0.00023	0.00027	0.00034	0.00040	0.00054	0.00081	0.00100	
Tool Steels & Die Steels O7, M1, M2, M3, M4, M7, T1, T2, T4, T5, T8, T15, A2, A3, A6, A7, H10, H11, H12, H13, H19, H21, L3, L6, L7, P2, P20, S1, S5, S7, 52100, A 128, D2, D3, D4, D5, D7	P	28 to 44 Rc	●	●	●	200	0.00007	0.00015	0.00023	0.00027	0.00034	0.00040	0.00054	0.00081	0.00100	
Hardened Steels	H	45-55 Rc	●	○	○	100	0.00010	0.00030	0.00050	0.00140	0.00180	0.00210	0.00300	0.00360	0.00420	
Stainless Steel - Easy to Machine 430F, 301, 303, 410, 416 Annealed, 420F, 430, 430F	M	up to 28 Rc	●	x	○	400	0.00007	0.00015	0.00023	0.00027	0.00034	0.00040	0.00054	0.00081	0.00100	
Stainless Steel - Moderately Difficult 301, 302, 303 High Tensile, 304, 304L, 305, 420, 15-5PH, 17-4PH, 17-7PH	M	up to 28 Rc	●	x	○	200	0.00007	0.00015	0.00023	0.00027	0.00034	0.00040	0.00054	0.00081	0.00100	
Stainless Steel - Difficult to Machine 302B, 304B, 309, 310, 316, 316B, 316L, 316Ti, 317, 317L, 321, PH13-8Mo, Nitronics	M	over 28 Rc	●	x	○	150	0.00007	0.00015	0.00023	0.00027	0.00034	0.00040	0.00054	0.00081	0.00100	
Cast Iron	K	160-200 HB	●	○	○	400	0.00007	0.00015	0.00023	0.00027	0.00034	0.00040	0.00054	0.00081	0.00100	
Malleable / Ductile Cast Iron	K	200-250 HB	●	○	○	250	0.00007	0.00015	0.00023	0.00027	0.00034	0.00040	0.00054	0.00081	0.00100	
High Temp Alloys Nimonic, Inconel, Monel, Hastelloy	S	up to 42 Rc	●	x	x	70	0.00004	0.00008	0.00015	0.00023	0.00027	0.00034	0.00040	0.00054	0.00080	
Titanium Alloys 6Al-4V, 5Al-2.5 Sn, 6Al-2 Sn-4Zr-6Mo, 3Al-8V-6Cr4Mo-4Zr, 10V-2Fe-3Al, 13V-11Cr-3Al	S	up to 42 Rc	●	x	x	150	0.00004	0.00008	0.00015	0.00023	0.00027	0.00034	0.00040	0.00054	0.00080	
Aluminum < 10 % Si	N		●			750	0.00007	0.00015	0.00023	0.00027	0.00034	0.00040	0.00054	0.00081	0.00100	
Aluminum > 10 % Si	N		●			750	0.00007	0.00015	0.00023	0.00027	0.00034	0.00040	0.00054	0.00081	0.00100	

Technical data provided should be considered advisory only as variations may be necessary depending on the particular application.

For product information, call your local distributor.

Micro End Mill Recommended Cutting Data - Profile Milling

Length	2 Flute Series		3 Flute Series	4 Flute Series	
Stub	164	166	169	163	165

Metric - Stub Length

Ball Nose End Mills - If axial depth (ap) is less than the ball diameter, the speed is figured using the effective cutting diameter.

For diameters > 6mm, see Charts Starting on page 376.

Workpiece Material Group	ISO	Hardness	Coolant			Profile Milling 	End Mill Diameter (mm)									
			● Preferred ○ Possible x Not Possible				vc - m/min Increase speed by 30% for ALtima® coated tools.	.4	.8	1.2	1.6	2.0	2.5	3.0	5.0	6.0
			Max.	Air	MMS			13% Dia. ae				25% Dia. ae				
								<1 Dia. ap				<1 Dia. ap				
						fz - mm/tooth										
Free Machining & Low Carbon Steels 1006, 1008, 1015, 1018, 1020, 1022, 1025, 1117, 1140, 1141, 11L08, 11L14, 1213, 12L13, 12L14, 1215, 1330	P	up to 28 Rc	●	●	●	122	0.00170	0.00380	0.00580	0.00680	0.00860	0.01010	0.01370	0.02050	0.02540	
Medium Carbon & High Carbon Steels, Alloy Steels & Easy to Machine Tool Steels 1030, 1035, 1040, 1045, 1050, 1052, 1055, 1060, 1085, 1095, 1541, 1551, 9255, 2515, 3135, 3415, 4130, 4137, 4140, 4150, 4320, 4340, 4520, 5015, 5115, 5120, 5132, 5140, 5155, 6150, 8620, 9262, 9840, 52100, O1, O2, O6, S2, W1 to W310	P	28 to 38 Rc	●	●	●	92	0.00170	0.00380	0.00580	0.00680	0.00860	0.01010	0.01370	0.02050	0.02540	
Tool Steels & Die Steels O7, M1, M2, M3, M4, M7, T1, T2, T4, T5, T8, T15, A2, A3, A6, A7, H10, H11, H12, H13, H19, H21, L3, L6, L7, P2, P20, S1, S5, S7, 52100, A 128, D2, D3, D4, D5, D7	P	28 to 44 Rc	●	●	●	60	0.00170	0.00380	0.00580	0.00680	0.00860	0.01010	0.01370	0.02050	0.02540	
Hardened Steels	H	45-55 Rc	●	○	○	30	0.00250	0.00760	0.01270	0.03500	0.04500	0.05300	0.07600	0.09100	0.10600	
Stainless Steel - Easy to Machine 430F, 301, 303, 410, 416 Annealed, 420F, 430, 430F	M	up to 28 Rc	●	x	○	122	0.00170	0.00360	0.00580	0.00680	0.00860	0.01010	0.01370	0.02050	0.02540	
Stainless Steel - Moderately Difficult 301, 302, 303 High Tensile, 304, 304L, 305, 420, 15-5PH, 17-4PH, 17-7PH	M	up to 28 Rc	●	x	○	61	0.00170	0.00360	0.00580	0.00680	0.00860	0.01010	0.01370	0.02050	0.02540	
Stainless Steel - Difficult to Machine 302B, 304B, 309, 310, 316, 316B, 316L, 316Ti, 317, 317L, 321, PH13-8Mo, Nitronics	M	over 28 Rc	●	x	○	45	0.00170	0.00360	0.00580	0.00680	0.00860	0.01010	0.01370	0.02050	0.02540	
Cast Iron	K	160-200 HB	●	○	○	120	0.00170	0.00360	0.00580	0.00680	0.00860	0.01010	0.01370	0.02050	0.02540	
Malleable / Ductile Cast Iron	K	200-250 HB	●	○	○	76	0.00170	0.00360	0.00580	0.00680	0.00860	0.01010	0.01370	0.02050	0.02540	
High Temp Alloys Nimonic, Inconel, Monel, Hastelloy	S	up to 42 Rc	●	x	x	22	0.00100	0.00200	0.00380	0.00580	0.00680	0.00860	0.01010	0.01370	0.02000	
Titanium Alloys 6Al-4V, 5Al-2.5 Sn, 6Al-2 Sn-4Zr-6Mo, 3Al-8V-6Cr4Mo-4Zr, 10V-2Fe-3Al, 13V-11Cr-3Al	S	up to 42 Rc	●	x	x	45	0.00100	0.00200	0.00380	0.00580	0.00680	0.00860	0.01010	0.01370	0.02000	
Aluminum < 10 % Si	N		●			228	0.00170	0.00360	0.00580	0.00680	0.00860	0.01010	0.01370	0.02050	0.02540	
Aluminum > 10 % Si	N		●			228	0.00170	0.00360	0.00580	0.00680	0.00860	0.01010	0.01370	0.02050	0.02540	

Technical data provided should be considered advisory only as variations may be necessary depending on the particular application.





Micro End Mill Recommended Cutting Data - Slotting

Length	2 Flute Series		3 Flute Series
Standard	121	150	116

Inch - Standard 2-3 Flute

Ball Nose End Mills - If axial depth (ap) is less than the ball diameter, the speed is figured using the effective cutting diameter.

For diameters > 1/4", see Charts Starting on page 376.

Workpiece Material Group	ISO	Hardness	Coolant			Slotting	End Mill Diameter (Inch)								
			● Preferred	○ Possible	x Not Possible		.0150	.0310	.0470	.0620	.0780	.0930	.1250	.1870	.2500
							14%-Dia. ap			35%-Dia. ap					
			Max.	Air	MMS	vc - SFM Increase speed by 30% for ALtima® coated tools.	fz - in/tooth								
Free Machining & Low Carbon Steels 1006, 1008, 1015, 1018, 1020, 1022, 1025, 1117, 1140, 1141, 11L08, 11L14, 1213, 12L13, 12L14, 1215, 1330	P	up to 28 Rc	●	●	●	400	.0001	.0001	.0002	.0002	.0003	.0004	.0005	.0007	.0010
Medium Carbon & High Carbon Steels, Alloy Steels & Easy to Machine Tool Steels 1030, 1035, 1040, 1045, 1050, 1052, 1055, 1060, 1085, 1095, 1541, 1551, 9255, 2515, 3135, 3415, 4130, 4137, 4140, 4150, 4320, 4340, 4520, 5015, 5115, 5120, 5132, 5140, 5155, 6150, 8620, 9262, 9840, 52100, O1, O2, O6, S2, W1 to W310	P	28 to 38 Rc	●	●	●	300	.0001	.0001	.0002	.0002	.0003	.0003	.0004	.0007	.0009
Tool Steels & Die Steels O7, M1, M2, M3, M4, M7, T1, T2, T4, T5, T8, T15, A2, A3, A6, A7, H10, H11, H12, H13, H19, H21, L3, L6, L7, P2, P20, S1, S5, S7, 52100, A 128, D2, D3, D4, D5, D7	P	28 to 44 Rc	●	●	●	200	.0001	.0001	.0002	.0002	.0002	.0003	.0004	.0006	.0008
Hardened Steels	H	35-45 Rc	●	○	○	100	.0001	.0001	.0001	.0001	.0001	.0002	.0002	.0003	.0004
Stainless Steel - Easy to Machine 430F, 301, 303, 410, 416 Annealed, 420F, 430, 430F	M	up to 28 Rc	●	x	○	400	.0001	.0001	.0002	.0002	.0003	.0004	.0005	.0007	.0010
Stainless Steel - Moderately Difficult 301, 302, 303 High Tensile, 304, 304L, 305, 420, 15-5PH, 17-4PH, 17-7PH	M	up to 28 Rc	●	x	○	200	.0001	.0001	.0002	.0002	.0003	.0003	.0004	.0007	.0009
Stainless Steel - Difficult to Machine 302B, 304B, 309, 310, 316, 316B, 316L, 316Ti, 317, 317L, 321, PH13-8Mo, Nitronics	M	over 28 Rc	●	x	○	150	.0001	.0001	.0001	.0001	.0002	.0002	.0003	.0004	.0005
Cast Iron	K	160-200 HB	●	○	○	400	.0001	.0001	.0002	.0002	.0003	.0004	.0005	.0007	.0010
Malleable / Ductile Cast Iron	K	200-250 HB	●	○	○	250	.0001	.0001	.0002	.0002	.0003	.0003	.0004	.0007	.0009
High Temp Alloys Nimonic, Inconel, Monel, Hastelloy	S	up to 42 Rc	●	x	x	70	.0001	.0001	.0001	.0001	.0002	.0002	.0003	.0004	.0005
Titanium Alloys 6Al-4V, 5Al-2.5 Sn, 6Al-2 Sn-4Zr-6Mo, 3Al-8V-6Cr4Mo-4Zr, 10V-2Fe-3Al, 13V-11Cr-3Al	S	up to 42 Rc	●	x	x	150	.0001	.0001	.0001	.0001	.0002	.0002	.0003	.0004	.0005
Aluminum < 10 % Si	N		●			750	.0002	.0003	.0005	.0006	.0007	.0008	.0011	.0017	.0022
Aluminum > 10 % Si	N		●			750	.0002	.0003	.0005	.0006	.0007	.0008	.0011	.0017	.0022

Technical data provided should be considered advisory only as variations may be necessary depending on the particular application.

For product information, call your local distributor.





Micro End Mill Recommended Cutting Data - Slotting

Length	2 Flute Series		3 Flute Series
Standard	121	150	116

Metric - Standard 2-3 Flute

Ball Nose End Mills - If axial depth (ap) is less than the ball diameter, the speed is figured using the effective cutting diameter.

For diameters > 6mm, see Charts Starting on page 376.

Workpiece Material Group	ISO	Hardness	Coolant			Slotting	End Mill Diameter (mm)								
			• Preferred	o Possible	x Not Possible		.4	.8	1.2	1.6	2.0	2.5	3.0	5.0	6.0
							14%-Dia. ap				35%-Dia. ap				
			Max.	Air	MMS	vc-m/min Increase speed by 30% for ALtima® coated tools.	fz - mm/tooth								
Free Machining & Low Carbon Steels 1006, 1008, 1015, 1018, 1020, 1022, 1025, 1117, 1140, 1141, 11L08, 11L14, 1213, 12L13, 12L14, 1215, 1330	P	up to 28 Rc	•	•	•	122	.0018	.0033	.0051	.0058	.0074	.0089	.0119	.0180	.0241
Medium Carbon & High Carbon Steels, Alloy Steels & Easy to Machine Tool Steels 1030, 1035, 1040, 1045, 1050, 1052, 1055, 1060, 1085, 1095, 1541, 1551, 9255, 2515, 3135, 3415, 4130, 4137, 4140, 4150, 4320, 4340, 4520, 5015, 5115, 5120, 5132, 5140, 5155, 6150, 8620, 9262, 9840, 52100, O1, O2, O6, S2, W1 to W310	P	28 to 38 Rc	•	•	•	100	.0015	.0030	.0048	.0053	.0069	.0081	.0109	.0165	.0218
Tool Steels & Die Steels O7, M1, M2, M3, M4, M7, T1, T2, T4, T5, T8, T15, A2, A3, A6, A7, H10, H11, H12, H13, H19, H21, L3, L6, L7, P2, P20, S1, S5, S7, 52100, A 128, D2, D3, D4, D5, D7	P	28 to 44 Rc	•	•	•	60	.0013	.0028	.0043	.0048	.0061	.0074	.0098	.0147	.0198
Hardened Steels	H	35-45 Rc	•	o	o	30	.0008	.0015	.0023	.0028	.0033	.0041	.0056	.0081	.0109
Stainless Steel - Easy to Machine 430F, 301, 303, 410, 416 Annealed, 420F, 430, 430F	M	up to 28 Rc	•	x	o	122	.0018	.0033	.0051	.0058	.0074	.0089	.0119	.0180	.0241
Stainless Steel - Moderately Difficult 301, 302, 303 High Tensile, 304, 304L, 305, 420, 15-5PH, 17-4PH, 17-7PH	M	up to 28 Rc	•	x	o	60	.0015	.0030	.0048	.0053	.0069	.0081	.0109	.0165	.0218
Stainless Steel - Difficult to Machine 302B, 304B, 309, 310, 316, 316B, 316L, 316Ti, 317, 317L, 321, PH13-8Mo, Nitronics	M	over 28 Rc	•	x	o	45	.0010	.0020	.0030	.0033	.0043	.0051	.0069	.0102	.0137
Cast Iron	K	160-200 HB	•	o	o	120	.0018	.0033	.0051	.0058	.0074	.0089	.0119	.0180	.0241
Malleable / Ductile Cast Iron	K	200-250 HB	•	o	o	76	.0015	.0030	.0048	.0053	.0069	.0081	.0109	.0165	.0218
High Temp Alloys Nimonic, Inconel, Monel, Hastelloy	S	up to 42 Rc	•	x	x	22	.0010	.0020	.0030	.0033	.0043	.0051	.0069	.0102	.0137
Titanium Alloys 6Al-4V, 5Al-2.5 Sn, 6Al-2 Sn-4Zr-6Mo, 3Al-8V-6Cr4Mo-4Zr, 10V-2Fe-3Al, 13V-11Cr-3Al	S	up to 42 Rc	•	x	x	45	.0010	.0020	.0030	.0033	.0043	.0051	.0069	.0102	.0137
Aluminum < 10 % Si	N		•			228	.0038	.0078	.0114	.0139	.0175	.0208	.0279	.0419	.0558
Aluminum > 10 % Si	N														

Technical data provided should be considered advisory only as variations may be necessary depending on the particular application.





Micro End Mill Recommended Cutting Data - Slotting

Length	2 Flute Series		3 Flute Series
Stub	164	166	169

Inch - Stub Length 2-3 Flute

Ball Nose End Mills - If axial depth (ap) is less than the ball diameter, the speed is figured using the effective cutting diameter.

For diameters > 1/4", see Charts Starting on page 376.

Workpiece Material Group	ISO	Hardness	Coolant			Slotting	End Mill Diameter (Inch)								
			● Preferred	○ Possible	✗ Not Possible		.0150	.0310	.0470	.0620	.0780	.0930	.1250	.1870	.2500
							14%-Dia. ap				35%-Dia. ap				
			Max.	Air	MMS		fz - in/tooth								
Free Machining & Low Carbon Steels 1006, 1008, 1015, 1018, 1020, 1022, 1025, 1117, 1140, 1141, 11L08, 11L14, 1213, 12L13, 12L14, 1215, 1330	P	up to 28 Rc	●	●	●	400	.0001	.0002	.0002	.0003	.0003	.0004	.0005	.0008	.0010
Medium Carbon & High Carbon Steels, Alloy Steels & Easy to Machine Tool Steels 1030, 1035, 1040, 1045, 1050, 1052, 1055, 1060, 1085, 1095, 1541, 1551, 9255, 2515, 3135, 3415, 4130, 4137, 4140, 4150, 4320, 4340, 4520, 5015, 5115, 5120, 5132, 5140, 5155, 6150, 8620, 9262, 9840, 52100, O1, O2, O6, S2, W1 to W310	P	28 to 38 Rc	●	●	●	300	.0001	.0001	.0002	.0002	.0003	.0004	.0005	.0007	.0010
Tool Steels & Die Steels O7, M1, M2, M3, M4, M7, T1, T2, T4, T5, T8, T15, A2, A3, A6, A7, H10, H11, H12, H13, H19, H21, L3, L6, L7, P2, P20, S1, S5, S7, 52100, A 128, D2, D3, D4, D5, D7	P	28 to 44 Rc	●	●	●	200	.0001	.0001	.0002	.0002	.0003	.0004	.0006	.0008	
Hardened Steels	H	35-45 Rc	●	○	○	100	.0001	.0001	.0001	.0001	.0002	.0002	.0003	.0004	
Stainless Steel - Easy to Machine 430F, 301, 303, 410, 416 Annealed, 420F, 430, 430F	M	up to 28 Rc	●	✗	○	400	.0001	.0001	.0002	.0002	.0003	.0004	.0005	.0007	.0010
Stainless Steel - Moderately Difficult 301, 302, 303 High Tensile, 304, 304L, 305, 420, 15-5PH, 17-4PH, 17-7PH	M	up to 28 Rc	●	✗	○	200	.0001	.0001	.0002	.0002	.0003	.0003	.0004	.0007	.0009
Stainless Steel - Difficult to Machine 302B, 304B, 309, 310, 316, 316B, 316L, 316Ti, 317, 317L, 321, PH13-8Mo, Nitronics	M	over 28 Rc	●	✗	○	150	.0001	.0001	.0001	.0001	.0002	.0002	.0003	.0004	.0005
Cast Iron	K	160-200 HB	●	○	○	400	.0001	.0002	.0002	.0003	.0003	.0004	.0005	.0008	.0010
Malleable / Ductile Cast Iron	K	200-250 HB	●	○	○	250	.0001	.0001	.0002	.0002	.0003	.0004	.0005	.0007	.0010
High Temp Alloys Nimonic, Inconel, Monel, Hastelloy	S	up to 42 Rc	●	✗	✗	70	.0001	.0001	.0001	.0001	.0002	.0002	.0003	.0004	.0005
Titanium Alloys 6Al-4V, 5Al-2.5 Sn, 6Al-2 Sn-4Zr-6Mo, 3Al-8V-6Cr4Mo-4Zr, 10V-2Fe-3Al, 13V-11Cr-3Al	S	up to 42 Rc	●	✗	✗	150	.0001	.0001	.0001	.0001	.0002	.0002	.0003	.0004	.0005
Aluminum < 10 % Si	N		●			750	.0002	.0003	.0005	.0006	.0007	.0008	.0011	.0017	.0022
Aluminum > 10 % Si	N														

Technical data provided should be considered advisory only as variations may be necessary depending on the particular application.

For product information, call your local distributor.





Micro End Mill Recommended Cutting Data - Slotting

Length	2 Flute Series		3 Flute Series
Stub	164	166	169

Metric - Stub Length 2-3 Flute

Ball Nose End Mills - If axial depth (ap) is less than the ball diameter, the speed is figured using the effective cutting diameter.

For diameters > 6mm, see Charts Starting on page 376.

Workpiece Material Group	ISO	Hardness	Coolant			Slotting	End Mill Diameter (mm)								
			● Preferred	○ Possible	✗ Not Possible		.4	.8	1.2	1.6	2.0	2.5	3.0	5.0	6.0
							14%-Dia. ap			35%-Dia. ap					
			Max.	Air	MMS	vc - m/min Increase speed by 30% for ALtima® coated tools.	fz - mm/tooth								
Free Machining & Low Carbon Steels 1006, 1008, 1015, 1018, 1020, 1022, 1025, 1117, 1140, 1141, 11L08, 11L14, 1213, 12L13, 12L14, 1215, 1330	P	up to 28 Rc	●	●	●	122	.0017	.0038	.0056	.0066	.0081	.0099	.0132	.0198	.0254
Medium Carbon & High Carbon Steels, Alloy Steels & Easy to Machine Tool Steels 1030, 1035, 1040, 1045, 1050, 1052, 1055, 1060, 1085, 1095, 1541, 1551, 9255, 2515, 3135, 3415, 4130, 4137, 4140, 4150, 4320, 4340, 4520, 5015, 5115, 5120, 5132, 5140, 5155, 6150, 8620, 9262, 9840, 52100, O1, O2, O6, S2, W1 to W310	P	28 to 38 Rc	●	●	●	100	.0015	.0036	.0053	.0060	.0076	.0089	.0121	.0180	.0241
Tool Steels & Die Steels O7, M1, M2, M3, M4, M7, T1, T2, T4, T5, T8, T15, A2, A3, A6, A7, H10, H11, H12, H13, H19, H21, L3, L6, L7, P2, P20, S1, S5, S7, 52100, A 128, D2, D3, D4, D5, D7	P	28 to 44 Rc	●	●	●	60	.0013	.0028	.0043	.0048	.0061	.0074	.0098	.0147	.0198
Hardened Steels	H	35-45 Rc	●	○	○	30	.0008	.0015	.0023	.0028	.0033	.0041	.0056	.0081	.0109
Stainless Steel - Easy to Machine 430F, 301, 303, 410, 416 Annealed, 420F, 430, 430F	M	up to 28 Rc	●	✗	○	122	.0018	.0033	.0051	.0058	.0074	.0089	.0119	.0180	.0241
Stainless Steel - Moderately Difficult 301, 302, 303 High Tensile, 304, 304L, 305, 420, 15-5PH, 17-4PH, 17-7PH	M	up to 28 Rc	●	✗	○	60	.0015	.0030	.0048	.0053	.0069	.0081	.0109	.0165	.0218
Stainless Steel - Difficult to Machine 302B, 304B, 309, 310, 316, 316B, 316L, 316Ti, 317, 317L, 321, PH13-8Mo, Nitronics	M	over 28 Rc	●	✗	○	45	.0010	.0020	.0030	.0033	.0043	.0051	.0069	.0102	.0137
Cast Iron	K	160-200 HB	●	○	○	120	.0017	.0038	.0055	.0066	.0081	.0099	.0132	.0198	.0254
Malleable / Ductile Cast Iron	K	200-250 HB	●	○	○	76	.0015	.0035	.0053	.0060	.0076	.0088	.0121	.0180	.0241
High Temp Alloys Nimonic, Inconel, Monel, Hastelloy	S	up to 42 Rc	●	✗	✗	22	.0010	.0020	.0030	.0033	.0043	.0051	.0069	.0102	.0137
Titanium Alloys 6Al-4V, 5Al-2.5 Sn, 6Al-2 Sn-4Zr-6Mo, 3 Al-8V-6Cr-4Mo-4Zr, 10V-2Fe-3Al, 13V-11Cr-3Al	S	up to 42 Rc	●	✗	✗	45	.0010	.0020	.0030	.0033	.0043	.0051	.0069	.0102	.0137
Aluminum < 10 % Si	N		●			230	.0038	.0078	.0114	.0139	.0175	.0208	.0279	.0419	.0558
Aluminum > 10 % Si	N														

Technical data provided should be considered advisory only as variations may be necessary depending on the particular application.





Micro End Mill Recommended Cutting Data - Slotting

Length	4 Flute Series			
Standard	111	140	117	114
Long Length	122			132

Inch - Standard / Long Length 4 Flute

Ball Nose End Mills - If axial depth (ap) is less than the ball diameter, the speed is figured using the effective cutting diameter.

For diameters > 1/4", see Charts Starting on page 376.

Workpiece Material Group	ISO	Hardness	Coolant			Slotting 	End Mill Diameter (Inch)								
			● Preferred	○ Possible	x Not Possible		.0150	.0310	.0470	.0620	.0780	.0930	.1250	.1870	.2500
							14%-Dia. ap			35%-Dia. ap					
			Max.	Air	MMS		fz - in/tooth								
Free Machining & Low Carbon Steels 1006, 1008, 1015, 1018, 1020, 1022, 1025, 1117, 1140, 1141, 11L08, 11L14, 1213, 12L13, 12L14, 1215, 1330	P	up to 28 Rc	●	●	●	400	.0001	.0001	.0002	.0002	.0003	.0004	.0005	.0007	.0010
Medium Carbon & High Carbon Steels, Alloy Steels & Easy to Machine Tool Steels 1030, 1035, 1040, 1045, 1050, 1052, 1055, 1060, 1085, 1095, 1541, 1551, 9255, 2515, 3135, 3415, 4130, 4137, 4140, 4150, 4320, 4340, 4520, 5015, 5115, 5120, 5132, 5140, 5155, 6150, 8620, 9262, 9840, 52100, O1, O2, O6, S2, W1 to W310	P	28 to 38 Rc	●	●	●	300	.0001	.0001	.0002	.0002	.0003	.0003	.0004	.0007	.0009
Tool Steels & Die Steels O7, M1, M2, M3, M4, M7, T1, T2, T4, T5, T8, T15, A2, A3, A6, A7, H10, H11, H12, H13, H19, H21, L3, L6, L7, P2, P20, S1, S5, S7, 52100, A 128, D2, D3, D4, D5, D7	P	28 to 44 Rc	●	●	●	200	.0001	.0001	.0002	.0002	.0002	.0003	.0004	.0006	.0008
Hardened Steels	H	35-45 Rc	●	○	○	100	.0001	.0001	.0001	.0001	.0001	.0002	.0002	.0003	.0004
Stainless Steel - Easy to Machine 430F, 301, 303, 410, 416 Annealed, 420F, 430, 430F	M	up to 28 Rc	●	x	○	400	.0001	.0001	.0002	.0002	.0003	.0004	.0005	.0007	.0010
Stainless Steel - Moderately Difficult 301, 302, 303 High Tensile, 304, 304L, 305, 420, 15-5PH, 17-4PH, 17-7PH	M	up to 28 Rc	●	x	○	200	.0001	.0001	.0002	.0002	.0003	.0003	.0004	.0007	.0009
Stainless Steel - Difficult to Machine 302B, 304B, 309, 310, 316, 316B, 316L, 316Ti, 317, 317L, 321, PH13-8Mo, Nitronics	M	over 28 Rc	●	x	○	150	.0001	.0001	.0001	.0001	.0002	.0002	.0003	.0004	.0005
Cast Iron	K	160-200 HB	●	○	○	400	.0001	.0001	.0002	.0002	.0003	.0004	.0005	.0007	.0010
Malleable / Ductile Cast Iron	K	200-250 HB	●	○	○	250	.0001	.0001	.0002	.0002	.0003	.0003	.0004	.0007	.0009
High Temp Alloys Nimonic, Inconel, Monel, Hastelloy	S	up to 42 Rc	●	x	x	70	.0001	.0001	.0001	.0001	.0002	.0002	.0003	.0004	.0005
Titanium Alloys 6Al-4V, 5Al-2.5 Sn, 6Al-2 Sn-4Zr-6Mo, 3Al-8V-6Cr4Mo-4Zr, 10V-2Fe-3Al, 13V-11Cr-3Al	S	up to 42 Rc	●	x	x	150	.0001	.0001	.0001	.0001	.0002	.0002	.0003	.0004	.0005
Aluminum < 10 % Si	N		●			750	.0002	.0003	.0005	.0006	.0007	.0008	.0011	.0017	.0022
Aluminum > 10 % Si	N		●												

Technical data provided should be considered advisory only as variations may be necessary depending on the particular application.

For product information, call your local distributor.





Micro End Mill Recommended Cutting Data - Slotting

Length	4 Flute Series			
Standard	111	140	117	114
Long Length	122			132

Metric - Standard / Long Length 4 Flute

Ball Nose End Mills - If axial depth (ap) is less than the ball diameter, the speed is figured using the effective cutting diameter.

For diameters > 6mm, see Charts Starting on page 376.

Workpiece Material Group	ISO	Hardness	Coolant			Slotting	End Mill Diameter (mm)									
			● Preferred ○ Possible x Not Possible					.4	.8	1.2	1.6	2.0	2.5	3.0	5.0	6.0
								14%-Dia. ap			35%-Dia. ap					
			Max.	Air	MMS			fz - mm/tooth								
Free Machining & Low Carbon Steels 1006, 1008, 1015, 1018, 1020, 1022, 1025, 1117, 1140, 1141, 11L08, 11L14, 1213, 12L13, 12L14, 1215, 1330	P	up to 28 Rc	●	●	●	122	.0018	.0033	.0051	.0058	.0074	.0089	.0119	.0180	.0241	
Medium Carbon & High Carbon Steels, Alloy Steels & Easy to Machine Tool Steels 1030, 1035, 1040, 1045, 1050, 1052, 1055, 1060, 1085, 1095, 1541, 1551, 9255, 2515, 3135, 3415, 4130, 4137, 4140, 4150, 4320, 4340, 4520, 5015, 5115, 5120, 5132, 5140, 5155, 6150, 8620, 9262, 9840, 52100, O1, O2, O6, S2, W1 to W310	P	28 to 38 Rc	●	●	●	100	.0015	.0030	.0048	.0053	.0069	.0081	.0109	.0165	.0218	
Tool Steels & Die Steels O7, M1, M2, M3, M4, M7, T1, T2, T4, T5, T8, T15, A2, A3, A6, A7, H10, H11, H12, H13, H19, H21, L3, L6, L7, P2, P20, S1, S5, S7, 52100, A 128, D2, D3, D4, D5, D7	P	28 to 44 Rc	●	●	●	60	.0013	.0028	.0043	.0048	.0061	.0074	.0098	.0147	.0198	
Hardened Steels	H	35-45 Rc	●	○	○	30	.0008	.0015	.0023	.0028	.0033	.0041	.0056	.0081	.0109	
Stainless Steel - Easy to Machine 430F, 301, 303, 410, 416 Annealed, 420F, 430, 430F	M	up to 28 Rc	●	x	○	122	.0018	.0033	.0051	.0058	.0074	.0089	.0119	.0180	.0241	
Stainless Steel - Moderately Difficult 301, 302, 303 High Tensile, 304, 304L, 305, 420, 15-5PH, 17-4PH, 17-7PH	M	up to 28 Rc	●	x	○	60	.0015	.0030	.0048	.0053	.0069	.0081	.0109	.0165	.0218	
Stainless Steel - Difficult to Machine 302B, 304B, 309, 310, 316, 316B, 316L, 316Ti, 317, 317L, 321, PH13-8Mo, Nitronics	M	over 28 Rc	●	x	○	45	.0010	.0020	.0030	.0033	.0043	.0051	.0069	.0102	.0137	
Cast Iron	K	160-200 HB	●	○	○	120	.0018	.0033	.0051	.0058	.0074	.0089	.0119	.0180	.0241	
Malleable / Ductile Cast Iron	K	200-250 HB	●	○	○	76	.0015	.0030	.0048	.0053	.0069	.0081	.0109	.0165	.0218	
High Temp Alloys Nimonic, Inconel, Monel, Hastelloy	S	up to 42 Rc	●	x	x	22	.0010	.0020	.0030	.0033	.0043	.0051	.0069	.0102	.0137	
Titanium Alloys 6Al-4V, 5Al-2.5 Sn, 6Al-2 Sn-4Zr-6Mo, 3Al-8V-6Cr4Mo-4Zr, 10V-2Fe-3Al, 13V-11Cr-3Al	S	up to 42 Rc	●	x	x	45	.0010	.0020	.0030	.0033	.0043	.0051	.0069	.0102	.0137	
Aluminum < 10 % Si	N		●			228	.0038	.0078	.0114	.0139	.0175	.0208	.0279	.0419	.0558	
Aluminum > 10 % Si	N															

Technical data provided should be considered advisory only as variations may be necessary depending on the particular application.

Micro End Mill Recommended Cutting Data - Slotting

Length	4 Flute Series	
Stub	163	165

Inch - Stub Length 4 Flute

Ball Nose End Mills - If axial depth (ap) is less than the ball diameter, the speed is figured using the effective cutting diameter.

For diameters > 1/4", see Charts Starting on page 376.

Workpiece Material Group	ISO	Hardness	Coolant			Slotting	End Mill Diameter (Inch)								
			• Preferred o Possible x Not Possible					.0150	.0310	.0470	.0620	.0780	.0930	.1250	.1870
						vc - SFM Increase speed by 30% for ALtima® coated tools.		14%-Dia. ap			35%-Dia. ap				
			Max.	Air	MMS		fz - in/tooth								
Free Machining & Low Carbon Steels 1006, 1008, 1015, 1018, 1020, 1022, 1025, 1117, 1140, 1141, 11L08, 11L14, 1213, 12L13, 12L14, 1215, 1330	P	up to 28 Rc	•	•	•	400	.0001	.0001	.0002	.0002	.0003	.0004	.0005	.0007	.0010
Medium Carbon & High Carbon Steels, Alloy Steels & Easy to Machine Tool Steels 1030, 1035, 1040, 1045, 1050, 1052, 1055, 1060, 1085, 1095, 1541, 1551, 9255, 2515, 3135, 3415, 4130, 4137, 4140, 4150, 4320, 4340, 4520, 5015, 5115, 5120, 5132, 5140, 5155, 6150, 8620, 9262, 9840, 52100, O1, O2, O6, S2, W1 to W310	P	28 to 38 Rc	•	•	•	300	.0001	.0001	.0002	.0002	.0003	.0003	.0004	.0007	.0009
Tool Steels & Die Steels O7, M1, M2, M3, M4, M7, T1, T2, T4, T5, T8, T15, A2, A3, A6, A7, H10, H11, H12, H13, H19, H21, L3, L6, L7, P2, P20, S1, S5, S7, 52100, A 128, D2, D3, D4, D5, D7	P	28 to 44 Rc	•	•	•	200	.0001	.0001	.0002	.0002	.0002	.0003	.0004	.0006	.0008
Hardened Steels	H	35-45 Rc	•	o	o	100	.0001	.0001	.0001	.0001	.0001	.0002	.0002	.0003	.0004
Stainless Steel - Easy to Machine 430F, 301, 303, 410, 416 Annealed, 420F, 430, 430F	M	up to 28 Rc	•	x	o	400	.0001	.0001	.0002	.0002	.0003	.0004	.0005	.0007	.0010
Stainless Steel - Moderately Difficult 301, 302, 303 High Tensile, 304, 304L, 305, 420, 15-5PH, 17-4PH, 17-7PH	M	up to 28 Rc	•	x	o	200	.0001	.0001	.0002	.0002	.0003	.0003	.0004	.0007	.0009
Stainless Steel - Difficult to Machine 302B, 304B, 309, 310, 316, 316B, 316L, 316Ti, 317, 317L, 321, PH13-8Mo, Nitronics	M	over 28 Rc	•	x	o	150	.0001	.0001	.0001	.0001	.0002	.0002	.0003	.0004	.0005
Cast Iron	K	160-200 HB	•	o	o	400	.0001	.0001	.0002	.0002	.0003	.0004	.0005	.0007	.0010
Malleable / Ductile Cast Iron	K	200-250 HB	•	o	o	250	.0001	.0001	.0002	.0002	.0003	.0003	.0004	.0007	.0009
High Temp Alloys Nimonic, Inconel, Monel, Hastelloy	S	up to 42 Rc	•	x	x	70	.0001	.0001	.0001	.0001	.0002	.0002	.0003	.0004	.0005
Titanium Alloys 6Al-4V, 5Al-2.5 Sn, 6Al-2 Sn-4Zr-6Mo, 3Al-8V-6Cr4Mo-4Zr, 10V-2Fe-3Al, 13V-11Cr-3Al	S	up to 42 Rc	•	x	x	150	.0001	.0001	.0001	.0001	.0002	.0002	.0003	.0004	.0005
Aluminum < 10 % Si	N		•			750	.0002	.0003	.0005	.0006	.0007	.0008	.0011	.0017	.0022
Aluminum > 10 % Si	N		•												

Technical data provided should be considered advisory only as variations may be necessary depending on the particular application.

For product information, call your local distributor.





Micro End Mill Recommended Cutting Data - Slotting

Length	4 Flute Series	
Stub	163	165

Metric - Stub Length 4 Flute

Ball Nose End Mills - If axial depth (ap) is less than the ball diameter, the speed is figured using the effective cutting diameter.

For diameters > 6mm, see Charts Starting on page 376.

Workpiece Material Group	ISO	Hardness	Coolant			Slotting	End Mill Diameter (mm)								
			• Preferred	o Possible	x Not Possible		.4	.8	1.2	1.6	2.0	2.5	3.0	5.0	6.0
							14%-Dia. ap			35%-Dia. ap					
			Max.	Air	MMS	vc - m/min Increase speed by 30% for ALtima® coated tools.	fz - mm/tooth								
Free Machining & Low Carbon Steels 1006, 1008, 1015, 1018, 1020, 1022, 1025, 1117, 1140, 1141, 11L08, 11L14, 1213, 12L13, 12L14, 1215, 1330	P	up to 28 Rc	•	•	•	122	.0018	.0033	.0051	.0058	.0074	.0089	.0119	.0180	.0241
Medium Carbon & High Carbon Steels, Alloy Steels & Easy to Machine Tool Steels 1030, 1035, 1040, 1045, 1050, 1052, 1055, 1060, 1085, 1095, 1541, 1551, 9255, 2515, 3135, 3415, 4130, 4137, 4140, 4150, 4320, 4340, 4520, 5015, 5115, 5120, 5132, 5140, 5155, 6150, 8620, 9262, 9840, 52100, O1, O2, O6, S2, W1 to W310	P	28 to 38 Rc	•	•	•	100	.0015	.0030	.0048	.0053	.0069	.0081	.0109	.0165	.0218
Tool Steels & Die Steels O7, M1, M2, M3, M4, M7, T1, T2, T4, T5, T8, T15, A2, A3, A6, A7, H10, H11, H12, H13, H19, H21, L3, L6, L7, P2, P20, S1, S5, S7, 52100, A 128, D2, D3, D4, D5, D7	P	28 to 44 Rc	•	•	•	60	.0013	.0028	.0043	.0048	.0061	.0074	.0098	.0147	.0198
Hardened Steels	H	35-45 Rc	•	o	o	30	.0008	.0015	.0023	.0028	.0033	.0041	.0056	.0081	.0109
Stainless Steel - Easy to Machine 430F, 301, 303, 410, 416 Annealed, 420F, 430, 430F	M	up to 28 Rc	•	x	o	122	.0018	.0033	.0051	.0058	.0074	.0089	.0119	.0180	.0241
Stainless Steel - Moderately Difficult 301, 302, 303 High Tensile, 304, 304L, 305, 420, 15-5PH, 17-4PH, 17-7PH	M	up to 28 Rc	•	x	o	60	.0015	.0030	.0048	.0053	.0069	.0081	.0109	.0165	.0218
Stainless Steel - Difficult to Machine 302B, 304B, 309, 310, 316, 316B, 316L, 316Ti, 317, 317L, 321, PH13-8Mo, Nitronics	M	over 28 Rc	•	x	o	45	.0010	.0020	.0030	.0033	.0043	.0051	.0069	.0102	.0137
Cast Iron	K	160-200 HB	•	o	o	120	.0018	.0033	.0051	.0058	.0074	.0089	.0119	.0180	.0241
Malleable / Ductile Cast Iron	K	200-250 HB	•	o	o	76	.0015	.0030	.0048	.0053	.0069	.0081	.0109	.0165	.0218
High Temp Alloys Nimonic, Inconel, Monel, Hastelloy	S	up to 42 Rc	•	x	x	22	.0010	.0020	.0030	.0033	.0043	.0051	.0069	.0102	.0137
Titanium Alloys 6Al-4V, 5Al-2.5 Sn, 6Al-2 Sn-4Zr-6Mo, 3Al-8V-6Cr4Mo-4Zr, 10V-2Fe-3Al, 13V-11Cr-3Al	S	up to 42 Rc	•	x	x	45	.0010	.0020	.0030	.0033	.0043	.0051	.0069	.0102	.0137
Aluminum < 10 % Si	N		•			228	.0038	.0078	.0114	.0139	.0175	.0208	.0279	.0419	.0558
Aluminum > 10 % Si	N		•												

Technical data provided should be considered advisory only as variations may be necessary depending on the particular application.

Coatings

ALtima®

Aluminum Titanium Nitride (AlTiN). ALtima® is the original high performance coating. This coating allows tools to be run at higher speeds and feeds in a wide array of materials. Also, it allows the option of running tools dry due to the high oxidation temperature of the coating.

ALtima® Plus

This Aluminum Titanium Nitride (AlTiN) multi-layer coating has optimized coating structure, with pre and post treatment of the coating for optimized high performance drilling in any ferrous material.

ALtima® 52

Aluminum Titanium Nitride (AlTiN). ALtima® 52 is specially designed for milling hardened steels 52 Rc and above. It has very high hardness and the oxidation temperature of the coating makes this the absolute best choice for hardened steel milling. ALtima® 52 is designed to allow for dry machining.

ALtima® Blaze

Aluminum Chromium Nitride (AlCrN). ALtima® Blaze is designed to allow higher material removal rates. This coating has a higher oxidation temperature than a typical TiAlN coating. It has shown very good results in nickel alloys, titanium, and other difficult to machine materials. Tools coated with ALtima® Blaze can be used in dry machining.

ALtima® Micro

An ultra thin, nano structured, TiAlN coating developed specifically for micro tool applications.

ALtima® Xtreme

Designed for high speed and dry machining.

Fordlube

Titanium DiBoride (TiB₂) is a unique coating with low Aluminum affinity, smooth surface finish and high hardness. It is ideal for Aluminum and Magnesium alloys as it prevents build-up on cutting edge, provides superior chip flow along with extended wear resistance.

Gem+

Recommended for aluminium and aluminium alloys up to 12% Si, non-ferrous metals and composites. Gem+ provides excellent wear resistance and maintains sharp cutting edges.

GemX

A CVD diamond coating for composites and aluminum that offers the maximum hardness and wear resistance of any of our coatings.

TiN

Titanium Nitride (TiN). TiN coating has shown good results in low carbon steels and many iron-based applications. It is a very popular coating used in the industry today.

TiCN

Titanium Carbonitride (TiCN). TiCN is a multi-layer coating. Because of the multi-layer composition, TiCN is tougher than TiN, even though TiCN is harder. The added toughness of the TiCN coating makes it a good choice for mechanically stressed edges like in end mill applications. The higher hardness makes TiCN a good choice for abrasive applications where higher wear resistance is required.

CERAedge®

CERAedge® is a unique coating that provides excellent performance in titanium, aluminium, and composites.









Special Coatings

Upon request, M.A. Ford® can provide any commercially available coating. **Any standard uncoated M.A. Ford® cutting tool can be provided with coating if requested.**

Coating Properties









M.A. Ford® Coating	M.A. Ford® Tool Number Designation	Microhardness (HV)	Maximum Service Temp.	Friction Coefficient
ALtima®	A	3100	1100° C / 2012° F	0.42
ALtima® Plus	AP	3200	1100° C / 2012° F	0.25
ALtima® 52	A or AH	3600	1200° C / 2192° F	0.40
ALtima® Blaze	B	3200	1100° C / 2012° F	0.35
ALtima® Micro	AM	3300	900° C / 1652° F	0.30-0.35
ALtima® Xtreme	AX	3800	1100° C / 2012° F	0.30-0.50
Fordlube	F	4000	700° C / 1292° F	0.30
Gem+	GP	4710	500° C / 932° F	0.30
GemX	GX	10000	600° C / 1100° F	0.10
TiN	T	2300	600° C / 1112° F	0.40
TiCN	C	3000	400° C / 752° F	0.40
CERAedge®	CE	3400	1100° C / 2012° F	0.25

Material Conversion Chart

								
	USA	France	Brazil	German W-nr	German DIN	UK	Spain	Japan JIS
FREE MACHINING STEEL	12L13	S250Pb		1.0718	9SMnPb28		F.2112 -	
	1108	10F1		1.0721	10S20	210M15	F.2121 -	
	11L08	10PbF2		1.0722	10SPb20		F.2122 -	
				1.0723	15S20	210A15	F.210F.	
	1215	S300	1215	1.0736	9SMn36	240M07 EN 1B	F.2113-	
12L14	S300Pb		1.0737	9MnPb36		F.2114 -		
LOW CARBON STEEL	1010	AF34C10/XC10	1010	1.0301	C10	045M10		
	1015	AF37C12/XC18	1015	1.0401	C15	080M15;040A15	F.111	
	1020	AF42C20/XC25	1020	1.0402	C22	055M15 EN2C	F.112	
	1025	AF50C30		1.0406	C25	070M26	F.221	
	1212			1.0711	9S20	220M07		
	1213	S250	1213	1.0715	9SMn28	230M07	F.2111 -	
	1010	XC10	1010	1.1121	Ck10	040A10	F.1510 -	
	1022/1518	20M5		1.1133	20Mn5	120M19	F.1515 -	
	1015	XC15 / C15E	1015	1.1141	Ck15	080M15 EN 32C	F.1511 -	
	10201023	XC25 / C22E	1020	1.1151	Ck22	050A20	F.1120 -	
	1025	XC25 / C25E		1.1158	Ck25	070M26	F.1120 -	
	A350-LF5	15N6 / 15Ni6		1.5622	14Ni6		F.2641 -	
	3310/9314	12NC15		1.5752	14NiCr14	655M13/A12 EN 36A		
	MEDIUM CARBON STEEL	1035	AF56C35 /XC38	1035	1.0501	C35	060A35	F.113
1045		AF65C45 /C45	1045	1.0503	C45	080M46	F.114	
1040		AF60C40 /C40	1040	1.0511	C40		F.114.A	
1055		C55	1055	1.0535	C55	070M55		
1060		AF70C55 / C60	1060	1.0601	C60	080A62 EN 43D	F.115	
1140		35MF6	1140	1.0726	35S20	212M36 EN 8M	F.210G.	
1146		45MF4		1.0727	45S20	212M44		
9255		51S7		1.0903	51Si7	250A53 EN 45	F.1450 -	
9255		55S7	9254	1.0904	55Si7		F.1440-	
9260		60S7		1.0909	60Si7	250A58	F.1441 -	
9262		60SC7		1.0961	60SiCr7	250A61	F.1442 -	
1330/1536		35M5 / 30Mn5		1.1165/66	30Mn5/34Mn5	120M36/150M28	F.1203	
1335		40M5 / 36Mn5	1541	1.1167	36Mn5	150M36 EN 15	F.1203 -	
1330		20M5 / 28Mn6	1330	1.117	28Mn6	150M28 EN 14A		
1035		XC32 / C35R	1035	1.118	Cm35	080M36	F.1135 -	
1040		XC42H1 / C40E	1040	1.1186	Ck40	060A40/080A40		S 40 C
1045		XC42H1 / C45/XC45	1045	1.1191	Ck45	080M46/060A47	F.1140 -	S 45 C
1045		XC42H1 /C45R	1045	1.1201	Cm45	080M46	F.1145 -	
1055		XC55H1 / C55E	1055	1.1203	Ck55	060A57/070M55	F.1150 -	S55C
1050		XC48H1 / C50E	1050	1.1206	Ck50	080M50		
1050		XC48H1TS	1050	1.1213	Cf53	060A52		
1060	XC60 / C60E/2C60	1060	1.1221	Ck60	060A62	F.511/F.512	S58C	
1070	XC68	1070	1.1231	Ck67	060A67			
1080/1078/1086	XC75 / C75E/XC90	1074	1.1248/1269	Ck75	060A78	F.513/514/515		
1095	XC100	1095	1.1274	Ck101	060A96			
4135/4142	34CD4 /42CD4		1.233	35CrMo4/47CrMo4	708A37/M40		SCM435TK	
3135/3140	35NC6		1.5711/5711	36NiCr6/40NiCr6	640A35/M40 EN111A			
8620/8720	20NCD2	8620	1.6523/43	21NiCrMo2	805M20/A20 EN 362	F.1522 -	SNCM220(H)	
8740	40NCD2	8640	1.6546	40NiCrMo22	311-Type7	F.1204 -	SNCM240	
	18NCD6		1.6587	17CrNiMo8	820A16	F.1560 -		
5132	32C4 / 34Cr4		1.7033	34Cr4	530A32 EN18B	F.8221 /F.224	SCR430(H)	
5135	38C4 / 37Cr4	5135	1.7034	37Cr4	530A36	F.1201 -		
5140	42C4 / 41Cr4	5140	1.7035	41Cr4	530M40/A40 EN 18	F.1202 -	SCR440(H)	
5140	42C4TS	5140	1.7045	42Cr4	530A40	F.1202 -	SCR440	
5115	16MC5	5115	1.7131	16MnCr5	527M17	F.1515 -		
5155	55C3		1.7176	55Cr3	527A60 EN 48	F.1431 -	SUP9(A)	
4130	25CD4 / 25CrMo4	4130	1.7218	25CrMo4	1717CDS110	F.8330 -	SCM420/430	
4135/4137	35CD4 / 34CrMo4		1.722	34CrMo4	708A37 EN 19B	F.8231 -		
4140/4142	42CD4 / 42CrMo4	4140	1.7225	42CrMo4	708M40 EN 19A	F.8232 -		
4150	50CrMo4	4150	1.7228	50CrMo4	708A47			
6150	50CV4 / 51CrV4	6151	1.8159	50CrV4	735A50 EN 47	F.1430 -		

Technical data provided should be considered advisory only as variations may be necessary depending on the particular application.









Material Conversion Chart

								
	USA	France	Brazil	German W-nr	German DIN	UK	Spain	Japan JIS
HIGH STRENGTH ALLOY STEEL	A355Cl.D	30CAD6.12		1.8507	34CrAlMo5	905M31	F.1741 -	
	A355Cl.A	40CAD6.12		1.8509	41CrAlMo7	905M39 EN 41B	F.1740 -	
		18NC13		1.5755	31NiCr14	653M31	F.123	
	9840	40NCD3		1.6511	36CrNiMo4	816M40 EN 110	F.1280	
	4340		4340	1.6562	40NiCrMo73	817M40		SNCM 447
		30CND8		1.658	30CrNiMo8	823M30		
	4340	35NCD6	4340	1.6582	34CrNiMo8	817M40 EN 24	F.1272	SNCM 447
		35NCD14		1.6746	32NiCrMo145	830M31	F.1262	
		35NCD16		1.6747	30NiCrMo166	835M30	F.1260	
		30CD12		1.8515	31CrMoV139	722M24 EN 40B	F.1712	
			1.8523	39CrMoV139	897M39 EN 40C			
STRUCTURAL STEEL	A570 (36)	E24-2NE / S235JRG2	A36	1.0038	RS137-2	4360-40C		STKM 12A
	A570 (40)	E28-2 / S275JR		1.0044	SI44-2	4360-43A/B	A 430B	SM 400 A;B;C
	A570 (50)	A50-2 / E295		1.005	SI50-2	4360-50B		SS490
		A60-2 / E335-A70-2/E360		1.006/007	SI60-2/SI70-2	4360-55E		
	A284/A573/A611	E24-3;-4 / S235J2G3		1.0116	SI37-3	4360-40C/D-1449-37C	A360 C;D	
	A366/1012/A619	DC01		1.033/0333	SI12/13	1449 -2/3/4CR	AP 00/02	
	A620	DC04		1.0338	SI14	1449 1CR; 2CR	AP 04	
	A516Gr.65;-55;	A37CP;AP / P235GH		1.0345	H I	1501Gr.161-360/400	A 37 RC I;RA II	
		A42CP;AP / P265GH		1.0425	H II	161-400;	A42 RC I	
	A537	A52CP;AP / P335GH		1.0473	19Mn6		A 47 RB II	
	A516 (70)	A48CP;AP / P295GH		1.0481	17Mn4		A 47 RC I; RA II	
		E36-3/4 / S355J2G3		1.057	SI52-3	4360-50B;50C;50D	A 510 C;D	
	A204 (A)	15D3 / 15Mo3		1.5415	15Mo3	1501-240	F.2601 -	
	4520			1.5423	16Mo5	1503-245-420	F.2602 -	
	A350-LF3	12Ni14 / 12Ni14		1.5637	10Ni14	1501-503-690	F.152	
	3115	10NC6		1.5713	13NiCr6			
	3415	14NC11		1.5732	14NiCr10		F.1540	
	A182-F11;F12	15CD3.05		1.7335	13CrMo44	620Gr.27;31	F.2631	
	A387 (12)	15CD4.5		1.7337	16CrMo44	620Gr.27		
	A182F22	10CrMo9-10		1.738	10CrMo910	622Gr.31;45	TU.H	
A633Gr.E	E420RIFP / S420N		1.8902	SI420	4360-55E	AE 420 KG		
A633Gr.E	E460RIFP / S460N		1.8905	SI460		AE 460 KG		
HIGH TEMPERATURE ALLOYS	330	Z12NCS37.18		1.4864	X12NiCrSi3616	NA17	F.3313	
				1.4865	G-X40NiCrSi3818	330C40		
	B163	Z8NC3221		1.4876	X10NiCrAlTi3320	NA15(H)	F.3545	
	4544/SB127/164	NU30		2.436	NiCu30Fe	3072-76/NA13		
	4676			2.4375	NiCu30Al	3072-76/NA18/3146		
	5388 C	NC 17 DWY		2.4602	NiCr17Mo17FeW			
		NC 20 T		2.463	Ni-Cr20Ti	HR5/203-4/703-B		
		NC 20 TA		2.4631	NiCr20TiAl	HR 401HR601/736B		
		NCKD 20 ATV		2.4634	NiCo20Cr15MoAlTi	HR 3/5007		
	687	NCKD 20 AT		2.4636	NiCo15Cr15MoAlTi			
		NCK 20 D		2.465	NiCr20Co19MoTi	HR 10		
	5660C	Z8 NCDT 42		2.4662	NiCr15MoTi			
	5536E	Nc 22 FeD		2.4665	NiCr22Fe18Mo	HR 6/204		
		NC 19 FeNb		2.4668	NiCr19Fe19NbMo	HR 8		
	5542G	NC 15 Fe TNb		2.4669	NiCr16FeTi	HR 505		
	5391A	NC 13 AD		2.467	G-NiCr13Al6MoNb	HC 203		
		NK 15 CAT		2.4674	NiCo15Cr10MoAlTi	HC 204		
	5540	NC 15 Fe		2.4816	NiCr15Fe	3072-76		
	5581	NC 22 FeDNB		2.4856	NiCr22Mo9Nb			
		NC 21 FeDU		2.4858	NiCr21Mo	3072-76		
	NC 19 KDT		2.4973	NiCr19Co11MoTi				
684	NCK 19 DAT		2.4983	NiCr18Co18MoAlTi				
TITANIUM TITANIUM ALLOYS		T-35		3.7024/25	Ti 99.8	TA.1	Ti-PO1	
		T-U2		3.7124	TiCu2	TA.21-24/52-55/58	Ti-P11	
		T-A6ZD		3.7154	TiAl6Zr5Mo0.5Si0.2	TA.43/44	Ti-P67	
		T-A4DE		3.7184	TiAl4Mo4Sn2Si0.5	TA.45-51/57	Ti-P68	
	4941/42/51/4902	T-40		3.7034/35	Ti 99.7	TA.2/3/4/5	Ti-PO2	
	4901/21	T-60		3.7064/65	Ti99.5	TA.6/7/8/9	Ti-PO4	
	491128/35/54/65/67	T-A6V		3.7164/65	TiAl6V4	TA.10-13/28/56	Ti-P63	
	4900	T-50				DTD 5023/5283		

Technical data provided should be considered advisory only as variations may be necessary depending on the particular application.









For product information, call your local distributor.

Material Conversion Chart

								
	USA	France	Brazil	German W-nr	German DIN	UK	Spain	Japan JIS
STAINLESS STEELS	410S	Z3014		1.4001	X7Cr14	403S17	F.8401	
	405	Z6CA13 / Z6CrAl13		1.4002	X8CrAl13	405S17	F.3111	
	416	Z12CF13 / Z12CrS13		1.4005	X12CrS13	416S21	F.3411	SUS 416
	410/CA-15	Z12CN13 / Z12Cr13	410	1.4006	X10Cr13	410S21 ENEN 56A	F.3401	SUS 410
	430	Z8C17 / Z6Cr17		1.4016	X6Cr17	430S15 EN 60	F.3113	SUS 430
	420	Z20C13 / Z20Cr13	420	1.4021	X20Cr13	420S37	F.3402	SUS 420
		Z40C14 / Z40Cr14		1.4034	X46Cr13	420S45 EN 56D	F.3405	
	431	Z15CN16.02		1.4057	X20CrNi172	431S29 EN 57	F.3427	
	430F	Z10CF17		1.4104	X12CrMoS17		F.3117	
	434	Z8CD17.01		1.4113	X6CrMo17	434S17		
	440C	Z100CD17		1.4125	X105CrMo17			
	304/304H	Z6CN18.09	304	1.4301	X5CrNi1810	304S15 EN 58E	F.3451	SUS304
	308; 305	Z8CN18.12		1.4303	X5CrNi1812	305S19	F.3513	
	303	Z10CNF18.09	303	1.4305	X10CrNiS189	303S21 EN 58M	F.3508	SUS303
	304L	Z2CN18.10/Z3CN19.10M		1.4306	G-X2CrNi189/1911	304S12/S11/C12	F.3503	SCS19
	CF-8	Z6CN18.10M		1.4308	G-X6CrNi189	304C15		
	301	Z12CN17.07	302	1.431	X12CrNi177	301S21	F.3517	
	304LN	Z2CN18.10Az		1.4311	X2CrNi1810	304S62		
		Z10CN18.9M		1.4312	G-X10CrNi188	302C25		
	CA6-NM	Z4CND13.4M		1.4313	G-X5CrNi134	425C11		
	316/316L	Z6CND17.11	316	1.4401	X5CrNiMo17122	316S16/S31 EN 58J	F.3543	SUS316
	316L	Z2CND 18.13	316L	1.4404	X2CrNiMo17132	316S11/S12	F.3533	SUS316 L
	316LN	Z2CND 17.12Az		1.4406	2CrNiMo17122	316S61		SUS316LN
	CF-8M			1.4408	G-X6CrNiMo1810	316C16	F.8414	
	316LN	Z2CND17.13Az		1.4429	X2CrNiMo17133	316S62		SUS316LN
	316L	Z2CND17.13		1.4435	X2CrNiMo18143	316S11/S12	F.3533	SUS316LN
	316	Z6CND17.12		1.4436	X5CrNiMo17133	316S16	F.3534	SUS316
	317L	Z2CND19.15		1.4438	X2CrNiMo18164	317S12		SUS317L
	329		329 (DUPLEX)	1.446	X8CrNiMo275		F.3309	SUS329
	XM8/430Ti	Z8CT17		1.451	X6CrTi17		F.3114	
	409	Z6CT12		1.4512	X5CrTi12	409S19		
	321	Z6CNT18.10	321	1.4541	X6CrNiTi1810	321S12/S31 EN 58B	F.3523	SUS321
	630	Z6CNU17.04		1.4542	X5CrNiCuNb1714			SUS630
	347	Z6CNNb18.10		1.455	X6CrNiNb1810	347S17/S31 EN 58F	F.3552	SUS347
	316Ti	Z6CNDT17.12		1.4571	X6CrNiMoTi17122	320S31/S17 EN 58J	F.3552	
	316Ti			1.4573	X10CrNiMoTi1812	320S33		
	316Cb	Z6CNDNb17.12/19.13		1.458	X6CrNiMoNb17122	318S17		
	HNV3	Z45CS9		1.4718	X45CrSi93	401S45 EN52	F.3220	
		Z10C13		1.4724	X10CrAl13	403S17	F.13152	
		Z40CSD10		1.4731	X40CrSiMo102		F.3221	
	430	Z10CAS18		1.4742	X10CrAl18	430S15	F.3153	SUS430
	HNV6	Z80CSN20.02		1.4747	X80CrNiSi20	443S65 EN 59	F.3222	
	446	Z10CAS24		1.4762	X10CrAl24		F.3154	SUH446
	309	Z15CNS20.12		1.4828	X15CrNiSi2012	309S24		
	309S	Z15CN24.13		1.4833	X7CrNi2314	309S24		
314/310	Z15CNS25.20	314	1.4841	X15CrNiSi2520		F.3310		
310S	Z12CN25.20	310	1.4845	X12CrNi2521	310S24	F.331		
HK			1.4848	G-X40CrNiSi2520	310C40	F.8452		
EV8	Z52CMN21.09		1.4871	X53CrMnNiN219	349S54	F.3217		
	Z35CNWS14.14		1.4873	X45CrNiW189	331S40	F.3211		
321	T6CNT18.12(B)		1.4878	X12CrNiTi189	321S20	F.3523	SUS321	
A353	Z8N9		1.5662	X8Ni9	1501-509;510	F.2645		
2515	Z18N5		1.568	12Ni19				

Technical data provided should be considered advisory only as variations may be necessary depending on the particular application.









Material Conversion Chart

								
	USA	France	Brazil	German W-nr	German DIN	UK	Spain	Japan JIS
TOOL STEELS	A532IBNiCr-LC			0.962	G-X260NiCr42	Grade2A		
	A532IANiCr-HC			0.9625	G-X330NiCr42	Grade2B		
	A532IDNi-HiCr			0.963	G-X300CrNiSi952	Grade2C,D,E		
	A532IID20%CrMo-LC			0.9645	G-X260CrMoNi2021	Grade3C		
	A532IIIA25%Cr			0.965	G-X260Cr27	Grade3D		
	A532IIIA25%Cr			0.9655	G-X300CrMo271	Grade3E		
	W108	Y190;Y180		1.1525	C80W1			
	W110	Y1105		1.1545	C105W1			SK3
	W112	Y2120		1.1663	C125W		F.5123	
	W1			1.175/.1625	C75W/C80W1	BW1A/BW1B	F.1507	
	L3	Y100C6	52100	1.2067	100Cr6	BL3	F.5230	
	D3	Z200C12	420 (1.2083)	1.208	X210Cr12	BD3	F.5212	
	L2			1.221	115CrV3			
	H11	Z38CDV5	H11	1.2343	X38CrMoV51	BH11	F.5317	
	H13	Z40CDV5	H13	1.2344	X40CrMoV51	BH13	F.5318	SKD61
	A2	Z100CDV5	A2	1.2363	X100CrMoV51	BA2	F.5227	SKD12
	H10	32DCV28	H10	1.2365	X32CrMoV33	BH10	F.5313	
	D2	Z160CDV12	D2	1.2379	X155CrVMo121	BD2		
		105WC13		1.2419	105WCr6		F.5233	
			D6 (VC131)	1.2436	X210CrW12		F.5213	
	O1		O1 (VND)	1.251	100MnCrW4	BO1	F.5220	SKS 31
	S1		S1 (VW3)	1.2542	45WCrV7	BS1	F.5241	
		55WC20		1.255	60WCrV7			
	H21	Z30WCV9	H20/H21	1.2581	X30WCrV93	BH21	F.5323	SKD5
				1.2601	X165CrMoV12		F.5211	
	H12	Z35CWDV5	H12	1.2606	X37CrMoW51	BH12		
	L6	55NCDV7	(VMO)	1.2713	55NiCrMoV6		F.528	
	W210	Y1105V		1.2833	100V1	BW2		
	2	90MV8		1.2842	90MnCrV8	BO2		
	T15			1.3202	S12-1-4-5	BT15	F.5563	
		Z130WKCDV10-10-04-03		1.3207	S10-4-3-10		F.553	
		Z85WDKCV06-05-05-04-02	M35	1.3243	S6-5-2-5		F.5613	
	M41	Z110WKCDV07-05-04-04-02		1.3246	S7-4-2-5		F.5613	
	M42	Z110DKCWW09-08-04-02-01	M42	1.3247	S2-10-1-8	BT42	F.5615	
	M33/M34			1.3249	S2-9-2-8	BM34	F.5611	
	T4	Z80WKCV18-05-04-01		1.3255	S18-1-2-5	BT4	F.5530	
	T5			1.3265	S18-1-2-10	BT5	F.5540	
	M3	Z90WDCV06-05-04-03		1.3342	SC6-5-2			
	M2	Z85WDCV06-05-04-02	M2	1.3343	S6-5-2	BM2	F.5603	
	M3Class2	Z130WDCV06-05-04-04	M3:2	1.3344	S6-5-3		F.5605	
	H41/M1	Z85DCVW08-04-02-01		1.3346	S2-9-1	BM1		
	M7	Z100DCVW09-04-02-02	M7	1.3348	S2-9-2		F.5607	
	T1	Z80WCV18-04-01		1.3355	S18-0-1	BT1	F.5520	
	A128(A)	Z120M12 / Z120Mn12		1.3401	X120Mn12		F.82551	
	52100	100C6	52100	1.3505	100Cr6	534A99	F.1310	
HARDENED STEEL								
CAST ALUMINIUM	319,2	A-S5U		3.2151	G-AISI6Cu4	LM4/LM22	L-2660	
	380,1	A-S9U3		3.2161	G-AISI8Cu3	LM24	L-2630	
		A-S4G		3.2341	G-AISI5Mg	DTD716B		
	A356.2	A-S7G0,3		3.2371	G-AISI7Mg	2L99/LM25		
		A7-S10G		3.2373	G-AISI9Mg			
	A360	A-S10G		3.2381	G-AISI10Mg	LM9	L-2560	
	413,1	A-S12U		3.2583	G-AISI12Cu	LM20	L-2530	
	514.1	A-G6		3.3561	G-AIMg5	LM5		
	A413	A-S13		3.3581	G-AISI12	LM6	L-2520	
	520	A-G10-Y4		3.3591	G-AIMg10	LM10	L-2310	
	390				AISI17Cu4			
	393				AISI18-25CuNiMg	LM28/LM29		

Technical data provided should be considered advisory only as variations may be necessary depending on the particular application.

For product information, call your local distributor.

Material Conversion Chart

								
	USA	France	Brazil	German W-nr	German DIN	UK	Spain	Japan JIS
WROUGHT ALUMINIUM	1200	A4		3.0205	Al99	1C	L-3001	
	1050A	A5		3.0255	Al99,5	1B	L-3051	
	1350A	A5/L		3.0257	E-Al	1E	L-3052	
	1080A	A8		3.0285	Al99,8	1A	L-3081	
	1199	A99		3.0385	Al99,98R	1		
	3004	A-M1G		3.0526	AlMnMg1	N4	L-3820	
	2014	A-U4SG		3.1255	AlCuSiMn	H15	L-3130	
	2117	A-U2G		3.1305	AlCu2,5Mg0,5	3L86/HR13	L-3180	
	2017A	A-U4G		3.1325	AlCuMg1	H14	L-3120	
	2024	A-U4G1		3.1355	AlCuMg2	2L98	L3140	
	2003	A-U4Pb		3.1645	AlCuMgPb		L-3121	
	2011	A-U5PbBi		3.1655	AlCuBiPb	FC1	L-3182	
	6101B			3.2305	E-AlMgSi	91E	L-3431	
	6463	A85-GS		3.2307	Al99,85MGSi	BTR6		
	6181	A-SGMO,7		3.2315	Al-Si1 Mg	H30	L-3451	
	6060			3.3206	AlMGSi0,5	H9	L-3441	
	6101C	A-GS/L		3.3207	E-AlMgSi0,5	BTR6		
	5005A	A-G0,6		3.3315	AlMg1	N41	L-3350	
	5050B	A-G1,5		3.3316	AlMg1,5	3L44	L-3380	
	5052	A-G2,5C		3.3523	AlMg2,5	N5Mg3,5	L-3360	
	5251	A-G2M		3.3525	AlMg2Mn0,3	N4		
	5754	A-G3M		3.3535	AlMg3		L-3390	
	5454	A-G2,5MC		3.3537	AlMg2,7Mn	N51		
	5083	5083		3.3547	AlMg4,5Mn	N8	L-3321	
5056A			3.3555	AlMg5	N6	L-3320		
7020	A-Z5G		3.4335	AlZn4,5Mg1	H17	L-3741		
7075	A-Z5GU		3.4365	AlZnMgCu1,5	2L95	L-3710		
SG / NODULAR CAST IRON	60-40-18	FGS-400-12		0.704	GGG-40	420/12		
		FGS370-17		0.7043	GGG-40.3	370/17		
	65-45-12	FGS500-7		0.705	GGG-50	500/7		FDC500
	80-55-06	FGS 600-3		0.706	GGG-60	600/3		
	100-70-03	FGS 700-2		0.707	GGG-70	700/2		FDC700
	120-90-02	FGS 800-2		0.708	GGG-80	800/2		
		MB 35-7		0.8035	GTW-35-04	W 340/3		
		MB 40-10		0.804	GTW-40-05	W 410/4		
				0.8045	GTW-45-07			
	32 510	MN 35-10		0.8135	GTS-35-10	B 340/12		
		MP 50-5		0.8145	GTS-45-06	P 440/7		
		MP 60-3		0.8155	GTS-55-04	P 540/5		
				0.8165	GTS 65-02			
70 003	MP 70-2		0.817	GTS 70-02	P 690/2			
GREY / WHITE CAST IRON	A48-40B	Ft25D / FGL250		0.6025	GG25	Grade 260	FG 25	
	A48-20B	Ft10D / FGL100		0.601	GG10		FG 10	
	A48-25B	Ft15D / FGL150		0.6015	GG15	Grade 150	FG 15	
	A48-30B	Ft20D / FGL200		0.602	GG20	Grade 220	FG20	
	A48-45B	Ft30D / FGL300		0.603	GG30	Grade 300	FG 30	
	A48-50B	Ft35D / FGL350		0.6035	GG35	Grade 350	FG35	
	A48-60B	Ft40D / FGL400		0.604	GG40	Grade 400		
BRONZE ALUMINIUM-BRONZE TIN BRONZE	C 60 800	CuAl6		2.0918	CuAl5As			
	C 61 000	CuAl8		2.092	CuAl8			
	C 61 400	CuAl7Fe2		2.0932	CuAl8Fe3	CA 106		
	C 62 300	CuAl9Fe3Mn2		2.0936	CuAl10Fe3Mn2	CA 105		
	C 95 200	CuAl9Fe3		2.094	CuAl10Fe	AB 1		
	B 505	CuAl9Fe3		2.094	G-FeAlBzF50	AB 1		
		CuAl9Mn2		2.096	CuAl9Mn2			
	C 63 200	CuAl9Ni5Fe3Mn		2.0966	CuAl10Ni5Fe4	CA 104		
	C 95 800	CuAl9Ni5Fe		2.097	G-NiAlBzF50	AB 2		
		CuAl11Ni5Fe5		2.0978	CuAl11Ni6Fe5			
	C 94100	CuPb20Sn5		2.1188	G-CuPb20Sn	LB5		

Technical data provided should be considered advisory only as variations may be necessary depending on the particular application.

Material Conversion Chart

								
	USA	France	Brazil	German W-nr	German DIN	UK	Spain	Japan JIS
BRASS	C 21000/34500	CuZn5		2.022/2.032	CuZn5	CZ 125/101		
	C 85700	CuZn40-Y30		2.034	G-CuZn37Pb	PCB 3		
	C 28000/38500	CuZn40/44Pb2		2.036/2.041	CuZn40/44Pb2	CZ 109/CZ130		
	C 68700	CuZn22Al2		2.046	CuZn20Al2	CZ 110		
	C 44300			2.047	CuZn28Sn1	CZ 111		
	C 46400			2.053	CuZn38Sn1	CZ 112		
	C 67400			2.055	CuZn40Al2	CZ 114		
	C 86400			2.0591	G-CuZn38Al	PCB1, DCB 3		
	C 86400	CuZn40-Y30		2.0592	G-CuZn35Al1	HTB 1		
	C 86300			2.0598	G-CuZn25Al5	HTB 3		
	C 90500			2.105	G-CuSn10Zn	G1		
	C 90800	CuSn12		2.1052	G-CuSn12	Pb2		
	C 91700			2.106	G-CuSn12Ni	CT2		
	C 90250			2.1086	G-CuSn10	CT1		
	C 93200	CuSn7Pb6Zn4		2.109	G-CuSn7ZnPb			
	C 92410			2.1093	G-CuSn6ZnNi	LG4		
	C 83600	CuPb5Sn5Zn5		2.1096	G-CuSn5ZnPb/RG5	LG2		
	C 93700	CuPb10Sn10		2.1176	G-CuPb10Sn	LB2		
	C 93800			2.1182	G-CuPb15Sn	LB1		
COPPER COPPER/NICKEL ALLOYS	C 96200			2.0815	G-CuNi10			
	C 71300	CiNi25		2.083	CuNi25	CN 105		
	C 96400			2.0835	G-CuNi30	CN 2		
	C 72150	CuNi44		2.0842	CuNi44Mn1			
	C 70600	CuNi10Fe1Mn		2.0872	CuNi10Fe1Mn	CN 102		
	C 71500	CuNi30Mn1Fe		2.0882	CuNi30Mn1Fe	CN 107		
	C 17000	CuBe1,7		2.1245	CuBe1,7	CB 101		
	C 17200	CuBe1,9		2.1247	CuBe2			
	C 17500			2.1285	CuCo2Be	C 112		
	C 71640	CuNi30Fe2Mn2			CuNi30Fe2Mn2	CN 108		
	OF	Cu-c1/C2		2.004	OF-Cu	Cu-OF C 103/110		
	C 11000	Cu-a1/A2		2.006	E-Cu57	Cu-ETP-2 C 101		
	C 11000	Cu-a1		2.0065	E-Cu58	Cu-ETP-2 C 101		
	C 1200	Cu-b2		2.0076	SW-Cu			
	C 12200	Cu-b1		2.009	SF-Cu	Cu-DHP C 106		

Technical data provided should be considered advisory only as variations may be necessary depending on the particular application.

For product information, call your local distributor.



Worldwide Distribution World Class Service

Centrally located in Davenport, Iowa, with national and international distribution through an extensive network of distributors and manufacturer's representatives, M.A. Ford® responds effectively to customer tooling needs. Our extensive line of standard products are on the shelf for immediate shipping and technical support is just a phone call away.

Visit www.maford.com for your local M.A. Ford® representative.

Where *high performance* is the *standard*®

ISO 9001:2015 Certified



800-553-8024 • 563-391-6220
www.maford.com



Where **high performance** is the **standard**[®]

Also available:



M.A. Ford[®] Europe Ltd.

650 City Gate
London Road, Derby
DE24 8WY
United Kingdom

Tel: +44 (0) 1332 267960
Fax: +44 (0) 1332 267969
e-mail: sales@mafordeurope.com
www.mafordeurope.com

**M.A. Ford[®] Mfg. Co., Inc.
7737 Northwest Blvd.**

Davenport, IA 52806
USA

Tel: 563-391-6220 or 800-553-8024
Fax: 563-386-7660 or 800-892-9522
e-mail: sales@maford.com
www.maford.com

M.A. Ford[®] Asia-Pacific Limited

Room 1709, Level 17
Millennium City 2
378 Kwun Tong Road
Kowloon, Hong Kong

Tel: +852-2167-7150
Fax: +852-2167-8150
e-mail: sales@mafordeurope.com