

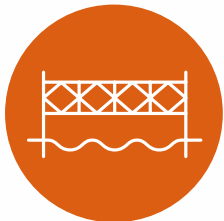

Temporary works. Trusted solutions.

# Temporary Bridging & Site Access





Welcome to

**mabeyhire**

**Every construction and infrastructure project brings unique challenges. That's where our expertise makes the difference.**

Covering the civil infrastructure, buildings and utilities sectors, we've been using our knowledge and experience on projects from bridging and railways to basements and tunneling for over 60 years.

We're the only temporary works specialists in the country that can work with you from early tender stage, design the right solution, supply all the equipment you need, install that equipment and then dismantle it.

All of this, combined with a national engineering team, the UK's widest range of temporary works equipment and a nationwide network of 16 depots, enables us to deliver the right solution for you, whatever the scale or complexity of your project.

# What makes Mabey Hire different?

## Rapid response

When you need a quick, simple temporary works equipment hire, our network of 16 nationwide depots are ready to deliver or for you to collect.



## A complete solution

No other UK temporary works provider can offer a complete in-house solution across design, supply, installation and monitoring for planned, reactive and emergency projects.

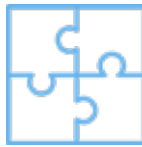

## Immersive technology

Explore your design like never before with EVE. Take a virtual walk through your project and identify any changes or potential risks before any work begins on site.



## Widest range

We have the UK's widest range of temporary works equipment, including groundworks, propping & jacking, formwork & falsework, temporary bridging & access and monitoring.



## All the technical info you need

Instantly access a standard design solution from our standard solutions platform, MyConstruct or find all user guides, Revit families and AutoCAD files on our Tech Hub.



## Working across all sectors

We have decades of experience helping our customers build, maintain and repair our country's infrastructure, utilities and buildings.



## Taking responsible action

We're committed to protecting the planet, caring for our people and communities, and being a responsible business.



# End-to-end solutions

We believe in a world without boundaries. At Mabey Hire we take our customer's project vision and make it our challenge to engineer the right temporary works solution to bring it to life.

## With you from the beginning.

Our engineers will work with you from initial concept, using creative solutions to provide the best design solution for your project. We can even create your project in a virtual environment using EVE, giving you the ability to explore your temporary works design like never before.

Our install team are also with you from the early stages of your project to make sure that any install challenges are foreseen and built into the design.

We can also scale our offer from a standard design to the bespoke, from a simple project to the most complex, in planned, reactive and emergency situations.

Read on to find out more, or talk to us about your project today on: **0330 191 5595** or email: [action@mabeyhire.co.uk](mailto:action@mabeyhire.co.uk).

## How we work with you on your temporary bridging projects

We'll work with you from the initial stages of your project to understand the full range of requirements to design a bespoke bridging solution to suit your criteria.

1

### Design brief

Our team will work with you to discover the finer details of the project, such as the ground bearing capacity, and requirements for span, weight and width.

2

### Site visit

During the visit we will carry out an assessment of the site layout and the available space, determining which type of launch is required.

3

### Concept design

A concept drawing will be completed using the design brief and site visit findings. The concept drawings will then be shared with the client.

4

### Refine the solution

Any final adjustments will be made to the design, the launch sequence will be planned. The design will then be submitted for acceptance.



5

## Delivery & pre-assembly

The bridge will be delivered typically in piece part, or part built dependent on the install method and available space.

6

## Install

Our team will be on site on the day to install the bridge, using the launch sequence from the design.

7

## Dismantle

Our teams will be on site to dismantle the bridge - typically using the reverse method to the install. Once dismantled our team will remove the bridge from site.

## Emergency response

We know that sometimes situations develop quickly, or disaster strikes and you need a fast, efficient response.

In an emergency, our customers can rely on us. As soon as you share your challenge with us, we will work 24/7 to resolve it. For some emergencies this means joining you at the site at any time, day or night.

You can call our emergency response team any time on **03303 119 824**.



# Temporary bridging and site access solutions

As an award winning temporary works specialist, we have over 60 years' experience designing and implementing temporary access solutions for a wide variety of applications across the construction, highways, rail and utilities sectors.

This range of products offer a cost effective solution for major road diversions, the rail network, or for site access challenges. Whether you need to cross a stream, unstable ground or a major roadway, on foot or in a HGV, we have the products to meet your needs.

## Our Temporary Bridging solutions

Our range of pre-assembled BeamBridges and modular Panel bridges offer great versatility, suitable for almost any project or bespoke design.

Our range of temporary bridges are also perfect for emergency bridging, such as reconnecting communities following floods.

## Our Site Access solutions

We have a variety of temporary site access equipment to help personnel get on or off site.

Our range of trench crossing units, temporary roadways and ground protection make the perfect temporary surface for heavy-duty roads, construction sites and even events, no matter what the ground condition.

Read on to find out more, or talk to us about your project today on: **0330 191 5595** or email: **[action@mabeyhire.co.uk](mailto:action@mabeyhire.co.uk)**.



**BeamBridge** (page 8)

Delivered to site fully assembled, ideal for situations needing rapid deployment.



**Panel Bridges** (page 12)

Designed for longer spans and higher traffic load capacities.



**Site Access** (page 20)

Our temporary site access range includes ground protection and trench crossing equipment.



# The right bridge for every project

We have two core types of temporary bridges available, BeamBridge and our Panel Bridges.

## BeamBridge

Our BeamBridges are pre-assembled, ready to lift in, making them the ideal solution where the required span is up to 20m in sites without overhead space restrictions.

The vehicle bridge format can cater for up to 12m carriage widths by using multiple units and is also available in a footbridge format with a walkway width of 1.9m.

## Panel Bridges

Our panel bridges are used to create bespoke designs to suit each individual project, and are ideal to install in awkward locations or on sites where access is restricted or limited.

Spans over 60m can be achieved and carriage widths of up to 7.35m are available.

Our panel bridges are capable of heavy traffic load capacities.

	BeamBridge	Panel Bridges
Span (m):	6 - 20	9m - 81m*
Install options:	Lift In	Launch or Lift In
Available as a footbridge:	Yes	Yes
Cantilever Walkway Available:	No	Yes
Carriage Widths (m):	3.4 - 12 (using multiple units)	2.1m, 3.15m, 4.2m, 4.5m, 7.35m

\*Only applies to Mabey Universal Bridge

For further information on any of temporary bridging & site access systems please refer to our website at [mabeyhire.co.uk](http://mabeyhire.co.uk)

call us on **0330 191 5595** or email [action@mabeyhire.co.uk](mailto:action@mabeyhire.co.uk)



## BeamBridge

Mabey Hire BeamBridges are delivered to site pre-assembled, ready to be lifted directly into position by crane for fast installation such as railway possessions.

Our BeamBridge is designed to accept Highways England loading plus up to 45 units of HB / can support any road vehicle including articulated lorries, concrete trucks and tipper vehicles, as well as mobile crane of up to 120Te GVW making them suitable for a wide range of applications.

Our modular BeamBridges span lengths between 6m-20m and can create unlimited widths or be positioned in staggered formats for more unusual applications.

Our BeamBridges are suitable for both temporary and permanent applications for both pedestrian or vehicular traffic and have a hard-wearing, proprietary epoxy surface for excellent lifespan and skid resistance. Used for flyovers and road diversions, with a low end-profile our BeamBridges can also be used for access to construction sites.





## Applications:



Vehicle And  
Pedestrian Flyovers



River Crossings



Road Diversions



Site Access Ramps



Emergency Bridging

# BeamBridge

With a 2m walkway, the BeamBridge is ideal for providing temporary access across rivers, railways and roadways, as well as providing event bridging solutions.

The BeamBridge comes with kerbs and parapets made from galvanized steel. The unique hinged parapets are laid flat for transportation and once positioned, are raised and pinned into position from on top of the unit, providing an immediate safe working environment.

The metal bridge requires minimal maintenance, offering an economical and attractive solution to suit the needs of most small-scale bridging requirements.



**Pedestrian BeamBridge dimensions**

	6m	12m	18m	24m
Overall length (L)	6000	12000	18005	24010
Walkway width (WW)	1940	1940	1940	1940
Unit depth (centre) (D)	686	686	686	686
Handrail height (H)	1500	1500	1500	1500
Unit weight (kg) (excluding parapets)	4650	8900	13450	18100

# Vehicle BeamBridge

Where a temporary bridge is required quickly, our vehicle BeamBridges provide a swift pre-assembled solution ready to be lifted-in.

Our BeamBridges are available in single or multi span options as spans can be laid side-by-side ranging from 6-20m. Units can even be installed in a skewed staggered format to accommodate more unusual situations.

With widths of 1725mm and complete with anti-skid surface, BeamBridge is designed to accept any road vehicle from articulated lorry to concrete trucks.

## Formats

The vehicle BeamBridges are available in two formats, Flat Top and Rollover, to suit your site requirements.

### Flat Top

Our Flat Top BeamBridges are designed with a traditional 'fish belly' format, ideal where its depth can be easily accommodated.

### Rollover

Our Rollover BeamBridge is particularly useful where clearance to the underside of the bridge is required in applications such as over bridging where existing structures are undergoing repair or strengthening.

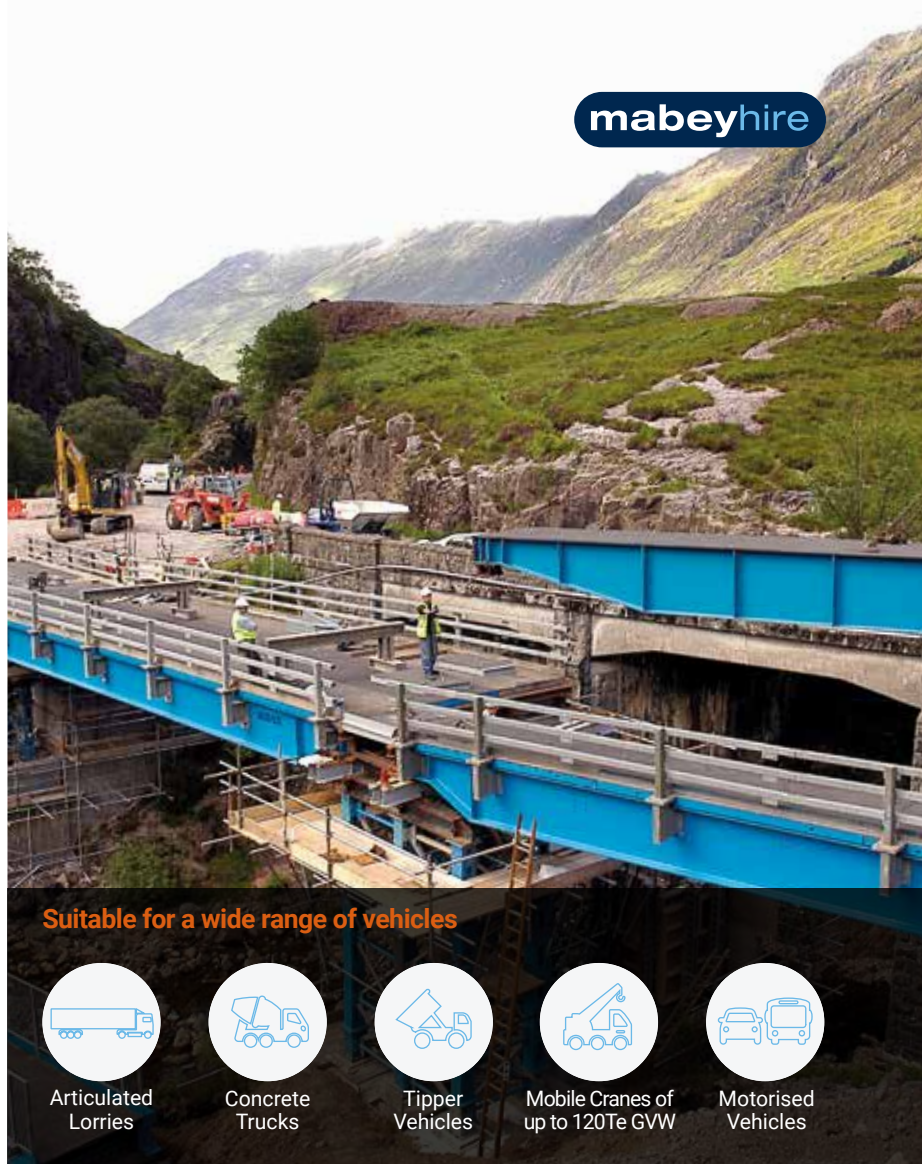

Suitable for a wide range of vehicles



Articulated Lorries



Concrete Trucks



Tipper Vehicles



Mobile Cranes of up to 120Te GVW



Motorised Vehicles

#### Parapets

BeamBridges are typically supplied with galvanized steel proprietary parapets and kerbs.

#### Anti-skid surfacing

BeamBridge units are provided with a proprietary epoxy anti-skid surface. This hard wearing material gives excellent lifespan and skid resistance.

Flat Top



Rollover

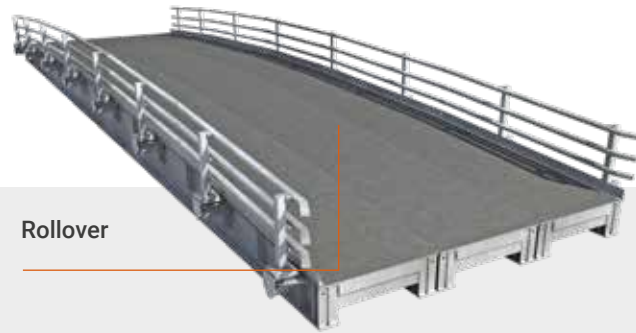

## Flat Top & Rollover Multiple unit widths

Number of units	Road width (RW) (mm)	Overall width (OW) (mm)
2	3400	4175
3	5125	5900
4	6850	7625
5	8575	9350
6	10300	11075
7	12025	12800

## Flat Top dimensions

	6m	9m	12m	16m	20m
Overall length (L)	6088	9140	12180	16240	20300
Max depth (centre) (D)	530	530	635	808	1050
Min depth (d) (ends including bearing)	320	320	320	502	502
Unit weight (kg) (excluding parapets)	3600	4960	7315	11160	14250
Weight of parapet & kerb (one side)	790	920	1340	1500	1960

## Rollover dimensions

	9m	12m	16m	20m
Overall length (L)	9140	12180	16240	20000
Max depth (centre) (D)	486	590	863	1015
Min depth (d) (ends including bearing)	320	320	502	616
Unit weight (kg) (excluding parapets)	5230	7095	12605	17055
Weight of parapet & kerb (one side)	920	1330	1500	2000

For further information on any of temporary bridging & site access systems please refer to our website at [mabeyhire.co.uk](http://mabeyhire.co.uk)

call us on 0330 191 5595 or email [action@mabeyhire.co.uk](mailto:action@mabeyhire.co.uk)



# Panel Bridges

Our panel bridging systems are ideal for situations where longer spans or heavy-duty bridging needs are required.

With a wide range of applications, these versatile bridges are designed to current Highways England loadings and incorporate heavy duty decks to support specialist plant with axles of up to 40 Te. The modular nature of these bridges can include cantilever walkways and service truss options for pipes, for example, to be incorporated into your bespoke design with solutions either positioned side-by-side or cantilevered off from the main carriageway.

Impressive major structures can quickly and safely be installed in the most restricted locations, using a small crane or hand-assembly when required. We will create a launch sequence either by crane or cantilever installation method and deliver component parts on vehicles no larger than 12m flat bed which are suitable for delivery to locations with restricted access.

## Features:

- Available with single, 2 or 3 lane carriageway
- Anti skid deck finish supplied as standard
- Highway parapets available as an option
- Range of installation methods to suit site situation
- Footbridges available



## Applications:



Vehicle and Pedestrian Flyovers



River Crossings and Flood Access



Diversions



Rail



Haul Roads



Site Access/Ramps



Emergency Bridging



Event Bridges

# Our most versatile bridging solution

## Built to suit your project requirements

The modular nature of our two panel bridge solutions - Compact 200 and Mabey Universal, allows for ultimate versatility when creating solutions for temporary bridging.

As well as numerous length and width configurations, there is also the option to include cantilever walkways and service trusses, giving maximum versatility to our customers.

### 1 Footbridges

Single or multi-span footbridges can be constructed using standard components from our panel bridge range.

Our panel footbridges can be clad or decked in timber if required for use in rural or sensitive applications

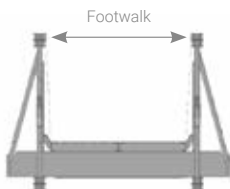

### 2 Service Support Truss & Box Bridges

Our team will design and build a bespoke truss to create a bridge for pipes that need to go over a river for example.

The support is designed to have the pipes fed through the bridge as it is being built.

Service Support Truss

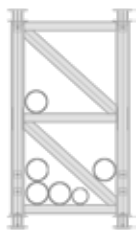

Box Bridge

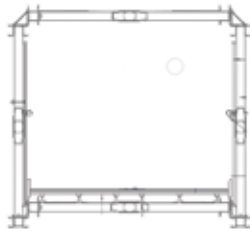

### 3 Available Widths

Carriageways vary in width from 2.0m for pedestrian bridges to 7.35m.

Other carriageway widths are often available or can be manufactured specifically for sale.

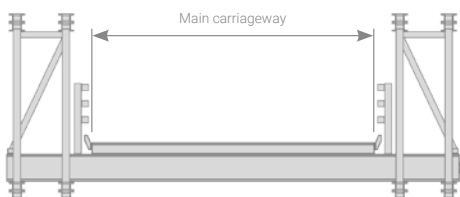

**4 Custom made solution**

Our panel bridges are designed using a number of standard compatible and interchangeable components, allowing us to design the perfect temporary bridging solution for your requirements.

We can design a bespoke bridging solution

which can include footbridges, service trusses and carriageways and additionally can have cantilevered footwalks and service supports attached to the bridge.

Our cantilevered pedestrian footwalks are available in either 1m or 1.5m widths and along with our carriageways are supplied complete with anti-slip surfacing.

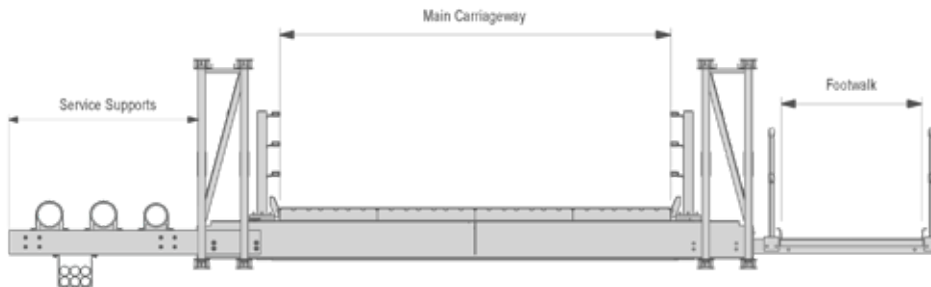

**Carriageway, Footwalk and Service Truss**



For further information on any of temporary bridging & site access systems please refer to our website at [mabeyhire.co.uk](http://mabeyhire.co.uk)

call us on **0330 191 5595** or email [action@mabeyhire.co.uk](mailto:action@mabeyhire.co.uk)

# Compact 200™ Panel Bridge

With a span of up to 60m the C200's versatility allows for many configurations.

Compact 200 is able to carry up to 2 lanes of traffic with options for internal and external footwalks to create single or multispan structures.

From traffic bridging through to pipe or utility support, this temporary panel bridging system can be adapted to your project needs.

## Vehicle Bridge

C200 Vehicle Bridge has options for 1 or 2 lanes of traffic, with carriageway widths from 3.15m to 7.35m. Cantilever walkways, of 1.5m, can be incorporated into the design.

Carriage Widths (m)	Cantilevered Pedestrian Walkway (m)	Truss Panels (m)	Span Length (m)
3.15 - 7.35	Up to 1.5	3.048	60m

## Footbridge

Designed for temporary pedestrian applications, these galvanized footbridges are available in 2.1m or 3.15m widths.

Steel mesh in-fill panels, can be attached to the trusses for improved safety and to prevent debris falling from the bridge. In addition, where used in rural or sensitive applications, these footbridges can be clad or decked in timber if required.

Carriage Widths (m)	Truss Panels (m)	Span Length (m)
2.1 - 3.15	3.048	60m



## Specifications

Both C200 Vehicle Bridge and C200 Pedestrian Bridge truss panels are 3.048m (10ft) long. Span lengths are therefore specified in increments of 3.048m. Available to 60m span lengths.

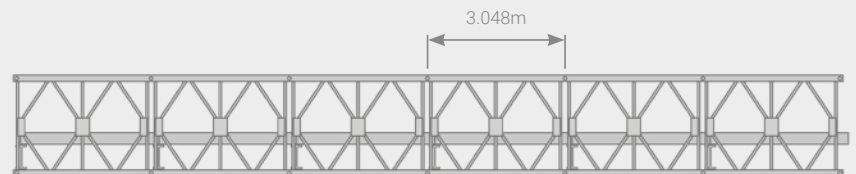



# Mabey Universal Bridge

Our Mabey Universal Bridge is our most robust, heavy duty temporary bridging system.

It is ideal for high load, longer span bridging, and can achieve single spans of up to 81m.

## Bespoke everytime

Usually constructed on-site, it is built using a number of components, allowing us to design the perfect vehicle bridge for your requirements.

Your Mabey Universal Vehicle Bridge will be designed according to the space and access on site, enabling its final positioning to be achieved by a cantilever launch, or a crane assisted lift-in.

## Single and multi-span solutions available

Multi-span solutions are available ensuring Mabey Universal bridge is not restricted by the length of crossing.

This bridge has high fatigue capability and therefore a long service life.

## Benefits

- Can be assembled using light plant
- Can be lifted or cantilever launched into place
- Long span capability
- Robust
- High fatigue capability
- Heavy axle / Wheel load capacity
- Optional footwalks, piers, parapets and barriers
- Various deck options available; 3.15m 4.2m, 4.5m & 7.35m



### Suitable for a wide range of uses

The Mabey Universal (MU) bridge's heavy load capacity makes it suitable for any vehicle whether that's highways loadings or heavy off road earth moving vehicles.



All Heavy Plant



Earth Movers



HGV's



Motorised Vehicles



Pedestrians



Pipes and Services

## Specifications

### Span lengths

Though standard truss panels are 4.5m width, half panels 2.25m in length are also available, therefore span lengths can be specified in increments of 2.25m.

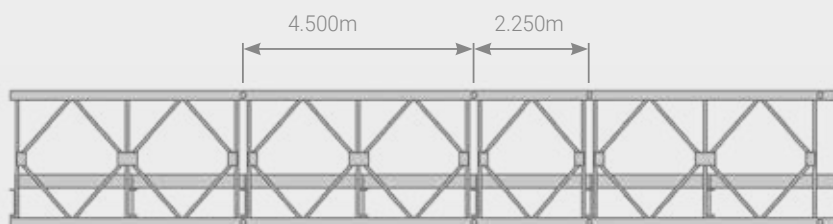

Module Length (m)	Carriageway widths (m)	Number of lanes	Cantilever pedestrian walkways (m)	Finish
4.5	3.15 – 7.35	1 or 2	Up to 1.5	Hot-dip galvanised: BS EN ISO 14713 & 1461 ASTM A123

For further information on any of temporary bridging & site access systems please refer to our website at [mabeyhire.co.uk](http://mabeyhire.co.uk)

call us on **0330 191 5595** or email [action@mabeyhire.co.uk](mailto:action@mabeyhire.co.uk)

# Installation

Our Panel Bridges have been installed throughout the world in situations ranging from green field sites to extreme conditions in inaccessible areas, war and disaster zones.

To accommodate this range of requirements, four principal methods of installation have been developed. Our engineers will discuss each specific use and choose the safest most economic installation method in conjunction with our client.

## Cantilever launch

Allows bridge installation without the use of large cranes or temporary supports. A working area of sufficient size to allow the construction of the bridge immediately adjacent to its final position will be required.

The bridge is constructed on rollers with a temporary skeletal structure or "launch nose" on the front. The launch nose ensures that when the structure is rolled forward the tip of the nose lands on the rollers on the far bank before the centre of gravity passes the launching rollers.

## Crane-assisted launch

The crane-assisted launch technique can be employed where the launch plane is restricted. The bridge is constructed on rollers and progressively moved forward during construction using a crane.

Before the point of balance is reached a crane positioned on the far bank is used to support the leading end of the bridge. As the launch progresses the crane supports the front end until the bridge can be landed on the far bank.



## Lift-in

Our panel bridges can be pre-constructed in skeletal form adjacent to their final position and lifted into position using mobile cranes.

To minimise the lift weight and therefore crane size and cost, the decking can be omitted and added after the skeleton bridge structure is in position.

## Tail Launch

This method is generally used when the site is severely restricted on the far bank. In this case, a launch tail is used instead of a launch nose. Landing rollers are generally not required, since the bridge can be launched directly onto its bearings on the far bank. This method is appropriate for spans less than 25m.

## Our Expert Installation Teams

For over 20 years, we've been the only temporary works specialist with our own site installation teams. They work nationally – and even internationally – on customer sites to install, maintain and dismantle our solutions, all in line with the requirements of BS5975, the code of practice for temporary works procedures.



Lift-in



Tail Launch



For further information on any of temporary bridging & site access systems please refer to our website at [mabeyhire.co.uk](http://mabeyhire.co.uk)

call us on **0330 191 5595** or email [action@mabeyhire.co.uk](mailto:action@mabeyhire.co.uk)



## Temporary Site Access

Keeping people and heavy equipment on stable and secure ground makes for a quicker, safer and more efficient working area. We have a variety of temporary site access solutions available, including ground protection and trench crossing equipment to help personnel get on or off site.

Our range of trench crossing units, temporary roads & ground protection and steel road plates make the perfect temporary surface for heavy-duty roads, construction sites, work and staging areas, no matter what the ground condition.



### **Trench Crossing Units**

Ideal for crossing small trenches, streams and ditches, our Trench Crossing Units provide temporary vehicle and pedestrian access for short span bridging requirements.

### **Temporary Roads and Ground Protection**

Our temporary roads are assembled with composite matting that interlocks to provide a stable surface for construction site access.

### **Steel Road Plates**

Our Steel Road Plates provide temporary vehicle access over narrow trenches, small manholes and other smaller site obstacles.

# Trench Crossing Unit

Trench Crossing Units enable greater widths of trench to be bridged than road plates.

The units are easy to install, with no on-site assembly required. The trench crossing units can simply be lifted straight into position, taking a matter of minutes to install.

They are capable of carrying single vehicles conforming to the Construction and Use Regulations such as cars, buses and lorries up to 40 tonnes Gross Vehicle Weight. This makes them ideal for both vehicle and pedestrian use.

The rollover design provides minimal end depths, removing the need for ramping onto the unit.

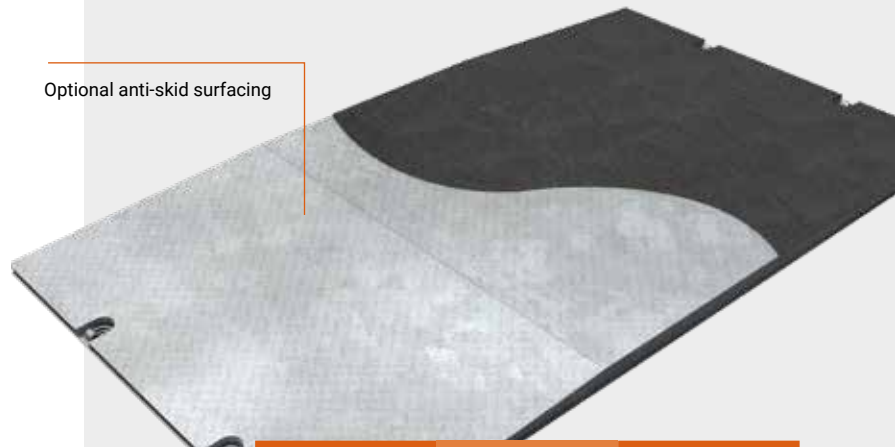

Sizes Available (m) (Length x width)	Weight (kg)	Edge Protection Type
3 x 1.6	950	Mesh
3.2 x 1.7	850	Mesh
4.5 x 1.7	1650	Mesh
6 x 1.7	2650	Not Available
6.1 x 1.7	2150	Mesh or P4 Parapet

# Temporary Roadways

## Steel Road Plates

Steel Road Plates provide temporary vehicle access over narrow trenches, small manholes and other smaller site obstacles. Our plates are designed to help keep construction workers safe to provide easy access across site, and are made with a range of handy features to ensure easy installation and reliability.

Installing our steel road plates is quick and easy, with holes cut into all four corners for simple installation by crane. This makes handling the road plates easy, allowing the plate to be chained when installing and removing.

## Roadforms

Roadforms are a simple form of shuttering, which provide a fast and efficient means of edging when creating concrete roads and pathways.

Our Roadforms are available in various forms to suit project requirements; rigid, square edge or flexible. All our Roadforms are 3000mm in length and available in depths of 100-250mm to accommodate most concrete pour requirements.

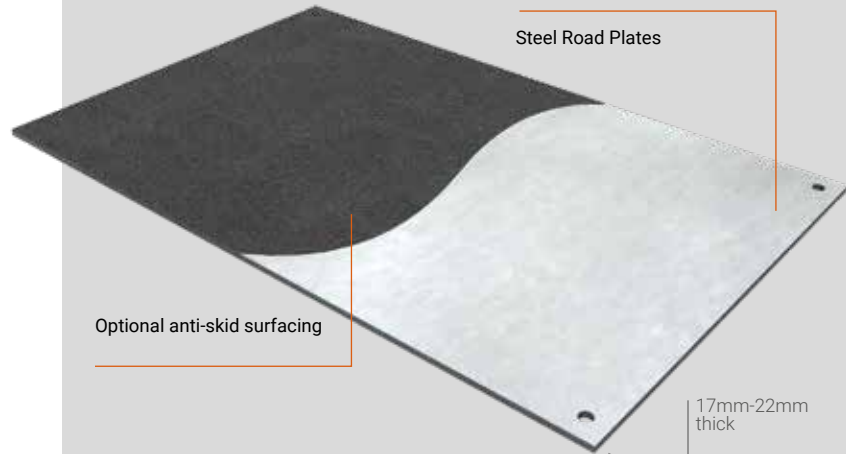

Size (ft)	Size (m)	Weight (kg)	Anti-Skid Surface Available
6' 6" x 9' 10"	2 x 3	940	No
6' 6" x 13' 1"	2 x 4	1260	No
4' x 6'	1.2 x 1.8	560	No
4' x 8'	1.2 x 2.4	720 (752 with anti-skid)	Yes



Form	Length (m)	Depth (m)	Weight (kg)
Rigid (round edges)	3	1-2.5	23.1-42.7
Rigid (with dowel bar holes)	3	1-2.5	23.1-42.7
Square Edge (with dowel bar holes)	3	1-2.5	23.1-42.7
Flexible	3	1-2.5	16.2-31.4

# Ground Protection Mats

Our temporary road matting is used to provide a stable surface for site access. Whether being used for pedestrian or vehicle access, for events or during the construction phase of a site, these mats help to maintain the existing ground and keep it from being damaged.

## Euromat®

**Euromat is tough and flexible and quick to install. This temporary access and ground protection mat is ideal for moving and operating light plant, equipment and personnel over soft or sensitive ground.**

Made from tough 12mm thick high density polyethylene (HDPE), Euromat is virtually indestructible. It weighs just 36kg per mat making the mats manhandleable and has a wide range of connections available for steep or sloping terrain.

## TuffTrak®

**TuffTrak is the ultimate heavy duty road mat, ideal for heavy plant, machinery and multiple vehicles with quick, simple installation, plus its flexible nature means it is able to take the shape of the land.**

It is made from tough 40mm thick high density polyethylene (HDPE) which is 100% recycled material and is also recyclable at its end of life. Tufftrak mats are lighter than aluminium or timber mats, have a unique chevron anti-slip traction surface and protect the ground by spreading the load giving an unrivalled level of grip in all weather conditions.

TuffTrak can sustain loadings of up to 150 tonnes. (Dependant on ground conditions and type/weight of vehicles, machinery and plant).



### Did you know...

Euromat® is the perfect solution for festivals, events and markets where high footfall is expected and the ground conditions are poor, or protection is required.

At just 36kg per mat, they are able to be lifted, moved and installed by hand. In addition, Euromat® is designed with hand cut-outs to make manual handling even easier! .

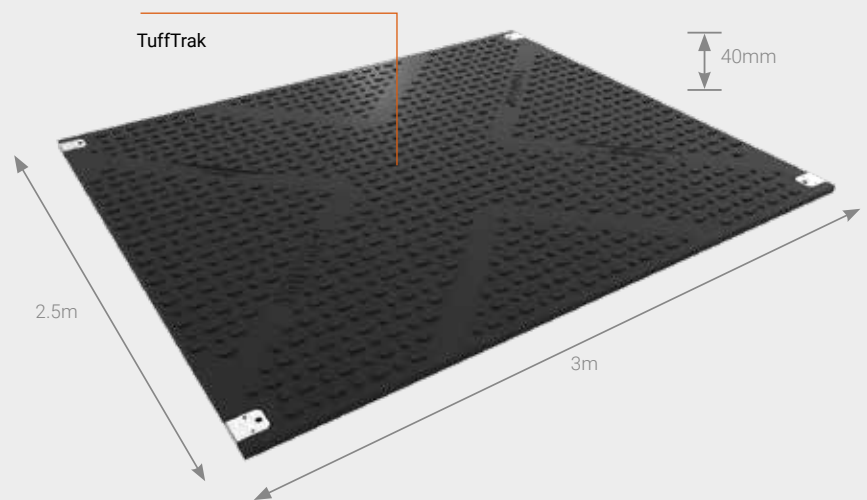
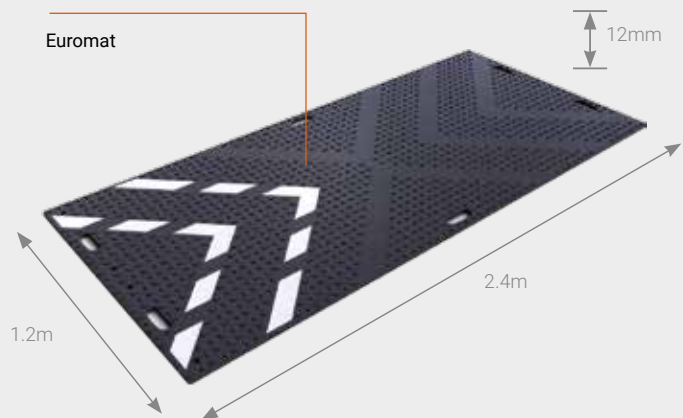

For further information on any of temporary bridging & site access systems please refer to our website at [mabeyhire.co.uk](http://mabeyhire.co.uk)

call us on **0330 191 5595** or email [action@mabeyhire.co.uk](mailto:action@mabeyhire.co.uk)



# Monitoring

We also offer an industry-leading range of monitoring solutions designed to provide you with vital, real-time information about structural movement and environmental impact.

Our expert team brings together a wealth of engineering experience with cutting edge technology to give you highly accurate measurement and real-time information about stress, load, noise and more. All of your data is instantly visible through our unique control of your site's safety, delivering both assurance and compliance.

Applying structural monitoring solutions to your project is an ideal way to monitor the structural behaviour of the temporary bridge. It will provide you with added assurance and confidence in the scheme, especially given that loading levels can change from day-to-day, depending on the amount and type of traffic using the bridge.

With structural monitoring, project teams can gain valuable insight and view live load data, as well as set up alert systems should the loading exceed a pre-determined level.

There are also numerous environmental factors that can impact the conditions on site or surrounding area, e.g. noise, dust, vibration, rainfall etc. Enviroguard continuously measures all of these factors plus more, analysing the site conditions to ensure compliance to Section 61 of the Control of Pollution Act 1974.

To talk to us about a monitoring solution for your project, call **0330 191 5594** or email us at [haydock@mabeyhire.co.uk](mailto:haydock@mabeyhire.co.uk).





**Our project management approach ensures you get the full monitoring solution, from start to finish.**

### Step 1

## System planning & design

Early engagement with our clients ensures that our expert engineers design a tailored monitoring solution to all projects.

### Step 3

## Data configuration

Our unique web based reporting software, Mabey LIVEsite is pre-configured for each project based on a clear understanding of client needs with built in trigger levels to alert users to any breaches.

### Step 5

## Reporting

Templates are set up within the LIVEsite system to enable quick and easy reporting.

1

2

3

4

5

### Step 2

## Installation & configuration

Our team will install and ensure accurate configuration of all monitoring equipment on site.

### Step 4

## Data visualisation

Clients are able to view accurate, real-time data that is easy to interpret through the use of graphs, schematics and 3D modelling.



# Engineering the future

Here at Mabey Hire, we are committed to driving our industry forward. Whether through using the latest technologies or through learning and development, we are constantly looking for ways to improve safety and efficiency for our customers.

With a dedicated digital engineering team embedded in our business, we use the latest technology to help our customers design winning bids, reduce the costs of construction, speed up delivery, improve safety and reduce the full-life cost of infrastructure.

We are extremely passionate about raising standards in the temporary works industry, that's why we have invested in our ICE accredited training programme and developed our STEM Education Programme.





## Immersive Technology

Developed by our in-house engineers, EVE uses immersive technology to create an intuitive 3D design for your construction project, incorporating all aspects of temporary works.

Rendering a fully explorable visualisation of your project, EVE allows users to see the full project before construction work begins.

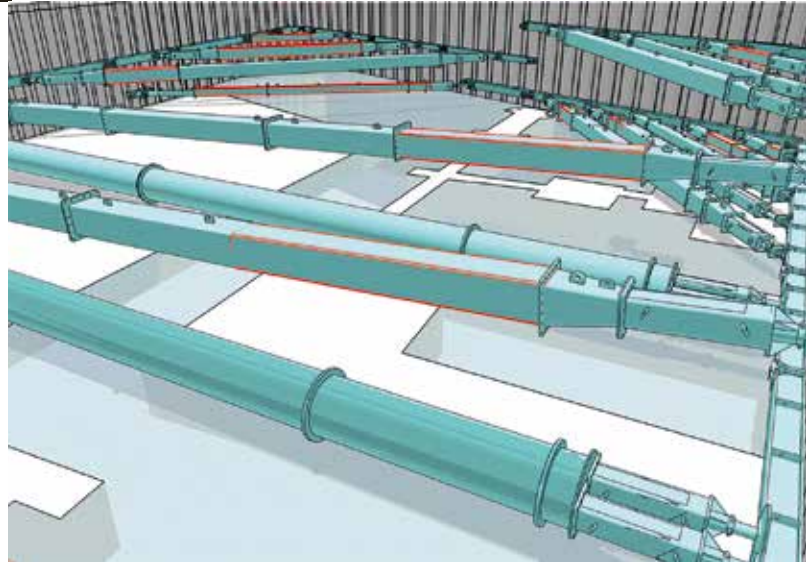

## BIM (Building Information Modelling)

Our early adoption of Revit 3D software in our scheme designs, enabled us to further help our clients to win and deliver projects. We have the capability/processes to work to BIM level 2 standards.



## STEM



We take our responsibility for encouraging the next generation of engineers seriously. That's why we have built the STEM Education programme (Science, Technology, Engineering & Mathematics), using LEGO® to inspire children to consider a career in engineering, delivered by our own STEM Ambassadors, enabling a new generation of engineers to take our industry forward.

## Learning & Development

With our in-house ICE accredited training programme we are committed to supporting the development of our engineers to raise standards within the temporary works industry.

The ICE has approved our structured training agreement and many of our engineering team are either Fellows of the ICE, Chartered Engineers or are working towards professional qualifications.

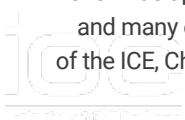

mabeyhire

Temporary works. Trusted solutions.

ACTROS

mabeyhire

Temporary works. Trusted solutions.

0845 741 3040

[mabeyhire.co.uk](http://mabeyhire.co.uk)

Propping & Jacking : Groundworks Support  
Formwork & Falsework : Monitoring  
Temporary Access : Temporary Bridging

YK23 JJX

# Working with Mabey Hire

**Any delay impacts a construction project significantly, so our customers demand a right first time service. We have built our business to ensure we meet that need.**

As an award-winning temporary works specialist - we have the knowledge, experience and the support network to ensure we deliver an unrivalled service. This ensures we can deliver a quick and efficient solution, from design through to delivery and installation, throughout the UK.

This service is backed by our commitment to quality, safety and the environment.

4.8/5



CUSTOMER  
SATISFACTION  
RATING

£2M



ANNUAL  
INVESTMENT  
IN EQUIPMENT

98.75%



ON TIME IN  
FULL INVOICE  
CORRECT

£1M



ANNUAL  
INVESTMENT  
IN VEHICLES

## GET IT RIGHT INITIATIVE

We're committed to eliminating error within the construction industry. With our membership to **GIRI (Get It Right Initiative)**, we're working directly with them and other members to improve productivity, quality, sustainability and safety through the drive of innovation and sharing of best practice.

## Site services

Successful completion of any contract requires co-operation and a desire to succeed from all parties. Our mission is to bring the benefit of our market-leading products together with our experienced engineers and our installation capability to offer safe, economic and least intrusive temporary works solutions, delivered on time and on budget. Our site management and installation teams work closely with the engineers and our clients to advise, plan and execute works on site in a safe, timely manner with due regard to the needs of others working around us.

## Customer service excellence

We pride ourselves on our commitment to customer service excellence and regularly conduct external research to refine and improve our service offering, striving for complete customer satisfaction.

## Commitment to quality, safety and the environment

Our health and safety programme has been recognised by numerous professional bodies across the construction and manufacturing industry.

# TAKING RE:SPONSIBLE ACTION



## ESG

Our activities help shape the world we live in and leave a lasting impact. That's why we're committed to protecting the planet, caring for our people and communities, and being a responsible business.

ESG stands for Environmental, Social and Governance and our strategy sets out how we're taking responsibility for protecting the planet, people and communities to achieve a sustainable future, from the way we behave and operate as a business, to the actions we all take every day.

Discover our full ESG strategy at: [mabeyhire.co.uk/esg](http://mabeyhire.co.uk/esg)

## RE:AFFIRMING OUR COMMITMENTS



### PROTECTING THE PLANET

Taking action today to protect our planet's future

- Net Zero by 2035
- Enhancing biodiversity
- Reducing waste to landfill
- Paper-lite business



### CARING FOR PEOPLE & COMMUNITY

Supporting a fair and inclusive society

- Providing an inclusive workplace with equal opportunities
- Engaging with the communities we work in
- Early career engagement
- Supporting our people



### BEING A RESPONSIBLE BUSINESS

Doing the right thing, always

- Fair and rewarding remuneration
- A compliant and responsible business
- Responsible procurement and supply chain management
- Transparent reporting



# Mabey Hire Near You

## NORTH

### GLASGOW

T: 01417 793535

Woodhead Rd, Muirhead,  
Chryston, Glasgow, G69 9JD

### INVERNESS

T: 01463 239222

41 Lotland Street,  
Inverness, IV1 1ST

### GARSWOOD

T: 01942 725341

198 Gibbons Road, Garswood,  
Nr Wigan, Lancashire, WN4 0YA

### NOTTINGHAM

T: 01159 301154

Oakwood Grange, Robinettes  
Lane Cossall, Nottinghamshire,  
NG16 2RX

### ABERDEEN

T: 01358 723650

Ellon Commercial Park,  
Balmacassie, Ellon, AB41 9RD

### DURHAM

T: 01915 175600

DEWSBURY  
Estate, Houghton-le-Spring,  
DL15 8RA  
T: 01924 464695

1-5 Railway Street, Scout Hill,  
Ravensthorpe, WF13 3EJ

### BILSTON

T: 01902 404512

Stag Industrial Estate, Oxford  
Street, Bilston, West Midlands,  
WV14 7HZ

## SOUTH

### BURY ST EDMUNDS

T: 01284 767600

Mercers Road, Compiegne Way,  
Business and Industrial Park, Bury  
St. Edmunds, Suffolk, IP32 7HX

### HATFIELD

T: 01707 267171

Dennis Works, Traveller's  
Lane, Welham Green, Hatfield,  
Hertfordshire, AL9 7HN

### ROMSEY

T: 01794 515666

Belbins Business Park,  
Cupernham Lane, Romsey,  
Hants, SO51 7JF

### CALNE

T: 01249 821193

Harris Road, Porte Marsh  
Industrial Estate, Calne,  
Wiltshire, SN11 9PT

### STROOD

T: 01634 722465

Commissioners Road, Strood,  
Rochester, Kent, ME2 4EQ

### NEWTON ABBOT

T: 01626 833391

Fairfax Road, Heathfield Industrial  
Estate, Newton Abbot, Devon,  
TQ12 6UD

### WELLINGBOROUGH

T: 01933 441155

15 Bradfield Close, Finedon  
Road Ind Est, Wellingborough,  
Northamptonshire, NN8 4RQ

### CARDIFF

T: 02920 396621

Gulf Works Industrial Estate,  
Penarth Road, Cardiff, CF11 8TT

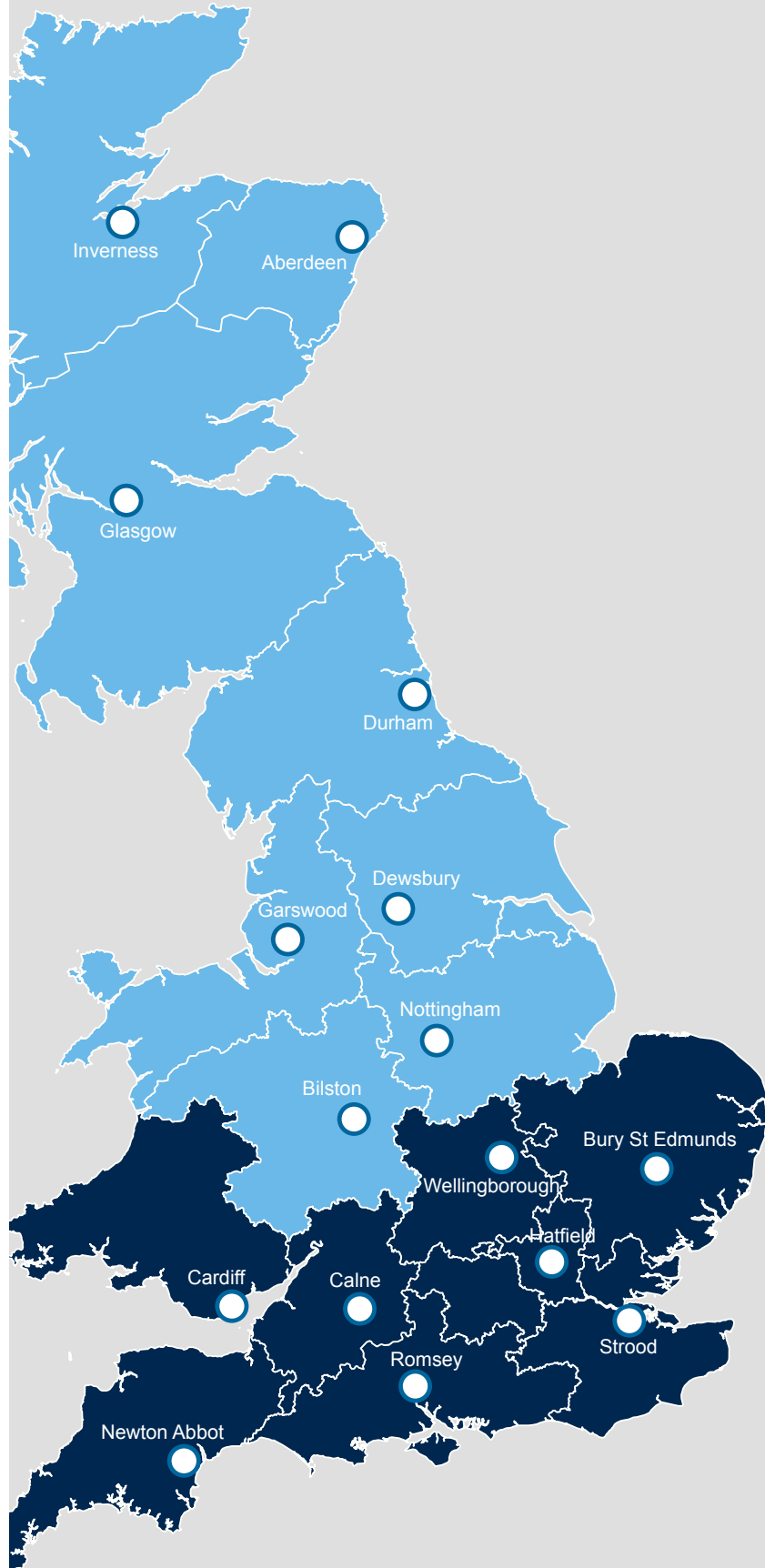



Temporary works. Trusted solutions.

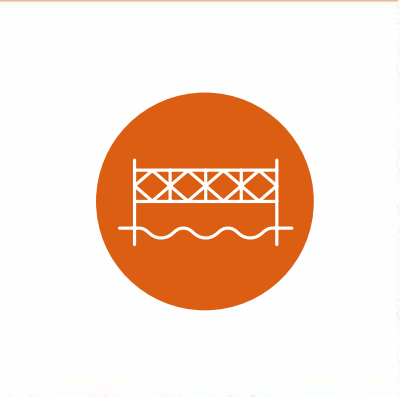

0330 191 5595  
action@mabeyhire.co.uk

