

Lyman® 2021

The Future of Reloading



Innovative Products for Shooters Since 1878

Dear Fellow Shooters-

2020 was a year of great challenge for our company, for our customers and for our nation. Thankfully, at Lyman we were able to continue operations throughout the year and were able to continue to serve our customers and keep our employees working while maintaining the highest levels of safety possible. We hope that you and your families are well, and we look forward to a return to normal sometime in the near future.

This past year was a year of research and innovation for Lyman. We challenged our engineering and manufacturing teams to develop the processes and the innovation to take the Mark 7 product line to the next level, and in 2021 we will start to see all their efforts come to fruition. In 2021 we will bring to the market, a new series of exciting products to serve both the commercial loader and the individual reloading community. Our new APEX 10 loading machine is a completely new press design and will be on the market in the first quarter of 2021. Along with that we will introduce our patented, new, Primer Xpress oscillating primer feed system that will work effortlessly with both the new APEX 10 press as well as the Mark 7 Evolution.

Our Commercial customers will finally see the new Titan series of automated loading systems. The Titan XL is the first automated modular system for the commercial loader than can handle calibers up to .338 Lapua. The new Titan Double Feed allows reloaders to double their production from 3500 rounds per hour to an effective speed of 7000 rounds per hour.

Our new Mark 7 Power Trim Xpress will tackle the toughest commercial trimming jobs but will also work efficiently with any Progressive, Automated, or Single Station press. In fact, when you use it with our Ideal Reloading press it can be turned into a high-speed case trimming workstation that can also case form 300 Blackout cases from .223 in a single stroke. As always, the Lyman Products line continues to innovate and expand so that we can bring you the best products at a competitive price. We will be adding more calibers to our new series of Lyman Stainless Pro Dies which are specially designed for progressive and automated loading.

Over the next few years, you will see more and more of our passion and dedication to providing the best solutions for loading cartridges found anywhere in the world. As always, our success lies in the hands of our customers. We encourage you to take a look at the Lyman and Mark 7 websites where you can get more information on these and other new products. We are sincerely interested in your input and we encourage you to sign up for our newsletter and share your thoughts with us!

Wishing you and your family success, happiness and safety in the coming year!



Rick Ranzinger, President & CEO

**How to Contact Us: Lyman 1-860-632-2020 or toll free at 1-800-22-Lyman (1-800-225-9626) • For Pachmayr/TacStar Products: 1-800-423-9704
Fax: 1-860-632-1699 or write to: Lyman Products Corp., 475 Smith Street, Middletown, CT 06457**

Lyman, Mark7, Pachmayr, TacStar, Trius, Uni-dot, A-Zoom, TurboSonic, Universal Trimmer, Prefit Recoil Pads, Decelerator, White Line, Vindicator, Bleacher Block, Auto Advance, Borecam, G10 Tactical, Renegade, Targ-Dots, Turbo® Tumbler, Pac-Skin, MagDriver, Butch's, SideSaddle, Turbo Sonic Solutions, Ideal, Victory, Brass Smith, and GuardianGrip are registered trademarks of Lyman Products Corp.

All-American 8, Case Trim Xpress, Cyclone, Qwik Draw, Great Plains, AccuTrimmer, Powder Pal, E-Zee Case Gauge, E-ZEE Prime, Gen5, Gen6, Accu-Touch, Micro-Touch, E-ZEE Trim, Case Prep Xpress, Multi-Tool, Quick Slick, Orange Magic, Black Powder Gold, American Legend Grips, Diamond Pro, Tactical Grip Gloves, Auto-Flo, Signature, Compac, Gripper, Sure-Grip, Crusher, Ammo Checkers, E-ZEE Flo, Pocket Touch, Pro-Touch, TargetMan, Bleacher Block, Universal are trademarks of Lyman Products Corp.

Eyepal is a registered trademark of RAS, LLC. Flippin' Critters is a registered trademark of Flippin' Critters LLC

©2021, Lyman Products Corporation, printed in U.S.A. All other trademarks in this catalog are the property of their respective owners.

Mark 7

NEW Apex•10 **2-3**
 Autodrives & Sensors 4-5
NEW Case Feeder **6**
NEW Primer Xpress **7**
 Powder Measure, 100 Round Ammo Checker 8
NEW Power Trim Xpress **9**

Lyman

Lyman Pro Dies 10-11
 Brass Smith Reloading Presses & Kits 12-15
New Press + Stand Kits **13**
 Universal Press Stand & Dust Cover 13
 Brass Smith Accessories 16
 Powder Handling & Brass Smith 500 Scale 17
 Electronic Scales 18-19
 E-ZEE Prime & Stuck Case Remover 20
 MSR Die Sets and Creedmoor Dies 21
 Dies & Die Sets 22-27
 Handbooks & Publications 28-29
NEW AR Reloading Handbook 2nd Ed. **29**
 Cyclone Rotary Tumbler & Stainless Steel Pin Magnet . . 30
 Cyclone Case Dryer 31
NEW Cyclone Case Cleaning Kit **31**
 Ultrasonic Cleaners & Solutions 32
 Power Pro 33
 Tumblers & Accessories 34-37
 Trimmers 38-39
NEW Case Trim Xpress **40**
NEW Xpress Case Processing Kit **41**
 Case Prep Tools & Accessories 41-45
 Loading Blocks 46-47
 Calipers, Micrometers & Gauges 48
 Ammo Checkers 49
 Casting Equipment, Moulds 50-56
NEW Pedersoli Great Plains Rifles **57**
 Deer Stalker & Trade Rifles 58
 Sights 59-60
 Targets & TargDots 61
 Shooting Bags 62
 Tac-Mats, Range Kits 63
 AccuSight Pistol Sight Tool, Torque Wrench 64
 Trigger Pull Gauges 65
 Borecam Pro Borescope 66
 Gun Mats 67
 Butch's Gun Care Products & Cleaning Tools 68
 Lyman Gunsmith Tools 69-70

Pachmayr

Pachmayr Gunsmith Tools, Pac-Mag 71
 Recoil Pads 72-77
 Pad Selection Guide 77
 Slip On Pads, Shock Shield 78
 Pachmayr Knives 79
 Custom Series Pistol Grips 80
 G10 Tactical Pistol Grips 81
 Renegade Wood Laminate Pistol Grips 82
 Tactical Grip Gloves 83
 Semi-Auto Pistol Grips 84
 American Legend Grips for 1911 & Revolver 85
 Gripper Slip-On Grips 86
 T/C Contender, Vindicator Grips 86
 GuardianGrip 87
 Speedloaders 87
 G10 & Renegade Revolver Grips 88
 Diamond Pro Grips 89
 Revolver Grips 90
 Grip Extenders 91
 Mag Sleeves 92

TacStar

Carbon Fiber Hand Guards 93
 SideSaddles 94-95
 Magazine Extensions 96
 Shotgun Grips & Accessories 96-97
 Brass Catchers 97
 Saddle Sights 97
 AR Grips & Recoil Pad 98
 Adjustable Match Rifle Stock 98
 Collapsible AR Stock & Adapters 99

Trius

Clay Target Traps 100-101
 Eyepal Sight Enhancer 101

A-Zoom

A-Zoom Blue Value Packs 102
 A-Zoom Striker Caps & Variety Packs 103
 Precision Metal Snap Caps 103-104



INTRODUCING APEX10™

10 STATION MANUAL LOADING MACHINE



COMES STANDARD WITH:

- ALL NEW 1 1/2" HIGH SPEED CASE FEEDER
- LYMAN PRO HOLD DOWN DIE INCLUDED
- MECHANICAL POWDER MEASURE
- STANDARD PRIMING WITH ALL NEW SHUTTLE DISK DELIVERY SYSTEM - SMALL/LARGE PRIMER CONVERSION INCLUDED



KEY FEATURES:

- UPGRADEABLE WITH MARK 7 AUTODRIVES AND SENSORS
- SMOOTH ERGONOMIC AMBIDEXTROUS HANDLE
- FULLY SUPPORTED MARK 7 COMMUNITY AND TECHNICAL HELP INCLUDED
- SUPPORTS ONE-PASS PROCESSING AND LOADING
- WORKS WITH NEW AND FIRED BRASS
- PRECISION CNC MACHINED ALUMINUM AND STEEL

Standard features include:

- A massive, robust 10-station cast iron tool head which allows you to “have it all”:
 Station 1: Case feeding
 Station 2: Sizing and decapping
 Station 3: Swage/Case trim
 Station 4: Primer seat with hold down
 Station 5: Case flare/neck expansion
 Station 6: Powder drop
 Station 7: Powder check
 Station 8: Bullet Dropper
 Station 9: Seating
 Station 10: Crimping

The above is just one possible set-up. The 10 station tool head offers a large variety of options for all your reloading and case processing needs.

- All New Large capacity, fast feeding case collator
- Ergonomically designed operating handle, which can be assembled for right or left-hand use
- 11” Case Feeder with variable speed motor
- Mechanical Powder Measure
- Shuttle Disk Stacked Priming System
- Supports one-pass rifle/pistol processing and loading
- Works with new AND fired brass
- Precision CNC machined aluminum and steel
- Upgradeable with Mark 7 Autodrives and sensors
- Fully supported Mark 7 community and technical help included
- Double Guide Rod support for the tool head for more stability
- A large assortment of accessories, upgrades and sensors are available.

Upgradeability

The Apex10 can easily be upgraded with the following options at any point:

- Autodrive
- Primer Express – Electronic Oscillating Primer System
- Digital Powder Measure (only with Autodrive)
- Digital Sensors (only with Autodrive)
- Machine caliber conversion kits that include everything required to convert the press from one caliber to another
- Trimmer kit for rifle processing

PLEASE NOTE: Hold Down Die is included, but additional dies and bullet feeder are not included with the Apex10 and must be purchased separately.

Dimensions

Press core dimensions are: 18” tall x 15” wide x 11” deep (45.7cm x 38.1cm x 27.9cm) Machine weight: 60lbs (15.9kg)

Available Calibers: (110V version)

- 380 ACP..... (#101-1260-08-01)
- 9mm/38 Super..... (#101-1260-01-01)
- 38 Super Comp..... (#101-1260-07-01)
- 38 Special /357 Mag..... (#101-1260-03-01)
- 40 S&W..... (#101-1260-02-01)
- 10mm..... (#101-1260-09-01)
- 44 Magnum/45 Long Colt..... (#101-1260-11-01)
- 45 ACP (Large Primer)..... (#101-1260-04-01)

- 223 Rem/300 Blkout..... (#101-1260-05-01)
- 6.5 Creedmoor..... (#101-1260-13-01)
- 308 Winchester..... (#101-1260-06-01)

See our website for pricing.

• 10 STATION TOOL HEAD



• ERGONOMIC HANDLE

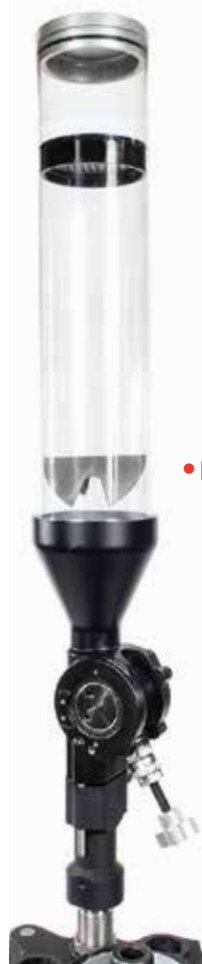

• MECHANICAL POWDER MEASURE



• SHUTTLE DISK STACKED PRIMING SYSTEM

• CNC MACHINED AND PRECISION FIT FOR SMOOTH OPERATION



• DOUBLE GUIDE ROD SUPPORT FOR THE TOOL HEAD CREATES MORE STABILITY

Available Calibers: (220V version)

- 380 ACP..... (#101-1260-08-02)
- 9mm/38 Super..... (#101-1260-01-02)
- 38 Super Comp..... (#101-1260-07-02)
- 38 Special /357 Mag..... (#101-1260-03-02)
- 40 S&W..... (#101-1260-02-02)
- 10mm..... (#101-1260-09-02)
- 44 Magnum/45 Long Colt..... (#101-1260-11-02)
- 45 ACP (Large Primer)..... (#101-1260-04-02)

- 223 Rem/300 Blkout..... (#101-1260-05-02)
- 6.5 Creedmoor..... (#101-1260-13-02)
- 308 Winchester..... (#101-1260-06-02)

See our website for pricing.



**Mark 7 Autodrives
Automate Your Press**

Tired of pulling on the handle of your press over and over and over? The Mark 7 Autodrive will fully automate your Dillon 650, 750, 1050 and Mark 7 Evolution manual presses for speed, efficiency and performance. The Autodrive is packed with features that make it the most advanced system ever designed. The patented digital drive system is computer operated allowing you to fully control the speed, torque, and dwell of the press with a simple to use high definition tablet. This is a true “plug and play” system that makes it easy to mount and set-up on your press. The included TorqueSense and JamSense sensors protect the press and system if anything gets out of place. The Autodrive controller can also accept additional sensor options for the ultimate level of protection. Autodrives come with their own rugged base and a drilled and tapped press mounting plate. The high torque motor and precision machined components combine for super smooth operation.



**All Autodrives
include a 10”
High Definition
Tablet and Mount**

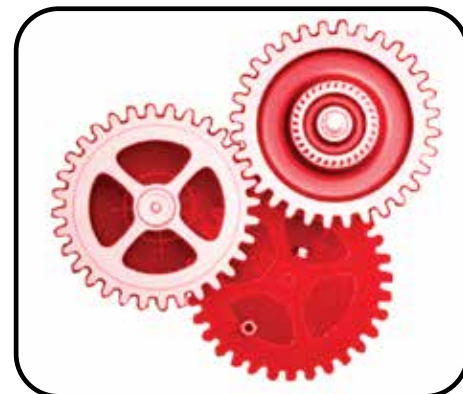

JamSense/Torque Sense

Included as a standard item on each machine is our patented digital clutch technology that is adjustable on-the-fly.

*Included with all Autodrive units

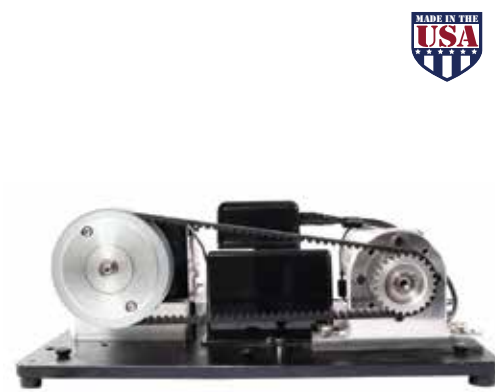
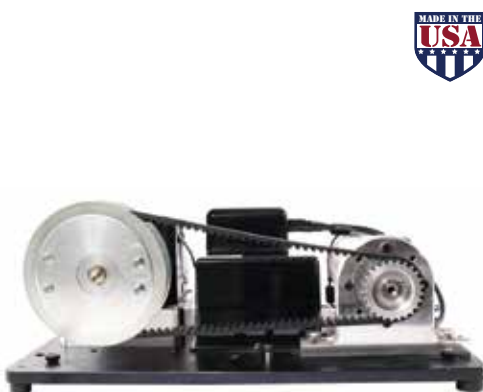

Dillon 650/750 Pro Autodrive

- Microprocessor controlled
- Includes 10” HD tablet
- Adjustable speed settings from 900 to 1800 rounds/hour (Note speeds over 1400 are for brass processing only)
- Adjustable digital clutch
- Digitally controlled jog and stop functions
- High torque motor with reliable direct drive operation
- Includes DecapSense, TorqueSense and JamSense
- Fits Dillon 650 and 750 presses – press not included

(#101-1017-01-01)\$1,999.95

Dillon RL 1050/Super 1050 Pro Autodrive

- Microprocessor controlled
- Includes 10” HD tablet
- Adjustable speed settings from 900 to 3500 rounds/hour (Note speeds can vary based on machine settings)
- Adjustable digital clutch
- Digitally controlled jog and stop functions
- High torque motor with super smooth belt driven operation
- Includes TorqueSense and JamSense
- Fits Dillon 1050 presses – press not included

(#101-1001-01-01)\$1,999.95

Mark 7 Evolution/Apex•10 Autodrive

- Microprocessor controlled
- Includes 10” HD tablet
- Adjustable speed settings from 900 to 3500 rounds/hour (Note speeds can vary based on machine settings)
- Adjustable digital clutch
- Digitally controlled jog and stop functions
- High torque motor with super smooth belt driven operation
- Includes TorqueSense and JamSense
- Fits Mark 7 manual Evolution or Apex•10 press – press not included

(#101-1046-01-01)\$1,999.95



Mark 7 Sensors
Digital Sensors for Mark 7 Autodrives

The ability to use a variety of sensors separates the Mark 7 system from the competition. Ammunition MUST be safe and reliable, whether you are a beginning shooter or a top-level competitor. Progressive and automated presses are also a large investment, so it is a wise move to protect them, your firearms and yourself with our proven sensors. Whether it is ensuring that the spent primer is removed, checking for a correct (or no) powder charge, ensuring that a bullet is present and positioned correctly, or that you are low on primers; we have you covered with the right sensor. All Mark 7 sensors are fully integrated with our computer control box; simply attach, plug in and add the sensor with your Mark 7 tablet. All sensors can be turned on and off via the tablet to coincide with your reloading needs.



PowderCheck

Automatically stops the machine if an incorrect powder level is detected inside the case.

Powder Check (#101-1130) \$249.95

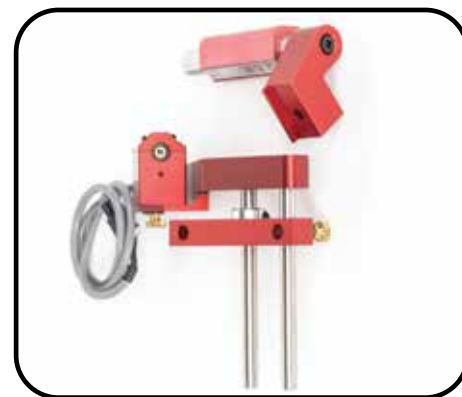

BulletSense

The digital bullet orientation sensor stops the machine instantly if a vertical bullet is not present.

For Dillon 1050 (#101-1082) \$349.95
For Dillon 650 (#101-1083) \$349.95
Evolution/Revolution(#101-1059) \$349.95



Optical DecapSense

Optical sensor that stops the machine and alerts you when a decapped primer is not present. *Included with all 650/750 Autodrives

For Dillon 1050 Super (#101-1011-01) \$199.99
For Dillon 1050 RL (#101-1011-02) \$199.99
For Dillon 650/750* (#101-1011-03) \$199.99
Evolution/Revolution(#101-1036) \$199.99



SwageSense

The first ever electronic sensor system that can stop the machine when unexpected primer pocket obstructions are sensed. (Not compatible with Dillon 650/750)

For Dillon 1050 (#101-1031) \$249.95
Evolution/Revolution(#101-1031) \$249.95



Wired Remote Stop Switch

Machine can stop instantly when the red button is pressed.

Remote Stop (#101-1016) \$29.95



Primer Orientation Sensor

Will stop your press in the event of a primer that is missing, upside down, misaligned, or not set deep enough.

Evolution/Revolution Only (#101-1040) \$324.95

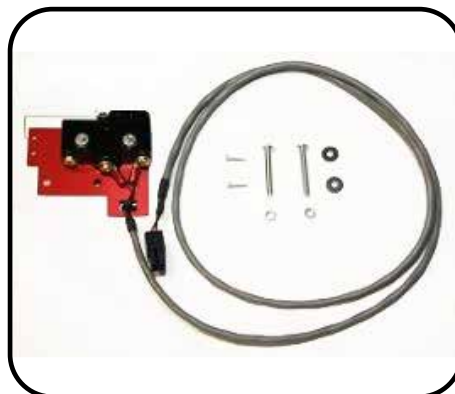

PrimerSense

Proprietary digital sensing mechanism that stops the machine when the primer supply is low.

Dillon 650/750/1050 Only (#101-1009) \$29.95



Mark 7 11" Case Feeder

Mark 7's new 11" High Speed Case Feeder is designed to handle the demanding speeds of our Autodrive units, but also works great on hand operated progressive presses. The 11" Case Feeder offers commercial grade performance and has innovative features to make your loading operations smooth and easy. We started with all metal construction for strength and durability and added a variable speed DC motor which can be fine turned for your specific application. An advanced and reliable proximity switch controls the flow of cases to the press. Our unique bowl design has a trap door which makes it easy to remove cases as well as an adjustable funnel to handle most calibers. The Case Feeder also features a quick detach funnel adapter for easy removal and installation. Two versions are available: Mount directly to your Apex10 press or Universal mount which attaches to your bench, just where you need it.

See website for pricing.

- 11" Case Feeder 110V with APEX/Evolution Pole & Attachments See website for pricing & plate selection
- 11" Case Feeder 220V with APEX/Evolution Pole & Attachments See website for pricing & plate selection
- 11" Case Feeder 110V with Universal Pole & Attachments See website for pricing & plate selection
- 11" Case Feeder 220V with Universal Pole & Attachments See website for pricing & plate selection

- Small Pistol Case Feeder Plate (#101-1267-01)
- Large Pistol Case Feeder Plate (#101-1267-02)
- Small Rifle Case Feeder Plate (#101-1267-03)
- Small Rifle Case Feeder Plate (#101-1267-04)

- All metal construction for strength and durability
- 11" bowl equipped with trap door for easy case removal
- Variable speed motor can be fine tuned to your desired speed
- Automatic advanced proximity on/off switch controls case feeding
- Quick detach funnel adapter

PRIMER XPRESS™

Oscillating Automated Priming System

• ADD PRIMERS EASILY WITHOUT STOPPING, THROUGH THE BUILT-IN FUNNEL

PATENT PENDING

• FAILSAFE SENSOR DETECTS INCORRECT PRIMERS AND STOPS OPERATION

• LARGE HOPPER HOLDS 300+ PRIMERS

• OSCILLATING PRIMER RESERVOIR EFFORTLESSLY ORIENTS PRIMERS

• SINGLE SLOT FEED DISC MECHANISM FOR POSITIVE, RELIABLE PRIMER POSITIONING



Mark 7's new Automated Priming System contains totally new, patent pending technology which provides nearly 100% successful primer orientation for your loading machine.

Hundreds of hours of development and testing have gone into the design of this system, along with the loading of hundreds of thousands of primers to ensure consistent, trouble-free operation.

This completely unique design features an oscillating primer reservoir which effortlessly orients primers and allows continuous primer feeding.

No more stopping your machine to reload primers using clumsy tubes! Simply add more primers into the built-in funnel without interruption to your loading operation. The large hopper can hold 300+ primers and includes a tough polycarbonate safety cover, which also keeps dust and debris out of the system.

In the unlikely event that an up-side-down primer does make it into the feed ramp, our failsafe sensor will detect it and sound an alarm for manual presses and stop the operation on automated machines.

In addition, change over between small and large size primers is easy to do and all parts are included. Dual optical sensors automatically start/stop the feed system to provide primers as needed. Primers are fed into your machine using a simplified single slot feed disc mechanism for positive, reliable primer positioning.

Works on Apex•10, Apex•10 Autodrive, Evolution, Evolution Autodrive and Revolution presses. Consumer friendly operation and price, with commercial level performance!

Primer Xpress for Evolution (includes shuttle priming system) (#101-1192-01) See website for pricing
 Primer Xpress for APEX•10 (#101-1192-02) See website for pricing



Mechanical Powder Measure

The new Mark 7 reloading press mounted mechanical powder measure, will give you all the performance and quality you've come to know from Mark 7 Reloading products.

For 2021 Mark 7 is proud to introduce our new press mounted mechanical powder measure. When using a press mounted powder measure there is no need to have a separate powder measure mounted to your bench saving space and time. The powder measure can be mounted to a wide variety of presses, from single stage to turret to progressive and everything in between.

Superior engineering means our powder measure is fully loaded with features. Accuracy within plus or minus a tenth of a grain (± 0.1 gr). Powder hopper capacity of 5,000 grains, and integrated powder screen to help keep out any unwanted debris. Powder baffle to ensure consistent and repeatable powder drops.

Case actuated operation, with built in compliance to work with varying case lengths. No trimming is required. The rotating barrel is built using deep groove ball bearings, and oil impregnated bronze bushings on all sliding surfaces to insure smooth operation and extended life. All stainless-steel internals for years of worry-free use with minimal wear. Simple disassembly for cleaning and converting from pistol to rifle and rifle to pistol.

Please see our website for more accessories.

Pistol Powder Measure (#101-1190-01) \$289.95
 Rifle Powder Measure (#101-1190-02) \$289.95



Integrated powder screen

Powder hopper capacity of 5,000 grains

Powder baffle

Rotating barrel is built using deep groove ball bearings

All stainless steel internals

Oil impregnated bronze bushings



Rifle Powder Measure



Pistol Powder Measure



9mm 100 Hole Ammo Checker Block

High volume reloaders and competition shooters know the significance of quality reloaded ammunition, and importance of dimensionally correct reloads. Lyman now offers a 100-hole 9mm Ammo Checker. This gauge is made to SAAMI minimum chamber specifications, meaning if your reloaded ammunition drops in the gauge it will chamber in your firearm. With the large 100-hole block it is now faster and easier for the high volume reloader and competition shooter to ensure their reloaded ammunition is dimensionally correct and will function flawlessly in their firearms.

9mm 100 Hole Ammo Checker (#7833036) . \$121.50



POWER TRIM XPRESS™

Trim Cases with Lightning Speed



Trims and case forms 300 Blackout from .223 brass with ONE STROKE!

Electric Press Mounted Case Trimmer

Slim motor design takes up minimal room

1-1/2" vacuum manifold to evacuate chips

Powerful industrial grade variable speed DC motor

Replaceable carbide cutter

Uses standard Trim-Dies



Works on most Progressive, Automated, Turret or Single Station Press

Our new Power Trim Xpress case trimmer will tackle the toughest commercial trimming jobs yet is priced to fit any reloaders budget. The trimmer features a powerful variable speed DC motor. The motor is often found on industrial CNC equipment, so you know that it is a tough work horse, yet it is also a slim design that takes up minimal room.

The trimmer will speed through standard trim jobs as well as easily handle cartridge conversions such as 223 to 300 Blackout.

The trimmer will accept standard trim dies and is equipped with a vacuum manifold to cleanly evacuate chips. In addition, the trimmer comes with a long-lasting carbide cutter.

Power Trim Xpress (#101-1196) \$314.95

Set up a Dedicated Trimming Station

Buy the Power Trim Xpress AND the Lyman Ideal Press in one kit and save time and money by having your own trimming station set up and ready to go all the time.

Power Trim Xpress Plus Ideal Press Kit (#7810354) \$384.95

Lyman® STAINLESS STEEL Pro Dies



**A NEW STANDARD
FOR RELOADING
DIE PERFORMANCE**



Lyman Pro Trim Dies



Lyman Pro Trim Dies are made in the USA to Lyman's highest quality standards. Made from stainless steel for a lifetime of use. Pro Trim Dies are threaded on the bottom in 7/8-14 to fit all Lyman, Mark 7, and all other reloading presses on the market. The top thread is 13/16-20 for use with Lyman's new press mounted trimmer or many of the other popular press mounted trimmers on the market.

Trim Die 223 Rem (#7702100)	\$42.95
Trim Die 300 AAC (#7702101)	\$42.95
Trim Die 308 Win (#7702102)	\$42.95



Lyman Pro Case Flare Dies



Our case flare dies are especially designed for use with progressive and automated reloading presses. The long tapered expanding plug allows you to adjust for just the right amount of case flair to properly position a bullet for seating. Our Case Flare Die is also made of corrosion resistant stainless steel which protects it from rust and keeps it looking like new for a lifetime of use.

9mm (#7701105)	\$42.95
.40 S&W (#7701106)	\$42.95
.45 ACP (#7701107)	\$42.95



**Universal Spring Loaded
Decapping Die**



Lyman's Universal Spring Loaded Decap Die is equipped with a spring-loaded decapping rod system that ensures the primer is forcefully ejected from the primer pocket every time. This die works great for processing brass on automated and progressive presses, as well as for prepping brass for cleaning on standard turret and single station presses. Works on all calibers 22 through 45 except for 378 and 460 Weatherby. (Will not remove Berdan primers.)

Univ. Spring Loaded Decap Die (#7701100) ..	\$42.95
Decapping Rod (#7702054)	\$5.00
Decapping Rod 10 Pack (#7702055)	\$29.95



Stainless Pro Carbide Sizing Dies



Tungsten carbide sizing dies were pioneered by Lyman, now we have made them even better. Our new Pro Carbide die bodies are made of stainless steel which is noted for its toughness and anti-corrosion qualities. No more rusted dies! Our sizing dies are equipped with highly polished carbide rings for the ultimate in wear resistance and reduced sizing force. The carbide rings have a generous radius on the mouth to allow cases to easily align on progressive presses. Rifle dies also include our super slick carbide expander buttons to reduce case stretch. In addition, the sizing dies are equipped with a spring-loaded decapping rod system to ensure that the primer is forcefully ejected from the primer pocket every time.

380 Auto (#7704238)	\$99.95
9mm (#7704230)	\$99.95
38 Super (#7704232)	\$99.95
40 S&W/10mm (#7704234)	\$99.95
45 ACP (#7704236)	\$99.95
223 (#7704240)	\$209.95
6.5 Creedmoor (#7704246)	\$209.95
300 AAC (#7704244)	\$209.95
308 (#7704242)	\$209.95



**Lyman Pro Series
Micrometer Taper Crimp Dies**



Our Micrometer Taper Crimp Die gives you exact the amount of crimp that you want. The Taper Crimp Die has a micrometer adjustable head for precise positioning of the floating crimp sleeve. If you want to change your bullet crimp a few thousandths of an inch, simply turn the micrometer head to the required setting. The floating crimp sleeve centers the cartridge and applies a perfect taper crimp. Our Micrometer Taper Crimp Die is also made of corrosion resistant stainless steel which protects it from rust and keeps it looking like new for a lifetime of use.

380 ACP (#7704560)	\$99.95
9mm (#7704554)	\$99.95
38 Super (#7704580)	\$99.95
40 S&W/10mm (#7704570)	\$99.95
45 Auto (#7704590)	\$99.95
223 (#7704600)	\$99.95
300 BLK (#7704610)	\$99.95
6.5 Creedmoor (#7704630)	\$99.95
308 (#7704620)	\$99.95



**Lyman Pro Micrometer
Seating Dies**



Our Micrometer Seating Die gives you exact bullet seating length and minimal run-out. The seating die has a micrometer adjustable seating head for precision bullet seating length. If you want to change your bullet seating depth a few thousandths of an inch, simply turn the micrometer head to the required setting. Its floating bullet seating punch centers the bullet on the case and eliminates excessive run-out. Our Micrometer Seating die is also made of corrosion resistant stainless steel which protects it from rust and keeps it looking like new for a lifetime of use.

380 (#7704360)	\$99.95
9mm (#7704354)	\$99.95
38 Super (#7704380)	\$99.95
40 S&W/10mm (#7704370)	\$99.95
45 ACP (#7704390)	\$99.95
223 (#7704400)	\$99.95
6.5 Creedmoor (#7704430)	\$99.95
300 BLK (#7704410)	\$99.95
308 (#7704420)	\$99.95



Universal Hold-Down Die

The Universal Hold-Down Die is designed for use on Mark 7 and other progressive presses which swage primer pockets. The die is equipped with a sturdy rod which is designed to reach down inside the case and hold the case firmly in position as the swaging operation takes place. This prevents cases from being torn out of the shell plate damaging it and the brass. Two rods are included to cover the full range of rifle and pistol cases. The die body is also made of corrosion resistant stainless steel which protects it from rust and keeps it looking like new for a lifetime of use.

Universal Hold-down Die (#7701101) \$42.95



Lyman Pro Die Spare Parts

- Pistol Decapping Rod (#7702215) \$4.95
- Pistol Decapping Rod 10 Pack (#7702216) . . . \$29.95
- Rifle Decapping Rod (#7702219) \$7.95
- Rifle Decapping Rod Tip (#7702217) \$3.50
- Rifle Decapping Rod Tip 10 Pack (#7702218) . \$20.95
- Universal Decapping Rod Tip (#7702054) \$4.95
- Universal Decapping Rod Tip 10pk(#7702055) \$29.95

Lyman Pro Die Packs

Lyman Pro dies will set a new standard for reloading die performance! Designed for the tremendous volume of our Mark 7 presses, every aspect of these precision dies was carefully engineered for top performance. Of course, they work great in regular progressive presses as well as turret and single station presses. Our first consideration was the material of the dies. Our size, seat and crimp dies are all made of stainless steel which was chosen for its toughness and anti-corrosion qualities. No more rusted dies! Our sizing dies are equipped with highly polished carbide rings for the ultimate in wear resistance and reduced sizing force. In addition, the sizing dies are equipped with a spring-loaded decapping rod system to ensure that the primer is forcefully ejected from the primer pocket. Our rifle sets get our famous M die neck expander, with its famous two step expander plug for just the right amount of neck tension and case mouth flare. The pistol sets include our flare die which are designed to allow bullets to properly sit on the case mouth prior to seating. Next is our Micrometer Seating die. This seating die has a micrometer adjustable seating head for precision bullet seating length. Its floating bullet seating punch centers the bullet on the case and eliminates excessive run-out. Finally, each set is equipped with a taper crimp die to fully remove any case mouth flare and to provide improved bullet retention. Lyman Pro dies offer more features at a better price than any competitive dies available!



- 380 (#7701016) \$249.95
- 9mm (#7701000) \$249.95
- 38 Super (#7707004) \$249.95
- 40 S&W/10mm (#7701008) \$249.95
- 45 ACP (#7701012) \$249.95
- 223 (#7701020) \$324.95
- 6.5 Creedmoor (#7701032) \$324.95
- 300 BLK (#7701028) \$324.95
- 308 (#7701024) \$324.95



Brass Smith Ideal Press

Lyman's Brass Smith Ideal Press is the perfect starting point for beginners or as a precision companion press for experienced reloaders. The compact design of the Ideal Press requires minimal bench space, but it is not some flimsy lightweight! The rugged press frame is made of cast iron, while other components are all steel. The press features compound linkage for optimum leverage, a 1" diameter ram, and a 3 7/8" press opening which can handle all pistol calibers and rifle cartridges with a loaded length of up to 3.700". The press has a central handle position for easy ambidextrous use and a ball handle for comfortable operation. The Ideal Press accepts all 7/8x14 thread dies and standard shell holders. The press will provide accuracy and precision for beginners or experts, and is the perfect auxiliary press for those wishing to perform a specific operation separate from their main press.

- Rugged cast iron frame
- Ambidextrous design
- Handles all pistol calibers and rifle cartridges up to 3.700 in length
- Accepts all standard 7/8"x14 dies and standard shell holders
- Durable powder coat finish
- Compound linkage and 1" diameter ram
- Weight 12.6 pounds

Brass Smith Ideal Press (#7726500) \$121.50

Brass Smith Victory Press

The Lyman Brass Smith Victory Press is the workhorse of our line. You cannot find a more sturdy, rugged, and rigid single station press available. We started with a heavy duty cast iron "O" frame, and added a 1" diameter ram, and compound linkage. Work the press handle and you will feel the tight, precision fit and smooth operation. Unlike many competitive presses, the Victory Press comes with a newly designed straight line primer feed. The straight line primer feed is completely reliable and simple to use. Simply push the priming arm forward at the bottom of the ram travel to position it beneath the shell holder. For added safety, the primer feed comes with a heavy steel shield which surrounds the primer tubes. The large 5" frame opening makes even the largest magnum calibers easy to load. The Victory Press is equipped with a comfortable ball handle which can be positioned for either right or left hand use. The Victory Press is designed for use with any standard 7/8"x14 thread dies and accepts standard shell holders.

- Heavy duty cast iron "O" frame
- 1" diameter ram
- Comes with straight line primer feed with large and small primer tubes
- Precision fit and smooth operation
- Large 5" frame opening, works with the largest cases
- For added safety, the primer feed comes with a heavy steel shield which surrounds the primer tubes.
- Right or left hand operation
- Durable powder coat finish
- Weight 18.1 pounds

Brass Smith Victory Press (#7726350) \$232.95

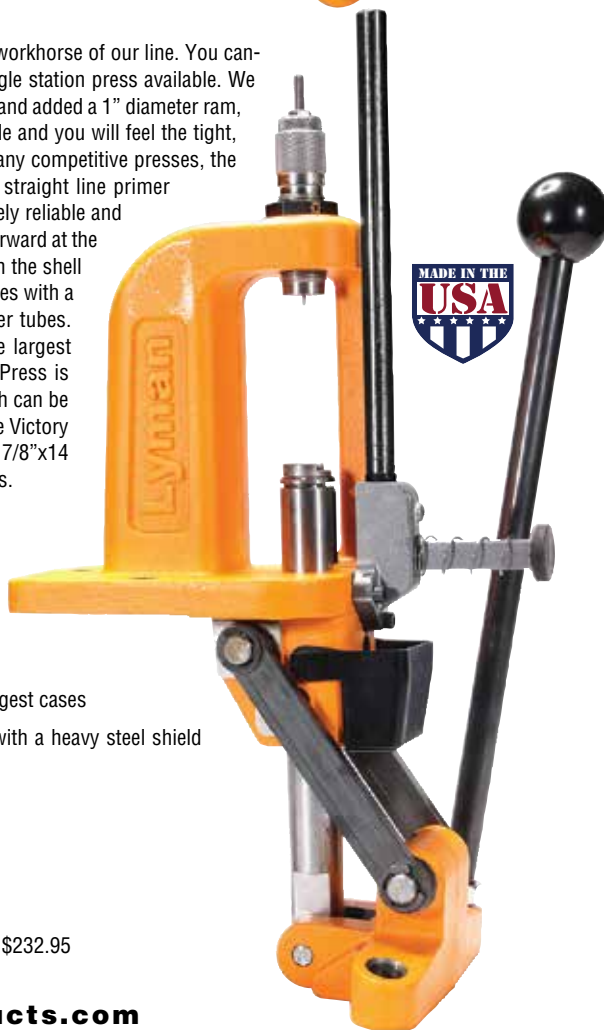

Lyman Universal Press Stand

The Lyman Universal Press Stand is the only press stand on the market that will accept most current single station, turret, and progressive presses of all brands. This heavy duty steel stand comes with two mounting plates pre-drilled for your favorite single station, turret, or progressive press. If by chance you have a press that does not match up with any of the numerous patterns, there is also a blank area where you can drill your own mounting holes. The stand will raise your press 9 1/4" above your bench surface, which will lessen fatigue from having to bend over to cycle your press and provides a clear view of all reloading operations. All hardware needed to mount your press is included. The Universal Press Stand is drilled to allow it to be bolted to your bench, or it can be C-clamped to provide quick removal if desired.

- All steel, heavy duty construction
- Accepts most single station, turret, and progressive presses
- Blank area allows custom drilling
- Raises your press 9 1/4" for a clear view of reloading operations
- Reduces fatigue
- Press mounting hardware is included
- Fits the following presses and more:
Lyman - Crusher, T-Mag, Ideal C-Frame, Victory, All-American 8 Turret,
RCBS - Rock Chucker, Rock Chucker Supreme, RCBS Turret, Pro 2000,
Hornady - AP, Iron, Lock-N-Load Classic,
Redding - T7, Lee - Load Master, Pro 1000, Classic, Value Turret,
Dillon - Square Deal, 550, 650

Universal Press Stand (#7726750) \$75.95





Brass Smith All-American 8 Turret Press

The eight station Brass Smith All-American 8 Press is the most feature-packed, rugged turret press on the market! Starting at the top, the extra-large 8 station turret is machined out of heavy duty cast iron. It is equipped with an easily removed turret bolt which makes swapping turrets simple. The 8 die station turret is the largest available and will hold two complete 4 die sets or up to four 2 die sets. Below the turret is a rigid cast iron frame, housing a 1" diameter ram and compound linkage. The frame is large enough to work with even the longest rifle cartridges. Work the press handle and you will feel the tight, precision fit and smooth operation. Unlike many competitive presses, the Brass Smith All-American 8 Press comes with a newly designed straight line primer feed. The straight line primer feed is completely reliable and simple to use. Simply push the priming arm forward at the bottom of the ram travel to position it beneath the shell holder. For added safety, the primer feed comes with a heavy steel shield which surrounds the primer tubes. The Brass Smith All-American 8 Press is equipped with a comfortable ball handle which can be positioned for either right or left hand use. The Brass Smith All-American 8 Press is designed for use with any standard 7/8"x14 thread dies and accepts standard shell holders.

- Heavy duty cast iron frame and turret
- Extra-large 8 station turret is easily removed to make swapping turrets simple.
- Holds two complete 4 die sets or up to four 2 die sets
- 1" diameter ram
- Comes with straight line primer feed with large and small primer tubes
- Precision fit and smooth operation
- Large press opening, works with the largest cases
- For added safety, the primer feed comes with a heavy steel shield which surrounds the primer tubes.
- Right or left hand operation
- Durable powder coat finish
- Weight 23 pounds



All-American 8 Press (#7040750) \$313.95
 Extra Turret (#7726165) \$60.75
 Extra Priming System (#7726100) \$50.95

Press Dust Cover

Protect your investment in top quality Lyman Presses with a Lyman Press Dust Cover. This simple cover will protect your presses from dust and dirt, maintaining their "like new" condition for years to come! Plus the good looking cover will make your reloading bench appear neat and organized.

Press Dust Cover (#7726740) \$21.25



Press + Stand Kits

Get both the Lyman Brass Smith press you want AND the Lyman Universal Press Stand to mount it on your bench and save money over buying the two items separately!

Brass Smith Ideal Press +
 Universal Press Stand (#7810352) \$171.95
 Brass Smith Victory Press +
 Universal Press Stand (#7810362) \$273.95
 Brass Smith All-American 8 Press +
 Universal Press Stand (#7810372) \$339.95



BRASS SMITH IDEAL RELOADING KIT

Lyman's Ideal Reloading Kit is the perfect starter kit for the new reloader. It features all the essential tools that you need but will never out grow as your experience increases. The kit includes Lyman's new Ideal Press, equipped with a rugged 1" ram and capable of handling all pistol and rifle cartridges up to 3.700" in length. You also get our new Brass Smith Powder Measure, our popular E-ZEE Prime Hand Priming Tool, the famous 50th Edition Reloading Handbook, the Pocket Touch 1500 digital scale with Funnel Pan and dipper, as well as the Case Prep Multi-Tool, loading block and Quick Slick Case Lube. All for a price that is a large savings over individual purchases!

Ideal Kit Includes:

- Brass Smith Ideal Press
- Brass Smith Powder Measure
- 50th Edition Reloading Handbook
- Pocket Touch 1500 electronic scale with Funnel Pan and Dipper
- Loading Block
- Case Prep Multi-Tool
- E-ZEE Prime Hand Priming Tool
- Quick Slick Case Lube

Brass Smith Ideal Kit (#7810350) \$299.95



BRASS SMITH VICTORY RELOADING KIT

Lyman used all 140 years of their reloading experience with the design of the new Brass Smith Victory Press. This workhorse cast iron press is equipped with our completely new Auto Primer Feed and is the most rugged yet precise single stage press available. Perfect for precision rifle shooters, the Brass Smith Victory Reloading Kit gives reloaders all of the expert grade equipment that they need! The kit features the heavy duty Victory Press, our new Brass Smith Powder Measure, the famous 50th Edition Reloading Handbook, 1500 grain capacity Pocket Touch Digital Scale with Funnel Pan and dipper, Case Prep Multi-Tool, our Magnum Bullet Puller as well as a loading block and Case Lube Kit.

Single Stage Press Kit includes:

- Brass Smith Single Stage Press
- Brass Smith Powder Measure
- 50th Edition Reloading Handbook
- Pocket Touch 1500 electronic scale with Funnel Pan and Dipper
- Loading Block
- Case Prep Multi-Tool
- Magnum Bullet Puller
- Primer Tray
- E-ZEE Powder Funnel
- Case Lube Kit
- Powder Dribbler

Brass Smith Victory Kit (#7810360) \$399.95





BRASS SMITH ALL-AMERICAN 8 RELOADING KIT

Lyman is proud to be celebrating our 140 years in business; however we are even prouder of our new All-American 8 Press. Our new turret press is the most features packed, rugged press on the market, and is the heart of the All-American 8 Reloading Kit. The heavy duty press is large enough to handle the biggest rifle cartridges, yet offers speed and precision for pistol shooters. Along with the smooth operating 8-station turret capable of holding up to 4 two die sets, the press is equipped with our brand new straight line Auto Primer Feed. To make this the most complete kit that you can find, we have included our new Brass Smith Powder Measure, our Universal Trimmer with 9 of the most popular caliber pilots, our 1500 grain capacity Pocket Touch Digital scale, the famous 50th Edition Reloading Handbook, our Magnum Bullet Puller, Case Prep Multi-Tool, loading block Case Lube Kit and Powder Dribbler.

All-American 8 Reloading Kit includes:

- Brass Smith All-American 8 Press
- Brass Smith Powder Measure
- 50th Edition Reloading Handbook
- Pocket Touch 1500 electronic scale with Funnel Pan and Dipper
- Universal Trimmer with pilot multi-pack
- Case Prep Multi-Tool
- Magnum Bullet Puller
- Case Lube Kit
- Loading Block
- Powder Dribbler
- E-ZEE Powder Funnel
- Primer Tray



All-American 8 Kit (#7810370) . . \$564.95



ULTIMATE RELOADING SYSTEM

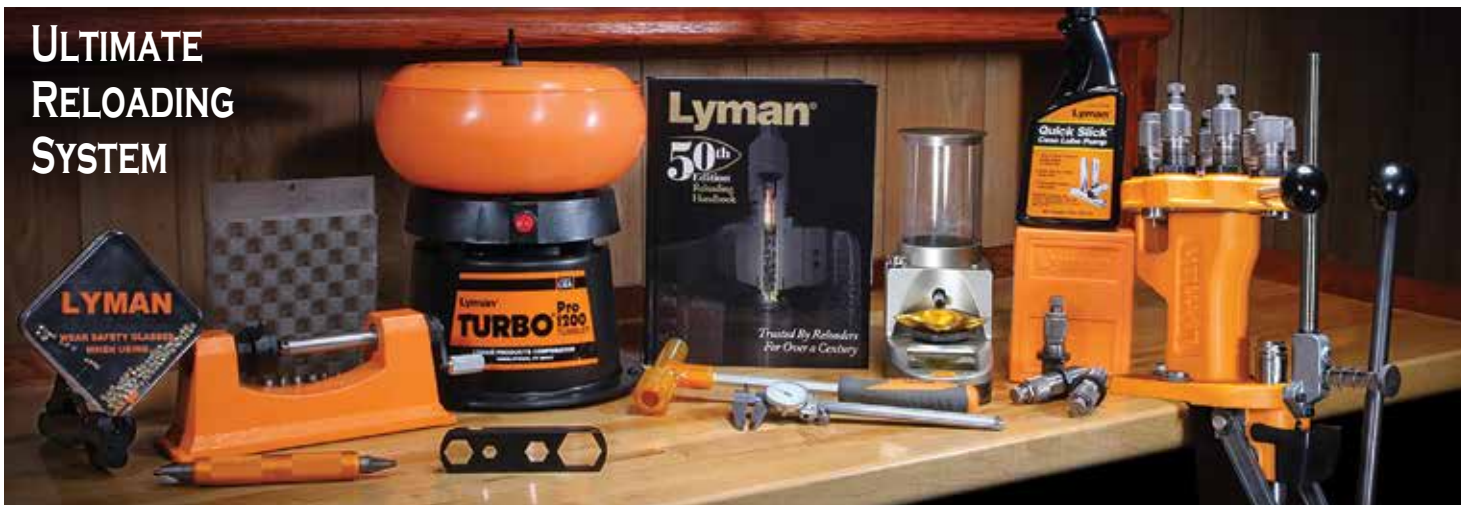

The Lyman Ultimate Reloading System is the only kit you'll ever need! Outfit an entire reloading bench with premium products designed to accomplish all steps in the reloading process. No other kit from any competitor can match this untouchable value! The Ultimate Reloading System includes top-of-the-line tools and accessories like our All American 8 turret press, Gen 6 Digital Powder System, Universal® Case Trimmer, Pro 1200 Turbo® Tumbler, and everything else needed to turn out high quality rounds fast! To top off this in-

credible value, get a free die set on us by filling out the enclosed die set rebate. Take your passion to the next level with the Lyman Ultimate Reloading System!

Ultimate Reloading System includes:

- All American 8 turret press
- Gen 6 Powder System
- Universal® Trimmer
- Pro 1200 Turbo® Tumbler
- Free Lyman Die Set Voucher
- 50th Edition Lyman Reloading Handbook

- Universal Loading Block
- Calibration Check weight
- Case Prep Multi Tool
- Bench Wrench
- E-ZEE Prime Hand Priming Tool
- Quick Slick™ Case Lube
- Magnum Inertia Bullet Puller
- Stainless Steel Calipers

Ultimate Reloading System (# 7810311) . . . \$759.95



 **WARNING:** Cancer and Reproductive Harm
www.p65warnings.ca.gov



Brass Smith™ Powder Trickler

The Lyman Brass Smith Powder Trickler was designed with the serious reloader in mind, combining all the features that they are looking for. It starts with a static free die cast aluminum body, which is adjustable for height. The base is machined out of a solid piece of steel, which gives the trickler plenty of weight and stability. The trickler also comes with an aluminum feed tube which can be set-up for a longer reach with the addition of the included feed tube extension. This allows it to be used with electronic scales with wider bodies, as well as mechanical beam scales. The large diameter knob on the feed tube gives you added precision and control when trickling powder out of the generously proportioned powder hopper. And finally, it has an attractive powder coat finish.

Powder Trickler (#7752500) \$23.95



Brass Smith Precision Funnel Set

Lyman's Precision Funnel Set is the "Perfect" system for the serious reloader. The Brass Smith Precision Funnel Set is made to be completely static free, no more powder clinging to surfaces which can happen with lightweight plastic funnels. The solid construction and quality of the Brass Smith Precision Funnel Set will be apparent in its first use. This is no "one size fits all" funnel, the Brass Smith Precision Funnel Set uses precision machined, caliber specific inserts to properly fit the case neck. The inserts can be quickly and easily installed by simply pushing them into place and then pulling them out when changing calibers. The Brass Smith Precision Funnel Set also comes with a padded storage case that neatly stores extra inserts when not in use.

The funnel comes with inserts for 22, 243/6mm, 25/6.5mm, 270/7mm, 30 and 338 caliber rifle cartridges.

- Static Free aluminum die cast body and turned aluminum components
- Precision fit, CNC turned aluminum inserts for calibers 22 to 338
- Inserts are quick and easy to install and remove
- Convenient handle
- Includes padded storage case
- Inserts are laser marked for caliber identification

Brass Smith Precision Funnel Set (#7752432) \$34.50

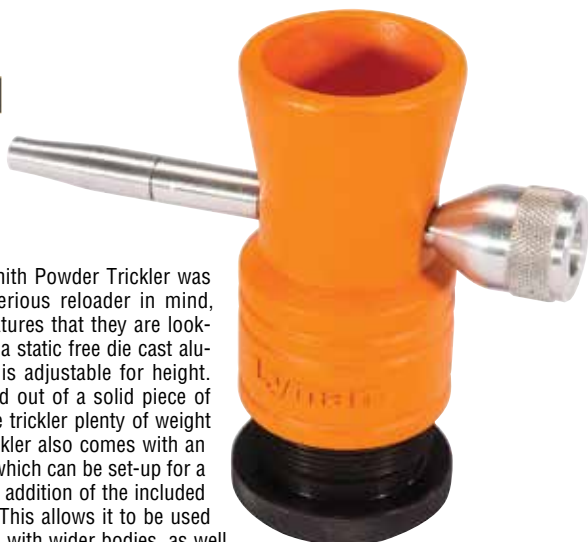

Brass Smith Powder Measure ⚠️

Whether dropping charges for small pistol cases or large rifle cases, this measure gives consistent and accurate performance. The CNC machined steel metering cylinder features a micrometer adjustable thimble with reference lines so resetting the measure is easy. The reservoir is equipped with a powder baffle which maintains a consistent powder level for top accuracy. Includes two drop tubes to cover the full range of calibers.

- Micrometer adjustment
- Ambidextrous metering cylinder/handle
- Multiple handle angle positions for optimum comfort
- CNC machined steel metering cylinder
- Includes powder baffle
- Machined with 7/8"x14 threads to fit all presses and stands

Brass Smith Powder Measure (#7767700) \$67.95



Brass Smith Powder Measure Stand

Lyman listened to the suggestions of our customers and have redesigned our powder measure stand. The new Brass Smith Powder Measure Stand can be mounted firmly to either a bench top or to a wall. Features standard 7/8"x 14 threads and will raise any measure high enough to easily position cases beneath the powder drop tube. Made of tough die cast aluminum.

Powder Measure Stand (#7767788) \$31.95





(Shown Setup for Left-Hand Use)

Brass Smith™ 500 Metal Reloading Scale

The Lyman Brass Smith 500 Metal Reloading Scale offers all of the features that serious reloaders are looking for. The Brass Smith 500 is built upon a sturdy aluminum body which reduces vibrations and ensures accuracy. The beam is double sided and the pan has two handles making it easy for right or left handed reloaders to use. In addition, the beam features black markings with a white background for easy reading throughout its 505 grain capacity. The scale also features magnetic dampening and precision ground knife edges for fast, smooth and accurate operation. Each scale is carefully calibrated at the factory and is accurate to plus or minus 1/10 grain.

500 Reloading Scale (#7752225) \$99.95



Powder Pal™ Universal Funnel Pan

An innovative product for the reloader. The One Piece Combination Powder Pal Funnel Pan. This unique Funnel Pan saves time by saving one step during reloading. It is no longer necessary to put the funnel on the cartridge case and pour the powder in. Just pour it directly from the Funnel Pan into the case. Every reloader with an electronic scale will want to replace the powder pan with a time saving Powder Pal Funnel Pan. More innovations from Lyman. For use with electronic scales only. (US Patent # D568436)

Funnel Pan (#7752433) \$8.50



Full range of height adjustment handles any reloading scale.

E-ZEE Flo™ Universal Powder Trickler

Now the first powder Trickler that works with any reloading scale. Lyman's E-ZEE Flo accessory powder Trickler features an adjustable base that adapts to even that highest scale platform. Powder Trickler tube has an extension that allows use with electronic scales that have larger platform bases. The combination of the two adjustments allows use with any scale, mechanical or electronic.

Powder Trickler (#7752477) \$28.95

Deluxe Weight Check Set



Shooter's Weight Check Set

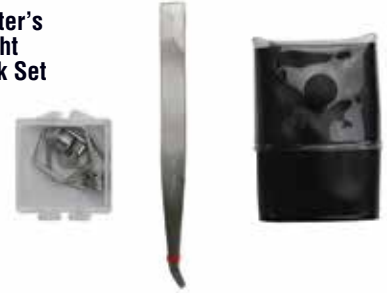

Scale Weight Check Sets

Assures that scales provide accurate readings. Deluxe 10-piece set has 210.5 grains total weight. Shooters set totals 60.5 grains for normal powder use range.

- | | |
|-----------------------------|-------------------------------|
| Deluxe set includes: | Shooters set includes: |
| (1) 100 grain weight | (2) 20 grain weights |
| (1) 50 grain weight | (1) 10 grain weight |
| (2) 20 grain weights | (1) 5 grain weight |
| (1) 10 grain weight | (2) 2 grain weights |
| (1) 5 grain weight | (1) 1 grain weight |
| (2) 2 grain weights | (1) .5 grain weight |
| (1) 1 grain weight | |
| (1) .5 grain weight | |

Deluxe Set (#7752313) \$52.50
 Shooters Set (#7752314) \$40.50



E-ZEE™ Powder Funnel

Redesigned with all of the latest cartridges in mind, the specially designed powder nozzle of this funnel handles everything from the smallest .22 up to the big .50 calibers. Including the Super Short Magnums.

Funnel (#7752431) \$6.50

WARNING: Cancer and Reproductive Harm
www.p65warnings.ca.gov

Gen6™

Compact Powder System



Extra Large, easy-to-read LCD Display



Quick drain to change powders



Gen6™ Compact Touch Screen Powder System

The compact Gen6 design takes a minimum of bench space and offers unrestricted pan and touch screen access for both right- and left-hand users. Accurate to one tenth grain, The Gen6 dispenses all types of smokeless powder at two grains per second. In addition, it features an auto repeat function that drops a precise charge each time the pan is reset.

Based on totally new digital technology that overcomes problems commonly experienced by older designs, the system is packed with additional state of the art improvements like fast, 3-minute warm-up, new anti-static and anti-drift technology and both have electronic shielding to resist interference from other electronic devices like cell phones, etc.

- 1500 Grain Capacity
- New Touch Screen Controls
- New Compact Size - Uses 50% Less Bench Space!
- Auto Repeat Function Drops Charges Each Time Pan Is Reset
- Fast Operation - Dispenses 2 Grains Per Second
- Easy To Use Controls and Powder Pan Access for both Right and Left Hand Users
- New Anti-Static/Anti-Drift Technology
- New Electronic Interference Shield Resists Interference from Cell Phones, etc.
- Quick-Drain Powder System for Easy Powder Changes



Gen6 (#7750550)(115/230V)\$316.95

Bushings / Dust Proof Seals Gen5/6 (2 PACK) (#7991070) \$3.50



Pocket Touch™ Digital Scale Set

The Pocket-Touch 1500 offers full size performance in a very compact, portable design. The scale is just 2¼" x 4¼" x ¾" yet provides advanced touch screen controls and a full 1500 grain capacity. The scale comes with our patented Universal Funnel Pan, powder scoop and calibration weight. The unique Funnel Pan allows powder charges to be poured directly from the pan into the case. No need for a separate funnel. The scale has an easy to read, lighted display, is powered by (2)AAA batteries (included) and has an Auto Shut-off.

- Touch Screen Controls –
 - On/Off, Tare, and Mode/Calibration keys
- 1500 grain capacity
- Universal Funnel Pan – combines a pour spout and a funnel end which accepts 20 caliber to 50 caliber cases
- Built-in, hinged dust cover
- Operates in grains or grams
- Handy powder scoop included
- 100 gram calibration weight included
- Easy to read, lighted, digital display

Pocket Touch (#7750725)(115/230V) \$34.50

Which Scale Fits Your Reloading Needs?



Features a Handy Pop-Out Tray for Storage!



Accu-Touch™ 2000 Electronic Reloading Scale

The Accu-Touch 2000 reloading scale from Lyman offers many revolutionary features. It comes with a removable powder trickler that can be mounted on the scale in a right or left-hand position. Unlike most competitive scales, the Accu-Touch 2000 is accurate to within 1/10 of a grain over its full, extra large, 2000 grain capacity. It works in either grain or gram mode. The handy pop-out tray on the back stores all your accessories, and the fold back dust cover keeps the scale protected. Also includes calibration weight, Universal AC Adapter, and cleaning brush. It will also run on a 9V battery (not included).

- New Touch Screen Controls
- 2000 Grain Capacity
- New Anti-Drift Technology Assures Accuracy to 1/10 Grain
- Includes Removable Powder Trickler that Works in Right or Left-Hand Position
- Includes Powder Brush & Universal AC Adapter
- Handy Pop-Out Tray Stores Accessories
- Fold Back Dust Cover to Protect Scale
- Grains or Grams

Accu-Touch 2000 (115/230V) (#7751558) . . \$171.95

Pro-Touch™ 1500 Electronic Reloading Scale

Lyman's Pro-Touch 1500 scale features a large, easy to use touch screen display with easy to read 7/8" tall numbers and full size control buttons. The Pro-Touch 1500 is accurate to +/- 1/10 grain over its full 1500 grain capacity. The dual spout powder pan allows for easy use by either right-handed or left-handed reloaders. The removable dust cover will protect the scale when not in use. The Pro-Touch 1500 will operate with either the supplied AC power adapter or with three AAA batteries (not included).

- Advanced Touch-Screen Technology
- 1500 Grain Capacity
- Accurate to 1/10 Grain
- Works in Grain or Gram Mode
- Removable Dust Cover
- Large, Easy to Read Digital Display with Full Size Control Buttons

Pro-Touch (#7750718) (115V/230V) \$105.95

Micro-Touch™ 1500 Electronic Reloading Scale

The Micro-Touch 1500 has all the features of much larger models combined with state-of-the-art touch screen controls. Just 3.25" wide by 5.375" long and 1.25" tall with the dust cover in place, this scale has a full 1500 grain capacity. It is powered by an included AC adapter, but can also function on battery power when at the range or camp. The Micro-Touch 1500 also includes its own powder pan and calibration weight.

- New Touch Screen Controls
- 1500 Grain Capacity
- Accurate to 1/10 Grain
- Works in Grain or Gram Mode
- Fold Back Dust Cover
- Works with AC Adapter (incl.) or 3 AAA Batteries (not included)
- Large Easy-to-Read Digital Display

Micro-Touch 1500 (115V/230V) (#7750700) . \$84.95

See our Check Weight Sets on page 17. Ideal for Electronic Scale Calibration.

Works with Lyman, RCBS,
Lee & Redding
Shellholders

Change primer size instantly
and use any shellholder you
already have.



Ergonomic shape
designed to minimize
hand fatigue.

Comes with large and
small size primer tray/
primer punch
assemblies.



E-ZEE Prime™ Hand Priming Tool

Lyman has introduced a dramatic improvement in hand-held priming systems: The E-ZEE Prime Hand Priming Tool. The system works with any popular brand of shellholder and allows instant changeover between primer sizes. Lyman's E-ZEE Prime Tool includes two primer trays, each of which incorporate their own built-in large or small primer punch assembly. There are no small parts to fuss with or lose. Each tray has a built-in shut-off gate to keep primers in place during change-over. The reloader simply removes the snap-in-place lock collar and installs the correct sized primer tray and his standard shellholder as needed. Then the lock collar is snapped in place and the change-over is complete. The primer trays also function as a primer flipper to properly orient primers for seating.

In addition, the tool has a comfortable ergonomic design that works with the tool's optimized leverage system to reduce hand fatigue.

- Ergonomic shape designed to minimize hand fatigue
- Accepts all popular brands of standard shell holders, including Hornady, RCBS, Redding, and Lee Precision
- Plenty of leverage, yet provides needed "feel" for precision primer seating
- Integral primer tray and primer punch assembly - no small parts to lose
- Comes with large and small size primer tray/primer punch assemblies
- Primer tray has a built-in shut-off gate to prevent spilling primers
- Primer tray doubles as a flipper to orient primers for use

E-ZEE Prime Hand Priming Tool (#7777810)	\$53.25
Replacement SMALL Tray (#7777807)	\$10.00
Replacement LARGE Tray (#7777808)	\$12.00

Lyman Stuck Case Remover Kit

The Lyman Stuck Case Remover will safely and easily remove stuck cases from sizing dies. Unlike other sets, all the tools that are needed are included. The set includes a unique dual purpose threaded cap that screws over the end of the die. This cap acts as both a drill guide and a guide for the pulling screw. An extra-long hex wrench is included which provides plenty of leverage when removing stuck cases and also doubles as a handle for the tap wrench.

- Set includes threaded cap, tap drill, 1/4-20 tap, hex screw, long hex wrench, and tap wrench.
- Everything needed is included in the set
- Included unique dual purpose threaded cap
- Long hex wrench provides plenty of leverage and doubles as a tap wrench handle
- Packed in an easy to display clam shell with full instructions

Stuck Case Remover Kit (#7680350)	\$25.25
---	---------

MSR Precision Die System



Lyman's MSR Die Sets are the only die sets engineered specifically for MSR ammo and are a must for anyone reloading for a modern sporting rifle.

- Ammo Checker cartridge "Go" gauge included with each set
- Available in 223/5.56, 6.8 Rem. SPC, 300 AAC Blackout, and 308 Winchester 3 die sets and 450 Bushmaster, 458 SOCOM and 50 Beowulf 4 die sets
- Small Base Size die for smooth chambering
- Separate Taper Crimp die for tight bullet grip
- Packed in a sturdy, clear cover storage case
- Black finish matches your favorite "black" rifle.

Ammo Checker individual cartridge "Go" gauge and Free Shellholder included with each set



223 Rem 3-Die Set (#7690100)	\$80.95
6.5 Grendel (#7690113)	\$80.95
6.8 Rem Special 3-Die Set (#7690102)	\$80.95
300 Blackout 3-Die Set (#7690104)	\$80.95
308 Win 3-Die Set (#7690106)	\$80.95
9mm 4-Die Set (#7690107)	\$136.95
450 Bushmaster 4-Die Set (#7690108)	\$105.95
458 SOCOM 4-Die Set (#7690110)	\$105.95
50 Beowulf 4-Die Set (#7690112)	\$105.95
224 Valkyrie 3-Die Set (#7690101)	\$80.95
350 Legend 3-Die Set (#7690103)	\$80.95



Creedmoor Neck Size Dies and Die Sets



The 6.5 Creedmoor cartridge has established itself as one of the top performing long range rounds available. The new 6mm version is also quickly making its mark in precision long range shooting. To go along with our standard 6.5 Creedmoor die set, we are now offering an accuracy enhancing separate neck sizing die in this caliber. We are also introducing both a standard two die set and a neck sizing die for the 6mm Creedmoor.

- Available for 6.5 and 6mm Creedmoor
- Two die sets and separate neck sizing dies
- Top quality, all steel construction
- Neck sizers maintain fired case dimensions for perfect chamber fit and improved accuracy

6mm Creedmoor Neck Size Die Only (#7135128)	\$40.50
6.5 Creedmoor Neck Size Die Only (#7135130)	\$40.50
6mm Creedmoor 2 Die Rifle Set (#7452361)	\$52.95
6.5 Creedmoor Deluxe Rifle 3 Die Set (#7680252)	\$90.95



WARNING: Cancer and Reproductive Harm
www.p65warnings.ca.gov

Multi-Expand Charge Die System

Designed to save the pistol reloader time. The hollow expanders allow you to expand the case and drop powder at the same time with your powder measure mounted on top. Fits all standard powder measures.

Includes expander body, hollow expanders for .32, 9mm, 38/.357, 10mm/40 S&W, .41, .44 and .45 plus a non-expanding universal powder drop tube.
Multi-Expand (#7767901) \$48.50

Universal Decapping Die

The ideal die for decapping primers prior to case cleaning. **It has a unique one piece hardened steel decapping rod.** Perfect for military crimped in primers. Works on all calibers .22 thru .45 except .378 and .460 Weatherby. (Will not remove Berdan primers)

If you use a vibratory tumbler or sonic cleaner, this die provides the necessary first-step.
Decapping Die (#7631290) \$25.95
Replacement Decapping Rod (#7990528) \$4.50

The first step before ultrasonic cleaning. 

Ram Prime Die System

Designed for sensitive one-at-a-time primer seating on top of a press. Works with all 7/8" x 14 threaded presses. Includes large and small primer punches.
Ram Prime (#7728040) \$28.50

Tungsten Carbide Die

Pioneered by Lyman, these premium dies use a diamond hard, tungsten carbide ring to size straight walled cases. The T-C ring is so hard that clean cases can be smoothly sized without case lube. A real time saver.

Neck Size Die

A Neck Size Die allows the reloader to properly size the case neck for optional bullet tension, while maintaining the fireformed dimension of the case body. Accuracy is increased when the case body closely fits into the chamber. The Neck Size Die includes a decapping rod and steel expander button.

The Two-Step Neck-Expanding (M) Die

Improves accuracy of cast and jacketed bullet reloads. Doesn't stretch cases as does standard expander button. Extends case life. A "Must-Have" die for the cast or flat-base bullet user.

Many reloaders consider Lyman's Neck Expanding (M) Die a valuable tool for improving the accuracy of their reloads. The die's expander plug has two steps. (See illustration)
(See charts pg. 24-25)

1) The first step expands the inside of the case neck to just under bullet diameter for precise case neck tension in the finished reload. (See Illus. A.)

2) The second step expands the case mouth to bullet diameter or slightly over. This allows the jacketed or cast bullet to be started perfectly centered in the case mouth and properly aligned with the axis of the case neck. (See Illus. B.)

NOTE: By adjusting the neck expanding plug slightly deeper, Step 2 also provides a slight flaring of the case mouth for reloaders using cast bullets. (See Illus. C.)



(See Die Charts pages 24-25 for complete listings)

Classic Rifle Calibers

Cowboy shooting and the fine reproduction Sharps and other classic rifles have generated new interest in shooting the "obsolete" rifle calibers. But the custom reloading dies needed for these fine guns have been expensive and hard to find.

Lyman's Classic Rifle Die Sets have eliminated all the problems of costly custom dies. Lyman's die sets are available in the popular Sharps calibers listed below. These standard 7/8" x 14 3-die sets will fit all popular reloading presses and include Lyman's popular "M" 2 Step neck expanding die.

Caliber	Part No.	Caliber	Part No.
40-65	#7460490	45-90	#7460499
45-75	#7460509	56-50 Spencer	#7460497

Price \$78.95

Black Powder Neck Size Dies

Classic rifle shooters rely on Lyman's neck size dies to retain the fireformed case dimensions. By not overworking the brass, these dies produce superior accuracy and extend the life of expensive shells. These neck size dies are available in the following sizes:

40 Cal. (40-65, 40-70 Sharps Straight) . . (#7135055)

45 Cal. Short (45-70, 45-90, 45-100) . . . (#7135057)

45 Cal. Long (45-110, 45-120) (#7135059)

Price. \$40.50

Black Powder Taper Crimp Dies

BP cartridges require compression for proper ignition. This requires firm neck tension to hold the bullet without damage. The Taper Crimp Dies have a minimum taper that allows the reloader to apply the proper neck tension without damaging the bullet for best accuracy.

40 Cal. (40-65, 40-70 Sharps Straight) . . (#7153120)

45 Cal. Short (45-70, 45-90, 45-100) . . . (#7153124)

Price. \$30.50

Deluxe Neck Size Dies with Carbide Expander Button

The Lyman Deluxe Neck Sizing Die features a precision machined and hardened die body along with a super hard and slick carbide expander button. The expander button also free floats on the rod to allow it to self-center in the case neck and the slick button easily passes through the case neck. The result is a die that will reduce case stretching, increase case life and provide enhanced accuracy for the reloader. (see page 23)

Taper Crimp Die

A Taper Crimp dies apply the proper taper crimp to pistol cases. Essential for proper function in auto pistols. Unlike some other die manufacturers, we feel that taper crimping is best done in a single purpose die station. Just add the taper crimp die to your current die set for a complete progressive reloading die set.

Each Taper Crimp die is heat treated to an RC50 minimum surface hardness. The interior is hand polished before and after heat treat to an 8 rms finish. (see pg24)

 **WARNING:** Cancer and Reproductive Harm
www.p65warnings.ca.gov



Two Sets in One!

Lyman gives you both full length and neck sizing in one set!



Deluxe 3-Die Rifle Sets



Lyman's Deluxe 3-Die Rifle Sets give reloaders all the options they need to enhance the accuracy of their reloads and extend the life of their brass. By adding both a premium Carbide Expander Assembly and a Neck Sizing Die, Lyman has created two die sets in one. Neck sizing eliminates over-working the brass, dramatically extending case life.

The set includes:

- **Deluxe Carbide Expander Assembly**, with a free floating carbide sizing button, which smooths neck expansion by moving the button up the decapping rod to better use the press' leverage. It eliminates the need for inside neck lube.
- **Neck Sizing Die** which allows the case to retain the precise chamber dimensions of the individual rifle while avoiding excessive working of the brass.
- **Standard Full Length Sizing Die** for taking brass down to factory Dimensions.
- **Standard Bullet Seating Die**

Deluxe 3-Die Rifle Sets:

3 Die Rifle Set .22-250	#7680232
3 Die Rifle Set .223	#7680234
3 Die Rifle Set .243	#7680236
3 Die Rifle Set 6.5 x 55	#7680238
3 Die Rifle Set .270 Win.	#7680240
3 Die Rifle Set .30-06	#7680242
3 Die Rifle Set .308	#7680244
3 Die Rifle Set .300 Win.	#7680246
3 Die Rifle Set 7mm Rem. Mag	#7680248
3 Die Rifle Set 338 Win. Mag	#7680249
3 Die Rifle Set .338 Lapua	#7680250
Price	\$90.95

Deluxe Carbide Expander/Decap Die Rod Complete



The Lyman Deluxe Carbide expander and decapping rod assembly features a super hard and slick carbide expander button with an adjustable positioning sleeve. The carbide button will offer easier extraction through case necks, which will help prevent case stretching and lessen case trimming. This will provide greater case life. The carbide button also floats free on the rod to allow for self-centering in the case neck. The button can be adjusted into two positions on the rod. This will allow it to be positioned for various cases of given calibers. It will also allow the user to adjust when the button pulls through the case neck so the press linkage can be positioned for better leverage. **Includes adapter for use with RCBS dies (#7126015).**

- Super hard and slick carbide expander button
 - Fits all Lyman rifle sizing dies
 - Carbide button can be adjusted for height
 - Carbide free floats on the rod for self-centering in case necks
 - Replaceable decapping pin
- | | |
|--------------|----------|
| .22 Caliber | #7680300 |
| 6mm | #7680302 |
| 6.5mm | #7680304 |
| .270 Caliber | #7680306 |
| 7mm | #7680308 |
| .30 Caliber | #7680310 |
| .338 Caliber | #7680312 |
| Price | \$38.50 |

Includes Adapter for use with RCBS Dies #7126015



Already have a full length die set? The Deluxe Carbide Neck Size Die is available separately so you can upgrade your current dies for maximum accuracy potential. The Deluxe Carbide Expand and Decap Rod assembly can also be purchased individually to fit both Lyman and RCBS Rifle sizing dies.

Deluxe Neck Size Dies with Carbide Expander Button



Lyman's Neck Size Die with carbide expander button enhances the value of any manufacturer's standard die set and eliminates the need to full-length resize and overwork the brass. It will also provide better accuracy - ask any target shooter! Use the full length sizing only when you need to.

The Lyman Deluxe Neck Sizing Die features a precision machined and hardened die body along with a super hard and slick carbide expander button. The expander button also free floats on the rod to allow it to self-center in the case neck and the slick button easily passes through the case neck. The result is a die that will reduce case stretching, increase case life and provide enhanced accuracy for the reloader.

.204 Ruger w/Carbide Button	#7135196
.223 w/Carbide Button	#7135200
.243 w/Carbide Button	#7135202
6.5 x 55 w/Carbide Button	#7135204
.270 Win w/Carbide Button	#7135206
.30-06 w/Carbide Button	#7135208
.308 w/Carbide Button	#7135210
.300 Win w/Carbide Button	#7135212
7mm Rem. Mag w/Carbide Button	#7135214
.338 Lapua w/Carbide Button	#7135218
.22-250 w/Carbide Button	#7135198
Price	\$47.95

Usage Chart

20 Cal.	22 Cal.	243 Cal.	6.5mm	270 Cal.	7mm	30 Cal.	338 Cal.
204 Ruger	222 Rem 223 Rem 22-250 220 Swift 223 WSSM	243 Win 243 WSSM 6mm Rem	6.5x55 260 Rem	6.8mm Rem 270 Win 270 WSM	7mm-08 7mm Mauser 7mm Rem Mag 7mm Rem Ultra 280 Rem	30-30 300 Savage 308 Win 30-06 300 Win Mag 300 WSM 300 Wea. Mag	338 Lapua 338 Win. Mag.

WARNING: Cancer and Reproductive Harm
www.p65warnings.ca.gov



Lyman® Precision Die Sets

Reloaders want volumes of reloads which deliver consistent quality. When it comes to precision, smoothness and versatility, Lyman Precision Dies are unsurpassed. Each sizing die is vented, polished, heat treated for toughness and receives a final micro-finish polish for extra smoothness. Lyman pistol die sets feature only solid, premium Tungsten Carbide sizing rings. They also include a one piece solid decapping rod made from hardened, heat treated tool steel that will not crack, even when depriming cases with crimped primer pockets.

Remember, Lyman dies fit all popular presses using industry standard 7/8" x 14 threads, including RCBS, Lee, Hornady, Dillon, Redding and others. Whether 2-, 3- or 4-die sets, these dies deliver round after round of the high performance ammo serious shooters demand.

3-Die Carbide Pistol Die Sets



Lyman was the originator of the Tungsten Carbide (T-C) sizing die and "Multi" concept with the addition of extra seating screws for pistol die sets. Combined with another Lyman original - the two step neck expanding die, our Multi-Deluxe Die Sets offer these features: a one piece hardened steel decapping rod and extra seating screws for all popular bullet nose shapes, and all steel construction.

Premium Carbide 4-Die Sets



In addition to all the features of our three die sets, the Premium Carbide 4-Die Sets also include a separate taper crimp die. The 4-die set is perfect for those loading pistol calibers that headspace on the case mouth.



Rifle 2-Die Sets



Set consists of a full length resizing die with decapping stem and neck expanding button and a bullet seating die. These die sets are the reloader's best choice for loading jacketed bullets in bottlenecked rifle cases. For those who load cast bullets, we suggest the addition of a neck expanding die, available separately.

Rifle 3-Die Sets



Straight wall rifle cases require these three die sets consisting of a full length resizing die with decapping stem, a **two step neck expanding (M) die** (described on pg 22) and a bullet seating die. These sets are ideal for loading cast bullets due to the inclusion of the neck expanding die.

3-Die Sets See Listing on pg 25

Precision Pistol Dies	Carbide 4 Die Set \$109.95	Carbide 3 Die Set \$78.95	Steel 3 Die Set \$60.75	Specialty Dies		
				TC Carbide Size Die Only \$66.95	Taper Crimp Die Only \$30.50	Neck Exp. (M) Die \$29.95
Cartridge						
5.7 x 28mm FN	—	—	7460486	—	—	—
.32 S&WACP/32 S&W Long	—	7680113	—	—	—	7342100
.327 Federal Mag	—	7680128	—	—	—	7342100
.380 Auto	—	7680112	—	—	—	7342081
.38 S&W	—	7680116	—	—	—	7341801
.38 Super Auto	—	7680116	—	—	—	7342081
9mm Luger	7680203	7680111	—	—	7153097	7342081
.38 Spec./357 Mag./357 Rem. Max	7680200	7680098	—	—	7153101	7341801
.40 Smith & Wesson/10mm Auto	7680207	7680118	—	—	—	7340833
.44 Mag. .44 Special/.445 Super Mag.	—	7680105	—	—	—	7340820
.45 A.C.P./45 Mag.	7680208	7680107	—	7596323	7153107	7340832
.45 Colt	—	7680110	—	—	7153107	7340832
.454 Casull	—	7680122	—	—	7153107	7340832
.500 Smith & Wesson	—	7680126	—	—	—	—

Special Purpose Dies

Cartridge	Two Die Set \$52.95	3-Die Set \$66.25	Classic 3-Die Rifle Set \$78.95	Deluxe 3-Die Rifle Set \$90.95	Neck Size Die Only \$40.50	Dlx. Neck Size Die Only \$47.95	Rifle (M) Die —	(M) Die Part Number \$29.95
.22 Hornet	7452277	—	—	—	—	—	22 Hornet	7349058
.222 Remington	7452282	—	—	—	—	—	22 Short	7342097
.223 Rem. (5.56mm)	7457111	—	—	7680234	7135006	7135200	22 Short	7342097
.22-250	7452280	—	—	7680232	7135063	—	22 Short	7342097
6mm Creedmoor	7452361	—	—	—	7135128	—	—	—
.243 Winchester	7452283	—	—	7680236	7135015	7135202	24	7349007
6mm Rem. (.244 Rem.)	7452334	—	—	—	—	—	24	7349007
.25-06 Remington	—	—	—	—	—	—	25 Long	7349057
.25-20 Winchester	—	7469042	—	—	—	—	25-20	—
.260 Rem.	—	—	—	—	—	—	26	7349052
6.5 Creedmoor	7452362	—	—	7680252	7135130	—	26	7349052
6.5 PRC	7452363	—	—	—	—	—	26	7349052
6.5mmx55 Swedish Mau.	7452340	—	—	7680238	7135124	7135204	26	7349052
26 Nosler	7452358	—	—	—	—	—	26	7349052
.270 Winchester	7452289	—	—	7680240	—	7135206	27	7349009
.270 WSM	—	—	—	—	—	—	27	7349009
7mm Rem. Magnum	7455496	—	—	7680248	—	7135214	28	7349011
7mmx57 Mauser	—	—	—	—	—	—	28	7349011
7mm-08 Remington	7455646	—	—	—	—	—	28	7349011
28 Nosler	7452360	—	—	—	—	—	28	7349011
30 M1 Carbine	—	7460475	—	—	—	—	30 MI	7349004
.30-30 Winchester	7452299	—	—	—	—	—	30 S	7349003
300 AAC Blackout	7455547	—	—	—	—	—	30 MI	7349004
.300 Savage	—	—	—	—	—	—	30 S	7349003
7.62x39mm	7459110	—	—	—	—	—	30 S	7349003
.30-06 (7.62x63mm)	7452301	—	—	7680242	7135049	7135208	30 L	7349002
.308 Win. (.307 Win.)	7452298	—	—	7680244	7135047	7135210	30 L	7349002
.300 Weatherby Mag.	7455638	—	—	—	—	—	30 L	7349002
.300 Winchester Mag.	7455647	—	—	7680246	7135051	7135212	30 L	7349002
300 WSM	—	—	—	—	—	—	30 L	7349002
300 Rem Ultra Mag Short	—	—	—	—	—	—	30 L	7349002
7.62x54 Russian	—	—	—	—	—	—	30 L	7349002
.303 British	7452296	—	—	—	—	—	31 L	7349005
7.65mm Arg. Mauser	7458843	—	—	—	—	—	31 L	7349005
32-20 Winchester	—	7460484	—	—	—	—	31 S	7343006
.32 Winchester Spec.	—	—	—	—	—	—	32	7342073
8mm x 57 Mauser	7452305	—	—	—	—	—	8mm	7349018
.338 Winchester Mag.	7452338	—	—	7680249	—	—	33	7340762
.338 Lapua Mag.	7452355	—	—	7680250	7135067	7135218	—	—
9.3 x 62	7459118	—	—	—	—	—	93 M	—
.375 H&H Magnum	7452316	—	—	—	—	—	37	7349015
.38-55 Winchester	—	7460494	—	—	7135126	—	37	7349015
.40-65	—	—	7460490	—	7135055	—	40L	—
.40-70 Sharps Straight	—	—	—	—	7135055	—	40L	—
.416 Rigby	7455449	—	—	—	—	—	—	—
.44-40 Winchester	—	7460495	—	—	—	—	44-40	7342102
.450 Marlin	—	7460524	—	—	—	—	45-70	7349053
.45-70 Government	—	7460496	—	—	7135057	—	45-70	7349053
.45-75 Win	—	—	7460509	—	—	—	45-60	—
.45-90	—	—	7460499	—	7135057	—	45-70	7349053
.45-100 Sharps	—	—	—	—	7135057	—	45-70	7349053
.45-110 Sharps	—	—	—	—	7135059	—	45-70	7349053
.45-120 Sharps	—	—	—	—	7135059	—	45-70	7349053
.50-70 Government	—	7660121	—	—	—	—	50-70	7342107
.56-50 Spencer	—	—	7460497	—	—	—	56-50	—

Decapping Rods and Assemblies

Pistol rods are available in two styles; our original (threaded) rod unit with replaceable decapping pins and our one piece system. This decapping rod is a stronger one piece design with a hardened pin. All pistol dies are currently equipped with this rod. Rifle dies have an improved centering system requiring two different decapping rod lengths, 3.5" or 4.25", depending on caliber of the die. When ordering decapping assemblies, please indicate length or style required.

Pistol

Decapping Rod Unit (with Replaceable Pin)(#7129001) . \$5.50
 One Piece Decapping Rod(#7990524) \$4.50

Rifle

Decapping/Expanding Unit (state caliber) Call for pricing
 Rod Only 3 1/2" (#7126011) \$3.50
 Rod Only 4 1/4" (#7126012) \$3.50
 Rod Only - Neck Sizing Dies (#7126014) \$3.50

Universal Decapping Die Rod only

(#7990528) \$4.50

Decapping Pins

Package of 10 (#7837786) \$5.25

Special Die Accessories

Split-lock Ring

Popular steel split ring. Fits all 7/8" x 14 dies
 (#7631304) \$5.25

New Style -7/8" Hex Nut

Works with Bench Wrench (#7990119P) \$3.15

Die Boxes

Durable plastic box with snap lock hinged cover
 For Die Set (#7980399) \$3.25

J to X Shell holder Adapter

For use with Lyman's older presses which used the older J-Type shell holders.
 Converts press to use current X-Type shell holders
 (#7095762) \$17.75

Special T Priming Punch

Required when using J to X shellholder adapter to seat primers in older style presses. Includes both large and small punches and sleeves.
 (#7095763) \$11.75

7/8 x 14 Adapter

For use in converting 310 dies for use in current 7/8 x 14 presses. Also mounts Model 55 Powder Measure to press.
 (#7392036) \$9.50

For information or to order
Lyman Die Parts, call Customer Service
at 1-800-22-LYMAN or visit our website at
www.lymanproducts.com

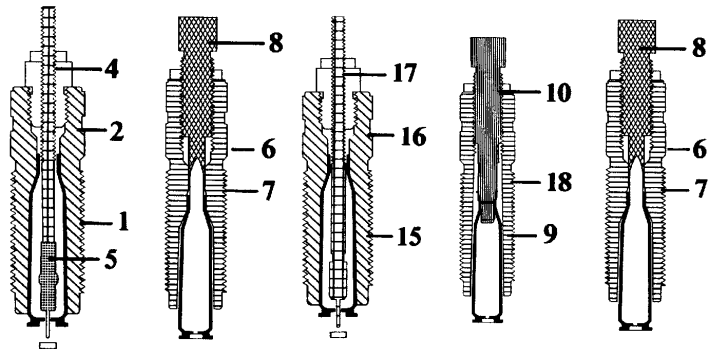

Standard Rifle 2-Die and 3-Die Sets

1. Full Length Resizing and Decapping Die
18. Two Step Neck Expanding die (3-Die set)
6. Bullet Seating Die Complete

Separate Die Parts: (State Caliber)

2. Die Body only (Sizing)
4. Decapping Rod only
5. Expanding Button only (2-Die Set)
Decapping Pin Lock Nut (3-Die Set)
9. Die Body only (Expanding) (3-Die Set)
10. Expanding Plug Complete (3-Die Set)
7. Die Body only (Seating)
8. Bullet Seating Screw only (State nose shape)
Decapping Rod Complete (2-Die Set)
Decapping Rod Complete (3-Die Set)

**Please Call
 Customer
 Service
 for Pricing
 and Information**

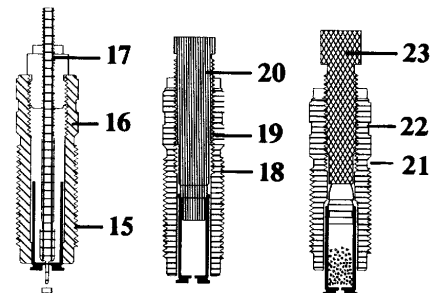

Standard and Carbide Pistol 3-Die and 4-Die Sets

Separate Dies, Complete (State Caliber)

15. Full Length Resizing & Decapping Die (carbide)
18. Two-Step Neck Expanding Die
22. Bullet Seating Die complete Taper Crimp Die (4-Die Set)

Separate Die Parts: (State Caliber)

16. Die Body only (Sizing) Carbide
17. Decapping Rod Unit
19. Die Body only (Neck Expanding)
20. Expanding Plug Complete
22. Die body only (seating)
23. Bullet Seating Screw only (State nose shape)

**Please Call
 Customer
 Service
 for Pricing
 and Information**



RIFLE Caliber	Shell Holders		Trimmer Pilots	
	No.	Item #	No.	Item #
.17 Remington	26	7738063	17	7821985
.204 Ruger	26	7738063	20	7821981
.22 Hornet	4	7738043	22	7821987
.221 Fireball	26	7738063	22	7821987
.22/250	2	7738041	22	7821987
.222 Remington	26	7738063	22	7821987
.222 Remington Mag	26	7738063	22	7821987
.223 Remington	26	7738063	22	7821987
.223 WSSM	34	7738148	22	7821987
.243 Winchester	2	7738041	24	7821988
.243 WSSM	34	7738148	24	7821988
.244, 6mm Remington	2	7738041	24	7821988
25 WSSM	34	7738148	25	7821986
.25-20	10	7738049	25	7821986
.25-06 Remington	2	7738041	25	7821986
.250-3000 Savage	2	7738041	25	7821986
6.5 Grendel	3	7738042	26	7822013
6.5 Creedmoor	2	7738041	26	7822013
6.5x55 Swedish	27	7738064	26	7822013
.260 Remington	2	7738041	26	7822013
26 Nosler	34	7738148	26	7822013
6.5 PRC	13	7738052	26	7822013
6.5x57 Mauser	2	7738041	26	7822013
6.8mm Remington	15	7738055	27	7821989
.270 Winchester	2	7738041	27	7821989
.270 WSM	34	7738148	27	7821989
7mm/08 Remington	2	7738041	28	7821999
7-30 Waters	6	7738045	28	7821999
7mm Remington Mag	13	7738052	28	7821999
7mm Weatherby Mag	13	7738052	28	7821999
7mm STW	13	7738052	28	7821999
7mm Rem. Ultra Mag.	13	7738052	28	7821999
7x57 Mauser	2	7738041	28	7821999
7x64 Brenneke	2	7738041	28	7821999
7x65R Brenneke	14B	7738054	28	7821999
.280 Rem (7mm Express)	2	7738041	28	7821999
28 Nosler	34	7738148	28	7821999
.30-30	6	7738045	30	7821991
.300 AAC	26	7738063	30	7821991
.300 Savage	2	7738041	30	7821991
.307 Winchester	6	7738045	30	7821991
.308 Winchester	2	7738041	30	7821991
.30-06	2	7738041	30	7821991
.300 WSM	34	7738148	30	7821991
.300 Winchester Mag	13	7738052	30	7821991
.300 Remington Ultra Mag.	13	7738052	30	7821991
.300 Remington Ultra Mag SA	13	7738052	30	7821991
.300 Weatherby Mag	13	7738052	30	7821991
7.62x39	3	7738042	30	7821991
.32-20	10	7738049	31	7821992
7.65 Argentine Mauser	2	7738041	31	7821992
7.62x54 Russian	17	7738057	31	7821992
.303 British	7	7738046	31	7821992
.32 Winchester Special	6	7738045	32	7821994
8x57 Mauser	2	7738041	8mm	7821995
8x57 JS	2	7738041	8mm	7821995
7.9x57	2	7738041	8mm	7821995
8x57 JRS	14B	7738054	8mm	7821995
8mm Remington Mag	13	7738052	8mm	7821995
325 WSM	34	7738148	8mm	7821995
.338 Winchester Mag	13	7738052	33	7821996
.338 Remington Ultra Mag.	13	7738052	33	7821996
.338 Lapua Mag	38	7738152	33	7821996
.35 Remington	2	7738041	35	7822001
350 Legend	26	7738063	35	7822001
.356 Winchester	6	7738045	35	7822001
.358 Winchester	2	7738041	35	7822001
.35 Whelen	2	7738041	35	7822001
9.3mm x 62	2	7738041	36	7822009
.375 Ruger	13	7738052	37	7822002
.375 Winchester	6	7738045	37	7822002
.38-55	6	7738045	37	7822002
.375 H&H Magnum	13	7738052	37	7822002
375 Rem. Ultra Mag.	13	7738052	37	7822002
40-60 Win	17	7738057	40	7822012
40-65	17	7738057	41	7822004
.416 Rigby	17	7738057	416	7822014
44-40 Winchester	14B	7738054	44A	7822005
.444 Marlin	14B	7738054	44	7822006
.450 Marlin	13	7738052	45	7822008
.45-60, .45-70 & 45-90	17	7738057	45	7822008
45-100	17	7738057	45	7822008
45-110	17	7738057	45	7822008
45-120	17	7738057	45	7822008
.50-70 Government	22	7738062	—	—
50-90	22	7738062	—	—
56-50 Spencer	22	7738062	50B	7821982

Shellholders

Detachable Shellholder

Precisely machined to insure perfect case fit. Fits all popular presses. See shellholder reference chart on this page.

Detachable Shellholder (3 oz.) select number \$9.60

J to X shellholder adapter (#7095762) \$17.75

Allows use of X Shellholder with older Lyman presses that used J-Type Shellholders.

Trimmer Pilots (Individual) \$5.95

Nine Pilot Multi-Pack (#7822202) \$22.95

Includes nine of the most popular pilots: 22, 24, 27, 28/7mm, 30, 9mm, 35 (38/357), 44 and 45A.

PISTOL Caliber	Shell Holders		Trimmer Pilots	
	No.	Item #	No.	Item #
5.7 x 28mm FN	35	—	22	7821987
7mm TCU	26	7738063	28	7821999
.30 Luger	12	7738051	30	7821991
.30 Mauser	12	7738051	30	7821991
.32 ACP	23	7737486	31	7821992
.32 S&W Long	9	7738048	31	7821992
.32 H&R Mag	9	7738048	31	7821992
.327 Fed Mag	9	7738048	31	7821992
.38 Super Auto	12	7738051	9mm	7821997
9mm Luger	12	7738051	9mm	7821997
9 x 23mm	12	7738051	9mm	7821997
.380 Auto	26	7738063	9mm	7821997
.38 S&W	21	7738075	35	7822001
.38/.357Mag	1	7738040	35	7822001
.357 Remington Maximum	1	7738040	35	7822001
9mm Makarov	12	7738051	36	7822009
.40 S&W & 10mm	15	7738055	39	7822003
.41 Mag	30	7737492	41	7822004
.41 Action Express	12	7738051	41	7822004
.44 Mag/Spl/.44 Russian	7	7738046	44	7822006
.44-40 Winchester	14B	7738054	44A	7822005
.45 ACP/.45 Win Mag	2	7738041	45A	7822007
.45 Schofield	14B	7738054	45A	7822007
.45 Colt	11	7738050	45A	7822007
.454 Casull	11	7738050	45A	7822007
.460 S&W	7	7738046	45A	7822007
.475 Wildey	2	7738041	47	7822010
.480 Ruger	17	7738057	47	7822010
.50 Action Express	7	7738046	50A	7821983
.50 S & W	17	7738057	50A	7821983

Shellholder Set

We have selected the 12 most used shellholders which fit the most popular pistol and rifle calibers and place them into a handy compartmented storage box. This set includes shellholders #1, 2, 6, 7, 11, 12, 13, 14B, 15, 17, 22 and 26 which fit well over 75 different calibers. (See reference chart for calibers). Best of all, this will save 60% over buying individual shells.

Shellholder Set with Box (#7712110) \$50.50



Best Value!
Save 50% Over
individual
Purchases

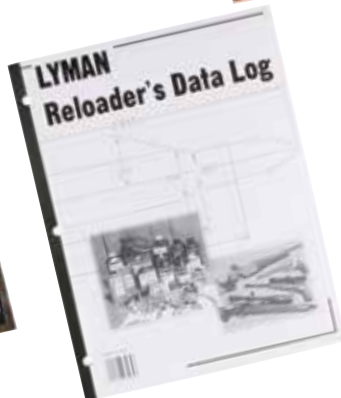
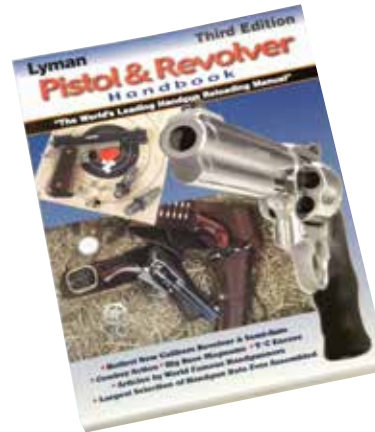
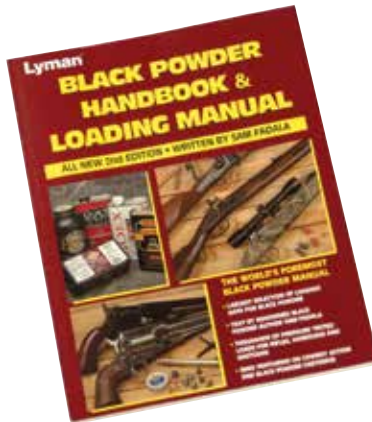
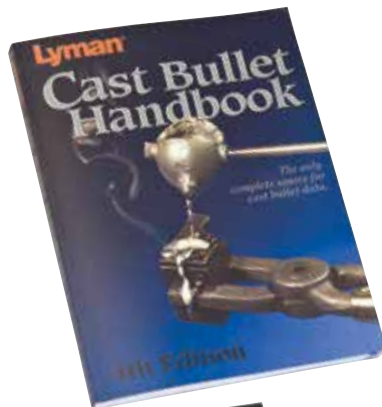

Cast Bullet Handbook, 4th Edition

The first new cast bullet data manual in 30 years contains data using the latest and most available components for bullet casters. In addition to data for Lyman's entire line of rifle and pistol moulds, the Cast Bullet Handbook includes data for selected moulds from other manufacturers. Like Lyman's other popular handbooks, this large edition covers valuable "how-to" editorial as well as important articles by acknowledged authorities in the field.

Cast Bullet Handbook (#9817004) \$30.98

Lyman Black Powder Handbook, 2nd Ed.

Edited by Sam Fadala, this is the most comprehensive black powder manual available. It includes thousands of pressure tested loads, along with a large assortment of round balls, conicals and sabots. Down range velocities and energies are also given for each load. Topics also covered include: choosing your muzzleloader, building the best loads, propellants, ignition, maintenance and black powder cartridges. There are also hundreds of pressure tested black powder cartridge loads for larger calibers.

Black Powder Handbook (#9827100) \$24.98

Lyman Pistol & Revolver Handbook, 3rd Ed.

The most complete handgun reloading data, encompassing all major brands of bullets, powders and primers. More than just data charts, this handbook also contains a number of captivating feature articles by well-known writers covering such popular subjects as: Cowboy Action shooting, loading for big bore revolvers and handgun varmint hunting.

Pistol & Revolver, 3rd Ed. (#9816500) \$24.98

The Lyman Shotshell Handbook, 5th Ed.

This is the most complete and up-to-date shotshell reloading manual available. It covers cases, wads, and primers currently offered by all leading manufacturers in all gauges from .410 to 10 gauge. Non-Toxic Data Section covers steel, bismuth and Hevi-Shot, plus complete how-to load instruction. Slug and Buckshot Loads are covered too, plus a how-to-load section.

Shotshell Reloading Handbook (#9827111) \$27.50

Lyman Reloading Data Log

The Lyman Reloading Data Log is a must for shooters who reload. The large, easy-to-use format has plenty of room to enter all important data such as bullet, powder, primer, case, firearm used, plus size, velocity, conditions and several lines for comments on your reloads. Large 8 1/2" x 11" size. 50 pages per log.

Reloading Data Log (#9847261) \$8.50

Reloading and Cast Bullet Users Guide

This booklet is filled with complete information on getting started in Reloading and Bullet Casting. It also includes detailed product instructions and parts drawings for Lyman presses, trimmers, scales, powder measure and tumblers.

Users Guide (#9837283) No charge

Lyman Load Data Series

Lyman's load data is now available by caliber or category in handy books. The Load Data Books are ideal for the reloader who only wants to reload for select calibers. Like all Lyman Handbooks, these cover all popular brands of powder, primers and bullets, even cast bullets. They are the perfect way to survey which components and loads to select before reloading a new cartridge. Lyman Load Data Booklets include:

20, 28, 410 Gauge (#9780002) \$7.50
20ga. 2 3/4", 28ga 2 3/4", 410 Bore 3", 410 Bore 2 1/2"
Lead Shot Data

Popular Revolver (#9780006) \$7.50
38 Spec, 357 Mag, 44 Mag, 45 Colt

Popular Varmint Calibers (#9780008) \$7.50
204 Ruger, 222 Rem, 223 Rem, 22-250 Rem

270, 7mm Calibers (#9780012) \$7.50
270 Win, 7mm-08 Rem, 7mm Mauser, 7mm Rem Mag, 7mm WSM

30 Caliber (#9780014) \$7.50
30-30 Win, 308 Win, 30-06 Springfield, 300 WSM, 300 Win Mag

Old Military Calibers (#9780016) \$7.50
30 m1, 7.62x39mm Rus, 7.62x54Rmm Rus, 7.65 Arg.Mau, 303 Brit, 8mm Mau

338, 8mm Calibers (#9780018) \$7.50
325 WSM, 338 Fed, 338 Win Mag, 338 Lapua

Big Bore Rifle Calibers (#9780022) \$7.50
375 H&H Mag, 416 Rigby, 416 Wea, 458 Win, 460 Wea.

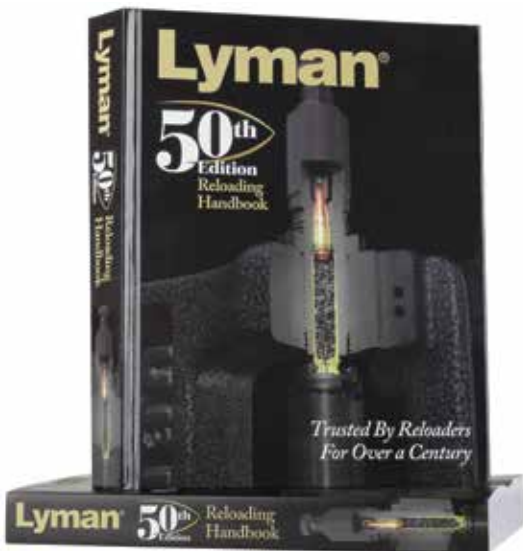

Lyman 50th Edition Reloading Handbook

For more than a century, the Ideal and then Lyman handbooks have been the reloaders' core resource for proven reloading data. Lyman pioneered the concept of delivering a wide range of components to use in generating safe, accurate loads. As reloading has grown, so have Lyman handbooks, with each edition eclipsing its predecessor, growing in size and quantity of data and becoming an important addition to every serious reloader's library.

Lyman's 50th Anniversary Edition continues our heritage as being the proven source for reloading data. Lyman handbooks have always used the widest selection of cartridges, bullets and powder from all the major manufacturers. This 50th Edition continues our tradition of being the only data source using multiple brands throughout our data.

- New Cartridges Included: 17 Hornet, 6.5 Grendel, 6.5 Creedmoor, 6.5-284, 26 Nosler, 28 Nosler, 300 Blackout, 300 RCM, 338 RCM, 450 Bushmaster, 458 SOCOM, 50 Beowulf
- Largest Selection of Bullets: Barnes, Hornady, Remington, Sierra, Speer, Swift and Winchester plus full selection of Cast Bullets
- Wide Range of Popular Powders: Accurate, Alliant, Hodgdon, IMR, Ramshot, VihtaVuori and Winchester
- Feature Articles by Top Gun Writers and Firearm Industry Experts
 - "Barrels – Looking into the Unknown" by Ryan Newport
 - "Advanced Case Preparation Techniques" by John Haviland
 - "What is a Ballistic Coefficient and How Do You Use It?" by Dave Emary and Lane Pearce
 - "The History of Modern Lyman Handbooks" by Ed Matunas, Ken Ramage and Tom Griffin
- New Full Color Edition - The 50th Anniversary edition is our first reloading handbook produced in full color

50th Handbook Hardcover (#9816050) \$44.50
 50th Handbook Soft cover (#9816051) \$32.50

AR Reloading Handbook - 2nd Edition

The first reloading handbook dedicated exclusively to the most popular semi-auto rifle in the United States has now been updated to include new calibers and data. The 2nd Edition of this comprehensive Lyman handbook provides the AR shooter with reloading data for nearly all AR based calibers. Reloaders will appreciate the extensive pressure tested data that encompasses all popular brands of bullets and powders. The 2nd Edition contains new calibers such as the 224 Valkyrie, 22 Nosler, 24 Nosler, 350 Legend, as well as sub-sonic data. In addition, articles by well-known authorities covering topics such as "Building An AR", and "AR15 Gas System Lengths" are included.

- The first reloading handbook dedicated exclusively to the Modern Sporting Rifle
- Reloading data for nearly all AR based calibers, including the 223, 224 Valkyrie, 6.8 Rem, 300 AAC, 7.62x39, 350 Legend, 450 Bushmaster, 50 Beowulf and many more
- Specialty articles by popular writers covering topics such as Reloading for Suppressors and Building ARs
- Data uses all popular brands of bullets and powders
- Includes cast bullet data and sub-sonic loads

AR Reloading Handbook 2nd Ed. (#9816046) \$17.50



300 AAC BLACKOUT/300 WHISPER

NEW FOR 2021

Test Components:
 Case: Hornady
 Bullet: Hornady
 Primer: Rem-UMC
 Powder: Hodgdon
 Neck: Hornady
 Tip: Hornady

Test Specifications:
 Chamber: Rem-UMC
 Rifle: Rem-UMC
 Scope: Leupold
 Sight: Leupold
 Bullet: Hornady
 Powder: Hodgdon
 Neck: Hornady
 Tip: Hornady

300 AAC BLACKOUT/300 WHISPER

Case	Bullet	Primer	Powder	Neck	Tip	Velocity	Pressure
300 AAC Blackout	Hornady	Rem-UMC	Hodgdon	Hornady	Hornady	1000	3500
300 AAC Blackout	Hornady	Rem-UMC	Hodgdon	Hornady	Hornady	1000	3500
300 AAC Blackout	Hornady	Rem-UMC	Hodgdon	Hornady	Hornady	1000	3500
300 AAC Blackout	Hornady	Rem-UMC	Hodgdon	Hornady	Hornady	1000	3500
300 AAC Blackout	Hornady	Rem-UMC	Hodgdon	Hornady	Hornady	1000	3500
300 AAC Blackout	Hornady	Rem-UMC	Hodgdon	Hornady	Hornady	1000	3500
300 AAC Blackout	Hornady	Rem-UMC	Hodgdon	Hornady	Hornady	1000	3500
300 AAC Blackout	Hornady	Rem-UMC	Hodgdon	Hornady	Hornady	1000	3500
300 AAC Blackout	Hornady	Rem-UMC	Hodgdon	Hornady	Hornady	1000	3500
300 AAC Blackout	Hornady	Rem-UMC	Hodgdon	Hornady	Hornady	1000	3500

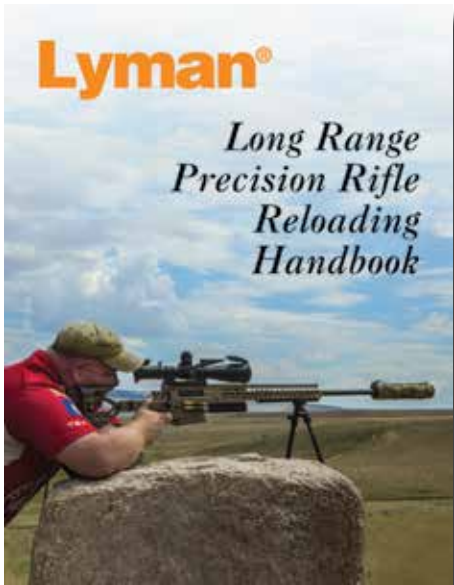

Long Range Precision Rifle Handbook

One of the fastest growing shooting sports in the country is precision long range rifle shooting. The Precision Rifle Series and Extended Long Range matches are being held all over the country and industry leaders are producing numerous rifles, scopes, bi-pods, and other accessories for this exciting sport. One area that has been lacking however is reliable reloading data, until now!

- Specific data for precision long range cartridges including: 223 Rem., 6mm Dasher, 6x47 Lapua, 6XC, 6mm Creedmoor, 243 Win., 6.5x47 Lapua, 6.5 Creedmoor, 260 Rem., 6.5-284 Norma, 308 Win., 300 Win Mag, 300 Norma Mag and 338 Lapua.
- Target bullets from Berger, Lapua, Sierra & Hornady
- Includes pressure and velocity data
- Articles by top PRS shooters and industry experts
- Printed in full color format

Long Range Handbook (#9816060) \$17.98

WARNING: Cancer and Reproductive Harm
www.p65warnings.ca.gov



Cyclone™ Rotary Tumbler

The Cyclone Rotary Tumbler takes brass cleaning to a whole new level. The rotary tumbling action combined with the stainless steel media and liquid cleaning solution gets brass cleaner on the outside than vibratory tumbling methods. The small stainless pins easily slip inside cases and into primer pockets to provide superior cleaning action in these areas. Something that a vibratory tumbler will not do! The large capacity drum holds up to 1000 pieces of .223 brass and features a rubber lining to protect brass and greatly reduce noise during operation. A built in timer in the base can be set to run from 0 to 3 hours, shutting off automatically. The drum features a large end cap to allow easy loading and unloading.

In addition, the tumbler comes with a pair of unique sifter pans which makes separating pins from the cases a breeze! Simply empty the tumbler into the stacked pans. The first pan catches the brass, while the second fine screen pan catches the pins. Five pounds of stainless media pins and a sample packet of Brass Cleaning Solution are also included.

- Cyclone Rotary Tumbler 115V (#7631550) \$278.50
- Cyclone Rotary Tumbler 230V (#7631551) \$324.94

The following items are INCLUDED with the Lyman Cyclone™ Rotary tumbler, but also available separately for use with other tumblers.

- Dual Sifter Set (#7631314) \$33.50
- Stainless Steel Cleaning Media 5lbs (#7631375) \$57.75



The Cyclone™ Rotary Tumbler has everything you need to get started: it includes 5 pounds of stainless steel media pins and sample packet of cleaning solution, as well as the unique Dual Sifter System.



Stainless Steel Pin Magnet

Lyman's Stainless Steel Pin Transfer Magnet is the answer for separating your cases from the media pins used in rotary tumblers. Simply pass the magnet over the mixture of cases and pins and the pins will be pulled out and grabbed by the magnet. To release the pins, just pull up on the handle. The large diameter, strong magnet will collect many pins in a single pass. Fast, convenient and simply to use! A perfect companion for the Lyman Cyclone Rotary Tumbler and other brands of rotary tumblers.

- Stainless Steel Pin Magnet(#7631370) \$20.25

Rotary Tumbler Cleaning Solutions

- Case Cleaning Solution 16oz (#7631705) \$19.75
- Case Cleaning Solution 32oz (#7631714) \$30.50



Lyman's Dual Sifter System separates pins from cases better than any other system. The first pan catches the brass, while the second pan catches the pins. Separate cases and media, all in one step!



Cyclone® Case Dryer

The perfect companion to any Ultrasonic or Rotary cleaning system. No longer will it be necessary to have to wait days for your brass to air dry! The forced heated air circulation of the Cyclone will dry your brass inside and out within an hour or two, with no unsightly water spots. The individual trays can keep your different caliber cases separate. Additionally, the dryer can also be used for gun parts that have been ultrasonically cleaned.

- Holds up to 1000 – 223 cases or 2000 – 9mm cases
- 3 hour timer
- Recessed handles on trays for easy loading and unloading
- Fast drying time
- 12" L x 9.5" W x 10.75" H (with 5 trays)
- Works with brass cases or gun parts
- Durable and long-lasting ABS trays
- Max temp 150 degrees Fahrenheit

Cyclone® Case Dryer 115V (#7631560) \$83.50
 Cyclone® Case Dryer 230V (#7631561) \$102.95
 (Note: 230V model contains a universal plug to work in most countries.)
 Replacement Tray (#7631565) \$10.95



GET IT ALL!

Cyclone® Case Cleaning Kit

Everything you need to get your cases or gun parts clean and dry in no time. This kit includes the Cyclone Rotary Tumbler AND the Cyclone Case Dryer AND the Stainless Steel Pin Magnet at a cost savings over buying each item separately!

Cyclone Case Cleaning Kit 115V(#7631340) . \$323.95





TurboSonic® Cleaning Solutions & Accessories

Cleaning with ultrasonics requires the correct solution for the specific cleaning application. Lyman has partnered with a renowned chemical research team to develop a broad line of superior solutions for use with any of today's new ultrasonic cleaners. Our TurboSonic Case Cleaning Solution is formulated to deliver superior results - inside and out.

Our Gun Parts Solution is the perfect choice for steel and stainless steel parts such as barrels, cylinders or other parts and tools.

For high volume gun cleaners, we have expanded our line of ultrasonic solutions with our new gallon size TurboSonic Steel Cleaner. Follow that up with Lyman Gun Lube, available in handy 1 gallon or even 5 gallon cans. The Steel Cleaning Solution and the Case Cleaning Solution are also available in 4oz, 16oz and 32oz bottles.

Ultrasonic cleaners are also great for cleaning jewelry! For the Sportsman who also wants to use a Lyman TurboSonic to clean fine jewelry or other valuable items, Lyman offers a special 16oz jewelry cleaning solution.

- TurboSonic Gun Lube 1 Gallon (#7631735) . . . \$100.95
- ⚠ TurboSonic Steel Clean Sol. 1 Gal. (#7631736) . . \$83.50
- ⚠ Case Cleaning Solution 16oz (#7631705) \$19.75
- ⚠ Steel Cleaning Solution 16oz (#7631707) \$19.75
- ⚠ Case Cleaning Solution 32oz (#7631714) \$30.50
- ⚠ Steel Cleaning Solution 32oz (#7631715) \$30.50
- ⚠ TurboSonic Measuring Cup (#7631716) \$5.50

TurboSonic® 2500

- Heated tank delivers Superior Ultrasonic Performance and more efficient action.
- Processes up to 900 9mm cases in less than 15 minutes
- Cleans cases inside & out, including primer pockets
- TurboSonic® Case Cleaning Solution is specially formulated for cleaning Brass Cases.
- Separate Gun Parts Solution for Steel & Stainless Steel Parts.
- All solutions can be used with any Ultrasonic Cleaner.

TurboSonic 2500 (115V) (#7631700) \$166.95
 TurboSonic 2500 (230V) (#7631702) \$186.95
 Replacement or Extra Basket (#7631710) . . . \$16.75

TurboSonic® 6000

- 6.3 quart tank (12.8"x8"x3.9") fits the biggest handguns or multiple pistol frames.
- Cleans up to 1300 9mm cases or 4 handgun frames.
- Powered by two industrial grade ultrasonic transducers.
- Tank has a built-in drain and hose for easy solution changes.
- Comes with a large plastic parts basket with convenient handles.
- Heated tank for optimum cleaning performance.
- 2 color LED display with 5 timed cleaning cycles.

TurboSonic 6000 (115V) (#7631725) \$435.50
 Replacement or Extra Basket (#7631708) . . . \$27.25

Model	Tank Size	Capacity	Timer	Heater	Drain Valve	Fits 9mm # Cases	Fits 223 # Cases	Fits 30-06 # Cases
TS-2500	9.84 x 5.90 x 3.15	2500ml (2.6qt)	5 Pre-set Settings	Yes	No	900	400	250
TS-6000	12.7 x 8.0 x 3.9	6000ml (6.3qt)	1-30 min. full range	Yes	Yes	1300	650	400

⚠ WARNING: This product can expose you to chemicals including Diethanolamine or Methanol, which are known to the State of California to cause cancer and/or birth defects or other reproductive harm. For more information go to www.p65warnings.ca.gov

**OUR LARGEST, MOST POWERFUL
ULTRASONIC CLEANER.**

Ten Powerful Ultrasonic Transducers Make This Machine Ideal for Industrial Use

Overall Dimensions
L 38½" W 10¾" H 14"
Tank Dimensions
L 35¾" W 8" H 6¼"

Handy built-in spout extends for pouring with no mess!



TurboSonic® Barrel & Gun Parts Lube

Specifically formulated for ultrasonic use right out of the bottle, TurboSonic Gun Lube displaces moisture and penetrates all the hard to reach areas of any part making it ideal for use after ultrasonic cleaning. Formulated for superior firearms lubrication and protection, the lube leaves a dry protective, lubricating film and can be reused repeatedly.

TurboSonic Gun Lube 1 Gallon (#7631735) . . . \$100.95

Now Available in 5-Gallon Can!

- Handy 5 Gallon Container for volume users - Ideal for Power Pro users!

- Pouring Spout extends for easy pouring with no mess TurboSonic Gun Lube 5 Gallon (#7631754) . . . \$415.50

TurboSonic® Steel Cleaner ⚠

Designed for high volume cleaning and lubrication, the new gallon containers of TurboSonic solutions give the gunsmith, armorer or advanced hobbyist plenty of cleaning concentrate.

Steel Cleaning Solution 1 Gallon (#7631736) . . . \$83.50

⚠ WARNING: This product can expose you to chemicals including Diethanolamine or Methanol, which are known to the State of California to cause cancer and/or birth defects or other reproductive harm. For more information go to www.p65warnings.ca.gov

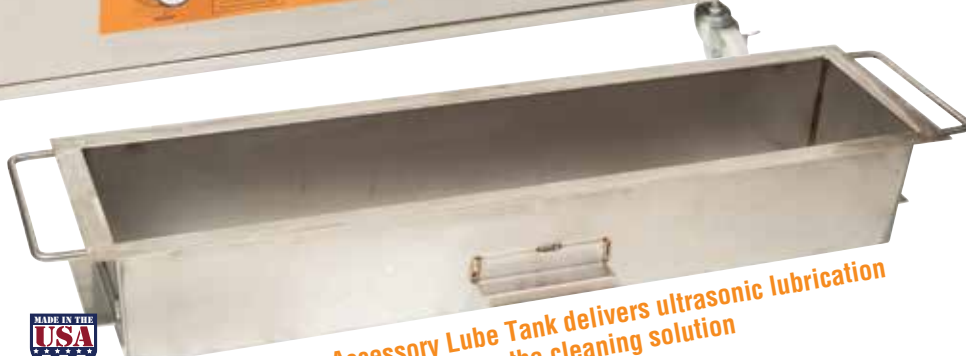

The Power Pro Accessory Lube Tank delivers ultrasonic lubrication without draining the cleaning solution

TurboSonic® Power Professional

Designed for high volume cleaning or for larger than normal items, the TurboSonic Power Pro's 34.75" heated stainless steel tank can easily handle most barreled actions, upper receivers, as well as several handguns at a time. The powerful industrial transducers aggressively deep clean and degrease items, both inside and out. In fact, the Power Pro is such an effective cleaner that Lyman recommends that cleaned parts immediately be ultrasonically treated with Lyman's TurboSonic Gun Lube. Changing from cleaning to lubrication is easy with the built in drain system. Lyman now offers both cleaning concentrate and parts lubricant in gallon containers.

For complete control of the process, the Power Pro has both a timer and an adjustable heat control. Temperatures up to 175 degrees can be selected.

TurboSonic Power Pro (115V) (#7631734) . . . \$2323.95
Replacement or Extra Basket (#7631745) . . . \$159.15
Replacement Heater (#7631749) . . . \$20.00

Power Pro Accessory Lube Tank

Now, users of Lyman's industrial strength Power Pro ultrasonic cleaner can easily and completely lube parts without draining the cleaning solution from the unit. This rugged, stainless tank is designed to sit in the Power Pro's cleaning tank which remains filled with cleaner. The unit's powerful ultrasonic action is transmitted through the cleaning solution into the accessory tank filled with lube. No tank draining or cleaning needed. 2 gallon capacity.

- Allows firearms to be lubricated without draining cleaning solution

- Side brackets support the accessory tank allowing it to sit in the cleaning solution, transferring the ultrasonic action to the lube

- Tough, welded metal construction
- Large handles make moving the tank easy

- Huge time savings when cleaning multiple firearms

Power Pro Accessory Lube Tank (#7631739) . . . \$425.95

The Industry Leader in Brass Cleaning



2200 Auto-Flo™ Tumbler
The Original Auto-Flo™



The 2200 features a high strength “Ultra-Thick” Roto Molded bowl which will last as long as you own your tumbler. The 1.5 gallon capacity is ideal for the large volume user and can clean 750 .38 Special cases in one cycle. The 2200 also features a clear see-thru lid for inspecting cases during cleaning. A media drain pan is also included.

2200 Auto-Flo 115V (#7631601) \$202.50

Replacement Parts:

2200 Auto-Flo Bowl (#8077170) \$59.95

2200 Auto-Flo Lid (#8094920) \$18.50

Auto-Flo Drain Plug (#8075970) \$1.19

2500 Pro Magnum Tumbler



Lyman’s Pro Magnum Tumbler is designed for the high volume reloader, and high volume reloaders are always looking for value. The two gallon capacity bowl is engineered to deliver powerful cleaning action even at full capacity. Handling up to 1000 .38 Special cases at a time, the heavy-duty motor and advanced drive system deliver fast cleaning and long life. For maximum convenience, Auto-Flo models are also available.

2500 Pro Magnum 115V (#7631692) \$116.50

2500 Pro Magnum Auto-Flo 115V (#7631697) . \$171.95

Replacement Parts:

2500 Tumbler Bowl (#8077020) \$34.95

2500 Auto-Flo Bowl (#8077022) \$34.95

2500 Auto-Flo Separating Chamber (#8077570) \$6.92

2500 Lid (All Models) (#8077310) \$8.50

Auto-Flo Drain Plug (#8075970) \$1.19

The Auto-Flo™ Advantage

The ultimate in case cleaning convenience, Lyman’s Auto-Flo Tumblers automatically separate clean cases from media using the unit’s normal vibrating motion. When cases are clean, the user simply pulls the drain plug and the media drains from the exit port into the media drain pan (included).

Lyman Turbo® Tumblers - Specifications and Capacities*					
	Media Charge (lbs.)	#.38 Spec. Cases	Bowl Capacity*	Bowl Size (Dia.)	Part No.
2500 Pro Mag Auto Flo	6.5	1000	1.75 Gal.	13"	7631697
2500 Pro Magnum	6	1000	1.75 Gal.	13"	7631692
2200 Auto-Flo ^{CE}	5	750	1.5 Gal.	12"	7631601
1200 Auto-Flo ^{CE}	3	350	1 Gal.	10"	7631630
1200 Pro ^{CE}	2	350	1 Gal.	10"	7631318
Twin Tumbler		Use 1200 specifications			7631327

**Best Selection
Best Value!**



**Two
Tumblers
In One!**



1200 Auto-Flo™ Tumbler ⚠️
The Turbo that started the revolution in case cleaning.

The 1200 Auto-Flo has the same capacity as the original 1200 but features the Auto-Flo self separating system. When cases are clean, the drain plug is removed and the media flows through the tumbler into the drain pan (included with all Auto-Flo tumblers).

- 1200 Auto-Flo 115V (#7631630) \$134.50
- 1200 Auto-Flo 230V (#7631632) \$156.95

Replacement Parts:

- 1200 Auto-Flo Bowl (#8095100P) \$18.79
- 1200 Auto-Flo Separating Chamber (#8077520) \$8.12
- Auto-Flo Drain Plug (#8075970) \$1.19



**Converts
Regular
Tumblers to
Auto-Flo™!**

Auto-Flo™ Conversion Kit ⚠️

Auto-Flo conversion systems can give your standard tumbler the "Auto-Flo Advantage". Works on Lyman Tumblers and most competitive models of similar bowl size. All systems include bowl, lid, Auto-Flo drain base and media dump pan.

- 600/1200 Auto-Flo Conversion Kit (#7631636) . . \$43.50

PRO 1200 Turbo® Tumbler ⚠️
Our best seller and a true value for reloaders.

The 1200 Pro features the same capacity as our original 1200 model at a very affordable price. The "built-in" sifter lid for quick and easy media separation saves you the cost of a separate media sifter. This economic 1200 Pro will hold 2 lbs. of media and will clean up to 350 cases per cycle.

- Turbo 1200 Pro Tumbler 115V (#7631318) \$85.95
- Turbo 1200 Pro Tumbler 230V (#7631319) . . . \$104.95

Replacement Parts:

- 1200 Tumbler Bowl (#8077000) \$18.79
- 1200 Slotted Lid (#8077460) \$7.50
- 1200 Solid Lid (#8077270) \$7.25



Turbo® Twin Tumbler ⚠️
Real versatility and value

Lyman's Turbo® Twin has become one of the most popular tumbler choices. It features our Lyman 1200 Pro Tumbler with an extra 600 bowl system so reloaders can interchange bowls for small or large capacity loads. 600 Bowl is also ideal for rock polishing or small polishing or deburring operations. This model also features Lyman advanced drive system for faster, more consistent tumbling action.

- Turbo Twin Tumbler 115V(#7631327) \$105.95
- Turbo Twin Tumbler 230V (#7631328) \$114.95

Replacement Parts:

- Rubber Well Nut for 1200/600 Tumblers (#8094090) \$1.19
- 600 Tumbler Bowl (#8076970) \$11.93
- 600 Tumbler (#8094151) \$4.08

Turbo® Accessory™ Bowls ⚠️

Allows for tumbler upgrade. 600 bowl for liquid use with 1200 tumbler. 1200 bowl doubles capacity of 600. Hardware included.

- 600 Accessory Bowl (#7631399) \$17.95
- 1200 Accessory Bowl (#7631323) \$24.95





Small



Medium



Large

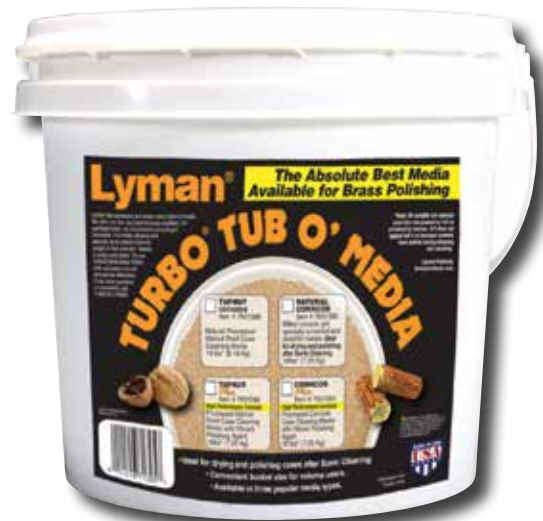

Jumbo

Lyman Turbo® Case Cleaning Media

Lyman Case Cleaning Media is the most effective choice for cleaning dirty and tarnished cases. A few hours in a Lyman Turbo® Tumbler and cases are clean, polished and ready for reloading. Note: weights are approximate, as containers are filled by volume, not weight. All media is a 12/20 grit.



WARNING: This product can expose you to chemicals including Hexavalent Chrome, which is known to the State of California to cause cancer and/or birth defects or other reproductive harm. For more information go to www.p65warnings.ca.gov

Tufnut™ Untreated

Made from natural processed walnut shells. An effective choice for cleaning dirty and tarnished cases.

- 7631331 Small Tufnut Untreated..... 3lbs.. \$10.10
- 7631395 Medium Tufnut Untreated.... 5.5lbs.. \$18.75
- 7631337 Large Tufnut Untreated..... 12lbs.. \$25.25
- 7631338 Jumbo Tub Tufnut Untreated 18lbs.. \$34.50

Natural Corncob

Made from natural processed corncobs. An effective choice for cleaning dirty and tarnished cases.

- 7631389 Small Natural Corncob..... 2lbs.. \$10.10
- 7631392 Medium Natural Corncob..... 3.5lbs.. \$18.25
- 7631393 Large Natural Corncob..... 10lbs.. \$22.95

Tufnut™ Plus



Natural processed walnut shells, combined with a vibrant polishing agent for polishing cases to a high luster.

- 7631332 Small Tufnut Plus 3lbs.. \$12.10
- 7631396 Medium Tufnut Plus 5.5lbs.. \$20.75
- 7631333 Large Tufnut Plus 12lbs.. \$25.25
- 7631334 Jumbo Tub Tufnut Plus 18lbs.. \$37.50

Corncob Plus



Natural processed corncob, combined with a vibrant polishing agent for polishing cases to a high luster.

- 7631307 Small Corncob Plus 2lbs.. \$12.75
- 7631394 Medium Corncob Plus 4.5lbs.. \$20.75
- 7631320 Large Corncob Plus 10lbs.. \$25.25
- 7631335 Jumbo Tub Corncob Plus 16lbs.... \$37.5



Turbo® Liquid Case Cleaner

Turbo® Case Cleaner is an excellent liquid pre-cleaner for extremely fouled cases. Also may be used as a wet media. Use manually or with a tumbler.

- Case Cleaner (16 fl. oz.) (#7631340) \$13.75

Turbo® Brite Brass Polish

Turbo® Brite Brass Polish is ideal for use as an additive when using untreated Corncob or Nutshell. Works with treated media to bring brass to a high luster.

- Brass Polish (5 oz. bottle) (#7631358) \$9.75
- Brass Polish (20 oz. bottle) (#7631361) \$25.25

Turbo® Charger Media Reactivator



Turbo® Charger Media Reactivator will restore previously used corncob media. Simply add as instructed directly to media.

- Media Reactivator (4 oz. bottle) (#7631322) . . . \$9.75
- Media Reactivator (16 oz. bottle) (#7631324) . \$20.25



WARNING: This product can expose you to chemicals including Chromium oxide, which is known to the State of California to cause cancer and/or birth defects or other reproductive harm. For more information go to www.p65warnings.ca.gov



Turbo® Super Sifter

The new Turbo Super Sifter allows cases to be easily separated from media while positioned over 7, 5, 3 or 2 gallon pails. These commonly available pails make the perfect container for storing used media. The sifter is equipped with large handles to make it easy to use with large volumes of cases and media. The extra deep design prevents media from spilling over the edges when pouring case and media from a tumbler and when in use.

- Works with commonly available 7, 5, 3 and 2 gallon pails
- Extra deep design keeps media inside the sifter and off the floor
- Large handles make the sifter easy to use

Turbo Sifter (#7631316) \$13.10



Flash Hole Cleaner

Designed to remove bits of media from flash holes and primer pockets.

Flash Hole Cleaner (#7777750) \$9.10

Turbo® Case/Media Separator

Lyman puts a new “spin” on the media separator. Lyman engineers took a look at the media separators on the market and decided that they could do better. The result is a separator that incorporates many new features that makes the messy job of sifting media from cases much easier. The inner basket can be positioned to prevent it from moving as cases are poured in. The crank handle cover spins freely on the crank, making it much more comfortable to use. Improved latches provide a solid lock-up for the basket and the outer cover. The covers have interlocking edges to seal media and dust inside.

- Free spinning crank handle cover
- Improved latches for a tight lock-up of the basket and cover
- Can be used with either right or left hand
- Tight seal to trap media and dust inside

Media Separator (#7631326) \$43.50





**Lyman Trimmers
Include 9
Most Popular
Trimmer Pilots**

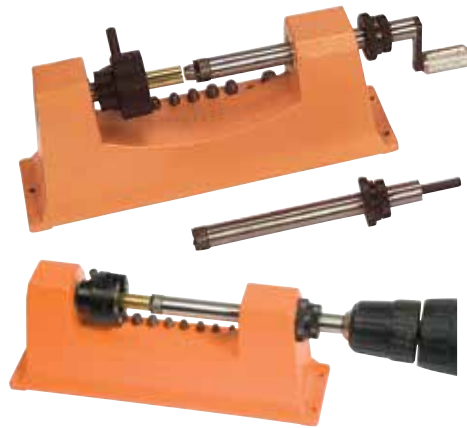

**Transform Your
Trimmer into a
Power Model**

**Power Adapter
Installs
in Seconds!**



**Carbide Cutter
is ideal
for high volume
reloaders**



**SPECIAL
50 BMG
PRODUCT**

Universal Trimmer®

Lyman's Universal Trimmer features the popular Universal Chuckhead which handles any case from .17 caliber to .458. No costly collets required! Features coarse and fine adjustments. Adjusting ring lets you "dial in to an approximate setting for quick repeatability". Includes 9 of the most popular pilots. Optional power adapter lets you upgrade to power in seconds.

Universal Trimmer (#7862000) \$123.95

Universal Trimmer® Power Adapter

Quickly convert to power trimming. Replace the existing trimmer shaft with the power adapter shaft and attach your drill. You're ready to power trim over 250 cases an hour. The adapter shaft comes with its own cutter and stop collars so you can convert back and forth from power to hand operation. The power adapter only fits the Lyman Universal Trimmer.

Power Adapter (#7862001) \$35.95

Universal Trimmer® Power Pack Combo

The Power Pack Combo combines Lyman's Power Adapter with Lyman's popular Universal Trimmer. This allows quick and simple conversion from hand to power trimming. All you need is a standard electric hand drill or power screwdriver. Simply unscrew the cutter head from the standard shaft and slide it out of the trimmer. Then slip the power adapter shaft in its place, screw on the cutter head and attach your drill. You're ready to power trim over 250 cases an hour. The adapter shaft comes with its own cutter and stop collars and includes 9 pilot multi-pack

Power Pack Combo (#7862003) \$144.95

Best Buy!

AccuTrimmer™

Trims cases .17 through .458 Win. Mag. Uses standard shellholders to position cartridge and standard Lyman cutter heads and pilots. Includes our popular nine Pilot Multi-Pack. Purchase with shellholder set shown on page 27 and reloader has universal "trimability".

AccuTrimmer Multi-Pack (#7862210) \$78.50

50 BMG AccuTrimmer™

An AccuTrimmer designed specifically for 50 BMG cartridges. The shell head fits into a special holder which centers the case with the cutting shaft. A special 50 BMG pilot is included for perfect alignment and easy trimming.

50 BMG (#7862130) \$90.95

Universal® Carbide Case Trimmer

This case trimmer adds the longer life and ultra-sharp cutting qualities of a carbide tool to Lyman's well-known Universal Trimmer. The Universal Carbide Case Trimmer takes advantage of the premium Carbide Cutter Head's fine grain and ultra-sharp cutting edge. This Carbide Head will hold its edge and dimensions longer, making this trimmer ideal for volume reloaders. Lyman's Universal Chuckhead handles any case from .17 caliber to .458 caliber with no collets or shell holders required and includes 9 of the most popular caliber pilots.

Universal Carbide Case Trimmer (#7862009) \$156.95

Accessory Carbide Cutter Head

An optional carbide cutter fits all Lyman trimmers. Ideal for volume reloader.
Cutter Head (2 oz.) (#7822204) \$57.75

Ream/Clean Accessory Set

A set of threaded accessories for Lyman trimmers or utility crank. Includes L & S primer pocket reamers and cleaners plus adapters.
Access. Set (3 oz.) (#777795) \$20.25



Case Trimmer Accessories

Replacement Cutter Head
Replacement (Steel) 2 pk. (4 oz.) (#7822203) \$44.50

Nine Pilot Multi-Pack
Includes nine of the most popular pilots: 22, 24, 27, 28/7mm, 30, 9mm, 35 (38/357), 44 and 45A.
Multi-Pack (2 oz.) (#7822202) \$22.95

Extra Pilot
Pilot (1 oz.) (State caliber, see list on Pg. 27) \$5.95

Lyman® **E-ZEE TRIM™** **HAND CASE TRIMMING SYSTEM**

MADE IN U.S.A.

- Trim cases by hand - fast & accurate
- Precision machined case length pilots guarantee accurate case length
- Accepts all brands of shellholders (sold separately)
- Precision CNC machined - solid steel construction

INCLUDES ADAPTER TO RUN TRIMMER WITH MOST POWER DRILLS

RIFLE PILOT SET
Includes: .223, .243, .270 Win, .308 Win, .30-06

Fast, Simple, Precise Case Trimming

Works With All Brands of Shellholders

www.lymanproducts.com



Choose a Pilot set for Rifle or Pistol Calibers, or purchase the Universal System and buy pilots individually.

E-ZEE TRIM PILOTS

"E-ZEE" Trim Pilot - .204 Ruger (#7821900)
"E-ZEE" Trim Pilot - .223* (#7821901)
"E-ZEE" Trim Pilot - .22-250 (#7821902)
"E-ZEE" Trim Pilot - 22 Nosler (#7821937)
"E-ZEE" Trim Pilot - 224 Valkyrie (#7821940)
"E-ZEE" Trim Pilot - .243* (#7821903)
"E-ZEE" Trim Pilot - 6mm Creedmoor (#7821936)
"E-ZEE" Trim Pilot - 25-06 (#7821911)
"E-ZEE" Trim Pilot - 6.5 Grendel (#7821939)
"E-ZEE" Trim Pilot - 6.5 x 55 (#7821912)
"E-ZEE" Trim Pilot - .270 Win.* (#7821904)
"E-ZEE" Trim Pilot - 7 x 57 (#7821913)
"E-ZEE" Trim Pilot - 7mm Rem Magnum (#7821905)
"E-ZEE" Trim Pilot - 30-30 (#7821906)
"E-ZEE" Trim Pilot - 300 AAC Black-Out (#7821914)
"E-ZEE" Trim Pilot - .308 Win.* (#7821907)
"E-ZEE" Trim Pilot - .30-06* (#7821908)
"E-ZEE" Trim Pilot - 300 Win. Mag. (#7821909)
"E-ZEE" Trim Pilot - 300 WSM (#7821915)
"E-ZEE" Trim Pilot - 7.62 x 39 (#7821916)
"E-ZEE" Trim Pilot - 303 British (#7821917)
"E-ZEE" Trim Pilot - 8 x 57 (#7821918)
"E-ZEE" Trim Pilot - 338 Win Mag (#7821919)
"E-ZEE" Trim Pilot - 458 SOCOM (#7821938)
"E-ZEE" Trim Pilot - 45-70 (#7821910)
"E-ZEE" Trim Pilot - 6.5 Creedmoor (#7821922)
"E-ZEE" Trim Pilot - 7mm-08 (#7821921)
"E-ZEE" Trim Pilot - 30 Carbine (#7821920)
"E-ZEE" Trim Pilot - 338 Lapua (#7821935)
"E-ZEE" Trim Pilot - 380 Auto (#7821931)
"E-ZEE" Trim Pilot - 9mm** (#7821928)
"E-ZEE" Trim Pilot - .38 Spec** (#7821925)
"E-ZEE" Trim Pilot - .357** (#7821926)
"E-ZEE" Trim Pilot - .40 S&W** (#7821929)
"E-ZEE" Trim Pilot - .44 Mag** (#7821927)
"E-ZEE" Trim Pilot - .45 ACP** (#7821930)
"E-ZEE" Trim Pilot - 45 Colt (#7821932)
"E-ZEE" Trim Pilot - 357 Sig (#7821933)
"E-ZEE" Trim Pilot - 10mm Auto (#7821934)
Price \$6.50 each

E-ZEE Trim™ Hand Case Trimmer

The industry leader in trimming and case prep innovation, Lyman introduces a new case trimming system for the reloader interested in economy or preferring to have an individual precision hand system for each caliber. The E-ZEE TRIM case trimming system allows the user to trim cases by hand or with a power attachment (included) to precise pre-set length - no adjustment of measuring needed. The trimmer comes with a case locking device, cutter, trim-to length pilot, cutter head and both hand and power trimming adapters. The trimmer works with any standard shell holder including Lyman, Redding, RCBS, Hornady and Lee Precision. Assembles in seconds and you are ready to trim cases. The E-ZEE TRIM system comes in three practical variations to make it simple for the consumer and simpler for the trade to stock.

E-ZEE TRIM Rifle Set

Includes hand trimmer, power adapter, cutter head and 5 most popular rifle caliber pilots (.223, .243, .270, .30-06, .308)

"E-ZEE" Trim Rifle Set (5 Pilots*) (#7821891) \$38.50

E-ZEE TRIM Handgun Set

Includes hand trimmer, power adapter, cutter head, and 6 most popular handgun caliber pilots (9mm, 38 Spec, 357, 40 S&W, 44 Mag, 45 ACP)

"E-ZEE" Trim Handgun Set (6 Pilots**) (#7821892) \$38.50

E-ZEE TRIM Universal Set

Includes hand trimmer, power adapter, and cutter head. Just add the pilot for the caliber you wish to trim.

"E-ZEE" Trim Universal (No Pilots) (#7821890) \$26.25

E-ZEE Trim™ Rubber Handle Accessory

Slips easily over the adapter handle to provide a cushioned, comfortable grip.

E-ZEE Trim Handle (#7821893) \$6.75



* Pilots included in Rifle Set. ** Pilots included in Pistol Set.



Endurance Tested for a Lifetime of Use

Brass Smith Case Trim Xpress™

Lyman's Case Trim Xpress gives rifle reloaders the speed and accuracy that they have been looking for when trimming cases! The unit has its own power source, and a strong variable speed motor, so there is no need to use power drills or purchase separate motors. By using bushings that contact on the shoulder of bottle neck type cases, the Case Trim Xpress will quickly and cleanly trim your brass by simply pushing the case against the long lasting carbide cutter. The trimmer comes with a set of 10 bushings (in orange type below) designed to fit most popular bottleneck rifle cases. The bushings support and center the case with the cutter. No pilots are needed! The bushings are spring loaded to provide a smooth, effortless cut; and allow the user to trim approximately 15 cases per minute. In addition, the Case Trim Xpress is equipped with an adjustment wheel, which allows case lengths to easily be "dialed in" to .001" increments. Plus it is made with a compact, low profile housing that doesn't eat up all of your bench space.

- Fast and accurate trims – approximately 15 cases per minute
- Variable speed motor and ultra-sharp, long lasting carbide cutter
- Utilizes case shoulders to center & trim (**Not for use on straight wall cases**)
- Comes with 10 bushings fitting most popular bottleneck rifle cartridges
- Smooth spring-loaded operation gives clean, chatter-free trims
- Compact, low profile design uses minimal bench space
- No pilots needed

Brass Smith Case Trim Xpress 115V (#7862015)\$171.95
 Brass Smith Case Trim Xpress 230V (#7862016)\$189.95
 Individual Bushings (see list at right)\$10.10 each
 Replacement Carbide Cutter (#7810244).....\$38.25

Item #	Individual Bushings: (*orange are incl. w/Trimmer)
7821701	#1 (17 Hornet, 22 Hornet)
7821702	#2 (218 Bee)
7821703	#3 (.223 Rem.,17 Rem.,.204 Ruger,.221 Fireball,.222 Rem., 222 Rem Mag,5.56 x 45)*
7821704	#4 (300 AAC,17 Rem Fireball)*
7821705	#5 (30 30 Win,6.8 Rem SPC,22 Nosler,24 Nosler,224 Valkyrie)*
7821706	#6 (220 Swift)
7821707	#7 (303 British,7.62 x 39,30-40 Krag,6.5 Grendel)
7821708	#8 (22-250 Rem,250 Savage,35 Remington)*
7821709	#9 (6mm Rem,7mm Mauser,8mm Mauser,257 Roberts)*
7821710	#10 (30/06,25/06,270 Win,.280 Rem,35 Whelen,6.5 Swedish)*
7821711	#11 (9.3 x 74r)
7821712	#12 (.308 Win,.243 Win,.260 Rem,7mm/08,338 Federal, 358 Win,300 Savage,9.3 x 62,6x47 Lapua,6 XC,6.5x47 Lap.)*
7821713	#13 (6.5mm Creedmoor,6mm Creedmoor,6mm BR Norma, .22 BR,6mm Dasher)*
7821714	#14 (375 H&H Mag)
7821715	#15 (7.62 x 54R)
7821716	#16 (.284 Win,6.5 x 284,6 x 284)
7821717	#17 (416 Rem Mag,8mm Rem Mag)
7821718	#18 (.300 Win Mag,.264 Win Mag,7mm Rem Mag, 7mm STW,.308 Norma Mag,.338 Win Mag)*
7821719	#19 (300 RCM,338 RCM,375 Ruger,6.5 PRC, 300 PRC)
7821720	#20 (.338 Ultramag,7mm Ultramag,.300 Ultramag,.338 Edge,375 RUM)
7821721	#21 (30 Nosler,28 Nosler,27 Nosler,26 Nosler)
7821722	#22 (7mm Rem SAUM, .300 Rem SAUM)
7821723	#23 (.300 WSM,.325 WSM,.270 WSM,7mm WSM)*
7821724	#24 (338 Lapua)
7821725	#25 (416 Rigby)



• Case Neck Lube Brushes



• Primer Pocket Uniformer



• Outside Deburr Tool



• Primer Pocket Cleaner



• VLD Inside Deburr



• Primer Pocket Reamer



New improved drivetrain for quieter, smoother operation with greater torque. Smaller “footprint” takes up less bench space and a repositioned On/Off switch for easier access.

Case Prep Xpress™

Lyman, the industry innovator in case preparation for decades, provides the most complete electric case prep system ever developed. The Case Prep Express is the only “All-Inclusive” System offering all the most popular case prep accessories driven by a high torque gear motor. The Case Prep Xpress allows the user to simultaneously do 5 different case prep operations. Removable dump pan provides easy clean up of brass shavings. The best part is that all accessories are included from the start, no need to have to separately purchase expensive additional accessories. Included

Accessories:

- Inside Deburr (VLD) Tool
- Outside Deburr Tool
- Primer Pocket Uniformers (Small & Large)
- Primer Pocket Reamers (Small & Large)
- Primer Pocket Cleaners (Small & Large)
- Case Neck Brushes (25 Cal, 30 Cal, 38 Cal, 45 Cal)
- Case Neck Lube (Mica)
- Removable Brass Shavings Dump Pan
- Clean-up brush

Case Prep Xpress (115V) (#7810220) \$212.95
 Case Prep Xpress (230V) (#7810223) \$232.95
 Spare Accessory Packet (#7999040) \$49.95

Cases Trimmed and Prepped So Fast You'll Actually Have Time to Shoot!



Xpress™ Case Processing Kit

All of your case prep chores, automated! Trim cases quickly and accurately with the Case Trim Xpress and then zip through deburring, reaming, cleaning and lubing on the Case Prep Xpress. All at a savings over purchasing items separately!

Xpress Ultimate Case Prep Kit (115V) (#7810213) \$333.95



**20mm Vulcan Case Prep Tool/
Novelty Round**

Lyman has machined the most unusual case prep tool available! Cut to the same dimensions as the 20mm round used in the famous Vulcan Rotary Cannon, the cartridge has a 8-32 thread in the base to accept case prep tools. It comes packed with large and small primer pocket reamers and cleaners. In addition, the round is hollow and can store the tools inside by unthreading the bullet from the case. When not in use, the round makes a great display piece and conversation starter! CNC machined from solid aluminum and anodized to resemble the real thing!

- Dimensioned the same as 20mm Vulcan ammo
- Doubles as a case prep tool
- Includes large and small primer pocket reamers and cleaners
- Bullet unthreads from the case to store case prep tools inside
- CNC machined from solid aluminum

20mm Vulcan Case Prep Tool (#7777820) . . . \$33.50



**ALL-IN-ONE TOOL FOR
50BMG SHOOTERS**

Case Prep Multi-Tool™

Lyman's Unique New Case Prep Multi-Tool provides the reloader with all the essential Case Prep Accessories in one compact, Double-ended Storage Tool. Unique knurled handle un-threads in the middle to store all parts. Both ends of the handle are threaded to allow two tool heads to be mounted simultaneously. Includes:

- Outside Deburring Tool
- VLD Inside Deburring Tool
- Large & Small Primer Pocket Cleaners
- Large & Small Primer Pocket Reamers

Case Prep Multi-Tool (#7777800) \$32.95

50 BMG Case Prep Multi-Tool™

Reloaders of the Big 50 no longer have to make do with undersized standard or makeshift tools to prep their 50 BMG cases. Lyman has engineered full-sized .50 caliber tools and put them together in a handy double ended storage handle - always ready and all in one place. The unique knurled handle un-threads in the middle to store all the parts. Both ends of the handle are threaded to allow a tool head to be mounted on each end. In addition to the double ended, storage handle the set includes:

- .50 Cal. Outside Deburring Tool
 - .50 Cal. VLD Inside Deburring Tool
 - .50 BMG Primer Pocket Reamer, Cleaner, Uniformer
- Case Prep Multi-Tool (#7777811) \$70.95



A. Outside Chamfer Tool

Bevels and removes burrs from the outside of the case mouth. Precision machined and hardened, fits all cases from .17 to .45 caliber.
 Outside Deburring Tool (#7810222) \$15.75

B. Lyman VLD (Very Low Drag) Chamfer/Reamer

Lyman's VLD Chamfer/ Reamer eliminates damage to bullets caused by the sharp edges of the cartridge case neck. The long boat tail on VLD bullets are cut by the case mouth when chamfered with a standard 45 degree reamer. The sharp 22 degrees on the VLD reamer allows all bullets to slip easily into the case ensuring the best accuracy. Recommended for Sierra VLD and other manufacturer's VLD bullets.
 Chamfer/Reamer (#7777789) \$15.95

C. Primer Pocket Uniformers

This precision tool allows reloaders to assure uniform primer depth which produces consistent ignition and improves accuracy. Uniforming tool has a pre-set stop collar set to SAAMI specs. Reloader simply inserts and turns. Available in large and small sizes. (Large for rifle cases only, Small for rifle or pistol cases)
 Uniformer Large (#7810215) \$26.25
 Uniformer Small (#7810218) \$26.25

Large Pistol Primer Pocket Uniformer

The Large Pistol Primer Pocket Uniformer is designed to cut primer pockets to a uniform depth that can produce more consistent ignition and lead to greater accuracy. The Primer Pocket Uniformer cuts to a uniform depth and at the same time squares the seating surface for the anvil of the primer.
 Large Pistol Uniformer (#7810219) \$26.95

D. Primer Pocket Cleaners

Clean out fouling of primer pocket bottoms. Available in large and small sizes.
 Cleaner Large (#7777790) \$12.10
 Cleaner Small (#7777791) \$12.10

E. Primer Pocket Reamers

Remove military crimps and rough metal edges from a primer pocket. Available in large and small sizes.
 Reamer Large (#7777785) \$12.10
 Reamer Small (#7777784) \$12.10



Primer Pocket Uniformer

Universal Case Prep Accessory Set

This handy kit is the perfect accessory to your Universal Case Trimmer. It contains everything you need to properly complete case preparation, all in a durable storage case. Save over 30% versus individual purchases.

- Set includes:
- Large & Small Primer Pocket Cleaners
 - Large & Small Primer Pocket Reamers
 - Large & Small Primer Pocket Uniformers
 - Outside Deburring Tool
 - Inside Deburring Tool VLD

Case Prep Accessory Set (#7810212) \$81.50



Ream/Clean Accessory Set

A set of threaded accessories for Lyman trimmers or utility crank. Includes L&S primer pocket reamers and cleaners plus adapters.
 Accessory Set (3 oz.) (#7777795) \$20.25





Lyman Magnum Inertia Bullet Puller

Safely strips loaded rounds in seconds without damage to bullet or case. Features newly engineered head design that allows use on full range of calibers from tiny 5.7 X 28FN to the largest Magnums. New "full size" ergonomic molded handle with rubber insert for comfort and sure grip.

- Bullet Puller (#7810216) \$26.25
- Replacement Small Collet (#7810224) \$5.85
- Replacement Large Collet (#7810225) \$5.85
- Replacement Threaded Cap (#7787786) \$2.50



Flash Hole Cleaner

Designed to remove bits of media from flash holes and primer pockets.
Flash Hole Cleaner (#7777750) \$9.10



Flash Hole Uniformer

This handy tool removes internal flash hole burrs. Features a tool steel cutter which is inserted into the flash hole through the case neck. Adjustable stop collar allows use with any size case. Burrs are removed with a clockwise turn. Fits .22 to .45 Calibers.
Flash Hole Uniformer (4 oz.) (#7777760) \$18.25



Lyman Case Care Kit

The utility crank accepts most Lyman accessories and any tool with an 8-32 thread. Kit includes both Large & Small Primer Pocket Reamers, Cleaners, & Uniformers, as well as Inside and Outside Deburring Tools.
Case Care Kit (1 lb.) (#7777793) \$56.25

WARNING: This product can expose you to chemicals including Propylene Glycol T-Butyl Ether or Toluene, which are known to the State of California to cause cancer and/or birth defects or other reproductive harm. For more information go to www.p65warnings.ca.gov

A. Quick Slick™ Pump Case Lube

Lyman's popular "Quick Slick" spray case lube is now available in a large and economical 16oz pump spray. The large ergonomic spray bottle allows you to spray an entire loading block of cases in seconds. Dries quickly to a light, clear film, and eliminates messy lube pads.
Quick Slick Pump Spray Lube 16oz. (#7631298) . \$23.95

B. Lyman Loading Block

Essential accessory for organization and speed, twin loading block holds 50 rifle or pistol cases .22 through .45 caliber. Molded of heavy duty plastic.
Loading Block (7 oz.) (#7728054) \$8.10

C. Case Neck Dipper

Prolongs case life and makes resizing easier by cleaning and lubricating the interior of bottleneck cases. After cleaning with brushes, dip the case mouths into dry lube to reduce friction from sizing die expander button. Includes 3 brushes and dry lube for cleaning all cases from .17 to .45 caliber.
Case Neck Dipper complete (2 oz.) (#7631360) . \$13.75
Replacement. Lube Refill (3.4a) (#7991415) \$6.25

D. Quick Slick™ Case Lube

This petroleum based lube in a can allows you to spray an entire loading block of cases in seconds. Super slick lube helps prevent case dents.
Spray Lube 5.5oz. (#7631296) \$10.50

E. Extra-Large Caliber Deburring Tool (extra large calibers up to .60)

This tool was designed for inside and outside deburring of cartridge cases from .17 caliber to 60 caliber. Ideal for black powder cartridge shooters. A must for 50 BMG reloading. The 30 degree angle cutter bevels inside the mouth of the case, allowing the bullets to slide in without deforming.
Extra-Large (#7810206) \$36.50

F. Deburring Tool

Bevels and removes burrs from both inside and outside of case mouth. Precision machined and hardened, fits all cases from .17 to .45 caliber.
Deburring Tool (2 oz.) (#7810199) \$24.25

G. Primer Tray

Flips primers anvil-side-up for easier loading. Spread on specially grooved surface, replace lid and shake. Made of durable plastic for safety.
Primer Tray (2 oz.) (#7728053) \$6.10

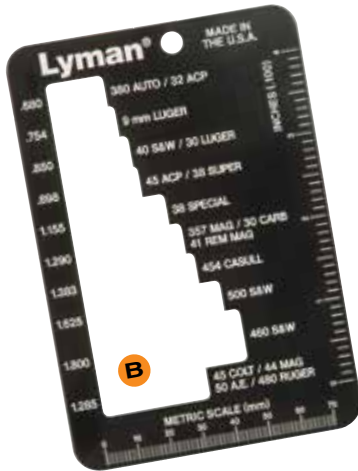

A. E-ZEE Case Gauge™

This full-size version measures the case length of over 70 popular rifle and pistol cases. Many new cartridges are included like the Winchester Short Mags, 204 Ruger, 500 S&W and others. Precisely made, this rugged metal gauge makes sorting cases quick, easy and accurate.

E-ZEE Case Gauge (#7832215) \$27.95

B. Pistol E-ZEE Case Gauge™

Here's Lyman's popular E-ZEE Case Gauge in a smaller, more convenient size yet covering virtually any pistol case. The precise metal "no-go" gauge makes judging case length fast, easy and accurate.

E-ZEE Case Gauge (#7832217) \$18.75

MSR E-ZEE™ Case Gauge

Lyman's E-ZEE Case Gauges have proven to be a real time saver for reloaders, and are available for most common calibers. The precisely machined metal "No-Go" gauge is cut to SAAMI maximum allowable case length. If a case fails to pass through the gauge, it needs to be trimmed. Lyman is now offering a specialized E-ZEE Case Gauge designed for those reloading for the wide range of MSR calibers. This convenient gauge is offered for the following calibers:

223/5.56, 224 Valkyrie, 6.5 Grendel, 6.5 Creedmoor, 6.8 SPC, 300 Blackout, 308 Win/7.62, 7.62x39, 9mm, 450 Bushmaster, 458SOCOM, 50 Beowulf plus 2.260" max. cartridge OAL

E-ZEE Case Gauge - MSR(#7832225) \$18.75

Case Lube Kit

Everything needed to clean and lube cases, inside and out, in one package. Large cloth lubricating pad in plastic case dispenses lube evenly. Includes 2 oz. of Lyman Case Lube, 3 interchangeable neck brushes and a cushioned plastic handle.

Case Lube Kit Complete (1 lb.) (#7631300) . . . \$25.25
 Case Lube (2 oz.) (#7631301) \$7.25
 Lube Pad Only (9 oz.) (#7631302) \$10.60



Ultra-Fine Dry Case Neck Lube

Many uses for this specialty lube. Dip case neck into lube before sizing to reduce friction from sizing die expander button. Also works great on keys that stick in locks.

Ultra-fine Lube (3.4a) (#7991415) \$6.25



Lyman Bleacher Blocks® For Handgun Calibers

Once reloaders began using our popular Bleacher Blocks for rifle cases, we quickly had requests for handgun size Bleacher Blocks. Our new Bleacher Blocks answer this request. The handgun blocks follow the same proven stepped design of the rifle blocks, however with shallower holes suitable for handgun cases. Just like the rifle blocks, the stepped design allows you to easily grip a single case without jamming your fingers down into a group of cases like in traditional loading blocks. The stepped design also produces a smaller footprint so they take up less valuable bench space. Made of tough, durable polymer, the handgun size Bleacher Blocks come in two sizes to fit most popular handgun calibers and hold 50 cases. Bleacher blocks measure 6 3/4" x 3 5/8".

- Molded to closely fit specific case sizes, .445", & .565"
- Made of tough, durable polymer
- Unique stepped design makes it easy to add or remove cases, even when full

- Takes up less bench space than traditional blocks
 - **.445" hole size fits:** 380 Auto, 9mm Luger, 38 Super, 357 Sig, 38 Special, 357 Mag, 40 S&W, 10mmAuto
 - **.565" hole size fits:** 44 Mag, 45 ACP, 45 GAP, 45 Colt, 454 Casull, 460 S&W, 500 S&W
- | | |
|--|--------|
| .445 Handgun Bleacher Blocks (#7728088) | \$8.05 |
| .565 Handgun Bleacher Blocks (#7728089) | \$8.05 |
| .445 Handgun Bleacher Block 4-pack (# 7991375) | 27.95 |
| .565 Handgun Bleacher Block 4-pack (# 7991376) | 27.95 |



Lyman Bleacher Blocks® for Rifle Calibers

Lyman has taken a "step up" in loading block design with our new Bleacher Blocks. Just as bleachers allow people to see over those in front of them, our new loading blocks allow for easier handling of cases in and out of the loading block. Our stepped design allows you to easily grip a single case without jamming your fingers down into a group of cases like in traditional loading blocks, and allows for a smaller "footprint" on your bench. Made of tough, durable polymer, the Bleacher Blocks are molded in three sizes to closely fit a variety of rifle cases. One size fits 223 size case heads, another fits 308 size case heads and the third fits belted magnum size cases. All hold 50 rounds. Bleacher blocks measure 6 3/4" x 3 5/8".

- Molded to closely fit specific case sizes, .388", .485", & .565"
- Made of tough, durable polymer
- Unique stepped design makes it easy to add or remove cases, even when full
- Takes up less bench space than traditional blocks
- **.388" hole size – fits:** 17 Rem., 17 Rem. Fireball, 204 Ruger, 222 Rem., 222 Rem. Mag., 223 Rem., 300 AAC

- **.485" hole size – fits:** 225 Win., 22-250, 220 Swift, 243 Win., 6mm Rem., 240 Wea. Mag, 250 Sav., 257 Roberts, 25-06, 260 Rem., 6.5x55, 270 Win., 7mm-08, 7mm Mauser, 280 Rem., 300 Sav., 308 Win., 30-06, 7.65 Arg. Mauser, 8mm Mauser, 338 Fed., 358 Win, 35 Whelen, 350 Legend
 - **.565" hole size – fits:** 223 WSSM, 243 WSSM, 25 WSSM, 257 Wea. Mag, 264 Win Mag, 270 WSM, 270 Wea. Mag, 7mm Rem. Mag, 7mm Wea. Mag, 7mm WSM, 7mm Rem. SAUM, 7mm STW, 7mm Rem. Ultra Mag, 300 H&H Mag, 300 Rem. SAUM, 300 WSM, 300 Win. Mag, 300 Rem. Ultra Mag, 300 Wea. Mag, 8mm Rem. Mag, 325 WSM, 338 Win. Mag, 340 Wea. Mag, 338 Rem. Ultra Mag, 375 H&H Mag, 375 Ruger, 375 Rem. Ultra Mag, 416 Rem. Mag, 450 Marlin, 458 Win. Mag, 6.5 PRC
- | | |
|--|--------|
| .388 Bleacher Block (#7728085) | \$8.05 |
| .485 Bleacher Block (#7728086) | \$8.05 |
| .565 Bleacher Block (#7728087) | \$8.05 |
| .388 Rifle Bleacher Block 4-pack (# 7991377) | 27.95 |
| .485 Rifle Bleacher Block 4-pack (# 7991378) | 27.95 |
| .565 Rifle Bleacher Block 4-pack (# 7991379) | 27.95 |



Custom Fit Loading Blocks

Lyman's Custom Fit Loading Blocks are designed to provide a precise fit for a family of cartridge sizes. Made from tough, durable polymer, Custom Fit Loading Blocks hold 50 cartridges and will securely nest together for easy storage. Custom Fit Loading Blocks come in 6 sizes to match up with a large variety of cartridges. Each block is clearly marked with the diameter of the cartridge storage hole.

- Custom Fit Loading Block .388 (#7728090)
- Custom Fit Loading Block .445 (#7728091)
- Custom Fit Loading Block .485 (#7728092)
- Custom Fit Loading Block .530 (#7728093)
- Custom Fit Loading Block .565 (#7728094)
- Custom Fit Loading Block .615 (#7728095)
- Price \$6.50

Lyman Deluxe Anodized Aluminum Loading Blocks

Lyman's Deluxe Anodized Aluminum Loading Blocks are made for precision reloaders who want their equipment to be as high quality as the ammunition that they produce. The blocks are CNC milled from a solid billet of 6061-T6 aluminum to tight tolerances for a close fit to specific cartridges, unlike the common one-size-fits-all plastic blocks. The blocks are made in three sizes to fit most common rifle head sizes, and will hold 50 rounds. Blocks come with stick-on rubber non-slip feet to keep them from sliding on your bench.

- **.388" hole size – fits:** 17 Rem., 17 Rem. Fireball, 204 Ruger, 222 Rem., 222 Rem. Mag., 223 Rem., 300 AAC
- **.485" hole size – fits:** 225 Win., 22-250, 220 Swift, 243 Win., 6mm Rem., 240 Wea. Mag, 250 Sav., 257 Roberts, 25-06, 260 Rem., 6.5 PRC, 6.5x55, 270 Win., 7mm-08, 7mm Mauser, 280 Rem., 300 Sav., 308 Win., 30-06, 7.65 Arg. Mauser, 8mm Mauser, 338 Fed., 358 Win, 35 Whelen, 350 Legend
- **.565" hole size – fits:** 223 WSSM, 243 WSSM, 25 WSSM, 257 Wea. Mag, 264 Win Mag, 270 WSM, 270 Wea. Mag, 7mm Rem. Mag, 7mm Wea. Mag, 7mm WSM, 7mm Rem. SAUM, 7mm STW, 7mm Rem. Ultra Mag, 300 H&H Mag, 300 Rem. SAUM, 300 WSM, 300 Win. Mag, 300 Rem. Ultra Mag, 300 Wea. Mag, 8mm Rem. Mag, 325 WSM, 338 Win. Mag, 340 Wea. Mag, 338 Rem. Ultra Mag, 375 H&H Mag, 375 Ruger, 375 Rem. Ultra Mag, 416 Rem. Mag, 450 Marlin, 458 Win. Mag

- .388 Aluminum Loading Block (#7728080)
- .485 Aluminum Loading Block (#7728081)
- .565 Aluminum Loading Block (#7728082)
- Price \$47.50

<p>0.388 Fits: 17 Hornet 17 Rem 17 Rem Fireball 204 Ruger 22 Hornet 222 Rem 222 Rem Mag</p> <p>0.445 Fits: 218 Bee 224 Wea. Mag 25-20 6.5 Grendel 6.8mm Rem 350 Legend 9mm Makarov 40 S&W 10mm Auto</p> <p>0.485 Fits: 225 Win 22-250 220 Swift 243 Win 6mm Rem 240 Wea. Mag 250 Sav 257 Roberts 25-06 260 Rem 6.5x55 6.5 Creedmoor 6.5-284 270 Win 7mm-08 7mm Mauser</p>	<p>223 Rem 30 Carbine 300 AAC 32 ACP 32 S&W L 32 H&R 327 Federal</p> <p>38 Super 357 Sig 38 S&W 38 Spec 357 Mag 32-20 380 Auto 9mm Luger</p> <p>280 Rem 300 Sav 308 Win 30-06 7.62x39 7.65 Arg. Mau. 8mm Mauser 338 Federal 35 Rem 358 Win 35 Whelen 9.3x62 450 Bushmaster 45 ACP 45 GAP</p>	<p>0.530 Fits: 284 Win 7-30 Waters 30-30 Win 32 Win Spc. 32-40 38-55 375 Win 38-40</p> <p>0.565 Fits: 223 WSSM 243 WSSM 25 WSSM 257 Wea. Mag 264 Win Mag 26 Nosler 270 WSM 270 Wea. Mag 7mm Rem Mag 7mm Wea. Mag 7mm WSM 7mm Rem SAUM 28 Nosler 7mm STW 7mm Rem Ultra Mag 30-40 Krag 300 H&H 300 Rem SAUM 300 RCM 300 WSM 300 Win Mag 300 PRC</p> <p>0.615 Fits: 30-378 Wea. Mag 7.62x54R 338-378 Wea. Mag 338 Lapua 348 Win 378 Wea. Mag 40-65 416 Rigby</p>	<p>44-40 41 Rem Mag 44 Special 44 Rem Mag 444 Marlin 45 Colt 454 Casull 460 S&W</p> <p>300 Rem Ultra Mag 300 Wea. Mag 303 British 8mm Rem Mag 325 WSM 338 RCM 338 Win Mag 340 Wea. Mag 338 Rem Ultra Mag 350 Rem Mag 375 H&H 375 Ruger 375 Rem Ultra Mag 405 Win 416 Rem Mag 450 Marlin 458 Win Mag 480 Ruger 50 AE 50 Beowulf 500 S&W 6.5 PRC</p> <p>416 Wea. Mag 45-70 45-90 45-100 45-110 45-120 460 Wea. Mag</p>
--	--	--	--





Rifle Case Length Headspace Gauges

To achieve the highest degree of safety and accuracy, Lyman recommends that all bottleneck rifle cases be inspected after resizing to ensure that the proper headspace dimension is maintained. Simply insert the case into the gauge to insure that it does not exceed the maximum or fall below the minimum allowable headspace. In addition, the gauge will identify a case which exceeds the maximum allowable case length. Caution: Cases found with excessive headspace should be destroyed immediately.

.204 Ruger	(#7990342)
.22-250	(#7832324)
.223	(#7832323)
.243 Win.	(#7832322)
7mm-08	(#7990343)
.270 Win.	(#7832325)
.308 Win.	(#7832321)
300AAC Blackout	(#7832338)
300 WSM	(#7990344)
30-06	(#7832320)
.338 Lapua	(#7990345)
7.62x39	(#7990394)
6mm Creedmoor	(#7832327)
22 Nosler	(#7832328)
224 Valkyrie	(#7832339)
6.5 Creedmoor	(#7990346)
260 Rem	(#7990341)
6.5 Grendel	(#7990340)
6.5x55 S.	(#7990339)
350 Legend	(#7990338)
327 Federal	(#7990337)
6.5 PRC	(#7990336)

Price..... \$29.95

Pistol Maximum Cartridge Gauges

These precision made gauges allow the reloader to check the case length, diameter and overall cartridge length of pistol ammunition. This inspection is considered mandatory by top competitive shooters who demand 100% reliability for their competition ammo.

.380 Auto	(#7832337)
.9mm	(#7832330)
.40 S&W	(#7832332)
10mm Auto Pistol Max	(#7832333)
.45 ACP	(#7832331)
44 Mag.	(#7832336)
Price.....	\$22.75

Reloading Accessories for MSR Cartridges

In Addition to the MSR Die Sets listed on page 21, Lyman is also offering everything else you'll need to reload the 224 Valkyrie cartridge.

Case Length/Headspace Gauges

Simply insert the case into the gauge to ensure that it does not exceed the maximum or fall below the minimum allowable headspace. In addition, the gauge will identify a case which exceeds the maximum allowable case length.

E-ZEE™ Trim Pilot

Fits the Lyman E-ZEE Trim Hand Case Trimming System. 224 Valkyrie E-ZEE Trim Pilot(#7821940) \$6.50

50 BMG Cartridge Length Headspace Gauge

50 BMG (#7832326) \$43.50



Stainless Steel Dial Caliper

This precision tool will deliver unflinching .001" accuracy. Includes storage case.

Stainless Steel Caliper (#7832212) \$43.50



Electronic Stainless Steel Caliper

Digital caliper features high tech stainless design with direct digital readout. Switch back & forth from inches to millimeters with the touch of a button. Accurate to .001"/0.1mm. Includes storage case. Uses SR44 battery.

Electronic Caliper (#7832218) \$44.50

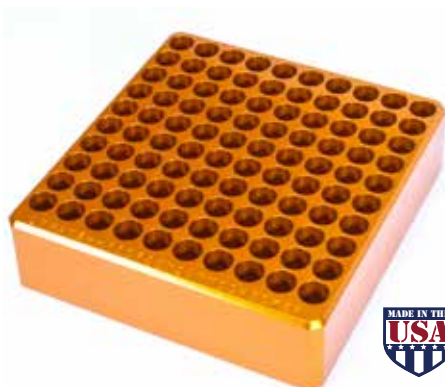

9mm 100 Hole Ammo Checker Block

Lyman now offers a 100-hole 9mm Ammo Checker. This gauge is made to SAAMI minimum chamber specifications, meaning if your reloaded ammunition drops in the gauge it will chamber in your firearm. With the large 100-hole block it is now faster and easier for the high volume reloader and competition shooter to ensure their reloaded ammunition is dimensionally correct and will function flawlessly in their firearms.

9mm 100 Hole Ammo Checker (#7833036) . \$121.50



Ammo Checkers™

Check the quality and consistency of both reloaded rounds and purchased ammo. A must for any auto shooter for easy and consistent feed. You can't afford mis-feeds, so get the easiest "go" gauge available today!

Lyman's Ammo Checkers are gauges that allow a reloader to quickly confirm that their ammunition will fit in their chamber. Machined from solid blocks of 6061 T6 aircraft grade aluminum and cut with custom tooling to SAAMI minimum chamber dimensions, Ammo Checkers are available in three designs covering most common handgun and rifle calibers. One gauge will work with a variety of calibers. (See photo.) Just drop your loaded rounds in the ammo checker, and if the round fits into the gauge, it will fit in the gun's chamber. Each caliber is clearly engraved on the gauge. Bright orange anodizing makes them easy to find on your reloading bench.

Handgun gauge works with 380 Auto, 9mm Luger, 38 Super, 40 S&W, 45 ACP, 38/357, 44 Mag/Spl, and 45 Colt

Small Rifle gauge works with 204 Ruger, 22 Hornet, 223 Rem, 22-250, 300 AAC Blackout and 7.62x39mm

Large Rifle gauge works with 243 Win, 270 Win, 30-30 Win, 308 Win, 30-06 and 300 WSM

Handgun Ammo Checker (#7833000) \$40.50
 Small Rifle Ammo Checker (#7833001) \$50.50
 Large Rifle Ammo Checker (#7833002) \$50.50



MSR Ammo Checker Block

Lyman MSR Ammo Checkers are machined from solid blocks of 6061 T6 aircraft grade aluminum and cut with custom tooling to minimum chamber dimensions. Their black anodized finish matches your favorite "black" rifle. Check the quality and consistency of both loaded rounds and purchased ammo. A must for any AR shooter. You can't afford mis-feeds, so get the easiest "Go" gauge available for modern sporting rifle calibers.

- Covers 223/5.56, 6.5 Grendel, 6.8 Rem. SPC, 7.62x39, 300AAC Blackout, 450 Bushmaster, 458 SOCOM and 50 Beowulf
- CNC machined to minimum chamber specs
- Confirm ammo will chamber smoothly

MSR Ammo Checker Block (#7833003) \$50.50



Multiple Blocks

Lyman's multi-caliber Ammo Checkers have been extremely popular with reloaders. Now based on demand from our customers, Lyman is adding gauges having 8 chambers with all being of the same caliber. Blocks will be available in 9mm, 45 ACP and 223 Rem. These gauges allow reloaders to take multiple cartridges right off the press and check them as they go. If they fit, they will chamber in your gun.

Ammo Checker Multiple Block 9mm (#7833032)
 Ammo Checker Multiple Block 45ACP . . (#7833033)
 Ammo Checker Multiple Block .223 Rem. (#7833034)

Price \$40.50

Single Caliber Model Ammo Checkers™

Lyman's multi-caliber Ammo Checkers have proven to be extremely popular with reloaders since their introduction last year. Ammo Checkers are gauges that verify the quality and consistency of both reloaded and factory ammo. They are machined from solid aluminum and cut with custom tooling to SAAMI minimum chamber tolerances. Just drop your cartridge into the gauge and if it fits, it will chamber in your gun.

Lyman has expanded their line of Ammo Checkers into other calibers that are not included in the multi-caliber blocks. Each gauge is clearly marked for caliber and is anodized in a bright orange color so that they will be easy to spot on your reloading bench.

- Single Caliber 223 Remington (#7833020)
- Single Caliber 224 Valkyrie (#7833030)
- Single Caliber 22 Nosler (#7833025)
- Single Caliber 22-250 (#7833040)
- Single Caliber 6mm Creedmoor (#7833021)
- Single Caliber .243 Win (#7833041)
- Single Caliber 6.5 Grendel (#7833042)
- Single Caliber 6.5 Creedmoor (#7833012)
- Single Caliber 6.5x55 S (#7833047)
- Single Caliber 260 Remington (#7833046)
- Single Caliber 6.5 PRC (#7833052)
- Single Caliber 6.8 Rem SPC (#7833022)
- Single Caliber 270 Win (#7833043)
- Single Caliber 7mm Rem Mag (#7833013)
- Single Caliber 300 AAC (#7833023)
- Single Caliber 308 Win (#7833024)
- Single Caliber 30-06 (#7833044)
- Single Caliber 300 Win Mag (#7833015)
- Single Caliber 7.62x39 (#7833045)
- Single Caliber 7.62 x 54R (#7833016)
- Single Caliber 8mm x 57 Mauser (#7833017)
- Single Caliber 338 Lapua Mag (#7833018)
- Single Caliber 350 Legend (#7833048)
- Single Caliber 450 Bushmaster (#7833026)
- Single Caliber 458 SOCOM (#7833027)
- Single Caliber 45-70 Govt. (#7833019)
- Single Caliber 50 Beowulf (#7833028)

- Single Caliber 327 Federal (#7833049)
- Single Caliber 9mm Luger (#7833029)
- Single Caliber 38 Super (#7833050)
- Single Caliber 45 ACP (#7833051)

Single Caliber 20ga (#7833011)
 Single Caliber 12ga (#7833010)

Price \$19.75

Mag 25 Digital Melting Furnace



Lyman has introduced their largest and most precise lead melting furnace yet: The Mag 25. The twenty five pound capacity is five pounds greater than Lyman's popular Mag 20. In addition, this new furnace is the first to offer an advanced digital thermal management system with key pad controls

Designed for the high volume bullet caster, the Mag 25 offers an array of features not found on any other furnace. With 850 watts of power, the furnace is quick to heat up, even with the increased capacity. In addition, the digital display on the front panel shows both the actual lead temperature as well as the desired temperature setting. Precise furnace operation is enhanced by the simple keypad controls.

For casting versatility, the furnace is equipped with a universal mould guide which can adjust for most popular mould blocks from Lyman, RCBS, Redding/Saeco & Lee. Lyman's proven bottom pour valve system and mould block preheating plate assure maximum casting volume.

The Mag 25 sits on a large, stable base with two, front-loading storage compartments for handy access to needed tools. This advanced furnace is offered in both 115 Volt and 230 Volt models.

- Advanced digital thermostat control with simple to use key pad
- Separate digital displays for temp. setting and actual lead temp.
- Larger 25 pound capacity
- Universal mould guide accepts most Lyman, RCBS, Redding/Saeco and Lee moulds
- Built-in storage compartment
- Powerful 850 watt heating system for fast warm-up
- Warming shelf for pre-heating mould blocks
- Reliable bottom pour valve system for increased bullet production

Mag 25 Digital Furnace 115V(#2800382)	\$479.95
Mag 25 Digital Furnace 230V(#2800386)	\$519.95
Spare Handle (#2800406)	\$7.50



**Largest Capacity,
Digital Accuracy
and Control**

**Mag 25 is designed
to work with Lyman,
RCBS, Redding, and
Lee Mould Blocks.**



WARNING: Melting lead and casting lead objects will expose you and others in the area to lead, which is known to cause birth defects, other reproductive harm and cancer. See Instructions on Reducing Exposure supplied with product.

Lyman's "Master Casting Kit"

The Best Way to Get Started in Bullet Casting.



The kit's low price includes Lyman's popular improved 4500 Bullet Sizer/Lubricator. Simply add the right top punch and sizing die and the 4500 will smoothly size down your bullet to the correct diameter while it evenly applies the provided Super Moly Lubricant.

Kit Includes:

- Big Dipper
- 4500 Sizer/Lubricator
- Long handled casting dipper
- Ingot mould
- Super Moly Bullet Lube
- Lyman Cast Bullet Handbook



All this for less than the price of most casting furnaces.

Master Casting Kit 115V(#2712000).....	\$333.95
--	----------

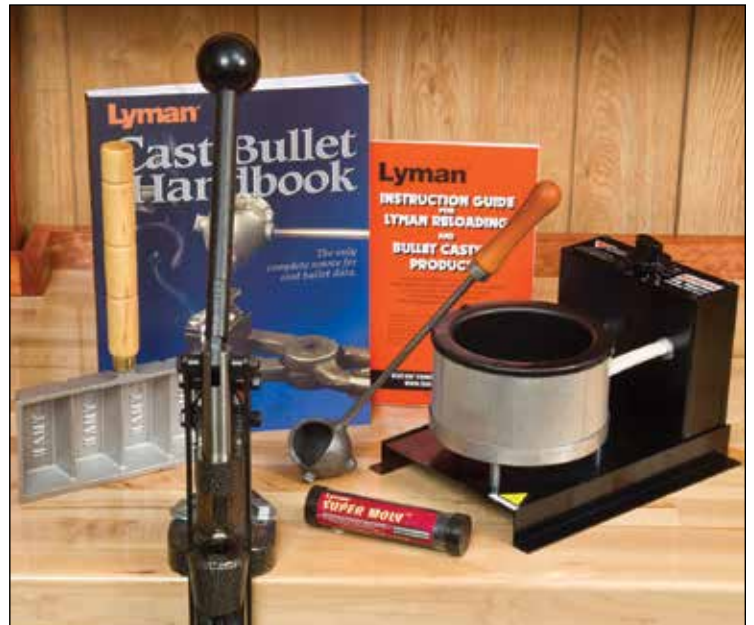

WARNING: Cancer and Reproductive Harm
www.p65warnings.ca.gov

4500 Lube Sizer



The 4500 Lube Sizer features solid one piece bottom casting, heating elements to fit both 115 volt and 230 volt, and a longer ball knob handle for more leverage for sizing and lubricating the largest bullets. Includes gas check seater and Super Moly Lube.

No Heater(#2745880) \$273.50
 With Heater 115V(#2745892) . . . \$283.50
 Heating Element 115V(#2745896) . \$55.50

Available with or without built-in heater



Gas Check Seater

This ingenious, unique device allows consistent, square seating of gas checks. Works on all Lyman #450, 4500 Sizer/Lubricators and RCBS Lube-A-Matic. Seater (4 oz.)(#2745881) \$12.95

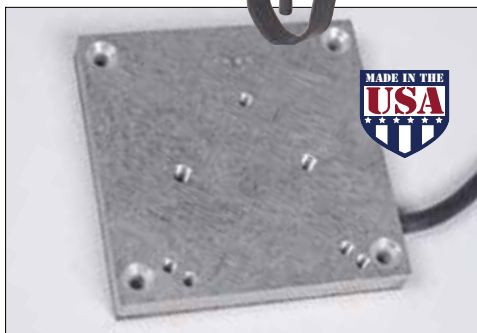

Universal Lube Heater Accessory

Designed for today's high temperature lubes, this heats the Lube/Sizer to the right temperature for smooth, effortless bullet lubrication. The mounting plate is drilled and tapped for Lyman 450, RCBS, Saeco and Star Lube/Sizers. Plugs into standard 110 volt outlet (comes complete with mounting hardware). Note: Do not confuse with 4500 heating element.

115V(#2745885) \$75.95

Orange Magic™ Premium Bullet Lube



This hard lubricant is guaranteed to provide higher velocities with cast pistol and rifle bullets without leading. It will not melt out of loaded ammunition at high temperatures. (Recommended for use with the Lyman Lube Heater.) Orange Magic Lube: (#2857286) \$5.95

Super Moly Bullet Lube



The Molybdenum Disulfide in this lube coats the barrel for increased velocity and improved accuracy. In addition, it virtually eliminates leading and it flows through lube sizers without heat, yet won't melt at 130°. Super Moly Lube: (#2857272) \$5.95

All Lyman stick lubricants are in a tube, fit the 4500 Sizer/ Lubricator and similar Sizing/Lubricating tools, including RCBS.

WARNING: Cancer and Reproductive Harm
www.p65warnings.ca.gov



Digital Lead Thermometer



The Lyman Digital Thermometer is a fast and accurate way to check the temperature of your casting alloy. The long 6" probe will work with the largest casting furnaces and keeps your hand away from molten lead. The large, easy to read display can be set for Fahrenheit or Celsius and also features a hold button to lock a reading on the display.

- Fast and Accurate
- 6" Long Probe to Work with Large Furnaces
- Easy to Read Display
- Fahrenheit or Celsius

Digital Lead Thermometer (#2867797)
 Price: \$33.50



Black Powder Gold™ Lube



Formulated for long range black powder shooting. It keeps fouling soft and flows through lube sizers. It can be applied by hand to muzzleloading bullets. Black Powder Gold Lube: (#2857266) \$5.95

Lyman Alox Lube



This is the original NRA formula developed for increased cast bullet velocities. Alox Lube (1 1/4 oz stick) (#2857277) \$5.95

Lyman Ideal Lube



A great all-purpose lube. Ideal Lube (1 1/4 oz stick)(#2857275) \$5.95

“Big Dipper” Electric Casting Furnace



This economical electric casting furnace has more than 10 lb. Capacity. Features fast heat-up time with heat control to +/- 10 degrees. Heats up to 850°. Easy “on-off” temperature dial. Compact size with wide mouth for easy ladling. Heavy duty aluminum construction with stable non-tip design. Pot is blackened steel. (115 Volt)

- Big Dipper Electric Casting Furnace 115V (#2800350) \$85.95
- Big Dipper Electric Casting Furnace 230V (#2800355) \$92.95



**Includes
Cast Bullet
Handbook**

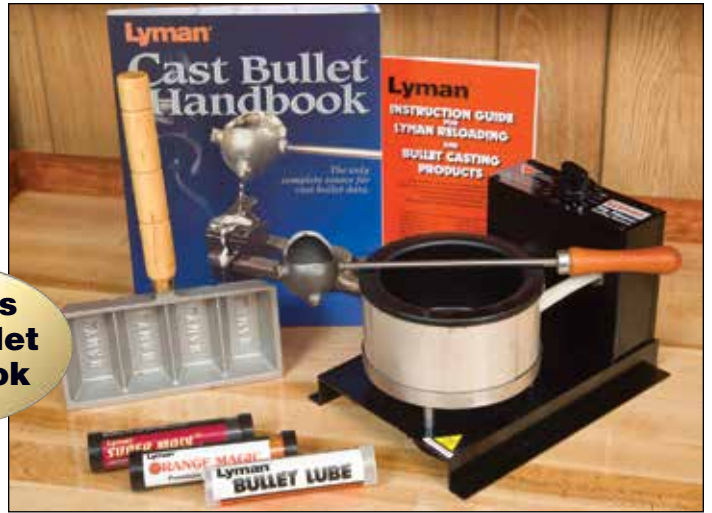

“Big Dipper” Casting Starter Kit



Features all the items needed to get started in casting bullets economically and efficiently. Includes “Big Dipper” electric casting furnace with 10+ lbs capacity, Lyman Casting Dipper, Ingot Mold for storing excess lead, Super Moly Bullet Lube, Orange Magic Bullet Lube, Alox Bullet Lube, and the Lyman Reloading and Cast Bullet Guide. Big Dipper Casting Kit 115V (#2800375) \$156.95

10lb. Cast Iron Lead Pot



10lb. capacity, made of cast iron with convenient pour spout. Lyman’s lead pot allows the bullet caster to use any source of heat for melting his lead alloy. Nominal pot capacity is ten pounds of alloy. Flat bottom prevents tipping. 10lb. Cast Iron Lead Pot (#2867795) \$27.25



A. Casting Ingot Mould



Useful when melting down scrap lead, emptying your furnace, or when blending alloys. Each mould forms four, easy-to-use ingots that stack easily and will weigh approximately 1 lb. Sides of mould have 30° draft for easy ejection of lead ingots. Ingot Mould (1 lb.) (#2837794) \$32.95



B. Casting Dipper



Our dipper with cast iron head is shaped for easy, accurate pouring and prevents air pockets in the finished bullet. The long stem dipper can also be used for stirring molten lead alloys. Wooden handle stays cool in use. Can be set up for right- or left-hand use. Casting Dipper (6 oz.) (#2867790) \$31.50

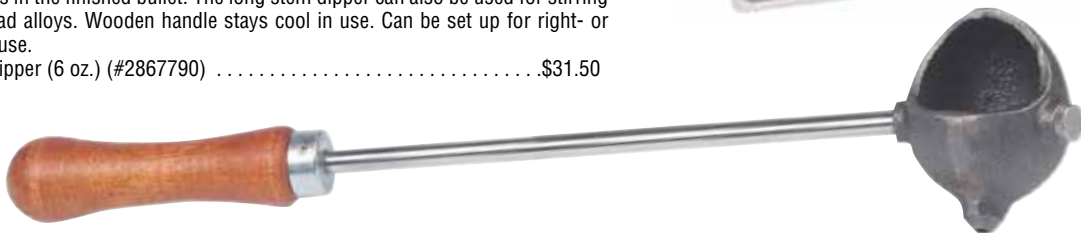

Dipper can be assembled for either right- or left-hand use!

Sizing Dies

Lyman improved sizing dies now have 90° hole spacing. It's now easy to lubricate bullets even with today's hard lubricants. Lyman sizing dies also feature a tapered mouth and hardened interior ensuring alignment for perfect cylindrical shape. Interior dimensions correspond to suggested diameters for all popular rifle and pistol calibers. Refer to the chart below for proper size. Lyman Top Punches are precisely machined to fit bullet nose shape exactly. This eliminates nose deformation. Refer to Lyman's bullet mould listing for suggested top punch number. (These are interchangeable with RCBS)



Sizing Dies \$38.50
Replacement O Rings (# 2991227) . .29¢ each

Lyman Sizing Die Diameter Chart

Dia.	Part No.	Dia.	Part No.	Dia.	Part No.
.224	2766462	.338	2766488	.427	2766508
.225	2766463	.354	2766534	.429	2766509
.243	2766542	.355	2766490	.430	2766510
.251	2766460	.356	2766491	.431	2766511
.257	2766466	.357	2766492	.439	2766541
.258	2766467	.358	2766493	.446	2766513
.264	2766543	.359	2766494	.450	2766514
.266	2766470	.360	2766495	.451	2766515
.277	2766551	.363	2766559	.452	2766516
.278	2766471	.375	2766497	.454	2766517
.285	2766473	.377	2766527	.457	2766519
.308	2766476	.378	2766524	.458	2766535
.309	2766477	.379	2766498	.459	2766530
.310	2766478	.380	2766499	.501	2766525
.311	2766479	.381	2766500	.512	2766521
.312	2766528	.400	2766501		
.313	2766480	.401	2766502		
.314	2766553	.406	2766504		
.321	2766485	.408	2766548		
.323	2766486	.409	2766550		
.325	2766487	.410	2766505		

Suggested and Alternative Sizing Die Diameters

Pistol Caliber	Dia. (inches)
.22 Jet, .221 Fireball	.224*, .225
25 ACP	.251*
.25 cal.	.257*, .258
.30 Luger, 30 Herritt, 30 Mauser	.310*
.32 ACP, .32/20, .32 S&W, .32 H&R Magnum	.311, .312, 313*, .314
9mm Luger*, .38, .38 Super Auto, .380 Auto	.354, .355*, .356
38 S&W, .38 Spl., 357 Mag.*, .357 Max.	.357, .358*, .359, .360
9mm Makarov	.363
.38/40, 10mm Auto, 40 S&W	.400*, .401
.41 S&W Mag., 41 Action Express	.410*
44 S&W Spl., 44 Mag.*, 44 Russian	.429*, .430, .431
45 ACP, .45 Auto Rim, .45 Colt* (post-WW II), .45 Sch. .45 Win. Mag.	.450, .451*, .452
.45 Colt (pre-WW II) & .455 Webley	.454*
500 S&W	.501
Rifle Caliber	Dia. (inches)
.22 cal. (except .22 Hi-power)	.224, .225*
.243, .244, 6mm	.243, .244*
.25 cal.	.257, .258*
.264 Win. Mag., 6.5mm	.264*, .266
.270 Win.*	.277, .278*
7mm, .280 Rem., .284 Win.	.284, .285*
.30 cal.	.308, .309*, .310
7.62mm Russian*	.310
.32/20 Win.	.311, .312*
7.65mm Mauser*	.311
.303 British*, 7.7mm Jap.*	.313, 314*
.32 Win. Spec. 32 S.L., .32 Rem.	.321
8mm Mauser (S Bore)	.323, .325*
.338 Win., .33 Win.	.338*
9mm x 56, 9mm x 57	.354, .355*, .356
.35 Cal.	.357, .358*, .359
.375 H&H Mag., .375 Win.	.375, .377*, .378
.38/55*	.379
.38/40	.400, 401*
40 Cal. Rifle	.406, 410
.44/40	.427, .428*
.44 Spl., .44 Magnum	.429, 430*
.444 Marlin	.430, .431*
.43 Spanish	.439
.45/70, .458 Win.	.457, 458*, .459
.50 Cal. Rifle	.509, .512*

* Wide variations in diameter. Suggest you slug barrel.
*Indicates suggested useful diameter, which may vary from gun to gun.

Gas Checks



These gilding metal cups fit the cast bullet base and protect it from hot powder gases. Easily seated during bullet sizing, the gas checks also permit higher velocities.

Specify caliber: (1000 per pack)

Cal.	Part No.
.22 (#2827261)	\$59.25
.25 (#2827263)	\$59.25
.30 (#2827267)	\$64.75
.32 (8mm) (#2827268)	\$64.75
.35 (.38 Spl. & .357) (#2827270)	\$64.75
.375 (#2827271)	\$75.50
.44 (#2827272)	\$84.95
.45 (#2827273)	\$84.95

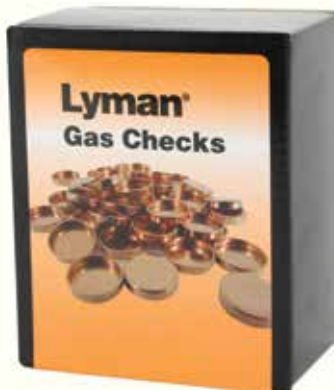

Lyman Mould Rebuild Kit



With proper care, a Lyman mould will last for generations. Rebuild kits provide replacement of those moving parts which may tend to wear after long use. Includes sprue cutter, washer, all screws for block and handle.

Large single cavity kit (2 oz.) (#2680100)	\$10.95
Double cavity kit (2 oz.) (#2680102)	\$10.95
Four cavity kit (6 oz.) (#2680104)	\$18.25

Mould Box

Spare mould box is made of tough plastic with a snap-lock cover. Impervious to moisture, bore cleaner or oil. Includes blank label. Fits single and double cavity moulds only.

(3 oz.) (#2735790)	\$4.50
Ten Pack (1 3/4 lbs.) (#2735789)	\$24.95

Pistol Moulds



Our standard offering of pistol moulds covers popular bullet designs, in double cavity style. Four cavity blocks for selected designs are also shown in the table below. Refer to the Devastator Hollow Point section for availability.

Double and single cavity mould blocks less handles.....	\$101.95
Four-cavity mould block, less handles.....	\$146.95
Top Punches.....	\$14.770



Symbol Key

- Cowboy Action Moulds
- Recommended for use on silhouettes
- Use 30 cal. gas check.
- EK** Indicates Elmer Keith Design.
- RT** Indicates Ray Thompson Design.
- GE** Indicates Gould Express bullet designed by John Barlow.
- ES** Indicates designed by Ed Schmitt.
- PM** Indicates designed by Paul Matthews.
- ★ Indicates single cavity mold.

Pistol	.30	.32	9mm				.38/.357		RT	★
Bullet Number	311252	313249	356242	356402	356242	356637	358091	358477	358156	358665
Weight (#2 Alloy)	75 gr.	85 gr.	90 gr.	120 gr.	120 gr.	147 gr.	150 gr.	150 gr.	155 gr.	158 gr.
Double Cavity Part #	2660252	2660249	2661242	2660402	2660242	2660637	—	2660477	2660156	2660665
Four Cavity Part #	—	—	—	2670402	—	2670637	not available	2670477	not available	2670665
Top Punch Number	465	226	311	402	311	637	495	429	429	495
Top Punch Part #	2786742	2786703	2786710	2786723	2786710	2786749	2786769	2786731	2786731	2786769

.38/.357	EK	40 S&W/10mm		.44/40		
Bullet Number	358311	358429	358430	401654	401638	427666
Weight (#2 Alloy)	160 gr.	170 gr.	195 gr.	150 gr.	175 gr.	200 gr.
Double Cavity Part #	not available	2660429	2660430	2660654	2660638	2660666
Four Cavity Part #	2670311	2670429	—	—	2670638	—
Top Punch Number	311	429	430	43	43	649
Top Punch Part #	2786710	2786731	2786732	2786691	2786691	2786778

New Pistol Moulds

#358439 – Lyman returns a famous Elmer Keith design to our mould line. Mould #358439 is Keith's extremely popular #358429 but in a hollow point version. The lighter weight hollow point bullet provided Keith with more velocity and expansion.

#429303 – Designed by Carl F. Hudson, he called it "Hi-Velo-Pen" for high velocity and penetration. In the 1958 Lyman Cast Bullet Handbook, Mr. Hudson states, "It passes through 3/16" steel plate as no other 44 has done for me".

.44	RT	EK	RT	.45 Auto					
Bullet Number	429215	429667	429421	429383	429244	429650	452460	452630	452374
Weight (#2 Alloy)	210 gr.	240 gr.	245 gr.	245 gr.	255 gr.	300 gr.	200 gr.	200 gr.	225 gr.
Double Cavity Part #	2660215	2660667	2660421	not available	2660244	2660650	2660460	—	2660374
Four Cavity Part #	2670215	—	2670421	—	—	—	2670460	2670630	2670374
Top Punch Number	421	649	421	251	421	421	460	460	374
Top Punch Part #	2786729	2786778	2786729	2786704	2786729	2786729	2786740	2786740	2786719

.45 Colt	.452 dia.	RT	.45	500 S&W		
Bullet Number	454190	452664	452424	452490	452651	501680
Weight (#2 Alloy)	250 gr.	250 gr.	255 gr.	255 gr.	325 gr.	375 gr.
Mould Part #	2660190	2660664	2660422	2660490	not available	not available
Four Cavity Part #	—	2670664	—	—	—	—
Top Punch Number	190	649	424	424	649	649
Top Punch Part #	2786700	2786778	2786730	2786730	2786778	2786778

NOTE: All standard rifle and pistol moulds use handles #2735793, and four-cavity moulds use handle #2735794. Bullet weights listed are nominal and may well vary from bullets dropped from a given mould. Variations between listed nominal weights and actual as-cast weights have absolutely no effect on accuracy. These bullet illustrations are artists' renderings. They are for general reference only and are not intended to be precise representation.

Devastator Hollow Point Moulds

38 spec./9 mm	.44 ★	.45	
Bullet Number	356637	429640	452374
Weight (#2 Alloy)	125 gr.	250 gr.	180 gr.
Mould Part #	2650637	2650640	2650374
Four Cavity Part #	637	649	374
Top Punch Number	2786749	2786778	2786719

★ Indicates single cavity.

Rifle Moulds







Lyman rifle moulds are the standard by which all other rifle moulds are judged. The designs shown below picture gas checks where appropriate. All Lyman rifle moulds are available in double cavity only, except those moulds where the size of the bullet necessitates a single cavity (indicated below by a ★). All rifle moulds shown below require double cavity handles, regardless of the number of cavities indicated. Hollow point designs are noted above bullet.

WARNING: Melting lead and casting lead objects will expose you and others in the area to lead, which is known to cause birth defects, other reproductive harm and cancer. See Instructions on Reducing Exposure supplied with product.

Rifle Moulds mould, less handles \$101.95
 Top Punches \$14.70



Rifle	.22			.25	6.5mm	.30 M1/ 7.62x39mm				
Bullet Number	225438	225415	225646	257420	266469	311359	311410	311672	311291	311041
Weight(#2 Alloy)	44 gr.	55 gr.	55 gr.	65 gr.	140 gr.	115 gr.	130 gr.	160 gr.	170 gr.	173 gr.
Mould Number	2660438	2660415	not available	2660420	2660469	2660359	2660410	2660672	2660291	2660041
Top Punch Number	438	415	646	420	463	359	467	644	465	8
Top Punch Part #	2786733	2786726	not available	2786728	2786741	2786772	2786743	2786758	2786742	2786690

	 .30		 .25	32/20	.314 dia.	32/40	8mm	35		
Bullet Number	311332	311644	311679	311299	311284	311008	314299	319247	323470	358315
Weight(#2 Alloy)	180 gr.	190 gr.	195 gr.	200 gr.	210 gr.	115 gr.	200 gr.	165 gr.	165 gr.	204 gr.
Mould Number	2660332	not available	not available	2661299	2660284	2660008	2660299	2660247	not available	not avail.
Top Punch Number	413	644	359	467	284	8	467	8	470	311
Top Punch Part #	2786725	—	2786772	2786743	2786707	2786690	2786743	2786690	2786745	2786710

	.381 dia.	.375 dia.	.378 ★ .38-55	.40 Cal. ★ .406 dia.	.40 Cal. ★ .410 dia.	★	43 Span.	43 Mauser ★	45	★
Bullet Number	380681	375449	378674	403169	410660	410663	439186	446110	457130	457191
Weight(#2 Alloy)	250 gr.	264 gr.	335 gr.	240 gr.	385 gr.	400 gr.	370 gr.	340 gr.	145 gr.	292 gr.
Mould Number	2660681	2660449	2640674	2660169	not available	2640663	2640186	2640110	2660130	2640191
Top Punch Number	449	449	663	43	658	663	251	251	130	191
Top Punch Part #	2786736	2786736	2786779	2786691	2786755	2786779	2786704	2786704	N/A	2786701





	45 H.P. ★ ★ GE	★	★	★	★	★ ES	★ PM	★	★ Postell	★	.50	★
Bullet Number	457122	457124	457643	457193	457671	457658	457677	457125	457132	515139	515141	
Weight(#2 Alloy)	330 gr.	385 gr.	400 gr.	405 gr.	475 gr.	480 gr.	490 gr.	500 gr.	535 gr.	340 gr.	425 gr.	
Mould Number	2650122	2640124	2640643	2640193	2640671	2640658	not available	2640125	2640132	2640139	2640141	
Top Punch Number	191	374	191	191	374	658	677	374	132	191	141	
Top Punch Part #	2786701	2786719	2786701	2786701	2786719	2786755	2786781	2786719	2786695	2786701	2786696	

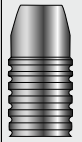
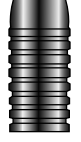
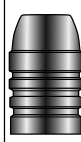
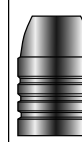
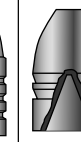
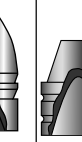
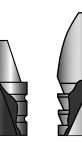
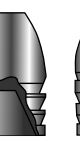

WARNING: Cancer and Reproductive Harm
www.p65warnings.ca.gov

WARNING:

Melting lead and casting lead objects will expose you and others in the area to lead, which is known to cause birth defects, other reproductive harm and cancer. See Instructions on Reducing Exposure supplied with product.

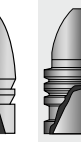
	.45 Conical		Plains Bullets		Minié Ball						Maxi Ball		
	Volunteer .451	Whitworth .45	.50	.54	.54	.58	Old Style	New Style	Parker Hale	Blue-Gray Target	.45	.50	
													
Bullet #	451114	457121PH	508656	548657	542622	575494	575213-OS	575213-NS	575213-PH	577611	578675	454616	504617
Wt. (Lead)	450 gr.	475 gr.	395 gr.	450 gr.	425 gr.	315 gr.	460 gr.	510 gr.	566 gr.	530 gr.	405 gr.	245 gr.	370 gr.
Mould #	2641114	2641121	2654656	2654657	2654622	not available	2654213	2651213	2650213	not available	2654675	not avail.	2640617
Handles #	2735793	2735793	2735793	2735793	2735793	2735793	2735793	2735793	2735793	2735793	2735793	2735793	2735793

Round Ball Moulds

Throw perfect, ball after ball, with a minimum sprue to ensure the kind of accuracy that target shooters have come to expect from Lyman precision moulds.
Round Ball Moulds \$101.95

Round Ball Suitability Chart			
Ball Diameter	Single Cavity Part # Price: \$99.95	2 Cavity Part # Price: \$99.95	Common Usage
*.375(P)	—	2665375	.36 Caliber
.445	—	2665445	.45 Caliber
.451(P)	—	2665451	.44 Caliber
.454(P)	—	2665454	.44 Caliber
.457(P)	—	2665457	.45 Ruger
*.490	—	2665490	.50 Caliber
.495	—	2665495	.50 Caliber
.535	2645535	—	.54 Caliber
*.570	2645570	—	.58 Caliber
.600	2645600	—	
.662	2645662	—	12 GA
*.715	2645715	—	.75 Caliber
.735	2645735	—	

*Recommended size depending on bore diameter.
(P)Recommended for percussion revolvers.
\$NOTE: All single cavity round ball moulds take double cavity handles.



.45 Conical & Plains Bullets

These offer the traditional muzzleloader a tapered bullet design for easy loading. Large deep lube grooves hold enough lube to keep fouling soft and ensure accuracy without leading.
Plains Bullets \$101.95

Minié and Maxi Mould

These designs are exactly reproduced from originals used over 100 years ago. The best bullets selected from American and British designs from 45 to 69 caliber.
Minié and Maxi Mould \$101.95

Uses Standard Plastic Wad

	
20 ga.	12 ga.
350 gr.	525 gr.
2654120	2654112
Use with STD Wads	

Lyman Shotgun Sabot Slug

Lyman Sabot slugs are designed to fit standard shotgun wads and star crimped. No special roll crimping tools necessary. Loading data available in the Lyman Shotshell Handbook 5th Edition for 12 ga.
12 GA Sabot (#2654112) \$101.95
20 GA Sabot (#2654120) \$101.95

Shotgun Slugs

	
20 ga.	12 ga.
345 gr.	475 gr.
2654020	2654012

Shotgun Slug Moulds

Available in 12 or 20 gauge, these moulds cast perfect hollow base slugs which do not require rifling. Slug moulds are single cavity only and cut into the larger double cavity block. They require double cavity handles.
Shotgun Slug Moulds \$101.95



Mould Handles

Solid metal frame is easily attached to blocks with slotted screws. Hardwood handles provide a cool secure grip. Designed to provide uniform grip with different mould blocks.

Lyman mould handles are offered in two sizes.
Double-cavity handles (#2735793) \$52.50
(for all current two-cavity and single cavity moulds)
Four-cavity handles (#2735794) \$52.50

Introducing the Next Generation of Lyman's Historic Great Plains Rifle Series.



Since its introduction in 1980, the Lyman Great Plains Rifle has been the standard for authenticity and accuracy in a traditional muzzleloader. Lyman is now proud to introduce the next generation of this classic rifle with the Great Plains Signature Series, made in cooperation with Davide Pedersoli & C. of Gardone, Italy. Pedersoli firearms have a worldwide reputation for precision manufacturing and the finest attention to detail. Their wood-to-metal fit is second to none in the firearms industry.

The authentic design and look of the Great Plains Signature series remains the same, including Double Set Triggers, and blackened metal furniture, but the rifle is now enhanced with a smooth operating, vintage style flat main spring lock, select Walnut stock with a rich exterior finish, and superior long-range accuracy. It's the new "Go-To" muzzleloader for sportsmen looking for Custom Performance in a production rifle.

Our standard Great Plains model is equipped with a 32" barrel, semi-buckhorn style rear sight and silver blade front sight and is available in percussion or flint. Our Great Plains Hunter model has a slightly shorter 30" barrel to reduce weight and provide easier handling when hunting. Additionally, the Hunter model is equipped with a 1-24" twist for top performance with sabot and conical bullets, a fiber optic rear sight teamed with a bead front sight. Both Great Plains and Great Plains Hunter models are drilled and tapped for our 57 GPR receiver sight.

Model and Specs:

- #6034000 – Great Plains 50 cal. Percussion, 32" barrel, 1-48" Twist \$1164.95
- #6034001 – Great Plains 54 cal. Percussion, 32" barrel, 1-65" Twist \$1164.95
- #6034002 – Great Plains 50 cal. Flint, 32" barrel, 1-48" Twist \$1240.95
- #6034003 – Great Plains 54 cal. Flint, 32" barrel, 1-65" Twist \$1240.95
- #6034004 – Great Plains Kit 50 cal. Percussion, 32" barrel, 1-48" Twist \$971.95
- #6034005 – Great Plains Kit 50 cal. Flint, 32" barrel, 1-48" Twist \$971.95
- #6034006 – Great Plains Hunter 50 cal. Percussion, 30" barrel, 1-24" Twist . . . \$1138.95
- #6034007 – Great Plains Hunter 54 cal. Percussion, 30" barrel, 1-24" Twist . . . \$1138.95
- #6034008 – Great Palins Hunter 50 cal. Flint, 30" barrel, 1-24" Twist \$1138.95

GREAT PLAINS *Signature Series* BY DAVIDE PEDERSOLI & C.





Lyman® Trade Rifle



The Lyman Trade Rifle is patterned after the sturdy and functional guns developed for the early Indian fur trade. Designed by such companies as Henry and Leman, these original guns were much sought after by trappers, Indians and other rugged wilderness survivors. Drop in barrels are also available.

- 50 Cal. Perc 1 in 48" (#6032125)..... \$607.50
- 50 Cal. Flint 1 in 48" (#6032129)..... \$669.95
- 54 Cal. Perc 1 in 48" (#6032126)..... \$607.50
- 54 Cal. Flint 1 in 48" (#6032130)..... \$669.95



Deerstalker Rifle



Lyman's Deerstalker Rifle has quickly earned the reputation as one of America's most reliable, accurate and affordable hunting muzzleloaders. All Deerstalkers have "Guaranteed" performance features such as a quiet single trigger, reliable coil mainspring and high quality Lyman fiber optic sights. The 24" barrel with 1 in 48" twist is ideal for roundball or maxi hunting bullets. Parts are blackened to avoid glare and a black rubber recoil pad mounted on the Deerstalker's handsome hardwood stock, makes for comfortable shooting in either .50 or .54 caliber. Drop in barrels available.

- .50 Cal. Perc 1 in 48" (#6033140) \$607.50
- .54 Cal. Flint 1 in 48" (#6033147) \$669.95
- .50 Cal. Flint 1 in 48" (#6033146) \$669.95
- .50 Cal. Flint 1 in 48" Left Hand (#6033171).... \$708.95

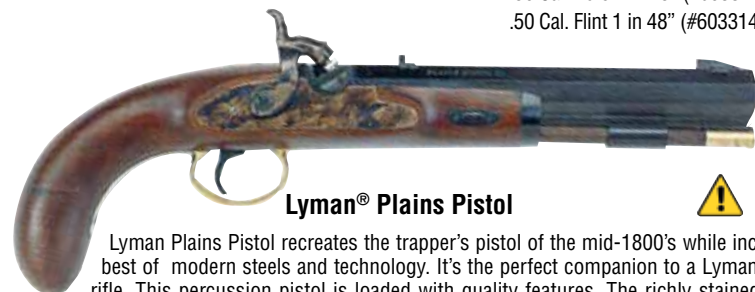

Lyman® Plains Pistol



Lyman Plains Pistol recreates the trapper's pistol of the mid-1800's while incorporating the best of modern steels and technology. It's the perfect companion to a Lyman black powder rifle. This percussion pistol is loaded with quality features. The richly stained walnut stock complements blackened iron furniture, polished brass trigger guard and ramrod tips. The hooked patent breech takes down quickly and easily for cleaning. Just like the originals, the thimble is recessed into the rib and a detachable belt hook provides an alternative to a holster.

A spring-loaded trigger and fast 1 in 30" twist make it amazingly accurate.

- 50 Cal. Perc 1 in 30" (#6010608)..... \$445.95
- 54 Cal. Perc 1 in 30" (#6010609)..... \$445.95
- 50 Cal. Perc "Kit" 1 in 30" (#6010610) \$374.50
- 54 Cal. Perc "Kit" 1 in 30" (#6010611) \$374.50



To Keep Your Muzzleloader Clean and Functioning Properly, Try our Butch's Black Powder Bore Shine and our Lyman Pick & Brush Set for cleaning

Butch's Black Powder Bore Shine 8oz. Page 68 (#02949)
Pick and Brush Set Page 68 (#04038)



Lyman Black Powder Accessories



- Unbreakable Ramrod fits barrels up to 36" (#6010030) \$17.25
- Flint Frizzen (#6030182) \$36.50
- Rifle Flints 2-pack (#6030106)..... \$14.75
- Rifle Nipple 3-pack (stainless) (#6030080) ... \$23.25
- Touch Hole Liner (#6030176) \$8.75
- Wedge Trade Rifle (#6030142) \$12.50
- Wedge Deerstalker (#6993112) \$12.95
- Rear Wedge Great Plains (#6030196) \$12.50
- Front Wedge Great Plains (#6030205)..... \$12.50
- Rifle Nipple Wrench (#6030105) \$13.50

PRODUCT SAFETY WARNING AND RECALL NOTICE

Lyman Products Corp. has voluntarily recalled black powder rifles and pistols due to the potential of separation in the breech plug. Lyman maintains a safety-first approach, so despite finding only a few firearms affected and no reported injuries, we are offering a recall program to have the issue corrected. Lyman regrets the inconvenience but remains committed to the safety of our customers.

This recall includes black powder rifles and pistols regardless of caliber (including Deerstalker, Great Plains, Great Plains Hunter, Trade Rifle, Plains Pistol, Black Powder Kits, and replacement barrels; excluding Percussion Left Hand Great Plains and Left Hand Great Plains Hunter models) manufactured from March 1, 2017 to December 22, 2017. Barrels with the serial number in the range of A595960-A599026 are subject to this recall.

To check your serial number, please go to:
<https://www.lymanproducts.com/recall>
or contact customer service at 860-632-2020





Henry Lever Action Rifle No. 2 Tang Sight

Lyman is proud to announce the addition of a #2 Tang Sight for the popular Henry line of lever action rifles. Like our other folding tang sights, this new Henry model will feature all steel construction, elevation locking sleeves, and both hunting and target style apertures. The Henry #2 Tang Sight fits these models:

- H006 – Big Boy, Big Boy Carbine, Big Boy Silver
- H009 – All-Weather 30-30
- H010 – All-Weather 45-70
- H012 – Big Boy All Weather, Big Boy Steel
- H018 – Lever Action 410 Shotgun

Henry Lever Action Rifle No. 2 Tang Sight. (#3902095) \$108.95

Upgrade Your Muzzleloader with Lyman® Black Powder Sights

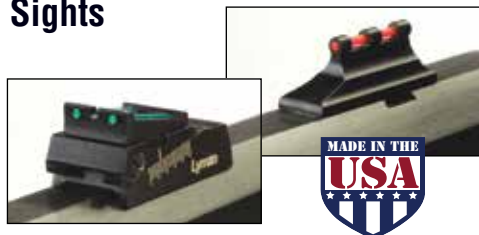

Fiber Optic Hunting Sights Fits Most European Imported Muzzleloaders

Now, black powder hunters can update their rifle sights with state-of-the-art fiber optic technology. These Lyman sights let hunters take advantage of every minute in the field. They are especially helpful in dawn and dusk periods when game is most active. Designed to fit the Lyman Great Plains™, Trade and Deerstalker Rifles; these bright, light-gathering sights will also fit most other European-made black powder rifles.

Fiber Optic Sights (#3090145) \$58.25

16AML and 37ML Hunting Sights

Tired of the same old traditional blade and buckhorn sights found on most muzzleloaders? These quality Lyman hunting sights will help an old gun shoot straight and true. Both have special .360 dovetail cuts that fit most European imports. The 16AML folding leaf sight is fully adjustable for elevation. The 37ML white bead front sight stands out in low light conditions.

- #16AML (Ht. 400-500) (#3090117) \$21.25
- #37ML (Ht. 445) (#3090118) \$15.75
- Special Value: Combination Set (#3090106) \$32.50

WARNING: Cancer and Reproductive Harm www.p65warnings.ca.gov

'73 Uberti No. 2 Tang Sights

This No. 2 Sight is all steel construction and features height index marks on the aperture post, with a maximum elevation of .800 for long range shooting. It includes both a .093 quick sighting hunting aperture and a .040 Large Disk Target Aperture. Mounting screws and instructions are included. (Note: some rifles may require the drilling and tapping of the forward mounting screw.)

No. 2 Tang Sight (Model '73) (#3902109) \$108.95

1894 No. 2 Tang Sight

This model fits most new and old 94 models plus these other historic Winchester Models: 1892 and 1894. The No. 2 will also fit other models when adjusted to full height. (Note: does not fit new rifles with Tang safety).

(Win. 94 Pre 2003) (#3902094) \$108.95

1886 No. 2 Tang Sight

This legendary tang sight is also available for the Winchester 1886 lever action rifle. For original Winchester model 1886 and Browning replicas, it features height index marks on the aperture post and an .800 maximum elevation adjustment. Also included is a .093 x 1/2" quick-sighting aperture and .040 x 5/8" target disk. Mounting screws and instructions are included. (Note: does not fit new rifles with Tang safety).

(Winchester '86) (#3902105) \$108.95

No. 2 Marlin Tang Sight

In 1995, Lyman introduced a new version of the No. 2 Tang for Marlin Models 336, 1894, 1895 and 30 series lever action rifles. The Marlin version features a special adapter base which allows mounting on the sight on the tang without damaging the serial number. All steel, this model has the same features and aperture discs as the 1886 model above. Mounting screws and instructions are included. (Marlin) (#3902100) \$108.95



Lyman® 57SML & 57GPR Receiver Sights

The most popular black powder receiver sight offers an immediate improvement in accuracy for the target shooter or hunter. Features 1/4 minute micrometer click adjustments for elevation and windage, quick release slide. 57SML fits perfectly on Lyman Deerstalker or Trade Rifle. Other models may require minor drilling and tapping depending on manufacturer. 57GPR fits Great Plains™ supplied with adapter.

57SML (4 oz.) (#3090114) \$121.50
57GPR (4 oz.) (#3090112) \$121.50



57 SML, 57 GPR (for Great Plains™)

Lyman® #17A Muzzleloader Front Sight

The ideal companion for the 57SML receiver sight, the 17 comes complete with a set of 8 interchangeable inserts (see Page 60). The 17AML fits low to the barrel with a height of .494". The 17ATC fits rifles that use a tall vernier type rear sight. The 17ATC has a height of .852". All 17's are machined from steel and have a standard 3/8 dovetail. (Except 17AEU which has a European dovetail for Investarm muzzleloaders. Lyman/Pedersoli muzzleloaders use the standard 3/8" dovetail sights.)

17AML (Ht. .494") (#3090115) \$46.50
17ATC (Ht. .852") (#3090116) \$46.50
17AEU (Eur. Dovetail) (#3171074) \$46.50



17 AML, 17 ATC, 17 AEU (European Dovetail)



Turn your Muzzleloader into a Target Rifle



16 AML Rear Sight



37 ML Front Sight



66A



90MJT



Lyman® 57 & 66 Receiver “Peep” Sights

The 66 is for flat receivers, such as lever action rifles, like the Winchester 94, Marlin 336 or modern shotguns. Features include 1/4 minute audible click micrometer adjustments for elevation and windage, quick-release slide, coin-slotted “stay-set” knobs and two interchangeable aperture discs (large hunting aperture and small target aperture) for any shooting condition.

- 57WJS fits Rem 700, Win 70, Sav 110 . . . (#3572088)
- 57SME fits Mauser, Springfield and (#3572087)
White Systems
- 57SMET for Mauser, Springfield and (#3572091)
White Systems - with target knobs
- 66A fits Win. 94 - pre. angle eject (#3662214)
- 66LA fits Marlin 336, 1894 and 1895 (#3662215)
- 66MC fits Marlin 39A (#3662218)
- 66WB fits Browning & Win. 1886. (#3662265)
- Price \$121.50

90MJT Target Receiver Sight

This sight is designed to mount on Lyman and other mounting bases available for most 22 bolt action rifles. It features audible click detente – target knobs scribed in quarter minute graduations – elevation and windage arrows. Adjustable zero scales and elevation stop screw permit instantaneous return to zero. Quick release slide allows slide to be removed with a press of the release button. Large 7/8” non-glare .040 aperture. Elevation adjustable from 1.060 to 1.560 above bore centerline.

- 90 MJT (#3902050) \$136.75
- Mounting Bases 540 for 1” receivers (#3902085) \$19.75
- Mounting Bases 640 for 15/16” receivers (#3902090) \$19.75

Replacement Sight Discs

- Standard hunting disc 1/2 x .093(#3060960) \$8.95
- Standard target disc 5/8 x .040(#3060964) \$8.95



Shotgun Sights



Lyman® Shotgun Sights

Lyman Shotgun Sights are equipped with oversized ivory-like beads, which are easy to see under any light conditions and can be fitted in minutes. No. 10 Front Sights (press fit) – For use on double barrel, or ribbed single barrel guns.

No. 10D Front Sights (screw fit)– For use on non-ribbed single barrel guns. These sights are supplied with a wrench.

Sight only (1/2 oz.) (#3101012) \$8.95

No. 11 Middle Sight (press fit) – This small middle sight is intended for use on double and ribbed single barrel guns.

Sight only (1/2 oz.) (#3111028) \$8.95

Note: Prices for the above sights do not include drill, tap or reamer. Drill, tap and reamer not available from Lyman. Consult local gunsmith for installation.



No. 16 Folding Leaf Sight

This open rear sight with adjustable elevation blade, is the perfect auxiliary sight for scope-mounted rifles. Folds close to the barrel when not in use. Designed to fit 3/8” dovetail slots.

Available in three models:

- 16A, .400 high, elevates to .500 (#3161066) . . . \$20.75
- 16B, .345 high, elevates to .445(#3161067) . . . \$20.75
- 16C, .500 high, elevates to .600(#3161068) . . . \$20.75

93 Match & Series 20 MJT Insert Set

For 20 MJT-LJT, and 93 MATCH.

Includes Anschutz size inserts.

Two post inserts .067 – .102 wide.

Five aperture inserts, .126 – .133 – .154 – .161 – .169
Series 20 MJT: (#3201165) \$22.75

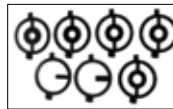

Series 17A Insert Set

Set includes two post-type inserts, (.050 and .100 wide), one bead insert (.062) and five aperture-type inserts, (One plastic insert with .120 hole and four steel inserts with .093, .102, .110 and .120 holes).

Insert Set (1 oz.) (#3171086) \$20.75

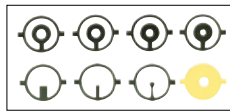

93 Match



20MJT



17A



93 Match Globe Front Sight

The 93 Match Globe Front Sight has been designed to fit any rifle. The 93 match sight (7/8” diameter) mounts on a standard dovetail base. It is supplied with seven Anschutz size inserts. The sight height is .550 from the top of the dovetail to the center of the aperture. Hooked locking bolt and nut provide a positive installation while allowing quick removal. Accepts most Anschutz accessories.

Globe Front Sight (2 oz.) (#3902035) \$80.95

20MJT Globe Front Sight

The 20 MJT – 7/8” diameter Globe Front Sights are machined from one solid piece of steel designed to be mounted in a 3/8” barrel dovetail. 20 MJT height .700” from the bottom of dovetail to the aperture center supplied with seven Anschutz size steel apertures (see above for sizes).

20 MJT (3 oz.) (#3201150) \$63.25

Series 17A Target Front Sights

17A Target Sights are machined from a solid piece of steel and are designed to be mounted in 3/8” dovetail slots. They are supplied with eight interchangeable inserts (see photo and description) that are locked in place with a threaded cap.

Sight Heights*

- 17AHB .404(#3171076) \$46.50
- 17AMI .494(#3171078) \$46.50
- 17AUG .584(#3171080) \$46.50
- 17AEU .464 (European Dovetail)(#3171074) . . . \$46.50

*From bottom of dovetail to center of aperture.

No. 12S Slot Blank

Fills dovetail when sight is removed. (1/2 oz.) (#3121040) \$11.50

See them
in action
on YouTube!



2" Diameter

Flippin' Critter™ Walking Targets

Flippin' Critters Walking Targets keeps your rimfire plinking sessions fun and interesting, while sharpening your shooting skills at the same time. Flippin' Critters have a unique "tri-pod" shape that causes the target to flip and walk away from you each time the target is hit. Each time the target flips it moves both backwards and at an angle, so you always have a new challenge for each shot. The targets are made from solid steel, so they hold up to year after year of plinking action. Available in round and prairie dog shapes and their bright color makes them easy to see.

Flippin' Critter Round Target (#4321220) \$21.25



Pachmayr Slide Rack Assist

The Pachmayr Slide Rack Assist is the answer for those who want extra assistance when racking the slide of semi auto handguns. Shooters with small hands, those with arthritis, and others with limited hand strength often struggle working the slide on many pistols. This innovative product fits over the slide and muzzle of your handgun, and provides a greatly increased gripping surface and significantly reduces the effort needed to rack a slide. The Slide Rack Assist is adjustable and fit most common semi-auto handguns. Fits most full size and compact semi-auto handguns, with the exception of CZ handguns, micro size handguns, and handguns with flared barrel muzzles greater than .660" in diameter.

Slide Rack Assist (Black) (#03890) \$21.25



Match Assortment Sheets

Each 7" x 10" sheet features an assortment of fluorescent cross hair and sighting targets. Includes special match target for use at ranges up to 200 yds. 10 sheets per pack. Over 200 individual target items.

Match Asst (#4026880) \$8.10
Varmint Asst (#4026970) \$8.10

TARG-DOT™

Stick-On Dots

Lyman has you covered - literally! Use our stick-on Targ-Dots to make your paper targets last all day. Available in every variety to meet your shooting needs.

Targ-Dots®

- 1/2" 110/pk(#4026050) \$5.10
- 1" 100/pk(#4026100) . \$5.10
- 2" 45/pk(#4026200) . . \$5.10
- 3" 25/pk(#4026300) . . \$5.10
- 6" 15/pk(#4026600) . . \$6.30



Accupoint Dots

- 1" 100pk(#4026760) \$5.10
- 2" 45 pk(#4026770) \$5.10



Reloader's Labels

- Fluorescent Green
- 1" x 2" 75/pk
- (#4026700) \$4.70
- 2" x 2 1/2" 40/pk
- (#4026750) \$6.25

Date	_____
Cartridge	_____
Case	_____
Primer	_____
Powder	_____ Wt.
Bullet	_____
Sights	E. ____ W. ____
Remarks	_____



Animal Targets

- Fluorescent
- 6" Turkey 10/pk
- (#4026650) \$7.10
- 3" Prairie Dog 25/pk
- (#4026790) \$6.25





Match Bag

Lyman Shooting Bags

Lyman is proud to introduce a whole line of shooting bags to help create a stable shooting platform in almost any situation. All of our Shooting Bags are made from heavy duty, abrasion resistant 600D nylon with micro-suede padding on rifle contact points. They are also equipped with a non-slip rubberized base to keep them stable and in place during use. The bags are supplied filled with a ground plastic material which holds its shape well and is light enough for easy carrying. Filling can be adjusted for optimal volume.

Match Bag

The Match Shooting Bag is shaped to tightly squeeze your rifle and give you a stable and secure shooting platform. The bag is equipped with a sturdy carry strap and an adjustable tensioning strap to adjust elevation. Dimensions: 8"W x 10"D x 6 1/2"H

Match Bag (#7837802)..... \$50.50

Crosshair Combo Set

The Crosshair Front Bag provides a stable front rest for any rifle. Dimensions: 6"W x 4 1/2"D x 7 1/2"H

The Crosshair Rear Bag features a notched design which holds the rifle stock in place. Dimensions: 5 1/2"W x 5"D x 5"H

The Crosshair Combo Set includes both the Front and Rear Bags that work perfectly together to create a customized shooting platform to meet your needs. The front and rear bags can also be clipped together for easy transportation.

Crosshair Combo Set (#7837805)..... \$45.50



Lyman Bag Jack™

How often do you set-up shooting rests at the range, only to find that your rifle isn't at the proper height; or the seat is too high for the bench? Lyman's Bag Jack is designed to make it easy to adjust the elevation of your rifle and bring it into line with your target, while also allowing you to maintain a comfortable shooting position. Compact, stable, and infinitely adjustable, the Bag Jack is the perfect platform to set up your shooting rest at the range. Create the optimal shooting position under any shooting conditions. The Bag Jack corrects the height with a simple turn of the adjustment knob. The lift is made from sturdy aluminum and steel components and has a non-slip textured platform. The lift is 10" x 10" so it can accommodate the largest size rests, and collapses for unmatched portability.

Bag Jack (#7837810)..... \$70.98
 Bag Jack and Match Bag Combo (#7837815) . . \$111.50



Tac-Mat™ Long Range Shooting Mats

Lyman's Long Range Shooting Mats are perfect for long range shooting, target or tactical shooting, and varmint hunting. They offer a large footprint that will work well for even the tallest shooter, yet they roll up to a compact, easy to transport size. These comfortable mats will protect you from dirt, rocks, wet surfaces, insects, hot truck beds, gravel or pavement. 6' x 3' (Tail adds 6")

Mats will be offered in two versions, a basic design in either black or FDE; or a heavy-duty (HD) version in black. The basic model features 600D construction, with a carry handle and shoulder strap. The shoulder strap can also be used as a bipod stop. The HD version features 1000D construction, elbow pads and a built-in bipod stop, as well as a carry handle and shoulder strap.

- Tac-Mat Long Range Shooting Mat Black(#7837850)..... \$85.98
- Tac-Mat Long Range Shooting Mat Flat Dark Earth (FDE)(#7837851)..... \$85.98
- Tac-Mat HD Long Range Padded Shooting Mat Black(#7837852)..... \$125.98



Range Kit - Pistol Starter Set



Lyman's new Pistol Starter Set gives shooters all of the basic accessories that they need to get started in pistol shooting. The Pistol Starter Set is housed in a durable, tough 600D nylon shooter's carry bag that is a must for transporting your equipment to and from the range. Shooting bag dimensions are 15.7" X 8.85" X 10.23". Inside the bag, are all the basics that you need for eye and ear protection. The set contains quality ear protection with 25DB noise reduction, eye protection, and also a QwikDraw™ barrel cleaner for cleaning your pistol afterwards. The QwikDraw is a fast, all-in-one cleaning tool that eliminates the need for traditional cleaning rods and patches. Best of all, the total package offers a great cost savings over purchasing the items individually.

- Pistol Starter Set 380/9mm/38/357 (#7837820) . \$40.50
- Handgun Range Bag (#7837830)..... \$15.75



L.E. Range Kit

This L.E. Range Kit is designed to give the Law Enforcement officer, competition shooter, or recreational range-goer everything they need to take their firearm from the firing line to the cleaning table. This kit includes a high quality range bag, hearing and eye protection, a QwikDraw bore cleaning rope, and A-Zoom Snap Caps for dry fire and shooting drill practice. There is also a pick and brush set, Butch's Bore Shine firearm cleaning solvent, patches and a full pistol cleaning kit with cleaning rod, brushes and jags. No other kit offers all of these items for such an affordable price and quality. Save time and money for the range by picking up everything you need in one handy kit.

L.E. Range Kit includes:

- Essential Handgun Starter Kit, 9mm
- Patches 2-1/4" Square - 35-45 Cal (150 Pack) Butch's Bore Shine 3.75 oz
- Pistol Cleaning Kit
- Pick and Brush Set
- A Zoom Blue Value 10/pack
- LE Range Kit (#7837825)..... \$121.50

WARNING: Cancer and Reproductive Harm
www.p65warnings.ca.gov

AccuSight

Lyman's new AccuSight Pistol Sight Tool sets the standard by which all others will be judged! Proudly made right here in our Middletown CT plant, the AccuSight tool is CNC machined from billet aluminum. It can adjust, install or remove front or rear dovetail pistol sights, and has a machined pocket for 1911 slides. The AccuSight features 4 horizontal and 1 vertical slide clamps, full range height adjustment, and 1/32" increment windage adjustment scale on the sight pusher. The large sight pusher handle provides plenty of torque to move even the most stubborn sights. The AccuSight Pistol Sight Tool is a must for gunsmiths, competition shooters, or anyone who wants to properly work on pistol sights.

- Adjusts, install or remove dovetail pistol sights
- CNC machined aluminum body
- 4 horizontal and 1 vertical slide clamps
- Includes straight and angled sight pusher blocks
- 1/32" increment adjustment scale
- Large sight pusher handle allows moving stubborn sights
- Works with most pistols with front or rear dovetailed sights

AccuSight: Pistol Sight Installation Tool (#7031287) \$141.95



Pro Drive Torque Wrench

The Lyman Torque Wrench is a must for accuracy minded shooters and gunsmiths. The Lyman Torque Wrench will allow you to safely and correctly attach scope bases, scope rings, action screws and other fasteners to firearms. Correct screw torque prevents damage to screw threads, screw heads, threaded surfaces and optics. Consistent screw torque will also help get the best accuracy from your firearm.

- Includes straight blade, hex, and 6-lobe bits, plus 1/2" socket and socket adapter
- Padded storage case
- Adjustable up to 80 inlb.

Pro Drive Torque Wrench (#7031300) \$100.95



Electronic Digital Trigger Pull Gauge

Lyman's revolutionary Digital Trigger Pull Gauge is designed to be the fastest and most accurate trigger pull gauge available. The state-of-the-art strain gauge technology allows for accuracy of 1/10 ounce/2 grams. The gauge will read to a maximum 12lb/5.4kg and features a large, easy-to-read LCD display. To operate, simply press the ready button, hook the roller around the trigger of your firearm and pull until the trigger releases. (Make sure firearm is not loaded.) The gauge will display and hold the exact trigger pull weight. For a new reading, just press the ready button and repeat. The gauge will also give you an average of up to the last 10 readings. Switch from ounces to grams with the push of a button. The fully adjustable rod works on any firearm. This is the perfect tool for target shooters, silhouette shooters, gunsmiths, hunters, or anyone who wants to adjust their trigger pull weight accurately and easily. Works with two included AAA batteries.

- Fully Adjustable Trigger Pull Rod allows use with all firearms
- Accurate up to 1/10 ounce/ 2 grams
- Ergonomic Design
- Roller "Self-Centers" on Face of Trigger
- Memory for Averaging up to 10 pulls
- Easy to read LCD Display reads in (pounds/ounces) or Metric (kilograms/grams)
- Ensures safe and accurate trigger adjustments

Electronic Digital Trigger Pull Gauge (#7832248) \$63.25



Specifications:
 Measuring Range:
 1oz - 12lbs / 2.8g - 5.4kg
 Resolution:
 0 - 5lbs: ± .1oz
 5 - 12lbs: ± .5oz
 0 - 2.2kg: ± 2g
 2.2 - 5.4kg: ± 10g

Lyman Mechanical Trigger Pull Gauge 

Lyman's mechanical trigger pull gauge is a simple, accurate and cost-effective way to measure the weight of your firearms trigger pull. Made of tough machined aluminum and steel components, the gauge will stand up to years of use. The gauge features a rolling trigger shoe, "T" handle, a sliding indicator that holds your highest weight and a zero-adjustment wheel. The gauge reads from 0 to 12 pounds in 2-ounce increments and is also equipped with a hanging loop for storage.

- Reads from 0 to 12 pounds
- 2-ounce increments
- Highest weight indicator
- Aluminum and steel construction
- "T" handle and hanging loop for storage

Mechanical Trigger Pull Gauge (#7832247) . . . \$23.25



BORECAM™ Digital Borescope



Borecam™ Pro Wireless Borescope

Lyman's new Borecam Pro borescope takes barrel inspection to a whole new level! The wireless Borecam Pro produces its own WiFi signal which sends super clean and detailed images directly to your phone. No wires or monitors to get in the way during use. Carefully inspect your bores for wear, throat erosion, tool marks and other rifling damage, as well as copper or lead fouling. The Borecam Pro will fit 20 caliber and larger barrels and is now equipped with a longer 24" rod. In addition to taking photos, the Borecam Pro now takes sharp, clear videos. The Borecam Pro's easy-to-use app makes storing and retrieving photos and video simple. Apps are available for iOS and Android phones and tablets.

- Wireless WiFi operation
- 720P Resolution for a clean, sharp image
- Fits 20 caliber and larger barrels
- 24" long rod
- Can take photos and video
- Easy to use apps for iOS and Android phones or tablets

Borecam Pro (#04059)..... \$354.50



Miniature digital camera technology and bright lighting combine to provide crisp clear images.



Unit charges via a USB cable and adapter.

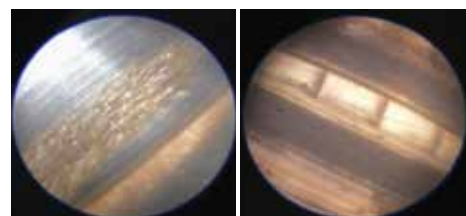



**Protect
Your Guns
and Your
Workbench!**

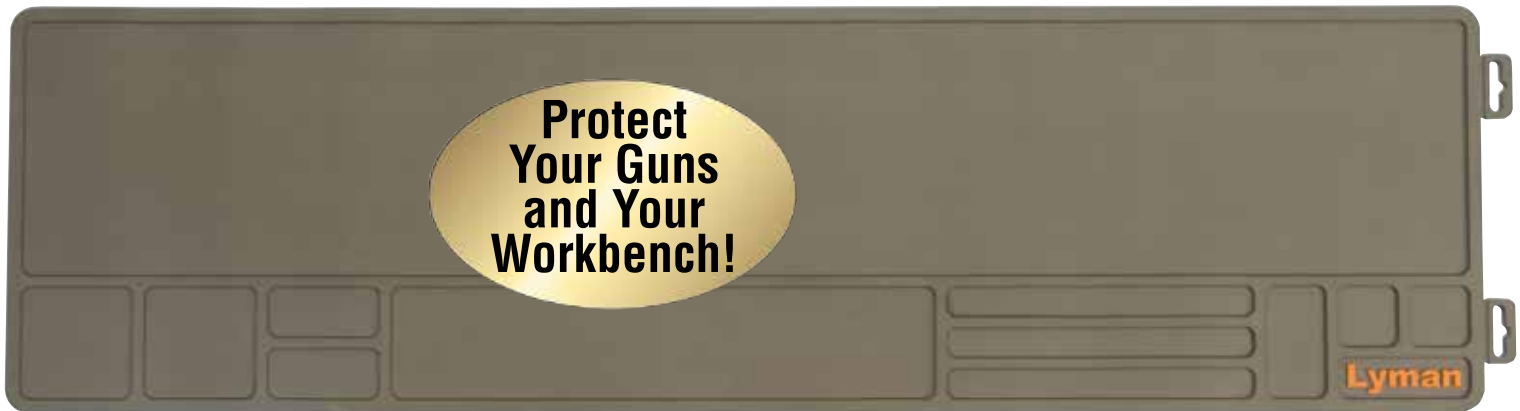

The Essential Gun Maintenance Mats

Protect your gun and your workbench. Work like a pro on your Lyman Gun Mat. The firm, yet cushioned surface is perfect for assembling and disassembling firearms (or lots of other hobbies!) for cleaning or maintenance and repair. The molded compartments contain spills and keep small parts out of the way of the main work area but still handy and organized. The mats are chemical resistant and clean easily with soap and water. Handgun mat measures 15.75" x 10". Rifle Mat measures 10" x 36".

- Chemical Resistant
- Made from synthetic rubber for a non-slip surface
- Protects your gun's finish and your bench's finish
- Molded-in storage compartments keep parts secured & organized

Essential Gun Mat (#04050)..... \$19.98
 Essential Rifle Mat (#04051) \$40.50





A. The Original Butch's® Bore Shine

Designed by well known bench rest competitor Butch Fisher, this non-abrasive chemical solvent is specifically designed to remove all forms of bore fouling including copper with an absolute minimum of effort and no damage. It will quickly remove carbon build-up, even in difficult to clean areas like the chamber throat. It also removes lead, wax and even plastic shotgun wad build up.

A significant improvement over conventional solvents, Butch's can also control the copper fouling by pushing a few patches soaked with Butch's prior to shooting. Butch's is safe to use on normal and stainless barrels. It is a true "All in One" Cleaner. Try it and you will never use anything else!

- Butch's Bore Shine 3.75 oz (#02937) \$12.00
- Butch's Bore Shine 8 oz (#02953) \$16.98
- Butch's Bore Shine 16 oz (#02941) \$30.50

⚠ WARNING: This product can expose you to chemicals including 1,2,4 Trimethylbenzene, which is known to the State of California to cause cancer and/or birth defects or other reproductive harm. For more information go to www.p65warnings.ca.gov



C. Butch's® "Triple Twill"™ Patches

Like Butch's bore shine, these patches offer superior performance. They hold more liquid and remove fouling faster than ordinary cotton flannel patches. A special fabric used in laboratories and cleanrooms, Triple Twill's special weave has hundreds of tiny "ridges and drop zones" which scrub and capture fouling residues far better than other patches. Butch's Triple Twill patches don't shed lint and have been specially treated for maximum absorbency.

- 1-1/8" SQ. 22-270 Cal. (Bag of 1000)(#02901) \$20.50
- 1-1/2" SQ. 6mm Bench Rest (Bag of 1000)(#02913) \$20.50
- 1-3/4" SQ. 7mm-35 Cal Rifle (Bag of 750)(#02904) \$20.50
- 2-1/4" SQ. 35 CAL - 45 Cal Rifle (Bag of 500) 10mm - 45 Cal Pistol (#02906) \$20.50
- 2-1/2" SQ. 45-58 Cal Rifle (Bag of 375) .410 - 20 Ga. Shotgun (#02908) \$18.75
- 3" SQ.10,12 & 16 Ga. Shotgun (Bag of 300)(#02911) \$20.50



D. Butch's® Gun Oil
U.S. Military proven formula

Butch's Gun Oil is an ideal bore protectant and conditioner, especially when used with Butch's solvent. It is a proprietary blend of natural oils that withstands the intense heat, friction and pressures produced in a firearm's chamber and bore. The product's rust inhibitor provides the absolute maximum in corrosion protection for both regular and stainless steel firearms. Butch's Gun Oil 4oz (#02948) \$9.00

B. Butch's® Black Powder Bore Shine - Benchrest clean for black powder guns

Butch's New Black Powder Bore Shine was developed specifically for the Black Powder Shooter who asked for a Better, faster way to clean their Rifles. Butch's Black Powder Bore Shine comes from a special cleaning solvent used by the U.S. Military. This New Black Powder bore cleaner, like the original Bore Shine does it all. Removes Powder, Lead and Plastic Fouling faster than any other cleaner. Best of all it is odorless, non-toxic, non-flammable, biodegradable and protects against rust and corrosion. You can't find a better cleaner for black powder anywhere. Black Powder Bore Shine 8oz. (#02949) \$10.98

⚠ WARNING: This product can expose you to chemicals including Methyl Pyrrolidone, which is known to the State of California to cause cancer and/or birth defects or other reproductive harm. For more information go to www.p65warnings.ca.gov



Universal Bore Guide Set

Lyman's Universal Bore Guide Set directs and centers your cleaning rod and jag through the chamber. This protects both the chamber and the bore from abrasion by the cleaning rod during regular cleaning. "Universal" means that this set will fit most bolt actions and even includes a special adapter sleeve for the AR-15.

Precision machined from durable, anodized aluminum, the set comes with interchangeable tips that cover bore sizes from .17 up to .416 and the thread-on nozzles prevent the guide's sticking in the chamber. The guide's specially machined port makes applying solvent to the inserted cleaning patch easier and neater than trying to push a wet patch into the open end of the guide. The Universal Bore Guide Set works with most cleaning rods like Lyman's new Universal Cleaning Rod System and Jag and Brush Set.

- Universal Bore Guide Set (.17 to .416)(#04045) \$21.50



Lyman's Pick and Brush Set

Allows you to clean out all those hard to reach grooves and corners that can't be reached with patches. The picks come in a variety of shapes so that you'll have just the right size to fit into those tight spots. A nylon utility brush is also included for scrubbing away tough powder residue. A "must have" for your cleaning supplies and range bags.

- Pick and Brush Set (#04038) \$4.76

⚠ WARNING: Cancer and Reproductive Harm www.p65warnings.ca.gov



Master Gunsmith Tool Set

Our Master Gunsmith Tool Set is one of the most complete gunsmith and maintenance kits available! The set includes our large 68 piece Gunsmith Tool Set to work on a large variety of firearms; our popular gun mat that protects finishes and organizes small parts; our large, non-marring X-Block used to safely support your pistols for parts removal; our Hammer and Punch Set with all the necessary punches, brass drift and a multi-faced hammer; a set of roll pin punches; our pick and brush set to clean all those tough to reach areas; as well as our Digital Trigger Pull Gauge to verify and adjust trigger pull weights.

Contains:

- Gun Mat
- X-Block
- 68 Piece Gunsmith Tool Set
- Hammer & Punch Set
- Roll Pin Punch Set
- Trigger Pull Gauge
- Pick and Brush Set

Master Gunsmith Tool Set (#7991373) \$212.95

All the Tools a Gunsmith Needs - Specifically Chosen for Gun Care



45pc. & 68pc. Lyman Master Gunsmith Tool Kits

Pachmayr's screwdriver sets provide all the bits needed by gunsmiths and all those who work on firearms. These complete sets come with bits for slotted screws, hex screws, 6-lobe screws, and Phillips screws; in addition to an assortment of specialty bits. The specialty bits include a Weaver scope ring bit, Glock front sight bit, 1911 grip bushing bit, as well as .062", .093" and .118" pin punches. The sets also include a ratchet wrench so the maximum torque can be applied to those tough-to-remove screws. The bits for slotted screws are hollow ground, so they properly fit screw slots and prevent cam-out which creates ugly, damaged screw slots. The sets are packed in compact, convenient storage cases.

45 Piece Set Contains

- 12 – hollow ground bits for slotted screws
- 15 – hex bits in standard and metric sizes
- 6 – Phillips bits, including two long bits
- 3 – 6-lobe bits
- 6 – specialty bits
- 1 – extension
- 1 – ratchet wrench
- 1 – handle

68 Piece Set Contains

- 32 – hollow ground bits for slotted screws
- 17 – hex bits in standard and metric sizes
- 6 – Phillips bits, including two long bits
- 4 – 6-lobe bits
- 6 – specialty bits
- 1 – extension
- 1 – ratchet wrench
- 1 – handle

Lyman Tool Kit 45 pieces (#7991360) \$47.50

Lyman Tool Kit 68 Pieces (#7991361) \$62.95



Multi Caliber Cleaning Pistol Cleaning Kit ⚠️

Covers 380 Auto, 9mm Luger, 38 Special, 357 Magnum, 40 S&W, 45 ACP and 45 Colt calibers. The handle features a rotating attachment point for the rod, which allows the rod to rotate and follow the rifling in your barrel. All the components are packed in a convenient plastic carrying case.

- 3 – bronze brushes
 - 3 – mops
 - 1 – cleaning rod handle
 - 1 – bag of patches
 - 2 – brass cleaning rods: 5 1/2" rod and 2" extension
 - 3 – brass jags
 - 1 – slotted patch holder
 - 1 – rod centering guide
 - 1 – bottle of gun oil
- Pistol Cleaning Kit (#04036) \$27.50

WARNING: Cancer and Reproductive Harm
www.p65warnings.ca.gov

The Tools You Need From the Company You Trust



Deluxe Hammer & Punch Set

The perfect companion for the home gunsmith or handyman. Each set features our complete selection of quality Gunsmith Punches plus the popular Brass Tapper Hammer. This unique set comes in a custom hardwood storage case which separates each punch by size for quick access.

- Deluxe Set (3 lbs.) (#7031298) \$63.75
- Replacement Steel Cap (#7991272) \$1.10
- Replacement Nylon Cap (#7991271) \$1.16
- Replacement Brass Cap (#7991273) \$3.48

Gunsmith's Punch Set

A good selection of properly made and correctly sized punches is no longer hard to find. Now they're available from Lyman. The Gunsmith's Punch Set offers a complete selection of quality steel punches with hardened steel punch tips including 1/16", 3/32", 1/8", 5/32", 3/16", 1/8" center punch and a brass drift punch. Deluxe Set including the interchangeable head "Brass Tapper" hammer is also available. (see above)

- Gunsmith Punch Set (12 oz.) (#7031273) \$35.95



Lyman "Brass Tapper" Hammer

For gunsmithing and other delicate jobs, this hammer has three interchangeable heads including nylon, brass and steel. For delicate tapping, a knurled brass drift pin stores inside the handle.

- Brass Tapper (11 oz.) (#7031290) \$25.95

Pistol Punch Set

For the specialized needs of pistol work, Lyman has put together a more economical assortment of punches. This basic set utilizes the same universal handle as the Gunsmith's Set with the following punches: 1/16", 3/32", 1/8", 5/32" and brass drift punch.

- Pistol Punch Set (8 oz.) (#7031271) \$22.75



Roll Pin Punch Set

Ideal tools for removing hollow, split roll pins. Special round nose design allows proper alignment of punch in roll pin to prevent damage to fine mechanisms such as trigger group parts. Roll Pin Punches come in 1/16, 3/32, 1/8, 5/32 sizes.

- Punch Set(10 oz.) (#7031277) \$23.25



"Essential" Tool

Having the right tool for the job is important, but sometimes its also important to have a "fun" tool for the job! Impress your friends with this 50 Caliber Bottle Opener. Precision CNC machined from solid aluminum and hard anodized, this bottle opener is sure to turn heads at your next event.

- 50 Cal Bottle Opener (#11460) \$12.70

Don't Leave Home Without it!



**Master Gunsmith™
277 Piece Slotted Screw Kit**

The ideal companion to the Master Gunsmith Screw Driver Set. This 277 piece kit is for the firearms owner and gunsmith. This set contains 12 each of 23 different "hard to find" screws that fit common applications in many guns. Screws are contained in handy storage kit and includes tweezers.

No gun owner should be without this kit.

KIT CONTAINS:

- #6-48 Fillister Head (7 different lengths)
- #6-48 Oval Head (7 different lengths)
- #8-40 Fillister head (3 different lengths)
- #8-40 Oval head (3 different lengths)
- #6-48 Plug Screws
- #8-40 Plug Screws
- #10-32 Plug Screws

Master Gunsmith Slotted Screw Kit (#03054) . \$62.98



**Master Gunsmith™
6-Lobe Ring & Base Screw Kit**

Contains 10 each of 20 premium 6L-10 and 6L-15 style scope ring and base screws. These difficult to find screws are favored for their non-slip design. Packaged in a handy storage box with individual compartments for each size screw. Kit includes tweezers and a thread size gauge, which also doubles as a shortening jig used to grind a screw to a shortly length.

KIT CONTAINS:

- #6-40 Fillister Head T-10 (3/8, 1/2)
- #6-40 Oval Head T-10 (1/4, 3/8)
- #6-48 Fillister Head T-10 (1/4, 3/8, 9/16)
- #6-48 Oval Head T-10 (1/4, 3/8)
- #8-40 Fillister Head T-10 (1/4, 3/8, 1/2)
- #8-40 Oval Head T-10 (1/4, 1/2)
- #8-40 Fillister Head T-15 (1/4, 3/8, 1/2)
- #8-40 Oval Head T-15 (1/4, 3/8, 1/2)

Master Gunsmith 6-Lobe Screw Kit (#03061) . \$43.50



**Master Gunsmith™
Hex Head Ring & Base Screw Kit**

Contains 10 each of 14 premium 3/32" hex style scope ring and base screws. These difficult to find screws are favored non-slip replacements for slotted screws. Packaged in a handy storage box with individual compartments for each size screw. Includes tweezers and a thread size gauge, which also doubles as a shortening jig used to grind a screw to a shorter length. (Hex Size: 3/32)

KIT CONTAINS:

- #6-40 Fillister Head (3/8, 1/2)
- #6-40 Oval Head (1/4, 3/8)
- #6-48 Fillister Head (1/4, 3/8, 9/16)
- #6-48 Oval Head (1/4, 3/8)
- #8-40 Fillister Head (1/4, 3/8, 1/2)
- #8-40 Oval Head (1/4, 1/2)

Master Gunsmith Hex Head Screw Kit (#03058)\$43.50

**Pac-Mag™
Gun Storage Magnet**



Versatile gun storage solution



Use under a desk, night stand, counter top, or dashboard; against a wall or inside a safe



Rated for up to 30 pounds

Pac-Mag™ Gun Storage Magnet

- 3 Magnet design gives the Pac-Mag more strength than any other gun magnet on the market
- Secure almost any gun – pistol, rifle or shotgun – practically anywhere!
- Holds rifles or shotguns, in addition to handguns
- Overmolded non-marring rubber protects your gun
- Includes mounting screws, drywall anchors, and double-sided adhesive tape

PacMag Gun Storage Magnet (#03190) \$21.98

WARNING: Cancer and Reproductive Harm
www.p65warnings.ca.gov



Pachmayr America's trusted name in recoil reduction



RP200 Rifle

The RP200 offers an economic design in a quick mounting shape and medium face texture. It also offers additional protection for the stock.



- Excellent for .22LR's and varmint rifles
- Medium face texture

RP200 Pad Specifications

Color: Black or Brown
 White Line® & Black base
 Size: Medium
 Price.....\$28.98

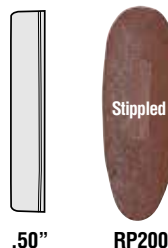

PART NO.	COLOR	BASE	SIZE	FACE SHAPE	FACE TEXTURE	LENGTH * (A)	WIDTH * (B)	INSERT WIDTH (F)	PAD THICKNESS (E)
00402	Brown	White Line®	Medium	Field	Stipple	5.40"	1.85"	No Insert	.50"
00401	Black	White Line®	Medium	Field	Stipple	5.40"	1.85"	No Insert	.50"
00406	Brown	Black	Medium	Field	Stipple	5.40"	1.85"	No Insert	.50"
00408	Black	Black	Medium	Field	Stipple	5.40"	1.85"	No Insert	.50"



F250 Lightweight Shotgun & Rifle

The F250 is a thinner version of our Deluxe F325 pad with the same excellent qualities. The pad is an ideal choice where recoil is moderate to light.



- Excellent for shotgun or rifle shooting
- Line checked for non-slip
- Field style

F250 Pad Specifications

Colors: Black and Brown
 F250 White Line®
 Sizes: Small, Medium, and Large
 Price.....\$33.50

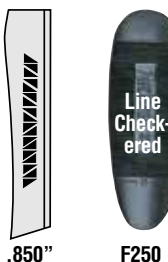

PART NO.	COLOR	BASE	SIZE	FACE SHAPE	FACE TEXTURE	LENGTH * (A)	WIDTH * (B)	INSERT WIDTH (F)	PAD THICKNESS (E)
00208	Brown	White Line®	Small	Field	Lined	5.10"	1.75"	No Insert	.85"
00205	Brown	White Line®	Medium	Field	Lined	5.35"	1.80"	No Insert	.85"
00207	Black	White Line®	Small	Field	Lined	5.10"	1.75"	No Insert	.85"
00204	Black	White Line®	Medium	Field	Lined	5.35"	1.80"	No Insert	.85"
00201	Black	White Line®	Large	Field	Lined	5.35"	1.90"	No Insert	.85"



WARNING: This product can expose you to chemicals including Ethylene Thiourea, which is known to the State of California to cause cancer and/or birth defects or other reproductive harm. For more information go to www.p65warnings.ca.gov

500B Presentation Rifle

The 500B is a popular replacement for a hard plastic or metal buttplate. This good looking design offers quick mounting and a reliable non-slip face texture.



- Basketweave face for good looks and non-slip
- Field style face for quick mounting



500B Pad Specifications

Colors: Black or Brown
 Black base only
 Sizes: Medium (Black or Brown)
 Small and Large (Black only)
 Price.....\$29.50

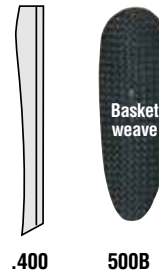

PART NO.	COLOR	BASE	SIZE	FACE SHAPE	FACE TEXTURE	LENGTH * (A)	WIDTH * (B)	INSERT WIDTH (F)	PAD THICKNESS (E)
00705	Brown	Black	Medium	Field	Bskt Weave	5.50"	1.80"	1.450"	.40"
00707	Black	Black	Small	Field	Bskt Weave	5.30"	1.68"	1.325"	.40"
00704	Black	Black	Medium	Field	Bskt Weave	5.50"	1.80"	1.450"	.40"
00701	Black	Black	Large	Field	Bskt Weave	5.75"	1.92"	1.575"	.40"

S325 Deluxe Upland Shotgun

The S325 Deluxe pads offer the same classic appearance and excellent recoil absorbing qualities of F325 but with a faster mounting upland or Skeet shape.



- Premium pad for Shotguns
- Excellent for Skeet & Upland Shooting
- Unique face allows a fast mount while controlling side movement



S325 Pad Specifications

Color: Black
 White Line®
 Sizes: Medium
 Price.....\$36.50



PART NO.	COLOR	BASE	SIZE	FACE SHAPE	FACE TEXTURE	LENGTH * (A)	WIDTH * (B)	INSERT WIDTH (F)	PAD THICKNESS (E)
00106	Black	White Line®	Medium	Skeet	Ribbed	5.40"	1.90"	No Insert	1.10"

F325 Deluxe Shotgun & Rifle

The F325 Deluxe pads are popular because of their classic appearance and excellent recoil absorbing qualities. These pads are an excellent choice for those who prefer a softer side to the pad for collar bone comfort.



- Premium Field Pad for Shotgun or Rifle
- Stippled face for non-slip
- Field style face for quick mounting



F325 Pad Specifications

Color: Black or Brown
 White Line® or Black base
 Sizes: Small, Medium and Large
 Price.....\$36.50

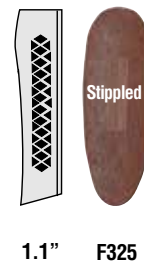

PART NO.	COLOR	BASE	SIZE	FACE SHAPE	FACE TEXTURE	LENGTH * (A)	WIDTH * (B)	INSERT WIDTH (F)	PAD THICKNESS (E)
00011	Brown	White Line®	Small	Field	Stipple	5.15"	1.80"	No Insert	1.00"
00007	Brown	White Line®	Medium	Field	Stipple	5.40"	1.95"	No Insert	1.10"
00002	Brown	White Line®	Large	Field	Stipple	5.70"	2.05"	No Insert	1.15"
00010	Black	White Line®	Small	Field	Stipple	5.15"	1.80"	No Insert	1.00"
00006	Black	White Line®	Medium	Field	Stipple	5.40"	1.95"	No Insert	1.10"
00001	Black	White Line®	Large	Field	Stipple	5.70"	2.05"	No Insert	1.15"
00310	Brown	Black	Small	Field	Stipple	5.15"	1.80"	No Insert	1.00"
00311	Brown	Black	Medium	Field	Stipple	5.40"	1.95"	No Insert	1.10"
00313	Black	Black	Small	Field	Stipple	5.15"	1.80"	No Insert	1.00"
00314	Black	Black	Medium	Field	Stipple	5.40"	1.95"	No Insert	1.10"
00315	Black	Black	Large	Field	Stipple	5.70"	2.05"	No Insert	1.15"

WARNING: This product can expose you to chemicals including Ethylene Thiourea, which is known to the State of California to cause cancer and/or birth defects or other reproductive harm. For more information go to www.p65warnings.ca.gov

D752B Decelerator® Old English

The D752B Decelerator® Old English pad delivers dramatic recoil reduction of the Decelerator® material with the popular Old English classic shape.



D752B Pad Specifications

Color: Black, Brown, Red
 Black base only
 Sizes: Small, Medium, Large, XL and Youth
 Price.....\$44.50



- Best selling Decelerator®
- “Old English Style Pad”
- Unique Pachmayr rounded edge design
- Recommended for Upland, Skeet, Sporting Clays and Rifle Shooting

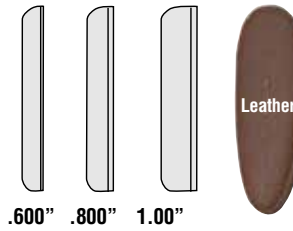

Available in three thickness shown

PART NO.	COLOR	BASE	SIZE	FACE SHAPE	FACE TEXTURE	LENGTH * (A)	WIDTH * (B)	INSERT WIDTH (F)	PAD THICKNESS (E)
01415	Black	Black	Small	Skeet	Leather	5.30"	1.68"	1.325"	.60"
01409	Black	Black	Medium	Skeet	Leather	5.50"	1.80"	1.450"	.60"
01403	Black	Black	Large	Skeet	Leather	5.75"	1.92"	1.575"	.60"
01417	Black	Black	Small	Skeet	Leather	5.30"	1.68"	1.325"	.80"
01412	Black	Black	Medium	Skeet	Leather	5.50"	1.80"	1.450"	.80"
01405	Black	Black	Large	Skeet	Leather	5.75"	1.92"	1.575"	.80"
01413	Black	Black	Small	Skeet	Leather	5.30"	1.68"	1.325"	1.00"
01407	Black	Black	Medium	Skeet	Leather	5.50"	1.80"	1.450"	1.00"
01401	Black	Black	Large	Skeet	Leather	5.75"	1.92"	1.575"	1.00"
01423	Red	Black	Medium	Skeet	Leather	5.50"	1.80"	1.450"	1.00"
01410	Brown	Black	Medium	Skeet	Leather	5.50"	1.80"	1.450"	.60"
01411	Brown	Black	Medium	Skeet	Leather	5.50"	1.80"	1.450"	.80"
01414	Brown	Black	Small	Skeet	Leather	5.30"	1.68"	1.325"	1.00"
01408	Brown	Black	Medium	Skeet	Leather	5.50"	1.80"	1.450"	1.00"
01402	Brown	Black	Large	Skeet	Leather	5.75"	1.92"	1.575"	1.00"
01380	Black	Black	Youth	Skeet	Leather	5.30"	1.68"	No Insert	1.00"



RED PADS

752B Old English

The Old English line remains immensely popular among Shotgunners due to its classic appearance and excellent recoil absorbing qualities. Rounded edges and Skeet style face provide quick, snag free mounting.



752B Pad Specifications

Colors: Black and Brown
 Black base only
 Sizes: Small, Medium, and Large
 Price.....\$35.50



- Fast mount, Classic design
- Skeet or Upland Shooting

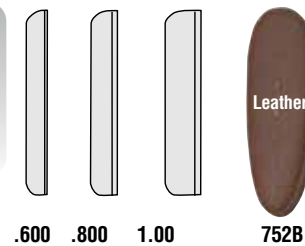

PART NO.	COLOR	BASE	SIZE	FACE SHAPE	FACE TEXTURE	LENGTH * (A)	WIDTH * (B)	INSERT WIDTH (F)	PAD THICKNESS (E)
01625*	Black	Black	Small	Skeet	Leather	5.30"	1.68"	1.325"	.60"
01615	Black	Black	Medium	Skeet	Leather	5.50"	1.80"	1.450"	.60"
01618	Black	Black	Medium	Skeet	Leather	5.50"	1.80"	1.450"	.80"
01621	Black	Black	Small	Skeet	Leather	5.30"	1.68"	1.325"	1.00"
01612	Black	Black	Medium	Skeet	Leather	5.50"	1.80"	1.450"	1.00"
01601	Black	Black	Large	Skeet	Leather	5.75"	1.92"	1.575"	1.00"

* OEM only



WARNING: This product can expose you to chemicals including Ethylene Thiourea, which is known to the State of California to cause cancer and/or birth defects or other reproductive harm. For more information go to www.p65warnings.ca.gov

DP200 & DP500 “Ultra Lite” Field Pads

Pachmayr DP200 and DP500's with Decelerator® ultra soft rubber technology offer the shooter a thin fast mounting 1/2" pad that is soft shooting.



DP200/DP500 Specifications

Color: Black only Black base only
 Sizes: Medium only
 (DP200 - Stipple only) (DP500 - Basketweave only)
 Price.....\$20.50

- Thin .500" pad mounts fast
- Classic field design
- Recommended for light to medium recoiling rifles and shotguns



PART NO.	COLOR	BASE	SIZE	FACE SHAPE	FACE TEXTURE	LENGTH * (A)	WIDTH * (B)	INSERT WIDTH (F)	PAD THICKNESS (E)
00426	Black	Black	Medium	Field	Stipple	5.40	1.95	No Insert	.500"
00450	Black	Black	Medium	Field	Bskt Weave	5.50	1.80	No Insert	.450"

D750B Decelerator® Field Style

The D750B Decelerator® Field Style pad delivers dramatic recoil reduction with a basketweave finish and a shape that is ideal for heavy recoiling rifles.



D750B Pad Specifications

Color: Black
 Black base only
 Sizes: Small, Medium and Large
 Price.....\$44.50

- Premium Rifle Pad
- Field style face for quick mounting and positive control
- Non-slip basketweave texture
- Recommended for heavy recoiling rifles

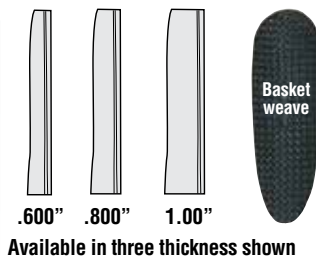

PART NO.	COLOR	BASE	SIZE	FACE SHAPE	FACE TEXTURE	LENGTH * (A)	WIDTH * (B)	INSERT WIDTH (F)	PAD THICKNESS (E)
01321	Black	Black	Medium	Field	Bskt Weave	5.50"	1.80"	1.450"	.60"
01325	Black	Black	Medium	Field	Bskt Weave	5.50"	1.80"	1.450"	.80"
01329	Black	Black	Small	Field	Bskt Weave	5.30"	1.68"	1.325"	1.00"
01317	Black	Black	Medium	Field	Bskt Weave	5.50"	1.80"	1.450"	1.00"
01305	Black	Black	Large	Field	Bskt Weave	5.75"	1.92"	1.575"	1.00"

SC100 Decelerator® Sporting Clay

A proven, unique design makes this the fastest mounting pad available. Made with a unique hard rubber heel and our famous Decelerator® Rubber, the Unique SC100 is the ideal choice for sporting clays shooting. The SC100 is also a superior pad for upland game or target shooting.



SC100 Pad Specifications

Color: Black, Brown or Red
 Black base only
 Sizes: Small, Medium, and Large
 Price.....\$58.98

- Unique design allows fastest mounting
- Old English classic good looks
- Decelerator® recoil absorption

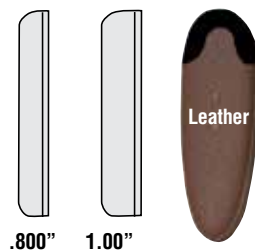

PART NO.	COLOR	BASE	SIZE	FACE SHAPE	FACE TEXTURE	LENGTH * (A)	WIDTH * (B)	INSERT WIDTH (F)	PAD THICKNESS (E)
03236	Brown	Black	Medium	Skeet	Leather	5.50"	1.80"	1.450"	1.00"
04856	Black	Black	Small	Skeet	Leather	5.30"	1.68"	1.325"	1.00"
03235	Black	Black	Medium	Skeet	Leather	5.50"	1.80"	1.450"	1.00"
03233	Black	Black	Large	Skeet	Leather	5.75"	1.92"	1.575"	1.00"
01912	Black	Black	Small	Skeet	Leather	5.30"	1.68"	1.325"	.80"
04793	Black	Black	Medium	Skeet	Leather	5.50"	1.80"	1.450"	.80"

WARNING: This product can expose you to chemicals including Ethylene Thiourea, which is known to the State of California to cause cancer and/or birth defects or other reproductive harm. For more information go to www.p65warnings.ca.gov

T550 Trap

The classic Pachmayr Trap design. Concave face and Double "X"™ sidecore design make for an attractive and comfortable pad. A favorite among competition Trap shooters.

Colors: Black
 White Line® only
 Sizes: Medium only
 Price.....\$42.50



1.1"

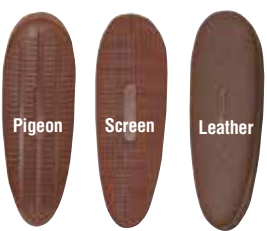

PART NO.	COLOR	BASE	SIZE	FACE SHAPE	FACE TEXTURE	LENGTH * (A)	WIDTH * (B)	INSERT WIDTH (F)	PAD THICKNESS (E)
00813*	Black	White Line®	Medium	Trap	Pigeon	5.35"	1.95"	No Insert	1.10"

* OEM only

D550 Decelerator® Trap

Our proven Trap design combined with the famous Decelerator® material for an attractive, functional pad for all trap shooting conditions. Great for .50BMG rifles.

Color: Black
 Black base only
 Sizes: Medium and Large
 Price.....\$59.98

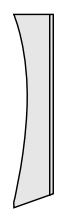

1.10"



PART NO.	COLOR	BASE	SIZE	FACE SHAPE	FACE TEXTURE	LENGTH * (A)	WIDTH * (B)	INSERT WIDTH (F)	PAD THICKNESS (E)
01303	Black	Black	Medium	Trap	Pigeon	5.35	1.95	1.450	1.10"
01301	Black	Black	Large	Trap	Pigeon	5.70	2.05	1.575	1.10"

XLT "Ultra Soft" Magnum Trap

After years of research and testing, Pachmayr engineers developed a trap pad that's almost 50% softer than the legendary Pachmayr Decelerator®. Even better, the super soft formula has the smooth grinding and installation characteristics of our popular Decelerator® pads.

Color: Black - Black base only
 Sizes: Medium & Large only
 Price.....\$60.75



1.2"



PART NO.	COLOR	BASE	SIZE	FACE SHAPE	FACE TEXTURE	LENGTH * (A)	WIDTH * (B)	INSERT WIDTH (F)	PAD THICKNESS (E)
01640	Black	Black	Medium	Trap	Leather	5.35"	1.95"	1.45"	1.1"
01641	Black	Black	Large	Trap	Leather	5.70"	2.05"	1.57"	1.2"

Find the Pachmayr® pad that meets your needs.

Pachmayr has a pad that will fit the needs of almost every shooter. The following suggestions will help you pinpoint your choices and find the pad for you. Template samples are available on our website to help you select the right size pad to fit your stock.

1. Select the Shape

What do you want the pad to do? How will you be using the rifle or shotgun? This will determine the face shape for optimum control.



Skeet

A convex pad design to make mounting the gun smooth without snagging. The skeet face is the best choice for wing shooting, skeet, or sporting clays.



Field

A combination of convex and concave shapes designed as a compromise for fast mounting and positive control.



Trap

A concave pad designed to provide a positive "hugging" grip on the shoulder. Specifically designed for Trap and Rifle shooting.

How much recoil absorption do you need? Pachmayr pads are available for all ranges of applications, from light to heavy recoil.

2. Consider the Core Design



Side Core

A side core design with the exposed XXXX configuration is the ultimate in recoil absorption because of the "shock absorbing" effect offered by the compressing "X" pattern. These pads have a solid base and are the best choice for those who may prefer a soft sided pad.



Bottom Core

A bottom core design is softer in the middle and has firmer sides to absorb the sharpest recoil. A classic appearance and availability in Decelerator® material makes this design the most popular and most copied Pachmayr design.

Stock Spacers

Need to add some length to your stock? Pachmayr spacers add approximately 1/4" each. Available in black and White Line® styles. Add up to four when installing a new pad or adding between existing pad and stock. White Line® accent spacers are available in 1/16".

- Easily add length to stock
 - White Line® and Black base styles
 - Add up to 1" in length
 - Gunsmith required
- Black Spacer(#02455) \$9.98
 White Spacer(#03472) \$9.98

3. Pick the Face Texture

How much control do you require in your shoulder? Will you be quick mounting or secure in your position for careful sighting? Face Texture will also play a role in your selection. Pachmayr offers several textures to optimize your shooting.



Leather Ribbed Line Checkered Stippled Basket weave Grooved Pigeon

Light Face Texture

Leather and ribbed faces are "light" face textures. These will maximize your speed when mounting.

Medium Face Texture

Line Checkered and stipple are "medium" face textures; best for use in field applications.

Heavy Face Texture

Basketweave and grooved are "heavy" face textures; best for precision shooting and big bore rifles. Our ultimate heavy design is pigeon, used ideally in live bird shoots and trap.

4. Find the Right Size Pad

Note: Pad and insert dimensions can vary for pad models.

1. It is best to measure your stock with the butt plate or old pad removed.
2. Always choose the pad size that is larger than your stock width and longer than the stock length to allow for toe angle.
3. Pads with inserts cannot be trimmed under the minimum width noted.
4. Keep in mind, it is not necessary for the pad holes to match your stock, since new holes should be drilled.
5. Complete size dimensions for each pad are printed on packaging.
6. Each pad comes with complete instructions.



Shock Shield

The Shock Shield is the simple solution to reducing recoil in a variety of rifles and shotguns. No need for different size pads, as its one size design stretches and contours to a variety of stock shapes and dimensions. Filled with a pocket of soft gel, felt recoil is greatly reduced. Easy on and easy off. Simply stretch it over the butt of your firearm. Keep one in your range bag so you always have it handy!

- Soft gel pad for greatly reduced recoil
- One size stretches to fit most rifles and shotguns
- Easy on and easy off
- Won't harm stocks
- Non-slip pad face texture

Shock Shield (#04428) \$20.75



Renegade® Slip-On Recoil Pads

Comfort doesn't have to cost you an arm (or a shoulder)!! Pachmayr has been the number one source for recoil pads for many years. We are proud to introduce a new line of slip-on pads that offers excellent recoil absorption, a clean modern appearance, and 1" of additional length of pull, all at a great price. The pads will be offered in black and brown, and be available in small, medium and large sizes. Comfort and performance doesn't have to be expensive.

Small Black (#04420) \$13.75
 Medium Black (#04421) \$13.75
 Large Black (#04422) \$13.75

 Small Brown (#04423) \$13.75
 Medium Brown (#04424) \$13.75
 Large Brown (#04425) \$13.75



Brown	Fits Stocks	Part #
Small	1-1/2" to 1-5/8" wide x 4-3/4" to 4-7/8" long	#04418
Medium	1-1/2" to 1-3/4" wide x 5" to 5-3/16" long	#04417
Large	1-3/4" to 1-7/8" wide x 5-3/16" to 5-7/16" long	#04416
Black	Fits Stocks	Part #
Small	1-1/2" to 1-5/8" wide x 4-3/4" to 4-7/8" long	#04414
Medium	1-1/2" to 1-3/4" wide x 5" to 5-3/16" long	#04413
Large	1-3/4" to 1-7/8" wide x 5-3/16" to 5-7/16" long	#04412



No other slip on has the unique Pachmayr Speed-Mount insert.

Decelerator® Slip-On Recoil Pads

Combining the advanced recoil control of the popular Decelerator® internal design and material with Pachmayr's unique insert, this great looking slip-on recoil pad is unmatched by any other hunting pad. In addition, the pad's material and design make installation easier than ever. A Pachmayr original design, the Speed-Mount insert gives hunters and target competitors alike the benefit of smooth, snag-free mounting while delivering maximum recoil reduction.

Price \$24.98

Brown	Fits Stocks	Part #
Small	1-1/2" to 1-5/8" wide x 4-3/4" to 4-7/8" long	#04418
Medium	1-1/2" to 1-3/4" wide x 5" to 5-3/16" long	#04417
Large	1-3/4" to 1-7/8" wide x 5-3/16" to 5-7/16" long	#04416
Black	Fits Stocks	Part #
Small	1-1/2" to 1-5/8" wide x 4-3/4" to 4-7/8" long	#04414
Medium	1-1/2" to 1-3/4" wide x 5" to 5-3/16" long	#04413
Large	1-3/4" to 1-7/8" wide x 5-3/16" to 5-7/16" long	#04412

Grappler



- OAL: 8.0" Blade: 3.40"
- 8Cr14Mov steel
- Liner lock
- Grappler G-10 handle
- Gray/Black
- Green/Black
- 2 way clip
- Ball Bearing
- Jimping on spine
- Flip assist

Blacktail



- OAL: 6.75" Blade: 3.0"
- 8Cr13Mov Steel
- Drop Point Blade
- Black Aluminum Body
- Flipper and ball bearing assist
- Jimping on spine

Griffin



- OAL: 7.80" Blade: 3.45"
- 5Cr15Mov Steel
- Classic Renegade Wood Handle
- Ball bearing assist w/liner lock & flipper
- 2 way clip
- Jimping on spine

Snare



- OAL: 7.0" Blade: 2.85"
- 8Cr14Mov steel
- FDE and OG G10 handle
- Liner lock w/ball bearing assist
- 4 way clip, blackened
- Jimping on spine

Grunt



- OAL: 7.75" Blade: 3.30"
- D2 steel
- G10 handle w/cross hatch texture
- Skeletonized liner
- Jimping on spine
- Ball bearing Liner lock
- 2 way clip, blackened

Dominator



- OAL: 8.5" Blade: 4.75"
- D2 steel
- Full ground blade with Kydex sheath
- G10 Handle, fine grappler texture
- Black/Gray or Black/Green
- Jimping on spine

Grappler Folding Knife Grey/Black (#04291)	\$33.98
Grappler Folding Knife Green/Black (#04292)	\$33.98
Blacktail Folding Knife (#04293)	\$29.50
Griffin Folding Knife (#04294)	\$33.98
Snare Folding Knife FDE (#04295)	\$39.98
Snare Folding Knife OD Green (#04296)	\$39.98
Grunt Folding Knife (#04297)	\$52.98
Dominator Fixed Blade Knife Grey/Black (#04298)	\$120.98
Dominator Fixed Blade Knife Green/Black (#04299)	\$120.98

G10 Tactical® Knife

Liner Lock Folding Knife with Black 420 High Carbon Stainless Steel Drop Point Blade, Blue G10 Handle with Safety Lock, and Heavy Duty Belt Clip.

G10 Tactical Knife (#03095)
\$18.50



LET YOUR GRIPS SHOW YOUR STYLE!

1911 Diamond Pro Grip



Building on the success of our popular Diamond Pro revolver grips, Pachmayr is proud to announce the addition of the 1911 Diamond Pro grip. Our first Diamond Pro semi-auto pistol grip is made from Pachmayr's proprietary blended rubber compound designed for enhanced shooting comfort and control. It has an aggressive, yet comfortable texture allowing for optimum recoil control and is equipped with low profile finger grooves which provide fast, positive hand placement. If desired, the front strap finger groove section could also be trimmed away to allow for use as grip panels.

This new pistol grip sets the standard for comfort and control, along with a stylish appearance.

Fits all standard full size 1911 frames with standard or ambidextrous safeties.

- Sets the standard for comfort and control
- Low profile finger grooves for fast, positive hand placement
- Proprietary rubber compound blend
- Sleek, modern appearance
- Fits ambidextrous safeties

Diamond Pro Grip 1911 (#02470) \$27.50

Custom Series Pearl Pistol Grips



Pachmayr's Brilliant Pearl grips add the ultimate custom look to your 1911. Our Brilliant Pearl grips replicate the appearance and feel of actual mother of pearl but at a much lower cost. Brilliant Pearl grips are strong and weather-resistant, as well as offering a smooth gripping surface which will not snag on clothing for concealed carry. Brilliant Pearl grips are available in both Black and White colors and have a recess cut for 1911's with ambidextrous safeties.

1911 Black Pearl Smooth (#62000) \$29.98
 1911 White Pearl Smooth (#62001) \$29.98
 1911 Cherry Blossom Pearl Smooth (#62005) . . \$29.98

Custom Series Carbon Fiber Pistol Grips



Pachmayr's Carbon Fiber 1911 G10 grips provide the toughness and strength of carbon fiber, while also adding to the appearance of your pistol. The carbon fiber weave offers a truly unique high tech look to your 1911, while also providing a strong, weatherproof set of grips. The grips are constructed with a tough G10 base, covered with a carbon fiber weaver. The smooth outer grip surface will not snag on clothing, making them perfect for concealed carry. Pachmayr carbon fiber 1911 grips have a recess cut for models with ambidextrous safeties.

1911 Carbon Fiber G10 (#62020) \$120.50

Custom Series Aluminum Pistol Grips



Pachmayr's Custom Series Aluminum grips are a stylish, tough and lightweight addition to your 1911 or Sig 938 pistol. The double-diamond checkering pattern adds classic good looks, while providing a non-slip grip surface. The black anodized aluminum grips are strong and impervious to weather or chemicals, and will also work on models with ambidextrous safeties.

1911 Aluminum Black Checkered (#62050) \$29.98
 Sig 938 Aluminum Black Checkered (#62060) . . \$29.98



**Sleek,
Stylish &
Durable**



G10 Tactical® Pistol Grips



G-10 material is a fiber glass based epoxy resin laminate. It is an extremely tough and durable material that is impervious to moisture, weather or chemicals, making it a perfect material for handgun grips. The multiple layered construction allows the use of different colors to be added to the grips, which create attractive patterns as it is machined. Our Pachmayr G10 Tactical pistol grips are available in two textures, our coarse Grappler pattern or checkered, and two color patterns, green/black and gray/black. Pachmayr G10 Tactical grips are the toughest, most durable and best looking grips available. Available to fit 1911's, Sig 238's and 938's, Ruger Mk III, 22/45's, Beretta 92's, and CZ 75's

G10 Tactical Pistol Grips \$45.98

- 1911 Green/Black Checkered (#61000)
- 1911 Gray/Black Checkered (#61001)
- 1911 Green/Black Grappler (#61010)
- 1911 Gray/Black Grappler (#61011)

- P238 Green/Black Checkered (#61020)
- P238 Gray/Black Checkered (#61021)
- P238 Green/Black Grappler (#61030)
- P238 Gray/Black Grappler (#61031)

- P938 Green/Black Checkered (#61040)
- P938 Gray/Black Checkered (#61041)
- P938 Green/Black Grappler (#61050)
- P938 Gray/Black Grappler (#61051)

- Ruger Mark II/III Green/Black Checkered (#61060)
- Ruger Mark II/III Gray/Black Checkered (#61061)
- Ruger Mark II/III Green/Black Grappler (#61070)
- Ruger Mark II/III Gray/Black Grappler (#61071)

- Beretta 92 FS Green/Black Checkered (#61080)
- Beretta 92 FS Gray/Black Checkered (#61081)
- Beretta 92 FS Green/Black Grappler (#61090)
- Beretta 92 FS Gray/Black Grappler (#61091)

- CZ 75 Gray/Black Checkered (#61101)
- CZ 75 Green/Black Grappler (#61110)

- Ruger 22/45 Green/Black Checkered (#61120)
- Ruger 22/45 Gray/Black Checkered (#61121)
- Ruger 22/45 Green/Black Grappler (#61130)
- Ruger 22/45 Gray/Black Grappler (#61131)

- CZ75 Compact G10 Green/Black Checkered ... (#61112)
- CZ75 Compact G10 Gray/Black Checkered ... (#61113)
- CZ75 Compact G10 Green/Black Grappler (#61114)
- CZ75 Compact G10 Gray/Black Grappler (#61115)

- 1911 Officer G10 Green/Black Checkered (#61140)
- 1911 Officer G10 Green/Black Grappler (#61150)
- 1911 Officer G10 Gray/Black Grappler (#61151)

- Ruger MarkIV Gray/Black Checkered (#61076)
- Ruger MarkIV Gray/Black Grappler (#61075)





Renegade™ Wood Laminate Pistol Grips

Pachmayr's deluxe wood laminate pistol grips are the ultimate in style and function. The wood laminate panels are highly polished and checkered, and available in two colors, Rosewood and Charcoal Silvertone. The Rosewood laminate provides classic good looks, while the Charcoal Silvertone perfectly accents stainless steel frames. The precision CNC cut checkering patterns provide a secure grip while maintaining the grip's attractive appearance. Available to fit 1911's, Ruger Mk III and 22/45's, Beretta 92's, CZ 75's and Sig 238's and 938's

- Polished wood laminate with tasteful checkering
- Available in Rosewood and Charcoal Silvertone
- Improves appearance and function
- Available for most popular semi-auto models



- 1911 Double Diamond Rosewood (#00440)
- 1911 Double Diamond Chk Charcoal Silvertone (#00441)
- 1911 Half Checkered Charcoal Silvertone (#00446)
- Beretta 92 Checkered Rosewood (#63200)
- CZ 75/85 Checkered Rosewood (#63220)
- CZ 75/85 Checkered Charcoal (#63221)
- Sig P238 Checkered Rosewood (#63140)
- Sig P238 Checkered Charcoal (#63141)
- Sig P938 Checkered Rosewood (#63160)
- Sig P938 Checkered Charcoal (#63161)
- Ruger Mark II/III Checkered Charcoal (#63181)

- Ruger 22/45 Checkered Rosewood (#63240)
- Ruger 22/45 Checkered Charcoal (#63241)
- CZ75 Compact Rosewood Checkered (#63230)
- CZ75 Compact Charcoal Checkered (#63231)
- 1911 Officer Rosewood Double Diamond . . . (#63250)
- 1911 Officer Charcoal Double Diamond (#63251)
- Browning Hi Power Rosewood Checkered . . . (#63270)
- Browning Hi Power Charcoal Smooth (#63281)
- Renegade Wood Laminate Pistol Grips \$32.00





Model #05158 Fits:
Ruger SR9 & SR40



Model #05160 Fits:
Beretta 92 FS, M9,
PX4 Storm



Model #05161 Fits:
Glock 42, 43, Kahr PM9,
PM40, MK9, MK40, CM9,
CM40



Model #05162 Fits:
CZ 75/85



Model #05163 Fits:
Kahr P45, CW45, TP9,
TP40, TP45, CT40, CT45,
Sig 320 Full & Carry



Model #05164 Fits:
Glock 17, 20, 21, 22,
31, 34, 35, 37



Model #05166 Fits:
S&W Sigma, Walther P99,
Taurus 24/7 (Full Size)
S&W M&P 2.0 Compact



Model #05167 Fits:
Sig P320 Compact
Glock 43X and 48



Model #05168 Fits:
Sig 220, 226, 228, 229,
Mosquito



Model #05170 Fits:
Springfield XD, XD(M)
Full Size Frames



Model #05172 Fits:
S&W M&P, M&P 2.0
Full Size



Model #05173 Fits:
*S&W Bodyguard 380
Kahr P380



Model #05174 Fits:
Glock Compacts 19, 23,
25, 32, 38



Model #05175 Fits:
Glock Sub Compacts 26, 27,
28, 29, 30, 33, 36, 39



Model #05176 Fits:
*Ruger LCP, Taurus TCP,
Kel-Tec P-3AT & P32,
Beretta Nano



Model #05177 Fits:
*Ruger LC9, LC380, SR9C, Sig P365,
P938, P238, P320 Sub-Comp, Kahr
PM9, PM40, MK 9 & 40, CM 9 & 40,
Spfd Hellcat.



Model #05178 Fits:
*Springfield XD(S)

*Plain front strap,
no finger grooves



Model #05179 Fits:
*S&W M&P Shield, Ruger
SR22, Walther PPS, Taurus
PT 740 Slim, PT 709 Slim

TACTICAL GRIP GLOVES™

These "Stretch-to-fit" Grip Gloves are custom molded for each top-selling pistol model. This makes them ideal for the popular polymer frame handguns which have no replacement grips available.

In addition, Pachmayr Decelerator® material delivers proven recoil reduction and enhanced control that no

other slip-on can match. They also have the right shape and flexibility to make installation "a snap" – no trimming, tearing or hard work - just a perfect fit.

Finally, the distinctive ventilated side panels and custom fit provide more instinctive gun orientation, enhanced control and they look more professional than the old, one-size-fits-all rubber band models. Tactical Grip Gloves are the only ones that "fit like a glove."

Tactical Grip Gloves \$11.98

See part numbers under individual photos



Concealed Carry

Our concealed carry models feature custom left and right handed palm swells to make the gun fit your hand perfectly.

Tactical Grip Glove™ for Mossberg Shockwave & Remington Tac-14

The Mossberg Shockwave and Remington Tac-14's have become two of the most popular weapons to be introduced in recent years. Their 14" barrels and unique birds head style pistol grip makes them fast and maneuverable, however they do also pack quite a kick. With this in mind, Pachmayr now introduces a new Tactical Grip Glove, developed specifically for these firearms. This slip-on grip is easy to install and offers much better control as well as reducing recoil of the Shockwave and Tac-14. The grip features a single finger positioning groove, non-slip texturing and a thicker padded area to give the palm of your hand better protection from recoil.

Tactical Grip Glove for Moss Shockwave & Rem Tac 14 (#05103). \$13.98



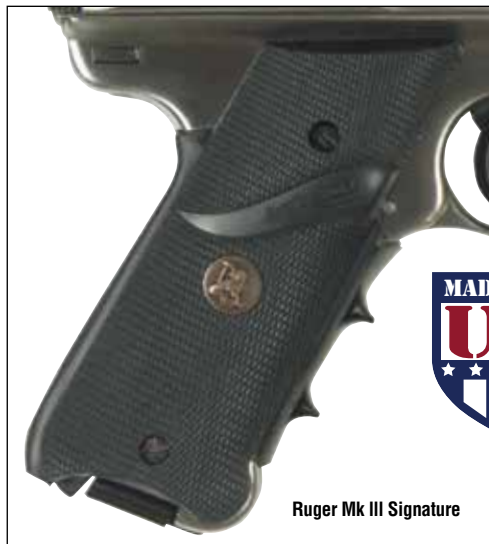

Ruger Mk III Signature



Kimber Ultra Carry II
Uses Co-45 Grip

Signature™ Grips With Backstraps 

Pachmayr Signature Grips feature our unique full wrap-around design and are made from rubber specially formulated for use on semi-automatic pistols. This rubber compound gives them a feel that is unmistakably Pachmayr. Built-in steel inserts ensure they maintain their shape. Signature Grips are the overwhelming choice of competitive shooters and law enforcement personnel alike. Available in the widest variety of models for most of the popular semi-automatic pistols. Each is designed for a specific pistol and its anticipated use. (See chart below.)

Signature™ Grips Without Backstraps 

These models of Pachmayr Signature Grips also feature our unique full wrap-around design, are also made from rubber specially formulated for use on semi-automatic pistols, but are supplied without backstraps so they can be used on pistols such as the Government .45 models that utilize grip safety mechanisms. They are offered in the same styles as the Pachmayr Full Signature Grips; Checkered, Thumb Reduction Combat, Sculptured Thumb Reduction Combat and Combat Plus finger groove. (See Chart below.)

Gun Mfr.	Description	Standard	Combat Gripper™
Beretta	84, D/A 380	B84 02485 (\$48.98)	
	B92FS/D/G, 96FS/D/G		B92FS-G* 02500 (\$48.98)
Browning	9mm Hi-Power & Adj. Sight Version		B-HPCG* 03952 (\$48.98)
	Military Hi-power Mk III	B-HP 02420 (\$49.98)	
	.380 ACP BDA	BDA380 02437 (\$49.98)	
Colt	1911, 1911A1 & copies, Gold Cup	GM-45/C 02921** (\$38.98)	
	Mk IV, Series 80, Delta Elite (See photos below)	GM-45 02919 (\$38.98)	GM-G* 05008 (\$37.98)
	Officer's Model	CO-45 02545 (\$38.98)	
Ruger	Mk III & Mk II	MkIII 03482 (\$48.98)	
S & W	39, 439, 539, 639 (1st & 2nd Gen.)	SW-39 03306 (\$48.98)	
Taurus	PT-92, PT-99, 100DC, 101DC (Decocker models)		PT-99D/G* 05043 (\$48.98)

*Model with Finger Groove **Combat Version

Colt 1911 Signature™ Grips Without Backstraps



1911 GM-45/C 

Signature™ Checkered Combat This grip has a flat side panel design and a checkered front strap.



1911 GM-45 

Signature™ Checkered with Thumb Swell This grip has raised front swells and a checkered front strap.



1911 GM-G 

Signature™ Combat Plus Finger Groove This grip has increased magazine release clearance, finger groove front strap, and will work on pistols with ambidextrous safeties.



Signature™ Grip for the Ruger Mark III & Mark II 

Pachmayr Classic wrap-around, finger groove design and Pachmayr material assure the most comfortable and secure grip for superior control and consistent hold.
Ruger Mark III Grip (#03482) \$48.98



American Legend™ Grip Models for 1911 

With proven recoil absorbing rubber panels, comfortable finger grooves and attractive wood trim, Pachmayr's popular American Legend Grips now offer a range of eye-catching colors. Choose Rosewood, Charcoal Silvertone, or Heritage Walnut laminate or be bold with Tropical Purple or Evergreen Camo. All feature the popular American Legend wraparound design with relief cuts for ambidextrous safeties and mainspring housing pin cut-out. Whether for blued, stainless or any finish, these new American Legend Grips will enhance both the looks and handling of 1911.

- 1911 Rosewood Laminate (#00423)
- 1911 "Charcoal Silvertone" Laminate (#00433)
- 1911 "Heritage Walnut" Laminate (#00434)
- 1911 "Passionwood" Laminate (#00431)
- 1911 "Evergreen Camo" Laminate (#00432)
- ALS 1911 Grips \$50.98

America's most trusted name in recoil reduction, firearms tools and accessories.

The classic combination of form and function - Pachmayr's American Legend grips combine the look of beautiful wood grain panels with the feel of soft, sturdy rubber to ensure a solid grip.

Classic - Just what you expect from Pachmayr®.



American Legend™ Grip Series for S&W Revolvers 

By popular demand, Pachmayr brings back – and improves – their American Legend Grips for Smith & Wesson "J", "K & L" and "N" Frame Round Butt models. The grips have updated and improved contours to evenly distribute and disperse recoil by better filling the hand.

The wraparound rubber panels that are the hallmark of these classic grips fit the wood panels with tighter tolerances than earlier designs. In addition, the grips are now offered in both traditional Rosewood and new Charcoal laminates for great looks on either blued or stainless models.

- S&W "J" Frame - Rosewood (#00455)
- S&W "J" Frame - Charcoal Silvertone (#00456)
- S&W "K&L" Frame - Rosewood (#00460)
- S&W "K&L" Frame - Charcoal Silvertone (#00461)
- S&W "N" Frame - Rosewood (#00465)
- S&W "N" Frame - Charcoal Silvertone (#00466)
- Fits Round Butt Frames.
- ALS Revolver Grips \$69.98



 **WARNING:** Cancer and Reproductive Harm
www.p65warnings.ca.gov

Gripper Universal Slip-On



Gripper™ Slip-On Grip

Pachmayr's Gripper Slip-On Grip has a unique design and contour, allowing it to fit a large variety of popular medium to full size pistols. The Gripper Slip-On features an attractive non-slip texture along with palm swells for great fit and control. Molded in trim lines also allow you to custom fit the grip to your pistol. Perfect for Glock and other polymer frame pistols.

- Optimal size to fit a large variety of pistols.
- Gripper Slip-On Grip can be trimmed for a customized fit and feature molded trim lines to provide a clean, even cut.
- Comfortable finger grooves offer increased control.
- Backside of finger grooves are recessed to allow use on pistols with or without finger grooves, perfect for all generations of Glock's.
- Non-slip texture and palm swells for great fit and control.
- Made from a tough rubber compound, the Gripper Slip-On is impervious to weather, sweat, oils & solvents.
- Perfect for Glock and other polymer frame pistols.

This grip will fit the following pistols (some models may require trimming):

- Glock 19, 23, 25, 32, 38
- Glock 17, 20, 21, 22, 31, 34, 35, 37
- S&W M&P Full Size & Compact
- S&W M&P Full Size & Compact
- S&W M&P M2.0 Full Size & Compact
- S&W Sigma, SD, SD VE
- Sig 226, 228, 229
- Sig P320 Full Size & Compact
- Ruger SR9, Ruger 22/45
- Beretta 92, 96
- CZ 75, CZ P-07
- Walther P99
- Hi Point 380/9mm/40/45
- Browning Hi-Power
- H&K USP

Note: Not for use on pistols with grip safeties.

- Gripper Universal Slip-On Black (# 05125) \$10.20
- Gripper Universal Pistol Slip-On FDE (# 05126) . . \$10.20



Vindicator® Pistol Grips



Vindicator® pistol grips for shotguns have our unique air pocket recoil chamber to reduce shock, while our checkered rubber provides a vastly better grip than hard molded synthetics. Makes recoil feel less intense. Improves accuracy on second and later shots. Installs in 15 minutes or less.

Rem 870 Presentation Grip G-870R(#04171) . . . \$68.50

T/C Contender Grip and Forend



The Thompson/Center Contender is a fine hunting handgun, it also packs quite a kick. The best way to control that recoil is with a Pachmayr Rubber Grip. Our Decelerator® Gripper™ model with finger grooves provides the ultimate in recoil control. (Does not fit G2)

TC Contender Gripper Decelerator® (#05054) . . . \$87.50

TC Contender Forend w/ Adapter (#03373) \$89.98

TC Contender Adapter for Forend Only (#03381) \$49.98



WARNING: Cancer and Reproductive Harm
www.p65warnings.ca.gov

GuardianGrip

Pachmayr's new GuardianGrip is a revolutionary and innovative design made for popular concealed carry revolvers. What makes the GuardianGrip so unique is its patented finger extension. With the simple press of a button, the spring loaded finger extension drops down out of the grip, converting a two finger compact grip into a controllable three finger grip. This is the first grip which allows the concealment of a compact grip with the shooting control of a full size grip.

- Carries like a compact, shoots like a full size grip
- Convert from a 2 finger grip to a 3 finger grip with the press of a button
- Contoured for use with Speedloaders
- Impervious to moisture, weather or chemicals
- Open backstrap design with checkered grip panels

GuardianGrip S&W J Frame (#02605) \$49.98
 GuardianGrip Ruger LCR (#02607) \$49.98
 GuardianGrip Taurus 85/856 (#02608) \$49.98



Aluminum Competition Speedloaders

Pachmayr's new revolver Speedloaders will set the standard for quality and performance. Unlike competitive models which are made of plastic, Pachmayr's Speedloaders are precision CNC machined from solid aluminum. The Speedloader bodies are cut in a polygon shape which produces the smallest possible outside dimensions and allows them to easily fit compact revolvers. The Speedloaders are also equipped with a rattle eliminating o-ring which contacts the cartridge bases and firmly holds the rounds in place. Cartridges are released with a simple twist of the large knurled knob. Speedloaders are available for the S&W "J" frame/Ruger LCR, as well as S&W "K" and S&W "L" frame revolvers.

- Available for .38/357 S&W "J" frame/Ruger LCR, as well as S&W "K" and S&W "L" frame revolvers (These Speedloaders will also fit other popular models. See package for details.)
- CNC machined from solid aluminum
- Polygon shape for the smallest outside dimensions
- Cartridges are held firmly with no rattle
- Simple twist knob cartridge release

J Frame .38/357 5-Shot (#02650) \$25.00
 K Frame .38/357 6-Shot (#02652) \$25.00
 L Frame .38/357 6-Shot (#02654) \$25.00
 N Frame .44 6-Shot (#02655) \$25.00
 Ruger LCR, SP101, 327 Federal 6-Shot (02651) \$25.00



Speedloaders fit the following models:

02650: S&W J Frames, Ruger LCR, Ruger SP101, Taurus 85, Rossi 68

02652: S&W K Frames; Taurus 65, 66, 80, 82, 856; Rossi 971, 951, 851, Colt Cobra, New King Cobra

02654: S&W L Frames; Ruger GP100 Python

02655: S&W N Frames, Dan Wesson; Ruger Redhawk, Super Redhawk; Colt Anaconda; Taurus .44, 444 Raging Bull

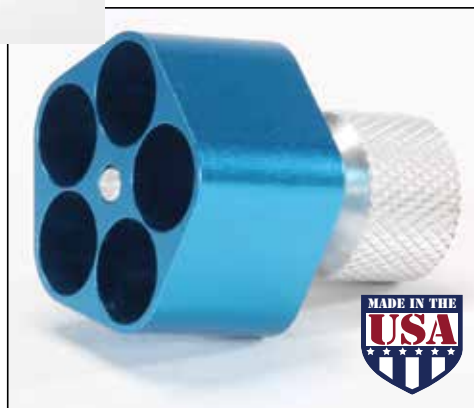

G10 fiberglass-based laminate is tough and durable



G10 Tactical™ Revolver Grips

Pachmayr's Deluxe Revolver Grips are the ultimate in style and function.

Now available in G10 designs.

G-10 material is a fiberglass-based epoxy resin laminate. It is an extremely tough and durable material that is impervious to moisture, weather or chemicals, making it a perfect material for handgun grips. The multiple layered construction allows the use of different colors to be added to the grips, which create attractive patterns as it is machined.

- J Frame G10 Gray/Black Checkered (#61161)
- Ruger SP101 G10 Gray/Black Checkered (#61221)
- Ruger LCR G10 Gray/Black Checkered (#61232)
- Ruger LCR G10 Red/Black Checkered (#61242)
- Taurus 85 G10 Gray/Black Checkered (#61252)
- Renegade Wood Laminate Revolver Grips \$79.98

Renegade™ Wood Laminate Revolver Grips



Pachmayr's Deluxe Laminate Revolver Grips are the ultimate in style and function. The highly polished wood laminate panels are offered either checkered or smooth. The Deluxe Laminate Grips are available in two colors, Rosewood and Charcoal Silvertone. The Rosewood laminate provides classic good looks, while the Charcoal Silvertone perfectly accents stainless steel frames. The precision CNC cut checkering patterns provide a secure grip while maintaining the grips attractive appearance. The smooth finish is often preferred for concealed carry. Available for Smith & Wesson round butt, "J", "K&L", and "N" frames

- S&W J Frame Checkered Rosewood (#63000)
- S&W J Frame Checkered Charcoal Silvertone . (#63001)
- S&W J Frame Smooth Rosewood (#63010)
- S&W J Frame Smooth Charcoal Silvertone . . (#63011)
- S&W K&L Frame Checkered Rosewood (#63020)
- S&W K&L Frame Checkered Charcoal Silvertone (#63021)
- S&W K&L Frame Smooth Rosewood (#63030)
- S&W K&L Frame Smooth Charcoal Silvertone . (#63031)

- S&W N Frame Checkered Rosewood (#63040)
- Ruger SP101 Grip Rosewood Checkered (#63060)
- Ruger SP101 Grip Rosewood Smooth (#63070)
- Taurus 85 Rosewood Checkered (#63080)
- Taurus 85 Rosewood Smooth (#63090)
- Renegade Wood Laminate Revolver Grips \$46.98

Polished laminate wood with tasteful checkering or smooth finish



1911 Diamond Pro Grip

Building on the success of our popular Diamond Pro revolver grips, Pachmayr is proud to announce the addition of the 1911 Diamond Pro grip. Our first Diamond Pro semi-auto pistol grip is made from Pachmayr's proprietary blended rubber compound designed for enhanced shooting comfort and control. It has an aggressive, yet comfortable texture allowing for optimum recoil control and is equipped with low profile finger grooves which provide fast, positive hand placement. If desired, the front strap finger groove section could also be trimmed away to allow for use as grip panels.

This new pistol grip sets the standard for comfort and control, along with a stylish appearance.

Fits all standard full size 1911 frames with standard or ambidextrous safeties.

- Sets the standard for comfort and control
- Low profile finger grooves for fast, positive hand placement
- Proprietary rubber compound blend
- Sleek, modern appearance
- Fits ambidextrous safeties

Diamond Pro Grip 1911 (#02470) \$27.50



**The softest,
best fitting,
best feeling
handgun grips
ever!**



Diamond Pro Revolver Grips

Pachmayr's Diamond Pro™ Series revolver grips have taken the revolver-shooting community by storm! These "Diamond Plate" textured, one-piece grips transform popular revolvers. The soft grips replace standard factory models by easily slipping over and fully wrapping around the revolver's grip frame – with no gaps or seams.

This new line of revolver grips has set a new standard with a modern look, and the extreme comfort and con-

trol shooters have come to expect from Pachmayr.

These grips fill the hand comfortably, with a natural feel and point. The unique shape is covered with our "Diamond Plate" texture, which gives you rugged good looks and absolute control of your revolver, even under the heaviest recoil. Pachmayr's proprietary blended rubber grip compound is formulated to give you the long lasting soft feel you expect and the best in recoil reduction you deserve.

The Diamond Pro™ series offers models to fit the popular line of Ruger Revolvers, including the Ruger LCR, the SP101 and the GP100, as well as Taurus Revolvers, including the Judge, Raging Bull, Tracker and Public Defender (standard and polymer frames), and the Smith & Wesson "J", "K&L", and "N" Frame Round Butt models.

Diamond Pro Grips \$27.50



- S&W "N" Frame Round Butt (#02480)
- S&W "K&L" Frame Round Butt (#02479)
- S&W "J" Frame Round Butt (#02478)



- Ruger GP100 (#02484)
- Ruger SP101 (#02483)
- Ruger LCR (#02482)



- Taurus Compact Public Defender (#02474)
- Taurus Compact Public Defender (Polymer) (#02475)

Presentation Grips



The first grip design developed by Frank Pachmayr. This popular grip has been the mainstay of our line since the beginning and it remains popular. Pachmayr Presentation Grips feature our unique design, classic styling, and a magnificent finish with deep checkering for control and a superb shiny finish.

Price \$43.50

Decelerator® Grips



All guns recoil, and recoil affects your accuracy, control, and overall shooting enjoyment. For those shooters who want the most out of their shooting experience, Pachmayr offers the Decelerator® Grips — 50% softer than a regular grip. The Finger Groove Decelerator® Grip is designed to control the recoil produced by a powerful revolver. Combined with recoil absorbing air cushions along the backstrap, this grip is ideal for shooters that require the ultimate control and shooting comfort.

Price \$48.50

Compac™ Grips



Pachmayr Compac Grips are made from a specially formulated black rubber compound and are designed to maintain concealability. Although compact in design, Compac Grips still give a shooter total control, Compac Grips provide a secure, non-slip finish. That's why they are the plainclothes officer's preferred way to a more positive grip without compromising concealability.

Price \$43.50

Gripper™ Grips



Pachmayr Gripper Grips for revolvers are made from a specially formulated rubber compound optimized for control and recoil absorption. The finger groove style is popular for combat shooting and hunting. A slight palm swell fills the hand but is not so large as to be uncomfortable. Gripper Grips are fully checkered for appearance as well as for control. Designed for correct hand position.

Price \$43.50

Gripper™ Professional Grips



These are smaller versions of our Gripper models. The design has an open back-strap and the overall shape has been downsized. This design makes it possible for shooters with small hands or shorter fingers to better reach the trigger and obtain the advantages of a reliable combat-style Pachmayr grip.

Price \$43.50

Compac™ Professional Grips



These are smaller versions of our Compac models that provide an even greater degree of concealability. The design has an open back strap and the overall shape has been downsized. Like the Gripper Pro series, this design makes it possible for shooters with small hands or a shorter finger to better reach the trigger and obtain the advantages of a reliable Pachmayr grip. Available in models to fit many popular revolvers.

Price \$43.50

Pachmayr® Grips
are all Proudly





GUN MFR.	DESCRIPTION	Presentation	Gripper™	Gripper™ Decelerator®	Gripper™ Professional	Compac™ & Compac™ Pro
Charter Arms	Bulldog (All Models)		CHA-G 02521			CHA/C 02523
	.22 L.R. Off Duty		CHA-G 02521			CHA/C 02523
	.22 L.R. Pathfinder (All Models)		CHA-G 02521			CHA/C 02523
	Undercover (All Models)		CHA-G 02521			CHA/C 02523
	.32 S&W Undercoverette (All Models)		CHA-G 02521			CHA/C 02523
Colt	Agent, Cobra, Det. Special, Police Pos. Special,					
	Agent, Cobra, Det. Special, Police Pos. Special,					
	Diamond Back, (Newer Small Frame)		CD-G 02513			CD/C 02515
	Official Model Match, Python		CI-G 02528			
Rossi	Official Police, Trooper, (Pre-1970)		CI-G 02528		CI-GP 02529	
	Small Revolvers 22, 32, & 38 Spec					ROS/C 03147
Ruger	.38/.357 Magnum Police Service Six, Security Six,					
	Service Six (Square Butt), (S/N Prefix 151 or Higher)		RS6-G 03175			
	New Model Blackhawk (not w/ Bisley Frame) , Old Army	RB 03137				
	RedHawk (Square Butt only)	RHK 03140		RHK-G/D 05058		
	SP-101					RSP/C 03183
	New Model Super Blackhawk, (sq. trigger guard only)	RSB 03163	RSB-G 05067	RSB-G/D 05134		
S & W	New Model Super Blackhawk Stainless (sq. trigger guard only)			RSB-G/D 05134		
	New Model Super Single Six, Single Six	RB 03137				
	Fits All J-Frame Models with Round Butt		SJ-G 03249			SJ-C 03252/ SJ-CP pro 03254
	Fits All J-Frame Models with Square Butt		SJ-GS 03250			SJ-CS 03255
	Fits All K & L Frame Models with Round Butt		SK-GR 03266			SK-C 03270 SK-CP pro 03272
	Fits All K & L Frame Models with Square Butt	SK-L 03267	SK-G 03264		SK-GP 03265	
	Fits All N-Frame Models with Round Butt			SN-GR/D 05148		SN-C 03297
Fits All N-Frame Models with Square Butt		SN-G 03292	SN-G/D 05056			



Pachmayr® Grip Extenders

Pachmayr's Grip Extenders will greatly increase your control and shooting comfort when added to popular compact and sub-compact handguns. The extensions perfectly match the shape and texture of the handgun, so they look like they are part of the pistol, rather than an add-on. Extenders are easy to install and are made of tough, high strength polymer that stands up to the roughest handling. In addition, the Extenders come in a pack of two for a price similar to others on the market that only contain one. Price \$10.98

Available models that improve comfort & control without increasing mag. capacity:

- 03881 - Glock 26, 27, 33, 39
- 03884 - Glock 26, 27, 33, 39 adds 1/4" additional gripping surface
- 03885 - Glock 42
- 03886 - Glock 43
- 03887 - S&W M&P Shield
- 03888 - Ruger LCP
- 03889 - Sig P320
- 03893 - S&W M&P Compact
- 03894 - Glock Full & Mid Size
- 03895 - Springfield XDS
- 03897 - Sig P365

*We Beat the Competition:
All Pachmayr Grip Extenders
are sold in 2 Packs!*

Available models that improve comfort & control, plus increase capacity:

- 03880 - Glock 26, 27, 33 converts 27 and 33 to 11 rounds, 26 to 13 rounds
- 03882 - Glock 26, 27, 33, 39 converts 39 to 7 rounds, 27 and 33 to 10 rounds, 26 to 12 rounds
- 03896 - Springfield XD MOD 2, plus 2 for 9mm and a plus 1 for 40 cal.

- XL Glock 26,27,33,39 (#03880)
Plus Capacity (+3 9mm, +2 40cal)
- Glock 26,27,33,39 (Standard). (#03881)
- Sub-Comp. Glock 26,27,33,39 .. (#03882)
Plus Capacity (+2 9mm, +1 40cal.)
- Glock 26,27,33,39 (XL). (#03884)
- Glock 42 (#03885)
- Glock 43 (#03886)
- Smith & Wesson Shield 9mm. (#03887)
(Not for E-Z Model)
- Ruger LCP..... (#03888)
- Sig P320 Subcompact (#03889)
- M&P Compact. (#03893)
Only fits 9mm & 40 cal. not 45
- Glock Mid & Full Size (#03894)
17/18/19/22/23/24/25/31/32/34/35/37
- Springfield XDS. (#03895)
- Springfield XD MOD (#03896)
2 Plus Capacity Only fits 13-round
Sub-Compact mags. 9mm & 40SW only
(Not 10-round mags) Does not fit 45 cal.
- Sig P365 (#03897)
(Fits 10-round mags only)

Due to increased magazine capacity, please check your state regulations before purchasing.



**More Fingers on the Grip =
More Shots on the Target**



03887



03888



03889



03893



03894



03895



03896



03897



03880



03881



03882



03884



03885



03886

+ Capacity

+ Capacity

+ Capacity



INCREASE THE CAPACITY OF YOUR HANDGUN USING A PACHMAYR MAG SLEEVE.

Pachmayr® Mag Sleeves

Many popular compact handgun models will accept magazines used in the full size version of the same model, thus increasing your magazine capacity. These longer magazines will extend down below the grip frame however, making the grip uncomfortable and unsightly. The Pachmayr Mag Sleeve fills this void, providing an enhanced grip and making the longer magazine look like it belongs! The Mag Sleeve simply slides over the magazine and is secured with a set screw. Available for most popular compact and sub-compact handguns.

Price \$12.60



Part # . . . For Gun(s)	Magazine
03850 . . . Glock 19/23/32	Glock 17/22/31 Mags
03851 . . . Glock 26/27	Glock 17/22 Mags
03852 . . . Glock 26/27	Glock 19/23 Mags
03853 . . . Glock 29/30	Glock 20/21 Mags
03854 . . . Sprgflid XD9/XD40 Sub Comp . .	Springfield XD9/XD40 Mags
03855 . . . Springfield XD45 Compact	Springfield XD45 Mags
03856 . . . S&W M&P 9C/M&P 40C	S&W M&P 9/M&P 40 Mags
03857 . . . Kahr PM9	Kahr P9 Mags
03858 . . . Kahr MK9	Kahr K9 Mags
03859 . . . Colt 1911 Officer	Colt 1911 Government Mags
03860 . . . Para P10	Para P13 Mags
03861 . . . Para P10	Para P14 Mags



Not Your Average “Lightweight”

**Carbon Fiber Technology:
Light weight with
Unbeatable Strength**



More Strength / Less Weight

Carbon Fiber AR-15 Handguards with Sight Rail

TacStar's New Carbon Fiber Handguards are a rugged, highly functional addition to your AR. Carbon fiber offers an unbeatable strength to weight ratio, offering durability and toughness to go along with their light weight and good looks. Unlike Handguards made of aluminum and other materials, carbon fiber Handguards stay cool to the touch even with extensive firing. The fully free floating octagon Handguards are equipped with multiple cooling slots and accessory mounting points. The mounting points will accept any M-LOK® style mounting hardware used with accessories such as slings, bi-pods, lights or vertical grips. Additionally the Handguards are equipped with a forward mounted Picatinny rail to attach sights. The Handguard attaches to the rifle using an innovative aluminum mounting sleeve. The sleeve simply clamps over the existing barrel nut meaning no special tools are needed for installation. Handguards are available in Carbine (10”), Mid (12”) and Rifle (15”) lengths to cover any standard gas port location.

- Made of durable, tough and light weight carbon fiber
- Free floating design
- Stays cool to the touch, even with extensive firing
- Multiple cooling slots and mounting points
- Accepts M-LOK® equipped mounting hardware
- Three lengths available, 10”, 12” and 15”
- Equipped with Picatinny rail for sight mounting
- Easy installation. Barrel nut does not need to be removed

Carbon Fiber AR-15 Handguard 10”, 7.5oz. (#1081115) \$171.98
 Carbon Fiber AR-15 Handguard 12”, 8.5oz. (#1081116) \$185.50
 Carbon Fiber AR-15 Handguard 15”, 9.5oz. (#1081117) \$212.50



Made of durable, tough and light weigh carbon fiber



Accepts M-LOK® equipped mounting hardware



Three lengths available, 10”, 12” and 15”



Shotgun Rail Mount with SideSaddle®



Here's a simple and effective tactical upgrade for 12 gauge Remington 870, 1100 and 11-87 shotguns and now also for Mossberg 500, 590 and 930 shotguns and Benelli M2 and M4 shotguns – no gunsmith needed. Ultra-rigid, this innovative lightweight aluminum unit straddles both sides of the receiver and is crafted with a non-glare anodized finish. The top Picatinny rail can mount a variety of accessories, yet is designed to sit just high enough to allow continued use of the shotgun's bead sight. Keeping six shells in readiness, the low profile design SideSaddle incorporates TacStar's proprietary material for durability and secure shell retention.

Remington (#1081035)	\$103.50
Mossberg 500, 590 (#1081029)	\$103.50
Benelli M2 (#1081021)	\$103.50
Benelli M4 (#1081022)	\$103.50
Mossberg 930 (#1081030)	\$103.50



The Original SideSaddle® Shotgun Carrier



The unique TacStar® SideSaddle mounts extra rounds on your shotgun in a convenient and accessible location for fast reloading. The Hytrel® polymer shell carrier is attached to an aluminum mounting plate that installs directly on the shotgun receiver. All mounting screws are included, no gunsmithing required. Installation is easy, and in most cases requires no alterations to the shotgun. Note: some field grade shotguns may require a modification to the shotgun's forend. Shotguns using the TacStar pistol grip forend do not require modification. The 4-round SideSaddle will also work smoothly with all models without modification. Works great as a separate Shotshell Storage Caddy for Duck Blind, Boat or Hunting Cabin!



6-Shot SideSaddle®



When combined with the TacStar® M-4 magazine extension, this 6-round delivers an awesome 13 round capacity that travels with the shotgun.

REQUESTED BY LAW ENFORCEMENT



Exposed Serial Number 4-Round SideSaddle® for the Remington 870 & 11-87 Requested by LE Professionals.



Armors and law enforcement agencies use serial numbers to track their firearms for maintenance, inventory and record keeping. The SideSaddle's convenient serial number port is the perfect answer.
Rem. 4-Shot Side Saddle (#1081166) \$40.50



TacStar 4-Shot SideSaddle®



TacStar's 4 round SideSaddle Shotgun Carrier is the perfect accessory for all your hunting shotguns. It mounts easily to the side of the receiver and requires no modifications to the shotgun. Each SideSaddle is designed to provide clearance for long forends, such as the Benelli Nova model, and come with all mounting hardware. SideSaddles keep extra shells securely in place and in the perfect location for reloading. No more digging in pockets for extra shells.

WARNING: Cancer and Reproductive Harm
www.p65warnings.ca.gov

Slimline SideSaddle®



Our SideSaddle line has gained a large following because of their convenient placement of shells right where you need them for a fast reload. We have now taken the SideSaddle to the next level with our streamlined version. We use a non-glare, anodized aluminum backing plate material and we have contoured the plate so that it takes up less space on the receiver and has fewer areas that could potentially snag. Additionally we have changed the shell carrier itself to our proprietary flexible synthetic rubber material, which offers durability and weather resistance as well as secure shell retention. Like the backing plate, the shell carrier also is smaller in size than our traditional SideSaddle, adding to its sleek appearance.

- Sleek, streamlined appearance
- Strong, rigid, non-glare, anodized aluminum backing plate
- Durable, flexible synthetic rubber shell carrier with secure shell retention
- Reduced size and streamlined shape reduce chances of snagging
- Available for Remington 870/1100/11-87 and Mossberg 500/590

Remington (#1081211) \$44.50
 Mossberg 500, 590 (#1081210) \$44.50
 Mossberg 930 (#1081212) \$44.50



Which SideSaddle Models are available for each Shotgun Model?

Shotgun Model	6 Shot (12ga) \$43.50	4 Shot (12ga) \$40.50	4 Shot (20ga) \$40.50	Slimline \$44.50	Rail Mount \$103.50
Benelli M2	—	—	—	—	1081021
Benelli M4	—	—	—	—	1081022
Mossberg 500, 590	1081159	1081167	1081134	1081210	1081029
Mossberg 930/935	1081158	—	—	1081212	1081030
Rem 870, 1100 & 11-87	1081157	1081168	1081130	1081211	1081035
Rem. 870 & 1187 (4-Shot Exp. Serial #)	—	1081166	—	—	—
Winchester 1200, 1300, FN TPS	1081161	—	—	—	—





Tactical Light Pressure Switch mounts easily onto Front Grip.



TacStar® Steel Magazine Extensions

Machined from solid steel*, popular TacStar Magazine Extensions are easy to install. No gunsmithing is needed and most can be removed to return the gun to the original configuration. The seven-shot extension allows for two extra rounds, the eight-shot adds three and the ten-shot adds five more rounds to the shotgun's capacity. Ten-shot extensions include a Barrel/Magazine Clamp. All extensions include a specially calibrated new spring. (*Note: Benelli M4 tube is aluminum.)



Light shown in Rail Mount photo above is not available from Lyman Products.

Shotgun Model	Mag. Ext.	Part No	
Benelli M-4 (Incl. Hi-Vis Follower)	8-Shot	(#1081185)	\$65.98
Rem. 870, 1100, 11-87	7-Shot	(#1081169)	\$65.98
Rem. 870, 1100, 11-87	8-Shot	(#1081170)	\$65.98
Remington 1100/11-87	10-Shot	(#1081180)	\$72.98
Winchester 1200/1300 Defender & Black Shadow	7-Shot	(#1081177)	\$65.98

Tactical Shotgun Rail Mounts

The TacStar® Shotgun Rail Mount is designed to fit standard 1" diameter magazine extensions and allows for easy mounting of tactical lights and/or lasers. The mount has three standard Picatinny rails positioned 90 degrees apart which allows for plenty of options when mounting accessories to the shotgun. The mount uses an easy to install clamping system which will not mar extensions, yet is strong and secure. Picatinny rails will accept most scope/light/laser mounting rings.

The shotgun rail mount is 4.1". Keep in mind space for a barrel/magazine clamp if used.

Note: Some semi-automatic shotguns are weight sensitive and accessories adding weight may cause short cycling with some ammunition. It is recommended that you function test the shotgun after installation.

Tactical Shotgun Rail Mount Short (#1081100) . . \$37.50



Tactical Grip Glove™ for Mossberg Shockwave & Remington Tac-14

The Mossberg Shockwave and Remington Tac-14's have become two of the most popular weapons to be introduced in recent years. Their 14" barrels and unique birds head style pistol grip makes them fast and maneuverable, however they do also pack quite a kick. With this in mind, Pachmayr now introduces a new Tactical Grip Glove, developed specifically for these firearms. This slip-on grip is easy to install and offers much better control as well as reducing recoil of the Shockwave and Tac-14. The grip features a single finger positioning groove, non-slip texturing and a thicker padded area to give the palm of your hand better protection from recoil.

Tactical Grip Glove for Moss Shockwave & Rem Tac 14(#05103) . . . \$14.25



Rail Mount



Universal

Saddle Sights - Ghost Ring Shotgun Sights

TacStar's Saddle Sights are the answer for those looking to equip their shotgun with ghost ring style sights, but don't want the hassle of drilling and tapping. These easy to install sights simply slide over the receiver and attach using the existing trigger assembly pin holes. The front sight slides over the muzzle and is locked in place using a non-marring clamping block. The sights install in a matter of minutes and are just as easily removed if you want to return your shotgun to its original set-up. The sights are made of tough, durable polymer and are adjustable for both windage and elevation. The front sight band is dimensioned to allow clearance for magazine extensions or other accessories, and fits barrels with bead or bead/pedestal base sights. The Saddle Sights are the perfect addition to a 3-Gun, home defense, or deer hunting shotgun.

- Easy to Install – No Gunsmithing Required!
- Adjustable for elevation and windage
- Tough, durable polymer construction
- Fast acquisition ghost ring style sights
- Front sight band is dimensioned for mag extension clearance



Ghost Ring Sights Remington 870 (#1081216) \$45.50
 Ghost Ring Sights Mossberg 500/590 (#1081215) \$45.50

Brass Catchers

TacStar's Brass Catchers are the perfect accessory for shooters who reload. No more walking around bent over trying to find where your brass flew! The Brass Catcher with Rail Mount simply clamps to the Picatinny rail of flat top AR's. The mounting bracket is adjustable and low profile, so it can be positioned to clear optics or scopes. The heat resistant catch bag can hold up to (120) .223 cases. When you are ready to empty the bag, simply pull it off of the mounting rail and dump out the shells! The bag also can be unsnapped from its aluminum deflector plate for thorough cleaning.

Our new Universal Brass Catcher has velcro straps that wrap securely around the stock of any rifle. No firearm modifications are needed. Adjustable and low profile, to clear optics or scopes. Heat resistant catch bag can hold up to (60) 223 cases. To empty, simply unzip the bottom of the bag and dump out the shells.

- Brass Catcher with Rail Mount clamps to Picatinny rails on flat top AR's
- Universal Brass Catcher has Velcro straps that wrap around the stock of any rifle
- No Modifications needed
- Shell bag empties easily
- Low profile and adjustable
- Rail Mount Brasscatcher holds up to 120 .223 cases
- Universal Brasscatcher holds up to 60 .223 cases
- Heat resistant bag

Brass Catcher with Rail Mount (#1081240) \$39.98
 Universal Brass Catcher (#1081245) \$30.50

Shotgun Accessories



High Visibility Follower

The TacStar® High Visibility Follower makes it easy to confirm that a shotgun magazine is empty. Its bright orange color will be easily spotted at the load port, confirming that the magazine is empty. The shape of the follower also provides improved functioning compared to factory followers and it is machined from solid aluminum for durability.

High Visibility Follower (#1081200) \$14.20



Universal Barrel Shroud

Our Universal Barrel Shroud fits most 12 gauge pump shotguns. It is machined from all-steel with a black oxide finish. It is 13 3/4" in length and designed with a circular friction-fit bracket at the rear and a locking clamp at the front for a recoil resistant fit on the barrel.

Universal Barrel Shroud (UBS) (#1081171) . . \$49.50



THE FULL RANGE OF TARGET ADJUSTMENTS IN ONE AR-15 STOCK



AR-15 AMRS Adjustable Match Rifle Stock

TacStar's new AR-15 Adjustable Match Rifle Stock offers a full range of adjustments and features that can give any AR-15 (with A2 tube) a precisely adjustable match-grade buttstock. Both comb height and length of pull can be adjusted to provide a match-grade, custom fit for any shooter. Built with the TacStar quality that shooters rely on, the AR-15 AMRS also carries other important features like a hidden Picatinny rail for a stabilizing monopod. In addition, there are several sling mounting points including ports for push button quick release swivels (swivels not included) and fixed sling loops. The AR-15 AMRS is the easiest, most practical final upgrade for any AR.



- Comb height adjustable by .75"
 - Adjustable butt plate adjusts length of pull by 1"
 - Hidden Picatinny rail accepts monopods
 - Push button quick release swivel ports, plus sling loops
- AR-15 AMRS (#1081123) \$169.98



AR-15 Rear Grip

Through the years, Pachmayr has listened to what our customers and MSR shooters have been looking for in an AR15 Grip. We then took this input and designed our new AR15 Grip. It has all of the features that have been asked for, including a hand-filling yet slim shape, shallow finger grooves for fast grip acquisition, and proper hand location for easy trigger reach and control. The grip has a synthetic rubber over-mold construction, along with a good looking yet non-slip texture. The grip is impervious to gun oils or solvents and will stand up to rough use.

AR Rear Grip (#02466) \$28.98



WARNING: Cancer and Reproductive Harm
www.p65warnings.ca.gov



TacStar® Collapsible AR Stock



TacStar's Collapsible AR Stock is a tough, versatile, feature packed replacement stock for AR carbines. The stock is made of super strong, glass reinforced polymer and has a unique "A" frame shape to protect the length adjustment lever. Multiple sling attachment options are provided, which include QD sling attachment ports on both sides as well as a sling slot. A removable rubber butt pad comes with the stock which provides secure, non-slip mounting and reduces felt recoil. The stock offers a precise fit to mil-spec (1.146" diameter) buffer tubes for smooth length adjustment.

AR15 Collapsible Stock (#1081118) \$37.50



TacStar® Stock Adapters

TacStar's Stock Adapters are designed to allow the use of any AR-15 type telescoping stocks and pistols grips on your shotgun. Unlike some competitive polymer adapters, TacStar's are made of a tough die cast metal alloy which not only provides greater strength, but also additional weight to reduce felt recoil. Designed to perfectly match the factory receiver contours and mount up seamlessly. The adapters are designed for proper drop to use bead or ghost ring sights. The adapters will accept any standard AR-15 grip without a beaver-tail, or one having a flexible rubber beaver-tail, such as Pachmayr's, Ergo's and some Hogues. The adapter also features QD sling attachment ports on both sides. Available for Mossberg 500/590 and Remington 870 shotguns. (Does not include buffer tube or stock.)

Mossberg 500 (#1081230) \$42.98
 Remington 870 (#1081231) \$42.98



WARNING: Cancer and Reproductive Harm
www.p65warnings.ca.gov



**92S The Original TRIUS® Trap
Built for the Serious Shooter!**



For more than 60 years the Original Trius Trap has been the trap that others have been judged by. The trap can be adjusted to throw beyond regulation distance. In addition, it throws doubles including piggyback doubles. Held in place with foot or mounted to a tire (bolt furnished), the trap features a High Angle Target Retainer for those challenging high angle targets. Large adjustment knobs make the TRIUS trap fully adjustable without tools.

92S Trius Trap (#10205) \$98.98

TRIOUS® Birdshooter 2™

TRIOUS Quality Priced for the Recreational Shooter!



The TRIUS Birdshooter has many of the fine features of our original foot trap but priced for the occasional shooter. Don't let the low price fool you, this trap has TRIUS quality and performance. A bit lighter weight than the original TRIUS Trap, this trap will out perform other traps in its price range. Regulation singles and piggyback doubles make this an excellent choice for the beginner and/or experienced shooter. Can be held with foot or tire mount (bolt furnished). Aluminum arm plus oil impregnated bushings give years of trouble-free shooting. A High Angle Target Retainer is included for adding variety to your shooting. Fully adjustable without tools.

Birdshooter 2 (#10220) \$68.98





The TRIUS® 1-Step™
A Trius Original 
One easy step cocks & releases target, almost effortlessly.

One person can throw and shoot! The most popular member of the TRIUS line, the One Step has become our best seller, whether you enjoy shooting alone or with a group. The TRIUS One Step is almost effortless to use. Arm is set and targets are placed on arm without tension. Step on pedal to put tension on the arm and release targets in one motion. Aluminum arm plus oil impregnated bushings deliver years of trouble-free shooting. Throw regulation singles plus piggyback doubles. High Angle Target Clip Included. Large knobs for adjusting tension and vertical angle make the TRIUS One Step trap fully adjustable without tools.
 Trius 1-Step (21 lbs.)(#10201) \$136.50



Eyepal®
Perfect Vision for Hunting or Target Shooting

PATENTED

This amazing product instantly improves eye focus for any shooter.

- Eliminates target fuzzing and distortion.
- Applies directly to your eyeglass lens.
- Won't scratch or harm your glasses, removes easily when not in use.
- Works with any prescription or safety glasses.
- Available in models for Bow Hunting, Handgun and Rifle Shooting
- CMP Approved for National Trophy Pistol and Rifle Match Competition

Are you frustrated because you can no longer make out your sights AND the target when aiming a rifle, handgun, or bow? Simply apply the EyePal to your glasses, and you'll be back on the range and shooting better than you have in years! The EyePal provides a small image where everything is in focus. This is particularly useful to shooters who have limited near vision but have good far vision.

The EyePal is a modern adaptation of the century-old peep sight. The EyePal enables you to simultaneously see the target, your front and rear sights — all in focus. And since its made out of a static cling material, it can be easily placed on and off of reading, prescription and safety glasses — without marring the surface or leaving any residue. Compact, lightweight and virtually indestructible, the EyePal is the ultimate addition to any shooter's kit.

- Eyepal Rifle(#3112000) \$26.25
- Eyepal Bow/Handgun (#3112001) \$26.25
- Eyepal Combo Pack (1 Rifle, 1 Handgun) (#3112002) ... \$26.25



Fuzzy target without Eyepal®



Sight picture in focus with Eyepal®!

A-Zoom Blue Value Packs



Shotshell (5 packs)

- 12 Gauge 5/pack .. (#12311) \$22.25
- 20 Gauge 5/pack .. (#12313) \$22.25

Savings
Up To
25%

Centerfire Pistol (10 packs)

- 380 10/pack .. (#15313) \$25.50
- 9mm 10/pack .. (#15316) \$25.50
- 40 S&W 10/pack .. (#15314) \$27.98
- 45 ACP 10/pack .. (#15315) \$27.98

Savings
Up To
32%

Revolver (12 packs)

- 38 Special 12/pack .. (#16318) \$28.98
- 357 Mag 12/pack .. (#16319) \$28.98

Savings
Up To
35%

Centerfire Rifle

- 223 10/pack .. (#12322) \$22.25
- 243 5/pack .. (#12323) \$22.25
- 270 5/pack .. (#12324) \$22.25
- 30-30 5/pack .. (#12329) \$22.25
- 308 10/pack .. (#12328) \$25.50
- 30-06 5/pack .. (#12327) \$12328
- 6.5 Creedmoor... 10/pack .. (#12321) \$38.98

Savings
From
20-60%

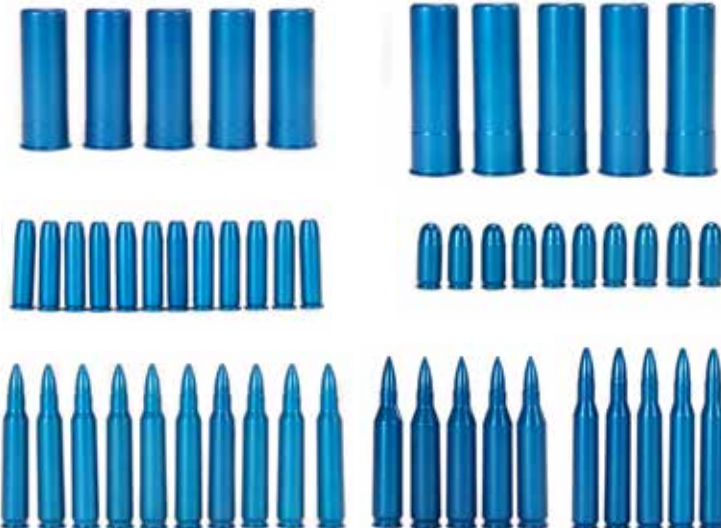

A-Zoom Orange Bulk Packs



Shotshell (6 packs)

- 12 Gauge 6/pack .. (#12411) \$20.25
- 20 Gauge 6/pack .. (#12413) \$20.25

Savings
Up To
43%

Centerfire Pistol (10 packs)

- 380 10/pack .. (#15413) \$20.25
- 9mm 10/pack .. (#15416) \$20.25
- 40 S&W 10/pack .. (#15414) \$20.25
- 45 ACP 10/pack .. (#15415) \$20.25

Savings
Up To
46%

Revolver (12 packs)

- 38 Special 12/pack .. (#16418) \$25.25
- 357 Mag 12/pack .. (#16419) \$25.25

Savings
Up To
43%

Centerfire Rifle

- 223 6/pack .. (#12422) \$22.25
- 243 6/pack .. (#12423) \$22.25
- 270 6/pack .. (#12424) \$22.25
- 30-30 6/pack .. (#12429) \$22.25
- 308 6/pack .. (#12428) \$22.25
- 30-06 6/pack .. (#12427) \$22.25

Savings
Up To
32%

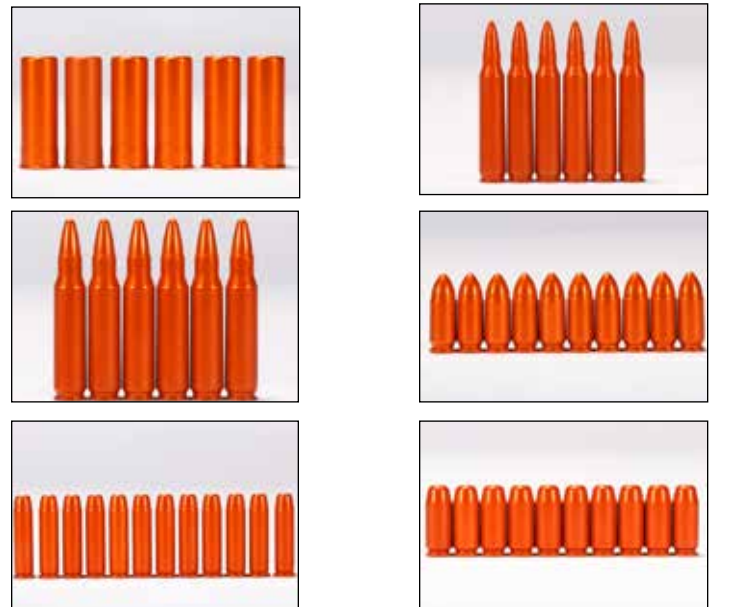



**A-Zoom® Variety Packs
Practice Makes Perfect**

We've listened to your requests, and paid attention to the folks who buy our A-Zoom Snap Caps the most, and now we've tried to make things as easy as possible for some of our most common customers by putting together the calibers you need into handy variety packs.



NRA Instructor Pack:

Designed to give NRA instructors all the most popular handgun training calibers in one convenient pack. Includes: (3) .22LR, (2) .380, (2) 9mm, (2) .40, (2) .45 A-Zoom Variety Pack NRA instructor (#16190) \$30.50



**Ideal for
Tactical
Training**

Military/LE Pack:

An all-inclusive combination of all the most common calibers used by today's military and law enforcement groups. Includes: (2) 9mm, (2) .40, (2) .45, (2) .223, (2) .308, (2) 12ga. A-Zoom Variety Pack Military/LE (#16185) \$45.50



Top Rifle Pack:

This pack includes all the most commonly used rifle training calibers, including rimfire. Includes: (2) .223, (1) .308, (3) .22 (plastic), (1) .30-06, (1) 7.62 x 39mm A-Zoom Variety Pack Top Rifle (#16195) \$28.98



StrikerCaps

Our extremely popular A-Zoom Snap Caps are the best choice for safety training, function testing and dry firing practice. Their rugged design has proven to withstand thousands of dry fires while still protecting the firing pin. One drawback with dry firing snap caps however is when they are used in striker fire type pistols. These firearms require that the slide be drawn back to cock the pistol, which then extracts and ejects the snap cap from the pistol. Our new StrikerCaps solve this problem. StrikerCaps are made without a rim and are equipped with a centering o-ring which grips the chamber walls and keeps the snap cap in place in the chamber. Once it is chambered, simply rack the slide to cock the pistol. StrikerCaps will absorb the firing pin hit just like standard A-Zooms, however will stay in place for quicker, easier dry fire practice. StrikerCaps will be available for 380 Auto, 9mm, 40 S&W and 45 ACP.



- StrikerCap 380 Auto 2/pk(#17101) \$9.25
- StrikerCap 9mm 2/pk(#17102) \$9.25
- StrikerCap 40 S&W 2/pk(#17103) \$9.25
- StrikerCap 45ACP 2/pk(#17104) \$9.25

A-Zoom® .22 Rimfire Action Proving Training Rounds

These .22 Rimfire dummy rounds are ideal for gun testing and shooter training. Not snap caps, but rather precisely dimensioned, functional dummies; A-Zoom Training Rounds are CNC machined from solid aluminum and hard anodized. A-Zoom .22 Rimfire dummies are widely used for hunter education and teaching safe firearms handling. Gunsmiths rely on them, too.



- 22 LR Training Rounds 12 p/pack (#12206) \$17.20
- 22 LR Training Rounds 6 p/pack (#12208) \$12.10
- 17 HMR Training Rounds 6 p/pack (#12202) \$12.10
- 17 Win Super Mag Training Rounds 6p/pack (#12282) \$11.98
- 22 Win Mag Training Rounds 6 p/pack (#12204) \$12.10

**Rugged .22 Rimfire Snap Caps
Dry fire .22 LR Rimfire safely
without chamber damage.**

Packed in handy 24 packs, these Pachmayr snap caps are precisely molded from a resilient polymer for many safe, damage-free hammer drops. After extensive experimentation and testing, these tough, polymer snap caps are proven to deliver long life and many hammer drops. In fact, testing has shown that these snap caps can withstand up to 5-times as many hammer drops as the other "disposable" rimfire snap caps.



- .22 Rimfire Snap Caps (#03200) \$12.50



For safety training, function testing or safely decocking without damaging the firing pin, A-Zoom training rounds are much more than conventional snap-caps. They are precision CNC machined from solid aluminum to precise cartridge dimensions, then hard anodized for ultra-smooth functioning and long life.

In addition, each round has A-Zoom's remarkably durable "Dead Cap" proven to withstand over three thousand dry fires while protecting the firing pin. A-Zoom Snap Caps last over 30 times longer than conventional plastic examples and are available in over 120 sizes from .22 Hornet to the .50BMG.

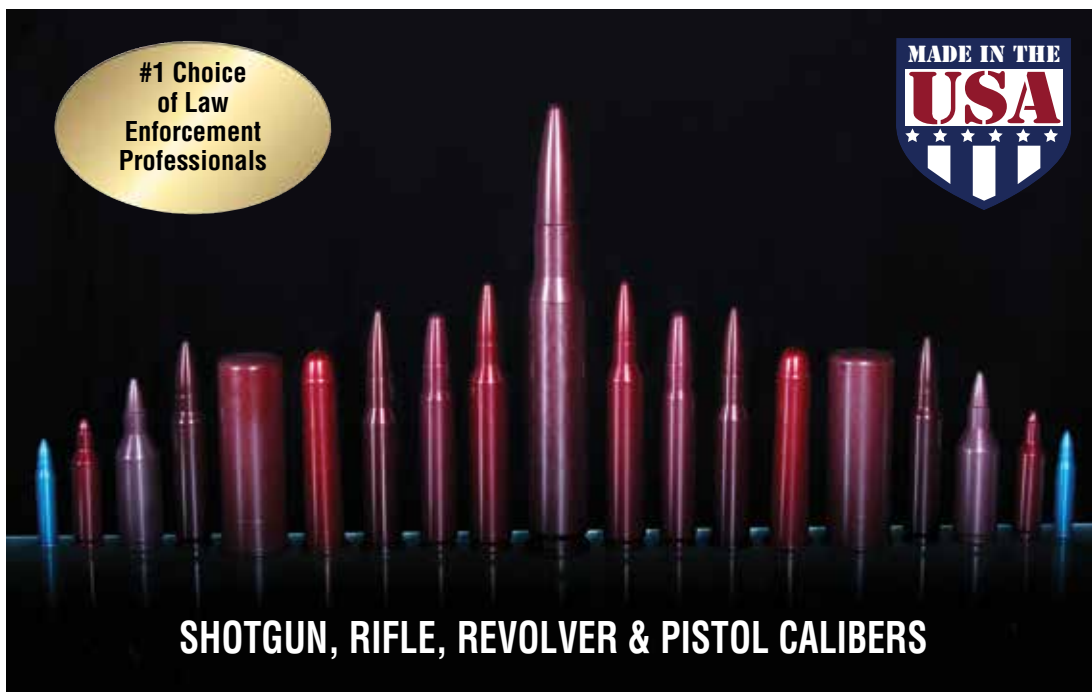

SHOTGUN - 2/pk \$14.20

12210 10 GAUGE

SHOTGUN - 2/pk \$11.98

12211 12 GAUGE

12212 16 GAUGE
12213 20 GAUGE

12214 28 GAUGE
12215 410 BORE

PISTOL

GROUP A - 5/pk \$18.75

15153 32 Auto
15113 380 Auto
15116 9mm Luger
15159 357 Sig
15114 40 S & W
15117 10mm Auto
15115 45 Auto

GROUP B - 5/pk \$20.25

15130 5.7 x 28mm
15152 25 Auto
15133 7.62 Tokarev
15132 9mm Makarov
15158 38 Super

REVOLVER

GROUP A - 6/pk \$22.25

16118 38 Special
16119 357 Magnum
16123 44-40 Win
16121 44 Special
16120 44 Magnum
16124 45 Colt

GROUP B - 6/pk \$24.25

16135 32 S&W Long
16137 32 H&R Mag
16127 41 Magnum
16126 454 Casull
16129 460 S&W
16144 500 S&W

GROUP C - 6/pk \$25.98

16125 38 S&W

GROUP A - 2/pk \$10.98

12218 204 Ruger
12236 22 Hornet
12238 222 Rem
12222 223 Rem
12254 22-250 Rem
12299 223 WSSM
12223 243 Win
12298 243 WSSM
12256 25-06 Rem
12251 6.5 x 55 Swed
12224 270 Win
12219 270 WSM
12252 7mm Rem Mag
12225 30 Carbine
12229 30-30 Win
12228 308 Win
12227 30-06 Sprg
12237 300 Win Mag
12296 300 WSM
12234 7.62 x 39
12226 303 British
12235 8 x 57 Mauser
12207 325 WSM
12230 338 Win Mag
12231 45-70 Govt

GROUP B - 2/pk \$15.70

12306 22 Nosler
12401 224 Valkyrie
12285 5.45 x 39R
12305 6mm Creedmoor
12304 6.5 Grendel
12300 6.5 Creedmoor
12307 6.5 PRC
12247 7mm-08 Rem
12232 7 x 57 Mauser
12242 7 x 57 R
12293 7 x 64 Brenneke
12244 7 x 65 R
12281 7.5 x 55 Swiss
12271 300 AAC Blackout
12239 30 R Blaser
12233 7.62 x 54 Russ
12273 350 Legend
12240 9.3 x 62 Mauser
12269 9.3 x 74 R
12248 375 HH Mag
12303 450 Bushmaster
12301 458 SOCOM
12302 50 Beowulf

RIFLE CALIBERS

GROUP C - 2/pk \$18.75

12276 6mm Rem
12258 257 Roberts
12287 260 Rem
12284 300 Wea Mag
12272 300 Savage
12264 7.7 x 58 JAP
12265 8 x 57 R
12250 338 Lapua Mag
12288 416 Rem Mag
12209 458 Lott

GROUP D - 1/pk

LARGE RIFLE/NITRO EXPRESS
11401 416 Rigby \$11.98
11451 50 BMG \$12.10

"Essential" Tool

Having the right tool for the job is important, but sometimes its also important to have a "fun" tool for the job!

Impress your friends with this 50 Caliber Bottle Opener.

Precision CNC machined from solid aluminum and hard anodized, this bottle opener is sure to turn heads at your next event.

50 Cal Bottle Opener (#11460) \$12.70



At Lyman, we love to stay connected with our customers.

We're shooters and reloaders too, and we appreciate your feedback and ideas.

Please keep in touch!

Like us on Facebook: facebook.com/LymanProducts

Follow us on Instagram: @lymanproducts

Check out our videos on YouTube: youtube.com/LymanProducts

Visit our website and sign up for our newsletter at the bottom of the home page to be the first to hear about what's new and cool at Lyman Products.

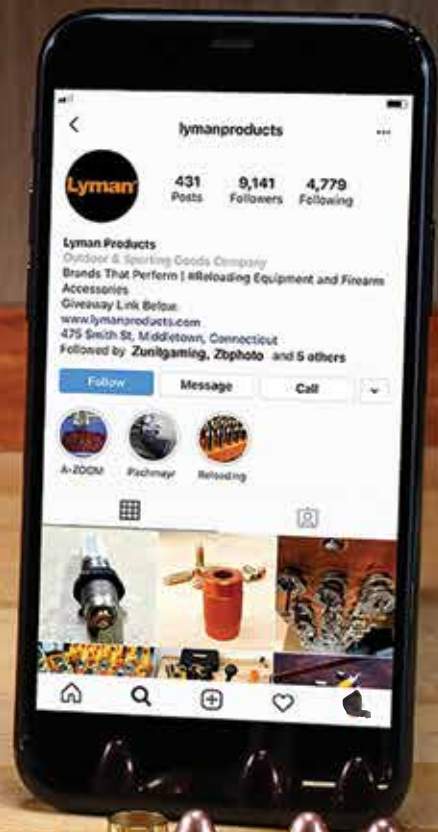

Lyman Products Corporation
475 Smith Street
Middletown, CT 06457

PRSRT STD
US POSTAGE PD
LYMAN PRODUCTS
CORPORATION

**Check out
What's New on our website,
find us on Facebook, Instagram
and watch us on YouTube!**



Part #9968237

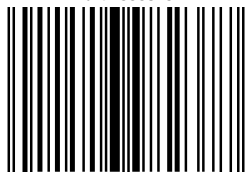

0 11516 98237 7

Printed in the U.S.A.